



COMUNE DI FOGGIA  
PROVINCIA DI FOGGIA



PROGETTO PER LA REALIZZAZIONE DI UN PARCO EOLICO

**RICHIESTA DI AUTORIZZAZIONE UNICA**

D.Lgs. 387/2003

**PROCEDIMENTO UNICO AMBIENTALE  
(PUA)**

**Valutazione di Impatto  
Ambientale (V.I.A.)**

D.Lgs. 152/2006 ss.mm.ii. (Art.27)  
*"Norme in materia ambientale"*

PROGETTO

Orione

DITTA

ATS Engineering srl

ALL. 24a

PAG. 0/305

Titolo dell'allegato:

**TABULATI DI CALCOLO PLINTO DI  
FONDAZIONE PER  
AEROGENERATORE TIPO**

1	EMISSIONE	14/04/2020
REV	DESCRIZIONE	DATA

**CARATTERISTICHE GENERALI D'IMPIANTO**

GENERATORE - Altezza mozzo: fino a 140 m.

Diametro rotore: fino a 162 m.

Potenza unitaria: fino a 6 MW.

IMPIANTO - Numero generatori: 10.

Potenza complessiva: fino a 60 MW.

**Il proponente:**

ATS Engineering srl  
P.zza Giovanni Paolo II, 8  
71017 Torremaggiore  
(FG) 0882/393197  
atsing@alice.it

**Il progettista:**

ATS Engineering srl  
P.zza Giovanni Paolo II, 8  
71017 Torremaggiore (FG)  
0882/393197  
atsing@alice.it

**L'Ingegnere responsabile:**

Ing. Eugenio Di Gianvito  
atsing@atsing.eu

## INDICE

INDICE .....	1
1 Rappresentazione generale dell'edificio .....	5
2 Normative .....	6
D.M. LL. PP. 11-03-88 .....	6
Circolare Ministeriale del 24-07-88, n. 30483/STC.....	6
Legge 02-02-74 n. 64, art. 1 - D.M. 11-03-88. ....	6
Norme Tecniche per le Costruzioni - D.M. 14-01-08.....	6
Norme Tecniche per le Costruzioni - D.M. 14-01-08.....	6
3 Descrizione del software .....	7
DESCRIZIONE DEL PROGRAMMA.....	7
SCHEMATIZZAZIONE STRUTTURALE E CRITERI DI CALCOLO DELLE SOLLECITAZIONI.....	7
VERIFICHE DELLE MEMBRATURE IN CEMENTO ARMATO .....	7
4 Descrizione hardware .....	8
5 Dati generali.....	9
5.1 Materiali .....	9
5.1.1 Materiali c.a. ....	9
5.1.2 Curve di materiali c.a. ....	9
5.1.3 Armature .....	10
5.2 Sezioni.....	10
5.2.1 Sezioni C.A. ....	10
5.2.1.1 Sezioni circolari C.A. ....	10
5.2.1.2 Caratteristiche inerziali sezioni C.A. ....	10
5.3 Fondazioni .....	10
5.3.1 Pali .....	10
5.3.1.1 Pali trivellati .....	10
5.4 Terreni .....	10
6 Dati di definizione.....	12



Progetto	Titolo	Rev.	Pag.
Orione	Orione_A24a.pdf "TABULATI DI CALCOLO PLINTO DI FONDAZIONE PER AEROGENERATORE TIPO"	0	1

6.1 Preferenze commessa .....	12
6.1.1 Preferenze di analisi .....	12
6.1.2 Preferenze di verifica .....	14
6.1.2.1 Normativa di verifica in uso .....	14
6.1.2.2 Normativa di verifica C.A. ....	14
6.1.2.3 Normativa di verifica legno .....	14
6.1.3 Preferenze FEM .....	15
6.1.4 Moltiplicatori inerziali.....	15
6.1.5 Preferenze di analisi non lineare FEM .....	16
6.1.6 Preferenze di analisi carichi superficiali .....	16
6.1.7 Preferenze del suolo .....	16
6.1.8 Preferenze progetto legno .....	17
6.1.9 Preferenze progetto acciaio .....	17
6.1.10 Preferenze progetto muratura .....	17
6.2 Azioni e carichi .....	17
6.2.1 Condizioni elementari di carico .....	17
6.2.2 Combinazioni di carico.....	18
6.2.3 Definizioni di carichi concentrati .....	19
6.3 Quote .....	20
6.3.1 Livelli .....	20
6.3.2 Tronchi.....	20
6.4 Sondaggi del sito.....	20
6.5 Elementi di input .....	20
6.5.1 Fili fissi .....	20
6.5.1.1 Fili fissi di piano .....	20
6.5.1.2 Fili fissi a quota generica .....	21
6.5.2 Fondazioni di piastre .....	22
6.5.3 Piastre C.A.....	22



Progetto	Titolo	Rev.	Pag.
Orione	Orione_A24a.pdf "TABULATI DI CALCOLO PLINTO DI FONDAZIONE PER AEROGENERATORE TIPO"	0	2

6.5.3.1 Piastre C.A. di piano.....	22
6.5.4 Piastre generiche .....	31
6.5.5 Fondazioni profonde .....	33
6.5.6 Pali .....	33
6.5.6.1 Pali di piano .....	33
6.5.7 Carichi concentrati.....	34
6.5.7.1 Carichi concentrati a quota generica.....	34
7 Dati di modellazione .....	35
7.1 Nodi modello .....	35
7.1.1 Nodi di definizione del modello.....	35
7.2 Carichi concentrati.....	45
7.3 Carichi concentrati sismici .....	71
7.5 Masse aggregate.....	97
7.6 Gusci .....	115
7.6.1 Caratteristiche meccaniche gusci .....	115
7.6.2 Definizioni gusci.....	115
7.7 Accelerazioni spettrali .....	139
8 Risultati numerici.....	143
8.1 Pressioni massime sul terreno.....	143
8.2 Tagli ai livelli.....	171
8.3 Risposta modale .....	173
8.4 Equilibrio forze.....	173
8.5 Risposta di spettro.....	175
8.6 Annotazioni solutore .....	175
8.7 Statistiche soluzione .....	175
9 Verifiche.....	176
9.1 Verifiche piastre e pareti C.A.....	176
9.2 Verifiche pali.....	181



Progetto	Titolo	Rev.	Pag.
Orione	Orione_A24a.pdf "TABULATI DI CALCOLO PLINTO DI FONDAZIONE PER AEROGENERATORE TIPO"	0	3



Progetto	Titolo	Rev.	Pag.
<i>Orione</i>	<i>Orione_A24a.pdf "TABULATI DI CALCOLO PLINTO DI FONDAZIONE PER AEROGENERATORE TIPO"</i>	<i>0</i>	<i>4</i>

## 1 Rappresentazione generale dell'edificio

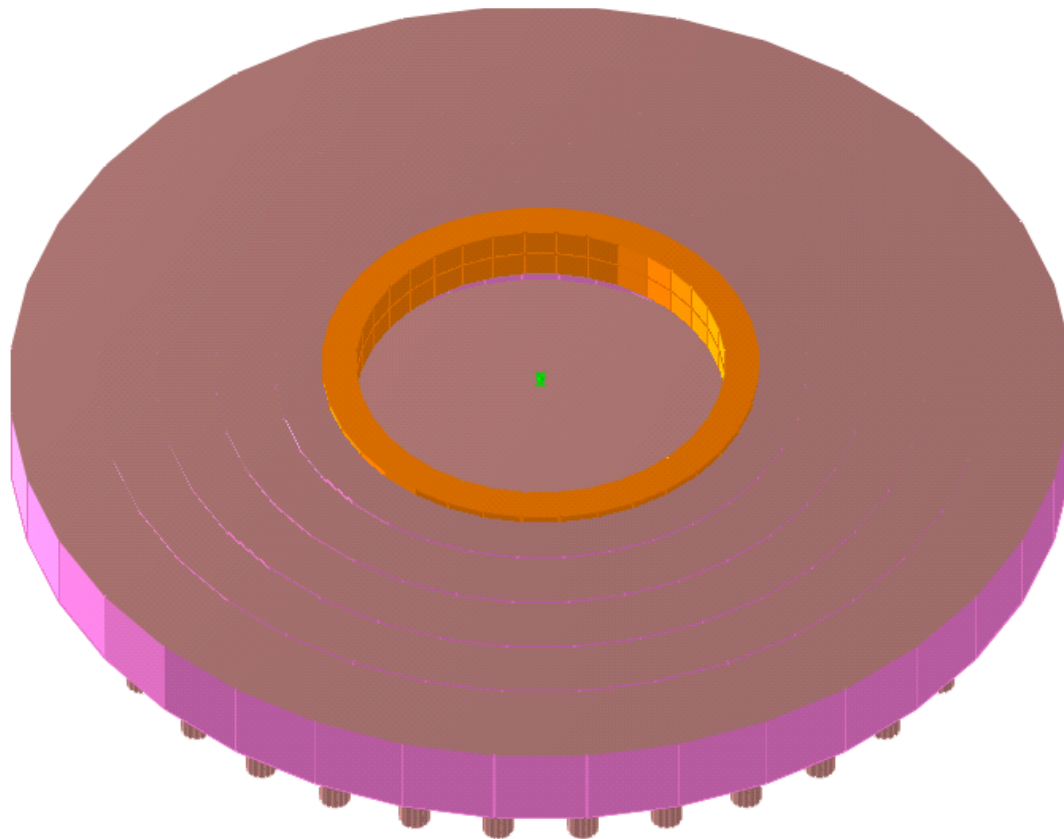

**Struttura**  
Vista assonometrica dell'edificio nella sua interezza

## 2 Normative

### D.M. LL. PP. 11-03-88

Norme Tecniche riguardanti le indagini sui terreni e sulle rocce, la stabilità dei pendii naturali e delle scarpate, i criteri generali e le prescrizioni per la progettazione, l'esecuzione ed il collaudo delle opere di sostegno delle terre e delle opere di fondazione.

### Circolare Ministeriale del 24-07-88, n. 30483/STC.

### Legge 02-02-74 n. 64, art. 1 - D.M. 11-03-88.

Norme Tecniche riguardanti le indagini sui terreni e sulle rocce, la stabilità dei pendii naturali e delle scarpate, i criteri generali e le prescrizioni per la progettazione, l'esecuzione ed il collaudo delle opere di sostegno delle terre e delle opere di fondazione.

### Norme Tecniche per le Costruzioni - D.M. 14-01-08

Sicurezza (cap.2), Azioni sulle costruzioni (cap.3), Progettazione geotecnica (cap.6), Progettazione per azioni sismiche (cap.7), Costruzioni esistenti (cap.8), Riferimenti tecnici (cap.12),

### Norme Tecniche per le Costruzioni - D.M. 14-01-08

Costruzioni in calcestruzzo (par.4.1), Costruzioni in legno (par.4.4), Costruzioni in muratura (par.4.5), Progettazione geotecnica (cap.6), Progettazione per azioni sismiche (cap.7), Costruzioni esistenti (cap.8), Riferimenti tecnici (cap.12), EC3.



Progetto	Titolo	Rev.	Pag.
Orione	Orione_A24a.pdf "TABULATI DI CALCOLO PLINTO DI FONDAZIONE PER AEROGENERATORE TIPO"	0	6

### 3 Descrizione del software

#### DESCRIZIONE DEL PROGRAMMA

Si tratta di un programma di calcolo strutturale che nella versione più estesa è dedicato al progetto e verifica degli elementi in cemento armato, acciaio, muratura e legno di opere civili. Il programma utilizza come analizzatore e solutore del modello strutturale un proprio solutore agli elementi finiti tridimensionale fornito col pacchetto. Il programma è sostanzialmente diviso in tre moduli: un pre processore che consente l'introduzione della geometria e dei carichi e crea il file dati di input al solutore; il solutore agli elementi finiti; un post processore che a soluzione avvenuta elabora i risultati eseguendo il progetto e la verifica delle membrature e producendo i grafici ed i tabulati di output.

#### SCHEMATIZZAZIONE STRUTTURALE E CRITERI DI CALCOLO DELLE SOLLECITAZIONI

Il programma schematizza la struttura attraverso l'introduzione nell'ordine di fondazioni, poste anche a quote diverse, platee, platee nervate, plinti e travi di fondazione poggianti tutte su suolo elastico alla Winkler, di elementi verticali, pilastri e pareti in c.a. anche con fori, di orizzontamenti costituiti da solai orizzontali e inclinati (falde), e relative travi di piano e di falda; è ammessa anche l'introduzione di elementi prismatici in c.a. di interpiano con possibilità di collegamento in inclinato a solai posti a quote diverse. I nodi strutturali possono essere connessi solo a travi, pilastri e pareti, simulando così impalcati infinitamente deformabili nel piano, oppure a elementi lastra di spessore dichiarato dall'utente simulando in tal modo impalcati a rigidità finita. I nodi appartenenti agli impalcati orizzontali possono essere connessi rigidamente ad uno o più nodi principali giacenti nel piano dell'impalcato; generalmente un nodo principale coincide con il baricentro delle masse. Tale opzione, oltre a ridurre significativamente i tempi di elaborazione, elimina le approssimazioni numeriche connesse all'utilizzo di elementi lastra quando si richiede l'analisi a impalcati infinitamente rigidi. Per quanto concerne i carichi, in fase di immissione dati, vengono definite, in numero a scelta dell'utente, condizioni di carico elementari le quali, in aggiunta alle azioni sismiche e variazioni termiche, vengono combinate attraverso coefficienti moltiplicativi per fornire le combinazioni richieste per le verifiche successive. L'effetto di disassamento delle forze orizzontali, indotto ad esempio dai torcenti di piano per costruzioni in zona sismica, viene simulato attraverso l'introduzione di eccentricità planari aggiuntive le quali costituiscono ulteriori condizioni elementari di carico da cumulare e combinare secondo i criteri del paragrafo precedente. Tipologicamente sono ammessi sulle travi e sulle pareti carichi uniformemente distribuiti e carichi trapezoidali; lungo le aste e nei nodi di incrocio delle membrature sono anche definibili componenti di forze e coppie concentrate comunque dirette nello spazio. Sono previste distribuzioni di temperatura, di intensità a scelta dell'utente, agenti anche su singole porzioni di struttura. Il calcolo delle sollecitazioni si basa sulle seguenti ipotesi e modalità: - travi e pilastri deformabili a sforzo normale, flessione deviata, taglio deviato e momento torcente. Sono previsti coefficienti riduttivi dei momenti di inerzia a scelta dell'utente per considerare la riduzione della rigidità flessionale e torsionale per effetto della fessurazione del conglomerato cementizio. E' previsto un moltiplicatore della rigidità assiale dei pilastri per considerare, se pure in modo approssimato, l'accorciamento dei pilastri per sforzo normale durante la costruzione. - le travi di fondazione su suolo alla Winkler sono risolte in forma chiusa tramite uno specifico elemento finito; - le pareti in c.a. sono analizzate schematizzandole come elementi lastra-piastra discretizzati con passo massimo assegnato in fase di immissione dati; - le pareti in muratura possono essere schematizzate con elementi lastra-piastra con spessore flessionale ridotto rispetto allo spessore membranale. - I plinti su suolo alla Winkler sono modellati con la introduzione di molle verticali elastoplastiche. La traslazione orizzontale a scelta dell'utente è bloccata o gestita da molle orizzontali di modulo di reazione proporzionale al verticale. - I pali sono modellati suddividendo l'asta in più aste immerse in terreni di stratigrafia definita dall'utente. Nei nodi di divisione tra le aste vengono inserite molle assialsimmetriche elastoplastiche precaricate dalla spinta a riposo che hanno come pressione limite minima la spinta attiva e come pressione limite massima la spinta passiva modificabile attraverso opportuni coefficienti. - i plinti su pali sono modellati attraverso aste di rigidità elevata che collegano un punto della struttura in elevazione con le aste che simulano la presenza dei pali; - le piastre sono discretizzate in un numero finito di elementi lastra-piastra con passo massimo assegnato in fase di immissione dati; nel caso di platee di fondazione i nodi sono collegati al suolo da molle aventi rigidità alla traslazione verticale ed richiesta anche orizzontale. - La deformabilità nel proprio piano di piani dichiarati non infinitamente rigidi e di falde (piani inclinati) può essere controllata attraverso la introduzione di elementi membranali nelle zone di solaio. - I disassamenti tra elementi asta sono gestiti automaticamente dal programma attraverso la introduzione di collegamenti rigidi locali. - Alle estremità di elementi asta è possibile inserire svincolamenti tradizionali così come cerniere parziali (che trasmettono una quota di ciò che trasmetterebbero in condizioni di collegamento rigido) o cerniere plastiche. - Alle estremità di elementi bidimensionali è possibile inserire svincolamenti con cerniere parziali del momento flettente avente come asse il bordo dell'elemento. - Il calcolo degli effetti del sisma è condotto, a scelta dell'utente, con analisi statica lineare, con analisi dinamica modale o con analisi statica non lineare, in accordo alle varie normative adottate. Le masse, nel caso di impalcati dichiarati rigidi sono concentrate nei nodi principali di piano altrimenti vengono considerate diffuse nei nodi giacenti sull'impalcato stesso. Nel caso di analisi sismica vengono anche controllati gli spostamenti di interpiano.

#### VERIFICHE DELLE MEMBRATURE IN CEMENTO ARMATO

Nel caso più generale le verifiche degli elementi in c.a. possono essere condotte col metodo delle tensioni ammissibili (D.M. 14-1-92) o agli stati limite in accordo al D.M. 09-01-96, al D.M. 14-01-08 o secondo Eurocodice 2. Le travi sono progettate e verificate a flessione retta e taglio; a richiesta è possibile la verifica per le sei componenti della sollecitazione. I pilastri ed i pali sono verificati per le sei componenti della sollecitazione. Per gli elementi bidimensionali giacenti in un medesimo piano è disponibile la modalità di verifica che consente di analizzare lo stato di verifica nei singoli nodi degli elementi. Nelle verifiche (a presso flessione e punzonamento) è ammessa la introduzione dei momenti di calcolo modificati in base alle direttive dell'EC2, Appendice A.2.8. I plinti superficiali sono verificati assumendo lo schema statico di mensole con incastri posti a filo o in asse pilastro. Gli ancoraggi delle armature delle membrature in c.a. sono calcolati sulla base della effettiva tensione normale che ogni barra assume nella sezione di verifica distinguendo le zone di ancoraggio in zone di buona o cattiva aderenza. In particolare il programma valuta la tensione normale che ciascuna barra può assumere in una sezione sviluppando l'aderenza sulla superficie cilindrica posta a sinistra o a destra della sezione considerata; se in una sezione una barra assume per effetto dell'aderenza una tensione normale minore di quella ammissibile, il suo contributo all'area complessiva viene ridotto dal programma nel rapporto tra la tensione normale che la barra può assumere per effetto dell'aderenza e quella ammissibile. Le verifiche sono effettuate a partire dalle aree di acciaio equivalenti così calcolate che vengono evidenziate in relazione. A seguito di analisi inelastiche eseguite in accordo a OPCM 3431 o D.M. 14-01-08 vengono condotte verifiche di resistenza per i meccanismi fragili (nodi e taglio) e verifiche di deformabilità per i meccanismi duttili.



Progetto	Titolo	Rev.	Pag.
Orione	Orione_A24a.pdf "TABULATI DI CALCOLO PLINTO DI FONDAZIONE PER AEROGENERATORE TIPO"	0	7



#### 4 Descrizione hardware

<b>Processore</b>	Intel(R) Core(TM) i5 CPU 750 @ 2.67GHz
<b>Architettura</b>	x86
<b>Frequenza</b>	2809 MHz
<b>Memoria</b>	
<b>Sistema operativo</b>	Microsoft Windows NT 6.1.7601 ServicePack 1



Progetto	Titolo	Rev.	Pag.
Orione	Orione_A24a.pdf "TABULATI DI CALCOLO PLINTO DI FONDAZIONE PER AEROGENERATORE TIPO"	0	8

## 5 Dati generali

### 5.1 Materiali

#### 5.1.1 Materiali c.a.

Descrizione: Descrizione o nome assegnato all'elemento.

Rck: Resistenza caratteristica cubica; valore medio nel caso di edificio esistente. [daN/cm<sup>2</sup>]

E: Modulo di elasticità longitudinale del materiale. [daN/cm<sup>2</sup>]

Gamma: Peso specifico del materiale. [daN/cm<sup>3</sup>]

Poisson: Coefficiente di Poisson, viene impiegato nella modellazione di elementi bidimensionali. Il valore è adimensionale.

G: Modulo di elasticità tangenziale del materiale, viene impiegato nella modellazione di aste. [daN/cm<sup>2</sup>]

Alfa: Coefficiente longitudinale di dilatazione termica. [°C<sup>-1</sup>]

Descrizione	Rck	E	Gamma	Poisson	G	Alfa
c30/37	370	330194	0.0025	0.1	150088.34	0.00001

#### 5.1.2 Curve di materiali c.a.

Rck: Resistenza caratteristica cubica; valore medio nel caso di edificio esistente. [daN/cm<sup>2</sup>]

E: Modulo di elasticità longitudinale del materiale. [daN/cm<sup>2</sup>]

Gamma: Peso specifico del materiale. [daN/cm<sup>3</sup>]

Poisson: Coefficiente di Poisson, viene impiegato nella modellazione di elementi bidimensionali. Il valore è adimensionale.

G: Modulo di elasticità tangenziale del materiale, viene impiegato nella modellazione di aste. [daN/cm<sup>2</sup>]

Alfa: Coefficiente longitudinale di dilatazione termica. [°C<sup>-1</sup>]

Curva: Curva caratteristica

Reaz.traz.: Reagisce a trazione.

Comp.frag.: Ha comportamento fragile.

E.compr.: Modulo di elasticità a compressione. [daN/cm<sup>2</sup>]

Incr.compr.: Incrudimento di compressione. Il valore è adimensionale.

EpsEc: Epsilon elastico a compressione. Il valore è adimensionale.

EpsUc: Epsilon ultimo a compressione. Il valore è adimensionale.

E.traz.: Modulo di elasticità a trazione. [daN/cm<sup>2</sup>]

Incr.traz.: Incrudimento di trazione. Il valore è adimensionale.

EpsEt: Epsilon elastico a trazione. Il valore è adimensionale.

EpsUt: Epsilon ultimo a trazione. Il valore è adimensionale.

Materiale: C30/37

Rck	E	Gamma	Poisson	G	Alfa
370	330194.35	0.0025	0.1	150088.34	0.00001

Curva									
Reaz.traz.	Comp.frag.	E.compr.	Incr.compr.	EpsEc	EpsUc	E.traz.	Incr.traz.	EpsEt	EpsUt
No	Si	330194.35	0.0001	-0.002	-0.0035	330194.35	0.0001	0.0000624	0.0000686

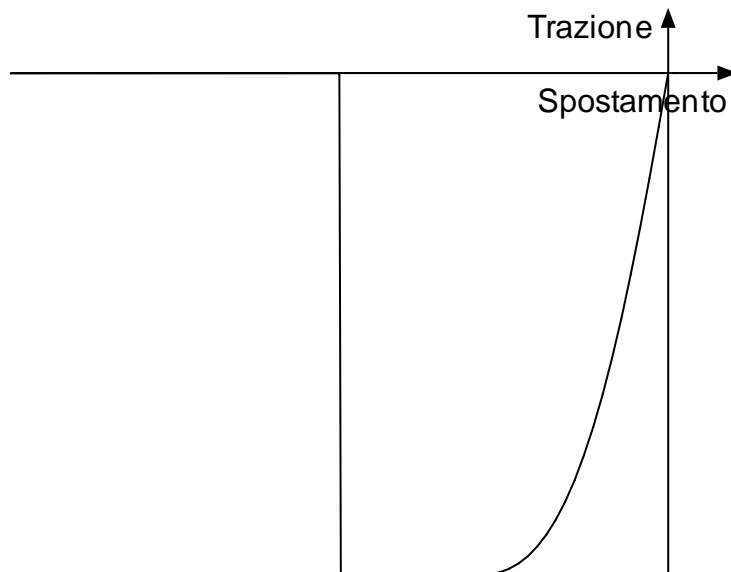

Progetto	Titolo	Rev.	Pag.
Orione	Orione_A24a.pdf "TABULATI DI CALCOLO PLINTO DI FONDAZIONE PER AEROGENERATORE TIPO"	0	9

### 5.1.3 Armature

Descrizione: Descrizione o nome assegnato all'elemento.

fyk: Resistenza caratteristica. [daN/cm<sup>2</sup>]

Sigma amm.: Tensione ammissibile. [daN/cm<sup>2</sup>]

Tipo: Tipo di barra.

E: Modulo di elasticità longitudinale del materiale. [daN/cm<sup>2</sup>]

Gamma: Peso specifico del materiale. [daN/cm<sup>3</sup>]

Poisson: Coefficiente di Poisson, viene impiegato nella modellazione di elementi bidimensionali. Il valore è adimensionale.

G: Modulo di elasticità tangenziale del materiale, viene impiegato nella modellazione di aste. [daN/cm<sup>2</sup>]

Alfa: Coefficiente longitudinale di dilatazione termica. [°C<sup>-1</sup>]

Descrizione	fyk	Sigma amm.	Tipo	E	Gamma	Poisson	G	Alfa
B450C	4500	2550	Aderenza migliorata	2060000	0.00785	0.3	792307.69	0.000012

## 5.2 Sezioni

### 5.2.1 Sezioni C.A.

#### 5.2.1.1 Sezioni circolari C.A.

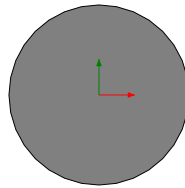

Descrizione: Descrizione o nome assegnato all'elemento.

Diametro: Diametro esterno della sezione. [cm]

Copriferro: Copriferro riferito alla superficie esterna della sezione. [cm]

Descrizione	Diametro	Copriferro
Circolare (D=100)	100	5

#### 5.2.1.2 Caratteristiche inerziali sezioni C.A.

Descrizione: Descrizione o nome assegnato all'elemento.

Xg: Ascissa del baricentro definita rispetto al sistema geometrico in cui sono definiti i vertici del poligono. [cm]

Yg: Ordinata del baricentro definita rispetto al sistema geometrico in cui sono definiti i vertici del poligono. [cm]

Area: Area inerziale nel sistema geometrico centrato nel baricentro. [cm<sup>2</sup>]

Jx: Momento d'inerzia attorno all'asse orizzontale baricentrico di definizione della sezione. [cm<sup>4</sup>]

Jy: Momento d'inerzia attorno all'asse verticale baricentrico di definizione della sezione. [cm<sup>4</sup>]

Jxy: Momento centrifugo rispetto al sistema di riferimento baricentrico di definizione della sezione. [cm<sup>4</sup>]

Jm: Momento d'inerzia attorno all'asse baricentrico principale M. [cm<sup>4</sup>]

Jn: Momento d'inerzia attorno all'asse baricentrico principale N. [cm<sup>4</sup>]

Jt: Momento d'inerzia torsionale. [cm<sup>4</sup>]

Alfa: Angolo tra gli assi del sistema di riferimento geometrico di definizione e quelli del sistema di riferimento principale. [deg]

Descrizione	Xg	Yg	Area	Jx	Jy	Jxy	Jm	Jn	Jt	Alfa
Circolare (D=100)	0	0	7853.98	4846019.67	4846019.67	0	4846019.67	4846019.67	9565500.71	0

## 5.3 Fondazioni

### 5.3.1 Pali

#### 5.3.1.1 Pali trivellati

Descrizione: Descrizione o nome assegnato all'elemento.

Materiale: Materiale costituente il palo trivellato.

Sezione: Sezione del palo trivellato.

Descrizione	Materiale	Sezione
Palo trivellato D 100	C30/37	Circolare (D=100)

## 5.4 Terreni

Descrizione: Descrizione o nome assegnato all'elemento.

Coesione: Coesione del terreno. [daN/cm<sup>2</sup>]

Attrito interno: Angolo di attrito interno del terreno. [deg]

Delta: Angolo di attrito all'interfaccia terreno-cls. [deg]

Adesione: Coeff. di adesione della coesione all'interfaccia terreno-cls. Il valore è adimensionale.

K0: Coefficiente di spinta a riposo del terreno. Il valore è adimensionale.

Gamma naturale: Peso specifico naturale del terreno in sito, assegnato alle zone non immerse. [daN/cm<sup>3</sup>]



Progetto	Titolo	Rev.	Pag.
Orione	Orione_A24a.pdf "TABULATI DI CALCOLO PLINTO DI FONDAZIONE PER AEROGENERATORE TIPO"	0	10

Gamma saturo: Peso specifico saturo del terreno in sito, assegnato alle zone immerse. [daN/cm<sup>3</sup>]

E: Modulo elastico longitudinale del terreno. [daN/cm<sup>2</sup>]

Poisson: Coefficiente di Poisson del terreno. Il valore è adimensionale.

Descrizione	Coesione	Attrito interno	Delta	Adesione	K0	Gamma naturale	Gamma saturo	E	Poisson
Terreno	0.03	14	0	1	0.5	0.00170	0.00200	500	0.3
Sabbia limosa	0.03	22	0	1	0.47	0.00195	0.00225	500	0.3
Argilla mediamente compatta	0.06	25	0	1	0.58	0.00198	0.00228	60	0.3



Progetto	Titolo	Rev.	Pag.
Orione	Orione_A24a.pdf "TABULATI DI CALCOLO PLINTO DI FONDAZIONE PER AEROGENERATORE TIPO"	0	11

## 6 Dati di definizione

### 6.1 Preferenze commessa

#### 6.1.1 Preferenze di analisi

Metodo di analisi (N.T.C.)	D.M. 14-01-08
Tipo di costruzione	2
Vn	50
Classe d'uso	II
Vr	50
Tipo di analisi dinamica	Lineare
Località	Foggia
Zona sismica 2	Zona
Categoria del suolo	C
Categoria topografica	T2
Ss orizzontale SLD	1.5
Tb orizzontale SLD	0.167 [s]
Tc orizzontale SLD	0.5 [s]
Td orizzontale SLD	1.829 [s]
Ss orizzontale SLV	1.49
Tb orizzontale SLV	0.2 [s]
Tc orizzontale SLV	0.601 [s]
Td orizzontale SLV	2.141 [s]
Ss verticale	1
Tb verticale	0.05 [s]
Tc verticale	0.15 [s]
Td verticale	1 [s]
St	1.2
Tr SLD	50
Ag/g SLD	0.0572
Fo SLD	2.534
Tc* SLD	0.33
Tr SLV	475
Ag/g SLV	0.1352
Fo SLV	2.6
Tc* SLV	0.435
Smorzamento viscoso (%)	5
Classe di duttilità dissipativa	Non
Rotazione del sisma	0 [deg]
Quota dello '0' sismico	- [cm]
90	



Progetto	Titolo	Rev.	Pag.
Orione	Orione_A24a.pdf "TABULATI DI CALCOLO PLINTO DI FONDAZIONE PER AEROGENERATORE TIPO"	0	12

Regolarità in pianta	No
Regolarità in elevazione	No
Edificio C.A.	Si
Tipologia C.A. $q_0=3.0 \cdot \alpha_U / \alpha_{f1}$	Strutture a telaio
<b>alfaU/alfa1 C.A.</b> $\alpha_U / \alpha_{f1} = (1.0 + 1.1) / 2$	Strutture a telaio di un piano
Altezza costruzione	200 [cm]
C1	0.075
T1	0.126 [s]
Lambda SLD	0.85
Lambda SLV	0.85
Lambda verticale	0.85
Numero modi	3
Metodo di Ritz	applicato
Torsione accidentale semplificata	No
Torsione accidentale per piani flessibili	No
Eccentricità X (per sisma Y) livello "Fondazione"	0 [cm]
Eccentricità Y (per sisma X) livello "Fondazione"	0 [cm]
Eccentricità X (per sisma Y) livello "Piano 2"	0 [cm]
Eccentricità Y (per sisma X) livello "Piano 2"	0 [cm]
Eccentricità X (per sisma Y) livello "Piano 1"	0.2 [cm]
Eccentricità Y (per sisma X) livello "Piano 1"	0 [cm]
Eccentricità X (per sisma Y) livello "Piano 3"	0 [cm]
Eccentricità Y (per sisma X) livello "Piano 3"	0 [cm]
Limite spostamenti interpiano	0.005
Moltiplicatore sisma X per combinazioni di default	1
Moltiplicatore sisma Y per combinazioni di default	1
Fattore di struttura per sisma X	1
Fattore di struttura per sisma Y	1
Fattore di struttura per sisma Z	1
Coefficiente di sicurezza portanza fondazioni superficiali	2.3
Coefficiente di sicurezza portanza punta pali infissi	1.15
Coefficiente di sicurezza portanza laterale compressione pali infissi	1.15
Coefficiente di sicurezza portanza laterale trazione pali infissi	1.25
Coefficiente di sicurezza portanza punta pali trivellati	1.35
Coefficiente di sicurezza portanza laterale compressione pali trivellati	1.15
Coefficiente di sicurezza portanza laterale trazione pali	



Progetto	Titolo	Rev.	Pag.
Orione	Orione_A24a.pdf "TABULATI DI CALCOLO PLINTO DI FONDAZIONE PER AEROGENERATORE TIPO"	0	13

trivellati	1.25
Coefficiente di sicurezza portanza punta micropali	1.35
Coefficiente di sicurezza portanza laterale compressione micropali	1.15
Coefficiente di sicurezza portanza laterale trazione micropali	1.25
Fattore di correlazione resistenza caratteristica dei pali in base alle verticali indagate	1.7

## 6.1.2 Preferenze di verifica

### 6.1.2.1 Normativa di verifica in uso

Norma di verifica (N.T.C.)	D.M. 14-01-08
-------------------------------	---------------

### 6.1.2.2 Normativa di verifica C.A.

Acciaio armature	B450C
Descrizione	B450C
fyk	4500 [daN/cm <sup>2</sup> ]
Sigma amm.	2550 [daN/cm <sup>2</sup> ]
Tipo migliorata E	Aderenza 2060000 [daN/cm <sup>2</sup> ]
Gamma	0.00785 [daN/cm <sup>3</sup> ]
Poisson	0.3
G	792307.69 [daN/cm <sup>2</sup> ]
Alfa	0.000012 [°C-1]
Coefficiente di omogeneizzazione	15
Beta EC2 7.4.3 (7.19)	1
Gamma s (fattore di sicurezza parziale per l'acciaio)	1.15
Gamma c (fattore di sicurezza parziale per il calcestruzzo)	1.5
Limite sigmac/fck in combinazione rara	0.6
Limite sigmac/fck in combinazione quasi permanente	0.45
Limite sigmaf/fyk in combinazione rara	0.8
Massima apertura delle fessure in combinazione frequente	0.04 [cm]
Massima apertura delle fessure in comb. quasi permanente	0.03 [cm]
Coefficiente di riduzione della tau per cattiva aderenza	0.7

### 6.1.2.3 Normativa di verifica legno

Gamma combinazioni fondamentali	1.5
Gamma combinazioni eccezionali	1
Gamma combinazioni esercizio	1
KMod durata istantaneo, classe 1	1
KMod durata istantaneo, classe 2	1
KMod durata istantaneo, classe 3	0.9
KMod durata breve, classe 1	0.9



Progetto	Titolo	Rev.	Pag.
Orione	Orione_A24a.pdf "TABULATI DI CALCOLO PLINTO DI FONDAZIONE PER AEROGENERATORE TIPO"	0	14

KMod durata breve, classe 2	0.9
KMod durata breve, classe 3	0.7
KMod durata media, classe 1	0.8
KMod durata media, classe 2	0.8
KMod durata media, classe 3	0.65
KMod durata lunga, classe 1	0.7
KMod durata lunga, classe 2	0.7
KMod durata lunga, classe 3	0.55
KMod durata permanente, classe 1	0.6
KMod durata permanente, classe 2	0.6
KMod durata permanente, classe 3	0.5
KDef classe 1	0.6
KDef classe 2	0.8
KDef classe 3	2

### 6.1.3 Preferenze FEM

Dimensione massima ottimale mesh pareti (default)	80 [cm]
Dimensione massima ottimale mesh piastre (default)	80 [cm]
Tipo di mesh dei gusci (default)	Quadrilateri o
Triangoli	
Tipo di mesh imposta ai gusci dell'elemento	Specifico
Metodo P-Delta utilizzato	non
Analisi buckling utilizzata	non
Rapporto spessore flessionale/membranale gusci muratura verticali	0.2
Tolleranza di parallelismo	4.99 [deg]
Tolleranza di unicità punti	10 [cm]
Tolleranza generazione nodi di aste	1 [cm]
Tolleranza di parallelismo in suddivisione aste	4.99 [deg]
Tolleranza generazione nodi di gusci	4 [cm]
Tolleranza eccentricità carichi concentrati	100 [cm]
Ricerca centri delle rigidezze richiesta	non
Considera deformazione a taglio delle piastre	No
Modello elastico pareti in muratura	Gusci

### 6.1.4 Moltiplicatori inerziali

Tipologia: Tipo di entità a cui si riferiscono i moltiplicatori inerziali.

J2: Moltiplicatore inerziale di J2. Il valore è adimensionale.

J3: Moltiplicatore inerziale di J3. Il valore è adimensionale.

Jt: Moltiplicatore inerziale di Jt. Il valore è adimensionale.

A: Moltiplicatore dell'area della sezione. Il valore è adimensionale.



Progetto	Titolo	Rev.	Pag.
Orione	Orione_A24a.pdf "TABULATI DI CALCOLO PLINTO DI FONDAZIONE PER AEROGENERATORE TIPO"	0	15



Conci rigidi: Fattore di riduzione dei tronchi rigidi. Il valore è adimensionale.

Tipologia	J2	J3	Jt	A	Conci rigidi
Trave C.A.	1	1	0.01	1	0.5
Pilastro C.A.	1	1	0.01	1	0.5
Trave di fondazione	1	1	0.01	1	0.5
Palo	1	1	0.01	1	0
Trave in legno	1	1	1	1	1
Colonna in legno	1	1	1	1	1
Trave in acciaio	1	1	1	1	1
Colonna in acciaio	1	1	1	1	1
Trave di reticolare in acciaio	1	1	1	1	1
Maschio in muratura	0	1	0	1	1
Trave di accoppiamento in muratura	0	1	0	1	1
Trave di scala C.A. nervata	1	1	1	1	0.5

### 6.1.5 Preferenze di analisi non lineare FEM

Metodo iterativo	Secante
Tolleranza iterazione	0.0001
Numero massimo iterazioni	50

### 6.1.6 Preferenze di analisi carichi superficiali

Detrazione peso proprio solai nelle zone di sovrapposizione applicata	non
Metodo di ripartizione d'influenza	a zone
Percentuale carico calcolato a trave continua	0
Esegui smoothing diagrammi di carico	applicata
Tolleranza smoothing altezza trapezi	0.001 [daN/cm]
Tolleranza smoothing altezza media trapezi	0.001 [daN/cm]

### 6.1.7 Preferenze del suolo

Fondazioni non modellate e struttura bloccata alla base	no
Fondazioni bloccate orizzontalmente	no
Considera peso sismico delle fondazioni	si
Fondazioni superficiali e profonde su suolo elastoplastico	no
Coefficiente di sottofondo verticale per fondazioni superficiali (default)	3 [daN/cm <sup>3</sup> ]
Rapporto di coefficiente sottofondo orizzontale/verticale	0.5
Pressione verticale limite sul terreno per abbassamento (default)	1 [daN/cm <sup>2</sup> ]
Pressione verticale limite sul terreno per innalzamento (default)	1 [daN/cm <sup>2</sup> ]
Metodo di calcolo della K verticale	Vesic
Metodo di calcolo della pressione limite	Terzaghi
Spessore terreno riporto superiore plinti e pali (default)	60 [cm]
Peso specifico terreno riporto superiore plinti e pali (default)	0.0016 [daN/cm <sup>3</sup> ]
Dimensione massima della discretizzazione del palo (default)	500 [cm]
Moltiplicatore coesione per pressione orizzontale limite nei pali	1
Moltiplicatore spinta passiva per pressione orizzontale pali	1
K punta palo (default)	4



Progetto	Titolo	Rev.	Pag.
Orione	Orione_A24a.pdf "TABULATI DI CALCOLO PLINTO DI FONDAZIONE PER AEROGENERATORE TIPO"	0	16

Pressione limite punta palo (default)	[ daN/cm <sup>3</sup> ] 25
Pressione limite rottura fondazioni superficiali	[ daN/cm <sup>2</sup> ] 7 [ daN/cm <sup>2</sup> ]

### 6.1.8 Preferenze progetto legno

Default Beta X cerniera- cerniera	1
Default Beta Y cerniera- cerniera	1
Default Beta X cerniera- incastro	0.8
Default Beta Y cerniera- incastro	0.8
Default Beta X incastro- incastro	0.7
Default Beta Y incastro- incastro	0.7
Default Beta X incastro- libero	2
Default Beta Y incastro- libero	2
Default luce su freccia per travi	300

### 6.1.9 Preferenze progetto acciaio

Default Beta X/m cerniera- cerniera	1
Default Beta Y/n cerniera- cerniera	1
Default Beta X/m cerniera- incastro	0.8
Default Beta Y/n cerniera- incastro	0.8
Default Beta X/m incastro- incastro	0.7
Default Beta Y/n incastro- incastro	0.7
Default Beta X/m incastro- libero	2
Default Beta Y/n incastro- libero	2
Default luce su freccia per travi	400
Rapporto di sottoutilizzo	0.8
Modalità di utilizzo del nomogramma fissi	nodi
Valutazione delle frecce nelle mensole considerando spostamento relativo tra nodo iniziale e nodo finale	si

### 6.1.10 Preferenze progetto muratura

Forza minima aggancio al piano (default)	0 [ daN/cm]
Denominatore per momento ortogonale (default)	8
Minima resistenza trazione travi (default)	30000 [ daN]
Angolo cuneo verifica ribaltamento (default)	30 [ deg]
Considera $d = 0.8 * h$ nei maschi senza fibre comprese	si

## 6.2 Azioni e carichi

### 6.2.1 Condizioni elementari di carico



Progetto	Titolo	Rev.	Pag.
Orione	Orione_A24a.pdf "TABULATI DI CALCOLO PLINTO DI FONDAZIONE PER AEROGENERATORE TIPO"	0	17

Descrizione: Nome assegnato alla condizione elementare.

I/II: Descrive la classificazione della condizione (necessario per strutture in acciaio e in legno).

Durata: Descrive la durata della condizione (necessario per strutture in legno).

Psi0: Coefficiente moltiplicatore Psi0. Il valore è adimensionale.

Psi1: Coefficiente moltiplicatore Psi1. Il valore è adimensionale.

Psi2: Coefficiente moltiplicatore Psi2. Il valore è adimensionale.

Var.segno: Descrive se la condizione elementare ha la possibilità di variare di segno.

Descrizione	I/II	Durata	Psi0	Psi1	Psi2	Var.segno
Pesi strutturali		Permanente	0	0	0	
Vento	I	Istantaneo	0.7	0.5	0.3	
Delta T	II	Media	0.6	0.5	0	No
Sisma X SLV			0	0	0	
Sisma Y SLV			0	0	0	
Sisma Z SLV			0	0	0	
Eccentricità Y per sisma X SLV			0	0	0	
Eccentricità X per sisma Y SLV			0	0	0	
Sisma X SLD			0	0	0	
Sisma Y SLD			0	0	0	
Sisma Z SLD			0	0	0	
Eccentricità Y per sisma X SLD			0	0	0	
Eccentricità X per sisma Y SLD			0	0	0	
Rig. Ux			0	0	0	
Rig. Uy			0	0	0	
Rig. Rz			0	0	0	

### 6.2.2 Combinazioni di carico

Tutte le combinazioni di carico vengono raggruppate per famiglia di appartenenza. Le celle di una riga contengono i coefficienti moltiplicatori della i-esima combinazione, dove il valore della prima cella è da intendersi come moltiplicatore associato alla prima condizione elementare, la seconda cella si riferisce alla seconda condizione elementare e così via.

#### Famiglia SLU

Nome	Pesi strutturali	Vento	Delta T
1	1	0	0
2	1	1,5	0
3	1,3	0	0
4	1,3	1,5	0

#### Famiglia SLE rara

Nome	Pesi strutturali	Vento	Delta T
1	1	0	0
2	1	1	0

#### Famiglia SLE frequente

Nome	Pesi strutturali	Vento	Delta T
1	1	0	0
2	1	0,5	0

#### Famiglia SLE quasi permanente

Nome	Pesi strutturali	Vento	Delta T
1	1	0	0
2	1	0,3	0

#### Famiglia SLU eccezionale

Nome	Pesi strutturali	Vento	Delta T
------	------------------	-------	---------

#### Famiglia SLD

Nome	Pesi strutturali	Vento	Delta T	Sisma X SLD	Sisma Y SLD	Sisma Z SLD	Eccentricità Y per sisma X SLD	Eccentricità X per sisma Y SLD
1	1	0	0	-1	-0,3	0	-1	0,3
2	1	0	0	-1	-0,3	0	1	-0,3
3	1	0	0	-1	0,3	0	-1	0,3
4	1	0	0	-1	0,3	0	1	-0,3
5	1	0	0	-0,3	-1	0	-0,3	1
6	1	0	0	-0,3	-1	0	0,3	-1
7	1	0	0	-0,3	1	0	-0,3	1
8	1	0	0	-0,3	1	0	0,3	-1
9	1	0	0	0,3	-1	0	-0,3	1



Nome	Pesi strutturali	Vento	Delta T	Sisma X SLD	Sisma Y SLD	Sisma Z SLD	Eccentricità Y per sisma X SLD	Eccentricità X per sisma Y SLD
10	1	0	0	0,3	-1	0	0,3	-1
11	1	0	0	0,3	1	0	-0,3	1
12	1	0	0	0,3	1	0	0,3	-1
13	1	0	0	1	-0,3	0	-1	0,3
14	1	0	0	1	-0,3	0	1	-0,3
15	1	0	0	1	0,3	0	-1	0,3
16	1	0	0	1	0,3	0	1	-0,3

### Famiglia SLV

Nome	Pesi strutturali	Vento	Delta T	Sisma X SLV	Sisma Y SLV	Sisma Z SLV	Eccentricità Y per sisma X SLV	Eccentricità X per sisma Y SLV
1	1	0	0	-1	-0,3	0	-1	0,3
2	1	0	0	-1	-0,3	0	1	-0,3
3	1	0	0	-1	0,3	0	-1	0,3
4	1	0	0	-1	0,3	0	1	-0,3
5	1	0	0	-0,3	-1	0	-0,3	1
6	1	0	0	-0,3	-1	0	0,3	-1
7	1	0	0	-0,3	1	0	-0,3	1
8	1	0	0	-0,3	1	0	0,3	-1
9	1	0	0	0,3	-1	0	-0,3	1
10	1	0	0	0,3	-1	0	0,3	-1
11	1	0	0	0,3	1	0	-0,3	1
12	1	0	0	0,3	1	0	0,3	-1
13	1	0	0	1	-0,3	0	-1	0,3
14	1	0	0	1	-0,3	0	1	-0,3
15	1	0	0	1	0,3	0	-1	0,3
16	1	0	0	1	0,3	0	1	-0,3

### Famiglia SLV fondazioni

Nome	Pesi strutturali	Vento	Delta T	Sisma X SLV	Sisma Y SLV	Sisma Z SLV	Eccentricità Y per sisma X SLV	Eccentricità X per sisma Y SLV
1	1	0	0	-1	-0,3	0	-1	0,3
2	1	0	0	-1	-0,3	0	1	-0,3
3	1	0	0	-1	0,3	0	-1	0,3
4	1	0	0	-1	0,3	0	1	-0,3
5	1	0	0	-0,3	-1	0	-0,3	1
6	1	0	0	-0,3	-1	0	0,3	-1
7	1	0	0	-0,3	1	0	-0,3	1
8	1	0	0	-0,3	1	0	0,3	-1
9	1	0	0	0,3	-1	0	-0,3	1
10	1	0	0	0,3	-1	0	0,3	-1
11	1	0	0	0,3	1	0	-0,3	1
12	1	0	0	0,3	1	0	0,3	-1
13	1	0	0	1	-0,3	0	-1	0,3
14	1	0	0	1	-0,3	0	1	-0,3
15	1	0	0	1	0,3	0	-1	0,3
16	1	0	0	1	0,3	0	1	-0,3

### Famiglia Calcolo centri rigidzze

Nome	Rig. Ux	Rig. Uy	Rig. Rz
Rig. Ux+	1	0	0
Rig. Ux-	-1	0	0
Rig. Uy+	0	1	0
Rig. Uy-	0	-1	0
Rig. Rz+	0	0	1
Rig. Rz-	0	0	-1

### 6.2.3 Definizioni di carichi concentrati

Nome: Nome identificativo della definizione di carico.

Valori: Valori associati alle condizioni di carico.

Condizione: Condizione di carico a cui sono associati i valori.

Descrizione: Nome assegnato alla condizione elementare.

Fx: Componente X del carico concentrato. [daN]

Fy: Componente Y del carico concentrato. [daN]

Fz: Componente Z del carico concentrato. [daN]

Mx: Componente di momento della coppia concentrata attorno all'asse X. [daN\*cm]

My: Componente di momento della coppia concentrata attorno all'asse Y. [daN\*cm]

Mz: Componente di momento della coppia concentrata attorno all'asse Z. [daN\*cm]

Nome	Condizione	Valori					
		Fx	Fy	Fz	Mx	My	Mz
1	Pesi strutturali	0	0	-7015600	0	0	0
	Vento	248000	0	0	2895420000	0	117000000



## 6.3 Quote

### 6.3.1 Livelli

Descrizione breve: Nome sintetico assegnato al livello.

Descrizione: Nome assegnato al livello.

Quota: Quota superiore espressa nel sistema di riferimento assoluto. [cm]

Spessore: Spessore del livello. [cm]

Descrizione breve	Descrizione	Quota	Spessore
L1	Fondazione	-90	0
L2	Piano 2	150	0
L3	Piano 1	300	0
L4	Piano 3	600	0

### 6.3.2 Tronchi

Descrizione breve: Nome sintetico assegnato al tronco.

Descrizione: Nome assegnato al tronco.

Quota 1: Riferimento della prima quota di definizione del tronco. esprimibile come livello, falda, piano orizzontale alla Z specificata. [cm]

Quota 2: Riferimento della seconda quota di definizione del tronco. esprimibile come livello, falda, piano orizzontale alla Z specificata. [cm]

Descrizione breve	Descrizione	Quota 1	Quota 2
T1	Fondazione - Piano 1	Fondazione	Piano 1
T2	Piano 1 - Piano 2	Piano 1	Piano 2
T3	Fondazione - Piano 2	Fondazione	Piano 2

## 6.4 Sondaggi del sito

Vengono elencati tutti i sondaggi definiti nella commessa.

Sondaggio: Sondaggio terreno tipo

Coordinate del sito in cui è stato effettuato il sondaggio: 0, 0, 0

Stratigrafie

Terreno: Terreno uniforme nello strato.

Spessore: Spessore dello strato. [cm]

K orizz. inferiore: Coefficiente K orizzontale al livello inferiore. [daN/cm<sup>3</sup>]

K orizz. superiore: Coefficiente K orizzontale al livello superiore. [daN/cm<sup>3</sup>]

K vert. inferiore: Coefficiente K verticale al livello inferiore. [daN/cm<sup>3</sup>]

K vert. superiore: Coefficiente K verticale al livello superiore. [daN/cm<sup>3</sup>]

Terreno	Spessore	K orizz. inferiore	K orizz. superiore	K vert. inferiore	K vert. superiore
Terreno	100	1.5	1	1	1
Sabbia limosa	800	1.5	1	1	1
Argilla compatta	3000	1.5	1	1	1

## 6.5 Elementi di input

### 6.5.1 Fili fissi

#### 6.5.1.1 Fili fissi di piano

Livello: Quota di inserimento esprimibile come livello, falda, piano orizzontale alla Z specificata. [cm]

Punto: Punto di inserimento.

X: Coordinata X. [cm]

Y: Coordinata Y. [cm]

Estradosso: Distanza dalla quota di inserimento misurata in direzione ortogonale al piano della quota e con verso positivo verso l'alto. [cm]

Angolo: Angolo misurato dal semiasse positivo delle ascisse in verso antiorario. [deg]

Tipo: Tipo di simbolo.

Testo: Testo visualizzato a fianco del simbolo.

Livello	Punto		Estradosso	Angolo	Tipo	Testo	Livello	Punto		Estradosso	Angolo	Tipo	Testo
	X	Y						X	Y				
L1	1732.4	-1000.2	0	240	Croce	284	L1	1532.4	-1285.8	0	230	Croce	282
L1	1970	-347.4	0	260	Croce	288	L1	1879.8	-684.2	0	250	Croce	286
L1	1285.8	-1532.4	0	220	Croce	280	L1	347.4	-1970	0	190	Croce	240
L1	0	-2000.4	0	180	Croce	144	L1	1000.2	-1732.4	0	210	Croce	278
L1	684.2	-1879.8	0	200	Croce	276	L1	1000.2	1732.4	0	330	Croce	279
L1	1285.8	1532.4	0	320	Croce	281	L1	347.4	1970	0	350	Croce	241
L1	684.2	1879.8	0	340	Croce	277	L1	1532.4	1285.8	0	310	Croce	283
L1	1970	347.4	0	280	Croce	289	L1	2000.4	0	0	270	Croce	290
L1	1732.4	1000.2	0	300	Croce	285	L1	1879.8	684.2	0	290	Croce	287
L1	-1732.4	1000.2	0	60	Croce	7	L1	-1532.4	1285.8	0	50	Croce	9
L1	-1970	347.4	0	80	Croce	3	L1	-1879.8	684.2	0	70	Croce	5
L1	-1285.8	1532.4	0	40	Croce	11	L1	-347.4	1970	0	10	Croce	51
L1	0	2000.4	0	0	Croce	147	L1	-1000.2	1732.4	0	30	Croce	13
L1	-684.2	1879.8	0	20	Croce	15	L1	-1000.2	-1732.4	0	150	Croce	12
L1	-1285.8	-1532.4	0	140	Croce	10	L1	-347.4	-1970	0	170	Croce	50



Progetto	Titolo	Rev.	Pag.
Orione	Orione_A24a.pdf "TABULATI DI CALCOLO PLINTO DI FONDAZIONE PER AEROGENERATORE TIPO"	0	20

Livello	Punto		Estradosso	Angolo	Tipo	Testo	Livello	Punto		Estradosso	Angolo	Tipo	Testo
	X	Y						X	Y				
L1	-684.2	-1879.8	0	160	Croce	14	L1	-1532.4	-1285.8	0	130	Croce	8
L1	-1970	-347.4	0	100	Croce	2	L1	-2000.4	0	0	90	Croce	1
L1	-1732.4	-1000.2	0	120	Croce	6	L1	-1879.8	-684.2	0	110	Croce	4
L4	0	0	0	0	Croce	145							

### 6.5.1.2 Fili fissi a quota generica

Quota: Quota di inserimento esprimibile come livello, falda, piano orizzontale alla Z specificata. [cm]

Punto: Punto di inserimento.

X: Coordinata X. [cm]

Y: Coordinata Y. [cm]

Angolo: Angolo misurato dal semiassse positivo delle ascisse in verso antiorario. [deg]

Tipo: Tipo di simbolo.

Testo: Testo visualizzato a fianco del simbolo.

Quota	Punto		Angolo	Tipo	Testo	Quota	Punto		Angolo	Tipo	Testo
	X	Y					X	Y			
100	559	391.4	190	Croce	263	100	618.5	288.4	180	Croce	266
100	-679.8	-59.5	340	Croce	16	100	391.4	559	210	Croce	247
100	482.5	482.5	200	Croce	255	100	659.1	176.6	170	Croce	270
100	618.5	-288.4	130	Croce	265	100	559	-391.4	120	Croce	261
100	659.1	-176.6	140	Croce	268	100	679.8	59.5	160	Croce	274
100	679.8	-59.5	150	Croce	272	100	-679.8	59.5	330	Croce	18
100	-288.4	618.5	270	Croce	80	100	-176.6	659.1	260	Croce	110
100	-559	391.4	300	Croce	30	100	-482.5	482.5	290	Croce	38
100	-391.4	559	280	Croce	46	100	-618.5	288.4	310	Croce	26
100	176.6	659.1	230	Croce	182	100	288.4	618.5	220	Croce	213
100	-659.1	176.6	320	Croce	22	100	-59.5	679.8	250	Croce	132
100	59.5	679.8	240	Croce	160	100	482.5	-482.5	110	Croce	252
100	-659.1	-176.6	350	Croce	20	100	-176.6	-659.1	50	Croce	109
100	176.6	-659.1	80	Croce	180	100	59.5	-679.8	70	Croce	158
100	-288.4	-618.5	40	Croce	78	100	-559	-391.4	10	Croce	28
100	-618.5	-288.4	0	Croce	25	100	-391.4	-559	30	Croce	44
100	-482.5	-482.5	20	Croce	36	100	-59.5	-679.8	60	Croce	131
100	391.4	-559	100	Croce	245	100	288.4	-618.5	90	Croce	210
150.2	29.6	-338.7	150	Croce	150	150.2	-143.7	-308.1	120	Croce	115
150.2	143.7	308.1	300	Croce	177	150.2	240.4	240.4	280	Croce	197
150.2	328.4	88	250	Croce	226	150.2	-88	-328.4	130	Croce	125
150.2	29.6	-338.7	150	Croce	151	150.2	143.7	308.1	300	Croce	176
150.2	328.4	88	250	Croce	227	150.2	278.5	195	270	Croce	205
150.2	-240.4	-240.4	100	Croce	94	150.2	195	278.5	290	Croce	188
150.2	308.1	143.7	260	Croce	219	150.2	-195	-278.5	110	Croce	102
150.2	-88	-328.4	130	Croce	124	150.2	-195	-278.5	110	Croce	103
150.2	240.4	240.4	280	Croce	196	150.2	-29.6	-338.7	140	Croce	138
150.2	278.5	195	270	Croce	204	150.2	-29.6	-338.7	140	Croce	139
150.2	-240.4	-240.4	100	Croce	95	150.2	-143.7	-308.1	120	Croce	114
150.2	195	278.5	290	Croce	189	150.2	308.1	143.7	260	Croce	218
150.2	-143.7	308.1	350	Croce	117	150.2	-328.4	88	40	Croce	67
150.2	-195	278.5	0	Croce	104	150.2	-338.7	29.6	50	Croce	58
150.2	-88	328.4	340	Croce	127	150.2	-338.7	29.6	50	Croce	59
150.2	-143.7	308.1	350	Croce	116	150.2	-308.1	143.7	30	Croce	75
150.2	-240.4	240.4	10	Croce	97	150.2	-278.5	195	20	Croce	89
150.2	-240.4	240.4	10	Croce	96	150.2	-328.4	88	40	Croce	66
150.2	-195	278.5	0	Croce	105	150.2	-308.1	143.7	30	Croce	74
150.2	-338.7	-29.6	60	Croce	56	150.2	-308.1	-143.7	80	Croce	73
150.2	29.6	338.7	320	Croce	152	150.2	-308.1	-143.7	80	Croce	72
150.2	88	328.4	310	Croce	166	150.2	-278.5	-195	90	Croce	87
150.2	88	328.4	310	Croce	167	150.2	-278.5	-195	90	Croce	86
150.2	-29.6	338.7	330	Croce	140	150.2	-338.7	-29.6	60	Croce	57
150.2	-88	328.4	340	Croce	126	150.2	-328.4	-88	70	Croce	64
150.2	29.6	338.7	320	Croce	153	150.2	-328.4	-88	70	Croce	65
150.2	-29.6	338.7	330	Croce	141	150.2	338.7	29.6	240	Croce	235
150.2	308.1	-143.7	210	Croce	217	150.2	240.4	-240.4	190	Croce	194
150.2	328.4	-88	220	Croce	225	150.2	195	-278.5	180	Croce	187
150.2	308.1	-143.7	210	Croce	216	150.2	278.5	-195	200	Croce	202
150.2	-278.5	195	20	Croce	88	150.2	240.4	-240.4	190	Croce	195
150.2	278.5	-195	200	Croce	203	150.2	88	-328.4	160	Croce	165
150.2	338.7	-29.6	230	Croce	233	150.2	88	-328.4	160	Croce	164
150.2	338.7	29.6	240	Croce	234	150.2	143.7	-308.1	170	Croce	174
150.2	328.4	-88	220	Croce	224	150.2	195	-278.5	180	Croce	186
150.2	338.7	-29.6	230	Croce	232	150.2	143.7	-308.1	170	Croce	175
200	0	0	280	Croce	146	274	-495.4	132.7	240	Croce	35
274	-464.8	216.7	230	Croce	41	274	-510.9	-44.7	260	Croce	32
274	-510.9	44.7	250	Croce	33	274	-294.2	420.1	200	Croce	77
274	-216.7	464.8	190	Croce	99	274	-420.1	294.2	220	Croce	43
274	-362.6	362.6	210	Croce	49	274	-495.4	-132.7	270	Croce	34
274	-132.7	-495.4	330	Croce	120	274	-216.7	-464.8	320	Croce	98
274	510.9	44.7	80	Croce	259	274	-44.7	-510.9	340	Croce	134
274	-420.1	-294.2	290	Croce	42	274	-464.8	-216.7	280	Croce	40
274	-294.2	-420.1	310	Croce	76	274	-362.6	-362.6	300	Croce	48
274	-132.7	495.4	180	Croce	121	274	495.4	-132.7	60	Croce	256
274	464.8	-216.7	50	Croce	250	274	132.7	-495.4	0	Croce	170
274	510.9	-44.7	70	Croce	258	274	294.2	-420.1	20	Croce	214
274	216.7	-464.8	10	Croce	192	274	420.1	-294.2	40	Croce	248
274	362.6	-362.6	30	Croce	242	274	495.4	132.7	90	Croce	257
274	132.7	495.4	150	Croce	171	274	216.7	464.8	140	Croce	193
274	-44.7	510.9	170	Croce	135	274	44.7	510.9	160	Croce	157
274	420.1	294.2	110	Croce	249	274	464.8	216.7	100	Croce	251
274	294.2	420.1	130	Croce	215	274	362.6	362.6	120	Croce	243
274	44.7	-510.9	350	Croce	156	300	288.4	618.5	220	Croce	212
300	391.4	559	210	Croce	246	300	59.5	679.8	240	Croce	161
300	176.6	659.1	230	Croce	183	300	618.5	288.4	180	Croce	267



Quota	Punto		Angolo	Tipo	Testo	Quota	Punto		Angolo	Tipo	Testo
	X	Y					X	Y			
300	659.1	176.6	170	Croce	271	300	482.5	482.5	200	Croce	254
300	559	391.4	190	Croce	262	300	-176.6	659.1	260	Croce	111
300	-679.8	59.5	330	Croce	19	300	-659.1	176.6	320	Croce	23
300	-659.1	-176.6	350	Croce	21	300	-679.8	-59.5	340	Croce	17
300	-618.5	288.4	310	Croce	27	300	-391.4	559	280	Croce	47
300	-288.4	618.5	270	Croce	81	300	-559	391.4	300	Croce	31
300	-482.5	482.5	290	Croce	39	300	-176.6	-659.1	50	Croce	108
300	-288.4	-618.5	40	Croce	79	300	59.5	-679.8	70	Croce	159
300	-59.5	-679.8	60	Croce	130	300	-391.4	-559	30	Croce	45
300	-618.5	-288.4	0	Croce	24	300	-59.5	679.8	250	Croce	133
300	-482.5	-482.5	20	Croce	37	300	-559	-391.4	10	Croce	29
300	176.6	-659.1	80	Croce	181	300	659.1	-176.6	140	Croce	269
300	559	-391.4	120	Croce	260	300	679.8	59.5	160	Croce	275
300	679.8	-59.5	150	Croce	273	300	288.4	-618.5	90	Croce	211
300	618.5	-288.4	130	Croce	264	300	391.4	-559	100	Croce	244
300	482.5	-482.5	110	Croce	253	449.8	144.4	-309.6	180	Croce	172
449.8	329.9	-88.4	230	Croce	228	449.8	329.9	-88.4	230	Croce	229
449.8	144.4	-309.6	180	Croce	173	449.8	340.3	-29.8	240	Croce	237
449.8	88.4	-329.9	170	Croce	162	449.8	340.3	29.8	250	Croce	238
449.8	88.4	-329.9	170	Croce	163	449.8	340.3	-29.8	240	Croce	236
449.8	241.5	-241.5	200	Croce	199	449.8	279.8	-195.9	210	Croce	207
449.8	-29.8	340.3	340	Croce	142	449.8	279.8	-195.9	210	Croce	206
449.8	241.5	-241.5	200	Croce	198	449.8	309.6	-144.4	220	Croce	220
449.8	195.9	-279.8	190	Croce	184	449.8	309.6	-144.4	220	Croce	221
449.8	195.9	-279.8	190	Croce	185	449.8	-340.3	-29.8	70	Croce	53
449.8	-29.8	340.3	340	Croce	143	449.8	-329.9	-88.4	80	Croce	60
449.8	-340.3	29.8	60	Croce	55	449.8	-88.4	329.9	350	Croce	129
449.8	-340.3	-29.8	70	Croce	52	449.8	29.8	340.3	330	Croce	155
449.8	88.4	329.9	320	Croce	169	449.8	-309.6	-144.4	90	Croce	69
449.8	88.4	329.9	320	Croce	168	449.8	-329.9	-88.4	80	Croce	61
449.8	29.8	340.3	330	Croce	154	449.8	-309.6	-144.4	90	Croce	68
449.8	-88.4	329.9	350	Croce	128	449.8	-241.5	241.5	20	Croce	92
449.8	-309.6	144.4	40	Croce	71	449.8	-195.9	279.8	10	Croce	107
449.8	-279.8	195.9	30	Croce	84	449.8	-241.5	241.5	20	Croce	93
449.8	-279.8	195.9	30	Croce	85	449.8	-309.6	144.4	40	Croce	70
449.8	-329.9	88.4	50	Croce	63	449.8	-144.4	309.6	0	Croce	118
449.8	-340.3	29.8	60	Croce	54	449.8	-195.9	279.8	10	Croce	106
449.8	-329.9	88.4	50	Croce	62	449.8	-144.4	309.6	0	Croce	119
449.8	309.6	144.4	270	Croce	222	449.8	-88.4	-329.9	140	Croce	122
449.8	309.6	144.4	270	Croce	223	449.8	-144.4	-309.6	130	Croce	113
449.8	279.8	195.9	280	Croce	208	449.8	-88.4	-329.9	140	Croce	123
449.8	-29.8	-340.3	150	Croce	136	449.8	29.8	-340.3	160	Croce	148
449.8	340.3	29.8	250	Croce	239	449.8	29.8	-340.3	160	Croce	149
449.8	329.9	88.4	260	Croce	231	449.8	-29.8	-340.3	150	Croce	137
449.8	329.9	88.4	260	Croce	230	449.8	279.8	195.9	280	Croce	209
449.8	144.4	309.6	310	Croce	179	449.8	-241.5	-241.5	110	Croce	90
449.8	195.9	279.8	300	Croce	191	449.8	-279.8	-195.9	100	Croce	82
449.8	144.4	309.6	310	Croce	178	449.8	-279.8	-195.9	100	Croce	83
449.8	-241.5	-241.5	110	Croce	91	449.8	-195.9	-279.8	120	Croce	101
449.8	241.5	241.5	290	Croce	200	449.8	-144.4	-309.6	130	Croce	112
449.8	195.9	279.8	300	Croce	190	449.8	-195.9	-279.8	120	Croce	100
449.8	241.5	241.5	290	Croce	201						

### 6.5.2 Fondazioni di piastre

Descrizione breve: Descrizione breve usata nelle tabelle dei capitoli delle piastre di fondazione.

Stratigrafia: Stratigrafia del terreno nel punto medio in pianta dell'elemento.

Sondaggio: È possibile indicare esplicitamente un sondaggio definito nelle preferenze oppure richiedere di estrapolare il sondaggio dalla definizione del sito espressa nelle preferenze.

Estradosso: Distanza dalla quota superiore del sondaggio misurata in verticale con verso positivo verso l'alto. [cm]

Deformazione volumetrica: Valore della deformazione volumetrica impiegato nel calcolo della pressione limite a rottura con la formula di Vesic. Il valore è adimensionale. Accetta anche il valore di default espresso nelle preferenze.

K verticale: Coefficiente di sottofondo verticale del letto di molle. [daN/cm<sup>3</sup>]

Limite compressione: Pressione limite di plasticizzazione a compressione del letto di molle. [daN/cm<sup>2</sup>]

Limite trazione: Pressione limite di plasticizzazione a trazione del letto di molle. [daN/cm<sup>2</sup>]

Descrizione breve	Stratigrafia			K verticale	Limite compressione	Limite trazione
	Sondaggio	Estradosso	Deformazione volumetrica			
FS1	Da sito	0		Default	Default	Default

### 6.5.3 Piastre C.A.

#### 6.5.3.1 Piastre C.A. di piano

Livello: Quota di inserimento esprimibile come livello, falda, piano orizzontale alla Z specificata. [cm]

Sp.: Spessore misurato in direzione ortogonale al piano medio dell'elemento. [cm]

Punti: Punti di definizione in pianta.

I.: Indice del punto corrente nell'insieme dei punti di definizione dell'elemento.

X: Coordinata X. [cm]

Y: Coordinata Y. [cm]

Estr.: Distanza dalla quota di inserimento misurata in direzione ortogonale al piano della quota e con verso positivo verso l'alto. [cm]

Mat.: Riferimento ad una definizione di materiale cemento armato.

Car.sup.: Riferimento alla definizione di un carico superficiale. Accetta anche il valore "Nessuno".

Car.pot.: Riferimento alla definizione di un carico potenziale. Accetta anche il valore "Nessuno".

DeltaT: Riferimento alla definizione di una variazione termica. Accetta anche il valore "Nessuno".



Progetto	Titolo	Rev.	Pag.
Orione	Orione_A24a.pdf "TABULATI DI CALCOLO PLINTO DI FONDAZIONE PER AEROGENERATORE TIPO"	0	22

Sovr.: Aliquota di sovraresistenza da assicurare in verifica.

S.Z: Indica se l'elemento deve essere verificato considerando il sisma verticale.

P.sup.: Peso per unità di superficie. [daN/cm2]

Fond.: Riferimento alla fondazione sottostante l'elemento.

Fori: Riferimenti a tutti gli elementi che forano la piastra.

Livello	Sp.	Punti			Estr.	Mat.	Car.sup.	Car.pot.	DeltaT	Sovr.	S.Z	P.sup.	Fond.	Fori
		I.	X	Y										
L1	360	1	566.9	-475.7	360	C30/37				0	No	0.9	FS1	
		2	689.4	-578.5										
		3	779.4	-450										
		4	640.9	-370										
L1	50	1	475.7	-566.9	50	C30/37				0	No	0.125	FS1	
		2	566.9	-475.7										
		3	0	0										
L1	300	1	964.2	-1149.1	300	C30/37				0	No	0.75	FS1	
		2	1157.2	-1379.2										
		3	1379.2	-1157.2										
		4	1149.1	-964.2										
L1	315	1	995.9	-835.6	315	C30/37				0	No	0.7875	FS1	
		2	1149.1	-964.2										
		3	1299	-750										
		4	1125.8	-650										
L1	330	1	842.6	-707.1	330	C30/37				0	No	0.825	FS1	
		2	995.9	-835.6										
		3	1125.8	-650										
		4	952.6	-550										
L1	345	1	689.4	-578.5	345	C30/37				0	No	0.8625	FS1	
		2	842.6	-707.1										
		3	952.6	-550										
		4	779.4	-450										
L1	315	1	835.6	-995.9	315	C30/37				0	No	0.7875	FS1	
		2	964.2	-1149.1										
		3	1149.1	-964.2										
		4	995.9	-835.6										
L1	50	1	370	-640.9	50	C30/37				0	No	0.125	FS1	
		2	475.7	-566.9										
		3	0	0										
L1	300	1	750	-1299	300	C30/37				0	No	0.75	FS1	
		2	900.2	-1559.2										
		3	1157.2	-1379.2										
		4	964.2	-1149.1										
L1	315	1	650	-1125.8	315	C30/37				0	No	0.7875	FS1	
		2	750	-1299										
		3	964.2	-1149.1										
		4	835.6	-995.9										
L1	330	1	707.1	-842.6	330	C30/37				0	No	0.825	FS1	
		2	835.6	-995.9										
		3	995.9	-835.6										
		4	842.6	-707.1										
L1	345	1	578.5	-689.4	345	C30/37				0	No	0.8625	FS1	
		2	707.1	-842.6										
		3	842.6	-707.1										
		4	689.4	-578.5										
L1	360	1	475.7	-566.9	360	C30/37				0	No	0.9	FS1	
		2	578.5	-689.4										
		3	689.4	-578.5										
		4	566.9	-475.7										
L1	300	1	1149.1	-964.2	300	C30/37				0	No	0.75	FS1	
		2	1379.2	-1157.2										
		3	1559.2	-900.2										
		4	1299	-750										
L1	330	1	1033.7	-376.2	330	C30/37				0	No	0.825	FS1	
		2	1221.6	-444.6										
		3	1280.3	-225.7										
		4	1083.3	-191										
L1	345	1	845.7	-307.8	345	C30/37				0	No	0.8625	FS1	
		2	1033.7	-376.2										
		3	1083.3	-191										
		4	886.3	-156.3										
L1	360	1	695.4	-253.1	360	C30/37				0	No	0.9	FS1	
		2	845.7	-307.8										
		3	886.3	-156.3										
		4	728.8	-128.5										
L1	50	1	695.4	-253.1	50	C30/37				0	No	0.125	FS1	
		2	728.8	-128.5										
		3	0	0										
L1	300	1	1409.5	-513	300	C30/37				0	No	0.75	FS1	
		2	1691.8	-615.8										
		3	1773	-312.6										
		4	1477.2	-260.5										
L1	315	1	1221.6	-444.6	315	C30/37				0	No	0.7875	FS1	
		2	1409.5	-513										
		3	1477.2	-260.5										
		4	1280.3	-225.7										
L1	50	1	640.9	-370	50	C30/37				0	No	0.125	FS1	
		2	695.4	-253.1										
		3	0	0										
L1	345	1	779.4	-450	345	C30/37				0	No	0.8625	FS1	
		2	952.6	-550										
		3	1033.7	-376.2										
		4	845.7	-307.8										
L1	360	1	640.9	-370	360	C30/37				0	No	0.9	FS1	
		2	779.4	-450										
		3	845.7	-307.8										
		4	695.4	-253.1										





Tabulati di Calcolo Plinto di Fondazione per Aerogeneratore Tipo - Progetto Impianto Eolico - "Orione"

Livello	Sp.	Punti			Estr.	Mat.	Car.sup.	Car.pot.	DeltaT	Sovr.	S.Z	P.sup.	Fond.	Fori
		I.	X	Y										
L1	50	1	566.9	-475.7	50	C30/37				0	No	0.125	FS1	
		2	640.9	-370										
		3	0	0										
L1	300	1	1299	-750	300	C30/37				0	No	0.75	FS1	
		2	1559.2	-900.2										
		3	1691.8	-615.8										
		4	1409.5	-513										
L1	315	1	1125.8	-650	315	C30/37				0	No	0.7875	FS1	
		2	1299	-750										
		3	1409.5	-513										
		4	1221.6	-444.6										
L1	330	1	952.6	-550	330	C30/37				0	No	0.825	FS1	
		2	1125.8	-650										
		3	1221.6	-444.6										
		4	1033.7	-376.2										
L1	315	1	0	-1300	315	C30/37				0	No	0.7875	FS1	
		2	0	-1500										
		3	260.5	-1477.2										
		4	225.7	-1280.3										
L1	330	1	0	-1100	330	C30/37				0	No	0.825	FS1	
		2	0	-1300										
		3	225.7	-1280.3										
		4	191	-1083.3										
L1	345	1	0	-900	345	C30/37				0	No	0.8625	FS1	
		2	0	-1100										
		3	191	-1083.3										
		4	156.3	-886.3										
L1	360	1	128.5	-728.8	360	C30/37				0	No	0.9	FS1	
		2	156.3	-886.3										
		3	307.8	-845.7										
		4	253.1	-695.4										
L1	50	1	0	-740	50	C30/37				0	No	0.125	FS1	
		2	128.5	-728.8										
		3	0	0										
L1	300	1	0	-1500	300	C30/37				0	No	0.75	FS1	
		2	0	-1800.4										
		3	312.6	-1773										
		4	260.5	-1477.2										
L1	360	1	0	-740	360	C30/37				0	No	0.9	FS1	
		2	0	-900										
		3	156.3	-886.3										
		4	128.5	-728.8										
L1	330	1	-191	-1083.3	330	C30/37				0	No	0.825	FS1	
		2	-225.7	-1280.3										
		3	0	-1300										
		4	0	-1100										
L1	345	1	-156.3	-886.3	345	C30/37				0	No	0.8625	FS1	
		2	-191	-1083.3										
		3	0	-1100										
		4	0	-900										
L1	360	1	-128.5	-728.8	360	C30/37				0	No	0.9	FS1	
		2	-156.3	-886.3										
		3	0	-900										
		4	0	-740										
L1	50	1	-128.5	-728.8	50	C30/37				0	No	0.125	FS1	
		2	0	-740										
		3	0	0										
L1	300	1	-260.5	-1477.2	300	C30/37				0	No	0.75	FS1	
		2	-312.6	-1773										
		3	0	-1800.4										
		4	0	-1500										
L1	315	1	-225.7	-1280.3	315	C30/37				0	No	0.7875	FS1	
		2	-260.5	-1477.2										
		3	0	-1500										
		4	0	-1300										
L1	345	1	156.3	-886.3	345	C30/37				0	No	0.8625	FS1	
		2	191	-1083.3										
		3	376.2	-1033.7										
		4	307.8	-845.7										
L1	50	1	253.1	-695.4	50	C30/37				0	No	0.125	FS1	
		2	370	-640.9										
		3	0	0										
L1	300	1	513	-1409.5	300	C30/37				0	No	0.75	FS1	
		2	615.8	-1691.8										
		3	900.2	-1559.2										
		4	750	-1299										
L1	315	1	444.6	-1221.6	315	C30/37				0	No	0.7875	FS1	
		2	513	-1409.5										
		3	750	-1299										
		4	650	-1125.8										
L1	330	1	550	-952.6	330	C30/37				0	No	0.825	FS1	
		2	650	-1125.8										
		3	835.6	-995.9										
		4	707.1	-842.6										
L1	345	1	450	-779.4	345	C30/37				0	No	0.8625	FS1	
		2	550	-952.6										
		3	707.1	-842.6										
		4	578.5	-689.4										
L1	360	1	370	-640.9	360	C30/37				0	No	0.9	FS1	
		2	450	-779.4										
		3	578.5	-689.4										
		4	475.7	-566.9										
L1	330	1	376.2	-1033.7	330	C30/37				0	No	0.825	FS1	
		2	444.6	-1221.6										
		3	650	-1125.8										
		4	550	-952.6										



Tabulati di Calcolo Plinto di Fondazione per Aerogeneratore Tipo - Progetto Impianto Eolico - "Orione"

Livello	Sp.	Punti			Estr.	Mat.	Car.sup.	Car.pot.	DeltaT	Sovr.	S.Z	P.sup.	Fond.	Fori
		I.	X	Y										
L1	300	1	260.5	-1477.2	300	C30/37				0	No	0.75	FS1	
		2	312.6	-1773										
		3	615.8	-1691.8										
		4	513	-1409.5										
L1	315	1	225.7	-1280.3	315	C30/37				0	No	0.7875	FS1	
		2	260.5	-1477.2										
		3	513	-1409.5										
		4	444.6	-1221.6										
L1	330	1	191	-1083.3	330	C30/37				0	No	0.825	FS1	
		2	225.7	-1280.3										
		3	444.6	-1221.6										
		4	376.2	-1033.7										
L1	345	1	307.8	-845.7	345	C30/37				0	No	0.8625	FS1	
		2	376.2	-1033.7										
		3	550	-952.6										
		4	450	-779.4										
L1	360	1	253.1	-695.4	360	C30/37				0	No	0.9	FS1	
		2	307.8	-845.7										
		3	450	-779.4										
		4	370	-640.9										
L1	50	1	128.5	-728.8	50	C30/37				0	No	0.125	FS1	
		2	253.1	-695.4										
		3	0	0										
L1	360	1	475.7	566.9	360	C30/37				0	No	0.9	FS1	
		2	578.5	689.4										
		3	450	779.4										
		4	370	640.9										
L1	50	1	566.9	475.7	50	C30/37				0	No	0.125	FS1	
		2	475.7	566.9										
		3	0	0										
L1	300	1	1149.1	964.2	300	C30/37				0	No	0.75	FS1	
		2	1379.2	1157.2										
		3	1157.2	1379.2										
		4	964.2	1149.1										
L1	315	1	835.6	995.9	315	C30/37				0	No	0.7875	FS1	
		2	964.2	1149.1										
		3	750	1299										
		4	650	1125.8										
L1	330	1	707.1	842.6	330	C30/37				0	No	0.825	FS1	
		2	835.6	995.9										
		3	650	1125.8										
		4	550	952.6										
L1	345	1	578.5	689.4	345	C30/37				0	No	0.8625	FS1	
		2	707.1	842.6										
		3	550	952.6										
		4	450	779.4										
L1	315	1	995.9	835.6	315	C30/37				0	No	0.7875	FS1	
		2	1149.1	964.2										
		3	964.2	1149.1										
		4	835.6	995.9										
L1	50	1	640.9	370	50	C30/37				0	No	0.125	FS1	
		2	566.9	475.7										
		3	0	0										
L1	300	1	1299	750	300	C30/37				0	No	0.75	FS1	
		2	1559.2	900.2										
		3	1379.2	1157.2										
		4	1149.1	964.2										
L1	315	1	1125.8	650	315	C30/37				0	No	0.7875	FS1	
		2	1299	750										
		3	1149.1	964.2										
		4	995.9	835.6										
L1	330	1	842.6	707.1	330	C30/37				0	No	0.825	FS1	
		2	995.9	835.6										
		3	835.6	995.9										
		4	707.1	842.6										
L1	345	1	689.4	578.5	345	C30/37				0	No	0.8625	FS1	
		2	842.6	707.1										
		3	707.1	842.6										
		4	578.5	689.4										
L1	360	1	566.9	475.7	360	C30/37				0	No	0.9	FS1	
		2	689.4	578.5										
		3	578.5	689.4										
		4	475.7	566.9										
L1	300	1	964.2	1149.1	300	C30/37				0	No	0.75	FS1	
		2	1157.2	1379.2										
		3	900.2	1559.2										
		4	750	1299										
L1	330	1	376.2	1033.7	330	C30/37				0	No	0.825	FS1	
		2	444.6	1221.6										
		3	225.7	1280.3										
		4	191	1083.3										
L1	345	1	307.8	845.7	345	C30/37				0	No	0.8625	FS1	
		2	376.2	1033.7										
		3	191	1083.3										
		4	156.3	886.3										
L1	360	1	253.1	695.4	360	C30/37				0	No	0.9	FS1	
		2	307.8	845.7										
		3	156.3	886.3										
		4	128.5	728.8										
L1	50	1	253.1	695.4	50	C30/37				0	No	0.125	FS1	
		2	128.5	728.8										
		3	0	0										
L1	300	1	513	1409.5	300	C30/37				0	No	0.75	FS1	
		2	615.8	1691.8										
		3	312.6	1773										
		4	260.5	1477.2										



Tabulati di Calcolo Plinto di Fondazione per Aerogeneratore Tipo - Progetto Impianto Eolico - "Orione"

Livello	Sp.	Punti			Estr.	Mat.	Car.sup.	Car.pot.	DeltaT	Sovr.	S.Z	P.sup.	Fond.	Fori
		I.	X	Y										
L1	315	1	444.6	1221.6	315	C30/37				0	No	0.7875	FS1	
		2	513	1409.5										
		3	260.5	1477.2										
		4	225.7	1280.3										
L1	50	1	370	640.9	50	C30/37				0	No	0.125	FS1	
		2	253.1	695.4										
		3	0	0										
L1	345	1	450	779.4	345	C30/37				0	No	0.8625	FS1	
		2	550	952.6										
		3	376.2	1033.7										
		4	307.8	845.7										
L1	360	1	370	640.9	360	C30/37				0	No	0.9	FS1	
		2	450	779.4										
		3	307.8	845.7										
		4	253.1	695.4										
L1	50	1	475.7	566.9	50	C30/37				0	No	0.125	FS1	
		2	370	640.9										
		3	0	0										
L1	300	1	750	1299	300	C30/37				0	No	0.75	FS1	
		2	900.2	1559.2										
		3	615.8	1691.8										
		4	513	1409.5										
L1	315	1	650	1125.8	315	C30/37				0	No	0.7875	FS1	
		2	750	1299										
		3	513	1409.5										
		4	444.6	1221.6										
L1	330	1	550	952.6	330	C30/37				0	No	0.825	FS1	
		2	650	1125.8										
		3	444.6	1221.6										
		4	376.2	1033.7										
L1	315	1	1300	0	315	C30/37				0	No	0.7875	FS1	
		2	1500	0										
		3	1477.2	260.5										
		4	1280.3	225.7										
L1	330	1	1100	0	330	C30/37				0	No	0.825	FS1	
		2	1300	0										
		3	1280.3	225.7										
		4	1083.3	191										
L1	345	1	900	0	345	C30/37				0	No	0.8625	FS1	
		2	1100	0										
		3	1083.3	191										
		4	886.3	156.3										
L1	360	1	728.8	128.5	360	C30/37				0	No	0.9	FS1	
		2	886.3	156.3										
		3	845.7	307.8										
		4	695.4	253.1										
L1	50	1	740	0	50	C30/37				0	No	0.125	FS1	
		2	728.8	128.5										
		3	0	0										
L1	300	1	1500	0	300	C30/37				0	No	0.75	FS1	
		2	1800.4	0										
		3	1773	312.6										
		4	1477.2	260.5										
L1	360	1	740	0	360	C30/37				0	No	0.9	FS1	
		2	900	0										
		3	886.3	156.3										
		4	728.8	128.5										
L1	330	1	1083.3	-191	330	C30/37				0	No	0.825	FS1	
		2	1280.3	-225.7										
		3	1300	0										
		4	1100	0										
L1	345	1	886.3	-156.3	345	C30/37				0	No	0.8625	FS1	
		2	1083.3	-191										
		3	1100	0										
		4	900	0										
L1	360	1	728.8	-128.5	360	C30/37				0	No	0.9	FS1	
		2	886.3	-156.3										
		3	900	0										
		4	740	0										
L1	50	1	728.8	-128.5	50	C30/37				0	No	0.125	FS1	
		2	740	0										
		3	0	0										
L1	300	1	1477.2	-260.5	300	C30/37				0	No	0.75	FS1	
		2	1773	-312.6										
		3	1800.4	0										
		4	1500	0										
L1	315	1	1280.3	-225.7	315	C30/37				0	No	0.7875	FS1	
		2	1477.2	-260.5										
		3	1500	0										
		4	1300	0										
L1	345	1	886.3	156.3	345	C30/37				0	No	0.8625	FS1	
		2	1083.3	191										
		3	1033.7	376.2										
		4	845.7	307.8										
L1	50	1	695.4	253.1	50	C30/37				0	No	0.125	FS1	
		2	640.9	370										
		3	0	0										
L1	300	1	1409.5	513	300	C30/37				0	No	0.75	FS1	
		2	1691.8	615.8										
		3	1559.2	900.2										
		4	1299	750										
L1	315	1	1221.6	444.6	315	C30/37				0	No	0.7875	FS1	
		2	1409.5	513										
		3	1299	750										
		4	1125.8	650										
L1	330	1	952.6	550	330	C30/37				0	No	0.825	FS1	



Tabulati di Calcolo Plinto di Fondazione per Aerogeneratore Tipo - Progetto Impianto Eolico - "Orione"

Livello	Sp.	Punti			Estr.	Mat.	Car.sup.	Car.pot.	DeltaT	Sovr.	S.Z	P.sup.	Fond.	Fori
		I.	X	Y										
		2	1125.8	650										
		3	995.9	835.6										
		4	842.6	707.1										
L1	345	1	779.4	450	345	C30/37			0	No	0.8625	FS1		
		2	952.6	550										
		3	842.6	707.1										
		4	689.4	578.5										
L1	360	1	640.9	370	360	C30/37			0	No	0.9	FS1		
		2	779.4	450										
		3	689.4	578.5										
		4	566.9	475.7										
L1	330	1	1033.7	376.2	330	C30/37			0	No	0.825	FS1		
		2	1221.6	444.6										
		3	1125.8	650										
		4	952.6	550										
L1	300	1	1477.2	260.5	300	C30/37			0	No	0.75	FS1		
		2	1773	312.6										
		3	1691.8	615.8										
		4	1409.5	513										
L1	315	1	1280.3	225.7	315	C30/37			0	No	0.7875	FS1		
		2	1477.2	260.5										
		3	1409.5	513										
		4	1221.6	444.6										
L1	330	1	1083.3	191	330	C30/37			0	No	0.825	FS1		
		2	1280.3	225.7										
		3	1221.6	444.6										
		4	1033.7	376.2										
L1	345	1	845.7	307.8	345	C30/37			0	No	0.8625	FS1		
		2	1033.7	376.2										
		3	952.6	550										
		4	779.4	450										
L1	360	1	695.4	253.1	360	C30/37			0	No	0.9	FS1		
		2	845.7	307.8										
		3	779.4	450										
		4	640.9	370										
L1	50	1	728.8	128.5	50	C30/37			0	No	0.125	FS1		
		2	695.4	253.1										
		3	0	0										
L1	360	1	-566.9	475.7	360	C30/37			0	No	0.9	FS1		
		2	-689.4	578.5										
		3	-779.4	450										
		4	-640.9	370										
L1	50	1	-475.7	566.9	50	C30/37			0	No	0.125	FS1		
		2	-566.9	475.7										
		3	0	0										
L1	300	1	-964.2	1149.1	300	C30/37			0	No	0.75	FS1		
		2	-1157.2	1379.2										
		3	-1379.2	1157.2										
		4	-1149.1	964.2										
L1	315	1	-995.9	835.6	315	C30/37			0	No	0.7875	FS1		
		2	-1149.1	964.2										
		3	-1299	750										
		4	-1125.8	650										
L1	330	1	-842.6	707.1	330	C30/37			0	No	0.825	FS1		
		2	-995.9	835.6										
		3	-1125.8	650										
		4	-952.6	550										
L1	345	1	-689.4	578.5	345	C30/37			0	No	0.8625	FS1		
		2	-842.6	707.1										
		3	-952.6	550										
		4	-779.4	450										
L1	315	1	-835.6	995.9	315	C30/37			0	No	0.7875	FS1		
		2	-964.2	1149.1										
		3	-1149.1	964.2										
		4	-995.9	835.6										
L1	50	1	-370	640.9	50	C30/37			0	No	0.125	FS1		
		2	-475.7	566.9										
		3	0	0										
L1	300	1	-750	1299	300	C30/37			0	No	0.75	FS1		
		2	-900.2	1559.2										
		3	-1157.2	1379.2										
		4	-964.2	1149.1										
L1	315	1	-650	1125.8	315	C30/37			0	No	0.7875	FS1		
		2	-750	1299										
		3	-964.2	1149.1										
		4	-835.6	995.9										
L1	330	1	-707.1	842.6	330	C30/37			0	No	0.825	FS1		
		2	-835.6	995.9										
		3	-995.9	835.6										
		4	-842.6	707.1										
L1	345	1	-578.5	689.4	345	C30/37			0	No	0.8625	FS1		
		2	-707.1	842.6										
		3	-842.6	707.1										
		4	-689.4	578.5										
L1	360	1	-475.7	566.9	360	C30/37			0	No	0.9	FS1		
		2	-578.5	689.4										
		3	-689.4	578.5										
		4	-566.9	475.7										
L1	300	1	-1149.1	964.2	300	C30/37			0	No	0.75	FS1		
		2	-1379.2	1157.2										
		3	-1559.2	900.2										
		4	-1299	750										
L1	330	1	-1033.7	376.2	330	C30/37			0	No	0.825	FS1		
		2	-1221.6	444.6										
		3	-1280.3	225.7										
		4	-1083.3	191										



Tabulati di Calcolo Plinto di Fondazione per Aerogeneratore Tipo - Progetto Impianto Eolico - "Orione"

Livello	Sp.	Punti			Estr.	Mat.	Car.sup.	Car.pot.	DeltaT	Sovr.	S.Z	P.sup.	Fond.	Fori
		I.	X	Y										
L1	345	1	-845.7	307.8	345	C30/37				0	No	0.8625	FS1	
		2	-1033.7	376.2										
		3	-1083.3	191										
		4	-886.3	156.3										
L1	360	1	-695.4	253.1	360	C30/37				0	No	0.9	FS1	
		2	-845.7	307.8										
		3	-886.3	156.3										
		4	-728.8	128.5										
L1	50	1	-695.4	253.1	50	C30/37				0	No	0.125	FS1	
		2	-728.8	128.5										
		3	0	0										
L1	300	1	-1409.5	513	300	C30/37				0	No	0.75	FS1	
		2	-1691.8	615.8										
		3	-1773	312.6										
		4	-1477.2	260.5										
L1	315	1	-1221.6	444.6	315	C30/37				0	No	0.7875	FS1	
		2	-1409.5	513										
		3	-1477.2	260.5										
		4	-1280.3	225.7										
L1	50	1	-640.9	370	50	C30/37				0	No	0.125	FS1	
		2	-695.4	253.1										
		3	0	0										
L1	345	1	-779.4	450	345	C30/37				0	No	0.8625	FS1	
		2	-952.6	550										
		3	-1033.7	376.2										
		4	-845.7	307.8										
L1	360	1	-640.9	370	360	C30/37				0	No	0.9	FS1	
		2	-779.4	450										
		3	-845.7	307.8										
		4	-695.4	253.1										
L1	50	1	-566.9	475.7	50	C30/37				0	No	0.125	FS1	
		2	-640.9	370										
		3	0	0										
L1	300	1	-1299	750	300	C30/37				0	No	0.75	FS1	
		2	-1559.2	900.2										
		3	-1691.8	615.8										
		4	-1409.5	513										
L1	315	1	-1125.8	650	315	C30/37				0	No	0.7875	FS1	
		2	-1299	750										
		3	-1409.5	513										
		4	-1221.6	444.6										
L1	330	1	-952.6	550	330	C30/37				0	No	0.825	FS1	
		2	-1125.8	650										
		3	-1221.6	444.6										
		4	-1033.7	376.2										
L1	315	1	0	1300	315	C30/37				0	No	0.7875	FS1	
		2	0	1500										
		3	-260.5	1477.2										
		4	-225.7	1280.3										
L1	330	1	0	1100	330	C30/37				0	No	0.825	FS1	
		2	0	1300										
		3	-225.7	1280.3										
		4	-191	1083.3										
L1	345	1	0	900	345	C30/37				0	No	0.8625	FS1	
		2	0	1100										
		3	-191	1083.3										
		4	-156.3	886.3										
L1	360	1	-128.5	728.8	360	C30/37				0	No	0.9	FS1	
		2	-156.3	886.3										
		3	-307.8	845.7										
		4	-253.1	695.4										
L1	50	1	0	740	50	C30/37				0	No	0.125	FS1	
		2	-128.5	728.8										
		3	0	0										
L1	300	1	0	1500	300	C30/37				0	No	0.75	FS1	
		2	0	1800.4										
		3	-312.6	1773										
		4	-260.5	1477.2										
L1	360	1	0	740	360	C30/37				0	No	0.9	FS1	
		2	0	900										
		3	-156.3	886.3										
		4	-128.5	728.8										
L1	330	1	191	1083.3	330	C30/37				0	No	0.825	FS1	
		2	225.7	1280.3										
		3	0	1300										
		4	0	1100										
L1	345	1	156.3	886.3	345	C30/37				0	No	0.8625	FS1	
		2	191	1083.3										
		3	0	1100										
		4	0	900										
L1	360	1	128.5	728.8	360	C30/37				0	No	0.9	FS1	
		2	156.3	886.3										
		3	0	900										
		4	0	740										
L1	50	1	128.5	728.8	50	C30/37				0	No	0.125	FS1	
		2	0	740										
		3	0	0										
L1	300	1	260.5	1477.2	300	C30/37				0	No	0.75	FS1	
		2	312.6	1773										
		3	0	1800.4										
		4	0	1500										
L1	315	1	225.7	1280.3	315	C30/37				0	No	0.7875	FS1	
		2	260.5	1477.2										
		3	0	1500										
		4	0	1300										
L1	345	1	-156.3	886.3	345	C30/37				0	No	0.8625	FS1	



Tabulati di Calcolo Plinto di Fondazione per Aerogeneratore Tipo - Progetto Impianto Eolico - "Orione"

Livello	Sp.	Punti			Estr.	Mat.	Car.sup.	Car.pot.	DeltaT	Sovr.	S.Z	P.sup.	Fond.	Fori
		I.	X	Y										
		2	-191	1083.3										
		3	-376.2	1033.7										
		4	-307.8	845.7										
L1	50	1	-253.1	695.4	50	C30/37			0	No	0.125	FS1		
		2	-370	640.9										
		3	0	0										
L1	300	1	-513	1409.5	300	C30/37			0	No	0.75	FS1		
		2	-615.8	1691.8										
		3	-900.2	1559.2										
		4	-750	1299										
L1	315	1	-444.6	1221.6	315	C30/37			0	No	0.7875	FS1		
		2	-513	1409.5										
		3	-750	1299										
		4	-650	1125.8										
L1	330	1	-550	952.6	330	C30/37			0	No	0.825	FS1		
		2	-650	1125.8										
		3	-835.6	995.9										
		4	-707.1	842.6										
L1	345	1	-450	779.4	345	C30/37			0	No	0.8625	FS1		
		2	-550	952.6										
		3	-707.1	842.6										
		4	-578.5	689.4										
L1	360	1	-370	640.9	360	C30/37			0	No	0.9	FS1		
		2	-450	779.4										
		3	-578.5	689.4										
		4	-475.7	566.9										
L1	330	1	-376.2	1033.7	330	C30/37			0	No	0.825	FS1		
		2	-444.6	1221.6										
		3	-650	1125.8										
		4	-550	952.6										
L1	300	1	-260.5	1477.2	300	C30/37			0	No	0.75	FS1		
		2	-312.6	1773										
		3	-615.8	1691.8										
		4	-513	1409.5										
L1	315	1	-225.7	1280.3	315	C30/37			0	No	0.7875	FS1		
		2	-260.5	1477.2										
		3	-513	1409.5										
		4	-444.6	1221.6										
L1	330	1	-191	1083.3	330	C30/37			0	No	0.825	FS1		
		2	-225.7	1280.3										
		3	-444.6	1221.6										
		4	-376.2	1033.7										
L1	345	1	-307.8	845.7	345	C30/37			0	No	0.8625	FS1		
		2	-376.2	1033.7										
		3	-550	952.6										
		4	-450	779.4										
L1	360	1	-253.1	695.4	360	C30/37			0	No	0.9	FS1		
		2	-307.8	845.7										
		3	-450	779.4										
		4	-370	640.9										
L1	50	1	-128.5	728.8	50	C30/37			0	No	0.125	FS1		
		2	-253.1	695.4										
		3	0	0										
L1	360	1	-475.7	-566.9	360	C30/37			0	No	0.9	FS1		
		2	-578.5	-689.4										
		3	-450	-779.4										
		4	-370	-640.9										
L1	50	1	-566.9	-475.7	50	C30/37			0	No	0.125	FS1		
		2	-475.7	-566.9										
		3	0	0										
L1	300	1	-1149.1	-964.2	300	C30/37			0	No	0.75	FS1		
		2	-1379.2	-1157.2										
		3	-1157.2	-1379.2										
		4	-964.2	-1149.1										
L1	315	1	-835.6	-995.9	315	C30/37			0	No	0.7875	FS1		
		2	-964.2	-1149.1										
		3	-750	-1299										
		4	-650	-1125.8										
L1	330	1	-707.1	-842.6	330	C30/37			0	No	0.825	FS1		
		2	-835.6	-995.9										
		3	-650	-1125.8										
		4	-550	-952.6										
L1	345	1	-578.5	-689.4	345	C30/37			0	No	0.8625	FS1		
		2	-707.1	-842.6										
		3	-550	-952.6										
		4	-450	-779.4										
L1	315	1	-995.9	-835.6	315	C30/37			0	No	0.7875	FS1		
		2	-1149.1	-964.2										
		3	-964.2	-1149.1										
		4	-835.6	-995.9										
L1	50	1	-640.9	-370	50	C30/37			0	No	0.125	FS1		
		2	-566.9	-475.7										
		3	0	0										
L1	300	1	-1299	-750	300	C30/37			0	No	0.75	FS1		
		2	-1559.2	-900.2										
		3	-1379.2	-1157.2										
		4	-1149.1	-964.2										
L1	315	1	-1125.8	-650	315	C30/37			0	No	0.7875	FS1		
		2	-1299	-750										
		3	-1149.1	-964.2										
		4	-995.9	-835.6										
L1	330	1	-842.6	-707.1	330	C30/37			0	No	0.825	FS1		
		2	-995.9	-835.6										
		3	-835.6	-995.9										
		4	-707.1	-842.6										
L1	345	1	-689.4	-578.5	345	C30/37			0	No	0.8625	FS1		



Tabulati di Calcolo Plinto di Fondazione per Aerogeneratore Tipo - Progetto Impianto Eolico - "Orione"

Livello	Sp.	Punti			Estr.	Mat.	Car.sup.	Car.pot.	DeltaT	Sovr.	S.Z	P.sup.	Fond.	Fori
		I.	X	Y										
		2	-842.6	-707.1										
		3	-707.1	-842.6										
		4	-578.5	-689.4										
L1	360	1	-566.9	-475.7	360	C30/37			0	No	0.9	FS1		
		2	-689.4	-578.5										
		3	-578.5	-689.4										
		4	-475.7	-566.9										
L1	300	1	-964.2	-1149.1	300	C30/37			0	No	0.75	FS1		
		2	-1157.2	-1379.2										
		3	-900.2	-1559.2										
		4	-750	-1299										
L1	330	1	-376.2	-1033.7	330	C30/37			0	No	0.825	FS1		
		2	-444.6	-1221.6										
		3	-225.7	-1280.3										
		4	-191	-1083.3										
L1	345	1	-307.8	-845.7	345	C30/37			0	No	0.8625	FS1		
		2	-376.2	-1033.7										
		3	-191	-1083.3										
		4	-156.3	-886.3										
L1	360	1	-253.1	-695.4	360	C30/37			0	No	0.9	FS1		
		2	-307.8	-845.7										
		3	-156.3	-886.3										
		4	-128.5	-728.8										
L1	50	1	-253.1	-695.4	50	C30/37			0	No	0.125	FS1		
		2	-128.5	-728.8										
		3	0	0										
L1	300	1	-513	-1409.5	300	C30/37			0	No	0.75	FS1		
		2	-615.8	-1691.8										
		3	-312.6	-1773										
		4	-260.5	-1477.2										
L1	315	1	-444.6	-1221.6	315	C30/37			0	No	0.7875	FS1		
		2	-513	-1409.5										
		3	-260.5	-1477.2										
		4	-225.7	-1280.3										
L1	50	1	-370	-640.9	50	C30/37			0	No	0.125	FS1		
		2	-253.1	-695.4										
		3	0	0										
L1	345	1	-450	-779.4	345	C30/37			0	No	0.8625	FS1		
		2	-550	-952.6										
		3	-376.2	-1033.7										
		4	-307.8	-845.7										
L1	360	1	-370	-640.9	360	C30/37			0	No	0.9	FS1		
		2	-450	-779.4										
		3	-307.8	-845.7										
		4	-253.1	-695.4										
L1	50	1	-475.7	-566.9	50	C30/37			0	No	0.125	FS1		
		2	-370	-640.9										
		3	0	0										
L1	300	1	-750	-1299	300	C30/37			0	No	0.75	FS1		
		2	-900.2	-1559.2										
		3	-615.8	-1691.8										
		4	-513	-1409.5										
L1	315	1	-650	-1125.8	315	C30/37			0	No	0.7875	FS1		
		2	-750	-1299										
		3	-513	-1409.5										
		4	-444.6	-1221.6										
L1	330	1	-550	-952.6	330	C30/37			0	No	0.825	FS1		
		2	-650	-1125.8										
		3	-444.6	-1221.6										
		4	-376.2	-1033.7										
L1	315	1	-1300	0	315	C30/37			0	No	0.7875	FS1		
		2	-1500	0										
		3	-1477.2	-260.5										
		4	-1280.3	-225.7										
L1	330	1	-1100	0	330	C30/37			0	No	0.825	FS1		
		2	-1300	0										
		3	-1280.3	-225.7										
		4	-1083.3	-191										
L1	345	1	-900	0	345	C30/37			0	No	0.8625	FS1		
		2	-1100	0										
		3	-1083.3	-191										
		4	-886.3	-156.3										
L1	360	1	-728.8	-128.5	360	C30/37			0	No	0.9	FS1		
		2	-886.3	-156.3										
		3	-845.7	-307.8										
		4	-695.4	-253.1										
L1	50	1	-740	0	50	C30/37			0	No	0.125	FS1		
		2	-728.8	-128.5										
		3	0	0										
L1	300	1	-1500	0	300	C30/37			0	No	0.75	FS1		
		2	-1800.4	0										
		3	-1773	-312.6										
		4	-1477.2	-260.5										
L1	360	1	-740	0	360	C30/37			0	No	0.9	FS1		
		2	-900	0										
		3	-886.3	-156.3										
		4	-728.8	-128.5										
L1	330	1	-1083.3	191	330	C30/37			0	No	0.825	FS1		
		2	-1280.3	225.7										
		3	-1300	0										
		4	-1100	0										
L1	345	1	-886.3	156.3	345	C30/37			0	No	0.8625	FS1		
		2	-1083.3	191										
		3	-1100	0										
		4	-900	0										
L1	360	1	-728.8	128.5	360	C30/37			0	No	0.9	FS1		



Livello	Sp.	Punti			Estr.	Mat.	Car.sup.	Car.pot.	DeltaT	Sovr.	S.Z	P.sup.	Fond.	Fori
		I.	X	Y										
		2	-886.3	156.3										
		3	-900	0										
		4	-740	0										
L1	50	1	-728.8	128.5	50	C30/37			0	No	0.125	FS1		
		2	-740	0										
		3	0	0										
L1	300	1	-1477.2	260.5	300	C30/37			0	No	0.75	FS1		
		2	-1773	312.6										
		3	-1800.4	0										
		4	-1500	0										
L1	315	1	-1280.3	225.7	315	C30/37			0	No	0.7875	FS1		
		2	-1477.2	260.5										
		3	-1500	0										
		4	-1300	0										
L1	345	1	-886.3	-156.3	345	C30/37			0	No	0.8625	FS1		
		2	-1083.3	-191										
		3	-1033.7	-376.2										
		4	-845.7	-307.8										
L1	50	1	-695.4	-253.1	50	C30/37			0	No	0.125	FS1		
		2	-640.9	-370										
		3	0	0										
L1	300	1	-1409.5	-513	300	C30/37			0	No	0.75	FS1		
		2	-1691.8	-615.8										
		3	-1559.2	-900.2										
		4	-1299	-750										
L1	315	1	-1221.6	-444.6	315	C30/37			0	No	0.7875	FS1		
		2	-1409.5	-513										
		3	-1299	-750										
		4	-1125.8	-650										
L1	330	1	-952.6	-550	330	C30/37			0	No	0.825	FS1		
		2	-1125.8	-650										
		3	-995.9	-835.6										
		4	-842.6	-707.1										
L1	345	1	-779.4	-450	345	C30/37			0	No	0.8625	FS1		
		2	-952.6	-550										
		3	-842.6	-707.1										
		4	-689.4	-578.5										
L1	360	1	-640.9	-370	360	C30/37			0	No	0.9	FS1		
		2	-779.4	-450										
		3	-689.4	-578.5										
		4	-566.9	-475.7										
L1	330	1	-1033.7	-376.2	330	C30/37			0	No	0.825	FS1		
		2	-1221.6	-444.6										
		3	-1125.8	-650										
		4	-952.6	-550										
L1	300	1	-1477.2	-260.5	300	C30/37			0	No	0.75	FS1		
		2	-1773	-312.6										
		3	-1691.8	-615.8										
		4	-1409.5	-513										
L1	315	1	-1280.3	-225.7	315	C30/37			0	No	0.7875	FS1		
		2	-1477.2	-260.5										
		3	-1409.5	-513										
		4	-1221.6	-444.6										
L1	330	1	-1083.3	-191	330	C30/37			0	No	0.825	FS1		
		2	-1280.3	-225.7										
		3	-1221.6	-444.6										
		4	-1033.7	-376.2										
L1	345	1	-845.7	-307.8	345	C30/37			0	No	0.8625	FS1		
		2	-1033.7	-376.2										
		3	-952.6	-550										
		4	-779.4	-450										
L1	360	1	-695.4	-253.1	360	C30/37			0	No	0.9	FS1		
		2	-845.7	-307.8										
		3	-779.4	-450										
		4	-640.9	-370										
L1	50	1	-728.8	-128.5	50	C30/37			0	No	0.125	FS1		
		2	-695.4	-253.1										
		3	0	0										

### 6.5.4 Piastre generiche

Sp.: Spessore misurato in direzione ortogonale al piano medio dell'elemento. [cm]

Punti: Punti di definizione.

I.: Indice del punto corrente nell'insieme dei punti di definizione dell'elemento.

X: Coordinata X. [cm]

Y: Coordinata Y. [cm]

Z: Coordinata Z. [cm]

Mat.: Riferimento ad una definizione di materiale.

Car.sup.: Riferimento alla definizione di un carico superficiale. Accetta anche il valore "Nessuno".

Car.pot.: Riferimento alla definizione di un carico potenziale. Accetta anche il valore "Nessuno".

DeltaT: Riferimento alla definizione di una variazione termica. Accetta anche il valore "Nessuno".

Sovr.: Aliquota di sovrarresistenza da assicurare in verifica.

S.Z: Indica se l'elemento deve essere verificato considerando il sisma verticale.

P.sup.: Peso per unità di superficie. [daN/cm<sup>2</sup>]

Fond.: Riferimento alla fondazione sottostante l'elemento.

Fori: Riferimenti a tutti gli elementi che forano la piastra.

Sp.	Punti			Mat.	Car.sup.	Car.pot.	DeltaT	Sovr.	S.Z	P.sup.	Fond.	Fori
	I.	X	Y									
200	1	482.6	-405	300	C30/37			0	No	0.5		



Progetto	Titolo	Rev.	Pag.
Orione	Orione_A24a.pdf "TABULATI DI CALCOLO PLINTO DI FONDAZIONE PER AEROGENERATORE TIPO"	0	31



Tabulati di Calcolo Plinto di Fondazione per Aerogeneratore Tipo - Progetto Impianto Eolico - "Orione"

Sp.	Punti			Mat.	Car.sup.	Car.pot.	DeltaT	Sovr.	S.Z	P.sup.	Fond.	Fori
	I.	X	Y									
	2	545.6	-315	300								
	3	640.9	-370	300								
	4	566.9	-475.7	300								
200	1	405	-482.6	300	C30/37			0	No	0.5		
	2	482.6	-405	300								
	3	566.9	-475.7	300								
	4	475.7	-566.9	300								
200	1	592	-215.5	300	C30/37			0	No	0.5		
	2	620.4	-109.4	300								
	3	728.8	-128.5	300								
	4	695.4	-253.1	300								
200	1	545.6	-315	300	C30/37			0	No	0.5		
	2	592	-215.5	300								
	3	695.4	-253.1	300								
	4	640.9	-370	300								
200	1	315	-545.6	300	C30/37			0	No	0.5		
	2	405	-482.6	300								
	3	475.7	-566.9	300								
	4	370	-640.9	300								
200	1	0	-630	300	C30/37			0	No	0.5		
	2	109.4	-620.4	300								
	3	128.5	-728.8	300								
	4	0	-740	300								
200	1	-109.4	-620.4	300	C30/37			0	No	0.5		
	2	0	-630	300								
	3	0	-740	300								
	4	-128.5	-728.8	300								
200	1	215.5	-592	300	C30/37			0	No	0.5		
	2	315	-545.6	300								
	3	370	-640.9	300								
	4	253.1	-695.4	300								
200	1	109.4	-620.4	300	C30/37			0	No	0.5		
	2	215.5	-592	300								
	3	253.1	-695.4	300								
	4	128.5	-728.8	300								
200	1	405	482.6	300	C30/37			0	No	0.5		
	2	315	545.6	300								
	3	370	640.9	300								
	4	475.7	566.9	300								
200	1	482.6	405	300	C30/37			0	No	0.5		
	2	405	482.6	300								
	3	475.7	566.9	300								
	4	566.9	475.7	300								
200	1	215.5	592	300	C30/37			0	No	0.5		
	2	109.4	620.4	300								
	3	128.5	728.8	300								
	4	253.1	695.4	300								
200	1	315	545.6	300	C30/37			0	No	0.5		
	2	215.5	592	300								
	3	253.1	695.4	300								
	4	370	640.9	300								
200	1	545.6	315	300	C30/37			0	No	0.5		
	2	482.6	405	300								
	3	566.9	475.7	300								
	4	640.9	370	300								
200	1	630	0	300	C30/37			0	No	0.5		
	2	620.4	109.4	300								
	3	728.8	128.5	300								
	4	740	0	300								
200	1	620.4	-109.4	300	C30/37			0	No	0.5		
	2	630	0	300								
	3	740	0	300								
	4	728.8	-128.5	300								
200	1	592	215.5	300	C30/37			0	No	0.5		
	2	545.6	315	300								
	3	640.9	370	300								
	4	695.4	253.1	300								
200	1	620.4	109.4	300	C30/37			0	No	0.5		
	2	592	215.5	300								
	3	695.4	253.1	300								
	4	728.8	128.5	300								
200	1	-482.6	405	300	C30/37			0	No	0.5		
	2	-545.6	315	300								
	3	-640.9	370	300								
	4	-566.9	475.7	300								
200	1	-405	482.6	300	C30/37			0	No	0.5		
	2	-482.6	405	300								
	3	-566.9	475.7	300								
	4	-475.7	566.9	300								
200	1	-592	215.5	300	C30/37			0	No	0.5		
	2	-620.4	109.4	300								
	3	-728.8	128.5	300								
	4	-695.4	253.1	300								
200	1	-545.6	315	300	C30/37			0	No	0.5		
	2	-592	215.5	300								
	3	-695.4	253.1	300								
	4	-640.9	370	300								
200	1	-315	545.6	300	C30/37			0	No	0.5		
	2	-405	482.6	300								
	3	-475.7	566.9	300								
	4	-370	640.9	300								
200	1	0	630	300	C30/37			0	No	0.5		
	2	-109.4	620.4	300								
	3	-128.5	728.8	300								
	4	0	740	300								
200	1	109.4	620.4	300	C30/37			0	No	0.5		



Sp.	Punti			Mat.	Car.sup.	Car.pot.	DeltaT	Sovr.	S.Z	P.sup.	Fond.	Fori
	I.	X	Y									
	2	0	630	300								
	3	0	740	300								
	4	128.5	728.8	300								
200	1	-215.5	592	300	C30/37			0	No	0.5		
	2	-315	545.6	300								
	3	-370	640.9	300								
	4	-253.1	695.4	300								
200	1	-109.4	620.4	300	C30/37			0	No	0.5		
	2	-215.5	592	300								
	3	-253.1	695.4	300								
	4	-128.5	728.8	300								
200	1	-405	-482.6	300	C30/37			0	No	0.5		
	2	-315	-545.6	300								
	3	-370	-640.9	300								
	4	-475.7	-566.9	300								
200	1	-482.6	-405	300	C30/37			0	No	0.5		
	2	-405	-482.6	300								
	3	-475.7	-566.9	300								
	4	-566.9	-475.7	300								
200	1	-215.5	-592	300	C30/37			0	No	0.5		
	2	-109.4	-620.4	300								
	3	-128.5	-728.8	300								
	4	-253.1	-695.4	300								
200	1	-315	-545.6	300	C30/37			0	No	0.5		
	2	-215.5	-592	300								
	3	-253.1	-695.4	300								
	4	-370	-640.9	300								
200	1	-545.6	-315	300	C30/37			0	No	0.5		
	2	-482.6	-405	300								
	3	-566.9	-475.7	300								
	4	-640.9	-370	300								
200	1	-630	0	300	C30/37			0	No	0.5		
	2	-620.4	-109.4	300								
	3	-728.8	-128.5	300								
	4	-740	0	300								
200	1	-620.4	109.4	300	C30/37			0	No	0.5		
	2	-630	0	300								
	3	-740	0	300								
	4	-728.8	128.5	300								
200	1	-592	-215.5	300	C30/37			0	No	0.5		
	2	-545.6	-315	300								
	3	-640.9	-370	300								
	4	-695.4	-253.1	300								
200	1	-620.4	-109.4	300	C30/37			0	No	0.5		
	2	-592	-215.5	300								
	3	-695.4	-253.1	300								
	4	-728.8	-128.5	300								

### 6.5.5 Fondazioni profonde

Descrizione breve: Descrizione breve usata nelle tabelle dei capitoli dei pali e plinti su pali.

Stratigrafia: Stratigrafia del terreno nel punto medio in pianta dell'elemento.

Sondaggio: È possibile indicare esplicitamente un sondaggio definito nelle preferenze oppure richiedere di estrapolare il sondaggio dalla definizione del sito espressa nelle preferenze.

Estradosso: Distanza dalla quota superiore del sondaggio misurata in verticale con verso positivo verso l'alto. [cm]

Deformazione volumetrica: Valore della deformazione volumetrica impiegato nel calcolo della pressione limite a rottura con la formula di Vesic. Il valore è adimensionale. Accetta anche il valore di default espresso nelle preferenze.

K punta: Coefficiente di sottofondo verticale del terreno in punta palo. [daN/cm3]

Pressione limite punta: Valore limite di pressione del terreno in punta palo. [daN/cm2]

Descrizione breve	Stratigrafia			K punta	Pressione limite punta
	Sondaggio	Estradosso	Deformazione volumetrica		
FPP1	Da sito	0	0,2880122278	Default	Default

### 6.5.6 Pali

#### 6.5.6.1 Pali di piano

Palo: Riferimento ad una definizione di palo.

Liv.: Quota di inserimento esprimibile come livello, falda, piano orizzontale alla Z specificata. [cm]

Punto: Punto di inserimento.

X: Coordinata X. [cm]

Y: Coordinata Y. [cm]

Estr.: Distanza dalla quota di inserimento misurata in direzione ortogonale al piano della quota e con verso positivo verso l'alto. [cm]

Lungh.: Lunghezza del palo. [cm]

Coll. testa: Tipo di collegamento fra la testa del palo e l'eventuale sovrastruttura.

Capacità portante palo: Capacità portante ultima singolo palo, valutata con formula statica.

Fond.: Riferimento alla fondazione sottostante l'elemento.

Palo	Liv.	Punto		Estr.	Lungh.	Coll. testa	Capacità portante palo	Fond.
		X	Y					
Palo trivellato D 100	L1	-1083.4	-505.2	0	2500	Incastro	768260	FPP1
Palo trivellato D 100	L1	286.6	1625.1	0	2500	Incastro	768260	FPP1
Palo trivellato D 100	L1	564.4	1550.7	0	2500	Incastro	768260	FPP1
Palo trivellato D 100	L1	-104.2	-1190.9	0	2500	Incastro	768260	FPP1



Progetto	Titolo	Rev.	Pag.
Orione	Orione_A24a.pdf "TABULATI DI CALCOLO PLINTO DI FONDAZIONE PER AEROGENERATORE TIPO"	0	33

Palo	Liv.	Punto		Estr.	Lungh.	Coll. testa	Capacità portante palo	Fond.
		X	Y					
Palo trivellato D 100	L1	-505.2	-1083.4	0	2500	Incastro	768260	FPP1
Palo trivellato D 100	L1	-845.3	-845.3	0	2500	Incastro	768260	FPP1
Palo trivellato D 100	L1	825.1	1429.1	0	2500	Incastro	768260	FPP1
Palo trivellato D 100	L1	1550.7	564.4	0	2500	Incastro	768260	FPP1
Palo trivellato D 100	L1	1625.1	286.6	0	2500	Incastro	768260	FPP1
Palo trivellato D 100	L1	1650.2	0	0	2500	Incastro	768260	FPP1
Palo trivellato D 100	L1	1060.7	1264.1	0	2500	Incastro	768260	FPP1
Palo trivellato D 100	L1	1264.1	1060.7	0	2500	Incastro	768260	FPP1
Palo trivellato D 100	L1	1429.1	825.1	0	2500	Incastro	768260	FPP1
Palo trivellato D 100	L1	309.4	-1154.7	0	2500	Incastro	768260	FPP1
Palo trivellato D 100	L1	-685.7	979.2	0	2500	Incastro	768260	FPP1
Palo trivellato D 100	L1	-309.4	1154.7	0	2500	Incastro	768260	FPP1
Palo trivellato D 100	L1	104.2	1190.9	0	2500	Incastro	768260	FPP1
Palo trivellato D 100	L1	-1190.9	-104.2	0	2500	Incastro	768260	FPP1
Palo trivellato D 100	L1	-1154.7	309.4	0	2500	Incastro	768260	FPP1
Palo trivellato D 100	L1	-979.2	685.7	0	2500	Incastro	768260	FPP1
Palo trivellato D 100	L1	505.2	1083.4	0	2500	Incastro	768260	FPP1
Palo trivellato D 100	L1	1154.7	-309.4	0	2500	Incastro	768260	FPP1
Palo trivellato D 100	L1	979.2	-685.7	0	2500	Incastro	768260	FPP1
Palo trivellato D 100	L1	685.7	-979.2	0	2500	Incastro	768260	FPP1
Palo trivellato D 100	L1	845.3	845.3	0	2500	Incastro	768260	FPP1
Palo trivellato D 100	L1	1083.4	505.2	0	2500	Incastro	768260	FPP1
Palo trivellato D 100	L1	1190.9	104.2	0	2500	Incastro	768260	FPP1
Palo trivellato D 100	L1	-1650.2	0	0	2500	Incastro	768260	FPP1
Palo trivellato D 100	L1	-1625.1	286.6	0	2500	Incastro	768260	FPP1
Palo trivellato D 100	L1	-1550.7	564.4	0	2500	Incastro	768260	FPP1
Palo trivellato D 100	L1	-1429.1	-825.1	0	2500	Incastro	768260	FPP1
Palo trivellato D 100	L1	-1550.7	-564.4	0	2500	Incastro	768260	FPP1
Palo trivellato D 100	L1	-1625.1	-286.6	0	2500	Incastro	768260	FPP1
Palo trivellato D 100	L1	-1429.1	825.1	0	2500	Incastro	768260	FPP1
Palo trivellato D 100	L1	-564.4	1550.7	0	2500	Incastro	768260	FPP1
Palo trivellato D 100	L1	-286.6	1625.1	0	2500	Incastro	768260	FPP1
Palo trivellato D 100	L1	0	1650.2	0	2500	Incastro	768260	FPP1
Palo trivellato D 100	L1	-1264.1	1060.7	0	2500	Incastro	768260	FPP1
Palo trivellato D 100	L1	-1060.7	1264.1	0	2500	Incastro	768260	FPP1
Palo trivellato D 100	L1	-825.1	1429.1	0	2500	Incastro	768260	FPP1
Palo trivellato D 100	L1	-1264.1	-1060.7	0	2500	Incastro	768260	FPP1
Palo trivellato D 100	L1	1264.1	-1060.7	0	2500	Incastro	768260	FPP1
Palo trivellato D 100	L1	1060.7	-1264.1	0	2500	Incastro	768260	FPP1
Palo trivellato D 100	L1	825.1	-1429.1	0	2500	Incastro	768260	FPP1
Palo trivellato D 100	L1	1625.1	-286.6	0	2500	Incastro	768260	FPP1
Palo trivellato D 100	L1	1550.7	-564.4	0	2500	Incastro	768260	FPP1
Palo trivellato D 100	L1	1429.1	-825.1	0	2500	Incastro	768260	FPP1
Palo trivellato D 100	L1	564.4	-1550.7	0	2500	Incastro	768260	FPP1
Palo trivellato D 100	L1	-564.4	-1550.7	0	2500	Incastro	768260	FPP1
Palo trivellato D 100	L1	-825.1	-1429.1	0	2500	Incastro	768260	FPP1
Palo trivellato D 100	L1	-1060.7	-1264.1	0	2500	Incastro	768260	FPP1
Palo trivellato D 100	L1	286.6	-1625.1	0	2500	Incastro	768260	FPP1
Palo trivellato D 100	L1	0	-1650.2	0	2500	Incastro	768260	FPP1
Palo trivellato D 100	L1	-286.6	-1625.1	0	2500	Incastro	768260	FPP1

## 6.5.7 Carichi concentrati

### 6.5.7.1 Carichi concentrati a quota generica

Carico: Riferimento alla definizione di un carico concentrato.

Quota: Quota di inserimento esprimibile come livello, falda, piano orizzontale alla Z specificata. [cm]

Punto: Punto di inserimento.

X: Coordinata X. [cm]

Y: Coordinata Y. [cm]

Carico	Quota	Punto	
		X	Y
1	200	0	0

























Indice	Posizione			Indice	Posizione			Indice	Posizione			Indice	Posizione		
	X	Y	Z		X	Y	Z		X	Y	Z		X	Y	Z
3786	-88.4	-329.9	449.8	3787	88.4	-329.9	449.8	3788	-144.4	-309.6	449.8	3789	144.4	-309.6	449.8
3790	-195.9	-279.8	449.8	3791	195.9	-279.8	449.8	3792	-241.5	-241.5	449.8	3793	241.5	-241.5	449.8
3794	-279.8	-195.9	449.8	3795	279.8	-195.9	449.8	3796	-309.6	-144.4	449.8	3797	309.6	-144.4	449.8
3798	-329.9	-88.4	449.8	3799	329.9	-88.4	449.8	3800	-340.3	-29.8	449.8	3801	340.3	-29.8	449.8
3802	-340.3	29.8	449.8	3803	340.3	29.8	449.8	3804	-329.9	88.4	449.8	3805	329.9	88.4	449.8
3806	-309.6	144.4	449.8	3807	309.6	144.4	449.8	3808	-279.8	195.9	449.8	3809	279.8	195.9	449.8
3810	-241.5	241.5	449.8	3811	241.5	241.5	449.8	3812	-195.9	279.8	449.8	3813	195.9	279.8	449.8
3814	-144.4	309.6	449.8	3815	144.4	309.6	449.8	3816	-88.4	329.9	449.8	3817	88.4	329.9	449.8
3818	-29.8	340.3	449.8	3819	29.8	340.3	449.8	3820	0	0	600				

## 7.2 Carichi concentrati

Indice: Numero dell'elemento nell'insieme che lo contiene.

Nodo: Nodo su cui agisce il carico.

Condizione: Condizione elementare mappata nella quale agisce il carico.

Fx: Componente della forza lungo l'asse X. [daN]

Fy: Componente della forza lungo l'asse Y. [daN]

Fz: Componente della forza lungo l'asse Z. [daN]

Mx: Componente del momento attorno all'asse X. [daN\*cm]

My: Componente del momento attorno all'asse Y. [daN\*cm]

Mz: Componente del momento attorno all'asse Z. [daN\*cm]

Indice	Nodo	Condizione	Fx	Fy	Fz	Mx	My	Mz	Indice	Nodo	Condizione	Fx	Fy	Fz	Mx	My	Mz
1	3423	Pesi strutturali	0	0	-7.0E6	0	0	0	2	3423	Vento	248000	0	0	2.9E9	0	1.2E8
3	3820	Rig. Ux	1	0	0	0	0	0	4	3820	Rig. Uy	0	1	0	0	0	0
5	3820	Rig. Rz	0	0	0	0	0	0	6	1630	Sisma X SLV	0	0	0	0	0	0
7	1630	Sisma Y SLV	0	0	0	0	0	0	8	1630	Sisma X SLD	0	0	0	0	0	0
9	1630	Sisma Y SLD	0	0	0	0	0	0	10	2612	Sisma X SLV	0	0	0	0	0	0
11	2612	Sisma Y SLV	0	0	0	0	0	0	12	2612	Sisma X SLD	0	0	0	0	0	0
13	2612	Sisma Y SLD	0	0	0	0	0	0	14	2747	Sisma X SLV	0	0	0	0	0	0
15	2747	Sisma Y SLV	0	0	0	0	0	0	16	2747	Sisma X SLD	0	0	0	0	0	0
17	2747	Sisma Y SLD	0	0	0	0	0	0	18	2829	Sisma X SLV	0	0	0	0	0	0
19	2829	Sisma Y SLV	0	0	0	0	0	0	20	2829	Sisma X SLD	0	0	0	0	0	0
21	2829	Sisma Y SLD	0	0	0	0	0	0	22	3171	Sisma X SLV	374.2	0	0	0	0	0
23	3171	Sisma Y SLV	0	374.2	0	0	0	0	24	3171	Sisma X SLD	171.8	0	0	0	0	0
25	3171	Sisma Y SLD	0	171.8	0	0	0	0	26	3172	Sisma X SLV	374.2	0	0	0	0	0
27	3172	Sisma Y SLV	0	374.2	0	0	0	0	28	3172	Sisma X SLD	171.8	0	0	0	0	0
29	3172	Sisma Y SLD	0	171.8	0	0	0	0	30	3173	Sisma X SLV	374.2	0	0	0	0	0
31	3173	Sisma Y SLV	0	374.2	0	0	0	0	32	3173	Sisma X SLD	171.8	0	0	0	0	0
33	3173	Sisma Y SLD	0	171.8	0	0	0	0	34	3174	Sisma X SLV	374.2	0	0	0	0	0
35	3174	Sisma Y SLV	0	374.2	0	0	0	0	36	3174	Sisma X SLD	171.8	0	0	0	0	0
37	3174	Sisma Y SLD	0	171.8	0	0	0	0	38	3175	Sisma X SLV	374.2	0	0	0	0	0
39	3175	Sisma Y SLV	0	374.2	0	0	0	0	40	3175	Sisma X SLD	171.8	0	0	0	0	0
41	3175	Sisma Y SLD	0	171.8	0	0	0	0	42	3176	Sisma X SLV	374.2	0	0	0	0	0
43	3176	Sisma Y SLV	0	374.2	0	0	0	0	44	3176	Sisma X SLD	171.8	0	0	0	0	0
45	3176	Sisma Y SLD	0	171.8	0	0	0	0	46	3177	Sisma X SLV	374.2	0	0	0	0	0
47	3177	Sisma Y SLV	0	374.2	0	0	0	0	48	3177	Sisma X SLD	171.8	0	0	0	0	0
49	3177	Sisma Y SLD	0	171.8	0	0	0	0	50	3178	Sisma X SLV	374.2	0	0	0	0	0
51	3178	Sisma Y SLV	0	374.2	0	0	0	0	52	3178	Sisma X SLD	171.8	0	0	0	0	0
53	3178	Sisma Y SLD	0	171.8	0	0	0	0	54	3179	Sisma X SLV	374.2	0	0	0	0	0
55	3179	Sisma Y SLV	0	374.2	0	0	0	0	56	3179	Sisma X SLD	171.8	0	0	0	0	0
57	3179	Sisma Y SLD	0	171.8	0	0	0	0	58	3180	Sisma X SLV	374.2	0	0	0	0	0
59	3180	Sisma Y SLV	0	374.2	0	0	0	0	60	3180	Sisma X SLD	171.8	0	0	0	0	0
61	3180	Sisma Y SLD	0	171.8	0	0	0	0	62	3181	Sisma X SLV	374.2	0	0	0	0	0
63	3181	Sisma Y SLV	0	374.2	0	0	0	0	64	3181	Sisma X SLD	171.8	0	0	0	0	0
65	3181	Sisma Y SLD	0	171.8	0	0	0	0	66	3182	Sisma X SLV	374.2	0	0	0	0	0
67	3182	Sisma Y SLV	0	374.2	0	0	0	0	68	3182	Sisma X SLD	171.8	0	0	0	0	0
69	3182	Sisma Y SLD	0	171.8	0	0	0	0	70	3183	Sisma X SLV	374.2	0	0	0	0	0



Tabulati di Calcolo Plinto di Fondazione per Aerogeneratore Tipo - Progetto Impianto Eolico - "Orione"

Indice	Nodo	Condizione	Fx	Fy	Fz	Mx	My	Mz	Indice	Nodo	Condizione	Fx	Fy	Fz	Mx	My	Mz
71	3183	Sisma Y SLV	0	374.2	0	0	0	0	72	3183	Sisma X SLD	171.8	0	0	0	0	0
73	3183	Sisma Y SLD	0	171.8	0	0	0	0	74	3184	Sisma X SLV	374.2	0	0	0	0	0
75	3184	Sisma Y SLV	0	374.2	0	0	0	0	76	3184	Sisma X SLD	171.8	0	0	0	0	0
77	3184	Sisma Y SLD	0	171.8	0	0	0	0	78	3185	Sisma X SLV	374.2	0	0	0	0	0
79	3185	Sisma Y SLV	0	374.2	0	0	0	0	80	3185	Sisma X SLD	171.8	0	0	0	0	0
81	3185	Sisma Y SLD	0	171.8	0	0	0	0	82	3186	Sisma X SLV	374.2	0	0	0	0	0
83	3186	Sisma Y SLV	0	374.2	0	0	0	0	84	3186	Sisma X SLD	171.8	0	0	0	0	0
85	3186	Sisma Y SLD	0	171.8	0	0	0	0	86	3187	Sisma X SLV	374.2	0	0	0	0	0
87	3187	Sisma Y SLV	0	374.2	0	0	0	0	88	3187	Sisma X SLD	171.8	0	0	0	0	0
89	3187	Sisma Y SLD	0	171.8	0	0	0	0	90	3188	Sisma X SLV	374.2	0	0	0	0	0
91	3188	Sisma Y SLV	0	374.2	0	0	0	0	92	3188	Sisma X SLD	171.8	0	0	0	0	0
93	3188	Sisma Y SLD	0	171.8	0	0	0	0	94	3189	Sisma X SLV	374.2	0	0	0	0	0
95	3189	Sisma Y SLV	0	374.2	0	0	0	0	96	3189	Sisma X SLD	171.8	0	0	0	0	0
97	3189	Sisma Y SLD	0	171.8	0	0	0	0	98	3190	Sisma X SLV	374.2	0	0	0	0	0
99	3190	Sisma Y SLV	0	374.2	0	0	0	0	100	3190	Sisma X SLD	171.8	0	0	0	0	0
101	3190	Sisma Y SLD	0	171.8	0	0	0	0	102	3191	Sisma X SLV	374.2	0	0	0	0	0
103	3191	Sisma Y SLV	0	374.2	0	0	0	0	104	3191	Sisma X SLD	171.8	0	0	0	0	0
105	3191	Sisma Y SLD	0	171.8	0	0	0	0	106	3192	Sisma X SLV	374.2	0	0	0	0	0
107	3192	Sisma Y SLV	0	374.2	0	0	0	0	108	3192	Sisma X SLD	171.8	0	0	0	0	0
109	3192	Sisma Y SLD	0	171.8	0	0	0	0	110	3193	Sisma X SLV	374.2	0	0	0	0	0
111	3193	Sisma Y SLV	0	374.2	0	0	0	0	112	3193	Sisma X SLD	171.8	0	0	0	0	0
113	3193	Sisma Y SLD	0	171.8	0	0	0	0	114	3194	Sisma X SLV	374.2	0	0	0	0	0
115	3194	Sisma Y SLV	0	374.2	0	0	0	0	116	3194	Sisma X SLD	171.8	0	0	0	0	0
117	3194	Sisma Y SLD	0	171.8	0	0	0	0	118	3195	Sisma X SLV	374.2	0	0	0	0	0
119	3195	Sisma Y SLV	0	374.2	0	0	0	0	120	3195	Sisma X SLD	171.8	0	0	0	0	0
121	3195	Sisma Y SLD	0	171.8	0	0	0	0	122	3196	Sisma X SLV	374.2	0	0	0	0	0
123	3196	Sisma Y SLV	0	374.2	0	0	0	0	124	3196	Sisma X SLD	171.8	0	0	0	0	0
125	3196	Sisma Y SLD	0	171.8	0	0	0	0	126	3197	Sisma X SLV	374.2	0	0	0	0	0
127	3197	Sisma Y SLV	0	374.2	0	0	0	0	128	3197	Sisma X SLD	171.8	0	0	0	0	0
129	3197	Sisma Y SLD	0	171.8	0	0	0	0	130	3198	Sisma X SLV	374.2	0	0	0	0	0
131	3198	Sisma Y SLV	0	374.2	0	0	0	0	132	3198	Sisma X SLD	171.8	0	0	0	0	0
133	3198	Sisma Y SLD	0	171.8	0	0	0	0	134	3199	Sisma X SLV	374.2	0	0	0	0	0
135	3199	Sisma Y SLV	0	374.2	0	0	0	0	136	3199	Sisma X SLD	171.8	0	0	0	0	0
137	3199	Sisma Y SLD	0	171.8	0	0	0	0	138	3200	Sisma X SLV	374.2	0	0	0	0	0
139	3200	Sisma Y SLV	0	374.2	0	0	0	0	140	3200	Sisma X SLD	171.8	0	0	0	0	0
141	3200	Sisma Y SLD	0	171.8	0	0	0	0	142	3201	Sisma X SLV	374.2	0	0	0	0	0
143	3201	Sisma Y SLV	0	374.2	0	0	0	0	144	3201	Sisma X SLD	171.8	0	0	0	0	0
145	3201	Sisma Y SLD	0	171.8	0	0	0	0	146	3202	Sisma X SLV	374.2	0	0	0	0	0
147	3202	Sisma Y SLV	0	374.2	0	0	0	0	148	3202	Sisma X SLD	171.8	0	0	0	0	0
149	3202	Sisma Y SLD	0	171.8	0	0	0	0	150	3203	Sisma X SLV	374.2	0	0	0	0	0
151	3203	Sisma Y SLV	0	374.2	0	0	0	0	152	3203	Sisma X SLD	171.8	0	0	0	0	0
153	3203	Sisma Y SLD	0	171.8	0	0	0	0	154	3204	Sisma X SLV	374.2	0	0	0	0	0
155	3204	Sisma Y SLV	0	374.2	0	0	0	0	156	3204	Sisma X SLD	171.8	0	0	0	0	0
157	3204	Sisma Y SLD	0	171.8	0	0	0	0	158	3205	Sisma X SLV	374.2	0	0	0	0	0
159	3205	Sisma Y SLV	0	374.2	0	0	0	0	160	3205	Sisma X SLD	171.8	0	0	0	0	0
161	3205	Sisma Y SLD	0	171.8	0	0	0	0	162	3206	Sisma X SLV	374.2	0	0	0	0	0
163	3206	Sisma Y SLV	0	374.2	0	0	0	0	164	3206	Sisma X SLD	171.8	0	0	0	0	0
165	3206	Sisma Y SLD	0	171.8	0	0	0	0	166	3207	Sisma X SLV	922.1	0	0	0	0	0
167	3207	Sisma Y SLV	0	922.1	0	0	0	0	168	3207	Sisma X SLD	423.4	0	0	0	0	0
169	3207	Sisma Y SLD	0	423.4	0	0	0	0	170	3208	Sisma X SLV	922.1	0	0	0	0	0



Progetto	Titolo	Rev.	Pag.
Orione	Orione_A24a.pdf "TABULATI DI CALCOLO PLINTO DI FONDAZIONE PER AEROGENERATORE TIPO"	0	46

Tabulati di Calcolo Plinto di Fondazione per Aerogeneratore Tipo - Progetto Impianto Eolico - "Orione"

Indice	Nodo	Condizione	Fx	Fy	Fz	Mx	My	Mz	Indice	Nodo	Condizione	Fx	Fy	Fz	Mx	My	Mz
171	3208	Sisma Y SLV	0	922.1	0	0	0	0	172	3208	Sisma X SLD	423.4	0	0	0	0	0
173	3208	Sisma Y SLD	0	423.4	0	0	0	0	174	3209	Sisma X SLV	922.1	0	0	0	0	0
175	3209	Sisma Y SLV	0	922.1	0	0	0	0	176	3209	Sisma X SLD	423.4	0	0	0	0	0
177	3209	Sisma Y SLD	0	423.4	0	0	0	0	178	3210	Sisma X SLV	922.1	0	0	0	0	0
179	3210	Sisma Y SLV	0	922.1	0	0	0	0	180	3210	Sisma X SLD	423.4	0	0	0	0	0
181	3210	Sisma Y SLD	0	423.4	0	0	0	0	182	3211	Sisma X SLV	922.1	0	0	0	0	0
183	3211	Sisma Y SLV	0	922.1	0	0	0	0	184	3211	Sisma X SLD	423.4	0	0	0	0	0
185	3211	Sisma Y SLD	0	423.4	0	0	0	0	186	3212	Sisma X SLV	922.1	0	0	0	0	0
187	3212	Sisma Y SLV	0	922.1	0	0	0	0	188	3212	Sisma X SLD	423.4	0	0	0	0	0
189	3212	Sisma Y SLD	0	423.4	0	0	0	0	190	3213	Sisma X SLV	922.1	0	0	0	0	0
191	3213	Sisma Y SLV	0	922.1	0	0	0	0	192	3213	Sisma X SLD	423.4	0	0	0	0	0
193	3213	Sisma Y SLD	0	423.4	0	0	0	0	194	3214	Sisma X SLV	922.1	0	0	0	0	0
195	3214	Sisma Y SLV	0	922.1	0	0	0	0	196	3214	Sisma X SLD	423.4	0	0	0	0	0
197	3214	Sisma Y SLD	0	423.4	0	0	0	0	198	3215	Sisma X SLV	922.1	0	0	0	0	0
199	3215	Sisma Y SLV	0	922.1	0	0	0	0	200	3215	Sisma X SLD	423.4	0	0	0	0	0
201	3215	Sisma Y SLD	0	423.4	0	0	0	0	202	3216	Sisma X SLV	922.1	0	0	0	0	0
203	3216	Sisma Y SLV	0	922.1	0	0	0	0	204	3216	Sisma X SLD	423.4	0	0	0	0	0
205	3216	Sisma Y SLD	0	423.4	0	0	0	0	206	3217	Sisma X SLV	922.1	0	0	0	0	0
207	3217	Sisma Y SLV	0	922.1	0	0	0	0	208	3217	Sisma X SLD	423.4	0	0	0	0	0
209	3217	Sisma Y SLD	0	423.4	0	0	0	0	210	3218	Sisma X SLV	922.1	0	0	0	0	0
211	3218	Sisma Y SLV	0	922.1	0	0	0	0	212	3218	Sisma X SLD	423.4	0	0	0	0	0
213	3218	Sisma Y SLD	0	423.4	0	0	0	0	214	3219	Sisma X SLV	922.1	0	0	0	0	0
215	3219	Sisma Y SLV	0	922.1	0	0	0	0	216	3219	Sisma X SLD	423.4	0	0	0	0	0
217	3219	Sisma Y SLD	0	423.4	0	0	0	0	218	3220	Sisma X SLV	922.1	0	0	0	0	0
219	3220	Sisma Y SLV	0	922.1	0	0	0	0	220	3220	Sisma X SLD	423.4	0	0	0	0	0
221	3220	Sisma Y SLD	0	423.4	0	0	0	0	222	3221	Sisma X SLV	922.1	0	0	0	0	0
223	3221	Sisma Y SLV	0	922.1	0	0	0	0	224	3221	Sisma X SLD	423.4	0	0	0	0	0
225	3221	Sisma Y SLD	0	423.4	0	0	0	0	226	3222	Sisma X SLV	922.1	0	0	0	0	0
227	3222	Sisma Y SLV	0	922.1	0	0	0	0	228	3222	Sisma X SLD	423.4	0	0	0	0	0
229	3222	Sisma Y SLD	0	423.4	0	0	0	0	230	3223	Sisma X SLV	922.1	0	0	0	0	0
231	3223	Sisma Y SLV	0	922.1	0	0	0	0	232	3223	Sisma X SLD	423.4	0	0	0	0	0
233	3223	Sisma Y SLD	0	423.4	0	0	0	0	234	3224	Sisma X SLV	922.1	0	0	0	0	0
235	3224	Sisma Y SLV	0	922.1	0	0	0	0	236	3224	Sisma X SLD	423.4	0	0	0	0	0
237	3224	Sisma Y SLD	0	423.4	0	0	0	0	238	3225	Sisma X SLV	922.1	0	0	0	0	0
239	3225	Sisma Y SLV	0	922.1	0	0	0	0	240	3225	Sisma X SLD	423.4	0	0	0	0	0
241	3225	Sisma Y SLD	0	423.4	0	0	0	0	242	3226	Sisma X SLV	922.1	0	0	0	0	0
243	3226	Sisma Y SLV	0	922.1	0	0	0	0	244	3226	Sisma X SLD	423.4	0	0	0	0	0
245	3226	Sisma Y SLD	0	423.4	0	0	0	0	246	3227	Sisma X SLV	922.1	0	0	0	0	0
247	3227	Sisma Y SLV	0	922.1	0	0	0	0	248	3227	Sisma X SLD	423.4	0	0	0	0	0
249	3227	Sisma Y SLD	0	423.4	0	0	0	0	250	3228	Sisma X SLV	922.1	0	0	0	0	0
251	3228	Sisma Y SLV	0	922.1	0	0	0	0	252	3228	Sisma X SLD	423.4	0	0	0	0	0
253	3228	Sisma Y SLD	0	423.4	0	0	0	0	254	3229	Sisma X SLV	922.1	0	0	0	0	0
255	3229	Sisma Y SLV	0	922.1	0	0	0	0	256	3229	Sisma X SLD	423.4	0	0	0	0	0
257	3229	Sisma Y SLD	0	423.4	0	0	0	0	258	3230	Sisma X SLV	922.1	0	0	0	0	0
259	3230	Sisma Y SLV	0	922.1	0	0	0	0	260	3230	Sisma X SLD	423.4	0	0	0	0	0
261	3230	Sisma Y SLD	0	423.4	0	0	0	0	262	3231	Sisma X SLV	922.1	0	0	0	0	0
263	3231	Sisma Y SLV	0	922.1	0	0	0	0	264	3231	Sisma X SLD	423.4	0	0	0	0	0
265	3231	Sisma Y SLD	0	423.4	0	0	0	0	266	3232	Sisma X SLV	922.1	0	0	0	0	0
267	3232	Sisma Y SLV	0	922.1	0	0	0	0	268	3232	Sisma X SLD	423.4	0	0	0	0	0
269	3232	Sisma Y SLD	0	423.4	0	0	0	0	270	3233	Sisma X SLV	922.1	0	0	0	0	0



Progetto	Titolo	Rev.	Pag.
Orione	Orione_A24a.pdf "TABULATI DI CALCOLO PLINTO DI FONDAZIONE PER AEROGENERATORE TIPO"	0	47



Tabulati di Calcolo Plinto di Fondazione per Aerogeneratore Tipo - Progetto Impianto Eolico - "Orione"

Indice	Nodo	Condizione	Fx	Fy	Fz	Mx	My	Mz	Indice	Nodo	Condizione	Fx	Fy	Fz	Mx	My	Mz
271	3233	Sisma Y SLV	0	922.1	0	0	0	0	272	3233	Sisma X SLD	423.4	0	0	0	0	0
273	3233	Sisma Y SLD	0	423.4	0	0	0	0	274	3234	Sisma X SLV	922.1	0	0	0	0	0
275	3234	Sisma Y SLV	0	922.1	0	0	0	0	276	3234	Sisma X SLD	423.4	0	0	0	0	0
277	3234	Sisma Y SLD	0	423.4	0	0	0	0	278	3235	Sisma X SLV	922.1	0	0	0	0	0
279	3235	Sisma Y SLV	0	922.1	0	0	0	0	280	3235	Sisma X SLD	423.4	0	0	0	0	0
281	3235	Sisma Y SLD	0	423.4	0	0	0	0	282	3236	Sisma X SLV	922.1	0	0	0	0	0
283	3236	Sisma Y SLV	0	922.1	0	0	0	0	284	3236	Sisma X SLD	423.4	0	0	0	0	0
285	3236	Sisma Y SLD	0	423.4	0	0	0	0	286	3237	Sisma X SLV	922.1	0	0	0	0	0
287	3237	Sisma Y SLV	0	922.1	0	0	0	0	288	3237	Sisma X SLD	423.4	0	0	0	0	0
289	3237	Sisma Y SLD	0	423.4	0	0	0	0	290	3238	Sisma X SLV	922.1	0	0	0	0	0
291	3238	Sisma Y SLV	0	922.1	0	0	0	0	292	3238	Sisma X SLD	423.4	0	0	0	0	0
293	3238	Sisma Y SLD	0	423.4	0	0	0	0	294	3239	Sisma X SLV	922.1	0	0	0	0	0
295	3239	Sisma Y SLV	0	922.1	0	0	0	0	296	3239	Sisma X SLD	423.4	0	0	0	0	0
297	3239	Sisma Y SLD	0	423.4	0	0	0	0	298	3240	Sisma X SLV	922.1	0	0	0	0	0
299	3240	Sisma Y SLV	0	922.1	0	0	0	0	300	3240	Sisma X SLD	423.4	0	0	0	0	0
301	3240	Sisma Y SLD	0	423.4	0	0	0	0	302	3241	Sisma X SLV	922.1	0	0	0	0	0
303	3241	Sisma Y SLV	0	922.1	0	0	0	0	304	3241	Sisma X SLD	423.4	0	0	0	0	0
305	3241	Sisma Y SLD	0	423.4	0	0	0	0	306	3242	Sisma X SLV	922.1	0	0	0	0	0
307	3242	Sisma Y SLV	0	922.1	0	0	0	0	308	3242	Sisma X SLD	423.4	0	0	0	0	0
309	3242	Sisma Y SLD	0	423.4	0	0	0	0	310	3243	Sisma X SLV	1475.3	0	0	0	0	0
311	3243	Sisma Y SLV	0	1475.3	0	0	0	0	312	3243	Sisma X SLD	677.4	0	0	0	0	0
313	3243	Sisma Y SLD	0	677.4	0	0	0	0	314	3244	Sisma X SLV	1475.3	0	0	0	0	0
315	3244	Sisma Y SLV	0	1475.3	0	0	0	0	316	3244	Sisma X SLD	677.4	0	0	0	0	0
317	3244	Sisma Y SLD	0	677.4	0	0	0	0	318	3245	Sisma X SLV	1475.3	0	0	0	0	0
319	3245	Sisma Y SLV	0	1475.3	0	0	0	0	320	3245	Sisma X SLD	677.4	0	0	0	0	0
321	3245	Sisma Y SLD	0	677.4	0	0	0	0	322	3246	Sisma X SLV	1475.3	0	0	0	0	0
323	3246	Sisma Y SLV	0	1475.3	0	0	0	0	324	3246	Sisma X SLD	677.4	0	0	0	0	0
325	3246	Sisma Y SLD	0	677.4	0	0	0	0	326	3247	Sisma X SLV	1475.3	0	0	0	0	0
327	3247	Sisma Y SLV	0	1475.3	0	0	0	0	328	3247	Sisma X SLD	677.4	0	0	0	0	0
329	3247	Sisma Y SLD	0	677.4	0	0	0	0	330	3248	Sisma X SLV	1475.3	0	0	0	0	0
331	3248	Sisma Y SLV	0	1475.3	0	0	0	0	332	3248	Sisma X SLD	677.4	0	0	0	0	0
333	3248	Sisma Y SLD	0	677.4	0	0	0	0	334	3249	Sisma X SLV	1475.3	0	0	0	0	0
335	3249	Sisma Y SLV	0	1475.3	0	0	0	0	336	3249	Sisma X SLD	677.4	0	0	0	0	0
337	3249	Sisma Y SLD	0	677.4	0	0	0	0	338	3250	Sisma X SLV	1475.3	0	0	0	0	0
339	3250	Sisma Y SLV	0	1475.3	0	0	0	0	340	3250	Sisma X SLD	677.4	0	0	0	0	0
341	3250	Sisma Y SLD	0	677.4	0	0	0	0	342	3251	Sisma X SLV	1475.3	0	0	0	0	0
343	3251	Sisma Y SLV	0	1475.3	0	0	0	0	344	3251	Sisma X SLD	677.4	0	0	0	0	0
345	3251	Sisma Y SLD	0	677.4	0	0	0	0	346	3252	Sisma X SLV	1475.3	0	0	0	0	0
347	3252	Sisma Y SLV	0	1475.3	0	0	0	0	348	3252	Sisma X SLD	677.4	0	0	0	0	0
349	3252	Sisma Y SLD	0	677.4	0	0	0	0	350	3253	Sisma X SLV	1475.3	0	0	0	0	0
351	3253	Sisma Y SLV	0	1475.3	0	0	0	0	352	3253	Sisma X SLD	677.4	0	0	0	0	0
353	3253	Sisma Y SLD	0	677.4	0	0	0	0	354	3254	Sisma X SLV	1475.3	0	0	0	0	0
355	3254	Sisma Y SLV	0	1475.3	0	0	0	0	356	3254	Sisma X SLD	677.4	0	0	0	0	0
357	3254	Sisma Y SLD	0	677.4	0	0	0	0	358	3255	Sisma X SLV	1475.3	0	0	0	0	0
359	3255	Sisma Y SLV	0	1475.3	0	0	0	0	360	3255	Sisma X SLD	677.4	0	0	0	0	0
361	3255	Sisma Y SLD	0	677.4	0	0	0	0	362	3256	Sisma X SLV	1475.3	0	0	0	0	0
363	3256	Sisma Y SLV	0	1475.3	0	0	0	0	364	3256	Sisma X SLD	677.4	0	0	0	0	0
365	3256	Sisma Y SLD	0	677.4	0	0	0	0	366	3257	Sisma X SLV	1475.3	0	0	0	0	0
367	3257	Sisma Y SLV	0	1475.3	0	0	0	0	368	3257	Sisma X SLD	677.4	0	0	0	0	0
369	3257	Sisma Y SLD	0	677.4	0	0	0	0	370	3258	Sisma X SLV	1475.3	0	0	0	0	0



Tabulati di Calcolo Plinto di Fondazione per Aerogeneratore Tipo - Progetto Impianto Eolico - "Orione"

Indice	Nodo	Condizione	Fx	Fy	Fz	Mx	My	Mz	Indice	Nodo	Condizione	Fx	Fy	Fz	Mx	My	Mz
371	3258	Sisma Y SLV	0	1475.3	0	0	0	0	372	3258	Sisma X SLD	677.4	0	0	0	0	0
373	3258	Sisma Y SLD	0	677.4	0	0	0	0	374	3259	Sisma X SLV	1475.3	0	0	0	0	0
375	3259	Sisma Y SLV	0	1475.3	0	0	0	0	376	3259	Sisma X SLD	677.4	0	0	0	0	0
377	3259	Sisma Y SLD	0	677.4	0	0	0	0	378	3260	Sisma X SLV	1475.3	0	0	0	0	0
379	3260	Sisma Y SLV	0	1475.3	0	0	0	0	380	3260	Sisma X SLD	677.4	0	0	0	0	0
381	3260	Sisma Y SLD	0	677.4	0	0	0	0	382	3261	Sisma X SLV	1475.3	0	0	0	0	0
383	3261	Sisma Y SLV	0	1475.3	0	0	0	0	384	3261	Sisma X SLD	677.4	0	0	0	0	0
385	3261	Sisma Y SLD	0	677.4	0	0	0	0	386	3262	Sisma X SLV	1475.3	0	0	0	0	0
387	3262	Sisma Y SLV	0	1475.3	0	0	0	0	388	3262	Sisma X SLD	677.4	0	0	0	0	0
389	3262	Sisma Y SLD	0	677.4	0	0	0	0	390	3263	Sisma X SLV	1475.3	0	0	0	0	0
391	3263	Sisma Y SLV	0	1475.3	0	0	0	0	392	3263	Sisma X SLD	677.4	0	0	0	0	0
393	3263	Sisma Y SLD	0	677.4	0	0	0	0	394	3264	Sisma X SLV	1475.3	0	0	0	0	0
395	3264	Sisma Y SLV	0	1475.3	0	0	0	0	396	3264	Sisma X SLD	677.4	0	0	0	0	0
397	3264	Sisma Y SLD	0	677.4	0	0	0	0	398	3265	Sisma X SLV	1475.3	0	0	0	0	0
399	3265	Sisma Y SLV	0	1475.3	0	0	0	0	400	3265	Sisma X SLD	677.4	0	0	0	0	0
401	3265	Sisma Y SLD	0	677.4	0	0	0	0	402	3266	Sisma X SLV	1475.3	0	0	0	0	0
403	3266	Sisma Y SLV	0	1475.3	0	0	0	0	404	3266	Sisma X SLD	677.4	0	0	0	0	0
405	3266	Sisma Y SLD	0	677.4	0	0	0	0	406	3267	Sisma X SLV	1475.3	0	0	0	0	0
407	3267	Sisma Y SLV	0	1475.3	0	0	0	0	408	3267	Sisma X SLD	677.4	0	0	0	0	0
409	3267	Sisma Y SLD	0	677.4	0	0	0	0	410	3268	Sisma X SLV	1475.3	0	0	0	0	0
411	3268	Sisma Y SLV	0	1475.3	0	0	0	0	412	3268	Sisma X SLD	677.4	0	0	0	0	0
413	3268	Sisma Y SLD	0	677.4	0	0	0	0	414	3269	Sisma X SLV	1475.3	0	0	0	0	0
415	3269	Sisma Y SLV	0	1475.3	0	0	0	0	416	3269	Sisma X SLD	677.4	0	0	0	0	0
417	3269	Sisma Y SLD	0	677.4	0	0	0	0	418	3270	Sisma X SLV	1475.3	0	0	0	0	0
419	3270	Sisma Y SLV	0	1475.3	0	0	0	0	420	3270	Sisma X SLD	677.4	0	0	0	0	0
421	3270	Sisma Y SLD	0	677.4	0	0	0	0	422	3271	Sisma X SLV	1475.3	0	0	0	0	0
423	3271	Sisma Y SLV	0	1475.3	0	0	0	0	424	3271	Sisma X SLD	677.4	0	0	0	0	0
425	3271	Sisma Y SLD	0	677.4	0	0	0	0	426	3272	Sisma X SLV	1475.3	0	0	0	0	0
427	3272	Sisma Y SLV	0	1475.3	0	0	0	0	428	3272	Sisma X SLD	677.4	0	0	0	0	0
429	3272	Sisma Y SLD	0	677.4	0	0	0	0	430	3273	Sisma X SLV	1475.3	0	0	0	0	0
431	3273	Sisma Y SLV	0	1475.3	0	0	0	0	432	3273	Sisma X SLD	677.4	0	0	0	0	0
433	3273	Sisma Y SLD	0	677.4	0	0	0	0	434	3274	Sisma X SLV	1475.3	0	0	0	0	0
435	3274	Sisma Y SLV	0	1475.3	0	0	0	0	436	3274	Sisma X SLD	677.4	0	0	0	0	0
437	3274	Sisma Y SLD	0	677.4	0	0	0	0	438	3275	Sisma X SLV	1475.3	0	0	0	0	0
439	3275	Sisma Y SLV	0	1475.3	0	0	0	0	440	3275	Sisma X SLD	677.4	0	0	0	0	0
441	3275	Sisma Y SLD	0	677.4	0	0	0	0	442	3276	Sisma X SLV	1475.3	0	0	0	0	0
443	3276	Sisma Y SLV	0	1475.3	0	0	0	0	444	3276	Sisma X SLD	677.4	0	0	0	0	0
445	3276	Sisma Y SLD	0	677.4	0	0	0	0	446	3277	Sisma X SLV	1475.3	0	0	0	0	0
447	3277	Sisma Y SLV	0	1475.3	0	0	0	0	448	3277	Sisma X SLD	677.4	0	0	0	0	0
449	3277	Sisma Y SLD	0	677.4	0	0	0	0	450	3278	Sisma X SLV	1475.3	0	0	0	0	0
451	3278	Sisma Y SLV	0	1475.3	0	0	0	0	452	3278	Sisma X SLD	677.4	0	0	0	0	0
453	3278	Sisma Y SLD	0	677.4	0	0	0	0	454	3279	Sisma X SLV	336.4	0	0	0	0	0
455	3279	Sisma Y SLV	0	336.4	0	0	0	0	456	3279	Sisma X SLD	154.5	0	0	0	0	0
457	3279	Sisma Y SLD	0	154.5	0	0	0	0	458	3280	Sisma X SLV	336.4	0	0	0	0	0
459	3280	Sisma Y SLV	0	336.4	0	0	0	0	460	3280	Sisma X SLD	154.5	0	0	0	0	0
461	3280	Sisma Y SLD	0	154.5	0	0	0	0	462	3281	Sisma X SLV	336.4	0	0	0	0	0
463	3281	Sisma Y SLV	0	336.4	0	0	0	0	464	3281	Sisma X SLD	154.5	0	0	0	0	0
465	3281	Sisma Y SLD	0	154.5	0	0	0	0	466	3282	Sisma X SLV	336.4	0	0	0	0	0
467	3282	Sisma Y SLV	0	336.4	0	0	0	0	468	3282	Sisma X SLD	154.5	0	0	0	0	0
469	3282	Sisma Y SLD	0	154.5	0	0	0	0	470	3283	Sisma X SLV	336.4	0	0	0	0	0



Tabulati di Calcolo Plinto di Fondazione per Aerogeneratore Tipo - Progetto Impianto Eolico - "Orione"

Indice	Nodo	Condizione	Fx	Fy	Fz	Mx	My	Mz	Indice	Nodo	Condizione	Fx	Fy	Fz	Mx	My	Mz
471	3283	Sisma Y SLV	0	336.4	0	0	0	0	472	3283	Sisma X SLD	154.5	0	0	0	0	0
473	3283	Sisma Y SLD	0	154.5	0	0	0	0	474	3284	Sisma X SLV	336.4	0	0	0	0	0
475	3284	Sisma Y SLV	0	336.4	0	0	0	0	476	3284	Sisma X SLD	154.5	0	0	0	0	0
477	3284	Sisma Y SLD	0	154.5	0	0	0	0	478	3285	Sisma X SLV	336.4	0	0	0	0	0
479	3285	Sisma Y SLV	0	336.4	0	0	0	0	480	3285	Sisma X SLD	154.5	0	0	0	0	0
481	3285	Sisma Y SLD	0	154.5	0	0	0	0	482	3286	Sisma X SLV	336.4	0	0	0	0	0
483	3286	Sisma Y SLV	0	336.4	0	0	0	0	484	3286	Sisma X SLD	154.5	0	0	0	0	0
485	3286	Sisma Y SLD	0	154.5	0	0	0	0	486	3287	Sisma X SLV	336.4	0	0	0	0	0
487	3287	Sisma Y SLV	0	336.4	0	0	0	0	488	3287	Sisma X SLD	154.5	0	0	0	0	0
489	3287	Sisma Y SLD	0	154.5	0	0	0	0	490	3288	Sisma X SLV	336.4	0	0	0	0	0
491	3288	Sisma Y SLV	0	336.4	0	0	0	0	492	3288	Sisma X SLD	154.5	0	0	0	0	0
493	3288	Sisma Y SLD	0	154.5	0	0	0	0	494	3289	Sisma X SLV	336.4	0	0	0	0	0
495	3289	Sisma Y SLV	0	336.4	0	0	0	0	496	3289	Sisma X SLD	154.5	0	0	0	0	0
497	3289	Sisma Y SLD	0	154.5	0	0	0	0	498	3290	Sisma X SLV	336.4	0	0	0	0	0
499	3290	Sisma Y SLV	0	336.4	0	0	0	0	500	3290	Sisma X SLD	154.5	0	0	0	0	0
501	3290	Sisma Y SLD	0	154.5	0	0	0	0	502	3291	Sisma X SLV	336.4	0	0	0	0	0
503	3291	Sisma Y SLV	0	336.4	0	0	0	0	504	3291	Sisma X SLD	154.5	0	0	0	0	0
505	3291	Sisma Y SLD	0	154.5	0	0	0	0	506	3292	Sisma X SLV	336.4	0	0	0	0	0
507	3292	Sisma Y SLV	0	336.4	0	0	0	0	508	3292	Sisma X SLD	154.5	0	0	0	0	0
509	3292	Sisma Y SLD	0	154.5	0	0	0	0	510	3293	Sisma X SLV	336.4	0	0	0	0	0
511	3293	Sisma Y SLV	0	336.4	0	0	0	0	512	3293	Sisma X SLD	154.5	0	0	0	0	0
513	3293	Sisma Y SLD	0	154.5	0	0	0	0	514	3294	Sisma X SLV	336.4	0	0	0	0	0
515	3294	Sisma Y SLV	0	336.4	0	0	0	0	516	3294	Sisma X SLD	154.5	0	0	0	0	0
517	3294	Sisma Y SLD	0	154.5	0	0	0	0	518	3295	Sisma X SLV	336.4	0	0	0	0	0
519	3295	Sisma Y SLV	0	336.4	0	0	0	0	520	3295	Sisma X SLD	154.5	0	0	0	0	0
521	3295	Sisma Y SLD	0	154.5	0	0	0	0	522	3296	Sisma X SLV	336.4	0	0	0	0	0
523	3296	Sisma Y SLV	0	336.4	0	0	0	0	524	3296	Sisma X SLD	154.5	0	0	0	0	0
525	3296	Sisma Y SLD	0	154.5	0	0	0	0	526	3297	Sisma X SLV	336.4	0	0	0	0	0
527	3297	Sisma Y SLV	0	336.4	0	0	0	0	528	3297	Sisma X SLD	154.5	0	0	0	0	0
529	3297	Sisma Y SLD	0	154.5	0	0	0	0	530	3298	Sisma X SLV	336.4	0	0	0	0	0
531	3298	Sisma Y SLV	0	336.4	0	0	0	0	532	3298	Sisma X SLD	154.5	0	0	0	0	0
533	3298	Sisma Y SLD	0	154.5	0	0	0	0	534	3299	Sisma X SLV	336.4	0	0	0	0	0
535	3299	Sisma Y SLV	0	336.4	0	0	0	0	536	3299	Sisma X SLD	154.5	0	0	0	0	0
537	3299	Sisma Y SLD	0	154.5	0	0	0	0	538	3300	Sisma X SLV	336.4	0	0	0	0	0
539	3300	Sisma Y SLV	0	336.4	0	0	0	0	540	3300	Sisma X SLD	154.5	0	0	0	0	0
541	3300	Sisma Y SLD	0	154.5	0	0	0	0	542	3301	Sisma X SLV	336.4	0	0	0	0	0
543	3301	Sisma Y SLV	0	336.4	0	0	0	0	544	3301	Sisma X SLD	154.5	0	0	0	0	0
545	3301	Sisma Y SLD	0	154.5	0	0	0	0	546	3302	Sisma X SLV	336.4	0	0	0	0	0
547	3302	Sisma Y SLV	0	336.4	0	0	0	0	548	3302	Sisma X SLD	154.5	0	0	0	0	0
549	3302	Sisma Y SLD	0	154.5	0	0	0	0	550	3303	Sisma X SLV	336.4	0	0	0	0	0
551	3303	Sisma Y SLV	0	336.4	0	0	0	0	552	3303	Sisma X SLD	154.5	0	0	0	0	0
553	3303	Sisma Y SLD	0	154.5	0	0	0	0	554	3304	Sisma X SLV	316.9	0	0	0	0	0
555	3304	Sisma Y SLV	0	316.9	0	0	0	0	556	3304	Sisma X SLD	145.5	0	0	0	0	0
557	3304	Sisma Y SLD	0	145.5	0	0	0	0	558	3305	Sisma X SLV	316.9	0	0	0	0	0
559	3305	Sisma Y SLV	0	316.9	0	0	0	0	560	3305	Sisma X SLD	145.5	0	0	0	0	0
561	3305	Sisma Y SLD	0	145.5	0	0	0	0	562	3306	Sisma X SLV	316.9	0	0	0	0	0
563	3306	Sisma Y SLV	0	316.9	0	0	0	0	564	3306	Sisma X SLD	145.5	0	0	0	0	0
565	3306	Sisma Y SLD	0	145.5	0	0	0	0	566	3307	Sisma X SLV	316.9	0	0	0	0	0
567	3307	Sisma Y SLV	0	316.9	0	0	0	0	568	3307	Sisma X SLD	145.5	0	0	0	0	0
569	3307	Sisma Y SLD	0	145.5	0	0	0	0	570	3308	Sisma X SLV	316.9	0	0	0	0	0



Progetto	Titolo	Rev.	Pag.
Orione	Orione_A24a.pdf "TABULATI DI CALCOLO PLINTO DI FONDAZIONE PER AEROGENERATORE TIPO"	0	50

Tabulati di Calcolo Plinto di Fondazione per Aerogeneratore Tipo - Progetto Impianto Eolico - "Orione"

Indice	Nodo	Condizione	Fx	Fy	Fz	Mx	My	Mz	Indice	Nodo	Condizione	Fx	Fy	Fz	Mx	My	Mz
571	3308	Sisma Y SLV	0	316.9	0	0	0	0	572	3308	Sisma X SLD	145.5	0	0	0	0	0
573	3308	Sisma Y SLD	0	145.5	0	0	0	0	574	3309	Sisma X SLV	336.4	0	0	0	0	0
575	3309	Sisma Y SLV	0	336.4	0	0	0	0	576	3309	Sisma X SLD	154.5	0	0	0	0	0
577	3309	Sisma Y SLD	0	154.5	0	0	0	0	578	3310	Sisma X SLV	316.9	0	0	0	0	0
579	3310	Sisma Y SLV	0	316.9	0	0	0	0	580	3310	Sisma X SLD	145.5	0	0	0	0	0
581	3310	Sisma Y SLD	0	145.5	0	0	0	0	582	3311	Sisma X SLV	316.9	0	0	0	0	0
583	3311	Sisma Y SLV	0	316.9	0	0	0	0	584	3311	Sisma X SLD	145.5	0	0	0	0	0
585	3311	Sisma Y SLD	0	145.5	0	0	0	0	586	3312	Sisma X SLV	336.4	0	0	0	0	0
587	3312	Sisma Y SLV	0	336.4	0	0	0	0	588	3312	Sisma X SLD	154.5	0	0	0	0	0
589	3312	Sisma Y SLD	0	154.5	0	0	0	0	590	3313	Sisma X SLV	316.9	0	0	0	0	0
591	3313	Sisma Y SLV	0	316.9	0	0	0	0	592	3313	Sisma X SLD	145.5	0	0	0	0	0
593	3313	Sisma Y SLD	0	145.5	0	0	0	0	594	3314	Sisma X SLV	316.9	0	0	0	0	0
595	3314	Sisma Y SLV	0	316.9	0	0	0	0	596	3314	Sisma X SLD	145.5	0	0	0	0	0
597	3314	Sisma Y SLD	0	145.5	0	0	0	0	598	3315	Sisma X SLV	316.9	0	0	0	0	0
599	3315	Sisma Y SLV	0	316.9	0	0	0	0	600	3315	Sisma X SLD	145.5	0	0	0	0	0
601	3315	Sisma Y SLD	0	145.5	0	0	0	0	602	3316	Sisma X SLV	316.9	0	0	0	0	0
603	3316	Sisma Y SLV	0	316.9	0	0	0	0	604	3316	Sisma X SLD	145.5	0	0	0	0	0
605	3316	Sisma Y SLD	0	145.5	0	0	0	0	606	3317	Sisma X SLV	316.9	0	0	0	0	0
607	3317	Sisma Y SLV	0	316.9	0	0	0	0	608	3317	Sisma X SLD	145.5	0	0	0	0	0
609	3317	Sisma Y SLD	0	145.5	0	0	0	0	610	3318	Sisma X SLV	316.9	0	0	0	0	0
611	3318	Sisma Y SLV	0	316.9	0	0	0	0	612	3318	Sisma X SLD	145.5	0	0	0	0	0
613	3318	Sisma Y SLD	0	145.5	0	0	0	0	614	3319	Sisma X SLV	336.4	0	0	0	0	0
615	3319	Sisma Y SLV	0	336.4	0	0	0	0	616	3319	Sisma X SLD	154.5	0	0	0	0	0
617	3319	Sisma Y SLD	0	154.5	0	0	0	0	618	3320	Sisma X SLV	336.4	0	0	0	0	0
619	3320	Sisma Y SLV	0	336.4	0	0	0	0	620	3320	Sisma X SLD	154.5	0	0	0	0	0
621	3320	Sisma Y SLD	0	154.5	0	0	0	0	622	3321	Sisma X SLV	316.9	0	0	0	0	0
623	3321	Sisma Y SLV	0	316.9	0	0	0	0	624	3321	Sisma X SLD	145.5	0	0	0	0	0
625	3321	Sisma Y SLD	0	145.5	0	0	0	0	626	3322	Sisma X SLV	316.9	0	0	0	0	0
627	3322	Sisma Y SLV	0	316.9	0	0	0	0	628	3322	Sisma X SLD	145.5	0	0	0	0	0
629	3322	Sisma Y SLD	0	145.5	0	0	0	0	630	3323	Sisma X SLV	316.9	0	0	0	0	0
631	3323	Sisma Y SLV	0	316.9	0	0	0	0	632	3323	Sisma X SLD	145.5	0	0	0	0	0
633	3323	Sisma Y SLD	0	145.5	0	0	0	0	634	3324	Sisma X SLV	316.9	0	0	0	0	0
635	3324	Sisma Y SLV	0	316.9	0	0	0	0	636	3324	Sisma X SLD	145.5	0	0	0	0	0
637	3324	Sisma Y SLD	0	145.5	0	0	0	0	638	3325	Sisma X SLV	336.4	0	0	0	0	0
639	3325	Sisma Y SLV	0	336.4	0	0	0	0	640	3325	Sisma X SLD	154.5	0	0	0	0	0
641	3325	Sisma Y SLD	0	154.5	0	0	0	0	642	3326	Sisma X SLV	336.4	0	0	0	0	0
643	3326	Sisma Y SLV	0	336.4	0	0	0	0	644	3326	Sisma X SLD	154.5	0	0	0	0	0
645	3326	Sisma Y SLD	0	154.5	0	0	0	0	646	3327	Sisma X SLV	316.9	0	0	0	0	0
647	3327	Sisma Y SLV	0	316.9	0	0	0	0	648	3327	Sisma X SLD	145.5	0	0	0	0	0
649	3327	Sisma Y SLD	0	145.5	0	0	0	0	650	3328	Sisma X SLV	316.9	0	0	0	0	0
651	3328	Sisma Y SLV	0	316.9	0	0	0	0	652	3328	Sisma X SLD	145.5	0	0	0	0	0
653	3328	Sisma Y SLD	0	145.5	0	0	0	0	654	3329	Sisma X SLV	316.9	0	0	0	0	0
655	3329	Sisma Y SLV	0	316.9	0	0	0	0	656	3329	Sisma X SLD	145.5	0	0	0	0	0
657	3329	Sisma Y SLD	0	145.5	0	0	0	0	658	3330	Sisma X SLV	316.9	0	0	0	0	0
659	3330	Sisma Y SLV	0	316.9	0	0	0	0	660	3330	Sisma X SLD	145.5	0	0	0	0	0
661	3330	Sisma Y SLD	0	145.5	0	0	0	0	662	3331	Sisma X SLV	336.4	0	0	0	0	0
663	3331	Sisma Y SLV	0	336.4	0	0	0	0	664	3331	Sisma X SLD	154.5	0	0	0	0	0
665	3331	Sisma Y SLD	0	154.5	0	0	0	0	666	3332	Sisma X SLV	336.4	0	0	0	0	0
667	3332	Sisma Y SLV	0	336.4	0	0	0	0	668	3332	Sisma X SLD	154.5	0	0	0	0	0
669	3332	Sisma Y SLD	0	154.5	0	0	0	0	670	3333	Sisma X SLV	316.9	0	0	0	0	0



Progetto	Titolo	Rev.	Pag.
Orione	Orione_A24a.pdf "TABULATI DI CALCOLO PLINTO DI FONDAZIONE PER AEROGENERATORE TIPO"	0	51

Tabulati di Calcolo Plinto di Fondazione per Aerogeneratore Tipo - Progetto Impianto Eolico - "Orione"

Indice	Nodo	Condizione	Fx	Fy	Fz	Mx	My	Mz	Indice	Nodo	Condizione	Fx	Fy	Fz	Mx	My	Mz
671	3333	Sisma Y SLV	0	316.9	0	0	0	0	672	3333	Sisma X SLD	145.5	0	0	0	0	0
673	3333	Sisma Y SLD	0	145.5	0	0	0	0	674	3334	Sisma X SLV	316.9	0	0	0	0	0
675	3334	Sisma Y SLV	0	316.9	0	0	0	0	676	3334	Sisma X SLD	145.5	0	0	0	0	0
677	3334	Sisma Y SLD	0	145.5	0	0	0	0	678	3335	Sisma X SLV	316.9	0	0	0	0	0
679	3335	Sisma Y SLV	0	316.9	0	0	0	0	680	3335	Sisma X SLD	145.5	0	0	0	0	0
681	3335	Sisma Y SLD	0	145.5	0	0	0	0	682	3336	Sisma X SLV	316.9	0	0	0	0	0
683	3336	Sisma Y SLV	0	316.9	0	0	0	0	684	3336	Sisma X SLD	145.5	0	0	0	0	0
685	3336	Sisma Y SLD	0	145.5	0	0	0	0	686	3337	Sisma X SLV	336.4	0	0	0	0	0
687	3337	Sisma Y SLV	0	336.4	0	0	0	0	688	3337	Sisma X SLD	154.5	0	0	0	0	0
689	3337	Sisma Y SLD	0	154.5	0	0	0	0	690	3338	Sisma X SLV	336.4	0	0	0	0	0
691	3338	Sisma Y SLV	0	336.4	0	0	0	0	692	3338	Sisma X SLD	154.5	0	0	0	0	0
693	3338	Sisma Y SLD	0	154.5	0	0	0	0	694	3339	Sisma X SLV	316.9	0	0	0	0	0
695	3339	Sisma Y SLV	0	316.9	0	0	0	0	696	3339	Sisma X SLD	145.5	0	0	0	0	0
697	3339	Sisma Y SLD	0	145.5	0	0	0	0	698	3340	Sisma X SLV	316.9	0	0	0	0	0
699	3340	Sisma Y SLV	0	316.9	0	0	0	0	700	3340	Sisma X SLD	145.5	0	0	0	0	0
701	3340	Sisma Y SLD	0	145.5	0	0	0	0	702	3341	Sisma X SLV	336.4	0	0	0	0	0
703	3341	Sisma Y SLV	0	336.4	0	0	0	0	704	3341	Sisma X SLD	154.5	0	0	0	0	0
705	3341	Sisma Y SLD	0	154.5	0	0	0	0	706	3342	Sisma X SLV	336.4	0	0	0	0	0
707	3342	Sisma Y SLV	0	336.4	0	0	0	0	708	3342	Sisma X SLD	154.5	0	0	0	0	0
709	3342	Sisma Y SLD	0	154.5	0	0	0	0	710	3343	Sisma X SLV	316.9	0	0	0	0	0
711	3343	Sisma Y SLV	0	316.9	0	0	0	0	712	3343	Sisma X SLD	145.5	0	0	0	0	0
713	3343	Sisma Y SLD	0	145.5	0	0	0	0	714	3344	Sisma X SLV	316.9	0	0	0	0	0
715	3344	Sisma Y SLV	0	316.9	0	0	0	0	716	3344	Sisma X SLD	145.5	0	0	0	0	0
717	3344	Sisma Y SLD	0	145.5	0	0	0	0	718	3345	Sisma X SLV	336.4	0	0	0	0	0
719	3345	Sisma Y SLV	0	336.4	0	0	0	0	720	3345	Sisma X SLD	154.5	0	0	0	0	0
721	3345	Sisma Y SLD	0	154.5	0	0	0	0	722	3346	Sisma X SLV	316.9	0	0	0	0	0
723	3346	Sisma Y SLV	0	316.9	0	0	0	0	724	3346	Sisma X SLD	145.5	0	0	0	0	0
725	3346	Sisma Y SLD	0	145.5	0	0	0	0	726	3347	Sisma X SLV	316.9	0	0	0	0	0
727	3347	Sisma Y SLV	0	316.9	0	0	0	0	728	3347	Sisma X SLD	145.5	0	0	0	0	0
729	3347	Sisma Y SLD	0	145.5	0	0	0	0	730	3348	Sisma X SLV	336.4	0	0	0	0	0
731	3348	Sisma Y SLV	0	336.4	0	0	0	0	732	3348	Sisma X SLD	154.5	0	0	0	0	0
733	3348	Sisma Y SLD	0	154.5	0	0	0	0	734	3349	Sisma X SLV	316.9	0	0	0	0	0
735	3349	Sisma Y SLV	0	316.9	0	0	0	0	736	3349	Sisma X SLD	145.5	0	0	0	0	0
737	3349	Sisma Y SLD	0	145.5	0	0	0	0	738	3350	Sisma X SLV	316.9	0	0	0	0	0
739	3350	Sisma Y SLV	0	316.9	0	0	0	0	740	3350	Sisma X SLD	145.5	0	0	0	0	0
741	3350	Sisma Y SLD	0	145.5	0	0	0	0	742	3351	Sisma X SLV	336.4	0	0	0	0	0
743	3351	Sisma Y SLV	0	336.4	0	0	0	0	744	3351	Sisma X SLD	154.5	0	0	0	0	0
745	3351	Sisma Y SLD	0	154.5	0	0	0	0	746	3352	Sisma X SLV	336.4	0	0	0	0	0
747	3352	Sisma Y SLV	0	336.4	0	0	0	0	748	3352	Sisma X SLD	154.5	0	0	0	0	0
749	3352	Sisma Y SLD	0	154.5	0	0	0	0	750	3353	Sisma X SLV	316.9	0	0	0	0	0
751	3353	Sisma Y SLV	0	316.9	0	0	0	0	752	3353	Sisma X SLD	145.5	0	0	0	0	0
753	3353	Sisma Y SLD	0	145.5	0	0	0	0	754	3354	Sisma X SLV	316.9	0	0	0	0	0
755	3354	Sisma Y SLV	0	316.9	0	0	0	0	756	3354	Sisma X SLD	145.5	0	0	0	0	0
757	3354	Sisma Y SLD	0	145.5	0	0	0	0	758	3355	Sisma X SLV	336.4	0	0	0	0	0
759	3355	Sisma Y SLV	0	336.4	0	0	0	0	760	3355	Sisma X SLD	154.5	0	0	0	0	0
761	3355	Sisma Y SLD	0	154.5	0	0	0	0	762	3356	Sisma X SLV	336.4	0	0	0	0	0
763	3356	Sisma Y SLV	0	336.4	0	0	0	0	764	3356	Sisma X SLD	154.5	0	0	0	0	0
765	3356	Sisma Y SLD	0	154.5	0	0	0	0	766	3357	Sisma X SLV	316.9	0	0	0	0	0
767	3357	Sisma Y SLV	0	316.9	0	0	0	0	768	3357	Sisma X SLD	145.5	0	0	0	0	0
769	3357	Sisma Y SLD	0	145.5	0	0	0	0	770	3358	Sisma X SLV	316.9	0	0	0	0	0



Tabulati di Calcolo Plinto di Fondazione per Aerogeneratore Tipo - Progetto Impianto Eolico - "Orione"

Indice	Nodo	Condizione	Fx	Fy	Fz	Mx	My	Mz	Indice	Nodo	Condizione	Fx	Fy	Fz	Mx	My	Mz
771	3358	Sisma Y SLV	0	316.9	0	0	0	0	772	3358	Sisma X SLD	145.5	0	0	0	0	0
773	3358	Sisma Y SLD	0	145.5	0	0	0	0	774	3359	Sisma X SLV	316.9	0	0	0	0	0
775	3359	Sisma Y SLV	0	316.9	0	0	0	0	776	3359	Sisma X SLD	145.5	0	0	0	0	0
777	3359	Sisma Y SLD	0	145.5	0	0	0	0	778	3360	Sisma X SLV	316.9	0	0	0	0	0
779	3360	Sisma Y SLV	0	316.9	0	0	0	0	780	3360	Sisma X SLD	145.5	0	0	0	0	0
781	3360	Sisma Y SLD	0	145.5	0	0	0	0	782	3361	Sisma X SLV	336.4	0	0	0	0	0
783	3361	Sisma Y SLV	0	336.4	0	0	0	0	784	3361	Sisma X SLD	154.5	0	0	0	0	0
785	3361	Sisma Y SLD	0	154.5	0	0	0	0	786	3362	Sisma X SLV	336.4	0	0	0	0	0
787	3362	Sisma Y SLV	0	336.4	0	0	0	0	788	3362	Sisma X SLD	154.5	0	0	0	0	0
789	3362	Sisma Y SLD	0	154.5	0	0	0	0	790	3363	Sisma X SLV	316.9	0	0	0	0	0
791	3363	Sisma Y SLV	0	316.9	0	0	0	0	792	3363	Sisma X SLD	145.5	0	0	0	0	0
793	3363	Sisma Y SLD	0	145.5	0	0	0	0	794	3364	Sisma X SLV	316.9	0	0	0	0	0
795	3364	Sisma Y SLV	0	316.9	0	0	0	0	796	3364	Sisma X SLD	145.5	0	0	0	0	0
797	3364	Sisma Y SLD	0	145.5	0	0	0	0	798	3365	Sisma X SLV	336.4	0	0	0	0	0
799	3365	Sisma Y SLV	0	336.4	0	0	0	0	800	3365	Sisma X SLD	154.5	0	0	0	0	0
801	3365	Sisma Y SLD	0	154.5	0	0	0	0	802	3366	Sisma X SLV	336.4	0	0	0	0	0
803	3366	Sisma Y SLV	0	336.4	0	0	0	0	804	3366	Sisma X SLD	154.5	0	0	0	0	0
805	3366	Sisma Y SLD	0	154.5	0	0	0	0	806	3367	Sisma X SLV	316.9	0	0	0	0	0
807	3367	Sisma Y SLV	0	316.9	0	0	0	0	808	3367	Sisma X SLD	145.5	0	0	0	0	0
809	3367	Sisma Y SLD	0	145.5	0	0	0	0	810	3368	Sisma X SLV	316.9	0	0	0	0	0
811	3368	Sisma Y SLV	0	316.9	0	0	0	0	812	3368	Sisma X SLD	145.5	0	0	0	0	0
813	3368	Sisma Y SLD	0	145.5	0	0	0	0	814	3369	Sisma X SLV	336.4	0	0	0	0	0
815	3369	Sisma Y SLV	0	336.4	0	0	0	0	816	3369	Sisma X SLD	154.5	0	0	0	0	0
817	3369	Sisma Y SLD	0	154.5	0	0	0	0	818	3370	Sisma X SLV	336.4	0	0	0	0	0
819	3370	Sisma Y SLV	0	336.4	0	0	0	0	820	3370	Sisma X SLD	154.5	0	0	0	0	0
821	3370	Sisma Y SLD	0	154.5	0	0	0	0	822	3371	Sisma X SLV	316.9	0	0	0	0	0
823	3371	Sisma Y SLV	0	316.9	0	0	0	0	824	3371	Sisma X SLD	145.5	0	0	0	0	0
825	3371	Sisma Y SLD	0	145.5	0	0	0	0	826	3372	Sisma X SLV	316.9	0	0	0	0	0
827	3372	Sisma Y SLV	0	316.9	0	0	0	0	828	3372	Sisma X SLD	145.5	0	0	0	0	0
829	3372	Sisma Y SLD	0	145.5	0	0	0	0	830	3373	Sisma X SLV	336.4	0	0	0	0	0
831	3373	Sisma Y SLV	0	336.4	0	0	0	0	832	3373	Sisma X SLD	154.5	0	0	0	0	0
833	3373	Sisma Y SLD	0	154.5	0	0	0	0	834	3374	Sisma X SLV	336.4	0	0	0	0	0
835	3374	Sisma Y SLV	0	336.4	0	0	0	0	836	3374	Sisma X SLD	154.5	0	0	0	0	0
837	3374	Sisma Y SLD	0	154.5	0	0	0	0	838	3375	Sisma X SLV	316.9	0	0	0	0	0
839	3375	Sisma Y SLV	0	316.9	0	0	0	0	840	3375	Sisma X SLD	145.5	0	0	0	0	0
841	3375	Sisma Y SLD	0	145.5	0	0	0	0	842	3376	Sisma X SLV	316.9	0	0	0	0	0
843	3376	Sisma Y SLV	0	316.9	0	0	0	0	844	3376	Sisma X SLD	145.5	0	0	0	0	0
845	3376	Sisma Y SLD	0	145.5	0	0	0	0	846	3377	Sisma X SLV	316.9	0	0	0	0	0
847	3377	Sisma Y SLV	0	316.9	0	0	0	0	848	3377	Sisma X SLD	145.5	0	0	0	0	0
849	3377	Sisma Y SLD	0	145.5	0	0	0	0	850	3378	Sisma X SLV	316.9	0	0	0	0	0
851	3378	Sisma Y SLV	0	316.9	0	0	0	0	852	3378	Sisma X SLD	145.5	0	0	0	0	0
853	3378	Sisma Y SLD	0	145.5	0	0	0	0	854	3379	Sisma X SLV	336.4	0	0	0	0	0
855	3379	Sisma Y SLV	0	336.4	0	0	0	0	856	3379	Sisma X SLD	154.5	0	0	0	0	0
857	3379	Sisma Y SLD	0	154.5	0	0	0	0	858	3380	Sisma X SLV	336.4	0	0	0	0	0
859	3380	Sisma Y SLV	0	336.4	0	0	0	0	860	3380	Sisma X SLD	154.5	0	0	0	0	0
861	3380	Sisma Y SLD	0	154.5	0	0	0	0	862	3381	Sisma X SLV	316.9	0	0	0	0	0
863	3381	Sisma Y SLV	0	316.9	0	0	0	0	864	3381	Sisma X SLD	145.5	0	0	0	0	0
865	3381	Sisma Y SLD	0	145.5	0	0	0	0	866	3382	Sisma X SLV	316.9	0	0	0	0	0
867	3382	Sisma Y SLV	0	316.9	0	0	0	0	868	3382	Sisma X SLD	145.5	0	0	0	0	0
869	3382	Sisma Y SLD	0	145.5	0	0	0	0	870	3383	Sisma X SLV	336.4	0	0	0	0	0



Tabulati di Calcolo Plinto di Fondazione per Aerogeneratore Tipo - Progetto Impianto Eolico - "Orione"

Indice	Nodo	Condizione	Fx	Fy	Fz	Mx	My	Mz	Indice	Nodo	Condizione	Fx	Fy	Fz	Mx	My	Mz
871	3383	Sisma Y SLV	0	336.4	0	0	0	0	872	3383	Sisma X SLD	154.5	0	0	0	0	0
873	3383	Sisma Y SLD	0	154.5	0	0	0	0	874	3384	Sisma X SLV	336.4	0	0	0	0	0
875	3384	Sisma Y SLV	0	336.4	0	0	0	0	876	3384	Sisma X SLD	154.5	0	0	0	0	0
877	3384	Sisma Y SLD	0	154.5	0	0	0	0	878	3385	Sisma X SLV	316.9	0	0	0	0	0
879	3385	Sisma Y SLV	0	316.9	0	0	0	0	880	3385	Sisma X SLD	145.5	0	0	0	0	0
881	3385	Sisma Y SLD	0	145.5	0	0	0	0	882	3386	Sisma X SLV	316.9	0	0	0	0	0
883	3386	Sisma Y SLV	0	316.9	0	0	0	0	884	3386	Sisma X SLD	145.5	0	0	0	0	0
885	3386	Sisma Y SLD	0	145.5	0	0	0	0	886	3387	Sisma X SLV	336.4	0	0	0	0	0
887	3387	Sisma Y SLV	0	336.4	0	0	0	0	888	3387	Sisma X SLD	154.5	0	0	0	0	0
889	3387	Sisma Y SLD	0	154.5	0	0	0	0	890	3388	Sisma X SLV	336.4	0	0	0	0	0
891	3388	Sisma Y SLV	0	336.4	0	0	0	0	892	3388	Sisma X SLD	154.5	0	0	0	0	0
893	3388	Sisma Y SLD	0	154.5	0	0	0	0	894	3389	Sisma X SLV	316.9	0	0	0	0	0
895	3389	Sisma Y SLV	0	316.9	0	0	0	0	896	3389	Sisma X SLD	145.5	0	0	0	0	0
897	3389	Sisma Y SLD	0	145.5	0	0	0	0	898	3390	Sisma X SLV	316.9	0	0	0	0	0
899	3390	Sisma Y SLV	0	316.9	0	0	0	0	900	3390	Sisma X SLD	145.5	0	0	0	0	0
901	3390	Sisma Y SLD	0	145.5	0	0	0	0	902	3391	Sisma X SLV	336.4	0	0	0	0	0
903	3391	Sisma Y SLV	0	336.4	0	0	0	0	904	3391	Sisma X SLD	154.5	0	0	0	0	0
905	3391	Sisma Y SLD	0	154.5	0	0	0	0	906	3392	Sisma X SLV	336.4	0	0	0	0	0
907	3392	Sisma Y SLV	0	336.4	0	0	0	0	908	3392	Sisma X SLD	154.5	0	0	0	0	0
909	3392	Sisma Y SLD	0	154.5	0	0	0	0	910	3393	Sisma X SLV	316.9	0	0	0	0	0
911	3393	Sisma Y SLV	0	316.9	0	0	0	0	912	3393	Sisma X SLD	145.5	0	0	0	0	0
913	3393	Sisma Y SLD	0	145.5	0	0	0	0	914	3394	Sisma X SLV	316.9	0	0	0	0	0
915	3394	Sisma Y SLV	0	316.9	0	0	0	0	916	3394	Sisma X SLD	145.5	0	0	0	0	0
917	3394	Sisma Y SLD	0	145.5	0	0	0	0	918	3395	Sisma X SLV	336.4	0	0	0	0	0
919	3395	Sisma Y SLV	0	336.4	0	0	0	0	920	3395	Sisma X SLD	154.5	0	0	0	0	0
921	3395	Sisma Y SLD	0	154.5	0	0	0	0	922	3396	Sisma X SLV	336.4	0	0	0	0	0
923	3396	Sisma Y SLV	0	336.4	0	0	0	0	924	3396	Sisma X SLD	154.5	0	0	0	0	0
925	3396	Sisma Y SLD	0	154.5	0	0	0	0	926	3397	Sisma X SLV	316.9	0	0	0	0	0
927	3397	Sisma Y SLV	0	316.9	0	0	0	0	928	3397	Sisma X SLD	145.5	0	0	0	0	0
929	3397	Sisma Y SLD	0	145.5	0	0	0	0	930	3398	Sisma X SLV	316.9	0	0	0	0	0
931	3398	Sisma Y SLV	0	316.9	0	0	0	0	932	3398	Sisma X SLD	145.5	0	0	0	0	0
933	3398	Sisma Y SLD	0	145.5	0	0	0	0	934	3399	Sisma X SLV	316.9	0	0	0	0	0
935	3399	Sisma Y SLV	0	316.9	0	0	0	0	936	3399	Sisma X SLD	145.5	0	0	0	0	0
937	3399	Sisma Y SLD	0	145.5	0	0	0	0	938	3400	Sisma X SLV	316.9	0	0	0	0	0
939	3400	Sisma Y SLV	0	316.9	0	0	0	0	940	3400	Sisma X SLD	145.5	0	0	0	0	0
941	3400	Sisma Y SLD	0	145.5	0	0	0	0	942	3401	Sisma X SLV	336.4	0	0	0	0	0
943	3401	Sisma Y SLV	0	336.4	0	0	0	0	944	3401	Sisma X SLD	154.5	0	0	0	0	0
945	3401	Sisma Y SLD	0	154.5	0	0	0	0	946	3402	Sisma X SLV	336.4	0	0	0	0	0
947	3402	Sisma Y SLV	0	336.4	0	0	0	0	948	3402	Sisma X SLD	154.5	0	0	0	0	0
949	3402	Sisma Y SLD	0	154.5	0	0	0	0	950	3403	Sisma X SLV	316.9	0	0	0	0	0
951	3403	Sisma Y SLV	0	316.9	0	0	0	0	952	3403	Sisma X SLD	145.5	0	0	0	0	0
953	3403	Sisma Y SLD	0	145.5	0	0	0	0	954	3404	Sisma X SLV	316.9	0	0	0	0	0
955	3404	Sisma Y SLV	0	316.9	0	0	0	0	956	3404	Sisma X SLD	145.5	0	0	0	0	0
957	3404	Sisma Y SLD	0	145.5	0	0	0	0	958	3405	Sisma X SLV	336.4	0	0	0	0	0
959	3405	Sisma Y SLV	0	336.4	0	0	0	0	960	3405	Sisma X SLD	154.5	0	0	0	0	0
961	3405	Sisma Y SLD	0	154.5	0	0	0	0	962	3406	Sisma X SLV	336.4	0	0	0	0	0
963	3406	Sisma Y SLV	0	336.4	0	0	0	0	964	3406	Sisma X SLD	154.5	0	0	0	0	0
965	3406	Sisma Y SLD	0	154.5	0	0	0	0	966	3407	Sisma X SLV	316.9	0	0	0	0	0
967	3407	Sisma Y SLV	0	316.9	0	0	0	0	968	3407	Sisma X SLD	145.5	0	0	0	0	0
969	3407	Sisma Y SLD	0	145.5	0	0	0	0	970	3408	Sisma X SLV	316.9	0	0	0	0	0



Tabulati di Calcolo Plinto di Fondazione per Aerogeneratore Tipo - Progetto Impianto Eolico - "Orione"

Indice	Nodo	Condizione	Fx	Fy	Fz	Mx	My	Mz	Indice	Nodo	Condizione	Fx	Fy	Fz	Mx	My	Mz
971	3408	Sisma Y SLV	0	316.9	0	0	0	0	972	3408	Sisma X SLD	145.5	0	0	0	0	0
973	3408	Sisma Y SLD	0	145.5	0	0	0	0	974	3409	Sisma X SLV	336.4	0	0	0	0	0
975	3409	Sisma Y SLV	0	336.4	0	0	0	0	976	3409	Sisma X SLD	154.5	0	0	0	0	0
977	3409	Sisma Y SLD	0	154.5	0	0	0	0	978	3410	Sisma X SLV	336.4	0	0	0	0	0
979	3410	Sisma Y SLV	0	336.4	0	0	0	0	980	3410	Sisma X SLD	154.5	0	0	0	0	0
981	3410	Sisma Y SLD	0	154.5	0	0	0	0	982	3411	Sisma X SLV	316.9	0	0	0	0	0
983	3411	Sisma Y SLV	0	316.9	0	0	0	0	984	3411	Sisma X SLD	145.5	0	0	0	0	0
985	3411	Sisma Y SLD	0	145.5	0	0	0	0	986	3412	Sisma X SLV	316.9	0	0	0	0	0
987	3412	Sisma Y SLV	0	316.9	0	0	0	0	988	3412	Sisma X SLD	145.5	0	0	0	0	0
989	3412	Sisma Y SLD	0	145.5	0	0	0	0	990	3413	Sisma X SLV	336.4	0	0	0	0	0
991	3413	Sisma Y SLV	0	336.4	0	0	0	0	992	3413	Sisma X SLD	154.5	0	0	0	0	0
993	3413	Sisma Y SLD	0	154.5	0	0	0	0	994	3414	Sisma X SLV	336.4	0	0	0	0	0
995	3414	Sisma Y SLV	0	336.4	0	0	0	0	996	3414	Sisma X SLD	154.5	0	0	0	0	0
997	3414	Sisma Y SLD	0	154.5	0	0	0	0	998	3415	Sisma X SLV	316.9	0	0	0	0	0
999	3415	Sisma Y SLV	0	316.9	0	0	0	0	1000	3415	Sisma X SLD	145.5	0	0	0	0	0
1001	3415	Sisma Y SLD	0	145.5	0	0	0	0	1002	3416	Sisma X SLV	316.9	0	0	0	0	0
1003	3416	Sisma Y SLV	0	316.9	0	0	0	0	1004	3416	Sisma X SLD	145.5	0	0	0	0	0
1005	3416	Sisma Y SLD	0	145.5	0	0	0	0	1006	3417	Sisma X SLV	336.4	0	0	0	0	0
1007	3417	Sisma Y SLV	0	336.4	0	0	0	0	1008	3417	Sisma X SLD	154.5	0	0	0	0	0
1009	3417	Sisma Y SLD	0	154.5	0	0	0	0	1010	3418	Sisma X SLV	336.4	0	0	0	0	0
1011	3418	Sisma Y SLV	0	336.4	0	0	0	0	1012	3418	Sisma X SLD	154.5	0	0	0	0	0
1013	3418	Sisma Y SLD	0	154.5	0	0	0	0	1014	3419	Sisma X SLV	316.9	0	0	0	0	0
1015	3419	Sisma Y SLV	0	316.9	0	0	0	0	1016	3419	Sisma X SLD	145.5	0	0	0	0	0
1017	3419	Sisma Y SLD	0	145.5	0	0	0	0	1018	3420	Sisma X SLV	316.9	0	0	0	0	0
1019	3420	Sisma Y SLV	0	316.9	0	0	0	0	1020	3420	Sisma X SLD	145.5	0	0	0	0	0
1021	3420	Sisma Y SLD	0	145.5	0	0	0	0	1022	3421	Sisma X SLV	336.4	0	0	0	0	0
1023	3421	Sisma Y SLV	0	336.4	0	0	0	0	1024	3421	Sisma X SLD	154.5	0	0	0	0	0
1025	3421	Sisma Y SLD	0	154.5	0	0	0	0	1026	3422	Sisma X SLV	316.9	0	0	0	0	0
1027	3422	Sisma Y SLV	0	316.9	0	0	0	0	1028	3422	Sisma X SLD	145.5	0	0	0	0	0
1029	3422	Sisma Y SLD	0	145.5	0	0	0	0	1030	3423	Sisma X SLV	2.8E6	0	0	0	0	0
1031	3423	Sisma Y SLV	0	2.8E6	0	0	0	0	1032	3423	Sisma X SLD	1.3E6	0	0	0	0	0
1033	3423	Sisma Y SLD	0	1.3E6	0	0	0	0	1034	3424	Sisma X SLV	316.9	0	0	0	0	0
1035	3424	Sisma Y SLV	0	316.9	0	0	0	0	1036	3424	Sisma X SLD	145.5	0	0	0	0	0
1037	3424	Sisma Y SLD	0	145.5	0	0	0	0	1038	3425	Sisma X SLV	336.4	0	0	0	0	0
1039	3425	Sisma Y SLV	0	336.4	0	0	0	0	1040	3425	Sisma X SLD	154.5	0	0	0	0	0
1041	3425	Sisma Y SLD	0	154.5	0	0	0	0	1042	3426	Sisma X SLV	316.9	0	0	0	0	0
1043	3426	Sisma Y SLV	0	316.9	0	0	0	0	1044	3426	Sisma X SLD	145.5	0	0	0	0	0
1045	3426	Sisma Y SLD	0	145.5	0	0	0	0	1046	3427	Sisma X SLV	316.9	0	0	0	0	0
1047	3427	Sisma Y SLV	0	316.9	0	0	0	0	1048	3427	Sisma X SLD	145.5	0	0	0	0	0
1049	3427	Sisma Y SLD	0	145.5	0	0	0	0	1050	3428	Sisma X SLV	336.4	0	0	0	0	0
1051	3428	Sisma Y SLV	0	336.4	0	0	0	0	1052	3428	Sisma X SLD	154.5	0	0	0	0	0
1053	3428	Sisma Y SLD	0	154.5	0	0	0	0	1054	3429	Sisma X SLV	336.4	0	0	0	0	0
1055	3429	Sisma Y SLV	0	336.4	0	0	0	0	1056	3429	Sisma X SLD	154.5	0	0	0	0	0
1057	3429	Sisma Y SLD	0	154.5	0	0	0	0	1058	3430	Sisma X SLV	316.9	0	0	0	0	0
1059	3430	Sisma Y SLV	0	316.9	0	0	0	0	1060	3430	Sisma X SLD	145.5	0	0	0	0	0
1061	3430	Sisma Y SLD	0	145.5	0	0	0	0	1062	3431	Sisma X SLV	316.9	0	0	0	0	0
1063	3431	Sisma Y SLV	0	316.9	0	0	0	0	1064	3431	Sisma X SLD	145.5	0	0	0	0	0
1065	3431	Sisma Y SLD	0	145.5	0	0	0	0	1066	3432	Sisma X SLV	336.4	0	0	0	0	0
1067	3432	Sisma Y SLV	0	336.4	0	0	0	0	1068	3432	Sisma X SLD	154.5	0	0	0	0	0
1069	3432	Sisma Y SLD	0	154.5	0	0	0	0	1070	3433	Sisma X SLV	336.4	0	0	0	0	0





Tabulati di Calcolo Plinto di Fondazione per Aerogeneratore Tipo - Progetto Impianto Eolico - "Orione"

Indice	Nodo	Condizione	Fx	Fy	Fz	Mx	My	Mz	Indice	Nodo	Condizione	Fx	Fy	Fz	Mx	My	Mz
1071	3433	Sisma Y SLV	0	336.4	0	0	0	0	1072	3433	Sisma X SLD	154.5	0	0	0	0	0
1073	3433	Sisma Y SLD	0	154.5	0	0	0	0	1074	3434	Sisma X SLV	316.9	0	0	0	0	0
1075	3434	Sisma Y SLV	0	316.9	0	0	0	0	1076	3434	Sisma X SLD	145.5	0	0	0	0	0
1077	3434	Sisma Y SLD	0	145.5	0	0	0	0	1078	3435	Sisma X SLV	316.9	0	0	0	0	0
1079	3435	Sisma Y SLV	0	316.9	0	0	0	0	1080	3435	Sisma X SLD	145.5	0	0	0	0	0
1081	3435	Sisma Y SLD	0	145.5	0	0	0	0	1082	3436	Sisma X SLV	336.4	0	0	0	0	0
1083	3436	Sisma Y SLV	0	336.4	0	0	0	0	1084	3436	Sisma X SLD	154.5	0	0	0	0	0
1085	3436	Sisma Y SLD	0	154.5	0	0	0	0	1086	3437	Sisma X SLV	336.4	0	0	0	0	0
1087	3437	Sisma Y SLV	0	336.4	0	0	0	0	1088	3437	Sisma X SLD	154.5	0	0	0	0	0
1089	3437	Sisma Y SLD	0	154.5	0	0	0	0	1090	3438	Sisma X SLV	316.9	0	0	0	0	0
1091	3438	Sisma Y SLV	0	316.9	0	0	0	0	1092	3438	Sisma X SLD	145.5	0	0	0	0	0
1093	3438	Sisma Y SLD	0	145.5	0	0	0	0	1094	3439	Sisma X SLV	316.9	0	0	0	0	0
1095	3439	Sisma Y SLV	0	316.9	0	0	0	0	1096	3439	Sisma X SLD	145.5	0	0	0	0	0
1097	3439	Sisma Y SLD	0	145.5	0	0	0	0	1098	3440	Sisma X SLV	336.4	0	0	0	0	0
1099	3440	Sisma Y SLV	0	336.4	0	0	0	0	1100	3440	Sisma X SLD	154.5	0	0	0	0	0
1101	3440	Sisma Y SLD	0	154.5	0	0	0	0	1102	3441	Sisma X SLV	336.4	0	0	0	0	0
1103	3441	Sisma Y SLV	0	336.4	0	0	0	0	1104	3441	Sisma X SLD	154.5	0	0	0	0	0
1105	3441	Sisma Y SLD	0	154.5	0	0	0	0	1106	3442	Sisma X SLV	316.9	0	0	0	0	0
1107	3442	Sisma Y SLV	0	316.9	0	0	0	0	1108	3442	Sisma X SLD	145.5	0	0	0	0	0
1109	3442	Sisma Y SLD	0	145.5	0	0	0	0	1110	3443	Sisma X SLV	316.9	0	0	0	0	0
1111	3443	Sisma Y SLV	0	316.9	0	0	0	0	1112	3443	Sisma X SLD	145.5	0	0	0	0	0
1113	3443	Sisma Y SLD	0	145.5	0	0	0	0	1114	3444	Sisma X SLV	336.4	0	0	0	0	0
1115	3444	Sisma Y SLV	0	336.4	0	0	0	0	1116	3444	Sisma X SLD	154.5	0	0	0	0	0
1117	3444	Sisma Y SLD	0	154.5	0	0	0	0	1118	3445	Sisma X SLV	336.4	0	0	0	0	0
1119	3445	Sisma Y SLV	0	336.4	0	0	0	0	1120	3445	Sisma X SLD	154.5	0	0	0	0	0
1121	3445	Sisma Y SLD	0	154.5	0	0	0	0	1122	3446	Sisma X SLV	316.9	0	0	0	0	0
1123	3446	Sisma Y SLV	0	316.9	0	0	0	0	1124	3446	Sisma X SLD	145.5	0	0	0	0	0
1125	3446	Sisma Y SLD	0	145.5	0	0	0	0	1126	3447	Sisma X SLV	316.9	0	0	0	0	0
1127	3447	Sisma Y SLV	0	316.9	0	0	0	0	1128	3447	Sisma X SLD	145.5	0	0	0	0	0
1129	3447	Sisma Y SLD	0	145.5	0	0	0	0	1130	3448	Sisma X SLV	316.9	0	0	0	0	0
1131	3448	Sisma Y SLV	0	316.9	0	0	0	0	1132	3448	Sisma X SLD	145.5	0	0	0	0	0
1133	3448	Sisma Y SLD	0	145.5	0	0	0	0	1134	3449	Sisma X SLV	316.9	0	0	0	0	0
1135	3449	Sisma Y SLV	0	316.9	0	0	0	0	1136	3449	Sisma X SLD	145.5	0	0	0	0	0
1137	3449	Sisma Y SLD	0	145.5	0	0	0	0	1138	3450	Sisma X SLV	336.4	0	0	0	0	0
1139	3450	Sisma Y SLV	0	336.4	0	0	0	0	1140	3450	Sisma X SLD	154.5	0	0	0	0	0
1141	3450	Sisma Y SLD	0	154.5	0	0	0	0	1142	3451	Sisma X SLV	336.4	0	0	0	0	0
1143	3451	Sisma Y SLV	0	336.4	0	0	0	0	1144	3451	Sisma X SLD	154.5	0	0	0	0	0
1145	3451	Sisma Y SLD	0	154.5	0	0	0	0	1146	3452	Sisma X SLV	316.9	0	0	0	0	0
1147	3452	Sisma Y SLV	0	316.9	0	0	0	0	1148	3452	Sisma X SLD	145.5	0	0	0	0	0
1149	3452	Sisma Y SLD	0	145.5	0	0	0	0	1150	3453	Sisma X SLV	316.9	0	0	0	0	0
1151	3453	Sisma Y SLV	0	316.9	0	0	0	0	1152	3453	Sisma X SLD	145.5	0	0	0	0	0
1153	3453	Sisma Y SLD	0	145.5	0	0	0	0	1154	3454	Sisma X SLV	336.4	0	0	0	0	0
1155	3454	Sisma Y SLV	0	336.4	0	0	0	0	1156	3454	Sisma X SLD	154.5	0	0	0	0	0
1157	3454	Sisma Y SLD	0	154.5	0	0	0	0	1158	3455	Sisma X SLV	336.4	0	0	0	0	0
1159	3455	Sisma Y SLV	0	336.4	0	0	0	0	1160	3455	Sisma X SLD	154.5	0	0	0	0	0
1161	3455	Sisma Y SLD	0	154.5	0	0	0	0	1162	3456	Sisma X SLV	316.9	0	0	0	0	0
1163	3456	Sisma Y SLV	0	316.9	0	0	0	0	1164	3456	Sisma X SLD	145.5	0	0	0	0	0
1165	3456	Sisma Y SLD	0	145.5	0	0	0	0	1166	3457	Sisma X SLV	316.9	0	0	0	0	0
1167	3457	Sisma Y SLV	0	316.9	0	0	0	0	1168	3457	Sisma X SLD	145.5	0	0	0	0	0
1169	3457	Sisma Y SLD	0	145.5	0	0	0	0	1170	3458	Sisma X SLV	336.4	0	0	0	0	0



Tabulati di Calcolo Plinto di Fondazione per Aerogeneratore Tipo - Progetto Impianto Eolico - "Orione"

Indice	Nodo	Condizione	Fx	Fy	Fz	Mx	My	Mz	Indice	Nodo	Condizione	Fx	Fy	Fz	Mx	My	Mz
1171	3458	Sisma Y SLV	0	336.4	0	0	0	0	1172	3458	Sisma X SLD	154.5	0	0	0	0	0
1173	3458	Sisma Y SLD	0	154.5	0	0	0	0	1174	3459	Sisma X SLV	336.4	0	0	0	0	0
1175	3459	Sisma Y SLV	0	336.4	0	0	0	0	1176	3459	Sisma X SLD	154.5	0	0	0	0	0
1177	3459	Sisma Y SLD	0	154.5	0	0	0	0	1178	3460	Sisma X SLV	316.9	0	0	0	0	0
1179	3460	Sisma Y SLV	0	316.9	0	0	0	0	1180	3460	Sisma X SLD	145.5	0	0	0	0	0
1181	3460	Sisma Y SLD	0	145.5	0	0	0	0	1182	3461	Sisma X SLV	316.9	0	0	0	0	0
1183	3461	Sisma Y SLV	0	316.9	0	0	0	0	1184	3461	Sisma X SLD	145.5	0	0	0	0	0
1185	3461	Sisma Y SLD	0	145.5	0	0	0	0	1186	3462	Sisma X SLV	336.4	0	0	0	0	0
1187	3462	Sisma Y SLV	0	336.4	0	0	0	0	1188	3462	Sisma X SLD	154.5	0	0	0	0	0
1189	3462	Sisma Y SLD	0	154.5	0	0	0	0	1190	3463	Sisma X SLV	336.4	0	0	0	0	0
1191	3463	Sisma Y SLV	0	336.4	0	0	0	0	1192	3463	Sisma X SLD	154.5	0	0	0	0	0
1193	3463	Sisma Y SLD	0	154.5	0	0	0	0	1194	3464	Sisma X SLV	316.9	0	0	0	0	0
1195	3464	Sisma Y SLV	0	316.9	0	0	0	0	1196	3464	Sisma X SLD	145.5	0	0	0	0	0
1197	3464	Sisma Y SLD	0	145.5	0	0	0	0	1198	3465	Sisma X SLV	316.9	0	0	0	0	0
1199	3465	Sisma Y SLV	0	316.9	0	0	0	0	1200	3465	Sisma X SLD	145.5	0	0	0	0	0
1201	3465	Sisma Y SLD	0	145.5	0	0	0	0	1202	3466	Sisma X SLV	336.4	0	0	0	0	0
1203	3466	Sisma Y SLV	0	336.4	0	0	0	0	1204	3466	Sisma X SLD	154.5	0	0	0	0	0
1205	3466	Sisma Y SLD	0	154.5	0	0	0	0	1206	3467	Sisma X SLV	336.4	0	0	0	0	0
1207	3467	Sisma Y SLV	0	336.4	0	0	0	0	1208	3467	Sisma X SLD	154.5	0	0	0	0	0
1209	3467	Sisma Y SLD	0	154.5	0	0	0	0	1210	3468	Sisma X SLV	316.9	0	0	0	0	0
1211	3468	Sisma Y SLV	0	316.9	0	0	0	0	1212	3468	Sisma X SLD	145.5	0	0	0	0	0
1213	3468	Sisma Y SLD	0	145.5	0	0	0	0	1214	3469	Sisma X SLV	316.9	0	0	0	0	0
1215	3469	Sisma Y SLV	0	316.9	0	0	0	0	1216	3469	Sisma X SLD	145.5	0	0	0	0	0
1217	3469	Sisma Y SLD	0	145.5	0	0	0	0	1218	3470	Sisma X SLV	316.9	0	0	0	0	0
1219	3470	Sisma Y SLV	0	316.9	0	0	0	0	1220	3470	Sisma X SLD	145.5	0	0	0	0	0
1221	3470	Sisma Y SLD	0	145.5	0	0	0	0	1222	3471	Sisma X SLV	316.9	0	0	0	0	0
1223	3471	Sisma Y SLV	0	316.9	0	0	0	0	1224	3471	Sisma X SLD	145.5	0	0	0	0	0
1225	3471	Sisma Y SLD	0	145.5	0	0	0	0	1226	3472	Sisma X SLV	336.4	0	0	0	0	0
1227	3472	Sisma Y SLV	0	336.4	0	0	0	0	1228	3472	Sisma X SLD	154.5	0	0	0	0	0
1229	3472	Sisma Y SLD	0	154.5	0	0	0	0	1230	3473	Sisma X SLV	336.4	0	0	0	0	0
1231	3473	Sisma Y SLV	0	336.4	0	0	0	0	1232	3473	Sisma X SLD	154.5	0	0	0	0	0
1233	3473	Sisma Y SLD	0	154.5	0	0	0	0	1234	3474	Sisma X SLV	316.9	0	0	0	0	0
1235	3474	Sisma Y SLV	0	316.9	0	0	0	0	1236	3474	Sisma X SLD	145.5	0	0	0	0	0
1237	3474	Sisma Y SLD	0	145.5	0	0	0	0	1238	3475	Sisma X SLV	316.9	0	0	0	0	0
1239	3475	Sisma Y SLV	0	316.9	0	0	0	0	1240	3475	Sisma X SLD	145.5	0	0	0	0	0
1241	3475	Sisma Y SLD	0	145.5	0	0	0	0	1242	3476	Sisma X SLV	336.4	0	0	0	0	0
1243	3476	Sisma Y SLV	0	336.4	0	0	0	0	1244	3476	Sisma X SLD	154.5	0	0	0	0	0
1245	3476	Sisma Y SLD	0	154.5	0	0	0	0	1246	3477	Sisma X SLV	336.4	0	0	0	0	0
1247	3477	Sisma Y SLV	0	336.4	0	0	0	0	1248	3477	Sisma X SLD	154.5	0	0	0	0	0
1249	3477	Sisma Y SLD	0	154.5	0	0	0	0	1250	3478	Sisma X SLV	316.9	0	0	0	0	0
1251	3478	Sisma Y SLV	0	316.9	0	0	0	0	1252	3478	Sisma X SLD	145.5	0	0	0	0	0
1253	3478	Sisma Y SLD	0	145.5	0	0	0	0	1254	3479	Sisma X SLV	316.9	0	0	0	0	0
1255	3479	Sisma Y SLV	0	316.9	0	0	0	0	1256	3479	Sisma X SLD	145.5	0	0	0	0	0
1257	3479	Sisma Y SLD	0	145.5	0	0	0	0	1258	3480	Sisma X SLV	336.4	0	0	0	0	0
1259	3480	Sisma Y SLV	0	336.4	0	0	0	0	1260	3480	Sisma X SLD	154.5	0	0	0	0	0
1261	3480	Sisma Y SLD	0	154.5	0	0	0	0	1262	3481	Sisma X SLV	336.4	0	0	0	0	0
1263	3481	Sisma Y SLV	0	336.4	0	0	0	0	1264	3481	Sisma X SLD	154.5	0	0	0	0	0
1265	3481	Sisma Y SLD	0	154.5	0	0	0	0	1266	3482	Sisma X SLV	316.9	0	0	0	0	0
1267	3482	Sisma Y SLV	0	316.9	0	0	0	0	1268	3482	Sisma X SLD	145.5	0	0	0	0	0
1269	3482	Sisma Y SLD	0	145.5	0	0	0	0	1270	3483	Sisma X SLV	316.9	0	0	0	0	0



Tabulati di Calcolo Plinto di Fondazione per Aerogeneratore Tipo - Progetto Impianto Eolico - "Orione"

Indice	Nodo	Condizione	Fx	Fy	Fz	Mx	My	Mz	Indice	Nodo	Condizione	Fx	Fy	Fz	Mx	My	Mz
1271	3483	Sisma Y SLV	0	316.9	0	0	0	0	1272	3483	Sisma X SLD	145.5	0	0	0	0	0
1273	3483	Sisma Y SLD	0	145.5	0	0	0	0	1274	3484	Sisma X SLV	336.4	0	0	0	0	0
1275	3484	Sisma Y SLV	0	336.4	0	0	0	0	1276	3484	Sisma X SLD	154.5	0	0	0	0	0
1277	3484	Sisma Y SLD	0	154.5	0	0	0	0	1278	3485	Sisma X SLV	336.4	0	0	0	0	0
1279	3485	Sisma Y SLV	0	336.4	0	0	0	0	1280	3485	Sisma X SLD	154.5	0	0	0	0	0
1281	3485	Sisma Y SLD	0	154.5	0	0	0	0	1282	3486	Sisma X SLV	316.9	0	0	0	0	0
1283	3486	Sisma Y SLV	0	316.9	0	0	0	0	1284	3486	Sisma X SLD	145.5	0	0	0	0	0
1285	3486	Sisma Y SLD	0	145.5	0	0	0	0	1286	3487	Sisma X SLV	316.9	0	0	0	0	0
1287	3487	Sisma Y SLV	0	316.9	0	0	0	0	1288	3487	Sisma X SLD	145.5	0	0	0	0	0
1289	3487	Sisma Y SLD	0	145.5	0	0	0	0	1290	3488	Sisma X SLV	316.9	0	0	0	0	0
1291	3488	Sisma Y SLV	0	316.9	0	0	0	0	1292	3488	Sisma X SLD	145.5	0	0	0	0	0
1293	3488	Sisma Y SLD	0	145.5	0	0	0	0	1294	3489	Sisma X SLV	316.9	0	0	0	0	0
1295	3489	Sisma Y SLV	0	316.9	0	0	0	0	1296	3489	Sisma X SLD	145.5	0	0	0	0	0
1297	3489	Sisma Y SLD	0	145.5	0	0	0	0	1298	3490	Sisma X SLV	336.4	0	0	0	0	0
1299	3490	Sisma Y SLV	0	336.4	0	0	0	0	1300	3490	Sisma X SLD	154.5	0	0	0	0	0
1301	3490	Sisma Y SLD	0	154.5	0	0	0	0	1302	3491	Sisma X SLV	336.4	0	0	0	0	0
1303	3491	Sisma Y SLV	0	336.4	0	0	0	0	1304	3491	Sisma X SLD	154.5	0	0	0	0	0
1305	3491	Sisma Y SLD	0	154.5	0	0	0	0	1306	3492	Sisma X SLV	316.9	0	0	0	0	0
1307	3492	Sisma Y SLV	0	316.9	0	0	0	0	1308	3492	Sisma X SLD	145.5	0	0	0	0	0
1309	3492	Sisma Y SLD	0	145.5	0	0	0	0	1310	3493	Sisma X SLV	316.9	0	0	0	0	0
1311	3493	Sisma Y SLV	0	316.9	0	0	0	0	1312	3493	Sisma X SLD	145.5	0	0	0	0	0
1313	3493	Sisma Y SLD	0	145.5	0	0	0	0	1314	3494	Sisma X SLV	336.4	0	0	0	0	0
1315	3494	Sisma Y SLV	0	336.4	0	0	0	0	1316	3494	Sisma X SLD	154.5	0	0	0	0	0
1317	3494	Sisma Y SLD	0	154.5	0	0	0	0	1318	3495	Sisma X SLV	336.4	0	0	0	0	0
1319	3495	Sisma Y SLV	0	336.4	0	0	0	0	1320	3495	Sisma X SLD	154.5	0	0	0	0	0
1321	3495	Sisma Y SLD	0	154.5	0	0	0	0	1322	3496	Sisma X SLV	316.9	0	0	0	0	0
1323	3496	Sisma Y SLV	0	316.9	0	0	0	0	1324	3496	Sisma X SLD	145.5	0	0	0	0	0
1325	3496	Sisma Y SLD	0	145.5	0	0	0	0	1326	3497	Sisma X SLV	316.9	0	0	0	0	0
1327	3497	Sisma Y SLV	0	316.9	0	0	0	0	1328	3497	Sisma X SLD	145.5	0	0	0	0	0
1329	3497	Sisma Y SLD	0	145.5	0	0	0	0	1330	3498	Sisma X SLV	336.4	0	0	0	0	0
1331	3498	Sisma Y SLV	0	336.4	0	0	0	0	1332	3498	Sisma X SLD	154.5	0	0	0	0	0
1333	3498	Sisma Y SLD	0	154.5	0	0	0	0	1334	3499	Sisma X SLV	316.9	0	0	0	0	0
1335	3499	Sisma Y SLV	0	316.9	0	0	0	0	1336	3499	Sisma X SLD	145.5	0	0	0	0	0
1337	3499	Sisma Y SLD	0	145.5	0	0	0	0	1338	3500	Sisma X SLV	316.9	0	0	0	0	0
1339	3500	Sisma Y SLV	0	316.9	0	0	0	0	1340	3500	Sisma X SLD	145.5	0	0	0	0	0
1341	3500	Sisma Y SLD	0	145.5	0	0	0	0	1342	3501	Sisma X SLV	336.4	0	0	0	0	0
1343	3501	Sisma Y SLV	0	336.4	0	0	0	0	1344	3501	Sisma X SLD	154.5	0	0	0	0	0
1345	3501	Sisma Y SLD	0	154.5	0	0	0	0	1346	3502	Sisma X SLV	316.9	0	0	0	0	0
1347	3502	Sisma Y SLV	0	316.9	0	0	0	0	1348	3502	Sisma X SLD	145.5	0	0	0	0	0
1349	3502	Sisma Y SLD	0	145.5	0	0	0	0	1350	3503	Sisma X SLV	316.9	0	0	0	0	0
1351	3503	Sisma Y SLV	0	316.9	0	0	0	0	1352	3503	Sisma X SLD	145.5	0	0	0	0	0
1353	3503	Sisma Y SLD	0	145.5	0	0	0	0	1354	3504	Sisma X SLV	336.4	0	0	0	0	0
1355	3504	Sisma Y SLV	0	336.4	0	0	0	0	1356	3504	Sisma X SLD	154.5	0	0	0	0	0
1357	3504	Sisma Y SLD	0	154.5	0	0	0	0	1358	3505	Sisma X SLV	336.4	0	0	0	0	0
1359	3505	Sisma Y SLV	0	336.4	0	0	0	0	1360	3505	Sisma X SLD	154.5	0	0	0	0	0
1361	3505	Sisma Y SLD	0	154.5	0	0	0	0	1362	3506	Sisma X SLV	316.9	0	0	0	0	0
1363	3506	Sisma Y SLV	0	316.9	0	0	0	0	1364	3506	Sisma X SLD	145.5	0	0	0	0	0
1365	3506	Sisma Y SLD	0	145.5	0	0	0	0	1366	3507	Sisma X SLV	316.9	0	0	0	0	0
1367	3507	Sisma Y SLV	0	316.9	0	0	0	0	1368	3507	Sisma X SLD	145.5	0	0	0	0	0
1369	3507	Sisma Y SLD	0	145.5	0	0	0	0	1370	3508	Sisma X SLV	336.4	0	0	0	0	0



Tabulati di Calcolo Plinto di Fondazione per Aerogeneratore Tipo - Progetto Impianto Eolico - "Orione"

Indice	Nodo	Condizione	Fx	Fy	Fz	Mx	My	Mz	Indice	Nodo	Condizione	Fx	Fy	Fz	Mx	My	Mz
1371	3508	Sisma Y SLV	0	336.4	0	0	0	0	1372	3508	Sisma X SLD	154.5	0	0	0	0	0
1373	3508	Sisma Y SLD	0	154.5	0	0	0	0	1374	3509	Sisma X SLV	336.4	0	0	0	0	0
1375	3509	Sisma Y SLV	0	336.4	0	0	0	0	1376	3509	Sisma X SLD	154.5	0	0	0	0	0
1377	3509	Sisma Y SLD	0	154.5	0	0	0	0	1378	3510	Sisma X SLV	316.9	0	0	0	0	0
1379	3510	Sisma Y SLV	0	316.9	0	0	0	0	1380	3510	Sisma X SLD	145.5	0	0	0	0	0
1381	3510	Sisma Y SLD	0	145.5	0	0	0	0	1382	3511	Sisma X SLV	316.9	0	0	0	0	0
1383	3511	Sisma Y SLV	0	316.9	0	0	0	0	1384	3511	Sisma X SLD	145.5	0	0	0	0	0
1385	3511	Sisma Y SLD	0	145.5	0	0	0	0	1386	3512	Sisma X SLV	316.9	0	0	0	0	0
1387	3512	Sisma Y SLV	0	316.9	0	0	0	0	1388	3512	Sisma X SLD	145.5	0	0	0	0	0
1389	3512	Sisma Y SLD	0	145.5	0	0	0	0	1390	3513	Sisma X SLV	316.9	0	0	0	0	0
1391	3513	Sisma Y SLV	0	316.9	0	0	0	0	1392	3513	Sisma X SLD	145.5	0	0	0	0	0
1393	3513	Sisma Y SLD	0	145.5	0	0	0	0	1394	3514	Sisma X SLV	336.4	0	0	0	0	0
1395	3514	Sisma Y SLV	0	336.4	0	0	0	0	1396	3514	Sisma X SLD	154.5	0	0	0	0	0
1397	3514	Sisma Y SLD	0	154.5	0	0	0	0	1398	3515	Sisma X SLV	336.4	0	0	0	0	0
1399	3515	Sisma Y SLV	0	336.4	0	0	0	0	1400	3515	Sisma X SLD	154.5	0	0	0	0	0
1401	3515	Sisma Y SLD	0	154.5	0	0	0	0	1402	3516	Sisma X SLV	316.9	0	0	0	0	0
1403	3516	Sisma Y SLV	0	316.9	0	0	0	0	1404	3516	Sisma X SLD	145.5	0	0	0	0	0
1405	3516	Sisma Y SLD	0	145.5	0	0	0	0	1406	3517	Sisma X SLV	316.9	0	0	0	0	0
1407	3517	Sisma Y SLV	0	316.9	0	0	0	0	1408	3517	Sisma X SLD	145.5	0	0	0	0	0
1409	3517	Sisma Y SLD	0	145.5	0	0	0	0	1410	3518	Sisma X SLV	316.9	0	0	0	0	0
1411	3518	Sisma Y SLV	0	316.9	0	0	0	0	1412	3518	Sisma X SLD	145.5	0	0	0	0	0
1413	3518	Sisma Y SLD	0	145.5	0	0	0	0	1414	3519	Sisma X SLV	316.9	0	0	0	0	0
1415	3519	Sisma Y SLV	0	316.9	0	0	0	0	1416	3519	Sisma X SLD	145.5	0	0	0	0	0
1417	3519	Sisma Y SLD	0	145.5	0	0	0	0	1418	3520	Sisma X SLV	336.4	0	0	0	0	0
1419	3520	Sisma Y SLV	0	336.4	0	0	0	0	1420	3520	Sisma X SLD	154.5	0	0	0	0	0
1421	3520	Sisma Y SLD	0	154.5	0	0	0	0	1422	3521	Sisma X SLV	336.4	0	0	0	0	0
1423	3521	Sisma Y SLV	0	336.4	0	0	0	0	1424	3521	Sisma X SLD	154.5	0	0	0	0	0
1425	3521	Sisma Y SLD	0	154.5	0	0	0	0	1426	3522	Sisma X SLV	316.9	0	0	0	0	0
1427	3522	Sisma Y SLV	0	316.9	0	0	0	0	1428	3522	Sisma X SLD	145.5	0	0	0	0	0
1429	3522	Sisma Y SLD	0	145.5	0	0	0	0	1430	3523	Sisma X SLV	316.9	0	0	0	0	0
1431	3523	Sisma Y SLV	0	316.9	0	0	0	0	1432	3523	Sisma X SLD	145.5	0	0	0	0	0
1433	3523	Sisma Y SLD	0	145.5	0	0	0	0	1434	3524	Sisma X SLV	316.9	0	0	0	0	0
1435	3524	Sisma Y SLV	0	316.9	0	0	0	0	1436	3524	Sisma X SLD	145.5	0	0	0	0	0
1437	3524	Sisma Y SLD	0	145.5	0	0	0	0	1438	3525	Sisma X SLV	316.9	0	0	0	0	0
1439	3525	Sisma Y SLV	0	316.9	0	0	0	0	1440	3525	Sisma X SLD	145.5	0	0	0	0	0
1441	3525	Sisma Y SLD	0	145.5	0	0	0	0	1442	3526	Sisma X SLV	336.4	0	0	0	0	0
1443	3526	Sisma Y SLV	0	336.4	0	0	0	0	1444	3526	Sisma X SLD	154.5	0	0	0	0	0
1445	3526	Sisma Y SLD	0	154.5	0	0	0	0	1446	3527	Sisma X SLV	336.4	0	0	0	0	0
1447	3527	Sisma Y SLV	0	336.4	0	0	0	0	1448	3527	Sisma X SLD	154.5	0	0	0	0	0
1449	3527	Sisma Y SLD	0	154.5	0	0	0	0	1450	3528	Sisma X SLV	316.9	0	0	0	0	0
1451	3528	Sisma Y SLV	0	316.9	0	0	0	0	1452	3528	Sisma X SLD	145.5	0	0	0	0	0
1453	3528	Sisma Y SLD	0	145.5	0	0	0	0	1454	3529	Sisma X SLV	316.9	0	0	0	0	0
1455	3529	Sisma Y SLV	0	316.9	0	0	0	0	1456	3529	Sisma X SLD	145.5	0	0	0	0	0
1457	3529	Sisma Y SLD	0	145.5	0	0	0	0	1458	3530	Sisma X SLV	316.9	0	0	0	0	0
1459	3530	Sisma Y SLV	0	316.9	0	0	0	0	1460	3530	Sisma X SLD	145.5	0	0	0	0	0
1461	3530	Sisma Y SLD	0	145.5	0	0	0	0	1462	3531	Sisma X SLV	316.9	0	0	0	0	0
1463	3531	Sisma Y SLV	0	316.9	0	0	0	0	1464	3531	Sisma X SLD	145.5	0	0	0	0	0
1465	3531	Sisma Y SLD	0	145.5	0	0	0	0	1466	3532	Sisma X SLV	316.9	0	0	0	0	0
1467	3532	Sisma Y SLV	0	316.9	0	0	0	0	1468	3532	Sisma X SLD	145.5	0	0	0	0	0
1469	3532	Sisma Y SLD	0	145.5	0	0	0	0	1470	3533	Sisma X SLV	316.9	0	0	0	0	0



Tabulati di Calcolo Plinto di Fondazione per Aerogeneratore Tipo - Progetto Impianto Eolico - "Orione"

Indice	Nodo	Condizione	Fx	Fy	Fz	Mx	My	Mz	Indice	Nodo	Condizione	Fx	Fy	Fz	Mx	My	Mz
1471	3533	Sisma Y SLV	0	316.9	0	0	0	0	1472	3533	Sisma X SLD	145.5	0	0	0	0	0
1473	3533	Sisma Y SLD	0	145.5	0	0	0	0	1474	3534	Sisma X SLV	336.4	0	0	0	0	0
1475	3534	Sisma Y SLV	0	336.4	0	0	0	0	1476	3534	Sisma X SLD	154.5	0	0	0	0	0
1477	3534	Sisma Y SLD	0	154.5	0	0	0	0	1478	3535	Sisma X SLV	316.9	0	0	0	0	0
1479	3535	Sisma Y SLV	0	316.9	0	0	0	0	1480	3535	Sisma X SLD	145.5	0	0	0	0	0
1481	3535	Sisma Y SLD	0	145.5	0	0	0	0	1482	3536	Sisma X SLV	316.9	0	0	0	0	0
1483	3536	Sisma Y SLV	0	316.9	0	0	0	0	1484	3536	Sisma X SLD	145.5	0	0	0	0	0
1485	3536	Sisma Y SLD	0	145.5	0	0	0	0	1486	3537	Sisma X SLV	336.4	0	0	0	0	0
1487	3537	Sisma Y SLV	0	336.4	0	0	0	0	1488	3537	Sisma X SLD	154.5	0	0	0	0	0
1489	3537	Sisma Y SLD	0	154.5	0	0	0	0	1490	3538	Sisma X SLV	316.9	0	0	0	0	0
1491	3538	Sisma Y SLV	0	316.9	0	0	0	0	1492	3538	Sisma X SLD	145.5	0	0	0	0	0
1493	3538	Sisma Y SLD	0	145.5	0	0	0	0	1494	3539	Sisma X SLV	316.9	0	0	0	0	0
1495	3539	Sisma Y SLV	0	316.9	0	0	0	0	1496	3539	Sisma X SLD	145.5	0	0	0	0	0
1497	3539	Sisma Y SLD	0	145.5	0	0	0	0	1498	3540	Sisma X SLV	316.9	0	0	0	0	0
1499	3540	Sisma Y SLV	0	316.9	0	0	0	0	1500	3540	Sisma X SLD	145.5	0	0	0	0	0
1501	3540	Sisma Y SLD	0	145.5	0	0	0	0	1502	3541	Sisma X SLV	316.9	0	0	0	0	0
1503	3541	Sisma Y SLV	0	316.9	0	0	0	0	1504	3541	Sisma X SLD	145.5	0	0	0	0	0
1505	3541	Sisma Y SLD	0	145.5	0	0	0	0	1506	3542	Sisma X SLV	316.9	0	0	0	0	0
1507	3542	Sisma Y SLV	0	316.9	0	0	0	0	1508	3542	Sisma X SLD	145.5	0	0	0	0	0
1509	3542	Sisma Y SLD	0	145.5	0	0	0	0	1510	3543	Sisma X SLV	336.4	0	0	0	0	0
1511	3543	Sisma Y SLV	0	336.4	0	0	0	0	1512	3543	Sisma X SLD	154.5	0	0	0	0	0
1513	3543	Sisma Y SLD	0	154.5	0	0	0	0	1514	3544	Sisma X SLV	336.4	0	0	0	0	0
1515	3544	Sisma Y SLV	0	336.4	0	0	0	0	1516	3544	Sisma X SLD	154.5	0	0	0	0	0
1517	3544	Sisma Y SLD	0	154.5	0	0	0	0	1518	3545	Sisma X SLV	336.4	0	0	0	0	0
1519	3545	Sisma Y SLV	0	336.4	0	0	0	0	1520	3545	Sisma X SLD	154.5	0	0	0	0	0
1521	3545	Sisma Y SLD	0	154.5	0	0	0	0	1522	3546	Sisma X SLV	336.4	0	0	0	0	0
1523	3546	Sisma Y SLV	0	336.4	0	0	0	0	1524	3546	Sisma X SLD	154.5	0	0	0	0	0
1525	3546	Sisma Y SLD	0	154.5	0	0	0	0	1526	3547	Sisma X SLV	336.4	0	0	0	0	0
1527	3547	Sisma Y SLV	0	336.4	0	0	0	0	1528	3547	Sisma X SLD	154.5	0	0	0	0	0
1529	3547	Sisma Y SLD	0	154.5	0	0	0	0	1530	3548	Sisma X SLV	336.4	0	0	0	0	0
1531	3548	Sisma Y SLV	0	336.4	0	0	0	0	1532	3548	Sisma X SLD	154.5	0	0	0	0	0
1533	3548	Sisma Y SLD	0	154.5	0	0	0	0	1534	3549	Sisma X SLV	336.4	0	0	0	0	0
1535	3549	Sisma Y SLV	0	336.4	0	0	0	0	1536	3549	Sisma X SLD	154.5	0	0	0	0	0
1537	3549	Sisma Y SLD	0	154.5	0	0	0	0	1538	3550	Sisma X SLV	336.4	0	0	0	0	0
1539	3550	Sisma Y SLV	0	336.4	0	0	0	0	1540	3550	Sisma X SLD	154.5	0	0	0	0	0
1541	3550	Sisma Y SLD	0	154.5	0	0	0	0	1542	3551	Sisma X SLV	336.4	0	0	0	0	0
1543	3551	Sisma Y SLV	0	336.4	0	0	0	0	1544	3551	Sisma X SLD	154.5	0	0	0	0	0
1545	3551	Sisma Y SLD	0	154.5	0	0	0	0	1546	3552	Sisma X SLV	336.4	0	0	0	0	0
1547	3552	Sisma Y SLV	0	336.4	0	0	0	0	1548	3552	Sisma X SLD	154.5	0	0	0	0	0
1549	3552	Sisma Y SLD	0	154.5	0	0	0	0	1550	3553	Sisma X SLV	336.4	0	0	0	0	0
1551	3553	Sisma Y SLV	0	336.4	0	0	0	0	1552	3553	Sisma X SLD	154.5	0	0	0	0	0
1553	3553	Sisma Y SLD	0	154.5	0	0	0	0	1554	3554	Sisma X SLV	336.4	0	0	0	0	0
1555	3554	Sisma Y SLV	0	336.4	0	0	0	0	1556	3554	Sisma X SLD	154.5	0	0	0	0	0
1557	3554	Sisma Y SLD	0	154.5	0	0	0	0	1558	3555	Sisma X SLV	336.4	0	0	0	0	0
1559	3555	Sisma Y SLV	0	336.4	0	0	0	0	1560	3555	Sisma X SLD	154.5	0	0	0	0	0
1561	3555	Sisma Y SLD	0	154.5	0	0	0	0	1562	3556	Sisma X SLV	336.4	0	0	0	0	0
1563	3556	Sisma Y SLV	0	336.4	0	0	0	0	1564	3556	Sisma X SLD	154.5	0	0	0	0	0
1565	3556	Sisma Y SLD	0	154.5	0	0	0	0	1566	3557	Sisma X SLV	336.4	0	0	0	0	0
1567	3557	Sisma Y SLV	0	336.4	0	0	0	0	1568	3557	Sisma X SLD	154.5	0	0	0	0	0
1569	3557	Sisma Y SLD	0	154.5	0	0	0	0	1570	3558	Sisma X SLV	336.4	0	0	0	0	0



Tabulati di Calcolo Plinto di Fondazione per Aerogeneratore Tipo - Progetto Impianto Eolico - "Orione"

Indice	Nodo	Condizione	Fx	Fy	Fz	Mx	My	Mz	Indice	Nodo	Condizione	Fx	Fy	Fz	Mx	My	Mz
1571	3558	Sisma Y SLV	0	336.4	0	0	0	0	1572	3558	Sisma X SLD	154.5	0	0	0	0	0
1573	3558	Sisma Y SLD	0	154.5	0	0	0	0	1574	3559	Sisma X SLV	336.4	0	0	0	0	0
1575	3559	Sisma Y SLV	0	336.4	0	0	0	0	1576	3559	Sisma X SLD	154.5	0	0	0	0	0
1577	3559	Sisma Y SLD	0	154.5	0	0	0	0	1578	3560	Sisma X SLV	336.4	0	0	0	0	0
1579	3560	Sisma Y SLV	0	336.4	0	0	0	0	1580	3560	Sisma X SLD	154.5	0	0	0	0	0
1581	3560	Sisma Y SLD	0	154.5	0	0	0	0	1582	3561	Sisma X SLV	336.4	0	0	0	0	0
1583	3561	Sisma Y SLV	0	336.4	0	0	0	0	1584	3561	Sisma X SLD	154.5	0	0	0	0	0
1585	3561	Sisma Y SLD	0	154.5	0	0	0	0	1586	3562	Sisma X SLV	336.4	0	0	0	0	0
1587	3562	Sisma Y SLV	0	336.4	0	0	0	0	1588	3562	Sisma X SLD	154.5	0	0	0	0	0
1589	3562	Sisma Y SLD	0	154.5	0	0	0	0	1590	3563	Sisma X SLV	336.4	0	0	0	0	0
1591	3563	Sisma Y SLV	0	336.4	0	0	0	0	1592	3563	Sisma X SLD	154.5	0	0	0	0	0
1593	3563	Sisma Y SLD	0	154.5	0	0	0	0	1594	3564	Sisma X SLV	336.4	0	0	0	0	0
1595	3564	Sisma Y SLV	0	336.4	0	0	0	0	1596	3564	Sisma X SLD	154.5	0	0	0	0	0
1597	3564	Sisma Y SLD	0	154.5	0	0	0	0	1598	3565	Sisma X SLV	336.4	0	0	0	0	0
1599	3565	Sisma Y SLV	0	336.4	0	0	0	0	1600	3565	Sisma X SLD	154.5	0	0	0	0	0
1601	3565	Sisma Y SLD	0	154.5	0	0	0	0	1602	3566	Sisma X SLV	336.4	0	0	0	0	0
1603	3566	Sisma Y SLV	0	336.4	0	0	0	0	1604	3566	Sisma X SLD	154.5	0	0	0	0	0
1605	3566	Sisma Y SLD	0	154.5	0	0	0	0	1606	3567	Sisma X SLV	336.4	0	0	0	0	0
1607	3567	Sisma Y SLV	0	336.4	0	0	0	0	1608	3567	Sisma X SLD	154.5	0	0	0	0	0
1609	3567	Sisma Y SLD	0	154.5	0	0	0	0	1610	3568	Sisma X SLV	367.6	0	0	0	0	0
1611	3568	Sisma Y SLV	0	367.6	0	0	0	0	1612	3568	Sisma X SLD	168.8	0	0	0	0	0
1613	3568	Sisma Y SLD	0	168.8	0	0	0	0	1614	3569	Sisma X SLV	367.6	0	0	0	0	0
1615	3569	Sisma Y SLV	0	367.6	0	0	0	0	1616	3569	Sisma X SLD	168.8	0	0	0	0	0
1617	3569	Sisma Y SLD	0	168.8	0	0	0	0	1618	3570	Sisma X SLV	367.6	0	0	0	0	0
1619	3570	Sisma Y SLV	0	367.6	0	0	0	0	1620	3570	Sisma X SLD	168.8	0	0	0	0	0
1621	3570	Sisma Y SLD	0	168.8	0	0	0	0	1622	3571	Sisma X SLV	367.6	0	0	0	0	0
1623	3571	Sisma Y SLV	0	367.6	0	0	0	0	1624	3571	Sisma X SLD	168.8	0	0	0	0	0
1625	3571	Sisma Y SLD	0	168.8	0	0	0	0	1626	3572	Sisma X SLV	367.6	0	0	0	0	0
1627	3572	Sisma Y SLV	0	367.6	0	0	0	0	1628	3572	Sisma X SLD	168.8	0	0	0	0	0
1629	3572	Sisma Y SLD	0	168.8	0	0	0	0	1630	3573	Sisma X SLV	367.6	0	0	0	0	0
1631	3573	Sisma Y SLV	0	367.6	0	0	0	0	1632	3573	Sisma X SLD	168.8	0	0	0	0	0
1633	3573	Sisma Y SLD	0	168.8	0	0	0	0	1634	3574	Sisma X SLV	367.6	0	0	0	0	0
1635	3574	Sisma Y SLV	0	367.6	0	0	0	0	1636	3574	Sisma X SLD	168.8	0	0	0	0	0
1637	3574	Sisma Y SLD	0	168.8	0	0	0	0	1638	3575	Sisma X SLV	367.6	0	0	0	0	0
1639	3575	Sisma Y SLV	0	367.6	0	0	0	0	1640	3575	Sisma X SLD	168.8	0	0	0	0	0
1641	3575	Sisma Y SLD	0	168.8	0	0	0	0	1642	3576	Sisma X SLV	367.6	0	0	0	0	0
1643	3576	Sisma Y SLV	0	367.6	0	0	0	0	1644	3576	Sisma X SLD	168.8	0	0	0	0	0
1645	3576	Sisma Y SLD	0	168.8	0	0	0	0	1646	3577	Sisma X SLV	367.6	0	0	0	0	0
1647	3577	Sisma Y SLV	0	367.6	0	0	0	0	1648	3577	Sisma X SLD	168.8	0	0	0	0	0
1649	3577	Sisma Y SLD	0	168.8	0	0	0	0	1650	3578	Sisma X SLV	367.6	0	0	0	0	0
1651	3578	Sisma Y SLV	0	367.6	0	0	0	0	1652	3578	Sisma X SLD	168.8	0	0	0	0	0
1653	3578	Sisma Y SLD	0	168.8	0	0	0	0	1654	3579	Sisma X SLV	367.6	0	0	0	0	0
1655	3579	Sisma Y SLV	0	367.6	0	0	0	0	1656	3579	Sisma X SLD	168.8	0	0	0	0	0
1657	3579	Sisma Y SLD	0	168.8	0	0	0	0	1658	3580	Sisma X SLV	367.6	0	0	0	0	0
1659	3580	Sisma Y SLV	0	367.6	0	0	0	0	1660	3580	Sisma X SLD	168.8	0	0	0	0	0
1661	3580	Sisma Y SLD	0	168.8	0	0	0	0	1662	3581	Sisma X SLV	367.6	0	0	0	0	0
1663	3581	Sisma Y SLV	0	367.6	0	0	0	0	1664	3581	Sisma X SLD	168.8	0	0	0	0	0
1665	3581	Sisma Y SLD	0	168.8	0	0	0	0	1666	3582	Sisma X SLV	367.6	0	0	0	0	0
1667	3582	Sisma Y SLV	0	367.6	0	0	0	0	1668	3582	Sisma X SLD	168.8	0	0	0	0	0
1669	3582	Sisma Y SLD	0	168.8	0	0	0	0	1670	3583	Sisma X SLV	367.6	0	0	0	0	0



Tabulati di Calcolo Plinto di Fondazione per Aerogeneratore Tipo - Progetto Impianto Eolico - "Orione"

Indice	Nodo	Condizione	Fx	Fy	Fz	Mx	My	Mz	Indice	Nodo	Condizione	Fx	Fy	Fz	Mx	My	Mz
1671	3583	Sisma Y SLV	0	367.6	0	0	0	0	1672	3583	Sisma X SLD	168.8	0	0	0	0	0
1673	3583	Sisma Y SLD	0	168.8	0	0	0	0	1674	3584	Sisma X SLV	367.6	0	0	0	0	0
1675	3584	Sisma Y SLV	0	367.6	0	0	0	0	1676	3584	Sisma X SLD	168.8	0	0	0	0	0
1677	3584	Sisma Y SLD	0	168.8	0	0	0	0	1678	3585	Sisma X SLV	367.6	0	0	0	0	0
1679	3585	Sisma Y SLV	0	367.6	0	0	0	0	1680	3585	Sisma X SLD	168.8	0	0	0	0	0
1681	3585	Sisma Y SLD	0	168.8	0	0	0	0	1682	3586	Sisma X SLV	367.6	0	0	0	0	0
1683	3586	Sisma Y SLV	0	367.6	0	0	0	0	1684	3586	Sisma X SLD	168.8	0	0	0	0	0
1685	3586	Sisma Y SLD	0	168.8	0	0	0	0	1686	3587	Sisma X SLV	367.6	0	0	0	0	0
1687	3587	Sisma Y SLV	0	367.6	0	0	0	0	1688	3587	Sisma X SLD	168.8	0	0	0	0	0
1689	3587	Sisma Y SLD	0	168.8	0	0	0	0	1690	3588	Sisma X SLV	367.6	0	0	0	0	0
1691	3588	Sisma Y SLV	0	367.6	0	0	0	0	1692	3588	Sisma X SLD	168.8	0	0	0	0	0
1693	3588	Sisma Y SLD	0	168.8	0	0	0	0	1694	3589	Sisma X SLV	367.6	0	0	0	0	0
1695	3589	Sisma Y SLV	0	367.6	0	0	0	0	1696	3589	Sisma X SLD	168.8	0	0	0	0	0
1697	3589	Sisma Y SLD	0	168.8	0	0	0	0	1698	3590	Sisma X SLV	367.6	0	0	0	0	0
1699	3590	Sisma Y SLV	0	367.6	0	0	0	0	1700	3590	Sisma X SLD	168.8	0	0	0	0	0
1701	3590	Sisma Y SLD	0	168.8	0	0	0	0	1702	3591	Sisma X SLV	367.6	0	0	0	0	0
1703	3591	Sisma Y SLV	0	367.6	0	0	0	0	1704	3591	Sisma X SLD	168.8	0	0	0	0	0
1705	3591	Sisma Y SLD	0	168.8	0	0	0	0	1706	3592	Sisma X SLV	367.6	0	0	0	0	0
1707	3592	Sisma Y SLV	0	367.6	0	0	0	0	1708	3592	Sisma X SLD	168.8	0	0	0	0	0
1709	3592	Sisma Y SLD	0	168.8	0	0	0	0	1710	3593	Sisma X SLV	367.6	0	0	0	0	0
1711	3593	Sisma Y SLV	0	367.6	0	0	0	0	1712	3593	Sisma X SLD	168.8	0	0	0	0	0
1713	3593	Sisma Y SLD	0	168.8	0	0	0	0	1714	3594	Sisma X SLV	367.6	0	0	0	0	0
1715	3594	Sisma Y SLV	0	367.6	0	0	0	0	1716	3594	Sisma X SLD	168.8	0	0	0	0	0
1717	3594	Sisma Y SLD	0	168.8	0	0	0	0	1718	3595	Sisma X SLV	367.6	0	0	0	0	0
1719	3595	Sisma Y SLV	0	367.6	0	0	0	0	1720	3595	Sisma X SLD	168.8	0	0	0	0	0
1721	3595	Sisma Y SLD	0	168.8	0	0	0	0	1722	3596	Sisma X SLV	367.6	0	0	0	0	0
1723	3596	Sisma Y SLV	0	367.6	0	0	0	0	1724	3596	Sisma X SLD	168.8	0	0	0	0	0
1725	3596	Sisma Y SLD	0	168.8	0	0	0	0	1726	3597	Sisma X SLV	367.6	0	0	0	0	0
1727	3597	Sisma Y SLV	0	367.6	0	0	0	0	1728	3597	Sisma X SLD	168.8	0	0	0	0	0
1729	3597	Sisma Y SLD	0	168.8	0	0	0	0	1730	3598	Sisma X SLV	367.6	0	0	0	0	0
1731	3598	Sisma Y SLV	0	367.6	0	0	0	0	1732	3598	Sisma X SLD	168.8	0	0	0	0	0
1733	3598	Sisma Y SLD	0	168.8	0	0	0	0	1734	3599	Sisma X SLV	367.6	0	0	0	0	0
1735	3599	Sisma Y SLV	0	367.6	0	0	0	0	1736	3599	Sisma X SLD	168.8	0	0	0	0	0
1737	3599	Sisma Y SLD	0	168.8	0	0	0	0	1738	3600	Sisma X SLV	367.6	0	0	0	0	0
1739	3600	Sisma Y SLV	0	367.6	0	0	0	0	1740	3600	Sisma X SLD	168.8	0	0	0	0	0
1741	3600	Sisma Y SLD	0	168.8	0	0	0	0	1742	3601	Sisma X SLV	367.6	0	0	0	0	0
1743	3601	Sisma Y SLV	0	367.6	0	0	0	0	1744	3601	Sisma X SLD	168.8	0	0	0	0	0
1745	3601	Sisma Y SLD	0	168.8	0	0	0	0	1746	3602	Sisma X SLV	367.6	0	0	0	0	0
1747	3602	Sisma Y SLV	0	367.6	0	0	0	0	1748	3602	Sisma X SLD	168.8	0	0	0	0	0
1749	3602	Sisma Y SLD	0	168.8	0	0	0	0	1750	3603	Sisma X SLV	367.6	0	0	0	0	0
1751	3603	Sisma Y SLV	0	367.6	0	0	0	0	1752	3603	Sisma X SLD	168.8	0	0	0	0	0
1753	3603	Sisma Y SLD	0	168.8	0	0	0	0	1754	3604	Sisma X SLV	753.6	0	0	0	0	0
1755	3604	Sisma Y SLV	0	753.6	0	0	0	0	1756	3604	Sisma X SLD	346	0	0	0	0	0
1757	3604	Sisma Y SLD	0	346	0	0	0	0	1758	3605	Sisma X SLV	753.6	0	0	0	0	0
1759	3605	Sisma Y SLV	0	753.6	0	0	0	0	1760	3605	Sisma X SLD	346	0	0	0	0	0
1761	3605	Sisma Y SLD	0	346	0	0	0	0	1762	3606	Sisma X SLV	753.6	0	0	0	0	0
1763	3606	Sisma Y SLV	0	753.6	0	0	0	0	1764	3606	Sisma X SLD	346	0	0	0	0	0
1765	3606	Sisma Y SLD	0	346	0	0	0	0	1766	3607	Sisma X SLV	753.6	0	0	0	0	0
1767	3607	Sisma Y SLV	0	753.6	0	0	0	0	1768	3607	Sisma X SLD	346	0	0	0	0	0
1769	3607	Sisma Y SLD	0	346	0	0	0	0	1770	3608	Sisma X SLV	753.6	0	0	0	0	0



Tabulati di Calcolo Plinto di Fondazione per Aerogeneratore Tipo - Progetto Impianto Eolico - "Orione"

Indice	Nodo	Condizione	Fx	Fy	Fz	Mx	My	Mz	Indice	Nodo	Condizione	Fx	Fy	Fz	Mx	My	Mz
1771	3608	Sisma Y SLV	0	753.6	0	0	0	0	1772	3608	Sisma X SLD	346	0	0	0	0	0
1773	3608	Sisma Y SLD	0	346	0	0	0	0	1774	3609	Sisma X SLV	753.6	0	0	0	0	0
1775	3609	Sisma Y SLV	0	753.6	0	0	0	0	1776	3609	Sisma X SLD	346	0	0	0	0	0
1777	3609	Sisma Y SLD	0	346	0	0	0	0	1778	3610	Sisma X SLV	753.6	0	0	0	0	0
1779	3610	Sisma Y SLV	0	753.6	0	0	0	0	1780	3610	Sisma X SLD	346	0	0	0	0	0
1781	3610	Sisma Y SLD	0	346	0	0	0	0	1782	3611	Sisma X SLV	753.6	0	0	0	0	0
1783	3611	Sisma Y SLV	0	753.6	0	0	0	0	1784	3611	Sisma X SLD	346	0	0	0	0	0
1785	3611	Sisma Y SLD	0	346	0	0	0	0	1786	3612	Sisma X SLV	753.6	0	0	0	0	0
1787	3612	Sisma Y SLV	0	753.6	0	0	0	0	1788	3612	Sisma X SLD	346	0	0	0	0	0
1789	3612	Sisma Y SLD	0	346	0	0	0	0	1790	3613	Sisma X SLV	753.6	0	0	0	0	0
1791	3613	Sisma Y SLV	0	753.6	0	0	0	0	1792	3613	Sisma X SLD	346	0	0	0	0	0
1793	3613	Sisma Y SLD	0	346	0	0	0	0	1794	3614	Sisma X SLV	753.6	0	0	0	0	0
1795	3614	Sisma Y SLV	0	753.6	0	0	0	0	1796	3614	Sisma X SLD	346	0	0	0	0	0
1797	3614	Sisma Y SLD	0	346	0	0	0	0	1798	3615	Sisma X SLV	753.6	0	0	0	0	0
1799	3615	Sisma Y SLV	0	753.6	0	0	0	0	1800	3615	Sisma X SLD	346	0	0	0	0	0
1801	3615	Sisma Y SLD	0	346	0	0	0	0	1802	3616	Sisma X SLV	753.6	0	0	0	0	0
1803	3616	Sisma Y SLV	0	753.6	0	0	0	0	1804	3616	Sisma X SLD	346	0	0	0	0	0
1805	3616	Sisma Y SLD	0	346	0	0	0	0	1806	3617	Sisma X SLV	753.6	0	0	0	0	0
1807	3617	Sisma Y SLV	0	753.6	0	0	0	0	1808	3617	Sisma X SLD	346	0	0	0	0	0
1809	3617	Sisma Y SLD	0	346	0	0	0	0	1810	3618	Sisma X SLV	753.6	0	0	0	0	0
1811	3618	Sisma Y SLV	0	753.6	0	0	0	0	1812	3618	Sisma X SLD	346	0	0	0	0	0
1813	3618	Sisma Y SLD	0	346	0	0	0	0	1814	3619	Sisma X SLV	753.6	0	0	0	0	0
1815	3619	Sisma Y SLV	0	753.6	0	0	0	0	1816	3619	Sisma X SLD	346	0	0	0	0	0
1817	3619	Sisma Y SLD	0	346	0	0	0	0	1818	3620	Sisma X SLV	753.6	0	0	0	0	0
1819	3620	Sisma Y SLV	0	753.6	0	0	0	0	1820	3620	Sisma X SLD	346	0	0	0	0	0
1821	3620	Sisma Y SLD	0	346	0	0	0	0	1822	3621	Sisma X SLV	753.6	0	0	0	0	0
1823	3621	Sisma Y SLV	0	753.6	0	0	0	0	1824	3621	Sisma X SLD	346	0	0	0	0	0
1825	3621	Sisma Y SLD	0	346	0	0	0	0	1826	3622	Sisma X SLV	753.6	0	0	0	0	0
1827	3622	Sisma Y SLV	0	753.6	0	0	0	0	1828	3622	Sisma X SLD	346	0	0	0	0	0
1829	3622	Sisma Y SLD	0	346	0	0	0	0	1830	3623	Sisma X SLV	753.6	0	0	0	0	0
1831	3623	Sisma Y SLV	0	753.6	0	0	0	0	1832	3623	Sisma X SLD	346	0	0	0	0	0
1833	3623	Sisma Y SLD	0	346	0	0	0	0	1834	3624	Sisma X SLV	753.6	0	0	0	0	0
1835	3624	Sisma Y SLV	0	753.6	0	0	0	0	1836	3624	Sisma X SLD	346	0	0	0	0	0
1837	3624	Sisma Y SLD	0	346	0	0	0	0	1838	3625	Sisma X SLV	753.6	0	0	0	0	0
1839	3625	Sisma Y SLV	0	753.6	0	0	0	0	1840	3625	Sisma X SLD	346	0	0	0	0	0
1841	3625	Sisma Y SLD	0	346	0	0	0	0	1842	3626	Sisma X SLV	753.6	0	0	0	0	0
1843	3626	Sisma Y SLV	0	753.6	0	0	0	0	1844	3626	Sisma X SLD	346	0	0	0	0	0
1845	3626	Sisma Y SLD	0	346	0	0	0	0	1846	3627	Sisma X SLV	753.6	0	0	0	0	0
1847	3627	Sisma Y SLV	0	753.6	0	0	0	0	1848	3627	Sisma X SLD	346	0	0	0	0	0
1849	3627	Sisma Y SLD	0	346	0	0	0	0	1850	3628	Sisma X SLV	753.6	0	0	0	0	0
1851	3628	Sisma Y SLV	0	753.6	0	0	0	0	1852	3628	Sisma X SLD	346	0	0	0	0	0
1853	3628	Sisma Y SLD	0	346	0	0	0	0	1854	3629	Sisma X SLV	753.6	0	0	0	0	0
1855	3629	Sisma Y SLV	0	753.6	0	0	0	0	1856	3629	Sisma X SLD	346	0	0	0	0	0
1857	3629	Sisma Y SLD	0	346	0	0	0	0	1858	3630	Sisma X SLV	753.6	0	0	0	0	0
1859	3630	Sisma Y SLV	0	753.6	0	0	0	0	1860	3630	Sisma X SLD	346	0	0	0	0	0
1861	3630	Sisma Y SLD	0	346	0	0	0	0	1862	3631	Sisma X SLV	753.6	0	0	0	0	0
1863	3631	Sisma Y SLV	0	753.6	0	0	0	0	1864	3631	Sisma X SLD	346	0	0	0	0	0
1865	3631	Sisma Y SLD	0	346	0	0	0	0	1866	3632	Sisma X SLV	753.6	0	0	0	0	0
1867	3632	Sisma Y SLV	0	753.6	0	0	0	0	1868	3632	Sisma X SLD	346	0	0	0	0	0
1869	3632	Sisma Y SLD	0	346	0	0	0	0	1870	3633	Sisma X SLV	753.6	0	0	0	0	0



Progetto	Titolo	Rev.	Pag.
Orione	Orione_A24a.pdf "TABULATI DI CALCOLO PLINTO DI FONDAZIONE PER AEROGENERATORE TIPO"	0	63



Tabulati di Calcolo Plinto di Fondazione per Aerogeneratore Tipo - Progetto Impianto Eolico - "Orione"

Indice	Nodo	Condizione	Fx	Fy	Fz	Mx	My	Mz	Indice	Nodo	Condizione	Fx	Fy	Fz	Mx	My	Mz
1871	3633	Sisma Y SLV	0	753.6	0	0	0	0	1872	3633	Sisma X SLD	346	0	0	0	0	0
1873	3633	Sisma Y SLD	0	346	0	0	0	0	1874	3634	Sisma X SLV	753.6	0	0	0	0	0
1875	3634	Sisma Y SLV	0	753.6	0	0	0	0	1876	3634	Sisma X SLD	346	0	0	0	0	0
1877	3634	Sisma Y SLD	0	346	0	0	0	0	1878	3635	Sisma X SLV	753.6	0	0	0	0	0
1879	3635	Sisma Y SLV	0	753.6	0	0	0	0	1880	3635	Sisma X SLD	346	0	0	0	0	0
1881	3635	Sisma Y SLD	0	346	0	0	0	0	1882	3636	Sisma X SLV	753.6	0	0	0	0	0
1883	3636	Sisma Y SLV	0	753.6	0	0	0	0	1884	3636	Sisma X SLD	346	0	0	0	0	0
1885	3636	Sisma Y SLD	0	346	0	0	0	0	1886	3637	Sisma X SLV	753.6	0	0	0	0	0
1887	3637	Sisma Y SLV	0	753.6	0	0	0	0	1888	3637	Sisma X SLD	346	0	0	0	0	0
1889	3637	Sisma Y SLD	0	346	0	0	0	0	1890	3638	Sisma X SLV	753.6	0	0	0	0	0
1891	3638	Sisma Y SLV	0	753.6	0	0	0	0	1892	3638	Sisma X SLD	346	0	0	0	0	0
1893	3638	Sisma Y SLD	0	346	0	0	0	0	1894	3639	Sisma X SLV	753.6	0	0	0	0	0
1895	3639	Sisma Y SLV	0	753.6	0	0	0	0	1896	3639	Sisma X SLD	346	0	0	0	0	0
1897	3639	Sisma Y SLD	0	346	0	0	0	0	1898	3640	Sisma X SLV	719.2	0	0	0	0	0
1899	3640	Sisma Y SLV	0	719.2	0	0	0	0	1900	3640	Sisma X SLD	330.2	0	0	0	0	0
1901	3640	Sisma Y SLD	0	330.2	0	0	0	0	1902	3641	Sisma X SLV	719.2	0	0	0	0	0
1903	3641	Sisma Y SLV	0	719.2	0	0	0	0	1904	3641	Sisma X SLD	330.2	0	0	0	0	0
1905	3641	Sisma Y SLD	0	330.2	0	0	0	0	1906	3642	Sisma X SLV	719.2	0	0	0	0	0
1907	3642	Sisma Y SLV	0	719.2	0	0	0	0	1908	3642	Sisma X SLD	330.2	0	0	0	0	0
1909	3642	Sisma Y SLD	0	330.2	0	0	0	0	1910	3643	Sisma X SLV	719.2	0	0	0	0	0
1911	3643	Sisma Y SLV	0	719.2	0	0	0	0	1912	3643	Sisma X SLD	330.2	0	0	0	0	0
1913	3643	Sisma Y SLD	0	330.2	0	0	0	0	1914	3644	Sisma X SLV	719.2	0	0	0	0	0
1915	3644	Sisma Y SLV	0	719.2	0	0	0	0	1916	3644	Sisma X SLD	330.2	0	0	0	0	0
1917	3644	Sisma Y SLD	0	330.2	0	0	0	0	1918	3645	Sisma X SLV	719.2	0	0	0	0	0
1919	3645	Sisma Y SLV	0	719.2	0	0	0	0	1920	3645	Sisma X SLD	330.2	0	0	0	0	0
1921	3645	Sisma Y SLD	0	330.2	0	0	0	0	1922	3646	Sisma X SLV	719.2	0	0	0	0	0
1923	3646	Sisma Y SLV	0	719.2	0	0	0	0	1924	3646	Sisma X SLD	330.2	0	0	0	0	0
1925	3646	Sisma Y SLD	0	330.2	0	0	0	0	1926	3647	Sisma X SLV	719.2	0	0	0	0	0
1927	3647	Sisma Y SLV	0	719.2	0	0	0	0	1928	3647	Sisma X SLD	330.2	0	0	0	0	0
1929	3647	Sisma Y SLD	0	330.2	0	0	0	0	1930	3648	Sisma X SLV	719.2	0	0	0	0	0
1931	3648	Sisma Y SLV	0	719.2	0	0	0	0	1932	3648	Sisma X SLD	330.2	0	0	0	0	0
1933	3648	Sisma Y SLD	0	330.2	0	0	0	0	1934	3649	Sisma X SLV	719.2	0	0	0	0	0
1935	3649	Sisma Y SLV	0	719.2	0	0	0	0	1936	3649	Sisma X SLD	330.2	0	0	0	0	0
1937	3649	Sisma Y SLD	0	330.2	0	0	0	0	1938	3650	Sisma X SLV	719.2	0	0	0	0	0
1939	3650	Sisma Y SLV	0	719.2	0	0	0	0	1940	3650	Sisma X SLD	330.2	0	0	0	0	0
1941	3650	Sisma Y SLD	0	330.2	0	0	0	0	1942	3651	Sisma X SLV	719.2	0	0	0	0	0
1943	3651	Sisma Y SLV	0	719.2	0	0	0	0	1944	3651	Sisma X SLD	330.2	0	0	0	0	0
1945	3651	Sisma Y SLD	0	330.2	0	0	0	0	1946	3652	Sisma X SLV	719.2	0	0	0	0	0
1947	3652	Sisma Y SLV	0	719.2	0	0	0	0	1948	3652	Sisma X SLD	330.2	0	0	0	0	0
1949	3652	Sisma Y SLD	0	330.2	0	0	0	0	1950	3653	Sisma X SLV	719.2	0	0	0	0	0
1951	3653	Sisma Y SLV	0	719.2	0	0	0	0	1952	3653	Sisma X SLD	330.2	0	0	0	0	0
1953	3653	Sisma Y SLD	0	330.2	0	0	0	0	1954	3654	Sisma X SLV	719.2	0	0	0	0	0
1955	3654	Sisma Y SLV	0	719.2	0	0	0	0	1956	3654	Sisma X SLD	330.2	0	0	0	0	0
1957	3654	Sisma Y SLD	0	330.2	0	0	0	0	1958	3655	Sisma X SLV	719.2	0	0	0	0	0
1959	3655	Sisma Y SLV	0	719.2	0	0	0	0	1960	3655	Sisma X SLD	330.2	0	0	0	0	0
1961	3655	Sisma Y SLD	0	330.2	0	0	0	0	1962	3656	Sisma X SLV	719.2	0	0	0	0	0
1963	3656	Sisma Y SLV	0	719.2	0	0	0	0	1964	3656	Sisma X SLD	330.2	0	0	0	0	0
1965	3656	Sisma Y SLD	0	330.2	0	0	0	0	1966	3657	Sisma X SLV	719.2	0	0	0	0	0
1967	3657	Sisma Y SLV	0	719.2	0	0	0	0	1968	3657	Sisma X SLD	330.2	0	0	0	0	0
1969	3657	Sisma Y SLD	0	330.2	0	0	0	0	1970	3658	Sisma X SLV	719.2	0	0	0	0	0



Tabulati di Calcolo Plinto di Fondazione per Aerogeneratore Tipo - Progetto Impianto Eolico - "Orione"

Indice	Nodo	Condizione	Fx	Fy	Fz	Mx	My	Mz	Indice	Nodo	Condizione	Fx	Fy	Fz	Mx	My	Mz
1971	3658	Sisma Y SLV	0	719.2	0	0	0	0	1972	3658	Sisma X SLD	330.2	0	0	0	0	0
1973	3658	Sisma Y SLD	0	330.2	0	0	0	0	1974	3659	Sisma X SLV	719.2	0	0	0	0	0
1975	3659	Sisma Y SLV	0	719.2	0	0	0	0	1976	3659	Sisma X SLD	330.2	0	0	0	0	0
1977	3659	Sisma Y SLD	0	330.2	0	0	0	0	1978	3660	Sisma X SLV	719.2	0	0	0	0	0
1979	3660	Sisma Y SLV	0	719.2	0	0	0	0	1980	3660	Sisma X SLD	330.2	0	0	0	0	0
1981	3660	Sisma Y SLD	0	330.2	0	0	0	0	1982	3661	Sisma X SLV	719.2	0	0	0	0	0
1983	3661	Sisma Y SLV	0	719.2	0	0	0	0	1984	3661	Sisma X SLD	330.2	0	0	0	0	0
1985	3661	Sisma Y SLD	0	330.2	0	0	0	0	1986	3662	Sisma X SLV	719.2	0	0	0	0	0
1987	3662	Sisma Y SLV	0	719.2	0	0	0	0	1988	3662	Sisma X SLD	330.2	0	0	0	0	0
1989	3662	Sisma Y SLD	0	330.2	0	0	0	0	1990	3663	Sisma X SLV	719.2	0	0	0	0	0
1991	3663	Sisma Y SLV	0	719.2	0	0	0	0	1992	3663	Sisma X SLD	330.2	0	0	0	0	0
1993	3663	Sisma Y SLD	0	330.2	0	0	0	0	1994	3664	Sisma X SLV	719.2	0	0	0	0	0
1995	3664	Sisma Y SLV	0	719.2	0	0	0	0	1996	3664	Sisma X SLD	330.2	0	0	0	0	0
1997	3664	Sisma Y SLD	0	330.2	0	0	0	0	1998	3665	Sisma X SLV	719.2	0	0	0	0	0
1999	3665	Sisma Y SLV	0	719.2	0	0	0	0	2000	3665	Sisma X SLD	330.2	0	0	0	0	0
2001	3665	Sisma Y SLD	0	330.2	0	0	0	0	2002	3666	Sisma X SLV	719.2	0	0	0	0	0
2003	3666	Sisma Y SLV	0	719.2	0	0	0	0	2004	3666	Sisma X SLD	330.2	0	0	0	0	0
2005	3666	Sisma Y SLD	0	330.2	0	0	0	0	2006	3667	Sisma X SLV	719.2	0	0	0	0	0
2007	3667	Sisma Y SLV	0	719.2	0	0	0	0	2008	3667	Sisma X SLD	330.2	0	0	0	0	0
2009	3667	Sisma Y SLD	0	330.2	0	0	0	0	2010	3668	Sisma X SLV	719.2	0	0	0	0	0
2011	3668	Sisma Y SLV	0	719.2	0	0	0	0	2012	3668	Sisma X SLD	330.2	0	0	0	0	0
2013	3668	Sisma Y SLD	0	330.2	0	0	0	0	2014	3669	Sisma X SLV	719.2	0	0	0	0	0
2015	3669	Sisma Y SLV	0	719.2	0	0	0	0	2016	3669	Sisma X SLD	330.2	0	0	0	0	0
2017	3669	Sisma Y SLD	0	330.2	0	0	0	0	2018	3670	Sisma X SLV	719.2	0	0	0	0	0
2019	3670	Sisma Y SLV	0	719.2	0	0	0	0	2020	3670	Sisma X SLD	330.2	0	0	0	0	0
2021	3670	Sisma Y SLD	0	330.2	0	0	0	0	2022	3671	Sisma X SLV	719.2	0	0	0	0	0
2023	3671	Sisma Y SLV	0	719.2	0	0	0	0	2024	3671	Sisma X SLD	330.2	0	0	0	0	0
2025	3671	Sisma Y SLD	0	330.2	0	0	0	0	2026	3672	Sisma X SLV	719.2	0	0	0	0	0
2027	3672	Sisma Y SLV	0	719.2	0	0	0	0	2028	3672	Sisma X SLD	330.2	0	0	0	0	0
2029	3672	Sisma Y SLD	0	330.2	0	0	0	0	2030	3673	Sisma X SLV	719.2	0	0	0	0	0
2031	3673	Sisma Y SLV	0	719.2	0	0	0	0	2032	3673	Sisma X SLD	330.2	0	0	0	0	0
2033	3673	Sisma Y SLD	0	330.2	0	0	0	0	2034	3674	Sisma X SLV	719.2	0	0	0	0	0
2035	3674	Sisma Y SLV	0	719.2	0	0	0	0	2036	3674	Sisma X SLD	330.2	0	0	0	0	0
2037	3674	Sisma Y SLD	0	330.2	0	0	0	0	2038	3675	Sisma X SLV	719.2	0	0	0	0	0
2039	3675	Sisma Y SLV	0	719.2	0	0	0	0	2040	3675	Sisma X SLD	330.2	0	0	0	0	0
2041	3675	Sisma Y SLD	0	330.2	0	0	0	0	2042	3676	Sisma X SLV	405.5	0	0	0	0	0
2043	3676	Sisma Y SLV	0	405.5	0	0	0	0	2044	3676	Sisma X SLD	186.2	0	0	0	0	0
2045	3676	Sisma Y SLD	0	186.2	0	0	0	0	2046	3677	Sisma X SLV	405.5	0	0	0	0	0
2047	3677	Sisma Y SLV	0	405.5	0	0	0	0	2048	3677	Sisma X SLD	186.2	0	0	0	0	0
2049	3677	Sisma Y SLD	0	186.2	0	0	0	0	2050	3678	Sisma X SLV	405.5	0	0	0	0	0
2051	3678	Sisma Y SLV	0	405.5	0	0	0	0	2052	3678	Sisma X SLD	186.2	0	0	0	0	0
2053	3678	Sisma Y SLD	0	186.2	0	0	0	0	2054	3679	Sisma X SLV	405.5	0	0	0	0	0
2055	3679	Sisma Y SLV	0	405.5	0	0	0	0	2056	3679	Sisma X SLD	186.2	0	0	0	0	0
2057	3679	Sisma Y SLD	0	186.2	0	0	0	0	2058	3680	Sisma X SLV	405.5	0	0	0	0	0
2059	3680	Sisma Y SLV	0	405.5	0	0	0	0	2060	3680	Sisma X SLD	186.2	0	0	0	0	0
2061	3680	Sisma Y SLD	0	186.2	0	0	0	0	2062	3681	Sisma X SLV	405.5	0	0	0	0	0
2063	3681	Sisma Y SLV	0	405.5	0	0	0	0	2064	3681	Sisma X SLD	186.2	0	0	0	0	0
2065	3681	Sisma Y SLD	0	186.2	0	0	0	0	2066	3682	Sisma X SLV	405.5	0	0	0	0	0
2067	3682	Sisma Y SLV	0	405.5	0	0	0	0	2068	3682	Sisma X SLD	186.2	0	0	0	0	0
2069	3682	Sisma Y SLD	0	186.2	0	0	0	0	2070	3683	Sisma X SLV	405.5	0	0	0	0	0



Progetto	Titolo	Rev.	Pag.
Orione	Orione_A24a.pdf "TABULATI DI CALCOLO PLINTO DI FONDAZIONE PER AEROGENERATORE TIPO"	0	65

Tabulati di Calcolo Plinto di Fondazione per Aerogeneratore Tipo - Progetto Impianto Eolico - "Orione"

Indice	Nodo	Condizione	Fx	Fy	Fz	Mx	My	Mz	Indice	Nodo	Condizione	Fx	Fy	Fz	Mx	My	Mz
2071	3683	Sisma Y SLV	0	405.5	0	0	0	0	2072	3683	Sisma X SLD	186.2	0	0	0	0	0
2073	3683	Sisma Y SLD	0	186.2	0	0	0	0	2074	3684	Sisma X SLV	405.5	0	0	0	0	0
2075	3684	Sisma Y SLV	0	405.5	0	0	0	0	2076	3684	Sisma X SLD	186.2	0	0	0	0	0
2077	3684	Sisma Y SLD	0	186.2	0	0	0	0	2078	3685	Sisma X SLV	405.5	0	0	0	0	0
2079	3685	Sisma Y SLV	0	405.5	0	0	0	0	2080	3685	Sisma X SLD	186.2	0	0	0	0	0
2081	3685	Sisma Y SLD	0	186.2	0	0	0	0	2082	3686	Sisma X SLV	405.5	0	0	0	0	0
2083	3686	Sisma Y SLV	0	405.5	0	0	0	0	2084	3686	Sisma X SLD	186.2	0	0	0	0	0
2085	3686	Sisma Y SLD	0	186.2	0	0	0	0	2086	3687	Sisma X SLV	405.5	0	0	0	0	0
2087	3687	Sisma Y SLV	0	405.5	0	0	0	0	2088	3687	Sisma X SLD	186.2	0	0	0	0	0
2089	3687	Sisma Y SLD	0	186.2	0	0	0	0	2090	3688	Sisma X SLV	405.5	0	0	0	0	0
2091	3688	Sisma Y SLV	0	405.5	0	0	0	0	2092	3688	Sisma X SLD	186.2	0	0	0	0	0
2093	3688	Sisma Y SLD	0	186.2	0	0	0	0	2094	3689	Sisma X SLV	405.5	0	0	0	0	0
2095	3689	Sisma Y SLV	0	405.5	0	0	0	0	2096	3689	Sisma X SLD	186.2	0	0	0	0	0
2097	3689	Sisma Y SLD	0	186.2	0	0	0	0	2098	3690	Sisma X SLV	405.5	0	0	0	0	0
2099	3690	Sisma Y SLV	0	405.5	0	0	0	0	2100	3690	Sisma X SLD	186.2	0	0	0	0	0
2101	3690	Sisma Y SLD	0	186.2	0	0	0	0	2102	3691	Sisma X SLV	405.5	0	0	0	0	0
2103	3691	Sisma Y SLV	0	405.5	0	0	0	0	2104	3691	Sisma X SLD	186.2	0	0	0	0	0
2105	3691	Sisma Y SLD	0	186.2	0	0	0	0	2106	3692	Sisma X SLV	405.5	0	0	0	0	0
2107	3692	Sisma Y SLV	0	405.5	0	0	0	0	2108	3692	Sisma X SLD	186.2	0	0	0	0	0
2109	3692	Sisma Y SLD	0	186.2	0	0	0	0	2110	3693	Sisma X SLV	405.5	0	0	0	0	0
2111	3693	Sisma Y SLV	0	405.5	0	0	0	0	2112	3693	Sisma X SLD	186.2	0	0	0	0	0
2113	3693	Sisma Y SLD	0	186.2	0	0	0	0	2114	3694	Sisma X SLV	405.5	0	0	0	0	0
2115	3694	Sisma Y SLV	0	405.5	0	0	0	0	2116	3694	Sisma X SLD	186.2	0	0	0	0	0
2117	3694	Sisma Y SLD	0	186.2	0	0	0	0	2118	3695	Sisma X SLV	405.5	0	0	0	0	0
2119	3695	Sisma Y SLV	0	405.5	0	0	0	0	2120	3695	Sisma X SLD	186.2	0	0	0	0	0
2121	3695	Sisma Y SLD	0	186.2	0	0	0	0	2122	3696	Sisma X SLV	405.5	0	0	0	0	0
2123	3696	Sisma Y SLV	0	405.5	0	0	0	0	2124	3696	Sisma X SLD	186.2	0	0	0	0	0
2125	3696	Sisma Y SLD	0	186.2	0	0	0	0	2126	3697	Sisma X SLV	405.5	0	0	0	0	0
2127	3697	Sisma Y SLV	0	405.5	0	0	0	0	2128	3697	Sisma X SLD	186.2	0	0	0	0	0
2129	3697	Sisma Y SLD	0	186.2	0	0	0	0	2130	3698	Sisma X SLV	405.5	0	0	0	0	0
2131	3698	Sisma Y SLV	0	405.5	0	0	0	0	2132	3698	Sisma X SLD	186.2	0	0	0	0	0
2133	3698	Sisma Y SLD	0	186.2	0	0	0	0	2134	3699	Sisma X SLV	405.5	0	0	0	0	0
2135	3699	Sisma Y SLV	0	405.5	0	0	0	0	2136	3699	Sisma X SLD	186.2	0	0	0	0	0
2137	3699	Sisma Y SLD	0	186.2	0	0	0	0	2138	3700	Sisma X SLV	405.5	0	0	0	0	0
2139	3700	Sisma Y SLV	0	405.5	0	0	0	0	2140	3700	Sisma X SLD	186.2	0	0	0	0	0
2141	3700	Sisma Y SLD	0	186.2	0	0	0	0	2142	3701	Sisma X SLV	405.5	0	0	0	0	0
2143	3701	Sisma Y SLV	0	405.5	0	0	0	0	2144	3701	Sisma X SLD	186.2	0	0	0	0	0
2145	3701	Sisma Y SLD	0	186.2	0	0	0	0	2146	3702	Sisma X SLV	405.5	0	0	0	0	0
2147	3702	Sisma Y SLV	0	405.5	0	0	0	0	2148	3702	Sisma X SLD	186.2	0	0	0	0	0
2149	3702	Sisma Y SLD	0	186.2	0	0	0	0	2150	3703	Sisma X SLV	405.5	0	0	0	0	0
2151	3703	Sisma Y SLV	0	405.5	0	0	0	0	2152	3703	Sisma X SLD	186.2	0	0	0	0	0
2153	3703	Sisma Y SLD	0	186.2	0	0	0	0	2154	3704	Sisma X SLV	405.5	0	0	0	0	0
2155	3704	Sisma Y SLV	0	405.5	0	0	0	0	2156	3704	Sisma X SLD	186.2	0	0	0	0	0
2157	3704	Sisma Y SLD	0	186.2	0	0	0	0	2158	3705	Sisma X SLV	405.5	0	0	0	0	0
2159	3705	Sisma Y SLV	0	405.5	0	0	0	0	2160	3705	Sisma X SLD	186.2	0	0	0	0	0
2161	3705	Sisma Y SLD	0	186.2	0	0	0	0	2162	3706	Sisma X SLV	405.5	0	0	0	0	0
2163	3706	Sisma Y SLV	0	405.5	0	0	0	0	2164	3706	Sisma X SLD	186.2	0	0	0	0	0
2165	3706	Sisma Y SLD	0	186.2	0	0	0	0	2166	3707	Sisma X SLV	405.5	0	0	0	0	0
2167	3707	Sisma Y SLV	0	405.5	0	0	0	0	2168	3707	Sisma X SLD	186.2	0	0	0	0	0
2169	3707	Sisma Y SLD	0	186.2	0	0	0	0	2170	3708	Sisma X SLV	405.5	0	0	0	0	0



Tabulati di Calcolo Plinto di Fondazione per Aerogeneratore Tipo - Progetto Impianto Eolico - "Orione"

Indice	Nodo	Condizione	Fx	Fy	Fz	Mx	My	Mz	Indice	Nodo	Condizione	Fx	Fy	Fz	Mx	My	Mz
2171	3708	Sisma Y SLV	0	405.5	0	0	0	0	2172	3708	Sisma X SLD	186.2	0	0	0	0	0
2173	3708	Sisma Y SLD	0	186.2	0	0	0	0	2174	3709	Sisma X SLV	405.5	0	0	0	0	0
2175	3709	Sisma Y SLV	0	405.5	0	0	0	0	2176	3709	Sisma X SLD	186.2	0	0	0	0	0
2177	3709	Sisma Y SLD	0	186.2	0	0	0	0	2178	3710	Sisma X SLV	405.5	0	0	0	0	0
2179	3710	Sisma Y SLV	0	405.5	0	0	0	0	2180	3710	Sisma X SLD	186.2	0	0	0	0	0
2181	3710	Sisma Y SLD	0	186.2	0	0	0	0	2182	3711	Sisma X SLV	405.5	0	0	0	0	0
2183	3711	Sisma Y SLV	0	405.5	0	0	0	0	2184	3711	Sisma X SLD	186.2	0	0	0	0	0
2185	3711	Sisma Y SLD	0	186.2	0	0	0	0	2186	3712	Sisma X SLV	683.4	0	0	0	0	0
2187	3712	Sisma Y SLV	0	683.4	0	0	0	0	2188	3712	Sisma X SLD	313.8	0	0	0	0	0
2189	3712	Sisma Y SLD	0	313.8	0	0	0	0	2190	3713	Sisma X SLV	683.4	0	0	0	0	0
2191	3713	Sisma Y SLV	0	683.4	0	0	0	0	2192	3713	Sisma X SLD	313.8	0	0	0	0	0
2193	3713	Sisma Y SLD	0	313.8	0	0	0	0	2194	3714	Sisma X SLV	683.4	0	0	0	0	0
2195	3714	Sisma Y SLV	0	683.4	0	0	0	0	2196	3714	Sisma X SLD	313.8	0	0	0	0	0
2197	3714	Sisma Y SLD	0	313.8	0	0	0	0	2198	3715	Sisma X SLV	683.4	0	0	0	0	0
2199	3715	Sisma Y SLV	0	683.4	0	0	0	0	2200	3715	Sisma X SLD	313.8	0	0	0	0	0
2201	3715	Sisma Y SLD	0	313.8	0	0	0	0	2202	3716	Sisma X SLV	683.4	0	0	0	0	0
2203	3716	Sisma Y SLV	0	683.4	0	0	0	0	2204	3716	Sisma X SLD	313.8	0	0	0	0	0
2205	3716	Sisma Y SLD	0	313.8	0	0	0	0	2206	3717	Sisma X SLV	683.4	0	0	0	0	0
2207	3717	Sisma Y SLV	0	683.4	0	0	0	0	2208	3717	Sisma X SLD	313.8	0	0	0	0	0
2209	3717	Sisma Y SLD	0	313.8	0	0	0	0	2210	3718	Sisma X SLV	683.4	0	0	0	0	0
2211	3718	Sisma Y SLV	0	683.4	0	0	0	0	2212	3718	Sisma X SLD	313.8	0	0	0	0	0
2213	3718	Sisma Y SLD	0	313.8	0	0	0	0	2214	3719	Sisma X SLV	683.4	0	0	0	0	0
2215	3719	Sisma Y SLV	0	683.4	0	0	0	0	2216	3719	Sisma X SLD	313.8	0	0	0	0	0
2217	3719	Sisma Y SLD	0	313.8	0	0	0	0	2218	3720	Sisma X SLV	683.4	0	0	0	0	0
2219	3720	Sisma Y SLV	0	683.4	0	0	0	0	2220	3720	Sisma X SLD	313.8	0	0	0	0	0
2221	3720	Sisma Y SLD	0	313.8	0	0	0	0	2222	3721	Sisma X SLV	683.4	0	0	0	0	0
2223	3721	Sisma Y SLV	0	683.4	0	0	0	0	2224	3721	Sisma X SLD	313.8	0	0	0	0	0
2225	3721	Sisma Y SLD	0	313.8	0	0	0	0	2226	3722	Sisma X SLV	683.4	0	0	0	0	0
2227	3722	Sisma Y SLV	0	683.4	0	0	0	0	2228	3722	Sisma X SLD	313.8	0	0	0	0	0
2229	3722	Sisma Y SLD	0	313.8	0	0	0	0	2230	3723	Sisma X SLV	683.4	0	0	0	0	0
2231	3723	Sisma Y SLV	0	683.4	0	0	0	0	2232	3723	Sisma X SLD	313.8	0	0	0	0	0
2233	3723	Sisma Y SLD	0	313.8	0	0	0	0	2234	3724	Sisma X SLV	683.4	0	0	0	0	0
2235	3724	Sisma Y SLV	0	683.4	0	0	0	0	2236	3724	Sisma X SLD	313.8	0	0	0	0	0
2237	3724	Sisma Y SLD	0	313.8	0	0	0	0	2238	3725	Sisma X SLV	683.4	0	0	0	0	0
2239	3725	Sisma Y SLV	0	683.4	0	0	0	0	2240	3725	Sisma X SLD	313.8	0	0	0	0	0
2241	3725	Sisma Y SLD	0	313.8	0	0	0	0	2242	3726	Sisma X SLV	683.4	0	0	0	0	0
2243	3726	Sisma Y SLV	0	683.4	0	0	0	0	2244	3726	Sisma X SLD	313.8	0	0	0	0	0
2245	3726	Sisma Y SLD	0	313.8	0	0	0	0	2246	3727	Sisma X SLV	683.4	0	0	0	0	0
2247	3727	Sisma Y SLV	0	683.4	0	0	0	0	2248	3727	Sisma X SLD	313.8	0	0	0	0	0
2249	3727	Sisma Y SLD	0	313.8	0	0	0	0	2250	3728	Sisma X SLV	683.4	0	0	0	0	0
2251	3728	Sisma Y SLV	0	683.4	0	0	0	0	2252	3728	Sisma X SLD	313.8	0	0	0	0	0
2253	3728	Sisma Y SLD	0	313.8	0	0	0	0	2254	3729	Sisma X SLV	683.4	0	0	0	0	0
2255	3729	Sisma Y SLV	0	683.4	0	0	0	0	2256	3729	Sisma X SLD	313.8	0	0	0	0	0
2257	3729	Sisma Y SLD	0	313.8	0	0	0	0	2258	3730	Sisma X SLV	683.4	0	0	0	0	0
2259	3730	Sisma Y SLV	0	683.4	0	0	0	0	2260	3730	Sisma X SLD	313.8	0	0	0	0	0
2261	3730	Sisma Y SLD	0	313.8	0	0	0	0	2262	3731	Sisma X SLV	683.4	0	0	0	0	0
2263	3731	Sisma Y SLV	0	683.4	0	0	0	0	2264	3731	Sisma X SLD	313.8	0	0	0	0	0
2265	3731	Sisma Y SLD	0	313.8	0	0	0	0	2266	3732	Sisma X SLV	683.4	0	0	0	0	0
2267	3732	Sisma Y SLV	0	683.4	0	0	0	0	2268	3732	Sisma X SLD	313.8	0	0	0	0	0
2269	3732	Sisma Y SLD	0	313.8	0	0	0	0	2270	3733	Sisma X SLV	683.4	0	0	0	0	0



Tabulati di Calcolo Plinto di Fondazione per Aerogeneratore Tipo - Progetto Impianto Eolico - "Orione"

Indice	Nodo	Condizione	Fx	Fy	Fz	Mx	My	Mz	Indice	Nodo	Condizione	Fx	Fy	Fz	Mx	My	Mz
2271	3733	Sisma Y SLV	0	683.4	0	0	0	0	2272	3733	Sisma X SLD	313.8	0	0	0	0	0
2273	3733	Sisma Y SLD	0	313.8	0	0	0	0	2274	3734	Sisma X SLV	683.4	0	0	0	0	0
2275	3734	Sisma Y SLV	0	683.4	0	0	0	0	2276	3734	Sisma X SLD	313.8	0	0	0	0	0
2277	3734	Sisma Y SLD	0	313.8	0	0	0	0	2278	3735	Sisma X SLV	683.4	0	0	0	0	0
2279	3735	Sisma Y SLV	0	683.4	0	0	0	0	2280	3735	Sisma X SLD	313.8	0	0	0	0	0
2281	3735	Sisma Y SLD	0	313.8	0	0	0	0	2282	3736	Sisma X SLV	683.4	0	0	0	0	0
2283	3736	Sisma Y SLV	0	683.4	0	0	0	0	2284	3736	Sisma X SLD	313.8	0	0	0	0	0
2285	3736	Sisma Y SLD	0	313.8	0	0	0	0	2286	3737	Sisma X SLV	683.4	0	0	0	0	0
2287	3737	Sisma Y SLV	0	683.4	0	0	0	0	2288	3737	Sisma X SLD	313.8	0	0	0	0	0
2289	3737	Sisma Y SLD	0	313.8	0	0	0	0	2290	3738	Sisma X SLV	683.4	0	0	0	0	0
2291	3738	Sisma Y SLV	0	683.4	0	0	0	0	2292	3738	Sisma X SLD	313.8	0	0	0	0	0
2293	3738	Sisma Y SLD	0	313.8	0	0	0	0	2294	3739	Sisma X SLV	683.4	0	0	0	0	0
2295	3739	Sisma Y SLV	0	683.4	0	0	0	0	2296	3739	Sisma X SLD	313.8	0	0	0	0	0
2297	3739	Sisma Y SLD	0	313.8	0	0	0	0	2298	3740	Sisma X SLV	683.4	0	0	0	0	0
2299	3740	Sisma Y SLV	0	683.4	0	0	0	0	2300	3740	Sisma X SLD	313.8	0	0	0	0	0
2301	3740	Sisma Y SLD	0	313.8	0	0	0	0	2302	3741	Sisma X SLV	683.4	0	0	0	0	0
2303	3741	Sisma Y SLV	0	683.4	0	0	0	0	2304	3741	Sisma X SLD	313.8	0	0	0	0	0
2305	3741	Sisma Y SLD	0	313.8	0	0	0	0	2306	3742	Sisma X SLV	683.4	0	0	0	0	0
2307	3742	Sisma Y SLV	0	683.4	0	0	0	0	2308	3742	Sisma X SLD	313.8	0	0	0	0	0
2309	3742	Sisma Y SLD	0	313.8	0	0	0	0	2310	3743	Sisma X SLV	683.4	0	0	0	0	0
2311	3743	Sisma Y SLV	0	683.4	0	0	0	0	2312	3743	Sisma X SLD	313.8	0	0	0	0	0
2313	3743	Sisma Y SLD	0	313.8	0	0	0	0	2314	3744	Sisma X SLV	683.4	0	0	0	0	0
2315	3744	Sisma Y SLV	0	683.4	0	0	0	0	2316	3744	Sisma X SLD	313.8	0	0	0	0	0
2317	3744	Sisma Y SLD	0	313.8	0	0	0	0	2318	3745	Sisma X SLV	683.4	0	0	0	0	0
2319	3745	Sisma Y SLV	0	683.4	0	0	0	0	2320	3745	Sisma X SLD	313.8	0	0	0	0	0
2321	3745	Sisma Y SLD	0	313.8	0	0	0	0	2322	3746	Sisma X SLV	683.4	0	0	0	0	0
2323	3746	Sisma Y SLV	0	683.4	0	0	0	0	2324	3746	Sisma X SLD	313.8	0	0	0	0	0
2325	3746	Sisma Y SLD	0	313.8	0	0	0	0	2326	3747	Sisma X SLV	683.4	0	0	0	0	0
2327	3747	Sisma Y SLV	0	683.4	0	0	0	0	2328	3747	Sisma X SLD	313.8	0	0	0	0	0
2329	3747	Sisma Y SLD	0	313.8	0	0	0	0	2330	3748	Sisma X SLV	2021.2	0	0	0	0	0
2331	3748	Sisma Y SLV	0	2021.2	0	0	0	0	2332	3748	Sisma X SLD	928.1	0	0	0	0	0
2333	3748	Sisma Y SLD	0	928.1	0	0	0	0	2334	3749	Sisma X SLV	2021.2	0	0	0	0	0
2335	3749	Sisma Y SLV	0	2021.2	0	0	0	0	2336	3749	Sisma X SLD	928.1	0	0	0	0	0
2337	3749	Sisma Y SLD	0	928.1	0	0	0	0	2338	3750	Sisma X SLV	2021.2	0	0	0	0	0
2339	3750	Sisma Y SLV	0	2021.2	0	0	0	0	2340	3750	Sisma X SLD	928.1	0	0	0	0	0
2341	3750	Sisma Y SLD	0	928.1	0	0	0	0	2342	3751	Sisma X SLV	2021.2	0	0	0	0	0
2343	3751	Sisma Y SLV	0	2021.2	0	0	0	0	2344	3751	Sisma X SLD	928.1	0	0	0	0	0
2345	3751	Sisma Y SLD	0	928.1	0	0	0	0	2346	3752	Sisma X SLV	2021.2	0	0	0	0	0
2347	3752	Sisma Y SLV	0	2021.2	0	0	0	0	2348	3752	Sisma X SLD	928.1	0	0	0	0	0
2349	3752	Sisma Y SLD	0	928.1	0	0	0	0	2350	3753	Sisma X SLV	2021.2	0	0	0	0	0
2351	3753	Sisma Y SLV	0	2021.2	0	0	0	0	2352	3753	Sisma X SLD	928.1	0	0	0	0	0
2353	3753	Sisma Y SLD	0	928.1	0	0	0	0	2354	3754	Sisma X SLV	2021.2	0	0	0	0	0
2355	3754	Sisma Y SLV	0	2021.2	0	0	0	0	2356	3754	Sisma X SLD	928.1	0	0	0	0	0
2357	3754	Sisma Y SLD	0	928.1	0	0	0	0	2358	3755	Sisma X SLV	2021.2	0	0	0	0	0
2359	3755	Sisma Y SLV	0	2021.2	0	0	0	0	2360	3755	Sisma X SLD	928.1	0	0	0	0	0
2361	3755	Sisma Y SLD	0	928.1	0	0	0	0	2362	3756	Sisma X SLV	2021.2	0	0	0	0	0
2363	3756	Sisma Y SLV	0	2021.2	0	0	0	0	2364	3756	Sisma X SLD	928.1	0	0	0	0	0
2365	3756	Sisma Y SLD	0	928.1	0	0	0	0	2366	3757	Sisma X SLV	2021.2	0	0	0	0	0
2367	3757	Sisma Y SLV	0	2021.2	0	0	0	0	2368	3757	Sisma X SLD	928.1	0	0	0	0	0
2369	3757	Sisma Y SLD	0	928.1	0	0	0	0	2370	3758	Sisma X SLV	2021.2	0	0	0	0	0



Tabulati di Calcolo Plinto di Fondazione per Aerogeneratore Tipo - Progetto Impianto Eolico - "Orione"

Indice	Nodo	Condizione	Fx	Fy	Fz	Mx	My	Mz	Indice	Nodo	Condizione	Fx	Fy	Fz	Mx	My	Mz
2371	3758	Sisma Y SLV	0	2021.2	0	0	0	0	2372	3758	Sisma X SLD	928.1	0	0	0	0	0
2373	3758	Sisma Y SLD	0	928.1	0	0	0	0	2374	3759	Sisma X SLV	2021.2	0	0	0	0	0
2375	3759	Sisma Y SLV	0	2021.2	0	0	0	0	2376	3759	Sisma X SLD	928.1	0	0	0	0	0
2377	3759	Sisma Y SLD	0	928.1	0	0	0	0	2378	3760	Sisma X SLV	2021.2	0	0	0	0	0
2379	3760	Sisma Y SLV	0	2021.2	0	0	0	0	2380	3760	Sisma X SLD	928.1	0	0	0	0	0
2381	3760	Sisma Y SLD	0	928.1	0	0	0	0	2382	3761	Sisma X SLV	2021.2	0	0	0	0	0
2383	3761	Sisma Y SLV	0	2021.2	0	0	0	0	2384	3761	Sisma X SLD	928.1	0	0	0	0	0
2385	3761	Sisma Y SLD	0	928.1	0	0	0	0	2386	3762	Sisma X SLV	2021.2	0	0	0	0	0
2387	3762	Sisma Y SLV	0	2021.2	0	0	0	0	2388	3762	Sisma X SLD	928.1	0	0	0	0	0
2389	3762	Sisma Y SLD	0	928.1	0	0	0	0	2390	3763	Sisma X SLV	2021.2	0	0	0	0	0
2391	3763	Sisma Y SLV	0	2021.2	0	0	0	0	2392	3763	Sisma X SLD	928.1	0	0	0	0	0
2393	3763	Sisma Y SLD	0	928.1	0	0	0	0	2394	3764	Sisma X SLV	2021.2	0	0	0	0	0
2395	3764	Sisma Y SLV	0	2021.2	0	0	0	0	2396	3764	Sisma X SLD	928.1	0	0	0	0	0
2397	3764	Sisma Y SLD	0	928.1	0	0	0	0	2398	3765	Sisma X SLV	2021.2	0	0	0	0	0
2399	3765	Sisma Y SLV	0	2021.2	0	0	0	0	2400	3765	Sisma X SLD	928.1	0	0	0	0	0
2401	3765	Sisma Y SLD	0	928.1	0	0	0	0	2402	3766	Sisma X SLV	2021.2	0	0	0	0	0
2403	3766	Sisma Y SLV	0	2021.2	0	0	0	0	2404	3766	Sisma X SLD	928.1	0	0	0	0	0
2405	3766	Sisma Y SLD	0	928.1	0	0	0	0	2406	3767	Sisma X SLV	2021.2	0	0	0	0	0
2407	3767	Sisma Y SLV	0	2021.2	0	0	0	0	2408	3767	Sisma X SLD	928.1	0	0	0	0	0
2409	3767	Sisma Y SLD	0	928.1	0	0	0	0	2410	3768	Sisma X SLV	2021.2	0	0	0	0	0
2411	3768	Sisma Y SLV	0	2021.2	0	0	0	0	2412	3768	Sisma X SLD	928.1	0	0	0	0	0
2413	3768	Sisma Y SLD	0	928.1	0	0	0	0	2414	3769	Sisma X SLV	2021.2	0	0	0	0	0
2415	3769	Sisma Y SLV	0	2021.2	0	0	0	0	2416	3769	Sisma X SLD	928.1	0	0	0	0	0
2417	3769	Sisma Y SLD	0	928.1	0	0	0	0	2418	3770	Sisma X SLV	2021.2	0	0	0	0	0
2419	3770	Sisma Y SLV	0	2021.2	0	0	0	0	2420	3770	Sisma X SLD	928.1	0	0	0	0	0
2421	3770	Sisma Y SLD	0	928.1	0	0	0	0	2422	3771	Sisma X SLV	2021.2	0	0	0	0	0
2423	3771	Sisma Y SLV	0	2021.2	0	0	0	0	2424	3771	Sisma X SLD	928.1	0	0	0	0	0
2425	3771	Sisma Y SLD	0	928.1	0	0	0	0	2426	3772	Sisma X SLV	2021.2	0	0	0	0	0
2427	3772	Sisma Y SLV	0	2021.2	0	0	0	0	2428	3772	Sisma X SLD	928.1	0	0	0	0	0
2429	3772	Sisma Y SLD	0	928.1	0	0	0	0	2430	3773	Sisma X SLV	2021.2	0	0	0	0	0
2431	3773	Sisma Y SLV	0	2021.2	0	0	0	0	2432	3773	Sisma X SLD	928.1	0	0	0	0	0
2433	3773	Sisma Y SLD	0	928.1	0	0	0	0	2434	3774	Sisma X SLV	2021.2	0	0	0	0	0
2435	3774	Sisma Y SLV	0	2021.2	0	0	0	0	2436	3774	Sisma X SLD	928.1	0	0	0	0	0
2437	3774	Sisma Y SLD	0	928.1	0	0	0	0	2438	3775	Sisma X SLV	2021.2	0	0	0	0	0
2439	3775	Sisma Y SLV	0	2021.2	0	0	0	0	2440	3775	Sisma X SLD	928.1	0	0	0	0	0
2441	3775	Sisma Y SLD	0	928.1	0	0	0	0	2442	3776	Sisma X SLV	2021.2	0	0	0	0	0
2443	3776	Sisma Y SLV	0	2021.2	0	0	0	0	2444	3776	Sisma X SLD	928.1	0	0	0	0	0
2445	3776	Sisma Y SLD	0	928.1	0	0	0	0	2446	3777	Sisma X SLV	2021.2	0	0	0	0	0
2447	3777	Sisma Y SLV	0	2021.2	0	0	0	0	2448	3777	Sisma X SLD	928.1	0	0	0	0	0
2449	3777	Sisma Y SLD	0	928.1	0	0	0	0	2450	3778	Sisma X SLV	2021.2	0	0	0	0	0
2451	3778	Sisma Y SLV	0	2021.2	0	0	0	0	2452	3778	Sisma X SLD	928.1	0	0	0	0	0
2453	3778	Sisma Y SLD	0	928.1	0	0	0	0	2454	3779	Sisma X SLV	2021.2	0	0	0	0	0
2455	3779	Sisma Y SLV	0	2021.2	0	0	0	0	2456	3779	Sisma X SLD	928.1	0	0	0	0	0
2457	3779	Sisma Y SLD	0	928.1	0	0	0	0	2458	3780	Sisma X SLV	2021.2	0	0	0	0	0
2459	3780	Sisma Y SLV	0	2021.2	0	0	0	0	2460	3780	Sisma X SLD	928.1	0	0	0	0	0
2461	3780	Sisma Y SLD	0	928.1	0	0	0	0	2462	3781	Sisma X SLV	2021.2	0	0	0	0	0
2463	3781	Sisma Y SLV	0	2021.2	0	0	0	0	2464	3781	Sisma X SLD	928.1	0	0	0	0	0
2465	3781	Sisma Y SLD	0	928.1	0	0	0	0	2466	3782	Sisma X SLV	2021.2	0	0	0	0	0
2467	3782	Sisma Y SLV	0	2021.2	0	0	0	0	2468	3782	Sisma X SLD	928.1	0	0	0	0	0
2469	3782	Sisma Y SLD	0	928.1	0	0	0	0	2470	3783	Sisma X SLV	2021.2	0	0	0	0	0



Tabulati di Calcolo Plinto di Fondazione per Aerogeneratore Tipo - Progetto Impianto Eolico - "Orione"

Indice	Nodo	Condizione	Fx	Fy	Fz	Mx	My	Mz	Indice	Nodo	Condizione	Fx	Fy	Fz	Mx	My	Mz
2471	3783	Sisma Y SLV	0	2021.2	0	0	0	0	2472	3783	Sisma X SLD	928.1	0	0	0	0	0
2473	3783	Sisma Y SLD	0	928.1	0	0	0	0	2474	3784	Sisma X SLV	1684.3	0	0	0	0	0
2475	3784	Sisma Y SLV	0	1684.3	0	0	0	0	2476	3784	Sisma X SLD	773.4	0	0	0	0	0
2477	3784	Sisma Y SLD	0	773.4	0	0	0	0	2478	3785	Sisma X SLV	1684.3	0	0	0	0	0
2479	3785	Sisma Y SLV	0	1684.3	0	0	0	0	2480	3785	Sisma X SLD	773.4	0	0	0	0	0
2481	3785	Sisma Y SLD	0	773.4	0	0	0	0	2482	3786	Sisma X SLV	1684.3	0	0	0	0	0
2483	3786	Sisma Y SLV	0	1684.3	0	0	0	0	2484	3786	Sisma X SLD	773.4	0	0	0	0	0
2485	3786	Sisma Y SLD	0	773.4	0	0	0	0	2486	3787	Sisma X SLV	1684.3	0	0	0	0	0
2487	3787	Sisma Y SLV	0	1684.3	0	0	0	0	2488	3787	Sisma X SLD	773.4	0	0	0	0	0
2489	3787	Sisma Y SLD	0	773.4	0	0	0	0	2490	3788	Sisma X SLV	1684.3	0	0	0	0	0
2491	3788	Sisma Y SLV	0	1684.3	0	0	0	0	2492	3788	Sisma X SLD	773.4	0	0	0	0	0
2493	3788	Sisma Y SLD	0	773.4	0	0	0	0	2494	3789	Sisma X SLV	1684.3	0	0	0	0	0
2495	3789	Sisma Y SLV	0	1684.3	0	0	0	0	2496	3789	Sisma X SLD	773.4	0	0	0	0	0
2497	3789	Sisma Y SLD	0	773.4	0	0	0	0	2498	3790	Sisma X SLV	1684.3	0	0	0	0	0
2499	3790	Sisma Y SLV	0	1684.3	0	0	0	0	2500	3790	Sisma X SLD	773.4	0	0	0	0	0
2501	3790	Sisma Y SLD	0	773.4	0	0	0	0	2502	3791	Sisma X SLV	1684.3	0	0	0	0	0
2503	3791	Sisma Y SLV	0	1684.3	0	0	0	0	2504	3791	Sisma X SLD	773.4	0	0	0	0	0
2505	3791	Sisma Y SLD	0	773.4	0	0	0	0	2506	3792	Sisma X SLV	1684.3	0	0	0	0	0
2507	3792	Sisma Y SLV	0	1684.3	0	0	0	0	2508	3792	Sisma X SLD	773.4	0	0	0	0	0
2509	3792	Sisma Y SLD	0	773.4	0	0	0	0	2510	3793	Sisma X SLV	1684.3	0	0	0	0	0
2511	3793	Sisma Y SLV	0	1684.3	0	0	0	0	2512	3793	Sisma X SLD	773.4	0	0	0	0	0
2513	3793	Sisma Y SLD	0	773.4	0	0	0	0	2514	3794	Sisma X SLV	1684.3	0	0	0	0	0
2515	3794	Sisma Y SLV	0	1684.3	0	0	0	0	2516	3794	Sisma X SLD	773.4	0	0	0	0	0
2517	3794	Sisma Y SLD	0	773.4	0	0	0	0	2518	3795	Sisma X SLV	1684.3	0	0	0	0	0
2519	3795	Sisma Y SLV	0	1684.3	0	0	0	0	2520	3795	Sisma X SLD	773.4	0	0	0	0	0
2521	3795	Sisma Y SLD	0	773.4	0	0	0	0	2522	3796	Sisma X SLV	1684.3	0	0	0	0	0
2523	3796	Sisma Y SLV	0	1684.3	0	0	0	0	2524	3796	Sisma X SLD	773.4	0	0	0	0	0
2525	3796	Sisma Y SLD	0	773.4	0	0	0	0	2526	3797	Sisma X SLV	1684.3	0	0	0	0	0
2527	3797	Sisma Y SLV	0	1684.3	0	0	0	0	2528	3797	Sisma X SLD	773.4	0	0	0	0	0
2529	3797	Sisma Y SLD	0	773.4	0	0	0	0	2530	3798	Sisma X SLV	1684.3	0	0	0	0	0
2531	3798	Sisma Y SLV	0	1684.3	0	0	0	0	2532	3798	Sisma X SLD	773.4	0	0	0	0	0
2533	3798	Sisma Y SLD	0	773.4	0	0	0	0	2534	3799	Sisma X SLV	1684.3	0	0	0	0	0
2535	3799	Sisma Y SLV	0	1684.3	0	0	0	0	2536	3799	Sisma X SLD	773.4	0	0	0	0	0
2537	3799	Sisma Y SLD	0	773.4	0	0	0	0	2538	3800	Sisma X SLV	1684.3	0	0	0	0	0
2539	3800	Sisma Y SLV	0	1684.3	0	0	0	0	2540	3800	Sisma X SLD	773.4	0	0	0	0	0
2541	3800	Sisma Y SLD	0	773.4	0	0	0	0	2542	3801	Sisma X SLV	1684.3	0	0	0	0	0
2543	3801	Sisma Y SLV	0	1684.3	0	0	0	0	2544	3801	Sisma X SLD	773.4	0	0	0	0	0
2545	3801	Sisma Y SLD	0	773.4	0	0	0	0	2546	3802	Sisma X SLV	1684.3	0	0	0	0	0
2547	3802	Sisma Y SLV	0	1684.3	0	0	0	0	2548	3802	Sisma X SLD	773.4	0	0	0	0	0
2549	3802	Sisma Y SLD	0	773.4	0	0	0	0	2550	3803	Sisma X SLV	1684.3	0	0	0	0	0
2551	3803	Sisma Y SLV	0	1684.3	0	0	0	0	2552	3803	Sisma X SLD	773.4	0	0	0	0	0
2553	3803	Sisma Y SLD	0	773.4	0	0	0	0	2554	3804	Sisma X SLV	1684.3	0	0	0	0	0
2555	3804	Sisma Y SLV	0	1684.3	0	0	0	0	2556	3804	Sisma X SLD	773.4	0	0	0	0	0
2557	3804	Sisma Y SLD	0	773.4	0	0	0	0	2558	3805	Sisma X SLV	1684.3	0	0	0	0	0
2559	3805	Sisma Y SLV	0	1684.3	0	0	0	0	2560	3805	Sisma X SLD	773.4	0	0	0	0	0
2561	3805	Sisma Y SLD	0	773.4	0	0	0	0	2562	3806	Sisma X SLV	1684.3	0	0	0	0	0
2563	3806	Sisma Y SLV	0	1684.3	0	0	0	0	2564	3806	Sisma X SLD	773.4	0	0	0	0	0
2565	3806	Sisma Y SLD	0	773.4	0	0	0	0	2566	3807	Sisma X SLV	1684.3	0	0	0	0	0
2567	3807	Sisma Y SLV	0	1684.3	0	0	0	0	2568	3807	Sisma X SLD	773.4	0	0	0	0	0
2569	3807	Sisma Y SLD	0	773.4	0	0	0	0	2570	3808	Sisma X SLV	1684.3	0	0	0	0	0



Indice	Nodo	Condizione	Fx	Fy	Fz	Mx	My	Mz	Indice	Nodo	Condizione	Fx	Fy	Fz	Mx	My	Mz
2571	3808	Sisma Y SLV	0	1684.3	0	0	0	0	2572	3808	Sisma X SLD	773.4	0	0	0	0	0
2573	3808	Sisma Y SLD	0	773.4	0	0	0	0	2574	3809	Sisma X SLV	1684.3	0	0	0	0	0
2575	3809	Sisma Y SLV	0	1684.3	0	0	0	0	2576	3809	Sisma X SLD	773.4	0	0	0	0	0
2577	3809	Sisma Y SLD	0	773.4	0	0	0	0	2578	3810	Sisma X SLV	1684.3	0	0	0	0	0
2579	3810	Sisma Y SLV	0	1684.3	0	0	0	0	2580	3810	Sisma X SLD	773.4	0	0	0	0	0
2581	3810	Sisma Y SLD	0	773.4	0	0	0	0	2582	3811	Sisma X SLV	1684.3	0	0	0	0	0
2583	3811	Sisma Y SLV	0	1684.3	0	0	0	0	2584	3811	Sisma X SLD	773.4	0	0	0	0	0
2585	3811	Sisma Y SLD	0	773.4	0	0	0	0	2586	3812	Sisma X SLV	1684.3	0	0	0	0	0
2587	3812	Sisma Y SLV	0	1684.3	0	0	0	0	2588	3812	Sisma X SLD	773.4	0	0	0	0	0
2589	3812	Sisma Y SLD	0	773.4	0	0	0	0	2590	3813	Sisma X SLV	1684.3	0	0	0	0	0
2591	3813	Sisma Y SLV	0	1684.3	0	0	0	0	2592	3813	Sisma X SLD	773.4	0	0	0	0	0
2593	3813	Sisma Y SLD	0	773.4	0	0	0	0	2594	3814	Sisma X SLV	1684.3	0	0	0	0	0
2595	3814	Sisma Y SLV	0	1684.3	0	0	0	0	2596	3814	Sisma X SLD	773.4	0	0	0	0	0
2597	3814	Sisma Y SLD	0	773.4	0	0	0	0	2598	3815	Sisma X SLV	1684.3	0	0	0	0	0
2599	3815	Sisma Y SLV	0	1684.3	0	0	0	0	2600	3815	Sisma X SLD	773.4	0	0	0	0	0
2601	3815	Sisma Y SLD	0	773.4	0	0	0	0	2602	3816	Sisma X SLV	1684.3	0	0	0	0	0
2603	3816	Sisma Y SLV	0	1684.3	0	0	0	0	2604	3816	Sisma X SLD	773.4	0	0	0	0	0
2605	3816	Sisma Y SLD	0	773.4	0	0	0	0	2606	3817	Sisma X SLV	1684.3	0	0	0	0	0
2607	3817	Sisma Y SLV	0	1684.3	0	0	0	0	2608	3817	Sisma X SLD	773.4	0	0	0	0	0
2609	3817	Sisma Y SLD	0	773.4	0	0	0	0	2610	3818	Sisma X SLV	1684.3	0	0	0	0	0
2611	3818	Sisma Y SLV	0	1684.3	0	0	0	0	2612	3818	Sisma X SLD	773.4	0	0	0	0	0
2613	3818	Sisma Y SLD	0	773.4	0	0	0	0	2614	3819	Sisma X SLV	1684.3	0	0	0	0	0
2615	3819	Sisma Y SLV	0	1684.3	0	0	0	0	2616	3819	Sisma X SLD	773.4	0	0	0	0	0
2617	3819	Sisma Y SLD	0	773.4	0	0	0	0	2618	3820	Sisma X SLV	1.9E5	0	0	0	0	0
2619	3820	Sisma Y SLV	0	1.9E5	0	0	0	0	2620	3820	Sisma X SLD	8.6E4	0	0	0	0	0
2621	3820	Sisma Y SLD	0	8.6E4	0	0	0	0									

### 7.3 Carichi concentrati sismici

Indice: Numero dell'elemento nell'insieme che lo contiene.

Nodo: Nodo su cui agisce il carico.

Condizione: Condizione elementare mappata nella quale agisce il carico.

Fx: Componente della forza lungo l'asse X. [daN]

Fy: Componente della forza lungo l'asse Y. [daN]

Fz: Componente della forza lungo l'asse Z. [daN]

Mz: Componente del momento attorno all'asse Z. [daN\*cm]

Peso: Peso sismico. [daN]

Gamma: Coefficiente gamma. Il valore è adimensionale.

Indice	Nodo	Condizione	Fx	Fy	Fz	Mz	Peso	Gamma	Indice	Nodo	Condizione	Fx	Fy	Fz	Mz	Peso	Gamma
6	1630	Sisma X SLV	0	0	0	0	4.4E3	0	7	1630	Sisma Y SLV	0	0	0	0	4.4E3	0
8	1630	Sisma X SLD	0	0	0	0	4.4E3	0	9	1630	Sisma Y SLD	0	0	0	0	4.4E3	0
10	2612	Sisma X SLV	0	0	0	0	4.4E3	0	11	2612	Sisma Y SLV	0	0	0	0	4.4E3	0
12	2612	Sisma X SLD	0	0	0	0	4.4E3	0	13	2612	Sisma Y SLD	0	0	0	0	4.4E3	0
14	2747	Sisma X SLV	0	0	0	0	4.4E3	0	15	2747	Sisma Y SLV	0	0	0	0	4.4E3	0
16	2747	Sisma X SLD	0	0	0	0	4.4E3	0	17	2747	Sisma Y SLD	0	0	0	0	4.4E3	0
18	2829	Sisma X SLV	0	0	0	0	4.4E3	0	19	2829	Sisma Y SLV	0	0	0	0	4.4E3	0
20	2829	Sisma X SLD	0	0	0	0	4.4E3	0	21	2829	Sisma Y SLD	0	0	0	0	4.4E3	0
22	3171	Sisma X SLV	374.2	0	0	0	1.4E3	0.629	23	3171	Sisma Y SLV	0	374.2	0	0	1.4E3	0.629
24	3171	Sisma X SLD	171.8	0	0	0	1.4E3	0.629	25	3171	Sisma Y SLD	0	171.8	0	0	1.4E3	0.629
26	3172	Sisma X SLV	374.2	0	0	0	1.4E3	0.629	27	3172	Sisma Y SLV	0	374.2	0	0	1.4E3	0.629
28	3172	Sisma X SLD	171.8	0	0	0	1.4E3	0.629	29	3172	Sisma Y SLD	0	171.8	0	0	1.4E3	0.629
30	3173	Sisma X SLV	374.2	0	0	0	1.4E3	0.629	31	3173	Sisma Y SLV	0	374.2	0	0	1.4E3	0.629
32	3173	Sisma X SLD	171.8	0	0	0	1.4E3	0.629	33	3173	Sisma Y SLD	0	171.8	0	0	1.4E3	0.629
34	3174	Sisma X SLV	374.2	0	0	0	1.4E3	0.629	35	3174	Sisma Y SLV	0	374.2	0	0	1.4E3	0.629





Tabulati di Calcolo Plinto di Fondazione per Aerogeneratore Tipo - Progetto Impianto Eolico - "Orione"

Indice	Nodo	Condizione	Fx	Fy	Fz	Mz	Peso	Gamma	Indice	Nodo	Condizione	Fx	Fy	Fz	Mz	Peso	Gamma
36	3174	Sisma X SLD	171.8	0	0	0	1.4E3	0.629	37	3174	Sisma Y SLD	0	171.8	0	0	1.4E3	0.629
38	3175	Sisma X SLV	374.2	0	0	0	1.4E3	0.629	39	3175	Sisma Y SLV	0	374.2	0	0	1.4E3	0.629
40	3175	Sisma X SLD	171.8	0	0	0	1.4E3	0.629	41	3175	Sisma Y SLD	0	171.8	0	0	1.4E3	0.629
42	3176	Sisma X SLV	374.2	0	0	0	1.4E3	0.629	43	3176	Sisma Y SLV	0	374.2	0	0	1.4E3	0.629
44	3176	Sisma X SLD	171.8	0	0	0	1.4E3	0.629	45	3176	Sisma Y SLD	0	171.8	0	0	1.4E3	0.629
46	3177	Sisma X SLV	374.2	0	0	0	1.4E3	0.629	47	3177	Sisma Y SLV	0	374.2	0	0	1.4E3	0.629
48	3177	Sisma X SLD	171.8	0	0	0	1.4E3	0.629	49	3177	Sisma Y SLD	0	171.8	0	0	1.4E3	0.629
50	3178	Sisma X SLV	374.2	0	0	0	1.4E3	0.629	51	3178	Sisma Y SLV	0	374.2	0	0	1.4E3	0.629
52	3178	Sisma X SLD	171.8	0	0	0	1.4E3	0.629	53	3178	Sisma Y SLD	0	171.8	0	0	1.4E3	0.629
54	3179	Sisma X SLV	374.2	0	0	0	1.4E3	0.629	55	3179	Sisma Y SLV	0	374.2	0	0	1.4E3	0.629
56	3179	Sisma X SLD	171.8	0	0	0	1.4E3	0.629	57	3179	Sisma Y SLD	0	171.8	0	0	1.4E3	0.629
58	3180	Sisma X SLV	374.2	0	0	0	1.4E3	0.629	59	3180	Sisma Y SLV	0	374.2	0	0	1.4E3	0.629
60	3180	Sisma X SLD	171.8	0	0	0	1.4E3	0.629	61	3180	Sisma Y SLD	0	171.8	0	0	1.4E3	0.629
62	3181	Sisma X SLV	374.2	0	0	0	1.4E3	0.629	63	3181	Sisma Y SLV	0	374.2	0	0	1.4E3	0.629
64	3181	Sisma X SLD	171.8	0	0	0	1.4E3	0.629	65	3181	Sisma Y SLD	0	171.8	0	0	1.4E3	0.629
66	3182	Sisma X SLV	374.2	0	0	0	1.4E3	0.629	67	3182	Sisma Y SLV	0	374.2	0	0	1.4E3	0.629
68	3182	Sisma X SLD	171.8	0	0	0	1.4E3	0.629	69	3182	Sisma Y SLD	0	171.8	0	0	1.4E3	0.629
70	3183	Sisma X SLV	374.2	0	0	0	1.4E3	0.629	71	3183	Sisma Y SLV	0	374.2	0	0	1.4E3	0.629
72	3183	Sisma X SLD	171.8	0	0	0	1.4E3	0.629	73	3183	Sisma Y SLD	0	171.8	0	0	1.4E3	0.629
74	3184	Sisma X SLV	374.2	0	0	0	1.4E3	0.629	75	3184	Sisma Y SLV	0	374.2	0	0	1.4E3	0.629
76	3184	Sisma X SLD	171.8	0	0	0	1.4E3	0.629	77	3184	Sisma Y SLD	0	171.8	0	0	1.4E3	0.629
78	3185	Sisma X SLV	374.2	0	0	0	1.4E3	0.629	79	3185	Sisma Y SLV	0	374.2	0	0	1.4E3	0.629
80	3185	Sisma X SLD	171.8	0	0	0	1.4E3	0.629	81	3185	Sisma Y SLD	0	171.8	0	0	1.4E3	0.629
82	3186	Sisma X SLV	374.2	0	0	0	1.4E3	0.629	83	3186	Sisma Y SLV	0	374.2	0	0	1.4E3	0.629
84	3186	Sisma X SLD	171.8	0	0	0	1.4E3	0.629	85	3186	Sisma Y SLD	0	171.8	0	0	1.4E3	0.629
86	3187	Sisma X SLV	374.2	0	0	0	1.4E3	0.629	87	3187	Sisma Y SLV	0	374.2	0	0	1.4E3	0.629
88	3187	Sisma X SLD	171.8	0	0	0	1.4E3	0.629	89	3187	Sisma Y SLD	0	171.8	0	0	1.4E3	0.629
90	3188	Sisma X SLV	374.2	0	0	0	1.4E3	0.629	91	3188	Sisma Y SLV	0	374.2	0	0	1.4E3	0.629
92	3188	Sisma X SLD	171.8	0	0	0	1.4E3	0.629	93	3188	Sisma Y SLD	0	171.8	0	0	1.4E3	0.629
94	3189	Sisma X SLV	374.2	0	0	0	1.4E3	0.629	95	3189	Sisma Y SLV	0	374.2	0	0	1.4E3	0.629
96	3189	Sisma X SLD	171.8	0	0	0	1.4E3	0.629	97	3189	Sisma Y SLD	0	171.8	0	0	1.4E3	0.629
98	3190	Sisma X SLV	374.2	0	0	0	1.4E3	0.629	99	3190	Sisma Y SLV	0	374.2	0	0	1.4E3	0.629
100	3190	Sisma X SLD	171.8	0	0	0	1.4E3	0.629	101	3190	Sisma Y SLD	0	171.8	0	0	1.4E3	0.629
102	3191	Sisma X SLV	374.2	0	0	0	1.4E3	0.629	103	3191	Sisma Y SLV	0	374.2	0	0	1.4E3	0.629
104	3191	Sisma X SLD	171.8	0	0	0	1.4E3	0.629	105	3191	Sisma Y SLD	0	171.8	0	0	1.4E3	0.629
106	3192	Sisma X SLV	374.2	0	0	0	1.4E3	0.629	107	3192	Sisma Y SLV	0	374.2	0	0	1.4E3	0.629
108	3192	Sisma X SLD	171.8	0	0	0	1.4E3	0.629	109	3192	Sisma Y SLD	0	171.8	0	0	1.4E3	0.629
110	3193	Sisma X SLV	374.2	0	0	0	1.4E3	0.629	111	3193	Sisma Y SLV	0	374.2	0	0	1.4E3	0.629
112	3193	Sisma X SLD	171.8	0	0	0	1.4E3	0.629	113	3193	Sisma Y SLD	0	171.8	0	0	1.4E3	0.629
114	3194	Sisma X SLV	374.2	0	0	0	1.4E3	0.629	115	3194	Sisma Y SLV	0	374.2	0	0	1.4E3	0.629
116	3194	Sisma X SLD	171.8	0	0	0	1.4E3	0.629	117	3194	Sisma Y SLD	0	171.8	0	0	1.4E3	0.629
118	3195	Sisma X SLV	374.2	0	0	0	1.4E3	0.629	119	3195	Sisma Y SLV	0	374.2	0	0	1.4E3	0.629
120	3195	Sisma X SLD	171.8	0	0	0	1.4E3	0.629	121	3195	Sisma Y SLD	0	171.8	0	0	1.4E3	0.629
122	3196	Sisma X SLV	374.2	0	0	0	1.4E3	0.629	123	3196	Sisma Y SLV	0	374.2	0	0	1.4E3	0.629
124	3196	Sisma X SLD	171.8	0	0	0	1.4E3	0.629	125	3196	Sisma Y SLD	0	171.8	0	0	1.4E3	0.629
126	3197	Sisma X SLV	374.2	0	0	0	1.4E3	0.629	127	3197	Sisma Y SLV	0	374.2	0	0	1.4E3	0.629
128	3197	Sisma X SLD	171.8	0	0	0	1.4E3	0.629	129	3197	Sisma Y SLD	0	171.8	0	0	1.4E3	0.629
130	3198	Sisma X SLV	374.2	0	0	0	1.4E3	0.629	131	3198	Sisma Y SLV	0	374.2	0	0	1.4E3	0.629
132	3198	Sisma X SLD	171.8	0	0	0	1.4E3	0.629	133	3198	Sisma Y SLD	0	171.8	0	0	1.4E3	0.629
134	3199	Sisma X SLV	374.2	0	0	0	1.4E3	0.629	135	3199	Sisma Y SLV	0	374.2	0	0	1.4E3	0.629



Tabulati di Calcolo Plinto di Fondazione per Aerogeneratore Tipo - Progetto Impianto Eolico - "Orione"

Indice	Nodo	Condizione	Fx	Fy	Fz	Mz	Peso	Gamma	Indice	Nodo	Condizione	Fx	Fy	Fz	Mz	Peso	Gamma
136	3199	Sisma X SLD	171.8	0	0	0	1.4E3	0.629	137	3199	Sisma Y SLD	0	171.8	0	0	1.4E3	0.629
138	3200	Sisma X SLV	374.2	0	0	0	1.4E3	0.629	139	3200	Sisma Y SLV	0	374.2	0	0	1.4E3	0.629
140	3200	Sisma X SLD	171.8	0	0	0	1.4E3	0.629	141	3200	Sisma Y SLD	0	171.8	0	0	1.4E3	0.629
142	3201	Sisma X SLV	374.2	0	0	0	1.4E3	0.629	143	3201	Sisma Y SLV	0	374.2	0	0	1.4E3	0.629
144	3201	Sisma X SLD	171.8	0	0	0	1.4E3	0.629	145	3201	Sisma Y SLD	0	171.8	0	0	1.4E3	0.629
146	3202	Sisma X SLV	374.2	0	0	0	1.4E3	0.629	147	3202	Sisma Y SLV	0	374.2	0	0	1.4E3	0.629
148	3202	Sisma X SLD	171.8	0	0	0	1.4E3	0.629	149	3202	Sisma Y SLD	0	171.8	0	0	1.4E3	0.629
150	3203	Sisma X SLV	374.2	0	0	0	1.4E3	0.629	151	3203	Sisma Y SLV	0	374.2	0	0	1.4E3	0.629
152	3203	Sisma X SLD	171.8	0	0	0	1.4E3	0.629	153	3203	Sisma Y SLD	0	171.8	0	0	1.4E3	0.629
154	3204	Sisma X SLV	374.2	0	0	0	1.4E3	0.629	155	3204	Sisma Y SLV	0	374.2	0	0	1.4E3	0.629
156	3204	Sisma X SLD	171.8	0	0	0	1.4E3	0.629	157	3204	Sisma Y SLD	0	171.8	0	0	1.4E3	0.629
158	3205	Sisma X SLV	374.2	0	0	0	1.4E3	0.629	159	3205	Sisma Y SLV	0	374.2	0	0	1.4E3	0.629
160	3205	Sisma X SLD	171.8	0	0	0	1.4E3	0.629	161	3205	Sisma Y SLD	0	171.8	0	0	1.4E3	0.629
162	3206	Sisma X SLV	374.2	0	0	0	1.4E3	0.629	163	3206	Sisma Y SLV	0	374.2	0	0	1.4E3	0.629
164	3206	Sisma X SLD	171.8	0	0	0	1.4E3	0.629	165	3206	Sisma Y SLD	0	171.8	0	0	1.4E3	0.629
166	3207	Sisma X SLV	922.1	0	0	0	3.2E3	0.71	167	3207	Sisma Y SLV	0	922.1	0	0	3.2E3	0.71
168	3207	Sisma X SLD	423.4	0	0	0	3.2E3	0.71	169	3207	Sisma Y SLD	0	423.4	0	0	3.2E3	0.71
170	3208	Sisma X SLV	922.1	0	0	0	3.2E3	0.71	171	3208	Sisma Y SLV	0	922.1	0	0	3.2E3	0.71
172	3208	Sisma X SLD	423.4	0	0	0	3.2E3	0.71	173	3208	Sisma Y SLD	0	423.4	0	0	3.2E3	0.71
174	3209	Sisma X SLV	922.1	0	0	0	3.2E3	0.71	175	3209	Sisma Y SLV	0	922.1	0	0	3.2E3	0.71
176	3209	Sisma X SLD	423.4	0	0	0	3.2E3	0.71	177	3209	Sisma Y SLD	0	423.4	0	0	3.2E3	0.71
178	3210	Sisma X SLV	922.1	0	0	0	3.2E3	0.71	179	3210	Sisma Y SLV	0	922.1	0	0	3.2E3	0.71
180	3210	Sisma X SLD	423.4	0	0	0	3.2E3	0.71	181	3210	Sisma Y SLD	0	423.4	0	0	3.2E3	0.71
182	3211	Sisma X SLV	922.1	0	0	0	3.2E3	0.71	183	3211	Sisma Y SLV	0	922.1	0	0	3.2E3	0.71
184	3211	Sisma X SLD	423.4	0	0	0	3.2E3	0.71	185	3211	Sisma Y SLD	0	423.4	0	0	3.2E3	0.71
186	3212	Sisma X SLV	922.1	0	0	0	3.2E3	0.71	187	3212	Sisma Y SLV	0	922.1	0	0	3.2E3	0.71
188	3212	Sisma X SLD	423.4	0	0	0	3.2E3	0.71	189	3212	Sisma Y SLD	0	423.4	0	0	3.2E3	0.71
190	3213	Sisma X SLV	922.1	0	0	0	3.2E3	0.71	191	3213	Sisma Y SLV	0	922.1	0	0	3.2E3	0.71
192	3213	Sisma X SLD	423.4	0	0	0	3.2E3	0.71	193	3213	Sisma Y SLD	0	423.4	0	0	3.2E3	0.71
194	3214	Sisma X SLV	922.1	0	0	0	3.2E3	0.71	195	3214	Sisma Y SLV	0	922.1	0	0	3.2E3	0.71
196	3214	Sisma X SLD	423.4	0	0	0	3.2E3	0.71	197	3214	Sisma Y SLD	0	423.4	0	0	3.2E3	0.71
198	3215	Sisma X SLV	922.1	0	0	0	3.2E3	0.71	199	3215	Sisma Y SLV	0	922.1	0	0	3.2E3	0.71
200	3215	Sisma X SLD	423.4	0	0	0	3.2E3	0.71	201	3215	Sisma Y SLD	0	423.4	0	0	3.2E3	0.71
202	3216	Sisma X SLV	922.1	0	0	0	3.2E3	0.71	203	3216	Sisma Y SLV	0	922.1	0	0	3.2E3	0.71
204	3216	Sisma X SLD	423.4	0	0	0	3.2E3	0.71	205	3216	Sisma Y SLD	0	423.4	0	0	3.2E3	0.71
206	3217	Sisma X SLV	922.1	0	0	0	3.2E3	0.71	207	3217	Sisma Y SLV	0	922.1	0	0	3.2E3	0.71
208	3217	Sisma X SLD	423.4	0	0	0	3.2E3	0.71	209	3217	Sisma Y SLD	0	423.4	0	0	3.2E3	0.71
210	3218	Sisma X SLV	922.1	0	0	0	3.2E3	0.71	211	3218	Sisma Y SLV	0	922.1	0	0	3.2E3	0.71
212	3218	Sisma X SLD	423.4	0	0	0	3.2E3	0.71	213	3218	Sisma Y SLD	0	423.4	0	0	3.2E3	0.71
214	3219	Sisma X SLV	922.1	0	0	0	3.2E3	0.71	215	3219	Sisma Y SLV	0	922.1	0	0	3.2E3	0.71
216	3219	Sisma X SLD	423.4	0	0	0	3.2E3	0.71	217	3219	Sisma Y SLD	0	423.4	0	0	3.2E3	0.71
218	3220	Sisma X SLV	922.1	0	0	0	3.2E3	0.71	219	3220	Sisma Y SLV	0	922.1	0	0	3.2E3	0.71
220	3220	Sisma X SLD	423.4	0	0	0	3.2E3	0.71	221	3220	Sisma Y SLD	0	423.4	0	0	3.2E3	0.71
222	3221	Sisma X SLV	922.1	0	0	0	3.2E3	0.71	223	3221	Sisma Y SLV	0	922.1	0	0	3.2E3	0.71
224	3221	Sisma X SLD	423.4	0	0	0	3.2E3	0.71	225	3221	Sisma Y SLD	0	423.4	0	0	3.2E3	0.71
226	3222	Sisma X SLV	922.1	0	0	0	3.2E3	0.71	227	3222	Sisma Y SLV	0	922.1	0	0	3.2E3	0.71
228	3222	Sisma X SLD	423.4	0	0	0	3.2E3	0.71	229	3222	Sisma Y SLD	0	423.4	0	0	3.2E3	0.71
230	3223	Sisma X SLV	922.1	0	0	0	3.2E3	0.71	231	3223	Sisma Y SLV	0	922.1	0	0	3.2E3	0.71
232	3223	Sisma X SLD	423.4	0	0	0	3.2E3	0.71	233	3223	Sisma Y SLD	0	423.4	0	0	3.2E3	0.71
234	3224	Sisma X SLV	922.1	0	0	0	3.2E3	0.71	235	3224	Sisma Y SLV	0	922.1	0	0	3.2E3	0.71



Tabulati di Calcolo Plinto di Fondazione per Aerogeneratore Tipo - Progetto Impianto Eolico - "Orione"

Indice	Nodo	Condizione	Fx	Fy	Fz	Mz	Peso	Gamma	Indice	Nodo	Condizione	Fx	Fy	Fz	Mz	Peso	Gamma
236	3224	Sisma X SLD	423.4	0	0	0	3.2E3	0.71	237	3224	Sisma Y SLD	0	423.4	0	0	3.2E3	0.71
238	3225	Sisma X SLV	922.1	0	0	0	3.2E3	0.71	239	3225	Sisma Y SLV	0	922.1	0	0	3.2E3	0.71
240	3225	Sisma X SLD	423.4	0	0	0	3.2E3	0.71	241	3225	Sisma Y SLD	0	423.4	0	0	3.2E3	0.71
242	3226	Sisma X SLV	922.1	0	0	0	3.2E3	0.71	243	3226	Sisma Y SLV	0	922.1	0	0	3.2E3	0.71
244	3226	Sisma X SLD	423.4	0	0	0	3.2E3	0.71	245	3226	Sisma Y SLD	0	423.4	0	0	3.2E3	0.71
246	3227	Sisma X SLV	922.1	0	0	0	3.2E3	0.71	247	3227	Sisma Y SLV	0	922.1	0	0	3.2E3	0.71
248	3227	Sisma X SLD	423.4	0	0	0	3.2E3	0.71	249	3227	Sisma Y SLD	0	423.4	0	0	3.2E3	0.71
250	3228	Sisma X SLV	922.1	0	0	0	3.2E3	0.71	251	3228	Sisma Y SLV	0	922.1	0	0	3.2E3	0.71
252	3228	Sisma X SLD	423.4	0	0	0	3.2E3	0.71	253	3228	Sisma Y SLD	0	423.4	0	0	3.2E3	0.71
254	3229	Sisma X SLV	922.1	0	0	0	3.2E3	0.71	255	3229	Sisma Y SLV	0	922.1	0	0	3.2E3	0.71
256	3229	Sisma X SLD	423.4	0	0	0	3.2E3	0.71	257	3229	Sisma Y SLD	0	423.4	0	0	3.2E3	0.71
258	3230	Sisma X SLV	922.1	0	0	0	3.2E3	0.71	259	3230	Sisma Y SLV	0	922.1	0	0	3.2E3	0.71
260	3230	Sisma X SLD	423.4	0	0	0	3.2E3	0.71	261	3230	Sisma Y SLD	0	423.4	0	0	3.2E3	0.71
262	3231	Sisma X SLV	922.1	0	0	0	3.2E3	0.71	263	3231	Sisma Y SLV	0	922.1	0	0	3.2E3	0.71
264	3231	Sisma X SLD	423.4	0	0	0	3.2E3	0.71	265	3231	Sisma Y SLD	0	423.4	0	0	3.2E3	0.71
266	3232	Sisma X SLV	922.1	0	0	0	3.2E3	0.71	267	3232	Sisma Y SLV	0	922.1	0	0	3.2E3	0.71
268	3232	Sisma X SLD	423.4	0	0	0	3.2E3	0.71	269	3232	Sisma Y SLD	0	423.4	0	0	3.2E3	0.71
270	3233	Sisma X SLV	922.1	0	0	0	3.2E3	0.71	271	3233	Sisma Y SLV	0	922.1	0	0	3.2E3	0.71
272	3233	Sisma X SLD	423.4	0	0	0	3.2E3	0.71	273	3233	Sisma Y SLD	0	423.4	0	0	3.2E3	0.71
274	3234	Sisma X SLV	922.1	0	0	0	3.2E3	0.71	275	3234	Sisma Y SLV	0	922.1	0	0	3.2E3	0.71
276	3234	Sisma X SLD	423.4	0	0	0	3.2E3	0.71	277	3234	Sisma Y SLD	0	423.4	0	0	3.2E3	0.71
278	3235	Sisma X SLV	922.1	0	0	0	3.2E3	0.71	279	3235	Sisma Y SLV	0	922.1	0	0	3.2E3	0.71
280	3235	Sisma X SLD	423.4	0	0	0	3.2E3	0.71	281	3235	Sisma Y SLD	0	423.4	0	0	3.2E3	0.71
282	3236	Sisma X SLV	922.1	0	0	0	3.2E3	0.71	283	3236	Sisma Y SLV	0	922.1	0	0	3.2E3	0.71
284	3236	Sisma X SLD	423.4	0	0	0	3.2E3	0.71	285	3236	Sisma Y SLD	0	423.4	0	0	3.2E3	0.71
286	3237	Sisma X SLV	922.1	0	0	0	3.2E3	0.71	287	3237	Sisma Y SLV	0	922.1	0	0	3.2E3	0.71
288	3237	Sisma X SLD	423.4	0	0	0	3.2E3	0.71	289	3237	Sisma Y SLD	0	423.4	0	0	3.2E3	0.71
290	3238	Sisma X SLV	922.1	0	0	0	3.2E3	0.71	291	3238	Sisma Y SLV	0	922.1	0	0	3.2E3	0.71
292	3238	Sisma X SLD	423.4	0	0	0	3.2E3	0.71	293	3238	Sisma Y SLD	0	423.4	0	0	3.2E3	0.71
294	3239	Sisma X SLV	922.1	0	0	0	3.2E3	0.71	295	3239	Sisma Y SLV	0	922.1	0	0	3.2E3	0.71
296	3239	Sisma X SLD	423.4	0	0	0	3.2E3	0.71	297	3239	Sisma Y SLD	0	423.4	0	0	3.2E3	0.71
298	3240	Sisma X SLV	922.1	0	0	0	3.2E3	0.71	299	3240	Sisma Y SLV	0	922.1	0	0	3.2E3	0.71
300	3240	Sisma X SLD	423.4	0	0	0	3.2E3	0.71	301	3240	Sisma Y SLD	0	423.4	0	0	3.2E3	0.71
302	3241	Sisma X SLV	922.1	0	0	0	3.2E3	0.71	303	3241	Sisma Y SLV	0	922.1	0	0	3.2E3	0.71
304	3241	Sisma X SLD	423.4	0	0	0	3.2E3	0.71	305	3241	Sisma Y SLD	0	423.4	0	0	3.2E3	0.71
306	3242	Sisma X SLV	922.1	0	0	0	3.2E3	0.71	307	3242	Sisma Y SLV	0	922.1	0	0	3.2E3	0.71
308	3242	Sisma X SLD	423.4	0	0	0	3.2E3	0.71	309	3242	Sisma Y SLD	0	423.4	0	0	3.2E3	0.71
310	3243	Sisma X SLV	1475.3	0	0	0	4.5E3	0.795	311	3243	Sisma Y SLV	0	1475.3	0	0	4.5E3	0.795
312	3243	Sisma X SLD	677.4	0	0	0	4.5E3	0.795	313	3243	Sisma Y SLD	0	677.4	0	0	4.5E3	0.795
314	3244	Sisma X SLV	1475.3	0	0	0	4.5E3	0.795	315	3244	Sisma Y SLV	0	1475.3	0	0	4.5E3	0.795
316	3244	Sisma X SLD	677.4	0	0	0	4.5E3	0.795	317	3244	Sisma Y SLD	0	677.4	0	0	4.5E3	0.795
318	3245	Sisma X SLV	1475.3	0	0	0	4.5E3	0.795	319	3245	Sisma Y SLV	0	1475.3	0	0	4.5E3	0.795
320	3245	Sisma X SLD	677.4	0	0	0	4.5E3	0.795	321	3245	Sisma Y SLD	0	677.4	0	0	4.5E3	0.795
322	3246	Sisma X SLV	1475.3	0	0	0	4.5E3	0.795	323	3246	Sisma Y SLV	0	1475.3	0	0	4.5E3	0.795
324	3246	Sisma X SLD	677.4	0	0	0	4.5E3	0.795	325	3246	Sisma Y SLD	0	677.4	0	0	4.5E3	0.795
326	3247	Sisma X SLV	1475.3	0	0	0	4.5E3	0.795	327	3247	Sisma Y SLV	0	1475.3	0	0	4.5E3	0.795
328	3247	Sisma X SLD	677.4	0	0	0	4.5E3	0.795	329	3247	Sisma Y SLD	0	677.4	0	0	4.5E3	0.795
330	3248	Sisma X SLV	1475.3	0	0	0	4.5E3	0.795	331	3248	Sisma Y SLV	0	1475.3	0	0	4.5E3	0.795
332	3248	Sisma X SLD	677.4	0	0	0	4.5E3	0.795	333	3248	Sisma Y SLD	0	677.4	0	0	4.5E3	0.795
334	3249	Sisma X SLV	1475.3	0	0	0	4.5E3	0.795	335	3249	Sisma Y SLV	0	1475.3	0	0	4.5E3	0.795



Progetto	Titolo	Rev.	Pag.
Orione	Orione_A24a.pdf "TABULATI DI CALCOLO PLINTO DI FONDAZIONE PER AEROGENERATORE TIPO"	0	74

Tabulati di Calcolo Plinto di Fondazione per Aerogeneratore Tipo - Progetto Impianto Eolico - "Orione"

Indice	Nodo	Condizione	Fx	Fy	Fz	Mz	Peso	Gamma	Indice	Nodo	Condizione	Fx	Fy	Fz	Mz	Peso	Gamma
336	3249	Sisma X SLD	677.4	0	0	0	4.5E3	0.795	337	3249	Sisma Y SLD	0	677.4	0	0	4.5E3	0.795
338	3250	Sisma X SLV	1475.3	0	0	0	4.5E3	0.795	339	3250	Sisma Y SLV	0	1475.3	0	0	4.5E3	0.795
340	3250	Sisma X SLD	677.4	0	0	0	4.5E3	0.795	341	3250	Sisma Y SLD	0	677.4	0	0	4.5E3	0.795
342	3251	Sisma X SLV	1475.3	0	0	0	4.5E3	0.795	343	3251	Sisma Y SLV	0	1475.3	0	0	4.5E3	0.795
344	3251	Sisma X SLD	677.4	0	0	0	4.5E3	0.795	345	3251	Sisma Y SLD	0	677.4	0	0	4.5E3	0.795
346	3252	Sisma X SLV	1475.3	0	0	0	4.5E3	0.795	347	3252	Sisma Y SLV	0	1475.3	0	0	4.5E3	0.795
348	3252	Sisma X SLD	677.4	0	0	0	4.5E3	0.795	349	3252	Sisma Y SLD	0	677.4	0	0	4.5E3	0.795
350	3253	Sisma X SLV	1475.3	0	0	0	4.5E3	0.795	351	3253	Sisma Y SLV	0	1475.3	0	0	4.5E3	0.795
352	3253	Sisma X SLD	677.4	0	0	0	4.5E3	0.795	353	3253	Sisma Y SLD	0	677.4	0	0	4.5E3	0.795
354	3254	Sisma X SLV	1475.3	0	0	0	4.5E3	0.795	355	3254	Sisma Y SLV	0	1475.3	0	0	4.5E3	0.795
356	3254	Sisma X SLD	677.4	0	0	0	4.5E3	0.795	357	3254	Sisma Y SLD	0	677.4	0	0	4.5E3	0.795
358	3255	Sisma X SLV	1475.3	0	0	0	4.5E3	0.795	359	3255	Sisma Y SLV	0	1475.3	0	0	4.5E3	0.795
360	3255	Sisma X SLD	677.4	0	0	0	4.5E3	0.795	361	3255	Sisma Y SLD	0	677.4	0	0	4.5E3	0.795
362	3256	Sisma X SLV	1475.3	0	0	0	4.5E3	0.795	363	3256	Sisma Y SLV	0	1475.3	0	0	4.5E3	0.795
364	3256	Sisma X SLD	677.4	0	0	0	4.5E3	0.795	365	3256	Sisma Y SLD	0	677.4	0	0	4.5E3	0.795
366	3257	Sisma X SLV	1475.3	0	0	0	4.5E3	0.795	367	3257	Sisma Y SLV	0	1475.3	0	0	4.5E3	0.795
368	3257	Sisma X SLD	677.4	0	0	0	4.5E3	0.795	369	3257	Sisma Y SLD	0	677.4	0	0	4.5E3	0.795
370	3258	Sisma X SLV	1475.3	0	0	0	4.5E3	0.795	371	3258	Sisma Y SLV	0	1475.3	0	0	4.5E3	0.795
372	3258	Sisma X SLD	677.4	0	0	0	4.5E3	0.795	373	3258	Sisma Y SLD	0	677.4	0	0	4.5E3	0.795
374	3259	Sisma X SLV	1475.3	0	0	0	4.5E3	0.795	375	3259	Sisma Y SLV	0	1475.3	0	0	4.5E3	0.795
376	3259	Sisma X SLD	677.4	0	0	0	4.5E3	0.795	377	3259	Sisma Y SLD	0	677.4	0	0	4.5E3	0.795
378	3260	Sisma X SLV	1475.3	0	0	0	4.5E3	0.795	379	3260	Sisma Y SLV	0	1475.3	0	0	4.5E3	0.795
380	3260	Sisma X SLD	677.4	0	0	0	4.5E3	0.795	381	3260	Sisma Y SLD	0	677.4	0	0	4.5E3	0.795
382	3261	Sisma X SLV	1475.3	0	0	0	4.5E3	0.795	383	3261	Sisma Y SLV	0	1475.3	0	0	4.5E3	0.795
384	3261	Sisma X SLD	677.4	0	0	0	4.5E3	0.795	385	3261	Sisma Y SLD	0	677.4	0	0	4.5E3	0.795
386	3262	Sisma X SLV	1475.3	0	0	0	4.5E3	0.795	387	3262	Sisma Y SLV	0	1475.3	0	0	4.5E3	0.795
388	3262	Sisma X SLD	677.4	0	0	0	4.5E3	0.795	389	3262	Sisma Y SLD	0	677.4	0	0	4.5E3	0.795
390	3263	Sisma X SLV	1475.3	0	0	0	4.5E3	0.795	391	3263	Sisma Y SLV	0	1475.3	0	0	4.5E3	0.795
392	3263	Sisma X SLD	677.4	0	0	0	4.5E3	0.795	393	3263	Sisma Y SLD	0	677.4	0	0	4.5E3	0.795
394	3264	Sisma X SLV	1475.3	0	0	0	4.5E3	0.795	395	3264	Sisma Y SLV	0	1475.3	0	0	4.5E3	0.795
396	3264	Sisma X SLD	677.4	0	0	0	4.5E3	0.795	397	3264	Sisma Y SLD	0	677.4	0	0	4.5E3	0.795
398	3265	Sisma X SLV	1475.3	0	0	0	4.5E3	0.795	399	3265	Sisma Y SLV	0	1475.3	0	0	4.5E3	0.795
400	3265	Sisma X SLD	677.4	0	0	0	4.5E3	0.795	401	3265	Sisma Y SLD	0	677.4	0	0	4.5E3	0.795
402	3266	Sisma X SLV	1475.3	0	0	0	4.5E3	0.795	403	3266	Sisma Y SLV	0	1475.3	0	0	4.5E3	0.795
404	3266	Sisma X SLD	677.4	0	0	0	4.5E3	0.795	405	3266	Sisma Y SLD	0	677.4	0	0	4.5E3	0.795
406	3267	Sisma X SLV	1475.3	0	0	0	4.5E3	0.795	407	3267	Sisma Y SLV	0	1475.3	0	0	4.5E3	0.795
408	3267	Sisma X SLD	677.4	0	0	0	4.5E3	0.795	409	3267	Sisma Y SLD	0	677.4	0	0	4.5E3	0.795
410	3268	Sisma X SLV	1475.3	0	0	0	4.5E3	0.795	411	3268	Sisma Y SLV	0	1475.3	0	0	4.5E3	0.795
412	3268	Sisma X SLD	677.4	0	0	0	4.5E3	0.795	413	3268	Sisma Y SLD	0	677.4	0	0	4.5E3	0.795
414	3269	Sisma X SLV	1475.3	0	0	0	4.5E3	0.795	415	3269	Sisma Y SLV	0	1475.3	0	0	4.5E3	0.795
416	3269	Sisma X SLD	677.4	0	0	0	4.5E3	0.795	417	3269	Sisma Y SLD	0	677.4	0	0	4.5E3	0.795
418	3270	Sisma X SLV	1475.3	0	0	0	4.5E3	0.795	419	3270	Sisma Y SLV	0	1475.3	0	0	4.5E3	0.795
420	3270	Sisma X SLD	677.4	0	0	0	4.5E3	0.795	421	3270	Sisma Y SLD	0	677.4	0	0	4.5E3	0.795
422	3271	Sisma X SLV	1475.3	0	0	0	4.5E3	0.795	423	3271	Sisma Y SLV	0	1475.3	0	0	4.5E3	0.795
424	3271	Sisma X SLD	677.4	0	0	0	4.5E3	0.795	425	3271	Sisma Y SLD	0	677.4	0	0	4.5E3	0.795
426	3272	Sisma X SLV	1475.3	0	0	0	4.5E3	0.795	427	3272	Sisma Y SLV	0	1475.3	0	0	4.5E3	0.795
428	3272	Sisma X SLD	677.4	0	0	0	4.5E3	0.795	429	3272	Sisma Y SLD	0	677.4	0	0	4.5E3	0.795
430	3273	Sisma X SLV	1475.3	0	0	0	4.5E3	0.795	431	3273	Sisma Y SLV	0	1475.3	0	0	4.5E3	0.795
432	3273	Sisma X SLD	677.4	0	0	0	4.5E3	0.795	433	3273	Sisma Y SLD	0	677.4	0	0	4.5E3	0.795
434	3274	Sisma X SLV	1475.3	0	0	0	4.5E3	0.795	435	3274	Sisma Y SLV	0	1475.3	0	0	4.5E3	0.795



Progetto	Titolo	Rev.	Pag.
Orione	Orione_A24a.pdf "TABULATI DI CALCOLO PLINTO DI FONDAZIONE PER AEROGENERATORE TIPO"	0	75

Tabulati di Calcolo Plinto di Fondazione per Aerogeneratore Tipo - Progetto Impianto Eolico - "Orione"

Indice	Nodo	Condizione	Fx	Fy	Fz	Mz	Peso	Gamma	Indice	Nodo	Condizione	Fx	Fy	Fz	Mz	Peso	Gamma
436	3274	Sisma X SLD	677.4	0	0	0	4.5E3	0.795	437	3274	Sisma Y SLD	0	677.4	0	0	4.5E3	0.795
438	3275	Sisma X SLV	1475.3	0	0	0	4.5E3	0.795	439	3275	Sisma Y SLV	0	1475.3	0	0	4.5E3	0.795
440	3275	Sisma X SLD	677.4	0	0	0	4.5E3	0.795	441	3275	Sisma Y SLD	0	677.4	0	0	4.5E3	0.795
442	3276	Sisma X SLV	1475.3	0	0	0	4.5E3	0.795	443	3276	Sisma Y SLV	0	1475.3	0	0	4.5E3	0.795
444	3276	Sisma X SLD	677.4	0	0	0	4.5E3	0.795	445	3276	Sisma Y SLD	0	677.4	0	0	4.5E3	0.795
446	3277	Sisma X SLV	1475.3	0	0	0	4.5E3	0.795	447	3277	Sisma Y SLV	0	1475.3	0	0	4.5E3	0.795
448	3277	Sisma X SLD	677.4	0	0	0	4.5E3	0.795	449	3277	Sisma Y SLD	0	677.4	0	0	4.5E3	0.795
450	3278	Sisma X SLV	1475.3	0	0	0	4.5E3	0.795	451	3278	Sisma Y SLV	0	1475.3	0	0	4.5E3	0.795
452	3278	Sisma X SLD	677.4	0	0	0	4.5E3	0.795	453	3278	Sisma Y SLD	0	677.4	0	0	4.5E3	0.795
454	3279	Sisma X SLV	336.4	0	0	0	8.5E2	0.959	455	3279	Sisma Y SLV	0	336.4	0	0	8.5E2	0.959
456	3279	Sisma X SLD	154.5	0	0	0	8.5E2	0.959	457	3279	Sisma Y SLD	0	154.5	0	0	8.5E2	0.959
458	3280	Sisma X SLV	336.4	0	0	0	8.5E2	0.959	459	3280	Sisma Y SLV	0	336.4	0	0	8.5E2	0.959
460	3280	Sisma X SLD	154.5	0	0	0	8.5E2	0.959	461	3280	Sisma Y SLD	0	154.5	0	0	8.5E2	0.959
462	3281	Sisma X SLV	336.4	0	0	0	8.5E2	0.959	463	3281	Sisma Y SLV	0	336.4	0	0	8.5E2	0.959
464	3281	Sisma X SLD	154.5	0	0	0	8.5E2	0.959	465	3281	Sisma Y SLD	0	154.5	0	0	8.5E2	0.959
466	3282	Sisma X SLV	336.4	0	0	0	8.5E2	0.959	467	3282	Sisma Y SLV	0	336.4	0	0	8.5E2	0.959
468	3282	Sisma X SLD	154.5	0	0	0	8.5E2	0.959	469	3282	Sisma Y SLD	0	154.5	0	0	8.5E2	0.959
470	3283	Sisma X SLV	336.4	0	0	0	8.5E2	0.959	471	3283	Sisma Y SLV	0	336.4	0	0	8.5E2	0.959
472	3283	Sisma X SLD	154.5	0	0	0	8.5E2	0.959	473	3283	Sisma Y SLD	0	154.5	0	0	8.5E2	0.959
474	3284	Sisma X SLV	336.4	0	0	0	8.5E2	0.959	475	3284	Sisma Y SLV	0	336.4	0	0	8.5E2	0.959
476	3284	Sisma X SLD	154.5	0	0	0	8.5E2	0.959	477	3284	Sisma Y SLD	0	154.5	0	0	8.5E2	0.959
478	3285	Sisma X SLV	336.4	0	0	0	8.5E2	0.959	479	3285	Sisma Y SLV	0	336.4	0	0	8.5E2	0.959
480	3285	Sisma X SLD	154.5	0	0	0	8.5E2	0.959	481	3285	Sisma Y SLD	0	154.5	0	0	8.5E2	0.959
482	3286	Sisma X SLV	336.4	0	0	0	8.5E2	0.959	483	3286	Sisma Y SLV	0	336.4	0	0	8.5E2	0.959
484	3286	Sisma X SLD	154.5	0	0	0	8.5E2	0.959	485	3286	Sisma Y SLD	0	154.5	0	0	8.5E2	0.959
486	3287	Sisma X SLV	336.4	0	0	0	8.5E2	0.959	487	3287	Sisma Y SLV	0	336.4	0	0	8.5E2	0.959
488	3287	Sisma X SLD	154.5	0	0	0	8.5E2	0.959	489	3287	Sisma Y SLD	0	154.5	0	0	8.5E2	0.959
490	3288	Sisma X SLV	336.4	0	0	0	8.5E2	0.959	491	3288	Sisma Y SLV	0	336.4	0	0	8.5E2	0.959
492	3288	Sisma X SLD	154.5	0	0	0	8.5E2	0.959	493	3288	Sisma Y SLD	0	154.5	0	0	8.5E2	0.959
494	3289	Sisma X SLV	336.4	0	0	0	8.5E2	0.959	495	3289	Sisma Y SLV	0	336.4	0	0	8.5E2	0.959
496	3289	Sisma X SLD	154.5	0	0	0	8.5E2	0.959	497	3289	Sisma Y SLD	0	154.5	0	0	8.5E2	0.959
498	3290	Sisma X SLV	336.4	0	0	0	8.5E2	0.959	499	3290	Sisma Y SLV	0	336.4	0	0	8.5E2	0.959
500	3290	Sisma X SLD	154.5	0	0	0	8.5E2	0.959	501	3290	Sisma Y SLD	0	154.5	0	0	8.5E2	0.959
502	3291	Sisma X SLV	336.4	0	0	0	8.5E2	0.959	503	3291	Sisma Y SLV	0	336.4	0	0	8.5E2	0.959
504	3291	Sisma X SLD	154.5	0	0	0	8.5E2	0.959	505	3291	Sisma Y SLD	0	154.5	0	0	8.5E2	0.959
506	3292	Sisma X SLV	336.4	0	0	0	8.5E2	0.959	507	3292	Sisma Y SLV	0	336.4	0	0	8.5E2	0.959
508	3292	Sisma X SLD	154.5	0	0	0	8.5E2	0.959	509	3292	Sisma Y SLD	0	154.5	0	0	8.5E2	0.959
510	3293	Sisma X SLV	336.4	0	0	0	8.5E2	0.959	511	3293	Sisma Y SLV	0	336.4	0	0	8.5E2	0.959
512	3293	Sisma X SLD	154.5	0	0	0	8.5E2	0.959	513	3293	Sisma Y SLD	0	154.5	0	0	8.5E2	0.959
514	3294	Sisma X SLV	336.4	0	0	0	8.5E2	0.959	515	3294	Sisma Y SLV	0	336.4	0	0	8.5E2	0.959
516	3294	Sisma X SLD	154.5	0	0	0	8.5E2	0.959	517	3294	Sisma Y SLD	0	154.5	0	0	8.5E2	0.959
518	3295	Sisma X SLV	336.4	0	0	0	8.5E2	0.959	519	3295	Sisma Y SLV	0	336.4	0	0	8.5E2	0.959
520	3295	Sisma X SLD	154.5	0	0	0	8.5E2	0.959	521	3295	Sisma Y SLD	0	154.5	0	0	8.5E2	0.959
522	3296	Sisma X SLV	336.4	0	0	0	8.5E2	0.959	523	3296	Sisma Y SLV	0	336.4	0	0	8.5E2	0.959
524	3296	Sisma X SLD	154.5	0	0	0	8.5E2	0.959	525	3296	Sisma Y SLD	0	154.5	0	0	8.5E2	0.959
526	3297	Sisma X SLV	336.4	0	0	0	8.5E2	0.959	527	3297	Sisma Y SLV	0	336.4	0	0	8.5E2	0.959
528	3297	Sisma X SLD	154.5	0	0	0	8.5E2	0.959	529	3297	Sisma Y SLD	0	154.5	0	0	8.5E2	0.959
530	3298	Sisma X SLV	336.4	0	0	0	8.5E2	0.959	531	3298	Sisma Y SLV	0	336.4	0	0	8.5E2	0.959
532	3298	Sisma X SLD	154.5	0	0	0	8.5E2	0.959	533	3298	Sisma Y SLD	0	154.5	0	0	8.5E2	0.959
534	3299	Sisma X SLV	336.4	0	0	0	8.5E2	0.959	535	3299	Sisma Y SLV	0	336.4	0	0	8.5E2	0.959



Progetto	Titolo	Rev.	Pag.
Orione	Orione_A24a.pdf "TABULATI DI CALCOLO PLINTO DI FONDAZIONE PER AEROGENERATORE TIPO"	0	76

Tabulati di Calcolo Plinto di Fondazione per Aerogeneratore Tipo - Progetto Impianto Eolico - "Orione"

Indice	Nodo	Condizione	Fx	Fy	Fz	Mz	Peso	Gamma	Indice	Nodo	Condizione	Fx	Fy	Fz	Mz	Peso	Gamma
536	3299	Sisma X SLD	154.5	0	0	0	8.5E2	0.959	537	3299	Sisma Y SLD	0	154.5	0	0	8.5E2	0.959
538	3300	Sisma X SLV	336.4	0	0	0	8.5E2	0.959	539	3300	Sisma Y SLV	0	336.4	0	0	8.5E2	0.959
540	3300	Sisma X SLD	154.5	0	0	0	8.5E2	0.959	541	3300	Sisma Y SLD	0	154.5	0	0	8.5E2	0.959
542	3301	Sisma X SLV	336.4	0	0	0	8.5E2	0.959	543	3301	Sisma Y SLV	0	336.4	0	0	8.5E2	0.959
544	3301	Sisma X SLD	154.5	0	0	0	8.5E2	0.959	545	3301	Sisma Y SLD	0	154.5	0	0	8.5E2	0.959
546	3302	Sisma X SLV	336.4	0	0	0	8.5E2	0.959	547	3302	Sisma Y SLV	0	336.4	0	0	8.5E2	0.959
548	3302	Sisma X SLD	154.5	0	0	0	8.5E2	0.959	549	3302	Sisma Y SLD	0	154.5	0	0	8.5E2	0.959
550	3303	Sisma X SLV	336.4	0	0	0	8.5E2	0.959	551	3303	Sisma Y SLV	0	336.4	0	0	8.5E2	0.959
552	3303	Sisma X SLD	154.5	0	0	0	8.5E2	0.959	553	3303	Sisma Y SLD	0	154.5	0	0	8.5E2	0.959
554	3304	Sisma X SLV	316.9	0	0	0	8.0E2	0.959	555	3304	Sisma Y SLV	0	316.9	0	0	8.0E2	0.959
556	3304	Sisma X SLD	145.5	0	0	0	8.0E2	0.959	557	3304	Sisma Y SLD	0	145.5	0	0	8.0E2	0.959
558	3305	Sisma X SLV	316.9	0	0	0	8.0E2	0.959	559	3305	Sisma Y SLV	0	316.9	0	0	8.0E2	0.959
560	3305	Sisma X SLD	145.5	0	0	0	8.0E2	0.959	561	3305	Sisma Y SLD	0	145.5	0	0	8.0E2	0.959
562	3306	Sisma X SLV	316.9	0	0	0	8.0E2	0.959	563	3306	Sisma Y SLV	0	316.9	0	0	8.0E2	0.959
564	3306	Sisma X SLD	145.5	0	0	0	8.0E2	0.959	565	3306	Sisma Y SLD	0	145.5	0	0	8.0E2	0.959
566	3307	Sisma X SLV	316.9	0	0	0	8.0E2	0.959	567	3307	Sisma Y SLV	0	316.9	0	0	8.0E2	0.959
568	3307	Sisma X SLD	145.5	0	0	0	8.0E2	0.959	569	3307	Sisma Y SLD	0	145.5	0	0	8.0E2	0.959
570	3308	Sisma X SLV	316.9	0	0	0	8.0E2	0.959	571	3308	Sisma Y SLV	0	316.9	0	0	8.0E2	0.959
572	3308	Sisma X SLD	145.5	0	0	0	8.0E2	0.959	573	3308	Sisma Y SLD	0	145.5	0	0	8.0E2	0.959
574	3309	Sisma X SLV	336.4	0	0	0	8.5E2	0.959	575	3309	Sisma Y SLV	0	336.4	0	0	8.5E2	0.959
576	3309	Sisma X SLD	154.5	0	0	0	8.5E2	0.959	577	3309	Sisma Y SLD	0	154.5	0	0	8.5E2	0.959
578	3310	Sisma X SLV	316.9	0	0	0	8.0E2	0.959	579	3310	Sisma Y SLV	0	316.9	0	0	8.0E2	0.959
580	3310	Sisma X SLD	145.5	0	0	0	8.0E2	0.959	581	3310	Sisma Y SLD	0	145.5	0	0	8.0E2	0.959
582	3311	Sisma X SLV	316.9	0	0	0	8.0E2	0.959	583	3311	Sisma Y SLV	0	316.9	0	0	8.0E2	0.959
584	3311	Sisma X SLD	145.5	0	0	0	8.0E2	0.959	585	3311	Sisma Y SLD	0	145.5	0	0	8.0E2	0.959
586	3312	Sisma X SLV	336.4	0	0	0	8.5E2	0.959	587	3312	Sisma Y SLV	0	336.4	0	0	8.5E2	0.959
588	3312	Sisma X SLD	154.5	0	0	0	8.5E2	0.959	589	3312	Sisma Y SLD	0	154.5	0	0	8.5E2	0.959
590	3313	Sisma X SLV	316.9	0	0	0	8.0E2	0.959	591	3313	Sisma Y SLV	0	316.9	0	0	8.0E2	0.959
592	3313	Sisma X SLD	145.5	0	0	0	8.0E2	0.959	593	3313	Sisma Y SLD	0	145.5	0	0	8.0E2	0.959
594	3314	Sisma X SLV	316.9	0	0	0	8.0E2	0.959	595	3314	Sisma Y SLV	0	316.9	0	0	8.0E2	0.959
596	3314	Sisma X SLD	145.5	0	0	0	8.0E2	0.959	597	3314	Sisma Y SLD	0	145.5	0	0	8.0E2	0.959
598	3315	Sisma X SLV	316.9	0	0	0	8.0E2	0.959	599	3315	Sisma Y SLV	0	316.9	0	0	8.0E2	0.959
600	3315	Sisma X SLD	145.5	0	0	0	8.0E2	0.959	601	3315	Sisma Y SLD	0	145.5	0	0	8.0E2	0.959
602	3316	Sisma X SLV	316.9	0	0	0	8.0E2	0.959	603	3316	Sisma Y SLV	0	316.9	0	0	8.0E2	0.959
604	3316	Sisma X SLD	145.5	0	0	0	8.0E2	0.959	605	3316	Sisma Y SLD	0	145.5	0	0	8.0E2	0.959
606	3317	Sisma X SLV	316.9	0	0	0	8.0E2	0.959	607	3317	Sisma Y SLV	0	316.9	0	0	8.0E2	0.959
608	3317	Sisma X SLD	145.5	0	0	0	8.0E2	0.959	609	3317	Sisma Y SLD	0	145.5	0	0	8.0E2	0.959
610	3318	Sisma X SLV	316.9	0	0	0	8.0E2	0.959	611	3318	Sisma Y SLV	0	316.9	0	0	8.0E2	0.959
612	3318	Sisma X SLD	145.5	0	0	0	8.0E2	0.959	613	3318	Sisma Y SLD	0	145.5	0	0	8.0E2	0.959
614	3319	Sisma X SLV	336.4	0	0	0	8.5E2	0.959	615	3319	Sisma Y SLV	0	336.4	0	0	8.5E2	0.959
616	3319	Sisma X SLD	154.5	0	0	0	8.5E2	0.959	617	3319	Sisma Y SLD	0	154.5	0	0	8.5E2	0.959
618	3320	Sisma X SLV	336.4	0	0	0	8.5E2	0.959	619	3320	Sisma Y SLV	0	336.4	0	0	8.5E2	0.959
620	3320	Sisma X SLD	154.5	0	0	0	8.5E2	0.959	621	3320	Sisma Y SLD	0	154.5	0	0	8.5E2	0.959
622	3321	Sisma X SLV	316.9	0	0	0	8.0E2	0.959	623	3321	Sisma Y SLV	0	316.9	0	0	8.0E2	0.959
624	3321	Sisma X SLD	145.5	0	0	0	8.0E2	0.959	625	3321	Sisma Y SLD	0	145.5	0	0	8.0E2	0.959
626	3322	Sisma X SLV	316.9	0	0	0	8.0E2	0.959	627	3322	Sisma Y SLV	0	316.9	0	0	8.0E2	0.959
628	3322	Sisma X SLD	145.5	0	0	0	8.0E2	0.959	629	3322	Sisma Y SLD	0	145.5	0	0	8.0E2	0.959
630	3323	Sisma X SLV	316.9	0	0	0	8.0E2	0.959	631	3323	Sisma Y SLV	0	316.9	0	0	8.0E2	0.959
632	3323	Sisma X SLD	145.5	0	0	0	8.0E2	0.959	633	3323	Sisma Y SLD	0	145.5	0	0	8.0E2	0.959
634	3324	Sisma X SLV	316.9	0	0	0	8.0E2	0.959	635	3324	Sisma Y SLV	0	316.9	0	0	8.0E2	0.959



Progetto	Titolo	Rev.	Pag.
Orione	Orione_A24a.pdf "TABULATI DI CALCOLO PLINTO DI FONDAZIONE PER AEROGENERATORE TIPO"	0	77

Tabulati di Calcolo Plinto di Fondazione per Aerogeneratore Tipo - Progetto Impianto Eolico - "Orione"

Indice	Nodo	Condizione	Fx	Fy	Fz	Mz	Peso	Gamma	Indice	Nodo	Condizione	Fx	Fy	Fz	Mz	Peso	Gamma
636	3324	Sisma X SLD	145.5	0	0	0	8.0E2	0.959	637	3324	Sisma Y SLD	0	145.5	0	0	8.0E2	0.959
638	3325	Sisma X SLV	336.4	0	0	0	8.5E2	0.959	639	3325	Sisma Y SLV	0	336.4	0	0	8.5E2	0.959
640	3325	Sisma X SLD	154.5	0	0	0	8.5E2	0.959	641	3325	Sisma Y SLD	0	154.5	0	0	8.5E2	0.959
642	3326	Sisma X SLV	336.4	0	0	0	8.5E2	0.959	643	3326	Sisma Y SLV	0	336.4	0	0	8.5E2	0.959
644	3326	Sisma X SLD	154.5	0	0	0	8.5E2	0.959	645	3326	Sisma Y SLD	0	154.5	0	0	8.5E2	0.959
646	3327	Sisma X SLV	316.9	0	0	0	8.0E2	0.959	647	3327	Sisma Y SLV	0	316.9	0	0	8.0E2	0.959
648	3327	Sisma X SLD	145.5	0	0	0	8.0E2	0.959	649	3327	Sisma Y SLD	0	145.5	0	0	8.0E2	0.959
650	3328	Sisma X SLV	316.9	0	0	0	8.0E2	0.959	651	3328	Sisma Y SLV	0	316.9	0	0	8.0E2	0.959
652	3328	Sisma X SLD	145.5	0	0	0	8.0E2	0.959	653	3328	Sisma Y SLD	0	145.5	0	0	8.0E2	0.959
654	3329	Sisma X SLV	316.9	0	0	0	8.0E2	0.959	655	3329	Sisma Y SLV	0	316.9	0	0	8.0E2	0.959
656	3329	Sisma X SLD	145.5	0	0	0	8.0E2	0.959	657	3329	Sisma Y SLD	0	145.5	0	0	8.0E2	0.959
658	3330	Sisma X SLV	316.9	0	0	0	8.0E2	0.959	659	3330	Sisma Y SLV	0	316.9	0	0	8.0E2	0.959
660	3330	Sisma X SLD	145.5	0	0	0	8.0E2	0.959	661	3330	Sisma Y SLD	0	145.5	0	0	8.0E2	0.959
662	3331	Sisma X SLV	336.4	0	0	0	8.5E2	0.959	663	3331	Sisma Y SLV	0	336.4	0	0	8.5E2	0.959
664	3331	Sisma X SLD	154.5	0	0	0	8.5E2	0.959	665	3331	Sisma Y SLD	0	154.5	0	0	8.5E2	0.959
666	3332	Sisma X SLV	336.4	0	0	0	8.5E2	0.959	667	3332	Sisma Y SLV	0	336.4	0	0	8.5E2	0.959
668	3332	Sisma X SLD	154.5	0	0	0	8.5E2	0.959	669	3332	Sisma Y SLD	0	154.5	0	0	8.5E2	0.959
670	3333	Sisma X SLV	316.9	0	0	0	8.0E2	0.959	671	3333	Sisma Y SLV	0	316.9	0	0	8.0E2	0.959
672	3333	Sisma X SLD	145.5	0	0	0	8.0E2	0.959	673	3333	Sisma Y SLD	0	145.5	0	0	8.0E2	0.959
674	3334	Sisma X SLV	316.9	0	0	0	8.0E2	0.959	675	3334	Sisma Y SLV	0	316.9	0	0	8.0E2	0.959
676	3334	Sisma X SLD	145.5	0	0	0	8.0E2	0.959	677	3334	Sisma Y SLD	0	145.5	0	0	8.0E2	0.959
678	3335	Sisma X SLV	316.9	0	0	0	8.0E2	0.959	679	3335	Sisma Y SLV	0	316.9	0	0	8.0E2	0.959
680	3335	Sisma X SLD	145.5	0	0	0	8.0E2	0.959	681	3335	Sisma Y SLD	0	145.5	0	0	8.0E2	0.959
682	3336	Sisma X SLV	316.9	0	0	0	8.0E2	0.959	683	3336	Sisma Y SLV	0	316.9	0	0	8.0E2	0.959
684	3336	Sisma X SLD	145.5	0	0	0	8.0E2	0.959	685	3336	Sisma Y SLD	0	145.5	0	0	8.0E2	0.959
686	3337	Sisma X SLV	336.4	0	0	0	8.5E2	0.959	687	3337	Sisma Y SLV	0	336.4	0	0	8.5E2	0.959
688	3337	Sisma X SLD	154.5	0	0	0	8.5E2	0.959	689	3337	Sisma Y SLD	0	154.5	0	0	8.5E2	0.959
690	3338	Sisma X SLV	336.4	0	0	0	8.5E2	0.959	691	3338	Sisma Y SLV	0	336.4	0	0	8.5E2	0.959
692	3338	Sisma X SLD	154.5	0	0	0	8.5E2	0.959	693	3338	Sisma Y SLD	0	154.5	0	0	8.5E2	0.959
694	3339	Sisma X SLV	316.9	0	0	0	8.0E2	0.959	695	3339	Sisma Y SLV	0	316.9	0	0	8.0E2	0.959
696	3339	Sisma X SLD	145.5	0	0	0	8.0E2	0.959	697	3339	Sisma Y SLD	0	145.5	0	0	8.0E2	0.959
698	3340	Sisma X SLV	316.9	0	0	0	8.0E2	0.959	699	3340	Sisma Y SLV	0	316.9	0	0	8.0E2	0.959
700	3340	Sisma X SLD	145.5	0	0	0	8.0E2	0.959	701	3340	Sisma Y SLD	0	145.5	0	0	8.0E2	0.959
702	3341	Sisma X SLV	336.4	0	0	0	8.5E2	0.959	703	3341	Sisma Y SLV	0	336.4	0	0	8.5E2	0.959
704	3341	Sisma X SLD	154.5	0	0	0	8.5E2	0.959	705	3341	Sisma Y SLD	0	154.5	0	0	8.5E2	0.959
706	3342	Sisma X SLV	336.4	0	0	0	8.5E2	0.959	707	3342	Sisma Y SLV	0	336.4	0	0	8.5E2	0.959
708	3342	Sisma X SLD	154.5	0	0	0	8.5E2	0.959	709	3342	Sisma Y SLD	0	154.5	0	0	8.5E2	0.959
710	3343	Sisma X SLV	316.9	0	0	0	8.0E2	0.959	711	3343	Sisma Y SLV	0	316.9	0	0	8.0E2	0.959
712	3343	Sisma X SLD	145.5	0	0	0	8.0E2	0.959	713	3343	Sisma Y SLD	0	145.5	0	0	8.0E2	0.959
714	3344	Sisma X SLV	316.9	0	0	0	8.0E2	0.959	715	3344	Sisma Y SLV	0	316.9	0	0	8.0E2	0.959
716	3344	Sisma X SLD	145.5	0	0	0	8.0E2	0.959	717	3344	Sisma Y SLD	0	145.5	0	0	8.0E2	0.959
718	3345	Sisma X SLV	336.4	0	0	0	8.5E2	0.959	719	3345	Sisma Y SLV	0	336.4	0	0	8.5E2	0.959
720	3345	Sisma X SLD	154.5	0	0	0	8.5E2	0.959	721	3345	Sisma Y SLD	0	154.5	0	0	8.5E2	0.959
722	3346	Sisma X SLV	316.9	0	0	0	8.0E2	0.959	723	3346	Sisma Y SLV	0	316.9	0	0	8.0E2	0.959
724	3346	Sisma X SLD	145.5	0	0	0	8.0E2	0.959	725	3346	Sisma Y SLD	0	145.5	0	0	8.0E2	0.959
726	3347	Sisma X SLV	316.9	0	0	0	8.0E2	0.959	727	3347	Sisma Y SLV	0	316.9	0	0	8.0E2	0.959
728	3347	Sisma X SLD	145.5	0	0	0	8.0E2	0.959	729	3347	Sisma Y SLD	0	145.5	0	0	8.0E2	0.959
730	3348	Sisma X SLV	336.4	0	0	0	8.5E2	0.959	731	3348	Sisma Y SLV	0	336.4	0	0	8.5E2	0.959
732	3348	Sisma X SLD	154.5	0	0	0	8.5E2	0.959	733	3348	Sisma Y SLD	0	154.5	0	0	8.5E2	0.959
734	3349	Sisma X SLV	316.9	0	0	0	8.0E2	0.959	735	3349	Sisma Y SLV	0	316.9	0	0	8.0E2	0.959



Progetto	Titolo	Rev.	Pag.
Orione	Orione_A24a.pdf "TABULATI DI CALCOLO PLINTO DI FONDAZIONE PER AEROGENERATORE TIPO"	0	78

Tabulati di Calcolo Plinto di Fondazione per Aerogeneratore Tipo - Progetto Impianto Eolico - "Orione"

Indice	Nodo	Condizione	Fx	Fy	Fz	Mz	Peso	Gamma	Indice	Nodo	Condizione	Fx	Fy	Fz	Mz	Peso	Gamma
736	3349	Sisma X SLD	145.5	0	0	0	8.0E2	0.959	737	3349	Sisma Y SLD	0	145.5	0	0	8.0E2	0.959
738	3350	Sisma X SLV	316.9	0	0	0	8.0E2	0.959	739	3350	Sisma Y SLV	0	316.9	0	0	8.0E2	0.959
740	3350	Sisma X SLD	145.5	0	0	0	8.0E2	0.959	741	3350	Sisma Y SLD	0	145.5	0	0	8.0E2	0.959
742	3351	Sisma X SLV	336.4	0	0	0	8.5E2	0.959	743	3351	Sisma Y SLV	0	336.4	0	0	8.5E2	0.959
744	3351	Sisma X SLD	154.5	0	0	0	8.5E2	0.959	745	3351	Sisma Y SLD	0	154.5	0	0	8.5E2	0.959
746	3352	Sisma X SLV	336.4	0	0	0	8.5E2	0.959	747	3352	Sisma Y SLV	0	336.4	0	0	8.5E2	0.959
748	3352	Sisma X SLD	154.5	0	0	0	8.5E2	0.959	749	3352	Sisma Y SLD	0	154.5	0	0	8.5E2	0.959
750	3353	Sisma X SLV	316.9	0	0	0	8.0E2	0.959	751	3353	Sisma Y SLV	0	316.9	0	0	8.0E2	0.959
752	3353	Sisma X SLD	145.5	0	0	0	8.0E2	0.959	753	3353	Sisma Y SLD	0	145.5	0	0	8.0E2	0.959
754	3354	Sisma X SLV	316.9	0	0	0	8.0E2	0.959	755	3354	Sisma Y SLV	0	316.9	0	0	8.0E2	0.959
756	3354	Sisma X SLD	145.5	0	0	0	8.0E2	0.959	757	3354	Sisma Y SLD	0	145.5	0	0	8.0E2	0.959
758	3355	Sisma X SLV	336.4	0	0	0	8.5E2	0.959	759	3355	Sisma Y SLV	0	336.4	0	0	8.5E2	0.959
760	3355	Sisma X SLD	154.5	0	0	0	8.5E2	0.959	761	3355	Sisma Y SLD	0	154.5	0	0	8.5E2	0.959
762	3356	Sisma X SLV	336.4	0	0	0	8.5E2	0.959	763	3356	Sisma Y SLV	0	336.4	0	0	8.5E2	0.959
764	3356	Sisma X SLD	154.5	0	0	0	8.5E2	0.959	765	3356	Sisma Y SLD	0	154.5	0	0	8.5E2	0.959
766	3357	Sisma X SLV	316.9	0	0	0	8.0E2	0.959	767	3357	Sisma Y SLV	0	316.9	0	0	8.0E2	0.959
768	3357	Sisma X SLD	145.5	0	0	0	8.0E2	0.959	769	3357	Sisma Y SLD	0	145.5	0	0	8.0E2	0.959
770	3358	Sisma X SLV	316.9	0	0	0	8.0E2	0.959	771	3358	Sisma Y SLV	0	316.9	0	0	8.0E2	0.959
772	3358	Sisma X SLD	145.5	0	0	0	8.0E2	0.959	773	3358	Sisma Y SLD	0	145.5	0	0	8.0E2	0.959
774	3359	Sisma X SLV	316.9	0	0	0	8.0E2	0.959	775	3359	Sisma Y SLV	0	316.9	0	0	8.0E2	0.959
776	3359	Sisma X SLD	145.5	0	0	0	8.0E2	0.959	777	3359	Sisma Y SLD	0	145.5	0	0	8.0E2	0.959
778	3360	Sisma X SLV	316.9	0	0	0	8.0E2	0.959	779	3360	Sisma Y SLV	0	316.9	0	0	8.0E2	0.959
780	3360	Sisma X SLD	145.5	0	0	0	8.0E2	0.959	781	3360	Sisma Y SLD	0	145.5	0	0	8.0E2	0.959
782	3361	Sisma X SLV	336.4	0	0	0	8.5E2	0.959	783	3361	Sisma Y SLV	0	336.4	0	0	8.5E2	0.959
784	3361	Sisma X SLD	154.5	0	0	0	8.5E2	0.959	785	3361	Sisma Y SLD	0	154.5	0	0	8.5E2	0.959
786	3362	Sisma X SLV	336.4	0	0	0	8.5E2	0.959	787	3362	Sisma Y SLV	0	336.4	0	0	8.5E2	0.959
788	3362	Sisma X SLD	154.5	0	0	0	8.5E2	0.959	789	3362	Sisma Y SLD	0	154.5	0	0	8.5E2	0.959
790	3363	Sisma X SLV	316.9	0	0	0	8.0E2	0.959	791	3363	Sisma Y SLV	0	316.9	0	0	8.0E2	0.959
792	3363	Sisma X SLD	145.5	0	0	0	8.0E2	0.959	793	3363	Sisma Y SLD	0	145.5	0	0	8.0E2	0.959
794	3364	Sisma X SLV	316.9	0	0	0	8.0E2	0.959	795	3364	Sisma Y SLV	0	316.9	0	0	8.0E2	0.959
796	3364	Sisma X SLD	145.5	0	0	0	8.0E2	0.959	797	3364	Sisma Y SLD	0	145.5	0	0	8.0E2	0.959
798	3365	Sisma X SLV	336.4	0	0	0	8.5E2	0.959	799	3365	Sisma Y SLV	0	336.4	0	0	8.5E2	0.959
800	3365	Sisma X SLD	154.5	0	0	0	8.5E2	0.959	801	3365	Sisma Y SLD	0	154.5	0	0	8.5E2	0.959
802	3366	Sisma X SLV	336.4	0	0	0	8.5E2	0.959	803	3366	Sisma Y SLV	0	336.4	0	0	8.5E2	0.959
804	3366	Sisma X SLD	154.5	0	0	0	8.5E2	0.959	805	3366	Sisma Y SLD	0	154.5	0	0	8.5E2	0.959
806	3367	Sisma X SLV	316.9	0	0	0	8.0E2	0.959	807	3367	Sisma Y SLV	0	316.9	0	0	8.0E2	0.959
808	3367	Sisma X SLD	145.5	0	0	0	8.0E2	0.959	809	3367	Sisma Y SLD	0	145.5	0	0	8.0E2	0.959
810	3368	Sisma X SLV	316.9	0	0	0	8.0E2	0.959	811	3368	Sisma Y SLV	0	316.9	0	0	8.0E2	0.959
812	3368	Sisma X SLD	145.5	0	0	0	8.0E2	0.959	813	3368	Sisma Y SLD	0	145.5	0	0	8.0E2	0.959
814	3369	Sisma X SLV	336.4	0	0	0	8.5E2	0.959	815	3369	Sisma Y SLV	0	336.4	0	0	8.5E2	0.959
816	3369	Sisma X SLD	154.5	0	0	0	8.5E2	0.959	817	3369	Sisma Y SLD	0	154.5	0	0	8.5E2	0.959
818	3370	Sisma X SLV	336.4	0	0	0	8.5E2	0.959	819	3370	Sisma Y SLV	0	336.4	0	0	8.5E2	0.959
820	3370	Sisma X SLD	154.5	0	0	0	8.5E2	0.959	821	3370	Sisma Y SLD	0	154.5	0	0	8.5E2	0.959
822	3371	Sisma X SLV	316.9	0	0	0	8.0E2	0.959	823	3371	Sisma Y SLV	0	316.9	0	0	8.0E2	0.959
824	3371	Sisma X SLD	145.5	0	0	0	8.0E2	0.959	825	3371	Sisma Y SLD	0	145.5	0	0	8.0E2	0.959
826	3372	Sisma X SLV	316.9	0	0	0	8.0E2	0.959	827	3372	Sisma Y SLV	0	316.9	0	0	8.0E2	0.959
828	3372	Sisma X SLD	145.5	0	0	0	8.0E2	0.959	829	3372	Sisma Y SLD	0	145.5	0	0	8.0E2	0.959
830	3373	Sisma X SLV	336.4	0	0	0	8.5E2	0.959	831	3373	Sisma Y SLV	0	336.4	0	0	8.5E2	0.959
832	3373	Sisma X SLD	154.5	0	0	0	8.5E2	0.959	833	3373	Sisma Y SLD	0	154.5	0	0	8.5E2	0.959
834	3374	Sisma X SLV	336.4	0	0	0	8.5E2	0.959	835	3374	Sisma Y SLV	0	336.4	0	0	8.5E2	0.959



Progetto	Titolo	Rev.	Pag.
Orione	Orione_A24a.pdf "TABULATI DI CALCOLO PLINTO DI FONDAZIONE PER AEROGENERATORE TIPO"	0	79



Tabulati di Calcolo Plinto di Fondazione per Aerogeneratore Tipo - Progetto Impianto Eolico - "Orione"

Indice	Nodo	Condizione	Fx	Fy	Fz	Mz	Peso	Gamma	Indice	Nodo	Condizione	Fx	Fy	Fz	Mz	Peso	Gamma
836	3374	Sisma X SLD	154.5	0	0	0	8.5E2	0.959	837	3374	Sisma Y SLD	0	154.5	0	0	8.5E2	0.959
838	3375	Sisma X SLV	316.9	0	0	0	8.0E2	0.959	839	3375	Sisma Y SLV	0	316.9	0	0	8.0E2	0.959
840	3375	Sisma X SLD	145.5	0	0	0	8.0E2	0.959	841	3375	Sisma Y SLD	0	145.5	0	0	8.0E2	0.959
842	3376	Sisma X SLV	316.9	0	0	0	8.0E2	0.959	843	3376	Sisma Y SLV	0	316.9	0	0	8.0E2	0.959
844	3376	Sisma X SLD	145.5	0	0	0	8.0E2	0.959	845	3376	Sisma Y SLD	0	145.5	0	0	8.0E2	0.959
846	3377	Sisma X SLV	316.9	0	0	0	8.0E2	0.959	847	3377	Sisma Y SLV	0	316.9	0	0	8.0E2	0.959
848	3377	Sisma X SLD	145.5	0	0	0	8.0E2	0.959	849	3377	Sisma Y SLD	0	145.5	0	0	8.0E2	0.959
850	3378	Sisma X SLV	316.9	0	0	0	8.0E2	0.959	851	3378	Sisma Y SLV	0	316.9	0	0	8.0E2	0.959
852	3378	Sisma X SLD	145.5	0	0	0	8.0E2	0.959	853	3378	Sisma Y SLD	0	145.5	0	0	8.0E2	0.959
854	3379	Sisma X SLV	336.4	0	0	0	8.5E2	0.959	855	3379	Sisma Y SLV	0	336.4	0	0	8.5E2	0.959
856	3379	Sisma X SLD	154.5	0	0	0	8.5E2	0.959	857	3379	Sisma Y SLD	0	154.5	0	0	8.5E2	0.959
858	3380	Sisma X SLV	336.4	0	0	0	8.5E2	0.959	859	3380	Sisma Y SLV	0	336.4	0	0	8.5E2	0.959
860	3380	Sisma X SLD	154.5	0	0	0	8.5E2	0.959	861	3380	Sisma Y SLD	0	154.5	0	0	8.5E2	0.959
862	3381	Sisma X SLV	316.9	0	0	0	8.0E2	0.959	863	3381	Sisma Y SLV	0	316.9	0	0	8.0E2	0.959
864	3381	Sisma X SLD	145.5	0	0	0	8.0E2	0.959	865	3381	Sisma Y SLD	0	145.5	0	0	8.0E2	0.959
866	3382	Sisma X SLV	316.9	0	0	0	8.0E2	0.959	867	3382	Sisma Y SLV	0	316.9	0	0	8.0E2	0.959
868	3382	Sisma X SLD	145.5	0	0	0	8.0E2	0.959	869	3382	Sisma Y SLD	0	145.5	0	0	8.0E2	0.959
870	3383	Sisma X SLV	336.4	0	0	0	8.5E2	0.959	871	3383	Sisma Y SLV	0	336.4	0	0	8.5E2	0.959
872	3383	Sisma X SLD	154.5	0	0	0	8.5E2	0.959	873	3383	Sisma Y SLD	0	154.5	0	0	8.5E2	0.959
874	3384	Sisma X SLV	336.4	0	0	0	8.5E2	0.959	875	3384	Sisma Y SLV	0	336.4	0	0	8.5E2	0.959
876	3384	Sisma X SLD	154.5	0	0	0	8.5E2	0.959	877	3384	Sisma Y SLD	0	154.5	0	0	8.5E2	0.959
878	3385	Sisma X SLV	316.9	0	0	0	8.0E2	0.959	879	3385	Sisma Y SLV	0	316.9	0	0	8.0E2	0.959
880	3385	Sisma X SLD	145.5	0	0	0	8.0E2	0.959	881	3385	Sisma Y SLD	0	145.5	0	0	8.0E2	0.959
882	3386	Sisma X SLV	316.9	0	0	0	8.0E2	0.959	883	3386	Sisma Y SLV	0	316.9	0	0	8.0E2	0.959
884	3386	Sisma X SLD	145.5	0	0	0	8.0E2	0.959	885	3386	Sisma Y SLD	0	145.5	0	0	8.0E2	0.959
886	3387	Sisma X SLV	336.4	0	0	0	8.5E2	0.959	887	3387	Sisma Y SLV	0	336.4	0	0	8.5E2	0.959
888	3387	Sisma X SLD	154.5	0	0	0	8.5E2	0.959	889	3387	Sisma Y SLD	0	154.5	0	0	8.5E2	0.959
890	3388	Sisma X SLV	336.4	0	0	0	8.5E2	0.959	891	3388	Sisma Y SLV	0	336.4	0	0	8.5E2	0.959
892	3388	Sisma X SLD	154.5	0	0	0	8.5E2	0.959	893	3388	Sisma Y SLD	0	154.5	0	0	8.5E2	0.959
894	3389	Sisma X SLV	316.9	0	0	0	8.0E2	0.959	895	3389	Sisma Y SLV	0	316.9	0	0	8.0E2	0.959
896	3389	Sisma X SLD	145.5	0	0	0	8.0E2	0.959	897	3389	Sisma Y SLD	0	145.5	0	0	8.0E2	0.959
898	3390	Sisma X SLV	316.9	0	0	0	8.0E2	0.959	899	3390	Sisma Y SLV	0	316.9	0	0	8.0E2	0.959
900	3390	Sisma X SLD	145.5	0	0	0	8.0E2	0.959	901	3390	Sisma Y SLD	0	145.5	0	0	8.0E2	0.959
902	3391	Sisma X SLV	336.4	0	0	0	8.5E2	0.959	903	3391	Sisma Y SLV	0	336.4	0	0	8.5E2	0.959
904	3391	Sisma X SLD	154.5	0	0	0	8.5E2	0.959	905	3391	Sisma Y SLD	0	154.5	0	0	8.5E2	0.959
906	3392	Sisma X SLV	336.4	0	0	0	8.5E2	0.959	907	3392	Sisma Y SLV	0	336.4	0	0	8.5E2	0.959
908	3392	Sisma X SLD	154.5	0	0	0	8.5E2	0.959	909	3392	Sisma Y SLD	0	154.5	0	0	8.5E2	0.959
910	3393	Sisma X SLV	316.9	0	0	0	8.0E2	0.959	911	3393	Sisma Y SLV	0	316.9	0	0	8.0E2	0.959
912	3393	Sisma X SLD	145.5	0	0	0	8.0E2	0.959	913	3393	Sisma Y SLD	0	145.5	0	0	8.0E2	0.959
914	3394	Sisma X SLV	316.9	0	0	0	8.0E2	0.959	915	3394	Sisma Y SLV	0	316.9	0	0	8.0E2	0.959
916	3394	Sisma X SLD	145.5	0	0	0	8.0E2	0.959	917	3394	Sisma Y SLD	0	145.5	0	0	8.0E2	0.959
918	3395	Sisma X SLV	336.4	0	0	0	8.5E2	0.959	919	3395	Sisma Y SLV	0	336.4	0	0	8.5E2	0.959
920	3395	Sisma X SLD	154.5	0	0	0	8.5E2	0.959	921	3395	Sisma Y SLD	0	154.5	0	0	8.5E2	0.959
922	3396	Sisma X SLV	336.4	0	0	0	8.5E2	0.959	923	3396	Sisma Y SLV	0	336.4	0	0	8.5E2	0.959
924	3396	Sisma X SLD	154.5	0	0	0	8.5E2	0.959	925	3396	Sisma Y SLD	0	154.5	0	0	8.5E2	0.959
926	3397	Sisma X SLV	316.9	0	0	0	8.0E2	0.959	927	3397	Sisma Y SLV	0	316.9	0	0	8.0E2	0.959
928	3397	Sisma X SLD	145.5	0	0	0	8.0E2	0.959	929	3397	Sisma Y SLD	0	145.5	0	0	8.0E2	0.959
930	3398	Sisma X SLV	316.9	0	0	0	8.0E2	0.959	931	3398	Sisma Y SLV	0	316.9	0	0	8.0E2	0.959
932	3398	Sisma X SLD	145.5	0	0	0	8.0E2	0.959	933	3398	Sisma Y SLD	0	145.5	0	0	8.0E2	0.959
934	3399	Sisma X SLV	316.9	0	0	0	8.0E2	0.959	935	3399	Sisma Y SLV	0	316.9	0	0	8.0E2	0.959



Progetto	Titolo	Rev.	Pag.
Orione	Orione_A24a.pdf "TABULATI DI CALCOLO PLINTO DI FONDAZIONE PER AEROGENERATORE TIPO"	0	80

Tabulati di Calcolo Plinto di Fondazione per Aerogeneratore Tipo - Progetto Impianto Eolico - "Orione"

Indice	Nodo	Condizione	Fx	Fy	Fz	Mz	Peso	Gamma	Indice	Nodo	Condizione	Fx	Fy	Fz	Mz	Peso	Gamma
936	3399	Sisma X SLD	145.5	0	0	0	8.0E2	0.959	937	3399	Sisma Y SLD	0	145.5	0	0	8.0E2	0.959
938	3400	Sisma X SLV	316.9	0	0	0	8.0E2	0.959	939	3400	Sisma Y SLV	0	316.9	0	0	8.0E2	0.959
940	3400	Sisma X SLD	145.5	0	0	0	8.0E2	0.959	941	3400	Sisma Y SLD	0	145.5	0	0	8.0E2	0.959
942	3401	Sisma X SLV	336.4	0	0	0	8.5E2	0.959	943	3401	Sisma Y SLV	0	336.4	0	0	8.5E2	0.959
944	3401	Sisma X SLD	154.5	0	0	0	8.5E2	0.959	945	3401	Sisma Y SLD	0	154.5	0	0	8.5E2	0.959
946	3402	Sisma X SLV	336.4	0	0	0	8.5E2	0.959	947	3402	Sisma Y SLV	0	336.4	0	0	8.5E2	0.959
948	3402	Sisma X SLD	154.5	0	0	0	8.5E2	0.959	949	3402	Sisma Y SLD	0	154.5	0	0	8.5E2	0.959
950	3403	Sisma X SLV	316.9	0	0	0	8.0E2	0.959	951	3403	Sisma Y SLV	0	316.9	0	0	8.0E2	0.959
952	3403	Sisma X SLD	145.5	0	0	0	8.0E2	0.959	953	3403	Sisma Y SLD	0	145.5	0	0	8.0E2	0.959
954	3404	Sisma X SLV	316.9	0	0	0	8.0E2	0.959	955	3404	Sisma Y SLV	0	316.9	0	0	8.0E2	0.959
956	3404	Sisma X SLD	145.5	0	0	0	8.0E2	0.959	957	3404	Sisma Y SLD	0	145.5	0	0	8.0E2	0.959
958	3405	Sisma X SLV	336.4	0	0	0	8.5E2	0.959	959	3405	Sisma Y SLV	0	336.4	0	0	8.5E2	0.959
960	3405	Sisma X SLD	154.5	0	0	0	8.5E2	0.959	961	3405	Sisma Y SLD	0	154.5	0	0	8.5E2	0.959
962	3406	Sisma X SLV	336.4	0	0	0	8.5E2	0.959	963	3406	Sisma Y SLV	0	336.4	0	0	8.5E2	0.959
964	3406	Sisma X SLD	154.5	0	0	0	8.5E2	0.959	965	3406	Sisma Y SLD	0	154.5	0	0	8.5E2	0.959
966	3407	Sisma X SLV	316.9	0	0	0	8.0E2	0.959	967	3407	Sisma Y SLV	0	316.9	0	0	8.0E2	0.959
968	3407	Sisma X SLD	145.5	0	0	0	8.0E2	0.959	969	3407	Sisma Y SLD	0	145.5	0	0	8.0E2	0.959
970	3408	Sisma X SLV	316.9	0	0	0	8.0E2	0.959	971	3408	Sisma Y SLV	0	316.9	0	0	8.0E2	0.959
972	3408	Sisma X SLD	145.5	0	0	0	8.0E2	0.959	973	3408	Sisma Y SLD	0	145.5	0	0	8.0E2	0.959
974	3409	Sisma X SLV	336.4	0	0	0	8.5E2	0.959	975	3409	Sisma Y SLV	0	336.4	0	0	8.5E2	0.959
976	3409	Sisma X SLD	154.5	0	0	0	8.5E2	0.959	977	3409	Sisma Y SLD	0	154.5	0	0	8.5E2	0.959
978	3410	Sisma X SLV	336.4	0	0	0	8.5E2	0.959	979	3410	Sisma Y SLV	0	336.4	0	0	8.5E2	0.959
980	3410	Sisma X SLD	154.5	0	0	0	8.5E2	0.959	981	3410	Sisma Y SLD	0	154.5	0	0	8.5E2	0.959
982	3411	Sisma X SLV	316.9	0	0	0	8.0E2	0.959	983	3411	Sisma Y SLV	0	316.9	0	0	8.0E2	0.959
984	3411	Sisma X SLD	145.5	0	0	0	8.0E2	0.959	985	3411	Sisma Y SLD	0	145.5	0	0	8.0E2	0.959
986	3412	Sisma X SLV	316.9	0	0	0	8.0E2	0.959	987	3412	Sisma Y SLV	0	316.9	0	0	8.0E2	0.959
988	3412	Sisma X SLD	145.5	0	0	0	8.0E2	0.959	989	3412	Sisma Y SLD	0	145.5	0	0	8.0E2	0.959
990	3413	Sisma X SLV	336.4	0	0	0	8.5E2	0.959	991	3413	Sisma Y SLV	0	336.4	0	0	8.5E2	0.959
992	3413	Sisma X SLD	154.5	0	0	0	8.5E2	0.959	993	3413	Sisma Y SLD	0	154.5	0	0	8.5E2	0.959
994	3414	Sisma X SLV	336.4	0	0	0	8.5E2	0.959	995	3414	Sisma Y SLV	0	336.4	0	0	8.5E2	0.959
996	3414	Sisma X SLD	154.5	0	0	0	8.5E2	0.959	997	3414	Sisma Y SLD	0	154.5	0	0	8.5E2	0.959
998	3415	Sisma X SLV	316.9	0	0	0	8.0E2	0.959	999	3415	Sisma Y SLV	0	316.9	0	0	8.0E2	0.959
1000	3415	Sisma X SLD	145.5	0	0	0	8.0E2	0.959	1001	3415	Sisma Y SLD	0	145.5	0	0	8.0E2	0.959
1002	3416	Sisma X SLV	316.9	0	0	0	8.0E2	0.959	1003	3416	Sisma Y SLV	0	316.9	0	0	8.0E2	0.959
1004	3416	Sisma X SLD	145.5	0	0	0	8.0E2	0.959	1005	3416	Sisma Y SLD	0	145.5	0	0	8.0E2	0.959
1006	3417	Sisma X SLV	336.4	0	0	0	8.5E2	0.959	1007	3417	Sisma Y SLV	0	336.4	0	0	8.5E2	0.959
1008	3417	Sisma X SLD	154.5	0	0	0	8.5E2	0.959	1009	3417	Sisma Y SLD	0	154.5	0	0	8.5E2	0.959
1010	3418	Sisma X SLV	336.4	0	0	0	8.5E2	0.959	1011	3418	Sisma Y SLV	0	336.4	0	0	8.5E2	0.959
1012	3418	Sisma X SLD	154.5	0	0	0	8.5E2	0.959	1013	3418	Sisma Y SLD	0	154.5	0	0	8.5E2	0.959
1014	3419	Sisma X SLV	316.9	0	0	0	8.0E2	0.959	1015	3419	Sisma Y SLV	0	316.9	0	0	8.0E2	0.959
1016	3419	Sisma X SLD	145.5	0	0	0	8.0E2	0.959	1017	3419	Sisma Y SLD	0	145.5	0	0	8.0E2	0.959
1018	3420	Sisma X SLV	316.9	0	0	0	8.0E2	0.959	1019	3420	Sisma Y SLV	0	316.9	0	0	8.0E2	0.959
1020	3420	Sisma X SLD	145.5	0	0	0	8.0E2	0.959	1021	3420	Sisma Y SLD	0	145.5	0	0	8.0E2	0.959
1022	3421	Sisma X SLV	336.4	0	0	0	8.5E2	0.959	1023	3421	Sisma Y SLV	0	336.4	0	0	8.5E2	0.959
1024	3421	Sisma X SLD	154.5	0	0	0	8.5E2	0.959	1025	3421	Sisma Y SLD	0	154.5	0	0	8.5E2	0.959
1026	3422	Sisma X SLV	316.9	0	0	0	8.0E2	0.959	1027	3422	Sisma Y SLV	0	316.9	0	0	8.0E2	0.959
1028	3422	Sisma X SLD	145.5	0	0	0	8.0E2	0.959	1029	3422	Sisma Y SLD	0	145.5	0	0	8.0E2	0.959
1030	3423	Sisma X SLV	2.8E6	0	0	0	7.1E6	0.959	1031	3423	Sisma Y SLV	0	2.8E6	0	0	7.1E6	0.959
1032	3423	Sisma X SLD	1.3E6	0	0	0	7.1E6	0.959	1033	3423	Sisma Y SLD	0	1.3E6	0	0	7.1E6	0.959
1034	3424	Sisma X SLV	316.9	0	0	0	8.0E2	0.959	1035	3424	Sisma Y SLV	0	316.9	0	0	8.0E2	0.959



Progetto	Titolo	Rev.	Pag.
Orione	Orione_A24a.pdf "TABULATI DI CALCOLO PLINTO DI FONDAZIONE PER AEROGENERATORE TIPO"	0	81

Tabulati di Calcolo Plinto di Fondazione per Aerogeneratore Tipo - Progetto Impianto Eolico - "Orione"

Indice	Nodo	Condizione	Fx	Fy	Fz	Mz	Peso	Gamma	Indice	Nodo	Condizione	Fx	Fy	Fz	Mz	Peso	Gamma
1036	3424	Sisma X SLD	145.5	0	0	0	8.0E2	0.959	1037	3424	Sisma Y SLD	0	145.5	0	0	8.0E2	0.959
1038	3425	Sisma X SLV	336.4	0	0	0	8.5E2	0.959	1039	3425	Sisma Y SLV	0	336.4	0	0	8.5E2	0.959
1040	3425	Sisma X SLD	154.5	0	0	0	8.5E2	0.959	1041	3425	Sisma Y SLD	0	154.5	0	0	8.5E2	0.959
1042	3426	Sisma X SLV	316.9	0	0	0	8.0E2	0.959	1043	3426	Sisma Y SLV	0	316.9	0	0	8.0E2	0.959
1044	3426	Sisma X SLD	145.5	0	0	0	8.0E2	0.959	1045	3426	Sisma Y SLD	0	145.5	0	0	8.0E2	0.959
1046	3427	Sisma X SLV	316.9	0	0	0	8.0E2	0.959	1047	3427	Sisma Y SLV	0	316.9	0	0	8.0E2	0.959
1048	3427	Sisma X SLD	145.5	0	0	0	8.0E2	0.959	1049	3427	Sisma Y SLD	0	145.5	0	0	8.0E2	0.959
1050	3428	Sisma X SLV	336.4	0	0	0	8.5E2	0.959	1051	3428	Sisma Y SLV	0	336.4	0	0	8.5E2	0.959
1052	3428	Sisma X SLD	154.5	0	0	0	8.5E2	0.959	1053	3428	Sisma Y SLD	0	154.5	0	0	8.5E2	0.959
1054	3429	Sisma X SLV	336.4	0	0	0	8.5E2	0.959	1055	3429	Sisma Y SLV	0	336.4	0	0	8.5E2	0.959
1056	3429	Sisma X SLD	154.5	0	0	0	8.5E2	0.959	1057	3429	Sisma Y SLD	0	154.5	0	0	8.5E2	0.959
1058	3430	Sisma X SLV	316.9	0	0	0	8.0E2	0.959	1059	3430	Sisma Y SLV	0	316.9	0	0	8.0E2	0.959
1060	3430	Sisma X SLD	145.5	0	0	0	8.0E2	0.959	1061	3430	Sisma Y SLD	0	145.5	0	0	8.0E2	0.959
1062	3431	Sisma X SLV	316.9	0	0	0	8.0E2	0.959	1063	3431	Sisma Y SLV	0	316.9	0	0	8.0E2	0.959
1064	3431	Sisma X SLD	145.5	0	0	0	8.0E2	0.959	1065	3431	Sisma Y SLD	0	145.5	0	0	8.0E2	0.959
1066	3432	Sisma X SLV	336.4	0	0	0	8.5E2	0.959	1067	3432	Sisma Y SLV	0	336.4	0	0	8.5E2	0.959
1068	3432	Sisma X SLD	154.5	0	0	0	8.5E2	0.959	1069	3432	Sisma Y SLD	0	154.5	0	0	8.5E2	0.959
1070	3433	Sisma X SLV	336.4	0	0	0	8.5E2	0.959	1071	3433	Sisma Y SLV	0	336.4	0	0	8.5E2	0.959
1072	3433	Sisma X SLD	154.5	0	0	0	8.5E2	0.959	1073	3433	Sisma Y SLD	0	154.5	0	0	8.5E2	0.959
1074	3434	Sisma X SLV	316.9	0	0	0	8.0E2	0.959	1075	3434	Sisma Y SLV	0	316.9	0	0	8.0E2	0.959
1076	3434	Sisma X SLD	145.5	0	0	0	8.0E2	0.959	1077	3434	Sisma Y SLD	0	145.5	0	0	8.0E2	0.959
1078	3435	Sisma X SLV	316.9	0	0	0	8.0E2	0.959	1079	3435	Sisma Y SLV	0	316.9	0	0	8.0E2	0.959
1080	3435	Sisma X SLD	145.5	0	0	0	8.0E2	0.959	1081	3435	Sisma Y SLD	0	145.5	0	0	8.0E2	0.959
1082	3436	Sisma X SLV	336.4	0	0	0	8.5E2	0.959	1083	3436	Sisma Y SLV	0	336.4	0	0	8.5E2	0.959
1084	3436	Sisma X SLD	154.5	0	0	0	8.5E2	0.959	1085	3436	Sisma Y SLD	0	154.5	0	0	8.5E2	0.959
1086	3437	Sisma X SLV	336.4	0	0	0	8.5E2	0.959	1087	3437	Sisma Y SLV	0	336.4	0	0	8.5E2	0.959
1088	3437	Sisma X SLD	154.5	0	0	0	8.5E2	0.959	1089	3437	Sisma Y SLD	0	154.5	0	0	8.5E2	0.959
1090	3438	Sisma X SLV	316.9	0	0	0	8.0E2	0.959	1091	3438	Sisma Y SLV	0	316.9	0	0	8.0E2	0.959
1092	3438	Sisma X SLD	145.5	0	0	0	8.0E2	0.959	1093	3438	Sisma Y SLD	0	145.5	0	0	8.0E2	0.959
1094	3439	Sisma X SLV	316.9	0	0	0	8.0E2	0.959	1095	3439	Sisma Y SLV	0	316.9	0	0	8.0E2	0.959
1096	3439	Sisma X SLD	145.5	0	0	0	8.0E2	0.959	1097	3439	Sisma Y SLD	0	145.5	0	0	8.0E2	0.959
1098	3440	Sisma X SLV	336.4	0	0	0	8.5E2	0.959	1099	3440	Sisma Y SLV	0	336.4	0	0	8.5E2	0.959
1100	3440	Sisma X SLD	154.5	0	0	0	8.5E2	0.959	1101	3440	Sisma Y SLD	0	154.5	0	0	8.5E2	0.959
1102	3441	Sisma X SLV	336.4	0	0	0	8.5E2	0.959	1103	3441	Sisma Y SLV	0	336.4	0	0	8.5E2	0.959
1104	3441	Sisma X SLD	154.5	0	0	0	8.5E2	0.959	1105	3441	Sisma Y SLD	0	154.5	0	0	8.5E2	0.959
1106	3442	Sisma X SLV	316.9	0	0	0	8.0E2	0.959	1107	3442	Sisma Y SLV	0	316.9	0	0	8.0E2	0.959
1108	3442	Sisma X SLD	145.5	0	0	0	8.0E2	0.959	1109	3442	Sisma Y SLD	0	145.5	0	0	8.0E2	0.959
1110	3443	Sisma X SLV	316.9	0	0	0	8.0E2	0.959	1111	3443	Sisma Y SLV	0	316.9	0	0	8.0E2	0.959
1112	3443	Sisma X SLD	145.5	0	0	0	8.0E2	0.959	1113	3443	Sisma Y SLD	0	145.5	0	0	8.0E2	0.959
1114	3444	Sisma X SLV	336.4	0	0	0	8.5E2	0.959	1115	3444	Sisma Y SLV	0	336.4	0	0	8.5E2	0.959
1116	3444	Sisma X SLD	154.5	0	0	0	8.5E2	0.959	1117	3444	Sisma Y SLD	0	154.5	0	0	8.5E2	0.959
1118	3445	Sisma X SLV	336.4	0	0	0	8.5E2	0.959	1119	3445	Sisma Y SLV	0	336.4	0	0	8.5E2	0.959
1120	3445	Sisma X SLD	154.5	0	0	0	8.5E2	0.959	1121	3445	Sisma Y SLD	0	154.5	0	0	8.5E2	0.959
1122	3446	Sisma X SLV	316.9	0	0	0	8.0E2	0.959	1123	3446	Sisma Y SLV	0	316.9	0	0	8.0E2	0.959
1124	3446	Sisma X SLD	145.5	0	0	0	8.0E2	0.959	1125	3446	Sisma Y SLD	0	145.5	0	0	8.0E2	0.959
1126	3447	Sisma X SLV	316.9	0	0	0	8.0E2	0.959	1127	3447	Sisma Y SLV	0	316.9	0	0	8.0E2	0.959
1128	3447	Sisma X SLD	145.5	0	0	0	8.0E2	0.959	1129	3447	Sisma Y SLD	0	145.5	0	0	8.0E2	0.959
1130	3448	Sisma X SLV	316.9	0	0	0	8.0E2	0.959	1131	3448	Sisma Y SLV	0	316.9	0	0	8.0E2	0.959
1132	3448	Sisma X SLD	145.5	0	0	0	8.0E2	0.959	1133	3448	Sisma Y SLD	0	145.5	0	0	8.0E2	0.959
1134	3449	Sisma X SLV	316.9	0	0	0	8.0E2	0.959	1135	3449	Sisma Y SLV	0	316.9	0	0	8.0E2	0.959



Progetto	Titolo	Rev.	Pag.
Orione	Orione_A24a.pdf "TABULATI DI CALCOLO PLINTO DI FONDAZIONE PER AEROGENERATORE TIPO"	0	82

Tabulati di Calcolo Plinto di Fondazione per Aerogeneratore Tipo - Progetto Impianto Eolico - "Orione"

Indice	Nodo	Condizione	Fx	Fy	Fz	Mz	Peso	Gamma	Indice	Nodo	Condizione	Fx	Fy	Fz	Mz	Peso	Gamma
1136	3449	Sisma X SLD	145.5	0	0	0	8.0E2	0.959	1137	3449	Sisma Y SLD	0	145.5	0	0	8.0E2	0.959
1138	3450	Sisma X SLV	336.4	0	0	0	8.5E2	0.959	1139	3450	Sisma Y SLV	0	336.4	0	0	8.5E2	0.959
1140	3450	Sisma X SLD	154.5	0	0	0	8.5E2	0.959	1141	3450	Sisma Y SLD	0	154.5	0	0	8.5E2	0.959
1142	3451	Sisma X SLV	336.4	0	0	0	8.5E2	0.959	1143	3451	Sisma Y SLV	0	336.4	0	0	8.5E2	0.959
1144	3451	Sisma X SLD	154.5	0	0	0	8.5E2	0.959	1145	3451	Sisma Y SLD	0	154.5	0	0	8.5E2	0.959
1146	3452	Sisma X SLV	316.9	0	0	0	8.0E2	0.959	1147	3452	Sisma Y SLV	0	316.9	0	0	8.0E2	0.959
1148	3452	Sisma X SLD	145.5	0	0	0	8.0E2	0.959	1149	3452	Sisma Y SLD	0	145.5	0	0	8.0E2	0.959
1150	3453	Sisma X SLV	316.9	0	0	0	8.0E2	0.959	1151	3453	Sisma Y SLV	0	316.9	0	0	8.0E2	0.959
1152	3453	Sisma X SLD	145.5	0	0	0	8.0E2	0.959	1153	3453	Sisma Y SLD	0	145.5	0	0	8.0E2	0.959
1154	3454	Sisma X SLV	336.4	0	0	0	8.5E2	0.959	1155	3454	Sisma Y SLV	0	336.4	0	0	8.5E2	0.959
1156	3454	Sisma X SLD	154.5	0	0	0	8.5E2	0.959	1157	3454	Sisma Y SLD	0	154.5	0	0	8.5E2	0.959
1158	3455	Sisma X SLV	336.4	0	0	0	8.5E2	0.959	1159	3455	Sisma Y SLV	0	336.4	0	0	8.5E2	0.959
1160	3455	Sisma X SLD	154.5	0	0	0	8.5E2	0.959	1161	3455	Sisma Y SLD	0	154.5	0	0	8.5E2	0.959
1162	3456	Sisma X SLV	316.9	0	0	0	8.0E2	0.959	1163	3456	Sisma Y SLV	0	316.9	0	0	8.0E2	0.959
1164	3456	Sisma X SLD	145.5	0	0	0	8.0E2	0.959	1165	3456	Sisma Y SLD	0	145.5	0	0	8.0E2	0.959
1166	3457	Sisma X SLV	316.9	0	0	0	8.0E2	0.959	1167	3457	Sisma Y SLV	0	316.9	0	0	8.0E2	0.959
1168	3457	Sisma X SLD	145.5	0	0	0	8.0E2	0.959	1169	3457	Sisma Y SLD	0	145.5	0	0	8.0E2	0.959
1170	3458	Sisma X SLV	336.4	0	0	0	8.5E2	0.959	1171	3458	Sisma Y SLV	0	336.4	0	0	8.5E2	0.959
1172	3458	Sisma X SLD	154.5	0	0	0	8.5E2	0.959	1173	3458	Sisma Y SLD	0	154.5	0	0	8.5E2	0.959
1174	3459	Sisma X SLV	336.4	0	0	0	8.5E2	0.959	1175	3459	Sisma Y SLV	0	336.4	0	0	8.5E2	0.959
1176	3459	Sisma X SLD	154.5	0	0	0	8.5E2	0.959	1177	3459	Sisma Y SLD	0	154.5	0	0	8.5E2	0.959
1178	3460	Sisma X SLV	316.9	0	0	0	8.0E2	0.959	1179	3460	Sisma Y SLV	0	316.9	0	0	8.0E2	0.959
1180	3460	Sisma X SLD	145.5	0	0	0	8.0E2	0.959	1181	3460	Sisma Y SLD	0	145.5	0	0	8.0E2	0.959
1182	3461	Sisma X SLV	316.9	0	0	0	8.0E2	0.959	1183	3461	Sisma Y SLV	0	316.9	0	0	8.0E2	0.959
1184	3461	Sisma X SLD	145.5	0	0	0	8.0E2	0.959	1185	3461	Sisma Y SLD	0	145.5	0	0	8.0E2	0.959
1186	3462	Sisma X SLV	336.4	0	0	0	8.5E2	0.959	1187	3462	Sisma Y SLV	0	336.4	0	0	8.5E2	0.959
1188	3462	Sisma X SLD	154.5	0	0	0	8.5E2	0.959	1189	3462	Sisma Y SLD	0	154.5	0	0	8.5E2	0.959
1190	3463	Sisma X SLV	336.4	0	0	0	8.5E2	0.959	1191	3463	Sisma Y SLV	0	336.4	0	0	8.5E2	0.959
1192	3463	Sisma X SLD	154.5	0	0	0	8.5E2	0.959	1193	3463	Sisma Y SLD	0	154.5	0	0	8.5E2	0.959
1194	3464	Sisma X SLV	316.9	0	0	0	8.0E2	0.959	1195	3464	Sisma Y SLV	0	316.9	0	0	8.0E2	0.959
1196	3464	Sisma X SLD	145.5	0	0	0	8.0E2	0.959	1197	3464	Sisma Y SLD	0	145.5	0	0	8.0E2	0.959
1198	3465	Sisma X SLV	316.9	0	0	0	8.0E2	0.959	1199	3465	Sisma Y SLV	0	316.9	0	0	8.0E2	0.959
1200	3465	Sisma X SLD	145.5	0	0	0	8.0E2	0.959	1201	3465	Sisma Y SLD	0	145.5	0	0	8.0E2	0.959
1202	3466	Sisma X SLV	336.4	0	0	0	8.5E2	0.959	1203	3466	Sisma Y SLV	0	336.4	0	0	8.5E2	0.959
1204	3466	Sisma X SLD	154.5	0	0	0	8.5E2	0.959	1205	3466	Sisma Y SLD	0	154.5	0	0	8.5E2	0.959
1206	3467	Sisma X SLV	336.4	0	0	0	8.5E2	0.959	1207	3467	Sisma Y SLV	0	336.4	0	0	8.5E2	0.959
1208	3467	Sisma X SLD	154.5	0	0	0	8.5E2	0.959	1209	3467	Sisma Y SLD	0	154.5	0	0	8.5E2	0.959
1210	3468	Sisma X SLV	316.9	0	0	0	8.0E2	0.959	1211	3468	Sisma Y SLV	0	316.9	0	0	8.0E2	0.959
1212	3468	Sisma X SLD	145.5	0	0	0	8.0E2	0.959	1213	3468	Sisma Y SLD	0	145.5	0	0	8.0E2	0.959
1214	3469	Sisma X SLV	316.9	0	0	0	8.0E2	0.959	1215	3469	Sisma Y SLV	0	316.9	0	0	8.0E2	0.959
1216	3469	Sisma X SLD	145.5	0	0	0	8.0E2	0.959	1217	3469	Sisma Y SLD	0	145.5	0	0	8.0E2	0.959
1218	3470	Sisma X SLV	316.9	0	0	0	8.0E2	0.959	1219	3470	Sisma Y SLV	0	316.9	0	0	8.0E2	0.959
1220	3470	Sisma X SLD	145.5	0	0	0	8.0E2	0.959	1221	3470	Sisma Y SLD	0	145.5	0	0	8.0E2	0.959
1222	3471	Sisma X SLV	316.9	0	0	0	8.0E2	0.959	1223	3471	Sisma Y SLV	0	316.9	0	0	8.0E2	0.959
1224	3471	Sisma X SLD	145.5	0	0	0	8.0E2	0.959	1225	3471	Sisma Y SLD	0	145.5	0	0	8.0E2	0.959
1226	3472	Sisma X SLV	336.4	0	0	0	8.5E2	0.959	1227	3472	Sisma Y SLV	0	336.4	0	0	8.5E2	0.959
1228	3472	Sisma X SLD	154.5	0	0	0	8.5E2	0.959	1229	3472	Sisma Y SLD	0	154.5	0	0	8.5E2	0.959
1230	3473	Sisma X SLV	336.4	0	0	0	8.5E2	0.959	1231	3473	Sisma Y SLV	0	336.4	0	0	8.5E2	0.959
1232	3473	Sisma X SLD	154.5	0	0	0	8.5E2	0.959	1233	3473	Sisma Y SLD	0	154.5	0	0	8.5E2	0.959
1234	3474	Sisma X SLV	316.9	0	0	0	8.0E2	0.959	1235	3474	Sisma Y SLV	0	316.9	0	0	8.0E2	0.959



Progetto	Titolo	Rev.	Pag.
Orione	Orione_A24a.pdf "TABULATI DI CALCOLO PLINTO DI FONDAZIONE PER AEROGENERATORE TIPO"	0	83

Tabulati di Calcolo Plinto di Fondazione per Aerogeneratore Tipo - Progetto Impianto Eolico - "Orione"

Indice	Nodo	Condizione	Fx	Fy	Fz	Mz	Peso	Gamma	Indice	Nodo	Condizione	Fx	Fy	Fz	Mz	Peso	Gamma
1236	3474	Sisma X SLD	145.5	0	0	0	8.0E2	0.959	1237	3474	Sisma Y SLD	0	145.5	0	0	8.0E2	0.959
1238	3475	Sisma X SLV	316.9	0	0	0	8.0E2	0.959	1239	3475	Sisma Y SLV	0	316.9	0	0	8.0E2	0.959
1240	3475	Sisma X SLD	145.5	0	0	0	8.0E2	0.959	1241	3475	Sisma Y SLD	0	145.5	0	0	8.0E2	0.959
1242	3476	Sisma X SLV	336.4	0	0	0	8.5E2	0.959	1243	3476	Sisma Y SLV	0	336.4	0	0	8.5E2	0.959
1244	3476	Sisma X SLD	154.5	0	0	0	8.5E2	0.959	1245	3476	Sisma Y SLD	0	154.5	0	0	8.5E2	0.959
1246	3477	Sisma X SLV	336.4	0	0	0	8.5E2	0.959	1247	3477	Sisma Y SLV	0	336.4	0	0	8.5E2	0.959
1248	3477	Sisma X SLD	154.5	0	0	0	8.5E2	0.959	1249	3477	Sisma Y SLD	0	154.5	0	0	8.5E2	0.959
1250	3478	Sisma X SLV	316.9	0	0	0	8.0E2	0.959	1251	3478	Sisma Y SLV	0	316.9	0	0	8.0E2	0.959
1252	3478	Sisma X SLD	145.5	0	0	0	8.0E2	0.959	1253	3478	Sisma Y SLD	0	145.5	0	0	8.0E2	0.959
1254	3479	Sisma X SLV	316.9	0	0	0	8.0E2	0.959	1255	3479	Sisma Y SLV	0	316.9	0	0	8.0E2	0.959
1256	3479	Sisma X SLD	145.5	0	0	0	8.0E2	0.959	1257	3479	Sisma Y SLD	0	145.5	0	0	8.0E2	0.959
1258	3480	Sisma X SLV	336.4	0	0	0	8.5E2	0.959	1259	3480	Sisma Y SLV	0	336.4	0	0	8.5E2	0.959
1260	3480	Sisma X SLD	154.5	0	0	0	8.5E2	0.959	1261	3480	Sisma Y SLD	0	154.5	0	0	8.5E2	0.959
1262	3481	Sisma X SLV	336.4	0	0	0	8.5E2	0.959	1263	3481	Sisma Y SLV	0	336.4	0	0	8.5E2	0.959
1264	3481	Sisma X SLD	154.5	0	0	0	8.5E2	0.959	1265	3481	Sisma Y SLD	0	154.5	0	0	8.5E2	0.959
1266	3482	Sisma X SLV	316.9	0	0	0	8.0E2	0.959	1267	3482	Sisma Y SLV	0	316.9	0	0	8.0E2	0.959
1268	3482	Sisma X SLD	145.5	0	0	0	8.0E2	0.959	1269	3482	Sisma Y SLD	0	145.5	0	0	8.0E2	0.959
1270	3483	Sisma X SLV	316.9	0	0	0	8.0E2	0.959	1271	3483	Sisma Y SLV	0	316.9	0	0	8.0E2	0.959
1272	3483	Sisma X SLD	145.5	0	0	0	8.0E2	0.959	1273	3483	Sisma Y SLD	0	145.5	0	0	8.0E2	0.959
1274	3484	Sisma X SLV	336.4	0	0	0	8.5E2	0.959	1275	3484	Sisma Y SLV	0	336.4	0	0	8.5E2	0.959
1276	3484	Sisma X SLD	154.5	0	0	0	8.5E2	0.959	1277	3484	Sisma Y SLD	0	154.5	0	0	8.5E2	0.959
1278	3485	Sisma X SLV	336.4	0	0	0	8.5E2	0.959	1279	3485	Sisma Y SLV	0	336.4	0	0	8.5E2	0.959
1280	3485	Sisma X SLD	154.5	0	0	0	8.5E2	0.959	1281	3485	Sisma Y SLD	0	154.5	0	0	8.5E2	0.959
1282	3486	Sisma X SLV	316.9	0	0	0	8.0E2	0.959	1283	3486	Sisma Y SLV	0	316.9	0	0	8.0E2	0.959
1284	3486	Sisma X SLD	145.5	0	0	0	8.0E2	0.959	1285	3486	Sisma Y SLD	0	145.5	0	0	8.0E2	0.959
1286	3487	Sisma X SLV	316.9	0	0	0	8.0E2	0.959	1287	3487	Sisma Y SLV	0	316.9	0	0	8.0E2	0.959
1288	3487	Sisma X SLD	145.5	0	0	0	8.0E2	0.959	1289	3487	Sisma Y SLD	0	145.5	0	0	8.0E2	0.959
1290	3488	Sisma X SLV	316.9	0	0	0	8.0E2	0.959	1291	3488	Sisma Y SLV	0	316.9	0	0	8.0E2	0.959
1292	3488	Sisma X SLD	145.5	0	0	0	8.0E2	0.959	1293	3488	Sisma Y SLD	0	145.5	0	0	8.0E2	0.959
1294	3489	Sisma X SLV	316.9	0	0	0	8.0E2	0.959	1295	3489	Sisma Y SLV	0	316.9	0	0	8.0E2	0.959
1296	3489	Sisma X SLD	145.5	0	0	0	8.0E2	0.959	1297	3489	Sisma Y SLD	0	145.5	0	0	8.0E2	0.959
1298	3490	Sisma X SLV	336.4	0	0	0	8.5E2	0.959	1299	3490	Sisma Y SLV	0	336.4	0	0	8.5E2	0.959
1300	3490	Sisma X SLD	154.5	0	0	0	8.5E2	0.959	1301	3490	Sisma Y SLD	0	154.5	0	0	8.5E2	0.959
1302	3491	Sisma X SLV	336.4	0	0	0	8.5E2	0.959	1303	3491	Sisma Y SLV	0	336.4	0	0	8.5E2	0.959
1304	3491	Sisma X SLD	154.5	0	0	0	8.5E2	0.959	1305	3491	Sisma Y SLD	0	154.5	0	0	8.5E2	0.959
1306	3492	Sisma X SLV	316.9	0	0	0	8.0E2	0.959	1307	3492	Sisma Y SLV	0	316.9	0	0	8.0E2	0.959
1308	3492	Sisma X SLD	145.5	0	0	0	8.0E2	0.959	1309	3492	Sisma Y SLD	0	145.5	0	0	8.0E2	0.959
1310	3493	Sisma X SLV	316.9	0	0	0	8.0E2	0.959	1311	3493	Sisma Y SLV	0	316.9	0	0	8.0E2	0.959
1312	3493	Sisma X SLD	145.5	0	0	0	8.0E2	0.959	1313	3493	Sisma Y SLD	0	145.5	0	0	8.0E2	0.959
1314	3494	Sisma X SLV	336.4	0	0	0	8.5E2	0.959	1315	3494	Sisma Y SLV	0	336.4	0	0	8.5E2	0.959
1316	3494	Sisma X SLD	154.5	0	0	0	8.5E2	0.959	1317	3494	Sisma Y SLD	0	154.5	0	0	8.5E2	0.959
1318	3495	Sisma X SLV	336.4	0	0	0	8.5E2	0.959	1319	3495	Sisma Y SLV	0	336.4	0	0	8.5E2	0.959
1320	3495	Sisma X SLD	154.5	0	0	0	8.5E2	0.959	1321	3495	Sisma Y SLD	0	154.5	0	0	8.5E2	0.959
1322	3496	Sisma X SLV	316.9	0	0	0	8.0E2	0.959	1323	3496	Sisma Y SLV	0	316.9	0	0	8.0E2	0.959
1324	3496	Sisma X SLD	145.5	0	0	0	8.0E2	0.959	1325	3496	Sisma Y SLD	0	145.5	0	0	8.0E2	0.959
1326	3497	Sisma X SLV	316.9	0	0	0	8.0E2	0.959	1327	3497	Sisma Y SLV	0	316.9	0	0	8.0E2	0.959
1328	3497	Sisma X SLD	145.5	0	0	0	8.0E2	0.959	1329	3497	Sisma Y SLD	0	145.5	0	0	8.0E2	0.959
1330	3498	Sisma X SLV	336.4	0	0	0	8.5E2	0.959	1331	3498	Sisma Y SLV	0	336.4	0	0	8.5E2	0.959
1332	3498	Sisma X SLD	154.5	0	0	0	8.5E2	0.959	1333	3498	Sisma Y SLD	0	154.5	0	0	8.5E2	0.959
1334	3499	Sisma X SLV	316.9	0	0	0	8.0E2	0.959	1335	3499	Sisma Y SLV	0	316.9	0	0	8.0E2	0.959



Tabulati di Calcolo Plinto di Fondazione per Aerogeneratore Tipo - Progetto Impianto Eolico - "Orione"

Indice	Nodo	Condizione	Fx	Fy	Fz	Mz	Peso	Gamma	Indice	Nodo	Condizione	Fx	Fy	Fz	Mz	Peso	Gamma
1336	3499	Sisma X SLD	145.5	0	0	0	8.0E2	0.959	1337	3499	Sisma Y SLD	0	145.5	0	0	8.0E2	0.959
1338	3500	Sisma X SLV	316.9	0	0	0	8.0E2	0.959	1339	3500	Sisma Y SLV	0	316.9	0	0	8.0E2	0.959
1340	3500	Sisma X SLD	145.5	0	0	0	8.0E2	0.959	1341	3500	Sisma Y SLD	0	145.5	0	0	8.0E2	0.959
1342	3501	Sisma X SLV	336.4	0	0	0	8.5E2	0.959	1343	3501	Sisma Y SLV	0	336.4	0	0	8.5E2	0.959
1344	3501	Sisma X SLD	154.5	0	0	0	8.5E2	0.959	1345	3501	Sisma Y SLD	0	154.5	0	0	8.5E2	0.959
1346	3502	Sisma X SLV	316.9	0	0	0	8.0E2	0.959	1347	3502	Sisma Y SLV	0	316.9	0	0	8.0E2	0.959
1348	3502	Sisma X SLD	145.5	0	0	0	8.0E2	0.959	1349	3502	Sisma Y SLD	0	145.5	0	0	8.0E2	0.959
1350	3503	Sisma X SLV	316.9	0	0	0	8.0E2	0.959	1351	3503	Sisma Y SLV	0	316.9	0	0	8.0E2	0.959
1352	3503	Sisma X SLD	145.5	0	0	0	8.0E2	0.959	1353	3503	Sisma Y SLD	0	145.5	0	0	8.0E2	0.959
1354	3504	Sisma X SLV	336.4	0	0	0	8.5E2	0.959	1355	3504	Sisma Y SLV	0	336.4	0	0	8.5E2	0.959
1356	3504	Sisma X SLD	154.5	0	0	0	8.5E2	0.959	1357	3504	Sisma Y SLD	0	154.5	0	0	8.5E2	0.959
1358	3505	Sisma X SLV	336.4	0	0	0	8.5E2	0.959	1359	3505	Sisma Y SLV	0	336.4	0	0	8.5E2	0.959
1360	3505	Sisma X SLD	154.5	0	0	0	8.5E2	0.959	1361	3505	Sisma Y SLD	0	154.5	0	0	8.5E2	0.959
1362	3506	Sisma X SLV	316.9	0	0	0	8.0E2	0.959	1363	3506	Sisma Y SLV	0	316.9	0	0	8.0E2	0.959
1364	3506	Sisma X SLD	145.5	0	0	0	8.0E2	0.959	1365	3506	Sisma Y SLD	0	145.5	0	0	8.0E2	0.959
1366	3507	Sisma X SLV	316.9	0	0	0	8.0E2	0.959	1367	3507	Sisma Y SLV	0	316.9	0	0	8.0E2	0.959
1368	3507	Sisma X SLD	145.5	0	0	0	8.0E2	0.959	1369	3507	Sisma Y SLD	0	145.5	0	0	8.0E2	0.959
1370	3508	Sisma X SLV	336.4	0	0	0	8.5E2	0.959	1371	3508	Sisma Y SLV	0	336.4	0	0	8.5E2	0.959
1372	3508	Sisma X SLD	154.5	0	0	0	8.5E2	0.959	1373	3508	Sisma Y SLD	0	154.5	0	0	8.5E2	0.959
1374	3509	Sisma X SLV	336.4	0	0	0	8.5E2	0.959	1375	3509	Sisma Y SLV	0	336.4	0	0	8.5E2	0.959
1376	3509	Sisma X SLD	154.5	0	0	0	8.5E2	0.959	1377	3509	Sisma Y SLD	0	154.5	0	0	8.5E2	0.959
1378	3510	Sisma X SLV	316.9	0	0	0	8.0E2	0.959	1379	3510	Sisma Y SLV	0	316.9	0	0	8.0E2	0.959
1380	3510	Sisma X SLD	145.5	0	0	0	8.0E2	0.959	1381	3510	Sisma Y SLD	0	145.5	0	0	8.0E2	0.959
1382	3511	Sisma X SLV	316.9	0	0	0	8.0E2	0.959	1383	3511	Sisma Y SLV	0	316.9	0	0	8.0E2	0.959
1384	3511	Sisma X SLD	145.5	0	0	0	8.0E2	0.959	1385	3511	Sisma Y SLD	0	145.5	0	0	8.0E2	0.959
1386	3512	Sisma X SLV	316.9	0	0	0	8.0E2	0.959	1387	3512	Sisma Y SLV	0	316.9	0	0	8.0E2	0.959
1388	3512	Sisma X SLD	145.5	0	0	0	8.0E2	0.959	1389	3512	Sisma Y SLD	0	145.5	0	0	8.0E2	0.959
1390	3513	Sisma X SLV	316.9	0	0	0	8.0E2	0.959	1391	3513	Sisma Y SLV	0	316.9	0	0	8.0E2	0.959
1392	3513	Sisma X SLD	145.5	0	0	0	8.0E2	0.959	1393	3513	Sisma Y SLD	0	145.5	0	0	8.0E2	0.959
1394	3514	Sisma X SLV	336.4	0	0	0	8.5E2	0.959	1395	3514	Sisma Y SLV	0	336.4	0	0	8.5E2	0.959
1396	3514	Sisma X SLD	154.5	0	0	0	8.5E2	0.959	1397	3514	Sisma Y SLD	0	154.5	0	0	8.5E2	0.959
1398	3515	Sisma X SLV	336.4	0	0	0	8.5E2	0.959	1399	3515	Sisma Y SLV	0	336.4	0	0	8.5E2	0.959
1400	3515	Sisma X SLD	154.5	0	0	0	8.5E2	0.959	1401	3515	Sisma Y SLD	0	154.5	0	0	8.5E2	0.959
1402	3516	Sisma X SLV	316.9	0	0	0	8.0E2	0.959	1403	3516	Sisma Y SLV	0	316.9	0	0	8.0E2	0.959
1404	3516	Sisma X SLD	145.5	0	0	0	8.0E2	0.959	1405	3516	Sisma Y SLD	0	145.5	0	0	8.0E2	0.959
1406	3517	Sisma X SLV	316.9	0	0	0	8.0E2	0.959	1407	3517	Sisma Y SLV	0	316.9	0	0	8.0E2	0.959
1408	3517	Sisma X SLD	145.5	0	0	0	8.0E2	0.959	1409	3517	Sisma Y SLD	0	145.5	0	0	8.0E2	0.959
1410	3518	Sisma X SLV	316.9	0	0	0	8.0E2	0.959	1411	3518	Sisma Y SLV	0	316.9	0	0	8.0E2	0.959
1412	3518	Sisma X SLD	145.5	0	0	0	8.0E2	0.959	1413	3518	Sisma Y SLD	0	145.5	0	0	8.0E2	0.959
1414	3519	Sisma X SLV	316.9	0	0	0	8.0E2	0.959	1415	3519	Sisma Y SLV	0	316.9	0	0	8.0E2	0.959
1416	3519	Sisma X SLD	145.5	0	0	0	8.0E2	0.959	1417	3519	Sisma Y SLD	0	145.5	0	0	8.0E2	0.959
1418	3520	Sisma X SLV	336.4	0	0	0	8.5E2	0.959	1419	3520	Sisma Y SLV	0	336.4	0	0	8.5E2	0.959
1420	3520	Sisma X SLD	154.5	0	0	0	8.5E2	0.959	1421	3520	Sisma Y SLD	0	154.5	0	0	8.5E2	0.959
1422	3521	Sisma X SLV	336.4	0	0	0	8.5E2	0.959	1423	3521	Sisma Y SLV	0	336.4	0	0	8.5E2	0.959
1424	3521	Sisma X SLD	154.5	0	0	0	8.5E2	0.959	1425	3521	Sisma Y SLD	0	154.5	0	0	8.5E2	0.959
1426	3522	Sisma X SLV	316.9	0	0	0	8.0E2	0.959	1427	3522	Sisma Y SLV	0	316.9	0	0	8.0E2	0.959
1428	3522	Sisma X SLD	145.5	0	0	0	8.0E2	0.959	1429	3522	Sisma Y SLD	0	145.5	0	0	8.0E2	0.959
1430	3523	Sisma X SLV	316.9	0	0	0	8.0E2	0.959	1431	3523	Sisma Y SLV	0	316.9	0	0	8.0E2	0.959
1432	3523	Sisma X SLD	145.5	0	0	0	8.0E2	0.959	1433	3523	Sisma Y SLD	0	145.5	0	0	8.0E2	0.959
1434	3524	Sisma X SLV	316.9	0	0	0	8.0E2	0.959	1435	3524	Sisma Y SLV	0	316.9	0	0	8.0E2	0.959



Tabulati di Calcolo Plinto di Fondazione per Aerogeneratore Tipo - Progetto Impianto Eolico - "Orione"

Indice	Nodo	Condizione	Fx	Fy	Fz	Mz	Peso	Gamma	Indice	Nodo	Condizione	Fx	Fy	Fz	Mz	Peso	Gamma
1436	3524	Sisma X SLD	145.5	0	0	0	8.0E2	0.959	1437	3524	Sisma Y SLD	0	145.5	0	0	8.0E2	0.959
1438	3525	Sisma X SLV	316.9	0	0	0	8.0E2	0.959	1439	3525	Sisma Y SLV	0	316.9	0	0	8.0E2	0.959
1440	3525	Sisma X SLD	145.5	0	0	0	8.0E2	0.959	1441	3525	Sisma Y SLD	0	145.5	0	0	8.0E2	0.959
1442	3526	Sisma X SLV	336.4	0	0	0	8.5E2	0.959	1443	3526	Sisma Y SLV	0	336.4	0	0	8.5E2	0.959
1444	3526	Sisma X SLD	154.5	0	0	0	8.5E2	0.959	1445	3526	Sisma Y SLD	0	154.5	0	0	8.5E2	0.959
1446	3527	Sisma X SLV	336.4	0	0	0	8.5E2	0.959	1447	3527	Sisma Y SLV	0	336.4	0	0	8.5E2	0.959
1448	3527	Sisma X SLD	154.5	0	0	0	8.5E2	0.959	1449	3527	Sisma Y SLD	0	154.5	0	0	8.5E2	0.959
1450	3528	Sisma X SLV	316.9	0	0	0	8.0E2	0.959	1451	3528	Sisma Y SLV	0	316.9	0	0	8.0E2	0.959
1452	3528	Sisma X SLD	145.5	0	0	0	8.0E2	0.959	1453	3528	Sisma Y SLD	0	145.5	0	0	8.0E2	0.959
1454	3529	Sisma X SLV	316.9	0	0	0	8.0E2	0.959	1455	3529	Sisma Y SLV	0	316.9	0	0	8.0E2	0.959
1456	3529	Sisma X SLD	145.5	0	0	0	8.0E2	0.959	1457	3529	Sisma Y SLD	0	145.5	0	0	8.0E2	0.959
1458	3530	Sisma X SLV	316.9	0	0	0	8.0E2	0.959	1459	3530	Sisma Y SLV	0	316.9	0	0	8.0E2	0.959
1460	3530	Sisma X SLD	145.5	0	0	0	8.0E2	0.959	1461	3530	Sisma Y SLD	0	145.5	0	0	8.0E2	0.959
1462	3531	Sisma X SLV	316.9	0	0	0	8.0E2	0.959	1463	3531	Sisma Y SLV	0	316.9	0	0	8.0E2	0.959
1464	3531	Sisma X SLD	145.5	0	0	0	8.0E2	0.959	1465	3531	Sisma Y SLD	0	145.5	0	0	8.0E2	0.959
1466	3532	Sisma X SLV	316.9	0	0	0	8.0E2	0.959	1467	3532	Sisma Y SLV	0	316.9	0	0	8.0E2	0.959
1468	3532	Sisma X SLD	145.5	0	0	0	8.0E2	0.959	1469	3532	Sisma Y SLD	0	145.5	0	0	8.0E2	0.959
1470	3533	Sisma X SLV	316.9	0	0	0	8.0E2	0.959	1471	3533	Sisma Y SLV	0	316.9	0	0	8.0E2	0.959
1472	3533	Sisma X SLD	145.5	0	0	0	8.0E2	0.959	1473	3533	Sisma Y SLD	0	145.5	0	0	8.0E2	0.959
1474	3534	Sisma X SLV	336.4	0	0	0	8.5E2	0.959	1475	3534	Sisma Y SLV	0	336.4	0	0	8.5E2	0.959
1476	3534	Sisma X SLD	154.5	0	0	0	8.5E2	0.959	1477	3534	Sisma Y SLD	0	154.5	0	0	8.5E2	0.959
1478	3535	Sisma X SLV	316.9	0	0	0	8.0E2	0.959	1479	3535	Sisma Y SLV	0	316.9	0	0	8.0E2	0.959
1480	3535	Sisma X SLD	145.5	0	0	0	8.0E2	0.959	1481	3535	Sisma Y SLD	0	145.5	0	0	8.0E2	0.959
1482	3536	Sisma X SLV	316.9	0	0	0	8.0E2	0.959	1483	3536	Sisma Y SLV	0	316.9	0	0	8.0E2	0.959
1484	3536	Sisma X SLD	145.5	0	0	0	8.0E2	0.959	1485	3536	Sisma Y SLD	0	145.5	0	0	8.0E2	0.959
1486	3537	Sisma X SLV	336.4	0	0	0	8.5E2	0.959	1487	3537	Sisma Y SLV	0	336.4	0	0	8.5E2	0.959
1488	3537	Sisma X SLD	154.5	0	0	0	8.5E2	0.959	1489	3537	Sisma Y SLD	0	154.5	0	0	8.5E2	0.959
1490	3538	Sisma X SLV	316.9	0	0	0	8.0E2	0.959	1491	3538	Sisma Y SLV	0	316.9	0	0	8.0E2	0.959
1492	3538	Sisma X SLD	145.5	0	0	0	8.0E2	0.959	1493	3538	Sisma Y SLD	0	145.5	0	0	8.0E2	0.959
1494	3539	Sisma X SLV	316.9	0	0	0	8.0E2	0.959	1495	3539	Sisma Y SLV	0	316.9	0	0	8.0E2	0.959
1496	3539	Sisma X SLD	145.5	0	0	0	8.0E2	0.959	1497	3539	Sisma Y SLD	0	145.5	0	0	8.0E2	0.959
1498	3540	Sisma X SLV	316.9	0	0	0	8.0E2	0.959	1499	3540	Sisma Y SLV	0	316.9	0	0	8.0E2	0.959
1500	3540	Sisma X SLD	145.5	0	0	0	8.0E2	0.959	1501	3540	Sisma Y SLD	0	145.5	0	0	8.0E2	0.959
1502	3541	Sisma X SLV	316.9	0	0	0	8.0E2	0.959	1503	3541	Sisma Y SLV	0	316.9	0	0	8.0E2	0.959
1504	3541	Sisma X SLD	145.5	0	0	0	8.0E2	0.959	1505	3541	Sisma Y SLD	0	145.5	0	0	8.0E2	0.959
1506	3542	Sisma X SLV	316.9	0	0	0	8.0E2	0.959	1507	3542	Sisma Y SLV	0	316.9	0	0	8.0E2	0.959
1508	3542	Sisma X SLD	145.5	0	0	0	8.0E2	0.959	1509	3542	Sisma Y SLD	0	145.5	0	0	8.0E2	0.959
1510	3543	Sisma X SLV	336.4	0	0	0	8.5E2	0.959	1511	3543	Sisma Y SLV	0	336.4	0	0	8.5E2	0.959
1512	3543	Sisma X SLD	154.5	0	0	0	8.5E2	0.959	1513	3543	Sisma Y SLD	0	154.5	0	0	8.5E2	0.959
1514	3544	Sisma X SLV	336.4	0	0	0	8.5E2	0.959	1515	3544	Sisma Y SLV	0	336.4	0	0	8.5E2	0.959
1516	3544	Sisma X SLD	154.5	0	0	0	8.5E2	0.959	1517	3544	Sisma Y SLD	0	154.5	0	0	8.5E2	0.959
1518	3545	Sisma X SLV	336.4	0	0	0	8.5E2	0.959	1519	3545	Sisma Y SLV	0	336.4	0	0	8.5E2	0.959
1520	3545	Sisma X SLD	154.5	0	0	0	8.5E2	0.959	1521	3545	Sisma Y SLD	0	154.5	0	0	8.5E2	0.959
1522	3546	Sisma X SLV	336.4	0	0	0	8.5E2	0.959	1523	3546	Sisma Y SLV	0	336.4	0	0	8.5E2	0.959
1524	3546	Sisma X SLD	154.5	0	0	0	8.5E2	0.959	1525	3546	Sisma Y SLD	0	154.5	0	0	8.5E2	0.959
1526	3547	Sisma X SLV	336.4	0	0	0	8.5E2	0.959	1527	3547	Sisma Y SLV	0	336.4	0	0	8.5E2	0.959
1528	3547	Sisma X SLD	154.5	0	0	0	8.5E2	0.959	1529	3547	Sisma Y SLD	0	154.5	0	0	8.5E2	0.959
1530	3548	Sisma X SLV	336.4	0	0	0	8.5E2	0.959	1531	3548	Sisma Y SLV	0	336.4	0	0	8.5E2	0.959
1532	3548	Sisma X SLD	154.5	0	0	0	8.5E2	0.959	1533	3548	Sisma Y SLD	0	154.5	0	0	8.5E2	0.959
1534	3549	Sisma X SLV	336.4	0	0	0	8.5E2	0.959	1535	3549	Sisma Y SLV	0	336.4	0	0	8.5E2	0.959



Progetto	Titolo	Rev.	Pag.
Orione	Orione_A24a.pdf "TABULATI DI CALCOLO PLINTO DI FONDAZIONE PER AEROGENERATORE TIPO"	0	86

Tabulati di Calcolo Plinto di Fondazione per Aerogeneratore Tipo - Progetto Impianto Eolico - "Orione"

Indice	Nodo	Condizione	Fx	Fy	Fz	Mz	Peso	Gamma	Indice	Nodo	Condizione	Fx	Fy	Fz	Mz	Peso	Gamma
1536	3549	Sisma X SLD	154.5	0	0	0	8.5E2	0.959	1537	3549	Sisma Y SLD	0	154.5	0	0	8.5E2	0.959
1538	3550	Sisma X SLV	336.4	0	0	0	8.5E2	0.959	1539	3550	Sisma Y SLV	0	336.4	0	0	8.5E2	0.959
1540	3550	Sisma X SLD	154.5	0	0	0	8.5E2	0.959	1541	3550	Sisma Y SLD	0	154.5	0	0	8.5E2	0.959
1542	3551	Sisma X SLV	336.4	0	0	0	8.5E2	0.959	1543	3551	Sisma Y SLV	0	336.4	0	0	8.5E2	0.959
1544	3551	Sisma X SLD	154.5	0	0	0	8.5E2	0.959	1545	3551	Sisma Y SLD	0	154.5	0	0	8.5E2	0.959
1546	3552	Sisma X SLV	336.4	0	0	0	8.5E2	0.959	1547	3552	Sisma Y SLV	0	336.4	0	0	8.5E2	0.959
1548	3552	Sisma X SLD	154.5	0	0	0	8.5E2	0.959	1549	3552	Sisma Y SLD	0	154.5	0	0	8.5E2	0.959
1550	3553	Sisma X SLV	336.4	0	0	0	8.5E2	0.959	1551	3553	Sisma Y SLV	0	336.4	0	0	8.5E2	0.959
1552	3553	Sisma X SLD	154.5	0	0	0	8.5E2	0.959	1553	3553	Sisma Y SLD	0	154.5	0	0	8.5E2	0.959
1554	3554	Sisma X SLV	336.4	0	0	0	8.5E2	0.959	1555	3554	Sisma Y SLV	0	336.4	0	0	8.5E2	0.959
1556	3554	Sisma X SLD	154.5	0	0	0	8.5E2	0.959	1557	3554	Sisma Y SLD	0	154.5	0	0	8.5E2	0.959
1558	3555	Sisma X SLV	336.4	0	0	0	8.5E2	0.959	1559	3555	Sisma Y SLV	0	336.4	0	0	8.5E2	0.959
1560	3555	Sisma X SLD	154.5	0	0	0	8.5E2	0.959	1561	3555	Sisma Y SLD	0	154.5	0	0	8.5E2	0.959
1562	3556	Sisma X SLV	336.4	0	0	0	8.5E2	0.959	1563	3556	Sisma Y SLV	0	336.4	0	0	8.5E2	0.959
1564	3556	Sisma X SLD	154.5	0	0	0	8.5E2	0.959	1565	3556	Sisma Y SLD	0	154.5	0	0	8.5E2	0.959
1566	3557	Sisma X SLV	336.4	0	0	0	8.5E2	0.959	1567	3557	Sisma Y SLV	0	336.4	0	0	8.5E2	0.959
1568	3557	Sisma X SLD	154.5	0	0	0	8.5E2	0.959	1569	3557	Sisma Y SLD	0	154.5	0	0	8.5E2	0.959
1570	3558	Sisma X SLV	336.4	0	0	0	8.5E2	0.959	1571	3558	Sisma Y SLV	0	336.4	0	0	8.5E2	0.959
1572	3558	Sisma X SLD	154.5	0	0	0	8.5E2	0.959	1573	3558	Sisma Y SLD	0	154.5	0	0	8.5E2	0.959
1574	3559	Sisma X SLV	336.4	0	0	0	8.5E2	0.959	1575	3559	Sisma Y SLV	0	336.4	0	0	8.5E2	0.959
1576	3559	Sisma X SLD	154.5	0	0	0	8.5E2	0.959	1577	3559	Sisma Y SLD	0	154.5	0	0	8.5E2	0.959
1578	3560	Sisma X SLV	336.4	0	0	0	8.5E2	0.959	1579	3560	Sisma Y SLV	0	336.4	0	0	8.5E2	0.959
1580	3560	Sisma X SLD	154.5	0	0	0	8.5E2	0.959	1581	3560	Sisma Y SLD	0	154.5	0	0	8.5E2	0.959
1582	3561	Sisma X SLV	336.4	0	0	0	8.5E2	0.959	1583	3561	Sisma Y SLV	0	336.4	0	0	8.5E2	0.959
1584	3561	Sisma X SLD	154.5	0	0	0	8.5E2	0.959	1585	3561	Sisma Y SLD	0	154.5	0	0	8.5E2	0.959
1586	3562	Sisma X SLV	336.4	0	0	0	8.5E2	0.959	1587	3562	Sisma Y SLV	0	336.4	0	0	8.5E2	0.959
1588	3562	Sisma X SLD	154.5	0	0	0	8.5E2	0.959	1589	3562	Sisma Y SLD	0	154.5	0	0	8.5E2	0.959
1590	3563	Sisma X SLV	336.4	0	0	0	8.5E2	0.959	1591	3563	Sisma Y SLV	0	336.4	0	0	8.5E2	0.959
1592	3563	Sisma X SLD	154.5	0	0	0	8.5E2	0.959	1593	3563	Sisma Y SLD	0	154.5	0	0	8.5E2	0.959
1594	3564	Sisma X SLV	336.4	0	0	0	8.5E2	0.959	1595	3564	Sisma Y SLV	0	336.4	0	0	8.5E2	0.959
1596	3564	Sisma X SLD	154.5	0	0	0	8.5E2	0.959	1597	3564	Sisma Y SLD	0	154.5	0	0	8.5E2	0.959
1598	3565	Sisma X SLV	336.4	0	0	0	8.5E2	0.959	1599	3565	Sisma Y SLV	0	336.4	0	0	8.5E2	0.959
1600	3565	Sisma X SLD	154.5	0	0	0	8.5E2	0.959	1601	3565	Sisma Y SLD	0	154.5	0	0	8.5E2	0.959
1602	3566	Sisma X SLV	336.4	0	0	0	8.5E2	0.959	1603	3566	Sisma Y SLV	0	336.4	0	0	8.5E2	0.959
1604	3566	Sisma X SLD	154.5	0	0	0	8.5E2	0.959	1605	3566	Sisma Y SLD	0	154.5	0	0	8.5E2	0.959
1606	3567	Sisma X SLV	336.4	0	0	0	8.5E2	0.959	1607	3567	Sisma Y SLV	0	336.4	0	0	8.5E2	0.959
1608	3567	Sisma X SLD	154.5	0	0	0	8.5E2	0.959	1609	3567	Sisma Y SLD	0	154.5	0	0	8.5E2	0.959
1610	3568	Sisma X SLV	367.6	0	0	0	9.2E2	0.968	1611	3568	Sisma Y SLV	0	367.6	0	0	9.2E2	0.968
1612	3568	Sisma X SLD	168.8	0	0	0	9.2E2	0.968	1613	3568	Sisma Y SLD	0	168.8	0	0	9.2E2	0.968
1614	3569	Sisma X SLV	367.6	0	0	0	9.2E2	0.968	1615	3569	Sisma Y SLV	0	367.6	0	0	9.2E2	0.968
1616	3569	Sisma X SLD	168.8	0	0	0	9.2E2	0.968	1617	3569	Sisma Y SLD	0	168.8	0	0	9.2E2	0.968
1618	3570	Sisma X SLV	367.6	0	0	0	9.2E2	0.968	1619	3570	Sisma Y SLV	0	367.6	0	0	9.2E2	0.968
1620	3570	Sisma X SLD	168.8	0	0	0	9.2E2	0.968	1621	3570	Sisma Y SLD	0	168.8	0	0	9.2E2	0.968
1622	3571	Sisma X SLV	367.6	0	0	0	9.2E2	0.968	1623	3571	Sisma Y SLV	0	367.6	0	0	9.2E2	0.968
1624	3571	Sisma X SLD	168.8	0	0	0	9.2E2	0.968	1625	3571	Sisma Y SLD	0	168.8	0	0	9.2E2	0.968
1626	3572	Sisma X SLV	367.6	0	0	0	9.2E2	0.968	1627	3572	Sisma Y SLV	0	367.6	0	0	9.2E2	0.968
1628	3572	Sisma X SLD	168.8	0	0	0	9.2E2	0.968	1629	3572	Sisma Y SLD	0	168.8	0	0	9.2E2	0.968
1630	3573	Sisma X SLV	367.6	0	0	0	9.2E2	0.968	1631	3573	Sisma Y SLV	0	367.6	0	0	9.2E2	0.968
1632	3573	Sisma X SLD	168.8	0	0	0	9.2E2	0.968	1633	3573	Sisma Y SLD	0	168.8	0	0	9.2E2	0.968
1634	3574	Sisma X SLV	367.6	0	0	0	9.2E2	0.968	1635	3574	Sisma Y SLV	0	367.6	0	0	9.2E2	0.968





Tabulati di Calcolo Plinto di Fondazione per Aerogeneratore Tipo - Progetto Impianto Eolico - "Orione"

Indice	Nodo	Condizione	Fx	Fy	Fz	Mz	Peso	Gamma	Indice	Nodo	Condizione	Fx	Fy	Fz	Mz	Peso	Gamma
1636	3574	Sisma X SLD	168.8	0	0	0	9.2E2	0.968	1637	3574	Sisma Y SLD	0	168.8	0	0	9.2E2	0.968
1638	3575	Sisma X SLV	367.6	0	0	0	9.2E2	0.968	1639	3575	Sisma Y SLV	0	367.6	0	0	9.2E2	0.968
1640	3575	Sisma X SLD	168.8	0	0	0	9.2E2	0.968	1641	3575	Sisma Y SLD	0	168.8	0	0	9.2E2	0.968
1642	3576	Sisma X SLV	367.6	0	0	0	9.2E2	0.968	1643	3576	Sisma Y SLV	0	367.6	0	0	9.2E2	0.968
1644	3576	Sisma X SLD	168.8	0	0	0	9.2E2	0.968	1645	3576	Sisma Y SLD	0	168.8	0	0	9.2E2	0.968
1646	3577	Sisma X SLV	367.6	0	0	0	9.2E2	0.968	1647	3577	Sisma Y SLV	0	367.6	0	0	9.2E2	0.968
1648	3577	Sisma X SLD	168.8	0	0	0	9.2E2	0.968	1649	3577	Sisma Y SLD	0	168.8	0	0	9.2E2	0.968
1650	3578	Sisma X SLV	367.6	0	0	0	9.2E2	0.968	1651	3578	Sisma Y SLV	0	367.6	0	0	9.2E2	0.968
1652	3578	Sisma X SLD	168.8	0	0	0	9.2E2	0.968	1653	3578	Sisma Y SLD	0	168.8	0	0	9.2E2	0.968
1654	3579	Sisma X SLV	367.6	0	0	0	9.2E2	0.968	1655	3579	Sisma Y SLV	0	367.6	0	0	9.2E2	0.968
1656	3579	Sisma X SLD	168.8	0	0	0	9.2E2	0.968	1657	3579	Sisma Y SLD	0	168.8	0	0	9.2E2	0.968
1658	3580	Sisma X SLV	367.6	0	0	0	9.2E2	0.968	1659	3580	Sisma Y SLV	0	367.6	0	0	9.2E2	0.968
1660	3580	Sisma X SLD	168.8	0	0	0	9.2E2	0.968	1661	3580	Sisma Y SLD	0	168.8	0	0	9.2E2	0.968
1662	3581	Sisma X SLV	367.6	0	0	0	9.2E2	0.968	1663	3581	Sisma Y SLV	0	367.6	0	0	9.2E2	0.968
1664	3581	Sisma X SLD	168.8	0	0	0	9.2E2	0.968	1665	3581	Sisma Y SLD	0	168.8	0	0	9.2E2	0.968
1666	3582	Sisma X SLV	367.6	0	0	0	9.2E2	0.968	1667	3582	Sisma Y SLV	0	367.6	0	0	9.2E2	0.968
1668	3582	Sisma X SLD	168.8	0	0	0	9.2E2	0.968	1669	3582	Sisma Y SLD	0	168.8	0	0	9.2E2	0.968
1670	3583	Sisma X SLV	367.6	0	0	0	9.2E2	0.968	1671	3583	Sisma Y SLV	0	367.6	0	0	9.2E2	0.968
1672	3583	Sisma X SLD	168.8	0	0	0	9.2E2	0.968	1673	3583	Sisma Y SLD	0	168.8	0	0	9.2E2	0.968
1674	3584	Sisma X SLV	367.6	0	0	0	9.2E2	0.968	1675	3584	Sisma Y SLV	0	367.6	0	0	9.2E2	0.968
1676	3584	Sisma X SLD	168.8	0	0	0	9.2E2	0.968	1677	3584	Sisma Y SLD	0	168.8	0	0	9.2E2	0.968
1678	3585	Sisma X SLV	367.6	0	0	0	9.2E2	0.968	1679	3585	Sisma Y SLV	0	367.6	0	0	9.2E2	0.968
1680	3585	Sisma X SLD	168.8	0	0	0	9.2E2	0.968	1681	3585	Sisma Y SLD	0	168.8	0	0	9.2E2	0.968
1682	3586	Sisma X SLV	367.6	0	0	0	9.2E2	0.968	1683	3586	Sisma Y SLV	0	367.6	0	0	9.2E2	0.968
1684	3586	Sisma X SLD	168.8	0	0	0	9.2E2	0.968	1685	3586	Sisma Y SLD	0	168.8	0	0	9.2E2	0.968
1686	3587	Sisma X SLV	367.6	0	0	0	9.2E2	0.968	1687	3587	Sisma Y SLV	0	367.6	0	0	9.2E2	0.968
1688	3587	Sisma X SLD	168.8	0	0	0	9.2E2	0.968	1689	3587	Sisma Y SLD	0	168.8	0	0	9.2E2	0.968
1690	3588	Sisma X SLV	367.6	0	0	0	9.2E2	0.968	1691	3588	Sisma Y SLV	0	367.6	0	0	9.2E2	0.968
1692	3588	Sisma X SLD	168.8	0	0	0	9.2E2	0.968	1693	3588	Sisma Y SLD	0	168.8	0	0	9.2E2	0.968
1694	3589	Sisma X SLV	367.6	0	0	0	9.2E2	0.968	1695	3589	Sisma Y SLV	0	367.6	0	0	9.2E2	0.968
1696	3589	Sisma X SLD	168.8	0	0	0	9.2E2	0.968	1697	3589	Sisma Y SLD	0	168.8	0	0	9.2E2	0.968
1698	3590	Sisma X SLV	367.6	0	0	0	9.2E2	0.968	1699	3590	Sisma Y SLV	0	367.6	0	0	9.2E2	0.968
1700	3590	Sisma X SLD	168.8	0	0	0	9.2E2	0.968	1701	3590	Sisma Y SLD	0	168.8	0	0	9.2E2	0.968
1702	3591	Sisma X SLV	367.6	0	0	0	9.2E2	0.968	1703	3591	Sisma Y SLV	0	367.6	0	0	9.2E2	0.968
1704	3591	Sisma X SLD	168.8	0	0	0	9.2E2	0.968	1705	3591	Sisma Y SLD	0	168.8	0	0	9.2E2	0.968
1706	3592	Sisma X SLV	367.6	0	0	0	9.2E2	0.968	1707	3592	Sisma Y SLV	0	367.6	0	0	9.2E2	0.968
1708	3592	Sisma X SLD	168.8	0	0	0	9.2E2	0.968	1709	3592	Sisma Y SLD	0	168.8	0	0	9.2E2	0.968
1710	3593	Sisma X SLV	367.6	0	0	0	9.2E2	0.968	1711	3593	Sisma Y SLV	0	367.6	0	0	9.2E2	0.968
1712	3593	Sisma X SLD	168.8	0	0	0	9.2E2	0.968	1713	3593	Sisma Y SLD	0	168.8	0	0	9.2E2	0.968
1714	3594	Sisma X SLV	367.6	0	0	0	9.2E2	0.968	1715	3594	Sisma Y SLV	0	367.6	0	0	9.2E2	0.968
1716	3594	Sisma X SLD	168.8	0	0	0	9.2E2	0.968	1717	3594	Sisma Y SLD	0	168.8	0	0	9.2E2	0.968
1718	3595	Sisma X SLV	367.6	0	0	0	9.2E2	0.968	1719	3595	Sisma Y SLV	0	367.6	0	0	9.2E2	0.968
1720	3595	Sisma X SLD	168.8	0	0	0	9.2E2	0.968	1721	3595	Sisma Y SLD	0	168.8	0	0	9.2E2	0.968
1722	3596	Sisma X SLV	367.6	0	0	0	9.2E2	0.968	1723	3596	Sisma Y SLV	0	367.6	0	0	9.2E2	0.968
1724	3596	Sisma X SLD	168.8	0	0	0	9.2E2	0.968	1725	3596	Sisma Y SLD	0	168.8	0	0	9.2E2	0.968
1726	3597	Sisma X SLV	367.6	0	0	0	9.2E2	0.968	1727	3597	Sisma Y SLV	0	367.6	0	0	9.2E2	0.968
1728	3597	Sisma X SLD	168.8	0	0	0	9.2E2	0.968	1729	3597	Sisma Y SLD	0	168.8	0	0	9.2E2	0.968
1730	3598	Sisma X SLV	367.6	0	0	0	9.2E2	0.968	1731	3598	Sisma Y SLV	0	367.6	0	0	9.2E2	0.968
1732	3598	Sisma X SLD	168.8	0	0	0	9.2E2	0.968	1733	3598	Sisma Y SLD	0	168.8	0	0	9.2E2	0.968
1734	3599	Sisma X SLV	367.6	0	0	0	9.2E2	0.968	1735	3599	Sisma Y SLV	0	367.6	0	0	9.2E2	0.968



Tabulati di Calcolo Plinto di Fondazione per Aerogeneratore Tipo - Progetto Impianto Eolico - "Orione"

Indice	Nodo	Condizione	Fx	Fy	Fz	Mz	Peso	Gamma	Indice	Nodo	Condizione	Fx	Fy	Fz	Mz	Peso	Gamma
1736	3599	Sisma X SLD	168.8	0	0	0	9.2E2	0.968	1737	3599	Sisma Y SLD	0	168.8	0	0	9.2E2	0.968
1738	3600	Sisma X SLV	367.6	0	0	0	9.2E2	0.968	1739	3600	Sisma Y SLV	0	367.6	0	0	9.2E2	0.968
1740	3600	Sisma X SLD	168.8	0	0	0	9.2E2	0.968	1741	3600	Sisma Y SLD	0	168.8	0	0	9.2E2	0.968
1742	3601	Sisma X SLV	367.6	0	0	0	9.2E2	0.968	1743	3601	Sisma Y SLV	0	367.6	0	0	9.2E2	0.968
1744	3601	Sisma X SLD	168.8	0	0	0	9.2E2	0.968	1745	3601	Sisma Y SLD	0	168.8	0	0	9.2E2	0.968
1746	3602	Sisma X SLV	367.6	0	0	0	9.2E2	0.968	1747	3602	Sisma Y SLV	0	367.6	0	0	9.2E2	0.968
1748	3602	Sisma X SLD	168.8	0	0	0	9.2E2	0.968	1749	3602	Sisma Y SLD	0	168.8	0	0	9.2E2	0.968
1750	3603	Sisma X SLV	367.6	0	0	0	9.2E2	0.968	1751	3603	Sisma Y SLV	0	367.6	0	0	9.2E2	0.968
1752	3603	Sisma X SLD	168.8	0	0	0	9.2E2	0.968	1753	3603	Sisma Y SLD	0	168.8	0	0	9.2E2	0.968
1754	3604	Sisma X SLV	753.6	0	0	0	1.7E3	1.07	1755	3604	Sisma Y SLV	0	753.6	0	0	1.7E3	1.07
1756	3604	Sisma X SLD	346	0	0	0	1.7E3	1.07	1757	3604	Sisma Y SLD	0	346	0	0	1.7E3	1.07
1758	3605	Sisma X SLV	753.6	0	0	0	1.7E3	1.07	1759	3605	Sisma Y SLV	0	753.6	0	0	1.7E3	1.07
1760	3605	Sisma X SLD	346	0	0	0	1.7E3	1.07	1761	3605	Sisma Y SLD	0	346	0	0	1.7E3	1.07
1762	3606	Sisma X SLV	753.6	0	0	0	1.7E3	1.07	1763	3606	Sisma Y SLV	0	753.6	0	0	1.7E3	1.07
1764	3606	Sisma X SLD	346	0	0	0	1.7E3	1.07	1765	3606	Sisma Y SLD	0	346	0	0	1.7E3	1.07
1766	3607	Sisma X SLV	753.6	0	0	0	1.7E3	1.07	1767	3607	Sisma Y SLV	0	753.6	0	0	1.7E3	1.07
1768	3607	Sisma X SLD	346	0	0	0	1.7E3	1.07	1769	3607	Sisma Y SLD	0	346	0	0	1.7E3	1.07
1770	3608	Sisma X SLV	753.6	0	0	0	1.7E3	1.07	1771	3608	Sisma Y SLV	0	753.6	0	0	1.7E3	1.07
1772	3608	Sisma X SLD	346	0	0	0	1.7E3	1.07	1773	3608	Sisma Y SLD	0	346	0	0	1.7E3	1.07
1774	3609	Sisma X SLV	753.6	0	0	0	1.7E3	1.07	1775	3609	Sisma Y SLV	0	753.6	0	0	1.7E3	1.07
1776	3609	Sisma X SLD	346	0	0	0	1.7E3	1.07	1777	3609	Sisma Y SLD	0	346	0	0	1.7E3	1.07
1778	3610	Sisma X SLV	753.6	0	0	0	1.7E3	1.07	1779	3610	Sisma Y SLV	0	753.6	0	0	1.7E3	1.07
1780	3610	Sisma X SLD	346	0	0	0	1.7E3	1.07	1781	3610	Sisma Y SLD	0	346	0	0	1.7E3	1.07
1782	3611	Sisma X SLV	753.6	0	0	0	1.7E3	1.07	1783	3611	Sisma Y SLV	0	753.6	0	0	1.7E3	1.07
1784	3611	Sisma X SLD	346	0	0	0	1.7E3	1.07	1785	3611	Sisma Y SLD	0	346	0	0	1.7E3	1.07
1786	3612	Sisma X SLV	753.6	0	0	0	1.7E3	1.07	1787	3612	Sisma Y SLV	0	753.6	0	0	1.7E3	1.07
1788	3612	Sisma X SLD	346	0	0	0	1.7E3	1.07	1789	3612	Sisma Y SLD	0	346	0	0	1.7E3	1.07
1790	3613	Sisma X SLV	753.6	0	0	0	1.7E3	1.07	1791	3613	Sisma Y SLV	0	753.6	0	0	1.7E3	1.07
1792	3613	Sisma X SLD	346	0	0	0	1.7E3	1.07	1793	3613	Sisma Y SLD	0	346	0	0	1.7E3	1.07
1794	3614	Sisma X SLV	753.6	0	0	0	1.7E3	1.07	1795	3614	Sisma Y SLV	0	753.6	0	0	1.7E3	1.07
1796	3614	Sisma X SLD	346	0	0	0	1.7E3	1.07	1797	3614	Sisma Y SLD	0	346	0	0	1.7E3	1.07
1798	3615	Sisma X SLV	753.6	0	0	0	1.7E3	1.07	1799	3615	Sisma Y SLV	0	753.6	0	0	1.7E3	1.07
1800	3615	Sisma X SLD	346	0	0	0	1.7E3	1.07	1801	3615	Sisma Y SLD	0	346	0	0	1.7E3	1.07
1802	3616	Sisma X SLV	753.6	0	0	0	1.7E3	1.07	1803	3616	Sisma Y SLV	0	753.6	0	0	1.7E3	1.07
1804	3616	Sisma X SLD	346	0	0	0	1.7E3	1.07	1805	3616	Sisma Y SLD	0	346	0	0	1.7E3	1.07
1806	3617	Sisma X SLV	753.6	0	0	0	1.7E3	1.07	1807	3617	Sisma Y SLV	0	753.6	0	0	1.7E3	1.07
1808	3617	Sisma X SLD	346	0	0	0	1.7E3	1.07	1809	3617	Sisma Y SLD	0	346	0	0	1.7E3	1.07
1810	3618	Sisma X SLV	753.6	0	0	0	1.7E3	1.07	1811	3618	Sisma Y SLV	0	753.6	0	0	1.7E3	1.07
1812	3618	Sisma X SLD	346	0	0	0	1.7E3	1.07	1813	3618	Sisma Y SLD	0	346	0	0	1.7E3	1.07
1814	3619	Sisma X SLV	753.6	0	0	0	1.7E3	1.07	1815	3619	Sisma Y SLV	0	753.6	0	0	1.7E3	1.07
1816	3619	Sisma X SLD	346	0	0	0	1.7E3	1.07	1817	3619	Sisma Y SLD	0	346	0	0	1.7E3	1.07
1818	3620	Sisma X SLV	753.6	0	0	0	1.7E3	1.07	1819	3620	Sisma Y SLV	0	753.6	0	0	1.7E3	1.07
1820	3620	Sisma X SLD	346	0	0	0	1.7E3	1.07	1821	3620	Sisma Y SLD	0	346	0	0	1.7E3	1.07
1822	3621	Sisma X SLV	753.6	0	0	0	1.7E3	1.07	1823	3621	Sisma Y SLV	0	753.6	0	0	1.7E3	1.07
1824	3621	Sisma X SLD	346	0	0	0	1.7E3	1.07	1825	3621	Sisma Y SLD	0	346	0	0	1.7E3	1.07
1826	3622	Sisma X SLV	753.6	0	0	0	1.7E3	1.07	1827	3622	Sisma Y SLV	0	753.6	0	0	1.7E3	1.07
1828	3622	Sisma X SLD	346	0	0	0	1.7E3	1.07	1829	3622	Sisma Y SLD	0	346	0	0	1.7E3	1.07
1830	3623	Sisma X SLV	753.6	0	0	0	1.7E3	1.07	1831	3623	Sisma Y SLV	0	753.6	0	0	1.7E3	1.07
1832	3623	Sisma X SLD	346	0	0	0	1.7E3	1.07	1833	3623	Sisma Y SLD	0	346	0	0	1.7E3	1.07
1834	3624	Sisma X SLV	753.6	0	0	0	1.7E3	1.07	1835	3624	Sisma Y SLV	0	753.6	0	0	1.7E3	1.07



Tabulati di Calcolo Plinto di Fondazione per Aerogeneratore Tipo - Progetto Impianto Eolico - "Orione"

Indice	Nodo	Condizione	Fx	Fy	Fz	Mz	Peso	Gamma	Indice	Nodo	Condizione	Fx	Fy	Fz	Mz	Peso	Gamma
1836	3624	Sisma X SLD	346	0	0	0	1.7E3	1.07	1837	3624	Sisma Y SLD	0	346	0	0	1.7E3	1.07
1838	3625	Sisma X SLV	753.6	0	0	0	1.7E3	1.07	1839	3625	Sisma Y SLV	0	753.6	0	0	1.7E3	1.07
1840	3625	Sisma X SLD	346	0	0	0	1.7E3	1.07	1841	3625	Sisma Y SLD	0	346	0	0	1.7E3	1.07
1842	3626	Sisma X SLV	753.6	0	0	0	1.7E3	1.07	1843	3626	Sisma Y SLV	0	753.6	0	0	1.7E3	1.07
1844	3626	Sisma X SLD	346	0	0	0	1.7E3	1.07	1845	3626	Sisma Y SLD	0	346	0	0	1.7E3	1.07
1846	3627	Sisma X SLV	753.6	0	0	0	1.7E3	1.07	1847	3627	Sisma Y SLV	0	753.6	0	0	1.7E3	1.07
1848	3627	Sisma X SLD	346	0	0	0	1.7E3	1.07	1849	3627	Sisma Y SLD	0	346	0	0	1.7E3	1.07
1850	3628	Sisma X SLV	753.6	0	0	0	1.7E3	1.07	1851	3628	Sisma Y SLV	0	753.6	0	0	1.7E3	1.07
1852	3628	Sisma X SLD	346	0	0	0	1.7E3	1.07	1853	3628	Sisma Y SLD	0	346	0	0	1.7E3	1.07
1854	3629	Sisma X SLV	753.6	0	0	0	1.7E3	1.07	1855	3629	Sisma Y SLV	0	753.6	0	0	1.7E3	1.07
1856	3629	Sisma X SLD	346	0	0	0	1.7E3	1.07	1857	3629	Sisma Y SLD	0	346	0	0	1.7E3	1.07
1858	3630	Sisma X SLV	753.6	0	0	0	1.7E3	1.07	1859	3630	Sisma Y SLV	0	753.6	0	0	1.7E3	1.07
1860	3630	Sisma X SLD	346	0	0	0	1.7E3	1.07	1861	3630	Sisma Y SLD	0	346	0	0	1.7E3	1.07
1862	3631	Sisma X SLV	753.6	0	0	0	1.7E3	1.07	1863	3631	Sisma Y SLV	0	753.6	0	0	1.7E3	1.07
1864	3631	Sisma X SLD	346	0	0	0	1.7E3	1.07	1865	3631	Sisma Y SLD	0	346	0	0	1.7E3	1.07
1866	3632	Sisma X SLV	753.6	0	0	0	1.7E3	1.07	1867	3632	Sisma Y SLV	0	753.6	0	0	1.7E3	1.07
1868	3632	Sisma X SLD	346	0	0	0	1.7E3	1.07	1869	3632	Sisma Y SLD	0	346	0	0	1.7E3	1.07
1870	3633	Sisma X SLV	753.6	0	0	0	1.7E3	1.07	1871	3633	Sisma Y SLV	0	753.6	0	0	1.7E3	1.07
1872	3633	Sisma X SLD	346	0	0	0	1.7E3	1.07	1873	3633	Sisma Y SLD	0	346	0	0	1.7E3	1.07
1874	3634	Sisma X SLV	753.6	0	0	0	1.7E3	1.07	1875	3634	Sisma Y SLV	0	753.6	0	0	1.7E3	1.07
1876	3634	Sisma X SLD	346	0	0	0	1.7E3	1.07	1877	3634	Sisma Y SLD	0	346	0	0	1.7E3	1.07
1878	3635	Sisma X SLV	753.6	0	0	0	1.7E3	1.07	1879	3635	Sisma Y SLV	0	753.6	0	0	1.7E3	1.07
1880	3635	Sisma X SLD	346	0	0	0	1.7E3	1.07	1881	3635	Sisma Y SLD	0	346	0	0	1.7E3	1.07
1882	3636	Sisma X SLV	753.6	0	0	0	1.7E3	1.07	1883	3636	Sisma Y SLV	0	753.6	0	0	1.7E3	1.07
1884	3636	Sisma X SLD	346	0	0	0	1.7E3	1.07	1885	3636	Sisma Y SLD	0	346	0	0	1.7E3	1.07
1886	3637	Sisma X SLV	753.6	0	0	0	1.7E3	1.07	1887	3637	Sisma Y SLV	0	753.6	0	0	1.7E3	1.07
1888	3637	Sisma X SLD	346	0	0	0	1.7E3	1.07	1889	3637	Sisma Y SLD	0	346	0	0	1.7E3	1.07
1890	3638	Sisma X SLV	753.6	0	0	0	1.7E3	1.07	1891	3638	Sisma Y SLV	0	753.6	0	0	1.7E3	1.07
1892	3638	Sisma X SLD	346	0	0	0	1.7E3	1.07	1893	3638	Sisma Y SLD	0	346	0	0	1.7E3	1.07
1894	3639	Sisma X SLV	753.6	0	0	0	1.7E3	1.07	1895	3639	Sisma Y SLV	0	753.6	0	0	1.7E3	1.07
1896	3639	Sisma X SLD	346	0	0	0	1.7E3	1.07	1897	3639	Sisma Y SLD	0	346	0	0	1.7E3	1.07
1898	3640	Sisma X SLV	719.2	0	0	0	1.6E3	1.106	1899	3640	Sisma Y SLV	0	719.2	0	0	1.6E3	1.106
1900	3640	Sisma X SLD	330.2	0	0	0	1.6E3	1.106	1901	3640	Sisma Y SLD	0	330.2	0	0	1.6E3	1.106
1902	3641	Sisma X SLV	719.2	0	0	0	1.6E3	1.106	1903	3641	Sisma Y SLV	0	719.2	0	0	1.6E3	1.106
1904	3641	Sisma X SLD	330.2	0	0	0	1.6E3	1.106	1905	3641	Sisma Y SLD	0	330.2	0	0	1.6E3	1.106
1906	3642	Sisma X SLV	719.2	0	0	0	1.6E3	1.106	1907	3642	Sisma Y SLV	0	719.2	0	0	1.6E3	1.106
1908	3642	Sisma X SLD	330.2	0	0	0	1.6E3	1.106	1909	3642	Sisma Y SLD	0	330.2	0	0	1.6E3	1.106
1910	3643	Sisma X SLV	719.2	0	0	0	1.6E3	1.106	1911	3643	Sisma Y SLV	0	719.2	0	0	1.6E3	1.106
1912	3643	Sisma X SLD	330.2	0	0	0	1.6E3	1.106	1913	3643	Sisma Y SLD	0	330.2	0	0	1.6E3	1.106
1914	3644	Sisma X SLV	719.2	0	0	0	1.6E3	1.106	1915	3644	Sisma Y SLV	0	719.2	0	0	1.6E3	1.106
1916	3644	Sisma X SLD	330.2	0	0	0	1.6E3	1.106	1917	3644	Sisma Y SLD	0	330.2	0	0	1.6E3	1.106
1918	3645	Sisma X SLV	719.2	0	0	0	1.6E3	1.106	1919	3645	Sisma Y SLV	0	719.2	0	0	1.6E3	1.106
1920	3645	Sisma X SLD	330.2	0	0	0	1.6E3	1.106	1921	3645	Sisma Y SLD	0	330.2	0	0	1.6E3	1.106
1922	3646	Sisma X SLV	719.2	0	0	0	1.6E3	1.106	1923	3646	Sisma Y SLV	0	719.2	0	0	1.6E3	1.106
1924	3646	Sisma X SLD	330.2	0	0	0	1.6E3	1.106	1925	3646	Sisma Y SLD	0	330.2	0	0	1.6E3	1.106
1926	3647	Sisma X SLV	719.2	0	0	0	1.6E3	1.106	1927	3647	Sisma Y SLV	0	719.2	0	0	1.6E3	1.106
1928	3647	Sisma X SLD	330.2	0	0	0	1.6E3	1.106	1929	3647	Sisma Y SLD	0	330.2	0	0	1.6E3	1.106
1930	3648	Sisma X SLV	719.2	0	0	0	1.6E3	1.106	1931	3648	Sisma Y SLV	0	719.2	0	0	1.6E3	1.106
1932	3648	Sisma X SLD	330.2	0	0	0	1.6E3	1.106	1933	3648	Sisma Y SLD	0	330.2	0	0	1.6E3	1.106
1934	3649	Sisma X SLV	719.2	0	0	0	1.6E3	1.106	1935	3649	Sisma Y SLV	0	719.2	0	0	1.6E3	1.106



Progetto	Titolo	Rev.	Pag.
Orione	Orione_A24a.pdf "TABULATI DI CALCOLO PLINTO DI FONDAZIONE PER AEROGENERATORE TIPO"	0	90

Tabulati di Calcolo Plinto di Fondazione per Aerogeneratore Tipo - Progetto Impianto Eolico - "Orione"

Indice	Nodo	Condizione	Fx	Fy	Fz	Mz	Peso	Gamma	Indice	Nodo	Condizione	Fx	Fy	Fz	Mz	Peso	Gamma
1936	3649	Sisma X SLD	330.2	0	0	0	1.6E3	1.106	1937	3649	Sisma Y SLD	0	330.2	0	0	1.6E3	1.106
1938	3650	Sisma X SLV	719.2	0	0	0	1.6E3	1.106	1939	3650	Sisma Y SLV	0	719.2	0	0	1.6E3	1.106
1940	3650	Sisma X SLD	330.2	0	0	0	1.6E3	1.106	1941	3650	Sisma Y SLD	0	330.2	0	0	1.6E3	1.106
1942	3651	Sisma X SLV	719.2	0	0	0	1.6E3	1.106	1943	3651	Sisma Y SLV	0	719.2	0	0	1.6E3	1.106
1944	3651	Sisma X SLD	330.2	0	0	0	1.6E3	1.106	1945	3651	Sisma Y SLD	0	330.2	0	0	1.6E3	1.106
1946	3652	Sisma X SLV	719.2	0	0	0	1.6E3	1.106	1947	3652	Sisma Y SLV	0	719.2	0	0	1.6E3	1.106
1948	3652	Sisma X SLD	330.2	0	0	0	1.6E3	1.106	1949	3652	Sisma Y SLD	0	330.2	0	0	1.6E3	1.106
1950	3653	Sisma X SLV	719.2	0	0	0	1.6E3	1.106	1951	3653	Sisma Y SLV	0	719.2	0	0	1.6E3	1.106
1952	3653	Sisma X SLD	330.2	0	0	0	1.6E3	1.106	1953	3653	Sisma Y SLD	0	330.2	0	0	1.6E3	1.106
1954	3654	Sisma X SLV	719.2	0	0	0	1.6E3	1.106	1955	3654	Sisma Y SLV	0	719.2	0	0	1.6E3	1.106
1956	3654	Sisma X SLD	330.2	0	0	0	1.6E3	1.106	1957	3654	Sisma Y SLD	0	330.2	0	0	1.6E3	1.106
1958	3655	Sisma X SLV	719.2	0	0	0	1.6E3	1.106	1959	3655	Sisma Y SLV	0	719.2	0	0	1.6E3	1.106
1960	3655	Sisma X SLD	330.2	0	0	0	1.6E3	1.106	1961	3655	Sisma Y SLD	0	330.2	0	0	1.6E3	1.106
1962	3656	Sisma X SLV	719.2	0	0	0	1.6E3	1.106	1963	3656	Sisma Y SLV	0	719.2	0	0	1.6E3	1.106
1964	3656	Sisma X SLD	330.2	0	0	0	1.6E3	1.106	1965	3656	Sisma Y SLD	0	330.2	0	0	1.6E3	1.106
1966	3657	Sisma X SLV	719.2	0	0	0	1.6E3	1.106	1967	3657	Sisma Y SLV	0	719.2	0	0	1.6E3	1.106
1968	3657	Sisma X SLD	330.2	0	0	0	1.6E3	1.106	1969	3657	Sisma Y SLD	0	330.2	0	0	1.6E3	1.106
1970	3658	Sisma X SLV	719.2	0	0	0	1.6E3	1.106	1971	3658	Sisma Y SLV	0	719.2	0	0	1.6E3	1.106
1972	3658	Sisma X SLD	330.2	0	0	0	1.6E3	1.106	1973	3658	Sisma Y SLD	0	330.2	0	0	1.6E3	1.106
1974	3659	Sisma X SLV	719.2	0	0	0	1.6E3	1.106	1975	3659	Sisma Y SLV	0	719.2	0	0	1.6E3	1.106
1976	3659	Sisma X SLD	330.2	0	0	0	1.6E3	1.106	1977	3659	Sisma Y SLD	0	330.2	0	0	1.6E3	1.106
1978	3660	Sisma X SLV	719.2	0	0	0	1.6E3	1.106	1979	3660	Sisma Y SLV	0	719.2	0	0	1.6E3	1.106
1980	3660	Sisma X SLD	330.2	0	0	0	1.6E3	1.106	1981	3660	Sisma Y SLD	0	330.2	0	0	1.6E3	1.106
1982	3661	Sisma X SLV	719.2	0	0	0	1.6E3	1.106	1983	3661	Sisma Y SLV	0	719.2	0	0	1.6E3	1.106
1984	3661	Sisma X SLD	330.2	0	0	0	1.6E3	1.106	1985	3661	Sisma Y SLD	0	330.2	0	0	1.6E3	1.106
1986	3662	Sisma X SLV	719.2	0	0	0	1.6E3	1.106	1987	3662	Sisma Y SLV	0	719.2	0	0	1.6E3	1.106
1988	3662	Sisma X SLD	330.2	0	0	0	1.6E3	1.106	1989	3662	Sisma Y SLD	0	330.2	0	0	1.6E3	1.106
1990	3663	Sisma X SLV	719.2	0	0	0	1.6E3	1.106	1991	3663	Sisma Y SLV	0	719.2	0	0	1.6E3	1.106
1992	3663	Sisma X SLD	330.2	0	0	0	1.6E3	1.106	1993	3663	Sisma Y SLD	0	330.2	0	0	1.6E3	1.106
1994	3664	Sisma X SLV	719.2	0	0	0	1.6E3	1.106	1995	3664	Sisma Y SLV	0	719.2	0	0	1.6E3	1.106
1996	3664	Sisma X SLD	330.2	0	0	0	1.6E3	1.106	1997	3664	Sisma Y SLD	0	330.2	0	0	1.6E3	1.106
1998	3665	Sisma X SLV	719.2	0	0	0	1.6E3	1.106	1999	3665	Sisma Y SLV	0	719.2	0	0	1.6E3	1.106
2000	3665	Sisma X SLD	330.2	0	0	0	1.6E3	1.106	2001	3665	Sisma Y SLD	0	330.2	0	0	1.6E3	1.106
2002	3666	Sisma X SLV	719.2	0	0	0	1.6E3	1.106	2003	3666	Sisma Y SLV	0	719.2	0	0	1.6E3	1.106
2004	3666	Sisma X SLD	330.2	0	0	0	1.6E3	1.106	2005	3666	Sisma Y SLD	0	330.2	0	0	1.6E3	1.106
2006	3667	Sisma X SLV	719.2	0	0	0	1.6E3	1.106	2007	3667	Sisma Y SLV	0	719.2	0	0	1.6E3	1.106
2008	3667	Sisma X SLD	330.2	0	0	0	1.6E3	1.106	2009	3667	Sisma Y SLD	0	330.2	0	0	1.6E3	1.106
2010	3668	Sisma X SLV	719.2	0	0	0	1.6E3	1.106	2011	3668	Sisma Y SLV	0	719.2	0	0	1.6E3	1.106
2012	3668	Sisma X SLD	330.2	0	0	0	1.6E3	1.106	2013	3668	Sisma Y SLD	0	330.2	0	0	1.6E3	1.106
2014	3669	Sisma X SLV	719.2	0	0	0	1.6E3	1.106	2015	3669	Sisma Y SLV	0	719.2	0	0	1.6E3	1.106
2016	3669	Sisma X SLD	330.2	0	0	0	1.6E3	1.106	2017	3669	Sisma Y SLD	0	330.2	0	0	1.6E3	1.106
2018	3670	Sisma X SLV	719.2	0	0	0	1.6E3	1.106	2019	3670	Sisma Y SLV	0	719.2	0	0	1.6E3	1.106
2020	3670	Sisma X SLD	330.2	0	0	0	1.6E3	1.106	2021	3670	Sisma Y SLD	0	330.2	0	0	1.6E3	1.106
2022	3671	Sisma X SLV	719.2	0	0	0	1.6E3	1.106	2023	3671	Sisma Y SLV	0	719.2	0	0	1.6E3	1.106
2024	3671	Sisma X SLD	330.2	0	0	0	1.6E3	1.106	2025	3671	Sisma Y SLD	0	330.2	0	0	1.6E3	1.106
2026	3672	Sisma X SLV	719.2	0	0	0	1.6E3	1.106	2027	3672	Sisma Y SLV	0	719.2	0	0	1.6E3	1.106
2028	3672	Sisma X SLD	330.2	0	0	0	1.6E3	1.106	2029	3672	Sisma Y SLD	0	330.2	0	0	1.6E3	1.106
2030	3673	Sisma X SLV	719.2	0	0	0	1.6E3	1.106	2031	3673	Sisma Y SLV	0	719.2	0	0	1.6E3	1.106
2032	3673	Sisma X SLD	330.2	0	0	0	1.6E3	1.106	2033	3673	Sisma Y SLD	0	330.2	0	0	1.6E3	1.106
2034	3674	Sisma X SLV	719.2	0	0	0	1.6E3	1.106	2035	3674	Sisma Y SLV	0	719.2	0	0	1.6E3	1.106



Tabulati di Calcolo Plinto di Fondazione per Aerogeneratore Tipo - Progetto Impianto Eolico - "Orione"

Indice	Nodo	Condizione	Fx	Fy	Fz	Mz	Peso	Gamma	Indice	Nodo	Condizione	Fx	Fy	Fz	Mz	Peso	Gamma
2036	3674	Sisma X SLD	330.2	0	0	0	1.6E3	1.106	2037	3674	Sisma Y SLD	0	330.2	0	0	1.6E3	1.106
2038	3675	Sisma X SLV	719.2	0	0	0	1.6E3	1.106	2039	3675	Sisma Y SLV	0	719.2	0	0	1.6E3	1.106
2040	3675	Sisma X SLD	330.2	0	0	0	1.6E3	1.106	2041	3675	Sisma Y SLD	0	330.2	0	0	1.6E3	1.106
2042	3676	Sisma X SLV	405.5	0	0	0	8.2E2	1.204	2043	3676	Sisma Y SLV	0	405.5	0	0	8.2E2	1.204
2044	3676	Sisma X SLD	186.2	0	0	0	8.2E2	1.204	2045	3676	Sisma Y SLD	0	186.2	0	0	8.2E2	1.204
2046	3677	Sisma X SLV	405.5	0	0	0	8.2E2	1.204	2047	3677	Sisma Y SLV	0	405.5	0	0	8.2E2	1.204
2048	3677	Sisma X SLD	186.2	0	0	0	8.2E2	1.204	2049	3677	Sisma Y SLD	0	186.2	0	0	8.2E2	1.204
2050	3678	Sisma X SLV	405.5	0	0	0	8.2E2	1.204	2051	3678	Sisma Y SLV	0	405.5	0	0	8.2E2	1.204
2052	3678	Sisma X SLD	186.2	0	0	0	8.2E2	1.204	2053	3678	Sisma Y SLD	0	186.2	0	0	8.2E2	1.204
2054	3679	Sisma X SLV	405.5	0	0	0	8.2E2	1.204	2055	3679	Sisma Y SLV	0	405.5	0	0	8.2E2	1.204
2056	3679	Sisma X SLD	186.2	0	0	0	8.2E2	1.204	2057	3679	Sisma Y SLD	0	186.2	0	0	8.2E2	1.204
2058	3680	Sisma X SLV	405.5	0	0	0	8.2E2	1.204	2059	3680	Sisma Y SLV	0	405.5	0	0	8.2E2	1.204
2060	3680	Sisma X SLD	186.2	0	0	0	8.2E2	1.204	2061	3680	Sisma Y SLD	0	186.2	0	0	8.2E2	1.204
2062	3681	Sisma X SLV	405.5	0	0	0	8.2E2	1.204	2063	3681	Sisma Y SLV	0	405.5	0	0	8.2E2	1.204
2064	3681	Sisma X SLD	186.2	0	0	0	8.2E2	1.204	2065	3681	Sisma Y SLD	0	186.2	0	0	8.2E2	1.204
2066	3682	Sisma X SLV	405.5	0	0	0	8.2E2	1.204	2067	3682	Sisma Y SLV	0	405.5	0	0	8.2E2	1.204
2068	3682	Sisma X SLD	186.2	0	0	0	8.2E2	1.204	2069	3682	Sisma Y SLD	0	186.2	0	0	8.2E2	1.204
2070	3683	Sisma X SLV	405.5	0	0	0	8.2E2	1.204	2071	3683	Sisma Y SLV	0	405.5	0	0	8.2E2	1.204
2072	3683	Sisma X SLD	186.2	0	0	0	8.2E2	1.204	2073	3683	Sisma Y SLD	0	186.2	0	0	8.2E2	1.204
2074	3684	Sisma X SLV	405.5	0	0	0	8.2E2	1.204	2075	3684	Sisma Y SLV	0	405.5	0	0	8.2E2	1.204
2076	3684	Sisma X SLD	186.2	0	0	0	8.2E2	1.204	2077	3684	Sisma Y SLD	0	186.2	0	0	8.2E2	1.204
2078	3685	Sisma X SLV	405.5	0	0	0	8.2E2	1.204	2079	3685	Sisma Y SLV	0	405.5	0	0	8.2E2	1.204
2080	3685	Sisma X SLD	186.2	0	0	0	8.2E2	1.204	2081	3685	Sisma Y SLD	0	186.2	0	0	8.2E2	1.204
2082	3686	Sisma X SLV	405.5	0	0	0	8.2E2	1.204	2083	3686	Sisma Y SLV	0	405.5	0	0	8.2E2	1.204
2084	3686	Sisma X SLD	186.2	0	0	0	8.2E2	1.204	2085	3686	Sisma Y SLD	0	186.2	0	0	8.2E2	1.204
2086	3687	Sisma X SLV	405.5	0	0	0	8.2E2	1.204	2087	3687	Sisma Y SLV	0	405.5	0	0	8.2E2	1.204
2088	3687	Sisma X SLD	186.2	0	0	0	8.2E2	1.204	2089	3687	Sisma Y SLD	0	186.2	0	0	8.2E2	1.204
2090	3688	Sisma X SLV	405.5	0	0	0	8.2E2	1.204	2091	3688	Sisma Y SLV	0	405.5	0	0	8.2E2	1.204
2092	3688	Sisma X SLD	186.2	0	0	0	8.2E2	1.204	2093	3688	Sisma Y SLD	0	186.2	0	0	8.2E2	1.204
2094	3689	Sisma X SLV	405.5	0	0	0	8.2E2	1.204	2095	3689	Sisma Y SLV	0	405.5	0	0	8.2E2	1.204
2096	3689	Sisma X SLD	186.2	0	0	0	8.2E2	1.204	2097	3689	Sisma Y SLD	0	186.2	0	0	8.2E2	1.204
2098	3690	Sisma X SLV	405.5	0	0	0	8.2E2	1.204	2099	3690	Sisma Y SLV	0	405.5	0	0	8.2E2	1.204
2100	3690	Sisma X SLD	186.2	0	0	0	8.2E2	1.204	2101	3690	Sisma Y SLD	0	186.2	0	0	8.2E2	1.204
2102	3691	Sisma X SLV	405.5	0	0	0	8.2E2	1.204	2103	3691	Sisma Y SLV	0	405.5	0	0	8.2E2	1.204
2104	3691	Sisma X SLD	186.2	0	0	0	8.2E2	1.204	2105	3691	Sisma Y SLD	0	186.2	0	0	8.2E2	1.204
2106	3692	Sisma X SLV	405.5	0	0	0	8.2E2	1.204	2107	3692	Sisma Y SLV	0	405.5	0	0	8.2E2	1.204
2108	3692	Sisma X SLD	186.2	0	0	0	8.2E2	1.204	2109	3692	Sisma Y SLD	0	186.2	0	0	8.2E2	1.204
2110	3693	Sisma X SLV	405.5	0	0	0	8.2E2	1.204	2111	3693	Sisma Y SLV	0	405.5	0	0	8.2E2	1.204
2112	3693	Sisma X SLD	186.2	0	0	0	8.2E2	1.204	2113	3693	Sisma Y SLD	0	186.2	0	0	8.2E2	1.204
2114	3694	Sisma X SLV	405.5	0	0	0	8.2E2	1.204	2115	3694	Sisma Y SLV	0	405.5	0	0	8.2E2	1.204
2116	3694	Sisma X SLD	186.2	0	0	0	8.2E2	1.204	2117	3694	Sisma Y SLD	0	186.2	0	0	8.2E2	1.204
2118	3695	Sisma X SLV	405.5	0	0	0	8.2E2	1.204	2119	3695	Sisma Y SLV	0	405.5	0	0	8.2E2	1.204
2120	3695	Sisma X SLD	186.2	0	0	0	8.2E2	1.204	2121	3695	Sisma Y SLD	0	186.2	0	0	8.2E2	1.204
2122	3696	Sisma X SLV	405.5	0	0	0	8.2E2	1.204	2123	3696	Sisma Y SLV	0	405.5	0	0	8.2E2	1.204
2124	3696	Sisma X SLD	186.2	0	0	0	8.2E2	1.204	2125	3696	Sisma Y SLD	0	186.2	0	0	8.2E2	1.204
2126	3697	Sisma X SLV	405.5	0	0	0	8.2E2	1.204	2127	3697	Sisma Y SLV	0	405.5	0	0	8.2E2	1.204
2128	3697	Sisma X SLD	186.2	0	0	0	8.2E2	1.204	2129	3697	Sisma Y SLD	0	186.2	0	0	8.2E2	1.204
2130	3698	Sisma X SLV	405.5	0	0	0	8.2E2	1.204	2131	3698	Sisma Y SLV	0	405.5	0	0	8.2E2	1.204
2132	3698	Sisma X SLD	186.2	0	0	0	8.2E2	1.204	2133	3698	Sisma Y SLD	0	186.2	0	0	8.2E2	1.204
2134	3699	Sisma X SLV	405.5	0	0	0	8.2E2	1.204	2135	3699	Sisma Y SLV	0	405.5	0	0	8.2E2	1.204



Tabulati di Calcolo Plinto di Fondazione per Aerogeneratore Tipo - Progetto Impianto Eolico - "Orione"

Indice	Nodo	Condizione	Fx	Fy	Fz	Mz	Peso	Gamma	Indice	Nodo	Condizione	Fx	Fy	Fz	Mz	Peso	Gamma
2136	3699	Sisma X SLD	186.2	0	0	0	8.2E2	1.204	2137	3699	Sisma Y SLD	0	186.2	0	0	8.2E2	1.204
2138	3700	Sisma X SLV	405.5	0	0	0	8.2E2	1.204	2139	3700	Sisma Y SLV	0	405.5	0	0	8.2E2	1.204
2140	3700	Sisma X SLD	186.2	0	0	0	8.2E2	1.204	2141	3700	Sisma Y SLD	0	186.2	0	0	8.2E2	1.204
2142	3701	Sisma X SLV	405.5	0	0	0	8.2E2	1.204	2143	3701	Sisma Y SLV	0	405.5	0	0	8.2E2	1.204
2144	3701	Sisma X SLD	186.2	0	0	0	8.2E2	1.204	2145	3701	Sisma Y SLD	0	186.2	0	0	8.2E2	1.204
2146	3702	Sisma X SLV	405.5	0	0	0	8.2E2	1.204	2147	3702	Sisma Y SLV	0	405.5	0	0	8.2E2	1.204
2148	3702	Sisma X SLD	186.2	0	0	0	8.2E2	1.204	2149	3702	Sisma Y SLD	0	186.2	0	0	8.2E2	1.204
2150	3703	Sisma X SLV	405.5	0	0	0	8.2E2	1.204	2151	3703	Sisma Y SLV	0	405.5	0	0	8.2E2	1.204
2152	3703	Sisma X SLD	186.2	0	0	0	8.2E2	1.204	2153	3703	Sisma Y SLD	0	186.2	0	0	8.2E2	1.204
2154	3704	Sisma X SLV	405.5	0	0	0	8.2E2	1.204	2155	3704	Sisma Y SLV	0	405.5	0	0	8.2E2	1.204
2156	3704	Sisma X SLD	186.2	0	0	0	8.2E2	1.204	2157	3704	Sisma Y SLD	0	186.2	0	0	8.2E2	1.204
2158	3705	Sisma X SLV	405.5	0	0	0	8.2E2	1.204	2159	3705	Sisma Y SLV	0	405.5	0	0	8.2E2	1.204
2160	3705	Sisma X SLD	186.2	0	0	0	8.2E2	1.204	2161	3705	Sisma Y SLD	0	186.2	0	0	8.2E2	1.204
2162	3706	Sisma X SLV	405.5	0	0	0	8.2E2	1.204	2163	3706	Sisma Y SLV	0	405.5	0	0	8.2E2	1.204
2164	3706	Sisma X SLD	186.2	0	0	0	8.2E2	1.204	2165	3706	Sisma Y SLD	0	186.2	0	0	8.2E2	1.204
2166	3707	Sisma X SLV	405.5	0	0	0	8.2E2	1.204	2167	3707	Sisma Y SLV	0	405.5	0	0	8.2E2	1.204
2168	3707	Sisma X SLD	186.2	0	0	0	8.2E2	1.204	2169	3707	Sisma Y SLD	0	186.2	0	0	8.2E2	1.204
2170	3708	Sisma X SLV	405.5	0	0	0	8.2E2	1.204	2171	3708	Sisma Y SLV	0	405.5	0	0	8.2E2	1.204
2172	3708	Sisma X SLD	186.2	0	0	0	8.2E2	1.204	2173	3708	Sisma Y SLD	0	186.2	0	0	8.2E2	1.204
2174	3709	Sisma X SLV	405.5	0	0	0	8.2E2	1.204	2175	3709	Sisma Y SLV	0	405.5	0	0	8.2E2	1.204
2176	3709	Sisma X SLD	186.2	0	0	0	8.2E2	1.204	2177	3709	Sisma Y SLD	0	186.2	0	0	8.2E2	1.204
2178	3710	Sisma X SLV	405.5	0	0	0	8.2E2	1.204	2179	3710	Sisma Y SLV	0	405.5	0	0	8.2E2	1.204
2180	3710	Sisma X SLD	186.2	0	0	0	8.2E2	1.204	2181	3710	Sisma Y SLD	0	186.2	0	0	8.2E2	1.204
2182	3711	Sisma X SLV	405.5	0	0	0	8.2E2	1.204	2183	3711	Sisma Y SLV	0	405.5	0	0	8.2E2	1.204
2184	3711	Sisma X SLD	186.2	0	0	0	8.2E2	1.204	2185	3711	Sisma Y SLD	0	186.2	0	0	8.2E2	1.204
2186	3712	Sisma X SLV	683.4	0	0	0	1.3E3	1.29	2187	3712	Sisma Y SLV	0	683.4	0	0	1.3E3	1.29
2188	3712	Sisma X SLD	313.8	0	0	0	1.3E3	1.29	2189	3712	Sisma Y SLD	0	313.8	0	0	1.3E3	1.29
2190	3713	Sisma X SLV	683.4	0	0	0	1.3E3	1.29	2191	3713	Sisma Y SLV	0	683.4	0	0	1.3E3	1.29
2192	3713	Sisma X SLD	313.8	0	0	0	1.3E3	1.29	2193	3713	Sisma Y SLD	0	313.8	0	0	1.3E3	1.29
2194	3714	Sisma X SLV	683.4	0	0	0	1.3E3	1.29	2195	3714	Sisma Y SLV	0	683.4	0	0	1.3E3	1.29
2196	3714	Sisma X SLD	313.8	0	0	0	1.3E3	1.29	2197	3714	Sisma Y SLD	0	313.8	0	0	1.3E3	1.29
2198	3715	Sisma X SLV	683.4	0	0	0	1.3E3	1.29	2199	3715	Sisma Y SLV	0	683.4	0	0	1.3E3	1.29
2200	3715	Sisma X SLD	313.8	0	0	0	1.3E3	1.29	2201	3715	Sisma Y SLD	0	313.8	0	0	1.3E3	1.29
2202	3716	Sisma X SLV	683.4	0	0	0	1.3E3	1.29	2203	3716	Sisma Y SLV	0	683.4	0	0	1.3E3	1.29
2204	3716	Sisma X SLD	313.8	0	0	0	1.3E3	1.29	2205	3716	Sisma Y SLD	0	313.8	0	0	1.3E3	1.29
2206	3717	Sisma X SLV	683.4	0	0	0	1.3E3	1.29	2207	3717	Sisma Y SLV	0	683.4	0	0	1.3E3	1.29
2208	3717	Sisma X SLD	313.8	0	0	0	1.3E3	1.29	2209	3717	Sisma Y SLD	0	313.8	0	0	1.3E3	1.29
2210	3718	Sisma X SLV	683.4	0	0	0	1.3E3	1.29	2211	3718	Sisma Y SLV	0	683.4	0	0	1.3E3	1.29
2212	3718	Sisma X SLD	313.8	0	0	0	1.3E3	1.29	2213	3718	Sisma Y SLD	0	313.8	0	0	1.3E3	1.29
2214	3719	Sisma X SLV	683.4	0	0	0	1.3E3	1.29	2215	3719	Sisma Y SLV	0	683.4	0	0	1.3E3	1.29
2216	3719	Sisma X SLD	313.8	0	0	0	1.3E3	1.29	2217	3719	Sisma Y SLD	0	313.8	0	0	1.3E3	1.29
2218	3720	Sisma X SLV	683.4	0	0	0	1.3E3	1.29	2219	3720	Sisma Y SLV	0	683.4	0	0	1.3E3	1.29
2220	3720	Sisma X SLD	313.8	0	0	0	1.3E3	1.29	2221	3720	Sisma Y SLD	0	313.8	0	0	1.3E3	1.29
2222	3721	Sisma X SLV	683.4	0	0	0	1.3E3	1.29	2223	3721	Sisma Y SLV	0	683.4	0	0	1.3E3	1.29
2224	3721	Sisma X SLD	313.8	0	0	0	1.3E3	1.29	2225	3721	Sisma Y SLD	0	313.8	0	0	1.3E3	1.29
2226	3722	Sisma X SLV	683.4	0	0	0	1.3E3	1.29	2227	3722	Sisma Y SLV	0	683.4	0	0	1.3E3	1.29
2228	3722	Sisma X SLD	313.8	0	0	0	1.3E3	1.29	2229	3722	Sisma Y SLD	0	313.8	0	0	1.3E3	1.29
2230	3723	Sisma X SLV	683.4	0	0	0	1.3E3	1.29	2231	3723	Sisma Y SLV	0	683.4	0	0	1.3E3	1.29
2232	3723	Sisma X SLD	313.8	0	0	0	1.3E3	1.29	2233	3723	Sisma Y SLD	0	313.8	0	0	1.3E3	1.29
2234	3724	Sisma X SLV	683.4	0	0	0	1.3E3	1.29	2235	3724	Sisma Y SLV	0	683.4	0	0	1.3E3	1.29



Progetto	Titolo	Rev.	Pag.
Orione	Orione_A24a.pdf "TABULATI DI CALCOLO PLINTO DI FONDAZIONE PER AEROGENERATORE TIPO"	0	93

Tabulati di Calcolo Plinto di Fondazione per Aerogeneratore Tipo - Progetto Impianto Eolico - "Orione"

Indice	Nodo	Condizione	Fx	Fy	Fz	Mz	Peso	Gamma	Indice	Nodo	Condizione	Fx	Fy	Fz	Mz	Peso	Gamma
2236	3724	Sisma X SLD	313.8	0	0	0	1.3E3	1.29	2237	3724	Sisma Y SLD	0	313.8	0	0	1.3E3	1.29
2238	3725	Sisma X SLV	683.4	0	0	0	1.3E3	1.29	2239	3725	Sisma Y SLV	0	683.4	0	0	1.3E3	1.29
2240	3725	Sisma X SLD	313.8	0	0	0	1.3E3	1.29	2241	3725	Sisma Y SLD	0	313.8	0	0	1.3E3	1.29
2242	3726	Sisma X SLV	683.4	0	0	0	1.3E3	1.29	2243	3726	Sisma Y SLV	0	683.4	0	0	1.3E3	1.29
2244	3726	Sisma X SLD	313.8	0	0	0	1.3E3	1.29	2245	3726	Sisma Y SLD	0	313.8	0	0	1.3E3	1.29
2246	3727	Sisma X SLV	683.4	0	0	0	1.3E3	1.29	2247	3727	Sisma Y SLV	0	683.4	0	0	1.3E3	1.29
2248	3727	Sisma X SLD	313.8	0	0	0	1.3E3	1.29	2249	3727	Sisma Y SLD	0	313.8	0	0	1.3E3	1.29
2250	3728	Sisma X SLV	683.4	0	0	0	1.3E3	1.29	2251	3728	Sisma Y SLV	0	683.4	0	0	1.3E3	1.29
2252	3728	Sisma X SLD	313.8	0	0	0	1.3E3	1.29	2253	3728	Sisma Y SLD	0	313.8	0	0	1.3E3	1.29
2254	3729	Sisma X SLV	683.4	0	0	0	1.3E3	1.29	2255	3729	Sisma Y SLV	0	683.4	0	0	1.3E3	1.29
2256	3729	Sisma X SLD	313.8	0	0	0	1.3E3	1.29	2257	3729	Sisma Y SLD	0	313.8	0	0	1.3E3	1.29
2258	3730	Sisma X SLV	683.4	0	0	0	1.3E3	1.29	2259	3730	Sisma Y SLV	0	683.4	0	0	1.3E3	1.29
2260	3730	Sisma X SLD	313.8	0	0	0	1.3E3	1.29	2261	3730	Sisma Y SLD	0	313.8	0	0	1.3E3	1.29
2262	3731	Sisma X SLV	683.4	0	0	0	1.3E3	1.29	2263	3731	Sisma Y SLV	0	683.4	0	0	1.3E3	1.29
2264	3731	Sisma X SLD	313.8	0	0	0	1.3E3	1.29	2265	3731	Sisma Y SLD	0	313.8	0	0	1.3E3	1.29
2266	3732	Sisma X SLV	683.4	0	0	0	1.3E3	1.29	2267	3732	Sisma Y SLV	0	683.4	0	0	1.3E3	1.29
2268	3732	Sisma X SLD	313.8	0	0	0	1.3E3	1.29	2269	3732	Sisma Y SLD	0	313.8	0	0	1.3E3	1.29
2270	3733	Sisma X SLV	683.4	0	0	0	1.3E3	1.29	2271	3733	Sisma Y SLV	0	683.4	0	0	1.3E3	1.29
2272	3733	Sisma X SLD	313.8	0	0	0	1.3E3	1.29	2273	3733	Sisma Y SLD	0	313.8	0	0	1.3E3	1.29
2274	3734	Sisma X SLV	683.4	0	0	0	1.3E3	1.29	2275	3734	Sisma Y SLV	0	683.4	0	0	1.3E3	1.29
2276	3734	Sisma X SLD	313.8	0	0	0	1.3E3	1.29	2277	3734	Sisma Y SLD	0	313.8	0	0	1.3E3	1.29
2278	3735	Sisma X SLV	683.4	0	0	0	1.3E3	1.29	2279	3735	Sisma Y SLV	0	683.4	0	0	1.3E3	1.29
2280	3735	Sisma X SLD	313.8	0	0	0	1.3E3	1.29	2281	3735	Sisma Y SLD	0	313.8	0	0	1.3E3	1.29
2282	3736	Sisma X SLV	683.4	0	0	0	1.3E3	1.29	2283	3736	Sisma Y SLV	0	683.4	0	0	1.3E3	1.29
2284	3736	Sisma X SLD	313.8	0	0	0	1.3E3	1.29	2285	3736	Sisma Y SLD	0	313.8	0	0	1.3E3	1.29
2286	3737	Sisma X SLV	683.4	0	0	0	1.3E3	1.29	2287	3737	Sisma Y SLV	0	683.4	0	0	1.3E3	1.29
2288	3737	Sisma X SLD	313.8	0	0	0	1.3E3	1.29	2289	3737	Sisma Y SLD	0	313.8	0	0	1.3E3	1.29
2290	3738	Sisma X SLV	683.4	0	0	0	1.3E3	1.29	2291	3738	Sisma Y SLV	0	683.4	0	0	1.3E3	1.29
2292	3738	Sisma X SLD	313.8	0	0	0	1.3E3	1.29	2293	3738	Sisma Y SLD	0	313.8	0	0	1.3E3	1.29
2294	3739	Sisma X SLV	683.4	0	0	0	1.3E3	1.29	2295	3739	Sisma Y SLV	0	683.4	0	0	1.3E3	1.29
2296	3739	Sisma X SLD	313.8	0	0	0	1.3E3	1.29	2297	3739	Sisma Y SLD	0	313.8	0	0	1.3E3	1.29
2298	3740	Sisma X SLV	683.4	0	0	0	1.3E3	1.29	2299	3740	Sisma Y SLV	0	683.4	0	0	1.3E3	1.29
2300	3740	Sisma X SLD	313.8	0	0	0	1.3E3	1.29	2301	3740	Sisma Y SLD	0	313.8	0	0	1.3E3	1.29
2302	3741	Sisma X SLV	683.4	0	0	0	1.3E3	1.29	2303	3741	Sisma Y SLV	0	683.4	0	0	1.3E3	1.29
2304	3741	Sisma X SLD	313.8	0	0	0	1.3E3	1.29	2305	3741	Sisma Y SLD	0	313.8	0	0	1.3E3	1.29
2306	3742	Sisma X SLV	683.4	0	0	0	1.3E3	1.29	2307	3742	Sisma Y SLV	0	683.4	0	0	1.3E3	1.29
2308	3742	Sisma X SLD	313.8	0	0	0	1.3E3	1.29	2309	3742	Sisma Y SLD	0	313.8	0	0	1.3E3	1.29
2310	3743	Sisma X SLV	683.4	0	0	0	1.3E3	1.29	2311	3743	Sisma Y SLV	0	683.4	0	0	1.3E3	1.29
2312	3743	Sisma X SLD	313.8	0	0	0	1.3E3	1.29	2313	3743	Sisma Y SLD	0	313.8	0	0	1.3E3	1.29
2314	3744	Sisma X SLV	683.4	0	0	0	1.3E3	1.29	2315	3744	Sisma Y SLV	0	683.4	0	0	1.3E3	1.29
2316	3744	Sisma X SLD	313.8	0	0	0	1.3E3	1.29	2317	3744	Sisma Y SLD	0	313.8	0	0	1.3E3	1.29
2318	3745	Sisma X SLV	683.4	0	0	0	1.3E3	1.29	2319	3745	Sisma Y SLV	0	683.4	0	0	1.3E3	1.29
2320	3745	Sisma X SLD	313.8	0	0	0	1.3E3	1.29	2321	3745	Sisma Y SLD	0	313.8	0	0	1.3E3	1.29
2322	3746	Sisma X SLV	683.4	0	0	0	1.3E3	1.29	2323	3746	Sisma Y SLV	0	683.4	0	0	1.3E3	1.29
2324	3746	Sisma X SLD	313.8	0	0	0	1.3E3	1.29	2325	3746	Sisma Y SLD	0	313.8	0	0	1.3E3	1.29
2326	3747	Sisma X SLV	683.4	0	0	0	1.3E3	1.29	2327	3747	Sisma Y SLV	0	683.4	0	0	1.3E3	1.29
2328	3747	Sisma X SLD	313.8	0	0	0	1.3E3	1.29	2329	3747	Sisma Y SLD	0	313.8	0	0	1.3E3	1.29
2330	3748	Sisma X SLV	2021.2	0	0	0	3.4E3	1.44	2331	3748	Sisma Y SLV	0	2021.2	0	0	3.4E3	1.44
2332	3748	Sisma X SLD	928.1	0	0	0	3.4E3	1.44	2333	3748	Sisma Y SLD	0	928.1	0	0	3.4E3	1.44
2334	3749	Sisma X SLV	2021.2	0	0	0	3.4E3	1.44	2335	3749	Sisma Y SLV	0	2021.2	0	0	3.4E3	1.44



Progetto	Titolo	Rev.	Pag.
Orione	Orione_A24a.pdf "TABULATI DI CALCOLO PLINTO DI FONDAZIONE PER AEROGENERATORE TIPO"	0	94

Tabulati di Calcolo Plinto di Fondazione per Aerogeneratore Tipo - Progetto Impianto Eolico - "Orione"

Indice	Nodo	Condizione	Fx	Fy	Fz	Mz	Peso	Gamma	Indice	Nodo	Condizione	Fx	Fy	Fz	Mz	Peso	Gamma
2336	3749	Sisma X SLD	928.1	0	0	0	3.4E3	1.44	2337	3749	Sisma Y SLD	0	928.1	0	0	3.4E3	1.44
2338	3750	Sisma X SLV	2021.2	0	0	0	3.4E3	1.44	2339	3750	Sisma Y SLV	0	2021.2	0	0	3.4E3	1.44
2340	3750	Sisma X SLD	928.1	0	0	0	3.4E3	1.44	2341	3750	Sisma Y SLD	0	928.1	0	0	3.4E3	1.44
2342	3751	Sisma X SLV	2021.2	0	0	0	3.4E3	1.44	2343	3751	Sisma Y SLV	0	2021.2	0	0	3.4E3	1.44
2344	3751	Sisma X SLD	928.1	0	0	0	3.4E3	1.44	2345	3751	Sisma Y SLD	0	928.1	0	0	3.4E3	1.44
2346	3752	Sisma X SLV	2021.2	0	0	0	3.4E3	1.44	2347	3752	Sisma Y SLV	0	2021.2	0	0	3.4E3	1.44
2348	3752	Sisma X SLD	928.1	0	0	0	3.4E3	1.44	2349	3752	Sisma Y SLD	0	928.1	0	0	3.4E3	1.44
2350	3753	Sisma X SLV	2021.2	0	0	0	3.4E3	1.44	2351	3753	Sisma Y SLV	0	2021.2	0	0	3.4E3	1.44
2352	3753	Sisma X SLD	928.1	0	0	0	3.4E3	1.44	2353	3753	Sisma Y SLD	0	928.1	0	0	3.4E3	1.44
2354	3754	Sisma X SLV	2021.2	0	0	0	3.4E3	1.44	2355	3754	Sisma Y SLV	0	2021.2	0	0	3.4E3	1.44
2356	3754	Sisma X SLD	928.1	0	0	0	3.4E3	1.44	2357	3754	Sisma Y SLD	0	928.1	0	0	3.4E3	1.44
2358	3755	Sisma X SLV	2021.2	0	0	0	3.4E3	1.44	2359	3755	Sisma Y SLV	0	2021.2	0	0	3.4E3	1.44
2360	3755	Sisma X SLD	928.1	0	0	0	3.4E3	1.44	2361	3755	Sisma Y SLD	0	928.1	0	0	3.4E3	1.44
2362	3756	Sisma X SLV	2021.2	0	0	0	3.4E3	1.44	2363	3756	Sisma Y SLV	0	2021.2	0	0	3.4E3	1.44
2364	3756	Sisma X SLD	928.1	0	0	0	3.4E3	1.44	2365	3756	Sisma Y SLD	0	928.1	0	0	3.4E3	1.44
2366	3757	Sisma X SLV	2021.2	0	0	0	3.4E3	1.44	2367	3757	Sisma Y SLV	0	2021.2	0	0	3.4E3	1.44
2368	3757	Sisma X SLD	928.1	0	0	0	3.4E3	1.44	2369	3757	Sisma Y SLD	0	928.1	0	0	3.4E3	1.44
2370	3758	Sisma X SLV	2021.2	0	0	0	3.4E3	1.44	2371	3758	Sisma Y SLV	0	2021.2	0	0	3.4E3	1.44
2372	3758	Sisma X SLD	928.1	0	0	0	3.4E3	1.44	2373	3758	Sisma Y SLD	0	928.1	0	0	3.4E3	1.44
2374	3759	Sisma X SLV	2021.2	0	0	0	3.4E3	1.44	2375	3759	Sisma Y SLV	0	2021.2	0	0	3.4E3	1.44
2376	3759	Sisma X SLD	928.1	0	0	0	3.4E3	1.44	2377	3759	Sisma Y SLD	0	928.1	0	0	3.4E3	1.44
2378	3760	Sisma X SLV	2021.2	0	0	0	3.4E3	1.44	2379	3760	Sisma Y SLV	0	2021.2	0	0	3.4E3	1.44
2380	3760	Sisma X SLD	928.1	0	0	0	3.4E3	1.44	2381	3760	Sisma Y SLD	0	928.1	0	0	3.4E3	1.44
2382	3761	Sisma X SLV	2021.2	0	0	0	3.4E3	1.44	2383	3761	Sisma Y SLV	0	2021.2	0	0	3.4E3	1.44
2384	3761	Sisma X SLD	928.1	0	0	0	3.4E3	1.44	2385	3761	Sisma Y SLD	0	928.1	0	0	3.4E3	1.44
2386	3762	Sisma X SLV	2021.2	0	0	0	3.4E3	1.44	2387	3762	Sisma Y SLV	0	2021.2	0	0	3.4E3	1.44
2388	3762	Sisma X SLD	928.1	0	0	0	3.4E3	1.44	2389	3762	Sisma Y SLD	0	928.1	0	0	3.4E3	1.44
2390	3763	Sisma X SLV	2021.2	0	0	0	3.4E3	1.44	2391	3763	Sisma Y SLV	0	2021.2	0	0	3.4E3	1.44
2392	3763	Sisma X SLD	928.1	0	0	0	3.4E3	1.44	2393	3763	Sisma Y SLD	0	928.1	0	0	3.4E3	1.44
2394	3764	Sisma X SLV	2021.2	0	0	0	3.4E3	1.44	2395	3764	Sisma Y SLV	0	2021.2	0	0	3.4E3	1.44
2396	3764	Sisma X SLD	928.1	0	0	0	3.4E3	1.44	2397	3764	Sisma Y SLD	0	928.1	0	0	3.4E3	1.44
2398	3765	Sisma X SLV	2021.2	0	0	0	3.4E3	1.44	2399	3765	Sisma Y SLV	0	2021.2	0	0	3.4E3	1.44
2400	3765	Sisma X SLD	928.1	0	0	0	3.4E3	1.44	2401	3765	Sisma Y SLD	0	928.1	0	0	3.4E3	1.44
2402	3766	Sisma X SLV	2021.2	0	0	0	3.4E3	1.44	2403	3766	Sisma Y SLV	0	2021.2	0	0	3.4E3	1.44
2404	3766	Sisma X SLD	928.1	0	0	0	3.4E3	1.44	2405	3766	Sisma Y SLD	0	928.1	0	0	3.4E3	1.44
2406	3767	Sisma X SLV	2021.2	0	0	0	3.4E3	1.44	2407	3767	Sisma Y SLV	0	2021.2	0	0	3.4E3	1.44
2408	3767	Sisma X SLD	928.1	0	0	0	3.4E3	1.44	2409	3767	Sisma Y SLD	0	928.1	0	0	3.4E3	1.44
2410	3768	Sisma X SLV	2021.2	0	0	0	3.4E3	1.44	2411	3768	Sisma Y SLV	0	2021.2	0	0	3.4E3	1.44
2412	3768	Sisma X SLD	928.1	0	0	0	3.4E3	1.44	2413	3768	Sisma Y SLD	0	928.1	0	0	3.4E3	1.44
2414	3769	Sisma X SLV	2021.2	0	0	0	3.4E3	1.44	2415	3769	Sisma Y SLV	0	2021.2	0	0	3.4E3	1.44
2416	3769	Sisma X SLD	928.1	0	0	0	3.4E3	1.44	2417	3769	Sisma Y SLD	0	928.1	0	0	3.4E3	1.44
2418	3770	Sisma X SLV	2021.2	0	0	0	3.4E3	1.44	2419	3770	Sisma Y SLV	0	2021.2	0	0	3.4E3	1.44
2420	3770	Sisma X SLD	928.1	0	0	0	3.4E3	1.44	2421	3770	Sisma Y SLD	0	928.1	0	0	3.4E3	1.44
2422	3771	Sisma X SLV	2021.2	0	0	0	3.4E3	1.44	2423	3771	Sisma Y SLV	0	2021.2	0	0	3.4E3	1.44
2424	3771	Sisma X SLD	928.1	0	0	0	3.4E3	1.44	2425	3771	Sisma Y SLD	0	928.1	0	0	3.4E3	1.44
2426	3772	Sisma X SLV	2021.2	0	0	0	3.4E3	1.44	2427	3772	Sisma Y SLV	0	2021.2	0	0	3.4E3	1.44
2428	3772	Sisma X SLD	928.1	0	0	0	3.4E3	1.44	2429	3772	Sisma Y SLD	0	928.1	0	0	3.4E3	1.44
2430	3773	Sisma X SLV	2021.2	0	0	0	3.4E3	1.44	2431	3773	Sisma Y SLV	0	2021.2	0	0	3.4E3	1.44
2432	3773	Sisma X SLD	928.1	0	0	0	3.4E3	1.44	2433	3773	Sisma Y SLD	0	928.1	0	0	3.4E3	1.44
2434	3774	Sisma X SLV	2021.2	0	0	0	3.4E3	1.44	2435	3774	Sisma Y SLV	0	2021.2	0	0	3.4E3	1.44



Progetto	Titolo	Rev.	Pag.
Orione	Orione_A24a.pdf "TABULATI DI CALCOLO PLINTO DI FONDAZIONE PER AEROGENERATORE TIPO"	0	95



Tabulati di Calcolo Plinto di Fondazione per Aerogeneratore Tipo - Progetto Impianto Eolico - "Orione"

Indice	Nodo	Condizione	Fx	Fy	Fz	Mz	Peso	Gamma	Indice	Nodo	Condizione	Fx	Fy	Fz	Mz	Peso	Gamma
2436	3774	Sisma X SLD	928.1	0	0	0	3.4E3	1.44	2437	3774	Sisma Y SLD	0	928.1	0	0	3.4E3	1.44
2438	3775	Sisma X SLV	2021.2	0	0	0	3.4E3	1.44	2439	3775	Sisma Y SLV	0	2021.2	0	0	3.4E3	1.44
2440	3775	Sisma X SLD	928.1	0	0	0	3.4E3	1.44	2441	3775	Sisma Y SLD	0	928.1	0	0	3.4E3	1.44
2442	3776	Sisma X SLV	2021.2	0	0	0	3.4E3	1.44	2443	3776	Sisma Y SLV	0	2021.2	0	0	3.4E3	1.44
2444	3776	Sisma X SLD	928.1	0	0	0	3.4E3	1.44	2445	3776	Sisma Y SLD	0	928.1	0	0	3.4E3	1.44
2446	3777	Sisma X SLV	2021.2	0	0	0	3.4E3	1.44	2447	3777	Sisma Y SLV	0	2021.2	0	0	3.4E3	1.44
2448	3777	Sisma X SLD	928.1	0	0	0	3.4E3	1.44	2449	3777	Sisma Y SLD	0	928.1	0	0	3.4E3	1.44
2450	3778	Sisma X SLV	2021.2	0	0	0	3.4E3	1.44	2451	3778	Sisma Y SLV	0	2021.2	0	0	3.4E3	1.44
2452	3778	Sisma X SLD	928.1	0	0	0	3.4E3	1.44	2453	3778	Sisma Y SLD	0	928.1	0	0	3.4E3	1.44
2454	3779	Sisma X SLV	2021.2	0	0	0	3.4E3	1.44	2455	3779	Sisma Y SLV	0	2021.2	0	0	3.4E3	1.44
2456	3779	Sisma X SLD	928.1	0	0	0	3.4E3	1.44	2457	3779	Sisma Y SLD	0	928.1	0	0	3.4E3	1.44
2458	3780	Sisma X SLV	2021.2	0	0	0	3.4E3	1.44	2459	3780	Sisma Y SLV	0	2021.2	0	0	3.4E3	1.44
2460	3780	Sisma X SLD	928.1	0	0	0	3.4E3	1.44	2461	3780	Sisma Y SLD	0	928.1	0	0	3.4E3	1.44
2462	3781	Sisma X SLV	2021.2	0	0	0	3.4E3	1.44	2463	3781	Sisma Y SLV	0	2021.2	0	0	3.4E3	1.44
2464	3781	Sisma X SLD	928.1	0	0	0	3.4E3	1.44	2465	3781	Sisma Y SLD	0	928.1	0	0	3.4E3	1.44
2466	3782	Sisma X SLV	2021.2	0	0	0	3.4E3	1.44	2467	3782	Sisma Y SLV	0	2021.2	0	0	3.4E3	1.44
2468	3782	Sisma X SLD	928.1	0	0	0	3.4E3	1.44	2469	3782	Sisma Y SLD	0	928.1	0	0	3.4E3	1.44
2470	3783	Sisma X SLV	2021.2	0	0	0	3.4E3	1.44	2471	3783	Sisma Y SLV	0	2021.2	0	0	3.4E3	1.44
2472	3783	Sisma X SLD	928.1	0	0	0	3.4E3	1.44	2473	3783	Sisma Y SLD	0	928.1	0	0	3.4E3	1.44
2474	3784	Sisma X SLV	1684.3	0	0	0	2.3E3	1.786	2475	3784	Sisma Y SLV	0	1684.3	0	0	2.3E3	1.786
2476	3784	Sisma X SLD	773.4	0	0	0	2.3E3	1.786	2477	3784	Sisma Y SLD	0	773.4	0	0	2.3E3	1.786
2478	3785	Sisma X SLV	1684.3	0	0	0	2.3E3	1.786	2479	3785	Sisma Y SLV	0	1684.3	0	0	2.3E3	1.786
2480	3785	Sisma X SLD	773.4	0	0	0	2.3E3	1.786	2481	3785	Sisma Y SLD	0	773.4	0	0	2.3E3	1.786
2482	3786	Sisma X SLV	1684.3	0	0	0	2.3E3	1.786	2483	3786	Sisma Y SLV	0	1684.3	0	0	2.3E3	1.786
2484	3786	Sisma X SLD	773.4	0	0	0	2.3E3	1.786	2485	3786	Sisma Y SLD	0	773.4	0	0	2.3E3	1.786
2486	3787	Sisma X SLV	1684.3	0	0	0	2.3E3	1.786	2487	3787	Sisma Y SLV	0	1684.3	0	0	2.3E3	1.786
2488	3787	Sisma X SLD	773.4	0	0	0	2.3E3	1.786	2489	3787	Sisma Y SLD	0	773.4	0	0	2.3E3	1.786
2490	3788	Sisma X SLV	1684.3	0	0	0	2.3E3	1.786	2491	3788	Sisma Y SLV	0	1684.3	0	0	2.3E3	1.786
2492	3788	Sisma X SLD	773.4	0	0	0	2.3E3	1.786	2493	3788	Sisma Y SLD	0	773.4	0	0	2.3E3	1.786
2494	3789	Sisma X SLV	1684.3	0	0	0	2.3E3	1.786	2495	3789	Sisma Y SLV	0	1684.3	0	0	2.3E3	1.786
2496	3789	Sisma X SLD	773.4	0	0	0	2.3E3	1.786	2497	3789	Sisma Y SLD	0	773.4	0	0	2.3E3	1.786
2498	3790	Sisma X SLV	1684.3	0	0	0	2.3E3	1.786	2499	3790	Sisma Y SLV	0	1684.3	0	0	2.3E3	1.786
2500	3790	Sisma X SLD	773.4	0	0	0	2.3E3	1.786	2501	3790	Sisma Y SLD	0	773.4	0	0	2.3E3	1.786
2502	3791	Sisma X SLV	1684.3	0	0	0	2.3E3	1.786	2503	3791	Sisma Y SLV	0	1684.3	0	0	2.3E3	1.786
2504	3791	Sisma X SLD	773.4	0	0	0	2.3E3	1.786	2505	3791	Sisma Y SLD	0	773.4	0	0	2.3E3	1.786
2506	3792	Sisma X SLV	1684.3	0	0	0	2.3E3	1.786	2507	3792	Sisma Y SLV	0	1684.3	0	0	2.3E3	1.786
2508	3792	Sisma X SLD	773.4	0	0	0	2.3E3	1.786	2509	3792	Sisma Y SLD	0	773.4	0	0	2.3E3	1.786
2510	3793	Sisma X SLV	1684.3	0	0	0	2.3E3	1.786	2511	3793	Sisma Y SLV	0	1684.3	0	0	2.3E3	1.786
2512	3793	Sisma X SLD	773.4	0	0	0	2.3E3	1.786	2513	3793	Sisma Y SLD	0	773.4	0	0	2.3E3	1.786
2514	3794	Sisma X SLV	1684.3	0	0	0	2.3E3	1.786	2515	3794	Sisma Y SLV	0	1684.3	0	0	2.3E3	1.786
2516	3794	Sisma X SLD	773.4	0	0	0	2.3E3	1.786	2517	3794	Sisma Y SLD	0	773.4	0	0	2.3E3	1.786
2518	3795	Sisma X SLV	1684.3	0	0	0	2.3E3	1.786	2519	3795	Sisma Y SLV	0	1684.3	0	0	2.3E3	1.786
2520	3795	Sisma X SLD	773.4	0	0	0	2.3E3	1.786	2521	3795	Sisma Y SLD	0	773.4	0	0	2.3E3	1.786
2522	3796	Sisma X SLV	1684.3	0	0	0	2.3E3	1.786	2523	3796	Sisma Y SLV	0	1684.3	0	0	2.3E3	1.786
2524	3796	Sisma X SLD	773.4	0	0	0	2.3E3	1.786	2525	3796	Sisma Y SLD	0	773.4	0	0	2.3E3	1.786
2526	3797	Sisma X SLV	1684.3	0	0	0	2.3E3	1.786	2527	3797	Sisma Y SLV	0	1684.3	0	0	2.3E3	1.786
2528	3797	Sisma X SLD	773.4	0	0	0	2.3E3	1.786	2529	3797	Sisma Y SLD	0	773.4	0	0	2.3E3	1.786
2530	3798	Sisma X SLV	1684.3	0	0	0	2.3E3	1.786	2531	3798	Sisma Y SLV	0	1684.3	0	0	2.3E3	1.786
2532	3798	Sisma X SLD	773.4	0	0	0	2.3E3	1.786	2533	3798	Sisma Y SLD	0	773.4	0	0	2.3E3	1.786
2534	3799	Sisma X SLV	1684.3	0	0	0	2.3E3	1.786	2535	3799	Sisma Y SLV	0	1684.3	0	0	2.3E3	1.786



Progetto	Titolo	Rev.	Pag.
Orione	Orione_A24a.pdf "TABULATI DI CALCOLO PLINTO DI FONDAZIONE PER AEROGENERATORE TIPO"	0	96

Tabulati di Calcolo Plinto di Fondazione per Aerogeneratore Tipo - Progetto Impianto Eolico - "Orione"

Indice	Nodo	Condizione	Fx	Fy	Fz	Mz	Peso	Gamma	Indice	Nodo	Condizione	Fx	Fy	Fz	Mz	Peso	Gamma
2536	3799	Sisma X SLD	773.4	0	0	0	2.3E3	1.786	2537	3799	Sisma Y SLD	0	773.4	0	0	2.3E3	1.786
2538	3800	Sisma X SLV	1684.3	0	0	0	2.3E3	1.786	2539	3800	Sisma Y SLV	0	1684.3	0	0	2.3E3	1.786
2540	3800	Sisma X SLD	773.4	0	0	0	2.3E3	1.786	2541	3800	Sisma Y SLD	0	773.4	0	0	2.3E3	1.786
2542	3801	Sisma X SLV	1684.3	0	0	0	2.3E3	1.786	2543	3801	Sisma Y SLV	0	1684.3	0	0	2.3E3	1.786
2544	3801	Sisma X SLD	773.4	0	0	0	2.3E3	1.786	2545	3801	Sisma Y SLD	0	773.4	0	0	2.3E3	1.786
2546	3802	Sisma X SLV	1684.3	0	0	0	2.3E3	1.786	2547	3802	Sisma Y SLV	0	1684.3	0	0	2.3E3	1.786
2548	3802	Sisma X SLD	773.4	0	0	0	2.3E3	1.786	2549	3802	Sisma Y SLD	0	773.4	0	0	2.3E3	1.786
2550	3803	Sisma X SLV	1684.3	0	0	0	2.3E3	1.786	2551	3803	Sisma Y SLV	0	1684.3	0	0	2.3E3	1.786
2552	3803	Sisma X SLD	773.4	0	0	0	2.3E3	1.786	2553	3803	Sisma Y SLD	0	773.4	0	0	2.3E3	1.786
2554	3804	Sisma X SLV	1684.3	0	0	0	2.3E3	1.786	2555	3804	Sisma Y SLV	0	1684.3	0	0	2.3E3	1.786
2556	3804	Sisma X SLD	773.4	0	0	0	2.3E3	1.786	2557	3804	Sisma Y SLD	0	773.4	0	0	2.3E3	1.786
2558	3805	Sisma X SLV	1684.3	0	0	0	2.3E3	1.786	2559	3805	Sisma Y SLV	0	1684.3	0	0	2.3E3	1.786
2560	3805	Sisma X SLD	773.4	0	0	0	2.3E3	1.786	2561	3805	Sisma Y SLD	0	773.4	0	0	2.3E3	1.786
2562	3806	Sisma X SLV	1684.3	0	0	0	2.3E3	1.786	2563	3806	Sisma Y SLV	0	1684.3	0	0	2.3E3	1.786
2564	3806	Sisma X SLD	773.4	0	0	0	2.3E3	1.786	2565	3806	Sisma Y SLD	0	773.4	0	0	2.3E3	1.786
2566	3807	Sisma X SLV	1684.3	0	0	0	2.3E3	1.786	2567	3807	Sisma Y SLV	0	1684.3	0	0	2.3E3	1.786
2568	3807	Sisma X SLD	773.4	0	0	0	2.3E3	1.786	2569	3807	Sisma Y SLD	0	773.4	0	0	2.3E3	1.786
2570	3808	Sisma X SLV	1684.3	0	0	0	2.3E3	1.786	2571	3808	Sisma Y SLV	0	1684.3	0	0	2.3E3	1.786
2572	3808	Sisma X SLD	773.4	0	0	0	2.3E3	1.786	2573	3808	Sisma Y SLD	0	773.4	0	0	2.3E3	1.786
2574	3809	Sisma X SLV	1684.3	0	0	0	2.3E3	1.786	2575	3809	Sisma Y SLV	0	1684.3	0	0	2.3E3	1.786
2576	3809	Sisma X SLD	773.4	0	0	0	2.3E3	1.786	2577	3809	Sisma Y SLD	0	773.4	0	0	2.3E3	1.786
2578	3810	Sisma X SLV	1684.3	0	0	0	2.3E3	1.786	2579	3810	Sisma Y SLV	0	1684.3	0	0	2.3E3	1.786
2580	3810	Sisma X SLD	773.4	0	0	0	2.3E3	1.786	2581	3810	Sisma Y SLD	0	773.4	0	0	2.3E3	1.786
2582	3811	Sisma X SLV	1684.3	0	0	0	2.3E3	1.786	2583	3811	Sisma Y SLV	0	1684.3	0	0	2.3E3	1.786
2584	3811	Sisma X SLD	773.4	0	0	0	2.3E3	1.786	2585	3811	Sisma Y SLD	0	773.4	0	0	2.3E3	1.786
2586	3812	Sisma X SLV	1684.3	0	0	0	2.3E3	1.786	2587	3812	Sisma Y SLV	0	1684.3	0	0	2.3E3	1.786
2588	3812	Sisma X SLD	773.4	0	0	0	2.3E3	1.786	2589	3812	Sisma Y SLD	0	773.4	0	0	2.3E3	1.786
2590	3813	Sisma X SLV	1684.3	0	0	0	2.3E3	1.786	2591	3813	Sisma Y SLV	0	1684.3	0	0	2.3E3	1.786
2592	3813	Sisma X SLD	773.4	0	0	0	2.3E3	1.786	2593	3813	Sisma Y SLD	0	773.4	0	0	2.3E3	1.786
2594	3814	Sisma X SLV	1684.3	0	0	0	2.3E3	1.786	2595	3814	Sisma Y SLV	0	1684.3	0	0	2.3E3	1.786
2596	3814	Sisma X SLD	773.4	0	0	0	2.3E3	1.786	2597	3814	Sisma Y SLD	0	773.4	0	0	2.3E3	1.786
2598	3815	Sisma X SLV	1684.3	0	0	0	2.3E3	1.786	2599	3815	Sisma Y SLV	0	1684.3	0	0	2.3E3	1.786
2600	3815	Sisma X SLD	773.4	0	0	0	2.3E3	1.786	2601	3815	Sisma Y SLD	0	773.4	0	0	2.3E3	1.786
2602	3816	Sisma X SLV	1684.3	0	0	0	2.3E3	1.786	2603	3816	Sisma Y SLV	0	1684.3	0	0	2.3E3	1.786
2604	3816	Sisma X SLD	773.4	0	0	0	2.3E3	1.786	2605	3816	Sisma Y SLD	0	773.4	0	0	2.3E3	1.786
2606	3817	Sisma X SLV	1684.3	0	0	0	2.3E3	1.786	2607	3817	Sisma Y SLV	0	1684.3	0	0	2.3E3	1.786
2608	3817	Sisma X SLD	773.4	0	0	0	2.3E3	1.786	2609	3817	Sisma Y SLD	0	773.4	0	0	2.3E3	1.786
2610	3818	Sisma X SLV	1684.3	0	0	0	2.3E3	1.786	2611	3818	Sisma Y SLV	0	1684.3	0	0	2.3E3	1.786
2612	3818	Sisma X SLD	773.4	0	0	0	2.3E3	1.786	2613	3818	Sisma Y SLD	0	773.4	0	0	2.3E3	1.786
2614	3819	Sisma X SLV	1684.3	0	0	0	2.3E3	1.786	2615	3819	Sisma Y SLV	0	1684.3	0	0	2.3E3	1.786
2616	3819	Sisma X SLD	773.4	0	0	0	2.3E3	1.786	2617	3819	Sisma Y SLD	0	773.4	0	0	2.3E3	1.786
2618	3820	Sisma X SLV	1.9E5	0	0	0	2.0E5	2.283	2619	3820	Sisma Y SLV	0	1.9E5	0	0	2.0E5	2.283
2620	3820	Sisma X SLD	8.6E4	0	0	0	2.0E5	2.283	2621	3820	Sisma Y SLD	0	8.6E4	0	0	2.0E5	2.283

7.5 Masse aggregate

Nodo: Indice del nodo in cui si considera l'aggregazione delle masse.

Massa X: Massa per la componente di spostamento lungo l'asse X. [daN/(cm/s<sup>2</sup>)]

Massa Y: Massa per la componente di spostamento lungo l'asse Y. [daN/(cm/s<sup>2</sup>)]

Massa Z: Massa per la componente di spostamento lungo l'asse Z. [daN/(cm/s<sup>2</sup>)]

Momento Z: Massa momento d'inerzia per la componente di rotazione attorno all'asse Z. [[daN/(cm/s<sup>2</sup>)]\*cm<sup>2</sup>]



Progetto	Titolo	Rev.	Pag.
Orione	Orione_A24a.pdf "TABULATI DI CALCOLO PLINTO DI FONDAZIONE PER AEROGENERATORE TIPO"	0	97

Nodo	Massa X	Massa Y	Massa Z	Momento Z	Nodo	Massa X	Massa Y	Massa Z	Momento Z
434	2.22	2.22	0		435	2.208	2.208	0	
436	2.22	2.22	0		437	2.208	2.208	0	
438	2.22	2.22	0		439	2.208	2.208	0	
440	2.22	2.22	0		441	2.208	2.208	0	
442	2.22	2.22	0		443	2.208	2.208	0	
444	2.22	2.22	0		445	2.208	2.208	0	
446	2.22	2.22	0		447	4.3	4.3	0	
448	4.288	4.288	0		449	4.311	4.311	0	
450	2.208	2.208	0		451	4.288	4.288	0	
452	4.311	4.311	0		453	2.22	2.22	0	
454	4.288	4.288	0		455	4.311	4.311	0	
456	4.288	4.288	0		457	4.311	4.311	0	
458	2.208	2.208	0		459	2.22	2.22	0	
460	4.288	4.288	0		461	4.311	4.311	0	
462	4.288	4.288	0		463	4.311	4.311	0	
464	2.208	2.208	0		465	2.22	2.22	0	
466	4.163	4.163	0		467	4.101	4.101	0	
468	4.124	4.124	0		469	4.288	4.288	0	
470	4.311	4.311	0		471	4.101	4.101	0	
472	4.124	4.124	0		473	4.101	4.101	0	
474	4.124	4.124	0		475	2.208	2.208	0	
476	4.151	4.151	0		477	4.174	4.174	0	
478	2.22	2.22	0		479	4.288	4.288	0	
480	4.311	4.311	0		481	4.101	4.101	0	
482	4.124	4.124	0		483	2.208	2.208	0	
484	2.22	2.22	0		485	4.288	4.288	0	
486	4.311	4.311	0		487	4.101	4.101	0	
488	4.124	4.124	0		489	3.925	3.925	0	
490	4.101	4.101	0		491	3.914	3.914	0	
492	3.937	3.937	0		493	4.124	4.124	0	
494	3.914	3.914	0		495	3.937	3.937	0	
496	2.208	2.208	0		497	2.22	2.22	0	
498	4.288	4.288	0		499	3.914	3.914	0	
500	3.937	3.937	0		501	4.311	4.311	0	
502	4.151	4.151	0		503	3.914	3.914	0	
504	3.937	3.937	0		505	4.174	4.174	0	
506	3.914	3.914	0		507	3.937	3.937	0	
508	4.288	4.288	0		509	4.311	4.311	0	
510	4.101	4.101	0		511	4.124	4.124	0	
512	3.914	3.914	0		513	3.937	3.937	0	
514	2.208	2.208	0		515	2.22	2.22	0	
516	4.463	4.463	0		517	3.914	3.914	0	
518	3.937	3.937	0		519	4.288	4.288	0	
520	4.463	4.463	0		521	4.474	4.474	0	
522	4.311	4.311	0		523	4.101	4.101	0	
524	4.124	4.124	0		525	4.463	4.463	0	
526	4.474	4.474	0		527	4.463	4.463	0	
528	4.474	4.474	0		529	3.914	3.914	0	
530	3.937	3.937	0		531	4.463	4.463	0	
532	4.474	4.474	0		533	2.208	2.208	0	
534	2.22	2.22	0		535	4.101	4.101	0	
536	4.441	4.441	0		537	4.474	4.474	0	
538	4.124	4.124	0		539	4.288	4.288	0	
540	3.914	3.914	0		541	3.937	3.937	0	
542	4.311	4.311	0		543	4.441	4.441	0	
544	4.474	4.474	0		545	4.151	4.151	0	
546	4.174	4.174	0		547	4.441	4.441	0	
548	4.474	4.474	0		549	2.208	2.208	0	
550	2.22	2.22	0		551	3.914	3.914	0	
552	3.937	3.937	0		553	4.441	4.441	0	
554	4.474	4.474	0		555	4.288	4.288	0	
556	4.311	4.311	0		557	4.901	4.901	0	
558	4.901	4.901	0		559	4.901	4.901	0	
560	3.914	3.914	0		561	3.937	3.937	0	
562	4.901	4.901	0		563	4.901	4.901	0	
564	4.101	4.101	0		565	4.124	4.124	0	
566	4.901	4.901	0		567	4.901	4.901	0	
568	4.441	4.441	0		569	4.474	4.474	0	
570	2.208	2.208	0		571	4.879	4.879	0	
572	4.901	4.901	0		573	2.22	2.22	0	
574	4.288	4.288	0		575	3.914	3.914	0	
576	3.937	3.937	0		577	4.311	4.311	0	
578	4.857	4.857	0		579	4.901	4.901	0	
580	4.441	4.441	0		581	4.474	4.474	0	
582	4.101	4.101	0		583	4.857	4.857	0	
584	4.901	4.901	0		585	4.124	4.124	0	
586	4.857	4.857	0		587	4.901	4.901	0	
588	4.441	4.441	0		589	4.474	4.474	0	
590	3.914	3.914	0		591	3.937	3.937	0	
592	2.22	2.22	0		593	2.22	2.22	0	
594	4.3	4.3	0		595	4.311	4.311	0	
596	4.857	4.857	0		597	4.901	4.901	0	
598	4.101	4.101	0		599	4.124	4.124	0	
600	4.441	4.441	0		601	4.658	4.658	0	
602	4.474	4.474	0		603	4.635	4.635	0	
604	4.658	4.658	0		605	4.857	4.857	0	
606	4.635	4.635	0		607	4.658	4.658	0	
608	4.901	4.901	0		609	3.914	3.914	0	
610	4.635	4.635	0		611	4.658	4.658	0	
612	3.937	3.937	0		613	4.613	4.613	0	
614	4.658	4.658	0		615	2.22	2.22	0	
616	4.311	4.311	0		617	4.311	4.311	0	
618	2.22	2.22	0		619	4.613	4.613	0	
620	4.658	4.658	0		621	4.163	4.163	0	
622	4.857	4.857	0		623	4.901	4.901	0	
624	4.174	4.174	0		625	4.441	4.441	0	



Tabulati di Calcolo Plinto di Fondazione per Aerogeneratore Tipo - Progetto Impianto Eolico - "Orione"

Nodo	Massa X	Massa Y	Massa Z	Momento Z	Nodo	Massa X	Massa Y	Massa Z	Momento Z
626	4.474	4.474	0		627	4.613	4.613	0	
628	4.658	4.658	0		629	3.914	3.914	0	
630	3.937	3.937	0		631	4.857	4.857	0	
632	4.901	4.901	0		633	4.613	4.613	0	
634	4.658	4.658	0		635	4.441	4.441	0	
636	4.474	4.474	0		637	4.613	4.613	0	
638	4.658	4.658	0		639	4.311	4.311	0	
640	4.311	4.311	0		641	2.22	2.22	0	
642	4.124	4.124	0		643	4.857	4.857	0	
644	4.901	4.901	0		645	4.124	4.124	0	
646	2.22	2.22	0		647	3.925	3.925	0	
648	3.937	3.937	0		649	4.381	4.381	0	
650	4.613	4.613	0		651	4.658	4.658	0	
652	4.358	4.358	0		653	4.404	4.404	0	
655	4.404	4.404	0		656	4.441	4.441	0	
657	4.358	4.358	0		658	4.404	4.404	0	
659	4.474	4.474	0		660	4.358	4.358	0	
661	4.404	4.404	0		662	4.857	4.857	0	
663	4.901	4.901	0		664	4.613	4.613	0	
665	4.658	4.658	0		666	4.358	4.358	0	
667	4.404	4.404	0		668	4.311	4.311	0	
669	4.124	4.124	0		670	4.124	4.124	0	
671	4.311	4.311	0		672	2.22	2.22	0	
673	3.937	3.937	0		674	3.937	3.937	0	
675	2.22	2.22	0		676	4.358	4.358	0	
678	4.453	4.453	0		679	4.613	4.613	0	
680	4.658	4.658	0		681	4.474	4.474	0	
682	4.857	4.857	0		683	4.901	4.901	0	
684	4.358	4.358	0		685	4.404	4.404	0	
686	4.358	4.358	0		687	4.404	4.404	0	
688	4.613	4.613	0		689	4.658	4.658	0	
690	4.124	4.124	0		691	4.124	4.124	0	
692	4.311	4.311	0		693	3.937	3.937	0	
694	3.937	3.937	0		695	4.311	4.311	0	
696	4.857	4.857	0		697	4.901	4.901	0	
698	4.358	4.358	0		699	4.404	4.404	0	
700	4.474	4.474	0		701	4.409	4.409	0	
702	4.105	4.105	0		703	4.081	4.081	0	
704	4.128	4.128	0		705	2.22	2.22	0	
706	4.613	4.613	0		707	4.59	4.59	0	
708	2.22	2.22	0		709	4.081	4.081	0	
710	4.128	4.128	0		711	4.081	4.081	0	
712	4.128	4.128	0		714	4.081	4.081	0	
715	4.128	4.128	0		716	4.404	4.404	0	
717	4.879	4.879	0		718	4.901	4.901	0	
719	4.081	4.081	0		720	4.128	4.128	0	
721	4.174	4.174	0		722	3.937	3.937	0	
723	4.613	4.613	0		724	4.358	4.358	0	
725	4.404	4.404	0		726	4.59	4.59	0	
727	3.937	3.937	0		728	4.174	4.174	0	
729	4.081	4.081	0		730	4.128	4.128	0	
731	4.474	4.474	0		732	4.409	4.409	0	
733	4.311	4.311	0		734	4.311	4.311	0	
735	4.081	4.081	0		736	4.128	4.128	0	
737	4.358	4.358	0		738	4.404	4.404	0	
739	4.081	4.081	0		740	4.128	4.128	0	
741	2.22	2.22	0		742	4.901	4.901	0	
743	4.613	4.613	0		744	4.59	4.59	0	
745	4.857	4.857	0		746	2.22	2.22	0	
747	3.937	3.937	0		748	4.081	4.081	0	
749	4.128	4.128	0		750	3.937	3.937	0	
751	4.474	4.474	0		752	4.409	4.409	0	
753	4.358	4.358	0		754	4.358	4.358	0	
755	4.124	4.124	0		756	4.124	4.124	0	
757	3.817	3.817	0		758	4.567	4.567	0	
759	3.793	3.793	0		760	3.841	3.841	0	
761	4.59	4.59	0		762	4.081	4.081	0	
763	3.793	3.793	0		764	3.841	3.841	0	
765	4.128	4.128	0		766	3.793	3.793	0	
767	3.841	3.841	0		768	4.311	4.311	0	
769	4.901	4.901	0		770	4.857	4.857	0	
771	3.793	3.793	0		772	3.841	3.841	0	
773	4.311	4.311	0		774	4.358	4.358	0	
776	4.081	4.081	0		777	3.793	3.793	0	
778	3.841	3.841	0		779	4.128	4.128	0	
780	2.22	2.22	0		781	4.474	4.474	0	
782	4.409	4.409	0		783	2.22	2.22	0	
784	3.793	3.793	0		785	3.841	3.841	0	
786	3.937	3.937	0		787	4.59	4.59	0	
788	4.68	4.68	0		789	3.937	3.937	0	
790	4.081	4.081	0		791	4.128	4.128	0	
792	3.793	3.793	0		793	3.841	3.841	0	
794	4.358	4.358	0		795	4.358	4.358	0	
796	4.124	4.124	0		797	4.901	4.901	0	
798	4.857	4.857	0		799	4.124	4.124	0	
800	3.793	3.793	0		801	3.841	3.841	0	
802	4.311	4.311	0		803	4.081	4.081	0	
804	4.151	4.151	0		805	4.311	4.311	0	
806	3.793	3.793	0		807	3.841	3.841	0	
808	4.335	4.335	0		809	4.358	4.358	0	
810	4.59	4.59	0		811	4.68	4.68	0	
812	4.474	4.474	0		813	4.474	4.474	0	
814	3.793	3.793	0		815	3.841	3.841	0	
816	2.22	2.22	0		817	3.937	3.937	0	
818	4.901	4.901	0		819	3.167	3.167	0	
820	4.857	4.857	0		821	3.937	3.937	0	
822	2.22	2.22	0		823	4.081	4.081	0	



Nodo	Massa X	Massa Y	Massa Z	Momento Z	Nodo	Massa X	Massa Y	Massa Z	Momento Z
824	4.151	4.151	0		825	3.151	3.151	0	
826	3.191	3.191	0		827	3.151	3.151	0	
828	3.191	3.191	0		829	3.151	3.151	0	
830	3.191	3.191	0		831	3.151	3.151	0	
832	3.191	3.191	0		833	4.124	4.124	0	
834	3.793	3.793	0		835	3.841	3.841	0	
836	4.124	4.124	0		837	4.358	4.358	0	
838	4.404	4.404	0		839	4.59	4.59	0	
840	3.151	3.151	0		841	3.191	3.191	0	
842	4.68	4.68	0		843	4.081	4.081	0	
844	4.151	4.151	0		845	3.793	3.793	0	
846	3.151	3.151	0		847	3.191	3.191	0	
848	3.841	3.841	0		849	4.311	4.311	0	
850	4.311	4.311	0		851	4.474	4.474	0	
852	4.474	4.474	0		853	3.151	3.151	0	
854	3.191	3.191	0		855	4.901	4.901	0	
856	4.901	4.901	0		858	3.151	3.151	0	
859	3.191	3.191	0		860	4.404	4.404	0	
861	3.937	3.937	0		862	3.937	3.937	0	
863	4.127	4.127	0		864	4.151	4.151	0	
865	3.793	3.793	0		866	3.841	3.841	0	
867	4.658	4.658	0		868	4.68	4.68	0	
869	2.22	2.22	0		870	3.151	3.151	0	
871	3.191	3.191	0		872	2.22	2.22	0	
873	4.174	4.174	0		874	4.174	4.174	0	
875	2.613	2.613	0		876	3.793	3.793	0	
877	2.597	2.597	0		878	2.629	2.629	0	
879	3.841	3.841	0		880	2.597	2.597	0	
881	2.629	2.629	0		882	3.151	3.151	0	
883	3.191	3.191	0		884	2.597	2.597	0	
885	2.629	2.629	0		886	4.358	4.358	0	
887	4.151	4.151	0		888	4.128	4.128	0	
889	2.597	2.597	0		890	2.629	2.629	0	
891	4.404	4.404	0		892	4.474	4.474	0	
893	4.474	4.474	0		894	4.901	4.901	0	
895	4.901	4.901	0		896	2.597	2.597	0	
897	2.629	2.629	0		898	3.151	3.151	0	
899	3.191	3.191	0		900	4.311	4.311	0	
901	4.311	4.311	0		902	3.793	3.793	0	
903	3.841	3.841	0		904	4.658	4.658	0	
905	2.597	2.597	0		906	2.629	2.629	0	
907	4.658	4.658	0		908	3.937	3.937	0	
909	3.937	3.937	0		910	3.151	3.151	0	
911	2.597	2.597	0		912	2.629	2.629	0	
913	3.191	3.191	0		914	4.151	4.151	0	
915	4.128	4.128	0		916	4.404	4.404	0	
917	2.597	2.597	0		918	2.629	2.629	0	
919	4.404	4.404	0		920	3.817	3.817	0	
921	3.841	3.841	0		922	4.124	4.124	0	
923	4.124	4.124	0		924	2.22	2.22	0	
925	2.22	2.22	0		926	3.151	3.151	0	
927	3.191	3.191	0		928	2.597	2.597	0	
929	2.629	2.629	0		930	4.474	4.474	0	
931	4.901	4.901	0		932	4.901	4.901	0	
933	4.474	4.474	0		934	4.658	4.658	0	
935	4.658	4.658	0		936	4.151	4.151	0	
937	2.597	2.597	0		938	1.344	1.344	0	
939	2.629	2.629	0		940	4.128	4.128	0	
941	1.331	1.331	0		942	1.347	1.347	0	
943	3.841	3.841	0		944	3.151	3.151	0	
945	1.32	1.32	0		946	1.336	1.336	0	
947	3.191	3.191	0		948	3.841	3.841	0	
949	1.331	1.331	0		950	1.347	1.347	0	
951	4.404	4.404	0		952	1.344	1.344	0	
953	1.36	1.36	0		954	4.404	4.404	0	
955	4.311	4.311	0		956	4.311	4.311	0	
957	3.937	3.937	0		958	2.597	2.597	0	
959	2.629	2.629	0		960	3.937	3.937	0	
961	1.331	1.331	0		962	1.347	1.347	0	
963	3.151	3.151	0		964	1.32	1.32	0	
965	1.336	1.336	0		966	3.191	3.191	0	
967	2.597	2.597	0		968	2.629	2.629	0	
969	4.128	4.128	0		970	4.128	4.128	0	
971	3.841	3.841	0		972	1.331	1.331	0	
973	1.347	1.347	0		974	3.841	3.841	0	
975	4.901	4.901	0		976	4.901	4.901	0	
977	4.658	4.658	0		978	4.658	4.658	0	
979	4.124	4.124	0		980	1.344	1.344	0	
981	1.36	1.36	0		982	4.124	4.124	0	
983	4.474	4.474	0		984	4.474	4.474	0	
985	3.175	3.175	0		986	2.597	2.597	0	
987	2.629	2.629	0		988	3.191	3.191	0	
989	2.22	2.22	0		990	2.22	2.22	0	
991	4.404	4.404	0		993	1.331	1.331	0	
994	0.184	0.184	0		995	0.184	0.184	0	
996	1.347	1.347	0		997	0.228	0.228	0	
998	0.232	0.232	0		999	3.841	3.841	0	
1000	0.232	0.232	0		1001	0.261	0.261	0	
1002	0.228	0.228	0		1003	3.841	3.841	0	
1004	2.597	2.597	0		1005	2.629	2.629	0	
1006	4.128	4.128	0		1007	1.32	1.32	0	
1008	1.336	1.336	0		1009	4.128	4.128	0	
1010	3.937	3.937	0		1011	3.937	3.937	0	
1012	3.191	3.191	0		1013	0.228	0.228	0	
1014	0.261	0.261	0		1015	0.261	0.261	0	
1016	0.232	0.232	0		1017	3.191	3.191	0	
1018	0.184	0.184	0		1019	0.184	0.184	0	



Nodo	Massa X	Massa Y	Massa Z	Momento Z	Nodo	Massa X	Massa Y	Massa Z	Momento Z
1020	4.311	4.311	0		1021	4.311	4.311	0	
1022	1.331	1.331	0		1023	1.347	1.347	0	
1024	4.59	4.59	0		1025	4.658	4.658	0	
1026	2.597	2.597	0		1027	2.629	2.629	0	
1028	0.232	0.232	0		1029	0.228	0.228	0	
1030	4.901	4.901	0		1031	4.901	4.901	0	
1032	4.404	4.404	0		1033	3.841	3.841	0	
1034	3.841	3.841	0		1035	4.404	4.404	0	
1036	1.344	1.344	0		1037	1.36	1.36	0	
1038	0.133	0.133	0		1039	0.133	0.133	0	
1040	3.191	3.191	0		1041	3.191	3.191	0	
1042	4.474	4.474	0		1043	0.261	0.261	0	
1044	0.261	0.261	0		1045	4.474	4.474	0	
1046	4.124	4.124	0		1047	4.124	4.124	0	
1048	4.128	4.128	0		1049	2.613	2.613	0	
1050	2.629	2.629	0		1051	4.128	4.128	0	
1052	0.228	0.228	0		1053	0.232	0.232	0	
1054	1.331	1.331	0		1055	1.347	1.347	0	
1056	0.184	0.184	0		1057	0.133	0.133	0	
1058	0.248	0.248	0		1059	0.248	0.248	0	
1060	0.133	0.133	0		1061	0.184	0.184	0	
1062	2.22	2.22	0		1063	0.248	0.248	0	
1064	0.248	0.248	0		1065	2.22	2.22	0	
1066	3.841	3.841	0		1067	3.191	3.191	0	
1068	0.302	0.302	0		1069	3.191	3.191	0	
1070	3.841	3.841	0		1071	1.32	1.32	0	
1072	0.248	0.248	0		1073	0.248	0.248	0	
1074	2.629	2.629	0		1075	1.336	1.336	0	
1076	0.232	0.232	0		1077	0.228	0.228	0	
1078	2.629	2.629	0		1079	3.937	3.937	0	
1080	4.358	4.358	0		1081	4.404	4.404	0	
1082	3.937	3.937	0		1083	4.59	4.59	0	
1084	4.59	4.59	0		1085	0.302	0.302	0	
1086	0.302	0.302	0		1087	0.248	0.248	0	
1088	0.248	0.248	0		1089	4.311	4.311	0	
1090	4.901	4.901	0		1091	4.128	4.128	0	
1092	4.128	4.128	0		1093	4.901	4.901	0	
1094	4.311	4.311	0		1095	1.331	1.331	0	
1096	1.347	1.347	0		1097	0.261	0.261	0	
1098	0.261	0.261	0		1099	0.133	0.133	0	
1100	0.133	0.133	0		1101	3.143	3.143	0	
1102	2.629	2.629	0		1103	2.629	2.629	0	
1104	3.191	3.191	0		1105	4.474	4.474	0	
1106	3.841	3.841	0		1107	3.841	3.841	0	
1108	4.474	4.474	0		1109	0.228	0.228	0	
1110	0.248	0.248	0		1111	0.248	0.248	0	
1112	0.232	0.232	0		1113	0.302	0.302	0	
1114	0.302	0.302	0		1115	1.36	1.36	0	
1116	1.36	1.36	0		1117	4.174	4.174	0	
1118	4.174	4.174	0		1119	0.184	0.184	0	
1120	0.184	0.184	0		1121	0.43	0.43	0	
1122	0.43	0.43	0		1123	4.358	4.358	0	
1124	0.248	0.248	0		1125	0.248	0.248	0	
1126	2.629	2.629	0		1127	2.629	2.629	0	
1128	4.358	4.358	0		1129	4.151	4.151	0	
1130	4.128	4.128	0		1131	4.59	4.59	0	
1132	3.143	3.143	0		1133	3.191	3.191	0	
1134	4.59	4.59	0		1135	1.347	1.347	0	
1136	1.347	1.347	0		1137	2.22	2.22	0	
1138	0.232	0.232	0		1139	0.228	0.228	0	
1140	2.22	2.22	0		1141	3.937	3.937	0	
1142	0.43	0.43	0		1143	0.404	0.404	0	
1144	0.43	0.43	0		1145	3.937	3.937	0	
1146	3.841	3.841	0		1147	3.841	3.841	0	
1148	4.901	4.901	0		1149	4.901	4.901	0	
1150	0.404	0.404	0		1151	0.404	0.404	0	
1152	2.597	2.597	0		1153	2.629	2.629	0	
1154	0.133	0.133	0		1155	0.133	0.133	0	
1156	0.302	0.302	0		1157	0.302	0.302	0	
1158	1.336	1.336	0		1159	1.336	1.336	0	
1160	0.248	0.248	0		1161	0.248	0.248	0	
1162	4.311	4.311	0		1163	4.311	4.311	0	
1164	0.261	0.261	0		1165	0.261	0.261	0	
1166	3.143	3.143	0		1167	3.191	3.191	0	
1168	4.474	4.474	0		1169	4.474	4.474	0	
1170	4.151	4.151	0		1172	0.404	0.404	0	
1173	0.404	0.404	0		1174	4.151	4.151	0	
1175	0.43	0.43	0		1176	0.43	0.43	0	
1177	4.358	4.358	0		1178	3.841	3.841	0	
1179	3.841	3.841	0		1180	1.347	1.347	0	
1181	0.232	0.232	0		1182	2.597	2.597	0	
1183	0.228	0.228	0		1184	1.347	1.347	0	
1185	2.629	2.629	0		1186	4.59	4.59	0	
1187	0.248	0.248	0		1188	0.248	0.248	0	
1189	4.59	4.59	0		1190	4.124	4.124	0	
1191	4.124	4.124	0		1192	0.184	0.184	0	
1193	3.143	3.143	0		1194	0.184	0.184	0	
1195	3.191	3.191	0		1196	4.901	4.901	0	
1197	4.901	4.901	0		1198	1.376	1.376	0	
1199	1.36	1.36	0		1200	3.937	3.937	0	
1201	0.389	0.389	0		1202	0.389	0.389	0	
1203	3.937	3.937	0		1204	0.368	0.368	0	
1205	2.597	2.597	0		1206	2.629	2.629	0	
1207	0.404	0.404	0		1208	0.404	0.404	0	
1209	2.22	2.22	0		1210	0.368	0.368	0	
1211	0.302	0.302	0		1212	2.22	2.22	0	
1213	4.151	4.151	0		1214	0.302	0.302	0	



Nodo	Massa X	Massa Y	Massa Z	Momento Z	Nodo	Massa X	Massa Y	Massa Z	Momento Z
1215	0.368	0.368	0		1216	4.151	4.151	0	
1217	3.841	3.841	0		1218	0.232	0.232	0	
1219	0.228	0.228	0		1220	3.841	3.841	0	
1221	4.358	4.358	0		1222	0.389	0.389	0	
1223	0.389	0.389	0		1224	4.358	4.358	0	
1225	0.43	0.43	0		1226	0.43	0.43	0	
1227	0.133	0.133	0		1228	0.133	0.133	0	
1229	0.248	0.248	0		1230	0.248	0.248	0	
1231	4.474	4.474	0		1232	3.191	3.191	0	
1233	1.363	1.363	0		1234	1.347	1.347	0	
1235	3.191	3.191	0		1236	4.474	4.474	0	
1237	4.311	4.311	0		1238	4.658	4.658	0	
1239	4.59	4.59	0		1240	4.311	4.311	0	
1241	0.368	0.368	0		1242	0.368	0.368	0	
1243	2.597	2.597	0		1244	2.629	2.629	0	
1245	0.261	0.261	0		1246	0.261	0.261	0	
1247	0.389	0.389	0		1248	0.389	0.389	0	
1249	4.124	4.124	0		1250	4.124	4.124	0	
1251	0.248	0.248	0		1252	0.248	0.248	0	
1253	1.352	1.352	0		1254	1.336	1.336	0	
1255	3.841	3.841	0		1256	3.841	3.841	0	
1257	4.901	4.901	0		1258	4.151	4.151	0	
1259	4.151	4.151	0		1260	4.901	4.901	0	
1261	3.191	3.191	0		1262	3.191	3.191	0	
1263	0.404	0.404	0		1264	0.404	0.404	0	
1265	0.232	0.232	0		1266	4.404	4.404	0	
1267	0.228	0.228	0		1268	2.629	2.629	0	
1269	2.629	2.629	0		1270	4.358	4.358	0	
1271	0.368	0.368	0		1272	0.368	0.368	0	
1273	3.937	3.937	0		1274	3.937	3.937	0	
1275	0.304	0.304	0		1276	0.309	0.309	0	
1277	0.309	0.309	0		1278	0.304	0.304	0	
1279	0.304	0.304	0		1280	1.363	1.363	0	
1281	1.347	1.347	0		1282	0.43	0.43	0	
1283	0.43	0.43	0		1284	0.184	0.184	0	
1285	0.184	0.184	0		1286	4.658	4.658	0	
1287	4.658	4.658	0		1288	2.22	2.22	0	
1289	0.302	0.302	0		1290	0.389	0.389	0	
1291	0.309	0.309	0		1292	0.309	0.309	0	
1293	0.389	0.389	0		1294	0.302	0.302	0	
1295	2.22	2.22	0		1296	4.474	4.474	0	
1297	4.474	4.474	0		1298	3.841	3.841	0	
1299	3.841	3.841	0		1300	3.191	3.191	0	
1301	0.304	0.304	0		1302	0.304	0.304	0	
1303	3.191	3.191	0		1304	2.629	2.629	0	
1305	2.629	2.629	0		1306	4.128	4.128	0	
1307	4.151	4.151	0		1308	4.311	4.311	0	
1309	0.248	0.248	0		1310	0.248	0.248	0	
1311	4.311	4.311	0		1312	1.36	1.36	0	
1313	1.36	1.36	0		1314	0.133	0.133	0	
1315	0.133	0.133	0		1316	0.232	0.232	0	
1317	0.309	0.309	0		1318	0.309	0.309	0	
1319	0.228	0.228	0		1320	4.901	4.901	0	
1321	4.901	4.901	0		1322	4.404	4.404	0	
1323	0.368	0.368	0		1324	0.368	0.368	0	
1325	4.404	4.404	0		1326	4.124	4.124	0	
1327	4.124	4.124	0		1328	0.304	0.304	0	
1329	0.304	0.304	0		1330	2.629	2.629	0	
1331	0.404	0.404	0		1332	0.404	0.404	0	
1333	2.629	2.629	0		1334	3.191	3.191	0	
1335	3.191	3.191	0		1336	3.841	3.841	0	
1337	3.841	3.841	0		1338	3.937	3.937	0	
1339	1.347	1.347	0		1340	1.347	1.347	0	
1341	0.248	0.248	0		1342	0.248	0.248	0	
1343	3.937	3.937	0		1344	0.261	0.261	0	
1345	0.251	0.251	0		1346	0.389	0.389	0	
1347	0.261	0.261	0		1348	4.658	4.658	0	
1349	0.389	0.389	0		1350	4.658	4.658	0	
1351	0.252	0.252	0		1352	0.252	0.252	0	
1353	0.251	0.251	0		1354	0.251	0.251	0	
1355	4.128	4.128	0		1356	0.309	0.309	0	
1357	0.309	0.309	0		1358	4.128	4.128	0	
1359	4.474	4.474	0		1360	0.252	0.252	0	
1361	0.252	0.252	0		1362	4.474	4.474	0	
1363	0.43	0.43	0		1364	0.43	0.43	0	
1365	0.251	0.251	0		1366	0.251	0.251	0	
1367	2.22	2.22	0		1368	2.629	2.629	0	
1369	2.629	2.629	0		1370	2.22	2.22	0	
1371	1.336	1.336	0		1372	0.228	0.228	0	
1373	0.232	0.232	0		1374	1.336	1.336	0	
1375	4.404	4.404	0		1376	0.304	0.304	0	
1377	0.304	0.304	0		1379	3.191	3.191	0	
1380	3.191	3.191	0		1381	0.252	0.252	0	
1382	0.252	0.252	0		1383	4.901	4.901	0	
1384	0.302	0.302	0		1385	0.368	0.368	0	
1386	0.368	0.368	0		1387	0.302	0.302	0	
1388	4.901	4.901	0		1389	4.311	4.311	0	
1390	3.841	3.841	0		1391	3.841	3.841	0	
1392	4.311	4.311	0		1393	0.251	0.251	0	
1394	0.251	0.251	0		1395	0.184	0.184	0	
1396	0.184	0.184	0		1397	4.174	4.174	0	
1398	4.174	4.174	0		1399	0.309	0.309	0	
1400	0.309	0.309	0		1401	4.128	4.128	0	
1402	4.128	4.128	0		1403	1.347	1.347	0	
1404	1.347	1.347	0		1405	4.658	4.658	0	
1406	2.629	2.629	0		1407	0.248	0.248	0	
1408	0.248	0.248	0		1409	2.629	2.629	0	



Nodo	Massa X	Massa Y	Massa Z	Momento Z	Nodo	Massa X	Massa Y	Massa Z	Momento Z
1410	4.658	4.658	0		1411	0.252	0.252	0	
1412	0.252	0.252	0		1413	3.937	3.937	0	
1414	0.389	0.389	0		1415	3.937	3.937	0	
1416	0.389	0.389	0		1417	3.191	3.191	0	
1418	0.133	0.133	0		1419	0.133	0.133	0	
1420	0.404	0.404	0		1421	0.2	0.2	0	
1422	0.404	0.404	0		1423	3.191	3.191	0	
1424	0.2	0.2	0		1425	0.2	0.2	0	
1426	0.2	0.2	0		1427	0.2	0.2	0	
1428	4.474	4.474	0		1429	0.232	0.232	0	
1430	0.228	0.228	0		1431	4.474	4.474	0	
1432	4.404	4.404	0		1433	0.304	0.304	0	
1434	0.2	0.2	0		1435	0.2	0.2	0	
1436	0.304	0.304	0		1437	4.404	4.404	0	
1438	3.841	3.841	0		1439	0.251	0.251	0	
1440	0.251	0.251	0		1441	3.841	3.841	0	
1442	1.36	1.36	0		1443	0.2	0.2	0	
1444	0.2	0.2	0		1445	1.36	1.36	0	
1446	2.629	2.629	0		1447	2.629	2.629	0	
1448	4.901	4.901	0		1449	0.248	0.248	0	
1450	0.2	0.2	0		1451	0.2	0.2	0	
1452	0.248	0.248	0		1453	4.901	4.901	0	
1454	4.128	4.128	0		1455	0.252	0.252	0	
1456	0.252	0.252	0		1457	4.128	4.128	0	
1458	0.43	0.43	0		1459	2.22	2.22	0	
1460	0.43	0.43	0		1461	0.368	0.368	0	
1462	0.368	0.368	0		1463	2.22	2.22	0	
1464	3.191	3.191	0		1465	0.2	0.2	0	
1466	0.2	0.2	0		1467	0.309	0.309	0	
1468	0.309	0.309	0		1469	3.191	3.191	0	
1470	0.261	0.261	0		1471	0.261	0.261	0	
1472	4.658	4.658	0		1473	4.658	4.658	0	
1474	4.311	4.311	0		1475	4.311	4.311	0	
1476	1.347	1.347	0		1477	1.347	1.347	0	
1478	0.2	0.2	0		1479	0.2	0.2	0	
1480	0.251	0.251	0		1481	0.251	0.251	0	
1482	4.124	4.124	0		1483	3.841	3.841	0	
1484	3.841	3.841	0		1485	4.124	4.124	0	
1486	2.629	2.629	0		1487	2.629	2.629	0	
1488	4.404	4.404	0		1489	4.404	4.404	0	
1490	0.302	0.302	0		1491	0.2	0.2	0	
1492	0.2	0.2	0		1493	0.302	0.302	0	
1494	3.937	3.937	0		1495	3.937	3.937	0	
1496	0.228	0.228	0		1497	0.304	0.304	0	
1498	0.15	0.15	0		1499	0.304	0.304	0	
1500	0.232	0.232	0		1501	0.389	0.389	0	
1502	0.15	0.15	0		1503	0.15	0.15	0	
1504	0.389	0.389	0		1505	0.15	0.15	0	
1506	0.15	0.15	0		1507	4.474	4.474	0	
1508	4.474	4.474	0		1509	3.191	3.191	0	
1510	0.15	0.15	0		1511	0.15	0.15	0	
1512	3.191	3.191	0		1513	0.252	0.252	0	
1514	0.252	0.252	0		1515	4.128	4.128	0	
1516	1.336	1.336	0		1517	1.336	1.336	0	
1518	4.128	4.128	0		1519	0.2	0.2	0	
1520	0.15	0.15	0		1521	0.15	0.15	0	
1522	0.2	0.2	0		1523	0.404	0.404	0	
1524	0.404	0.404	0		1525	4.901	4.901	0	
1526	0.15	0.15	0		1527	0.15	0.15	0	
1528	4.901	4.901	0		1529	0.248	0.248	0	
1530	0.248	0.248	0		1531	2.629	2.629	0	
1532	0.184	0.184	0		1533	0.184	0.184	0	
1534	2.629	2.629	0		1535	0.15	0.15	0	
1536	0.15	0.15	0		1537	3.841	3.841	0	
1538	0.2	0.2	0		1539	0.2	0.2	0	
1540	3.841	3.841	0		1541	0.309	0.309	0	
1542	4.658	4.658	0		1543	0.309	0.309	0	
1544	4.658	4.658	0		1545	0.251	0.251	0	
1546	0.251	0.251	0		1547	0.133	0.133	0	
1548	0.133	0.133	0		1549	0.15	0.15	0	
1550	0.15	0.15	0		1551	0.368	0.368	0	
1552	0.368	0.368	0		1553	1.347	1.347	0	
1554	1.347	1.347	0		1555	2.22	2.22	0	
1556	4.404	4.404	0		1557	3.191	3.191	0	
1558	3.191	3.191	0		1559	4.404	4.404	0	
1560	2.22	2.22	0		1561	0.2	0.2	0	
1562	0.15	0.15	0		1563	0.15	0.15	0	
1564	0.2	0.2	0		1565	4.311	4.311	0	
1566	4.311	4.311	0		1567	0.232	0.232	0	
1568	0.228	0.228	0		1569	0.43	0.43	0	
1570	4.124	4.124	0		1571	4.128	4.128	0	
1572	0.43	0.43	0		1573	2.629	2.629	0	
1574	0.15	0.15	0		1575	0.15	0.15	0	
1576	4.128	4.128	0		1577	4.124	4.124	0	
1578	0.252	0.252	0		1579	2.629	2.629	0	
1580	0.248	0.248	0		1581	0.252	0.252	0	
1582	0.248	0.248	0		1583	0.304	0.304	0	
1584	0.304	0.304	0		1585	3.937	3.937	0	
1586	3.937	3.937	0		1587	0.2	0.2	0	
1588	0.1	0.1	0		1589	0.1	0.1	0	
1590	0.1	0.1	0		1591	0.2	0.2	0	
1592	0.1	0.1	0		1593	0.1	0.1	0	
1594	4.474	4.474	0		1595	3.841	3.841	0	
1596	0.15	0.15	0		1597	0.1	0.1	0	
1598	0.1	0.1	0		1599	0.15	0.15	0	
1600	3.841	3.841	0		1601	4.474	4.474	0	
1602	1.36	1.36	0		1603	1.36	1.36	0	





Nodo	Massa X	Massa Y	Massa Z	Momento Z	Nodo	Massa X	Massa Y	Massa Z	Momento Z
1604	0.1	0.1	0	0	1605	0.1	0.1	0	0
1606	0.389	0.389	0	0	1607	4.901	4.901	0	0
1608	0.389	0.389	0	0	1609	0.1	0.1	0	0
1610	0.1	0.1	0	0	1611	4.901	4.901	0	0
1612	3.191	3.191	0	0	1613	0.261	0.261	0	0
1614	0.1	0.1	0	0	1615	0.1	0.1	0	0
1616	0.261	0.261	0	0	1617	3.191	3.191	0	0
1618	0.251	0.251	0	0	1619	0.15	0.15	0	0
1620	0.15	0.15	0	0	1621	0.251	0.251	0	0
1622	4.658	4.658	0	0	1623	0.2	0.2	0	0
1624	0.2	0.2	0	0	1625	4.658	4.658	0	0
1626	0.1	0.1	0	0	1627	0.1	0.1	0	0
1628	2.629	2.629	0	0	1629	2.629	2.629	0	0
1630	4.454	4.454	0	0	1631	0.302	0.302	0	0
1632	0.309	0.309	0	0	1633	0.309	0.309	0	0
1634	0.302	0.302	0	0	1635	4.404	4.404	0	0
1636	0.1	0.1	0	0	1637	0.1	0.1	0	0
1638	0.15	0.15	0	0	1639	0.15	0.15	0	0
1640	4.128	4.128	0	0	1641	1.347	1.347	0	0
1642	0.1	0.1	0	0	1643	0.1	0.1	0	0
1644	1.347	1.347	0	0	1645	4.128	4.128	0	0
1646	0.404	0.404	0	0	1647	0.404	0.404	0	0
1648	0.2	0.2	0	0	1649	0.2	0.2	0	0
1650	3.841	3.841	0	0	1651	0.228	0.228	0	0
1652	0.252	0.252	0	0	1653	0.1	0.1	0	0
1654	0.1	0.1	0	0	1655	0.252	0.252	0	0
1656	0.232	0.232	0	0	1657	3.841	3.841	0	0
1658	0.15	0.15	0	0	1659	0.15	0.15	0	0
1660	0.368	0.368	0	0	1661	0.368	0.368	0	0
1662	2.22	2.22	0	0	1663	3.191	3.191	0	0
1664	0.1	0.1	0	0	1665	0.1	0.1	0	0
1666	3.191	3.191	0	0	1667	2.22	2.22	0	0
1668	4.311	4.311	0	0	1669	0.248	0.248	0	0
1670	4.311	4.311	0	0	1671	0.248	0.248	0	0
1672	4.124	4.124	0	0	1673	2.629	2.629	0	0
1674	2.629	2.629	0	0	1675	4.124	4.124	0	0
1676	0.304	0.304	0	0	1677	0.2	0.2	0	0
1678	0.065	0.065	0	0	1679	0.065	0.065	0	0
1680	0.2	0.2	0	0	1681	0.304	0.304	0	0
1682	3.937	3.937	0	0	1683	0.15	0.15	0	0
1684	0.15	0.15	0	0	1685	3.937	3.937	0	0
1686	0.1	0.1	0	0	1687	0.065	0.065	0	0
1688	0.052	0.052	0	0	1689	0.065	0.065	0	0
1690	0.1	0.1	0	0	1691	0.052	0.052	0	0
1692	0.052	0.052	0	0	1693	4.474	4.474	0	0
1694	1.336	1.336	0	0	1695	1.336	1.336	0	0
1696	4.474	4.474	0	0	1697	0.065	0.065	0	0
1698	0.052	0.052	0	0	1699	0.052	0.052	0	0
1700	0.065	0.065	0	0	1701	4.901	4.901	0	0
1702	0.184	0.184	0	0	1703	4.901	4.901	0	0
1704	0.184	0.184	0	0	1705	0.251	0.251	0	0
1706	0.052	0.052	0	0	1707	0.052	0.052	0	0
1708	0.065	0.065	0	0	1709	0.251	0.251	0	0
1710	4.658	4.658	0	0	1711	0.1	0.1	0	0
1712	0.065	0.065	0	0	1713	0.1	0.1	0	0
1714	0.133	0.133	0	0	1715	0.133	0.133	0	0
1716	4.658	4.658	0	0	1717	4.404	4.404	0	0
1718	0.15	0.15	0	0	1719	0.052	0.052	0	0
1720	0.052	0.052	0	0	1721	0.15	0.15	0	0
1722	4.404	4.404	0	0	1723	0.065	0.065	0	0
1724	0.065	0.065	0	0	1725	0.43	0.43	0	0
1726	4.128	4.128	0	0	1727	0.43	0.43	0	0
1728	4.128	4.128	0	0	1729	0.2	0.2	0	0
1730	0.1	0.1	0	0	1731	0.1	0.1	0	0
1732	0.2	0.2	0	0	1733	3.841	3.841	0	0
1734	0.052	0.052	0	0	1735	0.052	0.052	0	0
1736	3.841	3.841	0	0	1737	0.389	0.389	0	0
1738	0.389	0.389	0	0	1739	0.065	0.065	0	0
1740	0.065	0.065	0	0	1741	3.191	3.191	0	0
1742	3.191	3.191	0	0	1743	2.629	2.629	0	0
1744	0.309	0.309	0	0	1745	0.15	0.15	0	0
1746	0.1	0.1	0	0	1747	0.1	0.1	0	0
1748	0.15	0.15	0	0	1749	0.309	0.309	0	0
1750	2.629	2.629	0	0	1751	0.248	0.248	0	0
1752	0.052	0.052	0	0	1753	0.052	0.052	0	0
1754	0.248	0.248	0	0	1755	1.347	1.347	0	0
1756	0.232	0.232	0	0	1757	0.228	0.228	0	0
1758	1.347	1.347	0	0	1759	0.252	0.252	0	0
1760	0.065	0.065	0	0	1761	0.065	0.065	0	0
1762	0.252	0.252	0	0	1763	0.2	0.2	0	0
1764	0.1	0.1	0	0	1765	0.052	0.052	0	0
1766	0.052	0.052	0	0	1767	0.1	0.1	0	0
1768	0.2	0.2	0	0	1769	0.15	0.15	0	0
1770	0.065	0.065	0	0	1771	0.065	0.065	0	0
1772	0.15	0.15	0	0	1773	0.1	0.1	0	0
1774	0.052	0.052	0	0	1775	0.052	0.052	0	0
1776	0.1	0.1	0	0	1777	0.065	0.065	0	0
1778	0.065	0.065	0	0	1779	2.22	2.22	0	0
1780	4.311	4.311	0	0	1781	4.174	4.174	0	0
1782	3.937	3.937	0	0	1783	4.474	4.474	0	0
1784	4.901	4.901	0	0	1785	4.658	4.658	0	0
1786	4.404	4.404	0	0	1787	4.128	4.128	0	0
1788	3.841	3.841	0	0	1789	3.191	3.191	0	0
1790	2.629	2.629	0	0	1791	1.36	1.36	0	0
1792	0.261	0.261	0	0	1793	0.302	0.302	0	0
1794	0.404	0.404	0	0	1795	0.368	0.368	0	0
1796	0.304	0.304	0	0	1797	0.251	0.251	0	0



Nodo	Massa X	Massa Y	Massa Z	Momento Z	Nodo	Massa X	Massa Y	Massa Z	Momento Z
1798	0.2	0.2	0		1799	0.15	0.15	0	
1800	0.1	0.1	0		1801	0.052	0.052	0	
1802	0.687	0.687	0		1803	0.052	0.052	0	
1804	0.1	0.1	0		1805	0.15	0.15	0	
1806	0.2	0.2	0		1807	0.251	0.251	0	
1808	0.304	0.304	0		1809	0.368	0.368	0	
1810	0.404	0.404	0		1811	0.302	0.302	0	
1812	0.261	0.261	0		1813	1.36	1.36	0	
1814	2.613	2.613	0		1815	3.175	3.175	0	
1816	3.817	3.817	0		1817	4.104	4.104	0	
1818	4.381	4.381	0		1819	4.635	4.635	0	
1820	4.879	4.879	0		1821	4.453	4.453	0	
1822	3.925	3.925	0		1823	4.163	4.163	0	
1824	4.3	4.3	0		1825	2.208	2.208	0	
1826	0.065	0.065	0		1827	0.065	0.065	0	
1828	0.1	0.1	0		1829	0.052	0.052	0	
1830	0.052	0.052	0		1831	0.1	0.1	0	
1832	0.15	0.15	0		1833	0.065	0.065	0	
1834	0.065	0.065	0		1835	0.15	0.15	0	
1836	0.2	0.2	0		1837	0.1	0.1	0	
1838	0.052	0.052	0		1839	0.052	0.052	0	
1840	0.1	0.1	0		1841	0.2	0.2	0	
1842	0.252	0.252	0		1843	0.065	0.065	0	
1844	0.065	0.065	0		1845	0.252	0.252	0	
1846	1.347	1.347	0		1847	0.228	0.228	0	
1848	0.232	0.232	0		1849	1.331	1.331	0	
1850	0.248	0.248	0		1851	0.052	0.052	0	
1852	0.052	0.052	0		1853	0.248	0.248	0	
1854	2.629	2.629	0		1855	0.309	0.309	0	
1856	0.15	0.15	0		1857	0.1	0.1	0	
1858	0.1	0.1	0		1859	0.15	0.15	0	
1860	0.309	0.309	0		1861	2.597	2.597	0	
1862	3.191	3.191	0		1863	3.151	3.151	0	
1864	0.065	0.065	0		1865	0.065	0.065	0	
1866	0.389	0.389	0		1867	0.389	0.389	0	
1868	3.841	3.841	0		1869	0.052	0.052	0	
1870	0.052	0.052	0		1871	3.793	3.793	0	
1872	0.2	0.2	0		1873	0.1	0.1	0	
1874	0.1	0.1	0		1875	0.2	0.2	0	
1876	4.128	4.128	0		1877	0.43	0.43	0	
1878	4.081	4.081	0		1879	0.43	0.43	0	
1880	0.065	0.065	0		1881	0.065	0.065	0	
1882	4.404	4.404	0		1883	0.15	0.15	0	
1884	0.052	0.052	0		1885	0.052	0.052	0	
1886	0.15	0.15	0		1887	4.358	4.358	0	
1888	4.658	4.658	0		1889	0.133	0.133	0	
1890	0.133	0.133	0		1891	0.1	0.1	0	
1892	0.065	0.065	0		1893	0.1	0.1	0	
1894	4.613	4.613	0		1895	0.251	0.251	0	
1896	0.065	0.065	0		1897	0.052	0.052	0	
1898	0.052	0.052	0		1899	0.251	0.251	0	
1900	0.184	0.184	0		1901	4.901	4.901	0	
1902	0.184	0.184	0		1903	4.857	4.857	0	
1904	1.336	1.336	0		1905	0.065	0.065	0	
1906	0.052	0.052	0		1907	0.052	0.052	0	
1908	0.065	0.065	0		1909	4.474	4.474	0	
1910	1.32	1.32	0		1911	4.441	4.441	0	
1912	0.052	0.052	0		1913	0.052	0.052	0	
1914	0.1	0.1	0		1915	0.065	0.065	0	
1916	0.052	0.052	0		1917	0.065	0.065	0	
1918	0.1	0.1	0		1919	3.937	3.937	0	
1920	0.15	0.15	0		1921	3.914	3.914	0	
1922	0.304	0.304	0		1923	0.2	0.2	0	
1924	0.15	0.15	0		1925	0.065	0.065	0	
1926	0.065	0.065	0		1927	0.2	0.2	0	
1928	0.304	0.304	0		1929	4.124	4.124	0	
1930	2.629	2.629	0		1931	2.597	2.597	0	
1932	4.101	4.101	0		1933	0.248	0.248	0	
1934	4.311	4.311	0		1935	0.248	0.248	0	
1936	4.288	4.288	0		1937	2.22	2.22	0	
1938	3.191	3.191	0		1939	0.1	0.1	0	
1940	0.1	0.1	0		1941	3.151	3.151	0	
1942	2.208	2.208	0		1943	0.368	0.368	0	
1944	0.368	0.368	0		1945	0.15	0.15	0	
1946	0.15	0.15	0		1947	3.841	3.841	0	
1948	0.232	0.232	0		1949	0.252	0.252	0	
1950	0.1	0.1	0		1951	0.1	0.1	0	
1952	0.252	0.252	0		1953	0.228	0.228	0	
1954	3.793	3.793	0		1955	0.2	0.2	0	
1956	0.2	0.2	0		1957	0.404	0.404	0	
1958	0.404	0.404	0		1959	4.128	4.128	0	
1960	1.347	1.347	0		1961	0.1	0.1	0	
1962	0.1	0.1	0		1963	1.331	1.331	0	
1964	4.081	4.081	0		1965	0.15	0.15	0	
1966	0.15	0.15	0		1967	0.1	0.1	0	
1968	0.1	0.1	0		1969	4.404	4.404	0	
1970	0.302	0.302	0		1971	0.309	0.309	0	
1972	0.309	0.309	0		1973	0.302	0.302	0	
1975	2.629	2.629	0		1976	2.597	2.597	0	
1977	0.1	0.1	0		1978	0.1	0.1	0	
1979	4.658	4.658	0		1980	0.2	0.2	0	
1981	0.2	0.2	0		1982	4.613	4.613	0	
1983	0.251	0.251	0		1984	0.15	0.15	0	
1985	0.15	0.15	0		1986	0.251	0.251	0	
1987	3.191	3.191	0		1988	0.261	0.261	0	
1989	0.1	0.1	0		1990	0.1	0.1	0	
1991	0.261	0.261	0		1992	3.151	3.151	0	



Nodo	Massa X	Massa Y	Massa Z	Momento Z	Nodo	Massa X	Massa Y	Massa Z	Momento Z
1993	4.901	4.901	0		1994	0.1	0.1	0	
1995	0.1	0.1	0		1996	0.389	0.389	0	
1997	4.857	4.857	0		1998	0.389	0.389	0	
1999	0.1	0.1	0		2000	0.1	0.1	0	
2001	1.36	1.36	0		2002	1.344	1.344	0	
2003	4.474	4.474	0		2004	3.841	3.841	0	
2005	0.15	0.15	0		2006	0.1	0.1	0	
2007	0.1	0.1	0		2008	0.15	0.15	0	
2009	3.793	3.793	0		2010	4.441	4.441	0	
2011	0.1	0.1	0		2012	0.1	0.1	0	
2013	0.2	0.2	0		2014	0.1	0.1	0	
2015	0.1	0.1	0		2016	0.1	0.1	0	
2017	0.2	0.2	0		2018	3.937	3.937	0	
2019	3.914	3.914	0		2020	0.304	0.304	0	
2021	0.304	0.304	0		2022	0.248	0.248	0	
2023	0.15	0.15	0		2024	0.252	0.252	0	
2025	0.248	0.248	0		2026	2.629	2.629	0	
2027	0.252	0.252	0		2028	4.124	4.124	0	
2029	4.128	4.128	0		2030	0.15	0.15	0	
2031	2.597	2.597	0		2032	0.43	0.43	0	
2033	4.081	4.081	0		2034	4.101	4.101	0	
2035	0.43	0.43	0		2036	0.232	0.232	0	
2037	4.311	4.311	0		2038	0.228	0.228	0	
2039	4.288	4.288	0		2040	0.2	0.2	0	
2041	0.15	0.15	0		2042	0.15	0.15	0	
2043	0.2	0.2	0		2044	2.22	2.22	0	
2045	4.404	4.404	0		2046	3.191	3.191	0	
2047	3.151	3.151	0		2048	4.358	4.358	0	
2049	2.208	2.208	0		2050	1.347	1.347	0	
2051	1.331	1.331	0		2052	0.368	0.368	0	
2053	0.368	0.368	0		2054	0.15	0.15	0	
2055	0.15	0.15	0		2056	0.133	0.133	0	
2057	0.133	0.133	0		2058	0.251	0.251	0	
2059	0.251	0.251	0		2060	4.658	4.658	0	
2061	0.309	0.309	0		2062	4.613	4.613	0	
2063	0.309	0.309	0		2064	3.841	3.841	0	
2065	0.2	0.2	0		2066	0.2	0.2	0	
2067	3.793	3.793	0		2068	0.15	0.15	0	
2069	0.15	0.15	0		2070	2.629	2.629	0	
2071	0.184	0.184	0		2072	0.184	0.184	0	
2073	2.597	2.597	0		2074	0.248	0.248	0	
2075	0.248	0.248	0		2076	4.901	4.901	0	
2077	0.15	0.15	0		2078	0.15	0.15	0	
2079	4.857	4.857	0		2080	0.404	0.404	0	
2081	0.404	0.404	0		2082	0.2	0.2	0	
2083	0.15	0.15	0		2084	0.15	0.15	0	
2085	0.2	0.2	0		2086	4.128	4.128	0	
2087	1.336	1.336	0		2088	1.32	1.32	0	
2089	4.081	4.081	0		2090	0.252	0.252	0	
2091	0.252	0.252	0		2092	3.191	3.191	0	
2093	3.151	3.151	0		2094	4.474	4.474	0	
2095	0.15	0.15	0		2096	0.15	0.15	0	
2097	4.441	4.441	0		2098	0.15	0.15	0	
2099	0.15	0.15	0		2100	0.389	0.389	0	
2101	0.15	0.15	0		2102	0.15	0.15	0	
2103	0.389	0.389	0		2104	0.232	0.232	0	
2105	0.304	0.304	0		2106	0.15	0.15	0	
2107	0.304	0.304	0		2108	0.228	0.228	0	
2109	3.937	3.937	0		2110	3.914	3.914	0	
2111	0.302	0.302	0		2112	0.2	0.2	0	
2113	0.2	0.2	0		2114	0.302	0.302	0	
2115	4.404	4.404	0		2116	4.358	4.358	0	
2117	2.629	2.629	0		2118	2.597	2.597	0	
2119	4.124	4.124	0		2120	3.841	3.841	0	
2121	3.793	3.793	0		2122	4.101	4.101	0	
2123	0.251	0.251	0		2124	0.251	0.251	0	
2125	0.2	0.2	0		2126	0.2	0.2	0	
2127	1.347	1.347	0		2128	1.331	1.331	0	
2129	4.311	4.311	0		2130	4.288	4.288	0	
2131	4.658	4.658	0		2132	4.613	4.613	0	
2133	0.261	0.261	0		2134	0.261	0.261	0	
2135	3.191	3.191	0		2136	0.309	0.309	0	
2137	0.309	0.309	0		2138	0.2	0.2	0	
2139	0.2	0.2	0		2140	3.151	3.151	0	
2141	2.22	2.22	0		2142	0.43	0.43	0	
2143	0.368	0.368	0		2144	0.368	0.368	0	
2145	0.43	0.43	0		2146	2.208	2.208	0	
2147	4.128	4.128	0		2148	0.252	0.252	0	
2149	0.252	0.252	0		2150	4.081	4.081	0	
2151	4.901	4.901	0		2152	0.248	0.248	0	
2153	0.2	0.2	0		2154	0.2	0.2	0	
2155	0.248	0.248	0		2156	4.857	4.857	0	
2157	2.629	2.629	0		2158	2.597	2.597	0	
2159	1.36	1.36	0		2160	0.2	0.2	0	
2161	0.2	0.2	0		2162	1.344	1.344	0	
2163	3.841	3.841	0		2164	0.251	0.251	0	
2165	0.251	0.251	0		2166	3.793	3.793	0	
2167	4.404	4.404	0		2168	0.304	0.304	0	
2169	0.2	0.2	0		2170	0.2	0.2	0	
2171	0.304	0.304	0		2172	4.358	4.358	0	
2173	4.474	4.474	0		2174	4.441	4.441	0	
2175	0.228	0.228	0		2176	0.232	0.232	0	
2177	0.2	0.2	0		2178	0.2	0.2	0	
2179	0.2	0.2	0		2180	0.2	0.2	0	
2181	3.191	3.191	0		2182	0.404	0.404	0	
2183	0.2	0.2	0		2184	0.404	0.404	0	
2185	0.133	0.133	0		2186	3.151	3.151	0	



Nodo	Massa X	Massa Y	Massa Z	Momento Z	Nodo	Massa X	Massa Y	Massa Z	Momento Z
2187	0.133	0.133	0		2188	3.937	3.937	0	
2189	0.389	0.389	0		2190	0.389	0.389	0	
2191	3.914	3.914	0		2192	0.252	0.252	0	
2193	0.252	0.252	0		2194	4.658	4.658	0	
2195	2.629	2.629	0		2196	0.248	0.248	0	
2197	0.248	0.248	0		2198	2.597	2.597	0	
2199	4.613	4.613	0		2200	1.347	1.347	0	
2201	1.331	1.331	0		2202	4.128	4.128	0	
2203	4.081	4.081	0		2204	0.309	0.309	0	
2205	0.309	0.309	0		2206	4.174	4.174	0	
2207	4.151	4.151	0		2208	0.184	0.184	0	
2209	0.184	0.184	0		2210	0.251	0.251	0	
2211	0.251	0.251	0		2212	4.311	4.311	0	
2213	3.841	3.841	0		2214	3.793	3.793	0	
2215	4.288	4.288	0		2216	4.901	4.901	0	
2217	0.302	0.302	0		2218	0.368	0.368	0	
2219	0.368	0.368	0		2220	0.302	0.302	0	
2221	4.857	4.857	0		2222	0.252	0.252	0	
2223	0.252	0.252	0		2224	3.191	3.191	0	
2225	3.151	3.151	0		2227	0.304	0.304	0	
2228	0.304	0.304	0		2229	4.358	4.358	0	
2230	1.336	1.336	0		2231	2.22	2.22	0	
2232	0.232	0.232	0		2233	0.228	0.228	0	
2234	1.32	1.32	0		2235	2.629	2.629	0	
2236	2.597	2.597	0		2237	2.208	2.208	0	
2238	0.251	0.251	0		2239	0.251	0.251	0	
2240	0.43	0.43	0		2241	0.43	0.43	0	
2242	4.474	4.474	0		2243	0.252	0.252	0	
2244	0.252	0.252	0		2245	4.441	4.441	0	
2246	4.128	4.128	0		2247	0.309	0.309	0	
2248	0.309	0.309	0		2249	4.081	4.081	0	
2250	0.251	0.251	0		2251	0.251	0.251	0	
2252	0.252	0.252	0		2253	0.252	0.252	0	
2254	4.658	4.658	0		2255	4.613	4.613	0	
2256	0.261	0.261	0		2257	0.389	0.389	0	
2258	0.251	0.251	0		2259	0.389	0.389	0	
2260	0.261	0.261	0		2261	3.937	3.937	0	
2262	0.248	0.248	0		2263	0.248	0.248	0	
2264	1.347	1.347	0		2265	1.331	1.331	0	
2266	3.914	3.914	0		2267	3.841	3.841	0	
2268	3.793	3.793	0		2269	3.191	3.191	0	
2270	3.151	3.151	0		2271	2.629	2.629	0	
2272	0.404	0.404	0		2273	0.404	0.404	0	
2274	2.597	2.597	0		2275	0.304	0.304	0	
2276	0.304	0.304	0		2277	4.124	4.124	0	
2278	4.101	4.101	0		2279	4.404	4.404	0	
2280	4.901	4.901	0		2281	0.368	0.368	0	
2282	0.368	0.368	0		2283	4.358	4.358	0	
2284	4.857	4.857	0		2285	0.228	0.228	0	
2286	0.309	0.309	0		2287	0.309	0.309	0	
2288	0.232	0.232	0		2289	0.133	0.133	0	
2290	0.133	0.133	0		2291	1.36	1.36	0	
2292	1.344	1.344	0		2293	4.311	4.311	0	
2294	0.248	0.248	0		2295	0.248	0.248	0	
2296	4.288	4.288	0		2297	4.128	4.128	0	
2298	4.081	4.081	0		2299	2.629	2.629	0	
2300	2.597	2.597	0		2301	3.191	3.191	0	
2302	0.304	0.304	0		2303	0.304	0.304	0	
2304	3.151	3.151	0		2305	3.841	3.841	0	
2306	3.793	3.793	0		2307	4.474	4.474	0	
2308	4.441	4.441	0		2309	2.22	2.22	0	
2310	0.309	0.309	0		2311	0.309	0.309	0	
2312	0.389	0.389	0		2313	4.658	4.658	0	
2314	0.302	0.302	0		2315	0.389	0.389	0	
2316	0.302	0.302	0		2317	2.208	2.208	0	
2318	4.613	4.613	0		2319	0.184	0.184	0	
2320	0.184	0.184	0		2321	0.43	0.43	0	
2322	0.43	0.43	0		2323	1.347	1.347	0	
2324	1.331	1.331	0		2325	0.304	0.304	0	
2326	0.304	0.304	0		2327	0.309	0.309	0	
2328	0.309	0.309	0		2329	0.304	0.304	0	
2330	3.937	3.937	0		2331	3.914	3.914	0	
2332	0.368	0.368	0		2333	0.368	0.368	0	
2334	4.404	4.404	0		2335	2.629	2.629	0	
2336	2.597	2.597	0		2337	4.358	4.358	0	
2338	0.232	0.232	0		2339	0.228	0.228	0	
2340	0.404	0.404	0		2341	0.404	0.404	0	
2342	3.191	3.191	0		2343	3.151	3.151	0	
2344	4.901	4.901	0		2345	4.128	4.128	0	
2346	4.081	4.081	0		2347	4.857	4.857	0	
2348	3.841	3.841	0		2349	3.793	3.793	0	
2350	1.336	1.336	0		2351	1.32	1.32	0	
2352	0.248	0.248	0		2353	0.248	0.248	0	
2354	4.124	4.124	0		2355	4.101	4.101	0	
2356	0.389	0.389	0		2357	0.389	0.389	0	
2358	0.261	0.261	0		2359	0.261	0.261	0	
2360	2.629	2.629	0		2361	2.597	2.597	0	
2362	0.368	0.368	0		2363	0.368	0.368	0	
2364	4.311	4.311	0		2365	4.658	4.658	0	
2366	4.613	4.613	0		2367	4.288	4.288	0	
2368	4.474	4.474	0		2369	3.191	3.191	0	
2370	1.347	1.347	0		2371	1.331	1.331	0	
2372	3.151	3.151	0		2373	4.441	4.441	0	
2374	0.248	0.248	0		2375	0.133	0.133	0	
2376	0.248	0.248	0		2377	0.133	0.133	0	
2378	0.43	0.43	0		2379	4.404	4.404	0	
2380	0.43	0.43	0		2381	0.389	0.389	0	



Nodo	Massa X	Massa Y	Massa Z	Momento Z	Nodo	Massa X	Massa Y	Massa Z	Momento Z
2382	0.389	0.389	0		2383	4.358	4.358	0	
2384	3.841	3.841	0		2385	0.228	0.228	0	
2386	0.232	0.232	0		2387	3.793	3.793	0	
2388	4.128	4.128	0		2389	0.302	0.302	0	
2390	4.081	4.081	0		2391	2.22	2.22	0	
2392	0.302	0.302	0		2393	0.368	0.368	0	
2394	0.368	0.368	0		2395	2.208	2.208	0	
2396	0.404	0.404	0		2397	0.404	0.404	0	
2398	2.629	2.629	0		2399	2.597	2.597	0	
2400	0.368	0.368	0		2401	3.937	3.937	0	
2402	0.389	0.389	0		2403	0.389	0.389	0	
2404	3.914	3.914	0		2405	1.36	1.36	0	
2406	1.344	1.344	0		2407	4.901	4.901	0	
2408	4.857	4.857	0		2409	3.191	3.191	0	
2410	3.151	3.151	0		2411	0.184	0.184	0	
2412	0.184	0.184	0		2413	4.124	4.124	0	
2414	4.101	4.101	0		2415	4.658	4.658	0	
2416	0.248	0.248	0		2417	0.248	0.248	0	
2418	4.613	4.613	0		2419	2.629	2.629	0	
2420	1.347	1.347	0		2421	0.228	0.228	0	
2422	1.347	1.347	0		2423	2.597	2.597	0	
2424	0.232	0.232	0		2425	3.841	3.841	0	
2426	3.793	3.793	0		2427	4.404	4.404	0	
2428	0.43	0.43	0		2429	0.43	0.43	0	
2431	4.128	4.128	0		2432	0.404	0.404	0	
2433	0.404	0.404	0		2434	4.081	4.081	0	
2435	4.474	4.474	0		2436	4.441	4.441	0	
2437	3.191	3.191	0		2438	3.151	3.151	0	
2439	0.261	0.261	0		2440	0.261	0.261	0	
2441	4.311	4.311	0		2442	4.288	4.288	0	
2443	0.248	0.248	0		2444	0.248	0.248	0	
2445	1.336	1.336	0		2446	1.336	1.336	0	
2447	0.302	0.302	0		2448	0.302	0.302	0	
2449	0.133	0.133	0		2450	0.133	0.133	0	
2451	2.629	2.629	0		2452	2.613	2.613	0	
2453	0.404	0.404	0		2454	0.404	0.404	0	
2455	4.901	4.901	0		2456	4.857	4.857	0	
2457	3.841	3.841	0		2458	3.793	3.793	0	
2459	3.937	3.937	0		2460	0.43	0.43	0	
2461	0.404	0.404	0		2462	0.228	0.228	0	
2463	0.43	0.43	0		2464	0.232	0.232	0	
2465	3.914	3.914	0		2466	2.22	2.22	0	
2467	2.208	2.208	0		2468	1.347	1.347	0	
2469	1.347	1.347	0		2470	4.658	4.658	0	
2471	3.191	3.191	0		2472	3.151	3.151	0	
2473	4.613	4.613	0		2474	4.128	4.128	0	
2475	4.081	4.081	0		2476	4.404	4.404	0	
2477	2.629	2.629	0		2478	2.629	2.629	0	
2479	0.248	0.248	0		2480	0.248	0.248	0	
2481	4.358	4.358	0		2482	0.43	0.43	0	
2483	0.43	0.43	0		2484	0.184	0.184	0	
2485	0.184	0.184	0		2486	4.174	4.174	0	
2487	4.151	4.151	0		2488	1.36	1.36	0	
2489	1.36	1.36	0		2490	0.302	0.302	0	
2491	0.302	0.302	0		2492	0.248	0.248	0	
2493	4.474	4.474	0		2494	3.841	3.841	0	
2495	0.232	0.232	0		2496	0.248	0.248	0	
2497	0.228	0.228	0		2498	3.793	3.793	0	
2499	4.441	4.441	0		2500	3.191	3.191	0	
2501	2.629	2.629	0		2502	2.629	2.629	0	
2503	3.167	3.167	0		2504	0.133	0.133	0	
2505	0.133	0.133	0		2506	0.261	0.261	0	
2507	0.261	0.261	0		2508	1.347	1.347	0	
2509	1.347	1.347	0		2510	4.311	4.311	0	
2511	4.901	4.901	0		2512	4.128	4.128	0	
2513	4.081	4.081	0		2514	4.857	4.857	0	
2515	4.288	4.288	0		2516	0.248	0.248	0	
2517	0.248	0.248	0		2518	0.302	0.302	0	
2519	0.302	0.302	0		2520	4.658	4.658	0	
2521	4.613	4.613	0		2522	3.937	3.937	0	
2523	4.404	4.404	0		2524	4.358	4.358	0	
2525	3.914	3.914	0		2526	2.629	2.629	0	
2527	0.228	0.228	0		2528	0.232	0.232	0	
2529	1.336	1.336	0		2530	2.629	2.629	0	
2531	0.248	0.248	0		2532	0.248	0.248	0	
2533	1.336	1.336	0		2534	3.191	3.191	0	
2535	0.302	0.302	0		2536	3.841	3.841	0	
2537	3.191	3.191	0		2538	3.793	3.793	0	
2539	2.22	2.22	0		2540	0.248	0.248	0	
2541	0.248	0.248	0		2542	2.208	2.208	0	
2543	0.184	0.184	0		2544	0.133	0.133	0	
2545	0.248	0.248	0		2546	0.248	0.248	0	
2547	0.133	0.133	0		2548	0.184	0.184	0	
2549	1.347	1.347	0		2550	1.347	1.347	0	
2551	0.232	0.232	0		2552	0.228	0.228	0	
2553	4.128	4.128	0		2554	2.629	2.629	0	
2555	2.629	2.629	0		2556	4.081	4.081	0	
2557	4.124	4.124	0		2558	4.101	4.101	0	
2559	4.474	4.474	0		2560	0.261	0.261	0	
2561	0.261	0.261	0		2562	4.441	4.441	0	
2563	3.191	3.191	0		2564	3.191	3.191	0	
2565	0.133	0.133	0		2566	0.133	0.133	0	
2567	1.36	1.36	0		2568	1.36	1.36	0	
2569	4.404	4.404	0		2570	3.841	3.841	0	
2571	3.817	3.817	0		2572	4.358	4.358	0	
2573	4.901	4.901	0		2574	4.857	4.857	0	
2575	0.228	0.228	0		2576	0.232	0.232	0	



Nodo	Massa X	Massa Y	Massa Z	Momento Z	Nodo	Massa X	Massa Y	Massa Z	Momento Z
2577	2.629	2.629	0		2578	2.629	2.629	0	
2579	4.658	4.658	0		2580	4.613	4.613	0	
2581	1.347	1.347	0		2582	1.347	1.347	0	
2583	4.311	4.311	0		2584	4.288	4.288	0	
2585	0.184	0.184	0		2586	0.184	0.184	0	
2587	3.191	3.191	0		2588	0.232	0.232	0	
2589	3.937	3.937	0		2590	0.261	0.261	0	
2591	0.261	0.261	0		2592	0.228	0.228	0	
2593	3.191	3.191	0		2594	3.914	3.914	0	
2595	4.128	4.128	0		2596	1.336	1.336	0	
2597	1.336	1.336	0		2598	4.081	4.081	0	
2599	2.629	2.629	0		2600	2.629	2.629	0	
2601	3.841	3.841	0		2602	0.228	0.228	0	
2603	0.261	0.261	0		2604	0.232	0.232	0	
2605	3.841	3.841	0		2606	0.232	0.232	0	
2607	0.228	0.228	0		2608	1.347	1.347	0	
2609	0.184	0.184	0		2610	0.184	0.184	0	
2611	1.347	1.347	0		2612	4.454	4.454	0	
2613	4.358	4.358	0		2614	2.22	2.22	0	
2615	2.208	2.208	0		2616	3.191	3.191	0	
2617	2.629	2.629	0		2618	2.629	2.629	0	
2619	3.191	3.191	0		2620	4.474	4.474	0	
2621	4.441	4.441	0		2622	4.124	4.124	0	
2623	1.36	1.36	0		2624	1.36	1.36	0	
2625	4.101	4.101	0		2626	4.658	4.658	0	
2627	4.613	4.613	0		2628	4.901	4.901	0	
2629	4.857	4.857	0		2630	3.841	3.841	0	
2631	1.347	1.347	0		2632	1.347	1.347	0	
2633	3.841	3.841	0		2634	4.128	4.128	0	
2635	4.105	4.105	0		2636	2.629	2.629	0	
2637	2.629	2.629	0		2638	3.191	3.191	0	
2639	1.336	1.336	0		2640	1.336	1.336	0	
2641	3.191	3.191	0		2642	1.347	1.347	0	
2643	1.347	1.347	0		2644	3.937	3.937	0	
2645	2.629	2.629	0		2646	2.629	2.629	0	
2647	3.914	3.914	0		2648	4.311	4.311	0	
2649	4.288	4.288	0		2650	4.404	4.404	0	
2651	1.36	1.36	0		2652	1.36	1.36	0	
2653	4.358	4.358	0		2654	1.347	1.347	0	
2655	1.347	1.347	0		2656	3.841	3.841	0	
2657	3.191	3.191	0		2658	1.336	1.336	0	
2659	1.336	1.336	0		2660	3.191	3.191	0	
2661	3.841	3.841	0		2662	1.347	1.347	0	
2663	1.347	1.347	0		2664	4.128	4.128	0	
2665	2.629	2.629	0		2666	1.36	1.36	0	
2667	2.629	2.629	0		2668	4.128	4.128	0	
2669	4.658	4.658	0		2670	4.613	4.613	0	
2671	4.474	4.474	0		2672	4.901	4.901	0	
2673	4.857	4.857	0		2674	4.441	4.441	0	
2675	2.629	2.629	0		2676	2.629	2.629	0	
2677	3.191	3.191	0		2678	3.191	3.191	0	
2679	2.22	2.22	0		2680	2.208	2.208	0	
2681	4.124	4.124	0		2682	4.101	4.101	0	
2683	3.841	3.841	0		2684	3.841	3.841	0	
2685	4.404	4.404	0		2686	2.629	2.629	0	
2687	2.629	2.629	0		2688	4.381	4.381	0	
2689	4.128	4.128	0		2690	4.128	4.128	0	
2691	3.191	3.191	0		2692	2.629	2.629	0	
2693	2.629	2.629	0		2694	3.191	3.191	0	
2695	3.937	3.937	0		2696	3.914	3.914	0	
2697	4.658	4.658	0		2698	2.629	2.629	0	
2699	2.629	2.629	0		2700	4.613	4.613	0	
2701	3.841	3.841	0		2702	3.841	3.841	0	
2703	4.311	4.311	0		2704	4.288	4.288	0	
2705	3.191	3.191	0		2706	3.191	3.191	0	
2707	2.629	2.629	0		2708	2.629	2.629	0	
2709	4.901	4.901	0		2710	4.857	4.857	0	
2711	4.474	4.474	0		2712	4.441	4.441	0	
2713	4.404	4.404	0		2714	2.629	2.629	0	
2715	2.629	2.629	0		2716	4.128	4.128	0	
2717	4.128	4.128	0		2718	4.404	4.404	0	
2719	2.629	2.629	0		2720	2.629	2.629	0	
2721	3.191	3.191	0		2722	3.191	3.191	0	
2723	2.629	2.629	0		2724	2.629	2.629	0	
2725	3.841	3.841	0		2726	2.629	2.629	0	
2727	2.629	2.629	0		2728	3.841	3.841	0	
2729	2.629	2.629	0		2730	4.174	4.174	0	
2731	4.151	4.151	0		2732	2.22	2.22	0	
2733	3.191	3.191	0		2734	3.191	3.191	0	
2735	2.208	2.208	0		2736	4.658	4.658	0	
2737	4.636	4.636	0		2738	3.841	3.841	0	
2739	3.841	3.841	0		2740	4.128	4.128	0	
2741	4.128	4.128	0		2742	3.937	3.937	0	
2743	3.914	3.914	0		2744	4.404	4.404	0	
2745	3.191	3.191	0		2746	3.191	3.191	0	
2747	4.454	4.454	0		2748	4.901	4.901	0	
2749	4.857	4.857	0		2750	3.191	3.191	0	
2751	3.191	3.191	0		2752	4.474	4.474	0	
2753	4.441	4.441	0		2754	4.311	4.311	0	
2755	4.288	4.288	0		2756	3.841	3.841	0	
2757	3.191	3.191	0		2758	3.191	3.191	0	
2759	3.841	3.841	0		2760	4.128	4.128	0	
2761	4.151	4.151	0		2762	4.658	4.658	0	
2763	3.191	3.191	0		2764	3.191	3.191	0	
2765	4.658	4.658	0		2766	4.404	4.404	0	
2767	4.404	4.404	0		2768	4.124	4.124	0	
2769	3.841	3.841	0		2770	3.841	3.841	0	



Nodo	Massa X	Massa Y	Massa Z	Momento Z	Nodo	Massa X	Massa Y	Massa Z	Momento Z
2771	4.101	4.101	0		2772	3.191	3.191	0	
2773	3.191	3.191	0		2774	3.191	3.191	0	
2775	3.191	3.191	0		2776	3.191	3.191	0	
2777	3.191	3.191	0		2778	3.191	3.191	0	
2779	3.191	3.191	0		2780	4.128	4.128	0	
2781	4.151	4.151	0		2782	2.22	2.22	0	
2783	3.937	3.937	0		2784	4.901	4.901	0	
2785	3.191	3.191	0		2786	4.879	4.879	0	
2787	3.914	3.914	0		2788	2.208	2.208	0	
2789	3.841	3.841	0		2790	3.841	3.841	0	
2791	4.474	4.474	0		2792	4.441	4.441	0	
2793	4.658	4.658	0		2794	4.658	4.658	0	
2795	4.404	4.404	0		2796	4.404	4.404	0	
2797	3.841	3.841	0		2798	3.841	3.841	0	
2799	4.311	4.311	0		2800	4.128	4.128	0	
2801	4.151	4.151	0		2802	4.288	4.288	0	
2803	3.841	3.841	0		2804	3.841	3.841	0	
2805	4.124	4.124	0		2806	4.901	4.901	0	
2807	4.901	4.901	0		2808	4.101	4.101	0	
2809	4.404	4.404	0		2810	4.358	4.358	0	
2811	3.841	3.841	0		2812	3.841	3.841	0	
2813	4.128	4.128	0		2814	4.151	4.151	0	
2815	3.937	3.937	0		2816	4.658	4.658	0	
2817	4.658	4.658	0		2818	3.914	3.914	0	
2819	3.841	3.841	0		2820	3.841	3.841	0	
2821	2.22	2.22	0		2822	4.474	4.474	0	
2823	4.463	4.463	0		2824	2.208	2.208	0	
2825	4.128	4.128	0		2826	3.841	3.841	0	
2827	3.841	3.841	0		2828	4.128	4.128	0	
2829	4.454	4.454	0		2830	4.358	4.358	0	
2831	4.311	4.311	0		2832	3.841	3.841	0	
2833	3.841	3.841	0		2834	4.901	4.901	0	
2835	4.901	4.901	0		2836	4.288	4.288	0	
2837	3.841	3.841	0		2838	3.841	3.841	0	
2839	4.128	4.128	0		2840	3.841	3.841	0	
2841	3.841	3.841	0		2842	4.128	4.128	0	
2843	4.658	4.658	0		2844	3.841	3.841	0	
2845	3.841	3.841	0		2846	4.658	4.658	0	
2847	3.841	3.841	0		2848	4.124	4.124	0	
2849	4.101	4.101	0		2850	4.404	4.404	0	
2851	4.358	4.358	0		2852	4.474	4.474	0	
2853	4.474	4.474	0		2854	3.937	3.937	0	
2855	4.128	4.128	0		2856	4.128	4.128	0	
2857	3.925	3.925	0		2858	2.22	2.22	0	
2859	4.901	4.901	0		2860	4.658	4.658	0	
2861	4.59	4.59	0		2862	4.901	4.901	0	
2863	2.208	2.208	0		2864	4.128	4.128	0	
2865	4.128	4.128	0		2866	4.404	4.404	0	
2867	4.358	4.358	0		2868	4.128	4.128	0	
2869	4.128	4.128	0		2870	4.311	4.311	0	
2871	4.288	4.288	0		2872	4.474	4.474	0	
2873	4.474	4.474	0		2874	4.128	4.128	0	
2875	4.128	4.128	0		2876	4.174	4.174	0	
2877	3.937	3.937	0		2878	4.658	4.658	0	
2879	4.404	4.404	0		2880	4.404	4.404	0	
2881	4.59	4.59	0		2882	3.937	3.937	0	
2883	4.163	4.163	0		2884	4.128	4.128	0	
2885	4.128	4.128	0		2886	4.901	4.901	0	
2887	4.901	4.901	0		2888	4.404	4.404	0	
2889	4.128	4.128	0		2890	4.128	4.128	0	
2892	4.128	4.128	0		2893	4.128	4.128	0	
2894	4.128	4.128	0		2895	4.128	4.128	0	
2896	2.22	2.22	0		2897	4.658	4.658	0	
2898	4.59	4.59	0		2899	2.208	2.208	0	
2900	4.128	4.128	0		2901	4.128	4.128	0	
2902	4.128	4.128	0		2903	4.474	4.474	0	
2904	4.474	4.474	0		2905	4.404	4.404	0	
2906	4.404	4.404	0		2907	4.901	4.901	0	
2908	4.901	4.901	0		2909	4.311	4.311	0	
2910	3.937	3.937	0		2911	3.937	3.937	0	
2912	4.3	4.3	0		2913	4.124	4.124	0	
2914	4.124	4.124	0		2915	4.658	4.658	0	
2916	4.59	4.59	0		2917	4.404	4.404	0	
2918	4.404	4.404	0		2919	4.404	4.404	0	
2920	4.404	4.404	0		2921	4.901	4.901	0	
2922	4.901	4.901	0		2923	4.474	4.474	0	
2924	4.658	4.658	0		2925	4.658	4.658	0	
2926	4.474	4.474	0		2928	4.404	4.404	0	
2929	2.22	2.22	0		2930	3.937	3.937	0	
2931	3.937	3.937	0		2932	2.22	2.22	0	
2933	4.311	4.311	0		2934	4.124	4.124	0	
2935	4.124	4.124	0		2936	4.311	4.311	0	
2937	4.404	4.404	0		2938	4.404	4.404	0	
2939	4.658	4.658	0		2940	4.658	4.658	0	
2941	4.901	4.901	0		2942	4.901	4.901	0	
2943	4.404	4.404	0		2944	4.404	4.404	0	
2945	4.474	4.474	0		2946	4.404	4.404	0	
2947	4.404	4.404	0		2948	4.474	4.474	0	
2949	4.404	4.404	0		2951	4.404	4.404	0	
2952	4.404	4.404	0		2953	4.658	4.658	0	
2954	4.658	4.658	0		2955	4.404	4.404	0	
2956	3.937	3.937	0		2957	3.937	3.937	0	
2958	2.22	2.22	0		2959	4.124	4.124	0	
2960	4.901	4.901	0		2961	4.901	4.901	0	
2962	4.124	4.124	0		2963	2.22	2.22	0	
2964	4.311	4.311	0		2965	4.311	4.311	0	
2966	4.658	4.658	0		2967	4.658	4.658	0	



Nodo	Massa X	Massa Y	Massa Z	Momento Z	Nodo	Massa X	Massa Y	Massa Z	Momento Z
2968	4.474	4.474	0		2969	4.474	4.474	0	
2970	4.658	4.658	0		2971	4.658	4.658	0	
2972	4.901	4.901	0		2973	4.901	4.901	0	
2974	3.937	3.937	0		2975	3.937	3.937	0	
2976	4.658	4.658	0		2977	4.658	4.658	0	
2978	4.474	4.474	0		2979	4.474	4.474	0	
2980	4.174	4.174	0		2981	4.901	4.901	0	
2982	4.901	4.901	0		2983	4.174	4.174	0	
2984	4.658	4.658	0		2985	4.658	4.658	0	
2986	2.22	2.22	0		2987	4.311	4.311	0	
2988	4.311	4.311	0		2989	2.22	2.22	0	
2990	4.658	4.658	0		2991	4.658	4.658	0	
2992	3.937	3.937	0		2993	4.658	4.658	0	
2994	4.68	4.68	0		2995	3.937	3.937	0	
2996	4.901	4.901	0		2997	4.658	4.658	0	
2998	4.68	4.68	0		2999	4.901	4.901	0	
3000	4.658	4.658	0		3001	4.68	4.68	0	
3002	4.474	4.474	0		3003	4.68	4.68	0	
3004	4.474	4.474	0		3005	4.124	4.124	0	
3006	4.124	4.124	0		3007	4.901	4.901	0	
3008	4.901	4.901	0		3009	4.311	4.311	0	
3010	4.311	4.311	0		3011	2.22	2.22	0	
3012	2.22	2.22	0		3013	3.937	3.937	0	
3014	3.937	3.937	0		3015	4.474	4.474	0	
3016	4.474	4.474	0		3017	4.901	4.901	0	
3018	4.901	4.901	0		3019	4.124	4.124	0	
3020	4.901	4.901	0		3021	4.901	4.901	0	
3022	4.124	4.124	0		3023	4.474	4.474	0	
3024	4.474	4.474	0		3025	4.901	4.901	0	
3026	4.901	4.901	0		3027	4.311	4.311	0	
3028	3.937	3.937	0		3029	3.937	3.937	0	
3030	4.311	4.311	0		3031	2.22	2.22	0	
3032	4.901	4.901	0		3033	4.901	4.901	0	
3034	2.22	2.22	0		3035	4.474	4.474	0	
3036	4.474	4.474	0		3037	4.901	4.901	0	
3038	4.857	4.857	0		3039	4.124	4.124	0	
3040	4.124	4.124	0		3041	4.901	4.901	0	
3042	4.857	4.857	0		3043	3.937	3.937	0	
3044	3.937	3.937	0		3045	4.901	4.901	0	
3046	4.857	4.857	0		3047	4.857	4.857	0	
3048	4.311	4.311	0		3049	4.311	4.311	0	
3050	4.474	4.474	0		3051	4.474	4.474	0	
3052	3.937	3.937	0		3053	3.937	3.937	0	
3054	2.22	2.22	0		3055	2.22	2.22	0	
3056	4.474	4.474	0		3057	4.474	4.474	0	
3058	4.174	4.174	0		3059	4.174	4.174	0	
3060	4.474	4.474	0		3061	4.474	4.474	0	
3062	4.311	4.311	0		3063	3.937	3.937	0	
3064	3.937	3.937	0		3065	4.311	4.311	0	
3066	4.124	4.124	0		3067	4.474	4.474	0	
3068	4.474	4.474	0		3069	4.124	4.124	0	
3070	2.22	2.22	0		3071	2.22	2.22	0	
3072	4.474	4.474	0		3073	4.474	4.474	0	
3074	3.937	3.937	0		3075	3.937	3.937	0	
3076	4.474	4.474	0		3077	4.409	4.409	0	
3078	4.474	4.474	0		3079	4.409	4.409	0	
3080	4.124	4.124	0		3081	4.124	4.124	0	
3082	4.311	4.311	0		3083	4.474	4.474	0	
3084	4.409	4.409	0		3085	4.311	4.311	0	
3086	3.937	3.937	0		3087	3.937	3.937	0	
3088	4.409	4.409	0		3089	2.22	2.22	0	
3090	2.22	2.22	0		3091	3.937	3.937	0	
3092	3.937	3.937	0		3093	4.124	4.124	0	
3094	4.124	4.124	0		3095	4.311	4.311	0	
3096	4.311	4.311	0		3097	3.937	3.937	0	
3098	3.937	3.937	0		3099	4.174	4.174	0	
3100	3.937	3.937	0		3101	3.937	3.937	0	
3102	4.174	4.174	0		3103	4.311	4.311	0	
3104	3.937	3.937	0		3105	3.937	3.937	0	
3106	4.311	4.311	0		3107	2.22	2.22	0	
3108	2.22	2.22	0		3109	3.937	3.937	0	
3110	3.937	3.937	0		3111	4.124	4.124	0	
3112	3.937	3.937	0		3113	3.937	3.937	0	
3114	4.124	4.124	0		3115	3.937	3.937	0	
3116	4.124	4.124	0		3117	4.124	4.124	0	
3118	4.311	4.311	0		3119	4.311	4.311	0	
3120	2.22	2.22	0		3121	2.22	2.22	0	
3122	4.124	4.124	0		3123	4.124	4.124	0	
3124	4.311	4.311	0		3125	4.311	4.311	0	
3126	2.22	2.22	0		3127	4.174	4.174	0	
3128	4.174	4.174	0		3129	2.22	2.22	0	
3130	4.124	4.124	0		3131	4.124	4.124	0	
3132	4.124	4.124	0		3133	4.124	4.124	0	
3134	4.311	4.311	0		3135	4.311	4.311	0	
3136	4.124	4.124	0		3137	4.124	4.124	0	
3138	4.174	4.174	0		3139	2.22	2.22	0	
3140	2.22	2.22	0		3141	4.311	4.311	0	
3142	4.311	4.311	0		3143	4.311	4.311	0	
3144	4.311	4.311	0		3145	2.22	2.22	0	
3146	2.22	2.22	0		3147	4.311	4.311	0	
3148	4.311	4.311	0		3149	4.311	4.311	0	
3150	4.311	4.311	0		3151	2.22	2.22	0	
3152	4.311	4.311	0		3153	4.311	4.311	0	
3154	2.22	2.22	0		3155	4.311	4.311	0	
3156	4.311	4.311	0		3157	4.311	4.311	0	
3158	2.22	2.22	0		3159	2.22	2.22	0	
3160	2.22	2.22	0		3161	2.22	2.22	0	





Nodo	Massa X	Massa Y	Massa Z	Momento Z	Nodo	Massa X	Massa Y	Massa Z	Momento Z
3162	2.22	2.22	0		3163	2.22	2.22	0	
3164	2.22	2.22	0		3165	2.22	2.22	0	
3166	2.22	2.22	0		3167	2.22	2.22	0	
3168	2.22	2.22	0		3169	2.22	2.22	0	
3170	2.22	2.22	0		3171	1.472	1.472	0	
3172	1.472	1.472	0		3173	1.472	1.472	0	
3174	1.472	1.472	0		3175	1.472	1.472	0	
3176	1.472	1.472	0		3177	1.472	1.472	0	
3178	1.472	1.472	0		3179	1.472	1.472	0	
3180	1.472	1.472	0		3181	1.472	1.472	0	
3182	1.472	1.472	0		3183	1.472	1.472	0	
3184	1.472	1.472	0		3185	1.472	1.472	0	
3186	1.472	1.472	0		3187	1.472	1.472	0	
3188	1.472	1.472	0		3189	1.472	1.472	0	
3190	1.472	1.472	0		3191	1.472	1.472	0	
3192	1.472	1.472	0		3193	1.472	1.472	0	
3194	1.472	1.472	0		3195	1.472	1.472	0	
3196	1.472	1.472	0		3197	1.472	1.472	0	
3198	1.472	1.472	0		3199	1.472	1.472	0	
3200	1.472	1.472	0		3201	1.472	1.472	0	
3202	1.472	1.472	0		3203	1.472	1.472	0	
3204	1.472	1.472	0		3205	1.472	1.472	0	
3206	1.472	1.472	0		3207	3.212	3.212	0	
3208	3.212	3.212	0		3209	3.212	3.212	0	
3210	3.212	3.212	0		3211	3.212	3.212	0	
3212	3.212	3.212	0		3213	3.212	3.212	0	
3214	3.212	3.212	0		3215	3.212	3.212	0	
3216	3.212	3.212	0		3217	3.212	3.212	0	
3218	3.212	3.212	0		3219	3.212	3.212	0	
3220	3.212	3.212	0		3221	3.212	3.212	0	
3222	3.212	3.212	0		3223	3.212	3.212	0	
3224	3.212	3.212	0		3225	3.212	3.212	0	
3226	3.212	3.212	0		3227	3.212	3.212	0	
3228	3.212	3.212	0		3229	3.212	3.212	0	
3230	3.212	3.212	0		3231	3.212	3.212	0	
3232	3.212	3.212	0		3233	3.212	3.212	0	
3234	3.212	3.212	0		3235	3.212	3.212	0	
3236	3.212	3.212	0		3237	3.212	3.212	0	
3238	3.212	3.212	0		3239	3.212	3.212	0	
3240	3.212	3.212	0		3241	3.212	3.212	0	
3242	3.212	3.212	0		3243	4.591	4.591	0	
3244	4.591	4.591	0		3245	4.591	4.591	0	
3246	4.591	4.591	0		3247	4.591	4.591	0	
3248	4.591	4.591	0		3249	4.591	4.591	0	
3250	4.591	4.591	0		3251	4.591	4.591	0	
3252	4.591	4.591	0		3253	4.591	4.591	0	
3254	4.591	4.591	0		3255	4.591	4.591	0	
3256	4.591	4.591	0		3257	4.591	4.591	0	
3258	4.591	4.591	0		3259	4.591	4.591	0	
3260	4.591	4.591	0		3261	4.591	4.591	0	
3262	4.591	4.591	0		3263	4.591	4.591	0	
3264	4.591	4.591	0		3265	4.591	4.591	0	
3266	4.591	4.591	0		3267	4.591	4.591	0	
3268	4.591	4.591	0		3269	4.591	4.591	0	
3270	4.591	4.591	0		3271	4.591	4.591	0	
3272	4.591	4.591	0		3273	4.591	4.591	0	
3274	4.591	4.591	0		3275	4.591	4.591	0	
3276	4.591	4.591	0		3277	4.591	4.591	0	
3278	4.591	4.591	0		3279	0.867	0.867	0	
3280	0.867	0.867	0		3281	0.867	0.867	0	
3282	0.867	0.867	0		3283	0.867	0.867	0	
3284	0.867	0.867	0		3285	0.867	0.867	0	
3286	0.867	0.867	0		3287	0.867	0.867	0	
3288	0.867	0.867	0		3289	0.867	0.867	0	
3290	0.867	0.867	0		3291	0.867	0.867	0	
3292	0.867	0.867	0		3293	0.867	0.867	0	
3294	0.867	0.867	0		3295	0.867	0.867	0	
3296	0.867	0.867	0		3297	0.867	0.867	0	
3298	0.867	0.867	0		3299	0.867	0.867	0	
3300	0.867	0.867	0		3301	0.867	0.867	0	
3302	0.867	0.867	0		3303	0.867	0.867	0	
3304	0.817	0.817	0		3305	0.817	0.817	0	
3306	0.817	0.817	0		3307	0.817	0.817	0	
3308	0.817	0.817	0		3309	0.867	0.867	0	
3310	0.817	0.817	0		3311	0.817	0.817	0	
3312	0.867	0.867	0		3313	0.817	0.817	0	
3314	0.817	0.817	0		3315	0.817	0.817	0	
3316	0.817	0.817	0		3317	0.817	0.817	0	
3318	0.817	0.817	0		3319	0.867	0.867	0	
3320	0.867	0.867	0		3321	0.817	0.817	0	
3322	0.817	0.817	0		3323	0.817	0.817	0	
3324	0.817	0.817	0		3325	0.867	0.867	0	
3326	0.867	0.867	0		3327	0.817	0.817	0	
3328	0.817	0.817	0		3329	0.817	0.817	0	
3330	0.817	0.817	0		3331	0.867	0.867	0	
3332	0.867	0.867	0		3333	0.817	0.817	0	
3334	0.817	0.817	0		3335	0.817	0.817	0	
3336	0.817	0.817	0		3337	0.867	0.867	0	
3338	0.867	0.867	0		3339	0.817	0.817	0	
3340	0.817	0.817	0		3341	0.867	0.867	0	
3342	0.867	0.867	0		3343	0.817	0.817	0	
3344	0.817	0.817	0		3345	0.867	0.867	0	
3346	0.817	0.817	0		3347	0.817	0.817	0	
3348	0.867	0.867	0		3349	0.817	0.817	0	
3350	0.817	0.817	0		3351	0.867	0.867	0	
3352	0.867	0.867	0		3353	0.817	0.817	0	
3354	0.817	0.817	0		3355	0.867	0.867	0	



Nodo	Massa X	Massa Y	Massa Z	Momento Z	Nodo	Massa X	Massa Y	Massa Z	Momento Z
3356	0.867	0.867	0		3357	0.817	0.817	0	
3358	0.817	0.817	0		3359	0.817	0.817	0	
3360	0.817	0.817	0		3361	0.867	0.867	0	
3362	0.867	0.867	0		3363	0.817	0.817	0	
3364	0.817	0.817	0		3365	0.867	0.867	0	
3366	0.867	0.867	0		3367	0.817	0.817	0	
3368	0.817	0.817	0		3369	0.867	0.867	0	
3370	0.867	0.867	0		3371	0.817	0.817	0	
3372	0.817	0.817	0		3373	0.867	0.867	0	
3374	0.867	0.867	0		3375	0.817	0.817	0	
3376	0.817	0.817	0		3377	0.817	0.817	0	
3378	0.817	0.817	0		3379	0.867	0.867	0	
3380	0.867	0.867	0		3381	0.817	0.817	0	
3382	0.817	0.817	0		3383	0.867	0.867	0	
3384	0.867	0.867	0		3385	0.817	0.817	0	
3386	0.817	0.817	0		3387	0.867	0.867	0	
3388	0.867	0.867	0		3389	0.817	0.817	0	
3390	0.817	0.817	0		3391	0.867	0.867	0	
3392	0.867	0.867	0		3393	0.817	0.817	0	
3394	0.817	0.817	0		3395	0.867	0.867	0	
3396	0.867	0.867	0		3397	0.817	0.817	0	
3398	0.817	0.817	0		3399	0.817	0.817	0	
3400	0.817	0.817	0		3401	0.867	0.867	0	
3402	0.867	0.867	0		3403	0.817	0.817	0	
3404	0.817	0.817	0		3405	0.867	0.867	0	
3406	0.867	0.867	0		3407	0.817	0.817	0	
3408	0.817	0.817	0		3409	0.867	0.867	0	
3410	0.867	0.867	0		3411	0.817	0.817	0	
3412	0.817	0.817	0		3413	0.867	0.867	0	
3414	0.867	0.867	0		3415	0.817	0.817	0	
3416	0.817	0.817	0		3417	0.867	0.867	0	
3418	0.867	0.867	0		3419	0.817	0.817	0	
3420	0.817	0.817	0		3421	0.867	0.867	0	
3422	0.817	0.817	0		3423	7240.005	7240.005	0	
3424	0.817	0.817	0		3425	0.867	0.867	0	
3426	0.817	0.817	0		3427	0.817	0.817	0	
3428	0.867	0.867	0		3429	0.867	0.867	0	
3430	0.817	0.817	0		3431	0.817	0.817	0	
3432	0.867	0.867	0		3433	0.867	0.867	0	
3434	0.817	0.817	0		3435	0.817	0.817	0	
3436	0.867	0.867	0		3437	0.867	0.867	0	
3438	0.817	0.817	0		3439	0.817	0.817	0	
3440	0.867	0.867	0		3441	0.867	0.867	0	
3442	0.817	0.817	0		3443	0.817	0.817	0	
3444	0.867	0.867	0		3445	0.867	0.867	0	
3446	0.817	0.817	0		3447	0.817	0.817	0	
3448	0.817	0.817	0		3449	0.817	0.817	0	
3450	0.867	0.867	0		3451	0.867	0.867	0	
3452	0.817	0.817	0		3453	0.817	0.817	0	
3454	0.867	0.867	0		3455	0.867	0.867	0	
3456	0.817	0.817	0		3457	0.817	0.817	0	
3458	0.867	0.867	0		3459	0.867	0.867	0	
3460	0.817	0.817	0		3461	0.817	0.817	0	
3462	0.867	0.867	0		3463	0.867	0.867	0	
3464	0.817	0.817	0		3465	0.817	0.817	0	
3466	0.867	0.867	0		3467	0.867	0.867	0	
3468	0.817	0.817	0		3469	0.817	0.817	0	
3470	0.817	0.817	0		3471	0.817	0.817	0	
3472	0.867	0.867	0		3473	0.867	0.867	0	
3474	0.817	0.817	0		3475	0.817	0.817	0	
3476	0.867	0.867	0		3477	0.867	0.867	0	
3478	0.817	0.817	0		3479	0.817	0.817	0	
3480	0.867	0.867	0		3481	0.867	0.867	0	
3482	0.817	0.817	0		3483	0.817	0.817	0	
3484	0.867	0.867	0		3485	0.867	0.867	0	
3486	0.817	0.817	0		3487	0.817	0.817	0	
3488	0.817	0.817	0		3489	0.817	0.817	0	
3490	0.867	0.867	0		3491	0.867	0.867	0	
3492	0.817	0.817	0		3493	0.817	0.817	0	
3494	0.867	0.867	0		3495	0.867	0.867	0	
3496	0.817	0.817	0		3497	0.817	0.817	0	
3498	0.867	0.867	0		3499	0.817	0.817	0	
3500	0.817	0.817	0		3501	0.867	0.867	0	
3502	0.817	0.817	0		3503	0.817	0.817	0	
3504	0.867	0.867	0		3505	0.867	0.867	0	
3506	0.817	0.817	0		3507	0.817	0.817	0	
3508	0.867	0.867	0		3509	0.867	0.867	0	
3510	0.817	0.817	0		3511	0.817	0.817	0	
3512	0.817	0.817	0		3513	0.817	0.817	0	
3514	0.867	0.867	0		3515	0.867	0.867	0	
3516	0.817	0.817	0		3517	0.817	0.817	0	
3518	0.817	0.817	0		3519	0.817	0.817	0	
3520	0.867	0.867	0		3521	0.867	0.867	0	
3522	0.817	0.817	0		3523	0.817	0.817	0	
3524	0.817	0.817	0		3525	0.817	0.817	0	
3526	0.867	0.867	0		3527	0.867	0.867	0	
3528	0.817	0.817	0		3529	0.817	0.817	0	
3530	0.817	0.817	0		3531	0.817	0.817	0	
3532	0.817	0.817	0		3533	0.817	0.817	0	
3534	0.867	0.867	0		3535	0.817	0.817	0	
3536	0.817	0.817	0		3537	0.867	0.867	0	
3538	0.817	0.817	0		3539	0.817	0.817	0	
3540	0.817	0.817	0		3541	0.817	0.817	0	
3542	0.817	0.817	0		3543	0.867	0.867	0	
3544	0.867	0.867	0		3545	0.867	0.867	0	
3546	0.867	0.867	0		3547	0.867	0.867	0	
3548	0.867	0.867	0		3549	0.867	0.867	0	



Nodo	Massa X	Massa Y	Massa Z	Momento Z	Nodo	Massa X	Massa Y	Massa Z	Momento Z
3550	0.867	0.867	0		3551	0.867	0.867	0	
3552	0.867	0.867	0		3553	0.867	0.867	0	
3554	0.867	0.867	0		3555	0.867	0.867	0	
3556	0.867	0.867	0		3557	0.867	0.867	0	
3558	0.867	0.867	0		3559	0.867	0.867	0	
3560	0.867	0.867	0		3561	0.867	0.867	0	
3562	0.867	0.867	0		3563	0.867	0.867	0	
3564	0.867	0.867	0		3565	0.867	0.867	0	
3566	0.867	0.867	0		3567	0.867	0.867	0	
3568	0.939	0.939	0		3569	0.939	0.939	0	
3570	0.939	0.939	0		3571	0.939	0.939	0	
3572	0.939	0.939	0		3573	0.939	0.939	0	
3574	0.939	0.939	0		3575	0.939	0.939	0	
3576	0.939	0.939	0		3577	0.939	0.939	0	
3578	0.939	0.939	0		3579	0.939	0.939	0	
3580	0.939	0.939	0		3581	0.939	0.939	0	
3582	0.939	0.939	0		3583	0.939	0.939	0	
3584	0.939	0.939	0		3585	0.939	0.939	0	
3586	0.939	0.939	0		3587	0.939	0.939	0	
3588	0.939	0.939	0		3589	0.939	0.939	0	
3590	0.939	0.939	0		3591	0.939	0.939	0	
3592	0.939	0.939	0		3593	0.939	0.939	0	
3594	0.939	0.939	0		3595	0.939	0.939	0	
3596	0.939	0.939	0		3597	0.939	0.939	0	
3598	0.939	0.939	0		3599	0.939	0.939	0	
3600	0.939	0.939	0		3601	0.939	0.939	0	
3602	0.939	0.939	0		3603	0.939	0.939	0	
3604	1.741	1.741	0		3605	1.741	1.741	0	
3606	1.741	1.741	0		3607	1.741	1.741	0	
3608	1.741	1.741	0		3609	1.741	1.741	0	
3610	1.741	1.741	0		3611	1.741	1.741	0	
3612	1.741	1.741	0		3613	1.741	1.741	0	
3614	1.741	1.741	0		3615	1.741	1.741	0	
3616	1.741	1.741	0		3617	1.741	1.741	0	
3618	1.741	1.741	0		3619	1.741	1.741	0	
3620	1.741	1.741	0		3621	1.741	1.741	0	
3622	1.741	1.741	0		3623	1.741	1.741	0	
3624	1.741	1.741	0		3625	1.741	1.741	0	
3626	1.741	1.741	0		3627	1.741	1.741	0	
3628	1.741	1.741	0		3629	1.741	1.741	0	
3630	1.741	1.741	0		3631	1.741	1.741	0	
3632	1.741	1.741	0		3633	1.741	1.741	0	
3634	1.741	1.741	0		3635	1.741	1.741	0	
3636	1.741	1.741	0		3637	1.741	1.741	0	
3638	1.741	1.741	0		3639	1.741	1.741	0	
3640	1.607	1.607	0		3641	1.607	1.607	0	
3642	1.607	1.607	0		3643	1.607	1.607	0	
3644	1.607	1.607	0		3645	1.607	1.607	0	
3646	1.607	1.607	0		3647	1.607	1.607	0	
3648	1.607	1.607	0		3649	1.607	1.607	0	
3650	1.607	1.607	0		3651	1.607	1.607	0	
3652	1.607	1.607	0		3653	1.607	1.607	0	
3654	1.607	1.607	0		3655	1.607	1.607	0	
3656	1.607	1.607	0		3657	1.607	1.607	0	
3658	1.607	1.607	0		3659	1.607	1.607	0	
3660	1.607	1.607	0		3661	1.607	1.607	0	
3662	1.607	1.607	0		3663	1.607	1.607	0	
3664	1.607	1.607	0		3665	1.607	1.607	0	
3666	1.607	1.607	0		3667	1.607	1.607	0	
3668	1.607	1.607	0		3669	1.607	1.607	0	
3670	1.607	1.607	0		3671	1.607	1.607	0	
3672	1.607	1.607	0		3673	1.607	1.607	0	
3674	1.607	1.607	0		3675	1.607	1.607	0	
3676	0.833	0.833	0		3677	0.833	0.833	0	
3678	0.833	0.833	0		3679	0.833	0.833	0	
3680	0.833	0.833	0		3681	0.833	0.833	0	
3682	0.833	0.833	0		3683	0.833	0.833	0	
3684	0.833	0.833	0		3685	0.833	0.833	0	
3686	0.833	0.833	0		3687	0.833	0.833	0	
3688	0.833	0.833	0		3689	0.833	0.833	0	
3690	0.833	0.833	0		3691	0.833	0.833	0	
3692	0.833	0.833	0		3693	0.833	0.833	0	
3694	0.833	0.833	0		3695	0.833	0.833	0	
3696	0.833	0.833	0		3697	0.833	0.833	0	
3698	0.833	0.833	0		3699	0.833	0.833	0	
3700	0.833	0.833	0		3701	0.833	0.833	0	
3702	0.833	0.833	0		3703	0.833	0.833	0	
3704	0.833	0.833	0		3705	0.833	0.833	0	
3706	0.833	0.833	0		3707	0.833	0.833	0	
3708	0.833	0.833	0		3709	0.833	0.833	0	
3710	0.833	0.833	0		3711	0.833	0.833	0	
3712	1.31	1.31	0		3713	1.31	1.31	0	
3714	1.31	1.31	0		3715	1.31	1.31	0	
3716	1.31	1.31	0		3717	1.31	1.31	0	
3718	1.31	1.31	0		3719	1.31	1.31	0	
3720	1.31	1.31	0		3721	1.31	1.31	0	
3722	1.31	1.31	0		3723	1.31	1.31	0	
3724	1.31	1.31	0		3725	1.31	1.31	0	
3726	1.31	1.31	0		3727	1.31	1.31	0	
3728	1.31	1.31	0		3729	1.31	1.31	0	
3730	1.31	1.31	0		3731	1.31	1.31	0	
3732	1.31	1.31	0		3733	1.31	1.31	0	
3734	1.31	1.31	0		3735	1.31	1.31	0	
3736	1.31	1.31	0		3737	1.31	1.31	0	
3738	1.31	1.31	0		3739	1.31	1.31	0	
3740	1.31	1.31	0		3741	1.31	1.31	0	
3742	1.31	1.31	0		3743	1.31	1.31	0	



Nodo	Massa X	Massa Y	Massa Z	Momento Z	Nodo	Massa X	Massa Y	Massa Z	Momento Z
3744	1.31	1.31	0		3745	1.31	1.31	0	
3746	1.31	1.31	0		3747	1.31	1.31	0	
3748	3.472	3.472	0		3749	3.472	3.472	0	
3750	3.472	3.472	0		3751	3.472	3.472	0	
3752	3.472	3.472	0		3753	3.472	3.472	0	
3754	3.472	3.472	0		3755	3.472	3.472	0	
3756	3.472	3.472	0		3757	3.472	3.472	0	
3758	3.472	3.472	0		3759	3.472	3.472	0	
3760	3.472	3.472	0		3761	3.472	3.472	0	
3762	3.472	3.472	0		3763	3.472	3.472	0	
3764	3.472	3.472	0		3765	3.472	3.472	0	
3766	3.472	3.472	0		3767	3.472	3.472	0	
3768	3.472	3.472	0		3769	3.472	3.472	0	
3770	3.472	3.472	0		3771	3.472	3.472	0	
3772	3.472	3.472	0		3773	3.472	3.472	0	
3774	3.472	3.472	0		3775	3.472	3.472	0	
3776	3.472	3.472	0		3777	3.472	3.472	0	
3778	3.472	3.472	0		3779	3.472	3.472	0	
3780	3.472	3.472	0		3781	3.472	3.472	0	
3782	3.472	3.472	0		3783	3.472	3.472	0	
3784	2.332	2.332	0		3785	2.332	2.332	0	
3786	2.332	2.332	0		3787	2.332	2.332	0	
3788	2.332	2.332	0		3789	2.332	2.332	0	
3790	2.332	2.332	0		3791	2.332	2.332	0	
3792	2.332	2.332	0		3793	2.332	2.332	0	
3794	2.332	2.332	0		3795	2.332	2.332	0	
3796	2.332	2.332	0		3797	2.332	2.332	0	
3798	2.332	2.332	0		3799	2.332	2.332	0	
3800	2.332	2.332	0		3801	2.332	2.332	0	
3802	2.332	2.332	0		3803	2.332	2.332	0	
3804	2.332	2.332	0		3805	2.332	2.332	0	
3806	2.332	2.332	0		3807	2.332	2.332	0	
3808	2.332	2.332	0		3809	2.332	2.332	0	
3810	2.332	2.332	0		3811	2.332	2.332	0	
3812	2.332	2.332	0		3813	2.332	2.332	0	
3814	2.332	2.332	0		3815	2.332	2.332	0	
3816	2.332	2.332	0		3817	2.332	2.332	0	
3818	2.332	2.332	0		3819	2.332	2.332	0	
3820	202.017	202.017	0						

## 7.6 Gusci

### 7.6.1 Caratteristiche meccaniche gusci

Indice: Numero dell'elemento nell'insieme che lo contiene.

E: Modulo di elasticità longitudinale. [daN/cm<sup>2</sup>]

Poisson: Modulo di Poisson. Il valore è adimensionale.

Alfa: Coefficiente di dilatazione termica longitudinale. [°C<sup>-1</sup>]

Peso unitario: Peso per unità di volume del guscio. [daN/cm<sup>3</sup>]

Indice	E	Poisson	Alfa	Peso unitario
1	330194	0.1	0.00001	0.0025

### 7.6.2 Definizioni gusci

Ind.: Numero dell'elemento nell'insieme che lo contiene.

Nodo I: Primo nodo di definizione dell'elemento.

Nodo J: Secondo nodo di definizione dell'elemento.

Nodo L: Terzo nodo di definizione dell'elemento; nel caso di elementi triangolari non è definito.

Nodo K: Ultimo nodo di definizione dell'elemento.

Sp.membranale: Spessore membranale dell'elemento. [cm]

Sp.flessionale: Spessore flessionale dell'elemento. [cm]

Materiale: Caratteristiche meccaniche dell'elemento.

Indice: Numero dell'elemento nell'insieme che lo contiene.

Var.term.: Variazione termica a cui è soggetto l'elemento. [°C]

Ind.	Nodo I	Nodo J	Nodo L	Nodo K	Sp.membranale	Sp.flessionale	Materiale	Var.term.	Ind.	Nodo I	Nodo J	Nodo L	Nodo K	Sp.membranale	Sp.flessionale	Materiale	Var.term.
								Indice									Indice
1	2773	2775	2720	2715	360	360	1	0	2	2715	2720	2655	2652	360	360	1	0
3	2775	2777	2724	2720	360	360	1	0	4	2720	2724	2659	2655	360	360	1	0
5	2777	2779	2727	2724	360	360	1	0	6	2724	2727	2663	2659	360	360	1	0
7	2779	2785	2729	2727	360	360	1	0	8	2727	2729	2666	2663	360	360	1	0
9	2890	2893	2838	2833	345	345	1	0	10	2833	2838	2775	2773	345	345	1	0
11	2893	2895	2841	2838	345	345	1	0	12	2838	2841	2777	2775	345	345	1	0
13	2895	2901	2845	2841	345	345	1	0	14	2841	2845	2779	2777	345	345	1	0
15	2901	2902	2847	2845	345	345	1	0	16	2845	2847	2785	2779	345	345	1	0
17	2991	2994	2947	2944	330	330	1	0	18	2944	2947	2893	2890	330	330	1	0
19	2994	2998	2950	2947	330	330	1	0	20	2947	2950	2895	2893	330	330	1	0
21	2998	3001	2952	2950	330	330	1	0	22	2950	2952	2901	2895	330	330	1	0
23	3001	3003	2955	2952	330	330	1	0	24	2952	2955	2902	2901	330	330	1	0
25	2991	3033	3038	2994	315	315	1	0	26	2994	3038	3042	2998	315	315	1	0
27	2998	3042	3046	3001	315	315	1	0	28	3001	3046	3047	3003	315	315	1	0
29	3033	3073	3077	3038	315	315	1	0	30	3038	3077	3079	3042	315	315	1	0
31	3042	3079	3084	3046	315	315	1	0	32	3046	3084	3088	3047	315	315	1	0
33	3163	3165	3150	3148	300	300	1	0	34	3148	3150	3131	3128	300	300	1	0
35	3128	3131	3105	3101	300	300	1	0	36	3101	3105	3077	3073	300	300	1	0
37	3165	3167	3153	3150	300	300	1	0	38	3150	3153	3133	3131	300	300	1	0















Tabulati di Calcolo Plinto di Fondazione per Aerogeneratore Tipo - Progetto Impianto Eolico - "Orione"

Ind.	Nodo I	Nodo J	Nodo L	Nodo K	Sp.membranale	Sp.flessionale	Materiale	Var.term.	Ind.	Nodo I	Nodo J	Nodo L	Nodo K	Sp.membranale	Sp.flessionale	Materiale	Var.term.
								Indice									Indice
999	1461	1497	1543	1501	50	50	1	0	1000	1497	1545	1581	1543	50	50	1	0
100	1545	1587	1623	1581	50	50	1	0	1002	1587	1638	1658	1623	50	50	1	0
100	1638	1686	1711	1658	50	50	1	0	1004	1686	1752	1760	1711	50	50	1	0
100	1802	1765	1760	1752	50	50	1	0	1006	1765	1730	1711	1760	50	50	1	0
100	1730	1683	1658	1711	50	50	1	0	1008	1407	1460	1449	1418	50	50	1	0
100	1449	1429	1395	1418	50	50	1	0	1010	1395	1372	1407	1418	50	50	1	0
101	3369	3373	3381	3377	200	200	1	0	1012	3373	3379	3385	3381	200	200	1	0
101	3379	3383	3389	3385	200	200	1	0	1014	3383	3387	3393	3389	200	200	1	0
101	1312	1268	1243	1280	360	360	1	0	1016	1280	1243	1205	1253	360	360	1	0
101	1253	1205	1182	1233	360	360	1	0	1018	1233	1182	1152	1198	360	360	1	0
101	1268	1232	1193	1243	360	360	1	0	1020	1243	1193	1166	1205	360	360	1	0
102	1205	1166	1132	1182	360	360	1	0	1022	1182	1132	1101	1152	360	360	1	0
102	1129	1091	1146	1178	345	345	1	0	1024	1178	1146	1193	1232	345	345	1	0
102	1091	1048	1106	1146	345	345	1	0	1026	1146	1106	1166	1193	345	345	1	0
102	1048	1006	1066	1106	345	345	1	0	1028	1106	1066	1132	1166	345	345	1	0
102	1006	969	1033	1066	345	345	1	0	1030	1066	1033	1101	1132	345	345	1	0
103	1024	977	1032	1080	330	330	1	0	1032	1080	1032	1091	1129	330	330	1	0
103	977	934	991	1032	330	330	1	0	1034	1032	991	1048	1091	330	330	1	0
103	934	904	951	991	330	330	1	0	1036	991	951	1006	1048	330	330	1	0
103	904	867	916	951	330	330	1	0	1038	951	916	969	1006	330	330	1	0
103	930	892	931	975	315	315	1	0	1040	975	931	977	1024	315	315	1	0
104	892	851	894	931	315	315	1	0	1042	931	894	934	977	315	315	1	0
104	851	812	855	894	315	315	1	0	1044	894	855	904	934	315	315	1	0
104	812	781	818	855	315	315	1	0	1046	855	818	867	904	315	315	1	0
104	816	780	802	849	300	300	1	0	1048	849	802	833	873	300	300	1	0
104	873	833	861	908	300	300	1	0	1050	908	861	892	930	300	300	1	0
105	780	741	768	802	300	300	1	0	1052	802	768	796	833	300	300	1	0
105	833	796	817	861	300	300	1	0	1054	861	817	851	892	300	300	1	0
105	741	705	733	768	300	300	1	0	1056	768	733	755	796	300	300	1	0
105	796	755	786	817	300	300	1	0	1058	817	786	812	851	300	300	1	0
105	705	672	692	733	300	300	1	0	1060	733	692	721	755	300	300	1	0
106	755	721	747	786	300	300	1	0	1062	786	747	781	812	300	300	1	0
106	1638	1587	1561	1619	50	50	1	0	1064	1587	1545	1513	1561	50	50	1	0
106	1545	1497	1467	1513	50	50	1	0	1066	1497	1461	1416	1467	50	50	1	0
106	1461	1420	1363	1416	50	50	1	0	1068	1420	1384	1341	1363	50	50	1	0
106	1384	1344	1316	1341	50	50	1	0	1070	1312	1280	1316	1344	50	50	1	0
107	1280	1253	1284	1316	50	50	1	0	1072	1253	1233	1267	1284	50	50	1	0
107	1198	1245	1267	1233	50	50	1	0	1074	1245	1289	1309	1267	50	50	1	0
107	1289	1331	1363	1309	50	50	1	0	1076	1331	1385	1416	1363	50	50	1	0
107	1385	1433	1467	1416	50	50	1	0	1078	1433	1480	1513	1467	50	50	1	0
107	1480	1538	1561	1513	50	50	1	0	1080	1538	1596	1619	1561	50	50	1	0
108	1596	1653	1664	1619	50	50	1	0	1082	1653	1734	1739	1664	50	50	1	0
108	1802	1752	1739	1734	50	50	1	0	1084	1752	1686	1664	1739	50	50	1	0
108	1686	1638	1619	1664	50	50	1	0	1086	1309	1363	1341	1314	50	50	1	0
108	1341	1316	1284	1314	50	50	1	0	1088	1284	1267	1309	1314	50	50	1	0
108	3351	3355	3367	3363	200	200	1	0	1090	3355	3361	3371	3367	200	200	1	0
109	3361	3365	3375	3371	200	200	1	0	1092	3365	3369	3377	3375	200	200	1	0
109	1101	1067	1126	1152	360	360	1	0	1094	1152	1126	1180	1198	360	360	1	0
109	1067	1040	1102	1126	360	360	1	0	1096	1126	1102	1158	1180	360	360	1	0
109	1040	1012	1074	1102	360	360	1	0	1098	1102	1074	1135	1158	360	360	1	0



Tabulati di Calcolo Plinto di Fondazione per Aerogeneratore Tipo - Progetto Impianto Eolico - "Orione"

Ind.	Nod o I	Nodo J	Nodo L	Nodo K	Sp.membranale	Sp.flessionale	Materiale	Var.term.	Ind.	Nodo I	Nodo J	Nodo L	Nodo K	Sp.membranale	Sp.flessionale	Materiale	Var.term.
							Indice									Indice	
109	1012	985	1049	1074	360	360	1	0	1100	1074	1049	1115	1135	360	360	1	0
110	969	936	999	1033	345	345	1	0	1102	1033	999	1067	1101	345	345	1	0
110	936	914	971	999	345	345	1	0	1104	999	971	1040	1067	345	345	1	0
110	914	887	943	971	345	345	1	0	1106	971	943	1012	1040	345	345	1	0
110	887	863	920	943	345	345	1	0	1108	943	920	985	1012	345	345	1	0
110	969	916	886	936	330	330	1	0	1110	936	886	857	914	330	330	1	0
111	914	857	837	887	330	330	1	0	1112	887	837	808	863	330	330	1	0
111	916	867	839	886	330	330	1	0	1114	886	839	810	857	330	330	1	0
111	857	810	787	837	330	330	1	0	1116	837	787	758	808	330	330	1	0
111	781	751	797	818	315	315	1	0	1118	818	797	839	867	315	315	1	0
111	751	731	769	797	315	315	1	0	1120	797	769	810	839	315	315	1	0
112	731	700	742	769	315	315	1	0	1122	769	742	787	810	315	315	1	0
112	700	678	717	742	315	315	1	0	1124	742	717	758	787	315	315	1	0
112	672	641	668	692	300	300	1	0	1126	692	668	690	721	300	300	1	0
112	721	690	722	747	300	300	1	0	1128	747	722	751	781	300	300	1	0
112	641	615	639	668	300	300	1	0	1130	668	639	669	690	300	300	1	0
113	690	669	693	722	300	300	1	0	1132	722	693	731	751	300	300	1	0
113	615	592	616	639	300	300	1	0	1134	639	616	642	669	300	300	1	0
113	669	642	673	693	300	300	1	0	1136	693	673	700	731	300	300	1	0
113	592	570	594	616	300	300	1	0	1138	616	594	621	642	300	300	1	0
113	642	621	647	673	300	300	1	0	1140	673	647	678	700	300	300	1	0
114	1596	1538	1519	1574	50	50	1	0	1142	1538	1480	1455	1519	50	50	1	0
114	1480	1433	1399	1455	50	50	1	0	1144	1433	1385	1349	1399	50	50	1	0
114	1385	1331	1282	1349	50	50	1	0	1146	1331	1289	1251	1282	50	50	1	0
114	1289	1245	1218	1251	50	50	1	0	1148	1198	1180	1218	1245	50	50	1	0
114	1180	1158	1194	1218	50	50	1	0	1150	1158	1135	1183	1194	50	50	1	0
115	1115	1164	1183	1135	50	50	1	0	1152	1164	1214	1229	1183	50	50	1	0
115	1214	1263	1282	1229	50	50	1	0	1154	1263	1323	1349	1282	50	50	1	0
115	1323	1376	1399	1349	50	50	1	0	1156	1376	1439	1455	1399	50	50	1	0
115	1439	1491	1519	1455	50	50	1	0	1158	1491	1562	1574	1519	50	50	1	0
115	1562	1636	1642	1574	50	50	1	0	1160	1636	1719	1723	1642	50	50	1	0
116	1802	1734	1723	1719	50	50	1	0	1162	1734	1653	1642	1723	50	50	1	0
116	1653	1596	1574	1642	50	50	1	0	1164	1229	1282	1251	1227	50	50	1	0
116	1251	1218	1194	1227	50	50	1	0	1166	1194	1183	1229	1227	50	50	1	0
116	3331	3337	3353	3349	200	200	1	0	1168	3337	3341	3357	3353	200	200	1	0
116	3341	3345	3359	3357	200	200	1	0	1170	3345	3351	3363	3359	200	200	1	0
117	1036	1054	986	967	360	360	1	0	1172	967	986	926	910	360	360	1	0
117	1054	1071	1004	986	360	360	1	0	1174	986	1004	944	926	360	360	1	0
117	1071	1095	1026	1004	360	360	1	0	1176	1004	1026	963	944	360	360	1	0
117	1095	1115	1049	1026	360	360	1	0	1178	1026	1049	985	963	360	360	1	0
117	910	926	865	845	345	345	1	0	1180	845	865	803	790	345	345	1	0
118	926	944	876	865	345	345	1	0	1182	865	876	823	803	345	345	1	0
118	944	963	902	876	345	345	1	0	1184	876	902	843	823	345	345	1	0
118	963	985	920	902	345	345	1	0	1186	902	920	863	843	345	345	1	0
118	790	803	753	737	330	330	1	0	1188	737	753	706	688	330	330	1	0
118	803	823	774	753	330	330	1	0	1190	753	774	723	706	330	330	1	0
119	823	843	794	774	330	330	1	0	1192	774	794	743	723	330	330	1	0
119	843	863	808	794	330	330	1	0	1194	794	808	758	743	330	330	1	0
119	688	706	662	643	315	315	1	0	1196	643	662	625	600	315	315	1	0



Tabulati di Calcolo Plinto di Fondazione per Aerogeneratore Tipo - Progetto Impianto Eolico - "Orione"

Ind.	Nodo I	Nodo J	Nodo L	Nodo K	Sp.membranale	Sp.flessionale	Materiale	Var.term.	Ind.	Nodo I	Nodo J	Nodo L	Nodo K	Sp.membranale	Sp.flessionale	Materiale	Var.term.
							Indice									Indice	
1197	706	723	682	662	315	315	1	0	1198	662	682	635	625	315	315	1	0
1199	723	743	696	682	315	315	1	0	1200	682	696	656	635	315	315	1	0
1201	743	758	717	696	315	315	1	0	1202	696	717	678	656	315	315	1	0
1203	600	625	590	575	300	300	1	0	1204	575	590	564	545	300	300	1	0
1205	545	564	539	519	300	300	1	0	1206	519	539	514	496	300	300	1	0
1207	625	635	609	590	300	300	1	0	1208	590	609	582	564	300	300	1	0
1209	564	582	555	539	300	300	1	0	1210	539	555	533	514	300	300	1	0
1211	635	656	629	609	300	300	1	0	1212	609	629	598	582	300	300	1	0
1213	582	598	574	555	300	300	1	0	1214	555	574	549	533	300	300	1	0
1215	656	678	647	629	300	300	1	0	1216	629	647	621	598	300	300	1	0
1217	598	621	594	574	300	300	1	0	1218	574	594	570	549	300	300	1	0
1219	1562	1491	1478	1549	50	50	1	0	1220	1491	1439	1411	1478	50	50	1	0
1221	1439	1376	1356	1411	50	50	1	0	1222	1376	1323	1290	1356	50	50	1	0
1223	1323	1263	1225	1290	50	50	1	0	1224	1263	1214	1187	1225	50	50	1	0
1225	1214	1164	1138	1187	50	50	1	0	1226	1115	1095	1138	1164	50	50	1	0
1227	1095	1071	1119	1138	50	50	1	0	1228	1071	1054	1109	1119	50	50	1	0
1229	1036	1097	1109	1054	50	50	1	0	1230	1097	1156	1160	1109	50	50	1	0
1231	1156	1207	1225	1160	50	50	1	0	1232	1207	1271	1290	1225	50	50	1	0
1233	1271	1328	1356	1290	50	50	1	0	1234	1328	1393	1411	1356	50	50	1	0
1235	1393	1465	1478	1411	50	50	1	0	1236	1465	1535	1549	1478	50	50	1	0
1237	1535	1614	1626	1549	50	50	1	0	1238	1614	1706	1712	1626	50	50	1	0
1239	1802	1719	1712	1706	50	50	1	0	1240	1719	1636	1626	1712	50	50	1	0
1241	1636	1562	1549	1626	50	50	1	0	1242	1160	1225	1187	1154	50	50	1	0
1243	1187	1138	1119	1154	50	50	1	0	1244	1119	1109	1160	1154	50	50	1	0
1245	3302	3309	3339	3335	200	200	1	0	1246	3309	3319	3343	3339	200	200	1	0
1247	3319	3325	3346	3343	200	200	1	0	1248	3325	3331	3349	3346	200	200	1	0
1249	980	993	928	917	360	360	1	0	1250	917	928	870	858	360	360	1	0
1251	993	1007	937	928	360	360	1	0	1252	928	937	882	870	360	360	1	0
1253	1007	1022	958	937	360	360	1	0	1254	937	958	898	882	360	360	1	0
1255	1022	1036	967	958	360	360	1	0	1256	958	967	910	898	360	360	1	0
1257	858	870	806	800	345	345	1	0	1258	800	806	748	739	345	345	1	0
1259	870	882	814	806	345	345	1	0	1260	806	814	762	748	345	345	1	0
1261	882	898	834	814	345	345	1	0	1262	814	834	776	762	345	345	1	0
1263	898	910	845	834	345	345	1	0	1264	834	845	790	776	345	345	1	0
1265	739	748	698	686	330	330	1	0	1266	686	698	650	637	330	330	1	0
1267	748	762	713	698	330	330	1	0	1268	698	713	664	650	330	330	1	0
1269	762	776	724	713	330	330	1	0	1270	713	724	679	664	330	330	1	0
1271	776	790	737	724	330	330	1	0	1272	724	737	688	679	330	330	1	0
1273	637	650	605	596	315	315	1	0	1274	596	605	568	553	315	315	1	0
1275	650	664	622	605	315	315	1	0	1276	605	622	580	568	315	315	1	0
1277	664	679	631	622	315	315	1	0	1278	622	631	588	580	315	315	1	0
1279	679	688	643	631	315	315	1	0	1280	631	643	600	588	315	315	1	0
1281	553	568	540	529	300	300	1	0	1282	529	540	510	502	300	300	1	0
1283	502	510	485	479	300	300	1	0	1284	479	485	464	458	300	300	1	0
1285	568	580	551	540	300	300	1	0	1286	540	551	523	510	300	300	1	0
1287	510	523	498	485	300	300	1	0	1288	485	498	475	464	300	300	1	0
1289	580	588	560	551	300	300	1	0	1290	551	560	535	523	300	300	1	0
1291	523	535	508	498	300	300	1	0	1292	498	508	483	475	300	300	1	0
1293	588	600	575	560	300	300	1	0	1294	560	575	545	535	300	300	1	0



Tabulati di Calcolo Plinto di Fondazione per Aerogeneratore Tipo - Progetto Impianto Eolico - "Orione"

Ind.	Nodo I	Nodo J	Nodo L	Nodo K	Sp.membranale	Sp.flessionale	Materiale	Var.term.	Ind.	Nodo I	Nodo J	Nodo L	Nodo K	Sp.membranale	Sp.flessionale	Materiale	Var.term.
							Indice									Indice	
1295	535	545	519	508	300	300	1	0	1296	508	519	496	483	300	300	1	0
1297	1535	1465	1450	1526	50	50	1	0	1298	1465	1393	1381	1450	50	50	1	0
1299	1393	1328	1317	1381	50	50	1	0	1300	1328	1271	1247	1317	50	50	1	0
1301	1271	1207	1175	1247	50	50	1	0	1302	1207	1156	1124	1175	50	50	1	0
1303	1156	1097	1076	1124	50	50	1	0	1304	1036	1022	1076	1097	50	50	1	0
1305	1022	1007	1056	1076	50	50	1	0	1306	1007	993	1052	1056	50	50	1	0
1307	980	1043	1052	993	50	50	1	0	1308	1043	1113	1110	1052	50	50	1	0
1309	1113	1172	1175	1110	50	50	1	0	1310	1172	1241	1247	1175	50	50	1	0
1311	1241	1301	1317	1247	50	50	1	0	1312	1301	1365	1381	1317	50	50	1	0
1313	1365	1443	1450	1381	50	50	1	0	1314	1443	1520	1526	1450	50	50	1	0
1315	1520	1604	1609	1526	50	50	1	0	1316	1604	1698	1697	1609	50	50	1	0
1317	1802	1706	1697	1698	50	50	1	0	1318	1706	1614	1609	1697	50	50	1	0
1319	1614	1535	1526	1609	50	50	1	0	1320	1110	1175	1124	1099	50	50	1	0
1321	1124	1076	1056	1099	50	50	1	0	1322	1056	1052	1110	1099	50	50	1	0
1323	3294	3296	3327	3323	200	200	1	0	1324	3296	3298	3329	3327	200	200	1	0
1325	3298	3300	3333	3329	200	200	1	0	1326	3300	3302	3335	3333	200	200	1	0
1327	952	961	896	889	360	360	1	0	1328	889	896	840	831	360	360	1	0
1329	961	964	905	896	360	360	1	0	1330	896	905	846	840	360	360	1	0
1331	964	972	911	905	360	360	1	0	1332	905	911	853	846	360	360	1	0
1333	972	980	917	911	360	360	1	0	1334	911	917	858	853	360	360	1	0
1335	831	840	777	771	345	345	1	0	1336	771	777	719	714	345	345	1	0
1337	840	846	784	777	345	345	1	0	1338	777	784	729	719	345	345	1	0
1339	846	853	792	784	345	345	1	0	1340	784	792	735	729	345	345	1	0
1341	853	858	800	792	345	345	1	0	1342	792	800	739	735	345	345	1	0
1343	714	719	666	660	330	330	1	0	1344	660	666	619	613	330	330	1	0
1345	719	729	676	666	330	330	1	0	1346	666	676	627	619	330	330	1	0
1347	729	735	684	676	330	330	1	0	1348	676	684	633	627	330	330	1	0
1349	735	739	686	684	330	330	1	0	1350	684	686	637	633	330	330	1	0
1351	613	619	578	571	315	315	1	0	1352	571	578	536	531	315	315	1	0
1353	619	627	583	578	315	315	1	0	1354	578	583	543	536	315	315	1	0
1355	627	633	586	583	315	315	1	0	1356	583	586	547	543	315	315	1	0
1357	633	637	596	586	315	315	1	0	1358	586	596	553	547	315	315	1	0
1359	531	536	506	503	300	300	1	0	1360	503	506	481	476	300	300	1	0
1361	476	481	460	456	300	300	1	0	1362	456	460	443	441	300	300	1	0
1363	536	543	512	506	300	300	1	0	1364	506	512	487	481	300	300	1	0
1365	481	487	462	460	300	300	1	0	1366	460	462	445	443	300	300	1	0
1367	543	547	517	512	300	300	1	0	1368	512	517	490	487	300	300	1	0
1369	487	490	469	462	300	300	1	0	1370	462	469	450	445	300	300	1	0
1371	547	553	529	517	300	300	1	0	1372	517	529	502	490	300	300	1	0
1373	490	502	479	469	300	300	1	0	1374	469	479	458	450	300	300	1	0
1375	1520	1443	1434	1510	50	50	1	0	1376	1443	1365	1360	1434	50	50	1	0
1377	1365	1301	1291	1360	50	50	1	0	1378	1301	1241	1222	1291	50	50	1	0
1379	1241	1172	1142	1222	50	50	1	0	1380	1172	1113	1087	1142	50	50	1	0
1381	1113	1043	1028	1087	50	50	1	0	1382	980	972	1028	1043	50	50	1	0
1383	972	964	1018	1028	50	50	1	0	1384	964	961	1013	1018	50	50	1	0
1385	952	1014	1013	961	50	50	1	0	1386	1014	1085	1072	1013	50	50	1	0
1387	1085	1150	1142	1072	50	50	1	0	1388	1150	1210	1222	1142	50	50	1	0
1389	1210	1278	1291	1222	50	50	1	0	1390	1278	1353	1360	1291	50	50	1	0
1391	1353	1426	1434	1360	50	50	1	0	1392	1426	1505	1510	1434	50	50	1	0



Tabulati di Calcolo Plinto di Fondazione per Aerogeneratore Tipo - Progetto Impianto Eolico - "Orione"

Ind.	Nodo I	Nodo J	Nodo L	Nodo K	Sp.membranale	Sp.flessionale	Materiale	Var.term.	Ind.	Nodo I	Nodo J	Nodo L	Nodo K	Sp.membranale	Sp.flessionale	Materiale	Var.term.
							Indice									Indice	
1393	1505	1592	1597	1510	50	50	1	0	1394	1592	1691	1687	1597	50	50	1	0
1395	1802	1698	1687	1691	50	50	1	0	1396	1698	1604	1597	1687	50	50	1	0
1397	1604	1520	1510	1597	50	50	1	0	1398	1072	1142	1087	1057	50	50	1	0
1399	1087	1028	1018	1057	50	50	1	0	1400	1018	1013	1072	1057	50	50	1	0
1401	3286	3288	3315	3313	200	200	1	0	1402	3288	3290	3317	3315	200	200	1	0
1403	3290	3292	3321	3317	200	200	1	0	1404	3292	3294	3323	3321	200	200	1	0
1405	938	941	877	875	360	360	1	0	1406	875	877	825	819	360	360	1	0
1407	941	945	880	877	360	360	1	0	1408	877	880	827	825	360	360	1	0
1409	945	949	884	880	360	360	1	0	1410	880	884	829	827	360	360	1	0
1411	949	952	889	884	360	360	1	0	1412	884	889	831	829	360	360	1	0
1413	819	825	759	757	345	345	1	0	1414	757	759	703	702	345	345	1	0
1415	825	827	763	759	345	345	1	0	1416	759	763	709	703	345	345	1	0
1417	827	829	766	763	345	345	1	0	1418	763	766	711	709	345	345	1	0
1419	829	831	771	766	345	345	1	0	1420	766	771	714	711	345	345	1	0
1421	702	703	652	649	330	330	1	0	1422	649	652	603	601	330	330	1	0
1423	703	709	654	652	330	330	1	0	1424	652	654	606	603	330	330	1	0
1425	709	711	657	654	330	330	1	0	1426	654	657	610	606	330	330	1	0
1427	711	714	660	657	330	330	1	0	1428	657	660	613	610	330	330	1	0
1429	531	527	566	571	315	315	1	0	1430	571	566	610	613	315	315	1	0
1431	527	525	562	566	315	315	1	0	1432	566	562	606	610	315	315	1	0
1433	525	520	558	562	315	315	1	0	1434	562	558	603	606	315	315	1	0
1435	520	516	557	558	315	315	1	0	1436	558	557	601	603	315	315	1	0
1437	516	520	491	489	300	300	1	0	1438	489	491	467	466	300	300	1	0
1439	466	467	448	447	300	300	1	0	1440	447	448	435	434	300	300	1	0
1441	520	525	494	491	300	300	1	0	1442	491	494	471	467	300	300	1	0
1443	467	471	451	448	300	300	1	0	1444	448	451	437	435	300	300	1	0
1445	525	527	499	494	300	300	1	0	1446	494	499	473	471	300	300	1	0
1447	471	473	454	451	300	300	1	0	1448	451	454	439	437	300	300	1	0
1449	527	531	503	499	300	300	1	0	1450	499	503	476	473	300	300	1	0
1451	473	476	456	454	300	300	1	0	1452	454	456	441	439	300	300	1	0
1453	1505	1426	1424	1502	50	50	1	0	1454	1426	1353	1351	1424	50	50	1	0
1455	1353	1278	1276	1351	50	50	1	0	1456	1278	1210	1201	1276	50	50	1	0
1457	1210	1150	1121	1201	50	50	1	0	1458	1150	1085	1063	1121	50	50	1	0
1459	1085	1014	1000	1063	50	50	1	0	1460	952	949	1000	1014	50	50	1	0
1461	949	945	994	1000	50	50	1	0	1462	945	941	997	994	50	50	1	0
1463	938	1001	997	941	50	50	1	0	1464	1001	1068	1058	997	50	50	1	0
1465	1068	1143	1121	1058	50	50	1	0	1466	1143	1204	1201	1121	50	50	1	0
1467	1204	1275	1276	1201	50	50	1	0	1468	1275	1345	1351	1276	50	50	1	0
1469	1345	1421	1424	1351	50	50	1	0	1470	1421	1498	1502	1424	50	50	1	0
1471	1498	1589	1588	1502	50	50	1	0	1472	1589	1688	1678	1588	50	50	1	0
1473	1802	1691	1678	1688	50	50	1	0	1474	1691	1592	1588	1678	50	50	1	0
1475	1592	1505	1502	1588	50	50	1	0	1476	1058	1121	1063	1038	50	50	1	0
1477	1063	1000	994	1038	50	50	1	0	1478	994	997	1058	1038	50	50	1	0
1479	3279	3280	3305	3304	200	200	1	0	1480	3280	3282	3307	3305	200	200	1	0
1481	3282	3284	3310	3307	200	200	1	0	1482	3284	3286	3313	3310	200	200	1	0
1483	819	826	878	875	360	360	1	0	1484	875	878	942	938	360	360	1	0
1485	826	828	881	878	360	360	1	0	1486	878	881	946	942	360	360	1	0
1487	828	830	885	881	360	360	1	0	1488	881	885	950	946	360	360	1	0
1489	830	832	890	885	360	360	1	0	1490	885	890	953	950	360	360	1	0



Tabulati di Calcolo Plinto di Fondazione per Aerogeneratore Tipo - Progetto Impianto Eolico - "Orione"

Ind.	Nodo I	Nodo J	Nodo L	Nodo K	Sp.membranale	Sp.flessionale	Materiale	Var.term.	Ind.	Nodo I	Nodo J	Nodo L	Nodo K	Sp.membranale	Sp.flessionale	Materiale	Var.term.
							Indice									Indice	
149	702	704	760	757	345	345	1	0	1492	757	760	826	819	345	345	1	0
149	704	710	764	760	345	345	1	0	1494	760	764	828	826	345	345	1	0
149	710	712	767	764	345	345	1	0	1496	764	767	830	828	345	345	1	0
149	712	715	772	767	345	345	1	0	1498	767	772	832	830	345	345	1	0
149	601	604	653	649	330	330	1	0	1500	649	653	704	702	330	330	1	0
150	604	607	655	653	330	330	1	0	1502	653	655	710	704	330	330	1	0
150	607	611	658	655	330	330	1	0	1504	655	658	712	710	330	330	1	0
150	611	614	661	658	330	330	1	0	1506	658	661	715	712	330	330	1	0
150	516	521	559	557	315	315	1	0	1508	557	559	604	601	315	315	1	0
150	521	526	563	559	315	315	1	0	1510	559	563	607	604	315	315	1	0
151	526	528	567	563	315	315	1	0	1512	563	567	611	607	315	315	1	0
151	528	532	572	567	315	315	1	0	1514	567	572	614	611	315	315	1	0
151	434	436	449	447	300	300	1	0	1516	447	449	468	466	300	300	1	0
151	466	468	492	489	300	300	1	0	1518	489	492	521	516	300	300	1	0
151	436	438	452	449	300	300	1	0	1520	449	452	472	468	300	300	1	0
152	468	472	495	492	300	300	1	0	1522	492	495	526	521	300	300	1	0
152	438	440	455	452	300	300	1	0	1524	452	455	474	472	300	300	1	0
152	472	474	500	495	300	300	1	0	1526	495	500	528	526	300	300	1	0
152	440	442	457	455	300	300	1	0	1528	455	457	477	474	300	300	1	0
152	474	477	504	500	300	300	1	0	1530	500	504	532	528	300	300	1	0
153	1498	1421	1425	1503	50	50	1	0	1532	1421	1345	1352	1425	50	50	1	0
153	1345	1275	1277	1352	50	50	1	0	1534	1275	1204	1202	1277	50	50	1	0
153	1204	1143	1122	1202	50	50	1	0	1536	1143	1068	1059	1122	50	50	1	0
153	1068	1001	998	1059	50	50	1	0	1538	998	942	998	1001	50	50	1	0
153	942	946	995	998	50	50	1	0	1540	946	950	1002	995	50	50	1	0
154	953	1015	1002	950	50	50	1	0	1542	1015	1086	1064	1002	50	50	1	0
154	1086	1151	1122	1064	50	50	1	0	1544	1151	1215	1202	1122	50	50	1	0
154	1215	1279	1277	1202	50	50	1	0	1546	1279	1354	1352	1277	50	50	1	0
154	1354	1427	1425	1352	50	50	1	0	1548	1427	1506	1503	1425	50	50	1	0
154	1506	1593	1590	1503	50	50	1	0	1550	1593	1692	1679	1590	50	50	1	0
155	1802	1688	1679	1692	50	50	1	0	1552	1688	1589	1590	1679	50	50	1	0
155	1589	1498	1503	1590	50	50	1	0	1554	1064	1122	1059	1039	50	50	1	0
155	1059	998	995	1039	50	50	1	0	1556	995	1002	1064	1039	50	50	1	0
155	3287	3285	3311	3314	200	200	1	0	1558	3285	3283	3308	3311	200	200	1	0
155	3283	3281	3306	3308	200	200	1	0	1560	3281	3279	3304	3306	200	200	1	0
156	832	841	897	890	360	360	1	0	1562	890	897	962	953	360	360	1	0
156	841	847	906	897	360	360	1	0	1564	897	906	965	962	360	360	1	0
156	847	854	912	906	360	360	1	0	1566	906	912	973	965	360	360	1	0
156	854	859	918	912	360	360	1	0	1568	912	918	981	973	360	360	1	0
156	715	720	778	772	345	345	1	0	1570	772	778	841	832	345	345	1	0
157	720	730	785	778	345	345	1	0	1572	778	785	847	841	345	345	1	0
157	730	736	793	785	345	345	1	0	1574	785	793	854	847	345	345	1	0
157	736	740	801	793	345	345	1	0	1576	793	801	859	854	345	345	1	0
157	614	620	667	661	330	330	1	0	1578	661	667	720	715	330	330	1	0
157	620	628	677	667	330	330	1	0	1580	667	677	730	720	330	330	1	0
158	628	634	685	677	330	330	1	0	1582	677	685	736	730	330	330	1	0
158	634	638	687	685	330	330	1	0	1584	685	687	740	736	330	330	1	0
158	532	537	579	572	315	315	1	0	1586	572	579	620	614	315	315	1	0
158	537	544	584	579	315	315	1	0	1588	579	584	628	620	315	315	1	0



Tabulati di Calcolo Plinto di Fondazione per Aerogeneratore Tipo - Progetto Impianto Eolico - "Orione"

Ind.	Nod o I	Nodo J	Nodo L	Nodo K	Sp.membranale	Sp.flessionale	Materiale	Var.term.	Ind.	Nodo I	Nodo J	Nodo L	Nodo K	Sp.membranale	Sp.flessionale	Materiale	Var.term.
							Indice									Indice	
1589	544	548	587	584	315	315	1	0	1590	584	587	634	628	315	315	1	0
1591	548	554	597	587	315	315	1	0	1592	587	597	638	634	315	315	1	0
1593	442	444	461	457	300	300	1	0	1594	457	461	482	477	300	300	1	0
1595	477	482	507	504	300	300	1	0	1596	504	507	537	532	300	300	1	0
1597	444	446	463	461	300	300	1	0	1598	461	463	488	482	300	300	1	0
1599	482	488	513	507	300	300	1	0	1600	507	513	544	537	300	300	1	0
1601	446	453	470	463	300	300	1	0	1602	463	470	493	488	300	300	1	0
1603	488	493	518	513	300	300	1	0	1604	513	518	548	544	300	300	1	0
1605	453	459	480	470	300	300	1	0	1606	470	480	505	493	300	300	1	0
1607	493	505	530	518	300	300	1	0	1608	518	530	554	548	300	300	1	0
1609	1506	1427	1435	1511	50	50	1	0	1610	1427	1354	1361	1435	50	50	1	0
1611	1354	1279	1292	1361	50	50	1	0	1612	1279	1215	1223	1292	50	50	1	0
1613	1215	1151	1144	1223	50	50	1	0	1614	1151	1086	1073	1144	50	50	1	0
1615	1086	1015	1016	1073	50	50	1	0	1616	953	962	1016	1015	50	50	1	0
1617	962	965	1019	1016	50	50	1	0	1618	965	973	1029	1019	50	50	1	0
1619	981	1044	1029	973	50	50	1	0	1620	1044	1114	1088	1029	50	50	1	0
1621	1114	1173	1144	1088	50	50	1	0	1622	1173	1242	1223	1144	50	50	1	0
1623	1242	1302	1292	1223	50	50	1	0	1624	1302	1366	1361	1292	50	50	1	0
1625	1366	1444	1435	1361	50	50	1	0	1626	1444	1521	1511	1435	50	50	1	0
1627	1521	1605	1598	1511	50	50	1	0	1628	1605	1699	1689	1598	50	50	1	0
1629	1802	1692	1689	1699	50	50	1	0	1630	1692	1593	1598	1689	50	50	1	0
1631	1593	1506	1511	1598	50	50	1	0	1632	1088	1144	1073	1060	50	50	1	0
1633	1073	1016	1019	1060	50	50	1	0	1634	1019	1029	1088	1060	50	50	1	0
1635	3295	3293	3322	3324	200	200	1	0	1636	3293	3291	3318	3322	200	200	1	0
1637	3291	3289	3316	3318	200	200	1	0	1638	3289	3287	3314	3316	200	200	1	0
1639	859	871	929	918	360	360	1	0	1640	918	929	996	981	360	360	1	0
1641	871	883	939	929	360	360	1	0	1642	929	939	1008	996	360	360	1	0
1643	883	899	959	939	360	360	1	0	1644	939	959	1023	1008	360	360	1	0
1645	899	913	968	959	360	360	1	0	1646	959	968	1037	1023	360	360	1	0
1647	740	749	807	801	345	345	1	0	1648	801	807	871	859	345	345	1	0
1649	749	765	815	807	345	345	1	0	1650	807	815	883	871	345	345	1	0
1651	765	779	835	815	345	345	1	0	1652	815	835	899	883	345	345	1	0
1653	779	791	848	835	345	345	1	0	1654	835	848	913	899	345	345	1	0
1655	638	651	699	687	330	330	1	0	1656	687	699	749	740	330	330	1	0
1657	651	665	716	699	330	330	1	0	1658	699	716	765	749	330	330	1	0
1659	665	680	725	716	330	330	1	0	1660	716	725	779	765	330	330	1	0
1661	680	689	738	725	330	330	1	0	1662	725	738	791	779	330	330	1	0
1663	554	569	608	597	315	315	1	0	1664	597	608	651	638	315	315	1	0
1665	569	581	623	608	315	315	1	0	1666	608	623	665	651	315	315	1	0
1667	581	589	632	623	315	315	1	0	1668	623	632	680	665	315	315	1	0
1669	589	602	644	632	315	315	1	0	1670	632	644	689	680	315	315	1	0
1671	459	465	486	480	300	300	1	0	1672	480	486	511	505	300	300	1	0
1673	505	511	541	530	300	300	1	0	1674	530	541	569	554	300	300	1	0
1675	465	478	501	486	300	300	1	0	1676	486	501	524	511	300	300	1	0
1677	511	524	552	541	300	300	1	0	1678	541	552	581	569	300	300	1	0
1679	478	484	509	501	300	300	1	0	1680	501	509	538	524	300	300	1	0
1681	524	538	561	552	300	300	1	0	1682	552	561	589	581	300	300	1	0
1683	484	497	522	509	300	300	1	0	1684	509	522	546	538	300	300	1	0
1685	538	546	576	561	300	300	1	0	1686	561	576	602	589	300	300	1	0





Tabulati di Calcolo Plinto di Fondazione per Aerogeneratore Tipo - Progetto Impianto Eolico - "Orione"

Ind.	Nod o I	Nodo J	Nodo L	Nodo K	Sp.membranale	Sp.flessionale	Materiale	Var.term.	Ind.	Nodo I	Nodo J	Nodo L	Nodo K	Sp.membranale	Sp.flessionale	Materiale	Var.term.
							Indice									Indice	
1687	1521	1444	1451	1527	50	50	1	0	1688	1444	1366	1382	1451	50	50	1	0
1689	1366	1302	1318	1382	50	50	1	0	1690	1302	1242	1248	1318	50	50	1	0
1691	1242	1173	1176	1248	50	50	1	0	1692	1173	1114	1111	1176	50	50	1	0
1693	1114	1044	1053	1111	50	50	1	0	1694	981	996	1053	1044	50	50	1	0
1695	996	1008	1061	1053	50	50	1	0	1696	1008	1023	1077	1061	50	50	1	0
1697	1037	1098	1077	1023	50	50	1	0	1698	1098	1157	1125	1077	50	50	1	0
1699	1157	1208	1176	1125	50	50	1	0	1700	1208	1272	1248	1176	50	50	1	0
1701	1272	1329	1318	1248	50	50	1	0	1702	1329	1394	1382	1318	50	50	1	0
1703	1394	1466	1451	1382	50	50	1	0	1704	1466	1536	1527	1451	50	50	1	0
1705	1536	1615	1610	1527	50	50	1	0	1706	1615	1707	1700	1610	50	50	1	0
1707	1802	1699	1700	1707	50	50	1	0	1708	1699	1605	1610	1700	50	50	1	0
1709	1605	1521	1527	1610	50	50	1	0	1710	1125	1176	1111	1100	50	50	1	0
1711	1111	1053	1061	1100	50	50	1	0	1712	1061	1077	1125	1100	50	50	1	0
1713	3303	3301	3334	3336	200	200	1	0	1714	3301	3299	3330	3334	200	200	1	0
1715	3299	3297	3328	3330	200	200	1	0	1716	3297	3295	3324	3328	200	200	1	0
1717	913	927	987	968	360	360	1	0	1718	968	987	1055	1037	360	360	1	0
1719	927	947	1005	987	360	360	1	0	1720	987	1005	1075	1055	360	360	1	0
1721	947	966	1027	1005	360	360	1	0	1722	1005	1027	1096	1075	360	360	1	0
1723	966	988	1050	1027	360	360	1	0	1724	1027	1050	1116	1096	360	360	1	0
1725	791	804	866	848	345	345	1	0	1726	848	866	927	913	345	345	1	0
1727	804	824	879	866	345	345	1	0	1728	866	879	947	927	345	345	1	0
1729	824	844	903	879	345	345	1	0	1730	879	903	966	947	345	345	1	0
1731	844	864	921	903	345	345	1	0	1732	903	921	988	966	345	345	1	0
1733	791	738	754	804	330	330	1	0	1734	804	754	775	824	330	330	1	0
1735	824	775	795	844	330	330	1	0	1736	844	795	809	864	330	330	1	0
1737	738	689	707	754	330	330	1	0	1738	754	707	726	775	330	330	1	0
1739	775	726	744	795	330	330	1	0	1740	795	744	761	809	330	330	1	0
1741	602	626	663	644	315	315	1	0	1742	644	663	707	689	315	315	1	0
1743	626	636	683	663	315	315	1	0	1744	663	683	726	707	315	315	1	0
1745	636	659	697	683	315	315	1	0	1746	683	697	744	726	315	315	1	0
1747	659	681	718	697	315	315	1	0	1748	697	718	761	744	315	315	1	0
1749	497	515	542	522	300	300	1	0	1750	522	542	565	546	300	300	1	0
1751	546	565	591	576	300	300	1	0	1752	576	591	626	602	300	300	1	0
1753	515	534	556	542	300	300	1	0	1754	542	556	585	565	300	300	1	0
1755	565	585	612	591	300	300	1	0	1756	591	612	636	626	300	300	1	0
1757	534	550	577	556	300	300	1	0	1758	556	577	599	585	300	300	1	0
1759	585	599	630	612	300	300	1	0	1760	612	630	659	636	300	300	1	0
1761	550	573	595	577	300	300	1	0	1762	577	595	624	599	300	300	1	0
1763	599	624	648	630	300	300	1	0	1764	630	648	681	659	300	300	1	0
1765	1536	1466	1479	1550	50	50	1	0	1766	1466	1394	1412	1479	50	50	1	0
1767	1394	1329	1357	1412	50	50	1	0	1768	1329	1272	1293	1357	50	50	1	0
1769	1272	1208	1226	1293	50	50	1	0	1770	1208	1157	1161	1226	50	50	1	0
1771	1157	1098	1112	1161	50	50	1	0	1772	1037	1055	1112	1098	50	50	1	0
1773	1055	1075	1120	1112	50	50	1	0	1774	1075	1096	1139	1120	50	50	1	0
1775	1116	1165	1139	1096	50	50	1	0	1776	1165	1211	1188	1139	50	50	1	0
1777	1211	1264	1226	1188	50	50	1	0	1778	1264	1324	1293	1226	50	50	1	0
1779	1324	1377	1357	1293	50	50	1	0	1780	1377	1440	1412	1357	50	50	1	0
1781	1440	1492	1479	1412	50	50	1	0	1782	1492	1563	1550	1479	50	50	1	0
1783	1563	1637	1627	1550	50	50	1	0	1784	1637	1720	1708	1627	50	50	1	0



Tabulati di Calcolo Plinto di Fondazione per Aerogeneratore Tipo - Progetto Impianto Eolico - "Orione"

Ind.	Nod o I	Nodo J	Nodo L	Nodo K	Sp.membranale	Sp.flessionale	Materiale	Var.term.	Ind.	Nodo I	Nodo J	Nodo L	Nodo K	Sp.membranale	Sp.flessionale	Materiale	Var.term.
							Indice									Indice	
1785	1802	1707	1708	1720	50	50	1	0	1786	1707	1615	1627	1708	50	50	1	0
1787	1615	1536	1550	1627	50	50	1	0	1788	1188	1226	1161	1155	50	50	1	0
1789	1161	1112	1120	1155	50	50	1	0	1790	1120	1139	1188	1155	50	50	1	0
1791	3332	3326	3347	3350	200	200	1	0	1792	3326	3320	3344	3347	200	200	1	0
1793	3320	3312	3340	3344	200	200	1	0	1794	3312	3303	3336	3340	200	200	1	0
1795	988	1017	1078	1050	360	360	1	0	1796	1050	1078	1136	1116	360	360	1	0
1797	1017	1041	1103	1078	360	360	1	0	1798	1078	1103	1159	1136	360	360	1	0
1799	1041	1069	1127	1103	360	360	1	0	1800	1103	1127	1184	1159	360	360	1	0
1801	1069	1104	1153	1127	360	360	1	0	1802	1127	1153	1199	1184	360	360	1	0
1803	864	888	948	921	345	345	1	0	1804	921	948	1017	988	345	345	1	0
1805	888	915	974	948	345	345	1	0	1806	948	974	1041	1017	345	345	1	0
1807	915	940	1003	974	345	345	1	0	1808	974	1003	1069	1041	345	345	1	0
1809	940	970	1034	1003	345	345	1	0	1810	1003	1034	1104	1069	345	345	1	0
1811	761	788	838	809	330	330	1	0	1812	809	838	888	864	330	330	1	0
1813	788	811	860	838	330	330	1	0	1814	838	860	915	888	330	330	1	0
1815	811	842	891	860	330	330	1	0	1816	860	891	940	915	330	330	1	0
1817	842	868	919	891	330	330	1	0	1818	891	919	970	940	330	330	1	0
1819	761	718	745	788	315	315	1	0	1820	788	745	770	811	315	315	1	0
1821	811	770	798	842	315	315	1	0	1822	842	798	820	868	315	315	1	0
1823	718	681	701	745	315	315	1	0	1824	745	701	732	770	315	315	1	0
1825	770	732	752	798	315	315	1	0	1826	798	752	782	820	315	315	1	0
1827	573	593	617	595	300	300	1	0	1828	595	617	645	624	300	300	1	0
1829	624	645	674	648	300	300	1	0	1830	648	674	701	681	300	300	1	0
1831	593	618	640	617	300	300	1	0	1832	617	640	670	645	300	300	1	0
1833	645	670	694	674	300	300	1	0	1834	674	694	732	701	300	300	1	0
1835	618	646	671	640	300	300	1	0	1836	640	671	691	670	300	300	1	0
1837	670	691	727	694	300	300	1	0	1838	694	727	752	732	300	300	1	0
1839	646	675	695	671	300	300	1	0	1840	671	695	728	691	300	300	1	0
1841	691	728	750	727	300	300	1	0	1842	727	750	782	752	300	300	1	0
1843	1563	1492	1522	1575	50	50	1	0	1844	1492	1440	1456	1522	50	50	1	0
1845	1440	1377	1400	1456	50	50	1	0	1846	1377	1324	1346	1400	50	50	1	0
1847	1324	1264	1283	1346	50	50	1	0	1848	1264	1211	1230	1283	50	50	1	0
1849	1211	1165	1181	1230	50	50	1	0	1850	1116	1136	1181	1165	50	50	1	0
1851	1136	1159	1192	1181	50	50	1	0	1852	1159	1184	1219	1192	50	50	1	0
1853	1199	1246	1219	1184	50	50	1	0	1854	1246	1294	1252	1219	50	50	1	0
1855	1294	1332	1283	1252	50	50	1	0	1856	1332	1386	1346	1283	50	50	1	0
1857	1386	1436	1400	1346	50	50	1	0	1858	1436	1481	1456	1400	50	50	1	0
1859	1481	1539	1522	1456	50	50	1	0	1860	1539	1599	1575	1522	50	50	1	0
1861	1599	1654	1643	1575	50	50	1	0	1862	1654	1735	1724	1643	50	50	1	0
1863	1802	1720	1724	1735	50	50	1	0	1864	1720	1637	1643	1724	50	50	1	0
1865	1637	1563	1575	1643	50	50	1	0	1866	1252	1283	1230	1228	50	50	1	0
1867	1230	1181	1192	1228	50	50	1	0	1868	1192	1219	1252	1228	50	50	1	0
1869	3352	3348	3360	3364	200	200	1	0	1870	3348	3342	3358	3360	200	200	1	0
1871	3342	3338	3354	3358	200	200	1	0	1872	3338	3332	3350	3354	200	200	1	0
1873	1104	1133	1185	1153	360	360	1	0	1874	1153	1185	1234	1199	360	360	1	0
1875	1133	1167	1206	1185	360	360	1	0	1876	1185	1206	1254	1234	360	360	1	0
1877	1167	1195	1244	1206	360	360	1	0	1878	1206	1244	1281	1254	360	360	1	0
1879	1195	1235	1269	1244	360	360	1	0	1880	1244	1269	1313	1281	360	360	1	0
1881	970	1009	1070	1034	345	345	1	0	1882	1034	1070	1133	1104	345	345	1	0



Tabulati di Calcolo Plinto di Fondazione per Aerogeneratore Tipo - Progetto Impianto Eolico - "Orione"

Ind.	Nod o I	Nodo J	Nodo L	Nodo K	Sp.membranale	Sp.flessionale	Materiale	Var.term.	Ind.	Nodo I	Nodo J	Nodo L	Nodo K	Sp.membranale	Sp.flessionale	Materiale	Var.term.
							Indice									Indice	
1883	1009	1051	1107	1070	345	345	1	0	1884	1070	1107	1167	1133	345	345	1	0
1885	1051	1092	1147	1107	345	345	1	0	1886	1107	1147	1195	1167	345	345	1	0
1887	1092	1130	1179	1147	345	345	1	0	1888	1147	1179	1235	1195	345	345	1	0
1889	868	907	954	919	330	330	1	0	1890	919	954	1009	970	330	330	1	0
1891	907	935	992	954	330	330	1	0	1892	954	992	1051	1009	330	330	1	0
1893	935	978	1035	992	330	330	1	0	1894	992	1035	1092	1051	330	330	1	0
1895	978	1025	1081	1035	330	330	1	0	1896	1035	1081	1130	1092	330	330	1	0
1897	782	813	856	820	315	315	1	0	1898	820	856	907	868	315	315	1	0
1899	813	852	895	856	315	315	1	0	1900	856	895	935	907	315	315	1	0
1901	852	893	932	895	315	315	1	0	1902	895	932	978	935	315	315	1	0
1903	893	933	976	932	315	315	1	0	1904	932	976	1025	978	315	315	1	0
1905	675	708	734	695	300	300	1	0	1906	695	734	756	728	300	300	1	0
1907	728	756	789	750	300	300	1	0	1908	750	789	813	782	300	300	1	0
1909	708	746	773	734	300	300	1	0	1910	734	773	799	756	300	300	1	0
1911	756	799	821	789	300	300	1	0	1912	789	821	852	813	300	300	1	0
1913	746	783	805	773	300	300	1	0	1914	773	805	836	799	300	300	1	0
1915	799	836	862	821	300	300	1	0	1916	821	862	893	852	300	300	1	0
1917	783	822	850	805	300	300	1	0	1918	805	850	874	836	300	300	1	0
1919	836	874	909	862	300	300	1	0	1920	862	909	933	893	300	300	1	0
1921	1599	1539	1564	1620	50	50	1	0	1922	1539	1481	1514	1564	50	50	1	0
1923	1481	1436	1468	1514	50	50	1	0	1924	1436	1386	1414	1468	50	50	1	0
1925	1386	1332	1364	1414	50	50	1	0	1926	1332	1294	1310	1364	50	50	1	0
1927	1294	1246	1265	1310	50	50	1	0	1928	1199	1234	1265	1246	50	50	1	0
1929	1234	1254	1285	1265	50	50	1	0	1930	1254	1281	1319	1285	50	50	1	0
1931	1313	1347	1319	1281	50	50	1	0	1932	1347	1387	1342	1319	50	50	1	0
1933	1387	1422	1364	1342	50	50	1	0	1934	1422	1462	1414	1364	50	50	1	0
1935	1462	1499	1468	1414	50	50	1	0	1936	1499	1546	1514	1468	50	50	1	0
1937	1546	1591	1564	1514	50	50	1	0	1938	1591	1639	1620	1564	50	50	1	0
1939	1639	1690	1665	1620	50	50	1	0	1940	1690	1753	1740	1665	50	50	1	0
1941	1802	1735	1740	1753	50	50	1	0	1942	1735	1654	1665	1740	50	50	1	0
1943	1654	1599	1620	1665	50	50	1	0	1944	1342	1364	1310	1315	50	50	1	0
1945	1310	1265	1285	1315	50	50	1	0	1946	1285	1319	1342	1315	50	50	1	0
1947	3370	3366	3376	3378	200	200	1	0	1948	3366	3362	3372	3376	200	200	1	0
1949	3362	3356	3368	3372	200	200	1	0	1950	3356	3352	3364	3368	200	200	1	0
1951	1235	1262	1305	1269	360	360	1	0	1952	1269	1305	1340	1313	360	360	1	0
1953	1262	1303	1333	1305	360	360	1	0	1954	1305	1333	1374	1340	360	360	1	0
1955	1303	1335	1369	1333	360	360	1	0	1956	1333	1369	1404	1374	360	360	1	0
1957	1335	1380	1409	1369	360	360	1	0	1958	1369	1409	1445	1404	360	360	1	0
1959	1130	1174	1220	1179	345	345	1	0	1960	1179	1220	1262	1235	345	345	1	0
1961	1174	1216	1256	1220	345	345	1	0	1962	1220	1256	1303	1262	345	345	1	0
1963	1216	1259	1299	1256	345	345	1	0	1964	1256	1299	1335	1303	345	345	1	0
1965	1259	1307	1337	1299	345	345	1	0	1966	1299	1337	1380	1335	345	345	1	0
1967	1130	1081	1128	1174	330	330	1	0	1968	1174	1128	1177	1216	330	330	1	0
1969	1216	1177	1224	1259	330	330	1	0	1970	1259	1224	1270	1307	330	330	1	0
1971	1081	1025	1084	1128	330	330	1	0	1972	1128	1084	1134	1177	330	330	1	0
1973	1177	1134	1189	1224	330	330	1	0	1974	1224	1189	1239	1270	330	330	1	0
1975	933	984	1031	976	315	315	1	0	1976	976	1031	1084	1025	315	315	1	0
1977	984	1045	1093	1031	315	315	1	0	1978	1031	1093	1134	1084	315	315	1	0
1979	1045	1108	1149	1093	315	315	1	0	1980	1093	1149	1189	1134	315	315	1	0



Tabulati di Calcolo Plinto di Fondazione per Aerogeneratore Tipo - Progetto Impianto Eolico - "Orione"

Ind.	Nodo I	Nodo J	Nodo L	Nodo K	Sp.membranale	Sp.flessionale	Materiale	Var.term.	Ind.	Nodo I	Nodo J	Nodo L	Nodo K	Sp.membranale	Sp.flessionale	Materiale	Var.term.
							Indice									Indice	
198	1108	1169	1197	1149	315	315	1	0	1982	1149	1197	1239	1189	315	315	1	0
198	822	872	901	850	300	300	1	0	1984	850	901	923	874	300	300	1	0
198	874	923	960	909	300	300	1	0	1986	909	960	984	933	300	300	1	0
198	872	925	956	901	300	300	1	0	1988	901	956	982	923	300	300	1	0
198	923	982	1011	960	300	300	1	0	1990	960	1011	1045	984	300	300	1	0
199	925	990	1021	956	300	300	1	0	1992	956	1021	1047	982	300	300	1	0
199	982	1047	1082	1011	300	300	1	0	1994	1011	1082	1108	1045	300	300	1	0
199	990	1065	1094	1021	300	300	1	0	1996	1021	1094	1118	1047	300	300	1	0
199	1047	1118	1145	1082	300	300	1	0	1998	1082	1145	1169	1108	300	300	1	0
199	1639	1591	1624	1659	50	50	1	0	2000	1591	1546	1578	1624	50	50	1	0
200	1546	1499	1541	1578	50	50	1	0	2002	1499	1462	1504	1541	50	50	1	0
200	1462	1422	1458	1504	50	50	1	0	2004	1422	1387	1408	1458	50	50	1	0
200	1387	1347	1373	1408	50	50	1	0	2006	1313	1340	1373	1347	50	50	1	0
200	1340	1374	1396	1373	50	50	1	0	2008	1374	1404	1430	1396	50	50	1	0
200	1445	1471	1430	1404	50	50	1	0	2010	1471	1493	1452	1430	50	50	1	0
201	1493	1524	1458	1452	50	50	1	0	2012	1524	1552	1504	1458	50	50	1	0
201	1552	1584	1541	1504	50	50	1	0	2014	1584	1621	1578	1541	50	50	1	0
201	1621	1649	1624	1578	50	50	1	0	2016	1649	1684	1659	1624	50	50	1	0
201	1684	1731	1713	1659	50	50	1	0	2018	1731	1766	1761	1713	50	50	1	0
201	1802	1753	1761	1766	50	50	1	0	2020	1753	1690	1713	1761	50	50	1	0
202	1690	1639	1659	1713	50	50	1	0	2022	1452	1458	1408	1419	50	50	1	0
202	1408	1373	1396	1419	50	50	1	0	2024	1396	1430	1452	1419	50	50	1	0
202	3388	3384	3390	3394	200	200	1	0	2026	3384	3380	3386	3390	200	200	1	0
202	3380	3374	3382	3386	200	200	1	0	2028	3374	3370	3378	3382	200	200	1	0
202	1380	1423	1447	1409	360	360	1	0	2030	1409	1447	1477	1445	360	360	1	0
203	1423	1469	1487	1447	360	360	1	0	2032	1447	1487	1517	1477	360	360	1	0
203	1469	1512	1534	1487	360	360	1	0	2034	1487	1534	1554	1517	360	360	1	0
203	1512	1558	1579	1534	360	360	1	0	2036	1534	1579	1603	1554	360	360	1	0
203	1307	1358	1391	1337	345	345	1	0	2038	1337	1391	1423	1380	345	345	1	0
203	1358	1402	1441	1391	345	345	1	0	2040	1391	1441	1469	1423	345	345	1	0
204	1402	1457	1484	1441	345	345	1	0	2042	1441	1484	1512	1469	345	345	1	0
204	1457	1518	1540	1484	345	345	1	0	2044	1484	1540	1558	1512	345	345	1	0
204	1239	1287	1325	1270	330	330	1	0	2046	1270	1325	1358	1307	330	330	1	0
204	1287	1350	1378	1325	330	330	1	0	2048	1325	1378	1402	1358	330	330	1	0
204	1350	1410	1437	1378	330	330	1	0	2050	1378	1437	1457	1402	330	330	1	0
205	1410	1473	1489	1437	330	330	1	0	2052	1437	1489	1518	1457	330	330	1	0
205	1169	1236	1260	1197	315	315	1	0	2054	1197	1260	1287	1239	315	315	1	0
205	1236	1297	1321	1260	315	315	1	0	2056	1260	1321	1350	1287	315	315	1	0
205	1297	1362	1388	1321	315	315	1	0	2058	1321	1388	1410	1350	315	315	1	0
205	1362	1431	1453	1388	315	315	1	0	2060	1388	1453	1473	1410	315	315	1	0
206	1065	1140	1163	1094	300	300	1	0	2062	1094	1163	1191	1118	300	300	1	0
206	1118	1191	1203	1145	300	300	1	0	2064	1145	1203	1236	1169	300	300	1	0
206	1140	1212	1240	1163	300	300	1	0	2066	1163	1240	1250	1191	300	300	1	0
206	1191	1250	1274	1203	300	300	1	0	2068	1203	1274	1297	1236	300	300	1	0
206	1212	1295	1311	1240	300	300	1	0	2070	1240	1311	1327	1250	300	300	1	0
207	1250	1327	1343	1274	300	300	1	0	2072	1274	1343	1362	1297	300	300	1	0
207	1295	1370	1392	1311	300	300	1	0	2074	1311	1392	1398	1327	300	300	1	0
207	1327	1398	1415	1343	300	300	1	0	2076	1343	1415	1431	1362	300	300	1	0
207	1684	1649	1680	1721	50	50	1	0	2078	1649	1621	1655	1680	50	50	1	0



Tabulati di Calcolo Plinto di Fondazione per Aerogeneratore Tipo - Progetto Impianto Eolico - "Orione"

Ind.	Nod o I	Nodo J	Nodo L	Nodo K	Sp.membranale	Sp.flessionale	Materiale	Var.term.	Ind.	Nodo I	Nodo J	Nodo L	Nodo K	Sp.membranale	Sp.flessionale	Materiale	Var.term.
							Indice									Indice	
207	1621	1584	1633	1655	50	50	1	0	2080	1584	1552	1606	1633	50	50	1	0
208	1552	1524	1569	1606	50	50	1	0	2082	1524	1493	1530	1569	50	50	1	0
208	1493	1471	1500	1530	50	50	1	0	2084	1445	1477	1500	1471	50	50	1	0
208	1477	1517	1533	1500	50	50	1	0	2086	1517	1554	1568	1533	50	50	1	0
208	1603	1616	1568	1554	50	50	1	0	2088	1616	1634	1582	1568	50	50	1	0
208	1634	1647	1569	1582	50	50	1	0	2090	1647	1661	1606	1569	50	50	1	0
209	1661	1681	1633	1606	50	50	1	0	2092	1681	1709	1655	1633	50	50	1	0
209	1709	1732	1680	1655	50	50	1	0	2094	1732	1748	1721	1680	50	50	1	0
209	1748	1767	1747	1721	50	50	1	0	2096	1767	1775	1771	1747	50	50	1	0
209	1802	1766	1771	1775	50	50	1	0	2098	1766	1731	1747	1771	50	50	1	0
209	1731	1684	1721	1747	50	50	1	0	2100	1582	1569	1530	1548	50	50	1	0
210	1530	1500	1533	1548	50	50	1	0	2102	1533	1568	1582	1548	50	50	1	0
210	3406	3402	3404	3408	200	200	1	0	2104	3402	3396	3400	3404	200	200	1	0
210	3396	3392	3398	3400	200	200	1	0	2106	3392	3388	3394	3398	200	200	1	0
210	1558	1617	1629	1579	360	360	1	0	2108	1579	1629	1644	1603	360	360	1	0
210	1617	1666	1674	1629	360	360	1	0	2110	1629	1674	1695	1644	360	360	1	0
211	1666	1742	1750	1674	360	360	1	0	2112	1674	1750	1758	1695	360	360	1	0
211	1742	1815	1814	1750	360	360	1	0	2114	1750	1814	1813	1758	360	360	1	0
211	1518	1576	1600	1540	345	345	1	0	2116	1540	1600	1617	1558	345	345	1	0
211	1576	1645	1657	1600	345	345	1	0	2118	1600	1657	1666	1617	345	345	1	0
211	1645	1728	1736	1657	345	345	1	0	2120	1657	1736	1742	1666	345	345	1	0
212	1728	1817	1816	1736	345	345	1	0	2122	1736	1816	1815	1742	345	345	1	0
212	1473	1544	1559	1489	330	330	1	0	2124	1489	1559	1576	1518	330	330	1	0
212	1544	1625	1635	1559	330	330	1	0	2126	1559	1635	1645	1576	330	330	1	0
212	1625	1716	1722	1635	330	330	1	0	2128	1635	1722	1728	1645	330	330	1	0
212	1716	1819	1818	1722	330	330	1	0	2130	1722	1818	1817	1728	330	330	1	0
213	1431	1508	1528	1453	315	315	1	0	2132	1453	1528	1544	1473	315	315	1	0
213	1508	1601	1611	1528	315	315	1	0	2134	1528	1611	1625	1544	315	315	1	0
213	1601	1696	1703	1611	315	315	1	0	2136	1611	1703	1716	1625	315	315	1	0
213	1696	1821	1820	1703	315	315	1	0	2138	1703	1820	1819	1716	315	315	1	0
213	1370	1463	1475	1392	300	300	1	0	2140	1392	1475	1485	1398	300	300	1	0
214	1398	1485	1495	1415	300	300	1	0	2142	1415	1495	1508	1431	300	300	1	0
214	1463	1560	1566	1475	300	300	1	0	2144	1475	1566	1577	1485	300	300	1	0
214	1485	1577	1586	1495	300	300	1	0	2146	1495	1586	1601	1508	300	300	1	0
214	1560	1667	1670	1566	300	300	1	0	2148	1566	1670	1675	1577	300	300	1	0
214	1577	1675	1685	1586	300	300	1	0	2150	1586	1685	1696	1601	300	300	1	0
215	1667	1825	1824	1670	300	300	1	0	2152	1670	1824	1823	1675	300	300	1	0
215	1675	1823	1822	1685	300	300	1	0	2154	1685	1822	1821	1696	300	300	1	0
215	1748	1732	1768	1772	50	50	1	0	2156	1732	1709	1762	1768	50	50	1	0
215	1709	1681	1749	1762	50	50	1	0	2158	1681	1661	1738	1749	50	50	1	0
215	1661	1647	1725	1738	50	50	1	0	2160	1647	1634	1669	1725	50	50	1	0
216	1634	1616	1656	1669	50	50	1	0	2162	1603	1644	1656	1616	50	50	1	0
216	1644	1695	1702	1656	50	50	1	0	2164	1695	1758	1757	1702	50	50	1	0
216	1813	1812	1757	1758	50	50	1	0	2166	1812	1811	1754	1757	50	50	1	0
216	1811	1810	1725	1754	50	50	1	0	2168	1810	1809	1738	1725	50	50	1	0
216	1809	1808	1749	1738	50	50	1	0	2170	1808	1807	1762	1749	50	50	1	0
217	1807	1806	1768	1762	50	50	1	0	2172	1806	1805	1772	1768	50	50	1	0
217	1805	1804	1776	1772	50	50	1	0	2174	1804	1803	1778	1776	50	50	1	0
217	1802	1775	1778	1803	50	50	1	0	2176	1775	1767	1776	1778	50	50	1	0



Tabulati di Calcolo Plinto di Fondazione per Aerogeneratore Tipo - Progetto Impianto Eolico - "Orione"

Ind.	Nod o I	Nodo J	Nodo L	Nodo K	Sp.membranale	Sp.flessionale	Materiale	Var.term.	Ind.	Nodo I	Nodo J	Nodo L	Nodo K	Sp.membranale	Sp.flessionale	Materiale	Var.term.
							Indice									Indice	
217	1767	1748	1772	1776	50	50	1	0	2178	1754	1725	1669	1715	50	50	1	0
217	1669	1656	1702	1715	50	50	1	0	2180	1702	1757	1754	1715	50	50	1	0
218	3425	3418	3420	3424	200	200	1	0	2182	3418	3414	3416	3420	200	200	1	0
218	3414	3410	3412	3416	200	200	1	0	2184	3410	3406	3408	3412	200	200	1	0
218	2002	1963	1976	2031	360	360	1	0	2186	2031	1976	1992	2047	360	360	1	0
218	1963	1910	1931	1976	360	360	1	0	2188	1976	1931	1941	1992	360	360	1	0
218	1910	1849	1861	1931	360	360	1	0	2190	1931	1861	1863	1941	360	360	1	0
219	1849	1813	1814	1861	360	360	1	0	2192	1861	1814	1815	1863	360	360	1	0
219	2047	1992	2009	2067	345	345	1	0	2194	2067	2009	2033	2089	345	345	1	0
219	1992	1941	1954	2009	345	345	1	0	2196	2009	1954	1964	2033	345	345	1	0
219	1941	1863	1871	1954	345	345	1	0	2198	1954	1871	1878	1964	345	345	1	0
219	1863	1815	1816	1871	345	345	1	0	2200	1871	1816	1817	1878	345	345	1	0
220	2089	2033	2048	2116	330	330	1	0	2202	2116	2048	2062	2132	330	330	1	0
220	2033	1964	1974	2048	330	330	1	0	2204	2048	1974	1982	2062	330	330	1	0
220	1964	1878	1887	1974	330	330	1	0	2206	1974	1887	1894	1982	330	330	1	0
220	1878	1817	1818	1887	330	330	1	0	2208	1887	1818	1819	1894	330	330	1	0
220	2132	2062	2079	2156	315	315	1	0	2210	2156	2079	2097	2174	315	315	1	0
221	2062	1982	1997	2079	315	315	1	0	2212	2079	1997	2010	2097	315	315	1	0
221	1982	1894	1903	1997	315	315	1	0	2214	1997	1903	1911	2010	315	315	1	0
221	1894	1819	1820	1903	315	315	1	0	2216	1903	1820	1821	1911	315	315	1	0
221	2174	2097	2110	2191	300	300	1	0	2218	2191	2110	2122	2207	300	300	1	0
221	2207	2122	2130	2215	300	300	1	0	2220	2215	2130	2146	2237	300	300	1	0
222	2097	2010	2019	2110	300	300	1	0	2222	2110	2019	2034	2122	300	300	1	0
222	2122	2034	2039	2130	300	300	1	0	2224	2130	2039	2049	2146	300	300	1	0
222	2010	1911	1921	2019	300	300	1	0	2226	2019	1921	1932	2034	300	300	1	0
222	2034	1932	1936	2039	300	300	1	0	2228	2039	1936	1942	2049	300	300	1	0
222	1911	1821	1822	1921	300	300	1	0	2230	1921	1822	1823	1932	300	300	1	0
223	1932	1823	1824	1936	300	300	1	0	2232	1936	1824	1825	1942	300	300	1	0
223	1805	1806	1841	1835	50	50	1	0	2234	1806	1807	1845	1841	50	50	1	0
223	1807	1808	1860	1845	50	50	1	0	2236	1808	1809	1867	1860	50	50	1	0
223	1809	1810	1877	1867	50	50	1	0	2238	1810	1811	1853	1877	50	50	1	0
223	1811	1812	1848	1853	50	50	1	0	2240	1813	1849	1848	1812	50	50	1	0
224	1849	1910	1900	1848	50	50	1	0	2242	1910	1963	1953	1900	50	50	1	0
224	2002	1991	1953	1963	50	50	1	0	2244	1991	1973	1933	1953	50	50	1	0
224	1973	1958	1877	1933	50	50	1	0	2246	1958	1944	1867	1877	50	50	1	0
224	1944	1928	1860	1867	50	50	1	0	2248	1928	1899	1845	1860	50	50	1	0
224	1899	1875	1841	1845	50	50	1	0	2250	1875	1859	1835	1841	50	50	1	0
225	1859	1840	1831	1835	50	50	1	0	2252	1840	1830	1827	1831	50	50	1	0
225	1802	1803	1827	1830	50	50	1	0	2254	1803	1804	1831	1827	50	50	1	0
225	1804	1805	1835	1831	50	50	1	0	2256	1933	1877	1853	1890	50	50	1	0
225	1853	1848	1900	1890	50	50	1	0	2258	1900	1953	1933	1890	50	50	1	0
225	3441	3437	3435	3439	200	200	1	0	2260	3437	3433	3431	3435	200	200	1	0
226	3433	3429	3427	3431	200	200	1	0	2262	3429	3425	3424	3427	200	200	1	0
226	2162	2128	2158	2198	360	360	1	0	2264	2198	2158	2186	2225	360	360	1	0
226	2128	2088	2118	2158	360	360	1	0	2266	2158	2118	2140	2186	360	360	1	0
226	2088	2051	2073	2118	360	360	1	0	2268	2118	2073	2093	2140	360	360	1	0
226	2051	2002	2031	2073	360	360	1	0	2270	2073	2031	2047	2093	360	360	1	0
227	2225	2186	2214	2268	345	345	1	0	2272	2268	2214	2249	2298	345	345	1	0
227	2186	2140	2166	2214	345	345	1	0	2274	2214	2166	2203	2249	345	345	1	0



Tabulati di Calcolo Plinto di Fondazione per Aerogeneratore Tipo - Progetto Impianto Eolico - "Orione"

Ind.	Nod o I	Nodo J	Nodo L	Nodo K	Sp.membranale	Sp.flessionale	Materiale	Var.term.	Ind.	Nodo I	Nodo J	Nodo L	Nodo K	Sp.membranale	Sp.flessionale	Materiale	Var.term.
							Indice									Indice	
2275	2140	2093	2121	2166	345	345	1	0	2276	2166	2121	2150	2203	345	345	1	0
2277	2093	2047	2067	2121	345	345	1	0	2278	2121	2067	2089	2150	345	345	1	0
2279	2298	2249	2283	2337	330	330	1	0	2280	2337	2283	2318	2366	330	330	1	0
2281	2249	2203	2229	2283	330	330	1	0	2282	2283	2229	2255	2318	330	330	1	0
2283	2203	2150	2172	2229	330	330	1	0	2284	2229	2172	2199	2255	330	330	1	0
2285	2150	2089	2116	2172	330	330	1	0	2286	2172	2116	2132	2199	330	330	1	0
2287	2366	2318	2347	2408	315	315	1	0	2288	2408	2347	2373	2436	315	315	1	0
2289	2318	2255	2284	2347	315	315	1	0	2290	2347	2284	2308	2373	315	315	1	0
2291	2255	2199	2221	2284	315	315	1	0	2292	2284	2221	2245	2308	315	315	1	0
2293	2199	2132	2156	2221	315	315	1	0	2294	2221	2156	2174	2245	315	315	1	0
2295	2436	2373	2404	2465	300	300	1	0	2296	2465	2404	2414	2487	300	300	1	0
2297	2487	2414	2442	2515	300	300	1	0	2298	2515	2442	2467	2542	300	300	1	0
2299	2373	2308	2331	2404	300	300	1	0	2300	2404	2331	2355	2414	300	300	1	0
2301	2414	2355	2367	2442	300	300	1	0	2302	2442	2367	2395	2467	300	300	1	0
2303	2308	2245	2266	2331	300	300	1	0	2304	2331	2266	2278	2355	300	300	1	0
2305	2355	2278	2296	2367	300	300	1	0	2306	2367	2296	2317	2395	300	300	1	0
2307	2245	2174	2191	2266	300	300	1	0	2308	2266	2191	2207	2278	300	300	1	0
2309	2278	2207	2215	2296	300	300	1	0	2310	2296	2215	2237	2317	300	300	1	0
2311	1859	1875	1927	1886	50	50	1	0	2312	1875	1899	1952	1927	50	50	1	0
2313	1899	1928	1972	1952	50	50	1	0	2314	1928	1944	1996	1972	50	50	1	0
2315	1944	1958	2032	1996	50	50	1	0	2316	1958	1973	2025	2032	50	50	1	0
2317	1973	1991	2036	2025	50	50	1	0	2318	2002	2051	2036	1991	50	50	1	0
2319	2051	2088	2072	2036	50	50	1	0	2320	2088	2128	2108	2072	50	50	1	0
2321	2162	2134	2108	2128	50	50	1	0	2322	2134	2114	2075	2108	50	50	1	0
2323	2114	2081	2032	2075	50	50	1	0	2324	2081	2053	1996	2032	50	50	1	0
2325	2053	2021	1972	1996	50	50	1	0	2326	2021	1986	1952	1972	50	50	1	0
2327	1986	1956	1927	1952	50	50	1	0	2328	1956	1924	1886	1927	50	50	1	0
2329	1924	1874	1858	1886	50	50	1	0	2330	1874	1839	1834	1858	50	50	1	0
2331	1802	1830	1834	1839	50	50	1	0	2332	1830	1840	1858	1834	50	50	1	0
2333	1840	1859	1886	1858	50	50	1	0	2334	2075	2032	2025	2057	50	50	1	0
2335	2025	2036	2072	2057	50	50	1	0	2336	2072	2108	2075	2057	50	50	1	0
2337	3459	3455	3449	3453	200	200	1	0	2338	3455	3451	3447	3449	200	200	1	0
2339	3451	3445	3443	3447	200	200	1	0	2340	3445	3441	3439	3443	200	200	1	0
2341	2292	2265	2300	2336	360	360	1	0	2342	2336	2300	2343	2372	360	360	1	0
2343	2265	2234	2274	2300	360	360	1	0	2344	2300	2274	2304	2343	360	360	1	0
2345	2234	2201	2236	2274	360	360	1	0	2346	2274	2236	2270	2304	360	360	1	0
2347	2201	2162	2198	2236	360	360	1	0	2348	2236	2198	2225	2270	360	360	1	0
2349	2372	2343	2387	2426	345	345	1	0	2350	2426	2387	2434	2475	345	345	1	0
2351	2343	2304	2349	2387	345	345	1	0	2352	2387	2349	2390	2434	345	345	1	0
2353	2304	2270	2306	2349	345	345	1	0	2354	2349	2306	2346	2390	345	345	1	0
2355	2270	2225	2268	2306	345	345	1	0	2356	2306	2268	2298	2346	345	345	1	0
2357	2475	2434	2481	2524	330	330	1	0	2358	2524	2481	2521	2580	330	330	1	0
2359	2434	2390	2430	2481	330	330	1	0	2360	2481	2430	2473	2521	330	330	1	0
2361	2390	2346	2383	2430	330	330	1	0	2362	2430	2383	2418	2473	330	330	1	0
2363	2346	2298	2337	2383	330	330	1	0	2364	2383	2337	2366	2418	330	330	1	0
2365	2580	2521	2574	2629	315	315	1	0	2366	2629	2574	2621	2674	315	315	1	0
2367	2521	2473	2514	2574	315	315	1	0	2368	2574	2514	2562	2621	315	315	1	0
2369	2473	2418	2456	2514	315	315	1	0	2370	2514	2456	2499	2562	315	315	1	0
2371	2418	2366	2408	2456	315	315	1	0	2372	2456	2408	2436	2499	315	315	1	0



Tabulati di Calcolo Plinto di Fondazione per Aerogeneratore Tipo - Progetto Impianto Eolico - "Orione"

Ind.	Nod o I	Nodo J	Nodo L	Nodo K	Sp.membranale	Sp.flessionale	Materiale	Var.term.	Ind.	Nodo I	Nodo J	Nodo L	Nodo K	Sp.membranale	Sp.flessionale	Materiale	Var.term.
							Indice									Indice	
2373	2674	2621	2647	2696	300	300	1	0	2374	2696	2647	2682	2731	300	300	1	0
2375	2731	2682	2704	2755	300	300	1	0	2376	2755	2704	2735	2788	300	300	1	0
2377	2621	2562	2594	2647	300	300	1	0	2378	2647	2594	2625	2682	300	300	1	0
2379	2682	2625	2649	2704	300	300	1	0	2380	2704	2649	2680	2735	300	300	1	0
2381	2562	2499	2525	2594	300	300	1	0	2382	2594	2525	2558	2625	300	300	1	0
2383	2625	2558	2584	2649	300	300	1	0	2384	2649	2584	2615	2680	300	300	1	0
2385	2499	2436	2465	2525	300	300	1	0	2386	2525	2465	2487	2558	300	300	1	0
2387	2558	2487	2515	2584	300	300	1	0	2388	2584	2515	2542	2615	300	300	1	0
2389	1924	1956	1981	1946	50	50	1	0	2390	1956	1986	2024	1981	50	50	1	0
2391	1986	2021	2061	2024	50	50	1	0	2392	2021	2053	2103	2061	50	50	1	0
2393	2053	2081	2145	2103	50	50	1	0	2394	2081	2114	2155	2145	50	50	1	0
2395	2114	2134	2176	2155	50	50	1	0	2396	2162	2201	2176	2134	50	50	1	0
2397	2201	2234	2209	2176	50	50	1	0	2398	2234	2265	2233	2209	50	50	1	0
2399	2292	2260	2233	2265	50	50	1	0	2400	2260	2220	2197	2233	50	50	1	0
2401	2220	2184	2145	2197	50	50	1	0	2402	2184	2144	2103	2145	50	50	1	0
2403	2144	2107	2061	2103	50	50	1	0	2404	2107	2059	2024	2061	50	50	1	0
2405	2059	2017	1981	2024	50	50	1	0	2406	2017	1966	1946	1981	50	50	1	0
2407	1966	1918	1893	1946	50	50	1	0	2408	1918	1852	1844	1893	50	50	1	0
2409	1802	1839	1844	1852	50	50	1	0	2410	1839	1874	1893	1844	50	50	1	0
2411	1874	1924	1946	1893	50	50	1	0	2412	2197	2145	2155	2185	50	50	1	0
2413	2155	2176	2209	2185	50	50	1	0	2414	2209	2233	2197	2185	50	50	1	0
2415	3477	3473	3465	3469	200	200	1	0	2416	3473	3467	3461	3465	200	200	1	0
2417	3467	3463	3457	3461	200	200	1	0	2418	3463	3459	3453	3457	200	200	1	0
2419	2406	2371	2423	2452	360	360	1	0	2420	2452	2423	2472	2503	360	360	1	0
2421	2371	2351	2399	2423	360	360	1	0	2422	2423	2399	2438	2472	360	360	1	0
2423	2351	2324	2361	2399	360	360	1	0	2424	2399	2361	2410	2438	360	360	1	0
2425	2324	2292	2336	2361	360	360	1	0	2426	2361	2336	2372	2410	360	360	1	0
2427	2503	2472	2538	2571	345	345	1	0	2428	2571	2538	2598	2635	345	345	1	0
2429	2472	2438	2498	2538	345	345	1	0	2430	2538	2498	2556	2598	345	345	1	0
2431	2438	2410	2458	2498	345	345	1	0	2432	2498	2458	2513	2556	345	345	1	0
2433	2410	2372	2426	2458	345	345	1	0	2434	2458	2426	2475	2513	345	345	1	0
2435	2635	2598	2653	2688	330	330	1	0	2436	2688	2653	2700	2737	330	330	1	0
2437	2598	2556	2613	2653	330	330	1	0	2438	2653	2613	2670	2700	330	330	1	0
2439	2556	2513	2572	2613	330	330	1	0	2440	2613	2572	2627	2670	330	330	1	0
2441	2513	2475	2524	2572	330	330	1	0	2442	2572	2524	2580	2627	330	330	1	0
2443	2737	2700	2749	2786	315	315	1	0	2444	2786	2749	2792	2823	315	315	1	0
2445	2700	2670	2710	2749	315	315	1	0	2446	2749	2710	2753	2792	315	315	1	0
2447	2670	2627	2673	2710	315	315	1	0	2448	2710	2673	2712	2753	315	315	1	0
2449	2627	2580	2629	2673	315	315	1	0	2450	2673	2629	2674	2712	315	315	1	0
2451	2823	2792	2818	2857	300	300	1	0	2452	2857	2818	2849	2883	300	300	1	0
2453	2883	2849	2871	2912	300	300	1	0	2454	2912	2871	2899	2932	300	300	1	0
2455	2792	2753	2787	2818	300	300	1	0	2456	2818	2787	2808	2849	300	300	1	0
2457	2849	2808	2836	2871	300	300	1	0	2458	2871	2836	2863	2899	300	300	1	0
2459	2753	2712	2743	2787	300	300	1	0	2460	2787	2743	2771	2808	300	300	1	0
2461	2808	2771	2802	2836	300	300	1	0	2462	2836	2802	2824	2863	300	300	1	0
2463	2712	2674	2696	2743	300	300	1	0	2464	2743	2696	2731	2771	300	300	1	0
2465	2771	2731	2755	2802	300	300	1	0	2466	2802	2755	2788	2824	300	300	1	0
2467	1966	2017	2043	1985	50	50	1	0	2468	2017	2059	2091	2043	50	50	1	0
2469	2059	2107	2137	2091	50	50	1	0	2470	2107	2144	2190	2137	50	50	1	0





Tabulati di Calcolo Plinto di Fondazione per Aerogeneratore Tipo - Progetto Impianto Eolico - "Orione"

Ind.	Nod o I	Nodo J	Nodo L	Nodo K	Sp.membranale	Sp.flessionale	Materiale	Var.term.	Ind.	Nodo I	Nodo J	Nodo L	Nodo K	Sp.membranale	Sp.flessionale	Materiale	Var.term.
							Indice									Indice	
247	2144	2184	2241	2190	50	50	1	0	2472	2184	2220	2263	2241	50	50	1	0
247	2220	2260	2288	2263	50	50	1	0	2474	2292	2324	2288	2260	50	50	1	0
247	2324	2351	2320	2288	50	50	1	0	2476	2351	2371	2339	2320	50	50	1	0
247	2406	2359	2339	2371	50	50	1	0	2478	2359	2316	2295	2339	50	50	1	0
247	2316	2273	2241	2295	50	50	1	0	2480	2273	2219	2190	2241	50	50	1	0
248	2219	2171	2137	2190	50	50	1	0	2482	2171	2124	2091	2137	50	50	1	0
248	2124	2066	2043	2091	50	50	1	0	2484	2066	2008	1985	2043	50	50	1	0
248	2008	1951	1940	1985	50	50	1	0	2486	1951	1870	1865	1940	50	50	1	0
248	1802	1852	1865	1870	50	50	1	0	2488	1852	1918	1940	1865	50	50	1	0
248	1918	1966	1985	1940	50	50	1	0	2490	2295	2241	2263	2290	50	50	1	0
249	2263	2288	2320	2290	50	50	1	0	2492	2320	2339	2295	2290	50	50	1	0
249	3495	3491	3479	3483	200	200	1	0	2494	3491	3485	3475	3479	200	200	1	0
249	3485	3481	3471	3475	200	200	1	0	2496	3481	3477	3469	3471	200	200	1	0
249	2503	2537	2478	2452	360	360	1	0	2498	2452	2478	2422	2406	360	360	1	0
249	2537	2564	2502	2478	360	360	1	0	2500	2478	2502	2446	2422	360	360	1	0
250	2564	2593	2530	2502	360	360	1	0	2502	2502	2530	2469	2446	360	360	1	0
250	2593	2619	2555	2530	360	360	1	0	2504	2530	2555	2489	2469	360	360	1	0
250	2635	2668	2605	2571	345	345	1	0	2506	2571	2605	2537	2503	345	345	1	0
250	2668	2690	2633	2605	345	345	1	0	2508	2605	2633	2564	2537	345	345	1	0
250	2690	2717	2661	2633	345	345	1	0	2510	2633	2661	2593	2564	345	345	1	0
251	2717	2741	2684	2661	345	345	1	0	2512	2661	2684	2619	2593	345	345	1	0
251	2737	2765	2718	2688	330	330	1	0	2514	2688	2718	2668	2635	330	330	1	0
251	2765	2794	2747	2718	330	330	1	0	2516	2718	2747	2690	2668	330	330	1	0
251	2794	2817	2767	2747	330	330	1	0	2518	2747	2767	2717	2690	330	330	1	0
251	2817	2846	2796	2767	330	330	1	0	2520	2767	2796	2741	2717	330	330	1	0
252	2823	2853	2807	2786	315	315	1	0	2522	2786	2807	2765	2737	315	315	1	0
252	2853	2873	2835	2807	315	315	1	0	2524	2807	2835	2794	2765	315	315	1	0
252	2873	2904	2862	2835	315	315	1	0	2526	2835	2862	2817	2794	315	315	1	0
252	2904	2926	2887	2862	315	315	1	0	2528	2862	2887	2846	2817	315	315	1	0
252	2932	2963	2936	2912	300	300	1	0	2530	2912	2936	2914	2883	300	300	1	0
253	2883	2914	2882	2857	300	300	1	0	2532	2857	2882	2853	2823	300	300	1	0
253	2963	2989	2965	2936	300	300	1	0	2534	2936	2965	2935	2914	300	300	1	0
253	2914	2935	2911	2882	300	300	1	0	2536	2882	2911	2873	2853	300	300	1	0
253	2989	3012	2988	2965	300	300	1	0	2538	2965	2988	2962	2935	300	300	1	0
253	2935	2962	2931	2911	300	300	1	0	2540	2911	2931	2904	2873	300	300	1	0
254	3012	3034	3010	2988	300	300	1	0	2542	2988	3010	2983	2962	300	300	1	0
254	2962	2983	2957	2931	300	300	1	0	2544	2931	2957	2926	2904	300	300	1	0
254	2008	2066	2085	2023	50	50	1	0	2546	2066	2124	2149	2085	50	50	1	0
254	2124	2171	2205	2149	50	50	1	0	2548	2171	2219	2259	2205	50	50	1	0
254	2219	2273	2322	2259	50	50	1	0	2550	2273	2316	2353	2322	50	50	1	0
255	2316	2359	2386	2353	50	50	1	0	2552	2406	2422	2386	2359	50	50	1	0
255	2422	2446	2412	2386	50	50	1	0	2554	2446	2469	2421	2412	50	50	1	0
255	2489	2440	2421	2469	50	50	1	0	2556	2440	2389	2374	2421	50	50	1	0
255	2389	2341	2322	2374	50	50	1	0	2558	2341	2282	2259	2322	50	50	1	0
255	2282	2228	2205	2259	50	50	1	0	2560	2228	2165	2149	2205	50	50	1	0
256	2165	2113	2085	2149	50	50	1	0	2562	2113	2042	2023	2085	50	50	1	0
256	2042	1968	1962	2023	50	50	1	0	2564	1968	1885	1881	1962	50	50	1	0
256	1802	1870	1881	1885	50	50	1	0	2566	1870	1951	1962	1881	50	50	1	0
256	1951	2008	2023	1962	50	50	1	0	2568	2374	2322	2353	2377	50	50	1	0



Tabulati di Calcolo Plinto di Fondazione per Aerogeneratore Tipo - Progetto Impianto Eolico - "Orione"

Ind.	Nod o I	Nodo J	Nodo L	Nodo K	Sp.membranale	Sp.flessionale	Materiale	Var.term.	Ind.	Nodo I	Nodo J	Nodo L	Nodo K	Sp.membranale	Sp.flessionale	Materiale	Var.term.
							Indice									Indice	
2569	2353	2386	2412	2377	50	50	1	0	2570	2412	2421	2374	2377	50	50	1	0
2571	3515	3509	3493	3497	200	200	1	0	2572	3509	3505	3489	3493	200	200	1	0
2573	3505	3501	3487	3489	200	200	1	0	2574	3501	3495	3483	3487	200	200	1	0
2575	2619	2641	2578	2555	360	360	1	0	2576	2555	2578	2509	2489	360	360	1	0
2577	2641	2660	2600	2578	360	360	1	0	2578	2578	2600	2533	2509	360	360	1	0
2579	2660	2678	2618	2600	360	360	1	0	2580	2600	2618	2550	2533	360	360	1	0
2581	2678	2694	2637	2618	360	360	1	0	2582	2618	2637	2568	2550	360	360	1	0
2583	2741	2761	2702	2684	345	345	1	0	2584	2684	2702	2641	2619	345	345	1	0
2585	2761	2781	2728	2702	345	345	1	0	2586	2702	2728	2660	2641	345	345	1	0
2587	2781	2801	2739	2728	345	345	1	0	2588	2728	2739	2678	2660	345	345	1	0
2589	2801	2814	2759	2739	345	345	1	0	2590	2739	2759	2694	2678	345	345	1	0
2591	2741	2796	2810	2761	330	330	1	0	2592	2761	2810	2830	2781	330	330	1	0
2593	2781	2830	2851	2801	330	330	1	0	2594	2801	2851	2867	2814	330	330	1	0
2595	2796	2846	2861	2810	330	330	1	0	2596	2810	2861	2881	2830	330	330	1	0
2597	2830	2881	2898	2851	330	330	1	0	2598	2851	2898	2916	2867	330	330	1	0
2599	2926	2948	2908	2887	315	315	1	0	2600	2887	2908	2861	2846	315	315	1	0
2601	2948	2969	2922	2908	315	315	1	0	2602	2908	2922	2881	2861	315	315	1	0
2603	2969	2979	2942	2922	315	315	1	0	2604	2922	2942	2898	2881	315	315	1	0
2605	2979	3004	2961	2942	315	315	1	0	2606	2942	2961	2916	2898	315	315	1	0
2607	3034	3055	3030	3010	300	300	1	0	2608	3010	3030	3006	2983	300	300	1	0
2609	2983	3006	2975	2957	300	300	1	0	2610	2957	2975	2948	2926	300	300	1	0
2611	3055	3071	3049	3030	300	300	1	0	2612	3030	3049	3022	3006	300	300	1	0
2613	3006	3022	2995	2975	300	300	1	0	2614	2975	2995	2969	2948	300	300	1	0
2615	3071	3090	3065	3049	300	300	1	0	2616	3049	3065	3040	3022	300	300	1	0
2617	3022	3040	3014	2995	300	300	1	0	2618	2995	3014	2979	2969	300	300	1	0
2619	3090	3108	3085	3065	300	300	1	0	2620	3065	3085	3059	3040	300	300	1	0
2621	3040	3059	3029	3014	300	300	1	0	2622	3014	3029	3004	2979	300	300	1	0
2623	2042	2113	2126	2055	50	50	1	0	2624	2113	2165	2193	2126	50	50	1	0
2625	2165	2228	2248	2193	50	50	1	0	2626	2228	2282	2312	2248	50	50	1	0
2627	2282	2341	2378	2312	50	50	1	0	2628	2341	2389	2417	2378	50	50	1	0
2629	2389	2440	2464	2417	50	50	1	0	2630	2489	2509	2464	2440	50	50	1	0
2631	2509	2533	2485	2464	50	50	1	0	2632	2533	2550	2497	2485	50	50	1	0
2633	2568	2507	2497	2550	50	50	1	0	2634	2507	2448	2444	2497	50	50	1	0
2635	2448	2397	2378	2444	50	50	1	0	2636	2397	2333	2312	2378	50	50	1	0
2637	2333	2276	2248	2312	50	50	1	0	2638	2276	2211	2193	2248	50	50	1	0
2639	2211	2139	2126	2193	50	50	1	0	2640	2139	2069	2055	2126	50	50	1	0
2641	2069	1990	1978	2055	50	50	1	0	2642	1990	1898	1892	1978	50	50	1	0
2643	1802	1885	1892	1898	50	50	1	0	2644	1885	1968	1978	1892	50	50	1	0
2645	1968	2042	2055	1978	50	50	1	0	2646	2444	2378	2417	2450	50	50	1	0
2647	2417	2464	2485	2450	50	50	1	0	2648	2485	2497	2444	2450	50	50	1	0
2649	3544	3537	3507	3511	200	200	1	0	2650	3537	3527	3503	3507	200	200	1	0
2651	3527	3521	3500	3503	200	200	1	0	2652	3521	3515	3497	3500	200	200	1	0
2653	2694	2706	2646	2637	360	360	1	0	2654	2637	2646	2582	2568	360	360	1	0
2655	2706	2722	2667	2646	360	360	1	0	2656	2646	2667	2597	2582	360	360	1	0
2657	2722	2734	2676	2667	360	360	1	0	2658	2667	2676	2611	2597	360	360	1	0
2659	2734	2746	2687	2676	360	360	1	0	2660	2676	2687	2624	2611	360	360	1	0
2661	2814	2828	2770	2759	345	345	1	0	2662	2759	2770	2706	2694	345	345	1	0
2663	2828	2842	2790	2770	345	345	1	0	2664	2770	2790	2722	2706	345	345	1	0
2665	2842	2856	2798	2790	345	345	1	0	2666	2790	2798	2734	2722	345	345	1	0



Tabulati di Calcolo Plinto di Fondazione per Aerogeneratore Tipo - Progetto Impianto Eolico - "Orione"

Ind.	Nodo I	Nodo J	Nodo L	Nodo K	Sp.membranale	Sp.flessionale	Materiale	Var.term.	Ind.	Nodo I	Nodo J	Nodo L	Nodo K	Sp.membranale	Sp.flessionale	Materiale	Var.term.
							Indice									Indice	
2667	2856	2865	2804	2798	345	345	1	0	2668	2798	2804	2746	2734	345	345	1	0
2669	2916	2925	2880	2867	330	330	1	0	2670	2867	2880	2828	2814	330	330	1	0
2671	2925	2940	2891	2880	330	330	1	0	2672	2880	2891	2842	2828	330	330	1	0
2673	2940	2954	2906	2891	330	330	1	0	2674	2891	2906	2856	2842	330	330	1	0
2675	2954	2967	2918	2906	330	330	1	0	2676	2906	2918	2865	2856	330	330	1	0
2677	3004	3016	2973	2961	315	315	1	0	2678	2961	2973	2925	2916	315	315	1	0
2679	3016	3024	2982	2973	315	315	1	0	2680	2973	2982	2940	2925	315	315	1	0
2681	3024	3036	2999	2982	315	315	1	0	2682	2982	2999	2954	2940	315	315	1	0
2683	3036	3051	3008	2999	315	315	1	0	2684	2999	3008	2967	2954	315	315	1	0
2685	3108	3121	3096	3085	300	300	1	0	2686	3085	3096	3069	3059	300	300	1	0
2687	3059	3069	3044	3029	300	300	1	0	2688	3029	3044	3016	3004	300	300	1	0
2689	3121	3129	3106	3096	300	300	1	0	2690	3096	3106	3081	3069	300	300	1	0
2691	3069	3081	3053	3044	300	300	1	0	2692	3044	3053	3024	3016	300	300	1	0
2693	3129	3140	3119	3106	300	300	1	0	2694	3106	3119	3094	3081	300	300	1	0
2695	3081	3094	3064	3053	300	300	1	0	2696	3053	3064	3036	3024	300	300	1	0
2697	3140	3146	3125	3119	300	300	1	0	2698	3119	3125	3102	3094	300	300	1	0
2699	3094	3102	3075	3064	300	300	1	0	2700	3064	3075	3051	3036	300	300	1	0
2701	2069	2139	2154	2078	50	50	1	0	2702	2139	2211	2223	2154	50	50	1	0
2703	2211	2276	2287	2223	50	50	1	0	2704	2276	2333	2357	2287	50	50	1	0
2705	2333	2397	2429	2357	50	50	1	0	2706	2397	2448	2480	2429	50	50	1	0
2707	2448	2507	2528	2480	50	50	1	0	2708	2568	2582	2528	2507	50	50	1	0
2709	2582	2597	2548	2528	50	50	1	0	2710	2597	2611	2552	2548	50	50	1	0
2711	2624	2561	2552	2611	50	50	1	0	2712	2561	2491	2492	2552	50	50	1	0
2713	2491	2433	2429	2492	50	50	1	0	2714	2433	2363	2357	2429	50	50	1	0
2715	2363	2303	2287	2357	50	50	1	0	2716	2303	2239	2223	2287	50	50	1	0
2717	2239	2161	2154	2223	50	50	1	0	2718	2161	2084	2078	2154	50	50	1	0
2719	2084	2000	1995	2078	50	50	1	0	2720	2000	1907	1908	1995	50	50	1	0
2721	1802	1898	1908	1907	50	50	1	0	2722	1898	1990	1995	1908	50	50	1	0
2723	1990	2069	2078	1995	50	50	1	0	2724	2492	2429	2480	2505	50	50	1	0
2725	2480	2528	2548	2505	50	50	1	0	2726	2548	2552	2492	2505	50	50	1	0
2727	3552	3550	3519	3523	200	200	1	0	2728	3550	3548	3517	3519	200	200	1	0
2729	3548	3546	3513	3517	200	200	1	0	2730	3546	3544	3511	3513	200	200	1	0
2731	2746	2751	2693	2687	360	360	1	0	2732	2687	2693	2632	2624	360	360	1	0
2733	2751	2758	2699	2693	360	360	1	0	2734	2693	2699	2640	2632	360	360	1	0
2735	2758	2764	2708	2699	360	360	1	0	2736	2699	2708	2643	2640	360	360	1	0
2737	2764	2773	2715	2708	360	360	1	0	2738	2708	2715	2652	2643	360	360	1	0
2739	2865	2869	2812	2804	345	345	1	0	2740	2804	2812	2751	2746	345	345	1	0
2741	2869	2875	2820	2812	345	345	1	0	2742	2812	2820	2758	2751	345	345	1	0
2743	2875	2885	2827	2820	345	345	1	0	2744	2820	2827	2764	2758	345	345	1	0
2745	2885	2890	2833	2827	345	345	1	0	2746	2827	2833	2773	2764	345	345	1	0
2747	2967	2971	2920	2918	330	330	1	0	2748	2918	2920	2869	2865	330	330	1	0
2749	2971	2977	2928	2920	330	330	1	0	2750	2920	2928	2875	2869	330	330	1	0
2751	2977	2985	2938	2928	330	330	1	0	2752	2928	2938	2885	2875	330	330	1	0
2753	2985	2991	2944	2938	330	330	1	0	2754	2938	2944	2890	2885	330	330	1	0
2755	3051	3057	3018	3008	315	315	1	0	2756	3008	3018	2971	2967	315	315	1	0
2757	3057	3061	3021	3018	315	315	1	0	2758	3018	3021	2977	2971	315	315	1	0
2759	3061	3068	3026	3021	315	315	1	0	2760	3021	3026	2985	2977	315	315	1	0
2761	3068	3073	3033	3026	315	315	1	0	2762	3026	3033	2991	2985	315	315	1	0
2763	3146	3154	3135	3125	300	300	1	0	2764	3125	3135	3114	3102	300	300	1	0



Ind.	Nodo I	Nodo J	Nodo L	Nodo K	Sp.membranale	Sp.flessionale	Materiale	Var.term.	Ind.	Nodo I	Nodo J	Nodo L	Nodo K	Sp.membranale	Sp.flessionale	Materiale	Var.term.
							Indice									Indice	
2765	3102	3114	3087	3075	300	300	1	0	2766	3075	3087	3057	3051	300	300	1	0
2767	3154	3159	3142	3135	300	300	1	0	2768	3135	3142	3117	3114	300	300	1	0
2769	3114	3117	3092	3087	300	300	1	0	2770	3087	3092	3061	3057	300	300	1	0
2771	3159	3161	3144	3142	300	300	1	0	2772	3142	3144	3123	3117	300	300	1	0
2773	3117	3123	3098	3092	300	300	1	0	2774	3092	3098	3068	3061	300	300	1	0
2775	3161	3163	3148	3144	300	300	1	0	2776	3144	3148	3128	3123	300	300	1	0
2777	3123	3128	3101	3098	300	300	1	0	2778	3098	3101	3073	3068	300	300	1	0
2779	2084	2161	2170	2096	50	50	1	0	2780	2161	2239	2244	2170	50	50	1	0
2781	2239	2303	2311	2244	50	50	1	0	2782	2303	2363	2382	2311	50	50	1	0
2783	2363	2433	2463	2382	50	50	1	0	2784	2433	2491	2517	2463	50	50	1	0
2785	2491	2561	2576	2517	50	50	1	0	2786	2624	2632	2576	2561	50	50	1	0
2787	2632	2640	2586	2576	50	50	1	0	2788	2640	2643	2592	2586	50	50	1	0
2789	2652	2591	2592	2643	50	50	1	0	2790	2591	2519	2532	2592	50	50	1	0
2791	2519	2454	2463	2532	50	50	1	0	2792	2454	2394	2382	2463	50	50	1	0
2793	2394	2326	2311	2382	50	50	1	0	2794	2326	2251	2244	2311	50	50	1	0
2795	2251	2178	2170	2244	50	50	1	0	2796	2178	2099	2096	2170	50	50	1	0
2797	2099	2012	2007	2096	50	50	1	0	2798	2012	1913	1917	2007	50	50	1	0
2799	1802	1907	1917	1913	50	50	1	0	2800	1907	2000	2007	1917	50	50	1	0
2801	2000	2084	2096	2007	50	50	1	0	2802	2532	2463	2517	2547	50	50	1	0
2803	2517	2576	2586	2547	50	50	1	0	2804	2586	2592	2532	2547	50	50	1	0
2805	3560	3558	3531	3533	200	200	1	0	2806	3558	3556	3529	3531	200	200	1	0
2807	3556	3554	3525	3529	200	200	1	0	2808	3554	3552	3523	3525	200	200	1	0

### 7.7 Accelerazioni spettrali

Ind.vertice: Indice del valore.

T: Periodo. [s]

a/g: Accelerazione normalizzata ottenuta dividendo l'accelerazione per l'accelerazione di gravità. Il valore è adimensionale.

#### Sisma X SLV

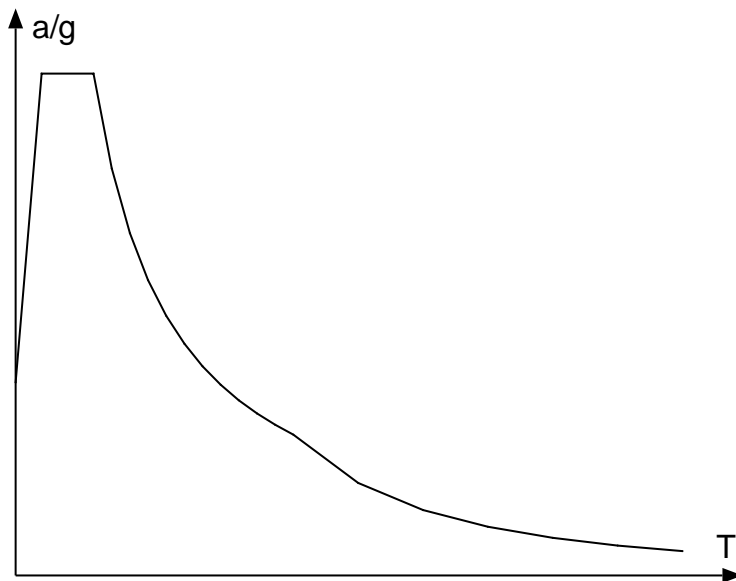

Ind.vertice	T	a/g
1	0	0.242
2	0.2	0.628
3	0.601	0.628
4	0.741	0.509
5	0.881	0.428
6	1.021	0.37
7	1.161	0.325



Ind.vertice	T	a/g
8	1.301	0.29
9	1.441	0.262
10	1.581	0.239
11	1.721	0.219
12	1.861	0.203
13	2.001	0.189
14	2.141	0.176
15	2.641	0.116
16	3.141	0.082
17	3.641	0.061
18	4.141	0.047
19	4.641	0.038
20	5.141	0.031

Sisma Y SLV

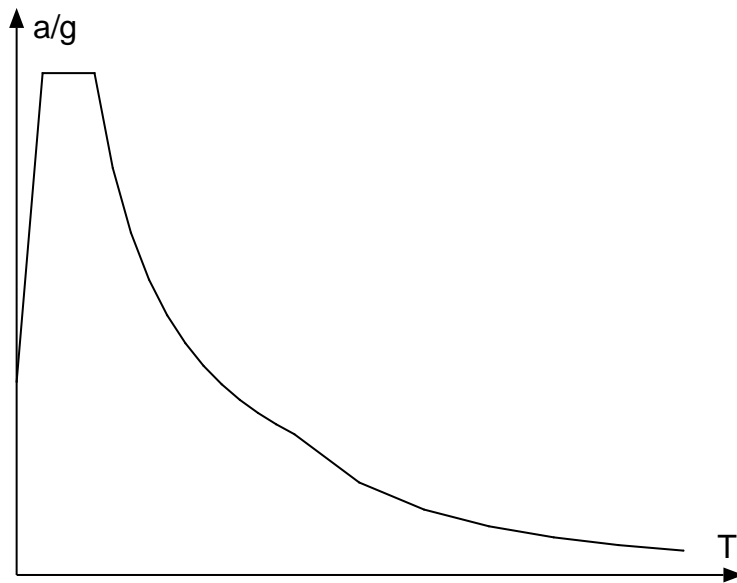

Ind.vertice	T	a/g
1	0	0.242
2	0.2	0.628
3	0.601	0.628
4	0.741	0.509
5	0.881	0.428
6	1.021	0.37
7	1.161	0.325
8	1.301	0.29
9	1.441	0.262
10	1.581	0.239
11	1.721	0.219
12	1.861	0.203
13	2.001	0.189
14	2.141	0.176
15	2.641	0.116
16	3.141	0.082
17	3.641	0.061
18	4.141	0.047
19	4.641	0.038
20	5.141	0.031



Sisma X SLD

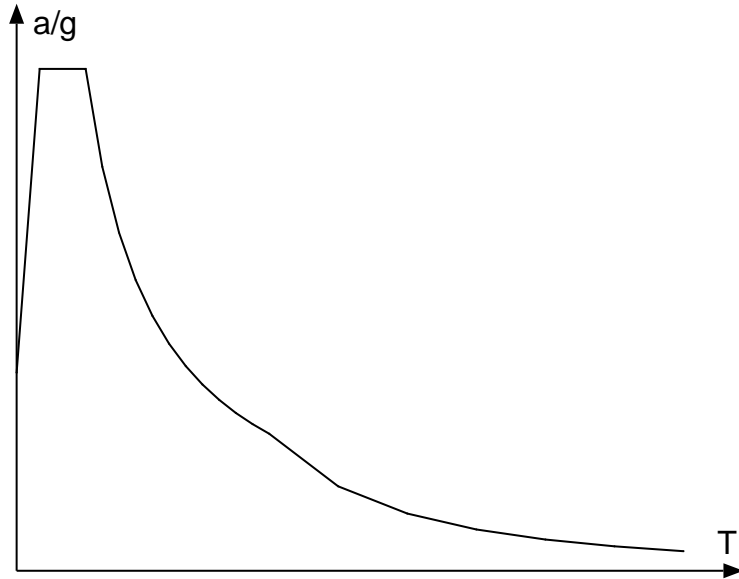

Ind.vertice	T	a/g
1	0	0.103
2	0.167	0.261
3	0.5	0.261
4	0.62	0.21
5	0.741	0.176
6	0.862	0.151
7	0.983	0.133
8	1.104	0.118
9	1.225	0.106
10	1.346	0.097
11	1.466	0.089
12	1.587	0.082
13	1.708	0.076
14	1.829	0.071
15	2.329	0.044
16	2.829	0.03
17	3.329	0.022
18	3.829	0.016
19	4.329	0.013
20	4.829	0.01

Sisma Y SLD

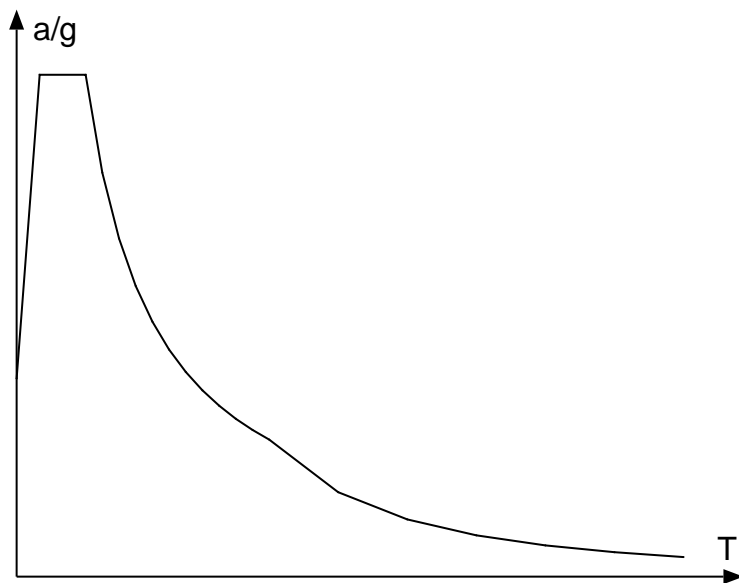

Ind.vertice	T	a/g
1	0	0.103
2	0.167	0.261
3	0.5	0.261



Ind.vertice	T	a/g
4	0.62	0.21
5	0.741	0.176
6	0.862	0.151
7	0.983	0.133
8	1.104	0.118
9	1.225	0.106
10	1.346	0.097
11	1.466	0.089
12	1.587	0.082
13	1.708	0.076
14	1.829	0.071
15	2.329	0.044
16	2.829	0.03
17	3.329	0.022
18	3.829	0.016
19	4.329	0.013
20	4.829	0.01



Progetto	Titolo	Rev.	Pag.
Orione	Orione_A24a.pdf "TABULATI DI CALCOLO PLINTO DI FONDAZIONE PER AEROGENERATORE TIPO"	0	142

## 8 Risultati numerici

### 8.1 Pressioni massime sul terreno

Nodo: Numero del nodo collocato sul terreno.

Contesto: Condizione o combinazione di carico a cui si riferisce la pressione minima.

uz min: Spostamento massimo verticale del nodo. [cm]

Minima: Pressione minima sul terreno del nodo. [daN/cm<sup>2</sup>]

Contesto: Condizione o combinazione di carico a cui si riferisce la pressione massima.

uz max: Spostamento minimo verticale del nodo. [cm]

Massima: Pressione massima sul terreno del nodo. [daN/cm<sup>2</sup>]

Compressione estrema massima -2.26271 al nodo di indice 942, di coordinate x = 32, y = -737, z = -90, nel contesto SLU 4.

Nodo	Contesto	uz min	Minima	Contesto	uz max	Massima
434	SLU 4	-0.27021	-0.81064	SLV fondazioni 11	-0.10982	-0.32947
435	SLU 4	-0.27251	-0.81754	SLV fondazioni 11	-0.11077	-0.33231
436	SLU 4	-0.27274	-0.81823	SLV fondazioni 7	-0.11075	-0.33224
437	SLU 4	-0.27306	-0.81918	SLV fondazioni 11	-0.11076	-0.33227
438	SLU 4	-0.27352	-0.82055	SLV fondazioni 7	-0.1107	-0.33209
439	SLU 4	-0.2718	-0.81541	SLV fondazioni 11	-0.10974	-0.32923
440	SLU 4	-0.27249	-0.81747	SLV fondazioni 7	-0.10964	-0.32893
441	SLU 4	-0.2688	-0.8064	SLV fondazioni 11	-0.10776	-0.32329
442	SLU 4	-0.26972	-0.80916	SLV fondazioni 7	-0.10763	-0.32289
443	SLU 4	-0.27061	-0.81183	SLV fondazioni 11	-0.1091	-0.32731
444	SLU 4	-0.27176	-0.81528	SLV fondazioni 7	-0.10894	-0.32682
445	SLU 4	-0.27067	-0.812	SLV fondazioni 11	-0.10948	-0.32845
446	SLU 4	-0.27205	-0.81616	SLV fondazioni 7	-0.10929	-0.32787
447	SLU 4	-0.3059	-0.9177	SLV fondazioni 11	-0.13295	-0.39884
448	SLU 4	-0.30809	-0.92427	SLV fondazioni 11	-0.13386	-0.40157
449	SLU 4	-0.30831	-0.92494	SLV fondazioni 7	-0.13384	-0.40151
450	SLU 4	-0.26894	-0.80681	SLV fondazioni 11	-0.10886	-0.32657
451	SLU 4	-0.30858	-0.92575	SLV fondazioni 11	-0.13385	-0.40155
452	SLU 4	-0.30903	-0.92709	SLV fondazioni 7	-0.13379	-0.40138
453	SLU 4	-0.27057	-0.81171	SLV fondazioni 7	-0.10864	-0.32592
454	SLU 4	-0.30732	-0.92197	SLV fondazioni 11	-0.13287	-0.39862
455	SLU 4	-0.30799	-0.92397	SLV fondazioni 7	-0.13278	-0.39835
456	SLU 4	-0.30438	-0.91313	SLV fondazioni 11	-0.13096	-0.39289
457	SLU 4	-0.30527	-0.91581	SLV fondazioni 7	-0.13084	-0.39252
458	SLU 4	-0.26548	-0.79644	SLV fondazioni 11	-0.10727	-0.3218
459	SLU 4	-0.26736	-0.80209	SLV fondazioni 7	-0.10703	-0.3211
460	SLU 4	-0.30602	-0.91805	SLV fondazioni 11	-0.13226	-0.39678
461	SLU 4	-0.30714	-0.92141	SLV fondazioni 7	-0.1321	-0.39631
462	SLU 4	-0.30596	-0.91788	SLV fondazioni 11	-0.13263	-0.39788
463	SLU 4	-0.30731	-0.92194	SLV fondazioni 7	-0.13245	-0.39734
464	SLU 4	-0.26679	-0.80038	SLV fondazioni 11	-0.109	-0.327
465	SLU 4	-0.26892	-0.80677	SLV fondazioni 7	-0.10875	-0.32626
466	SLU 4	-0.34182	-1.02546	SLV fondazioni 11	-0.15622	-0.46865
467	SLU 4	-0.34395	-1.03186	SLV fondazioni 11	-0.15708	-0.47125
468	SLU 4	-0.34418	-1.03253	SLV fondazioni 7	-0.15706	-0.47119
469	SLU 4	-0.30417	-0.9125	SLV fondazioni 11	-0.13202	-0.39607
470	SLU 4	-0.30575	-0.91725	SLV fondazioni 7	-0.13182	-0.39546
471	SLU 4	-0.34441	-1.03324	SLV fondazioni 11	-0.15707	-0.47122
472	SLU 4	-0.34485	-1.03455	SLV fondazioni 7	-0.15702	-0.47106
473	SLU 4	-0.34313	-1.0294	SLV fondazioni 11	-0.15615	-0.46845
474	SLU 4	-0.34378	-1.03135	SLV fondazioni 7	-0.15606	-0.46819
475	SLU 4	-0.26638	-0.79913	SLV fondazioni 11	-0.10977	-0.32931
476	SLU 4	-0.34018	-1.02055	SLV fondazioni 11	-0.15432	-0.46295
477	SLU 4	-0.34105	-1.02316	SLV fondazioni 7	-0.1542	-0.4626
478	SLU 4	-0.26875	-0.80626	SLV fondazioni 7	-0.10951	-0.32854
479	SLU 4	-0.30071	-0.90212	SLV fondazioni 11	-0.13049	-0.39147
480	SLU 4	-0.30254	-0.90761	SLV fondazioni 7	-0.13027	-0.39081
481	SLU 4	-0.34171	-1.02513	SLV fondazioni 11	-0.15555	-0.46666
482	SLU 4	-0.3428	-1.0284	SLV fondazioni 7	-0.15541	-0.46623
483	SLU 4	-0.2642	-0.7926	SLV fondazioni 11	-0.10953	-0.3286
484	SLU 4	-0.26683	-0.8005	SLV fondazioni 7	-0.10927	-0.32781
485	SLU 4	-0.30179	-0.90538	SLV fondazioni 11	-0.13216	-0.39649
486	SLU 4	-0.30387	-0.9116	SLV fondazioni 7	-0.13193	-0.3958
487	SLU 4	-0.34156	-1.02467	SLV fondazioni 11	-0.1559	-0.4677
488	SLU 4	-0.34287	-1.02861	SLV fondazioni 7	-0.15573	-0.46719
489	SLU 4	-0.37819	-1.13457	SLV fondazioni 11	-0.17963	-0.53888
490	SLU 4	-0.33968	-1.01905	SLV fondazioni 11	-0.15533	-0.46599
491	SLU 4	-0.38021	-1.14063	SLV fondazioni 11	-0.18043	-0.54129
492	SLU 4	-0.38043	-1.14129	SLV fondazioni 7	-0.18041	-0.54124
493	SLU 4	-0.34122	-1.02366	SLV fondazioni 7	-0.15514	-0.46542
494	SLU 4	-0.3806	-1.14181	SLV fondazioni 11	-0.1804	-0.5412
495	SLU 4	-0.38103	-1.1431	SLV fondazioni 7	-0.18036	-0.54107
496	SLU 4	-0.26034	-0.78101	SLV fondazioni 11	-0.10834	-0.32501
497	SLU 4	-0.26323	-0.78969	SLV fondazioni 7	-0.10807	-0.32422
498	SLU 4	-0.3012	-0.90361	SLV fondazioni 11	-0.1329	-0.39871
499	SLU 4	-0.37933	-1.13799	SLV fondazioni 11	-0.17953	-0.53858
500	SLU 4	-0.37997	-1.13991	SLV fondazioni 7	-0.17945	-0.53835
501	SLU 4	-0.30352	-0.91055	SLV fondazioni 7	-0.13266	-0.39799
502	SLU 4	-0.33616	-1.00848	SLV fondazioni 11	-0.15386	-0.46158
503	SLU 4	-0.37644	-1.12931	SLV fondazioni 11	-0.1778	-0.53341
504	SLU 4	-0.37729	-1.13186	SLV fondazioni 7	-0.17769	-0.53308
505	SLU 4	-0.33794	-1.01381	SLV fondazioni 7	-0.15366	-0.46097
506	SLU 4	-0.37779	-1.13337	SLV fondazioni 11	-0.17896	-0.53689
507	SLU 4	-0.37885	-1.13655	SLV fondazioni 7	-0.17882	-0.53647
508	SLU 4	-0.29891	-0.89672	SLV fondazioni 11	-0.13267	-0.39802
509	SLU 4	-0.30146	-0.90439	SLV fondazioni 7	-0.13243	-0.39729
510	SLU 4	-0.33707	-1.01122	SLV fondazioni 11	-0.15547	-0.4664
511	SLU 4	-0.33909	-1.01727	SLV fondazioni 7	-0.15525	-0.46576
512	SLU 4	-0.37752	-1.13255	SLV fondazioni 11	-0.17928	-0.53784
513	SLU 4	-0.37879	-1.13637	SLV fondazioni 7	-0.17912	-0.53735



Progetto	Titolo	Rev.	Pag.
Orione	Orione_A24a.pdf "TABULATI DI CALCOLO PLINTO DI FONDAZIONE PER AEROGENERATORE TIPO"	0	143



Tabulati di Calcolo Plinto di Fondazione per Aerogeneratore Tipo - Progetto Impianto Eolico - "Orione"

Nodo	Contesto	uz min	Minima	Contesto	uz max	Massima
514	SLU 4	-0.26117	-0.78352	SLV fondazioni 11	-0.11046	-0.33137
515	SLU 4	-0.26432	-0.79295	SLV fondazioni 7	-0.1102	-0.33059
516	SLU 4	-0.41487	-1.24461	SLV fondazioni 11	-0.20304	-0.60911
517	SLU 4	-0.37558	-1.12675	SLV fondazioni 11	-0.17875	-0.53624
518	SLU 4	-0.37708	-1.13124	SLV fondazioni 7	-0.17857	-0.53557
519	SLU 4	-0.29498	-0.88495	SLV fondazioni 11	-0.13152	-0.39457
520	SLU 4	-0.41677	-1.2503	SLV fondazioni 11	-0.20381	-0.61142
521	SLU 4	-0.41698	-1.25095	SLV fondazioni 7	-0.20238	-0.61139
522	SLU 4	-0.2978	-0.89339	SLV fondazioni 7	-0.13127	-0.39382
523	SLU 4	-0.33633	-1.00898	SLV fondazioni 11	-0.15617	-0.4685
524	SLU 4	-0.33858	-1.01573	SLV fondazioni 7	-0.15594	-0.46783
525	SLU 4	-0.41709	-1.25127	SLV fondazioni 11	-0.20377	-0.61131
526	SLU 4	-0.41752	-1.25256	SLV fondazioni 7	-0.20374	-0.61121
527	SLU 4	-0.41583	-1.24748	SLV fondazioni 11	-0.20293	-0.60879
528	SLU 4	-0.41646	-1.24937	SLV fondazioni 7	-0.20287	-0.6086
529	SLU 4	-0.37205	-1.11616	SLV fondazioni 11	-0.17737	-0.53211
530	SLU 4	-0.37378	-1.12134	SLV fondazioni 7	-0.17718	-0.53153
531	SLU 4	-0.413	-1.239	SLV fondazioni 11	-0.20129	-0.60386
532	SLU 4	-0.41383	-1.24148	SLV fondazioni 7	-0.20118	-0.60355
533	SLU 4	-0.26031	-0.78094	SLV fondazioni 11	-0.11161	-0.33483
534	SLU 4	-0.26371	-0.79113	SLV fondazioni 7	-0.11136	-0.33407
535	SLU 4	-0.33389	-1.00168	SLV fondazioni 11	-0.15595	-0.46786
536	SLU 4	-0.41417	-1.24252	SLV fondazioni 11	-0.2024	-0.6072
537	SLU 4	-0.4152	-1.24559	SLV fondazioni 7	-0.20227	-0.6068
538	SLU 4	-0.33638	-1.00913	SLV fondazioni 7	-0.15572	-0.46717
539	SLU 4	-0.29554	-0.88663	SLV fondazioni 11	-0.13357	-0.40071
540	SLU 4	-0.37273	-1.11819	SLV fondazioni 11	-0.17888	-0.53663
541	SLU 4	-0.37469	-1.12407	SLV fondazioni 7	-0.17868	-0.53603
542	SLU 4	-0.2986	-0.89579	SLV fondazioni 7	-0.13333	-0.39998
543	SLU 4	-0.41377	-1.24131	SLV fondazioni 11	-0.20271	-0.60812
544	SLU 4	-0.415	-1.24499	SLV fondazioni 7	-0.20254	-0.60763
545	SLU 4	-0.32985	-0.98956	SLV fondazioni 11	-0.15486	-0.46457
546	SLU 4	-0.33258	-0.99774	SLV fondazioni 7	-0.15462	-0.46387
547	SLU 4	-0.41178	-1.23534	SLV fondazioni 11	-0.20222	-0.60659
548	SLU 4	-0.41323	-1.23969	SLV fondazioni 7	-0.20202	-0.60606
549	SLU 4	-0.25774	-0.77322	SLV fondazioni 11	-0.11176	-0.33527
550	SLU 4	-0.26139	-0.78418	SLV fondazioni 7	-0.11151	-0.33454
551	SLU 4	-0.3718	-1.11541	SLV fondazioni 11	-0.17954	-0.53861
552	SLU 4	-0.37399	-1.12198	SLV fondazioni 7	-0.17933	-0.538
553	SLU 4	-0.40825	-1.22474	SLV fondazioni 11	-0.20087	-0.60262
554	SLU 4	-0.40993	-1.22978	SLV fondazioni 7	-0.20069	-0.60208
555	SLU 4	-0.29446	-0.88337	SLV fondazioni 11	-0.13468	-0.40403
556	SLU 4	-0.29775	-0.89326	SLV fondazioni 7	-0.13444	-0.40332
557	SLU 4	-0.46386	-1.39157	SLV fondazioni 11	-0.23422	-0.70265
558	SLU 4	-0.46559	-1.39678	SLV fondazioni 11	-0.23492	-0.70476
559	SLU 4	-0.46582	-1.39747	SLV fondazioni 7	-0.23493	-0.70478
560	SLU 4	-0.36925	-1.10776	SLV fondazioni 11	-0.17935	-0.53806
561	SLU 4	-0.37167	-1.115	SLV fondazioni 7	-0.17914	-0.53742
562	SLU 4	-0.46583	-1.39749	SLV fondazioni 11	-0.23488	-0.70464
563	SLU 4	-0.46627	-1.39882	SLV fondazioni 7	-0.23487	-0.70462
564	SLU 4	-0.33018	-0.99055	SLV fondazioni 11	-0.15693	-0.47048
565	SLU 4	-0.33315	-0.99944	SLV fondazioni 7	-0.1566	-0.46979
566	SLU 4	-0.46457	-1.39372	SLV fondazioni 11	-0.23409	-0.70228
567	SLU 4	-0.4652	-1.3956	SLV fondazioni 7	-0.23405	-0.70216
568	SLU 4	-0.40868	-1.22604	SLV fondazioni 11	-0.20232	-0.60695
569	SLU 4	-0.41059	-1.23177	SLV fondazioni 7	-0.20214	-0.60641
570	SLU 4	-0.25353	-0.76059	SLV fondazioni 11	-0.11095	-0.33284
571	SLU 4	-0.46183	-1.38549	SLV fondazioni 11	-0.23257	-0.6977
572	SLU 4	-0.46262	-1.38787	SLV fondazioni 7	-0.23247	-0.69742
573	SLU 4	-0.25745	-0.77235	SLV fondazioni 7	-0.11072	-0.33216
574	SLU 4	-0.29171	-0.87512	SLV fondazioni 11	-0.13481	-0.40444
575	SLU 4	-0.36515	-1.09545	SLV fondazioni 11	-0.17833	-0.53499
576	SLU 4	-0.36779	-1.10338	SLV fondazioni 7	-0.17811	-0.53433
577	SLU 4	-0.29525	-0.88576	SLV fondazioni 7	-0.13459	-0.40376
578	SLU 4	-0.46278	-1.38834	SLV fondazioni 11	-0.23361	-0.70084
579	SLU 4	-0.46374	-1.39122	SLV fondazioni 7	-0.23347	-0.70042
580	SLU 4	-0.40756	-1.22268	SLV fondazioni 11	-0.20295	-0.60885
581	SLU 4	-0.40969	-1.22908	SLV fondazioni 7	-0.20277	-0.6083
582	SLU 4	-0.32889	-0.98667	SLV fondazioni 11	-0.15788	-0.47363
583	SLU 4	-0.46222	-1.38665	SLV fondazioni 11	-0.2339	-0.70171
584	SLU 4	-0.46336	-1.39009	SLV fondazioni 7	-0.23373	-0.7012
585	SLU 4	-0.33209	-0.99626	SLV fondazioni 7	-0.15765	-0.47296
586	SLU 4	-0.46014	-1.38042	SLV fondazioni 11	-0.23342	-0.70027
587	SLU 4	-0.46151	-1.38453	SLV fondazioni 7	-0.23325	-0.69974
588	SLU 4	-0.4049	-1.21469	SLV fondazioni 11	-0.20278	-0.60834
589	SLU 4	-0.40725	-1.22175	SLV fondazioni 7	-0.20259	-0.60776
590	SLU 4	-0.36519	-1.09558	SLV fondazioni 11	-0.18018	-0.54055
591	SLU 4	-0.36806	-1.10419	SLV fondazioni 7	-0.17997	-0.5399
592	SLU 4	-0.25392	-0.76176	SLV fondazioni 15	-0.11288	-0.33864
593	SLU 4	-0.25809	-0.77426	SLV fondazioni 3	-0.11267	-0.33801
594	SLU 4	-0.28739	-0.86216	SLV fondazioni 11	-0.13403	-0.4021
595	SLU 4	-0.29119	-0.87357	SLV fondazioni 7	-0.13382	-0.40147
596	SLU 4	-0.45658	-1.36975	SLV fondazioni 11	-0.23218	-0.69655
597	SLU 4	-0.4582	-1.37459	SLV fondazioni 7	-0.23202	-0.69606
598	SLU 4	-0.32595	-0.97785	SLV fondazioni 11	-0.15801	-0.47403
599	SLU 4	-0.32938	-0.98815	SLV fondazioni 7	-0.1578	-0.47339
600	SLU 4	-0.40074	-1.20221	SLV fondazioni 11	-0.2018	-0.6054
601	SLU 4	-0.51264	-1.53793	SLV fondazioni 7	-0.26537	-0.7961
602	SLU 4	-0.4033	-1.20991	SLV fondazioni 7	-0.2016	-0.60479
603	SLU 4	-0.51419	-1.54257	SLV fondazioni 11	-0.26599	-0.79798
604	SLU 4	-0.51447	-1.54341	SLV fondazioni 7	-0.26603	-0.7981
605	SLU 4	-0.45669	-1.37008	SLV fondazioni 11	-0.23352	-0.70057
606	SLU 4	-0.51434	-1.54302	SLV fondazioni 11	-0.26593	-0.7978
607	SLU 4	-0.51484	-1.54453	SLV fondazioni 7	-0.26599	-0.79797
608	SLU 4	-0.45854	-1.37563	SLV fondazioni 7	-0.23338	-0.70013
609	SLU 4	-0.36366	-1.09099	SLV fondazioni 11	-0.18119	-0.54356
610	SLU 4	-0.51309	-1.53928	SLV fondazioni 11	-0.26521	-0.79564



Progetto	Titolo	Rev.	Pag.
Orione	Orione_A24a.pdf "TABULATI DI CALCOLO PLINTO DI FONDAZIONE PER AEROGENERATORE TIPO"	0	144

Tabulati di Calcolo Plinto di Fondazione per Aerogeneratore Tipo - Progetto Impianto Eolico - "Orione"

Nodo	Contesto	uz min	Minima	Contesto	uz max	Massima
611	SLU 4	-0.51375	-1.54125	SLV fondazioni 7	-0.26522	-0.79567
612	SLU 4	-0.36676	-1.10027	SLV fondazioni 7	-0.18097	-0.54292
613	SLU 4	-0.51046	-1.53139	SLV fondazioni 11	-0.26382	-0.79145
614	SLU 4	-0.51122	-1.53366	SLV fondazioni 7	-0.26374	-0.79122
615	SLU 4	-0.25267	-0.75801	SLV fondazioni 15	-0.11212	-0.33636
616	SLU 4	-0.28746	-0.86237	SLV fondazioni 15	-0.13592	-0.40775
617	SLU 4	-0.2915	-0.87449	SLV fondazioni 3	-0.13572	-0.40717
618	SLU 4	-0.25708	-0.77123	SLV fondazioni 3	-0.11193	-0.33579
619	SLU 4	-0.5112	-1.53359	SLV fondazioni 11	-0.26481	-0.79442
620	SLU 4	-0.51205	-1.53616	SLV fondazioni 7	-0.26464	-0.79393
621	SLU 4	-0.32146	-0.96437	SLV fondazioni 11	-0.15727	-0.47181
622	SLU 4	-0.45532	-1.36597	SLV fondazioni 11	-0.23412	-0.70235
623	SLU 4	-0.4574	-1.3722	SLV fondazioni 7	-0.23398	-0.70193
624	SLU 4	-0.32514	-0.97542	SLV fondazioni 7	-0.15707	-0.47122
625	SLU 4	-0.40049	-1.20147	SLV fondazioni 11	-0.20358	-0.61074
626	SLU 4	-0.40326	-1.20979	SLV fondazioni 7	-0.20337	-0.61012
627	SLU 4	-0.51048	-1.53144	SLV fondazioni 11	-0.26508	-0.79525
628	SLU 4	-0.51149	-1.53448	SLV fondazioni 7	-0.26487	-0.79461
629	SLU 4	-0.36055	-1.08166	SLV fondazioni 11	-0.18134	-0.54401
630	SLU 4	-0.36388	-1.09164	SLV fondazioni 7	-0.18114	-0.54341
631	SLU 4	-0.4525	-1.3575	SLV fondazioni 11	-0.23397	-0.7019
632	SLU 4	-0.45478	-1.36433	SLV fondazioni 7	-0.23381	-0.70143
633	SLU 4	-0.50831	-1.52494	SLV fondazioni 11	-0.26463	-0.7939
634	SLU 4	-0.50956	-1.52867	SLV fondazioni 7	-0.26444	-0.79331
635	SLU 4	-0.39871	-1.19614	SLV fondazioni 11	-0.20455	-0.61364
636	SLU 4	-0.4017	-1.20511	SLV fondazioni 7	-0.20434	-0.61302
637	SLU 4	-0.50473	-1.51419	SLV fondazioni 11	-0.26347	-0.79041
638	SLU 4	-0.50626	-1.51879	SLV fondazioni 7	-0.26333	-0.78998
639	SLU 4	-0.28593	-0.85779	SLV fondazioni 15	-0.13519	-0.40558
640	SLU 4	-0.2902	-0.87061	SLV fondazioni 3	-0.13502	-0.40506
641	SLU 4	-0.24976	-0.74929	SLV fondazioni 15	-0.11036	-0.33107
642	SLU 4	-0.32125	-0.96375	SLV fondazioni 15	-0.15909	-0.47727
643	SLU 4	-0.44826	-1.34478	SLV fondazioni 11	-0.23307	-0.69921
644	SLU 4	-0.45072	-1.35215	SLV fondazioni 7	-0.23289	-0.69866
645	SLU 4	-0.32516	-0.97549	SLV fondazioni 3	-0.15891	-0.47674
646	SLU 4	-0.25442	-0.76325	SLV fondazioni 3	-0.11019	-0.33056
647	SLU 4	-0.35594	-1.06782	SLV fondazioni 11	-0.18065	-0.54195
648	SLU 4	-0.35951	-1.07852	SLV fondazioni 7	-0.18047	-0.5414
649	SLU 4	-0.56087	-1.6826	SLV fondazioni 7	-0.29646	-0.88939
650	SLU 4	-0.50448	-1.51345	SLV fondazioni 11	-0.26469	-0.79408
651	SLU 4	-0.5063	-1.5189	SLV fondazioni 7	-0.26461	-0.79382
652	SLU 4	-0.5622	-1.6866	SLV fondazioni 11	-0.29704	-0.89112
653	SLU 4	-0.56253	-1.6876	SLV fondazioni 7	-0.29709	-0.89126
654	SLU 4	-0.56222	-1.68667	SLV fondazioni 11	-0.29697	-0.8909
655	SLU 4	-0.56282	-1.68846	SLV fondazioni 7	-0.29705	-0.89114
656	SLU 4	-0.39543	-1.1863	SLV fondazioni 11	-0.2047	-0.61409
657	SLU 4	-0.56103	-1.68309	SLV fondazioni 11	-0.29631	-0.88893
658	SLU 4	-0.56172	-1.68515	SLV fondazioni 7	-0.29634	-0.88903
659	SLU 4	-0.39865	-1.19595	SLV fondazioni 7	-0.20451	-0.61352
660	SLU 4	-0.55854	-1.67562	SLV fondazioni 11	-0.29504	-0.88512
661	SLU 4	-0.55925	-1.67775	SLV fondazioni 7	-0.29497	-0.88492
662	SLU 4	-0.44763	-1.3429	SLV fondazioni 11	-0.23475	-0.70425
663	SLU 4	-0.45027	-1.3508	SLV fondazioni 7	-0.23454	-0.70362
664	SLU 4	-0.50286	-1.50859	SLV fondazioni 11	-0.26524	-0.79572
665	SLU 4	-0.50491	-1.51473	SLV fondazioni 7	-0.26517	-0.79552
666	SLU 4	-0.55904	-1.67713	SLV fondazioni 11	-0.29596	-0.88788
667	SLU 4	-0.55977	-1.67931	SLV fondazioni 7	-0.2958	-0.8874
668	SLU 4	-0.2828	-0.8484	SLV fondazioni 15	-0.13351	-0.40052
669	SLU 4	-0.31947	-0.9584	SLV fondazioni 15	-0.1584	-0.47521
670	SLU 4	-0.32361	-0.97082	SLV fondazioni 3	-0.15825	-0.47474
671	SLU 4	-0.28731	-0.86192	SLV fondazioni 3	-0.13335	-0.40005
672	SLU 4	-0.24529	-0.73587	SLV fondazioni 15	-0.10762	-0.32287
673	SLU 4	-0.35539	-1.06618	SLV fondazioni 15	-0.18241	-0.54723
674	SLU 4	-0.35919	-1.07756	SLV fondazioni 3	-0.18225	-0.54676
675	SLU 4	-0.25018	-0.75055	SLV fondazioni 3	-0.10748	-0.32243
676	SLU 4	-0.55817	-1.6745	SLV fondazioni 11	-0.29622	-0.88865
677	SLU 4	-0.55899	-1.67698	SLV fondazioni 7	-0.296	-0.88799
678	SLU 4	-0.3907	-1.17211	SLV fondazioni 11	-0.20404	-0.61211
679	SLU 4	-0.49989	-1.49967	SLV fondazioni 11	-0.26512	-0.79537
680	SLU 4	-0.5021	-1.50631	SLV fondazioni 7	-0.26502	-0.79505
681	SLU 4	-0.39416	-1.18247	SLV fondazioni 7	-0.20387	-0.61161
682	SLU 4	-0.44555	-1.33664	SLV fondazioni 11	-0.23566	-0.70699
683	SLU 4	-0.44837	-1.34512	SLV fondazioni 7	-0.23546	-0.70637
684	SLU 4	-0.55592	-1.66776	SLV fondazioni 11	-0.29581	-0.88742
685	SLU 4	-0.55701	-1.67104	SLV fondazioni 7	-0.29561	-0.88684
686	SLU 4	-0.55233	-1.65699	SLV fondazioni 11	-0.29473	-0.88419
687	SLU 4	-0.55376	-1.66129	SLV fondazioni 7	-0.29461	-0.88382
688	SLU 4	-0.49559	-1.48678	SLV fondazioni 11	-0.26432	-0.79297
689	SLU 4	-0.49793	-1.49378	SLV fondazioni 7	-0.26415	-0.79245
690	SLU 4	-0.3161	-0.9483	SLV fondazioni 15	-0.1568	-0.4704
691	SLU 4	-0.32046	-0.96139	SLV fondazioni 3	-0.15666	-0.46998
692	SLU 4	-0.27817	-0.83451	SLV fondazioni 15	-0.13087	-0.39261
693	SLU 4	-0.35333	-1.05998	SLV fondazioni 15	-0.18173	-0.54518
694	SLU 4	-0.35734	-1.07202	SLV fondazioni 3	-0.18159	-0.54476
695	SLU 4	-0.28291	-0.84874	SLV fondazioni 3	-0.13073	-0.3922
696	SLU 4	-0.44203	-1.32608	SLV fondazioni 11	-0.23581	-0.70743
697	SLU 4	-0.44508	-1.33523	SLV fondazioni 7	-0.23563	-0.70688
698	SLU 4	-0.55171	-1.65513	SLV fondazioni 11	-0.29585	-0.88755
699	SLU 4	-0.55348	-1.66043	SLV fondazioni 7	-0.2958	-0.88739
700	SLU 4	-0.38981	-1.16943	SLV fondazioni 15	-0.20578	-0.61734
701	SLU 4	-0.39348	-1.18045	SLV fondazioni 3	-0.20564	-0.61691
702	SLU 4	-0.60805	-1.82415	SLV fondazioni 7	-0.32742	-0.98225
703	SLU 4	-0.60925	-1.82774	SLV fondazioni 11	-0.32796	-0.98389
704	SLU 4	-0.60949	-1.82847	SLV fondazioni 7	-0.32797	-0.9839
705	SLU 4	-0.2453	-0.73589	SLV fondazioni 15	-0.10822	-0.32465
706	SLU 4	-0.4946	-1.48379	SLV fondazioni 11	-0.2659	-0.79771
707	SLU 4	-0.49704	-1.49111	SLV fondazioni 7	-0.26567	-0.79702



Tabulati di Calcolo Plinto di Fondazione per Aerogeneratore Tipo - Progetto Impianto Eolico - "Orione"

Nodo	Contesto	uz min	Minima	Contesto	uz max	Massima
708	SLV 4	-0.25041	-0.75122	SLV fondazioni 3	-0.10809	-0.32428
709	SLV 4	-0.60923	-1.82768	SLV fondazioni 11	-0.32793	-0.9838
710	SLV 4	-0.60967	-1.829	SLV fondazioni 7	-0.32793	-0.98378
711	SLV 4	-0.60801	-1.82403	SLV fondazioni 11	-0.32732	-0.98196
712	SLV 4	-0.60858	-1.82573	SLV fondazioni 7	-0.3273	-0.98189
713	SLV 4	-0.5498	-1.6494	SLV fondazioni 11	-0.29635	-0.88905
714	SLV 4	-0.60559	-1.81676	SLV fondazioni 11	-0.32613	-0.9784
715	SLV 4	-0.60623	-1.8187	SLV fondazioni 7	-0.32607	-0.97822
716	SLV 4	-0.55183	-1.6555	SLV fondazioni 7	-0.29632	-0.88897
717	SLV 4	-0.43712	-1.31136	SLV fondazioni 11	-0.23519	-0.70558
718	SLV 4	-0.44041	-1.32124	SLV fondazioni 7	-0.23505	-0.70516
719	SLV 4	-0.6058	-1.8174	SLV fondazioni 11	-0.32696	-0.98087
720	SLV 4	-0.60652	-1.81957	SLV fondazioni 7	-0.32686	-0.98058
721	SLV 4	-0.31125	-0.93376	SLV fondazioni 15	-0.15426	-0.46279
722	SLV 4	-0.34974	-1.04923	SLV fondazioni 15	-0.18019	-0.54058
723	SLV 4	-0.4922	-1.47661	SLV fondazioni 11	-0.26676	-0.80029
724	SLV 4	-0.54671	-1.64014	SLV fondazioni 11	-0.29626	-0.88879
725	SLV 4	-0.54885	-1.64656	SLV fondazioni 7	-0.29619	-0.88856
726	SLV 4	-0.49481	-1.48442	SLV fondazioni 7	-0.26652	-0.79956
727	SLV 4	-0.35397	-1.0619	SLV fondazioni 3	-0.18007	-0.54021
728	SLV 4	-0.31584	-0.94752	SLV fondazioni 3	-0.15414	-0.46242
729	SLV 4	-0.60475	-1.81425	SLV fondazioni 11	-0.32719	-0.98157
730	SLV 4	-0.6056	-1.81681	SLV fondazioni 7	-0.32707	-0.98122
731	SLV 4	-0.38744	-1.16233	SLV fondazioni 15	-0.20511	-0.61534
732	SLV 4	-0.39133	-1.174	SLV fondazioni 3	-0.20499	-0.61498
733	SLV 4	-0.27782	-0.83345	SLV fondazioni 15	-0.13144	-0.39432
734	SLV 4	-0.28277	-0.8483	SLV fondazioni 3	-0.13133	-0.39399
735	SLV 4	-0.60245	-1.80734	SLV fondazioni 11	-0.32683	-0.98048
736	SLV 4	-0.6035	-1.8105	SLV fondazioni 7	-0.3267	-0.98011
737	SLV 4	-0.5424	-1.62719	SLV fondazioni 11	-0.29555	-0.88664
738	SLV 4	-0.54457	-1.63372	SLV fondazioni 7	-0.29538	-0.88615
739	SLV 4	-0.59892	-1.79675	SLV fondazioni 11	-0.32587	-0.97762
740	SLV 4	-0.60022	-1.80066	SLV fondazioni 7	-0.32576	-0.97729
741	SLV 4	-0.24372	-0.73116	SLV fondazioni 15	-0.10785	-0.32355
742	SLV 4	-0.43576	-1.30728	SLV fondazioni 15	-0.23691	-0.71073
743	SLV 4	-0.48844	-1.46531	SLV fondazioni 11	-0.2669	-0.8007
744	SLV 4	-0.49127	-1.47381	SLV fondazioni 7	-0.26671	-0.80013
745	SLV 4	-0.43929	-1.31786	SLV fondazioni 3	-0.2368	-0.7104
746	SLV 4	-0.24905	-0.74714	SLV fondazioni 3	-0.10775	-0.32326
747	SLV 4	-0.34473	-1.03418	SLV fondazioni 15	-0.1778	-0.5334
748	SLV 4	-0.598	-1.79401	SLV fondazioni 11	-0.32693	-0.98078
749	SLV 4	-0.59955	-1.79865	SLV fondazioni 7	-0.32683	-0.9805
750	SLV 4	-0.34916	-1.04749	SLV fondazioni 3	-0.17769	-0.53308
751	SLV 4	-0.38364	-1.15093	SLV fondazioni 15	-0.20364	-0.61092
752	SLV 4	-0.38774	-1.16321	SLV fondazioni 3	-0.20354	-0.61061
753	SLV 4	-0.54102	-1.62306	SLV fondazioni 11	-0.29701	-0.89104
754	SLV 4	-0.54322	-1.62965	SLV fondazioni 7	-0.29678	-0.89034
755	SLV 4	-0.31058	-0.93174	SLV fondazioni 15	-0.1548	-0.46441
756	SLV 4	-0.31537	-0.94611	SLV fondazioni 3	-0.1547	-0.46411
757	SLV 4	-0.65331	-1.95993	SLV fondazioni 11	-0.35791	-1.07372
758	SLV 4	-0.48335	-1.45005	SLV fondazioni 11	-0.26632	-0.79897
759	SLV 4	-0.65434	-1.96302	SLV fondazioni 11	-0.35841	-1.07523
760	SLV 4	-0.6545	-1.96349	SLV fondazioni 7	-0.3584	-1.0752
761	SLV 4	-0.48647	-1.4594	SLV fondazioni 7	-0.26621	-0.79863
762	SLV 4	-0.59589	-1.78768	SLV fondazioni 11	-0.32741	-0.98223
763	SLV 4	-0.65425	-1.96275	SLV fondazioni 11	-0.35839	-1.07518
764	SLV 4	-0.65455	-1.96366	SLV fondazioni 7	-0.35837	-1.07511
765	SLV 4	-0.59764	-1.79292	SLV fondazioni 7	-0.32731	-0.98194
766	SLV 4	-0.65305	-1.95914	SLV fondazioni 11	-0.35786	-1.07357
767	SLV 4	-0.65348	-1.96045	SLV fondazioni 7	-0.35782	-1.07346
768	SLV 4	-0.27593	-0.82778	SLV fondazioni 15	-0.1311	-0.39329
769	SLV 4	-0.43301	-1.29902	SLV fondazioni 15	-0.23627	-0.70882
770	SLV 4	-0.43675	-1.31024	SLV fondazioni 3	-0.2362	-0.70859
771	SLV 4	-0.65073	-1.9522	SLV fondazioni 11	-0.3568	-1.07041
772	SLV 4	-0.6513	-1.95389	SLV fondazioni 7	-0.35675	-1.07024
773	SLV 4	-0.28108	-0.84324	SLV fondazioni 3	-0.13101	-0.39303
774	SLV 4	-0.53832	-1.61495	SLV fondazioni 11	-0.29781	-0.89344
775	SLV 4	-0.54062	-1.62185	SLV fondazioni 7	-0.29757	-0.8927
776	SLV 4	-0.59263	-1.77788	SLV fondazioni 11	-0.32731	-0.98193
777	SLV 4	-0.65064	-1.95191	SLV fondazioni 11	-0.35753	-1.0726
778	SLV 4	-0.65132	-1.95396	SLV fondazioni 7	-0.35746	-1.07239
779	SLV 4	-0.59451	-1.78353	SLV fondazioni 7	-0.3272	-0.98161
780	SLV 4	-0.24056	-0.72169	SLV fondazioni 15	-0.10648	-0.31945
781	SLV 4	-0.37846	-1.13539	SLV fondazioni 15	-0.20136	-0.60407
782	SLV 4	-0.38276	-1.14827	SLV fondazioni 3	-0.20126	-0.60378
783	SLV 4	-0.2461	-0.7383	SLV fondazioni 3	-0.10641	-0.31924
784	SLV 4	-0.64941	-1.94824	SLV fondazioni 11	-0.35775	-1.07324
785	SLV 4	-0.65023	-1.95069	SLV fondazioni 7	-0.35766	-1.07299
786	SLV 4	-0.34368	-1.03103	SLV fondazioni 15	-0.1783	-0.5349
787	SLV 4	-0.4815	-1.44451	SLV fondazioni 15	-0.26803	-0.80409
788	SLV 4	-0.48489	-1.45466	SLV fondazioni 3	-0.26797	-0.8039
789	SLV 4	-0.34831	-1.04492	SLV fondazioni 3	-0.17821	-0.53463
790	SLV 4	-0.58822	-1.76466	SLV fondazioni 11	-0.32663	-0.9799
791	SLV 4	-0.59019	-1.77058	SLV fondazioni 7	-0.3265	-0.9795
792	SLV 4	-0.64707	-1.94121	SLV fondazioni 11	-0.35743	-1.0723
793	SLV 4	-0.64804	-1.94412	SLV fondazioni 7	-0.35734	-1.07203
794	SLV 4	-0.53432	-1.60295	SLV fondazioni 11	-0.29794	-0.89383
795	SLV 4	-0.53688	-1.61065	SLV fondazioni 7	-0.29777	-0.89331
796	SLV 4	-0.30839	-0.92518	SLV fondazioni 15	-0.15447	-0.46342
797	SLV 4	-0.42891	-1.28672	SLV fondazioni 15	-0.23489	-0.70467
798	SLV 4	-0.43283	-1.29849	SLV fondazioni 3	-0.23482	-0.70447
799	SLV 4	-0.31338	-0.94013	SLV fondazioni 3	-0.1544	-0.46319
800	SLV 4	-0.64364	-1.93091	SLV fondazioni 11	-0.3566	-1.0698
801	SLV 4	-0.64477	-1.93431	SLV fondazioni 7	-0.3565	-1.06951
802	SLV 4	-0.2725	-0.8175	SLV fondazioni 15	-0.12978	-0.38935
803	SLV 4	-0.5864	-1.75921	SLV fondazioni 11	-0.32796	-0.98387
804	SLV 4	-0.58846	-1.76537	SLV fondazioni 7	-0.32781	-0.98343



Progetto	Titolo	Rev.	Pag.
Orione	Orione_A24a.pdf "TABULATI DI CALCOLO PLINTO DI FONDAZIONE PER AEROGENERATORE TIPO"	0	146

Tabulati di Calcolo Plinto di Fondazione per Aerogeneratore Tipo - Progetto Impianto Eolico - "Orione"

Nodo	Contesto	uz min	Minima	Contesto	uz max	Massima
805	SLV 4	-0.27786	-0.83358	SLV fondazioni 3	-0.12972	-0.38917
806	SLV 4	-0.6424	-1.92721	SLV fondazioni 11	-0.35755	-1.07266
807	SLV 4	-0.64369	-1.93108	SLV fondazioni 7	-0.35746	-1.07237
808	SLV 4	-0.52907	-1.58721	SLV fondazioni 11	-0.29741	-0.89224
809	SLV 4	-0.53197	-1.59591	SLV fondazioni 7	-0.29733	-0.89199
810	SLV 4	-0.47836	-1.43508	SLV fondazioni 15	-0.26741	-0.80224
811	SLV 4	-0.48196	-1.44589	SLV fondazioni 3	-0.26741	-0.80223
812	SLV 4	-0.37703	-1.1311	SLV fondazioni 15	-0.20184	-0.60553
813	SLV 4	-0.3815	-1.1445	SLV fondazioni 3	-0.20176	-0.60528
814	SLV 4	-0.64008	-1.92023	SLV fondazioni 11	-0.35799	-1.07397
815	SLV 4	-0.64151	-1.92454	SLV fondazioni 7	-0.35789	-1.07367
816	SLV 4	-0.2359	-0.70771	SLV fondazioni 15	-0.10415	-0.31244
817	SLV 4	-0.34117	-1.0235	SLV fondazioni 15	-0.17797	-0.53339
818	SLV 4	-0.42351	-1.27052	SLV fondazioni 15	-0.23276	-0.69827
819	SLV 4	-0.69551	-2.08652	SLV fondazioni 11	-0.3876	-1.16279
820	SLV 4	-0.4276	-1.28279	SLV fondazioni 3	-0.23268	-0.69805
821	SLV 4	-0.34598	-1.03794	SLV fondazioni 3	-0.1779	-0.53369
822	SLV 4	-0.24166	-0.72497	SLV fondazioni 3	-0.10411	-0.31232
823	SLV 4	-0.58338	-1.75014	SLV fondazioni 11	-0.32869	-0.98606
824	SLV 4	-0.58556	-1.75668	SLV fondazioni 7	-0.32855	-0.98565
825	SLV 4	-0.69633	-2.08899	SLV fondazioni 11	-0.38806	-1.16418
826	SLV 4	-0.69644	-2.08933	SLV fondazioni 7	-0.38805	-1.16415
827	SLV 4	-0.69616	-2.08848	SLV fondazioni 11	-0.38807	-1.1642
828	SLV 4	-0.69638	-2.08915	SLV fondazioni 7	-0.38805	-1.16414
829	SLV 4	-0.69499	-2.08498	SLV fondazioni 11	-0.38762	-1.16286
830	SLV 4	-0.69533	-2.08598	SLV fondazioni 7	-0.38759	-1.16276
831	SLV 4	-0.69284	-2.07853	SLV fondazioni 11	-0.38672	-1.16015
832	SLV 4	-0.69329	-2.07987	SLV fondazioni 7	-0.38667	-1.16001
833	SLV 4	-0.30469	-0.91407	SLV fondazioni 15	-0.15323	-0.45969
834	SLV 4	-0.63667	-1.91001	SLV fondazioni 11	-0.3579	-1.07371
835	SLV 4	-0.63825	-1.91475	SLV fondazioni 7	-0.3578	-1.0734
836	SLV 4	-0.30987	-0.92961	SLV fondazioni 3	-0.15318	-0.45953
837	SLV 4	-0.52671	-1.58013	SLV fondazioni 11	-0.29906	-0.89719
838	SLV 4	-0.52993	-1.58978	SLV fondazioni 7	-0.29907	-0.89721
839	SLV 4	-0.47396	-1.42189	SLV fondazioni 15	-0.26613	-0.79838
840	SLV 4	-0.69245	-2.07735	SLV fondazioni 11	-0.38737	-1.16211
841	SLV 4	-0.69301	-2.07902	SLV fondazioni 7	-0.38731	-1.16194
842	SLV 4	-0.47772	-1.43317	SLV fondazioni 3	-0.26613	-0.79838
843	SLV 4	-0.57918	-1.73753	SLV fondazioni 11	-0.32882	-0.98647
844	SLV 4	-0.58155	-1.74466	SLV fondazioni 7	-0.32871	-0.98612
845	SLV 4	-0.63222	-1.89666	SLV fondazioni 11	-0.3573	-1.07189
846	SLV 4	-0.69107	-2.0732	SLV fondazioni 11	-0.38757	-1.1627
847	SLV 4	-0.69173	-2.0752	SLV fondazioni 7	-0.3875	-1.16251
848	SLV 4	-0.63393	-1.9018	SLV fondazioni 7	-0.35719	-1.07158
849	SLV 4	-0.26764	-0.80293	SLV fondazioni 15	-0.12753	-0.38259
850	SLV 4	-0.27321	-0.81964	SLV fondazioni 3	-0.1275	-0.3825
851	SLV 4	-0.37418	-1.12255	SLV fondazioni 15	-0.20192	-0.60455
852	SLV 4	-0.37883	-1.13649	SLV fondazioni 3	-0.20145	-0.60435
853	SLV 4	-0.6887	-2.0661	SLV fondazioni 11	-0.38731	-1.16192
854	SLV 4	-0.68948	-2.06844	SLV fondazioni 7	-0.38723	-1.1617
855	SLV 4	-0.42157	-1.26472	SLV fondazioni 15	-0.23321	-0.69964
856	SLV 4	-0.42581	-1.27743	SLV fondazioni 3	-0.23313	-0.6994
857	SLV 4	-0.52315	-1.56944	SLV fondazioni 15	-0.29855	-0.89566
858	SLV 4	-0.68537	-2.0561	SLV fondazioni 11	-0.38659	-1.15977
859	SLV 4	-0.68627	-2.05881	SLV fondazioni 7	-0.38651	-1.15953
860	SLV 4	-0.52661	-1.57983	SLV fondazioni 3	-0.2986	-0.89579
861	SLV 4	-0.3372	-1.0116	SLV fondazioni 15	-0.17678	-0.53034
862	SLV 4	-0.34221	-1.02662	SLV fondazioni 3	-0.17673	-0.5302
863	SLV 4	-0.57384	-1.72151	SLV fondazioni 11	-0.32837	-0.9851
864	SLV 4	-0.57646	-1.72939	SLV fondazioni 7	-0.32829	-0.98487
865	SLV 4	-0.62996	-1.88988	SLV fondazioni 11	-0.35847	-1.07542
866	SLV 4	-0.63179	-1.89536	SLV fondazioni 7	-0.35837	-1.07512
867	SLV 4	-0.46837	-1.40511	SLV fondazioni 15	-0.26416	-0.79249
868	SLV 4	-0.47223	-1.41669	SLV fondazioni 3	-0.26412	-0.79236
869	SLV 4	-0.23559	-0.70676	SLV fondazioni 15	-0.10516	-0.31549
870	SLV 4	-0.68379	-2.05138	SLV fondazioni 11	-0.38743	-1.1623
871	SLV 4	-0.6848	-2.05441	SLV fondazioni 7	-0.38735	-1.16205
872	SLV 4	-0.24152	-0.72456	SLV fondazioni 3	-0.10515	-0.31546
873	SLV 4	-0.29958	-0.89873	SLV fondazioni 15	-0.15106	-0.45319
874	SLV 4	-0.30496	-0.91488	SLV fondazioni 3	-0.15104	-0.45312
875	SLV 4	-0.72626	-2.17879	SLV fondazioni 11	-0.41056	-1.23169
876	SLV 4	-0.62662	-1.87986	SLV fondazioni 11	-0.35913	-1.07739
877	SLV 4	-0.72691	-2.18073	SLV fondazioni 11	-0.411	-1.23301
878	SLV 4	-0.72699	-2.18097	SLV fondazioni 7	-0.411	-1.233
879	SLV 4	-0.62858	-1.88574	SLV fondazioni 7	-0.35903	-1.0771
880	SLV 4	-0.72667	-2.18	SLV fondazioni 11	-0.41104	-1.23313
881	SLV 4	-0.72683	-2.18048	SLV fondazioni 7	-0.41103	-1.23308
882	SLV 4	-0.68124	-2.04373	SLV fondazioni 11	-0.38782	-1.16345
883	SLV 4	-0.68237	-2.0471	SLV fondazioni 7	-0.38773	-1.1632
884	SLV 4	-0.72555	-2.17665	SLV fondazioni 11	-0.41068	-1.23204
885	SLV 4	-0.72579	-2.17738	SLV fondazioni 7	-0.41065	-1.23195
886	SLV 4	-0.5185	-1.5555	SLV fondazioni 15	-0.29737	-0.89212
887	SLV 4	-0.57105	-1.71315	SLV fondazioni 11	-0.32991	-0.98972
888	SLV 4	-0.5739	-1.72171	SLV fondazioni 7	-0.32986	-0.98959
889	SLV 4	-0.72355	-2.17066	SLV fondazioni 11	-0.40991	-1.22972
890	SLV 4	-0.72388	-2.17164	SLV fondazioni 7	-0.40987	-1.22961
891	SLV 4	-0.52206	-1.56617	SLV fondazioni 3	-0.29742	-0.89225
892	SLV 4	-0.36996	-1.10988	SLV fondazioni 15	-0.20038	-0.60113
893	SLV 4	-0.37479	-1.12437	SLV fondazioni 3	-0.20034	-0.60101
894	SLV 4	-0.41829	-1.25488	SLV fondazioni 15	-0.23291	-0.69873
895	SLV 4	-0.42269	-1.26806	SLV fondazioni 3	-0.23284	-0.69851
896	SLV 4	-0.72293	-2.1688	SLV fondazioni 11	-0.4105	-1.23151
897	SLV 4	-0.72334	-2.17001	SLV fondazioni 7	-0.41046	-1.23137
898	SLV 4	-0.67774	-2.03321	SLV fondazioni 11	-0.38774	-1.16323
899	SLV 4	-0.67898	-2.03693	SLV fondazioni 7	-0.38766	-1.16298
900	SLV 4	-0.26694	-0.80081	SLV fondazioni 15	-0.12851	-0.38553
901	SLV 4	-0.27268	-0.81804	SLV fondazioni 3	-0.12851	-0.38553



Progetto	Titolo	Rev.	Pag.
Orione	Orione_A24a.pdf "TABULATI DI CALCOLO PLINTO DI FONDAZIONE PER AEROGENERATORE TIPO"	0	147

Tabulati di Calcolo Plinto di Fondazione per Aerogeneratore Tipo - Progetto Impianto Eolico - "Orione"

Nodo	Contesto	uz min	Minima	Contesto	uz max	Massima
902	SLU 4	-0.62223	-1.8667	SLV fondazioni 11	-0.35926	-1.07778
903	SLU 4	-0.62434	-1.87303	SLV fondazioni 7	-0.35917	-1.07752
904	SLU 4	-0.46594	-1.39783	SLV fondazioni 15	-0.26461	-0.79382
905	SLU 4	-0.72143	-2.16428	SLV fondazioni 11	-0.4107	-1.23209
906	SLU 4	-0.72191	-2.16573	SLV fondazioni 7	-0.41064	-1.23192
907	SLU 4	-0.46988	-1.40965	SLV fondazioni 3	-0.26451	-0.79353
908	SLU 4	-0.33188	-0.99563	SLV fondazioni 15	-0.17474	-0.52421
909	SLU 4	-0.33708	-1.01123	SLV fondazioni 3	-0.17472	-0.52417
910	SLU 4	-0.67331	-2.01992	SLV fondazioni 11	-0.38721	-1.16164
911	SLU 4	-0.71906	-2.15717	SLV fondazioni 11	-0.41048	-1.23144
912	SLU 4	-0.71962	-2.15887	SLV fondazioni 7	-0.41042	-1.23126
913	SLU 4	-0.67467	-2.02401	SLV fondazioni 7	-0.38713	-1.16139
914	SLU 4	-0.56715	-1.70145	SLV fondazioni 15	-0.32967	-0.989
915	SLU 4	-0.57019	-1.71056	SLV fondazioni 3	-0.32964	-0.98893
916	SLU 4	-0.51274	-1.53821	SLV fondazioni 15	-0.29558	-0.88675
917	SLU 4	-0.71583	-2.14749	SLV fondazioni 11	-0.40986	-1.22957
918	SLU 4	-0.71649	-2.14946	SLV fondazioni 7	-0.40979	-1.22937
919	SLU 4	-0.51632	-1.54897	SLV fondazioni 3	-0.29557	-0.8867
920	SLU 4	-0.61684	-1.85053	SLV fondazioni 11	-0.35887	-1.07661
921	SLU 4	-0.61912	-1.85735	SLV fondazioni 7	-0.3588	-1.07639
922	SLU 4	-0.29851	-0.89554	SLV fondazioni 15	-0.152	-0.45599
923	SLU 4	-0.30407	-0.9122	SLV fondazioni 3	-0.15201	-0.45602
924	SLU 4	-0.23376	-0.70128	SLV fondazioni 15	-0.10522	-0.31566
925	SLU 4	-0.23987	-0.7196	SLV fondazioni 3	-0.10524	-0.31573
926	SLU 4	-0.67062	-2.01187	SLV fondazioni 11	-0.38824	-1.16472
927	SLU 4	-0.67209	-2.01626	SLV fondazioni 7	-0.38816	-1.16448
928	SLU 4	-0.71398	-2.14194	SLV fondazioni 11	-0.41061	-1.23182
929	SLU 4	-0.71471	-2.14414	SLV fondazioni 7	-0.41054	-1.23161
930	SLU 4	-0.36442	-1.09327	SLV fondazioni 15	-0.19842	-0.59526
931	SLU 4	-0.4137	-1.24111	SLV fondazioni 15	-0.23184	-0.69551
932	SLU 4	-0.41828	-1.25484	SLV fondazioni 3	-0.23179	-0.69537
933	SLU 4	-0.36945	-1.10835	SLV fondazioni 3	-0.19841	-0.59524
934	SLU 4	-0.46223	-1.38669	SLV fondazioni 15	-0.26433	-0.79299
935	SLU 4	-0.4663	-1.39891	SLV fondazioni 3	-0.26421	-0.79264
936	SLU 4	-0.56219	-1.68656	SLV fondazioni 15	-0.32859	-0.98577
937	SLU 4	-0.71126	-2.13377	SLV fondazioni 11	-0.41095	-1.23284
938	SLU 4	-0.75372	-2.26116	SLV fondazioni 11	-0.43268	-1.29805
939	SLU 4	-0.71207	-2.13621	SLV fondazioni 7	-0.41088	-1.23263
940	SLU 4	-0.56535	-1.69604	SLV fondazioni 3	-0.32858	-0.98575
941	SLU 4	-0.75419	-2.26258	SLV fondazioni 11	-0.43312	-1.29937
942	SLU 4	-0.75424	-2.26271	SLV fondazioni 7	-0.43312	-1.29936
943	SLU 4	-0.61361	-1.84084	SLV fondazioni 11	-0.36025	-1.08076
944	SLU 4	-0.667	-2.00099	SLV fondazioni 11	-0.38881	-1.16643
945	SLU 4	-0.75389	-2.26168	SLV fondazioni 11	-0.43321	-1.29964
946	SLU 4	-0.75397	-2.26192	SLV fondazioni 7	-0.4332	-1.2996
947	SLU 4	-0.66857	-2.0057	SLV fondazioni 7	-0.38873	-1.1662
948	SLU 4	-0.61603	-1.84809	SLV fondazioni 7	-0.36019	-1.08058
949	SLU 4	-0.75283	-2.25849	SLV fondazioni 11	-0.43293	-1.2988
950	SLU 4	-0.75295	-2.25885	SLV fondazioni 7	-0.43291	-1.29874
951	SLU 4	-0.50981	-1.52943	SLV fondazioni 15	-0.296	-0.88801
952	SLU 4	-0.751	-2.25299	SLV fondazioni 11	-0.4323	-1.2969
953	SLU 4	-0.75116	-2.25349	SLV fondazioni 7	-0.43227	-1.29682
954	SLU 4	-0.5134	-1.5402	SLV fondazioni 3	-0.29592	-0.88776
955	SLU 4	-0.26476	-0.79429	SLV fondazioni 15	-0.12857	-0.38571
956	SLU 4	-0.27067	-0.81202	SLV fondazioni 3	-0.1286	-0.3858
957	SLU 4	-0.3304	-0.99121	SLV fondazioni 15	-0.17561	-0.52682
958	SLU 4	-0.7077	-2.1231	SLV fondazioni 11	-0.41088	-1.23265
959	SLU 4	-0.7086	-2.1258	SLV fondazioni 7	-0.41081	-1.23244
960	SLU 4	-0.33577	-1.00731	SLV fondazioni 3	-0.17562	-0.52687
961	SLU 4	-0.75016	-2.25047	SLV fondazioni 11	-0.43285	-1.29856
962	SLU 4	-0.75036	-2.25109	SLV fondazioni 7	-0.43282	-1.29845
963	SLU 4	-0.66245	-1.98735	SLV fondazioni 11	-0.38892	-1.16676
964	SLU 4	-0.74855	-2.24564	SLV fondazioni 11	-0.43305	-1.29916
965	SLU 4	-0.74879	-2.24637	SLV fondazioni 7	-0.43301	-1.29903
966	SLU 4	-0.66414	-1.99241	SLV fondazioni 7	-0.38895	-1.16656
967	SLU 4	-0.70332	-2.10995	SLV fondazioni 11	-0.41041	-1.23123
968	SLU 4	-0.70431	-2.11294	SLV fondazioni 7	-0.41034	-1.23103
969	SLU 4	-0.5562	-1.6686	SLV fondazioni 15	-0.32694	-0.98081
970	SLU 4	-0.55944	-1.67833	SLV fondazioni 3	-0.32692	-0.98077
971	SLU 4	-0.60936	-1.82809	SLV fondazioni 15	-0.36033	-1.08098
972	SLU 4	-0.74618	-2.23855	SLV fondazioni 11	-0.43288	-1.29864
973	SLU 4	-0.74647	-2.23942	SLV fondazioni 7	-0.43283	-1.29849
974	SLU 4	-0.61192	-1.83575	SLV fondazioni 3	-0.3603	-1.08089
975	SLU 4	-0.40787	-1.22361	SLV fondazioni 15	-0.23	-0.69
976	SLU 4	-0.41265	-1.23796	SLV fondazioni 3	-0.23	-0.69
977	SLU 4	-0.45727	-1.37182	SLV fondazioni 15	-0.26333	-0.78998
978	SLU 4	-0.46154	-1.38462	SLV fondazioni 3	-0.26325	-0.78975
979	SLU 4	-0.29601	-0.88802	SLV fondazioni 15	-0.15205	-0.45615
980	SLU 4	-0.74307	-2.2292	SLV fondazioni 11	-0.43235	-1.29704
981	SLU 4	-0.74341	-2.23024	SLV fondazioni 7	-0.43229	-1.29688
982	SLU 4	-0.30172	-0.90517	SLV fondazioni 3	-0.15209	-0.45627
983	SLU 4	-0.36253	-1.08758	SLV fondazioni 15	-0.19926	-0.59777
984	SLU 4	-0.36772	-1.10315	SLV fondazioni 3	-0.19928	-0.59785
985	SLU 4	-0.65703	-1.97108	SLV fondazioni 11	-0.38857	-1.16572
986	SLU 4	-0.70031	-2.10094	SLV fondazioni 11	-0.41131	-1.23392
987	SLU 4	-0.70138	-2.10414	SLV fondazioni 7	-0.41124	-1.23372
988	SLU 4	-0.65884	-1.97651	SLV fondazioni 7	-0.38852	-1.16555
989	SLU 4	-0.23043	-0.69128	SLV fondazioni 15	-0.10427	-0.31282
990	SLU 4	-0.23671	-0.71012	SLV fondazioni 3	-0.10433	-0.31299
991	SLU 4	-0.50567	-1.517	SLV fondazioni 15	-0.29575	-0.88726
992	SLU 4	-0.50933	-1.52799	SLV fondazioni 3	-0.29563	-0.88688
993	SLU 4	-0.74095	-2.22286	SLV fondazioni 11	-0.43301	-1.29903
994	SLU 4	-0.7462	-2.23861	SLV fondazioni 11	-0.43301	-1.29902
995	SLU 4	-0.74624	-2.23873	SLV fondazioni 7	-0.433	-1.299
996	SLU 4	-0.74133	-2.224	SLV fondazioni 7	-0.43295	-1.29886
997	SLU 4	-0.74366	-2.23098	SLV fondazioni 11	-0.43167	-1.29502
998	SLU 4	-0.74375	-2.23125	SLV fondazioni 7	-0.43171	-1.29512



Progetto	Titolo	Rev.	Pag.
Orione	Orione_A24a.pdf "TABULATI DI CALCOLO PLINTO DI FONDAZIONE PER AEROGENERATORE TIPO"	0	148

Tabulati di Calcolo Plinto di Fondazione per Aerogeneratore Tipo - Progetto Impianto Eolico - "Orione"

Nodo	Contesto	uz min	Minima	Contesto	uz max	Massima
999	SLU 4	-0.60413	-1.8124	SLV fondazioni 15	-0.35939	-1.07818
1000	SLU 4	-0.7425	-2.22751	SLV fondazioni 11	-0.43163	-1.29488
1001	SLU 4	-0.74036	-2.22109	SLV fondazioni 7	-0.43009	-1.29027
1002	SLU 4	-0.74248	-2.22743	SLV fondazioni 7	-0.43158	-1.29474
1003	SLU 4	-0.60682	-1.82045	SLV fondazioni 3	-0.35937	-1.07812
1004	SLU 4	-0.69647	-2.0894	SLV fondazioni 11	-0.41179	-1.23538
1005	SLU 4	-0.69761	-2.09283	SLV fondazioni 7	-0.41173	-1.2352
1006	SLU 4	-0.55272	-1.65816	SLV fondazioni 15	-0.32731	-0.98192
1007	SLU 4	-0.73809	-2.21426	SLV fondazioni 11	-0.43331	-1.29994
1008	SLU 4	-0.7385	-2.21551	SLV fondazioni 7	-0.43325	-1.29976
1009	SLU 4	-0.55602	-1.66805	SLV fondazioni 3	-0.32728	-0.98185
1010	SLU 4	-0.32754	-0.98261	SLV fondazioni 15	-0.17564	-0.52692
1011	SLU 4	-0.33306	-0.99919	SLV fondazioni 3	-0.17569	-0.52706
1012	SLU 4	-0.65334	-1.96001	SLV fondazioni 11	-0.38977	-1.16931
1013	SLU 4	-0.73965	-2.21895	SLV fondazioni 11	-0.43158	-1.29474
1014	SLU 4	-0.73776	-2.21327	SLV fondazioni 11	-0.42994	-1.28981
1015	SLU 4	-0.7378	-2.21339	SLV fondazioni 7	-0.42992	-1.28975
1016	SLU 4	-0.7398	-2.21941	SLV fondazioni 7	-0.43158	-1.29475
1017	SLU 4	-0.65525	-1.96574	SLV fondazioni 7	-0.38972	-1.16916
1018	SLU 4	-0.74096	-2.22288	SLV fondazioni 11	-0.43297	-1.29891
1019	SLU 4	-0.74108	-2.22325	SLV fondazioni 7	-0.43293	-1.2988
1020	SLU 4	-0.26113	-0.78339	SLV fondazioni 15	-0.12766	-0.38299
1021	SLU 4	-0.2672	-0.80161	SLV fondazioni 3	-0.12772	-0.38317
1022	SLU 4	-0.73449	-2.20347	SLV fondazioni 11	-0.43324	-1.29972
1023	SLU 4	-0.73496	-2.20487	SLV fondazioni 7	-0.43318	-1.29955
1024	SLU 4	-0.45114	-1.35343	SLV fondazioni 15	-0.2616	-0.7848
1025	SLU 4	-0.45565	-1.36694	SLV fondazioni 3	-0.26161	-0.78482
1026	SLU 4	-0.69182	-2.07546	SLV fondazioni 11	-0.41187	-1.23562
1027	SLU 4	-0.69305	-2.07916	SLV fondazioni 7	-0.41182	-1.23546
1028	SLU 4	-0.73609	-2.20828	SLV fondazioni 11	-0.43167	-1.295
1029	SLU 4	-0.73614	-2.20841	SLV fondazioni 7	-0.43159	-1.29478
1030	SLU 4	-0.40541	-1.21623	SLV fondazioni 15	-0.23077	-0.6923
1031	SLU 4	-0.41036	-1.23109	SLV fondazioni 3	-0.23082	-0.69246
1032	SLU 4	-0.50036	-1.50107	SLV fondazioni 15	-0.29483	-0.8845
1033	SLU 4	-0.59797	-1.79391	SLV fondazioni 15	-0.35793	-1.07379
1034	SLU 4	-0.60078	-1.80233	SLV fondazioni 3	-0.35792	-1.07376
1035	SLU 4	-0.50425	-1.51274	SLV fondazioni 3	-0.29475	-0.88424
1036	SLU 4	-0.73017	-2.19052	SLV fondazioni 11	-0.43281	-1.29844
1037	SLU 4	-0.7307	-2.19211	SLV fondazioni 7	-0.43276	-1.29827
1038	SLU 4	-0.71318	-2.13955	SLV fondazioni 11	-0.41654	-1.24963
1039	SLU 4	-0.71319	-2.13958	SLV fondazioni 7	-0.41653	-1.2496
1040	SLU 4	-0.64875	-1.94625	SLV fondazioni 15	-0.39025	-1.17075
1041	SLU 4	-0.65076	-1.95228	SLV fondazioni 3	-0.39023	-1.1707
1042	SLU 4	-0.35929	-1.07788	SLV fondazioni 15	-0.19928	-0.59785
1043	SLU 4	-0.73005	-2.19015	SLV fondazioni 11	-0.43005	-1.29016
1044	SLU 4	-0.73014	-2.19041	SLV fondazioni 7	-0.43001	-1.29004
1045	SLU 4	-0.36464	-1.09391	SLV fondazioni 3	-0.19934	-0.59803
1046	SLU 4	-0.29207	-0.8762	SLV fondazioni 15	-0.15119	-0.45357
1047	SLU 4	-0.29794	-0.89382	SLV fondazioni 3	-0.15126	-0.45377
1048	SLU 4	-0.54814	-1.64442	SLV fondazioni 15	-0.32708	-0.98125
1049	SLU 4	-0.6864	-2.0592	SLV fondazioni 11	-0.41155	-1.23465
1050	SLU 4	-0.68773	-2.06319	SLV fondazioni 7	-0.4115	-1.23451
1051	SLU 4	-0.55154	-1.65462	SLV fondazioni 3	-0.32706	-0.98117
1052	SLU 4	-0.73056	-2.19168	SLV fondazioni 11	-0.43177	-1.2953
1053	SLU 4	-0.73079	-2.19237	SLV fondazioni 7	-0.43175	-1.29526
1054	SLU 4	-0.72687	-2.1806	SLV fondazioni 11	-0.43357	-1.30072
1055	SLU 4	-0.72743	-2.18228	SLV fondazioni 7	-0.43352	-1.30056
1056	SLU 4	-0.73066	-2.19199	SLV fondazioni 11	-0.43322	-1.29967
1057	SLU 4	-0.70822	-2.12465	SLV fondazioni 11	-0.41658	-1.24973
1058	SLU 4	-0.69105	-2.07315	SLV fondazioni 11	-0.4046	-1.2138
1059	SLU 4	-0.69119	-2.07358	SLV fondazioni 7	-0.40468	-1.21403
1060	SLU 4	-0.70824	-2.12473	SLV fondazioni 7	-0.41655	-1.24964
1061	SLU 4	-0.73088	-2.19265	SLV fondazioni 7	-0.43317	-1.29951
1062	SLU 4	-0.22567	-0.67701	SLV fondazioni 15	-0.10237	-0.3071
1063	SLU 4	-0.69031	-2.07092	SLV fondazioni 11	-0.40467	-1.21401
1064	SLU 4	-0.69015	-2.07045	SLV fondazioni 7	-0.40458	-1.21374
1065	SLU 4	-0.23212	-0.69637	SLV fondazioni 3	-0.10245	-0.30736
1066	SLU 4	-0.59394	-1.78182	SLV fondazioni 15	-0.35827	-1.07481
1067	SLU 4	-0.6433	-1.92989	SLV fondazioni 15	-0.38948	-1.16845
1068	SLU 4	-0.67337	-2.02012	SLV fondazioni 7	-0.39492	-1.18476
1069	SLU 4	-0.64541	-1.93624	SLV fondazioni 3	-0.38948	-1.16843
1070	SLU 4	-0.59684	-1.79051	SLV fondazioni 3	-0.35827	-1.07481
1071	SLU 4	-0.72283	-2.1685	SLV fondazioni 11	-0.43397	-1.30192
1072	SLU 4	-0.68714	-2.06143	SLV fondazioni 11	-0.40463	-1.21389
1073	SLU 4	-0.68728	-2.06183	SLV fondazioni 7	-0.40469	-1.21406
1074	SLU 4	-0.68235	-2.04706	SLV fondazioni 11	-0.41258	-1.23774
1075	SLU 4	-0.72343	-2.1703	SLV fondazioni 7	-0.43392	-1.30177
1076	SLU 4	-0.72472	-2.17415	SLV fondazioni 11	-0.43198	-1.29594
1077	SLU 4	-0.72484	-2.17452	SLV fondazioni 7	-0.4319	-1.29569
1078	SLU 4	-0.68375	-2.05125	SLV fondazioni 7	-0.41254	-1.23762
1079	SLU 4	-0.3233	-0.96991	SLV fondazioni 15	-0.17483	-0.52449
1080	SLU 4	-0.49394	-1.48182	SLV fondazioni 15	-0.29324	-0.87972
1081	SLU 4	-0.49812	-1.49436	SLV fondazioni 3	-0.29325	-0.87974
1082	SLU 4	-0.32898	-0.98694	SLV fondazioni 3	-0.1749	-0.52471
1083	SLU 4	-0.44809	-1.34428	SLV fondazioni 15	-0.26229	-0.78688
1084	SLU 4	-0.45281	-1.35843	SLV fondazioni 3	-0.26239	-0.78716
1085	SLU 4	-0.67106	-2.01317	SLV fondazioni 11	-0.39492	-1.18477
1086	SLU 4	-0.67101	-2.01302	SLV fondazioni 7	-0.39491	-1.18473
1087	SLU 4	-0.68464	-2.05391	SLV fondazioni 11	-0.40476	-1.21429
1088	SLU 4	-0.68448	-2.05343	SLV fondazioni 7	-0.40466	-1.21397
1089	SLU 4	-0.25615	-0.76844	SLV fondazioni 15	-0.12582	-0.37747
1090	SLU 4	-0.40169	-1.20506	SLV fondazioni 15	-0.23079	-0.69237
1091	SLU 4	-0.5425	-1.62751	SLV fondazioni 15	-0.32626	-0.97877
1092	SLU 4	-0.54607	-1.6382	SLV fondazioni 3	-0.32625	-0.97874
1093	SLU 4	-0.4068	-1.22039	SLV fondazioni 3	-0.23088	-0.69263
1094	SLU 4	-0.26239	-0.78717	SLV fondazioni 3	-0.12591	-0.37774
1095	SLU 4	-0.71811	-2.15433	SLV fondazioni 11	-0.434	-1.30201



Progetto	Titolo	Rev.	Pag.
Orione	Orione_A24a.pdf "TABULATI DI CALCOLO PLINTO DI FONDAZIONE PER AEROGENERATORE TIPO"	0	149

Tabulati di Calcolo Plinto di Fondazione per Aerogeneratore Tipo - Progetto Impianto Eolico - "Orione"

Nodo	Contesto	uz min	Minima	Contesto	uz max	Massima
1096	SLV 4	-0.71876	-2.15629	SLV fondazioni 7	-0.43396	-1.30188
1097	SLV 4	-0.71748	-2.15243	SLV fondazioni 11	-0.43043	-1.29133
1098	SLV 4	-0.71762	-2.15287	SLV fondazioni 7	-0.43039	-1.29116
1099	SLV 4	-0.69844	-2.09531	SLV fondazioni 11	-0.41682	-1.25045
1100	SLV 4	-0.69849	-2.09548	SLV fondazioni 7	-0.41677	-1.25031
1101	SLV 4	-0.63703	-1.91108	SLV fondazioni 15	-0.38825	-1.16474
1102	SLV 4	-0.67751	-2.03252	SLV fondazioni 11	-0.4132	-1.2396
1103	SLV 4	-0.67897	-2.03692	SLV fondazioni 7	-0.41317	-1.23952
1104	SLV 4	-0.63926	-1.91778	SLV fondazioni 3	-0.38825	-1.16475
1105	SLV 4	-0.35476	-1.06429	SLV fondazioni 15	-0.19851	-0.59552
1106	SLV 4	-0.58893	-1.7668	SLV fondazioni 15	-0.35808	-1.07425
1107	SLV 4	-0.59194	-1.77581	SLV fondazioni 3	-0.3581	-1.07429
1108	SLV 4	-0.36025	-1.08076	SLV fondazioni 3	-0.19859	-0.59577
1109	SLV 4	-0.71667	-2.15001	SLV fondazioni 11	-0.43222	-1.29667
1110	SLV 4	-0.67855	-2.03564	SLV fondazioni 11	-0.40483	-1.21449
1111	SLV 4	-0.67868	-2.03603	SLV fondazioni 7	-0.40487	-1.21461
1112	SLV 4	-0.71698	-2.15095	SLV fondazioni 7	-0.43221	-1.29663
1113	SLV 4	-0.66412	-1.99237	SLV fondazioni 11	-0.39508	-1.18523
1114	SLV 4	-0.66404	-1.99211	SLV fondazioni 7	-0.39504	-1.18513
1115	SLV 4	-0.71271	-2.13812	SLV fondazioni 11	-0.43368	-1.30104
1116	SLV 4	-0.71343	-2.14029	SLV fondazioni 7	-0.43364	-1.30093
1117	SLV 4	-0.2868	-0.8604	SLV fondazioni 15	-0.14943	-0.44828
1118	SLV 4	-0.29283	-0.87849	SLV fondazioni 3	-0.14952	-0.44856
1119	SLV 4	-0.71563	-2.1469	SLV fondazioni 11	-0.43375	-1.30125
1120	SLV 4	-0.71596	-2.14787	SLV fondazioni 7	-0.43371	-1.30112
1121	SLV 4	-0.60623	-1.81869	SLV fondazioni 11	-0.35797	-1.07391
1122	SLV 4	-0.6062	-1.8186	SLV fondazioni 7	-0.35796	-1.07389
1123	SLV 4	-0.49029	-1.47086	SLV fondazioni 15	-0.29387	-0.88161
1124	SLV 4	-0.67435	-2.02306	SLV fondazioni 11	-0.40502	-1.21507
1125	SLV 4	-0.6742	-2.0226	SLV fondazioni 7	-0.4049	-1.21471
1126	SLV 4	-0.67191	-2.01573	SLV fondazioni 15	-0.41286	-1.23857
1127	SLV 4	-0.67346	-2.02039	SLV fondazioni 3	-0.41286	-1.23859
1128	SLV 4	-0.49472	-1.48417	SLV fondazioni 3	-0.29398	-0.88193
1129	SLV 4	-0.53587	-1.60762	SLV fondazioni 15	-0.32483	-0.97449
1130	SLV 4	-0.53965	-1.61894	SLV fondazioni 3	-0.32485	-0.97456
1131	SLV 4	-0.44388	-1.33163	SLV fondazioni 15	-0.2623	-0.78689
1132	SLV 4	-0.63248	-1.89743	SLV fondazioni 15	-0.38859	-1.16577
1133	SLV 4	-0.63479	-1.90436	SLV fondazioni 3	-0.3886	-1.16581
1134	SLV 4	-0.44876	-1.34627	SLV fondazioni 3	-0.26245	-0.78734
1135	SLV 4	-0.70832	-2.12496	SLV fondazioni 11	-0.43453	-1.30358
1136	SLV 4	-0.70907	-2.12721	SLV fondazioni 7	-0.4345	-1.3035
1137	SLV 4	-0.22511	-0.67532	SLV fondazioni 15	-0.10382	-0.31147
1138	SLV 4	-0.70871	-2.12614	SLV fondazioni 11	-0.43256	-1.29767
1139	SLV 4	-0.70893	-2.1268	SLV fondazioni 7	-0.43248	-1.29745
1140	SLV 4	-0.23169	-0.69506	SLV fondazioni 3	-0.10394	-0.31183
1141	SLV 4	-0.3178	-0.95339	SLV fondazioni 15	-0.17317	-0.51951
1142	SLV 4	-0.60207	-1.80622	SLV fondazioni 11	-0.35802	-1.07406
1143	SLV 4	-0.57752	-1.73255	SLV fondazioni 7	-0.34151	-1.02453
1144	SLV 4	-0.60199	-1.80596	SLV fondazioni 7	-0.358	-1.07399
1145	SLV 4	-0.32362	-0.97086	SLV fondazioni 3	-0.17327	-0.5198
1146	SLV 4	-0.583	-1.749	SLV fondazioni 15	-0.35737	-1.0721
1147	SLV 4	-0.58613	-1.75838	SLV fondazioni 3	-0.35739	-1.07217
1148	SLV 4	-0.39676	-1.19027	SLV fondazioni 15	-0.23006	-0.69019
1149	SLV 4	-0.402	-1.20599	SLV fondazioni 3	-0.23017	-0.6905
1150	SLV 4	-0.57557	-1.72671	SLV fondazioni 11	-0.34148	-1.02443
1151	SLV 4	-0.57547	-1.72641	SLV fondazioni 7	-0.34146	-1.02438
1152	SLV 4	-0.6656	-1.99679	SLV fondazioni 15	-0.41183	-1.23549
1153	SLV 4	-0.66724	-2.00173	SLV fondazioni 3	-0.41184	-1.23553
1154	SLV 4	-0.68414	-2.05241	SLV fondazioni 11	-0.41724	-1.25173
1155	SLV 4	-0.68424	-2.05271	SLV fondazioni 7	-0.41721	-1.25162
1156	SLV 4	-0.65279	-1.95836	SLV fondazioni 11	-0.39536	-1.18609
1157	SLV 4	-0.65267	-1.95802	SLV fondazioni 7	-0.39533	-1.18599
1158	SLV 4	-0.70325	-2.10975	SLV fondazioni 11	-0.43502	-1.30505
1159	SLV 4	-0.70404	-2.11211	SLV fondazioni 7	-0.435	-1.30499
1160	SLV 4	-0.66552	-1.99655	SLV fondazioni 11	-0.40519	-1.21556
1161	SLV 4	-0.66566	-1.99698	SLV fondazioni 7	-0.40523	-1.21568
1162	SLV 4	-0.25517	-0.76551	SLV fondazioni 15	-0.12723	-0.38169
1163	SLV 4	-0.26153	-0.7846	SLV fondazioni 3	-0.12735	-0.38205
1164	SLV 4	-0.70042	-2.10126	SLV fondazioni 11	-0.43105	-1.29316
1165	SLV 4	-0.70064	-2.10192	SLV fondazioni 7	-0.43102	-1.29307
1166	SLV 4	-0.62708	-1.88123	SLV fondazioni 15	-0.38846	-1.16539
1167	SLV 4	-0.62948	-1.88843	SLV fondazioni 3	-0.38849	-1.16547
1168	SLV 4	-0.34902	-1.04706	SLV fondazioni 15	-0.19692	-0.59077
1169	SLV 4	-0.35464	-1.06393	SLV fondazioni 3	-0.19702	-0.59107
1170	SLV 4	-0.53169	-1.59508	SLV fondazioni 15	-0.32544	-0.97633
1171	SLV 4	-0.48556	-1.45667	SLV fondazioni 15	-0.29386	-0.88158
1172	SLV 4	-0.56969	-1.70907	SLV fondazioni 11	-0.3415	-1.02449
1173	SLV 4	-0.5695	-1.70849	SLV fondazioni 7	-0.34147	-1.02441
1174	SLV 4	-0.53565	-1.60694	SLV fondazioni 3	-0.32551	-0.97653
1175	SLV 4	-0.59385	-1.78156	SLV fondazioni 11	-0.35815	-1.07444
1176	SLV 4	-0.59372	-1.78116	SLV fondazioni 7	-0.35811	-1.07434
1177	SLV 4	-0.49018	-1.47055	SLV fondazioni 3	-0.29404	-0.88212
1178	SLV 4	-0.57619	-1.72858	SLV fondazioni 15	-0.35611	-1.06834
1179	SLV 4	-0.57946	-1.73838	SLV fondazioni 3	-0.35615	-1.06846
1180	SLV 4	-0.69754	-2.09262	SLV fondazioni 11	-0.43514	-1.30543
1181	SLV 4	-0.6988	-2.09641	SLV fondazioni 7	-0.43294	-1.29881
1182	SLV 4	-0.66065	-1.98196	SLV fondazioni 15	-0.41219	-1.23658
1183	SLV 4	-0.6984	-2.09519	SLV fondazioni 11	-0.43293	-1.29878
1184	SLV 4	-0.69838	-2.09513	SLV fondazioni 7	-0.43513	-1.3054
1185	SLV 4	-0.66235	-1.98706	SLV fondazioni 3	-0.41222	-1.23665
1186	SLV 4	-0.43855	-1.31566	SLV fondazioni 15	-0.26163	-0.7849
1187	SLV 4	-0.65977	-1.97931	SLV fondazioni 11	-0.40543	-1.2163
1188	SLV 4	-0.65964	-1.97893	SLV fondazioni 7	-0.40532	-1.21597
1189	SLV 4	-0.44354	-1.33061	SLV fondazioni 3	-0.26178	-0.78535
1190	SLV 4	-0.28544	-0.85633	SLV fondazioni 15	-0.15077	-0.45232
1191	SLV 4	-0.29159	-0.87478	SLV fondazioni 3	-0.1509	-0.45269
1192	SLV 4	-0.69676	-2.09027	SLV fondazioni 7	-0.43452	-1.30355



Progetto	Titolo	Rev.	Pag.
Orione	Orione_A24a.pdf "TABULATI DI CALCOLO PLINTO DI FONDAZIONE PER AEROGENERATORE TIPO"	0	150

Tabulati di Calcolo Plinto di Fondazione per Aerogeneratore Tipo - Progetto Impianto Eolico - "Orione"

Nodo	Contesto	uz min	Minima	Contesto	uz max	Massima
1193	SLU 4	-0.62087	-1.86262	SLV fondazioni 15	-0.38787	-1.16361
1194	SLU 4	-0.69632	-2.08896	SLV fondazioni 11	-0.43453	-1.30366
1195	SLU 4	-0.62337	-1.87011	SLV fondazioni 3	-0.38791	-1.16372
1196	SLU 4	-0.39069	-1.17206	SLV fondazioni 15	-0.22859	-0.68577
1197	SLU 4	-0.39604	-1.18811	SLV fondazioni 3	-0.22869	-0.68608
1198	SLU 4	-0.6912	-2.07361	SLV fondazioni 15	-0.43469	-1.30408
1199	SLU 4	-0.69211	-2.07633	SLV fondazioni 3	-0.43472	-1.30416
1200	SLU 4	-0.31601	-0.94802	SLV fondazioni 15	-0.17444	-0.52331
1201	SLU 4	-0.47657	-1.42971	SLV fondazioni 1	-0.28357	-0.85072
1202	SLU 4	-0.47652	-1.42957	SLV fondazioni 13	-0.28357	-0.85072
1203	SLU 4	-0.32194	-0.96583	SLV fondazioni 3	-0.17456	-0.52367
1204	SLU 4	-0.47096	-1.41288	SLV fondazioni 5	-0.28011	-0.84032
1205	SLU 4	-0.65496	-1.96488	SLV fondazioni 15	-0.41214	-1.23642
1206	SLU 4	-0.65672	-1.97017	SLV fondazioni 3	-0.41217	-1.23652
1207	SLU 4	-0.56005	-1.68015	SLV fondazioni 11	-0.34157	-1.02471
1208	SLU 4	-0.55978	-1.67934	SLV fondazioni 7	-0.34154	-1.02463
1209	SLU 4	-0.2231	-0.66931	SLV fondazioni 15	-0.10432	-0.31296
1210	SLU 4	-0.4694	-1.40821	SLV fondazioni 1	-0.27972	-0.83917
1211	SLU 4	-0.63727	-1.9118	SLV fondazioni 7	-0.39575	-1.18725
1212	SLU 4	-0.22981	-0.68944	SLV fondazioni 3	-0.10447	-0.31341
1213	SLU 4	-0.52653	-1.57958	SLV fondazioni 15	-0.32547	-0.97641
1214	SLU 4	-0.63739	-1.91216	SLV fondazioni 11	-0.39577	-1.18732
1215	SLU 4	-0.46928	-1.40784	SLV fondazioni 13	-0.27972	-0.83916
1216	SLU 4	-0.53062	-1.59185	SLV fondazioni 3	-0.32557	-0.9767
1217	SLU 4	-0.57148	-1.71444	SLV fondazioni 15	-0.35669	-1.07006
1218	SLU 4	-0.68857	-2.06572	SLV fondazioni 11	-0.43337	-1.30011
1219	SLU 4	-0.68889	-2.06668	SLV fondazioni 7	-0.43332	-1.29997
1220	SLU 4	-0.57485	-1.72455	SLV fondazioni 3	-0.35675	-1.07024
1221	SLU 4	-0.47988	-1.43963	SLV fondazioni 15	-0.29326	-0.87978
1222	SLU 4	-0.47335	-1.42005	SLV fondazioni 1	-0.28305	-0.84914
1223	SLU 4	-0.47321	-1.41962	SLV fondazioni 13	-0.28305	-0.84916
1224	SLU 4	-0.48455	-1.45366	SLV fondazioni 3	-0.29343	-0.88029
1225	SLU 4	-0.58182	-1.74546	SLV fondazioni 11	-0.35834	-1.07501
1226	SLU 4	-0.58165	-1.74496	SLV fondazioni 7	-0.35831	-1.07493
1227	SLU 4	-0.66576	-1.99728	SLV fondazioni 11	-0.41784	-1.25353
1228	SLU 4	-0.66591	-1.99774	SLV fondazioni 7	-0.41783	-1.25348
1229	SLU 4	-0.64845	-1.94536	SLV fondazioni 11	-0.40568	-1.21704
1230	SLU 4	-0.64862	-1.94586	SLV fondazioni 7	-0.40574	-1.21722
1231	SLU 4	-0.34679	-1.04036	SLV fondazioni 15	-0.19814	-0.59442
1232	SLU 4	-0.61392	-1.84176	SLV fondazioni 15	-0.3868	-1.16041
1233	SLU 4	-0.68589	-2.05766	SLV fondazioni 15	-0.43511	-1.30533
1234	SLU 4	-0.68682	-2.06045	SLV fondazioni 3	-0.43514	-1.30543
1235	SLU 4	-0.61653	-1.84958	SLV fondazioni 3	-0.38685	-1.16056
1236	SLU 4	-0.35251	-1.05754	SLV fondazioni 3	-0.19826	-0.59477
1237	SLU 4	-0.2528	-0.75839	SLV fondazioni 15	-0.12771	-0.38312
1238	SLU 4	-0.43219	-1.29656	SLV fondazioni 15	-0.26029	-0.78086
1239	SLU 4	-0.43722	-1.31167	SLV fondazioni 3	-0.2604	-0.78119
1240	SLU 4	-0.25928	-0.77785	SLV fondazioni 3	-0.12786	-0.38358
1241	SLU 4	-0.46465	-1.39396	SLV fondazioni 1	-0.27919	-0.83758
1242	SLU 4	-0.46441	-1.39323	SLV fondazioni 13	-0.2792	-0.8376
1243	SLU 4	-0.64858	-1.94574	SLV fondazioni 15	-0.41166	-1.23499
1244	SLU 4	-0.65042	-1.95126	SLV fondazioni 3	-0.41171	-1.23513
1245	SLU 4	-0.6794	-2.03819	SLV fondazioni 11	-0.4319	-1.29569
1246	SLU 4	-0.6797	-2.03909	SLV fondazioni 7	-0.4319	-1.29569
1247	SLU 4	-0.46695	-1.40086	SLV fondazioni 1	-0.28254	-0.84763
1248	SLU 4	-0.46672	-1.40017	SLV fondazioni 13	-0.28256	-0.84767
1249	SLU 4	-0.28272	-0.84815	SLV fondazioni 15	-0.15123	-0.45368
1250	SLU 4	-0.28898	-0.86695	SLV fondazioni 3	-0.15138	-0.45413
1251	SLU 4	-0.64133	-1.924	SLV fondazioni 11	-0.40598	-1.21793
1252	SLU 4	-0.64124	-1.92372	SLV fondazioni 7	-0.40589	-1.21766
1253	SLU 4	-0.67994	-2.03982	SLV fondazioni 15	-0.43516	-1.30547
1254	SLU 4	-0.6809	-2.0427	SLV fondazioni 3	-0.4352	-1.3056
1255	SLU 4	-0.56587	-1.69761	SLV fondazioni 15	-0.35673	-1.07018
1256	SLU 4	-0.56934	-1.70801	SLV fondazioni 3	-0.35681	-1.07042
1257	SLU 4	-0.38788	-1.16364	SLV fondazioni 15	-0.22974	-0.68921
1258	SLU 4	-0.52043	-1.5613	SLV fondazioni 15	-0.32491	-0.97473
1259	SLU 4	-0.52461	-1.57382	SLV fondazioni 3	-0.32502	-0.97506
1260	SLU 4	-0.3933	-1.17991	SLV fondazioni 3	-0.22984	-0.68952
1261	SLU 4	-0.60867	-1.82601	SLV fondazioni 15	-0.38734	-1.16202
1262	SLU 4	-0.61134	-1.83402	SLV fondazioni 3	-0.3874	-1.16221
1263	SLU 4	-0.54695	-1.64084	SLV fondazioni 11	-0.34169	-1.02507
1264	SLU 4	-0.54661	-1.63984	SLV fondazioni 7	-0.34167	-1.02502
1265	SLU 4	-0.67681	-2.03042	SLV fondazioni 7	-0.4339	-1.30169
1266	SLU 4	-0.47323	-1.4197	SLV fondazioni 15	-0.29204	-0.87611
1267	SLU 4	-0.6763	-2.0289	SLV fondazioni 11	-0.43386	-1.30158
1268	SLU 4	-0.64154	-1.92463	SLV fondazioni 15	-0.41076	-1.23229
1269	SLU 4	-0.64347	-1.93042	SLV fondazioni 3	-0.41082	-1.23246
1270	SLU 4	-0.4779	-1.43371	SLV fondazioni 3	-0.29215	-0.87644
1271	SLU 4	-0.45685	-1.37056	SLV fondazioni 1	-0.2787	-0.83609
1272	SLU 4	-0.4565	-1.36951	SLV fondazioni 13	-0.27871	-0.83614
1273	SLU 4	-0.3129	-0.9387	SLV fondazioni 15	-0.17486	-0.52457
1274	SLU 4	-0.31895	-0.95684	SLV fondazioni 3	-0.175	-0.52501
1275	SLU 4	-0.36643	-1.09928	SLV fondazioni 5	-0.21686	-0.65058
1276	SLU 4	-0.36569	-1.09706	SLV fondazioni 5	-0.21649	-0.64947
1277	SLU 4	-0.36563	-1.09689	SLV fondazioni 9	-0.21649	-0.64948
1278	SLU 4	-0.36523	-1.0957	SLV fondazioni 5	-0.21667	-0.65002
1279	SLU 4	-0.3651	-1.09531	SLV fondazioni 9	-0.21668	-0.65005
1280	SLU 4	-0.67341	-2.02023	SLV fondazioni 15	-0.43481	-1.30444
1281	SLU 4	-0.67442	-2.02326	SLV fondazioni 3	-0.43486	-1.30459
1282	SLU 4	-0.56634	-1.69901	SLV fondazioni 11	-0.35859	-1.07577
1283	SLU 4	-0.56615	-1.69846	SLV fondazioni 7	-0.35858	-1.07573
1284	SLU 4	-0.67332	-2.01996	SLV fondazioni 15	-0.43541	-1.30623
1285	SLU 4	-0.67387	-2.0216	SLV fondazioni 3	-0.43545	-1.30636
1286	SLU 4	-0.42881	-1.28642	SLV fondazioni 15	-0.26137	-0.78412
1287	SLU 4	-0.43387	-1.3016	SLV fondazioni 3	-0.26144	-0.78432
1288	SLU 4	-0.21968	-0.65903	SLV fondazioni 15	-0.10381	-0.31143
1289	SLU 4	-0.6184	-1.85519	SLV fondazioni 11	-0.39629	-1.18887



Progetto	Titolo	Rev.	Pag.
Orione	Orione_A24a.pdf "TABULATI DI CALCOLO PLINTO DI FONDAZIONE PER AEROGENERATORE TIPO"	0	151



Tabulati di Calcolo Plinto di Fondazione per Aerogeneratore Tipo - Progetto Impianto Eolico - "Orione"

Nodo	Contesto	uz min	Minima	Contesto	uz max	Massima
1290	SLV 4	-0.45758	-1.37273	SLV fondazioni 1	-0.28207	-0.84622
1291	SLV 4	-0.36324	-1.08973	SLV fondazioni 5	-0.21632	-0.64896
1292	SLV 4	-0.36307	-1.08922	SLV fondazioni 9	-0.21634	-0.64901
1293	SLV 4	-0.45728	-1.37183	SLV fondazioni 13	-0.2821	-0.8463
1294	SLV 4	-0.61828	-1.85484	SLV fondazioni 7	-0.39629	-1.18887
1295	SLV 4	-0.22651	-0.67954	SLV fondazioni 3	-0.104	-0.31199
1296	SLV 4	-0.34329	-1.02987	SLV fondazioni 15	-0.19854	-0.59563
1297	SLV 4	-0.34912	-1.04736	SLV fondazioni 3	-0.19868	-0.59605
1298	SLV 4	-0.55942	-1.67825	SLV fondazioni 15	-0.35624	-1.06871
1299	SLV 4	-0.56297	-1.68892	SLV fondazioni 3	-0.35633	-1.069
1300	SLV 4	-0.60263	-1.8079	SLV fondazioni 15	-0.3874	-1.16221
1301	SLV 4	-0.36156	-1.08469	SLV fondazioni 5	-0.21653	-0.64958
1302	SLV 4	-0.36131	-1.08393	SLV fondazioni 13	-0.21654	-0.64962
1303	SLV 4	-0.60538	-1.81613	SLV fondazioni 3	-0.38748	-1.16245
1304	SLV 4	-0.63588	-1.90763	SLV fondazioni 15	-0.41128	-1.23384
1305	SLV 4	-0.63784	-1.91353	SLV fondazioni 3	-0.41135	-1.23404
1306	SLV 4	-0.51347	-1.5404	SLV fondazioni 15	-0.32376	-0.97129
1307	SLV 4	-0.51768	-1.55305	SLV fondazioni 3	-0.32388	-0.97163
1308	SLV 4	-0.24905	-0.74715	SLV fondazioni 15	-0.12722	-0.38165
1309	SLV 4	-0.62788	-1.88363	SLV fondazioni 11	-0.4063	-1.2189
1310	SLV 4	-0.62808	-1.88424	SLV fondazioni 7	-0.40638	-1.21915
1311	SLV 4	-0.25566	-0.76697	SLV fondazioni 3	-0.1274	-0.3822
1312	SLV 4	-0.66632	-1.99895	SLV fondazioni 15	-0.43409	-1.30227
1313	SLV 4	-0.6674	-2.00219	SLV fondazioni 3	-0.43415	-1.30245
1314	SLV 4	-0.64386	-1.93158	SLV fondazioni 11	-0.4186	-1.25581
1315	SLV 4	-0.64408	-1.93223	SLV fondazioni 7	-0.41861	-1.25583
1316	SLV 4	-0.66492	-1.99475	SLV fondazioni 15	-0.43404	-1.30211
1317	SLV 4	-0.35837	-1.07511	SLV fondazioni 1	-0.21596	-0.64787
1318	SLV 4	-0.35809	-1.07428	SLV fondazioni 13	-0.21597	-0.64792
1319	SLV 4	-0.66534	-1.99602	SLV fondazioni 3	-0.43406	-1.30217
1320	SLV 4	-0.38387	-1.15162	SLV fondazioni 15	-0.23012	-0.69036
1321	SLV 4	-0.38939	-1.16816	SLV fondazioni 3	-0.23024	-0.69071
1322	SLV 4	-0.46928	-1.40784	SLV fondazioni 15	-0.29305	-0.87914
1323	SLV 4	-0.44624	-1.33871	SLV fondazioni 1	-0.27824	-0.83473
1324	SLV 4	-0.4458	-1.33741	SLV fondazioni 13	-0.27827	-0.83482
1325	SLV 4	-0.4739	-1.42171	SLV fondazioni 3	-0.2931	-0.87931
1326	SLV 4	-0.27864	-0.83591	SLV fondazioni 15	-0.15076	-0.45229
1327	SLV 4	-0.28502	-0.85505	SLV fondazioni 3	-0.15095	-0.45284
1328	SLV 4	-0.35553	-1.06658	SLV fondazioni 1	-0.21594	-0.64783
1329	SLV 4	-0.35516	-1.06547	SLV fondazioni 13	-0.21596	-0.64787
1330	SLV 4	-0.62952	-1.88855	SLV fondazioni 15	-0.41137	-1.23411
1331	SLV 4	-0.53078	-1.59233	SLV fondazioni 15	-0.3418	-1.02541
1332	SLV 4	-0.5304	-1.59121	SLV fondazioni 3	-0.34184	-1.02551
1333	SLV 4	-0.63154	-1.89461	SLV fondazioni 3	-0.41145	-1.23435
1334	SLV 4	-0.59586	-1.78759	SLV fondazioni 15	-0.38699	-1.16098
1335	SLV 4	-0.59869	-1.79606	SLV fondazioni 3	-0.38709	-1.16126
1336	SLV 4	-0.55218	-1.65653	SLV fondazioni 15	-0.35522	-1.06565
1337	SLV 4	-0.55582	-1.66747	SLV fondazioni 3	-0.35532	-1.06597
1338	SLV 4	-0.3085	-0.92551	SLV fondazioni 15	-0.17443	-0.52328
1339	SLV 4	-0.66025	-1.98075	SLV fondazioni 15	-0.43461	-1.30382
1340	SLV 4	-0.66135	-1.98404	SLV fondazioni 3	-0.43468	-1.30403
1341	SLV 4	-0.6196	-1.85881	SLV fondazioni 11	-0.40664	-1.21992
1342	SLV 4	-0.61956	-1.85867	SLV fondazioni 7	-0.40657	-1.21972
1343	SLV 4	-0.31466	-0.94399	SLV fondazioni 3	-0.17461	-0.52382
1344	SLV 4	-0.65505	-1.96515	SLV fondazioni 15	-0.43235	-1.29705
1345	SLV 4	-0.27196	-0.81587	SLV fondazioni 5	-0.15997	-0.4799
1346	SLV 4	-0.44515	-1.33545	SLV fondazioni 13	-0.2817	-0.84509
1347	SLV 4	-0.65544	-1.96631	SLV fondazioni 3	-0.43241	-1.29723
1348	SLV 4	-0.42429	-1.27288	SLV fondazioni 15	-0.26174	-0.78521
1349	SLV 4	-0.44551	-1.33652	SLV fondazioni 1	-0.28165	-0.84496
1350	SLV 4	-0.42942	-1.28826	SLV fondazioni 3	-0.2618	-0.7854
1351	SLV 4	-0.2704	-0.81121	SLV fondazioni 5	-0.15906	-0.47717
1352	SLV 4	-0.27034	-0.81102	SLV fondazioni 9	-0.15906	-0.47717
1353	SLV 4	-0.27108	-0.81325	SLV fondazioni 5	-0.15978	-0.47935
1354	SLV 4	-0.27096	-0.81288	SLV fondazioni 9	-0.15979	-0.47937
1355	SLV 4	-0.50889	-1.52668	SLV fondazioni 15	-0.32468	-0.97403
1356	SLV 4	-0.35121	-1.05364	SLV fondazioni 1	-0.2154	-0.64619
1357	SLV 4	-0.35085	-1.05254	SLV fondazioni 13	-0.21542	-0.64626
1358	SLV 4	-0.51311	-1.53934	SLV fondazioni 3	-0.32478	-0.97435
1359	SLV 4	-0.33858	-1.01573	SLV fondazioni 15	-0.19813	-0.5944
1360	SLV 4	-0.26861	-0.80583	SLV fondazioni 5	-0.1589	-0.4767
1361	SLV 4	-0.26843	-0.80529	SLV fondazioni 9	-0.15891	-0.47674
1362	SLV 4	-0.34452	-1.03355	SLV fondazioni 3	-0.19831	-0.59492
1363	SLV 4	-0.54788	-1.64365	SLV fondazioni 11	-0.35889	-1.07668
1364	SLV 4	-0.5477	-1.64309	SLV fondazioni 7	-0.3589	-1.0767
1365	SLV 4	-0.26837	-0.80511	SLV fondazioni 5	-0.15966	-0.47898
1366	SLV 4	-0.26813	-0.80439	SLV fondazioni 9	-0.15968	-0.47903
1367	SLV fondazioni 1	-0.21675	-0.65024	SLV fondazioni 15	-0.10234	-0.30702
1368	SLV 4	-0.62254	-1.86762	SLV fondazioni 15	-0.41104	-1.23311
1369	SLV 4	-0.62462	-1.87387	SLV fondazioni 3	-0.41113	-1.23339
1370	SLV 4	-0.22187	-0.66562	SLV fondazioni 3	-0.10256	-0.30769
1371	SLV 4	-0.65361	-1.96084	SLV fondazioni 15	-0.43475	-1.30425
1372	SLV 4	-0.65106	-1.95317	SLV fondazioni 15	-0.43392	-1.30177
1373	SLV 4	-0.65166	-1.95498	SLV fondazioni 3	-0.43402	-1.30207
1374	SLV 4	-0.65473	-1.9642	SLV fondazioni 3	-0.43483	-1.30449
1375	SLV 4	-0.46426	-1.39278	SLV fondazioni 15	-0.29339	-0.88017
1376	SLV 4	-0.3473	-1.04191	SLV fondazioni 1	-0.21542	-0.64625
1377	SLV 4	-0.34684	-1.04051	SLV fondazioni 13	-0.21544	-0.64633
1378	SLV 4	-0.4689	-1.40671	SLV fondazioni 3	-0.29343	-0.88028
1379	SLV 4	-0.58842	-1.76526	SLV fondazioni 15	-0.38611	-1.15834
1380	SLV 4	-0.59133	-1.77399	SLV fondazioni 3	-0.38622	-1.15866
1381	SLV 4	-0.26502	-0.79506	SLV fondazioni 5	-0.15881	-0.47644
1382	SLV 4	-0.26473	-0.79418	SLV fondazioni 9	-0.15883	-0.4765
1383	SLV 4	-0.37872	-1.13616	SLV fondazioni 15	-0.22973	-0.6892
1384	SLV 4	-0.59639	-1.78918	SLV fondazioni 11	-0.3969	-1.19071
1385	SLV 4	-0.43313	-1.2994	SLV fondazioni 1	-0.27785	-0.83355
1386	SLV 4	-0.43263	-1.29789	SLV fondazioni 13	-0.2779	-0.83369



Progetto	Titolo	Rev.	Pag.
Orione	Orione_A24a.pdf "TABULATI DI CALCOLO PLINTO DI FONDAZIONE PER AEROGENERATORE TIPO"	0	152

Tabulati di Calcolo Plinto di Fondazione per Aerogeneratore Tipo - Progetto Impianto Eolico - "Orione"

Nodo	Contesto	uz min	Minima	Contesto	uz max	Massima
1387	SLV 4	-0.5963	-1.78889	SLV fondazioni 7	-0.39692	-1.19077
1388	SLV 4	-0.38434	-1.15303	SLV fondazioni 3	-0.22989	-0.68967
1389	SLV 4	-0.24404	-0.73211	SLV fondazioni 15	-0.1258	-0.3774
1390	SLV 4	-0.54699	-1.64096	SLV fondazioni 15	-0.35603	-1.0681
1391	SLV 4	-0.55068	-1.65203	SLV fondazioni 3	-0.35615	-1.06846
1392	SLV 4	-0.25076	-0.75229	SLV fondazioni 3	-0.12602	-0.37805
1393	SLV 4	-0.26389	-0.79168	SLV fondazioni 1	-0.15941	-0.47823
1394	SLV 4	-0.26355	-0.79064	SLV fondazioni 13	-0.15942	-0.47827
1395	SLV 4	-0.64733	-1.942	SLV fondazioni 15	-0.43524	-1.30571
1396	SLV 4	-0.64799	-1.94396	SLV fondazioni 3	-0.43531	-1.30594
1397	SLV 4	-0.27332	-0.81996	SLV fondazioni 15	-0.14941	-0.44822
1398	SLV 4	-0.27982	-0.83945	SLV fondazioni 3	-0.14962	-0.44887
1399	SLV 4	-0.34199	-1.02598	SLV fondazioni 1	-0.21491	-0.64474
1400	SLV 4	-0.34155	-1.02465	SLV fondazioni 13	-0.21495	-0.64484
1401	SLV 4	-0.50337	-1.5101	SLV fondazioni 15	-0.32499	-0.97496
1402	SLV 4	-0.50764	-1.52291	SLV fondazioni 3	-0.32511	-0.97533
1403	SLV 4	-0.64646	-1.93937	SLV fondazioni 15	-0.43449	-1.30348
1404	SLV 4	-0.64762	-1.94287	SLV fondazioni 3	-0.43458	-1.30374
1405	SLV 4	-0.4187	-1.2561	SLV fondazioni 15	-0.26138	-0.78413
1406	SLV 4	-0.61498	-1.84493	SLV fondazioni 15	-0.41027	-1.23082
1407	SLV 4	-0.60441	-1.81324	SLV fondazioni 11	-0.40703	-1.2211
1408	SLV 4	-0.60466	-1.81397	SLV fondazioni 7	-0.40714	-1.22143
1409	SLV 4	-0.61714	-1.85142	SLV fondazioni 3	-0.41038	-1.23113
1410	SLV 4	-0.42395	-1.27184	SLV fondazioni 3	-0.26149	-0.78447
1411	SLV 4	-0.25974	-0.77922	SLV fondazioni 1	-0.15833	-0.475
1412	SLV 4	-0.25934	-0.77803	SLV fondazioni 13	-0.15835	-0.47505
1413	SLV 4	-0.30292	-0.90876	SLV fondazioni 15	-0.17315	-0.51946
1414	SLV 4	-0.43071	-1.29214	SLV fondazioni 13	-0.28136	-0.84408
1415	SLV 4	-0.30919	-0.92757	SLV fondazioni 3	-0.17337	-0.5201
1416	SLV 4	-0.43111	-1.29333	SLV fondazioni 1	-0.2813	-0.84389
1417	SLV 4	-0.58265	-1.74796	SLV fondazioni 15	-0.38684	-1.16053
1418	SLV 4	-0.61911	-1.85734	SLV fondazioni 15	-0.41908	-1.25724
1419	SLV 4	-0.61939	-1.85817	SLV fondazioni 3	-0.41915	-1.25745
1420	SLV 4	-0.51203	-1.5361	SLV fondazioni 15	-0.34172	-1.02516
1421	SLV 4	-0.19204	-0.57611	SLV fondazioni 5	-0.11214	-0.33641
1422	SLV 4	-0.51164	-1.53491	SLV fondazioni 3	-0.34178	-1.02533
1423	SLV 4	-0.5856	-1.75681	SLV fondazioni 3	-0.38696	-1.16089
1424	SLV 4	-0.19088	-0.57265	SLV fondazioni 5	-0.11145	-0.33434
1425	SLV 4	-0.19083	-0.57249	SLV fondazioni 9	-0.11145	-0.33434
1426	SLV 4	-0.19143	-0.57428	SLV fondazioni 5	-0.11198	-0.33593
1427	SLV 4	-0.19132	-0.57397	SLV fondazioni 9	-0.11198	-0.33595
1428	SLV 4	-0.33273	-0.99818	SLV fondazioni 15	-0.19691	-0.59073
1429	SLV 4	-0.63846	-1.91538	SLV fondazioni 15	-0.43393	-1.30179
1430	SLV 4	-0.63898	-1.91694	SLV fondazioni 3	-0.43398	-1.30195
1431	SLV 4	-0.33878	-1.01633	SLV fondazioni 3	-0.19712	-0.59136
1432	SLV 4	-0.45824	-1.37471	SLV fondazioni 15	-0.29306	-0.87917
1433	SLV 4	-0.33715	-1.01144	SLV fondazioni 1	-0.21498	-0.64493
1434	SLV 4	-0.18962	-0.56887	SLV fondazioni 5	-0.11132	-0.33395
1435	SLV 4	-0.18947	-0.5684	SLV fondazioni 9	-0.11133	-0.33398
1436	SLV 4	-0.3366	-1.0098	SLV fondazioni 13	-0.21502	-0.64505
1437	SLV 4	-0.46304	-1.38911	SLV fondazioni 3	-0.29316	-0.87948
1438	SLV 4	-0.54097	-1.6229	SLV fondazioni 15	-0.35632	-1.06895
1439	SLV 4	-0.25779	-0.77338	SLV fondazioni 1	-0.15889	-0.47668
1440	SLV 4	-0.25735	-0.77206	SLV fondazioni 13	-0.15891	-0.47674
1441	SLV 4	-0.54471	-1.63414	SLV fondazioni 3	-0.35645	-1.06936
1442	SLV 4	-0.63881	-1.91643	SLV fondazioni 15	-0.43385	-1.30155
1443	SLV 4	-0.18951	-0.56853	SLV fondazioni 5	-0.11188	-0.33564
1444	SLV 4	-0.1893	-0.56791	SLV fondazioni 9	-0.11189	-0.33568
1445	SLV 4	-0.64004	-1.92012	SLV fondazioni 3	-0.43395	-1.30185
1446	SLV 4	-0.60878	-1.82633	SLV fondazioni 15	-0.41094	-1.23283
1447	SLV 4	-0.61096	-1.83289	SLV fondazioni 3	-0.41106	-1.23318
1448	SLV 4	-0.3725	-1.11749	SLV fondazioni 15	-0.22859	-0.68576
1449	SLV 4	-0.59524	-1.78572	SLV fondazioni 15	-0.40731	-1.22193
1450	SLV 4	-0.18708	-0.56125	SLV fondazioni 5	-0.11125	-0.33376
1451	SLV 4	-0.18683	-0.56049	SLV fondazioni 9	-0.11127	-0.33381
1452	SLV 4	-0.59525	-1.78574	SLV fondazioni 3	-0.4073	-1.22191
1453	SLV 4	-0.37824	-1.13473	SLV fondazioni 3	-0.22879	-0.68638
1454	SLV 4	-0.49694	-1.49082	SLV fondazioni 15	-0.32469	-0.97408
1455	SLV 4	-0.25293	-0.75878	SLV fondazioni 1	-0.15786	-0.47358
1456	SLV 4	-0.25244	-0.75733	SLV fondazioni 13	-0.15788	-0.47365
1457	SLV 4	-0.50131	-1.50394	SLV fondazioni 3	-0.32484	-0.97453
1458	SLV 4	-0.52684	-1.58051	SLV fondazioni 7	-0.35927	-1.07781
1459	SLV fondazioni 1	-0.21776	-0.65328	SLV fondazioni 15	-0.10424	-0.31271
1460	SLV 4	-0.52701	-1.58104	SLV fondazioni 11	-0.35924	-1.07772
1461	SLV 4	-0.41794	-1.25382	SLV fondazioni 1	-0.27753	-0.83258
1462	SLV 4	-0.41739	-1.25216	SLV fondazioni 13	-0.2776	-0.83279
1463	SLV 4	-0.22121	-0.66362	SLV fondazioni 3	-0.10449	-0.31348
1464	SLV 4	-0.57618	-1.72853	SLV fondazioni 15	-0.3871	-1.16131
1465	SLV 4	-0.18634	-0.55903	SLV fondazioni 1	-0.11183	-0.3355
1466	SLV 4	-0.18604	-0.55813	SLV fondazioni 13	-0.11184	-0.33553
1467	SLV 4	-0.33099	-0.99298	SLV fondazioni 1	-0.21452	-0.64356
1468	SLV 4	-0.33049	-0.99147	SLV fondazioni 13	-0.21457	-0.6437
1469	SLV 4	-0.57917	-1.73752	SLV fondazioni 3	-0.38724	-1.16171
1470	SLV 4	-0.62813	-1.88438	SLV fondazioni 15	-0.43231	-1.29694
1471	SLV 4	-0.62859	-1.88577	SLV fondazioni 3	-0.4324	-1.29721
1472	SLV 4	-0.4121	-1.23629	SLV fondazioni 15	-0.26029	-0.78088
1473	SLV 4	-0.41751	-1.25252	SLV fondazioni 3	-0.2605	-0.7815
1474	SLV 4	-0.24287	-0.7286	SLV fondazioni 15	-0.12763	-0.38289
1475	SLV 4	-0.24967	-0.74902	SLV fondazioni 3	-0.12788	-0.38364
1476	SLV 4	-0.63219	-1.89658	SLV fondazioni 15	-0.43447	-1.30341
1477	SLV 4	-0.63343	-1.90028	SLV fondazioni 3	-0.43458	-1.30374
1478	SLV 4	-0.18335	-0.55004	SLV fondazioni 1	-0.11099	-0.33298
1479	SLV 4	-0.18301	-0.54902	SLV fondazioni 13	-0.11101	-0.33302
1480	SLV 4	-0.25026	-0.75077	SLV fondazioni 1	-0.15846	-0.47539
1481	SLV 4	-0.24974	-0.74921	SLV fondazioni 13	-0.15849	-0.47548
1482	SLV 4	-0.27176	-0.81527	SLV fondazioni 15	-0.15116	-0.45349
1483	SLV 4	-0.53417	-1.60251	SLV fondazioni 15	-0.35606	-1.06819



Progetto	Titolo	Rev.	Pag.
Orione	Orione_A24a.pdf "TABULATI DI CALCOLO PLINTO DI FONDAZIONE PER AEROGENERATORE TIPO"	0	153

Tabulati di Calcolo Plinto di Fondazione per Aerogeneratore Tipo - Progetto Impianto Eolico - "Orione"

Nodo	Contesto	uz min	Minima	Contesto	uz max	Massima
1484	SLU 4	-0.53799	-1.61397	SLV fondazioni 3	-0.35622	-1.06865
1485	SLU 4	-0.27833	-0.83499	SLV fondazioni 3	-0.15141	-0.45424
1486	SLU 4	-0.60196	-1.80587	SLV fondazioni 15	-0.41119	-1.23356
1487	SLU 4	-0.60418	-1.81253	SLV fondazioni 3	-0.41131	-1.23394
1488	SLU 4	-0.45128	-1.35383	SLV fondazioni 15	-0.29205	-0.87616
1489	SLU 4	-0.45629	-1.36886	SLV fondazioni 3	-0.29226	-0.87677
1490	SLU 4	-0.57205	-1.71614	SLV fondazioni 11	-0.39759	-1.19278
1491	SLU 4	-0.18202	-0.54607	SLV fondazioni 1	-0.11137	-0.33412
1492	SLU 4	-0.18164	-0.54493	SLV fondazioni 13	-0.11139	-0.33417
1493	SLU 4	-0.57198	-1.71594	SLV fondazioni 7	-0.39764	-1.19293
1494	SLU 4	-0.30091	-0.90273	SLV fondazioni 15	-0.17481	-0.52442
1495	SLU 4	-0.30726	-0.92177	SLV fondazioni 3	-0.17505	-0.52516
1496	SLU 4	-0.62344	-1.87032	SLV fondazioni 15	-0.43393	-1.30178
1497	SLU 4	-0.32537	-0.9761	SLV fondazioni 1	-0.21463	-0.6439
1498	SLU 4	-0.12862	-0.38587	SLV fondazioni 9	-0.07472	-0.22417
1499	SLU 4	-0.32476	-0.97428	SLV fondazioni 13	-0.21469	-0.64406
1500	SLU 4	-0.62413	-1.87238	SLV fondazioni 3	-0.43406	-1.30218
1501	SLU 4	-0.41482	-1.24447	SLV fondazioni 1	-0.28102	-0.84306
1502	SLU 4	-0.1281	-0.38431	SLV fondazioni 5	-0.0744	-0.2232
1503	SLU 4	-0.12806	-0.38419	SLV fondazioni 9	-0.0744	-0.22321
1504	SLU 4	-0.4144	-1.24321	SLV fondazioni 13	-0.2811	-0.8433
1505	SLU 4	-0.12822	-0.38467	SLV fondazioni 5	-0.0746	-0.22379
1506	SLU 4	-0.12814	-0.38442	SLV fondazioni 9	-0.0746	-0.2238
1507	SLU 4	-0.33026	-0.99077	SLV fondazioni 15	-0.19849	-0.59547
1508	SLU 4	-0.33639	-1.00916	SLV fondazioni 3	-0.19874	-0.59621
1509	SLU 4	-0.56904	-1.70712	SLV fondazioni 15	-0.38689	-1.16066
1510	SLU 4	-0.12726	-0.38179	SLV fondazioni 5	-0.0743	-0.2229
1511	SLU 4	-0.12714	-0.38143	SLV fondazioni 9	-0.07431	-0.22292
1512	SLU 4	-0.5721	-1.71629	SLV fondazioni 3	-0.38704	-1.16111
1513	SLU 4	-0.24479	-0.73438	SLV fondazioni 1	-0.15748	-0.47244
1514	SLU 4	-0.24424	-0.73272	SLV fondazioni 13	-0.15752	-0.47255
1515	SLU 4	-0.48968	-1.46905	SLV fondazioni 15	-0.3238	-0.9714
1516	SLU 4	-0.62507	-1.87521	SLV fondazioni 15	-0.43471	-1.30412
1517	SLU 4	-0.62632	-1.87896	SLV fondazioni 3	-0.43483	-1.30448
1518	SLU 4	-0.49421	-1.48262	SLV fondazioni 3	-0.32399	-0.97197
1519	SLU 4	-0.17852	-0.53557	SLV fondazioni 1	-0.11057	-0.33172
1520	SLU 4	-0.12695	-0.38084	SLV fondazioni 5	-0.07452	-0.22357
1521	SLU 4	-0.12679	-0.38036	SLV fondazioni 9	-0.07453	-0.2236
1522	SLU 4	-0.17811	-0.53432	SLV fondazioni 13	-0.11059	-0.33178
1523	SLU 4	-0.49129	-1.47387	SLV fondazioni 15	-0.34168	-1.02503
1524	SLU 4	-0.49089	-1.47266	SLV fondazioni 3	-0.34176	-1.02529
1525	SLU 4	-0.36942	-1.10825	SLV fondazioni 15	-0.23006	-0.69017
1526	SLU 4	-0.12557	-0.37671	SLV fondazioni 5	-0.07426	-0.22278
1527	SLU 4	-0.12537	-0.37611	SLV fondazioni 9	-0.07427	-0.22281
1528	SLU 4	-0.37525	-1.12576	SLV fondazioni 3	-0.23032	-0.69095
1529	SLU 4	-0.57878	-1.73634	SLV fondazioni 15	-0.4073	-1.2219
1530	SLU 4	-0.57906	-1.73719	SLV fondazioni 3	-0.40747	-1.22241
1531	SLU 4	-0.59459	-1.78376	SLV fondazioni 15	-0.411	-1.233
1532	SLU 4	-0.61915	-1.85745	SLV fondazioni 15	-0.43528	-1.30584
1533	SLU 4	-0.6199	-1.85969	SLV fondazioni 3	-0.43539	-1.30618
1534	SLU 4	-0.59686	-1.79057	SLV fondazioni 3	-0.41114	-1.23342
1535	SLU 4	-0.12483	-0.3745	SLV fondazioni 5	-0.07451	-0.22354
1536	SLU 4	-0.1246	-0.3738	SLV fondazioni 9	-0.07453	-0.22358
1537	SLU 4	-0.52666	-1.57997	SLV fondazioni 15	-0.35527	-1.06582
1538	SLU 4	-0.17668	-0.53005	SLV fondazioni 1	-0.111	-0.33299
1539	SLU 4	-0.17623	-0.5287	SLV fondazioni 13	-0.11102	-0.33305
1540	SLU 4	-0.53057	-1.59171	SLV fondazioni 3	-0.35545	-1.06635
1541	SLU 4	-0.318	-0.95399	SLV fondazioni 13	-0.21429	-0.64288
1542	SLU 4	-0.40839	-1.22516	SLV fondazioni 15	-0.26164	-0.78493
1543	SLU 4	-0.31854	-0.95563	SLV fondazioni 1	-0.21423	-0.64269
1544	SLU 4	-0.41392	-1.24176	SLV fondazioni 3	-0.26194	-0.78581
1545	SLU 4	-0.24151	-0.72453	SLV fondazioni 1	-0.15814	-0.47442
1546	SLU 4	-0.24093	-0.72278	SLV fondazioni 13	-0.15818	-0.47453
1547	SLU 4	-0.59227	-1.7768	SLV fondazioni 15	-0.41917	-1.25752
1548	SLU 4	-0.5926	-1.77781	SLV fondazioni 3	-0.41927	-1.25782
1549	SLU 4	-0.12307	-0.36921	SLV fondazioni 1	-0.07413	-0.2224
1550	SLU 4	-0.1228	-0.36841	SLV fondazioni 13	-0.07414	-0.22243
1551	SLU 4	-0.40112	-1.20335	SLV fondazioni 1	-0.27729	-0.83187
1552	SLU 4	-0.40054	-1.20161	SLV fondazioni 13	-0.27738	-0.83214
1553	SLU 4	-0.61751	-1.85252	SLV fondazioni 15	-0.43454	-1.30362
1554	SLU 4	-0.61879	-1.85638	SLV fondazioni 3	-0.43467	-1.30401
1555	SLV fondazioni 1	-0.21779	-0.65338	SLV fondazioni 15	-0.10517	-0.31551
1556	SLU 4	-0.44692	-1.34076	SLV fondazioni 15	-0.29329	-0.87987
1557	SLU 4	-0.5613	-1.68391	SLV fondazioni 15	-0.3862	-1.15859
1558	SLU 4	-0.56443	-1.6933	SLV fondazioni 3	-0.38636	-1.15908
1559	SLU 4	-0.4521	-1.3563	SLV fondazioni 3	-0.29359	-0.88077
1560	SLU 4	-0.21919	-0.65756	SLV fondazioni 3	-0.10546	-0.31637
1561	SLU 4	-0.17276	-0.51829	SLV fondazioni 1	-0.11024	-0.33073
1562	SLU 4	-0.12195	-0.36586	SLV fondazioni 1	-0.07421	-0.22262
1563	SLU 4	-0.12165	-0.36496	SLV fondazioni 13	-0.07422	-0.22266
1564	SLU 4	-0.17228	-0.51685	SLV fondazioni 13	-0.11027	-0.33081
1565	SLU 4	-0.24039	-0.72117	SLV fondazioni 15	-0.12852	-0.38557
1566	SLU 4	-0.24726	-0.74179	SLV fondazioni 3	-0.12881	-0.38643
1567	SLU 4	-0.61001	-1.83003	SLV fondazioni 15	-0.43403	-1.30209
1568	SLU 4	-0.61061	-1.83184	SLV fondazioni 3	-0.43412	-1.30235
1569	SLU 4	-0.50421	-1.51263	SLV fondazioni 3	-0.35955	-1.07864
1570	SLU 4	-0.26891	-0.80673	SLV fondazioni 15	-0.15201	-0.45603
1571	SLU 4	-0.48475	-1.45426	SLV fondazioni 15	-0.32497	-0.9749
1572	SLU 4	-0.50437	-1.51311	SLV fondazioni 15	-0.35944	-1.07833
1573	SLU 4	-0.58671	-1.76013	SLV fondazioni 15	-0.41038	-1.23115
1574	SLU 4	-0.11985	-0.35954	SLV fondazioni 1	-0.0738	-0.2214
1575	SLU 4	-0.11952	-0.35855	SLV fondazioni 13	-0.07381	-0.22144
1576	SLU 4	-0.48938	-1.46814	SLV fondazioni 3	-0.32519	-0.97558
1577	SLU 4	-0.27555	-0.82665	SLV fondazioni 3	-0.15229	-0.45687
1578	SLU 4	-0.23498	-0.70495	SLV fondazioni 13	-0.15726	-0.47177
1579	SLU 4	-0.58904	-1.76713	SLV fondazioni 3	-0.41054	-1.23161
1580	SLU 4	-0.56899	-1.70698	SLV fondazioni 15	-0.40743	-1.2223



Progetto	Titolo	Rev.	Pag.
Orione	Orione_A24a.pdf "TABULATI DI CALCOLO PLINTO DI FONDAZIONE PER AEROGENERATORE TIPO"	0	154

Tabulati di Calcolo Plinto di Fondazione per Aerogeneratore Tipo - Progetto Impianto Eolico - "Orione"

Nodo	Contesto	uz min	Minima	Contesto	uz max	Massima
1581	SLV 4	-0.23559	-0.70676	SLV fondazioni 1	-0.15721	-0.47164
1582	SLV 4	-0.56905	-1.70715	SLV fondazioni 3	-0.40746	-1.22238
1583	SLV 4	-0.31232	-0.93696	SLV fondazioni 1	-0.2144	-0.6432
1584	SLV 4	-0.31167	-0.93502	SLV fondazioni 13	-0.21447	-0.6434
1585	SLV 4	-0.29767	-0.893	SLV fondazioni 15	-0.17561	-0.52683
1586	SLV 4	-0.30408	-0.91225	SLV fondazioni 3	-0.17589	-0.52766
1587	SLV 4	-0.17049	-0.51146	SLV fondazioni 1	-0.11072	-0.33215
1588	SLV 4	-0.08219	-0.24657	SLV fondazioni 5	-0.04828	-0.14485
1589	SLV 4	-0.08203	-0.24608	SLV fondazioni 9	-0.04821	-0.14464
1590	SLV 4	-0.08216	-0.24649	SLV fondazioni 9	-0.04828	-0.14485
1591	SLV 4	-0.16998	-0.50993	SLV fondazioni 13	-0.11074	-0.33223
1592	SLV 4	-0.08179	-0.24536	SLV fondazioni 5	-0.04812	-0.14437
1593	SLV 4	-0.08173	-0.24519	SLV fondazioni 9	-0.04813	-0.14438
1594	SLV 4	-0.32661	-0.97984	SLV fondazioni 15	-0.19926	-0.59778
1595	SLV 4	-0.52115	-1.56346	SLV fondazioni 15	-0.35633	-1.06898
1596	SLV 4	-0.11839	-0.35516	SLV fondazioni 1	-0.07391	-0.22173
1597	SLV 4	-0.08168	-0.24504	SLV fondazioni 5	-0.04822	-0.14465
1598	SLV 4	-0.0816	-0.24479	SLV fondazioni 9	-0.04822	-0.14466
1599	SLV 4	-0.11803	-0.35409	SLV fondazioni 13	-0.07392	-0.22177
1600	SLV 4	-0.52511	-1.57532	SLV fondazioni 3	-0.35652	-1.06956
1601	SLV 4	-0.33281	-0.99842	SLV fondazioni 3	-0.19954	-0.59862
1602	SLV 4	-0.60952	-1.82856	SLV fondazioni 15	-0.43399	-1.30197
1603	SLV 4	-0.61086	-1.83259	SLV fondazioni 3	-0.43413	-1.30239
1604	SLV 4	-0.08102	-0.24305	SLV fondazioni 5	-0.04808	-0.14424
1605	SLV 4	-0.08091	-0.24272	SLV fondazioni 9	-0.04808	-0.14425
1606	SLV 4	-0.39672	-1.19015	SLV fondazioni 13	-0.28093	-0.84278
1607	SLV 4	-0.36524	-1.09571	SLV fondazioni 15	-0.23078	-0.69235
1608	SLV 4	-0.39715	-1.19144	SLV fondazioni 1	-0.28082	-0.84247
1609	SLV 4	-0.08065	-0.24195	SLV fondazioni 5	-0.04819	-0.14457
1610	SLV 4	-0.08052	-0.24155	SLV fondazioni 9	-0.0482	-0.14459
1611	SLV 4	-0.37114	-1.11343	SLV fondazioni 3	-0.23108	-0.69323
1612	SLV 4	-0.55522	-1.66566	SLV fondazioni 15	-0.38712	-1.16137
1613	SLV 4	-0.59944	-1.79833	SLV fondazioni 15	-0.43247	-1.2974
1614	SLV 4	-0.07974	-0.23922	SLV fondazioni 5	-0.04808	-0.14423
1615	SLV 4	-0.07958	-0.23874	SLV fondazioni 9	-0.04808	-0.14425
1616	SLV 4	-0.59997	-1.79992	SLV fondazioni 3	-0.43259	-1.29778
1617	SLV 4	-0.55837	-1.6751	SLV fondazioni 3	-0.3873	-1.1619
1618	SLV 4	-0.23182	-0.69546	SLV fondazioni 1	-0.15793	-0.47378
1619	SLV 4	-0.11599	-0.34797	SLV fondazioni 1	-0.07354	-0.22062
1620	SLV 4	-0.11561	-0.34683	SLV fondazioni 13	-0.07356	-0.22067
1621	SLV 4	-0.2312	-0.69359	SLV fondazioni 13	-0.15798	-0.47393
1622	SLV 4	-0.40367	-1.21101	SLV fondazioni 15	-0.26231	-0.78693
1623	SLV 4	-0.16624	-0.49871	SLV fondazioni 1	-0.11002	-0.33005
1624	SLV 4	-0.16571	-0.49713	SLV fondazioni 13	-0.11005	-0.33014
1625	SLV 4	-0.40928	-1.22785	SLV fondazioni 3	-0.26265	-0.78795
1626	SLV 4	-0.07913	-0.23739	SLV fondazioni 1	-0.04814	-0.14441
1627	SLV 4	-0.07895	-0.23684	SLV fondazioni 13	-0.04814	-0.14442
1628	SLV 4	-0.58019	-1.74056	SLV fondazioni 15	-0.4112	-1.23361
1629	SLV 4	-0.58252	-1.74757	SLV fondazioni 3	-0.41136	-1.23409
1630	SLV 4	-0.44164	-1.32493	SLV fondazioni 15	-0.2939	-0.88171
1631	SLV 4	-0.5461	-1.63831	SLV fondazioni 15	-0.39776	-1.19328
1632	SLV 4	-0.30502	-0.91507	SLV fondazioni 1	-0.21405	-0.64216
1633	SLV 4	-0.30445	-0.91336	SLV fondazioni 13	-0.21413	-0.64239
1634	SLV 4	-0.54607	-1.63821	SLV fondazioni 3	-0.39787	-1.19361
1635	SLV 4	-0.44693	-1.3408	SLV fondazioni 3	-0.29425	-0.88276
1636	SLV 4	-0.078	-0.23399	SLV fondazioni 1	-0.0479	-0.14369
1637	SLV 4	-0.07779	-0.23338	SLV fondazioni 13	-0.0479	-0.14371
1638	SLV 4	-0.11424	-0.34273	SLV fondazioni 1	-0.07369	-0.22107
1639	SLV 4	-0.11384	-0.34153	SLV fondazioni 13	-0.07371	-0.22112
1640	SLV 4	-0.47899	-1.43698	SLV fondazioni 15	-0.32555	-0.97664
1641	SLV 4	-0.60257	-1.80771	SLV fondazioni 15	-0.4347	-1.3041
1642	SLV 4	-0.07717	-0.2315	SLV fondazioni 1	-0.0479	-0.14371
1643	SLV 4	-0.07694	-0.23082	SLV fondazioni 13	-0.04791	-0.14373
1644	SLV 4	-0.60391	-1.81172	SLV fondazioni 3	-0.43485	-1.30455
1645	SLV 4	-0.48368	-1.45105	SLV fondazioni 3	-0.3258	-0.97739
1646	SLV 4	-0.46917	-1.40752	SLV fondazioni 15	-0.34168	-1.02505
1647	SLV 4	-0.46878	-1.40634	SLV fondazioni 3	-0.34179	-1.02538
1648	SLV 4	-0.16362	-0.49085	SLV fondazioni 1	-0.11054	-0.33162
1649	SLV 4	-0.16307	-0.48921	SLV fondazioni 13	-0.11057	-0.33172
1650	SLV 4	-0.5149	-1.5447	SLV fondazioni 15	-0.35685	-1.07054
1651	SLV 4	-0.59428	-1.78285	SLV fondazioni 15	-0.43413	-1.3024
1652	SLV 4	-0.22558	-0.67675	SLV fondazioni 1	-0.15706	-0.47119
1653	SLV 4	-0.07584	-0.22752	SLV fondazioni 1	-0.04769	-0.14307
1654	SLV 4	-0.0756	-0.22679	SLV fondazioni 13	-0.0477	-0.14309
1655	SLV 4	-0.22495	-0.67484	SLV fondazioni 13	-0.15711	-0.47134
1656	SLV 4	-0.59504	-1.78511	SLV fondazioni 3	-0.4343	-1.3029
1657	SLV 4	-0.51889	-1.55668	SLV fondazioni 3	-0.35706	-1.07117
1658	SLV 4	-0.11162	-0.33487	SLV fondazioni 1	-0.07336	-0.22009
1659	SLV 4	-0.1112	-0.33361	SLV fondazioni 13	-0.07338	-0.22014
1660	SLV 4	-0.38318	-1.14954	SLV fondazioni 1	-0.27714	-0.83142
1661	SLV 4	-0.38259	-1.14776	SLV fondazioni 13	-0.27725	-0.83175
1662	SLV fondazioni 1	-0.21684	-0.65052	SLV fondazioni 15	-0.1051	-0.31529
1663	SLV 4	-0.5485	-1.64551	SLV fondazioni 15	-0.38758	-1.16273
1664	SLV 4	-0.07482	-0.22446	SLV fondazioni 1	-0.04772	-0.14317
1665	SLV 4	-0.07456	-0.22367	SLV fondazioni 13	-0.04773	-0.1432
1666	SLV 4	-0.55168	-1.65503	SLV fondazioni 3	-0.38776	-1.16329
1667	SLV fondazioni 13	-0.21726	-0.65178	SLV fondazioni 3	-0.10542	-0.31626
1668	SLV 3	-0.23678	-0.71034	SLV fondazioni 15	-0.12845	-0.38536
1669	SLV 4	-0.55208	-1.65624	SLV fondazioni 3	-0.40768	-1.22303
1670	SLV 4	-0.24356	-0.73068	SLV fondazioni 3	-0.12877	-0.3863
1671	SLV 4	-0.55176	-1.65528	SLV fondazioni 15	-0.40748	-1.22243
1672	SLV 4	-0.2648	-0.7944	SLV fondazioni 15	-0.15195	-0.45584
1673	SLV 4	-0.57312	-1.71935	SLV fondazioni 15	-0.41159	-1.23477
1674	SLV 4	-0.57547	-1.72641	SLV fondazioni 3	-0.41177	-1.2353
1675	SLV 4	-0.2715	-0.81451	SLV fondazioni 3	-0.15225	-0.45676
1676	SLV 4	-0.2984	-0.89521	SLV fondazioni 1	-0.21428	-0.64285
1677	SLV 4	-0.15915	-0.47744	SLV fondazioni 1	-0.1099	-0.32969



Tabulati di Calcolo Plinto di Fondazione per Aerogeneratore Tipo - Progetto Impianto Eolico - "Orione"

Nodo	Contesto	uz min	Minima	Contesto	uz max	Massima
1678	SLU 4	-0.05264	-0.15793	SLV fondazioni 5	-0.03311	-0.09932
1679	SLU 4	-0.05263	-0.15788	SLV fondazioni 9	-0.03311	-0.09932
1680	SLU 4	-0.15859	-0.47577	SLV fondazioni 13	-0.10993	-0.32979
1681	SLU 4	-0.29774	-0.89322	SLV fondazioni 13	-0.21436	-0.64309
1682	SLU 4	-0.29323	-0.8797	SLV fondazioni 15	-0.17557	-0.5267
1683	SLU 4	-0.10965	-0.32896	SLV fondazioni 1	-0.07355	-0.22066
1684	SLU 4	-0.10922	-0.32766	SLV fondazioni 13	-0.07357	-0.22072
1685	SLU 4	-0.2997	-0.89911	SLV fondazioni 3	-0.17587	-0.52761
1686	SLU 4	-0.07333	-0.22	SLV fondazioni 1	-0.04754	-0.14262
1687	SLU 4	-0.05239	-0.15718	SLV fondazioni 5	-0.03307	-0.09921
1688	SLU 4	-0.05162	-0.15485	SLV fondazioni 9	-0.03266	-0.09798
1689	SLU 4	-0.05235	-0.15705	SLV fondazioni 9	-0.03307	-0.09922
1690	SLU 4	-0.07306	-0.21918	SLV fondazioni 13	-0.04755	-0.14265
1691	SLU 4	-0.05151	-0.15452	SLV fondazioni 5	-0.03261	-0.09784
1692	SLU 4	-0.05148	-0.15443	SLV fondazioni 9	-0.03262	-0.09785
1693	SLU 4	-0.32185	-0.96554	SLV fondazioni 15	-0.19923	-0.59768
1694	SLU 4	-0.59519	-1.78556	SLV fondazioni 15	-0.43503	-1.30508
1695	SLU 4	-0.59653	-1.78958	SLV fondazioni 3	-0.43519	-1.30556
1696	SLU 4	-0.3281	-0.98429	SLV fondazioni 3	-0.19953	-0.59858
1697	SLU 4	-0.05189	-0.15567	SLV fondazioni 5	-0.03306	-0.09918
1698	SLU 4	-0.05115	-0.15344	SLV fondazioni 5	-0.03259	-0.09777
1699	SLU 4	-0.05109	-0.15327	SLV fondazioni 9	-0.03259	-0.09778
1700	SLU 4	-0.05182	-0.15546	SLV fondazioni 9	-0.03306	-0.09919
1701	SLU 4	-0.36002	-1.08007	SLV fondazioni 15	-0.23076	-0.69228
1702	SLU 4	-0.59045	-1.77134	SLV fondazioni 3	-0.43569	-1.30706
1703	SLU 4	-0.36597	-1.09792	SLV fondazioni 3	-0.23106	-0.69319
1704	SLU 4	-0.58963	-1.7689	SLV fondazioni 15	-0.43554	-1.30662
1705	SLU 4	-0.22148	-0.66444	SLV fondazioni 1	-0.15784	-0.47351
1706	SLU 4	-0.05055	-0.15164	SLV fondazioni 5	-0.03259	-0.09777
1707	SLU 4	-0.05047	-0.1514	SLV fondazioni 9	-0.0326	-0.09779
1708	SLU 4	-0.05105	-0.15315	SLV fondazioni 13	-0.03304	-0.09911
1709	SLU 4	-0.22084	-0.66251	SLV fondazioni 13	-0.15789	-0.47368
1710	SLU 4	-0.39801	-1.19403	SLV fondazioni 15	-0.26231	-0.78694
1711	SLU 4	-0.07216	-0.21647	SLV fondazioni 1	-0.0476	-0.14281
1712	SLU 4	-0.05115	-0.15344	SLV fondazioni 1	-0.03303	-0.0991
1713	SLU 4	-0.07187	-0.21561	SLV fondazioni 13	-0.04761	-0.14284
1714	SLU 4	-0.56414	-1.69242	SLV fondazioni 15	-0.41939	-1.25816
1715	SLU 4	-0.56453	-1.69359	SLV fondazioni 3	-0.41952	-1.25855
1716	SLU 4	-0.40365	-1.21095	SLV fondazioni 3	-0.26264	-0.78791
1717	SLU 4	-0.43558	-1.30673	SLV fondazioni 15	-0.29393	-0.88178
1718	SLU 4	-0.10687	-0.32062	SLV fondazioni 1	-0.07327	-0.21981
1719	SLU 4	-0.04973	-0.14919	SLV fondazioni 1	-0.0325	-0.09751
1720	SLU 4	-0.04963	-0.14888	SLV fondazioni 13	-0.03251	-0.09752
1721	SLU 4	-0.10643	-0.3193	SLV fondazioni 13	-0.07329	-0.21988
1722	SLU 4	-0.44085	-1.32255	SLV fondazioni 3	-0.29424	-0.88272
1723	SLU 4	-0.05018	-0.15055	SLV fondazioni 1	-0.03291	-0.09873
1724	SLU 4	-0.05007	-0.1502	SLV fondazioni 13	-0.03291	-0.09874
1725	SLU 4	-0.4805	-1.4415	SLV fondazioni 3	-0.35966	-1.07898
1726	SLU 4	-0.47247	-1.4174	SLV fondazioni 15	-0.32554	-0.97662
1727	SLU 4	-0.48064	-1.44191	SLV fondazioni 15	-0.35953	-1.07859
1728	SLU 4	-0.47718	-1.43153	SLV fondazioni 3	-0.32579	-0.97738
1729	SLU 4	-0.15628	-0.46885	SLV fondazioni 1	-0.11047	-0.33142
1730	SLU 4	-0.07056	-0.21167	SLV fondazioni 1	-0.04745	-0.14234
1731	SLU 4	-0.07026	-0.21078	SLV fondazioni 13	-0.04746	-0.14238
1732	SLU 4	-0.15572	-0.46715	SLV fondazioni 13	-0.11051	-0.33154
1733	SLU 4	-0.50797	-1.5239	SLV fondazioni 15	-0.35683	-1.0705
1734	SLU 4	-0.04872	-0.14616	SLV fondazioni 1	-0.0324	-0.0972
1735	SLU 4	-0.0486	-0.14579	SLV fondazioni 13	-0.0324	-0.0972
1736	SLU 4	-0.51199	-1.53598	SLV fondazioni 3	-0.35706	-1.07117
1737	SLU 4	-0.37861	-1.13584	SLV fondazioni 1	-0.28072	-0.84216
1738	SLU 4	-0.37819	-1.13457	SLV fondazioni 13	-0.28084	-0.84252
1739	SLU 4	-0.04903	-0.1471	SLV fondazioni 1	-0.03282	-0.09845
1740	SLU 4	-0.0489	-0.14669	SLV fondazioni 13	-0.03282	-0.09846
1741	SLU 4	-0.54121	-1.62362	SLV fondazioni 15	-0.38755	-1.16266
1742	SLU 4	-0.54441	-1.63324	SLV fondazioni 3	-0.38775	-1.16326
1743	SLU 4	-0.56557	-1.69672	SLV fondazioni 15	-0.41155	-1.23466
1744	SLU 4	-0.29085	-0.87254	SLV fondazioni 1	-0.214	-0.64199
1745	SLU 4	-0.10475	-0.31426	SLV fondazioni 1	-0.07351	-0.22053
1746	SLU 4	-0.06926	-0.20779	SLV fondazioni 1	-0.04754	-0.14263
1747	SLU 4	-0.06896	-0.20688	SLV fondazioni 13	-0.04756	-0.14267
1748	SLU 4	-0.1043	-0.3129	SLV fondazioni 13	-0.07353	-0.2206
1749	SLU 4	-0.29027	-0.87082	SLV fondazioni 13	-0.21408	-0.64225
1750	SLU 4	-0.56796	-1.70387	SLV fondazioni 3	-0.41174	-1.23522
1751	SLU 4	-0.54166	-1.62497	SLV fondazioni 15	-0.40764	-1.22292
1752	SLU 4	-0.04754	-0.14263	SLV fondazioni 1	-0.03232	-0.09697
1753	SLU 4	-0.0474	-0.14221	SLV fondazioni 13	-0.03233	-0.09698
1754	SLU 4	-0.54176	-1.62528	SLV fondazioni 3	-0.40769	-1.22308
1755	SLU 4	-0.58744	-1.76231	SLV fondazioni 15	-0.43495	-1.30486
1756	SLU 4	-0.58044	-1.74131	SLV fondazioni 15	-0.43433	-1.30299
1757	SLU 4	-0.5811	-1.74331	SLV fondazioni 3	-0.43445	-1.30335
1758	SLU 4	-0.5888	-1.76641	SLV fondazioni 3	-0.43512	-1.30537
1759	SLU 4	-0.21509	-0.64527	SLV fondazioni 1	-0.15703	-0.4711
1760	SLU 4	-0.04773	-0.14319	SLV fondazioni 1	-0.03275	-0.09826
1761	SLU 4	-0.04758	-0.14274	SLV fondazioni 13	-0.03276	-0.09827
1762	SLU 4	-0.21444	-0.64333	SLV fondazioni 13	-0.15709	-0.47128
1763	SLU 4	-0.15171	-0.45512	SLV fondazioni 1	-0.10989	-0.32966
1764	SLU 4	-0.06759	-0.20277	SLV fondazioni 1	-0.04742	-0.14226
1765	SLU 4	-0.04624	-0.13872	SLV fondazioni 1	-0.03228	-0.09683
1766	SLU 4	-0.04609	-0.13827	SLV fondazioni 13	-0.03228	-0.09684
1767	SLU 4	-0.06728	-0.20184	SLV fondazioni 13	-0.04743	-0.1423
1768	SLU 4	-0.15114	-0.45341	SLV fondazioni 13	-0.10993	-0.32978
1769	SLU 4	-0.10189	-0.30567	SLV fondazioni 1	-0.07327	-0.21982
1770	SLU 4	-0.04631	-0.13894	SLV fondazioni 1	-0.03272	-0.09816
1771	SLU 4	-0.04615	-0.13846	SLV fondazioni 13	-0.03273	-0.09818
1772	SLU 4	-0.10144	-0.30431	SLV fondazioni 13	-0.0733	-0.21989
1773	SLU 4	-0.06623	-0.19868	SLV fondazioni 1	-0.04755	-0.14264
1774	SLU 4	-0.04485	-0.13454	SLV fondazioni 1	-0.03226	-0.09679



Progetto	Titolo	Rev.	Pag.
Orione	Orione_A24a.pdf "TABULATI DI CALCOLO PLINTO DI FONDAZIONE PER AEROGENERATORE TIPO"	0	156

Tabulati di Calcolo Plinto di Fondazione per Aerogeneratore Tipo - Progetto Impianto Eolico - "Orione"

Nodo	Contesto	uz min	Minima	Contesto	uz max	Massima
1775	SLU 4	-0.04469	-0.13407	SLV fondazioni 13	-0.03227	-0.09681
1776	SLU 4	-0.06591	-0.19774	SLV fondazioni 13	-0.04756	-0.14268
1777	SLU 4	-0.04483	-0.13448	SLV fondazioni 1	-0.03272	-0.09817
1778	SLU 4	-0.04466	-0.13398	SLV fondazioni 13	-0.03273	-0.09819
1779	SLV fondazioni 3	-0.21512	-0.64537	SLV fondazioni 13	-0.10385	-0.31155
1780	SLU 3	-0.23493	-0.7048	SLV fondazioni 13	-0.12725	-0.38175
1781	SLU 3	-0.26268	-0.78805	SLV fondazioni 13	-0.1508	-0.45239
1782	SLU 3	-0.29072	-0.87217	SLV fondazioni 13	-0.17449	-0.52346
1783	SLU 3	-0.31895	-0.95685	SLV fondazioni 13	-0.19819	-0.59457
1784	SLU 3	-0.3566	-1.0698	SLV fondazioni 13	-0.2298	-0.68939
1785	SLU 3	-0.39407	-1.1822	SLV fondazioni 13	-0.26143	-0.78429
1786	SLU 3	-0.4311	-1.29331	SLV fondazioni 13	-0.29311	-0.87933
1787	SLU 3	-0.46737	-1.40212	SLV fondazioni 13	-0.32477	-0.9743
1788	SLU 3	-0.50224	-1.50673	SLV fondazioni 13	-0.35613	-1.06838
1789	SLU 3	-0.53483	-1.6045	SLV fondazioni 13	-0.38691	-1.16072
1790	SLU 3	-0.55864	-1.67592	SLV fondazioni 13	-0.41094	-1.23283
1791	SLU 3	-0.57988	-1.73964	SLV fondazioni 13	-0.43436	-1.30308
1792	SLU 3	-0.57001	-1.71003	SLV fondazioni 13	-0.43268	-1.29803
1793	SLU 4	-0.51935	-1.55805	SLV fondazioni 13	-0.39785	-1.19356
1794	SLU 4	-0.44636	-1.33909	SLV fondazioni 13	-0.34165	-1.02494
1795	SLU 4	-0.36467	-1.09401	SLV fondazioni 1	-0.27709	-0.83126
1796	SLU 4	-0.28404	-0.85213	SLV fondazioni 1	-0.21428	-0.64285
1797	SLU 4	-0.21081	-0.63243	SLV fondazioni 1	-0.15787	-0.47361
1798	SLU 4	-0.14872	-0.44615	SLV fondazioni 1	-0.11052	-0.33156
1799	SLU 4	-0.09969	-0.29907	SLV fondazioni 1	-0.07355	-0.22066
1800	SLU 4	-0.06452	-0.19357	SLV fondazioni 3	-0.04745	-0.14236
1801	SLU 4	-0.04341	-0.13023	SLV fondazioni 3	-0.03228	-0.09683
1802	SLU 3	-0.03633	-0.10899	SLV fondazioni 11	-0.02793	-0.08379
1803	SLU 3	-0.04334	-0.13001	SLV fondazioni 15	-0.03228	-0.09683
1804	SLU 3	-0.06438	-0.19313	SLV fondazioni 15	-0.04746	-0.14239
1805	SLU 3	-0.09947	-0.29842	SLV fondazioni 13	-0.07358	-0.22073
1806	SLU 3	-0.14845	-0.44534	SLV fondazioni 13	-0.11056	-0.33169
1807	SLU 3	-0.21051	-0.63153	SLV fondazioni 13	-0.15793	-0.4738
1808	SLU 3	-0.28375	-0.85124	SLV fondazioni 13	-0.21437	-0.64312
1809	SLU 3	-0.36443	-1.09329	SLV fondazioni 13	-0.27721	-0.83163
1810	SLU 3	-0.44624	-1.33872	SLV fondazioni 1	-0.34181	-1.02542
1811	SLU 3	-0.51943	-1.55829	SLV fondazioni 1	-0.39802	-1.19405
1812	SLU 4	-0.57045	-1.71136	SLV fondazioni 1	-0.43287	-1.2986
1813	SLU 4	-0.58075	-1.74226	SLV fondazioni 1	-0.43457	-1.3037
1814	SLU 4	-0.56003	-1.68009	SLV fondazioni 1	-0.41116	-1.23349
1815	SLU 4	-0.53664	-1.60993	SLV fondazioni 1	-0.38714	-1.16142
1816	SLU 4	-0.50447	-1.51341	SLV fondazioni 1	-0.35638	-1.06913
1817	SLU 4	-0.46993	-1.40979	SLV fondazioni 1	-0.32504	-0.97512
1818	SLU 4	-0.43392	-1.30176	SLV fondazioni 1	-0.2934	-0.88021
1819	SLU 4	-0.3971	-1.1913	SLV fondazioni 1	-0.26173	-0.78518
1820	SLU 4	-0.35982	-1.07945	SLV fondazioni 1	-0.23009	-0.69028
1821	SLU 4	-0.32233	-0.96699	SLV fondazioni 1	-0.19849	-0.59547
1822	SLU 4	-0.29422	-0.88266	SLV fondazioni 1	-0.17479	-0.52438
1823	SLU 4	-0.2663	-0.79891	SLV fondazioni 1	-0.15111	-0.45333
1824	SLU 4	-0.23868	-0.71604	SLV fondazioni 1	-0.12757	-0.3827
1825	SLV fondazioni 15	-0.2156	-0.64681	SLV fondazioni 1	-0.10418	-0.31253
1826	SLU 3	-0.04398	-0.13195	SLV fondazioni 3	-0.03272	-0.09815
1827	SLU 3	-0.04399	-0.13197	SLV fondazioni 15	-0.03272	-0.09816
1828	SLU 3	-0.06452	-0.19355	SLV fondazioni 3	-0.04754	-0.14263
1829	SLU 3	-0.04333	-0.12998	SLU 2	-0.03197	-0.09591
1830	SLU 3	-0.04333	-0.13	SLU 2	-0.03181	-0.09544
1831	SLU 3	-0.06453	-0.1936	SLV fondazioni 15	-0.04755	-0.14266
1832	SLU 3	-0.09911	-0.29734	SLV fondazioni 3	-0.07328	-0.21983
1833	SLU 3	-0.04398	-0.13195	SLU 2	-0.03167	-0.09501
1834	SLU 3	-0.04399	-0.13197	SLU 2	-0.03151	-0.09452
1835	SLU 3	-0.09914	-0.29743	SLV fondazioni 15	-0.07329	-0.21988
1836	SLU 3	-0.14761	-0.44284	SLV fondazioni 3	-0.1099	-0.3297
1837	SLU 3	-0.06436	-0.19307	SLU 2	-0.0466	-0.13981
1838	SLU 3	-0.04333	-0.12998	SLU 2	-0.03057	-0.09172
1839	SLU 3	-0.04333	-0.13	SLU 2	-0.03042	-0.09126
1840	SLU 3	-0.06437	-0.19312	SLU 2	-0.04629	-0.13887
1841	SLU 3	-0.14766	-0.44298	SLU 2	-0.1095	-0.32851
1842	SLU 3	-0.20939	-0.62817	SLU 2	-0.15611	-0.46832
1843	SLU 3	-0.04398	-0.13195	SLU 2	-0.03024	-0.09073
1844	SLU 3	-0.04399	-0.13197	SLU 2	-0.03009	-0.09027
1845	SLU 3	-0.20946	-0.62838	SLU 2	-0.15545	-0.46634
1846	SLU 3	-0.58037	-1.74112	SLV fondazioni 13	-0.4348	-1.30441
1847	SLU 3	-0.57263	-1.7179	SLU 2	-0.43233	-1.297
1848	SLU 3	-0.57295	-1.71886	SLU 2	-0.43305	-1.29916
1849	SLU 3	-0.58067	-1.742	SLV fondazioni 1	-0.43502	-1.30505
1850	SLU 3	-0.53282	-1.59847	SLU 2	-0.40121	-1.20363
1851	SLU 3	-0.04333	-0.12998	SLU 2	-0.02926	-0.08777
1852	SLU 3	-0.04333	-0.13	SLU 2	-0.02912	-0.08735
1853	SLU 3	-0.53317	-1.59951	SLU 2	-0.40148	-1.20443
1854	SLU 3	-0.55928	-1.67785	SLV fondazioni 13	-0.4114	-1.23419
1855	SLU 3	-0.28329	-0.84988	SLU 2	-0.21107	-0.6332
1856	SLU 3	-0.09944	-0.29833	SLU 2	-0.07167	-0.21502
1857	SLU 3	-0.06452	-0.19355	SLU 2	-0.0452	-0.13561
1858	SLU 3	-0.06453	-0.1936	SLU 2	-0.0449	-0.13469
1859	SLU 3	-0.09947	-0.29842	SLU 2	-0.07122	-0.21366
1860	SLU 3	-0.2834	-0.85019	SLU 2	-0.21048	-0.63144
1861	SLU 3	-0.55961	-1.67882	SLV fondazioni 1	-0.41162	-1.23487
1862	SLU 3	-0.53562	-1.60687	SLV fondazioni 13	-0.38739	-1.16216
1863	SLU 3	-0.53597	-1.60791	SLV fondazioni 1	-0.38763	-1.16289
1864	SLU 3	-0.04398	-0.13194	SLU 2	-0.02892	-0.08677
1865	SLU 3	-0.04399	-0.13196	SLU 2	-0.02879	-0.08636
1866	SLU 3	-0.3689	-1.1067	SLU 2	-0.27466	-0.82398
1867	SLU 3	-0.36904	-1.10713	SLU 2	-0.27422	-0.82265
1868	SLU 3	-0.5032	-1.50961	SLV fondazioni 13	-0.35666	-1.06999
1869	SLU 3	-0.04333	-0.12998	SLU 2	-0.02807	-0.0842
1870	SLU 3	-0.04333	-0.13	SLU 2	-0.02794	-0.08383
1871	SLU 3	-0.50357	-1.51071	SLV fondazioni 1	-0.35692	-1.07076



Progetto	Titolo	Rev.	Pag.
Orione	Orione_A24a.pdf "TABULATI DI CALCOLO PLINTO DI FONDAZIONE PER AEROGENERATORE TIPO"	0	157

Tabulati di Calcolo Plinto di Fondazione per Aerogeneratore Tipo - Progetto Impianto Eolico - "Orione"

Nodo	Contesto	uz min	Minima	Contesto	uz max	Massima
1872	SLU 3	-0.1484	-0.44519	SLU 2	-0.10689	-0.32068
1873	SLU 3	-0.06436	-0.19307	SLU 2	-0.04362	-0.13087
1874	SLU 3	-0.06437	-0.19312	SLU 2	-0.04333	-0.12998
1875	SLU 3	-0.14844	-0.44533	SLU 2	-0.10632	-0.31896
1876	SLU 3	-0.46851	-1.40553	SLV fondazioni 13	-0.32537	-0.97611
1877	SLU 3	-0.46859	-1.40578	SLU 2	-0.34829	-1.04486
1878	SLU 3	-0.46886	-1.40658	SLV fondazioni 1	-0.32563	-0.9769
1879	SLU 3	-0.4684	-1.4052	SLU 2	-0.34845	-1.04534
1880	SLU 3	-0.04398	-0.13194	SLU 2	-0.02776	-0.08327
1881	SLU 3	-0.04399	-0.13196	SLU 2	-0.02764	-0.08291
1882	SLU 3	-0.4324	-1.29719	SLV fondazioni 13	-0.29379	-0.88138
1883	SLU 3	-0.09911	-0.29734	SLU 2	-0.06896	-0.20687
1884	SLU 3	-0.04333	-0.12998	SLU 2	-0.02704	-0.08111
1885	SLU 3	-0.04333	-0.13	SLU 2	-0.02693	-0.0808
1886	SLU 3	-0.09914	-0.29742	SLU 2	-0.06851	-0.20554
1887	SLU 3	-0.43272	-1.29815	SLV fondazioni 1	-0.29402	-0.88207
1888	SLU 3	-0.39547	-1.1864	SLV fondazioni 13	-0.26217	-0.78651
1889	SLU 3	-0.54991	-1.64973	SLU 2	-0.40869	-1.22606
1890	SLU 3	-0.55016	-1.65048	SLU 2	-0.40905	-1.22716
1891	SLU 3	-0.06452	-0.19355	SLU 2	-0.04229	-0.12688
1892	SLU 3	-0.04399	-0.13196	SLU 2	-0.02667	-0.08002
1893	SLU 3	-0.06453	-0.19359	SLU 2	-0.04201	-0.12602
1894	SLU 3	-0.39586	-1.18759	SLV fondazioni 1	-0.26241	-0.78724
1895	SLU 3	-0.21044	-0.63131	SLU 2	-0.15157	-0.4547
1896	SLU 3	-0.04398	-0.13194	SLU 2	-0.02677	-0.08031
1897	SLU 3	-0.04333	-0.12998	SLU 2	-0.0262	-0.07859
1898	SLU 3	-0.04333	-0.12999	SLU 2	-0.02611	-0.07834
1899	SLU 3	-0.21051	-0.63153	SLU 2	-0.15092	-0.45275
1900	SLU 3	-0.57518	-1.72553	SLU 2	-0.4278	-1.28339
1901	SLU 3	-0.3581	-1.0743	SLV fondazioni 13	-0.23058	-0.69173
1902	SLU 3	-0.5749	-1.7247	SLU 2	-0.42701	-1.28102
1903	SLU 3	-0.35856	-1.07568	SLV fondazioni 1	-0.23087	-0.6926
1904	SLU 3	-0.58052	-1.74157	SLU 2	-0.4309	-1.2927
1905	SLU 3	-0.04398	-0.13195	SLU 2	-0.026	-0.07801
1906	SLU 3	-0.04333	-0.12998	SLU 2	-0.02557	-0.07672
1907	SLU 3	-0.04333	-0.12999	SLU 2	-0.02552	-0.07655
1908	SLU 3	-0.04399	-0.13196	SLU 2	-0.02593	-0.07779
1909	SLU 3	-0.32056	-0.96167	SLV fondazioni 13	-0.19902	-0.59707
1910	SLU 3	-0.58083	-1.74248	SLU 2	-0.43222	-1.29665
1911	SLU 3	-0.32105	-0.96315	SLV fondazioni 1	-0.19933	-0.598
1912	SLU 3	-0.04333	-0.12998	SLU 2	-0.02518	-0.07555
1913	SLU 3	-0.04333	-0.12999	SLU 2	-0.02516	-0.07547
1914	SLU 3	-0.06436	-0.19307	SLU 2	-0.04082	-0.12247
1915	SLU 3	-0.04398	-0.13195	SLU 2	-0.02547	-0.07641
1916	SLU 3	-0.04333	-0.12999	SLU 2	-0.02504	-0.07513
1917	SLU 3	-0.04398	-0.13195	SLU 2	-0.02543	-0.07628
1918	SLU 3	-0.06437	-0.19312	SLU 2	-0.04055	-0.12165
1919	SLU 3	-0.29241	-0.87724	SLV fondazioni 13	-0.17535	-0.52605
1920	SLU 3	-0.09944	-0.29832	SLU 2	-0.06675	-0.20026
1921	SLU 3	-0.29293	-0.87878	SLV fondazioni 1	-0.17567	-0.52702
1922	SLU 3	-0.28364	-0.85092	SLU 2	-0.20422	-0.61265
1923	SLU 3	-0.14761	-0.44283	SLU 2	-0.10263	-0.30788
1924	SLU 3	-0.09947	-0.29841	SLU 2	-0.06632	-0.19897
1925	SLU 3	-0.04398	-0.13195	SLU 2	-0.02519	-0.07558
1926	SLU 3	-0.04398	-0.13195	SLU 2	-0.02518	-0.07554
1927	SLU 3	-0.14766	-0.44297	SLU 2	-0.10207	-0.3062
1928	SLU 3	-0.28374	-0.85123	SLU 2	-0.20355	-0.61065
1929	SLU 3	-0.26446	-0.79337	SLV fondazioni 13	-0.15172	-0.45517
1930	SLU 3	-0.55949	-1.67847	SLV fondazioni 13	-0.41142	-1.23426
1931	SLU 3	-0.55982	-1.67947	SLV fondazioni 1	-0.41166	-1.23497
1932	SLU 3	-0.26499	-0.79496	SLV fondazioni 1	-0.15206	-0.45617
1933	SLU 3	-0.53306	-1.59917	SLU 2	-0.39119	-1.17357
1934	SLU 3	-0.23675	-0.71025	SLV fondazioni 13	-0.12822	-0.38467
1935	SLU 3	-0.53293	-1.59878	SLU 2	-0.39108	-1.17324
1936	SLU 4	-0.23743	-0.71229	SLV fondazioni 1	-0.12856	-0.39569
1937	SLV fondazioni 3	-0.21703	-0.65109	SLV fondazioni 13	-0.10486	-0.31458
1938	SLU 3	-0.53588	-1.60764	SLV fondazioni 13	-0.3874	-1.16219
1939	SLU 3	-0.06451	-0.19354	SLU 2	-0.03961	-0.11882
1940	SLU 3	-0.06453	-0.19359	SLU 2	-0.03935	-0.11804
1941	SLU 3	-0.53624	-1.60872	SLV fondazioni 1	-0.38765	-1.16295
1942	SLV fondazioni 15	-0.21755	-0.65264	SLV fondazioni 1	-0.10521	-0.31563
1943	SLU 3	-0.36428	-1.09285	SLU 2	-0.26209	-0.78627
1944	SLU 3	-0.36443	-1.09328	SLU 2	-0.2615	-0.78449
1945	SLU 3	-0.09911	-0.29733	SLU 2	-0.06418	-0.19255
1946	SLU 3	-0.09914	-0.29742	SLU 2	-0.06377	-0.19131
1947	SLU 3	-0.50352	-1.51055	SLV fondazioni 13	-0.35666	-1.06999
1948	SLU 3	-0.57267	-1.71802	SLU 2	-0.41848	-1.25544
1949	SLU 3	-0.20938	-0.62815	SLU 2	-0.1456	-0.43679
1950	SLU 3	-0.06436	-0.19307	SLU 2	-0.03829	-0.11486
1951	SLU 3	-0.06437	-0.19311	SLU 2	-0.03804	-0.11413
1952	SLU 3	-0.20946	-0.62837	SLU 2	-0.14496	-0.43489
1953	SLU 3	-0.5729	-1.7187	SLU 2	-0.41913	-1.25739
1954	SLU 3	-0.5039	-1.51169	SLV fondazioni 1	-0.35693	-1.07079
1955	SLU 3	-0.14839	-0.44518	SLU 2	-0.09954	-0.29861
1956	SLU 3	-0.14844	-0.44533	SLU 2	-0.09899	-0.29698
1957	SLU 3	-0.44605	-1.33814	SLU 2	-0.32061	-0.96184
1958	SLU 3	-0.44624	-1.33871	SLU 2	-0.32022	-0.96066
1959	SLU 3	-0.46888	-1.40665	SLV fondazioni 13	-0.32538	-0.97613
1960	SLU 3	-0.58036	-1.74107	SLU 2	-0.42323	-1.2697
1961	SLU 3	-0.06451	-0.19354	SLU 2	-0.03722	-0.11167
1962	SLU 3	-0.06453	-0.19358	SLU 2	-0.037	-0.11099
1963	SLU 3	-0.58067	-1.74201	SLU 2	-0.42456	-1.27369
1964	SLU 3	-0.46923	-1.40768	SLV fondazioni 1	-0.32564	-0.97691
1965	SLU 3	-0.09944	-0.29832	SLU 2	-0.06213	-0.18639
1966	SLU 3	-0.09947	-0.29841	SLU 2	-0.06173	-0.1852
1967	SLU 3	-0.06436	-0.19307	SLU 2	-0.03609	-0.10827
1968	SLU 3	-0.06437	-0.1931	SLU 2	-0.03589	-0.10766



Progetto	Titolo	Rev.	Pag.
Orione	Orione_A24a.pdf "TABULATI DI CALCOLO PLINTO DI FONDAZIONE PER AEROGENERATORE TIPO"	0	158

Tabulati di Calcolo Plinto di Fondazione per Aerogeneratore Tipo - Progetto Impianto Eolico - "Orione"

Nodo	Contesto	uz min	Minima	Contesto	uz max	Massima
1969	SLU 3	-0.43282	-1.29846	SLV fondazioni 13	-0.29381	-0.88144
1970	SLU 3	-0.51919	-1.55758	SLU 2	-0.37278	-1.11835
1971	SLU 3	-0.28329	-0.84986	SLU 2	-0.19688	-0.59064
1972	SLU 3	-0.28339	-0.85018	SLU 2	-0.19632	-0.58895
1973	SLU 3	-0.51943	-1.55829	SLU 2	-0.37275	-1.11826
1974	SLU 3	-0.4331	-1.2993	SLV fondazioni 1	-0.294	-0.882
1975	SLU 3	-0.55927	-1.6778	SLU 2	-0.40732	-1.22195
1976	SLU 3	-0.55961	-1.67883	SLU 2	-0.40966	-1.22897
1977	SLU 3	-0.06451	-0.19354	SLU 2	-0.03522	-0.10565
1978	SLU 3	-0.06453	-0.19358	SLU 2	-0.03503	-0.1051
1979	SLU 3	-0.39593	-1.18779	SLV fondazioni 13	-0.26219	-0.78656
1980	SLU 3	-0.14761	-0.44282	SLU 2	-0.0955	-0.28651
1981	SLU 3	-0.14765	-0.44296	SLU 2	-0.09498	-0.28495
1982	SLU 3	-0.39633	-1.18898	SLV fondazioni 1	-0.26241	-0.78724
1983	SLU 3	-0.21043	-0.63129	SLU 2	-0.1412	-0.42361
1984	SLU 3	-0.09911	-0.29733	SLU 2	-0.05978	-0.17933
1985	SLU 3	-0.09914	-0.29741	SLU 2	-0.0594	-0.17821
1986	SLU 3	-0.2105	-0.63151	SLU 2	-0.14059	-0.42176
1987	SLU 3	-0.5356	-1.60681	SLV fondazioni 13	-0.38693	-1.1608
1988	SLU 3	-0.56998	-1.70995	SLU 2	-0.40878	-1.22635
1989	SLU 3	-0.06436	-0.19307	SLU 2	-0.0343	-0.1029
1990	SLU 3	-0.06437	-0.1931	SLU 2	-0.03414	-0.10243
1991	SLU 3	-0.57027	-1.7108	SLU 2	-0.40932	-1.22797
1992	SLU 3	-0.53598	-1.60793	SLV fondazioni 1	-0.38719	-1.16157
1993	SLU 3	-0.3586	-1.07579	SLV fondazioni 13	-0.2306	-0.69179
1994	SLU 3	-0.06452	-0.19355	SLU 2	-0.03365	-0.10094
1995	SLU 3	-0.06452	-0.19357	SLU 2	-0.03351	-0.10054
1996	SLU 3	-0.36904	-1.10711	SLU 2	-0.2557	-0.76711
1997	SLU 3	-0.35907	-1.07721	SLV fondazioni 1	-0.23089	-0.69266
1998	SLU 3	-0.36889	-1.10667	SLU 2	-0.25612	-0.76836
1999	SLU 3	-0.06436	-0.19307	SLU 2	-0.03298	-0.09893
2000	SLU 3	-0.06436	-0.19309	SLU 2	-0.03287	-0.0986
2001	SLU 3	-0.57985	-1.73954	SLU 2	-0.41537	-1.24612
2002	SLU 3	-0.58017	-1.7405	SLU 2	-0.41674	-1.25021
2003	SLU 3	-0.32109	-0.96326	SLV fondazioni 13	-0.19904	-0.59713
2004	SLU 3	-0.50318	-1.50955	SLV fondazioni 13	-0.35613	-1.06839
2005	SLU 3	-0.09944	-0.29832	SLU 2	-0.05794	-0.17383
2006	SLU 3	-0.06452	-0.19355	SLU 2	-0.03257	-0.09777
2007	SLU 3	-0.06452	-0.19357	SLU 2	-0.03248	-0.09745
2008	SLU 3	-0.09947	-0.2984	SLU 2	-0.05759	-0.17278
2009	SLU 3	-0.50358	-1.51075	SLV fondazioni 1	-0.3564	-1.06921
2010	SLU 3	-0.32161	-0.96482	SLV fondazioni 1	-0.19937	-0.59811
2011	SLU 3	-0.06436	-0.19307	SLU 2	-0.03215	-0.09646
2012	SLU 3	-0.06436	-0.19309	SLU 2	-0.0321	-0.09629
2013	SLU 3	-0.14839	-0.44517	SLU 2	-0.09263	-0.27788
2014	SLU 3	-0.06452	-0.19355	SLU 2	-0.032	-0.09601
2015	SLU 3	-0.06436	-0.19308	SLU 2	-0.03186	-0.09557
2016	SLU 3	-0.06452	-0.19356	SLU 2	-0.03198	-0.09593
2017	SLU 3	-0.14844	-0.44531	SLU 2	-0.09213	-0.27639
2018	SLU 3	-0.29298	-0.87894	SLV fondazioni 13	-0.17538	-0.52613
2019	SLU 3	-0.29352	-0.88057	SLV fondazioni 1	-0.17572	-0.52716
2020	SLU 3	-0.28363	-0.85089	SLU 2	-0.19027	-0.57082
2021	SLU 3	-0.28374	-0.85122	SLU 2	-0.18965	-0.56894
2022	SLU 3	-0.5328	-1.5984	SLU 2	-0.37389	-1.12168
2023	SLU 3	-0.09913	-0.2974	SLU 2	-0.05555	-0.16665
2024	SLU 3	-0.20945	-0.62836	SLU 2	-0.13497	-0.4049
2025	SLU 3	-0.53317	-1.5995	SLU 2	-0.37417	-1.12252
2026	SLU 3	-0.5586	-1.67581	SLU 2	-0.39963	-1.19888
2027	SLU 3	-0.20938	-0.62814	SLU 2	-0.13556	-0.40667
2028	SLU 3	-0.26505	-0.79516	SLV fondazioni 13	-0.15177	-0.45531
2029	SLU 3	-0.46849	-1.40547	SLV fondazioni 13	-0.32478	-0.97434
2030	SLU 3	-0.09911	-0.29733	SLU 2	-0.05587	-0.16761
2031	SLU 3	-0.55896	-1.67688	SLU 2	-0.40199	-1.20596
2032	SLU 3	-0.46859	-1.40577	SLU 2	-0.32458	-0.97374
2033	SLU 3	-0.46888	-1.40663	SLV fondazioni 1	-0.32505	-0.97515
2034	SLU 3	-0.26562	-0.79685	SLV fondazioni 1	-0.15212	-0.45637
2035	SLU 3	-0.46838	-1.40514	SLU 2	-0.32472	-0.97415
2036	SLU 3	-0.57295	-1.71886	SLU 2	-0.40352	-1.21056
2037	SLU 3	-0.23736	-0.71208	SLV fondazioni 13	-0.12828	-0.38483
2038	SLU 3	-0.57261	-1.71782	SLU 2	-0.40279	-1.20837
2039	SLU 3	-0.23794	-0.71382	SLV fondazioni 1	-0.12864	-0.38592
2040	SLU 3	-0.1476	-0.44281	SLU 2	-0.08893	-0.26679
2041	SLU 3	-0.09944	-0.29832	SLU 2	-0.05432	-0.16296
2042	SLU 3	-0.09946	-0.29839	SLU 2	-0.05403	-0.16208
2043	SLU 3	-0.14765	-0.44295	SLU 2	-0.08846	-0.26538
2044	SLV fondazioni 3	-0.21796	-0.65387	SLV fondazioni 13	-0.10491	-0.31474
2045	SLU 3	-0.43237	-1.29712	SLV fondazioni 13	-0.29315	-0.87946
2046	SLU 3	-0.5348	-1.60439	SLU 2	-0.38213	-1.14639
2047	SLU 3	-0.53518	-1.60555	SLU 2	-0.3853	-1.15589
2048	SLU 3	-0.43274	-1.29821	SLV fondazioni 1	-0.29338	-0.88015
2049	SLV fondazioni 15	-0.2185	-0.65551	SLV fondazioni 1	-0.10528	-0.31585
2050	SLU 3	-0.58034	-1.74103	SLU 2	-0.40832	-1.22497
2051	SLU 3	-0.58067	-1.74201	SLU 2	-0.40965	-1.22896
2052	SLU 3	-0.36427	-1.09281	SLU 2	-0.24413	-0.7324
2053	SLU 3	-0.36442	-1.09326	SLU 2	-0.24358	-0.73073
2054	SLU 3	-0.09911	-0.29733	SLU 2	-0.05258	-0.15775
2055	SLU 3	-0.09913	-0.29739	SLU 2	-0.05232	-0.15697
2056	SLU 3	-0.54989	-1.64966	SLU 2	-0.38059	-1.14176
2057	SLU 3	-0.55016	-1.65047	SLU 2	-0.38096	-1.14288
2058	SLU 3	-0.21043	-0.63128	SLU 2	-0.13147	-0.3944
2059	SLU 3	-0.2105	-0.6315	SLU 2	-0.1309	-0.39271
2060	SLU 3	-0.39544	-1.18633	SLV fondazioni 13	-0.26148	-0.78444
2061	SLU 3	-0.28339	-0.85016	SLU 2	-0.18281	-0.54842
2062	SLU 3	-0.39589	-1.18766	SLV fondazioni 1	-0.26174	-0.78522
2063	SLU 3	-0.28328	-0.84984	SLU 2	-0.18333	-0.54999
2064	SLU 3	-0.5022	-1.50661	SLV fondazioni 13	-0.35506	-1.06518
2065	SLU 3	-0.14839	-0.44517	SLU 2	-0.08637	-0.25912





Tabulati di Calcolo Plinto di Fondazione per Aerogeneratore Tipo - Progetto Impianto Eolico - "Orione"

Nodo	Contesto	uz min	Minima	Contesto	uz max	Massima
2066	SLU 3	-0.14843	-0.4453	SLU 2	-0.08593	-0.2578
2067	SLU 3	-0.50263	-1.50789	SLV fondazioni 1	-0.35534	-1.06603
2068	SLU 3	-0.09944	-0.29832	SLU 2	-0.05137	-0.15412
2069	SLU 3	-0.09946	-0.29837	SLU 2	-0.05115	-0.15344
2070	SLU 3	-0.55925	-1.67776	SLU 2	-0.39296	-1.17889
2071	SLU 3	-0.57487	-1.72462	SLU 2	-0.39753	-1.19259
2072	SLU 3	-0.57517	-1.72552	SLU 2	-0.39832	-1.19495
2073	SLU 3	-0.55961	-1.67884	SLU 2	-0.39528	-1.18585
2074	SLU 3	-0.53291	-1.59872	SLU 2	-0.36407	-1.09221
2075	SLU 3	-0.53305	-1.59915	SLU 2	-0.3642	-1.09259
2076	SLU 3	-0.35808	-1.07423	SLV fondazioni 13	-0.22984	-0.68953
2077	SLU 3	-0.09911	-0.29733	SLU 2	-0.05002	-0.15005
2078	SLU 3	-0.09913	-0.29738	SLU 2	-0.04983	-0.14948
2079	SLU 3	-0.35859	-1.07576	SLV fondazioni 1	-0.23016	-0.69048
2080	SLU 3	-0.44603	-1.3381	SLU 2	-0.29849	-0.89548
2081	SLU 3	-0.44623	-1.33869	SLU 2	-0.29813	-0.89438
2082	SLU 3	-0.1476	-0.44281	SLU 2	-0.08311	-0.24932
2083	SLU 3	-0.09944	-0.29832	SLU 2	-0.04919	-0.14757
2084	SLU 3	-0.09945	-0.29836	SLU 2	-0.04903	-0.1471
2085	SLU 3	-0.14764	-0.44293	SLU 2	-0.0827	-0.24811
2086	SLU 3	-0.46733	-1.402	SLV fondazioni 13	-0.32358	-0.97074
2087	SLU 3	-0.5805	-1.74149	SLU 2	-0.40107	-1.20321
2088	SLU 3	-0.58083	-1.74248	SLU 2	-0.40238	-1.20713
2089	SLU 3	-0.4678	-1.40339	SLV fondazioni 1	-0.32388	-0.97164
2090	SLU 3	-0.20938	-0.62813	SLU 2	-0.1263	-0.37889
2091	SLU 3	-0.20945	-0.62834	SLU 2	-0.12576	-0.37729
2092	SLU 3	-0.53559	-1.60676	SLU 2	-0.37587	-1.1276
2093	SLU 3	-0.53598	-1.60795	SLU 2	-0.37899	-1.13698
2094	SLU 3	-0.32053	-0.96159	SLV fondazioni 13	-0.19825	-0.59475
2095	SLU 3	-0.09911	-0.29734	SLU 2	-0.04825	-0.14475
2096	SLU 3	-0.09912	-0.29736	SLU 2	-0.04813	-0.14439
2097	SLU 3	-0.32108	-0.96325	SLV fondazioni 1	-0.1986	-0.59579
2098	SLU 3	-0.09944	-0.29833	SLU 2	-0.04784	-0.14351
2099	SLU 3	-0.09945	-0.29835	SLU 2	-0.04776	-0.14327
2100	SLU 3	-0.36888	-1.10664	SLU 2	-0.23842	-0.71527
2101	SLU 3	-0.09911	-0.29734	SLU 2	-0.04733	-0.14199
2102	SLU 3	-0.09912	-0.29735	SLU 2	-0.04729	-0.14187
2103	SLU 3	-0.36903	-1.10709	SLU 2	-0.23804	-0.71412
2104	SLU 3	-0.57265	-1.71795	SLU 2	-0.38936	-1.16809
2105	SLU 3	-0.28363	-0.85088	SLU 2	-0.17718	-0.53155
2106	SLU 3	-0.09945	-0.29834	SLU 2	-0.04735	-0.14206
2107	SLU 3	-0.28373	-0.85119	SLU 2	-0.17661	-0.52983
2108	SLU 3	-0.57289	-1.71868	SLU 2	-0.39001	-1.17003
2109	SLU 3	-0.29239	-0.87717	SLV fondazioni 13	-0.17455	-0.52366
2110	SLU 3	-0.29296	-0.87889	SLV fondazioni 1	-0.17491	-0.52474
2111	SLU 3	-0.51917	-1.55752	SLU 2	-0.34685	-1.04056
2112	SLU 3	-0.14839	-0.44517	SLU 2	-0.08096	-0.24289
2113	SLU 3	-0.14843	-0.44528	SLU 2	-0.08059	-0.24178
2114	SLU 3	-0.51942	-1.55827	SLU 2	-0.34684	-1.04052
2115	SLU 3	-0.43106	-1.29317	SLV fondazioni 13	-0.29182	-0.87547
2116	SLU 3	-0.43156	-1.29467	SLV fondazioni 1	-0.29214	-0.87642
2117	SLU 3	-0.55946	-1.67838	SLU 2	-0.38601	-1.15803
2118	SLU 3	-0.55983	-1.67948	SLU 2	-0.38831	-1.16492
2119	SLU 3	-0.26443	-0.7933	SLV fondazioni 13	-0.1509	-0.45271
2120	SLU 3	-0.50315	-1.50946	SLU 2	-0.3526	-1.05781
2121	SLU 3	-0.5036	-1.51081	SLV fondazioni 1	-0.35612	-1.06837
2122	SLU 3	-0.26503	-0.79508	SLV fondazioni 1	-0.15128	-0.45383
2123	SLU 3	-0.21042	-0.63127	SLU 2	-0.12266	-0.36798
2124	SLU 3	-0.21049	-0.63147	SLU 2	-0.12216	-0.36649
2125	SLU 3	-0.1476	-0.44281	SLU 2	-0.07821	-0.23462
2126	SLU 3	-0.14764	-0.44291	SLU 2	-0.07788	-0.23364
2127	SLU 3	-0.58033	-1.741	SLU 2	-0.39368	-1.18104
2128	SLU 3	-0.58067	-1.742	SLU 2	-0.39498	-1.18495
2129	SLV fondazioni 3	-0.23683	-0.71049	SLV fondazioni 13	-0.12736	-0.38208
2130	SLV fondazioni 15	-0.23739	-0.71217	SLV fondazioni 1	-0.12774	-0.38323
2131	SLU 3	-0.39402	-1.18206	SLV fondazioni 13	-0.26005	-0.78015
2132	SLU 3	-0.39455	-1.18365	SLV fondazioni 1	-0.26039	-0.78116
2133	SLU 3	-0.56996	-1.70988	SLU 2	-0.38014	-1.14042
2134	SLU 3	-0.57026	-1.71078	SLU 2	-0.38068	-1.14203
2135	SLU 3	-0.53585	-1.60754	SLU 2	-0.36925	-1.10775
2136	SLU 3	-0.28327	-0.84982	SLU 2	-0.17084	-0.51251
2137	SLU 3	-0.28338	-0.85013	SLU 2	-0.17037	-0.5111
2138	SLU 3	-0.14839	-0.44517	SLU 2	-0.07656	-0.22969
2139	SLU 3	-0.14842	-0.44526	SLU 2	-0.07628	-0.22883
2140	SLU 3	-0.53625	-1.60875	SLU 2	-0.37234	-1.11703
2141	SLV fondazioni 3	-0.21789	-0.65368	SLV fondazioni 13	-0.10396	-0.31188
2142	SLU 3	-0.46837	-1.4051	SLU 2	-0.30208	-0.90623
2143	SLU 3	-0.36426	-1.09279	SLU 2	-0.22728	-0.68183
2144	SLU 3	-0.36441	-1.09323	SLU 2	-0.22677	-0.6803
2145	SLU 3	-0.46858	-1.40573	SLU 2	-0.30196	-0.90587
2146	SLV fondazioni 15	-0.21847	-0.65541	SLV fondazioni 1	-0.10435	-0.31306
2147	SLU 3	-0.46841	-1.40523	SLV fondazioni 13	-0.32443	-0.9733
2148	SLU 3	-0.20938	-0.62813	SLU 2	-0.11809	-0.35428
2149	SLU 3	-0.20944	-0.62831	SLU 2	-0.11764	-0.35291
2150	SLU 3	-0.46895	-1.40684	SLV fondazioni 1	-0.32477	-0.9743
2151	SLU 3	-0.35655	-1.06966	SLV fondazioni 13	-0.22833	-0.68499
2152	SLU 3	-0.53278	-1.59835	SLU 2	-0.34768	-1.04304
2153	SLU 3	-0.14761	-0.44282	SLU 2	-0.07438	-0.22315
2154	SLU 3	-0.14763	-0.44289	SLU 2	-0.07414	-0.22243
2155	SLU 3	-0.53316	-1.59947	SLU 2	-0.34795	-1.04386
2156	SLU 3	-0.35711	-1.07133	SLV fondazioni 1	-0.22868	-0.68605
2157	SLU 3	-0.55924	-1.67772	SLU 2	-0.37884	-1.13651
2158	SLU 3	-0.55961	-1.67893	SLU 2	-0.38112	-1.14336
2159	SLU 3	-0.57982	-1.73947	SLU 2	-0.38617	-1.1585
2160	SLU 3	-0.14839	-0.44518	SLU 2	-0.0733	-0.21991
2161	SLU 3	-0.14841	-0.44524	SLU 2	-0.07311	-0.21933
2162	SLU 3	-0.58016	-1.74048	SLU 2	-0.38749	-1.16247



Tabulati di Calcolo Plinto di Fondazione per Aerogeneratore Tipo - Progetto Impianto Eolico - "Orione"

Nodo	Contesto	uz min	Minima	Contesto	uz max	Massima
2163	SLU 3	-0.50347	-1.5104	SLU 2	-0.34643	-1.0393
2164	SLU 3	-0.21042	-0.63127	SLU 2	-0.11504	-0.34513
2165	SLU 3	-0.21048	-0.63145	SLU 2	-0.11463	-0.34388
2166	SLU 3	-0.50393	-1.51179	SLU 2	-0.35033	-1.05099
2167	SLU 3	-0.43224	-1.29672	SLV fondazioni 13	-0.29273	-0.8782
2168	SLU 3	-0.28362	-0.85087	SLU 2	-0.16534	-0.49602
2169	SLU 3	-0.14761	-0.44283	SLU 2	-0.07175	-0.21525
2170	SLU 3	-0.14762	-0.44287	SLU 2	-0.0716	-0.21481
2171	SLU 3	-0.28372	-0.85116	SLU 2	-0.16484	-0.49451
2172	SLU 3	-0.43287	-1.2986	SLV fondazioni 1	-0.29314	-0.87941
2173	SLU 3	-0.3189	-0.95671	SLV fondazioni 13	-0.19664	-0.58993
2174	SLU 3	-0.31949	-0.95846	SLV fondazioni 1	-0.19701	-0.59104
2175	SLU 3	-0.57259	-1.71776	SLU 2	-0.3744	-1.1232
2176	SLU 3	-0.57294	-1.71882	SLU 2	-0.37511	-1.12532
2177	SLU 3	-0.1484	-0.44519	SLU 2	-0.07129	-0.21387
2178	SLU 3	-0.14841	-0.44522	SLU 2	-0.07119	-0.21357
2179	SLU 3	-0.14761	-0.44284	SLU 2	-0.07039	-0.21117
2180	SLU 3	-0.14762	-0.44285	SLU 2	-0.07034	-0.21102
2181	SLU 3	-0.53557	-1.60672	SLU 2	-0.36234	-1.08701
2182	SLU 3	-0.44602	-1.33807	SLU 2	-0.27773	-0.8332
2183	SLU 3	-0.1484	-0.44521	SLU 2	-0.07058	-0.21173
2184	SLU 3	-0.44622	-1.33865	SLU 2	-0.2774	-0.83221
2185	SLU 3	-0.55014	-1.65043	SLU 2	-0.35415	-1.06244
2186	SLU 3	-0.53598	-1.60795	SLU 2	-0.36541	-1.09622
2187	SLU 3	-0.54987	-1.64961	SLU 2	-0.35378	-1.06134
2188	SLU 3	-0.29067	-0.87202	SLV fondazioni 13	-0.17288	-0.51863
2189	SLU 3	-0.36887	-1.10662	SLU 2	-0.22211	-0.66633
2190	SLU 3	-0.36902	-1.10705	SLU 2	-0.22177	-0.6653
2191	SLU 3	-0.29128	-0.87383	SLV fondazioni 1	-0.17326	-0.51978
2192	SLU 3	-0.20938	-0.62813	SLU 2	-0.1112	-0.33359
2193	SLU 3	-0.20943	-0.62828	SLU 2	-0.11083	-0.33248
2194	SLU 3	-0.39536	-1.18608	SLV fondazioni 13	-0.26105	-0.78315
2195	SLU 3	-0.55858	-1.67574	SLU 2	-0.37149	-1.11448
2196	SLU 3	-0.53289	-1.59867	SLU 2	-0.33846	-1.01539
2197	SLU 3	-0.53304	-1.59911	SLU 2	-0.33859	-1.01578
2198	SLU 3	-0.55895	-1.67686	SLU 2	-0.37377	-1.12132
2199	SLU 3	-0.39597	-1.18791	SLV fondazioni 1	-0.26146	-0.78438
2200	SLU 3	-0.58032	-1.74097	SLU 2	-0.37947	-1.1384
2201	SLU 3	-0.58066	-1.74198	SLU 2	-0.38074	-1.14223
2202	SLU 3	-0.46876	-1.40629	SLU 2	-0.32212	-0.96637
2203	SLU 3	-0.46933	-1.408	SLV fondazioni 1	-0.32505	-0.97515
2204	SLU 3	-0.28327	-0.84982	SLU 2	-0.15977	-0.47932
2205	SLU 3	-0.28336	-0.85009	SLU 2	-0.15937	-0.47811
2206	SLU 3	-0.26263	-0.7879	SLV fondazioni 13	-0.14912	-0.44737
2207	SLU 3	-0.26326	-0.78977	SLV fondazioni 1	-0.14952	-0.44855
2208	SLU 3	-0.57486	-1.72457	SLU 2	-0.36942	-1.10825
2209	SLU 3	-0.57516	-1.72548	SLU 2	-0.37017	-1.11052
2210	SLU 3	-0.21043	-0.63128	SLU 2	-0.10885	-0.32656
2211	SLU 3	-0.21047	-0.63142	SLU 2	-0.10853	-0.32559
2212	SLV fondazioni 3	-0.23585	-0.70755	SLV fondazioni 13	-0.12551	-0.37652
2213	SLU 3	-0.50314	-1.50942	SLU 2	-0.33989	-1.01967
2214	SLU 3	-0.5036	-1.51081	SLU 2	-0.34375	-1.03125
2215	SLV fondazioni 15	-0.23644	-0.70931	SLV fondazioni 1	-0.12591	-0.37773
2216	SLU 3	-0.35803	-1.0741	SLV fondazioni 13	-0.22943	-0.6883
2217	SLU 3	-0.51916	-1.55749	SLU 2	-0.32252	-0.96757
2218	SLU 3	-0.36426	-1.09278	SLU 2	-0.21203	-0.63609
2219	SLU 3	-0.36439	-1.09318	SLU 2	-0.21158	-0.63475
2220	SLU 3	-0.5194	-1.55821	SLU 2	-0.32252	-0.96756
2221	SLU 3	-0.35863	-1.0759	SLV fondazioni 1	-0.22983	-0.68948
2222	SLU 3	-0.20938	-0.62814	SLU 2	-0.10582	-0.31745
2223	SLU 3	-0.20942	-0.62825	SLU 2	-0.10555	-0.31664
2224	SLU 3	-0.53477	-1.60431	SLU 2	-0.35519	-1.06556
2225	SLU 3	-0.53518	-1.60554	SLU 2	-0.35824	-1.07472
2226	SLU 3	-0.4326	-1.29781	SLV fondazioni 13	-0.29301	-0.87902
2227	SLU 3	-0.28362	-0.85087	SLU 2	-0.15511	-0.46532
2228	SLU 3	-0.28371	-0.85112	SLU 2	-0.15468	-0.46405
2229	SLU 3	-0.43331	-1.29992	SLV fondazioni 1	-0.29346	-0.88038
2230	SLU 3	-0.58048	-1.74143	SLU 2	-0.37263	-1.1179
2231	SLV fondazioni 3	-0.21685	-0.65055	SLV fondazioni 13	-0.10204	-0.30613
2232	SLU 3	-0.57263	-1.7179	SLU 2	-0.36181	-1.08543
2233	SLU 3	-0.57288	-1.71863	SLU 2	-0.36243	-1.08728
2234	SLU 3	-0.58081	-1.74244	SLU 2	-0.37388	-1.12163
2235	SLU 3	-0.55923	-1.67769	SLU 2	-0.36516	-1.09549
2236	SLU 3	-0.5596	-1.67881	SLU 2	-0.36738	-1.10215
2237	SLV fondazioni 15	-0.21746	-0.65237	SLV fondazioni 1	-0.10246	-0.30737
2238	SLU 3	-0.21043	-0.63129	SLU 2	-0.10427	-0.31282
2239	SLU 3	-0.21046	-0.63139	SLU 2	-0.10405	-0.31216
2240	SLU 3	-0.46836	-1.40508	SLU 2	-0.28121	-0.84363
2241	SLU 3	-0.46856	-1.40568	SLU 2	-0.28111	-0.84333
2242	SLU 3	-0.3205	-0.96151	SLV fondazioni 13	-0.19784	-0.59351
2243	SLU 3	-0.20938	-0.62815	SLU 2	-0.10212	-0.30636
2244	SLU 3	-0.20941	-0.62822	SLU 2	-0.10195	-0.30586
2245	SLU 3	-0.32111	-0.96334	SLV fondazioni 1	-0.19823	-0.59469
2246	SLU 3	-0.46839	-1.40518	SLU 2	-0.31599	-0.94798
2247	SLU 3	-0.28327	-0.84982	SLU 2	-0.15048	-0.45144
2248	SLU 3	-0.28335	-0.85005	SLU 2	-0.15016	-0.45047
2249	SLU 3	-0.46895	-1.40685	SLU 2	-0.3205	-0.96149
2250	SLU 3	-0.21044	-0.63131	SLU 2	-0.10145	-0.30434
2251	SLU 3	-0.21045	-0.63136	SLU 2	-0.10133	-0.304
2252	SLU 3	-0.20939	-0.62817	SLU 2	-0.10021	-0.30064
2253	SLU 3	-0.2094	-0.6282	SLU 2	-0.10016	-0.30047
2254	SLU 3	-0.3958	-1.1874	SLV fondazioni 13	-0.26136	-0.78409
2255	SLU 3	-0.39645	-1.18935	SLV fondazioni 1	-0.26181	-0.78544
2256	SLU 3	-0.56995	-1.70984	SLU 2	-0.35328	-1.05984
2257	SLU 3	-0.36887	-1.10661	SLU 2	-0.20767	-0.62302
2258	SLU 3	-0.21044	-0.63133	SLU 2	-0.10046	-0.30137
2259	SLU 3	-0.369	-1.107	SLU 2	-0.20738	-0.62214



Tabulati di Calcolo Plinto di Fondazione per Aerogeneratore Tipo - Progetto Impianto Eolico - "Orione"

Nodo	Contesto	uz min	Minima	Contesto	uz max	Massima
2260	SLU 3	-0.57024	-1.71071	SLU 2	-0.35379	-1.06136
2261	SLU 3	-0.29236	-0.87709	SLV fondazioni 13	-0.17413	-0.52238
2262	SLU 3	-0.53277	-1.59832	SLU 2	-0.32336	-0.97008
2263	SLU 3	-0.53313	-1.5994	SLU 2	-0.32362	-0.97086
2264	SLU 3	-0.58032	-1.74095	SLU 2	-0.36574	-1.09721
2265	SLU 3	-0.58065	-1.74194	SLU 2	-0.36697	-1.1009
2266	SLU 3	-0.29299	-0.87898	SLV fondazioni 1	-0.17453	-0.52358
2267	SLU 3	-0.50217	-1.50652	SLU 2	-0.33304	-0.99911
2268	SLU 3	-0.50263	-1.50789	SLU 2	-0.33686	-1.01058
2269	SLU 3	-0.53556	-1.60669	SLU 2	-0.34924	-1.04771
2270	SLU 3	-0.53597	-1.60792	SLU 2	-0.35222	-1.05667
2271	SLU 3	-0.55944	-1.67832	SLU 2	-0.35862	-1.07586
2272	SLU 3	-0.44602	-1.33806	SLU 2	-0.25896	-0.77689
2273	SLU 3	-0.4462	-1.33859	SLU 2	-0.25868	-0.77603
2274	SLU 3	-0.55981	-1.67944	SLU 2	-0.36079	-1.08238
2275	SLU 3	-0.28363	-0.85088	SLU 2	-0.14679	-0.44037
2276	SLU 3	-0.28369	-0.85108	SLU 2	-0.14646	-0.43939
2277	SLU 3	-0.26441	-0.79323	SLV fondazioni 13	-0.15046	-0.45137
2278	SLU 3	-0.26505	-0.79516	SLV fondazioni 1	-0.15087	-0.4526
2279	SLU 3	-0.43222	-1.29667	SLU 2	-0.29121	-0.87364
2280	SLU 3	-0.35852	-1.07556	SLV fondazioni 13	-0.22979	-0.68937
2281	SLU 3	-0.36426	-1.09278	SLU 2	-0.19866	-0.59658
2282	SLU 3	-0.36437	-1.09312	SLU 2	-0.19849	-0.59546
2283	SLU 3	-0.43287	-1.29861	SLV fondazioni 1	-0.29311	-0.87932
2284	SLU 3	-0.35914	-1.07743	SLV fondazioni 1	-0.2302	-0.69061
2285	SLU 3	-0.57257	-1.71772	SLU 2	-0.34803	-1.04408
2286	SLU 3	-0.28328	-0.84984	SLU 2	-0.14324	-0.42972
2287	SLU 3	-0.28333	-0.85	SLU 2	-0.143	-0.429
2288	SLU 3	-0.57292	-1.71875	SLU 2	-0.34868	-1.04604
2289	SLU 3	-0.54986	-1.64958	SLU 2	-0.32908	-0.98725
2290	SLU 3	-0.55012	-1.65036	SLU 2	-0.32942	-0.98827
2291	SLU 3	-0.57981	-1.73943	SLU 2	-0.35879	-1.07636
2292	SLU 3	-0.58014	-1.74042	SLU 2	-0.36002	-1.08006
2293	SLV fondazioni 3	-0.23725	-0.71175	SLV fondazioni 13	-0.12691	-0.38072
2294	SLU 3	-0.53288	-1.59865	SLU 2	-0.31503	-0.94511
2295	SLU 3	-0.53301	-1.59904	SLU 2	-0.31516	-0.94547
2296	SLV fondazioni 15	-0.23786	-0.71357	SLV fondazioni 1	-0.12732	-0.38197
2297	SLU 3	-0.4673	-1.40191	SLU 2	-0.30949	-0.92846
2298	SLU 3	-0.4678	-1.40341	SLU 2	-0.31391	-0.94174
2299	SLU 3	-0.55922	-1.67767	SLU 2	-0.35193	-1.05579
2300	SLU 3	-0.55959	-1.67878	SLU 2	-0.35407	-1.06221
2301	SLU 3	-0.53583	-1.60748	SLU 2	-0.34301	-1.02904
2302	SLU 3	-0.28363	-0.8509	SLU 2	-0.14065	-0.42194
2303	SLU 3	-0.28368	-0.85103	SLU 2	-0.14042	-0.42127
2304	SLU 3	-0.53624	-1.60871	SLU 2	-0.34594	-1.03782
2305	SLU 3	-0.50314	-1.50942	SLU 2	-0.3276	-0.98279
2306	SLU 3	-0.50358	-1.51075	SLU 2	-0.33133	-0.994
2307	SLU 3	-0.32103	-0.9631	SLV fondazioni 13	-0.19822	-0.59467
2308	SLU 3	-0.32166	-0.96499	SLV fondazioni 1	-0.19863	-0.59589
2309	SLV fondazioni 3	-0.21833	-0.65498	SLV fondazioni 13	-0.10349	-0.31048
2310	SLU 3	-0.28329	-0.84986	SLU 2	-0.13827	-0.4148
2311	SLU 3	-0.28332	-0.84996	SLU 2	-0.13812	-0.41437
2312	SLU 3	-0.36898	-1.10694	SLU 2	-0.19531	-0.58594
2313	SLU 3	-0.39534	-1.18603	SLV fondazioni 13	-0.26101	-0.78303
2314	SLU 3	-0.51916	-1.55747	SLU 2	-0.30053	-0.9016
2315	SLU 3	-0.36887	-1.10662	SLU 2	-0.19555	-0.58665
2316	SLU 3	-0.51938	-1.55814	SLU 2	-0.30054	-0.90161
2317	SLV fondazioni 15	-0.21895	-0.65686	SLV fondazioni 1	-0.10392	-0.31176
2318	SLU 3	-0.39598	-1.18793	SLV fondazioni 1	-0.26144	-0.78432
2319	SLU 3	-0.57485	-1.72454	SLU 2	-0.34352	-1.03056
2320	SLU 3	-0.57513	-1.7254	SLU 2	-0.34422	-1.03265
2321	SLU 3	-0.46836	-1.40507	SLU 2	-0.26275	-0.78825
2322	SLU 3	-0.46854	-1.40561	SLU 2	-0.26267	-0.788
2323	SLU 3	-0.58031	-1.74093	SLU 2	-0.35265	-1.05795
2324	SLU 3	-0.58063	-1.7419	SLU 2	-0.35383	-1.06148
2325	SLU 3	-0.28364	-0.85092	SLU 2	-0.13686	-0.41058
2326	SLU 3	-0.28366	-0.85099	SLU 2	-0.13675	-0.41024
2327	SLU 3	-0.2833	-0.84989	SLU 2	-0.13572	-0.40716
2328	SLU 3	-0.28331	-0.84992	SLU 2	-0.13567	-0.40701
2329	SLU 3	-0.28365	-0.85095	SLU 2	-0.13555	-0.40664
2330	SLU 3	-0.29293	-0.8788	SLV fondazioni 13	-0.17454	-0.52361
2331	SLU 3	-0.29358	-0.88074	SLV fondazioni 1	-0.17495	-0.52484
2332	SLU 3	-0.36426	-1.09279	SLU 2	-0.18816	-0.56449
2333	SLU 3	-0.36435	-1.09306	SLU 2	-0.18788	-0.56363
2334	SLU 3	-0.43103	-1.29308	SLU 2	-0.28509	-0.85528
2335	SLU 3	-0.55856	-1.67569	SLU 2	-0.34514	-1.03541
2336	SLU 3	-0.55893	-1.67679	SLU 2	-0.34725	-1.04176
2337	SLU 3	-0.43157	-1.2947	SLU 2	-0.29	-0.87
2338	SLU 3	-0.57263	-1.71788	SLU 2	-0.33665	-1.00996
2339	SLU 3	-0.57285	-1.71855	SLU 2	-0.33721	-1.01164
2340	SLU 3	-0.44602	-1.33806	SLU 2	-0.24275	-0.72826
2341	SLU 3	-0.44617	-1.33851	SLU 2	-0.24252	-0.72755
2342	SLU 3	-0.53556	-1.60667	SLU 2	-0.33657	-1.00971
2343	SLU 3	-0.53596	-1.60788	SLU 2	-0.33944	-1.01833
2344	SLU 3	-0.35802	-1.07405	SLV fondazioni 13	-0.2294	-0.6882
2345	SLU 3	-0.46844	-1.40533	SLU 2	-0.30459	-0.91376
2346	SLU 3	-0.46888	-1.40665	SLU 2	-0.30889	-0.92666
2347	SLU 3	-0.35864	-1.07592	SLV fondazioni 1	-0.22981	-0.68943
2348	SLU 3	-0.50346	-1.51038	SLU 2	-0.3218	-0.96539
2349	SLU 3	-0.5039	-1.51169	SLU 2	-0.32546	-0.97638
2350	SLU 3	-0.58047	-1.7414	SLU 2	-0.34645	-1.03935
2351	SLU 3	-0.58078	-1.74235	SLU 2	-0.34758	-1.04275
2352	SLU 3	-0.53277	-1.59831	SLU 2	-0.30167	-0.90502
2353	SLU 3	-0.53311	-1.59932	SLU 2	-0.30191	-0.90572
2354	SLU 3	-0.26501	-0.79503	SLV fondazioni 13	-0.1509	-0.45271
2355	SLU 3	-0.26567	-0.79702	SLV fondazioni 1	-0.15132	-0.45397
2356	SLU 3	-0.36888	-1.10664	SLU 2	-0.18611	-0.55833



Progetto	Titolo	Rev.	Pag.
Orione	Orione_A24a.pdf "TABULATI DI CALCOLO PLINTO DI FONDAZIONE PER AEROGENERATORE TIPO"	0	162

Tabulati di Calcolo Plinto di Fondazione per Aerogeneratore Tipo - Progetto Impianto Eolico - "Orione"

Nodo	Contesto	uz min	Minima	Contesto	uz max	Massima
2357	SLU 3	-0.36896	-1.10687	SLU 2	-0.18594	-0.55781
2358	SLU 3	-0.56994	-1.70982	SLU 2	-0.32901	-0.98703
2359	SLU 3	-0.57021	-1.71062	SLU 2	-0.32947	-0.9884
2360	SLU 3	-0.55922	-1.67765	SLU 2	-0.33934	-1.01803
2361	SLU 3	-0.55958	-1.67873	SLU 2	-0.34139	-1.02416
2362	SLU 3	-0.36427	-1.09282	SLU 2	-0.18027	-0.5408
2363	SLU 3	-0.36433	-1.093	SLU 2	-0.18007	-0.54021
2364	SLV fondazioni 3	-0.23772	-0.71317	SLV fondazioni 13	-0.12738	-0.38213
2365	SLU 3	-0.39399	-1.18196	SLV fondazioni 13	-0.25997	-0.77992
2366	SLU 3	-0.39456	-1.18369	SLV fondazioni 1	-0.26034	-0.78102
2367	SLV fondazioni 15	-0.23835	-0.71504	SLV fondazioni 1	-0.12781	-0.38342
2368	SLU 3	-0.32049	-0.96146	SLV fondazioni 13	-0.19781	-0.59342
2369	SLU 3	-0.53475	-1.60426	SLU 2	-0.32996	-0.98989
2370	SLU 3	-0.58031	-1.74092	SLU 2	-0.34025	-1.02076
2371	SLU 3	-0.58062	-1.74185	SLU 2	-0.34136	-1.02409
2372	SLU 3	-0.53516	-1.60547	SLU 2	-0.33279	-0.99838
2373	SLU 3	-0.32113	-0.96338	SLV fondazioni 1	-0.19822	-0.59465
2374	SLU 3	-0.53298	-1.59894	SLU 2	-0.29459	-0.88378
2375	SLU 3	-0.54986	-1.64958	SLU 2	-0.30725	-0.92174
2376	SLU 3	-0.53288	-1.59865	SLU 2	-0.29449	-0.88347
2377	SLU 3	-0.55009	-1.65026	SLU 2	-0.30754	-0.92263
2378	SLU 3	-0.46851	-1.40552	SLU 2	-0.24719	-0.74158
2379	SLU 3	-0.43233	-1.29698	SLU 2	-0.28074	-0.84221
2380	SLU 3	-0.46836	-1.40508	SLU 2	-0.24726	-0.74177
2381	SLU 3	-0.36889	-1.10667	SLU 2	-0.17964	-0.53892
2382	SLU 3	-0.36894	-1.10681	SLU 2	-0.17954	-0.53861
2383	SLU 3	-0.43275	-1.29825	SLU 2	-0.28548	-0.85645
2384	SLU 3	-0.50313	-1.5094	SLU 2	-0.3157	-0.94711
2385	SLU 3	-0.57257	-1.71771	SLU 2	-0.32447	-0.9734
2386	SLU 3	-0.57288	-1.71865	SLU 2	-0.32505	-0.97514
2387	SLU 3	-0.50357	-1.51072	SLU 2	-0.3193	-0.95789
2388	SLU 3	-0.46882	-1.40647	SLU 2	-0.29925	-0.89774
2389	SLU 3	-0.51935	-1.55804	SLU 2	-0.28156	-0.84468
2390	SLU 3	-0.46924	-1.40771	SLU 2	-0.30345	-0.91034
2391	SLV fondazioni 3	-0.21882	-0.65646	SLV fondazioni 13	-0.10398	-0.31194
2392	SLU 3	-0.51916	-1.55747	SLU 2	-0.28155	-0.84466
2393	SLU 3	-0.36428	-1.09285	SLU 2	-0.17541	-0.52623
2394	SLU 3	-0.36432	-1.09295	SLU 2	-0.17531	-0.52593
2395	SLV fondazioni 15	-0.21946	-0.65839	SLV fondazioni 1	-0.10442	-0.31327
2396	SLU 3	-0.44603	-1.33808	SLU 2	-0.2296	-0.68879
2397	SLU 3	-0.44614	-1.33843	SLU 2	-0.22941	-0.68824
2398	SLU 3	-0.55943	-1.67828	SLU 2	-0.33341	-1.00024
2399	SLU 3	-0.55978	-1.67934	SLU 2	-0.33539	-1.00617
2400	SLU 3	-0.3643	-1.09289	SLU 2	-0.17374	-0.52123
2401	SLU 3	-0.29235	-0.87704	SLV fondazioni 13	-0.1741	-0.5223
2402	SLU 3	-0.3689	-1.10671	SLU 2	-0.17634	-0.52902
2403	SLU 3	-0.36892	-1.10676	SLU 2	-0.1763	-0.52891
2404	SLU 3	-0.293	-0.87901	SLV fondazioni 1	-0.17452	-0.52355
2405	SLU 3	-0.5798	-1.73941	SLU 2	-0.33407	-1.0022
2406	SLU 3	-0.5801	-1.74031	SLU 2	-0.33517	-1.0055
2407	SLU 3	-0.35652	-1.06956	SLV fondazioni 13	-0.22826	-0.68479
2408	SLU 3	-0.35713	-1.07138	SLV fondazioni 1	-0.22865	-0.68595
2409	SLU 3	-0.53555	-1.60664	SLU 2	-0.32452	-0.97357
2410	SLU 3	-0.53595	-1.60784	SLU 2	-0.32727	-0.9818
2411	SLU 3	-0.57484	-1.72453	SLU 2	-0.32063	-0.9619
2412	SLU 3	-0.5751	-1.72529	SLU 2	-0.32124	-0.96371
2413	SLU 3	-0.26439	-0.79318	SLV fondazioni 13	-0.15043	-0.4513
2414	SLU 3	-0.26507	-0.7952	SLV fondazioni 1	-0.15086	-0.45258
2415	SLU 3	-0.3954	-1.18619	SLU 2	-0.25642	-0.76925
2416	SLU 3	-0.53277	-1.59832	SLU 2	-0.28328	-0.84983
2417	SLU 3	-0.53307	-1.59921	SLU 2	-0.28348	-0.85044
2418	SLU 3	-0.39591	-1.18772	SLU 2	-0.26159	-0.78477
2419	SLU 3	-0.55921	-1.67764	SLU 2	-0.3274	-0.98221
2420	SLU 3	-0.5803	-1.74091	SLU 2	-0.32869	-0.98607
2421	SLU 3	-0.57281	-1.71844	SLU 2	-0.31514	-0.94541
2422	SLU 3	-0.5806	-1.74179	SLU 2	-0.32973	-0.98918
2423	SLU 3	-0.55956	-1.67867	SLU 2	-0.32933	-0.98799
2424	SLU 3	-0.57262	-1.71787	SLU 2	-0.31466	-0.94397
2425	SLU 3	-0.50216	-1.50647	SLU 2	-0.30936	-0.92809
2426	SLU 3	-0.50261	-1.50782	SLU 2	-0.3129	-0.93871
2427	SLU 3	-0.43276	-1.29828	SLU 2	-0.27587	-0.82761
2428	SLU 3	-0.46837	-1.40511	SLU 2	-0.2352	-0.70561
2429	SLU 3	-0.46848	-1.40543	SLU 2	-0.23516	-0.70547
2430	SLU 3	-0.43312	-1.29936	SLU 2	-0.28049	-0.84146
2431	SLU 3	-0.46844	-1.40531	SLU 2	-0.29352	-0.88057
2432	SLU 3	-0.44604	-1.33811	SLU 2	-0.21989	-0.65968
2433	SLU 3	-0.44612	-1.33835	SLU 2	-0.21977	-0.65931
2434	SLU 3	-0.46887	-1.40661	SLU 2	-0.29766	-0.89298
2435	SLU 3	-0.31887	-0.95661	SLV fondazioni 13	-0.19658	-0.58975
2436	SLU 3	-0.31951	-0.95853	SLV fondazioni 1	-0.19699	-0.59096
2437	SLU 3	-0.53581	-1.60744	SLU 2	-0.31889	-0.95666
2438	SLU 3	-0.5362	-1.60861	SLU 2	-0.32155	-0.96464
2439	SLU 3	-0.56994	-1.70983	SLU 2	-0.30807	-0.92422
2440	SLU 3	-0.57017	-1.71051	SLU 2	-0.30846	-0.92537
2441	SLV fondazioni 3	-0.23725	-0.71175	SLV fondazioni 13	-0.12688	-0.38064
2442	SLV fondazioni 15	-0.23789	-0.71366	SLV fondazioni 1	-0.12732	-0.38195
2443	SLU 3	-0.53289	-1.59866	SLU 2	-0.27746	-0.83238
2444	SLU 3	-0.53295	-1.59884	SLU 2	-0.27754	-0.83261
2445	SLU 3	-0.58046	-1.74139	SLU 2	-0.32331	-0.96994
2446	SLU 3	-0.58074	-1.74223	SLU 2	-0.3243	-0.97289
2447	SLU 3	-0.51916	-1.55749	SLU 2	-0.26616	-0.79847
2448	SLU 3	-0.51931	-1.55794	SLU 2	-0.26616	-0.79849
2449	SLU 3	-0.54986	-1.64959	SLU 2	-0.28893	-0.8668
2450	SLU 3	-0.55005	-1.65015	SLU 2	-0.28918	-0.86753
2451	SLU 3	-0.55856	-1.67567	SLU 2	-0.32136	-0.96407
2452	SLU 3	-0.55889	-1.67668	SLU 2	-0.32324	-0.96971
2453	SLU 3	-0.44605	-1.33815	SLU 2	-0.21394	-0.64182



Progetto	Titolo	Rev.	Pag.
Orione	Orione_A24a.pdf "TABULATI DI CALCOLO PLINTO DI FONDAZIONE PER AEROGENERATORE TIPO"	0	163

Tabulati di Calcolo Plinto di Fondazione per Aerogeneratore Tipo - Progetto Impianto Eolico - "Orione"

Nodo	Contesto	uz min	Minima	Contesto	uz max	Massima
2454	SLU 3	-0.44609	-1.33828	SLU 2	-0.21387	-0.64162
2455	SLU 3	-0.35803	-1.07408	SLV fondazioni 13	-0.22974	-0.68923
2456	SLU 3	-0.35861	-1.07584	SLV fondazioni 1	-0.23011	-0.69032
2457	SLU 3	-0.50311	-1.50934	SLU 2	-0.30439	-0.91317
2458	SLU 3	-0.50357	-1.5107	SLU 2	-0.30783	-0.92349
2459	SLU 3	-0.29064	-0.87192	SLV fondazioni 13	-0.17282	-0.51846
2460	SLU 3	-0.46838	-1.40515	SLU 2	-0.22696	-0.68087
2461	SLU 3	-0.44607	-1.33821	SLU 2	-0.21191	-0.63573
2462	SLU 3	-0.57257	-1.71772	SLU 2	-0.30444	-0.91331
2463	SLU 3	-0.46845	-1.40535	SLU 2	-0.22693	-0.68078
2464	SLU 3	-0.57284	-1.71853	SLU 2	-0.30492	-0.91476
2465	SLU 3	-0.2913	-0.8739	SLV fondazioni 1	-0.17324	-0.51972
2466	SLV fondazioni 3	-0.21833	-0.65498	SLV fondazioni 13	-0.10347	-0.3104
2467	SLV fondazioni 15	-0.21898	-0.65695	SLV fondazioni 1	-0.10392	-0.31175
2468	SLU 3	-0.58031	-1.74092	SLU 2	-0.318	-0.95401
2469	SLU 3	-0.58057	-1.74172	SLU 2	-0.31895	-0.95685
2470	SLU 3	-0.39587	-1.1876	SLU 2	-0.25203	-0.75608
2471	SLU 3	-0.53554	-1.60663	SLU 2	-0.3131	-0.93931
2472	SLU 3	-0.53592	-1.60777	SLU 2	-0.31568	-0.94705
2473	SLU 3	-0.39635	-1.18905	SLU 2	-0.25708	-0.77125
2474	SLU 3	-0.46728	-1.40185	SLU 2	-0.28748	-0.86245
2475	SLU 3	-0.46778	-1.40333	SLU 2	-0.29158	-0.87473
2476	SLU 3	-0.43232	-1.29695	SLU 2	-0.27055	-0.81164
2477	SLU 3	-0.55921	-1.67763	SLU 2	-0.3163	-0.94889
2478	SLU 3	-0.55953	-1.6786	SLU 2	-0.31809	-0.95426
2479	SLU 3	-0.53278	-1.59835	SLU 2	-0.26873	-0.8062
2480	SLU 3	-0.53303	-1.5991	SLU 2	-0.2689	-0.80669
2481	SLU 3	-0.43274	-1.29821	SLU 2	-0.27511	-0.82534
2482	SLU 3	-0.4684	-1.4052	SLU 2	-0.22276	-0.66829
2483	SLU 3	-0.46842	-1.40527	SLU 2	-0.22275	-0.66826
2484	SLU 3	-0.57485	-1.72454	SLU 2	-0.30144	-0.90433
2485	SLU 3	-0.57506	-1.72517	SLU 2	-0.30193	-0.9058
2486	SLU 3	-0.2626	-0.7878	SLV fondazioni 13	-0.14907	-0.44721
2487	SLU 3	-0.26328	-0.78985	SLV fondazioni 1	-0.1495	-0.44849
2488	SLU 3	-0.5798	-1.73941	SLU 2	-0.31275	-0.93826
2489	SLU 3	-0.58006	-1.74018	SLU 2	-0.31368	-0.94103
2490	SLU 3	-0.51918	-1.55753	SLU 2	-0.25481	-0.76444
2491	SLU 3	-0.51928	-1.55784	SLU 2	-0.25482	-0.76445
2492	SLU 3	-0.53291	-1.59873	SLU 2	-0.2645	-0.79351
2493	SLU 3	-0.32048	-0.96145	SLV fondazioni 13	-0.19816	-0.59448
2494	SLU 3	-0.50343	-1.51029	SLU 2	-0.29914	-0.89742
2495	SLU 3	-0.57263	-1.71789	SLU 2	-0.29649	-0.88947
2496	SLU 3	-0.5329	-1.5987	SLU 2	-0.26446	-0.79339
2497	SLU 3	-0.57277	-1.71831	SLU 2	-0.29687	-0.89061
2498	SLU 3	-0.50388	-1.51164	SLU 2	-0.30248	-0.90745
2499	SLU 3	-0.32111	-0.96334	SLV fondazioni 1	-0.19855	-0.59566
2500	SLU 3	-0.53475	-1.60424	SLU 2	-0.30722	-0.92165
2501	SLU 3	-0.55943	-1.67828	SLU 2	-0.31116	-0.93349
2502	SLU 3	-0.55974	-1.67921	SLU 2	-0.31287	-0.93862
2503	SLU 3	-0.53511	-1.60534	SLU 2	-0.30973	-0.92919
2504	SLU 3	-0.54987	-1.64962	SLU 2	-0.2747	-0.82409
2505	SLU 3	-0.55001	-1.65004	SLU 2	-0.27487	-0.82462
2506	SLU 3	-0.56995	-1.70985	SLU 2	-0.2911	-0.87331
2507	SLU 3	-0.57013	-1.71038	SLU 2	-0.2914	-0.87421
2508	SLU 3	-0.58031	-1.74092	SLU 2	-0.30831	-0.92494
2509	SLU 3	-0.58055	-1.74165	SLU 2	-0.30917	-0.92751
2510	SLV fondazioni 3	-0.23585	-0.70756	SLV fondazioni 13	-0.12545	-0.37636
2511	SLU 3	-0.35853	-1.07559	SLU 2	-0.22793	-0.68378
2512	SLU 3	-0.46837	-1.4051	SLU 2	-0.28298	-0.84894
2513	SLU 3	-0.46891	-1.40673	SLU 2	-0.28699	-0.86097
2514	SLU 3	-0.3591	-1.07731	SLV fondazioni 1	-0.23081	-0.69244
2515	SLV fondazioni 15	-0.2365	-0.70949	SLV fondazioni 1	-0.1259	-0.37769
2516	SLU 3	-0.5328	-1.59839	SLU 2	-0.25848	-0.77544
2517	SLU 3	-0.533	-1.599	SLU 2	-0.2586	-0.77581
2518	SLU 3	-0.5192	-1.55759	SLU 2	-0.24797	-0.7436
2519	SLU 3	-0.51925	-1.55774	SLU 2	-0.24787	-0.74361
2520	SLU 3	-0.39539	-1.18616	SLU 2	-0.24712	-0.74136
2521	SLU 3	-0.39589	-1.18768	SLU 2	-0.2521	-0.75629
2522	SLU 3	-0.29234	-0.87702	SLV fondazioni 13	-0.17447	-0.5234
2523	SLU 3	-0.43101	-1.29303	SLU 2	-0.26483	-0.7945
2524	SLU 3	-0.43154	-1.29461	SLU 2	-0.26937	-0.80812
2525	SLU 3	-0.293	-0.879	SLV fondazioni 1	-0.17488	-0.52464
2526	SLU 3	-0.55921	-1.67764	SLU 2	-0.30601	-0.91804
2527	SLU 3	-0.57258	-1.71775	SLU 2	-0.28855	-0.86564
2528	SLU 3	-0.5728	-1.71841	SLU 2	-0.28892	-0.86675
2529	SLU 3	-0.58047	-1.74141	SLU 2	-0.30393	-0.91178
2530	SLU 3	-0.55951	-1.67853	SLU 2	-0.30765	-0.92296
2531	SLU 3	-0.53292	-1.59875	SLU 2	-0.25589	-0.76766
2532	SLU 3	-0.53288	-1.59863	SLU 2	-0.25589	-0.76768
2533	SLU 3	-0.5807	-1.74209	SLU 2	-0.30473	-0.91418
2534	SLU 3	-0.53554	-1.60663	SLU 2	-0.30248	-0.90743
2535	SLU 3	-0.51922	-1.55766	SLU 2	-0.24553	-0.73659
2536	SLU 3	-0.50311	-1.50933	SLU 2	-0.29367	-0.88102
2537	SLU 3	-0.5359	-1.60769	SLU 2	-0.30488	-0.91463
2538	SLU 3	-0.50354	-1.51063	SLU 2	-0.29691	-0.89074
2539	SLV fondazioni 3	-0.21685	-0.65056	SLV fondazioni 13	-0.10199	-0.30597
2540	SLU 3	-0.53282	-1.59845	SLU 2	-0.25283	-0.7585
2541	SLU 3	-0.53297	-1.5989	SLU 2	-0.25291	-0.75874
2542	SLV fondazioni 15	-0.21752	-0.65255	SLV fondazioni 1	-0.10245	-0.30734
2543	SLU 3	-0.57486	-1.72458	SLU 2	-0.28654	-0.85961
2544	SLU 3	-0.54989	-1.64967	SLU 2	-0.26497	-0.79491
2545	SLU 3	-0.53294	-1.59882	SLU 2	-0.252	-0.756
2546	SLU 3	-0.53284	-1.59853	SLU 2	-0.25196	-0.75589
2547	SLU 3	-0.54998	-1.64993	SLU 2	-0.26508	-0.79524
2548	SLU 3	-0.57501	-1.72504	SLU 2	-0.2869	-0.8607
2549	SLU 3	-0.58031	-1.74094	SLU 2	-0.29966	-0.89898
2550	SLU 3	-0.58053	-1.74158	SLU 2	-0.30041	-0.90124



Progetto	Titolo	Rev.	Pag.
Orione	Orione_A24a.pdf "TABULATI DI CALCOLO PLINTO DI FONDAZIONE PER AEROGENERATORE TIPO"	0	164

Tabulati di Calcolo Plinto di Fondazione per Aerogeneratore Tipo - Progetto Impianto Eolico - "Orione"

Nodo	Contesto	uz min	Minima	Contesto	uz max	Massima
2551	SLU 3	-0.57264	-1.71793	SLU 2	-0.28271	-0.84812
2552	SLU 3	-0.57273	-1.71818	SLU 2	-0.28297	-0.84891
2553	SLU 3	-0.46873	-1.40618	SLU 2	-0.27814	-0.83442
2554	SLU 3	-0.55856	-1.67567	SLU 2	-0.30087	-0.90262
2555	SLU 3	-0.55884	-1.67653	SLU 2	-0.30245	-0.90736
2556	SLU 3	-0.46928	-1.40785	SLU 2	-0.28205	-0.84614
2557	SLU 3	-0.26438	-0.79315	SLV fondazioni 13	-0.15082	-0.45245
2558	SLU 3	-0.26507	-0.79525	SLV fondazioni 1	-0.15125	-0.45374
2559	SLU 3	-0.32102	-0.96306	SLV fondazioni 13	-0.19892	-0.59677
2560	SLU 3	-0.56996	-1.70989	SLU 2	-0.27861	-0.83584
2561	SLU 3	-0.57009	-1.71026	SLU 2	-0.27882	-0.83646
2562	SLU 3	-0.32165	-0.96494	SLV fondazioni 1	-0.19931	-0.59794
2563	SLU 3	-0.53581	-1.60744	SLU 2	-0.29761	-0.89282
2564	SLU 3	-0.53615	-1.60845	SLU 2	-0.2999	-0.89971
2565	SLU 3	-0.54991	-1.64974	SLU 2	-0.26005	-0.78015
2566	SLU 3	-0.54994	-1.64983	SLU 2	-0.26009	-0.78026
2567	SLU 3	-0.57981	-1.73944	SLU 2	-0.2955	-0.88649
2568	SLU 3	-0.58001	-1.74004	SLU 2	-0.29622	-0.88865
2569	SLU 3	-0.4322	-1.29659	SLU 2	-0.2608	-0.78241
2570	SLU 3	-0.50215	-1.50645	SLU 2	-0.28803	-0.8641
2571	SLU 3	-0.50256	-1.50767	SLU 2	-0.29117	-0.87352
2572	SLU 3	-0.43283	-1.29849	SLU 2	-0.26528	-0.79585
2573	SLU 3	-0.35802	-1.07406	SLU 2	-0.22345	-0.67034
2574	SLU 3	-0.3586	-1.0758	SLU 2	-0.22877	-0.68663
2575	SLU 3	-0.5726	-1.7178	SLU 2	-0.27728	-0.83183
2576	SLU 3	-0.57276	-1.71828	SLU 2	-0.27753	-0.83258
2577	SLU 3	-0.55921	-1.67764	SLU 2	-0.29671	-0.89014
2578	SLU 3	-0.55948	-1.67845	SLU 2	-0.29819	-0.89458
2579	SLU 3	-0.39397	-1.18191	SLU 2	-0.24177	-0.72531
2580	SLU 3	-0.39453	-1.1836	SLU 2	-0.24668	-0.74004
2581	SLU 3	-0.58032	-1.74096	SLU 2	-0.29214	-0.87641
2582	SLU 3	-0.5805	-1.74151	SLU 2	-0.29279	-0.87837
2583	SLV fondazioni 3	-0.23684	-0.71051	SLV fondazioni 13	-0.12728	-0.38183
2584	SLV fondazioni 15	-0.23748	-0.71244	SLV fondazioni 1	-0.12772	-0.38316
2585	SLU 3	-0.57488	-1.72463	SLU 2	-0.27637	-0.8291
2586	SLU 3	-0.57497	-1.72492	SLU 2	-0.27659	-0.82976
2587	SLU 3	-0.53555	-1.60664	SLU 2	-0.29265	-0.87795
2588	SLU 3	-0.57266	-1.71799	SLU 2	-0.27372	-0.82117
2589	SLU 3	-0.29291	-0.87874	SLV fondazioni 13	-0.17526	-0.52579
2590	SLU 3	-0.56999	-1.70996	SLU 2	-0.27099	-0.81296
2591	SLU 3	-0.57005	-1.71014	SLU 2	-0.27109	-0.81328
2592	SLU 3	-0.57269	-1.71806	SLU 2	-0.27386	-0.82159
2593	SLU 3	-0.53587	-1.60761	SLU 2	-0.29485	-0.88454
2594	SLU 3	-0.29357	-0.88071	SLV fondazioni 1	-0.17567	-0.52702
2595	SLU 3	-0.46836	-1.40509	SLU 2	-0.27302	-0.81906
2596	SLU 3	-0.58048	-1.74144	SLU 2	-0.28888	-0.86664
2597	SLU 3	-0.58065	-1.74195	SLU 2	-0.28947	-0.86841
2598	SLU 3	-0.46888	-1.40665	SLU 2	-0.2768	-0.8304
2599	SLU 3	-0.55943	-1.67829	SLU 2	-0.29254	-0.87762
2600	SLU 3	-0.55968	-1.67905	SLU 2	-0.29393	-0.88178
2601	SLU 3	-0.50312	-1.50936	SLU 2	-0.28372	-0.85115
2602	SLU 3	-0.57262	-1.71787	SLU 2	-0.27097	-0.81292
2603	SLU 3	-0.57001	-1.71004	SLU 2	-0.26845	-0.80536
2604	SLU 3	-0.57272	-1.71817	SLU 2	-0.27109	-0.81328
2605	SLU 3	-0.5035	-1.5105	SLU 2	-0.28672	-0.86015
2606	SLU 3	-0.57269	-1.71807	SLU 2	-0.26981	-0.80943
2607	SLU 3	-0.57265	-1.71796	SLU 2	-0.26982	-0.80947
2608	SLU 3	-0.58033	-1.74098	SLU 2	-0.28578	-0.85734
2609	SLU 3	-0.5749	-1.72471	SLU 2	-0.27124	-0.81372
2610	SLU 3	-0.57494	-1.72481	SLU 2	-0.27132	-0.81395
2611	SLU 3	-0.58048	-1.74144	SLU 2	-0.28632	-0.85895
2612	SLU 3	-0.43257	-1.2977	SLU 2	-0.25637	-0.76912
2613	SLU 3	-0.43325	-1.29976	SLU 2	-0.26076	-0.78228
2614	SLV fondazioni 3	-0.21789	-0.65368	SLV fondazioni 13	-0.10388	-0.31164
2615	SLV fondazioni 15	-0.21856	-0.65569	SLV fondazioni 1	-0.10434	-0.31301
2616	SLU 3	-0.53475	-1.60424	SLU 2	-0.28765	-0.86294
2617	SLU 3	-0.55922	-1.67766	SLU 2	-0.2884	-0.86519
2618	SLU 3	-0.55946	-1.67837	SLU 2	-0.2897	-0.86911
2619	SLU 3	-0.53506	-1.60517	SLU 2	-0.28975	-0.86926
2620	SLU 3	-0.32047	-0.96142	SLV fondazioni 13	-0.19887	-0.59662
2621	SLU 3	-0.3211	-0.9633	SLV fondazioni 1	-0.19926	-0.59779
2622	SLU 3	-0.26499	-0.79496	SLV fondazioni 13	-0.15166	-0.45498
2623	SLU 3	-0.57983	-1.73949	SLU 2	-0.28282	-0.84846
2624	SLU 3	-0.57997	-1.7399	SLU 2	-0.28331	-0.84993
2625	SLU 3	-0.26567	-0.797	SLV fondazioni 1	-0.15209	-0.45626
2626	SLU 3	-0.39532	-1.18595	SLU 2	-0.23826	-0.71477
2627	SLU 3	-0.39594	-1.18781	SLU 2	-0.24307	-0.7292
2628	SLU 3	-0.3565	-1.0695	SLU 2	-0.21847	-0.65541
2629	SLU 3	-0.3571	-1.0713	SLU 2	-0.22369	-0.67108
2630	SLU 3	-0.50345	-1.51034	SLU 2	-0.27919	-0.83757
2631	SLU 3	-0.58034	-1.74101	SLU 2	-0.28066	-0.84197
2632	SLU 3	-0.58046	-1.74137	SLU 2	-0.28108	-0.84324
2633	SLU 3	-0.5038	-1.51141	SLU 2	-0.28206	-0.84618
2634	SLU 3	-0.46728	-1.40183	SLU 2	-0.26767	-0.80302
2635	SLU 3	-0.46772	-1.40316	SLU 2	-0.2713	-0.81391
2636	SLU 3	-0.55857	-1.6757	SLU 2	-0.28431	-0.85294
2637	SLU 3	-0.55879	-1.67637	SLU 2	-0.28554	-0.85663
2638	SLU 3	-0.53555	-1.60664	SLU 2	-0.28376	-0.85129
2639	SLU 3	-0.5805	-1.7415	SLU 2	-0.27863	-0.83589
2640	SLU 3	-0.5806	-1.74181	SLU 2	-0.27899	-0.83697
2641	SLU 3	-0.53584	-1.60752	SLU 2	-0.28575	-0.85724
2642	SLU 3	-0.58035	-1.74105	SLU 2	-0.27679	-0.83037
2643	SLU 3	-0.58044	-1.74131	SLU 2	-0.27709	-0.83127
2644	SLU 3	-0.29233	-0.87699	SLV fondazioni 13	-0.17521	-0.52563
2645	SLU 3	-0.55923	-1.67768	SLU 2	-0.28119	-0.84358
2646	SLU 3	-0.55943	-1.67829	SLU 2	-0.28232	-0.84695
2647	SLU 3	-0.29298	-0.87895	SLV fondazioni 1	-0.17562	-0.52685



Tabulati di Calcolo Plinto di Fondazione per Aerogeneratore Tipo - Progetto Impianto Eolico - "Orione"

Nodo	Contesto	uz min	Minima	Contesto	uz max	Massima
2648	SLU 3	-0.23729	-0.71188	SLV fondazioni 13	-0.12817	-0.3845
2649	SLU 3	-0.238	-0.71399	SLV fondazioni 1	-0.12861	-0.38583
2650	SLU 3	-0.43219	-1.29657	SLU 2	-0.25164	-0.75492
2651	SLU 3	-0.57985	-1.73956	SLU 2	-0.27511	-0.82532
2652	SLU 3	-0.57992	-1.73977	SLU 2	-0.27536	-0.82607
2653	SLU 3	-0.4328	-1.2984	SLU 2	-0.25586	-0.76757
2654	SLU 3	-0.58036	-1.74109	SLU 2	-0.27422	-0.82265
2655	SLU 3	-0.58041	-1.74124	SLU 2	-0.2744	-0.82321
2656	SLU 3	-0.50312	-1.50937	SLU 2	-0.2745	-0.82351
2657	SLU 3	-0.53582	-1.60745	SLU 2	-0.27981	-0.83944
2658	SLU 3	-0.58053	-1.74159	SLU 2	-0.27349	-0.82046
2659	SLU 3	-0.58056	-1.74169	SLU 2	-0.27361	-0.82083
2660	SLU 3	-0.53609	-1.60828	SLU 2	-0.28168	-0.84503
2661	SLU 3	-0.50347	-1.5104	SLU 2	-0.27725	-0.83175
2662	SLU 3	-0.58038	-1.74114	SLU 2	-0.27296	-0.81887
2663	SLU 3	-0.5804	-1.74119	SLU 2	-0.27302	-0.81905
2664	SLU 3	-0.46842	-1.40527	SLU 2	-0.2638	-0.7914
2665	SLU 3	-0.55944	-1.67833	SLU 2	-0.27811	-0.83433
2666	SLU 3	-0.57988	-1.73965	SLU 2	-0.27259	-0.81778
2667	SLU 3	-0.55963	-1.67889	SLU 2	-0.27913	-0.8374
2668	SLU 3	-0.46879	-1.40637	SLU 2	-0.26725	-0.80174
2669	SLU 3	-0.39576	-1.18729	SLU 2	-0.23428	-0.70284
2670	SLU 3	-0.39639	-1.18918	SLU 2	-0.23897	-0.7169
2671	SLU 3	-0.31885	-0.95655	SLU 2	-0.19505	-0.58516
2672	SLU 3	-0.35799	-1.07396	SLU 2	-0.21547	-0.6464
2673	SLU 3	-0.3586	-1.07579	SLU 2	-0.22056	-0.66168
2674	SLU 3	-0.31948	-0.95844	SLV fondazioni 1	-0.19841	-0.59522
2675	SLU 3	-0.55924	-1.67771	SLU 2	-0.2751	-0.8253
2676	SLU 3	-0.5594	-1.67821	SLU 2	-0.27603	-0.82808
2677	SLU 3	-0.53555	-1.60666	SLU 2	-0.27583	-0.82748
2678	SLU 3	-0.53581	-1.60743	SLU 2	-0.27758	-0.83273
2679	SLV fondazioni 3	-0.21796	-0.65387	SLV fondazioni 13	-0.10481	-0.31442
2680	SLV fondazioni 15	-0.21862	-0.65587	SLV fondazioni 1	-0.10526	-0.31578
2681	SLU 3	-0.26437	-0.79312	SLV fondazioni 13	-0.15159	-0.45476
2682	SLU 3	-0.26505	-0.79515	SLV fondazioni 1	-0.15201	-0.45603
2683	SLU 3	-0.50215	-1.50645	SLU 2	-0.2697	-0.8091
2684	SLU 3	-0.50249	-1.50748	SLU 2	-0.27233	-0.817
2685	SLU 3	-0.431	-1.293	SLU 2	-0.24661	-0.73982
2686	SLU 3	-0.55859	-1.67576	SLU 2	-0.27218	-0.81653
2687	SLU 3	-0.55874	-1.67621	SLU 2	-0.27301	-0.81904
2688	SLU 3	-0.43148	-1.29444	SLU 2	-0.25063	-0.7519
2689	SLU 3	-0.46881	-1.40643	SLU 2	-0.25964	-0.77892
2690	SLU 3	-0.46913	-1.4074	SLU 2	-0.26293	-0.78879
2691	SLU 3	-0.53476	-1.60427	SLU 2	-0.27184	-0.81552
2692	SLU 3	-0.55925	-1.67774	SLU 2	-0.27021	-0.81062
2693	SLU 3	-0.55938	-1.67813	SLU 2	-0.27094	-0.81281
2694	SLU 3	-0.535	-1.60499	SLU 2	-0.27348	-0.82044
2695	SLU 3	-0.29062	-0.87187	SLV fondazioni 13	-0.17431	-0.52294
2696	SLU 3	-0.29127	-0.87381	SLV fondazioni 1	-0.17472	-0.52417
2697	SLU 3	-0.39531	-1.18594	SLU 2	-0.2299	-0.6897
2698	SLU 3	-0.55947	-1.6784	SLU 2	-0.26831	-0.80494
2699	SLU 3	-0.55958	-1.67874	SLU 2	-0.26894	-0.80681
2700	SLU 3	-0.3959	-1.18771	SLU 2	-0.23443	-0.70329
2701	SLU 3	-0.50311	-1.50934	SLU 2	-0.26618	-0.79853
2702	SLU 3	-0.50345	-1.51034	SLU 2	-0.26866	-0.80599
2703	SLU 3	-0.23667	-0.71	SLV fondazioni 13	-0.12809	-0.38426
2704	SLU 3	-0.23736	-0.71209	SLV fondazioni 1	-0.12853	-0.38558
2705	SLU 3	-0.53556	-1.60668	SLU 2	-0.26895	-0.80686
2706	SLU 3	-0.53578	-1.60734	SLU 2	-0.27046	-0.81137
2707	SLU 3	-0.55926	-1.67778	SLU 2	-0.26652	-0.79955
2708	SLU 3	-0.55935	-1.67806	SLU 2	-0.26704	-0.80113
2709	SLU 3	-0.35848	-1.07545	SLU 2	-0.21193	-0.6358
2710	SLU 3	-0.35909	-1.07727	SLU 2	-0.21689	-0.65066
2711	SLU 3	-0.32046	-0.96137	SLU 2	-0.19255	-0.57765
2712	SLU 3	-0.32108	-0.96324	SLU 2	-0.19791	-0.59372
2713	SLU 3	-0.43231	-1.29692	SLU 2	-0.24318	-0.72955
2714	SLU 3	-0.55861	-1.67584	SLU 2	-0.26483	-0.79449
2715	SLU 3	-0.55869	-1.67606	SLU 2	-0.26526	-0.79577
2716	SLU 3	-0.46843	-1.40528	SLU 2	-0.25525	-0.76574
2717	SLU 3	-0.46875	-1.40626	SLU 2	-0.2584	-0.77521
2718	SLU 3	-0.43265	-1.29795	SLU 2	-0.24699	-0.74096
2719	SLU 3	-0.55927	-1.67782	SLU 2	-0.26409	-0.79226
2720	SLU 3	-0.55933	-1.67799	SLU 2	-0.2644	-0.79321
2721	SLU 3	-0.53583	-1.6075	SLU 2	-0.26605	-0.79814
2722	SLU 3	-0.53603	-1.6081	SLU 2	-0.26742	-0.80225
2723	SLU 3	-0.5595	-1.67849	SLU 2	-0.26344	-0.79033
2724	SLU 3	-0.55953	-1.6786	SLU 2	-0.26366	-0.79097
2725	SLU 3	-0.50343	-1.5103	SLU 2	-0.26251	-0.78754
2726	SLU 3	-0.55929	-1.67788	SLU 2	-0.26292	-0.78875
2727	SLU 3	-0.55931	-1.67793	SLU 2	-0.26302	-0.78907
2728	SLU 3	-0.50376	-1.51127	SLU 2	-0.26485	-0.79456
2729	SLU 3	-0.55865	-1.67594	SLU 2	-0.2625	-0.7875
2730	SLU 3	-0.26258	-0.78774	SLV fondazioni 13	-0.15063	-0.45189
2731	SLU 3	-0.26325	-0.78976	SLV fondazioni 1	-0.15105	-0.45315
2732	SLV fondazioni 3	-0.21703	-0.6511	SLV fondazioni 13	-0.10473	-0.31419
2733	SLU 3	-0.53557	-1.60671	SLU 2	-0.26315	-0.78944
2734	SLU 3	-0.53575	-1.60725	SLU 2	-0.26439	-0.79317
2735	SLV fondazioni 15	-0.21769	-0.65308	SLV fondazioni 1	-0.10518	-0.31554
2736	SLU 3	-0.39396	-1.18189	SLU 2	-0.22516	-0.67549
2737	SLU 3	-0.39447	-1.18341	SLU 2	-0.22952	-0.68855
2738	SLU 3	-0.50312	-1.50935	SLU 2	-0.25875	-0.77624
2739	SLU 3	-0.50341	-1.51024	SLU 2	-0.26094	-0.78283
2740	SLU 3	-0.46728	-1.40184	SLU 2	-0.25066	-0.75198
2741	SLU 3	-0.46765	-1.40295	SLU 2	-0.2537	-0.76111
2742	SLU 3	-0.29232	-0.87696	SLU 2	-0.17534	-0.52603
2743	SLU 3	-0.29296	-0.87888	SLV fondazioni 1	-0.17674	-0.53022
2744	SLU 3	-0.43274	-1.29823	SLU 2	-0.23941	-0.71822



Tabulati di Calcolo Plinto di Fondazione per Aerogeneratore Tipo - Progetto Impianto Eolico - "Orione"

Nodo	Contesto	uz min	Minima	Contesto	uz max	Massima
2745	SLU 3	-0.53478	-1.60433	SLU 2	-0.26028	-0.78084
2746	SLU 3	-0.53494	-1.60482	SLU 2	-0.2614	-0.7842
2747	SLU 3	-0.433	-1.29901	SLU 2	-0.24301	-0.72904
2748	SLU 3	-0.35798	-1.07395	SLU 2	-0.20793	-0.62378
2749	SLU 3	-0.35856	-1.07569	SLU 2	-0.21272	-0.63817
2750	SLU 3	-0.53558	-1.60674	SLU 2	-0.2585	-0.77549
2751	SLU 3	-0.53572	-1.60717	SLU 2	-0.25947	-0.77842
2752	SLU 3	-0.321	-0.96299	SLU 2	-0.18946	-0.56837
2753	SLU 3	-0.32161	-0.96482	SLU 2	-0.19466	-0.58399
2754	SLU 3	-0.23483	-0.7045	SLV fondazioni 13	-0.12709	-0.38126
2755	SLU 3	-0.23553	-0.70658	SLV fondazioni 1	-0.12752	-0.38256
2756	SLU 3	-0.50216	-1.50649	SLU 2	-0.25491	-0.76474
2757	SLU 3	-0.53585	-1.60756	SLU 2	-0.25673	-0.77019
2758	SLU 3	-0.53598	-1.60794	SLU 2	-0.25757	-0.77271
2759	SLU 3	-0.50243	-1.50728	SLU 2	-0.25696	-0.77088
2760	SLU 3	-0.46837	-1.4051	SLU 2	-0.2475	-0.74249
2761	SLU 3	-0.46878	-1.40634	SLU 2	-0.2504	-0.75119
2762	SLU 3	-0.39538	-1.18613	SLU 2	-0.22218	-0.66653
2763	SLU 3	-0.53559	-1.60678	SLU 2	-0.255	-0.76499
2764	SLU 3	-0.5357	-1.6071	SLU 2	-0.2557	-0.7671
2765	SLU 3	-0.3958	-1.18739	SLU 2	-0.22632	-0.67896
2766	SLU 3	-0.43231	-1.29692	SLU 2	-0.23532	-0.70596
2767	SLU 3	-0.43261	-1.29783	SLU 2	-0.2388	-0.71639
2768	SLU 3	-0.26437	-0.7931	SLV fondazioni 13	-0.15277	-0.45832
2769	SLU 3	-0.50314	-1.50942	SLU 2	-0.25233	-0.75698
2770	SLU 3	-0.50337	-1.5101	SLU 2	-0.2542	-0.76261
2771	SLU 3	-0.26502	-0.79507	SLV fondazioni 1	-0.15319	-0.45957
2772	SLU 3	-0.53481	-1.60442	SLU 2	-0.25332	-0.75995
2773	SLU 3	-0.53489	-1.60466	SLU 2	-0.25389	-0.76166
2774	SLU 3	-0.53561	-1.60684	SLU 2	-0.25271	-0.75812
2775	SLU 3	-0.53567	-1.60702	SLU 2	-0.25313	-0.75939
2776	SLU 3	-0.53589	-1.60767	SLU 2	-0.25214	-0.75642
2777	SLU 3	-0.53593	-1.60778	SLU 2	-0.25242	-0.75727
2778	SLU 3	-0.53563	-1.60689	SLU 2	-0.25163	-0.75488
2779	SLU 3	-0.53565	-1.60695	SLU 2	-0.25177	-0.75533
2780	SLU 3	-0.46873	-1.40619	SLU 2	-0.24413	-0.7324
2781	SLU 3	-0.46914	-1.40743	SLU 2	-0.24687	-0.74062
2782	SLV fondazioni 3	-0.21512	-0.64537	SLV fondazioni 13	-0.10369	-0.31107
2783	SLU 3	-0.2929	-0.87869	SLU 2	-0.17258	-0.51775
2784	SLU 3	-0.35649	-1.06948	SLU 2	-0.2035	-0.61051
2785	SLU 3	-0.53484	-1.60453	SLU 2	-0.25116	-0.75349
2786	SLU 3	-0.35703	-1.07109	SLU 2	-0.20813	-0.62439
2787	SLU 3	-0.29352	-0.88056	SLV fondazioni 1	-0.1779	-0.53369
2788	SLV fondazioni 15	-0.21578	-0.64733	SLV fondazioni 1	-0.10414	-0.31241
2789	SLU 3	-0.50347	-1.51041	SLU 2	-0.24965	-0.74895
2790	SLU 3	-0.50367	-1.51101	SLU 2	-0.25136	-0.75407
2791	SLU 3	-0.32045	-0.96136	SLU 2	-0.18583	-0.55749
2792	SLU 3	-0.32104	-0.96313	SLU 2	-0.19087	-0.57261
2793	SLU 3	-0.39585	-1.18756	SLU 2	-0.21878	-0.65634
2794	SLU 3	-0.39623	-1.18868	SLU 2	-0.22273	-0.6682
2795	SLU 3	-0.431	-1.29301	SLU 2	-0.23097	-0.69292
2796	SLU 3	-0.4314	-1.2942	SLU 2	-0.23435	-0.70304
2797	SLU 3	-0.50315	-1.50945	SLU 2	-0.24691	-0.74072
2798	SLU 3	-0.50333	-1.51	SLU 2	-0.24846	-0.74537
2799	SLU 3	-0.23666	-0.70997	SLV fondazioni 13	-0.12932	-0.38796
2800	SLU 3	-0.46837	-1.40512	SLU 2	-0.24061	-0.72183
2801	SLU 3	-0.46874	-1.40622	SLU 2	-0.24317	-0.72952
2802	SLU 3	-0.23734	-0.71201	SLV fondazioni 1	-0.12974	-0.38923
2803	SLU 3	-0.50218	-1.50655	SLU 2	-0.24413	-0.73238
2804	SLU 3	-0.50236	-1.50708	SLU 2	-0.24552	-0.73657
2805	SLU 3	-0.26497	-0.79492	SLV fondazioni 13	-0.154	-0.46201
2806	SLU 3	-0.35801	-1.07403	SLU 2	-0.20095	-0.60284
2807	SLU 3	-0.3585	-1.07549	SLU 2	-0.20538	-0.61613
2808	SLU 3	-0.26561	-0.79684	SLV fondazioni 1	-0.15441	-0.46322
2809	SLU 3	-0.4322	-1.29659	SLU 2	-0.22817	-0.68451
2810	SLU 3	-0.43269	-1.29806	SLU 2	-0.23141	-0.69423
2811	SLU 3	-0.50315	-1.50945	SLU 2	-0.24257	-0.72777
2812	SLU 3	-0.50332	-1.50995	SLU 2	-0.2438	-0.73139
2813	SLU 3	-0.46729	-1.40188	SLU 2	-0.23696	-0.71088
2814	SLU 3	-0.46758	-1.40273	SLU 2	-0.23933	-0.71798
2815	SLU 3	-0.29232	-0.87695	SLU 2	-0.16923	-0.5077
2816	SLU 3	-0.39538	-1.18614	SLU 2	-0.21502	-0.64505
2817	SLU 3	-0.39576	-1.18727	SLU 2	-0.2188	-0.65641
2818	SLU 3	-0.29292	-0.87876	SLU 2	-0.17446	-0.52338
2819	SLU 3	-0.50348	-1.51043	SLU 2	-0.24096	-0.72288
2820	SLU 3	-0.50363	-1.51088	SLU 2	-0.24202	-0.72605
2821	SLV fondazioni 3	-0.21575	-0.64724	SLV fondazioni 13	-0.10601	-0.31802
2822	SLU 3	-0.31885	-0.95654	SLU 2	-0.18172	-0.54516
2823	SLU 3	-0.31941	-0.95822	SLU 2	-0.18659	-0.55978
2824	SLV fondazioni 15	-0.21638	-0.64915	SLV fondazioni 1	-0.10644	-0.31933
2825	SLU 3	-0.46844	-1.40533	SLU 2	-0.23469	-0.70407
2826	SLU 3	-0.50316	-1.50949	SLU 2	-0.23932	-0.71796
2827	SLU 3	-0.50329	-1.50987	SLU 2	-0.24021	-0.72062
2828	SLU 3	-0.46864	-1.40593	SLU 2	-0.23684	-0.71051
2829	SLU 3	-0.43257	-1.29772	SLU 2	-0.22511	-0.67532
2830	SLU 3	-0.4331	-1.29931	SLU 2	-0.22819	-0.68456
2831	SLU 3	-0.23728	-0.71184	SLV fondazioni 13	-0.13061	-0.39184
2832	SLU 3	-0.50221	-1.50664	SLU 2	-0.23767	-0.713
2833	SLU 3	-0.5023	-1.50691	SLU 2	-0.23837	-0.71512
2834	SLU 3	-0.35852	-1.07555	SLU 2	-0.19793	-0.59379
2835	SLU 3	-0.35897	-1.07691	SLU 2	-0.20217	-0.6065
2836	SLU 3	-0.23794	-0.71382	SLV fondazioni 1	-0.13103	-0.39308
2837	SLU 3	-0.50319	-1.50958	SLU 2	-0.23722	-0.71165
2838	SLU 3	-0.50325	-1.50975	SLU 2	-0.23774	-0.71322
2839	SLU 3	-0.46883	-1.4065	SLU 2	-0.23225	-0.69675
2840	SLU 3	-0.50353	-1.51059	SLU 2	-0.23674	-0.71022
2841	SLU 3	-0.50356	-1.51067	SLU 2	-0.23708	-0.71125





Tabulati di Calcolo Plinto di Fondazione per Aerogeneratore Tipo - Progetto Impianto Eolico - "Orione"

Nodo	Contesto	uz min	Minima	Contesto	uz max	Massima
2842	SLU 3	-0.46898	-1.40695	SLU 2	-0.2342	-0.7026
2843	SLU 3	-0.39397	-1.1819	SLU 2	-0.21094	-0.63281
2844	SLU 3	-0.50321	-1.50964	SLU 2	-0.23624	-0.70872
2845	SLU 3	-0.50322	-1.50967	SLU 2	-0.23641	-0.70924
2846	SLU 3	-0.39439	-1.18316	SLU 2	-0.21458	-0.64374
2847	SLU 3	-0.50225	-1.50676	SLU 2	-0.23573	-0.70718
2848	SLU 3	-0.26436	-0.79309	SLU 2	-0.1527	-0.45811
2849	SLU 3	-0.26498	-0.79495	SLV fondazioni 1	-0.1547	-0.46411
2850	SLU 3	-0.4322	-1.29661	SLU 2	-0.22185	-0.66555
2851	SLU 3	-0.43264	-1.29793	SLU 2	-0.22471	-0.67413
2852	SLU 3	-0.32046	-0.96139	SLU 2	-0.1796	-0.53881
2853	SLU 3	-0.32099	-0.96297	SLU 2	-0.18428	-0.55283
2854	SLU 3	-0.29062	-0.87185	SLU 2	-0.16536	-0.49608
2855	SLU 3	-0.46846	-1.40537	SLU 2	-0.22968	-0.68903
2856	SLU 3	-0.46861	-1.40582	SLU 2	-0.23145	-0.69434
2857	SLU 3	-0.29119	-0.87358	SLU 2	-0.17041	-0.51124
2858	SLV fondazioni 3	-0.21539	-0.64617	SLV fondazioni 13	-0.10736	-0.32207
2859	SLU 3	-0.35801	-1.07403	SLU 2	-0.1945	-0.58349
2860	SLU 3	-0.39532	-1.18595	SLU 2	-0.20853	-0.62559
2861	SLU 3	-0.39578	-1.18733	SLU 2	-0.212	-0.636
2862	SLU 3	-0.35845	-1.07535	SLU 2	-0.19855	-0.59564
2863	SLV fondazioni 15	-0.21601	-0.64803	SLV fondazioni 1	-0.10778	-0.32334
2864	SLU 3	-0.46731	-1.40194	SLU 2	-0.22699	-0.68097
2865	SLU 3	-0.4675	-1.40251	SLU 2	-0.2286	-0.68581
2866	SLU 3	-0.43102	-1.29305	SLU 2	-0.2184	-0.65521
2867	SLU 3	-0.43132	-1.29396	SLU 2	-0.22102	-0.66307
2868	SLU 3	-0.46841	-1.40522	SLU 2	-0.22565	-0.67695
2869	SLU 3	-0.46864	-1.40591	SLU 2	-0.22709	-0.68127
2870	SLU 3	-0.23666	-0.70997	SLV fondazioni 13	-0.13094	-0.39282
2871	SLU 3	-0.23729	-0.71188	SLV fondazioni 1	-0.13134	-0.39402
2872	SLU 3	-0.32101	-0.96302	SLU 2	-0.17697	-0.53091
2873	SLU 3	-0.32151	-0.96452	SLU 2	-0.18144	-0.54433
2874	SLU 3	-0.46878	-1.40633	SLU 2	-0.2242	-0.6726
2875	SLU 3	-0.469	-1.40701	SLU 2	-0.22545	-0.67636
2876	SLU 3	-0.26258	-0.87773	SLU 2	-0.14907	-0.4472
2877	SLU 3	-0.29232	-0.87697	SLU 2	-0.16357	-0.49072
2878	SLU 3	-0.39577	-1.18731	SLU 2	-0.2058	-0.61739
2879	SLU 3	-0.43233	-1.29698	SLU 2	-0.21644	-0.64933
2880	SLU 3	-0.43249	-1.29747	SLU 2	-0.2188	-0.65641
2881	SLU 3	-0.39623	-1.18869	SLU 2	-0.20908	-0.62723
2882	SLU 3	-0.29287	-0.87861	SLU 2	-0.16842	-0.50527
2883	SLU 3	-0.26317	-0.78951	SLV fondazioni 1	-0.15413	-0.46239
2884	SLU 3	-0.46842	-1.40527	SLU 2	-0.22266	-0.66799
2885	SLU 3	-0.4686	-1.40581	SLU 2	-0.22371	-0.67112
2886	SLU 3	-0.3565	-1.0695	SLU 2	-0.19069	-0.57208
2887	SLU 3	-0.35694	-1.07082	SLU 2	-0.19457	-0.5837
2888	SLU 3	-0.43277	-1.29831	SLU 2	-0.21425	-0.64276
2889	SLU 3	-0.46735	-1.40204	SLU 2	-0.22105	-0.66316
2890	SLU 3	-0.46744	-1.40233	SLU 2	-0.22187	-0.66561
2891	SLU 3	-0.43284	-1.29853	SLU 2	-0.21638	-0.64913
2892	SLU 3	-0.4685	-1.40551	SLU 2	-0.22076	-0.66229
2893	SLU 3	-0.46851	-1.40554	SLU 2	-0.22135	-0.66405
2894	SLU 3	-0.4689	-1.4067	SLU 2	-0.22038	-0.66113
2895	SLU 3	-0.46886	-1.40658	SLU 2	-0.22075	-0.66225
2896	SLV fondazioni 3	-0.21405	-0.64214	SLV fondazioni 13	-0.1077	-0.32311
2897	SLU 3	-0.39532	-1.18597	SLU 2	-0.20278	-0.60835
2898	SLU 3	-0.39573	-1.1872	SLU 2	-0.20584	-0.61753
2899	SLV fondazioni 15	-0.21465	-0.64394	SLV fondazioni 1	-0.10811	-0.32434
2900	SLU 3	-0.46853	-1.40558	SLU 2	-0.21989	-0.65968
2901	SLU 3	-0.46849	-1.40546	SLU 2	-0.22007	-0.66022
2902	SLU 3	-0.46739	-1.40217	SLU 2	-0.21933	-0.65798
2903	SLU 3	-0.32047	-0.9614	SLU 2	-0.17386	-0.52159
2904	SLU 3	-0.32094	-0.96282	SLU 2	-0.17814	-0.53441
2905	SLU 3	-0.43234	-1.29702	SLU 2	-0.21185	-0.63556
2906	SLU 3	-0.43245	-1.29735	SLU 2	-0.2138	-0.64139
2907	SLU 3	-0.35799	-1.07397	SLU 2	-0.18867	-0.56602
2908	SLU 3	-0.35843	-1.07529	SLU 2	-0.19234	-0.57703
2909	SLU 3	-0.23483	-0.70448	SLV fondazioni 13	-0.13035	-0.39105
2910	SLU 3	-0.2929	-0.8787	SLU 2	-0.16123	-0.48369
2911	SLU 3	-0.29342	-0.88026	SLU 2	-0.16587	-0.49762
2912	SLU 3	-0.23544	-0.70632	SLV fondazioni 1	-0.13073	-0.3922
2913	SLU 3	-0.26436	-0.79309	SLU 2	-0.14761	-0.44282
2914	SLU 3	-0.26493	-0.79479	SLU 2	-0.15263	-0.45789
2915	SLU 3	-0.39398	-1.18194	SLU 2	-0.19952	-0.59855
2916	SLU 3	-0.3943	-1.18289	SLU 2	-0.20235	-0.60704
2917	SLU 3	-0.43104	-1.29312	SLU 2	-0.20928	-0.62783
2918	SLU 3	-0.43124	-1.29373	SLU 2	-0.21106	-0.63319
2919	SLU 3	-0.43224	-1.29671	SLU 2	-0.20815	-0.62445
2920	SLU 3	-0.43253	-1.29759	SLU 2	-0.20976	-0.62929
2921	SLU 3	-0.35849	-1.07547	SLU 2	-0.18626	-0.55879
2922	SLU 3	-0.35891	-1.07674	SLU 2	-0.18972	-0.56917
2923	SLU 3	-0.31885	-0.95655	SLU 2	-0.17033	-0.511
2924	SLU 3	-0.3954	-1.1862	SLU 2	-0.19786	-0.59357
2925	SLU 3	-0.39562	-1.18687	SLU 2	-0.20043	-0.6013
2926	SLU 3	-0.31931	-0.95792	SLU 2	-0.17441	-0.52323
2927	SLU 3	-0.43262	-1.29786	SLU 2	-0.20685	-0.62056
2928	SLU 3	-0.43295	-1.29885	SLU 2	-0.20827	-0.62482
2929	SLV fondazioni 3	-0.21172	-0.63515	SLV fondazioni 13	-0.10709	-0.32127
2930	SLU 3	-0.29232	-0.87697	SLU 2	-0.15836	-0.47508
2931	SLU 3	-0.29282	-0.87845	SLU 2	-0.1628	-0.48839
2932	SLV fondazioni 15	-0.21229	-0.63688	SLV fondazioni 1	-0.10749	-0.32246
2933	SLU 3	-0.23666	-0.70997	SLU 2	-0.13173	-0.39519
2934	SLU 3	-0.26498	-0.79493	SLU 2	-0.14554	-0.43663
2935	SLU 3	-0.26551	-0.79654	SLU 2	-0.15035	-0.45106
2936	SLU 3	-0.23724	-0.71172	SLV fondazioni 1	-0.13334	-0.40001
2937	SLU 3	-0.43226	-1.29677	SLU 2	-0.20543	-0.6163
2938	SLU 3	-0.4325	-1.29749	SLU 2	-0.20661	-0.61982



Tabulati di Calcolo Plinto di Fondazione per Aerogeneratore Tipo - Progetto Impianto Eolico - "Orione"

Nodo	Contesto	uz min	Minima	Contesto	uz max	Massima
2939	SLU 3	-0.39588	-1.18764	SLU 2	-0.19591	-0.58772
2940	SLU 3	-0.39605	-1.18816	SLU 2	-0.19825	-0.59474
2941	SLU 3	-0.358	-1.07399	SLU 2	-0.1835	-0.55051
2942	SLU 3	-0.35838	-1.07514	SLU 2	-0.18674	-0.56022
2943	SLU 3	-0.43108	-1.29323	SLU 2	-0.20387	-0.61162
2944	SLU 3	-0.43118	-1.29353	SLU 2	-0.20478	-0.61434
2945	SLU 3	-0.32046	-0.96138	SLU 2	-0.16869	-0.50608
2946	SLU 3	-0.43239	-1.29717	SLU 2	-0.20374	-0.61122
2947	SLU 3	-0.43235	-1.29705	SLU 2	-0.20437	-0.61312
2948	SLU 3	-0.3209	-0.9627	SLU 2	-0.17255	-0.51764
2949	SLU 3	-0.43284	-1.29852	SLU 2	-0.20344	-0.61031
2950	SLU 3	-0.43271	-1.29813	SLU 2	-0.20382	-0.61146
2951	SLU 3	-0.43241	-1.29724	SLU 2	-0.20298	-0.60893
2952	SLU 3	-0.43232	-1.29697	SLU 2	-0.20315	-0.60946
2953	SLU 3	-0.39541	-1.18623	SLU 2	-0.19369	-0.58108
2954	SLU 3	-0.39558	-1.18675	SLU 2	-0.19582	-0.58746
2955	SLU 3	-0.43112	-1.29336	SLU 2	-0.20236	-0.60708
2956	SLU 3	-0.29062	-0.87186	SLU 2	-0.15503	-0.46509
2957	SLU 3	-0.29109	-0.87327	SLU 2	-0.15925	-0.47776
2958	SLV fondazioni 3	-0.21194	-0.63583	SLV fondazioni 13	-0.10981	-0.32942
2959	SLU 3	-0.26437	-0.7931	SLU 2	-0.14291	-0.42874
2960	SLU 3	-0.35651	-1.06954	SLU 2	-0.18043	-0.54129
2961	SLU 3	-0.35684	-1.07053	SLU 2	-0.18344	-0.55031
2962	SLU 3	-0.26488	-0.79463	SLU 2	-0.14751	-0.44252
2963	SLV fondazioni 15	-0.21249	-0.63747	SLV fondazioni 1	-0.11018	-0.33055
2964	SLU 3	-0.23728	-0.71184	SLU 2	-0.12994	-0.38982
2965	SLU 3	-0.23783	-0.7135	SLU 2	-0.13492	-0.40476
2966	SLU 3	-0.394	-1.18201	SLU 2	-0.19125	-0.57375
2967	SLU 3	-0.39422	-1.18265	SLU 2	-0.19318	-0.57953
2968	SLU 3	-0.321	-0.96301	SLU 2	-0.1666	-0.49981
2969	SLU 3	-0.32142	-0.96425	SLU 2	-0.17023	-0.5107
2970	SLU 3	-0.39536	-1.18608	SLU 2	-0.19036	-0.57108
2971	SLU 3	-0.39561	-1.18683	SLU 2	-0.19208	-0.57624
2972	SLU 3	-0.35803	-1.0741	SLU 2	-0.17907	-0.5372
2973	SLU 3	-0.35831	-1.07493	SLU 2	-0.18182	-0.54547
2974	SLU 3	-0.29232	-0.87697	SLU 2	-0.15367	-0.46102
2975	SLU 3	-0.29277	-0.87831	SLU 2	-0.15767	-0.473
2976	SLU 3	-0.39582	-1.18746	SLU 2	-0.18924	-0.56773
2977	SLU 3	-0.39607	-1.1882	SLU 2	-0.19073	-0.5722
2978	SLU 3	-0.32047	-0.96141	SLU 2	-0.1641	-0.4923
2979	SLU 3	-0.32085	-0.96255	SLU 2	-0.1675	-0.5025
2980	SLU 3	-0.26258	-0.78774	SLU 2	-0.13978	-0.41933
2981	SLU 3	-0.35855	-1.07564	SLU 2	-0.17736	-0.53208
2982	SLU 3	-0.35878	-1.07635	SLU 2	-0.17987	-0.53961
2983	SLU 3	-0.26306	-0.78919	SLU 2	-0.14416	-0.43247
2984	SLU 3	-0.39538	-1.18614	SLU 2	-0.18791	-0.56374
2985	SLU 3	-0.39558	-1.18673	SLU 2	-0.18916	-0.56747
2986	SLV fondazioni 3	-0.21119	-0.63358	SLV fondazioni 13	-0.11155	-0.33466
2987	SLU 3	-0.23666	-0.70998	SLU 2	-0.12755	-0.38265
2988	SLU 3	-0.23718	-0.71155	SLU 2	-0.13231	-0.39693
2989	SLV fondazioni 15	-0.21171	-0.63514	SLV fondazioni 1	-0.11191	-0.33573
2990	SLU 3	-0.39404	-1.18212	SLU 2	-0.18639	-0.55916
2991	SLU 3	-0.39415	-1.18244	SLU 2	-0.18737	-0.5621
2992	SLU 3	-0.2929	-0.87871	SLU 2	-0.15183	-0.45548
2993	SLU 3	-0.39547	-1.1864	SLU 2	-0.18639	-0.55916
2994	SLU 3	-0.39548	-1.18644	SLU 2	-0.18709	-0.56128
2995	SLU 3	-0.29332	-0.87997	SLU 2	-0.15558	-0.46675
2996	SLU 3	-0.35805	-1.07414	SLU 2	-0.17534	-0.52601
2997	SLU 3	-0.39595	-1.18785	SLU 2	-0.18616	-0.55849
2998	SLU 3	-0.39591	-1.18774	SLU 2	-0.18662	-0.55985
2999	SLU 3	-0.35827	-1.0748	SLU 2	-0.17761	-0.53284
3000	SLU 3	-0.39549	-1.18647	SLU 2	-0.18573	-0.55718
3001	SLU 3	-0.39545	-1.18635	SLU 2	-0.18594	-0.55783
3002	SLU 3	-0.31886	-0.95659	SLU 2	-0.16123	-0.48368
3003	SLU 3	-0.39409	-1.18226	SLU 2	-0.18508	-0.55523
3004	SLU 3	-0.31921	-0.95762	SLU 2	-0.16439	-0.49317
3005	SLU 3	-0.26437	-0.79311	SLU 2	-0.1387	-0.4161
3006	SLU 3	-0.26482	-0.79447	SLU 2	-0.14284	-0.42851
3007	SLU 3	-0.35654	-1.06962	SLU 2	-0.17303	-0.51908
3008	SLU 3	-0.35676	-1.07027	SLU 2	-0.17507	-0.52522
3009	SLU 3	-0.23483	-0.7045	SLU 2	-0.12463	-0.37388
3010	SLU 3	-0.23533	-0.70598	SLU 2	-0.12916	-0.38748
3011	SLV fondazioni 3	-0.20946	-0.62837	SLV fondazioni 1	-0.11226	-0.33679
3012	SLV fondazioni 15	-0.20995	-0.62984	SLV fondazioni 1	-0.11264	-0.33791
3013	SLU 3	-0.29233	-0.877	SLU 2	-0.14951	-0.44854
3014	SLU 3	-0.29272	-0.87815	SLU 2	-0.15303	-0.4591
3015	SLU 3	-0.32049	-0.96147	SLU 2	-0.16016	-0.48048
3016	SLU 3	-0.32079	-0.96238	SLU 2	-0.16307	-0.48921
3017	SLU 3	-0.35804	-1.07411	SLU 2	-0.17237	-0.51711
3018	SLU 3	-0.35825	-1.07476	SLU 2	-0.17418	-0.52253
3019	SLU 3	-0.26498	-0.79495	SLU 2	-0.13709	-0.41126
3020	SLU 3	-0.35854	-1.07562	SLU 2	-0.17142	-0.51426
3021	SLU 3	-0.35874	-1.07622	SLU 2	-0.17298	-0.51894
3022	SLU 3	-0.26541	-0.79622	SLU 2	-0.14098	-0.42294
3023	SLU 3	-0.32104	-0.96311	SLU 2	-0.1587	-0.47609
3024	SLU 3	-0.32131	-0.96393	SLU 2	-0.16135	-0.48406
3025	SLU 3	-0.35805	-1.07416	SLU 2	-0.17019	-0.51058
3026	SLU 3	-0.35822	-1.07465	SLU 2	-0.1715	-0.51449
3027	SLU 3	-0.23666	-0.70999	SLU 2	-0.1238	-0.37141
3028	SLU 3	-0.29064	-0.87191	SLU 2	-0.14678	-0.44035
3029	SLU 3	-0.29099	-0.87296	SLU 2	-0.15006	-0.45018
3030	SLU 3	-0.23713	-0.71138	SLU 2	-0.12808	-0.38425
3031	SLV fondazioni 7	-0.20893	-0.62678	SLU 2	-0.10952	-0.32857
3032	SLU 3	-0.35658	-1.06973	SLU 2	-0.1687	-0.50611
3033	SLU 3	-0.35669	-1.07006	SLU 2	-0.16974	-0.50923
3034	SLV fondazioni 11	-0.20943	-0.62829	SLV fondazioni 5	-0.11017	-0.33051
3035	SLU 3	-0.3205	-0.9615	SLU 2	-0.15686	-0.47058



Tabulati di Calcolo Plinto di Fondazione per Aerogeneratore Tipo - Progetto Impianto Eolico - "Orione"

Nodo	Contesto	uz min	Minima	Contesto	uz max	Massima
3036	SLU 3	-0.32075	-0.96224	SLU 2	-0.15927	-0.47778
3037	SLU 3	-0.3581	-1.0743	SLU 2	-0.16884	-0.50651
3038	SLU 3	-0.35816	-1.07447	SLU 2	-0.16961	-0.50882
3039	SLU 3	-0.26438	-0.79313	SLU 2	-0.13496	-0.40489
3040	SLU 3	-0.26477	-0.79431	SLU 2	-0.13861	-0.41582
3041	SLU 3	-0.35862	-1.07586	SLU 2	-0.16869	-0.50607
3042	SLU 3	-0.35864	-1.07592	SLU 2	-0.1692	-0.50759
3043	SLU 3	-0.29235	-0.87704	SLU 2	-0.14595	-0.43784
3044	SLU 3	-0.29266	-0.87799	SLU 2	-0.14896	-0.44688
3045	SLU 3	-0.35813	-1.07438	SLU 2	-0.16828	-0.50483
3046	SLU 3	-0.35813	-1.07438	SLU 2	-0.16853	-0.50558
3047	SLU 3	-0.35663	-1.06988	SLU 2	-0.1676	-0.5028
3048	SLU 3	-0.23729	-0.71187	SLU 2	-0.12242	-0.36725
3049	SLU 3	-0.23772	-0.71317	SLU 2	-0.12644	-0.37933
3050	SLU 3	-0.31889	-0.95667	SLU 2	-0.15468	-0.46405
3051	SLU 3	-0.31912	-0.95735	SLU 2	-0.15684	-0.47052
3052	SLU 3	-0.29293	-0.8788	SLU 2	-0.14467	-0.434
3053	SLU 3	-0.29322	-0.87965	SLU 2	-0.14742	-0.44227
3054	SLV fondazioni 7	-0.21107	-0.6332	SLU 2	-0.10897	-0.3269
3055	SLV fondazioni 11	-0.21154	-0.63461	SLV fondazioni 5	-0.11095	-0.33286
3056	SLU 3	-0.32051	-0.96152	SLU 2	-0.15425	-0.46276
3057	SLU 3	-0.32071	-0.96214	SLU 2	-0.15615	-0.46844
3058	SLU 3	-0.2626	-0.78779	SLU 2	-0.13238	-0.39715
3059	SLU 3	-0.26296	-0.78887	SLU 2	-0.13578	-0.40733
3060	SLU 3	-0.32106	-0.96317	SLU 2	-0.15347	-0.4604
3061	SLU 3	-0.32124	-0.96372	SLU 2	-0.1551	-0.4653
3062	SLU 3	-0.23667	-0.71001	SLU 2	-0.12049	-0.36146
3063	SLU 3	-0.29236	-0.87708	SLU 2	-0.14297	-0.4289
3064	SLU 3	-0.29262	-0.87785	SLU 2	-0.14546	-0.43638
3065	SLU 3	-0.23707	-0.71121	SLU 2	-0.12426	-0.37277
3066	SLU 3	-0.26439	-0.79317	SLU 2	-0.13177	-0.39531
3067	SLU 3	-0.32053	-0.96158	SLU 2	-0.15234	-0.45703
3068	SLU 3	-0.32068	-0.96203	SLU 2	-0.15371	-0.46112
3069	SLU 3	-0.26472	-0.79415	SLU 2	-0.13489	-0.40467
3070	SLV fondazioni 7	-0.21222	-0.63666	SLU 2	-0.10781	-0.32343
3071	SLV fondazioni 11	-0.21266	-0.63798	SLV fondazioni 5	-0.11078	-0.33235
3072	SLU 3	-0.31893	-0.95679	SLU 2	-0.1509	-0.4527
3073	SLU 3	-0.31904	-0.95713	SLU 2	-0.15199	-0.45598
3074	SLU 3	-0.29066	-0.87199	SLU 2	-0.14088	-0.42265
3075	SLU 3	-0.29089	-0.87268	SLU 2	-0.14312	-0.42935
3076	SLU 3	-0.32056	-0.96168	SLU 2	-0.15116	-0.45349
3077	SLU 3	-0.32063	-0.9619	SLU 2	-0.15198	-0.45594
3078	SLU 3	-0.32111	-0.96334	SLU 2	-0.1511	-0.45329
3079	SLU 3	-0.32116	-0.96347	SLU 2	-0.15164	-0.45492
3080	SLU 3	-0.26501	-0.79502	SLU 2	-0.13067	-0.39201
3081	SLU 3	-0.2653	-0.7959	SLU 2	-0.13352	-0.40057
3082	SLU 3	-0.23485	-0.70455	SLU 2	-0.11807	-0.3542
3083	SLU 3	-0.32058	-0.96175	SLU 2	-0.1507	-0.45211
3084	SLU 3	-0.3206	-0.96181	SLU 2	-0.15097	-0.45292
3085	SLU 3	-0.23522	-0.70565	SLU 2	-0.12158	-0.36474
3086	SLU 3	-0.29237	-0.87712	SLU 2	-0.14062	-0.42186
3087	SLU 3	-0.29258	-0.87773	SLU 2	-0.14258	-0.42775
3088	SLU 3	-0.31898	-0.95694	SLU 2	-0.14999	-0.44998
3089	SLV fondazioni 7	-0.21239	-0.63716	SLU 2	-0.10607	-0.31821
3090	SLV fondazioni 11	-0.21279	-0.63838	SLV fondazioni 5	-0.10961	-0.32882
3091	SLU 3	-0.29296	-0.87887	SLU 2	-0.13996	-0.41988
3092	SLU 3	-0.29314	-0.87941	SLU 2	-0.14165	-0.42495
3093	SLU 3	-0.2644	-0.79321	SLU 2	-0.1291	-0.38731
3094	SLU 3	-0.26467	-0.794	SLU 2	-0.13169	-0.39506
3095	SLU 3	-0.23668	-0.71005	SLU 2	-0.11765	-0.35296
3096	SLU 3	-0.23702	-0.71105	SLU 2	-0.12089	-0.36266
3097	SLU 3	-0.29239	-0.87717	SLU 2	-0.13891	-0.41674
3098	SLU 3	-0.29254	-0.87762	SLU 2	-0.14032	-0.42097
3099	SLU 3	-0.26262	-0.78787	SLU 2	-0.12711	-0.38134
3100	SLU 3	-0.2907	-0.8721	SLU 2	-0.1375	-0.4125
3101	SLU 3	-0.29082	-0.87245	SLU 2	-0.13863	-0.41589
3102	SLU 3	-0.26286	-0.78858	SLU 2	-0.12943	-0.38828
3103	SLU 3	-0.23731	-0.71194	SLU 2	-0.11673	-0.35018
3104	SLU 3	-0.29242	-0.87726	SLU 2	-0.13787	-0.4136
3105	SLU 3	-0.2925	-0.8775	SLU 2	-0.13872	-0.41615
3106	SLU 3	-0.23761	-0.71284	SLU 2	-0.11968	-0.35904
3107	SLV fondazioni 7	-0.21157	-0.63472	SLU 2	-0.10379	-0.31137
3108	SLV fondazioni 11	-0.21195	-0.63585	SLU 2	-0.10742	-0.32227
3109	SLU 3	-0.29301	-0.87903	SLU 2	-0.13786	-0.41359
3110	SLU 3	-0.29306	-0.87918	SLU 2	-0.13843	-0.41528
3111	SLU 3	-0.26442	-0.79325	SLU 2	-0.12702	-0.38105
3112	SLU 3	-0.29244	-0.87733	SLU 2	-0.13748	-0.41245
3113	SLU 3	-0.29247	-0.87741	SLU 2	-0.13777	-0.4133
3114	SLU 3	-0.26463	-0.79388	SLU 2	-0.12905	-0.38714
3115	SLU 3	-0.29075	-0.87226	SLU 2	-0.13674	-0.41022
3116	SLU 3	-0.26504	-0.79511	SLU 2	-0.12648	-0.37944
3117	SLU 3	-0.26522	-0.79565	SLU 2	-0.12822	-0.38467
3118	SLU 3	-0.2367	-0.71009	SLU 2	-0.1153	-0.3459
3119	SLU 3	-0.23697	-0.7109	SLU 2	-0.11798	-0.35393
3120	SLV fondazioni 7	-0.21332	-0.63996	SLU 2	-0.10359	-0.31077
3121	SLV fondazioni 11	-0.21366	-0.64099	SLU 2	-0.10693	-0.3208
3122	SLU 3	-0.26444	-0.79331	SLU 2	-0.12551	-0.37652
3123	SLU 3	-0.26459	-0.79376	SLU 2	-0.12697	-0.3809
3124	SLU 3	-0.23488	-0.70463	SLU 2	-0.11342	-0.34026
3125	SLU 3	-0.23512	-0.70535	SLU 2	-0.11581	-0.34744
3126	SLV fondazioni 7	-0.21409	-0.64226	SLU 2	-0.10284	-0.30852
3127	SLU 3	-0.26266	-0.78799	SLU 2	-0.12413	-0.37238
3128	SLU 3	-0.26278	-0.78834	SLU 2	-0.1253	-0.3759
3129	SLV fondazioni 11	-0.2144	-0.64319	SLU 2	-0.10589	-0.31768
3130	SLU 3	-0.26446	-0.79339	SLU 2	-0.1246	-0.37379
3131	SLU 3	-0.26455	-0.79365	SLU 2	-0.12547	-0.37642
3132	SLU 3	-0.26509	-0.79526	SLU 2	-0.12465	-0.37395



Nodo	Contesto	uz min	Minima	Contesto	uz max	Massima
3133	SLU 3	-0.26514	-0.79542	SLU 2	-0.12524	-0.37571
3134	SLU 3	-0.23671	-0.71014	SLU 2	-0.11347	-0.3404
3135	SLU 3	-0.23692	-0.71077	SLU 2	-0.11557	-0.3467
3136	SLU 3	-0.26449	-0.79347	SLU 2	-0.12428	-0.37285
3137	SLU 3	-0.26452	-0.79355	SLU 2	-0.12458	-0.37373
3138	SLU 3	-0.26272	-0.78815	SLU 2	-0.12352	-0.37055
3139	SLV fondazioni 7	-0.21386	-0.64158	SLU 2	-0.10155	-0.30466
3140	SLV fondazioni 11	-0.21414	-0.64242	SLU 2	-0.10432	-0.31295
3141	SLU 3	-0.23734	-0.71203	SLU 2	-0.11304	-0.33913
3142	SLU 3	-0.23753	-0.71258	SLU 2	-0.11485	-0.34455
3143	SLU 3	-0.23673	-0.7102	SLU 2	-0.11215	-0.33645
3144	SLU 3	-0.23688	-0.71065	SLU 2	-0.11366	-0.34098
3145	SLV fondazioni 7	-0.21266	-0.63797	SLU 2	-0.09976	-0.29927
3146	SLV fondazioni 11	-0.21291	-0.63872	SLU 2	-0.10223	-0.3067
3147	SLU 3	-0.23492	-0.70475	SLU 2	-0.11082	-0.33246
3148	SLU 3	-0.23503	-0.7051	SLU 2	-0.11203	-0.3361
3149	SLU 3	-0.23676	-0.71027	SLU 2	-0.11138	-0.33413
3150	SLU 3	-0.23684	-0.71053	SLU 2	-0.11228	-0.33685
3151	SLV fondazioni 7	-0.21401	-0.64202	SLU 2	-0.09996	-0.29989
3152	SLU 3	-0.23739	-0.71218	SLU 2	-0.11148	-0.33445
3153	SLU 3	-0.23745	-0.71235	SLU 2	-0.11209	-0.33626
3154	SLV fondazioni 11	-0.21422	-0.64267	SLU 2	-0.10213	-0.3064
3155	SLU 3	-0.23678	-0.71035	SLU 2	-0.11114	-0.33341
3156	SLU 3	-0.23681	-0.71044	SLU 2	-0.11144	-0.33432
3157	SLU 3	-0.23497	-0.70491	SLU 2	-0.11035	-0.33106
3158	SLV fondazioni 7	-0.21437	-0.64312	SLU 2	-0.09966	-0.29897
3159	SLV fondazioni 11	-0.21456	-0.64368	SLU 2	-0.10152	-0.30457
3160	SLV fondazioni 7	-0.21375	-0.64126	SLU 2	-0.09884	-0.29653
3161	SLV fondazioni 11	-0.21391	-0.64173	SLU 2	-0.1004	-0.30121
3162	SLV fondazioni 7	-0.21215	-0.63645	SLU 2	-0.09754	-0.29263
3163	SLV fondazioni 11	-0.21228	-0.63683	SLU 2	-0.0988	-0.29639
3164	SLV fondazioni 7	-0.21311	-0.63932	SLU 2	-0.0982	-0.29459
3165	SLV fondazioni 11	-0.2132	-0.6396	SLU 2	-0.09914	-0.29741
3166	SLV fondazioni 7	-0.21308	-0.63925	SLU 2	-0.09836	-0.29508
3167	SLV fondazioni 11	-0.21315	-0.63944	SLU 2	-0.09899	-0.29696
3168	SLV fondazioni 7	-0.21207	-0.63621	SLU 2	-0.09803	-0.29409
3169	SLV fondazioni 11	-0.2121	-0.63631	SLU 2	-0.09834	-0.29503
3170	SLV fondazioni 11	-0.21008	-0.63023	SLU 2	-0.09722	-0.29166

## 8.2 Tagli ai livelli

Livello: Livello rispetto a cui è calcolato il taglio.

Contesto: Contesto nel quale viene valutato il taglio.

Totale: Totale del taglio al livello.

F: Forza del taglio. [daN]

X: Componente lungo l'asse X globale. [daN]

Y: Componente lungo l'asse Y globale. [daN]

Z: Componente lungo l'asse Z globale. [daN]

Aste verticali: Contributo al taglio totale dato dalle aste verticali.

F: Forza del taglio. [daN]

X: Componente lungo l'asse X globale. [daN]

Y: Componente lungo l'asse Y globale. [daN]

Z: Componente lungo l'asse Z globale. [daN]

Pareti: Contributo al taglio totale dato dalle pareti e piastre generiche verticali.

F: Forza del taglio. [daN]

X: Componente lungo l'asse X globale. [daN]

Y: Componente lungo l'asse Y globale. [daN]

Z: Componente lungo l'asse Z globale. [daN]

Livello	Contesto	Totale			Aste verticali			Pareti		
		X	Y	Z	X	Y	Z	X	Y	Z
Piano 2	Condizione Pesi strutturali	5	-4	-188795	0	0	0	0	0	0
Piano 2	Condizione Vento	10444	-122528	-57	0	0	0	0	0	0
Piano 2	Condizione Sisma X SLV	512980	-31	33	0	0	0	0	0	0
Piano 2	Condizione Sisma Y SLV	-200	689389	1153	0	0	0	0	0	0
Piano 2	Condizione Sisma X SLD	219368	-14	14	0	0	0	0	0	0
Piano 2	Condizione Sisma Y SLD	-86	295125	494	0	0	0	0	0	0
Piano 2	Condizione Rig. Ux	1	0	0	0	0	0	0	0	0
Piano 2	Condizione Rig. Uy	0	1	0	0	0	0	0	0	0
Piano 2	Condizione Rig. Rz	0	0	0	0	0	0	0	0	0
Piano 2	SLU 1	5	-4	-188795	0	0	0	0	0	0
Piano 2	SLU 2	15671	-183796	-188880	0	0	0	0	0	0
Piano 2	SLU 3	7	-5	-245433	0	0	0	0	0	0
Piano 2	SLU 4	15673	-183797	-245518	0	0	0	0	0	0
Piano 2	SLE rara 1	5	-4	-188795	0	0	0	0	0	0
Piano 2	SLE rara 2	10449	-122532	-188851	0	0	0	0	0	0
Piano 2	SLE frequente 1	5	-4	-188795	0	0	0	0	0	0
Piano 2	SLE frequente 2	5227	-61268	-188823	0	0	0	0	0	0
Piano 2	SLE quasi permanente 1	5	-4	-188795	0	0	0	0	0	0
Piano 2	SLE quasi permanente 2	3138	-36762	-188812	0	0	0	0	0	0
Piano 2	SLD 1	-219337	-88527	-188957	0	0	0	0	0	0



Tabulati di Calcolo Plinto di Fondazione per Aerogeneratore Tipo - Progetto Impianto Eolico - "Orione"

Livello	Contesto	Totale			Aste verticali			Pareti		
		F			F			F		
		X	Y	Z	X	Y	Z	X	Y	Z
Piano 2	SLD 2	-219337	-88527	-188957	0	0	0	0	0	0
Piano 2	SLD 3	-219389	88548	-188661	0	0	0	0	0	0
Piano 2	SLD 4	-219389	88548	-188661	0	0	0	0	0	0
Piano 2	SLD 5	-65719	-295124	-189293	0	0	0	0	0	0
Piano 2	SLD 6	-65719	-295124	-189293	0	0	0	0	0	0
Piano 2	SLD 7	-65891	295125	-188305	0	0	0	0	0	0
Piano 2	SLD 8	-65891	295125	-188305	0	0	0	0	0	0
Piano 2	SLD 9	65902	-295133	-189284	0	0	0	0	0	0
Piano 2	SLD 10	65902	-295133	-189284	0	0	0	0	0	0
Piano 2	SLD 11	65730	295117	-188297	0	0	0	0	0	0
Piano 2	SLD 12	65730	295117	-188297	0	0	0	0	0	0
Piano 2	SLD 13	219400	-88555	-188929	0	0	0	0	0	0
Piano 2	SLD 14	219400	-88555	-188929	0	0	0	0	0	0
Piano 2	SLD 15	219348	88520	-188633	0	0	0	0	0	0
Piano 2	SLD 16	219348	88520	-188633	0	0	0	0	0	0
Piano 2	SLV 1	-512914	-206789	-189173	0	0	0	0	0	0
Piano 2	SLV 2	-512914	-206789	-189173	0	0	0	0	0	0
Piano 2	SLV 3	-513034	206844	-188481	0	0	0	0	0	0
Piano 2	SLV 4	-513034	206844	-188481	0	0	0	0	0	0
Piano 2	SLV 5	-153689	-689383	-189958	0	0	0	0	0	0
Piano 2	SLV 6	-153689	-689383	-189958	0	0	0	0	0	0
Piano 2	SLV 7	-154089	689395	-187651	0	0	0	0	0	0
Piano 2	SLV 8	-154089	689395	-187651	0	0	0	0	0	0
Piano 2	SLV 9	154099	-689402	-189938	0	0	0	0	0	0
Piano 2	SLV 10	154099	-689402	-189938	0	0	0	0	0	0
Piano 2	SLV 11	153699	689376	-187632	0	0	0	0	0	0
Piano 2	SLV 12	153699	689376	-187632	0	0	0	0	0	0
Piano 2	SLV 13	513045	-206852	-189108	0	0	0	0	0	0
Piano 2	SLV 14	513045	-206852	-189108	0	0	0	0	0	0
Piano 2	SLV 15	512925	206782	-188416	0	0	0	0	0	0
Piano 2	SLV 16	512925	206782	-188416	0	0	0	0	0	0
Piano 2	SLV fondazioni 1	-512914	-206789	-189173	0	0	0	0	0	0
Piano 2	SLV fondazioni 2	-512914	-206789	-189173	0	0	0	0	0	0
Piano 2	SLV fondazioni 3	-513034	206844	-188481	0	0	0	0	0	0
Piano 2	SLV fondazioni 4	-513034	206844	-188481	0	0	0	0	0	0
Piano 2	SLV fondazioni 5	-153689	-689383	-189958	0	0	0	0	0	0
Piano 2	SLV fondazioni 6	-153689	-689383	-189958	0	0	0	0	0	0
Piano 2	SLV fondazioni 7	-154089	689395	-187651	0	0	0	0	0	0
Piano 2	SLV fondazioni 8	-154089	689395	-187651	0	0	0	0	0	0
Piano 2	SLV fondazioni 9	154099	-689402	-189938	0	0	0	0	0	0
Piano 2	SLV fondazioni 10	154099	-689402	-189938	0	0	0	0	0	0
Piano 2	SLV fondazioni 11	153699	689376	-187632	0	0	0	0	0	0
Piano 2	SLV fondazioni 12	153699	689376	-187632	0	0	0	0	0	0
Piano 2	SLV fondazioni 13	513045	-206852	-189108	0	0	0	0	0	0
Piano 2	SLV fondazioni 14	513045	-206852	-189108	0	0	0	0	0	0
Piano 2	SLV fondazioni 15	512925	206782	-188416	0	0	0	0	0	0
Piano 2	SLV fondazioni 16	512925	206782	-188416	0	0	0	0	0	0
Piano 2	Calcolo centri rigidzze Rig. Ux+	1	0	0	0	0	0	0	0	0
Piano 2	Calcolo centri rigidzze Rig. Ux-	-1	0	0	0	0	0	0	0	0
Piano 2	Calcolo centri rigidzze Rig. Uy+	0	1	0	0	0	0	0	0	0
Piano 2	Calcolo centri rigidzze Rig. Uy-	0	-1	0	0	0	0	0	0	0
Piano 2	Calcolo centri rigidzze Rig. Rz+	0	0	0	0	0	0	0	0	0
Piano 2	Calcolo centri rigidzze Rig. Rz-	0	0	0	0	0	0	0	0	0
Piano 1	Condizione Pesi strutturali	23	-26	-552940	0	0	0	0	0	0
Piano 1	Condizione Vento	9465	628400	3	0	0	0	0	0	0
Piano 1	Condizione Sisma X SLV	364283	43	68	0	0	0	0	0	0
Piano 1	Condizione Sisma Y SLV	-189	506343	-829	0	0	0	0	0	0
Piano 1	Condizione Sisma X SLD	155787	18	29	0	0	0	0	0	0
Piano 1	Condizione Sisma Y SLD	-81	216763	-355	0	0	0	0	0	0
Piano 1	Condizione Rig. Ux	1	0	0	0	0	0	0	0	0
Piano 1	Condizione Rig. Uy	0	1	0	0	0	0	0	0	0
Piano 1	Condizione Rig. Rz	0	0	0	0	0	0	0	0	0
Piano 1	SLU 1	23	-26	-552940	0	0	0	0	0	0
Piano 1	SLU 2	14221	942575	-552936	0	0	0	0	0	0
Piano 1	SLU 3	30	-33	-718823	0	0	0	0	0	0
Piano 1	SLU 4	14228	942567	-718818	0	0	0	0	0	0
Piano 1	SLE rara 1	23	-26	-552940	0	0	0	0	0	0
Piano 1	SLE rara 2	9488	628375	-552937	0	0	0	0	0	0
Piano 1	SLE frequente 1	23	-26	-552940	0	0	0	0	0	0
Piano 1	SLE frequente 2	4755	314174	-552939	0	0	0	0	0	0
Piano 1	SLE quasi permanente 1	23	-26	-552940	0	0	0	0	0	0
Piano 1	SLE quasi permanente 2	2862	188494	-552940	0	0	0	0	0	0
Piano 1	SLD 1	-155740	-65073	-552863	0	0	0	0	0	0
Piano 1	SLD 2	-155740	-65073	-552863	0	0	0	0	0	0
Piano 1	SLD 3	-155789	64985	-553076	0	0	0	0	0	0
Piano 1	SLD 4	-155789	64985	-553076	0	0	0	0	0	0
Piano 1	SLD 5	-46632	-216795	-552594	0	0	0	0	0	0
Piano 1	SLD 6	-46632	-216795	-552594	0	0	0	0	0	0
Piano 1	SLD 7	-46794	216732	-553304	0	0	0	0	0	0
Piano 1	SLD 8	-46794	216732	-553304	0	0	0	0	0	0
Piano 1	SLD 9	46840	-216784	-552577	0	0	0	0	0	0
Piano 1	SLD 10	46840	-216784	-552577	0	0	0	0	0	0
Piano 1	SLD 11	46678	216743	-553287	0	0	0	0	0	0



Livello	Contesto	Totale			Aste verticali			Pareti		
		X	Y	Z	X	Y	Z	X	Y	Z
Piano 1	SLD 12	46678	216743	-553287	0	0	0	0	0	0
Piano 1	SLD 13	155834	-65037	-552805	0	0	0	0	0	0
Piano 1	SLD 14	155834	-65037	-552805	0	0	0	0	0	0
Piano 1	SLD 15	155786	65021	-553018	0	0	0	0	0	0
Piano 1	SLD 16	155786	65021	-553018	0	0	0	0	0	0
Piano 1	SLV 1	-364204	-151971	-552760	0	0	0	0	0	0
Piano 1	SLV 2	-364204	-151971	-552760	0	0	0	0	0	0
Piano 1	SLV 3	-364317	151835	-553257	0	0	0	0	0	0
Piano 1	SLV 4	-364317	151835	-553257	0	0	0	0	0	0
Piano 1	SLV 5	-109074	-506382	-552132	0	0	0	0	0	0
Piano 1	SLV 6	-109074	-506382	-552132	0	0	0	0	0	0
Piano 1	SLV 7	-109451	506305	-553790	0	0	0	0	0	0
Piano 1	SLV 8	-109451	506305	-553790	0	0	0	0	0	0
Piano 1	SLV 9	109496	-506356	-552091	0	0	0	0	0	0
Piano 1	SLV 10	109496	-506356	-552091	0	0	0	0	0	0
Piano 1	SLV 11	109119	506330	-553749	0	0	0	0	0	0
Piano 1	SLV 12	109119	506330	-553749	0	0	0	0	0	0
Piano 1	SLV 13	364363	-151886	-552624	0	0	0	0	0	0
Piano 1	SLV 14	364363	-151886	-552624	0	0	0	0	0	0
Piano 1	SLV 15	364249	151920	-553121	0	0	0	0	0	0
Piano 1	SLV 16	364249	151920	-553121	0	0	0	0	0	0
Piano 1	SLV fondazioni 1	-364204	-151971	-552760	0	0	0	0	0	0
Piano 1	SLV fondazioni 2	-364204	-151971	-552760	0	0	0	0	0	0
Piano 1	SLV fondazioni 3	-364317	151835	-553257	0	0	0	0	0	0
Piano 1	SLV fondazioni 4	-364317	151835	-553257	0	0	0	0	0	0
Piano 1	SLV fondazioni 5	-109074	-506382	-552132	0	0	0	0	0	0
Piano 1	SLV fondazioni 6	-109074	-506382	-552132	0	0	0	0	0	0
Piano 1	SLV fondazioni 7	-109451	506305	-553790	0	0	0	0	0	0
Piano 1	SLV fondazioni 8	-109451	506305	-553790	0	0	0	0	0	0
Piano 1	SLV fondazioni 9	109496	-506356	-552091	0	0	0	0	0	0
Piano 1	SLV fondazioni 10	109496	-506356	-552091	0	0	0	0	0	0
Piano 1	SLV fondazioni 11	109119	506330	-553749	0	0	0	0	0	0
Piano 1	SLV fondazioni 12	109119	506330	-553749	0	0	0	0	0	0
Piano 1	SLV fondazioni 13	364363	-151886	-552624	0	0	0	0	0	0
Piano 1	SLV fondazioni 14	364363	-151886	-552624	0	0	0	0	0	0
Piano 1	SLV fondazioni 15	364249	151920	-553121	0	0	0	0	0	0
Piano 1	SLV fondazioni 16	364249	151920	-553121	0	0	0	0	0	0
Piano 1	Calcolo centri rigidezze Rig. Ux+	1	0	0	0	0	0	0	0	0
Piano 1	Calcolo centri rigidezze Rig. Ux-	-1	0	0	0	0	0	0	0	0
Piano 1	Calcolo centri rigidezze Rig. Uy+	0	1	0	0	0	0	0	0	0
Piano 1	Calcolo centri rigidezze Rig. Uy-	0	-1	0	0	0	0	0	0	0
Piano 1	Calcolo centri rigidezze Rig. Rz+	0	0	0	0	0	0	0	0	0
Piano 1	Calcolo centri rigidezze Rig. Rz-	0	0	0	0	0	0	0	0	0

### 8.3 Risposta modale

Modo: Identificativo del modo di vibrare.

Periodo: Periodo. [s]

Massa X: Massa partecipante in direzione globale X. Il valore è adimensionale.

Massa Y: Massa partecipante in direzione globale Y. Il valore è adimensionale.

Massa Z: Massa partecipante in direzione globale Z. Il valore è adimensionale.

Massa rot X: Massa rotazionale partecipante attorno la direzione globale X. Il valore è adimensionale.

Massa rot Y: Massa rotazionale partecipante attorno la direzione globale Y. Il valore è adimensionale.

Massa rot Z: Massa rotazionale partecipante attorno la direzione globale Z. Il valore è adimensionale.

Totale masse partecipanti:

Traslazione X: 0.99976

Traslazione Y: 0.9968

Traslazione Z: 0

Rotazione X: 0.20801

Rotazione Y: 0.78153

Rotazione Z: 0.02932

Modo	Periodo	Massa X	Massa Y	Massa Z	Massa rot X	Massa rot Y	Massa rot Z
1	0.191053	0.99518	0	0	0	0.21695	0
2	0.19075	0	0.9968	0	0.20801	0	0
3	0.045342	0.00458	0	0	0	0.56458	0.02932

### 8.4 Equilibrio forze

Contributo: Nome attribuito al sistema risultante.

Fx: Componente X di traslazione del sistema risultante. [daN]

Fy: Componente Y di traslazione del sistema risultante. [daN]

Fz: Componente Z di traslazione del sistema risultante. [daN]

Mx: Componente di momento attorno l'asse X del sistema risultante. [daN\*cm]

My: Componente di momento attorno l'asse Y del sistema risultante. [daN\*cm]

Mz: Componente di momento attorno l'asse Z del sistema risultante. [daN\*cm]



Progetto	Titolo	Rev.	Pag.
Orione	Orione_A24a.pdf "TABULATI DI CALCOLO PLINTO DI FONDAZIONE PER AEROGENERATORE TIPO"	0	173

**Bilancio in condizione di carico: Pesì strutturali**

Contributo	Fx	Fy	Fz	Mx	My	Mz
Applicate	0	0	-17920000	0	0	0
Reazioni	0	0	17920000	0	0	0
PDelta	0	0	0	0	0	0
Totale	0	0	0	0	0	0

**Bilancio in condizione di carico: Vento**

Contributo	Fx	Fy	Fz	Mx	My	Mz
Applicate	248000	0	0	2895000000	49600000	117000000
Reazioni	-248000	0	0	-2895000000	-49600000	-117000000
PDelta	0	0	0	0	0	0
Totale	0	0	0	0	0	0

**Bilancio in condizione di carico: Sisma X SLV**

Contributo	Fx	Fy	Fz	Mx	My	Mz
Applicate	3428000	0	0	0	785100000	0
Reazioni	-3428000	0	0	0	-785100000	0
PDelta	0	0	0	0	0	0
Totale	0	0	0	0	0	0

**Bilancio in condizione di carico: Sisma Y SLV**

Contributo	Fx	Fy	Fz	Mx	My	Mz
Applicate	0	3428000	0	-785100000	0	0
Reazioni	0	-3428000	0	785100000	0	0
PDelta	0	0	0	0	0	0
Totale	0	0	0	0	0	0

**Bilancio in condizione di carico: Sisma X SLD**

Contributo	Fx	Fy	Fz	Mx	My	Mz
Applicate	1574000	0	0	0	360500000	0
Reazioni	-1574000	0	0	0	-360500000	0
PDelta	0	0	0	0	0	0
Totale	0	0	0	0	0	0

**Bilancio in condizione di carico: Sisma Y SLD**

Contributo	Fx	Fy	Fz	Mx	My	Mz
Applicate	0	1574000	0	-360500000	0	0
Reazioni	0	-1574000	0	360500000	0	0
PDelta	0	0	0	0	0	0
Totale	0	0	0	0	0	0

**Bilancio in condizione di carico: Rig. Ux**

Contributo	Fx	Fy	Fz	Mx	My	Mz
Applicate	1	0	0	0	600	0
Reazioni	-1	0	0	0	-600	0
PDelta	0	0	0	0	0	0
Totale	0	0	0	0	0	0

**Bilancio in condizione di carico: Rig. Uy**

Contributo	Fx	Fy	Fz	Mx	My	Mz
Applicate	0	1	0	-600	0	0
Reazioni	0	-1	0	600	0	0
PDelta	0	0	0	0	0	0
Totale	0	0	0	0	0	0

**Bilancio in condizione di carico: Rig. Rz**

Contributo	Fx	Fy	Fz	Mx	My	Mz
Applicate	0	0	0	0	0	1
Reazioni	0	0	0	0	0	-1
PDelta	0	0	0	0	0	0
Totale	0	0	0	0	0	0



## 8.5 Risposta di spettro

Spettro: Condizione elementare corrispondente allo spettro.

Fx: Componente della forza lungo l'asse X. [daN]

Fy: Componente della forza lungo l'asse Y. [daN]

Fz: Componente della forza lungo l'asse Z. [daN]

Mx: Componente della coppia attorno all'asse X. [daN\*cm]

My: Componente della coppia attorno all'asse Y. [daN\*cm]

Mz: Componente della coppia attorno all'asse Z. [daN\*cm]

Max X: Massima reazione lungo l'asse X.

Valore: Valore massimo della reazione. [daN]

Angolo: Angolo d'ingresso del sisma che provoca il valore massimo della reazione. [deg]

Max Y: Massima reazione lungo l'asse Y.

Valore: Valore massimo della reazione. [daN]

Angolo: Angolo d'ingresso del sisma che provoca il valore massimo della reazione. [deg]

Max Z: Massima reazione lungo l'asse Z.

Valore: Valore massimo della reazione. [daN]

Angolo: Angolo d'ingresso del sisma che provoca il valore massimo della reazione. [deg]

Spettro	Fx	Fy	Fz	Mx	My	Mz	Max X		Max Y		Max Z	
							Valore	Angolo	Valore	Angolo	Valore	Angolo
Sisma X SLV	9247600	377.78	0	78929	7.81E08	54870000	9247600	0	9253700	90	0	0
Sisma Y SLV	377.78	9253700	0	7.63E08	111580	8384900	9247600	0	9253700	90	0	0
Sisma X SLD	3955100	162.13	0	34680	3.34E08	24297000	3955100	179	3961500	90	0	0
Sisma Y SLD	162.13	3961500	0	3.27E08	48823	3589600	3955100	179	3961500	90	0	0

## 8.6 Annotazioni solutore

Informazioni: Informazioni fornite dal solutore al termine del calcolo del modello.

Informazioni

## 8.7 Statistiche soluzione

Tipo di equazioni	Lineari
Tecnica di soluzione	Matrici sparse
Numero equazioni	20322
Elemento minimo diagonale	487000
Elemento massimo	32090000000000
Rapporto max/min	65890000
Elementi non nulli	511728



Progetto	Titolo	Rev.	Pag.
Orione	Orione_A24a.pdf "TABULATI DI CALCOLO PLINTO DI FONDAZIONE PER AEROGENERATORE TIPO"	0	175



9 Verifiche

9.1 Verifiche piastre e pareti C.A.

VERIFICA PRIMO ANELLO

Valori in daN, cm

rck 370

fyk 4500

Verifica di stato limite ultimo

nod sez	B	H	Af+	Af-	c+	c-	c.s.	comb	N	M	Nu	Mu
543	o 100 300	32.2	21.2	9.8	8.9	2.700	4 SLU	0	13362919	0	-36081700	
	v 100 300	32.2	21.2	6.6	6.3	1.131	4 SLU	0	32267767	0	-36484313	
544	o 100 300	32.2	21.2	9.8	8.9	2.740	4 SLU	0	13168103	0	-36081700	
	v 100 300	32.2	21.2	6.6	6.3	1.139	4 SLU	0	32035183	0	-36484313	
1779	o 100 300	24.1	15.9	9.8	8.9	1.328	4 SLU	0	20439533	0	-27147926	
	v 0 0	0.0	0.0	0.0	0.0	0.000	0	0	0	0	0	0

Combinazione rara

nod sez	B	H	Af+	Af-	c+	c-	sc	c	N	M	sf	c	N	M	Wk (mm)	st	Sm (mm)	c
543	o 100 300	32.2	21.2	9.8	8.9	-13.7	2	0.00E00	9.65E06	1089.3	2	0.00E00	9.65E06	0.00	6.2	0.0	1	
	v 100 300	32.2	21.2	6.6	6.3	-33.0	2	0.00E00	2.38E07	2647.2	2	0.00E00	2.38E07	0.00	15.4	0.0	1	
544	o 100 300	32.2	21.2	9.8	8.9	-13.5	2	0.00E00	9.51E06	1073.4	2	0.00E00	9.51E06	0.00	6.2	0.0	1	
	v 100 300	32.2	21.2	6.6	6.3	-32.7	2	0.00E00	2.36E07	2627.8	2	0.00E00	2.36E07	0.00	15.2	0.0	1	

Combinazione frequente

nod sez	B	H	Af+	Af-	c+	c-	sc	c	N	M	sf	c	N	M	Wk (mm)	st	Sm (mm)	c
543	o 100 300	32.2	21.2	9.8	8.9	-10.8	2	0.00E00	7.62E06	860.3	2	0.00E00	7.62E06	0.00	4.9	0.0	1	
	v 100 300	32.2	21.2	6.6	6.3	-28.2	2	0.00E00	2.03E07	2262.1	2	0.00E00	2.03E07	0.00	13.1	0.0	1	
544	o 100 300	32.2	21.2	9.8	8.9	-10.7	2	0.00E00	7.51E06	847.4	2	0.00E00	7.51E06	0.00	4.9	0.0	1	
	v 100 300	32.2	21.2	6.6	6.3	-27.9	2	0.00E00	2.01E07	2244.4	2	0.00E00	2.01E07	0.00	13.0	0.0	1	

Combinazione quasi permanente

nod sez	B	H	Af+	Af-	c+	c-	sc	c	N	M	sf	c	N	M	Wk (mm)	st	Sm (mm)	c
543	o 100 300	32.2	21.2	9.8	8.9	-9.7	2	0.00E00	6.81E06	768.6	2	0.00E00	6.81E06	0.00	4.4	0.0	1	
	v 100 300	32.2	21.2	6.6	6.3	-26.2	2	0.00E00	1.89E07	2108.1	2	0.00E00	1.89E07	0.00	12.2	0.0	1	
544	o 100 300	32.2	21.2	9.8	8.9	-9.5	2	0.00E00	6.71E06	757.0	2	0.00E00	6.71E06	0.00	4.3	0.0	1	
	v 100 300	32.2	21.2	6.6	6.3	-26.0	2	0.00E00	1.88E07	2091.0	2	0.00E00	1.88E07	0.00	12.1	0.0	1	

VERIFICA SECONDO ANELLO

Valori in daN, cm

rck 370

fyk 4500

Verifica di stato limite ultimo

nod sez	B	H	Af+	Af-	c+	c-	c.s.	comb	N	M	Nu	Mu
627	o 100 315	40.2	26.5	9.8	8.9	1.875	4 SLU	0	25234923	0	-47306887	
	v 100 315	40.2	26.5	6.6	6.3	1.082	4 SLU	0	44225559	0	-47831814	
633	o 100 315	40.2	26.5	9.8	8.9	1.715	4 SLU	0	27577084	0	-47306887	
	v 100 315	40.2	26.5	6.6	6.3	1.080	4 SLU	0	44292654	0	-47831814	
1231	o 100 315	40.2	26.5	9.8	8.9	1.591	4 SLU	0	29729806	0	-47306887	
	v 100 315	48.3	26.5	6.6	6.3	5.783	2 SLU	0	-5491288	0	31753972	
1236	o 100 315	40.2	26.5	9.8	8.9	1.574	4 SLU	0	30051198	0	-47306887	
	v 100 315	48.3	26.5	6.6	6.3	6.084	2 SLU	0	-5219455	0	31753972	
1296	o 100 315	40.2	26.5	9.8	8.9	1.518	4 SLU	0	31170592	0	-47306887	
	v 100 315	40.2	26.5	6.6	6.3	5.076	2 SLU	0	-6256840	0	31762689	
1297	o 100 315	41.9	26.5	9.8	8.9	1.581	4 SLU	0	31184232	0	-49305569	
	v 100 315	40.2	26.5	6.6	6.3	6.332	2 SLU	0	-5016466	0	31762689	
1359	o 100 315	40.2	26.5	9.8	8.9	1.478	4 SLU	0	31999148	0	-47306887	
	v 100 315	40.2	26.5	6.6	6.3	4.814	2 SLU	0	-6598133	0	31762689	
1362	o 100 315	48.0	26.5	9.8	8.9	1.774	4 SLU	0	31756952	0	-56341031	
	v 100 315	40.2	26.5	6.6	6.3	5.751	2 SLU	0	-5523355	0	31762689	
1428	o 100 315	40.2	21.2	9.8	8.9	1.459	4 SLU	0	32432739	0	-47316277	
	v 100 315	48.1	26.5	6.6	6.3	4.237	2 SLU	0	-7495292	0	31756277	
1431	o 100 315	40.2	21.2	9.8	8.9	1.470	4 SLU	0	32186568	0	-47316277	
	v 100 315	48.1	26.5	6.6	6.3	4.409	2 SLU	0	-7203419	0	31756277	
1507	o 100 315	40.2	26.5	9.8	8.9	1.442	4 SLU	0	32815802	0	-47306887	
	v 100 315	40.2	26.5	6.6	6.3	5.078	2 SLU	0	-6254803	0	31762689	
1508	o 100 315	40.2	26.5	9.8	8.9	1.441	4 SLU	0	32831115	0	-47306887	
	v 100 315	40.2	26.5	6.6	6.3	5.161	2 SLU	0	-6154248	0	31762689	

Combinazione rara

nod sez	B	H	Af+	Af-	c+	c-	sc	c	N	M	sf	c	N	M	Wk (mm)	st	Sm (mm)	c
627	o 100 315	40.2	26.5	9.8	8.9	-21.5	2	0.00E00	1.82E07	1571.1	2	0.00E00	1.82E07	0.00	10.7	0.0	1	
	v 100 315	40.2	26.5	6.6	6.3	-37.5	2	0.00E00	3.24E07	2757.4	2	0.00E00	3.24E07	0.00	18.9	0.0	1	
633	o 100 315	40.2	26.5	9.8	8.9	-23.5	2	0.00E00	1.99E07	1715.5	2	0.00E00	1.99E07	0.00	11.6	0.0	1	
	v 100 315	40.2	26.5	6.6	6.3	-37.5	2	0.00E00	3.25E07	2763.6	2	0.00E00	3.25E07	0.00	18.9	0.0	1	
1231	o 100 315	40.2	26.5	9.8	8.9	-25.9	2	0.00E00	2.19E07	1885.6	2	0.00E00	2.19E07	0.00	12.8	0.0	1	
	v 100 315	48.3	26.5	6.6	6.3	-6.9	1	0.00E00	6.46E06	460.0	1	0.00E00	6.46E06	0.00	3.7	0.0	2	
1236	o 100 315	40.2	26.5	9.8	8.9	-25.9	2	0.00E00	2.20E07	1891.7	2	0.00E00	2.20E07	0.00	12.8	0.0	1	
	v 100 315	48.3	26.5	6.6	6.3	-6.9	1	0.00E00	6.41E06	457.1	1	0.00E00	6.41E06	0.00	3.7	0.0	2	
1296	o 100 315	40.2	26.5	9.8	8.9	-26.4	2	0.00E00	2.24E07	1928.6	2	0.00E00	2.24E07	0.00	13.1	0.0	1	
	v 100 315	40.2	26.5	6.6	6.3	-6.4	1	0.00E00	5.53E06	470.7	1	0.00E00	5.53E06	0.00	3.2	0.0	2	
1297	o 100 315	41.9	26.5	9.8	8.9	-26.0	2	0.00E00	2.24E07	1854.9	2	0.00E00	2.24E07	0.00	13.1	0.0	1	
	v 100 315	40.2	26.5	6.6	6.3	-6.5	1	0.00E00	5.64E06	479.9	1	0.00E00	5.64E06	0.00	3.3	0.0	2	
1359	o 100 315	40.2	26.5	9.8	8.9	-27.3	2	0.00E00	2.31E07	1989.1	2	0.00E00	2.31E07	0.00	13.5	0.0	1	
	v 100 315	40.2	26.5	6.6	6.3	-5.2	1	0.00E00	4.51E06	383.5	1	0.00E00	4.51E06	0.00	2.6	0.0	2	
1362	o 100 315	48.0	26.5	9.8	8.9	-25.2	2	0.00E00	2.29E07	1660.3	2	0.00E00	2.29E07	0.00	13.3	0.0	1	
	v 100 315	40.2	26.5	6.6	6.3	-5.4	1	0.00E00	4.68E06	397.9	1	0.00E00	4.68E06	0.00	2.7	0.0	2	











**VERIFICA CORDOLO INTERFACCIA TORRE**

Valori in daN, cm  
rck 370  
fyk 4500

Verifica di stato limite ultimo

nod sez	B	H	Af+	Af-	c+	c-	c.s.	comb	N	M	Nu	Mu
3299 o	13	200	14.9	14.9	9.8	9.8	1.444	4 SLU	0	-7297066	0	10534179
v	13	200	18.1	18.1	6.6	6.6	3.915	4 SLU	0	-3362250	0	13162216
3306 o	25	200	36.7	36.7	9.8	9.8	6.101	2 SLU	0	4239487	0	-25863874
v	13	200	8.0	8.0	6.6	6.6	1.260	4 SLU	0	4671091	0	-5883331
3310 o	25	200	34.8	34.8	9.8	9.8	44.581	4 SLU	0	550466	0	-24540494
v	13	200	8.0	8.0	6.6	6.6	1.236	4 SLU	0	4758285	0	-5883331
3554 o	13	200	21.8	21.8	9.8	9.8	3.043	11 SLV	0	-5051384	0	15373218
v	13	200	16.1	16.1	6.6	6.6	6.962	11 SLV	0	-1677879	0	11681957

Combinazione rara

nod sez	B	H	Af+	Af-	c+	c-	sc	c	N	M	sf	c	N	M	Wk (mm)	st	Sm (mm)	c
3299 o	13	200	14.9	14.9	9.8	9.8	-56.1	2	0.00E00	-5.23E06	2011.9	2	0.00E00	-5.23E06	0.09	0.0	112.8	2
v	13	200	18.1	18.1	6.6	6.6	-21.8	2	0.00E00	-2.39E06	736.4	2	0.00E00	-2.39E06	0.00	22.9	0.0	2
3306 o	25	200	36.7	36.7	9.8	9.8	-12.8	2	0.00E00	2.68E06	420.0	2	0.00E00	2.68E06	0.00	13.0	0.0	1
v	13	200	8.0	8.0	6.6	6.6	-45.8	2	0.00E00	3.22E06	2216.4	2	0.00E00	3.22E06	0.09	0.0	98.6	2
3310 o	25	200	34.8	34.8	9.8	9.8	-1.9	2	0.00E00	3.87E05	63.9	2	0.00E00	3.87E05	0.00	1.9	0.0	1
v	13	200	8.0	8.0	6.6	6.6	-46.2	2	0.00E00	3.25E06	2236.3	2	0.00E00	3.25E06	0.09	0.0	98.6	2
3554 o	13	200	21.8	21.8	9.8	9.8	-26.4	1	0.00E00	-3.07E06	807.5	1	0.00E00	-3.07E06	0.02	0.0	78.7	1
v	13	200	16.1	16.1	6.6	6.6	-6.2	1	0.00E00	6.37E05	221.2	1	0.00E00	6.37E05	0.00	6.2	0.0	2

Combinazione frequente

nod sez	B	H	Af+	Af-	c+	c-	sc	c	N	M	sf	c	N	M	Wk (mm)	st	Sm (mm)	c
3299 o	13	200	14.9	14.9	9.8	9.8	-42.8	2	0.00E00	-4.00E06	1537.7	2	0.00E00	-4.00E06	0.07	0.0	112.8	2
v	13	200	18.1	18.1	6.6	6.6	-15.8	2	0.00E00	-1.73E06	533.8	2	0.00E00	-1.73E06	0.00	16.6	0.0	2
3306 o	25	200	36.7	36.7	9.8	9.8	-5.4	2	0.00E00	1.13E06	176.2	2	0.00E00	1.13E06	0.00	5.5	0.0	1
v	13	200	8.0	8.0	6.6	6.6	-28.4	2	0.00E00	1.99E06	1372.8	2	0.00E00	1.99E06	0.00	21.5	0.0	1
3310 o	25	200	34.8	34.8	9.8	9.8	-1.3	2	0.00E00	2.69E05	44.4	2	0.00E00	2.69E05	0.00	1.3	0.0	1
v	13	200	8.0	8.0	6.6	6.6	-27.0	2	0.00E00	1.90E06	1307.3	2	0.00E00	1.90E06	0.00	20.5	0.0	1
3554 o	13	200	21.8	21.8	9.8	9.8	-26.4	1	0.00E00	-3.07E06	807.5	1	0.00E00	-3.07E06	0.02	0.0	78.7	1
v	13	200	16.1	16.1	6.6	6.6	-6.2	1	0.00E00	6.37E05	221.2	1	0.00E00	6.37E05	0.00	6.2	0.0	2

Combinazione quasi permanente

nod sez	B	H	Af+	Af-	c+	c-	sc	c	N	M	sf	c	N	M	Wk (mm)	st	Sm (mm)	c
3299 o	13	200	14.9	14.9	9.8	9.8	-37.6	2	0.00E00	-3.51E06	1348.0	2	0.00E00	-3.51E06	0.06	0.0	112.8	2
v	13	200	18.1	18.1	6.6	6.6	-13.2	2	0.00E00	-1.45E06	445.8	2	0.00E00	-1.45E06	0.00	13.8	0.0	2
3306 o	25	200	36.7	36.7	9.8	9.8	-2.4	2	0.00E00	5.01E05	78.5	2	0.00E00	5.01E05	0.00	2.4	0.0	1
v	13	200	8.0	8.0	6.6	6.6	-21.4	2	0.00E00	1.50E06	1035.4	2	0.00E00	1.50E06	0.00	16.2	0.0	1
3310 o	25	200	34.8	34.8	9.8	9.8	-1.1	2	0.00E00	2.21E05	36.5	2	0.00E00	2.21E05	0.00	1.1	0.0	1
v	13	200	8.0	8.0	6.6	6.6	-19.3	2	0.00E00	1.36E06	935.7	2	0.00E00	1.36E06	0.00	14.6	0.0	1
3554 o	13	200	21.8	21.8	9.8	9.8	-26.4	1	0.00E00	-3.07E06	807.5	1	0.00E00	-3.07E06	0.02	0.0	78.7	1
v	13	200	16.1	16.1	6.6	6.6	-6.2	1	0.00E00	6.37E05	221.2	1	0.00E00	6.37E05	0.00	6.2	0.0	2

**9.2 Verifiche pali**

**Pali (0; 1650)-(-287; 1625)-(-564; 1551)-(-825; 1429)-(-1061; 1264)-(-1264; 1061)-(-1429; 825)-(-1551; 564)-(-1625; 287)-(-1650; 0)-(-1625; -287)-(-1551; -564)-(-1429; -825)-(-1264; -1061)-(-1061; -1264)-(-825; -1429)-(-564; -1551)-(-287; -1625)-(0; -1650)-(-287; -1625)-(564; -1551)-(-825; -1429)-(1061; -1264)-(1264; -1061)-(1429; -825)-(1551; -564)-(1625; -287)-(1650; 0)-(1625; 287)-(1551; 564)-(1429; 825)-(1264; 1061)-(1061; 1264)-(825; 1429)-(564; 1551)-(287; 1625)-(-1083; -505)-(-845; -845)-(-505; -1083)-(-104; -1191)-(-309; -1155)-(686; -979)-(979; -686)-(1155; -309)-(-1191; 104)-(1083; 505)-(845; 845)-(505; 1083)-(-104; 1191)-(-309; 1155)-(-686; 979)-(-979; 686)-(-1155; 309)-(-1191; -104)**

Unità di misura: daN, cm

Metodo di calcolo:

Caratteristiche dei materiali:

Calcestruzzo Rck 370  
fyk 4500

Caratteristiche geometriche:

Quota di testa -90 cm  
Quota di punta -2590 cm  
Diametro 100,0 cm

Palo alle coordinate X=0 Y=1650

Sollecitazioni massime in testa palo:

Combinazione corrispondente alla minima compressione in testa

N	Mx	My	Tx	Ty	comb
-4.029E+04	1.3886E+05	-1.299E+06	-3.046E+03	-5.632E+02	2 sl



Progetto	Titolo	Rev.	Pag.
Orione	Orione_A24a.pdf "TABULATI DI CALCOLO PLINTO DI FONDAZIONE PER AEROGENERATORE TIPO"	0	181

-5.706E+04 9.2287E+04 -1.538E+06 -3.556E+03 -3.749E+02 2 ra  
 -7.383E+04 4.5713E+04 -1.777E+06 -4.066E+03 -1.866E+02 2 fr  
 -8.054E+04 2.7083E+04 -1.873E+06 -4.270E+03 -1.112E+02 2 qp  
 -6.103E+04 -2.043E+06 5.0642E+06 2.3274E+04 8.0521E+03 5 SLV fond

Combinazione corrispondente alla massima compressione in testa  
 N Mx My Tx Ty comb  
 -1.178E+05 -1.120E+03 -2.621E+06 -5.949E+03 2.2849E+00 3 sl  
 -9.060E+04 -8.615E+02 -2.016E+06 -4.576E+03 1.7576E+00 1 ra  
 -9.060E+04 -8.615E+02 -2.016E+06 -4.576E+03 1.7576E+00 1 fr  
 -9.060E+04 -8.615E+02 -2.016E+06 -4.576E+03 1.7576E+00 1 qp  
 -1.202E+05 2.0409E+06 -9.096E+06 -3.243E+04 -8.049E+03 11 SLV fond

Combinazione corrispondente al massimo taglio in testa  
 N Mx My Tx Ty comb  
 -1.178E+05 -1.120E+03 -2.621E+06 -5.949E+03 2.2849E+00 3 sl  
 -9.060E+04 -8.615E+02 -2.016E+06 -4.576E+03 1.7576E+00 1 ra  
 -9.060E+04 -8.615E+02 -2.016E+06 -4.576E+03 1.7576E+00 1 fr  
 -9.060E+04 -8.615E+02 -2.016E+06 -4.576E+03 1.7576E+00 1 qp  
 -1.202E+05 -2.043E+06 -9.096E+06 -3.243E+04 8.0549E+03 7 SLV fond

Verifica di capacità portante riferita al palo singolo:

Fattore di correlazione Psi scelto in base alla conoscenza del sito = 1.7  
 Coeff. parziale di sicurezza sulla resistenza laterale = 1.15  
 Coeff. parziale di sicurezza sulla resistenza alla punta = 1.35  
 Portanza laterale di progetto = 292537.1  
 Portanza di punta di progetto = 85555.4  
 verifica condotta in combinazione SLU 3  
 Sforzo normale = -117777.3  
 Peso del palo = 49087.4 \* 1.3  
 Carico totale di progetto = -181590.9  
 Resistenza totale di progetto = 378092.5  
 Coefficiente di sicurezza = 2.08 > 1

Verifica di resistenza allo stato limite:

quota	Af	cop.	c.s.	Mx	My	N	comb
-90	0.0	6.50	0.00	0.0000E+00	0.0000E+00	0.0000E+00	-
-170	78.5	6.00	3.52	-1.415E+06	-6.558E+06	-1.211E+05	7SLV
-250	78.5	6.00	6.53	-7.888E+05	-4.023E+06	-1.227E+05	7SLV
-330	78.5	6.00	11.90	-3.310E+05	-2.132E+06	-9.450E+04	7SLV
-410	78.5	6.00	15.70	-1.545E+05	-1.315E+06	-9.607E+04	7SLV
-490	78.5	6.00	18.88	-2.272E+04	-4.978E+05	-9.764E+04	11SLV
-570	78.5	6.00	18.58	-1.989E+05	3.1926E+05	-9.921E+04	11SLV
-650	78.5	6.00	15.81	-3.752E+05	1.1363E+06	-1.008E+05	11SLV
-730	78.5	6.00	14.54	-4.734E+05	-1.640E+06	-3.609E+04	9SLV
-810	78.5	6.00	15.59	4.4067E+05	1.5409E+06	-7.598E+04	7SLV
-890	78.5	6.00	15.99	4.0804E+05	1.4636E+06	-7.755E+04	7SLV
-970	78.5	6.00	16.40	-3.752E+05	1.3864E+06	-7.912E+04	11SLV
-1050	78.5	6.00	16.84	-3.426E+05	1.3091E+06	-8.069E+04	11SLV
-1130	124.0	6.00	22.93	3.0761E+05	1.2121E+06	-5.444E+04	7SLV
-1210	78.5	6.00	22.31	2.6419E+05	1.0507E+06	-5.601E+04	7SLV
-1290	78.5	6.00	24.30	2.2077E+05	8.8926E+05	-5.758E+04	7SLV
-1370	78.5	6.00	26.33	-1.772E+05	7.2784E+05	-5.915E+04	11SLV
-1450	78.5	6.00	28.14	-1.338E+05	5.6639E+05	-6.072E+04	11SLV
-1530	78.5	6.00	29.51	5.0347E+01	1.1847E+05	-6.247E+04	3SLU
-1610	78.5	6.00	46.56	-7.225E+04	3.2933E+05	-3.736E+04	11SLV
-1690	78.5	6.00	47.35	-5.533E+04	2.5795E+05	-3.893E+04	11SLV
-1770	78.5	6.00	45.51	-3.841E+04	1.8656E+05	-4.050E+04	11SLV
-1850	78.5	6.00	43.72	2.3731E+01	5.2043E+04	-4.216E+04	3SLU
-1930	78.5	6.00	41.70	1.7040E+01	3.5420E+04	-4.420E+04	3SLU
-2010	78.5	6.00	93.96	8.4986E+02	1.7778E+04	-1.962E+04	11SLV
-2090	78.5	6.00	87.00	6.6548E+02	1.3921E+04	-2.119E+04	11SLV
-2170	124.0	6.00	89.39	4.8110E+02	1.0064E+04	-2.276E+04	11SLV
-2250	78.5	6.00	74.37	4.5236E+00	9.1315E+03	-2.478E+04	3SLU
-2330	78.5	6.00	68.71	1.7128E+00	3.4575E+03	-2.683E+04	3SLU
-2410	78.5	6.00	100.00	4.7144E-11	-8.819E-11	-2.391E+03	11SLV
-2490	78.5	6.00	100.00	2.3533E-11	-1.581E-10	-3.962E+03	11SLV

Verifica di esercizio (combinazione rara):

quota	Af	cop.	sigmaf	sigmac	Mx	My	N	comb	Wk
-90	0.0	6.50	0.0	0.0	0.0000E+00	0.0000E+00	0.0000E+00	-	0.000
-170	78.5	6.00		24.2	-7.205E+02	-1.647E+06	-9.155E+04	1	0.000
-170	78.5	6.00	58.6		6.3097E+04	-1.252E+06	-5.817E+04	2	0.000
-250	78.5	6.00		21.0	-5.794E+02	-1.277E+06	-9.312E+04	1	0.000
-250	78.5	6.00	8.0		3.3960E+04	-9.650E+05	-5.974E+04	2	0.000
-330	78.5	6.00		15.9	-4.579E+02	-9.697E+05	-7.030E+04	1	0.000
-330	78.5	6.00	9.9		1.2796E+04	-7.276E+05	-4.314E+04	2	0.000
-410	78.5	6.00		14.4	-3.689E+02	-7.653E+05	-7.187E+04	1	0.000
-490	78.5	6.00		12.8	-2.800E+02	-5.608E+05	-7.344E+04	1	0.000
-570	78.5	6.00		11.3	-1.910E+02	-3.563E+05	-7.501E+04	1	0.000
-650	78.5	6.00		9.8	-1.020E+02	-1.518E+05	-7.658E+04	1	0.000
-730	78.5	6.00		6.2	-3.916E+01	-1.117E+04	-5.525E+04	1	0.000
-810	78.5	6.00		6.5	-1.979E+01	2.3130E+04	-5.682E+04	1	0.000
-890	78.5	6.00		7.0	-4.282E-01	5.7434E+04	-5.839E+04	1	0.000
-970	78.5	6.00		7.4	1.8936E+01	9.1738E+04	-5.996E+04	1	0.000



Tabulati di Calcolo Plinto di Fondazione per Aerogeneratore Tipo - Progetto Impianto Eolico - "Orione"

-1050	78.5	6.00	7.9	3.8299E+01	1.2604E+05	-6.153E+04	1	0.000
-1130	124.0	6.00	5.3	5.2480E+01	1.4957E+05	-4.020E+04	1	0.000
-1210	78.5	6.00	5.8	4.9730E+01	1.3788E+05	-4.177E+04	1	0.000
-1290	78.5	6.00	5.9	4.6979E+01	1.2619E+05	-4.334E+04	1	0.000
-1370	78.5	6.00	5.9	4.4229E+01	1.1450E+05	-4.491E+04	1	0.000
-1450	78.5	6.00	6.0	4.1479E+01	1.0282E+05	-4.648E+04	1	0.000
-1530	78.5	6.00	6.1	3.8729E+01	9.1130E+04	-4.805E+04	1	0.000
-1610	78.5	6.00	3.7	3.3694E+01	7.8394E+04	-2.772E+04	1	0.000
-1690	78.5	6.00	3.8	2.8548E+01	6.5607E+04	-2.929E+04	1	0.000
-1770	78.5	6.00	3.9	2.3401E+01	5.2820E+04	-3.086E+04	1	0.000
-1850	78.5	6.00	3.9	1.8254E+01	4.0033E+04	-3.243E+04	1	0.000
-1930	78.5	6.00	4.0	1.3108E+01	2.7246E+04	-3.400E+04	1	0.000
-2010	78.5	6.00	1.8	9.9662E+00	2.0118E+04	-1.435E+04	1	0.000
-2090	78.5	6.00	1.9	7.8040E+00	1.5753E+04	-1.592E+04	1	0.000
-2170	124.0	6.00	1.9	5.6418E+00	1.1389E+04	-1.749E+04	1	0.000
-2250	78.5	6.00	2.2	3.4797E+00	7.0242E+03	-1.907E+04	1	0.000
-2330	78.5	6.00	2.3	1.3175E+00	2.6596E+03	-2.064E+04	1	0.000
-2410	78.5	6.00	0.2	1.6938E-14	7.5319E-12	-1.386E+03	1	0.000
-2490	78.5	6.00	0.3	1.0277E-14	-1.975E-11	-2.957E+03	1	0.000

Verifica di esercizio (combinazione quasi permanente):

quota	Af	cop.	sigmaf	sigmac	Mx	My	N	comb	Wk
-90	0.0	6.50	0.0	0.0	0.0000E+00	0.0000E+00	0.0000E+00	-	0.000
-170	78.5	6.00		24.2	-7.205E+02	-1.647E+06	-9.155E+04	1	0.000
-170	78.5	6.00	41.5		1.8425E+04	-1.528E+06	-8.154E+04	2	0.000
-250	78.5	6.00		21.0	-5.794E+02	-1.277E+06	-9.312E+04	1	0.000
-330	78.5	6.00		15.9	-4.579E+02	-9.697E+05	-7.030E+04	1	0.000
-410	78.5	6.00		14.4	-3.689E+02	-7.653E+05	-7.187E+04	1	0.000
-490	78.5	6.00		12.8	-2.800E+02	-5.608E+05	-7.344E+04	1	0.000
-570	78.5	6.00		11.3	-1.910E+02	-3.563E+05	-7.501E+04	1	0.000
-650	78.5	6.00		9.8	-1.020E+02	-1.518E+05	-7.658E+04	1	0.000
-730	78.5	6.00		6.2	-3.916E+01	-1.117E+04	-5.525E+04	1	0.000
-810	78.5	6.00		6.5	-1.979E+01	2.3130E+04	-5.682E+04	1	0.000
-890	78.5	6.00		7.0	-4.282E-01	5.7434E+04	-5.839E+04	1	0.000
-970	78.5	6.00		7.4	1.8936E+01	9.1738E+04	-5.996E+04	1	0.000
-1050	78.5	6.00		7.9	3.8299E+01	1.2604E+05	-6.153E+04	1	0.000
-1130	124.0	6.00		5.3	5.2480E+01	1.4957E+05	-4.020E+04	1	0.000
-1210	78.5	6.00		5.8	4.9730E+01	1.3788E+05	-4.177E+04	1	0.000
-1290	78.5	6.00		5.9	4.6979E+01	1.2619E+05	-4.334E+04	1	0.000
-1370	78.5	6.00		5.9	4.4229E+01	1.1450E+05	-4.491E+04	1	0.000
-1450	78.5	6.00		6.0	4.1479E+01	1.0282E+05	-4.648E+04	1	0.000
-1530	78.5	6.00		6.1	3.8729E+01	9.1130E+04	-4.805E+04	1	0.000
-1610	78.5	6.00		3.7	3.3694E+01	7.8394E+04	-2.772E+04	1	0.000
-1690	78.5	6.00		3.8	2.8548E+01	6.5607E+04	-2.929E+04	1	0.000
-1770	78.5	6.00		3.9	2.3401E+01	5.2820E+04	-3.086E+04	1	0.000
-1850	78.5	6.00		3.9	1.8254E+01	4.0033E+04	-3.243E+04	1	0.000
-1930	78.5	6.00		4.0	1.3108E+01	2.7246E+04	-3.400E+04	1	0.000
-2010	78.5	6.00		1.8	9.9662E+00	2.0118E+04	-1.435E+04	1	0.000
-2090	78.5	6.00		1.9	7.8040E+00	1.5753E+04	-1.592E+04	1	0.000
-2170	124.0	6.00		1.9	5.6418E+00	1.1389E+04	-1.749E+04	1	0.000
-2250	78.5	6.00		2.2	3.4797E+00	7.0242E+03	-1.907E+04	1	0.000
-2330	78.5	6.00		2.3	1.3175E+00	2.6596E+03	-2.064E+04	1	0.000
-2410	78.5	6.00		0.2	1.6938E-14	7.5319E-12	-1.386E+03	1	0.000
-2490	78.5	6.00		0.3	1.0277E-14	-1.975E-11	-2.957E+03	1	0.000

Verifica a taglio:

quota	Ast	Vsd	Vsdx	Vsdy	N	comb	VRd,c	VRd,max	VRd,S	Vwd
-90	0.16	33412	-32426	8055	-120160	7SLV	39902	231056	84225	44323 Vsd < VRd,
-170	0.16	32640	-31687	7833	-121137	7SLV	43926	231056	88249	44323 Vsd < VRd,
-250	0.08	32640	-31687	7833	-122708	7SLV	44144	231056	66306	22162 Vsd < VRd,
-330	0.08	10449	-10213	2207	-94500	7SLV	40223	231056	62385	22162 Vsd < VRd,
-410	0.08	10449	-10213	2207	-96071	7SLV	40442	231056	62603	22162 Vsd < VRd,
-490	0.08	10449	-10213	2207	-97641	7SLV	40660	231056	62822	22162 Vsd < VRd,
-570	0.08	10449	-10213	2207	-99212	7SLV	40878	231056	63040	22162 Vsd < VRd,
-650	0.08	10449	-10213	2207	-100783	7SLV	41097	231056	63258	22162 Vsd < VRd,
-730	0.08	1868	-1823	408	-36087	9SLV	32104	231056	54266	22162 Vsd < VRd,
-810	0.08	1868	-1823	408	-37657	9SLV	32322	231056	54484	22162 Vsd < VRd,
-890	0.08	1868	-1823	408	-39228	9SLV	32541	231056	54702	22162 Vsd < VRd,
-970	0.08	1868	-1823	408	-40799	9SLV	32759	231056	54921	22162 Vsd < VRd,
-1050	0.08	1868	-1823	408	-42370	9SLV	32977	231056	55139	22162 Vsd < VRd,
-1130	0.08	2090	2018	-543	-54437	7SLV	39111	231056	61273	22162 Vsd < VRd,
-1210	0.08	2090	2018	-543	-56008	7SLV	34873	231056	57035	22162 Vsd < VRd,
-1290	0.08	2090	2018	-543	-57579	7SLV	35091	231056	57253	22162 Vsd < VRd,
-1370	0.08	2090	2018	-543	-59149	7SLV	35310	231056	57471	22162 Vsd < VRd,
-1450	0.08	2090	2018	-543	-60720	7SLV	35528	231056	57690	22162 Vsd < VRd,
-1530	0.08	2090	2018	-543	-62291	7SLV	35746	231056	57908	22162 Vsd < VRd,
-1610	0.08	917	892	-212	-37357	7SLV	32281	231056	54442	22162 Vsd < VRd,
-1690	0.08	917	892	-212	-38928	7SLV	32499	231056	54661	22162 Vsd < VRd,
-1770	0.08	917	892	-212	-40499	7SLV	32717	231056	54879	22162 Vsd < VRd,
-1850	0.08	917	892	-212	-42070	7SLV	32936	231056	55097	22162 Vsd < VRd,
-1930	0.08	917	892	-212	-43641	7SLV	33154	231056	55316	22162 Vsd < VRd,
-2010	0.08	71	71	0	-18658	3SLU	29681	231056	51843	22162 Vsd < VRd,
-2090	0.08	71	71	0	-20700	3SLU	29965	231056	52127	22162 Vsd < VRd,
-2170	0.08	71	71	0	-22742	3SLU	34705	231056	56867	22162 Vsd < VRd,
-2250	0.08	71	71	0	-24785	3SLU	30533	231056	52695	22162 Vsd < VRd,
-2330	0.08	71	71	0	-26827	3SLU	30817	231056	52979	22162 Vsd < VRd,



Progetto	Titolo	Rev.	Pag.
Orione	Orione_A24a.pdf "TABULATI DI CALCOLO PLINTO DI FONDAZIONE PER AEROGENERATORE TIPO"	0	183



**Tabulati di Calcolo Plinto di Fondazione per Aerogeneratore Tipo - Progetto Impianto Eolico - "Orione"**

-2410 0.08 0 0 0 -2391 11SLV 27420 231056 49582 22162 Vsd < VRd,  
 -2490 0.08 0 0 0 -3962 11SLV 27639 231056 49800 22162 Vsd < VRd,

Palo alle coordinate X=-287 Y=1625

Sollecitazioni massime in testa palo:

Combinazione corrispondente alla minima compressione in testa

N	Mx	My	Tx	Ty	comb	
-4.068E+04	-2.502E+04	-1.277E+06	-2.954E+03	-1.780E+02	2	sl
-5.731E+04	-1.340E+05	-1.513E+06	-3.471E+03	1.5298E+02	2	ra
-7.394E+04	-2.430E+05	-1.749E+06	-3.988E+03	4.8392E+02	2	fr
-8.059E+04	-2.866E+05	-1.844E+06	-4.195E+03	6.1630E+02	2	qp
-5.976E+04	1.7115E+06	5.0999E+06	2.3364E+04	-7.314E+03	9	SLV fond

Combinazione corrispondente alla massima compressione in testa

N	Mx	My	Tx	Ty	comb	
-1.177E+05	-4.576E+05	-2.581E+06	-5.857E+03	1.0593E+03	3	sl
-9.057E+04	-3.520E+05	-1.985E+06	-4.505E+03	8.1487E+02	1	ra
-9.057E+04	-3.520E+05	-1.985E+06	-4.505E+03	8.1487E+02	1	fr
-9.057E+04	-3.520E+05	-1.985E+06	-4.505E+03	8.1487E+02	1	qp
-1.214E+05	-2.415E+06	-9.071E+06	-3.237E+04	8.9437E+03	7	SLV fond

Combinazione corrispondente al massimo taglio in testa

N	Mx	My	Tx	Ty	comb	
-1.177E+05	-4.576E+05	-2.581E+06	-5.857E+03	1.0593E+03	3	sl
-9.057E+04	-3.520E+05	-1.985E+06	-4.505E+03	8.1487E+02	1	ra
-9.057E+04	-3.520E+05	-1.985E+06	-4.505E+03	8.1487E+02	1	fr
-9.057E+04	-3.520E+05	-1.985E+06	-4.505E+03	8.1487E+02	1	qp
-1.214E+05	-2.415E+06	-9.071E+06	-3.237E+04	8.9437E+03	7	SLV fond

Verifica di capacità portante riferita al palo singolo:

Fattore di correlazione Psi scelto in base alla conoscenza del sito = 1.7  
 Coeff. parziale di sicurezza sulla resistenza laterale = 1.15  
 Coeff. parziale di sicurezza sulla resistenza alla punta = 1.35  
 Portanza laterale di progetto = 292537.1  
 Portanza di punta di progetto = 85555.4  
 verifica condotta in combinazione SLU 3  
 Sforzo normale = -117744.2  
 Peso del palo = 49087.4 \* 1.3  
 Carico totale di progetto = -181557.8  
 Resistenza totale di progetto = 378092.5  
 Coefficiente di sicurezza = 2.08 > 1

Verifica di resistenza allo stato limite:

quota	Af	cop.	c.s.	Mx	My	N	comb
-90	0.0	6.50	0.00	0.0000E+00	0.0000E+00	0.0000E+00	-
-170	78.5	6.00	3.50	-1.717E+06	-6.536E+06	-1.224E+05	7SLV
-250	78.5	6.00	6.48	-1.020E+06	-4.005E+06	-1.239E+05	7SLV
-330	78.5	6.00	11.79	-5.037E+05	-2.118E+06	-9.549E+04	7SLV
-410	78.5	6.00	15.55	-2.898E+05	-1.304E+06	-9.706E+04	7SLV
-490	78.5	6.00	18.69	-7.600E+04	-4.894E+05	-9.863E+04	7SLV
-570	78.5	6.00	18.39	1.3628E+05	3.2404E+05	-1.002E+05	7SLV
-650	78.5	6.00	15.73	3.5165E+05	1.1395E+06	-1.018E+05	7SLV
-730	78.5	6.00	14.40	-4.790E+05	-1.641E+06	-3.527E+04	9SLV
-810	78.5	6.00	15.51	4.4833E+05	1.5415E+06	-7.676E+04	7SLV
-890	78.5	6.00	15.90	4.2145E+05	1.4637E+06	-7.833E+04	7SLV
-970	78.5	6.00	16.30	3.9458E+05	1.3858E+06	-7.990E+04	7SLV
-1050	78.5	6.00	16.73	3.6770E+05	1.3080E+06	-8.147E+04	7SLV
-1130	124.0	6.00	22.78	3.3638E+05	1.2106E+06	-5.502E+04	7SLV
-1210	78.5	6.00	22.15	2.9055E+05	1.0493E+06	-5.659E+04	7SLV
-1290	78.5	6.00	24.12	2.4471E+05	8.8789E+05	-5.816E+04	7SLV
-1370	78.5	6.00	26.11	1.9887E+05	7.2652E+05	-5.973E+04	7SLV
-1450	78.5	6.00	27.90	1.5304E+05	5.6515E+05	-6.130E+04	7SLV
-1530	78.5	6.00	29.32	1.0720E+05	4.0378E+05	-6.287E+04	7SLV
-1610	78.5	6.00	46.12	8.6642E+04	3.2832E+05	-3.775E+04	7SLV
-1690	78.5	6.00	46.87	6.7329E+04	2.5709E+05	-3.932E+04	7SLV
-1770	78.5	6.00	45.07	4.8016E+04	1.8586E+05	-4.089E+04	7SLV
-1850	78.5	6.00	43.41	2.8703E+04	1.1463E+05	-4.246E+04	7SLV
-1930	78.5	6.00	41.71	6.1059E+03	3.4886E+04	-4.419E+04	3SLU
-2010	78.5	6.00	92.94	2.6648E+03	1.7479E+04	-1.983E+04	7SLV
-2090	78.5	6.00	86.12	2.0867E+03	1.3687E+04	-2.140E+04	7SLV
-2170	124.0	6.00	88.55	1.5085E+03	9.8948E+03	-2.297E+04	7SLV
-2250	78.5	6.00	74.39	1.5720E+03	8.9938E+03	-2.478E+04	3SLU
-2330	78.5	6.00	68.72	5.9522E+02	3.4053E+03	-2.682E+04	3SLU
-2410	78.5	6.00	100.00	-5.820E-12	-8.866E-11	-2.432E+03	7SLV
-2490	78.5	6.00	100.00	-3.138E-11	1.4742E-10	-4.003E+03	7SLV

Verifica di esercizio (combinazione rara):

quota	Af	cop.	sigmaf	sigmac	Mx	My	N	comb	Wk
-90	0.0	6.50	0.0	0.0	0.0000E+00	0.0000E+00	0.0000E+00	-	0.000
-170	78.5	6.00		24.2	-2.871E+05	-1.622E+06	-9.153E+04	1	0.000



Progetto	Titolo	Rev.	Pag.
Orione	Orione_A24a.pdf "TABULATI DI CALCOLO PLINTO DI FONDAZIONE PER AEROGENERATORE TIPO"	0	184

Tabulati di Calcolo Plinto di Fondazione per Aerogeneratore Tipo - Progetto Impianto Eolico - "Orione"

-170	78.5	6.00	55.1		-1.212E+05	-1.233E+06	-5.843E+04	2	0.000
-250	78.5	6.00		21.0	-2.222E+05	-1.258E+06	-9.310E+04	1	0.000
-250	78.5	6.00	6.7		-1.083E+05	-9.530E+05	-6.000E+04	2	0.000
-330	78.5	6.00		15.9	-1.683E+05	-9.550E+05	-7.028E+04	1	0.000
-330	78.5	6.00	9.3		-9.463E+04	-7.206E+05	-4.335E+04	2	0.000
-410	78.5	6.00		14.4	-1.328E+05	-7.536E+05	-7.185E+04	1	0.000
-490	78.5	6.00		12.8	-9.732E+04	-5.523E+05	-7.342E+04	1	0.000
-570	78.5	6.00		11.3	-6.182E+04	-3.509E+05	-7.499E+04	1	0.000
-650	78.5	6.00		9.8	-2.633E+04	-1.495E+05	-7.656E+04	1	0.000
-730	78.5	6.00		6.2	-1.912E+03	-1.100E+04	-5.523E+04	1	0.000
-810	78.5	6.00		6.5	4.0458E+03	2.2783E+04	-5.680E+04	1	0.000
-890	78.5	6.00		7.0	1.0003E+04	5.6565E+04	-5.837E+04	1	0.000
-970	78.5	6.00		7.4	1.5960E+04	9.0347E+04	-5.994E+04	1	0.000
-1050	78.5	6.00		7.9	2.1918E+04	1.2413E+05	-6.151E+04	1	0.000
-1130	124.0	6.00		5.3	2.6000E+04	1.4729E+05	-4.018E+04	1	0.000
-1210	78.5	6.00		5.8	2.3958E+04	1.3579E+05	-4.176E+04	1	0.000
-1290	78.5	6.00		5.9	2.1916E+04	1.2428E+05	-4.333E+04	1	0.000
-1370	78.5	6.00		5.9	1.9875E+04	1.1277E+05	-4.490E+04	1	0.000
-1450	78.5	6.00		6.0	1.7833E+04	1.0126E+05	-4.647E+04	1	0.000
-1530	78.5	6.00		6.1	1.5791E+04	8.9748E+04	-4.804E+04	1	0.000
-1610	78.5	6.00		3.7	1.3579E+04	7.7206E+04	-2.771E+04	1	0.000
-1690	78.5	6.00		3.8	1.1358E+04	6.4614E+04	-2.928E+04	1	0.000
-1770	78.5	6.00		3.9	9.1378E+03	5.2021E+04	-3.085E+04	1	0.000
-1850	78.5	6.00		3.9	6.9173E+03	3.9428E+04	-3.242E+04	1	0.000
-1930	78.5	6.00		4.0	4.6968E+03	2.6835E+04	-3.399E+04	1	0.000
-2010	78.5	6.00		1.8	3.4634E+03	1.9815E+04	-1.435E+04	1	0.000
-2090	78.5	6.00		1.9	2.7120E+03	1.5516E+04	-1.592E+04	1	0.000
-2170	124.0	6.00		1.9	1.9606E+03	1.1217E+04	-1.749E+04	1	0.000
-2250	78.5	6.00		2.2	1.2092E+03	6.9183E+03	-1.906E+04	1	0.000
-2330	78.5	6.00		2.3	4.5786E+02	2.6195E+03	-2.063E+04	1	0.000
-2410	78.5	6.00		0.2	3.6593E-12	3.8939E-12	-1.385E+03	1	0.000
-2490	78.5	6.00		0.3	1.3856E-12	-2.339E-11	-2.956E+03	1	0.000

Verifica di esercizio (combinazione quasi permanente):

quota	Af	cop.	sigmaf	sigmac	Mx	My	N	comb	Wk
-90	0.0	6.50	0.0	0.0	0.0000E+00	0.0000E+00	0.0000E+00	-	0.000
-170	78.5	6.00		24.2	-2.871E+05	-1.622E+06	-9.153E+04	1	0.000
-170	78.5	6.00	40.6		-2.373E+05	-1.505E+06	-8.160E+04	2	0.000
-250	78.5	6.00		21.0	-2.222E+05	-1.258E+06	-9.310E+04	1	0.000
-330	78.5	6.00		15.9	-1.683E+05	-9.550E+05	-7.028E+04	1	0.000
-410	78.5	6.00		14.4	-1.328E+05	-7.536E+05	-7.185E+04	1	0.000
-490	78.5	6.00		12.8	-9.732E+04	-5.523E+05	-7.342E+04	1	0.000
-570	78.5	6.00		11.3	-6.182E+04	-3.509E+05	-7.499E+04	1	0.000
-650	78.5	6.00		9.8	-2.633E+04	-1.495E+05	-7.656E+04	1	0.000
-730	78.5	6.00		6.2	-1.912E+03	-1.100E+04	-5.523E+04	1	0.000
-810	78.5	6.00		6.5	4.0458E+03	2.2783E+04	-5.680E+04	1	0.000
-890	78.5	6.00		7.0	1.0003E+04	5.6565E+04	-5.837E+04	1	0.000
-970	78.5	6.00		7.4	1.5960E+04	9.0347E+04	-5.994E+04	1	0.000
-1050	78.5	6.00		7.9	2.1918E+04	1.2413E+05	-6.151E+04	1	0.000
-1130	124.0	6.00		5.3	2.6000E+04	1.4729E+05	-4.018E+04	1	0.000
-1210	78.5	6.00		5.8	2.3958E+04	1.3579E+05	-4.176E+04	1	0.000
-1290	78.5	6.00		5.9	2.1916E+04	1.2428E+05	-4.333E+04	1	0.000
-1370	78.5	6.00		5.9	1.9875E+04	1.1277E+05	-4.490E+04	1	0.000
-1450	78.5	6.00		6.0	1.7833E+04	1.0126E+05	-4.647E+04	1	0.000
-1530	78.5	6.00		6.1	1.5791E+04	8.9748E+04	-4.804E+04	1	0.000
-1610	78.5	6.00		3.7	1.3579E+04	7.7206E+04	-2.771E+04	1	0.000
-1690	78.5	6.00		3.8	1.1358E+04	6.4614E+04	-2.928E+04	1	0.000
-1770	78.5	6.00		3.9	9.1378E+03	5.2021E+04	-3.085E+04	1	0.000
-1850	78.5	6.00		3.9	6.9173E+03	3.9428E+04	-3.242E+04	1	0.000
-1930	78.5	6.00		4.0	4.6968E+03	2.6835E+04	-3.399E+04	1	0.000
-2010	78.5	6.00		1.8	3.4634E+03	1.9815E+04	-1.435E+04	1	0.000
-2090	78.5	6.00		1.9	2.7120E+03	1.5516E+04	-1.592E+04	1	0.000
-2170	124.0	6.00		1.9	1.9606E+03	1.1217E+04	-1.749E+04	1	0.000
-2250	78.5	6.00		2.2	1.2092E+03	6.9183E+03	-1.906E+04	1	0.000
-2330	78.5	6.00		2.3	4.5786E+02	2.6195E+03	-2.063E+04	1	0.000
-2410	78.5	6.00		0.2	3.6593E-12	3.8939E-12	-1.385E+03	1	0.000
-2490	78.5	6.00		0.3	1.3856E-12	-2.339E-11	-2.956E+03	1	0.000

Verifica a taglio:

quota	Ast	Vsd	Vsdx	Vsdy	N	comb	VRd,c	VRd,max	VRd,S	Vwd
-90	0.16	33586	-32374	8944	-121385	7SLV	40072	231056	84395	44323 Vsd < VRd,
-170	0.16	32813	-31634	8717	-122355	7SLV	44095	231056	88419	44323 Vsd < VRd,
-250	0.08	32813	-31634	8717	-123926	7SLV	44314	231056	66475	22162 Vsd < VRd,
-330	0.08	10525	-10180	2673	-95491	7SLV	40361	231056	62523	22162 Vsd < VRd,
-410	0.08	10525	-10180	2673	-97062	7SLV	40579	231056	62741	22162 Vsd < VRd,
-490	0.08	10525	-10180	2673	-98632	7SLV	40798	231056	62959	22162 Vsd < VRd,
-570	0.08	10525	-10180	2673	-100203	7SLV	41016	231056	63178	22162 Vsd < VRd,
-650	0.08	10525	-10180	2673	-101774	7SLV	41234	231056	63396	22162 Vsd < VRd,
-730	0.08	1881	-1817	485	-35270	9SLV	31990	231056	54152	22162 Vsd < VRd,
-810	0.08	1881	-1817	485	-36840	9SLV	32209	231056	54370	22162 Vsd < VRd,
-890	0.08	1881	-1817	485	-38411	9SLV	32427	231056	54589	22162 Vsd < VRd,
-970	0.08	1881	-1817	485	-39982	9SLV	32645	231056	54807	22162 Vsd < VRd,
-1050	0.08	1881	-1817	485	-41553	9SLV	32864	231056	55025	22162 Vsd < VRd,
-1130	0.08	2097	2017	-573	-55020	7SLV	39192	231056	61354	22162 Vsd < VRd,
-1210	0.08	2097	2017	-573	-56590	7SLV	34954	231056	57116	22162 Vsd < VRd,
-1290	0.08	2097	2017	-573	-58161	7SLV	35172	231056	57334	22162 Vsd < VRd,



Progetto	Titolo	Rev.	Pag.
Orione	Orione_A24a.pdf "TABULATI DI CALCOLO PLINTO DI FONDAZIONE PER AEROGENERATORE TIPO"	0	185

**Tabulati di Calcolo Plinto di Fondazione per Aerogeneratore Tipo - Progetto Impianto Eolico - "Orione"**

-1370	0.08	2097	2017	-573	-59732	7SLV	35391	231056	57552	22162	Vsd < VRd,
-1450	0.08	2097	2017	-573	-61303	7SLV	35609	231056	57771	22162	Vsd < VRd,
-1530	0.08	2097	2017	-573	-62873	7SLV	35827	231056	57989	22162	Vsd < VRd,
-1610	0.08	923	890	-241	-37752	7SLV	32335	231056	54497	22162	Vsd < VRd,
-1690	0.08	923	890	-241	-39323	7SLV	32554	231056	54715	22162	Vsd < VRd,
-1770	0.08	923	890	-241	-40893	7SLV	32772	231056	54934	22162	Vsd < VRd,
-1850	0.08	923	890	-241	-42464	7SLV	32990	231056	55152	22162	Vsd < VRd,
-1930	0.08	923	890	-241	-44035	7SLV	33209	231056	55370	22162	Vsd < VRd,
-2010	0.08	71	70	-12	-18652	3SLU	29681	231056	51842	22162	Vsd < VRd,
-2090	0.08	71	70	-12	-20694	3SLU	29964	231056	52126	22162	Vsd < VRd,
-2170	0.08	71	70	-12	-22737	3SLU	34705	231056	56866	22162	Vsd < VRd,
-2250	0.08	71	70	-12	-24779	3SLU	30532	231056	52694	22162	Vsd < VRd,
-2330	0.08	71	70	-12	-26821	3SLU	30816	231056	52978	22162	Vsd < VRd,
-2410	0.08	0	0	0	-453	5SLV	27151	231056	49313	22162	Vsd < VRd,
-2490	0.08	0	0	0	-2023	5SLV	27369	231056	49531	22162	Vsd < VRd,

Palo alle coordinate X=-564 Y=1551

Sollecitazioni massime in testa palo:

Combinazione corrispondente alla minima compressione in testa

N	Mx	My	Tx	Ty	comb	
-4.260E+04	-1.959E+05	-1.256E+06	-2.864E+03	2.1564E+02	2	sl
-5.858E+04	-3.613E+05	-1.469E+06	-3.340E+03	6.7794E+02	2	ra
-7.457E+04	-5.267E+05	-1.681E+06	-3.817E+03	1.1402E+03	2	fr
-8.096E+04	-5.929E+05	-1.766E+06	-4.008E+03	1.3252E+03	2	qp
-5.943E+04	1.3928E+06	5.1880E+06	2.3564E+04	-6.604E+03	9	SLV fond

Combinazione corrispondente alla massima compressione in testa

N	Mx	My	Tx	Ty	comb	
-1.177E+05	-8.998E+05	-2.462E+06	-5.582E+03	2.0833E+03	3	sl
-9.055E+04	-6.921E+05	-1.894E+06	-4.294E+03	1.6025E+03	1	ra
-9.055E+04	-6.921E+05	-1.894E+06	-4.294E+03	1.6025E+03	1	fr
-9.055E+04	-6.921E+05	-1.894E+06	-4.294E+03	1.6025E+03	1	qp
-1.217E+05	-2.777E+06	-8.976E+06	-3.215E+04	9.8094E+03	7	SLV fond

Combinazione corrispondente al massimo taglio in testa

N	Mx	My	Tx	Ty	comb	
-1.177E+05	-8.998E+05	-2.462E+06	-5.582E+03	2.0833E+03	3	sl
-9.055E+04	-6.921E+05	-1.894E+06	-4.294E+03	1.6025E+03	1	ra
-9.055E+04	-6.921E+05	-1.894E+06	-4.294E+03	1.6025E+03	1	fr
-9.055E+04	-6.921E+05	-1.894E+06	-4.294E+03	1.6025E+03	1	qp
-1.217E+05	-2.777E+06	-8.976E+06	-3.215E+04	9.8094E+03	7	SLV fond

Verifica di capacità portante riferita al palo singolo:

Fattore di correlazione Psi scelto in base alla conoscenza del sito = 1.7  
 Coeff. parziale di sicurezza sulla resistenza laterale = 1.15  
 Coeff. parziale di sicurezza sulla resistenza alla punta = 1.35  
 Portanza laterale di progetto = 292537.1  
 Portanza di punta di progetto = 85555.4  
 verifica condotta in combinazione SLU 3  
 Sforzo normale = -117720.4  
 Peso del palo = 49087.4 \* 1.3  
 Carico totale di progetto = -181534  
 Resistenza totale di progetto = 378092.5  
 Coefficiente di sicurezza = 2.08 > 1

Verifica di resistenza allo stato limite:

quota	Af	cop.	c.s.	Mx	My	N	comb
-90	0.0	6.50	0.00	0.0000E+00	0.0000E+00	0.0000E+00	-
-170	78.5	6.00	3.49	-2.010E+06	-6.459E+06	-1.226E+05	7SLV
-250	78.5	6.00	6.47	-1.244E+06	-3.946E+06	-1.242E+05	7SLV
-330	78.5	6.00	11.77	-6.710E+05	-2.074E+06	-9.573E+04	7SLV
-410	78.5	6.00	15.52	-4.210E+05	-1.269E+06	-9.730E+04	7SLV
-490	78.5	6.00	18.64	-1.710E+05	-4.639E+05	-9.887E+04	7SLV
-570	78.5	6.00	18.35	7.6087E+04	3.3915E+05	-1.004E+05	7SLV
-650	78.5	6.00	15.71	3.2912E+05	1.1460E+06	-1.020E+05	7SLV
-730	78.5	6.00	14.36	-4.848E+05	-1.640E+06	-3.506E+04	9SLV
-810	78.5	6.00	15.50	4.5606E+05	1.5400E+06	-7.695E+04	7SLV
-890	78.5	6.00	15.88	4.3473E+05	1.4607E+06	-7.852E+04	7SLV
-970	78.5	6.00	16.28	4.1340E+05	1.3813E+06	-8.009E+04	7SLV
-1050	78.5	6.00	16.70	3.9207E+05	1.3020E+06	-8.166E+04	7SLV
-1130	124.0	6.00	22.74	3.6444E+05	1.2035E+06	-5.516E+04	7SLV
-1210	78.5	6.00	22.12	3.1623E+05	1.0427E+06	-5.673E+04	7SLV
-1290	78.5	6.00	24.09	2.6803E+05	8.8193E+05	-5.830E+04	7SLV
-1370	78.5	6.00	26.07	2.1982E+05	7.2114E+05	-5.987E+04	7SLV
-1450	78.5	6.00	27.85	1.7162E+05	5.6035E+05	-6.144E+04	7SLV
-1530	78.5	6.00	29.25	1.2341E+05	3.9956E+05	-6.301E+04	7SLV
-1610	78.5	6.00	46.03	1.0054E+05	3.2470E+05	-3.785E+04	7SLV
-1690	78.5	6.00	46.76	7.8908E+04	2.5406E+05	-3.942E+04	7SLV
-1770	78.5	6.00	44.97	5.7279E+04	1.8343E+05	-4.099E+04	7SLV
-1850	78.5	6.00	43.31	3.5651E+04	1.1280E+05	-4.256E+04	7SLV
-1930	78.5	6.00	41.72	1.2003E+04	3.3304E+04	-4.418E+04	3SLU
-2010	78.5	6.00	92.70	6.0437E+03	1.6572E+04	-1.988E+04	7SLV



<b>Progetto</b>	<b>Titolo</b>	<b>Rev.</b>	<b>Pag.</b>
Orione	Orione_A24a.pdf "TABULATI DI CALCOLO PLINTO DI FONDAZIONE PER AEROGENERATORE TIPO"	0	186

Tabulati di Calcolo Plinto di Fondazione per Aerogeneratore Tipo - Progetto Impianto Eolico - "Orione"

-2090	78.5	6.00	85.91	4.7325E+03	1.2977E+04	-2.145E+04	7SLV
-2170	124.0	6.00	88.35	3.4213E+03	9.3815E+03	-2.302E+04	7SLV
-2250	78.5	6.00	74.40	3.0902E+03	8.5866E+03	-2.477E+04	3SLU
-2330	78.5	6.00	68.74	1.1700E+03	3.2511E+03	-2.682E+04	3SLU
-2410	78.5	6.00	100.00	-4.008E-11	-7.884E-11	-2.442E+03	7SLV
-2490	78.5	6.00	100.00	-4.157E-11	-1.442E-10	-4.013E+03	7SLV

Verifica di esercizio (combinazione rara):

quota	Af	cop.	sigmaf	sigmac	Mx	My	N	comb	Wk
-90	0.0	6.50	0.0	0.0	0.0000E+00	0.0000E+00	0.0000E+00	-	0.000
-170	78.5	6.00		24.2	-5.645E+05	-1.547E+06	-9.151E+04	1	0.000
-170	78.5	6.00	50.9		-3.066E+05	-1.199E+06	-5.969E+04	2	0.000
-250	78.5	6.00		21.0	-4.368E+05	-1.200E+06	-9.308E+04	1	0.000
-250	78.5	6.00	4.7		-2.519E+05	-9.292E+05	-6.126E+04	2	0.000
-330	78.5	6.00		15.9	-3.309E+05	-9.114E+05	-7.026E+04	1	0.000
-330	78.5	6.00	8.1		-2.036E+05	-7.048E+05	-4.438E+04	2	0.000
-410	78.5	6.00		14.4	-2.611E+05	-7.192E+05	-7.183E+04	1	0.000
-490	78.5	6.00		12.8	-1.913E+05	-5.270E+05	-7.341E+04	1	0.000
-570	78.5	6.00		11.3	-1.215E+05	-3.349E+05	-7.498E+04	1	0.000
-650	78.5	6.00		9.8	-5.172E+04	-1.427E+05	-7.655E+04	1	0.000
-730	78.5	6.00		6.2	-3.716E+03	-1.051E+04	-5.522E+04	1	0.000
-810	78.5	6.00		6.5	7.9918E+03	2.1733E+04	-5.679E+04	1	0.000
-890	78.5	6.00		7.0	1.9700E+04	5.3972E+04	-5.836E+04	1	0.000
-970	78.5	6.00		7.4	3.1407E+04	8.6211E+04	-5.993E+04	1	0.000
-1050	78.5	6.00		7.9	4.3115E+04	1.1845E+05	-6.150E+04	1	0.000
-1130	124.0	6.00		5.3	5.1137E+04	1.4056E+05	-4.017E+04	1	0.000
-1210	78.5	6.00		5.8	4.7119E+04	1.2958E+05	-4.175E+04	1	0.000
-1290	78.5	6.00		5.9	4.3102E+04	1.1860E+05	-4.332E+04	1	0.000
-1370	78.5	6.00		5.9	3.9084E+04	1.0762E+05	-4.489E+04	1	0.000
-1450	78.5	6.00		6.0	3.5066E+04	9.6638E+04	-4.646E+04	1	0.000
-1530	78.5	6.00		6.1	3.1049E+04	8.5658E+04	-4.803E+04	1	0.000
-1610	78.5	6.00		3.7	2.6699E+04	7.3689E+04	-2.770E+04	1	0.000
-1690	78.5	6.00		3.8	2.2332E+04	6.1671E+04	-2.927E+04	1	0.000
-1770	78.5	6.00		3.9	1.7966E+04	4.9654E+04	-3.084E+04	1	0.000
-1850	78.5	6.00		3.9	1.3600E+04	3.7636E+04	-3.241E+04	1	0.000
-1930	78.5	6.00		4.0	9.2332E+03	2.5618E+04	-3.398E+04	1	0.000
-2010	78.5	6.00		1.8	6.8081E+03	1.8918E+04	-1.434E+04	1	0.000
-2090	78.5	6.00		1.9	5.3311E+03	1.4813E+04	-1.592E+04	1	0.000
-2170	124.0	6.00		1.9	3.8541E+03	1.0709E+04	-1.749E+04	1	0.000
-2250	78.5	6.00		2.2	2.3770E+03	6.6050E+03	-1.906E+04	1	0.000
-2330	78.5	6.00		2.3	9.0002E+02	2.5009E+03	-2.063E+04	1	0.000
-2410	78.5	6.00		0.2	9.1376E-12	1.6584E-11	-1.384E+03	1	0.000
-2490	78.5	6.00		0.3	4.5902E-12	-6.153E-12	-2.955E+03	1	0.000

Verifica di esercizio (combinazione quasi permanente):

quota	Af	cop.	sigmaf	sigmac	Mx	My	N	comb	Wk
-90	0.0	6.50	0.0	0.0	0.0000E+00	0.0000E+00	0.0000E+00	-	0.000
-170	78.5	6.00		24.2	-5.645E+05	-1.547E+06	-9.151E+04	1	0.000
-170	78.5	6.00	39.5		-4.871E+05	-1.443E+06	-8.196E+04	2	0.000
-250	78.5	6.00		21.0	-4.368E+05	-1.200E+06	-9.308E+04	1	0.000
-330	78.5	6.00		15.9	-3.309E+05	-9.114E+05	-7.026E+04	1	0.000
-410	78.5	6.00		14.4	-2.611E+05	-7.192E+05	-7.183E+04	1	0.000
-490	78.5	6.00		12.8	-1.913E+05	-5.270E+05	-7.341E+04	1	0.000
-570	78.5	6.00		11.3	-1.215E+05	-3.349E+05	-7.498E+04	1	0.000
-650	78.5	6.00		9.8	-5.172E+04	-1.427E+05	-7.655E+04	1	0.000
-730	78.5	6.00		6.2	-3.716E+03	-1.051E+04	-5.522E+04	1	0.000
-810	78.5	6.00		6.5	7.9918E+03	2.1733E+04	-5.679E+04	1	0.000
-890	78.5	6.00		7.0	1.9700E+04	5.3972E+04	-5.836E+04	1	0.000
-970	78.5	6.00		7.4	3.1407E+04	8.6211E+04	-5.993E+04	1	0.000
-1050	78.5	6.00		7.9	4.3115E+04	1.1845E+05	-6.150E+04	1	0.000
-1130	124.0	6.00		5.3	5.1137E+04	1.4056E+05	-4.017E+04	1	0.000
-1210	78.5	6.00		5.8	4.7119E+04	1.2958E+05	-4.175E+04	1	0.000
-1290	78.5	6.00		5.9	4.3102E+04	1.1860E+05	-4.332E+04	1	0.000
-1370	78.5	6.00		5.9	3.9084E+04	1.0762E+05	-4.489E+04	1	0.000
-1450	78.5	6.00		6.0	3.5066E+04	9.6638E+04	-4.646E+04	1	0.000
-1530	78.5	6.00		6.1	3.1049E+04	8.5658E+04	-4.803E+04	1	0.000
-1610	78.5	6.00		3.7	2.6699E+04	7.3689E+04	-2.770E+04	1	0.000
-1690	78.5	6.00		3.8	2.2332E+04	6.1671E+04	-2.927E+04	1	0.000
-1770	78.5	6.00		3.9	1.7966E+04	4.9654E+04	-3.084E+04	1	0.000
-1850	78.5	6.00		3.9	1.3600E+04	3.7636E+04	-3.241E+04	1	0.000
-1930	78.5	6.00		4.0	9.2332E+03	2.5618E+04	-3.398E+04	1	0.000
-2010	78.5	6.00		1.8	6.8081E+03	1.8918E+04	-1.434E+04	1	0.000
-2090	78.5	6.00		1.9	5.3311E+03	1.4813E+04	-1.592E+04	1	0.000
-2170	124.0	6.00		1.9	3.8541E+03	1.0709E+04	-1.749E+04	1	0.000
-2250	78.5	6.00		2.2	2.3770E+03	6.6050E+03	-1.906E+04	1	0.000
-2330	78.5	6.00		2.3	9.0002E+02	2.5009E+03	-2.063E+04	1	0.000
-2410	78.5	6.00		0.2	9.1376E-12	1.6584E-11	-1.384E+03	1	0.000
-2490	78.5	6.00		0.3	4.5902E-12	-6.153E-12	-2.955E+03	1	0.000

Verifica a taglio:

quota	Ast	Vsd	Vsdx	Vsdy	N	comb	VRd,c	VRd,max	VRd,S	Vwd
-90	0.16	33615	-32152	9809	-121681	7SLV	40113	231056	84436	44323 Vsd < VRd,
-170	0.16	32841	-31414	9577	-122650	7SLV	44136	231056	88459	44323 Vsd < VRd,
-250	0.08	32841	-31414	9577	-124220	7SLV	44354	231056	66516	22162 Vsd < VRd,



Progetto	Titolo	Rev.	Pag.
Orione	Orione_A24a.pdf "TABULATI DI CALCOLO PLINTO DI FONDAZIONE PER AEROGENERATORE TIPO"	0	187

Tabulati di Calcolo Plinto di Fondazione per Aerogeneratore Tipo - Progetto Impianto Eolico - "Orione"

-330	0.08	10536	-10062	3125	-95730	7SLV	40394	231056	62556	22162	Vsd < VRd,
-410	0.08	10536	-10062	3125	-97300	7SLV	40613	231056	62774	22162	Vsd < VRd,
-490	0.08	10536	-10062	3125	-98871	7SLV	40831	231056	62993	22162	Vsd < VRd,
-570	0.08	10536	-10062	3125	-100442	7SLV	41049	231056	63211	22162	Vsd < VRd,
-650	0.08	10536	-10062	3125	-102013	7SLV	41268	231056	63429	22162	Vsd < VRd,
-730	0.08	1883	-1798	559	-35056	9SLV	31961	231056	54122	22162	Vsd < VRd,
-810	0.08	1883	-1798	559	-36627	9SLV	32179	231056	54341	22162	Vsd < VRd,
-890	0.08	1883	-1798	559	-38197	9SLV	32397	231056	54559	22162	Vsd < VRd,
-970	0.08	1883	-1798	559	-39768	9SLV	32616	231056	54777	22162	Vsd < VRd,
-1050	0.08	1883	-1798	559	-41339	9SLV	32834	231056	54996	22162	Vsd < VRd,
-1130	0.08	2098	2010	-603	-55160	7SLV	39211	231056	61373	22162	Vsd < VRd,
-1210	0.08	2098	2010	-603	-56731	7SLV	34973	231056	57135	22162	Vsd < VRd,
-1290	0.08	2098	2010	-603	-58301	7SLV	35192	231056	57353	22162	Vsd < VRd,
-1370	0.08	2098	2010	-603	-59872	7SLV	35410	231056	57572	22162	Vsd < VRd,
-1450	0.08	2098	2010	-603	-61443	7SLV	35628	231056	57790	22162	Vsd < VRd,
-1530	0.08	2098	2010	-603	-63014	7SLV	35847	231056	58008	22162	Vsd < VRd,
-1610	0.08	923	883	-270	-37847	7SLV	32349	231056	54510	22162	Vsd < VRd,
-1690	0.08	923	883	-270	-39418	7SLV	32567	231056	54729	22162	Vsd < VRd,
-1770	0.08	923	883	-270	-40988	7SLV	32785	231056	54947	22162	Vsd < VRd,
-1850	0.08	923	883	-270	-42559	7SLV	33004	231056	55165	22162	Vsd < VRd,
-1930	0.08	923	883	-270	-44130	7SLV	33222	231056	55384	22162	Vsd < VRd,
-2010	0.08	71	67	-24	-18648	3SLU	29680	231056	51842	22162	Vsd < VRd,
-2090	0.08	71	67	-24	-20690	3SLU	29964	231056	52126	22162	Vsd < VRd,
-2170	0.08	71	67	-24	-22732	3SLU	34704	231056	56866	22162	Vsd < VRd,
-2250	0.08	71	67	-24	-24774	3SLU	30532	231056	52693	22162	Vsd < VRd,
-2330	0.08	71	67	-24	-26816	3SLU	30815	231056	52977	22162	Vsd < VRd,
-2410	0.08	0	0	0	-2216	11SLV	27396	231056	49558	22162	Vsd < VRd,
-2490	0.08	0	0	0	-3787	11SLV	27614	231056	49776	22162	Vsd < VRd,

Palo alle coordinate X=-825 Y=1429

Sollecitazioni massime in testa palo:

Combinazione corrispondente alla minima compressione in testa

N	Mx	My	Tx	Ty	comb	
-4.597E+04	-3.837E+05	-1.229E+06	-2.758E+03	6.3993E+02	2	sl
-6.083E+04	-5.930E+05	-1.401E+06	-3.155E+03	1.2074E+03	2	ra
-7.569E+04	-8.023E+05	-1.573E+06	-3.552E+03	1.7749E+03	2	fr
-8.163E+04	-8.860E+05	-1.642E+06	-3.711E+03	2.0018E+03	2	qp
-6.005E+04	1.0921E+06	5.3267E+06	2.3873E+04	-5.933E+03	9	SLV fond

Combinazione corrispondente alla massima compressione in testa

N	Mx	My	Tx	Ty	comb	
-1.177E+05	-1.315E+06	-2.269E+06	-5.133E+03	3.0450E+03	3	sl
-9.054E+04	-1.012E+06	-1.745E+06	-3.949E+03	2.3423E+03	1	ra
-9.054E+04	-1.012E+06	-1.745E+06	-3.949E+03	2.3423E+03	1	fr
-9.054E+04	-1.012E+06	-1.745E+06	-3.949E+03	2.3423E+03	1	qp
-1.210E+05	-3.115E+06	-8.817E+06	-3.177E+04	1.0617E+04	7	SLV fond

Combinazione corrispondente al massimo taglio in testa

N	Mx	My	Tx	Ty	comb	
-1.177E+05	-1.315E+06	-2.269E+06	-5.133E+03	3.0450E+03	3	sl
-9.054E+04	-1.012E+06	-1.745E+06	-3.949E+03	2.3423E+03	1	ra
-9.054E+04	-1.012E+06	-1.745E+06	-3.949E+03	2.3423E+03	1	fr
-9.054E+04	-1.012E+06	-1.745E+06	-3.949E+03	2.3423E+03	1	qp
-1.210E+05	-3.115E+06	-8.817E+06	-3.177E+04	1.0617E+04	7	SLV fond

Verifica di capacità portante riferita al palo singolo:

Fattore di correlazione Psi scelto in base alla conoscenza del sito = 1.7

Coeff. parziale di sicurezza sulla resistenza laterale = 1.15

Coeff. parziale di sicurezza sulla resistenza alla punta = 1.35

Portanza laterale di progetto = 292537.1

Portanza di punta di progetto = 85555.4

verifica condotta in combinazione SLU 3

Sforzo normale = -117705.6

Peso del palo = 49087.4 \* 1.3

Carico totale di progetto = -181519.2

Resistenza totale di progetto = 378092.5

Coefficiente di sicurezza = 2.08 > 1

Verifica di resistenza allo stato limite:

quota	Af	cop.	c.s.	Mx	My	N	comb
-90	0.0	6.50	0.00	0.0000E+00	0.0000E+00	0.0000E+00	-
-170	78.5	6.00	3.51	-2.284E+06	-6.331E+06	-1.220E+05	7SLV
-250	78.5	6.00	6.51	-1.453E+06	-3.848E+06	-1.236E+05	7SLV
-330	78.5	6.00	11.85	-8.279E+05	-2.000E+06	-9.521E+04	7SLV
-410	78.5	6.00	15.62	-5.440E+05	-1.211E+06	-9.678E+04	7SLV
-490	78.5	6.00	18.74	-2.600E+05	-4.221E+05	-9.835E+04	7SLV
-570	78.5	6.00	18.45	1.9845E+04	3.6424E+05	-9.992E+04	7SLV
-650	78.5	6.00	15.74	3.0781E+05	1.1559E+06	-1.015E+05	7SLV
-730	78.5	6.00	14.42	-4.901E+05	-1.638E+06	-3.545E+04	9SLV
-810	78.5	6.00	15.53	4.6310E+05	1.5366E+06	-7.654E+04	7SLV
-890	78.5	6.00	15.92	4.4699E+05	1.4548E+06	-7.811E+04	7SLV
-970	78.5	6.00	16.33	4.3087E+05	1.3730E+06	-7.968E+04	7SLV



Progetto	Titolo	Rev.	Pag.
Orione	Orione_A24a.pdf "TABULATI DI CALCOLO PLINTO DI FONDAZIONE PER AEROGENERATORE TIPO"	0	188

Tabulati di Calcolo Plinto di Fondazione per Aerogeneratore Tipo - Progetto Impianto Eolico - "Orione"

-1050	78.5	6.00	16.77	4.1476E+05	1.2912E+06	-8.125E+04	7SLV		
-1130	124.0	6.00	22.84	3.9060E+05	1.1911E+06	-5.485E+04	7SLV		
-1210	78.5	6.00	22.21	3.4020E+05	1.0314E+06	-5.642E+04	7SLV		
-1290	78.5	6.00	24.19	2.8979E+05	8.7165E+05	-5.799E+04	7SLV		
-1370	78.5	6.00	26.19	2.3939E+05	7.1190E+05	-5.957E+04	7SLV		
-1450	78.5	6.00	27.98	1.8898E+05	5.5216E+05	-6.114E+04	7SLV		
-1530	78.5	6.00	29.39	1.3858E+05	3.9241E+05	-6.271E+04	7SLV		
-1610	78.5	6.00	46.27	1.1354E+05	3.1857E+05	-3.764E+04	7SLV		
-1690	78.5	6.00	47.01	8.9742E+04	2.4896E+05	-3.921E+04	7SLV		
-1770	78.5	6.00	45.20	6.5949E+04	1.7935E+05	-4.078E+04	7SLV		
-1850	78.5	6.00	43.52	4.2157E+04	1.0974E+05	-4.235E+04	7SLV		
-1930	78.5	6.00	41.73	1.7543E+04	3.0720E+04	-4.417E+04	3SLU		
-2010	78.5	6.00	93.23	9.2133E+03	1.5084E+04	-1.977E+04	7SLV		
-2090	78.5	6.00	86.37	7.2145E+03	1.1812E+04	-2.134E+04	7SLV		
-2170	124.0	6.00	88.79	5.2157E+03	8.5392E+03	-2.291E+04	7SLV		
-2250	78.5	6.00	74.41	4.5162E+03	7.9213E+03	-2.477E+04	3SLU		
-2330	78.5	6.00	68.74	1.7100E+03	2.9992E+03	-2.681E+04	3SLU		
-2410	78.5	6.00	100.00	-3.683E-11	-4.046E-11	-2.421E+03	7SLV		
-2490	78.5	6.00	100.00	-7.441E-11	-6.774E-11	-3.991E+03	7SLV		

Verifica di esercizio (combinazione rara):

quota	Af	cop.	sigmaf	sigmac	Mx	My	N	comb	Wk
-90	0.0	6.50	0.0	0.0	0.0000E+00	0.0000E+00	0.0000E+00	-	0.000
-170	78.5	6.00		24.2	-8.250E+05	-1.426E+06	-9.150E+04	1	0.000
-170	78.5	6.00	46.4		-4.961E+05	-1.146E+06	-6.192E+04	2	0.000
-250	78.5	6.00		21.0	-6.384E+05	-1.106E+06	-9.307E+04	1	0.000
-250	78.5	6.00	2.2		-3.992E+05	-8.907E+05	-6.350E+04	2	0.000
-330	78.5	6.00		15.9	-4.836E+05	-8.402E+05	-7.025E+04	1	0.000
-330	78.5	6.00	6.3		-3.157E+05	-6.778E+05	-4.619E+04	2	0.000
-410	78.5	6.00		14.4	-3.816E+05	-6.630E+05	-7.182E+04	1	0.000
-490	78.5	6.00		12.8	-2.796E+05	-4.859E+05	-7.340E+04	1	0.000
-570	78.5	6.00		11.3	-1.776E+05	-3.087E+05	-7.497E+04	1	0.000
-650	78.5	6.00		9.8	-7.558E+04	-1.316E+05	-7.654E+04	1	0.000
-730	78.5	6.00		6.2	-5.417E+03	-9.705E+03	-5.521E+04	1	0.000
-810	78.5	6.00		6.5	1.1693E+04	2.0013E+04	-5.678E+04	1	0.000
-890	78.5	6.00		7.0	2.8802E+04	4.9731E+04	-5.835E+04	1	0.000
-970	78.5	6.00		7.4	4.5912E+04	7.9449E+04	-5.992E+04	1	0.000
-1050	78.5	6.00		7.9	6.3022E+04	1.0917E+05	-6.149E+04	1	0.000
-1130	124.0	6.00		5.3	7.4745E+04	1.2955E+05	-4.017E+04	1	0.000
-1210	78.5	6.00		5.8	6.8872E+04	1.1943E+05	-4.174E+04	1	0.000
-1290	78.5	6.00		5.9	6.2999E+04	1.0932E+05	-4.331E+04	1	0.000
-1370	78.5	6.00		5.9	5.7126E+04	9.9204E+04	-4.488E+04	1	0.000
-1450	78.5	6.00		6.0	5.1253E+04	8.9088E+04	-4.645E+04	1	0.000
-1530	78.5	6.00		6.1	4.5380E+04	7.8973E+04	-4.802E+04	1	0.000
-1610	78.5	6.00		3.7	3.9022E+04	6.7941E+04	-2.770E+04	1	0.000
-1690	78.5	6.00		3.8	3.2640E+04	5.6863E+04	-2.927E+04	1	0.000
-1770	78.5	6.00		3.9	2.6258E+04	4.5786E+04	-3.084E+04	1	0.000
-1850	78.5	6.00		3.9	1.9876E+04	3.4708E+04	-3.241E+04	1	0.000
-1930	78.5	6.00		4.0	1.3494E+04	2.3631E+04	-3.398E+04	1	0.000
-2010	78.5	6.00		1.8	9.9499E+03	1.7452E+04	-1.434E+04	1	0.000
-2090	78.5	6.00		1.9	7.7913E+03	1.3666E+04	-1.591E+04	1	0.000
-2170	124.0	6.00		1.9	5.6327E+03	9.8794E+03	-1.748E+04	1	0.000
-2250	78.5	6.00		2.2	3.4740E+03	6.0933E+03	-1.905E+04	1	0.000
-2330	78.5	6.00		2.3	1.3154E+03	2.3071E+03	-2.063E+04	1	0.000
-2410	78.5	6.00		0.2	2.0137E-11	2.2084E-11	-1.384E+03	1	0.000
-2490	78.5	6.00		0.3	6.4946E-12	-5.201E-12	-2.955E+03	1	0.000

Verifica di esercizio (combinazione quasi permanente):

quota	Af	cop.	sigmaf	sigmac	Mx	My	N	comb	Wk
-90	0.0	6.50	0.0	0.0	0.0000E+00	0.0000E+00	0.0000E+00	-	0.000
-170	78.5	6.00		24.2	-8.250E+05	-1.426E+06	-9.150E+04	1	0.000
-170	78.5	6.00	38.4		-7.263E+05	-1.342E+06	-8.262E+04	2	0.000
-250	78.5	6.00		21.0	-6.384E+05	-1.106E+06	-9.307E+04	1	0.000
-330	78.5	6.00		15.9	-4.836E+05	-8.402E+05	-7.025E+04	1	0.000
-410	78.5	6.00		14.4	-3.816E+05	-6.630E+05	-7.182E+04	1	0.000
-490	78.5	6.00		12.8	-2.796E+05	-4.859E+05	-7.340E+04	1	0.000
-570	78.5	6.00		11.3	-1.776E+05	-3.087E+05	-7.497E+04	1	0.000
-650	78.5	6.00		9.8	-7.558E+04	-1.316E+05	-7.654E+04	1	0.000
-730	78.5	6.00		6.2	-5.417E+03	-9.705E+03	-5.521E+04	1	0.000
-810	78.5	6.00		6.5	1.1693E+04	2.0013E+04	-5.678E+04	1	0.000
-890	78.5	6.00		7.0	2.8802E+04	4.9731E+04	-5.835E+04	1	0.000
-970	78.5	6.00		7.4	4.5912E+04	7.9449E+04	-5.992E+04	1	0.000
-1050	78.5	6.00		7.9	6.3022E+04	1.0917E+05	-6.149E+04	1	0.000
-1130	124.0	6.00		5.3	7.4745E+04	1.2955E+05	-4.017E+04	1	0.000
-1210	78.5	6.00		5.8	6.8872E+04	1.1943E+05	-4.174E+04	1	0.000
-1290	78.5	6.00		5.9	6.2999E+04	1.0932E+05	-4.331E+04	1	0.000
-1370	78.5	6.00		5.9	5.7126E+04	9.9204E+04	-4.488E+04	1	0.000
-1450	78.5	6.00		6.0	5.1253E+04	8.9088E+04	-4.645E+04	1	0.000
-1530	78.5	6.00		6.1	4.5380E+04	7.8973E+04	-4.802E+04	1	0.000
-1610	78.5	6.00		3.7	3.9022E+04	6.7941E+04	-2.770E+04	1	0.000
-1690	78.5	6.00		3.8	3.2640E+04	5.6863E+04	-2.927E+04	1	0.000
-1770	78.5	6.00		3.9	2.6258E+04	4.5786E+04	-3.084E+04	1	0.000
-1850	78.5	6.00		3.9	1.9876E+04	3.4708E+04	-3.241E+04	1	0.000
-1930	78.5	6.00		4.0	1.3494E+04	2.3631E+04	-3.398E+04	1	0.000
-2010	78.5	6.00		1.8	9.9499E+03	1.7452E+04	-1.434E+04	1	0.000
-2090	78.5	6.00		1.9	7.7913E+03	1.3666E+04	-1.591E+04	1	0.000



Progetto	Titolo	Rev.	Pag.
Orione	Orione_A24a.pdf "TABULATI DI CALCOLO PLINTO DI FONDAZIONE PER AEROGENERATORE TIPO"	0	189

Tabulati di Calcolo Plinto di Fondazione per Aerogeneratore Tipo - Progetto Impianto Eolico - "Orione"

-2170	124.0	6.00	1.9	5.6327E+03	9.8794E+03	-1.748E+04	1	0.000
-2250	78.5	6.00	2.2	3.4740E+03	6.0933E+03	-1.905E+04	1	0.000
-2330	78.5	6.00	2.3	1.3154E+03	2.3071E+03	-2.063E+04	1	0.000
-2410	78.5	6.00	0.2	2.0137E-11	2.2084E-11	-1.384E+03	1	0.000
-2490	78.5	6.00	0.3	6.4946E-12	-5.201E-12	-2.955E+03	1	0.000

Verifica a taglio:

quota	Ast	Vsd	Vsdx	Vsdy	N	comb	VRd,c	VRd,max	VRd,S	Vwd
-90	0.16	33498	-31771	10617	-121038	7SLV	40024	231056	84347	44323 Vsd < VRd,
-170	0.16	32725	-31035	10380	-122010	7SLV	44047	231056	88370	44323 Vsd < VRd,
-250	0.08	32725	-31035	10380	-123581	7SLV	44265	231056	66427	22162 Vsd < VRd,
-330	0.08	10482	-9862	3549	-95208	7SLV	40322	231056	62483	22162 Vsd < VRd,
-410	0.08	10482	-9862	3549	-96779	7SLV	40540	231056	62702	22162 Vsd < VRd,
-490	0.08	10482	-9862	3549	-98350	7SLV	40758	231056	62920	22162 Vsd < VRd,
-570	0.08	10482	-9862	3549	-99920	7SLV	40977	231056	63138	22162 Vsd < VRd,
-650	0.08	10482	-9862	3549	-101491	7SLV	41195	231056	63357	22162 Vsd < VRd,
-730	0.08	1874	-1765	629	-35452	9SLV	32016	231056	54177	22162 Vsd < VRd,
-810	0.08	1874	-1765	629	-37023	9SLV	32234	231056	54396	22162 Vsd < VRd,
-890	0.08	1874	-1765	629	-38593	9SLV	32452	231056	54614	22162 Vsd < VRd,
-970	0.08	1874	-1765	629	-40164	9SLV	32671	231056	54832	22162 Vsd < VRd,
-1050	0.08	1874	-1765	629	-41735	9SLV	32889	231056	55051	22162 Vsd < VRd,
-1130	0.08	2094	1997	-630	-54853	7SLV	39169	231056	61330	22162 Vsd < VRd,
-1210	0.08	2094	1997	-630	-56424	7SLV	34931	231056	57092	22162 Vsd < VRd,
-1290	0.08	2094	1997	-630	-57994	7SLV	35149	231056	57311	22162 Vsd < VRd,
-1370	0.08	2094	1997	-630	-59565	7SLV	35367	231056	57529	22162 Vsd < VRd,
-1450	0.08	2094	1997	-630	-61136	7SLV	35586	231056	57747	22162 Vsd < VRd,
-1530	0.08	2094	1997	-630	-62707	7SLV	35804	231056	57966	22162 Vsd < VRd,
-1610	0.08	920	870	-297	-37639	7SLV	32320	231056	54481	22162 Vsd < VRd,
-1690	0.08	920	870	-297	-39210	7SLV	32538	231056	54700	22162 Vsd < VRd,
-1770	0.08	920	870	-297	-40781	7SLV	32756	231056	54918	22162 Vsd < VRd,
-1850	0.08	920	870	-297	-42351	7SLV	32975	231056	55136	22162 Vsd < VRd,
-1930	0.08	920	870	-297	-43922	7SLV	33193	231056	55355	22162 Vsd < VRd,
-2010	0.08	71	62	-35	-18645	3SLU	29680	231056	51841	22162 Vsd < VRd,
-2090	0.08	71	62	-35	-20687	3SLU	29963	231056	52125	22162 Vsd < VRd,
-2170	0.08	71	62	-35	-22729	3SLU	34703	231056	56865	22162 Vsd < VRd,
-2250	0.08	71	62	-35	-24771	3SLU	30531	231056	52693	22162 Vsd < VRd,
-2330	0.08	71	62	-35	-26813	3SLU	30815	231056	52977	22162 Vsd < VRd,
-2410	0.08	0	0	0	-572	13SLV	27168	231056	49329	22162 Vsd < VRd,
-2490	0.08	0	0	0	-2143	13SLV	27386	231056	49548	22162 Vsd < VRd,

Palo alle coordinate X=-1061 Y=1264

Sollecitazioni massime in testa palo:

Combinazione corrispondente alla minima compressione in testa

N	Mx	My	Tx	Ty	comb
-5.071E+04	-5.934E+05	-1.184E+06	-2.611E+03	1.1065E+03	2 sl
-6.398E+04	-8.290E+05	-1.304E+06	-2.901E+03	1.7411E+03	2 ra
-7.726E+04	-1.065E+06	-1.423E+06	-3.191E+03	2.3758E+03	2 fr
-8.257E+04	-1.159E+06	-1.471E+06	-3.307E+03	2.6296E+03	2 qp
-6.160E+04	8.178E+05	5.513E+06	2.4288E+04	-5.317E+03	9 SLV fond

Combinazione corrispondente alla massima compressione in testa

N	Mx	My	Tx	Ty	comb
-1.177E+05	-1.690E+06	-2.006E+06	-4.525E+03	3.9135E+03	3 sl
-9.054E+04	-1.300E+06	-1.543E+06	-3.481E+03	3.0104E+03	1 ra
-9.054E+04	-1.300E+06	-1.543E+06	-3.481E+03	3.0104E+03	1 fr
-9.054E+04	-1.300E+06	-1.543E+06	-3.481E+03	3.0104E+03	1 qp
-1.195E+05	-3.418E+06	-8.600E+06	-3.125E+04	1.1338E+04	7 SLV fond

Combinazione corrispondente al massimo taglio in testa

N	Mx	My	Tx	Ty	comb
-1.177E+05	-1.690E+06	-2.006E+06	-4.525E+03	3.9135E+03	3 sl
-9.054E+04	-1.300E+06	-1.543E+06	-3.481E+03	3.0104E+03	1 ra
-9.054E+04	-1.300E+06	-1.543E+06	-3.481E+03	3.0104E+03	1 fr
-9.054E+04	-1.300E+06	-1.543E+06	-3.481E+03	3.0104E+03	1 qp
-1.195E+05	-3.418E+06	-8.600E+06	-3.125E+04	1.1338E+04	7 SLV fond

Verifica di capacità portante riferita al palo singolo:

Fattore di correlazione Psi scelto in base alla conoscenza del sito = 1.7  
 Coeff. parziale di sicurezza sulla resistenza laterale = 1.15  
 Coeff. parziale di sicurezza sulla resistenza alla punta = 1.35  
 Portanza laterale di progetto = 292537.1  
 Portanza di punta di progetto = 85555.4  
 verifica condotta in combinazione SLU 3  
 Sforzo normale = -117699.1  
 Peso del palo = 49087.4 \* 1.3  
 Carico totale di progetto = -181512.7  
 Resistenza totale di progetto = 378092.5  
 Coefficiente di sicurezza = 2.08 > 1

Verifica di resistenza allo stato limite:



Progetto	Titolo	Rev.	Pag.
Orione	Orione_A24a.pdf "TABULATI DI CALCOLO PLINTO DI FONDAZIONE PER AEROGENERATORE TIPO"	0	190

quota	Af	cop.	c.s.	Mx	My	N	comb
-90	0.0	6.50	0.00	0.0000E+00	0.0000E+00	0.0000E+00	-
-170	78.5	6.00	3.55	-2.529E+06	-6.155E+06	-1.205E+05	7SLV
-250	78.5	6.00	6.59	-1.642E+06	-3.713E+06	-1.220E+05	7SLV
-330	78.5	6.00	12.02	-9.689E+05	-1.900E+06	-9.394E+04	7SLV
-410	78.5	6.00	15.84	-6.546E+05	-1.133E+06	-9.551E+04	7SLV
-490	78.5	6.00	18.99	-3.403E+05	-3.654E+05	-9.708E+04	7SLV
-570	78.5	6.00	18.68	-3.061E+04	3.9874E+05	-9.865E+04	7SLV
-650	78.5	6.00	15.84	2.8824E+05	1.1691E+06	-1.002E+05	7SLV
-730	78.5	6.00	14.59	-4.943E+05	-1.634E+06	-3.645E+04	9SLV
-810	78.5	6.00	15.63	4.6901E+05	1.5317E+06	-7.553E+04	7SLV
-890	78.5	6.00	16.04	4.5763E+05	1.4466E+06	-7.710E+04	7SLV
-970	78.5	6.00	16.46	4.4624E+05	1.3615E+06	-7.867E+04	7SLV
-1050	78.5	6.00	16.91	4.3486E+05	1.2764E+06	-8.024E+04	7SLV
-1130	124.0	6.00	23.05	4.1388E+05	1.1742E+06	-5.411E+04	7SLV
-1210	78.5	6.00	22.42	3.6153E+05	1.0159E+06	-5.568E+04	7SLV
-1290	78.5	6.00	24.43	3.0919E+05	8.5758E+05	-5.725E+04	7SLV
-1370	78.5	6.00	26.48	2.5684E+05	6.9928E+05	-5.882E+04	7SLV
-1450	78.5	6.00	28.30	2.0450E+05	5.4097E+05	-6.039E+04	7SLV
-1530	78.5	6.00	29.53	7.5818E+04	9.0884E+04	-6.242E+04	3SLU
-1610	78.5	6.00	46.87	1.2518E+05	3.1023E+05	-3.713E+04	7SLV
-1690	78.5	6.00	47.62	9.9449E+04	2.4201E+05	-3.870E+04	7SLV
-1770	78.5	6.00	45.77	7.3723E+04	1.7379E+05	-4.028E+04	7SLV
-1850	78.5	6.00	43.75	3.3207E+04	3.9961E+04	-4.213E+04	3SLU
-1930	78.5	6.00	41.73	2.2545E+04	2.7217E+04	-4.417E+04	3SLU
-2010	78.5	6.00	94.55	1.2070E+04	1.3064E+04	-1.949E+04	7SLV
-2090	78.5	6.00	87.50	9.4515E+03	1.0230E+04	-2.106E+04	7SLV
-2170	124.0	6.00	89.51	9.4102E+03	1.1381E+04	-2.273E+04	3SLU
-2250	78.5	6.00	74.42	5.8039E+03	7.0195E+03	-2.477E+04	3SLU
-2330	78.5	6.00	68.75	2.1975E+03	2.6578E+03	-2.681E+04	3SLU
-2410	78.5	6.00	100.00	-5.346E-11	-2.046E-10	-2.368E+03	7SLV
-2490	78.5	6.00	100.00	-7.234E-11	-1.449E-10	-3.939E+03	7SLV

Verifica di esercizio (combinazione rara):

quota	Af	cop.	sigmaf	sigmac	Mx	My	N	comb	Wk
-90	0.0	6.50	0.0	0.0	0.0000E+00	0.0000E+00	0.0000E+00	-	0.000
-170	78.5	6.00		24.2	-1.060E+06	-1.261E+06	-9.149E+04	1	0.000
-170	78.5	6.00	41.7		-6.895E+05	-1.069E+06	-6.506E+04	2	0.000
-250	78.5	6.00		21.0	-8.205E+05	-9.788E+05	-9.306E+04	1	0.000
-330	78.5	6.00		15.9	-6.215E+05	-7.436E+05	-7.025E+04	1	0.000
-330	78.5	6.00	4.1		-4.310E+05	-6.365E+05	-4.875E+04	2	0.000
-410	78.5	6.00		14.4	-4.904E+05	-5.868E+05	-7.182E+04	1	0.000
-490	78.5	6.00		12.8	-3.593E+05	-4.300E+05	-7.339E+04	1	0.000
-570	78.5	6.00		11.3	-2.282E+05	-2.733E+05	-7.496E+04	1	0.000
-650	78.5	6.00		9.8	-9.712E+04	-1.165E+05	-7.653E+04	1	0.000
-730	78.5	6.00		6.2	-6.948E+03	-8.629E+03	-5.520E+04	1	0.000
-810	78.5	6.00		6.5	1.5040E+04	1.7673E+04	-5.677E+04	1	0.000
-890	78.5	6.00		7.0	3.7027E+04	4.3975E+04	-5.835E+04	1	0.000
-970	78.5	6.00		7.4	5.9014E+04	7.0277E+04	-5.992E+04	1	0.000
-1050	78.5	6.00		7.9	8.1001E+04	9.6579E+04	-6.149E+04	1	0.000
-1130	124.0	6.00		5.3	9.6066E+04	1.1462E+05	-4.016E+04	1	0.000
-1210	78.5	6.00		5.8	8.8517E+04	1.0568E+05	-4.174E+04	1	0.000
-1290	78.5	6.00		5.9	8.0968E+04	9.6737E+04	-4.331E+04	1	0.000
-1370	78.5	6.00		5.9	7.3419E+04	8.7795E+04	-4.488E+04	1	0.000
-1450	78.5	6.00		6.0	6.5870E+04	7.8853E+04	-4.645E+04	1	0.000
-1530	78.5	6.00		6.1	5.8322E+04	6.9911E+04	-4.802E+04	1	0.000
-1610	78.5	6.00		3.7	5.0150E+04	6.0148E+04	-2.769E+04	1	0.000
-1690	78.5	6.00		3.8	4.1948E+04	5.0345E+04	-2.926E+04	1	0.000
-1770	78.5	6.00		3.9	3.3746E+04	4.0542E+04	-3.084E+04	1	0.000
-1850	78.5	6.00		3.9	2.5544E+04	3.0739E+04	-3.241E+04	1	0.000
-1930	78.5	6.00		4.0	1.7342E+04	2.0936E+04	-3.398E+04	1	0.000
-2010	78.5	6.00		1.8	1.2787E+04	1.5465E+04	-1.434E+04	1	0.000
-2090	78.5	6.00		1.9	1.0013E+04	1.2110E+04	-1.591E+04	1	0.000
-2170	124.0	6.00		1.9	7.2386E+03	8.7547E+03	-1.748E+04	1	0.000
-2250	78.5	6.00		2.2	4.4645E+03	5.3996E+03	-1.905E+04	1	0.000
-2330	78.5	6.00		2.3	1.6904E+03	2.0445E+03	-2.062E+04	1	0.000
-2410	78.5	6.00		0.2	2.3860E-11	1.4723E-11	-1.384E+03	1	0.000
-2490	78.5	6.00		0.3	1.1230E-12	-3.467E-12	-2.955E+03	1	0.000

Verifica di esercizio (combinazione quasi permanente):

quota	Af	cop.	sigmaf	sigmac	Mx	My	N	comb	Wk
-90	0.0	6.50	0.0	0.0	0.0000E+00	0.0000E+00	0.0000E+00	-	0.000
-170	78.5	6.00		24.2	-1.060E+06	-1.261E+06	-9.149E+04	1	0.000
-170	78.5	6.00	37.2		-9.490E+05	-1.203E+06	-8.356E+04	2	0.000
-250	78.5	6.00		21.0	-8.205E+05	-9.788E+05	-9.306E+04	1	0.000
-330	78.5	6.00		15.9	-6.215E+05	-7.436E+05	-7.025E+04	1	0.000
-410	78.5	6.00		14.4	-4.904E+05	-5.868E+05	-7.182E+04	1	0.000
-490	78.5	6.00		12.8	-3.593E+05	-4.300E+05	-7.339E+04	1	0.000
-570	78.5	6.00		11.3	-2.282E+05	-2.733E+05	-7.496E+04	1	0.000
-650	78.5	6.00		9.8	-9.712E+04	-1.165E+05	-7.653E+04	1	0.000
-730	78.5	6.00		6.2	-6.948E+03	-8.629E+03	-5.520E+04	1	0.000
-810	78.5	6.00		6.5	1.5040E+04	1.7673E+04	-5.677E+04	1	0.000
-890	78.5	6.00		7.0	3.7027E+04	4.3975E+04	-5.835E+04	1	0.000
-970	78.5	6.00		7.4	5.9014E+04	7.0277E+04	-5.992E+04	1	0.000
-1050	78.5	6.00		7.9	8.1001E+04	9.6579E+04	-6.149E+04	1	0.000
-1130	124.0	6.00		5.3	9.6066E+04	1.1462E+05	-4.016E+04	1	0.000





Tabulati di Calcolo Plinto di Fondazione per Aerogeneratore Tipo - Progetto Impianto Eolico - "Orione"

-1210	78.5	6.00	5.8	8.8517E+04	1.0568E+05	-4.174E+04	1	0.000
-1290	78.5	6.00	5.9	8.0968E+04	9.6737E+04	-4.331E+04	1	0.000
-1370	78.5	6.00	5.9	7.3419E+04	8.7795E+04	-4.488E+04	1	0.000
-1450	78.5	6.00	6.0	6.5870E+04	7.8853E+04	-4.645E+04	1	0.000
-1530	78.5	6.00	6.1	5.8322E+04	6.9911E+04	-4.802E+04	1	0.000
-1610	78.5	6.00	3.7	5.0150E+04	6.0148E+04	-2.769E+04	1	0.000
-1690	78.5	6.00	3.8	4.1948E+04	5.0345E+04	-2.926E+04	1	0.000
-1770	78.5	6.00	3.9	3.3746E+04	4.0542E+04	-3.084E+04	1	0.000
-1850	78.5	6.00	3.9	2.5544E+04	3.0739E+04	-3.241E+04	1	0.000
-1930	78.5	6.00	4.0	1.7342E+04	2.0936E+04	-3.398E+04	1	0.000
-2010	78.5	6.00	1.8	1.2787E+04	1.5465E+04	-1.434E+04	1	0.000
-2090	78.5	6.00	1.9	1.0013E+04	1.2110E+04	-1.591E+04	1	0.000
-2170	124.0	6.00	1.9	7.2386E+03	8.7547E+03	-1.748E+04	1	0.000
-2250	78.5	6.00	2.2	4.4645E+03	5.3996E+03	-1.905E+04	1	0.000
-2330	78.5	6.00	2.3	1.6904E+03	2.0445E+03	-2.062E+04	1	0.000
-2410	78.5	6.00	0.2	2.3860E-11	1.4723E-11	-1.384E+03	1	0.000
-2490	78.5	6.00	0.3	1.1230E-12	-3.467E-12	-2.955E+03	1	0.000

Verifica a taglio:

quota	Ast	Vsd	Vsdx	Vsdy	N	comb	VRd,c	VRd,max	VRd,S	Vwd
-90	0.16	33243	-31250	11338	-119474	7SLV	39806	231056	84130	44323 Vsd < VRd,
-170	0.16	32472	-30517	11096	-120452	7SLV	43831	231056	88154	44323 Vsd < VRd,
-250	0.08	32472	-30517	11096	-122023	7SLV	44049	231056	66211	22162 Vsd < VRd,
-330	0.08	10364	-9591	3928	-93939	7SLV	40145	231056	62307	22162 Vsd < VRd,
-410	0.08	10364	-9591	3928	-95510	7SLV	40364	231056	62525	22162 Vsd < VRd,
-490	0.08	10364	-9591	3928	-97081	7SLV	40582	231056	62744	22162 Vsd < VRd,
-570	0.08	10364	-9591	3928	-98652	7SLV	40800	231056	62962	22162 Vsd < VRd,
-650	0.08	10364	-9591	3928	-100223	7SLV	41019	231056	63180	22162 Vsd < VRd,
-730	0.08	1855	-1721	692	-36446	9SLV	32154	231056	54316	22162 Vsd < VRd,
-810	0.08	1855	-1721	692	-38017	9SLV	32372	231056	54534	22162 Vsd < VRd,
-890	0.08	1855	-1721	692	-39588	9SLV	32591	231056	54752	22162 Vsd < VRd,
-970	0.08	1855	-1721	692	-41158	9SLV	32809	231056	54971	22162 Vsd < VRd,
-1050	0.08	1855	-1721	692	-42729	9SLV	33027	231056	55189	22162 Vsd < VRd,
-1130	0.08	2084	1979	-654	-54107	7SLV	39065	231056	61227	22162 Vsd < VRd,
-1210	0.08	2084	1979	-654	-55677	7SLV	34827	231056	56989	22162 Vsd < VRd,
-1290	0.08	2084	1979	-654	-57248	7SLV	35045	231056	57207	22162 Vsd < VRd,
-1370	0.08	2084	1979	-654	-58819	7SLV	35264	231056	57425	22162 Vsd < VRd,
-1450	0.08	2084	1979	-654	-60390	7SLV	35482	231056	57644	22162 Vsd < VRd,
-1530	0.08	2084	1979	-654	-61961	7SLV	35700	231056	57862	22162 Vsd < VRd,
-1610	0.08	911	853	-322	-37134	7SLV	32250	231056	54411	22162 Vsd < VRd,
-1690	0.08	911	853	-322	-38704	7SLV	32468	231056	54630	22162 Vsd < VRd,
-1770	0.08	911	853	-322	-40275	7SLV	32686	231056	54848	22162 Vsd < VRd,
-1850	0.08	911	853	-322	-41846	7SLV	32905	231056	55066	22162 Vsd < VRd,
-1930	0.08	911	853	-322	-43417	7SLV	33123	231056	55285	22162 Vsd < VRd,
-2010	0.08	71	55	-45	-18643	3SLU	29679	231056	51841	22162 Vsd < VRd,
-2090	0.08	71	55	-45	-20685	3SLU	29963	231056	52125	22162 Vsd < VRd,
-2170	0.08	71	55	-45	-22727	3SLU	34703	231056	56865	22162 Vsd < VRd,
-2250	0.08	71	55	-45	-24769	3SLU	30531	231056	52693	22162 Vsd < VRd,
-2330	0.08	71	55	-45	-26811	3SLU	30815	231056	52976	22162 Vsd < VRd,
-2410	0.08	0	0	0	-400	9SLV	27144	231056	49305	22162 Vsd < VRd,
-2490	0.08	0	0	0	-1970	9SLV	27362	231056	49524	22162 Vsd < VRd,

Palo alle coordinate X=-1264 Y=1061

Sollecitazioni massime in testa palo:

Combinazione corrispondente alla minima compressione in testa										
N	Mx	My	Tx	Ty	comb					
-5.666E+04	-8.250E+05	-1.106E+06	-2.391E+03	1.6154E+03	2	sl				
-6.795E+04	-1.066E+06	-1.169E+06	-2.562E+03	2.2728E+03	2	ra				
-7.925E+04	-1.308E+06	-1.231E+06	-2.733E+03	2.9302E+03	2	fr				
-8.376E+04	-1.405E+06	-1.256E+06	-2.801E+03	3.1932E+03	2	qp				
-5.976E+04	5.3664E+06	9.0133E+05	5.7059E+03	-2.365E+04	13	SLV fond				

Combinazione corrispondente alla massima compressione in testa										
N	Mx	My	Tx	Ty	comb					
-1.177E+05	-2.014E+06	-1.682E+06	-3.775E+03	4.6640E+03	3	sl				
-9.054E+04	-1.549E+06	-1.294E+06	-2.904E+03	3.5877E+03	1	ra				
-9.054E+04	-1.549E+06	-1.294E+06	-2.904E+03	3.5877E+03	1	fr				
-9.054E+04	-1.549E+06	-1.294E+06	-2.904E+03	3.5877E+03	1	qp				
-1.213E+05	-8.465E+06	-3.489E+06	-1.151E+04	3.0829E+04	3	SLV fond				

Combinazione corrispondente al massimo taglio in testa										
N	Mx	My	Tx	Ty	comb					
-1.177E+05	-2.014E+06	-1.682E+06	-3.775E+03	4.6640E+03	3	sl				
-9.054E+04	-1.549E+06	-1.294E+06	-2.904E+03	3.5877E+03	1	ra				
-9.054E+04	-1.549E+06	-1.294E+06	-2.904E+03	3.5877E+03	1	fr				
-9.054E+04	-1.549E+06	-1.294E+06	-2.904E+03	3.5877E+03	1	qp				
-1.213E+05	-8.465E+06	-3.489E+06	-1.151E+04	3.0829E+04	3	SLV fond				

Verifica di capacità portante riferita al palo singolo:

Fattore di correlazione Psi scelto in base alla conoscenza del sito = 1.7  
 Coeff. parziale di sicurezza sulla resistenza laterale = 1.15  
 Coeff. parziale di sicurezza sulla resistenza alla punta = 1.35



Progetto	Titolo	Rev.	Pag.
Orione	Orione_A24a.pdf "TABULATI DI CALCOLO PLINTO DI FONDAZIONE PER AEROGENERATORE TIPO"	0	192

Tabulati di Calcolo Plinto di Fondazione per Aerogeneratore Tipo - Progetto Impianto Eolico - "Orione"

Portanza laterale di progetto = 292537.1  
 Portanza di punta di progetto = 85555.4  
 verifica condotta in combinazione SLU 3  
 Sforzo normale = -117700.1  
 Peso del palo = 49087.4 \* 1.3  
 Carico totale di progetto = -181513.7  
 Resistenza totale di progetto = 378092.5  
 Coefficiente di sicurezza = 2.08 > 1

Verifica di resistenza allo stato limite:

quota	Af	cop.	c.s.	Mx	My	N	comb
-90	0.0	6.50	0.00	0.0000E+00	0.0000E+00	0.0000E+00	-
-170	78.5	6.00	3.61	-2.738E+06	-5.938E+06	-1.180E+05	7SLV
-250	78.5	6.00	6.65	-3.651E+06	-1.675E+06	-1.237E+05	3SLV
-330	78.5	6.00	12.06	-1.865E+06	-9.876E+05	-9.524E+04	3SLV
-410	78.5	6.00	15.76	-1.111E+06	-6.658E+05	-9.682E+04	3SLV
-490	78.5	6.00	18.73	-3.573E+05	-3.439E+05	-9.839E+04	3SLV
-570	78.5	6.00	18.44	3.9528E+05	-3.325E+04	-9.996E+04	3SLV
-650	78.5	6.00	15.77	1.1506E+06	2.9979E+05	-1.015E+05	3SLV
-730	78.5	6.00	14.69	-1.607E+06	-5.109E+05	-3.542E+04	13SLV
-810	78.5	6.00	15.67	1.5066E+06	4.8409E+05	-7.655E+04	3SLV
-890	78.5	6.00	16.07	1.4228E+06	4.7183E+05	-7.812E+04	3SLV
-970	78.5	6.00	16.49	1.3390E+06	4.5956E+05	-7.970E+04	3SLV
-1050	78.5	6.00	16.93	1.2553E+06	4.4730E+05	-8.127E+04	3SLV
-1130	124.0	6.00	23.10	1.1546E+06	4.2529E+05	-5.486E+04	3SLV
-1210	78.5	6.00	22.46	9.9886E+05	3.7146E+05	-5.644E+04	3SLV
-1290	78.5	6.00	24.45	8.4311E+05	3.1763E+05	-5.801E+04	3SLV
-1370	78.5	6.00	26.37	6.8736E+05	2.6380E+05	-5.958E+04	3SLV
-1450	78.5	6.00	28.16	5.3161E+05	2.0997E+05	-6.115E+04	3SLV
-1530	78.5	6.00	29.39	3.7586E+05	1.5614E+05	-6.272E+04	3SLV
-1610	78.5	6.00	46.57	3.0465E+05	1.2846E+05	-3.765E+04	3SLV
-1690	78.5	6.00	47.00	2.3759E+05	1.0206E+05	-3.922E+04	3SLV
-1770	78.5	6.00	45.19	1.7053E+05	7.5661E+04	-4.079E+04	3SLV
-1850	78.5	6.00	43.51	1.0348E+05	4.9264E+04	-4.236E+04	3SLV
-1930	78.5	6.00	41.73	2.6868E+04	2.2894E+04	-4.417E+04	3SLV
-2010	78.5	6.00	93.21	1.2581E+04	1.2397E+04	-1.977E+04	3SLV
-2090	78.5	6.00	86.35	9.8514E+03	9.7076E+03	-2.135E+04	3SLV
-2170	124.0	6.00	88.77	7.1220E+03	7.0180E+03	-2.292E+04	3SLV
-2250	78.5	6.00	74.42	6.9167E+03	5.9066E+03	-2.477E+04	3SLU
-2330	78.5	6.00	68.75	2.6189E+03	2.2364E+03	-2.681E+04	3SLU
-2410	78.5	6.00	100.00	-5.520E-10	-4.090E-12	-2.422E+03	3SLV
-2490	78.5	6.00	100.00	-4.089E-10	3.2752E-11	-3.992E+03	3SLV

Verifica di esercizio (combinazione rara):

quota	Af	cop.	sigmaf	sigmac	Mx	My	N	comb	Wk
-90	0.0	6.50	0.0	0.0	0.0000E+00	0.0000E+00	0.0000E+00	-	0.000
-170	78.5	6.00		24.2	-1.264E+06	-1.058E+06	-9.149E+04	1	0.000
-170	78.5	6.00	37.0		-8.845E+05	-9.603E+05	-6.901E+04	2	0.000
-250	78.5	6.00		21.0	-9.778E+05	-8.215E+05	-9.306E+04	1	0.000
-330	78.5	6.00		15.9	-7.406E+05	-6.244E+05	-7.025E+04	1	0.000
-330	78.5	6.00	1.4		-5.480E+05	-5.766E+05	-5.196E+04	2	0.000
-410	78.5	6.00		14.4	-5.844E+05	-4.928E+05	-7.182E+04	1	0.000
-490	78.5	6.00		12.8	-4.282E+05	-3.611E+05	-7.339E+04	1	0.000
-570	78.5	6.00		11.3	-2.720E+05	-2.295E+05	-7.496E+04	1	0.000
-650	78.5	6.00		9.8	-1.157E+05	-9.786E+04	-7.653E+04	1	0.000
-730	78.5	6.00		6.2	-8.277E+03	-7.298E+03	-5.520E+04	1	0.000
-810	78.5	6.00		6.5	1.7926E+04	1.4788E+04	-5.677E+04	1	0.000
-890	78.5	6.00		7.0	4.4129E+04	3.6875E+04	-5.834E+04	1	0.000
-970	78.5	6.00		7.4	7.0332E+04	5.8961E+04	-5.991E+04	1	0.000
-1050	78.5	6.00		7.9	9.6535E+04	8.1047E+04	-6.149E+04	1	0.000
-1130	124.0	6.00		5.3	1.1449E+05	9.6201E+04	-4.016E+04	1	0.000
-1210	78.5	6.00		5.8	1.0549E+05	8.8706E+04	-4.173E+04	1	0.000
-1290	78.5	6.00		5.9	9.6495E+04	8.1212E+04	-4.331E+04	1	0.000
-1370	78.5	6.00		5.9	8.7498E+04	7.3717E+04	-4.488E+04	1	0.000
-1450	78.5	6.00		6.0	7.8502E+04	6.6223E+04	-4.645E+04	1	0.000
-1530	78.5	6.00		6.1	6.9505E+04	5.8728E+04	-4.802E+04	1	0.000
-1610	78.5	6.00		3.7	5.9767E+04	5.0532E+04	-2.769E+04	1	0.000
-1690	78.5	6.00		3.8	4.9992E+04	4.2302E+04	-2.926E+04	1	0.000
-1770	78.5	6.00		3.9	4.0217E+04	3.4071E+04	-3.083E+04	1	0.000
-1850	78.5	6.00		3.9	3.0442E+04	2.5841E+04	-3.241E+04	1	0.000
-1930	78.5	6.00		4.0	2.0667E+04	1.7611E+04	-3.398E+04	1	0.000
-2010	78.5	6.00		1.8	1.5239E+04	1.3013E+04	-1.434E+04	1	0.000
-2090	78.5	6.00		1.9	1.1933E+04	1.0190E+04	-1.591E+04	1	0.000
-2170	124.0	6.00		1.9	8.6266E+03	7.3668E+03	-1.748E+04	1	0.000
-2250	78.5	6.00		2.2	5.3206E+03	4.5436E+03	-1.905E+04	1	0.000
-2330	78.5	6.00		2.3	2.0145E+03	1.7203E+03	-2.062E+04	1	0.000
-2410	78.5	6.00		0.2	1.2861E-11	-3.553E-12	-1.384E+03	1	0.000
-2490	78.5	6.00		0.3	-7.814E-13	-1.265E-11	-2.954E+03	1	0.000

Verifica di esercizio (combinazione quasi permanente):

quota	Af	cop.	sigmaf	sigmac	Mx	My	N	comb	Wk
-90	0.0	6.50	0.0	0.0	0.0000E+00	0.0000E+00	0.0000E+00	-	0.000
-170	78.5	6.00		24.2	-1.264E+06	-1.058E+06	-9.149E+04	1	0.000
-170	78.5	6.00	36.1		-1.264E+06	-1.058E+06	-9.149E+04	1	0.000



Progetto	Titolo	Rev.	Pag.
Orione	Orione_A24a.pdf "TABULATI DI CALCOLO PLINTO DI FONDAZIONE PER AEROGENERATORE TIPO"	0	193

-250	78.5	6.00	21.0	-9.778E+05	-8.215E+05	-9.306E+04	1	0.000
-330	78.5	6.00	15.9	-7.406E+05	-6.244E+05	-7.025E+04	1	0.000
-410	78.5	6.00	14.4	-5.844E+05	-4.928E+05	-7.182E+04	1	0.000
-490	78.5	6.00	12.8	-4.282E+05	-3.611E+05	-7.339E+04	1	0.000
-570	78.5	6.00	11.3	-2.720E+05	-2.295E+05	-7.496E+04	1	0.000
-650	78.5	6.00	9.8	-1.157E+05	-9.786E+04	-7.653E+04	1	0.000
-730	78.5	6.00	6.2	-8.277E+03	-7.298E+03	-5.520E+04	1	0.000
-810	78.5	6.00	6.5	1.7926E+04	1.4788E+04	-5.677E+04	1	0.000
-890	78.5	6.00	7.0	4.4129E+04	3.6875E+04	-5.834E+04	1	0.000
-970	78.5	6.00	7.4	7.0332E+04	5.8961E+04	-5.991E+04	1	0.000
-1050	78.5	6.00	7.9	9.6535E+04	8.1047E+04	-6.149E+04	1	0.000
-1130	124.0	6.00	5.3	1.1449E+05	9.6201E+04	-4.016E+04	1	0.000
-1210	78.5	6.00	5.8	1.0549E+05	8.8706E+04	-4.173E+04	1	0.000
-1290	78.5	6.00	5.9	9.6495E+04	8.1212E+04	-4.331E+04	1	0.000
-1370	78.5	6.00	5.9	8.7498E+04	7.3717E+04	-4.488E+04	1	0.000
-1450	78.5	6.00	6.0	7.8502E+04	6.6223E+04	-4.645E+04	1	0.000
-1530	78.5	6.00	6.1	6.9505E+04	5.8728E+04	-4.802E+04	1	0.000
-1610	78.5	6.00	3.7	5.9767E+04	5.0532E+04	-2.769E+04	1	0.000
-1690	78.5	6.00	3.8	4.9992E+04	4.2302E+04	-2.926E+04	1	0.000
-1770	78.5	6.00	3.9	4.0217E+04	3.4071E+04	-3.083E+04	1	0.000
-1850	78.5	6.00	3.9	3.0442E+04	2.5841E+04	-3.241E+04	1	0.000
-1930	78.5	6.00	4.0	2.0667E+04	1.7611E+04	-3.398E+04	1	0.000
-2010	78.5	6.00	1.8	1.5239E+04	1.3013E+04	-1.434E+04	1	0.000
-2090	78.5	6.00	1.9	1.1933E+04	1.0190E+04	-1.591E+04	1	0.000
-2170	124.0	6.00	1.9	8.6266E+03	7.3668E+03	-1.748E+04	1	0.000
-2250	78.5	6.00	2.2	5.3206E+03	4.5436E+03	-1.905E+04	1	0.000
-2330	78.5	6.00	2.3	2.0145E+03	1.7203E+03	-2.062E+04	1	0.000
-2410	78.5	6.00	0.2	1.2861E-11	-3.553E-12	-1.384E+03	1	0.000
-2490	78.5	6.00	0.3	-7.814E-13	-1.265E-11	-2.954E+03	1	0.000

Verifica a taglio:

quota	Ast	Vsd	Vsdx	Vsdy	N	comb	VRd,c	VRd,max	VRd,S	Vwd
-90	0.16	32909	-11513	30829	-121314	3SLV	40062	231056	84386	44323 Vsd < VRd,
-170	0.16	32129	-11332	30064	-122170	3SLV	44069	231056	88393	44323 Vsd < VRd,
-250	0.08	32129	-11332	30064	-123741	3SLV	44288	231056	66449	22162 Vsd < VRd,
-330	0.08	10247	-4023	9424	-95245	3SLV	40327	231056	62489	22162 Vsd < VRd,
-410	0.08	10247	-4023	9424	-96816	3SLV	40545	231056	62707	22162 Vsd < VRd,
-490	0.08	10247	-4023	9424	-98386	3SLV	40764	231056	62925	22162 Vsd < VRd,
-570	0.08	10247	-4023	9424	-99957	3SLV	40982	231056	63144	22162 Vsd < VRd,
-650	0.08	10247	-4023	9424	-101528	3SLV	41200	231056	63362	22162 Vsd < VRd,
-730	0.08	1843	-705	1702	-35421	13SLV	32011	231056	54173	22162 Vsd < VRd,
-810	0.08	1843	-705	1702	-36992	13SLV	32230	231056	54391	22162 Vsd < VRd,
-890	0.08	1843	-705	1702	-38563	13SLV	32448	231056	54610	22162 Vsd < VRd,
-970	0.08	1843	-705	1702	-40133	13SLV	32666	231056	54828	22162 Vsd < VRd,
-1050	0.08	1843	-705	1702	-41704	13SLV	32885	231056	55046	22162 Vsd < VRd,
-1130	0.08	2069	1957	-674	-52943	7SLV	38903	231056	61065	22162 Vsd < VRd,
-1210	0.08	2069	1957	-674	-54514	7SLV	34665	231056	56827	22162 Vsd < VRd,
-1290	0.08	2069	1957	-674	-56085	7SLV	34884	231056	57045	22162 Vsd < VRd,
-1370	0.08	2069	1957	-674	-57656	7SLV	35102	231056	57264	22162 Vsd < VRd,
-1450	0.08	2069	1957	-674	-59226	7SLV	35320	231056	57482	22162 Vsd < VRd,
-1530	0.08	2069	1957	-674	-60797	7SLV	35539	231056	57700	22162 Vsd < VRd,
-1610	0.08	901	330	-838	-37648	3SLV	32321	231056	54483	22162 Vsd < VRd,
-1690	0.08	901	330	-838	-39219	3SLV	32539	231056	54701	22162 Vsd < VRd,
-1770	0.08	901	330	-838	-40789	3SLV	32758	231056	54919	22162 Vsd < VRd,
-1850	0.08	901	330	-838	-42360	3SLV	32976	231056	55138	22162 Vsd < VRd,
-1930	0.08	901	330	-838	-43931	3SLV	33194	231056	55356	22162 Vsd < VRd,
-2010	0.08	71	46	-54	-18642	3SLU	29679	231056	51841	22162 Vsd < VRd,
-2090	0.08	71	46	-54	-20685	3SLU	29963	231056	52125	22162 Vsd < VRd,
-2170	0.08	71	46	-54	-22727	3SLU	34703	231056	56865	22162 Vsd < VRd,
-2250	0.08	71	46	-54	-24769	3SLU	30531	231056	52692	22162 Vsd < VRd,
-2330	0.08	71	46	-54	-26811	3SLU	30815	231056	52976	22162 Vsd < VRd,
-2410	0.08	0	0	0	-2032	1SLV	27370	231056	49532	22162 Vsd < VRd,
-2490	0.08	0	0	0	-3603	1SLV	27589	231056	49750	22162 Vsd < VRd,

Palo alle coordinate X=-1429 Y=825

Sollecitazioni massime in testa palo:

Combinazione corrispondente alla minima compressione in testa

N	Mx	My	Tx	Ty	comb
-6.364E+04	-1.071E+06	-9.810E+05	-2.068E+03	2.1512E+03	2 sl
-7.261E+04	-1.298E+06	-9.891E+05	-2.124E+03	2.7860E+03	2 ra
-8.158E+04	-1.525E+06	-9.972E+05	-2.180E+03	3.4208E+03	2 fr
-8.517E+04	-1.615E+06	-1.000E+06	-2.202E+03	3.6747E+03	2 qp
-5.776E+04	5.1894E+06	1.1797E+06	6.3369E+03	-2.328E+04	13 SLV fond

Combinazione corrispondente alla massima compressione in testa

N	Mx	My	Tx	Ty	comb
-1.177E+05	-2.277E+06	-1.307E+06	-2.906E+03	5.2722E+03	3 sl
-9.055E+04	-1.751E+06	-1.005E+06	-2.235E+03	4.0555E+03	1 ra
-9.055E+04	-1.751E+06	-1.005E+06	-2.235E+03	4.0555E+03	1 fr
-9.055E+04	-1.751E+06	-1.005E+06	-2.235E+03	4.0555E+03	1 qp
-1.233E+05	-8.692E+06	-3.190E+06	-1.081E+04	3.1390E+04	3 SLV fond

Combinazione corrispondente al massimo taglio in testa

N	Mx	My	Tx	Ty	comb
---	----	----	----	----	------



Progetto	Titolo	Rev.	Pag.
Orione	Orione_A24a.pdf "TABULATI DI CALCOLO PLINTO DI FONDAZIONE PER AEROGENERATORE TIPO"	0	194

-1.177E+05 -2.277E+06 -1.307E+06 -2.906E+03 5.2722E+03 3 sl  
 -9.055E+04 -1.751E+06 -1.005E+06 -2.235E+03 4.0555E+03 1 ra  
 -9.055E+04 -1.751E+06 -1.005E+06 -2.235E+03 4.0555E+03 1 fr  
 -9.055E+04 -1.751E+06 -1.005E+06 -2.235E+03 4.0555E+03 1 qp  
 -1.233E+05 -8.692E+06 -3.190E+06 -1.081E+04 3.1390E+04 3 SLV fond

Verifica di capacità portante riferita al palo singolo:

Fattore di correlazione Psi scelto in base alla conoscenza del sito = 1.7  
 Coeff. parziale di sicurezza sulla resistenza laterale = 1.15  
 Coeff. parziale di sicurezza sulla resistenza alla punta = 1.35  
 Portanza laterale di progetto = 292537.1  
 Portanza di punta di progetto = 85555.4  
 verifica condotta in combinazione SLU 3  
 Sforzo normale = -117708.6  
 Peso del palo = 49087.4 \* 1.3  
 Carico totale di progetto = -181522.2  
 Resistenza totale di progetto = 378092.5  
 Coefficiente di sicurezza = 2.08 > 1

Verifica di resistenza allo stato limite:

quota	Af	cop.	c.s.	Mx	My	N	comb
-90	0.0	6.50	0.00	0.0000E+00	0.0000E+00	0.0000E+00	-
-170	78.5	6.00	3.58	-6.239E+06	-2.339E+06	-1.242E+05	3SLV
-250	78.5	6.00	6.56	-3.789E+06	-1.488E+06	-1.257E+05	3SLV
-330	78.5	6.00	11.87	-1.967E+06	-8.474E+05	-9.687E+04	3SLV
-410	78.5	6.00	15.52	-1.190E+06	-5.555E+05	-9.844E+04	3SLV
-490	78.5	6.00	18.43	-4.138E+05	-2.637E+05	-1.000E+05	3SLV
-570	78.5	6.00	18.14	3.6149E+05	1.7326E+04	-1.016E+05	3SLV
-650	78.5	6.00	15.63	1.1392E+06	3.2011E+05	-1.032E+05	3SLV
-730	78.5	6.00	14.45	-1.613E+06	-5.077E+05	-3.414E+04	13SLV
-810	78.5	6.00	15.54	1.5137E+06	4.7907E+05	-7.784E+04	3SLV
-890	78.5	6.00	15.92	1.4330E+06	4.6202E+05	-7.941E+04	3SLV
-970	78.5	6.00	16.33	1.3523E+06	4.4496E+05	-8.098E+04	3SLV
-1050	78.5	6.00	16.75	1.2717E+06	4.2790E+05	-8.255E+04	3SLV
-1130	124.0	6.00	22.84	1.1731E+06	4.0266E+05	-5.582E+04	3SLV
-1210	78.5	6.00	22.20	1.0156E+06	3.5068E+05	-5.739E+04	3SLV
-1290	78.5	6.00	24.15	8.5824E+05	2.9870E+05	-5.896E+04	3SLV
-1370	78.5	6.00	26.02	7.0084E+05	2.4672E+05	-6.053E+04	3SLV
-1450	78.5	6.00	27.77	5.4344E+05	1.9474E+05	-6.210E+04	3SLV
-1530	78.5	6.00	28.95	3.8604E+05	1.4276E+05	-6.368E+04	3SLV
-1610	78.5	6.00	45.85	3.1334E+05	1.1697E+05	-3.830E+04	3SLV
-1690	78.5	6.00	46.24	2.4480E+05	9.2472E+04	-3.987E+04	3SLV
-1770	78.5	6.00	44.48	1.7627E+05	6.7973E+04	-4.144E+04	3SLV
-1850	78.5	6.00	42.86	1.0774E+05	4.3473E+04	-4.301E+04	3SLV
-1930	78.5	6.00	41.35	3.9208E+04	1.8973E+04	-4.458E+04	3SLV
-2010	78.5	6.00	91.57	1.4592E+04	9.5430E+03	-2.013E+04	3SLV
-2090	78.5	6.00	84.94	1.1426E+04	7.4727E+03	-2.170E+04	3SLV
-2170	124.0	6.00	87.42	8.2606E+03	5.4023E+03	-2.327E+04	3SLV
-2250	78.5	6.00	74.20	5.0948E+03	3.3319E+03	-2.484E+04	3SLV
-2330	78.5	6.00	68.75	2.9604E+03	1.7489E+03	-2.681E+04	3SLU
-2410	78.5	6.00	100.00	-3.734E-11	-5.389E-11	-2.489E+03	3SLV
-2490	78.5	6.00	100.00	-5.534E-11	-4.566E-11	-4.060E+03	3SLV

Verifica di esercizio (combinazione rara):

quota	Af	cop.	sigmaf	sigmac	Mx	My	N	comb	Wk
-90	0.0	6.50	0.0	0.0	0.0000E+00	0.0000E+00	0.0000E+00	-	0.000
-170	78.5	6.00	36.1	24.2	-1.428E+06	-8.225E+05	-9.150E+04	1	0.000
-250	78.5	6.00		21.0	-1.105E+06	-6.394E+05	-9.307E+04	1	0.000
-330	78.5	6.00		15.9	-8.372E+05	-4.865E+05	-7.025E+04	1	0.000
-410	78.5	6.00		14.4	-6.606E+05	-3.840E+05	-7.182E+04	1	0.000
-490	78.5	6.00		12.8	-4.840E+05	-2.814E+05	-7.339E+04	1	0.000
-570	78.5	6.00		11.3	-3.074E+05	-1.789E+05	-7.496E+04	1	0.000
-650	78.5	6.00		9.8	-1.308E+05	-7.632E+04	-7.653E+04	1	0.000
-730	78.5	6.00		6.2	-9.351E+03	-5.767E+03	-5.520E+04	1	0.000
-810	78.5	6.00		6.5	2.0268E+04	1.1442E+04	-5.677E+04	1	0.000
-890	78.5	6.00		7.0	4.9887E+04	2.8651E+04	-5.835E+04	1	0.000
-970	78.5	6.00		7.4	7.9506E+04	4.5860E+04	-5.992E+04	1	0.000
-1050	78.5	6.00		7.9	1.0912E+05	6.3069E+04	-6.149E+04	1	0.000
-1130	124.0	6.00		5.3	1.2942E+05	7.4881E+04	-4.016E+04	1	0.000
-1210	78.5	6.00		5.8	1.1925E+05	6.9062E+04	-4.174E+04	1	0.000
-1290	78.5	6.00		5.9	1.0908E+05	6.3243E+04	-4.331E+04	1	0.000
-1370	78.5	6.00		5.9	9.8908E+04	5.7425E+04	-4.488E+04	1	0.000
-1450	78.5	6.00		6.0	8.8738E+04	5.1606E+04	-4.645E+04	1	0.000
-1530	78.5	6.00		6.1	7.8568E+04	4.5787E+04	-4.802E+04	1	0.000
-1610	78.5	6.00		3.7	6.7560E+04	3.9404E+04	-2.769E+04	1	0.000
-1690	78.5	6.00		3.8	5.6511E+04	3.2994E+04	-2.926E+04	1	0.000
-1770	78.5	6.00		3.9	4.5461E+04	2.6584E+04	-3.084E+04	1	0.000
-1850	78.5	6.00		3.9	3.4412E+04	2.0174E+04	-3.241E+04	1	0.000
-1930	78.5	6.00		4.0	2.3362E+04	1.3763E+04	-3.398E+04	1	0.000
-2010	78.5	6.00		1.8	1.7226E+04	1.0176E+04	-1.434E+04	1	0.000
-2090	78.5	6.00		1.9	1.3488E+04	7.9687E+03	-1.591E+04	1	0.000
-2170	124.0	6.00		1.9	9.7514E+03	5.7609E+03	-1.748E+04	1	0.000
-2250	78.5	6.00		2.2	6.0143E+03	3.5531E+03	-1.905E+04	1	0.000
-2330	78.5	6.00		2.3	2.2772E+03	1.3453E+03	-2.062E+04	1	0.000
-2410	78.5	6.00		0.2	2.5636E-11	1.1973E-11	-1.384E+03	1	0.000



Tabulati di Calcolo Plinto di Fondazione per Aerogeneratore Tipo - Progetto Impianto Eolico - "Orione"

-2490 78.5 6.00 0.3 7.4468E-12 -3.943E-12 -2.955E+03 1 0.000

Verifica di esercizio (combinazione quasi permanente):

quota	Af	cop.	sigmaf	sigmac	Mx	My	N	comb	Wk
-90	0.0	6.50	0.0	0.0	0.0000E+00	0.0000E+00	0.0000E+00	-	0.000
-170	78.5	6.00	36.1	24.2	-1.428E+06	-8.225E+05	-9.150E+04	1	0.000
-250	78.5	6.00		21.0	-1.105E+06	-6.394E+05	-9.307E+04	1	0.000
-330	78.5	6.00		15.9	-8.372E+05	-4.865E+05	-7.025E+04	1	0.000
-410	78.5	6.00		14.4	-6.606E+05	-3.840E+05	-7.182E+04	1	0.000
-490	78.5	6.00		12.8	-4.840E+05	-2.814E+05	-7.339E+04	1	0.000
-570	78.5	6.00		11.3	-3.074E+05	-1.789E+05	-7.496E+04	1	0.000
-650	78.5	6.00		9.8	-1.308E+05	-7.632E+04	-7.653E+04	1	0.000
-730	78.5	6.00		6.2	-9.351E+03	-5.767E+03	-5.520E+04	1	0.000
-810	78.5	6.00		6.5	2.0268E+04	1.1442E+04	-5.677E+04	1	0.000
-890	78.5	6.00		7.0	4.9887E+04	2.8651E+04	-5.835E+04	1	0.000
-970	78.5	6.00		7.4	7.9506E+04	4.5860E+04	-5.992E+04	1	0.000
-1050	78.5	6.00		7.9	1.0912E+05	6.3069E+04	-6.149E+04	1	0.000
-1130	124.0	6.00		5.3	1.2942E+05	7.4881E+04	-4.016E+04	1	0.000
-1210	78.5	6.00		5.8	1.1925E+05	6.9062E+04	-4.174E+04	1	0.000
-1290	78.5	6.00		5.9	1.0908E+05	6.3243E+04	-4.331E+04	1	0.000
-1370	78.5	6.00		5.9	9.8908E+04	5.7425E+04	-4.488E+04	1	0.000
-1450	78.5	6.00		6.0	8.8738E+04	5.1606E+04	-4.645E+04	1	0.000
-1530	78.5	6.00		6.1	7.8568E+04	4.5787E+04	-4.802E+04	1	0.000
-1610	78.5	6.00		3.7	6.7560E+04	3.9404E+04	-2.769E+04	1	0.000
-1690	78.5	6.00		3.8	5.6511E+04	3.2994E+04	-2.926E+04	1	0.000
-1770	78.5	6.00		3.9	4.5461E+04	2.6584E+04	-3.084E+04	1	0.000
-1850	78.5	6.00		3.9	3.4412E+04	2.0174E+04	-3.241E+04	1	0.000
-1930	78.5	6.00		4.0	2.3362E+04	1.3763E+04	-3.398E+04	1	0.000
-2010	78.5	6.00		1.8	1.7226E+04	1.0176E+04	-1.434E+04	1	0.000
-2090	78.5	6.00		1.9	1.3488E+04	7.9687E+03	-1.591E+04	1	0.000
-2170	124.0	6.00		1.9	9.7514E+03	5.7609E+03	-1.748E+04	1	0.000
-2250	78.5	6.00		2.2	6.0143E+03	3.5531E+03	-1.905E+04	1	0.000
-2330	78.5	6.00		2.3	2.2772E+03	1.3453E+03	-2.062E+04	1	0.000
-2410	78.5	6.00		0.2	2.5636E-11	1.1973E-11	-1.384E+03	1	0.000
-2490	78.5	6.00		0.3	7.4468E-12	-3.943E-12	-2.955E+03	1	0.000

Verifica a taglio:

quota	Ast	Vsd	Vsdx	Vsdy	N	comb	VRd,c	VRd,max	VRd,S	Vwd
-90	0.16	33198	-10808	31390	-123328	3SLV	40342	231056	84665	44323 Vsd < VRd,
-170	0.16	32414	-10631	30621	-124173	3SLV	44348	231056	88671	44323 Vsd < VRd,
-250	0.08	32414	-10631	30621	-125744	3SLV	44566	231056	66728	22162 Vsd < VRd,
-330	0.08	10370	-3648	9706	-96872	3SLV	40553	231056	62715	22162 Vsd < VRd,
-410	0.08	10370	-3648	9706	-98443	3SLV	40771	231056	62933	22162 Vsd < VRd,
-490	0.08	10370	-3648	9706	-100013	3SLV	40990	231056	63151	22162 Vsd < VRd,
-570	0.08	10370	-3648	9706	-101584	3SLV	41208	231056	63370	22162 Vsd < VRd,
-650	0.08	10370	-3648	9706	-103155	3SLV	41426	231056	63588	22162 Vsd < VRd,
-730	0.08	1863	-643	1749	-34138	13SLV	31833	231056	53995	22162 Vsd < VRd,
-810	0.08	1863	-643	1749	-35709	13SLV	32051	231056	54213	22162 Vsd < VRd,
-890	0.08	1863	-643	1749	-37279	13SLV	32270	231056	54431	22162 Vsd < VRd,
-970	0.08	1863	-643	1749	-38850	13SLV	32488	231056	54650	22162 Vsd < VRd,
-1050	0.08	1863	-643	1749	-40421	13SLV	32706	231056	54868	22162 Vsd < VRd,
-1130	0.08	2072	650	-1968	-55821	3SLV	39303	231056	61465	22162 Vsd < VRd,
-1210	0.08	2072	650	-1968	-57392	3SLV	35065	231056	57227	22162 Vsd < VRd,
-1290	0.08	2072	650	-1968	-58963	3SLV	35284	231056	57445	22162 Vsd < VRd,
-1370	0.08	2072	650	-1968	-60533	3SLV	35502	231056	57664	22162 Vsd < VRd,
-1450	0.08	2072	650	-1968	-62104	3SLV	35720	231056	57882	22162 Vsd < VRd,
-1530	0.08	2072	650	-1968	-63675	3SLV	35939	231056	58100	22162 Vsd < VRd,
-1610	0.08	910	306	-857	-38295	3SLV	32411	231056	54573	22162 Vsd < VRd,
-1690	0.08	910	306	-857	-39866	3SLV	32629	231056	54791	22162 Vsd < VRd,
-1770	0.08	910	306	-857	-41437	3SLV	32848	231056	55009	22162 Vsd < VRd,
-1850	0.08	910	306	-857	-43008	3SLV	33066	231056	55228	22162 Vsd < VRd,
-1930	0.08	910	306	-857	-44578	3SLV	33284	231056	55446	22162 Vsd < VRd,
-2010	0.08	71	36	-61	-18643	3SLU	29679	231056	51841	22162 Vsd < VRd,
-2090	0.08	71	36	-61	-20685	3SLU	29963	231056	52125	22162 Vsd < VRd,
-2170	0.08	71	36	-61	-22727	3SLU	34703	231056	56865	22162 Vsd < VRd,
-2250	0.08	71	36	-61	-24769	3SLU	30531	231056	52693	22162 Vsd < VRd,
-2330	0.08	71	36	-61	-26811	3SLU	30815	231056	52976	22162 Vsd < VRd,
-2410	0.08	0	0	0	-1605	11SLV	27311	231056	49473	22162 Vsd < VRd,
-2490	0.08	0	0	0	-3175	11SLV	27529	231056	49691	22162 Vsd < VRd,

Palo alle coordinate X=-1551 Y=564

Sollecitazioni massime in testa palo:

Combinazione corrispondente alla minima compressione in testa

N	Mx	My	Tx	Ty	comb
-7.146E+04	-1.319E+06	-7.965E+05	-1.614E+03	2.6855E+03	2 sl
-7.782E+04	-1.513E+06	-7.596E+05	-1.574E+03	3.2572E+03	2 ra
-8.419E+04	-1.707E+06	-7.227E+05	-1.535E+03	3.8289E+03	2 fr
-8.674E+04	-1.784E+06	-7.080E+05	-1.519E+03	4.0576E+03	2 qp
-5.677E+04	5.0600E+06	1.4822E+06	7.0145E+03	-2.301E+04	13 SLV fond

Combinazione corrispondente alla massima compressione in testa



Progetto	Titolo	Rev.	Pag.
Orione	Orione_A24a.pdf "TABULATI DI CALCOLO PLINTO DI FONDAZIONE PER AEROGENERATORE TIPO"	0	196

N	Mx	My	Tx	Ty	comb
-1.177E+05	-2.471E+06	-8.916E+05	-1.944E+03	5.7208E+03	3 sl
-9.056E+04	-1.900E+06	-6.859E+05	-1.495E+03	4.4006E+03	1 ra
-9.056E+04	-1.900E+06	-6.859E+05	-1.495E+03	4.4006E+03	1 fr
-9.056E+04	-1.900E+06	-6.859E+05	-1.495E+03	4.4006E+03	1 qp
-1.244E+05	-8.861E+06	-2.854E+06	-1.001E+04	3.1809E+04	3 SLV fond

Combinazione corrispondente al massimo taglio in testa

N	Mx	My	Tx	Ty	comb
-1.177E+05	-2.471E+06	-8.916E+05	-1.944E+03	5.7208E+03	3 sl
-9.056E+04	-1.900E+06	-6.859E+05	-1.495E+03	4.4006E+03	1 ra
-9.056E+04	-1.900E+06	-6.859E+05	-1.495E+03	4.4006E+03	1 fr
-9.056E+04	-1.900E+06	-6.859E+05	-1.495E+03	4.4006E+03	1 qp
-1.244E+05	-8.861E+06	-2.854E+06	-1.001E+04	3.1809E+04	3 SLV fond

Verifica di capacità portante riferita al palo singolo:

Fattore di correlazione Psi scelto in base alla conoscenza del sito = 1.7  
 Coeff. parziale di sicurezza sulla resistenza laterale = 1.15  
 Coeff. parziale di sicurezza sulla resistenza alla punta = 1.35  
 Portanza laterale di progetto = 292537.1  
 Portanza di punta di progetto = 85555.4  
 verifica condotta in combinazione SLU 3  
 Sforzo normale = -117725.5  
 Peso del palo = 49087.4 \* 1.3  
 Carico totale di progetto = -181539.1  
 Resistenza totale di progetto = 378092.5  
 Coefficiente di sicurezza = 2.08 > 1

Verifica di resistenza allo stato limite:

quota	Af	cop.	c.s.	Mx	My	N	comb
-90	0.0	6.50	0.00	0.0000E+00	0.0000E+00	0.0000E+00	-
-170	78.5	6.00	3.56	-6.374E+06	-2.066E+06	-1.252E+05	3SLV
-250	78.5	6.00	6.52	-3.891E+06	-1.279E+06	-1.268E+05	3SLV
-330	78.5	6.00	11.79	-2.042E+06	-6.909E+05	-9.770E+04	3SLV
-410	78.5	6.00	15.40	-1.249E+06	-4.328E+05	-9.927E+04	3SLV
-490	78.5	6.00	18.28	-4.554E+05	-1.746E+05	-1.008E+05	3SLV
-570	78.5	6.00	18.00	3.3694E+05	7.3815E+04	-1.024E+05	3SLV
-650	78.5	6.00	15.56	1.1311E+06	3.4170E+05	-1.040E+05	3SLV
-730	78.5	6.00	14.32	-1.618E+06	-5.028E+05	-3.350E+04	13SLV
-810	78.5	6.00	15.47	1.5191E+06	4.7239E+05	-7.849E+04	3SLV
-890	78.5	6.00	15.85	1.4408E+06	4.5010E+05	-8.006E+04	3SLV
-970	78.5	6.00	16.24	1.3624E+06	4.2780E+05	-8.163E+04	3SLV
-1050	78.5	6.00	16.66	1.2840E+06	4.0550E+05	-8.320E+04	3SLV
-1130	124.0	6.00	22.70	1.1868E+06	3.7675E+05	-5.631E+04	3SLV
-1210	78.5	6.00	22.07	1.0282E+06	3.2694E+05	-5.788E+04	3SLV
-1290	78.5	6.00	24.01	8.6954E+05	2.7712E+05	-5.945E+04	3SLV
-1370	78.5	6.00	25.85	7.1089E+05	2.2731E+05	-6.102E+04	3SLV
-1450	78.5	6.00	27.58	5.5224E+05	1.7750E+05	-6.259E+04	3SLV
-1530	78.5	6.00	28.73	3.9359E+05	1.2768E+05	-6.416E+04	3SLV
-1610	78.5	6.00	45.50	3.1979E+05	1.0404E+05	-3.862E+04	3SLV
-1690	78.5	6.00	45.86	2.5016E+05	8.1691E+04	-4.019E+04	3SLV
-1770	78.5	6.00	44.13	1.8053E+05	5.9341E+04	-4.176E+04	3SLV
-1850	78.5	6.00	42.53	1.1090E+05	3.6990E+04	-4.334E+04	3SLV
-1930	78.5	6.00	41.05	4.1265E+04	1.4639E+04	-4.491E+04	3SLV
-2010	78.5	6.00	90.77	1.6073E+04	6.3761E+03	-2.031E+04	3SLV
-2090	78.5	6.00	84.25	1.2586E+04	4.9928E+03	-2.188E+04	3SLV
-2170	124.0	6.00	86.75	9.0989E+03	3.6095E+03	-2.345E+04	3SLV
-2250	78.5	6.00	73.67	5.6118E+03	2.2262E+03	-2.502E+04	3SLV
-2330	78.5	6.00	68.74	3.2123E+03	1.2090E+03	-2.681E+04	3SLU
-2410	78.5	6.00	100.00	-8.728E-11	-5.985E-11	-2.523E+03	3SLV
-2490	78.5	6.00	100.00	-1.831E-11	-7.865E-13	-4.094E+03	3SLV

Verifica di esercizio (combinazione rara):

quota	Af	cop.	sigmaf	sigmac	Mx	My	N	comb	Wk
-90	0.0	6.50	0.0	0.0	0.0000E+00	0.0000E+00	0.0000E+00	-	0.000
-170	78.5	6.00	36.1	24.2	-1.550E+06	-5.620E+05	-9.151E+04	1	0.000
-250	78.5	6.00		21.0	-1.199E+06	-4.378E+05	-9.308E+04	1	0.000
-330	78.5	6.00		15.9	-9.085E+05	-3.338E+05	-7.026E+04	1	0.000
-410	78.5	6.00		14.4	-7.168E+05	-2.635E+05	-7.183E+04	1	0.000
-490	78.5	6.00		12.8	-5.252E+05	-1.932E+05	-7.340E+04	1	0.000
-570	78.5	6.00		11.3	-3.336E+05	-1.228E+05	-7.497E+04	1	0.000
-650	78.5	6.00		9.8	-1.420E+05	-5.246E+04	-7.654E+04	1	0.000
-730	78.5	6.00		6.2	-1.015E+04	-4.067E+03	-5.521E+04	1	0.000
-810	78.5	6.00		6.5	2.1990E+04	7.7406E+03	-5.678E+04	1	0.000
-890	78.5	6.00		7.0	5.4130E+04	1.9548E+04	-5.835E+04	1	0.000
-970	78.5	6.00		7.4	8.6270E+04	3.1355E+04	-5.992E+04	1	0.000
-1050	78.5	6.00		7.9	1.1841E+05	4.3163E+04	-6.149E+04	1	0.000
-1130	124.0	6.00		5.3	1.4043E+05	5.1274E+04	-4.017E+04	1	0.000
-1210	78.5	6.00		5.8	1.2939E+05	4.7310E+04	-4.174E+04	1	0.000
-1290	78.5	6.00		5.9	1.1836E+05	4.3347E+04	-4.331E+04	1	0.000
-1370	78.5	6.00		5.9	1.0732E+05	3.9383E+04	-4.488E+04	1	0.000
-1450	78.5	6.00		6.0	9.6289E+04	3.5420E+04	-4.645E+04	1	0.000
-1530	78.5	6.00		6.1	8.5254E+04	3.1456E+04	-4.802E+04	1	0.000
-1610	78.5	6.00		3.7	7.3309E+04	2.7082E+04	-2.770E+04	1	0.000
-1690	78.5	6.00		3.8	6.1319E+04	2.2687E+04	-2.927E+04	1	0.000



Tabulati di Calcolo Plinto di Fondazione per Aerogeneratore Tipo - Progetto Impianto Eolico - "Orione"

-1770	78.5	6.00	3.9	4.9329E+04	1.8292E+04	-3.084E+04	1	0.000
-1850	78.5	6.00	3.9	3.7340E+04	1.3897E+04	-3.241E+04	1	0.000
-1930	78.5	6.00	4.0	2.5350E+04	9.5023E+03	-3.398E+04	1	0.000
-2010	78.5	6.00	1.8	1.8691E+04	7.0348E+03	-1.434E+04	1	0.000
-2090	78.5	6.00	1.9	1.4636E+04	5.5086E+03	-1.591E+04	1	0.000
-2170	124.0	6.00	1.9	1.0581E+04	3.9824E+03	-1.748E+04	1	0.000
-2250	78.5	6.00	2.2	6.5261E+03	2.4562E+03	-1.905E+04	1	0.000
-2330	78.5	6.00	2.3	2.4710E+03	9.2999E+02	-2.063E+04	1	0.000
-2410	78.5	6.00	0.2	7.3613E-12	6.3878E-12	-1.384E+03	1	0.000
-2490	78.5	6.00	0.3	-1.734E-12	4.1141E-12	-2.955E+03	1	0.000

Verifica di esercizio (combinazione quasi permanente):

quota	Af	cop.	sigmaf	sigmac	Mx	My	N	comb	Wk
-90	0.0	6.50	0.0	0.0	0.0000E+00	0.0000E+00	0.0000E+00	-	0.000
-170	78.5	6.00	36.1	24.2	-1.550E+06	-5.620E+05	-9.151E+04	1	0.000
-250	78.5	6.00		21.0	-1.199E+06	-4.378E+05	-9.308E+04	1	0.000
-330	78.5	6.00		15.9	-9.085E+05	-3.338E+05	-7.026E+04	1	0.000
-410	78.5	6.00		14.4	-7.168E+05	-2.635E+05	-7.183E+04	1	0.000
-490	78.5	6.00		12.8	-5.252E+05	-1.932E+05	-7.340E+04	1	0.000
-570	78.5	6.00		11.3	-3.336E+05	-1.228E+05	-7.497E+04	1	0.000
-650	78.5	6.00		9.8	-1.420E+05	-5.246E+04	-7.654E+04	1	0.000
-730	78.5	6.00		6.2	-1.015E+04	-4.067E+03	-5.521E+04	1	0.000
-810	78.5	6.00		6.5	2.1990E+04	7.7406E+03	-5.678E+04	1	0.000
-890	78.5	6.00		7.0	5.4130E+04	1.9548E+04	-5.835E+04	1	0.000
-970	78.5	6.00		7.4	8.6270E+04	3.1355E+04	-5.992E+04	1	0.000
-1050	78.5	6.00		7.9	1.1841E+05	4.3163E+04	-6.149E+04	1	0.000
-1130	124.0	6.00		5.3	1.4043E+05	5.1274E+04	-4.017E+04	1	0.000
-1210	78.5	6.00		5.8	1.2939E+05	4.7310E+04	-4.174E+04	1	0.000
-1290	78.5	6.00		5.9	1.1836E+05	4.3347E+04	-4.331E+04	1	0.000
-1370	78.5	6.00		5.9	1.0732E+05	3.9383E+04	-4.488E+04	1	0.000
-1450	78.5	6.00		6.0	9.6289E+04	3.5420E+04	-4.645E+04	1	0.000
-1530	78.5	6.00		6.1	8.5254E+04	3.1456E+04	-4.802E+04	1	0.000
-1610	78.5	6.00		3.7	7.3309E+04	2.7082E+04	-2.770E+04	1	0.000
-1690	78.5	6.00		3.8	6.1319E+04	2.2687E+04	-2.927E+04	1	0.000
-1770	78.5	6.00		3.9	4.9329E+04	1.8292E+04	-3.084E+04	1	0.000
-1850	78.5	6.00		3.9	3.7340E+04	1.3897E+04	-3.241E+04	1	0.000
-1930	78.5	6.00		4.0	2.5350E+04	9.5023E+03	-3.398E+04	1	0.000
-2010	78.5	6.00		1.8	1.8691E+04	7.0348E+03	-1.434E+04	1	0.000
-2090	78.5	6.00		1.9	1.4636E+04	5.5086E+03	-1.591E+04	1	0.000
-2170	124.0	6.00		1.9	1.0581E+04	3.9824E+03	-1.748E+04	1	0.000
-2250	78.5	6.00		2.2	6.5261E+03	2.4562E+03	-1.905E+04	1	0.000
-2330	78.5	6.00		2.3	2.4710E+03	9.2999E+02	-2.063E+04	1	0.000
-2410	78.5	6.00		0.2	7.3613E-12	6.3878E-12	-1.384E+03	1	0.000
-2490	78.5	6.00		0.3	-1.734E-12	4.1141E-12	-2.955E+03	1	0.000

Verifica a taglio:

quota	Ast	Vsd	Vsdx	Vsdy	N	comb	VRd,c	VRd,max	VRd,S	Vwd
-90	0.16	33345	-10005	31809	-124350	3SLV	40484	231056	84807	44323 Vsd < VRd,
-170	0.16	32557	-9835	31036	-125190	3SLV	44489	231056	88812	44323 Vsd < VRd,
-250	0.08	32557	-9835	31036	-126760	3SLV	44707	231056	66869	22162 Vsd < VRd,
-330	0.08	10428	-3227	9916	-97696	3SLV	40668	231056	62829	22162 Vsd < VRd,
-410	0.08	10428	-3227	9916	-99267	3SLV	40886	231056	63048	22162 Vsd < VRd,
-490	0.08	10428	-3227	9916	-100838	3SLV	41104	231056	63266	22162 Vsd < VRd,
-570	0.08	10428	-3227	9916	-102409	3SLV	41323	231056	63484	22162 Vsd < VRd,
-650	0.08	10428	-3227	9916	-103980	3SLV	41541	231056	63703	22162 Vsd < VRd,
-730	0.08	1873	-574	1783	-33497	13SLV	31744	231056	53906	22162 Vsd < VRd,
-810	0.08	1873	-574	1783	-35068	13SLV	31962	231056	54124	22162 Vsd < VRd,
-890	0.08	1873	-574	1783	-36639	13SLV	32181	231056	54342	22162 Vsd < VRd,
-970	0.08	1873	-574	1783	-38210	13SLV	32399	231056	54561	22162 Vsd < VRd,
-1050	0.08	1873	-574	1783	-39781	13SLV	32617	231056	54779	22162 Vsd < VRd,
-1130	0.08	2079	623	-1983	-56305	3SLV	39371	231056	61532	22162 Vsd < VRd,
-1210	0.08	2079	623	-1983	-57876	3SLV	35133	231056	57294	22162 Vsd < VRd,
-1290	0.08	2079	623	-1983	-59447	3SLV	35351	231056	57513	22162 Vsd < VRd,
-1370	0.08	2079	623	-1983	-61018	3SLV	35569	231056	57731	22162 Vsd < VRd,
-1450	0.08	2079	623	-1983	-62588	3SLV	35788	231056	57949	22162 Vsd < VRd,
-1530	0.08	2079	623	-1983	-64159	3SLV	36006	231056	58168	22162 Vsd < VRd,
-1610	0.08	914	279	-870	-38623	3SLV	32457	231056	54618	22162 Vsd < VRd,
-1690	0.08	914	279	-870	-40194	3SLV	32675	231056	54837	22162 Vsd < VRd,
-1770	0.08	914	279	-870	-41765	3SLV	32893	231056	55055	22162 Vsd < VRd,
-1850	0.08	914	279	-870	-43335	3SLV	33112	231056	55273	22162 Vsd < VRd,
-1930	0.08	914	279	-870	-44906	3SLV	33330	231056	55492	22162 Vsd < VRd,
-2010	0.08	70	25	-66	-18645	3SLU	29680	231056	51841	22162 Vsd < VRd,
-2090	0.08	70	25	-66	-20687	3SLU	29963	231056	52125	22162 Vsd < VRd,
-2170	0.08	70	25	-66	-22729	3SLU	34704	231056	56865	22162 Vsd < VRd,
-2250	0.08	70	25	-66	-24771	3SLU	30531	231056	52693	22162 Vsd < VRd,
-2330	0.08	70	25	-66	-26813	3SLU	30815	231056	52977	22162 Vsd < VRd,
-2410	0.08	0	0	0	-2044	7SLV	27372	231056	49534	22162 Vsd < VRd,
-2490	0.08	0	0	0	-3614	7SLV	27590	231056	49752	22162 Vsd < VRd,

Palo alle coordinate X=-1625 Y=287

Sollecitazioni massime in testa palo:



Progetto	Titolo	Rev.	Pag.
Orione	Orione_A24a.pdf "TABULATI DI CALCOLO PLINTO DI FONDAZIONE PER AEROGENERATORE TIPO"	0	198

Combinazione corrispondente alla minima compressione in testa

N	Mx	My	Tx	Ty	comb
-7.986E+04	-1.550E+06	-5.453E+05	-1.013E+03	3.1776E+03	2 sl
-8.343E+04	-1.697E+06	-4.788E+05	-9.115E+02	3.6557E+03	2 ra
-8.701E+04	-1.845E+06	-4.123E+05	-8.096E+02	4.1337E+03	2 fr
-8.843E+04	-1.903E+06	-3.857E+05	-7.688E+02	4.3249E+03	2 qp
-5.680E+04	4.9812E+06	1.8008E+06	7.7240E+03	-2.284E+04	13 SLV fond

Combinazione corrispondente alla massima compressione in testa

N	Mx	My	Tx	Ty	comb
-1.178E+05	-2.589E+06	-4.495E+05	-9.200E+02	5.9953E+03	3 sl
-9.058E+04	-1.992E+06	-3.458E+05	-7.077E+02	4.6118E+03	1 ra
-9.058E+04	-1.992E+06	-3.458E+05	-7.077E+02	4.6118E+03	1 fr
-9.058E+04	-1.992E+06	-3.458E+05	-7.077E+02	4.6118E+03	1 qp
-1.244E+05	-8.965E+06	-2.492E+06	-9.139E+03	3.2067E+04	3 SLV fond

Combinazione corrispondente al massimo taglio in testa

N	Mx	My	Tx	Ty	comb
-1.178E+05	-2.589E+06	-4.495E+05	-9.200E+02	5.9953E+03	3 sl
-9.058E+04	-1.992E+06	-3.458E+05	-7.077E+02	4.6118E+03	1 ra
-9.058E+04	-1.992E+06	-3.458E+05	-7.077E+02	4.6118E+03	1 fr
-9.058E+04	-1.992E+06	-3.458E+05	-7.077E+02	4.6118E+03	1 qp
-1.244E+05	-8.965E+06	-2.492E+06	-9.139E+03	3.2067E+04	3 SLV fond

Verifica di capacità portante riferita al palo singolo:

Fattore di correlazione Psi scelto in base alla conoscenza del sito = 1.7  
 Coeff. parziale di sicurezza sulla resistenza laterale = 1.15  
 Coeff. parziale di sicurezza sulla resistenza alla punta = 1.35  
 Portanza laterale di progetto = 292537.1  
 Portanza di punta di progetto = 85555.4  
 verifica condotta in combinazione SLU 3  
 Sforzo normale = -117752.2  
 Peso del palo = 49087.4 \* 1.3  
 Carico totale di progetto = -181565.8  
 Resistenza totale di progetto = 378092.5  
 Coefficiente di sicurezza = 2.08 > 1

Verifica di resistenza allo stato limite:

quota	Af	cop.	c.s.	Mx	My	N	comb
-90	0.0	6.50	0.00	0.0000E+00	0.0000E+00	0.0000E+00	-
-170	78.5	6.00	3.56	-6.457E+06	-1.774E+06	-1.252E+05	3SLV
-250	78.5	6.00	6.52	-3.954E+06	-1.056E+06	-1.268E+05	3SLV
-330	78.5	6.00	11.80	-2.088E+06	-5.236E+05	-9.769E+04	3SLV
-410	78.5	6.00	15.41	-1.284E+06	-3.017E+05	-9.927E+04	3SLV
-490	78.5	6.00	18.28	-4.808E+05	-7.975E+04	-1.008E+05	3SLV
-570	78.5	6.00	18.00	3.2226E+05	1.3432E+05	-1.024E+05	3SLV
-650	78.5	6.00	15.55	1.1263E+06	3.6418E+05	-1.040E+05	3SLV
-730	78.5	6.00	14.31	-1.621E+06	-4.970E+05	-3.352E+04	13SLV
-810	78.5	6.00	15.46	1.5227E+06	4.6462E+05	-7.849E+04	3SLV
-890	78.5	6.00	15.84	1.4457E+06	4.3679E+05	-8.006E+04	3SLV
-970	78.5	6.00	16.24	1.3687E+06	4.0895E+05	-8.163E+04	3SLV
-1050	78.5	6.00	16.66	1.2917E+06	3.8112E+05	-8.320E+04	3SLV
-1130	124.0	6.00	22.71	1.1954E+06	3.4869E+05	-5.630E+04	3SLV
-1210	78.5	6.00	22.07	1.0360E+06	3.0124E+05	-5.787E+04	3SLV
-1290	78.5	6.00	24.01	8.7652E+05	2.5380E+05	-5.945E+04	3SLV
-1370	78.5	6.00	25.85	7.1709E+05	2.0636E+05	-6.102E+04	3SLV
-1450	78.5	6.00	27.58	5.5767E+05	1.5891E+05	-6.259E+04	3SLV
-1530	78.5	6.00	28.73	3.9824E+05	1.1147E+05	-6.416E+04	3SLV
-1610	78.5	6.00	45.51	3.2375E+05	9.0150E+04	-3.862E+04	3SLV
-1690	78.5	6.00	45.86	2.5344E+05	7.0115E+04	-4.019E+04	3SLV
-1770	78.5	6.00	44.13	1.8313E+05	5.0080E+04	-4.176E+04	3SLV
-1850	78.5	6.00	42.53	1.1283E+05	3.0045E+04	-4.333E+04	3SLV
-1930	78.5	6.00	41.05	4.2520E+04	1.0011E+04	-4.491E+04	3SLV
-2010	78.5	6.00	90.77	1.6975E+04	2.9998E+03	-2.031E+04	3SLV
-2090	78.5	6.00	84.25	1.3292E+04	2.3490E+03	-2.188E+04	3SLV
-2170	124.0	6.00	86.75	9.6096E+03	1.6982E+03	-2.345E+04	3SLV
-2250	78.5	6.00	73.67	5.9268E+03	1.0474E+03	-2.502E+04	3SLV
-2330	78.5	6.00	68.73	3.3665E+03	6.3425E+02	-2.682E+04	3SLU
-2410	78.5	6.00	100.00	1.1137E-11	5.8104E-12	-2.523E+03	3SLV
-2490	78.5	6.00	100.00	-1.369E-10	-2.154E-14	-4.094E+03	3SLV

Verifica di esercizio (combinazione rara):

quota	Af	cop.	sigmaf	sigmac	Mx	My	N	comb	Wk
-90	0.0	6.50	0.0	0.0	0.0000E+00	0.0000E+00	0.0000E+00	-	0.000
-170	78.5	6.00	36.2	24.2	-1.624E+06	-2.846E+05	-9.153E+04	1	0.000
-250	78.5	6.00		21.0	-1.257E+06	-2.232E+05	-9.310E+04	1	0.000
-330	78.5	6.00		15.9	-9.521E+05	-1.713E+05	-7.027E+04	1	0.000
-410	78.5	6.00		14.4	-7.512E+05	-1.352E+05	-7.184E+04	1	0.000
-490	78.5	6.00		12.8	-5.504E+05	-9.918E+04	-7.341E+04	1	0.000
-570	78.5	6.00		11.3	-3.496E+05	-6.313E+04	-7.498E+04	1	0.000
-650	78.5	6.00		9.8	-1.488E+05	-2.707E+04	-7.655E+04	1	0.000
-730	78.5	6.00		6.2	-1.064E+04	-2.265E+03	-5.522E+04	1	0.000
-810	78.5	6.00		6.5	2.3042E+04	3.7930E+03	-5.679E+04	1	0.000
-890	78.5	6.00		7.0	5.6725E+04	9.8509E+03	-5.836E+04	1	0.000
-970	78.5	6.00		7.4	9.0407E+04	1.5909E+04	-5.993E+04	1	0.000





Tabulati di Calcolo Plinto di Fondazione per Aerogeneratore Tipo - Progetto Impianto Eolico - "Orione"

-1050	78.5	6.00	7.9	1.2409E+05	2.1967E+04	-6.150E+04	1	0.000
-1130	124.0	6.00	5.3	1.4717E+05	2.6139E+04	-4.018E+04	1	0.000
-1210	78.5	6.00	5.8	1.3560E+05	2.4151E+04	-4.175E+04	1	0.000
-1290	78.5	6.00	5.9	1.2404E+05	2.2163E+04	-4.332E+04	1	0.000
-1370	78.5	6.00	5.9	1.1247E+05	2.0175E+04	-4.489E+04	1	0.000
-1450	78.5	6.00	6.0	1.0091E+05	1.8188E+04	-4.646E+04	1	0.000
-1530	78.5	6.00	6.1	8.9345E+04	1.6200E+04	-4.803E+04	1	0.000
-1610	78.5	6.00	3.7	7.6827E+04	1.3963E+04	-2.770E+04	1	0.000
-1690	78.5	6.00	3.8	6.4262E+04	1.1714E+04	-2.927E+04	1	0.000
-1770	78.5	6.00	3.9	5.1697E+04	9.4647E+03	-3.084E+04	1	0.000
-1850	78.5	6.00	3.9	3.9132E+04	7.2156E+03	-3.241E+04	1	0.000
-1930	78.5	6.00	4.0	2.6567E+04	4.9665E+03	-3.398E+04	1	0.000
-2010	78.5	6.00	1.8	1.9588E+04	3.6905E+03	-1.435E+04	1	0.000
-2090	78.5	6.00	1.9	1.5339E+04	2.8899E+03	-1.592E+04	1	0.000
-2170	124.0	6.00	1.9	1.1089E+04	2.0892E+03	-1.749E+04	1	0.000
-2250	78.5	6.00	2.2	6.8393E+03	1.2886E+03	-1.906E+04	1	0.000
-2330	78.5	6.00	2.3	2.5896E+03	4.8789E+02	-2.063E+04	1	0.000
-2410	78.5	6.00	0.2	1.8190E-11	3.2152E-12	-1.385E+03	1	0.000
-2490	78.5	6.00	0.3	1.8190E-11	-1.953E-13	-2.955E+03	1	0.000

Verifica di esercizio (combinazione quasi permanente):

quota	Af	cop.	sigmaf	sigmac	Mx	My	N	comb	Wk
-90	0.0	6.50	0.0	0.0	0.0000E+00	0.0000E+00	0.0000E+00	-	0.000
-170	78.5	6.00	36.2	24.2	-1.624E+06	-2.846E+05	-9.153E+04	1	0.000
-250	78.5	6.00		21.0	-1.257E+06	-2.232E+05	-9.310E+04	1	0.000
-330	78.5	6.00		15.9	-9.521E+05	-1.713E+05	-7.027E+04	1	0.000
-410	78.5	6.00		14.4	-7.512E+05	-1.352E+05	-7.184E+04	1	0.000
-490	78.5	6.00		12.8	-5.504E+05	-9.918E+04	-7.341E+04	1	0.000
-570	78.5	6.00		11.3	-3.496E+05	-6.313E+04	-7.498E+04	1	0.000
-650	78.5	6.00		9.8	-1.488E+05	-2.707E+04	-7.655E+04	1	0.000
-730	78.5	6.00		6.2	-1.064E+05	-2.265E+03	-5.522E+04	1	0.000
-810	78.5	6.00		6.5	2.3042E+04	3.7930E+03	-5.679E+04	1	0.000
-890	78.5	6.00		7.0	5.6725E+04	9.8509E+03	-5.836E+04	1	0.000
-970	78.5	6.00		7.4	9.0407E+04	1.5909E+04	-5.993E+04	1	0.000
-1050	78.5	6.00		7.9	1.2409E+05	2.1967E+04	-6.150E+04	1	0.000
-1130	124.0	6.00		5.3	1.4717E+05	2.6139E+04	-4.018E+04	1	0.000
-1210	78.5	6.00		5.8	1.3560E+05	2.4151E+04	-4.175E+04	1	0.000
-1290	78.5	6.00		5.9	1.2404E+05	2.2163E+04	-4.332E+04	1	0.000
-1370	78.5	6.00		5.9	1.1247E+05	2.0175E+04	-4.489E+04	1	0.000
-1450	78.5	6.00		6.0	1.0091E+05	1.8188E+04	-4.646E+04	1	0.000
-1530	78.5	6.00		6.1	8.9345E+04	1.6200E+04	-4.803E+04	1	0.000
-1610	78.5	6.00		3.7	7.6827E+04	1.3963E+04	-2.770E+04	1	0.000
-1690	78.5	6.00		3.8	6.4262E+04	1.1714E+04	-2.927E+04	1	0.000
-1770	78.5	6.00		3.9	5.1697E+04	9.4647E+03	-3.084E+04	1	0.000
-1850	78.5	6.00		3.9	3.9132E+04	7.2156E+03	-3.241E+04	1	0.000
-1930	78.5	6.00		4.0	2.6567E+04	4.9665E+03	-3.398E+04	1	0.000
-2010	78.5	6.00		1.8	1.9588E+04	3.6905E+03	-1.435E+04	1	0.000
-2090	78.5	6.00		1.9	1.5339E+04	2.8899E+03	-1.592E+04	1	0.000
-2170	124.0	6.00		1.9	1.1089E+04	2.0892E+03	-1.749E+04	1	0.000
-2250	78.5	6.00		2.2	6.8393E+03	1.2886E+03	-1.906E+04	1	0.000
-2330	78.5	6.00		2.3	2.5896E+03	4.8789E+02	-2.063E+04	1	0.000
-2410	78.5	6.00		0.2	1.8190E-11	3.2152E-12	-1.385E+03	1	0.000
-2490	78.5	6.00		0.3	1.8190E-11	-1.953E-13	-2.955E+03	1	0.000

Verifica a taglio:

quota	Ast	Vsd	Vsdx	Vsdy	N	comb	VRd,c	VRd,max	VRd,S	Vwd
-90	0.16	33344	-9139	32067	-124352	3SLV	40484	231056	84808	44323 Vsd < VRd,
-170	0.16	32554	-8974	31293	-125191	3SLV	44489	231056	88813	44323 Vsd < VRd,
-250	0.08	32554	-8974	31293	-126762	3SLV	44708	231056	66869	22162 Vsd < VRd,
-330	0.08	10421	-2774	10044	-97695	3SLV	40667	231056	62829	22162 Vsd < VRd,
-410	0.08	10421	-2774	10044	-99265	3SLV	40886	231056	63047	22162 Vsd < VRd,
-490	0.08	10421	-2774	10044	-100836	3SLV	41104	231056	63266	22162 Vsd < VRd,
-570	0.08	10421	-2774	10044	-102407	3SLV	41322	231056	63484	22162 Vsd < VRd,
-650	0.08	10421	-2774	10044	-103978	3SLV	41541	231056	63702	22162 Vsd < VRd,
-730	0.08	1872	-499	1805	-33520	13SLV	31747	231056	53909	22162 Vsd < VRd,
-810	0.08	1872	-499	1805	-35091	13SLV	31966	231056	54127	22162 Vsd < VRd,
-890	0.08	1872	-499	1805	-36661	13SLV	32184	231056	54346	22162 Vsd < VRd,
-970	0.08	1872	-499	1805	-38232	13SLV	32402	231056	54564	22162 Vsd < VRd,
-1050	0.08	1872	-499	1805	-39803	13SLV	32621	231056	54782	22162 Vsd < VRd,
-1130	0.08	2079	593	-1993	-56304	3SLV	39370	231056	61532	22162 Vsd < VRd,
-1210	0.08	2079	593	-1993	-57875	3SLV	35132	231056	57294	22162 Vsd < VRd,
-1290	0.08	2079	593	-1993	-59445	3SLV	35351	231056	57512	22162 Vsd < VRd,
-1370	0.08	2079	593	-1993	-61016	3SLV	35569	231056	57731	22162 Vsd < VRd,
-1450	0.08	2079	593	-1993	-62587	3SLV	35787	231056	57949	22162 Vsd < VRd,
-1530	0.08	2079	593	-1993	-64158	3SLV	36006	231056	58167	22162 Vsd < VRd,
-1610	0.08	914	250	-879	-38622	3SLV	32456	231056	54618	22162 Vsd < VRd,
-1690	0.08	914	250	-879	-40193	3SLV	32675	231056	54836	22162 Vsd < VRd,
-1770	0.08	914	250	-879	-41764	3SLV	32893	231056	55055	22162 Vsd < VRd,
-1850	0.08	914	250	-879	-43334	3SLV	33111	231056	55273	22162 Vsd < VRd,
-1930	0.08	914	250	-879	-44905	3SLV	33330	231056	55491	22162 Vsd < VRd,
-2010	0.08	70	13	-69	-18649	3SLU	29680	231056	51842	22162 Vsd < VRd,
-2090	0.08	70	13	-69	-20691	3SLU	29964	231056	52126	22162 Vsd < VRd,
-2170	0.08	70	13	-69	-22733	3SLU	34704	231056	56866	22162 Vsd < VRd,
-2250	0.08	70	13	-69	-24775	3SLU	30532	231056	52693	22162 Vsd < VRd,
-2330	0.08	70	13	-69	-26817	3SLU	30815	231056	52977	22162 Vsd < VRd,
-2410	0.08	0	0	0	-246	13SLV	27122	231056	49284	22162 Vsd < VRd,



Progetto	Titolo	Rev.	Pag.
Orione	Orione_A24a.pdf "TABULATI DI CALCOLO PLINTO DI FONDAZIONE PER AEROGENERATORE TIPO"	0	200

Tabulati di Calcolo Plinto di Fondazione per Aerogeneratore Tipo - Progetto Impianto Eolico - "Orione"

-2490 0.08 0 0 0 -1817 13SLV 27341 231056 49502 22162 Vsd < VRd,

Palo alle coordinate X=-1650 Y=0

Sollecitazioni massime in testa palo:

Combinazione corrispondente alla minima compressione in testa

N	Mx	My	Tx	Ty	comb	
-8.860E+04	-1.743E+06	-2.261E+05	-2.644E+02	3.5797E+03	2	sl
-8.927E+04	-1.836E+06	-1.489E+05	-1.411E+02	3.9475E+03	2	ra
-8.994E+04	-1.929E+06	-7.182E+04	-1.782E+01	4.3152E+03	2	fr
-9.021E+04	-1.967E+06	-4.097E+04	3.1494E+01	4.4623E+03	2	qp
-5.781E+04	4.9558E+06	-2.118E+06	-8.244E+03	-2.279E+04	15	SLV fond

Combinazione corrispondente alla massima compressione in testa

N	Mx	My	Tx	Ty	comb	
-1.178E+05	-2.629E+06	6.8913E+03	1.3709E+02	6.0879E+03	3	sl
-9.061E+04	-2.022E+06	5.3010E+03	1.0546E+02	4.6830E+03	1	ra
-9.061E+04	-2.022E+06	5.3010E+03	1.0546E+02	4.6830E+03	1	fr
-9.061E+04	-2.022E+06	5.3010E+03	1.0546E+02	4.6830E+03	1	qp
-1.234E+05	-9.001E+06	2.1291E+06	8.4545E+03	3.2160E+04	1	SLV fond

Combinazione corrispondente al massimo taglio in testa

N	Mx	My	Tx	Ty	comb	
-1.178E+05	-2.629E+06	6.8913E+03	1.3709E+02	6.0879E+03	3	sl
-9.061E+04	-2.022E+06	5.3010E+03	1.0546E+02	4.6830E+03	1	ra
-9.061E+04	-2.022E+06	5.3010E+03	1.0546E+02	4.6830E+03	1	fr
-9.061E+04	-2.022E+06	5.3010E+03	1.0546E+02	4.6830E+03	1	qp
-1.234E+05	-9.001E+06	2.1291E+06	8.4545E+03	3.2160E+04	1	SLV fond

Verifica di capacità portante riferita al palo singolo:

Fattore di correlazione Psi scelto in base alla conoscenza del sito = 1.7  
 Coeff. parziale di sicurezza sulla resistenza laterale = 1.15  
 Coeff. parziale di sicurezza sulla resistenza alla punta = 1.35  
 Portanza laterale di progetto = 292537.1  
 Portanza di punta di progetto = 85555.4  
 verifica condotta in combinazione SLU 3  
 Sforzo normale = -117790.5  
 Peso del palo = 49087.4 \* 1.3  
 Carico totale di progetto = -181604.1  
 Resistenza totale di progetto = 378092.5  
 Coefficiente di sicurezza = 2.08 > 1

Verifica di resistenza allo stato limite:

quota	Af	cop.	c.s.	Mx	My	N	comb
-90	0.0	6.50	0.00	0.0000E+00	0.0000E+00	0.0000E+00	-
-170	78.5	6.00	3.58	-6.485E+06	-1.471E+06	-1.242E+05	3SLV
-250	78.5	6.00	6.57	-3.975E+06	-8.243E+05	-1.257E+05	3SLV
-330	78.5	6.00	11.90	-2.103E+06	-3.509E+05	-9.687E+04	3SLV
-410	78.5	6.00	15.55	-1.296E+06	-1.664E+05	-9.844E+04	3SLV
-490	78.5	6.00	18.43	-4.891E+05	1.8145E+04	-1.000E+05	3SLV
-570	78.5	6.00	18.15	3.1791E+05	1.9710E+05	-1.016E+05	3SLV
-650	78.5	6.00	15.61	1.1250E+06	3.8721E+05	-1.032E+05	3SLV
-730	78.5	6.00	14.41	-1.622E+06	-4.908E+05	-3.421E+04	13SLV
-810	78.5	6.00	15.52	1.5241E+06	4.5643E+05	-7.784E+04	3SLV
-890	78.5	6.00	15.91	1.4475E+06	4.2289E+05	-7.941E+04	3SLV
-970	78.5	6.00	16.32	1.3710E+06	3.8936E+05	-8.098E+04	3SLV
-1050	78.5	6.00	16.75	1.2944E+06	3.5582E+05	-8.255E+04	3SLV
-1130	124.0	6.00	22.84	1.1983E+06	3.1960E+05	-5.582E+04	3SLV
-1210	78.5	6.00	22.20	1.0386E+06	2.7462E+05	-5.739E+04	3SLV
-1290	78.5	6.00	24.16	8.7893E+05	2.2964E+05	-5.896E+04	3SLV
-1370	78.5	6.00	26.03	7.1923E+05	1.8466E+05	-6.053E+04	3SLV
-1450	78.5	6.00	27.78	5.5952E+05	1.3968E+05	-6.210E+04	3SLV
-1530	78.5	6.00	28.95	3.9981E+05	9.4705E+04	-6.367E+04	3SLV
-1610	78.5	6.00	45.88	3.2509E+05	7.5784E+04	-3.829E+04	3SLV
-1690	78.5	6.00	46.24	2.5455E+05	5.8146E+04	-3.986E+04	3SLV
-1770	78.5	6.00	44.49	1.8401E+05	4.0508E+04	-4.143E+04	3SLV
-1850	78.5	6.00	42.86	1.1348E+05	2.2869E+04	-4.301E+04	3SLV
-1930	78.5	6.00	41.35	4.2937E+04	5.2315E+03	-4.458E+04	3SLV
-2010	78.5	6.00	91.58	1.7272E+04	-4.851E+02	-2.013E+04	3SLV
-2090	78.5	6.00	84.95	1.3525E+04	-3.799E+02	-2.170E+04	3SLV
-2170	124.0	6.00	87.43	9.7777E+03	-2.746E+02	-2.327E+04	3SLV
-2250	78.5	6.00	74.21	6.0306E+03	-1.694E+02	-2.484E+04	3SLV
-2330	78.5	6.00	68.72	3.4186E+03	4.0937E+01	-2.682E+04	3SLV
-2410	78.5	6.00	100.00	-9.247E-11	6.6129E-13	-2.489E+03	3SLV
-2490	78.5	6.00	100.00	-1.350E-10	9.5844E-12	-4.060E+03	3SLV

Verifica di esercizio (combinazione rara):

quota	Af	cop.	sigmaf	sigmac	Mx	My	N	comb	Wk
-90	0.0	6.50	0.0	0.0	0.0000E+00	0.0000E+00	0.0000E+00	-	0.000
-170	78.5	6.00	36.1	24.2	-1.649E+06	1.6613E+03	-9.156E+04	1	0.000
-250	78.5	6.00		21.0	-1.276E+06	-1.659E+03	-9.313E+04	1	0.000



Progetto	Titolo	Rev.	Pag.
Orione	Orione_A24a.pdf "TABULATI DI CALCOLO PLINTO DI FONDAZIONE PER AEROGENERATORE TIPO"	0	201

Tabulati di Calcolo Plinto di Fondazione per Aerogeneratore Tipo - Progetto Impianto Eolico - "Orione"

-330	78.5	6.00	15.9	-9.668E+05	-3.487E+03	-7.029E+04	1	0.000
-410	78.5	6.00	14.3	-7.629E+05	-2.829E+03	-7.186E+04	1	0.000
-490	78.5	6.00	12.8	-5.589E+05	-2.171E+03	-7.343E+04	1	0.000
-570	78.5	6.00	11.4	-3.735E+05	-4.723E+04	-7.392E+04	2	0.000
-650	78.5	6.00	10.0	-1.856E+05	-3.005E+04	-7.549E+04	2	0.000
-730	78.5	6.00	6.5	-5.421E+04	-1.744E+04	-5.438E+04	2	0.000
-810	78.5	6.00	6.5	2.3391E+04	-2.754E+02	-5.681E+04	1	0.000
-890	78.5	6.00	7.0	5.7595E+04	-1.534E+02	-5.838E+04	1	0.000
-970	78.5	6.00	7.4	9.1799E+04	-3.138E+01	-5.995E+04	1	0.000
-1050	78.5	6.00	7.9	1.2600E+05	9.0634E+01	-6.152E+04	1	0.000
-1130	124.0	6.00	5.3	1.4944E+05	1.9604E+02	-4.019E+04	1	0.000
-1210	78.5	6.00	5.8	1.3770E+05	2.4718E+02	-4.176E+04	1	0.000
-1290	78.5	6.00	5.9	1.2595E+05	2.9832E+02	-4.333E+04	1	0.000
-1370	78.5	6.00	5.9	1.1421E+05	3.4947E+02	-4.490E+04	1	0.000
-1450	78.5	6.00	6.0	1.0247E+05	4.0061E+02	-4.647E+04	1	0.000
-1530	78.5	6.00	6.1	9.0726E+04	4.5175E+02	-4.804E+04	1	0.000
-1610	78.5	6.00	3.7	7.8014E+04	4.2144E+02	-2.771E+04	1	0.000
-1690	78.5	6.00	3.8	6.5255E+04	3.8713E+02	-2.928E+04	1	0.000
-1770	78.5	6.00	3.9	5.2496E+04	3.5281E+02	-3.085E+04	1	0.000
-1850	78.5	6.00	3.9	3.9737E+04	3.1850E+02	-3.242E+04	1	0.000
-1930	78.5	6.00	4.0	2.6978E+04	2.8418E+02	-3.399E+04	1	0.000
-2010	78.5	6.00	1.8	1.9892E+04	2.3820E+02	-1.435E+04	1	0.000
-2090	78.5	6.00	1.9	1.5576E+04	1.8652E+02	-1.592E+04	1	0.000
-2170	124.0	6.00	1.9	1.1261E+04	1.3485E+02	-1.749E+04	1	0.000
-2250	78.5	6.00	2.2	6.9452E+03	8.3168E+01	-1.906E+04	1	0.000
-2330	78.5	6.00	2.3	2.6297E+03	3.1490E+01	-2.063E+04	1	0.000
-2410	78.5	6.00	0.2	3.6380E-12	-5.595E-12	-1.385E+03	1	0.000
-2490	78.5	6.00	0.3	3.6380E-12	-3.037E-12	-2.956E+03	1	0.000

Verifica di esercizio (combinazione quasi permanente):

quota	Af	cop.	sigmaf	sigmac	Mx	My	N	comb	Wk
-90	0.0	6.50	0.0	0.0	0.0000E+00	0.0000E+00	0.0000E+00	-	0.000
-170	78.5	6.00	36.1	24.2	-1.649E+06	1.6613E+03	-9.156E+04	1	0.000
-250	78.5	6.00		21.0	-1.276E+06	-1.659E+03	-9.313E+04	1	0.000
-330	78.5	6.00		15.9	-9.668E+05	-3.487E+03	-7.029E+04	1	0.000
-410	78.5	6.00		14.3	-7.629E+05	-2.829E+03	-7.186E+04	1	0.000
-490	78.5	6.00		12.8	-5.589E+05	-2.171E+03	-7.343E+04	1	0.000
-570	78.5	6.00		11.3	-3.605E+05	-1.523E+04	-7.468E+04	2	0.000
-650	78.5	6.00		9.8	-1.614E+05	-9.612E+03	-7.625E+04	2	0.000
-730	78.5	6.00		6.3	-2.383E+04	-5.510E+03	-5.498E+04	2	0.000
-810	78.5	6.00		6.5	2.3391E+04	-2.754E+02	-5.681E+04	1	0.000
-890	78.5	6.00		7.0	5.7595E+04	-1.534E+02	-5.838E+04	1	0.000
-970	78.5	6.00		7.4	9.1799E+04	-3.138E+01	-5.995E+04	1	0.000
-1050	78.5	6.00		7.9	1.2600E+05	9.0634E+01	-6.152E+04	1	0.000
-1130	124.0	6.00		5.3	1.4944E+05	1.9604E+02	-4.019E+04	1	0.000
-1210	78.5	6.00		5.8	1.3770E+05	2.4718E+02	-4.176E+04	1	0.000
-1290	78.5	6.00		5.9	1.2595E+05	2.9832E+02	-4.333E+04	1	0.000
-1370	78.5	6.00		5.9	1.1421E+05	3.4947E+02	-4.490E+04	1	0.000
-1450	78.5	6.00		6.0	1.0247E+05	4.0061E+02	-4.647E+04	1	0.000
-1530	78.5	6.00		6.1	9.0726E+04	4.5175E+02	-4.804E+04	1	0.000
-1610	78.5	6.00		3.7	7.8014E+04	4.2144E+02	-2.771E+04	1	0.000
-1690	78.5	6.00		3.8	6.5255E+04	3.8713E+02	-2.928E+04	1	0.000
-1770	78.5	6.00		3.9	5.2496E+04	3.5281E+02	-3.085E+04	1	0.000
-1850	78.5	6.00		3.9	3.9737E+04	3.1850E+02	-3.242E+04	1	0.000
-1930	78.5	6.00		4.0	2.6978E+04	2.8418E+02	-3.399E+04	1	0.000
-2010	78.5	6.00		1.8	1.9892E+04	2.3820E+02	-1.435E+04	1	0.000
-2090	78.5	6.00		1.9	1.5576E+04	1.8652E+02	-1.592E+04	1	0.000
-2170	124.0	6.00		1.9	1.1261E+04	1.3485E+02	-1.749E+04	1	0.000
-2250	78.5	6.00		2.2	6.9452E+03	8.3168E+01	-1.906E+04	1	0.000
-2330	78.5	6.00		2.3	2.6297E+03	3.1490E+01	-2.063E+04	1	0.000
-2410	78.5	6.00		0.2	3.6380E-12	-5.595E-12	-1.385E+03	1	0.000
-2490	78.5	6.00		0.3	3.6380E-12	-3.037E-12	-2.956E+03	1	0.000

Verifica a taglio:

quota	Ast	Vsd	Vsdx	Vsdy	N	comb	VRd, c	VRd, max	VRd, S	Vwd
-90	0.16	33252	8455	32160	-123404	1SLV	40353	231056	84676	44323 Vsd < VRd,
-170	0.16	32429	8167	31384	-124148	1SLV	44344	231056	88668	44323 Vsd < VRd,
-250	0.08	32429	8167	31384	-125719	1SLV	44563	231056	66724	22162 Vsd < VRd,
-330	0.08	10348	-2307	10088	-96869	3SLV	40553	231056	62714	22162 Vsd < VRd,
-410	0.08	10348	-2307	10088	-98439	3SLV	40771	231056	62933	22162 Vsd < VRd,
-490	0.08	10348	-2307	10088	-100010	3SLV	40989	231056	63151	22162 Vsd < VRd,
-570	0.08	10348	-2307	10088	-101581	3SLV	41208	231056	63369	22162 Vsd < VRd,
-650	0.08	10348	-2307	10088	-103152	3SLV	41426	231056	63588	22162 Vsd < VRd,
-730	0.08	1860	419	1812	-34296	15SLV	31855	231056	54017	22162 Vsd < VRd,
-810	0.08	1860	419	1812	-35867	15SLV	32073	231056	54235	22162 Vsd < VRd,
-890	0.08	1860	419	1812	-37438	15SLV	32292	231056	54453	22162 Vsd < VRd,
-970	0.08	1860	419	1812	-39009	15SLV	32510	231056	54672	22162 Vsd < VRd,
-1050	0.08	1860	419	1812	-40579	15SLV	32728	231056	54890	22162 Vsd < VRd,
-1130	0.08	2074	562	-1996	-55817	3SLV	39303	231056	61464	22162 Vsd < VRd,
-1210	0.08	2074	562	-1996	-57388	3SLV	35065	231056	57227	22162 Vsd < VRd,
-1290	0.08	2074	562	-1996	-58959	3SLV	35283	231056	57445	22162 Vsd < VRd,
-1370	0.08	2074	562	-1996	-60530	3SLV	35502	231056	57663	22162 Vsd < VRd,
-1450	0.08	2074	562	-1996	-62101	3SLV	35720	231056	57882	22162 Vsd < VRd,
-1530	0.08	2074	562	-1996	-63671	3SLV	35938	231056	58100	22162 Vsd < VRd,
-1610	0.08	909	220	-882	-38293	3SLV	32411	231056	54572	22162 Vsd < VRd,
-1690	0.08	909	220	-882	-39863	3SLV	32629	231056	54791	22162 Vsd < VRd,



Progetto	Titolo	Rev.	Pag.
Orione	Orione_A24a.pdf "TABULATI DI CALCOLO PLINTO DI FONDAZIONE PER AEROGENERATORE TIPO"	0	202

Tabulati di Calcolo Plinto di Fondazione per Aerogeneratore Tipo - Progetto Impianto Eolico - "Orione"

-1770	0.08	909	220	-882	-41434	3SLV	32847	231056	55009	22162	Vsd < VRd,
-1850	0.08	909	220	-882	-43005	3SLV	33066	231056	55227	22162	Vsd < VRd,
-1930	0.08	909	220	-882	-44576	3SLV	33284	231056	55446	22162	Vsd < VRd,
-2010	0.08	71	10	-70	-18301	4SLU	29632	231056	51793	22162	Vsd < VRd,
-2090	0.08	71	10	-70	-20343	4SLU	29916	231056	52077	22162	Vsd < VRd,
-2170	0.08	71	10	-70	-22385	4SLU	34656	231056	56817	22162	Vsd < VRd,
-2250	0.08	71	10	-70	-24427	4SLU	30483	231056	52645	22162	Vsd < VRd,
-2330	0.08	71	10	-70	-26469	4SLU	30767	231056	52929	22162	Vsd < VRd,
-2410	0.08	0	0	0	-2489	3SLV	27434	231056	49596	22162	Vsd < VRd,
-2490	0.08	0	0	0	-4060	3SLV	27652	231056	49814	22162	Vsd < VRd,

Palo alle coordinate X=-1625 Y=-287

Sollecitazioni massime in testa palo:

Combinazione corrispondente alla minima compressione in testa

N	Mx	My	Tx	Ty	comb	
-9.065E+04	-1.992E+06	3.5599E+05	9.1778E+02	4.6120E+03	1	sl
-9.065E+04	-1.992E+06	3.5599E+05	9.1778E+02	4.6120E+03	1	ra
-9.065E+04	-1.992E+06	3.5599E+05	9.1778E+02	4.6120E+03	1	fr
-9.065E+04	-1.992E+06	3.5599E+05	9.1778E+02	4.6120E+03	1	qp
-5.679E+04	4.9949E+06	-1.747E+06	-7.358E+03	-2.290E+04	15	SLV fond

Combinazione corrispondente alla massima compressione in testa

N	Mx	My	Tx	Ty	comb	
-1.246E+05	-2.473E+06	2.6094E+05	8.9171E+02	5.2256E+03	4	sl
-9.516E+04	-1.914E+06	2.2143E+05	7.1685E+02	4.0987E+03	2	ra
-9.290E+04	-1.953E+06	2.8871E+05	8.1731E+02	4.3553E+03	2	fr
-9.200E+04	-1.969E+06	3.1562E+05	8.5750E+02	4.4580E+03	2	qp
-1.245E+05	-8.979E+06	2.4589E+06	9.1939E+03	3.2120E+04	1	SLV fond

Combinazione corrispondente al massimo taglio in testa

N	Mx	My	Tx	Ty	comb	
-1.178E+05	-2.589E+06	4.6279E+05	1.1931E+03	5.9956E+03	3	sl
-9.065E+04	-1.992E+06	3.5599E+05	9.1778E+02	4.6120E+03	1	ra
-9.065E+04	-1.992E+06	3.5599E+05	9.1778E+02	4.6120E+03	1	fr
-9.065E+04	-1.992E+06	3.5599E+05	9.1778E+02	4.6120E+03	1	qp
-1.245E+05	-8.979E+06	2.4589E+06	9.1939E+03	3.2120E+04	1	SLV fond

Verifica di capacità portante riferita al palo singolo:

Fattore di correlazione Psi scelto in base alla conoscenza del sito = 1.7  
 Coeff. parziale di sicurezza sulla resistenza laterale = 1.15  
 Coeff. parziale di sicurezza sulla resistenza alla punta = 1.35  
 Portanza laterale di progetto = 292537.1  
 Portanza di punta di progetto = 85555.4  
 verifica condotta in combinazione SLU 4  
 Sforzo normale = -124608.7  
 Peso del palo = 49087.4 \* 1.3  
 Carico totale di progetto = -188422.3  
 Resistenza totale di progetto = 378092.5  
 Coefficiente di sicurezza = 2.01 > 1

Verifica di resistenza allo stato limite:

quota	Af	cop.	c.s.	Mx	My	N	comb
-90	0.0	6.50	0.00	0.0000E+00	0.0000E+00	0.0000E+00	-
-170	78.5	6.00	3.56	-6.467E+06	1.7453E+06	-1.252E+05	1SLV
-250	78.5	6.00	6.52	-3.960E+06	1.0333E+06	-1.268E+05	1SLV
-330	78.5	6.00	11.80	-2.091E+06	5.0696E+05	-9.765E+04	1SLV
-410	78.5	6.00	15.42	-1.286E+06	2.9030E+05	-9.922E+04	1SLV
-490	78.5	6.00	17.99	-7.720E+05	3.8786E+04	-1.010E+05	4SLU
-570	78.5	6.00	17.89	-5.182E+05	1.5516E+04	-1.030E+05	4SLU
-650	78.5	6.00	15.55	1.1286E+06	-3.597E+05	-1.039E+05	1SLV
-730	78.5	6.00	14.33	-1.624E+06	4.8772E+05	-3.364E+04	15SLV
-810	78.5	6.00	15.46	1.5254E+06	-4.572E+05	-7.845E+04	1SLV
-890	78.5	6.00	15.84	1.4483E+06	-4.295E+05	-8.002E+04	1SLV
-970	78.5	6.00	16.24	1.3711E+06	-4.019E+05	-8.159E+04	1SLV
-1050	78.5	6.00	16.66	1.2939E+06	-3.743E+05	-8.316E+04	1SLV
-1130	124.0	6.00	22.71	1.1974E+06	-3.422E+05	-5.627E+04	1SLV
-1210	78.5	6.00	22.08	1.0377E+06	-2.955E+05	-5.784E+04	1SLV
-1290	78.5	6.00	24.02	8.7798E+05	-2.487E+05	-5.941E+04	1SLV
-1370	78.5	6.00	25.86	7.1827E+05	-2.020E+05	-6.098E+04	1SLV
-1450	78.5	6.00	27.59	5.5856E+05	-1.553E+05	-6.255E+04	1SLV
-1530	78.5	6.00	28.06	1.1112E+05	-1.072E+04	-6.570E+04	4SLU
-1610	78.5	6.00	45.54	3.2425E+05	-8.770E+04	-3.860E+04	1SLV
-1690	78.5	6.00	45.78	8.1389E+04	-7.154E+03	-4.026E+04	4SLU
-1770	78.5	6.00	43.57	6.6395E+04	-5.404E+03	-4.230E+04	4SLU
-1850	78.5	6.00	41.57	5.1401E+04	-3.654E+03	-4.434E+04	4SLU
-1930	78.5	6.00	39.74	3.6408E+04	-1.904E+03	-4.639E+04	4SLU
-2010	78.5	6.00	90.82	1.6982E+04	-2.455E+03	-2.029E+04	1SLV
-2090	78.5	6.00	84.19	2.1520E+04	-9.088E+02	-2.189E+04	4SLU
-2170	124.0	6.00	84.98	1.5557E+04	-6.570E+02	-2.394E+04	4SLU
-2250	78.5	6.00	70.95	9.5952E+03	-4.052E+02	-2.598E+04	4SLU
-2330	78.5	6.00	65.78	3.6331E+03	-1.534E+02	-2.802E+04	4SLU
-2410	78.5	6.00	100.00	-2.621E-10	4.7358E-11	-2.521E+03	1SLV



Progetto	Titolo	Rev.	Pag.
Orione	Orione_A24a.pdf "TABULATI DI CALCOLO PLINTO DI FONDAZIONE PER AEROGENERATORE TIPO"	0	203

Tabulati di Calcolo Plinto di Fondazione per Aerogeneratore Tipo - Progetto Impianto Eolico - "Orione"

-2490 78.5 6.00 100.00 -2.738E-11 1.0952E-11 -4.092E+03 1SLV

Verifica di esercizio (combinazione rara):

quota	Af	cop.	sigmaf	sigmac	Mx	My	N	comb	Wk
-90	0.0	6.50	0.0	0.0	0.0000E+00	0.0000E+00	0.0000E+00	-	0.000
-170	78.5	6.00	36.1	24.2	-1.624E+06	2.8765E+05	-9.160E+04	1	0.000
-250	78.5	6.00		21.4	-1.259E+06	1.1840E+05	-9.766E+04	2	0.000
-330	78.5	6.00		16.4	-9.801E+05	7.8767E+04	-7.397E+04	2	0.000
-410	78.5	6.00		15.0	-7.841E+05	5.8627E+04	-7.554E+04	2	0.000
-490	78.5	6.00		13.5	-5.881E+05	3.8488E+04	-7.711E+04	2	0.000
-570	78.5	6.00		12.0	-3.921E+05	1.8348E+04	-7.868E+04	2	0.000
-650	78.5	6.00		10.6	-1.961E+05	-1.792E+03	-8.026E+04	2	0.000
-730	78.5	6.00		7.0	-5.893E+04	-1.489E+04	-5.815E+04	2	0.000
-810	78.5	6.00		6.9	-1.979E+04	-1.625E+04	-5.972E+04	2	0.000
-890	78.5	6.00		7.0	1.9341E+04	-1.760E+04	-6.129E+04	2	0.000
-970	78.5	6.00		7.5	5.8474E+04	-1.896E+04	-6.286E+04	2	0.000
-1050	78.5	6.00		8.0	9.7608E+04	-2.031E+04	-6.443E+04	2	0.000
-1130	124.0	6.00		5.3	1.2571E+05	-2.081E+04	-4.235E+04	2	0.000
-1210	78.5	6.00		5.9	1.1777E+05	-1.848E+04	-4.392E+04	2	0.000
-1290	78.5	6.00		6.0	1.0982E+05	-1.616E+04	-4.549E+04	2	0.000
-1370	78.5	6.00		6.1	1.0188E+05	-1.383E+04	-4.706E+04	2	0.000
-1450	78.5	6.00		6.2	9.3939E+04	-1.151E+04	-4.863E+04	2	0.000
-1530	78.5	6.00		6.3	8.5996E+04	-9.182E+03	-5.021E+04	2	0.000
-1610	78.5	6.00		3.9	7.4500E+04	-7.684E+03	-2.917E+04	2	0.000
-1690	78.5	6.00		3.9	6.2828E+04	-6.226E+03	-3.075E+04	2	0.000
-1770	78.5	6.00		4.0	5.1157E+04	-4.769E+03	-3.232E+04	2	0.000
-1850	78.5	6.00		4.1	3.9486E+04	-3.312E+03	-3.389E+04	2	0.000
-1930	78.5	6.00		4.2	2.7814E+04	-1.855E+03	-3.546E+04	2	0.000
-2010	78.5	6.00		1.9	2.0933E+04	-1.202E+03	-1.515E+04	2	0.000
-2090	78.5	6.00		2.0	1.6392E+04	-9.410E+02	-1.672E+04	2	0.000
-2170	124.0	6.00		2.0	1.1850E+04	-6.803E+02	-1.829E+04	2	0.000
-2250	78.5	6.00		2.3	7.3089E+03	-4.196E+02	-1.986E+04	2	0.000
-2330	78.5	6.00		2.4	2.7674E+03	-1.589E+02	-2.143E+04	2	0.000
-2410	78.5	6.00		0.2	2.7285E-11	-2.069E-12	-1.538E+03	2	0.000
-2490	78.5	6.00		0.3	2.7285E-11	3.3315E-12	-3.109E+03	2	0.000

Verifica di esercizio (combinazione quasi permanente):

quota	Af	cop.	sigmaf	sigmac	Mx	My	N	comb	Wk
-90	0.0	6.50	0.0	0.0	0.0000E+00	0.0000E+00	0.0000E+00	-	0.000
-170	78.5	6.00	36.1	24.2	-1.624E+06	2.8765E+05	-9.160E+04	1	0.000
-250	78.5	6.00		21.1	-1.258E+06	1.8927E+05	-9.451E+04	2	0.000
-330	78.5	6.00		16.0	-9.605E+05	1.3852E+05	-7.142E+04	2	0.000
-410	78.5	6.00		14.5	-7.612E+05	1.0819E+05	-7.299E+04	2	0.000
-490	78.5	6.00		13.0	-5.618E+05	7.7856E+04	-7.456E+04	2	0.000
-570	78.5	6.00		11.5	-3.624E+05	4.7524E+04	-7.613E+04	2	0.000
-650	78.5	6.00		10.0	-1.630E+05	1.7191E+04	-7.770E+04	2	0.000
-730	78.5	6.00		6.5	-2.514E+04	-3.443E+03	-5.612E+04	2	0.000
-810	78.5	6.00		6.5	1.0180E+04	-7.915E+03	-5.770E+04	2	0.000
-890	78.5	6.00		7.0	4.5502E+04	-1.239E+04	-5.927E+04	2	0.000
-970	78.5	6.00		7.5	8.0824E+04	-1.686E+04	-6.084E+04	2	0.000
-1050	78.5	6.00		7.9	1.1615E+05	-2.133E+04	-6.241E+04	2	0.000
-1130	124.0	6.00		5.3	1.4073E+05	-2.425E+04	-4.085E+04	2	0.000
-1210	78.5	6.00		5.8	1.3026E+05	-2.209E+04	-4.242E+04	2	0.000
-1290	78.5	6.00		5.9	1.1978E+05	-1.993E+04	-4.399E+04	2	0.000
-1370	78.5	6.00		6.0	1.0930E+05	-1.777E+04	-4.556E+04	2	0.000
-1450	78.5	6.00		6.1	9.8823E+04	-1.561E+04	-4.713E+04	2	0.000
-1530	78.5	6.00		6.2	8.8346E+04	-1.345E+04	-4.870E+04	2	0.000
-1610	78.5	6.00		3.8	7.6133E+04	-1.148E+04	-2.816E+04	2	0.000
-1690	78.5	6.00		3.8	6.3836E+04	-9.517E+03	-2.973E+04	2	0.000
-1770	78.5	6.00		3.9	5.1538E+04	-7.555E+03	-3.130E+04	2	0.000
-1850	78.5	6.00		4.0	3.9241E+04	-5.593E+03	-3.287E+04	2	0.000
-1930	78.5	6.00		4.1	2.6943E+04	-3.632E+03	-3.444E+04	2	0.000
-2010	78.5	6.00		1.8	1.9994E+04	-2.608E+03	-1.459E+04	2	0.000
-2090	78.5	6.00		1.9	1.5656E+04	-2.042E+03	-1.616E+04	2	0.000
-2170	124.0	6.00		1.9	1.1318E+04	-1.476E+03	-1.774E+04	2	0.000
-2250	78.5	6.00		2.2	6.9808E+03	-9.105E+02	-1.931E+04	2	0.000
-2330	78.5	6.00		2.3	2.6432E+03	-3.447E+02	-2.088E+04	2	0.000
-2410	78.5	6.00		0.2	2.3465E-11	-4.485E-12	-1.432E+03	2	0.000
-2490	78.5	6.00		0.3	2.3465E-11	1.9096E-12	-3.003E+03	2	0.000

Verifica a taglio:

quota	Ast	Vsd	Vsdx	Vsdy	N	comb	VRd,c	VRd,max	VRd,S	Vwd
-90	0.16	33410	9194	32120	-124502	1SLV	40505	231056	84829	44323 Vsd < VRd,
-170	0.16	32584	8901	31344	-125240	1SLV	44496	231056	88819	44323 Vsd < VRd,
-250	0.08	32584	8901	31344	-126810	1SLV	44714	231056	66876	22162 Vsd < VRd,
-330	0.08	10418	2708	10060	-97651	1SLV	40661	231056	62823	22162 Vsd < VRd,
-410	0.08	10418	2708	10060	-99222	1SLV	40880	231056	63041	22162 Vsd < VRd,
-490	0.08	10418	2708	10060	-100792	1SLV	41098	231056	63260	22162 Vsd < VRd,
-570	0.08	10418	2708	10060	-102363	1SLV	41316	231056	63478	22162 Vsd < VRd,
-650	0.08	10418	2708	10060	-103934	1SLV	41535	231056	63696	22162 Vsd < VRd,
-730	0.08	1872	490	1807	-33641	15SLV	31764	231056	53926	22162 Vsd < VRd,
-810	0.08	1872	490	1807	-35212	15SLV	31982	231056	54144	22162 Vsd < VRd,
-890	0.08	1872	490	1807	-36783	15SLV	32201	231056	54362	22162 Vsd < VRd,
-970	0.08	1872	490	1807	-38354	15SLV	32419	231056	54581	22162 Vsd < VRd,



Progetto	Titolo	Rev.	Pag.
Orione	Orione_A24a.pdf "TABULATI DI CALCOLO PLINTO DI FONDAZIONE PER AEROGENERATORE TIPO"	0	204

Tabulati di Calcolo Plinto di Fondazione per Aerogeneratore Tipo - Progetto Impianto Eolico - "Orione"

-1050	0.08	1872	490	1807	-39924	15SLV	32637	231056	54799	22162	Vsd < VRd,
-1130	0.08	2080	-584	-1996	-56269	1SLV	39366	231056	61527	22162	Vsd < VRd,
-1210	0.08	2080	-584	-1996	-57840	1SLV	35128	231056	57289	22162	Vsd < VRd,
-1290	0.08	2080	-584	-1996	-59411	1SLV	35346	231056	57508	22162	Vsd < VRd,
-1370	0.08	2080	-584	-1996	-60982	1SLV	35564	231056	57726	22162	Vsd < VRd,
-1450	0.08	2080	-584	-1996	-62552	1SLV	35783	231056	57944	22162	Vsd < VRd,
-1530	0.08	2080	-584	-1996	-64123	1SLV	36001	231056	58163	22162	Vsd < VRd,
-1610	0.08	914	-245	-880	-38599	1SLV	32453	231056	54615	22162	Vsd < VRd,
-1690	0.08	914	-245	-880	-40170	1SLV	32672	231056	54833	22162	Vsd < VRd,
-1770	0.08	914	-245	-880	-41741	1SLV	32890	231056	55052	22162	Vsd < VRd,
-1850	0.08	914	-245	-880	-43312	1SLV	33108	231056	55270	22162	Vsd < VRd,
-1930	0.08	914	-245	-880	-44882	1SLV	33327	231056	55488	22162	Vsd < VRd,
-2010	0.08	75	-3	-75	-19853	4SLU	29847	231056	52009	22162	Vsd < VRd,
-2090	0.08	75	-3	-75	-21895	4SLU	30131	231056	52293	22162	Vsd < VRd,
-2170	0.08	75	-3	-75	-23937	4SLU	34871	231056	57033	22162	Vsd < VRd,
-2250	0.08	75	-3	-75	-25979	4SLU	30699	231056	52861	22162	Vsd < VRd,
-2330	0.08	75	-3	-75	-28021	4SLU	30983	231056	53145	22162	Vsd < VRd,
-2410	0.08	0	0	0	-2521	1SLV	27438	231056	49600	22162	Vsd < VRd,
-2490	0.08	0	0	0	-4092	1SLV	27657	231056	49818	22162	Vsd < VRd,

Palo alle coordinate X=-1551 Y=-564

Sollecitazioni massime in testa palo:

Combinazione corrispondente alla minima compressione in testa

N	Mx	My	Tx	Ty	comb	
-9.070E+04	-1.901E+06	6.9638E+05	1.7062E+03	4.4008E+03	1	sl
-9.070E+04	-1.901E+06	6.9638E+05	1.7062E+03	4.4008E+03	1	ra
-9.070E+04	-1.901E+06	6.9638E+05	1.7062E+03	4.4008E+03	1	fr
-9.070E+04	-1.901E+06	6.9638E+05	1.7062E+03	4.4008E+03	1	qp
-5.681E+04	5.0856E+06	-1.411E+06	-6.609E+03	-2.311E+04	15	SLV fond

Combinazione corrispondente alla massima compressione in testa

N	Mx	My	Tx	Ty	comb	
-1.332E+05	-2.497E+06	7.9062E+05	2.1095E+03	5.2385E+03	4	sl
-1.009E+05	-1.918E+06	6.1993E+05	1.6338E+03	4.0791E+03	2	ra
-9.581E+04	-1.909E+06	6.5816E+05	1.6700E+03	4.2400E+03	2	fr
-9.376E+04	-1.906E+06	6.7345E+05	1.6845E+03	4.3043E+03	2	qp
-1.246E+05	-8.887E+06	2.8035E+06	1.0022E+04	3.1909E+04	1	SLV fond

Combinazione corrispondente al massimo taglio in testa

N	Mx	My	Tx	Ty	comb	
-1.179E+05	-2.471E+06	9.0530E+05	2.2180E+03	5.7211E+03	3	sl
-9.070E+04	-1.901E+06	6.9638E+05	1.7062E+03	4.4008E+03	1	ra
-9.070E+04	-1.901E+06	6.9638E+05	1.7062E+03	4.4008E+03	1	fr
-9.070E+04	-1.901E+06	6.9638E+05	1.7062E+03	4.4008E+03	1	qp
-1.246E+05	-8.887E+06	2.8035E+06	1.0022E+04	3.1909E+04	1	SLV fond

Verifica di capacità portante riferita al palo singolo:

Fattore di correlazione Psi scelto in base alla conoscenza del sito = 1.7  
 Coeff. parziale di sicurezza sulla resistenza laterale = 1.15  
 Coeff. parziale di sicurezza sulla resistenza alla punta = 1.35  
 Portanza laterale di progetto = 292537.1  
 Portanza di punta di progetto = 85555.4  
 verifica condotta in combinazione SLU 4  
 Sforzo normale = -133247.8  
 Peso del palo = 49087.4 \* 1.3  
 Carico totale di progetto = -197061.4  
 Resistenza totale di progetto = 378092.5  
 Coefficiente di sicurezza = 1.92 > 1

Verifica di resistenza allo stato limite:

quota	Af	cop.	c.s.	Mx	My	N	comb
-90	0.0	6.50	0.00	0.0000E+00	0.0000E+00	0.0000E+00	-
-170	78.5	6.00	3.56	-6.392E+06	2.0260E+06	-1.253E+05	1SLV
-250	78.5	6.00	6.51	-3.902E+06	1.2502E+06	-1.269E+05	1SLV
-330	78.5	6.00	11.79	-2.047E+06	6.7119E+05	-9.771E+04	1SLV
-410	78.5	6.00	15.41	-1.251E+06	4.2023E+05	-9.928E+04	1SLV
-490	78.5	6.00	16.90	-7.858E+05	1.8759E+05	-1.080E+05	4SLU
-570	78.5	6.00	16.75	-5.293E+05	1.1086E+05	-1.100E+05	4SLU
-650	78.5	6.00	15.55	1.1354E+06	-3.330E+05	-1.040E+05	1SLV
-730	78.5	6.00	14.33	-1.624E+06	4.8822E+05	-3.365E+04	15SLV
-810	78.5	6.00	15.46	1.5244E+06	-4.600E+05	-7.849E+04	1SLV
-890	78.5	6.00	15.84	1.4457E+06	-4.383E+05	-8.006E+04	1SLV
-970	78.5	6.00	16.24	1.3669E+06	-4.166E+05	-8.164E+04	1SLV
-1050	78.5	6.00	16.65	1.2882E+06	-3.949E+05	-8.321E+04	1SLV
-1130	124.0	6.00	22.70	1.1906E+06	-3.669E+05	-5.631E+04	1SLV
-1210	78.5	6.00	22.06	1.0315E+06	-3.183E+05	-5.788E+04	1SLV
-1290	78.5	6.00	24.00	8.7228E+05	-2.696E+05	-5.945E+04	1SLV
-1370	78.5	6.00	25.84	7.1310E+05	-2.210E+05	-6.102E+04	1SLV
-1450	78.5	6.00	27.20	1.2153E+05	-4.044E+04	-6.776E+04	4SLU
-1530	78.5	6.00	26.41	1.1219E+05	-3.444E+04	-6.981E+04	4SLU
-1610	78.5	6.00	44.96	9.7367E+04	-2.932E+04	-4.100E+04	4SLU
-1690	78.5	6.00	42.82	8.2276E+04	-2.425E+04	-4.304E+04	4SLU



Progetto	Titolo	Rev.	Pag.
Orione	Orione_A24a.pdf "TABULATI DI CALCOLO PLINTO DI FONDAZIONE PER AEROGENERATORE TIPO"	0	205

Tabulati di Calcolo Plinto di Fondazione per Aerogeneratore Tipo - Progetto Impianto Eolico - "Orione"

-1770	78.5	6.00	40.88	6.7184E+04	-1.919E+04	-4.508E+04	4SLU
-1850	78.5	6.00	39.11	5.2093E+04	-1.412E+04	-4.713E+04	4SLU
-1930	78.5	6.00	37.49	3.7002E+04	-9.048E+03	-4.917E+04	4SLU
-2010	78.5	6.00	86.25	2.7972E+04	-6.446E+03	-2.137E+04	4SLU
-2090	78.5	6.00	78.72	2.1904E+04	-5.047E+03	-2.341E+04	4SLU
-2170	124.0	6.00	79.91	1.5835E+04	-3.649E+03	-2.546E+04	4SLU
-2250	78.5	6.00	67.03	9.7665E+03	-2.250E+03	-2.750E+04	4SLU
-2330	78.5	6.00	62.40	3.6979E+03	-8.521E+02	-2.954E+04	4SLU
-2410	78.5	6.00	100.00	-2.890E-10	7.3353E-11	-2.523E+03	1SLV
-2490	78.5	6.00	100.00	1.0102E-11	8.4788E-12	-4.362E+03	4SLU

Verifica di esercizio (combinazione rara):

quota	Af	cop.	sigmaf	sigmac	Mx	My	N	comb	Wk
-90	0.0	6.50	0.0	0.0	0.0000E+00	0.0000E+00	0.0000E+00	-	0.000
-170	78.5	6.00	36.0	25.3	-1.591E+06	4.9535E+05	-1.018E+05	2	0.000
-170	78.5	6.00	36.0	25.3	-1.550E+06	5.6524E+05	-9.164E+04	1	0.000
-250	78.5	6.00	36.0	22.5	-1.265E+06	3.7119E+05	-1.034E+05	2	0.000
-330	78.5	6.00	36.0	17.3	-9.871E+05	2.7095E+05	-7.864E+04	2	0.000
-410	78.5	6.00	36.0	15.7	-7.905E+05	2.1059E+05	-8.021E+04	2	0.000
-490	78.5	6.00	36.0	14.2	-5.939E+05	1.5023E+05	-8.178E+04	2	0.000
-570	78.5	6.00	36.0	12.7	-3.973E+05	8.9875E+04	-8.335E+04	2	0.000
-650	78.5	6.00	36.0	11.1	-2.007E+05	2.9518E+04	-8.492E+04	2	0.000
-730	78.5	6.00	36.0	7.4	-6.296E+04	-1.131E+04	-6.184E+04	2	0.000
-810	78.5	6.00	36.0	7.3	-2.321E+04	-1.960E+04	-6.341E+04	2	0.000
-890	78.5	6.00	36.0	7.5	1.6539E+04	-2.789E+04	-6.498E+04	2	0.000
-970	78.5	6.00	36.0	8.0	5.6288E+04	-3.618E+04	-6.655E+04	2	0.000
-1050	78.5	6.00	36.0	8.5	9.6037E+04	-4.447E+04	-6.812E+04	2	0.000
-1130	124.0	6.00	36.0	5.7	1.2466E+05	-4.975E+04	-4.509E+04	2	0.000
-1210	78.5	6.00	36.0	6.2	1.1696E+05	-4.521E+04	-4.666E+04	2	0.000
-1290	78.5	6.00	36.0	6.3	1.0926E+05	-4.066E+04	-4.824E+04	2	0.000
-1370	78.5	6.00	36.0	6.4	1.0156E+05	-3.612E+04	-4.981E+04	2	0.000
-1450	78.5	6.00	36.0	6.5	9.3862E+04	-3.157E+04	-5.138E+04	2	0.000
-1530	78.5	6.00	36.0	6.6	8.6161E+04	-2.703E+04	-5.295E+04	2	0.000
-1610	78.5	6.00	36.0	4.1	7.4687E+04	-2.305E+04	-3.103E+04	2	0.000
-1690	78.5	6.00	36.0	4.2	6.3027E+04	-1.909E+04	-3.260E+04	2	0.000
-1770	78.5	6.00	36.0	4.2	5.1368E+04	-1.513E+04	-3.417E+04	2	0.000
-1850	78.5	6.00	36.0	4.3	3.9708E+04	-1.118E+04	-3.574E+04	2	0.000
-1930	78.5	6.00	36.0	4.4	2.8048E+04	-7.223E+03	-3.731E+04	2	0.000
-2010	78.5	6.00	36.0	2.0	2.1141E+04	-5.171E+03	-1.616E+04	2	0.000
-2090	78.5	6.00	36.0	2.1	1.6554E+04	-4.049E+03	-1.773E+04	2	0.000
-2170	124.0	6.00	36.0	2.1	1.1968E+04	-2.928E+03	-1.930E+04	2	0.000
-2250	78.5	6.00	36.0	2.4	7.3813E+03	-1.806E+03	-2.088E+04	2	0.000
-2330	78.5	6.00	36.0	2.5	2.7948E+03	-6.837E+02	-2.245E+04	2	0.000
-2410	78.5	6.00	36.0	0.2	3.1602E-11	-7.121E-12	-1.732E+03	2	0.000
-2490	78.5	6.00	36.0	0.4	7.7275E-12	6.6633E-12	-3.302E+03	2	0.000

Verifica di esercizio (combinazione quasi permanente):

quota	Af	cop.	sigmaf	sigmac	Mx	My	N	comb	Wk
-90	0.0	6.50	0.0	0.0	0.0000E+00	0.0000E+00	0.0000E+00	-	0.000
-170	78.5	6.00	36.0	24.5	-1.562E+06	5.4428E+05	-9.470E+04	2	0.000
-170	78.5	6.00	36.0	24.5	-1.550E+06	5.6524E+05	-9.164E+04	1	0.000
-250	78.5	6.00	36.0	21.4	-1.219E+06	4.1548E+05	-9.627E+04	2	0.000
-330	78.5	6.00	36.0	16.3	-9.322E+05	3.1007E+05	-7.284E+04	2	0.000
-410	78.5	6.00	36.0	14.8	-7.390E+05	2.4365E+05	-7.441E+04	2	0.000
-490	78.5	6.00	36.0	13.2	-5.459E+05	1.7723E+05	-7.598E+04	2	0.000
-570	78.5	6.00	36.0	11.7	-3.528E+05	1.1080E+05	-7.755E+04	2	0.000
-650	78.5	6.00	36.0	10.2	-1.596E+05	4.4381E+04	-7.912E+04	2	0.000
-730	78.5	6.00	36.0	6.6	-2.602E+04	-1.100E+03	-5.725E+04	2	0.000
-810	78.5	6.00	36.0	6.7	8.4082E+03	-1.168E+04	-5.882E+04	2	0.000
-890	78.5	6.00	36.0	7.1	4.2837E+04	-2.226E+04	-6.039E+04	2	0.000
-970	78.5	6.00	36.0	7.6	7.7266E+04	-3.284E+04	-6.196E+04	2	0.000
-1050	78.5	6.00	36.0	8.1	1.1169E+05	-4.342E+04	-6.353E+04	2	0.000
-1130	124.0	6.00	36.0	5.4	1.3570E+05	-5.054E+04	-4.169E+04	2	0.000
-1210	78.5	6.00	36.0	5.9	1.2567E+05	-4.633E+04	-4.326E+04	2	0.000
-1290	78.5	6.00	36.0	6.0	1.1563E+05	-4.212E+04	-4.483E+04	2	0.000
-1370	78.5	6.00	36.0	6.1	1.0560E+05	-3.791E+04	-4.640E+04	2	0.000
-1450	78.5	6.00	36.0	6.2	9.5567E+04	-3.370E+04	-4.797E+04	2	0.000
-1530	78.5	6.00	36.0	6.3	8.5533E+04	-2.949E+04	-4.954E+04	2	0.000
-1610	78.5	6.00	36.0	3.8	7.3728E+04	-2.528E+04	-2.872E+04	2	0.000
-1690	78.5	6.00	36.0	3.9	6.1837E+04	-2.106E+04	-3.029E+04	2	0.000
-1770	78.5	6.00	36.0	4.0	4.9946E+04	-1.685E+04	-3.187E+04	2	0.000
-1850	78.5	6.00	36.0	4.1	3.8054E+04	-1.263E+04	-3.344E+04	2	0.000
-1930	78.5	6.00	36.0	4.1	2.6163E+04	-8.420E+03	-3.501E+04	2	0.000
-2010	78.5	6.00	36.0	1.8	1.9429E+04	-6.142E+03	-1.490E+04	2	0.000
-2090	78.5	6.00	36.0	2.0	1.5214E+04	-4.809E+03	-1.647E+04	2	0.000
-2170	124.0	6.00	36.0	2.0	1.0999E+04	-3.477E+03	-1.804E+04	2	0.000
-2250	78.5	6.00	36.0	2.2	6.7836E+03	-2.144E+03	-1.962E+04	2	0.000
-2330	78.5	6.00	36.0	2.4	2.5685E+03	-8.119E+02	-2.119E+04	2	0.000
-2410	78.5	6.00	36.0	0.2	2.7426E-11	-7.971E-12	-1.491E+03	2	0.000
-2490	78.5	6.00	36.0	0.3	7.5310E-12	7.3059E-12	-3.062E+03	2	0.000

Verifica a taglio:

quota	Ast	Vsd	Vsdx	Vsdy	N	comb	VRd,c	VRd,max	VRd,S	Vwd
-90	0.16	33445	10022	31909	-124583	1SLV	40517	231056	84840	44323 Vsd < VRd,



Progetto	Titolo	Rev.	Pag.
Orione	Orione_A24a.pdf "TABULATI DI CALCOLO PLINTO DI FONDAZIONE PER AEROGENERATORE TIPO"	0	206

-170	0.16	32609	9698	31133	-125320	1SLV	44507	231056	88831	44323	Vsd < VRd,
-250	0.08	32609	9698	31133	-126890	1SLV	44726	231056	66887	22162	Vsd < VRd,
-330	0.08	10428	3137	9944	-97713	1SLV	40670	231056	62832	22162	Vsd < VRd,
-410	0.08	10428	3137	9944	-99284	1SLV	40888	231056	63050	22162	Vsd < VRd,
-490	0.08	10428	3137	9944	-100855	1SLV	41107	231056	63268	22162	Vsd < VRd,
-570	0.08	10428	3137	9944	-102426	1SLV	41325	231056	63487	22162	Vsd < VRd,
-650	0.08	10428	3137	9944	-103996	1SLV	41543	231056	63705	22162	Vsd < VRd,
-730	0.08	1874	561	1788	-33649	15SLV	31765	231056	53927	22162	Vsd < VRd,
-810	0.08	1874	561	1788	-35220	15SLV	31984	231056	54145	22162	Vsd < VRd,
-890	0.08	1874	561	1788	-36791	15SLV	32202	231056	54364	22162	Vsd < VRd,
-970	0.08	1874	561	1788	-38362	15SLV	32420	231056	54582	22162	Vsd < VRd,
-1050	0.08	1874	561	1788	-39933	15SLV	32639	231056	54800	22162	Vsd < VRd,
-1130	0.08	2080	-608	-1990	-56305	1SLV	39371	231056	61532	22162	Vsd < VRd,
-1210	0.08	2080	-608	-1990	-57876	1SLV	35133	231056	57294	22162	Vsd < VRd,
-1290	0.08	2080	-608	-1990	-59447	1SLV	35351	231056	57513	22162	Vsd < VRd,
-1370	0.08	2080	-608	-1990	-61018	1SLV	35569	231056	57731	22162	Vsd < VRd,
-1450	0.08	2080	-608	-1990	-62588	1SLV	35788	231056	57949	22162	Vsd < VRd,
-1530	0.08	2080	-608	-1990	-64159	1SLV	36006	231056	58168	22162	Vsd < VRd,
-1610	0.08	914	-272	-873	-38624	1SLV	32457	231056	54618	22162	Vsd < VRd,
-1690	0.08	914	-272	-873	-40194	1SLV	32675	231056	54837	22162	Vsd < VRd,
-1770	0.08	914	-272	-873	-41765	1SLV	32893	231056	55055	22162	Vsd < VRd,
-1850	0.08	914	-272	-873	-43336	1SLV	33112	231056	55273	22162	Vsd < VRd,
-1930	0.08	914	-272	-873	-44907	1SLV	33330	231056	55492	22162	Vsd < VRd,
-2010	0.08	78	-17	-76	-21372	4SLU	30059	231056	52220	22162	Vsd < VRd,
-2090	0.08	78	-17	-76	-23414	4SLU	30342	231056	52504	22162	Vsd < VRd,
-2170	0.08	78	-17	-76	-25456	4SLU	35083	231056	57244	22162	Vsd < VRd,
-2250	0.08	78	-17	-76	-27498	4SLU	30910	231056	53072	22162	Vsd < VRd,
-2330	0.08	78	-17	-76	-29540	4SLU	31194	231056	53356	22162	Vsd < VRd,
-2410	0.08	0	0	0	-2323	3SLV	27411	231056	49573	22162	Vsd < VRd,
-2490	0.08	0	0	0	-3894	3SLV	27629	231056	49791	22162	Vsd < VRd,

Palo alle coordinate X=-1429 Y=-825

Sollecitazioni massime in testa palo:

Combinazione corrispondente alla minima compressione in testa

N	Mx	My	Tx	Ty	comb
-9.075E+04	-1.752E+06	1.0155E+06	2.4453E+03	4.0562E+03	1 sl
-9.075E+04	-1.752E+06	1.0155E+06	2.4453E+03	4.0562E+03	1 ra
-9.075E+04	-1.752E+06	1.0155E+06	2.4453E+03	4.0562E+03	1 fr
-9.075E+04	-1.752E+06	1.0155E+06	2.4453E+03	4.0562E+03	1 qp
-5.786E+04	5.2260E+06	-1.113E+06	-5.949E+03	-2.342E+04	15 SLV fond

Combinazione corrispondente alla massima compressione in testa

N	Mx	My	Tx	Ty	comb
-1.414E+05	-2.405E+06	1.3393E+06	3.3631E+03	4.9901E+03	4 sl
-1.064E+05	-1.837E+06	1.0283E+06	2.5681E+03	3.8675E+03	2 ra
-9.857E+04	-1.794E+06	1.0219E+06	2.5067E+03	3.9619E+03	2 fr
-9.544E+04	-1.777E+06	1.0193E+06	2.4822E+03	3.9996E+03	2 qp
-1.236E+05	-8.730E+06	3.1442E+06	1.0840E+04	3.1534E+04	1 SLV fond

Combinazione corrispondente al massimo taglio in testa

N	Mx	My	Tx	Ty	comb
-1.180E+05	-2.277E+06	1.3202E+06	3.1789E+03	5.2731E+03	3 sl
-9.075E+04	-1.752E+06	1.0155E+06	2.4453E+03	4.0562E+03	1 ra
-9.075E+04	-1.752E+06	1.0155E+06	2.4453E+03	4.0562E+03	1 fr
-9.075E+04	-1.752E+06	1.0155E+06	2.4453E+03	4.0562E+03	1 qp
-1.236E+05	-8.730E+06	3.1442E+06	1.0840E+04	3.1534E+04	1 SLV fond

Verifica di capacità portante riferita al palo singolo:

Fattore di correlazione Psi scelto in base alla conoscenza del sito = 1.7  
 Coeff. parziale di sicurezza sulla resistenza laterale = 1.15  
 Coeff. parziale di sicurezza sulla resistenza alla punta = 1.35  
 Portanza laterale di progetto = 292537.1  
 Portanza di punta di progetto = 85555.4  
 verifica condotta in combinazione SLU 4  
 Sforzo normale = -141436  
 Peso del palo = 49087.4 \* 1.3  
 Carico totale di progetto = -205249.6  
 Resistenza totale di progetto = 378092.5  
 Coefficiente di sicurezza = 1.84 > 1

Verifica di resistenza allo stato limite:

quota	Af	cop.	c.s.	Mx	My	N	comb
-90	0.0	6.50	0.00	0.0000E+00	0.0000E+00	0.0000E+00	-
-170	78.5	6.00	3.57	-6.265E+06	2.3017E+06	-1.244E+05	1SLV
-250	78.5	6.00	6.55	-3.804E+06	1.4609E+06	-1.260E+05	1SLV
-330	78.5	6.00	11.87	-1.974E+06	8.2844E+05	-9.695E+04	1SLV
-410	78.5	6.00	15.01	-1.015E+06	4.7521E+05	-1.126E+05	4SLU
-490	78.5	6.00	15.99	-7.670E+05	3.4303E+05	-1.146E+05	4SLU
-570	78.5	6.00	15.80	-5.193E+05	2.1085E+05	-1.166E+05	4SLU
-650	78.5	6.00	15.53	-2.717E+05	7.8670E+04	-1.187E+05	4SLU
-730	78.5	6.00	14.43	-1.621E+06	4.9379E+05	-3.432E+04	15SLV
-810	78.5	6.00	15.51	1.5213E+06	-4.674E+05	-7.789E+04	1SLV



Progetto	Titolo	Rev.	Pag.
Orione	Orione_A24a.pdf "TABULATI DI CALCOLO PLINTO DI FONDAZIONE PER AEROGENERATORE TIPO"	0	207



-890	78.5	6.00	15.90	1.4401E+06	-4.509E+05	-7.946E+04	1SLV		
-970	78.5	6.00	16.30	1.3589E+06	-4.344E+05	-8.103E+04	1SLV		
-1050	78.5	6.00	16.73	1.2777E+06	-4.179E+05	-8.260E+04	1SLV		
-1130	124.0	6.00	22.81	1.1785E+06	-3.934E+05	-5.586E+04	1SLV		
-1210	78.5	6.00	22.17	1.0204E+06	-3.425E+05	-5.743E+04	1SLV		
-1290	78.5	6.00	24.13	8.6219E+05	-2.916E+05	-5.900E+04	1SLV		
-1370	78.5	6.00	26.00	7.0403E+05	-2.407E+05	-6.057E+04	1SLV		
-1450	78.5	6.00	25.72	1.1656E+05	-6.798E+04	-7.166E+04	4SLU		
-1530	78.5	6.00	25.01	1.0810E+05	-5.901E+04	-7.370E+04	4SLU		
-1610	78.5	6.00	42.24	9.3908E+04	-5.049E+04	-4.364E+04	4SLU		
-1690	78.5	6.00	40.35	7.9439E+04	-4.199E+04	-4.568E+04	4SLU		
-1770	78.5	6.00	38.62	6.4969E+04	-3.350E+04	-4.772E+04	4SLU		
-1850	78.5	6.00	37.04	5.0499E+04	-2.500E+04	-4.976E+04	4SLU		
-1930	78.5	6.00	35.58	3.6030E+04	-1.650E+04	-5.180E+04	4SLU		
-2010	78.5	6.00	80.80	2.7302E+04	-1.197E+04	-2.281E+04	4SLU		
-2090	78.5	6.00	74.16	2.1379E+04	-9.371E+03	-2.485E+04	4SLU		
-2170	124.0	6.00	75.64	1.5456E+04	-6.775E+03	-2.690E+04	4SLU		
-2250	78.5	6.00	63.70	9.5325E+03	-4.178E+03	-2.894E+04	4SLU		
-2330	78.5	6.00	59.50	3.6093E+03	-1.582E+03	-3.098E+04	4SLU		
-2410	78.5	6.00	100.00	3.5693E-11	-2.031E-11	-2.595E+03	4SLU		
-2490	78.5	6.00	100.00	3.1373E-11	-1.440E-11	-4.637E+03	4SLU		

Verifica di esercizio (combinazione rara):

quota	Af	cop.	sigmaf	sigmac	Mx	My	N	comb	Wk
-90	0.0	6.50	0.0	0.0	0.0000E+00	0.0000E+00	0.0000E+00	-	0.000
-170	78.5	6.00		26.5	-1.527E+06	8.2939E+05	-1.073E+05	2	0.000
-170	78.5	6.00	35.9		-1.429E+06	8.2549E+05	-9.170E+04	1	0.000
-250	78.5	6.00		23.5	-1.218E+06	6.3097E+05	-1.088E+05	2	0.000
-330	78.5	6.00		18.1	-9.532E+05	4.6885E+05	-8.306E+04	2	0.000
-410	78.5	6.00		16.5	-7.645E+05	3.6723E+05	-8.463E+04	2	0.000
-490	78.5	6.00		14.9	-5.759E+05	2.6562E+05	-8.620E+04	2	0.000
-570	78.5	6.00		13.3	-3.872E+05	1.6400E+05	-8.777E+04	2	0.000
-650	78.5	6.00		11.7	-1.986E+05	6.2391E+04	-8.934E+04	2	0.000
-730	78.5	6.00		7.8	-6.608E+04	-6.928E+03	-6.533E+04	2	0.000
-810	78.5	6.00		7.7	-2.720E+04	-2.242E+04	-6.691E+04	2	0.000
-890	78.5	6.00		7.9	1.1671E+04	-3.792E+04	-6.848E+04	2	0.000
-970	78.5	6.00		8.4	5.0545E+04	-5.341E+04	-7.005E+04	2	0.000
-1050	78.5	6.00		8.9	8.9420E+04	-6.890E+04	-7.162E+04	2	0.000
-1130	124.0	6.00		6.0	1.1754E+05	-7.918E+04	-4.769E+04	2	0.000
-1210	78.5	6.00		6.6	1.1054E+05	-7.241E+04	-4.926E+04	2	0.000
-1290	78.5	6.00		6.7	1.0354E+05	-6.564E+04	-5.083E+04	2	0.000
-1370	78.5	6.00		6.8	9.6543E+04	-5.887E+04	-5.241E+04	2	0.000
-1450	78.5	6.00		6.9	8.9543E+04	-5.209E+04	-5.398E+04	2	0.000
-1530	78.5	6.00		7.0	8.2543E+04	-4.532E+04	-5.555E+04	2	0.000
-1610	78.5	6.00		4.3	7.1616E+04	-3.880E+04	-3.279E+04	2	0.000
-1690	78.5	6.00		4.4	6.0496E+04	-3.229E+04	-3.436E+04	2	0.000
-1770	78.5	6.00		4.5	4.9376E+04	-2.578E+04	-3.593E+04	2	0.000
-1850	78.5	6.00		4.5	3.8256E+04	-1.927E+04	-3.750E+04	2	0.000
-1930	78.5	6.00		4.6	2.7136E+04	-1.276E+04	-3.907E+04	2	0.000
-2010	78.5	6.00		2.1	2.0499E+04	-9.271E+03	-1.712E+04	2	0.000
-2090	78.5	6.00		2.2	1.6052E+04	-7.260E+03	-1.869E+04	2	0.000
-2170	124.0	6.00		2.2	1.1605E+04	-5.248E+03	-2.027E+04	2	0.000
-2250	78.5	6.00		2.5	7.1572E+03	-3.237E+03	-2.184E+04	2	0.000
-2330	78.5	6.00		2.6	2.7100E+03	-1.226E+03	-2.341E+04	2	0.000
-2410	78.5	6.00		0.2	2.5487E-11	-1.573E-11	-1.915E+03	2	0.000
-2490	78.5	6.00		0.4	2.3213E-11	-1.118E-11	-3.486E+03	2	0.000

Verifica di esercizio (combinazione quasi permanente):

quota	Af	cop.	sigmaf	sigmac	Mx	My	N	comb	Wk
-90	0.0	6.50	0.0	0.0	0.0000E+00	0.0000E+00	0.0000E+00	-	0.000
-170	78.5	6.00		24.9	-1.458E+06	8.2666E+05	-9.637E+04	2	0.000
-170	78.5	6.00	35.9		-1.429E+06	8.2549E+05	-9.170E+04	1	0.000
-250	78.5	6.00		21.8	-1.139E+06	6.3438E+05	-9.794E+04	2	0.000
-330	78.5	6.00		16.5	-8.722E+05	4.7621E+05	-7.420E+04	2	0.000
-410	78.5	6.00		15.0	-6.920E+05	3.7489E+05	-7.577E+04	2	0.000
-490	78.5	6.00		13.4	-5.117E+05	2.7357E+05	-7.734E+04	2	0.000
-570	78.5	6.00		11.9	-3.315E+05	1.7225E+05	-7.891E+04	2	0.000
-650	78.5	6.00		10.3	-1.512E+05	7.0926E+04	-8.048E+04	2	0.000
-730	78.5	6.00		6.7	-2.641E+04	1.4051E+03	-5.832E+04	2	0.000
-810	78.5	6.00		6.8	5.9962E+03	-1.511E+04	-5.989E+04	2	0.000
-890	78.5	6.00		7.3	3.8403E+04	-3.163E+04	-6.147E+04	2	0.000
-970	78.5	6.00		7.7	7.0809E+04	-4.815E+04	-6.304E+04	2	0.000
-1050	78.5	6.00		8.2	1.0322E+05	-6.467E+04	-6.461E+04	2	0.000
-1130	124.0	6.00		5.5	1.2587E+05	-7.587E+04	-4.248E+04	2	0.000
-1210	78.5	6.00		6.0	1.1665E+05	-6.970E+04	-4.405E+04	2	0.000
-1290	78.5	6.00		6.1	1.0743E+05	-6.352E+04	-4.562E+04	2	0.000
-1370	78.5	6.00		6.2	9.8212E+04	-5.735E+04	-4.720E+04	2	0.000
-1450	78.5	6.00		6.3	8.9993E+04	-5.118E+04	-4.877E+04	2	0.000
-1530	78.5	6.00		6.4	7.9775E+04	-4.500E+04	-5.034E+04	2	0.000
-1610	78.5	6.00		3.9	6.8790E+04	-3.862E+04	-2.926E+04	2	0.000
-1690	78.5	6.00		4.0	5.7717E+04	-3.223E+04	-3.083E+04	2	0.000
-1770	78.5	6.00		4.0	4.6645E+04	-2.584E+04	-3.240E+04	2	0.000
-1850	78.5	6.00		4.1	3.5573E+04	-1.945E+04	-3.398E+04	2	0.000
-1930	78.5	6.00		4.2	2.4500E+04	-1.306E+04	-3.555E+04	2	0.000
-2010	78.5	6.00		1.9	1.8212E+04	-9.569E+03	-1.520E+04	2	0.000
-2090	78.5	6.00		2.0	1.4261E+04	-7.493E+03	-1.677E+04	2	0.000



Tabulati di Calcolo Plinto di Fondazione per Aerogeneratore Tipo - Progetto Impianto Eolico - "Orione"

-2170	124.0	6.00	2.0	1.0310E+04	-5.417E+03	-1.834E+04	2	0.000
-2250	78.5	6.00	2.3	6.3589E+03	-3.341E+03	-1.991E+04	2	0.000
-2330	78.5	6.00	2.4	2.4077E+03	-1.265E+03	-2.148E+04	2	0.000
-2410	78.5	6.00	0.2	1.6529E-11	-1.621E-11	-1.547E+03	2	0.000
-2490	78.5	6.00	0.3	1.9030E-11	-1.166E-11	-3.118E+03	2	0.000

Verifica a taglio:

quota	Ast	Vsd	Vsdx	Vsdy	N	comb	VRd, c	VRd, max	VRd, S	Vwd	
-90	0.16	33345	10840	31534	-123645	1SLV	40386	231056	84709	44323	Vsd < VRd,
-170	0.16	32507	10510	30761	-124384	1SLV	44377	231056	88701	44323	Vsd < VRd,
-250	0.08	32507	10510	30761	-125955	1SLV	44596	231056	66757	22162	Vsd < VRd,
-330	0.08	10378	3563	9747	-96950	1SLV	40564	231056	62726	22162	Vsd < VRd,
-410	0.08	10378	3563	9747	-98521	1SLV	40782	231056	62944	22162	Vsd < VRd,
-490	0.08	10378	3563	9747	-100091	1SLV	41001	231056	63162	22162	Vsd < VRd,
-570	0.08	10378	3563	9747	-101662	1SLV	41219	231056	63381	22162	Vsd < VRd,
-650	0.08	10378	3563	9747	-103233	1SLV	41437	231056	63599	22162	Vsd < VRd,
-730	0.08	1865	630	1756	-34321	15SLV	31859	231056	54020	22162	Vsd < VRd,
-810	0.08	1865	630	1756	-35891	15SLV	32077	231056	54239	22162	Vsd < VRd,
-890	0.08	1865	630	1756	-37462	15SLV	32295	231056	54457	22162	Vsd < VRd,
-970	0.08	1865	630	1756	-39033	15SLV	32514	231056	54675	22162	Vsd < VRd,
-1050	0.08	1865	630	1756	-40604	15SLV	32732	231056	54894	22162	Vsd < VRd,
-1130	0.08	2077	-636	-1977	-55856	1SLV	39308	231056	61470	22162	Vsd < VRd,
-1210	0.08	2077	-636	-1977	-57427	1SLV	35070	231056	57232	22162	Vsd < VRd,
-1290	0.08	2077	-636	-1977	-58998	1SLV	35289	231056	57450	22162	Vsd < VRd,
-1370	0.08	2077	-636	-1977	-60568	1SLV	35507	231056	57669	22162	Vsd < VRd,
-1450	0.08	2077	-636	-1977	-62139	1SLV	35725	231056	57887	22162	Vsd < VRd,
-1530	0.08	2077	-636	-1977	-63710	1SLV	35944	231056	58105	22162	Vsd < VRd,
-1610	0.08	911	-299	-860	-38319	1SLV	32414	231056	54576	22162	Vsd < VRd,
-1690	0.08	911	-299	-860	-39890	1SLV	32633	231056	54794	22162	Vsd < VRd,
-1770	0.08	911	-299	-860	-41461	1SLV	32851	231056	55013	22162	Vsd < VRd,
-1850	0.08	911	-299	-860	-43032	1SLV	33069	231056	55231	22162	Vsd < VRd,
-1930	0.08	911	-299	-860	-44602	1SLV	33288	231056	55449	22162	Vsd < VRd,
-2010	0.08	81	-32	-74	-22811	4SLU	30259	231056	52420	22162	Vsd < VRd,
-2090	0.08	81	-32	-74	-24853	4SLU	30543	231056	52704	22162	Vsd < VRd,
-2170	0.08	81	-32	-74	-26895	4SLU	35283	231056	57444	22162	Vsd < VRd,
-2250	0.08	81	-32	-74	-28937	4SLU	31110	231056	53272	22162	Vsd < VRd,
-2330	0.08	81	-32	-74	-30979	4SLU	31394	231056	53556	22162	Vsd < VRd,
-2410	0.08	0	0	0	-1184	7SLV	27253	231056	49414	22162	Vsd < VRd,
-2490	0.08	0	0	0	-2754	7SLV	27471	231056	49633	22162	Vsd < VRd,

Palo alle coordinate X=-1264 Y=-1061

Sollecitazioni massime in testa palo:

Combinazione corrispondente alla minima compressione in testa										
N	Mx	My	Tx	Ty	comb					
-9.081E+04	-1.550E+06	1.3043E+06	3.1142E+03	3.5879E+03	1	sl				
-9.081E+04	-1.550E+06	1.3043E+06	3.1142E+03	3.5879E+03	1	ra				
-9.081E+04	-1.550E+06	1.3043E+06	3.1142E+03	3.5879E+03	1	fr				
-9.081E+04	-1.550E+06	1.3043E+06	3.1142E+03	3.5879E+03	1	qp				
-5.991E+04	5.4136E+06	-8.412E+05	-5.342E+03	-2.384E+04	15	SLV fond				

Combinazione corrispondente alla massima compressione in testa										
N	Mx	My	Tx	Ty	comb					
-1.489E+05	-2.190E+06	1.8784E+06	4.5876E+03	4.4613E+03	4	sl				
-1.114E+05	-1.667E+06	1.4262E+06	3.4736E+03	3.4526E+03	2	ra				
-1.011E+05	-1.608E+06	1.3652E+06	3.2939E+03	3.5202E+03	2	fr				
-9.698E+04	-1.585E+06	1.3409E+06	3.2221E+03	3.5473E+03	2	qp				
-1.217E+05	-8.513E+06	3.4499E+06	1.1570E+04	3.1013E+04	1	SLV fond				

Combinazione corrispondente al massimo taglio in testa										
N	Mx	My	Tx	Ty	comb					
-1.489E+05	-2.190E+06	1.8784E+06	4.5876E+03	4.4613E+03	4	sl				
-1.114E+05	-1.667E+06	1.4262E+06	3.4736E+03	3.4526E+03	2	ra				
-1.011E+05	-1.608E+06	1.3652E+06	3.2939E+03	3.5202E+03	2	fr				
-9.698E+04	-1.585E+06	1.3409E+06	3.2221E+03	3.5473E+03	2	qp				
-1.217E+05	-8.513E+06	3.4499E+06	1.1570E+04	3.1013E+04	1	SLV fond				

Verifica di capacità portante riferita al palo singolo:

Fattore di correlazione Psi scelto in base alla conoscenza del sito = 1.7  
 Coeff. parziale di sicurezza sulla resistenza laterale = 1.15  
 Coeff. parziale di sicurezza sulla resistenza alla punta = 1.35  
 Portanza laterale di progetto = 292537.1  
 Portanza di punta di progetto = 85555.4  
 verifica condotta in combinazione SLU 4  
 Sforzo normale = -148918.7  
 Peso del palo = 49087.4 \* 1.3  
 Carico totale di progetto = -212732.3  
 Resistenza totale di progetto = 378092.5  
 Coefficiente di sicurezza = 1.78 > 1

Verifica di resistenza allo stato limite:



Progetto	Titolo	Rev.	Pag.
Orione	Orione_A24a.pdf "TABULATI DI CALCOLO PLINTO DI FONDAZIONE PER AEROGENERATORE TIPO"	0	209

quota	Af	cop.	c.s.	Mx	My	N	comb
-90	0.0	6.50	0.00	0.0000E+00	0.0000E+00	0.0000E+00	-
-170	78.5	6.00	3.60	-6.090E+06	2.5493E+06	-1.225E+05	1SLV
-250	78.5	6.00	6.63	-3.670E+06	1.6504E+06	-1.240E+05	1SLV
-330	78.5	6.00	12.05	-1.874E+06	9.7016E+05	-9.538E+04	1SLV
-410	78.5	6.00	14.31	-9.390E+05	6.8372E+05	-1.186E+05	4SLU
-490	78.5	6.00	15.24	-7.128E+05	4.9699E+05	-1.206E+05	4SLU
-570	78.5	6.00	15.02	-4.866E+05	3.1026E+05	-1.227E+05	4SLU
-650	78.5	6.00	14.78	-2.604E+05	1.2353E+05	-1.247E+05	4SLU
-730	78.5	6.00	14.65	-1.617E+06	4.9862E+05	-3.563E+04	15SLV
-810	78.5	6.00	15.62	1.5164E+06	-4.738E+05	-7.665E+04	1SLV
-890	78.5	6.00	16.03	1.4319E+06	-4.620E+05	-7.822E+04	1SLV
-970	78.5	6.00	16.45	1.3474E+06	-4.502E+05	-7.979E+04	1SLV
-1050	78.5	6.00	16.89	1.2630E+06	-4.385E+05	-8.136E+04	1SLV
-1130	124.0	6.00	23.05	1.1616E+06	-4.170E+05	-5.493E+04	1SLV
-1210	78.5	6.00	22.41	1.0049E+06	-3.642E+05	-5.650E+04	1SLV
-1290	78.5	6.00	24.40	8.4815E+05	-3.113E+05	-5.808E+04	1SLV
-1370	78.5	6.00	25.19	1.1231E+05	-1.068E+05	-7.317E+04	4SLU
-1450	78.5	6.00	24.51	1.0538E+05	-9.499E+04	-7.522E+04	4SLU
-1530	78.5	6.00	23.86	9.8448E+04	-8.316E+04	-7.726E+04	4SLU
-1610	78.5	6.00	40.03	8.5661E+04	-7.131E+04	-4.605E+04	4SLU
-1690	78.5	6.00	38.33	7.2587E+04	-5.945E+04	-4.809E+04	4SLU
-1770	78.5	6.00	36.77	5.9512E+04	-4.759E+04	-5.013E+04	4SLU
-1850	78.5	6.00	35.33	4.6438E+04	-3.573E+04	-5.217E+04	4SLU
-1930	78.5	6.00	34.00	3.3363E+04	-2.387E+04	-5.421E+04	4SLU
-2010	78.5	6.00	76.40	2.5374E+04	-1.744E+04	-2.413E+04	4SLU
-2090	78.5	6.00	70.44	1.9869E+04	-1.365E+04	-2.617E+04	4SLU
-2170	124.0	6.00	72.11	1.4364E+04	-9.871E+03	-2.821E+04	4SLU
-2250	78.5	6.00	60.93	8.8594E+03	-6.088E+03	-3.025E+04	4SLU
-2330	78.5	6.00	57.07	3.3545E+03	-2.305E+03	-3.229E+04	4SLU
-2410	78.5	6.00	100.00	2.9256E-11	-6.554E-12	-2.846E+03	4SLU
-2490	78.5	6.00	100.00	2.7551E-11	6.1224E-12	-4.888E+03	4SLU

Verifica di esercizio (combinazione rara):

quota	Af	cop.	sigmaf	sigmac	Mx	My	N	comb	Wk
-90	0.0	6.50	0.0	0.0	0.0000E+00	0.0000E+00	0.0000E+00	-	0.000
-170	78.5	6.00	35.8	27.6	-1.390E+06	1.1553E+06	-1.122E+05	2	0.000
-170	78.5	6.00	35.8	27.6	-1.264E+06	1.0610E+06	-9.176E+04	1	0.000
-250	78.5	6.00	35.8	24.5	-1.113E+06	8.8484E+05	-1.138E+05	2	0.000
-330	78.5	6.00	35.8	18.8	-8.756E+05	6.6262E+05	-8.710E+04	2	0.000
-410	78.5	6.00	35.8	17.2	-7.039E+05	5.2076E+05	-8.867E+04	2	0.000
-490	78.5	6.00	35.8	15.5	-5.323E+05	3.7890E+05	-9.024E+04	2	0.000
-570	78.5	6.00	35.8	13.8	-3.607E+05	2.3704E+05	-9.181E+04	2	0.000
-650	78.5	6.00	35.8	12.1	-1.890E+05	9.5176E+04	-9.338E+04	2	0.000
-730	78.5	6.00	35.8	8.2	-6.810E+04	-1.966E+03	-6.853E+04	2	0.000
-810	78.5	6.00	35.8	8.1	-3.170E+04	-2.458E+04	-7.010E+04	2	0.000
-890	78.5	6.00	35.8	8.4	4.6983E+03	-4.719E+04	-7.167E+04	2	0.000
-970	78.5	6.00	35.8	8.8	4.1095E+04	-6.980E+04	-7.324E+04	2	0.000
-1050	78.5	6.00	35.8	9.3	7.7493E+04	-9.241E+04	-7.481E+04	2	0.000
-1130	124.0	6.00	35.8	6.3	1.0400E+05	-1.076E+05	-5.007E+04	2	0.000
-1210	78.5	6.00	35.8	6.9	9.8176E+04	-9.874E+04	-5.164E+04	2	0.000
-1290	78.5	6.00	35.8	7.0	9.2357E+04	-8.984E+04	-5.321E+04	2	0.000
-1370	78.5	6.00	35.8	7.1	8.6539E+04	-8.094E+04	-5.478E+04	2	0.000
-1450	78.5	6.00	35.8	7.2	8.0720E+04	-7.205E+04	-5.635E+04	2	0.000
-1530	78.5	6.00	35.8	7.3	7.4901E+04	-6.315E+04	-5.792E+04	2	0.000
-1610	78.5	6.00	35.8	4.5	6.5078E+04	-5.416E+04	-3.440E+04	2	0.000
-1690	78.5	6.00	35.8	4.6	5.5058E+04	-4.517E+04	-3.597E+04	2	0.000
-1770	78.5	6.00	35.8	4.7	4.5038E+04	-3.617E+04	-3.754E+04	2	0.000
-1850	78.5	6.00	35.8	4.7	3.5018E+04	-2.718E+04	-3.911E+04	2	0.000
-1930	78.5	6.00	35.8	4.8	2.4999E+04	-1.819E+04	-4.068E+04	2	0.000
-2010	78.5	6.00	35.8	2.2	1.8949E+04	-1.330E+04	-1.800E+04	2	0.000
-2090	78.5	6.00	35.8	2.3	1.4838E+04	-1.041E+04	-1.957E+04	2	0.000
-2170	124.0	6.00	35.8	2.3	1.0727E+04	-7.527E+03	-2.114E+04	2	0.000
-2250	78.5	6.00	35.8	2.6	6.6159E+03	-4.642E+03	-2.271E+04	2	0.000
-2330	78.5	6.00	35.8	2.7	2.5050E+03	-1.758E+03	-2.429E+04	2	0.000
-2410	78.5	6.00	35.8	0.2	2.0474E-11	-4.865E-12	-2.083E+03	2	0.000
-2490	78.5	6.00	35.8	0.4	1.9337E-11	4.7978E-12	-3.654E+03	2	0.000

Verifica di esercizio (combinazione quasi permanente):

quota	Af	cop.	sigmaf	sigmac	Mx	My	N	comb	Wk
-90	0.0	6.50	0.0	0.0	0.0000E+00	0.0000E+00	0.0000E+00	-	0.000
-170	78.5	6.00	35.8	25.2	-1.302E+06	1.0893E+06	-9.790E+04	2	0.000
-170	78.5	6.00	35.8	25.2	-1.264E+06	1.0610E+06	-9.176E+04	1	0.000
-250	78.5	6.00	35.8	22.1	-1.019E+06	8.3814E+05	-9.947E+04	2	0.000
-330	78.5	6.00	35.8	16.8	-7.813E+05	6.3099E+05	-7.544E+04	2	0.000
-410	78.5	6.00	35.8	15.2	-6.204E+05	4.9721E+05	-7.701E+04	2	0.000
-490	78.5	6.00	35.8	13.6	-4.595E+05	3.6343E+05	-7.858E+04	2	0.000
-570	78.5	6.00	35.8	12.1	-2.987E+05	2.2965E+05	-8.015E+04	2	0.000
-650	78.5	6.00	35.8	10.5	-1.378E+05	9.5868E+04	-8.173E+04	2	0.000
-730	78.5	6.00	35.8	6.8	-2.626E+04	3.9771E+03	-5.931E+04	2	0.000
-810	78.5	6.00	35.8	6.9	3.0060E+03	-1.810E+04	-6.088E+04	2	0.000
-890	78.5	6.00	35.8	7.4	3.2276E+04	-4.017E+04	-6.245E+04	2	0.000
-970	78.5	6.00	35.8	7.8	6.1545E+04	-6.224E+04	-6.402E+04	2	0.000
-1050	78.5	6.00	35.8	8.3	9.0815E+04	-8.432E+04	-6.559E+04	2	0.000
-1130	124.0	6.00	35.8	5.6	1.1134E+05	-9.935E+04	-4.321E+04	2	0.000
-1210	78.5	6.00	35.8	6.1	1.0330E+05	-9.136E+04	-4.478E+04	2	0.000



-1290	78.5	6.00	6.2	9.5256E+04	-8.338E+04	-4.636E+04	2	0.000
-1370	78.5	6.00	6.3	8.7215E+04	-7.539E+04	-4.793E+04	2	0.000
-1450	78.5	6.00	6.4	7.9173E+04	-6.740E+04	-4.950E+04	2	0.000
-1530	78.5	6.00	6.5	7.1132E+04	-5.942E+04	-5.107E+04	2	0.000
-1610	78.5	6.00	4.0	6.1367E+04	-5.103E+04	-2.976E+04	2	0.000
-1690	78.5	6.00	4.0	5.1518E+04	-4.262E+04	-3.133E+04	2	0.000
-1770	78.5	6.00	4.1	4.1669E+04	-3.421E+04	-3.290E+04	2	0.000
-1850	78.5	6.00	4.2	3.1820E+04	-2.580E+04	-3.447E+04	2	0.000
-1930	78.5	6.00	4.2	2.1971E+04	-1.739E+04	-3.604E+04	2	0.000
-2010	78.5	6.00	1.9	1.6355E+04	-1.276E+04	-1.547E+04	2	0.000
-2090	78.5	6.00	2.0	1.2807E+04	-9.995E+03	-1.704E+04	2	0.000
-2170	124.0	6.00	2.0	9.2586E+03	-7.226E+03	-1.861E+04	2	0.000
-2250	78.5	6.00	2.3	5.7104E+03	-4.457E+03	-2.018E+04	2	0.000
-2330	78.5	6.00	2.4	2.1621E+03	-1.687E+03	-2.175E+04	2	0.000
-2410	78.5	6.00	0.2	1.1235E-11	-4.066E-12	-1.599E+03	2	0.000
-2490	78.5	6.00	0.4	1.0894E-11	5.1994E-12	-3.170E+03	2	0.000

Verifica a taglio:

quota	Ast	Vsd	Vsdx	Vsdy	N	comb	VRd,c	VRd,max	VRd,S	Vwd	
-90	0.16	33101	11570	31013	-121712	1SLV	40117	231056	84441	44323	Vsd < VRd,
-170	0.16	32263	11237	30243	-122460	1SLV	44110	231056	88433	44323	Vsd < VRd,
-250	0.08	32263	11237	30243	-124030	1SLV	44328	231056	66490	22162	Vsd < VRd,
-330	0.08	10265	3946	9476	-95382	1SLV	40346	231056	62508	22162	Vsd < VRd,
-410	0.08	10265	3946	9476	-96953	1SLV	40564	231056	62726	22162	Vsd < VRd,
-490	0.08	10265	3946	9476	-98523	1SLV	40783	231056	62944	22162	Vsd < VRd,
-570	0.08	10265	3946	9476	-100094	1SLV	41001	231056	63163	22162	Vsd < VRd,
-650	0.08	10265	3946	9476	-101665	1SLV	41219	231056	63381	22162	Vsd < VRd,
-730	0.08	1846	693	1711	-35633	15SLV	32041	231056	54203	22162	Vsd < VRd,
-810	0.08	1846	693	1711	-37203	15SLV	32259	231056	54421	22162	Vsd < VRd,
-890	0.08	1846	693	1711	-38774	15SLV	32478	231056	54639	22162	Vsd < VRd,
-970	0.08	1846	693	1711	-40345	15SLV	32696	231056	54858	22162	Vsd < VRd,
-1050	0.08	1846	693	1711	-41916	15SLV	32914	231056	55076	22162	Vsd < VRd,
-1130	0.08	2069	-1955	-678	-52862	5SLV	38892	231056	61054	22162	Vsd < VRd,
-1210	0.08	2069	-1955	-678	-54432	5SLV	34654	231056	56816	22162	Vsd < VRd,
-1290	0.08	2069	-1955	-678	-56003	5SLV	34872	231056	57034	22162	Vsd < VRd,
-1370	0.08	2069	-1955	-678	-57574	5SLV	35091	231056	57252	22162	Vsd < VRd,
-1450	0.08	2069	-1955	-678	-59145	5SLV	35309	231056	57471	22162	Vsd < VRd,
-1530	0.08	2069	-1955	-678	-60716	5SLV	35527	231056	57689	22162	Vsd < VRd,
-1610	0.08	903	-324	-843	-37695	1SLV	32327	231056	54489	22162	Vsd < VRd,
-1690	0.08	903	-324	-843	-39265	1SLV	32546	231056	54707	22162	Vsd < VRd,
-1770	0.08	903	-324	-843	-40836	1SLV	32764	231056	54926	22162	Vsd < VRd,
-1850	0.08	903	-324	-843	-42407	1SLV	32982	231056	55144	22162	Vsd < VRd,
-1930	0.08	903	-324	-843	-43978	1SLV	33201	231056	55363	22162	Vsd < VRd,
-2010	0.08	83	-47	-69	-24127	4SLU	30442	231056	52603	22162	Vsd < VRd,
-2090	0.08	83	-47	-69	-26169	4SLU	30725	231056	52887	22162	Vsd < VRd,
-2170	0.08	83	-47	-69	-28211	4SLU	35465	231056	57627	22162	Vsd < VRd,
-2250	0.08	83	-47	-69	-30253	4SLU	31293	231056	53455	22162	Vsd < VRd,
-2330	0.08	83	-47	-69	-32295	4SLU	31577	231056	53739	22162	Vsd < VRd,
-2410	0.08	0	0	0	-2426	1SLV	27425	231056	49587	22162	Vsd < VRd,
-2490	0.08	0	0	0	-3997	1SLV	27644	231056	49805	22162	Vsd < VRd,

Palo alle coordinate X=-1061 Y=-1264

Sollecitazioni massime in testa palo:

Combinazione corrispondente alla minima compressione in testa

N	Mx	My	Tx	Ty	comb	
-9.087E+04	-1.300E+06	1.5536E+06	3.6916E+03	3.0106E+03	1	sl
-9.087E+04	-1.300E+06	1.5536E+06	3.6916E+03	3.0106E+03	1	ra
-9.087E+04	-1.300E+06	1.5536E+06	3.6916E+03	3.0106E+03	1	fr
-9.087E+04	-1.300E+06	1.5536E+06	3.6916E+03	3.0106E+03	1	qp
-6.161E+04	8.3523E+05	-5.497E+06	-2.409E+04	-5.383E+03	11	SLV fond

Combinazione corrispondente alla massima compressione in testa

N	Mx	My	Tx	Ty	comb	
-1.555E+05	-1.852E+06	2.3749E+06	5.7083E+03	3.6558E+03	4	sl
-1.158E+05	-1.408E+06	1.7904E+06	4.2977E+03	2.8386E+03	2	ra
-1.033E+05	-1.354E+06	1.6720E+06	3.9947E+03	2.9246E+03	2	fr
-9.833E+04	-1.333E+06	1.6247E+06	3.8734E+03	2.9590E+03	2	qp
-1.201E+05	-3.436E+06	8.6042E+06	3.1473E+04	1.1404E+04	5	SLV fond

Combinazione corrispondente al massimo taglio in testa

N	Mx	My	Tx	Ty	comb	
-1.555E+05	-1.852E+06	2.3749E+06	5.7083E+03	3.6558E+03	4	sl
-1.158E+05	-1.408E+06	1.7904E+06	4.2977E+03	2.8386E+03	2	ra
-1.033E+05	-1.354E+06	1.6720E+06	3.9947E+03	2.9246E+03	2	fr
-9.833E+04	-1.333E+06	1.6247E+06	3.8734E+03	2.9590E+03	2	qp
-1.201E+05	-3.436E+06	8.6042E+06	3.1473E+04	1.1404E+04	5	SLV fond

Verifica di capacità portante riferita al palo singolo:

Fattore di correlazione Psi scelto in base alla conoscenza del sito = 1.7  
 Coeff. parziale di sicurezza sulla resistenza laterale = 1.15  
 Coeff. parziale di sicurezza sulla resistenza alla punta = 1.35  
 Portanza laterale di progetto = 292537.1



Progetto	Titolo	Rev.	Pag.
Orione	Orione_A24a.pdf "TABULATI DI CALCOLO PLINTO DI FONDAZIONE PER AEROGENERATORE TIPO"	0	211

**Tabulati di Calcolo Plinto di Fondazione per Aerogeneratore Tipo - Progetto Impianto Eolico - "Orione"**

Portanza di punta di progetto = 85555.4  
 verifica condotta in combinazione SLU 4  
 Sforzo normale = -155459.6  
 Peso del palo = 49087.4 \* 1.3  
 Carico totale di progetto = -219273.2  
 Resistenza totale di progetto = 378092.5  
 Coefficiente di sicurezza = 1.72 > 1

Verifica di resistenza allo stato limite:

quota	Af	cop.	c.s.	Mx	My	N	comb
-90	0.0	6.50	0.00	0.0000E+00	0.0000E+00	0.0000E+00	-
-170	78.5	6.00	3.55	-2.542E+06	6.1530E+06	-1.208E+05	5SLV
-250	78.5	6.00	6.59	-1.649E+06	3.7063E+06	-1.223E+05	5SLV
-330	78.5	6.00	12.05	-9.726E+05	1.8902E+06	-9.391E+04	5SLV
-410	78.5	6.00	13.76	-8.157E+05	8.7707E+05	-1.239E+05	4SLU
-490	78.5	6.00	14.64	-6.234E+05	6.4003E+05	-1.259E+05	4SLU
-570	78.5	6.00	14.40	-4.311E+05	4.0299E+05	-1.280E+05	4SLU
-650	78.5	6.00	14.18	-2.387E+05	1.6595E+05	-1.300E+05	4SLU
-730	78.5	6.00	14.67	-4.979E+05	1.6313E+06	-3.687E+04	11SLV
-810	78.5	6.00	15.64	4.7234E+05	-1.530E+06	-7.547E+04	5SLV
-890	78.5	6.00	16.04	4.6075E+05	-1.445E+06	-7.704E+04	5SLV
-970	78.5	6.00	16.47	4.4917E+05	-1.360E+06	-7.862E+04	5SLV
-1050	78.5	6.00	16.92	4.3758E+05	-1.275E+06	-8.019E+04	5SLV
-1130	124.0	6.00	23.07	4.1637E+05	-1.172E+06	-5.406E+04	5SLV
-1210	78.5	6.00	22.44	3.6368E+05	-1.014E+06	-5.563E+04	5SLV
-1290	78.5	6.00	24.46	3.1100E+05	-8.559E+05	-5.720E+04	5SLV
-1370	78.5	6.00	24.16	9.2792E+04	-1.342E+05	-7.628E+04	4SLU
-1450	78.5	6.00	23.53	8.8041E+04	-1.198E+05	-7.833E+04	4SLU
-1530	78.5	6.00	22.93	8.3291E+04	-1.054E+05	-8.037E+04	4SLU
-1610	78.5	6.00	38.28	7.2666E+04	-9.049E+04	-4.815E+04	4SLU
-1690	78.5	6.00	36.72	6.1752E+04	-7.555E+04	-5.019E+04	4SLU
-1770	78.5	6.00	35.29	5.0838E+04	-6.060E+04	-5.224E+04	4SLU
-1850	78.5	6.00	33.96	3.9923E+04	-4.565E+04	-5.428E+04	4SLU
-1930	78.5	6.00	32.73	2.9009E+04	-3.071E+04	-5.632E+04	4SLU
-2010	78.5	6.00	72.92	2.2193E+04	-2.252E+04	-2.528E+04	4SLU
-2090	78.5	6.00	67.47	1.7378E+04	-1.763E+04	-2.732E+04	4SLU
-2170	124.0	6.00	69.29	1.2563E+04	-1.275E+04	-2.936E+04	4SLU
-2250	78.5	6.00	58.70	7.7487E+03	-7.863E+03	-3.140E+04	4SLU
-2330	78.5	6.00	55.11	2.9339E+03	-2.977E+03	-3.344E+04	4SLU
-2410	78.5	6.00	100.00	4.0972E-11	-1.787E-11	-3.066E+03	4SLU
-2490	78.5	6.00	100.00	7.0939E-12	1.0894E-11	-5.108E+03	4SLU

Verifica di esercizio (combinazione rara):

quota	Af	cop.	sigmaf	sigmac	Mx	My	N	comb	Wk
-90	0.0	6.50	0.0	0.0	0.0000E+00	0.0000E+00	0.0000E+00	-	0.000
-170	78.5	6.00		28.7	-1.180E+06	1.4540E+06	-1.166E+05	2	0.000
-170	78.5	6.00	35.7		-1.060E+06	1.2643E+06	-9.181E+04	1	0.000
-250	78.5	6.00		25.4	-9.520E+05	1.1180E+06	-1.182E+05	2	0.000
-330	78.5	6.00		19.5	-7.549E+05	8.4095E+05	-9.063E+04	2	0.000
-410	78.5	6.00		17.8	-6.092E+05	6.6220E+05	-9.221E+04	2	0.000
-490	78.5	6.00		16.0	-4.635E+05	4.8345E+05	-9.378E+04	2	0.000
-570	78.5	6.00		14.3	-3.178E+05	3.0469E+05	-9.535E+04	2	0.000
-650	78.5	6.00		12.6	-1.721E+05	1.2594E+05	-9.692E+04	2	0.000
-730	78.5	6.00		8.5	-6.893E+04	3.2628E+03	-7.133E+04	2	0.000
-810	78.5	6.00		8.5	-3.660E+04	-2.596E+04	-7.290E+04	2	0.000
-890	78.5	6.00		8.7	-4.267E+03	-5.518E+04	-7.447E+04	2	0.000
-970	78.5	6.00		9.2	2.8064E+04	-8.440E+04	-7.604E+04	2	0.000
-1050	78.5	6.00		9.7	6.0395E+04	-1.136E+05	-7.761E+04	2	0.000
-1130	124.0	6.00		6.6	8.4170E+04	-1.335E+05	-5.215E+04	2	0.000
-1210	78.5	6.00		7.2	7.9997E+04	-1.227E+05	-5.372E+04	2	0.000
-1290	78.5	6.00		7.3	7.5824E+04	-1.119E+05	-5.529E+04	2	0.000
-1370	78.5	6.00		7.4	7.1651E+04	-1.011E+05	-5.686E+04	2	0.000
-1450	78.5	6.00		7.4	6.7478E+04	-9.027E+04	-5.843E+04	2	0.000
-1530	78.5	6.00		7.5	6.3305E+04	-7.948E+04	-6.000E+04	2	0.000
-1610	78.5	6.00		4.7	5.5132E+04	-6.824E+04	-3.581E+04	2	0.000
-1690	78.5	6.00		4.8	4.6762E+04	-5.697E+04	-3.738E+04	2	0.000
-1770	78.5	6.00		4.8	3.8392E+04	-4.571E+04	-3.895E+04	2	0.000
-1850	78.5	6.00		4.9	3.0022E+04	-3.445E+04	-4.052E+04	2	0.000
-1930	78.5	6.00		4.9	2.1653E+04	-2.319E+04	-4.209E+04	2	0.000
-2010	78.5	6.00		2.3	1.6501E+04	-1.701E+04	-1.877E+04	2	0.000
-2090	78.5	6.00		2.4	1.2921E+04	-1.332E+04	-2.034E+04	2	0.000
-2170	124.0	6.00		2.4	9.3412E+03	-9.630E+03	-2.191E+04	2	0.000
-2250	78.5	6.00		2.7	5.7613E+03	-5.940E+03	-2.348E+04	2	0.000
-2330	78.5	6.00		2.8	2.1814E+03	-2.249E+03	-2.505E+04	2	0.000
-2410	78.5	6.00		0.2	3.0248E-11	-1.339E-11	-2.230E+03	2	0.000
-2490	78.5	6.00		0.4	5.2371E-12	8.2100E-12	-3.800E+03	2	0.000

Verifica di esercizio (combinazione quasi permanente):

quota	Af	cop.	sigmaf	sigmac	Mx	My	N	comb	Wk
-90	0.0	6.50	0.0	0.0	0.0000E+00	0.0000E+00	0.0000E+00	-	0.000
-170	78.5	6.00		25.6	-1.096E+06	1.3212E+06	-9.924E+04	2	0.000
-170	78.5	6.00	35.7		-1.060E+06	1.2643E+06	-9.181E+04	1	0.000
-250	78.5	6.00		22.3	-8.601E+05	1.0182E+06	-1.008E+05	2	0.000
-330	78.5	6.00		17.0	-6.616E+05	7.6790E+05	-7.653E+04	2	0.000



Progetto	Titolo	Rev.	Pag.
Orione	Orione_A24a.pdf "TABULATI DI CALCOLO PLINTO DI FONDAZIONE PER AEROGENERATORE TIPO"	0	212

Tabulati di Calcolo Plinto di Fondazione per Aerogeneratore Tipo - Progetto Impianto Eolico - "Orione"

-410	78.5	6.00	15.4	-5.262E+05	6.0546E+05	-7.810E+04	2	0.000
-490	78.5	6.00	13.8	-3.907E+05	4.4302E+05	-7.967E+04	2	0.000
-570	78.5	6.00	12.2	-2.552E+05	2.8058E+05	-8.124E+04	2	0.000
-650	78.5	6.00	10.6	-1.197E+05	1.1813E+05	-8.281E+04	2	0.000
-730	78.5	6.00	6.9	-2.558E+04	6.4796E+03	-6.017E+04	2	0.000
-810	78.5	6.00	7.0	-4.834E+02	-2.053E+04	-6.174E+04	2	0.000
-890	78.5	6.00	7.5	2.4615E+04	-4.754E+04	-6.331E+04	2	0.000
-970	78.5	6.00	8.0	4.9714E+04	-7.454E+04	-6.488E+04	2	0.000
-1050	78.5	6.00	8.4	7.4813E+04	-1.016E+05	-6.645E+04	2	0.000
-1130	124.0	6.00	5.7	9.2497E+04	-1.200E+05	-4.385E+04	2	0.000
-1210	78.5	6.00	6.2	8.5963E+04	-1.104E+05	-4.542E+04	2	0.000
-1290	78.5	6.00	6.3	7.9428E+04	-1.009E+05	-4.700E+04	2	0.000
-1370	78.5	6.00	6.4	7.2894E+04	-9.128E+04	-4.857E+04	2	0.000
-1450	78.5	6.00	6.5	6.6359E+04	-8.171E+04	-5.014E+04	2	0.000
-1530	78.5	6.00	6.5	5.9825E+04	-7.214E+04	-5.171E+04	2	0.000
-1610	78.5	6.00	4.0	5.1652E+04	-6.198E+04	-3.019E+04	2	0.000
-1690	78.5	6.00	4.1	4.3399E+04	-5.179E+04	-3.176E+04	2	0.000
-1770	78.5	6.00	4.2	3.5146E+04	-4.160E+04	-3.333E+04	2	0.000
-1850	78.5	6.00	4.2	2.6892E+04	-3.141E+04	-3.490E+04	2	0.000
-1930	78.5	6.00	4.3	1.8639E+04	-2.121E+04	-3.647E+04	2	0.000
-2010	78.5	6.00	1.9	1.3904E+04	-1.560E+04	-1.570E+04	2	0.000
-2090	78.5	6.00	2.1	1.0888E+04	-1.221E+04	-1.728E+04	2	0.000
-2170	124.0	6.00	2.0	7.8713E+03	-8.829E+03	-1.885E+04	2	0.000
-2250	78.5	6.00	2.3	4.8547E+03	-5.445E+03	-2.042E+04	2	0.000
-2330	78.5	6.00	2.5	1.8382E+03	-2.062E+03	-2.199E+04	2	0.000
-2410	78.5	6.00	0.2	2.4473E-11	-1.178E-11	-1.644E+03	2	0.000
-2490	78.5	6.00	0.4	4.2373E-12	7.4366E-12	-3.215E+03	2	0.000

Verifica a taglio:

quota	Ast	Vsd	Vsdx	Vsdy	N	comb	VRd,c	VRd,max	VRd,S	Vwd	
-90	0.16	33476	31473	11404	-120125	5SLV	39897	231056	84220	44323	Vsd < VRd,
-170	0.16	32557	30585	11161	-120766	5SLV	43874	231056	88198	44323	Vsd < VRd,
-250	0.08	32557	30585	11161	-122337	5SLV	44093	231056	66254	22162	Vsd < VRd,
-330	0.08	10345	9561	3948	-93911	5SLV	40141	231056	62303	22162	Vsd < VRd,
-410	0.08	10345	9561	3948	-95482	5SLV	40360	231056	62521	22162	Vsd < VRd,
-490	0.08	10345	9561	3948	-97053	5SLV	40578	231056	62740	22162	Vsd < VRd,
-570	0.08	10345	9561	3948	-98623	5SLV	40796	231056	62958	22162	Vsd < VRd,
-650	0.08	10345	9561	3948	-100194	5SLV	41015	231056	63177	22162	Vsd < VRd,
-730	0.08	1852	1717	695	-36872	11SLV	32213	231056	54375	22162	Vsd < VRd,
-810	0.08	1852	1717	695	-38443	11SLV	32432	231056	54593	22162	Vsd < VRd,
-890	0.08	1852	1717	695	-40014	11SLV	32650	231056	54812	22162	Vsd < VRd,
-970	0.08	1852	1717	695	-41585	11SLV	32868	231056	55030	22162	Vsd < VRd,
-1050	0.08	1852	1717	695	-43155	11SLV	33087	231056	55248	22162	Vsd < VRd,
-1130	0.08	2085	-1978	-659	-54060	5SLV	39058	231056	61220	22162	Vsd < VRd,
-1210	0.08	2085	-1978	-659	-55631	5SLV	34821	231056	56982	22162	Vsd < VRd,
-1290	0.08	2085	-1978	-659	-57201	5SLV	35039	231056	57201	22162	Vsd < VRd,
-1370	0.08	2085	-1978	-659	-58772	5SLV	35257	231056	57419	22162	Vsd < VRd,
-1450	0.08	2085	-1978	-659	-60343	5SLV	35476	231056	57637	22162	Vsd < VRd,
-1530	0.08	2085	-1978	-659	-61914	5SLV	35694	231056	57856	22162	Vsd < VRd,
-1610	0.08	910	-851	-323	-37103	5SLV	32245	231056	54407	22162	Vsd < VRd,
-1690	0.08	910	-851	-323	-38674	5SLV	32464	231056	54625	22162	Vsd < VRd,
-1770	0.08	910	-851	-323	-40245	5SLV	32682	231056	54844	22162	Vsd < VRd,
-1850	0.08	910	-851	-323	-41816	5SLV	32900	231056	55062	22162	Vsd < VRd,
-1930	0.08	910	-851	-323	-43387	5SLV	33119	231056	55280	22162	Vsd < VRd,
-2010	0.08	86	-61	-60	-25277	4SLU	30601	231056	52763	22162	Vsd < VRd,
-2090	0.08	86	-61	-60	-27319	4SLU	30885	231056	53047	22162	Vsd < VRd,
-2170	0.08	86	-61	-60	-29361	4SLU	35625	231056	57787	22162	Vsd < VRd,
-2250	0.08	86	-61	-60	-31403	4SLU	31453	231056	53615	22162	Vsd < VRd,
-2330	0.08	86	-61	-60	-33445	4SLU	31737	231056	53898	22162	Vsd < VRd,
-2410	0.08	0	0	0	-847	7SLV	27206	231056	49367	22162	Vsd < VRd,
-2490	0.08	0	0	0	-2418	7SLV	27424	231056	49586	22162	Vsd < VRd,

Palo alle coordinate X=-825 Y=-1429

Sollecitazioni massime in testa palo:

Combinazione corrispondente alla minima compressione in testa

N	Mx	My	Tx	Ty	comb	
-9.090E+04	-1.011E+06	1.7563E+06	4.1609E+03	2.3406E+03	1	sl
-9.090E+04	-1.011E+06	1.7563E+06	4.1609E+03	2.3406E+03	1	ra
-9.090E+04	-1.011E+06	1.7563E+06	4.1609E+03	2.3406E+03	1	fr
-9.090E+04	-1.011E+06	1.7563E+06	4.1609E+03	2.3406E+03	1	qp
-6.006E+04	1.1116E+06	-5.311E+06	-2.368E+04	-6.006E+03	11	SLV fond

Combinazione corrispondente alla massima compressione in testa

N	Mx	My	Tx	Ty	comb	
-1.608E+05	-1.400E+06	2.7978E+06	6.6546E+03	2.5949E+03	4	sl
-1.193E+05	-1.068E+06	2.0994E+06	4.9912E+03	2.0420E+03	2	ra
-1.051E+05	-1.040E+06	1.9278E+06	4.5761E+03	2.1913E+03	2	fr
-9.944E+04	-1.028E+06	1.8592E+06	4.4100E+03	2.2510E+03	2	qp
-1.217E+05	-3.134E+06	8.8237E+06	3.2004E+04	1.0687E+04	5	SLV fond

Combinazione corrispondente al massimo taglio in testa

N	Mx	My	Tx	Ty	comb	
-1.608E+05	-1.400E+06	2.7978E+06	6.6546E+03	2.5949E+03	4	sl
-1.193E+05	-1.068E+06	2.0994E+06	4.9912E+03	2.0420E+03	2	ra



Progetto	Titolo	Rev.	Pag.
Orione	Orione_A24a.pdf "TABULATI DI CALCOLO PLINTO DI FONDAZIONE PER AEROGENERATORE TIPO"	0	213

**Tabulati di Calcolo Plinto di Fondazione per Aerogeneratore Tipo - Progetto Impianto Eolico - "Orione"**

-1.051E+05 -1.040E+06 1.9278E+06 4.5761E+03 2.1913E+03 2 fr  
 -9.944E+04 -1.028E+06 1.8592E+06 4.4100E+03 2.2510E+03 2 qp  
 -1.217E+05 -3.134E+06 8.8237E+06 3.2004E+04 1.0687E+04 5 SLV fond

Verifica di capacità portante riferita al palo singolo:

Fattore di correlazione Psi scelto in base alla conoscenza del sito = 1.7  
 Coeff. parziale di sicurezza sulla resistenza laterale = 1.15  
 Coeff. parziale di sicurezza sulla resistenza alla punta = 1.35  
 Portanza laterale di progetto = 292537.1  
 Portanza di punta di progetto = 85555.4  
 verifica condotta in combinazione SLU 4  
 Sforzo normale = -160840.2  
 Peso del palo = 49087.4 \* 1.3  
 Carico totale di progetto = -224653.8  
 Resistenza totale di progetto = 378092.5  
 Coefficiente di sicurezza = 1.68 > 1

Verifica di resistenza allo stato limite:

quota	Af	cop.	c.s.	Mx	My	N	comb
-90	0.0	6.50	0.00	0.0000E+00	0.0000E+00	0.0000E+00	-
-170	78.5	6.00	3.51	-2.296E+06	6.3304E+06	-1.224E+05	5SLV
-250	78.5	6.00	6.51	-1.461E+06	3.8416E+06	-1.239E+05	5SLV
-330	78.5	6.00	11.88	-8.312E+05	1.9910E+06	-9.522E+04	5SLV
-410	78.5	6.00	13.33	-6.481E+05	1.0432E+06	-1.282E+05	4SLU
-490	78.5	6.00	14.15	-5.012E+05	7.6322E+05	-1.303E+05	4SLU
-570	78.5	6.00	13.93	-3.542E+05	4.8327E+05	-1.323E+05	4SLU
-650	78.5	6.00	13.72	-2.073E+05	2.0332E+05	-1.344E+05	4SLU
-730	78.5	6.00	14.50	-4.940E+05	1.6353E+06	-3.588E+04	11SLV
-810	78.5	6.00	15.54	4.6675E+05	-1.536E+06	-7.651E+04	5SLV
-890	78.5	6.00	15.93	4.5039E+05	-1.454E+06	-7.808E+04	5SLV
-970	78.5	6.00	16.34	4.3403E+05	-1.372E+06	-7.965E+04	5SLV
-1050	78.5	6.00	16.77	4.1767E+05	-1.290E+06	-8.122E+04	5SLV
-1130	124.0	6.00	22.85	3.9324E+05	-1.190E+06	-5.483E+04	5SLV
-1210	78.5	6.00	22.22	3.4247E+05	-1.030E+06	-5.640E+04	5SLV
-1290	78.5	6.00	24.00	6.8990E+04	-1.738E+05	-7.680E+04	4SLU
-1370	78.5	6.00	23.38	6.7003E+04	-1.574E+05	-7.884E+04	4SLU
-1450	78.5	6.00	22.79	6.5017E+04	-1.409E+05	-8.089E+04	4SLU
-1530	78.5	6.00	22.23	6.3030E+04	-1.244E+05	-8.293E+04	4SLU
-1610	78.5	6.00	36.95	5.5268E+04	-1.068E+05	-4.989E+04	4SLU
-1690	78.5	6.00	35.50	4.7222E+04	-8.928E+04	-5.193E+04	4SLU
-1770	78.5	6.00	34.15	3.9176E+04	-7.172E+04	-5.397E+04	4SLU
-1850	78.5	6.00	32.91	3.1130E+04	-5.415E+04	-5.601E+04	4SLU
-1930	78.5	6.00	31.75	2.3084E+04	-3.658E+04	-5.805E+04	4SLU
-2010	78.5	6.00	70.29	1.7843E+04	-2.690E+04	-2.622E+04	4SLU
-2090	78.5	6.00	65.21	1.3972E+04	-2.106E+04	-2.826E+04	4SLU
-2170	124.0	6.00	67.12	1.0101E+04	-1.523E+04	-3.031E+04	4SLU
-2250	78.5	6.00	56.98	6.2298E+03	-9.391E+03	-3.235E+04	4SLU
-2330	78.5	6.00	53.60	2.3588E+03	-3.556E+03	-3.439E+04	4SLU
-2410	78.5	6.00	100.00	5.8737E-12	-4.310E-11	-3.246E+03	4SLU
-2490	78.5	6.00	100.00	5.0779E-12	9.3076E-12	-5.288E+03	4SLU

Verifica di esercizio (combinazione rara):

quota	Af	cop.	sigmaf	sigmac	Mx	My	N	comb	Wk
-90	0.0	6.50	0.0	0.0	0.0000E+00	0.0000E+00	0.0000E+00	-	0.000
-170	78.5	6.00	35.6	29.6	-9.037E+05	1.7077E+06	-1.202E+05	2	0.000
-170	78.5	6.00	35.6	29.6	-8.245E+05	1.4296E+06	-9.185E+04	1	0.000
-250	78.5	6.00	35.6	26.1	-7.391E+05	1.3165E+06	-1.217E+05	2	0.000
-330	78.5	6.00	35.6	20.0	-5.944E+05	9.9321E+05	-9.354E+04	2	0.000
-410	78.5	6.00	35.6	18.2	-4.829E+05	7.8313E+05	-9.511E+04	2	0.000
-490	78.5	6.00	35.6	16.4	-3.714E+05	5.7304E+05	-9.668E+04	2	0.000
-570	78.5	6.00	35.6	14.6	-2.598E+05	3.6296E+05	-9.825E+04	2	0.000
-650	78.5	6.00	35.6	12.9	-1.483E+05	1.5287E+05	-9.982E+04	2	0.000
-730	78.5	6.00	35.6	8.8	-6.855E+04	8.4697E+03	-7.362E+04	2	0.000
-810	78.5	6.00	35.6	8.8	-4.176E+04	-2.646E+04	-7.520E+04	2	0.000
-890	78.5	6.00	35.6	9.1	-1.498E+04	-6.140E+04	-7.677E+04	2	0.000
-970	78.5	6.00	35.6	9.5	1.1804E+04	-9.633E+04	-7.834E+04	2	0.000
-1050	78.5	6.00	35.6	10.0	3.8588E+04	-1.313E+05	-7.991E+04	2	0.000
-1130	124.0	6.00	35.6	6.8	5.8600E+04	-1.551E+05	-5.385E+04	2	0.000
-1210	78.5	6.00	35.6	7.4	5.6494E+04	-1.428E+05	-5.542E+04	2	0.000
-1290	78.5	6.00	35.6	7.5	5.4387E+04	-1.304E+05	-5.700E+04	2	0.000
-1370	78.5	6.00	35.6	7.6	5.2280E+04	-1.180E+05	-5.857E+04	2	0.000
-1450	78.5	6.00	35.6	7.7	5.0173E+04	-1.057E+05	-6.014E+04	2	0.000
-1530	78.5	6.00	35.6	7.7	4.8067E+04	-9.332E+04	-6.171E+04	2	0.000
-1610	78.5	6.00	35.6	4.9	4.2045E+04	-8.018E+04	-3.696E+04	2	0.000
-1690	78.5	6.00	35.6	4.9	3.5831E+04	-6.700E+04	-3.853E+04	2	0.000
-1770	78.5	6.00	35.6	5.0	2.9616E+04	-5.382E+04	-4.010E+04	2	0.000
-1850	78.5	6.00	35.6	5.0	2.3402E+04	-4.064E+04	-4.168E+04	2	0.000
-1930	78.5	6.00	35.6	5.1	1.7187E+04	-2.746E+04	-4.325E+04	2	0.000
-2010	78.5	6.00	35.6	2.4	1.3221E+04	-2.020E+04	-1.940E+04	2	0.000
-2090	78.5	6.00	35.6	2.5	1.0353E+04	-1.581E+04	-2.097E+04	2	0.000
-2170	124.0	6.00	35.6	2.4	7.4845E+03	-1.143E+04	-2.254E+04	2	0.000
-2250	78.5	6.00	35.6	2.8	4.6162E+03	-7.052E+03	-2.411E+04	2	0.000
-2330	78.5	6.00	35.6	2.9	1.7478E+03	-2.670E+03	-2.568E+04	2	0.000
-2410	78.5	6.00	35.6	0.3	3.1939E-12	-3.266E-11	-2.350E+03	2	0.000
-2490	78.5	6.00	35.6	0.4	2.0570E-12	7.1297E-12	-3.921E+03	2	0.000



Verifica di esercizio (combinazione quasi permanente):

quota	Af	cop.	sigmaf	sigmac	Mx	My	N	comb	Wk
-90	0.0	6.50	0.0	0.0	0.0000E+00	0.0000E+00	0.0000E+00	-	0.000
-170	78.5	6.00		25.8	-8.482E+05	1.5130E+06	-1.003E+05	2	0.000
-170	78.5	6.00	35.6		-8.245E+05	1.4296E+06	-9.185E+04	1	0.000
-250	78.5	6.00		22.5	-6.684E+05	1.1673E+06	-1.019E+05	2	0.000
-330	78.5	6.00		17.1	-5.166E+05	8.8140E+05	-7.742E+04	2	0.000
-410	78.5	6.00		15.5	-4.118E+05	6.9526E+05	-7.899E+04	2	0.000
-490	78.5	6.00		13.9	-3.070E+05	5.0911E+05	-8.056E+04	2	0.000
-570	78.5	6.00		12.3	-2.022E+05	3.2296E+05	-8.213E+04	2	0.000
-650	78.5	6.00		10.7	-9.738E+04	1.3682E+05	-8.371E+04	2	0.000
-730	78.5	6.00		7.0	-2.437E+04	8.8053E+03	-6.087E+04	2	0.000
-810	78.5	6.00		7.1	-4.367E+03	-2.232E+04	-6.244E+04	2	0.000
-890	78.5	6.00		7.6	1.5640E+04	-5.344E+04	-6.402E+04	2	0.000
-970	78.5	6.00		8.1	3.5647E+04	-8.456E+04	-6.559E+04	2	0.000
-1050	78.5	6.00		8.5	5.5654E+04	-1.157E+05	-6.716E+04	2	0.000
-1130	124.0	6.00		5.7	6.9860E+04	-1.370E+05	-4.438E+04	2	0.000
-1210	78.5	6.00		6.3	6.5121E+04	-1.261E+05	-4.595E+04	2	0.000
-1290	78.5	6.00		6.4	6.0382E+04	-1.152E+05	-4.752E+04	2	0.000
-1370	78.5	6.00		6.4	5.5643E+04	-1.044E+05	-4.909E+04	2	0.000
-1450	78.5	6.00		6.5	5.0904E+04	-9.352E+04	-5.066E+04	2	0.000
-1530	78.5	6.00		6.6	4.6165E+04	-8.266E+04	-5.223E+04	2	0.000
-1610	78.5	6.00		4.1	3.9911E+04	-7.104E+04	-3.055E+04	2	0.000
-1690	78.5	6.00		4.1	3.3583E+04	-5.938E+04	-3.212E+04	2	0.000
-1770	78.5	6.00		4.2	2.7254E+04	-4.771E+04	-3.369E+04	2	0.000
-1850	78.5	6.00		4.3	2.0926E+04	-3.605E+04	-3.526E+04	2	0.000
-1930	78.5	6.00		4.3	1.4597E+04	-2.439E+04	-3.683E+04	2	0.000
-2010	78.5	6.00		1.9	1.0928E+04	-1.795E+04	-1.590E+04	2	0.000
-2090	78.5	6.00		2.1	8.5568E+03	-1.405E+04	-1.747E+04	2	0.000
-2170	124.0	6.00		2.1	6.1861E+03	-1.016E+04	-1.904E+04	2	0.000
-2250	78.5	6.00		2.4	3.8153E+03	-6.266E+03	-2.061E+04	2	0.000
-2330	78.5	6.00		2.5	1.4446E+03	-2.372E+03	-2.218E+04	2	0.000
-2410	78.5	6.00		0.2	-2.832E-12	-3.041E-11	-1.681E+03	2	0.000
-2490	78.5	6.00		0.4	-6.356E-12	6.9929E-12	-3.252E+03	2	0.000

Verifica a taglio:

quota	Ast	Vsd	Vsdx	Vsdy	N	comb	VRd,c	VRd,max	VRd,S	Vwd
-90	0.16	33741	32004	10687	-121742	5SLV	40122	231056	84445	44323 Vsd < VRd,
-170	0.16	32818	31111	10448	-122374	5SLV	44098	231056	88421	44323 Vsd < VRd,
-250	0.08	32818	31111	10448	-123945	5SLV	44316	231056	66478	22162 Vsd < VRd,
-330	0.08	10463	9836	3569	-95217	5SLV	40323	231056	62485	22162 Vsd < VRd,
-410	0.08	10463	9836	3569	-96788	5SLV	40541	231056	62703	22162 Vsd < VRd,
-490	0.08	10463	9836	3569	-98359	5SLV	40760	231056	62921	22162 Vsd < VRd,
-570	0.08	10463	9836	3569	-99930	5SLV	40978	231056	63140	22162 Vsd < VRd,
-650	0.08	10463	9836	3569	-101501	5SLV	41196	231056	63358	22162 Vsd < VRd,
-730	0.08	1871	1761	632	-35882	11SLV	32076	231056	54237	22162 Vsd < VRd,
-810	0.08	1871	1761	632	-37453	11SLV	32294	231056	54456	22162 Vsd < VRd,
-890	0.08	1871	1761	632	-39024	11SLV	32512	231056	54674	22162 Vsd < VRd,
-970	0.08	1871	1761	632	-40595	11SLV	32731	231056	54892	22162 Vsd < VRd,
-1050	0.08	1871	1761	632	-42166	11SLV	32949	231056	55111	22162 Vsd < VRd,
-1130	0.08	2095	-1996	-635	-54827	5SLV	39165	231056	61327	22162 Vsd < VRd,
-1210	0.08	2095	-1996	-635	-56398	5SLV	34927	231056	57089	22162 Vsd < VRd,
-1290	0.08	2095	-1996	-635	-57969	5SLV	35146	231056	57307	22162 Vsd < VRd,
-1370	0.08	2095	-1996	-635	-59540	5SLV	35364	231056	57526	22162 Vsd < VRd,
-1450	0.08	2095	-1996	-635	-61111	5SLV	35582	231056	57744	22162 Vsd < VRd,
-1530	0.08	2095	-1996	-635	-62681	5SLV	35801	231056	57962	22162 Vsd < VRd,
-1610	0.08	918	-868	-299	-37623	5SLV	32318	231056	54479	22162 Vsd < VRd,
-1690	0.08	918	-868	-299	-39194	5SLV	32536	231056	54698	22162 Vsd < VRd,
-1770	0.08	918	-868	-299	-40765	5SLV	32754	231056	54916	22162 Vsd < VRd,
-1850	0.08	918	-868	-299	-42336	5SLV	32973	231056	55134	22162 Vsd < VRd,
-1930	0.08	918	-868	-299	-43906	5SLV	33191	231056	55353	22162 Vsd < VRd,
-2010	0.08	88	-73	-48	-26223	4SLU	30733	231056	52895	22162 Vsd < VRd,
-2090	0.08	88	-73	-48	-28265	4SLU	31017	231056	53178	22162 Vsd < VRd,
-2170	0.08	88	-73	-48	-30307	4SLU	35757	231056	57918	22162 Vsd < VRd,
-2250	0.08	88	-73	-48	-32349	4SLU	31584	231056	53746	22162 Vsd < VRd,
-2330	0.08	88	-73	-48	-34391	4SLU	31868	231056	54030	22162 Vsd < VRd,
-2410	0.08	0	0	0	-2088	9SLV	27378	231056	49540	22162 Vsd < VRd,
-2490	0.08	0	0	0	-3659	9SLV	27597	231056	49758	22162 Vsd < VRd,

Palo alle coordinate X=-564 Y=-1551

Sollecitazioni massime in testa palo:

Combinazione corrispondente alla minima compressione in testa

N	Mx	My	Tx	Ty	comb
-9.091E+04	-6.909E+05	1.9056E+06	4.5068E+03	1.5997E+03	1 sl
-9.091E+04	-6.909E+05	1.9056E+06	4.5068E+03	1.5997E+03	1 ra
-9.091E+04	-6.909E+05	1.9056E+06	4.5068E+03	1.5997E+03	1 fr
-9.091E+04	-6.909E+05	1.9056E+06	4.5068E+03	1.5997E+03	1 qp
-5.943E+04	1.4137E+06	-5.174E+06	-2.338E+04	-6.682E+03	11 SLV fond

Combinazione corrispondente alla massima compressione in testa



Progetto	Titolo	Rev.	Pag.
Orione	Orione_A24a.pdf "TABULATI DI CALCOLO PLINTO DI FONDAZIONE PER AEROGENERATORE TIPO"	0	215



N	Mx	My	Tx	Ty	comb
-1.649E+05	-8.552E+05	3.1171E+06	7.3595E+03	1.3262E+03	4 sl
-1.220E+05	-6.622E+05	2.3322E+06	5.5073E+03	1.0974E+03	2 ra
-1.065E+05	-6.766E+05	2.1189E+06	5.0070E+03	1.3485E+03	2 fr
-1.003E+05	-6.823E+05	2.0336E+06	4.8069E+03	1.4490E+03	2 qp
-1.224E+05	-2.796E+06	8.9857E+06	3.2395E+04	9.8819E+03	5 SLV fond

Combinazione corrispondente al massimo taglio in testa

N	Mx	My	Tx	Ty	comb
-1.649E+05	-8.552E+05	3.1171E+06	7.3595E+03	1.3262E+03	4 sl
-1.220E+05	-6.622E+05	2.3322E+06	5.5073E+03	1.0974E+03	2 ra
-1.065E+05	-6.766E+05	2.1189E+06	5.0070E+03	1.3485E+03	2 fr
-1.003E+05	-6.823E+05	2.0336E+06	4.8069E+03	1.4490E+03	2 qp
-1.224E+05	-2.796E+06	8.9857E+06	3.2395E+04	9.8819E+03	5 SLV fond

Verifica di capacità portante riferita al palo singolo:

Fattore di correlazione Psi scelto in base alla conoscenza del sito = 1.7  
 Coeff. parziale di sicurezza sulla resistenza laterale = 1.15  
 Coeff. parziale di sicurezza sulla resistenza alla punta = 1.35  
 Portanza laterale di progetto = 292537.1  
 Portanza di punta di progetto = 85555.4  
 verifica condotta in combinazione SLU 4  
 Sforzo normale = -164882.4  
 Peso del palo = 49087.4 \* 1.3  
 Carico totale di progetto = -228696  
 Resistenza totale di progetto = 378092.5  
 Coefficiente di sicurezza = 1.65 > 1

Verifica di resistenza allo stato limite:

quota	Af	cop.	c.s.	Mx	My	N	comb
-90	0.0	6.50	0.00	0.0000E+00	0.0000E+00	0.0000E+00	-
-170	78.5	6.00	3.49	-2.023E+06	6.4613E+06	-1.230E+05	5SLV
-250	78.5	6.00	6.47	-1.251E+06	3.9414E+06	-1.246E+05	5SLV
-330	78.5	6.00	11.80	-6.740E+05	2.0653E+06	-9.574E+04	5SLV
-410	78.5	6.00	13.02	-4.438E+05	1.1704E+06	-1.315E+05	4SLU
-490	78.5	6.00	13.80	-3.518E+05	8.5799E+05	-1.336E+05	4SLU
-570	78.5	6.00	13.59	-2.598E+05	5.4554E+05	-1.356E+05	4SLU
-650	78.5	6.00	13.39	-1.677E+05	2.3310E+05	-1.376E+05	4SLU
-730	78.5	6.00	14.42	-4.891E+05	1.6384E+06	-3.547E+04	11SLV
-810	78.5	6.00	15.49	4.6002E+05	-1.539E+06	-7.692E+04	5SLV
-890	78.5	6.00	15.88	4.3839E+05	-1.460E+06	-7.849E+04	5SLV
-970	78.5	6.00	16.28	4.1677E+05	-1.380E+06	-8.007E+04	5SLV
-1050	78.5	6.00	16.71	3.9515E+05	-1.301E+06	-8.164E+04	5SLV
-1130	124.0	6.00	22.75	3.6720E+05	-1.202E+06	-5.514E+04	5SLV
-1210	78.5	6.00	22.13	3.1861E+05	-1.041E+06	-5.671E+04	5SLV
-1290	78.5	6.00	23.41	3.4857E+04	-1.927E+05	-7.872E+04	4SLU
-1370	78.5	6.00	22.82	3.6101E+04	-1.747E+05	-8.077E+04	4SLU
-1450	78.5	6.00	22.26	3.7345E+04	-1.567E+05	-8.281E+04	4SLU
-1530	78.5	6.00	21.72	3.8588E+04	-1.387E+05	-8.485E+04	4SLU
-1610	78.5	6.00	36.01	3.4263E+04	-1.192E+05	-5.119E+04	4SLU
-1690	78.5	6.00	34.63	2.9663E+04	-9.969E+04	-5.323E+04	4SLU
-1770	78.5	6.00	33.35	2.5063E+04	-8.015E+04	-5.527E+04	4SLU
-1850	78.5	6.00	32.16	2.0463E+04	-6.062E+04	-5.731E+04	4SLU
-1930	78.5	6.00	31.05	1.5863E+04	-4.109E+04	-5.936E+04	4SLU
-2010	78.5	6.00	68.44	1.2528E+04	-3.027E+04	-2.693E+04	4SLU
-2090	78.5	6.00	63.61	9.8098E+03	-2.370E+04	-2.898E+04	4SLU
-2170	124.0	6.00	65.58	7.0919E+03	-1.713E+04	-3.102E+04	4SLU
-2250	78.5	6.00	55.75	4.3740E+03	-1.057E+04	-3.306E+04	4SLU
-2330	78.5	6.00	52.51	1.6562E+03	-4.001E+03	-3.510E+04	4SLU
-2410	78.5	6.00	100.00	2.1975E-11	-6.099E-11	-3.382E+03	4SLU
-2490	78.5	6.00	100.00	6.2864E-12	-1.620E-11	-5.424E+03	4SLU

Verifica di esercizio (combinazione rara):

quota	Af	cop.	sigmaf	sigmac	Mx	My	N	comb	Wk
-90	0.0	6.50	0.0	0.0	0.0000E+00	0.0000E+00	0.0000E+00	-	0.000
-170	78.5	6.00		30.3	-5.730E+05	1.8994E+06	-1.228E+05	2	0.000
-170	78.5	6.00	35.6		-5.635E+05	1.5514E+06	-9.186E+04	1	0.000
-250	78.5	6.00		26.7	-4.836E+05	1.4671E+06	-1.244E+05	2	0.000
-330	78.5	6.00		20.5	-4.013E+05	1.1092E+06	-9.572E+04	2	0.000
-410	78.5	6.00		18.6	-3.306E+05	8.7548E+05	-9.729E+04	2	0.000
-490	78.5	6.00		16.8	-2.600E+05	6.4172E+05	-9.886E+04	2	0.000
-570	78.5	6.00		14.9	-1.894E+05	4.0797E+05	-1.004E+05	2	0.000
-650	78.5	6.00		13.1	-1.187E+05	1.7421E+05	-1.020E+05	2	0.000
-730	78.5	6.00		8.9	-6.706E+04	1.3347E+04	-7.535E+04	2	0.000
-810	78.5	6.00		9.0	-4.704E+04	-2.603E+04	-7.692E+04	2	0.000
-890	78.5	6.00		9.3	-2.703E+04	-6.540E+04	-7.849E+04	2	0.000
-970	78.5	6.00		9.8	-7.019E+03	-1.048E+05	-8.006E+04	2	0.000
-1050	78.5	6.00		10.3	1.2994E+04	-1.441E+05	-8.163E+04	2	0.000
-1130	124.0	6.00		7.0	2.8386E+04	-1.711E+05	-5.514E+04	2	0.000
-1210	78.5	6.00		7.6	2.8680E+04	-1.577E+05	-5.671E+04	2	0.000
-1290	78.5	6.00		7.7	2.8975E+04	-1.442E+05	-5.828E+04	2	0.000
-1370	78.5	6.00		7.8	2.9269E+04	-1.307E+05	-5.985E+04	2	0.000
-1450	78.5	6.00		7.8	2.9564E+04	-1.172E+05	-6.142E+04	2	0.000
-1530	78.5	6.00		7.9	2.9858E+04	-1.038E+05	-6.299E+04	2	0.000
-1610	78.5	6.00		5.0	2.6395E+04	-8.920E+04	-3.783E+04	2	0.000



Tabulati di Calcolo Plinto di Fondazione per Aerogeneratore Tipo - Progetto Impianto Eolico - "Orione"

-1690	78.5	6.00	5.0	2.2748E+04	-7.458E+04	-3.940E+04	2	0.000
-1770	78.5	6.00	5.1	1.9100E+04	-5.997E+04	-4.097E+04	2	0.000
-1850	78.5	6.00	5.1	1.5452E+04	-4.535E+04	-4.254E+04	2	0.000
-1930	78.5	6.00	5.2	1.1804E+04	-3.073E+04	-4.411E+04	2	0.000
-2010	78.5	6.00	2.4	9.2580E+03	-2.264E+04	-1.988E+04	2	0.000
-2090	78.5	6.00	2.5	7.2495E+03	-1.773E+04	-2.145E+04	2	0.000
-2170	124.0	6.00	2.5	5.2410E+03	-1.282E+04	-2.302E+04	2	0.000
-2250	78.5	6.00	2.8	3.2324E+03	-7.904E+03	-2.459E+04	2	0.000
-2330	78.5	6.00	2.9	1.2239E+03	-2.993E+03	-2.616E+04	2	0.000
-2410	78.5	6.00	0.3	1.6478E-11	-4.579E-11	-2.441E+03	2	0.000
-2490	78.5	6.00	0.4	5.1090E-12	-1.169E-11	-4.011E+03	2	0.000

Verifica di esercizio (combinazione quasi permanente):

quota	Af	cop.	sigmaf	sigmac	Mx	My	N	comb	Wk
-90	0.0	6.50	0.0	0.0	0.0000E+00	0.0000E+00	0.0000E+00	-	0.000
-170	78.5	6.00		26.1	-5.663E+05	1.6558E+06	-1.011E+05	2	0.000
-170	78.5	6.00	35.6		-5.635E+05	1.5514E+06	-9.186E+04	1	0.000
-250	78.5	6.00		22.7	-4.503E+05	1.2784E+06	-1.027E+05	2	0.000
-330	78.5	6.00		17.3	-3.516E+05	9.6618E+05	-7.808E+04	2	0.000
-410	78.5	6.00		15.6	-2.816E+05	7.6239E+05	-7.965E+04	2	0.000
-490	78.5	6.00		14.0	-2.117E+05	5.5861E+05	-8.122E+04	2	0.000
-570	78.5	6.00		12.4	-1.417E+05	3.5482E+05	-8.279E+04	2	0.000
-650	78.5	6.00		10.8	-7.176E+04	1.5103E+05	-8.436E+04	2	0.000
-730	78.5	6.00		7.0	-2.272E+04	1.0827E+04	-6.139E+04	2	0.000
-810	78.5	6.00		7.2	-8.533E+03	-2.339E+04	-6.297E+04	2	0.000
-890	78.5	6.00		7.7	5.6526E+03	-5.762E+04	-6.454E+04	2	0.000
-970	78.5	6.00		8.1	1.9838E+04	-9.184E+04	-6.611E+04	2	0.000
-1050	78.5	6.00		8.6	3.4024E+04	-1.261E+05	-6.768E+04	2	0.000
-1130	124.0	6.00		5.8	4.4247E+04	-1.495E+05	-4.476E+04	2	0.000
-1210	78.5	6.00		6.4	4.1529E+04	-1.377E+05	-4.634E+04	2	0.000
-1290	78.5	6.00		6.4	3.8810E+04	-1.259E+05	-4.791E+04	2	0.000
-1370	78.5	6.00		6.5	3.6091E+04	-1.141E+05	-4.948E+04	2	0.000
-1450	78.5	6.00		6.6	3.3372E+04	-1.023E+05	-5.105E+04	2	0.000
-1530	78.5	6.00		6.6	3.0654E+04	-9.048E+04	-5.262E+04	2	0.000
-1610	78.5	6.00		4.1	2.6575E+04	-7.777E+04	-3.081E+04	2	0.000
-1690	78.5	6.00		4.2	2.2430E+04	-6.502E+04	-3.238E+04	2	0.000
-1770	78.5	6.00		4.2	1.8284E+04	-5.227E+04	-3.395E+04	2	0.000
-1850	78.5	6.00		4.3	1.4139E+04	-3.952E+04	-3.552E+04	2	0.000
-1930	78.5	6.00		4.4	9.9935E+03	-2.676E+04	-3.709E+04	2	0.000
-2010	78.5	6.00		2.0	7.5349E+03	-1.971E+04	-1.604E+04	2	0.000
-2090	78.5	6.00		2.1	5.9002E+03	-1.543E+04	-1.761E+04	2	0.000
-2170	124.0	6.00		2.1	4.2655E+03	-1.116E+04	-1.918E+04	2	0.000
-2250	78.5	6.00		2.4	2.6308E+03	-6.881E+03	-2.075E+04	2	0.000
-2330	78.5	6.00		2.5	9.9611E+02	-2.605E+03	-2.232E+04	2	0.000
-2410	78.5	6.00		0.2	1.4538E-11	-4.069E-11	-1.708E+03	2	0.000
-2490	78.5	6.00		0.4	6.3524E-12	-8.172E-12	-3.279E+03	2	0.000

Verifica a taglio:

quota	Ast	Vsd	Vsdx	Vsdy	N	comb	VRd,c	VRd,max	VRd,S	Vwd
-90	0.16	33869	32395	9882	-122395	5SLV	40212	231056	84536	44323 Vsd < VRd,
-170	0.16	32943	31499	9647	-123023	5SLV	44188	231056	88511	44323 Vsd < VRd,
-250	0.08	32943	31499	9647	-124594	5SLV	44406	231056	66568	22162 Vsd < VRd,
-330	0.08	10519	10038	3145	-95744	5SLV	40396	231056	62558	22162 Vsd < VRd,
-410	0.08	10519	10038	3145	-97315	5SLV	40615	231056	62776	22162 Vsd < VRd,
-490	0.08	10519	10038	3145	-98886	5SLV	40833	231056	62995	22162 Vsd < VRd,
-570	0.08	10519	10038	3145	-100457	5SLV	41051	231056	63213	22162 Vsd < VRd,
-650	0.08	10519	10038	3145	-102028	5SLV	41270	231056	63431	22162 Vsd < VRd,
-730	0.08	1880	1794	562	-35474	11SLV	32019	231056	54181	22162 Vsd < VRd,
-810	0.08	1880	1794	562	-37045	11SLV	32237	231056	54399	22162 Vsd < VRd,
-890	0.08	1880	1794	562	-38616	11SLV	32456	231056	54617	22162 Vsd < VRd,
-970	0.08	1880	1794	562	-40187	11SLV	32674	231056	54836	22162 Vsd < VRd,
-1050	0.08	1880	1794	562	-41757	11SLV	32892	231056	55054	22162 Vsd < VRd,
-1130	0.08	2100	-2010	-607	-55137	5SLV	39208	231056	61370	22162 Vsd < VRd,
-1210	0.08	2100	-2010	-607	-56708	5SLV	34970	231056	57132	22162 Vsd < VRd,
-1290	0.08	2100	-2010	-607	-58279	5SLV	35189	231056	57350	22162 Vsd < VRd,
-1370	0.08	2100	-2010	-607	-59849	5SLV	35407	231056	57569	22162 Vsd < VRd,
-1450	0.08	2100	-2010	-607	-61420	5SLV	35625	231056	57787	22162 Vsd < VRd,
-1530	0.08	2100	-2010	-607	-62991	5SLV	35844	231056	58005	22162 Vsd < VRd,
-1610	0.08	922	-881	-272	-37833	5SLV	32347	231056	54508	22162 Vsd < VRd,
-1690	0.08	922	-881	-272	-39404	5SLV	32565	231056	54727	22162 Vsd < VRd,
-1770	0.08	922	-881	-272	-40974	5SLV	32783	231056	54945	22162 Vsd < VRd,
-1850	0.08	922	-881	-272	-42545	5SLV	33002	231056	55163	22162 Vsd < VRd,
-1930	0.08	922	-881	-272	-44116	5SLV	33220	231056	55382	22162 Vsd < VRd,
-2010	0.08	89	-82	-34	-26933	4SLU	30832	231056	52993	22162 Vsd < VRd,
-2090	0.08	89	-82	-34	-28975	4SLU	31116	231056	53277	22162 Vsd < VRd,
-2170	0.08	89	-82	-34	-31017	4SLU	35856	231056	58017	22162 Vsd < VRd,
-2250	0.08	89	-82	-34	-33059	4SLU	31683	231056	53845	22162 Vsd < VRd,
-2330	0.08	89	-82	-34	-35101	4SLU	31967	231056	54129	22162 Vsd < VRd,
-2410	0.08	0	0	0	-737	15SLV	27190	231056	49352	22162 Vsd < VRd,
-2490	0.08	0	0	0	-2308	15SLV	27409	231056	49571	22162 Vsd < VRd,

Palo alle coordinate X=-287 Y=-1625



Progetto	Titolo	Rev.	Pag.
Orione	Orione_A24a.pdf "TABULATI DI CALCOLO PLINTO DI FONDAZIONE PER AEROGENERATORE TIPO"	0	217

Sollecitazioni massime in testa palo:

Combinazione corrispondente alla minima compressione in testa

N	Mx	My	Tx	Ty	comb	
-9.089E+04	-3.496E+05	1.9973E+06	4.7191E+03	8.0955E+02	1	sl
-9.089E+04	-3.496E+05	1.9973E+06	4.7191E+03	8.0955E+02	1	ra
-9.089E+04	-3.496E+05	1.9973E+06	4.7191E+03	8.0955E+02	1	fr
-9.089E+04	-3.496E+05	1.9973E+06	4.7191E+03	8.0955E+02	1	qp
-5.972E+04	1.7343E+06	-5.088E+06	-2.319E+04	-7.399E+03	11	SLV fond

Combinazione corrispondente alla massima compressione in testa

N	Mx	My	Tx	Ty	comb	
-1.675E+05	-2.437E+05	3.3105E+06	7.7725E+03	-8.939E+01	4	sl
-1.238E+05	-2.091E+05	2.4733E+06	5.8109E+03	4.8345E+01	2	ra
-1.073E+05	-2.794E+05	2.2353E+06	5.2650E+03	4.2895E+02	2	fr
-1.008E+05	-3.075E+05	2.1401E+06	5.0466E+03	5.8119E+02	2	qp
-1.221E+05	-2.434E+06	9.0828E+06	3.2626E+04	9.0179E+03	5	SLV fond

Combinazione corrispondente al massimo taglio in testa

N	Mx	My	Tx	Ty	comb	
-1.675E+05	-2.437E+05	3.3105E+06	7.7725E+03	-8.939E+01	4	sl
-1.238E+05	-2.091E+05	2.4733E+06	5.8109E+03	4.8345E+01	2	ra
-1.073E+05	-2.794E+05	2.2353E+06	5.2650E+03	4.2895E+02	2	fr
-1.008E+05	-3.075E+05	2.1401E+06	5.0466E+03	5.8119E+02	2	qp
-1.221E+05	-2.434E+06	9.0828E+06	3.2626E+04	9.0179E+03	5	SLV fond

Verifica di capacità portante riferita al palo singolo:

Fattore di correlazione Psi scelto in base alla conoscenza del sito = 1.7  
 Coeff. parziale di sicurezza sulla resistenza laterale = 1.15  
 Coeff. parziale di sicurezza sulla resistenza alla punta = 1.35  
 Portanza laterale di progetto = 292537.1  
 Portanza di punta di progetto = 85555.4  
 verifica condotta in combinazione SLU 4  
 Sforzo normale = -167460.7  
 Peso del palo = 49087.4 \* 1.3  
 Carico totale di progetto = -231274.3  
 Resistenza totale di progetto = 378092.5  
 Coefficiente di sicurezza = 1.63 > 1

Verifica di resistenza allo stato limite:

quota	Af	cop.	c.s.	Mx	My	N	comb
-90	0.0	6.50	0.00	0.0000E+00	0.0000E+00	0.0000E+00	-
-170	78.5	6.00	3.49	-1.729E+06	6.5400E+06	-1.227E+05	5SLV
-250	78.5	6.00	6.48	-1.026E+06	4.0017E+06	-1.243E+05	5SLV
-330	78.5	6.00	11.82	-5.061E+05	2.1105E+06	-9.547E+04	5SLV
-410	78.5	6.00	12.83	-2.131E+05	1.2501E+06	-1.336E+05	4SLU
-490	78.5	6.00	13.59	-1.827E+05	9.1783E+05	-1.356E+05	4SLU
-570	78.5	6.00	13.39	-1.524E+05	5.8559E+05	-1.377E+05	4SLU
-650	78.5	6.00	13.19	-1.220E+05	2.5334E+05	-1.397E+05	4SLU
-730	78.5	6.00	14.45	-4.835E+05	1.6398E+06	-3.566E+04	11SLV
-810	78.5	6.00	15.51	4.5258E+05	-1.541E+06	-7.671E+04	5SLV
-890	78.5	6.00	15.90	4.2536E+05	-1.463E+06	-7.828E+04	5SLV
-970	78.5	6.00	16.30	3.9814E+05	-1.385E+06	-7.985E+04	5SLV
-1050	78.5	6.00	16.49	-2.719E+04	-2.022E+05	-1.118E+05	4SLU
-1130	124.0	6.00	22.78	3.3924E+05	-1.210E+06	-5.498E+04	5SLV
-1210	78.5	6.00	22.16	2.9299E+05	-1.048E+06	-5.655E+04	5SLV
-1290	78.5	6.00	23.05	-3.215E+03	-2.037E+05	-7.995E+04	4SLU
-1370	78.5	6.00	22.48	1.5755E+03	-1.849E+05	-8.199E+04	4SLU
-1450	78.5	6.00	21.93	6.3665E+03	-1.661E+05	-8.403E+04	4SLU
-1530	78.5	6.00	21.41	1.1158E+04	-1.474E+05	-8.608E+04	4SLU
-1610	78.5	6.00	35.43	1.0674E+04	-1.267E+05	-5.202E+04	4SLU
-1690	78.5	6.00	34.10	9.9319E+03	-1.060E+05	-5.406E+04	4SLU
-1770	78.5	6.00	32.85	9.1893E+03	-8.533E+04	-5.610E+04	4SLU
-1850	78.5	6.00	31.70	8.4467E+03	-6.462E+04	-5.814E+04	4SLU
-1930	78.5	6.00	30.63	7.7042E+03	-4.391E+04	-6.019E+04	4SLU
-2010	78.5	6.00	67.30	6.5114E+03	-3.239E+04	-2.739E+04	4SLU
-2090	78.5	6.00	62.63	5.0987E+03	-2.537E+04	-2.943E+04	4SLU
-2170	124.0	6.00	64.64	3.6861E+03	-1.834E+04	-3.147E+04	4SLU
-2250	78.5	6.00	55.00	2.2734E+03	-1.131E+04	-3.351E+04	4SLU
-2330	78.5	6.00	51.84	8.6080E+02	-4.282E+03	-3.555E+04	4SLU
-2410	78.5	6.00	100.00	2.1228E-11	-6.489E-11	-3.469E+03	4SLU
-2490	78.5	6.00	100.00	7.5860E-12	-2.361E-12	-5.511E+03	4SLU

Verifica di esercizio (combinazione rara):

quota	Af	cop.	sigmaf	sigmac	Mx	My	N	comb	Wk
-90	0.0	6.50	0.0	0.0	0.0000E+00	0.0000E+00	0.0000E+00	-	0.000
-170	78.5	6.00		30.9	-2.034E+05	2.0163E+06	-1.245E+05	2	0.000
-170	78.5	6.00	35.7		-2.851E+05	1.6261E+06	-9.183E+04	1	0.000
-250	78.5	6.00		27.1	-1.976E+05	1.5598E+06	-1.261E+05	2	0.000
-330	78.5	6.00		20.8	-1.846E+05	1.1814E+06	-9.711E+04	2	0.000
-410	78.5	6.00		18.9	-1.597E+05	9.3318E+05	-9.868E+04	2	0.000
-490	78.5	6.00		17.0	-1.347E+05	6.8500E+05	-1.003E+05	2	0.000
-570	78.5	6.00		15.1	-1.098E+05	4.3681E+05	-1.018E+05	2	0.000
-650	78.5	6.00		13.2	-8.482E+04	1.8862E+05	-1.034E+05	2	0.000
-730	78.5	6.00		9.1	-6.460E+04	1.7655E+04	-7.645E+04	2	0.000



Tabulati di Calcolo Plinto di Fondazione per Aerogeneratore Tipo - Progetto Impianto Eolico - "Orione"

-810	78.5	6.00	9.2	-5.226E+04	-2.460E+04	-7.802E+04	2	0.000
-890	78.5	6.00	9.5	-3.991E+04	-6.685E+04	-7.959E+04	2	0.000
-970	78.5	6.00	10.0	-2.757E+04	-1.091E+05	-8.116E+04	2	0.000
-1050	78.5	6.00	10.5	-1.522E+04	-1.513E+05	-8.273E+04	2	0.000
-1130	124.0	6.00	7.1	-5.087E+03	-1.804E+05	-5.595E+04	2	0.000
-1210	78.5	6.00	7.8	-2.164E+03	-1.663E+05	-5.752E+04	2	0.000
-1290	78.5	6.00	7.8	7.5951E+02	-1.523E+05	-5.909E+04	2	0.000
-1370	78.5	6.00	7.9	3.6829E+03	-1.382E+05	-6.066E+04	2	0.000
-1450	78.5	6.00	8.0	6.6062E+03	-1.242E+05	-6.223E+04	2	0.000
-1530	78.5	6.00	8.0	9.5296E+03	-1.101E+05	-6.381E+04	2	0.000
-1610	78.5	6.00	5.1	8.9145E+03	-9.468E+04	-3.838E+04	2	0.000
-1690	78.5	6.00	5.1	8.1254E+03	-7.921E+04	-3.995E+04	2	0.000
-1770	78.5	6.00	5.2	7.3362E+03	-6.373E+04	-4.153E+04	2	0.000
-1850	78.5	6.00	5.2	6.5471E+03	-4.825E+04	-4.310E+04	2	0.000
-1930	78.5	6.00	5.2	5.7580E+03	-3.278E+04	-4.467E+04	2	0.000
-2010	78.5	6.00	2.4	4.7994E+03	-2.418E+04	-2.018E+04	2	0.000
-2090	78.5	6.00	2.6	3.7582E+03	-1.893E+04	-2.175E+04	2	0.000
-2170	124.0	6.00	2.5	2.7170E+03	-1.369E+04	-2.332E+04	2	0.000
-2250	78.5	6.00	2.8	1.6757E+03	-8.441E+03	-2.489E+04	2	0.000
-2330	78.5	6.00	3.0	6.3448E+02	-3.196E+03	-2.646E+04	2	0.000
-2410	78.5	6.00	0.3	1.4637E-11	-4.865E-11	-2.498E+03	2	0.000
-2490	78.5	6.00	0.5	5.5424E-12	-9.032E-13	-4.069E+03	2	0.000

Verifica di esercizio (combinazione quasi permanente):

quota	Af	cop.	sigmaf	sigmac	Mx	My	N	comb	Wk
-90	0.0	6.50	0.0	0.0	0.0000E+00	0.0000E+00	0.0000E+00	-	0.000
-170	78.5	6.00		26.2	-2.606E+05	1.7432E+06	-1.016E+05	2	0.000
-170	78.5	6.00	35.7		-2.851E+05	1.6261E+06	-9.183E+04	1	0.000
-250	78.5	6.00		22.8	-2.137E+05	1.3467E+06	-1.032E+05	2	0.000
-330	78.5	6.00		17.3	-1.724E+05	1.0185E+06	-7.849E+04	2	0.000
-410	78.5	6.00		15.7	-1.402E+05	8.0390E+05	-8.006E+04	2	0.000
-490	78.5	6.00		14.1	-1.081E+05	5.8931E+05	-8.163E+04	2	0.000
-570	78.5	6.00		12.4	-7.589E+04	3.7472E+05	-8.320E+04	2	0.000
-650	78.5	6.00		10.8	-4.373E+04	1.6014E+05	-8.477E+04	2	0.000
-730	78.5	6.00		7.1	-2.069E+04	1.2457E+04	-6.171E+04	2	0.000
-810	78.5	6.00		7.3	-1.285E+04	-2.371E+04	-6.329E+04	2	0.000
-890	78.5	6.00		7.7	-5.005E+03	-5.988E+04	-6.486E+04	2	0.000
-970	78.5	6.00		8.2	2.8374E+03	-9.605E+04	-6.643E+04	2	0.000
-1050	78.5	6.00		8.7	1.0680E+04	-1.322E+05	-6.800E+04	2	0.000
-1130	124.0	6.00		5.8	1.6557E+04	-1.570E+05	-4.500E+04	2	0.000
-1210	78.5	6.00		6.4	1.6013E+04	-1.447E+05	-4.657E+04	2	0.000
-1290	78.5	6.00		6.5	1.5469E+04	-1.323E+05	-4.814E+04	2	0.000
-1370	78.5	6.00		6.5	1.4925E+04	-1.200E+05	-4.971E+04	2	0.000
-1450	78.5	6.00		6.6	1.4382E+04	-1.076E+05	-5.129E+04	2	0.000
-1530	78.5	6.00		6.7	1.3838E+04	-9.526E+04	-5.286E+04	2	0.000
-1610	78.5	6.00		4.1	1.2115E+04	-8.189E+04	-3.097E+04	2	0.000
-1690	78.5	6.00		4.2	1.0334E+04	-6.848E+04	-3.254E+04	2	0.000
-1770	78.5	6.00		4.3	8.5536E+03	-5.506E+04	-3.411E+04	2	0.000
-1850	78.5	6.00		4.3	6.7728E+03	-4.165E+04	-3.568E+04	2	0.000
-1930	78.5	6.00		4.4	4.9921E+03	-2.823E+04	-3.725E+04	2	0.000
-2010	78.5	6.00		2.0	3.8470E+03	-2.080E+04	-1.613E+04	2	0.000
-2090	78.5	6.00		2.1	3.0124E+03	-1.629E+04	-1.770E+04	2	0.000
-2170	124.0	6.00		2.1	2.1778E+03	-1.177E+04	-1.927E+04	2	0.000
-2250	78.5	6.00		2.4	1.3432E+03	-7.262E+03	-2.084E+04	2	0.000
-2330	78.5	6.00		2.5	5.0858E+02	-2.750E+03	-2.241E+04	2	0.000
-2410	78.5	6.00		0.2	6.9378E-12	-4.291E-11	-1.725E+03	2	0.000
-2490	78.5	6.00		0.4	4.2093E-12	3.2500E-12	-3.296E+03	2	0.000

Verifica a taglio:

quota	Ast	Vsd	Vsdx	Vsdy	N	comb	VRd,c	VRd,max	VRd,S	Vwd
-90	0.16	33850	32626	9018	-122063	5SLV	40166	231056	84490	44323 Vsd < VRd,
-170	0.16	32924	31729	8789	-122693	5SLV	44142	231056	88465	44323 Vsd < VRd,
-250	0.08	32924	31729	8789	-124263	5SLV	44360	231056	66522	22162 Vsd < VRd,
-330	0.08	10510	10160	2692	-95475	5SLV	40359	231056	62520	22162 Vsd < VRd,
-410	0.08	10510	10160	2692	-97045	5SLV	40577	231056	62739	22162 Vsd < VRd,
-490	0.08	10510	10160	2692	-98616	5SLV	40795	231056	62957	22162 Vsd < VRd,
-570	0.08	10510	10160	2692	-100187	5SLV	41014	231056	63175	22162 Vsd < VRd,
-650	0.08	10510	10160	2692	-101758	5SLV	41232	231056	63394	22162 Vsd < VRd,
-730	0.08	1879	1814	488	-35661	11SLV	32045	231056	54206	22162 Vsd < VRd,
-810	0.08	1879	1814	488	-37231	11SLV	32263	231056	54425	22162 Vsd < VRd,
-890	0.08	1879	1814	488	-38802	11SLV	32481	231056	54643	22162 Vsd < VRd,
-970	0.08	1879	1814	488	-40373	11SLV	32700	231056	54861	22162 Vsd < VRd,
-1050	0.08	1879	1814	488	-41944	11SLV	32918	231056	55080	22162 Vsd < VRd,
-1130	0.08	2099	-2018	-578	-54978	5SLV	39186	231056	61348	22162 Vsd < VRd,
-1210	0.08	2099	-2018	-578	-56549	5SLV	34948	231056	57110	22162 Vsd < VRd,
-1290	0.08	2099	-2018	-578	-58120	5SLV	35167	231056	57328	22162 Vsd < VRd,
-1370	0.08	2099	-2018	-578	-59691	5SLV	35385	231056	57547	22162 Vsd < VRd,
-1450	0.08	2099	-2018	-578	-61261	5SLV	35603	231056	57765	22162 Vsd < VRd,
-1530	0.08	2099	-2018	-578	-62832	5SLV	35822	231056	57983	22162 Vsd < VRd,
-1610	0.08	922	-889	-243	-37725	5SLV	32332	231056	54493	22162 Vsd < VRd,
-1690	0.08	922	-889	-243	-39296	5SLV	32550	231056	54712	22162 Vsd < VRd,
-1770	0.08	922	-889	-243	-40867	5SLV	32768	231056	54930	22162 Vsd < VRd,
-1850	0.08	922	-889	-243	-42438	5SLV	32987	231056	55148	22162 Vsd < VRd,
-1930	0.08	922	-889	-243	-44009	5SLV	33205	231056	55367	22162 Vsd < VRd,
-2010	0.08	90	-88	-18	-27387	4SLU	30895	231056	53056	22162 Vsd < VRd,
-2090	0.08	90	-88	-18	-29429	4SLU	31179	231056	53340	22162 Vsd < VRd,



Progetto	Titolo	Rev.	Pag.
Orione	Orione_A24a.pdf "TABULATI DI CALCOLO PLINTO DI FONDAZIONE PER AEROGENERATORE TIPO"	0	219

**Tabulati di Calcolo Plinto di Fondazione per Aerogeneratore Tipo - Progetto Impianto Eolico - "Orione"**

-2170	0.08	90	-88	-18	-31471	4SLU	35919	231056	58080	22162	Vsd < VRd,
-2250	0.08	90	-88	-18	-33513	4SLU	31746	231056	53908	22162	Vsd < VRd,
-2330	0.08	90	-88	-18	-35555	4SLU	32030	231056	54192	22162	Vsd < VRd,
-2410	0.08	0	0	0	-473	7SLV	27154	231056	49315	22162	Vsd < VRd,
-2490	0.08	0	0	0	-2044	7SLV	27372	231056	49534	22162	Vsd < VRd,

Palo alle coordinate X=0 Y=-1650

Sollecitazioni massime in testa palo:

Combinazione corrispondente alla minima compressione in testa

N	Mx	My	Tx	Ty	comb	
-9.085E+04	1.6897E+03	2.0283E+06	4.7909E+03	-3.931E+00	1	sl
-9.085E+04	1.6897E+03	2.0283E+06	4.7909E+03	-3.931E+00	1	ra
-9.085E+04	1.6897E+03	2.0283E+06	4.7909E+03	-3.931E+00	1	fr
-9.085E+04	1.6897E+03	2.0283E+06	4.7909E+03	-3.931E+00	1	qp
-6.094E+04	2.0667E+06	-5.056E+06	-2.311E+04	-8.145E+03	11	SLV fond

Combinazione corrispondente alla massima compressione in testa

N	Mx	My	Tx	Ty	comb	
-1.685E+05	3.9962E+05	3.3631E+06	7.8606E+03	-1.572E+03	4	sl
-1.245E+05	2.6664E+05	2.5125E+06	5.8792E+03	-1.049E+03	2	ra
-1.077E+05	1.3417E+05	2.2704E+06	5.3351E+03	-5.264E+02	2	fr
-1.009E+05	8.1175E+04	2.1735E+06	5.1174E+03	-3.174E+02	2	qp
-1.208E+05	-2.063E+06	9.1123E+06	3.2693E+04	8.1370E+03	5	SLV fond

Combinazione corrispondente al massimo taglio in testa

N	Mx	My	Tx	Ty	comb	
-1.685E+05	3.9962E+05	3.3631E+06	7.8606E+03	-1.572E+03	4	sl
-1.245E+05	2.6664E+05	2.5125E+06	5.8792E+03	-1.049E+03	2	ra
-1.077E+05	1.3417E+05	2.2704E+06	5.3351E+03	-5.264E+02	2	fr
-1.009E+05	8.1175E+04	2.1735E+06	5.1174E+03	-3.174E+02	2	qp
-1.208E+05	-2.063E+06	9.1123E+06	3.2693E+04	8.1370E+03	5	SLV fond

Verifica di capacità portante riferita al palo singolo:

Fattore di correlazione Psi scelto in base alla conoscenza del sito = 1.7  
 Coeff. parziale di sicurezza sulla resistenza laterale = 1.15  
 Coeff. parziale di sicurezza sulla resistenza alla punta = 1.35  
 Portanza laterale di progetto = 292537.1  
 Portanza di punta di progetto = 85555.4  
 verifica condotta in combinazione SLU 4  
 Sforzo normale = -168509  
 Peso del palo = 49087.4 \* 1.3  
 Carico totale di progetto = -232322.6  
 Resistenza totale di progetto = 378092.5  
 Coefficiente di sicurezza = 1.63 > 1

Verifica di resistenza allo stato limite:

quota	Af	cop.	c.s.	Mx	My	N	comb
-90	0.0	6.50	0.00	0.0000E+00	0.0000E+00	0.0000E+00	-
-170	78.5	6.00	3.51	1.4305E+06	6.5644E+06	-1.214E+05	9SLV
-250	78.5	6.00	6.53	7.9737E+05	4.0207E+06	-1.230E+05	9SLV
-330	78.5	6.00	11.92	6.5312E+04	1.6141E+06	-1.324E+05	4SLU
-410	78.5	6.00	12.74	3.0759E+04	1.2763E+06	-1.345E+05	4SLU
-490	78.5	6.00	13.50	-3.795E+03	9.3842E+05	-1.365E+05	4SLU
-570	78.5	6.00	13.30	-3.835E+04	6.0057E+05	-1.385E+05	4SLU
-650	78.5	6.00	13.11	-7.290E+04	2.6273E+05	-1.406E+05	4SLU
-730	78.5	6.00	14.58	-4.784E+05	1.6397E+06	-3.644E+04	11SLV
-810	78.5	6.00	15.59	4.4536E+05	-1.541E+06	-7.588E+04	5SLV
-890	78.5	6.00	15.98	4.1235E+05	-1.464E+06	-7.745E+04	5SLV
-970	78.5	6.00	16.40	3.7934E+05	-1.387E+06	-7.902E+04	5SLV
-1050	78.5	6.00	16.39	-6.684E+04	-2.033E+05	-1.124E+05	4SLU
-1130	124.0	6.00	22.94	3.1077E+05	-1.212E+06	-5.436E+04	5SLV
-1210	78.5	6.00	22.31	2.6690E+05	-1.050E+06	-5.593E+04	5SLV
-1290	78.5	6.00	22.91	-4.309E+04	-2.060E+05	-8.045E+04	4SLU
-1370	78.5	6.00	22.34	-3.463E+04	-1.872E+05	-8.249E+04	4SLU
-1450	78.5	6.00	21.80	-2.617E+04	-1.685E+05	-8.453E+04	4SLU
-1530	78.5	6.00	21.29	-1.770E+04	-1.497E+05	-8.657E+04	4SLU
-1610	78.5	6.00	35.21	-1.415E+04	-1.288E+05	-5.236E+04	4SLU
-1690	78.5	6.00	33.88	-1.085E+04	-1.078E+05	-5.440E+04	4SLU
-1770	78.5	6.00	32.66	-7.538E+03	-8.684E+04	-5.644E+04	4SLU
-1850	78.5	6.00	31.52	-4.230E+03	-6.584E+04	-5.848E+04	4SLU
-1930	78.5	6.00	30.45	-9.219E+02	-4.484E+04	-6.052E+04	4SLU
-2010	78.5	6.00	66.85	1.4277E+02	-3.312E+04	-2.757E+04	4SLU
-2090	78.5	6.00	62.24	1.1180E+02	-2.594E+04	-2.961E+04	4SLU
-2170	124.0	6.00	64.26	8.0822E+01	-1.875E+04	-3.166E+04	4SLU
-2250	78.5	6.00	54.70	4.9847E+01	-1.157E+04	-3.370E+04	4SLU
-2330	78.5	6.00	51.57	1.8872E+01	-4.379E+03	-3.574E+04	4SLU
-2410	78.5	6.00	100.00	1.6366E-11	-4.962E-11	-3.504E+03	4SLU
-2490	78.5	6.00	100.00	1.6389E-11	-2.927E-11	-5.546E+03	4SLU

Verifica di esercizio (combinazione rara):



<b>Progetto</b>	<b>Titolo</b>	<b>Rev.</b>	<b>Pag.</b>
Orione	Orione_A24a.pdf "TABULATI DI CALCOLO PLINTO DI FONDAZIONE PER AEROGENERATORE TIPO"	0	220

Tabulati di Calcolo Plinto di Fondazione per Aerogeneratore Tipo - Progetto Impianto Eolico - "Orione"

quota	Af	cop.	sigmaf	sigmac	Mx	My	N	comb	Wk
-90	0.0	6.50	0.0	0.0	0.0000E+00	0.0000E+00	0.0000E+00	-	0.000
-170	78.5	6.00		31.2	1.8490E+05	2.0500E+06	-1.252E+05	2	0.000
-170	78.5	6.00	35.9		1.3765E+03	1.6514E+06	-9.179E+04	1	0.000
-250	78.5	6.00		27.4	1.0330E+05	1.5879E+06	-1.268E+05	2	0.000
-330	78.5	6.00		20.9	4.3649E+04	1.2045E+06	-9.767E+04	2	0.000
-410	78.5	6.00		19.0	2.0590E+04	9.5220E+05	-9.924E+04	2	0.000
-490	78.5	6.00		17.0	-2.468E+03	6.9986E+05	-1.008E+05	2	0.000
-570	78.5	6.00		15.1	-2.553E+04	4.4752E+05	-1.024E+05	2	0.000
-650	78.5	6.00		13.2	-4.858E+04	1.9518E+05	-1.040E+05	2	0.000
-730	78.5	6.00		9.1	-6.142E+04	2.1204E+04	-7.689E+04	2	0.000
-810	78.5	6.00		9.2	-5.721E+04	-2.217E+04	-7.846E+04	2	0.000
-890	78.5	6.00		9.6	-5.300E+04	-6.555E+04	-8.003E+04	2	0.000
-970	78.5	6.00		10.1	-4.879E+04	-1.089E+05	-8.160E+04	2	0.000
-1050	78.5	6.00		10.6	-4.458E+04	-1.523E+05	-8.318E+04	2	0.000
-1130	124.0	6.00		7.2	-4.003E+04	-1.822E+05	-5.628E+04	2	0.000
-1210	78.5	6.00		7.9	-3.439E+04	-1.681E+05	-5.785E+04	2	0.000
-1290	78.5	6.00		7.9	-2.874E+04	-1.541E+05	-5.942E+04	2	0.000
-1370	78.5	6.00		8.0	-2.310E+04	-1.400E+05	-6.099E+04	2	0.000
-1450	78.5	6.00		8.0	-1.746E+04	-1.259E+05	-6.256E+04	2	0.000
-1530	78.5	6.00		8.1	-1.181E+04	-1.119E+05	-6.414E+04	2	0.000
-1610	78.5	6.00		5.1	-9.444E+03	-9.624E+04	-3.861E+04	2	0.000
-1690	78.5	6.00		5.1	-7.238E+03	-8.054E+04	-4.018E+04	2	0.000
-1770	78.5	6.00		5.2	-5.031E+03	-6.485E+04	-4.175E+04	2	0.000
-1850	78.5	6.00		5.2	-2.824E+03	-4.915E+04	-4.332E+04	2	0.000
-1930	78.5	6.00		5.3	-6.176E+02	-3.346E+04	-4.489E+04	2	0.000
-2010	78.5	6.00		2.5	9.2981E+01	-2.470E+04	-2.030E+04	2	0.000
-2090	78.5	6.00		2.6	7.2808E+01	-1.934E+04	-2.187E+04	2	0.000
-2170	124.0	6.00		2.5	5.2636E+01	-1.398E+04	-2.344E+04	2	0.000
-2250	78.5	6.00		2.9	3.2463E+01	-8.625E+03	-2.501E+04	2	0.000
-2330	78.5	6.00		3.0	1.2290E+01	-3.266E+03	-2.658E+04	2	0.000
-2410	78.5	6.00		0.3	1.0910E-11	-3.697E-11	-2.522E+03	2	0.000
-2490	78.5	6.00		0.5	1.0928E-11	-2.219E-11	-4.092E+03	2	0.000

Verifica di esercizio (combinazione quasi permanente):

quota	Af	cop.	sigmaf	sigmac	Mx	My	N	comb	Wk
-90	0.0	6.50	0.0	0.0	0.0000E+00	0.0000E+00	0.0000E+00	-	0.000
-170	78.5	6.00		26.3	5.6433E+04	1.7710E+06	-1.018E+05	2	0.000
-170	78.5	6.00	35.9		1.3765E+03	1.6514E+06	-9.179E+04	1	0.000
-250	78.5	6.00		22.9	3.1733E+04	1.3689E+06	-1.034E+05	2	0.000
-330	78.5	6.00		17.4	1.3657E+04	1.0358E+06	-7.863E+04	2	0.000
-410	78.5	6.00		15.7	6.6208E+03	8.1777E+05	-8.020E+04	2	0.000
-490	78.5	6.00		14.1	-4.159E+02	5.9976E+05	-8.177E+04	2	0.000
-570	78.5	6.00		12.5	-7.453E+03	3.8174E+05	-8.334E+04	2	0.000
-650	78.5	6.00		10.8	-1.449E+04	1.6372E+05	-8.491E+04	2	0.000
-730	78.5	6.00		7.1	-1.842E+04	1.3628E+04	-6.183E+04	2	0.000
-810	78.5	6.00		7.3	-1.718E+04	-2.324E+04	-6.340E+04	2	0.000
-890	78.5	6.00		7.7	-1.593E+04	-6.012E+04	-6.497E+04	2	0.000
-970	78.5	6.00		8.2	-1.469E+04	-9.699E+04	-6.654E+04	2	0.000
-1050	78.5	6.00		8.7	-1.345E+04	-1.339E+05	-6.811E+04	2	0.000
-1130	124.0	6.00		5.9	-1.210E+04	-1.592E+05	-4.509E+04	2	0.000
-1210	78.5	6.00		6.4	-1.040E+04	-1.467E+05	-4.666E+04	2	0.000
-1290	78.5	6.00		6.5	-8.697E+03	-1.342E+05	-4.823E+04	2	0.000
-1370	78.5	6.00		6.6	-6.997E+03	-1.217E+05	-4.980E+04	2	0.000
-1450	78.5	6.00		6.6	-5.297E+03	-1.092E+05	-5.137E+04	2	0.000
-1530	78.5	6.00		6.7	-3.597E+03	-9.676E+04	-5.294E+04	2	0.000
-1610	78.5	6.00		4.1	-2.879E+03	-8.320E+04	-3.103E+04	2	0.000
-1690	78.5	6.00		4.2	-2.209E+03	-6.958E+04	-3.260E+04	2	0.000
-1770	78.5	6.00		4.3	-1.540E+03	-5.596E+04	-3.417E+04	2	0.000
-1850	78.5	6.00		4.3	-8.705E+02	-4.234E+04	-3.574E+04	2	0.000
-1930	78.5	6.00		4.4	-2.010E+02	-2.872E+04	-3.731E+04	2	0.000
-2010	78.5	6.00		2.0	1.6344E+01	-2.117E+04	-1.616E+04	2	0.000
-2090	78.5	6.00		2.1	1.2798E+01	-1.658E+04	-1.773E+04	2	0.000
-2170	124.0	6.00		2.1	9.2521E+00	-1.198E+04	-1.930E+04	2	0.000
-2250	78.5	6.00		2.4	5.7061E+00	-7.392E+03	-2.087E+04	2	0.000
-2330	78.5	6.00		2.5	2.1602E+00	-2.799E+03	-2.244E+04	2	0.000
-2410	78.5	6.00		0.2	3.2705E-12	-3.152E-11	-1.731E+03	2	0.000
-2490	78.5	6.00		0.4	3.2882E-12	-2.072E-11	-3.302E+03	2	0.000

Verifica a taglio:

quota	Ast	Vsd	Vsdx	Vsdy	N comb	VRd, c	VRd, max	VRd, S	Vwd
-90	0.16	33690	32693	8137	-120764 5SLV	39986	231056	84309	44323 Vsd < VRd,
-170	0.16	32765	31796	7913	-121400 5SLV	43962	231056	88286	44323 Vsd < VRd,
-250	0.08	32765	31796	7913	-122971 5SLV	44181	231056	66342	22162 Vsd < VRd,
-330	0.08	10438	10197	-2230	-94417 9SLV	40212	231056	62373	22162 Vsd < VRd,
-410	0.08	10438	10197	-2230	-95988 9SLV	40430	231056	62592	22162 Vsd < VRd,
-490	0.08	10438	10197	-2230	-97558 9SLV	40648	231056	62810	22162 Vsd < VRd,
-570	0.08	10438	10197	-2230	-99129 9SLV	40867	231056	63028	22162 Vsd < VRd,
-650	0.08	10438	10197	-2230	-100700 9SLV	41085	231056	63247	22162 Vsd < VRd,
-730	0.08	1867	1820	-412	-36445 7SLV	32154	231056	54315	22162 Vsd < VRd,
-810	0.08	1867	1820	-412	-38016 7SLV	32372	231056	54534	22162 Vsd < VRd,
-890	0.08	1867	1820	-412	-39587 7SLV	32590	231056	54752	22162 Vsd < VRd,
-970	0.08	1867	1820	-412	-41157 7SLV	32809	231056	54970	22162 Vsd < VRd,
-1050	0.08	1867	1820	-412	-42728 7SLV	33027	231056	55189	22162 Vsd < VRd,
-1130	0.08	2093	-2020	-548	-54360 5SLV	39100	231056	61262	22162 Vsd < VRd,
-1210	0.08	2093	-2020	-548	-55931 5SLV	34862	231056	57024	22162 Vsd < VRd,



Progetto	Titolo	Rev.	Pag.
Orione	Orione_A24a.pdf "TABULATI DI CALCOLO PLINTO DI FONDAZIONE PER AEROGENERATORE TIPO"	0	221

-1290	0.08	2093	-2020	-548	-57501	5SLV	35081	231056	57242	22162	Vsd < VRd,
-1370	0.08	2093	-2020	-548	-59072	5SLV	35299	231056	57461	22162	Vsd < VRd,
-1450	0.08	2093	-2020	-548	-60643	5SLV	35517	231056	57679	22162	Vsd < VRd,
-1530	0.08	2093	-2020	-548	-62214	5SLV	35736	231056	57897	22162	Vsd < VRd,
-1610	0.08	917	-891	214	-37304	9SLV	32273	231056	54435	22162	Vsd < VRd,
-1690	0.08	917	-891	214	-38875	9SLV	32492	231056	54653	22162	Vsd < VRd,
-1770	0.08	917	-891	214	-40446	9SLV	32710	231056	54872	22162	Vsd < VRd,
-1850	0.08	917	-891	214	-42017	9SLV	32928	231056	55090	22162	Vsd < VRd,
-1930	0.08	917	-891	214	-43587	9SLV	33147	231056	55308	22162	Vsd < VRd,
-2010	0.08	90	-90	0	-27571	4SLU	30920	231056	53082	22162	Vsd < VRd,
-2090	0.08	90	-90	0	-29613	4SLU	31204	231056	53366	22162	Vsd < VRd,
-2170	0.08	90	-90	0	-31655	4SLU	35944	231056	58106	22162	Vsd < VRd,
-2250	0.08	90	-90	0	-33697	4SLU	31772	231056	53934	22162	Vsd < VRd,
-2330	0.08	90	-90	0	-35739	4SLU	32056	231056	54217	22162	Vsd < VRd,
-2410	0.08	0	0	0	-2386	9SLV	27420	231056	49581	22162	Vsd < VRd,
-2490	0.08	0	0	0	-3957	9SLV	27638	231056	49800	22162	Vsd < VRd,

Palo alle coordinate X=287 Y=-1625

Sollecitazioni massime in testa palo:

Combinazione corrispondente alla minima compressione in testa

N	Mx	My	Tx	Ty	comb	
-9.080E+04	3.5295E+05	1.9978E+06	4.7204E+03	-8.173E+02	1	sl
-9.080E+04	3.5295E+05	1.9978E+06	4.7204E+03	-8.173E+02	1	ra
-9.080E+04	3.5295E+05	1.9978E+06	4.7204E+03	-8.173E+02	1	fr
-9.080E+04	3.5295E+05	1.9978E+06	4.7204E+03	-8.173E+02	1	qp
-5.964E+04	-1.732E+06	-5.087E+06	-2.319E+04	7.3961E+03	7	SLV fond

Combinazione corrispondente alla massima compressione in testa

N	Mx	My	Tx	Ty	comb	
-1.680E+05	1.0397E+06	3.2705E+06	7.6143E+03	-3.042E+03	4	sl
-1.241E+05	7.4016E+05	2.4467E+06	5.7056E+03	-2.137E+03	2	ra
-1.075E+05	5.4655E+05	2.2222E+06	5.2130E+03	-1.477E+03	2	fr
-1.008E+05	4.6911E+05	2.1325E+06	5.0160E+03	-1.213E+03	2	qp
-1.220E+05	2.4383E+06	9.0830E+06	3.2626E+04	-9.031E+03	9	SLV fond

Combinazione corrispondente al massimo taglio in testa

N	Mx	My	Tx	Ty	comb	
-1.680E+05	1.0397E+06	3.2705E+06	7.6143E+03	-3.042E+03	4	sl
-1.241E+05	7.4016E+05	2.4467E+06	5.7056E+03	-2.137E+03	2	ra
-1.075E+05	5.4655E+05	2.2222E+06	5.2130E+03	-1.477E+03	2	fr
-1.008E+05	4.6911E+05	2.1325E+06	5.0160E+03	-1.213E+03	2	qp
-1.220E+05	2.4383E+06	9.0830E+06	3.2626E+04	-9.031E+03	9	SLV fond

Verifica di capacità portante riferita al palo singolo:

Fattore di correlazione Psi scelto in base alla conoscenza del sito = 1.7  
 Coeff. parziale di sicurezza sulla resistenza laterale = 1.15  
 Coeff. parziale di sicurezza sulla resistenza alla punta = 1.35  
 Portanza laterale di progetto = 292537.1  
 Portanza di punta di progetto = 85555.4  
 verifica condotta in combinazione SLU 4  
 Sforzo normale = -168016.7  
 Peso del palo = 49087.4 \* 1.3  
 Carico totale di progetto = -231830.3  
 Resistenza totale di progetto = 378092.5  
 Coefficiente di sicurezza = 1.63 > 1

Verifica di resistenza allo stato limite:

quota	Af	cop.	c.s.	Mx	My	N	comb
-90	0.0	6.50	0.00	0.0000E+00	0.0000E+00	0.0000E+00	-
-170	78.5	6.00	3.49	1.7330E+06	6.5403E+06	-1.226E+05	9SLV
-250	78.5	6.00	6.48	1.0289E+06	4.0019E+06	-1.242E+05	9SLV
-330	78.5	6.00	11.82	5.0790E+05	2.1107E+06	-9.539E+04	9SLV
-410	78.5	6.00	12.77	2.7438E+05	1.2471E+06	-1.341E+05	4SLU
-490	78.5	6.00	13.54	1.7519E+05	9.1834E+05	-1.361E+05	4SLU
-570	78.5	6.00	13.34	7.5993E+04	5.8956E+05	-1.381E+05	4SLU
-650	78.5	6.00	13.15	-2.320E+04	2.6077E+05	-1.402E+05	4SLU
-730	78.5	6.00	14.45	4.8383E+05	1.6396E+06	-3.561E+04	7SLV
-810	78.5	6.00	15.52	-4.529E+05	-1.541E+06	-7.665E+04	9SLV
-890	78.5	6.00	15.90	-4.257E+05	-1.463E+06	-7.822E+04	9SLV
-970	78.5	6.00	16.31	-3.985E+05	-1.385E+06	-7.979E+04	9SLV
-1050	78.5	6.00	16.44	-1.059E+05	-1.955E+05	-1.121E+05	4SLU
-1130	124.0	6.00	22.79	-3.397E+05	-1.210E+06	-5.493E+04	9SLV
-1210	78.5	6.00	22.16	-2.934E+05	-1.048E+06	-5.650E+04	9SLV
-1290	78.5	6.00	22.98	-8.262E+04	-1.993E+05	-8.022E+04	4SLU
-1370	78.5	6.00	22.41	-7.055E+04	-1.814E+05	-8.226E+04	4SLU
-1450	78.5	6.00	21.87	-5.849E+04	-1.635E+05	-8.430E+04	4SLU
-1530	78.5	6.00	21.35	-4.642E+04	-1.456E+05	-8.634E+04	4SLU
-1610	78.5	6.00	35.31	-3.887E+04	-1.253E+05	-5.220E+04	4SLU
-1690	78.5	6.00	33.98	-3.153E+04	-1.049E+05	-5.424E+04	4SLU
-1770	78.5	6.00	32.75	-2.420E+04	-8.457E+04	-5.628E+04	4SLU
-1850	78.5	6.00	31.60	-1.687E+04	-6.420E+04	-5.832E+04	4SLU
-1930	78.5	6.00	30.53	-9.540E+03	-4.382E+04	-6.037E+04	4SLU



Tabulati di Calcolo Plinto di Fondazione per Aerogeneratore Tipo - Progetto Impianto Eolico - "Orione"

-2010	78.5	6.00	67.06	-6.227E+03	-3.241E+04	-2.748E+04	4SLU
-2090	78.5	6.00	62.43	-4.876E+03	-2.538E+04	-2.953E+04	4SLU
-2170	124.0	6.00	64.44	-3.525E+03	-1.835E+04	-3.157E+04	4SLU
-2250	78.5	6.00	54.84	-2.174E+03	-1.132E+04	-3.361E+04	4SLU
-2330	78.5	6.00	51.70	-8.232E+02	-4.285E+03	-3.565E+04	4SLU
-2410	78.5	6.00	100.00	2.1238E-12	-1.885E-11	-3.487E+03	4SLU
-2490	78.5	6.00	100.00	-1.287E-12	3.6970E-11	-5.529E+03	4SLU

Verifica di esercizio (combinazione rara):

quota	Af	cop.	sigmaf	sigmac	Mx	My	N	comb	Wk
-90	0.0	6.50	0.0	0.0	0.0000E+00	0.0000E+00	0.0000E+00	-	0.000
-170	78.5	6.00	36.1	31.4	5.7166E+05	1.9979E+06	-1.249E+05	2	0.000
-170	78.5	6.00	36.1		2.8783E+05	1.6266E+06	-9.175E+04	1	0.000
-250	78.5	6.00		27.4	4.0333E+05	1.5495E+06	-1.265E+05	2	0.000
-330	78.5	6.00		20.9	2.7154E+05	1.1771E+06	-9.740E+04	2	0.000
-410	78.5	6.00		18.9	2.0067E+05	9.3124E+05	-9.897E+04	2	0.000
-490	78.5	6.00		17.0	1.2979E+05	6.8535E+05	-1.005E+05	2	0.000
-570	78.5	6.00		15.1	5.8921E+04	4.3946E+05	-1.021E+05	2	0.000
-650	78.5	6.00		13.1	-1.195E+04	1.9357E+05	-1.037E+05	2	0.000
-730	78.5	6.00		9.0	-5.773E+04	2.3886E+04	-7.668E+04	2	0.000
-810	78.5	6.00		9.2	-6.169E+04	-1.880E+04	-7.825E+04	2	0.000
-890	78.5	6.00		9.6	-6.565E+04	-6.148E+04	-7.982E+04	2	0.000
-970	78.5	6.00		10.1	-6.961E+04	-1.042E+05	-8.139E+04	2	0.000
-1050	78.5	6.00		10.6	-7.357E+04	-1.468E+05	-8.296E+04	2	0.000
-1130	124.0	6.00		7.2	-7.465E+04	-1.764E+05	-5.612E+04	2	0.000
-1210	78.5	6.00		7.9	-6.633E+04	-1.629E+05	-5.769E+04	2	0.000
-1290	78.5	6.00		7.9	-5.801E+04	-1.494E+05	-5.926E+04	2	0.000
-1370	78.5	6.00		8.0	-4.969E+04	-1.359E+05	-6.084E+04	2	0.000
-1450	78.5	6.00		8.0	-4.137E+04	-1.224E+05	-6.241E+04	2	0.000
-1530	78.5	6.00		8.1	-3.306E+04	-1.089E+05	-6.398E+04	2	0.000
-1610	78.5	6.00		5.1	-2.773E+04	-9.374E+04	-3.850E+04	2	0.000
-1690	78.5	6.00		5.1	-2.254E+04	-7.848E+04	-4.007E+04	2	0.000
-1770	78.5	6.00		5.2	-1.736E+04	-6.323E+04	-4.164E+04	2	0.000
-1850	78.5	6.00		5.2	-1.217E+04	-4.797E+04	-4.321E+04	2	0.000
-1930	78.5	6.00		5.3	-6.988E+03	-3.272E+04	-4.478E+04	2	0.000
-2010	78.5	6.00		2.5	-4.614E+03	-2.419E+04	-2.024E+04	2	0.000
-2090	78.5	6.00		2.6	-3.613E+03	-1.894E+04	-2.181E+04	2	0.000
-2170	124.0	6.00		2.5	-2.612E+03	-1.369E+04	-2.338E+04	2	0.000
-2250	78.5	6.00		2.8	-1.611E+03	-8.445E+03	-2.495E+04	2	0.000
-2330	78.5	6.00		3.0	-6.100E+02	-3.198E+03	-2.652E+04	2	0.000
-2410	78.5	6.00		0.3	9.3082E-13	-1.358E-11	-2.510E+03	2	0.000
-2490	78.5	6.00		0.5	-1.343E-12	2.8481E-11	-4.081E+03	2	0.000

Verifica di esercizio (combinazione quasi permanente):

quota	Af	cop.	sigmaf	sigmac	Mx	My	N	comb	Wk
-90	0.0	6.50	0.0	0.0	0.0000E+00	0.0000E+00	0.0000E+00	-	0.000
-170	78.5	6.00	36.1	26.4	3.7298E+05	1.7379E+06	-1.017E+05	2	0.000
-170	78.5	6.00	36.1		2.8783E+05	1.6266E+06	-9.175E+04	1	0.000
-250	78.5	6.00		22.9	2.7691E+05	1.3439E+06	-1.033E+05	2	0.000
-330	78.5	6.00		17.4	1.9956E+05	1.0174E+06	-7.852E+04	2	0.000
-410	78.5	6.00		15.7	1.5338E+05	8.0343E+05	-8.009E+04	2	0.000
-490	78.5	6.00		14.1	1.0721E+05	5.8950E+05	-8.167E+04	2	0.000
-570	78.5	6.00		12.4	6.1037E+04	3.7556E+05	-8.324E+04	2	0.000
-650	78.5	6.00		10.8	1.4864E+04	1.6163E+05	-8.481E+04	2	0.000
-730	78.5	6.00		7.0	-1.601E+04	1.4309E+04	-6.174E+04	2	0.000
-810	78.5	6.00		7.3	-2.137E+04	-2.199E+04	-6.332E+04	2	0.000
-890	78.5	6.00		7.8	-2.674E+04	-5.830E+04	-6.489E+04	2	0.000
-970	78.5	6.00		8.2	-3.210E+04	-9.460E+04	-6.646E+04	2	0.000
-1050	78.5	6.00		8.7	-3.747E+04	-1.309E+05	-6.803E+04	2	0.000
-1130	124.0	6.00		5.9	-4.065E+04	-1.558E+05	-4.502E+04	2	0.000
-1210	78.5	6.00		6.4	-3.672E+04	-1.437E+05	-4.660E+04	2	0.000
-1290	78.5	6.00		6.5	-3.279E+04	-1.315E+05	-4.817E+04	2	0.000
-1370	78.5	6.00		6.6	-2.886E+04	-1.193E+05	-4.974E+04	2	0.000
-1450	78.5	6.00		6.6	-2.493E+04	-1.071E+05	-5.131E+04	2	0.000
-1530	78.5	6.00		6.7	-2.100E+04	-9.492E+04	-5.288E+04	2	0.000
-1610	78.5	6.00		4.1	-1.785E+04	-8.163E+04	-3.098E+04	2	0.000
-1690	78.5	6.00		4.2	-1.473E+04	-6.827E+04	-3.256E+04	2	0.000
-1770	78.5	6.00		4.3	-1.162E+04	-5.492E+04	-3.413E+04	2	0.000
-1850	78.5	6.00		4.3	-8.506E+03	-4.157E+04	-3.570E+04	2	0.000
-1930	78.5	6.00		4.4	-5.392E+03	-2.822E+04	-3.727E+04	2	0.000
-2010	78.5	6.00		2.0	-3.814E+03	-2.081E+04	-1.614E+04	2	0.000
-2090	78.5	6.00		2.1	-2.986E+03	-1.629E+04	-1.771E+04	2	0.000
-2170	124.0	6.00		2.1	-2.159E+03	-1.178E+04	-1.928E+04	2	0.000
-2250	78.5	6.00		2.4	-1.332E+03	-7.264E+03	-2.085E+04	2	0.000
-2330	78.5	6.00		2.5	-5.042E+02	-2.750E+03	-2.242E+04	2	0.000
-2410	78.5	6.00		0.2	-2.267E-12	-9.407E-12	-1.727E+03	2	0.000
-2490	78.5	6.00		0.4	-2.949E-12	2.8678E-11	-3.298E+03	2	0.000

Verifica a taglio:

quota	Ast	Vsd	Vsdx	Vsdy	N	comb	VRd,c	VRd,max	VRd,S	Vwd
-90	0.16	33853	32626	-9031	-121963	9SLV	40152	231056	84476	44323 Vsd < VRd,
-170	0.16	32927	31729	-8801	-122594	9SLV	44128	231056	88452	44323 Vsd < VRd,
-250	0.08	32927	31729	-8801	-124165	9SLV	44347	231056	66508	22162 Vsd < VRd,
-330	0.08	10512	10160	-2698	-95394	9SLV	40348	231056	62509	22162 Vsd < VRd,



Progetto	Titolo	Rev.	Pag.
Orione	Orione_A24a.pdf "TABULATI DI CALCOLO PLINTO DI FONDAZIONE PER AEROGENERATORE TIPO"	0	223



-410	0.08	10512	10160	-2698	-96965	9SLV	40566	231056	62728	22162	Vsd < VRd,
-490	0.08	10512	10160	-2698	-98536	9SLV	40784	231056	62946	22162	Vsd < VRd,
-570	0.08	10512	10160	-2698	-100107	9SLV	41003	231056	63164	22162	Vsd < VRd,
-650	0.08	10512	10160	-2698	-101678	9SLV	41221	231056	63383	22162	Vsd < VRd,
-730	0.08	1879	1814	-489	-35613	7SLV	32038	231056	54200	22162	Vsd < VRd,
-810	0.08	1879	1814	-489	-37183	7SLV	32256	231056	54418	22162	Vsd < VRd,
-890	0.08	1879	1814	-489	-38754	7SLV	32475	231056	54636	22162	Vsd < VRd,
-970	0.08	1879	1814	-489	-40325	7SLV	32693	231056	54855	22162	Vsd < VRd,
-1050	0.08	1879	1814	-489	-41896	7SLV	32911	231056	55073	22162	Vsd < VRd,
-1130	0.08	2099	-2018	579	-54931	9SLV	39180	231056	61341	22162	Vsd < VRd,
-1210	0.08	2099	-2018	579	-56502	9SLV	34942	231056	57103	22162	Vsd < VRd,
-1290	0.08	2099	-2018	579	-58073	9SLV	35160	231056	57322	22162	Vsd < VRd,
-1370	0.08	2099	-2018	579	-59643	9SLV	35378	231056	57540	22162	Vsd < VRd,
-1450	0.08	2099	-2018	579	-61214	9SLV	35597	231056	57758	22162	Vsd < VRd,
-1530	0.08	2099	-2018	579	-62785	9SLV	35815	231056	57977	22162	Vsd < VRd,
-1610	0.08	922	-889	244	-37693	9SLV	32327	231056	54489	22162	Vsd < VRd,
-1690	0.08	922	-889	244	-39264	9SLV	32546	231056	54707	22162	Vsd < VRd,
-1770	0.08	922	-889	244	-40835	9SLV	32764	231056	54926	22162	Vsd < VRd,
-1850	0.08	922	-889	244	-42406	9SLV	32982	231056	55144	22162	Vsd < VRd,
-1930	0.08	922	-889	244	-43977	9SLV	33201	231056	55362	22162	Vsd < VRd,
-2010	0.08	90	-88	17	-27485	4SLU	30908	231056	53070	22162	Vsd < VRd,
-2090	0.08	90	-88	17	-29527	4SLU	31192	231056	53354	22162	Vsd < VRd,
-2170	0.08	90	-88	17	-31569	4SLU	35932	231056	58094	22162	Vsd < VRd,
-2250	0.08	90	-88	17	-33611	4SLU	31760	231056	53922	22162	Vsd < VRd,
-2330	0.08	90	-88	17	-35653	4SLU	32044	231056	54205	22162	Vsd < VRd,
-2410	0.08	0	0	0	-1493	1SLV	27296	231056	49457	22162	Vsd < VRd,
-2490	0.08	0	0	0	-3064	1SLV	27514	231056	49676	22162	Vsd < VRd,

Palo alle coordinate X=564 Y=-1551

Sollecitazioni massime in testa palo:

Combinazione corrispondente alla minima compressione in testa

N	Mx	My	Tx	Ty	comb	
-9.076E+04	6.9299E+05	1.9069E+06	4.5099E+03	-1.605E+03	1	sl
-9.076E+04	6.9299E+05	1.9069E+06	4.5099E+03	-1.605E+03	1	ra
-9.076E+04	6.9299E+05	1.9069E+06	4.5099E+03	-1.605E+03	1	fr
-9.076E+04	6.9299E+05	1.9069E+06	4.5099E+03	-1.605E+03	1	qp
-5.930E+04	-1.412E+06	-5.172E+06	-2.337E+04	6.6794E+03	7	SLV fond

Combinazione corrispondente alla massima compressione in testa

N	Mx	My	Tx	Ty	comb	
-1.660E+05	1.6393E+06	3.0383E+06	7.0475E+03	-4.415E+03	4	sl
-1.228E+05	1.1853E+06	2.2798E+06	5.2997E+03	-3.157E+03	2	ra
-1.068E+05	9.3913E+05	2.0933E+06	4.9048E+03	-2.381E+03	2	fr
-1.004E+05	8.4067E+05	2.0188E+06	4.7469E+03	-2.071E+03	2	qp
-1.222E+05	2.7982E+06	8.9855E+06	3.2392E+04	-9.889E+03	9	SLV fond

Combinazione corrispondente al massimo taglio in testa

N	Mx	My	Tx	Ty	comb	
-1.660E+05	1.6393E+06	3.0383E+06	7.0475E+03	-4.415E+03	4	sl
-1.228E+05	1.1853E+06	2.2798E+06	5.2997E+03	-3.157E+03	2	ra
-1.068E+05	9.3913E+05	2.0933E+06	4.9048E+03	-2.381E+03	2	fr
-1.004E+05	8.4067E+05	2.0188E+06	4.7469E+03	-2.071E+03	2	qp
-1.222E+05	2.7982E+06	8.9855E+06	3.2392E+04	-9.889E+03	9	SLV fond

Verifica di capacità portante riferita al palo singolo:

Fattore di correlazione Psi scelto in base alla conoscenza del sito = 1.7  
 Coeff. parziale di sicurezza sulla resistenza laterale = 1.15  
 Coeff. parziale di sicurezza sulla resistenza alla punta = 1.35  
 Portanza laterale di progetto = 292537.1  
 Portanza di punta di progetto = 85555.4  
 verifica condotta in combinazione SLU 4  
 Sforzo normale = -166017.8  
 Peso del palo = 49087.4 \* 1.3  
 Carico totale di progetto = -229831.3  
 Resistenza totale di progetto = 378092.5  
 Coefficiente di sicurezza = 1.65 > 1

Verifica di resistenza allo stato limite:

quota	Af	cop.	c.s.	Mx	My	N	comb
-90	0.0	6.50	0.00	0.0000E+00	0.0000E+00	0.0000E+00	-
-170	78.5	6.00	3.49	2.0247E+06	6.4613E+06	-1.229E+05	9SLV
-250	78.5	6.00	6.47	1.2523E+06	3.9417E+06	-1.244E+05	9SLV
-330	78.5	6.00	11.80	6.7514E+05	2.0657E+06	-9.561E+04	9SLV
-410	78.5	6.00	12.90	5.0352E+05	1.1647E+06	-1.324E+05	4SLU
-490	78.5	6.00	13.71	3.4372E+05	8.5910E+05	-1.345E+05	4SLU
-570	78.5	6.00	13.50	1.8392E+05	5.5346E+05	-1.365E+05	4SLU
-650	78.5	6.00	13.30	2.4124E+04	2.4782E+05	-1.386E+05	4SLU
-730	78.5	6.00	14.42	4.8911E+05	1.6379E+06	-3.539E+04	7SLV
-810	78.5	6.00	15.50	-4.602E+05	-1.539E+06	-7.682E+04	9SLV
-890	78.5	6.00	15.89	-4.386E+05	-1.460E+06	-7.839E+04	9SLV
-970	78.5	6.00	16.29	-4.170E+05	-1.380E+06	-7.996E+04	9SLV
-1050	78.5	6.00	16.63	-1.423E+05	-1.792E+05	-1.108E+05	4SLU



Progetto	Titolo	Rev.	Pag.
Orione	Orione_A24a.pdf "TABULATI DI CALCOLO PLINTO DI FONDAZIONE PER AEROGENERATORE TIPO"	0	224

-1130	124.0	6.00	22.76	-3.674E+05	-1.202E+06	-5.506E+04	9SLV		
-1210	78.5	6.00	22.14	-3.188E+05	-1.041E+06	-5.663E+04	9SLV		
-1290	78.5	6.00	23.25	-1.195E+05	-1.841E+05	-7.927E+04	4SLU		
-1370	78.5	6.00	22.67	-1.041E+05	-1.678E+05	-8.131E+04	4SLU		
-1450	78.5	6.00	22.11	-8.872E+04	-1.515E+05	-8.335E+04	4SLU		
-1530	78.5	6.00	21.59	-7.332E+04	-1.352E+05	-8.539E+04	4SLU		
-1610	78.5	6.00	35.75	-6.203E+04	-1.164E+05	-5.155E+04	4SLU		
-1690	78.5	6.00	34.39	-5.093E+04	-9.755E+04	-5.360E+04	4SLU		
-1770	78.5	6.00	33.13	-3.984E+04	-7.867E+04	-5.564E+04	4SLU		
-1850	78.5	6.00	31.96	-2.874E+04	-5.980E+04	-5.768E+04	4SLU		
-1930	78.5	6.00	30.86	-1.765E+04	-4.092E+04	-5.972E+04	4SLU		
-2010	78.5	6.00	67.93	-1.222E+04	-3.031E+04	-2.713E+04	4SLU		
-2090	78.5	6.00	63.18	-9.573E+03	-2.373E+04	-2.918E+04	4SLU		
-2170	124.0	6.00	65.16	-6.921E+03	-1.716E+04	-3.122E+04	4SLU		
-2250	78.5	6.00	55.42	-4.268E+03	-1.058E+04	-3.326E+04	4SLU		
-2330	78.5	6.00	52.21	-1.616E+03	-4.006E+03	-3.530E+04	4SLU		
-2410	78.5	6.00	100.00	-3.511E-12	-4.425E-11	-3.420E+03	4SLU		
-2490	78.5	6.00	100.00	-7.376E-12	2.4186E-11	-5.462E+03	4SLU		

Verifica di esercizio (combinazione rara):

quota	Af	cop.	sigmaf	sigmac	Mx	My	N	comb	Wk
-90	0.0	6.50	0.0	0.0	0.0000E+00	0.0000E+00	0.0000E+00	-	0.000
-170	78.5	6.00		31.3	9.3546E+05	1.8632E+06	-1.236E+05	2	0.000
-170	78.5	6.00	36.2		5.6513E+05	1.5524E+06	-9.171E+04	1	0.000
-250	78.5	6.00		27.3	6.8583E+05	1.4470E+06	-1.251E+05	2	0.000
-330	78.5	6.00		20.7	4.8637E+05	1.1010E+06	-9.632E+04	2	0.000
-410	78.5	6.00		18.8	3.7052E+05	8.7174E+05	-9.789E+04	2	0.000
-490	78.5	6.00		16.8	2.5468E+05	6.4251E+05	-9.946E+04	2	0.000
-570	78.5	6.00		14.9	1.3883E+05	4.1327E+05	-1.010E+05	2	0.000
-650	78.5	6.00		13.0	2.2980E+04	1.8403E+05	-1.026E+05	2	0.000
-730	78.5	6.00		8.9	-5.381E+04	2.5674E+04	-7.582E+04	2	0.000
-810	78.5	6.00		9.2	-6.551E+04	-1.456E+04	-7.739E+04	2	0.000
-890	78.5	6.00		9.6	-7.721E+04	-5.480E+04	-7.897E+04	2	0.000
-970	78.5	6.00		10.0	-8.891E+04	-9.503E+04	-8.054E+04	2	0.000
-1050	78.5	6.00		10.5	-1.006E+05	-1.353E+05	-8.211E+04	2	0.000
-1130	124.0	6.00		7.2	-1.070E+05	-1.632E+05	-5.549E+04	2	0.000
-1210	78.5	6.00		7.8	-9.624E+04	-1.508E+05	-5.706E+04	2	0.000
-1290	78.5	6.00		7.9	-8.543E+04	-1.385E+05	-5.863E+04	2	0.000
-1370	78.5	6.00		7.9	-7.463E+04	-1.261E+05	-6.020E+04	2	0.000
-1450	78.5	6.00		8.0	-6.383E+04	-1.138E+05	-6.177E+04	2	0.000
-1530	78.5	6.00		8.0	-5.303E+04	-1.014E+05	-6.334E+04	2	0.000
-1610	78.5	6.00		5.1	-4.492E+04	-8.734E+04	-3.807E+04	2	0.000
-1690	78.5	6.00		5.1	-3.694E+04	-7.316E+04	-3.964E+04	2	0.000
-1770	78.5	6.00		5.1	-2.896E+04	-5.898E+04	-4.121E+04	2	0.000
-1850	78.5	6.00		5.2	-2.098E+04	-4.480E+04	-4.278E+04	2	0.000
-1930	78.5	6.00		5.2	-1.300E+04	-3.062E+04	-4.435E+04	2	0.000
-2010	78.5	6.00		2.4	-9.059E+03	-2.267E+04	-2.001E+04	2	0.000
-2090	78.5	6.00		2.6	-7.093E+03	-1.775E+04	-2.158E+04	2	0.000
-2170	124.0	6.00		2.5	-5.128E+03	-1.283E+04	-2.315E+04	2	0.000
-2250	78.5	6.00		2.8	-3.163E+03	-7.914E+03	-2.472E+04	2	0.000
-2330	78.5	6.00		3.0	-1.198E+03	-2.996E+03	-2.629E+04	2	0.000
-2410	78.5	6.00		0.3	-2.707E-12	-3.369E-11	-2.466E+03	2	0.000
-2490	78.5	6.00		0.4	-4.981E-12	1.8608E-11	-4.036E+03	2	0.000

Verifica di esercizio (combinazione quasi permanente):

quota	Af	cop.	sigmaf	sigmac	Mx	My	N	comb	Wk
-90	0.0	6.50	0.0	0.0	0.0000E+00	0.0000E+00	0.0000E+00	-	0.000
-170	78.5	6.00		26.3	6.7623E+05	1.6456E+06	-1.013E+05	2	0.000
-170	78.5	6.00	36.2		5.6513E+05	1.5524E+06	-9.171E+04	1	0.000
-250	78.5	6.00		22.9	5.1186E+05	1.2730E+06	-1.028E+05	2	0.000
-330	78.5	6.00		17.3	3.7776E+05	9.6409E+05	-7.818E+04	2	0.000
-410	78.5	6.00		15.7	2.9410E+05	7.6157E+05	-7.975E+04	2	0.000
-490	78.5	6.00		14.0	2.1044E+05	5.5905E+05	-8.132E+04	2	0.000
-570	78.5	6.00		12.4	1.2677E+05	3.5653E+05	-8.289E+04	2	0.000
-650	78.5	6.00		10.7	4.3106E+04	1.5401E+05	-8.446E+04	2	0.000
-730	78.5	6.00		7.0	-1.358E+04	1.4500E+04	-6.147E+04	2	0.000
-810	78.5	6.00		7.3	-2.529E+04	-1.999E+04	-6.304E+04	2	0.000
-890	78.5	6.00		7.7	-3.700E+04	-5.448E+04	-6.461E+04	2	0.000
-970	78.5	6.00		8.2	-4.871E+04	-8.897E+04	-6.618E+04	2	0.000
-1050	78.5	6.00		8.7	-6.042E+04	-1.235E+05	-6.775E+04	2	0.000
-1130	124.0	6.00		5.8	-6.796E+04	-1.472E+05	-4.482E+04	2	0.000
-1210	78.5	6.00		6.4	-6.190E+04	-1.357E+05	-4.639E+04	2	0.000
-1290	78.5	6.00		6.5	-5.585E+04	-1.242E+05	-4.796E+04	2	0.000
-1370	78.5	6.00		6.5	-4.979E+04	-1.128E+05	-4.953E+04	2	0.000
-1450	78.5	6.00		6.6	-4.373E+04	-1.013E+05	-5.110E+04	2	0.000
-1530	78.5	6.00		6.7	-3.767E+04	-8.983E+04	-5.268E+04	2	0.000
-1610	78.5	6.00		4.1	-3.219E+04	-7.725E+04	-3.085E+04	2	0.000
-1690	78.5	6.00		4.2	-2.673E+04	-6.462E+04	-3.242E+04	2	0.000
-1770	78.5	6.00		4.2	-2.128E+04	-5.200E+04	-3.399E+04	2	0.000
-1850	78.5	6.00		4.3	-1.582E+04	-3.937E+04	-3.556E+04	2	0.000
-1930	78.5	6.00		4.4	-1.037E+04	-2.674E+04	-3.713E+04	2	0.000
-2010	78.5	6.00		2.0	-7.488E+03	-1.972E+04	-1.606E+04	2	0.000
-2090	78.5	6.00		2.1	-5.863E+03	-1.544E+04	-1.763E+04	2	0.000
-2170	124.0	6.00		2.1	-4.239E+03	-1.117E+04	-1.920E+04	2	0.000
-2250	78.5	6.00		2.4	-2.614E+03	-6.886E+03	-2.077E+04	2	0.000
-2330	78.5	6.00		2.5	-9.898E+02	-2.607E+03	-2.235E+04	2	0.000



Tabulati di Calcolo Plinto di Fondazione per Aerogeneratore Tipo - Progetto Impianto Eolico - "Orione"

-2410 78.5 6.00 0.2 -2.737E-12 -3.208E-11 -1.712E+03 2 0.000  
 -2490 78.5 6.00 0.4 -1.828E-12 1.8623E-11 -3.283E+03 2 0.000

Verifica a taglio:

quota	Ast	Vsd	Vsdx	Vsdy	N	comb	VRd, c	VRd, max	VRd, S	Vwd
-90	0.16	33868	32392	-9889	-122233	9SLV	40190	231056	84513	44323 Vsd < VRd,
-170	0.16	32942	31496	-9655	-122863	9SLV	44166	231056	88489	44323 Vsd < VRd,
-250	0.08	32942	31496	-9655	-124434	9SLV	44384	231056	66546	22162 Vsd < VRd,
-330	0.08	10520	10038	-3149	-95614	9SLV	40378	231056	62540	22162 Vsd < VRd,
-410	0.08	10520	10038	-3149	-97185	9SLV	40597	231056	62758	22162 Vsd < VRd,
-490	0.08	10520	10038	-3149	-98756	9SLV	40815	231056	62977	22162 Vsd < VRd,
-570	0.08	10520	10038	-3149	-100326	9SLV	41033	231056	63195	22162 Vsd < VRd,
-650	0.08	10520	10038	-3149	-101897	9SLV	41252	231056	63413	22162 Vsd < VRd,
-730	0.08	1880	1794	-563	-35390	7SLV	32007	231056	54169	22162 Vsd < VRd,
-810	0.08	1880	1794	-563	-36961	7SLV	32225	231056	54387	22162 Vsd < VRd,
-890	0.08	1880	1794	-563	-38531	7SLV	32444	231056	54605	22162 Vsd < VRd,
-970	0.08	1880	1794	-563	-40102	7SLV	32662	231056	54824	22162 Vsd < VRd,
-1050	0.08	1880	1794	-563	-41673	7SLV	32880	231056	55042	22162 Vsd < VRd,
-1130	0.08	2100	-2010	608	-55060	9SLV	39197	231056	61359	22162 Vsd < VRd,
-1210	0.08	2100	-2010	608	-56631	9SLV	34960	231056	57121	22162 Vsd < VRd,
-1290	0.08	2100	-2010	608	-58202	9SLV	35178	231056	57340	22162 Vsd < VRd,
-1370	0.08	2100	-2010	608	-59773	9SLV	35396	231056	57558	22162 Vsd < VRd,
-1450	0.08	2100	-2010	608	-61343	9SLV	35615	231056	57776	22162 Vsd < VRd,
-1530	0.08	2100	-2010	608	-62914	9SLV	35833	231056	57995	22162 Vsd < VRd,
-1610	0.08	922	-881	272	-37781	9SLV	32339	231056	54501	22162 Vsd < VRd,
-1690	0.08	922	-881	272	-39352	9SLV	32558	231056	54720	22162 Vsd < VRd,
-1770	0.08	922	-881	272	-40923	9SLV	32776	231056	54938	22162 Vsd < VRd,
-1850	0.08	922	-881	272	-42493	9SLV	32995	231056	55156	22162 Vsd < VRd,
-1930	0.08	922	-881	272	-44064	9SLV	33213	231056	55375	22162 Vsd < VRd,
-2010	0.08	89	-82	33	-27134	4SLU	30860	231056	53021	22162 Vsd < VRd,
-2090	0.08	89	-82	33	-29176	4SLU	31143	231056	53305	22162 Vsd < VRd,
-2170	0.08	89	-82	33	-31218	4SLU	35883	231056	58045	22162 Vsd < VRd,
-2250	0.08	89	-82	33	-33260	4SLU	31711	231056	53873	22162 Vsd < VRd,
-2330	0.08	89	-82	33	-35302	4SLU	31995	231056	54157	22162 Vsd < VRd,
-2410	0.08	0	0	0	-1487	15SLV	27295	231056	49456	22162 Vsd < VRd,
-2490	0.08	0	0	0	-3057	15SLV	27513	231056	49675	22162 Vsd < VRd,

Palo alle coordinate X=825 Y=-1429

Sollecitazioni massime in testa palo:

Combinazione corrispondente alla minima compressione in testa

N	Mx	My	Tx	Ty	comb
-9.074E+04	1.0123E+06	1.7581E+06	4.1654E+03	-2.344E+03	1 sl
-9.074E+04	1.0123E+06	1.7581E+06	4.1654E+03	-2.344E+03	1 ra
-9.074E+04	1.0123E+06	1.7581E+06	4.1654E+03	-2.344E+03	1 fr
-9.074E+04	1.0123E+06	1.7581E+06	4.1654E+03	-2.344E+03	1 qp
-5.991E+04	-1.110E+06	-5.308E+06	-2.367E+04	6.0009E+03	7 SLV fond

Combinazione corrispondente alla massima compressione in testa

N	Mx	My	Tx	Ty	comb
-1.626E+05	2.1671E+06	2.6817E+06	6.1954E+03	-5.618E+03	4 sl
-1.205E+05	1.5797E+06	2.0222E+06	4.6857E+03	-4.058E+03	2 ra
-1.056E+05	1.2960E+06	1.8902E+06	4.4255E+03	-3.201E+03	2 fr
-9.966E+04	1.1825E+06	1.8373E+06	4.3215E+03	-2.858E+03	2 qp
-1.216E+05	3.1346E+06	8.8246E+06	3.2004E+04	-1.069E+04	9 SLV fond

Combinazione corrispondente al massimo taglio in testa

N	Mx	My	Tx	Ty	comb
-1.626E+05	2.1671E+06	2.6817E+06	6.1954E+03	-5.618E+03	4 sl
-1.205E+05	1.5797E+06	2.0222E+06	4.6857E+03	-4.058E+03	2 ra
-1.056E+05	1.2960E+06	1.8902E+06	4.4255E+03	-3.201E+03	2 fr
-9.966E+04	1.1825E+06	1.8373E+06	4.3215E+03	-2.858E+03	2 qp
-1.216E+05	3.1346E+06	8.8246E+06	3.2004E+04	-1.069E+04	9 SLV fond

Verifica di capacità portante riferita al palo singolo:

Fattore di correlazione Psi scelto in base alla conoscenza del sito = 1.7  
 Coeff. parziale di sicurezza sulla resistenza laterale = 1.15  
 Coeff. parziale di sicurezza sulla resistenza alla punta = 1.35  
 Portanza laterale di progetto = 292537.1  
 Portanza di punta di progetto = 85555.4  
 verifica condotta in combinazione SLU 4  
 Sforzo normale = -162581  
 Peso del palo = 49087.4 \* 1.3  
 Carico totale di progetto = -226394.6  
 Resistenza totale di progetto = 378092.5  
 Coefficiente di sicurezza = 1.67 > 1

Verifica di resistenza allo stato limite:

quota	Af	cop.	c.s.	Mx	My	N	comb
-90	0.0	6.50	0.00	0.0000E+00	0.0000E+00	0.0000E+00	-
-170	78.5	6.00	3.51	2.2974E+06	6.3313E+06	-1.222E+05	9SLV



Progetto	Titolo	Rev.	Pag.
Orione	Orione_A24a.pdf "TABULATI DI CALCOLO PLINTO DI FONDAZIONE PER AEROGENERATORE TIPO"	0	226

-250	78.5	6.00	6.51	1.4614E+06	3.8424E+06	-1.238E+05	9SLV		
-330	78.5	6.00	11.88	8.3175E+05	1.9918E+06	-9.507E+04	9SLV		
-410	78.5	6.00	13.15	7.0614E+05	1.0347E+06	-1.297E+05	4SLU		
-490	78.5	6.00	13.99	4.9295E+05	7.6481E+05	-1.317E+05	4SLU		
-570	78.5	6.00	13.78	2.7977E+05	4.9489E+05	-1.337E+05	4SLU		
-650	78.5	6.00	13.57	6.6579E+04	2.2496E+05	-1.358E+05	4SLU		
-730	78.5	6.00	14.49	4.9383E+05	1.6350E+06	-3.579E+04	7SLV		
-810	78.5	6.00	15.55	-4.668E+05	-1.535E+06	-7.639E+04	9SLV		
-890	78.5	6.00	15.94	-4.504E+05	-1.453E+06	-7.796E+04	9SLV		
-970	78.5	6.00	16.35	-4.341E+05	-1.372E+06	-7.953E+04	9SLV		
-1050	78.5	6.00	16.78	-4.177E+05	-1.290E+06	-8.111E+04	9SLV		
-1130	124.0	6.00	22.86	-3.933E+05	-1.190E+06	-5.474E+04	9SLV		
-1210	78.5	6.00	22.23	-3.425E+05	-1.030E+06	-5.631E+04	9SLV		
-1290	78.5	6.00	23.74	-1.519E+05	-1.612E+05	-7.763E+04	4SLU		
-1370	78.5	6.00	23.13	-1.336E+05	-1.472E+05	-7.967E+04	4SLU		
-1450	78.5	6.00	22.56	-1.153E+05	-1.332E+05	-8.172E+04	4SLU		
-1530	78.5	6.00	22.01	-9.701E+04	-1.192E+05	-8.376E+04	4SLU		
-1610	78.5	6.00	36.54	-8.242E+04	-1.027E+05	-5.045E+04	4SLU		
-1690	78.5	6.00	35.12	-6.802E+04	-8.613E+04	-5.249E+04	4SLU		
-1770	78.5	6.00	33.80	-5.362E+04	-6.953E+04	-5.453E+04	4SLU		
-1850	78.5	6.00	32.58	-3.922E+04	-5.293E+04	-5.657E+04	4SLU		
-1930	78.5	6.00	31.45	-2.482E+04	-3.633E+04	-5.862E+04	4SLU		
-2010	78.5	6.00	69.48	-1.754E+04	-2.695E+04	-2.653E+04	4SLU		
-2090	78.5	6.00	64.51	-1.373E+04	-2.111E+04	-2.857E+04	4SLU		
-2170	124.0	6.00	66.45	-9.927E+03	-1.526E+04	-3.061E+04	4SLU		
-2250	78.5	6.00	56.44	-6.123E+03	-9.411E+03	-3.266E+04	4SLU		
-2330	78.5	6.00	53.12	-2.318E+03	-3.563E+03	-3.470E+04	4SLU		
-2410	78.5	6.00	100.00	-1.126E-11	-3.142E-11	-3.305E+03	4SLU		
-2490	78.5	6.00	100.00	6.4728E-12	-2.658E-12	-5.347E+03	4SLU		

Verifica di esercizio (combinazione rara):

quota	Af	cop.	sigmaf	sigmac	Mx	My	N	comb	Wk
-90	0.0	6.50	0.0	0.0	0.0000E+00	0.0000E+00	0.0000E+00	-	0.000
-170	78.5	6.00		31.0	1.2581E+06	1.6543E+06	-1.213E+05	2	0.000
-170	78.5	6.00	36.3		8.2553E+05	1.4311E+06	-9.168E+04	1	0.000
-250	78.5	6.00		26.9	9.3668E+05	1.2869E+06	-1.229E+05	2	0.000
-330	78.5	6.00		20.4	6.7739E+05	9.8101E+05	-9.447E+04	2	0.000
-410	78.5	6.00		18.5	5.2166E+05	7.7758E+05	-9.604E+04	2	0.000
-490	78.5	6.00		16.5	3.6593E+05	5.7416E+05	-9.761E+04	2	0.000
-570	78.5	6.00		14.6	2.1019E+05	3.7074E+05	-9.918E+04	2	0.000
-650	78.5	6.00		12.7	5.4462E+04	1.6731E+05	-1.007E+05	2	0.000
-730	78.5	6.00		8.7	-4.986E+04	2.6598E+04	-7.436E+04	2	0.000
-810	78.5	6.00		9.0	-6.848E+04	-9.602E+03	-7.593E+04	2	0.000
-890	78.5	6.00		9.4	-8.711E+04	-4.580E+04	-7.750E+04	2	0.000
-970	78.5	6.00		9.9	-1.057E+05	-8.200E+04	-7.907E+04	2	0.000
-1050	78.5	6.00		10.4	-1.244E+05	-1.182E+05	-8.064E+04	2	0.000
-1130	124.0	6.00		7.1	-1.356E+05	-1.434E+05	-5.440E+04	2	0.000
-1210	78.5	6.00		7.7	-1.226E+05	-1.327E+05	-5.597E+04	2	0.000
-1290	78.5	6.00		7.8	-1.096E+05	-1.220E+05	-5.754E+04	2	0.000
-1370	78.5	6.00		7.8	-9.667E+04	-1.113E+05	-5.911E+04	2	0.000
-1450	78.5	6.00		7.8	-8.370E+04	-1.006E+05	-6.068E+04	2	0.000
-1530	78.5	6.00		7.9	-7.073E+04	-8.990E+04	-6.225E+04	2	0.000
-1610	78.5	6.00		5.0	-6.016E+04	-7.745E+04	-3.733E+04	2	0.000
-1690	78.5	6.00		5.0	-4.970E+04	-6.491E+04	-3.890E+04	2	0.000
-1770	78.5	6.00		5.0	-3.925E+04	-5.237E+04	-4.047E+04	2	0.000
-1850	78.5	6.00		5.1	-2.880E+04	-3.984E+04	-4.204E+04	2	0.000
-1930	78.5	6.00		5.1	-1.835E+04	-2.730E+04	-4.361E+04	2	0.000
-2010	78.5	6.00		2.4	-1.302E+04	-2.024E+04	-1.960E+04	2	0.000
-2090	78.5	6.00		2.5	-1.019E+04	-1.585E+04	-2.117E+04	2	0.000
-2170	124.0	6.00		2.5	-7.369E+03	-1.146E+04	-2.274E+04	2	0.000
-2250	78.5	6.00		2.8	-4.545E+03	-7.065E+03	-2.431E+04	2	0.000
-2330	78.5	6.00		2.9	-1.721E+03	-2.675E+03	-2.589E+04	2	0.000
-2410	78.5	6.00		0.3	-9.223E-12	-2.339E-11	-2.389E+03	2	0.000
-2490	78.5	6.00		0.4	4.4194E-12	-1.794E-12	-3.959E+03	2	0.000

Verifica di esercizio (combinazione quasi permanente):

quota	Af	cop.	sigmaf	sigmac	Mx	My	N	comb	Wk
-90	0.0	6.50	0.0	0.0	0.0000E+00	0.0000E+00	0.0000E+00	-	0.000
-170	78.5	6.00		26.3	9.5530E+05	1.4981E+06	-1.006E+05	2	0.000
-170	78.5	6.00	36.3		8.2553E+05	1.4311E+06	-9.168E+04	1	0.000
-250	78.5	6.00		22.8	7.2817E+05	1.1592E+06	-1.021E+05	2	0.000
-330	78.5	6.00		17.2	5.4190E+05	8.7832E+05	-7.761E+04	2	0.000
-410	78.5	6.00		15.6	4.2373E+05	6.9405E+05	-7.918E+04	2	0.000
-490	78.5	6.00		13.9	3.0557E+05	5.0977E+05	-8.075E+04	2	0.000
-570	78.5	6.00		12.3	1.8740E+05	3.2549E+05	-8.232E+04	2	0.000
-650	78.5	6.00		10.6	6.9234E+04	1.4121E+05	-8.389E+04	2	0.000
-730	78.5	6.00		6.9	-1.121E+04	1.4219E+04	-6.102E+04	2	0.000
-810	78.5	6.00		7.2	-2.877E+04	-1.730E+04	-6.259E+04	2	0.000
-890	78.5	6.00		7.7	-4.634E+04	-4.882E+04	-6.416E+04	2	0.000
-970	78.5	6.00		8.2	-6.391E+04	-8.034E+04	-6.573E+04	2	0.000
-1050	78.5	6.00		8.6	-8.148E+04	-1.119E+05	-6.730E+04	2	0.000
-1130	124.0	6.00		5.8	-9.305E+04	-1.336E+05	-4.449E+04	2	0.000
-1210	78.5	6.00		6.4	-8.504E+04	-1.232E+05	-4.606E+04	2	0.000
-1290	78.5	6.00		6.4	-7.703E+04	-1.128E+05	-4.763E+04	2	0.000
-1370	78.5	6.00		6.5	-6.902E+04	-1.024E+05	-4.920E+04	2	0.000
-1450	78.5	6.00		6.6	-6.101E+04	-9.207E+04	-5.077E+04	2	0.000



Progetto	Titolo	Rev.	Pag.
Orione	Orione_A24a.pdf "TABULATI DI CALCOLO PLINTO DI FONDAZIONE PER AEROGENERATORE TIPO"	0	227

Tabulati di Calcolo Plinto di Fondazione per Aerogeneratore Tipo - Progetto Impianto Eolico - "Orione"

-1530	78.5	6.00	6.6	-5.301E+04	-8.169E+04	-5.234E+04	2	0.000
-1610	78.5	6.00	4.1	-4.538E+04	-7.027E+04	-3.062E+04	2	0.000
-1690	78.5	6.00	4.2	-3.777E+04	-5.879E+04	-3.219E+04	2	0.000
-1770	78.5	6.00	4.2	-3.017E+04	-4.731E+04	-3.376E+04	2	0.000
-1850	78.5	6.00	4.3	-2.256E+04	-3.583E+04	-3.533E+04	2	0.000
-1930	78.5	6.00	4.3	-1.495E+04	-2.436E+04	-3.690E+04	2	0.000
-2010	78.5	6.00	1.9	-1.087E+04	-1.797E+04	-1.594E+04	2	0.000
-2090	78.5	6.00	2.1	-8.514E+03	-1.407E+04	-1.751E+04	2	0.000
-2170	124.0	6.00	2.1	-6.155E+03	-1.017E+04	-1.908E+04	2	0.000
-2250	78.5	6.00	2.4	-3.796E+03	-6.274E+03	-2.065E+04	2	0.000
-2330	78.5	6.00	2.5	-1.437E+03	-2.376E+03	-2.222E+04	2	0.000
-2410	78.5	6.00	0.2	-1.177E-11	-1.987E-11	-1.689E+03	2	0.000
-2490	78.5	6.00	0.4	1.8728E-12	-6.579E-13	-3.260E+03	2	0.000

Verifica a taglio:

quota	Ast	Vsd	Vsdx	Vsdy	N comb	VRd,c	VRd,max	VRd,S	Vwd	
-90	0.16	33742	32004	-10690	-121563	9SLV	40097	231056	84420	44323 Vsd < VRd,
-170	0.16	32819	31111	-10450	-122197	9SLV	44073	231056	88396	44323 Vsd < VRd,
-250	0.08	32819	31111	-10450	-123768	9SLV	44291	231056	66453	22162 Vsd < VRd,
-330	0.08	10465	9837	-3570	-95073	9SLV	40303	231056	62465	22162 Vsd < VRd,
-410	0.08	10465	9837	-3570	-96644	9SLV	40521	231056	62683	22162 Vsd < VRd,
-490	0.08	10465	9837	-3570	-98215	9SLV	40740	231056	62901	22162 Vsd < VRd,
-570	0.08	10465	9837	-3570	-99786	9SLV	40958	231056	63120	22162 Vsd < VRd,
-650	0.08	10465	9837	-3570	-101356	9SLV	41176	231056	63338	22162 Vsd < VRd,
-730	0.08	1871	1761	-632	-35787	7SLV	32062	231056	54224	22162 Vsd < VRd,
-810	0.08	1871	1761	-632	-37358	7SLV	32281	231056	54442	22162 Vsd < VRd,
-890	0.08	1871	1761	-632	-38928	7SLV	32499	231056	54661	22162 Vsd < VRd,
-970	0.08	1871	1761	-632	-40499	7SLV	32717	231056	54879	22162 Vsd < VRd,
-1050	0.08	1871	1761	-632	-42070	7SLV	32936	231056	55097	22162 Vsd < VRd,
-1130	0.08	2095	-1996	635	-54743	9SLV	39153	231056	61315	22162 Vsd < VRd,
-1210	0.08	2095	-1996	635	-56313	9SLV	34915	231056	57077	22162 Vsd < VRd,
-1290	0.08	2095	-1996	635	-57884	9SLV	35134	231056	57295	22162 Vsd < VRd,
-1370	0.08	2095	-1996	635	-59455	9SLV	35352	231056	57514	22162 Vsd < VRd,
-1450	0.08	2095	-1996	635	-61026	9SLV	35570	231056	57732	22162 Vsd < VRd,
-1530	0.08	2095	-1996	635	-62597	9SLV	35789	231056	57950	22162 Vsd < VRd,
-1610	0.08	919	-868	299	-37566	9SLV	32310	231056	54471	22162 Vsd < VRd,
-1690	0.08	919	-868	299	-39137	9SLV	32528	231056	54690	22162 Vsd < VRd,
-1770	0.08	919	-868	299	-40707	9SLV	32746	231056	54908	22162 Vsd < VRd,
-1850	0.08	919	-868	299	-42278	9SLV	32965	231056	55126	22162 Vsd < VRd,
-1930	0.08	919	-868	299	-43849	9SLV	33183	231056	55345	22162 Vsd < VRd,
-2010	0.08	87	-73	48	-26530	4SLU	30776	231056	52937	22162 Vsd < VRd,
-2090	0.08	87	-73	48	-28572	4SLU	31059	231056	53221	22162 Vsd < VRd,
-2170	0.08	87	-73	48	-30614	4SLU	35799	231056	57961	22162 Vsd < VRd,
-2250	0.08	87	-73	48	-32656	4SLU	31627	231056	53789	22162 Vsd < VRd,
-2330	0.08	87	-73	48	-34698	4SLU	31911	231056	54073	22162 Vsd < VRd,
-2410	0.08	0	0	0	-3305	4SLU	27547	231056	49709	22162 Vsd < VRd,
-2490	0.08	0	0	0	-5347	4SLU	27831	231056	49993	22162 Vsd < VRd,

Palo alle coordinate X=1061 Y=-1264

Sollecitazioni massime in testa palo:

Combinazione corrispondente alla minima compressione in testa

N	Mx	My	Tx	Ty	comb	
-9.073E+04	1.3007E+06	1.5563E+06	3.6979E+03	-3.012E+03	1	sl
-9.073E+04	1.3007E+06	1.5563E+06	3.6979E+03	-3.012E+03	1	ra
-9.073E+04	1.3007E+06	1.5563E+06	3.6979E+03	-3.012E+03	1	fr
-9.073E+04	1.3007E+06	1.5563E+06	3.6979E+03	-3.012E+03	1	qp
-6.148E+04	-8.342E+05	-5.493E+06	-2.408E+04	5.3781E+03	7	SLV fond

Combinazione corrispondente alla massima compressione in testa

N	Mx	My	Tx	Ty	comb	
-1.578E+05	2.5951E+06	2.2247E+06	5.1138E+03	-6.588E+03	4	sl
-1.173E+05	1.9035E+06	1.6906E+06	3.9023E+03	-4.794E+03	2	ra
-1.040E+05	1.6021E+06	1.6235E+06	3.8001E+03	-3.903E+03	2	fr
-9.870E+04	1.4815E+06	1.5966E+06	3.7592E+03	-3.547E+03	2	qp
-1.200E+05	3.4356E+06	8.6054E+06	3.1473E+04	-1.140E+04	9	SLV fond

Combinazione corrispondente al massimo taglio in testa

N	Mx	My	Tx	Ty	comb	
-1.578E+05	2.5951E+06	2.2247E+06	5.1138E+03	-6.588E+03	4	sl
-1.173E+05	1.9035E+06	1.6906E+06	3.9023E+03	-4.794E+03	2	ra
-1.040E+05	1.6021E+06	1.6235E+06	3.8001E+03	-3.903E+03	2	fr
-9.870E+04	1.4815E+06	1.5966E+06	3.7592E+03	-3.547E+03	2	qp
-1.200E+05	3.4356E+06	8.6054E+06	3.1473E+04	-1.140E+04	9	SLV fond

Verifica di capacità portante riferita al palo singolo:

Fattore di correlazione Psi scelto in base alla conoscenza del sito = 1.7  
 Coeff. parziale di sicurezza sulla resistenza laterale = 1.15  
 Coeff. parziale di sicurezza sulla resistenza alla punta = 1.35  
 Portanza laterale di progetto = 292537.1  
 Portanza di punta di progetto = 85555.4  
 verifica condotta in combinazione SLU 4  
 Sforzo normale = -157810.4



Progetto	Titolo	Rev.	Pag.
Orione	Orione_A24a.pdf "TABULATI DI CALCOLO PLINTO DI FONDAZIONE PER AEROGENERATORE TIPO"	0	228

Tabulati di Calcolo Plinto di Fondazione per Aerogeneratore Tipo - Progetto Impianto Eolico - "Orione"

Peso del palo = 49087.4 \* 1.3  
 Carico totale di progetto = -221624  
 Resistenza totale di progetto = 378092.5  
 Coefficiente di sicurezza = 1.71 > 1

Verifica di resistenza allo stato limite:

quota	Af	cop.	c.s.	Mx	My	N	comb
-90	0.0	6.50	0.00	0.0000E+00	0.0000E+00	0.0000E+00	-
-170	78.5	6.00	3.55	2.5416E+06	6.1542E+06	-1.206E+05	9SLV
-250	78.5	6.00	6.59	1.6489E+06	3.7074E+06	-1.222E+05	9SLV
-330	78.5	6.00	12.05	9.7248E+05	1.8913E+06	-9.379E+04	9SLV
-410	78.5	6.00	13.50	8.7147E+05	8.6622E+05	-1.258E+05	4SLU
-490	78.5	6.00	14.42	6.1495E+05	6.4215E+05	-1.278E+05	4SLU
-570	78.5	6.00	14.19	3.5843E+05	4.1809E+05	-1.299E+05	4SLU
-650	78.5	6.00	13.97	1.0190E+05	1.9402E+05	-1.319E+05	4SLU
-730	78.5	6.00	14.67	4.9760E+05	1.6309E+06	-3.679E+04	7SLV
-810	78.5	6.00	15.65	-4.723E+05	-1.530E+06	-7.538E+04	9SLV
-890	78.5	6.00	16.05	-4.607E+05	-1.445E+06	-7.695E+04	9SLV
-970	78.5	6.00	16.48	-4.491E+05	-1.360E+06	-7.852E+04	9SLV
-1050	78.5	6.00	16.93	-4.375E+05	-1.275E+06	-8.009E+04	9SLV
-1130	124.0	6.00	23.08	-4.163E+05	-1.172E+06	-5.399E+04	9SLV
-1210	78.5	6.00	22.45	-3.636E+05	-1.014E+06	-5.556E+04	9SLV
-1290	78.5	6.00	24.46	-1.779E+05	-1.322E+05	-7.536E+04	4SLU
-1370	78.5	6.00	23.81	-1.573E+05	-1.211E+05	-7.741E+04	4SLU
-1450	78.5	6.00	23.20	-1.368E+05	-1.099E+05	-7.945E+04	4SLU
-1530	78.5	6.00	22.62	-1.162E+05	-9.875E+04	-8.149E+04	4SLU
-1610	78.5	6.00	37.68	-9.897E+04	-8.517E+04	-4.891E+04	4SLU
-1690	78.5	6.00	36.17	-8.190E+04	-7.147E+04	-5.095E+04	4SLU
-1770	78.5	6.00	34.78	-6.482E+04	-5.778E+04	-5.300E+04	4SLU
-1850	78.5	6.00	33.49	-4.775E+04	-4.408E+04	-5.504E+04	4SLU
-1930	78.5	6.00	32.29	-3.067E+04	-3.038E+04	-5.708E+04	4SLU
-2010	78.5	6.00	71.74	-2.188E+04	-2.260E+04	-2.569E+04	4SLU
-2090	78.5	6.00	66.46	-1.713E+04	-1.769E+04	-2.773E+04	4SLU
-2170	124.0	6.00	68.32	-1.239E+04	-1.279E+04	-2.978E+04	4SLU
-2250	78.5	6.00	57.93	-7.639E+03	-7.889E+03	-3.182E+04	4SLU
-2330	78.5	6.00	54.44	-2.892E+03	-2.987E+03	-3.386E+04	4SLU
-2410	78.5	6.00	100.00	4.1837E-12	-3.412E-11	-3.145E+03	4SLU
-2490	78.5	6.00	100.00	4.1837E-12	-4.269E-12	-5.187E+03	4SLU

Verifica di esercizio (combinazione rara):

quota	Af	cop.	sigmaf	sigmac	Mx	My	N	comb	Wk
-90	0.0	6.50	0.0	0.0	0.0000E+00	0.0000E+00	0.0000E+00	-	0.000
-170	78.5	6.00	36.4	30.6	1.5232E+06	1.3850E+06	-1.181E+05	2	0.000
-250	78.5	6.00		26.4	1.1431E+06	1.0798E+06	-1.197E+05	2	0.000
-330	78.5	6.00		20.0	8.3488E+05	8.2523E+05	-9.189E+04	2	0.000
-410	78.5	6.00		18.1	6.4638E+05	6.5509E+05	-9.346E+04	2	0.000
-490	78.5	6.00		16.1	4.5788E+05	4.8496E+05	-9.503E+04	2	0.000
-570	78.5	6.00		14.2	2.6938E+05	3.1482E+05	-9.660E+04	2	0.000
-650	78.5	6.00		12.3	8.0879E+04	1.4467E+05	-9.818E+04	2	0.000
-730	78.5	6.00		8.5	-4.608E+04	2.6763E+04	-7.232E+04	2	0.000
-810	78.5	6.00		8.8	-7.046E+04	-4.103E+03	-7.389E+04	2	0.000
-890	78.5	6.00		9.2	-9.485E+04	-3.497E+04	-7.546E+04	2	0.000
-970	78.5	6.00		9.7	-1.192E+05	-6.584E+04	-7.703E+04	2	0.000
-1050	78.5	6.00		10.2	-1.436E+05	-9.670E+04	-7.860E+04	2	0.000
-1130	124.0	6.00		7.0	-1.588E+05	-1.183E+05	-5.289E+04	2	0.000
-1210	78.5	6.00		7.6	-1.441E+05	-1.097E+05	-5.446E+04	2	0.000
-1290	78.5	6.00		7.6	-1.294E+05	-1.010E+05	-5.603E+04	2	0.000
-1370	78.5	6.00		7.6	-1.147E+05	-9.235E+04	-5.760E+04	2	0.000
-1450	78.5	6.00		7.7	-9.997E+04	-8.370E+04	-5.917E+04	2	0.000
-1530	78.5	6.00		7.7	-8.525E+04	-7.505E+04	-6.074E+04	2	0.000
-1610	78.5	6.00		4.8	-7.267E+04	-6.470E+04	-3.631E+04	2	0.000
-1690	78.5	6.00		4.9	-6.019E+04	-5.427E+04	-3.788E+04	2	0.000
-1770	78.5	6.00		4.9	-4.772E+04	-4.384E+04	-3.945E+04	2	0.000
-1850	78.5	6.00		5.0	-3.524E+04	-3.341E+04	-4.102E+04	2	0.000
-1930	78.5	6.00		5.0	-2.276E+04	-2.298E+04	-4.259E+04	2	0.000
-2010	78.5	6.00		2.3	-1.629E+04	-1.707E+04	-1.904E+04	2	0.000
-2090	78.5	6.00		2.4	-1.276E+04	-1.336E+04	-2.061E+04	2	0.000
-2170	124.0	6.00		2.4	-9.222E+03	-9.661E+03	-2.218E+04	2	0.000
-2250	78.5	6.00		2.7	-5.688E+03	-5.958E+03	-2.376E+04	2	0.000
-2330	78.5	6.00		2.8	-2.154E+03	-2.256E+03	-2.533E+04	2	0.000
-2410	78.5	6.00		0.3	1.8190E-12	-2.568E-11	-2.282E+03	2	0.000
-2490	78.5	6.00		0.4	1.8190E-12	-3.354E-12	-3.853E+03	2	0.000

Verifica di esercizio (combinazione quasi permanente):

quota	Af	cop.	sigmaf	sigmac	Mx	My	N	comb	Wk
-90	0.0	6.50	0.0	0.0	0.0000E+00	0.0000E+00	0.0000E+00	-	0.000
-170	78.5	6.00	36.3	26.1	1.1994E+06	1.3020E+06	-9.961E+04	2	0.000
-250	78.5	6.00		22.6	9.1747E+05	1.0079E+06	-1.012E+05	2	0.000
-330	78.5	6.00		17.1	6.8561E+05	7.6406E+05	-7.683E+04	2	0.000
-410	78.5	6.00		15.5	5.3726E+05	6.0402E+05	-7.840E+04	2	0.000
-490	78.5	6.00		13.8	3.8892E+05	4.4397E+05	-7.997E+04	2	0.000
-570	78.5	6.00		12.2	2.4057E+05	2.8392E+05	-8.154E+04	2	0.000
-650	78.5	6.00		10.5	9.2220E+04	1.2387E+05	-8.311E+04	2	0.000
-730	78.5	6.00		6.9	-9.012E+03	1.3521E+04	-6.041E+04	2	0.000



Progetto	Titolo	Rev.	Pag.
Orione	Orione_A24a.pdf "TABULATI DI CALCOLO PLINTO DI FONDAZIONE PER AEROGENERATORE TIPO"	0	229

-810	78.5	6.00	7.2	-3.172E+04	-1.401E+04	-6.198E+04	2	0.000
-890	78.5	6.00	7.6	-5.442E+04	-4.154E+04	-6.355E+04	2	0.000
-970	78.5	6.00	8.1	-7.713E+04	-6.907E+04	-6.512E+04	2	0.000
-1050	78.5	6.00	8.6	-9.984E+04	-9.660E+04	-6.669E+04	2	0.000
-1130	124.0	6.00	5.8	-1.149E+05	-1.156E+05	-4.403E+04	2	0.000
-1210	78.5	6.00	6.3	-1.052E+05	-1.066E+05	-4.560E+04	2	0.000
-1290	78.5	6.00	6.4	-9.553E+04	-9.771E+04	-4.717E+04	2	0.000
-1370	78.5	6.00	6.4	-8.583E+04	-8.877E+04	-4.874E+04	2	0.000
-1450	78.5	6.00	6.5	-7.612E+04	-7.984E+04	-5.031E+04	2	0.000
-1530	78.5	6.00	6.6	-6.642E+04	-7.090E+04	-5.188E+04	2	0.000
-1610	78.5	6.00	4.1	-5.692E+04	-6.099E+04	-3.031E+04	2	0.000
-1690	78.5	6.00	4.1	-4.743E+04	-5.104E+04	-3.188E+04	2	0.000
-1770	78.5	6.00	4.2	-3.795E+04	-4.108E+04	-3.345E+04	2	0.000
-1850	78.5	6.00	4.2	-2.846E+04	-3.113E+04	-3.502E+04	2	0.000
-1930	78.5	6.00	4.3	-1.897E+04	-2.117E+04	-3.659E+04	2	0.000
-2010	78.5	6.00	1.9	-1.384E+04	-1.563E+04	-1.577E+04	2	0.000
-2090	78.5	6.00	2.1	-1.084E+04	-1.224E+04	-1.734E+04	2	0.000
-2170	124.0	6.00	2.0	-7.835E+03	-8.848E+03	-1.891E+04	2	0.000
-2250	78.5	6.00	2.3	-4.832E+03	-5.457E+03	-2.048E+04	2	0.000
-2330	78.5	6.00	2.5	-1.830E+03	-2.066E+03	-2.205E+04	2	0.000
-2410	78.5	6.00	0.2	-4.547E-12	-2.310E-11	-1.657E+03	2	0.000
-2490	78.5	6.00	0.4	-4.547E-12	-3.672E-12	-3.227E+03	2	0.000

Verifica a taglio:

quota	Ast	Vsd	Vsdx	Vsdy	N	comb	VRd,c	VRd,max	VRd,S	Vwd
-90	0.16	33475	31473	-11403	-119974	9SLV	39876	231056	84199	44323 Vsd < VRd,
-170	0.16	32557	30585	-11159	-120616	9SLV	43853	231056	88177	44323 Vsd < VRd,
-250	0.08	32557	30585	-11159	-122186	9SLV	44072	231056	66233	22162 Vsd < VRd,
-330	0.08	10346	9563	-3948	-93789	9SLV	40124	231056	62286	22162 Vsd < VRd,
-410	0.08	10346	9563	-3948	-95359	9SLV	40343	231056	62504	22162 Vsd < VRd,
-490	0.08	10346	9563	-3948	-96930	9SLV	40561	231056	62723	22162 Vsd < VRd,
-570	0.08	10346	9563	-3948	-98501	9SLV	40779	231056	62941	22162 Vsd < VRd,
-650	0.08	10346	9563	-3948	-100072	9SLV	40998	231056	63159	22162 Vsd < VRd,
-730	0.08	1852	1717	-694	-36792	7SLV	32202	231056	54364	22162 Vsd < VRd,
-810	0.08	1852	1717	-694	-38362	7SLV	32420	231056	54582	22162 Vsd < VRd,
-890	0.08	1852	1717	-694	-39933	7SLV	32639	231056	54800	22162 Vsd < VRd,
-970	0.08	1852	1717	-694	-41504	7SLV	32857	231056	55019	22162 Vsd < VRd,
-1050	0.08	1852	1717	-694	-43075	7SLV	33075	231056	55237	22162 Vsd < VRd,
-1130	0.08	2084	-1978	658	-53988	9SLV	39048	231056	61210	22162 Vsd < VRd,
-1210	0.08	2084	-1978	658	-55559	9SLV	34811	231056	56972	22162 Vsd < VRd,
-1290	0.08	2084	-1978	658	-57129	9SLV	35029	231056	57191	22162 Vsd < VRd,
-1370	0.08	2084	-1978	658	-58700	9SLV	35247	231056	57409	22162 Vsd < VRd,
-1450	0.08	2084	-1978	658	-60271	9SLV	35466	231056	57627	22162 Vsd < VRd,
-1530	0.08	2084	-1978	658	-61842	9SLV	35684	231056	57846	22162 Vsd < VRd,
-1610	0.08	910	-851	323	-37055	9SLV	32239	231056	54400	22162 Vsd < VRd,
-1690	0.08	910	-851	323	-38625	9SLV	32457	231056	54619	22162 Vsd < VRd,
-1770	0.08	910	-851	323	-40196	9SLV	32675	231056	54837	22162 Vsd < VRd,
-1850	0.08	910	-851	323	-41767	9SLV	32894	231056	55055	22162 Vsd < VRd,
-1930	0.08	910	-851	323	-43338	9SLV	33112	231056	55274	22162 Vsd < VRd,
-2010	0.08	85	-61	59	-25692	4SLU	30659	231056	52821	22162 Vsd < VRd,
-2090	0.08	85	-61	59	-27734	4SLU	30943	231056	53105	22162 Vsd < VRd,
-2170	0.08	85	-61	59	-29776	4SLU	35683	231056	57845	22162 Vsd < VRd,
-2250	0.08	85	-61	59	-31818	4SLU	31511	231056	53672	22162 Vsd < VRd,
-2330	0.08	85	-61	59	-33860	4SLU	31794	231056	53956	22162 Vsd < VRd,
-2410	0.08	0	0	0	-1869	15SLV	27348	231056	49510	22162 Vsd < VRd,
-2490	0.08	0	0	0	-3440	15SLV	27566	231056	49728	22162 Vsd < VRd,

Palo alle coordinate X=1264 Y=-1061

Sollecitazioni massime in testa palo:

Combinazione corrispondente alla minima compressione in testa

N	Mx	My	Tx	Ty	comb
-9.073E+04	1.5498E+06	1.3071E+06	3.1207E+03	-3.589E+03	1 sl
-9.073E+04	1.5498E+06	1.3071E+06	3.1207E+03	-3.589E+03	1 ra
-9.073E+04	1.5498E+06	1.3071E+06	3.1207E+03	-3.589E+03	1 fr
-9.073E+04	1.5498E+06	1.3071E+06	3.1207E+03	-3.589E+03	1 qp
-5.983E+04	-5.413E+06	-8.388E+05	-5.336E+03	2.3834E+04	3 SLV fond

Combinazione corrispondente alla massima compressione in testa

N	Mx	My	Tx	Ty	comb
-1.518E+05	2.9051E+06	1.6965E+06	3.8700E+03	-7.283E+03	4 sl
-1.133E+05	2.1434E+06	1.3053E+06	2.9961E+03	-5.334E+03	2 ra
-1.020E+05	1.8466E+06	1.3062E+06	3.0584E+03	-4.462E+03	2 fr
-9.751E+04	1.7279E+06	1.3065E+06	3.0833E+03	-4.113E+03	2 qp
-1.216E+05	8.5127E+06	3.4529E+06	1.1577E+04	-3.101E+04	13 SLV fond

Combinazione corrispondente al massimo taglio in testa

N	Mx	My	Tx	Ty	comb
-1.518E+05	2.9051E+06	1.6965E+06	3.8700E+03	-7.283E+03	4 sl
-1.133E+05	2.1434E+06	1.3053E+06	2.9961E+03	-5.334E+03	2 ra
-1.020E+05	1.8466E+06	1.3062E+06	3.0584E+03	-4.462E+03	2 fr
-9.751E+04	1.7279E+06	1.3065E+06	3.0833E+03	-4.113E+03	2 qp
-1.216E+05	8.5127E+06	3.4529E+06	1.1577E+04	-3.101E+04	13 SLV fond



Verifica di capacità portante riferita al palo singolo:

Fattore di correlazione Psi scelto in base alla conoscenza del sito = 1.7  
 Coeff. parziale di sicurezza sulla resistenza laterale = 1.15  
 Coeff. parziale di sicurezza sulla resistenza alla punta = 1.35  
 Portanza laterale di progetto = 292537.1  
 Portanza di punta di progetto = 85555.4  
 verifica condotta in combinazione SLU 4  
 Sforzo normale = -151847.8  
 Peso del palo = 49087.4 \* 1.3  
 Carico totale di progetto = -215661.4  
 Resistenza totale di progetto = 378092.5  
 Coefficiente di sicurezza = 1.75 > 1

Verifica di resistenza allo stato limite:

quota	Af	cop.	c.s.	Mx	My	N	comb
-90	0.0	6.50	0.00	0.0000E+00	0.0000E+00	0.0000E+00	-
-170	78.5	6.00	3.60	6.0893E+06	2.5518E+06	-1.224E+05	13SLV
-250	78.5	6.00	6.63	3.6699E+06	1.6523E+06	-1.239E+05	13SLV
-330	78.5	6.00	12.05	1.8735E+06	9.7165E+05	-9.531E+04	13SLV
-410	78.5	6.00	13.98	9.9261E+05	6.7020E+05	-1.210E+05	4SLU
-490	78.5	6.00	14.98	7.0463E+05	4.9919E+05	-1.230E+05	4SLU
-570	78.5	6.00	14.74	4.1664E+05	3.2819E+05	-1.251E+05	4SLU
-650	78.5	6.00	14.50	1.2866E+05	1.5719E+05	-1.271E+05	4SLU
-730	78.5	6.00	14.64	1.6173E+06	4.9858E+05	-3.558E+04	3SLV
-810	78.5	6.00	15.63	-1.516E+06	-4.738E+05	-7.659E+04	13SLV
-890	78.5	6.00	16.03	-1.432E+06	-4.621E+05	-7.816E+04	13SLV
-970	78.5	6.00	16.45	-1.347E+06	-4.504E+05	-7.973E+04	13SLV
-1050	78.5	6.00	16.90	-1.263E+06	-4.386E+05	-8.131E+04	13SLV
-1130	124.0	6.00	23.05	-1.162E+06	-4.173E+05	-5.489E+04	13SLV
-1210	78.5	6.00	22.42	-1.005E+06	-3.644E+05	-5.646E+04	13SLV
-1290	78.5	6.00	24.40	-8.481E+05	-3.115E+05	-5.803E+04	13SLV
-1370	78.5	6.00	24.72	-1.744E+05	-9.098E+04	-7.457E+04	4SLU
-1450	78.5	6.00	24.06	-1.523E+05	-8.304E+04	-7.661E+04	4SLU
-1530	78.5	6.00	23.43	-1.301E+05	-7.509E+04	-7.866E+04	4SLU
-1610	78.5	6.00	39.22	-1.110E+05	-6.486E+04	-4.699E+04	4SLU
-1690	78.5	6.00	37.59	-9.197E+04	-5.451E+04	-4.904E+04	4SLU
-1770	78.5	6.00	36.09	-7.297E+04	-4.416E+04	-5.108E+04	4SLU
-1850	78.5	6.00	34.70	-5.396E+04	-3.381E+04	-5.312E+04	4SLU
-1930	78.5	6.00	33.41	-3.496E+04	-2.346E+04	-5.516E+04	4SLU
-2010	78.5	6.00	74.79	-2.507E+04	-1.752E+04	-2.464E+04	4SLU
-2090	78.5	6.00	69.07	-1.963E+04	-1.372E+04	-2.669E+04	4SLU
-2170	124.0	6.00	70.81	-1.419E+04	-9.916E+03	-2.873E+04	4SLU
-2250	78.5	6.00	59.90	-8.753E+03	-6.116E+03	-3.077E+04	4SLU
-2330	78.5	6.00	56.18	-3.314E+03	-2.316E+03	-3.281E+04	4SLU
-2410	78.5	6.00	100.00	-3.388E-11	-2.580E-11	-2.945E+03	4SLU
-2490	78.5	6.00	100.00	-2.888E-11	-1.733E-11	-4.987E+03	4SLU

Verifica di esercizio (combinazione rara):

quota	Af	cop.	sigmaf	sigmac	Mx	My	N	comb	Wk
-90	0.0	6.50	0.0	0.0	0.0000E+00	0.0000E+00	0.0000E+00	-	0.000
-170	78.5	6.00	40.6	29.9	1.7200E+06	1.0716E+06	-1.142E+05	2	0.000
-250	78.5	6.00		25.7	1.2968E+06	8.3837E+05	-1.157E+05	2	0.000
-330	78.5	6.00		19.4	9.5249E+05	6.4330E+05	-8.868E+04	2	0.000
-410	78.5	6.00		17.5	7.3967E+05	5.1189E+05	-9.025E+04	2	0.000
-490	78.5	6.00		15.6	5.2685E+05	3.8047E+05	-9.182E+04	2	0.000
-570	78.5	6.00		13.7	3.1402E+05	2.4905E+05	-9.339E+04	2	0.000
-650	78.5	6.00		11.9	1.0120E+05	1.1764E+05	-9.496E+04	2	0.000
-730	78.5	6.00		8.2	-4.260E+04	2.6288E+04	-6.978E+04	2	0.000
-810	78.5	6.00		8.5	-7.135E+04	1.7145E+03	-7.135E+04	2	0.000
-890	78.5	6.00		9.0	-1.001E+05	-2.286E+04	-7.292E+04	2	0.000
-970	78.5	6.00		9.4	-1.288E+05	-4.743E+04	-7.449E+04	2	0.000
-1050	78.5	6.00		9.9	-1.576E+05	-7.201E+04	-7.606E+04	2	0.000
-1130	124.0	6.00		6.8	-1.759E+05	-8.934E+04	-5.100E+04	2	0.000
-1210	78.5	6.00		7.3	-1.599E+05	-8.303E+04	-5.257E+04	2	0.000
-1290	78.5	6.00		7.4	-1.439E+05	-7.672E+04	-5.414E+04	2	0.000
-1370	78.5	6.00		7.4	-1.280E+05	-7.041E+04	-5.571E+04	2	0.000
-1450	78.5	6.00		7.4	-1.120E+05	-6.410E+04	-5.728E+04	2	0.000
-1530	78.5	6.00		7.5	-9.602E+04	-5.779E+04	-5.885E+04	2	0.000
-1610	78.5	6.00		4.7	-8.196E+04	-4.988E+04	-3.503E+04	2	0.000
-1690	78.5	6.00		4.7	-6.798E+04	-4.189E+04	-3.660E+04	2	0.000
-1770	78.5	6.00		4.8	-5.401E+04	-3.390E+04	-3.817E+04	2	0.000
-1850	78.5	6.00		4.8	-4.004E+04	-2.591E+04	-3.974E+04	2	0.000
-1930	78.5	6.00		4.9	-2.606E+04	-1.792E+04	-4.131E+04	2	0.000
-2010	78.5	6.00		2.2	-1.875E+04	-1.335E+04	-1.834E+04	2	0.000
-2090	78.5	6.00		2.4	-1.468E+04	-1.046E+04	-1.992E+04	2	0.000
-2170	124.0	6.00		2.3	-1.061E+04	-7.559E+03	-2.149E+04	2	0.000
-2250	78.5	6.00		2.6	-6.545E+03	-4.662E+03	-2.306E+04	2	0.000
-2330	78.5	6.00		2.8	-2.478E+03	-1.765E+03	-2.463E+04	2	0.000
-2410	78.5	6.00		0.2	-2.551E-11	-1.939E-11	-2.148E+03	2	0.000
-2490	78.5	6.00		0.4	-2.096E-11	-1.313E-11	-3.719E+03	2	0.000

Verifica di esercizio (combinazione quasi permanente):

quota	Af	cop.	sigmaf	sigmac	Mx	My	N	comb	Wk
-------	----	------	--------	--------	----	----	---	------	----



Progetto	Titolo	Rev.	Pag.
Orione	Orione_A24a.pdf "TABULATI DI CALCOLO PLINTO DI FONDAZIONE PER AEROGENERATORE TIPO"	0	231



Tabulati di Calcolo Plinto di Fondazione per Aerogeneratore Tipo - Progetto Impianto Eolico - "Orione"

-90	0.0	6.50	0.0	0.0	0.0000E+00	0.0000E+00	0.0000E+00	-	0.000
-170	78.5	6.00	36.9	25.9	1.4007E+06	1.0658E+06	-9.842E+04	2	0.000
-250	78.5	6.00		22.4	1.0736E+06	8.2541E+05	-9.999E+04	2	0.000
-330	78.5	6.00		16.9	8.0426E+05	6.2611E+05	-7.587E+04	2	0.000
-410	78.5	6.00		15.3	6.3103E+05	4.9527E+05	-7.744E+04	2	0.000
-490	78.5	6.00		13.7	4.5780E+05	3.6443E+05	-7.901E+04	2	0.000
-570	78.5	6.00		12.0	2.8457E+05	2.3359E+05	-8.058E+04	2	0.000
-650	78.5	6.00		10.4	1.1134E+05	1.0274E+05	-8.215E+04	2	0.000
-730	78.5	6.00		6.8	-7.043E+03	1.2455E+04	-5.965E+04	2	0.000
-810	78.5	6.00		7.1	-3.401E+04	-1.024E+04	-6.122E+04	2	0.000
-890	78.5	6.00		7.6	-6.097E+04	-3.293E+04	-6.279E+04	2	0.000
-970	78.5	6.00		8.0	-8.793E+04	-5.563E+04	-6.436E+04	2	0.000
-1050	78.5	6.00		8.5	-1.149E+05	-7.832E+04	-6.593E+04	2	0.000
-1130	124.0	6.00		5.7	-1.329E+05	-9.400E+04	-4.346E+04	2	0.000
-1210	78.5	6.00		6.3	-1.218E+05	-8.678E+04	-4.504E+04	2	0.000
-1290	78.5	6.00		6.3	-1.108E+05	-7.956E+04	-4.661E+04	2	0.000
-1370	78.5	6.00		6.4	-9.966E+04	-7.234E+04	-4.818E+04	2	0.000
-1450	78.5	6.00		6.4	-8.857E+04	-6.512E+04	-4.975E+04	2	0.000
-1530	78.5	6.00		6.5	-7.747E+04	-5.790E+04	-5.132E+04	2	0.000
-1610	78.5	6.00		4.0	-6.643E+04	-4.982E+04	-2.993E+04	2	0.000
-1690	78.5	6.00		4.1	-5.540E+04	-4.170E+04	-3.150E+04	2	0.000
-1770	78.5	6.00		4.1	-4.436E+04	-3.357E+04	-3.307E+04	2	0.000
-1850	78.5	6.00		4.2	-3.332E+04	-2.545E+04	-3.464E+04	2	0.000
-1930	78.5	6.00		4.3	-2.229E+04	-1.733E+04	-3.621E+04	2	0.000
-2010	78.5	6.00		1.9	-1.629E+04	-1.280E+04	-1.556E+04	2	0.000
-2090	78.5	6.00		2.0	-1.276E+04	-1.002E+04	-1.713E+04	2	0.000
-2170	124.0	6.00		2.0	-9.222E+03	-7.246E+03	-1.870E+04	2	0.000
-2250	78.5	6.00		2.3	-5.688E+03	-4.469E+03	-2.027E+04	2	0.000
-2330	78.5	6.00		2.5	-2.154E+03	-1.692E+03	-2.184E+04	2	0.000
-2410	78.5	6.00		0.2	-2.299E-11	-1.731E-11	-1.617E+03	2	0.000
-2490	78.5	6.00		0.4	-1.526E-11	-1.225E-11	-3.188E+03	2	0.000

Verifica a taglio:

quota	Ast	Vsd	Vsdx	Vsdy	N comb	VRd, c	VRd, max	VRd, S	Vwd	
-90	0.16	33103	11577	-31013	-121624	13SLV	40105	231056	84429	44323 Vsd < VRd,
-170	0.16	32266	11243	-30243	-122373	13SLV	44098	231056	88421	44323 Vsd < VRd,
-250	0.08	32266	11243	-30243	-123944	13SLV	44316	231056	66478	22162 Vsd < VRd,
-330	0.08	10266	3950	-9476	-95311	13SLV	40336	231056	62498	22162 Vsd < VRd,
-410	0.08	10266	3950	-9476	-96882	13SLV	40554	231056	62716	22162 Vsd < VRd,
-490	0.08	10266	3950	-9476	-98453	13SLV	40773	231056	62934	22162 Vsd < VRd,
-570	0.08	10266	3950	-9476	-100023	13SLV	40991	231056	63153	22162 Vsd < VRd,
-650	0.08	10266	3950	-9476	-101594	13SLV	41209	231056	63371	22162 Vsd < VRd,
-730	0.08	1846	694	-1711	-35583	3SLV	32034	231056	54196	22162 Vsd < VRd,
-810	0.08	1846	694	-1711	-37154	3SLV	32252	231056	54414	22162 Vsd < VRd,
-890	0.08	1846	694	-1711	-38724	3SLV	32471	231056	54632	22162 Vsd < VRd,
-970	0.08	1846	694	-1711	-40295	3SLV	32689	231056	54851	22162 Vsd < VRd,
-1050	0.08	1846	694	-1711	-41866	3SLV	32907	231056	55069	22162 Vsd < VRd,
-1130	0.08	2070	-1955	678	-52818	9SLV	38886	231056	61048	22162 Vsd < VRd,
-1210	0.08	2070	-1955	678	-54389	9SLV	34648	231056	56810	22162 Vsd < VRd,
-1290	0.08	2070	-1955	678	-55960	9SLV	34866	231056	57028	22162 Vsd < VRd,
-1370	0.08	2070	-1955	678	-57531	9SLV	35085	231056	57246	22162 Vsd < VRd,
-1450	0.08	2070	-1955	678	-59102	9SLV	35303	231056	57465	22162 Vsd < VRd,
-1530	0.08	2070	-1955	678	-60672	9SLV	35521	231056	57683	22162 Vsd < VRd,
-1610	0.08	903	-324	843	-37666	13SLV	32324	231056	54485	22162 Vsd < VRd,
-1690	0.08	903	-324	843	-39237	13SLV	32542	231056	54704	22162 Vsd < VRd,
-1770	0.08	903	-324	843	-40808	13SLV	32760	231056	54922	22162 Vsd < VRd,
-1850	0.08	903	-324	843	-42379	13SLV	32979	231056	55140	22162 Vsd < VRd,
-1930	0.08	903	-324	843	-43950	13SLV	33197	231056	55359	22162 Vsd < VRd,
-2010	0.08	83	-48	68	-24644	4SLU	30513	231056	52675	22162 Vsd < VRd,
-2090	0.08	83	-48	68	-26686	4SLU	30797	231056	52959	22162 Vsd < VRd,
-2170	0.08	83	-48	68	-28728	4SLU	35537	231056	57699	22162 Vsd < VRd,
-2250	0.08	83	-48	68	-30770	4SLU	31365	231056	53527	22162 Vsd < VRd,
-2330	0.08	83	-48	68	-32812	4SLU	31649	231056	53810	22162 Vsd < VRd,
-2410	0.08	0	0	0	-354	3SLV	27137	231056	49299	22162 Vsd < VRd,
-2490	0.08	0	0	0	-1925	3SLV	27356	231056	49517	22162 Vsd < VRd,

Palo alle coordinate X=1429 Y=-825

Sollecitazioni massime in testa palo:

Combinazione corrispondente alla minima compressione in testa

N	Mx	My	Tx	Ty	comb	
-9.074E+04	1.7517E+06	1.0187E+06	2.4526E+03	-4.057E+03	1	sl
-9.074E+04	1.7517E+06	1.0187E+06	2.4526E+03	-4.057E+03	1	ra
-9.074E+04	1.7517E+06	1.0187E+06	2.4526E+03	-4.057E+03	1	fr
-9.074E+04	1.7517E+06	1.0187E+06	2.4526E+03	-4.057E+03	1	qp
-5.785E+04	-5.226E+06	-1.110E+06	-5.943E+03	2.3420E+04	3	SLV fond

Combinazione corrispondente alla massima compressione in testa

N	Mx	My	Tx	Ty	comb	
-1.449E+05	3.0867E+06	1.1309E+06	2.5422E+03	-7.680E+03	4	sl
-1.087E+05	2.2913E+06	8.8979E+05	2.0218E+03	-5.661E+03	2	ra
-9.971E+04	2.0215E+06	9.5425E+05	2.2372E+03	-4.859E+03	2	fr
-9.613E+04	1.9136E+06	9.8003E+05	2.3234E+03	-4.538E+03	2	qp
-1.236E+05	8.7293E+06	3.1476E+06	1.0848E+04	-3.153E+04	13	SLV fond



Progetto	Titolo	Rev.	Pag.
Orione	Orione_A24a.pdf "TABULATI DI CALCOLO PLINTO DI FONDAZIONE PER AEROGENERATORE TIPO"	0	232

Combinazione corrispondente al massimo taglio in testa

N	Mx	My	Tx	Ty	comb
-1.449E+05	3.0867E+06	1.1309E+06	2.5422E+03	-7.680E+03	4 sl
-1.087E+05	2.2913E+06	8.8979E+05	2.0218E+03	-5.661E+03	2 ra
-9.971E+04	2.0215E+06	9.5425E+05	2.2372E+03	-4.859E+03	2 fr
-9.613E+04	1.9136E+06	9.8003E+05	2.3234E+03	-4.538E+03	2 qp
-1.236E+05	8.7293E+06	3.1476E+06	1.0848E+04	-3.153E+04	13 SLV fond

Verifica di capacità portante riferita al palo singolo:

Fattore di correlazione Psi scelto in base alla conoscenza del sito = 1.7  
 Coeff. parziale di sicurezza sulla resistenza laterale = 1.15  
 Coeff. parziale di sicurezza sulla resistenza alla punta = 1.35  
 Portanza laterale di progetto = 292537.1  
 Portanza di punta di progetto = 85555.4  
 verifica condotta in combinazione SLU 4  
 Sforzo normale = -144872.4  
 Peso del palo = 49087.4 \* 1.3  
 Carico totale di progetto = -208686  
 Resistenza totale di progetto = 378092.5  
 Coefficiente di sicurezza = 1.81 > 1

Verifica di resistenza allo stato limite:

quota	Af	cop.	c.s.	Mx	My	N	comb
-90	0.0	6.50	0.00	0.0000E+00	0.0000E+00	0.0000E+00	-
-170	78.5	6.00	3.57	6.2646E+06	2.3045E+06	-1.244E+05	13SLV
-250	78.5	6.00	6.55	3.8037E+06	1.4631E+06	-1.260E+05	13SLV
-330	78.5	6.00	11.87	1.9733E+06	8.3014E+05	-9.695E+04	13SLV
-410	78.5	6.00	14.60	1.0655E+06	4.5954E+05	-1.153E+05	4SLU
-490	78.5	6.00	15.70	7.5896E+05	3.4539E+05	-1.174E+05	4SLU
-570	78.5	6.00	15.43	4.5246E+05	2.3123E+05	-1.194E+05	4SLU
-650	78.5	6.00	15.17	1.4596E+05	1.1707E+05	-1.215E+05	4SLU
-730	78.5	6.00	14.43	1.6211E+06	4.9381E+05	-3.431E+04	3SLV
-810	78.5	6.00	15.51	-1.521E+06	-4.674E+05	-7.789E+04	13SLV
-890	78.5	6.00	15.90	-1.440E+06	-4.509E+05	-7.946E+04	13SLV
-970	78.5	6.00	16.30	-1.359E+06	-4.345E+05	-8.103E+04	13SLV
-1050	78.5	6.00	16.73	-1.278E+06	-4.181E+05	-8.260E+04	13SLV
-1130	124.0	6.00	22.81	-1.179E+06	-3.936E+05	-5.585E+04	13SLV
-1210	78.5	6.00	22.17	-1.020E+06	-3.427E+05	-5.743E+04	13SLV
-1290	78.5	6.00	24.13	-8.622E+05	-2.918E+05	-5.900E+04	13SLV
-1370	78.5	6.00	25.87	-1.842E+05	-5.884E+04	-7.126E+04	4SLU
-1450	78.5	6.00	25.15	-1.613E+05	-5.430E+04	-7.330E+04	4SLU
-1530	78.5	6.00	24.47	-1.383E+05	-4.976E+04	-7.534E+04	4SLU
-1610	78.5	6.00	41.19	-1.180E+05	-4.310E+04	-4.475E+04	4SLU
-1690	78.5	6.00	39.39	-9.790E+04	-3.633E+04	-4.679E+04	4SLU
-1770	78.5	6.00	37.75	-7.778E+04	-2.956E+04	-4.883E+04	4SLU
-1850	78.5	6.00	36.23	-5.766E+04	-2.280E+04	-5.087E+04	4SLU
-1930	78.5	6.00	34.83	-3.754E+04	-1.603E+04	-5.292E+04	4SLU
-2010	78.5	6.00	78.71	-2.700E+04	-1.205E+04	-2.342E+04	4SLU
-2090	78.5	6.00	72.40	-2.115E+04	-9.437E+03	-2.546E+04	4SLU
-2170	124.0	6.00	73.97	-1.529E+04	-6.822E+03	-2.750E+04	4SLU
-2250	78.5	6.00	62.39	-9.428E+03	-4.208E+03	-2.954E+04	4SLU
-2330	78.5	6.00	58.36	-3.570E+03	-1.593E+03	-3.159E+04	4SLU
-2410	78.5	6.00	100.00	-4.347E-12	-1.224E-11	-2.711E+03	4SLU
-2490	78.5	6.00	100.00	2.271E-11	-6.331E-12	-4.753E+03	4SLU

Verifica di esercizio (combinazione rara):

quota	Af	cop.	sigmaf	sigmac	Mx	My	N	comb	Wk
-90	0.0	6.50	0.0	0.0	0.0000E+00	0.0000E+00	0.0000E+00	-	0.000
-170	78.5	6.00	44.6	29.1	1.8418E+06	7.3353E+05	-1.095E+05	2	0.000
-250	78.5	6.00		24.9	1.3925E+06	5.7764E+05	-1.111E+05	2	0.000
-330	78.5	6.00		18.8	1.0263E+06	4.4659E+05	-8.492E+04	2	0.000
-410	78.5	6.00		16.9	7.9839E+05	3.5695E+05	-8.649E+04	2	0.000
-490	78.5	6.00		15.0	5.7050E+05	2.6731E+05	-8.806E+04	2	0.000
-570	78.5	6.00		13.2	3.4262E+05	1.7767E+05	-8.963E+04	2	0.000
-650	78.5	6.00		11.3	1.1474E+05	8.8023E+04	-9.120E+04	2	0.000
-730	78.5	6.00		7.8	-3.952E+04	2.5347E+04	-6.681E+04	2	0.000
-810	78.5	6.00		8.2	-7.109E+04	7.6170E+03	-6.838E+04	2	0.000
-890	78.5	6.00		8.6	-1.027E+05	-1.011E+04	-6.995E+04	2	0.000
-970	78.5	6.00		9.1	-1.342E+05	-2.784E+04	-7.152E+04	2	0.000
-1050	78.5	6.00		9.6	-1.658E+05	-4.557E+04	-7.309E+04	2	0.000
-1130	124.0	6.00		6.5	-1.861E+05	-5.825E+04	-4.879E+04	2	0.000
-1210	78.5	6.00		7.1	-1.694E+05	-5.444E+04	-5.036E+04	2	0.000
-1290	78.5	6.00		7.1	-1.527E+05	-5.062E+04	-5.193E+04	2	0.000
-1370	78.5	6.00		7.1	-1.360E+05	-4.681E+04	-5.350E+04	2	0.000
-1450	78.5	6.00		7.2	-1.193E+05	-4.299E+04	-5.507E+04	2	0.000
-1530	78.5	6.00		7.2	-1.027E+05	-3.918E+04	-5.664E+04	2	0.000
-1610	78.5	6.00		4.5	-8.769E+04	-3.389E+04	-3.353E+04	2	0.000
-1690	78.5	6.00		4.6	-7.281E+04	-2.853E+04	-3.510E+04	2	0.000
-1770	78.5	6.00		4.6	-5.792E+04	-2.317E+04	-3.667E+04	2	0.000
-1850	78.5	6.00		4.6	-4.303E+04	-1.781E+04	-3.824E+04	2	0.000
-1930	78.5	6.00		4.7	-2.814E+04	-1.245E+04	-3.981E+04	2	0.000
-2010	78.5	6.00		2.1	-2.030E+04	-9.331E+03	-1.753E+04	2	0.000
-2090	78.5	6.00		2.3	-1.590E+04	-7.307E+03	-1.910E+04	2	0.000
-2170	124.0	6.00		2.2	-1.149E+04	-5.282E+03	-2.067E+04	2	0.000
-2250	78.5	6.00		2.5	-7.087E+03	-3.258E+03	-2.224E+04	2	0.000



Tabulati di Calcolo Plinto di Fondazione per Aerogeneratore Tipo - Progetto Impianto Eolico - "Orione"

-2330	78.5	6.00	2.7	-2.684E+03	-1.234E+03	-2.381E+04	2	0.000
-2410	78.5	6.00	0.2	-2.920E-12	-9.138E-12	-1.992E+03	2	0.000
-2490	78.5	6.00	0.4	1.7543E-11	-4.590E-12	-3.563E+03	2	0.000

Verifica di esercizio (combinazione quasi permanente):

quota	Af	cop.	sigmaf	sigmac	Mx	My	N	comb	Wk
-90	0.0	6.50	0.0	0.0	0.0000E+00	0.0000E+00	0.0000E+00	-	0.000
-170	78.5	6.00	38.0	25.7	1.5525E+06	7.9974E+05	-9.705E+04	2	0.000
-250	78.5	6.00		22.2	1.1915E+06	6.1981E+05	-9.862E+04	2	0.000
-330	78.5	6.00		16.7	8.9392E+05	4.7063E+05	-7.475E+04	2	0.000
-410	78.5	6.00		15.1	7.0193E+05	3.7267E+05	-7.632E+04	2	0.000
-490	78.5	6.00		13.5	5.0994E+05	2.7471E+05	-7.789E+04	2	0.000
-570	78.5	6.00		11.9	3.1795E+05	1.7675E+05	-7.946E+04	2	0.000
-650	78.5	6.00		10.2	1.2595E+05	7.8796E+04	-8.103E+04	2	0.000
-730	78.5	6.00		6.6	-5.368E+03	1.1112E+04	-5.876E+04	2	0.000
-810	78.5	6.00		7.0	-3.557E+04	-6.118E+03	-6.033E+04	2	0.000
-890	78.5	6.00		7.5	-6.576E+04	-2.335E+04	-6.190E+04	2	0.000
-970	78.5	6.00		7.9	-9.596E+04	-4.058E+04	-6.347E+04	2	0.000
-1050	78.5	6.00		8.4	-1.262E+05	-5.781E+04	-6.504E+04	2	0.000
-1130	124.0	6.00		5.6	-1.464E+05	-6.976E+04	-4.281E+04	2	0.000
-1210	78.5	6.00		6.2	-1.343E+05	-6.446E+04	-4.438E+04	2	0.000
-1290	78.5	6.00		6.2	-1.222E+05	-5.916E+04	-4.595E+04	2	0.000
-1370	78.5	6.00		6.3	-1.101E+05	-5.386E+04	-4.752E+04	2	0.000
-1450	78.5	6.00		6.4	-9.793E+04	-4.856E+04	-4.909E+04	2	0.000
-1530	78.5	6.00		6.4	-8.580E+04	-4.326E+04	-5.066E+04	2	0.000
-1610	78.5	6.00		4.0	-7.360E+04	-3.723E+04	-2.948E+04	2	0.000
-1690	78.5	6.00		4.0	-6.140E+04	-3.118E+04	-3.105E+04	2	0.000
-1770	78.5	6.00		4.1	-4.920E+04	-2.512E+04	-3.263E+04	2	0.000
-1850	78.5	6.00		4.1	-3.700E+04	-1.906E+04	-3.420E+04	2	0.000
-1930	78.5	6.00		4.2	-2.480E+04	-1.300E+04	-3.577E+04	2	0.000
-2010	78.5	6.00		1.9	-1.815E+04	-9.609E+03	-1.532E+04	2	0.000
-2090	78.5	6.00		2.0	-1.421E+04	-7.524E+03	-1.689E+04	2	0.000
-2170	124.0	6.00		2.0	-1.027E+04	-5.440E+03	-1.846E+04	2	0.000
-2250	78.5	6.00		2.3	-6.336E+03	-3.355E+03	-2.003E+04	2	0.000
-2330	78.5	6.00		2.4	-2.399E+03	-1.270E+03	-2.160E+04	2	0.000
-2410	78.5	6.00		0.2	-9.956E-13	-7.864E-12	-1.570E+03	2	0.000
-2490	78.5	6.00		0.3	1.7876E-11	-3.317E-12	-3.141E+03	2	0.000

Verifica a taglio:

quota	Ast	Vsd	Vsdx	Vsdy	N	comb	VRd,c	VRd,max	VRd,S	Vwd
-90	0.16	33347	10848	-31534	-123642	13SLV	40386	231056	84709	44323 Vsd < VRd,
-170	0.16	32509	10518	-30761	-124382	13SLV	44377	231056	88700	44323 Vsd < VRd,
-250	0.08	32509	10518	-30761	-125953	13SLV	44595	231056	66757	22162 Vsd < VRd,
-330	0.08	10379	3568	-9747	-96948	13SLV	40564	231056	62725	22162 Vsd < VRd,
-410	0.08	10379	3568	-9747	-98518	13SLV	40782	231056	62944	22162 Vsd < VRd,
-490	0.08	10379	3568	-9747	-100089	13SLV	41000	231056	63162	22162 Vsd < VRd,
-570	0.08	10379	3568	-9747	-101660	13SLV	41219	231056	63380	22162 Vsd < VRd,
-650	0.08	10379	3568	-9747	-103231	13SLV	41437	231056	63599	22162 Vsd < VRd,
-730	0.08	1865	631	-1755	-34311	3SLV	31857	231056	54019	22162 Vsd < VRd,
-810	0.08	1865	631	-1755	-35882	3SLV	32076	231056	54237	22162 Vsd < VRd,
-890	0.08	1865	631	-1755	-37453	3SLV	32294	231056	54456	22162 Vsd < VRd,
-970	0.08	1865	631	-1755	-39024	3SLV	32512	231056	54674	22162 Vsd < VRd,
-1050	0.08	1865	631	-1755	-40594	3SLV	32731	231056	54892	22162 Vsd < VRd,
-1130	0.08	2077	-636	1977	-55855	13SLV	39308	231056	61470	22162 Vsd < VRd,
-1210	0.08	2077	-636	1977	-57426	13SLV	35070	231056	57232	22162 Vsd < VRd,
-1290	0.08	2077	-636	1977	-58996	13SLV	35288	231056	57450	22162 Vsd < VRd,
-1370	0.08	2077	-636	1977	-60567	13SLV	35507	231056	57668	22162 Vsd < VRd,
-1450	0.08	2077	-636	1977	-62138	13SLV	35725	231056	57887	22162 Vsd < VRd,
-1530	0.08	2077	-636	1977	-63709	13SLV	35943	231056	58105	22162 Vsd < VRd,
-1610	0.08	911	-299	860	-38318	13SLV	32414	231056	54576	22162 Vsd < VRd,
-1690	0.08	911	-299	860	-39889	13SLV	32633	231056	54794	22162 Vsd < VRd,
-1770	0.08	911	-299	860	-41460	13SLV	32851	231056	55013	22162 Vsd < VRd,
-1850	0.08	911	-299	860	-43031	13SLV	33069	231056	55231	22162 Vsd < VRd,
-1930	0.08	911	-299	860	-44602	13SLV	33288	231056	55449	22162 Vsd < VRd,
-2010	0.08	80	-33	73	-23418	4SLU	30343	231056	52505	22162 Vsd < VRd,
-2090	0.08	80	-33	73	-25460	4SLU	30627	231056	52789	22162 Vsd < VRd,
-2170	0.08	80	-33	73	-27502	4SLU	35367	231056	57529	22162 Vsd < VRd,
-2250	0.08	80	-33	73	-29544	4SLU	31195	231056	53356	22162 Vsd < VRd,
-2330	0.08	80	-33	73	-31586	4SLU	31478	231056	53640	22162 Vsd < VRd,
-2410	0.08	0	0	0	-287	3SLV	27128	231056	49290	22162 Vsd < VRd,
-2490	0.08	0	0	0	-1858	3SLV	27346	231056	49508	22162 Vsd < VRd,

Palo alle coordinate X=1551 Y=-564

Sollecitazioni massime in testa palo:

Combinazione corrispondente alla minima compressione in testa

N	Mx	My	Tx	Ty	comb
-9.077E+04	1.9004E+06	6.9933E+05	1.7128E+03	-4.401E+03	1 sl
-9.077E+04	1.9004E+06	6.9933E+05	1.7128E+03	-4.401E+03	1 ra
-9.077E+04	1.9004E+06	6.9933E+05	1.7128E+03	-4.401E+03	1 fr
-9.077E+04	1.9004E+06	6.9933E+05	1.7128E+03	-4.401E+03	1 qp
-5.687E+04	-5.086E+06	-1.408E+06	-6.604E+03	2.3106E+04	3 SLV fond



Progetto	Titolo	Rev.	Pag.
Orione	Orione_A24a.pdf "TABULATI DI CALCOLO PLINTO DI FONDAZIONE PER AEROGENERATORE TIPO"	0	234

Combinazione corrispondente alla massima compressione in testa

N	Mx	My	Tx	Ty	comb	
-1.371E+05	3.1405E+06	5.6036E+05	1.2052E+03	-7.780E+03	4	sl
-1.035E+05	2.3471E+06	4.6682E+05	1.0318E+03	-5.774E+03	2	ra
-9.714E+04	2.1238E+06	5.8307E+05	1.3723E+03	-5.087E+03	2	fr
-9.459E+04	2.0344E+06	6.2958E+05	1.5085E+03	-4.813E+03	2	qp
-1.247E+05	8.8864E+06	2.8068E+06	1.0029E+04	-3.191E+04	13	SLV fond

Combinazione corrispondente al massimo taglio in testa

N	Mx	My	Tx	Ty	comb	
-1.371E+05	3.1405E+06	5.6036E+05	1.2052E+03	-7.780E+03	4	sl
-1.035E+05	2.3471E+06	4.6682E+05	1.0318E+03	-5.774E+03	2	ra
-9.714E+04	2.1238E+06	5.8307E+05	1.3723E+03	-5.087E+03	2	fr
-9.459E+04	2.0344E+06	6.2958E+05	1.5085E+03	-4.813E+03	2	qp
-1.247E+05	8.8864E+06	2.8068E+06	1.0029E+04	-3.191E+04	13	SLV fond

Verifica di capacità portante riferita al palo singolo:

Fattore di correlazione Psi scelto in base alla conoscenza del sito = 1.7  
 Coeff. parziale di sicurezza sulla resistenza laterale = 1.15  
 Coeff. parziale di sicurezza sulla resistenza alla punta = 1.35  
 Portanza laterale di progetto = 292537.1  
 Portanza di punta di progetto = 85555.4  
 verifica condotta in combinazione SLU 4  
 Sforzo normale = -137097.8  
 Peso del palo = 49087.4 \* 1.3  
 Carico totale di progetto = -200911.4  
 Resistenza totale di progetto = 378092.5  
 Coefficiente di sicurezza = 1.88 > 1

Verifica di resistenza allo stato limite:

quota	Af	cop.	c.s.	Mx	My	N	comb
-90	0.0	6.50	0.00	0.0000E+00	0.0000E+00	0.0000E+00	-
-170	78.5	6.00	3.56	6.3919E+06	2.0288E+06	-1.254E+05	13SLV
-250	78.5	6.00	6.51	3.9013E+06	1.2523E+06	-1.270E+05	13SLV
-330	78.5	6.00	11.79	2.0464E+06	6.7282E+05	-9.779E+04	13SLV
-410	78.5	6.00	15.35	1.0903E+06	2.4646E+05	-1.091E+05	4SLU
-490	78.5	6.00	16.55	7.7815E+05	1.8967E+05	-1.111E+05	4SLU
-570	78.5	6.00	16.29	4.6600E+05	1.3289E+05	-1.131E+05	4SLU
-650	78.5	6.00	15.54	-1.136E+06	-3.328E+05	-1.041E+05	13SLV
-730	78.5	6.00	14.34	1.6234E+06	4.8829E+05	-3.369E+04	3SLV
-810	78.5	6.00	15.46	-1.524E+06	-4.600E+05	-7.855E+04	13SLV
-890	78.5	6.00	15.83	-1.446E+06	-4.384E+05	-8.012E+04	13SLV
-970	78.5	6.00	16.23	-1.367E+06	-4.167E+05	-8.169E+04	13SLV
-1050	78.5	6.00	16.65	-1.288E+06	-3.951E+05	-8.326E+04	13SLV
-1130	124.0	6.00	22.69	-1.191E+06	-3.671E+05	-5.635E+04	13SLV
-1210	78.5	6.00	22.06	-1.031E+06	-3.185E+05	-5.792E+04	13SLV
-1290	78.5	6.00	23.99	-8.723E+05	-2.698E+05	-5.949E+04	13SLV
-1370	78.5	6.00	25.83	-7.131E+05	-2.212E+05	-6.106E+04	13SLV
-1450	78.5	6.00	26.48	-1.638E+05	-2.534E+04	-6.960E+04	4SLU
-1530	78.5	6.00	25.73	-1.407E+05	-2.421E+04	-7.164E+04	4SLU
-1610	78.5	6.00	43.63	-1.202E+05	-2.115E+04	-4.224E+04	4SLU
-1690	78.5	6.00	41.62	-9.972E+04	-1.799E+04	-4.429E+04	4SLU
-1770	78.5	6.00	39.79	-7.929E+04	-1.483E+04	-4.633E+04	4SLU
-1850	78.5	6.00	38.11	-5.886E+04	-1.167E+04	-4.837E+04	4SLU
-1930	78.5	6.00	36.56	-3.843E+04	-8.507E+03	-5.041E+04	4SLU
-2010	78.5	6.00	83.59	-2.769E+04	-6.519E+03	-2.205E+04	4SLU
-2090	78.5	6.00	76.50	-2.168E+04	-5.105E+03	-2.409E+04	4SLU
-2170	124.0	6.00	77.84	-1.567E+04	-3.691E+03	-2.614E+04	4SLU
-2250	78.5	6.00	65.41	-9.667E+03	-2.276E+03	-2.818E+04	4SLU
-2330	78.5	6.00	60.99	-3.660E+03	-8.619E+02	-3.022E+04	4SLU
-2410	78.5	6.00	100.00	1.3916E-10	-1.260E-12	-2.526E+03	13SLV
-2490	78.5	6.00	100.00	-2.221E-13	-5.879E-12	-4.492E+03	4SLU

Verifica di esercizio (combinazione rara):

quota	Af	cop.	sigmaf	sigmac	Mx	My	N	comb	Wk
-90	0.0	6.50	0.0	0.0	0.0000E+00	0.0000E+00	0.0000E+00	-	0.000
-170	78.5	6.00	48.6	28.1	1.8885E+06	3.8920E+05	-1.044E+05	2	0.000
-250	78.5	6.00		24.0	1.4302E+06	3.1191E+05	-1.060E+05	2	0.000
-330	78.5	6.00		18.0	1.0561E+06	2.4594E+05	-8.073E+04	2	0.000
-410	78.5	6.00		16.2	8.2243E+05	1.9884E+05	-8.230E+04	2	0.000
-490	78.5	6.00		14.4	5.8878E+05	1.5174E+05	-8.387E+04	2	0.000
-570	78.5	6.00		12.6	3.5513E+05	1.0463E+05	-8.544E+04	2	0.000
-650	78.5	6.00		10.8	1.2149E+05	5.7533E+04	-8.701E+04	2	0.000
-730	78.5	6.00		7.4	-3.686E+04	2.4074E+04	-6.349E+04	2	0.000
-810	78.5	6.00		7.8	-6.970E+04	1.3354E+04	-6.506E+04	2	0.000
-890	78.5	6.00		8.3	-1.025E+05	2.6331E+03	-6.663E+04	2	0.000
-970	78.5	6.00		8.7	-1.354E+05	-8.087E+03	-6.820E+04	2	0.000
-1050	78.5	6.00		9.2	-1.682E+05	-1.881E+04	-6.978E+04	2	0.000
-1130	124.0	6.00		6.2	-1.894E+05	-2.671E+04	-4.632E+04	2	0.000
-1210	78.5	6.00		6.8	-1.726E+05	-2.542E+04	-4.789E+04	2	0.000
-1290	78.5	6.00		6.8	-1.557E+05	-2.412E+04	-4.947E+04	2	0.000
-1370	78.5	6.00		6.8	-1.389E+05	-2.283E+04	-5.104E+04	2	0.000
-1450	78.5	6.00		6.9	-1.220E+05	-2.153E+04	-5.261E+04	2	0.000
-1530	78.5	6.00		6.9	-1.052E+05	-2.023E+04	-5.418E+04	2	0.000



Tabulati di Calcolo Plinto di Fondazione per Aerogeneratore Tipo - Progetto Impianto Eolico - "Orione"

-1610	78.5	6.00	4.3	-8.988E+04	-1.761E+04	-3.186E+04	2	0.000
-1690	78.5	6.00	4.4	-7.466E+04	-1.493E+04	-3.344E+04	2	0.000
-1770	78.5	6.00	4.4	-5.944E+04	-1.224E+04	-3.501E+04	2	0.000
-1850	78.5	6.00	4.4	-4.422E+04	-9.554E+03	-3.658E+04	2	0.000
-1930	78.5	6.00	4.5	-2.900E+04	-6.868E+03	-3.815E+04	2	0.000
-2010	78.5	6.00	2.0	-2.095E+04	-5.225E+03	-1.662E+04	2	0.000
-2090	78.5	6.00	2.2	-1.640E+04	-4.091E+03	-1.819E+04	2	0.000
-2170	124.0	6.00	2.1	-1.186E+04	-2.958E+03	-1.976E+04	2	0.000
-2250	78.5	6.00	2.4	-7.315E+03	-1.824E+03	-2.133E+04	2	0.000
-2330	78.5	6.00	2.6	-2.770E+03	-6.907E+02	-2.290E+04	2	0.000
-2410	78.5	6.00	0.2	-1.836E-11	-7.763E-12	-1.819E+03	2	0.000
-2490	78.5	6.00	0.4	-1.708E-13	-4.352E-12	-3.389E+03	2	0.000

Verifica di esercizio (combinazione quasi permanente):

quota	Af	cop.	sigmaf	sigmac	Mx	My	N	comb	Wk
-90	0.0	6.50	0.0	0.0	0.0000E+00	0.0000E+00	0.0000E+00	-	0.000
-170	78.5	6.00	39.1	25.4	1.6514E+06	5.1412E+05	-9.552E+04	2	0.000
-250	78.5	6.00		21.9	1.2685E+06	3.9901E+05	-9.709E+04	2	0.000
-330	78.5	6.00		16.5	9.5265E+05	3.0358E+05	-7.351E+04	2	0.000
-410	78.5	6.00		14.9	7.4843E+05	2.4092E+05	-7.508E+04	2	0.000
-490	78.5	6.00		13.3	5.4421E+05	1.7827E+05	-7.665E+04	2	0.000
-570	78.5	6.00		11.7	3.3998E+05	1.1562E+05	-7.822E+04	2	0.000
-650	78.5	6.00		10.1	1.3576E+05	5.2962E+04	-7.979E+04	2	0.000
-730	78.5	6.00		6.5	-4.007E+03	9.5484E+03	-5.778E+04	2	0.000
-810	78.5	6.00		6.9	-3.635E+04	-1.799E+03	-5.935E+04	2	0.000
-890	78.5	6.00		7.4	-6.869E+04	-1.315E+04	-6.092E+04	2	0.000
-970	78.5	6.00		7.8	-1.010E+05	-2.449E+04	-6.249E+04	2	0.000
-1050	78.5	6.00		8.3	-1.334E+05	-3.584E+04	-6.407E+04	2	0.000
-1130	124.0	6.00		5.6	-1.551E+05	-4.377E+04	-4.208E+04	2	0.000
-1210	78.5	6.00		6.1	-1.424E+05	-4.053E+04	-4.365E+04	2	0.000
-1290	78.5	6.00		6.2	-1.296E+05	-3.728E+04	-4.522E+04	2	0.000
-1370	78.5	6.00		6.2	-1.168E+05	-3.404E+04	-4.679E+04	2	0.000
-1450	78.5	6.00		6.3	-1.040E+05	-3.079E+04	-4.836E+04	2	0.000
-1530	78.5	6.00		6.3	-9.123E+04	-2.755E+04	-4.993E+04	2	0.000
-1610	78.5	6.00		3.9	-7.828E+04	-2.373E+04	-2.899E+04	2	0.000
-1690	78.5	6.00		4.0	-6.532E+04	-1.988E+04	-3.056E+04	2	0.000
-1770	78.5	6.00		4.0	-5.236E+04	-1.603E+04	-3.213E+04	2	0.000
-1850	78.5	6.00		4.1	-3.940E+04	-1.219E+04	-3.370E+04	2	0.000
-1930	78.5	6.00		4.2	-2.644E+04	-8.342E+03	-3.527E+04	2	0.000
-2010	78.5	6.00		1.8	-1.937E+04	-6.179E+03	-1.505E+04	2	0.000
-2090	78.5	6.00		2.0	-1.516E+04	-4.838E+03	-1.662E+04	2	0.000
-2170	124.0	6.00		2.0	-1.096E+04	-3.498E+03	-1.819E+04	2	0.000
-2250	78.5	6.00		2.3	-6.762E+03	-2.157E+03	-1.976E+04	2	0.000
-2330	78.5	6.00		2.4	-2.560E+03	-8.168E+02	-2.133E+04	2	0.000
-2410	78.5	6.00		0.2	-1.836E-11	-9.377E-12	-1.519E+03	2	0.000
-2490	78.5	6.00		0.3	-1.708E-13	-3.579E-12	-3.090E+03	2	0.000

Verifica a taglio:

quota	Ast	Vsd	Vsdx	Vsdy	N	comb	VRd,c	VRd,max	VRd,S	Vwd
-90	0.16	33447	10029	-31908	-124675	13SLV	40529	231056	84853	44323 Vsd < VRd,
-170	0.16	32610	9706	-31132	-125411	13SLV	44520	231056	88843	44323 Vsd < VRd,
-250	0.08	32610	9706	-31132	-126981	13SLV	44738	231056	66900	22162 Vsd < VRd,
-330	0.08	10428	3142	-9944	-97787	13SLV	40680	231056	62842	22162 Vsd < VRd,
-410	0.08	10428	3142	-9944	-99358	13SLV	40899	231056	63060	22162 Vsd < VRd,
-490	0.08	10428	3142	-9944	-100929	13SLV	41117	231056	63279	22162 Vsd < VRd,
-570	0.08	10428	3142	-9944	-102500	13SLV	41335	231056	63497	22162 Vsd < VRd,
-650	0.08	10428	3142	-9944	-104070	13SLV	41554	231056	63715	22162 Vsd < VRd,
-730	0.08	1874	561	-1788	-33688	3SLV	31771	231056	53932	22162 Vsd < VRd,
-810	0.08	1874	561	-1788	-35259	3SLV	31989	231056	54151	22162 Vsd < VRd,
-890	0.08	1874	561	-1788	-36829	3SLV	32207	231056	54369	22162 Vsd < VRd,
-970	0.08	1874	561	-1788	-38400	3SLV	32426	231056	54587	22162 Vsd < VRd,
-1050	0.08	1874	561	-1788	-39971	3SLV	32644	231056	54806	22162 Vsd < VRd,
-1130	0.08	2081	-608	1990	-56349	13SLV	39377	231056	61538	22162 Vsd < VRd,
-1210	0.08	2081	-608	1990	-57920	13SLV	35139	231056	57300	22162 Vsd < VRd,
-1290	0.08	2081	-608	1990	-59490	13SLV	35357	231056	57519	22162 Vsd < VRd,
-1370	0.08	2081	-608	1990	-61061	13SLV	35575	231056	57737	22162 Vsd < VRd,
-1450	0.08	2081	-608	1990	-62632	13SLV	35794	231056	57955	22162 Vsd < VRd,
-1530	0.08	2081	-608	1990	-64203	13SLV	36012	231056	58174	22162 Vsd < VRd,
-1610	0.08	914	-272	873	-38653	13SLV	32461	231056	54622	22162 Vsd < VRd,
-1690	0.08	914	-272	873	-40224	13SLV	32679	231056	54841	22162 Vsd < VRd,
-1770	0.08	914	-272	873	-41795	13SLV	32897	231056	55059	22162 Vsd < VRd,
-1850	0.08	914	-272	873	-43365	13SLV	33116	231056	55277	22162 Vsd < VRd,
-1930	0.08	914	-272	873	-44936	13SLV	33334	231056	55496	22162 Vsd < VRd,
-2010	0.08	77	-18	75	-22051	4SLU	30153	231056	52315	22162 Vsd < VRd,
-2090	0.08	77	-18	75	-24093	4SLU	30437	231056	52599	22162 Vsd < VRd,
-2170	0.08	77	-18	75	-26135	4SLU	35177	231056	57339	22162 Vsd < VRd,
-2250	0.08	77	-18	75	-28177	4SLU	31005	231056	53166	22162 Vsd < VRd,
-2330	0.08	77	-18	75	-30219	4SLU	31288	231056	53450	22162 Vsd < VRd,
-2410	0.08	0	0	0	-455	1SLV	27151	231056	49313	22162 Vsd < VRd,
-2490	0.08	0	0	0	-2026	1SLV	27370	231056	49531	22162 Vsd < VRd,

Palo alle coordinate X=1625 Y=-287



Progetto	Titolo	Rev.	Pag.
Orione	Orione_A24a.pdf "TABULATI DI CALCOLO PLINTO DI FONDAZIONE PER AEROGENERATORE TIPO"	0	236

Sollecitazioni massime in testa palo:

Combinazione corrispondente alla minima compressione in testa

N	Mx	My	Tx	Ty	comb	
-9.081E+04	1.9913E+06	3.5920E+05	9.2500E+02	-4.611E+03	1	sl
-9.081E+04	1.9913E+06	3.5920E+05	9.2500E+02	-4.611E+03	1	ra
-9.081E+04	1.9913E+06	3.5920E+05	9.2500E+02	-4.611E+03	1	fr
-9.081E+04	1.9913E+06	3.5920E+05	9.2500E+02	-4.611E+03	1	qp
-5.693E+04	-4.995E+06	-1.744E+06	-7.351E+03	2.2896E+04	3	SLV fond

Combinazione corrispondente alla massima compressione in testa

N	Mx	My	Tx	Ty	comb	
-1.288E+05	3.0754E+06	1.5994E+04	-6.880E+01	-7.605E+03	4	sl
-9.795E+04	2.3158E+06	5.8556E+04	7.7467E+01	-5.685E+03	2	ra
-9.438E+04	2.1535E+06	2.0888E+05	5.0123E+02	-5.148E+03	2	fr
-9.295E+04	2.0887E+06	2.6901E+05	6.7074E+02	-4.933E+03	2	qp
-1.247E+05	8.9778E+06	2.4619E+06	9.2013E+03	-3.212E+04	13	SLV fond

Combinazione corrispondente al massimo taglio in testa

N	Mx	My	Tx	Ty	comb	
-1.288E+05	3.0754E+06	1.5994E+04	-6.880E+01	-7.605E+03	4	sl
-9.795E+04	2.3158E+06	5.8556E+04	7.7467E+01	-5.685E+03	2	ra
-9.438E+04	2.1535E+06	2.0888E+05	5.0123E+02	-5.148E+03	2	fr
-9.295E+04	2.0887E+06	2.6901E+05	6.7074E+02	-4.933E+03	2	qp
-1.247E+05	8.9778E+06	2.4619E+06	9.2013E+03	-3.212E+04	13	SLV fond

Verifica di capacità portante riferita al palo singolo:

Fattore di correlazione Psi scelto in base alla conoscenza del sito = 1.7  
 Coeff. parziale di sicurezza sulla resistenza laterale = 1.15  
 Coeff. parziale di sicurezza sulla resistenza alla punta = 1.35  
 Portanza laterale di progetto = 292537.1  
 Portanza di punta di progetto = 85555.4  
 verifica condotta in combinazione SLU 4  
 Sforzo normale = -128757  
 Peso del palo = 49087.4 \* 1.3  
 Carico totale di progetto = -192570.6  
 Resistenza totale di progetto = 378092.5  
 Coefficiente di sicurezza = 1.96 > 1

Verifica di resistenza allo stato limite:

quota	Af	cop.	c.s.	Mx	My	N	comb
-90	0.0	6.50	0.00	0.0000E+00	0.0000E+00	0.0000E+00	-
-170	78.5	6.00	3.56	6.4665E+06	1.7478E+06	-1.254E+05	13SLV
-250	78.5	6.00	6.52	3.9590E+06	1.0352E+06	-1.270E+05	13SLV
-330	78.5	6.00	11.80	2.0901E+06	5.0842E+05	-9.780E+04	13SLV
-410	78.5	6.00	15.41	1.2854E+06	2.9145E+05	-9.937E+04	13SLV
-490	78.5	6.00	17.56	7.6455E+05	4.0743E+04	-1.043E+05	4SLU
-570	78.5	6.00	17.33	4.5876E+05	3.8703E+04	-1.064E+05	4SLU
-650	78.5	6.00	15.54	-1.129E+06	-3.595E+05	-1.041E+05	13SLV
-730	78.5	6.00	14.34	1.6238E+06	4.8783E+05	-3.373E+04	3SLV
-810	78.5	6.00	15.45	-1.525E+06	-4.572E+05	-7.857E+04	13SLV
-890	78.5	6.00	15.83	-1.448E+06	-4.296E+05	-8.014E+04	13SLV
-970	78.5	6.00	16.23	-1.371E+06	-4.021E+05	-8.171E+04	13SLV
-1050	78.5	6.00	16.65	-1.294E+06	-3.745E+05	-8.328E+04	13SLV
-1130	124.0	6.00	22.69	-1.197E+06	-3.424E+05	-5.636E+04	13SLV
-1210	78.5	6.00	22.06	-1.038E+06	-2.957E+05	-5.793E+04	13SLV
-1290	78.5	6.00	24.00	-8.779E+05	-2.489E+05	-5.950E+04	13SLV
-1370	78.5	6.00	25.83	-7.182E+05	-2.022E+05	-6.107E+04	13SLV
-1450	78.5	6.00	27.56	-5.585E+05	-1.555E+05	-6.264E+04	13SLV
-1530	78.5	6.00	27.24	-1.378E+05	1.5744E+02	-6.768E+04	4SLU
-1610	78.5	6.00	45.49	-3.242E+05	-8.781E+04	-3.866E+04	13SLV
-1690	78.5	6.00	44.31	-9.770E+04	-4.840E+02	-4.160E+04	4SLU
-1770	78.5	6.00	42.23	-7.771E+04	-7.619E+02	-4.364E+04	4SLU
-1850	78.5	6.00	40.35	-5.772E+04	-1.040E+03	-4.568E+04	4SLU
-1930	78.5	6.00	38.62	-3.773E+04	-1.318E+03	-4.773E+04	4SLU
-2010	78.5	6.00	89.54	-2.720E+04	-1.230E+03	-2.058E+04	4SLU
-2090	78.5	6.00	81.46	-2.130E+04	-9.630E+02	-2.263E+04	4SLU
-2170	124.0	6.00	82.46	-1.540E+04	-6.962E+02	-2.467E+04	4SLU
-2250	78.5	6.00	69.01	-9.498E+03	-4.294E+02	-2.671E+04	4SLU
-2330	78.5	6.00	64.11	-3.596E+03	-1.626E+02	-2.875E+04	4SLU
-2410	78.5	6.00	100.00	1.9221E-10	4.1269E-11	-2.527E+03	13SLV
-2490	78.5	6.00	100.00	-5.228E-11	-1.572E-12	-4.212E+03	4SLU

Verifica di esercizio (combinazione rara):

quota	Af	cop.	sigmaf	sigmac	Mx	My	N	comb	Wk
-90	0.0	6.50	0.0	0.0	0.0000E+00	0.0000E+00	0.0000E+00	-	0.000
-170	78.5	6.00	52.2	27.0	1.8642E+06	5.6731E+04	-9.886E+04	2	0.000
-250	78.5	6.00		23.0	1.4129E+06	5.5198E+04	-1.004E+05	2	0.000
-330	78.5	6.00		17.2	1.0443E+06	5.1979E+04	-7.623E+04	2	0.000
-410	78.5	6.00		15.4	8.1370E+05	4.5948E+04	-7.781E+04	2	0.000
-490	78.5	6.00		13.7	5.8307E+05	3.9918E+04	-7.938E+04	2	0.000
-570	78.5	6.00		12.0	3.5243E+05	3.3887E+04	-8.095E+04	2	0.000
-650	78.5	6.00		10.2	1.2180E+05	2.7857E+04	-8.252E+04	2	0.000
-730	78.5	6.00		7.0	-3.460E+04	2.2617E+04	-5.994E+04	2	0.000
-810	78.5	6.00		7.4	-6.724E+04	1.8693E+04	-6.151E+04	2	0.000



Tabulati di Calcolo Plinto di Fondazione per Aerogeneratore Tipo - Progetto Impianto Eolico - "Orione"

-890	78.5	6.00	7.9	-9.989E+04	1.4770E+04	-6.308E+04	2	0.000
-970	78.5	6.00	8.3	-1.325E+05	1.0846E+04	-6.465E+04	2	0.000
-1050	78.5	6.00	8.7	-1.652E+05	6.9231E+03	-6.622E+04	2	0.000
-1130	124.0	6.00	5.9	-1.863E+05	3.6564E+03	-4.368E+04	2	0.000
-1210	78.5	6.00	6.4	-1.698E+05	2.5348E+03	-4.525E+04	2	0.000
-1290	78.5	6.00	6.5	-1.533E+05	1.4133E+03	-4.682E+04	2	0.000
-1370	78.5	6.00	6.5	-1.368E+05	2.9172E+02	-4.839E+04	2	0.000
-1450	78.5	6.00	6.6	-1.203E+05	-8.298E+02	-4.997E+04	2	0.000
-1530	78.5	6.00	6.6	-1.038E+05	-1.951E+03	-5.154E+04	2	0.000
-1610	78.5	6.00	4.1	-8.870E+04	-1.901E+03	-3.008E+04	2	0.000
-1690	78.5	6.00	4.1	-7.370E+04	-1.794E+03	-3.165E+04	2	0.000
-1770	78.5	6.00	4.2	-5.870E+04	-1.686E+03	-3.322E+04	2	0.000
-1850	78.5	6.00	4.2	-4.369E+04	-1.578E+03	-3.479E+04	2	0.000
-1930	78.5	6.00	4.3	-2.869E+04	-1.470E+03	-3.636E+04	2	0.000
-2010	78.5	6.00	1.9	-2.075E+04	-1.252E+03	-1.564E+04	2	0.000
-2090	78.5	6.00	2.0	-1.625E+04	-9.806E+02	-1.721E+04	2	0.000
-2170	124.0	6.00	2.0	-1.174E+04	-7.089E+02	-1.878E+04	2	0.000
-2250	78.5	6.00	2.3	-7.244E+03	-4.372E+02	-2.035E+04	2	0.000
-2330	78.5	6.00	2.5	-2.743E+03	-1.656E+02	-2.192E+04	2	0.000
-2410	78.5	6.00	0.2	-3.084E-11	-3.659E-12	-1.632E+03	2	0.000
-2490	78.5	6.00	0.4	-3.993E-11	-1.386E-12	-3.203E+03	2	0.000

Verifica di esercizio (combinazione quasi permanente):

quota	Af	cop.	sigmaf	sigmac	Mx	My	N	comb	Wk
-90	0.0	6.50	0.0	0.0	0.0000E+00	0.0000E+00	0.0000E+00	-	0.000
-170	78.5	6.00	39.9	25.0	1.6960E+06	2.2022E+05	-9.389E+04	2	0.000
-250	78.5	6.00		21.6	1.3035E+06	1.7176E+05	-9.546E+04	2	0.000
-330	78.5	6.00		16.3	9.7956E+05	1.3160E+05	-7.219E+04	2	0.000
-410	78.5	6.00		14.7	7.6983E+05	1.0527E+05	-7.376E+04	2	0.000
-490	78.5	6.00		13.1	5.6009E+05	7.8943E+04	-7.533E+04	2	0.000
-570	78.5	6.00		11.5	3.5035E+05	5.2616E+04	-7.690E+04	2	0.000
-650	78.5	6.00		9.9	1.4062E+05	2.6289E+04	-7.847E+04	2	0.000
-730	78.5	6.00		6.4	-2.979E+03	7.8533E+03	-5.673E+04	2	0.000
-810	78.5	6.00		6.8	-3.634E+04	2.5692E+03	-5.831E+04	2	0.000
-890	78.5	6.00		7.2	-6.970E+04	-2.715E+03	-5.988E+04	2	0.000
-970	78.5	6.00		7.7	-1.031E+05	-7.999E+03	-6.145E+04	2	0.000
-1050	78.5	6.00		8.2	-1.364E+05	-1.328E+04	-6.302E+04	2	0.000
-1130	124.0	6.00		5.5	-1.589E+05	-1.706E+04	-4.130E+04	2	0.000
-1210	78.5	6.00		6.0	-1.459E+05	-1.593E+04	-4.287E+04	2	0.000
-1290	78.5	6.00		6.1	-1.328E+05	-1.479E+04	-4.444E+04	2	0.000
-1370	78.5	6.00		6.1	-1.198E+05	-1.365E+04	-4.601E+04	2	0.000
-1450	78.5	6.00		6.2	-1.067E+05	-1.252E+04	-4.759E+04	2	0.000
-1530	78.5	6.00		6.3	-9.366E+04	-1.138E+04	-4.916E+04	2	0.000
-1610	78.5	6.00		3.8	-8.038E+04	-9.831E+03	-2.846E+04	2	0.000
-1690	78.5	6.00		3.9	-6.708E+04	-8.260E+03	-3.003E+04	2	0.000
-1770	78.5	6.00		4.0	-5.379E+04	-6.689E+03	-3.161E+04	2	0.000
-1850	78.5	6.00		4.0	-4.049E+04	-5.118E+03	-3.318E+04	2	0.000
-1930	78.5	6.00		4.1	-2.720E+04	-3.547E+03	-3.475E+04	2	0.000
-2010	78.5	6.00		1.8	-1.993E+04	-2.646E+03	-1.476E+04	2	0.000
-2090	78.5	6.00		1.9	-1.561E+04	-2.072E+03	-1.633E+04	2	0.000
-2170	124.0	6.00		1.9	-1.128E+04	-1.498E+03	-1.790E+04	2	0.000
-2250	78.5	6.00		2.2	-6.959E+03	-9.239E+02	-1.947E+04	2	0.000
-2330	78.5	6.00		2.4	-2.635E+03	-3.498E+02	-2.104E+04	2	0.000
-2410	78.5	6.00		0.2	-2.956E-11	-5.258E-12	-1.464E+03	2	0.000
-2490	78.5	6.00		0.3	-3.866E-11	-2.189E-12	-3.035E+03	2	0.000

Verifica a taglio:

quota	Ast	Vsd	Vsdx	Vsdy	N	comb	VRd,c	VRd,max	VRd,S	Vwd
-90	0.16	33411	9201	-32119	-124690	13SLV	40531	231056	84855	44323 Vsd < VRd,
-170	0.16	32584	8908	-31343	-125427	13SLV	44522	231056	88845	44323 Vsd < VRd,
-250	0.08	32584	8908	-31343	-126998	13SLV	44740	231056	66902	22162 Vsd < VRd,
-330	0.08	10418	2712	-10059	-97803	13SLV	40682	231056	62844	22162 Vsd < VRd,
-410	0.08	10418	2712	-10059	-99374	13SLV	40901	231056	63062	22162 Vsd < VRd,
-490	0.08	10418	2712	-10059	-100945	13SLV	41119	231056	63281	22162 Vsd < VRd,
-570	0.08	10418	2712	-10059	-102515	13SLV	41337	231056	63499	22162 Vsd < VRd,
-650	0.08	10418	2712	-10059	-104086	13SLV	41556	231056	63717	22162 Vsd < VRd,
-730	0.08	1872	491	-1807	-33730	3SLV	31776	231056	53938	22162 Vsd < VRd,
-810	0.08	1872	491	-1807	-35301	3SLV	31995	231056	54156	22162 Vsd < VRd,
-890	0.08	1872	491	-1807	-36871	3SLV	32213	231056	54375	22162 Vsd < VRd,
-970	0.08	1872	491	-1807	-38442	3SLV	32431	231056	54593	22162 Vsd < VRd,
-1050	0.08	1872	491	-1807	-40013	3SLV	32650	231056	54811	22162 Vsd < VRd,
-1130	0.08	2080	-584	1996	-56359	13SLV	39378	231056	61540	22162 Vsd < VRd,
-1210	0.08	2080	-584	1996	-57930	13SLV	35140	231056	57302	22162 Vsd < VRd,
-1290	0.08	2080	-584	1996	-59500	13SLV	35358	231056	57520	22162 Vsd < VRd,
-1370	0.08	2080	-584	1996	-61071	13SLV	35577	231056	57738	22162 Vsd < VRd,
-1450	0.08	2080	-584	1996	-62642	13SLV	35795	231056	57957	22162 Vsd < VRd,
-1530	0.08	2080	-584	1996	-64213	13SLV	36013	231056	58175	22162 Vsd < VRd,
-1610	0.08	914	-245	880	-38660	13SLV	32462	231056	54623	22162 Vsd < VRd,
-1690	0.08	914	-245	880	-40231	13SLV	32680	231056	54842	22162 Vsd < VRd,
-1770	0.08	914	-245	880	-41801	13SLV	32898	231056	55060	22162 Vsd < VRd,
-1850	0.08	914	-245	880	-43372	13SLV	33117	231056	55278	22162 Vsd < VRd,
-1930	0.08	914	-245	880	-44943	13SLV	33335	231056	55497	22162 Vsd < VRd,
-2010	0.08	74	-3	74	-20585	4SLU	29949	231056	52111	22162 Vsd < VRd,
-2090	0.08	74	-3	74	-22627	4SLU	30233	231056	52395	22162 Vsd < VRd,
-2170	0.08	74	-3	74	-24669	4SLU	34973	231056	57135	22162 Vsd < VRd,
-2250	0.08	74	-3	74	-26711	4SLU	30801	231056	52962	22162 Vsd < VRd,



Progetto	Titolo	Rev.	Pag.
Orione	Orione_A24a.pdf "TABULATI DI CALCOLO PLINTO DI FONDAZIONE PER AEROGENERATORE TIPO"	0	238

**Tabulati di Calcolo Plinto di Fondazione per Aerogeneratore Tipo - Progetto Impianto Eolico - "Orione"**

-2330	0.08	74	-3	74	-28753	4SLU	31085	231056	53246	22162	Vsd < VRd,
-2410	0.08	0	0	0	-2428	15SLV	27425	231056	49587	22162	Vsd < VRd,
-2490	0.08	0	0	0	-3999	15SLV	27644	231056	49805	22162	Vsd < VRd,

Palo alle coordinate X=1650 Y=0

Sollecitazioni massime in testa palo:

Combinazione corrispondente alla minima compressione in testa

N	Mx	My	Tx	Ty	comb	
-9.085E+04	2.0218E+06	7.8309E+03	1.1126E+02	-4.682E+03	1	sl
-9.085E+04	2.0218E+06	7.8309E+03	1.1126E+02	-4.682E+03	1	ra
-9.085E+04	2.0218E+06	7.8309E+03	1.1126E+02	-4.682E+03	1	fr
-9.085E+04	2.0218E+06	7.8309E+03	1.1126E+02	-4.682E+03	1	qp
-5.803E+04	-4.957E+06	-2.116E+06	-8.238E+03	2.2796E+04	3	SLV fond

Combinazione corrispondente alla massima compressione in testa

N	Mx	My	Tx	Ty	comb	
-1.201E+05	2.9081E+06	-4.781E+05	-1.224E+03	-7.191E+03	4	sl
-9.218E+04	2.2083E+06	-3.177E+05	-8.010E+02	-5.419E+03	2	ra
-9.152E+04	2.1150E+06	-1.549E+05	-3.449E+02	-5.050E+03	2	fr
-9.125E+04	2.0777E+06	-8.983E+04	-1.624E+02	-4.903E+03	2	qp
-1.237E+05	9.0002E+06	2.1313E+06	8.4600E+03	-3.216E+04	13	SLV fond

Combinazione corrispondente al massimo taglio in testa

N	Mx	My	Tx	Ty	comb	
-1.201E+05	2.9081E+06	-4.781E+05	-1.224E+03	-7.191E+03	4	sl
-9.218E+04	2.2083E+06	-3.177E+05	-8.010E+02	-5.419E+03	2	ra
-9.152E+04	2.1150E+06	-1.549E+05	-3.449E+02	-5.050E+03	2	fr
-9.125E+04	2.0777E+06	-8.983E+04	-1.624E+02	-4.903E+03	2	qp
-1.237E+05	9.0002E+06	2.1313E+06	8.4600E+03	-3.216E+04	13	SLV fond

Verifica di capacità portante riferita al palo singolo:

Fattore di correlazione Psi scelto in base alla conoscenza del sito = 1.7  
 Coeff. parziale di sicurezza sulla resistenza laterale = 1.15  
 Coeff. parziale di sicurezza sulla resistenza alla punta = 1.35  
 Portanza laterale di progetto = 292537.1  
 Portanza di punta di progetto = 85555.4  
 verifica condotta in combinazione SLU 4  
 Sforzo normale = -120096.9  
 Peso del palo = 49087.4 \* 1.3  
 Carico totale di progetto = -183910.5  
 Resistenza totale di progetto = 378092.5  
 Coefficiente di sicurezza = 2.06 > 1

Verifica di resistenza allo stato limite:

quota	Af	cop.	c.s.	Mx	My	N	comb
-90	0.0	6.50	0.00	0.0000E+00	0.0000E+00	0.0000E+00	-
-170	78.5	6.00	3.59	6.4843E+06	-1.469E+06	-1.245E+05	15SLV
-250	78.5	6.00	6.57	3.9741E+06	-8.224E+05	-1.260E+05	15SLV
-330	78.5	6.00	11.90	2.1026E+06	-3.494E+05	-9.710E+04	15SLV
-410	78.5	6.00	15.53	1.2957E+06	-1.652E+05	-9.867E+04	15SLV
-490	78.5	6.00	18.39	4.8877E+05	1.8998E+04	-1.002E+05	15SLV
-570	78.5	6.00	18.10	-3.181E+05	1.9755E+05	-1.018E+05	15SLV
-650	78.5	6.00	15.58	-1.125E+06	3.8752E+05	-1.034E+05	15SLV
-730	78.5	6.00	14.43	1.6223E+06	-4.908E+05	-3.433E+04	1SLV
-810	78.5	6.00	15.50	-1.524E+06	4.5647E+05	-7.802E+04	15SLV
-890	78.5	6.00	15.89	-1.448E+06	4.2288E+05	-7.959E+04	15SLV
-970	78.5	6.00	16.30	-1.371E+06	3.8928E+05	-8.116E+04	15SLV
-1050	78.5	6.00	16.73	-1.294E+06	3.5569E+05	-8.273E+04	15SLV
-1130	124.0	6.00	22.82	-1.198E+06	3.1943E+05	-5.596E+04	15SLV
-1210	78.5	6.00	22.18	-1.039E+06	2.7446E+05	-5.753E+04	15SLV
-1290	78.5	6.00	24.14	-8.789E+05	2.2949E+05	-5.910E+04	15SLV
-1370	78.5	6.00	25.99	-7.192E+05	1.8452E+05	-6.067E+04	15SLV
-1450	78.5	6.00	27.74	-5.595E+05	1.3955E+05	-6.224E+04	15SLV
-1530	78.5	6.00	28.89	-3.998E+05	9.4579E+04	-6.381E+04	15SLV
-1610	78.5	6.00	45.80	-3.250E+05	7.5675E+04	-3.839E+04	15SLV
-1690	78.5	6.00	46.13	-2.545E+05	5.8054E+04	-3.996E+04	15SLV
-1770	78.5	6.00	44.39	-1.840E+05	4.0433E+04	-4.153E+04	15SLV
-1850	78.5	6.00	42.77	-1.134E+05	2.2812E+04	-4.310E+04	15SLV
-1930	78.5	6.00	41.02	-3.567E+04	5.2198E+03	-4.494E+04	4SLU
-2010	78.5	6.00	91.35	-1.726E+04	-5.160E+02	-2.018E+04	15SLV
-2090	78.5	6.00	84.75	-1.352E+04	-4.040E+02	-2.175E+04	15SLV
-2170	124.0	6.00	87.23	-9.771E+03	-2.921E+02	-2.332E+04	15SLV
-2250	78.5	6.00	73.18	-8.980E+03	1.2511E+03	-2.519E+04	4SLU
-2330	78.5	6.00	67.69	-3.400E+03	4.7370E+02	-2.723E+04	4SLU
-2410	78.5	6.00	100.00	3.4137E-10	-7.893E-11	-2.498E+03	15SLV
-2490	78.5	6.00	100.00	2.6316E-10	-2.127E-11	-4.069E+03	15SLV

Verifica di esercizio (combinazione rara):

quota	Af	cop.	sigmaf	sigmac	Mx	My	N	comb	Wk
-90	0.0	6.50	0.0	0.0	0.0000E+00	0.0000E+00	0.0000E+00	-	0.000



<b>Progetto</b>	<b>Titolo</b>	<b>Rev.</b>	<b>Pag.</b>
Orione	Orione_A24a.pdf "TABULATI DI CALCOLO PLINTO DI FONDAZIONE PER AEROGENERATORE TIPO"	0	239



Tabulati di Calcolo Plinto di Fondazione per Aerogeneratore Tipo - Progetto Impianto Eolico - "Orione"

-170	78.5	6.00	55.5	25.8	1.7779E+06	-2.498E+05	-9.312E+04	2	0.000
-250	78.5	6.00		21.9	1.3477E+06	-1.816E+05	-9.469E+04	2	0.000
-330	78.5	6.00		16.3	9.9631E+05	-1.271E+05	-7.157E+04	2	0.000
-410	78.5	6.00		14.7	7.7635E+05	-9.522E+04	-7.314E+04	2	0.000
-490	78.5	6.00		13.0	5.5640E+05	-6.339E+04	-7.471E+04	2	0.000
-570	78.5	6.00		11.3	3.5483E+05	-1.034E+03	-7.520E+04	1	0.000
-650	78.5	6.00		9.8	1.5098E+05	-6.305E+02	-7.677E+04	1	0.000
-730	78.5	6.00		6.6	-3.267E+04	2.1048E+04	-5.625E+04	2	0.000
-810	78.5	6.00		7.0	-6.384E+04	2.3419E+04	-5.782E+04	2	0.000
-890	78.5	6.00		7.4	-9.502E+04	2.5791E+04	-5.939E+04	2	0.000
-970	78.5	6.00		7.9	-1.262E+05	2.8163E+04	-6.096E+04	2	0.000
-1050	78.5	6.00		8.3	-1.574E+05	3.0534E+04	-6.253E+04	2	0.000
-1130	124.0	6.00		5.6	-1.776E+05	3.1568E+04	-4.094E+04	2	0.000
-1210	78.5	6.00		6.1	-1.618E+05	2.8234E+04	-4.251E+04	2	0.000
-1290	78.5	6.00		6.1	-1.461E+05	2.4899E+04	-4.408E+04	2	0.000
-1370	78.5	6.00		6.2	-1.304E+05	2.1564E+04	-4.565E+04	2	0.000
-1450	78.5	6.00		6.2	-1.147E+05	1.8230E+04	-4.722E+04	2	0.000
-1530	78.5	6.00		6.3	-9.896E+04	1.4895E+04	-4.879E+04	2	0.000
-1610	78.5	6.00		3.9	-8.459E+04	1.2579E+04	-2.822E+04	2	0.000
-1690	78.5	6.00		3.9	-7.028E+04	1.0312E+04	-2.979E+04	2	0.000
-1770	78.5	6.00		4.0	-5.598E+04	8.0459E+03	-3.136E+04	2	0.000
-1850	78.5	6.00		4.0	-4.168E+04	5.7795E+03	-3.293E+04	2	0.000
-1930	78.5	6.00		4.1	-2.738E+04	3.5131E+03	-3.450E+04	2	0.000
-2010	78.5	6.00		1.8	-1.980E+04	2.4171E+03	-1.463E+04	2	0.000
-2090	78.5	6.00		1.9	-1.550E+04	1.8927E+03	-1.620E+04	2	0.000
-2170	124.0	6.00		1.9	-1.121E+04	1.3683E+03	-1.777E+04	2	0.000
-2250	78.5	6.00		2.2	-6.912E+03	8.4394E+02	-1.934E+04	2	0.000
-2330	78.5	6.00		2.3	-2.617E+03	3.1954E+02	-2.091E+04	2	0.000
-2410	78.5	6.00		0.2	-4.505E-12	-7.931E-13	-1.438E+03	2	0.000
-2490	78.5	6.00		0.3	-9.052E-12	-1.077E-12	-3.009E+03	2	0.000

Verifica di esercizio (combinazione quasi permanente):

quota	Af	cop.	sigmaf	sigmac	Mx	My	N	comb	Wk
-90	0.0	6.50	0.0	0.0	0.0000E+00	0.0000E+00	0.0000E+00	-	0.000
-170	78.5	6.00	40.7	24.7	1.6875E+06	-7.232E+04	-9.220E+04	2	0.000
-250	78.5	6.00		21.3	1.2974E+06	-5.451E+04	-9.377E+04	2	0.000
-330	78.5	6.00		16.0	9.7537E+05	-3.969E+04	-7.081E+04	2	0.000
-410	78.5	6.00		14.4	7.6668E+05	-2.986E+04	-7.238E+04	2	0.000
-490	78.5	6.00		12.9	5.5800E+05	-2.002E+04	-7.395E+04	2	0.000
-570	78.5	6.00		11.3	3.5483E+05	-1.034E+03	-7.520E+04	1	0.000
-650	78.5	6.00		9.8	1.5098E+05	-6.305E+02	-7.677E+04	1	0.000
-730	78.5	6.00		6.2	1.0752E+04	-3.504E+02	-5.539E+04	1	0.000
-810	78.5	6.00		6.7	-3.556E+04	6.8330E+03	-5.722E+04	2	0.000
-890	78.5	6.00		7.1	-6.884E+04	7.5969E+03	-5.879E+04	2	0.000
-970	78.5	6.00		7.6	-1.021E+05	8.3607E+03	-6.036E+04	2	0.000
-1050	78.5	6.00		8.0	-1.354E+05	9.1246E+03	-6.193E+04	2	0.000
-1130	124.0	6.00		5.4	-1.579E+05	9.4855E+03	-4.049E+04	2	0.000
-1210	78.5	6.00		5.9	-1.449E+05	8.5296E+03	-4.207E+04	2	0.000
-1290	78.5	6.00		6.0	-1.320E+05	7.5738E+03	-4.364E+04	2	0.000
-1370	78.5	6.00		6.0	-1.190E+05	6.6179E+03	-4.521E+04	2	0.000
-1450	78.5	6.00		6.1	-1.061E+05	5.6621E+03	-4.678E+04	2	0.000
-1530	78.5	6.00		6.2	-9.317E+04	4.7062E+03	-4.835E+04	2	0.000
-1610	78.5	6.00		3.8	-7.997E+04	4.0008E+03	-2.792E+04	2	0.000
-1690	78.5	6.00		3.8	-6.675E+04	3.3078E+03	-2.949E+04	2	0.000
-1770	78.5	6.00		3.9	-5.353E+04	2.6147E+03	-3.106E+04	2	0.000
-1850	78.5	6.00		4.0	-4.031E+04	1.9217E+03	-3.263E+04	2	0.000
-1930	78.5	6.00		4.0	-2.709E+04	1.2286E+03	-3.420E+04	2	0.000
-2010	78.5	6.00		1.8	-1.986E+04	8.7381E+02	-1.446E+04	2	0.000
-2090	78.5	6.00		1.9	-1.555E+04	6.8424E+02	-1.603E+04	2	0.000
-2170	124.0	6.00		1.9	-1.124E+04	4.9466E+02	-1.760E+04	2	0.000
-2250	78.5	6.00		2.2	-6.933E+03	3.0509E+02	-1.918E+04	2	0.000
-2330	78.5	6.00		2.3	-2.625E+03	1.1552E+02	-2.075E+04	2	0.000
-2410	78.5	6.00		0.2	-3.898E-12	-1.430E-12	-1.407E+03	2	0.000
-2490	78.5	6.00		0.3	-5.262E-12	-1.714E-12	-2.978E+03	2	0.000

Verifica a taglio:

quota	Ast	Vsd	Vsdx	Vsdy	N	comb	VRd,c	VRd,max	VRd,S	Vwd
-90	0.16	33253	8460	-32159	-123681	13SLV	40391	231056	84714	44323 Vsd < VRd,
-170	0.16	32430	8172	-31384	-124424	13SLV	44383	231056	88706	44323 Vsd < VRd,
-250	0.08	32430	8172	-31384	-125994	13SLV	44601	231056	66763	22162 Vsd < VRd,
-330	0.08	10346	-2303	-10086	-97103	15SLV	40585	231056	62747	22162 Vsd < VRd,
-410	0.08	10346	-2303	-10086	-98674	15SLV	40803	231056	62965	22162 Vsd < VRd,
-490	0.08	10346	-2303	-10086	-100245	15SLV	41022	231056	63183	22162 Vsd < VRd,
-570	0.08	10346	-2303	-10086	-101815	15SLV	41240	231056	63402	22162 Vsd < VRd,
-650	0.08	10346	-2303	-10086	-103386	15SLV	41458	231056	63620	22162 Vsd < VRd,
-730	0.08	1860	420	-1812	-34433	3SLV	31874	231056	54036	22162 Vsd < VRd,
-810	0.08	1860	420	-1812	-36004	3SLV	32092	231056	54254	22162 Vsd < VRd,
-890	0.08	1860	420	-1812	-37574	3SLV	32311	231056	54472	22162 Vsd < VRd,
-970	0.08	1860	420	-1812	-39145	3SLV	32529	231056	54691	22162 Vsd < VRd,
-1050	0.08	1860	420	-1812	-40716	3SLV	32747	231056	54909	22162 Vsd < VRd,
-1130	0.08	2074	562	1996	-55955	15SLV	39322	231056	61484	22162 Vsd < VRd,
-1210	0.08	2074	562	1996	-57526	15SLV	35084	231056	57246	22162 Vsd < VRd,
-1290	0.08	2074	562	1996	-59097	15SLV	35302	231056	57464	22162 Vsd < VRd,
-1370	0.08	2074	562	1996	-60668	15SLV	35521	231056	57682	22162 Vsd < VRd,
-1450	0.08	2074	562	1996	-62238	15SLV	35739	231056	57901	22162 Vsd < VRd,
-1530	0.08	2074	562	1996	-63809	15SLV	35957	231056	58119	22162 Vsd < VRd,



Progetto	Titolo	Rev.	Pag.
Orione	Orione_A24a.pdf "TABULATI DI CALCOLO PLINTO DI FONDAZIONE PER AEROGENERATORE TIPO"	0	240

Tabulati di Calcolo Plinto di Fondazione per Aerogeneratore Tipo - Progetto Impianto Eolico - "Orione"

-1610	0.08	909	220	882	-38386	15SLV	32424	231056	54585	22162	Vsd < VRd,
-1690	0.08	909	220	882	-39957	15SLV	32642	231056	54804	22162	Vsd < VRd,
-1770	0.08	909	220	882	-41528	15SLV	32860	231056	55022	22162	Vsd < VRd,
-1850	0.08	909	220	882	-43098	15SLV	33079	231056	55240	22162	Vsd < VRd,
-1930	0.08	909	220	882	-44669	15SLV	33297	231056	55459	22162	Vsd < VRd,
-2010	0.08	70	10	70	-19062	4SLU	29738	231056	51899	22162	Vsd < VRd,
-2090	0.08	70	10	70	-21104	4SLU	30021	231056	52183	22162	Vsd < VRd,
-2170	0.08	70	10	70	-23146	4SLU	34761	231056	56923	22162	Vsd < VRd,
-2250	0.08	70	10	70	-25188	4SLU	30589	231056	52751	22162	Vsd < VRd,
-2330	0.08	70	10	70	-27230	4SLU	30873	231056	53035	22162	Vsd < VRd,
-2410	0.08	0	0	0	-1733	11SLV	27329	231056	49491	22162	Vsd < VRd,
-2490	0.08	0	0	0	-3304	11SLV	27547	231056	49709	22162	Vsd < VRd,

Palo alle coordinate X=1625 Y=287

Sollecitazioni massime in testa palo:

Combinazione corrispondente alla minima compressione in testa

N	Mx	My	Tx	Ty	comb	
-8.410E+04	2.0629E+06	-8.001E+05	-2.005E+03	-5.208E+03	2	sl
-8.636E+04	2.0389E+06	-6.480E+05	-1.571E+03	-5.009E+03	2	ra
-8.862E+04	2.0148E+06	-4.958E+05	-1.137E+03	-4.809E+03	2	fr
-8.953E+04	2.0052E+06	-4.349E+05	-9.631E+02	-4.730E+03	2	qp
-5.706E+04	-4.982E+06	1.8027E+06	7.7286E+03	2.2844E+04	1	SLV fond

Combinazione corrispondente alla massima compressione in testa

N	Mx	My	Tx	Ty	comb	
-1.182E+05	2.5880E+06	-4.467E+05	-9.134E+02	-5.993E+03	3	sl
-9.089E+04	1.9908E+06	-3.436E+05	-7.026E+02	-4.610E+03	1	ra
-9.089E+04	1.9908E+06	-3.436E+05	-7.026E+02	-4.610E+03	1	fr
-9.089E+04	1.9908E+06	-3.436E+05	-7.026E+02	-4.610E+03	1	qp
-1.247E+05	8.9631E+06	-2.490E+06	-9.134E+03	-3.206E+04	15	SLV fond

Combinazione corrispondente al massimo taglio in testa

N	Mx	My	Tx	Ty	comb	
-1.114E+05	2.6601E+06	-9.032E+05	-2.216E+03	-6.591E+03	4	sl
-8.636E+04	2.0389E+06	-6.480E+05	-1.571E+03	-5.009E+03	2	ra
-8.862E+04	2.0148E+06	-4.958E+05	-1.137E+03	-4.809E+03	2	fr
-8.953E+04	2.0052E+06	-4.349E+05	-9.631E+02	-4.730E+03	2	qp
-1.247E+05	8.9631E+06	-2.490E+06	-9.134E+03	-3.206E+04	15	SLV fond

Verifica di capacità portante riferita al palo singolo:

Fattore di correlazione Psi scelto in base alla conoscenza del sito = 1.7  
 Coeff. parziale di sicurezza sulla resistenza laterale = 1.15  
 Coeff. parziale di sicurezza sulla resistenza alla punta = 1.35  
 Portanza laterale di progetto = 292537.1  
 Portanza di punta di progetto = 85555.4  
 verifica condotta in combinazione SLU 3  
 Sforzo normale = -118151.1  
 Peso del palo = 49087.4 \* 1.3  
 Carico totale di progetto = -181964.7  
 Resistenza totale di progetto = 378092.5  
 Coefficiente di sicurezza = 2.08 > 1

Verifica di resistenza allo stato limite:

quota	Af	cop.	c.s.	Mx	My	N	comb
-90	0.0	6.50	0.00	0.0000E+00	0.0000E+00	0.0000E+00	-
-170	78.5	6.00	3.57	6.4561E+06	-1.772E+06	-1.256E+05	15SLV
-250	78.5	6.00	6.52	3.9530E+06	-1.054E+06	-1.271E+05	15SLV
-330	78.5	6.00	11.79	2.0872E+06	-5.225E+05	-9.799E+04	15SLV
-410	78.5	6.00	15.39	1.2838E+06	-3.008E+05	-9.956E+04	15SLV
-490	78.5	6.00	18.23	4.8040E+05	-7.905E+04	-1.011E+05	15SLV
-570	78.5	6.00	17.95	-3.225E+05	1.3472E+05	-1.027E+05	15SLV
-650	78.5	6.00	15.52	-1.126E+06	3.6439E+05	-1.043E+05	15SLV
-730	78.5	6.00	14.34	1.6209E+06	-4.970E+05	-3.368E+04	15SLV
-810	78.5	6.00	15.45	-1.523E+06	4.6463E+05	-7.872E+04	15SLV
-890	78.5	6.00	15.82	-1.446E+06	4.3675E+05	-8.029E+04	15SLV
-970	78.5	6.00	16.22	-1.369E+06	4.0887E+05	-8.186E+04	15SLV
-1050	78.5	6.00	16.64	-1.292E+06	3.8098E+05	-8.343E+04	15SLV
-1130	124.0	6.00	22.68	-1.195E+06	3.4852E+05	-5.648E+04	15SLV
-1210	78.5	6.00	22.05	-1.036E+06	3.0109E+05	-5.805E+04	15SLV
-1290	78.5	6.00	23.98	-8.764E+05	2.5366E+05	-5.962E+04	15SLV
-1370	78.5	6.00	25.80	-7.170E+05	2.0623E+05	-6.119E+04	15SLV
-1450	78.5	6.00	27.53	-5.576E+05	1.5880E+05	-6.276E+04	15SLV
-1530	78.5	6.00	28.65	-3.982E+05	1.1136E+05	-6.433E+04	15SLV
-1610	78.5	6.00	45.42	-3.237E+05	9.0058E+04	-3.874E+04	15SLV
-1690	78.5	6.00	45.73	-2.534E+05	7.0038E+04	-4.031E+04	15SLV
-1770	78.5	6.00	44.01	-1.831E+05	5.0018E+04	-4.188E+04	15SLV
-1850	78.5	6.00	42.42	-1.128E+05	2.9998E+04	-4.345E+04	15SLV
-1930	78.5	6.00	40.94	-4.250E+04	9.9782E+03	-4.502E+04	15SLV
-2010	78.5	6.00	90.48	-1.696E+04	2.9754E+03	-2.037E+04	15SLV
-2090	78.5	6.00	84.01	-1.328E+04	2.3299E+03	-2.194E+04	15SLV
-2170	124.0	6.00	86.52	-9.602E+03	1.6844E+03	-2.351E+04	15SLV
-2250	78.5	6.00	73.48	-5.922E+03	1.0389E+03	-2.508E+04	15SLV



Progetto	Titolo	Rev.	Pag.
Orione	Orione_A24a.pdf "TABULATI DI CALCOLO PLINTO DI FONDAZIONE PER AEROGENERATORE TIPO"	0	241

Tabulati di Calcolo Plinto di Fondazione per Aerogeneratore Tipo - Progetto Impianto Eolico - "Orione"

-2330	78.5	6.00	68.55	-3.365E+03	6.3061E+02	-2.689E+04	3SLU
-2410	78.5	6.00	100.00	7.2811E-11	-1.166E-11	-2.535E+03	15SLV
-2490	78.5	6.00	100.00	-5.420E-12	-6.213E-11	-4.106E+03	15SLV

Verifica di esercizio (combinazione rara):

quota	Af	cop.	sigmaf	sigmac	Mx	My	N	comb	Wk
-90	0.0	6.50	0.0	0.0	0.0000E+00	0.0000E+00	0.0000E+00	-	0.000
-170	78.5	6.00	58.4	24.6	1.6410E+06	-5.189E+05	-8.733E+04	2	0.000
-250	78.5	6.00		21.0	1.2564E+06	-2.218E+05	-9.341E+04	1	0.000
-330	78.5	6.00		15.9	9.5160E+05	-1.703E+05	-7.052E+04	1	0.000
-410	78.5	6.00		14.4	7.5087E+05	-1.344E+05	-7.209E+04	1	0.000
-490	78.5	6.00		12.8	5.5014E+05	-9.857E+04	-7.366E+04	1	0.000
-570	78.5	6.00		11.3	3.4941E+05	-6.273E+04	-7.523E+04	1	0.000
-650	78.5	6.00		9.8	1.4868E+05	-2.689E+04	-7.680E+04	1	0.000
-730	78.5	6.00		6.3	1.0601E+04	-2.236E+03	-5.542E+04	1	0.000
-810	78.5	6.00		6.6	-5.966E+04	2.7364E+04	-5.409E+04	2	0.000
-890	78.5	6.00		7.0	-5.672E+04	9.8031E+03	-5.856E+04	1	0.000
-970	78.5	6.00		7.5	-9.039E+04	1.5823E+04	-6.013E+04	1	0.000
-1050	78.5	6.00		7.9	-1.241E+05	2.1842E+04	-6.170E+04	1	0.000
-1130	124.0	6.00		5.3	-1.471E+05	2.5988E+04	-4.032E+04	1	0.000
-1210	78.5	6.00		5.8	-1.356E+05	2.4011E+04	-4.189E+04	1	0.000
-1290	78.5	6.00		5.9	-1.240E+05	2.2035E+04	-4.346E+04	1	0.000
-1370	78.5	6.00		6.0	-1.124E+05	2.0058E+04	-4.503E+04	1	0.000
-1450	78.5	6.00		6.0	-1.009E+05	1.8082E+04	-4.661E+04	1	0.000
-1530	78.5	6.00		6.1	-8.931E+04	1.6105E+04	-4.818E+04	1	0.000
-1610	78.5	6.00		3.7	-7.679E+04	1.3882E+04	-2.780E+04	1	0.000
-1690	78.5	6.00		3.8	-6.423E+04	1.1646E+04	-2.937E+04	1	0.000
-1770	78.5	6.00		3.9	-5.167E+04	9.4097E+03	-3.094E+04	1	0.000
-1850	78.5	6.00		3.9	-3.911E+04	7.1738E+03	-3.251E+04	1	0.000
-1930	78.5	6.00		4.0	-2.655E+04	4.9379E+03	-3.408E+04	1	0.000
-2010	78.5	6.00		1.8	-1.958E+04	3.6693E+03	-1.440E+04	1	0.000
-2090	78.5	6.00		1.9	-1.533E+04	2.8733E+03	-1.597E+04	1	0.000
-2170	124.0	6.00		1.9	-1.108E+04	2.0772E+03	-1.754E+04	1	0.000
-2250	78.5	6.00		2.2	-6.836E+03	1.2812E+03	-1.911E+04	1	0.000
-2330	78.5	6.00		2.3	-2.588E+03	4.8509E+02	-2.068E+04	1	0.000
-2410	78.5	6.00		0.2	-2.183E-11	2.1327E-14	-1.395E+03	1	0.000
-2490	78.5	6.00		0.3	-2.183E-11	-2.252E-12	-2.966E+03	1	0.000

Verifica di esercizio (combinazione quasi permanente):

quota	Af	cop.	sigmaf	sigmac	Mx	My	N	comb	Wk
-90	0.0	6.50	0.0	0.0	0.0000E+00	0.0000E+00	0.0000E+00	-	0.000
-170	78.5	6.00	41.4	24.3	1.6288E+06	-3.537E+05	-9.048E+04	2	0.000
-250	78.5	6.00		21.0	1.2564E+06	-2.218E+05	-9.341E+04	1	0.000
-330	78.5	6.00		15.9	9.5160E+05	-1.703E+05	-7.052E+04	1	0.000
-410	78.5	6.00		14.4	7.5087E+05	-1.344E+05	-7.209E+04	1	0.000
-490	78.5	6.00		12.8	5.5014E+05	-9.857E+04	-7.366E+04	1	0.000
-570	78.5	6.00		11.3	3.4941E+05	-6.273E+04	-7.523E+04	1	0.000
-650	78.5	6.00		9.8	1.4868E+05	-2.689E+04	-7.680E+04	1	0.000
-730	78.5	6.00		6.3	1.0601E+04	-2.236E+03	-5.542E+04	1	0.000
-810	78.5	6.00		6.5	-3.404E+04	1.0858E+04	-5.612E+04	2	0.000
-890	78.5	6.00		7.0	-5.672E+04	9.8031E+03	-5.856E+04	1	0.000
-970	78.5	6.00		7.5	-9.039E+04	1.5823E+04	-6.013E+04	1	0.000
-1050	78.5	6.00		7.9	-1.241E+05	2.1842E+04	-6.170E+04	1	0.000
-1130	124.0	6.00		5.3	-1.471E+05	2.5988E+04	-4.032E+04	1	0.000
-1210	78.5	6.00		5.8	-1.356E+05	2.4011E+04	-4.189E+04	1	0.000
-1290	78.5	6.00		5.9	-1.240E+05	2.2035E+04	-4.346E+04	1	0.000
-1370	78.5	6.00		6.0	-1.124E+05	2.0058E+04	-4.503E+04	1	0.000
-1450	78.5	6.00		6.0	-1.009E+05	1.8082E+04	-4.661E+04	1	0.000
-1530	78.5	6.00		6.1	-8.931E+04	1.6105E+04	-4.818E+04	1	0.000
-1610	78.5	6.00		3.7	-7.679E+04	1.3882E+04	-2.780E+04	1	0.000
-1690	78.5	6.00		3.8	-6.423E+04	1.1646E+04	-2.937E+04	1	0.000
-1770	78.5	6.00		3.9	-5.167E+04	9.4097E+03	-3.094E+04	1	0.000
-1850	78.5	6.00		3.9	-3.911E+04	7.1738E+03	-3.251E+04	1	0.000
-1930	78.5	6.00		4.0	-2.655E+04	4.9379E+03	-3.408E+04	1	0.000
-2010	78.5	6.00		1.8	-1.958E+04	3.6693E+03	-1.440E+04	1	0.000
-2090	78.5	6.00		1.9	-1.533E+04	2.8733E+03	-1.597E+04	1	0.000
-2170	124.0	6.00		1.9	-1.108E+04	2.0772E+03	-1.754E+04	1	0.000
-2250	78.5	6.00		2.2	-6.836E+03	1.2812E+03	-1.911E+04	1	0.000
-2330	78.5	6.00		2.3	-2.588E+03	4.8509E+02	-2.068E+04	1	0.000
-2410	78.5	6.00		0.2	-2.183E-11	2.1327E-14	-1.395E+03	1	0.000
-2490	78.5	6.00		0.3	-2.183E-11	-2.252E-12	-2.966E+03	1	0.000

Verifica a taglio:

quota	Ast	Vsd	Vsdx	Vsdy	N	comb	VRd,c	VRd,max	VRd,S	Vwd
-90	0.16	33340	-9134	-32064	-124715	15SLV	40535	231056	84858	44323 Vsd < VRd,
-170	0.16	32549	-8969	-31289	-125551	15SLV	44539	231056	88863	44323 Vsd < VRd,
-250	0.08	32549	-8969	-31289	-127122	15SLV	44758	231056	66919	22162 Vsd < VRd,
-330	0.08	10418	-2771	-10043	-97988	15SLV	40708	231056	62870	22162 Vsd < VRd,
-410	0.08	10418	-2771	-10043	-99559	15SLV	40926	231056	63088	22162 Vsd < VRd,
-490	0.08	10418	-2771	-10043	-101130	15SLV	41145	231056	63307	22162 Vsd < VRd,
-570	0.08	10418	-2771	-10043	-102700	15SLV	41363	231056	63525	22162 Vsd < VRd,
-650	0.08	10418	-2771	-10043	-104271	15SLV	41582	231056	63743	22162 Vsd < VRd,
-730	0.08	1872	-499	-1804	-33681	1SLV	31770	231056	53931	22162 Vsd < VRd,
-810	0.08	1872	-499	-1804	-35252	1SLV	31988	231056	54150	22162 Vsd < VRd,



Progetto	Titolo	Rev.	Pag.
Orione	Orione_A24a.pdf "TABULATI DI CALCOLO PLINTO DI FONDAZIONE PER AEROGENERATORE TIPO"	0	242

-890	0.08	1872	-499	-1804	-36822	1SLV	32206	231056	54368	22162	Vsd < VRd,
-970	0.08	1872	-499	-1804	-38393	1SLV	32425	231056	54586	22162	Vsd < VRd,
-1050	0.08	1872	-499	-1804	-39964	1SLV	32643	231056	54805	22162	Vsd < VRd,
-1130	0.08	2079	593	1993	-56476	15SLV	39394	231056	61556	22162	Vsd < VRd,
-1210	0.08	2079	593	1993	-58047	15SLV	35156	231056	57318	22162	Vsd < VRd,
-1290	0.08	2079	593	1993	-59618	15SLV	35375	231056	57536	22162	Vsd < VRd,
-1370	0.08	2079	593	1993	-61189	15SLV	35593	231056	57755	22162	Vsd < VRd,
-1450	0.08	2079	593	1993	-62759	15SLV	35811	231056	57973	22162	Vsd < VRd,
-1530	0.08	2079	593	1993	-64330	15SLV	36030	231056	58191	22162	Vsd < VRd,
-1610	0.08	914	250	879	-38739	15SLV	32473	231056	54634	22162	Vsd < VRd,
-1690	0.08	914	250	879	-40310	15SLV	32691	231056	54853	22162	Vsd < VRd,
-1770	0.08	914	250	879	-41880	15SLV	32909	231056	55071	22162	Vsd < VRd,
-1850	0.08	914	250	879	-43451	15SLV	33128	231056	55289	22162	Vsd < VRd,
-1930	0.08	914	250	879	-45022	15SLV	33346	231056	55508	22162	Vsd < VRd,
-2010	0.08	70	13	69	-18719	3SLU	29690	231056	51852	22162	Vsd < VRd,
-2090	0.08	70	13	69	-20761	3SLU	29974	231056	52135	22162	Vsd < VRd,
-2170	0.08	70	13	69	-22803	3SLU	34714	231056	56875	22162	Vsd < VRd,
-2250	0.08	70	13	69	-24845	3SLU	30541	231056	52703	22162	Vsd < VRd,
-2330	0.08	70	13	69	-26887	3SLU	30825	231056	52987	22162	Vsd < VRd,
-2410	0.08	0	0	0	-887	5SLV	27211	231056	49373	22162	Vsd < VRd,
-2490	0.08	0	0	0	-2457	5SLV	27430	231056	49591	22162	Vsd < VRd,

Palo alle coordinate X=1551 Y=564

Sollecitazioni massime in testa palo:

Combinazione corrispondente alla minima compressione in testa										
N	Mx	My	Tx	Ty	comb					
-7.554E+04	1.7860E+06	-1.044E+06	-2.575E+03	-4.540E+03	2	sl				
-8.066E+04	1.8237E+06	-9.245E+05	-2.214E+03	-4.492E+03	2	ra				
-8.578E+04	1.8614E+06	-8.047E+05	-1.854E+03	-4.445E+03	2	fr				
-8.782E+04	1.8765E+06	-7.568E+05	-1.709E+03	-4.426E+03	2	qp				
-5.704E+04	-5.061E+06	1.4827E+06	7.0159E+03	2.3009E+04	1	SLV fond				

Combinazione corrispondente alla massima compressione in testa										
N	Mx	My	Tx	Ty	comb					
-1.182E+05	2.4689E+06	-8.905E+05	-1.941E+03	-5.717E+03	3	sl				
-9.089E+04	1.8992E+06	-6.850E+05	-1.493E+03	-4.398E+03	1	ra				
-9.089E+04	1.8992E+06	-6.850E+05	-1.493E+03	-4.398E+03	1	fr				
-9.089E+04	1.8992E+06	-6.850E+05	-1.493E+03	-4.398E+03	1	qp				
-1.247E+05	8.8591E+06	-2.853E+06	-1.000E+04	-3.180E+04	15	SLV fond				

Combinazione corrispondente al massimo taglio in testa										
N	Mx	My	Tx	Ty	comb					
-1.028E+05	2.3558E+06	-1.250E+06	-3.022E+03	-5.859E+03	4	sl				
-8.066E+04	1.8237E+06	-9.245E+05	-2.214E+03	-4.492E+03	2	ra				
-8.578E+04	1.8614E+06	-8.047E+05	-1.854E+03	-4.445E+03	2	fr				
-8.782E+04	1.8765E+06	-7.568E+05	-1.709E+03	-4.426E+03	2	qp				
-1.247E+05	8.8591E+06	-2.853E+06	-1.000E+04	-3.180E+04	15	SLV fond				

Verifica di capacità portante riferita al palo singolo:

Fattore di correlazione Psi scelto in base alla conoscenza del sito = 1.7  
 Coeff. parziale di sicurezza sulla resistenza laterale = 1.15  
 Coeff. parziale di sicurezza sulla resistenza alla punta = 1.35  
 Portanza laterale di progetto = 292537.1  
 Portanza di punta di progetto = 85555.4  
 verifica condotta in combinazione SLU 3  
 Sforzo normale = -118162.9  
 Peso del palo = 49087.4 \* 1.3  
 Carico totale di progetto = -181976.5  
 Resistenza totale di progetto = 378092.5  
 Coefficiente di sicurezza = 2.08 > 1

Verifica di resistenza allo stato limite:

quota	Af	cop.	c.s.	Mx	My	N	comb
-90	0.0	6.50	0.00	0.0000E+00	0.0000E+00	0.0000E+00	-
-170	78.5	6.00	3.56	6.3727E+06	-2.065E+06	-1.256E+05	15SLV
-250	78.5	6.00	6.52	3.8901E+06	-1.279E+06	-1.272E+05	15SLV
-330	78.5	6.00	11.78	2.0411E+06	-6.904E+05	-9.802E+04	15SLV
-410	78.5	6.00	15.37	1.2480E+06	-4.324E+05	-9.959E+04	15SLV
-490	78.5	6.00	18.22	4.5493E+05	-1.743E+05	-1.012E+05	15SLV
-570	78.5	6.00	17.94	-3.373E+05	7.3928E+04	-1.027E+05	15SLV
-650	78.5	6.00	15.53	-1.131E+06	3.4175E+05	-1.043E+05	15SLV
-730	78.5	6.00	14.35	1.6178E+06	-5.028E+05	-3.367E+04	18SLV
-810	78.5	6.00	15.45	-1.519E+06	4.7234E+05	-7.875E+04	15SLV
-890	78.5	6.00	15.83	-1.441E+06	4.5003E+05	-8.032E+04	15SLV
-970	78.5	6.00	16.22	-1.362E+06	4.2772E+05	-8.189E+04	15SLV
-1050	78.5	6.00	16.64	-1.284E+06	4.0540E+05	-8.346E+04	15SLV
-1130	124.0	6.00	22.68	-1.187E+06	3.7664E+05	-5.649E+04	15SLV
-1210	78.5	6.00	22.04	-1.028E+06	3.2684E+05	-5.807E+04	15SLV
-1290	78.5	6.00	23.98	-8.694E+05	2.7704E+05	-5.964E+04	15SLV
-1370	78.5	6.00	25.80	-7.108E+05	2.2723E+05	-6.121E+04	15SLV
-1450	78.5	6.00	27.52	-5.522E+05	1.7743E+05	-6.278E+04	15SLV
-1530	78.5	6.00	28.64	-3.935E+05	1.2762E+05	-6.435E+04	15SLV



Tabulati di Calcolo Plinto di Fondazione per Aerogeneratore Tipo - Progetto Impianto Eolico - "Orione"

-1610	78.5	6.00	45.40	-3.197E+05	1.0399E+05	-3.875E+04	15SLV		
-1690	78.5	6.00	45.71	-2.501E+05	8.1652E+04	-4.032E+04	15SLV		
-1770	78.5	6.00	44.00	-1.805E+05	5.9310E+04	-4.189E+04	15SLV		
-1850	78.5	6.00	42.41	-1.109E+05	3.6967E+04	-4.346E+04	15SLV		
-1930	78.5	6.00	40.93	-4.124E+04	1.4625E+04	-4.503E+04	15SLV		
-2010	78.5	6.00	90.45	-1.606E+04	6.3660E+03	-2.038E+04	15SLV		
-2090	78.5	6.00	83.98	-1.257E+04	4.9849E+03	-2.195E+04	15SLV		
-2170	124.0	6.00	86.49	-9.089E+03	3.6038E+03	-2.352E+04	15SLV		
-2250	78.5	6.00	73.46	-5.606E+03	2.2227E+03	-2.509E+04	15SLV		
-2330	78.5	6.00	68.55	-3.210E+03	1.2078E+03	-2.689E+04	3SLU		
-2410	78.5	6.00	100.00	3.1937E-10	1.1183E-11	-2.537E+03	15SLV		
-2490	78.5	6.00	100.00	8.9103E-11	6.2349E-11	-4.107E+03	15SLV		

Verifica di esercizio (combinazione rara):

quota	Af	cop.	sigmaf	sigmac	Mx	My	N	comb	Wk
-90	0.0	6.50	0.0	0.0	0.0000E+00	0.0000E+00	0.0000E+00	-	0.000
-170	78.5	6.00		24.2	1.5488E+06	-5.613E+05	-9.184E+04	1	0.000
-170	78.5	6.00	60.9		1.4670E+06	-7.444E+05	-8.166E+04	2	0.000
-250	78.5	6.00		21.0	1.1985E+06	-4.373E+05	-9.342E+04	1	0.000
-330	78.5	6.00		15.9	9.0779E+05	-3.335E+05	-7.053E+04	1	0.000
-410	78.5	6.00		14.4	7.1631E+05	-2.632E+05	-7.210E+04	1	0.000
-490	78.5	6.00		12.9	5.2482E+05	-1.929E+05	-7.367E+04	1	0.000
-570	78.5	6.00		11.3	3.3333E+05	-1.227E+05	-7.524E+04	1	0.000
-650	78.5	6.00		9.8	1.4184E+05	-5.242E+04	-7.681E+04	1	0.000
-730	78.5	6.00		6.3	1.0118E+04	-4.085E+03	-5.542E+04	1	0.000
-810	78.5	6.00		6.5	-2.200E+04	7.7112E+03	-5.700E+04	1	0.000
-890	78.5	6.00		7.0	-5.411E+04	1.9507E+04	-5.857E+04	1	0.000
-970	78.5	6.00		7.5	-8.622E+04	3.1303E+04	-6.014E+04	1	0.000
-1050	78.5	6.00		7.9	-1.183E+05	4.3098E+04	-6.171E+04	1	0.000
-1130	124.0	6.00		5.3	-1.403E+05	5.1202E+04	-4.033E+04	1	0.000
-1210	78.5	6.00		5.8	-1.293E+05	4.7245E+04	-4.190E+04	1	0.000
-1290	78.5	6.00		5.9	-1.183E+05	4.3288E+04	-4.347E+04	1	0.000
-1370	78.5	6.00		6.0	-1.073E+05	3.9332E+04	-4.504E+04	1	0.000
-1450	78.5	6.00		6.0	-9.622E+04	3.5375E+04	-4.661E+04	1	0.000
-1530	78.5	6.00		6.1	-8.519E+04	3.1418E+04	-4.818E+04	1	0.000
-1610	78.5	6.00		3.7	-7.326E+04	2.7049E+04	-2.780E+04	1	0.000
-1690	78.5	6.00		3.8	-6.128E+04	2.2660E+04	-2.938E+04	1	0.000
-1770	78.5	6.00		3.9	-4.929E+04	1.8271E+04	-3.095E+04	1	0.000
-1850	78.5	6.00		3.9	-3.731E+04	1.3881E+04	-3.252E+04	1	0.000
-1930	78.5	6.00		4.0	-2.533E+04	9.4922E+03	-3.409E+04	1	0.000
-2010	78.5	6.00		1.8	-1.868E+04	7.0276E+03	-1.440E+04	1	0.000
-2090	78.5	6.00		1.9	-1.463E+04	5.5030E+03	-1.597E+04	1	0.000
-2170	124.0	6.00		1.9	-1.057E+04	3.9783E+03	-1.754E+04	1	0.000
-2250	78.5	6.00		2.2	-6.521E+03	2.4537E+03	-1.911E+04	1	0.000
-2330	78.5	6.00		2.3	-2.469E+03	9.2905E+02	-2.068E+04	1	0.000
-2410	78.5	6.00		0.2	-2.733E-11	7.3613E-12	-1.395E+03	1	0.000
-2490	78.5	6.00		0.3	-2.278E-11	-1.734E-12	-2.966E+03	1	0.000

Verifica di esercizio (combinazione quasi permanente):

quota	Af	cop.	sigmaf	sigmac	Mx	My	N	comb	Wk
-90	0.0	6.50	0.0	0.0	0.0000E+00	0.0000E+00	0.0000E+00	-	0.000
-170	78.5	6.00		24.2	1.5488E+06	-5.613E+05	-9.184E+04	1	0.000
-170	78.5	6.00	41.9		1.5242E+06	-6.162E+05	-8.879E+04	2	0.000
-250	78.5	6.00		21.0	1.1985E+06	-4.373E+05	-9.342E+04	1	0.000
-330	78.5	6.00		15.9	9.0779E+05	-3.335E+05	-7.053E+04	1	0.000
-410	78.5	6.00		14.4	7.1631E+05	-2.632E+05	-7.210E+04	1	0.000
-490	78.5	6.00		12.9	5.2482E+05	-1.929E+05	-7.367E+04	1	0.000
-570	78.5	6.00		11.3	3.3333E+05	-1.227E+05	-7.524E+04	1	0.000
-650	78.5	6.00		9.8	1.4184E+05	-5.242E+04	-7.681E+04	1	0.000
-730	78.5	6.00		6.3	1.0118E+04	-4.085E+03	-5.542E+04	1	0.000
-810	78.5	6.00		6.5	-2.200E+04	7.7112E+03	-5.700E+04	1	0.000
-890	78.5	6.00		7.0	-5.411E+04	1.9507E+04	-5.857E+04	1	0.000
-970	78.5	6.00		7.5	-8.622E+04	3.1303E+04	-6.014E+04	1	0.000
-1050	78.5	6.00		7.9	-1.183E+05	4.3098E+04	-6.171E+04	1	0.000
-1130	124.0	6.00		5.3	-1.403E+05	5.1202E+04	-4.033E+04	1	0.000
-1210	78.5	6.00		5.8	-1.293E+05	4.7245E+04	-4.190E+04	1	0.000
-1290	78.5	6.00		5.9	-1.183E+05	4.3288E+04	-4.347E+04	1	0.000
-1370	78.5	6.00		6.0	-1.073E+05	3.9332E+04	-4.504E+04	1	0.000
-1450	78.5	6.00		6.0	-9.622E+04	3.5375E+04	-4.661E+04	1	0.000
-1530	78.5	6.00		6.1	-8.519E+04	3.1418E+04	-4.818E+04	1	0.000
-1610	78.5	6.00		3.7	-7.326E+04	2.7049E+04	-2.780E+04	1	0.000
-1690	78.5	6.00		3.8	-6.128E+04	2.2660E+04	-2.938E+04	1	0.000
-1770	78.5	6.00		3.9	-4.929E+04	1.8271E+04	-3.095E+04	1	0.000
-1850	78.5	6.00		3.9	-3.731E+04	1.3881E+04	-3.252E+04	1	0.000
-1930	78.5	6.00		4.0	-2.533E+04	9.4922E+03	-3.409E+04	1	0.000
-2010	78.5	6.00		1.8	-1.868E+04	7.0276E+03	-1.440E+04	1	0.000
-2090	78.5	6.00		1.9	-1.463E+04	5.5030E+03	-1.597E+04	1	0.000
-2170	124.0	6.00		1.9	-1.057E+04	3.9783E+03	-1.754E+04	1	0.000
-2250	78.5	6.00		2.2	-6.521E+03	2.4537E+03	-1.911E+04	1	0.000
-2330	78.5	6.00		2.3	-2.469E+03	9.2905E+02	-2.068E+04	1	0.000
-2410	78.5	6.00		0.2	-2.733E-11	7.3613E-12	-1.395E+03	1	0.000
-2490	78.5	6.00		0.3	-2.278E-11	-1.734E-12	-2.966E+03	1	0.000

Verifica a taglio:



Progetto	Titolo	Rev.	Pag.
Orione	Orione_A24a.pdf "TABULATI DI CALCOLO PLINTO DI FONDAZIONE PER AEROGENERATORE TIPO"	0	244

quota	Ast	Vsd	Vsdx	Vsdy	N	comb	VRd,c	VRd,max	VRd,S	Vwd
-90	0.16	33340	-10002	-31804	-124748	15SLV	40539	231056	84863	44323 Vsd < VRd,
-170	0.16	32552	-9831	-31032	-125585	15SLV	44544	231056	88868	44323 Vsd < VRd,
-250	0.08	32552	-9831	-31032	-127156	15SLV	44762	231056	66924	22162 Vsd < VRd,
-330	0.08	10425	-3225	-9914	-98018	15SLV	40712	231056	62874	22162 Vsd < VRd,
-410	0.08	10425	-3225	-9914	-99589	15SLV	40931	231056	63092	22162 Vsd < VRd,
-490	0.08	10425	-3225	-9914	-101160	15SLV	41149	231056	63311	22162 Vsd < VRd,
-570	0.08	10425	-3225	-9914	-102731	15SLV	41367	231056	63529	22162 Vsd < VRd,
-650	0.08	10425	-3225	-9914	-104301	15SLV	41586	231056	63747	22162 Vsd < VRd,
-730	0.08	1873	-574	-1783	-33674	1SLV	31769	231056	53930	22162 Vsd < VRd,
-810	0.08	1873	-574	-1783	-35244	1SLV	31987	231056	54149	22162 Vsd < VRd,
-890	0.08	1873	-574	-1783	-36815	1SLV	32205	231056	54367	22162 Vsd < VRd,
-970	0.08	1873	-574	-1783	-38386	1SLV	32424	231056	54585	22162 Vsd < VRd,
-1050	0.08	1873	-574	-1783	-39957	1SLV	32642	231056	54804	22162 Vsd < VRd,
-1130	0.08	2078	623	1983	-56495	15SLV	39397	231056	61559	22162 Vsd < VRd,
-1210	0.08	2078	623	1983	-58065	15SLV	35159	231056	57321	22162 Vsd < VRd,
-1290	0.08	2078	623	1983	-59636	15SLV	35377	231056	57539	22162 Vsd < VRd,
-1370	0.08	2078	623	1983	-61207	15SLV	35596	231056	57757	22162 Vsd < VRd,
-1450	0.08	2078	623	1983	-62778	15SLV	35814	231056	57976	22162 Vsd < VRd,
-1530	0.08	2078	623	1983	-64349	15SLV	36032	231056	58194	22162 Vsd < VRd,
-1610	0.08	914	279	870	-38751	15SLV	32474	231056	54636	22162 Vsd < VRd,
-1690	0.08	914	279	870	-40322	15SLV	32693	231056	54854	22162 Vsd < VRd,
-1770	0.08	914	279	870	-41893	15SLV	32911	231056	55073	22162 Vsd < VRd,
-1850	0.08	914	279	870	-43464	15SLV	33129	231056	55291	22162 Vsd < VRd,
-1930	0.08	914	279	870	-45034	15SLV	33348	231056	55509	22162 Vsd < VRd,
-2010	0.08	70	25	66	-18722	3SLU	29690	231056	51852	22162 Vsd < VRd,
-2090	0.08	70	25	66	-20764	3SLU	29974	231056	52136	22162 Vsd < VRd,
-2170	0.08	70	25	66	-22806	3SLU	34714	231056	56876	22162 Vsd < VRd,
-2250	0.08	70	25	66	-24848	3SLU	30542	231056	52704	22162 Vsd < VRd,
-2330	0.08	70	25	66	-26890	3SLU	30826	231056	52987	22162 Vsd < VRd,
-2410	0.08	0	0	0	-1436	7SLV	27288	231056	49449	22162 Vsd < VRd,
-2490	0.08	0	0	0	-3006	7SLV	27506	231056	49668	22162 Vsd < VRd,

Palo alle coordinate X=1429 Y=825

Sollecitazioni massime in testa palo:

Combinazione corrispondente alla minima compressione in testa

N	Mx	My	Tx	Ty	comb	
-6.742E+04	1.4942E+06	-1.213E+06	-2.965E+03	-3.836E+03	2	sl
-7.524E+04	1.5794E+06	-1.144E+06	-2.721E+03	-3.908E+03	2	ra
-8.306E+04	1.6646E+06	-1.074E+06	-2.478E+03	-3.980E+03	2	fr
-8.619E+04	1.6987E+06	-1.047E+06	-2.380E+03	-4.009E+03	2	qp
-5.803E+04	-5.190E+06	1.1798E+06	6.3371E+03	2.3281E+04	1	SLV fond

Combinazione corrispondente alla massima compressione in testa

N	Mx	My	Tx	Ty	comb	
-1.181E+05	2.2748E+06	-1.306E+06	-2.904E+03	-5.268E+03	3	sl
-9.088E+04	1.7498E+06	-1.005E+06	-2.234E+03	-4.052E+03	1	ra
-9.088E+04	1.7498E+06	-1.005E+06	-2.234E+03	-4.052E+03	1	fr
-9.088E+04	1.7498E+06	-1.005E+06	-2.234E+03	-4.052E+03	1	qp
-1.237E+05	8.6900E+06	-3.190E+06	-1.080E+04	-3.138E+04	15	SLV fond

Combinazione corrispondente al massimo taglio in testa

N	Mx	My	Tx	Ty	comb	
-9.469E+04	2.0192E+06	-1.514E+06	-3.635E+03	-5.052E+03	4	sl
-7.524E+04	1.5794E+06	-1.144E+06	-2.721E+03	-3.908E+03	2	ra
-8.306E+04	1.6646E+06	-1.074E+06	-2.478E+03	-3.980E+03	2	fr
-8.619E+04	1.6987E+06	-1.047E+06	-2.380E+03	-4.009E+03	2	qp
-1.237E+05	8.6900E+06	-3.190E+06	-1.080E+04	-3.138E+04	15	SLV fond

Verifica di capacità portante riferita al palo singolo:

Fattore di correlazione Psi scelto in base alla conoscenza del sito = 1.7

Coeff. parziale di sicurezza sulla resistenza laterale = 1.15

Coeff. parziale di sicurezza sulla resistenza alla punta = 1.35

Portanza laterale di progetto = 292537.1

Portanza di punta di progetto = 85555.4

verifica condotta in combinazione SLU 3

Sforzo normale = -118137.9

Peso del palo = 49087.4 \* 1.3

Carico totale di progetto = -181951.5

Resistenza totale di progetto = 378092.5

Coefficiente di sicurezza = 2.08 > 1

Verifica di resistenza allo stato limite:

quota	Af	cop.	c.s.	Mx	My	N	comb
-90	0.0	6.50	0.00	0.0000E+00	0.0000E+00	0.0000E+00	-
-170	78.5	6.00	3.58	6.2369E+06	-2.338E+06	-1.246E+05	15SLV
-250	78.5	6.00	6.56	3.7877E+06	-1.488E+06	-1.261E+05	15SLV
-330	78.5	6.00	11.86	1.9658E+06	-8.472E+05	-9.719E+04	15SLV
-410	78.5	6.00	15.49	1.1895E+06	-5.554E+05	-9.876E+04	15SLV
-490	78.5	6.00	18.37	4.1321E+05	-2.636E+05	-1.003E+05	15SLV
-570	78.5	6.00	18.09	-3.619E+05	1.7315E+04	-1.019E+05	15SLV
-650	78.5	6.00	15.60	-1.139E+06	3.2003E+05	-1.035E+05	15SLV



Progetto	Titolo	Rev.	Pag.
Orione	Orione_A24a.pdf "TABULATI DI CALCOLO PLINTO DI FONDAZIONE PER AEROGENERATORE TIPO"	0	245

-730	78.5	6.00	14.47	1.6129E+06	-5.076E+05	-3.431E+04	1SLV		
-810	78.5	6.00	15.52	-1.514E+06	4.7897E+05	-7.809E+04	15SLV		
-890	78.5	6.00	15.90	-1.433E+06	4.6191E+05	-7.966E+04	15SLV		
-970	78.5	6.00	16.31	-1.352E+06	4.4486E+05	-8.123E+04	15SLV		
-1050	78.5	6.00	16.73	-1.272E+06	4.2781E+05	-8.280E+04	15SLV		
-1130	124.0	6.00	22.81	-1.173E+06	4.0257E+05	-5.601E+04	15SLV		
-1210	78.5	6.00	22.17	-1.015E+06	3.5060E+05	-5.758E+04	15SLV		
-1290	78.5	6.00	24.12	-8.581E+05	2.9863E+05	-5.915E+04	15SLV		
-1370	78.5	6.00	25.97	-7.007E+05	2.4667E+05	-6.072E+04	15SLV		
-1450	78.5	6.00	27.71	-5.433E+05	1.9470E+05	-6.229E+04	15SLV		
-1530	78.5	6.00	28.86	-3.859E+05	1.4273E+05	-6.386E+04	15SLV		
-1610	78.5	6.00	45.75	-3.133E+05	1.1695E+05	-3.842E+04	15SLV		
-1690	78.5	6.00	46.09	-2.447E+05	9.2454E+04	-3.999E+04	15SLV		
-1770	78.5	6.00	44.35	-1.762E+05	6.7959E+04	-4.156E+04	15SLV		
-1850	78.5	6.00	42.73	-1.077E+05	4.3465E+04	-4.313E+04	15SLV		
-1930	78.5	6.00	41.23	-3.918E+04	1.8970E+04	-4.470E+04	15SLV		
-2010	78.5	6.00	91.26	-1.457E+04	9.5419E+03	-2.020E+04	15SLV		
-2090	78.5	6.00	84.68	-1.141E+04	7.4718E+03	-2.177E+04	15SLV		
-2170	124.0	6.00	87.16	-8.249E+03	5.4017E+03	-2.334E+04	15SLV		
-2250	78.5	6.00	74.00	-5.088E+03	3.3315E+03	-2.491E+04	15SLV		
-2330	78.5	6.00	68.55	-2.958E+03	1.7487E+03	-2.689E+04	3SLU		
-2410	78.5	6.00	100.00	3.8933E-10	8.6378E-11	-2.502E+03	15SLV		
-2490	78.5	6.00	100.00	1.6811E-10	2.5722E-11	-4.073E+03	15SLV		

Verifica di esercizio (combinazione rara):

quota	Af	cop.	sigmaf	sigmac	Mx	My	N	comb	Wk
-90	0.0	6.50	0.0	0.0	0.0000E+00	0.0000E+00	0.0000E+00	-	0.000
-170	78.5	6.00		24.2	1.4270E+06	-8.222E+05	-9.183E+04	1	0.000
-170	78.5	6.00	62.8		1.2691E+06	-9.233E+05	-7.627E+04	2	0.000
-250	78.5	6.00		21.0	1.1043E+06	-6.392E+05	-9.340E+04	1	0.000
-250	78.5	6.00	1.7		9.5898E+05	-7.028E+05	-7.784E+04	2	0.000
-330	78.5	6.00		15.9	8.3642E+05	-4.864E+05	-7.052E+04	1	0.000
-330	78.5	6.00	0.6		7.0625E+05	-5.219E+05	-5.786E+04	2	0.000
-410	78.5	6.00		14.4	6.5999E+05	-3.839E+05	-7.209E+04	1	0.000
-490	78.5	6.00		12.9	4.8356E+05	-2.814E+05	-7.366E+04	1	0.000
-570	78.5	6.00		11.3	3.0712E+05	-1.789E+05	-7.523E+04	1	0.000
-650	78.5	6.00		9.8	1.3069E+05	-7.634E+04	-7.680E+04	1	0.000
-730	78.5	6.00		6.3	9.3196E+03	-5.811E+03	-5.542E+04	1	0.000
-810	78.5	6.00		6.5	-2.027E+04	1.1398E+04	-5.699E+04	1	0.000
-890	78.5	6.00		7.0	-4.986E+04	2.8607E+04	-5.856E+04	1	0.000
-970	78.5	6.00		7.5	-7.945E+04	4.5817E+04	-6.013E+04	1	0.000
-1050	78.5	6.00		7.9	-1.090E+05	6.3026E+04	-6.170E+04	1	0.000
-1130	124.0	6.00		5.3	-1.293E+05	7.4840E+04	-4.032E+04	1	0.000
-1210	78.5	6.00		5.8	-1.191E+05	6.9026E+04	-4.189E+04	1	0.000
-1290	78.5	6.00		5.9	-1.090E+05	6.3212E+04	-4.346E+04	1	0.000
-1370	78.5	6.00		6.0	-9.882E+04	5.7399E+04	-4.503E+04	1	0.000
-1450	78.5	6.00		6.0	-8.866E+04	5.1585E+04	-4.661E+04	1	0.000
-1530	78.5	6.00		6.1	-7.850E+04	4.5772E+04	-4.818E+04	1	0.000
-1610	78.5	6.00		3.7	-6.750E+04	3.9392E+04	-2.780E+04	1	0.000
-1690	78.5	6.00		3.8	-5.646E+04	3.2984E+04	-2.937E+04	1	0.000
-1770	78.5	6.00		3.9	-4.542E+04	2.6576E+04	-3.094E+04	1	0.000
-1850	78.5	6.00		3.9	-3.438E+04	2.0169E+04	-3.251E+04	1	0.000
-1930	78.5	6.00		4.0	-2.334E+04	1.3761E+04	-3.408E+04	1	0.000
-2010	78.5	6.00		1.8	-1.721E+04	1.0175E+04	-1.440E+04	1	0.000
-2090	78.5	6.00		1.9	-1.348E+04	7.9678E+03	-1.597E+04	1	0.000
-2170	124.0	6.00		1.9	-9.742E+03	5.7603E+03	-1.754E+04	1	0.000
-2250	78.5	6.00		2.2	-6.008E+03	3.5527E+03	-1.911E+04	1	0.000
-2330	78.5	6.00		2.3	-2.275E+03	1.3452E+03	-2.068E+04	1	0.000
-2410	78.5	6.00		0.2	-2.014E-11	1.3792E-11	-1.395E+03	1	0.000
-2490	78.5	6.00		0.3	-6.495E-12	-2.124E-12	-2.966E+03	1	0.000

Verifica di esercizio (combinazione quasi permanente):

quota	Af	cop.	sigmaf	sigmac	Mx	My	N	comb	Wk
-90	0.0	6.50	0.0	0.0	0.0000E+00	0.0000E+00	0.0000E+00	-	0.000
-170	78.5	6.00		24.2	1.4270E+06	-8.222E+05	-9.183E+04	1	0.000
-170	78.5	6.00	42.4		1.3797E+06	-8.525E+05	-8.716E+04	2	0.000
-250	78.5	6.00		21.0	1.1043E+06	-6.392E+05	-9.340E+04	1	0.000
-330	78.5	6.00		15.9	8.3642E+05	-4.864E+05	-7.052E+04	1	0.000
-410	78.5	6.00		14.4	6.5999E+05	-3.839E+05	-7.209E+04	1	0.000
-490	78.5	6.00		12.9	4.8356E+05	-2.814E+05	-7.366E+04	1	0.000
-570	78.5	6.00		11.3	3.0712E+05	-1.789E+05	-7.523E+04	1	0.000
-650	78.5	6.00		9.8	1.3069E+05	-7.634E+04	-7.680E+04	1	0.000
-730	78.5	6.00		6.3	9.3196E+03	-5.811E+03	-5.542E+04	1	0.000
-810	78.5	6.00		6.5	-2.027E+04	1.1398E+04	-5.699E+04	1	0.000
-890	78.5	6.00		7.0	-4.986E+04	2.8607E+04	-5.856E+04	1	0.000
-970	78.5	6.00		7.5	-7.945E+04	4.5817E+04	-6.013E+04	1	0.000
-1050	78.5	6.00		7.9	-1.090E+05	6.3026E+04	-6.170E+04	1	0.000
-1130	124.0	6.00		5.3	-1.293E+05	7.4840E+04	-4.032E+04	1	0.000
-1210	78.5	6.00		5.8	-1.191E+05	6.9026E+04	-4.189E+04	1	0.000
-1290	78.5	6.00		5.9	-1.090E+05	6.3212E+04	-4.346E+04	1	0.000
-1370	78.5	6.00		6.0	-9.882E+04	5.7399E+04	-4.503E+04	1	0.000
-1450	78.5	6.00		6.0	-8.866E+04	5.1585E+04	-4.661E+04	1	0.000
-1530	78.5	6.00		6.1	-7.850E+04	4.5772E+04	-4.818E+04	1	0.000
-1610	78.5	6.00		3.7	-6.750E+04	3.9392E+04	-2.780E+04	1	0.000
-1690	78.5	6.00		3.8	-5.646E+04	3.2984E+04	-2.937E+04	1	0.000
-1770	78.5	6.00		3.9	-4.542E+04	2.6576E+04	-3.094E+04	1	0.000



Progetto	Titolo	Rev.	Pag.
Orione	Orione_A24a.pdf "TABULATI DI CALCOLO PLINTO DI FONDAZIONE PER AEROGENERATORE TIPO"	0	246

Tabulati di Calcolo Plinto di Fondazione per Aerogeneratore Tipo - Progetto Impianto Eolico - "Orione"

-1850	78.5	6.00	3.9	-3.438E+04	2.0169E+04	-3.251E+04	1	0.000
-1930	78.5	6.00	4.0	-2.334E+04	1.3761E+04	-3.408E+04	1	0.000
-2010	78.5	6.00	1.8	-1.721E+04	1.0175E+04	-1.440E+04	1	0.000
-2090	78.5	6.00	1.9	-1.348E+04	7.9678E+03	-1.597E+04	1	0.000
-2170	124.0	6.00	1.9	-9.742E+03	5.7603E+03	-1.754E+04	1	0.000
-2250	78.5	6.00	2.2	-6.008E+03	3.5527E+03	-1.911E+04	1	0.000
-2330	78.5	6.00	2.3	-2.275E+03	1.3452E+03	-2.068E+04	1	0.000
-2410	78.5	6.00	0.2	-2.014E-11	1.3792E-11	-1.395E+03	1	0.000
-2490	78.5	6.00	0.3	-6.495E-12	-2.124E-12	-2.966E+03	1	0.000

Verifica a taglio:

quota	Ast	Vsd	Vsdx	Vsdy	N	comb	VRd,c	VRd,max	VRd,S	Vwd	
-90	0.16	33193	-10805	-31385	-123719	15SLV	40396	231056	84720	44323	Vsd < VRd,
-170	0.16	32408	-10629	-30616	-124562	15SLV	44402	231056	88725	44323	Vsd < VRd,
-250	0.08	32408	-10629	-30616	-126133	15SLV	44620	231056	66782	22162	Vsd < VRd,
-330	0.08	10367	-3648	-9704	-97188	15SLV	40597	231056	62759	22162	Vsd < VRd,
-410	0.08	10367	-3648	-9704	-98759	15SLV	40815	231056	62977	22162	Vsd < VRd,
-490	0.08	10367	-3648	-9704	-100330	15SLV	41034	231056	63195	22162	Vsd < VRd,
-570	0.08	10367	-3648	-9704	-101901	15SLV	41252	231056	63414	22162	Vsd < VRd,
-650	0.08	10367	-3648	-9704	-103472	15SLV	41470	231056	63632	22162	Vsd < VRd,
-730	0.08	1863	-643	-1748	-34310	1SLV	31857	231056	54019	22162	Vsd < VRd,
-810	0.08	1863	-643	-1748	-35881	1SLV	32075	231056	54237	22162	Vsd < VRd,
-890	0.08	1863	-643	-1748	-37452	1SLV	32294	231056	54455	22162	Vsd < VRd,
-970	0.08	1863	-643	-1748	-39023	1SLV	32512	231056	54674	22162	Vsd < VRd,
-1050	0.08	1863	-643	-1748	-40594	1SLV	32730	231056	54892	22162	Vsd < VRd,
-1130	0.08	2072	650	1967	-56007	15SLV	39329	231056	61491	22162	Vsd < VRd,
-1210	0.08	2072	650	1967	-57578	15SLV	35091	231056	57253	22162	Vsd < VRd,
-1290	0.08	2072	650	1967	-59149	15SLV	35310	231056	57471	22162	Vsd < VRd,
-1370	0.08	2072	650	1967	-60720	15SLV	35528	231056	57690	22162	Vsd < VRd,
-1450	0.08	2072	650	1967	-62290	15SLV	35746	231056	57908	22162	Vsd < VRd,
-1530	0.08	2072	650	1967	-63861	15SLV	35965	231056	58126	22162	Vsd < VRd,
-1610	0.08	910	306	856	-38421	15SLV	32428	231056	54590	22162	Vsd < VRd,
-1690	0.08	910	306	856	-39992	15SLV	32647	231056	54808	22162	Vsd < VRd,
-1770	0.08	910	306	856	-41563	15SLV	32865	231056	55027	22162	Vsd < VRd,
-1850	0.08	910	306	856	-43134	15SLV	33083	231056	55245	22162	Vsd < VRd,
-1930	0.08	910	306	856	-44704	15SLV	33302	231056	55464	22162	Vsd < VRd,
-2010	0.08	70	36	61	-18719	3SLV	29690	231056	51852	22162	Vsd < VRd,
-2090	0.08	70	36	61	-20761	3SLV	29974	231056	52135	22162	Vsd < VRd,
-2170	0.08	70	36	61	-22803	3SLV	34714	231056	56875	22162	Vsd < VRd,
-2250	0.08	70	36	61	-24845	3SLV	30541	231056	52703	22162	Vsd < VRd,
-2330	0.08	70	36	61	-26887	3SLV	30825	231056	52987	22162	Vsd < VRd,
-2410	0.08	0	0	0	-288	1SLV	27128	231056	49290	22162	Vsd < VRd,
-2490	0.08	0	0	0	-1858	1SLV	27346	231056	49508	22162	Vsd < VRd,

Palo alle coordinate X=1264 Y=1061

Sollecitazioni massime in testa palo:

Combinazione corrispondente alla minima compressione in testa

N	Mx	My	Tx	Ty	comb	
-6.000E+04	1.2073E+06	-1.314E+06	-3.195E+03	-3.144E+03	2	sl
-7.028E+04	1.3206E+06	-1.307E+06	-3.098E+03	-3.290E+03	2	ra
-8.055E+04	1.4339E+06	-1.301E+06	-3.001E+03	-3.437E+03	2	fr
-8.467E+04	1.4793E+06	-1.298E+06	-2.962E+03	-3.495E+03	2	qp
-6.000E+04	-5.368E+06	9.0077E+05	5.7050E+03	2.3656E+04	1	SLV fond

Combinazione corrispondente alla massima compressione in testa

N	Mx	My	Tx	Ty	comb	
-1.181E+05	2.0114E+06	-1.683E+06	-3.775E+03	-4.658E+03	3	sl
-9.083E+04	1.5473E+06	-1.294E+06	-2.904E+03	-3.583E+03	1	ra
-9.083E+04	1.5473E+06	-1.294E+06	-2.904E+03	-3.583E+03	1	fr
-9.083E+04	1.5473E+06	-1.294E+06	-2.904E+03	-3.583E+03	1	qp
-1.217E+05	8.4624E+06	-3.489E+06	-1.151E+04	-3.082E+04	15	SLV fond

Combinazione corrispondente al massimo taglio in testa

N	Mx	My	Tx	Ty	comb	
-1.181E+05	2.0114E+06	-1.683E+06	-3.775E+03	-4.658E+03	3	sl
-9.083E+04	1.5473E+06	-1.294E+06	-2.904E+03	-3.583E+03	1	ra
-9.083E+04	1.5473E+06	-1.294E+06	-2.904E+03	-3.583E+03	1	fr
-9.083E+04	1.5473E+06	-1.294E+06	-2.904E+03	-3.583E+03	1	qp
-1.217E+05	8.4624E+06	-3.489E+06	-1.151E+04	-3.082E+04	15	SLV fond

Verifica di capacità portante riferita al palo singolo:

Fattore di correlazione Psi scelto in base alla conoscenza del sito = 1.7  
 Coeff. parziale di sicurezza sulla resistenza laterale = 1.15  
 Coeff. parziale di sicurezza sulla resistenza alla punta = 1.35  
 Portanza laterale di progetto = 292537.1  
 Portanza di punta di progetto = 85555.4  
 verifica condotta in combinazione SLU 3  
 Sforzo normale = -118081.2  
 Peso del palo = 49087.4 \* 1.3  
 Carico totale di progetto = -181894.8  
 Resistenza totale di progetto = 378092.5  
 Coefficiente di sicurezza = 2.08 > 1



Progetto	Titolo	Rev.	Pag.
Orione	Orione_A24a.pdf "TABULATI DI CALCOLO PLINTO DI FONDAZIONE PER AEROGENERATORE TIPO"	0	247



Verifica di resistenza allo stato limite:

quota	Af	cop.	c.s.	Mx	My	N	comb
-90	0.0	6.50	0.00	0.0000E+00	0.0000E+00	0.0000E+00	-
-170	78.5	6.00	3.61	2.7356E+06	-5.937E+06	-1.184E+05	11SLV
-250	78.5	6.00	6.65	3.6494E+06	-1.675E+06	-1.241E+05	15SLV
-330	78.5	6.00	12.05	1.8639E+06	-9.880E+05	-9.553E+04	15SLV
-410	78.5	6.00	15.74	1.1102E+06	-6.661E+05	-9.710E+04	15SLV
-490	78.5	6.00	18.68	3.5654E+05	-3.442E+05	-9.867E+04	15SLV
-570	78.5	6.00	18.39	-3.958E+05	-3.342E+04	-1.002E+05	15SLV
-650	78.5	6.00	15.74	-1.151E+06	2.9964E+05	-1.018E+05	15SLV
-730	78.5	6.00	14.71	1.6068E+06	-5.110E+05	-3.557E+04	15SLV
-810	78.5	6.00	15.65	-1.507E+06	4.8400E+05	-7.678E+04	15SLV
-890	78.5	6.00	16.05	-1.423E+06	4.7176E+05	-7.835E+04	15SLV
-970	78.5	6.00	16.47	-1.339E+06	4.5951E+05	-7.992E+04	15SLV
-1050	78.5	6.00	16.91	-1.255E+06	4.4727E+05	-8.149E+04	15SLV
-1130	124.0	6.00	23.08	-1.154E+06	4.2528E+05	-5.503E+04	15SLV
-1210	78.5	6.00	22.44	-9.987E+05	3.7146E+05	-5.660E+04	15SLV
-1290	78.5	6.00	24.42	-8.429E+05	3.1763E+05	-5.817E+04	15SLV
-1370	78.5	6.00	26.33	-6.872E+05	2.6381E+05	-5.974E+04	15SLV
-1450	78.5	6.00	28.10	-5.315E+05	2.0998E+05	-6.131E+04	15SLV
-1530	78.5	6.00	29.31	-3.757E+05	1.5616E+05	-6.288E+04	15SLV
-1610	78.5	6.00	46.47	-3.045E+05	1.2847E+05	-3.776E+04	15SLV
-1690	78.5	6.00	46.86	-2.375E+05	1.0207E+05	-3.933E+04	15SLV
-1770	78.5	6.00	45.06	-1.705E+05	7.5675E+04	-4.090E+04	15SLV
-1850	78.5	6.00	43.40	-1.034E+05	4.9276E+04	-4.247E+04	15SLV
-1930	78.5	6.00	41.62	-2.683E+04	2.2907E+04	-4.429E+04	3SLU
-2010	78.5	6.00	92.92	-1.255E+04	1.2406E+04	-1.984E+04	15SLV
-2090	78.5	6.00	86.10	-9.831E+03	9.7145E+03	-2.141E+04	15SLV
-2170	124.0	6.00	88.53	-7.107E+03	7.0230E+03	-2.298E+04	15SLV
-2250	78.5	6.00	74.22	-6.906E+03	5.9103E+03	-2.484E+04	3SLU
-2330	78.5	6.00	68.58	-2.615E+03	2.2378E+03	-2.688E+04	3SLU
-2410	78.5	6.00	100.00	3.6813E-10	-7.841E-11	-2.433E+03	15SLV
-2490	78.5	6.00	100.00	2.2517E-10	-1.506E-11	-4.004E+03	15SLV

Verifica di esercizio (combinazione rara):

quota	Af	cop.	sigmaf	sigmac	Mx	My	N	comb	Wk
-90	0.0	6.50	0.0	0.0	0.0000E+00	0.0000E+00	0.0000E+00	-	0.000
-170	78.5	6.00		24.2	1.2618E+06	-1.058E+06	-9.178E+04	1	0.000
-170	78.5	6.00	64.2		1.0595E+06	-1.057E+06	-7.133E+04	2	0.000
-250	78.5	6.00		21.0	9.7644E+05	-8.218E+05	-9.335E+04	1	0.000
-250	78.5	6.00	4.3		7.9843E+05	-8.071E+05	-7.290E+04	2	0.000
-330	78.5	6.00		15.9	7.3957E+05	-6.247E+05	-7.048E+04	1	0.000
-330	78.5	6.00	3.3		5.8614E+05	-6.013E+05	-5.385E+04	2	0.000
-410	78.5	6.00		14.4	5.8357E+05	-4.931E+05	-7.205E+04	1	0.000
-490	78.5	6.00		12.9	4.2756E+05	-3.614E+05	-7.363E+04	1	0.000
-570	78.5	6.00		11.3	2.7155E+05	-2.297E+05	-7.520E+04	1	0.000
-650	78.5	6.00		9.8	1.1554E+05	-9.797E+04	-7.677E+04	1	0.000
-730	78.5	6.00		6.3	8.2281E+03	-7.373E+03	-5.539E+04	1	0.000
-810	78.5	6.00		6.5	-1.793E+04	1.4732E+04	-5.696E+04	1	0.000
-890	78.5	6.00		7.0	-4.409E+04	3.6836E+04	-5.853E+04	1	0.000
-970	78.5	6.00		7.4	-7.026E+04	5.8940E+04	-6.010E+04	1	0.000
-1050	78.5	6.00		7.9	-9.642E+04	8.1044E+04	-6.167E+04	1	0.000
-1130	124.0	6.00		5.3	-1.143E+05	9.6212E+04	-4.030E+04	1	0.000
-1210	78.5	6.00		5.8	-1.054E+05	8.8719E+04	-4.187E+04	1	0.000
-1290	78.5	6.00		5.9	-9.637E+04	8.1227E+04	-4.344E+04	1	0.000
-1370	78.5	6.00		6.0	-8.738E+04	7.3734E+04	-4.502E+04	1	0.000
-1450	78.5	6.00		6.0	-7.840E+04	6.6242E+04	-4.659E+04	1	0.000
-1530	78.5	6.00		6.1	-6.941E+04	5.8750E+04	-4.816E+04	1	0.000
-1610	78.5	6.00		3.7	-5.968E+04	5.0551E+04	-2.779E+04	1	0.000
-1690	78.5	6.00		3.8	-4.992E+04	4.2319E+04	-2.936E+04	1	0.000
-1770	78.5	6.00		3.9	-4.016E+04	3.4086E+04	-3.093E+04	1	0.000
-1850	78.5	6.00		3.9	-3.040E+04	2.5853E+04	-3.250E+04	1	0.000
-1930	78.5	6.00		4.0	-2.064E+04	1.7621E+04	-3.407E+04	1	0.000
-2010	78.5	6.00		1.8	-1.522E+04	1.3021E+04	-1.439E+04	1	0.000
-2090	78.5	6.00		1.9	-1.191E+04	1.0196E+04	-1.596E+04	1	0.000
-2170	124.0	6.00		1.9	-8.614E+03	7.3714E+03	-1.753E+04	1	0.000
-2250	78.5	6.00		2.2	-5.313E+03	4.5464E+03	-1.910E+04	1	0.000
-2330	78.5	6.00		2.3	-2.012E+03	1.7214E+03	-2.068E+04	1	0.000
-2410	78.5	6.00		0.2	-9.223E-12	2.5722E-11	-1.394E+03	1	0.000
-2490	78.5	6.00		0.3	4.4194E-12	-1.563E-12	-2.964E+03	1	0.000

Verifica di esercizio (combinazione quasi permanente):

quota	Af	cop.	sigmaf	sigmac	Mx	My	N	comb	Wk
-90	0.0	6.50	0.0	0.0	0.0000E+00	0.0000E+00	0.0000E+00	-	0.000
-170	78.5	6.00		24.2	1.2618E+06	-1.058E+06	-9.178E+04	1	0.000
-170	78.5	6.00	42.8		1.2011E+06	-1.058E+06	-8.565E+04	2	0.000
-250	78.5	6.00		21.0	9.7644E+05	-8.218E+05	-9.335E+04	1	0.000
-330	78.5	6.00		15.9	7.3957E+05	-6.247E+05	-7.048E+04	1	0.000
-410	78.5	6.00		14.4	5.8357E+05	-4.931E+05	-7.205E+04	1	0.000
-490	78.5	6.00		12.9	4.2756E+05	-3.614E+05	-7.363E+04	1	0.000
-570	78.5	6.00		11.3	2.7155E+05	-2.297E+05	-7.520E+04	1	0.000
-650	78.5	6.00		9.8	1.1554E+05	-9.797E+04	-7.677E+04	1	0.000
-730	78.5	6.00		6.3	8.2281E+03	-7.373E+03	-5.539E+04	1	0.000



-810	78.5	6.00	6.5	-1.793E+04	1.4732E+04	-5.696E+04	1	0.000
-890	78.5	6.00	7.0	-4.409E+04	3.6836E+04	-5.853E+04	1	0.000
-970	78.5	6.00	7.4	-7.026E+04	5.8940E+04	-6.010E+04	1	0.000
-1050	78.5	6.00	7.9	-9.642E+04	8.1044E+04	-6.167E+04	1	0.000
-1130	124.0	6.00	5.3	-1.143E+05	9.6212E+04	-4.030E+04	1	0.000
-1210	78.5	6.00	5.8	-1.054E+05	8.8719E+04	-4.187E+04	1	0.000
-1290	78.5	6.00	5.9	-9.637E+04	8.1227E+04	-4.344E+04	1	0.000
-1370	78.5	6.00	6.0	-8.738E+04	7.3734E+04	-4.502E+04	1	0.000
-1450	78.5	6.00	6.0	-7.840E+04	6.6242E+04	-4.659E+04	1	0.000
-1530	78.5	6.00	6.1	-6.941E+04	5.8750E+04	-4.816E+04	1	0.000
-1610	78.5	6.00	3.7	-5.968E+04	5.0551E+04	-2.779E+04	1	0.000
-1690	78.5	6.00	3.8	-4.992E+04	4.2319E+04	-2.936E+04	1	0.000
-1770	78.5	6.00	3.9	-4.016E+04	3.4086E+04	-3.093E+04	1	0.000
-1850	78.5	6.00	3.9	-3.040E+04	2.5853E+04	-3.250E+04	1	0.000
-1930	78.5	6.00	4.0	-2.064E+04	1.7621E+04	-3.407E+04	1	0.000
-2010	78.5	6.00	1.8	-1.522E+04	1.3021E+04	-1.439E+04	1	0.000
-2090	78.5	6.00	1.9	-1.191E+04	1.0196E+04	-1.596E+04	1	0.000
-2170	124.0	6.00	1.9	-8.614E+03	7.3714E+03	-1.753E+04	1	0.000
-2250	78.5	6.00	2.2	-5.313E+03	4.5464E+03	-1.910E+04	1	0.000
-2330	78.5	6.00	2.3	-2.012E+03	1.7214E+03	-2.068E+04	1	0.000
-2410	78.5	6.00	0.2	-9.223E-12	2.5722E-11	-1.394E+03	1	0.000
-2490	78.5	6.00	0.3	4.4194E-12	-1.563E-12	-2.964E+03	1	0.000

Verifica a taglio:

quota	Ast	Vsd	Vsdx	Vsdy	N comb	VRd,c	VRd,max	VRd,S	Vwd
-90	0.16	32902	-11513	-30822	-121662 15SLV	40111	231056	84434	44323 Vsd < VRd,
-170	0.16	32123	-11332	-30058	-122517 15SLV	44118	231056	88441	44323 Vsd < VRd,
-250	0.08	32123	-11332	-30058	-124088 15SLV	44336	231056	66498	22162 Vsd < VRd,
-330	0.08	10244	-4024	-9421	-95526 15SLV	40366	231056	62528	22162 Vsd < VRd,
-410	0.08	10244	-4024	-9421	-97097 15SLV	40584	231056	62746	22162 Vsd < VRd,
-490	0.08	10244	-4024	-9421	-98668 15SLV	40803	231056	62964	22162 Vsd < VRd,
-570	0.08	10244	-4024	-9421	-100239 15SLV	41021	231056	63183	22162 Vsd < VRd,
-650	0.08	10244	-4024	-9421	-101810 15SLV	41239	231056	63401	22162 Vsd < VRd,
-730	0.08	1842	-706	-1702	-35574 1SLV	32033	231056	54194	22162 Vsd < VRd,
-810	0.08	1842	-706	-1702	-37144 1SLV	32251	231056	54413	22162 Vsd < VRd,
-890	0.08	1842	-706	-1702	-38715 1SLV	32469	231056	54631	22162 Vsd < VRd,
-970	0.08	1842	-706	-1702	-40286 1SLV	32688	231056	54849	22162 Vsd < VRd,
-1050	0.08	1842	-706	-1702	-41857 1SLV	32906	231056	55068	22162 Vsd < VRd,
-1130	0.08	2069	1956	674	-53118 11SLV	38928	231056	61089	22162 Vsd < VRd,
-1210	0.08	2069	1956	674	-54689 11SLV	34690	231056	56851	22162 Vsd < VRd,
-1290	0.08	2069	1956	674	-56260 11SLV	34908	231056	57070	22162 Vsd < VRd,
-1370	0.08	2069	1956	674	-57830 11SLV	35126	231056	57288	22162 Vsd < VRd,
-1450	0.08	2069	1956	674	-59401 11SLV	35345	231056	57506	22162 Vsd < VRd,
-1530	0.08	2069	1956	674	-60972 11SLV	35563	231056	57725	22162 Vsd < VRd,
-1610	0.08	901	330	838	-37760 15SLV	32337	231056	54498	22162 Vsd < VRd,
-1690	0.08	901	330	838	-39331 15SLV	32555	231056	54717	22162 Vsd < VRd,
-1770	0.08	901	330	838	-40902 15SLV	32773	231056	54935	22162 Vsd < VRd,
-1850	0.08	901	330	838	-42472 15SLV	32992	231056	55153	22162 Vsd < VRd,
-1930	0.08	901	330	838	-44043 15SLV	33210	231056	55372	22162 Vsd < VRd,
-2010	0.08	71	46	54	-18710 3SLU	29689	231056	51850	22162 Vsd < VRd,
-2090	0.08	71	46	54	-20752 3SLU	29972	231056	52134	22162 Vsd < VRd,
-2170	0.08	71	46	54	-22794 3SLU	34712	231056	56874	22162 Vsd < VRd,
-2250	0.08	71	46	54	-24836 3SLU	30540	231056	52702	22162 Vsd < VRd,
-2330	0.08	71	46	54	-26878 3SLU	30824	231056	52986	22162 Vsd < VRd,
-2410	0.08	0	0	0	-489 5SLV	27156	231056	49318	22162 Vsd < VRd,
-2490	0.08	0	0	0	-2060 5SLV	27374	231056	49536	22162 Vsd < VRd,

Palo alle coordinate X=1061 Y=1264

Sollecitazioni massime in testa palo:

Combinazione corrispondente alla minima compressione in testa

N	Mx	My	Tx	Ty	comb
-5.350E+04	9.4025E+05	-1.360E+06	-3.291E+03	-2.498E+03	2 sl
-6.593E+04	1.0595E+06	-1.421E+06	-3.354E+03	-2.668E+03	2 ra
-7.835E+04	1.1788E+06	-1.482E+06	-3.418E+03	-2.837E+03	2 fr
-8.332E+04	1.2265E+06	-1.507E+06	-3.443E+03	-2.905E+03	2 qp
-6.177E+04	-8.187E+05	5.5123E+06	2.4284E+04	5.3175E+03	5 SLV fond

Combinazione corrispondente alla massima compressione in testa

N	Mx	My	Tx	Ty	comb
-1.180E+05	1.6875E+06	-2.006E+06	-4.525E+03	-3.908E+03	3 sl
-9.078E+04	1.2981E+06	-1.543E+06	-3.481E+03	-3.006E+03	1 ra
-9.078E+04	1.2981E+06	-1.543E+06	-3.481E+03	-3.006E+03	1 fr
-9.078E+04	1.2981E+06	-1.543E+06	-3.481E+03	-3.006E+03	1 qp
-1.198E+05	3.4149E+06	-8.599E+06	-3.125E+04	-1.133E+04	11 SLV fond

Combinazione corrispondente al massimo taglio in testa

N	Mx	My	Tx	Ty	comb
-1.180E+05	1.6875E+06	-2.006E+06	-4.525E+03	-3.908E+03	3 sl
-9.078E+04	1.2981E+06	-1.543E+06	-3.481E+03	-3.006E+03	1 ra
-9.078E+04	1.2981E+06	-1.543E+06	-3.481E+03	-3.006E+03	1 fr
-9.078E+04	1.2981E+06	-1.543E+06	-3.481E+03	-3.006E+03	1 qp
-1.198E+05	3.4149E+06	-8.599E+06	-3.125E+04	-1.133E+04	11 SLV fond



Verifica di capacità portante riferita al palo singolo:

Fattore di correlazione Psi scelto in base alla conoscenza del sito = 1.7  
 Coeff. parziale di sicurezza sulla resistenza laterale = 1.15  
 Coeff. parziale di sicurezza sulla resistenza alla punta = 1.35  
 Portanza laterale di progetto = 292537.1  
 Portanza di punta di progetto = 85555.4  
 verifica condotta in combinazione SLU 3  
 Sforzo normale = -118008.3  
 Peso del palo = 49087.4 \* 1.3  
 Carico totale di progetto = -181821.9  
 Resistenza totale di progetto = 378092.5  
 Coefficiente di sicurezza = 2.08 > 1

Verifica di resistenza allo stato limite:

quota	Af	cop.	c.s.	Mx	My	N	comb
-90	0.0	6.50	0.00	0.0000E+00	0.0000E+00	0.0000E+00	-
-170	78.5	6.00	3.55	2.5267E+06	-6.154E+06	-1.208E+05	11SLV
-250	78.5	6.00	6.59	1.6396E+06	-3.713E+06	-1.223E+05	11SLV
-330	78.5	6.00	12.02	9.6749E+05	-1.900E+06	-9.419E+04	11SLV
-410	78.5	6.00	15.81	6.5352E+05	-1.133E+06	-9.576E+04	11SLV
-490	78.5	6.00	18.94	3.3956E+05	-3.656E+05	-9.733E+04	11SLV
-570	78.5	6.00	18.64	3.0212E+04	3.9849E+05	-9.890E+04	11SLV
-650	78.5	6.00	15.81	-2.884E+05	1.1688E+06	-1.005E+05	11SLV
-730	78.5	6.00	14.61	4.9410E+05	-1.634E+06	-3.656E+04	5SLV
-810	78.5	6.00	15.62	-4.689E+05	1.5314E+06	-7.573E+04	11SLV
-890	78.5	6.00	16.02	-4.575E+05	1.4464E+06	-7.730E+04	11SLV
-970	78.5	6.00	16.45	-4.460E+05	1.3613E+06	-7.887E+04	11SLV
-1050	78.5	6.00	16.89	-4.346E+05	1.2763E+06	-8.044E+04	11SLV
-1130	124.0	6.00	23.03	-4.136E+05	1.1740E+06	-5.425E+04	11SLV
-1210	78.5	6.00	22.40	-3.613E+05	1.0158E+06	-5.582E+04	11SLV
-1290	78.5	6.00	24.41	-3.090E+05	8.5749E+05	-5.739E+04	11SLV
-1370	78.5	6.00	26.44	-2.566E+05	6.9920E+05	-5.896E+04	11SLV
-1450	78.5	6.00	28.26	-2.043E+05	5.4092E+05	-6.054E+04	11SLV
-1530	78.5	6.00	29.46	-7.570E+04	9.0906E+04	-6.257E+04	3SLU
-1610	78.5	6.00	46.78	-1.251E+05	3.1021E+05	-3.723E+04	11SLV
-1690	78.5	6.00	47.50	-9.935E+04	2.4200E+05	-3.880E+04	11SLV
-1770	78.5	6.00	45.65	-7.364E+04	1.7378E+05	-4.037E+04	11SLV
-1850	78.5	6.00	43.65	-3.315E+04	3.9974E+04	-4.223E+04	3SLU
-1930	78.5	6.00	41.64	-2.251E+04	2.7228E+04	-4.427E+04	3SLU
-2010	78.5	6.00	94.29	-1.204E+04	1.3072E+04	-1.955E+04	11SLV
-2090	78.5	6.00	87.28	-9.431E+03	1.0236E+04	-2.112E+04	11SLV
-2170	124.0	6.00	89.29	-9.394E+03	1.1386E+04	-2.278E+04	3SLU
-2250	78.5	6.00	74.25	-5.794E+03	7.0226E+03	-2.482E+04	3SLU
-2330	78.5	6.00	68.61	-2.194E+03	2.6590E+03	-2.687E+04	3SLU
-2410	78.5	6.00	100.00	3.4418E-11	-2.288E-10	-2.378E+03	11SLV
-2490	78.5	6.00	100.00	1.6561E-11	-9.085E-11	-3.949E+03	11SLV

Verifica di esercizio (combinazione rara):

quota	Af	cop.	sigmaf	sigmac	Mx	My	N	comb	Wk
-90	0.0	6.50	0.0	0.0	0.0000E+00	0.0000E+00	0.0000E+00	-	0.000
-170	78.5	6.00		24.2	1.0586E+06	-1.261E+06	-9.173E+04	1	0.000
-170	78.5	6.00	64.8		8.4791E+05	-1.151E+06	-6.700E+04	2	0.000
-250	78.5	6.00		21.0	8.1919E+05	-9.791E+05	-9.330E+04	1	0.000
-250	78.5	6.00	6.4		6.3641E+05	-8.803E+05	-6.857E+04	2	0.000
-330	78.5	6.00		15.9	6.2047E+05	-7.439E+05	-7.044E+04	1	0.000
-330	78.5	6.00	5.7		4.6487E+05	-6.575E+05	-5.032E+04	2	0.000
-410	78.5	6.00		14.4	4.8958E+05	-5.870E+05	-7.201E+04	1	0.000
-490	78.5	6.00		12.9	3.5870E+05	-4.302E+05	-7.358E+04	1	0.000
-570	78.5	6.00		11.3	2.2781E+05	-2.734E+05	-7.515E+04	1	0.000
-650	78.5	6.00		9.8	9.6927E+04	-1.166E+05	-7.672E+04	1	0.000
-730	78.5	6.00		6.2	6.8939E+03	-8.701E+03	-5.536E+04	1	0.000
-810	78.5	6.00		6.5	-1.505E+04	1.7617E+04	-5.693E+04	1	0.000
-890	78.5	6.00		7.0	-3.700E+04	4.3935E+04	-5.850E+04	1	0.000
-970	78.5	6.00		7.4	-5.895E+04	7.0253E+04	-6.007E+04	1	0.000
-1050	78.5	6.00		7.9	-8.090E+04	9.6571E+04	-6.164E+04	1	0.000
-1130	124.0	6.00		5.3	-9.593E+04	1.1463E+05	-4.028E+04	1	0.000
-1210	78.5	6.00		5.8	-8.839E+04	1.0569E+05	-4.185E+04	1	0.000
-1290	78.5	6.00		5.9	-8.085E+04	9.6747E+04	-4.342E+04	1	0.000
-1370	78.5	6.00		6.0	-7.331E+04	8.7807E+04	-4.499E+04	1	0.000
-1450	78.5	6.00		6.0	-6.577E+04	7.8868E+04	-4.656E+04	1	0.000
-1530	78.5	6.00		6.1	-5.823E+04	6.9928E+04	-4.813E+04	1	0.000
-1610	78.5	6.00		3.7	-5.007E+04	6.0164E+04	-2.777E+04	1	0.000
-1690	78.5	6.00		3.8	-4.188E+04	5.0359E+04	-2.934E+04	1	0.000
-1770	78.5	6.00		3.9	-3.369E+04	4.0554E+04	-3.091E+04	1	0.000
-1850	78.5	6.00		3.9	-2.550E+04	3.0749E+04	-3.248E+04	1	0.000
-1930	78.5	6.00		4.0	-1.731E+04	2.0945E+04	-3.405E+04	1	0.000
-2010	78.5	6.00		1.8	-1.277E+04	1.5472E+04	-1.438E+04	1	0.000
-2090	78.5	6.00		1.9	-9.996E+03	1.2115E+04	-1.595E+04	1	0.000
-2170	124.0	6.00		1.9	-7.226E+03	8.7587E+03	-1.752E+04	1	0.000
-2250	78.5	6.00		2.2	-4.457E+03	5.4020E+03	-1.910E+04	1	0.000
-2330	78.5	6.00		2.3	-1.688E+03	2.0454E+03	-2.067E+04	1	0.000
-2410	78.5	6.00		0.2	-1.278E-11	2.1998E-11	-1.392E+03	1	0.000
-2490	78.5	6.00		0.3	-8.228E-12	3.8088E-12	-2.963E+03	1	0.000

Verifica di esercizio (combinazione quasi permanente):



Progetto	Titolo	Rev.	Pag.
Orione	Orione_A24a.pdf "TABULATI DI CALCOLO PLINTO DI FONDAZIONE PER AEROGENERATORE TIPO"	0	250

Tabulati di Calcolo Plinto di Fondazione per Aerogeneratore Tipo - Progetto Impianto Eolico - "Orione"

quota	Af	cop.	sigmaf	sigmac	Mx	My	N	comb	Wk
-90	0.0	6.50	0.0	0.0	0.0000E+00	0.0000E+00	0.0000E+00	-	0.000
-170	78.5	6.00		24.2	1.0586E+06	-1.261E+06	-9.173E+04	1	0.000
-170	78.5	6.00	43.0		9.9540E+05	-1.228E+06	-8.431E+04	2	0.000
-250	78.5	6.00		21.0	8.1919E+05	-9.791E+05	-9.330E+04	1	0.000
-330	78.5	6.00		15.9	6.2047E+05	-7.439E+05	-7.044E+04	1	0.000
-410	78.5	6.00		14.4	4.8958E+05	-5.870E+05	-7.201E+04	1	0.000
-490	78.5	6.00		12.9	3.5870E+05	-4.302E+05	-7.358E+04	1	0.000
-570	78.5	6.00		11.3	2.2781E+05	-2.734E+05	-7.515E+04	1	0.000
-650	78.5	6.00		9.8	9.6927E+04	-1.166E+05	-7.672E+04	1	0.000
-730	78.5	6.00		6.2	6.8939E+03	-8.701E+03	-5.536E+04	1	0.000
-810	78.5	6.00		6.5	-1.505E+04	1.7617E+04	-5.693E+04	1	0.000
-890	78.5	6.00		7.0	-3.700E+04	4.3935E+04	-5.850E+04	1	0.000
-970	78.5	6.00		7.4	-5.895E+04	7.0253E+04	-6.007E+04	1	0.000
-1050	78.5	6.00		7.9	-8.090E+04	9.6571E+04	-6.164E+04	1	0.000
-1130	124.0	6.00		5.3	-9.593E+04	1.1463E+05	-4.028E+04	1	0.000
-1210	78.5	6.00		5.8	-8.839E+04	1.0569E+05	-4.185E+04	1	0.000
-1290	78.5	6.00		5.9	-8.085E+04	9.6747E+04	-4.342E+04	1	0.000
-1370	78.5	6.00		6.0	-7.331E+04	8.7807E+04	-4.499E+04	1	0.000
-1450	78.5	6.00		6.0	-6.577E+04	7.8868E+04	-4.656E+04	1	0.000
-1530	78.5	6.00		6.1	-5.823E+04	6.9928E+04	-4.813E+04	1	0.000
-1610	78.5	6.00		3.7	-5.007E+04	6.0164E+04	-2.777E+04	1	0.000
-1690	78.5	6.00		3.8	-4.188E+04	5.0359E+04	-2.934E+04	1	0.000
-1770	78.5	6.00		3.9	-3.369E+04	4.0554E+04	-3.091E+04	1	0.000
-1850	78.5	6.00		3.9	-2.550E+04	3.0749E+04	-3.248E+04	1	0.000
-1930	78.5	6.00		4.0	-1.731E+04	2.0945E+04	-3.405E+04	1	0.000
-2010	78.5	6.00		1.8	-1.277E+04	1.5472E+04	-1.438E+04	1	0.000
-2090	78.5	6.00		1.9	-9.996E+03	1.2115E+04	-1.595E+04	1	0.000
-2170	124.0	6.00		1.9	-7.226E+03	8.7587E+03	-1.752E+04	1	0.000
-2250	78.5	6.00		2.2	-4.457E+03	5.4020E+03	-1.910E+04	1	0.000
-2330	78.5	6.00		2.3	-1.688E+03	2.0454E+03	-2.067E+04	1	0.000
-2410	78.5	6.00		0.2	-1.278E-11	2.1998E-11	-1.392E+03	1	0.000
-2490	78.5	6.00		0.3	-8.228E-12	3.8088E-12	-2.963E+03	1	0.000

Verifica a taglio:

quota	Ast	Vsd	Vsdx	Vsdy	N	comb	VRd,c	VRd,max	VRd,S	Vwd
-90	0.16	33237	-31246	-11330	-119779	11SLV	39849	231056	84172	44323 Vsd < VRd,
-170	0.16	32466	-30513	-11088	-120756	11SLV	43873	231056	88196	44323 Vsd < VRd,
-250	0.08	32466	-30513	-11088	-122327	11SLV	44091	231056	66253	22162 Vsd < VRd,
-330	0.08	10362	-9590	-3925	-94186	11SLV	40180	231056	62341	22162 Vsd < VRd,
-410	0.08	10362	-9590	-3925	-95757	11SLV	40398	231056	62560	22162 Vsd < VRd,
-490	0.08	10362	-9590	-3925	-97328	11SLV	40616	231056	62778	22162 Vsd < VRd,
-570	0.08	10362	-9590	-3925	-98899	11SLV	40835	231056	62996	22162 Vsd < VRd,
-650	0.08	10362	-9590	-3925	-100470	11SLV	41053	231056	63215	22162 Vsd < VRd,
-730	0.08	1855	-1721	-691	-36555	5SLV	32169	231056	54331	22162 Vsd < VRd,
-810	0.08	1855	-1721	-691	-38126	5SLV	32387	231056	54549	22162 Vsd < VRd,
-890	0.08	1855	-1721	-691	-39697	5SLV	32606	231056	54767	22162 Vsd < VRd,
-970	0.08	1855	-1721	-691	-41267	5SLV	32824	231056	54986	22162 Vsd < VRd,
-1050	0.08	1855	-1721	-691	-42838	5SLV	33042	231056	55204	22162 Vsd < VRd,
-1130	0.08	2084	1979	654	-54252	11SLV	39085	231056	61247	22162 Vsd < VRd,
-1210	0.08	2084	1979	654	-55823	11SLV	34847	231056	57009	22162 Vsd < VRd,
-1290	0.08	2084	1979	654	-57393	11SLV	35066	231056	57227	22162 Vsd < VRd,
-1370	0.08	2084	1979	654	-58964	11SLV	35284	231056	57446	22162 Vsd < VRd,
-1450	0.08	2084	1979	654	-60535	11SLV	35502	231056	57664	22162 Vsd < VRd,
-1530	0.08	2084	1979	654	-62106	11SLV	35721	231056	57882	22162 Vsd < VRd,
-1610	0.08	911	853	321	-37232	11SLV	32263	231056	54425	22162 Vsd < VRd,
-1690	0.08	911	853	321	-38803	11SLV	32482	231056	54643	22162 Vsd < VRd,
-1770	0.08	911	853	321	-40374	11SLV	32700	231056	54862	22162 Vsd < VRd,
-1850	0.08	911	853	321	-41944	11SLV	32918	231056	55080	22162 Vsd < VRd,
-1930	0.08	911	853	321	-43515	11SLV	33137	231056	55298	22162 Vsd < VRd,
-2010	0.08	71	55	45	-18698	3SLU	29687	231056	51849	22162 Vsd < VRd,
-2090	0.08	71	55	45	-20740	3SLU	29971	231056	52132	22162 Vsd < VRd,
-2170	0.08	71	55	45	-22782	3SLU	34711	231056	56872	22162 Vsd < VRd,
-2250	0.08	71	55	45	-24824	3SLU	30538	231056	52700	22162 Vsd < VRd,
-2330	0.08	71	55	45	-26866	3SLU	30822	231056	52984	22162 Vsd < VRd,
-2410	0.08	0	0	0	-405	5SLV	27144	231056	49306	22162 Vsd < VRd,
-2490	0.08	0	0	0	-1976	5SLV	27363	231056	49524	22162 Vsd < VRd,

Palo alle coordinate X=825 Y=1429

Sollecitazioni massime in testa palo:

Combinazione corrispondente alla minima compressione in testa

N	Mx	My	Tx	Ty	comb
-4.814E+04	7.0109E+05	-1.367E+06	-3.291E+03	-1.919E+03	2 sl
-6.233E+04	8.0385E+05	-1.493E+06	-3.510E+03	-2.058E+03	2 ra
-7.653E+04	9.0662E+05	-1.620E+06	-3.730E+03	-2.198E+03	2 fr
-8.220E+04	9.4772E+05	-1.670E+06	-3.818E+03	-2.254E+03	2 qp
-6.017E+04	-1.094E+06	5.3254E+06	2.3869E+04	5.9353E+03	5 SLV fond

Combinazione corrispondente alla massima compressione in testa

N	Mx	My	Tx	Ty	comb
-1.179E+05	1.3122E+06	-2.269E+06	-5.134E+03	-3.039E+03	3 sl
-9.072E+04	1.0094E+06	-1.746E+06	-3.949E+03	-2.338E+03	1 ra



Progetto	Titolo	Rev.	Pag.
Orione	Orione_A24a.pdf "TABULATI DI CALCOLO PLINTO DI FONDAZIONE PER AEROGENERATORE TIPO"	0	251

Tabulati di Calcolo Plinto di Fondazione per Aerogeneratore Tipo - Progetto Impianto Eolico - "Orione"

-9.072E+04 1.0094E+06 -1.746E+06 -3.949E+03 -2.338E+03 1 fr  
 -9.072E+04 1.0094E+06 -1.746E+06 -3.949E+03 -2.338E+03 1 qp  
 -1.213E+05 3.1123E+06 -8.817E+06 -3.177E+04 -1.061E+04 11 SLV fond

Combinazione corrispondente al massimo taglio in testa

N	Mx	My	Tx	Ty	comb
-1.179E+05	1.3122E+06	-2.269E+06	-5.134E+03	-3.039E+03	3 sl
-9.072E+04	1.0094E+06	-1.746E+06	-3.949E+03	-2.338E+03	1 ra
-9.072E+04	1.0094E+06	-1.746E+06	-3.949E+03	-2.338E+03	1 fr
-9.072E+04	1.0094E+06	-1.746E+06	-3.949E+03	-2.338E+03	1 qp
-1.213E+05	3.1123E+06	-8.817E+06	-3.177E+04	-1.061E+04	11 SLV fond

Verifica di capacità portante riferita al palo singolo:

Fattore di correlazione Psi scelto in base alla conoscenza del sito = 1.7  
 Coeff. parziale di sicurezza sulla resistenza laterale = 1.15  
 Coeff. parziale di sicurezza sulla resistenza alla punta = 1.35  
 Portanza laterale di progetto = 292537.1  
 Portanza di punta di progetto = 85555.4  
 verifica condotta in combinazione SLU 3  
 Sforzo normale = -117935.4  
 Peso del palo = 49087.4 \* 1.3  
 Carico totale di progetto = -181749  
 Resistenza totale di progetto = 378092.5  
 Coefficiente di sicurezza = 2.08 > 1

Verifica di resistenza allo stato limite:

quota	Af	cop.	c.s.	Mx	My	N	comb
-90	0.0	6.50	0.00	0.0000E+00	0.0000E+00	0.0000E+00	-
-170	78.5	6.00	3.51	2.2813E+06	-6.330E+06	-1.222E+05	11SLV
-250	78.5	6.00	6.51	1.4514E+06	-3.848E+06	-1.238E+05	11SLV
-330	78.5	6.00	11.85	8.2642E+05	-2.000E+06	-9.539E+04	11SLV
-410	78.5	6.00	15.60	5.4280E+05	-1.211E+06	-9.697E+04	11SLV
-490	78.5	6.00	18.71	2.5919E+05	-4.223E+05	-9.854E+04	11SLV
-570	78.5	6.00	18.41	-2.024E+04	3.6400E+05	-1.001E+05	11SLV
-650	78.5	6.00	15.73	-3.080E+05	1.1556E+06	-1.017E+05	11SLV
-730	78.5	6.00	14.44	4.8993E+05	-1.638E+06	-3.553E+04	5SLV
-810	78.5	6.00	15.53	-4.631E+05	1.5363E+06	-7.668E+04	11SLV
-890	78.5	6.00	15.91	-4.469E+05	1.4546E+06	-7.825E+04	11SLV
-970	78.5	6.00	16.32	-4.307E+05	1.3728E+06	-7.983E+04	11SLV
-1050	78.5	6.00	16.75	-4.146E+05	1.2911E+06	-8.140E+04	11SLV
-1130	124.0	6.00	22.82	-3.904E+05	1.1910E+06	-5.496E+04	11SLV
-1210	78.5	6.00	22.19	-3.400E+05	1.0313E+06	-5.653E+04	11SLV
-1290	78.5	6.00	24.17	-2.896E+05	8.7158E+05	-5.810E+04	11SLV
-1370	78.5	6.00	26.16	-2.392E+05	7.1185E+05	-5.967E+04	11SLV
-1450	78.5	6.00	27.95	-1.888E+05	5.5213E+05	-6.125E+04	11SLV
-1530	78.5	6.00	29.34	-1.384E+05	3.9240E+05	-6.282E+04	11SLV
-1610	78.5	6.00	46.21	-1.134E+05	3.1857E+05	-3.771E+04	11SLV
-1690	78.5	6.00	46.92	-8.964E+04	2.4896E+05	-3.928E+04	11SLV
-1770	78.5	6.00	45.12	-6.587E+04	1.7935E+05	-4.085E+04	11SLV
-1850	78.5	6.00	43.45	-4.210E+04	1.0974E+05	-4.243E+04	11SLV
-1930	78.5	6.00	41.66	-1.750E+04	3.0733E+04	-4.425E+04	3SLU
-2010	78.5	6.00	93.04	-9.183E+03	1.5093E+04	-1.981E+04	11SLV
-2090	78.5	6.00	86.21	-7.191E+03	1.1819E+04	-2.138E+04	11SLV
-2170	124.0	6.00	88.63	-5.199E+03	8.5443E+03	-2.295E+04	11SLV
-2250	78.5	6.00	74.29	-4.505E+03	7.9250E+03	-2.481E+04	3SLU
-2330	78.5	6.00	68.64	-1.706E+03	3.0006E+03	-2.685E+04	3SLU
-2410	78.5	6.00	100.00	8.9306E-11	-4.676E-10	-2.428E+03	11SLV
-2490	78.5	6.00	100.00	2.5071E-12	-1.696E-10	-3.999E+03	11SLV

Verifica di esercizio (combinazione rara):

quota	Af	cop.	sigmaf	sigmac	Mx	My	N	comb	Wk
-90	0.0	6.50	0.0	0.0	0.0000E+00	0.0000E+00	0.0000E+00	-	0.000
-170	78.5	6.00		24.2	8.2315E+05	-1.426E+06	-9.167E+04	1	0.000
-170	78.5	6.00	64.6		6.4068E+05	-1.211E+06	-6.342E+04	2	0.000
-250	78.5	6.00		21.0	6.3697E+05	-1.107E+06	-9.324E+04	1	0.000
-250	78.5	6.00	7.8		4.7762E+05	-9.277E+05	-6.499E+04	2	0.000
-330	78.5	6.00		15.9	4.8244E+05	-8.405E+05	-7.040E+04	1	0.000
-330	78.5	6.00	7.6		3.4596E+05	-6.945E+05	-4.741E+04	2	0.000
-410	78.5	6.00		14.4	3.8067E+05	-6.633E+05	-7.197E+04	1	0.000
-490	78.5	6.00		12.8	2.7890E+05	-4.861E+05	-7.354E+04	1	0.000
-570	78.5	6.00		11.3	1.7712E+05	-3.089E+05	-7.511E+04	1	0.000
-650	78.5	6.00		9.8	7.5352E+04	-1.317E+05	-7.668E+04	1	0.000
-730	78.5	6.00		6.2	5.3453E+03	-9.773E+03	-5.532E+04	1	0.000
-810	78.5	6.00		6.5	-1.172E+04	1.9963E+04	-5.689E+04	1	0.000
-890	78.5	6.00		7.0	-2.878E+04	4.9699E+04	-5.846E+04	1	0.000
-970	78.5	6.00		7.4	-4.585E+04	7.9435E+04	-6.003E+04	1	0.000
-1050	78.5	6.00		7.9	-6.291E+04	1.0917E+05	-6.160E+04	1	0.000
-1130	124.0	6.00		5.3	-7.460E+04	1.2957E+05	-4.025E+04	1	0.000
-1210	78.5	6.00		5.8	-6.874E+04	1.1945E+05	-4.182E+04	1	0.000
-1290	78.5	6.00		5.9	-6.287E+04	1.0934E+05	-4.339E+04	1	0.000
-1370	78.5	6.00		6.0	-5.701E+04	9.9225E+04	-4.497E+04	1	0.000
-1450	78.5	6.00		6.0	-5.114E+04	8.9111E+04	-4.654E+04	1	0.000
-1530	78.5	6.00		6.1	-4.528E+04	7.8997E+04	-4.811E+04	1	0.000
-1610	78.5	6.00		3.7	-3.894E+04	6.7962E+04	-2.775E+04	1	0.000
-1690	78.5	6.00		3.8	-3.257E+04	5.6882E+04	-2.932E+04	1	0.000



Progetto	Titolo	Rev.	Pag.
Orione	Orione_A24a.pdf "TABULATI DI CALCOLO PLINTO DI FONDAZIONE PER AEROGENERATORE TIPO"	0	252

Tabulati di Calcolo Plinto di Fondazione per Aerogeneratore Tipo - Progetto Impianto Eolico - "Orione"

-1770	78.5	6.00	3.9	-2.620E+04	4.5801E+04	-3.089E+04	1	0.000
-1850	78.5	6.00	3.9	-1.983E+04	3.4721E+04	-3.247E+04	1	0.000
-1930	78.5	6.00	4.0	-1.346E+04	2.3641E+04	-3.404E+04	1	0.000
-2010	78.5	6.00	1.8	-9.925E+03	1.7460E+04	-1.437E+04	1	0.000
-2090	78.5	6.00	1.9	-7.772E+03	1.3672E+04	-1.594E+04	1	0.000
-2170	124.0	6.00	1.9	-5.619E+03	9.8841E+03	-1.751E+04	1	0.000
-2250	78.5	6.00	2.2	-3.465E+03	6.0961E+03	-1.909E+04	1	0.000
-2330	78.5	6.00	2.3	-1.312E+03	2.3082E+03	-2.066E+04	1	0.000
-2410	78.5	6.00	0.2	-5.500E-12	3.4689E-11	-1.390E+03	1	0.000
-2490	78.5	6.00	0.3	-9.522E-13	2.1046E-11	-2.961E+03	1	0.000

Verifica di esercizio (combinazione quasi permanente):

quota	Af	cop.	sigmaf	sigmac	Mx	My	N	comb	Wk
-90	0.0	6.50	0.0	0.0	0.0000E+00	0.0000E+00	0.0000E+00	-	0.000
-170	78.5	6.00		24.2	8.2315E+05	-1.426E+06	-9.167E+04	1	0.000
-170	78.5	6.00	42.9		7.6841E+05	-1.362E+06	-8.320E+04	2	0.000
-250	78.5	6.00		21.0	6.3697E+05	-1.107E+06	-9.324E+04	1	0.000
-330	78.5	6.00		15.9	4.8244E+05	-8.405E+05	-7.040E+04	1	0.000
-410	78.5	6.00		14.4	3.8067E+05	-6.633E+05	-7.197E+04	1	0.000
-490	78.5	6.00		12.8	2.7890E+05	-4.861E+05	-7.354E+04	1	0.000
-570	78.5	6.00		11.3	1.7712E+05	-3.089E+05	-7.511E+04	1	0.000
-650	78.5	6.00		9.8	7.5352E+04	-1.317E+05	-7.668E+04	1	0.000
-730	78.5	6.00		6.2	5.3453E+03	-9.773E+03	-5.532E+04	1	0.000
-810	78.5	6.00		6.5	-1.172E+04	1.9963E+04	-5.689E+04	1	0.000
-890	78.5	6.00		7.0	-2.878E+04	4.9699E+04	-5.846E+04	1	0.000
-970	78.5	6.00		7.4	-4.585E+04	7.9435E+04	-6.003E+04	1	0.000
-1050	78.5	6.00		7.9	-6.291E+04	1.0917E+05	-6.160E+04	1	0.000
-1130	124.0	6.00		5.3	-7.460E+04	1.2957E+05	-4.025E+04	1	0.000
-1210	78.5	6.00		5.8	-6.874E+04	1.1945E+05	-4.182E+04	1	0.000
-1290	78.5	6.00		5.9	-6.287E+04	1.0934E+05	-4.339E+04	1	0.000
-1370	78.5	6.00		6.0	-5.701E+04	9.9225E+04	-4.497E+04	1	0.000
-1450	78.5	6.00		6.0	-5.114E+04	8.9111E+04	-4.654E+04	1	0.000
-1530	78.5	6.00		6.1	-4.528E+04	7.8997E+04	-4.811E+04	1	0.000
-1610	78.5	6.00		3.7	-3.894E+04	6.7962E+04	-2.775E+04	1	0.000
-1690	78.5	6.00		3.8	-3.257E+04	5.6882E+04	-2.932E+04	1	0.000
-1770	78.5	6.00		3.9	-2.620E+04	4.5801E+04	-3.089E+04	1	0.000
-1850	78.5	6.00		3.9	-1.983E+04	3.4721E+04	-3.247E+04	1	0.000
-1930	78.5	6.00		4.0	-1.346E+04	2.3641E+04	-3.404E+04	1	0.000
-2010	78.5	6.00		1.8	-9.925E+03	1.7460E+04	-1.437E+04	1	0.000
-2090	78.5	6.00		1.9	-7.772E+03	1.3672E+04	-1.594E+04	1	0.000
-2170	124.0	6.00		1.9	-5.619E+03	9.8841E+03	-1.751E+04	1	0.000
-2250	78.5	6.00		2.2	-3.465E+03	6.0961E+03	-1.909E+04	1	0.000
-2330	78.5	6.00		2.3	-1.312E+03	2.3082E+03	-2.066E+04	1	0.000
-2410	78.5	6.00		0.2	-5.500E-12	3.4689E-11	-1.390E+03	1	0.000
-2490	78.5	6.00		0.3	-9.522E-13	2.1046E-11	-2.961E+03	1	0.000

Verifica a taglio:

quota	Ast	Vsd	Vsdx	Vsdy	N	comb	VRd,c	VRd,max	VRd,S	Vwd
-90	0.16	33493	-31768	-10610	-121268	11SLV	40056	231056	84379	44323 Vsd < VRd,
-170	0.16	32720	-31033	-10373	-122239	11SLV	44079	231056	88402	44323 Vsd < VRd,
-250	0.08	32720	-31033	-10373	-123810	11SLV	44297	231056	66459	22162 Vsd < VRd,
-330	0.08	10480	-9862	-3545	-95394	11SLV	40348	231056	62509	22162 Vsd < VRd,
-410	0.08	10480	-9862	-3545	-96965	11SLV	40566	231056	62728	22162 Vsd < VRd,
-490	0.08	10480	-9862	-3545	-98536	11SLV	40784	231056	62946	22162 Vsd < VRd,
-570	0.08	10480	-9862	-3545	-100107	11SLV	41003	231056	63164	22162 Vsd < VRd,
-650	0.08	10480	-9862	-3545	-101678	11SLV	41221	231056	63383	22162 Vsd < VRd,
-730	0.08	1874	-1765	-629	-35531	5SLV	32027	231056	54188	22162 Vsd < VRd,
-810	0.08	1874	-1765	-629	-37102	5SLV	32245	231056	54407	22162 Vsd < VRd,
-890	0.08	1874	-1765	-629	-38672	5SLV	32463	231056	54625	22162 Vsd < VRd,
-970	0.08	1874	-1765	-629	-40243	5SLV	32682	231056	54843	22162 Vsd < VRd,
-1050	0.08	1874	-1765	-629	-41814	5SLV	32900	231056	55062	22162 Vsd < VRd,
-1130	0.08	2094	1997	630	-54962	11SLV	39184	231056	61346	22162 Vsd < VRd,
-1210	0.08	2094	1997	630	-56533	11SLV	34946	231056	57108	22162 Vsd < VRd,
-1290	0.08	2094	1997	630	-58104	11SLV	35164	231056	57326	22162 Vsd < VRd,
-1370	0.08	2094	1997	630	-59675	11SLV	35383	231056	57544	22162 Vsd < VRd,
-1450	0.08	2094	1997	630	-61246	11SLV	35601	231056	57763	22162 Vsd < VRd,
-1530	0.08	2094	1997	630	-62816	11SLV	35819	231056	57981	22162 Vsd < VRd,
-1610	0.08	919	870	297	-37713	11SLV	32330	231056	54492	22162 Vsd < VRd,
-1690	0.08	919	870	297	-39284	11SLV	32548	231056	54710	22162 Vsd < VRd,
-1770	0.08	919	870	297	-40855	11SLV	32767	231056	54928	22162 Vsd < VRd,
-1850	0.08	919	870	297	-42426	11SLV	32985	231056	55147	22162 Vsd < VRd,
-1930	0.08	919	870	297	-43996	11SLV	33203	231056	55365	22162 Vsd < VRd,
-2010	0.08	71	62	35	-18685	3SLU	29685	231056	51847	22162 Vsd < VRd,
-2090	0.08	71	62	35	-20727	3SLU	29969	231056	52131	22162 Vsd < VRd,
-2170	0.08	71	62	35	-22769	3SLU	34709	231056	56871	22162 Vsd < VRd,
-2250	0.08	71	62	35	-24811	3SLU	30537	231056	52698	22162 Vsd < VRd,
-2330	0.08	71	62	35	-26853	3SLU	30821	231056	52982	22162 Vsd < VRd,
-2410	0.08	0	0	0	-682	9SLV	27183	231056	49344	22162 Vsd < VRd,
-2490	0.08	0	0	0	-2253	9SLV	27401	231056	49563	22162 Vsd < VRd,

Palo alle coordinate X=564 Y=1551

Sollecitazioni massime in testa palo:



Progetto	Titolo	Rev.	Pag.
Orione	Orione_A24a.pdf "TABULATI DI CALCOLO PLINTO DI FONDAZIONE PER AEROGENERATORE TIPO"	0	253

Combinazione corrispondente alla minima compressione in testa

N	Mx	My	Tx	Ty	comb
-4.407E+04	4.9165E+05	-1.351E+06	-3.230E+03	-1.411E+03	2 sl
-5.961E+04	5.5787E+05	-1.532E+06	-3.585E+03	-1.474E+03	2 ra
-7.514E+04	6.2410E+05	-1.713E+06	-3.939E+03	-1.536E+03	2 fr
-8.135E+04	6.5059E+05	-1.786E+06	-4.081E+03	-1.561E+03	2 qp
-5.951E+04	-1.394E+06	5.1860E+06	2.3557E+04	6.6063E+03	5 SLV fond

Combinazione corrispondente alla massima compressione in testa

N	Mx	My	Tx	Ty	comb
-1.179E+05	8.9743E+05	-2.463E+06	-5.582E+03	-2.078E+03	3 sl
-9.067E+04	6.9033E+05	-1.894E+06	-4.294E+03	-1.599E+03	1 ra
-9.067E+04	6.9033E+05	-1.894E+06	-4.294E+03	-1.599E+03	1 fr
-9.067E+04	6.9033E+05	-1.894E+06	-4.294E+03	-1.599E+03	1 qp
-1.218E+05	2.7745E+06	-8.975E+06	-3.215E+04	-9.804E+03	11 SLV fond

Combinazione corrispondente al massimo taglio in testa

N	Mx	My	Tx	Ty	comb
-1.179E+05	8.9743E+05	-2.463E+06	-5.582E+03	-2.078E+03	3 sl
-9.067E+04	6.9033E+05	-1.894E+06	-4.294E+03	-1.599E+03	1 ra
-9.067E+04	6.9033E+05	-1.894E+06	-4.294E+03	-1.599E+03	1 fr
-9.067E+04	6.9033E+05	-1.894E+06	-4.294E+03	-1.599E+03	1 qp
-1.218E+05	2.7745E+06	-8.975E+06	-3.215E+04	-9.804E+03	11 SLV fond

Verifica di capacità portante riferita al palo singolo:

Fattore di correlazione Psi scelto in base alla conoscenza del sito = 1.7  
 Coeff. parziale di sicurezza sulla resistenza laterale = 1.15  
 Coeff. parziale di sicurezza sulla resistenza alla punta = 1.35  
 Portanza laterale di progetto = 292537.1  
 Portanza di punta di progetto = 85555.4  
 verifica condotta in combinazione SLU 3  
 Sforzo normale = -117871.2  
 Peso del palo = 49087.4 \* 1.3  
 Carico totale di progetto = -181684.8  
 Resistenza totale di progetto = 378092.5  
 Coefficiente di sicurezza = 2.08 > 1

Verifica di resistenza allo stato limite:

quota	Af	cop.	c.s.	Mx	My	N	comb
-90	0.0	6.50	0.00	0.0000E+00	0.0000E+00	0.0000E+00	-
-170	78.5	6.00	3.50	2.0077E+06	-6.458E+06	-1.228E+05	11SLV
-250	78.5	6.00	6.47	1.2420E+06	-3.946E+06	-1.244E+05	11SLV
-330	78.5	6.00	11.77	6.6974E+05	-2.074E+06	-9.585E+04	11SLV
-410	78.5	6.00	15.51	4.1996E+05	-1.269E+06	-9.742E+04	11SLV
-490	78.5	6.00	18.62	1.7018E+05	-4.640E+05	-9.900E+04	11SLV
-570	78.5	6.00	18.33	-7.637E+04	3.3886E+05	-1.006E+05	11SLV
-650	78.5	6.00	15.70	-3.294E+05	1.1456E+06	-1.021E+05	11SLV
-730	78.5	6.00	14.37	4.8475E+05	-1.640E+06	-3.511E+04	5SLV
-810	78.5	6.00	15.49	-4.561E+05	1.5396E+06	-7.705E+04	11SLV
-890	78.5	6.00	15.87	-4.347E+05	1.4603E+06	-7.862E+04	11SLV
-970	78.5	6.00	16.27	-4.133E+05	1.3810E+06	-8.019E+04	11SLV
-1050	78.5	6.00	16.70	-3.919E+05	1.3016E+06	-8.176E+04	11SLV
-1130	124.0	6.00	22.74	-3.643E+05	1.2032E+06	-5.523E+04	11SLV
-1210	78.5	6.00	22.11	-3.161E+05	1.0425E+06	-5.680E+04	11SLV
-1290	78.5	6.00	24.08	-2.679E+05	8.8174E+05	-5.837E+04	11SLV
-1370	78.5	6.00	26.05	-2.197E+05	7.2099E+05	-5.995E+04	11SLV
-1450	78.5	6.00	27.83	-1.715E+05	5.6024E+05	-6.152E+04	11SLV
-1530	78.5	6.00	29.22	-1.233E+05	3.9949E+05	-6.309E+04	11SLV
-1610	78.5	6.00	45.99	-1.004E+05	3.2464E+05	-3.790E+04	11SLV
-1690	78.5	6.00	46.70	-7.882E+04	2.5403E+05	-3.947E+04	11SLV
-1770	78.5	6.00	44.91	-5.721E+04	1.8341E+05	-4.104E+04	11SLV
-1850	78.5	6.00	43.26	-3.560E+04	1.1279E+05	-4.261E+04	11SLV
-1930	78.5	6.00	41.68	-1.197E+04	3.3311E+04	-4.423E+04	3SLU
-2010	78.5	6.00	92.58	-6.016E+03	1.6578E+04	-1.991E+04	11SLV
-2090	78.5	6.00	85.81	-4.711E+03	1.2982E+04	-2.148E+04	11SLV
-2170	124.0	6.00	88.25	-3.406E+03	9.3850E+03	-2.305E+04	11SLV
-2250	78.5	6.00	74.32	-3.081E+03	8.5885E+03	-2.480E+04	3SLU
-2330	78.5	6.00	68.67	-1.167E+03	3.2519E+03	-2.684E+04	3SLU
-2410	78.5	6.00	100.00	8.0631E-11	-2.039E-10	-2.447E+03	11SLV
-2490	78.5	6.00	100.00	1.4363E-11	-2.062E-11	-4.018E+03	11SLV

Verifica di esercizio (combinazione rara):

quota	Af	cop.	sigmaf	sigmac	Mx	My	N	comb	Wk
-90	0.0	6.50	0.0	0.0	0.0000E+00	0.0000E+00	0.0000E+00	-	0.000
-170	78.5	6.00		24.2	5.6296E+05	-1.548E+06	-9.162E+04	1	0.000
-170	78.5	6.00	63.5		4.4123E+05	-1.244E+06	-6.071E+04	2	0.000
-250	78.5	6.00		21.0	4.3562E+05	-1.201E+06	-9.319E+04	1	0.000
-250	78.5	6.00	8.6		3.2466E+05	-9.547E+05	-6.228E+04	2	0.000
-330	78.5	6.00		15.9	3.2993E+05	-9.116E+05	-7.036E+04	1	0.000
-330	78.5	6.00	9.0		2.3132E+05	-7.162E+05	-4.521E+04	2	0.000
-410	78.5	6.00		14.4	2.6033E+05	-7.194E+05	-7.193E+04	1	0.000
-490	78.5	6.00		12.8	1.9073E+05	-5.272E+05	-7.350E+04	1	0.000
-570	78.5	6.00		11.3	1.2113E+05	-3.350E+05	-7.507E+04	1	0.000
-650	78.5	6.00		9.8	5.1522E+04	-1.428E+05	-7.664E+04	1	0.000



Tabulati di Calcolo Plinto di Fondazione per Aerogeneratore Tipo - Progetto Impianto Eolico - "Orione"

-730	78.5	6.00	6.2	3.6449E+03	-1.055E+04	-5.529E+04	1	0.000
-810	78.5	6.00	6.5	-8.024E+03	2.1697E+04	-5.686E+04	1	0.000
-890	78.5	6.00	7.0	-1.969E+04	5.3946E+04	-5.843E+04	1	0.000
-970	78.5	6.00	7.4	-3.136E+04	8.6195E+04	-6.000E+04	1	0.000
-1050	78.5	6.00	7.9	-4.303E+04	1.1844E+05	-6.157E+04	1	0.000
-1130	124.0	6.00	5.3	-5.102E+04	1.4056E+05	-4.023E+04	1	0.000
-1210	78.5	6.00	5.8	-4.701E+04	1.2958E+05	-4.180E+04	1	0.000
-1290	78.5	6.00	5.9	-4.300E+04	1.1860E+05	-4.337E+04	1	0.000
-1370	78.5	6.00	6.0	-3.899E+04	1.0763E+05	-4.494E+04	1	0.000
-1450	78.5	6.00	6.0	-3.498E+04	9.6647E+04	-4.651E+04	1	0.000
-1530	78.5	6.00	6.1	-3.097E+04	8.5668E+04	-4.808E+04	1	0.000
-1610	78.5	6.00	3.7	-2.663E+04	7.3698E+04	-2.774E+04	1	0.000
-1690	78.5	6.00	3.8	-2.227E+04	6.1680E+04	-2.931E+04	1	0.000
-1770	78.5	6.00	3.9	-1.792E+04	4.9661E+04	-3.088E+04	1	0.000
-1850	78.5	6.00	3.9	-1.356E+04	3.7642E+04	-3.245E+04	1	0.000
-1930	78.5	6.00	4.0	-9.206E+03	2.5624E+04	-3.402E+04	1	0.000
-2010	78.5	6.00	1.8	-6.788E+03	1.8922E+04	-1.437E+04	1	0.000
-2090	78.5	6.00	1.9	-5.315E+03	1.4817E+04	-1.594E+04	1	0.000
-2170	124.0	6.00	1.9	-3.842E+03	1.0712E+04	-1.751E+04	1	0.000
-2250	78.5	6.00	2.2	-2.370E+03	6.6066E+03	-1.908E+04	1	0.000
-2330	78.5	6.00	2.3	-8.973E+02	2.5015E+03	-2.065E+04	1	0.000
-2410	78.5	6.00	0.2	-5.500E-12	1.6584E-11	-1.388E+03	1	0.000
-2490	78.5	6.00	0.3	-9.522E-13	-6.153E-12	-2.959E+03	1	0.000

Verifica di esercizio (combinazione quasi permanente):

quota	Af	cop.	sigmaf	sigmac	Mx	My	N	comb	Wk
-90	0.0	6.50	0.0	0.0	0.0000E+00	0.0000E+00	0.0000E+00	-	0.000
-170	78.5	6.00		24.2	5.6296E+05	-1.548E+06	-9.162E+04	1	0.000
-170	78.5	6.00	42.7		5.2644E+05	-1.456E+06	-8.235E+04	2	0.000
-250	78.5	6.00		21.0	4.3562E+05	-1.201E+06	-9.319E+04	1	0.000
-330	78.5	6.00		15.9	3.2993E+05	-9.116E+05	-7.036E+04	1	0.000
-410	78.5	6.00		14.4	2.6033E+05	-7.194E+05	-7.193E+04	1	0.000
-490	78.5	6.00		12.8	1.9073E+05	-5.272E+05	-7.350E+04	1	0.000
-570	78.5	6.00		11.3	1.2113E+05	-3.350E+05	-7.507E+04	1	0.000
-650	78.5	6.00		9.8	5.1522E+04	-1.428E+05	-7.664E+04	1	0.000
-730	78.5	6.00		6.2	3.6449E+03	-1.055E+04	-5.529E+04	1	0.000
-810	78.5	6.00		6.5	-8.024E+03	2.1697E+04	-5.686E+04	1	0.000
-890	78.5	6.00		7.0	-1.969E+04	5.3946E+04	-5.843E+04	1	0.000
-970	78.5	6.00		7.4	-3.136E+04	8.6195E+04	-6.000E+04	1	0.000
-1050	78.5	6.00		7.9	-4.303E+04	1.1844E+05	-6.157E+04	1	0.000
-1130	124.0	6.00		5.3	-5.102E+04	1.4056E+05	-4.023E+04	1	0.000
-1210	78.5	6.00		5.8	-4.701E+04	1.2958E+05	-4.180E+04	1	0.000
-1290	78.5	6.00		5.9	-4.300E+04	1.1860E+05	-4.337E+04	1	0.000
-1370	78.5	6.00		6.0	-3.899E+04	1.0763E+05	-4.494E+04	1	0.000
-1450	78.5	6.00		6.0	-3.498E+04	9.6647E+04	-4.651E+04	1	0.000
-1530	78.5	6.00		6.1	-3.097E+04	8.5668E+04	-4.808E+04	1	0.000
-1610	78.5	6.00		3.7	-2.663E+04	7.3698E+04	-2.774E+04	1	0.000
-1690	78.5	6.00		3.8	-2.227E+04	6.1680E+04	-2.931E+04	1	0.000
-1770	78.5	6.00		3.9	-1.792E+04	4.9661E+04	-3.088E+04	1	0.000
-1850	78.5	6.00		3.9	-1.356E+04	3.7642E+04	-3.245E+04	1	0.000
-1930	78.5	6.00		4.0	-9.206E+03	2.5624E+04	-3.402E+04	1	0.000
-2010	78.5	6.00		1.8	-6.788E+03	1.8922E+04	-1.437E+04	1	0.000
-2090	78.5	6.00		1.9	-5.315E+03	1.4817E+04	-1.594E+04	1	0.000
-2170	124.0	6.00		1.9	-3.842E+03	1.0712E+04	-1.751E+04	1	0.000
-2250	78.5	6.00		2.2	-2.370E+03	6.6066E+03	-1.908E+04	1	0.000
-2330	78.5	6.00		2.3	-8.973E+02	2.5015E+03	-2.065E+04	1	0.000
-2410	78.5	6.00		0.2	-5.500E-12	1.6584E-11	-1.388E+03	1	0.000
-2490	78.5	6.00		0.3	-9.522E-13	-6.153E-12	-2.959E+03	1	0.000

Verifica a taglio:

quota	Ast	Vsd	Vsdx	Vsdy	N	comb	VRd,c	VRd,max	VRd,S	Vwd
-90	0.16	33607	-32145	-9804	-121834	11SLV	40134	231056	84458	44323 Vsd < VRd,
-170	0.16	32833	-31407	-9571	-122802	11SLV	44157	231056	88481	44323 Vsd < VRd,
-250	0.08	32833	-31407	-9571	-124373	11SLV	44376	231056	66537	22162 Vsd < VRd,
-330	0.08	10534	-10060	-3122	-95854	11SLV	40412	231056	62573	22162 Vsd < VRd,
-410	0.08	10534	-10060	-3122	-97425	11SLV	40630	231056	62792	22162 Vsd < VRd,
-490	0.08	10534	-10060	-3122	-98995	11SLV	40848	231056	63010	22162 Vsd < VRd,
-570	0.08	10534	-10060	-3122	-100566	11SLV	41067	231056	63228	22162 Vsd < VRd,
-650	0.08	10534	-10060	-3122	-102137	11SLV	41285	231056	63447	22162 Vsd < VRd,
-730	0.08	1883	-1798	-559	-35106	5SLV	31968	231056	54129	22162 Vsd < VRd,
-810	0.08	1883	-1798	-559	-36677	5SLV	32186	231056	54348	22162 Vsd < VRd,
-890	0.08	1883	-1798	-559	-38248	5SLV	32404	231056	54566	22162 Vsd < VRd,
-970	0.08	1883	-1798	-559	-39819	5SLV	32623	231056	54784	22162 Vsd < VRd,
-1050	0.08	1883	-1798	-559	-41389	5SLV	32841	231056	55003	22162 Vsd < VRd,
-1130	0.08	2098	2009	602	-55233	11SLV	39221	231056	61383	22162 Vsd < VRd,
-1210	0.08	2098	2009	602	-56804	11SLV	34984	231056	57145	22162 Vsd < VRd,
-1290	0.08	2098	2009	602	-58374	11SLV	35202	231056	57364	22162 Vsd < VRd,
-1370	0.08	2098	2009	602	-59945	11SLV	35420	231056	57582	22162 Vsd < VRd,
-1450	0.08	2098	2009	602	-61516	11SLV	35639	231056	57800	22162 Vsd < VRd,
-1530	0.08	2098	2009	602	-63087	11SLV	35857	231056	58019	22162 Vsd < VRd,
-1610	0.08	923	883	270	-37896	11SLV	32356	231056	54517	22162 Vsd < VRd,
-1690	0.08	923	883	270	-39467	11SLV	32574	231056	54736	22162 Vsd < VRd,
-1770	0.08	923	883	270	-41038	11SLV	32792	231056	54954	22162 Vsd < VRd,
-1850	0.08	923	883	270	-42609	11SLV	33011	231056	55172	22162 Vsd < VRd,
-1930	0.08	923	883	270	-44179	11SLV	33229	231056	55391	22162 Vsd < VRd,
-2010	0.08	71	67	24	-18674	3SLU	29684	231056	51845	22162 Vsd < VRd,



Progetto	Titolo	Rev.	Pag.
Orione	Orione_A24a.pdf "TABULATI DI CALCOLO PLINTO DI FONDAZIONE PER AEROGENERATORE TIPO"	0	255



Tabulati di Calcolo Plinto di Fondazione per Aerogeneratore Tipo - Progetto Impianto Eolico - "Orione"

-2090	0.08	71	67	24	-20717	3SLU	29968	231056	52129	22162	Vsd < VRd,
-2170	0.08	71	67	24	-22759	3SLU	34708	231056	56869	22162	Vsd < VRd,
-2250	0.08	71	67	24	-24801	3SLU	30535	231056	52697	22162	Vsd < VRd,
-2330	0.08	71	67	24	-26843	3SLU	30819	231056	52981	22162	Vsd < VRd,
-2410	0.08	0	0	0	-555	9SLV	27165	231056	49327	22162	Vsd < VRd,
-2490	0.08	0	0	0	-2126	9SLV	27384	231056	49545	22162	Vsd < VRd,

Palo alle coordinate X=287 Y=1625

Sollecitazioni massime in testa palo:

Combinazione corrispondente alla minima compressione in testa

N	Mx	My	Tx	Ty	comb	
-4.143E+04	3.0715E+05	-1.325E+06	-3.141E+03	-9.656E+02	2	sl
-5.783E+04	3.2141E+05	-1.545E+06	-3.596E+03	-9.139E+02	2	ra
-7.423E+04	3.3568E+05	-1.765E+06	-4.050E+03	-8.623E+02	2	fr
-8.079E+04	3.4138E+05	-1.853E+06	-4.232E+03	-8.416E+02	2	qp
-5.980E+04	-1.713E+06	5.0980E+06	2.3356E+04	7.3183E+03	5	SLV fond

Combinazione corrispondente alla massima compressione in testa

N	Mx	My	Tx	Ty	comb	
-1.178E+05	4.5492E+05	-2.581E+06	-5.857E+03	-1.054E+03	3	sl
-9.063E+04	3.4994E+05	-1.985E+06	-4.505E+03	-8.106E+02	1	ra
-9.063E+04	3.4994E+05	-1.985E+06	-4.505E+03	-8.106E+02	1	fr
-9.063E+04	3.4994E+05	-1.985E+06	-4.505E+03	-8.106E+02	1	qp
-1.215E+05	2.4132E+06	-9.069E+06	-3.237E+04	-8.940E+03	11	SLV fond

Combinazione corrispondente al massimo taglio in testa

N	Mx	My	Tx	Ty	comb	
-1.178E+05	4.5492E+05	-2.581E+06	-5.857E+03	-1.054E+03	3	sl
-9.063E+04	3.4994E+05	-1.985E+06	-4.505E+03	-8.106E+02	1	ra
-9.063E+04	3.4994E+05	-1.985E+06	-4.505E+03	-8.106E+02	1	fr
-9.063E+04	3.4994E+05	-1.985E+06	-4.505E+03	-8.106E+02	1	qp
-1.215E+05	2.4132E+06	-9.069E+06	-3.237E+04	-8.940E+03	11	SLV fond

Verifica di capacità portante riferita al palo singolo:

Fattore di correlazione Psi scelto in base alla conoscenza del sito = 1.7  
 Coeff. parziale di sicurezza sulla resistenza laterale = 1.15  
 Coeff. parziale di sicurezza sulla resistenza alla punta = 1.35  
 Portanza laterale di progetto = 292537.1  
 Portanza di punta di progetto = 85555.4  
 verifica condotta in combinazione SLU 3  
 Sforzo normale = -117819.1  
 Peso del palo = 49087.4 \* 1.3  
 Carico totale di progetto = -181632.7  
 Resistenza totale di progetto = 378092.5  
 Coefficiente di sicurezza = 2.08 > 1

Verifica di resistenza allo stato limite:

quota	Af	cop.	c.s.	Mx	My	N	comb
-90	0.0	6.50	0.00	0.0000E+00	0.0000E+00	0.0000E+00	-
-170	78.5	6.00	3.50	1.7151E+06	-6.535E+06	-1.224E+05	11SLV
-250	78.5	6.00	6.48	1.0181E+06	-4.005E+06	-1.240E+05	11SLV
-330	78.5	6.00	11.79	5.0235E+05	-2.118E+06	-9.555E+04	11SLV
-410	78.5	6.00	15.55	2.8876E+05	-1.304E+06	-9.712E+04	11SLV
-490	78.5	6.00	18.68	7.5175E+04	-4.895E+05	-9.870E+04	11SLV
-570	78.5	6.00	18.38	-1.366E+05	3.2382E+05	-1.003E+05	11SLV
-650	78.5	6.00	15.73	-3.520E+05	1.1391E+06	-1.018E+05	11SLV
-730	78.5	6.00	14.40	4.7903E+05	-1.641E+06	-3.529E+04	5SLV
-810	78.5	6.00	15.51	-4.484E+05	1.5411E+06	-7.681E+04	11SLV
-890	78.5	6.00	15.90	-4.215E+05	1.4633E+06	-7.838E+04	11SLV
-970	78.5	6.00	16.30	-3.946E+05	1.3855E+06	-7.995E+04	11SLV
-1050	78.5	6.00	16.72	-3.676E+05	1.3077E+06	-8.152E+04	11SLV
-1130	124.0	6.00	22.77	-3.363E+05	1.2104E+06	-5.506E+04	11SLV
-1210	78.5	6.00	22.15	-2.904E+05	1.0490E+06	-5.663E+04	11SLV
-1290	78.5	6.00	24.12	-2.446E+05	8.8770E+05	-5.820E+04	11SLV
-1370	78.5	6.00	26.11	-1.988E+05	7.2637E+05	-5.977E+04	11SLV
-1450	78.5	6.00	27.89	-1.529E+05	5.6504E+05	-6.134E+04	11SLV
-1530	78.5	6.00	29.30	-1.071E+05	4.0371E+05	-6.291E+04	11SLV
-1610	78.5	6.00	46.10	-8.655E+04	3.2827E+05	-3.778E+04	11SLV
-1690	78.5	6.00	46.84	-6.725E+04	2.5705E+05	-3.935E+04	11SLV
-1770	78.5	6.00	45.05	-4.795E+04	1.8584E+05	-4.092E+04	11SLV
-1850	78.5	6.00	43.38	-2.865E+04	1.1462E+05	-4.249E+04	11SLV
-1930	78.5	6.00	41.69	-6.066E+03	3.4890E+04	-4.421E+04	3SLU
-2010	78.5	6.00	92.88	-2.635E+03	1.7483E+04	-1.985E+04	11SLV
-2090	78.5	6.00	86.07	-2.064E+03	1.3690E+04	-2.142E+04	11SLV
-2170	124.0	6.00	88.50	-1.492E+03	9.8970E+03	-2.299E+04	11SLV
-2250	78.5	6.00	74.35	-1.561E+03	8.9951E+03	-2.479E+04	3SLU
-2330	78.5	6.00	68.69	-5.912E+02	3.4058E+03	-2.683E+04	3SLU
-2410	78.5	6.00	100.00	6.1994E-11	-9.903E-11	-2.435E+03	11SLV
-2490	78.5	6.00	100.00	4.0049E-11	-1.605E-11	-4.006E+03	11SLV

Verifica di esercizio (combinazione rara):



Progetto	Titolo	Rev.	Pag.
Orione	Orione_A24a.pdf "TABULATI DI CALCOLO PLINTO DI FONDAZIONE PER AEROGENERATORE TIPO"	0	256

Tabulati di Calcolo Plinto di Fondazione per Aerogeneratore Tipo - Progetto Impianto Eolico - "Orione"

quota	Af	cop.	sigmaf	sigmac	Mx	My	N	comb	Wk
-90	0.0	6.50	0.0	0.0	0.0000E+00	0.0000E+00	0.0000E+00	-	0.000
-170	78.5	6.00		24.2	2.8536E+05	-1.622E+06	-9.158E+04	1	0.000
-170	78.5	6.00	61.5		2.4931E+05	-1.256E+06	-5.894E+04	2	0.000
-250	78.5	6.00		21.0	2.2080E+05	-1.258E+06	-9.315E+04	1	0.000
-250	78.5	6.00	8.7		1.7728E+05	-9.660E+05	-6.051E+04	2	0.000
-330	78.5	6.00		15.9	1.6722E+05	-9.551E+05	-7.033E+04	1	0.000
-330	78.5	6.00	9.8		1.2067E+05	-7.265E+05	-4.377E+04	2	0.000
-410	78.5	6.00		14.4	1.3194E+05	-7.537E+05	-7.190E+04	1	0.000
-490	78.5	6.00		12.8	9.6658E+04	-5.523E+05	-7.347E+04	1	0.000
-570	78.5	6.00		11.3	6.1376E+04	-3.509E+05	-7.504E+04	1	0.000
-650	78.5	6.00		9.8	2.6094E+04	-1.496E+05	-7.661E+04	1	0.000
-730	78.5	6.00		6.2	1.8263E+03	-1.102E+04	-5.527E+04	1	0.000
-810	78.5	6.00		6.5	-4.086E+03	2.2764E+04	-5.684E+04	1	0.000
-890	78.5	6.00		7.0	-9.998E+03	5.6552E+04	-5.841E+04	1	0.000
-970	78.5	6.00		7.4	-1.591E+04	9.0340E+04	-5.998E+04	1	0.000
-1050	78.5	6.00		7.9	-2.182E+04	1.2413E+05	-6.155E+04	1	0.000
-1130	124.0	6.00		5.3	-2.587E+04	1.4730E+05	-4.021E+04	1	0.000
-1210	78.5	6.00		5.8	-2.384E+04	1.3579E+05	-4.178E+04	1	0.000
-1290	78.5	6.00		5.9	-2.180E+04	1.2428E+05	-4.335E+04	1	0.000
-1370	78.5	6.00		6.0	-1.977E+04	1.1277E+05	-4.492E+04	1	0.000
-1450	78.5	6.00		6.0	-1.773E+04	1.0127E+05	-4.649E+04	1	0.000
-1530	78.5	6.00		6.1	-1.570E+04	8.9757E+04	-4.807E+04	1	0.000
-1610	78.5	6.00		3.7	-1.350E+04	7.7214E+04	-2.773E+04	1	0.000
-1690	78.5	6.00		3.8	-1.129E+04	6.4620E+04	-2.930E+04	1	0.000
-1770	78.5	6.00		3.9	-9.082E+03	5.2026E+04	-3.087E+04	1	0.000
-1850	78.5	6.00		3.9	-6.874E+03	3.9432E+04	-3.244E+04	1	0.000
-1930	78.5	6.00		4.0	-4.666E+03	2.6839E+04	-3.401E+04	1	0.000
-2010	78.5	6.00		1.8	-3.440E+03	1.9818E+04	-1.436E+04	1	0.000
-2090	78.5	6.00		1.9	-2.694E+03	1.5518E+04	-1.593E+04	1	0.000
-2170	124.0	6.00		1.9	-1.947E+03	1.1219E+04	-1.750E+04	1	0.000
-2250	78.5	6.00		2.2	-1.201E+03	6.9193E+03	-1.907E+04	1	0.000
-2330	78.5	6.00		2.3	-4.547E+02	2.6199E+03	-2.064E+04	1	0.000
-2410	78.5	6.00		0.2	-4.103E-12	2.7413E-11	-1.387E+03	1	0.000
-2490	78.5	6.00		0.3	-2.967E-12	1.3771E-11	-2.958E+03	1	0.000

Verifica di esercizio (combinazione quasi permanente):

quota	Af	cop.	sigmaf	sigmac	Mx	My	N	comb	Wk
-90	0.0	6.50	0.0	0.0	0.0000E+00	0.0000E+00	0.0000E+00	-	0.000
-170	78.5	6.00		24.2	2.8536E+05	-1.622E+06	-9.158E+04	1	0.000
-170	78.5	6.00	42.2		2.7455E+05	-1.512E+06	-8.179E+04	2	0.000
-250	78.5	6.00		21.0	2.2080E+05	-1.258E+06	-9.315E+04	1	0.000
-330	78.5	6.00		15.9	1.6722E+05	-9.551E+05	-7.033E+04	1	0.000
-410	78.5	6.00		14.4	1.3194E+05	-7.537E+05	-7.190E+04	1	0.000
-490	78.5	6.00		12.8	9.6658E+04	-5.523E+05	-7.347E+04	1	0.000
-570	78.5	6.00		11.3	6.1376E+04	-3.509E+05	-7.504E+04	1	0.000
-650	78.5	6.00		9.8	2.6094E+04	-1.496E+05	-7.661E+04	1	0.000
-730	78.5	6.00		6.2	1.8263E+03	-1.102E+04	-5.527E+04	1	0.000
-810	78.5	6.00		6.5	-4.086E+03	2.2764E+04	-5.684E+04	1	0.000
-890	78.5	6.00		7.0	-9.998E+03	5.6552E+04	-5.841E+04	1	0.000
-970	78.5	6.00		7.4	-1.591E+04	9.0340E+04	-5.998E+04	1	0.000
-1050	78.5	6.00		7.9	-2.182E+04	1.2413E+05	-6.155E+04	1	0.000
-1130	124.0	6.00		5.3	-2.587E+04	1.4730E+05	-4.021E+04	1	0.000
-1210	78.5	6.00		5.8	-2.384E+04	1.3579E+05	-4.178E+04	1	0.000
-1290	78.5	6.00		5.9	-2.180E+04	1.2428E+05	-4.335E+04	1	0.000
-1370	78.5	6.00		6.0	-1.977E+04	1.1277E+05	-4.492E+04	1	0.000
-1450	78.5	6.00		6.0	-1.773E+04	1.0127E+05	-4.649E+04	1	0.000
-1530	78.5	6.00		6.1	-1.570E+04	8.9757E+04	-4.807E+04	1	0.000
-1610	78.5	6.00		3.7	-1.350E+04	7.7214E+04	-2.773E+04	1	0.000
-1690	78.5	6.00		3.8	-1.129E+04	6.4620E+04	-2.930E+04	1	0.000
-1770	78.5	6.00		3.9	-9.082E+03	5.2026E+04	-3.087E+04	1	0.000
-1850	78.5	6.00		3.9	-6.874E+03	3.9432E+04	-3.244E+04	1	0.000
-1930	78.5	6.00		4.0	-4.666E+03	2.6839E+04	-3.401E+04	1	0.000
-2010	78.5	6.00		1.8	-3.440E+03	1.9818E+04	-1.436E+04	1	0.000
-2090	78.5	6.00		1.9	-2.694E+03	1.5518E+04	-1.593E+04	1	0.000
-2170	124.0	6.00		1.9	-1.947E+03	1.1219E+04	-1.750E+04	1	0.000
-2250	78.5	6.00		2.2	-1.201E+03	6.9193E+03	-1.907E+04	1	0.000
-2330	78.5	6.00		2.3	-4.547E+02	2.6199E+03	-2.064E+04	1	0.000
-2410	78.5	6.00		0.2	-4.103E-12	2.7413E-11	-1.387E+03	1	0.000
-2490	78.5	6.00		0.3	-2.967E-12	1.3771E-11	-2.958E+03	1	0.000

Verifica a taglio:

quota	Ast	Vsd	Vsdx	Vsdy	N comb	VRd,c	VRd,max	VRd,S	Vwd
-90	0.16	33579	-32367	-8940	-121462 11SLV	44083	231056	84406	44323 Vsd < VRd,
-170	0.16	32806	-31628	-8712	-122433 11SLV	44106	231056	88429	44323 Vsd < VRd,
-250	0.08	32806	-31628	-8712	-124003 11SLV	44324	231056	66486	22162 Vsd < VRd,
-330	0.08	10523	-10179	-2670	-95554 11SLV	40370	231056	62531	22162 Vsd < VRd,
-410	0.08	10523	-10179	-2670	-97124 11SLV	40588	231056	62750	22162 Vsd < VRd,
-490	0.08	10523	-10179	-2670	-98695 11SLV	40806	231056	62968	22162 Vsd < VRd,
-570	0.08	10523	-10179	-2670	-100266 11SLV	41025	231056	63186	22162 Vsd < VRd,
-650	0.08	10523	-10179	-2670	-101837 11SLV	41243	231056	63405	22162 Vsd < VRd,
-730	0.08	1881	-1817	-485	-35294 5SLV	31994	231056	54155	22162 Vsd < VRd,
-810	0.08	1881	-1817	-485	-36864 5SLV	32212	231056	54374	22162 Vsd < VRd,
-890	0.08	1881	-1817	-485	-38435 5SLV	32430	231056	54592	22162 Vsd < VRd,
-970	0.08	1881	-1817	-485	-40006 5SLV	32649	231056	54810	22162 Vsd < VRd,



Progetto	Titolo	Rev.	Pag.
Orione	Orione_A24a.pdf "TABULATI DI CALCOLO PLINTO DI FONDAZIONE PER AEROGENERATORE TIPO"	0	257

Tabulati di Calcolo Plinto di Fondazione per Aerogeneratore Tipo - Progetto Impianto Eolico - "Orione"

-1050	0.08	1881	-1817	-485	-41577	5SLV	32867	231056	55029	22162	Vsd < VRd,
-1130	0.08	2096	2017	573	-55056	11SLV	39197	231056	61359	22162	Vsd < VRd,
-1210	0.08	2096	2017	573	-56627	11SLV	34959	231056	57121	22162	Vsd < VRd,
-1290	0.08	2096	2017	573	-58198	11SLV	35177	231056	57339	22162	Vsd < VRd,
-1370	0.08	2096	2017	573	-59769	11SLV	35396	231056	57557	22162	Vsd < VRd,
-1450	0.08	2096	2017	573	-61340	11SLV	35614	231056	57776	22162	Vsd < VRd,
-1530	0.08	2096	2017	573	-62910	11SLV	35832	231056	57994	22162	Vsd < VRd,
-1610	0.08	922	890	241	-37777	11SLV	32339	231056	54501	22162	Vsd < VRd,
-1690	0.08	922	890	241	-39348	11SLV	32557	231056	54719	22162	Vsd < VRd,
-1770	0.08	922	890	241	-40918	11SLV	32776	231056	54937	22162	Vsd < VRd,
-1850	0.08	922	890	241	-42489	11SLV	32994	231056	55156	22162	Vsd < VRd,
-1930	0.08	922	890	241	-44060	11SLV	33212	231056	55374	22162	Vsd < VRd,
-2010	0.08	71	70	12	-18666	3SLU	29682	231056	51844	22162	Vsd < VRd,
-2090	0.08	71	70	12	-20708	3SLU	29966	231056	52128	22162	Vsd < VRd,
-2170	0.08	71	70	12	-22750	3SLU	34706	231056	56868	22162	Vsd < VRd,
-2250	0.08	71	70	12	-24792	3SLU	30534	231056	52696	22162	Vsd < VRd,
-2330	0.08	71	70	12	-26834	3SLU	30818	231056	52980	22162	Vsd < VRd,
-2410	0.08	0	0	0	-454	9SLV	27151	231056	49313	22162	Vsd < VRd,
-2490	0.08	0	0	0	-2025	9SLV	27369	231056	49531	22162	Vsd < VRd,

Palo alle coordinate X=-1083 Y=-505

Sollecitazioni massime in testa palo:

Combinazione corrispondente alla minima compressione in testa

N	Mx	My	Tx	Ty	comb	
-1.744E+05	-1.832E+06	8.6676E+05	2.1828E+03	4.2752E+03	1	sl
-1.744E+05	-1.832E+06	8.6676E+05	2.1828E+03	4.2752E+03	1	ra
-1.744E+05	-1.832E+06	8.6676E+05	2.1828E+03	4.2752E+03	1	fr
-1.744E+05	-1.832E+06	8.6676E+05	2.1828E+03	4.2752E+03	1	qp
-1.493E+05	5.1394E+06	-1.244E+06	-6.168E+03	-2.324E+04	15	SLV fond

Combinazione corrispondente alla massima compressione in testa

N	Mx	My	Tx	Ty	comb	
-2.605E+05	-2.635E+06	7.3077E+05	2.0929E+03	5.5779E+03	4	sl
-1.969E+05	-2.001E+06	6.0275E+05	1.6863E+03	4.2886E+03	2	ra
-1.857E+05	-1.916E+06	7.3475E+05	1.9346E+03	4.2819E+03	2	fr
-1.812E+05	-1.883E+06	7.8756E+05	2.0339E+03	4.2792E+03	2	qp
-1.996E+05	-8.804E+06	2.9778E+06	1.0533E+04	3.1787E+04	1	SLV fond

Combinazione corrispondente al massimo taglio in testa

N	Mx	My	Tx	Ty	comb	
-2.268E+05	-2.382E+06	1.1268E+06	2.8377E+03	5.5577E+03	3	sl
-1.744E+05	-1.832E+06	8.6676E+05	2.1828E+03	4.2752E+03	1	ra
-1.744E+05	-1.832E+06	8.6676E+05	2.1828E+03	4.2752E+03	1	fr
-1.744E+05	-1.832E+06	8.6676E+05	2.1828E+03	4.2752E+03	1	qp
-1.996E+05	-8.804E+06	2.9778E+06	1.0533E+04	3.1787E+04	1	SLV fond

Verifica di capacità portante riferita al palo singolo:

Fattore di correlazione Psi scelto in base alla conoscenza del sito = 1.7  
 Coeff. parziale di sicurezza sulla resistenza laterale = 1.15  
 Coeff. parziale di sicurezza sulla resistenza alla punta = 1.35  
 Portanza laterale di progetto = 292537.1  
 Portanza di punta di progetto = 85555.4  
 verifica condotta in combinazione SLU 4  
 Sforzo normale = -260524.7  
 Peso del palo = 49087.4 \* 1.3  
 Carico totale di progetto = -324338.3  
 Resistenza totale di progetto = 378092.5  
 Coefficiente di sicurezza = 1.17 > 1

Verifica di resistenza allo stato limite:

quota	Af	cop.	c.s.	Mx	My	N	comb
-90	0.0	6.50	0.00	0.0000E+00	0.0000E+00	0.0000E+00	-
-170	78.5	6.00	4.01	-6.319E+06	2.1629E+06	-1.999E+05	1SLV
-250	78.5	6.00	6.04	-3.839E+06	1.3516E+06	-2.015E+05	1SLV
-330	78.5	6.00	8.91	-1.361E+06	3.0063E+05	-2.069E+05	4SLU
-410	78.5	6.00	8.82	-1.091E+06	2.3137E+05	-2.090E+05	4SLU
-490	78.5	6.00	8.74	-8.203E+05	1.6211E+05	-2.110E+05	4SLU
-570	78.5	6.00	8.65	-5.500E+05	9.2847E+04	-2.131E+05	4SLU
-650	78.5	6.00	8.57	-2.798E+05	2.3584E+04	-2.151E+05	4SLU
-730	78.5	6.00	11.29	-9.018E+04	-2.281E+04	-1.632E+05	4SLU
-810	78.5	6.00	11.15	-3.507E+04	-3.109E+04	-1.653E+05	4SLU
-890	78.5	6.00	11.02	2.0047E+04	-3.936E+04	-1.673E+05	4SLU
-970	78.5	6.00	10.88	7.5161E+04	-4.764E+04	-1.693E+05	4SLU
-1050	78.5	6.00	10.75	1.3028E+05	-5.592E+04	-1.714E+05	4SLU
-1130	124.0	6.00	16.93	1.7005E+05	-6.086E+04	-1.202E+05	4SLU
-1210	78.5	6.00	15.08	1.5971E+05	-5.490E+04	-1.222E+05	4SLU
-1290	78.5	6.00	14.83	1.4937E+05	-4.894E+04	-1.243E+05	4SLU
-1370	78.5	6.00	14.59	1.3904E+05	-4.297E+04	-1.263E+05	4SLU
-1450	78.5	6.00	14.36	1.2870E+05	-3.701E+04	-1.283E+05	4SLU
-1530	78.5	6.00	14.14	1.1836E+05	-3.105E+04	-1.304E+05	4SLU
-1610	78.5	6.00	22.47	1.0264E+05	-2.633E+04	-8.202E+04	4SLU
-1690	78.5	6.00	21.93	8.6657E+04	-2.167E+04	-8.407E+04	4SLU



Progetto	Titolo	Rev.	Pag.
Orione	Orione_A24a.pdf "TABULATI DI CALCOLO PLINTO DI FONDAZIONE PER AEROGENERATORE TIPO"	0	258

Tabulati di Calcolo Plinto di Fondazione per Aerogeneratore Tipo - Progetto Impianto Eolico - "Orione"

-1770	78.5	6.00	21.41	7.0672E+04	-1.701E+04	-8.611E+04	4SLU
-1850	78.5	6.00	20.91	5.4687E+04	-1.235E+04	-8.815E+04	4SLU
-1930	78.5	6.00	20.44	3.8701E+04	-7.692E+03	-9.019E+04	4SLU
-2010	78.5	6.00	42.11	2.9200E+04	-5.379E+03	-4.377E+04	4SLU
-2090	78.5	6.00	40.24	2.2865E+04	-4.212E+03	-4.581E+04	4SLU
-2170	124.0	6.00	42.51	1.6530E+04	-3.045E+03	-4.785E+04	4SLU
-2250	78.5	6.00	36.94	1.0195E+04	-1.878E+03	-4.989E+04	4SLU
-2330	78.5	6.00	35.49	3.8602E+03	-7.111E+02	-5.194E+04	4SLU
-2410	78.5	6.00	100.00	3.7029E-11	4.0826E-12	-6.597E+03	4SLU
-2490	78.5	6.00	100.00	6.5616E-12	1.2438E-11	-8.639E+03	4SLU

Verifica di esercizio (combinazione rara):

quota	Af	cop.	sigmaf	sigmac	Mx	My	N	comb	Wk
-90	0.0	6.50	0.0	0.0	0.0000E+00	0.0000E+00	0.0000E+00	-	0.000
-170	78.5	6.00		36.3	-1.658E+06	4.7762E+05	-1.974E+05	2	0.000
-250	78.5	6.00		33.5	-1.314E+06	3.5315E+05	-1.989E+05	2	0.000
-330	78.5	6.00		26.2	-1.023E+06	2.5378E+05	-1.564E+05	2	0.000
-410	78.5	6.00		24.6	-8.184E+05	1.9624E+05	-1.579E+05	2	0.000
-490	78.5	6.00		23.0	-6.136E+05	1.3870E+05	-1.595E+05	2	0.000
-570	78.5	6.00		21.4	-4.088E+05	8.1157E+04	-1.611E+05	2	0.000
-650	78.5	6.00		19.8	-2.041E+05	2.3616E+04	-1.627E+05	2	0.000
-730	78.5	6.00		14.2	-6.079E+04	-1.511E+04	-1.233E+05	2	0.000
-810	78.5	6.00		14.1	-2.001E+04	-2.248E+04	-1.249E+05	2	0.000
-890	78.5	6.00		14.4	2.0780E+04	-2.984E+04	-1.265E+05	2	0.000
-970	78.5	6.00		14.8	6.1566E+04	-3.721E+04	-1.280E+05	2	0.000
-1050	78.5	6.00		15.3	1.0235E+05	-4.458E+04	-1.296E+05	2	0.000
-1130	124.0	6.00		10.4	1.3162E+05	-4.912E+04	-9.080E+04	2	0.000
-1210	78.5	6.00		11.4	1.2327E+05	-4.444E+04	-9.237E+04	2	0.000
-1290	78.5	6.00		11.5	1.1492E+05	-3.976E+04	-9.394E+04	2	0.000
-1370	78.5	6.00		11.6	1.0657E+05	-3.509E+04	-9.551E+04	2	0.000
-1450	78.5	6.00		11.7	9.8218E+04	-3.041E+04	-9.708E+04	2	0.000
-1530	78.5	6.00		11.7	8.9866E+04	-2.573E+04	-9.865E+04	2	0.000
-1610	78.5	6.00		7.6	7.7844E+04	-2.187E+04	-6.198E+04	2	0.000
-1690	78.5	6.00		7.6	6.5640E+04	-1.804E+04	-6.355E+04	2	0.000
-1770	78.5	6.00		7.7	5.3437E+04	-1.422E+04	-6.512E+04	2	0.000
-1850	78.5	6.00		7.8	4.1233E+04	-1.039E+04	-6.669E+04	2	0.000
-1930	78.5	6.00		7.8	2.9030E+04	-6.571E+03	-6.826E+04	2	0.000
-2010	78.5	6.00		3.9	2.1842E+04	-4.640E+03	-3.306E+04	2	0.000
-2090	78.5	6.00		4.0	1.7103E+04	-3.634E+03	-3.463E+04	2	0.000
-2170	124.0	6.00		3.8	1.2365E+04	-2.627E+03	-3.620E+04	2	0.000
-2250	78.5	6.00		4.3	7.6261E+03	-1.620E+03	-3.777E+04	2	0.000
-2330	78.5	6.00		4.4	2.8875E+03	-6.134E+02	-3.934E+04	2	0.000
-2410	78.5	6.00		0.6	2.5679E-11	1.9771E-12	-4.958E+03	2	0.000
-2490	78.5	6.00		0.7	2.9420E-12	9.3666E-12	-6.529E+03	2	0.000

Verifica di esercizio (combinazione quasi permanente):

quota	Af	cop.	sigmaf	sigmac	Mx	My	N	comb	Wk
-90	0.0	6.50	0.0	0.0	0.0000E+00	0.0000E+00	0.0000E+00	-	0.000
-170	78.5	6.00		34.1	-1.541E+06	6.3387E+05	-1.817E+05	2	0.000
-250	78.5	6.00		31.2	-1.200E+06	4.8078E+05	-1.833E+05	2	0.000
-330	78.5	6.00		24.2	-9.156E+05	3.5625E+05	-1.436E+05	2	0.000
-410	78.5	6.00		22.6	-7.251E+05	2.7932E+05	-1.452E+05	2	0.000
-490	78.5	6.00		21.1	-5.345E+05	2.0239E+05	-1.468E+05	2	0.000
-570	78.5	6.00		19.5	-3.440E+05	1.2546E+05	-1.483E+05	2	0.000
-650	78.5	6.00		18.0	-1.534E+05	4.8525E+04	-1.499E+05	2	0.000
-730	78.5	6.00		12.8	-2.176E+04	-4.024E+03	-1.132E+05	2	0.000
-810	78.5	6.00		12.9	1.1700E+04	-1.594E+04	-1.148E+05	2	0.000
-890	78.5	6.00		13.4	4.5165E+04	-2.785E+04	-1.164E+05	2	0.000
-970	78.5	6.00		13.9	7.8630E+04	-3.976E+04	-1.180E+05	2	0.000
-1050	78.5	6.00		14.3	1.1209E+05	-5.167E+04	-1.195E+05	2	0.000
-1130	124.0	6.00		9.7	1.3533E+05	-5.960E+04	-8.330E+04	2	0.000
-1210	78.5	6.00		10.6	1.2516E+05	-5.451E+04	-8.487E+04	2	0.000
-1290	78.5	6.00		10.7	1.1499E+05	-4.941E+04	-8.644E+04	2	0.000
-1370	78.5	6.00		10.7	1.0483E+05	-4.432E+04	-8.801E+04	2	0.000
-1450	78.5	6.00		10.8	9.4656E+04	-3.922E+04	-8.958E+04	2	0.000
-1530	78.5	6.00		10.9	8.4487E+04	-3.413E+04	-9.115E+04	2	0.000
-1610	78.5	6.00		7.0	7.2782E+04	-2.921E+04	-5.690E+04	2	0.000
-1690	78.5	6.00		7.0	6.1002E+04	-2.429E+04	-5.847E+04	2	0.000
-1770	78.5	6.00		7.1	4.9222E+04	-1.938E+04	-6.004E+04	2	0.000
-1850	78.5	6.00		7.2	3.7442E+04	-1.446E+04	-6.161E+04	2	0.000
-1930	78.5	6.00		7.3	2.5661E+04	-9.550E+03	-6.318E+04	2	0.000
-2010	78.5	6.00		3.5	1.9023E+04	-6.927E+03	-3.029E+04	2	0.000
-2090	78.5	6.00		3.7	1.4896E+04	-5.424E+03	-3.186E+04	2	0.000
-2170	124.0	6.00		3.5	1.0769E+04	-3.922E+03	-3.343E+04	2	0.000
-2250	78.5	6.00		4.0	6.6419E+03	-2.419E+03	-3.500E+04	2	0.000
-2330	78.5	6.00		4.1	2.5148E+03	-9.158E+02	-3.657E+04	2	0.000
-2410	78.5	6.00		0.5	1.2916E-11	-3.316E-12	-4.429E+03	2	0.000
-2490	78.5	6.00		0.7	-6.638E-12	8.4501E-12	-6.000E+03	2	0.000

Verifica a taglio:

quota	Ast	Vsd	Vsdx	Vsdy	N	comb	VRd,c	VRd,max	VRd,S	Vwd
-90	0.16	33487	10533	31787	-199571	1SLV	50940	231056	95263	44323 Vsd < VRd,
-170	0.16	32632	10167	31008	-199946	1SLV	54880	231056	99204	44323 Vsd < VRd,
-250	0.08	32632	10167	31008	-201517	1SLV	55099	231056	77260	22162 Vsd < VRd,



Progetto	Titolo	Rev.	Pag.
Orione	Orione_A24a.pdf "TABULATI DI CALCOLO PLINTO DI FONDAZIONE PER AEROGENERATORE TIPO"	0	259

-330	0.08	10385	3344	9832	-158421	1SLV	49108	231056	71270	22162	Vsd < VRd,
-410	0.08	10385	3344	9832	-159992	1SLV	49327	231056	71488	22162	Vsd < VRd,
-490	0.08	10385	3344	9832	-161563	1SLV	49545	231056	71707	22162	Vsd < VRd,
-570	0.08	10385	3344	9832	-163133	1SLV	49763	231056	71925	22162	Vsd < VRd,
-650	0.08	10385	3344	9832	-164704	1SLV	49982	231056	72143	22162	Vsd < VRd,
-730	0.08	1875	596	1778	-92888	15SLV	39999	231056	62161	22162	Vsd < VRd,
-810	0.08	1875	596	1778	-94459	15SLV	40218	231056	62379	22162	Vsd < VRd,
-890	0.08	1875	596	1778	-96030	15SLV	40436	231056	62598	22162	Vsd < VRd,
-970	0.08	1875	596	1778	-97600	15SLV	40654	231056	62816	22162	Vsd < VRd,
-1050	0.08	1875	596	1778	-99171	15SLV	40873	231056	63034	22162	Vsd < VRd,
-1130	0.08	2088	-627	-1992	-91998	1SLV	44332	231056	66493	22162	Vsd < VRd,
-1210	0.08	2088	-627	-1992	-93568	1SLV	40094	231056	62256	22162	Vsd < VRd,
-1290	0.08	2088	-627	-1992	-95139	1SLV	40312	231056	62474	22162	Vsd < VRd,
-1370	0.08	2088	-627	-1992	-96710	1SLV	40531	231056	62692	22162	Vsd < VRd,
-1450	0.08	2088	-627	-1992	-98281	1SLV	40749	231056	62911	22162	Vsd < VRd,
-1530	0.08	2088	-627	-1992	-99851	1SLV	40967	231056	63129	22162	Vsd < VRd,
-1610	0.08	913	-286	-868	-62793	1SLV	35816	231056	57978	22162	Vsd < VRd,
-1690	0.08	913	-286	-868	-64363	1SLV	36034	231056	58196	22162	Vsd < VRd,
-1770	0.08	913	-286	-868	-65934	1SLV	36253	231056	58414	22162	Vsd < VRd,
-1850	0.08	913	-286	-868	-67505	1SLV	36471	231056	58633	22162	Vsd < VRd,
-1930	0.08	913	-286	-868	-69076	1SLV	36689	231056	58851	22162	Vsd < VRd,
-2010	0.08	81	-15	-79	-43768	4SLU	33172	231056	55333	22162	Vsd < VRd,
-2090	0.08	81	-15	-79	-45810	4SLU	33456	231056	55617	22162	Vsd < VRd,
-2170	0.08	81	-15	-79	-47852	4SLU	38196	231056	60357	22162	Vsd < VRd,
-2250	0.08	81	-15	-79	-49894	4SLU	34023	231056	56185	22162	Vsd < VRd,
-2330	0.08	81	-15	-79	-51936	4SLU	34307	231056	56469	22162	Vsd < VRd,
-2410	0.08	0	0	0	-3361	15SLV	27555	231056	49717	22162	Vsd < VRd,
-2490	0.08	0	0	0	-4932	15SLV	27773	231056	49935	22162	Vsd < VRd,

Palo alle coordinate X=-845 Y=-845

Sollecitazioni massime in testa palo:

Combinazione corrispondente alla minima compressione in testa

N	Mx	My	Tx	Ty	comb	
-1.745E+05	-1.430E+06	1.4417E+06	3.5247E+03	3.3354E+03	1	sl
-1.745E+05	-1.430E+06	1.4417E+06	3.5247E+03	3.3354E+03	1	ra
-1.745E+05	-1.430E+06	1.4417E+06	3.5247E+03	3.3354E+03	1	fr
-1.745E+05	-1.430E+06	1.4417E+06	3.5247E+03	3.3354E+03	1	qp
-1.523E+05	5.5301E+06	-6.885E+05	-4.905E+03	-2.412E+04	15	SLV fond

Combinazione corrispondente alla massima compressione in testa

N	Mx	My	Tx	Ty	comb	
-2.846E+05	-2.259E+06	1.9375E+06	4.8530E+03	4.6472E+03	4	sl
-2.130E+05	-1.697E+06	1.4839E+06	3.7053E+03	3.5428E+03	2	ra
-1.938E+05	-1.563E+06	1.4628E+06	3.6150E+03	3.4391E+03	2	fr
-1.861E+05	-1.510E+06	1.4543E+06	3.5789E+03	3.3976E+03	2	qp
-1.967E+05	-8.389E+06	3.5719E+06	1.1955E+04	3.0788E+04	1	SLV fond

Combinazione corrispondente al massimo taglio in testa

N	Mx	My	Tx	Ty	comb	
-2.846E+05	-2.259E+06	1.9375E+06	4.8530E+03	4.6472E+03	4	sl
-2.130E+05	-1.697E+06	1.4839E+06	3.7053E+03	3.5428E+03	2	ra
-1.938E+05	-1.563E+06	1.4628E+06	3.6150E+03	3.4391E+03	2	fr
-1.861E+05	-1.510E+06	1.4543E+06	3.5789E+03	3.3976E+03	2	qp
-1.960E+05	-3.553E+06	8.4913E+06	3.1334E+04	1.1707E+04	5	SLV fond

Verifica di capacità portante riferita al palo singolo:

Fattore di correlazione Psi scelto in base alla conoscenza del sito = 1.7  
 Coeff. parziale di sicurezza sulla resistenza laterale = 1.15  
 Coeff. parziale di sicurezza sulla resistenza alla punta = 1.35  
 Portanza laterale di progetto = 292537.1  
 Portanza di punta di progetto = 85555.4  
 verifica condotta in combinazione SLU 4  
 Sforzo normale = -284610.9  
 Peso del palo = 49087.4 \* 1.3  
 Carico totale di progetto = -348424.5  
 Resistenza totale di progetto = 378092.5  
 Coefficiente di sicurezza = 1.09 > 1

Verifica di resistenza allo stato limite:

quota	Af	cop.	c.s.	Mx	My	N	comb
-90	0.0	6.50	0.00	0.0000E+00	0.0000E+00	0.0000E+00	-
-170	78.5	6.00	4.06	-2.635E+06	6.0543E+06	-1.963E+05	5SLV
-250	78.5	6.00	6.14	-1.718E+06	3.6219E+06	-1.978E+05	5SLV
-330	78.5	6.00	8.14	-1.193E+06	8.8645E+05	-2.264E+05	4SLU
-410	78.5	6.00	8.07	-9.605E+05	6.9527E+05	-2.285E+05	4SLU
-490	78.5	6.00	8.00	-7.275E+05	5.0409E+05	-2.305E+05	4SLU
-570	78.5	6.00	7.93	-4.945E+05	3.1291E+05	-2.325E+05	4SLU
-650	78.5	6.00	7.86	-2.615E+05	1.2174E+05	-2.346E+05	4SLU
-730	78.5	6.00	10.32	-9.716E+04	-8.884E+03	-1.786E+05	4SLU
-810	78.5	6.00	10.20	-4.715E+04	-3.858E+04	-1.807E+05	4SLU
-890	78.5	6.00	10.09	2.8658E+03	-6.827E+04	-1.827E+05	4SLU
-970	78.5	6.00	9.98	5.2880E+04	-9.797E+04	-1.848E+05	4SLU



Progetto	Titolo	Rev.	Pag.
Orione	Orione_A24a.pdf "TABULATI DI CALCOLO PLINTO DI FONDAZIONE PER AEROGENERATORE TIPO"	0	260

-1050	78.5	6.00	9.87	1.0289E+05	-1.277E+05	-1.868E+05	4SLU		
-1130	124.0	6.00	15.45	1.3941E+05	-1.475E+05	-1.316E+05	4SLU		
-1210	78.5	6.00	13.79	1.3184E+05	-1.350E+05	-1.337E+05	4SLU		
-1290	78.5	6.00	13.58	1.2427E+05	-1.225E+05	-1.357E+05	4SLU		
-1370	78.5	6.00	13.38	1.1669E+05	-1.100E+05	-1.378E+05	4SLU		
-1450	78.5	6.00	13.18	1.0912E+05	-9.755E+04	-1.398E+05	4SLU		
-1530	78.5	6.00	12.99	1.0155E+05	-8.507E+04	-1.418E+05	4SLU		
-1610	78.5	6.00	20.53	8.8286E+04	-7.286E+04	-8.978E+04	4SLU		
-1690	78.5	6.00	20.07	7.4744E+04	-6.066E+04	-9.182E+04	4SLU		
-1770	78.5	6.00	19.64	6.1201E+04	-4.847E+04	-9.387E+04	4SLU		
-1850	78.5	6.00	19.22	4.7658E+04	-3.627E+04	-9.591E+04	4SLU		
-1930	78.5	6.00	18.82	3.4116E+04	-2.408E+04	-9.795E+04	4SLU		
-2010	78.5	6.00	38.40	2.5897E+04	-1.752E+04	-4.800E+04	4SLU		
-2090	78.5	6.00	36.83	2.0279E+04	-1.372E+04	-5.005E+04	4SLU		
-2170	124.0	6.00	39.05	1.4660E+04	-9.918E+03	-5.209E+04	4SLU		
-2250	78.5	6.00	34.05	9.0419E+03	-6.117E+03	-5.413E+04	4SLU		
-2330	78.5	6.00	32.81	3.4236E+03	-2.316E+03	-5.617E+04	4SLU		
-2410	78.5	6.00	100.00	4.0861E-11	-2.624E-11	-7.406E+03	4SLU		
-2490	78.5	6.00	100.00	1.8806E-11	1.6419E-11	-9.448E+03	4SLU		

Verifica di esercizio (combinazione rara):

quota	Af	cop.	sigmaf	sigmac	Mx	My	N	comb	Wk
-90	0.0	6.50	0.0	0.0	0.0000E+00	0.0000E+00	0.0000E+00	-	0.000
-170	78.5	6.00		39.2	-1.413E+06	1.1984E+06	-2.134E+05	2	0.000
-250	78.5	6.00		36.0	-1.129E+06	9.1363E+05	-2.149E+05	2	0.000
-330	78.5	6.00		28.1	-8.861E+05	6.8069E+05	-1.694E+05	2	0.000
-410	78.5	6.00		26.4	-7.116E+05	5.3416E+05	-1.709E+05	2	0.000
-490	78.5	6.00		24.7	-5.371E+05	3.8763E+05	-1.725E+05	2	0.000
-570	78.5	6.00		23.0	-3.626E+05	2.4109E+05	-1.741E+05	2	0.000
-650	78.5	6.00		21.3	-1.881E+05	9.4558E+04	-1.757E+05	2	0.000
-730	78.5	6.00		15.4	-6.530E+04	-5.617E+03	-1.336E+05	2	0.000
-810	78.5	6.00		15.4	-2.880E+04	-2.853E+04	-1.352E+05	2	0.000
-890	78.5	6.00		15.6	7.6936E+03	-5.144E+04	-1.368E+05	2	0.000
-970	78.5	6.00		16.1	4.4192E+04	-7.435E+04	-1.383E+05	2	0.000
-1050	78.5	6.00		16.6	8.0690E+04	-9.727E+04	-1.399E+05	2	0.000
-1130	124.0	6.00		11.3	1.0718E+05	-1.126E+05	-9.844E+04	2	0.000
-1210	78.5	6.00		12.3	1.0100E+05	-1.031E+05	-1.000E+05	2	0.000
-1290	78.5	6.00		12.4	9.4809E+04	-9.362E+04	-1.016E+05	2	0.000
-1370	78.5	6.00		12.5	8.8623E+04	-8.414E+04	-1.032E+05	2	0.000
-1450	78.5	6.00		12.6	8.2436E+04	-7.466E+04	-1.047E+05	2	0.000
-1530	78.5	6.00		12.7	7.6249E+04	-6.518E+04	-1.063E+05	2	0.000
-1610	78.5	6.00		8.2	6.6203E+04	-5.584E+04	-6.716E+04	2	0.000
-1690	78.5	6.00		8.2	5.5968E+04	-4.651E+04	-6.873E+04	2	0.000
-1770	78.5	6.00		8.3	4.5733E+04	-3.717E+04	-7.030E+04	2	0.000
-1850	78.5	6.00		8.4	3.5498E+04	-2.784E+04	-7.187E+04	2	0.000
-1930	78.5	6.00		8.4	2.5263E+04	-1.851E+04	-7.344E+04	2	0.000
-2010	78.5	6.00		4.2	1.9118E+04	-1.348E+04	-3.588E+04	2	0.000
-2090	78.5	6.00		4.3	1.4970E+04	-1.055E+04	-3.745E+04	2	0.000
-2170	124.0	6.00		4.1	1.0823E+04	-7.631E+03	-3.903E+04	2	0.000
-2250	78.5	6.00		4.6	6.6751E+03	-4.706E+03	-4.060E+04	2	0.000
-2330	78.5	6.00		4.7	2.5274E+03	-1.782E+03	-4.217E+04	2	0.000
-2410	78.5	6.00		0.6	3.0163E-11	-2.020E-11	-5.498E+03	2	0.000
-2490	78.5	6.00		0.8	1.4247E-11	1.2483E-11	-7.069E+03	2	0.000

Verifica di esercizio (combinazione quasi permanente):

quota	Af	cop.	sigmaf	sigmac	Mx	My	N	comb	Wk
-90	0.0	6.50	0.0	0.0	0.0000E+00	0.0000E+00	0.0000E+00	-	0.000
-170	78.5	6.00		35.0	-1.239E+06	1.1777E+06	-1.866E+05	2	0.000
-250	78.5	6.00		31.9	-9.676E+05	9.0180E+05	-1.881E+05	2	0.000
-330	78.5	6.00		24.8	-7.407E+05	6.7528E+05	-1.476E+05	2	0.000
-410	78.5	6.00		23.2	-5.876E+05	5.3114E+05	-1.491E+05	2	0.000
-490	78.5	6.00		21.6	-4.345E+05	3.8700E+05	-1.507E+05	2	0.000
-570	78.5	6.00		20.0	-2.815E+05	2.4286E+05	-1.523E+05	2	0.000
-650	78.5	6.00		18.5	-1.284E+05	9.8721E+04	-1.538E+05	2	0.000
-730	78.5	6.00		13.1	-2.236E+04	-8.004E+01	-1.164E+05	2	0.000
-810	78.5	6.00		13.3	5.1542E+03	-2.332E+04	-1.179E+05	2	0.000
-890	78.5	6.00		13.8	3.2669E+04	-4.655E+04	-1.195E+05	2	0.000
-970	78.5	6.00		14.2	6.0184E+04	-6.979E+04	-1.211E+05	2	0.000
-1050	78.5	6.00		14.7	8.7699E+04	-9.302E+04	-1.226E+05	2	0.000
-1130	124.0	6.00		10.0	1.0693E+05	-1.087E+05	-8.562E+04	2	0.000
-1210	78.5	6.00		10.9	9.9095E+04	-9.978E+04	-8.719E+04	2	0.000
-1290	78.5	6.00		10.9	9.1261E+04	-9.084E+04	-8.876E+04	2	0.000
-1370	78.5	6.00		11.0	8.3427E+04	-8.190E+04	-9.033E+04	2	0.000
-1450	78.5	6.00		11.1	7.5592E+04	-7.296E+04	-9.190E+04	2	0.000
-1530	78.5	6.00		11.2	6.7758E+04	-6.401E+04	-9.347E+04	2	0.000
-1610	78.5	6.00		7.2	5.8427E+04	-5.491E+04	-5.847E+04	2	0.000
-1690	78.5	6.00		7.2	4.9022E+04	-4.579E+04	-6.004E+04	2	0.000
-1770	78.5	6.00		7.3	3.9617E+04	-3.668E+04	-6.161E+04	2	0.000
-1850	78.5	6.00		7.4	3.0211E+04	-2.756E+04	-6.318E+04	2	0.000
-1930	78.5	6.00		7.4	2.0806E+04	-1.845E+04	-6.476E+04	2	0.000
-2010	78.5	6.00		3.6	1.5466E+04	-1.349E+04	-3.114E+04	2	0.000
-2090	78.5	6.00		3.8	1.2111E+04	-1.056E+04	-3.271E+04	2	0.000
-2170	124.0	6.00		3.6	8.7553E+03	-7.637E+03	-3.429E+04	2	0.000
-2250	78.5	6.00		4.0	5.3999E+03	-4.711E+03	-3.586E+04	2	0.000
-2330	78.5	6.00		4.2	2.0446E+03	-1.784E+03	-3.743E+04	2	0.000
-2410	78.5	6.00		0.5	2.4388E-11	-2.028E-11	-4.593E+03	2	0.000



Tabulati di Calcolo Plinto di Fondazione per Aerogeneratore Tipo - Progetto Impianto Eolico - "Orione"

-2490 78.5 6.00 0.7 1.3247E-11 1.1812E-11 -6.163E+03 2 0.000

Verifica a taglio:

quota	Ast	Vsd	Vsdx	Vsdy	N	comb	VRd,c	VRd,max	VRd,S	Vwd
-90	0.16	33449	31334	11707	-195975	5SLV	50440	231056	94763	44323 Vsd < VRd,
-170	0.16	32493	30405	11460	-196251	5SLV	54367	231056	98690	44323 Vsd < VRd,
-250	0.08	32493	30405	11460	-197822	5SLV	54585	231056	76747	22162 Vsd < VRd,
-330	0.08	10255	9403	4092	-155319	5SLV	48677	231056	70839	22162 Vsd < VRd,
-410	0.08	10255	9403	4092	-156890	5SLV	48895	231056	71057	22162 Vsd < VRd,
-490	0.08	10255	9403	4092	-158460	5SLV	49114	231056	71275	22162 Vsd < VRd,
-570	0.08	10255	9403	4092	-160031	5SLV	49332	231056	71494	22162 Vsd < VRd,
-650	0.08	10255	9403	4092	-161602	5SLV	49550	231056	71712	22162 Vsd < VRd,
-730	0.08	1839	1692	720	-95456	11SLV	40356	231056	62518	22162 Vsd < VRd,
-810	0.08	1839	1692	720	-97027	11SLV	40575	231056	62736	22162 Vsd < VRd,
-890	0.08	1839	1692	720	-98598	11SLV	40793	231056	62955	22162 Vsd < VRd,
-970	0.08	1839	1692	720	-100169	11SLV	41011	231056	63173	22162 Vsd < VRd,
-1050	0.08	1839	1692	720	-101740	11SLV	41230	231056	63391	22162 Vsd < VRd,
-1130	0.08	2089	-1978	-671	-90164	5SLV	44077	231056	66239	22162 Vsd < VRd,
-1210	0.08	2089	-1978	-671	-91735	5SLV	39839	231056	62001	22162 Vsd < VRd,
-1290	0.08	2089	-1978	-671	-93305	5SLV	40057	231056	62219	22162 Vsd < VRd,
-1370	0.08	2089	-1978	-671	-94876	5SLV	40276	231056	62437	22162 Vsd < VRd,
-1450	0.08	2089	-1978	-671	-96447	5SLV	40494	231056	62656	22162 Vsd < VRd,
-1530	0.08	2089	-1978	-671	-98018	5SLV	40712	231056	62874	22162 Vsd < VRd,
-1610	0.08	906	-842	-333	-61551	5SLV	35644	231056	57805	22162 Vsd < VRd,
-1690	0.08	906	-842	-333	-63122	5SLV	35862	231056	58024	22162 Vsd < VRd,
-1770	0.08	906	-842	-333	-64693	5SLV	36080	231056	58242	22162 Vsd < VRd,
-1850	0.08	906	-842	-333	-66264	5SLV	36299	231056	58460	22162 Vsd < VRd,
-1930	0.08	906	-842	-333	-67835	5SLV	36517	231056	58679	22162 Vsd < VRd,
-2010	0.08	85	-48	-70	-48004	4SLU	33760	231056	55922	22162 Vsd < VRd,
-2090	0.08	85	-48	-70	-50046	4SLU	34044	231056	56206	22162 Vsd < VRd,
-2170	0.08	85	-48	-70	-52088	4SLU	38784	231056	60946	22162 Vsd < VRd,
-2250	0.08	85	-48	-70	-54130	4SLU	34612	231056	56774	22162 Vsd < VRd,
-2330	0.08	85	-48	-70	-56172	4SLU	34896	231056	57057	22162 Vsd < VRd,
-2410	0.08	0	0	0	-4914	5SLV	27771	231056	49933	22162 Vsd < VRd,
-2490	0.08	0	0	0	-6485	5SLV	27989	231056	50151	22162 Vsd < VRd,

Palo alle coordinate X=-505 Y=-1083

Sollecitazioni massime in testa palo:

Combinazione corrispondente alla minima compressione in testa

N	Mx	My	Tx	Ty	comb
-1.746E+05	-8.537E+05	1.8449E+06	4.4659E+03	1.9919E+03	1 sl
-1.746E+05	-8.537E+05	1.8449E+06	4.4659E+03	1.9919E+03	1 ra
-1.746E+05	-8.537E+05	1.8449E+06	4.4659E+03	1.9919E+03	1 fr
-1.746E+05	-8.537E+05	1.8449E+06	4.4659E+03	1.9919E+03	1 qp
-1.507E+05	1.2548E+06	-5.228E+06	-2.343E+04	-6.318E+03	11 SLV fond

Combinazione corrispondente alla massima compressione in testa

N	Mx	My	Tx	Ty	comb
-3.017E+05	-1.320E+06	2.9138E+06	7.0594E+03	2.4456E+03	4 sl
-2.244E+05	-9.937E+05	2.1885E+06	5.3017E+03	1.8960E+03	2 ra
-1.995E+05	-9.237E+05	2.0167E+06	4.8838E+03	1.9439E+03	2 fr
-1.895E+05	-8.957E+05	1.9480E+06	4.7166E+03	1.9631E+03	2 qp
-1.985E+05	-2.962E+06	8.9180E+06	3.2365E+04	1.0302E+04	5 SLV fond

Combinazione corrispondente al massimo taglio in testa

N	Mx	My	Tx	Ty	comb
-3.017E+05	-1.320E+06	2.9138E+06	7.0594E+03	2.4456E+03	4 sl
-2.244E+05	-9.937E+05	2.1885E+06	5.3017E+03	1.8960E+03	2 ra
-1.995E+05	-9.237E+05	2.0167E+06	4.8838E+03	1.9439E+03	2 fr
-1.895E+05	-8.957E+05	1.9480E+06	4.7166E+03	1.9631E+03	2 qp
-1.985E+05	-2.962E+06	8.9180E+06	3.2365E+04	1.0302E+04	5 SLV fond

Verifica di capacità portante riferita al palo singolo:

Fattore di correlazione Psi scelto in base alla conoscenza del sito = 1.7  
 Coeff. parziale di sicurezza sulla resistenza laterale = 1.15  
 Coeff. parziale di sicurezza sulla resistenza alla punta = 1.35  
 Portanza laterale di progetto = 292537.1  
 Portanza di punta di progetto = 85555.4  
 verifica condotta in combinazione SLU 4  
 Sforzo normale = -301690  
 Peso del palo = 49087.4 \* 1.3  
 Carico totale di progetto = -365503.6  
 Resistenza totale di progetto = 378092.5  
 Coefficiente di sicurezza = 1.03 > 1

Verifica di resistenza allo stato limite:

quota	Af	cop.	c.s.	Mx	My	N	comb
-90	0.0	6.50	0.00	0.0000E+00	0.0000E+00	0.0000E+00	-
-170	78.5	6.00	3.97	-2.156E+06	6.3991E+06	-1.987E+05	5SLV
-250	78.5	6.00	6.01	-1.351E+06	3.8850E+06	-2.003E+05	5SLV



Progetto	Titolo	Rev.	Pag.
Orione	Orione_A24a.pdf "TABULATI DI CALCOLO PLINTO DI FONDAZIONE PER AEROGENERATORE TIPO"	0	262

-330	78.5	6.00	7.67	-7.495E+05	1.3653E+06	-2.402E+05	4SLU			
-410	78.5	6.00	7.61	-6.110E+05	1.0752E+06	-2.423E+05	4SLU			
-490	78.5	6.00	7.54	-4.725E+05	7.8519E+05	-2.443E+05	4SLU			
-570	78.5	6.00	7.48	-3.340E+05	4.9514E+05	-2.464E+05	4SLU			
-650	78.5	6.00	7.42	-1.955E+05	2.0509E+05	-2.484E+05	4SLU			
-730	78.5	6.00	9.72	-9.598E+04	5.9915E+03	-1.896E+05	4SLU			
-810	78.5	6.00	9.62	-6.132E+04	-4.153E+04	-1.916E+05	4SLU			
-890	78.5	6.00	9.52	-2.666E+04	-8.906E+04	-1.936E+05	4SLU			
-970	78.5	6.00	9.42	7.9973E+03	-1.366E+05	-1.957E+05	4SLU			
-1050	78.5	6.00	9.32	4.2656E+04	-1.841E+05	-1.977E+05	4SLU			
-1130	124.0	6.00	14.56	6.8753E+04	-2.164E+05	-1.398E+05	4SLU			
-1210	78.5	6.00	13.00	6.6886E+04	-1.989E+05	-1.418E+05	4SLU			
-1290	78.5	6.00	12.81	6.5018E+04	-1.813E+05	-1.438E+05	4SLU			
-1370	78.5	6.00	12.63	6.3151E+04	-1.638E+05	-1.459E+05	4SLU			
-1450	78.5	6.00	12.46	6.1283E+04	-1.463E+05	-1.479E+05	4SLU			
-1530	78.5	6.00	12.29	5.9416E+04	-1.288E+05	-1.500E+05	4SLU			
-1610	78.5	6.00	19.34	5.2100E+04	-1.106E+05	-9.528E+04	4SLU			
-1690	78.5	6.00	18.94	4.4516E+04	-9.230E+04	-9.733E+04	4SLU			
-1770	78.5	6.00	18.55	3.6932E+04	-7.403E+04	-9.937E+04	4SLU			
-1850	78.5	6.00	18.18	2.9348E+04	-5.577E+04	-1.014E+05	4SLU			
-1930	78.5	6.00	17.82	2.1764E+04	-3.751E+04	-1.035E+05	4SLU			
-2010	78.5	6.00	36.14	1.6823E+04	-2.750E+04	-5.101E+04	4SLU			
-2090	78.5	6.00	34.75	1.3173E+04	-2.154E+04	-5.305E+04	4SLU			
-2170	124.0	6.00	36.93	9.5235E+03	-1.557E+04	-5.509E+04	4SLU			
-2250	78.5	6.00	32.26	5.8737E+03	-9.603E+03	-5.713E+04	4SLU			
-2330	78.5	6.00	31.15	2.2240E+03	-3.636E+03	-5.918E+04	4SLU			
-2410	78.5	6.00	100.00	2.2971E-11	-5.734E-11	-7.979E+03	4SLU			
-2490	78.5	6.00	100.00	7.7373E-12	-4.813E-12	-1.002E+04	4SLU			

Verifica di esercizio (combinazione rara):

quota	Af	cop.	sigmaf	sigmac	Mx	My	N	comb	Wk
-90	0.0	6.50	0.0	0.0	0.0000E+00	0.0000E+00	0.0000E+00	-	0.000
-170	78.5	6.00		41.4	-8.409E+05	1.7761E+06	-2.247E+05	2	0.000
-250	78.5	6.00		37.9	-6.881E+05	1.3644E+06	-2.263E+05	2	0.000
-330	78.5	6.00		29.6	-5.537E+05	1.0254E+06	-1.786E+05	2	0.000
-410	78.5	6.00		27.7	-4.499E+05	8.0758E+05	-1.802E+05	2	0.000
-490	78.5	6.00		25.9	-3.461E+05	5.8972E+05	-1.817E+05	2	0.000
-570	78.5	6.00		24.1	-2.423E+05	3.7185E+05	-1.833E+05	2	0.000
-650	78.5	6.00		22.3	-1.385E+05	1.5399E+05	-1.849E+05	2	0.000
-730	78.5	6.00		16.2	-6.430E+04	4.4475E+03	-1.409E+05	2	0.000
-810	78.5	6.00		16.3	-3.931E+04	-3.124E+04	-1.425E+05	2	0.000
-890	78.5	6.00		16.6	-1.432E+04	-6.693E+04	-1.441E+05	2	0.000
-970	78.5	6.00		17.1	1.0669E+04	-1.026E+05	-1.456E+05	2	0.000
-1050	78.5	6.00		17.6	3.5659E+04	-1.383E+05	-1.472E+05	2	0.000
-1130	124.0	6.00		12.0	5.4341E+04	-1.625E+05	-1.039E+05	2	0.000
-1210	78.5	6.00		13.0	5.2416E+04	-1.494E+05	-1.054E+05	2	0.000
-1290	78.5	6.00		13.1	5.0491E+04	-1.362E+05	-1.070E+05	2	0.000
-1370	78.5	6.00		13.2	4.8566E+04	-1.231E+05	-1.086E+05	2	0.000
-1450	78.5	6.00		13.2	4.6641E+04	-1.099E+05	-1.101E+05	2	0.000
-1530	78.5	6.00		13.3	4.4716E+04	-9.674E+04	-1.117E+05	2	0.000
-1610	78.5	6.00		8.6	3.9120E+04	-8.305E+04	-7.082E+04	2	0.000
-1690	78.5	6.00		8.7	3.3344E+04	-6.933E+04	-7.240E+04	2	0.000
-1770	78.5	6.00		8.7	2.7567E+04	-5.561E+04	-7.397E+04	2	0.000
-1850	78.5	6.00		8.8	2.1790E+04	-4.189E+04	-7.554E+04	2	0.000
-1930	78.5	6.00		8.8	1.6014E+04	-2.817E+04	-7.711E+04	2	0.000
-2010	78.5	6.00		4.4	1.2322E+04	-2.066E+04	-3.789E+04	2	0.000
-2090	78.5	6.00		4.5	9.6490E+03	-1.618E+04	-3.946E+04	2	0.000
-2170	124.0	6.00		4.3	6.9756E+03	-1.169E+04	-4.103E+04	2	0.000
-2250	78.5	6.00		4.8	4.3023E+03	-7.213E+03	-4.260E+04	2	0.000
-2330	78.5	6.00		4.9	1.6290E+03	-2.731E+03	-4.417E+04	2	0.000
-2410	78.5	6.00		0.7	1.5568E-11	-4.311E-11	-5.880E+03	2	0.000
-2490	78.5	6.00		0.8	4.1995E-12	-4.456E-12	-7.451E+03	2	0.000

Verifica di esercizio (combinazione quasi permanente):

quota	Af	cop.	sigmaf	sigmac	Mx	My	N	comb	Wk
-90	0.0	6.50	0.0	0.0	0.0000E+00	0.0000E+00	0.0000E+00	-	0.000
-170	78.5	6.00		35.7	-7.389E+05	1.5809E+06	-1.900E+05	2	0.000
-250	78.5	6.00		32.5	-5.820E+05	1.2144E+06	-1.916E+05	2	0.000
-330	78.5	6.00		25.2	-4.497E+05	9.1265E+05	-1.504E+05	2	0.000
-410	78.5	6.00		23.6	-3.584E+05	7.1870E+05	-1.519E+05	2	0.000
-490	78.5	6.00		22.0	-2.671E+05	5.2475E+05	-1.535E+05	2	0.000
-570	78.5	6.00		20.4	-1.758E+05	3.3079E+05	-1.551E+05	2	0.000
-650	78.5	6.00		18.8	-8.454E+04	1.3684E+05	-1.566E+05	2	0.000
-730	78.5	6.00		13.4	-2.095E+04	3.7134E+03	-1.186E+05	2	0.000
-810	78.5	6.00		13.6	-3.562E+03	-2.803E+04	-1.201E+05	2	0.000
-890	78.5	6.00		14.0	1.3830E+04	-5.977E+04	-1.217E+05	2	0.000
-970	78.5	6.00		14.5	3.1221E+04	-9.151E+04	-1.233E+05	2	0.000
-1050	78.5	6.00		15.0	4.8613E+04	-1.232E+05	-1.249E+05	2	0.000
-1130	124.0	6.00		10.2	6.0956E+04	-1.448E+05	-8.726E+04	2	0.000
-1210	78.5	6.00		11.1	5.6809E+04	-1.331E+05	-8.883E+04	2	0.000
-1290	78.5	6.00		11.2	5.2662E+04	-1.213E+05	-9.040E+04	2	0.000
-1370	78.5	6.00		11.2	4.8514E+04	-1.096E+05	-9.197E+04	2	0.000
-1450	78.5	6.00		11.3	4.4367E+04	-9.787E+04	-9.354E+04	2	0.000
-1530	78.5	6.00		11.4	4.0220E+04	-8.614E+04	-9.511E+04	2	0.000
-1610	78.5	6.00		7.3	3.4768E+04	-7.395E+04	-5.958E+04	2	0.000
-1690	78.5	6.00		7.4	2.9252E+04	-6.173E+04	-6.115E+04	2	0.000





-1770	78.5	6.00	7.4	2.3736E+04	-4.951E+04	-6.273E+04	2	0.000
-1850	78.5	6.00	7.5	1.8220E+04	-3.730E+04	-6.430E+04	2	0.000
-1930	78.5	6.00	7.6	1.2704E+04	-2.508E+04	-6.587E+04	2	0.000
-2010	78.5	6.00	3.7	9.5083E+03	-1.839E+04	-3.175E+04	2	0.000
-2090	78.5	6.00	3.8	7.4455E+03	-1.440E+04	-3.332E+04	2	0.000
-2170	124.0	6.00	3.7	5.3826E+03	-1.041E+04	-3.489E+04	2	0.000
-2250	78.5	6.00	4.1	3.3198E+03	-6.421E+03	-3.646E+04	2	0.000
-2330	78.5	6.00	4.3	1.2570E+03	-2.431E+03	-3.803E+04	2	0.000
-2410	78.5	6.00	0.5	6.0034E-12	-3.858E-11	-4.709E+03	2	0.000
-2490	78.5	6.00	0.7	-3.774E-12	-7.883E-12	-6.279E+03	2	0.000

Verifica a taglio:

quota	Ast	Vsd	Vsdx	Vsdy	N	comb	VRd,c	VRd,max	VRd,S	Vwd
-90	0.16	33965	32365	10302	-198485	5SLV	50789	231056	95112	44323 Vsd < VRd,
-170	0.16	32999	31427	10064	-198748	5SLV	54714	231056	99037	44323 Vsd < VRd,
-250	0.08	32999	31427	10064	-200319	5SLV	54932	231056	77094	22162 Vsd < VRd,
-330	0.08	10486	9936	3352	-157347	5SLV	48959	231056	71121	22162 Vsd < VRd,
-410	0.08	10486	9936	3352	-158918	5SLV	49177	231056	71339	22162 Vsd < VRd,
-490	0.08	10486	9936	3352	-160489	5SLV	49396	231056	71557	22162 Vsd < VRd,
-570	0.08	10486	9936	3352	-162060	5SLV	49614	231056	71776	22162 Vsd < VRd,
-650	0.08	10486	9936	3352	-163630	5SLV	49832	231056	71994	22162 Vsd < VRd,
-730	0.08	1877	1779	597	-93915	11SLV	40142	231056	62304	22162 Vsd < VRd,
-810	0.08	1877	1779	597	-95486	11SLV	40360	231056	62522	22162 Vsd < VRd,
-890	0.08	1877	1779	597	-97056	11SLV	40579	231056	62740	22162 Vsd < VRd,
-970	0.08	1877	1779	597	-98627	11SLV	40797	231056	62959	22162 Vsd < VRd,
-1050	0.08	1877	1779	597	-100198	11SLV	41015	231056	63177	22162 Vsd < VRd,
-1130	0.08	2108	-2014	-624	-91356	5SLV	44242	231056	66404	22162 Vsd < VRd,
-1210	0.08	2108	-2014	-624	-92927	5SLV	40005	231056	62166	22162 Vsd < VRd,
-1290	0.08	2108	-2014	-624	-94497	5SLV	40223	231056	62385	22162 Vsd < VRd,
-1370	0.08	2108	-2014	-624	-96068	5SLV	40441	231056	62603	22162 Vsd < VRd,
-1450	0.08	2108	-2014	-624	-97639	5SLV	40660	231056	62821	22162 Vsd < VRd,
-1530	0.08	2108	-2014	-624	-99210	5SLV	40878	231056	63040	22162 Vsd < VRd,
-1610	0.08	922	-877	-286	-62358	5SLV	35756	231056	57917	22162 Vsd < VRd,
-1690	0.08	922	-877	-286	-63929	5SLV	35974	231056	58136	22162 Vsd < VRd,
-1770	0.08	922	-877	-286	-65500	5SLV	36192	231056	58354	22162 Vsd < VRd,
-1850	0.08	922	-877	-286	-67071	5SLV	36411	231056	58572	22162 Vsd < VRd,
-1930	0.08	922	-877	-286	-68642	5SLV	36629	231056	58791	22162 Vsd < VRd,
-2010	0.08	87	-75	-46	-51007	4SLU	34178	231056	56340	22162 Vsd < VRd,
-2090	0.08	87	-75	-46	-53049	4SLU	34462	231056	56623	22162 Vsd < VRd,
-2170	0.08	87	-75	-46	-55091	4SLU	39202	231056	61363	22162 Vsd < VRd,
-2250	0.08	87	-75	-46	-57133	4SLU	35029	231056	57191	22162 Vsd < VRd,
-2330	0.08	87	-75	-46	-59175	4SLU	35313	231056	57475	22162 Vsd < VRd,
-2410	0.08	0	0	0	-3415	11SLV	27563	231056	49724	22162 Vsd < VRd,
-2490	0.08	0	0	0	-4985	11SLV	27781	231056	49943	22162 Vsd < VRd,

Palo alle coordinate X=-104 Y=-1191

Sollecitazioni massime in testa palo:

Combinazione corrispondente alla minima compressione in testa

N	Mx	My	Tx	Ty	comb	
-1.746E+05	-1.748E+05	2.0274E+06	4.8918E+03	4.0764E+02	1	sl
-1.746E+05	-1.748E+05	2.0274E+06	4.8918E+03	4.0764E+02	1	ra
-1.746E+05	-1.748E+05	2.0274E+06	4.8918E+03	4.0764E+02	1	fr
-1.746E+05	-1.748E+05	2.0274E+06	4.8918E+03	4.0764E+02	1	qp
-1.511E+05	1.9082E+06	-5.054E+06	-2.303E+04	-7.803E+03	11	SLV fond

Combinazione corrispondente alla massima compressione in testa

N	Mx	My	Tx	Ty	comb	
-3.097E+05	1.0072E+04	3.3754E+06	8.0731E+03	-6.275E+02	4	sl
-2.297E+05	-1.659E+04	2.5206E+06	6.0343E+03	-3.640E+02	2	ra
-2.021E+05	-9.568E+04	2.2740E+06	5.4631E+03	2.1828E+01	2	fr
-1.911E+05	-1.273E+05	2.1754E+06	5.2346E+03	1.7615E+02	2	qp
-1.981E+05	-2.258E+06	9.1085E+06	3.2817E+04	8.6185E+03	5	SLV fond

Combinazione corrispondente al massimo taglio in testa

N	Mx	My	Tx	Ty	comb	
-3.097E+05	1.0072E+04	3.3754E+06	8.0731E+03	-6.275E+02	4	sl
-2.297E+05	-1.659E+04	2.5206E+06	6.0343E+03	-3.640E+02	2	ra
-2.021E+05	-9.568E+04	2.2740E+06	5.4631E+03	2.1828E+01	2	fr
-1.911E+05	-1.273E+05	2.1754E+06	5.2346E+03	1.7615E+02	2	qp
-1.981E+05	-2.258E+06	9.1085E+06	3.2817E+04	8.6185E+03	5	SLV fond

Verifica di capacità portante riferita al palo singolo:

Fattore di correlazione Psi scelto in base alla conoscenza del sito = 1.7  
 Coeff. parziale di sicurezza sulla resistenza laterale = 1.15  
 Coeff. parziale di sicurezza sulla resistenza alla punta = 1.35  
 Portanza laterale di progetto = 292537.1  
 Portanza di punta di progetto = 85555.4  
 verifica condotta in combinazione SLU 4  
 Sforzo normale = -309650.5  
 Peso del palo = 49087.4 \* 1.3  
 Carico totale di progetto = -373464.1  
 Resistenza totale di progetto = 378092.5



Progetto	Titolo	Rev.	Pag.
Orione	Orione_A24a.pdf "TABULATI DI CALCOLO PLINTO DI FONDAZIONE PER AEROGENERATORE TIPO"	0	264

**Tabulati di Calcolo Plinto di Fondazione per Aerogeneratore Tipo - Progetto Impianto Eolico - "Orione"**

Coefficiente di sicurezza = 1.01 > 1

Verifica di resistenza allo stato limite:

quota	Af	cop.	c.s.	Mx	My	N	comb
-90	0.0	6.50	0.00	0.0000E+00	0.0000E+00	0.0000E+00	-
-170	78.5	6.00	3.98	-1.585E+06	6.5536E+06	-1.983E+05	5SLV
-250	78.5	6.00	5.91	-8.466E+04	2.1168E+06	-3.120E+05	4SLU
-330	78.5	6.00	7.47	-1.126E+05	1.5975E+06	-2.467E+05	4SLU
-410	78.5	6.00	7.41	-1.082E+05	1.2604E+06	-2.487E+05	4SLU
-490	78.5	6.00	7.35	-1.039E+05	9.2333E+05	-2.508E+05	4SLU
-570	78.5	6.00	7.29	-9.954E+04	5.8626E+05	-2.528E+05	4SLU
-650	78.5	6.00	7.23	-9.519E+04	2.4920E+05	-2.548E+05	4SLU
-730	78.5	6.00	9.47	-8.796E+04	1.7327E+04	-1.947E+05	4SLU
-810	78.5	6.00	9.37	-7.592E+04	-3.922E+04	-1.967E+05	4SLU
-890	78.5	6.00	9.27	-6.388E+04	-9.578E+04	-1.987E+05	4SLU
-970	78.5	6.00	9.18	-5.184E+04	-1.523E+05	-2.008E+05	4SLU
-1050	78.5	6.00	9.09	-3.979E+04	-2.089E+05	-2.028E+05	4SLU
-1130	124.0	6.00	14.17	-2.922E+04	-2.476E+05	-1.435E+05	4SLU
-1210	78.5	6.00	12.66	-2.342E+04	-2.280E+05	-1.456E+05	4SLU
-1290	78.5	6.00	12.49	-1.763E+04	-2.083E+05	-1.476E+05	4SLU
-1370	78.5	6.00	12.31	-1.183E+04	-1.887E+05	-1.497E+05	4SLU
-1450	78.5	6.00	12.15	-6.038E+03	-1.691E+05	-1.517E+05	4SLU
-1530	78.5	6.00	11.99	-2.431E+02	-1.495E+05	-1.538E+05	4SLU
-1610	78.5	6.00	18.84	7.8941E+02	-1.284E+05	-9.785E+04	4SLU
-1690	78.5	6.00	18.45	1.5876E+03	-1.074E+05	-9.989E+04	4SLU
-1770	78.5	6.00	18.08	2.3858E+03	-8.625E+04	-1.019E+05	4SLU
-1850	78.5	6.00	17.73	3.1840E+03	-6.516E+04	-1.040E+05	4SLU
-1930	78.5	6.00	17.39	3.9822E+03	-4.406E+04	-1.060E+05	4SLU
-2010	78.5	6.00	35.17	3.7042E+03	-3.241E+04	-5.241E+04	4SLU
-2090	78.5	6.00	33.85	2.9006E+03	-2.538E+04	-5.445E+04	4SLU
-2170	124.0	6.00	36.01	2.0969E+03	-1.835E+04	-5.649E+04	4SLU
-2250	78.5	6.00	31.49	1.2933E+03	-1.132E+04	-5.853E+04	4SLU
-2330	78.5	6.00	30.43	4.8969E+02	-4.285E+03	-6.057E+04	4SLU
-2410	78.5	6.00	100.00	-1.230E-12	-4.067E-11	-8.247E+03	4SLU
-2490	78.5	6.00	100.00	-3.447E-12	3.3793E-11	-1.029E+04	4SLU

Verifica di esercizio (combinazione rara):

quota	Af	cop.	sigmaf	sigmac	Mx	My	N	comb	Wk
-90	0.0	6.50	0.0	0.0	0.0000E+00	0.0000E+00	0.0000E+00	-	0.000
-170	78.5	6.00		42.7	-4.390E+04	2.0498E+06	-2.300E+05	2	0.000
-250	78.5	6.00		38.9	-7.108E+04	1.5799E+06	-2.316E+05	2	0.000
-330	78.5	6.00		30.3	-8.611E+04	1.1918E+06	-1.829E+05	2	0.000
-410	78.5	6.00		28.4	-8.087E+04	9.4010E+05	-1.845E+05	2	0.000
-490	78.5	6.00		26.5	-7.563E+04	6.8845E+05	-1.860E+05	2	0.000
-570	78.5	6.00		24.5	-7.038E+04	4.3680E+05	-1.876E+05	2	0.000
-650	78.5	6.00		22.7	-6.514E+04	1.8514E+05	-1.892E+05	2	0.000
-730	78.5	6.00		16.5	-5.871E+04	1.2069E+04	-1.443E+05	2	0.000
-810	78.5	6.00		16.7	-5.029E+04	-3.004E+04	-1.459E+05	2	0.000
-890	78.5	6.00		17.1	-4.188E+04	-7.215E+04	-1.474E+05	2	0.000
-970	78.5	6.00		17.6	-3.347E+04	-1.143E+05	-1.490E+05	2	0.000
-1050	78.5	6.00		18.1	-2.505E+04	-1.564E+05	-1.506E+05	2	0.000
-1130	124.0	6.00		12.4	-1.774E+04	-1.852E+05	-1.064E+05	2	0.000
-1210	78.5	6.00		13.4	-1.401E+04	-1.705E+05	-1.080E+05	2	0.000
-1290	78.5	6.00		13.5	-1.029E+04	-1.557E+05	-1.095E+05	2	0.000
-1370	78.5	6.00		13.5	-6.565E+03	-1.410E+05	-1.111E+05	2	0.000
-1450	78.5	6.00		13.6	-2.841E+03	-1.263E+05	-1.127E+05	2	0.000
-1530	78.5	6.00		13.6	8.8317E+02	-1.116E+05	-1.142E+05	2	0.000
-1610	78.5	6.00		8.9	1.4244E+03	-9.591E+04	-7.253E+04	2	0.000
-1690	78.5	6.00		8.9	1.8090E+03	-8.015E+04	-7.410E+04	2	0.000
-1770	78.5	6.00		9.0	2.1937E+03	-6.439E+04	-7.567E+04	2	0.000
-1850	78.5	6.00		9.0	2.5783E+03	-4.862E+04	-7.725E+04	2	0.000
-1930	78.5	6.00		9.0	2.9630E+03	-3.286E+04	-7.882E+04	2	0.000
-2010	78.5	6.00		4.5	2.6962E+03	-2.417E+04	-3.882E+04	2	0.000
-2090	78.5	6.00		4.7	2.1112E+03	-1.892E+04	-4.039E+04	2	0.000
-2170	124.0	6.00		4.4	1.5263E+03	-1.368E+04	-4.196E+04	2	0.000
-2250	78.5	6.00		4.9	9.4137E+02	-8.437E+03	-4.353E+04	2	0.000
-2330	78.5	6.00		5.0	3.5643E+02	-3.195E+03	-4.510E+04	2	0.000
-2410	78.5	6.00		0.7	-6.661E-13	-3.008E-11	-6.059E+03	2	0.000
-2490	78.5	6.00		0.8	-2.371E-12	2.5625E-11	-7.629E+03	2	0.000

Verifica di esercizio (combinazione quasi permanente):

quota	Af	cop.	sigmaf	sigmac	Mx	My	N	comb	Wk
-90	0.0	6.50	0.0	0.0	0.0000E+00	0.0000E+00	0.0000E+00	-	0.000
-170	78.5	6.00		36.1	-1.128E+05	1.7670E+06	-1.916E+05	2	0.000
-250	78.5	6.00		32.8	-9.822E+04	1.3593E+06	-1.931E+05	2	0.000
-330	78.5	6.00		25.4	-8.391E+04	1.0232E+06	-1.516E+05	2	0.000
-410	78.5	6.00		23.8	-7.002E+04	8.0621E+05	-1.532E+05	2	0.000
-490	78.5	6.00		22.1	-5.613E+04	5.8926E+05	-1.548E+05	2	0.000
-570	78.5	6.00		20.5	-4.224E+04	3.7230E+05	-1.563E+05	2	0.000
-650	78.5	6.00		18.9	-2.835E+04	1.5535E+05	-1.579E+05	2	0.000
-730	78.5	6.00		13.5	-1.797E+04	6.3414E+03	-1.196E+05	2	0.000
-810	78.5	6.00		13.7	-1.341E+04	-2.944E+04	-1.212E+05	2	0.000
-890	78.5	6.00		14.2	-8.862E+03	-6.522E+04	-1.227E+05	2	0.000
-970	78.5	6.00		14.7	-4.311E+03	-1.010E+05	-1.243E+05	2	0.000



<b>Progetto</b>	<b>Titolo</b>	<b>Rev.</b>	<b>Pag.</b>
Orione	Orione_A24a.pdf "TABULATI DI CALCOLO PLINTO DI FONDAZIONE PER AEROGENERATORE TIPO"	0	265

Tabulati di Calcolo Plinto di Fondazione per Aerogeneratore Tipo - Progetto Impianto Eolico - "Orione"

-1050	78.5	6.00	15.1	2.4063E+02	-1.368E+05	-1.259E+05	2	0.000
-1130	124.0	6.00	10.3	3.8161E+03	-1.611E+05	-8.801E+04	2	0.000
-1210	78.5	6.00	11.2	4.2034E+03	-1.482E+05	-8.958E+04	2	0.000
-1290	78.5	6.00	11.3	4.5906E+03	-1.352E+05	-9.115E+04	2	0.000
-1370	78.5	6.00	11.3	4.9779E+03	-1.223E+05	-9.272E+04	2	0.000
-1450	78.5	6.00	11.4	5.3651E+03	-1.093E+05	-9.429E+04	2	0.000
-1530	78.5	6.00	11.5	5.7524E+03	-9.634E+04	-9.586E+04	2	0.000
-1610	78.5	6.00	7.4	5.1425E+03	-8.273E+04	-6.009E+04	2	0.000
-1690	78.5	6.00	7.4	4.4835E+03	-6.909E+04	-6.166E+04	2	0.000
-1770	78.5	6.00	7.5	3.8246E+03	-5.545E+04	-6.323E+04	2	0.000
-1850	78.5	6.00	7.6	3.1657E+03	-4.181E+04	-6.480E+04	2	0.000
-1930	78.5	6.00	7.6	2.5067E+03	-2.817E+04	-6.638E+04	2	0.000
-2010	78.5	6.00	3.7	1.9991E+03	-2.068E+04	-3.203E+04	2	0.000
-2090	78.5	6.00	3.9	1.5654E+03	-1.620E+04	-3.360E+04	2	0.000
-2170	124.0	6.00	3.7	1.1317E+03	-1.171E+04	-3.517E+04	2	0.000
-2250	78.5	6.00	4.1	6.9799E+02	-7.221E+03	-3.674E+04	2	0.000
-2330	78.5	6.00	4.3	2.6428E+02	-2.734E+03	-3.831E+04	2	0.000
-2410	78.5	6.00	0.5	6.0717E-13	-2.460E-11	-4.762E+03	2	0.000
-2490	78.5	6.00	0.7	-1.098E-12	2.3941E-11	-6.332E+03	2	0.000

Verifica a taglio:

quota	Ast	Vsd	Vsdx	Vsdy	N	comb	VRd, c	VRd, max	VRd, S	Vwd
-90	0.16	33930	32817	8619	-198059	5SLV	50730	231056	95053	44323 Vsd < VRd,
-170	0.16	32962	31877	8391	-198324	5SLV	54655	231056	98978	44323 Vsd < VRd,
-250	0.08	32962	31877	8391	-199894	5SLV	54873	231056	77035	22162 Vsd < VRd,
-330	0.08	10470	10175	2470	-157000	5SLV	48911	231056	71072	22162 Vsd < VRd,
-410	0.08	10470	10175	2470	-158571	5SLV	49129	231056	71291	22162 Vsd < VRd,
-490	0.08	10470	10175	2470	-160142	5SLV	49347	231056	71509	22162 Vsd < VRd,
-570	0.08	10470	10175	2470	-161713	5SLV	49566	231056	71727	22162 Vsd < VRd,
-650	0.08	10470	10175	2470	-163283	5SLV	49784	231056	71946	22162 Vsd < VRd,
-730	0.08	1872	1817	452	-94168	11SLV	40177	231056	62339	22162 Vsd < VRd,
-810	0.08	1872	1817	452	-95739	11SLV	40396	231056	62557	22162 Vsd < VRd,
-890	0.08	1872	1817	452	-97309	11SLV	40614	231056	62776	22162 Vsd < VRd,
-970	0.08	1872	1817	452	-98880	11SLV	40832	231056	62994	22162 Vsd < VRd,
-1050	0.08	1872	1817	452	-100451	11SLV	41051	231056	63212	22162 Vsd < VRd,
-1130	0.08	2106	-2029	-566	-91151	5SLV	44214	231056	66376	22162 Vsd < VRd,
-1210	0.08	2106	-2029	-566	-92722	5SLV	39976	231056	62138	22162 Vsd < VRd,
-1290	0.08	2106	-2029	-566	-94293	5SLV	40195	231056	62356	22162 Vsd < VRd,
-1370	0.08	2106	-2029	-566	-95864	5SLV	40413	231056	62575	22162 Vsd < VRd,
-1450	0.08	2106	-2029	-566	-97435	5SLV	40631	231056	62793	22162 Vsd < VRd,
-1530	0.08	2106	-2029	-566	-99005	5SLV	40850	231056	63011	22162 Vsd < VRd,
-1610	0.08	921	-892	-230	-62220	5SLV	35736	231056	57898	22162 Vsd < VRd,
-1690	0.08	921	-892	-230	-63791	5SLV	35955	231056	58117	22162 Vsd < VRd,
-1770	0.08	921	-892	-230	-65362	5SLV	36173	231056	58335	22162 Vsd < VRd,
-1850	0.08	921	-892	-230	-66933	5SLV	36392	231056	58553	22162 Vsd < VRd,
-1930	0.08	921	-892	-230	-68503	5SLV	36610	231056	58772	22162 Vsd < VRd,
-2010	0.08	88	-88	-10	-52407	4SLU	34372	231056	56534	22162 Vsd < VRd,
-2090	0.08	88	-88	-10	-54449	4SLU	34656	231056	56818	22162 Vsd < VRd,
-2170	0.08	88	-88	-10	-56491	4SLU	39396	231056	61558	22162 Vsd < VRd,
-2250	0.08	88	-88	-10	-58533	4SLU	35224	231056	57386	22162 Vsd < VRd,
-2330	0.08	88	-88	-10	-60575	4SLU	35508	231056	57669	22162 Vsd < VRd,
-2410	0.08	0	0	0	-4051	3SLV	27651	231056	49813	22162 Vsd < VRd,
-2490	0.08	0	0	0	-5622	3SLV	27869	231056	50031	22162 Vsd < VRd,

Palo alle coordinate X=309 Y=-1155

Sollecitazioni massime in testa palo:

Combinazione corrispondente alla minima compressione in testa

N	Mx	My	Tx	Ty	comb	
-1.745E+05	5.2449E+05	1.9668E+06	4.7506E+03	-1.224E+03	1	sl
-1.745E+05	5.2449E+05	1.9668E+06	4.7506E+03	-1.224E+03	1	ra
-1.745E+05	5.2449E+05	1.9668E+06	4.7506E+03	-1.224E+03	1	fr
-1.745E+05	5.2449E+05	1.9668E+06	4.7506E+03	-1.224E+03	1	qp
-1.504E+05	-1.572E+06	-5.111E+06	-2.316E+04	7.0394E+03	7	SLV fond

Combinazione corrispondente alla massima compressione in testa

N	Mx	My	Tx	Ty	comb	
-3.076E+05	1.4161E+06	3.1776E+06	7.5709E+03	-3.858E+03	4	sl
-2.283E+05	1.0140E+06	2.3807E+06	5.6807E+03	-2.735E+03	2	ra
-2.014E+05	7.6923E+05	2.1738E+06	5.2157E+03	-1.980E+03	2	fr
-1.907E+05	6.7133E+05	2.0910E+06	5.0297E+03	-1.677E+03	2	qp
-1.986E+05	2.6211E+06	9.0444E+06	3.2664E+04	-9.488E+03	9	SLV fond

Combinazione corrispondente al massimo taglio in testa

N	Mx	My	Tx	Ty	comb	
-3.076E+05	1.4161E+06	3.1776E+06	7.5709E+03	-3.858E+03	4	sl
-2.283E+05	1.0140E+06	2.3807E+06	5.6807E+03	-2.735E+03	2	ra
-2.014E+05	7.6923E+05	2.1738E+06	5.2157E+03	-1.980E+03	2	fr
-1.907E+05	6.7133E+05	2.0910E+06	5.0297E+03	-1.677E+03	2	qp
-1.986E+05	2.6211E+06	9.0444E+06	3.2664E+04	-9.488E+03	9	SLV fond

Verifica di capacità portante riferita al palo singolo:

Fattore di correlazione Psi scelto in base alla conoscenza del sito = 1.7



Progetto	Titolo	Rev.	Pag.
Orione	Orione_A24a.pdf "TABULATI DI CALCOLO PLINTO DI FONDAZIONE PER AEROGENERATORE TIPO"	0	266

**Tabulati di Calcolo Plinto di Fondazione per Aerogeneratore Tipo - Progetto Impianto Eolico - "Orione"**

Coeff. parziale di sicurezza sulla resistenza laterale = 1.15  
 Coeff. parziale di sicurezza sulla resistenza alla punta = 1.35  
 Portanza laterale di progetto = 292537.1  
 Portanza di punta di progetto = 85555.4  
 verifica condotta in combinazione SLU 4  
 Sforzo normale = -307577.7  
 Peso del palo = 49087.4 \* 1.3  
 Carico totale di progetto = -371391.3  
 Resistenza totale di progetto = 378092.5  
 Coefficiente di sicurezza = 1.02 > 1

Verifica di resistenza allo stato limite:

quota	Af	cop.	c.s.	Mx	My	N	comb
-90	0.0	6.50	0.00	0.0000E+00	0.0000E+00	0.0000E+00	-
-170	78.5	6.00	3.96	1.8796E+06	6.5018E+06	-1.988E+05	9SLV
-250	78.5	6.00	5.95	8.0649E+05	1.9985E+06	-3.099E+05	4SLU
-330	78.5	6.00	7.52	5.6446E+05	1.5113E+06	-2.450E+05	4SLU
-410	78.5	6.00	7.46	4.2681E+05	1.1937E+06	-2.470E+05	4SLU
-490	78.5	6.00	7.40	2.8917E+05	8.7623E+05	-2.491E+05	4SLU
-570	78.5	6.00	7.34	1.5152E+05	5.5871E+05	-2.511E+05	4SLU
-650	78.5	6.00	7.28	1.3874E+04	2.4119E+05	-2.532E+05	4SLU
-730	78.5	6.00	9.53	-7.675E+04	2.2465E+04	-1.933E+05	4SLU
-810	78.5	6.00	9.43	-8.900E+04	-3.160E+04	-1.954E+05	4SLU
-890	78.5	6.00	9.34	-1.012E+05	-8.567E+04	-1.974E+05	4SLU
-970	78.5	6.00	9.24	-1.135E+05	-1.397E+05	-1.995E+05	4SLU
-1050	78.5	6.00	9.15	-1.257E+05	-1.938E+05	-2.015E+05	4SLU
-1130	124.0	6.00	14.27	-1.319E+05	-2.310E+05	-1.426E+05	4SLU
-1210	78.5	6.00	12.75	-1.182E+05	-2.129E+05	-1.446E+05	4SLU
-1290	78.5	6.00	12.57	-1.045E+05	-1.948E+05	-1.466E+05	4SLU
-1370	78.5	6.00	12.40	-9.076E+04	-1.768E+05	-1.487E+05	4SLU
-1450	78.5	6.00	12.23	-7.704E+04	-1.587E+05	-1.507E+05	4SLU
-1530	78.5	6.00	12.07	-6.332E+04	-1.406E+05	-1.528E+05	4SLU
-1610	78.5	6.00	18.97	-5.349E+04	-1.209E+05	-9.718E+04	4SLU
-1690	78.5	6.00	18.58	-4.386E+04	-1.011E+05	-9.922E+04	4SLU
-1770	78.5	6.00	18.20	-3.422E+04	-8.131E+04	-1.013E+05	4SLU
-1850	78.5	6.00	17.84	-2.458E+04	-6.151E+04	-1.033E+05	4SLU
-1930	78.5	6.00	17.50	-1.495E+04	-4.171E+04	-1.053E+05	4SLU
-2010	78.5	6.00	35.42	-1.028E+04	-3.074E+04	-5.204E+04	4SLU
-2090	78.5	6.00	34.08	-8.053E+03	-2.407E+04	-5.408E+04	4SLU
-2170	124.0	6.00	36.24	-5.822E+03	-1.740E+04	-5.613E+04	4SLU
-2250	78.5	6.00	31.69	-3.591E+03	-1.073E+04	-5.817E+04	4SLU
-2330	78.5	6.00	30.61	-1.360E+03	-4.063E+03	-6.021E+04	4SLU
-2410	78.5	6.00	100.00	-4.449E-12	-3.160E-11	-8.177E+03	4SLU
-2490	78.5	6.00	100.00	4.4187E-12	2.0925E-11	-1.022E+04	4SLU

Verifica di esercizio (combinazione rara):

quota	Af	cop.	sigmaf	sigmac	Mx	My	N	comb	Wk
-90	0.0	6.50	0.0	0.0	0.0000E+00	0.0000E+00	0.0000E+00	-	0.000
-170	78.5	6.00		42.9	7.9770E+05	1.9379E+06	-2.286E+05	2	0.000
-250	78.5	6.00		39.0	5.8160E+05	1.4959E+06	-2.302E+05	2	0.000
-330	78.5	6.00		30.2	4.0948E+05	1.1305E+06	-1.818E+05	2	0.000
-410	78.5	6.00		28.3	3.1068E+05	8.9265E+05	-1.833E+05	2	0.000
-490	78.5	6.00		26.3	2.1188E+05	6.5484E+05	-1.849E+05	2	0.000
-570	78.5	6.00		24.3	1.1307E+05	4.1703E+05	-1.865E+05	2	0.000
-650	78.5	6.00		22.4	1.4268E+04	1.7922E+05	-1.880E+05	2	0.000
-730	78.5	6.00		16.4	-5.098E+04	1.5470E+04	-1.434E+05	2	0.000
-810	78.5	6.00		16.7	-6.030E+04	-2.485E+04	-1.450E+05	2	0.000
-890	78.5	6.00		17.1	-6.963E+04	-6.517E+04	-1.466E+05	2	0.000
-970	78.5	6.00		17.6	-7.895E+04	-1.055E+05	-1.481E+05	2	0.000
-1050	78.5	6.00		18.1	-8.827E+04	-1.458E+05	-1.497E+05	2	0.000
-1130	124.0	6.00		12.4	-9.317E+04	-1.735E+05	-1.057E+05	2	0.000
-1210	78.5	6.00		13.4	-8.360E+04	-1.599E+05	-1.073E+05	2	0.000
-1290	78.5	6.00		13.5	-7.404E+04	-1.462E+05	-1.089E+05	2	0.000
-1370	78.5	6.00		13.5	-6.448E+04	-1.326E+05	-1.104E+05	2	0.000
-1450	78.5	6.00		13.5	-5.492E+04	-1.190E+05	-1.120E+05	2	0.000
-1530	78.5	6.00		13.6	-4.535E+04	-1.054E+05	-1.136E+05	2	0.000
-1610	78.5	6.00		8.8	-3.836E+04	-9.058E+04	-7.209E+04	2	0.000
-1690	78.5	6.00		8.9	-3.149E+04	-7.573E+04	-7.366E+04	2	0.000
-1770	78.5	6.00		8.9	-2.462E+04	-6.088E+04	-7.523E+04	2	0.000
-1850	78.5	6.00		9.0	-1.776E+04	-4.604E+04	-7.680E+04	2	0.000
-1930	78.5	6.00		9.0	-1.089E+04	-3.119E+04	-7.837E+04	2	0.000
-2010	78.5	6.00		4.5	-7.536E+03	-2.297E+04	-3.858E+04	2	0.000
-2090	78.5	6.00		4.6	-5.901E+03	-1.799E+04	-4.015E+04	2	0.000
-2170	124.0	6.00		4.4	-4.266E+03	-1.300E+04	-4.172E+04	2	0.000
-2250	78.5	6.00		4.9	-2.631E+03	-8.020E+03	-4.329E+04	2	0.000
-2330	78.5	6.00		5.0	-9.962E+02	-3.037E+03	-4.486E+04	2	0.000
-2410	78.5	6.00		0.7	-3.702E-12	-2.401E-11	-6.012E+03	2	0.000
-2490	78.5	6.00		0.8	3.1192E-12	1.4644E-11	-7.583E+03	2	0.000

Verifica di esercizio (combinazione quasi permanente):

quota	Af	cop.	sigmaf	sigmac	Mx	My	N	comb	Wk
-90	0.0	6.50	0.0	0.0	0.0000E+00	0.0000E+00	0.0000E+00	-	0.000
-170	78.5	6.00		36.1	5.3821E+05	1.6989E+06	-1.911E+05	2	0.000
-250	78.5	6.00		32.8	4.0516E+05	1.3075E+06	-1.927E+05	2	0.000



<b>Progetto</b>	<b>Titolo</b>	<b>Rev.</b>	<b>Pag.</b>
Orione	Orione_A24a.pdf "TABULATI DI CALCOLO PLINTO DI FONDAZIONE PER AEROGENERATORE TIPO"	0	267

-330	78.5	6.00	25.4	2.9703E+05	9.8464E+05	-1.513E+05	2	0.000
-410	78.5	6.00	23.7	2.3043E+05	7.7611E+05	-1.528E+05	2	0.000
-490	78.5	6.00	22.1	1.6383E+05	5.6758E+05	-1.544E+05	2	0.000
-570	78.5	6.00	20.4	9.7228E+04	3.5905E+05	-1.560E+05	2	0.000
-650	78.5	6.00	18.8	3.0629E+04	1.5051E+05	-1.576E+05	2	0.000
-730	78.5	6.00	13.4	-1.432E+04	7.2306E+03	-1.193E+05	2	0.000
-810	78.5	6.00	13.7	-2.319E+04	-2.731E+04	-1.209E+05	2	0.000
-890	78.5	6.00	14.2	-3.206E+04	-6.185E+04	-1.224E+05	2	0.000
-970	78.5	6.00	14.7	-4.093E+04	-9.639E+04	-1.240E+05	2	0.000
-1050	78.5	6.00	15.1	-4.980E+04	-1.309E+05	-1.256E+05	2	0.000
-1130	124.0	6.00	10.3	-5.540E+04	-1.545E+05	-8.780E+04	2	0.000
-1210	78.5	6.00	11.2	-5.033E+04	-1.421E+05	-8.937E+04	2	0.000
-1290	78.5	6.00	11.3	-4.527E+04	-1.297E+05	-9.094E+04	2	0.000
-1370	78.5	6.00	11.3	-4.020E+04	-1.173E+05	-9.251E+04	2	0.000
-1450	78.5	6.00	11.4	-3.514E+04	-1.049E+05	-9.408E+04	2	0.000
-1530	78.5	6.00	11.4	-3.007E+04	-9.256E+04	-9.565E+04	2	0.000
-1610	78.5	6.00	7.4	-2.566E+04	-7.950E+04	-5.995E+04	2	0.000
-1690	78.5	6.00	7.4	-2.127E+04	-6.640E+04	-6.152E+04	2	0.000
-1770	78.5	6.00	7.5	-1.689E+04	-5.330E+04	-6.309E+04	2	0.000
-1850	78.5	6.00	7.5	-1.250E+04	-4.021E+04	-6.466E+04	2	0.000
-1930	78.5	6.00	7.6	-8.117E+03	-2.711E+04	-6.623E+04	2	0.000
-2010	78.5	6.00	3.7	-5.829E+03	-1.991E+04	-3.195E+04	2	0.000
-2090	78.5	6.00	3.9	-4.564E+03	-1.559E+04	-3.352E+04	2	0.000
-2170	124.0	6.00	3.7	-3.300E+03	-1.127E+04	-3.509E+04	2	0.000
-2250	78.5	6.00	4.1	-2.035E+03	-6.952E+03	-3.666E+04	2	0.000
-2330	78.5	6.00	4.3	-7.706E+02	-2.632E+03	-3.823E+04	2	0.000
-2410	78.5	6.00	0.5	-4.975E-12	-2.266E-11	-4.746E+03	2	0.000
-2490	78.5	6.00	0.7	1.8459E-12	8.0336E-12	-6.317E+03	2	0.000

Verifica a taglio:

quota	Ast	Vsd	Vsdx	Vsdy	N	comb	VRd, c	VRd, max	VRd, S	Vwd
-90	0.16	34014	32664	-9488	-198579	9SLV	50802	231056	95125	44323 Vsd < VRd,
-170	0.16	33047	31725	-9254	-198841	9SLV	54727	231056	99050	44323 Vsd < VRd,
-250	0.08	33047	31725	-9254	-200412	9SLV	54945	231056	77107	22162 Vsd < VRd,
-330	0.08	10510	10095	-2924	-157422	9SLV	48969	231056	71131	22162 Vsd < VRd,
-410	0.08	10510	10095	-2924	-158993	9SLV	49188	231056	71349	22162 Vsd < VRd,
-490	0.08	10510	10095	-2924	-160563	9SLV	49406	231056	71568	22162 Vsd < VRd,
-570	0.08	10510	10095	-2924	-162134	9SLV	49624	231056	71786	22162 Vsd < VRd,
-650	0.08	10510	10095	-2924	-163705	9SLV	49843	231056	72004	22162 Vsd < VRd,
-730	0.08	1880	1804	-526	-93770	7SLV	40122	231056	62284	22162 Vsd < VRd,
-810	0.08	1880	1804	-526	-95341	7SLV	40340	231056	62502	22162 Vsd < VRd,
-890	0.08	1880	1804	-526	-96912	7SLV	40559	231056	62720	22162 Vsd < VRd,
-970	0.08	1880	1804	-526	-98482	7SLV	40777	231056	62939	22162 Vsd < VRd,
-1050	0.08	1880	1804	-526	-100053	7SLV	40995	231056	63157	22162 Vsd < VRd,
-1130	0.08	2110	-2024	596	-91399	9SLV	44249	231056	66410	22162 Vsd < VRd,
-1210	0.08	2110	-2024	596	-92970	9SLV	40011	231056	62172	22162 Vsd < VRd,
-1290	0.08	2110	-2024	596	-94541	9SLV	40229	231056	62391	22162 Vsd < VRd,
-1370	0.08	2110	-2024	596	-96112	9SLV	40447	231056	62609	22162 Vsd < VRd,
-1450	0.08	2110	-2024	596	-97683	9SLV	40666	231056	62827	22162 Vsd < VRd,
-1530	0.08	2110	-2024	596	-99253	9SLV	40884	231056	63046	22162 Vsd < VRd,
-1610	0.08	924	-887	259	-62388	9SLV	35760	231056	57922	22162 Vsd < VRd,
-1690	0.08	924	-887	259	-63959	9SLV	35978	231056	58140	22162 Vsd < VRd,
-1770	0.08	924	-887	259	-65530	9SLV	36197	231056	58358	22162 Vsd < VRd,
-1850	0.08	924	-887	259	-67100	9SLV	36415	231056	58577	22162 Vsd < VRd,
-1930	0.08	924	-887	259	-68671	9SLV	36633	231056	58795	22162 Vsd < VRd,
-2010	0.08	88	-83	28	-52043	4SLU	34322	231056	56484	22162 Vsd < VRd,
-2090	0.08	88	-83	28	-54085	4SLU	34606	231056	56767	22162 Vsd < VRd,
-2170	0.08	88	-83	28	-56127	4SLU	39346	231056	61507	22162 Vsd < VRd,
-2250	0.08	88	-83	28	-58169	4SLU	35173	231056	57335	22162 Vsd < VRd,
-2330	0.08	88	-83	28	-60211	4SLU	35457	231056	57619	22162 Vsd < VRd,
-2410	0.08	0	0	0	-3771	3SLV	27612	231056	49774	22162 Vsd < VRd,
-2490	0.08	0	0	0	-5342	3SLV	27831	231056	49992	22162 Vsd < VRd,

Palo alle coordinate X=686 Y=-979

Sollecitazioni massime in testa palo:

Combinazione corrispondente alla minima compressione in testa

N	Mx	My	Tx	Ty	comb	
-1.745E+05	1.1601E+06	1.6707E+06	4.0595E+03	-2.708E+03	1	sl
-1.745E+05	1.1601E+06	1.6707E+06	4.0595E+03	-2.708E+03	1	ra
-1.745E+05	1.1601E+06	1.6707E+06	4.0595E+03	-2.708E+03	1	fr
-1.745E+05	1.1601E+06	1.6707E+06	4.0595E+03	-2.708E+03	1	qp
-1.514E+05	-9.580E+05	-5.390E+06	-2.379E+04	5.6407E+03	7	SLV fond

Combinazione corrispondente alla massima compressione in testa

N	Mx	My	Tx	Ty	comb	
-2.958E+05	2.5558E+06	2.3745E+06	5.6797E+03	-6.468E+03	4	sl
-2.205E+05	1.8586E+06	1.8058E+06	4.3278E+03	-4.673E+03	2	ra
-1.975E+05	1.5094E+06	1.7382E+06	4.1936E+03	-3.690E+03	2	fr
-1.883E+05	1.3697E+06	1.7112E+06	4.1400E+03	-3.297E+03	2	qp
-1.975E+05	3.2783E+06	8.7310E+06	3.1909E+04	-1.106E+04	9	SLV fond

Combinazione corrispondente al massimo taglio in testa

N	Mx	My	Tx	Ty	comb	
-2.958E+05	2.5558E+06	2.3745E+06	5.6797E+03	-6.468E+03	4	sl



Progetto	Titolo	Rev.	Pag.
Orione	Orione_A24a.pdf "TABULATI DI CALCOLO PLINTO DI FONDAZIONE PER AEROGENERATORE TIPO"	0	268

**Tabulati di Calcolo Plinto di Fondazione per Aerogeneratore Tipo - Progetto Impianto Eolico - "Orione"**

-2.205E+05 1.8586E+06 1.8058E+06 4.3278E+03 -4.673E+03 2 ra  
 -1.975E+05 1.5094E+06 1.7382E+06 4.1936E+03 -3.690E+03 2 fr  
 -1.883E+05 1.3697E+06 1.7112E+06 4.1400E+03 -3.297E+03 2 qp  
 -1.975E+05 3.2783E+06 8.7310E+06 3.1909E+04 -1.106E+04 9 SLV fond

Verifica di capacità portante riferita al palo singolo:

Fattore di correlazione Psi scelto in base alla conoscenza del sito = 1.7  
 Coeff. parziale di sicurezza sulla resistenza laterale = 1.15  
 Coeff. parziale di sicurezza sulla resistenza alla punta = 1.35  
 Portanza laterale di progetto = 292537.1  
 Portanza di punta di progetto = 85555.4  
 verifica condotta in combinazione SLU 4  
 Sforzo normale = -295799.3  
 Peso del palo = 49087.4 \* 1.3  
 Carico totale di progetto = -359612.9  
 Resistenza totale di progetto = 378092.5  
 Coefficiente di sicurezza = 1.05 > 1

Verifica di resistenza allo stato limite:

quota	Af	cop.	c.s.	Mx	My	N	comb
-90	0.0	6.50	0.00	0.0000E+00	0.0000E+00	0.0000E+00	-
-170	78.5	6.00	4.00	2.4120E+06	6.2483E+06	-1.978E+05	9SLV
-250	78.5	6.00	6.06	1.5470E+06	3.7703E+06	-1.994E+05	9SLV
-330	78.5	6.00	7.83	1.1149E+06	1.1323E+06	-2.355E+05	4SLU
-410	78.5	6.00	7.76	8.6203E+05	8.9544E+05	-2.375E+05	4SLU
-490	78.5	6.00	7.69	6.0921E+05	6.5859E+05	-2.396E+05	4SLU
-570	78.5	6.00	7.63	3.5639E+05	4.2174E+05	-2.416E+05	4SLU
-650	78.5	6.00	7.57	1.0357E+05	1.8490E+05	-2.436E+05	4SLU
-730	78.5	6.00	9.92	-6.648E+04	2.1507E+04	-1.858E+05	4SLU
-810	78.5	6.00	9.81	-9.859E+04	-1.946E+04	-1.878E+05	4SLU
-890	78.5	6.00	9.71	-1.307E+05	-6.042E+04	-1.899E+05	4SLU
-970	78.5	6.00	9.60	-1.628E+05	-1.014E+05	-1.919E+05	4SLU
-1050	78.5	6.00	9.50	-1.949E+05	-1.423E+05	-1.940E+05	4SLU
-1130	124.0	6.00	14.85	-2.148E+05	-1.706E+05	-1.370E+05	4SLU
-1210	78.5	6.00	13.26	-1.947E+05	-1.574E+05	-1.390E+05	4SLU
-1290	78.5	6.00	13.07	-1.747E+05	-1.442E+05	-1.410E+05	4SLU
-1370	78.5	6.00	12.88	-1.546E+05	-1.311E+05	-1.431E+05	4SLU
-1450	78.5	6.00	12.70	-1.345E+05	-1.179E+05	-1.451E+05	4SLU
-1530	78.5	6.00	12.52	-1.145E+05	-1.047E+05	-1.472E+05	4SLU
-1610	78.5	6.00	19.74	-9.752E+04	-9.004E+04	-9.339E+04	4SLU
-1690	78.5	6.00	19.31	-8.072E+04	-7.532E+04	-9.543E+04	4SLU
-1770	78.5	6.00	18.91	-6.393E+04	-6.061E+04	-9.747E+04	4SLU
-1850	78.5	6.00	18.52	-4.714E+04	-4.590E+04	-9.951E+04	4SLU
-1930	78.5	6.00	18.15	-3.034E+04	-3.119E+04	-1.016E+05	4SLU
-2010	78.5	6.00	36.88	-2.167E+04	-2.301E+04	-4.997E+04	4SLU
-2090	78.5	6.00	35.44	-1.697E+04	-1.802E+04	-5.201E+04	4SLU
-2170	124.0	6.00	37.63	-1.227E+04	-1.302E+04	-5.406E+04	4SLU
-2250	78.5	6.00	32.86	-7.568E+03	-8.033E+03	-5.610E+04	4SLU
-2330	78.5	6.00	31.70	-2.865E+03	-3.041E+03	-5.814E+04	4SLU
-2410	78.5	6.00	100.00	-9.523E-12	-3.814E-11	-7.782E+03	4SLU
-2490	78.5	6.00	100.00	-2.702E-12	-2.584E-11	-9.824E+03	4SLU

Verifica di esercizio (combinazione rara):

quota	Af	cop.	sigmaf	sigmac	Mx	My	N	comb	Wk
-90	0.0	6.50	0.0	0.0	0.0000E+00	0.0000E+00	0.0000E+00	-	0.000
-170	78.5	6.00		42.0	1.4878E+06	1.4704E+06	-2.208E+05	2	0.000
-250	78.5	6.00		38.0	1.1173E+06	1.1357E+06	-2.224E+05	2	0.000
-330	78.5	6.00		29.4	8.1663E+05	8.5907E+05	-1.754E+05	2	0.000
-410	78.5	6.00		27.4	6.3251E+05	6.7902E+05	-1.770E+05	2	0.000
-490	78.5	6.00		25.4	4.4839E+05	4.9896E+05	-1.786E+05	2	0.000
-570	78.5	6.00		23.5	2.6427E+05	3.1891E+05	-1.801E+05	2	0.000
-650	78.5	6.00		21.5	8.0149E+04	1.3886E+05	-1.817E+05	2	0.000
-730	78.5	6.00		15.8	-4.391E+04	1.4723E+04	-1.384E+05	2	0.000
-810	78.5	6.00		16.1	-6.787E+04	-1.621E+04	-1.400E+05	2	0.000
-890	78.5	6.00		16.6	-9.183E+04	-4.714E+04	-1.415E+05	2	0.000
-970	78.5	6.00		17.1	-1.158E+05	-7.807E+04	-1.431E+05	2	0.000
-1050	78.5	6.00		17.6	-1.398E+05	-1.090E+05	-1.447E+05	2	0.000
-1130	124.0	6.00		12.1	-1.547E+05	-1.303E+05	-1.020E+05	2	0.000
-1210	78.5	6.00		13.1	-1.404E+05	-1.202E+05	-1.036E+05	2	0.000
-1290	78.5	6.00		13.1	-1.261E+05	-1.100E+05	-1.051E+05	2	0.000
-1370	78.5	6.00		13.1	-1.118E+05	-9.989E+04	-1.067E+05	2	0.000
-1450	78.5	6.00		13.1	-9.755E+04	-8.976E+04	-1.083E+05	2	0.000
-1530	78.5	6.00		13.2	-8.325E+04	-7.962E+04	-1.098E+05	2	0.000
-1610	78.5	6.00		8.6	-7.097E+04	-6.847E+04	-6.956E+04	2	0.000
-1690	78.5	6.00		8.6	-5.880E+04	-5.726E+04	-7.113E+04	2	0.000
-1770	78.5	6.00		8.6	-4.662E+04	-4.606E+04	-7.270E+04	2	0.000
-1850	78.5	6.00		8.7	-3.445E+04	-3.486E+04	-7.427E+04	2	0.000
-1930	78.5	6.00		8.7	-2.227E+04	-2.365E+04	-7.584E+04	2	0.000
-2010	78.5	6.00		4.3	-1.595E+04	-1.743E+04	-3.720E+04	2	0.000
-2090	78.5	6.00		4.5	-1.249E+04	-1.365E+04	-3.877E+04	2	0.000
-2170	124.0	6.00		4.3	-9.031E+03	-9.869E+03	-4.034E+04	2	0.000
-2250	78.5	6.00		4.7	-5.570E+03	-6.087E+03	-4.191E+04	2	0.000
-2330	78.5	6.00		4.9	-2.109E+03	-2.305E+03	-4.348E+04	2	0.000
-2410	78.5	6.00		0.6	-7.319E-12	-2.907E-11	-5.748E+03	2	0.000
-2490	78.5	6.00		0.8	-2.771E-12	-2.026E-11	-7.319E+03	2	0.000



Progetto	Titolo	Rev.	Pag.
Orione	Orione_A24a.pdf "TABULATI DI CALCOLO PLINTO DI FONDAZIONE PER AEROGENERATORE TIPO"	0	269

Verifica di esercizio (combinazione quasi permanente):

quota	Af	cop.	sigmaf	sigmac	Mx	My	N	comb	Wk
-90	0.0	6.50	0.0	0.0	0.0000E+00	0.0000E+00	0.0000E+00	-	0.000
-170	78.5	6.00		35.8	1.1075E+06	1.3899E+06	-1.888E+05	2	0.000
-250	78.5	6.00		32.5	8.4544E+05	1.0692E+06	-1.903E+05	2	0.000
-330	78.5	6.00		25.1	6.3029E+05	8.0484E+05	-1.493E+05	2	0.000
-410	78.5	6.00		23.5	4.9330E+05	6.3451E+05	-1.509E+05	2	0.000
-490	78.5	6.00		21.8	3.5631E+05	4.6418E+05	-1.525E+05	2	0.000
-570	78.5	6.00		20.2	2.1933E+05	2.9384E+05	-1.541E+05	2	0.000
-650	78.5	6.00		18.5	8.2341E+04	1.2351E+05	-1.556E+05	2	0.000
-730	78.5	6.00		13.2	-1.101E+04	6.4369E+03	-1.178E+05	2	0.000
-810	78.5	6.00		13.6	-3.163E+04	-2.185E+04	-1.193E+05	2	0.000
-890	78.5	6.00		14.1	-5.225E+04	-5.015E+04	-1.209E+05	2	0.000
-970	78.5	6.00		14.5	-7.287E+04	-7.844E+04	-1.225E+05	2	0.000
-1050	78.5	6.00		15.0	-9.349E+04	-1.067E+05	-1.241E+05	2	0.000
-1130	124.0	6.00		10.2	-1.071E+05	-1.260E+05	-8.667E+04	2	0.000
-1210	78.5	6.00		11.1	-9.799E+04	-1.159E+05	-8.824E+04	2	0.000
-1290	78.5	6.00		11.1	-8.884E+04	-1.058E+05	-8.981E+04	2	0.000
-1370	78.5	6.00		11.2	-7.969E+04	-9.573E+04	-9.138E+04	2	0.000
-1450	78.5	6.00		11.3	-7.055E+04	-8.563E+04	-9.295E+04	2	0.000
-1530	78.5	6.00		11.3	-6.140E+04	-7.554E+04	-9.452E+04	2	0.000
-1610	78.5	6.00		7.3	-5.259E+04	-6.487E+04	-5.918E+04	2	0.000
-1690	78.5	6.00		7.3	-4.379E+04	-5.418E+04	-6.075E+04	2	0.000
-1770	78.5	6.00		7.4	-3.500E+04	-4.349E+04	-6.232E+04	2	0.000
-1850	78.5	6.00		7.5	-2.621E+04	-3.280E+04	-6.389E+04	2	0.000
-1930	78.5	6.00		7.5	-1.741E+04	-2.211E+04	-6.547E+04	2	0.000
-2010	78.5	6.00		3.7	-1.268E+04	-1.624E+04	-3.153E+04	2	0.000
-2090	78.5	6.00		3.8	-9.928E+03	-1.271E+04	-3.310E+04	2	0.000
-2170	124.0	6.00		3.7	-7.178E+03	-9.191E+03	-3.467E+04	2	0.000
-2250	78.5	6.00		4.1	-4.427E+03	-5.669E+03	-3.624E+04	2	0.000
-2330	78.5	6.00		4.2	-1.676E+03	-2.146E+03	-3.781E+04	2	0.000
-2410	78.5	6.00		0.5	-7.289E-12	-2.785E-11	-4.667E+03	2	0.000
-2490	78.5	6.00		0.7	-5.925E-12	-2.202E-11	-6.237E+03	2	0.000

Verifica a taglio:

quota	Ast	Vsd	Vsdx	Vsdy	N	comb	VRd,c	VRd,max	VRd,S	Vwd
-90	0.16	33770	31909	-11056	-197512	9SLV	50653	231056	94977	44323 Vsd < VRd,
-170	0.16	32809	30975	-10813	-197780	9SLV	54579	231056	98902	44323 Vsd < VRd,
-250	0.08	32809	30975	-10813	-199351	9SLV	54797	231056	76959	22162 Vsd < VRd,
-330	0.08	10401	9703	-3748	-156561	9SLV	48850	231056	71011	22162 Vsd < VRd,
-410	0.08	10401	9703	-3748	-158132	9SLV	49068	231056	71230	22162 Vsd < VRd,
-490	0.08	10401	9703	-3748	-159703	9SLV	49286	231056	71448	22162 Vsd < VRd,
-570	0.08	10401	9703	-3748	-161273	9SLV	49505	231056	71666	22162 Vsd < VRd,
-650	0.08	10401	9703	-3748	-162844	9SLV	49723	231056	71885	22162 Vsd < VRd,
-730	0.08	1863	1741	-662	-94414	7SLV	40211	231056	62373	22162 Vsd < VRd,
-810	0.08	1863	1741	-662	-95985	7SLV	40430	231056	62591	22162 Vsd < VRd,
-890	0.08	1863	1741	-662	-97555	7SLV	40648	231056	62810	22162 Vsd < VRd,
-970	0.08	1863	1741	-662	-99126	7SLV	40866	231056	63028	22162 Vsd < VRd,
-1050	0.08	1863	1741	-662	-100697	7SLV	41085	231056	63246	22162 Vsd < VRd,
-1130	0.08	2100	-1998	649	-90894	9SLV	44178	231056	66340	22162 Vsd < VRd,
-1210	0.08	2100	-1998	649	-92465	9SLV	39940	231056	62102	22162 Vsd < VRd,
-1290	0.08	2100	-1998	649	-94035	9SLV	40159	231056	62320	22162 Vsd < VRd,
-1370	0.08	2100	-1998	649	-95606	9SLV	40377	231056	62539	22162 Vsd < VRd,
-1450	0.08	2100	-1998	649	-97177	9SLV	40595	231056	62757	22162 Vsd < VRd,
-1530	0.08	2100	-1998	649	-98748	9SLV	40814	231056	62975	22162 Vsd < VRd,
-1610	0.08	916	-862	311	-62046	9SLV	35712	231056	57874	22162 Vsd < VRd,
-1690	0.08	916	-862	311	-63617	9SLV	35931	231056	58092	22162 Vsd < VRd,
-1770	0.08	916	-862	311	-65187	9SLV	36149	231056	58311	22162 Vsd < VRd,
-1850	0.08	916	-862	311	-66758	9SLV	36367	231056	58529	22162 Vsd < VRd,
-1930	0.08	916	-862	311	-68329	9SLV	36586	231056	58747	22162 Vsd < VRd,
-2010	0.08	86	-62	59	-49972	4SLU	34034	231056	56196	22162 Vsd < VRd,
-2090	0.08	86	-62	59	-52014	4SLU	34318	231056	56480	22162 Vsd < VRd,
-2170	0.08	86	-62	59	-54056	4SLU	39058	231056	61220	22162 Vsd < VRd,
-2250	0.08	86	-62	59	-56098	4SLU	34886	231056	57047	22162 Vsd < VRd,
-2330	0.08	86	-62	59	-58140	4SLU	35169	231056	57331	22162 Vsd < VRd,
-2410	0.08	0	0	0	-3441	7SLV	27566	231056	49728	22162 Vsd < VRd,
-2490	0.08	0	0	0	-5012	7SLV	27785	231056	49946	22162 Vsd < VRd,

Palo alle coordinate X=979 Y=-686

Sollecitazioni massime in testa palo:

Combinazione corrispondente alla minima compressione in testa

N	Mx	My	Tx	Ty	comb
-1.745E+05	1.6560E+06	1.1748E+06	2.9019E+03	-3.865E+03	1 sl
-1.745E+05	1.6560E+06	1.1748E+06	2.9019E+03	-3.865E+03	1 ra
-1.745E+05	1.6560E+06	1.1748E+06	2.9019E+03	-3.865E+03	1 fr
-1.745E+05	1.6560E+06	1.1748E+06	2.9019E+03	-3.865E+03	1 qp
-1.504E+05	-5.311E+06	-9.465E+05	-5.493E+03	2.3623E+04	3 SLV fond

Combinazione corrispondente alla massima compressione in testa

N	Mx	My	Tx	Ty	comb
---	----	----	----	----	------



Progetto	Titolo	Rev.	Pag.
Orione	Orione_A24a.pdf "TABULATI DI CALCOLO PLINTO DI FONDAZIONE PER AEROGENERATORE TIPO"	0	270

-2.758E+05	3.1790E+06	1.1975E+06	2.9283E+03	-7.890E+03	4	sl
-2.071E+05	2.3401E+06	9.5501E+05	2.3391E+03	-5.775E+03	2	ra
-1.908E+05	1.9981E+06	1.0649E+06	2.6205E+03	-4.820E+03	2	fr
-1.843E+05	1.8612E+06	1.1089E+06	2.7331E+03	-4.438E+03	2	qp
-1.985E+05	8.6229E+06	3.2961E+06	1.1297E+04	-3.135E+04	13	SLV fond

Combinazione corrispondente al massimo taglio in testa

N	Mx	My	Tx	Ty	comb
-2.758E+05	3.1790E+06	1.1975E+06	2.9283E+03	-7.890E+03	4 sl
-2.071E+05	2.3401E+06	9.5501E+05	2.3391E+03	-5.775E+03	2 ra
-1.908E+05	1.9981E+06	1.0649E+06	2.6205E+03	-4.820E+03	2 fr
-1.843E+05	1.8612E+06	1.1089E+06	2.7331E+03	-4.438E+03	2 qp
-1.985E+05	8.6229E+06	3.2961E+06	1.1297E+04	-3.135E+04	13 SLV fond

Verifica di capacità portante riferita al palo singolo:

Fattore di correlazione Psi scelto in base alla conoscenza del sito = 1.7  
 Coeff. parziale di sicurezza sulla resistenza laterale = 1.15  
 Coeff. parziale di sicurezza sulla resistenza alla punta = 1.35  
 Portanza laterale di progetto = 292537.1  
 Portanza di punta di progetto = 85555.4  
 verifica condotta in combinazione SLU 4  
 Sforzo normale = -275750.2  
 Peso del palo = 49087.4 \* 1.3  
 Carico totale di progetto = -339563.8  
 Resistenza totale di progetto = 378092.5  
 Coefficiente di sicurezza = 1.11 > 1

Verifica di resistenza allo stato limite:

quota	Af	cop.	c.s.	Mx	My	N	comb
-90	0.0	6.50	0.00	0.0000E+00	0.0000E+00	0.0000E+00	-
-170	78.5	6.00	4.04	6.1729E+06	2.4202E+06	-1.989E+05	13SLV
-250	78.5	6.00	6.08	3.7268E+06	1.5463E+06	-2.005E+05	13SLV
-330	78.5	6.00	8.41	1.4168E+06	5.7278E+05	-2.193E+05	4SLU
-410	78.5	6.00	8.33	1.1010E+06	4.5433E+05	-2.213E+05	4SLU
-490	78.5	6.00	8.25	7.8516E+05	3.3587E+05	-2.233E+05	4SLU
-570	78.5	6.00	8.18	4.6932E+05	2.1741E+05	-2.254E+05	4SLU
-650	78.5	6.00	8.10	1.5347E+05	9.8949E+04	-2.274E+05	4SLU
-730	78.5	6.00	10.66	-6.008E+04	1.6917E+04	-1.730E+05	4SLU
-810	78.5	6.00	10.53	-1.031E+05	-4.402E+03	-1.750E+05	4SLU
-890	78.5	6.00	10.41	-1.462E+05	-2.572E+04	-1.771E+05	4SLU
-970	78.5	6.00	10.29	-1.893E+05	-4.704E+04	-1.791E+05	4SLU
-1050	78.5	6.00	10.18	-2.324E+05	-6.836E+04	-1.811E+05	4SLU
-1130	124.0	6.00	15.96	-2.598E+05	-8.322E+04	-1.274E+05	4SLU
-1210	78.5	6.00	14.24	-2.363E+05	-7.697E+04	-1.295E+05	4SLU
-1290	78.5	6.00	14.02	-2.129E+05	-7.073E+04	-1.315E+05	4SLU
-1370	78.5	6.00	13.80	-1.894E+05	-6.448E+04	-1.336E+05	4SLU
-1450	78.5	6.00	13.59	-1.659E+05	-5.824E+04	-1.356E+05	4SLU
-1530	78.5	6.00	13.39	-1.424E+05	-5.199E+04	-1.376E+05	4SLU
-1610	78.5	6.00	21.20	-1.216E+05	-4.476E+04	-8.693E+04	4SLU
-1690	78.5	6.00	20.72	-1.009E+05	-3.747E+04	-8.897E+04	4SLU
-1770	78.5	6.00	20.25	-8.020E+04	-3.019E+04	-9.102E+04	4SLU
-1850	78.5	6.00	19.81	-5.950E+04	-2.290E+04	-9.306E+04	4SLU
-1930	78.5	6.00	19.38	-3.880E+04	-1.562E+04	-9.510E+04	4SLU
-2010	78.5	6.00	39.68	-2.794E+04	-1.155E+04	-4.645E+04	4SLU
-2090	78.5	6.00	38.01	-2.188E+04	-9.041E+03	-4.849E+04	4SLU
-2170	124.0	6.00	40.26	-1.581E+04	-6.536E+03	-5.053E+04	4SLU
-2250	78.5	6.00	35.06	-9.754E+03	-4.031E+03	-5.257E+04	4SLU
-2330	78.5	6.00	33.75	-3.693E+03	-1.526E+03	-5.462E+04	4SLU
-2410	78.5	6.00	100.00	-2.145E-11	-2.612E-11	-7.109E+03	4SLU
-2490	78.5	6.00	100.00	-3.714E-12	-1.009E-11	-9.151E+03	4SLU

Verifica di esercizio (combinazione rara):

quota	Af	cop.	sigmaf	sigmac	Mx	My	N	comb	Wk
-90	0.0	6.50	0.0	0.0	0.0000E+00	0.0000E+00	0.0000E+00	-	0.000
-170	78.5	6.00		40.0	1.8815E+06	7.7751E+05	-2.075E+05	2	0.000
-250	78.5	6.00		36.1	1.4231E+06	6.0066E+05	-2.091E+05	2	0.000
-330	78.5	6.00		27.8	1.0493E+06	4.5470E+05	-1.646E+05	2	0.000
-410	78.5	6.00		25.9	8.1653E+05	3.6023E+05	-1.662E+05	2	0.000
-490	78.5	6.00		24.0	5.8375E+05	2.6575E+05	-1.677E+05	2	0.000
-570	78.5	6.00		22.1	3.5096E+05	1.7128E+05	-1.693E+05	2	0.000
-650	78.5	6.00		20.2	1.1817E+05	7.6808E+04	-1.709E+05	2	0.000
-730	78.5	6.00		14.8	-3.946E+04	1.1485E+04	-1.298E+05	2	0.000
-810	78.5	6.00		15.2	-7.183E+04	-5.255E+03	-1.314E+05	2	0.000
-890	78.5	6.00		15.7	-1.042E+05	-2.200E+04	-1.330E+05	2	0.000
-970	78.5	6.00		16.1	-1.366E+05	-3.874E+04	-1.345E+05	2	0.000
-1050	78.5	6.00		16.6	-1.689E+05	-5.548E+04	-1.361E+05	2	0.000
-1130	124.0	6.00		11.4	-1.897E+05	-6.710E+04	-9.563E+04	2	0.000
-1210	78.5	6.00		12.3	-1.727E+05	-6.198E+04	-9.720E+04	2	0.000
-1290	78.5	6.00		12.4	-1.558E+05	-5.687E+04	-9.877E+04	2	0.000
-1370	78.5	6.00		12.4	-1.388E+05	-5.176E+04	-1.003E+05	2	0.000
-1450	78.5	6.00		12.4	-1.218E+05	-4.665E+04	-1.019E+05	2	0.000
-1530	78.5	6.00		12.4	-1.049E+05	-4.153E+04	-1.035E+05	2	0.000
-1610	78.5	6.00		8.1	-8.957E+04	-3.573E+04	-6.525E+04	2	0.000
-1690	78.5	6.00		8.1	-7.438E+04	-2.990E+04	-6.682E+04	2	0.000
-1770	78.5	6.00		8.1	-5.918E+04	-2.407E+04	-6.839E+04	2	0.000





Tabulati di Calcolo Plinto di Fondazione per Aerogeneratore Tipo - Progetto Impianto Eolico - "Orione"

-1850	78.5	6.00	8.2	-4.398E+04	-1.823E+04	-6.996E+04	2	0.000
-1930	78.5	6.00	8.2	-2.878E+04	-1.240E+04	-7.154E+04	2	0.000
-2010	78.5	6.00	4.1	-2.077E+04	-9.151E+03	-3.485E+04	2	0.000
-2090	78.5	6.00	4.2	-1.626E+04	-7.166E+03	-3.642E+04	2	0.000
-2170	124.0	6.00	4.0	-1.176E+04	-5.180E+03	-3.799E+04	2	0.000
-2250	78.5	6.00	4.5	-7.252E+03	-3.195E+03	-3.956E+04	2	0.000
-2330	78.5	6.00	4.6	-2.746E+03	-1.210E+03	-4.113E+04	2	0.000
-2410	78.5	6.00	0.6	-1.650E-11	-2.058E-11	-5.300E+03	2	0.000
-2490	78.5	6.00	0.8	-2.857E-12	-8.076E-12	-6.870E+03	2	0.000

Verifica di esercizio (combinazione quasi permanente):

quota	Af	cop.	sigmaf	sigmac	Mx	My	N	comb	Wk
-90	0.0	6.50	0.0	0.0	0.0000E+00	0.0000E+00	0.0000E+00	-	0.000
-170	78.5	6.00		35.2	1.5082E+06	8.9938E+05	-1.848E+05	2	0.000
-250	78.5	6.00		31.9	1.1553E+06	6.9052E+05	-1.863E+05	2	0.000
-330	78.5	6.00		24.7	8.6479E+05	5.1883E+05	-1.461E+05	2	0.000
-410	78.5	6.00		23.0	6.7826E+05	4.0911E+05	-1.477E+05	2	0.000
-490	78.5	6.00		21.4	4.9173E+05	2.9940E+05	-1.492E+05	2	0.000
-570	78.5	6.00		19.8	3.0520E+05	1.8968E+05	-1.508E+05	2	0.000
-650	78.5	6.00		18.1	1.1868E+05	7.9964E+04	-1.524E+05	2	0.000
-730	78.5	6.00		12.9	-8.737E+03	4.5324E+03	-1.152E+05	2	0.000
-810	78.5	6.00		13.3	-3.762E+04	-1.376E+04	-1.168E+05	2	0.000
-890	78.5	6.00		13.8	-6.651E+04	-3.205E+04	-1.184E+05	2	0.000
-970	78.5	6.00		14.2	-9.539E+04	-5.034E+04	-1.199E+05	2	0.000
-1050	78.5	6.00		14.7	-1.243E+05	-6.863E+04	-1.215E+05	2	0.000
-1130	124.0	6.00		10.0	-1.436E+05	-8.111E+04	-8.476E+04	2	0.000
-1210	78.5	6.00		10.9	-1.315E+05	-7.460E+04	-8.633E+04	2	0.000
-1290	78.5	6.00		10.9	-1.195E+05	-6.808E+04	-8.790E+04	2	0.000
-1370	78.5	6.00		11.0	-1.075E+05	-6.157E+04	-8.947E+04	2	0.000
-1450	78.5	6.00		11.0	-9.547E+04	-5.506E+04	-9.104E+04	2	0.000
-1530	78.5	6.00		11.1	-8.345E+04	-4.854E+04	-9.262E+04	2	0.000
-1610	78.5	6.00		7.1	-7.154E+04	-4.168E+04	-5.789E+04	2	0.000
-1690	78.5	6.00		7.2	-5.965E+04	-3.479E+04	-5.946E+04	2	0.000
-1770	78.5	6.00		7.2	-4.775E+04	-2.791E+04	-6.103E+04	2	0.000
-1850	78.5	6.00		7.3	-3.585E+04	-2.103E+04	-6.260E+04	2	0.000
-1930	78.5	6.00		7.4	-2.395E+04	-1.415E+04	-6.418E+04	2	0.000
-2010	78.5	6.00		3.6	-1.750E+04	-1.038E+04	-3.083E+04	2	0.000
-2090	78.5	6.00		3.7	-1.370E+04	-8.125E+03	-3.240E+04	2	0.000
-2170	124.0	6.00		3.6	-9.906E+03	-5.874E+03	-3.397E+04	2	0.000
-2250	78.5	6.00		4.0	-6.110E+03	-3.623E+03	-3.554E+04	2	0.000
-2330	78.5	6.00		4.1	-2.313E+03	-1.372E+03	-3.711E+04	2	0.000
-2410	78.5	6.00		0.5	-1.650E-11	-2.282E-11	-4.532E+03	2	0.000
-2490	78.5	6.00		0.7	-2.857E-12	-9.515E-12	-6.103E+03	2	0.000

Verifica a taglio:

quota	Ast	Vsd	Vsdx	Vsdy	N	comb	VRd,c	VRd,max	VRd,S	Vwd
-90	0.16	33326	11297	-31353	-198523	13SLV	50794	231056	95117	44323 Vsd < VRd,
-170	0.16	32470	10925	-30577	-198903	13SLV	54735	231056	99058	44323 Vsd < VRd,
-250	0.08	32470	10925	-30577	-200474	13SLV	54953	231056	77115	22162 Vsd < VRd,
-330	0.08	10308	3741	-9605	-157570	13SLV	48990	231056	71152	22162 Vsd < VRd,
-410	0.08	10308	3741	-9605	-159140	13SLV	49208	231056	71370	22162 Vsd < VRd,
-490	0.08	10308	3741	-9605	-160711	13SLV	49427	231056	71588	22162 Vsd < VRd,
-570	0.08	10308	3741	-9605	-162282	13SLV	49645	231056	71807	22162 Vsd < VRd,
-650	0.08	10308	3741	-9605	-163853	13SLV	49863	231056	72025	22162 Vsd < VRd,
-730	0.08	1861	662	-1739	-93613	3SLV	40100	231056	62262	22162 Vsd < VRd,
-810	0.08	1861	662	-1739	-95183	3SLV	40318	231056	62480	22162 Vsd < VRd,
-890	0.08	1861	662	-1739	-96754	3SLV	40537	231056	62698	22162 Vsd < VRd,
-970	0.08	1861	662	-1739	-98325	3SLV	40755	231056	62917	22162 Vsd < VRd,
-1050	0.08	1861	662	-1739	-99896	3SLV	40973	231056	63135	22162 Vsd < VRd,
-1130	0.08	2082	-653	1977	-91496	13SLV	44262	231056	66424	22162 Vsd < VRd,
-1210	0.08	2082	-653	1977	-93067	13SLV	40024	231056	62186	22162 Vsd < VRd,
-1290	0.08	2082	-653	1977	-94638	13SLV	40243	231056	62404	22162 Vsd < VRd,
-1370	0.08	2082	-653	1977	-96209	13SLV	40461	231056	62623	22162 Vsd < VRd,
-1450	0.08	2082	-653	1977	-97780	13SLV	40679	231056	62841	22162 Vsd < VRd,
-1530	0.08	2082	-653	1977	-99350	13SLV	40898	231056	63059	22162 Vsd < VRd,
-1610	0.08	908	-311	853	-62453	13SLV	35769	231056	57931	22162 Vsd < VRd,
-1690	0.08	908	-311	853	-64024	13SLV	35987	231056	58149	22162 Vsd < VRd,
-1770	0.08	908	-311	853	-65595	13SLV	36206	231056	58367	22162 Vsd < VRd,
-1850	0.08	908	-311	853	-67166	13SLV	36424	231056	58586	22162 Vsd < VRd,
-1930	0.08	908	-311	853	-68736	13SLV	36642	231056	58804	22162 Vsd < VRd,
-2010	0.08	82	-31	76	-46447	4SLU	33544	231056	55706	22162 Vsd < VRd,
-2090	0.08	82	-31	76	-48489	4SLU	33828	231056	55990	22162 Vsd < VRd,
-2170	0.08	82	-31	76	-50531	4SLU	38568	231056	60730	22162 Vsd < VRd,
-2250	0.08	82	-31	76	-52573	4SLU	34396	231056	56557	22162 Vsd < VRd,
-2330	0.08	82	-31	76	-54615	4SLU	34679	231056	56841	22162 Vsd < VRd,
-2410	0.08	0	0	0	-3399	3SLV	27560	231056	49722	22162 Vsd < VRd,
-2490	0.08	0	0	0	-4970	3SLV	27779	231056	49940	22162 Vsd < VRd,

Palo alle coordinate X=1155 Y=-309

Sollecitazioni massime in testa palo:

Combinazione corrispondente alla minima compressione in testa



Progetto	Titolo	Rev.	Pag.
Orione	Orione_A24a.pdf "TABULATI DI CALCOLO PLINTO DI FONDAZIONE PER AEROGENERATORE TIPO"	0	272

N	Mx	My	Tx	Ty	comb	
-1.745E+05	1.9521E+06	5.3899E+05	1.4178E+03	-4.556E+03	1	sl
-1.745E+05	1.9521E+06	5.3899E+05	1.4178E+03	-4.556E+03	1	ra
-1.745E+05	1.9521E+06	5.3899E+05	1.4178E+03	-4.556E+03	1	fr
-1.745E+05	1.9521E+06	5.3899E+05	1.4178E+03	-4.556E+03	1	qp
-1.490E+05	-5.020E+06	-1.571E+06	-6.889E+03	2.2961E+04	3	SLV fond

Combinazione corrispondente alla massima compressione in testa

N	Mx	My	Tx	Ty	comb	
-2.498E+05	3.2096E+06	-3.508E+04	4.3233E+01	-7.948E+03	4	sl
-1.898E+05	2.4000E+06	4.8476E+04	2.1786E+02	-5.906E+03	2	ra
-1.822E+05	2.1760E+06	2.9373E+05	8.1782E+02	-5.231E+03	2	fr
-1.791E+05	2.0865E+06	3.9183E+05	1.0578E+03	-4.961E+03	2	qp
-2.000E+05	8.9239E+06	2.6493E+06	9.7241E+03	-3.207E+04	13	SLV fond

Combinazione corrispondente al massimo taglio in testa

N	Mx	My	Tx	Ty	comb	
-2.498E+05	3.2096E+06	-3.508E+04	4.3233E+01	-7.948E+03	4	sl
-1.898E+05	2.4000E+06	4.8476E+04	2.1786E+02	-5.906E+03	2	ra
-1.822E+05	2.1760E+06	2.9373E+05	8.1782E+02	-5.231E+03	2	fr
-1.791E+05	2.0865E+06	3.9183E+05	1.0578E+03	-4.961E+03	2	qp
-2.000E+05	8.9239E+06	2.6493E+06	9.7241E+03	-3.207E+04	13	SLV fond

Verifica di capacità portante riferita al palo singolo:

Fattore di correlazione Psi scelto in base alla conoscenza del sito = 1.7  
 Coeff. parziale di sicurezza sulla resistenza laterale = 1.15  
 Coeff. parziale di sicurezza sulla resistenza alla punta = 1.35  
 Portanza laterale di progetto = 292537.1  
 Portanza di punta di progetto = 85555.4  
 verifica condotta in combinazione SLU 4  
 Sforzo normale = -249845.4  
 Peso del palo = 49087.4 \* 1.3  
 Carico totale di progetto = -313659  
 Resistenza totale di progetto = 378092.5  
 Coefficiente di sicurezza = 1.21 > 1

Verifica di resistenza allo stato limite:

quota	Af	cop.	c.s.	Mx	My	N	comb
-90	0.0	6.50	0.00	0.0000E+00	0.0000E+00	0.0000E+00	-
-170	78.5	6.00	4.00	6.4166E+06	1.8975E+06	-2.004E+05	13SLV
-250	78.5	6.00	6.03	3.9133E+06	1.1474E+06	-2.019E+05	13SLV
-330	78.5	6.00	9.27	1.4339E+06	-1.296E+04	-1.983E+05	4SLU
-410	78.5	6.00	9.20	1.1148E+06	-7.479E+03	-2.003E+05	4SLU
-490	78.5	6.00	9.11	7.9580E+05	-1.993E+03	-2.024E+05	4SLU
-570	78.5	6.00	9.02	4.7676E+05	3.4916E+03	-2.044E+05	4SLU
-650	78.5	6.00	8.93	1.5772E+05	8.9767E+03	-2.065E+05	4SLU
-730	78.5	6.00	11.79	-5.811E+04	1.2122E+04	-1.564E+05	4SLU
-810	78.5	6.00	11.63	-1.019E+05	1.1368E+04	-1.584E+05	4SLU
-890	78.5	6.00	11.49	-1.458E+05	1.0614E+04	-1.605E+05	4SLU
-970	78.5	6.00	11.34	-1.896E+05	9.8602E+03	-1.625E+05	4SLU
-1050	78.5	6.00	11.20	-2.335E+05	9.1061E+03	-1.646E+05	4SLU
-1130	124.0	6.00	17.67	-2.615E+05	8.2883E+03	-1.151E+05	4SLU
-1210	78.5	6.00	15.73	-2.380E+05	7.2620E+03	-1.171E+05	4SLU
-1290	78.5	6.00	15.46	-2.144E+05	6.2356E+03	-1.192E+05	4SLU
-1370	78.5	6.00	15.20	-1.909E+05	5.2093E+03	-1.212E+05	4SLU
-1450	78.5	6.00	14.95	-1.673E+05	4.1829E+03	-1.233E+05	4SLU
-1530	78.5	6.00	14.71	-1.438E+05	3.1566E+03	-1.253E+05	4SLU
-1610	78.5	6.00	23.45	-1.228E+05	2.6394E+03	-7.859E+04	4SLU
-1690	78.5	6.00	22.86	-1.019E+05	2.1473E+03	-8.063E+04	4SLU
-1770	78.5	6.00	22.30	-8.105E+04	1.6552E+03	-8.267E+04	4SLU
-1850	78.5	6.00	21.76	-6.017E+04	1.1631E+03	-8.471E+04	4SLU
-1930	78.5	6.00	21.25	-3.929E+04	6.7102E+02	-8.676E+04	4SLU
-2010	78.5	6.00	44.00	-2.831E+04	4.4472E+02	-4.189E+04	4SLU
-2090	78.5	6.00	41.95	-2.217E+04	3.4824E+02	-4.393E+04	4SLU
-2170	124.0	6.00	44.25	-1.603E+04	2.5175E+02	-4.598E+04	4SLU
-2250	78.5	6.00	38.39	-9.886E+03	1.5527E+02	-4.802E+04	4SLU
-2330	78.5	6.00	36.82	-3.743E+03	5.8791E+01	-5.006E+04	4SLU
-2410	78.5	6.00	100.00	-3.783E-11	9.2580E-13	-6.239E+03	4SLU
-2490	78.5	6.00	100.00	-3.783E-11	8.8838E-12	-8.281E+03	4SLU

Verifica di esercizio (combinazione rara):

quota	Af	cop.	sigmaf	sigmac	Mx	My	N	comb	Wk
-90	0.0	6.50	0.0	0.0	0.0000E+00	0.0000E+00	0.0000E+00	-	0.000
-170	78.5	6.00		37.3	1.9309E+06	3.9276E+04	-1.903E+05	2	0.000
-250	78.5	6.00		33.5	1.4620E+06	3.0624E+04	-1.919E+05	2	0.000
-330	78.5	6.00		25.7	1.0794E+06	2.3976E+04	-1.506E+05	2	0.000
-410	78.5	6.00		23.9	8.4052E+05	2.0667E+04	-1.522E+05	2	0.000
-490	78.5	6.00		22.1	6.0162E+05	1.7358E+04	-1.538E+05	2	0.000
-570	78.5	6.00		20.3	3.6273E+05	1.4049E+04	-1.553E+05	2	0.000
-650	78.5	6.00		18.5	1.2384E+05	1.0740E+04	-1.569E+05	2	0.000
-730	78.5	6.00		13.5	-3.804E+04	8.0611E+03	-1.188E+05	2	0.000
-810	78.5	6.00		14.0	-7.157E+04	6.4333E+03	-1.204E+05	2	0.000
-890	78.5	6.00		14.4	-1.051E+05	4.8054E+03	-1.219E+05	2	0.000
-970	78.5	6.00		14.9	-1.386E+05	3.1776E+03	-1.235E+05	2	0.000
-1050	78.5	6.00		15.3	-1.722E+05	1.5498E+03	-1.251E+05	2	0.000



Progetto	Titolo	Rev.	Pag.
Orione	Orione_A24a.pdf "TABULATI DI CALCOLO PLINTO DI FONDAZIONE PER AEROGENERATORE TIPO"	0	273

-1130	124.0	6.00	10.5	-1.938E+05	2.4666E+02	-8.742E+04	2	0.000
-1210	78.5	6.00	11.4	-1.765E+05	4.1484E+00	-8.899E+04	2	0.000
-1290	78.5	6.00	11.4	-1.593E+05	-2.384E+02	-9.056E+04	2	0.000
-1370	78.5	6.00	11.4	-1.420E+05	-4.809E+02	-9.213E+04	2	0.000
-1450	78.5	6.00	11.5	-1.248E+05	-7.234E+02	-9.370E+04	2	0.000
-1530	78.5	6.00	11.5	-1.075E+05	-9.659E+02	-9.527E+04	2	0.000
-1610	78.5	6.00	7.4	-9.190E+04	-8.698E+02	-5.969E+04	2	0.000
-1690	78.5	6.00	7.4	-7.633E+04	-7.570E+02	-6.126E+04	2	0.000
-1770	78.5	6.00	7.5	-6.077E+04	-6.442E+02	-6.283E+04	2	0.000
-1850	78.5	6.00	7.5	-4.520E+04	-5.314E+02	-6.440E+04	2	0.000
-1930	78.5	6.00	7.6	-2.963E+04	-4.186E+02	-6.597E+04	2	0.000
-2010	78.5	6.00	3.7	-2.141E+04	-3.330E+02	-3.181E+04	2	0.000
-2090	78.5	6.00	3.9	-1.676E+04	-2.608E+02	-3.338E+04	2	0.000
-2170	124.0	6.00	3.7	-1.212E+04	-1.885E+02	-3.495E+04	2	0.000
-2250	78.5	6.00	4.1	-7.474E+03	-1.163E+02	-3.652E+04	2	0.000
-2330	78.5	6.00	4.3	-2.830E+03	-4.403E+01	-3.809E+04	2	0.000
-2410	78.5	6.00	0.5	-2.910E-11	-9.735E-13	-4.720E+03	2	0.000
-2490	78.5	6.00	0.7	-2.910E-11	5.8477E-12	-6.291E+03	2	0.000

Verifica di esercizio (combinazione quasi permanente):

quota	Af	cop.	sigmaf	sigmac	Mx	My	N	comb	Wk
-90	0.0	6.50	0.0	0.0	0.0000E+00	0.0000E+00	0.0000E+00	-	0.000
-170	78.5	6.00		34.3	1.6918E+06	3.1556E+05	-1.796E+05	2	0.000
-250	78.5	6.00		31.1	1.2972E+06	2.3985E+05	-1.812E+05	2	0.000
-330	78.5	6.00		24.0	9.7218E+05	1.7844E+05	-1.419E+05	2	0.000
-410	78.5	6.00		22.4	7.6296E+05	1.4088E+05	-1.435E+05	2	0.000
-490	78.5	6.00		20.8	5.5373E+05	1.0331E+05	-1.451E+05	2	0.000
-570	78.5	6.00		19.2	3.4451E+05	6.5750E+04	-1.467E+05	2	0.000
-650	78.5	6.00		17.6	1.3528E+05	2.8187E+04	-1.482E+05	2	0.000
-730	78.5	6.00		12.5	-7.736E+03	2.3115E+03	-1.119E+05	2	0.000
-810	78.5	6.00		13.0	-4.040E+04	-4.084E+03	-1.135E+05	2	0.000
-890	78.5	6.00		13.4	-7.307E+04	-1.048E+04	-1.151E+05	2	0.000
-970	78.5	6.00		13.9	-1.057E+05	-1.687E+04	-1.166E+05	2	0.000
-1050	78.5	6.00		14.3	-1.384E+05	-2.327E+04	-1.182E+05	2	0.000
-1130	124.0	6.00		9.7	-1.603E+05	-2.764E+04	-8.231E+04	2	0.000
-1210	78.5	6.00		10.6	-1.469E+05	-2.539E+04	-8.388E+04	2	0.000
-1290	78.5	6.00		10.6	-1.336E+05	-2.315E+04	-8.545E+04	2	0.000
-1370	78.5	6.00		10.7	-1.202E+05	-2.090E+04	-8.702E+04	2	0.000
-1450	78.5	6.00		10.8	-1.069E+05	-1.866E+04	-8.859E+04	2	0.000
-1530	78.5	6.00		10.8	-9.355E+04	-1.641E+04	-9.016E+04	2	0.000
-1610	78.5	6.00		6.9	-8.023E+04	-1.407E+04	-5.623E+04	2	0.000
-1690	78.5	6.00		7.0	-6.691E+04	-1.172E+04	-5.780E+04	2	0.000
-1770	78.5	6.00		7.1	-5.359E+04	-9.368E+03	-5.937E+04	2	0.000
-1850	78.5	6.00		7.1	-4.027E+04	-7.020E+03	-6.095E+04	2	0.000
-1930	78.5	6.00		7.2	-2.695E+04	-4.672E+03	-6.252E+04	2	0.000
-2010	78.5	6.00		3.5	-1.970E+04	-3.405E+03	-2.992E+04	2	0.000
-2090	78.5	6.00		3.6	-1.543E+04	-2.666E+03	-3.149E+04	2	0.000
-2170	124.0	6.00		3.5	-1.115E+04	-1.927E+03	-3.306E+04	2	0.000
-2250	78.5	6.00		3.9	-6.880E+03	-1.189E+03	-3.463E+04	2	0.000
-2330	78.5	6.00		4.0	-2.605E+03	-4.501E+02	-3.620E+04	2	0.000
-2410	78.5	6.00		0.5	-2.910E-11	-8.643E-12	-4.359E+03	2	0.000
-2490	78.5	6.00		0.7	-2.910E-11	1.3612E-12	-5.930E+03	2	0.000

Verifica a taglio:

quota	Ast	Vsd	VsdX	VsdY	N	comb	VRd,c	VRd,max	VRd,S	Vwd
-90	0.16	33514	9724	-32072	-200002	13SLV	51000	231056	95323	44323 Vsd < VRd,
-170	0.16	32667	9378	-31292	-200377	13SLV	54940	231056	99263	44323 Vsd < VRd,
-250	0.08	32667	9378	-31292	-201948	13SLV	55158	231056	77320	22162 Vsd < VRd,
-330	0.08	10405	2936	-9982	-158774	13SLV	49157	231056	71319	22162 Vsd < VRd,
-410	0.08	10405	2936	-9982	-160345	13SLV	49376	231056	71537	22162 Vsd < VRd,
-490	0.08	10405	2936	-9982	-161915	13SLV	49594	231056	71756	22162 Vsd < VRd,
-570	0.08	10405	2936	-9982	-163486	13SLV	49812	231056	71974	22162 Vsd < VRd,
-650	0.08	10405	2936	-9982	-165057	13SLV	50031	231056	72192	22162 Vsd < VRd,
-730	0.08	1878	524	-1803	-92710	3SLV	39974	231056	62136	22162 Vsd < VRd,
-810	0.08	1878	524	-1803	-94280	3SLV	40193	231056	62354	22162 Vsd < VRd,
-890	0.08	1878	524	-1803	-95851	3SLV	40411	231056	62573	22162 Vsd < VRd,
-970	0.08	1878	524	-1803	-97422	3SLV	40629	231056	62791	22162 Vsd < VRd,
-1050	0.08	1878	524	-1803	-98993	3SLV	40848	231056	63010	22162 Vsd < VRd,
-1130	0.08	2090	-600	2002	-92205	13SLV	44361	231056	66522	22162 Vsd < VRd,
-1210	0.08	2090	-600	2002	-93776	13SLV	40123	231056	62284	22162 Vsd < VRd,
-1290	0.08	2090	-600	2002	-95347	13SLV	40341	231056	62503	22162 Vsd < VRd,
-1370	0.08	2090	-600	2002	-96918	13SLV	40559	231056	62721	22162 Vsd < VRd,
-1450	0.08	2090	-600	2002	-98489	13SLV	40778	231056	62939	22162 Vsd < VRd,
-1530	0.08	2090	-600	2002	-100059	13SLV	40996	231056	63158	22162 Vsd < VRd,
-1610	0.08	915	-260	877	-62933	13SLV	35836	231056	57997	22162 Vsd < VRd,
-1690	0.08	915	-260	877	-64504	13SLV	36054	231056	58216	22162 Vsd < VRd,
-1770	0.08	915	-260	877	-66075	13SLV	36272	231056	58434	22162 Vsd < VRd,
-1850	0.08	915	-260	877	-67646	13SLV	36491	231056	58652	22162 Vsd < VRd,
-1930	0.08	915	-260	877	-69217	13SLV	36709	231056	58871	22162 Vsd < VRd,
-2010	0.08	77	1	77	-41892	4SLU	32911	231056	55073	22162 Vsd < VRd,
-2090	0.08	77	1	77	-43934	4SLU	33195	231056	55356	22162 Vsd < VRd,
-2170	0.08	77	1	77	-45976	4SLU	37935	231056	60096	22162 Vsd < VRd,
-2250	0.08	77	1	77	-48018	4SLU	33762	231056	55924	22162 Vsd < VRd,
-2330	0.08	77	1	77	-50060	4SLU	34046	231056	56208	22162 Vsd < VRd,
-2410	0.08	0	0	0	-4635	9SLV	27732	231056	49894	22162 Vsd < VRd,
-2490	0.08	0	0	0	-6206	9SLV	27951	231056	50112	22162 Vsd < VRd,



Palo alle coordinate X=1191 Y=104

Sollecitazioni massime in testa palo:

Combinazione corrispondente alla minima compressione in testa

N	Mx	My	Tx	Ty	comb	
-1.688E+05	2.1527E+06	-9.917E+05	-2.260E+03	-5.479E+03	2	sl
-1.707E+05	2.1060E+06	-7.146E+05	-1.578E+03	-5.218E+03	2	ra
-1.726E+05	2.0593E+06	-4.375E+05	-8.964E+02	-4.957E+03	2	fr
-1.734E+05	2.0406E+06	-3.267E+05	-6.237E+02	-4.853E+03	2	qp
-1.496E+05	-4.949E+06	1.9712E+06	8.1758E+03	2.2783E+04	1	SLV fond

Combinazione corrispondente alla massima compressione in testa

N	Mx	My	Tx	Ty	comb	
-2.269E+05	2.6164E+06	-2.086E+05	-2.791E+02	-6.106E+03	3	sl
-1.746E+05	2.0126E+06	-1.604E+05	-2.147E+02	-4.697E+03	1	ra
-1.746E+05	2.0126E+06	-1.604E+05	-2.147E+02	-4.697E+03	1	fr
-1.746E+05	2.0126E+06	-1.604E+05	-2.147E+02	-4.697E+03	1	qp
-1.995E+05	8.9739E+06	-2.292E+06	-8.605E+03	-3.218E+04	15	SLV fond

Combinazione corrispondente al massimo taglio in testa

N	Mx	My	Tx	Ty	comb	
-2.212E+05	2.7565E+06	-1.040E+06	-2.324E+03	-6.888E+03	4	sl
-1.707E+05	2.1060E+06	-7.146E+05	-1.578E+03	-5.218E+03	2	ra
-1.726E+05	2.0593E+06	-4.375E+05	-8.964E+02	-4.957E+03	2	fr
-1.734E+05	2.0406E+06	-3.267E+05	-6.237E+02	-4.853E+03	2	qp
-1.995E+05	8.9739E+06	-2.292E+06	-8.605E+03	-3.218E+04	15	SLV fond

Verifica di capacità portante riferita al palo singolo:

Fattore di correlazione Psi scelto in base alla conoscenza del sito = 1.7

Coeff. parziale di sicurezza sulla resistenza laterale = 1.15

Coeff. parziale di sicurezza sulla resistenza alla punta = 1.35

Portanza laterale di progetto = 292537.1

Portanza di punta di progetto = 85555.4

verifica condotta in combinazione SLU 3

Sforzo normale = -226918.7

Peso del palo = 49087.4 \* 1.3

Carico totale di progetto = -290732.3

Resistenza totale di progetto = 378092.5

Coefficiente di sicurezza = 1.3 > 1

Verifica di resistenza allo stato limite:

quota	Af	cop.	c.s.	Mx	My	N	comb
-90	0.0	6.50	0.00	0.0000E+00	0.0000E+00	0.0000E+00	-
-170	78.5	6.00	4.02	6.4583E+06	-1.613E+06	-2.000E+05	15SLV
-250	78.5	6.00	6.05	3.9466E+06	-9.346E+05	-2.016E+05	15SLV
-330	78.5	6.00	9.63	2.0754E+06	-4.346E+05	-1.586E+05	15SLV
-410	78.5	6.00	10.14	9.7810E+05	-8.980E+04	-1.818E+05	3SLU
-490	78.5	6.00	10.03	7.1471E+05	-6.619E+04	-1.838E+05	3SLU
-570	78.5	6.00	9.92	4.5132E+05	-4.257E+04	-1.859E+05	3SLU
-650	78.5	6.00	9.81	1.8793E+05	-1.896E+04	-1.879E+05	3SLU
-730	78.5	6.00	12.17	-1.612E+06	4.9089E+05	-1.251E+05	15SLV
-810	78.5	6.00	12.31	-1.534E+06	4.6012E+05	-1.266E+05	15SLV
-890	78.5	6.00	12.45	-1.455E+06	4.2936E+05	-1.282E+05	15SLV
-970	78.5	6.00	12.47	-1.228E+05	9.5570E+03	-1.478E+05	3SLU
-1050	78.5	6.00	12.30	-1.661E+05	1.3632E+04	-1.499E+05	3SLU
-1130	124.0	6.00	18.06	-1.200E+06	3.3347E+05	-9.208E+04	15SLV
-1210	78.5	6.00	17.20	-1.040E+06	2.8736E+05	-9.365E+04	15SLV
-1290	78.5	6.00	17.02	-1.643E+05	1.4231E+04	-1.083E+05	3SLU
-1370	78.5	6.00	16.71	-1.486E+05	1.3103E+04	-1.103E+05	3SLU
-1450	78.5	6.00	16.40	-1.330E+05	1.1975E+04	-1.124E+05	3SLU
-1530	78.5	6.00	16.11	-1.174E+05	1.0847E+04	-1.144E+05	3SLU
-1610	78.5	6.00	25.89	-1.008E+05	9.4045E+03	-7.120E+04	3SLU
-1690	78.5	6.00	25.17	-8.427E+04	7.9468E+03	-7.324E+04	3SLU
-1770	78.5	6.00	24.48	-6.770E+04	6.4891E+03	-7.528E+04	3SLU
-1850	78.5	6.00	23.84	-5.114E+04	5.0314E+03	-7.732E+04	3SLU
-1930	78.5	6.00	23.22	-3.458E+04	3.5737E+03	-7.937E+04	3SLU
-2010	78.5	6.00	48.69	-2.543E+04	2.7016E+03	-3.786E+04	3SLU
-2090	78.5	6.00	46.20	-1.992E+04	2.1155E+03	-3.990E+04	3SLU
-2170	124.0	6.00	48.50	-1.440E+04	1.5294E+03	-4.194E+04	3SLU
-2250	78.5	6.00	41.91	-8.880E+03	9.4326E+02	-4.398E+04	3SLU
-2330	78.5	6.00	40.05	-3.362E+03	3.5715E+02	-4.603E+04	3SLU
-2410	78.5	6.00	100.00	-1.892E-11	-2.977E-12	-5.468E+03	3SLU
-2490	78.5	6.00	100.00	-1.892E-11	-7.598E-13	-7.510E+03	3SLU

Verifica di esercizio (combinazione rara):

quota	Af	cop.	sigmaf	sigmac	Mx	My	N	comb	Wk
-90	0.0	6.50	0.0	0.0	0.0000E+00	0.0000E+00	0.0000E+00	-	0.000
-170	78.5	6.00		34.0	1.6917E+06	-5.815E+05	-1.713E+05	2	0.000
-250	78.5	6.00		30.5	1.2776E+06	-4.480E+05	-1.729E+05	2	0.000
-330	78.5	6.00		23.4	9.5499E+05	-8.724E+04	-1.383E+05	1	0.000



Progetto	Titolo	Rev.	Pag.
Orione	Orione_A24a.pdf "TABULATI DI CALCOLO PLINTO DI FONDAZIONE PER AEROGENERATORE TIPO"	0	275

Tabulati di Calcolo Plinto di Fondazione per Aerogeneratore Tipo - Progetto Impianto Eolico - "Orione"

-410	78.5	6.00	21.8	7.5238E+05	-6.908E+04	-1.398E+05	1	0.000
-490	78.5	6.00	20.3	5.4978E+05	-5.091E+04	-1.414E+05	1	0.000
-570	78.5	6.00	18.8	3.4717E+05	-3.275E+04	-1.430E+05	1	0.000
-650	78.5	6.00	17.3	1.4456E+05	-1.458E+04	-1.445E+05	1	0.000
-730	78.5	6.00	12.2	-3.850E+04	6.2356E+03	-1.066E+05	2	0.000
-810	78.5	6.00	12.6	-6.721E+04	1.7177E+04	-1.081E+05	2	0.000
-890	78.5	6.00	13.0	-9.593E+04	2.8118E+04	-1.097E+05	2	0.000
-970	78.5	6.00	13.5	-1.246E+05	3.9059E+04	-1.113E+05	2	0.000
-1050	78.5	6.00	13.9	-1.534E+05	5.0001E+04	-1.128E+05	2	0.000
-1130	124.0	6.00	9.5	-1.717E+05	5.7248E+04	-7.833E+04	2	0.000
-1210	78.5	6.00	10.3	-1.562E+05	5.2430E+04	-7.990E+04	2	0.000
-1290	78.5	6.00	10.3	-1.264E+05	1.0947E+04	-8.329E+04	1	0.000
-1370	78.5	6.00	10.4	-1.143E+05	1.0079E+04	-8.486E+04	1	0.000
-1450	78.5	6.00	10.5	-1.023E+05	9.2115E+03	-8.643E+04	1	0.000
-1530	78.5	6.00	10.5	-9.027E+04	8.3436E+03	-8.800E+04	1	0.000
-1610	78.5	6.00	6.7	-7.756E+04	7.2342E+03	-5.477E+04	1	0.000
-1690	78.5	6.00	6.8	-6.482E+04	6.1129E+03	-5.634E+04	1	0.000
-1770	78.5	6.00	6.9	-5.208E+04	4.9916E+03	-5.791E+04	1	0.000
-1850	78.5	6.00	6.9	-3.934E+04	3.8703E+03	-5.948E+04	1	0.000
-1930	78.5	6.00	7.0	-2.660E+04	2.7490E+03	-6.105E+04	1	0.000
-2010	78.5	6.00	3.4	-1.957E+04	2.0782E+03	-2.912E+04	1	0.000
-2090	78.5	6.00	3.5	-1.532E+04	1.6273E+03	-3.069E+04	1	0.000
-2170	124.0	6.00	3.4	-1.108E+04	1.1764E+03	-3.226E+04	1	0.000
-2250	78.5	6.00	3.8	-6.831E+03	7.2559E+02	-3.383E+04	1	0.000
-2330	78.5	6.00	4.0	-2.586E+03	2.7473E+02	-3.540E+04	1	0.000
-2410	78.5	6.00	0.5	-1.455E-11	-2.290E-12	-4.206E+03	1	0.000
-2490	78.5	6.00	0.6	-1.455E-11	-5.844E-13	-5.777E+03	1	0.000

Verifica di esercizio (combinazione quasi permanente):

quota	Af	cop.	sigmaf	sigmac	Mx	My	N	comb	Wk
-90	0.0	6.50	0.0	0.0	0.0000E+00	0.0000E+00	0.0000E+00	-	0.000
-170	78.5	6.00		33.3	1.6545E+06	-2.693E+05	-1.740E+05	2	0.000
-250	78.5	6.00		30.2	1.2686E+06	-2.114E+05	-1.755E+05	2	0.000
-330	78.5	6.00		23.4	9.5499E+05	-8.724E+04	-1.383E+05	1	0.000
-410	78.5	6.00		21.8	7.5238E+05	-6.908E+04	-1.398E+05	1	0.000
-490	78.5	6.00		20.3	5.4978E+05	-5.091E+04	-1.414E+05	1	0.000
-570	78.5	6.00		18.8	3.4717E+05	-3.275E+04	-1.430E+05	1	0.000
-650	78.5	6.00		17.3	1.4456E+05	-1.458E+04	-1.445E+05	1	0.000
-730	78.5	6.00		12.2	5.4420E+03	-2.052E+03	-1.090E+05	1	0.000
-810	78.5	6.00		12.5	-3.966E+04	5.9106E+03	-1.098E+05	2	0.000
-890	78.5	6.00		13.0	-7.159E+04	1.1387E+04	-1.114E+05	2	0.000
-970	78.5	6.00		13.4	-1.035E+05	1.6864E+04	-1.130E+05	2	0.000
-1050	78.5	6.00		13.9	-1.278E+05	1.0486E+04	-1.153E+05	1	0.000
-1130	124.0	6.00		9.4	-1.568E+05	2.6052E+04	-7.960E+04	2	0.000
-1210	78.5	6.00		10.2	-1.384E+05	1.1815E+04	-8.172E+04	1	0.000
-1290	78.5	6.00		10.3	-1.264E+05	1.0947E+04	-8.329E+04	1	0.000
-1370	78.5	6.00		10.4	-1.143E+05	1.0079E+04	-8.486E+04	1	0.000
-1450	78.5	6.00		10.5	-1.023E+05	9.2115E+03	-8.643E+04	1	0.000
-1530	78.5	6.00		10.5	-9.027E+04	8.3436E+03	-8.800E+04	1	0.000
-1610	78.5	6.00		6.7	-7.756E+04	7.2342E+03	-5.477E+04	1	0.000
-1690	78.5	6.00		6.8	-6.482E+04	6.1129E+03	-5.634E+04	1	0.000
-1770	78.5	6.00		6.9	-5.208E+04	4.9916E+03	-5.791E+04	1	0.000
-1850	78.5	6.00		6.9	-3.934E+04	3.8703E+03	-5.948E+04	1	0.000
-1930	78.5	6.00		7.0	-2.660E+04	2.7490E+03	-6.105E+04	1	0.000
-2010	78.5	6.00		3.4	-1.957E+04	2.0782E+03	-2.912E+04	1	0.000
-2090	78.5	6.00		3.5	-1.532E+04	1.6273E+03	-3.069E+04	1	0.000
-2170	124.0	6.00		3.4	-1.108E+04	1.1764E+03	-3.226E+04	1	0.000
-2250	78.5	6.00		3.8	-6.831E+03	7.2559E+02	-3.383E+04	1	0.000
-2330	78.5	6.00		4.0	-2.586E+03	2.7473E+02	-3.540E+04	1	0.000
-2410	78.5	6.00		0.5	-1.455E-11	-2.290E-12	-4.206E+03	1	0.000
-2490	78.5	6.00		0.6	-1.455E-11	-5.844E-13	-5.777E+03	1	0.000

Verifica a taglio:

quota	Ast	Vsd	Vsdx	Vsdy	N comb	VRd,c	VRd,max	VRd,S	Vwd	
-90	0.16	33307	-8605	-32177	-199525	15SLV	50933	231056	95257	44323 Vsd < VRd,
-170	0.16	32522	-8480	-31396	-200002	15SLV	54888	231056	99211	44323 Vsd < VRd,
-250	0.08	32522	-8480	-31396	-201573	15SLV	55106	231056	77268	22162 Vsd < VRd,
-330	0.08	10361	-2532	-10047	-158552	15SLV	49127	231056	71288	22162 Vsd < VRd,
-410	0.08	10361	-2532	-10047	-160123	15SLV	49345	231056	71507	22162 Vsd < VRd,
-490	0.08	10361	-2532	-10047	-161694	15SLV	49563	231056	71725	22162 Vsd < VRd,
-570	0.08	10361	-2532	-10047	-163265	15SLV	49782	231056	71943	22162 Vsd < VRd,
-650	0.08	10361	-2532	-10047	-164836	15SLV	50000	231056	72162	22162 Vsd < VRd,
-730	0.08	1873	-463	-1815	-92940	1SLV	40006	231056	62168	22162 Vsd < VRd,
-810	0.08	1873	-463	-1815	-94511	1SLV	40225	231056	62387	22162 Vsd < VRd,
-890	0.08	1873	-463	-1815	-96082	1SLV	40443	231056	62605	22162 Vsd < VRd,
-970	0.08	1873	-463	-1815	-97652	1SLV	40662	231056	62823	22162 Vsd < VRd,
-1050	0.08	1873	-463	-1815	-99223	1SLV	40880	231056	63042	22162 Vsd < VRd,
-1130	0.08	2085	576	2004	-92084	15SLV	44344	231056	66505	22162 Vsd < VRd,
-1210	0.08	2085	576	2004	-93655	15SLV	40106	231056	62268	22162 Vsd < VRd,
-1290	0.08	2085	576	2004	-95226	15SLV	40324	231056	62486	22162 Vsd < VRd,
-1370	0.08	2085	576	2004	-96796	15SLV	40543	231056	62704	22162 Vsd < VRd,
-1450	0.08	2085	576	2004	-98367	15SLV	40761	231056	62923	22162 Vsd < VRd,
-1530	0.08	2085	576	2004	-99938	15SLV	40979	231056	63141	22162 Vsd < VRd,
-1610	0.08	912	235	881	-62851	15SLV	35824	231056	57986	22162 Vsd < VRd,
-1690	0.08	912	235	881	-64421	15SLV	36042	231056	58204	22162 Vsd < VRd,
-1770	0.08	912	235	881	-65992	15SLV	36261	231056	58422	22162 Vsd < VRd,



Progetto	Titolo	Rev.	Pag.
Orione	Orione_A24a.pdf "TABULATI DI CALCOLO PLINTO DI FONDAZIONE PER AEROGENERATORE TIPO"	0	276

-1850	0.08	912	235	881	-67563	15SLV	36479	231056	58641	22162	Vsd < VRd,
-1930	0.08	912	235	881	-69134	15SLV	36697	231056	58859	22162	Vsd < VRd,
-2010	0.08	70	27	65	-36852	4SLU	32210	231056	54372	22162	Vsd < VRd,
-2090	0.08	70	27	65	-38894	4SLU	32494	231056	54656	22162	Vsd < VRd,
-2170	0.08	70	27	65	-40936	4SLU	37234	231056	59396	22162	Vsd < VRd,
-2250	0.08	70	27	65	-42978	4SLU	33062	231056	55223	22162	Vsd < VRd,
-2330	0.08	70	27	65	-45020	4SLU	33346	231056	55507	22162	Vsd < VRd,
-2410	0.08	0	0	0	-3364	1SLV	27556	231056	49717	22162	Vsd < VRd,
-2490	0.08	0	0	0	-4934	1SLV	27774	231056	49936	22162	Vsd < VRd,

Palo alle coordinate X=1083 Y=505

Sollecitazioni massime in testa palo:

Combinazione corrispondente alla minima compressione in testa

N	Mx	My	Tx	Ty	comb	
-1.408E+05	1.4985E+06	-1.413E+06	-3.279E+03	-3.942E+03	2	sl
-1.521E+05	1.6091E+06	-1.222E+06	-2.786E+03	-4.052E+03	2	ra
-1.633E+05	1.7197E+06	-1.031E+06	-2.293E+03	-4.161E+03	2	fr
-1.678E+05	1.7639E+06	-9.542E+05	-2.095E+03	-4.205E+03	2	qp
-1.495E+05	-5.117E+06	1.3133E+06	6.6844E+03	2.3149E+04	1	SLV fond

Combinazione corrispondente alla massima compressione in testa

N	Mx	My	Tx	Ty	comb	
-2.269E+05	2.3793E+06	-1.091E+06	-2.339E+03	-5.552E+03	3	sl
-1.746E+05	1.8302E+06	-8.395E+05	-1.799E+03	-4.271E+03	1	ra
-1.746E+05	1.8302E+06	-8.395E+05	-1.799E+03	-4.271E+03	1	fr
-1.746E+05	1.8302E+06	-8.395E+05	-1.799E+03	-4.271E+03	1	qp
-1.996E+05	8.7779E+06	-2.992E+06	-1.028E+04	-3.169E+04	15	SLV fond

Combinazione corrispondente al massimo taglio in testa

N	Mx	My	Tx	Ty	comb	
-1.932E+05	2.0476E+06	-1.665E+06	-3.819E+03	-5.224E+03	4	sl
-1.521E+05	1.6091E+06	-1.222E+06	-2.786E+03	-4.052E+03	2	ra
-1.633E+05	1.7197E+06	-1.031E+06	-2.293E+03	-4.161E+03	2	fr
-1.678E+05	1.7639E+06	-9.542E+05	-2.095E+03	-4.205E+03	2	qp
-1.996E+05	8.7779E+06	-2.992E+06	-1.028E+04	-3.169E+04	15	SLV fond

Verifica di capacità portante riferita al palo singolo:

Fattore di correlazione Psi scelto in base alla conoscenza del sito = 1.7  
 Coeff. parziale di sicurezza sulla resistenza laterale = 1.15  
 Coeff. parziale di sicurezza sulla resistenza alla punta = 1.35  
 Portanza laterale di progetto = 292537.1  
 Portanza di punta di progetto = 85555.4  
 verifica condotta in combinazione SLU 3  
 Sforzo normale = -226918  
 Peso del palo = 49087.4 \* 1.3  
 Carico totale di progetto = -290731.6  
 Resistenza totale di progetto = 378092.5  
 Coefficiente di sicurezza = 1.3 > 1

Verifica di resistenza allo stato limite:

quota	Af	cop.	c.s.	Mx	My	N	comb
-90	0.0	6.50	0.00	0.0000E+00	0.0000E+00	0.0000E+00	-
-170	78.5	6.00	4.01	6.3008E+06	-2.180E+06	-2.001E+05	15SLV
-250	78.5	6.00	6.04	3.8277E+06	-1.368E+06	-2.017E+05	15SLV
-330	78.5	6.00	9.61	1.9878E+06	-7.584E+05	-1.586E+05	15SLV
-410	78.5	6.00	10.14	8.8947E+05	-4.199E+05	-1.818E+05	3SLU
-490	78.5	6.00	10.03	6.4995E+05	-3.074E+05	-1.838E+05	3SLU
-570	78.5	6.00	9.92	4.1043E+05	-1.949E+05	-1.859E+05	3SLU
-650	78.5	6.00	9.81	1.7090E+05	-8.242E+04	-1.879E+05	3SLU
-730	78.5	6.00	12.17	-1.609E+06	4.9534E+05	-1.251E+05	15SLV
-810	78.5	6.00	12.31	-1.528E+06	4.7528E+05	-1.267E+05	15SLV
-890	78.5	6.00	12.44	-1.446E+06	4.5523E+05	-1.283E+05	15SLV
-970	78.5	6.00	12.47	-1.117E+05	5.0957E+04	-1.478E+05	3SLU
-1050	78.5	6.00	12.30	-1.510E+05	6.9646E+04	-1.499E+05	3SLU
-1130	124.0	6.00	18.05	-1.184E+06	3.8787E+05	-9.213E+04	15SLV
-1210	78.5	6.00	17.19	-1.025E+06	3.3715E+05	-9.370E+04	15SLV
-1290	78.5	6.00	17.02	-1.494E+05	6.9649E+04	-1.083E+05	3SLU
-1370	78.5	6.00	16.71	-1.352E+05	6.3247E+04	-1.103E+05	3SLU
-1450	78.5	6.00	16.40	-1.209E+05	5.6844E+04	-1.124E+05	3SLU
-1530	78.5	6.00	16.11	-1.067E+05	5.0442E+04	-1.144E+05	3SLU
-1610	78.5	6.00	25.89	-9.169E+04	4.3426E+04	-7.120E+04	3SLU
-1690	78.5	6.00	25.17	-7.663E+04	3.6380E+04	-7.324E+04	3SLU
-1770	78.5	6.00	24.48	-6.157E+04	2.9334E+04	-7.529E+04	3SLU
-1850	78.5	6.00	23.84	-4.651E+04	2.2288E+04	-7.733E+04	3SLU
-1930	78.5	6.00	23.22	-3.144E+04	1.5243E+04	-7.937E+04	3SLU
-2010	78.5	6.00	48.69	-2.313E+04	1.1286E+04	-3.786E+04	3SLU
-2090	78.5	6.00	46.19	-1.811E+04	8.8371E+03	-3.990E+04	3SLU
-2170	124.0	6.00	48.50	-1.309E+04	6.3887E+03	-4.194E+04	3SLU
-2250	78.5	6.00	41.90	-8.076E+03	3.9403E+03	-4.399E+04	3SLU
-2330	78.5	6.00	40.05	-3.058E+03	1.4919E+03	-4.603E+04	3SLU
-2410	78.5	6.00	100.00	-4.498E-11	7.1495E-12	-5.469E+03	3SLU
-2490	78.5	6.00	100.00	-3.907E-11	1.2379E-12	-7.511E+03	3SLU



Verifica di esercizio (combinazione rara):

quota	Af	cop.	sigmaf	sigmac	Mx	My	N	comb	Wk
-90	0.0	6.50	0.0	0.0	0.0000E+00	0.0000E+00	0.0000E+00	-	0.000
-170	78.5	6.00		33.2	1.4901E+06	-6.883E+05	-1.751E+05	1	0.000
-250	78.5	6.00		30.2	1.1501E+06	-5.367E+05	-1.767E+05	1	0.000
-330	78.5	6.00		23.4	8.6845E+05	-4.095E+05	-1.383E+05	1	0.000
-410	78.5	6.00		21.9	6.8420E+05	-3.230E+05	-1.398E+05	1	0.000
-490	78.5	6.00		20.3	4.9996E+05	-2.365E+05	-1.414E+05	1	0.000
-570	78.5	6.00		18.8	3.1571E+05	-1.499E+05	-1.430E+05	1	0.000
-650	78.5	6.00		17.3	1.3147E+05	-6.340E+04	-1.445E+05	1	0.000
-730	78.5	6.00		12.2	4.9552E+03	-3.929E+03	-1.090E+05	1	0.000
-810	78.5	6.00		12.5	-2.533E+04	1.0446E+04	-1.106E+05	1	0.000
-890	78.5	6.00		13.0	-5.561E+04	2.4822E+04	-1.121E+05	1	0.000
-970	78.5	6.00		13.4	-8.589E+04	3.9198E+04	-1.137E+05	1	0.000
-1050	78.5	6.00		13.9	-1.162E+05	5.3574E+04	-1.153E+05	1	0.000
-1130	124.0	6.00		9.4	-1.368E+05	6.3426E+04	-8.015E+04	1	0.000
-1210	78.5	6.00		10.2	-1.259E+05	5.8501E+04	-8.172E+04	1	0.000
-1290	78.5	6.00		10.3	-1.149E+05	5.3576E+04	-8.329E+04	1	0.000
-1370	78.5	6.00		10.4	-1.040E+05	4.8651E+04	-8.486E+04	1	0.000
-1450	78.5	6.00		10.5	-9.303E+04	4.3726E+04	-8.643E+04	1	0.000
-1530	78.5	6.00		10.5	-8.209E+04	3.8802E+04	-8.800E+04	1	0.000
-1610	78.5	6.00		6.7	-7.053E+04	3.3405E+04	-5.477E+04	1	0.000
-1690	78.5	6.00		6.8	-5.895E+04	2.7985E+04	-5.634E+04	1	0.000
-1770	78.5	6.00		6.9	-4.736E+04	2.2565E+04	-5.791E+04	1	0.000
-1850	78.5	6.00		6.9	-3.577E+04	1.7145E+04	-5.948E+04	1	0.000
-1930	78.5	6.00		7.0	-2.419E+04	1.1725E+04	-6.105E+04	1	0.000
-2010	78.5	6.00		3.4	-1.779E+04	8.6812E+03	-2.912E+04	1	0.000
-2090	78.5	6.00		3.5	-1.393E+04	6.7978E+03	-3.069E+04	1	0.000
-2170	124.0	6.00		3.4	-1.007E+04	4.9144E+03	-3.226E+04	1	0.000
-2250	78.5	6.00		3.8	-6.212E+03	3.0310E+03	-3.384E+04	1	0.000
-2330	78.5	6.00		4.0	-2.352E+03	1.1476E+03	-3.541E+04	1	0.000
-2410	78.5	6.00		0.5	-3.460E-11	5.4996E-12	-4.207E+03	1	0.000
-2490	78.5	6.00		0.6	-3.006E-11	9.5220E-13	-5.777E+03	1	0.000

Verifica di esercizio (combinazione quasi permanente):

quota	Af	cop.	sigmaf	sigmac	Mx	My	N	comb	Wk
-90	0.0	6.50	0.0	0.0	0.0000E+00	0.0000E+00	0.0000E+00	-	0.000
-170	78.5	6.00		33.2	1.4901E+06	-6.883E+05	-1.751E+05	1	0.000
-250	78.5	6.00		30.2	1.1501E+06	-5.367E+05	-1.767E+05	1	0.000
-330	78.5	6.00		23.4	8.6845E+05	-4.095E+05	-1.383E+05	1	0.000
-410	78.5	6.00		21.9	6.8420E+05	-3.230E+05	-1.398E+05	1	0.000
-490	78.5	6.00		20.3	4.9996E+05	-2.365E+05	-1.414E+05	1	0.000
-570	78.5	6.00		18.8	3.1571E+05	-1.499E+05	-1.430E+05	1	0.000
-650	78.5	6.00		17.3	1.3147E+05	-6.340E+04	-1.445E+05	1	0.000
-730	78.5	6.00		12.2	4.9552E+03	-3.929E+03	-1.090E+05	1	0.000
-810	78.5	6.00		12.5	-2.533E+04	1.0446E+04	-1.106E+05	1	0.000
-890	78.5	6.00		13.0	-5.561E+04	2.4822E+04	-1.121E+05	1	0.000
-970	78.5	6.00		13.4	-8.589E+04	3.9198E+04	-1.137E+05	1	0.000
-1050	78.5	6.00		13.9	-1.162E+05	5.3574E+04	-1.153E+05	1	0.000
-1130	124.0	6.00		9.4	-1.368E+05	6.3426E+04	-8.015E+04	1	0.000
-1210	78.5	6.00		10.2	-1.259E+05	5.8501E+04	-8.172E+04	1	0.000
-1290	78.5	6.00		10.3	-1.149E+05	5.3576E+04	-8.329E+04	1	0.000
-1370	78.5	6.00		10.4	-1.040E+05	4.8651E+04	-8.486E+04	1	0.000
-1450	78.5	6.00		10.5	-9.303E+04	4.3726E+04	-8.643E+04	1	0.000
-1530	78.5	6.00		10.5	-8.209E+04	3.8802E+04	-8.800E+04	1	0.000
-1610	78.5	6.00		6.7	-7.053E+04	3.3405E+04	-5.477E+04	1	0.000
-1690	78.5	6.00		6.8	-5.895E+04	2.7985E+04	-5.634E+04	1	0.000
-1770	78.5	6.00		6.9	-4.736E+04	2.2565E+04	-5.791E+04	1	0.000
-1850	78.5	6.00		6.9	-3.577E+04	1.7145E+04	-5.948E+04	1	0.000
-1930	78.5	6.00		7.0	-2.419E+04	1.1725E+04	-6.105E+04	1	0.000
-2010	78.5	6.00		3.4	-1.779E+04	8.6812E+03	-2.912E+04	1	0.000
-2090	78.5	6.00		3.5	-1.393E+04	6.7978E+03	-3.069E+04	1	0.000
-2170	124.0	6.00		3.4	-1.007E+04	4.9144E+03	-3.226E+04	1	0.000
-2250	78.5	6.00		3.8	-6.212E+03	3.0310E+03	-3.384E+04	1	0.000
-2330	78.5	6.00		4.0	-2.352E+03	1.1476E+03	-3.541E+04	1	0.000
-2410	78.5	6.00		0.5	-3.460E-11	5.4996E-12	-4.207E+03	1	0.000
-2490	78.5	6.00		0.6	-3.006E-11	9.5220E-13	-5.777E+03	1	0.000

Verifica a taglio:

quota	Ast	Vsd	Vsdx	Vsdy	N comb	VRd,c	VRd,max	VRd,S	Vwd	
-90	0.16	33318	-10283	-31691	-199611	15SLV	50945	231056	95269	44323 Vsd < VRd,
-170	0.16	32538	-10147	-30915	-200090	15SLV	54900	231056	99224	44323 Vsd < VRd,
-250	0.08	32538	-10147	-30915	-201661	15SLV	55119	231056	77280	22162 Vsd < VRd,
-330	0.08	10379	-3409	-9803	-158630	15SLV	49137	231056	71299	22162 Vsd < VRd,
-410	0.08	10379	-3409	-9803	-160200	15SLV	49356	231056	71517	22162 Vsd < VRd,
-490	0.08	10379	-3409	-9803	-161771	15SLV	49574	231056	71736	22162 Vsd < VRd,
-570	0.08	10379	-3409	-9803	-163342	15SLV	49792	231056	71954	22162 Vsd < VRd,
-650	0.08	10379	-3409	-9803	-164913	15SLV	50011	231056	72172	22162 Vsd < VRd,
-730	0.08	1875	-610	-1773	-92889	1SLV	39999	231056	62161	22162 Vsd < VRd,
-810	0.08	1875	-610	-1773	-94460	1SLV	40218	231056	62379	22162 Vsd < VRd,
-890	0.08	1875	-610	-1773	-96030	1SLV	40436	231056	62598	22162 Vsd < VRd,
-970	0.08	1875	-610	-1773	-97601	1SLV	40654	231056	62816	22162 Vsd < VRd,
-1050	0.08	1875	-610	-1773	-99172	1SLV	40873	231056	63034	22162 Vsd < VRd,



-1130	0.08	2085	634	1986	-92131	15SLV	44350	231056	66512	22162	Vsd < VRd,
-1210	0.08	2085	634	1986	-93701	15SLV	40112	231056	62274	22162	Vsd < VRd,
-1290	0.08	2085	634	1986	-95272	15SLV	40331	231056	62492	22162	Vsd < VRd,
-1370	0.08	2085	634	1986	-96843	15SLV	40549	231056	62711	22162	Vsd < VRd,
-1450	0.08	2085	634	1986	-98414	15SLV	40767	231056	62929	22162	Vsd < VRd,
-1530	0.08	2085	634	1986	-99984	15SLV	40986	231056	63147	22162	Vsd < VRd,
-1610	0.08	913	291	865	-62882	15SLV	35829	231056	57990	22162	Vsd < VRd,
-1690	0.08	913	291	865	-64453	15SLV	36047	231056	58209	22162	Vsd < VRd,
-1770	0.08	913	291	865	-66024	15SLV	36265	231056	58427	22162	Vsd < VRd,
-1850	0.08	913	291	865	-67595	15SLV	36484	231056	58645	22162	Vsd < VRd,
-1930	0.08	913	291	865	-69165	15SLV	36702	231056	58864	22162	Vsd < VRd,
-2010	0.08	70	31	63	-37860	3SLU	32350	231056	54512	22162	Vsd < VRd,
-2090	0.08	70	31	63	-39902	3SLU	32634	231056	54796	22162	Vsd < VRd,
-2170	0.08	70	31	63	-41944	3SLU	37374	231056	59536	22162	Vsd < VRd,
-2250	0.08	70	31	63	-43986	3SLU	33202	231056	55364	22162	Vsd < VRd,
-2330	0.08	70	31	63	-46028	3SLU	33486	231056	55647	22162	Vsd < VRd,
-2410	0.08	0	0	0	-3652	5SLV	27596	231056	49757	22162	Vsd < VRd,
-2490	0.08	0	0	0	-5223	5SLV	27814	231056	49976	22162	Vsd < VRd,

Palo alle coordinate X=845 Y=845

Sollecitazioni massime in testa palo:

Combinazione corrispondente alla minima compressione in testa

N	Mx	My	Tx	Ty	comb	
-1.168E+05	8.9349E+05	-1.496E+06	-3.509E+03	-2.501E+03	2	sl
-1.360E+05	1.0714E+06	-1.469E+06	-3.387E+03	-2.778E+03	2	ra
-1.553E+05	1.2493E+06	-1.442E+06	-3.265E+03	-3.054E+03	2	fr
-1.630E+05	1.3204E+06	-1.431E+06	-3.216E+03	-3.165E+03	2	qp
-1.524E+05	-5.494E+06	7.4818E+05	5.3874E+03	2.3974E+04	1	SLV fond

Combinazione corrispondente alla massima compressione in testa

N	Mx	My	Tx	Ty	comb	
-2.268E+05	1.8553E+06	-1.840E+06	-4.086E+03	-4.330E+03	3	sl
-1.745E+05	1.4272E+06	-1.415E+06	-3.143E+03	-3.331E+03	1	ra
-1.745E+05	1.4272E+06	-1.415E+06	-3.143E+03	-3.331E+03	1	fr
-1.745E+05	1.4272E+06	-1.415E+06	-3.143E+03	-3.331E+03	1	qp
-1.966E+05	8.3484E+06	-3.579E+06	-1.167E+04	-3.064E+04	15	SLV fond

Combinazione corrispondente al massimo taglio in testa

N	Mx	My	Tx	Ty	comb	
-2.268E+05	1.8553E+06	-1.840E+06	-4.086E+03	-4.330E+03	3	sl
-1.745E+05	1.4272E+06	-1.415E+06	-3.143E+03	-3.331E+03	1	ra
-1.745E+05	1.4272E+06	-1.415E+06	-3.143E+03	-3.331E+03	1	fr
-1.745E+05	1.4272E+06	-1.415E+06	-3.143E+03	-3.331E+03	1	qp
-1.956E+05	3.5360E+06	-8.469E+06	-3.094E+04	-1.165E+04	11	SLV fond

Verifica di capacità portante riferita al palo singolo:

Fattore di correlazione Psi scelto in base alla conoscenza del sito = 1.7

Coeff. parziale di sicurezza sulla resistenza laterale = 1.15

Coeff. parziale di sicurezza sulla resistenza alla punta = 1.35

Portanza laterale di progetto = 292537.1

Portanza di punta di progetto = 85555.4

verifica condotta in combinazione SLU 3

Sforzo normale = -226834.5

Peso del palo = 49087.4 \* 1.3

Carico totale di progetto = -290648.1

Resistenza totale di progetto = 378092.5

Coefficiente di sicurezza = 1.3 > 1

Verifica di resistenza allo stato limite:

quota	Af	cop.	c.s.	Mx	My	N	comb
-90	0.0	6.50	0.00	0.0000E+00	0.0000E+00	0.0000E+00	-
-170	78.5	6.00	4.06	2.6225E+06	-6.046E+06	-1.962E+05	11SLV
-250	78.5	6.00	6.14	1.7103E+06	-3.627E+06	-1.978E+05	11SLV
-330	78.5	6.00	9.78	1.0179E+06	-1.831E+06	-1.556E+05	11SLV
-410	78.5	6.00	10.14	6.9356E+05	-6.997E+05	-1.817E+05	3SLU
-490	78.5	6.00	10.03	5.0679E+05	-5.119E+05	-1.838E+05	3SLU
-570	78.5	6.00	9.92	3.2002E+05	-3.240E+05	-1.858E+05	3SLU
-650	78.5	6.00	9.81	1.3325E+05	-1.362E+05	-1.878E+05	3SLU
-730	78.5	6.00	12.28	-4.852E+05	1.6245E+06	-1.227E+05	11SLV
-810	78.5	6.00	12.43	-4.751E+05	1.5363E+06	-1.243E+05	11SLV
-890	78.5	6.00	12.58	-4.649E+05	1.4481E+06	-1.259E+05	11SLV
-970	78.5	6.00	12.47	-8.708E+04	8.6063E+04	-1.478E+05	3SLU
-1050	78.5	6.00	12.30	-1.178E+05	1.1714E+05	-1.498E+05	3SLU
-1130	124.0	6.00	18.29	-4.244E+05	1.1673E+06	-9.035E+04	11SLV
-1210	78.5	6.00	17.36	-1.276E+05	1.2751E+05	-1.062E+05	3SLU
-1290	78.5	6.00	17.03	-1.165E+05	1.1663E+05	-1.082E+05	3SLU
-1370	78.5	6.00	16.71	-1.054E+05	1.0576E+05	-1.103E+05	3SLU
-1450	78.5	6.00	16.41	-9.431E+04	9.4883E+04	-1.123E+05	3SLU
-1530	78.5	6.00	16.12	-8.322E+04	8.4009E+04	-1.144E+05	3SLU
-1610	78.5	6.00	25.90	-7.150E+04	7.2268E+04	-7.118E+04	3SLU
-1690	78.5	6.00	25.17	-5.976E+04	6.0484E+04	-7.322E+04	3SLU
-1770	78.5	6.00	24.49	-4.801E+04	4.8701E+04	-7.526E+04	3SLU



Progetto	Titolo	Rev.	Pag.
Orione	Orione_A24a.pdf "TABULATI DI CALCOLO PLINTO DI FONDAZIONE PER AEROGENERATORE TIPO"	0	279



Tabulati di Calcolo Plinto di Fondazione per Aerogeneratore Tipo - Progetto Impianto Eolico - "Orione"

-1850	78.5	6.00	23.84	-3.626E+04	3.6918E+04	-7.730E+04	3SLU		
-1930	78.5	6.00	23.23	-2.452E+04	2.5134E+04	-7.935E+04	3SLU		
-2010	78.5	6.00	48.70	-1.804E+04	1.8562E+04	-3.785E+04	3SLU		
-2090	78.5	6.00	46.21	-1.412E+04	1.4535E+04	-3.989E+04	3SLU		
-2170	124.0	6.00	48.51	-1.021E+04	1.0508E+04	-4.193E+04	3SLU		
-2250	78.5	6.00	41.92	-6.297E+03	6.4809E+03	-4.397E+04	3SLU		
-2330	78.5	6.00	40.06	-2.384E+03	2.4539E+03	-4.602E+04	3SLU		
-2410	78.5	6.00	100.00	-2.607E-11	1.6608E-11	-5.466E+03	3SLU		
-2490	78.5	6.00	100.00	-2.016E-11	1.0697E-11	-7.508E+03	3SLU		

Verifica di esercizio (combinazione rara):

quota	Af	cop.	sigmaf	sigmac	Mx	My	N	comb	Wk
-90	0.0	6.50	0.0	0.0	0.0000E+00	0.0000E+00	0.0000E+00	-	0.000
-170	78.5	6.00		33.1	1.1619E+06	-1.157E+06	-1.750E+05	1	0.000
-250	78.5	6.00		30.2	8.9678E+05	-8.985E+05	-1.766E+05	1	0.000
-330	78.5	6.00		23.4	6.7718E+05	-6.827E+05	-1.382E+05	1	0.000
-410	78.5	6.00		21.9	5.3351E+05	-5.382E+05	-1.398E+05	1	0.000
-490	78.5	6.00		20.3	3.8984E+05	-3.937E+05	-1.414E+05	1	0.000
-570	78.5	6.00		18.8	2.4617E+05	-2.493E+05	-1.429E+05	1	0.000
-650	78.5	6.00		17.3	1.0250E+05	-1.048E+05	-1.445E+05	1	0.000
-730	78.5	6.00		12.2	3.8492E+03	-5.509E+03	-1.090E+05	1	0.000
-810	78.5	6.00		12.5	-1.976E+04	1.8394E+04	-1.105E+05	1	0.000
-890	78.5	6.00		13.0	-4.337E+04	4.2298E+04	-1.121E+05	1	0.000
-970	78.5	6.00		13.4	-6.699E+04	6.6202E+04	-1.137E+05	1	0.000
-1050	78.5	6.00		13.9	-9.060E+04	9.0106E+04	-1.153E+05	1	0.000
-1130	124.0	6.00		9.4	-1.067E+05	1.0645E+05	-8.012E+04	1	0.000
-1210	78.5	6.00		10.2	-9.814E+04	9.8082E+04	-8.170E+04	1	0.000
-1290	78.5	6.00		10.3	-8.961E+04	8.9717E+04	-8.327E+04	1	0.000
-1370	78.5	6.00		10.4	-8.108E+04	8.1352E+04	-8.484E+04	1	0.000
-1450	78.5	6.00		10.5	-7.255E+04	7.2987E+04	-8.641E+04	1	0.000
-1530	78.5	6.00		10.5	-6.401E+04	6.4622E+04	-8.798E+04	1	0.000
-1610	78.5	6.00		6.7	-5.500E+04	5.5591E+04	-5.475E+04	1	0.000
-1690	78.5	6.00		6.8	-4.597E+04	4.6527E+04	-5.632E+04	1	0.000
-1770	78.5	6.00		6.9	-3.693E+04	3.7462E+04	-5.789E+04	1	0.000
-1850	78.5	6.00		6.9	-2.790E+04	2.8398E+04	-5.946E+04	1	0.000
-1930	78.5	6.00		7.0	-1.886E+04	1.9334E+04	-6.104E+04	1	0.000
-2010	78.5	6.00		3.4	-1.387E+04	1.4278E+04	-2.911E+04	1	0.000
-2090	78.5	6.00		3.5	-1.086E+04	1.1181E+04	-3.068E+04	1	0.000
-2170	124.0	6.00		3.4	-7.854E+03	8.0830E+03	-3.225E+04	1	0.000
-2250	78.5	6.00		3.8	-4.844E+03	4.9853E+03	-3.383E+04	1	0.000
-2330	78.5	6.00		4.0	-1.834E+03	1.8876E+03	-3.540E+04	1	0.000
-2410	78.5	6.00		0.5	-2.005E-11	1.2776E-11	-4.205E+03	1	0.000
-2490	78.5	6.00		0.6	-1.550E-11	8.2282E-12	-5.776E+03	1	0.000

Verifica di esercizio (combinazione quasi permanente):

quota	Af	cop.	sigmaf	sigmac	Mx	My	N	comb	Wk
-90	0.0	6.50	0.0	0.0	0.0000E+00	0.0000E+00	0.0000E+00	-	0.000
-170	78.5	6.00		33.1	1.1619E+06	-1.157E+06	-1.750E+05	1	0.000
-250	78.5	6.00		30.2	8.9678E+05	-8.985E+05	-1.766E+05	1	0.000
-330	78.5	6.00		23.4	6.7718E+05	-6.827E+05	-1.382E+05	1	0.000
-410	78.5	6.00		21.9	5.3351E+05	-5.382E+05	-1.398E+05	1	0.000
-490	78.5	6.00		20.3	3.8984E+05	-3.937E+05	-1.414E+05	1	0.000
-570	78.5	6.00		18.8	2.4617E+05	-2.493E+05	-1.429E+05	1	0.000
-650	78.5	6.00		17.3	1.0250E+05	-1.048E+05	-1.445E+05	1	0.000
-730	78.5	6.00		12.2	3.8492E+03	-5.509E+03	-1.090E+05	1	0.000
-810	78.5	6.00		12.5	-1.976E+04	1.8394E+04	-1.105E+05	1	0.000
-890	78.5	6.00		13.0	-4.337E+04	4.2298E+04	-1.121E+05	1	0.000
-970	78.5	6.00		13.4	-6.699E+04	6.6202E+04	-1.137E+05	1	0.000
-1050	78.5	6.00		13.9	-9.060E+04	9.0106E+04	-1.153E+05	1	0.000
-1130	124.0	6.00		9.4	-1.067E+05	1.0645E+05	-8.012E+04	1	0.000
-1210	78.5	6.00		10.2	-9.814E+04	9.8082E+04	-8.170E+04	1	0.000
-1290	78.5	6.00		10.3	-8.961E+04	8.9717E+04	-8.327E+04	1	0.000
-1370	78.5	6.00		10.4	-8.108E+04	8.1352E+04	-8.484E+04	1	0.000
-1450	78.5	6.00		10.5	-7.255E+04	7.2987E+04	-8.641E+04	1	0.000
-1530	78.5	6.00		10.5	-6.401E+04	6.4622E+04	-8.798E+04	1	0.000
-1610	78.5	6.00		6.7	-5.500E+04	5.5591E+04	-5.475E+04	1	0.000
-1690	78.5	6.00		6.8	-4.597E+04	4.6527E+04	-5.632E+04	1	0.000
-1770	78.5	6.00		6.9	-3.693E+04	3.7462E+04	-5.789E+04	1	0.000
-1850	78.5	6.00		6.9	-2.790E+04	2.8398E+04	-5.946E+04	1	0.000
-1930	78.5	6.00		7.0	-1.886E+04	1.9334E+04	-6.104E+04	1	0.000
-2010	78.5	6.00		3.4	-1.387E+04	1.4278E+04	-2.911E+04	1	0.000
-2090	78.5	6.00		3.5	-1.086E+04	1.1181E+04	-3.068E+04	1	0.000
-2170	124.0	6.00		3.4	-7.854E+03	8.0830E+03	-3.225E+04	1	0.000
-2250	78.5	6.00		3.8	-4.844E+03	4.9853E+03	-3.383E+04	1	0.000
-2330	78.5	6.00		4.0	-1.834E+03	1.8876E+03	-3.540E+04	1	0.000
-2410	78.5	6.00		0.5	-2.005E-11	1.2776E-11	-4.205E+03	1	0.000
-2490	78.5	6.00		0.6	-1.550E-11	8.2282E-12	-5.776E+03	1	0.000

Verifica a taglio:

quota	Ast	Vsd	Vsdx	Vsdy	N comb	VRd,c	VRd,max	VRd,S	Vwd	
-90	0.16	33063	-30943	-11648	-195621	11SLV	50391	231056	94714	44323 Vsd < VRd,
-170	0.16	32324	-30246	-11403	-196235	11SLV	54364	231056	98688	44323 Vsd < VRd,
-250	0.08	32324	-30246	-11403	-197806	11SLV	54583	231056	76744	22162 Vsd < VRd,
-330	0.08	10271	-9429	-4073	-155589	11SLV	48715	231056	70876	22162 Vsd < VRd,



Progetto	Titolo	Rev.	Pag.
Orione	Orione_A24a.pdf "TABULATI DI CALCOLO PLINTO DI FONDAZIONE PER AEROGENERATORE TIPO"	0	280

-410	0.08	10271	-9429	-4073	-157159	11SLV	48933	231056	71095	22162	Vsd < VRd,
-490	0.08	10271	-9429	-4073	-158730	11SLV	49151	231056	71313	22162	Vsd < VRd,
-570	0.08	10271	-9429	-4073	-160301	11SLV	49370	231056	71531	22162	Vsd < VRd,
-650	0.08	10271	-9429	-4073	-161872	11SLV	49588	231056	71750	22162	Vsd < VRd,
-730	0.08	1845	-1700	-717	-95211	5SLV	40322	231056	62484	22162	Vsd < VRd,
-810	0.08	1845	-1700	-717	-96782	5SLV	40540	231056	62702	22162	Vsd < VRd,
-890	0.08	1845	-1700	-717	-98352	5SLV	40759	231056	62920	22162	Vsd < VRd,
-970	0.08	1845	-1700	-717	-99923	5SLV	40977	231056	63139	22162	Vsd < VRd,
-1050	0.08	1845	-1700	-717	-101494	5SLV	41195	231056	63357	22162	Vsd < VRd,
-1130	0.08	2085	1975	667	-90352	11SLV	44103	231056	66265	22162	Vsd < VRd,
-1210	0.08	2085	1975	667	-91923	11SLV	39865	231056	62027	22162	Vsd < VRd,
-1290	0.08	2085	1975	667	-93494	11SLV	40083	231056	62245	22162	Vsd < VRd,
-1370	0.08	2085	1975	667	-95065	11SLV	40302	231056	62463	22162	Vsd < VRd,
-1450	0.08	2085	1975	667	-96635	11SLV	40520	231056	62682	22162	Vsd < VRd,
-1530	0.08	2085	1975	667	-98206	11SLV	40738	231056	62900	22162	Vsd < VRd,
-1610	0.08	906	844	331	-61677	11SLV	35661	231056	57823	22162	Vsd < VRd,
-1690	0.08	906	844	331	-63248	11SLV	35879	231056	58041	22162	Vsd < VRd,
-1770	0.08	906	844	331	-64819	11SLV	36098	231056	58259	22162	Vsd < VRd,
-1850	0.08	906	844	331	-66390	11SLV	36316	231056	58478	22162	Vsd < VRd,
-1930	0.08	906	844	331	-67961	11SLV	36534	231056	58696	22162	Vsd < VRd,
-2010	0.08	70	50	49	-37847	3SLU	32349	231056	54510	22162	Vsd < VRd,
-2090	0.08	70	50	49	-39889	3SLU	32632	231056	54794	22162	Vsd < VRd,
-2170	0.08	70	50	49	-41931	3SLU	37373	231056	59534	22162	Vsd < VRd,
-2250	0.08	70	50	49	-43973	3SLU	33200	231056	55362	22162	Vsd < VRd,
-2330	0.08	70	50	49	-46015	3SLU	33484	231056	55646	22162	Vsd < VRd,
-2410	0.08	0	0	0	-3483	5SLV	27572	231056	49734	22162	Vsd < VRd,
-2490	0.08	0	0	0	-5054	5SLV	27790	231056	49952	22162	Vsd < VRd,

Palo alle coordinate X=505 Y=1083

Sollecitazioni massime in testa palo:

Combinazione corrispondente alla minima compressione in testa

N	Mx	My	Tx	Ty	comb
-9.975E+04	4.7160E+05	-1.396E+06	-3.291E+03	-1.468E+03	2 sl
-1.246E+05	5.9853E+05	-1.537E+06	-3.555E+03	-1.642E+03	2 ra
-1.495E+05	7.2546E+05	-1.677E+06	-3.819E+03	-1.816E+03	2 fr
-1.595E+05	7.7623E+05	-1.733E+06	-3.924E+03	-1.885E+03	2 qp
-1.509E+05	-1.240E+06	5.2566E+06	2.3792E+04	6.2606E+03	5 SLV fond

Combinazione corrispondente alla massima compressione in testa

N	Mx	My	Tx	Ty	comb
-2.267E+05	1.1081E+06	-2.363E+06	-5.308E+03	-2.586E+03	3 sl
-1.744E+05	8.5239E+05	-1.818E+06	-4.083E+03	-1.989E+03	1 ra
-1.744E+05	8.5239E+05	-1.818E+06	-4.083E+03	-1.989E+03	1 fr
-1.744E+05	8.5239E+05	-1.818E+06	-4.083E+03	-1.989E+03	1 qp
-1.979E+05	2.9447E+06	-8.892E+06	-3.196E+04	-1.024E+04	11 SLV fond

Combinazione corrispondente al massimo taglio in testa

N	Mx	My	Tx	Ty	comb
-2.267E+05	1.1081E+06	-2.363E+06	-5.308E+03	-2.586E+03	3 sl
-1.744E+05	8.5239E+05	-1.818E+06	-4.083E+03	-1.989E+03	1 ra
-1.744E+05	8.5239E+05	-1.818E+06	-4.083E+03	-1.989E+03	1 fr
-1.744E+05	8.5239E+05	-1.818E+06	-4.083E+03	-1.989E+03	1 qp
-1.979E+05	2.9447E+06	-8.892E+06	-3.196E+04	-1.024E+04	11 SLV fond

Verifica di capacità portante riferita al palo singolo:

Fattore di correlazione Psi scelto in base alla conoscenza del sito = 1.7

Coeff. parziale di sicurezza sulla resistenza laterale = 1.15

Coeff. parziale di sicurezza sulla resistenza alla punta = 1.35

Portanza laterale di progetto = 292537.1

Portanza di punta di progetto = 85555.4

verifica condotta in combinazione SLU 3

Sforzo normale = -226724.7

Peso del palo = 49087.4 \* 1.3

Carico totale di progetto = -290538.3

Resistenza totale di progetto = 378092.5

Coefficiente di sicurezza = 1.3 > 1

Verifica di resistenza allo stato limite:

quota	Af	cop.	c.s.	Mx	My	N	comb
-90	0.0	6.50	0.00	0.0000E+00	0.0000E+00	0.0000E+00	-
-170	78.5	6.00	3.98	2.1433E+06	-6.388E+06	-1.985E+05	11SLV
-250	78.5	6.00	6.02	1.3431E+06	-3.888E+06	-2.001E+05	11SLV
-330	78.5	6.00	9.60	7.4299E+05	-2.026E+06	-1.575E+05	11SLV
-410	78.5	6.00	10.15	4.1421E+05	-8.953E+05	-1.816E+05	3SLU
-490	78.5	6.00	10.04	3.0266E+05	-6.548E+05	-1.837E+05	3SLU
-570	78.5	6.00	9.92	1.9111E+05	-4.143E+05	-1.857E+05	3SLU
-650	78.5	6.00	9.82	7.9557E+04	-1.738E+05	-1.878E+05	3SLU
-730	78.5	6.00	12.19	-4.826E+05	1.6276E+06	-1.242E+05	11SLV
-810	78.5	6.00	12.32	-4.633E+05	1.5458E+06	-1.258E+05	11SLV
-890	78.5	6.00	12.46	-4.439E+05	1.4640E+06	-1.274E+05	11SLV
-970	78.5	6.00	12.48	-5.202E+04	1.1063E+05	-1.477E+05	3SLU
-1050	78.5	6.00	12.31	-7.035E+04	1.5036E+05	-1.498E+05	3SLU



Progetto	Titolo	Rev.	Pag.
Orione	Orione_A24a.pdf "TABULATI DI CALCOLO PLINTO DI FONDAZIONE PER AEROGENERATORE TIPO"	0	281

-1130	124.0	6.00	18.07	-3.788E+05	1.2002E+06	-9.146E+04	11SLV		
-1210	78.5	6.00	17.21	-3.292E+05	1.0394E+06	-9.303E+04	11SLV		
-1290	78.5	6.00	17.04	-6.958E+04	1.4949E+05	-1.082E+05	3SLU		
-1370	78.5	6.00	16.72	-6.296E+04	1.3549E+05	-1.102E+05	3SLU		
-1450	78.5	6.00	16.42	-5.633E+04	1.2148E+05	-1.123E+05	3SLU		
-1530	78.5	6.00	16.12	-4.970E+04	1.0748E+05	-1.143E+05	3SLU		
-1610	78.5	6.00	25.91	-4.270E+04	9.2435E+04	-7.115E+04	3SLU		
-1690	78.5	6.00	25.18	-3.569E+04	7.7339E+04	-7.319E+04	3SLU		
-1770	78.5	6.00	24.50	-2.867E+04	6.2242E+04	-7.523E+04	3SLU		
-1850	78.5	6.00	23.85	-2.166E+04	4.7146E+04	-7.727E+04	3SLU		
-1930	78.5	6.00	23.24	-1.464E+04	3.2049E+04	-7.931E+04	3SLU		
-2010	78.5	6.00	48.72	-1.077E+04	2.3648E+04	-3.783E+04	3SLU		
-2090	78.5	6.00	46.23	-8.434E+03	1.8518E+04	-3.987E+04	3SLU		
-2170	124.0	6.00	48.54	-6.097E+03	1.3387E+04	-4.191E+04	3SLU		
-2250	78.5	6.00	41.93	-3.761E+03	8.2568E+03	-4.396E+04	3SLU		
-2330	78.5	6.00	40.07	-1.424E+03	3.1263E+03	-4.600E+04	3SLU		
-2410	78.5	6.00	100.00	-1.419E-11	3.1129E-11	-5.463E+03	3SLU		
-2490	78.5	6.00	100.00	-1.419E-11	-1.025E-11	-7.505E+03	3SLU		

Verifica di esercizio (combinazione rara):

quota	Af	cop.	sigmaf	sigmac	Mx	My	N	comb	Wk
-90	0.0	6.50	0.0	0.0	0.0000E+00	0.0000E+00	0.0000E+00	-	0.000
-170	78.5	6.00		33.1	6.9396E+05	-1.485E+06	-1.750E+05	1	0.000
-250	78.5	6.00		30.2	5.3559E+05	-1.151E+06	-1.765E+05	1	0.000
-330	78.5	6.00		23.4	4.0443E+05	-8.737E+05	-1.381E+05	1	0.000
-410	78.5	6.00		21.9	3.1862E+05	-6.887E+05	-1.397E+05	1	0.000
-490	78.5	6.00		20.3	2.3281E+05	-5.037E+05	-1.413E+05	1	0.000
-570	78.5	6.00		18.8	1.4701E+05	-3.187E+05	-1.429E+05	1	0.000
-650	78.5	6.00		17.3	6.1198E+04	-1.337E+05	-1.444E+05	1	0.000
-730	78.5	6.00		12.2	2.2808E+03	-6.587E+03	-1.089E+05	1	0.000
-810	78.5	6.00		12.5	-1.182E+04	2.3975E+04	-1.105E+05	1	0.000
-890	78.5	6.00		13.0	-2.592E+04	5.4538E+04	-1.121E+05	1	0.000
-970	78.5	6.00		13.4	-4.002E+04	8.5101E+04	-1.136E+05	1	0.000
-1050	78.5	6.00		13.9	-5.412E+04	1.1566E+05	-1.152E+05	1	0.000
-1130	124.0	6.00		9.4	-6.372E+04	1.3654E+05	-8.009E+04	1	0.000
-1210	78.5	6.00		10.2	-5.862E+04	1.2577E+05	-8.166E+04	1	0.000
-1290	78.5	6.00		10.3	-5.352E+04	1.1499E+05	-8.323E+04	1	0.000
-1370	78.5	6.00		10.4	-4.843E+04	1.0422E+05	-8.480E+04	1	0.000
-1450	78.5	6.00		10.5	-4.333E+04	9.3450E+04	-8.637E+04	1	0.000
-1530	78.5	6.00		10.5	-3.823E+04	8.2678E+04	-8.794E+04	1	0.000
-1610	78.5	6.00		6.7	-3.285E+04	7.1104E+04	-5.473E+04	1	0.000
-1690	78.5	6.00		6.8	-2.745E+04	5.9491E+04	-5.630E+04	1	0.000
-1770	78.5	6.00		6.9	-2.206E+04	4.7879E+04	-5.787E+04	1	0.000
-1850	78.5	6.00		6.9	-1.666E+04	3.6266E+04	-5.944E+04	1	0.000
-1930	78.5	6.00		7.0	-1.126E+04	2.4653E+04	-6.101E+04	1	0.000
-2010	78.5	6.00		3.4	-8.285E+03	1.8191E+04	-2.910E+04	1	0.000
-2090	78.5	6.00		3.5	-6.488E+03	1.4244E+04	-3.067E+04	1	0.000
-2170	124.0	6.00		3.4	-4.690E+03	1.0298E+04	-3.224E+04	1	0.000
-2250	78.5	6.00		3.8	-2.893E+03	6.3514E+03	-3.381E+04	1	0.000
-2330	78.5	6.00		4.0	-1.095E+03	2.4048E+03	-3.538E+04	1	0.000
-2410	78.5	6.00		0.5	-1.091E-11	2.3945E-11	-4.202E+03	1	0.000
-2490	78.5	6.00		0.6	-1.091E-11	-7.887E-12	-5.773E+03	1	0.000

Verifica di esercizio (combinazione quasi permanente):

quota	Af	cop.	sigmaf	sigmac	Mx	My	N	comb	Wk
-90	0.0	6.50	0.0	0.0	0.0000E+00	0.0000E+00	0.0000E+00	-	0.000
-170	78.5	6.00		33.1	6.9396E+05	-1.485E+06	-1.750E+05	1	0.000
-250	78.5	6.00		30.2	5.3559E+05	-1.151E+06	-1.765E+05	1	0.000
-330	78.5	6.00		23.4	4.0443E+05	-8.737E+05	-1.381E+05	1	0.000
-410	78.5	6.00		21.9	3.1862E+05	-6.887E+05	-1.397E+05	1	0.000
-490	78.5	6.00		20.3	2.3281E+05	-5.037E+05	-1.413E+05	1	0.000
-570	78.5	6.00		18.8	1.4701E+05	-3.187E+05	-1.429E+05	1	0.000
-650	78.5	6.00		17.3	6.1198E+04	-1.337E+05	-1.444E+05	1	0.000
-730	78.5	6.00		12.2	2.2808E+03	-6.587E+03	-1.089E+05	1	0.000
-810	78.5	6.00		12.5	-1.182E+04	2.3975E+04	-1.105E+05	1	0.000
-890	78.5	6.00		13.0	-2.592E+04	5.4538E+04	-1.121E+05	1	0.000
-970	78.5	6.00		13.4	-4.002E+04	8.5101E+04	-1.136E+05	1	0.000
-1050	78.5	6.00		13.9	-5.412E+04	1.1566E+05	-1.152E+05	1	0.000
-1130	124.0	6.00		9.4	-6.372E+04	1.3654E+05	-8.009E+04	1	0.000
-1210	78.5	6.00		10.2	-5.862E+04	1.2577E+05	-8.166E+04	1	0.000
-1290	78.5	6.00		10.3	-5.352E+04	1.1499E+05	-8.323E+04	1	0.000
-1370	78.5	6.00		10.4	-4.843E+04	1.0422E+05	-8.480E+04	1	0.000
-1450	78.5	6.00		10.5	-4.333E+04	9.3450E+04	-8.637E+04	1	0.000
-1530	78.5	6.00		10.5	-3.823E+04	8.2678E+04	-8.794E+04	1	0.000
-1610	78.5	6.00		6.7	-3.285E+04	7.1104E+04	-5.473E+04	1	0.000
-1690	78.5	6.00		6.8	-2.745E+04	5.9491E+04	-5.630E+04	1	0.000
-1770	78.5	6.00		6.9	-2.206E+04	4.7879E+04	-5.787E+04	1	0.000
-1850	78.5	6.00		6.9	-1.666E+04	3.6266E+04	-5.944E+04	1	0.000
-1930	78.5	6.00		7.0	-1.126E+04	2.4653E+04	-6.101E+04	1	0.000
-2010	78.5	6.00		3.4	-8.285E+03	1.8191E+04	-2.910E+04	1	0.000
-2090	78.5	6.00		3.5	-6.488E+03	1.4244E+04	-3.067E+04	1	0.000
-2170	124.0	6.00		3.4	-4.690E+03	1.0298E+04	-3.224E+04	1	0.000
-2250	78.5	6.00		3.8	-2.893E+03	6.3514E+03	-3.381E+04	1	0.000
-2330	78.5	6.00		4.0	-1.095E+03	2.4048E+03	-3.538E+04	1	0.000
-2410	78.5	6.00		0.5	-1.091E-11	2.3945E-11	-4.202E+03	1	0.000
-2490	78.5	6.00		0.6	-1.091E-11	-7.887E-12	-5.773E+03	1	0.000



Verifica a taglio:

quota	Ast	Vsd	Vsdx	Vsdy	N	comb	VRd,c	VRd,max	VRd,S	Vwd	
-90	0.16	33557	-31957	-10239	-197937	11SLV	50713	231056	95036	44323	Vsd < VRd,
-170	0.16	32816	-31254	-10003	-198541	11SLV	54685	231056	99008	44323	Vsd < VRd,
-250	0.08	32816	-31254	-10003	-200112	11SLV	54903	231056	77065	22162	Vsd < VRd,
-330	0.08	10501	-9958	-3332	-157468	11SLV	48976	231056	71137	22162	Vsd < VRd,
-410	0.08	10501	-9958	-3332	-159039	11SLV	49194	231056	71356	22162	Vsd < VRd,
-490	0.08	10501	-9958	-3332	-160609	11SLV	49412	231056	71574	22162	Vsd < VRd,
-570	0.08	10501	-9958	-3332	-162180	11SLV	49631	231056	71792	22162	Vsd < VRd,
-650	0.08	10501	-9958	-3332	-163751	11SLV	49849	231056	72011	22162	Vsd < VRd,
-730	0.08	1882	-1786	-594	-93622	5SLV	40101	231056	62263	22162	Vsd < VRd,
-810	0.08	1882	-1786	-594	-95193	5SLV	40320	231056	62481	22162	Vsd < VRd,
-890	0.08	1882	-1786	-594	-96764	5SLV	40538	231056	62700	22162	Vsd < VRd,
-970	0.08	1882	-1786	-594	-98335	5SLV	40756	231056	62918	22162	Vsd < VRd,
-1050	0.08	1882	-1786	-594	-99905	5SLV	40975	231056	63136	22162	Vsd < VRd,
-1130	0.08	2104	2010	620	-91458	11SLV	44257	231056	66418	22162	Vsd < VRd,
-1210	0.08	2104	2010	620	-93029	11SLV	40019	231056	62180	22162	Vsd < VRd,
-1290	0.08	2104	2010	620	-94599	11SLV	40237	231056	62399	22162	Vsd < VRd,
-1370	0.08	2104	2010	620	-96170	11SLV	40455	231056	62617	22162	Vsd < VRd,
-1450	0.08	2104	2010	620	-97741	11SLV	40674	231056	62836	22162	Vsd < VRd,
-1530	0.08	2104	2010	620	-99312	11SLV	40892	231056	63054	22162	Vsd < VRd,
-1610	0.08	922	878	284	-62426	11SLV	35765	231056	57927	22162	Vsd < VRd,
-1690	0.08	922	878	284	-63997	11SLV	35983	231056	58145	22162	Vsd < VRd,
-1770	0.08	922	878	284	-65568	11SLV	36202	231056	58363	22162	Vsd < VRd,
-1850	0.08	922	878	284	-67139	11SLV	36420	231056	58582	22162	Vsd < VRd,
-1930	0.08	922	878	284	-68709	11SLV	36638	231056	58800	22162	Vsd < VRd,
-2010	0.08	70	64	29	-37829	3SLU	32346	231056	54508	22162	Vsd < VRd,
-2090	0.08	70	64	29	-39871	3SLU	32630	231056	54792	22162	Vsd < VRd,
-2170	0.08	70	64	29	-41913	3SLU	37370	231056	59532	22162	Vsd < VRd,
-2250	0.08	70	64	29	-43955	3SLU	33198	231056	55359	22162	Vsd < VRd,
-2330	0.08	70	64	29	-45997	3SLU	33482	231056	55643	22162	Vsd < VRd,
-2410	0.08	0	0	0	-3608	9SLV	27590	231056	49751	22162	Vsd < VRd,
-2490	0.08	0	0	0	-5179	9SLV	27808	231056	49970	22162	Vsd < VRd,

Palo alle coordinate X=104 Y=1191

Sollecitazioni massime in testa palo:

Combinazione corrispondente alla minima compressione in testa

N	Mx	My	Tx	Ty	comb	
-9.171E+04	2.2376E+05	-1.292E+06	-3.025E+03	-8.333E+02	2	sl
-1.193E+05	2.0746E+05	-1.527E+06	-3.519E+03	-6.916E+02	2	ra
-1.468E+05	1.9116E+05	-1.763E+06	-4.013E+03	-5.499E+02	2	fr
-1.578E+05	1.8464E+05	-1.858E+06	-4.210E+03	-4.933E+02	2	qp
-1.513E+05	-1.892E+06	5.0806E+06	2.3386E+04	7.7397E+03	5	SLV fond

Combinazione corrispondente alla massima compressione in testa

N	Mx	My	Tx	Ty	comb	
-2.266E+05	2.2731E+05	-2.599E+06	-5.858E+03	-5.307E+02	3	sl
-1.743E+05	1.7485E+05	-1.999E+06	-4.507E+03	-4.083E+02	1	ra
-1.743E+05	1.7485E+05	-1.999E+06	-4.507E+03	-4.083E+02	1	fr
-1.743E+05	1.7485E+05	-1.999E+06	-4.507E+03	-4.083E+02	1	qp
-1.974E+05	2.2414E+06	-9.079E+06	-3.240E+04	-8.556E+03	11	SLV fond

Combinazione corrispondente al massimo taglio in testa

N	Mx	My	Tx	Ty	comb	
-2.266E+05	2.2731E+05	-2.599E+06	-5.858E+03	-5.307E+02	3	sl
-1.743E+05	1.7485E+05	-1.999E+06	-4.507E+03	-4.083E+02	1	ra
-1.743E+05	1.7485E+05	-1.999E+06	-4.507E+03	-4.083E+02	1	fr
-1.743E+05	1.7485E+05	-1.999E+06	-4.507E+03	-4.083E+02	1	qp
-1.974E+05	2.2414E+06	-9.079E+06	-3.240E+04	-8.556E+03	11	SLV fond

Verifica di capacità portante riferita al palo singolo:

Fattore di correlazione Psi scelto in base alla conoscenza del sito = 1.7  
 Coeff. parziale di sicurezza sulla resistenza laterale = 1.15  
 Coeff. parziale di sicurezza sulla resistenza alla punta = 1.35  
 Portanza laterale di progetto = 292537.1  
 Portanza di punta di progetto = 85555.4  
 verifica condotta in combinazione SLU 3  
 Sforzo normale = -226636.3  
 Peso del palo = 49087.4 \* 1.3  
 Carico totale di progetto = -290449.9  
 Resistenza totale di progetto = 378092.5  
 Coefficiente di sicurezza = 1.3 > 1

Verifica di resistenza allo stato limite:

quota	Af	cop.	c.s.	Mx	My	N	comb
-90	0.0	6.50	0.00	0.0000E+00	0.0000E+00	0.0000E+00	-
-170	78.5	6.00	3.99	1.5738E+06	-6.540E+06	-1.980E+05	11SLV
-250	78.5	6.00	6.03	9.0745E+05	-4.005E+06	-1.996E+05	11SLV
-330	78.5	6.00	9.62	4.1740E+05	-2.114E+06	-1.570E+05	11SLV



Progetto	Titolo	Rev.	Pag.
Orione	Orione_A24a.pdf "TABULATI DI CALCOLO PLINTO DI FONDAZIONE PER AEROGENERATORE TIPO"	0	283

-410	78.5	6.00	10.15	8.4926E+04	-9.834E+05	-1.816E+05	3SLU		
-490	78.5	6.00	10.04	6.2045E+04	-7.192E+05	-1.836E+05	3SLU		
-570	78.5	6.00	9.93	3.9164E+04	-4.549E+05	-1.857E+05	3SLU		
-650	78.5	6.00	9.82	1.6284E+04	-1.907E+05	-1.877E+05	3SLU		
-730	78.5	6.00	12.21	-4.784E+05	1.6278E+06	-1.239E+05	11SLV		
-810	78.5	6.00	12.35	-4.483E+05	1.5490E+06	-1.255E+05	11SLV		
-890	78.5	6.00	12.49	-4.181E+05	1.4703E+06	-1.270E+05	11SLV		
-970	78.5	6.00	12.48	-1.069E+04	1.2172E+05	-1.477E+05	3SLU		
-1050	78.5	6.00	12.31	-1.445E+04	1.6535E+05	-1.497E+05	3SLU		
-1130	124.0	6.00	18.10	-3.243E+05	1.2145E+06	-9.121E+04	11SLV		
-1210	78.5	6.00	17.25	-2.793E+05	1.0525E+06	-9.278E+04	11SLV		
-1290	78.5	6.00	17.04	-1.428E+04	1.6431E+05	-1.082E+05	3SLU		
-1370	78.5	6.00	16.73	-1.292E+04	1.4889E+05	-1.102E+05	3SLU		
-1450	78.5	6.00	16.42	-1.156E+04	1.3348E+05	-1.122E+05	3SLU		
-1530	78.5	6.00	16.13	-1.020E+04	1.1806E+05	-1.143E+05	3SLU		
-1610	78.5	6.00	25.92	-8.760E+03	1.0153E+05	-7.112E+04	3SLU		
-1690	78.5	6.00	25.19	-7.320E+03	8.4935E+04	-7.316E+04	3SLU		
-1770	78.5	6.00	24.51	-5.881E+03	6.8345E+04	-7.520E+04	3SLU		
-1850	78.5	6.00	23.86	-4.442E+03	5.1755E+04	-7.724E+04	3SLU		
-1930	78.5	6.00	23.25	-3.002E+03	3.5165E+04	-7.929E+04	3SLU		
-2010	78.5	6.00	48.74	-2.208E+03	2.5940E+04	-3.781E+04	3SLU		
-2090	78.5	6.00	46.25	-1.729E+03	2.0312E+04	-3.986E+04	3SLU		
-2170	124.0	6.00	48.55	-1.250E+03	1.4685E+04	-4.190E+04	3SLU		
-2250	78.5	6.00	41.95	-7.709E+02	9.0570E+03	-4.394E+04	3SLU		
-2330	78.5	6.00	40.09	-2.919E+02	3.4293E+03	-4.598E+04	3SLU		
-2410	78.5	6.00	100.00	-3.547E-12	2.3980E-11	-5.460E+03	3SLU		
-2490	78.5	6.00	100.00	-3.547E-12	-1.149E-11	-7.502E+03	3SLU		

Verifica di esercizio (combinazione rara):

quota	Af	cop.	sigmaf	sigmac	Mx	My	N	comb	Wk
-90	0.0	6.50	0.0	0.0	0.0000E+00	0.0000E+00	0.0000E+00	-	0.000
-170	78.5	6.00		33.1	1.4234E+05	-1.633E+06	-1.749E+05	1	0.000
-250	78.5	6.00		30.2	1.0984E+05	-1.265E+06	-1.765E+05	1	0.000
-330	78.5	6.00		23.4	8.2928E+04	-9.598E+05	-1.381E+05	1	0.000
-410	78.5	6.00		21.9	6.5327E+04	-7.565E+05	-1.397E+05	1	0.000
-490	78.5	6.00		20.3	4.7727E+04	-5.532E+05	-1.412E+05	1	0.000
-570	78.5	6.00		18.8	3.0126E+04	-3.500E+05	-1.428E+05	1	0.000
-650	78.5	6.00		17.3	1.2526E+04	-1.467E+05	-1.444E+05	1	0.000
-730	78.5	6.00		12.2	4.4228E+02	-7.056E+03	-1.089E+05	1	0.000
-810	78.5	6.00		12.5	-2.447E+03	2.6506E+04	-1.104E+05	1	0.000
-890	78.5	6.00		13.0	-5.335E+03	6.0068E+04	-1.120E+05	1	0.000
-970	78.5	6.00		13.4	-8.224E+03	9.3630E+04	-1.136E+05	1	0.000
-1050	78.5	6.00		13.9	-1.111E+04	1.2719E+05	-1.152E+05	1	0.000
-1130	124.0	6.00		9.4	-1.308E+04	1.5011E+05	-8.006E+04	1	0.000
-1210	78.5	6.00		10.2	-1.203E+04	1.3825E+05	-8.163E+04	1	0.000
-1290	78.5	6.00		10.3	-1.098E+04	1.2639E+05	-8.320E+04	1	0.000
-1370	78.5	6.00		10.4	-9.937E+03	1.1453E+05	-8.477E+04	1	0.000
-1450	78.5	6.00		10.5	-8.890E+03	1.0267E+05	-8.634E+04	1	0.000
-1530	78.5	6.00		10.5	-7.843E+03	9.0816E+04	-8.791E+04	1	0.000
-1610	78.5	6.00		6.7	-6.738E+03	7.8097E+04	-5.471E+04	1	0.000
-1690	78.5	6.00		6.8	-5.631E+03	6.5335E+04	-5.628E+04	1	0.000
-1770	78.5	6.00		6.9	-4.524E+03	5.2573E+04	-5.785E+04	1	0.000
-1850	78.5	6.00		6.9	-3.417E+03	3.9812E+04	-5.942E+04	1	0.000
-1930	78.5	6.00		7.0	-2.309E+03	2.7050E+04	-6.099E+04	1	0.000
-2010	78.5	6.00		3.4	-1.698E+03	1.9954E+04	-2.909E+04	1	0.000
-2090	78.5	6.00		3.5	-1.330E+03	1.5625E+04	-3.066E+04	1	0.000
-2170	124.0	6.00		3.4	-9.615E+02	1.1296E+04	-3.223E+04	1	0.000
-2250	78.5	6.00		3.8	-5.930E+02	6.9669E+03	-3.380E+04	1	0.000
-2330	78.5	6.00		4.0	-2.245E+02	2.6379E+03	-3.537E+04	1	0.000
-2410	78.5	6.00		0.5	-2.728E-12	1.8446E-11	-4.200E+03	1	0.000
-2490	78.5	6.00		0.6	-2.728E-12	-8.839E-12	-5.771E+03	1	0.000

Verifica di esercizio (combinazione quasi permanente):

quota	Af	cop.	sigmaf	sigmac	Mx	My	N	comb	Wk
-90	0.0	6.50	0.0	0.0	0.0000E+00	0.0000E+00	0.0000E+00	-	0.000
-170	78.5	6.00		33.1	1.4234E+05	-1.633E+06	-1.749E+05	1	0.000
-250	78.5	6.00		30.2	1.0984E+05	-1.265E+06	-1.765E+05	1	0.000
-330	78.5	6.00		23.4	8.2928E+04	-9.598E+05	-1.381E+05	1	0.000
-410	78.5	6.00		21.9	6.5327E+04	-7.565E+05	-1.397E+05	1	0.000
-490	78.5	6.00		20.3	4.7727E+04	-5.532E+05	-1.412E+05	1	0.000
-570	78.5	6.00		18.8	3.0126E+04	-3.500E+05	-1.428E+05	1	0.000
-650	78.5	6.00		17.3	1.2526E+04	-1.467E+05	-1.444E+05	1	0.000
-730	78.5	6.00		12.2	4.4228E+02	-7.056E+03	-1.089E+05	1	0.000
-810	78.5	6.00		12.5	-2.447E+03	2.6506E+04	-1.104E+05	1	0.000
-890	78.5	6.00		13.0	-5.335E+03	6.0068E+04	-1.120E+05	1	0.000
-970	78.5	6.00		13.4	-8.224E+03	9.3630E+04	-1.136E+05	1	0.000
-1050	78.5	6.00		13.9	-1.111E+04	1.2719E+05	-1.152E+05	1	0.000
-1130	124.0	6.00		9.4	-1.308E+04	1.5011E+05	-8.006E+04	1	0.000
-1210	78.5	6.00		10.2	-1.203E+04	1.3825E+05	-8.163E+04	1	0.000
-1290	78.5	6.00		10.3	-1.098E+04	1.2639E+05	-8.320E+04	1	0.000
-1370	78.5	6.00		10.4	-9.937E+03	1.1453E+05	-8.477E+04	1	0.000
-1450	78.5	6.00		10.5	-8.890E+03	1.0267E+05	-8.634E+04	1	0.000
-1530	78.5	6.00		10.5	-7.843E+03	9.0816E+04	-8.791E+04	1	0.000
-1610	78.5	6.00		6.7	-6.738E+03	7.8097E+04	-5.471E+04	1	0.000
-1690	78.5	6.00		6.8	-5.631E+03	6.5335E+04	-5.628E+04	1	0.000
-1770	78.5	6.00		6.9	-4.524E+03	5.2573E+04	-5.785E+04	1	0.000



Tabulati di Calcolo Plinto di Fondazione per Aerogeneratore Tipo - Progetto Impianto Eolico - "Orione"

-1850	78.5	6.00	6.9	-3.417E+03	3.9812E+04	-5.942E+04	1	0.000
-1930	78.5	6.00	7.0	-2.309E+03	2.7050E+04	-6.099E+04	1	0.000
-2010	78.5	6.00	3.4	-1.698E+03	1.9954E+04	-2.909E+04	1	0.000
-2090	78.5	6.00	3.5	-1.330E+03	1.5625E+04	-3.066E+04	1	0.000
-2170	124.0	6.00	3.4	-9.615E+02	1.1296E+04	-3.223E+04	1	0.000
-2250	78.5	6.00	3.8	-5.930E+02	6.9669E+03	-3.380E+04	1	0.000
-2330	78.5	6.00	4.0	-2.245E+02	2.6379E+03	-3.537E+04	1	0.000
-2410	78.5	6.00	0.5	-2.728E-12	1.8446E-11	-4.200E+03	1	0.000
-2490	78.5	6.00	0.6	-2.728E-12	-8.839E-12	-5.771E+03	1	0.000

Verifica a taglio:

quota	Ast	Vsd	Vsdx	Vsdy	N	comb	VRd,c	VRd,max	VRd,S	Vwd
-90	0.16	33510	-32399	-8556	-197418	11SLV	50640	231056	94964	44323 Vsd < VRd,
-170	0.16	32770	-31694	-8330	-198025	11SLV	54613	231056	98936	44323 Vsd < VRd,
-250	0.08	32770	-31694	-8330	-199596	11SLV	54831	231056	76993	22162 Vsd < VRd,
-330	0.08	10484	-10193	-2452	-157049	11SLV	48918	231056	71079	22162 Vsd < VRd,
-410	0.08	10484	-10193	-2452	-158620	11SLV	49136	231056	71298	22162 Vsd < VRd,
-490	0.08	10484	-10193	-2452	-160191	11SLV	49354	231056	71516	22162 Vsd < VRd,
-570	0.08	10484	-10193	-2452	-161762	11SLV	49573	231056	71734	22162 Vsd < VRd,
-650	0.08	10484	-10193	-2452	-163332	11SLV	49791	231056	71953	22162 Vsd < VRd,
-730	0.08	1878	-1824	-449	-93869	5SLV	40136	231056	62297	22162 Vsd < VRd,
-810	0.08	1878	-1824	-449	-95440	5SLV	40354	231056	62516	22162 Vsd < VRd,
-890	0.08	1878	-1824	-449	-97011	5SLV	40572	231056	62734	22162 Vsd < VRd,
-970	0.08	1878	-1824	-449	-98581	5SLV	40791	231056	62952	22162 Vsd < VRd,
-1050	0.08	1878	-1824	-449	-100152	5SLV	41009	231056	63171	22162 Vsd < VRd,
-1130	0.08	2101	2025	562	-91212	11SLV	44223	231056	66384	22162 Vsd < VRd,
-1210	0.08	2101	2025	562	-92783	11SLV	39985	231056	62146	22162 Vsd < VRd,
-1290	0.08	2101	2025	562	-94354	11SLV	40203	231056	62365	22162 Vsd < VRd,
-1370	0.08	2101	2025	562	-95924	11SLV	40421	231056	62583	22162 Vsd < VRd,
-1450	0.08	2101	2025	562	-97495	11SLV	40640	231056	62801	22162 Vsd < VRd,
-1530	0.08	2101	2025	562	-99066	11SLV	40858	231056	63020	22162 Vsd < VRd,
-1610	0.08	921	892	228	-62260	11SLV	35742	231056	57904	22162 Vsd < VRd,
-1690	0.08	921	892	228	-63830	11SLV	35960	231056	58122	22162 Vsd < VRd,
-1770	0.08	921	892	228	-65401	11SLV	36179	231056	58340	22162 Vsd < VRd,
-1850	0.08	921	892	228	-66972	11SLV	36397	231056	58559	22162 Vsd < VRd,
-1930	0.08	921	892	228	-68543	11SLV	36615	231056	58777	22162 Vsd < VRd,
-2010	0.08	71	70	6	-37814	3SLU	32344	231056	54506	22162 Vsd < VRd,
-2090	0.08	71	70	6	-39856	3SLU	32628	231056	54790	22162 Vsd < VRd,
-2170	0.08	71	70	6	-41898	3SLU	37368	231056	59530	22162 Vsd < VRd,
-2250	0.08	71	70	6	-43940	3SLU	33196	231056	55357	22162 Vsd < VRd,
-2330	0.08	71	70	6	-45982	3SLU	33479	231056	55641	22162 Vsd < VRd,
-2410	0.08	0	0	0	-4987	11SLV	27781	231056	49943	22162 Vsd < VRd,
-2490	0.08	0	0	0	-6558	11SLV	28000	231056	50161	22162 Vsd < VRd,

Palo alle coordinate X=-309 Y=1155

Sollecitazioni massime in testa palo:

Combinazione corrispondente alla minima compressione in testa

N	Mx	My	Tx	Ty	comb
-9.366E+04	2.7425E+04	-1.284E+06	-2.942E+03	-3.332E+02	2 sl
-1.205E+05	-1.564E+05	-1.502E+06	-3.416E+03	1.8539E+02	2 ra
-1.474E+05	-3.402E+05	-1.720E+06	-3.890E+03	7.0397E+02	2 fr
-1.582E+05	-4.137E+05	-1.807E+06	-4.079E+03	9.1140E+02	2 qp
-1.506E+05	1.5568E+06	5.1422E+06	2.3532E+04	-6.980E+03	9 SLV fond

Combinazione corrispondente alla massima compressione in testa

N	Mx	My	Tx	Ty	comb
-2.266E+05	-6.812E+05	-2.519E+06	-5.673E+03	1.5893E+03	3 sl
-1.743E+05	-5.240E+05	-1.938E+06	-4.364E+03	1.2226E+03	1 ra
-1.743E+05	-5.240E+05	-1.938E+06	-4.364E+03	1.2226E+03	1 fr
-1.743E+05	-5.240E+05	-1.938E+06	-4.364E+03	1.2226E+03	1 qp
-1.979E+05	-2.605E+06	-9.018E+06	-3.226E+04	9.4255E+03	7 SLV fond

Combinazione corrispondente al massimo taglio in testa

N	Mx	My	Tx	Ty	comb
-2.266E+05	-6.812E+05	-2.519E+06	-5.673E+03	1.5893E+03	3 sl
-1.743E+05	-5.240E+05	-1.938E+06	-4.364E+03	1.2226E+03	1 ra
-1.743E+05	-5.240E+05	-1.938E+06	-4.364E+03	1.2226E+03	1 fr
-1.743E+05	-5.240E+05	-1.938E+06	-4.364E+03	1.2226E+03	1 qp
-1.979E+05	-2.605E+06	-9.018E+06	-3.226E+04	9.4255E+03	7 SLV fond

Verifica di capacità portante riferita al palo singolo:

Fattore di correlazione Psi scelto in base alla conoscenza del sito = 1.7  
 Coeff. parziale di sicurezza sulla resistenza laterale = 1.15  
 Coeff. parziale di sicurezza sulla resistenza alla punta = 1.35  
 Portanza laterale di progetto = 292537.1  
 Portanza di punta di progetto = 85555.4  
 verifica condotta in combinazione SLU 3  
 Sforzo normale = -226579.9  
 Peso del palo = 49087.4 \* 1.3  
 Carico totale di progetto = -290393.5  
 Resistenza totale di progetto = 378092.5  
 Coefficiente di sicurezza = 1.3 > 1



Progetto	Titolo	Rev.	Pag.
Orione	Orione_A24a.pdf "TABULATI DI CALCOLO PLINTO DI FONDAZIONE PER AEROGENERATORE TIPO"	0	285

Verifica di resistenza allo stato limite:

quota	Af	cop.	c.s.	Mx	My	N	comb
-90	0.0	6.50	0.00	0.0000E+00	0.0000E+00	0.0000E+00	-
-170	78.5	6.00	3.97	-1.868E+06	-6.490E+06	-1.985E+05	7SLV
-250	78.5	6.00	6.01	-1.133E+06	-3.966E+06	-2.001E+05	7SLV
-330	78.5	6.00	9.59	-5.857E+05	-2.085E+06	-1.575E+05	7SLV
-410	78.5	6.00	10.15	-2.547E+05	-9.537E+05	-1.815E+05	3SLU
-490	78.5	6.00	10.04	-1.861E+05	-6.974E+05	-1.836E+05	3SLU
-570	78.5	6.00	9.93	-1.176E+05	-4.412E+05	-1.856E+05	3SLU
-650	78.5	6.00	9.82	-4.897E+04	-1.849E+05	-1.876E+05	3SLU
-730	78.5	6.00	12.19	4.8052E+05	1.6284E+06	-1.242E+05	7SLV
-810	78.5	6.00	12.32	4.5597E+05	1.5485E+06	-1.258E+05	7SLV
-890	78.5	6.00	12.46	4.3142E+05	1.4687E+06	-1.274E+05	7SLV
-970	78.5	6.00	12.49	3.1944E+04	1.1800E+05	-1.476E+05	3SLU
-1050	78.5	6.00	12.31	4.3220E+04	1.6031E+05	-1.497E+05	3SLU
-1130	124.0	6.00	18.06	3.5242E+05	1.2100E+06	-9.146E+04	7SLV
-1210	78.5	6.00	17.20	3.0507E+05	1.0484E+06	-9.303E+04	7SLV
-1290	78.5	6.00	17.05	4.2761E+04	1.5932E+05	-1.081E+05	3SLU
-1370	78.5	6.00	16.73	3.8692E+04	1.4437E+05	-1.102E+05	3SLU
-1450	78.5	6.00	16.43	3.4622E+04	1.2943E+05	-1.122E+05	3SLU
-1530	78.5	6.00	16.13	3.0553E+04	1.1449E+05	-1.143E+05	3SLU
-1610	78.5	6.00	25.92	2.6252E+04	9.8458E+04	-7.110E+04	3SLU
-1690	78.5	6.00	25.20	2.1940E+04	8.2371E+04	-7.314E+04	3SLU
-1770	78.5	6.00	24.52	1.7628E+04	6.6285E+04	-7.518E+04	3SLU
-1850	78.5	6.00	23.87	1.3316E+04	5.0198E+04	-7.723E+04	3SLU
-1930	78.5	6.00	23.25	9.0042E+03	3.4112E+04	-7.927E+04	3SLU
-2010	78.5	6.00	48.76	6.6237E+03	2.5165E+04	-3.780E+04	3SLU
-2090	78.5	6.00	46.26	5.1867E+03	1.9706E+04	-3.985E+04	3SLU
-2170	124.0	6.00	48.56	3.7497E+03	1.4246E+04	-4.189E+04	3SLU
-2250	78.5	6.00	41.96	2.3127E+03	8.7864E+03	-4.393E+04	3SLU
-2330	78.5	6.00	40.09	8.7565E+02	3.3268E+03	-4.597E+04	3SLU
-2410	78.5	6.00	100.00	4.7294E-12	1.4299E-11	-5.458E+03	3SLU
-2490	78.5	6.00	100.00	4.7294E-12	2.4757E-12	-7.500E+03	3SLU

Verifica di esercizio (combinazione rara):

quota	Af	cop.	sigmaf	sigmac	Mx	My	N	comb	Wk
-90	0.0	6.50	0.0	0.0	0.0000E+00	0.0000E+00	0.0000E+00	-	0.000
-170	78.5	6.00	33.1	-4.266E+05	-1.583E+06	-1.748E+05	1	0.000	
-250	78.5	6.00	30.2	-3.293E+05	-1.227E+06	-1.764E+05	1	0.000	
-330	78.5	6.00	23.4	-2.487E+05	-9.307E+05	-1.381E+05	1	0.000	
-410	78.5	6.00	21.9	-1.959E+05	-7.336E+05	-1.396E+05	1	0.000	
-490	78.5	6.00	20.3	-1.432E+05	-5.365E+05	-1.412E+05	1	0.000	
-570	78.5	6.00	18.8	-9.042E+04	-3.394E+05	-1.428E+05	1	0.000	
-650	78.5	6.00	17.3	-3.767E+04	-1.423E+05	-1.443E+05	1	0.000	
-730	78.5	6.00	12.2	-1.450E+03	-6.873E+03	-1.089E+05	1	0.000	
-810	78.5	6.00	12.5	7.2238E+03	2.5673E+04	-1.104E+05	1	0.000	
-890	78.5	6.00	13.0	1.5898E+04	5.8220E+04	-1.120E+05	1	0.000	
-970	78.5	6.00	13.4	2.4572E+04	9.0766E+04	-1.136E+05	1	0.000	
-1050	78.5	6.00	13.9	3.3247E+04	1.2331E+05	-1.151E+05	1	0.000	
-1130	124.0	6.00	9.4	3.9154E+04	1.4554E+05	-8.003E+04	1	0.000	
-1210	78.5	6.00	10.2	3.6024E+04	1.3404E+05	-8.161E+04	1	0.000	
-1290	78.5	6.00	10.3	3.2893E+04	1.2255E+05	-8.318E+04	1	0.000	
-1370	78.5	6.00	10.4	2.9763E+04	1.1106E+05	-8.475E+04	1	0.000	
-1450	78.5	6.00	10.5	2.6633E+04	9.9563E+04	-8.632E+04	1	0.000	
-1530	78.5	6.00	10.5	2.3502E+04	8.8070E+04	-8.789E+04	1	0.000	
-1610	78.5	6.00	6.7	2.0194E+04	7.5737E+04	-5.469E+04	1	0.000	
-1690	78.5	6.00	6.8	1.6877E+04	6.3362E+04	-5.626E+04	1	0.000	
-1770	78.5	6.00	6.9	1.3560E+04	5.0988E+04	-5.783E+04	1	0.000	
-1850	78.5	6.00	6.9	1.0243E+04	3.8614E+04	-5.940E+04	1	0.000	
-1930	78.5	6.00	7.0	6.9263E+03	2.6240E+04	-6.097E+04	1	0.000	
-2010	78.5	6.00	3.4	5.0952E+03	1.9358E+04	-2.908E+04	1	0.000	
-2090	78.5	6.00	3.5	3.9898E+03	1.5158E+04	-3.065E+04	1	0.000	
-2170	124.0	6.00	3.4	2.8844E+03	1.0958E+04	-3.222E+04	1	0.000	
-2250	78.5	6.00	3.8	1.7790E+03	6.7588E+03	-3.379E+04	1	0.000	
-2330	78.5	6.00	4.0	6.7358E+02	2.5591E+03	-3.536E+04	1	0.000	
-2410	78.5	6.00	0.5	3.6380E-12	1.0999E-11	-4.198E+03	1	0.000	
-2490	78.5	6.00	0.6	3.6380E-12	1.9044E-12	-5.769E+03	1	0.000	

Verifica di esercizio (combinazione quasi permanente):

quota	Af	cop.	sigmaf	sigmac	Mx	My	N	comb	Wk
-90	0.0	6.50	0.0	0.0	0.0000E+00	0.0000E+00	0.0000E+00	-	0.000
-170	78.5	6.00	33.1	-4.266E+05	-1.583E+06	-1.748E+05	1	0.000	
-250	78.5	6.00	30.2	-3.293E+05	-1.227E+06	-1.764E+05	1	0.000	
-330	78.5	6.00	23.4	-2.487E+05	-9.307E+05	-1.381E+05	1	0.000	
-410	78.5	6.00	21.9	-1.959E+05	-7.336E+05	-1.396E+05	1	0.000	
-490	78.5	6.00	20.3	-1.432E+05	-5.365E+05	-1.412E+05	1	0.000	
-570	78.5	6.00	18.8	-9.042E+04	-3.394E+05	-1.428E+05	1	0.000	
-650	78.5	6.00	17.3	-3.767E+04	-1.423E+05	-1.443E+05	1	0.000	
-730	78.5	6.00	12.2	-1.450E+03	-6.873E+03	-1.089E+05	1	0.000	
-810	78.5	6.00	12.5	7.2238E+03	2.5673E+04	-1.104E+05	1	0.000	
-890	78.5	6.00	13.0	1.5898E+04	5.8220E+04	-1.120E+05	1	0.000	
-970	78.5	6.00	13.4	2.4572E+04	9.0766E+04	-1.136E+05	1	0.000	
-1050	78.5	6.00	13.9	3.3247E+04	1.2331E+05	-1.151E+05	1	0.000	



-1130	124.0	6.00	9.4	3.9154E+04	1.4554E+05	-8.003E+04	1	0.000
-1210	78.5	6.00	10.2	3.6024E+04	1.3404E+05	-8.161E+04	1	0.000
-1290	78.5	6.00	10.3	3.2893E+04	1.2255E+05	-8.318E+04	1	0.000
-1370	78.5	6.00	10.4	2.9763E+04	1.1106E+05	-8.475E+04	1	0.000
-1450	78.5	6.00	10.5	2.6633E+04	9.9563E+04	-8.632E+04	1	0.000
-1530	78.5	6.00	10.5	2.3502E+04	8.8070E+04	-8.789E+04	1	0.000
-1610	78.5	6.00	6.7	2.0194E+04	7.5737E+04	-5.469E+04	1	0.000
-1690	78.5	6.00	6.8	1.6877E+04	6.3362E+04	-5.626E+04	1	0.000
-1770	78.5	6.00	6.9	1.3560E+04	5.0988E+04	-5.783E+04	1	0.000
-1850	78.5	6.00	6.9	1.0243E+04	3.8614E+04	-5.940E+04	1	0.000
-1930	78.5	6.00	7.0	6.9263E+03	2.6240E+04	-6.097E+04	1	0.000
-2010	78.5	6.00	3.4	5.0952E+03	1.9358E+04	-2.908E+04	1	0.000
-2090	78.5	6.00	3.5	3.9898E+03	1.5158E+04	-3.065E+04	1	0.000
-2170	124.0	6.00	3.4	2.8844E+03	1.0958E+04	-3.222E+04	1	0.000
-2250	78.5	6.00	3.8	1.7790E+03	6.7588E+03	-3.379E+04	1	0.000
-2330	78.5	6.00	4.0	6.7358E+02	2.5591E+03	-3.536E+04	1	0.000
-2410	78.5	6.00	0.5	3.6380E-12	1.0999E-11	-4.198E+03	1	0.000
-2490	78.5	6.00	0.6	3.6380E-12	1.9044E-12	-5.769E+03	1	0.000

Verifica a taglio:

quota	Ast	Vsd	Vsdx	Vsdy	N	comb	VRd, c	VRd, max	VRd, S	Vwd
-90	0.16	33608	-32259	9426	-197935	7SLV	50712	231056	95036	44323 Vsd < VRd,
-170	0.16	32867	-31555	9194	-198540	7SLV	54685	231056	99008	44323 Vsd < VRd,
-250	0.08	32867	-31555	9194	-200110	7SLV	54903	231056	77065	22162 Vsd < VRd,
-330	0.08	10525	-10116	2907	-157468	7SLV	48976	231056	71137	22162 Vsd < VRd,
-410	0.08	10525	-10116	2907	-159038	7SLV	49194	231056	71356	22162 Vsd < VRd,
-490	0.08	10525	-10116	2907	-160609	7SLV	49412	231056	71574	22162 Vsd < VRd,
-570	0.08	10525	-10116	2907	-162180	7SLV	49631	231056	71792	22162 Vsd < VRd,
-650	0.08	10525	-10116	2907	-163751	7SLV	49849	231056	72011	22162 Vsd < VRd,
-730	0.08	1886	-1812	524	-93482	9SLV	40082	231056	62243	22162 Vsd < VRd,
-810	0.08	1886	-1812	524	-95052	9SLV	40300	231056	62462	22162 Vsd < VRd,
-890	0.08	1886	-1812	524	-96623	9SLV	40518	231056	62680	22162 Vsd < VRd,
-970	0.08	1886	-1812	524	-98194	9SLV	40737	231056	62898	22162 Vsd < VRd,
-1050	0.08	1886	-1812	524	-99765	9SLV	40955	231056	63117	22162 Vsd < VRd,
-1130	0.08	2105	2021	-592	-91458	7SLV	44257	231056	66418	22162 Vsd < VRd,
-1210	0.08	2105	2021	-592	-93029	7SLV	40019	231056	62181	22162 Vsd < VRd,
-1290	0.08	2105	2021	-592	-94599	7SLV	40237	231056	62399	22162 Vsd < VRd,
-1370	0.08	2105	2021	-592	-96170	7SLV	40456	231056	62617	22162 Vsd < VRd,
-1450	0.08	2105	2021	-592	-97741	7SLV	40674	231056	62836	22162 Vsd < VRd,
-1530	0.08	2105	2021	-592	-99312	7SLV	40892	231056	63054	22162 Vsd < VRd,
-1610	0.08	924	888	-257	-62426	7SLV	35765	231056	57927	22162 Vsd < VRd,
-1690	0.08	924	888	-257	-63997	7SLV	35983	231056	58145	22162 Vsd < VRd,
-1770	0.08	924	888	-257	-65568	7SLV	36202	231056	58363	22162 Vsd < VRd,
-1850	0.08	924	888	-257	-67139	7SLV	36420	231056	58582	22162 Vsd < VRd,
-1930	0.08	924	888	-257	-68709	7SLV	36638	231056	58800	22162 Vsd < VRd,
-2010	0.08	71	68	-18	-37804	3SLU	32343	231056	54504	22162 Vsd < VRd,
-2090	0.08	71	68	-18	-39846	3SLU	32627	231056	54788	22162 Vsd < VRd,
-2170	0.08	71	68	-18	-41888	3SLU	37367	231056	59528	22162 Vsd < VRd,
-2250	0.08	71	68	-18	-43930	3SLU	33194	231056	55356	22162 Vsd < VRd,
-2330	0.08	71	68	-18	-45972	3SLU	33478	231056	55640	22162 Vsd < VRd,
-2410	0.08	0	0	0	-4209	15SLV	27673	231056	49835	22162 Vsd < VRd,
-2490	0.08	0	0	0	-5779	15SLV	27891	231056	50053	22162 Vsd < VRd,

Palo alle coordinate X=-686 Y=979

Sollecitazioni massime in testa palo:

Combinazione corrispondente alla minima compressione in testa

N	Mx	My	Tx	Ty	comb
-1.053E+05	-2.673E+05	-1.344E+06	-2.988E+03	3.6097E+02	2 sl
-1.283E+05	-5.648E+05	-1.443E+06	-3.216E+03	1.1428E+03	2 ra
-1.513E+05	-8.623E+05	-1.542E+06	-3.444E+03	1.9245E+03	2 fr
-1.605E+05	-9.813E+05	-1.582E+06	-3.535E+03	2.2373E+03	2 qp
-1.516E+05	9.4356E+05	5.4256E+06	2.4177E+04	-5.587E+03	9 SLV fond

Combinazione corrispondente alla massima compressione in testa

N	Mx	My	Tx	Ty	comb
-2.266E+05	-1.508E+06	-2.134E+06	-4.773E+03	3.5182E+03	3 sl
-1.743E+05	-1.160E+06	-1.641E+06	-3.672E+03	2.7063E+03	1 ra
-1.743E+05	-1.160E+06	-1.641E+06	-3.672E+03	2.7063E+03	1 fr
-1.743E+05	-1.160E+06	-1.641E+06	-3.672E+03	2.7063E+03	1 qp
-1.969E+05	-3.263E+06	-8.708E+06	-3.152E+04	1.1000E+04	7 SLV fond

Combinazione corrispondente al massimo taglio in testa

N	Mx	My	Tx	Ty	comb
-2.266E+05	-1.508E+06	-2.134E+06	-4.773E+03	3.5182E+03	3 sl
-1.743E+05	-1.160E+06	-1.641E+06	-3.672E+03	2.7063E+03	1 ra
-1.743E+05	-1.160E+06	-1.641E+06	-3.672E+03	2.7063E+03	1 fr
-1.743E+05	-1.160E+06	-1.641E+06	-3.672E+03	2.7063E+03	1 qp
-1.969E+05	-3.263E+06	-8.708E+06	-3.152E+04	1.1000E+04	7 SLV fond

Verifica di capacità portante riferita al palo singolo:

Fattore di correlazione Psi scelto in base alla conoscenza del sito = 1.7

Coeff. parziale di sicurezza sulla resistenza laterale = 1.15



Progetto	Titolo	Rev.	Pag.
Orione	Orione_A24a.pdf "TABULATI DI CALCOLO PLINTO DI FONDAZIONE PER AEROGENERATORE TIPO"	0	287



**Tabulati di Calcolo Plinto di Fondazione per Aerogeneratore Tipo - Progetto Impianto Eolico - "Orione"**

Coeff. parziale di sicurezza sulla resistenza alla punta = 1.35  
 Portanza laterale di progetto = 292537.1  
 Portanza di punta di progetto = 85555.4  
 verifica condotta in combinazione SLU 3  
 Sforzo normale = -226555  
 Peso del palo = 49087.4 \* 1.3  
 Carico totale di progetto = -290368.6  
 Resistenza totale di progetto = 378092.5  
 Coefficiente di sicurezza = 1.3 > 1

Verifica di resistenza allo stato limite:

quota	Af	cop.	c.s.	Mx	My	N	comb
-90	0.0	6.50	0.00	0.0000E+00	0.0000E+00	0.0000E+00	-
-170	78.5	6.00	4.01	-2.401E+06	-6.239E+06	-1.975E+05	7SLV
-250	78.5	6.00	6.06	-1.541E+06	-3.774E+06	-1.991E+05	7SLV
-330	78.5	6.00	9.67	-8.907E+05	-1.941E+06	-1.566E+05	7SLV
-410	78.5	6.00	10.16	-5.637E+05	-8.095E+05	-1.815E+05	3SLU
-490	78.5	6.00	10.04	-4.119E+05	-5.921E+05	-1.835E+05	3SLU
-570	78.5	6.00	9.93	-2.601E+05	-3.747E+05	-1.856E+05	3SLU
-650	78.5	6.00	9.82	-1.083E+05	-1.572E+05	-1.876E+05	3SLU
-730	78.5	6.00	12.23	4.8428E+05	1.6267E+06	-1.236E+05	7SLV
-810	78.5	6.00	12.37	4.6985E+05	1.5421E+06	-1.251E+05	7SLV
-890	78.5	6.00	12.51	4.5542E+05	1.4575E+06	-1.267E+05	7SLV
-970	78.5	6.00	12.49	7.0736E+04	9.9912E+04	-1.476E+05	3SLU
-1050	78.5	6.00	12.32	9.5689E+04	1.3584E+05	-1.497E+05	3SLU
-1130	124.0	6.00	18.16	4.0342E+05	1.1861E+06	-9.096E+04	7SLV
-1210	78.5	6.00	17.30	3.5177E+05	1.0264E+06	-9.254E+04	7SLV
-1290	78.5	6.00	17.05	9.4660E+04	1.3511E+05	-1.081E+05	3SLU
-1370	78.5	6.00	16.73	8.5649E+04	1.2247E+05	-1.102E+05	3SLU
-1450	78.5	6.00	16.43	7.6638E+04	1.0984E+05	-1.122E+05	3SLU
-1530	78.5	6.00	16.13	6.7627E+04	9.7199E+04	-1.142E+05	3SLU
-1610	78.5	6.00	25.93	5.8107E+04	8.3600E+04	-7.109E+04	3SLU
-1690	78.5	6.00	25.20	4.8563E+04	6.9954E+04	-7.313E+04	3SLU
-1770	78.5	6.00	24.52	3.9018E+04	5.6308E+04	-7.517E+04	3SLU
-1850	78.5	6.00	23.87	2.9473E+04	4.2662E+04	-7.722E+04	3SLU
-1930	78.5	6.00	23.26	1.9928E+04	2.9016E+04	-7.926E+04	3SLU
-2010	78.5	6.00	48.76	1.4659E+04	2.1417E+04	-3.780E+04	3SLU
-2090	78.5	6.00	46.26	1.1479E+04	1.6771E+04	-3.984E+04	3SLU
-2170	124.0	6.00	48.57	8.2985E+03	1.2124E+04	-4.188E+04	3SLU
-2250	78.5	6.00	41.96	5.1182E+03	7.4777E+03	-4.392E+04	3SLU
-2330	78.5	6.00	40.10	1.9379E+03	2.8313E+03	-4.597E+04	3SLU
-2410	78.5	6.00	100.00	4.7294E-12	9.5696E-12	-5.457E+03	3SLU
-2490	78.5	6.00	100.00	4.7294E-12	-2.254E-12	-7.499E+03	3SLU

Verifica di esercizio (combinazione rara):

quota	Af	cop.	sigmaf	sigmac	Mx	My	N	comb	Wk
-90	0.0	6.50	0.0	0.0	0.0000E+00	0.0000E+00	0.0000E+00	-	0.000
-170	78.5	6.00		33.1	-9.443E+05	-1.341E+06	-1.748E+05	1	0.000
-250	78.5	6.00		30.2	-7.288E+05	-1.041E+06	-1.764E+05	1	0.000
-330	78.5	6.00		23.4	-5.504E+05	-7.900E+05	-1.380E+05	1	0.000
-410	78.5	6.00		21.8	-4.336E+05	-6.227E+05	-1.396E+05	1	0.000
-490	78.5	6.00		20.3	-3.169E+05	-4.555E+05	-1.412E+05	1	0.000
-570	78.5	6.00		18.8	-2.001E+05	-2.882E+05	-1.428E+05	1	0.000
-650	78.5	6.00		17.3	-8.334E+04	-1.210E+05	-1.443E+05	1	0.000
-730	78.5	6.00		12.2	-3.171E+03	-6.060E+03	-1.088E+05	1	0.000
-810	78.5	6.00		12.5	1.6023E+04	2.1579E+04	-1.104E+05	1	0.000
-890	78.5	6.00		13.0	3.5218E+04	4.9217E+04	-1.120E+05	1	0.000
-970	78.5	6.00		13.4	5.4413E+04	7.6855E+04	-1.135E+05	1	0.000
-1050	78.5	6.00		13.9	7.3607E+04	1.0449E+05	-1.151E+05	1	0.000
-1130	124.0	6.00		9.4	8.6678E+04	1.2338E+05	-8.002E+04	1	0.000
-1210	78.5	6.00		10.2	7.9747E+04	1.1365E+05	-8.159E+04	1	0.000
-1290	78.5	6.00		10.3	7.2815E+04	1.0393E+05	-8.317E+04	1	0.000
-1370	78.5	6.00		10.4	6.5884E+04	9.4211E+04	-8.474E+04	1	0.000
-1450	78.5	6.00		10.5	5.8953E+04	8.4490E+04	-8.631E+04	1	0.000
-1530	78.5	6.00		10.5	5.2021E+04	7.4768E+04	-8.788E+04	1	0.000
-1610	78.5	6.00		6.7	4.4698E+04	6.4308E+04	-5.468E+04	1	0.000
-1690	78.5	6.00		6.8	3.7356E+04	5.3811E+04	-5.625E+04	1	0.000
-1770	78.5	6.00		6.9	3.0014E+04	4.3314E+04	-5.783E+04	1	0.000
-1850	78.5	6.00		6.9	2.2671E+04	3.2817E+04	-5.940E+04	1	0.000
-1930	78.5	6.00		7.0	1.5329E+04	2.2320E+04	-6.097E+04	1	0.000
-2010	78.5	6.00		3.4	1.1276E+04	1.6475E+04	-2.908E+04	1	0.000
-2090	78.5	6.00		3.5	8.8299E+03	1.2900E+04	-3.065E+04	1	0.000
-2170	124.0	6.00		3.4	6.3835E+03	9.3262E+03	-3.222E+04	1	0.000
-2250	78.5	6.00		3.8	3.9371E+03	5.7521E+03	-3.379E+04	1	0.000
-2330	78.5	6.00		4.0	1.4907E+03	2.1779E+03	-3.536E+04	1	0.000
-2410	78.5	6.00		0.5	3.6380E-12	7.3613E-12	-4.198E+03	1	0.000
-2490	78.5	6.00		0.6	3.6380E-12	-1.734E-12	-5.768E+03	1	0.000

Verifica di esercizio (combinazione quasi permanente):

quota	Af	cop.	sigmaf	sigmac	Mx	My	N	comb	Wk
-90	0.0	6.50	0.0	0.0	0.0000E+00	0.0000E+00	0.0000E+00	-	0.000
-170	78.5	6.00		33.1	-9.443E+05	-1.341E+06	-1.748E+05	1	0.000
-250	78.5	6.00		30.2	-7.288E+05	-1.041E+06	-1.764E+05	1	0.000
-330	78.5	6.00		23.4	-5.504E+05	-7.900E+05	-1.380E+05	1	0.000



<b>Progetto</b>	<b>Titolo</b>	<b>Rev.</b>	<b>Pag.</b>
Orione	Orione_A24a.pdf "TABULATI DI CALCOLO PLINTO DI FONDAZIONE PER AEROGENERATORE TIPO"	0	288

-410	78.5	6.00	21.8	-4.336E+05	-6.227E+05	-1.396E+05	1	0.000
-490	78.5	6.00	20.3	-3.169E+05	-4.555E+05	-1.412E+05	1	0.000
-570	78.5	6.00	18.8	-2.001E+05	-2.882E+05	-1.428E+05	1	0.000
-650	78.5	6.00	17.3	-8.334E+04	-1.210E+05	-1.443E+05	1	0.000
-730	78.5	6.00	12.2	-3.171E+03	-6.060E+03	-1.088E+05	1	0.000
-810	78.5	6.00	12.5	1.6023E+04	2.1579E+04	-1.104E+05	1	0.000
-890	78.5	6.00	13.0	3.5218E+04	4.9217E+04	-1.120E+05	1	0.000
-970	78.5	6.00	13.4	5.4413E+04	7.6855E+04	-1.135E+05	1	0.000
-1050	78.5	6.00	13.9	7.3607E+04	1.0449E+05	-1.151E+05	1	0.000
-1130	124.0	6.00	9.4	8.6678E+04	1.2338E+05	-8.002E+04	1	0.000
-1210	78.5	6.00	10.2	7.9747E+04	1.1365E+05	-8.159E+04	1	0.000
-1290	78.5	6.00	10.3	7.2815E+04	1.0393E+05	-8.317E+04	1	0.000
-1370	78.5	6.00	10.4	6.5884E+04	9.4211E+04	-8.474E+04	1	0.000
-1450	78.5	6.00	10.5	5.8953E+04	8.4490E+04	-8.631E+04	1	0.000
-1530	78.5	6.00	10.5	5.2021E+04	7.4768E+04	-8.788E+04	1	0.000
-1610	78.5	6.00	6.7	4.4698E+04	6.4308E+04	-5.468E+04	1	0.000
-1690	78.5	6.00	6.8	3.7356E+04	5.3811E+04	-5.625E+04	1	0.000
-1770	78.5	6.00	6.9	3.0014E+04	4.3314E+04	-5.783E+04	1	0.000
-1850	78.5	6.00	6.9	2.2671E+04	3.2817E+04	-5.940E+04	1	0.000
-1930	78.5	6.00	7.0	1.5329E+04	2.2320E+04	-6.097E+04	1	0.000
-2010	78.5	6.00	3.4	1.1276E+04	1.6475E+04	-2.908E+04	1	0.000
-2090	78.5	6.00	3.5	8.8299E+03	1.2900E+04	-3.065E+04	1	0.000
-2170	124.0	6.00	3.4	6.3835E+03	9.3262E+03	-3.222E+04	1	0.000
-2250	78.5	6.00	3.8	3.9371E+03	5.7521E+03	-3.379E+04	1	0.000
-2330	78.5	6.00	4.0	1.4907E+03	2.1779E+03	-3.536E+04	1	0.000
-2410	78.5	6.00	0.5	3.6380E-12	7.3613E-12	-4.198E+03	1	0.000
-2490	78.5	6.00	0.6	3.6380E-12	-1.734E-12	-5.768E+03	1	0.000

Verifica a taglio:

quota	Ast	Vsd	Vsdx	Vsdy	N	comb	VRd,c	VRd,max	VRd,S	Vwd
-90	0.16	33384	-31520	11000	-196905	7SLV	50569	231056	94892	44323 Vsd < VRd,
-170	0.16	32643	-30819	10759	-197513	7SLV	54542	231056	98865	44323 Vsd < VRd,
-250	0.08	32643	-30819	10759	-199084	7SLV	54760	231056	76922	22162 Vsd < VRd,
-330	0.08	10419	-9728	3731	-156630	7SLV	48859	231056	71021	22162 Vsd < VRd,
-410	0.08	10419	-9728	3731	-158201	7SLV	49078	231056	71239	22162 Vsd < VRd,
-490	0.08	10419	-9728	3731	-159772	7SLV	49296	231056	71458	22162 Vsd < VRd,
-570	0.08	10419	-9728	3731	-161342	7SLV	49514	231056	71676	22162 Vsd < VRd,
-650	0.08	10419	-9728	3731	-162913	7SLV	49733	231056	71894	22162 Vsd < VRd,
-730	0.08	1869	-1749	660	-94115	9SLV	40170	231056	62332	22162 Vsd < VRd,
-810	0.08	1869	-1749	660	-95686	9SLV	40388	231056	62550	22162 Vsd < VRd,
-890	0.08	1869	-1749	660	-97257	9SLV	40607	231056	62768	22162 Vsd < VRd,
-970	0.08	1869	-1749	660	-98827	9SLV	40825	231056	62987	22162 Vsd < VRd,
-1050	0.08	1869	-1749	660	-100398	9SLV	41043	231056	63205	22162 Vsd < VRd,
-1130	0.08	2097	1995	-646	-90965	7SLV	44188	231056	66350	22162 Vsd < VRd,
-1210	0.08	2097	1995	-646	-92536	7SLV	39950	231056	62112	22162 Vsd < VRd,
-1290	0.08	2097	1995	-646	-94106	7SLV	40169	231056	62330	22162 Vsd < VRd,
-1370	0.08	2097	1995	-646	-95677	7SLV	40387	231056	62549	22162 Vsd < VRd,
-1450	0.08	2097	1995	-646	-97248	7SLV	40605	231056	62767	22162 Vsd < VRd,
-1530	0.08	2097	1995	-646	-98819	7SLV	40824	231056	62985	22162 Vsd < VRd,
-1610	0.08	917	863	-310	-62092	7SLV	35719	231056	57880	22162 Vsd < VRd,
-1690	0.08	917	863	-310	-63663	7SLV	35937	231056	58099	22162 Vsd < VRd,
-1770	0.08	917	863	-310	-65234	7SLV	36155	231056	58317	22162 Vsd < VRd,
-1850	0.08	917	863	-310	-66805	7SLV	36374	231056	58535	22162 Vsd < VRd,
-1930	0.08	917	863	-310	-68376	7SLV	36592	231056	58754	22162 Vsd < VRd,
-2010	0.08	70	58	-40	-37798	3SLU	32342	231056	54504	22162 Vsd < VRd,
-2090	0.08	70	58	-40	-39841	3SLU	32626	231056	54787	22162 Vsd < VRd,
-2170	0.08	70	58	-40	-41883	3SLU	37366	231056	59527	22162 Vsd < VRd,
-2250	0.08	70	58	-40	-43925	3SLU	33193	231056	55355	22162 Vsd < VRd,
-2330	0.08	70	58	-40	-45967	3SLU	33477	231056	55639	22162 Vsd < VRd,
-2410	0.08	0	0	0	-3425	9SLV	27564	231056	49726	22162 Vsd < VRd,
-2490	0.08	0	0	0	-4996	9SLV	27782	231056	49944	22162 Vsd < VRd,

Palo alle coordinate X=-979 Y=686

Sollecitazioni massime in testa palo:

Combinazione corrispondente alla minima compressione in testa

N	Mx	My	Tx	Ty	comb
-1.254E+05	-7.386E+05	-1.330E+06	-2.855E+03	1.4211E+03	2 sl
-1.417E+05	-1.044E+06	-1.268E+06	-2.741E+03	2.2354E+03	2 ra
-1.580E+05	-1.350E+06	-1.207E+06	-2.628E+03	3.0498E+03	2 fr
-1.645E+05	-1.472E+06	-1.182E+06	-2.582E+03	3.3755E+03	2 qp
-1.504E+05	5.2803E+06	1.0155E+06	6.0046E+03	-2.351E+04	13 SLV fond

Combinazione corrispondente alla massima compressione in testa

N	Mx	My	Tx	Ty	comb
-2.266E+05	-2.153E+06	-1.489E+06	-3.268E+03	5.0234E+03	3 sl
-1.743E+05	-1.656E+06	-1.145E+06	-2.514E+03	3.8641E+03	1 ra
-1.743E+05	-1.656E+06	-1.145E+06	-2.514E+03	3.8641E+03	1 fr
-1.743E+05	-1.656E+06	-1.145E+06	-2.514E+03	3.8641E+03	1 qp
-1.982E+05	-8.592E+06	-3.306E+06	-1.103E+04	3.1233E+04	3 SLV fond

Combinazione corrispondente al massimo taglio in testa

N	Mx	My	Tx	Ty	comb
-2.266E+05	-2.153E+06	-1.489E+06	-3.268E+03	5.0234E+03	3 sl
-1.743E+05	-1.656E+06	-1.145E+06	-2.514E+03	3.8641E+03	1 ra



Progetto	Titolo	Rev.	Pag.
Orione	Orione_A24a.pdf "TABULATI DI CALCOLO PLINTO DI FONDAZIONE PER AEROGENERATORE TIPO"	0	289

*Tabulati di Calcolo Plinto di Fondazione per Aerogeneratore Tipo - Progetto Impianto Eolico - "Orione"*

-1.743E+05 -1.656E+06 -1.145E+06 -2.514E+03 3.8641E+03 1 fr  
 -1.743E+05 -1.656E+06 -1.145E+06 -2.514E+03 3.8641E+03 1 qp  
 -1.982E+05 -8.592E+06 -3.306E+06 -1.103E+04 3.1233E+04 3 SLV fond

Verifica di capacità portante riferita al palo singolo:

Fattore di correlazione Psi scelto in base alla conoscenza del sito = 1.7  
 Coeff. parziale di sicurezza sulla resistenza laterale = 1.15  
 Coeff. parziale di sicurezza sulla resistenza alla punta = 1.35  
 Portanza laterale di progetto = 292537.1  
 Portanza di punta di progetto = 85555.4  
 verifica condotta in combinazione SLU 3  
 Sforzo normale = -226559.7  
 Peso del palo = 49087.4 \* 1.3  
 Carico totale di progetto = -290373.3  
 Resistenza totale di progetto = 378092.5  
 Coefficiente di sicurezza = 1.3 > 1

Verifica di resistenza allo stato limite:

quota	Af	cop.	c.s.	Mx	My	N	comb
-90	0.0	6.50	0.00	0.0000E+00	0.0000E+00	0.0000E+00	-
-170	78.5	6.00	4.04	-6.152E+06	-2.434E+06	-1.987E+05	3SLV
-250	78.5	6.00	6.09	-3.715E+06	-1.563E+06	-2.002E+05	3SLV
-330	78.5	6.00	9.69	-1.904E+06	-9.043E+05	-1.575E+05	3SLV
-410	78.5	6.00	10.16	-8.048E+05	-5.684E+05	-1.815E+05	3SLU
-490	78.5	6.00	10.04	-5.881E+05	-4.159E+05	-1.835E+05	3SLU
-570	78.5	6.00	9.93	-3.714E+05	-2.634E+05	-1.856E+05	3SLU
-650	78.5	6.00	9.82	-1.547E+05	-1.109E+05	-1.876E+05	3SLU
-730	78.5	6.00	12.23	1.6058E+06	4.9673E+05	-1.242E+05	3SLV
-810	78.5	6.00	12.37	1.5219E+06	4.8156E+05	-1.258E+05	3SLV
-890	78.5	6.00	12.51	1.4380E+06	4.6638E+05	-1.274E+05	3SLV
-970	78.5	6.00	12.49	1.0100E+05	6.9647E+04	-1.476E+05	3SLU
-1050	78.5	6.00	12.32	1.3663E+05	9.4905E+04	-1.497E+05	3SLU
-1130	124.0	6.00	18.17	1.1692E+06	4.1204E+05	-9.145E+04	3SLV
-1210	78.5	6.00	17.30	1.0117E+06	3.5930E+05	-9.302E+04	3SLV
-1290	78.5	6.00	17.05	1.3516E+05	9.4619E+04	-1.081E+05	3SLU
-1370	78.5	6.00	16.73	1.2229E+05	8.5837E+04	-1.102E+05	3SLU
-1450	78.5	6.00	16.43	1.0942E+05	7.7054E+04	-1.122E+05	3SLU
-1530	78.5	6.00	16.13	9.6557E+04	6.8272E+04	-1.142E+05	3SLU
-1610	78.5	6.00	25.93	8.2964E+04	5.8745E+04	-7.109E+04	3SLU
-1690	78.5	6.00	25.20	6.9336E+04	4.9182E+04	-7.313E+04	3SLU
-1770	78.5	6.00	24.52	5.5708E+04	3.9619E+04	-7.517E+04	3SLU
-1850	78.5	6.00	23.87	4.2080E+04	3.0056E+04	-7.721E+04	3SLU
-1930	78.5	6.00	23.26	2.8452E+04	2.0493E+04	-7.926E+04	3SLU
-2010	78.5	6.00	48.77	2.0929E+04	1.5147E+04	-3.780E+04	3SLU
-2090	78.5	6.00	46.27	1.6389E+04	1.1861E+04	-3.984E+04	3SLU
-2170	124.0	6.00	48.57	1.1848E+04	8.5747E+03	-4.188E+04	3SLU
-2250	78.5	6.00	41.96	7.3075E+03	5.2886E+03	-4.392E+04	3SLU
-2330	78.5	6.00	40.10	2.7669E+03	2.0024E+03	-4.597E+04	3SLU
-2410	78.5	6.00	100.00	2.1227E-11	1.6775E-11	-5.457E+03	3SLU
-2490	78.5	6.00	100.00	2.7138E-11	-6.872E-12	-7.499E+03	3SLU

Verifica di esercizio (combinazione rara):

quota	Af	cop.	sigmaf	sigmac	Mx	My	N	comb	Wk
-90	0.0	6.50	0.0	0.0	0.0000E+00	0.0000E+00	0.0000E+00	-	0.000
-170	78.5	6.00		33.1	-1.348E+06	-9.373E+05	-1.748E+05	1	0.000
-250	78.5	6.00		30.2	-1.041E+06	-7.288E+05	-1.764E+05	1	0.000
-330	78.5	6.00		23.4	-7.858E+05	-5.546E+05	-1.380E+05	1	0.000
-410	78.5	6.00		21.8	-6.191E+05	-4.372E+05	-1.396E+05	1	0.000
-490	78.5	6.00		20.3	-4.524E+05	-3.199E+05	-1.412E+05	1	0.000
-570	78.5	6.00		18.8	-2.857E+05	-2.026E+05	-1.428E+05	1	0.000
-650	78.5	6.00		17.3	-1.190E+05	-8.532E+04	-1.443E+05	1	0.000
-730	78.5	6.00		12.2	-4.517E+03	-4.713E+03	-1.088E+05	1	0.000
-810	78.5	6.00		12.5	2.2887E+04	1.4717E+04	-1.104E+05	1	0.000
-890	78.5	6.00		13.0	5.0292E+04	3.4146E+04	-1.120E+05	1	0.000
-970	78.5	6.00		13.4	7.7696E+04	5.3575E+04	-1.135E+05	1	0.000
-1050	78.5	6.00		13.9	1.0510E+05	7.3004E+04	-1.151E+05	1	0.000
-1130	124.0	6.00		9.4	1.2376E+05	8.6296E+04	-8.002E+04	1	0.000
-1210	78.5	6.00		10.2	1.1386E+05	7.9540E+04	-8.159E+04	1	0.000
-1290	78.5	6.00		10.3	1.0397E+05	7.2784E+04	-8.316E+04	1	0.000
-1370	78.5	6.00		10.4	9.4069E+04	6.6028E+04	-8.473E+04	1	0.000
-1450	78.5	6.00		10.5	8.4172E+04	5.9272E+04	-8.631E+04	1	0.000
-1530	78.5	6.00		10.5	7.4275E+04	5.2517E+04	-8.788E+04	1	0.000
-1610	78.5	6.00		6.7	6.3819E+04	4.5188E+04	-5.468E+04	1	0.000
-1690	78.5	6.00		6.8	5.3336E+04	3.7832E+04	-5.625E+04	1	0.000
-1770	78.5	6.00		6.9	4.2852E+04	3.0476E+04	-5.782E+04	1	0.000
-1850	78.5	6.00		6.9	3.2369E+04	2.3120E+04	-5.940E+04	1	0.000
-1930	78.5	6.00		7.0	2.1886E+04	1.5764E+04	-6.097E+04	1	0.000
-2010	78.5	6.00		3.4	1.6100E+04	1.1652E+04	-2.908E+04	1	0.000
-2090	78.5	6.00		3.5	1.2607E+04	9.1238E+03	-3.065E+04	1	0.000
-2170	124.0	6.00		3.4	9.1139E+03	6.5960E+03	-3.222E+04	1	0.000
-2250	78.5	6.00		3.8	5.6211E+03	4.0681E+03	-3.379E+04	1	0.000
-2330	78.5	6.00		4.0	2.1283E+03	1.5403E+03	-3.536E+04	1	0.000
-2410	78.5	6.00		0.5	1.6328E-11	1.2904E-11	-4.198E+03	1	0.000
-2490	78.5	6.00		0.6	2.0876E-11	-5.286E-12	-5.768E+03	1	0.000



Progetto	Titolo	Rev.	Pag.
Orione	Orione_A24a.pdf "TABULATI DI CALCOLO PLINTO DI FONDAZIONE PER AEROGENERATORE TIPO"	0	290

Tabulati di Calcolo Plinto di Fondazione per Aerogeneratore Tipo - Progetto Impianto Eolico - "Orione"

Verifica di esercizio (combinazione quasi permanente):

quota	Af	cop.	sigmaf	sigmac	Mx	My	N	comb	Wk
-90	0.0	6.50	0.0	0.0	0.0000E+00	0.0000E+00	0.0000E+00	-	0.000
-170	78.5	6.00		33.1	-1.348E+06	-9.373E+05	-1.748E+05	1	0.000
-250	78.5	6.00		30.2	-1.041E+06	-7.288E+05	-1.764E+05	1	0.000
-330	78.5	6.00		23.4	-7.858E+05	-5.546E+05	-1.380E+05	1	0.000
-410	78.5	6.00		21.8	-6.191E+05	-4.372E+05	-1.396E+05	1	0.000
-490	78.5	6.00		20.3	-4.524E+05	-3.199E+05	-1.412E+05	1	0.000
-570	78.5	6.00		18.8	-2.857E+05	-2.026E+05	-1.428E+05	1	0.000
-650	78.5	6.00		17.3	-1.190E+05	-8.532E+04	-1.443E+05	1	0.000
-730	78.5	6.00		12.2	-4.517E+03	-4.713E+03	-1.088E+05	1	0.000
-810	78.5	6.00		12.5	2.2887E+04	1.4717E+04	-1.104E+05	1	0.000
-890	78.5	6.00		13.0	5.0292E+04	3.4146E+04	-1.120E+05	1	0.000
-970	78.5	6.00		13.4	7.7696E+04	5.3575E+04	-1.135E+05	1	0.000
-1050	78.5	6.00		13.9	1.0510E+05	7.3004E+04	-1.151E+05	1	0.000
-1130	124.0	6.00		9.4	1.2376E+05	8.6296E+04	-8.002E+04	1	0.000
-1210	78.5	6.00		10.2	1.1386E+05	7.9540E+04	-8.159E+04	1	0.000
-1290	78.5	6.00		10.3	1.0397E+05	7.2784E+04	-8.316E+04	1	0.000
-1370	78.5	6.00		10.4	9.4069E+04	6.6028E+04	-8.473E+04	1	0.000
-1450	78.5	6.00		10.5	8.4172E+04	5.9272E+04	-8.631E+04	1	0.000
-1530	78.5	6.00		10.5	7.4275E+04	5.2517E+04	-8.788E+04	1	0.000
-1610	78.5	6.00		6.7	6.3819E+04	4.5188E+04	-5.468E+04	1	0.000
-1690	78.5	6.00		6.8	5.3336E+04	3.7832E+04	-5.625E+04	1	0.000
-1770	78.5	6.00		6.9	4.2852E+04	3.0476E+04	-5.782E+04	1	0.000
-1850	78.5	6.00		6.9	3.2369E+04	2.3120E+04	-5.940E+04	1	0.000
-1930	78.5	6.00		7.0	2.1886E+04	1.5764E+04	-6.097E+04	1	0.000
-2010	78.5	6.00		3.4	1.6100E+04	1.1652E+04	-2.908E+04	1	0.000
-2090	78.5	6.00		3.5	1.2607E+04	9.1238E+03	-3.065E+04	1	0.000
-2170	124.0	6.00		3.4	9.1139E+03	6.5960E+03	-3.222E+04	1	0.000
-2250	78.5	6.00		3.8	5.6211E+03	4.0681E+03	-3.379E+04	1	0.000
-2330	78.5	6.00		4.0	2.1283E+03	1.5403E+03	-3.536E+04	1	0.000
-2410	78.5	6.00		0.5	1.6328E-11	1.2904E-11	-4.198E+03	1	0.000
-2490	78.5	6.00		0.6	2.0876E-11	-5.286E-12	-5.768E+03	1	0.000

Verifica a taglio:

quota	Ast	Vsd	Vsdx	Vsdy	N	comb	VRd,c	VRd,max	VRd,S	Vwd
-90	0.16	33124	-11032	31233	-198182	3SLV	50747	231056	95070	44323 Vsd < VRd,
-170	0.16	32349	-10891	30461	-198669	3SLV	54703	231056	99026	44323 Vsd < VRd,
-250	0.08	32349	-10891	30461	-200240	3SLV	54921	231056	77083	22162 Vsd < VRd,
-330	0.08	10299	-3802	9572	-157476	3SLV	48977	231056	71139	22162 Vsd < VRd,
-410	0.08	10299	-3802	9572	-159046	3SLV	49195	231056	71357	22162 Vsd < VRd,
-490	0.08	10299	-3802	9572	-160617	3SLV	49414	231056	71575	22162 Vsd < VRd,
-570	0.08	10299	-3802	9572	-162188	3SLV	49632	231056	71794	22162 Vsd < VRd,
-650	0.08	10299	-3802	9572	-163759	3SLV	49850	231056	72012	22162 Vsd < VRd,
-730	0.08	1860	-675	1733	-93453	13SLV	40078	231056	62240	22162 Vsd < VRd,
-810	0.08	1860	-675	1733	-95024	13SLV	40296	231056	62458	22162 Vsd < VRd,
-890	0.08	1860	-675	1733	-96595	13SLV	40515	231056	62676	22162 Vsd < VRd,
-970	0.08	1860	-675	1733	-98166	13SLV	40733	231056	62895	22162 Vsd < VRd,
-1050	0.08	1860	-675	1733	-99737	13SLV	40951	231056	63113	22162 Vsd < VRd,
-1130	0.08	2077	659	-1969	-91453	3SLV	44256	231056	66418	22162 Vsd < VRd,
-1210	0.08	2077	659	-1969	-93023	3SLV	40018	231056	62180	22162 Vsd < VRd,
-1290	0.08	2077	659	-1969	-94594	3SLV	40236	231056	62398	22162 Vsd < VRd,
-1370	0.08	2077	659	-1969	-96165	3SLV	40455	231056	62616	22162 Vsd < VRd,
-1450	0.08	2077	659	-1969	-97736	3SLV	40673	231056	62835	22162 Vsd < VRd,
-1530	0.08	2077	659	-1969	-99307	3SLV	40891	231056	63053	22162 Vsd < VRd,
-1610	0.08	907	316	-850	-62423	3SLV	35765	231056	57926	22162 Vsd < VRd,
-1690	0.08	907	316	-850	-63994	3SLV	35983	231056	58145	22162 Vsd < VRd,
-1770	0.08	907	316	-850	-65565	3SLV	36201	231056	58363	22162 Vsd < VRd,
-1850	0.08	907	316	-850	-67135	3SLV	36420	231056	58581	22162 Vsd < VRd,
-1930	0.08	907	316	-850	-68706	3SLV	36638	231056	58800	22162 Vsd < VRd,
-2010	0.08	70	41	-57	-37798	3SLU	32342	231056	54503	22162 Vsd < VRd,
-2090	0.08	70	41	-57	-39840	3SLU	32626	231056	54787	22162 Vsd < VRd,
-2170	0.08	70	41	-57	-41882	3SLU	37366	231056	59527	22162 Vsd < VRd,
-2250	0.08	70	41	-57	-43924	3SLU	33193	231056	55355	22162 Vsd < VRd,
-2330	0.08	70	41	-57	-45966	3SLU	33477	231056	55639	22162 Vsd < VRd,
-2410	0.08	0	0	0	-4844	7SLV	27761	231056	49923	22162 Vsd < VRd,
-2490	0.08	0	0	0	-6414	7SLV	27980	231056	50141	22162 Vsd < VRd,

Palo alle coordinate X=-1155 Y=309

Sollecitazioni massime in testa palo:

Combinazione corrispondente alla minima compressione in testa

N	Mx	My	Tx	Ty	comb
-1.513E+05	-1.330E+06	-1.067E+06	-2.166E+03	2.7219E+03	2 sl
-1.590E+05	-1.538E+06	-8.814E+05	-1.787E+03	3.3333E+03	2 ra
-1.666E+05	-1.745E+06	-6.955E+05	-1.408E+03	3.9447E+03	2 fr
-1.697E+05	-1.828E+06	-6.211E+05	-1.257E+03	4.1893E+03	2 qp
-1.489E+05	5.0046E+06	1.6341E+06	7.4127E+03	-2.290E+04	13 SLV fond

Combinazione corrispondente alla massima compressione in testa

N	Mx	My	Tx	Ty	comb
-2.266E+05	-2.538E+06	-6.624E+05	-1.339E+03	5.9230E+03	3 sl



Progetto	Titolo	Rev.	Pag.
Orione	Orione_A24a.pdf "TABULATI DI CALCOLO PLINTO DI FONDAZIONE PER AEROGENERATORE TIPO"	0	291

**Tabulati di Calcolo Plinto di Fondazione per Aerogeneratore Tipo - Progetto Impianto Eolico - "Orione"**

-1.743E+05 -1.953E+06 -5.095E+05 -1.030E+03 4.5562E+03 1 ra  
 -1.743E+05 -1.953E+06 -5.095E+05 -1.030E+03 4.5562E+03 1 fr  
 -1.743E+05 -1.953E+06 -5.095E+05 -1.030E+03 4.5562E+03 1 qp  
 -1.997E+05 -8.910E+06 -2.653E+06 -9.472E+03 3.2017E+04 3 SLV fond

Combinazione corrispondente al massimo taglio in testa  
 N Mx My Tx Ty comb  
 -2.266E+05 -2.538E+06 -6.624E+05 -1.339E+03 5.9230E+03 3 sl  
 -1.743E+05 -1.953E+06 -5.095E+05 -1.030E+03 4.5562E+03 1 ra  
 -1.743E+05 -1.953E+06 -5.095E+05 -1.030E+03 4.5562E+03 1 fr  
 -1.743E+05 -1.953E+06 -5.095E+05 -1.030E+03 4.5562E+03 1 qp  
 -1.997E+05 -8.910E+06 -2.653E+06 -9.472E+03 3.2017E+04 3 SLV fond

Verifica di capacità portante riferita al palo singolo:

Fattore di correlazione Psi scelto in base alla conoscenza del sito = 1.7  
 Coeff. parziale di sicurezza sulla resistenza laterale = 1.15  
 Coeff. parziale di sicurezza sulla resistenza alla punta = 1.35  
 Portanza laterale di progetto = 292537.1  
 Portanza di punta di progetto = 85555.4  
 verifica condotta in combinazione SLU 3  
 Sforzo normale = -226594.5  
 Peso del palo = 49087.4 \* 1.3  
 Carico totale di progetto = -290408.1  
 Resistenza totale di progetto = 378092.5  
 Coefficiente di sicurezza = 1.3 > 1

Verifica di resistenza allo stato limite:

quota	Af	cop.	c.s.	Mx	My	N	comb
-90	0.0	6.50	0.00	0.0000E+00	0.0000E+00	0.0000E+00	-
-170	78.5	6.00	4.00	-6.407E+06	-1.905E+06	-2.001E+05	3SLV
-250	78.5	6.00	6.03	-3.908E+06	-1.158E+06	-2.017E+05	3SLV
-330	78.5	6.00	9.60	-2.047E+06	-6.013E+05	-1.587E+05	3SLV
-410	78.5	6.00	10.15	-9.490E+05	-2.594E+05	-1.815E+05	3SLU
-490	78.5	6.00	10.04	-6.934E+05	-1.901E+05	-1.836E+05	3SLU
-570	78.5	6.00	9.93	-4.379E+05	-1.208E+05	-1.856E+05	3SLU
-650	78.5	6.00	9.82	-1.824E+05	-5.155E+04	-1.876E+05	3SLU
-730	78.5	6.00	12.16	1.6111E+06	4.9343E+05	-1.252E+05	3SLV
-810	78.5	6.00	12.30	1.5316E+06	4.6815E+05	-1.267E+05	3SLV
-890	78.5	6.00	12.44	1.4522E+06	4.4288E+05	-1.283E+05	3SLV
-970	78.5	6.00	12.49	1.1909E+05	3.0857E+04	-1.476E+05	3SLU
-1050	78.5	6.00	12.32	1.6110E+05	4.2440E+04	-1.497E+05	3SLU
-1130	124.0	6.00	18.04	1.1949E+06	3.6160E+05	-9.215E+04	3SLV
-1210	78.5	6.00	17.17	1.0351E+06	3.1310E+05	-9.373E+04	3SLV
-1290	78.5	6.00	17.05	1.5936E+05	4.2725E+04	-1.081E+05	3SLU
-1370	78.5	6.00	16.73	1.4419E+05	3.8883E+04	-1.102E+05	3SLU
-1450	78.5	6.00	16.43	1.2902E+05	3.5042E+04	-1.122E+05	3SLU
-1530	78.5	6.00	16.13	1.1385E+05	3.1200E+04	-1.142E+05	3SLU
-1610	78.5	6.00	25.93	9.7824E+04	2.6892E+04	-7.110E+04	3SLU
-1690	78.5	6.00	25.20	8.1755E+04	2.2562E+04	-7.314E+04	3SLU
-1770	78.5	6.00	24.52	6.5686E+04	1.8231E+04	-7.518E+04	3SLU
-1850	78.5	6.00	23.87	4.9617E+04	1.3901E+04	-7.722E+04	3SLU
-1930	78.5	6.00	23.25	3.3548E+04	9.5702E+03	-7.926E+04	3SLU
-2010	78.5	6.00	48.76	2.4678E+04	7.1124E+03	-3.780E+04	3SLU
-2090	78.5	6.00	46.26	1.9324E+04	5.5694E+03	-3.984E+04	3SLU
-2170	124.0	6.00	48.57	1.3970E+04	4.0263E+03	-4.189E+04	3SLU
-2250	78.5	6.00	41.96	8.6163E+03	2.4833E+03	-4.393E+04	3SLU
-2330	78.5	6.00	40.10	3.2624E+03	9.4026E+02	-4.597E+04	3SLU
-2410	78.5	6.00	100.00	2.3647E-11	2.3924E-12	-5.458E+03	3SLU
-2490	78.5	6.00	100.00	2.3647E-11	-5.634E-13	-7.500E+03	3SLU

Verifica di esercizio (combinazione rara):

quota	Af	cop.	sigmaf	sigmac	Mx	My	N	comb	Wk
-90	0.0	6.50	0.0	0.0	0.0000E+00	0.0000E+00	0.0000E+00	-	0.000
-170	78.5	6.00		33.1	-1.590E+06	-4.197E+05	-1.749E+05	1	0.000
-250	78.5	6.00		30.2	-1.227E+06	-3.293E+05	-1.764E+05	1	0.000
-330	78.5	6.00		23.4	-9.265E+05	-2.529E+05	-1.381E+05	1	0.000
-410	78.5	6.00		21.8	-7.300E+05	-1.996E+05	-1.396E+05	1	0.000
-490	78.5	6.00		20.3	-5.334E+05	-1.463E+05	-1.412E+05	1	0.000
-570	78.5	6.00		18.8	-3.369E+05	-9.296E+04	-1.428E+05	1	0.000
-650	78.5	6.00		17.3	-1.403E+05	-3.965E+04	-1.443E+05	1	0.000
-730	78.5	6.00		12.2	-5.327E+03	-2.994E+03	-1.088E+05	1	0.000
-810	78.5	6.00		12.5	2.6985E+04	5.9164E+03	-1.104E+05	1	0.000
-890	78.5	6.00		13.0	5.9298E+04	1.4826E+04	-1.120E+05	1	0.000
-970	78.5	6.00		13.4	9.1610E+04	2.3736E+04	-1.136E+05	1	0.000
-1050	78.5	6.00		13.9	1.2392E+05	3.2646E+04	-1.151E+05	1	0.000
-1130	124.0	6.00		9.4	1.4593E+05	3.8775E+04	-8.003E+04	1	0.000
-1210	78.5	6.00		10.2	1.3426E+05	3.5820E+04	-8.160E+04	1	0.000
-1290	78.5	6.00		10.3	1.2259E+05	3.2865E+04	-8.317E+04	1	0.000
-1370	78.5	6.00		10.4	1.1092E+05	2.9910E+04	-8.474E+04	1	0.000
-1450	78.5	6.00		10.5	9.9247E+04	2.6955E+04	-8.631E+04	1	0.000
-1530	78.5	6.00		10.5	8.7578E+04	2.4000E+04	-8.788E+04	1	0.000
-1610	78.5	6.00		6.7	7.5249E+04	2.0686E+04	-5.469E+04	1	0.000
-1690	78.5	6.00		6.8	6.2888E+04	1.7355E+04	-5.626E+04	1	0.000
-1770	78.5	6.00		6.9	5.0528E+04	1.4024E+04	-5.783E+04	1	0.000
-1850	78.5	6.00		6.9	3.8167E+04	1.0693E+04	-5.940E+04	1	0.000



<b>Progetto</b>	<b>Titolo</b>	<b>Rev.</b>	<b>Pag.</b>
Orione	Orione_A24a.pdf "TABULATI DI CALCOLO PLINTO DI FONDAZIONE PER AEROGENERATORE TIPO"	0	292

Tabulati di Calcolo Plinto di Fondazione per Aerogeneratore Tipo - Progetto Impianto Eolico - "Orione"

-1930	78.5	6.00	7.0	2.5806E+04	7.3617E+03	-6.097E+04	1	0.000
-2010	78.5	6.00	3.4	1.8983E+04	5.4711E+03	-2.908E+04	1	0.000
-2090	78.5	6.00	3.5	1.4865E+04	4.2841E+03	-3.065E+04	1	0.000
-2170	124.0	6.00	3.4	1.0746E+04	3.0972E+03	-3.222E+04	1	0.000
-2250	78.5	6.00	3.8	6.6279E+03	1.9102E+03	-3.379E+04	1	0.000
-2330	78.5	6.00	4.0	2.5096E+03	7.2328E+02	-3.536E+04	1	0.000
-2410	78.5	6.00	0.5	1.8190E-11	1.8403E-12	-4.198E+03	1	0.000
-2490	78.5	6.00	0.6	1.8190E-11	-4.334E-13	-5.769E+03	1	0.000

Verifica di esercizio (combinazione quasi permanente):

quota	Af	cop.	sigmaf	sigmac	Mx	My	N	comb	Wk
-90	0.0	6.50	0.0	0.0	0.0000E+00	0.0000E+00	0.0000E+00	-	0.000
-170	78.5	6.00		33.1	-1.590E+06	-4.197E+05	-1.749E+05	1	0.000
-250	78.5	6.00		30.2	-1.227E+06	-3.293E+05	-1.764E+05	1	0.000
-330	78.5	6.00		23.4	-9.265E+05	-2.529E+05	-1.381E+05	1	0.000
-410	78.5	6.00		21.8	-7.300E+05	-1.996E+05	-1.396E+05	1	0.000
-490	78.5	6.00		20.3	-5.334E+05	-1.463E+05	-1.412E+05	1	0.000
-570	78.5	6.00		18.8	-3.369E+05	-9.296E+04	-1.428E+05	1	0.000
-650	78.5	6.00		17.3	-1.403E+05	-3.965E+04	-1.443E+05	1	0.000
-730	78.5	6.00		12.2	-5.327E+03	-2.994E+03	-1.088E+05	1	0.000
-810	78.5	6.00		12.5	2.6985E+04	5.9164E+03	-1.104E+05	1	0.000
-890	78.5	6.00		13.0	5.9298E+04	1.4826E+04	-1.120E+05	1	0.000
-970	78.5	6.00		13.4	9.1610E+04	2.3736E+04	-1.136E+05	1	0.000
-1050	78.5	6.00		13.9	1.2392E+05	3.2646E+04	-1.151E+05	1	0.000
-1130	124.0	6.00		9.4	1.4593E+05	3.8775E+04	-8.003E+04	1	0.000
-1210	78.5	6.00		10.2	1.3426E+05	3.5820E+04	-8.160E+04	1	0.000
-1290	78.5	6.00		10.3	1.2259E+05	3.2865E+04	-8.317E+04	1	0.000
-1370	78.5	6.00		10.4	1.1092E+05	2.9910E+04	-8.474E+04	1	0.000
-1450	78.5	6.00		10.5	9.9247E+04	2.6955E+04	-8.631E+04	1	0.000
-1530	78.5	6.00		10.5	8.7578E+04	2.4000E+04	-8.788E+04	1	0.000
-1610	78.5	6.00		6.7	7.5249E+04	2.0686E+04	-5.469E+04	1	0.000
-1690	78.5	6.00		6.8	6.2888E+04	1.7355E+04	-5.626E+04	1	0.000
-1770	78.5	6.00		6.9	5.0528E+04	1.4024E+04	-5.783E+04	1	0.000
-1850	78.5	6.00		6.9	3.8167E+04	1.0693E+04	-5.940E+04	1	0.000
-1930	78.5	6.00		7.0	2.5806E+04	7.3617E+03	-6.097E+04	1	0.000
-2010	78.5	6.00		3.4	1.8983E+04	5.4711E+03	-2.908E+04	1	0.000
-2090	78.5	6.00		3.5	1.4865E+04	4.2841E+03	-3.065E+04	1	0.000
-2170	124.0	6.00		3.4	1.0746E+04	3.0972E+03	-3.222E+04	1	0.000
-2250	78.5	6.00		3.8	6.6279E+03	1.9102E+03	-3.379E+04	1	0.000
-2330	78.5	6.00		4.0	2.5096E+03	7.2328E+02	-3.536E+04	1	0.000
-2410	78.5	6.00		0.5	1.8190E-11	1.8403E-12	-4.198E+03	1	0.000
-2490	78.5	6.00		0.6	1.8190E-11	-4.334E-13	-5.769E+03	1	0.000

Verifica a taglio:

quota	Ast	Vsd	Vsdx	Vsdy	N	comb	VRd,c	VRd,max	VRd,S	Vwd
-90	0.16	33389	-9472	32017	-199667	3SLV	50953	231056	95276	44323 Vsd < VRd,
-170	0.16	32605	-9342	31238	-200144	3SLV	54908	231056	99231	44323 Vsd < VRd,
-250	0.08	32605	-9342	31238	-201715	3SLV	55126	231056	77288	22162 Vsd < VRd,
-330	0.08	10404	-2984	9967	-158671	3SLV	49143	231056	71305	22162 Vsd < VRd,
-410	0.08	10404	-2984	9967	-160242	3SLV	49361	231056	71523	22162 Vsd < VRd,
-490	0.08	10404	-2984	9967	-161812	3SLV	49580	231056	71741	22162 Vsd < VRd,
-570	0.08	10404	-2984	9967	-163383	3SLV	49798	231056	71960	22162 Vsd < VRd,
-650	0.08	10404	-2984	9967	-164954	3SLV	50016	231056	72178	22162 Vsd < VRd,
-730	0.08	1880	-539	1801	-92532	13SLV	39950	231056	62112	22162 Vsd < VRd,
-810	0.08	1880	-539	1801	-94103	13SLV	40168	231056	62330	22162 Vsd < VRd,
-890	0.08	1880	-539	1801	-95674	13SLV	40387	231056	62548	22162 Vsd < VRd,
-970	0.08	1880	-539	1801	-97245	13SLV	40605	231056	62767	22162 Vsd < VRd,
-1050	0.08	1880	-539	1801	-98815	13SLV	40823	231056	62985	22162 Vsd < VRd,
-1130	0.08	2088	606	-1998	-92154	3SLV	44353	231056	66515	22162 Vsd < VRd,
-1210	0.08	2088	606	-1998	-93725	3SLV	40116	231056	62277	22162 Vsd < VRd,
-1290	0.08	2088	606	-1998	-95296	3SLV	40334	231056	62496	22162 Vsd < VRd,
-1370	0.08	2088	606	-1998	-96867	3SLV	40552	231056	62714	22162 Vsd < VRd,
-1450	0.08	2088	606	-1998	-98437	3SLV	40771	231056	62932	22162 Vsd < VRd,
-1530	0.08	2088	606	-1998	-100008	3SLV	40989	231056	63151	22162 Vsd < VRd,
-1610	0.08	915	264	-876	-62898	3SLV	35831	231056	57992	22162 Vsd < VRd,
-1690	0.08	915	264	-876	-64469	3SLV	36049	231056	58211	22162 Vsd < VRd,
-1770	0.08	915	264	-876	-66040	3SLV	36267	231056	58429	22162 Vsd < VRd,
-1850	0.08	915	264	-876	-67611	3SLV	36486	231056	58647	22162 Vsd < VRd,
-1930	0.08	915	264	-876	-69181	3SLV	36704	231056	58866	22162 Vsd < VRd,
-2010	0.08	70	19	-67	-37802	3SLU	32342	231056	54504	22162 Vsd < VRd,
-2090	0.08	70	19	-67	-39844	3SLU	32626	231056	54788	22162 Vsd < VRd,
-2170	0.08	70	19	-67	-41886	3SLU	37366	231056	59528	22162 Vsd < VRd,
-2250	0.08	70	19	-67	-43928	3SLU	33194	231056	55356	22162 Vsd < VRd,
-2330	0.08	70	19	-67	-45970	3SLU	33478	231056	55639	22162 Vsd < VRd,
-2410	0.08	0	0	0	-3756	9SLV	27610	231056	49772	22162 Vsd < VRd,
-2490	0.08	0	0	0	-5326	9SLV	27828	231056	49990	22162 Vsd < VRd,

Palo alle coordinate X=-1191 Y=-104

Sollecitazioni massime in testa palo:

Combinazione corrispondente alla minima compressione in testa

N	Mx	My	Tx	Ty	comb
---	----	----	----	----	------



Progetto	Titolo	Rev.	Pag.
Orione	Orione_A24a.pdf "TABULATI DI CALCOLO PLINTO DI FONDAZIONE PER AEROGENERATORE TIPO"	0	293

-1.744E+05	-2.014E+06	1.8922E+05	6.0132E+02	4.6990E+03	1	sl
-1.744E+05	-2.014E+06	1.8922E+05	6.0132E+02	4.6990E+03	1	ra
-1.744E+05	-2.014E+06	1.8922E+05	6.0132E+02	4.6990E+03	1	fr
-1.744E+05	-2.014E+06	1.8922E+05	6.0132E+02	4.6990E+03	1	qp
-1.493E+05	4.9542E+06	-1.932E+06	-7.741E+03	-2.281E+04	15	SLV fond

Combinazione corrispondente alla massima compressione in testa

N	Mx	My	Tx	Ty	comb
-2.324E+05	-2.462E+06	-3.961E+05	-5.194E+02	5.2646E+03	4 sl
-1.782E+05	-1.910E+06	-2.389E+05	-2.661E+02	4.1363E+03	2 ra
-1.763E+05	-1.962E+06	-2.482E+04	1.6761E+02	4.4176E+03	2 fr
-1.755E+05	-1.983E+06	6.0793E+04	3.4109E+02	4.5302E+03	2 qp
-1.994E+05	-8.982E+06	2.3100E+06	8.9437E+03	3.2203E+04	1 SLV fond

Combinazione corrispondente al massimo taglio in testa

N	Mx	My	Tx	Ty	comb
-2.267E+05	-2.618E+06	2.4598E+05	7.8172E+02	6.1087E+03	3 sl
-1.744E+05	-2.014E+06	1.8922E+05	6.0132E+02	4.6990E+03	1 ra
-1.744E+05	-2.014E+06	1.8922E+05	6.0132E+02	4.6990E+03	1 fr
-1.744E+05	-2.014E+06	1.8922E+05	6.0132E+02	4.6990E+03	1 qp
-1.994E+05	-8.982E+06	2.3100E+06	8.9437E+03	3.2203E+04	1 SLV fond

Verifica di capacità portante riferita al palo singolo:

Fattore di correlazione Psi scelto in base alla conoscenza del sito = 1.7  
 Coeff. parziale di sicurezza sulla resistenza laterale = 1.15  
 Coeff. parziale di sicurezza sulla resistenza alla punta = 1.35  
 Portanza laterale di progetto = 292537.1  
 Portanza di punta di progetto = 85555.4  
 verifica condotta in combinazione SLU 4  
 Sforzo normale = -232390  
 Peso del palo = 49087.4 \* 1.3  
 Carico totale di progetto = -296203.6  
 Resistenza totale di progetto = 378092.5  
 Coefficiente di sicurezza = 1.28 > 1

Verifica di resistenza allo stato limite:

quota	Af	cop.	c.s.	Mx	My	N	comb
-90	0.0	6.50	0.00	0.0000E+00	0.0000E+00	0.0000E+00	-
-170	78.5	6.00	4.02	-6.464E+06	1.6197E+06	-1.998E+05	1SLV
-250	78.5	6.00	6.05	-3.950E+06	9.3110E+05	-2.013E+05	1SLV
-330	78.5	6.00	9.64	-2.077E+06	4.2550E+05	-1.583E+05	1SLV
-410	78.5	6.00	9.90	-1.010E+06	-1.959E+05	-1.862E+05	4SLU
-490	78.5	6.00	9.79	-7.575E+05	-1.517E+05	-1.882E+05	4SLU
-570	78.5	6.00	9.69	-5.054E+05	-1.074E+05	-1.903E+05	4SLU
-650	78.5	6.00	9.58	-2.532E+05	-6.314E+04	-1.923E+05	4SLU
-730	78.5	6.00	12.18	1.6136E+06	-4.906E+05	-1.248E+05	1SLV
-810	78.5	6.00	12.32	1.5349E+06	-4.596E+05	-1.264E+05	1SLV
-890	78.5	6.00	12.35	2.4184E+04	-9.136E+03	-1.493E+05	4SLU
-970	78.5	6.00	12.18	7.4645E+04	1.9544E+03	-1.513E+05	4SLU
-1050	78.5	6.00	12.02	1.2511E+05	1.3044E+04	-1.534E+05	4SLU
-1130	124.0	6.00	18.08	1.2012E+06	-3.323E+05	-9.192E+04	1SLV
-1210	78.5	6.00	16.94	1.5121E+05	2.1022E+04	-1.088E+05	4SLU
-1290	78.5	6.00	16.62	1.4105E+05	2.0605E+04	-1.109E+05	4SLU
-1370	78.5	6.00	16.32	1.3090E+05	2.0189E+04	-1.129E+05	4SLU
-1450	78.5	6.00	16.03	1.2075E+05	1.9773E+04	-1.150E+05	4SLU
-1530	78.5	6.00	15.75	1.1060E+05	1.9357E+04	-1.170E+05	4SLU
-1610	78.5	6.00	25.26	9.5824E+04	1.7037E+04	-7.296E+04	4SLU
-1690	78.5	6.00	24.58	8.0822E+04	1.4624E+04	-7.500E+04	4SLU
-1770	78.5	6.00	23.92	6.5820E+04	1.2210E+04	-7.704E+04	4SLU
-1850	78.5	6.00	23.31	5.0818E+04	9.7967E+03	-7.909E+04	4SLU
-1930	78.5	6.00	22.72	3.5816E+04	7.3832E+03	-8.113E+04	4SLU
-2010	78.5	6.00	47.48	2.6963E+04	5.7527E+03	-3.882E+04	4SLU
-2090	78.5	6.00	45.11	2.1113E+04	4.5046E+03	-4.086E+04	4SLU
-2170	124.0	6.00	47.41	1.5264E+04	3.2566E+03	-4.290E+04	4SLU
-2250	78.5	6.00	41.01	9.4140E+03	2.0085E+03	-4.495E+04	4SLU
-2330	78.5	6.00	39.23	3.5644E+03	7.6050E+02	-4.699E+04	4SLU
-2410	78.5	6.00	100.00	5.5844E-11	6.6223E-12	-5.652E+03	4SLU
-2490	78.5	6.00	100.00	1.6963E-11	8.4412E-12	-7.694E+03	4SLU

Verifica di esercizio (combinazione rara):

quota	Af	cop.	sigmaf	sigmac	Mx	My	N	comb	Wk
-90	0.0	6.50	0.0	0.0	0.0000E+00	0.0000E+00	0.0000E+00	-	0.000
-170	78.5	6.00		33.2	-1.640E+06	1.4920E+05	-1.749E+05	1	0.000
-250	78.5	6.00		30.6	-1.248E+06	-1.788E+05	-1.803E+05	2	0.000
-330	78.5	6.00		23.9	-9.686E+05	-1.496E+05	-1.412E+05	2	0.000
-410	78.5	6.00		22.4	-7.735E+05	-1.224E+05	-1.428E+05	2	0.000
-490	78.5	6.00		20.9	-5.783E+05	-9.516E+04	-1.443E+05	2	0.000
-570	78.5	6.00		19.5	-3.832E+05	-6.793E+04	-1.459E+05	2	0.000
-650	78.5	6.00		18.0	-1.881E+05	-4.069E+04	-1.475E+05	2	0.000
-730	78.5	6.00		12.8	-5.189E+04	-2.102E+04	-1.113E+05	2	0.000
-810	78.5	6.00		12.7	-1.381E+04	-1.398E+04	-1.129E+05	2	0.000
-890	78.5	6.00		13.0	6.1147E+04	-6.408E+03	-1.120E+05	1	0.000
-970	78.5	6.00		13.4	6.2360E+04	9.5056E+01	-1.160E+05	2	0.000
-1050	78.5	6.00		13.9	1.0044E+05	7.1350E+03	-1.176E+05	2	0.000
-1130	124.0	6.00		9.4	1.2764E+05	1.2498E+04	-8.187E+04	2	0.000



**Tabulati di Calcolo Plinto di Fondazione per Aerogeneratore Tipo - Progetto Impianto Eolico - "Orione"**

-1210	78.5	6.00	10.3	1.1927E+05	1.2384E+04	-8.344E+04	2	0.000
-1290	78.5	6.00	10.4	1.1089E+05	1.2269E+04	-8.501E+04	2	0.000
-1370	78.5	6.00	10.5	1.0252E+05	1.2155E+04	-8.658E+04	2	0.000
-1450	78.5	6.00	10.6	9.4148E+04	1.2041E+04	-8.815E+04	2	0.000
-1530	78.5	6.00	10.7	8.5776E+04	1.1926E+04	-8.972E+04	2	0.000
-1610	78.5	6.00	6.8	7.4231E+04	1.0526E+04	-5.593E+04	2	0.000
-1690	78.5	6.00	6.9	6.2529E+04	9.0626E+03	-5.750E+04	2	0.000
-1770	78.5	6.00	7.0	5.0828E+04	7.5992E+03	-5.908E+04	2	0.000
-1850	78.5	6.00	7.1	3.9127E+04	6.1359E+03	-6.065E+04	2	0.000
-1930	78.5	6.00	7.2	2.7426E+04	4.6725E+03	-6.222E+04	2	0.000
-2010	78.5	6.00	3.5	2.0586E+04	3.6590E+03	-2.976E+04	2	0.000
-2090	78.5	6.00	3.6	1.6120E+04	2.8652E+03	-3.133E+04	2	0.000
-2170	124.0	6.00	3.5	1.1654E+04	2.0713E+03	-3.290E+04	2	0.000
-2250	78.5	6.00	3.9	7.1875E+03	1.2775E+03	-3.447E+04	2	0.000
-2330	78.5	6.00	4.0	2.7214E+03	4.8371E+02	-3.604E+04	2	0.000
-2410	78.5	6.00	0.5	4.2114E-11	3.6167E-12	-4.328E+03	2	0.000
-2490	78.5	6.00	0.7	1.2556E-11	5.8904E-12	-5.899E+03	2	0.000

Verifica di esercizio (combinazione quasi permanente):

quota	Af	cop.	sigmaf	sigmac	Mx	My	N	comb	Wk
-90	0.0	6.50	0.0	0.0	0.0000E+00	0.0000E+00	0.0000E+00	-	0.000
-170	78.5	6.00	33.2	-1.640E+06	1.4920E+05	-1.749E+05	1	0.000	
-250	78.5	6.00	30.3	-1.260E+06	2.3171E+04	-1.776E+05	2	0.000	
-330	78.5	6.00	23.5	-9.595E+05	1.0178E+04	-1.390E+05	2	0.000	
-410	78.5	6.00	22.0	-7.591E+05	6.4251E+03	-1.406E+05	2	0.000	
-490	78.5	6.00	20.5	-5.586E+05	2.6723E+03	-1.422E+05	2	0.000	
-570	78.5	6.00	19.0	-3.582E+05	-1.080E+03	-1.437E+05	2	0.000	
-650	78.5	6.00	17.5	-1.577E+05	-4.833E+03	-1.453E+05	2	0.000	
-730	78.5	6.00	12.4	-1.942E+04	-7.082E+03	-1.096E+05	2	0.000	
-810	78.5	6.00	12.5	2.7819E+04	-3.758E+03	-1.104E+05	1	0.000	
-890	78.5	6.00	13.0	6.1147E+04	-6.408E+03	-1.120E+05	1	0.000	
-970	78.5	6.00	13.4	9.4475E+04	-9.059E+03	-1.136E+05	1	0.000	
-1050	78.5	6.00	13.9	1.1960E+05	-6.056E+03	-1.159E+05	2	0.000	
-1130	124.0	6.00	9.4	1.4364E+05	-5.667E+03	-8.060E+04	2	0.000	
-1210	78.5	6.00	10.2	1.3271E+05	-4.846E+03	-8.217E+04	2	0.000	
-1290	78.5	6.00	10.3	1.2177E+05	-4.024E+03	-8.374E+04	2	0.000	
-1370	78.5	6.00	10.4	1.1083E+05	-3.203E+03	-8.531E+04	2	0.000	
-1450	78.5	6.00	10.5	9.9896E+04	-2.381E+03	-8.688E+04	2	0.000	
-1530	78.5	6.00	10.6	8.8960E+04	-1.560E+03	-8.845E+04	2	0.000	
-1610	78.5	6.00	6.8	7.6596E+04	-1.211E+03	-5.507E+04	2	0.000	
-1690	78.5	6.00	6.8	6.4162E+04	-8.856E+02	-5.664E+04	2	0.000	
-1770	78.5	6.00	6.9	5.1728E+04	-5.600E+02	-5.821E+04	2	0.000	
-1850	78.5	6.00	7.0	3.9293E+04	-2.344E+02	-5.978E+04	2	0.000	
-1930	78.5	6.00	7.0	2.6859E+04	9.1224E+01	-6.136E+04	2	0.000	
-2010	78.5	6.00	3.4	1.9881E+04	1.7287E+02	-2.929E+04	2	0.000	
-2090	78.5	6.00	3.6	1.5568E+04	1.3537E+02	-3.086E+04	2	0.000	
-2170	124.0	6.00	3.4	1.1255E+04	9.7863E+01	-3.243E+04	2	0.000	
-2250	78.5	6.00	3.8	6.9415E+03	6.0358E+01	-3.400E+04	2	0.000	
-2330	78.5	6.00	4.0	2.6283E+03	2.2854E+01	-3.557E+04	2	0.000	
-2410	78.5	6.00	0.5	3.8279E-11	-3.105E-12	-4.238E+03	2	0.000	
-2490	78.5	6.00	0.6	1.0313E-11	3.1472E-12	-5.809E+03	2	0.000	

Verifica a taglio:

quota	Ast	Vsd	Vsdx	Vsdy	N	comb	VRd,c	VRd,max	VRd,S	Vwd	
-90	0.16	33422	8944	32203	-199392	1SLV	50915	231056	95238	44323	Vsd < VRd,
-170	0.16	32580	8608	31423	-199770	1SLV	54856	231056	99179	44323	Vsd < VRd,
-250	0.08	32580	8608	31423	-201341	1SLV	55074	231056	77236	22162	Vsd < VRd,
-330	0.08	10363	2507	10056	-158283	1SLV	49089	231056	71251	22162	Vsd < VRd,
-410	0.08	10363	2507	10056	-159854	1SLV	49307	231056	71469	22162	Vsd < VRd,
-490	0.08	10363	2507	10056	-161425	1SLV	49526	231056	71687	22162	Vsd < VRd,
-570	0.08	10363	2507	10056	-162995	1SLV	49744	231056	71906	22162	Vsd < VRd,
-650	0.08	10363	2507	10056	-164566	1SLV	49962	231056	72124	22162	Vsd < VRd,
-730	0.08	1872	453	1816	-92906	15SLV	40002	231056	62163	22162	Vsd < VRd,
-810	0.08	1872	453	1816	-94477	15SLV	40220	231056	62382	22162	Vsd < VRd,
-890	0.08	1872	453	1816	-96047	15SLV	40438	231056	62600	22162	Vsd < VRd,
-970	0.08	1872	453	1816	-97618	15SLV	40657	231056	62818	22162	Vsd < VRd,
-1050	0.08	1872	453	1816	-99189	15SLV	40875	231056	63037	22162	Vsd < VRd,
-1130	0.08	2087	-577	-2006	-91918	1SLV	44321	231056	66482	22162	Vsd < VRd,
-1210	0.08	2087	-577	-2006	-93488	1SLV	40083	231056	62244	22162	Vsd < VRd,
-1290	0.08	2087	-577	-2006	-95059	1SLV	40301	231056	62463	22162	Vsd < VRd,
-1370	0.08	2087	-577	-2006	-96630	1SLV	40519	231056	62681	22162	Vsd < VRd,
-1450	0.08	2087	-577	-2006	-98201	1SLV	40738	231056	62899	22162	Vsd < VRd,
-1530	0.08	2087	-577	-2006	-99772	1SLV	40956	231056	63118	22162	Vsd < VRd,
-1610	0.08	912	-233	-882	-62738	1SLV	35809	231056	57970	22162	Vsd < VRd,
-1690	0.08	912	-233	-882	-64309	1SLV	36027	231056	58189	22162	Vsd < VRd,
-1770	0.08	912	-233	-882	-65880	1SLV	36245	231056	58407	22162	Vsd < VRd,
-1850	0.08	912	-233	-882	-67451	1SLV	36464	231056	58625	22162	Vsd < VRd,
-1930	0.08	912	-233	-882	-69022	1SLV	36682	231056	58844	22162	Vsd < VRd,
-2010	0.08	75	16	-73	-38820	4SLU	32484	231056	54646	22162	Vsd < VRd,
-2090	0.08	75	16	-73	-40862	4SLU	32768	231056	54929	22162	Vsd < VRd,
-2170	0.08	75	16	-73	-42904	4SLU	37508	231056	59669	22162	Vsd < VRd,
-2250	0.08	75	16	-73	-44946	4SLU	33335	231056	55497	22162	Vsd < VRd,
-2330	0.08	75	16	-73	-46988	4SLU	33619	231056	55781	22162	Vsd < VRd,
-2410	0.08	0	0	0	-3362	15SLV	27555	231056	49717	22162	Vsd < VRd,
-2490	0.08	0	0	0	-4933	15SLV	27774	231056	49935	22162	Vsd < VRd,



Progetto	Titolo	Rev.	Pag.
Orione	Orione_A24a.pdf "TABULATI DI CALCOLO PLINTO DI FONDAZIONE PER AEROGENERATORE TIPO"	0	295



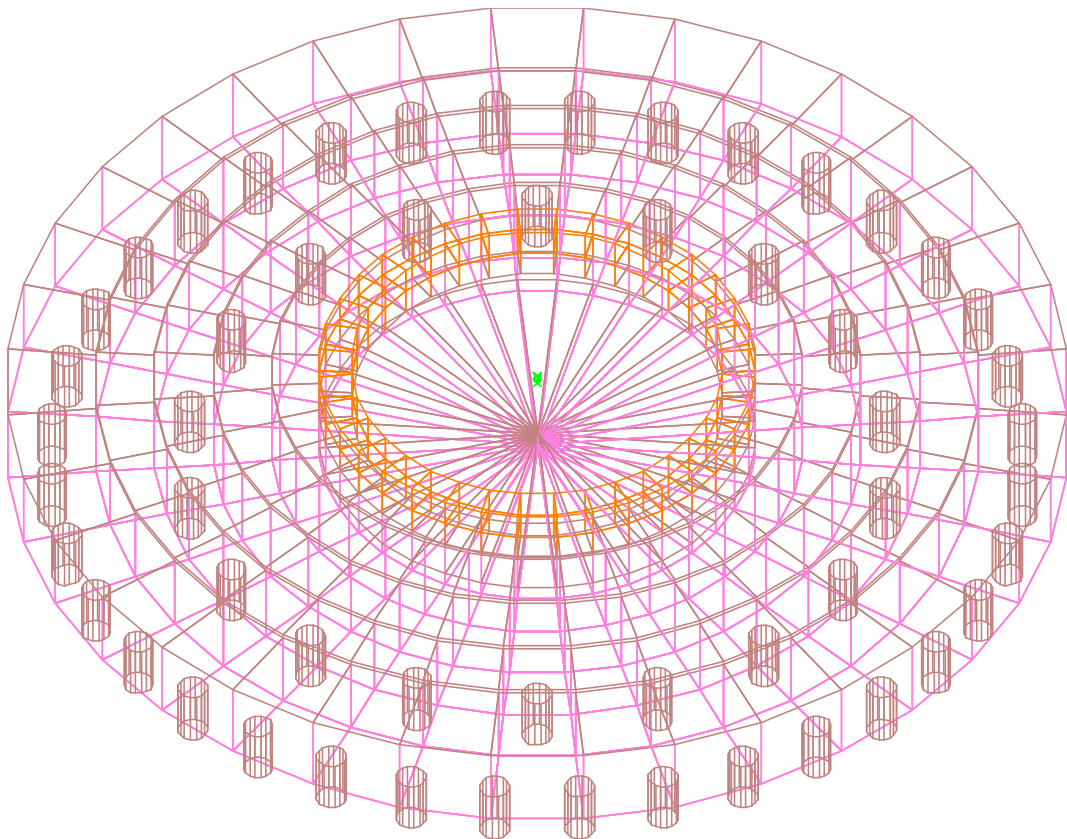
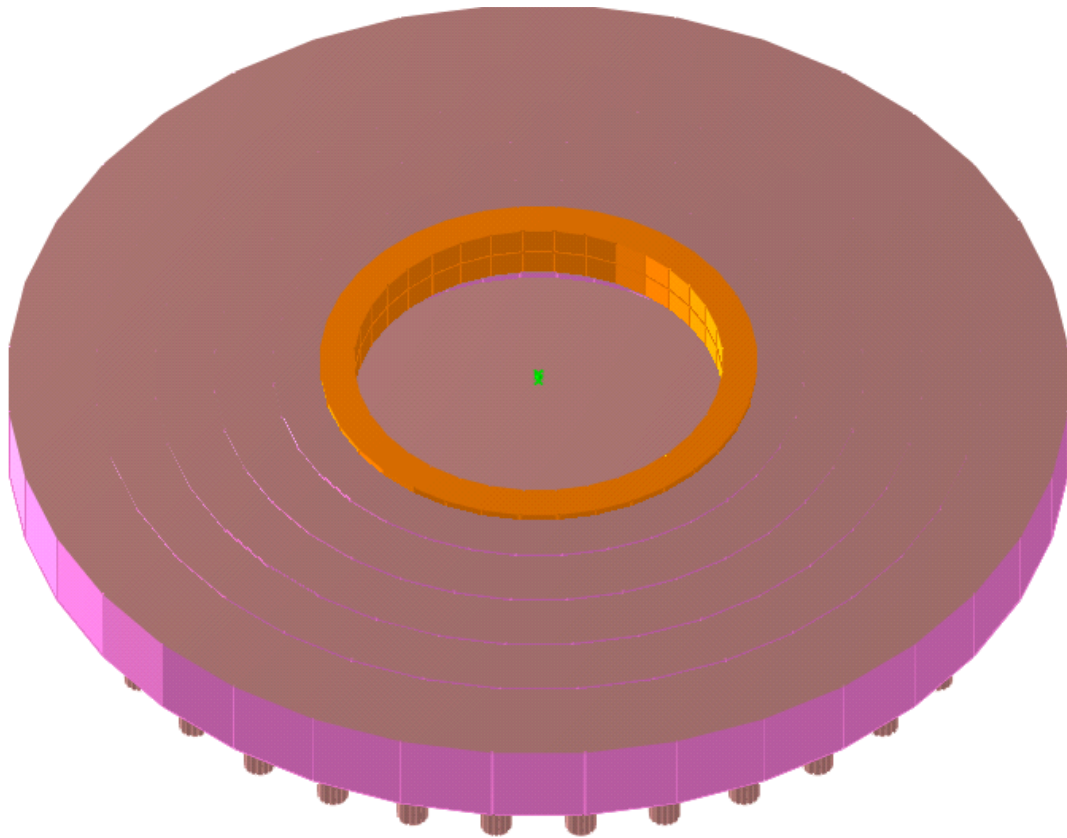

Struttura



Progetto	Titolo	Rev.	Pag.
Orione	Orione_A24a.pdf "TABULATI DI CALCOLO PLINTO DI FONDAZIONE PER AEROGENERATORE TIPO"	0	296

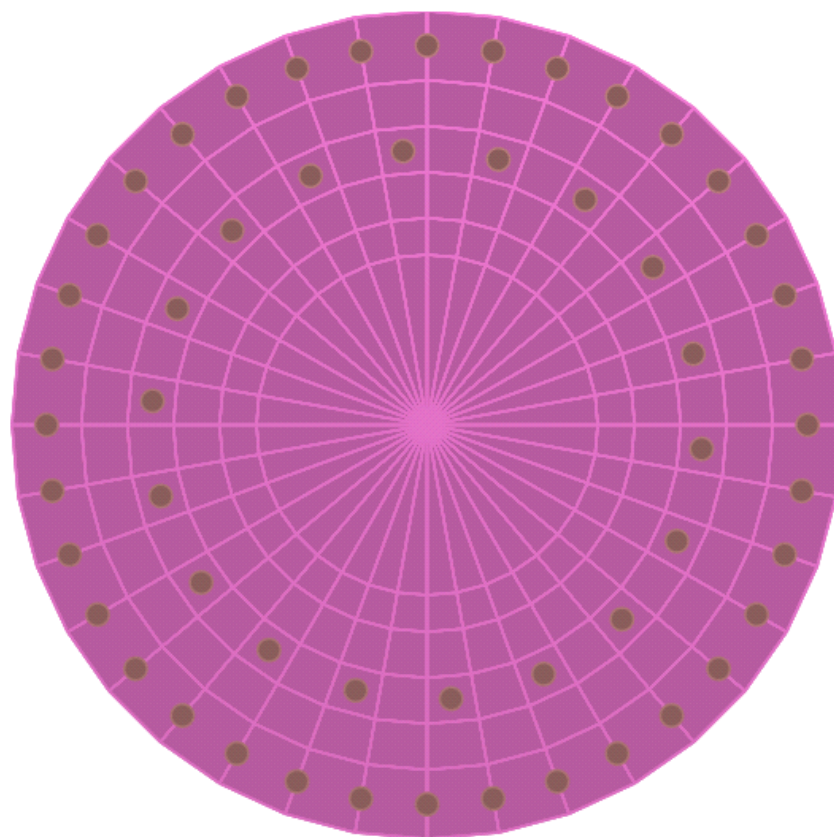

**Struttura**



Progetto	Titolo	Rev.	Pag.
Orione	Orione_A24a.pdf "TABULATI DI CALCOLO PLINTO DI FONDAZIONE PER AEROGENERATORE TIPO"	0	297

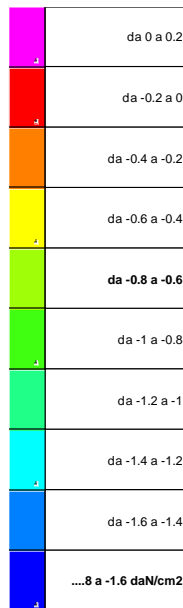
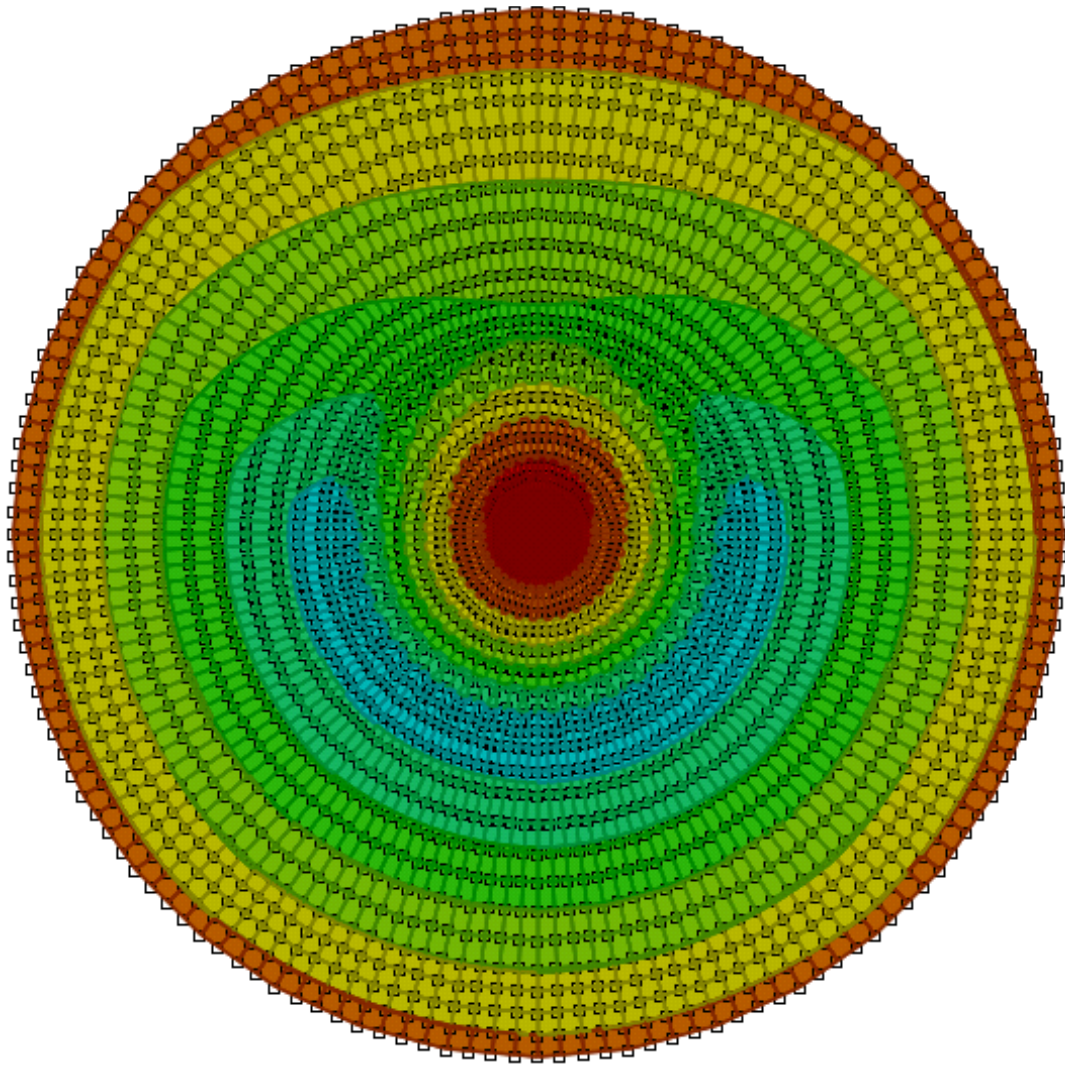

Pressioni terreno massime



Progetto	Titolo	Rev.	Pag.
Orione	Orione_A24a.pdf "TABULATI DI CALCOLO PLINTO DI FONDAZIONE PER AEROGENERATORE TIPO"	0	298

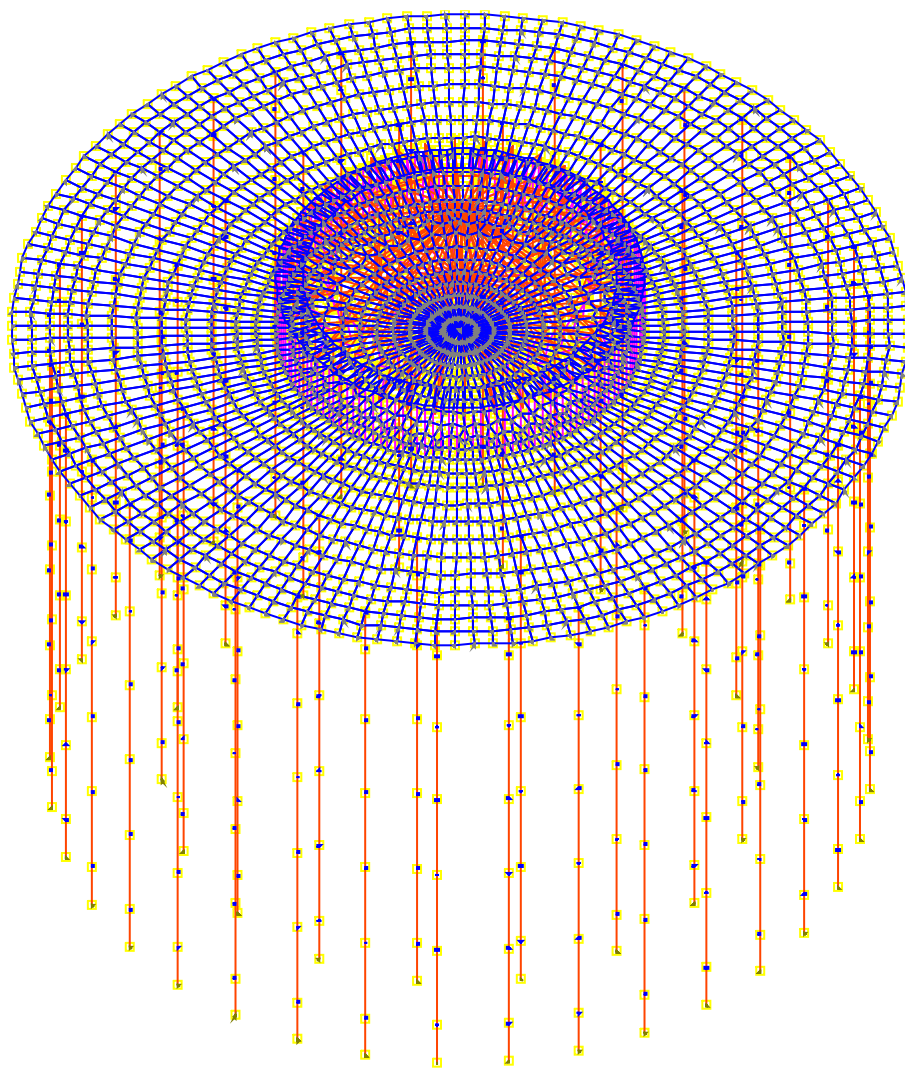

Modello



Progetto	Titolo	Rev.	Pag.
Orione	Orione_A24a.pdf "TABULATI DI CALCOLO PLINTO DI FONDAZIONE PER AEROGENERATORE TIPO"	0	299

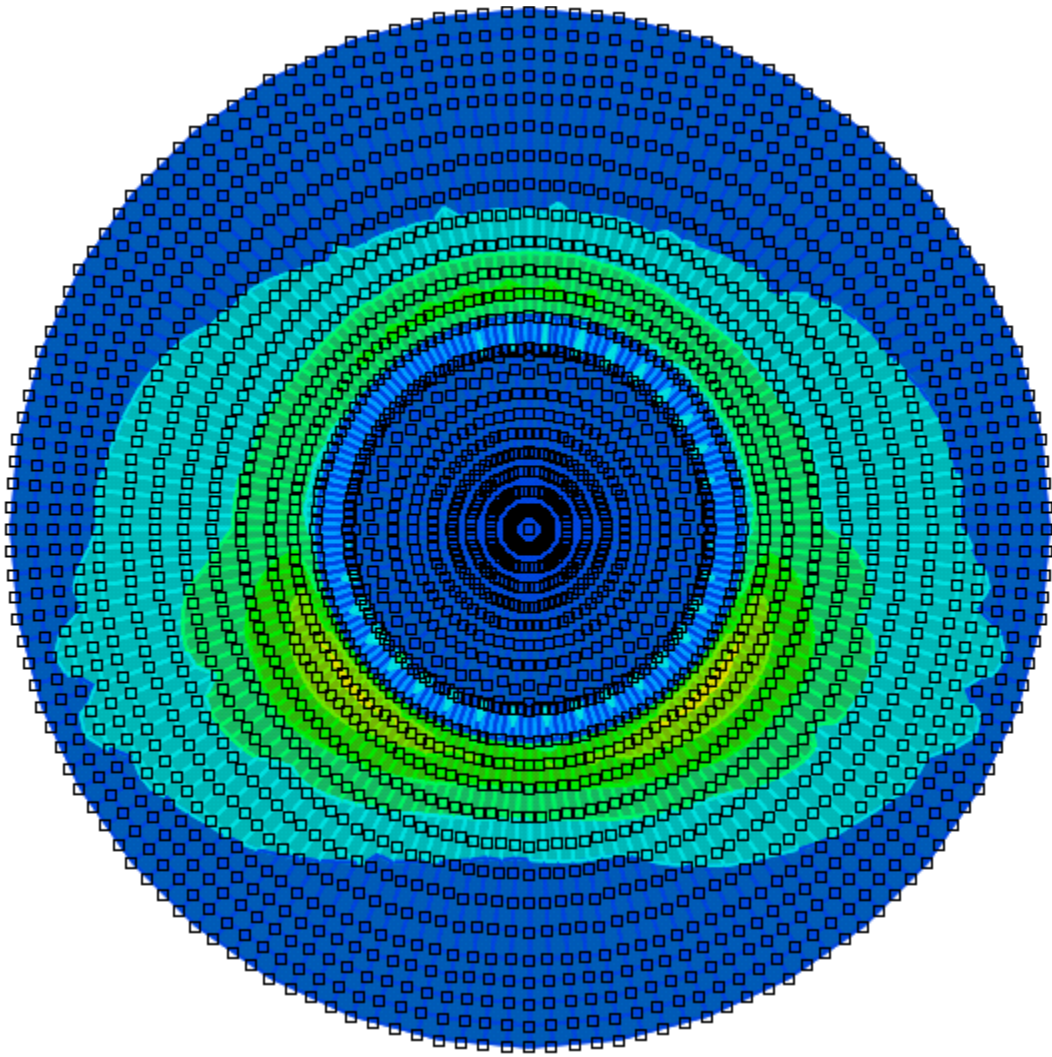

	...600000 a 1800000
	...400000 a 1600000
	...200000 a 1400000
	...000000 a 1200000
	...800000 a 1000000
	da 600000 a 800000
	da 400000 a 600000
	da 200000 a 400000
	da 0 a 200000
	...00 a 0 daN*cm/cm

Sollecitazioni gusci Myy massime



Progetto	Titolo	Rev.	Pag.
Orione	Orione_A24a.pdf "TABULATI DI CALCOLO PLINTO DI FONDAZIONE PER AEROGENERATORE TIPO"	0	300

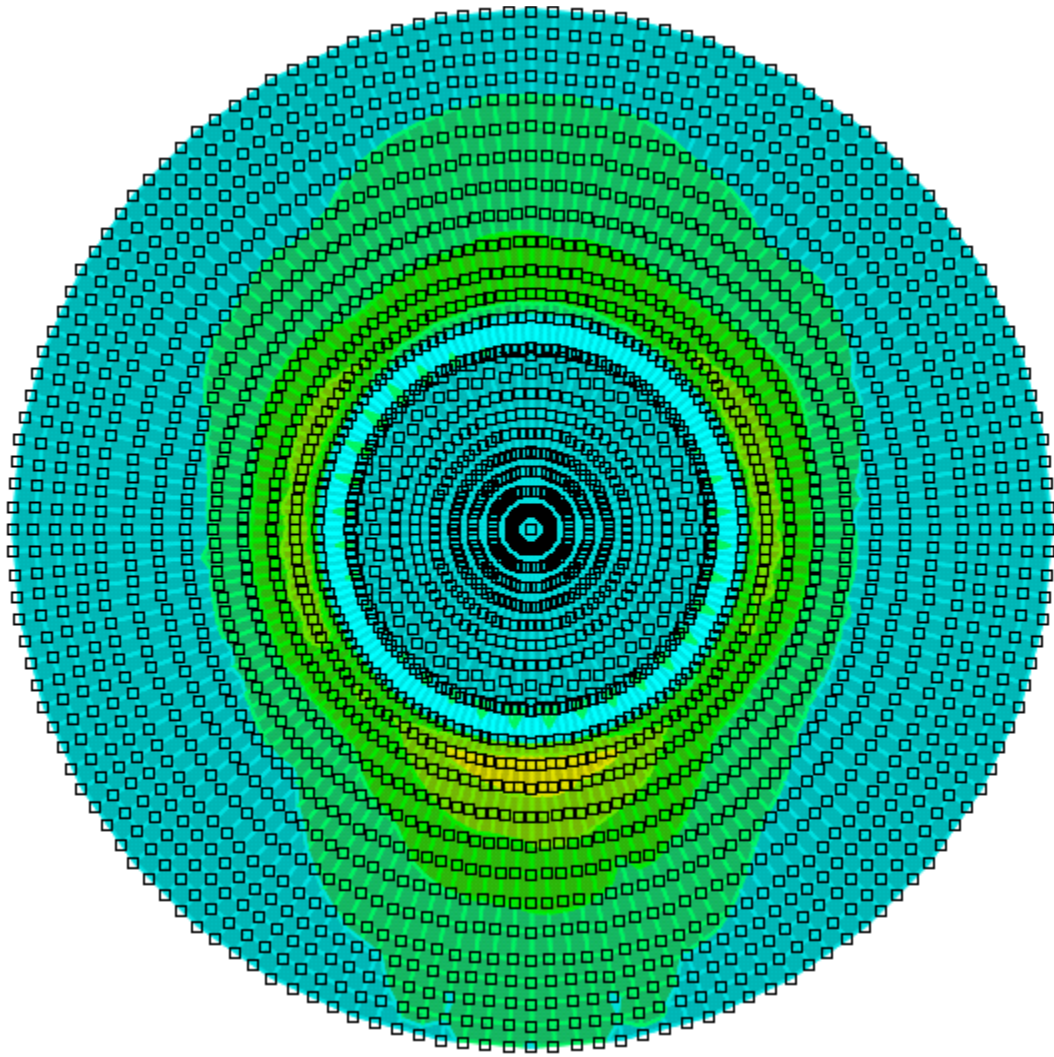

	...400000 a 1600000
	...200000 a 1400000
	...000000 a 1200000
	...800000 a 1000000
	da 600000 a 800000
	da 400000 a 600000
	da 200000 a 400000
	da 0 a 200000
	da -200000 a 0
	...00000 daN/cm/cm

Sollecitazioni gusci Mxx massime



Progetto	Titolo	Rev.	Pag.
Orione	Orione_A24a.pdf "TABULATI DI CALCOLO PLINTO DI FONDAZIONE PER AEROGENERATORE TIPO"	0	301

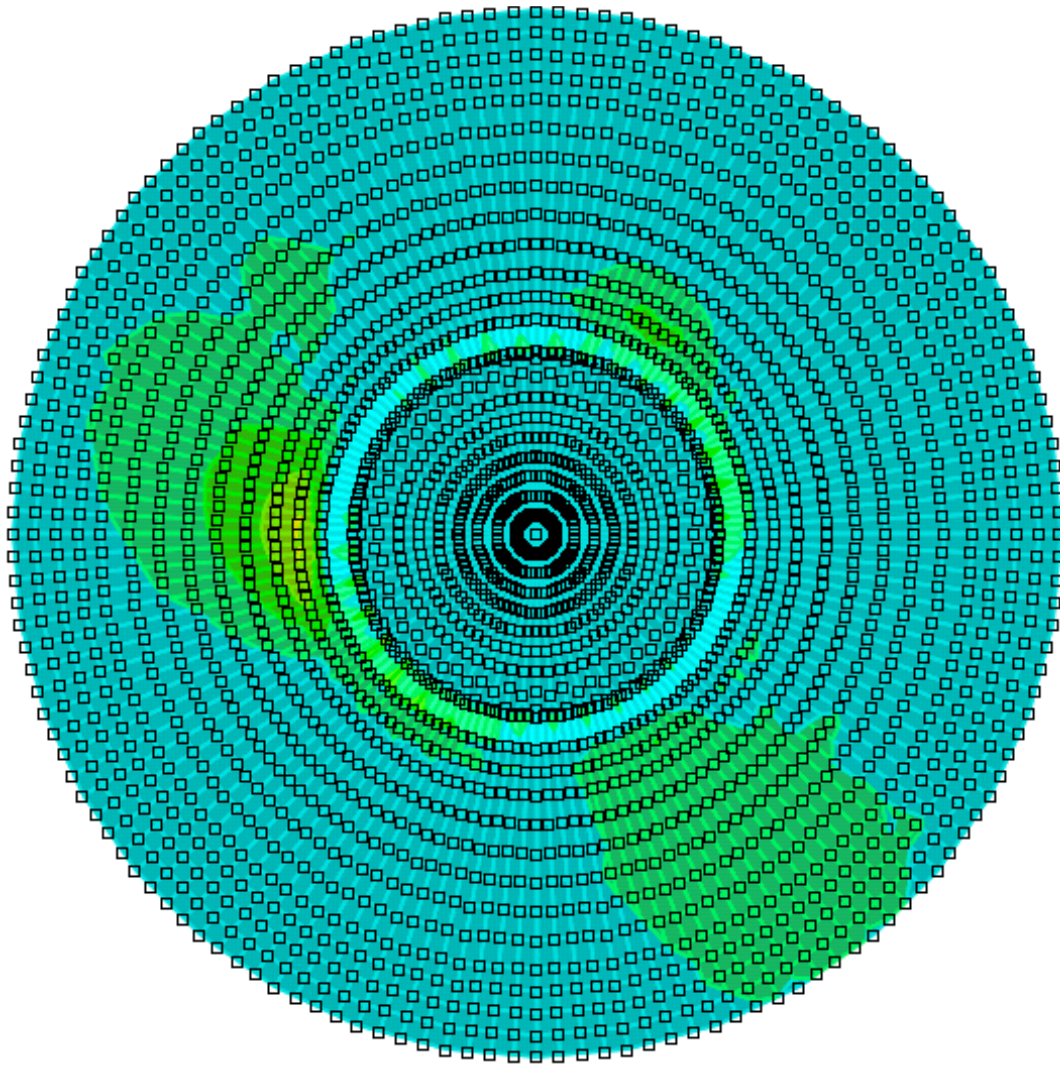

	da 700000 a 800000
	da 600000 a 700000
	da 500000 a 600000
	da 400000 a 500000
	da 300000 a 400000
	da 200000 a 300000
	da 100000 a 200000
	da 0 a 100000
	da -100000 a 0
	...00000 daN*cm/cm

Sollecitazioni gusci Mxy massime



Progetto	Titolo	Rev.	Pag.
Orione	Orione_A24a.pdf "TABULATI DI CALCOLO PLINTO DI FONDAZIONE PER AEROGENERATORE TIPO"	0	302

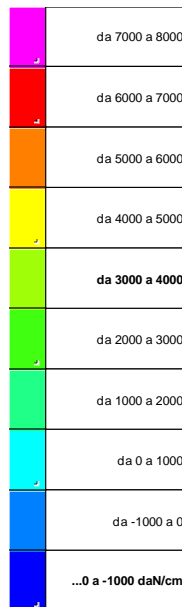
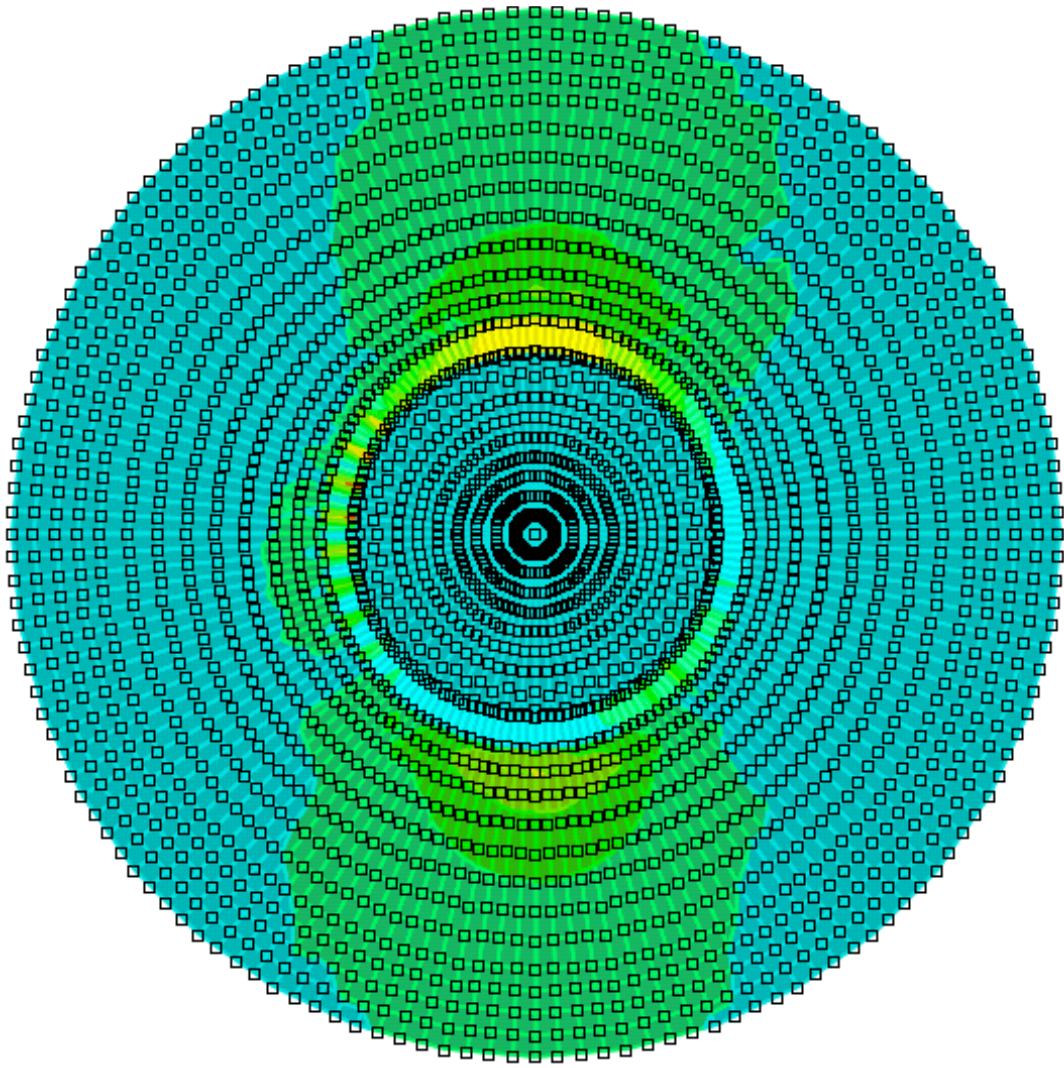

Sollecitazioni gusci Fxx massime



Progetto	Titolo	Rev.	Pag.
Orione	Orione_A24a.pdf "TABULATI DI CALCOLO PLINTO DI FONDAZIONE PER AEROGENERATORE TIPO"	0	303



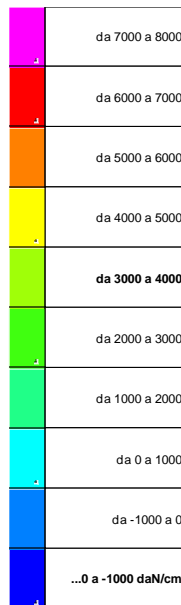
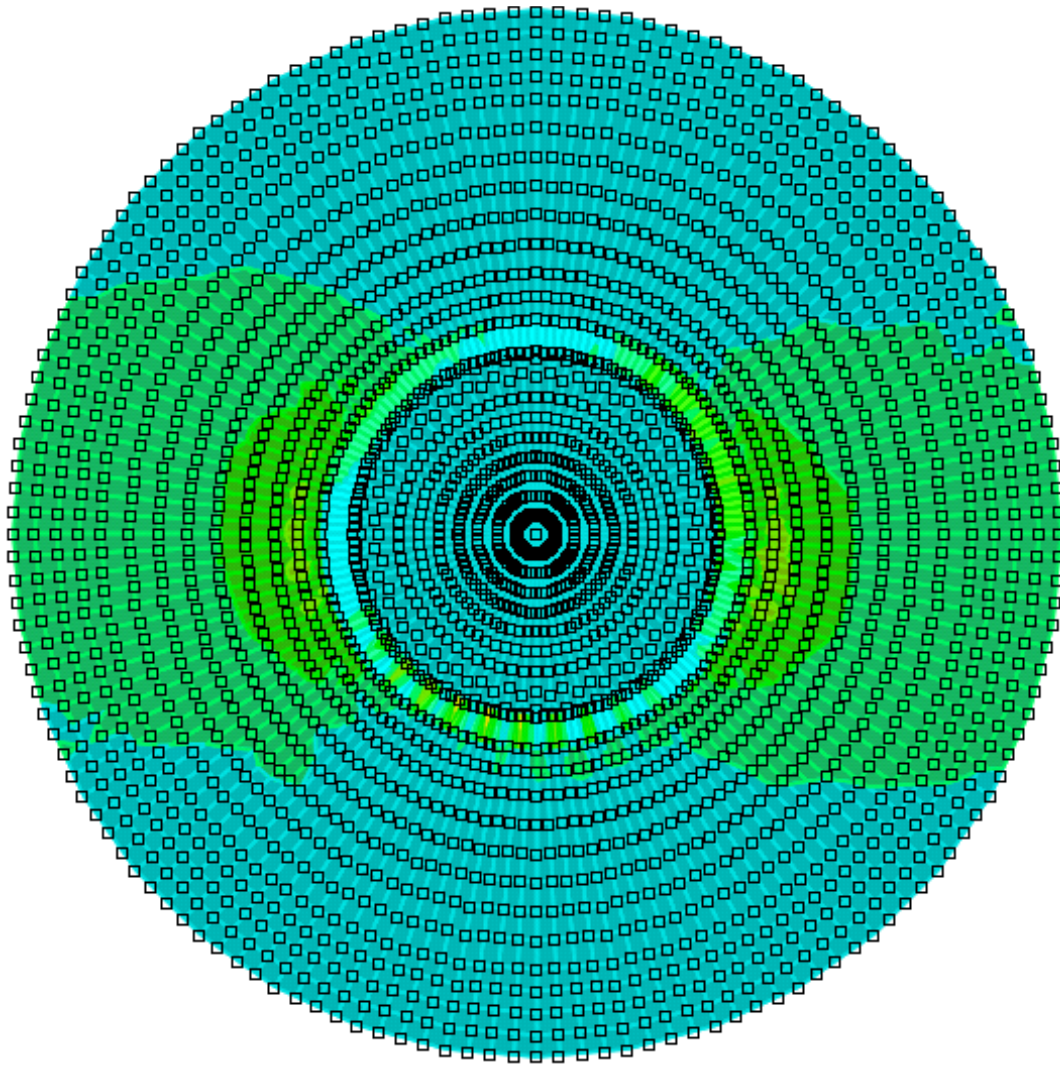

Sollecitazioni gusci Fyy massime



Progetto	Titolo	Rev.	Pag.
Orione	Orione_A24a.pdf "TABULATI DI CALCOLO PLINTO DI FONDAZIONE PER AEROGENERATORE TIPO"	0	304

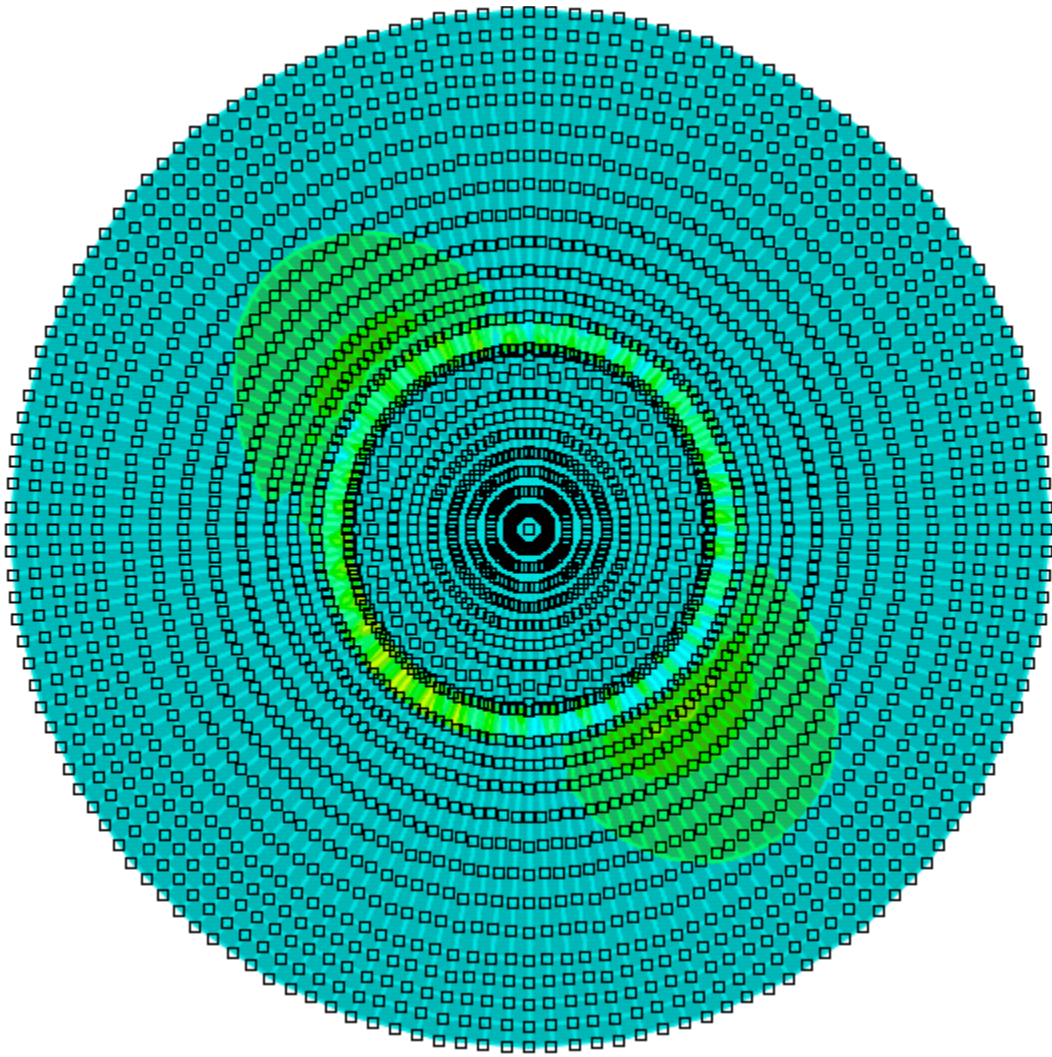

	da 7000 a 8000
	da 6000 a 7000
	da 5000 a 6000
	da 4000 a 5000
	<b>da 3000 a 4000</b>
	da 2000 a 3000
	da 1000 a 2000
	da 0 a 1000
	da -1000 a 0
	...0 a -1000 daN/cm

Sollecitazioni gusci Fxy massime



Progetto	Titolo	Rev.	Pag.
Orione	Orione_A24a.pdf "TABULATI DI CALCOLO PLINTO DI FONDAZIONE PER AEROGENERATORE TIPO"	0	305