

## CONTROSOFFITO DI BANCHINA TIPO CS1

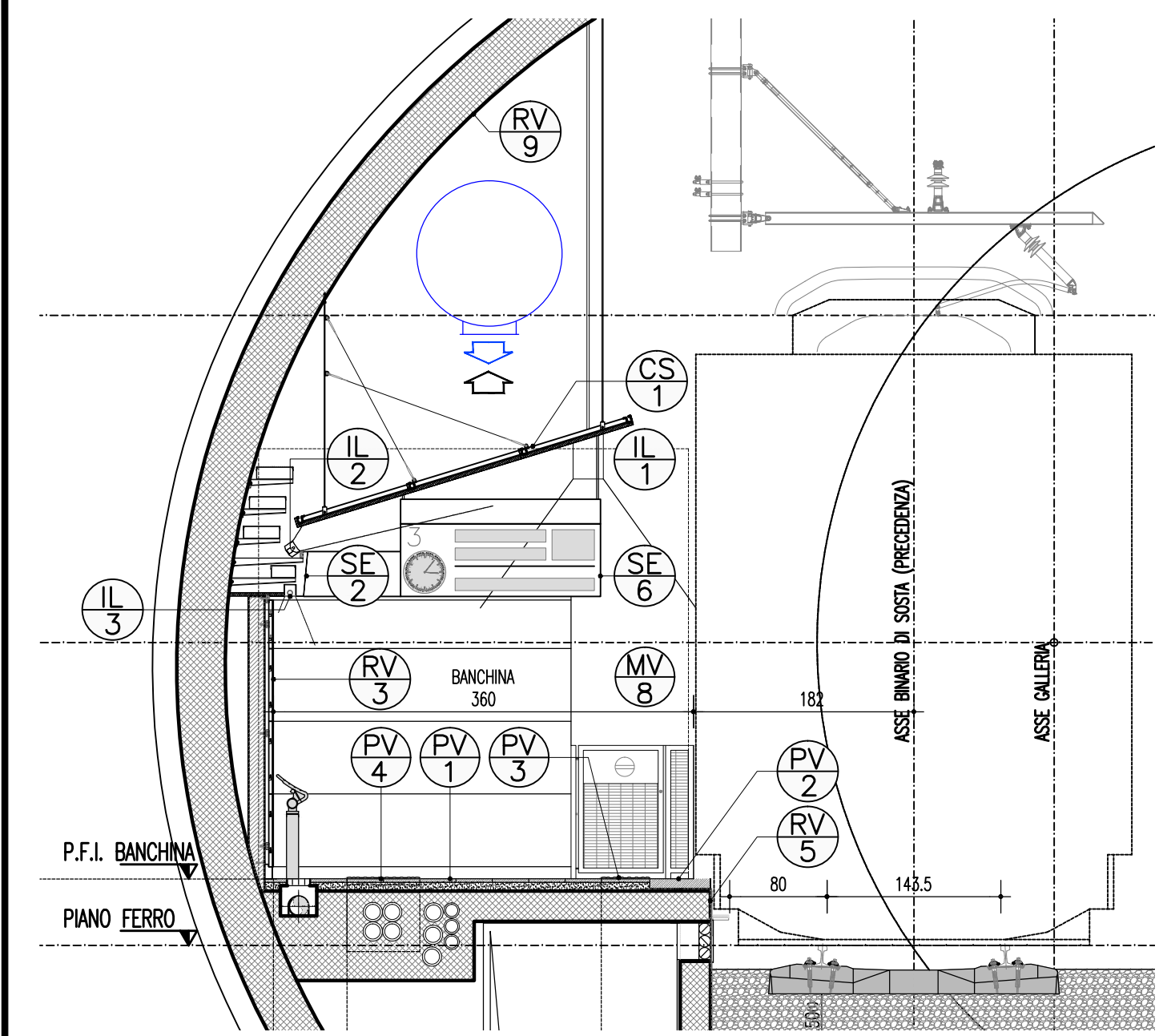

### SEZIONE LONGITUDINALE E TRASVERSALE

SCALA 1:2

INCORSOIO DELLA STRUTTURA CON BARRA FILETTATA Ø 8 VERNICIATA NERA E GRUO M8  
STRUTTURA TUBOLARE 30x40 mm  
LAMA DI VETRO CLASSE 1° 50kg/mc. SP. 50mm  
PANNELLO IN LAMERA ZINCATO SP. 0,710 985-988-989-990 (2000x1800mm) POST VERNICIATA ALLE FUSOLE TERMINANTI - FORATURA 1522 - Ø 6 A SCALA

### STRALCIO BANCHINA - SEZIONE E PIANTE

SCALA 1:50

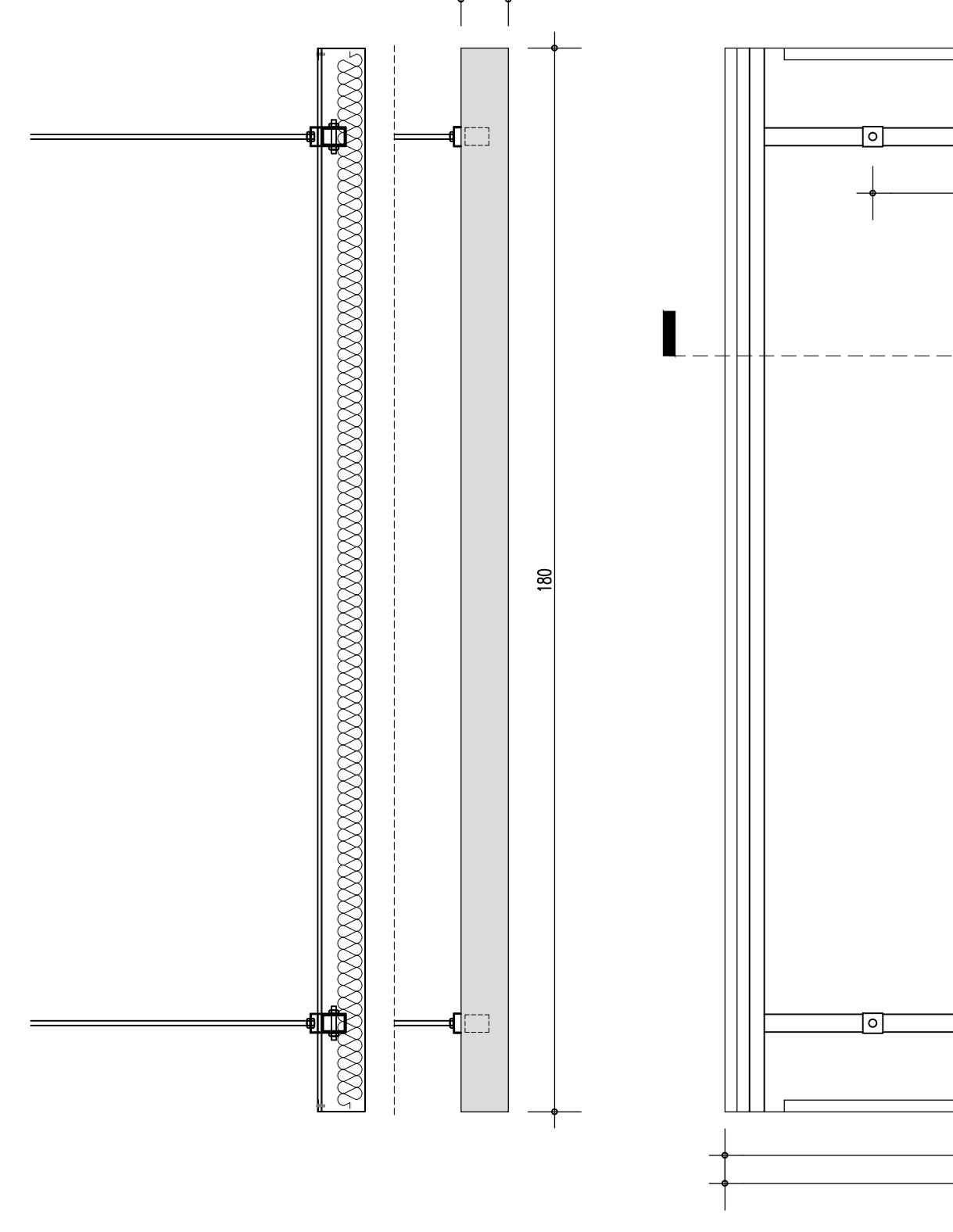
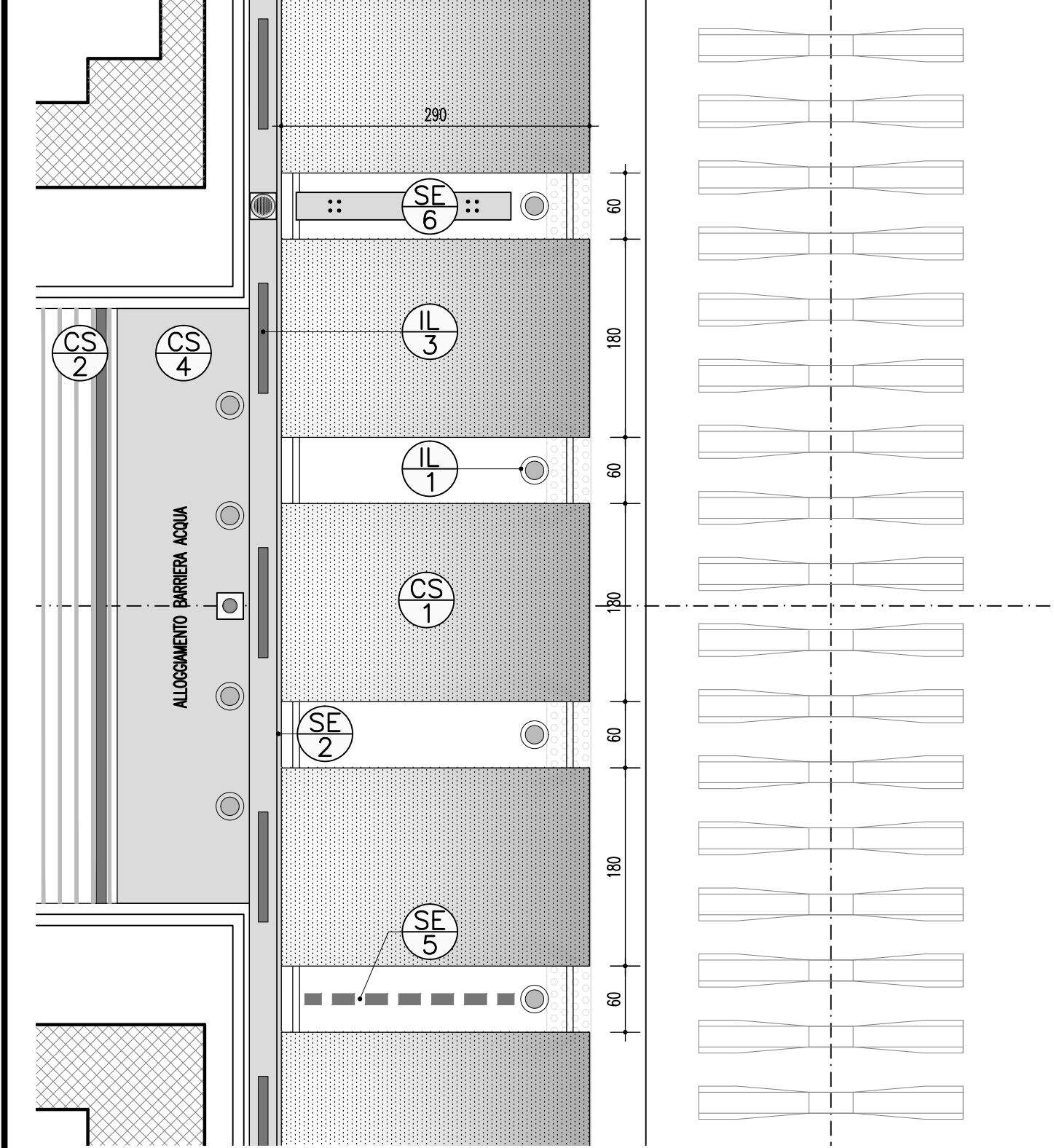

## CONTROSOFFITO IN TUBOLARI TIPO CS2

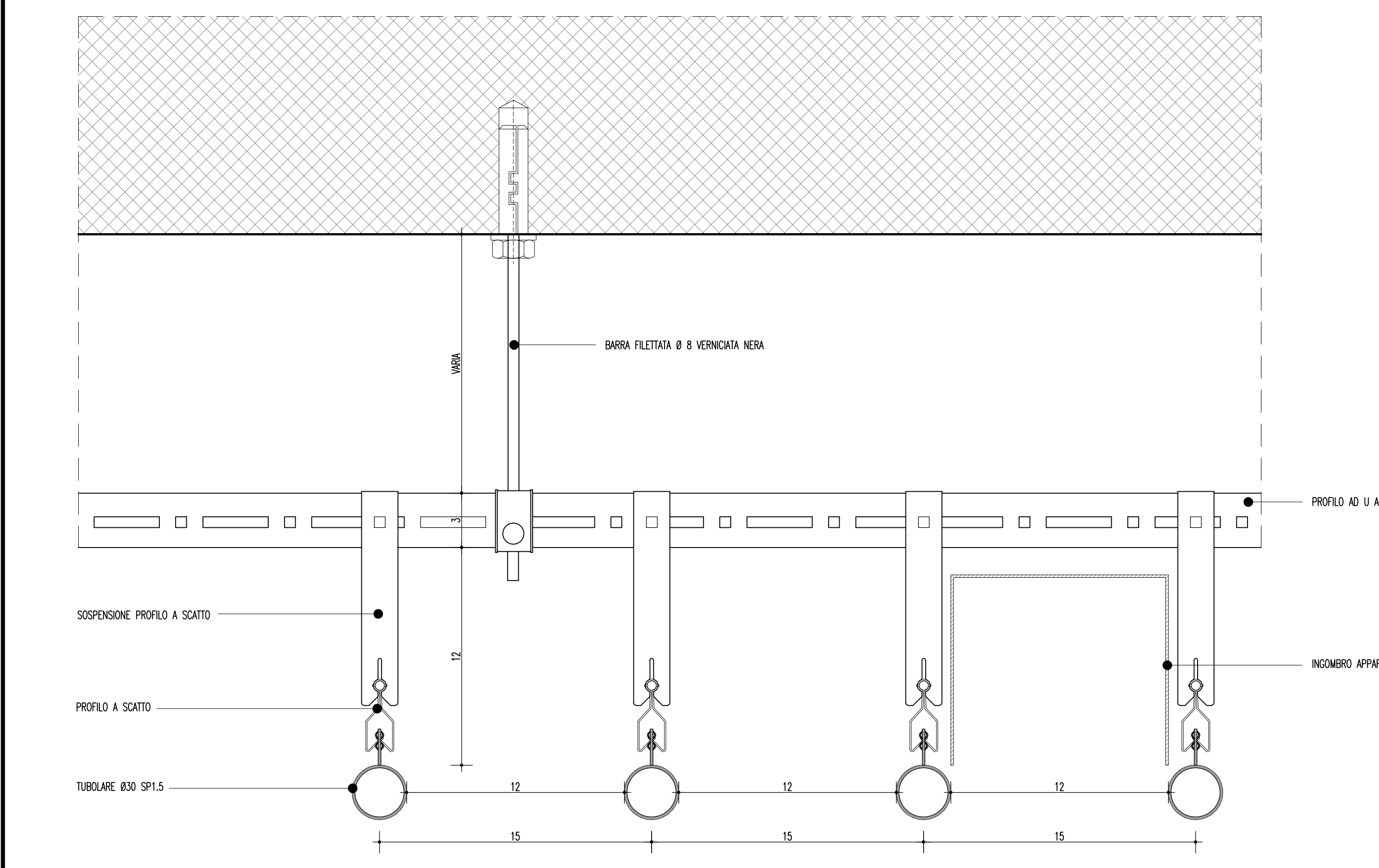

### SEZIONE - VISTA TRASVERSALE DEL PANNELLO

SCALA 1:2

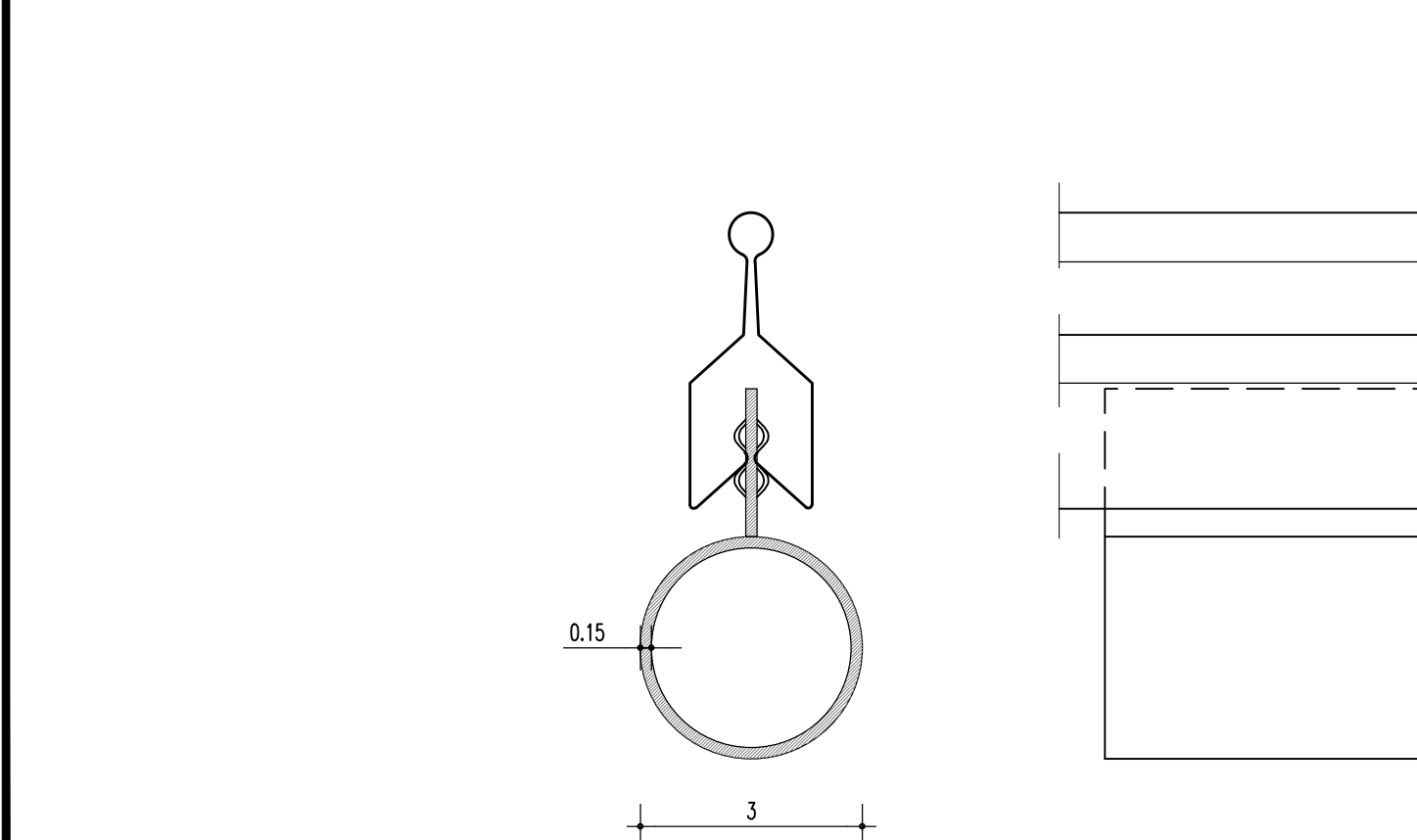

### SEZIONE DI DETTAGLIO

SCALA 1:1

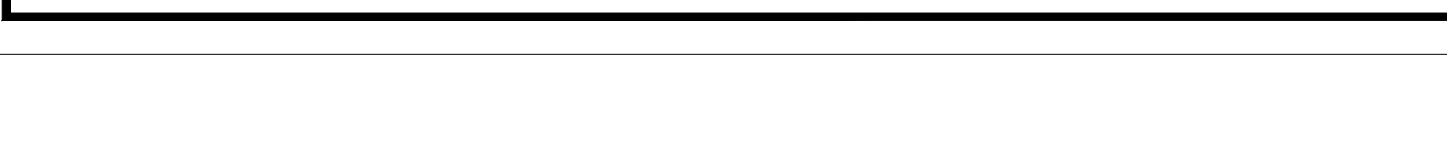

### VISTA ASSONOMETRICA

SCALA 1:2



### SEZIONE - VISTA LONGITUDINALE DEL PANNELLO

SCALA 1:2



### DETAGLIO PROFILO DI BATTUTA

SCALA 1:1



## CONTROSOFFITO TIPO CS4

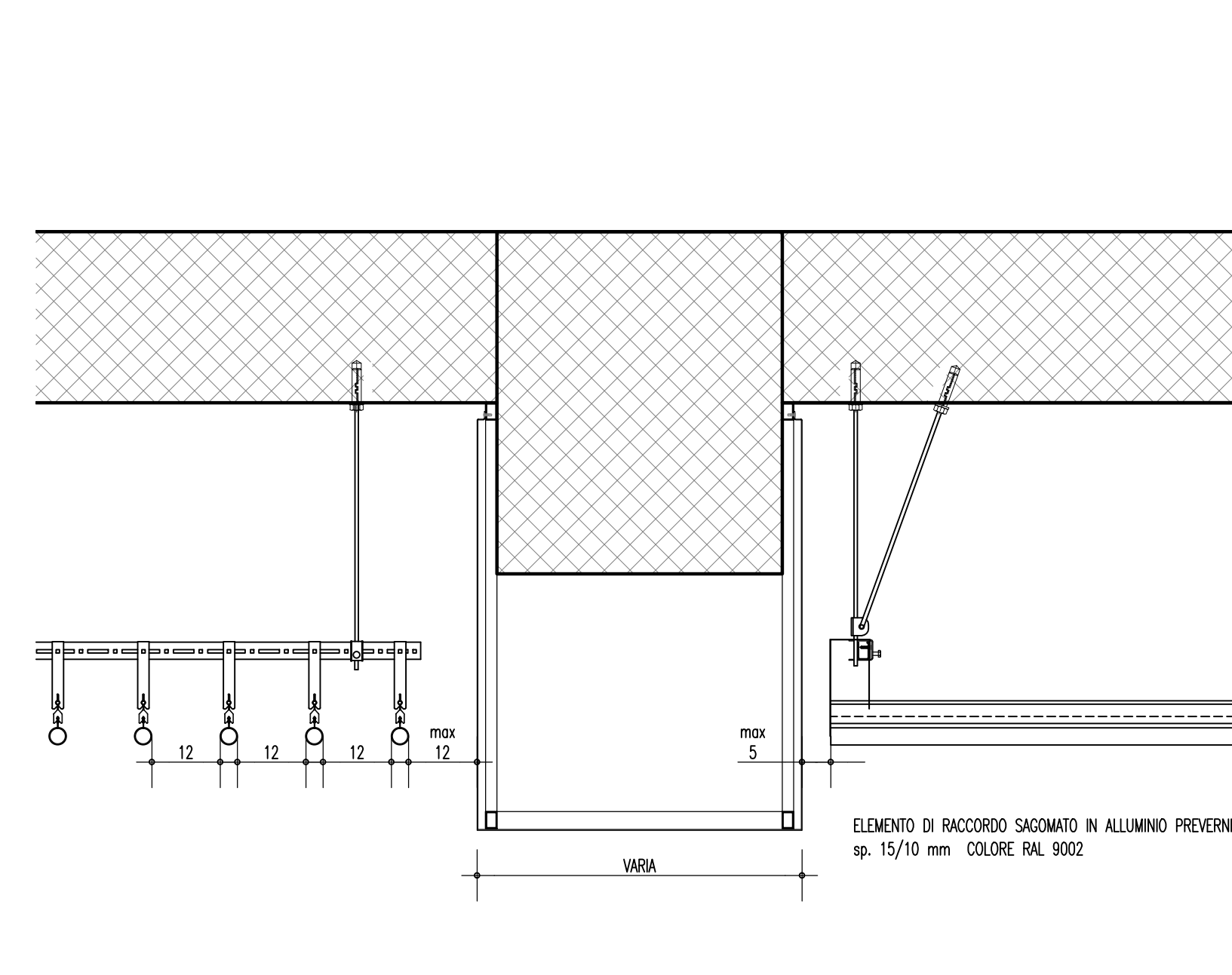

## CONTROSOFFITO TIPO CS3

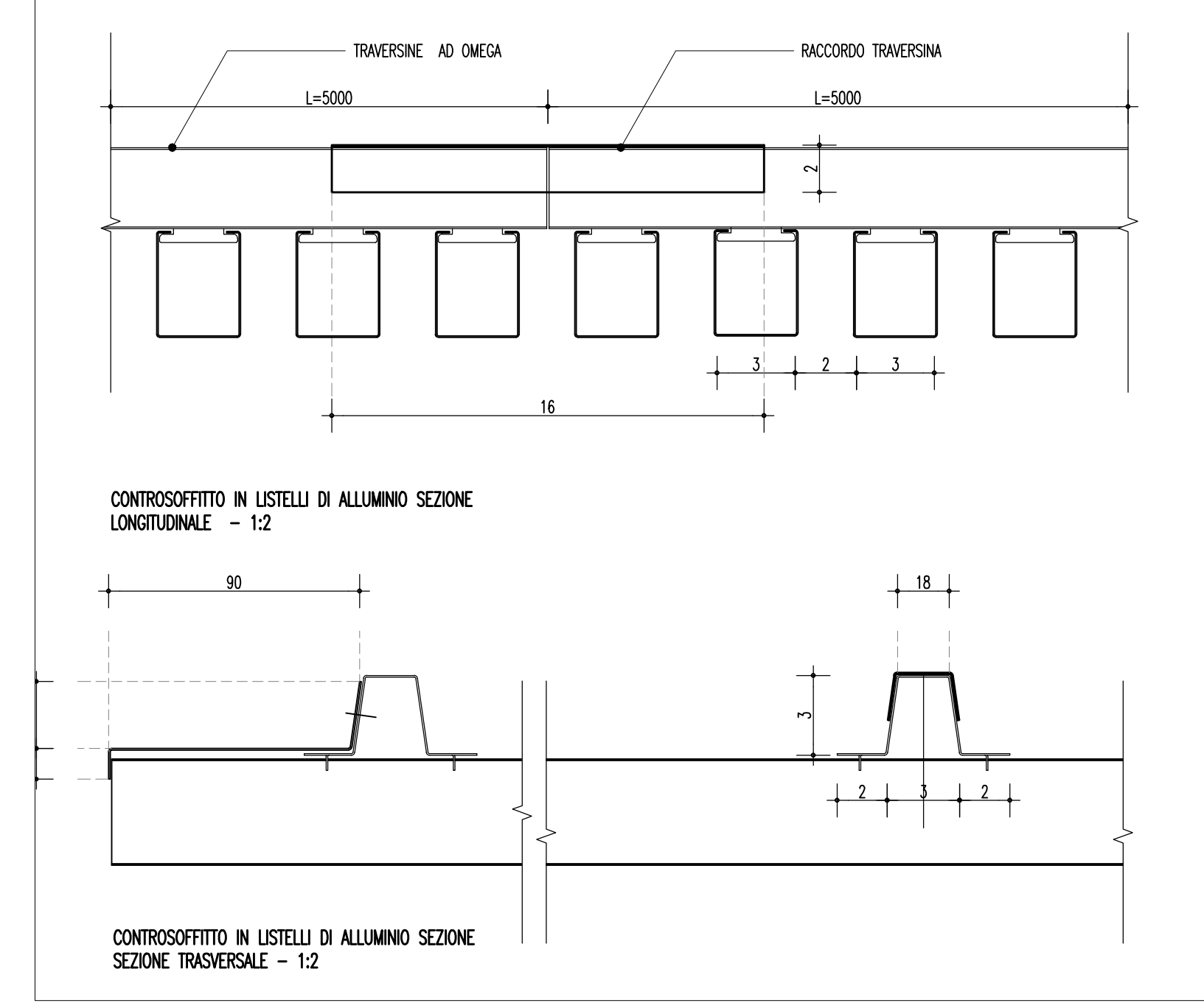

### CONTROSOFFITO IN LISTELLI DI ALLUMINIO SEZIONE TRASVERSALE - 12

SCALA 1:2



### CONTROSOFFITO IN LISTELLI DI ALLUMINIO SEZIONE LONGITUDINALE - 12

SCALA 1:2



### CONTROSOFFITO IN LISTELLI DI ALLUMINIO SEZIONE TRASVERSALE - 12

SCALA 1:2



### CONTROSOFFITO IN LISTELLI DI ALLUMINIO SEZIONE LONGITUDINALE - 12

SCALA 1:2



### CONTROSOFFITO IN LISTELLI DI ALLUMINIO SEZIONE TRASVERSALE - 12

SCALA 1:2



### CONTROSOFFITO IN LISTELLI DI ALLUMINIO SEZIONE LONGITUDINALE - 12

SCALA 1:2



### CONTROSOFFITO IN LISTELLI DI ALLUMINIO SEZIONE TRASVERSALE - 12

SCALA 1:2



### CONTROSOFFITO IN LISTELLI DI ALLUMINIO SEZIONE LONGITUDINALE - 12

SCALA 1:2



### CONTROSOFFITO IN LISTELLI DI ALLUMINIO SEZIONE TRASVERSALE - 12

SCALA 1:2



### CONTROSOFFITO IN LISTELLI DI ALLUMINIO SEZIONE LONGITUDINALE - 12

SCALA 1:2



### CONTROSOFFITO IN LISTELLI DI ALLUMINIO SEZIONE TRASVERSALE - 12

SCALA 1:2



### CONTROSOFFITO IN LISTELLI DI ALLUMINIO SEZIONE LONGITUDINALE - 12

SCALA 1:2



### CONTROSOFFITO IN LISTELLI DI ALLUMINIO SEZIONE TRASVERSALE - 12

SCALA 1:2



### CONTROSOFFITO IN LISTELLI DI ALLUMINIO SEZIONE LONGITUDINALE - 12

SCALA 1:2



### CONTROSOFFITO IN LISTELLI DI ALLUMINIO SEZIONE TRASVERSALE - 12

SCALA 1:2



### CONTROSOFFITO IN LISTELLI DI ALLUMINIO SEZIONE LONGITUDINALE - 12

SCALA 1:2



### CONTROSOFFITO IN LISTELLI DI ALLUMINIO SEZIONE TRASVERSALE - 12

SCALA 1:2



### CONTROSOFFITO IN LISTELLI DI ALLUMINIO SEZIONE LONGITUDINALE - 12

SCALA 1:2



### CONTROSOFFITO IN LISTELLI DI ALLUMINIO SEZIONE TRASVERSALE - 12

SCALA 1:2



### CONTROSOFFITO IN LISTELLI DI ALLUMINIO SEZIONE LONGITUDINALE - 12

SCALA 1:2



### CONTROSOFFITO IN LISTELLI DI ALLUMINIO SEZIONE TRASVERSALE - 12

SCALA 1:2



### CONTROSOFFITO IN LISTELLI DI ALLUMINIO SEZIONE LONGITUDINALE - 12

SCALA 1:2



### CONTROSOFFITO IN LISTELLI DI ALLUMINIO SEZIONE TRASVERSALE - 12

SCALA 1:2



### CONTROSOFFITO IN LISTELLI DI ALLUMINIO SEZIONE LONGITUDINALE - 12

SCALA 1:2



### CONTROSOFFITO IN LISTELLI DI ALLUMINIO SEZIONE TRASVERSALE - 12

SCALA 1:2



### CONTROSOFFITO IN LISTELLI DI ALLUMINIO SEZIONE LONGITUDINALE - 12

SCALA 1:2



### CONTROSOFFITO IN LISTELLI DI ALLUMINIO SEZIONE TRASVERSALE - 12

SCALA 1:2



### CONTROSOFFITO IN LISTELLI DI ALLUMINIO SEZIONE LONGITUDINALE - 12

SCALA 1:2

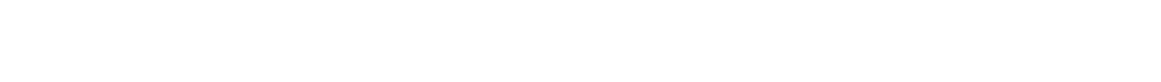

### CONTROSOFFITO IN LISTELLI DI ALLUMINIO SEZIONE TRASVERSALE - 12

SCALA 1:2



### CONTROSOFFITO IN LISTELLI DI ALLUMINIO SEZIONE LONGITUDINALE - 12

SCALA 1:2



### CONTROSOFFITO IN LISTELLI DI ALLUMINIO SEZIONE TRASVERSALE - 12

SCALA 1:2



### CONTROSOFFITO IN LISTELLI DI ALLUMINIO SEZIONE LONGITUDINALE - 12

SCALA 1:2



### CONTROSOFFITO IN LISTELLI DI ALLUMINIO SEZIONE TRASVERSALE - 12

SCALA 1:2



### CONTROSOFFITO IN LISTELLI DI ALLUMINIO SEZIONE LONGITUDINALE - 12

SCALA 1:2



### CONTROSOFFITO IN LISTELLI DI ALLUMINIO SEZIONE TRASVERSALE - 12

SCALA 1:2



### CONTROSOFFITO IN LISTELLI DI ALLUMINIO SEZIONE LONGITUDINALE - 12

SCALA 1:2



### CONTROSOFFITO IN LISTELLI DI ALLUMINIO SEZIONE TRASVERSALE - 12

SCALA 1:2

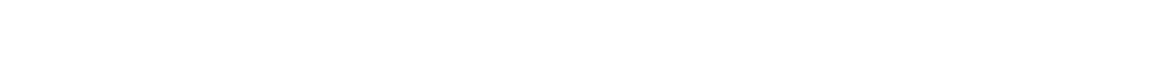

### CONTROSOFFITO IN LISTELLI DI ALLUMINIO SEZIONE LONGITUDINALE - 12

SCALA 1:2



### CONTROSOFFITO IN LISTELLI DI ALLUMINIO SEZIONE TRASVERSALE - 12

SCALA 1:2



### CONTROSOFFITO IN LISTELLI DI ALLUMINIO SEZIONE LONGITUDINALE - 12

SCALA 1:2



### CONTROSOFFITO IN LISTELLI DI ALLUMINIO SEZIONE TRASVERSALE - 12

SCALA 1:2



### CONTROSOFFITO IN LISTELLI DI ALLUMINIO SEZIONE LONGITUDINALE - 12

SCALA 1:2



### CONTROSOFFITO IN LISTELLI DI ALLUMINIO SEZIONE TRASVERSALE - 12

SCALA 1:2



### CONTROSOFFITO IN LISTELLI DI ALLUMINIO SEZIONE LONGITUDINALE - 12

SCALA 1:2



### CONTROSOFFITO IN LISTELLI DI ALLUMINIO SEZIONE TRASVERSALE - 12

SCALA 1:2



### CONTROSOFFITO IN LISTELLI DI ALLUMINIO SEZIONE LONGITUDINALE - 12

SCALA 1:2



### CONTROSOFFITO IN LISTELLI DI ALLUMINIO SEZIONE TRASVERSALE - 12

SCALA 1:2

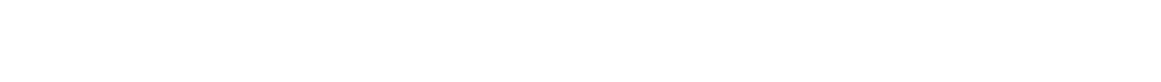

### CONTROSOFFITO IN LISTELLI DI ALLUMINIO SEZIONE LONGITUDINALE - 12

SCALA 1:2



### CONTROSOFFITO IN LISTELLI DI ALLUMINIO SEZIONE TRASVERSALE - 12

SCALA