

PLANIMETRIA SEGNALETICA
TAV. 5 di 14

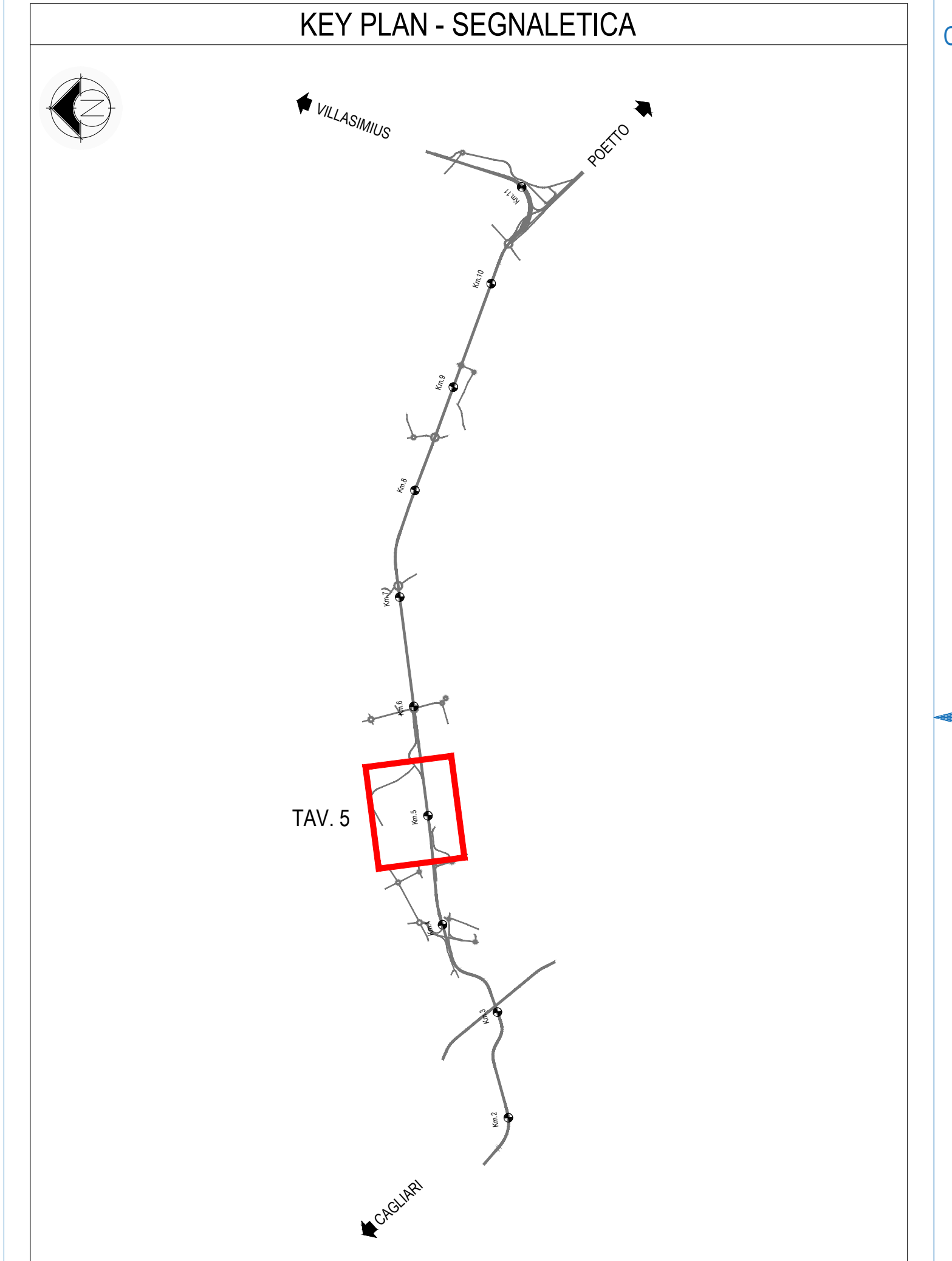
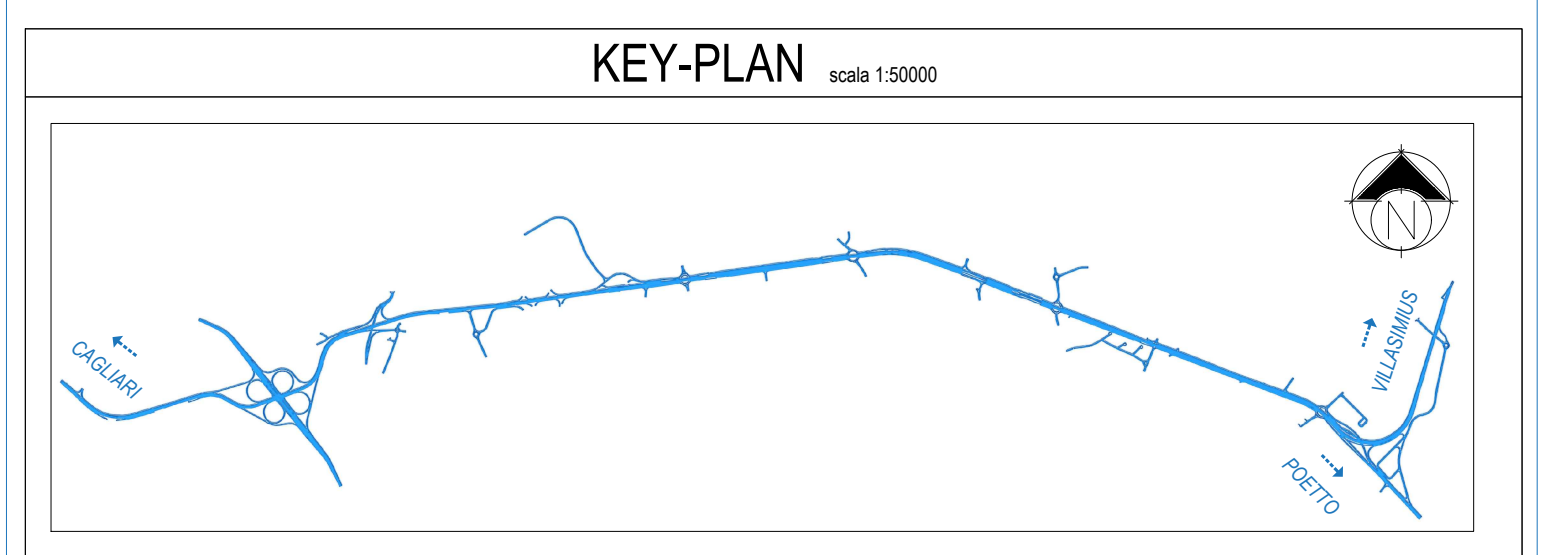
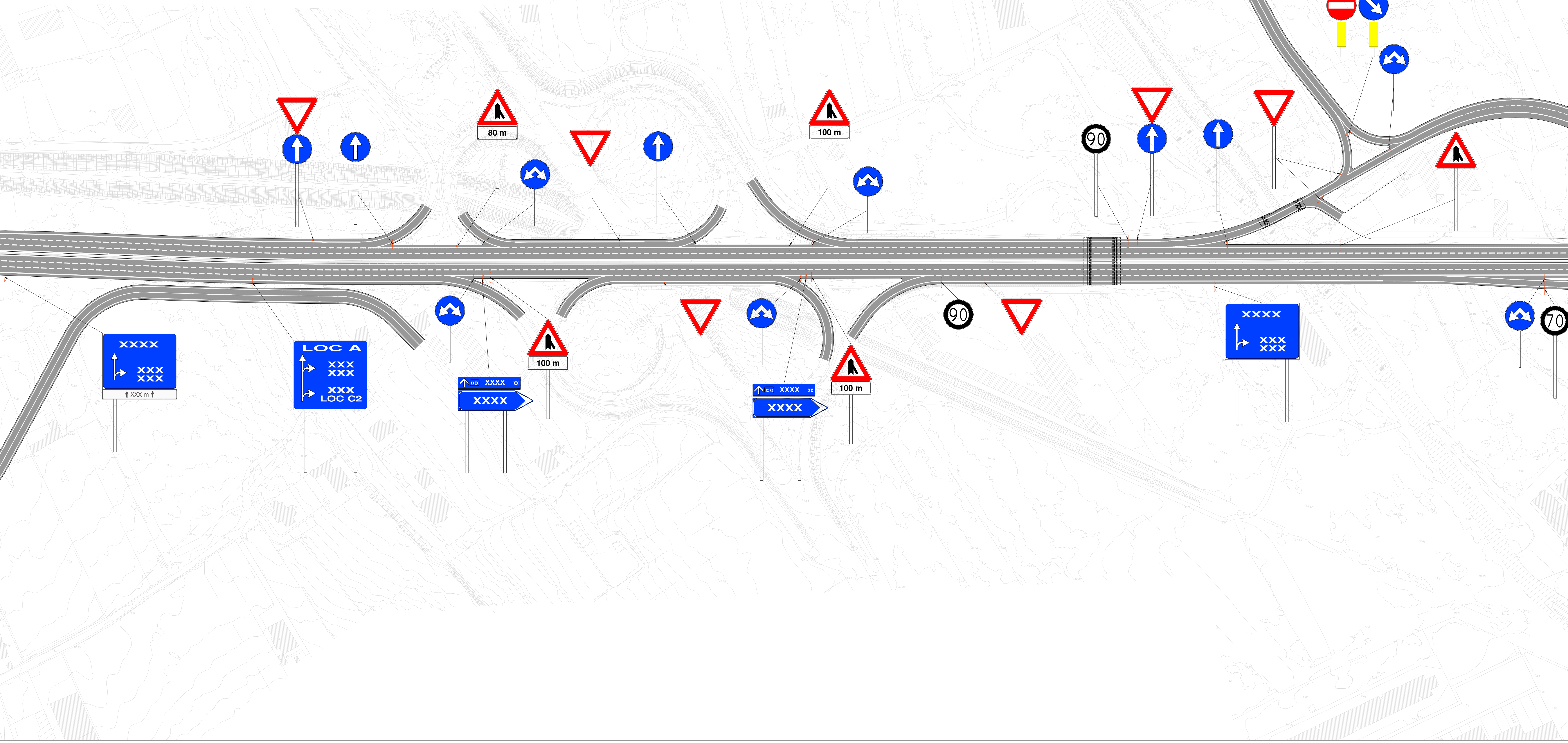
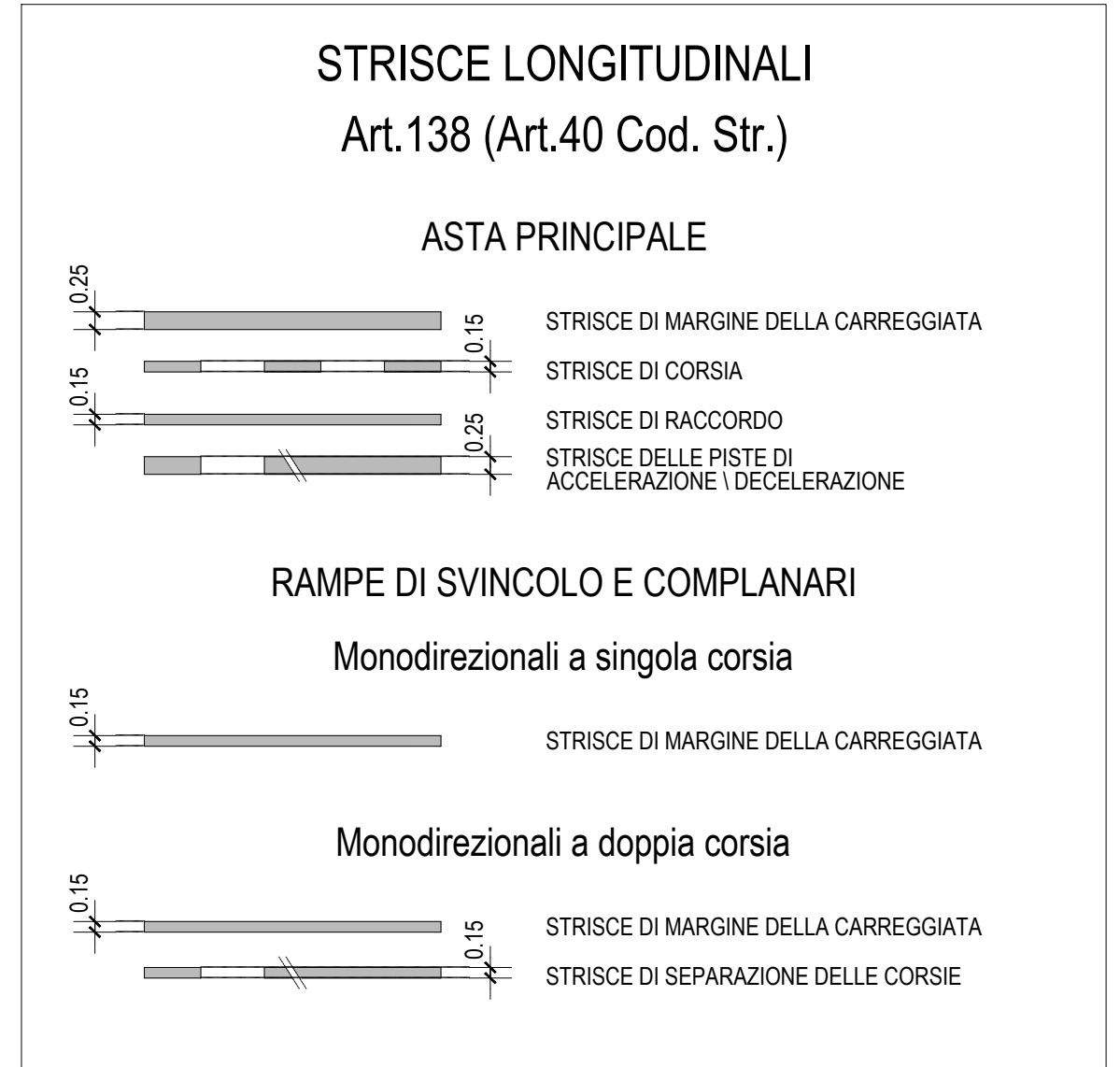
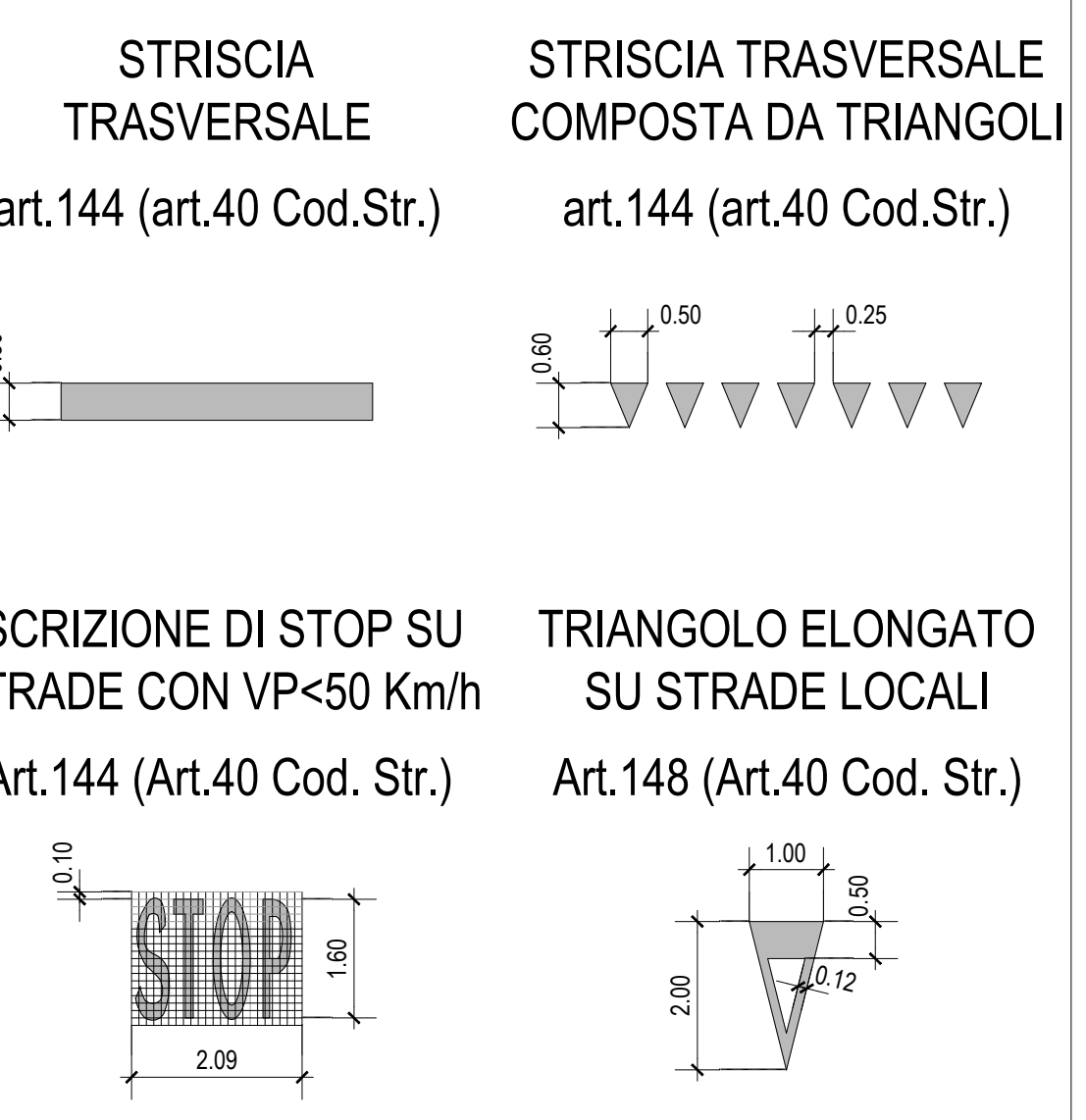
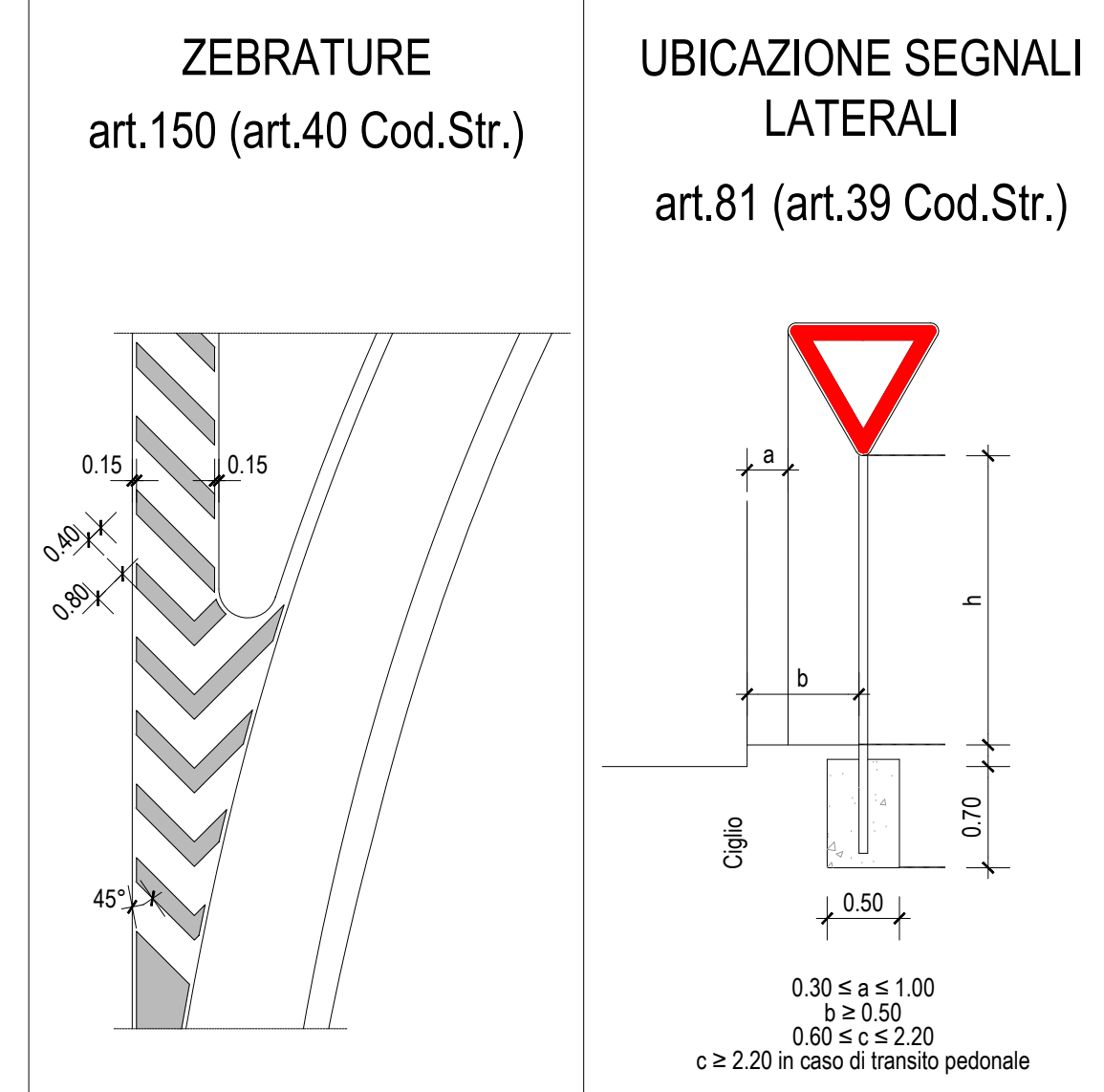
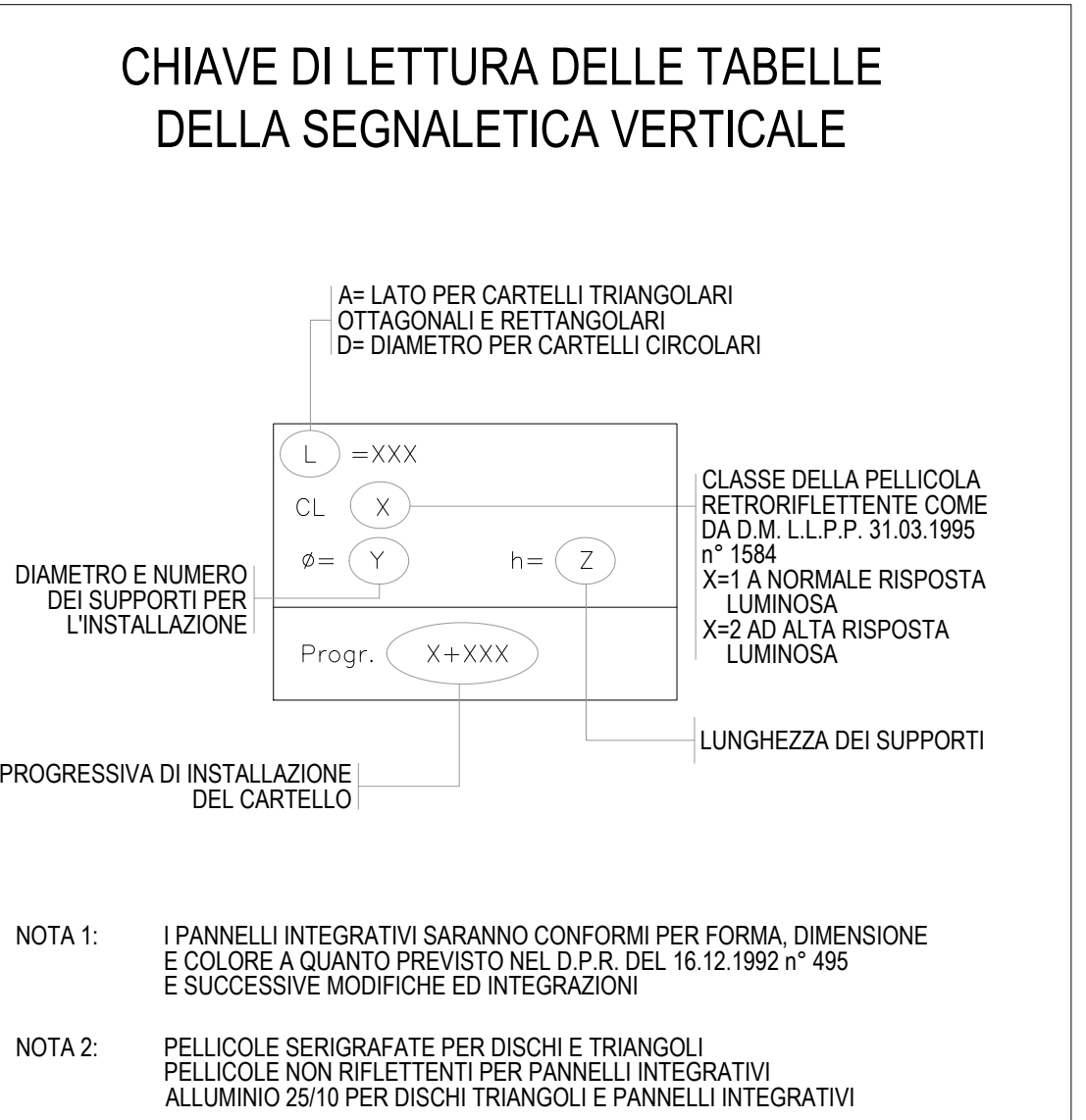
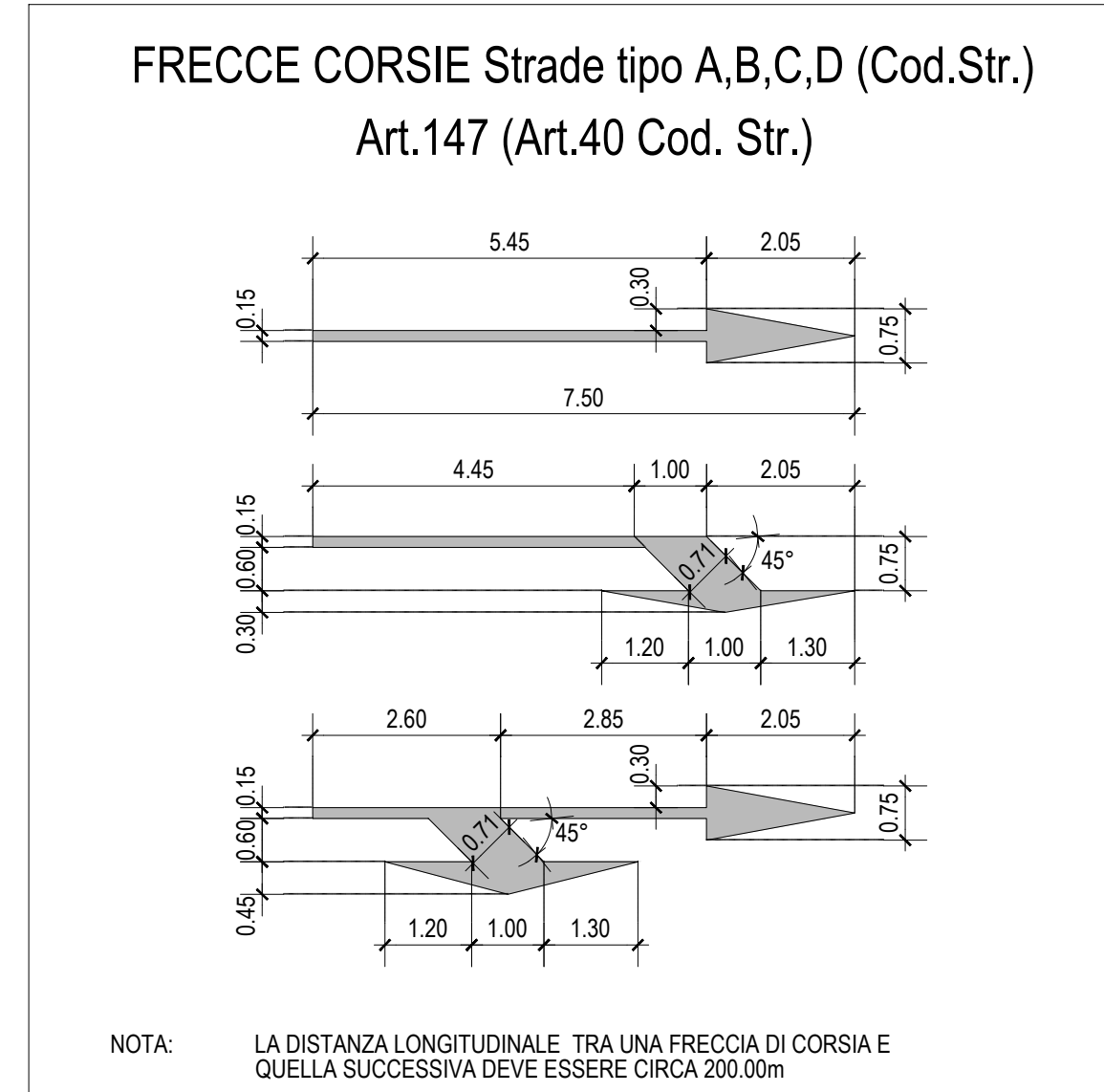

Anas SpA
Direzione Centrale Progettazione

GARA CA 08/15 - NUOVA SS 554 CAGLIARITANA
ADEGUAMENTO DELL'ASSE ATTREZZATO URBANO ED ELIMINAZIONE DELLE INTERSEZIONI A RASO DAL KM 1+500 AL KM 11+850

PROGETTO DEFINITIVO
ASSE STRADALE PRINCIPALE
PROGETTO STRADALE
ASSE STRADALE PRINCIPALE
Planimetria segnaletica - Tav. 5 di 14

CODICE PROGETTO		CODICE ELABORATO				SCALA	DATA
progetto	liv. numero	campo 1	campo 2	campo 3	campo 4	rev.	
DPCA 06 D	1501	T00	PS01	TRA	PP37	C	1:1000 03/05/2019

CONCORRENTE:

ASTALDI

PROGETTISTA INDICATO COSTITUENDO R.T.P.
Capogruppo Mandataria R.T.P. Mandante Mandante

SWS **ASTALDI** ING. FRANCESCA LEO

RESPONSABILE DELL'INTEGRAZIONE
FRA LE PRESTAZIONI SPECIALISTICHE
Ing. Paolo Cucino

RESPONSABILE ELABORATO
Ing. Paolo Cucino