



**Anas SpA**  
Direzione Centrale Progettazione

CUP F2602000340001 CIG 652449686B



**GARA CA 08/15 - NUOVA SS 554 CAGLIARITANA**  
ADEGUAMENTO DELL'ASSE ATTREZZATO URBANO ED ELIMINAZIONE  
DELLE INTERSEZIONI A RASO DAL KM 1+500 AL KM 11+850

## PROGETTO DEFINITIVO

### VIABILITA' DI SERVIZIO

### PROGETTO STRADALE

VIABILITA' DI SERVIZIO E COMPLANARE km. 6+000 - 7+000 (S03)

Quaderno delle sezioni

CODICE PROGETTO			CODICE ELABORATO					SCALA	DATA	35.13
progetto	liv.	numero	campo 1	campo 2	campo 3	campo 4	rev			
D P C A 0 6	D	1 5 0 1	S 0 0	P S 1 6	T R A	S Z 0 1	B	1:200	30/11/19	

CONCORRENTE:



PROGETTISTA INDICATO COSTITUENDO R.T.P.

Capogruppo Mandataria R.T.P.



Mandante



Mandante

ING. FRANCESCA LEO

RESPONSABILE DELL'INTEGRAZIONE  
FRA LE PRESTAZIONI SPECIALISTICHE

Ing. Paolo Cucino

RESPONSABILE ELABORATO

Ing. Paolo Cucino

PROFILO S03\_COMPLANARE

SEZIONE 1

PROGRESSIVA 0.00

AA SCAVO	m?	0.04
BA RILEVATO	m?	3.04
DA SCOTICO SCAVO	m?	0.03
DB SCOTICO RILEVATO	m?	0.26
EA BONIFICA	m?	0.04
GA USURA 4	m?	0.22
GB BINDER 4	m?	0.34
GC BASE 4	m?	0.55
GD FONDAZIONE 4	m?	1.87
HA VEGETALE	m?	0.19
IC REINTERRO D. MURI	m?	7.71
ge AREA PAVIMENT. 4	m	5.50
hb SUPERF. VEGETALE	m	0.30
ic AREA REINT. D.MURI	m	8.21

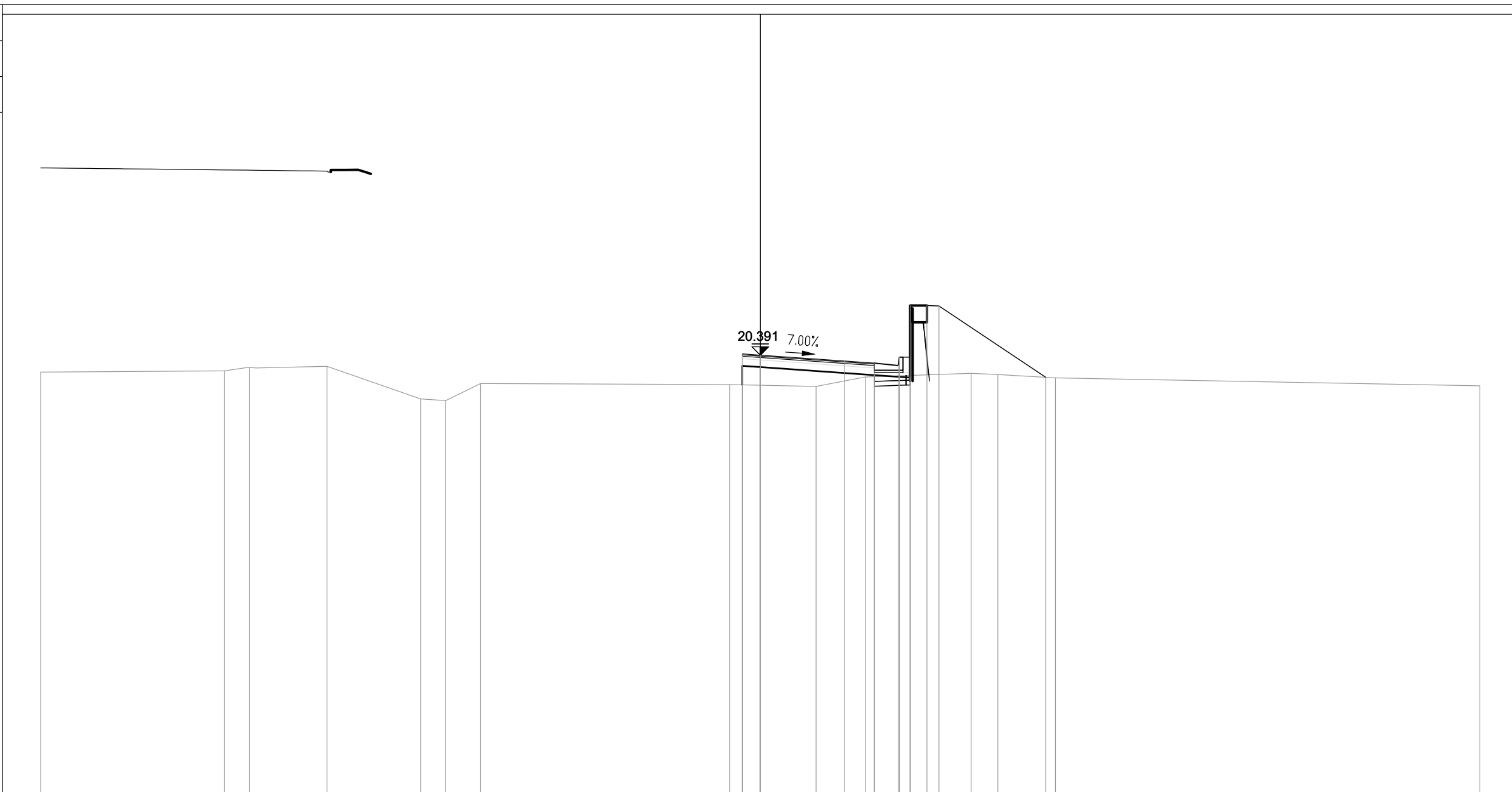

PROGRESSIVE TERRENO	-30.00	-22.35	-21.29	-18.07	-14.16	-13.12	-11.66	-1.28	2.33	4.39	8.79	9.91	12.31	30.00			
PARZIALI TERRENO	7.65	1.06	3.22	3.91	1.04	1.46	10.38	3.61	2.06	4.40	1.12	2.40	17.69				
QUOTE TERRENO	19.68	19.74	19.88	19.92	18.57	18.50	19.20	19.16	19.08	19.48	19.63	19.58	19.45	19.11			
PROGRESSIVE PROGETTO								-0.75	0.00	3.50	4.75	5.75	6.25	6.25	6.95	7.45	11.90
PARZIALI PROGETTO								0.75	3.50	1.25	1.00	0.05	0.45	0.70	0.50	4.45	
QUOTE PROGETTO								20.44	20.39	20.15	20.06	19.96	20.31	22.46	22.46	22.44	19.47
PROGRESSIVE RILEVATO								-0.75	-0.75	0.00	4.75	6.25	6.25	6.25	6.25	6.95	7.45
PARZIALI RILEVATO								0.75	5.50	0.75	1.50						
QUOTE RILEVATO								19.94	19.94	19.89	19.56	19.55	19.45				



PROFILO S03\_COMPLANARE

SEZIONE 2

PROGRESSIVA 20.00

AA SCAVO	m?	1.05
BA RILEVATO	m?	0.13
CA DEM. BITUME SC.	m?	1.83
CC DEM. FONDAZ. SC.	m?	2.20
DA SCOTICO SCAVO	m?	2.03
DB SCOTICO RILEVATO	m?	0.51
EA BONIFICA	m?	1.37
GA USURA 4	m?	0.22
GB BINDER 4	m?	0.33
GC BASE 4	m?	0.55
GD FONDAZIONE 4	m?	2.36
HA VEGETALE	m?	0.19
IA SCAVO S. VIADOTTO	m?	9.65
IB REINTERRO S. VIAD.	m?	0.13
IC REINTERRO D. MURI	m?	9.18
ge AREA PAVIMENT. 4	m	5.50
hb SUPERF. VEGETALE	m	0.30
ia AREA REINT. S. VIAD.	m	13.00
ic AREA REINT. D.MURI	m	8.86

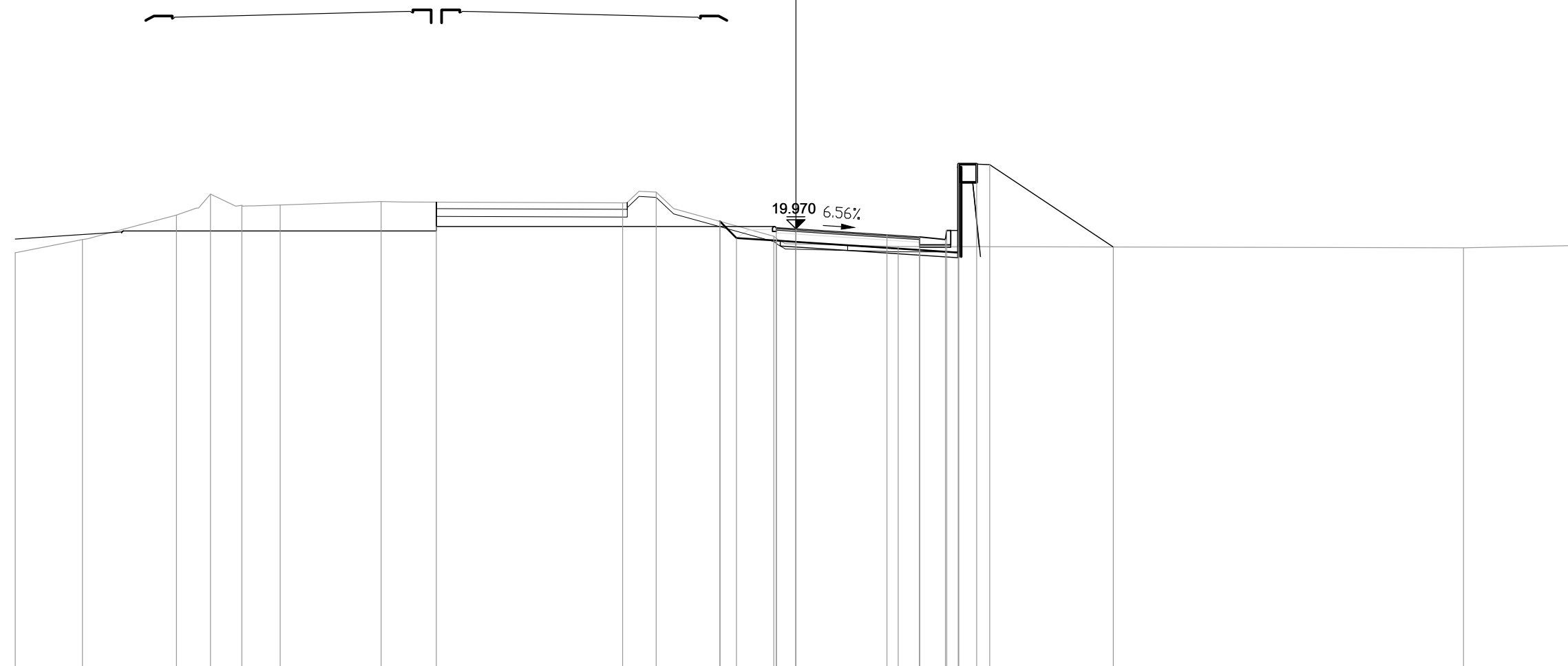

PROGRESSIVE TERRENO	-30.00	-27.42	-23.81	-22.50	-21.29	-19.82	-15.94	-6.66	-5.37	-0.85	3.93	25.66	30.00
PARZIALI TERRENO	2.58	3.61	1.31	1.21	1.47	3.88	9.28	1.29	4.52	4.78	21.73	4.34	
QUOTE TERRENO	19.05	19.56	20.50	21.30	20.87	20.89	21.02	20.97	21.38	19.69	19.29	19.24	19.33
PROGRESSIVE PROGETTO							-13.82			-0.75	0.00	3.50	12.20
PARZIALI PROGETTO							13.07			0.75	3.50	1.25	4.75
QUOTE PROGETTO						20.06				20.02	19.97	19.74	19.27
PROGRESSIVE RILEVATO									-2.92	-0.75	0.00	4.75	6.25
PARZIALI RILEVATO									0.64	2.13	0.75	5.075	1.50
QUOTE RILEVATO									20.26	19.62	19.52	19.16	19.06

PROFILO S03\_COMPLANARE

SEZIONE 3

PROGRESSIVA 40.00

AA SCAVO	m?	0.50
BA RILEVATO	m?	2.90
CA DEM. BITUME SC.	m?	1.82
CC DEM. FONDAZ. SC.	m?	2.18
DA SCOTICO SCAVO	m?	1.07
DB SCOTICO RILEVATO	m?	1.49
EA BONIFICA	m?	2.53
GA USURA 4	m?	0.22
GB BINDER 4	m?	0.33
GC BASE 4	m?	0.55
GD FONDAZIONE 4	m?	2.35
HA VEGETALE	m?	0.20
IA SCAVO S. VIADOTTO	m?	13.86
IB REINTERRO S. VIAD.	m?	0.17
IC REINTERRO D. MURI	m?	10.91
dc SUPERF. GRADON.	m	6.57
ge AREA PAVIMENT. 4	m	5.50
hb SUPERF. VEGETALE	m	0.30
ia AREA REINT. S. VIAD.	m	12.95
ic AREA REINT. D.MURI	m	9.77

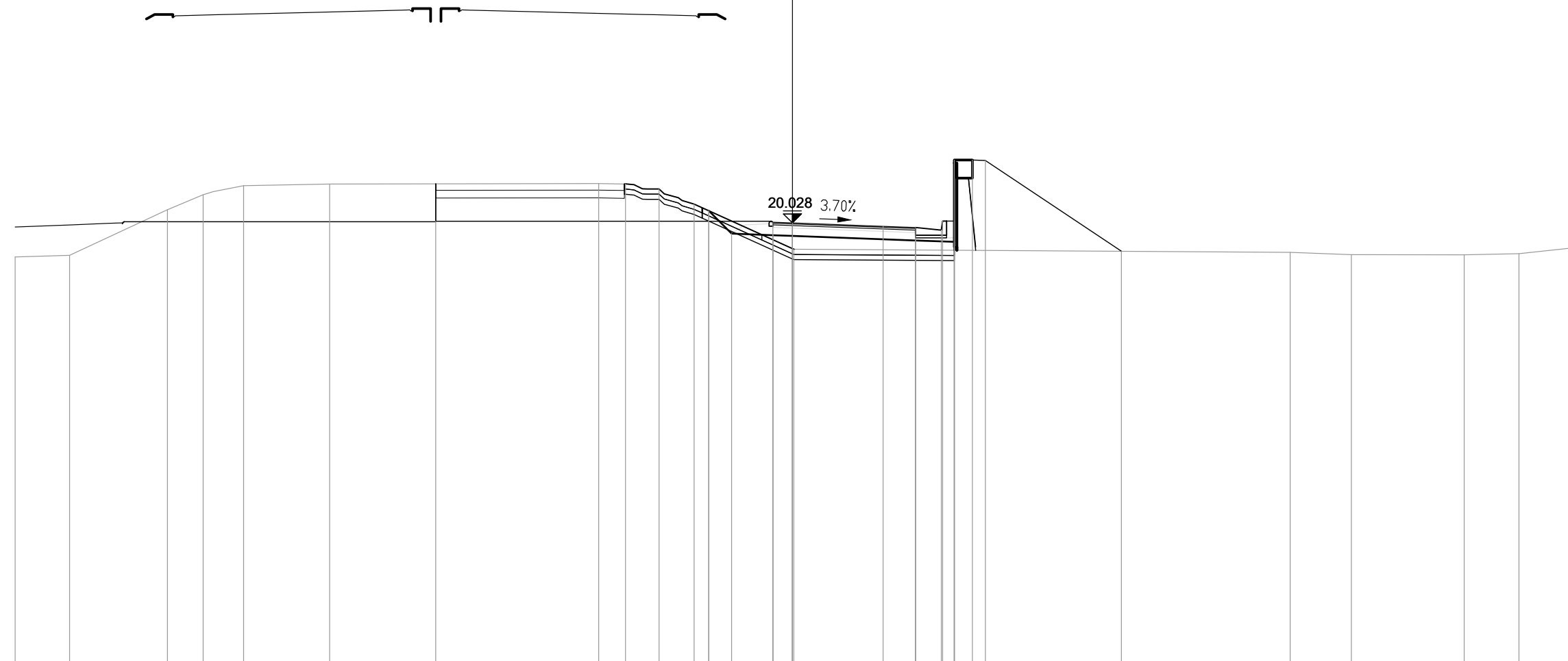

3

200  
200

PROGRESSIVE TERRENO	-30.00	-27.90	-24.12	-22.74	-21.19	-17.86		-7.47	-6.44	-5.15	-3.79	0.06				19.21	21.58	25.94	28.05	30.00						
PARZIALI TERRENO	2.10	3.78	1.38	1.55	3.33		10.39	1.03	1.29	1.36	3.85		19.15		2.37	4.36	2.11	1.95								
QUOTE TERRENO	18.71	18.78	20.54	21.11	21.46	21.53		21.55	21.54	21.34	20.75	19.01				18.90	18.81	18.80	18.84	19.05						
PROGRESSIVE PROGETTO							-13.77					-0.75	0.00	3.50	1.25	3.50	1.00	0.05	0.45	6.25	6.25	6.95	7.45		12.70	
PARZIALI PROGETTO							13.02					0.75	3.50	1.25	1.00	0.05	0.45	0.70	0.50	5.25						
QUOTE PROGETTO						20.10						20.06	20.03	19.90	19.85	19.75	20.10	22.46	20.10	22.46	22.44				18.94	
PROGRESSIVE RILEVATO												-3.23	-2.35	-0.75	0.00	4.75	6.25	6.25								
PARZIALI RILEVATO												0.88	2.48	0.75	5.675	1.50										
QUOTE RILEVATO												20.50	19.61	19.56	19.53	19.35	18.98	19.30								

PROFILO S03\_COMPLANARE

SEZIONE 4

PROGRESSIVA 60.00

AA SCAVO	m?	0.16
BA RILEVATO	m?	7.63
CA DEM. BITUME SC.	m?	1.81
CC DEM. FONDAZ. SC.	m?	2.17
DA SCOTICO SCAVO	m?	0.95
DB SCOTICO RILEVATO	m?	1.60
EA BONIFICA	m?	0.40
GA USURA 4	m?	0.23
GB BINDER 4	m?	0.33
GC BASE 4	m?	0.55
GD FONDAZIONE 4	m?	2.33
HA VEGETALE	m?	0.19
IB REINTERRO S. VIAD.	m?	0.31
IC REINTERRO D. MURI	m?	11.68
dc SUPERF. GRADON.	m	7.22
ge AREA PAVIMENT. 4	m	5.50
hb SUPERF. VEGETALE	m	0.30
ia AREA REINT. S. VIAD.	m	12.89
ic AREA REINT. D.MURI	m	10.22

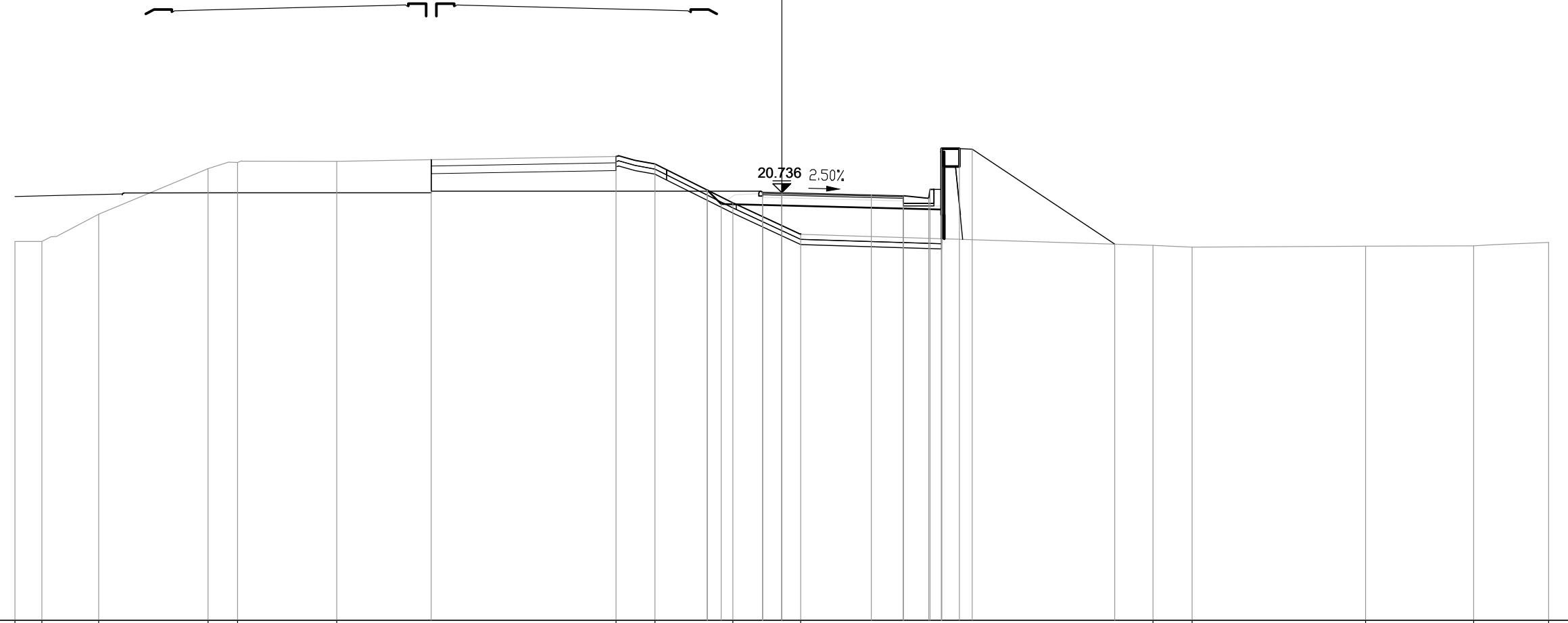

PROGRESSIVE TERRENO	-30.00	-28.95	-26.73	-22.45	-21.29	-17.41		-6.48	-4.96	-1.91	0.74				14.52	16.05		22.84	27.07	30.00						
PARZIALI TERRENO	1.05	2.22	4.28	1.16	3.88		10.93	1.52	3.05	2.65		13.78		1.53	6.79		4.23	2.93								
QUOTE TERRENO	18.82	18.83	19.89	21.68	21.92	21.97		22.15	21.86	20.34	19.11			18.68	18.61		18.64	18.66	18.79							
PROGRESSIVE PROGETTO							13.71																			
PARZIALI PROGETTO							12.96					3.50	1.25	1.00	0.05	0.45	0.70	0.50	5.57							
QUOTE PROGETTO						20.79						20.65	20.62	20.52	20.87	22.46	20.87	22.46	22.44	18.72						
PROGRESSIVE RILEVATO																										
PARZIALI RILEVATO												2.92	2.37	0.55	0.75	0.75	5.675	1.50								
QUOTE RILEVATO												20.84	20.29	20.25	20.24	20.75	20.74	20.65	20.62	20.52	20.87	22.46	20.87	22.46	22.44	18.72



PROFILO S03\_COMPLANARE

SEZIONE 5A

PROGRESSIVA 86.66

BA RILEVATO	m?	13.78
CA DEM. BITUME SC.	m?	1.82
CC DEM. FONDAZ. SC.	m?	2.17
DA SCOTICO SCAVO	m?	0.69
DB SCOTICO RILEVATO	m?	1.82
EA BONIFICA	m?	2.49
GA USURA 4	m?	0.20
GB BINDER 4	m?	0.33
GC BASE 4	m?	0.55
GD FONDAZIONE 4	m?	2.37
HA VEGETALE	m?	0.19
IA SCAVO S. VIADOTTO	m?	7.76
IB REINTERRO S. VIAD.	m?	0.82
IC REINTERRO D. MURI	m?	9.61
dc SUPERF. GRADON.	m	8.01
ge AREA PAVIMENT. 4	m	5.50
hb SUPERF. VEGETALE	m	0.30
ia AREA REINT. S. VIAD.	m	12.83
ic AREA REINT. D.MURI	m	9.15

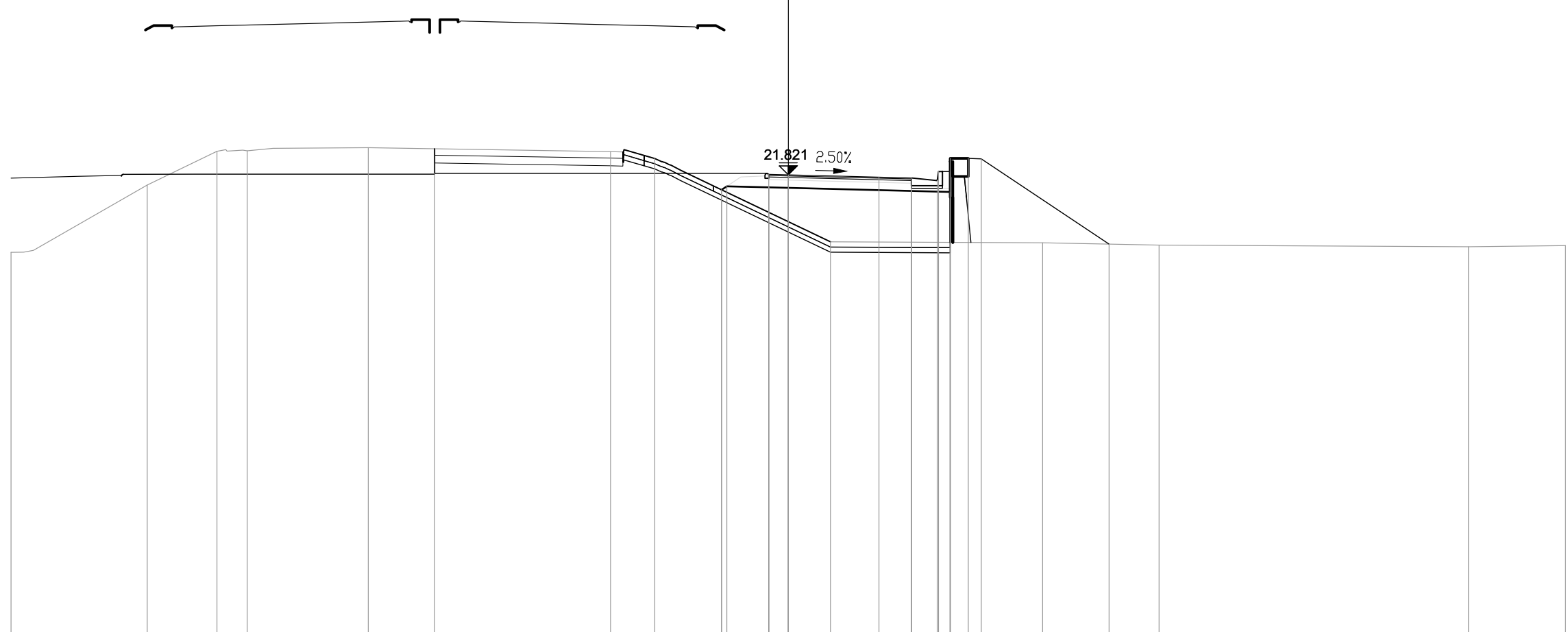

PROGRESSIVE TERRENO	-30.00	-24.75	-22.05	-20.88		-16.21		-6.86	-5.15		1.63		9.82		14.31		26.26	30.00
PARZIALI TERRENO		5.25	2.70	1.17	4.67		9.35	1.71	6.78		8.19		4.49		11.95		3.74	
QUOTE TERRENO	18.83	21.43	22.73	22.75		22.87		22.72	22.45		19.24		19.20		19.11		19.05	19.10
PROGRESSIVE PROGETTO							-13.65											
PARZIALI PROGETTO								12.90			3.50	1.25	4.93					
QUOTE PROGETTO						21.88					21.73	21.70	19.15					
PROGRESSIVE RILEVATO																		
PARZIALI RILEVATO											5.675	1.50						
QUOTE RILEVATO											21.24	21.34	21.20	19.22	21.16			



PROFILO S03\_COMPLANARE

SEZIONE 5Abis

PROGRESSIVA 86.66

AA SCAVO	m?	11.33
BA RILEVATO	m?	17.16
CA DEM. BITUME. SC.	m?	1.82
CC DEM. FONDAZ. SC.	m?	2.17
DA SCOTICO SCAVO	m?	0.69
DB SCOTICO RILEVATO	m?	2.46
EA BONIFICA	m?	1.57
GA USURA 4	m?	0.20
GB BINDER 4	m?	0.33
GC BASE 4	m?	0.55
GD FONDAZIONE 4	m?	7.90
HA VEGETALE	m?	2.71
dc SUPERF. GRADON.	m	8.01
ge AREA PAVIMENT. 4	m	5.50
hb SUPERF. VEGETALE	m	18.74



4  
200  
200

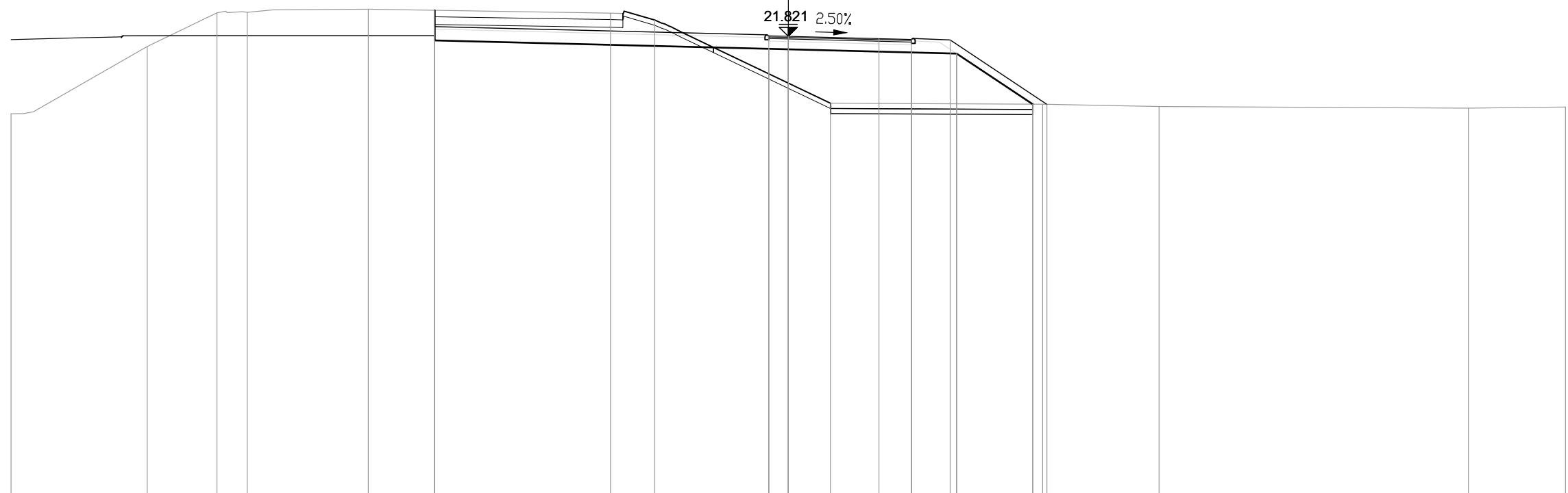

PROGRESSIVE TERRENO	-30.00	-24.75	-22.05	-20.88	-16.22	-6.86	-5.15	1.63	9.82	14.32	26.26	30.00	
PARZIALI TERRENO	5.25	2.70	1.17	4.66	9.36	1.71	6.78	8.19	4.50	11.94	3.74		
QUOTE TERRENO	18.83	21.43	22.73	22.75	22.87	22.72	22.45	19.24	19.20	19.11	19.05	19.09	
PROGRESSIVE PROGETTO					-13.65			-0.75	0.00	3.50	4.75	6.25	9.98
PARZIALI PROGETTO					12.90			0.75	3.50	1.25	1.50	3.73	
QUOTE PROGETTO					22.20			21.73	21.70	21.68	19.20		
PROGRESSIVE RILEVATO					-13.65			-0.75	0.00	4.75	6.50	9.44	
PARZIALI RILEVATO					12.90			0.75	5.05	1.75	2.94		
QUOTE RILEVATO					21.66			21.34	21.32	21.20	21.16	19.20	

PROFILO S03\_COMPLANARE

SEZIONE 5B

PROGRESSIVA 92.56

AA SCAVO	m?	0.36
BA RILEVATO	m?	18.08
DA SCOTICO SCAVO	m?	0.24
DB SCOTICO RILEVATO	m?	2.52
EA BONIFICA	m?	1.54
GA USURA 4	m?	0.21
GB BINDER 4	m?	0.32
GC BASE 4	m?	0.55
GD FONDAZIONE 4	m?	3.79
HA VEGETALE	m?	1.80
dc SUPERF. GRADON.	m	6.10
ge AREA PAVIMENT. 4	m	5.50
hb SUPERF. VEGETALE	m	9.50

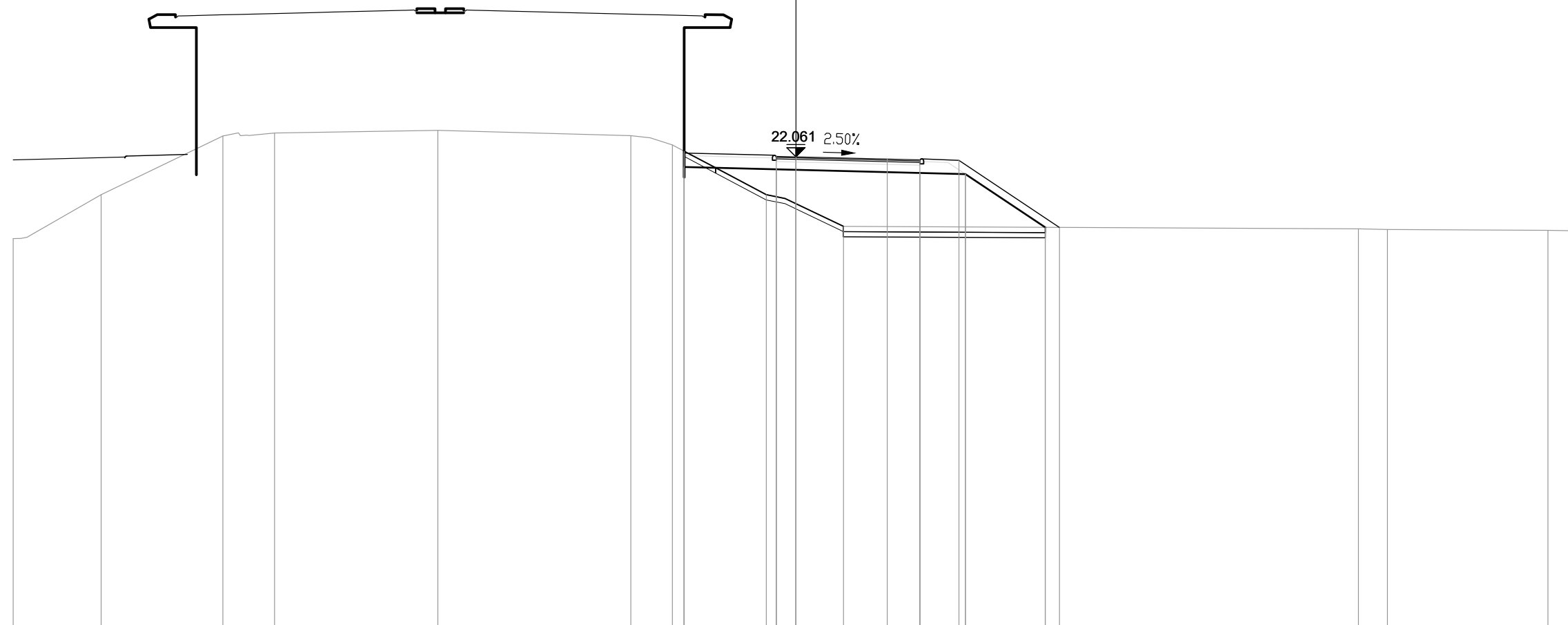

200  
200

PROGRESSIVE TERRENO	-30.00	-26.63	-21.97	-19.98	-13.72	-6.33	-4.73	-1.13	1.82					21.56	22.68			28.83	30.00
PARZIALI TERRENO		3.37	4.66	1.99	6.26		7.39	1.60	3.60	2.95			19.74		1.12	6.15		1.17	
QUOTE TERRENO	18.93	20.61	22.86	22.97	23.07	22.87	22.52	20.61	19.40					19.30	19.28			19.25	19.23
PROGRESSIVE PROGETTO							-4.28	-0.75	0.00	3.50	4.75	6.25	10.10						
PARZIALI PROGETTO							3.53	0.75	3.50	1.25	1.50	3.85							
QUOTE PROGETTO							22.21	22.08	22.06	21.97	21.94	21.92	19.36						
PROGRESSIVE RILEVATO							-4.28	-0.75	0.00	4.75	6.50	9.56							
PARZIALI RILEVATO							3.53	0.75	5.075	1.75	3.06								
QUOTE RILEVATO							21.67	21.58	21.56	21.44	21.40	19.36							

PROFILO S03\_COMPLANARE

SEZIONE 5Bbis

PROGRESSIVA 92.56

AA SCAVO	m?	0.36
BA RILEVATO	m?	18.08
DA SCOTICO SCAVO	m?	0.24
DB SCOTICO RILEVATO	m?	2.52
EA BONIFICA	m?	1.54
GA USURA 4	m?	0.21
GB BINDER 4	m?	0.32
GC BASE 4	m?	0.55
GD FONDAZIONE 4	m?	3.79
HA VEGETALE	m?	1.80
dc SUPERF. GRADON.	m	6.10
ge AREA PAVIMENT. 4	m	5.50
hb SUPERF. VEGETALE	m	9.50

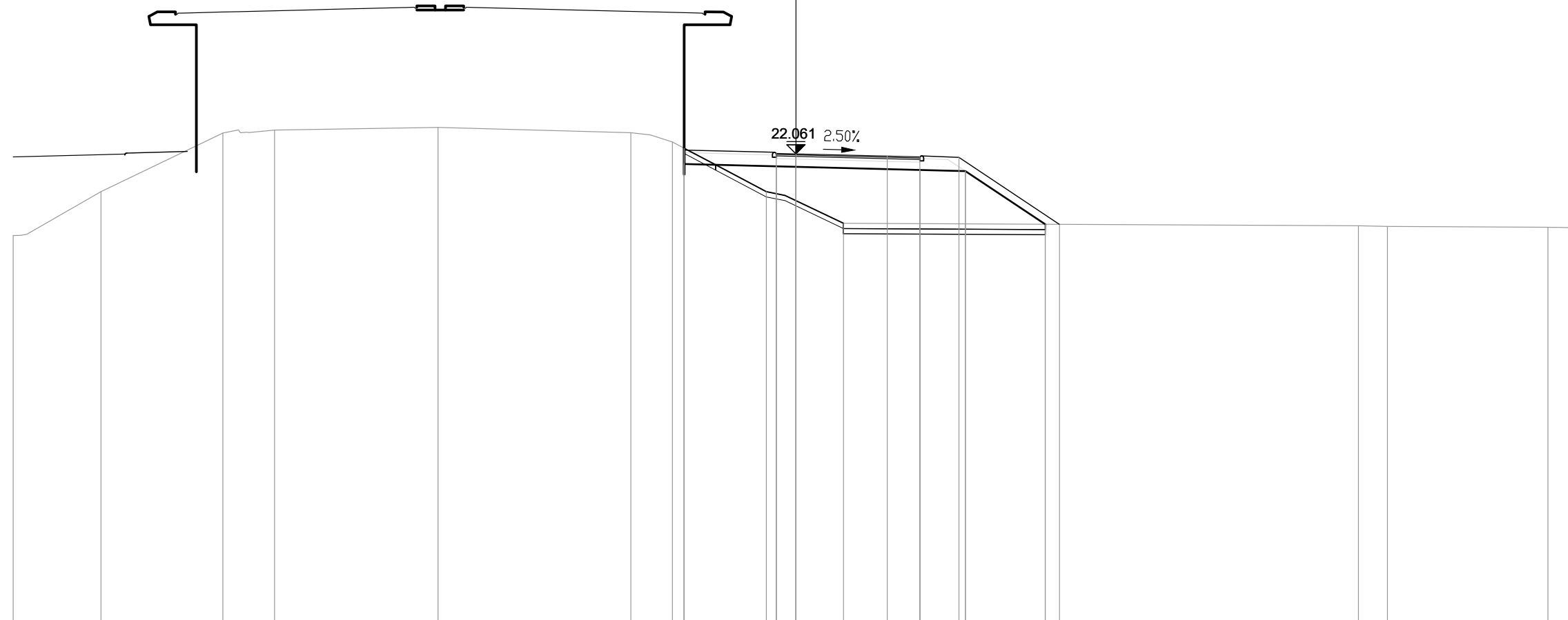

PROGRESSIVE TERRENO	-30.00	-26.64	-21.97	-19.98	-13.72	-6.33	-4.73	-1.13	1.82					21.57	22.68		28.83	30.00
PARZIALI TERRENO		3.36	4.67	1.99	6.26		7.39	1.60	3.60	2.95		19.75		1.11	6.15		1.17	
QUOTE TERRENO	18.93	20.61	22.86	22.97	23.07	22.87	22.52	20.61	19.40					19.30	19.28		19.25	19.23
PROGRESSIVE PROGETTO							-4.28	-0.75	0.00	3.50	4.75	6.25	10.10					
PARZIALI PROGETTO							3.53	0.75	3.50	1.25	1.50	3.85						
QUOTE PROGETTO							22.21	22.08	22.06	21.97	21.94	21.92	19.36					
PROGRESSIVE RILEVATO							-4.28	-0.75	0.00	4.75	6.50	9.56						
PARZIALI RILEVATO							3.53	0.75	5.075	1.75	3.06							
QUOTE RILEVATO							21.67	21.58	21.56	21.44	21.40	19.36						



PROFILO S03\_COMPLANARE

SEZIONE 7

PROGRESSIVA 120.00

BA RILEVATO m? 26.06  
 DB SCOTICO RILEVATO m? 2.72  
 EA BONIFICA m? 1.64  
 GA USURA 4 m? 0.21  
 GB BINDER 4 m? 0.33  
 GC BASE 4 m? 0.54  
 GD FONDAZIONE 4 m? 3.09  
 HA VEGETALE m? 2.12  
 dc SUPERF. GRADON. m 5.45  
 ge AREA PAVIMENT. 4 m 5.50  
 hb SUPERF. VEGETALE m 9.66

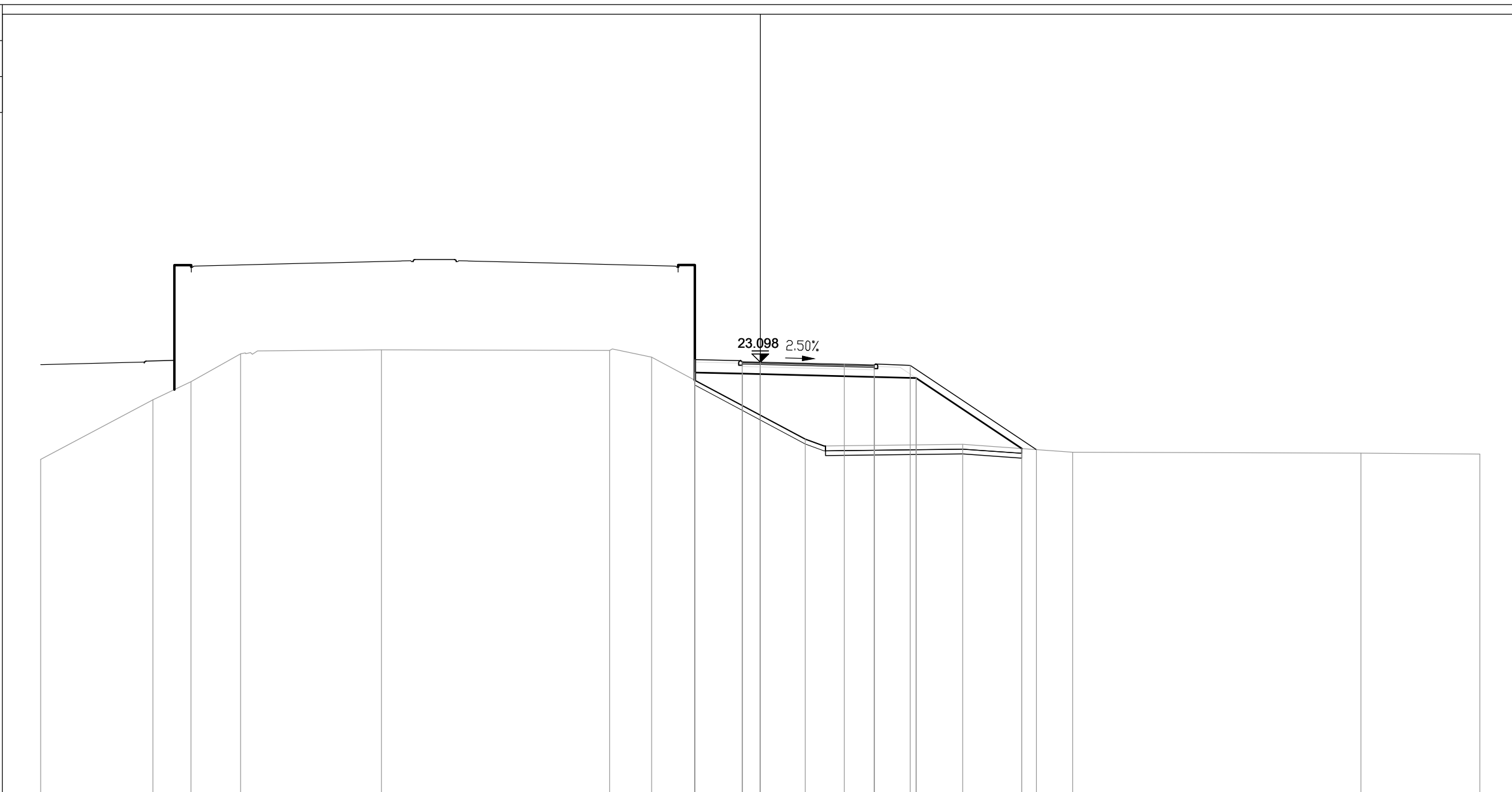

5

200

PROGRESSIVE TERRENO	-30.00	-25.33	-23.74	-21.67	-15.79	-6.28	-4.53		1.88	8.44	13.03	25.05	30.00
PARZIALI TERRENO		4.67	1.59	2.07	5.88	9.51	1.75	6.41	6.56	4.59	12.02	4.95	
QUOTE TERRENO	19.04	21.53	22.28	23.45	23.61	23.59	23.30	19.89	19.67	19.35	19.30	19.27	
PROGRESSIVE PROGETTO								-2.73	-0.75	0.00	3.50	4.75	6.25
PARZIALI PROGETTO								1.98	0.75	3.50	1.25	1.50	5.26
QUOTE PROGETTO								23.20	23.12	23.10	23.01	22.98	22.96
PROGRESSIVE RILEVATO								-2.73	-2.73	-0.75	0.00	4.75	6.50
PARZIALI RILEVATO								1.98	0.75	5.45	1.75	4.41	10.91
QUOTE RILEVATO								22.67	22.64	22.62	22.60	22.48	22.44

PROFILO S03\_COMPLANARE

SEZIONE 8

PROGRESSIVA 140.00

BA RILEVATO m? 36.76  
 DB SCOTICO RILEVATO m? 2.98  
 EA BONIFICA m? 1.85  
 GA USURA 4 m? 0.21  
 GB BINDER 4 m? 0.34  
 GC BASE 4 m? 0.55  
 GD FONDAZIONE 4 m? 3.18  
 HA VEGETALE m? 2.56  
 dc SUPERF. GRADON. m 5.73  
 ge AREA PAVIMENT. 4 m 5.50  
 hb SUPERF. VEGETALE m 11.13

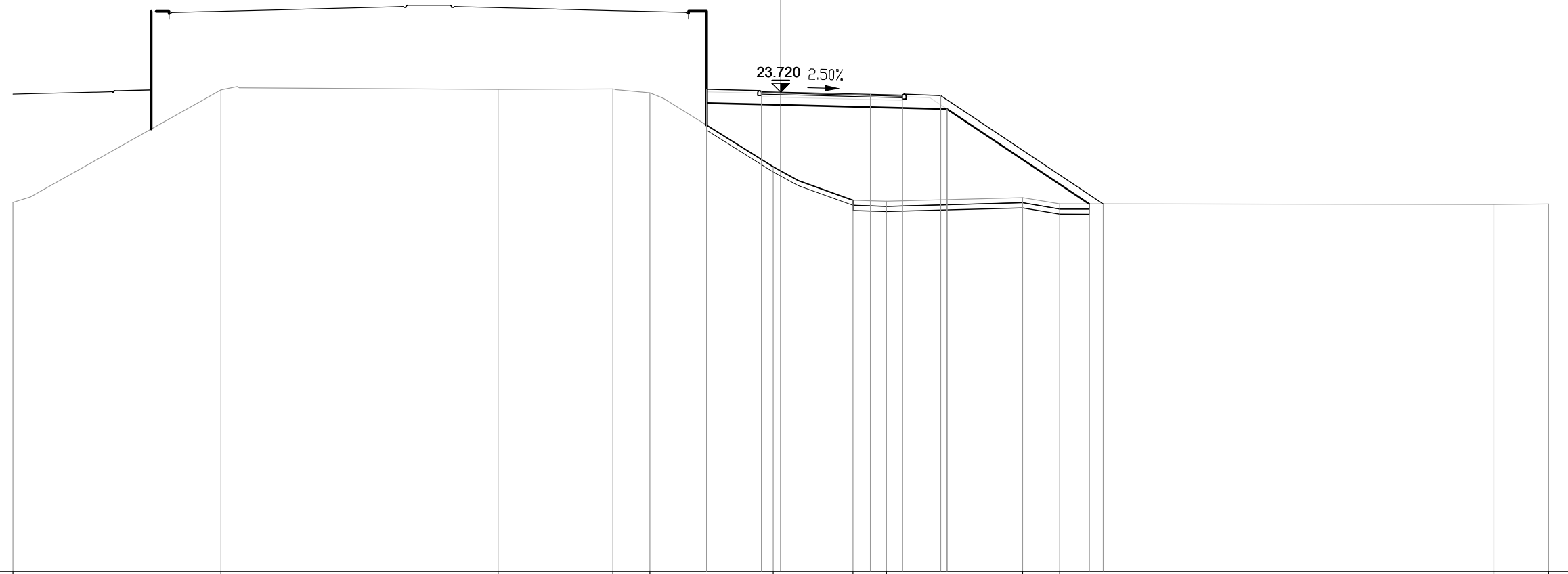

PROGRESSIVE TERRENO	-30.00	-21.88		-11.04	-6.56	-5.12		-0.30	2.82	4.13		9.45	10.90		27.86	30.00
PARZIALI TERRENO		8.12		10.84		4.48	1.44	4.82	3.12	1.31	5.32	1.45		16.96		2.14
QUOTE TERRENO	19.41	23.81		23.83	23.85	23.69		20.80	19.50	19.46		19.60	19.35		19.33	19.35
PROGRESSIVE PROGETTO								-2.90	-0.75	0.00	3.50	4.75	6.25		12.60	
PARZIALI PROGETTO								2.15	0.75	3.50	1.25	1.50	6.35			
QUOTE PROGETTO								23.83	23.74	23.72	23.63	23.60	23.58		19.35	
PROGRESSIVE RILEVATO								-2.90	-2.90	-0.75	0.00	4.75	6.50		12.06	19.35
PARZIALI RILEVATO								2.15	0.75	5.50	1.75	5.56				
QUOTE RILEVATO								23.29	23.22	23.24	23.22	23.10	23.06		19.35	



PROFILO S03\_COMPLANARE

SEZIONE 9A

PROGRESSIVA 177.49

BA RILEVATO m? 53.61  
 DB SCOTICO RILEVATO m? 3.18  
 EA BONIFICA m? 2.31  
 GA USURA 4 m? 0.20  
 GB BINDER 4 m? 0.33  
 GC BASE 4 m? 0.55  
 GD FONDAZIONE 4 m? 2.86  
 HA VEGETALE m? 3.08  
 dc SUPERF. GRADON. m 4.36  
 ge AREA PAVIMENT. 4 m 5.50  
 hb SUPERF. VEGETALE m 12.40

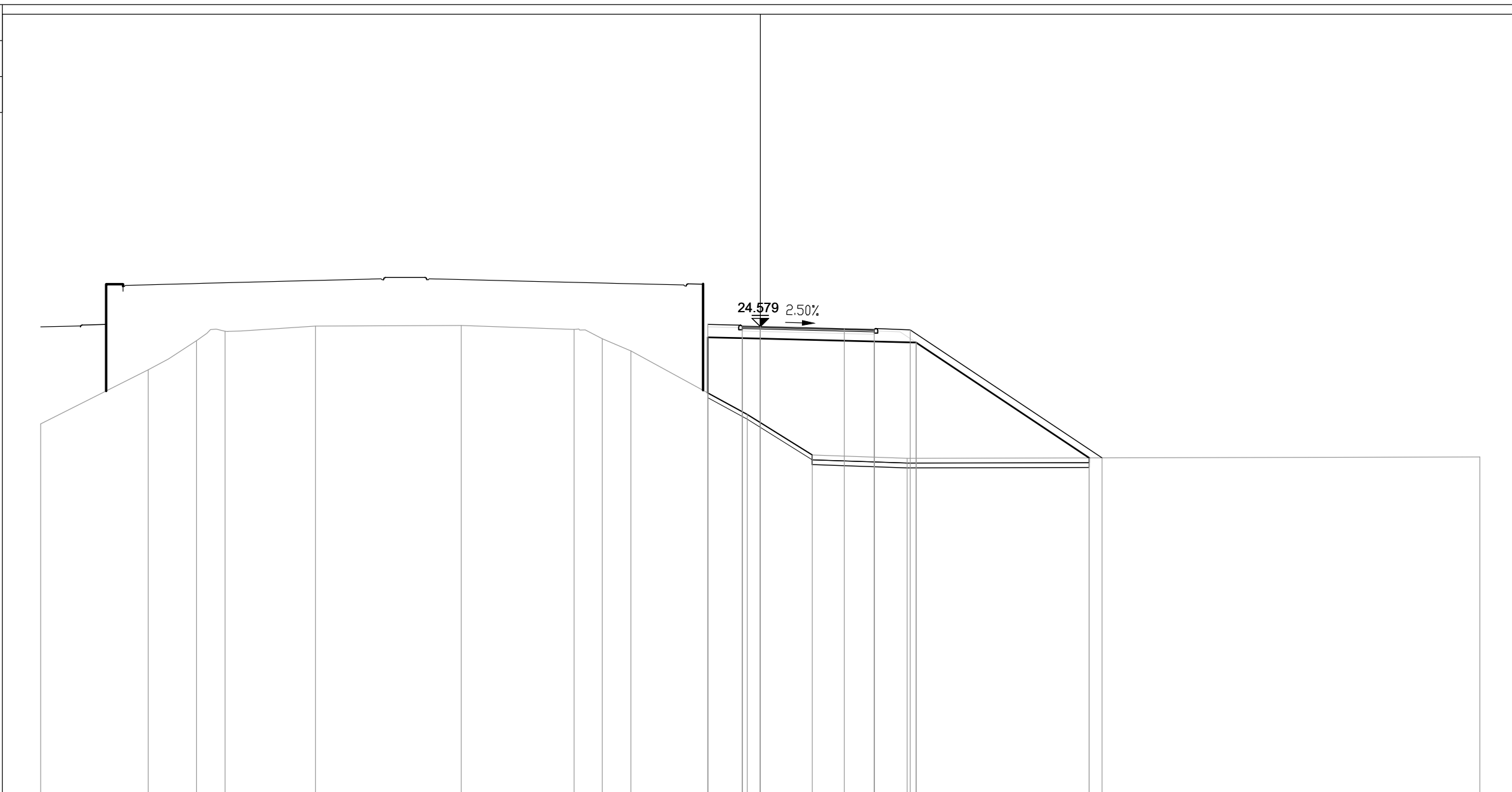

PROGRESSIVE TERRENO	-30.00	-25.52	-23.51	-22.32	-18.54	-12.47	-7.76	-6.59	-5.39	-0.54	2.17	6.12	30.00			
PARZIALI TERRENO	4.48	2.01	1.19	3.78	6.07	4.71	1.17	1.20	4.85	2.71	3.95	23.88				
QUOTE TERRENO	20.53	22.78	23.99	24.39	24.60	24.63	24.46	24.08	23.57	20.92	19.23	19.09	19.15			
PROGRESSIVE PROGETTO										-2.19	-0.75	0.00	3.50	4.75	6.25	14.25
PARZIALI PROGETTO										1.44	0.75	3.50	1.25	1.50	8.00	
QUOTE PROGETTO										24.67	24.60	24.58	24.49	24.46	24.44	19.11
PROGRESSIVE RILEVATO										-2.19	-2.19	-0.75	0.00	4.75	6.50	13.71
PARZIALI RILEVATO										1.44	0.75	5.075	1.75	7.21		
QUOTE RILEVATO										24.13	21.82	24.10	24.08	23.96	23.92	19.11



PROFILO S03\_COMPLANARE

SEZIONE 9Abis

PROGRESSIVA 177.49

BA RILEVATO m? 53.61  
 DB SCOTICO RILEVATO m? 3.18  
 EA BONIFICA m? 2.31  
 GA USURA 4 m? 0.20  
 GB BINDER 4 m? 0.33  
 GC BASE 4 m? 0.55  
 GD FONDAZIONE 4 m? 2.86  
 HA VEGETALE m? 3.08  
 dc SUPERF. GRADON. m 4.36  
 ge AREA PAVIMENT. 4 m 5.50  
 hb SUPERF. VEGETALE m 12.40

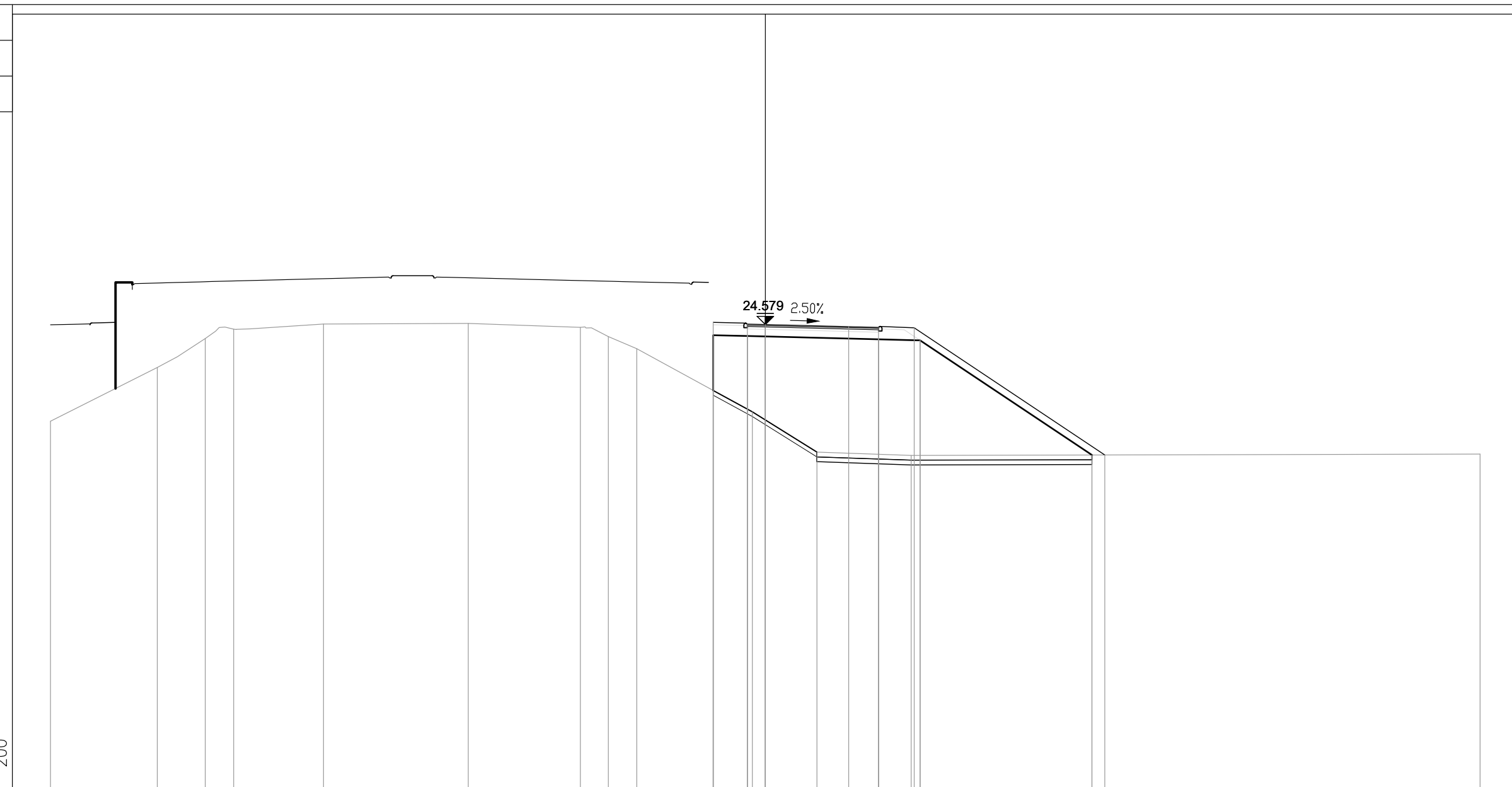

PROGRESSIVE TERRENO	-30.00	-25.52	-23.51	-22.32	-18.54	-12.47	-7.76	-6.59	-5.39	-0.54	2.17	6.12	30.00
PARZIALI TERRENO	4.48	2.01	1.19	3.78	6.07	4.71	1.17	1.20	4.85	2.71	3.95	23.88	
QUOTE TERRENO	20.53	22.78	23.99	24.39	24.60	24.63	24.46	24.08	23.57	20.92	19.23	19.09	19.15
PROGRESSIVE PROGETTO										-2.19	-0.75	0.00	14.25
PARZIALI PROGETTO										1.44	0.75	3.50	8.00
QUOTE PROGETTO							24.67	24.60	24.58	24.49	24.46	24.44	19.11
PROGRESSIVE RILEVATO							-2.19	-0.75	0.00		4.75	6.50	13.71
PARZIALI RILEVATO							1.44	0.75	5.05	1.75	7.21		
QUOTE RILEVATO							24.13	24.10	24.08	23.96	23.92	19.11	

PROFILO S03\_COMPLANARE

SEZIONE 10

PROGRESSIVA 180.00

BA RILEVATO m? 53.38  
 DB SCOTICO RILEVATO m? 3.21  
 EA BONIFICA m? 2.35  
 GA USURA 4 m? 0.22  
 GB BINDER 4 m? 0.33  
 GC BASE 4 m? 0.55  
 GD FONDAZIONE 4 m? 2.86  
 HA VEGETALE m? 3.18  
 dc SUPERF. GRADON. m 4.26  
 ge AREA PAVIMENT. 4 m 5.50  
 hb SUPERF. VEGETALE m 12.56

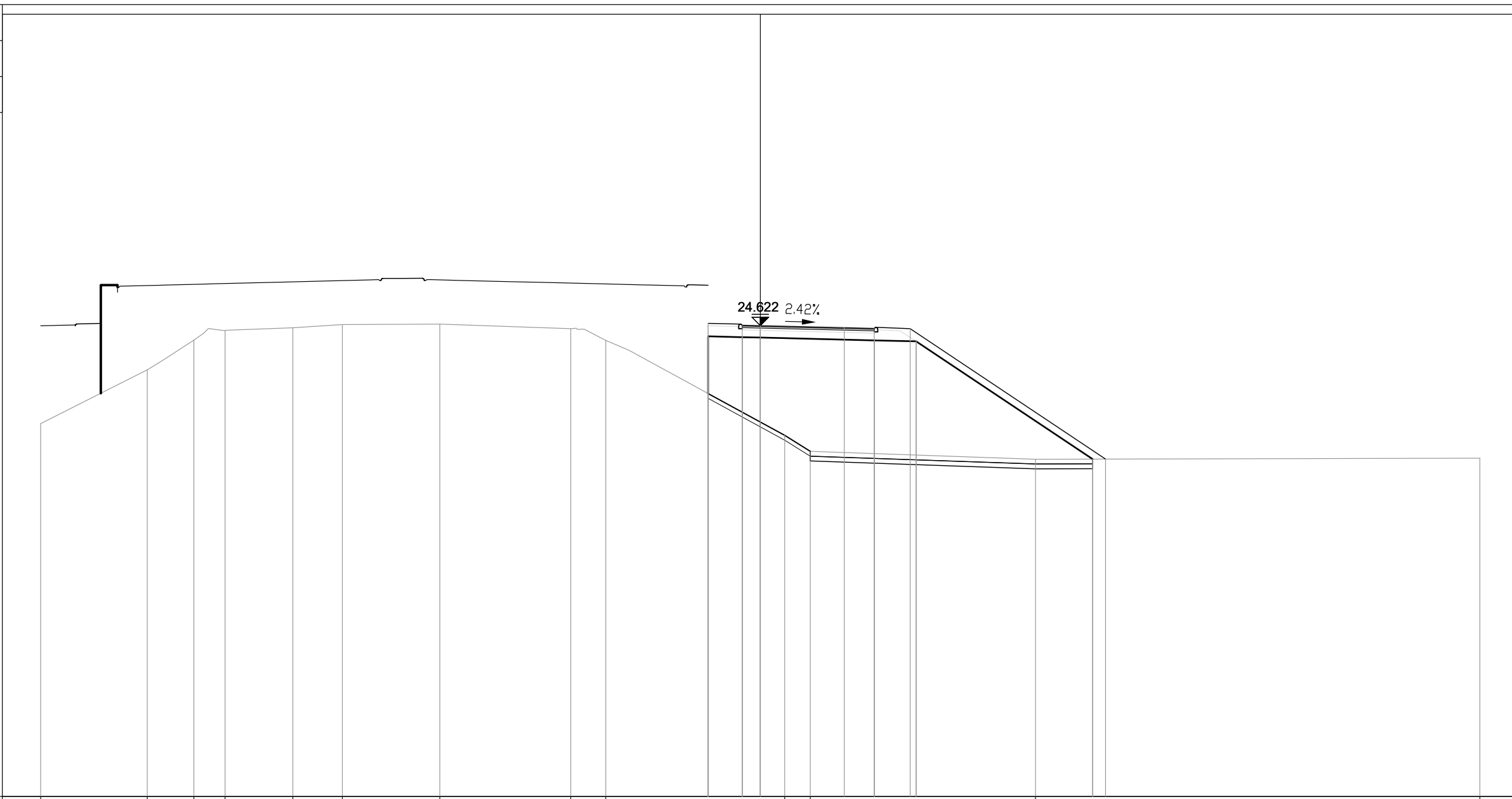

PROGRESSIVE TERRENO	-30.00	-25.56	-23.61	-22.31	-19.49	-17.43		-13.36		-7.90	-6.44		1.02	2.09		11.48		30.00
PARZIALI TERRENO		4.44	1.95	1.30	2.82	2.06	4.07	5.46	1.46	7.46	1.07	9.39	18.52					
QUOTE TERRENO	20.54	22.78	24.01	24.41	24.53	24.66	24.68	24.49	24.01	20.05	19.38	19.05	19.10					
PROGRESSIVE PROGETTO										-2.17	-0.75	0.00	3.50	4.75	6.25	14.40		
PARZIALI PROGETTO										1.42	0.75	3.50	1.25	1.50	8.15			
QUOTE PROGETTO										24.71	24.64	24.62	24.54	24.51	24.49	19.06		
PROGRESSIVE RILEVATO										-2.17	-2.17	-0.75	0.00	4.75	6.50	13.86		
PARZIALI RILEVATO										1.42	0.75	5.075	1.75	7.36				
QUOTE RILEVATO										24.17	24.14	24.12	24.01	23.96	19.06			

PROFILO S03\_COMPLANARE

SEZIONE 11

PROGRESSIVA 200.00

BA RILEVATO m? 64.42  
 DB SCOTICO RILEVATO m? 3.37  
 EA BONIFICA m? 2.68  
 GA USURA 4 m? 0.23  
 GB BINDER 4 m? 0.33  
 GC BASE 4 m? 0.55  
 GD FONDAZIONE 4 m? 2.70  
 HA VEGETALE m? 3.51  
 dc SUPERF. GRADON. m 3.53  
 ge AREA PAVIMENT. 4 m 5.50  
 hb SUPERF. VEGETALE m 13.62

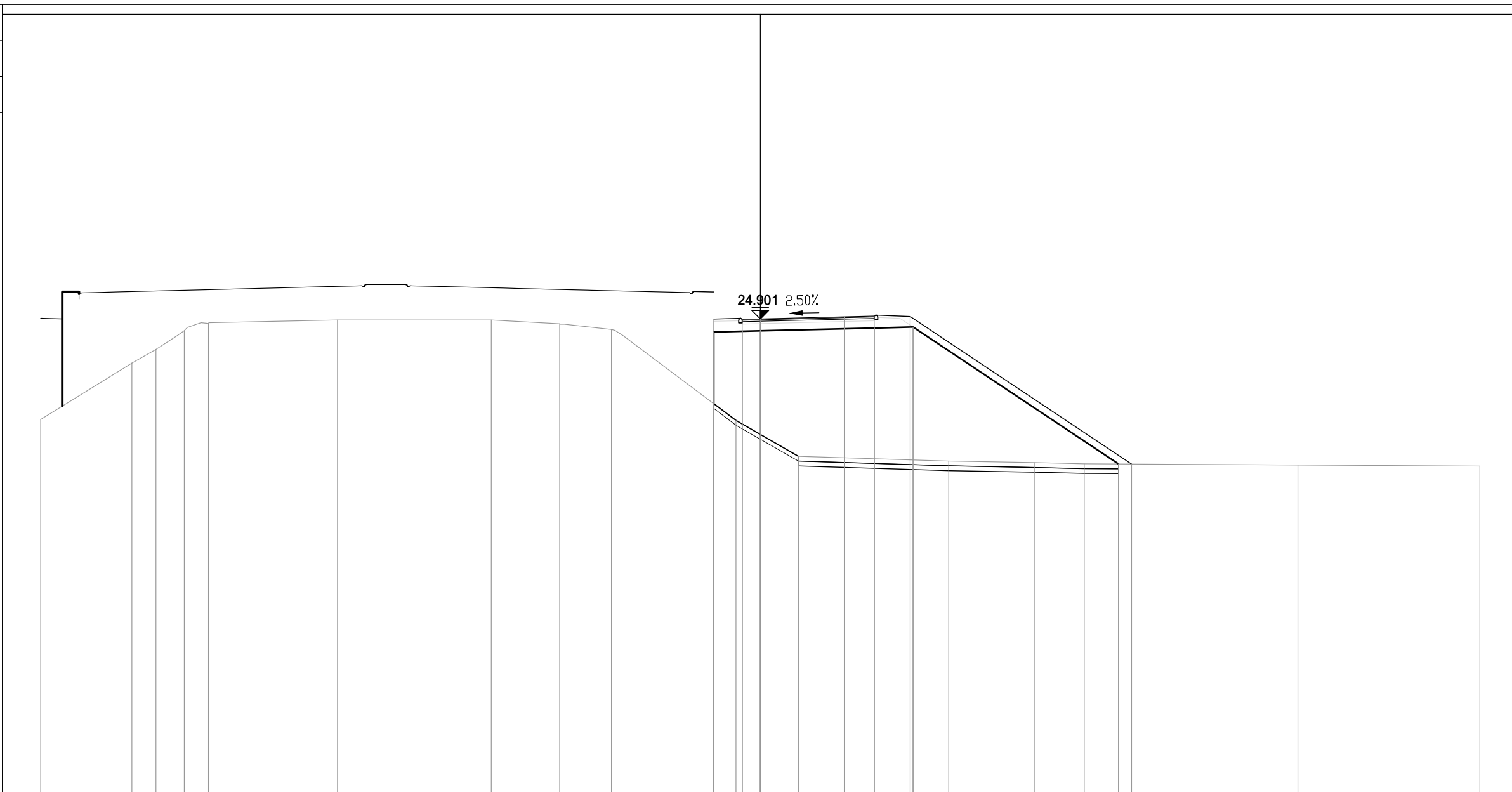

PROGRESSIVE TERRENO	-30.00	-26.20	-25.19	-24.02	-23.01		-17.63		-11.22	-8.36	-6.20		-1.01	1.59		7.86	11.42	13.51		22.42	30.00
PARZIALI TERRENO		3.80	1.01	1.17	1.01	5.38	6.41	2.86	2.16	5.19	2.60	6.27	3.56	2.09	8.91	7.58					
QUOTE TERRENO	20.71	23.06	23.63	24.41	24.71	24.86	24.85	24.70	24.46	20.67	19.17	18.98	18.91	18.86	18.81	18.77					
PROGRESSIVE PROGETTO										-1.94	-0.75	0.00	3.50	4.75	6.25					15.48	
PARZIALI PROGETTO										1.19	0.75	3.50	1.25	1.50	9.23						
QUOTE PROGETTO										24.89	24.88	24.90	24.99	25.02	25.00	18.85					
PROGRESSIVE RILEVATO										-1.94	-1.94	-0.75	0.00	4.75	6.37	14.94					
PARZIALI RILEVATO										1.19	0.75	5.675	1.62	8.57							
QUOTE RILEVATO										24.35	21.37	24.38	24.40	24.52	24.56	18.85					

PROFILO S03\_COMPLANARE

SEZIONE 12

PROGRESSIVA 220.00

BA RILEVATO m? 61.51  
 DB SCOTICO RILEVATO m? 3.40  
 EA BONIFICA m? 2.86  
 GA USURA 4 m? 0.20  
 GB BINDER 4 m? 0.33  
 GC BASE 4 m? 0.55  
 GD FONDAZIONE 4 m? 2.50  
 HA VEGETALE m? 3.65  
 dc SUPERF. GRADON. m 2.57  
 ge AREA PAVIMENT. 4 m 5.50  
 hb SUPERF. VEGETALE m 13.85

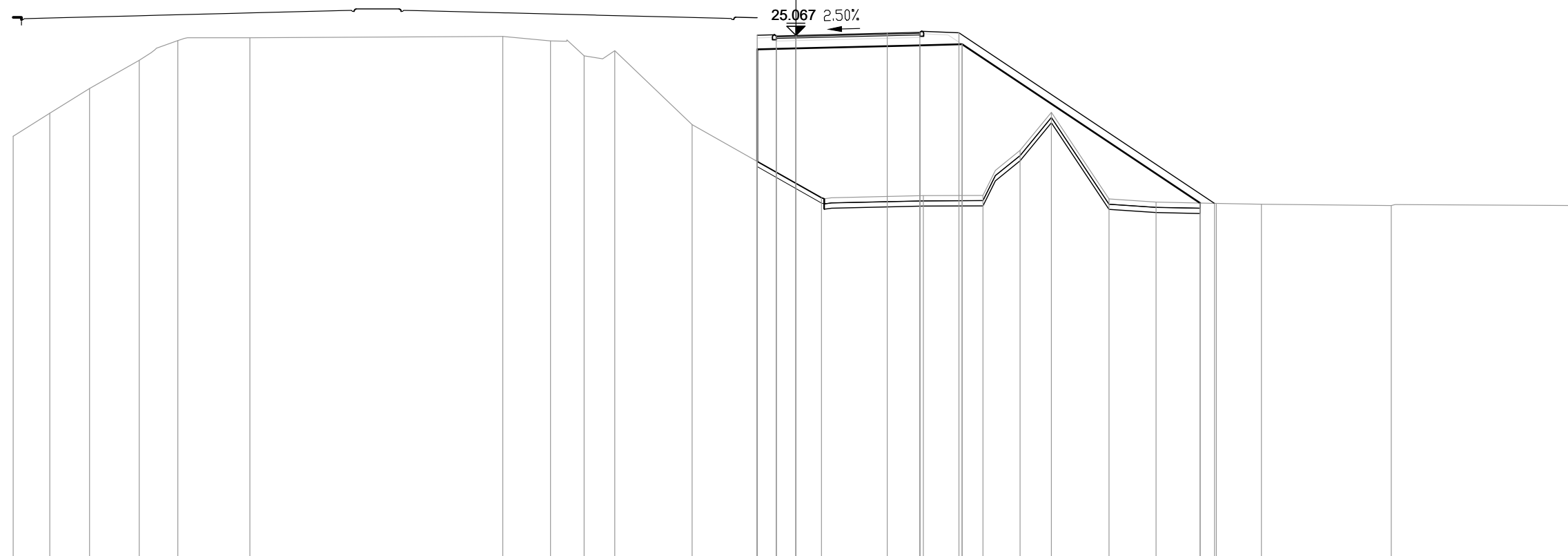

PROGRESSIVE TERRENO	-30.00	-28.60	-27.08	-25.17	-23.69	-20.93		-11.23	-9.41	-8.12	-6.94	-3.98	0.98	4.88	7.17	8.59	9.79	12.00	13.81	16.12	17.84	22.82	30.00	
PARZIALI TERRENO	1.40	1.52	1.91	1.48	2.76		9.70	1.82	1.29	1.18	2.96	4.96	3.90	2.29	1.42	1.20	2.21	1.81	2.31	1.72	4.98	7.18		
QUOTE TERRENO	21.21	22.09	23.03	24.11	24.87	24.98		25.03	24.86	24.28	24.48	21.65	18.85	18.93	18.94	20.66	22.12	18.80	18.68	18.63	18.60	18.55	18.55	
PROGRESSIVE PROGETTO													-1.48	-0.75	0.00									
PARZIALI PROGETTO													3.50	1.25	1.50		9.80							
QUOTE PROGETTO													25.15	25.19	25.17		18.63							
PROGRESSIVE RILEVATO													-1.48	-1.48	-0.75	0.00								
PARZIALI RILEVATO													4.75	1.62		9.12								
QUOTE RILEVATO													24.53	20.24	24.55	24.57		24.69	24.73		18.65			

PROFILO S03\_COMPLANARE

SEZIONE 13

PROGRESSIVA 240.00

BA RILEVATO m? 77.87  
 DB SCOTICO RILEVATO m? 3.33  
 EA BONIFICA m? 3.37  
 GA USURA 4 m? 0.19  
 GB BINDER 4 m? 0.34  
 GC BASE 4 m? 0.55  
 GD FONDAZIONE 4 m? 2.55  
 HA VEGETALE m? 3.59  
 ge AREA PAVIMENT. 4 m 5.50  
 hb SUPERF. VEGETALE m 13.52

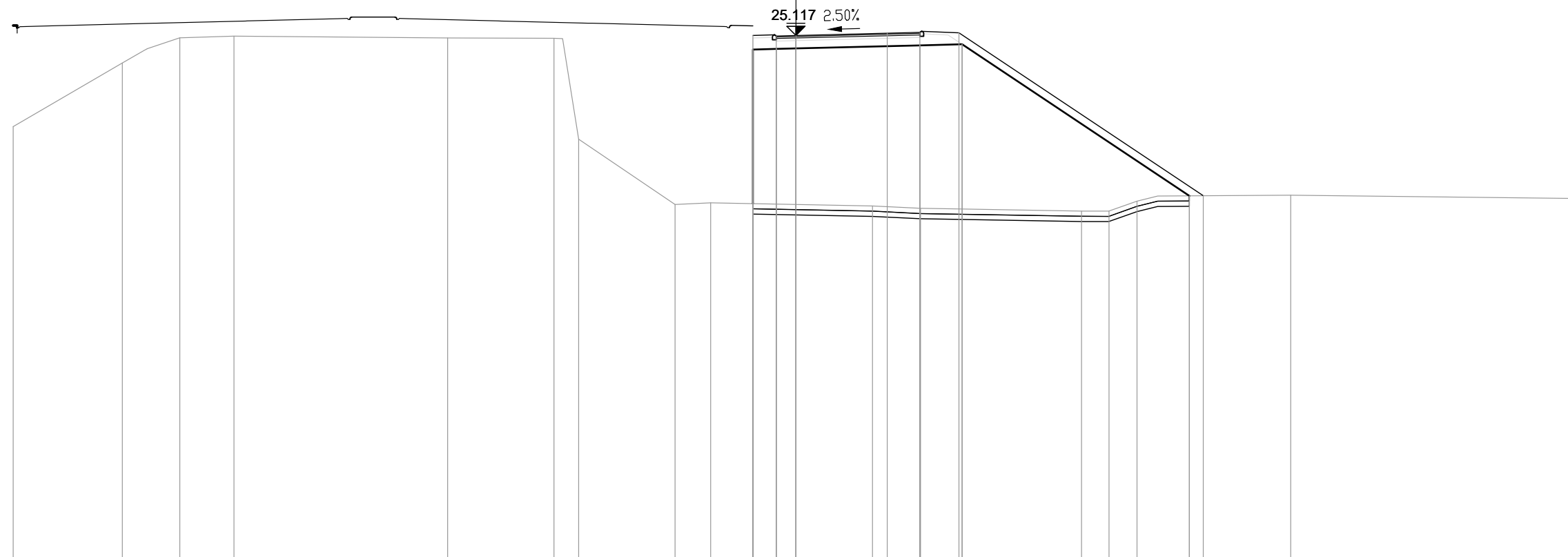

PROGRESSIVE TERRENO	-30.00	-25.82	-23.62	-21.54		-13.35	-9.27	-8.33	-4.63	-3.26		2.94	4.78		10.95	12.01	13.08		18.97	30.00
PARZIALI TERRENO		4.18	2.20	2.08		8.19		4.08	0.94	3.70	1.37	6.20	1.84	6.17	1.06	1.07	5.89		11.03	
QUOTE TERRENO	21.62	24.06	25.02	25.09		25.02	25.01	21.14	18.64	18.70		18.58	18.49		18.39	18.38	18.77		19.00	18.87
PROGRESSIVE PROGETTO												-1.65	-0.75	0.00	3.50	4.75	6.25		15.62	
PARZIALI PROGETTO												0.90	0.75	3.50	1.25	1.50	9.37			
QUOTE PROGETTO												25.20	25.24	25.22	25.20	25.24	25.22		18.98	
PROGRESSIVE RILEVATO												-1.65	-1.65	-0.75	0.00	4.75	6.37		15.08	
PARZIALI RILEVATO												0.90	0.75	4.75	1.62	8.71				
QUOTE RILEVATO												24.58	24.60	24.62	24.74	24.78	18.97			



PROFILO S03\_COMPLANARE

SEZIONE 15

PROGRESSIVA 280.00

BA RILEVATO m? 69.65  
 DB SCOTICO RILEVATO m? 3.41  
 EA BONIFICA m? 2.82  
 GA USURA 4 m? 0.23  
 GB BINDER 4 m? 0.33  
 GC BASE 4 m? 0.55  
 GD FONDAZIONE 4 m? 2.61  
 HA VEGETALE m? 3.60  
 dc SUPERF. GRADON. m 2.78  
 ge AREA PAVIMENT. 4 m 5.50  
 hb SUPERF. VEGETALE m 13.74

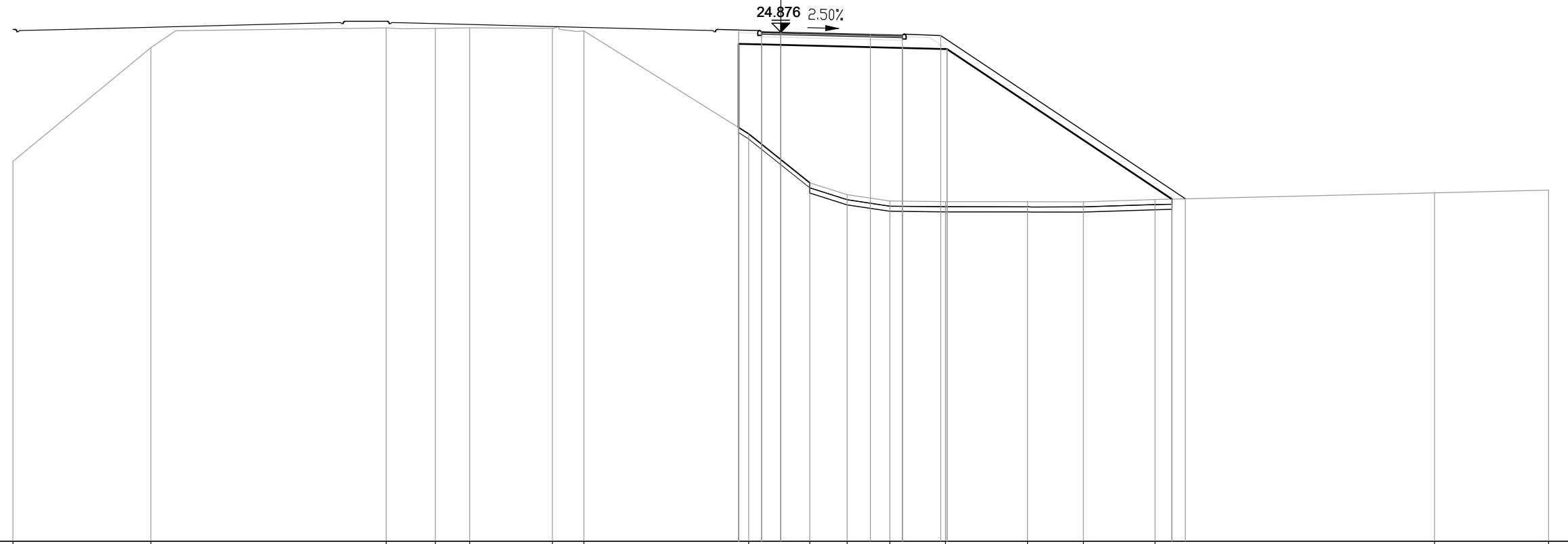

5

200  
200

PROGRESSIVE TERRENO	-30.00	-24.61		-15.42	-13.50	-12.15	-8.92	-7.69		-1.25	1.13	2.59	4.26	6.44	9.64	11.82	14.63		25.55	30.00
PARZIALI TERRENO		5.39	9.19	1.92	1.35	3.23	1.23	6.44	2.38	1.46	1.67	2.18	3.20	2.18	2.81	10.92	4.45			
QUOTE TERRENO	19.84	24.27		25.04	25.02	25.04	25.02	24.93		20.91	18.99	18.53	18.28	18.26	18.26	18.25	18.34		18.60	18.71
PROGRESSIVE PROGETTO										-1.65	-1.65	-0.75	0.00							
PARZIALI PROGETTO										0.90	0.75	3.50	1.25	1.50	9.55					
QUOTE PROGETTO										24.96	24.89	24.79	24.76	24.74			18.37			
PROGRESSIVE RILEVATO										-1.65	-1.65	-0.75	0.00							
PARZIALI RILEVATO										0.90	0.75	4.75	1.75	8.78						
QUOTE RILEVATO										24.42	24.39	24.38	24.26	24.21			18.36			

PROFILO S03\_COMPLANARE

SEZIONE 16

PROGRESSIVA 300.00

BA RILEVATO m? 65.22  
 DB SCOTICO RILEVATO m? 3.31  
 EA BONIFICA m? 2.80  
 GA USURA 4 m? 0.20  
 GB BINDER 4 m? 0.34  
 GC BASE 4 m? 0.54  
 GD FONDAZIONE 4 m? 2.62  
 HA VEGETALE m? 3.52  
 dc SUPERF. GRADON. m 2.58  
 ge AREA PAVIMENT. 4 m 5.50  
 hb SUPERF. VEGETALE m 13.26

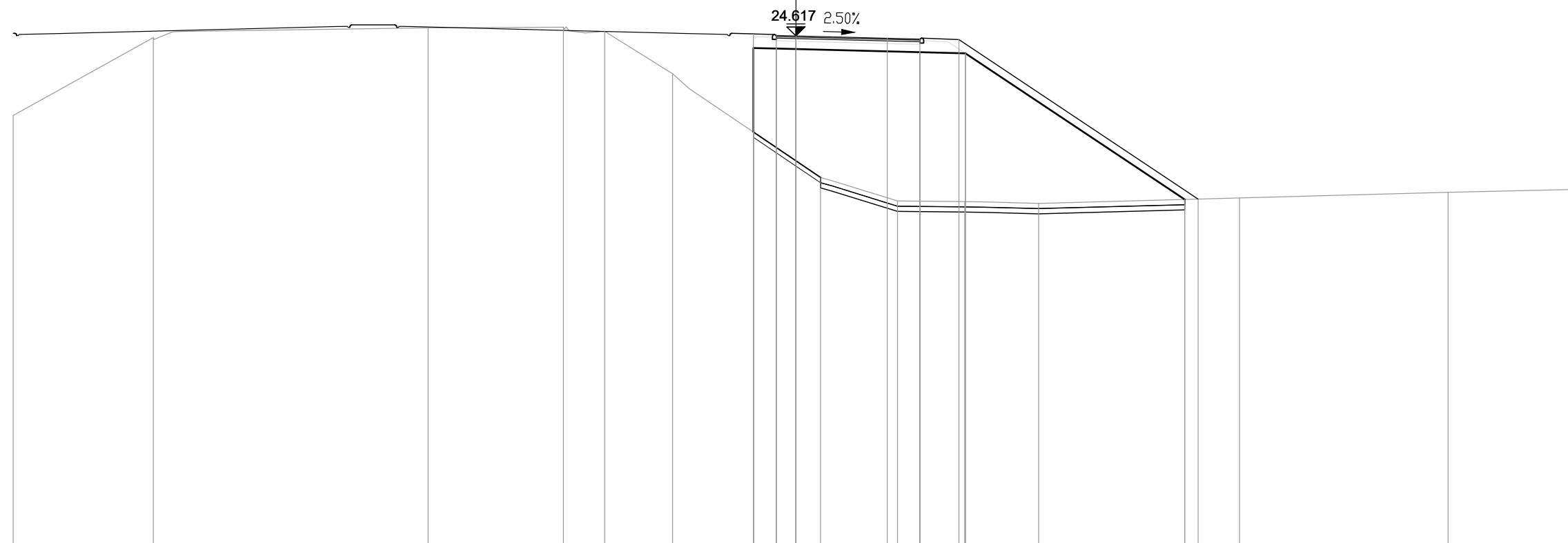

PROGRESSIVE TERRENO	-30.00	-24.63		-14.10		-8.91	-7.33	-4.73		0.95	3.89	6.47	9.30		17.01	25.00	30.00
PARZIALI TERRENO		5.37		10.53		5.19	1.58	2.60		5.68	2.94	2.58	2.83		7.71	7.99	5.00
QUOTE TERRENO	21.57	24.56		24.93		24.96	24.80	23.18		19.19	18.30	18.27	18.20		18.41	18.63	18.74
PROGRESSIVE PROGETTO										-1.63	-0.75	0.00					15.42
PARZIALI PROGETTO										3.50	1.25	1.50			9.17		
QUOTE PROGETTO										24.53	24.50	24.48			18.37		
PROGRESSIVE RILEVATO										-1.63	-1.63	0.00					14.90
PARZIALI RILEVATO										4.75	1.75				8.40		
QUOTE RILEVATO										24.16	20.94	24.14	24.12		24.00	23.95	18.35



PROFILO S03\_COMPLANARE

SEZIONE 17

PROGRESSIVA 320.00

BA RILEVATO m? 60.69  
 DB SCOTICO RILEVATO m? 3.17  
 EA BONIFICA m? 2.76  
 GA USURA 4 m? 0.23  
 GB BINDER 4 m? 0.33  
 GC BASE 4 m? 0.55  
 GD FONDAZIONE 4 m? 2.46  
 HA VEGETALE m? 3.31  
 dc SUPERF. GRADON. m 2.04  
 ge AREA PAVIMENT. 4 m 5.50  
 hb SUPERF. VEGETALE m 12.50

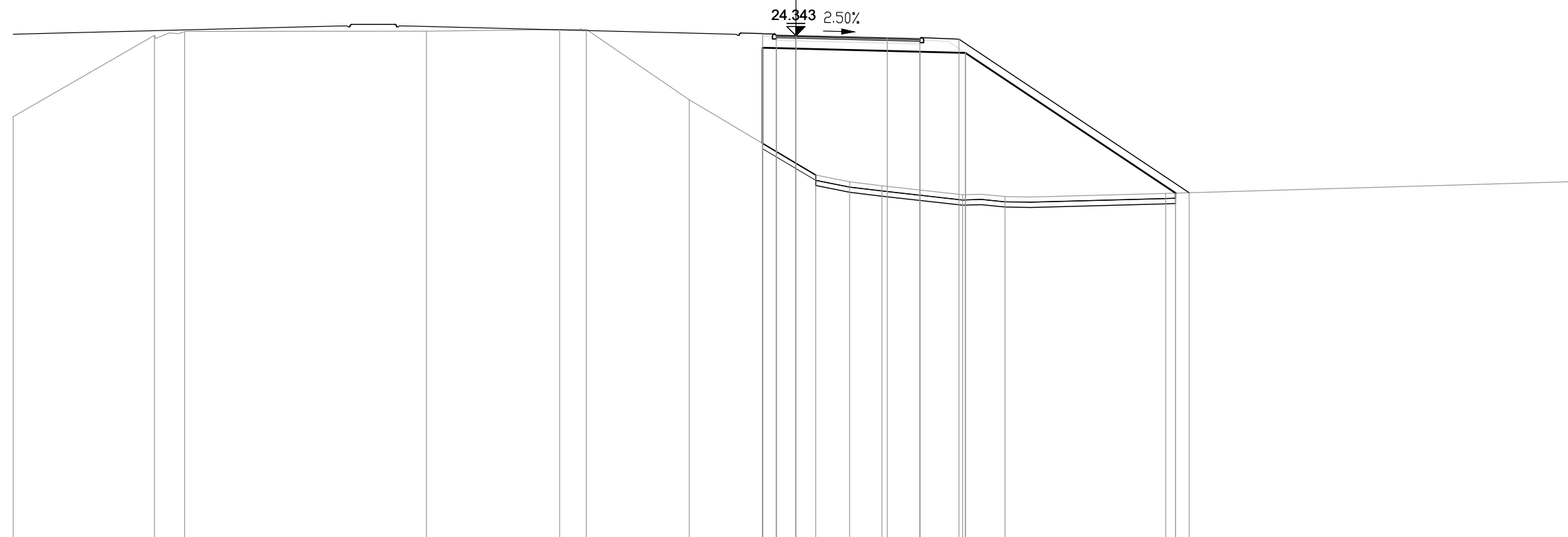

5

200

PROGRESSIVE TERRENO	-30.00	-24.59	-23.43	-14.16	-9.06	-8.04	-4.08	0.76	2.06	3.30	6.39	8.01	14.17	30.00
PARZIALI TERRENO	5.41	1.16	9.27	5.10	1.02	3.96	4.84	1.30	1.24	3.09	1.62	6.16	15.83	
QUOTE TERRENO	21.24	24.35	24.50	24.51	24.57	24.58	21.88	19.00	18.74	18.59	18.25	18.17	18.30	18.75
PROGRESSIVE PROGETTO								-1.28	-0.75	0.00	3.50	4.75	6.25	15.07
PARZIALI PROGETTO								0.53	0.75	3.50	1.25	1.50	8.82	
QUOTE PROGETTO								24.41	24.36	24.26	24.22	24.21	18.32	
PROGRESSIVE RILEVATO								-1.28	-0.75	0.00	4.75	6.50	14.56	
PARZIALI RILEVATO								0.53	0.75	4.75	1.75	8.06		
QUOTE RILEVATO								23.87	20.21	23.86	23.84	23.72	23.68	18.31

PROFILO S03\_COMPLANARE

SEZIONE 17A

PROGRESSIVA 332.09

BA RILEVATO m? 54.33  
 DB SCOTICO RILEVATO m? 2.99  
 EA BONIFICA m? 2.68  
 GA USURA 4 m? 0.23  
 GB BINDER 4 m? 0.33  
 GC BASE 4 m? 0.55  
 GD FONDAZIONE 4 m? 2.24  
 HA VEGETALE m? 3.12  
 dc SUPERF. GRADON. m 1.50  
 ge AREA PAVIMENT. 4 m 5.50  
 hb SUPERF. VEGETALE m 11.48

4  
 200  
 200

24.143 2.50%

PROGRESSIVE TERRENO	-30.00	-27.95	-24.52	-23.44		-13.82		-8.89	-7.65		-0.19	1.32	2.85	5.65	8.81		30.00
PARZIALI TERRENO	2.05	3.43	1.08		9.62		4.93	1.24		7.46	1.51	1.53	2.80	3.16		21.19	
QUOTE TERRENO	20.87	22.15	24.13	24.20		24.13		24.18	23.70		19.70	19.00	18.65	18.33	18.30		18.79
PROGRESSIVE PROGETTO											-0.75	0.00	3.50	4.75	6.25		14.61
PARZIALI PROGETTO											0.75	3.50	1.25	1.50	8.36		
QUOTE PROGETTO											24.16	24.14	24.06	24.02	24.01		18.43
PROGRESSIVE RILEVATO											-0.75	-0.75	0.00	4.75	6.50		14.09
PARZIALI RILEVATO											0.75	5.075	1.75	7.59			
QUOTE RILEVATO											23.66	20.00	23.64	23.52	23.48		18.42

PROFILO S03\_COMPLANARE

SEZIONE 17Abis

PROGRESSIVA 332.09

BA RILEVATO m? 54.33  
 DB SCOTICO RILEVATO m? 2.99  
 EA BONIFICA m? 2.68  
 GA USURA 4 m? 0.23  
 GB BINDER 4 m? 0.33  
 GC BASE 4 m? 0.55  
 GD FONDAZIONE 4 m? 2.24  
 HA VEGETALE m? 3.12  
 dc SUPERF. GRADON. m 1.50  
 ge AREA PAVIMENT. 4 m 5.50  
 hb SUPERF. VEGETALE m 11.48

4  
 200  
 200

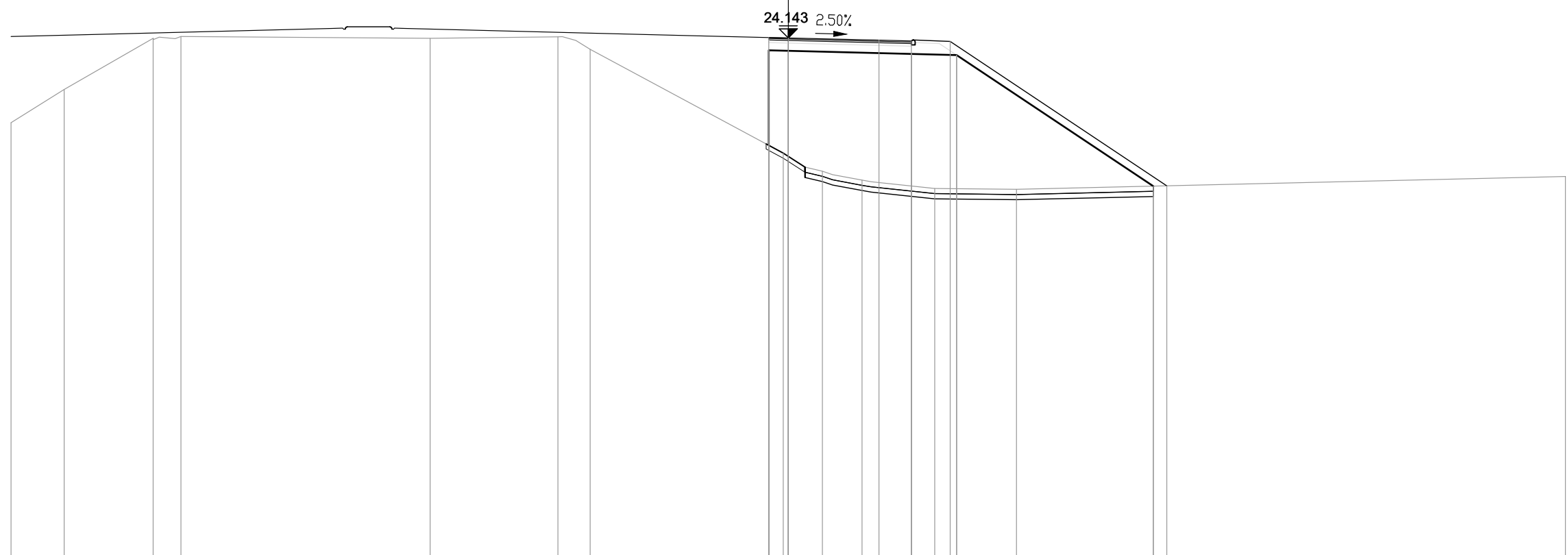

PROGRESSIVE TERRENO	-30.00	-27.95	-24.52	-23.44		-13.82		-8.89	-7.65		-0.19	1.32	2.85	5.65	8.81		30.00
PARZIALI TERRENO	2.05	3.43	1.08		9.62		4.93	1.24		7.46	1.51	1.53	2.80	3.16		21.19	
QUOTE TERRENO	20.87	22.15	24.13	24.20		24.13		24.18	23.70		19.70	19.00	18.65	18.33	18.30		18.79
PROGRESSIVE PROGETTO											-0.75	0.00		3.50	4.75	6.25	14.61
PARZIALI PROGETTO											0.75	3.50	1.25	1.50		8.36	
QUOTE PROGETTO											24.16	24.14		24.06	24.02	24.01	18.43
PROGRESSIVE RILEVATO											-0.75	-0.75	0.00	4.75	6.50		14.09
PARZIALI RILEVATO											0.75	5.075	1.75		7.59		
QUOTE RILEVATO											23.66	20.00	23.64		23.52	23.48	18.42

PROFILO S03\_COMPLANARE

SEZIONE 18

PROGRESSIVA 340.00

BA RILEVATO m? 63.83  
 DB SCOTICO RILEVATO m? 3.08  
 EA BONIFICA m? 2.69  
 GA USURA 4 m? 0.37  
 GB BINDER 4 m? 0.54  
 GC BASE 4 m? 0.90  
 GD FONDAZIONE 4 m? 3.28  
 HA VEGETALE m? 3.07  
 dc SUPERF. GRADON. m 2.12  
 ge AREA PAVIMENT. 4 m 9.00  
 hb SUPERF. VEGETALE m 11.27

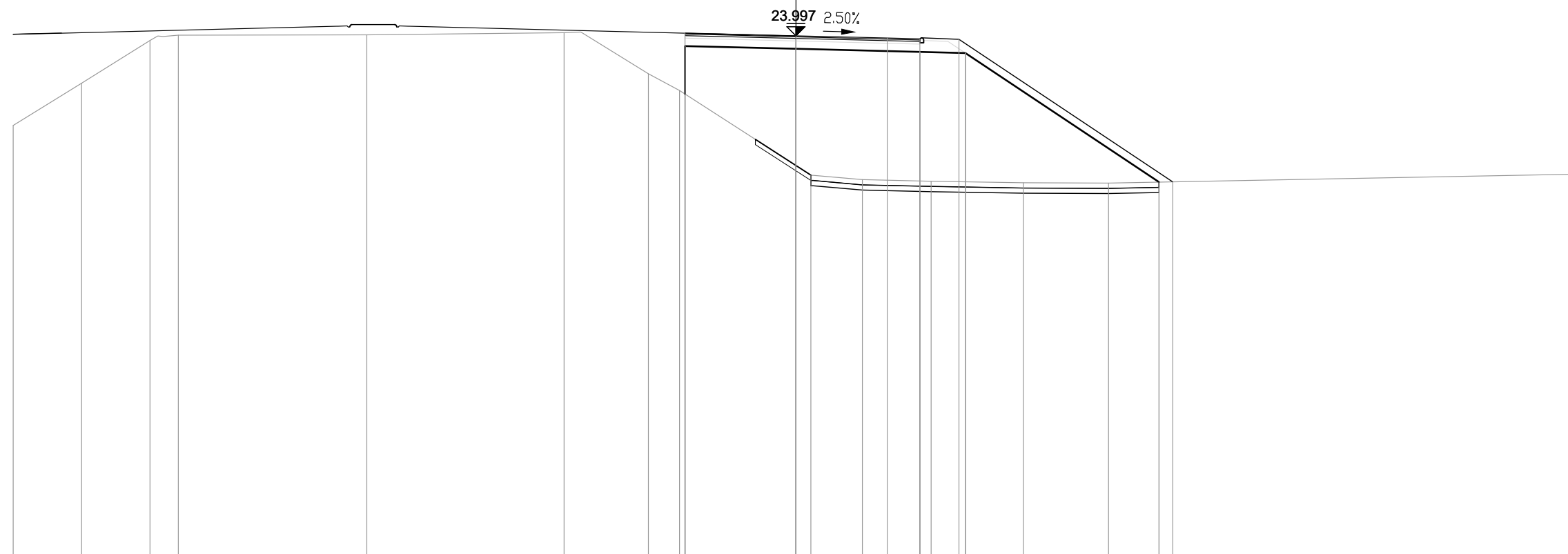

200  
200

PROGRESSIVE TERRENO	-30.00	-27.38	-24.76	-23.67		-16.45		-8.89	-5.65	-4.46		0.57	2.55	5.18		8.72	11.98		30.00
PARZIALI TERRENO		2.62	2.62	1.09	7.22		7.56	3.24	1.19	5.03	1.98	2.63	3.54	3.26		18.02			
QUOTE TERRENO	20.56	22.18	23.82	24.02		24.03		24.12	22.54	21.90		18.65	18.48	18.42	18.36	18.35			18.69
PROGRESSIVE PROGETTO									-4.25	0.00	3.50	4.75	6.25			14.45			
PARZIALI PROGETTO									4.25	3.50	1.25	1.50	8.20						
QUOTE PROGETTO									24.10	24.00	23.91	23.88	23.86			18.40			
PROGRESSIVE RILEVATO									-4.25	-4.25	0.00	4.75	6.50			13.92			
PARZIALI RILEVATO									4.25	4.75	1.75	7.42							
QUOTE RILEVATO									23.60	21.76	23.50	23.38	23.33			18.39			

PROFILO S03\_COMPLANARE

SEZIONE 19

PROGRESSIVA 360.00

BA RILEVATO m? 55.20  
 DB SCOTICO RILEVATO m? 3.27  
 EA BONIFICA m? 2.50  
 GA USURA 4 m? 0.36  
 GB BINDER 4 m? 0.53  
 GC BASE 4 m? 0.90  
 GD FONDAZIONE 4 m? 3.31  
 HA VEGETALE m? 2.68  
 dc SUPERF. GRADON. m 3.70  
 ge AREA PAVIMENT. 4 m 9.00  
 hb SUPERF. VEGETALE m 10.20



200  
200

PROGRESSIVE TERRENO	-30.00	-24.41		-10.16	-8.91	-6.13		-1.86	0.39	1.55	4.08		8.49		26.24	29.19	30.00
PARZIALI TERRENO		5.59	14.25	1.25	2.78	4.27	2.25	1.16	2.53	4.41		17.75		2.95	0.81		
QUOTE TERRENO	20.16	23.26		23.61	23.61	22.20	19.79	19.02	18.74	18.63	18.60		18.46	18.40	18.40		
PROGRESSIVE PROGETTO						-4.25	0.00	3.50	4.75	6.25		13.56					
PARZIALI PROGETTO						4.25	3.50	1.25	1.50	7.31							
QUOTE PROGETTO						23.68	23.57	23.48	23.45	23.43		18.56					
PROGRESSIVE RILEVATO				-4.25	-4.25	0.00	4.75	6.50		13.01							
PARZIALI RILEVATO				4.25	4.75	1.75	6.51										
QUOTE RILEVATO				23.18	21.14	23.07	22.95	22.91		18.57							













PROFILO S03\_COMPLANARE

SEZIONE 23

PROGRESSIVA 440.00

BA RILEVATO m? 37.36  
 DB SCOTICO RILEVATO m? 3.23  
 EA BONIFICA m? 2.56  
 GA USURA 4 m? 0.37  
 GB BINDER 4 m? 0.54  
 GC BASE 4 m? 0.89  
 GD FONDAZIONE 4 m? 3.69  
 HA VEGETALE m? 2.06  
 dc SUPERF. GRADON. m 3.28  
 ge AREA PAVIMENT. 4 m 9.00  
 hb SUPERF. VEGETALE m 8.50

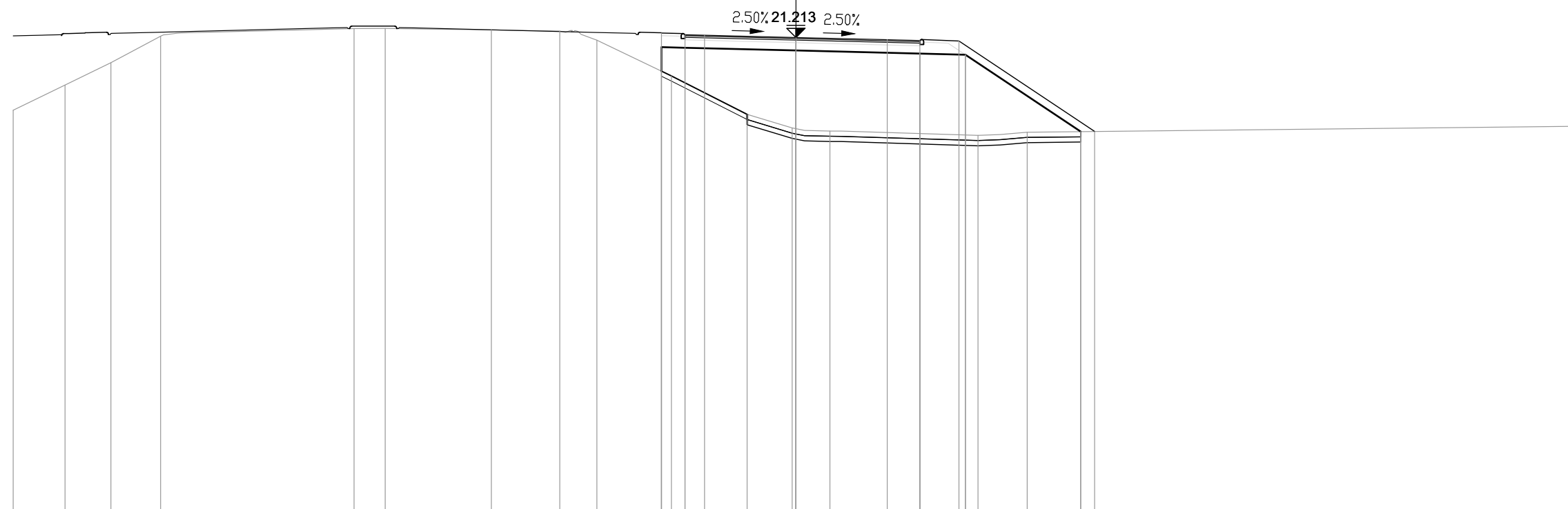

PROGRESSIVE TERRENO	-30.00	-28.02	-26.26	-24.35		-16.94	-15.74		-11.67	-9.05	-7.63	-4.77	-1.87	-0.14	1.30		6.98	8.87		30.00	
PARZIALI TERRENO	1.98	1.76	1.91		7.41	1.20	4.07		2.62	1.42	2.86	2.90	1.73	1.44		5.68	1.89		21.13		
QUOTE TERRENO	18.42	19.39	20.25	21.26		21.55	21.56		21.50	21.46	21.11	19.74	18.27	17.74	17.62		17.46	17.58		17.81	
PROGRESSIVE PROGETTO												-5.15	-4.25	-3.50	0.00		3.50	4.75	6.25		11.45
PARZIALI PROGETTO												0.90	0.75	3.50	3.50		1.25	1.50	5.20		
QUOTE PROGETTO												21.38	21.32	21.30	21.21		21.13	21.09	21.08		17.61
PROGRESSIVE RILEVATO												-5.15	-5.15	-4.25	0.00		4.75	6.50			10.92
PARZIALI RILEVATO												0.90	5.425	4.75	4.75		1.75	4.42			
QUOTE RILEVATO												20.84	20.82	20.71			20.59	20.55			17.60

PROFILO S03\_COMPLANARE

SEZIONE 24

PROGRESSIVA 460.00

BA RILEVATO m? 32.34  
 DB SCOTICO RILEVATO m? 3.02  
 EA BONIFICA m? 2.55  
 GA USURA 4 m? 0.34  
 GB BINDER 4 m? 0.54  
 GC BASE 4 m? 0.90  
 GD FONDAZIONE 4 m? 3.69  
 HA VEGETALE m? 1.74  
 dc SUPERF. GRADON. m 2.43  
 ge AREA PAVIMENT. 4 m 9.00  
 hb SUPERF. VEGETALE m 7.42

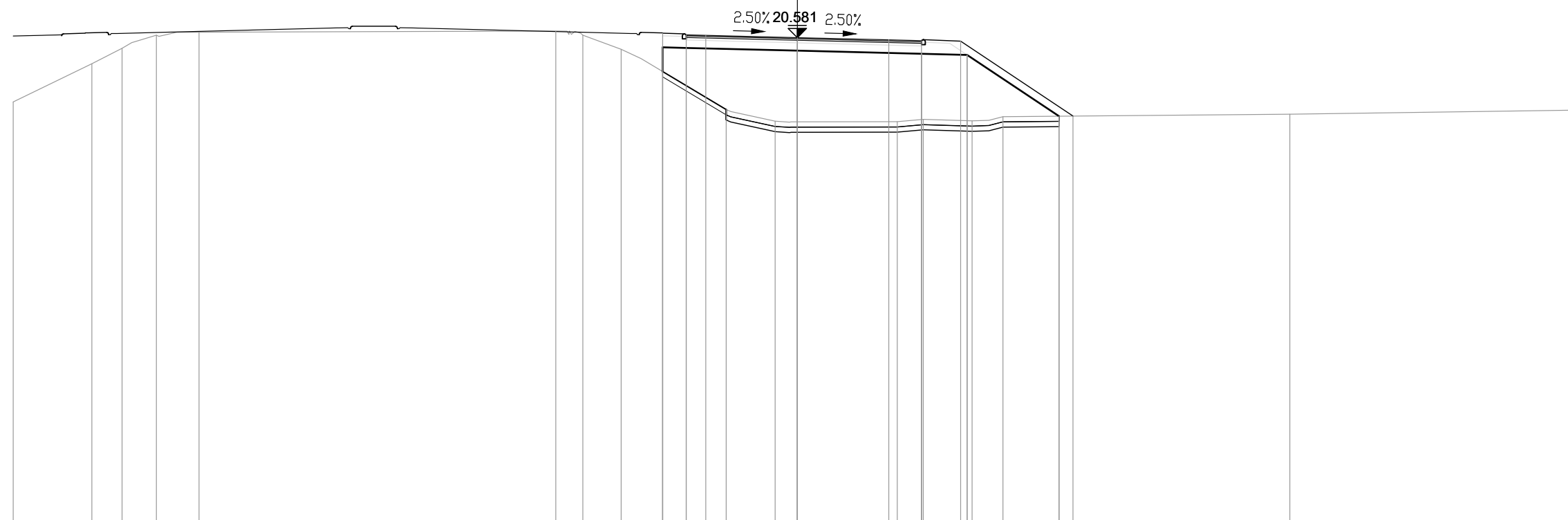

200  
200

PROGRESSIVE TERRENO	-30.00	-26.99	-25.84	-24.53	-22.89	-9.24	-8.21	-6.74	-2.72	-0.85	3.82	4.82	6.69	7.87	18.85	30.00
PARZIALI TERRENO	3.01	1.15	1.31	1.64	13.65	1.03	1.47	4.02	1.87	4.67	1.00	1.87	1.18	10.98	11.15	
QUOTE TERRENO	18.12	19.59	20.17	20.68	20.79	20.83	20.68	20.13	17.83	17.38	17.36	17.45	17.39	17.56	17.65	17.81
PROGRESSIVE PROGETTO									-5.15	0.00	3.50	4.75	6.25	10.55		
PARZIALI PROGETTO									0.90	3.50	1.25	1.50	4.30			
QUOTE PROGETTO									20.75	20.58	20.49	20.46	20.45	17.58		
PROGRESSIVE RILEVATO									-5.15	0.00	4.75	6.50	10.01			
PARZIALI RILEVATO									0.90	5.425	4.75	1.75	3.51			
QUOTE RILEVATO									20.21	20.08	19.96	19.92	17.58			

PROFILO S03\_COMPLANARE

SEZIONE 25

PROGRESSIVA 480.00

BA RILEVATO m? 25.47  
 DB SCOTICO RILEVATO m? 2.90  
 EA BONIFICA m? 2.56  
 GA USURA 4 m? 0.35  
 GB BINDER 4 m? 0.55  
 GC BASE 4 m? 0.90  
 GD FONDAZIONE 4 m? 3.69  
 HA VEGETALE m? 1.44  
 dc SUPERF. GRADON. m 1.58  
 ge AREA PAVIMENT. 4 m 9.00  
 hb SUPERF. VEGETALE m 6.59

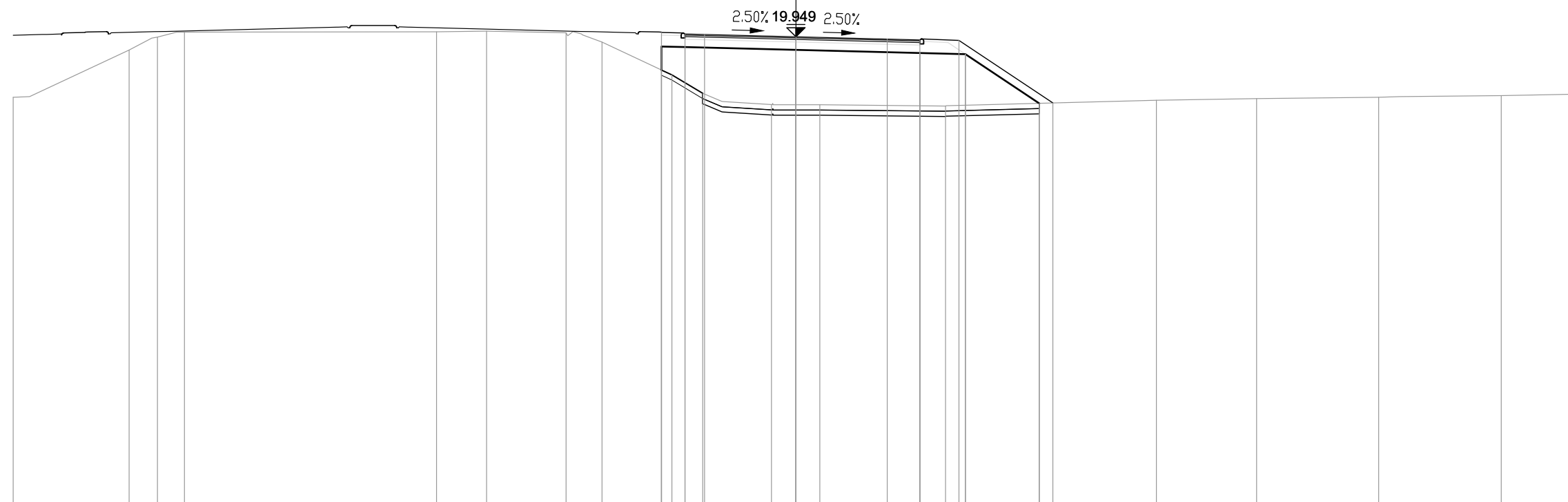

PROGRESSIVE TERRENO	-30.00	-25.56	-24.47	-23.44		-13.77	-11.86	-8.81	-7.43	-4.75	-3.57	-0.94	0.92		5.74		13.82	17.66	22.34	27.04	30.00
PARZIALI TERRENO		4.44	1.09	1.03		9.67	1.91	3.05	1.38	2.68	1.18	2.63	1.86		4.82		8.08	3.84	4.68	4.70	2.96
QUOTE TERRENO	17.64	19.44	19.94	20.13		20.14	20.17	20.10	19.74	18.49	17.78	17.35	17.35		17.30		17.52	17.58	17.63	17.70	17.75
PROGRESSIVE PROGETTO										-5.15	-4.25	-3.50	0.00		3.50	4.75	6.25	9.85			
PARZIALI PROGETTO										0.90	0.75	3.50	3.50		1.25	1.50	3.60				
QUOTE PROGETTO										20.12	20.06	20.04	19.95		19.86	19.83	19.81	17.41			
PROGRESSIVE RILEVATO										-5.15	-5.15	-4.25	0.00		4.75	6.50	9.33				
PARZIALI RILEVATO										0.90	5.4825		4.75		1.75	2.83					
QUOTE RILEVATO										19.58	18.68	19.56	19.45		19.33	19.29	17.40				





PROFILO S03\_COMPLANARE

SEZIONE 28

PROGRESSIVA 540.00

BA RILEVATO	m?	6.24
DB SCOTICO RILEVATO	m?	2.40
EA BONIFICA	m?	2.41
GA USURA 4	m?	0.32
GB BINDER 4	m?	0.54
GC BASE 4	m?	0.90
GD FONDAZIONE 4	m?	3.69
HA VEGETALE	m?	0.61
dc SUPERF. GRADON.	m	0.00
ge AREA PAVIMENT. 4	m	9.00
hb SUPERF. VEGETALE	m	3.68

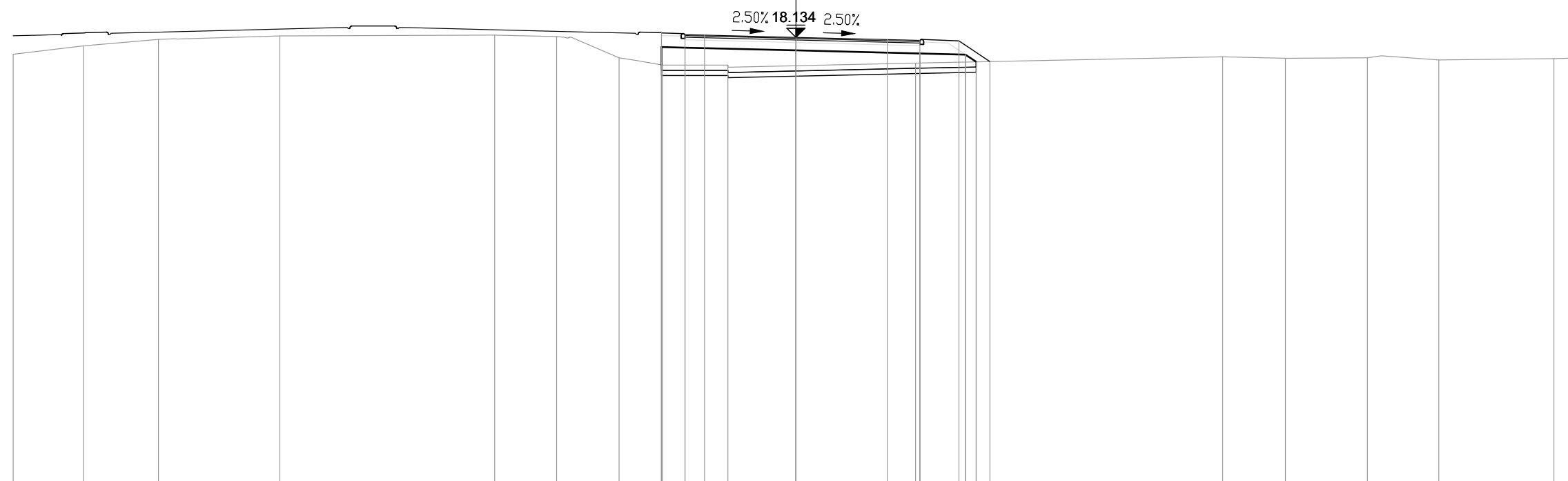

PROGRESSIVE TERRENO	-30.00	-27.31	-24.44	-19.78	-11.55	-9.17	-6.78	-5.11	-2.61	4.59	16.36	18.76	21.91	24.65	29.06	30.00
PARZIALI TERRENO	2.69	2.87	4.66	8.23	2.38	2.39	1.67	2.50	7.20	11.77	2.40	3.15	2.74	4.41	0.94	30.00
QUOTE TERRENO	17.49	17.80	18.06	18.19	18.22	18.17	17.35	17.07	17.07	17.15	17.39	17.33	17.35	17.26	17.32	17.35
PROGRESSIVE PROGETTO								-5.15	-4.25	-3.50	0.00	3.50	4.75	6.25	7.44	
PARZIALI PROGETTO								0.90	0.75	3.50	3.50	1.25	1.50	1.19		
QUOTE PROGETTO								18.30	18.24	18.22	18.13	18.05	18.02	18.00	17.21	
PROGRESSIVE RILEVATO								-5.15	-5.15	-4.25	0.00	4.75	6.50	6.91		
PARZIALI RILEVATO								0.90	5.48	5	4.75	1.75	0.41			
QUOTE RILEVATO								17.76	17.08	17.74	17.63	17.52	17.47	17.20		





PROFILO S03\_COMPLANARE

SEZIONE 30

PROGRESSIVA 580.00

AA SCAVO	m?	3.57
DA SCOTICO SCAVO	m?	2.42
EA BONIFICA	m?	2.33
GA USURA 4	m?	0.34
GB BINDER 4	m?	0.55
GC BASE 4	m?	0.90
GD FONDAZIONE 4	m?	3.68
HA VEGETALE	m?	0.45
ge AREA PAVIMENT. 4	m	9.00
hb SUPERF. VEGETALE	m	2.48

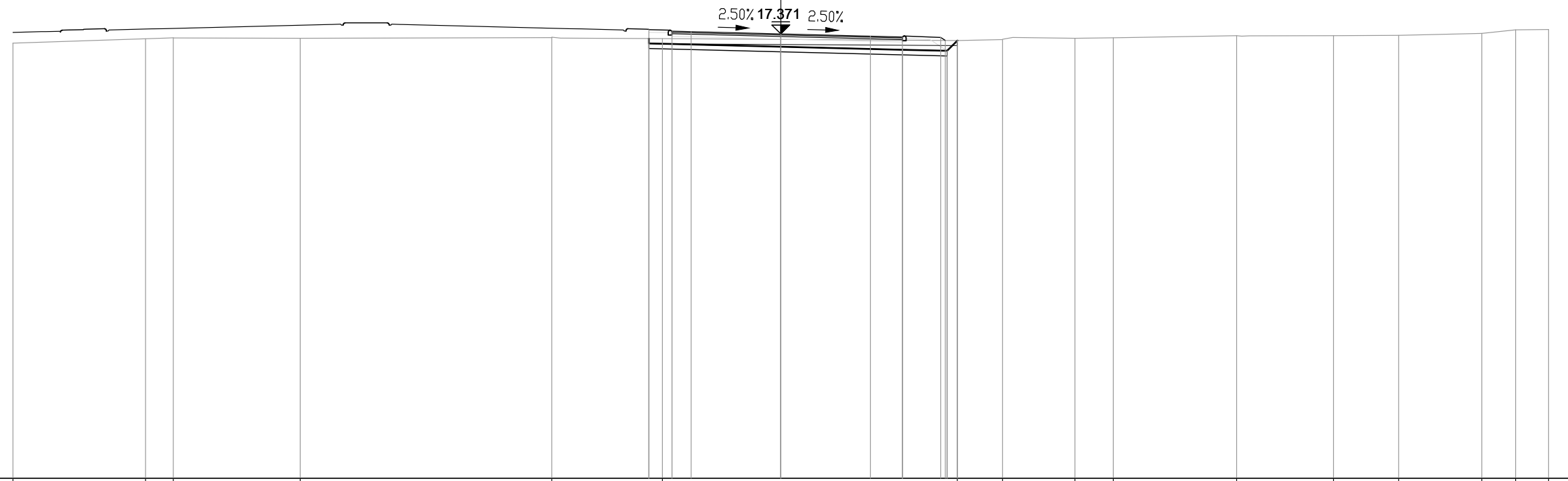

PROGRESSIVE TERRENO	-30.00	-24.82	-23.74	-18.78	-8.95	-4.63	6.90	8.67	11.50	12.99	17.81	21.60	24.14	27.40	28.72	30.00
PARZIALI TERRENO	5.18	1.08	4.96	9.83	4.32	11.53	1.77	2.83	1.49	4.82	3.79	2.54	3.26	1.32	1.28	
QUOTE TERRENO	17.01	17.18	17.22	17.20	17.23	17.19	17.11	17.15	17.20	17.22	17.30	17.30	17.31	17.39	17.53	17.54
PROGRESSIVE PROGETTO						-5.15	0.00	3.50	4.75	6.25	6.43					
PARZIALI PROGETTO						0.90	3.50	1.25	1.50	0.18						
QUOTE PROGETTO						17.54	17.37	17.28	17.25	17.24	17.12					
PROGRESSIVE RILEVATO						-5.15	0.00	4.75	6.50	6.90						
PARZIALI RILEVATO						0.90	4.75	1.75	0.40							
QUOTE RILEVATO						17.00	16.87	16.75	16.71	17.11						

PROFILO S03\_COMPLANARE

SEZIONE 31

PROGRESSIVA 600.00

AA SCAVO	m?	6.91
DA SCOTICO SCAVO	m?	2.40
EA BONIFICA	m?	2.21
GA USURA 4	m?	0.34
GB BINDER 4	m?	0.54
GC BASE 4	m?	0.91
GD FONDAZIONE 4	m?	3.22
HA VEGETALE	m?	0.38
ge AREA PAVIMENT. 4	m	9.00
hb SUPERF. VEGETALE	m	1.68

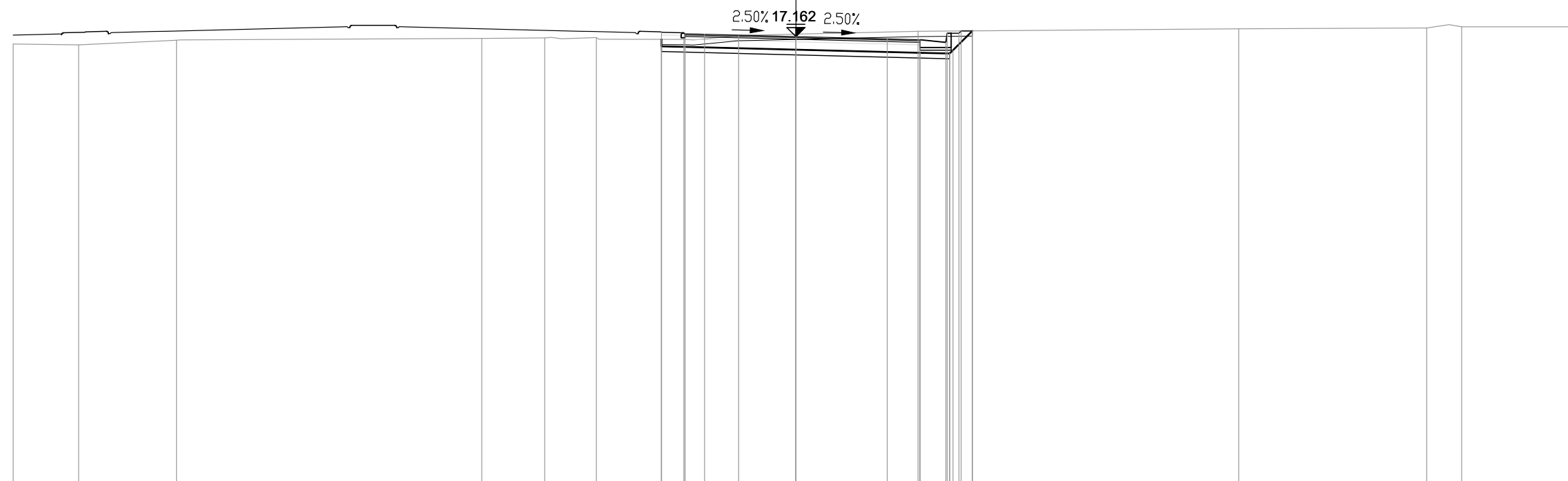

PROGRESSIVE TERRENO	-30.00	-27.49	-23.74		-12.04	-9.63	-7.65	-4.30	-2.19		4.69		16.97	24.18	25.52	30.00	
PARZIALI TERRENO		2.51	3.75		11.70	2.41	1.98	3.35	2.11	6.88		12.28	7.21	1.34	4.48		
QUOTE TERRENO	16.87	16.85	17.03		17.09	17.11	17.12	17.05	17.20		17.36		17.46	17.49	17.54	17.54	
PROGRESSIVE PROGETTO								-5.15	-4.25	-3.50	0.00	3.50	4.75	5.75	5.80	6.25	6.33
PARZIALI PROGETTO								0.90	0.75	3.50	3.50	1.25	1.00	0.05	0.45	0.08	
QUOTE PROGETTO								17.33	17.27	17.25	17.16	17.07	17.04	16.94	17.29	17.29	17.38
PROGRESSIVE RILEVATO								-5.15	-5.15	-4.25	0.00	4.75	5.90	6.00	6.76	6.74	
PARZIALI RILEVATO								0.90	5.48	5	4.75	1.13	1.12	0.86	0.74		
QUOTE RILEVATO								16.79	16.00	16.77	16.66	16.54	16.51	16.64	17.38		

PROFILO S03\_COMPLANARE

SEZIONE 32

PROGRESSIVA 620.00

AA SCAVO	m?	8.68
DA SCOTICO SCAVO	m?	2.43
EA BONIFICA	m?	2.21
GA USURA 4	m?	0.39
GB BINDER 4	m?	0.54
GC BASE 4	m?	0.90
GD FONDAZIONE 4	m?	3.20
HA VEGETALE	m?	0.48
ge AREA PAVIMENT. 4	m	9.00
hb SUPERF. VEGETALE	m	2.01

2.50% 17.059 2.50%



200  
200

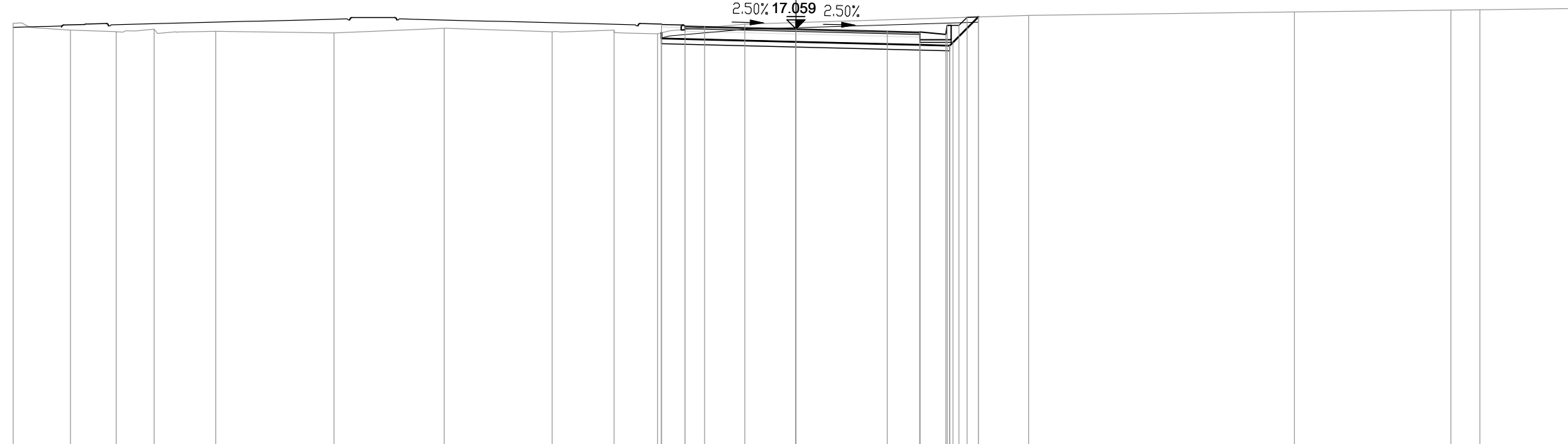

PROGRESSIVE TERRENO	-30.00	-27.81	-26.06	-24.60	-22.24		-17.70	-13.48	-9.35	-6.97	-5.31	-1.96		8.92		19.11		25.11	26.22	30.00			
PARZIALI TERRENO		2.19	1.75	1.46	2.36	4.54	4.22	4.13	2.38	1.66	3.35		10.88		10.19		6.00	1.11	3.78				
QUOTE TERRENO	17.27	17.00	16.95	17.05	16.96		16.90	17.08	16.95	17.01	16.87	17.24		17.57		17.71		17.78	17.79	17.84			
PROGRESSIVE PROGETTO											-5.15	-4.25	-3.50	0.00				3.50	4.75	5.75	5.80	6.25	6.56
PARZIALI PROGETTO											0.90	0.75	3.50	3.50	1.25	1.00	0.05	0.45	0.31				
QUOTE PROGETTO											17.23	17.16	17.15	17.06	16.97	16.94	16.84	17.19	17.19	17.50			
PROGRESSIVE RILEVATO											-5.15	-5.15	-4.25	0.00				4.75	5.90	6.00	7.00		
PARZIALI RILEVATO											0.90	5.48	5	4.75	1.15	1.12	0.12	0.38					
QUOTE RILEVATO											16.69	16.66	16.66	16.56	16.44	16.41	16.44	17.51					

PROFILO S03\_COMPLANARE

SEZIONE 33

PROGRESSIVA 640.00

AA SCAVO m? 10.67  
 DA SCOTICO SCAVO m? 2.48  
 EA BONIFICA m? 2.21  
 GA USURA 4 m? 0.39  
 GB BINDER 4 m? 0.54  
 GC BASE 4 m? 0.90  
 GD FONDAZIONE 4 m? 3.19  
 HA VEGETALE m? 0.57  
 ge AREA PAVIMENT. 4 m 9.00  
 hb SUPERF. VEGETALE m 2.33

0  
 200  
 200

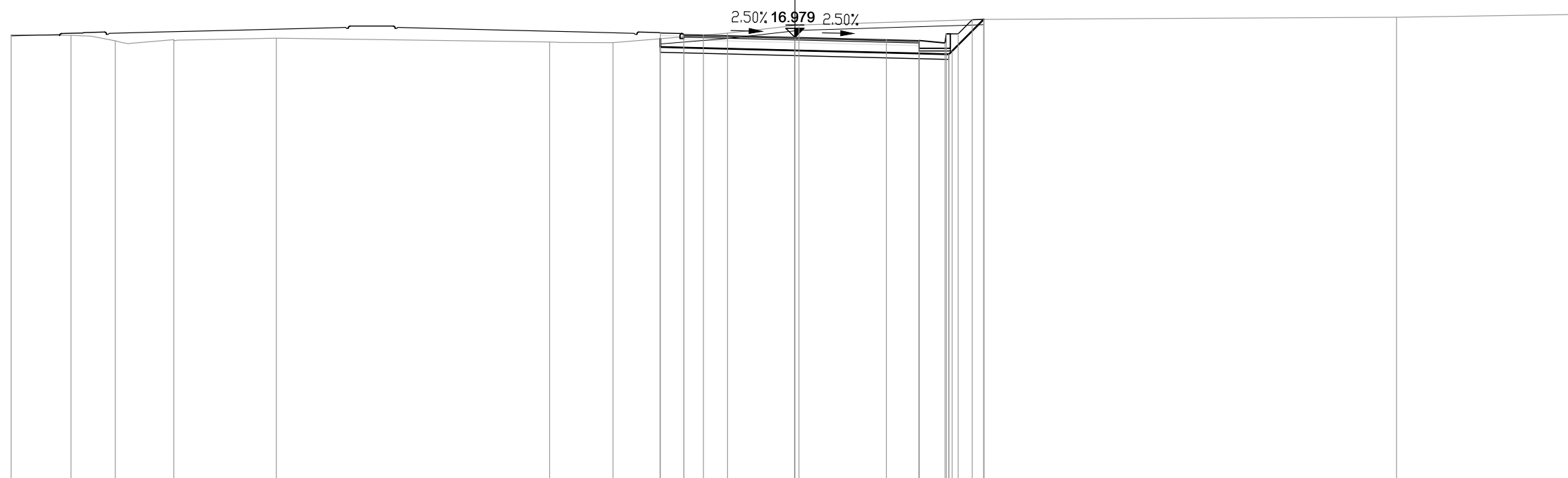

PROGRESSIVE TERRENO	-30.00	-27.71	-26.02	-23.77	-19.85	-9.39	-6.96	-2.58	0.16	7.24	23.03	30.00
PARZIALI TERRENO	2.29	1.69	2.25	3.92	10.46	2.43	4.38	2.74	7.08	15.79	6.97	
QUOTE TERRENO	17.07	17.06	16.85	16.89	16.95	16.80	16.77	17.14	17.45	17.66	17.75	17.85
PROGRESSIVE PROGETTO								-5.15	0.00	3.50	4.75	5.80
PARZIALI PROGETTO								0.90	3.50	3.50	1.25	1.00
QUOTE PROGETTO								17.15	16.98	16.89	16.86	16.76
PROGRESSIVE RILEVATO								-5.15	0.00	4.75	5.90	6.00
PARZIALI RILEVATO								0.90	5.48	4.75	1.15	0.12
QUOTE RILEVATO								16.61	16.48	16.36	16.33	16.48





PROFILO S03\_COMPLANARE

SEZIONE 34

PROGRESSIVA 660.00

AA SCAVO	m?	9.06
DA SCOTICO SCAVO	m?	2.37
EA BONIFICA	m?	2.13
GA USURA 4	m?	0.37
GB BINDER 4	m?	0.54
GC BASE 4	m?	0.90
GD FONDAZIONE 4	m?	2.83
HA VEGETALE	m?	0.41
ge AREA PAVIMENT. 4	m	9.00
hb SUPERF. VEGETALE	m	1.28



PROGRESSIVE TERRENO	-30.00	-27.34	-26.30	-24.30		-17.46		-12.12	-9.12	-7.37		-2.11		8.02	30.00		
PARZIALI TERRENO		2.66	1.04	2.00	6.84		5.34	3.00	1.75	5.26		10.13		21.98			
QUOTE TERRENO	17.04	17.00	16.85	16.80		16.93		16.85	16.74	16.69		17.12		17.45	17.55		
PROGRESSIVE PROGETTO										-4.25	0.00	3.50	4.75	5.75	5.80	6.25	6.63
PARZIALI PROGETTO										4.25	3.50	1.25	1.00	0.05	0.45	0.38	
QUOTE PROGETTO										17.00	16.90	16.81	16.78	16.68	17.03	17.03	17.41
PROGRESSIVE RILEVATO										-4.25	-4.25	0.00	4.75	5.90	6.00	7.07	
PARZIALI RILEVATO										4.25	4.75	1.15	1.12	0.12	1.10	0.5	
QUOTE RILEVATO										16.50	16.96	16.40	16.28	16.25	16.26	17.42	



PROFILO S03\_COMPLANARE

SEZIONE 35

PROGRESSIVA 680.00

AA SCAVO	m?	5.87
DA SCOTICO SCAVO	m?	1.94
EA BONIFICA	m?	1.77
GA USURA 4	m?	0.37
GB BINDER 4	m?	0.54
GC BASE 4	m?	0.90
GD FONDAZIONE 4	m?	2.83
HA VEGETALE	m?	0.28
ge AREA PAVIMENT. 4	m	9.00
hb SUPERF. VEGETALE	m	0.82

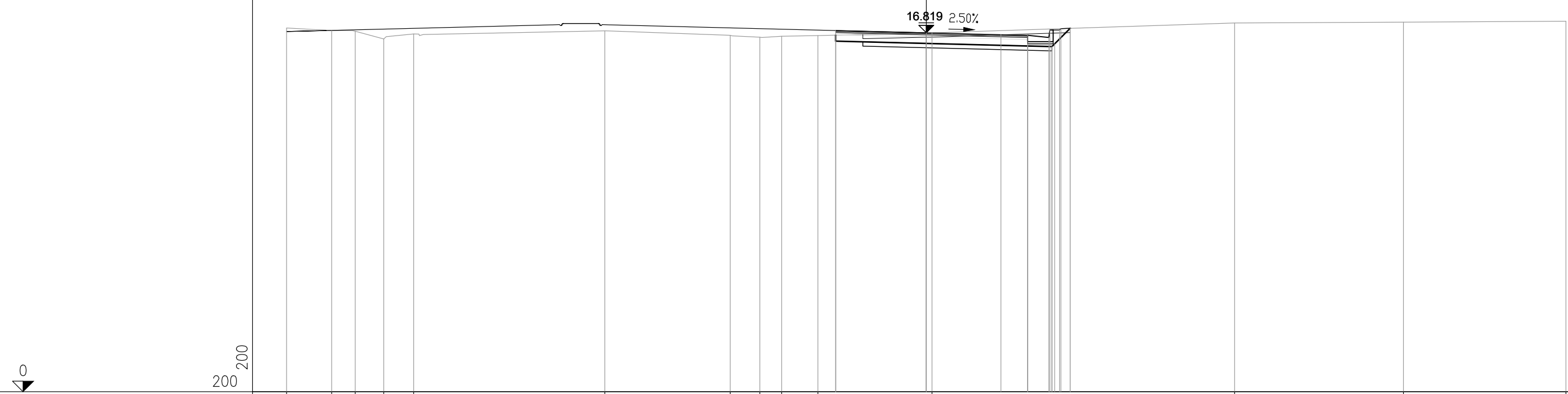

PROGRESSIVE TERRENO	-30.00	-27.89	-26.78	-25.44	-24.04		-15.08		-9.20	-7.80	-6.79	-5.08	0.27		14.46	22.38	30.00
PARZIALI TERRENO	2.11	1.11	1.34	1.40		8.96		5.88	1.40	1.01	1.71		5.35		14.19		7.62
QUOTE TERRENO	17.04	16.92	16.89	16.53	16.76		16.91		16.70	16.61	16.65	16.69	16.81		17.28	17.32	17.36
PROGRESSIVE PROGETTO												-4.25	0.00	3.50	4.75	5.80	6.31
PARZIALI PROGETTO												4.25	3.50	1.25	1.00	0.05	0.45
QUOTE PROGETTO												16.92	16.82	16.73	16.70	16.60	16.95
PROGRESSIVE RILEVATO												-4.25	0.00	4.75	5.90	6.00	6.75
PARZIALI RILEVATO												4.25	4.75	1.15	0.12	0.85	0.73
QUOTE RILEVATO												16.42	16.32	16.20	16.17	16.30	17.03



























PROFILO S03\_COMPLANARE

SEZIONE 44

PROGRESSIVA 860.00

BA RILEVATO m? 16.34  
 DB SCOTICO RILEVATO m? 2.46  
 EA BONIFICA m? 2.47  
 GA USURA 4 m? 0.23  
 GB BINDER 4 m? 0.33  
 GC BASE 4 m? 0.55  
 GD FONDAZIONE 4 m? 2.79  
 HA VEGETALE m? 1.10  
 IB REINTERRO S. VIAD. m? 1.77  
 ge AREA PAVIMENT. 4 m 5.50  
 hb SUPERF. VEGETALE m 4.82  
 ia AREA REINT. S. VIAD. m 3.04

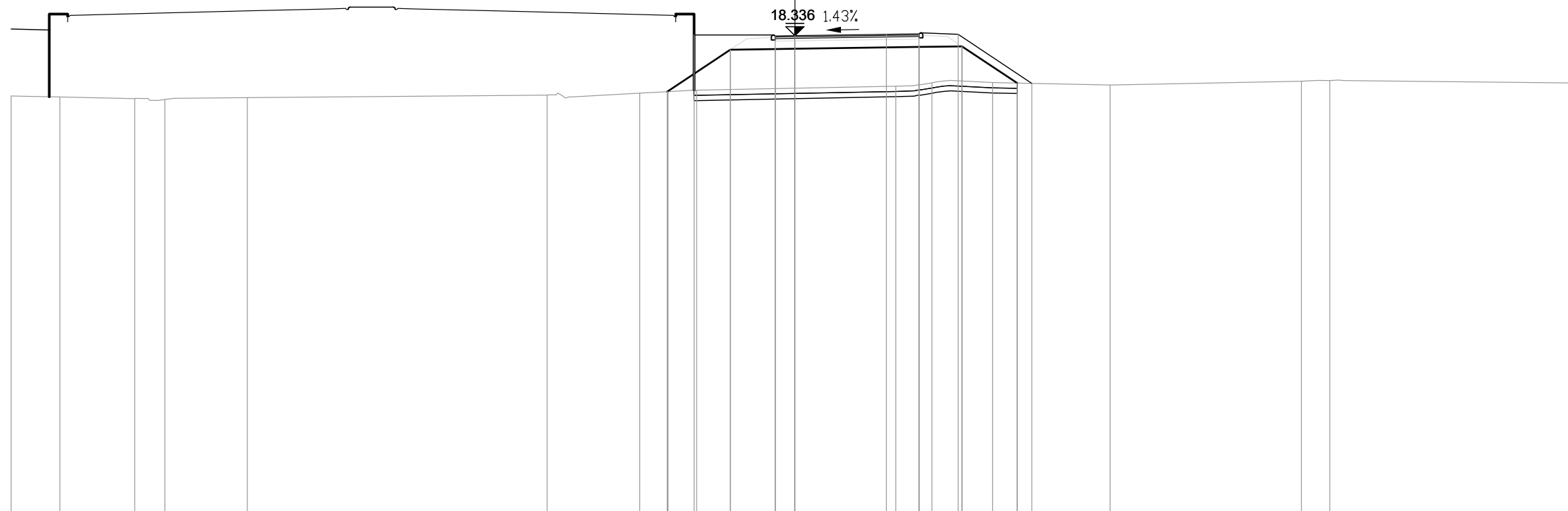

PROGRESSIVE TERRENO	-30.00	-28.14	-25.27	-24.12	-20.96	-9.48	-5.94	-4.85	-3.76		3.87	5.25	7.57	12.06	19.39	20.48	30.00	
PARZIALI TERRENO	1.86	2.87	1.15	3.16		11.48		3.54	1.09	1.09	7.63	1.38	2.32	4.49		7.33	1.09	9.52
QUOTE TERRENO	16.02	15.99	15.93	15.89	15.96	16.06	16.13	16.19	16.25		16.40	16.53	16.54	16.45	16.59	16.62	16.52	
PROGRESSIVE PROGETTO									-3.86		-0.75	0.00		3.50	4.75	6.25	9.07	
PARZIALI PROGETTO										3.11		3.50	1.25	1.50	2.82			
QUOTE PROGETTO									18.37		18.33	18.34		18.39	18.40	18.39	16.51	
PROGRESSIVE RILEVATO								-4.88	-2.47	-0.75	0.00		4.75	6.40	8.51			
PARZIALI RILEVATO								2.41	1.72	0.75	5.05	1.65	2.11					
QUOTE RILEVATO								16.19	17.80	17.83	17.84		17.90	17.93	16.52			











PROFILO S03\_COMPLANARE

SEZIONE 45Bbis

PROGRESSIVA 892.02

BA RILEVATO m? 17.39  
 DB SCOTICO RILEVATO m? 2.59  
 EA BONIFICA m? 2.59  
 GA USURA 4 m? 0.22  
 GB BINDER 4 m? 0.33  
 GC BASE 4 m? 0.55  
 GD FONDAZIONE 4 m? 2.38  
 HA VEGETALE m? 0.19  
 IB REINTERRO S. VIAD. m? 7.99  
 IC REINTERRO D. MURI m? 4.10  
 ge AREA PAVIMENT. 4 m 5.50  
 hb SUPERF. VEGETALE m 0.30  
 ia AREA REINT. S. VIAD. m 5.83  
 ic AREA REINT. D.MURI m 5.59

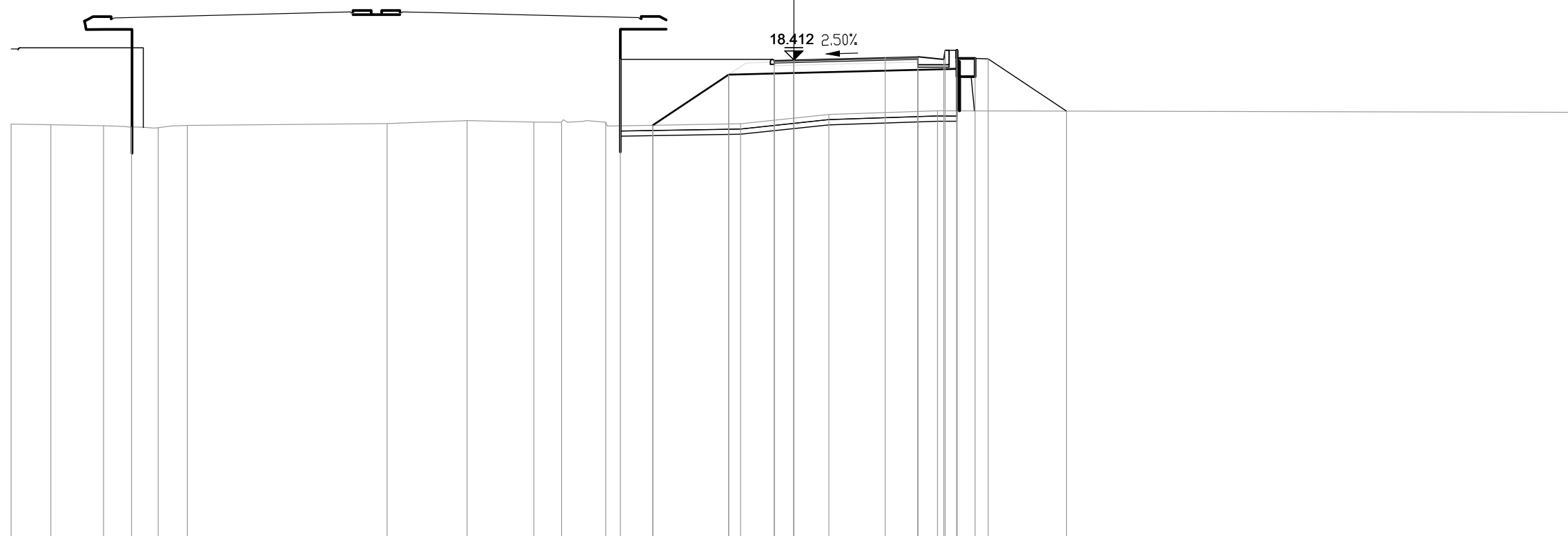

PROGRESSIVE TERRENO	-30.00	-28.48	-26.46	-25.39	-24.36	-23.24		-15.59	-12.52	-9.97	-8.91	-7.21		-2.04	1.34	5.51		29.94	30.00					
PARZIALI TERRENO	1.52	2.02	1.07	1.03	1.12		7.65	3.07	2.55	1.06	1.70		5.17	3.38	4.17		24.43	0.06						
QUOTE TERRENO	15.96	15.93	15.89	15.84	15.81	15.91		15.98	16.09	16.03	16.03	16.02		15.97	16.33	16.46		16.41	16.41					
PROGRESSIVE PROGETTO												-6.65		-0.75	0.00	3.50	4.75	5.80	6.25	6.25	6.95	7.45	10.45	
PARZIALI PROGETTO												5.90		3.50	1.25	1.00	0.05	0.45	0.70	0.50	3.00			
QUOTE PROGETTO												18.43		18.39	18.41	18.50	18.53	18.43	18.78	18.47	18.78	18.47	18.45	16.45
PROGRESSIVE RILEVATO													-5.41	-2.50	-0.75	0.00	4.75	6.25	6.25					
PARZIALI RILEVATO													2.91	1.75	0.75	5.075	1.50							
QUOTE RILEVATO													15.91	17.85	17.89	17.91	18.03	16.46	18.07					

PROFILO S03\_COMPLANARE

SEZIONE 46

PROGRESSIVA 900.00

BA RILEVATO	m?	18.42
CB DEM. BITUME RIL.	m?	1.78
CD DEM. FONDAZ. RIL.	m?	2.15
DB SCOTICO RILEVATO	m?	2.97
EA BONIFICA	m?	2.98
GA USURA 4	m?	0.23
GB BINDER 4	m?	0.33
GC BASE 4	m?	0.55
GD FONDAZIONE 4	m?	2.36
HA VEGETALE	m?	0.19
IB REINTERRO S. VIAD.	m?	29.70
IC REINTERRO D. MURI	m?	3.57
ge AREA PAVIMENT. 4 m	m	5.50
hb SUPERF. VEGETALE m	m	0.30
ia AREA REINT. S. VIAD.	m	15.03
ic AREA REINT. D.MURI m	m	5.17

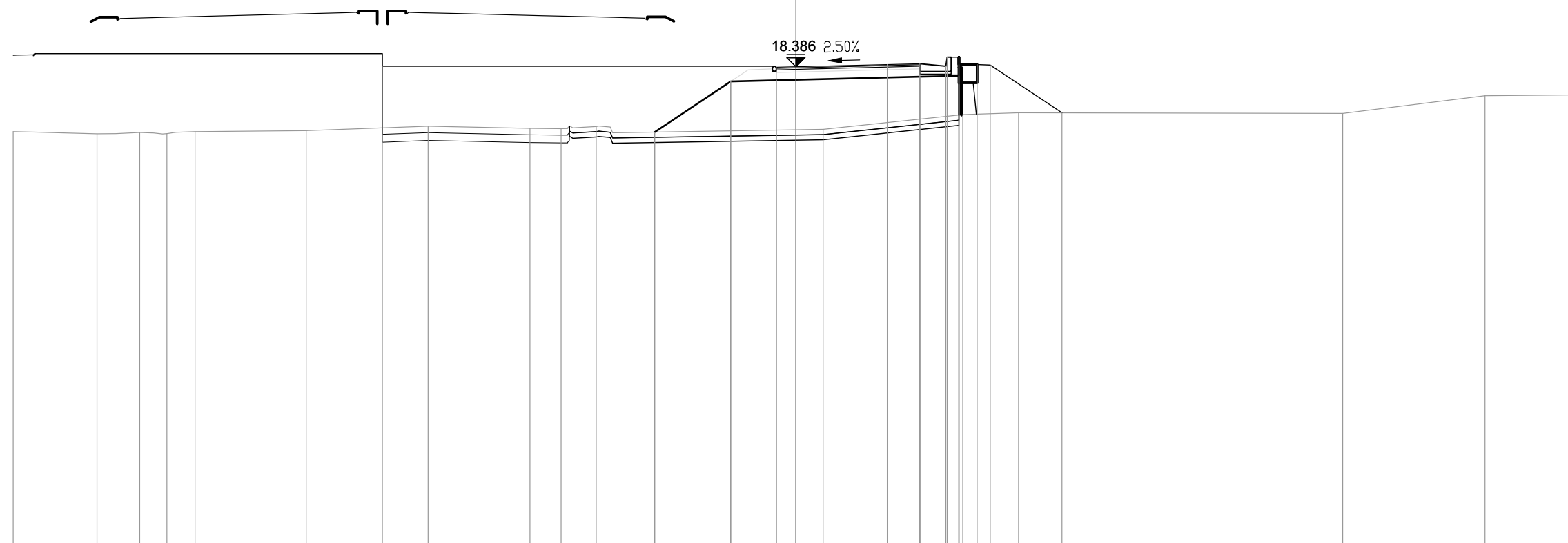

PROGRESSIVE TERRENO	-30.00	-26.79	-25.15	-24.11	-23.03	-18.77	-14.10	-10.20	-9.00	-7.65	1.04	6.40	8.54	20.96	26.41	30.00
PARZIALI TERRENO		3.21	1.64	1.04	1.08	4.26	4.67	3.90	1.20	1.35	8.69	5.36	2.14	12.42	5.45	3.59
QUOTE TERRENO	15.90	15.82	15.87	15.82	15.90	15.94	16.11	16.03	16.02	16.10	15.99	16.55	16.63	16.60	17.27	17.31
PROGRESSIVE PROGETTO						-15.85					-0.75	0.00	3.50	4.75	5.80	6.25
PARZIALI PROGETTO							15.10				3.50	1.25	1.00	0.05	0.45	0.70
QUOTE PROGETTO						18.41					18.47	18.50	18.40	18.75	18.47	18.45
PROGRESSIVE RILEVATO							-5.41	-2.50	-0.75	0.00	4.75	6.25	6.25	18.00	16.54	18.04
PARZIALI RILEVATO							2.91	1.75	0.75	0.75	5.475	1.50				
QUOTE RILEVATO							15.88	17.82	17.87	17.89	18.00	16.54	18.04			



PROFILO S03\_COMPLANARE

SEZIONE 48

PROGRESSIVA 940.00

BA RILEVATO	m?	16.21
CB DEM. BITUME RIL.	m?	1.78
CD DEM. FONDAZ. RIL.	m?	2.16
DB SCOTICO RILEVATO	m?	2.70
GA USURA 4	m?	0.20
GB BINDER 4	m?	0.34
GC BASE 4	m?	0.54
GD FONDAZIONE 4	m?	2.37
HA VEGETALE	m?	0.19
IB REINTERRO S. VIAD.	m?	23.57
IC REINTERRO D. MURI	m?	6.17
dc SUPERF. GRADON.	m	0.00
ge AREA PAVIMENT. 4	m	5.50
hb SUPERF. VEGETALE	m	0.30
ia AREA REINT. S. VIAD.	m	13.63
ic AREA REINT. D.MURI	m	7.06

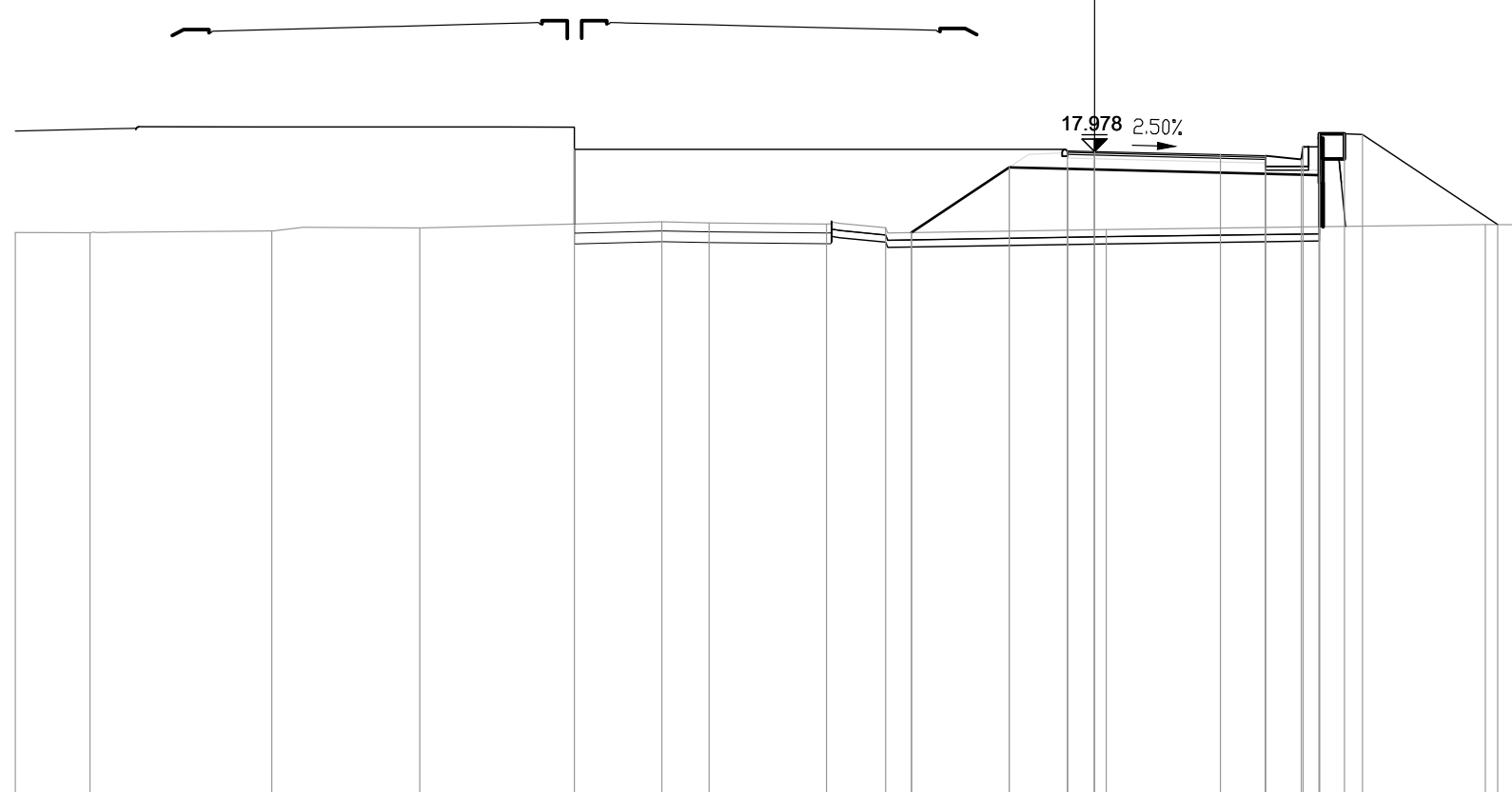

PROGRESSIVE TERRENO	-30.00	-27.93	-22.87	-18.76		-12.03	-10.71	-7.45	-5.81		0.33		10.86	16.15	30.00
PARZIALI TERRENO	2.07	5.06	4.11	6.73	1.32	3.26	1.64	6.14	10.53	5.29	13.85				
QUOTE TERRENO	15.73	15.72	15.77	15.85	16.02	16.00	15.97	15.86	15.81	15.95	15.92	16.17			
PROGRESSIVE PROGETTO						-14.46					-0.75	0.00	3.50	4.75	5.80
PARZIALI PROGETTO						13.71				3.50	1.25	1.00	0.05	0.45	0.70
QUOTE PROGETTO					18.04					17.89	17.86	17.76	18.11	18.47	18.47
PROGRESSIVE RILEVATO								-5.09	-2.37	-0.75	0.00	4.75	6.25	6.25	6.25
PARZIALI RILEVATO								2.72	1.62	0.75	5.075	1.50			
QUOTE RILEVATO								15.73	17.54	17.50	17.48	17.36	15.89	17.32	

PROFILO S03\_COMPLANARE

SEZIONE 49

PROGRESSIVA 960.00

BA RILEVATO	m?	13.26
CB DEM. BITUME RIL.	m?	1.78
CD DEM. FONDAZ. RIL.	m?	2.14
DB SCOTICO RILEVATO	m?	2.55
EA BONIFICA	m?	2.54
GA USURA 4	m?	0.22
GB BINDER 4	m?	0.33
GC BASE 4	m?	0.55
GD FONDAZIONE 4	m?	2.34
HA VEGETALE	m?	0.20
IB REINTERRO S. VIAD.	m?	18.39
IC REINTERRO D. MURI	m?	6.49
ge AREA PAVIMENT. 4 m		5.50
hb SUPERF. VEGETALE m		0.30
ia AREA REINT. S. VIAD	m	12.80
ic AREA REINT. D.MURI m		7.25

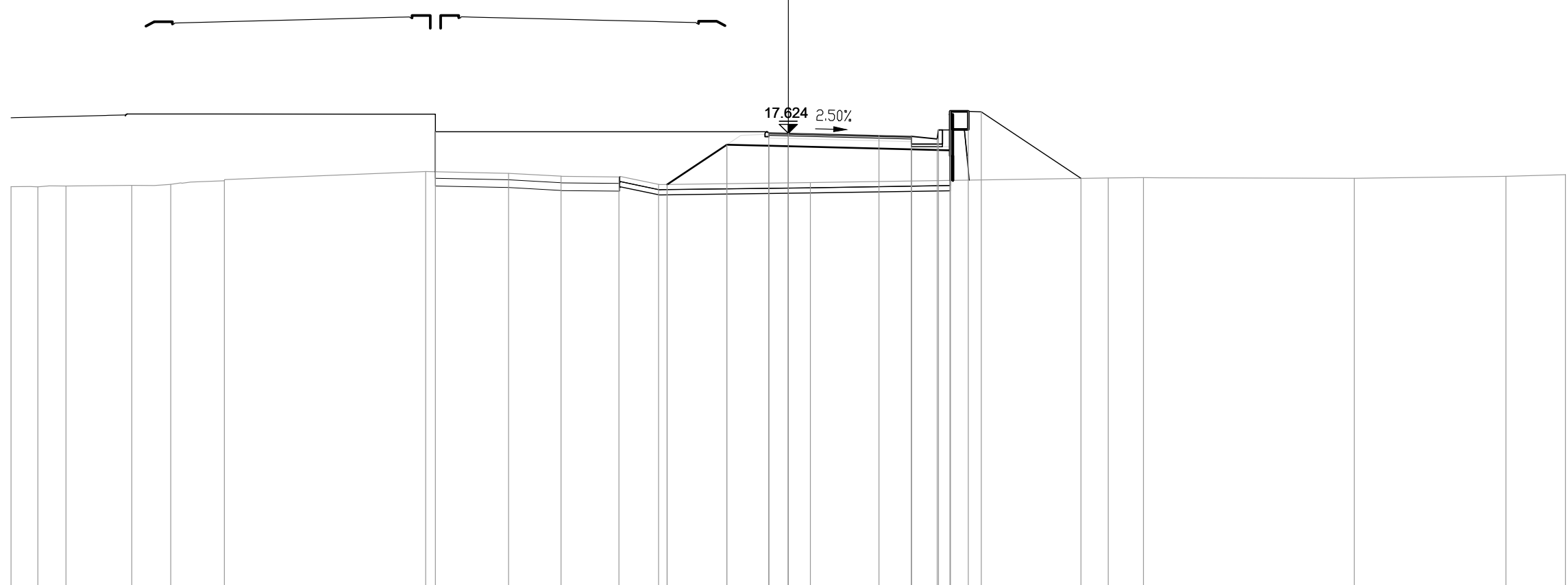

PROGRESSIVE TERRENO	-30.00	-28.97	-27.88	-25.34	-23.84	-21.77	-14.00	-10.80	-8.77	-6.54	-5.01	0.86	12.35	13.71	21.85	27.70	30.00				
PARZIALI TERRENO	1.03	1.09	2.54	1.50	2.07	7.77	3.20	2.03	2.23	1.53	5.87	11.49	1.36	8.14	5.85	2.30					
QUOTE TERRENO	15.56	15.56	15.59	15.62	15.65	15.79	16.15	16.08	15.97	15.94	15.65	15.72	15.90	15.91	15.88	15.97	16.02				
PROGRESSIVE PROGETTO							-13.62					-0.75	0.00	3.50	4.75	5.80	6.25	6.25	6.95	7.45	11.30
PARZIALI PROGETTO							12.87					3.50	1.25	1.00	0.05	0.45	0.70	0.50	3.85		
QUOTE PROGETTO							17.68					17.54	17.51	17.41	17.76	18.47	17.76	18.47	18.45	15.88	
PROGRESSIVE RILEVATO											-4.68	-2.37	-0.75	0.00	17.62	17.54	17.41	17.76	18.47	18.45	15.88
PARZIALI RILEVATO											2.31	1.62	0.75	0.00	5.675	4.75	6.25	6.25	1.50		
QUOTE RILEVATO											15.65	17.18	17.14	17.12	17.01	15.81	16.97				

PROFILO S03\_COMPLANARE

SEZIONE 50

PROGRESSIVA 980.00

BA RILEVATO	m?	5.78
CB DEM. BITUME RIL.	m?	1.88
CD DEM. FONDAZ. RIL.	m?	2.24
DB SCOTICO RILEVATO	m?	2.38
EA BONIFICA	m?	2.37
GA USURA 4	m?	0.20
GB BINDER 4	m?	0.34
GC BASE 4	m?	0.55
GD FONDAZIONE 4	m?	2.35
HA VEGETALE	m?	0.20
IB REINTERRO S. VIAD.	m?	14.12
IC REINTERRO D. MURI	m?	4.20
ge AREA PAVIMENT. 4	m	5.50
hb SUPERF. VEGETALE	m	0.30
ia AREA REINT. S. VIAD.	m	12.22
ic AREA REINT. D.MURI	m	5.62



17.261 2.50%



PROGRESSIVE TERRENO	-30.00	-25.81	-24.60	-23.15	-18.00	-14.80	-13.30	-11.62	-10.08	-5.43	-4.18	5.41	11.21	16.66	24.74	30.00
PARZIALI TERRENO	4.19	1.21	1.45	5.15	3.20	1.50	1.68	1.54	4.65	1.25	9.59	5.80	5.45	8.08	5.26	
QUOTE TERRENO	15.68	15.60	15.73	15.77	15.95	16.09	16.13	16.09	16.02	15.90	15.70	16.33	16.50	16.43	16.34	16.51
PROGRESSIVE PROGETTO							-13.05					3.50	4.75	5.80	6.25	6.25
PARZIALI PROGETTO							12.30					3.50	1.25	1.00	0.05	0.45
QUOTE PROGETTO							17.32					17.17	17.14	17.04	17.39	18.47
PROGRESSIVE RILEVATO										-3.95	-2.37	-0.75	0.00	4.75	6.25	6.25
PARZIALI RILEVATO										1.58	1.62	0.75	5.675	1.50		
QUOTE RILEVATO										15.77	16.82	16.78	16.76	16.64	16.36	16.60













PROFILO S03\_COMPLANARE

SEZIONE 55

PROGRESSIVA 1076.32

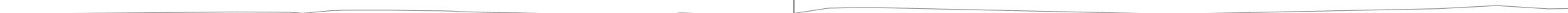

0

200

PROGRESSIVE  
TERRENO

PARZIALI  
TERRENO

QUOTE  
TERRENO

PROGRESSIVE  
PROGETTO

PARZIALI  
PROGETTO

QUOTE  
PROGETTO

PROGRESSIVE  
RILEVATO

PARZIALI  
RILEVATO

QUOTE  
RILEVATO