

COMMITTENTE:



DIREZIONE LAVORI:



APPALTATORE:
CONSORZIO:



SOCI:



PROGETTAZIONE:
MANDATARIA:



MANDANTI:



PROGETTO ESECUTIVO

ITINERARIO NAPOLI - BARI RADDOPPIO TRATTA APICE - ORSARA I LOTTO FUNZIONALE APICE - HIRPINIA

VIADOTTI

VI04 - VIADOTTO UFITA APICE DA KM 16+713 A KM 17+418

RELAZIONE DI CALCOLO FONDAZIONI PILE DA P17 A P20

APPALTATORE	DIRETTORE DELLA PROGETTAZIONE	PROGETTISTA
Consorzio HIRPINIA AV Il Direttore Tecnico Ing. Vincenzo Moriello 10/06/2020	Il Responsabile integrazione fra le varie prestazioni specialistiche Ing. G. Cassani	Alpina S.p.A. Ing. Paolo Galvanin

COMMESSA LOTTO FASE ENTE TIPO DOC. OPERA/DISCIPLINA Progr. REV. SCALA:

IF28	01	E	ZZ	CL	VI0403	008	B	-
------	----	---	----	----	--------	-----	---	---

Rev.	Descrizione	Redatto	Data	Verificato	Data	Approvato	Data	Autorizzato Data
A	Emissione per consegna	P.Pazzaglia	21/02/2020	L.Zanelotti	21/02/2020	M.Vernaleone	21/02/2020	P.Galvanin
B	Recepimento Istrutorie	P.Pazzaglia	10/06/2020	L.Zanelotti	10/06/2020	M.Vernaleone	10/06/2020	
								10/06/2020

File: IF2801EZZCLVI0403008B

n. Elab.:

APPALTATORE: <u>Consorzio</u> HIRPINIA AV	<u>Soci</u> SALINI IMPREGILO S.P.A. ASTALDI S.P.A.	ITINERARIO NAPOLI – BARI RADDOPPIO TRATTA APICE – ORSARA I LOTTO FUNZIONALE APICE – HIRPINIA				
PROGETTAZIONE: <u>Mandatario</u> ROCKSOIL S.P.A.	<u>Mandanti</u> NET ENGINEERING S.P.A. ALPINA S.P.A.					
PROGETTO ESECUTIVO RELAZIONE DI CALCOLO FONDAZIONI PILE DA P17 A P20	COMMESSA IF28	LOTTO 01	CODIFICA E ZZ CL	DOCUMENTO VI0403 008	REV. B	FOGLIO 2 di 143

Indice

1	INTRODUZIONE	4
2	DOCUMENTI DI RIFERIMENTO E NORMATIVA.....	5
2.1	DOCUMENTI DI RIFERIMENTO.....	5
2.2	NORMATIVA E STRANDARD DI RIFERIMENTO	6
2.3	SOFTWARE	6
3	MATERIALI.....	7
3.1	ACCIAIO.....	7
3.1.1	ACCIAIO PER ARMATURA STRUTTURE IN C.A.	7
3.1.2	PROFILATI E PIASTRE METALLICHE.....	7
3.2	CALCESTRUZZO.....	7
3.2.1	CALCESTRUZZO MAGRO PER GETTI DI LIVELLAMENTO	7
3.2.2	CALCESTRUZZO PALI, DIAFRAMMI DI FONDAZIONE, CORDOLI E OPERE PROVVISORIALI	7
3.2.3	CALCESTRUZZO PER FONDAZIONI PILE E SPALLE	7
4	DESCRIZIONE DELLE FONDAZIONI E STRATIGRAFIA DI PROGETTO	9
4.1	DESCRIZIONE DEL SISTEMA FONDAZIONALE	9
4.2	STRATIGRAFIA DI RIFERIMENTO.....	9
5	CRITERI DI VERIFICA.....	10
6	SCARICHI DI FONDAZIONE	11
6.1	SCARICHI ALLA BASE DELLA PILA.....	11
6.1.1	COMBINAZIONI DELLE AZIONI AGLI STATI LIMITE ULTIMI SISMICI.....	11
6.1.2	COMBINAZIONI DELLE AZIONI AGLI STATI LIMITE ULTIMI STATICI (SLU).....	12
6.1.3	COMBINAZIONI DELLE AZIONI AGLI STATI LIMITE DI ESERCIZIO (SLE).....	12
6.2	SCARICHI A INTRADOSSO PLINTO.....	13
6.2.1	COMBINAZIONI DELLE AZIONI AGLI STATI LIMITE ULTIMI SISMICI (SLV).....	13
6.2.2	COMBINAZIONI DELLE AZIONI AGLI STATI LIMITE ULTIMI STATICI (SLU).....	14
6.2.3	COMBINAZIONI DELLE AZIONI AGLI STATI LIMITE DI ESERCIZIO (SLE).....	14
7	ANALISI DELL'INTERAZIONE FONDAZIONE-TERRENO	15
7.1	DESCRIZIONE DEL MODELLO DI CALCOLO GROUP	15
7.2	SINTESI DEI RISULTATI AGLI STATI LIMITE DI ESERCIZIO (SLE)	21
7.2.1	SPOSTAMENTI.....	23
7.3	SINTESI DEI RISULTATI AGLI STATI LIMITE ULTIMI STATICI (SLU).....	24
7.4	SINTESI DEI RISULTATI AGLI STATI LIMITE ULTIMI SISMICI (SLV).....	26

APPALTATORE: Consorzio Soci   	ITINERARIO NAPOLI – BARI RADDOPPIO TRATTA APICE – ORSARA I LOTTO FUNZIONALE APICE – HIRPINIA																	
PROGETTAZIONE: Mandataria Mandanti   	<table border="1" style="width: 100%; border-collapse: collapse;"> <tr> <td style="width: 16.6%;">COMMESSA</td> <td style="width: 16.6%;">LOTTO</td> <td style="width: 16.6%;">CODIFICA</td> <td style="width: 16.6%;">DOCUMENTO</td> <td style="width: 16.6%;">REV.</td> <td style="width: 16.6%;">FOGLIO</td> </tr> <tr> <td>IF1N</td> <td>01 E ZZ</td> <td>RG</td> <td>MD0000 001</td> <td>B</td> <td>3 di 143</td> </tr> </table>						COMMESSA	LOTTO	CODIFICA	DOCUMENTO	REV.	FOGLIO	IF1N	01 E ZZ	RG	MD0000 001	B	3 di 143
COMMESSA	LOTTO	CODIFICA	DOCUMENTO	REV.	FOGLIO													
IF1N	01 E ZZ	RG	MD0000 001	B	3 di 143													

8	VERIFICA DEI PALI DI FONDAZIONE	29
8.1.1	SCHEMI ARMATURA E INCIDENZA DEL PALO	33
9	VERIFICHE ALLO SLU DI TIPO GEOTECNICO	36
9.1	VERIFICA DI CAPACITÀ PORTANTE DEL PALO SINGOLO	36
9.1.1	CAPACITÀ PORTANTE VERTICALE DEL PALO SINGOLO	36
9.1.2	VERIFICA DI CAPACITÀ PORTANTE VERTICALE DEL GRUPPO DI PALI.....	41
9.1.3	VERIFICA DI CAPACITÀ PORTANTE ORIZZONTALE DEL GRUPPO DI PALI	42
10	DIMENSIONAMENTO E VERIFICA DEL PLINTO DI FONDAZIONE [P2 P17 P18 P19 P20]	43
10.1	DESCRIZIONE DEL MODELLO	43
10.1.1	COMBINAZIONI E CARICHI	45
10.2	SOLLECITAZIONI.....	48
10.2.1	SOLLECITAZIONI SLV.....	48
10.2.2	SOLLECITAZIONI SLU	51
10.2.3	SOLLECITAZIONI SLE.....	53
10.3	VERIFICHE SLU/SLE	54
10.3.1	SOLLECITAZIONI DI VERIFICA	54
10.3.2	VERIFICHE A FLESSIONE E TAGLIO.....	58
10.4	VERIFICA PUNZONAMENTO	72
10.5	VERIFICA TIRANTE-PUNTORE.....	73
10.6	STIMA INCIDENZE DI ARMATURA.....	75
11	ALLEGATO: TABULATI GROUP.....	76
11.1	PILA SLE.....	76
11.2	PILA SLU – SLV.....	90

APPALTATORE: <u>Consorzio</u> <u>Soci</u> HIRPINIA AV SALINI IMPREGILO S.P.A. ASTALDI S.P.A	ITINERARIO NAPOLI – BARI RADDOPPIO TRATTA APICE – ORSARA I LOTTO FUNZIONALE APICE – HIRPINIA					
PROGETTAZIONE: <u>Mandatario</u> <u>Mandanti</u> ROCKSOIL S.P.A NET ENGINEERING S.P.A. ALPINA S.P.A.						
PROGETTO ESECUTIVO RELAZIONE DI CALCOLO FONDAZIONI PILE DA P17 A P20	COMMESSA IF28	LOTTO 01	CODIFICA E ZZ CL	DOCUMENTO VI0403 008	REV. B	FOGLIO 4 di 143

1 INTRODUZIONE

Nell'ambito della redazione del Progetto Esecutivo della tratta Apice - Orsara del Lotto 1 Apice – Irpinia - potenziamento della linea ferroviaria Napoli – Bari, la presente relazione riporta i risultati del dimensionamento e verifiche delle fondazioni – plinto su pali – delle pile da P17 a P20 del Viadotto VI04 denominato Viadotto Ufita Apice.

Le pile sostengono le campate di luce 25m, costituite da n. 4 cassoncini/travi in c.a.p. affiancati e solidarizzati da una soletta in c.a. gettata in opera.

Considerate le caratteristiche geometriche, le condizioni geotecniche e l'entità dei carichi agenti, le analisi sono sviluppate in riferimento alla pila P20.

Per quanto riguarda i criteri di verifica adottati per le analisi del sistema di fondazione adottato si rimanda al documento IF2801EZZRBVI0003001: Viadotti ferroviari – Relazione sui criteri di calcolo delle fondazioni.

APPALTATORE: Consorzio Soci   	ITINERARIO NAPOLI – BARI RADDOPPIO TRATTA APICE – ORSARA I LOTTO FUNZIONALE APICE – HIRPINIA																	
PROGETTAZIONE: Mandataria Mandanti   	<table border="1" style="width: 100%; border-collapse: collapse;"> <tr> <td style="width: 16.6%;">COMMESSA</td> <td style="width: 16.6%;">LOTTO</td> <td style="width: 16.6%;">CODIFICA</td> <td style="width: 16.6%;">DOCUMENTO</td> <td style="width: 16.6%;">REV.</td> <td style="width: 16.6%;">FOGLIO</td> </tr> <tr> <td>IF1N</td> <td>01 E ZZ</td> <td>RG</td> <td>MD0000 001</td> <td>B</td> <td>5 di 143</td> </tr> </table>						COMMESSA	LOTTO	CODIFICA	DOCUMENTO	REV.	FOGLIO	IF1N	01 E ZZ	RG	MD0000 001	B	5 di 143
COMMESSA	LOTTO	CODIFICA	DOCUMENTO	REV.	FOGLIO													
IF1N	01 E ZZ	RG	MD0000 001	B	5 di 143													
PROGETTO ESECUTIVO RELAZIONE DI CALCOLO FONDAZIONI PILE DA P17 A P20																		

2 Documenti di riferimento e normativa

2.1 DOCUMENTI DI RIFERIMENTO

- 1) IF2801EZZRGVI0000001 - Relazione Tecnico-Descrittiva delle Opere Civili - Viadotti VI01, VI02, VI03 e VI04;
- 2) IF2801EZZRBVI0003001 - Relazione sui criteri di calcolo delle fondazioni;
- 3) IF2801EZZRBOC0101001 - Relazione Geotecnica Generale;
- 4) IF2801EZZF6OC0101001 - Profilo geologico - Tratta all'aperto Isca Girasole, da pk 0+000 a 2+705;
- 5) IF2801EZZF6OC0101002 - Profilo geologico - Tratta all'aperto valle Ufita, da pk 4+695 a pk 5+090;
- 6) IF2801EZZF6OC0101003 - Profilo geologico - Tratta all'aperto Castel del Fiego, da pk 9+550 a pk 10+090;
- 7) IF2801EZZF6OC0101004 - Profilo geologico - Tratta all'aperto Iscalonga, da pk 16+610 a pk 18+700;
- 8) IF2801EZZRBOC0301001 - Relazione Sismica generale;
- 9) IF2801EZZP9VI0400000 - Pianta fondazioni e sezioni (tav. 1 di 6)
- 10) IF2801EZZP9VI0400001 - Pianta fondazioni e sezioni (tav. 2 di 6)
- 11) IF2801EZZP9VI0400002 - Pianta fondazioni e sezioni (tav. 3 di 6)
- 12) IF2801EZZP9VI0400003 - Pianta fondazioni e sezioni (tav. 4 di 6)
- 13) IF2801EZZP9VI0400004 - Pianta fondazioni e sezioni (tav. 5 di 6)
- 14) IF2801EZZP9VI0400005 - Pianta fondazioni e sezioni (tav. 6 di 6)
- 15) IF2801EZZP9VI0400006 - Pianta impalcato e prospetto (tav. 1 di 6)
- 16) IF2801EZZP9VI0400007 - Pianta impalcato e prospetto (tav. 2 di 6)
- 17) IF2801EZZP9VI0400008 - Pianta impalcato e prospetto (tav. 3 di 6)
- 18) IF2801EZZP9VI0400009 - Pianta impalcato e prospetto (tav. 4 di 6)
- 19) IF2801EZZP9VI0400010 - Pianta impalcato e prospetto (tav. 5 di 6)
- 20) IF2801EZZP9VI0400011 - Pianta impalcato e prospetto (tav. 6 di 6)
- 21) IF2801EZZCLVI0404001 - Spalla A: Relazione di calcolo strutture in elevazione
- 22) IF2801EZZCLVI0405001 - Pile P1, P2, P21, P22, P23 e P24: Relazione di calcolo strutture in elevazione
- 23) IF2801EZZCLVI0405002 - Pila P3: Relazione di calcolo strutture in elevazione
- 24) IF2801EZZCLVI0405003 - Pila P4 : Relazione di calcolo strutture in elevazione
- 25) IF2801EZZCLVI0405004 - Pila P5: Relazione di calcolo strutture in elevazione
- 26) IF2801EZZCLVI0405005 - Pila P6: Relazione di calcolo strutture in elevazione
- 27) IF2801EZZCLVI0405006 - Pila da P7 a P16: Relazione di calcolo strutture in elevazione
- 28) IF2801EZZCLVI0405007 - Pile da P17 a P20: Relazione di calcolo strutture in elevazione
- 29) IF2801EZZCLVI0404002 - Spalla B: Relazione di calcolo strutture in elevazione

APPALTATORE: Consorzio Soci   	ITINERARIO NAPOLI – BARI RADDOPPIO TRATTA APICE – ORSARA I LOTTO FUNZIONALE APICE – HIRPINIA																	
PROGETTAZIONE: Mandataria Mandanti   	<table border="1" style="width: 100%; border-collapse: collapse;"> <tr> <td style="width: 16.6%;">COMMESSA</td> <td style="width: 16.6%;">LOTTO</td> <td style="width: 16.6%;">CODIFICA</td> <td style="width: 16.6%;">DOCUMENTO</td> <td style="width: 16.6%;">REV.</td> <td style="width: 16.6%;">FOGLIO</td> </tr> <tr> <td>IF1N</td> <td>01 E ZZ</td> <td>RG</td> <td>MD0000 001</td> <td>B</td> <td>6 di 143</td> </tr> </table>						COMMESSA	LOTTO	CODIFICA	DOCUMENTO	REV.	FOGLIO	IF1N	01 E ZZ	RG	MD0000 001	B	6 di 143
COMMESSA	LOTTO	CODIFICA	DOCUMENTO	REV.	FOGLIO													
IF1N	01 E ZZ	RG	MD0000 001	B	6 di 143													

- 30) IF2801EZZCLVI0403001 - Relazione di calcolo fondazioni spalla A e spalla B
- 31) IF2801EZZCLVI0403002 - Relazione di calcolo fondazioni pile Pile P1, P2, P21, P22,P23 e P24
- 32) IF2801EZZCLVI0403003 - Relazione di calcolo fondazioni pile P3 e P6
- 33) IF2801EZZCLVI0403004 - Relazione di calcolo fondazioni pile P4 e P5
- 34) IF2801EZZCLVI0403007 - Relazione di calcolo fondazioni pile da P7 a P16
- 35) IF2801EZZCLVI0403008 - Relazione di calcolo fondazioni pile da P17 a P20.

2.2 **NORMATIVA E STRANDARD DI RIFERIMENTO**

- 36) Decreto Ministeriale del 14/01/2008: “Approvazione delle Nuove Norma Tecniche per le Costruzioni”, G.U. n.29 del 04/02/2008, Supplemento Ordinario n.30;
- 37) Circolare 01/02/2009, n.617 - Istruzione per l'applicazione delle “Nuove Norme Tecniche per le Costruzioni” di cui al D.M. 14/01/2008;
- 38) DM 06/05/2008 - “Integrazione al DM 14/01/2008 di approvazione delle Nuove Norme Tecniche per le Costruzioni”;
- 39) RFI DTC SI MA IFS 001 A - “Manuale di progettazione delle opere civili”;
- 40) RFI DTC SI SP IFS 001 A - “Capitolato generale tecnico d'appalto delle opere civili”;
- 41) UNI EN 1997-1: Eurocodice 7 - Progettazione Geotecnica - Parte 1: Regole generali;
- 42) UNI EN 1998-5: Eurocodice 8 - Progettazione delle strutture per la resistenza sismica - Parte 5: Fondazioni, strutture di contenimento ed aspetti geotecnici;
- 43) Caltrans. Guidelines on Foundation Loading and Deformation Due to Liquefaction Induced Lateral Spreading. California Department of Transportation, Sacramento, California, 2012;
- 44) JRA (2002) – Specifications for Highway Bridges, JapanRoad Association. Part V: Seismic Design.

2.3 **SOFTWARE**

- 45) Lpile, Ensoft Inc, versione 2016, release n. 9;
- 46) Group, Ensoft Inc, versione 2016, release n.10;
- 47) GeoStru, RC-SEC, Calcolo di sezioni in Cemento Armato;
- 48) Pozzi J – Pozzi di fondazione o di stabilizzazione – VOL. 4, T. Collotta 2010.

APPALTATORE: Consorzio Soci   	ITINERARIO NAPOLI – BARI RADDOPPIO TRATTA APICE – ORSARA I LOTTO FUNZIONALE APICE – HIRPINIA																	
PROGETTAZIONE: Mandataria Mandanti   	<table border="1" style="width: 100%; border-collapse: collapse;"> <tr> <td style="width: 16.6%;">COMMESSA</td> <td style="width: 16.6%;">LOTTO</td> <td style="width: 16.6%;">CODIFICA</td> <td style="width: 16.6%;">DOCUMENTO</td> <td style="width: 16.6%;">REV.</td> <td style="width: 16.6%;">FOGLIO</td> </tr> <tr> <td>IF1N</td> <td>01 E ZZ</td> <td>RG</td> <td>MD0000 001</td> <td>B</td> <td>7 di 143</td> </tr> </table>						COMMESSA	LOTTO	CODIFICA	DOCUMENTO	REV.	FOGLIO	IF1N	01 E ZZ	RG	MD0000 001	B	7 di 143
COMMESSA	LOTTO	CODIFICA	DOCUMENTO	REV.	FOGLIO													
IF1N	01 E ZZ	RG	MD0000 001	B	7 di 143													
PROGETTO ESECUTIVO RELAZIONE DI CALCOLO FONDAZIONI PILE DA P17 A P20																		

3 Materiali

Il progetto strutturale delle fondazioni prevede l'uso dei materiali con le caratteristiche meccaniche minime riportate nei paragrafi seguenti.

3.1 ACCIAIO

3.1.1 Acciaio per armatura strutture in c.a.

Barre ad aderenza migliorata, saldabile, tipo B450C dotato delle seguenti caratteristiche meccaniche:

- tensione caratteristica di rottura: $f_{tk} \geq 540$ MPa
- tensione caratteristica di snervamento: $f_{yk} \geq 450$ MPa
- allungamento caratteristico: ≥ 7.5 %
- rapporto tensione di rottura/ tensione di snervamento: $1.15 \leq f_{tk}/f_{yk} < 1.35$

3.1.2 Profilati e piastre metalliche

- - Acciaio tipo: EN 10025-S275 JR
- - Tensione di rottura a trazione: $f_{tk} \geq 430$ MPa
- - Tensione di snervamento: $f_{yk} \geq 275$ MPa

3.2 CALCESTRUZZO

3.2.1 Calcestruzzo magro per getti di livellamento

- Classe di resistenza: C12/15
- classe di esposizione: X0

3.2.2 Calcestruzzo pali, diaframmi di fondazione, cordoli e opere provvisionali

- Classe di resistenza: C25/30
- classe di consistenza: S4
- classe di esposizione: XC2
- dimensione massima dell'inerte: $D_{max} = 32$ mm
- copriferro minimo: $C_{f,min} \geq 60$ mm

3.2.3 Calcestruzzo per fondazioni pile e spalle

- Classe di resistenza: C28/35
- classe di consistenza: S4
- classe di esposizione: XC2

APPALTATORE: Consorzio Soci   	ITINERARIO NAPOLI – BARI RADDOPPIO TRATTA APICE – ORSARA I LOTTO FUNZIONALE APICE – HIRPINIA																	
PROGETTAZIONE: Mandataria Mandanti   	<table border="1" style="width: 100%; border-collapse: collapse;"> <tr> <td style="width: 16.6%;">COMMESSA</td> <td style="width: 16.6%;">LOTTO</td> <td style="width: 16.6%;">CODIFICA</td> <td style="width: 16.6%;">DOCUMENTO</td> <td style="width: 16.6%;">REV.</td> <td style="width: 16.6%;">FOGLIO</td> </tr> <tr> <td style="text-align: center;">IF1N</td> <td style="text-align: center;">01 E ZZ</td> <td style="text-align: center;">RG</td> <td style="text-align: center;">MD0000 001</td> <td style="text-align: center;">B</td> <td style="text-align: center;">8 di 143</td> </tr> </table>						COMMESSA	LOTTO	CODIFICA	DOCUMENTO	REV.	FOGLIO	IF1N	01 E ZZ	RG	MD0000 001	B	8 di 143
COMMESSA	LOTTO	CODIFICA	DOCUMENTO	REV.	FOGLIO													
IF1N	01 E ZZ	RG	MD0000 001	B	8 di 143													

- dimensione massima dell'inerte:
 $D_{max} = 25 \text{ mm}$
- copriferro minimo:
 $C_{f,min} \geq 40 \text{ mm}$

APPALTATORE: Consorzio Soci   	ITINERARIO NAPOLI – BARI RADDOPPIO TRATTA APICE – ORSARA I LOTTO FUNZIONALE APICE – HIRPINIA					
PROGETTAZIONE: Mandataria Mandanti   						
PROGETTO ESECUTIVO RELAZIONE DI CALCOLO FONDAZIONI PILE DA P17 A P20	COMMESSA IF1N	LOTTO 01 E ZZ	CODIFICA RG	DOCUMENTO MD0000 001	REV. B	FOGLIO 9 di 143

4 DESCRIZIONE DELLE FONDAZIONI E STRATIGRAFIA DI PROGETTO

4.1 DESCRIZIONE DEL SISTEMA FONDAZIONALE

La fondazione della pila P17 è costituita da: un plinto a sezione rettangolare di dimensioni 12.0 m x 16.5 m² e altezza di 2.5 m; su n.12 pali trivellati di diametro $\varnothing = 1500$ mm e lunghezza variabile L = 24.0 m.

4.2 STRATIGRAFIA DI RIFERIMENTO

In accordo con quanto riportato nella Relazione Geotecnica Generale - ref. 3), la stratigrafia e i parametri geotecnici di riferimento sono riportati nella seguente Tabella 1 unitamente alla portanza limite laterale e di base dei diaframmi.

La quota piano campagna di riferimento è ca. 154.60 m s.l.m.. Si considera la profondità della testa del palo da p.c. di ca. 5.5m.

STRATIGRAFIA da quota testa palo				PARAMETRI GEOTECNICI DI RIFERIMENTO			PORTANZA LIMITE DEGLI ELEMENTI FONDAZIONE	
DA	A	ΔH	UNITA' DI RIFERIMENTO	γ	φ	Cu	qs	qb
[m]	[m]	[m]		[kN/m ³]	[°]	[kPa]	[kPa]	[kPa]
0,0	2,30	2,30	ALL2-S	19	29	-	45	-
2,3	8,00	5,70	BNA3	20.5		105	76.85	2173.7
8,0	14,00	6,00	BNA3	20.5	33		93	2900
14,0	20,60	6,60	BNA3	20.5		200	106.07	3000
20,6	29,20	8,60	BNA3	20.5	33		150	4300
29,2	BNA3	20.5		300	129.9	3674.2

Tabella 1 Stratigrafia e parametri geotecnici di riferimento

La falda è assunta alla profondità di 1m dalla quota testa palo.

APPALTATORE: Consorzio Soci   	ITINERARIO NAPOLI – BARI RADDOPPIO TRATTA APICE – ORSARA I LOTTO FUNZIONALE APICE – HIRPINIA																	
PROGETTAZIONE: Mandataria Mandanti   	<table border="1" style="width: 100%; border-collapse: collapse;"> <tr> <td style="width: 16.6%;">COMMESSA</td> <td style="width: 16.6%;">LOTTO</td> <td style="width: 16.6%;">CODIFICA</td> <td style="width: 16.6%;">DOCUMENTO</td> <td style="width: 16.6%;">REV.</td> <td style="width: 16.6%;">FOGLIO</td> </tr> <tr> <td style="text-align: center;">IF1N</td> <td style="text-align: center;">01 E ZZ</td> <td style="text-align: center;">RG</td> <td style="text-align: center;">MD0000 001</td> <td style="text-align: center;">B</td> <td style="text-align: center;">10 di 143</td> </tr> </table>						COMMESSA	LOTTO	CODIFICA	DOCUMENTO	REV.	FOGLIO	IF1N	01 E ZZ	RG	MD0000 001	B	10 di 143
COMMESSA	LOTTO	CODIFICA	DOCUMENTO	REV.	FOGLIO													
IF1N	01 E ZZ	RG	MD0000 001	B	10 di 143													
PROGETTO ESECUTIVO RELAZIONE DI CALCOLO FONDAZIONI PILE DA P17 A P20																		

5 CRITERI DI VERIFICA

Per ogni stato limite ultimo deve essere rispettata la condizione:

$$Ed \leq Rd;$$

dove Ed è il valore di progetto dell'azione o dell'effetto dell'azione e Rd è il valore di progetto della resistenza.

Le verifiche sono sviluppate secondo l'approccio 2:

combinazione: A1+M1+R3,

in cui è previsto un'unica combinazione di gruppi di coefficienti, da adottare sia nelle verifiche strutturali (STR) sia nelle verifiche geotecniche (GEO).

Per maggiori dettagli sui criteri di calcolo e verifica si rimanda alla relazione ref. 2).

Per le verifiche a fessurazione si ricorda che sono svolte per condizioni ambientali ordinarie e armature poco sensibili (vedasi § 9.3.1 di ref. 2)).

APPALTATORE: Consorzio Soci 	ITINERARIO NAPOLI – BARI RADDOPPIO TRATTA APICE – ORSARA I LOTTO FUNZIONALE APICE – HIRPINIA					
PROGETTAZIONE: Mandataria Mandanti 						
PROGETTO ESECUTIVO RELAZIONE DI CALCOLO FONDAZIONI PILE DA P17 A P20	COMMESSA IF1N	LOTTO 01 E ZZ	CODIFICA RG	DOCUMENTO MD0000 001	REV. B	FOGLIO 11 di 143

6 SCARICHI DI FONDAZIONE

Di seguito si esaminano gli scarichi a quota spiccato pila, derivanti dall'analisi strutturale complessiva del viadotto, e si valutano le azioni ad intradosso plinto considerando i trasporti delle azioni di taglio, e i contributi addizionali, in termini di azioni permanenti, dovuti ai pesi propri del plinto di fondazione e del terreno di ricoprimento definitivo.

6.1 SCARICHI ALLA BASE DELLA PILA

Di seguito si riportano gli scarichi alla base della pila per le combinazioni di carico sismiche (SLV), statiche (SLU) e di esercizio (SLE).

Nella **Figura 6-1** la convenzione dei segni assunta per le pile.



Figura 6-1: Sistema di riferimento proprio delle pile

6.1.1 Combinazioni delle azioni agli stati limite ultimi sismici

Nella seguente **Tabella 2** si riportano le combinazioni di carico più gravose agli stati limite ultimi (SLV) in presenza di sisma.

Tali carichi sono stati ottenuti considerando la struttura in elevazione in classe di duttilità B (fattore di struttura $q=1.5$). Per il dimensionamento e le verifiche del sistema fondazione le azioni da considerare sono le resistenze degli elementi strutturali soprastanti, con il limite, in accordo alle NTC 2008 (ref. 36)), che il fattore di amplificazione non superi $\gamma_{Rd} = 1.1$.

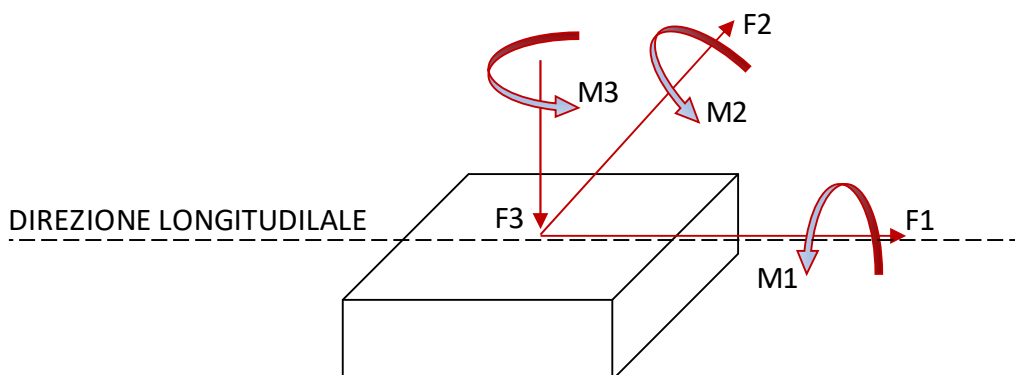
APPALTATORE: Consorzio Soci   	ITINERARIO NAPOLI – BARI RADDOPPIO TRATTA APICE – ORSARA I LOTTO FUNZIONALE APICE – HIRPINIA
PROGETTAZIONE: Mandataria Mandanti   	
PROGETTO ESECUTIVO RELAZIONE DI CALCOLO FONDAZIONI PILE DA P17 A P20	COMMESSA LOTTO CODIFICA DOCUMENTO REV. FOGLIO IF1N 01 E ZZ RG MD0000 001 B 12 di 143

Sollecitazioni estradosso fondazione SLV							
sollecitazione	combinazione	F1	F2	F3	M1	M2	M3
		KN	KN	KN	KN-m	KN-m	kN-m
MAX F1	slu-SISMA6	11902	2957	12042	-30635	112121	162
MIN F1	slu-SISMA1	-11365	-2907	19010	31461	-106211	-113
MAX F2	slu-SISMA32	3674	9824	12528	-102819	34368	377
MIN F2	slu-SISMA28	-3347	-9692	11393	104837	-32436	376
MAX F3	slu-SISMA48	-3410	-2907	29035	31626	-31899	-113
MIN F3	slu-SISMA41	3472	2907	958	-31437	32382	113
MAX M1	slu-SISMA26	3472	9692	9845	-104829	32426	376
MIN M1	slu-SISMA21	-3236	-9609	19556	107326	-30201	-376
MAX M2	slu-SISMA6	11902	2957	12042	-30635	112121	162
MIN M2	slu-SISMA1	-11365	-2907	19010	31461	-106211	-113

Tabella 2: Combinazioni sismiche SLV: azioni agenti a base pila

6.1.2 Combinazioni delle azioni agli stati limite ultimi statici (SLU)

Nella seguente Tabella 3 si riportano le combinazioni agli stati limite ultimi statici (SLU); i carichi sono amplificati con i coefficienti parziali A1.

Sollecitazioni estradosso fondazione SLU-STR							
sollecitazione	combinazione	F1	F2	F3	M1	M2	M3
		KN	KN	KN	KN-m	KN-m	kN-m
MAX F1	slu60	3534	1098	25936	-16880	39807	361
MAX F2	slu26	1340	1635	29456	-24792	12828	5
MAX F3	slu52	1750	1635	29456	-24792	16850	5
MIN F3	slu25	255	1282	13653	-19109	2496	0
MAX M1	slu63	1152	1320	25188	-27612	11055	0
MAX M2	slu60	3534	1098	25936	-16880	39807	361

Tabella 3: Combinazioni statiche SLU-A1: azioni agenti a base pila

6.1.3 Combinazioni delle azioni agli stati limite di esercizio (SLE)

Nella seguente Tabella 4 si riportano le combinazioni di carico caratteristiche impiegate per gli stati limite di esercizio (SLE).

Sollecitazioni estradosso fondazione SLE-RARA							
sollecitazione	combinazione	F1	F2	F3	M1	M2	M3
		KN	KN	KN	KN-m	KN-m	kN-m
MAX F3	SLE-RARA44	-1201	-1110	20875	16834	-11560	-3

APPALTATORE: Consorzio HirpiniaAV Soci salini impregio ASTALDI	ITINERARIO NAPOLI – BARI RADDOPPIO TRATTA APICE – ORSARA I LOTTO FUNZIONALE APICE – HIRPINIA					
PROGETTAZIONE: Mandataria ROKSOJL Mandanti NETENGINEERING Alpina						
PROGETTO ESECUTIVO RELAZIONE DI CALCOLO FONDAZIONI PILE DA P17 A P20	COMMESSA IF1N	LOTTO 01 E ZZ	CODIFICA RG	DOCUMENTO MD0000 001	REV. B	FOGLIO 13 di 143

MIN F3	SLE-RARA25	-170	-855	13653	12739	-1664	0
MAX M1	SLE-RARA55	-791	-893	17931	18780	-7591	0
MAX M2	SLE-RARA85	-2437	-738	18447	11356	-27453	-248

Tabella 4: Combinazioni di esercizio SLE: azioni agenti a base pila

6.2 SCARICHI A INTRADOSSO PLINTO

6.2.1 Combinazioni delle azioni agli stati limite ultimi sismici (SLV)

Nella Tabella 6 si riportano le combinazioni di carico agli stati limite ultimi (SLV) in presenza dell'azione sismica, ottenute:

- amplificando le azioni di taglio e i momenti a base pila del coefficiente $\gamma_{Rd} = 1.1$;
- considerando il trasporto dei momenti da spiccato pila a intradosso plinto;
- aggiungendo il peso proprio del plinto e del terreno di ricoprimento (Tabella 5).

plinto	B trasv	16.5	m
	L long	12.0	m
	H	2.5	m
ricoprimento	h	1.0	m
	peso plinto	12375.0	kN
	peso rinterro	3960,0	kN

Tabella 5: Plinto: caratteristiche geometriche

Sollecitazioni intradosso fondazione SLV							
sollecitazione	combinazione	F1	F2	F3	M1	M2	M3
		KN	KN	KN	KN-m	KN-m	kN-m
MAX F1	slu-SISMA6	11902	2957	28377	-38027	141876	162
MIN F1	slu-SISMA1	-11365	-2907	35345	38729	-134624	-113
MAX F2	slu-SISMA32	3674	9824	28863	-127379	43553	377
MIN F2	slu-SISMA28	-3347	-9692	27728	129067	-40804	376
MAX F3	slu-SISMA48	-3410	-2907	45370	38894	-40424	-113
MIN F3	slu-SISMA41	3472	2907	17293	-38705	41061	113
MAX M1	slu-SISMA26	3472	9692	26180	-129059	41105	376
MIN M1	slu-SISMA21	-3236	-9609	35891	131347	-38291	-376
MAX M2	slu-SISMA6	11902	2957	28377	-38027	141876	162
MIN M2	slu-SISMA1	-11365	-2907	35345	38729	-134624	-113

Tabella 6: Combinazioni sismiche SLV: azioni agenti ad intradosso plinto

APPALTATORE: Consorzio Soci   	ITINERARIO NAPOLI – BARI RADDOPPIO TRATTA APICE – ORSARA I LOTTO FUNZIONALE APICE – HIRPINIA
PROGETTAZIONE: Mandataria Mandanti   	
PROGETTO ESECUTIVO RELAZIONE DI CALCOLO FONDAZIONI PILE DA P17 A P20	COMMESSA LOTTO CODIFICA DOCUMENTO REV. FOGLIO IF1N 01 E ZZ RG MD0000 001 B 14 di 143

6.2.2 Combinazioni delle azioni agli stati limite ultimi statici (SLU)

Nella **Tabella 7** si riportano gli scarichi per gli stati limite ultimi statici (SLU), ottenuti:

- considerando il trasporto dei momenti da spiccato pila a intradosso plinto;
- aggiungendo il peso proprio del plinto e del terreno di ricoprimento (**Tabella 5**), fattorizzati per il fattore 1.3.

Sollecitazioni intradosso fondazione SLU-STR							
sollecitazione	combinazione	F1	F2	F3	M1	M2	M3
		KN	KN	KN	KN-m	KN-m	kN-m
MAX F1	slu60	3534	1098	47172	-19625	48642	361
MAX F2	slu26	1340	1635	50692	-28880	16178	5
MAX F3	slu52	1750	1635	50692	-28880	21225	5
MIN F3	slu25	255	1282	34889	-22314	3134	0
MAX M1	slu63	1152	1320	46424	-30912	13935	0
MAX M2	slu60	3534	1098	47172	-19625	48642	361

Tabella 7: Combinazioni di statiche SLU-A1: azioni agenti ad intradosso plinto

6.2.3 Combinazioni delle azioni agli stati limite di esercizio (SLE)

Nella **Tabella 8** si riportano le combinazioni di carico caratteristiche impiegate per gli stati limite di esercizio ottenute:

- considerando il trasporto dei momenti da spiccato pila a intradosso plinto;
- aggiungendo il peso proprio del plinto e del terreno di ricoprimento (**Tabella 5**).

Sollecitazioni estradosso fondazione SLE-RARA							
sollecitazione	combinazione	F1	F2	F3	M1	M2	M3
		KN	KN	KN	KN-m	KN-m	kN-m
MAX F3	SLE-RARA44	-1201	-1110	37210	19609	-14563	-3
MIN F3	SLE-RARA25	-170	-855	29988	14877	-2089	0
MAX M1	SLE-RARA55	-791	-893	34266	21013	-9569	0
MAX M2	SLE-RARA85	-2437	-738	34782	13201	-33546	-248

Tabella 8: Combinazioni di esercizio SLE: azioni agenti ad intradosso plinto

APPALTATORE: Consorzio Soci   	ITINERARIO NAPOLI – BARI RADDOPPIO TRATTA APICE – ORSARA I LOTTO FUNZIONALE APICE – HIRPINIA																	
PROGETTAZIONE: Mandataria Mandanti   	<table border="1" style="width: 100%; border-collapse: collapse;"> <tr> <td style="width: 16.6%;">COMMESSA</td> <td style="width: 16.6%;">LOTTO</td> <td style="width: 16.6%;">CODIFICA</td> <td style="width: 16.6%;">DOCUMENTO</td> <td style="width: 16.6%;">REV.</td> <td style="width: 16.6%;">FOGLIO</td> </tr> <tr> <td style="text-align: center;">IF1N</td> <td style="text-align: center;">01 E ZZ</td> <td style="text-align: center;">RG</td> <td style="text-align: center;">MD0000 001</td> <td style="text-align: center;">B</td> <td style="text-align: center;">15 di 143</td> </tr> </table>						COMMESSA	LOTTO	CODIFICA	DOCUMENTO	REV.	FOGLIO	IF1N	01 E ZZ	RG	MD0000 001	B	15 di 143
COMMESSA	LOTTO	CODIFICA	DOCUMENTO	REV.	FOGLIO													
IF1N	01 E ZZ	RG	MD0000 001	B	15 di 143													
PROGETTO ESECUTIVO RELAZIONE DI CALCOLO FONDAZIONI PILE DA P17 A P20																		

7 ANALISI DELL'INTERAZIONE FONDAZIONE-TERRENO

L'analisi di interazione terreno-fondazione è stata sviluppata con il software GROUP della Ensoft.

Il programma considera che il comportamento di un palo soggetto ad azioni orizzontali all'interno di un gruppo differisce da quello di un palo singolo ed isolato. In un gruppo di pali caricato da azioni orizzontali i fenomeni di interazione reciproca palo – terreno – palo determinano, complessivamente, una diminuzione della rigidità del sistema.

La diversità di comportamento si manifesta mediante un differente valore dello sforzo di taglio agente in testa a ciascun palo, differenti valori di momento flettente, diversa ubicazione del valore massimo di momento al variare della profondità (nell'ipotesi in cui il vincolo in testa al palo non sia un incastro). La modalità di risposta di ciascun palo è funzione essenzialmente dalla posizione geometrica che questo occupa all'interno del gruppo. Precisamente, la risposta del singolo palo all'interno del gruppo è condizionata:

- dalla fila di appartenenza all'interno del gruppo (effetto ombra o shadowing);
- dalla posizione all'interno della singola fila (effetto di bordo).

7.1 DESCRIZIONE DEL MODELLO DI CALCOLO GROUP

Il modello di calcolo è stato costruito nel seguente modo:

APPALTATORE: Consorzio Soci   	ITINERARIO NAPOLI – BARI RADDOPPIO TRATTA APICE – ORSARA I LOTTO FUNZIONALE APICE – HIRPINIA																	
PROGETTAZIONE: Mandataria Mandanti   	<table border="1" style="width: 100%; border-collapse: collapse;"> <tr> <td style="width: 12.5%;">COMMESSA</td> <td style="width: 12.5%;">LOTTO</td> <td style="width: 12.5%;">CODIFICA</td> <td style="width: 12.5%;">DOCUMENTO</td> <td style="width: 12.5%;">REV.</td> <td style="width: 12.5%;">FOGLIO</td> </tr> <tr> <td>IF1N</td> <td>01 E ZZ</td> <td>RG</td> <td>MD0000 001</td> <td>B</td> <td>16 di 143</td> </tr> </table>						COMMESSA	LOTTO	CODIFICA	DOCUMENTO	REV.	FOGLIO	IF1N	01 E ZZ	RG	MD0000 001	B	16 di 143
COMMESSA	LOTTO	CODIFICA	DOCUMENTO	REV.	FOGLIO													
IF1N	01 E ZZ	RG	MD0000 001	B	16 di 143													
PROGETTO ESECUTIVO RELAZIONE DI CALCOLO FONDAZIONI PILE DA P17 A P20																		



Figura 7-1: Vista frontale del modello GROUPv2016

APPALTATORE: Consorzio Soci 	ITINERARIO NAPOLI – BARI RADDOPPIO TRATTA APICE – ORSARA I LOTTO FUNZIONALE APICE – HIRPINIA					
PROGETTAZIONE: Mandataria Mandanti 						
PROGETTO ESECUTIVO RELAZIONE DI CALCOLO FONDAZIONI PILE DA P17 A P20	COMMESSA IF1N	LOTTO 01 E ZZ	CODIFICA RG	DOCUMENTO MD0000 001	REV. B	FOGLIO 17 di 143

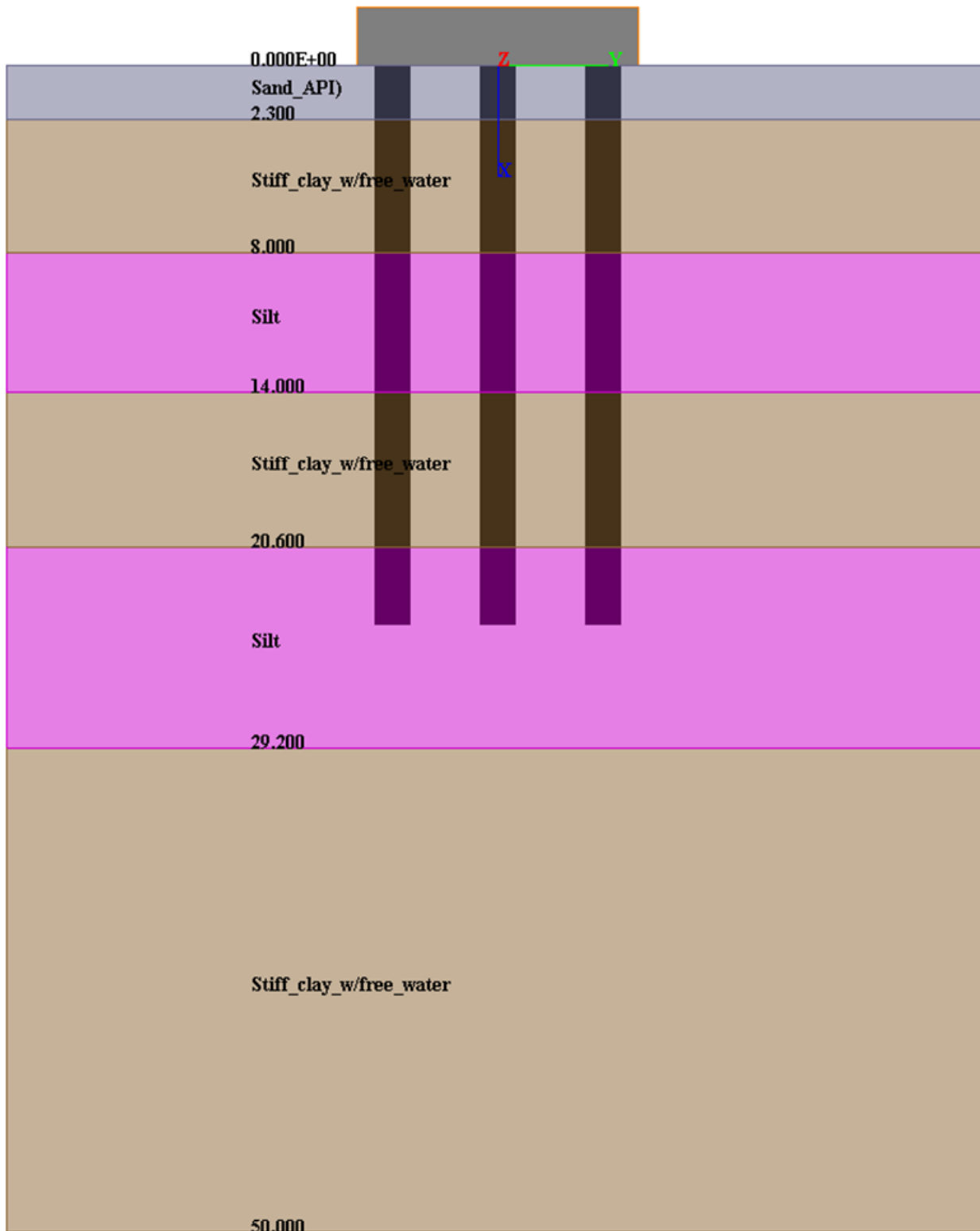

Figura 7-2: Vista in pianta del modello GROUPv2016

In accordo al § 4.2 nelle seguenti Figura 7-3 ÷ Figura 7-9 si riporta il modello stratigrafico di calcolo e i parametri geotecnici assegnati ai singoli strati. I parametri di rigidità del terreno sono stati assunti in accordo ai criteri illustrati nella relazione al ref. 2), § 8.1.1 per le “stiff clays with free water”.

APPALTATORE: Consorzio Soci 	ITINERARIO NAPOLI – BARI RADDOPPIO TRATTA APICE – ORSARA I LOTTO FUNZIONALE APICE – HIRPINIA
PROGETTAZIONE: Mandataria Mandanti 	
PROGETTO ESECUTIVO RELAZIONE DI CALCOLO FONDAZIONI PILE DA P17 A P20	COMMESSA LOTTO CODIFICA DOCUMENTO REV. FOGLIO IF1N 01 E ZZ RG MD0000 001 B 18 di 143

Layer	Soil Type	Depth for Top of Soil Layer (m)	Depth for Bottom of Soil Layer (m)	Properties of Layer
1	API Sand (O'Neil)	0	2.3	1: API Sand
2	Stiff Clay with Free Water (Reese)	2.3	8	2: Stiff Clay with Free Water
3	Silt (cemented c-phi)	8	14	3: Cemented c-phi Soil
4	Stiff Clay with Free Water (Reese)	14	20.6	4: Stiff Clay with Free Water
5	Silt (cemented c-phi)	20.6	29.2	5: Cemented c-phi Soil
6	Stiff Clay with Free Water (Reese)	29.2	50	6: Stiff Clay with Free Water

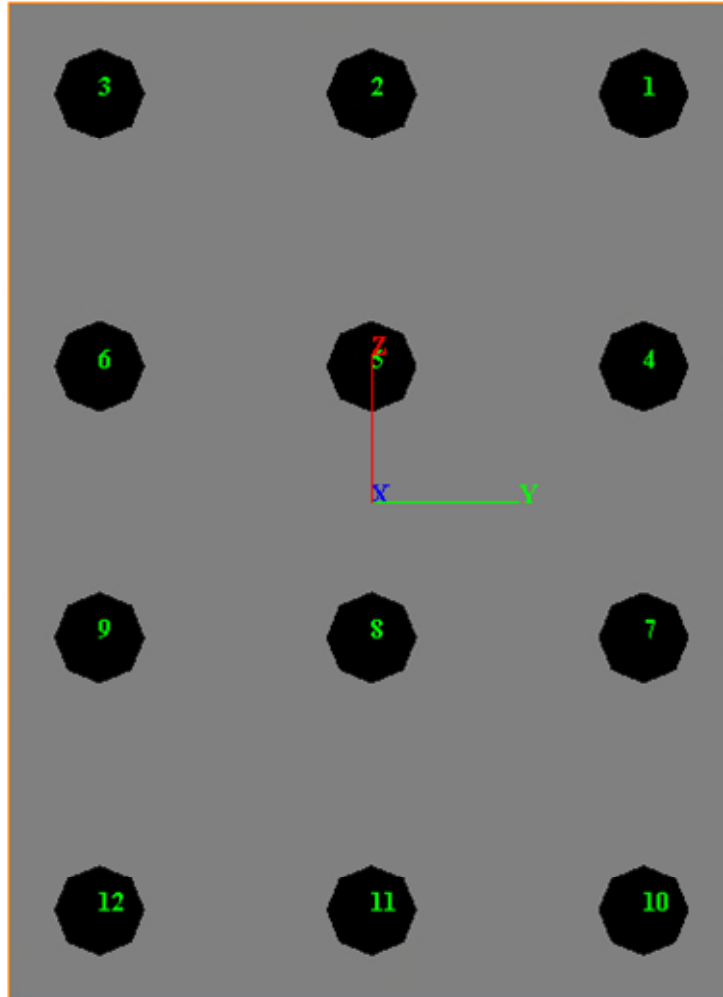
Figura 7-3: Modello stratigrafico GROUP V2016

1=Top, 2=Bottom	Effective Unit Weight (kN/m ³)	Friction Angle (DEG.)	p-y Modulus, k (kN/m ³)	Ultimate Unit Side Friction (kN/m ²)	Ultimate Unit Tip Resistance (kN/m ²)
1	9	29	25150	45	0
2	9	29	25150	45	0

A linear interpolation with depth will be used to compute values between the top and bottom of the layer.

p-y Modulus, k:

- Always check recommended value in Geotechnical Investigation Reports.
- Program will help to estimate value for p-y Modulus, k, if zero input value is entered.

Ultimate Unit Side Friction and Ultimate Unit Tip Resistance:

- The program uses Ultimate Unit Side Friction to generate t-z curves.
- The program uses Ultimate Unit Tip Resistance to generate q-w curves.
- Always check recommended values in Geotechnical Investigation Reports.
- Program will help to estimate values for Ultimate Unit Side Friction and Ultimate Unit Tip Resistance if zero input values are entered.

Figura 7-4: Layer no.1 (ALL2-S)

APPALTATORE: Consorzio Soci 	ITINERARIO NAPOLI – BARI RADDOPPIO TRATTA APICE – ORSARA I LOTTO FUNZIONALE APICE – HIRPINIA
PROGETTAZIONE: Mandataria Mandanti 	
PROGETTO ESECUTIVO RELAZIONE DI CALCOLO FONDAZIONI PILE DA P17 A P20	COMMESSA LOTTO CODIFICA DOCUMENTO REV. FOGLIO IF1N 01 E ZZ RG MD0000 001 B 19 di 143



Figura 7-5: Layer no.2 (BNA3)



Figura 7-6: Layer no.3 (BNA3)

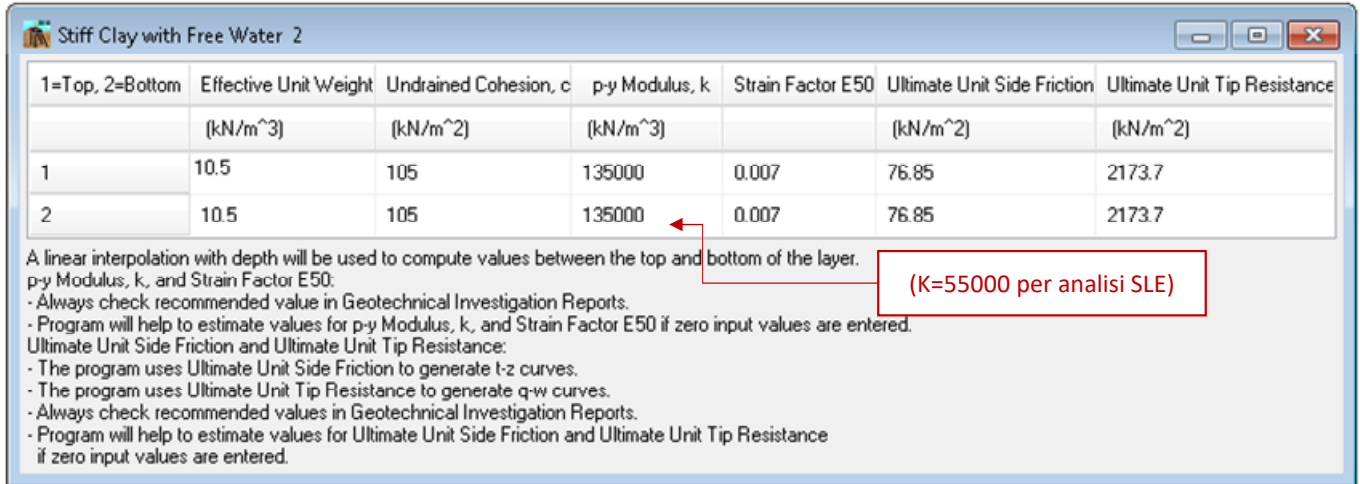

Figura 7-7: Layer no.4 (BNA3)

APPALTATORE: Consorzio Soci   	ITINERARIO NAPOLI – BARI RADDOPPIO TRATTA APICE – ORSARA I LOTTO FUNZIONALE APICE – HIRPINIA
PROGETTAZIONE: Mandataria Mandanti   	
PROGETTO ESECUTIVO RELAZIONE DI CALCOLO FONDAZIONI PILE DA P17 A P20	COMMESSA LOTTO CODIFICA DOCUMENTO REV. FOGLIO IF1N 01 E ZZ RG MD0000 001 B 20 di 143

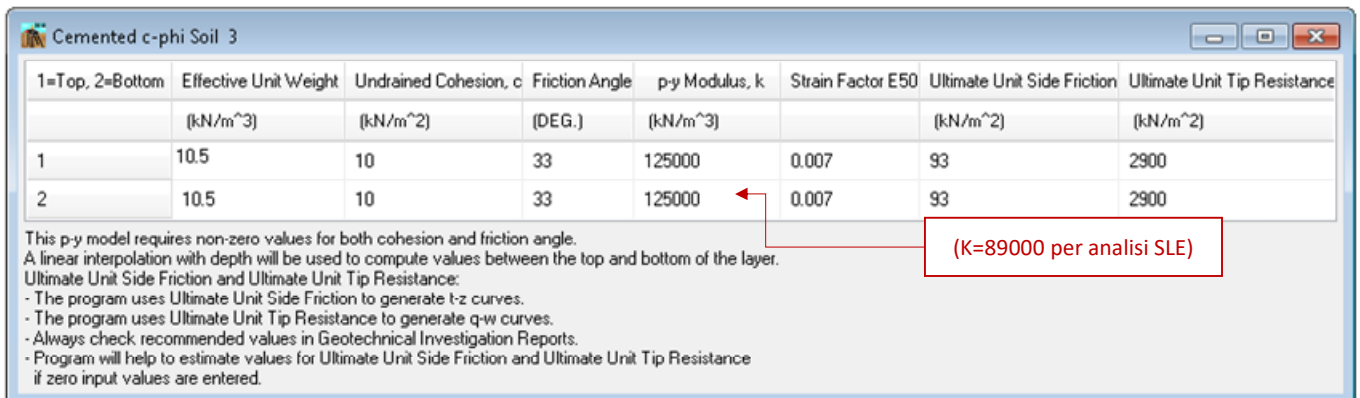
Cemented c-phi Soil 5

1=Top, 2=Bottom	Effective Unit Weight (kN/m ³)	Undrained Cohesion, c (kN/m ²)	Friction Angle (DEG.)	p-y Modulus, k (kN/m ³)	Strain Factor E50	Ultimate Unit Side Friction (kN/m ²)	Ultimate Unit Tip Resistance (kN/m ²)
1	10.5	10	33	125000	0.007	150	4300
2	10.5	10	33	125000	0.007	150	4300

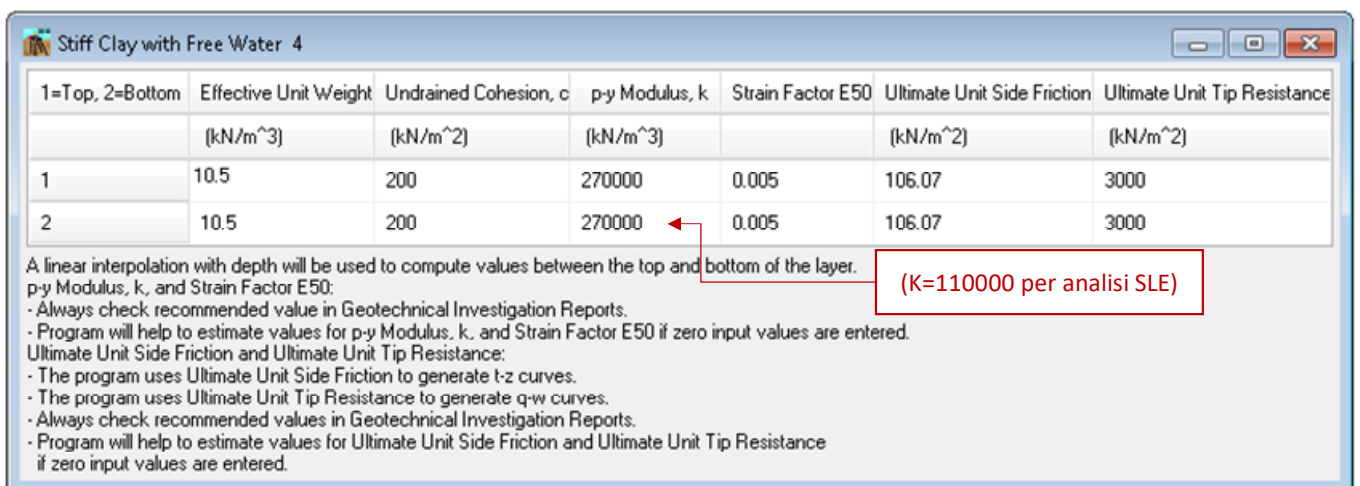
This p-y model requires non-zero values for both cohesion and friction angle.
 A linear interpolation with depth will be used to compute values between the top and bottom of the layer.
 Ultimate Unit Side Friction and Ultimate Unit Tip Resistance:
 - The program uses Ultimate Unit Side Friction to generate t-z curves.
 - The program uses Ultimate Unit Tip Resistance to generate q-w curves.
 - Always check recommended values in Geotechnical Investigation Reports.
 - Program will help to estimate values for Ultimate Unit Side Friction and Ultimate Unit Tip Resistance if zero input values are entered.

(K=89000 per analisi SLE)

Figura 7-8: Layer no.5 (BNA3)

Stiff Clay with Free Water 6

1=Top, 2=Bottom	Effective Unit Weight (kN/m ³)	Undrained Cohesion, c (kN/m ²)	p-y Modulus, k (kN/m ³)	Strain Factor E50	Ultimate Unit Side Friction (kN/m ²)	Ultimate Unit Tip Resistance (kN/m ²)
1	10.5	300	540000	0.004	129.9	3674.2
2	10.5	300	540000	0.004	129.9	3674.2

A linear interpolation with depth will be used to compute values between the top and bottom of the layer.
 p-y Modulus, k, and Strain Factor E50:
 - Always check recommended value in Geotechnical Investigation Reports.
 - Program will help to estimate values for p-y Modulus, k, and Strain Factor E50 if zero input values are entered.
 Ultimate Unit Side Friction and Ultimate Unit Tip Resistance:
 - The program uses Ultimate Unit Side Friction to generate t-z curves.
 - The program uses Ultimate Unit Tip Resistance to generate q-w curves.
 - Always check recommended values in Geotechnical Investigation Reports.
 - Program will help to estimate values for Ultimate Unit Side Friction and Ultimate Unit Tip Resistance if zero input values are entered.

(K=220000 per analisi SLE)

Figura 7-9: Layer no.6 (BNA3)

APPALTATORE: Consorzio Soci   	ITINERARIO NAPOLI – BARI RADDOPPIO TRATTA APICE – ORSARA I LOTTO FUNZIONALE APICE – HIRPINIA																	
PROGETTAZIONE: Mandataria Mandanti   	<table border="1" style="width: 100%; border-collapse: collapse;"> <tr> <td style="width: 16.6%;">COMMESSA</td> <td style="width: 16.6%;">LOTTO</td> <td style="width: 16.6%;">CODIFICA</td> <td style="width: 16.6%;">DOCUMENTO</td> <td style="width: 16.6%;">REV.</td> <td style="width: 16.6%;">FOGLIO</td> </tr> <tr> <td>IF1N</td> <td>01 E ZZ</td> <td>RG</td> <td>MD0000 001</td> <td>B</td> <td>21 di 143</td> </tr> </table>						COMMESSA	LOTTO	CODIFICA	DOCUMENTO	REV.	FOGLIO	IF1N	01 E ZZ	RG	MD0000 001	B	21 di 143
COMMESSA	LOTTO	CODIFICA	DOCUMENTO	REV.	FOGLIO													
IF1N	01 E ZZ	RG	MD0000 001	B	21 di 143													
PROGETTO ESECUTIVO RELAZIONE DI CALCOLO FONDAZIONI PILE DA P17 A P20																		

7.2 SINTESI DEI RISULTATI AGLI STATI LIMITE DI ESERCIZIO (SLE)

Si riassumono nel seguito le sollecitazioni massime di sforzo assiale, taglio e momento, agenti in testa ai pali.

Si ricorda che per le analisi allo SLE (vedasi Ref. 2)) sono stati utilizzati per le curve p-y i coefficienti di rigidezza del terreno suggeriti dal programma per carichi ciclici; facendo riferimento alle Figura 7-4 e Figura 7-9 sono stati utilizzati i valori evidenziati di lato.

SLE	FOR. X, KN	FOR.H, KN	MOM, KN-M	MOM X, KN- M
	*****	*****	*****	*****
max	4291,6	265,0	517,9	1,0
min	1505,4	61,2	140,6	-0,1

Tabella 9: Sollecitazioni allo SLE massime e minime per i pali di fondazione

Nelle seguenti figure sono diagrammati l'andamento con la profondità del momento flettente e del taglio relativi alle combinazioni in cui tali sollecitazioni risultano massime.

APPALTATORE: Consorzio Soci   		ITINERARIO NAPOLI – BARI RADDOPPIO TRATTA APICE – ORSARA I LOTTO FUNZIONALE APICE – HIRPINIA					
PROGETTAZIONE: Mandataria Mandanti   		COMMESSA	LOTTO	CODIFICA	DOCUMENTO	REV.	FOGLIO
PROGETTO ESECUTIVO RELAZIONE DI CALCOLO FONDAZIONI PILE DA P17 A P20		IF1N	01 E ZZ	RG	MD0000 001	B	22 di 143



Figura 7-10: Combinazioni SLE: Andamento con la profondità del momento (combo SLE4 max M2).

APPALTATORE: Consorzio Soci 		ITINERARIO NAPOLI – BARI RADDOPPIO TRATTA APICE – ORSARA I LOTTO FUNZIONALE APICE – HIRPINIA					
PROGETTAZIONE: Mandataria Mandanti 							
PROGETTO ESECUTIVO RELAZIONE DI CALCOLO FONDAZIONI PILE DA P17 A P20		COMMESSA IF1N	LOTTO 01 E ZZ	CODIFICA RG	DOCUMENTO MD0000 001	REV. B	FOGLIO 23 di 143

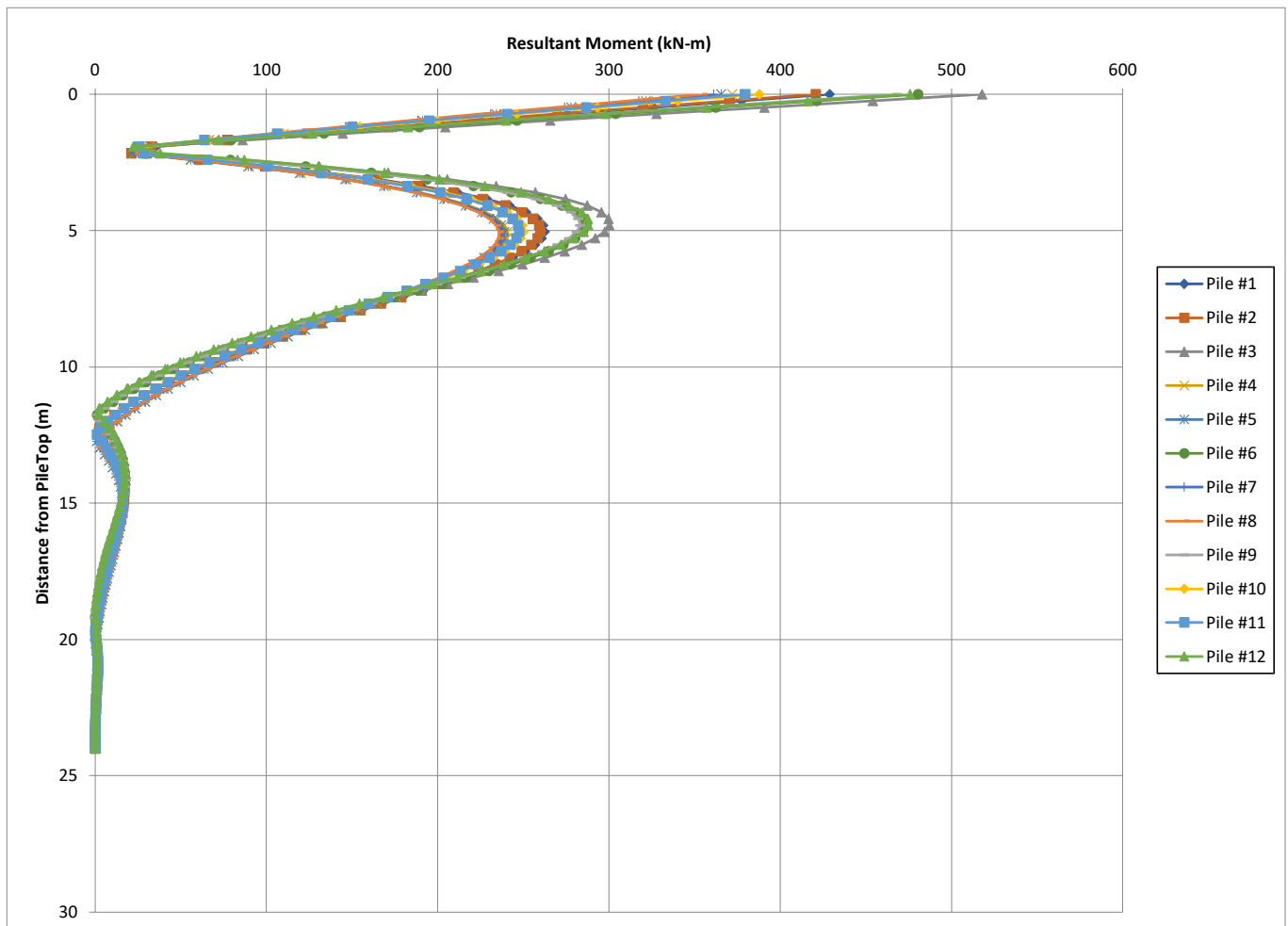

Figura 7-11: Combinazioni SLE: Andamento con la profondità del taglio (combo SLE4 max M2).

7.2.1 Spostamenti

Nella Tabella 7-10 si riportano gli spostamenti e le rotazioni ad intradosso plinto e sommità pila.

Gli spostamenti orizzontali (direzione y-2) e direzione z-3) tengono già conto dell'interazione fra pali e sono quindi rappresentativi degli spostamenti orizzontali del gruppo di pali; lo spostamento verticale non tiene conto dell'effetto gruppo.

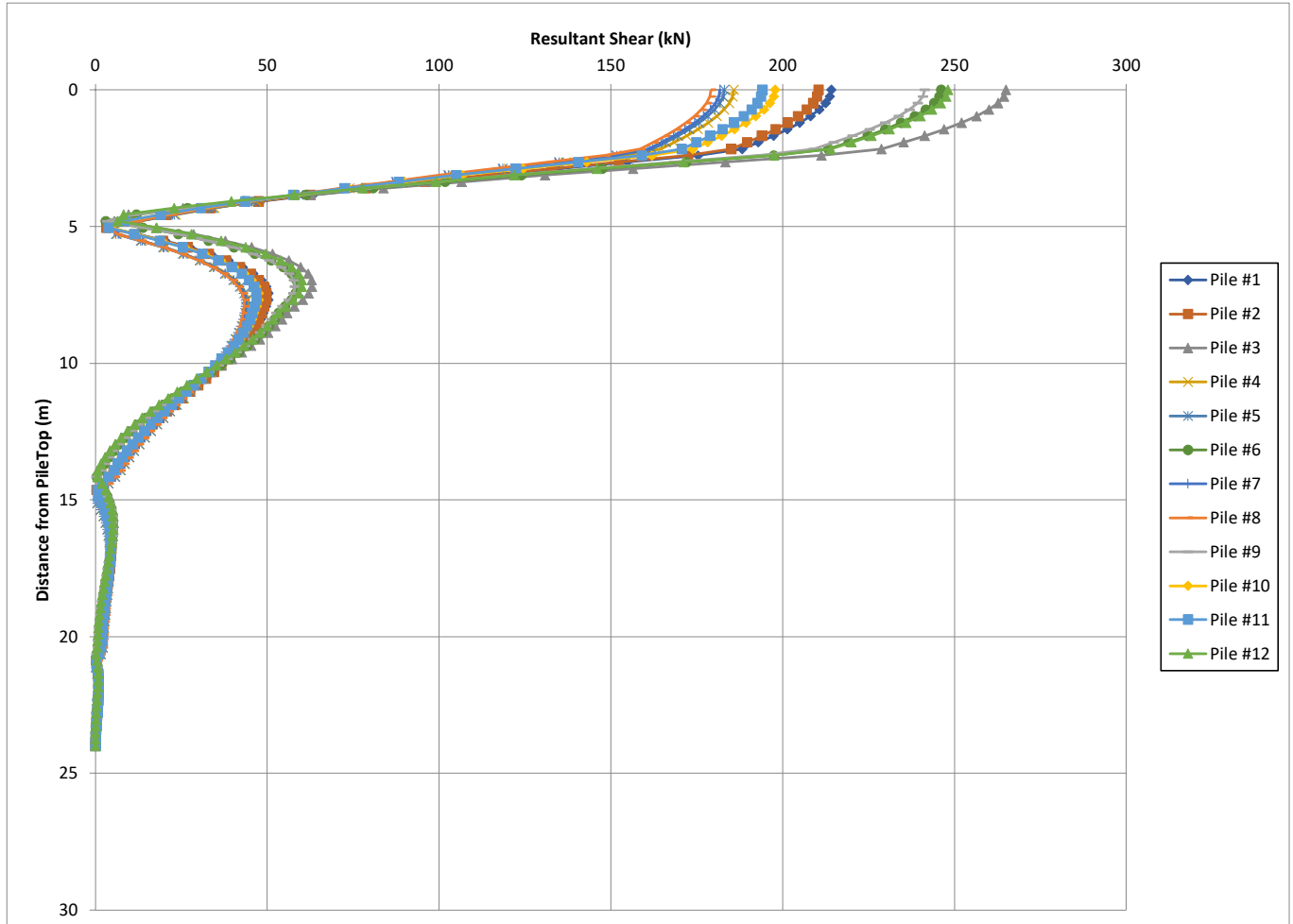
Il coefficiente amplificativo del cedimento verticale per effetto gruppo E_G viene valutato in accordo a Mandolini et al. (2005) ed è riportato in Tabella 7-11.

VERTICAL , M	HORIZONTAL Y, M	HORIZONTAL Z, M	ANGLE ROT. X,RAD	ANGLE ROT. Y,RAD	ANGLE ROT. Z,RAD	Ppostamento testa pila - sle		
						H pila (m)	asse Y (mm)	asse Z (mm)
0,00134939	0,00545267	-0,00118471	7,48438E-06	-8,75949E-05	-0,000581231	11,672	-2,122	2,716
0,00168871	-0,00517039	0,00116578	1,06014E-05	9,19635E-05	0,000567374	-11,241	2,150	3,399
0,00126268	0,00158851	-0,00363599	-1,06592E-05	-0,00026738	-0,000175002	3,461	-6,497	2,542
0,00120804	-0,00144758	0,00357696	-1,03932E-05	0,000267923	0,000162182	-3,183	6,444	2,432

Tabella 7-10: Combinazioni SLE: spostamenti e rotazioni ad intradosso plinto.

APPALTATORE: Consorzio Soci   	ITINERARIO NAPOLI – BARI RADDOPPIO TRATTA APICE – ORSARA I LOTTO FUNZIONALE APICE – HIRPINIA					
PROGETTAZIONE: Mandataria Mandanti   						
PROGETTO ESECUTIVO RELAZIONE DI CALCOLO FONDAZIONI PILE DA P17 A P20	COMMESSA IF1N	LOTTO 01 E ZZ	CODIFICA RG	DOCUMENTO MD0000 001	REV. B	FOGLIO 24 di 143

DATI FONDAZIONE		
Larghezza plinto	12	m
Profondità plinto	16,5	m
Diametro palo	1,5	m
Lunghezza palo	24	m
interasse palo	4,5	m
numero pali	12	-
Coefficiente R	1,5	-
Coefficiente RG	0,1678	-
Coeff. amplificazione cedimento del gruppo EG	2,01	-

Tabella 7-11: Coefficiente amplificativo del cedimento verticale per effetto gruppo.

7.3 SINTESI DEI RISULTATI AGLI STATI LIMITE ULTIMI STATICI (SLU)

Si riassumono nel seguito le sollecitazioni massime di sforzo assiale, taglio e momento, agenti in testa ai pali.

SLU	FOR. X, KN	FOR.H, KN	MOM, KN-M	MOM X, KN- M
	*****	*****	*****	*****
max	5782,5	372,5	659,6	0,1
min	1820,4	92,6	180,5	-0,2

Tabella 12: Sollecitazioni allo SLU massime e minime per i pali di fondazione

Nelle seguenti figure sono diagrammati l'andamento con la profondità del momento flettente e del taglio relativi alle combinazioni in cui tali sollecitazioni risultano massime.

APPALTATORE: Consorzio Soci 		ITINERARIO NAPOLI – BARI RADDOPPIO TRATTA APICE – ORSARA I LOTTO FUNZIONALE APICE – HIRPINIA											
PROGETTAZIONE: Mandataria Mandanti 		COMMESSA IF1N		LOTTO 01 E ZZ		CODIFICA RG		DOCUMENTO MD0000 001		REV. B		FOGLIO 25 di 143	
PROGETTO ESECUTIVO RELAZIONE DI CALCOLO FONDAZIONI PILE DA P17 A P20													



Figura 7-12: Combinazioni statica SLU: Andamento con la profondità del momento (combo SLU11 max F1).

APPALTATORE: Consorzio Soci 		ITINERARIO NAPOLI – BARI RADDOPPIO TRATTA APICE – ORSARA I LOTTO FUNZIONALE APICE – HIRPINIA											
PROGETTAZIONE: Mandataria Mandanti 		COMMESSA IF1N		LOTTO 01 E ZZ		CODIFICA RG		DOCUMENTO MD0000 001		REV. B		FOGLIO 26 di 143	
PROGETTO ESECUTIVO RELAZIONE DI CALCOLO FONDAZIONI PILE DA P17 A P20													

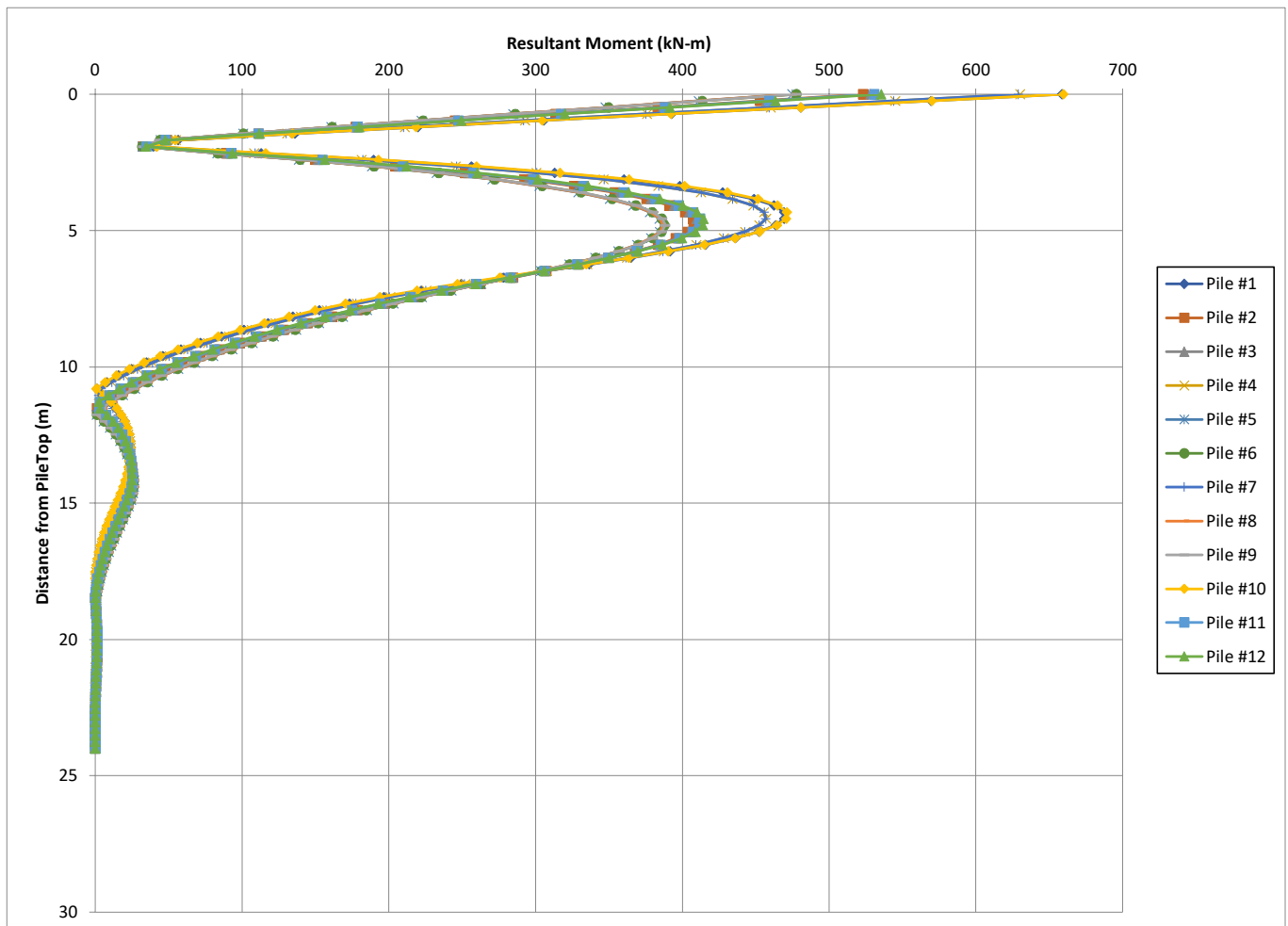

Figura 7-13: Combinazioni statica SLU: Andamento con la profondità del taglio (combo SLU11 max F1).

7.4 SINTESI DEI RISULTATI AGLI STATI LIMITE ULTIMI SISMICI (SLV)

Si riassumono nel seguito le sollecitazioni massime di sforzo assiale, taglio e momento, agenti in testa ai pali.

SLV	FOR. X, KN	FOR.H, KN	MOM, KN-M	MOM X, KN- M
max	7692,5	1279,9	2858,3	4,1
min	-3639,0	319,1	669,9	-4,2

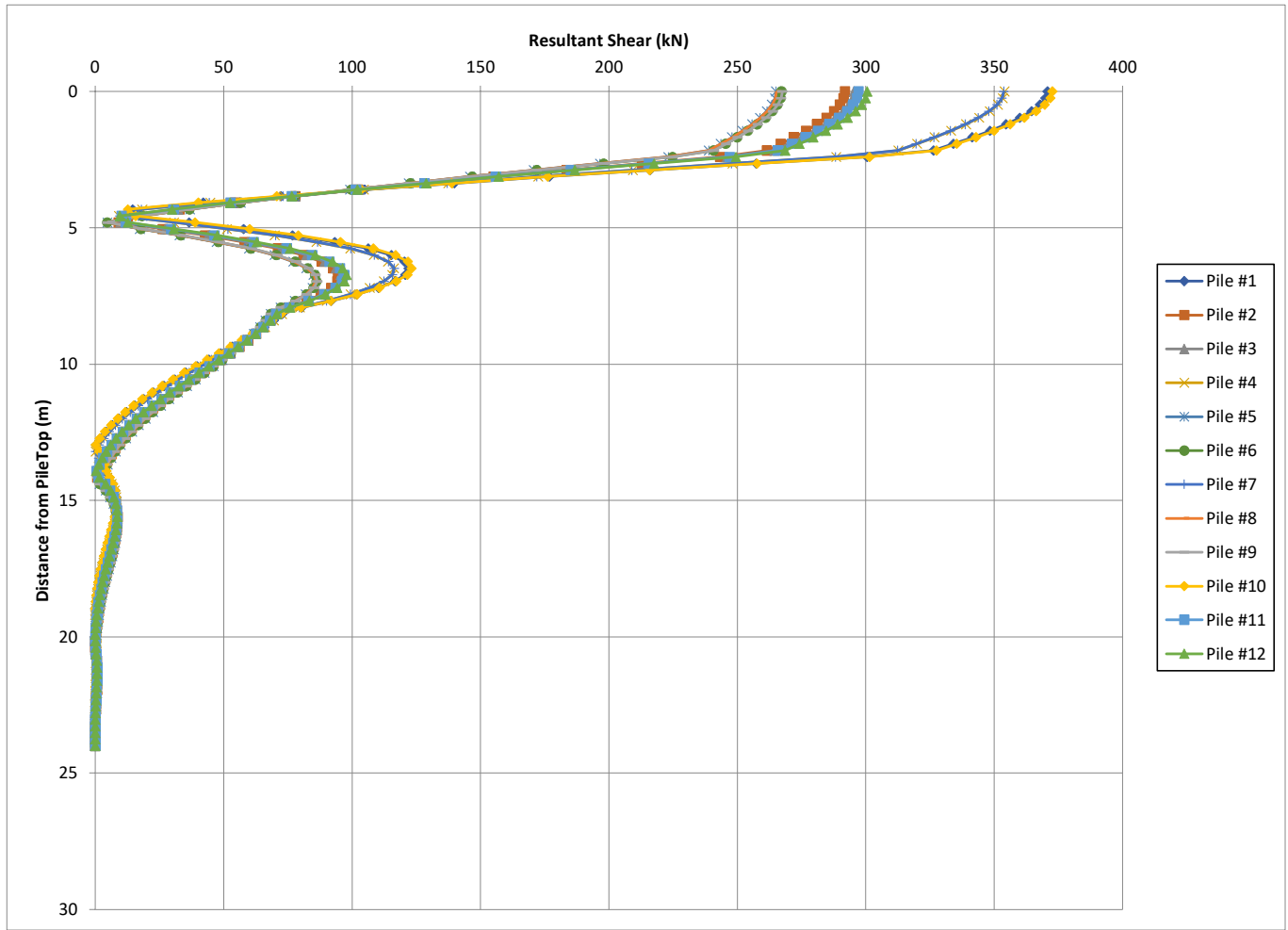
Tabella 13: Sollecitazioni allo SLV massime e minime per i pali di fondazione

Nelle seguenti figure sono diagrammati l'andamento con la profondità del momento flettente e del taglio relativi alle combinazioni in cui tali sollecitazioni risultano massime.

APPALTATORE: Consorzio Soci 		ITINERARIO NAPOLI – BARI RADDOPPIO TRATTA APICE – ORSARA I LOTTO FUNZIONALE APICE – HIRPINIA					
PROGETTAZIONE: Mandataria Mandanti 							
PROGETTO ESECUTIVO RELAZIONE DI CALCOLO FONDAZIONI PILE DA P17 A P20		COMMESSA IF1N	LOTTO 01 E ZZ	CODIFICA RG	DOCUMENTO MD0000 001	REV. B	FOGLIO 27 di 143



Figura 7-14: Combinazioni sismica SLV: Andamento con la profondità del momento (combo SLV1 max F1).

APPALTATORE: Consorzio Soci 		ITINERARIO NAPOLI – BARI RADDOPPIO TRATTA APICE – ORSARA I LOTTO FUNZIONALE APICE – HIRPINIA											
PROGETTAZIONE: Mandataria Mandanti 		COMMESSA IF1N		LOTTO 01 E ZZ		CODIFICA RG		DOCUMENTO MD0000 001		REV. B		FOGLIO 28 di 143	
PROGETTO ESECUTIVO RELAZIONE DI CALCOLO FONDAZIONI PILE DA P17 A P20													

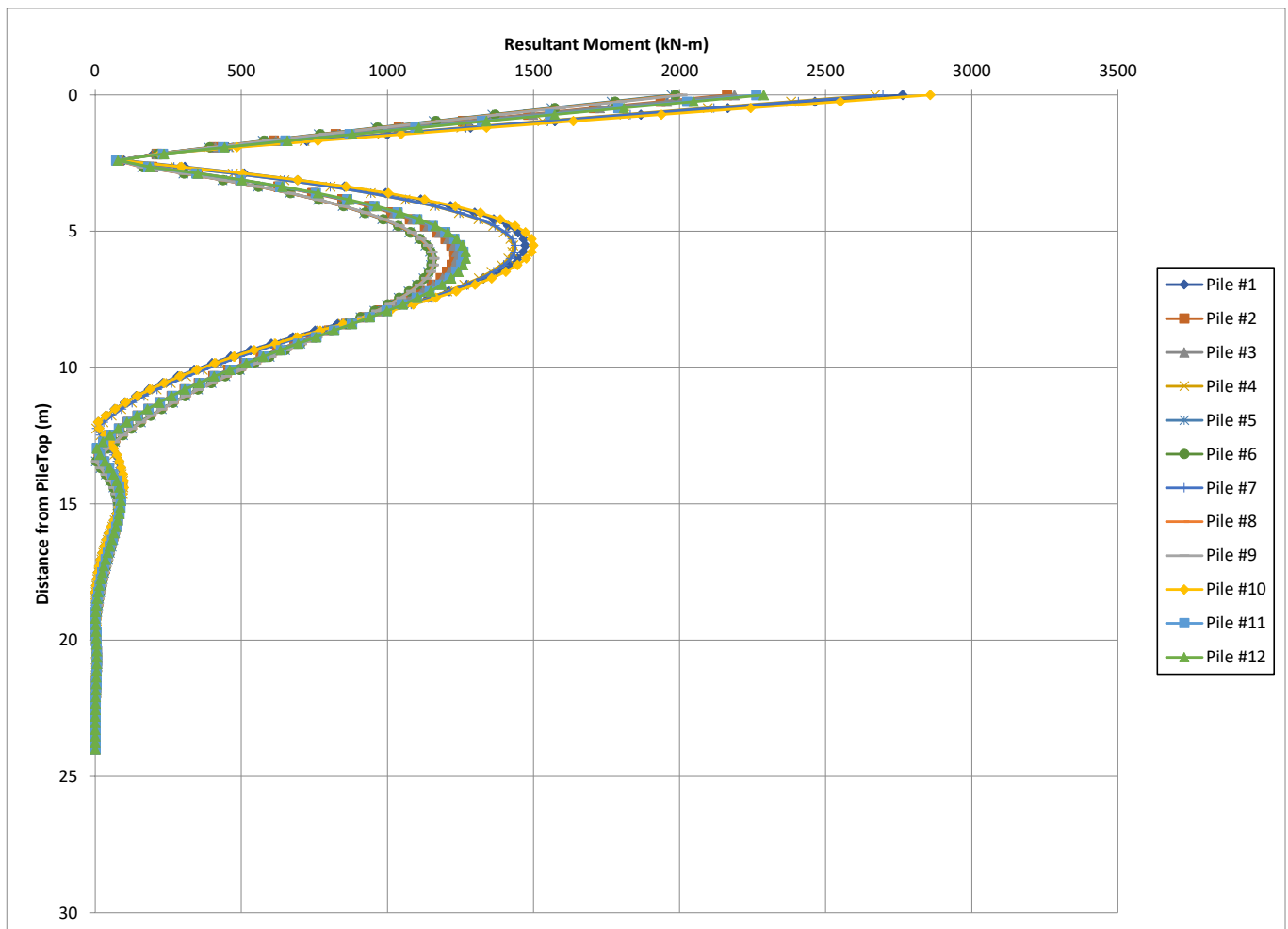

Figura 7-15: Combinazioni sismica SLV: Andamento con la profondità del taglio (combo SLV1 max F1).

APPALTATORE: Consorzio Soci   	ITINERARIO NAPOLI – BARI RADDOPPIO TRATTA APICE – ORSARA I LOTTO FUNZIONALE APICE – HIRPINIA					
PROGETTAZIONE: Mandataria Mandanti   						
PROGETTO ESECUTIVO RELAZIONE DI CALCOLO FONDAZIONI PILE DA P17 A P20	COMMESSA IF1N	LOTTO 01 E ZZ	CODIFICA RG	DOCUMENTO MD0000 001	REV. B	FOGLIO 29 di 143

8 VERIFICA DEI PALI DI FONDAZIONE

Nel seguito di riportano le verifiche strutturali dei pali di fondazione.

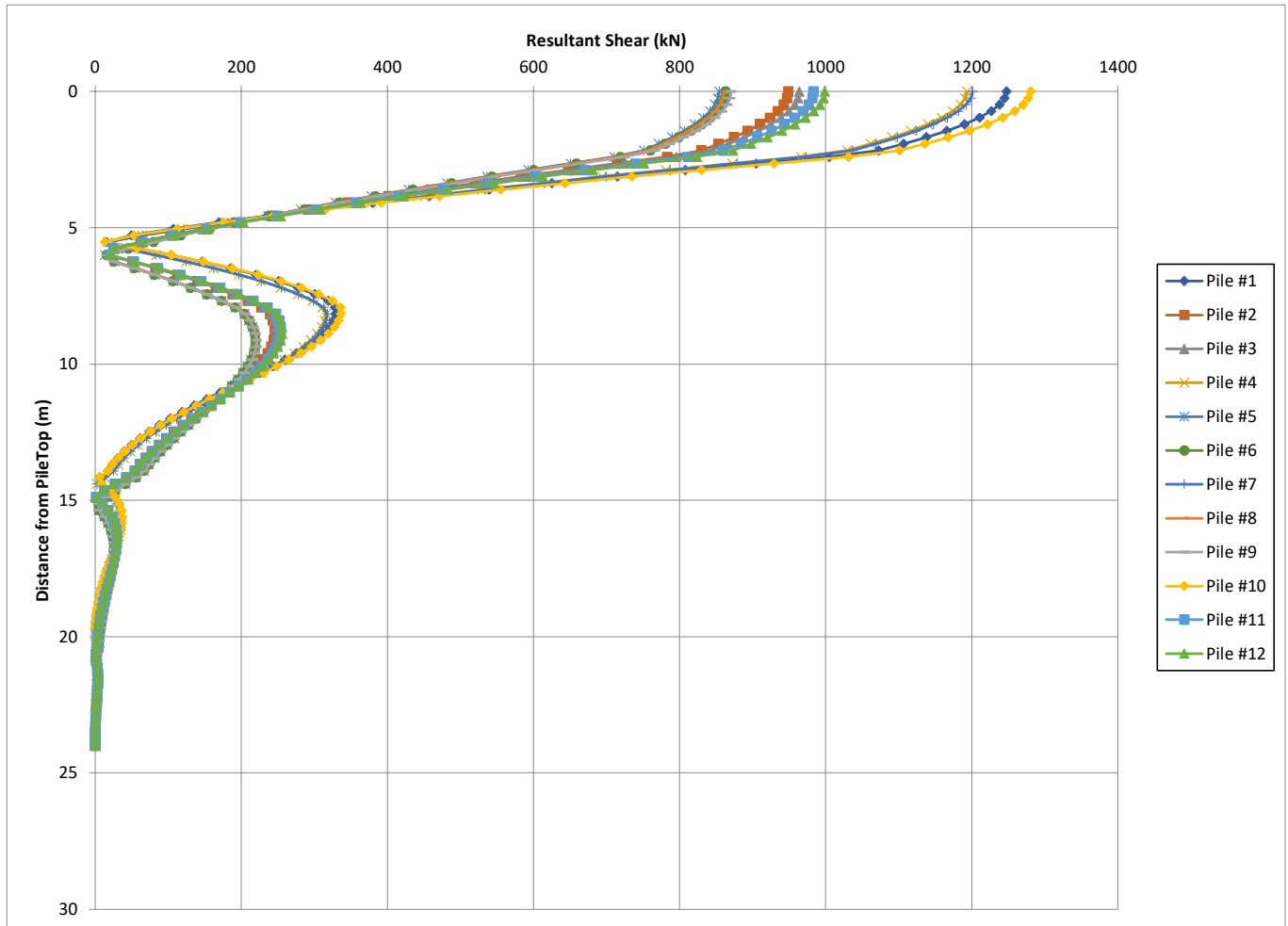
Le sollecitazioni massime agenti lungo il fusto del palo sono riassunte nella **Tabella 14**.

LOAD CASE :	PILE GROUP	FOR. X, KN	FOR. Y, KN	FOR. Z, KN	MOM X, KN- M	MOM Y, KN- M	MOM Z, KN- M	FOR.H, KN	MOM, KN-M
*****	*****	*****	*****	*****	*****	*****	*****		
SLV-1	3	-3639	932,32	-244,89	2,9162	637,11	2092,5	963,95	2187,34
SLV-1	10	7561,5	1246	-292,55	2,9162	719,29	2766,3	1279,88	2858,29

LOAD CASE :	PILE GROUP	FOR. X, KN	FOR. Y, KN	FOR. Z, KN	MOM X, KN- M	MOM Y, KN- M	MOM Z, KN- M	FOR.H, KN	MOM, KN-M
*****	*****	*****	*****	*****	*****	*****	*****		
SLE-4.00	3					-148,23	-496,24		517,91
SLE-4.00	10	1505,4	-	-	-	-	-		-

Tabella 14: Sollecitazioni massime agenti nel palo

Nel seguito si riportano le verifiche strutturali del palo trivellato di diametro $\varnothing = 1500\text{mm}$ in cls – C25/30 e lunghezza L 24 m. Per le verifiche si considerano le sollecitazioni risultanti. Sono risultate più severe le verifiche in presenza di trazione.

In riferimento all'andamento dei momenti lungo il fusto del palo- Momenti Figura 7-14 e Taglio Figura 7-15- sono state previste n. 3 ordini di armature principali:

1. L'armatura massima:
 - o ferri correnti: corona esterna n.26 \varnothing 26;
 - o ferri correnti: corona interna n.13 \varnothing 26;
 - o staffatura: spirale \varnothing 12 passo 10.
2. L'armatura media:
 - o ferri correnti: corona esterna n.26 \varnothing 26;
 - o staffatura: spirale \varnothing 12 passo 20.
3. L'armatura minima:
 - o ferri correnti: corona esterna n.26 \varnothing 24;
 - o staffatura: spirale \varnothing 12 passo 20.

Le verifiche strutturali del palo sono soddisfatte; di seguito le schede di calcolo.

APPALTATORE: Consorzio HirpiniaAV Soci salini impregilo ASTALDI	ITINERARIO NAPOLI – BARI RADDOPPIO TRATTA APICE – ORSARA I LOTTO FUNZIONALE APICE – HIRPINIA
PROGETTAZIONE: Mandataria ROKSOJL Mandanti NETENGINEERING Alpina	
PROGETTO ESECUTIVO RELAZIONE DI CALCOLO FONDAZIONI PILE DA P17 A P20	
COMMESSA IF1N LOTTO 01 E ZZ CODIFICA RG DOCUMENTO MD0000 001 REV. B FOGLIO 30 di 143	

geometria				
sezione trasversale				
D	c	d	passo	interferro
[cm]	[cm]	[cm]	[cm]	[cm]
150	6,0	141,5	16,1	13,5
armatura longitudinale				
n _{barre}	φ	r _i	A _{sI}	c _i
	[mm]	[cm]	[cm ²]	[cm]
26	26	66,50	138,04	8,50
13	26	59,90	69,02	15,10
armatura a taglio				
Tipo	φ	ρ	A _{sw}	
	[mm]	[cm]	[cm ²]	
spirale	12	10	2,26	

sollecitazioni e risultati	
SLE	SLU
M _{Ek} 517,9 [kNm]	M _{Ed} 2187,3 [kNm]
N _{Ek} -1505,4 [kN]	N _{Ed} 3639,0 [kN]
	V _{Ed} 1279,9 [kN]
momento di cracking	presso-flessione
M _{cr} 1191,6 [kNm]	M _{Rd} 2684,3 [kNm]
quota asse neutro	FS 1,23
y _n 111,30 [cm]	taglio
tensioni e fessure	V _{Rdc} 111,4 [kN]
σ _{c,min} -2,1 [MPa]	predisporre armatura a taglio
σ _{s,min} -28,5 [MPa]	
σ _{s,max} 8,3 [MPa]	
	V _{Rds} 1419,4 [kN]
k ₂ 0,5	V _{Rdmax} 4493,4 [kN]
ε _{sm-ε_{cm}} - [%]	θ 30,0 [°]
S _{r,max} - [cm]	sezione duttile
W _k - [mm]	a _l 92,4 [cm]

materiali			
calcestruzzo		acciaio	
R _{ck}	30 [MPa]	f _{yk}	450 [MPa]
f _{ck}	24,9 [MPa]	γ _s	1,15
γ _c	1,5	f _{yd}	391,3 [MPa]
α _{cc}	0,85	E _s	200000 [MPa]
f _{cd}	14,1 [MPa]	ε _{uk}	10 [‰]
v	0,5		
ε _{c2}	2,0 [‰]		
ε _{cu2}	3,5 [‰]		
α _e	15,0		
k _t	0,6		
		valori limite	
k ₁	0,8	0,55 f _{ck}	13,7 [MPa]
k ₃	3,4	0,75 f _{yk}	337,5 [MPa]
k ₄	0,425	W _{k,lim}	0,2 [mm]



Tabella 8-15: Verifica del palo D=1500mm; armatura massima

APPALTATORE: Consorzio HirpiniaAV Soci salini impregilo ASTALDI	ITINERARIO NAPOLI – BARI RADDOPPIO TRATTA APICE – ORSARA I LOTTO FUNZIONALE APICE – HIRPINIA
PROGETTAZIONE: Mandataria ROKSOJL Mandanti NETENGINEERING Alpina	
PROGETTO ESECUTIVO RELAZIONE DI CALCOLO FONDAZIONI PILE DA P17 A P20	
COMMESSA IF1N LOTTO 01 E ZZ CODIFICA RG DOCUMENTO MD0000 001 REV. B FOGLIO 31 di 143	

geometria				
sezione trasversale				
D	c	d	passo	interferro
[cm]	[cm]	[cm]	[cm]	[cm]
150	6,0	141,5	16,1	13,5
armatura longitudinale				
n _{barre}	φ	r _i	A _{sl}	c _i
	[mm]	[cm]	[cm ²]	[cm]
26	26	66,50	138,04	8,50
61,20				
armatura a taglio				
Tipo	φ	p	A _{sw}	
	[mm]	[cm]	[cm ²]	
spirale	12	20	2,26	

sollecitazioni e risultati	
SLE	SLU
M _{Ek} 517,9 [kNm]	M _{Ed} 1009,9 [kNm]
N _{Ek} -1505,4 [kN]	N _{Ed} 3639,0 [kN]
momento di cracking	
M _{cr} 1135,7 [kNm]	
quota asse neutro	
y _n 109,72 [cm]	
tensioni e fessure	
σ _{c,min} -2,2 [MPa]	
σ _{s,min} -30,4 [MPa]	
σ _{s,max} 9,4 [MPa]	
prezzo-flessione	
M _{Rd} 1131,3 [kNm]	
FS 1,12	
taglio	
V _{Rdc} 32,2 [kN]	
predisporre armatura a taglio	
V _{Rds} 709,1 [kN]	
V _{Rdmax} 4493,4 [kN]	
θ 30,0 [°]	
sezione duttile	
a _i 90,4 [cm]	

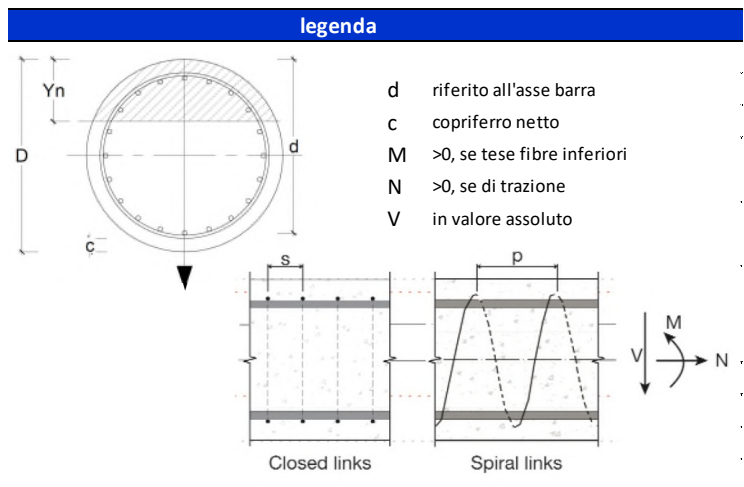
materiali			
calcestruzzo		acciaio	
R _{ck}	30 [MPa]	f _{yk}	450 [MPa]
f _{ck}	24,9 [MPa]	γ _s	1,15
γ _c	1,5	f _{yd}	391,3 [MPa]
α _{cc}	0,85	E _s	200000 [MPa]
f _{cd}	14,1 [MPa]	ε _{uk}	10 [‰]
v	0,5		
ε _{c2}	2,0 [‰]		
ε _{cu2}	3,5 [‰]		
α _e	15,0		
k _t	0,6		
k ₁	0,8	valori limite	
k ₃	3,4	0,55 f _{ck}	13,7 [MPa]
k ₄	0,425	0,75 f _{yk}	337,5 [MPa]
		w _{k,lim}	0,2 [mm]



Tabella 8-16: Verifica del palo D=1500mm; armatura media

APPALTATORE: Consorzio HirpiniaAV Soci salini impregilo ASTALDI		ITINERARIO NAPOLI – BARI RADDOPPIO TRATTA APICE – ORSARA I LOTTO FUNZIONALE APICE – HIRPINIA					
PROGETTAZIONE: Mandataria ROKSOJL Mandanti NETENGINEERING Alpina							
PROGETTO ESECUTIVO RELAZIONE DI CALCOLO FONDAZIONI PILE DA P17 A P20		COMMESSA IF1N	LOTTO 01 E ZZ	CODIFICA RG	DOCUMENTO MD0000 001	REV. B	FOGLIO 32 di 143

geometria				
sezione trasversale				
D	c	d	passo	interferro
[cm]	[cm]	[cm]	[cm]	[cm]
150	6,0	141,6	16,1	13,7
armatura longitudinale				
n _{barre}	φ	r _i	A _{sl}	c _i
	[mm]	[cm]	[cm ²]	[cm]
26	24	66,60	117,62	8,40
61,40				
armatura a taglio				
Tipo	φ	p	A _{sw}	
	[mm]	[cm]	[cm ²]	
spirale	12	20	2,26	

sollecitazioni e risultati	
SLE	SLU
M _{Ek} 517,9 [kNm]	M _{Ed} 88,3 [kNm]
N _{Ek} -1505,4 [kN]	N _{Ed} 3639,0 [kN]
momento di cracking	
M _{cr} 1114,6 [kNm]	
quota asse neutro	
y _n 108,83 [cm]	
tensioni e fessure	
σ _{c,min} -2,3 [MPa]	
σ _{s,min} -31,2 [MPa]	
σ _{s,max} 10,1 [MPa]	
prezzo-flessione	
M _{Rd} 628,6 [kNm]	
FS 7,12	
taglio	
V _{Rdc} 3,8 [kN]	
predisporre armatura a taglio	
V _{Rds} 709,6 [kN]	
V _{Rdmax} 4496,6 [kN]	
θ 30,0 [°]	
sezione duttile	
a _i 90,4 [cm]	

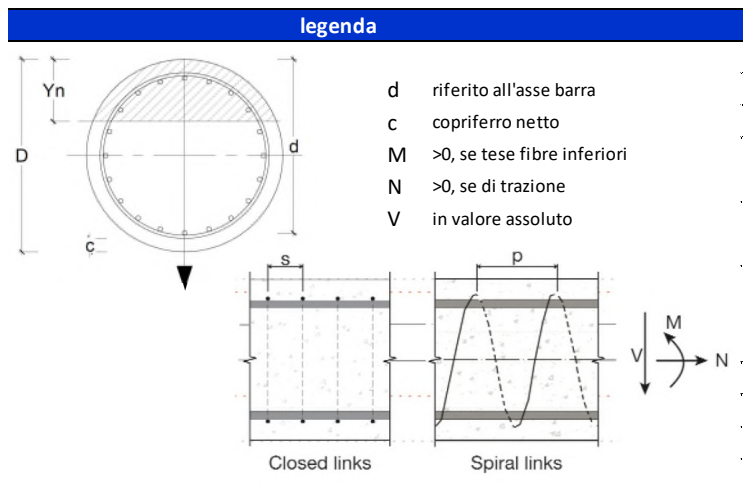
materiali			
calcestruzzo		acciaio	
R _{ck}	30 [MPa]	f _{yk}	450 [MPa]
f _{ck}	24,9 [MPa]	γ _s	1,15
γ _c	1,5	f _{yd}	391,3 [MPa]
α _{cc}	0,85	E _s	200000 [MPa]
f _{cd}	14,1 [MPa]	ε _{uk}	10 [‰]
v	0,5	valori limite	
ε _{c2}	2,0 [‰]	0,55 f _{ck}	13,7 [MPa]
ε _{cu2}	3,5 [‰]	0,75 f _{yk}	337,5 [MPa]
α _e	15,0	w _{k,lim}	0,2 [mm]
k _t	0,6		
k ₁	0,8		
k ₃	3,4		
k ₄	0,425		



Tabella 8-17: Verifica del palo D=1500mm; armatura minima

APPALTATORE: Consorzio HirpiniaAV Soci salini impregilo ASTALDI		ITINERARIO NAPOLI – BARI					
PROGETTAZIONE: Mandataria ROKSOJL Mandanti NETENGINEERING Alpina		RADDOPPIO TRATTA APICE – ORSARA I LOTTO FUNZIONALE APICE – HIRPINIA					
PROGETTO ESECUTIVO RELAZIONE DI CALCOLO FONDAZIONI PILE DA P17 A P20		COMMESSA IF1N	LOTTO 01 E ZZ	CODIFICA RG	DOCUMENTO MD0000 001	REV. B	FOGLIO 34 di 143

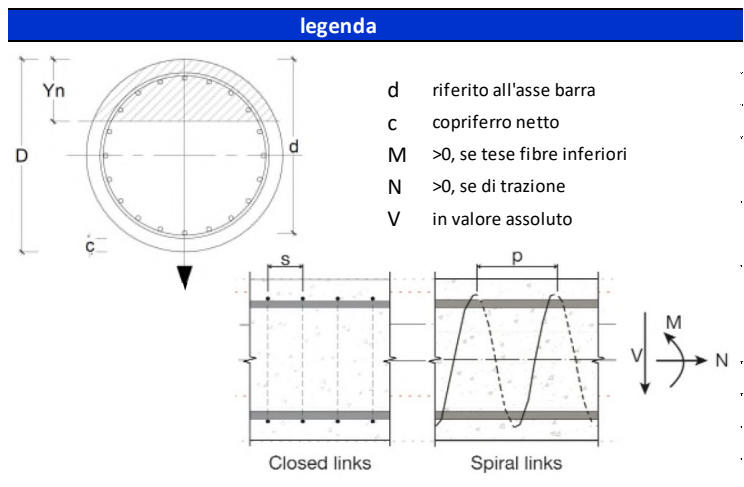

Figura 8-1: VI04 P20 Schema armatura gabbie

APPALTATORE: Consorzio HirpiniaAV Soci salini impregilo ASTALDI		ITINERARIO NAPOLI – BARI RADDOPPIO TRATTA APICE – ORSARA I LOTTO FUNZIONALE APICE – HIRPINIA					
PROGETTAZIONE: Mandataria ROKSOJL Mandanti NETENGINEERING Alpina							
PROGETTO ESECUTIVO RELAZIONE DI CALCOLO FONDAZIONI PILE DA P17 A P20		COMMESSA IF1N	LOTTO 01 E ZZ	CODIFICA RG	DOCUMENTO MD0000 001	REV. B	FOGLIO 35 di 143

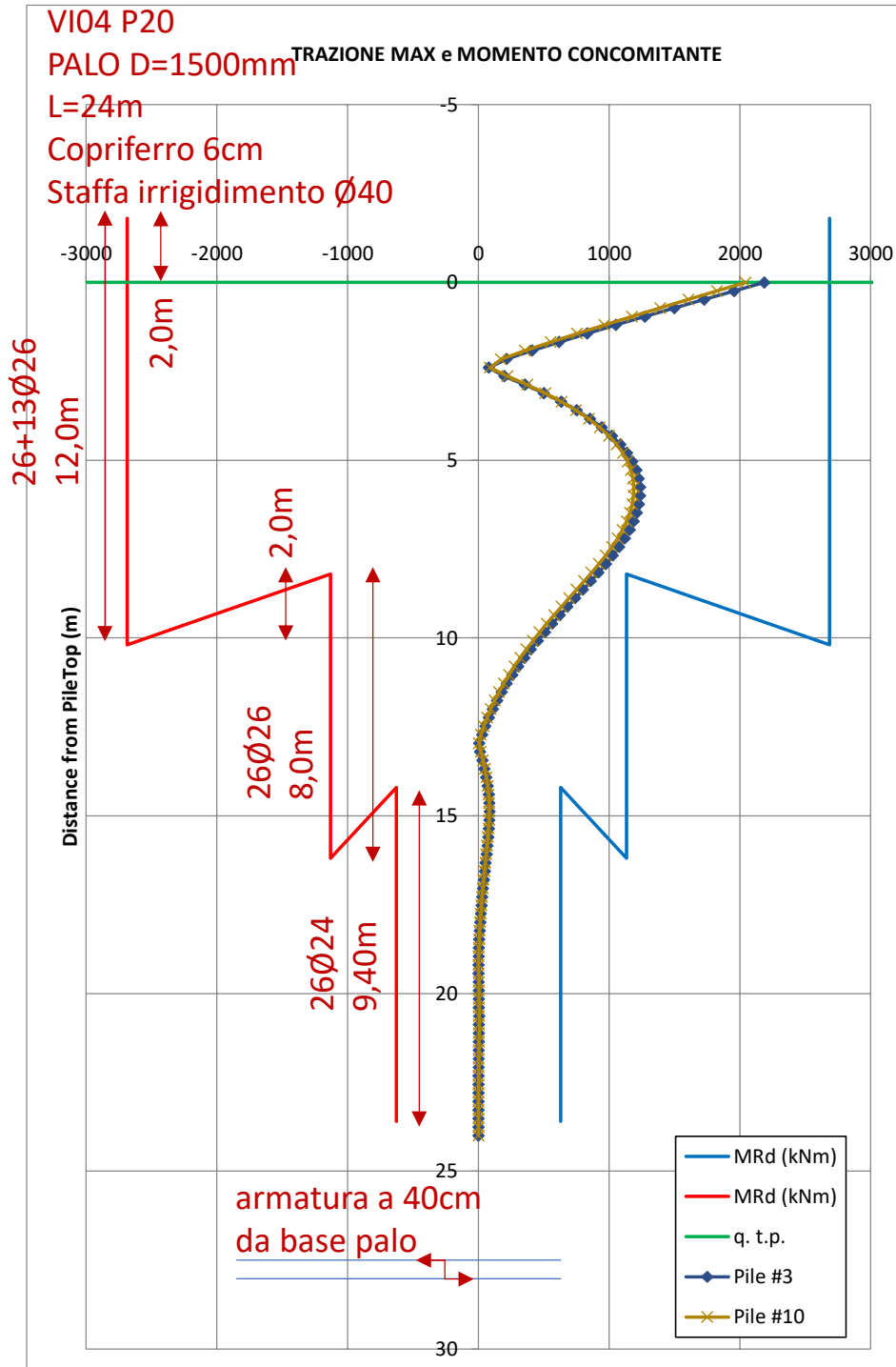

Figura 8-2: VI04 P20 Schema armatura a taglio

APPALTATORE: Consorzio Soci 	ITINERARIO NAPOLI – BARI RADDOPPIO TRATTA APICE – ORSARA I LOTTO FUNZIONALE APICE – HIRPINIA					
PROGETTAZIONE: Mandataria Mandanti 						
PROGETTO ESECUTIVO RELAZIONE DI CALCOLO FONDAZIONI PILE DA P17 A P20	COMMESSA IF1N	LOTTO 01 E ZZ	CODIFICA RG	DOCUMENTO MD0000 001	REV. B	FOGLIO 36 di 143

9 VERIFICHE ALLO SLU DI TIPO GEOTECNICO

9.1 VERIFICA DI CAPACITÀ PORTANTE DEL PALO SINGOLO

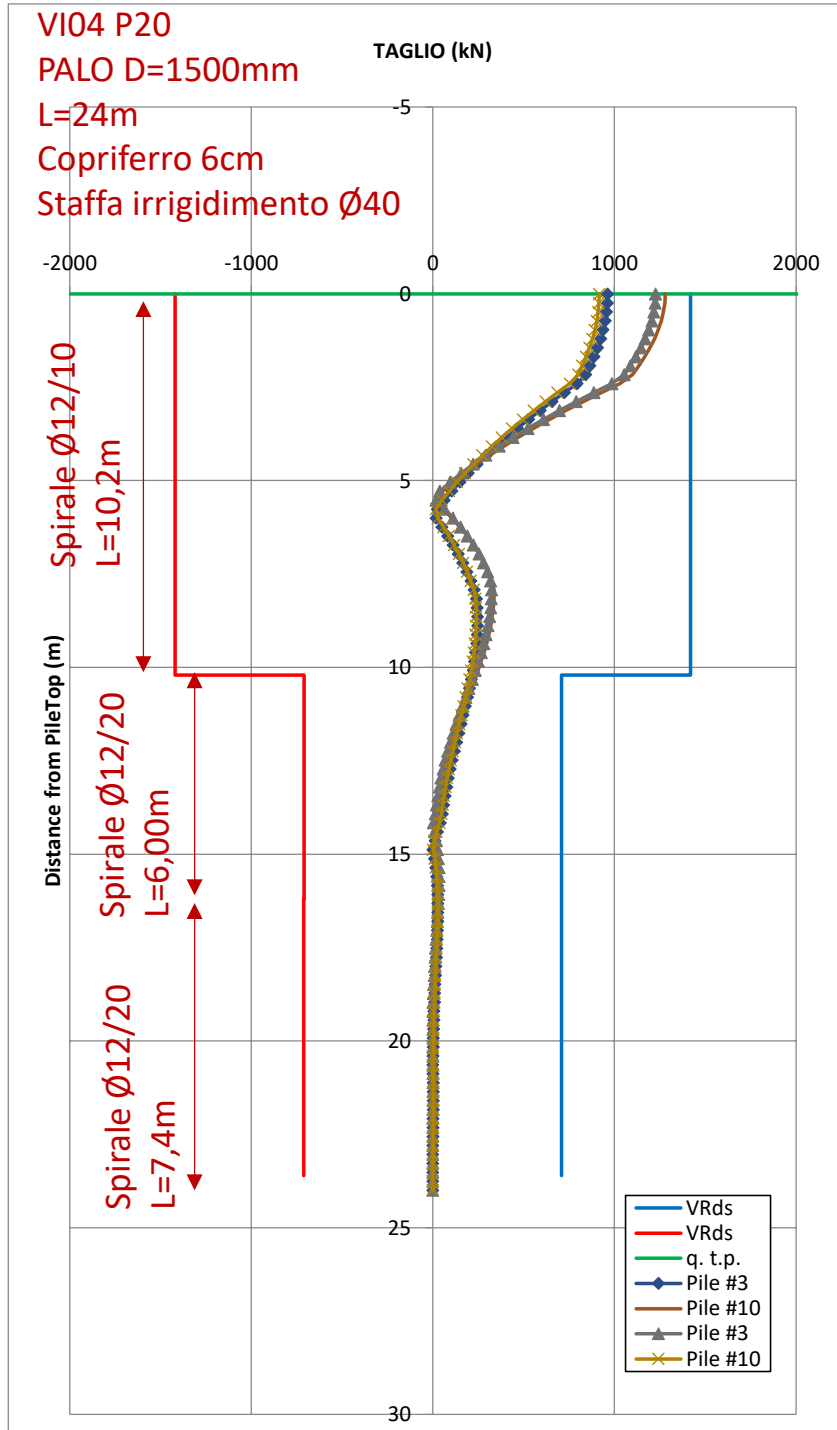
La verifica di capacità portante verticale per il singolo palo è stata condotta in accordo ai criteri esposti nel documento di cui al ref. 2).

Di seguito si riporta, per i pali di fondazione di lunghezza $L = 24$ m, la capacità portante a compressione ($R_{c,d}$) e a trazione ($R_{t,d}$), secondo l'approccio 2 ($A1+M1+R3$).

I carichi assiali massimi agenti sui pali sono riassunti nella seguente tabella:

Massima compressione, N_{dc} , max [kN]	7692,5 (SLV)
Massima trazione, N_{dt} , max [kN]	-3639,0 (SLV)

Tabella 19: Combinazione SLU e SLV: Sollecitazioni massime di compressione e trazione

Si verifica inoltre che lo sforzo assiale massimo in esercizio (Tabella 19) sia inferiore della resistenza laterale di calcolo ($R_{c,s,k}$) divisa per un fattore pari a 1.25.

Massima compressione, N_{dcSLE} , max [kN]	4291,6 (SLE)
--	--------------

Tabella 20: Combinazione SLE: Sollecitazione massima di compressione

In Tabella 9-21 si riporta, per i pali di lunghezza 24.0 m, la capacità portante a compressione ($R_{c,d}$) e a trazione ($R_{t,d}$) del palo isolato secondo l'Approccio 2 ($A1+M1+R3$).

Combinazione SLU A1+M1+R3 (metodo AGI)							Comb. SLU A1+M1+R3 (metodo AGI)				
L palo	Q l-c,k	Q b-c,k	Q l-c,d	Q b-c,d	ΔW palo	Q c,d	L palo	Q l-t,k	Q l-t,d	ΔW palo	Q t,d
m	kN	kN	kN	kN	kN	kN	m	kN	kN	kN	kN
24,0	10447,3	7076,6	6056,4	3494,6	827,0	8724,0	24,0	10447,3	5571,9	636,2	6208,1

Tabella 9-21: Capacità portante a compressione e a trazione dei pali di fondazione secondo l'Approccio 2 ($A1+M1+R3$).

9.1.1 Capacità portante verticale del palo singolo

Stratigrafia e parametri geotecnici

Dati di input		
Diametro Palo	1.5	m
Sovraccarico efficace	112,8	kPa
Hw da testa palo	1	m
γ acqua	10	kN/m ³
Δz palo da p.c. originario	5,5	m
N° diametri per qb	4	(-)
L palo fuori terra	0	(m)

APPALTATORE: Consorzio Soci   		ITINERARIO NAPOLI – BARI RADDOPPIO TRATTA APICE – ORSARA I LOTTO FUNZIONALE APICE – HIRPINIA					
PROGETTAZIONE: Mandataria Mandanti   							
PROGETTO ESECUTIVO RELAZIONE DI CALCOLO FONDAZIONI PILE DA P17 A P20							

Peso calcestruzzo	25	kN/m³
Pressione max sul cls.	11.34	MPa





Caratteristiche del terreno													
Profondità (m)		Strato	Terreno	γ_{tot}	Nspt		c_u (kPa)		$\Delta-z$	ϕ°		Nq	
da	a	No.	(S,SL,G,A)	kN/m3	da	a	da	a	(m)	da	a	da	a
0,0	2,30	1	S	19,0					1,00	29	29	9,1	9,1
2,3	8,00	2	A	20,5			105	105	1,00				
8,0	14,00	3	S	20,5					1,00	33	33	11,95	11,95
14,0	20,60	4	A	20,5			200	200	1,00				
20,6	29,20	5	S	20,5					1,00	32	32	11,95	11,95
29,2	50,0	6	A	20,5			300	300	1,00				

Verticali di indagine	ξ_3	ξ_4
5	1.50	1.34

Scelta di ξ	ξ
3	1.5

APPALTATORE: Consorzio Soci   	ITINERARIO NAPOLI – BARI RADDOPPIO TRATTA APICE – ORSARA I LOTTO FUNZIONALE APICE – HIRPINIA
PROGETTAZIONE: Mandataria Mandanti   	
PROGETTO ESECUTIVO RELAZIONE DI CALCOLO FONDAZIONI PILE DA P17 A P20	COMMESSA LOTTO CODIFICA DOCUMENTO REV. FOGLIO IF1N 01 E ZZ RG MD0000 001 B 38 di 143

Combinazione SLE (metodo AGI)						
L palo	τ_s calcolo	q_{ub} calcolo	$R_{c,s,k}$	$R_{c,b,k}$	ΔW palo	$Q_{c,s,k}/1.25$
m	kPa	kPa	kN	kN	kN	kN
1,0	40,7	543,4	191,6	960,3	26,5	126,8
2,0	45,3	1086,9	405,1	1920,6	53,0	271,1
2,3	47,3	1249,9	472,0	2208,7	61,0	316,6
2,3	47,7	1249,9	472,0	2208,7	61,0	316,6
3,0	76,9	1434,7	725,5	2535,4	79,5	500,8
4,0	76,9	1619,5	1087,6	2861,8	106,0	764,1
5,0	76,9	1804,2	1449,8	3188,3	132,5	1027,3
6,0	76,9	1989,0	1811,9	3514,8	159,0	1290,5
7,0	76,9	2173,7	2174,1	3841,3	185,6	1553,7
8,0	76,9	2173,7	2536,2	3841,3	212,1	1816,9
8,0	76,9	2173,7	2536,2	3841,3	212,1	1816,9
9,0	78,2	2394,5	2904,7	4231,4	238,6	2085,2
10,0	82,1	2615,3	3291,7	4621,5	265,1	2368,3
11,0	86,1	2805,9	3697,3	4958,4	291,6	2666,2
12,0	90,0	2854,4	4121,4	5044,1	318,1	2979,0
13,0	93,9	2902,9	4564,1	5129,9	344,6	3306,7
14,0	97,9	2951,5	5025,3	5215,7	371,1	3649,1
14,0	99,8	2951,5	5025,3	5215,7	371,1	3649,1
15,0	106,1	3000,0	5525,1	5301,4	397,6	4022,5
16,0	106,1	3000,0	6024,9	5301,4	424,1	4395,8
17,0	106,1	3000,0	6524,8	5301,4	450,6	4769,2
18,0	106,1	3000,0	7024,6	5301,4	477,1	5142,5
19,0	106,1	3000,0	7524,4	5301,4	503,6	5515,9
20,0	106,1	3000,0	8024,2	5301,4	530,1	5889,2
20,6	106,1	3000,0	8324,1	5301,4	546,0	6113,3
20,6	106,1	3000,0	8324,1	5301,4	546,0	6113,3
21,0	126,6	3118,2	8562,8	5510,3	556,7	6293,6
22,0	129,4	3413,6	9172,4	6032,4	583,2	6754,8
23,0	133,3	3709,1	9800,6	6554,5	609,7	7230,8
24,0	137,2	4004,5	10447,3	7076,6	636,2	7721,7
25,0	141,2	4300,0	11112,6	7598,7	662,7	8227,4
26,0	145,1	4300,0	11796,4	7598,7	689,2	8748,0
27,0	149,1	4143,6	12498,8	7322,3	715,7	9283,3
28,0	153,0	3987,1	13219,7	7045,8	742,2	9833,6
29,0	156,9	3830,7	13959,2	6769,4	768,7	10398,7
29,2	159,3	3799,4	14109,3	6714,1	774,0	10513,5
29,2	159,7	3799,4	14109,3	6714,1	774,0	10513,5
30,0	129,9	3674,2	14599,1	6492,9	795,2	10884,0
31,0	129,9	3674,2	15211,2	6492,9	821,7	11347,3
32,0	129,9	3674,2	15823,4	6492,9	848,2	11810,5
33,0	129,9	3674,2	16435,5	6492,9	874,7	12273,7
34,0	129,9	3674,2	17047,7	6492,9	901,2	12736,9
35,0	129,9	3674,2	17659,9	6492,9	927,8	13200,1
36,0	129,9	3674,2	18272,0	6492,9	954,3	13663,4
37,0	129,9	3674,2	18884,2	6492,9	980,8	14126,6
38,0	129,9	3674,2	19496,3	6492,9	1007,3	14589,8
39,0	129,9	3674,2	20108,5	6492,9	1033,8	15053,0
40,0	129,9	3674,2	20720,6	6492,9	1060,3	15516,2

APPALTATORE: Consorzio Soci   	ITINERARIO NAPOLI – BARI RADDOPPIO TRATTA APICE – ORSARA I LOTTO FUNZIONALE APICE – HIRPINIA
PROGETTAZIONE: Mandataria Mandanti   	
PROGETTO ESECUTIVO RELAZIONE DI CALCOLO FONDAZIONI PILE DA P17 A P20	COMMESSA LOTTO CODIFICA DOCUMENTO REV. FOGLIO IF1N 01 E ZZ RG MD0000 001 B 39 di 143

Combinazione SLU A1+M1+R3 (metodo AGI)						
L palo	Q I-c,k	Q b-c,k	Q I-c,d	Q b-c,d	ΔW palo	Q c,d
m	kN	kN	kN	kN	kN	kN
1,0	191,6	960,3	111,07	474,23	34,46	550,8
2,0	405,1	1920,6	234,86	948,46	68,92	1114,4
2,3	472,0	2208,7	273,60	1090,73	79,26	1285,1
2,3	472,0	2208,7	273,60	1090,73	79,26	1285,1
3,0	725,5	2535,4	420,56	1252,03	103,38	1569,2
4,0	1087,6	2861,8	630,50	1413,25	137,84	1905,9
5,0	1449,8	3188,3	840,45	1574,47	172,30	2242,6
6,0	1811,9	3514,8	1050,40	1735,69	206,76	2579,3
7,0	2174,1	3841,3	1260,34	1896,92	241,22	2916,0
8,0	2536,2	3841,3	1470,29	1896,92	275,67	3091,5
8,0	2536,2	3841,3	1470,29	1896,92	275,67	3091,5
9,0	2904,7	4231,4	1683,89	2089,58	310,13	3463,3
10,0	3291,7	4621,5	1908,24	2282,24	344,59	3845,9
11,0	3697,3	4958,4	2143,35	2448,57	379,05	4212,9
12,0	4121,4	5044,1	2389,22	2490,93	413,51	4466,6
13,0	4564,1	5129,9	2645,84	2533,28	447,97	4731,1
14,0	5025,3	5215,7	2913,21	2575,64	482,43	5006,4
14,0	5025,3	5215,7	2913,21	2575,64	482,43	5006,4
15,0	5525,1	5301,4	3202,96	2617,99	516,89	5304,1
16,0	6024,9	5301,4	3492,71	2617,99	551,35	5559,4
17,0	6524,8	5301,4	3782,47	2617,99	585,81	5814,7
18,0	7024,6	5301,4	4072,22	2617,99	620,27	6069,9
19,0	7524,4	5301,4	4361,97	2617,99	654,73	6325,2
20,0	8024,2	5301,4	4651,73	2617,99	689,19	6580,5
20,6	8324,1	5301,4	4825,58	2617,99	709,86	6733,7
20,6	8324,1	5301,4	4825,58	2617,99	709,86	6733,7
21,0	8562,8	5510,3	4963,93	2721,13	723,65	6961,4
22,0	9172,4	6032,4	5317,34	2978,96	758,11	7538,2
23,0	9800,6	6554,5	5681,50	3236,79	792,56	8125,7
24,0	10447,3	7076,6	6056,4	3494,6	827,0	8724,0
25,0	11112,6	7598,7	6442,08	3752,46	861,48	9333,1
26,0	11796,4	7598,7	6838,51	3752,46	895,94	9695,0
27,0	12498,8	7322,3	7245,68	3615,94	930,40	9931,2
28,0	13219,7	7045,8	7663,62	3479,42	964,86	10178,2
29,0	13959,2	6769,4	8092,30	3342,90	999,32	10435,9
29,2	14109,3	6714,1	8179,33	3315,59	1006,21	10488,7
29,2	14109,3	6714,1	8179,33	3315,59	1006,21	10488,7
30,0	14599,1	6492,9	8463,23	3206,37	1033,78	10635,8
31,0	15211,2	6492,9	8818,10	3206,37	1068,24	10956,2
32,0	15823,4	6492,9	9172,98	3206,37	1102,70	11276,7
33,0	16435,5	6492,9	9527,85	3206,37	1137,16	11597,1
34,0	17047,7	6492,9	9882,72	3206,37	1171,62	11917,5
35,0	17659,9	6492,9	10237,60	3206,37	1206,08	12237,9
36,0	18272,0	6492,9	10592,47	3206,37	1240,54	12558,3
37,0	18884,2	6492,9	10947,35	3206,37	1275,00	12878,7
38,0	19496,3	6492,9	11302,22	3206,37	1309,46	13199,1
39,0	20108,5	6492,9	11657,09	3206,37	1343,91	13519,6
40,0	20720,6	6492,9	12011,97	3206,37	1378,37	13840,0

Comb. SLU A1+M1+R3 (metodo AGI)				
L palo	Q I-t,k	Q I-t,d	ΔW palo	Q t,d
m	kN	kN	kN	kN
1,0	191,6	102,19	26,51	128,7
2,0	405,1	216,07	53,01	269,1
2,3	472,0	251,71	60,97	312,7
2,3	472,0	251,71	60,97	312,7
3,0	725,5	386,91	79,52	466,4
4,0	1087,6	580,06	106,03	686,1
5,0	1449,8	773,21	132,54	905,8
6,0	1811,9	966,36	159,04	1125,4
7,0	2174,1	1159,52	185,55	1345,1
8,0	2536,2	1352,67	212,06	1564,7
8,0	2536,2	1352,67	212,06	1564,7
9,0	2904,7	1549,18	238,56	1787,7
10,0	3291,7	1755,59	265,07	2020,7
11,0	3697,3	1971,89	291,58	2263,5
12,0	4121,4	2198,08	318,09	2516,2
13,0	4564,1	2434,17	344,59	2778,8
14,0	5025,3	2680,15	371,10	3051,3
14,0	5025,3	2680,15	371,10	3051,3
15,0	5525,1	2946,72	397,61	3344,3
16,0	6024,9	3213,30	424,12	3637,4
17,0	6524,8	3479,87	450,62	3930,5
18,0	7024,6	3746,44	477,13	4223,6
19,0	7524,4	4013,02	503,64	4516,7
20,0	8024,2	4279,59	530,14	4809,7
20,6	8324,1	4439,53	546,05	4985,6
20,6	8324,1	4439,53	546,05	4985,6
21,0	8562,8	4566,82	556,65	5123,5
22,0	9172,4	4891,95	583,16	5475,1
23,0	9800,6	5226,98	609,67	5836,6
24,0	10447,3	5571,9	636,2	6208,1
25,0	11112,6	5926,72	662,68	6589,4
26,0	11796,4	6291,43	689,19	6980,6
27,0	12498,8	6666,03	715,69	7381,7
28,0	13219,7	7050,53	742,20	7792,7
29,0	13959,2	7444,92	768,71	8213,6
29,2	14109,3	7524,98	774,01	8299,0
29,2	14109,3	7524,98	774,01	8299,0
30,0	14599,1	7786,17	795,22	8581,4
31,0	15211,2	8112,65	821,72	8934,4
32,0	15823,4	8439,14	848,23	9287,4
33,0	16435,5	8765,62	874,74	9640,4
34,0	17047,7	9092,11	901,24	9993,4
35,0	17659,9	9418,59	927,75	10346,3
36,0	18272,0	9745,07	954,26	10699,3
37,0	18884,2	10071,56	980,77	11052,3
38,0	19496,3	10398,04	1007,27	11405,3
39,0	20108,5	10724,53	1033,78	11758,3
40,0	20720,6	11051,01	1060,29	12111,3

APPALTATORE: Consorzio HirpiniaAV Soci salini impregio ASTALDI		ITINERARIO NAPOLI – BARI RADDOPPIO TRATTA APICE – ORSARA I LOTTO FUNZIONALE APICE – HIRPINIA					
PROGETTAZIONE: Mandataria ROKSOJL Mandanti NETENGINEERING Alpina							
PROGETTO ESECUTIVO RELAZIONE DI CALCOLO FONDAZIONI PILE DA P17 A P20		COMMESSA IF1N	LOTTO 01 E ZZ	CODIFICA RG	DOCUMENTO MD0000 001	REV. B	FOGLIO 40 di 143



Figura 9-1: Capacità portante del palo singolo

APPALTATORE: Consorzio  Soci  	ITINERARIO NAPOLI – BARI RADDOPPIO TRATTA APICE – ORSARA I LOTTO FUNZIONALE APICE – HIRPINIA					
PROGETTAZIONE: Mandataria  Mandanti  						
PROGETTO ESECUTIVO RELAZIONE DI CALCOLO FONDAZIONI PILE DA P17 A P20	COMMESSA IF1N	LOTTO 01 E ZZ	CODIFICA RG	DOCUMENTO MD0000 001	REV. B	FOGLIO 41 di 143

9.1.2 Verifica di capacità portante verticale del gruppo di pali

La verifica di capacità portante verticale del blocco è stata condotta in accordo ai criteri descritti nel documento di cui al Ref. 2) §7.1.

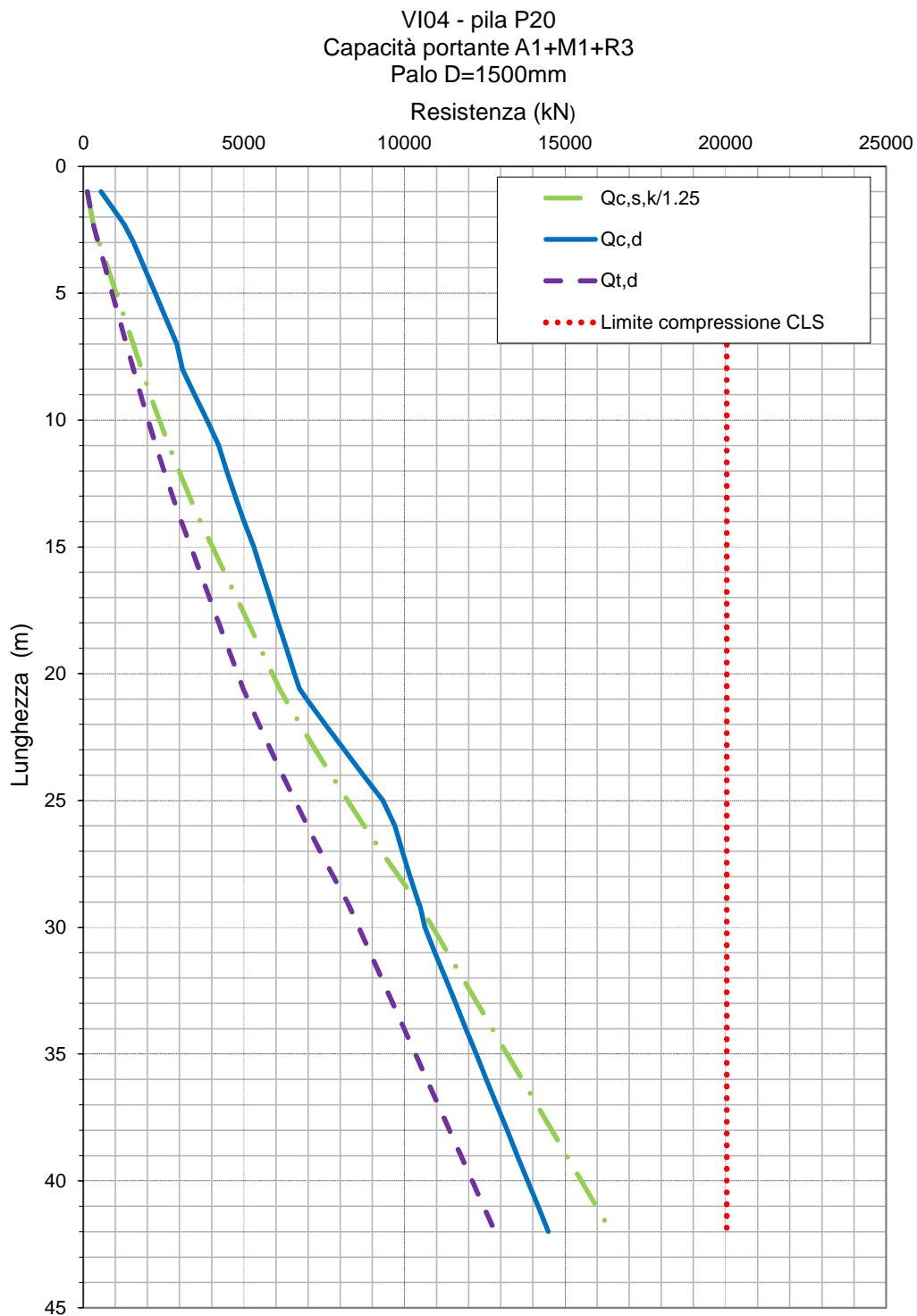
Nella seguente tabella si riporta la capacità portante del blocco valutata secondo l'Approccio 2 (A1+M1+R3).

CAPACITA' PORTANTE VERTICALE GRUPPI DI PALI				
B	10,5		m	larghezza pozzo
L	15		m	lunghezza pozzo
D	24		m	profondità pozzo
i	4,5		m	interasse pali
n°	12			numero dei pali
γ_R cap.port.	2,3			coefficiente sicurezza globale per capacità portante
ξ_3	1,5			fattore di correlazione in base alle verticali indagate
γ_s	1,15			coefficiente di resistenza laterale
γ_b	1,35			coefficiente di resistenza base
$Cu_{b,calc}$	300		kPa	coesione non drenata di calcolo, base
$Cu_{b,d}$	148		kPa	coesione non drenata di progetto, base
$Cu_{s,i}$	200	300	kPa	coesione strato i
di	24	0	m	altezza strato i-esimo
$Cu_{s,calc}$	200		kPa	coesione non drenata di calcolo, laterale
$Cu_{s,d}$	116		kPa	coesione non drenata di progetto, laterale
As	1224		m ²	area laterale
Ab	158		m ²	area base
S_block	1			fattore forma
Nc	5,14			fattore di portanza alla base
Rblock,c,d	113862		kN	resistenza di progetto
Valutazione alternativa dell'Area di Base				
Ab,diafr	21,20575		m ²	area di impronta dei soli pali o pannelli
Rpunz,c,d	68724		kN	Resistenza di progetto con area di base
Valutazione alternativa dell'Area di Base				
Verifica:				
N slu, max	50691,5		kN	
FSblock	2,25		ok	
FSpunz	1,36		ok	

Tabella 22: Capacità portante del blocco (Approccio 2: A1+M1+R3)

APPALTATORE: Consorzio HirpiniaAV Soci salini impregilo ASTALDI	ITINERARIO NAPOLI – BARI RADDOPPIO TRATTA APICE – ORSARA I LOTTO FUNZIONALE APICE – HIRPINIA
PROGETTAZIONE: Mandataria SOJL Mandanti NETENGINEERING Alpina	
PROGETTO ESECUTIVO RELAZIONE DI CALCOLO FONDAZIONI PILE DA P17 A P20	COMMESSA IF1N LOTTO 01 E ZZ CODIFICA RG DOCUMENTO MD0000 001 REV. B FOGLIO 42 di 143

9.1.3 Verifica di capacità portante orizzontale del gruppo di pali

La verifica di capacità portante orizzontale del gruppo di pali è stata condotta con i criteri descritti nel documento di cui al Ref. 2) §6.2, con i metodi basati sulle curve p-y.

Considerata la presenza di successioni stratigrafiche abbastanza articolate, con contrasti di rigidezza anche marcati e caratteristiche diverse delle varie unità geotecniche, si è fatto uso del programma FEM non lineare LPile, considerando negli strati di terreno curve p-y non lineari, definibili lungo il fuso del palo, e opportunamente ridotte secondo il coefficiente parziale $\xi \times \gamma_T$.

Si ricava una curva "pushover" del palo singolo: incrementando progressivamente il carico orizzontale applicato alla testa del palo, fino al raggiungimento del collasso, vale a dire della completa plasticizzazione del terreno. Tale plasticizzazione si rende "visibile" attraverso il cambiamento del comportamento deformativo del palo stesso, al raggiungimento del "plateau" di resistenza.

Nella seguente Figura 9-2 è illustrata la curva push-over ottenuta per il palo in oggetto, con il vincolo di invastro, al crescere dell'azione H applicata alla testa dello stesso.

Il taglio massimo agente è pari a $T_{longSLV} = 1279,9 \text{ kN}$.

La verifica a capacità portante orizzontale risulta soddisfatta, poiché il carico limite $H_{lim} = 4476.0 \text{ kN}$ risulta superiore al valore di progetto.



Figura 9-2: Analisi push-over palo

APPALTATORE: Consorzio Soci 	ITINERARIO NAPOLI – BARI RADDOPPIO TRATTA APICE – ORSARA I LOTTO FUNZIONALE APICE – HIRPINIA																	
PROGETTAZIONE: Mandataria Mandanti 	<table border="1" style="width: 100%; border-collapse: collapse;"> <tr> <td style="width: 16.6%;">COMMESSA</td> <td style="width: 16.6%;">LOTTO</td> <td style="width: 16.6%;">CODIFICA</td> <td style="width: 16.6%;">DOCUMENTO</td> <td style="width: 16.6%;">REV.</td> <td style="width: 16.6%;">FOGLIO</td> </tr> <tr> <td>IF1N</td> <td>01 E ZZ</td> <td>RG</td> <td>MD0000 001</td> <td>B</td> <td>43 di 143</td> </tr> </table>						COMMESSA	LOTTO	CODIFICA	DOCUMENTO	REV.	FOGLIO	IF1N	01 E ZZ	RG	MD0000 001	B	43 di 143
COMMESSA	LOTTO	CODIFICA	DOCUMENTO	REV.	FOGLIO													
IF1N	01 E ZZ	RG	MD0000 001	B	43 di 143													
PROGETTO ESECUTIVO RELAZIONE DI CALCOLO FONDAZIONI PILE DA P17 A P20																		

10 DIMENSIONAMENTO E VERIFICA DEL PLINTO DI FONDAZIONE [P2 P17 P18 P19 P20]

10.1 DESCRIZIONE DEL MODELLO

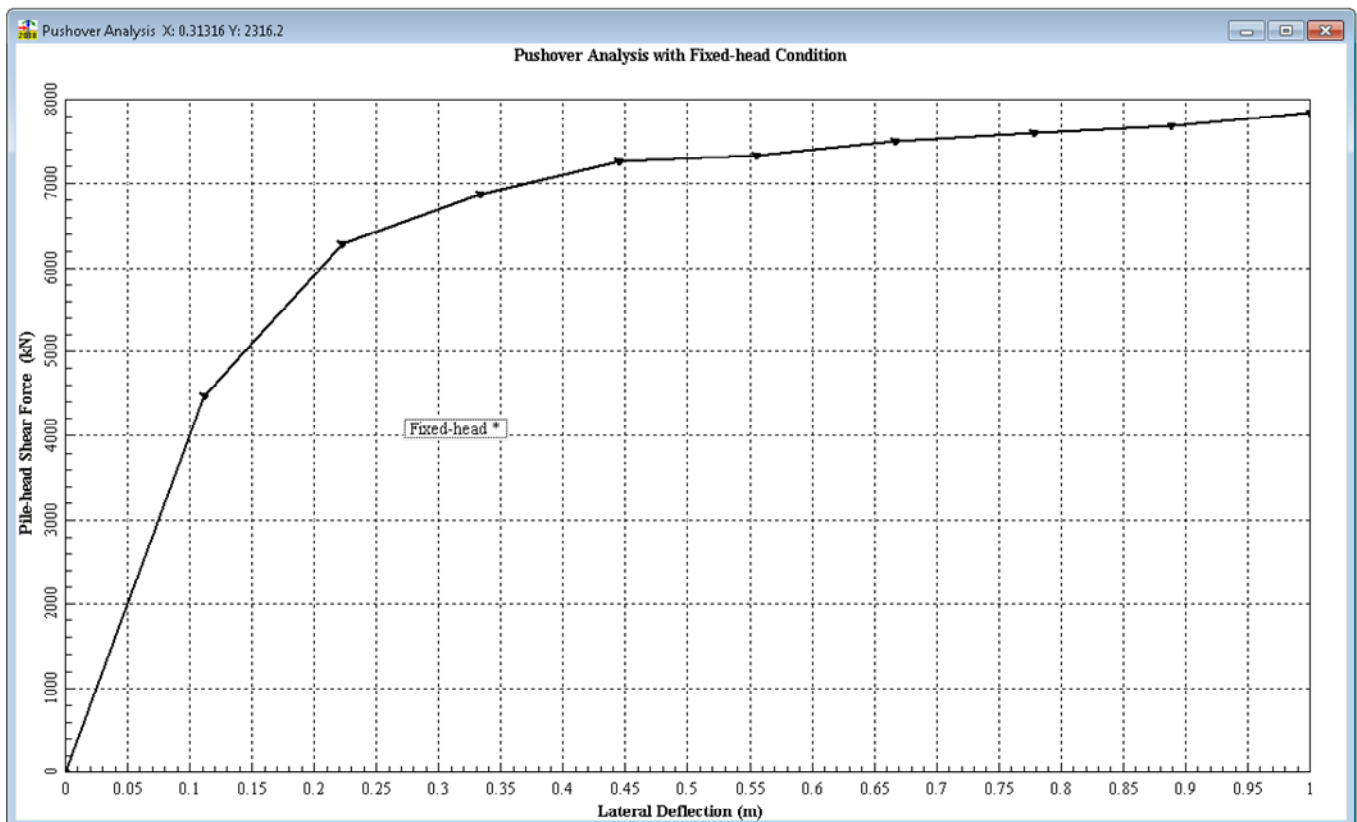
La platea di fondazione ha le seguenti dimensioni 16 m x 12 m x 2,5 m, con un ricoprimento minimo di 0.9 m; la platea presenta 12 pali.

Il dimensionamento a flessione e taglio del plinto di fondazione viene fatta a filo della pila, in modo da valutare le massime sollecitazioni, **Figura 10.1**.





Figura 10.1 Pianta del plinto

La platea di fondazione è stata modellata mediante il software SAP2000, con elementi shell.

APPALTATORE: Consorzio Soci   	ITINERARIO NAPOLI – BARI RADDOPPIO TRATTA APICE – ORSARA I LOTTO FUNZIONALE APICE – HIRPINIA																	
PROGETTAZIONE: Mandataria Mandanti   	<table border="1" style="width: 100%; border-collapse: collapse;"> <tr> <td style="width: 16.6%;">COMMESSA</td> <td style="width: 16.6%;">LOTTO</td> <td style="width: 16.6%;">CODIFICA</td> <td style="width: 16.6%;">DOCUMENTO</td> <td style="width: 16.6%;">REV.</td> <td style="width: 16.6%;">FOGLIO</td> </tr> <tr> <td style="text-align: center;">IF1N</td> <td style="text-align: center;">01 E ZZ</td> <td style="text-align: center;">RG</td> <td style="text-align: center;">MD0000 001</td> <td style="text-align: center;">B</td> <td style="text-align: center;">44 di 143</td> </tr> </table>						COMMESSA	LOTTO	CODIFICA	DOCUMENTO	REV.	FOGLIO	IF1N	01 E ZZ	RG	MD0000 001	B	44 di 143
COMMESSA	LOTTO	CODIFICA	DOCUMENTO	REV.	FOGLIO													
IF1N	01 E ZZ	RG	MD0000 001	B	44 di 143													

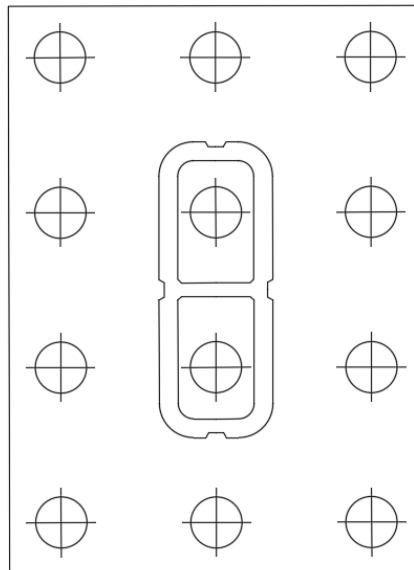

Figura 10.2 Modello numerico

A partire dalle azioni interne delle fondazioni profonde, definiti precedentemente, è stato possibile caricare la platea in esame, considerando il carico concentrato proveniente dalle differenti combinazioni per ogni palo nel proprio baricentro.

La platea è stata vincolata in corrispondenza del fusto pila attraverso dei vincoli traslazionali che non interrompono la continuità del momento, **Figura 10.3**.

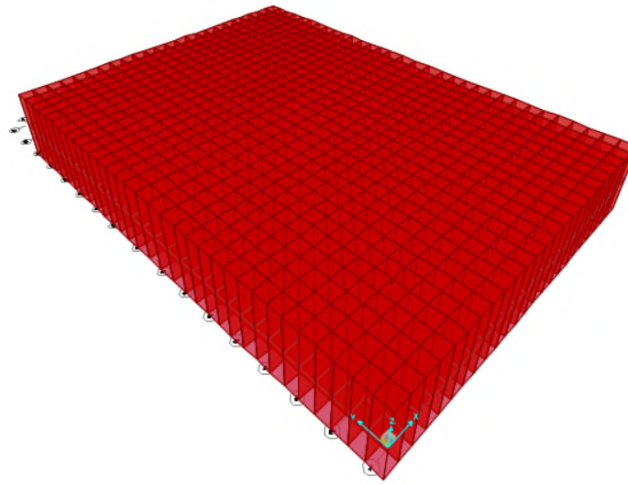

Figura 10.3 Modello numerico con le condizioni al contorno

APPALTATORE: Consorzio Soci   	ITINERARIO NAPOLI – BARI RADDOPPIO TRATTA APICE – ORSARA I LOTTO FUNZIONALE APICE – HIRPINIA					
PROGETTAZIONE: Mandataria Mandanti   						
PROGETTO ESECUTIVO RELAZIONE DI CALCOLO FONDAZIONI PILE DA P17 A P20	COMMESSA IF1N	LOTTO 01 E ZZ	CODIFICA RG	DOCUMENTO MD0000 001	REV. B	FOGLIO 45 di 143

10.1.1 Combinazioni e carichi

Le combinazioni introdotte nel modello numerico ad elementi finiti sono caratterizzate da non avere coefficienti di amplificazione per i vari Stati Limite, in quanto gli scarichi dei pali considerano già tale amplificazione.

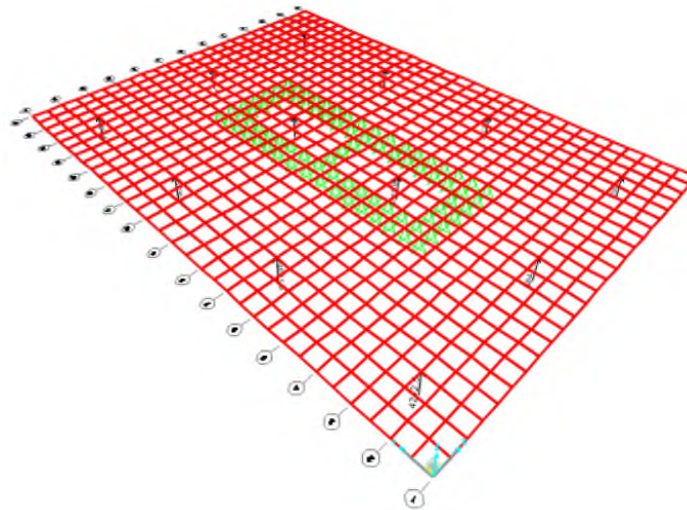
Sono state considerate:

- 10 Combinazioni SLV, stato limite di salvaguardia della vita;
- 6 Combinazioni SLU, stato limite ultimo;
- 4 Combinazioni SLE-R, stato limite di esercizio caratteristico.

Gli scarichi sui pali sono stati quelli determinati attraverso il software Group come definito al paragrafo 7.1.

Ai carichi sopra citati, viene aggiunto il carico distribuito dato dal terreno di ricoprimento minimo, considerando tale carico permanente non strutturale.

I carichi sui pali risultano essere:

SLE- Caratteristica					
Point load	Combination	F [kN]	Point load	Combination	F [kN]
Palo1	Pali SLE1	3119,2	Palo1	Pali SLE3	3052,8
Palo2	Pali SLE1	3591,4	Palo2	Pali SLE3	3363,3
Palo3	Pali SLE1	4063,6	Palo3	Pali SLE3	3673,8
Palo4	Pali SLE1	2792,1	Palo4	Pali SLE3	2714,3
Palo5	Pali SLE1	3264,4	Palo5	Pali SLE3	3024,8
Palo6	Pali SLE1	3736,6	Palo6	Pali SLE3	3335,2
Palo7	Pali SLE1	2465,1	Palo7	Pali SLE3	2375,8
Palo8	Pali SLE1	2937,3	Palo8	Pali SLE3	2686,2
Palo9	Pali SLE1	3409,5	Palo9	Pali SLE3	2996,7
Palo10	Pali SLE1	2138,1	Palo10	Pali SLE3	2037,2
Palo11	Pali SLE1	2610,3	Palo11	Pali SLE3	2347,7
Palo12	Pali SLE1	3082,5	Palo12	Pali SLE3	2658,2
Palo1	Pali SLE2	2804,5	Palo1	Pali SLE4	2164,9
Palo2	Pali SLE2	2872,2	Palo2	Pali SLE4	3228,2
Palo3	Pali SLE2	2939,8	Palo3	Pali SLE4	4291,6
Palo4	Pali SLE2	2555,7	Palo4	Pali SLE4	1945
Palo5	Pali SLE2	2623,4	Palo5	Pali SLE4	3008,4
Palo6	Pali SLE2	2691	Palo6	Pali SLE4	4071,8
Palo7	Pali SLE2	2307	Palo7	Pali SLE4	1725,2
Palo8	Pali SLE2	2374,6	Palo8	Pali SLE4	2788,6
Palo9	Pali SLE2	2442,3	Palo9	Pali SLE4	3852
Palo10	Pali SLE2	2058,2	Palo10	Pali SLE4	1505,4
Palo11	Pali SLE2	2125,8	Palo11	Pali SLE4	2568,8
Palo12	Pali SLE2	2193,5	Palo12	Pali SLE4	3632,1

SLU					
Point load	Combination	F [kN]	Point load	Combination	F [kN]

APPALTATORE: Consorzio Soci   		ITINERARIO NAPOLI – BARI					
PROGETTAZIONE: Mandataria Mandanti   		RADDOPPIO TRATTA APICE – ORSARA I LOTTO FUNZIONALE APICE – HIRPINIA					
PROGETTO ESECUTIVO RELAZIONE DI CALCOLO FONDAZIONI PILE DA P17 A P20		COMMESSA IF1N	LOTTO 01 E ZZ	CODIFICA RG	DOCUMENTO MD0000 001	REV. B	FOGLIO 46 di 143

Palo1	Pali SLU1	5038,3	Palo1	Pali SLU4	2455,9
Palo2	Pali SLU1	3476,6	Palo2	Pali SLU4	2356,8
Palo3	Pali SLU1	1820,4	Palo3	Pali SLU4	2257,7
Palo4	Pali SLU1	5286,4	Palo4	Pali SLU4	2823
Palo5	Pali SLU1	3838,4	Palo5	Pali SLU4	2723,8
Palo6	Pali SLU1	2182,2	Palo6	Pali SLU4	2624,7
Palo7	Pali SLU1	5534,5	Palo7	Pali SLU4	3190
Palo8	Pali SLU1	4200,2	Palo8	Pali SLU4	3090,9
Palo9	Pali SLU1	2544,1	Palo9	Pali SLU4	2991,8
Palo10	Pali SLU1	5782,5	Palo10	Pali SLU4	3557,1
Palo11	Pali SLU1	4562	Palo11	Pali SLU4	3458
Palo12	Pali SLU1	2905,9	Palo12	Pali SLU4	3358,8
Palo1	Pali SLU2	4046,6	Palo1	Pali SLU5	3577
Palo2	Pali SLU2	3495,2	Palo2	Pali SLU5	3125
Palo3	Pali SLU2	2943,8	Palo3	Pali SLU5	2673
Palo4	Pali SLU2	4552,5	Palo4	Pali SLU5	4077
Palo5	Pali SLU2	4001,1	Palo5	Pali SLU5	3625
Palo6	Pali SLU2	3449,8	Palo6	Pali SLU5	3173
Palo7	Pali SLU2	4987,4	Palo7	Pali SLU5	4577,1
Palo8	Pali SLU2	4507,1	Palo8	Pali SLU5	4125
Palo9	Pali SLU2	3955,7	Palo9	Pali SLU5	3673
Palo10	Pali SLU2	5334,3	Palo10	Pali SLU5	5000,2
Palo11	Pali SLU2	4956,3	Palo11	Pali SLU5	4625
Palo12	Pali SLU2	4461,7	Palo12	Pali SLU5	4173
Palo1	Pali SLU3	4219,6	Palo1	Pali SLU6	5038,3
Palo2	Pali SLU3	3491,9	Palo2	Pali SLU6	3476,6
Palo3	Pali SLU3	2764,1	Palo3	Pali SLU6	1820,4
Palo4	Pali SLU3	4735,1	Palo4	Pali SLU6	5286,4
Palo5	Pali SLU3	4007,3	Palo5	Pali SLU6	3838,4
Palo6	Pali SLU3	3279,6	Palo6	Pali SLU6	2182,2
Palo7	Pali SLU3	5119,1	Palo7	Pali SLU6	5534,5
Palo8	Pali SLU3	4522,8	Palo8	Pali SLU6	4200,2
Palo9	Pali SLU3	3795,1	Palo9	Pali SLU6	2544,1
Palo10	Pali SLU3	5472,6	Palo10	Pali SLU6	5782,5
Palo11	Pali SLU3	4973,6	Palo11	Pali SLU6	4562
Palo12	Pali SLU3	4310,6	Palo12	Pali SLU6	2905,9

SLV					
Point load	Combination	F [kN]	Point load	Combination	F [kN]
Palo1	Pali SLV1	6114,8	Palo1	Pali SLV6	1778,1
Palo2	Pali SLV1	1547,2	Palo2	Pali SLV6	438,18
Palo3	Pali SLV1	-3639	Palo3	Pali SLV6	-920,73
Palo4	Pali SLV1	6647,5	Palo4	Pali SLV6	2437,7

APPALTATORE: Consorzio  Soci  		ITINERARIO NAPOLI – BARI RADDOPPIO TRATTA APICE – ORSARA I LOTTO FUNZIONALE APICE – HIRPINIA					
PROGETTAZIONE: Mandataria  Mandanti  							
PROGETTO ESECUTIVO RELAZIONE DI CALCOLO FONDAZIONI PILE DA P17 A P20		COMMESSA IF1N	LOTTO 01 E ZZ	CODIFICA RG	DOCUMENTO MD0000 001	REV. B	FOGLIO 47 di 143

Palo5	Pali SLV1	2324,2	Palo5	Pali SLV6	1127,8
Palo6	Pali SLV1	-2875,9	Palo6	Pali SLV6	-241,73
Palo7	Pali SLV1	7180,2	Palo7	Pali SLV6	3097,2
Palo8	Pali SLV1	3101,2	Palo8	Pali SLV6	1787,4
Palo9	Pali SLV1	-2112,9	Palo9	Pali SLV6	448,03
Palo10	Pali SLV1	7561,5	Palo10	Pali SLV6	3756,8
Palo11	Pali SLV1	3878,2	Palo11	Pali SLV6	2447
Palo12	Pali SLV1	-1349,9	Palo12	Pali SLV6	1137,2
Palo1	Pali SLV2	-494,56	Palo1	Pali SLV7	146,75
Palo2	Pali SLV2	4605,1	Palo2	Pali SLV7	-1327,1
Palo3	Pali SLV2	7692,5	Palo3	Pali SLV7	-2747,2
Palo4	Pali SLV2	-1316,4	Palo4	Pali SLV7	2557,4
Palo5	Pali SLV2	3789,4	Palo5	Pali SLV7	1111,2
Palo6	Pali SLV2	7515,6	Palo6	Pali SLV7	-399,2
Palo7	Pali SLV2	-2117,4	Palo7	Pali SLV7	4894,4
Palo8	Pali SLV2	2973,7	Palo8	Pali SLV7	3476,6
Palo9	Pali SLV2	7008,5	Palo9	Pali SLV7	2030,5
Palo10	Pali SLV2	-2918,5	Palo10	Pali SLV7	6516,1
Palo11	Pali SLV2	2157,9	Palo11	Pali SLV7	5524,6
Palo12	Pali SLV2	6449,2	Palo12	Pali SLV7	4395,9
Palo1	Pali SLV3	510,15	Palo1	Pali SLV8	5318
Palo2	Pali SLV3	-1092,9	Palo2	Pali SLV8	6277,1
Palo3	Pali SLV3	-2617,3	Palo3	Pali SLV8	7236,2
Palo4	Pali SLV3	2908,2	Palo4	Pali SLV8	3045,4
Palo5	Pali SLV3	1355,9	Palo5	Pali SLV8	4444,4
Palo6	Pali SLV3	-256,55	Palo6	Pali SLV8	5525,5
Palo7	Pali SLV3	5139,3	Palo7	Pali SLV8	524,69
Palo8	Pali SLV3	3727,6	Palo8	Pali SLV8	1949,2
Palo9	Pali SLV3	2175,3	Palo9	Pali SLV8	3348,2
Palo10	Pali SLV3	6765,3	Palo10	Pali SLV8	-2005,3
Palo11	Pali SLV3	5701	Palo11	Pali SLV8	-616,4
Palo12	Pali SLV3	4547	Palo12	Pali SLV8	843,99
Palo1	Pali SLV4	4560,3	Palo1	Pali SLV9	6114,8
Palo2	Pali SLV4	5632,1	Palo2	Pali SLV9	1547,2
Palo3	Pali SLV4	6618,4	Palo3	Pali SLV9	-3639
Palo4	Pali SLV4	2183,7	Palo4	Pali SLV9	6647,5
Palo5	Pali SLV4	3622,3	Palo5	Pali SLV9	2324,2
Palo6	Pali SLV4	4989,1	Palo6	Pali SLV9	-2875,9
Palo7	Pali SLV4	-252,85	Palo7	Pali SLV9	7180,2
Palo8	Pali SLV4	1245,8	Palo8	Pali SLV9	3101,2
Palo9	Pali SLV4	2684,4	Palo9	Pali SLV9	-2112,9
Palo10	Pali SLV4	-2618,5	Palo10	Pali SLV9	7561,5
Palo11	Pali SLV4	-1205,8	Palo11	Pali SLV9	3878,2

APPALTATORE: Consorzio Soci 		ITINERARIO NAPOLI – BARI RADDOPPIO TRATTA APICE – ORSARA I LOTTO FUNZIONALE APICE – HIRPINIA					
PROGETTAZIONE: Mandataria Mandanti 							
PROGETTO ESECUTIVO RELAZIONE DI CALCOLO FONDAZIONI PILE DA P17 A P20		COMMESSA IF1N	LOTTO 01 E ZZ	CODIFICA RG	DOCUMENTO MD0000 001	REV. B	FOGLIO 48 di 143

Palo12	Pali SLV4	268,99	Palo12	Pali SLV9	-1349,9
Palo1	Pali SLV5	3545,2	Palo1	Pali SLV10	-494,56
Palo2	Pali SLV5	4906,5	Palo2	Pali SLV10	4605,1
Palo3	Pali SLV5	5863,1	Palo3	Pali SLV10	7692,5
Palo4	Pali SLV5	2814,4	Palo4	Pali SLV10	-1316,4
Palo5	Pali SLV5	4209,7	Palo5	Pali SLV10	3789,4
Palo6	Pali SLV5	5362,2	Palo6	Pali SLV10	7515,6
Palo7	Pali SLV5	2083,7	Palo7	Pali SLV10	-2117,4
Palo8	Pali SLV5	3479	Palo8	Pali SLV10	2973,7
Palo9	Pali SLV5	4861,2	Palo9	Pali SLV10	7008,5
Palo10	Pali SLV5	1353	Palo10	Pali SLV10	-2918,5
Palo11	Pali SLV5	2748,3	Palo11	Pali SLV10	2157,9
Palo12	Pali SLV5	4143,6	Palo12	Pali SLV10	6449,2

10.2 SOLLECITAZIONI

10.2.1 Sollecitazioni SLV



Figura 10.4 M11 max SLV



Figura 10.5 M11 min SLV

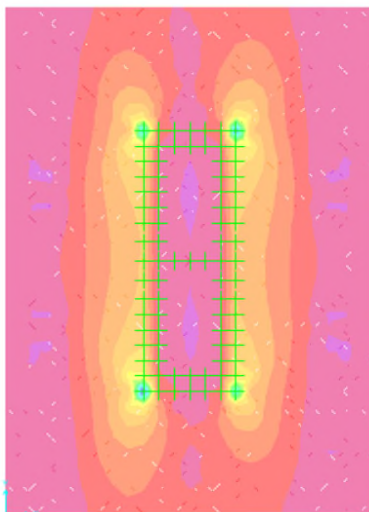

APPALTATORE:

Consorzio

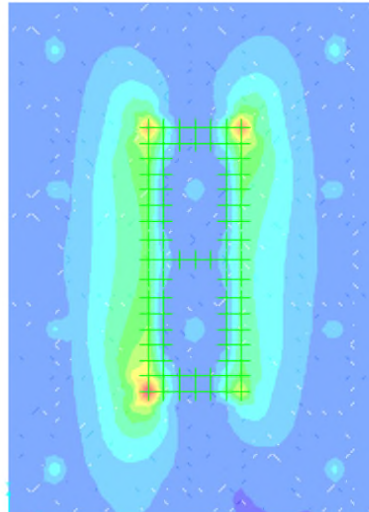
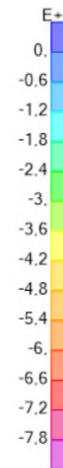
Soci



PROGETTAZIONE:

Mandataria

Mandanti



ITINERARIO NAPOLI – BARI

RADDOPPIO TRATTA APICE – ORSARA
I LOTTO FUNZIONALE APICE – HIRPINIA

PROGETTO ESECUTIVO

RELAZIONE DI CALCOLO FONDAZIONI PILE DA P17 A P20

COMMESSA
IF1N

LOTTO
01 E ZZ

CODIFICA
RG

DOCUMENTO
MD0000 001

REV.
B

FOGLIO
49 di 143



Figura 10.6 M22 max SLV



Figura 10.7 M22 min SLV

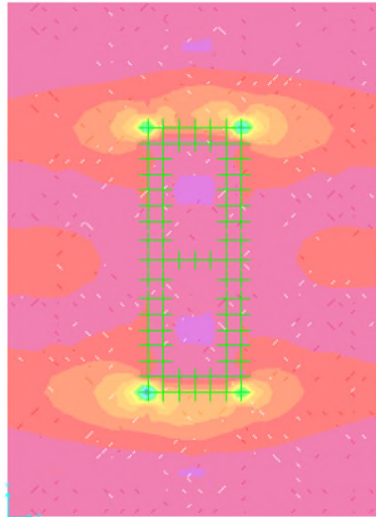

Figura 10.8 M12 max SLV

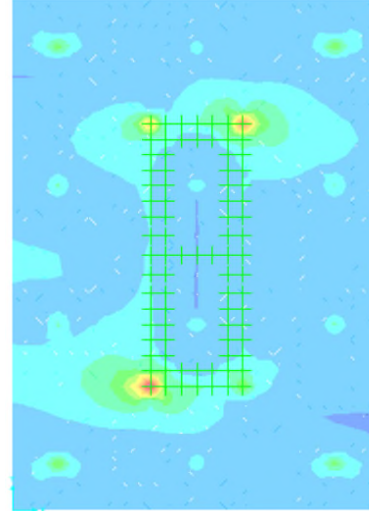

Figura 10.9 M12 min SLV

APPALTATORE:

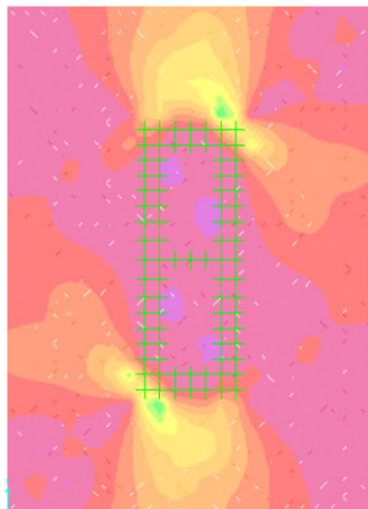
Consorzio

Soci

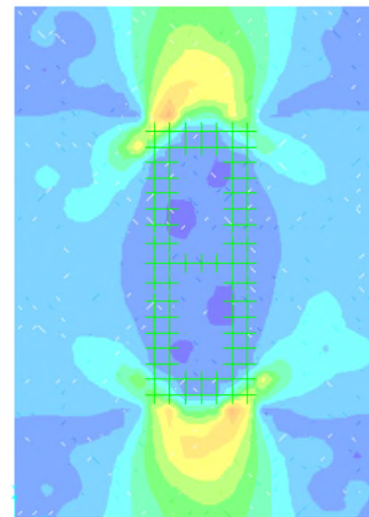

PROGETTAZIONE:

Mandataria

Mandanti



ITINERARIO NAPOLI – BARI

RADDOPPIO TRATTA APICE – ORSARA
I LOTTO FUNZIONALE APICE – HIRPINIA

PROGETTO ESECUTIVO

RELAZIONE DI CALCOLO FONDAZIONI PILE DA P17 A P20

COMMESSA
IF1N

LOTTO
01 E ZZ

CODIFICA
RG

DOCUMENTO
MD0000 001

REV.
B

FOGLIO
50 di 143



Figura 10.10 V13 max SLV



Figura 10.11 V13 min SLV

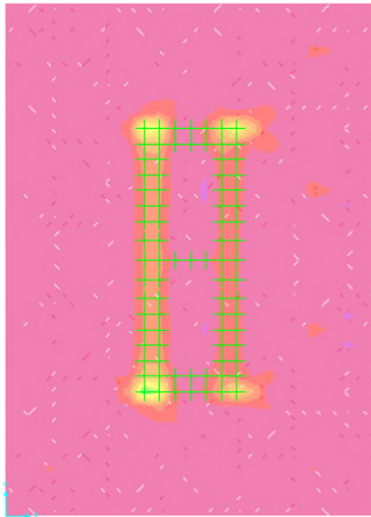

Figura 10.12 V23 max SLV

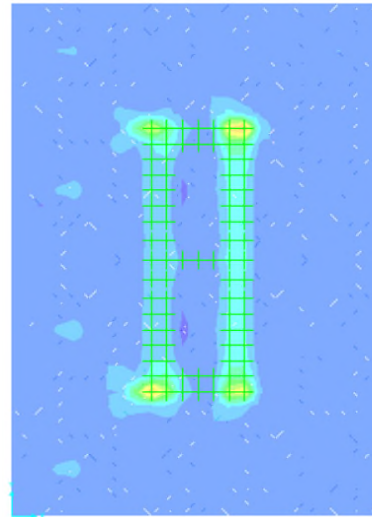

Figura 10.13 V23 min SLV

APPALTATORE: Consorzio Soci 		ITINERARIO NAPOLI – BARI RADDOPPIO TRATTA APICE – ORSARA I LOTTO FUNZIONALE APICE – HIRPINIA											
PROGETTAZIONE: Mandataria Mandanti 		COMMESSA IF1N		LOTTO 01 E ZZ		CODIFICA RG		DOCUMENTO MD0000 001		REV. B		FOGLIO 51 di 143	
PROGETTO ESECUTIVO RELAZIONE DI CALCOLO FONDAZIONI PILE DA P17 A P20													

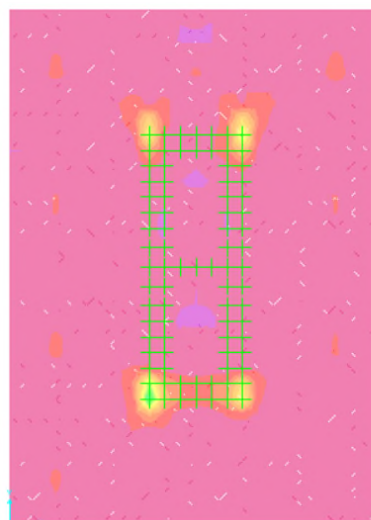
10.2.2 Sollecitazioni SLU

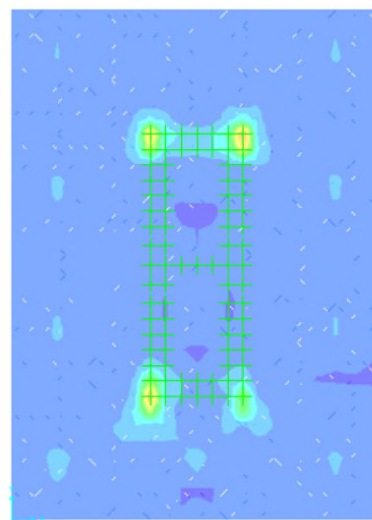

Figura 10.14 M11 max SLU



Figura 10.15 M11 min SLU

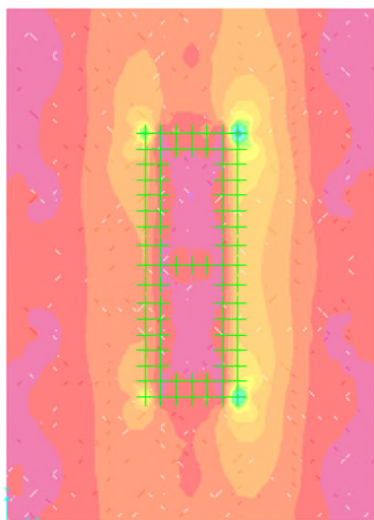

Figura 10.16 M22 max SLU

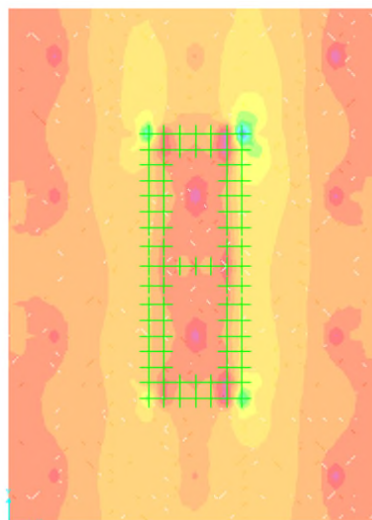
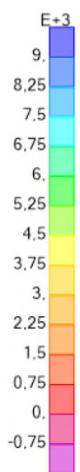

Figura 10.17 M22 min SLU

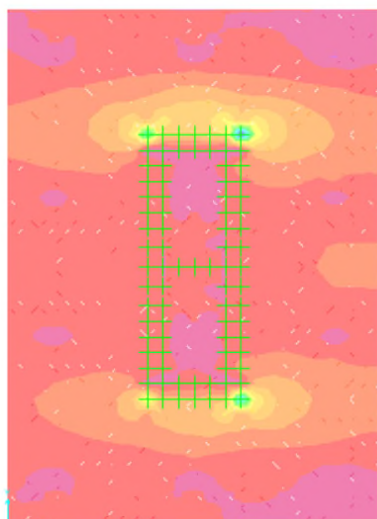

APPALTATORE:

Consorzio

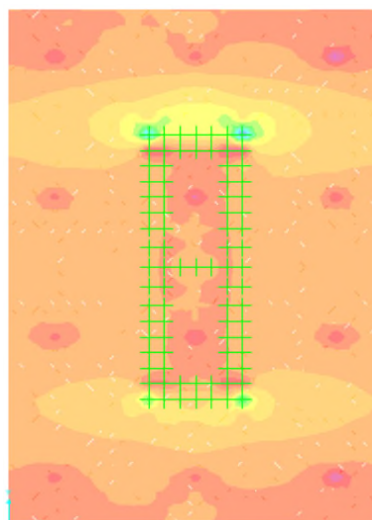
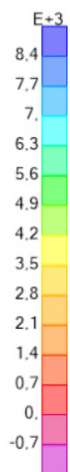
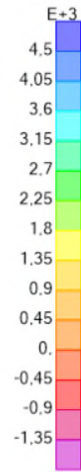
Soci



PROGETTAZIONE:

Mandataria

Mandanti



ITINERARIO NAPOLI – BARI

RADDOPPIO TRATTA APICE – ORSARA I LOTTO FUNZIONALE APICE – HIRPINIA

PROGETTO ESECUTIVO

RELAZIONE DI CALCOLO FONDAZIONI PILE DA P17 A P20

COMMESSA
IF1N

LOTTO
01 E ZZ

CODIFICA
RG

DOCUMENTO
MD0000 001

REV.
B

FOGLIO
52 di 143



Figura 10.18 M12 max SLU



Figura 10.19 M12 min SLU

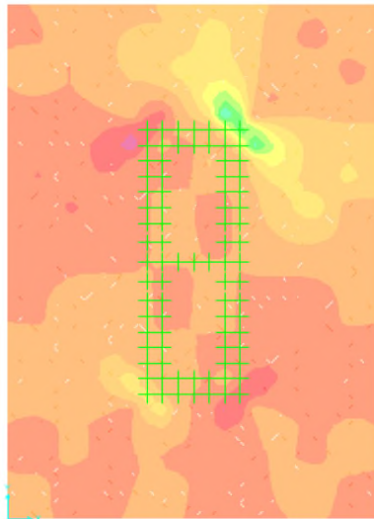

Figura 10.20 V13 max SLU

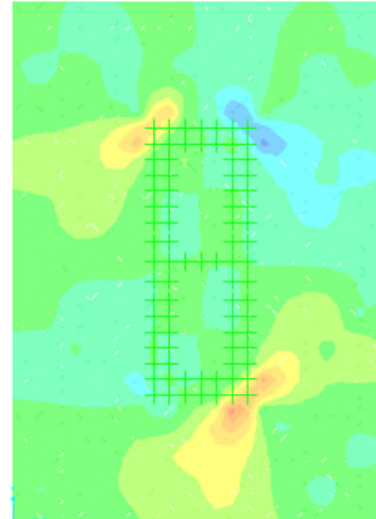

Figura 10.21 V13 min SLU

APPALTATORE:

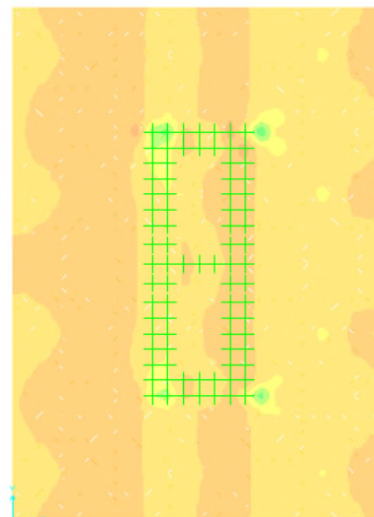
Consorzio

Soci

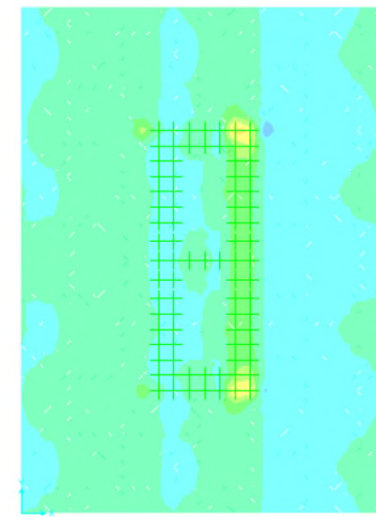

PROGETTAZIONE:

Mandataria

Mandanti



ITINERARIO NAPOLI – BARI

RADDOPPIO TRATTA APICE – ORSARA I LOTTO FUNZIONALE APICE – HIRPINIA

PROGETTO ESECUTIVO

RELAZIONE DI CALCOLO FONDAZIONI PILE DA P17 A P20

COMMESSA
IF1N

LOTTO
01 E ZZ

CODIFICA
RG

DOCUMENTO
MD0000 001

REV.
B

FOGLIO
53 di 143



Figura 10.22 V23 max SLU



Figura 10.23 V23 min SLU

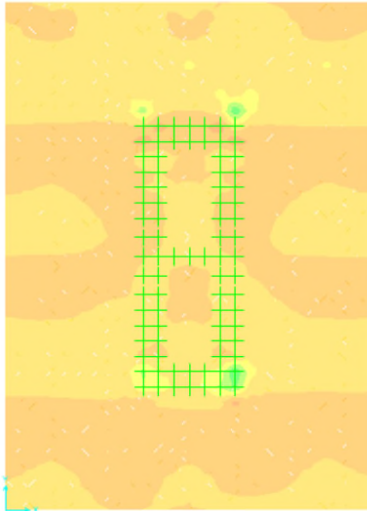

10.2.3 Sollecitazioni SLE

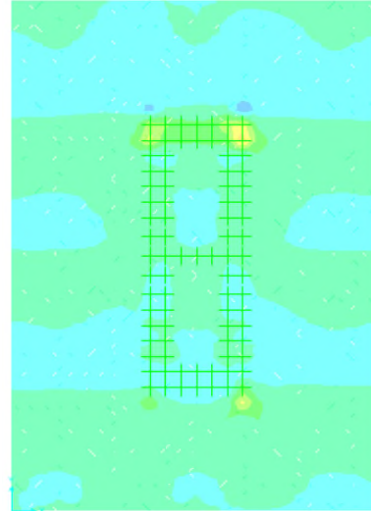

Figura 10.24 M11 max SLE



Figura 10.25 M11 min SLE

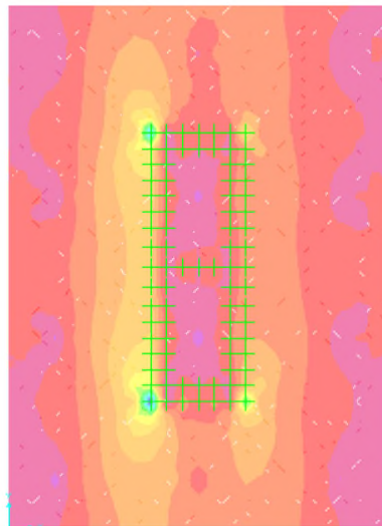

APPALTATORE: Consorzio Soci   		ITINERARIO NAPOLI – BARI RADDOPPIO TRATTA APICE – ORSARA I LOTTO FUNZIONALE APICE – HIRPINIA					
PROGETTAZIONE: Mandataria Mandanti   		COMMESSA	LOTTO	CODIFICA	DOCUMENTO	REV.	FOGLIO
PROGETTO ESECUTIVO RELAZIONE DI CALCOLO FONDAZIONI PILE DA P17 A P20		IF1N	01 E ZZ	RG	MD0000 001	B	54 di 143

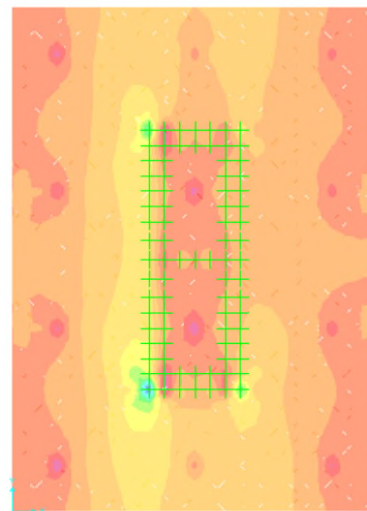
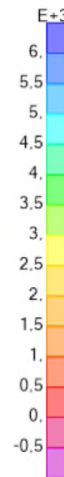

Figura 10.26 M22 max SLE



Figura 10.27 M22 min SLE

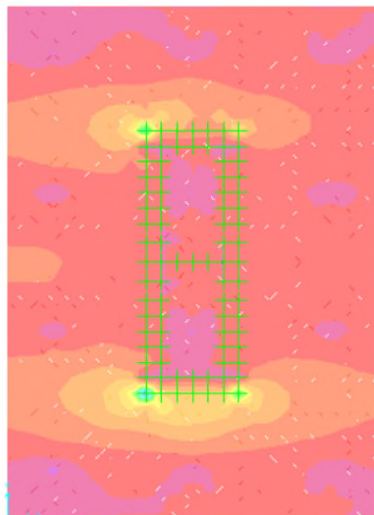

Figura 10.28 M12 max SLE

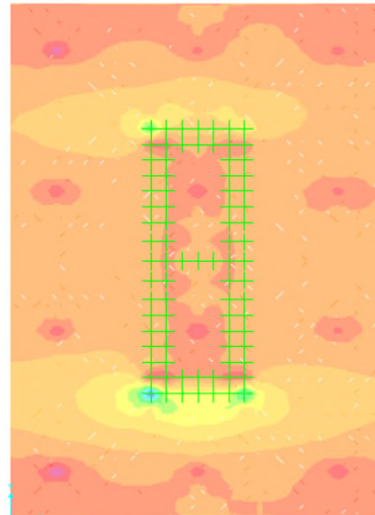

Figura 10.29 M12 min SLE

10.3 VERIFICHE SLU/SLE

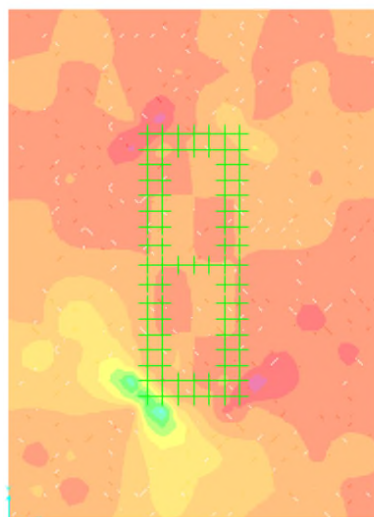
10.3.1 Sollecitazioni di verifica

A partire dallo stato di sollecitazione determinato attraverso il software, sono state definite section-cut di 1m sul filo della pila nelle due direzioni.

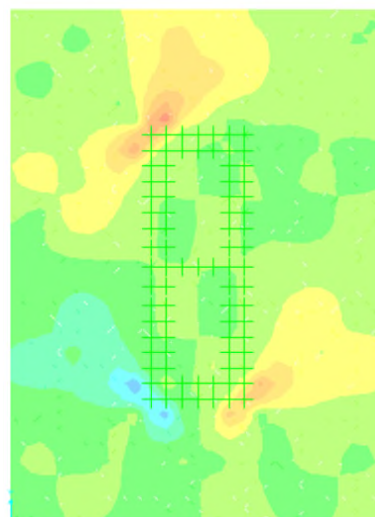
La definizione delle section-cut permette attraverso il post-processing definire la sollecitazione media su un metro di piastra, ciò al fine di by-passare la concentrazione delle azioni su porzioni infinitesime di piastra, che sono dovuti alla schematizzazione dei vincoli come puntuali.

Quindi le azioni interne sono definite secondo sezioni come indicato nelle seguenti immagini:

APPALTATORE: Consorzio Soci 	ITINERARIO NAPOLI – BARI RADDOPPIO TRATTA APICE – ORSARA I LOTTO FUNZIONALE APICE – HIRPINIA					
PROGETTAZIONE: Mandataria Mandanti 						
PROGETTO ESECUTIVO RELAZIONE DI CALCOLO FONDAZIONI PILE DA P17 A P20	COMMESSA IF1N	LOTTO 01 E ZZ	CODIFICA RG	DOCUMENTO MD0000 001	REV. B	FOGLIO 55 di 143



Figura 10.30 Definizione delle Section-cut

A partire dalle azioni così definite è possibile involuppare geometricamente secondo i due assi di simmetria del plinto di fondazione in modo da garantire la copertura massima delle azioni sollecitanti, in aggiunta ad uno schema d'armatura doppiamente simmetrico.

Di seguito sono riportati i vari involuppi geometrici:

Longitudinale	Trasversale
Max (L1, L16, L17, L32)	Max (T1, T12, T13, T24)
Max (L2, L15, L18, L31)	Max (T2, T11, T14, T23)
Max (L3, L14, L19, L30)	Max (T3, T10, T15, T22)
Max (L4, L13, L20, L29)	Max (T4, T9, T16, T21)
Max (L5, L12, L21, L28)	Max (T5, T8, T17, T20)
Max (L6, L11, L22, L27)	Max (T6, T7, T18, T19)
Max (L7, L10, L23, L26)	
Max (L8, L9, L24, L25)	

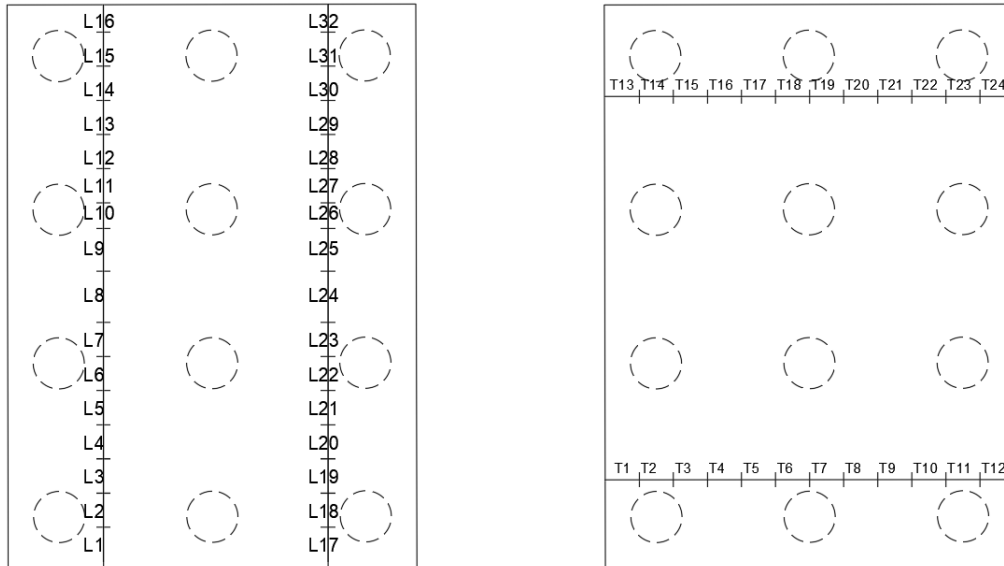
Il momento torcente è stato sommato in modulo a fine di massimizzare l'effetto della flessione.

APPALTATORE: Consorzio  Soci  		ITINERARIO NAPOLI – BARI RADDOPPIO TRATTA APICE – ORSARA I LOTTO FUNZIONALE APICE – HIRPINIA					
PROGETTAZIONE: Mandataria  Mandanti  							
PROGETTO ESECUTIVO RELAZIONE DI CALCOLO FONDAZIONI PILE DA P17 A P20		COMMESSA IF1N	LOTTO 01 E ZZ	CODIFICA RG	DOCUMENTO MD0000 001	REV. B	FOGLIO 56 di 143

Di seguito sono riportate le sollecitazioni ai vari stati limite.

	EnvSLV	M		V		
		min	max	min	max	
		Longitudinale	1	-3439,2	2441,267	
	2	-3915,36	3028,034	-513,512	335,826	max(L2,L19,L22,L39)
	3	-5045,04	3923,779	-1079,54	717,337	max(L3,L18,L23,L38)
	4	-5308,76	4096,091	-3681,9	5696,929	max(L4,L17,L24,L37)
	5	-10027	6715,369	-3677,43	4779,154	max(L5,L16,L25,L36)
	6	-5765,36	3710,941	-1535,63	1142,038	max(L6,L15,L26,L35)
	7	-4645,68	3032,137	-1107,36	929,268	max(L7,L14,L27,L34)
	8	-5177,15	3388,123	-1315,4	1172,363	max(L8,L13,L28,L33)

	EnvSLV	M		V		
		min	max	min	max	
		Trasversale	1	-1313,86	2155,285	
	2	-1562,23	2486,746	-673,524	478,419	max(T2,T15,T18,T31)
	3	-1987	3066,765	-1019,25	733,572	max(T3,T14,T19,T30)
	4	-3554,36	4055,908	-2661,66	1829,001	max(T4,T13,T20,T29)
	5	-4512,17	7111,694	-5624,74	7235,696	max(T5,T12,T21,T28)
	6	-5000,86	7223,806	-2177,73	1412,504	max(T6,T11,T22,T27)

	EnvSLU	M		V		
		min	max	min	max	
		Longitudinale	1	-2078,6	-1006,12	
	2	-2289,12	-1035,51	-400,577	142,915	max(L2,L19,L22,L39)
	3	-2691,04	-1068,37	-853,011	122,614	max(L3,L18,L23,L38)
	4	-3722,93	-1050,78	-2167,54	3044,231	max(L4,L17,L24,L37)
	5	-5726,61	-1277,43	-2406,6	1915,11	max(L5,L16,L25,L36)
	6	-4008,72	-564,856	-977,023	97,358	max(L6,L15,L26,L35)
	7	-3158,89	-503,711	-706,006	203,454	max(L7,L14,L27,L34)
	8	-3422,02	-662,152	-880,697	381,231	max(L8,L13,L28,L33)

	EnvSLU	M		V		
		min	max	min	max	
		Trasversale	1	-1101,89	1517,193	
	2	-1315,14	1760,508	-397,021	159,234	max(T2,T15,T18,T31)
	3	-1681,65	2235,766	-592,839	188,706	max(T3,T14,T19,T30)
	4	-2377,56	3067,623	-1541,84	667,187	max(T4,T13,T20,T29)
	5	-3148,58	5178,289	-1675,17	6887,908	max(T5,T12,T21,T28)
	6	-2474,26	3604,124	-1105,52	-201,976	max(T6,T11,T22,T27)

APPALTATORE: Consorzio  Soci  		ITINERARIO NAPOLI – BARI RADDOPPIO TRATTA APICE – ORSARA I LOTTO FUNZIONALE APICE – HIRPINIA					
PROGETTAZIONE: Mandataria  Mandanti  							
PROGETTO ESECUTIVO RELAZIONE DI CALCOLO FONDAZIONI PILE DA P17 A P20		COMMESSA IF1N	LOTTO 01 E ZZ	CODIFICA RG	DOCUMENTO MD0000 001	REV. B	FOGLIO 57 di 143

	EnvSLE	M		
		min	max	
		Longitudinale	1	
2	-1775,37		-678,631	max(L2,L19,L22,L39)
3	-2273,4		-636,371	max(L3,L18,L23,L38)
4	-2604,23		-443,776	max(L4,L17,L24,L37)
5	-4709,71		-563,254	max(L5,L16,L25,L36)
6	-2380,52		-324,04	max(L6,L15,L26,L35)
7	-1975,88		-281,356	max(L7,L14,L27,L34)
8	-2208,16		-371,437	max(L8,L13,L28,L33)

	EnvSLE	M		
		min	max	
		Trasversale	1	
2	-791,11		1112,32	max(T2,T11,T14,T23)
3	-993,27		1352,441	max(T3,T10,T15,T22)
4	-1824,73		1491,673	max(T4,T9,T16,T21)
5	-2063,8		2962,004	max(T5,T8,T17,T20)
6	-1734,92		2926,75	max(T6,T7,T18,T19)

Inviluppando SLU ed SLV, per le verifiche agli stati limite ultimi si ottiene:

	EnvSLV/SLU	M		V		
		min	max	min	max	
		Longitudinale	1	-3439,2	2441,267	
2	-3915,36		3028,034	-513,512	335,826	max(L2,L19,L22,L39)
3	-5045,04		3923,779	-1079,54	717,337	max(L3,L18,L23,L38)
4	-5308,76		4096,091	-3681,9	5696,929	max(L4,L17,L24,L37)
5	-10027		6715,369	-3677,43	4779,154	max(L5,L16,L25,L36)
6	-5765,36		3710,941	-1535,63	1142,038	max(L6,L15,L26,L35)
7	-4645,68		3032,137	-1107,36	929,268	max(L7,L14,L27,L34)
8	-5177,15		3388,123	-1315,4	1172,363	max(L8,L13,L28,L33)

APPALTATORE: Consorzio Soci 		ITINERARIO NAPOLI – BARI					
PROGETTAZIONE: Mandataria Mandanti 		RADDOPPIO TRATTA APICE – ORSARA I LOTTO FUNZIONALE APICE – HIRPINIA					
PROGETTO ESECUTIVO RELAZIONE DI CALCOLO FONDAZIONI PILE DA P17 A P20		COMMESSA IF1N	LOTTO 01 E ZZ	CODIFICA RG	DOCUMENTO MD0000 001	REV. B	FOGLIO 58 di 143

Trasversale	EnvSLV/SLU	M		V		
		min	max	min	max	
	1	-1014,05	1933,521	-619,56	430,27	
2	-1210,22	2236,47	-632,23	478,419	max(T2,T11,T14,T23)	
3	-1547,44	2,65,84	-9943,08	733,572	max(T3,T10,T15,T22)	
4	-3554,36	4055,908	-2661,66	1829,001	max(T4,T9,T16,T21)	
5	-4512,17	7111,694	-5624,74	7235,696	max(T5,T8,T17,T20)	
6	-5000,86	7223,806	-2177,73	1412,504	max(T6,T7,T18,T19)	

10.3.2 Verifiche a flessione e taglio

I criteri di verifica per gli stati limite ultimi e per gli stati limite di esercizio (fessurazione e limiti tensionali) sono stati esplicitati in precedenza.

Caratteristiche materiali e parametri di verifica sono sintetizzati di seguito:

materiali			
calcestruzzo		acciaio	
R _{ck}	35 [MPa]	f _{yk}	450 [MPa]
f _{ck}	29,1 [MPa]	γ _s	1,15
γ _c	1,5	f _{yd}	391,3 [MPa]
α _{cc}	0,85	E _s	210000 [MPa]
f _{cd}	16,5 [MPa]	ε _{uk}	75 [%]
v	0,530		
ε _{c2}	2,0 [%]		
ε _{cu2}	3,5 [%]		
α _e	15,0		
k _t	0,4		
		valori limite	
k ₁	0,8	0,45 f _{ck}	13,1 [MPa]
k ₃	3,4	0,8 f _{yk}	360,0 [MPa]
k ₄	0,425	w _{k,lim}	0,2 [mm]

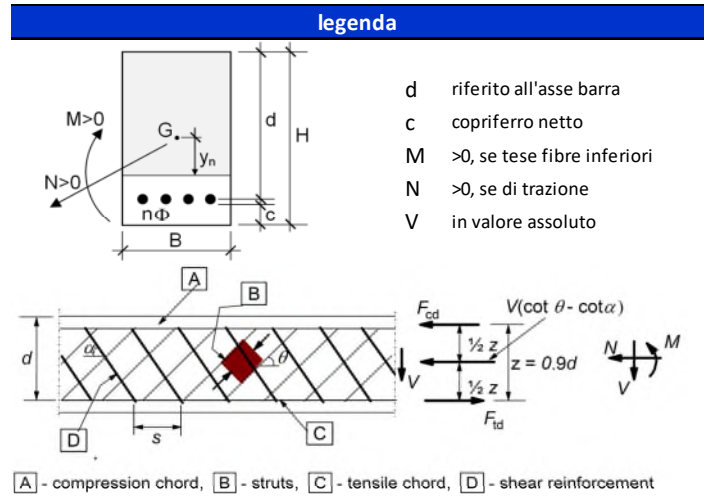

L'armatura base è composta da una maglia di $\phi 32$ con passo 15cm, la quale viene aggiunto un raffittimento nelle zone maggiormente sollecitate, in quale possono essere a passo 30cm. L'armatura in direzione trasversale è posta sopra la longitudinale motivo per cui nelle seguenti verifiche si ha un copriferro maggiore nelle armature trasversali. Si considera che gli spilli non siano legati alle barre più interne, motivo per cui non sono considerate nel calcolo del copriferro.

A favore di sicurezza nelle seguenti verifiche si considera solo lo strato più esterno di armatura compressa.

APPALTATORE: Consorzio HirpiniaAV Soci salini impregio ASTALDI	ITINERARIO NAPOLI – BARI RADDOPPIO TRATTA APICE – ORSARA I LOTTO FUNZIONALE APICE – HIRPINIA					
PROGETTAZIONE: Mandataria SOJL Mandanti NETENGINEERING Alpina						
PROGETTO ESECUTIVO RELAZIONE DI CALCOLO FONDAZIONI PILE DA P17 A P20	COMMESSA IF1N	LOTTO 01 E ZZ	CODIFICA RG	DOCUMENTO MD0000 001	REV. B	FOGLIO 59 di 143

Sezione 1 longitudinale:

- *verifica armature inferiori:*

geometria				
sezione trasversale				
B	H	c	d	z
[cm]	[cm]	[cm]	[cm]	[cm]
100	250	5,0	243,4	219,1
armatura longitudinale				
nbarre	φ	d	Asl	
	[mm]	[cm]	[cm ²]	
6,66667	32	6,6	53,62	
6,66667	32	243,4	53,62	
armatura a taglio				
nbracci	φ	s	α	Asw
	[mm]	[cm]	[°]	[cm ²]
3,33333	16	60	90	6,70

- *verifica armature superiore:*

geometria				
sezione trasversale				
B	H	c	d	z
[cm]	[cm]	[cm]	[cm]	[cm]
100	250	5,0	243,4	219,1
armatura longitudinale				
nbarre	φ	d	Asl	
	[mm]	[cm]	[cm ²]	
6,66667	32	6,6	53,62	
6,66667	32	243,4	53,62	
armatura a taglio				
nbracci	φ	s	α	Asw
	[mm]	[cm]	[°]	[cm ²]
3,33333	16	60	90	6,70

sollecitazioni e risultati	
SLE	SLU
MEk 1569,00 [kNm]	MEd 3439,00 [kNm]
NEk 0 [kN]	NEd 0 [kN]
tensioni e fessure	
Mdec 0,0 [kNm]	
Mcr 2858,7 [kNm]	
yn -75,66 [cm]	
σc,min -2,2 [MPa]	
σs,min -28,1 [MPa]	
σs,max 127,7 [MPa]	
k2 0,5	
εsm-εcm - [%o]	
Sr,max - [cm]	
Wk - [mm]	
presso-flessione	
MRd 5001,0 [kNm]	
FS 1,45	
taglio	
VRdc 697,7 [kN]	
non serve armatura a taglio	
VRds 1658,4 [kN]	
VRdmax 8280,2 [kN]	
θ 30,0 [°]	
sezione duttile	
ai 243,4 [cm]	

sollecitazioni e risultati	
SLE	SLU
MEk 0,00 [kNm]	MEd 2442,00 [kNm]
NEk 0 [kN]	NEd 0 [kN]
VEd 433,00 [kN]	
tensioni e fessure	
Mdec 0,0 [kNm]	
Mcr -2858,7 [kNm]	
yn 75,66 [cm]	
σc,min 0,0 [MPa]	
σs,min 0,0 [MPa]	
σs,max 0,0 [MPa]	
k2 0,5	
εsm-εcm - [%o]	
Sr,max - [cm]	
Wk - [mm]	
presso-flessione	
MRd 5001,0 [kNm]	
FS 2,05	
taglio	
VRdc 697,7 [kN]	
non serve armatura a taglio	
VRds 1658,4 [kN]	
VRdmax 8280,2 [kN]	
θ 30,0 [°]	
sezione duttile	
ai 243,4 [cm]	

APPALTATORE: Consorzio HirpiniaAV Soci salini impregilo ASTALDI	ITINERARIO NAPOLI – BARI RADDOPPIO TRATTA APICE – ORSARA I LOTTO FUNZIONALE APICE – HIRPINIA					
PROGETTAZIONE: Mandataria SOJL Mandanti NETENGINEERING Alpina						
PROGETTO ESECUTIVO RELAZIONE DI CALCOLO FONDAZIONI PILE DA P17 A P20	COMMESSA IF1N	LOTTO 01 E ZZ	CODIFICA RG	DOCUMENTO MD0000 001	REV. B	FOGLIO 60 di 143

Sezione 2 longitudinale:

- *verifica armature inferiori:*

geometria				
sezione trasversale				
B	H	c	d	z
[cm]	[cm]	[cm]	[cm]	[cm]
100	250	5,0	243,4	219,1
armatura longitudinale				
nbarre	φ	d	Asl	
	[mm]	[cm]	[cm ²]	
6,66667	32	6,6	53,62	
6,66667	32	243,4	53,62	
armatura a taglio				
nbracci	φ	s	α	Asw
	[mm]	[cm]	[°]	[cm ²]
3,33333	16	60	90	6,70

- *verifica armature superiore:*

geometria				
sezione trasversale				
B	H	c	d	z
[cm]	[cm]	[cm]	[cm]	[cm]
100	250	5,0	243,4	219,1
armatura longitudinale				
nbarre	φ	d	Asl	
	[mm]	[cm]	[cm ²]	
6,66667	32	6,6	53,62	
6,66667	32	243,4	53,62	
armatura a taglio				
nbracci	φ	s	α	Asw
	[mm]	[cm]	[°]	[cm ²]
3,33333	16	60	90	6,70

sollecitazioni e risultati	
SLE	SLU
MEk 1776,00 [kNm]	MEd 3916,00 [kNm]
NEk 0 [kN]	NEd 0 [kN]
tensioni e fessure	
Mdec 0,0 [kNm]	
Mcr 2858,7 [kNm]	
presso-flessione	
	MRd 5001,0 [kNm]
	FS 1,28
taglio	
	VRdc 697,7 [kN]
	non serve armatura a taglio
	VRds 1658,4 [kN]
	VRdmax 8280,2 [kN]
	θ 30,0 [°]
	sezione duttile
	ai 243,4 [cm]

sollecitazioni e risultati	
SLE	SLU
MEk 0,00 [kNm]	MEd 3029,00 [kNm]
NEk 0 [kN]	NEd 0 [kN]
tensioni e fessure	
Mdec 0,0 [kNm]	
Mcr -2858,7 [kNm]	
presso-flessione	
	MRd 5001,0 [kNm]
	FS 1,65
taglio	
	VRdc 697,7 [kN]
	non serve armatura a taglio
	VRds 1658,4 [kN]
	VRdmax 8280,2 [kN]
	θ 30,0 [°]
	sezione duttile
	ai 243,4 [cm]

APPALTATORE: Consorzio HirpiniaAV Soci salini impregilo ASTALDI	ITINERARIO NAPOLI – BARI RADDOPPIO TRATTA APICE – ORSARA I LOTTO FUNZIONALE APICE – HIRPINIA					
PROGETTAZIONE: Mandataria SOJL Mandanti NETENGINEERING Alpina						
PROGETTO ESECUTIVO RELAZIONE DI CALCOLO FONDAZIONI PILE DA P17 A P20	COMMESSA IF1N	LOTTO 01 E ZZ	CODIFICA RG	DOCUMENTO MD0000 001	REV. B	FOGLIO 61 di 143

Sezione 3 longitudinale:

- *verifica armature inferiori:*

geometria				
sezione trasversale				
B	H	c	d	z
[cm]	[cm]	[cm]	[cm]	[cm]
100	250	5,0	243,4	219,1
armatura longitudinale				
nbarre	φ	d	Asl	
	[mm]	[cm]	[cm ²]	
6,66667	32	6,6	53,62	
10	32	243,4	80,42	
armatura a taglio				
nbracci	φ	s	α	Asw
	[mm]	[cm]	[°]	[cm ²]
3,33333	16	60	90	6,70

- *verifica armature superiore:*

geometria				
sezione trasversale				
B	H	c	d	z
[cm]	[cm]	[cm]	[cm]	[cm]
100	250	5,0	243,4	219,1
armatura longitudinale				
nbarre	φ	d	Asl	
	[mm]	[cm]	[cm ²]	
10	32	6,6	80,42	
6,66667	32	243,4	53,62	
armatura a taglio				
nbracci	φ	s	α	Asw
	[mm]	[cm]	[°]	[cm ²]
3,33333	16	60	90	6,70

sollecitazioni e risultati	
SLE	SLU
MEk 2274,00 [kNm]	MEd 5045,00 [kNm]
NEk 0 [kN]	NEd 0 [kN]
VEd 1080,00 [kN]	
tensioni e fessure	
Mdec 0,0 [kNm]	
Mcr 2996,4 [kNm]	
yn -65,21 [cm]	
σc,min -2,7 [MPa]	
σs,min -36,2 [MPa]	
σs,max 125,1 [MPa]	
k2 0,5	
εsm-εcm - [%o]	
Sr,max - [cm]	
Wk - [mm]	
presso-flessione	
MRd 7479,7 [kNm]	
FS 1,48	
taglio	
VRdc 798,7 [kN]	
predisporre armatura a taglio	
VRds 1658,4 [kN]	
VRdmax 8280,2 [kN]	
θ 30,0 [°]	
sezione duttile	
ai 189,7 [cm]	

sollecitazioni e risultati	
SLE	SLU
MEk 0,00 [kNm]	MEd 3924,00 [kNm]
NEk 0 [kN]	NEd 0 [kN]
VEd 1080,00 [kN]	
tensioni e fessure	
Mdec 0,0 [kNm]	
Mcr -2996,4 [kNm]	
yn 65,21 [cm]	
σc,min 0,0 [MPa]	
σs,min 0,0 [MPa]	
σs,max 0,0 [MPa]	
k2 0,5	
εsm-εcm - [%o]	
Sr,max - [cm]	
Wk - [mm]	
presso-flessione	
MRd 5001,7 [kNm]	
FS 1,27	
taglio	
VRdc 697,7 [kN]	
predisporre armatura a taglio	
VRds 1658,4 [kN]	
VRdmax 8280,2 [kN]	
θ 30,0 [°]	
sezione duttile	
ai 189,7 [cm]	

APPALTATORE: Consorzio HirpiniaAV Soci salini impregilo ASTALDI	ITINERARIO NAPOLI – BARI RADDOPPIO TRATTA APICE – ORSARA I LOTTO FUNZIONALE APICE – HIRPINIA					
PROGETTAZIONE: Mandataria SOJL Mandanti NETENGINEERING Alpina						
PROGETTO ESECUTIVO RELAZIONE DI CALCOLO FONDAZIONI PILE DA P17 A P20	COMMESSA IF1N	LOTTO 01 E ZZ	CODIFICA RG	DOCUMENTO MD0000 001	REV. B	FOGLIO 62 di 143

Sezione 4 longitudinale:

- *verifica armature inferiori:*

geometria				
sezione trasversale				
B	H	c	d	z
[cm]	[cm]	[cm]	[cm]	[cm]
100	250	5,0	243,4	219,1
armatura longitudinale				
nbarre	φ	d	Asl	
	[mm]	[cm]	[cm ²]	
6,66667	32	6,6	53,62	
10	32	243,4	80,42	
armatura a taglio				
nbracci	φ	s	α	Asw
	[mm]	[cm]	[°]	[cm ²]
3,33333	16	15	90	6,70

- *verifica armature superiore:*

geometria				
sezione trasversale				
B	H	c	d	z
[cm]	[cm]	[cm]	[cm]	[cm]
100	250	5,0	243,4	219,1
armatura longitudinale				
nbarre	φ	d	Asl	
	[mm]	[cm]	[cm ²]	
10	32	6,6	80,42	
6,66667	32	243,4	53,62	
armatura a taglio				
nbracci	φ	s	α	Asw
	[mm]	[cm]	[°]	[cm ²]
3,33333	16	15	90	6,70

sollecitazioni e risultati	
SLE	SLU
MEk 2605,00 [kNm]	MEd 5309,00 [kNm]
NEk 0 [kN]	NEd 0 [kN]
tensioni e fessure	
Mdec 0,0 [kNm]	
Mcr 2996,4 [kNm]	
presso-flessione	
	MRd 7479,7 [kNm]
	FS 1,41
taglio	
	VRdc 798,7 [kN]
	predisporre armatura a taglio
	VRds 6633,7 [kN]
	VRdmax 8280,2 [kN]
	θ 30,0 [°]
	sezione duttile
	ai 189,7 [cm]

sollecitazioni e risultati	
SLE	SLU
MEk 0,00 [kNm]	MEd 4097,00 [kNm]
NEk 0 [kN]	NEd 0 [kN]
tensioni e fessure	
Mdec 0,0 [kNm]	
Mcr -2996,4 [kNm]	
presso-flessione	
	MRd 5001,7 [kNm]
	FS 1,22
taglio	
	VRdc 697,7 [kN]
	predisporre armatura a taglio
	VRds 6633,7 [kN]
	VRdmax 8280,2 [kN]
	θ 30,0 [°]
	sezione duttile
	ai 189,7 [cm]

APPALTATORE: Consorzio HirpiniaAV Soci salini impregio ASTALDI		ITINERARIO NAPOLI – BARI RADDOPPIO TRATTA APICE – ORSARA I LOTTO FUNZIONALE APICE – HIRPINIA					
PROGETTAZIONE: Mandataria ROKSOJL Mandanti NETENGINEERING Alpina							
PROGETTO ESECUTIVO RELAZIONE DI CALCOLO FONDAZIONI PILE DA P17 A P20		COMMESSA IF1N	LOTTO 01 E ZZ	CODIFICA RG	DOCUMENTO MD0000 001	REV. B	FOGLIO 63 di 143

Sezione 5 longitudinale:

- *verifica armature inferiori:*

geometria				
sezione trasversale				
B	H	c	d	z
[cm]	[cm]	[cm]	[cm]	[cm]
100	250	5,0	241,3	217,1
armatura longitudinale				
nbarre	φ	d	Asl	
	[mm]	[cm]	[cm ²]	
13,3333	32	6,6	107,23	
6,66667	32	237,0	53,62	
13,3333	32	243,4	107,23	
armatura a taglio				
nbracci	φ	s	α	Asw
	[mm]	[cm]	[°]	[cm ²]
3,33333	16	15	90	6,70

- *verifica armature superiore:*

geometria				
sezione trasversale				
B	H	c	d	z
[cm]	[cm]	[cm]	[cm]	[cm]
100	250	5,0	243,4	219,1
armatura longitudinale				
nbarre	φ	d	Asl	
	[mm]	[cm]	[cm ²]	
13,3333	32	6,6	107,23	
13,3333	32	243,4	107,23	
armatura a taglio				
nbracci	φ	s	α	Asw
	[mm]	[cm]	[°]	[cm ²]
3,33333	16	15	90	6,70

sollecitazioni e risultati	
SLE	SLU
MEk 4710,00 [kNm]	MEd 10027,00 [kNm]
NEk 0 [kN]	NEd 0 [kN]
VEd 4780,00 [kN]	
tensioni e fessure	
Mdec 0,0 [kNm]	
Mcr 3511,9 [kNm]	
yn -49,14 [cm]	
σ _{c,min} -4,0 [MPa]	
σ _{s,min} -55,4 [MPa]	
σ _{s,max} 134,1 [MPa]	
k ₂ 0,5	
ε _{sm} -ε _{cm} 0,48 [‰]	
S _{r,max} 25,3 [cm]	
w _k 0,120 [mm]	
presso-flessione	
MRd 14764,5 [kNm]	
FS 1,47	
taglio	
VRdc 1001,4 [kN]	
predisporre armatura a taglio	
VRds 6575,6 [kN]	
VRdmax 8207,7 [kN]	
θ 30,0 [°]	
sezione duttile	
ai 188,0 [cm]	

sollecitazioni e risultati	
SLE	SLU
MEk 0,00 [kNm]	MEd 6716,00 [kNm]
NEk 0 [kN]	NEd 0 [kN]
VEd 4780,00 [kN]	
tensioni e fessure	
Mdec 0,0 [kNm]	
Mcr -3256,5 [kNm]	
yn 61,89 [cm]	
σ _{c,min} 0,0 [MPa]	
σ _{s,min} 0,0 [MPa]	
σ _{s,max} 0,0 [MPa]	
k ₂ 0,5	
ε _{sm} -ε _{cm} - [‰]	
S _{r,max} - [cm]	
w _k - [mm]	
presso-flessione	
MRd 9966,3 [kNm]	
FS 1,48	
taglio	
VRdc 879,1 [kN]	
predisporre armatura a taglio	
VRds 6633,7 [kN]	
VRdmax 8280,2 [kN]	
θ 30,0 [°]	
sezione duttile	
ai 189,7 [cm]	

APPALTATORE: Consorzio HirpiniaAV Soci salini impregilo ASTALDI	ITINERARIO NAPOLI – BARI RADDOPPIO TRATTA APICE – ORSARA I LOTTO FUNZIONALE APICE – HIRPINIA					
PROGETTAZIONE: Mandataria ROKSOJL Mandanti NETENGINEERING Alpina						
PROGETTO ESECUTIVO RELAZIONE DI CALCOLO FONDAZIONI PILE DA P17 A P20	COMMESSA IF1N	LOTTO 01 E ZZ	CODIFICA RG	DOCUMENTO MD0000 001	REV. B	FOGLIO 64 di 143

Sezione 6 longitudinale:

- *verifica armature inferiori:*

geometria				
sezione trasversale				
B	H	c	d	z
[cm]	[cm]	[cm]	[cm]	[cm]
100	250	5,0	243,4	219,1
armatura longitudinale				
nbarre	φ	d	Asl	
	[mm]	[cm]	[cm ²]	
6,66667	32	6,6	53,62	
10	32	243,4	80,42	
armatura a taglio				
nbracci	φ	s	α	Asw
	[mm]	[cm]	[°]	[cm ²]
3,33333	16	30	90	6,70

- *verifica armature superiore:*

geometria				
sezione trasversale				
B	H	c	d	z
[cm]	[cm]	[cm]	[cm]	[cm]
100	250	5,0	243,4	219,1
armatura longitudinale				
nbarre	φ	d	Asl	
	[mm]	[cm]	[cm ²]	
10	32	6,6	80,42	
6,66667	32	243,4	53,62	
armatura a taglio				
nbracci	φ	s	α	Asw
	[mm]	[cm]	[°]	[cm ²]
3,33333	16	30	90	6,70

sollecitazioni e risultati	
SLE	SLU
MEk 2381,00 [kNm]	MEd 5766,00 [kNm]
NEk 0 [kN]	NEd 0 [kN]
tensioni e fessure	
Mdec 0,0 [kNm]	
Mcr 2996,4 [kNm]	
yn -65,21 [cm]	
σ _{c,min} -2,8 [MPa]	
σ _{s,min} -37,9 [MPa]	
σ _{s,max} 131,0 [MPa]	
k ₂ 0,5	
ε _{sm} -ε _{cm} - [%o]	
S _{r,max} - [cm]	
w _k - [mm]	
presso-flessione	
MRd 7479,7 [kNm]	
FS 1,30	
taglio	
VRdc 798,7 [kN]	
predisporre armatura a taglio	
VRds 3316,8 [kN]	
VRdmax 8280,2 [kN]	
θ 30,0 [°]	
sezione duttile	
ai 189,7 [cm]	

sollecitazioni e risultati	
SLE	SLU
MEk 0,00 [kNm]	MEd 3711,00 [kNm]
NEk 0 [kN]	NEd 0 [kN]
VEd 1536,00 [kN]	
tensioni e fessure	
Mdec 0,0 [kNm]	
Mcr -2996,4 [kNm]	
yn 65,21 [cm]	
σ _{c,min} 0,0 [MPa]	
σ _{s,min} 0,0 [MPa]	
σ _{s,max} 0,0 [MPa]	
k ₂ 0,5	
ε _{sm} -ε _{cm} - [%o]	
S _{r,max} - [cm]	
w _k - [mm]	
presso-flessione	
MRd 5001,7 [kNm]	
FS 1,35	
taglio	
VRdc 697,7 [kN]	
predisporre armatura a taglio	
VRds 3316,8 [kN]	
VRdmax 8280,2 [kN]	
θ 30,0 [°]	
sezione duttile	
ai 189,7 [cm]	

APPALTATORE: Consorzio HirpiniaAV Soci salini impregilo ASTALDI	ITINERARIO NAPOLI – BARI RADDOPPIO TRATTA APICE – ORSARA I LOTTO FUNZIONALE APICE – HIRPINIA					
PROGETTAZIONE: Mandataria SOJL Mandanti NETENGINEERING Alpina						
PROGETTO ESECUTIVO RELAZIONE DI CALCOLO FONDAZIONI PILE DA P17 A P20	COMMESSA IF1N	LOTTO 01 E ZZ	CODIFICA RG	DOCUMENTO MD0000 001	REV. B	FOGLIO 65 di 143

Sezione 7 longitudinale:

- *verifica armature inferiori:*

geometria				
sezione trasversale				
B	H	c	d	z
[cm]	[cm]	[cm]	[cm]	[cm]
100	250	5,0	243,4	219,1
armatura longitudinale				
nbarre	φ	d	Asl	
	[mm]	[cm]	[cm ²]	
6,66667	32	6,6	53,62	
10	32	243,4	80,42	
armatura a taglio				
nbracci	φ	s	α	Asw
	[mm]	[cm]	[°]	[cm ²]
3,33333	16	30	90	6,70

- *verifica armature superiore:*

geometria				
sezione trasversale				
B	H	c	d	z
[cm]	[cm]	[cm]	[cm]	[cm]
100	250	5,0	243,4	219,1
armatura longitudinale				
nbarre	φ	d	Asl	
	[mm]	[cm]	[cm ²]	
10	32	6,6	80,42	
6,66667	32	243,4	53,62	
armatura a taglio				
nbracci	φ	s	α	Asw
	[mm]	[cm]	[°]	[cm ²]
3,33333	16	30	90	6,70

sollecitazioni e risultati	
SLE	SLU
MEk 1975,00 [kNm]	MEd 4645,00 [kNm]
NEk 0 [kN]	NEd 0 [kN]
tensioni e fessure	
Mdec 0,0 [kNm]	
Mcr 2996,4 [kNm]	
yn -65,21 [cm]	
σc,min -2,4 [MPa]	
σs,min -31,5 [MPa]	
σs,max 108,6 [MPa]	
k2 0,5	
εsm-εcm - [%o]	
Sr,max - [cm]	
Wk - [mm]	
presso-flessione	
MRd 7479,7 [kNm]	
FS 1,61	
taglio	
VRdc 798,7 [kN]	
predisporre armatura a taglio	
VRds 3316,8 [kN]	
VRdmax 8280,2 [kN]	
θ 30,0 [°]	
sezione duttile	
ai 189,7 [cm]	

sollecitazioni e risultati	
SLE	SLU
MEk 0,00 [kNm]	MEd 3032,00 [kNm]
NEk 0 [kN]	NEd 0 [kN]
VEd 1107,00 [kN]	
tensioni e fessure	
Mdec 0,0 [kNm]	
Mcr -2996,4 [kNm]	
yn 65,21 [cm]	
σc,min 0,0 [MPa]	
σs,min 0,0 [MPa]	
σs,max 0,0 [MPa]	
k2 0,5	
εsm-εcm - [%o]	
Sr,max - [cm]	
Wk - [mm]	
presso-flessione	
MRd 5001,7 [kNm]	
FS 1,65	
taglio	
VRdc 697,7 [kN]	
predisporre armatura a taglio	
VRds 3316,8 [kN]	
VRdmax 8280,2 [kN]	
θ 30,0 [°]	
sezione duttile	
ai 189,7 [cm]	

APPALTATORE: Consorzio HirpiniaAV Soci salini impregilo ASTALDI	ITINERARIO NAPOLI – BARI RADDOPPIO TRATTA APICE – ORSARA I LOTTO FUNZIONALE APICE – HIRPINIA					
PROGETTAZIONE: Mandataria SOJL Mandanti NETENGINEERING Alpina						
PROGETTO ESECUTIVO RELAZIONE DI CALCOLO FONDAZIONI PILE DA P17 A P20	COMMESSA IF1N	LOTTO 01 E ZZ	CODIFICA RG	DOCUMENTO MD0000 001	REV. B	FOGLIO 66 di 143

Sezione 8 longitudinale:

- *verifica armature inferiori:*

geometria				
sezione trasversale				
B	H	c	d	z
[cm]	[cm]	[cm]	[cm]	[cm]
100	250	5,0	243,4	219,1
armatura longitudinale				
nbarre	φ	d	Asl	
	[mm]	[cm]	[cm ²]	
6,66667	32	6,6	53,62	
10	32	243,4	80,42	
armatura a taglio				
nbracci	φ	s	α	Asw
	[mm]	[cm]	[°]	[cm ²]
3,33333	16	30	90	6,70

- *verifica armature superiore:*

geometria				
sezione trasversale				
B	H	c	d	z
[cm]	[cm]	[cm]	[cm]	[cm]
100	250	5,0	243,4	219,1
armatura longitudinale				
nbarre	φ	d	Asl	
	[mm]	[cm]	[cm ²]	
10	32	6,6	80,42	
6,66667	32	243,4	53,62	
armatura a taglio				
nbracci	φ	s	α	Asw
	[mm]	[cm]	[°]	[cm ²]
3,33333	16	30	90	6,70

sollecitazioni e risultati	
SLE	SLU
MEk 2209,00 [kNm]	MEd 5178,00 [kNm]
NEk 0 [kN]	NEd 0 [kN]
tensioni e fessure	presso-flessione
Mdec 0,0 [kNm]	MRd 7479,7 [kNm]
Mcr 2996,4 [kNm]	FS 1,44
yn -65,21 [cm]	taglio
σc,min -2,6 [MPa]	VRdc 798,7 [kN]
σs,min -35,2 [MPa]	predisporre armatura a taglio
σs,max 121,5 [MPa]	VRds 3316,8 [kN]
k2 0,5	VRdmax 8280,2 [kN]
εsm-εcm - [%o]	θ 30,0 [°]
Sr,max - [cm]	sezione duttile
Wk - [mm]	ai 189,7 [cm]

sollecitazioni e risultati	
SLE	SLU
MEk 0,00 [kNm]	MEd 3389,00 [kNm]
NEk 0 [kN]	NEd 0 [kN]
tensioni e fessure	presso-flessione
Mdec 0,0 [kNm]	MRd 5001,7 [kNm]
Mcr -2996,4 [kNm]	FS 1,48
yn 65,21 [cm]	taglio
σc,min 0,0 [MPa]	VRdc 697,7 [kN]
σs,min 0,0 [MPa]	predisporre armatura a taglio
σs,max 0,0 [MPa]	VRds 3316,8 [kN]
k2 0,5	VRdmax 8280,2 [kN]
εsm-εcm - [%o]	θ 30,0 [°]
Sr,max - [cm]	sezione duttile
Wk - [mm]	ai 189,7 [cm]

APPALTATORE: Consorzio HirpiniaAV Soci salini impregilo ASTALDI	ITINERARIO NAPOLI – BARI RADDOPPIO TRATTA APICE – ORSARA I LOTTO FUNZIONALE APICE – HIRPINIA					
PROGETTAZIONE: Mandataria SOJL Mandanti NETENGINEERING Alpina						
PROGETTO ESECUTIVO RELAZIONE DI CALCOLO FONDAZIONI PILE DA P17 A P20	COMMESSA IF1N	LOTTO 01 E ZZ	CODIFICA RG	DOCUMENTO MD0000 001	REV. B	FOGLIO 67 di 143

Sezione 1 trasversale:

- *verifica armature inferiori:*

geometria				
sezione trasversale				
B	H	c	d	z
[cm]	[cm]	[cm]	[cm]	[cm]
100	250	8,2	240,2	216,2
armatura longitudinale				
nbarre	φ	d	Asi	
	[mm]	[cm]	[cm ²]	
6,66667	32	9,8	53,62	
6,66667	32	240,2	53,62	
armatura a taglio				
nbracci	φ	s	α	Asw
	[mm]	[cm]	[°]	[cm ²]
3,33333	16	60	90	6,70

- *verifica armature superiore:*

geometria				
sezione trasversale				
B	H	c	d	z
[cm]	[cm]	[cm]	[cm]	[cm]
100	250	8,2	240,2	216,2
armatura longitudinale				
nbarre	φ	d	Asi	
	[mm]	[cm]	[cm ²]	
6,66667	32	9,8	53,62	
6,66667	32	240,2	53,62	
armatura a taglio				
nbracci	φ	s	α	Asw
	[mm]	[cm]	[°]	[cm ²]
3,33333	16	60	90	6,70

sollecitazioni e risultati	
SLE	SLU
MEk 678,00 [kNm]	MEd 1015,00 [kNm]
NEk 0 [kN]	NEd 0 [kN]
tensioni e fessure	
Mdec 0,0 [kNm]	
Mcr 2837,5 [kNm]	
yn -75,66 [cm]	
σ _{c,min} -1,0 [MPa]	
σ _{s,min} -11,6 [MPa]	
σ _{s,max} 56,2 [MPa]	
k ₂ 0,5	
ε _{sm} -ε _{cm} - [%o]	
Sr,max - [cm]	
Wk - [mm]	
presso-flessione	
MRd 4910,2 [kNm]	
FS 4,84	
taglio	
VRdc 692,6 [kN]	
non serve armatura a taglio	
VRds 1636,6 [kN]	
VRdmax 8171,4 [kN]	
θ 30,0 [°]	
sezione duttile	
ai 240,2 [cm]	

sollecitazioni e risultati	
SLE	SLU
MEk 956,00 [kNm]	MEd 1934,00 [kNm]
NEk 0 [kN]	NEd 0 [kN]
VEk 620,00 [kN]	VED 620,00 [kN]
tensioni e fessure	
Mdec 0,0 [kNm]	
Mcr 2837,5 [kNm]	
yn -75,66 [cm]	
σ _{c,min} -1,4 [MPa]	
σ _{s,min} -16,4 [MPa]	
σ _{s,max} 79,2 [MPa]	
k ₂ 0,5	
ε _{sm} -ε _{cm} - [%o]	
Sr,max - [cm]	
Wk - [mm]	
presso-flessione	
MRd 4910,2 [kNm]	
FS 2,54	
taglio	
VRdc 692,6 [kN]	
non serve armatura a taglio	
VRds 1636,6 [kN]	
VRdmax 8171,4 [kN]	
θ 30,0 [°]	
sezione duttile	
ai 240,2 [cm]	

APPALTATORE: Consorzio HirpiniaAV Soci salini impregilo ASTALDI	ITINERARIO NAPOLI – BARI RADDOPPIO TRATTA APICE – ORSARA I LOTTO FUNZIONALE APICE – HIRPINIA					
PROGETTAZIONE: Mandataria SOJL Mandanti NETENGINEERING Alpina						
PROGETTO ESECUTIVO RELAZIONE DI CALCOLO FONDAZIONI PILE DA P17 A P20	COMMESSA IF1N	LOTTO 01 E ZZ	CODIFICA RG	DOCUMENTO MD0000 001	REV. B	FOGLIO 68 di 143

Sezione 2 trasversale:

- *verifica armature inferiori:*

geometria				
sezione trasversale				
B	H	c	d	z
[cm]	[cm]	[cm]	[cm]	[cm]
100	250	8,2	240,2	216,2
armatura longitudinale				
nbarre	φ	d	Asi	
	[mm]	[cm]	[cm ²]	
6,66667	32	9,8	53,62	
6,66667	32	240,2	53,62	
armatura a taglio				
nbracci	φ	s	α	Asw
	[mm]	[cm]	[°]	[cm ²]
3,33333	16	60	90	6,70

- *verifica armature superiore:*

geometria				
sezione trasversale				
B	H	c	d	z
[cm]	[cm]	[cm]	[cm]	[cm]
100	250	8,2	240,2	216,2
armatura longitudinale				
nbarre	φ	d	Asi	
	[mm]	[cm]	[cm ²]	
6,66667	32	9,8	53,62	
6,66667	32	240,2	53,62	
armatura a taglio				
nbracci	φ	s	α	Asw
	[mm]	[cm]	[°]	[cm ²]
3,33333	16	60	90	6,70

sollecitazioni e risultati	
SLE	SLU
MEk 791,00 [kNm]	MEd 1211,00 [kNm]
NEk 0 [kN]	NEd 0 [kN]
tensioni e fessure	
Mdec 0,0 [kNm]	
Mcr 2837,5 [kNm]	
yn -75,66 [cm]	
σ _{c,min} -1,1 [MPa]	
σ _{s,min} -13,6 [MPa]	
σ _{s,max} 65,5 [MPa]	
k ₂ 0,5	
ε _{sm} -ε _{cm} - [%]	
Sr,max - [cm]	
Wk - [mm]	
presso-flessione	
MRd 4910,2 [kNm]	
FS 4,05	
taglio	
VRdc 692,6 [kN]	
non serve armatura a taglio	
VRds 1636,6 [kN]	
VRdmax 8171,4 [kN]	
θ 30,0 [°]	
sezione duttile	
ai 240,2 [cm]	

sollecitazioni e risultati	
SLE	SLU
MEk 1113,00 [kNm]	MEd 2237,00 [kNm]
NEk 0 [kN]	NEd 0 [kN]
tensioni e fessure	
Mdec 0,0 [kNm]	
Mcr 2837,5 [kNm]	
yn -75,66 [cm]	
σ _{c,min} -1,6 [MPa]	
σ _{s,min} -19,1 [MPa]	
σ _{s,max} 92,2 [MPa]	
k ₂ 0,5	
ε _{sm} -ε _{cm} - [%]	
Sr,max - [cm]	
Wk - [mm]	
presso-flessione	
MRd 4910,2 [kNm]	
FS 2,20	
taglio	
VRdc 692,6 [kN]	
non serve armatura a taglio	
VRds 1636,6 [kN]	
VRdmax 8171,4 [kN]	
θ 30,0 [°]	
sezione duttile	
ai 240,2 [cm]	

APPALTATORE: Consorzio HirpiniaAV Soci salini impregilo ASTALDI	ITINERARIO NAPOLI – BARI RADDOPPIO TRATTA APICE – ORSARA I LOTTO FUNZIONALE APICE – HIRPINIA					
PROGETTAZIONE: Mandataria SOJL Mandanti NETENGINEERING Alpina						
PROGETTO ESECUTIVO RELAZIONE DI CALCOLO FONDAZIONI PILE DA P17 A P20	COMMESSA IF1N	LOTTO 01 E ZZ	CODIFICA RG	DOCUMENTO MD0000 001	REV. B	FOGLIO 69 di 143

Sezione 3 trasversale:

- *verifica armature inferiori:*

geometria				
sezione trasversale				
B	H	c	d	z
[cm]	[cm]	[cm]	[cm]	[cm]
100	250	8,2	240,2	216,2
armatura longitudinale				
nbarre	φ	d	Asi	
	[mm]	[cm]	[cm ²]	
6,66667	32	9,8	53,62	
6,66667	32	240,2	53,62	
armatura a taglio				
nbracci	φ	s	α	Asw
	[mm]	[cm]	[°]	[cm ²]
3,33333	16	60	90	6,70

- *verifica armature superiore:*

geometria				
sezione trasversale				
B	H	c	d	z
[cm]	[cm]	[cm]	[cm]	[cm]
100	250	8,2	240,2	216,2
armatura longitudinale				
nbarre	φ	d	Asi	
	[mm]	[cm]	[cm ²]	
6,66667	32	9,8	53,62	
6,66667	32	240,2	53,62	
armatura a taglio				
nbracci	φ	s	α	Asw
	[mm]	[cm]	[°]	[cm ²]
3,33333	16	60	90	6,70

sollecitazioni e risultati	
SLE	SLU
MEk 994,00 [kNm]	MEd 1548,00 [kNm]
NEk 0 [kN]	NEd 0 [kN]
tensioni e fessure	
Mdec 0,0 [kNm]	
Mcr 2837,5 [kNm]	
yn -75,66 [cm]	
σ _{c,min} -1,4 [MPa]	
σ _{s,min} -17,1 [MPa]	
σ _{s,max} 82,3 [MPa]	
k ₂ 0,5	
ε _{sm-εcm} - [%]	
Sr,max - [cm]	
Wk - [mm]	
presso-flessione	
MRd 4910,2 [kNm]	
FS 3,17	
taglio	
VRdc 692,6 [kN]	
predisporre armatura a taglio	
VRds 1636,6 [kN]	
VRdmax 8171,4 [kN]	
θ 30,0 [°]	
sezione duttile	
ai 187,2 [cm]	

sollecitazioni e risultati	
SLE	SLU
MEk 1351,00 [kNm]	MEd 2766,00 [kNm]
NEk 0 [kN]	NEd 0 [kN]
tensioni e fessure	
Mdec 0,0 [kNm]	
Mcr 2837,5 [kNm]	
yn -75,66 [cm]	
σ _{c,min} -1,9 [MPa]	
σ _{s,min} -23,2 [MPa]	
σ _{s,max} 111,9 [MPa]	
k ₂ 0,5	
ε _{sm-εcm} - [%]	
Sr,max - [cm]	
Wk - [mm]	
presso-flessione	
MRd 4910,2 [kNm]	
FS 1,78	
taglio	
VRdc 692,6 [kN]	
predisporre armatura a taglio	
VRds 1636,6 [kN]	
VRdmax 8171,4 [kN]	
θ 30,0 [°]	
sezione duttile	
ai 187,2 [cm]	

APPALTATORE: Consorzio HirpiniaAV Soci salini impregilo ASTALDI		ITINERARIO NAPOLI – BARI RADDOPPIO TRATTA APICE – ORSARA I LOTTO FUNZIONALE APICE – HIRPINIA				
PROGETTAZIONE: Mandataria SOJL Mandanti NETENGINEERING Alpina						
PROGETTO ESECUTIVO RELAZIONE DI CALCOLO FONDAZIONI PILE DA P17 A P20						
COMMESSA	LOTTO	CODIFICA	DOCUMENTO	REV.	FOGLIO	
IF1N	01 E ZZ	RG	MD0000 001	B	70 di 143	

Sezione 4 trasversale:

- *verifica armature inferiori:*

geometria				
sezione trasversale				
B	H	c	d	z
[cm]	[cm]	[cm]	[cm]	[cm]
100	250	8,2	240,2	216,2
armatura longitudinale				
nbarre	φ	d	Asl	
	[mm]	[cm]	[cm ²]	
6,66667	32	9,8	53,62	
6,66667	32	240,2	53,62	
armatura a taglio				
nbracci	φ	s	α	Asw
	[mm]	[cm]	[°]	[cm ²]
3,33333	16	30	90	6,70

- *verifica armature superiore:*

geometria				
sezione trasversale				
B	H	c	d	z
[cm]	[cm]	[cm]	[cm]	[cm]
100	250	8,2	240,2	216,2
armatura longitudinale				
nbarre	φ	d	Asl	
	[mm]	[cm]	[cm ²]	
6,66667	32	9,8	53,62	
6,66667	32	240,2	53,62	
armatura a taglio				
nbracci	φ	s	α	Asw
	[mm]	[cm]	[°]	[cm ²]
3,33333	16	30	90	6,70

sollecitazioni e risultati			
SLE	SLU		
MEk	1824,00 [kNm]	MEd	3555,00 [kNm]
NEk	0 [kN]	NEd	0 [kN]
tensioni e fessure		presso-flessione	
Mdec	0,0 [kNm]	MRd	4910,2 [kNm]
Mcr	2837,5 [kNm]	FS	1,38
yn		taglio	
σc,min	-2,6 [MPa]	VRdc	692,6 [kN]
σs,min	-31,3 [MPa]	predisporre armatura a taglio	
σs,max	151,1 [MPa]	VRds	3273,2 [kN]
k2		VRdmax	8171,4 [kN]
εsm-εcm	- [‰]	θ	30,0 [°]
Sr,max	- [cm]	sezione duttile	
Wk	- [mm]	ai	187,2 [cm]

sollecitazioni e risultati			
SLE	SLU		
MEk	1492,00 [kNm]	MEd	4056,00 [kNm]
NEk	0 [kN]	NEd	0 [kN]
tensioni e fessure		presso-flessione	
Mdec	0,0 [kNm]	MRd	4910,2 [kNm]
Mcr	2837,5 [kNm]	FS	1,21
yn		taglio	
σc,min	-2,1 [MPa]	VRdc	692,6 [kN]
σs,min	-25,6 [MPa]	predisporre armatura a taglio	
σs,max	123,6 [MPa]	VRds	3273,2 [kN]
k2		VRdmax	8171,4 [kN]
εsm-εcm	- [‰]	θ	30,0 [°]
Sr,max	- [cm]	sezione duttile	
Wk	- [mm]	ai	187,2 [cm]

APPALTATORE: Consorzio HirpiniaAV Soci salini impregilo ASTALDI	ITINERARIO NAPOLI – BARI RADDOPPIO TRATTA APICE – ORSARA I LOTTO FUNZIONALE APICE – HIRPINIA					
PROGETTAZIONE: Mandataria ROKSOJL Mandanti NETENGINEERING Alpina						
PROGETTO ESECUTIVO RELAZIONE DI CALCOLO FONDAZIONI PILE DA P17 A P20	COMMESSA IF1N	LOTTO 01 E ZZ	CODIFICA RG	DOCUMENTO MD0000 001	REV. B	FOGLIO 71 di 143

Sezione 5 trasversale:

- *verifica armature inferiori:*

geometria				
sezione trasversale				
B	H	c	d	z
[cm]	[cm]	[cm]	[cm]	[cm]
100	250	8,2	240,2	216,2
armatura longitudinale				
nbarre	φ	d	Asl	
	[mm]	[cm]	[cm ²]	
10	32	9,8	80,42	
10	32	240,2	80,42	
armatura a taglio				
nbracci	φ	s	α	Asw
	[mm]	[cm]	[°]	[cm ²]
3,33333	16	15	90	6,70

- *verifica armature superiore:*

geometria				
sezione trasversale				
B	H	c	d	z
[cm]	[cm]	[cm]	[cm]	[cm]
100	250	8,2	240,2	216,2
armatura longitudinale				
nbarre	φ	d	Asl	
	[mm]	[cm]	[cm ²]	
10	32	9,8	80,42	
10	32	240,2	80,42	
armatura a taglio				
nbracci	φ	s	α	Asw
	[mm]	[cm]	[°]	[cm ²]
3,33333	16	15	90	6,70

sollecitazioni e risultati	
SLE	SLU
MEk 2064,00 [kNm]	MEd 4513,00 [kNm]
NEk 0 [kN]	NEd 0 [kN]
VEd 7236,00 [kN]	
tensioni e fessure	
Mdec 0,0 [kNm]	
Mcr 3025,8 [kNm]	
yn -67,80 [cm]	
σc,min -2,4 [MPa]	
σs,min -29,7 [MPa]	
σs,max 114,8 [MPa]	
k2 0,5	
εsm-εcm - [%o]	
Sr,max - [cm]	
Wk - [mm]	
presso-flessione	
MRd 7323,8 [kNm]	
FS 1,62	
taglio	
VRdc 792,8 [kN]	
predisporre armatura a taglio	
VRds 7417,9 [kN]	
VRdmax 7633,5 [kN]	
θ 27,0 [°]	
sezione duttile	
ai 212,1 [cm]	

sollecitazioni e risultati	
SLE	SLU
MEk 2963,00 [kNm]	MEd 7112,00 [kNm]
NEk 0 [kN]	NEd 0 [kN]
VEd 7236,00 [kN]	
tensioni e fessure	
Mdec 0,0 [kNm]	
Mcr 3025,8 [kNm]	
yn -67,80 [cm]	
σc,min -3,4 [MPa]	
σs,min -42,7 [MPa]	
σs,max 164,8 [MPa]	
k2 0,5	
εsm-εcm - [%o]	
Sr,max - [cm]	
Wk - [mm]	
presso-flessione	
MRd 7323,8 [kNm]	
FS 1,03	
taglio	
VRdc 792,8 [kN]	
predisporre armatura a taglio	
VRds 7417,9 [kN]	
VRdmax 7633,5 [kN]	
θ 27,0 [°]	
sezione duttile	
ai 212,1 [cm]	

APPALTATORE: Consorzio HirpiniaAV Soci salini impregilo ASTALDI	ITINERARIO NAPOLI – BARI RADDOPPIO TRATTA APICE – ORSARA I LOTTO FUNZIONALE APICE – HIRPINIA					
PROGETTAZIONE: Mandataria SOJL Mandanti NETENGINEERING Alpina						
PROGETTO ESECUTIVO RELAZIONE DI CALCOLO FONDAZIONI PILE DA P17 A P20	COMMESSA IF1N	LOTTO 01 E ZZ	CODIFICA RG	DOCUMENTO MD0000 001	REV. B	FOGLIO 72 di 143

Sezione 6 trasversale:

- *verifica armature inferiori:*

geometria				
sezione trasversale				
B	H	c	d	z
[cm]	[cm]	[cm]	[cm]	[cm]
100	250	8,2	240,2	216,2
armatura longitudinale				
nbarre	φ	d	Asl	
	[mm]	[cm]	[cm ²]	
10	32	9,8	80,42	
10	32	240,2	80,42	
armatura a taglio				
nbracci	φ	s	α	Asw
	[mm]	[cm]	[°]	[cm ²]
3,33333	16	30	90	6,70

- *verifica armature superiore:*

geometria				
sezione trasversale				
B	H	c	d	z
[cm]	[cm]	[cm]	[cm]	[cm]
100	250	8,2	240,2	216,2
armatura longitudinale				
nbarre	φ	d	Asl	
	[mm]	[cm]	[cm ²]	
10	32	9,8	80,42	
10	32	240,2	80,42	
armatura a taglio				
nbracci	φ	s	α	Asw
	[mm]	[cm]	[°]	[cm ²]
3,33333	16	30	90	6,70

sollecitazioni e risultati	
SLE	SLU
MEk 1735,00 [kNm]	MEd 5001,00 [kNm]
NEk 0 [kN]	NEd 0 [kN]
VEd 2178,00 [kN]	
tensioni e fessure	
Mdec 0,0 [kNm]	
Mcr 3025,8 [kNm]	
yn -67,80 [cm]	
σc,min -2,0 [MPa]	
σs,min -25,0 [MPa]	
σs,max 96,5 [MPa]	
k2 0,5	
εsm-εcm - [%o]	
Sr,max - [cm]	
Wk - [mm]	
presso-flessione	
MRd 7323,8 [kNm]	
FS 1,46	
taglio	
VRdc 792,8 [kN]	
predisporre armatura a taglio	
VRds 3709,0 [kN]	
VRdmax 7633,5 [kN]	
θ 27,0 [°]	
sezione duttile	
ai 212,1 [cm]	

sollecitazioni e risultati	
SLE	SLU
MEk 2927,00 [kNm]	MEd 7224,00 [kNm]
NEk 0 [kN]	NEd 0 [kN]
VEd 2178,00 [kN]	
tensioni e fessure	
Mdec 0,0 [kNm]	
Mcr 3025,8 [kNm]	
yn -67,80 [cm]	
σc,min -3,4 [MPa]	
σs,min -42,2 [MPa]	
σs,max 162,8 [MPa]	
k2 0,5	
εsm-εcm - [%o]	
Sr,max - [cm]	
Wk - [mm]	
presso-flessione	
MRd 7323,8 [kNm]	
FS 1,01	
taglio	
VRdc 792,8 [kN]	
predisporre armatura a taglio	
VRds 3709,0 [kN]	
VRdmax 7633,5 [kN]	
θ 27,0 [°]	
sezione duttile	
ai 212,1 [cm]	

10.4 VERIFICA PUNZONAMENTO

La verifica a punzonamento viene eseguita in prima istanza trascurando la presenza di armatura e considerando l'azione assiale massima di compressione agente sui pali e ipotizzando di questa sia riferita ad un palo di bordo.

La verifica è eseguita sul perimetro del palo, u_0 , e sul perimetro composto dal quadrato di lato 3,75m che traccia l'interasse tra i pali, u_1 .

APPALTATORE: Consorzio Soci 	ITINERARIO NAPOLI – BARI RADDOPPIO TRATTA APICE – ORSARA I LOTTO FUNZIONALE APICE – HIRPINIA
PROGETTAZIONE: Mandataria Mandanti 	
PROGETTO ESECUTIVO RELAZIONE DI CALCOLO FONDAZIONI PILE DA P17 A P20	COMMESSA IF1N LOTTO 01 E ZZ CODIFICA RG DOCUMENTO MD0000 001 REV. B FOGLIO 73 di 143

- Verifica su u_0 :

$$v_{ED,0} = \frac{\beta N_{ED}}{u_0 H} \leq v_{RD,max} = 0,5 v f_{cd}$$

- Verifica su u_1 :

$$v_{ED,1} = \frac{N_{ED}}{u_1 H} \leq v_{RD,max} = 0,5 f_{ctd}$$

Caratteristiche meccaniche			
R_{ck}	resistenza cubica a compressione caratteristica	35	MPa
f_{ck}	resistenza cilindrica a compressione caratteristica	29,1	MPa
f_{cd}	resistenza cilindrica a compressione di progetto	16,5	MPa
f_{ctd}	resistenza cilindrica a trazione di progetto	1,32	MPa
v	$0,6 \times (1 - f_{ck} / 250)$	0,53	[-]
Caratteristiche geometriche			
D_{palo}	diametro palo	1,5	m
u_0	perimetro palo	4,7	m
H_{plinto}	altezza plinto	2,5	m
u_1	perimetro interno posto ad interasse pali di bordo	7,5	m
β	fattore di posizione del palo	1,5	[-]
Sollecitazione			
N_{Ed}	azione assiale sollecitante	7692,0	kN
Verifica su u_0			
$V_{Ed,0}$	sforzo agente su u_0	0,98	MPa
$V_{Rd,0}$	sforzo resistente su u_0	4,36	MPa
FS	fattore di sicurezza	4,46	[-]
Verifica su u_1			
$V_{Ed,1}$	sforzo agente su u_1	0,41	MPa
$V_{Rd,1}$	sforzo resistente su u_1	0,66	MPa
FS	fattore di sicurezza	1,61	[-]

Tale verifica risulta soddisfatta nelle condizioni esplicitate, quindi non viene eseguita la verifica considerando la presenza di armatura e l'effettiva posizione del palo.

10.5 VERIFICA TIRANTE-PUNTONE

La verifica tirante-puntone viene eseguita considerando le sollecitazioni del palo più sollecitato, i quali risulta avere un carico allo SLV, ed è di 7693 kN. Tale verifica viene eseguita secondo l'EC2.

Il riferimento per le dimensioni sono quelle in pianta dell'area che interessa il singolo palo, quindi l'armatura di verifica di riferimento è su base di 2.65m.

APPALTATORE: Consorzio Soci 	ITINERARIO NAPOLI – BARI RADDOPPIO TRATTA APICE – ORSARA I LOTTO FUNZIONALE APICE – HIRPINIA
PROGETTAZIONE: Mandataria Mandanti 	
PROGETTO ESECUTIVO RELAZIONE DI CALCOLO FONDAZIONI PILE DA P17 A P20	COMMESSA LOTTO CODIFICA DOCUMENTO REV. FOGLIO IF1N 01 E ZZ RG MD0000 001 B 74 di 143

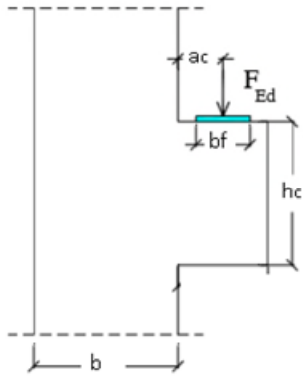
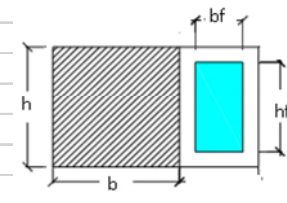
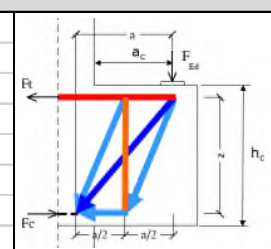
SQUAT CANTILEVER VERIFICATION BY STRUT AND TIE MODEL				
Norm: [1] UNI EN 1992-1-1:2005				
MATERIAL PROPERTIES				
Concrete				
Characteristic cube strength	R_{ck}	=	35	N/mm ²
Characteristic cylinder strength	f_{ck}	=	29	N/mm ²
Partial safety factor for concrete	γ_c	=	1,50	
Coefficient for long-term effects	α_{cc}	=	0,85	
Design value of compression resistance	f_{cd}	=	16,46	N/mm ² $f_{cd} = f_{ck} \alpha_{cc} / \gamma_c$
Steel				
Characteristic yield strength of reinforcement	f_{yk}	=	450	N/mm ²
Partial safety factor for steel	γ_s	=	1,15	N/mm ²
Design yield strength of reinforcement	f_{yd}	=	391	N/mm ² $f_{yd} = f_{yk} / \gamma_s$
DEFINITION OF GEOMETRY				
Overall depth of a cantilever cross-section	h_c	=	3000	mm
Distance between force and column	a_c	=	2600	mm
Overall width of a column cross-section	b	=	3000	mm
Overall depth of a column cross-section	h	=	3000	mm
Concrete cover of a cantilever cross-section	d'	=	50	mm
Width plate on acting force	b_f	=	1200	mm
Depth plate on acting force	h_f	=	2650	mm
Effective depth of a cantilever cross-section	d	=	2950	mm
Internal arm	z	=	2900	mm
Area of the primary tensile reinforcement	A_s	=	21313	mm ²
Dimameter of stirrups	ϕ_{sw}	=	16	mm
Number of arms	n_b	=	8,83	mm
Number of the stirrups	n	=	8,83	mm
Area of the secondary reinforcement	$A_{s,ink}$	=	15688	mm ²
CASE $a_c > h_c/2$				
YES!!				
				
NODE DESIGN RESISTANCE				
	k_1	=	1,00	
	k_2	=	0,85	
	k_3	=	0,75	
	v'	=	1,04	
Resistance of node face 1	$\sigma_{1RD,max}$	=	17,1	N/mm ²
Resistance of node face 2	$\sigma_{2RD,max}$	=	14,5	kN
Resistance of node face 3	$\sigma_{3RD,max}$	=	12,8	kN
				
ACTION FORCES ON NODES				
Acting force	F_{Ed}	=	7693	kN
	x_1	=	149,82	mm
	y_1	=	590,00	mm
Principal Traction Force	F_t	=	7095,89	kN
Compression Force	F_c	=	3547,94	kN
Stresses on node 1	$\sigma_{1,Ed}$	=	1,00	N/mm ²
Stresses on node 2	$\sigma_{2,Ed}$	=	2,42	N/mm ²
Secondary Traction Force	F_{Wd}	=	2166,259	kN
				
CHECKS				
Chech nodes 1	$\varepsilon_d / \sigma_{1RD,max}$	=	0,06	< 1
	$A_{s,min} / A_s$	=	0,85	< 1
	$A_s * k_1 / A_{s,ink}$	=	0,34	< 1
	$k_{,min} / A_{s,ink}$	=	0,35	< 1
Chech nodes 2	$\varepsilon_d / \sigma_{2RD,max}$	=	0,17	< 1

APPALTATORE: Consorzio Soci   	ITINERARIO NAPOLI – BARI RADDOPPIO TRATTA APICE – ORSARA I LOTTO FUNZIONALE APICE – HIRPINIA																	
PROGETTAZIONE: Mandataria Mandanti   	<table border="1" style="width: 100%; border-collapse: collapse;"> <tr> <td style="width: 16.6%;">COMMESSA</td> <td style="width: 16.6%;">LOTTO</td> <td style="width: 16.6%;">CODIFICA</td> <td style="width: 16.6%;">DOCUMENTO</td> <td style="width: 16.6%;">REV.</td> <td style="width: 16.6%;">FOGLIO</td> </tr> <tr> <td style="text-align: center;">IF1N</td> <td style="text-align: center;">01 E ZZ</td> <td style="text-align: center;">RG</td> <td style="text-align: center;">MD0000 001</td> <td style="text-align: center;">B</td> <td style="text-align: center;">75 di 143</td> </tr> </table>						COMMESSA	LOTTO	CODIFICA	DOCUMENTO	REV.	FOGLIO	IF1N	01 E ZZ	RG	MD0000 001	B	75 di 143
COMMESSA	LOTTO	CODIFICA	DOCUMENTO	REV.	FOGLIO													
IF1N	01 E ZZ	RG	MD0000 001	B	75 di 143													
PROGETTO ESECUTIVO RELAZIONE DI CALCOLO FONDAZIONI PILE DA P17 A P20																		

10.6 STIMA INCIDENZE DI ARMATURA

Per la stima delle incidenze di armatura dei plinti di fondazione si rimanda al Viadotto VI01 che presenta configurazione di carichi e geometrie assimilabili a quelle in oggetto.

APPALTATORE: <u>Consorzio</u> <u>Soci</u> HIRPINIA AV SALINI IMPREGILO S.P.A. ASTALDI S.P.A.	ITINERARIO NAPOLI – BARI					
PROGETTAZIONE: <u>Mandatario</u> <u>Mandanti</u> ROCKSOIL S.P.A. NET ENGINEERING S.P.A. ALPINA S.P.A.	RADDOPPIO TRATTA APICE – ORSARA I LOTTO FUNZIONALE APICE – HIRPINIA					
PROGETTO ESECUTIVO RELAZIONE DI CALCOLO FONDAZIONI PILE DA P17 A P20	COMMESSA IF28	LOTTO 01	CODIFICA E ZZ CL	DOCUMENTO VI0403 008	REV. B	FOGLIO 76 di 143

11 ALLEGATO: TABULATI GROUP

11.1 PILA SLE

=====

GROUP for Windows, Version 2016.10.13

Serial Number : 228330872

Analysis of A Group of Piles
Subjected to Axial and Lateral Loading

(c) Copyright ENSOFT, Inc., 1987-2015
All Rights Reserved

=====

Time and Date of Analysis

Date: July 07, 2020 Time: 17:28:23

***** COMPUTATION RESULTS *****

New Group

***** LOAD CASES RESULTS *****

LOAD CASE : 1
CASE NAME : Load Case
LOAD TYPE : Special, Sp

REDUCTION FACTORS FOR CLOSELY-SPACED PILE GROUPS, COMBINED Y AND Z DIRECTIONS
ESTIMATED USING MOVEMENT IN THE DIRECTION OF PILE CAP DISPLACEMENTS



GROUP NO	P-FACTOR	Y-FACTOR
1	0.7153	1.0000
2	0.6824	1.0000
3	0.8661	1.0000
4	0.5319	1.0000
5	0.4955	1.0000
6	0.7199	1.0000
7	0.5164	1.0000
8	0.4818	1.0000
9	0.7085	1.0000
10	0.5845	1.0000
11	0.5463	1.0000
12	0.7617	1.0000

* TABLE L * COMPUTATION ON PILE CAP

* EQUIVALENT CONCENTRATED LOAD AT ORIGIN *

VERT. LOAD, KN 37210.0	HOR. LOAD Y, KN -1201.00	HOR. LOAD Z, KN 1110.00
MOMENT X, KN- M 3.00000	MOMENT Y, KN- M 19609.0	MOMENT Z, KN- M 14562.5

* DISPLACEMENT OF GROUPED PILE FOUNDATION AT ORIGIN *

APPALTATORE: Consorzio  Soci  	ITINERARIO NAPOLI – BARI RADDOPPIO TRATTA APICE – ORSARA I LOTTO FUNZIONALE APICE – HIRPINIA				
PROGETTAZIONE: Mandataria  Mandanti  					
PROGETTO ESECUTIVO RELAZIONE DI CALCOLO FONDAZIONI PILE DA P17 A P20					
COMMESSA IF1N	LOTTO 01 E ZZ	CODIFICA RG	DOCUMENTO MD0000 001	REV. B	FOGLIO 77 di 143

VERTICAL , M 1.54631E-03	HORIZONTAL Y, M -4.29766E-04	HORIZONTAL Z, M 3.62789E-04
ANGLE ROT. X,RAD 1.63818E-07	ANGLE ROT. Y,RAD 3.68694E-05	ANGLE ROT. Z,RAD 5.32369E-05

THE GLOBAL STRUCTURAL COORDINATE SYSTEM

* PILE TOP DISPLACEMENTS *

PILE GROUP	DISP. X, M	DISP. Y, M	DISP. Z, M	ROT. X,RAD	ROT. Y,RAD	ROT. Z,RAD
*****	*****	*****	*****	*****	*****	*****
1	1.5556E-03	-4.3087E-04	3.6353E-04	1.6382E-07	3.6869E-05	5.3237E-05
2	1.7952E-03	-4.3087E-04	3.6279E-04	1.6382E-07	3.6869E-05	5.3237E-05
3	2.0347E-03	-4.3087E-04	3.6205E-04	1.6382E-07	3.6869E-05	5.3237E-05
4	1.3897E-03	-4.3013E-04	3.6353E-04	1.6382E-07	3.6869E-05	5.3237E-05
5	1.6293E-03	-4.3013E-04	3.6279E-04	1.6382E-07	3.6869E-05	5.3237E-05
6	1.8688E-03	-4.3013E-04	3.6205E-04	1.6382E-07	3.6869E-05	5.3237E-05
7	1.2238E-03	-4.2940E-04	3.6353E-04	1.6382E-07	3.6869E-05	5.3237E-05
8	1.4633E-03	-4.2940E-04	3.6279E-04	1.6382E-07	3.6869E-05	5.3237E-05
9	1.7029E-03	-4.2940E-04	3.6205E-04	1.6382E-07	3.6869E-05	5.3237E-05
10	1.0579E-03	-4.2866E-04	3.6353E-04	1.6382E-07	3.6869E-05	5.3237E-05
11	1.2974E-03	-4.2866E-04	3.6279E-04	1.6382E-07	3.6869E-05	5.3237E-05
12	1.5370E-03	-4.2866E-04	3.6205E-04	1.6382E-07	3.6869E-05	5.3237E-05
MINIMUM	1.0579E-03	-4.3087E-04	3.6205E-04	1.6382E-07	3.6869E-05	5.3237E-05
Pile N.	10	1	3	1	1	1
MAXIMUM	2.0347E-03	-4.2866E-04	3.6353E-04	1.6382E-07	3.6869E-05	5.3237E-05
Pile N.	3	10	1	1	1	1

* PILE TOP REACTIONS *

PILE GROUP	FOR. X, KN	FOR. Y, KN	FOR. Z, KN	MOM X, KN- M	MOM Y, KN- M	MOM Z, KN- M
*****	*****	*****	*****	*****	*****	*****
1	3119.2	-108.94	100.33	0.063831	-220.55	-220.04
2	3591.4	-105.72	97.196	0.063831	-214.60	-214.26
3	4063.6	-122.71	111.96	0.063831	-241.04	-244.70
4	2792.1	-89.991	83.654	0.063831	-189.25	-184.62
5	3264.4	-85.942	79.797	0.063831	-181.62	-176.95
6	3736.6	-109.05	100.12	0.063831	-219.73	-220.08
7	2465.1	-88.081	82.153	0.063831	-186.31	-180.70
8	2937.3	-84.181	78.424	0.063831	-178.90	-173.28
9	3409.5	-107.71	99.180	0.063831	-217.97	-217.33
10	2138.1	-95.146	88.716	0.063831	-198.83	-193.77
11	2610.3	-91.074	84.815	0.063831	-191.23	-186.18
12	3082.5	-112.45	103.65	0.063831	-226.07	-225.56
MINIMUM	2138.1	-122.71	78.424	0.063831	-241.04	-244.70
Pile N.	10	3	8	1	3	8
MAXIMUM	4063.6	-84.181	111.96	0.063831	-178.90	-173.28
Pile N.	3	8	3	1	8	8

THE PILE COORDINATE SYSTEM (LOCAL AXES)

* PILE TOP DISPLACEMENTS *

PILE GROUP	DISP. x, M	DISP. y, M	DISP. z, M	ROT. x,RAD	ROT. y,RAD	ROT. z,RAD
*****	*****	*****	*****	*****	*****	*****
1	1.5556E-03	-4.3087E-04	3.6353E-04	1.6382E-07	3.6869E-05	5.3237E-05
2	1.7952E-03	-4.3087E-04	3.6279E-04	1.6382E-07	3.6869E-05	5.3237E-05
3	2.0347E-03	-4.3087E-04	3.6205E-04	1.6382E-07	3.6869E-05	5.3237E-05
4	1.3897E-03	-4.3013E-04	3.6353E-04	1.6382E-07	3.6869E-05	5.3237E-05
5	1.6293E-03	-4.3013E-04	3.6279E-04	1.6382E-07	3.6869E-05	5.3237E-05
6	1.8688E-03	-4.3013E-04	3.6205E-04	1.6382E-07	3.6869E-05	5.3237E-05
7	1.2238E-03	-4.2940E-04	3.6353E-04	1.6382E-07	3.6869E-05	5.3237E-05
8	1.4633E-03	-4.2940E-04	3.6279E-04	1.6382E-07	3.6869E-05	5.3237E-05
9	1.7029E-03	-4.2940E-04	3.6205E-04	1.6382E-07	3.6869E-05	5.3237E-05
10	1.0579E-03	-4.2866E-04	3.6353E-04	1.6382E-07	3.6869E-05	5.3237E-05
11	1.2974E-03	-4.2866E-04	3.6279E-04	1.6382E-07	3.6869E-05	5.3237E-05
12	1.5370E-03	-4.2866E-04	3.6205E-04	1.6382E-07	3.6869E-05	5.3237E-05
MINIMUM	1.0579E-03	-4.3087E-04	3.6205E-04	1.6382E-07	3.6869E-05	5.3237E-05
Pile N.	10	1	3	1	1	1
MAXIMUM	2.0347E-03	-4.2866E-04	3.6353E-04	1.6382E-07	3.6869E-05	5.3237E-05
Pile N.	3	10	1	1	1	1

* PILE TOP REACTIONS *

PILE GROUP	AXIAL, KN	LAT. y, KN	LAT. z, KN	MOM x, KN- M	MOM y, KN- M	MOM z, KN- M
*****	*****	*****	*****	*****	*****	*****
1	3119.2	-108.94	100.33	0.063831	-220.55	-220.04
2	3591.4	-105.72	97.196	0.063831	-214.60	-214.26
3	4063.6	-122.71	111.96	0.063831	-241.04	-244.70
4	2792.1	-89.991	83.654	0.063831	-189.25	-184.62

APPALTATORE:

Consorzio

Soci



ITINERARIO NAPOLI – BARI

PROGETTAZIONE:

Mandatario

Mandanti

RADDOPPIO TRATTA APICE – ORSARA
I LOTTO FUNZIONALE APICE – HIRPINIA

PROGETTO ESECUTIVO

RELAZIONE DI CALCOLO FONDAZIONI PILE DA P17 A P20

COMMESSA
IF1NLOTTO
01 E ZZCODIFICA
RGDOCUMENTO
MD0000 001REV.
BFOGLIO
78 di 143

5	3264.4	-85.942	79.797	0.063831	-181.62	-176.95
6	3736.6	-109.05	100.12	0.063831	-219.73	-220.08
7	2465.1	-88.081	82.153	0.063831	-186.31	-180.70
8	2937.3	-84.181	78.424	0.063831	-178.90	-173.28
9	3409.5	-107.71	99.180	0.063831	-217.97	-217.33
10	2138.1	-95.146	88.716	0.063831	-198.83	-193.77
11	2610.3	-91.074	84.815	0.063831	-191.23	-186.18
12	3082.5	-112.45	103.65	0.063831	-226.07	-225.56
MINIMUM	2138.1	-122.71	78.424	0.063831	-241.04	-244.70
Pile N.	10	3	8	1	3	3
MAXIMUM	4063.6	-84.181	111.96	0.063831	-178.90	-173.28
Pile N.	3	8	3	1	8	8

PILE GROUP STRESS, KN/ M**2

*****	*****
1	2705.3
2	2947.5
3	3336.2
4	2378.0
5	2612.5
6	3053.1
7	2178.3
8	2413.8
9	2858.4
10	2047.8
11	2282.6
12	2708.1
MINIMUM	2047.8
Pile N.	10
MAXIMUM	3336.2
Pile N.	3

* EFFECTS FOR LATERALLY LOADED PILE *

* MINIMUM VALUES AND LOCATIONS *

PILE	DISPL. y-Dir M	DISPL. z-Dir M	MOMENT z-Dir KN- M	MOMENT y-Dir KN- M	SHEAR y-Dir KN	SHEAR z-Dir KN	SOIL REACT y-Dir KN/ M	SOIL REACT z-Dir KN/ M	TOTAL STRESS KN/ M**2	FLEX. RIG. z-Dir KN- M**2	FLEX. RIG. y-Dir KN- M**2
*****	*****	*****	*****	*****	*****	*****	*****	*****	*****	*****	*****
1	-4.3087E-04	-1.3781E-05	-125.89	-220.55	-108.95	-21.156	-45.679	-4.2638	1765.1	7.8279E+06	7.8279E+06
x(M)	0.0000	9.8400	4.8000	0.0000	0.0000	7.4400	2.4000	10.800	24.000	0.0000	0.0000
2	-4.3087E-04	-1.3684E-05	-123.56	-214.60	-105.73	-20.482	-43.788	-4.1029	2032.3	7.8279E+06	7.8279E+06
x(M)	0.0000	9.8400	5.0400	0.0000	0.0000	7.6800	2.4000	10.800	24.000	0.0000	0.0000
3	-4.3087E-04	-1.3915E-05	-136.02	-241.04	-122.73	-23.894	-54.184	-4.8773	2299.5	7.8279E+06	7.8279E+06
x(M)	0.0000	9.6000	4.8000	0.0000	0.0000	7.2000	2.4000	10.560	24.000	0.0000	0.0000
4	-4.3013E-04	-1.3225E-05	-111.80	-189.25	-89.999	-17.607	-34.893	-3.4663	1580.0	7.8279E+06	7.8279E+06
x(M)	0.0000	10.320	5.0400	0.0000	0.0000	7.9200	2.4000	14.160	24.000	0.0000	0.0000
5	-4.3013E-04	-1.3039E-05	-108.74	-181.62	-85.951	-16.867	-32.718	-3.4791	1847.2	7.8279E+06	7.8279E+06
x(M)	0.0000	10.560	5.2800	0.0000	0.0000	8.1600	2.4000	14.160	24.000	0.0000	0.0000
6	-4.3013E-04	-1.3746E-05	-126.03	-219.73	-109.07	-21.173	-45.843	-4.2686	2114.5	7.8279E+06	7.8279E+06
x(M)	0.0000	9.8400	4.8000	0.0000	0.0000	7.4400	2.4000	10.800	24.000	0.0000	0.0000
7	-4.2940E-04	-1.3135E-05	-110.29	-186.31	-88.088	-17.290	-33.900	-3.4767	1395.0	7.8279E+06	7.8279E+06
x(M)	0.0000	10.320	5.0400	0.0000	0.0000	8.1600	2.4000	14.160	24.000	0.0000	0.0000
8	-4.2940E-04	-1.2963E-05	-107.40	-178.90	-84.189	-16.589	-31.825	-3.4815	1662.2	7.8279E+06	7.8279E+06
x(M)	0.0000	10.560	5.2800	0.0000	0.0000	8.1600	2.4000	14.160	24.000	0.0000	0.0000
9	-4.2940E-04	-1.3720E-05	-125.00	-217.97	-107.72	-20.944	-45.100	-4.2161	1929.4	7.8279E+06	7.8279E+06
x(M)	0.0000	9.8400	4.8000	0.0000	0.0000	7.4400	2.4000	10.800	24.000	0.0000	0.0000
10	-4.2866E-04	-1.3406E-05	-115.72	-198.83	-95.153	-18.606	-37.848	-3.6331	1209.9	7.8279E+06	7.8279E+06
x(M)	0.0000	10.320	5.0400	0.0000	0.0000	7.9200	2.4000	11.280	24.000	0.0000	0.0000
11	-4.2866E-04	-1.3264E-05	-112.64	-191.23	-91.082	-17.853	-35.596	-3.4447	1477.1	7.8279E+06	7.8279E+06
x(M)	0.0000	10.320	5.0400	0.0000	0.0000	7.9200	2.4000	14.160	24.000	0.0000	0.0000
12	-4.2866E-04	-1.3786E-05	-128.54	-226.07	-112.46	-21.954	-48.018	-4.4465	1744.3	7.8279E+06	7.8279E+06
x(M)	0.0000	9.8400	4.8000	0.0000	0.0000	7.4400	2.4000	10.800	24.000	0.0000	0.0000
Min.	-4.3087E-04	-1.3915E-05	-136.02	-241.04	-122.73	-23.894	-54.184	-4.8773	1209.9	7.8279E+06	7.8279E+06
Pile N.	1	3	3	3	3	3	3	3	10	1	1

* MAXIMUM VALUES AND LOCATIONS *

PILE	DISPL. y-Dir M	DISPL. z-Dir M	MOMENT z-Dir KN- M	MOMENT y-Dir KN- M	SHEAR y-Dir KN	SHEAR z-Dir KN	SOIL REACT y-Dir KN/ M	SOIL REACT z-Dir KN/ M	TOTAL STRESS KN/ M**2	FLEX. RIG. z-Dir KN- M**2	FLEX. RIG. y-Dir KN- M**2
*****	*****	*****	*****	*****	*****	*****	*****	*****	*****	*****	*****
1	1.6544E-05	3.6353E-04	220.04	105.72	25.176	100.34	5.0038	40.145	2705.3	7.8279E+06	7.8279E+06
x(M)	9.6000	0.0000	0.0000	0.0000	7.4400	0.0000	10.800	2.4000	0.0000	0.0000	0.0000
2	1.6520E-05	3.6279E-04	214.26	103.49	24.457	97.208	4.8377	38.397	2947.5	7.8279E+06	7.8279E+06
x(M)	9.8400	0.0000	0.0000	0.0000	7.4400	0.0000	10.800	2.4000	0.0000	0.0000	0.0000
3	1.6709E-05	3.6205E-04	244.70	113.73	28.532	111.97	5.7178	47.364	3336.2	7.8279E+06	7.8279E+06
x(M)	9.3600	0.0000	0.0000	4.8000	7.2000	0.0000	10.560	2.4000	0.0000	0.0000	0.0000
4	1.6040E-05	3.6353E-04	184.62	93.775	20.876	83.662	3.9756	30.760	2378.0	7.8279E+06	7.8279E+06
x(M)	10.320	0.0000	0.0000	5.2800	7.6800	0.0000	11.280	2.4000	0.0000	0.0000	0.0000
5	1.5908E-05	3.6279E-04	176.95	90.901	20.026	79.806	3.9344	28.780	2612.5	7.8279E+06	7.8279E+06
x(M)	10.320	0.0000	0.0000	5.2800	7.9200	0.0000	14.160	2.4000	0.0000	0.0000	0.0000
6	1.6541E-05	3.6205E-04	220.08	105.59	25.246	100.14	5.0199	40.180	3053.1	7.8279E+06	7.8279E+06
x(M)	9.6000	0.0000	0.0000	5.0400	7.4400	0.0000	10.800	2.4000	0.0000	0.0000	0.0000

APPALTATORE: Consorzio  Soci  	ITINERARIO NAPOLI – BARI RADDOPPIO TRATTA APICE – ORSARA I LOTTO FUNZIONALE APICE – HIRPINIA												
PROGETTAZIONE: Mandataria  Mandanti  													
PROGETTO ESECUTIVO RELAZIONE DI CALCOLO FONDAZIONI PILE DA P17 A P20	<table border="1"> <tr> <td>COMMESSA</td> <td>LOTTO</td> <td>CODIFICA</td> <td>DOCUMENTO</td> <td>REV.</td> <td>FOGLIO</td> </tr> <tr> <td>IF1N</td> <td>01 E ZZ</td> <td>RG</td> <td>MD0000 001</td> <td>B</td> <td>79 di 143</td> </tr> </table>	COMMESSA	LOTTO	CODIFICA	DOCUMENTO	REV.	FOGLIO	IF1N	01 E ZZ	RG	MD0000 001	B	79 di 143
COMMESSA	LOTTO	CODIFICA	DOCUMENTO	REV.	FOGLIO								
IF1N	01 E ZZ	RG	MD0000 001	B	79 di 143								

	7	1.5959E-05	3.6353E-04	180.70	92.638	20.456	82.160	3.9068	29.951	2178.3	7.8279E+06	7.8279E+06
x(M)		10.320	0.0000	0.0000	5.2800	7.9200	0.0000	14.160	2.4000	0.0000	0.0000	0.0000
	8	1.5802E-05	3.6279E-04	173.28	89.889	19.661	78.432	3.9333	28.057	2413.8	7.8279E+06	7.8279E+06
x(M)		10.320	0.0000	0.0000	5.5200	7.9200	0.0000	14.160	2.4000	0.0000	0.0000	0.0000
	9	1.6488E-05	3.6205E-04	217.33	104.90	24.952	99.191	4.9535	39.615	2858.4	7.8279E+06	7.8279E+06
x(M)		9.8400	0.0000	0.0000	5.0400	7.4400	0.0000	10.800	2.4000	0.0000	0.0000	0.0000
	10	1.6184E-05	3.6353E-04	193.77	97.409	22.045	88.723	4.2708	33.497	2047.8	7.8279E+06	7.8279E+06
x(M)		10.080	0.0000	0.0000	5.2800	7.6800	0.0000	11.040	2.4000	0.0000	0.0000	0.0000
	11	1.6052E-05	3.6279E-04	186.18	94.611	21.157	84.822	4.0444	31.435	2282.6	7.8279E+06	7.8279E+06
x(M)		10.080	0.0000	0.0000	5.2800	7.6800	0.0000	11.280	2.4000	0.0000	0.0000	0.0000
	12	1.6548E-05	3.6205E-04	225.56	108.02	26.089	103.66	5.2051	42.257	2708.1	7.8279E+06	7.8279E+06
x(M)		9.6000	0.0000	0.0000	5.0400	7.2000	0.0000	10.560	2.4000	0.0000	0.0000	0.0000
Max.		1.6709E-05	3.6353E-04	244.70	113.73	28.532	111.97	5.7178	47.364	3336.2	7.8279E+06	7.8279E+06
Pile N.		3	1	3	3	3	3	3	3	3	1	1

LOAD CASE : 2
CASE NAME : Load Case
LOAD TYPE : Special, Sp

REDUCTION FACTORS FOR CLOSELY-SPACED PILE GROUPS, COMBINED Y AND Z DIRECTIONS
ESTIMATED USING MOVEMENT IN THE DIRECTION OF PILE CAP DISPLACEMENTS

GROUP NO	P-FACTOR	Y-FACTOR
1	0.8551	1.0000
2	0.7963	1.0000
3	0.8661	1.0000
4	0.5755	1.0000
5	0.4961	1.0000
6	0.5914	1.0000
7	0.5423	1.0000
8	0.4641	1.0000
9	0.5592	1.0000
10	0.5845	1.0000
11	0.5007	1.0000
12	0.6004	1.0000

* TABLE L * COMPUTATION ON PILE CAP

* EQUIVALENT CONCENTRATED LOAD AT ORIGIN *

VERT. LOAD, KN	HOR. LOAD Y, KN	HOR. LOAD Z, KN
29988.0	-170.000	855.000
MOMENT X, KN- M	MOMENT Y, KN- M	MOMENT Z, KN- M
0.00000	14876.5	2089.00

* DISPLACEMENT OF GROUPED PILE FOUNDATION AT ORIGIN *

VERTICAL, M	HORIZONTAL Y, M	HORIZONTAL Z, M
1.24099E-03	-6.18707E-05	2.81501E-04
ANGLE ROT. X, RAD	ANGLE ROT. Y, RAD	ANGLE ROT. Z, RAD
-3.58185E-07	2.80467E-05	7.62622E-06

THE GLOBAL STRUCTURAL COORDINATE SYSTEM

* PILE TOP DISPLACEMENTS *

PILE GROUP	DISP. X, M	DISP. Y, M	DISP. Z, M	ROT. X, RAD	ROT. Y, RAD	ROT. Z, RAD
*****	*****	*****	*****	*****	*****	*****
1	1.3960E-03	-5.9453E-05	2.7989E-04	-3.5818E-07	2.8047E-05	7.6262E-06
2	1.4303E-03	-5.9453E-05	2.8150E-04	-3.5818E-07	2.8047E-05	7.6262E-06
3	1.4646E-03	-5.9453E-05	2.8311E-04	-3.5818E-07	2.8047E-05	7.6262E-06
4	1.2698E-03	-6.1065E-05	2.7989E-04	-3.5818E-07	2.8047E-05	7.6262E-06
5	1.3041E-03	-6.1065E-05	2.8150E-04	-3.5818E-07	2.8047E-05	7.6262E-06
6	1.3384E-03	-6.1065E-05	2.8311E-04	-3.5818E-07	2.8047E-05	7.6262E-06
7	1.1436E-03	-6.2677E-05	2.7989E-04	-3.5818E-07	2.8047E-05	7.6262E-06
8	1.1779E-03	-6.2677E-05	2.8150E-04	-3.5818E-07	2.8047E-05	7.6262E-06
9	1.2122E-03	-6.2677E-05	2.8311E-04	-3.5818E-07	2.8047E-05	7.6262E-06
10	1.0173E-03	-6.4288E-05	2.7989E-04	-3.5818E-07	2.8047E-05	7.6262E-06
11	1.0517E-03	-6.4288E-05	2.8150E-04	-3.5818E-07	2.8047E-05	7.6262E-06
12	1.0860E-03	-6.4288E-05	2.8311E-04	-3.5818E-07	2.8047E-05	7.6262E-06
MINIMUM	1.0173E-03	-6.4288E-05	2.7989E-04	-3.5818E-07	2.8047E-05	7.6262E-06
Pile N.	10	10	1	1	1	1
MAXIMUM	1.4646E-03	-5.9453E-05	2.8311E-04	-3.5818E-07	2.8047E-05	7.6262E-06

APPALTATORE:

Consorzio

Soci



ITINERARIO NAPOLI – BARI

PROGETTAZIONE:

Mandatario

Mandanti



RADDOPPIO TRATTA APICE – ORSARA
I LOTTO FUNZIONALE APICE – HIRPINIA

PROGETTO ESECUTIVO

RELAZIONE DI CALCOLO FONDAZIONI PILE DA P17 A P20

COMMESSA
IF1N

LOTTO
01 E ZZ

CODIFICA
RG

DOCUMENTO
MD0000 001

REV.
B

FOGLIO
80 di 143

Pile N. 3 1 3 1 1 1

* PILE TOP REACTIONS *

PILE GROUP	FOR. X, KN	FOR. Y, KN	FOR. Z, KN	MOM X, KN- M	MOM Y, KN- M	MOM Z, KN- M
1	2804.5	-16.501	86.473	-0.1396	-187.22	-32.268
2	2872.2	-15.778	83.492	-0.1396	-182.49	-30.996
3	2939.8	-16.631	88.496	-0.1396	-192.02	-32.499
4	2555.7	-13.378	67.977	-0.1396	-153.28	-27.181
5	2623.4	-12.156	62.509	-0.1396	-143.27	-24.862
6	2691.0	-13.613	70.234	-0.1396	-158.60	-27.622
7	2307.0	-13.408	65.539	-0.1396	-148.60	-27.753
8	2374.6	-12.126	59.971	-0.1396	-138.27	-25.292
9	2442.3	-13.673	67.862	-0.1396	-154.07	-28.256
10	2058.2	-14.621	68.653	-0.1396	-154.51	-30.556
11	2125.8	-13.246	62.885	-0.1396	-143.96	-27.944
12	2193.5	-14.870	70.908	-0.1396	-159.83	-31.025
MINIMUM	2058.2	-16.631	59.971	-0.1396	-192.02	-32.499
Pile N.	10	3	8	1	3	3
MAXIMUM	2939.8	-12.126	88.496	-0.1396	-138.27	-24.862
Pile N.	3	8	3	1	8	5

THE PILE COORDINATE SYSTEM (LOCAL AXES)

* PILE TOP DISPLACEMENTS *

PILE GROUP	DISP. x, M	DISP. y, M	DISP. z, M	ROT. x,RAD	ROT. y,RAD	ROT. z,RAD
1	1.3960E-03	-5.9453E-05	2.7989E-04	-3.5818E-07	2.8047E-05	7.6262E-06
2	1.4303E-03	-5.9453E-05	2.8150E-04	-3.5818E-07	2.8047E-05	7.6262E-06
3	1.4646E-03	-5.9453E-05	2.8311E-04	-3.5818E-07	2.8047E-05	7.6262E-06
4	1.2698E-03	-6.1065E-05	2.7989E-04	-3.5818E-07	2.8047E-05	7.6262E-06
5	1.3041E-03	-6.1065E-05	2.8150E-04	-3.5818E-07	2.8047E-05	7.6262E-06
6	1.3384E-03	-6.1065E-05	2.8311E-04	-3.5818E-07	2.8047E-05	7.6262E-06
7	1.1436E-03	-6.2677E-05	2.7989E-04	-3.5818E-07	2.8047E-05	7.6262E-06
8	1.1779E-03	-6.2677E-05	2.8150E-04	-3.5818E-07	2.8047E-05	7.6262E-06
9	1.2122E-03	-6.2677E-05	2.8311E-04	-3.5818E-07	2.8047E-05	7.6262E-06
10	1.0173E-03	-6.4288E-05	2.7989E-04	-3.5818E-07	2.8047E-05	7.6262E-06
11	1.0517E-03	-6.4288E-05	2.8150E-04	-3.5818E-07	2.8047E-05	7.6262E-06
12	1.0860E-03	-6.4288E-05	2.8311E-04	-3.5818E-07	2.8047E-05	7.6262E-06
MINIMUM	1.0173E-03	-6.4288E-05	2.7989E-04	-3.5818E-07	2.8047E-05	7.6262E-06
Pile N.	10	10	1	1	1	1
MAXIMUM	1.4646E-03	-5.9453E-05	2.8311E-04	-3.5818E-07	2.8047E-05	7.6262E-06
Pile N.	3	1	3	1	1	1

* PILE TOP REACTIONS *

PILE GROUP	AXIAL, KN	LAT. y, KN	LAT. z, KN	MOM x, KN- M	MOM y, KN- M	MOM z, KN- M
1	2804.5	-16.501	86.473	-0.1396	-187.22	-32.268
2	2872.2	-15.778	83.492	-0.1396	-182.49	-30.996
3	2939.8	-16.631	88.496	-0.1396	-192.02	-32.499
4	2555.7	-13.378	67.977	-0.1396	-153.28	-27.181
5	2623.4	-12.156	62.509	-0.1396	-143.27	-24.862
6	2691.0	-13.613	70.234	-0.1396	-158.60	-27.622
7	2307.0	-13.408	65.539	-0.1396	-148.60	-27.753
8	2374.6	-12.126	59.971	-0.1396	-138.27	-25.292
9	2442.3	-13.673	67.862	-0.1396	-154.07	-28.256
10	2058.2	-14.621	68.653	-0.1396	-154.51	-30.556
11	2125.8	-13.246	62.885	-0.1396	-143.96	-27.944
12	2193.5	-14.870	70.908	-0.1396	-159.83	-31.025
MINIMUM	2058.2	-16.631	59.971	-0.1396	-192.02	-32.499
Pile N.	10	3	8	1	3	3
MAXIMUM	2939.8	-12.126	88.496	-0.1396	-138.27	-24.862
Pile N.	3	8	3	1	8	5

PILE GROUP STRESS, KN/ M**2

1	2160.4
2	2184.0
3	2251.4
4	1916.1
5	1923.4
6	2008.7
7	1761.7
8	1768.0
9	1854.8
10	1640.1
11	1645.5
12	1732.6
MINIMUM	1640.1

APPALDATTORE: Consorzio Soci 	<h2 style="margin: 0;">ITINERARIO NAPOLI – BARI</h2> <h3 style="margin: 0;">RADDOPPIO TRATTA APICE – ORSARA</h3> <h3 style="margin: 0;">I LOTTO FUNZIONALE APICE – HIRPINIA</h3>												
PROGETTAZIONE: Mandataria Mandanti 													
PROGETTO ESECUTIVO RELAZIONE DI CALCOLO FONDAZIONI PILE DA P17 A P20	<table style="width:100%; border-collapse: collapse;"> <tr> <td style="width:15%;">COMMESSA</td> <td style="width:15%;">LOTTO</td> <td style="width:15%;">CODIFICA</td> <td style="width:20%;">DOCUMENTO</td> <td style="width:15%;">REV.</td> <td style="width:20%;">FOGLIO</td> </tr> <tr> <td style="text-align: center;">IF1N</td> <td style="text-align: center;">01 E ZZ</td> <td style="text-align: center;">RG</td> <td style="text-align: center;">MD0000 001</td> <td style="text-align: center;">B</td> <td style="text-align: center;">81 di 143</td> </tr> </table>	COMMESSA	LOTTO	CODIFICA	DOCUMENTO	REV.	FOGLIO	IF1N	01 E ZZ	RG	MD0000 001	B	81 di 143
COMMESSA	LOTTO	CODIFICA	DOCUMENTO	REV.	FOGLIO								
IF1N	01 E ZZ	RG	MD0000 001	B	81 di 143								

Pile N. 10
 MAXIMUM 2251.4
 Pile N. 3

*** EFFECTS FOR Laterally Loaded PILE ***

*** MINIMUM VALUES AND LOCATIONS ***

PILE	DISPL. y-Dir M	DISPL. z-Dir M	MOMENT z-Dir KN-M	MOMENT y-Dir KN-M	SHEAR y-Dir KN	SHEAR z-Dir KN	SOIL REACT y-Dir KN/M	SOIL REACT z-Dir KN/M	TOTAL STRESS KN/M**2	FLEX. RIG. z-Dir KN-M**2	FLEX. RIG. y-Dir KN-M**2
*****	*****	*****	*****	*****	*****	*****	*****	*****	*****	*****	*****
1	-5.9453E-05	-1.0737E-05	-18.691	-187.22	-16.502	-18.288	-7.3281	-3.7382	1587.0	7.8279E+06	7.8279E+06
x(M)	0.0000	9.6000	4.8000	0.0000	0.0000	7.2000	2.4000	10.560	24.000	0.0000	0.0000
2	-5.9453E-05	-1.0748E-05	-18.175	-182.49	-15.779	-17.555	-6.8767	-3.5718	1625.3	7.8279E+06	7.8279E+06
x(M)	0.0000	9.6000	4.8000	0.0000	0.0000	7.4400	2.4000	10.560	24.000	0.0000	0.0000
3	-5.9453E-05	-1.0863E-05	-18.784	-192.02	-16.633	-18.658	-7.4114	-3.8179	1663.6	7.8279E+06	7.8279E+06
x(M)	0.0000	9.6000	4.8000	0.0000	0.0000	7.2000	2.4000	10.560	24.000	0.0000	0.0000
4	-6.1065E-05	-1.0299E-05	-16.390	-153.28	-13.379	-14.205	-5.3088	-2.7652	1446.3	7.8279E+06	7.8279E+06
x(M)	0.0000	10.320	5.0400	0.0000	0.0000	7.9200	2.4000	11.280	24.000	0.0000	0.0000
5	-6.1065E-05	-1.0088E-05	-15.449	-143.27	-12.157	-13.092	-4.6397	-2.7098	1484.5	7.8279E+06	7.8279E+06
x(M)	0.0000	10.560	5.2800	0.0000	0.0000	8.1600	2.4000	14.160	24.000	0.0000	0.0000
6	-6.1065E-05	-1.0444E-05	-16.568	-158.60	-13.614	-14.601	-5.4414	-2.8592	1522.8	7.8279E+06	7.8279E+06
x(M)	0.0000	10.320	5.0400	0.0000	0.0000	7.9200	2.4000	11.280	24.000	0.0000	0.0000
7	-6.2677E-05	-1.0201E-05	-16.396	-148.60	-13.409	-13.710	-5.1955	-2.6686	1305.5	7.8279E+06	7.8279E+06
x(M)	0.0000	10.320	5.0400	0.0000	0.0000	7.9200	2.4000	14.160	24.000	0.0000	0.0000
8	-6.2677E-05	-9.9378E-06	-15.432	-138.27	-12.127	-12.581	-4.5093	-2.7106	1343.8	7.8279E+06	7.8279E+06
x(M)	0.0000	10.560	5.2800	0.0000	0.0000	8.1600	2.4000	14.160	24.000	0.0000	0.0000
9	-6.2677E-05	-1.0364E-05	-16.601	-154.07	-13.674	-14.127	-5.3416	-2.7330	1382.0	7.8279E+06	7.8279E+06
x(M)	0.0000	10.320	5.0400	0.0000	0.0000	7.9200	2.4000	11.280	24.000	0.0000	0.0000
10	-6.4288E-05	-1.0312E-05	-17.308	-154.51	-14.622	-14.327	-5.7368	-2.7981	1164.7	7.8279E+06	7.8279E+06
x(M)	0.0000	10.320	5.0400	0.0000	0.0000	7.9200	2.4000	11.280	24.000	0.0000	0.0000
11	-6.4288E-05	-1.0098E-05	-16.280	-143.96	-13.247	-13.155	-4.9856	-2.7080	1203.0	7.8279E+06	7.8279E+06
x(M)	0.0000	10.560	5.2800	0.0000	0.0000	8.1600	2.4000	14.160	24.000	0.0000	0.0000
12	-6.4288E-05	-1.0468E-05	-17.497	-159.83	-14.871	-14.735	-5.8773	-2.8945	1241.3	7.8279E+06	7.8279E+06
x(M)	0.0000	10.080	5.0400	0.0000	0.0000	7.6800	2.4000	11.040	24.000	0.0000	0.0000
Min.	-6.4288E-05	-1.0863E-05	-18.784	-192.02	-16.633	-18.658	-7.4114	-3.8179	1164.7	7.8279E+06	7.8279E+06
Pile N.	10	3	3	3	3	3	3	3	10	1	1

*** MAXIMUM VALUES AND LOCATIONS ***

PILE	DISPL. y-Dir M	DISPL. z-Dir M	MOMENT z-Dir KN-M	MOMENT y-Dir KN-M	SHEAR y-Dir KN	SHEAR z-Dir KN	SOIL REACT y-Dir KN/M	SOIL REACT z-Dir KN/M	TOTAL STRESS KN/M**2	FLEX. RIG. z-Dir KN-M**2	FLEX. RIG. y-Dir KN-M**2
*****	*****	*****	*****	*****	*****	*****	*****	*****	*****	*****	*****
1	2.3077E-06	2.7989E-04	32.268	87.414	3.9047	86.481	0.7794	36.312	2160.4	7.8279E+06	7.8279E+06
x(M)	9.3600	0.0000	0.0000	5.0400	7.2000	0.0000	10.560	2.4000	0.0000	0.0000	0.0000
2	2.3024E-06	2.8150E-04	30.996	85.484	3.7316	83.500	0.7435	34.316	2184.0	7.8279E+06	7.8279E+06
x(M)	9.6000	0.0000	0.0000	5.0400	7.2000	0.0000	10.560	2.4000	0.0000	0.0000	0.0000
3	2.3087E-06	2.8311E-04	32.499	88.869	3.9361	88.505	0.7863	37.221	2251.4	7.8279E+06	7.8279E+06
x(M)	9.3600	0.0000	0.0000	5.0400	7.2000	0.0000	10.320	2.4000	0.0000	0.0000	0.0000
4	2.3047E-06	2.7989E-04	27.181	74.524	3.1127	67.983	0.6011	25.486	1916.1	7.8279E+06	7.8279E+06
x(M)	10.080	0.0000	0.0000	5.2800	7.6800	0.0000	11.040	2.4000	0.0000	0.0000	0.0000
5	2.2603E-06	2.8150E-04	24.862	70.523	2.8437	62.515	0.5570	22.438	1923.4	7.8279E+06	7.8279E+06
x(M)	10.320	0.0000	0.0000	5.5200	7.9200	0.0000	14.160	2.4000	0.0000	0.0000	0.0000
6	2.3112E-06	2.8311E-04	27.622	76.201	3.1646	70.240	0.6143	26.476	2008.7	7.8279E+06	7.8279E+06
x(M)	10.080	0.0000	0.0000	5.2800	7.6800	0.0000	11.040	2.4000	0.0000	0.0000	0.0000
7	2.3351E-06	2.7989E-04	27.753	72.744	3.0752	65.544	0.5880	24.156	1761.7	7.8279E+06	7.8279E+06
x(M)	10.080	0.0000	0.0000	5.2800	7.6800	0.0000	11.280	2.4000	0.0000	0.0000	0.0000
8	2.2819E-06	2.8150E-04	25.292	68.700	2.8027	59.976	0.5775	21.120	1768.0	7.8279E+06	7.8279E+06
x(M)	10.560	0.0000	0.0000	5.5200	7.9200	0.0000	14.160	2.4000	0.0000	0.0000	0.0000
9	2.3474E-06	2.8311E-04	28.256	74.490	3.1354	67.868	0.6027	25.172	1854.8	7.8279E+06	7.8279E+06
x(M)	10.080	0.0000	0.0000	5.2800	7.6800	0.0000	11.040	2.4000	0.0000	0.0000	0.0000
10	2.4129E-06	2.7989E-04	30.556	74.983	3.3017	68.657	0.6409	25.848	1640.1	7.8279E+06	7.8279E+06
x(M)	10.080	0.0000	0.0000	5.2800	7.6800	0.0000	11.040	2.4000	0.0000	0.0000	0.0000
11	2.3605E-06	2.8150E-04	27.944	70.765	3.0053	62.890	0.5939	22.626	1645.5	7.8279E+06	7.8279E+06
x(M)	10.320	0.0000	0.0000	5.5200	7.9200	0.0000	14.160	2.4000	0.0000	0.0000	0.0000
12	2.4207E-06	2.8311E-04	31.025	76.655	3.3568	70.914	0.6548	26.840	1732.6	7.8279E+06	7.8279E+06
x(M)	10.080	0.0000	0.0000	5.2800	7.6800	0.0000	11.040	2.4000	0.0000	0.0000	0.0000
Max.	2.4207E-06	2.8311E-04	32.499	88.869	3.9361	88.505	0.7863	37.221	2251.4	7.8279E+06	7.8279E+06
Pile N.	12	3	3	3	3	3	3	3	3	1	1

LOAD CASE : 3
 CASE NAME : Load Case
 LOAD TYPE : Special, Sp

REDUCTION FACTORS FOR CLOSELY-SPACED PILE GROUPS, COMBINED Y AND Z DIRECTIONS ESTIMATED USING MOVEMENT IN THE DIRECTION OF PILE CAP DISPLACEMENTS

GROUP NO	P-FACTOR	Y-FACTOR
1	0.7537	1.0000
2	0.7134	1.0000
3	0.8661	1.0000

APPALTATORE: Consorzio  Soci  	ITINERARIO NAPOLI – BARI RADDOPPIO TRATTA APICE – ORSARA I LOTTO FUNZIONALE APICE – HIRPINIA				
PROGETTAZIONE: Mandataria  Mandanti  					
PROGETTO ESECUTIVO RELAZIONE DI CALCOLO FONDAZIONI PILE DA P17 A P20					
COMMESSA IF1N	LOTTO 01 E ZZ	CODIFICA RG	DOCUMENTO MD0000 001	REV. B	FOGLIO 82 di 143

4	0.5434	1.0000
5	0.4957	1.0000
6	0.6891	1.0000
7	0.5232	1.0000
8	0.4773	1.0000
9	0.6733	1.0000
10	0.5845	1.0000
11	0.5349	1.0000
12	0.7237	1.0000

* TABLE L * COMPUTATION ON PILE CAP

* EQUIVALENT CONCENTRATED LOAD AT ORIGIN *

VERT. LOAD, KN 34266.0	HOR. LOAD Y, KN -791.000	HOR. LOAD Z, KN 893.000
MOMENT X, KN- M 0.00000	MOMENT Y, KN- M 21012.5	MOMENT Z, KN- M 9568.50

* DISPLACEMENT OF GROUPED PILE FOUNDATION AT ORIGIN *

VERTICAL, M 1.42185E-03	HORIZONTAL Y, M -2.83367E-04	HORIZONTAL Z, M 3.16036E-04
ANGLE ROT. X, RAD -2.24152E-07	ANGLE ROT. Y, RAD 3.81651E-05	ANGLE ROT. Z, RAD 3.50005E-05

THE GLOBAL STRUCTURAL COORDINATE SYSTEM

* PILE TOP DISPLACEMENTS *

PILE GROUP	DISP. X, M	DISP. Y, M	DISP. Z, M	ROT. X, RAD	ROT. Y, RAD	ROT. Z, RAD
*****	*****	*****	*****	*****	*****	*****
1	1.5220E-03	-2.8185E-04	3.1503E-04	-2.2415E-07	3.8165E-05	3.5000E-05
2	1.6795E-03	-2.8185E-04	3.1604E-04	-2.2415E-07	3.8165E-05	3.5000E-05
3	1.8370E-03	-2.8185E-04	3.1704E-04	-2.2415E-07	3.8165E-05	3.5000E-05
4	1.3502E-03	-2.8286E-04	3.1503E-04	-2.2415E-07	3.8165E-05	3.5000E-05
5	1.5077E-03	-2.8286E-04	3.1604E-04	-2.2415E-07	3.8165E-05	3.5000E-05
6	1.6652E-03	-2.8286E-04	3.1704E-04	-2.2415E-07	3.8165E-05	3.5000E-05
7	1.1785E-03	-2.8387E-04	3.1503E-04	-2.2415E-07	3.8165E-05	3.5000E-05
8	1.3360E-03	-2.8387E-04	3.1604E-04	-2.2415E-07	3.8165E-05	3.5000E-05
9	1.4935E-03	-2.8387E-04	3.1704E-04	-2.2415E-07	3.8165E-05	3.5000E-05
10	1.0067E-03	-2.8488E-04	3.1503E-04	-2.2415E-07	3.8165E-05	3.5000E-05
11	1.1642E-03	-2.8488E-04	3.1604E-04	-2.2415E-07	3.8165E-05	3.5000E-05
12	1.3217E-03	-2.8488E-04	3.1704E-04	-2.2415E-07	3.8165E-05	3.5000E-05
MINIMUM	1.0067E-03	-2.8488E-04	3.1503E-04	-2.2415E-07	3.8165E-05	3.5000E-05
Pile N.	10	10	1	1	1	1
MAXIMUM	1.8370E-03	-2.8185E-04	3.1704E-04	-2.2415E-07	3.8165E-05	3.5000E-05
Pile N.	3	1	3	1	1	1

* PILE TOP REACTIONS *

PILE GROUP	FOR. X, KN	FOR. Y, KN	FOR. Z, KN	MOM X, KN- M	MOM Y, KN- M	MOM Z, KN- M
*****	*****	*****	*****	*****	*****	*****
1	3052.8	-73.469	83.135	-0.087339	-169.01	-147.47
2	3363.3	-70.960	80.695	-0.087339	-165.00	-142.98
3	3673.8	-80.104	91.460	-0.087339	-184.60	-159.28
4	2714.3	-60.023	67.617	-0.087339	-140.35	-123.02
5	3024.8	-56.552	64.040	-0.087339	-133.86	-116.42
6	3335.2	-69.805	79.340	-0.087339	-162.89	-141.23
7	2375.8	-58.913	66.008	-0.087339	-137.25	-121.19
8	2686.2	-55.504	62.512	-0.087339	-130.87	-114.68
9	2996.7	-69.174	78.205	-0.087339	-160.78	-140.40
10	2037.2	-63.614	70.868	-0.087339	-146.41	-130.37
11	2347.7	-60.088	67.281	-0.087339	-140.00	-123.75
12	2658.2	-72.794	81.840	-0.087339	-167.35	-147.30
MINIMUM	2037.2	-80.104	62.512	-0.087339	-184.60	-159.28
Pile N.	10	3	8	1	3	3
MAXIMUM	3673.8	-55.504	91.460	-0.087339	-130.87	-114.68
Pile N.	3	8	3	1	8	8

THE PILE COORDINATE SYSTEM (LOCAL AXES)

* PILE TOP DISPLACEMENTS *

APPALDATTORE: Consorzio Soci 	<h2 style="margin: 0;">ITINERARIO NAPOLI – BARI</h2> <h3 style="margin: 0;">RADDOPPIO TRATTA APICE – ORSARA</h3> <h3 style="margin: 0;">I LOTTO FUNZIONALE APICE – HIRPINIA</h3>												
PROGETTAZIONE: Mandataria Mandanti 													
PROGETTO ESECUTIVO RELAZIONE DI CALCOLO FONDAZIONI PILE DA P17 A P20	<table style="width: 100%; border-collapse: collapse;"> <tr> <td style="text-align: center;">COMMESSA</td> <td style="text-align: center;">LOTTO</td> <td style="text-align: center;">CODIFICA</td> <td style="text-align: center;">DOCUMENTO</td> <td style="text-align: center;">REV.</td> <td style="text-align: center;">FOGLIO</td> </tr> <tr> <td style="text-align: center;">IF1N</td> <td style="text-align: center;">01 E ZZ</td> <td style="text-align: center;">RG</td> <td style="text-align: center;">MD0000 001</td> <td style="text-align: center;">B</td> <td style="text-align: center;">83 di 143</td> </tr> </table>	COMMESSA	LOTTO	CODIFICA	DOCUMENTO	REV.	FOGLIO	IF1N	01 E ZZ	RG	MD0000 001	B	83 di 143
COMMESSA	LOTTO	CODIFICA	DOCUMENTO	REV.	FOGLIO								
IF1N	01 E ZZ	RG	MD0000 001	B	83 di 143								

PILE GROUP	DISP. x, M	DISP. y, M	DISP. z, M	ROT. x,RAD	ROT. y,RAD	ROT. z,RAD
*****	*****	*****	*****	*****	*****	*****
1	1.5220E-03	-2.8185E-04	3.1503E-04	-2.2415E-07	3.8165E-05	3.5000E-05
2	1.6795E-03	-2.8185E-04	3.1604E-04	-2.2415E-07	3.8165E-05	3.5000E-05
3	1.8370E-03	-2.8185E-04	3.1704E-04	-2.2415E-07	3.8165E-05	3.5000E-05
4	1.3502E-03	-2.8286E-04	3.1503E-04	-2.2415E-07	3.8165E-05	3.5000E-05
5	1.5077E-03	-2.8286E-04	3.1604E-04	-2.2415E-07	3.8165E-05	3.5000E-05
6	1.6652E-03	-2.8286E-04	3.1704E-04	-2.2415E-07	3.8165E-05	3.5000E-05
7	1.1785E-03	-2.8387E-04	3.1503E-04	-2.2415E-07	3.8165E-05	3.5000E-05
8	1.3360E-03	-2.8387E-04	3.1604E-04	-2.2415E-07	3.8165E-05	3.5000E-05
9	1.4935E-03	-2.8387E-04	3.1704E-04	-2.2415E-07	3.8165E-05	3.5000E-05
10	1.0067E-03	-2.8488E-04	3.1503E-04	-2.2415E-07	3.8165E-05	3.5000E-05
11	1.1642E-03	-2.8488E-04	3.1604E-04	-2.2415E-07	3.8165E-05	3.5000E-05
12	1.3217E-03	-2.8488E-04	3.1704E-04	-2.2415E-07	3.8165E-05	3.5000E-05
MINIMUM	1.0067E-03	-2.8488E-04	3.1503E-04	-2.2415E-07	3.8165E-05	3.5000E-05
Pile N.	10	10	1	1	1	1
MAXIMUM	1.8370E-03	-2.8185E-04	3.1704E-04	-2.2415E-07	3.8165E-05	3.5000E-05
Pile N.	3	1	3	1	1	1

* PILE TOP REACTIONS *

PILE GROUP	AXIAL, KN	LAT. y, KN	LAT. z, KN	MOM x, KN- M	MOM y, KN- M	MOM z, KN- M
*****	*****	*****	*****	*****	*****	*****
1	3052.8	-73.469	83.135	-0.087339	-169.01	-147.47
2	3363.3	-70.960	80.695	-0.087339	-165.00	-142.98
3	3673.8	-80.104	91.460	-0.087339	-184.60	-159.28
4	2714.3	-60.023	67.617	-0.087339	-140.35	-123.02
5	3024.8	-56.552	64.040	-0.087339	-133.86	-116.42
6	3335.2	-69.805	79.340	-0.087339	-162.89	-141.23
7	2375.8	-58.913	66.008	-0.087339	-137.25	-121.19
8	2686.2	-55.504	62.512	-0.087339	-130.87	-114.68
9	2996.7	-69.174	78.205	-0.087339	-160.78	-140.40
10	2037.2	-63.614	70.868	-0.087339	-146.41	-130.37
11	2347.7	-60.088	67.281	-0.087339	-140.00	-123.75
12	2658.2	-72.794	81.840	-0.087339	-167.35	-147.30
MINIMUM	2037.2	-80.104	62.512	-0.087339	-184.60	-159.28
Pile N.	10	3	8	1	3	3
MAXIMUM	3673.8	-55.504	91.460	-0.087339	-130.87	-114.68
Pile N.	3	8	3	1	8	8

PILE GROUP STRESS, KN/ M**2

*****	*****
1	2404.5
2	2562.2
3	2814.8
4	2099.3
5	2247.1
6	2538.0
7	1897.0
8	2045.3
9	2340.0
10	1744.5
11	1892.4
12	2177.1
MINIMUM	1744.5
Pile N.	10
MAXIMUM	2814.8
Pile N.	3

* EFFECTS FOR Laterally LOADED PILE *

* MINIMUM VALUES AND LOCATIONS *

PILE	DISPL.	DISPL.	MOMENT	MOMENT	SHEAR	SHEAR	SOIL REACT	SOIL REACT	TOTAL STRESS	FLEX. RIG.	FLEX. RIG.
	y-DIR	z-DIR	z-DIR	y-DIR	y-DIR	z-DIR	y-DIR	z-DIR		KN- M**2	KN- M**2
*****	*****	*****	*****	*****	*****	*****	*****	*****	*****	*****	*****
1	-2.8185E-04	-1.2128E-05	-84.156	-169.01	-73.476	-19.010	-31.278	-3.8001	1727.6	7.8279E+06	7.8279E+06
x(M)	0.0000	9.6000	4.8000	0.0000	0.0000	7.2000	2.4000	10.560	24.000	0.0000	0.0000
2	-2.8185E-04	-1.2114E-05	-82.290	-165.00	-70.967	-18.430	-29.775	-3.6687	1903.2	7.8279E+06	7.8279E+06
x(M)	0.0000	9.8400	4.8000	0.0000	0.0000	7.4400	2.4000	10.800	24.000	0.0000	0.0000
3	-2.8185E-04	-1.2270E-05	-88.981	-184.60	-80.113	-20.977	-35.404	-4.2154	2078.9	7.8279E+06	7.8279E+06
x(M)	0.0000	9.3600	4.8000	0.0000	0.0000	7.2000	2.4000	10.560	24.000	0.0000	0.0000
4	-2.8286E-04	-1.1739E-05	-74.157	-140.35	-60.028	-15.480	-23.399	-2.9618	1536.0	7.8279E+06	7.8279E+06
x(M)	0.0000	10.0000	5.0400	0.0000	0.0000	7.6800	2.4000	11.280	24.000	0.0000	0.0000
5	-2.8286E-04	-1.1634E-05	-71.515	-133.86	-56.557	-14.705	-21.523	-2.9094	1711.7	7.8279E+06	7.8279E+06
x(M)	0.0000	10.3200	5.2800	0.0000	0.0000	7.9200	2.4000	14.160	24.000	0.0000	0.0000
6	-2.8286E-04	-1.2131E-05	-81.421	-162.89	-69.813	-18.089	-28.992	-3.5890	1887.4	7.8279E+06	7.8279E+06
x(M)	0.0000	9.8400	5.0400	0.0000	0.0000	7.4400	2.4000	10.800	24.000	0.0000	0.0000
7	-2.8387E-04	-1.1685E-05	-73.263	-137.25	-58.917	-15.115	-22.708	-2.8795	1344.4	7.8279E+06	7.8279E+06
x(M)	0.0000	10.3200	5.0400	0.0000	0.0000	7.9200	2.4000	14.160	24.000	0.0000	0.0000
8	-2.8387E-04	-1.1544E-05	-70.720	-130.87	-55.509	-14.374	-20.888	-2.9157	1520.1	7.8279E+06	7.8279E+06
x(M)	0.0000	10.3200	5.2800	0.0000	0.0000	7.9200	2.4000	14.160	24.000	0.0000	0.0000
9	-2.8387E-04	-1.2107E-05	-80.972	-160.78	-69.181	-17.816	-28.518	-3.5257	1695.8	7.8279E+06	7.8279E+06
x(M)	0.0000	9.8400	5.0400	0.0000	0.0000	7.4400	2.4000	10.800	24.000	0.0000	0.0000

APPALTATORE: Consorzio Soci PROGETTAZIONE: Mandataria Mandanti 	ITINERARIO NAPOLI – BARI RADDOPPIO TRATTA APICE – ORSARA I LOTTO FUNZIONALE APICE – HIRPINIA
PROGETTO ESECUTIVO RELAZIONE DI CALCOLO FONDAZIONI PILE DA P17 A P20	COMMESSA LOTTO CODIFICA DOCUMENTO REV. FOGLIO IF1N 01 E ZZ RG MD0000 001 B 84 di 143

10	-2.8488E-04	-1.1855E-05	-76.853	-146.41	-63.618	-16.188	-25.217	-3.1395	1152.8	7.8279E+06	7.8279E+06
x(M)	0.0000	10.000	5.0400	0.0000	0.0000	7.6800	2.4000	11.040	24.000	0.0000	0.0000
11	-2.8488E-04	-1.1747E-05	-74.165	-140.00	-60.092	-15.366	-23.270	-2.9335	1328.5	7.8279E+06	7.8279E+06
x(M)	0.0000	10.320	5.0400	0.0000	0.0000	7.6800	2.4000	11.280	24.000	0.0000	0.0000
12	-2.8488E-04	-1.2148E-05	-83.597	-167.35	-72.800	-18.641	-30.559	-3.7165	1504.2	7.8279E+06	7.8279E+06
x(M)	0.0000	9.6000	4.8000	0.0000	0.0000	7.4400	2.4000	10.800	24.000	0.0000	0.0000
Min. Pile N.	-2.8488E-04	-1.2270E-05	-88.981	-184.60	-80.113	-20.977	-35.404	-4.2154	1152.8	7.8279E+06	7.8279E+06
	10	3	3	3	3	3	3	3	10	1	1

* MAXIMUM VALUES AND LOCATIONS *

PILE	DISPL.		MOMENT		SHEAR		SOIL REACT		TOTAL STRESS KN/ M**2	FLEX. RIG.	
	y- M	z- M	y- KN- M	z- KN- M	y- KN	z- KN	y- KN/ M	z- KN/ M		z- KN- M**2	y- KN- M**2
1	1.0874E-05	3.1503E-04	147.47	93.939	17.033	83.143	3.3961	35.158	2404.5	7.8279E+06	7.8279E+06
x(M)	9.6000	0.0000	0.0000	4.8000	7.2000	0.0000	10.560	2.4000	0.0000	0.0000	0.0000
2	1.0828E-05	3.1604E-04	142.98	92.128	16.448	80.703	3.2669	33.601	2562.2	7.8279E+06	7.8279E+06
x(M)	9.6000	0.0000	0.0000	5.0400	7.4400	0.0000	10.800	2.4000	0.0000	0.0000	0.0000
3	1.0930E-05	3.1704E-04	159.28	100.00	18.660	91.470	3.7376	40.105	2814.8	7.8279E+06	7.8279E+06
x(M)	9.3600	0.0000	0.0000	4.8000	7.2000	0.0000	10.560	2.4000	0.0000	0.0000	0.0000
4	1.0578E-05	3.1503E-04	123.02	82.462	13.914	67.623	2.6585	26.189	2099.3	7.8279E+06	7.8279E+06
x(M)	10.080	0.0000	0.0000	5.0400	7.6800	0.0000	11.280	2.4000	0.0000	0.0000	0.0000
5	1.0458E-05	3.1604E-04	116.42	79.806	13.169	64.046	2.5872	24.186	2247.1	7.8279E+06	7.8279E+06
x(M)	10.320	0.0000	0.0000	5.2800	7.9200	0.0000	14.160	2.4000	0.0000	0.0000	0.0000
6	1.0849E-05	3.1704E-04	141.23	91.192	16.153	79.348	3.1982	32.701	2538.0	7.8279E+06	7.8279E+06
x(M)	9.8400	0.0000	0.0000	5.0400	7.4400	0.0000	10.800	2.4000	0.0000	0.0000	0.0000
7	1.0556E-05	3.1503E-04	121.19	81.215	13.625	66.013	2.5885	25.304	1897.0	7.8279E+06	7.8279E+06
x(M)	10.320	0.0000	0.0000	5.2800	7.6800	0.0000	11.280	2.4000	0.0000	0.0000	0.0000
8	1.0413E-05	3.1604E-04	114.68	78.640	12.920	62.517	2.6050	23.369	2045.3	7.8279E+06	7.8279E+06
x(M)	10.320	0.0000	0.0000	5.2800	7.9200	0.0000	14.160	2.4000	0.0000	0.0000	0.0000
9	1.0865E-05	3.1704E-04	140.40	90.366	15.967	78.212	3.1541	32.027	2340.0	7.8279E+06	7.8279E+06
x(M)	9.8400	0.0000	0.0000	5.0400	7.4400	0.0000	10.800	2.4000	0.0000	0.0000	0.0000
10	1.0739E-05	3.1503E-04	130.37	84.916	14.645	70.873	2.8385	27.977	1744.5	7.8279E+06	7.8279E+06
x(M)	10.080	0.0000	0.0000	5.0400	7.6800	0.0000	11.040	2.4000	0.0000	0.0000	0.0000
11	1.0613E-05	3.1604E-04	123.75	82.168	13.864	67.286	2.6439	25.919	1892.4	7.8279E+06	7.8279E+06
x(M)	10.320	0.0000	0.0000	5.0400	7.6800	0.0000	11.280	2.4000	0.0000	0.0000	0.0000
12	1.0939E-05	3.1704E-04	147.30	92.922	16.757	81.847	3.3355	34.168	2177.1	7.8279E+06	7.8279E+06
x(M)	9.6000	0.0000	0.0000	4.8000	7.4400	0.0000	10.800	2.4000	0.0000	0.0000	0.0000
Max. Pile N.	1.0939E-05	3.1704E-04	159.28	100.00	18.660	91.470	3.7376	40.105	2814.8	7.8279E+06	7.8279E+06
	12	3	3	3	3	3	3	3	3	1	1

LOAD CASE : 4
CASE NAME : Load Case
LOAD TYPE : Special, Sp

REDUCTION FACTORS FOR CLOSELY-SPACED PILE GROUPS, COMBINED Y AND Z DIRECTIONS
ESTIMATED USING MOVEMENT IN THE DIRECTION OF PILE CAP DISPLACEMENTS

GROUP NO	P-FACTOR	Y-FACTOR
1	0.6075	1.0000
2	0.5969	1.0000
3	0.8661	1.0000
4	0.5016	1.0000
5	0.4952	1.0000
6	0.7921	1.0000
7	0.4990	1.0000
8	0.4930	1.0000
9	0.7905	1.0000
10	0.5845	1.0000
11	0.5739	1.0000
12	0.8501	1.0000

* TABLE L * COMPUTATION ON PILE CAP

* EQUIVALENT CONCENTRATED LOAD AT ORIGIN *

VERT. LOAD, KN	HOR. LOAD Y, KN	HOR. LOAD Z, KN
34782.0	-2437.00	738.000
MOMENT X, KN- M	MOMENT Y, KN- M	MOMENT Z, KN- M
248.000	13201.0	33545.5

* DISPLACEMENT OF GROUPED PILE FOUNDATION AT ORIGIN *

VERTICAL, M	HORIZONTAL Y, M	HORIZONTAL Z, M
1.44366E-03	-9.04430E-04	2.42607E-04

APPALTATORE:

Consorzio

Soci



ITINERARIO NAPOLI – BARI

RADDOPPIO TRATTA APICE – ORSARA
I LOTTO FUNZIONALE APICE – HIRPINIA

PROGETTAZIONE:

Mandataria

Mandanti



PROGETTO ESECUTIVO

RELAZIONE DI CALCOLO FONDAZIONI PILE DA P17 A P20

COMMESSA

LOTTO

CODIFICA

DOCUMENTO

REV.

FOGLIO

IF1N

01 E ZZ

RG

MD0000 001

B

85 di 143

ANGLE ROT. X,RAD ANGLE ROT. Y,RAD ANGLE ROT. Z,RAD
2.55108E-06 2.47817E-05 1.19882E-04

THE GLOBAL STRUCTURAL COORDINATE SYSTEM

* PILE TOP DISPLACEMENTS *

PILE GROUP	DISP. X, M	DISP. Y, M	DISP. Z, M	ROT. X,RAD	ROT. Y,RAD	ROT. Z,RAD
*****	*****	*****	*****	*****	*****	*****
1	1.0715E-03	-9.2165E-04	2.5409E-04	2.5511E-06	2.4782E-05	1.1988E-04
2	1.6109E-03	-9.2165E-04	2.4261E-04	2.5511E-06	2.4782E-05	1.1988E-04
3	2.1504E-03	-9.2165E-04	2.3113E-04	2.5511E-06	2.4782E-05	1.1988E-04
4	9.5995E-04	-9.1017E-04	2.5409E-04	2.5511E-06	2.4782E-05	1.1988E-04
5	1.4994E-03	-9.1017E-04	2.4261E-04	2.5511E-06	2.4782E-05	1.1988E-04
6	2.0389E-03	-9.1017E-04	2.3113E-04	2.5511E-06	2.4782E-05	1.1988E-04
7	8.4844E-04	-8.9869E-04	2.5409E-04	2.5511E-06	2.4782E-05	1.1988E-04
8	1.3879E-03	-8.9869E-04	2.4261E-04	2.5511E-06	2.4782E-05	1.1988E-04
9	1.9274E-03	-8.9869E-04	2.3113E-04	2.5511E-06	2.4782E-05	1.1988E-04
10	7.3692E-04	-8.8721E-04	2.5409E-04	2.5511E-06	2.4782E-05	1.1988E-04
11	1.2764E-03	-8.8721E-04	2.4261E-04	2.5511E-06	2.4782E-05	1.1988E-04
12	1.8158E-03	-8.8721E-04	2.3113E-04	2.5511E-06	2.4782E-05	1.1988E-04
MINIMUM	7.3692E-04	-9.2165E-04	2.3113E-04	2.5511E-06	2.4782E-05	1.1988E-04
Pile N.	10	1	3	1	1	1
MAXIMUM	2.1504E-03	-8.8721E-04	2.5409E-04	2.5511E-06	2.4782E-05	1.1988E-04
Pile N.	3	10	1	1	1	1

* PILE TOP REACTIONS *

PILE GROUP	FOR. X, KN	FOR. Y, KN	FOR. Z, KN	MOM X, KN- M	MOM Y, KN- M	MOM Z, KN- M
*****	*****	*****	*****	*****	*****	*****
1	2164.9	-204.22	64.436	0.9940	-145.90	-403.27
2	3228.2	-201.79	59.738	0.9940	-133.40	-399.10
3	4291.6	-255.54	70.021	0.9940	-148.23	-496.24
4	1945.0	-176.74	57.279	0.9940	-132.18	-347.75
5	3008.4	-175.13	53.206	0.9940	-120.87	-345.01
6	4071.8	-236.99	66.335	0.9940	-141.65	-459.17
7	1725.2	-172.56	57.103	0.9940	-131.81	-336.10
8	2788.6	-171.07	53.067	0.9940	-120.58	-333.59
9	3852.0	-232.08	66.260	0.9940	-141.50	-446.13
10	1505.4	-187.51	62.960	0.9940	-143.05	-360.50
11	2568.8	-185.15	58.330	0.9940	-130.68	-356.43
12	3632.1	-238.24	69.263	0.9940	-146.84	-452.56
MINIMUM	1505.4	-255.54	53.067	0.9940	-148.23	-496.24
Pile N.	10	3	8	1	3	3
MAXIMUM	4291.6	-171.07	70.021	0.9940	-120.58	-333.59
Pile N.	3	8	3	1	8	8

THE PILE COORDINATE SYSTEM (LOCAL AXES)

* PILE TOP DISPLACEMENTS *

PILE GROUP	DISP. x, M	DISP. y, M	DISP. z, M	ROT. x,RAD	ROT. y,RAD	ROT. z,RAD
*****	*****	*****	*****	*****	*****	*****
1	1.0715E-03	-9.2165E-04	2.5409E-04	2.5511E-06	2.4782E-05	1.1988E-04
2	1.6109E-03	-9.2165E-04	2.4261E-04	2.5511E-06	2.4782E-05	1.1988E-04
3	2.1504E-03	-9.2165E-04	2.3113E-04	2.5511E-06	2.4782E-05	1.1988E-04
4	9.5995E-04	-9.1017E-04	2.5409E-04	2.5511E-06	2.4782E-05	1.1988E-04
5	1.4994E-03	-9.1017E-04	2.4261E-04	2.5511E-06	2.4782E-05	1.1988E-04
6	2.0389E-03	-9.1017E-04	2.3113E-04	2.5511E-06	2.4782E-05	1.1988E-04
7	8.4844E-04	-8.9869E-04	2.5409E-04	2.5511E-06	2.4782E-05	1.1988E-04
8	1.3879E-03	-8.9869E-04	2.4261E-04	2.5511E-06	2.4782E-05	1.1988E-04
9	1.9274E-03	-8.9869E-04	2.3113E-04	2.5511E-06	2.4782E-05	1.1988E-04
10	7.3692E-04	-8.8721E-04	2.5409E-04	2.5511E-06	2.4782E-05	1.1988E-04
11	1.2764E-03	-8.8721E-04	2.4261E-04	2.5511E-06	2.4782E-05	1.1988E-04
12	1.8158E-03	-8.8721E-04	2.3113E-04	2.5511E-06	2.4782E-05	1.1988E-04
MINIMUM	7.3692E-04	-9.2165E-04	2.3113E-04	2.5511E-06	2.4782E-05	1.1988E-04
Pile N.	10	1	3	1	1	1
MAXIMUM	2.1504E-03	-8.8721E-04	2.5409E-04	2.5511E-06	2.4782E-05	1.1988E-04
Pile N.	3	10	1	1	1	1

* PILE TOP REACTIONS *

PILE GROUP	AXIAL, KN	LAT. y, KN	LAT. z, KN	MOM x, KN- M	MOM y, KN- M	MOM z, KN- M
*****	*****	*****	*****	*****	*****	*****
1	2164.9	-204.22	64.436	0.9940	-145.90	-403.27
2	3228.2	-201.79	59.738	0.9940	-133.40	-399.10
3	4291.6	-255.54	70.021	0.9940	-148.23	-496.24
4	1945.0	-176.74	57.279	0.9940	-132.18	-347.75
5	3008.4	-175.13	53.206	0.9940	-120.87	-345.01
6	4071.8	-236.99	66.335	0.9940	-141.65	-459.17

APPALDATTORE:

Consorzio

Soci



ITINERARIO NAPOLI – BARI

PROGETTAZIONE:

Mandataria

Mandanti



**RADDOPPIO TRATTA APICE – ORSARA
I LOTTO FUNZIONALE APICE – HIRPINIA**

PROGETTO ESECUTIVO

RELAZIONE DI CALCOLO FONDAZIONI PILE DA P17 A P20

COMMESSA	LOTTO	CODIFICA	DOCUMENTO	REV.	FOGLIO
IF1N	01 E ZZ	RG	MD0000 001	B	86 di 143

7	1725.2	-172.56	57.103	0.9940	-131.81	-336.10
8	2788.6	-171.07	53.067	0.9940	-120.58	-333.59
9	3852.0	-232.08	66.260	0.9940	-141.50	-446.13
10	1505.4	-187.51	62.960	0.9940	-143.05	-360.50
11	2568.8	-185.15	58.330	0.9940	-130.68	-356.43
12	3632.1	-238.24	69.263	0.9940	-146.84	-452.56

MINIMUM	1505.4	-255.54	53.067	0.9940	-148.23	-496.24
Pile N.	10	3	8	1	3	3
MAXIMUM	4291.6	-171.07	70.021	0.9940	-120.58	-333.59
Pile N.	3	8	3	1	8	8

PILE GROUP STRESS, KN/ M**2

1	2519.4
2	3096.8
3	3991.6
4	2223.5
5	2805.7
6	3754.4
7	2065.9
8	2648.6
9	3592.3
10	2022.4
11	2599.4
12	3491.3

MINIMUM	2022.4
Pile N.	10
MAXIMUM	3991.6
Pile N.	3

* EFFECTS FOR LATERALLY LOADED PILE *

* MINIMUM VALUES AND LOCATIONS *

PILE	DISPL. y-DIR	DISPL. z-DIR	MOMENT z-DIR	MOMENT y-DIR	SHEAR y-DIR	SHEAR z-DIR	SOIL REACT y-DIR	SOIL REACT z-DIR	TOTAL STRESS	FLEX. RIG. z-DIR	FLEX. RIG. y-DIR
*****	M	M	KN- M	KN- M	KN	KN	KN/ M	KN/ M	KN/ M**2	KN- M**2	KN- M**2
1	-9.2165E-04	-9.4010E-06	-253.23	-145.90	-204.24	-13.322	-83.318	-2.6242	1225.1	7.8279E+06	7.8279E+06
x(M)	0.0000	10.080	5.0400	0.0000	0.0000	7.6800	2.4000	11.040	24.000	0.0000	0.0000
2	-9.2165E-04	-8.9987E-06	-251.58	-133.40	-201.81	-12.598	-82.000	-2.4695	1826.8	7.8279E+06	7.8279E+06
x(M)	0.0000	10.080	5.0400	0.0000	0.0000	7.6800	2.4000	11.040	24.000	0.0000	0.0000
3	-9.2165E-04	-8.8953E-06	-291.37	-148.23	-255.57	-15.269	-114.50	-3.1026	2428.5	7.8279E+06	7.8279E+06
x(M)	0.0000	9.6000	4.8000	0.0000	0.0000	7.2000	2.4000	10.560	24.000	0.0000	0.0000
4	-9.1017E-04	-9.0949E-06	-232.29	-132.18	-176.75	-11.888	-68.926	-2.4547	1100.7	7.8279E+06	7.8279E+06
x(M)	0.0000	10.560	5.0400	0.0000	0.0000	8.1600	2.4000	14.160	24.000	0.0000	0.0000
5	-9.1017E-04	-8.7196E-06	-231.18	-120.87	-175.14	-11.271	-68.121	-2.3239	1702.4	7.8279E+06	7.8279E+06
x(M)	0.0000	10.560	5.0400	0.0000	0.0000	8.1600	2.4000	14.160	24.000	0.0000	0.0000
6	-9.1017E-04	-8.8654E-06	-278.06	-141.65	-237.01	-14.376	-104.10	-2.9131	2304.2	7.8279E+06	7.8279E+06
x(M)	0.0000	9.6000	4.8000	0.0000	0.0000	7.4400	2.4000	10.560	24.000	0.0000	0.0000
7	-8.9869E-04	-9.0832E-06	-229.16	-131.81	-172.57	-11.849	-67.510	-2.4550	976.27	7.8279E+06	7.8279E+06
x(M)	0.0000	10.560	5.0400	0.0000	0.0000	8.1600	2.4000	14.160	24.000	0.0000	0.0000
8	-8.9869E-04	-8.7181E-06	-228.14	-120.58	-171.08	-11.240	-66.769	-2.3241	1578.0	7.8279E+06	7.8279E+06
x(M)	0.0000	10.560	5.0400	0.0000	0.0000	8.1600	2.4000	14.160	24.000	0.0000	0.0000
9	-8.9869E-04	-8.8619E-06	-274.49	-141.50	-232.11	-14.355	-102.27	-2.9080	2179.8	7.8279E+06	7.8279E+06
x(M)	0.0000	9.6000	4.8000	0.0000	0.0000	7.4400	2.4000	10.560	24.000	0.0000	0.0000
10	-8.8721E-04	-9.3369E-06	-240.71	-143.05	-187.51	-13.006	-76.699	-2.5410	851.88	7.8279E+06	7.8279E+06
x(M)	0.0000	10.320	5.0400	0.0000	0.0000	7.9200	2.4000	11.280	24.000	0.0000	0.0000
11	-8.8721E-04	-8.9376E-06	-239.10	-130.68	-185.16	-12.289	-75.430	-2.3903	1453.6	7.8279E+06	7.8279E+06
x(M)	0.0000	10.320	5.0400	0.0000	0.0000	7.9200	2.4000	11.280	24.000	0.0000	0.0000
12	-8.8721E-04	-8.8890E-06	-278.79	-146.84	-238.26	-15.072	-107.39	-3.0622	2055.4	7.8279E+06	7.8279E+06
x(M)	0.0000	9.6000	4.8000	0.0000	0.0000	7.2000	2.4000	10.560	24.000	0.0000	0.0000
Min.	-9.2165E-04	-9.4010E-06	-291.37	-148.23	-255.57	-15.269	-114.50	-3.1026	851.88	7.8279E+06	7.8279E+06
Pile N.	1	1	3	3	3	3	3	3	10	1	1

* MAXIMUM VALUES AND LOCATIONS *

PILE	DISPL. y-DIR	DISPL. z-DIR	MOMENT z-DIR	MOMENT y-DIR	SHEAR y-DIR	SHEAR z-DIR	SOIL REACT y-DIR	SOIL REACT z-DIR	TOTAL STRESS	FLEX. RIG. z-DIR	FLEX. RIG. y-DIR
*****	M	M	KN- M	KN- M	KN	KN	KN/ M	KN/ M	KN/ M**2	KN- M**2	KN- M**2
1	3.5119E-05	2.5409E-04	403.27	69.108	48.622	64.441	9.4485	24.413	2519.4	7.8279E+06	7.8279E+06
x(M)	9.8400	0.0000	0.0000	5.2800	7.4400	0.0000	11.040	2.4000	0.0000	0.0000	0.0000
2	3.5102E-05	2.4261E-04	399.10	65.573	48.118	59.744	9.3343	22.751	3096.8	7.8279E+06	7.8279E+06
x(M)	10.080	0.0000	0.0000	5.2800	7.4400	0.0000	11.040	2.4000	0.0000	0.0000	0.0000
3	3.5871E-05	2.3113E-04	496.24	72.695	61.117	70.031	12.190	29.946	3991.6	7.8279E+06	7.8279E+06
x(M)	9.3600	0.0000	0.0000	4.8000	6.9600	0.0000	10.320	2.4000	0.0000	0.0000	0.0000
4	3.4028E-05	2.5409E-04	347.75	63.905	42.709	57.283	8.1656	20.535	2223.5	7.8279E+06	7.8279E+06
x(M)	10.320	0.0000	0.0000	5.5200	7.6800	0.0000	14.160	2.4000	0.0000	0.0000	0.0000
5	3.4029E-05	2.4261E-04	345.01	60.777	42.413	53.212	8.1805	19.215	2805.7	7.8279E+06	7.8279E+06
x(M)	10.320	0.0000	0.0000	5.2800	7.6800	0.0000	14.160	2.4000	0.0000	0.0000	0.0000
6	3.5352E-05	2.3113E-04	459.17	70.072	57.062	66.344	11.333	27.664	3754.4	7.8279E+06	7.8279E+06
x(M)	9.6000	0.0000	0.0000	5.0400	7.2000	0.0000	10.560	2.4000	0.0000	0.0000	0.0000
7	3.3648E-05	2.5409E-04	336.10	63.772	42.066	57.107	8.0363	20.439	2065.9	7.8279E+06	7.8279E+06
x(M)	10.320	0.0000	0.0000	5.5200	7.6800	0.0000	14.160	2.4000	0.0000	0.0000	0.0000

APPALTATORE:

Consorzio

Soci



ITINERARIO NAPOLI – BARI

RADDOPPIO TRATTA APICE – ORSARA
I LOTTO FUNZIONALE APICE – HIRPINIA

PROGETTAZIONE:

Mandatario

Mandanti



PROGETTO ESECUTIVO

COMMESSA

LOTTO

CODIFICA

DOCUMENTO

REV.

FOGLIO

RELAZIONE DI CALCOLO FONDAZIONI PILE DA P17 A P20

IF1N

01 E ZZ

RG

MD0000 001

B

87 di 143

	8	3.3653E-05	2.4261E-04	333.59	60.662	41.797	53.072	8.0501	19.138	2648.6	7.8279E+06	7.8279E+06
x(M)		10.320	0.0000	0.0000	5.2800	7.6800	0.0000	14.160	2.4000	0.0000	0.0000	0.0000
	9	3.4929E-05	2.3113E-04	446.13	70.012	56.290	66.269	11.163	27.613	3592.3	7.8279E+06	7.8279E+06
x(M)		9.6000	0.0000	0.0000	5.0400	7.2000	0.0000	10.560	2.4000	0.0000	0.0000	0.0000
	10	3.3848E-05	2.5409E-04	360.50	68.035	45.757	62.963	8.8227	23.581	2022.4	7.8279E+06	7.8279E+06
x(M)		10.080	0.0000	0.0000	5.2800	7.4400	0.0000	11.040	2.4000	0.0000	0.0000	0.0000
	11	3.3857E-05	2.4261E-04	356.43	64.546	45.273	58.335	8.7099	21.959	2599.4	7.8279E+06	7.8279E+06
x(M)		10.080	0.0000	0.0000	5.2800	7.6800	0.0000	11.040	2.4000	0.0000	0.0000	0.0000
	12	3.4599E-05	2.3113E-04	452.56	72.122	58.219	69.272	11.550	29.457	3491.3	7.8279E+06	7.8279E+06
x(M)		9.3600	0.0000	0.0000	4.8000	6.9600	0.0000	10.320	2.4000	0.0000	0.0000	0.0000
Max.	3.5871E-05	2.5409E-04	496.24	72.695	61.117	70.031	12.190	29.946	3991.6	7.8279E+06	7.8279E+06	
Pile N.	3	1	3	3	3	3	3	3	3	1	1	

***** SUMMARY FOR LOAD CASES AND COMBINATIONS *****

***** LOAD CASES RESULTS *****

LOAD CASE : 1

* TABLE L * COMPUTATION ON PILE CAP

* EQUIVALENT CONCENTRATED LOAD AT ORIGIN *

LOAD X, KN	LOAD Y, KN	LOAD Z, KN	MOM X, KN- M	MOM Y, KN- M	MOM Z, KN- M
37210.0	-1201.00	1110.00	3.00000	19609.0	14562.5

* DISPLACEMENT OF GROUPED PILE FOUNDATION AT ORIGIN *

DISP X, M	DISP Y, M	DISP Z, M	ROT X,RAD	ROT Y,RAD	ROT Z,RAD
1.54631E-03	-4.29766E-04	3.62789E-04	1.63818E-07	3.68694E-05	5.32369E-05

* PILE TOP DISPLACEMENTS, GLOBAL *

	DISP. X, M	DISP. Y, M	DISP. Z, M	ROT. X,RAD	ROT. Y,RAD	ROT. Z,RAD
MINIMUM	1.0579E-03	-4.3087E-04	3.6205E-04	1.6382E-07	3.6869E-05	5.3237E-05
Pile N.	10	1	3	1	1	1
MAXIMUM	2.0347E-03	-4.2866E-04	3.6353E-04	1.6382E-07	3.6869E-05	5.3237E-05
Pile N.	3	10	1	1	1	1

* PILE TOP REACTIONS, GLOBAL *

	FOR. X, KN	FOR. Y, KN	FOR. Z, KN	MOM X, KN- M	MOM Y, KN- M	MOM Z, KN- M
MINIMUM	2138.1	-122.71	78.424	0.063831	-241.04	-244.70
Pile N.	10	3	8	1	3	3
MAXIMUM	4063.6	-84.181	111.96	0.063831	-178.90	-173.28
Pile N.	3	8	3	1	8	8

* PILE TOP DISPLACEMENTS, LOCAL *

	DISP. x, M	DISP. y, M	DISP. z, M	ROT. x,RAD	ROT. y,RAD	ROT. z,RAD
MINIMUM	1.0579E-03	-4.3087E-04	3.6205E-04	1.6382E-07	3.6869E-05	5.3237E-05
Pile N.	10	1	3	1	1	1
MAXIMUM	2.0347E-03	-4.2866E-04	3.6353E-04	1.6382E-07	3.6869E-05	5.3237E-05
Pile N.	3	10	1	1	1	1

* PILE TOP REACTIONS, LOCAL *

	AXIAL, KN	LAT. y, KN	LAT. z, KN	MOM x, KN- M	MOM y, KN- M	MOM z, KN- M
MINIMUM	2138.1	-122.71	78.424	0.063831	-241.04	-244.70
Pile N.	10	3	8	1	3	3
MAXIMUM	4063.6	-84.181	111.96	0.063831	-178.90	-173.28
Pile N.	3	8	3	1	8	8

* EFFECTS FOR LATERALLY LOADED PILE *

PILE	DISPL. y-DIR M	DISPL. z-DIR M	MOMENT z-DIR KN- M	MOMENT y-DIR KN- M	SHEAR y-DIR KN	SHEAR z-DIR KN	SOIL REACT y-DIR KN/ M	SOIL REACT z-DIR KN/ M	TOTAL STRESS KN/ M**2
*****	*****	*****	*****	*****	*****	*****	*****	*****	*****
Min.	-4.3087E-04	-1.3915E-05	-136.02	-241.04	-122.73	-23.894	-54.184	-4.8773	1209.9
Pile N.	1	3	3	3	3	3	3	3	10
Max.	1.6709E-05	3.6353E-04	244.70	113.73	28.532	111.97	5.7178	47.364	3336.2
Pile N.	3	1	3	3	3	3	3	3	3

LOAD CASE : 2

* TABLE L * COMPUTATION ON PILE CAP

* EQUIVALENT CONCENTRATED LOAD AT ORIGIN *

LOAD X, KN	LOAD Y, KN	LOAD Z, KN	MOM X, KN- M	MOM Y, KN- M	MOM Z, KN- M
29988.0	-170.000	855.000	0.00000	14876.5	2089.00

* DISPLACEMENT OF GROUPED PILE FOUNDATION AT ORIGIN *

DISP X, M	DISP Y, M	DISP Z, M	ROT X,RAD	ROT Y,RAD	ROT Z,RAD
1.24099E-03	-6.18707E-05	2.81501E-04	-3.58185E-07	2.80467E-05	7.62622E-06

APPALTATORE:

Consorzio

Soci



ITINERARIO NAPOLI – BARI

PROGETTAZIONE:

Mandataria

Mandanti



RADDOPPIO TRATTA APICE – ORSARA
I LOTTO FUNZIONALE APICE – HIRPINIA

PROGETTO ESECUTIVO

RELAZIONE DI CALCOLO FONDAZIONI PILE DA P17 A P20

COMMESSA IF1N	LOTTO 01 E ZZ	CODIFICA RG	DOCUMENTO MD0000 001	REV. B	FOGLIO 88 di 143
------------------	------------------	----------------	-------------------------	-----------	---------------------

* PILE TOP DISPLACEMENTS, GLOBAL *

	DISP. X, M	DISP. Y, M	DISP. Z, M	ROT. X,RAD	ROT. Y,RAD	ROT. Z,RAD
MINIMUM	1.0173E-03	-6.4288E-05	2.7989E-04	-3.5818E-07	2.8047E-05	7.6262E-06
Pile N.	10	1	1	1	1	1
MAXIMUM	1.4646E-03	-5.9453E-05	2.8311E-04	-3.5818E-07	2.8047E-05	7.6262E-06
Pile N.	3	1	3	1	1	1

* PILE TOP REACTIONS, GLOBAL *

	FOR. X, KN	FOR. Y, KN	FOR. Z, KN	MOM X, KN- M	MOM Y, KN- M	MOM Z, KN- M
MINIMUM	2058.2	-16.631	59.971	-0.1396	-192.02	-32.499
Pile N.	10	3	8	1	3	3
MAXIMUM	2939.8	-12.126	88.496	-0.1396	-138.27	-24.862
Pile N.	3	8	3	1	8	5

* PILE TOP DISPLACEMENTS, LOCAL *

	DISP. X, M	DISP. y, M	DISP. z, M	ROT. x,RAD	ROT. y,RAD	ROT. z,RAD
MINIMUM	1.0173E-03	-6.4288E-05	2.7989E-04	-3.5818E-07	2.8047E-05	7.6262E-06
Pile N.	10	10	1	1	1	1
MAXIMUM	1.4646E-03	-5.9453E-05	2.8311E-04	-3.5818E-07	2.8047E-05	7.6262E-06
Pile N.	3	1	3	1	1	1

* PILE TOP REACTIONS, LOCAL *

	AXIAL, KN	LAT. y, KN	LAT. z, KN	MOM x, KN- M	MOM y, KN- M	MOM z, KN- M
MINIMUM	2058.2	-16.631	59.971	-0.1396	-192.02	-32.499
Pile N.	10	3	8	1	3	3
MAXIMUM	2939.8	-12.126	88.496	-0.1396	-138.27	-24.862
Pile N.	3	8	3	1	8	5

* EFFECTS FOR LATERALLY LOADED PILE *

PILE	DISPL. y-DIR	DISPL. z-DIR	MOMENT z-DIR	MOMENT y-DIR	SHEAR y-DIR	SHEAR z-DIR	SOIL REACT y-DIR	SOIL REACT z-DIR	TOTAL STRESS
	M	M	KN- M	KN- M	KN	KN	KN/ M	KN/ M	KN/ M**2
Min.	-6.4288E-05	-1.0863E-05	-18.784	-192.02	-16.633	-18.658	-7.4114	-3.8179	1164.7
Pile N.	10	3	3	3	3	3	3	3	10
Max.	2.4207E-06	2.8311E-04	32.499	88.869	3.9361	88.505	0.7863	37.221	2251.4
Pile N.	12	3	3	3	3	3	3	3	3

LOAD CASE : 3

* TABLE L * COMPUTATION ON PILE CAP

* EQUIVALENT CONCENTRATED LOAD AT ORIGIN *

LOAD X, KN	LOAD Y, KN	LOAD Z, KN	MOM X, KN- M	MOM Y, KN- M	MOM Z, KN- M
34266.0	-791.000	893.000	0.00000	21012.5	9568.50

* DISPLACEMENT OF GROUPED PILE FOUNDATION AT ORIGIN *

DISP X, M	DISP Y, M	DISP Z, M	ROT X,RAD	ROT Y,RAD	ROT Z,RAD
1.42185E-03	-2.83367E-04	3.16036E-04	-2.24152E-07	3.81651E-05	3.50005E-05

* PILE TOP DISPLACEMENTS, GLOBAL *

	DISP. X, M	DISP. Y, M	DISP. Z, M	ROT. X,RAD	ROT. Y,RAD	ROT. Z,RAD
MINIMUM	1.0067E-03	-2.8488E-04	3.1503E-04	-2.2415E-07	3.8165E-05	3.5000E-05
Pile N.	10	10	1	1	1	1
MAXIMUM	1.8370E-03	-2.8185E-04	3.1704E-04	-2.2415E-07	3.8165E-05	3.5000E-05
Pile N.	3	1	3	1	1	1

* PILE TOP REACTIONS, GLOBAL *

	FOR. X, KN	FOR. Y, KN	FOR. Z, KN	MOM X, KN- M	MOM Y, KN- M	MOM Z, KN- M
MINIMUM	2037.2	-80.104	62.512	-0.087339	-184.60	-159.28
Pile N.	10	3	8	1	3	3
MAXIMUM	3673.8	-55.504	91.460	-0.087339	-130.87	-114.68
Pile N.	3	8	3	1	8	8

* PILE TOP DISPLACEMENTS, LOCAL *

	DISP. X, M	DISP. y, M	DISP. z, M	ROT. x,RAD	ROT. y,RAD	ROT. z,RAD
MINIMUM	1.0067E-03	-2.8488E-04	3.1503E-04	-2.2415E-07	3.8165E-05	3.5000E-05
Pile N.	10	10	1	1	1	1
MAXIMUM	1.8370E-03	-2.8185E-04	3.1704E-04	-2.2415E-07	3.8165E-05	3.5000E-05
Pile N.	3	1	3	1	1	1

* PILE TOP REACTIONS, LOCAL *

	AXIAL, KN	LAT. y, KN	LAT. z, KN	MOM x, KN- M	MOM y, KN- M	MOM z, KN- M
MINIMUM	2037.2	-80.104	62.512	-0.087339	-184.60	-159.28
Pile N.	10	3	8	1	3	3
MAXIMUM	3673.8	-55.504	91.460	-0.087339	-130.87	-114.68
Pile N.	3	8	3	1	8	8

APPALTATORE: Consorzio Soci   		ITINERARIO NAPOLI – BARI RADDOPPIO TRATTA APICE – ORSARA I LOTTO FUNZIONALE APICE – HIRPINIA
PROGETTAZIONE: Mandataria Mandanti   		
PROGETTO ESECUTIVO RELAZIONE DI CALCOLO FONDAZIONI PILE DA P17 A P20		COMMESSA LOTTO CODIFICA DOCUMENTO REV. FOGLIO IF1N 01 E ZZ RG MD0000 001 B 89 di 143

* EFFECTS FOR LATERALLY LOADED PILE *

PILE	DISPL. y-DIR M	DISPL. z-DIR M	MOMENT z-DIR KN- M	MOMENT y-DIR KN- M	SHEAR y-DIR KN	SHEAR z-DIR KN	SOIL REACT y-DIR KN/ M	SOIL REACT z-DIR KN/ M	TOTAL STRESS KN/ M**2
*****	*****	*****	*****	*****	*****	*****	*****	*****	*****
Min.	-2.8488E-04	-1.2270E-05	-88.981	-184.60	-80.113	-20.977	-35.404	-4.2154	1152.8
Pile N.	10	3	3	3	3	3	3	3	10
Max.	1.0939E-05	3.1704E-04	159.28	100.00	18.660	91.470	3.7376	40.105	2814.8
Pile N.	12	3	3	3	3	3	3	3	3

LOAD CASE : 4

* TABLE L * COMPUTATION ON PILE CAP

* EQUIVALENT CONCENTRATED LOAD AT ORIGIN *

LOAD X, KN	LOAD Y, KN	LOAD Z, KN	MOM X, KN- M	MOM Y, KN- M	MOM Z, KN- M
34782.0	-2437.00	738.000	248.000	13201.0	33545.5

* DISPLACEMENT OF GROUPED PILE FOUNDATION AT ORIGIN *

DISP X, M	DISP Y, M	DISP Z, M	ROT X,RAD	ROT Y,RAD	ROT Z,RAD
1.44366E-03	-9.04430E-04	2.42607E-04	2.55108E-06	2.47817E-05	1.19882E-04

* PILE TOP DISPLACEMENTS, GLOBAL *

	DISP. X, M	DISP. Y, M	DISP. Z, M	ROT. X,RAD	ROT. Y,RAD	ROT. Z,RAD
MINIMUM	7.3692E-04	-9.2165E-04	2.3113E-04	2.5511E-06	2.4782E-05	1.1988E-04
Pile N.	10	1	3	1	1	1
MAXIMUM	2.1504E-03	-8.8721E-04	2.5409E-04	2.5511E-06	2.4782E-05	1.1988E-04
Pile N.	3	10	1	1	1	1

* PILE TOP REACTIONS, GLOBAL *

	FOR. X, KN	FOR. Y, KN	FOR. Z, KN	MOM X, KN- M	MOM Y, KN- M	MOM Z, KN- M
MINIMUM	1505.4	-255.54	53.067	0.9940	-148.23	-496.24
Pile N.	10	3	8	1	3	3
MAXIMUM	4291.6	-171.07	70.021	0.9940	-120.58	-333.59
Pile N.	3	8	3	1	8	8

* PILE TOP DISPLACEMENTS, LOCAL *

	DISP. x, M	DISP. y, M	DISP. z, M	ROT. x,RAD	ROT. y,RAD	ROT. z,RAD
MINIMUM	7.3692E-04	-9.2165E-04	2.3113E-04	2.5511E-06	2.4782E-05	1.1988E-04
Pile N.	10	1	3	1	1	1
MAXIMUM	2.1504E-03	-8.8721E-04	2.5409E-04	2.5511E-06	2.4782E-05	1.1988E-04
Pile N.	3	10	1	1	1	1

* PILE TOP REACTIONS, LOCAL *

	AXIAL, KN	LAT. y, KN	LAT. z, KN	MOM x, KN- M	MOM y, KN- M	MOM z, KN- M
MINIMUM	1505.4	-255.54	53.067	0.9940	-148.23	-496.24
Pile N.	10	3	8	1	3	3
MAXIMUM	4291.6	-171.07	70.021	0.9940	-120.58	-333.59
Pile N.	3	8	3	1	8	8

* EFFECTS FOR LATERALLY LOADED PILE *

PILE	DISPL. y-DIR M	DISPL. z-DIR M	MOMENT z-DIR KN- M	MOMENT y-DIR KN- M	SHEAR y-DIR KN	SHEAR z-DIR KN	SOIL REACT y-DIR KN/ M	SOIL REACT z-DIR KN/ M	TOTAL STRESS KN/ M**2
*****	*****	*****	*****	*****	*****	*****	*****	*****	*****
Min.	-9.2165E-04	-9.4010E-06	-291.37	-148.23	-255.57	-15.269	-114.50	-3.1026	851.88
Pile N.	1	1	3	3	3	3	3	3	10
Max.	3.5871E-05	2.5409E-04	496.24	72.695	61.117	70.031	12.190	29.946	3991.6
Pile N.	3	1	3	3	3	3	3	3	3

APPALTATORE: <u>Consorzio</u> <u>Soci</u> HIRPINIA AV SALINI IMPREGILO S.P.A. ASTALDI S.P.A.	ITINERARIO NAPOLI – BARI					
PROGETTAZIONE: <u>Mandatario</u> <u>Mandanti</u> ROCKSOIL S.P.A. NET ENGINEERING S.P.A. ALPINA S.P.A.	RADDOPPIO TRATTA APICE – ORSARA I LOTTO FUNZIONALE APICE – HIRPINIA					
PROGETTO ESECUTIVO RELAZIONE DI CALCOLO FONDAZIONI PILE DA P17 A P20	COMMESSA IF28	LOTTO 01	CODIFICA E ZZ CL	DOCUMENTO VI0403 008	REV. B	FOGLIO 90 di 143

11.2 PILA SLU – SLV

```
=====
GROUP for Windows, Version 2016.10.13

Serial Number : 228330872

Analysis of A Group of Piles
Subjected to Axial and Lateral Loading

(c) Copyright ENSOFT, Inc., 1987-2015
All Rights Reserved
=====
```

```
-----
Time and Date of Analysis
-----
Date: July 07, 2020      Time: 16:44:46
```

***** COMPUTATION RESULTS *****

New Group

***** LOAD CASES RESULTS *****

LOAD CASE : 1
CASE NAME : Load Case
LOAD TYPE : Special, Sp

REDUCTION FACTORS FOR CLOSELY-SPACED PILE GROUPS, COMBINED Y AND Z DIRECTIONS
ESTIMATED USING MOVEMENT IN THE DIRECTION OF PILE CAP DISPLACEMENTS

GROUP NO	P-FACTOR	Y-FACTOR
1	0.8554	1.0000
2	0.5756	1.0000
3	0.5845	1.0000
4	0.7954	1.0000
5	0.4937	1.0000
6	0.4978	1.0000
7	0.7965	1.0000
8	0.4951	1.0000
9	0.4996	1.0000
10	0.8661	1.0000
11	0.5911	1.0000
12	0.6001	1.0000

* TABLE L * COMPUTATION ON PILE CAP

* EQUIVALENT CONCENTRATED LOAD AT ORIGIN *

VERT. LOAD, KN	HOR. LOAD Y, KN	HOR. LOAD Z, KN
28377.0	11902.0	-2956.80
MOMENT X, KN- M	MOMENT Y, KN- M	MOMENT Z, KN- M
-162.000	-38027.0	-1.41876E+05

* DISPLACEMENT OF GROUPED PILE FOUNDATION AT ORIGIN *

VERTICAL, M	HORIZONTAL Y, M	HORIZONTAL Z, M
1.34939E-03	5.45267E-03	-1.18471E-03
ANGLE ROT. X, RAD	ANGLE ROT. Y, RAD	ANGLE ROT. Z, RAD
7.48438E-06	-8.75949E-05	-5.81231E-04

APPALTATORE: Consorzio  Soci  		ITINERARIO NAPOLI – BARI RADDOPPIO TRATTA APICE – ORSARA I LOTTO FUNZIONALE APICE – HIRPINIA					
PROGETTAZIONE: Mandataria  Mandanti  							
PROGETTO ESECUTIVO RELAZIONE DI CALCOLO FONDAZIONI PILE DA P17 A P20							

THE GLOBAL STRUCTURAL COORDINATE SYSTEM

* PILE TOP DISPLACEMENTS *

PILE GROUP	DISP. X, M	DISP. Y, M	DISP. Z, M	ROT. X,RAD	ROT. Y,RAD	ROT. Z,RAD
*****	*****	*****	*****	*****	*****	*****
1	3.3737E-03	5.4021E-03	-1.1510E-03	7.4844E-06	-8.7595E-05	-5.8123E-04
2	7.5813E-04	5.4021E-03	-1.1847E-03	7.4844E-06	-8.7595E-05	-5.8123E-04
3	-1.8574E-03	5.4021E-03	-1.2184E-03	7.4844E-06	-8.7595E-05	-5.8123E-04
4	3.7678E-03	5.4358E-03	-1.1510E-03	7.4844E-06	-8.7595E-05	-5.8123E-04
5	1.1523E-03	5.4358E-03	-1.1847E-03	7.4844E-06	-8.7595E-05	-5.8123E-04
6	-1.4632E-03	5.4358E-03	-1.2184E-03	7.4844E-06	-8.7595E-05	-5.8123E-04
7	4.1620E-03	5.4695E-03	-1.1510E-03	7.4844E-06	-8.7595E-05	-5.8123E-04
8	1.5465E-03	5.4695E-03	-1.1847E-03	7.4844E-06	-8.7595E-05	-5.8123E-04
9	-1.0691E-03	5.4695E-03	-1.2184E-03	7.4844E-06	-8.7595E-05	-5.8123E-04
10	4.5562E-03	5.5032E-03	-1.1510E-03	7.4844E-06	-8.7595E-05	-5.8123E-04
11	1.9407E-03	5.5032E-03	-1.1847E-03	7.4844E-06	-8.7595E-05	-5.8123E-04
12	-6.7488E-04	5.5032E-03	-1.2184E-03	7.4844E-06	-8.7595E-05	-5.8123E-04
MINIMUM	-1.8574E-03	5.4021E-03	-1.2184E-03	7.4844E-06	-8.7595E-05	-5.8123E-04
Pile N.	3	1	3	1	1	1
MAXIMUM	4.5562E-03	5.5032E-03	-1.1510E-03	7.4844E-06	-8.7595E-05	-5.8123E-04
Pile N.	10	10	1	1	1	1

* PILE TOP REACTIONS *

PILE GROUP	FOR. X, KN	FOR. Y, KN	FOR. Z, KN	MOM X, KN- M	MOM Y, KN- M	MOM Z, KN- M
*****	*****	*****	*****	*****	*****	*****
1	6114.8	1212.5	-292.41	2.9162	718.71	2668.5
2	1547.2	919.53	-233.19	2.9162	605.94	2075.7
3	-3639.0	932.32	-244.89	2.9162	637.11	2092.5
4	6647.5	1160.2	-277.94	2.9162	690.42	2578.6
5	2324.2	827.82	-209.24	2.9162	554.73	1892.2
6	-2875.9	835.39	-218.82	2.9162	581.45	1898.5
7	7180.2	1168.6	-277.47	2.9162	689.59	2605.7
8	3101.2	834.73	-209.04	2.9162	554.53	1916.4
9	-2112.9	842.71	-218.70	2.9162	581.42	1923.5
10	7561.5	1246.0	-292.55	2.9162	719.29	2766.3
11	3878.2	954.61	-235.39	2.9162	611.26	2178.4
12	-1349.9	967.59	-247.14	2.9162	642.53	2195.4
MINIMUM	-3639.0	827.82	-292.55	2.9162	554.53	1892.2
Pile N.	3	5	10	1	8	5
MAXIMUM	7561.5	1246.0	-209.04	2.9162	719.29	2766.3
Pile N.	10	10	8	1	10	10

THE PILE COORDINATE SYSTEM (LOCAL AXES)

* PILE TOP DISPLACEMENTS *

PILE GROUP	DISP. x, M	DISP. y, M	DISP. z, M	ROT. x,RAD	ROT. y,RAD	ROT. z,RAD
*****	*****	*****	*****	*****	*****	*****
1	3.3737E-03	5.4021E-03	-1.1510E-03	7.4844E-06	-8.7595E-05	-5.8123E-04
2	7.5813E-04	5.4021E-03	-1.1847E-03	7.4844E-06	-8.7595E-05	-5.8123E-04
3	-1.8574E-03	5.4021E-03	-1.2184E-03	7.4844E-06	-8.7595E-05	-5.8123E-04
4	3.7678E-03	5.4358E-03	-1.1510E-03	7.4844E-06	-8.7595E-05	-5.8123E-04
5	1.1523E-03	5.4358E-03	-1.1847E-03	7.4844E-06	-8.7595E-05	-5.8123E-04
6	-1.4632E-03	5.4358E-03	-1.2184E-03	7.4844E-06	-8.7595E-05	-5.8123E-04
7	4.1620E-03	5.4695E-03	-1.1510E-03	7.4844E-06	-8.7595E-05	-5.8123E-04
8	1.5465E-03	5.4695E-03	-1.1847E-03	7.4844E-06	-8.7595E-05	-5.8123E-04
9	-1.0691E-03	5.4695E-03	-1.2184E-03	7.4844E-06	-8.7595E-05	-5.8123E-04
10	4.5562E-03	5.5032E-03	-1.1510E-03	7.4844E-06	-8.7595E-05	-5.8123E-04
11	1.9407E-03	5.5032E-03	-1.1847E-03	7.4844E-06	-8.7595E-05	-5.8123E-04
12	-6.7488E-04	5.5032E-03	-1.2184E-03	7.4844E-06	-8.7595E-05	-5.8123E-04
MINIMUM	-1.8574E-03	5.4021E-03	-1.2184E-03	7.4844E-06	-8.7595E-05	-5.8123E-04
Pile N.	3	1	3	1	1	1
MAXIMUM	4.5562E-03	5.5032E-03	-1.1510E-03	7.4844E-06	-8.7595E-05	-5.8123E-04
Pile N.	10	10	1	1	1	1

* PILE TOP REACTIONS *

PILE GROUP	AXIAL, KN	LAT. y, KN	LAT. z, KN	MOM x, KN- M	MOM y, KN- M	MOM z, KN- M
*****	*****	*****	*****	*****	*****	*****
1	6114.8	1212.5	-292.41	2.9162	718.71	2668.5
2	1547.2	919.53	-233.19	2.9162	605.94	2075.7
3	-3639.0	932.32	-244.89	2.9162	637.11	2092.5
4	6647.5	1160.2	-277.94	2.9162	690.42	2578.6
5	2324.2	827.82	-209.24	2.9162	554.73	1892.2
6	-2875.9	835.39	-218.82	2.9162	581.45	1898.5
7	7180.2	1168.6	-277.47	2.9162	689.59	2605.7
8	3101.2	834.73	-209.04	2.9162	554.53	1916.4
9	-2112.9	842.71	-218.70	2.9162	581.42	1923.5

APPALTATORE:

Consorzio

Soci



ITINERARIO NAPOLI – BARI

PROGETTAZIONE:

Mandatario

Mandanti



RADDOPPIO TRATTA APICE – ORSARA
I LOTTO FUNZIONALE APICE – HIRPINIA

PROGETTO ESECUTIVO

RELAZIONE DI CALCOLO FONDAZIONI PILE DA P17 A P20

COMMESSA LOTTO CODIFICA DOCUMENTO REV. FOGLIO
IF1N 01 E ZZ RG MD0000 001 B 92 di 143

10	7561.5	1246.0	-292.55	2.9162	719.29	2766.3
11	3878.2	954.61	-235.39	2.9162	611.26	2178.4
12	-1349.9	967.59	-247.14	2.9162	642.53	2195.4
MINIMUM	-3639.0	827.82	-292.55	2.9162	554.53	1892.2
Pile N.	3	5	10	1	8	5
MAXIMUM	7561.5	1246.0	-209.04	2.9162	719.29	2766.3
Pile N.	10	10	8	1	10	10

PILE GROUP STRESS, KN/ M**2

1	1.1801E+04
2	7401.6
3	8660.8
4	1.1818E+04
5	7266.4
6	7620.0
7	1.2198E+04
8	7775.9
9	7260.4
10	1.2905E+04
11	9023.1
12	7667.7
MINIMUM	7260.4
Pile N.	9
MAXIMUM	1.2905E+04
Pile N.	10

* EFFECTS FOR LATERALLY LOADED PILE *

* MINIMUM VALUES AND LOCATIONS *

PILE	DISPL. y-DIR M	DISPL. z-DIR M	MOMENT z-DIR KN- M	MOMENT y-DIR KN- M	SHEAR y-DIR KN	SHEAR z-DIR KN	SOIL REACT y-DIR KN/ M	SOIL REACT z-DIR KN/ M	TOTAL STRESS KN/ M**2	FLEX. RIG. z-DIR KN- M**2	FLEX. RIG. y-DIR KN- M**2
1	-1.4152E-04	-1.1510E-03	-2668.5	-310.04	-321.20	-292.48	-74.522	-92.417	3460.3	7.8279E+06	7.8279E+06
x(M)	10.080	0.0000	0.0000	5.7600	8.1600	0.0000	10.800	2.4000	24.000	0.0000	0.0000
2	-1.1998E-04	-1.1847E-03	-2075.7	-265.45	-240.08	-233.21	-65.434	-65.648	875.54	7.8279E+06	7.8279E+06
x(M)	10.800	0.0000	0.0000	6.2400	8.8800	0.0000	14.160	2.4000	24.000	0.0000	0.0000
3	-1.1970E-04	-1.2184E-03	-2092.5	-274.57	-241.23	-244.86	-65.704	-68.710	2059.2	7.8279E+06	7.8279E+06
x(M)	10.800	0.0000	0.0000	6.2400	8.8800	0.0000	14.160	2.4000	24.000	0.0000	0.0000
4	-1.3911E-04	-1.1510E-03	-2578.6	-299.33	-308.77	-278.01	-70.528	-86.013	3761.7	7.8279E+06	7.8279E+06
x(M)	10.080	0.0000	0.0000	5.7600	8.1600	0.0000	14.160	2.4000	24.000	0.0000	0.0000
5	-1.1145E-04	-1.1847E-03	-1892.2	-246.05	-214.37	-209.26	-61.222	-56.546	1315.2	7.8279E+06	7.8279E+06
x(M)	11.280	0.0000	0.0000	6.4800	9.1200	0.0000	14.160	2.4000	24.000	0.0000	0.0000
6	-1.1063E-04	-1.2184E-03	-1898.5	-253.60	-214.11	-218.80	-61.324	-58.796	1627.4	7.8279E+06	7.8279E+06
x(M)	11.280	0.0000	0.0000	6.4800	9.1200	0.0000	14.160	2.4000	24.000	0.0000	0.0000
7	-1.3956E-04	-1.1510E-03	-2605.7	-299.01	-310.58	-277.54	-71.165	-85.841	4063.2	7.8279E+06	7.8279E+06
x(M)	10.080	0.0000	0.0000	5.7600	8.1600	0.0000	14.160	2.4000	24.000	0.0000	0.0000
8	-1.1187E-04	-1.1847E-03	-1916.4	-245.99	-215.81	-209.07	-61.609	-56.516	1754.9	7.8279E+06	7.8279E+06
x(M)	11.280	0.0000	0.0000	6.4800	9.1200	0.0000	14.160	2.4000	24.000	0.0000	0.0000
9	-1.1109E-04	-1.2184E-03	-1923.5	-253.60	-215.65	-218.68	-61.730	-58.797	1195.7	7.8279E+06	7.8279E+06
x(M)	11.280	0.0000	0.0000	6.4800	9.1200	0.0000	14.160	2.4000	24.000	0.0000	0.0000
10	-1.4348E-04	-1.1510E-03	-2766.3	-310.23	-328.90	-292.63	-76.543	-92.584	4278.9	7.8279E+06	7.8279E+06
x(M)	10.080	0.0000	0.0000	5.7600	8.1600	0.0000	10.800	2.4000	24.000	0.0000	0.0000
11	-1.2252E-04	-1.1847E-03	-2178.4	-267.48	-248.31	-235.43	-67.129	-66.657	2194.6	7.8279E+06	7.8279E+06
x(M)	10.800	0.0000	0.0000	6.2400	8.8800	0.0000	14.160	2.4000	24.000	0.0000	0.0000
12	-1.2220E-04	-1.2184E-03	-2195.4	-276.63	-249.43	-247.13	-67.386	-69.743	763.89	7.8279E+06	7.8279E+06
x(M)	10.800	0.0000	0.0000	6.2400	8.8800	0.0000	14.160	2.4000	24.000	0.0000	0.0000
Min. Pile N.	-1.4348E-04 10	-1.2184E-03 3	-2766.3 10	-310.23 10	-328.90 10	-292.63 10	-76.543 10	-92.584 10	763.89 12	7.8279E+06 1	7.8279E+06 1

* MAXIMUM VALUES AND LOCATIONS *

PILE	DISPL. y-DIR M	DISPL. z-DIR M	MOMENT z-DIR KN- M	MOMENT y-DIR KN- M	SHEAR y-DIR KN	SHEAR z-DIR KN	SOIL REACT y-DIR KN/ M	SOIL REACT z-DIR KN/ M	TOTAL STRESS KN/ M**2	FLEX. RIG. z-DIR KN- M**2	FLEX. RIG. y-DIR KN- M**2
1	5.4022E-03	3.0556E-05	1439.1	718.71	1212.8	71.227	410.01	16.496	1.1801E+04	7.8279E+06	7.8279E+06
x(M)	0.0000	10.000	5.5200	0.0000	0.0000	8.1600	2.4000	0.0000	0.0000	0.0000	0.0000
2	5.4022E-03	2.5675E-05	1200.8	605.94	919.58	53.617	281.28	15.700	7401.6	7.8279E+06	7.8279E+06
x(M)	0.0000	11.040	6.0000	0.0000	0.0000	9.1200	2.4000	14.160	0.0000	0.0000	0.0000
3	5.4022E-03	2.6339E-05	1206.6	637.11	932.20	55.515	285.26	16.310	8660.8	7.8279E+06	7.8279E+06
x(M)	0.0000	11.040	5.7600	0.0000	0.0000	9.1200	2.4000	14.160	0.0000	0.0000	0.0000
4	5.4358E-03	2.9728E-05	1399.6	690.42	1160.5	67.510	384.30	16.547	1.1818E+04	7.8279E+06	7.8279E+06
x(M)	0.0000	10.320	5.5200	0.0000	0.0000	8.4000	2.4000	14.160	0.0000	0.0000	0.0000
5	5.4358E-03	2.3389E-05	1124.7	554.73	827.89	47.335	243.90	14.416	7266.4	7.8279E+06	7.8279E+06
x(M)	0.0000	11.520	6.0000	0.0000	0.0000	9.3600	2.4000	14.160	0.0000	0.0000	0.0000
6	5.4358E-03	2.3846E-05	1126.1	581.45	835.31	48.682	245.70	14.922	7620.0	7.8279E+06	7.8279E+06
x(M)	0.0000	11.520	6.0000	0.0000	0.0000	9.3600	2.4000	14.160	0.0000	0.0000	0.0000
7	5.4695E-03	2.9638E-05	1407.0	689.59	1168.8	67.434	386.37	16.557	1.2198E+04	7.8279E+06	7.8279E+06
x(M)	0.0000	10.320	5.5200	0.0000	0.0000	8.4000	2.4000	14.160	0.0000	0.0000	0.0000
8	5.4695E-03	2.3357E-05	1131.3	554.53	834.82	47.356	245.59	14.397	7775.9	7.8279E+06	7.8279E+06
x(M)	0.0000	11.520	6.0000	0.0000	0.0000	9.3600	2.4000	14.160	0.0000	0.0000	0.0000
9	5.4695E-03	2.3821E-05	1133.0	581.42	842.65	48.726	247.54	14.908	7260.4	7.8279E+06	7.8279E+06

APPALTATORE: Consorzio Soci   		ITINERARIO NAPOLI – BARI RADDOPPIO TRATTA APICE – ORSARA I LOTTO FUNZIONALE APICE – HIRPINIA			
PROGETTAZIONE: Mandataria Mandanti   					
PROGETTO ESECUTIVO RELAZIONE DI CALCOLO FONDAZIONI PILE DA P17 A P20					
COMMESSA IF1N	LOTTO 01 E ZZ	CODIFICA RG	DOCUMENTO MD0000 001	REV. B	FOGLIO 93 di 143

x(M)	0.0000	11.520	6.0000	0.0000	0.0000	9.6000	2.4000	14.160	0.0000	0.0000	0.0000
10	5.5032E-03	3.0393E-05	1467.6	719.29	1246.3	71.416	419.95	16.596	1.2905E+04	7.8279E+06	7.8279E+06
x(M)	0.0000	10.080	5.5200	0.0000	0.0000	8.1600	2.4000	10.800	0.0000	0.0000	0.0000
11	5.5032E-03	2.5828E-05	1232.5	611.26	954.74	54.411	292.06	15.751	9023.1	7.8279E+06	7.8279E+06
x(M)	0.0000	11.040	6.0000	0.0000	0.0000	9.1200	2.4000	14.160	0.0000	0.0000	0.0000
12	5.5032E-03	2.6489E-05	1238.0	642.53	967.55	56.323	296.09	16.357	7667.7	7.8279E+06	7.8279E+06
x(M)	0.0000	11.040	5.7600	0.0000	0.0000	9.1200	2.4000	14.160	0.0000	0.0000	0.0000
Max.	5.5032E-03	3.0556E-05	1467.6	719.29	1246.3	71.416	419.95	16.596	1.2905E+04	7.8279E+06	7.8279E+06
Pile N.	10	1	10	10	10	10	10	10	10	1	1

LOAD CASE : 2
CASE NAME : Load Case
LOAD TYPE : Special, Sp

REDUCTION FACTORS FOR CLOSELY-SPACED PILE GROUPS, COMBINED Y AND Z DIRECTIONS
ESTIMATED USING MOVEMENT IN THE DIRECTION OF PILE CAP DISPLACEMENTS

GROUP NO	P-FACTOR	Y-FACTOR
1	0.6012	1.0000
2	0.5920	1.0000
3	0.8661	1.0000
4	0.4999	1.0000
5	0.4952	1.0000
6	0.7958	1.0000
7	0.4980	1.0000
8	0.4936	1.0000
9	0.7946	1.0000
10	0.5845	1.0000
11	0.5754	1.0000
12	0.8546	1.0000

* TABLE L * COMPUTATION ON PILE CAP

* EQUIVALENT CONCENTRATED LOAD AT ORIGIN *

VERT. LOAD, KN	HOR. LOAD Y, KN	HOR. LOAD Z, KN
35345.0	-11365.2	2907.30
MOMENT X, KN- M	MOMENT Y, KN- M	MOMENT Z, KN- M
113.000	38729.3	1.34624E+05

* DISPLACEMENT OF GROUPED PILE FOUNDATION AT ORIGIN *

VERTICAL, M	HORIZONTAL Y, M	HORIZONTAL Z, M
1.68871E-03	-5.17039E-03	1.16578E-03
ANGLE ROT. X, RAD	ANGLE ROT. Y, RAD	ANGLE ROT. Z, RAD
1.06014E-05	9.19635E-05	5.67374E-04

THE GLOBAL STRUCTURAL COORDINATE SYSTEM

* PILE TOP DISPLACEMENTS *

PILE GROUP	DISP. X, M	DISP. Y, M	DISP. Z, M	ROT. X, RAD	ROT. Y, RAD	ROT. Z, RAD
*****	*****	*****	*****	*****	*****	*****
1	-2.4372E-04	-5.2420E-03	1.2135E-03	1.0601E-05	9.1963E-05	5.6737E-04
2	2.3095E-03	-5.2420E-03	1.1658E-03	1.0601E-05	9.1963E-05	5.6737E-04
3	4.8626E-03	-5.2420E-03	1.1181E-03	1.0601E-05	9.1963E-05	5.6737E-04
4	-6.5756E-04	-5.1942E-03	1.2135E-03	1.0601E-05	9.1963E-05	5.6737E-04
5	1.8956E-03	-5.1942E-03	1.1658E-03	1.0601E-05	9.1963E-05	5.6737E-04
6	4.4488E-03	-5.1942E-03	1.1181E-03	1.0601E-05	9.1963E-05	5.6737E-04
7	-1.0714E-03	-5.1465E-03	1.2135E-03	1.0601E-05	9.1963E-05	5.6737E-04
8	1.4818E-03	-5.1465E-03	1.1658E-03	1.0601E-05	9.1963E-05	5.6737E-04
9	4.0350E-03	-5.1465E-03	1.1181E-03	1.0601E-05	9.1963E-05	5.6737E-04
10	-1.4852E-03	-5.0988E-03	1.2135E-03	1.0601E-05	9.1963E-05	5.6737E-04
11	1.0680E-03	-5.0988E-03	1.1658E-03	1.0601E-05	9.1963E-05	5.6737E-04
12	3.6211E-03	-5.0988E-03	1.1181E-03	1.0601E-05	9.1963E-05	5.6737E-04
MINIMUM	-1.4852E-03	-5.2420E-03	1.1181E-03	1.0601E-05	9.1963E-05	5.6737E-04
Pile N.	10	1	3	1	1	1
MAXIMUM	4.8626E-03	-5.0988E-03	1.2135E-03	1.0601E-05	9.1963E-05	5.6737E-04
Pile N.	3	10	1	1	1	1

* PILE TOP REACTIONS *

PILE GROUP	FOR. X, KN	FOR. Y, KN	FOR. Z, KN	MOM X, KN- M	MOM Y, KN- M	MOM Z, KN- M
------------	------------	------------	------------	--------------	--------------	--------------

APPALTATORE: Consorzio  Soci  		ITINERARIO NAPOLI – BARI RADDOPPIO TRATTA APICE – ORSARA I LOTTO FUNZIONALE APICE – HIRPINIA					
PROGETTAZIONE: Mandataria  Mandanti  							
PROGETTO ESECUTIVO RELAZIONE DI CALCOLO FONDAZIONI PILE DA P17 A P20							

*****	*****	*****	*****	*****	*****	*****
1	-494.56	-928.07	246.79	4.1308	-631.97	-2077.8
2	4605.1	-915.74	231.25	4.1308	-589.13	-2061.7
3	7692.5	-1194.9	282.50	4.1308	-679.89	-2620.0
4	-1316.4	-804.72	218.42	4.1308	-571.35	-1806.9
5	3789.4	-797.09	205.32	4.1308	-533.66	-1800.1
6	7515.6	-1116.2	268.00	4.1308	-651.79	-2454.2
7	-2117.4	-794.82	218.77	4.1308	-571.92	-1773.1
8	2973.7	-787.63	205.75	4.1308	-534.38	-1767.1
9	7008.5	-1104.4	268.76	4.1308	-653.22	-2416.2
10	-2918.5	-883.88	245.13	4.1308	-627.90	-1945.8
11	2157.9	-871.85	229.64	4.1308	-585.17	-1930.2
12	6449.2	-1165.9	286.97	4.1308	-691.44	-2530.3
MINIMUM	-2918.5	-1194.9	205.32	4.1308	-691.44	-2620.0
Pile N.	10	3	5	1	12	3
MAXIMUM	7692.5	-787.63	286.97	4.1308	-533.66	-1767.1
Pile N.	3	8	12	1	5	8

THE PILE COORDINATE SYSTEM (LOCAL AXES)

* PILE TOP DISPLACEMENTS *

PILE GROUP	DISP. x, M	DISP. y, M	DISP. z, M	ROT. x,RAD	ROT. y,RAD	ROT. z,RAD
*****	*****	*****	*****	*****	*****	*****
1	-2.4372E-04	-5.2420E-03	1.2135E-03	1.0601E-05	9.1963E-05	5.6737E-04
2	2.3095E-03	-5.2420E-03	1.1658E-03	1.0601E-05	9.1963E-05	5.6737E-04
3	4.8626E-03	-5.2420E-03	1.1181E-03	1.0601E-05	9.1963E-05	5.6737E-04
4	-6.5756E-04	-5.1942E-03	1.2135E-03	1.0601E-05	9.1963E-05	5.6737E-04
5	1.8956E-03	-5.1942E-03	1.1658E-03	1.0601E-05	9.1963E-05	5.6737E-04
6	4.4488E-03	-5.1942E-03	1.1181E-03	1.0601E-05	9.1963E-05	5.6737E-04
7	-1.0714E-03	-5.1465E-03	1.2135E-03	1.0601E-05	9.1963E-05	5.6737E-04
8	1.4818E-03	-5.1465E-03	1.1658E-03	1.0601E-05	9.1963E-05	5.6737E-04
9	4.0350E-03	-5.1465E-03	1.1181E-03	1.0601E-05	9.1963E-05	5.6737E-04
10	-1.4852E-03	-5.0988E-03	1.2135E-03	1.0601E-05	9.1963E-05	5.6737E-04
11	1.0680E-03	-5.0988E-03	1.1658E-03	1.0601E-05	9.1963E-05	5.6737E-04
12	3.6211E-03	-5.0988E-03	1.1181E-03	1.0601E-05	9.1963E-05	5.6737E-04
MINIMUM	-1.4852E-03	-5.2420E-03	1.1181E-03	1.0601E-05	9.1963E-05	5.6737E-04
Pile N.	10	1	3	1	1	1
MAXIMUM	4.8626E-03	-5.0988E-03	1.2135E-03	1.0601E-05	9.1963E-05	5.6737E-04
Pile N.	3	10	1	1	1	1

* PILE TOP REACTIONS *

PILE GROUP	AXIAL, KN	LAT. y, KN	LAT. z, KN	MOM x, KN- M	MOM y, KN- M	MOM z, KN- M
*****	*****	*****	*****	*****	*****	*****
1	-494.56	-928.07	246.79	4.1308	-631.97	-2077.8
2	4605.1	-915.74	231.25	4.1308	-589.13	-2061.7
3	7692.5	-1194.9	282.50	4.1308	-679.89	-2620.0
4	-1316.4	-804.72	218.42	4.1308	-571.35	-1806.9
5	3789.4	-797.09	205.32	4.1308	-533.66	-1800.1
6	7515.6	-1116.2	268.00	4.1308	-651.79	-2454.2
7	-2117.4	-794.82	218.77	4.1308	-571.92	-1773.1
8	2973.7	-787.63	205.75	4.1308	-534.38	-1767.1
9	7008.5	-1104.4	268.76	4.1308	-653.22	-2416.2
10	-2918.5	-883.88	245.13	4.1308	-627.90	-1945.8
11	2157.9	-871.85	229.64	4.1308	-585.17	-1930.2
12	6449.2	-1165.9	286.97	4.1308	-691.44	-2530.3
MINIMUM	-2918.5	-1194.9	205.32	4.1308	-691.44	-2620.0
Pile N.	10	3	5	1	12	3
MAXIMUM	7692.5	-787.63	286.97	4.1308	-533.66	-1767.1
Pile N.	3	8	12	1	5	8

PILE GROUP	STRESS, KN/ M**2
*****	*****
1	6834.3
2	9077.5
3	1.2522E+04
4	6464.5
5	7810.8
6	1.1917E+04
7	6821.1
8	7254.5
9	1.1520E+04
10	7822.3
11	7308.4
12	1.1566E+04
MINIMUM	6464.5
Pile N.	4
MAXIMUM	1.2522E+04
Pile N.	3

* EFFECTS FOR LATERALLY LOADED PILE *

APPALTATORE:

Consorzio

Soci



PROGETTAZIONE:

Mandatario

Mandanti



ITINERARIO NAPOLI – BARI

RADDOPPIO TRATTA APICE – ORSARA
I LOTTO FUNZIONALE APICE – HIRPINIA

PROGETTO ESECUTIVO

RELAZIONE DI CALCOLO FONDAZIONI PILE DA P17 A P20

COMMESSA IF1N	LOTTO 01 E ZZ	CODIFICA RG	DOCUMENTO MD0000 001	REV. B	FOGLIO 95 di 143
------------------	------------------	----------------	-------------------------	-----------	---------------------

* MINIMUM VALUES AND LOCATIONS *

PILE	DISPL. y-DIR M	DISPL. z-DIR M	MOMENT z-DIR KN- M	MOMENT y-DIR KN- M	SHEAR y-DIR KN	SHEAR z-DIR KN	SOIL REACT y-DIR KN/ M	SOIL REACT z-DIR KN/ M	TOTAL STRESS KN/ M**2	FLEX. RIG. z-DIR KN- M**2	FLEX. RIG. y-DIR KN- M**2
*****	*****	*****	*****	*****	*****	*****	*****	*****	*****	*****	*****
1	-5.2419E-03	-2.7382E-05	-1196.2	-631.97	-928.05	-57.309	-288.04	-16.530	279.86	7.8279E+06	7.8279E+06
x(M)	0.0000	11.040	5.7600	0.0000	0.0000	8.8800	2.4000	14.160	24.000	0.0000	0.0000
2	-5.2419E-03	-2.6403E-05	-1190.8	-589.13	-915.89	-54.657	-284.13	-15.676	2606.0	7.8279E+06	7.8279E+06
x(M)	0.0000	11.040	5.7600	0.0000	0.0000	8.8800	2.4000	14.160	24.000	0.0000	0.0000
3	-5.2419E-03	-3.0160E-05	-1414.3	-679.89	-1195.2	-69.773	-408.13	-16.229	4353.1	7.8279E+06	7.8279E+06
x(M)	0.0000	10.000	5.5200	0.0000	0.0000	8.1600	2.4000	10.800	24.000	0.0000	0.0000
4	-5.1942E-03	-2.4651E-05	-1092.0	-571.35	-804.69	-49.528	-240.05	-15.102	744.91	7.8279E+06	7.8279E+06
x(M)	0.0000	11.520	6.0000	0.0000	0.0000	9.3600	2.4000	14.160	24.000	0.0000	0.0000
5	-5.1942E-03	-2.3895E-05	-1090.4	-533.66	-797.19	-47.513	-238.12	-14.376	2144.4	7.8279E+06	7.8279E+06
x(M)	0.0000	11.520	6.0000	0.0000	0.0000	9.3600	2.4000	14.160	24.000	0.0000	0.0000
6	-5.1942E-03	-2.9621E-05	-1353.5	-651.79	-1116.5	-66.396	-374.44	-15.598	4253.0	7.8279E+06	7.8279E+06
x(M)	0.0000	10.320	5.5200	0.0000	0.0000	8.1600	2.4000	14.160	24.000	0.0000	0.0000
7	-5.1465E-03	-2.4733E-05	-1083.0	-571.92	-794.76	-49.548	-237.71	-15.140	1198.2	7.8279E+06	7.8279E+06
x(M)	0.0000	11.520	6.0000	0.0000	0.0000	9.3600	2.4000	14.160	24.000	0.0000	0.0000
8	-5.1465E-03	-2.3982E-05	-1081.6	-534.38	-787.71	-47.553	-235.94	-14.417	1682.7	7.8279E+06	7.8279E+06
x(M)	0.0000	11.520	6.0000	0.0000	0.0000	9.3600	2.4000	14.160	24.000	0.0000	0.0000
9	-5.1465E-03	-2.9773E-05	-1343.4	-653.22	-1104.6	-66.579	-371.62	-15.579	3966.0	7.8279E+06	7.8279E+06
x(M)	0.0000	10.320	5.5200	0.0000	0.0000	8.1600	2.4000	14.160	24.000	0.0000	0.0000
10	-5.0988E-03	-2.7449E-05	-1157.6	-627.90	-883.80	-56.649	-275.28	-16.555	1651.5	7.8279E+06	7.8279E+06
x(M)	0.0000	11.040	5.7600	0.0000	0.0000	8.8800	2.4000	14.160	24.000	0.0000	0.0000
11	-5.0988E-03	-2.6467E-05	-1152.3	-585.17	-871.92	-54.017	-271.45	-15.698	1221.1	7.8279E+06	7.8279E+06
x(M)	0.0000	11.040	5.7600	0.0000	0.0000	8.8800	2.4000	14.160	24.000	0.0000	0.0000
12	-5.0988E-03	-3.2461E-05	-1405.3	-691.44	-1166.2	-73.064	-397.24	-16.872	3649.5	7.8279E+06	7.8279E+06
x(M)	0.0000	9.8400	5.5200	0.0000	0.0000	7.9200	2.4000	10.800	24.000	0.0000	0.0000
Min.	-5.2419E-03	-3.2461E-05	-1414.3	-691.44	-1195.2	-73.064	-408.13	-16.872	279.86	7.8279E+06	7.8279E+06
Pile N.	1	12	3	12	3	12	3	12	1	1	1

* MAXIMUM VALUES AND LOCATIONS *

PILE	DISPL. y-DIR M	DISPL. z-DIR M	MOMENT z-DIR KN- M	MOMENT y-DIR KN- M	SHEAR y-DIR KN	SHEAR z-DIR KN	SOIL REACT y-DIR KN/ M	SOIL REACT z-DIR KN/ M	TOTAL STRESS KN/ M**2	FLEX. RIG. z-DIR KN- M**2	FLEX. RIG. y-DIR KN- M**2
*****	*****	*****	*****	*****	*****	*****	*****	*****	*****	*****	*****
1	1.2063E-04	1.2135E-03	2077.8	278.90	242.85	246.79	65.260	70.790	6834.3	7.8279E+06	7.8279E+06
x(M)	10.800	0.0000	0.0000	6.2400	8.6400	0.0000	14.160	2.4000	0.0000	0.0000	0.0000
2	1.2105E-04	1.1658E-03	2061.7	266.32	241.69	231.29	64.995	66.720	9077.5	7.8279E+06	7.8279E+06
x(M)	10.800	0.0000	0.0000	6.2400	8.6400	0.0000	14.160	2.4000	0.0000	0.0000	0.0000
3	1.3938E-04	1.1181E-03	2620.0	304.10	317.18	282.58	73.566	91.204	1.2522E+04	7.8279E+06	7.8279E+06
x(M)	10.080	0.0000	0.0000	5.7600	7.9200	0.0000	10.800	2.4000	0.0000	0.0000	0.0000
4	1.0946E-04	1.2135E-03	1806.9	255.89	209.10	218.41	59.680	59.709	6464.5	7.8279E+06	7.8279E+06
x(M)	11.280	0.0000	0.0000	6.2400	9.1200	0.0000	14.160	2.4000	0.0000	0.0000	0.0000
5	1.1026E-04	1.1658E-03	1800.1	245.24	209.20	205.35	59.575	56.586	7810.8	7.8279E+06	7.8279E+06
x(M)	11.280	0.0000	0.0000	6.2400	9.1200	0.0000	14.160	2.4000	0.0000	0.0000	0.0000
6	1.3656E-04	1.1181E-03	2454.2	293.71	299.03	268.08	68.043	84.626	1.1917E+04	7.8279E+06	7.8279E+06
x(M)	10.080	0.0000	0.0000	5.7600	8.1600	0.0000	10.800	2.4000	0.0000	0.0000	0.0000
7	1.0894E-04	1.2135E-03	1773.1	256.12	207.18	218.76	59.144	59.791	6821.1	7.8279E+06	7.8279E+06
x(M)	11.280	0.0000	0.0000	6.2400	9.1200	0.0000	14.160	2.4000	0.0000	0.0000	0.0000
8	1.0977E-04	1.1658E-03	1767.1	245.54	207.38	205.77	59.059	56.697	7254.5	7.8279E+06	7.8279E+06
x(M)	11.280	0.0000	0.0000	6.2400	9.1200	0.0000	14.160	2.4000	0.0000	0.0000	0.0000
9	1.3594E-04	1.1181E-03	2416.2	294.29	296.57	268.83	67.476	84.926	1.1520E+04	7.8279E+06	7.8279E+06
x(M)	10.080	0.0000	0.0000	5.7600	8.1600	0.0000	10.800	2.4000	0.0000	0.0000	0.0000
10	1.1800E-04	1.2135E-03	1945.8	277.45	233.28	245.10	63.132	69.959	7822.3	7.8279E+06	7.8279E+06
x(M)	10.800	0.0000	0.0000	6.2400	8.6400	0.0000	14.160	2.4000	0.0000	0.0000	0.0000
11	1.1840E-04	1.1658E-03	1930.2	264.91	232.13	229.66	62.861	65.915	7308.4	7.8279E+06	7.8279E+06
x(M)	10.800	0.0000	0.0000	6.2400	8.6400	0.0000	14.160	2.4000	0.0000	0.0000	0.0000
12	1.4571E-04	1.1181E-03	2530.3	312.02	322.07	287.04	73.970	91.746	1.1566E+04	7.8279E+06	7.8279E+06
x(M)	9.8400	0.0000	0.0000	5.7600	7.6800	0.0000	10.560	2.4000	0.0000	0.0000	0.0000
Max.	1.4571E-04	1.2135E-03	2620.0	312.02	322.07	287.04	73.970	91.746	1.2522E+04	7.8279E+06	7.8279E+06
Pile N.	12	1	3	12	12	12	12	12	3	1	1

LOAD CASE : 3
CASE NAME : Load Case
LOAD TYPE : Special, Sp

REDUCTION FACTORS FOR CLOSELY-SPACED PILE GROUPS, COMBINED Y AND Z DIRECTIONS
ESTIMATED USING MOVEMENT IN THE DIRECTION OF PILE CAP DISPLACEMENTS

GROUP NO	P-FACTOR	Y-FACTOR
1	0.6381	1.0000
2	0.5107	1.0000
3	0.5845	1.0000
4	0.5940	1.0000
5	0.4679	1.0000
6	0.5369	1.0000
7	0.6209	1.0000
8	0.4960	1.0000

APPALTATORE: Consorzio Soci   	ITINERARIO NAPOLI – BARI RADDOPPIO TRATTA APICE – ORSARA I LOTTO FUNZIONALE APICE – HIRPINIA				
PROGETTAZIONE: Mandataria Mandanti   					
PROGETTO ESECUTIVO RELAZIONE DI CALCOLO FONDAZIONI PILE DA P17 A P20					
COMMESSA IF1N	LOTTO 01 E ZZ	CODIFICA RG	DOCUMENTO MD0000 001	REV. B	FOGLIO 96 di 143

9	0.5665	1.0000
10	0.8661	1.0000
11	0.7735	1.0000
12	0.8274	1.0000

* TABLE L * COMPUTATION ON PILE CAP

* EQUIVALENT CONCENTRATED LOAD AT ORIGIN *

VERT. LOAD, KN	HOR. LOAD Y, KN	HOR. LOAD Z, KN
28863.0	3674.00	-9824.10
MOMENT X, KN- M	MOMENT Y, KN- M	MOMENT Z, KN- M
-377.000	-1.27379E+05	-43553.4

* DISPLACEMENT OF GROUPED PILE FOUNDATION AT ORIGIN *

VERTICAL, M	HORIZONTAL Y, M	HORIZONTAL Z, M
1.26268E-03	1.58851E-03	-3.63599E-03
ANGLE ROT. X, RAD	ANGLE ROT. Y, RAD	ANGLE ROT. Z, RAD
-1.06592E-05	-2.67380E-04	-1.75002E-04

THE GLOBAL STRUCTURAL COORDINATE SYSTEM

* PILE TOP DISPLACEMENTS *

PILE GROUP	DISP. X, M	DISP. Y, M	DISP. Z, M	ROT. X, RAD	ROT. Y, RAD	ROT. Z, RAD
*****	*****	*****	*****	*****	*****	*****
1	2.4537E-04	1.6605E-03	-3.6840E-03	-1.0659E-05	-2.6738E-04	-1.7500E-04
2	-5.4213E-04	1.6605E-03	-3.6360E-03	-1.0659E-05	-2.6738E-04	-1.7500E-04
3	-1.3296E-03	1.6605E-03	-3.5880E-03	-1.0659E-05	-2.6738E-04	-1.7500E-04
4	1.4486E-03	1.6125E-03	-3.6840E-03	-1.0659E-05	-2.6738E-04	-1.7500E-04
5	6.6108E-04	1.6125E-03	-3.6360E-03	-1.0659E-05	-2.6738E-04	-1.7500E-04
6	-1.2643E-04	1.6125E-03	-3.5880E-03	-1.0659E-05	-2.6738E-04	-1.7500E-04
7	2.6518E-03	1.5645E-03	-3.6840E-03	-1.0659E-05	-2.6738E-04	-1.7500E-04
8	1.8643E-03	1.5645E-03	-3.6360E-03	-1.0659E-05	-2.6738E-04	-1.7500E-04
9	1.0768E-03	1.5645E-03	-3.5880E-03	-1.0659E-05	-2.6738E-04	-1.7500E-04
10	3.8550E-03	1.5166E-03	-3.6840E-03	-1.0659E-05	-2.6738E-04	-1.7500E-04
11	3.0675E-03	1.5166E-03	-3.6360E-03	-1.0659E-05	-2.6738E-04	-1.7500E-04
12	2.2800E-03	1.5166E-03	-3.5880E-03	-1.0659E-05	-2.6738E-04	-1.7500E-04
MINIMUM	-1.3296E-03	1.5166E-03	-3.6840E-03	-1.0659E-05	-2.6738E-04	-1.7500E-04
Pile N.	3	10	1	1	1	1
MAXIMUM	3.8550E-03	1.6605E-03	-3.5880E-03	-1.0659E-05	-2.6738E-04	-1.7500E-04
Pile N.	10	1	3	1	1	1

* PILE TOP REACTIONS *

PILE GROUP	FOR. X, KN	FOR. Y, KN	FOR. Z, KN	MOM X, KN- M	MOM Y, KN- M	MOM Z, KN- M
*****	*****	*****	*****	*****	*****	*****
1	510.15	332.33	-842.18	-4.1533	2134.9	746.10
2	-1092.9	285.18	-715.78	-4.1533	1858.0	649.07
3	-2617.3	315.69	-775.15	-4.1533	1968.9	711.21
4	2908.2	302.67	-802.94	-4.1533	2057.2	674.36
5	1355.9	256.19	-674.25	-4.1533	1772.1	577.53
6	-256.55	284.61	-732.07	-4.1533	1882.0	636.13
7	5139.3	298.66	-827.54	-4.1533	2110.6	654.10
8	3727.6	255.32	-702.03	-4.1533	1834.6	564.91
9	2175.3	282.70	-759.51	-4.1533	1942.3	620.70
10	6765.3	364.61	-1043.8	-4.1533	2547.1	770.06
11	5701.0	339.24	-959.52	-4.1533	2370.6	722.45
12	4547.0	356.80	-989.30	-4.1533	2411.1	754.91
MINIMUM	-2617.3	255.32	-1043.8	-4.1533	1772.1	564.91
Pile N.	3	8	10	1	5	8
MAXIMUM	6765.3	364.61	-674.25	-4.1533	2547.1	770.06
Pile N.	10	10	5	1	10	10

THE PILE COORDINATE SYSTEM (LOCAL AXES)

* PILE TOP DISPLACEMENTS *

PILE GROUP	DISP. x, M	DISP. y, M	DISP. z, M	ROT. x, RAD	ROT. y, RAD	ROT. z, RAD
*****	*****	*****	*****	*****	*****	*****
1	2.4537E-04	1.6605E-03	-3.6840E-03	-1.0659E-05	-2.6738E-04	-1.7500E-04
2	-5.4213E-04	1.6605E-03	-3.6360E-03	-1.0659E-05	-2.6738E-04	-1.7500E-04
3	-1.3296E-03	1.6605E-03	-3.5880E-03	-1.0659E-05	-2.6738E-04	-1.7500E-04

APPALTATORE:

Consorzio

Soci



ITINERARIO NAPOLI – BARI

PROGETTAZIONE:

Mandatario

Mandanti



RADDOPPIO TRATTA APICE – ORSARA
I LOTTO FUNZIONALE APICE – HIRPINIA

PROGETTO ESECUTIVO

RELAZIONE DI CALCOLO FONDAZIONI PILE DA P17 A P20

COMMESSA	LOTTO	CODIFICA	DOCUMENTO	REV.	FOGLIO
IF1N	01 E ZZ	RG	MD0000 001	B	97 di 143

4	1.4486E-03	1.6125E-03	-3.6840E-03	-1.0659E-05	-2.6738E-04	-1.7500E-04
5	6.6108E-04	1.6125E-03	-3.6360E-03	-1.0659E-05	-2.6738E-04	-1.7500E-04
6	-1.2643E-04	1.6125E-03	-3.5880E-03	-1.0659E-05	-2.6738E-04	-1.7500E-04
7	2.6518E-03	1.5645E-03	-3.6840E-03	-1.0659E-05	-2.6738E-04	-1.7500E-04
8	1.8643E-03	1.5645E-03	-3.6360E-03	-1.0659E-05	-2.6738E-04	-1.7500E-04
9	1.0768E-03	1.5645E-03	-3.5880E-03	-1.0659E-05	-2.6738E-04	-1.7500E-04
10	3.8550E-03	1.5166E-03	-3.6840E-03	-1.0659E-05	-2.6738E-04	-1.7500E-04
11	3.0675E-03	1.5166E-03	-3.6360E-03	-1.0659E-05	-2.6738E-04	-1.7500E-04
12	2.2800E-03	1.5166E-03	-3.5880E-03	-1.0659E-05	-2.6738E-04	-1.7500E-04
MINIMUM	-1.3296E-03	1.5166E-03	-3.6840E-03	-1.0659E-05	-2.6738E-04	-1.7500E-04
Pile N.	3	10	1	1	1	1
MAXIMUM	3.8550E-03	1.6605E-03	-3.5880E-03	-1.0659E-05	-2.6738E-04	-1.7500E-04
Pile N.	10	1	3	1	1	1

* PILE TOP REACTIONS *

PILE GROUP	AXIAL, KN	LAT. y, KN	LAT. z, KN	MOM x, KN- M	MOM y, KN- M	MOM z, KN- M
1	510.15	332.33	-842.18	-4.1533	2134.9	746.10
2	-1092.9	285.18	-715.78	-4.1533	1858.0	649.07
3	-2617.3	315.69	-775.15	-4.1533	1968.9	711.21
4	2908.2	302.67	-802.94	-4.1533	2057.2	674.36
5	1355.9	256.19	-674.25	-4.1533	1772.1	577.53
6	-256.55	284.61	-732.07	-4.1533	1882.0	636.13
7	5139.3	298.66	-827.54	-4.1533	2110.6	654.10
8	3727.6	255.32	-702.03	-4.1533	1834.6	564.91
9	2175.3	282.70	-759.51	-4.1533	1942.3	620.70
10	6765.3	364.61	-1043.8	-4.1533	2547.1	770.06
11	5701.0	339.24	-959.52	-4.1533	2370.6	722.45
12	4547.0	356.80	-989.30	-4.1533	2411.1	754.91
MINIMUM	-2617.3	255.32	-1043.8	-4.1533	1772.1	564.91
Pile N.	3	8	10	1	5	8
MAXIMUM	6765.3	364.61	-674.25	-4.1533	2547.1	770.06
Pile N.	10	10	5	1	10	10

PILE GROUP	STRESS, KN/ M**2
1	7114.0
2	6558.3
3	7799.2
4	8179.6
5	6392.4
6	6140.9
7	9577.1
8	7902.7
9	7385.0
10	1.1859E+04
11	1.0706E+04
12	1.0198E+04

MINIMUM	6140.9
Pile N.	6
MAXIMUM	1.1859E+04
Pile N.	10

* EFFECTS FOR LATERALLY LOADED PILE *

* MINIMUM VALUES AND LOCATIONS *

PILE	DISPL. y-DIR	DISPL. z-DIR	MOMENT z-DIR	MOMENT y-DIR	SHEAR y-DIR	SHEAR z-DIR	SOIL REACT y-DIR	SOIL REACT z-DIR	TOTAL STRESS	FLEX. RIG. z-DIR	FLEX. RIG. y-DIR
*****	*****	*****	*****	*****	*****	*****	*****	*****	*****	*****	*****
1	-4.2261E-05	-3.6840E-03	-746.10	-905.76	-84.422	-842.20	-23.181	-255.79	288.69	7.8279E+06	7.8279E+06
x(M)	10.560	0.0000	0.0000	6.0000	8.4000	0.0000	14.160	2.4000	24.000	0.0000	0.0000
2	-3.8048E-05	-3.6360E-03	-649.07	-805.59	-71.280	-715.75	-21.347	-205.31	618.48	7.8279E+06	7.8279E+06
x(M)	11.040	0.0000	0.0000	6.2400	8.8800	0.0000	14.160	2.4000	24.000	0.0000	0.0000
3	-4.0992E-05	-3.5880E-03	-711.21	-850.26	-79.420	-775.07	-22.748	-231.26	1481.1	7.8279E+06	7.8279E+06
x(M)	10.560	0.0000	0.0000	6.0000	8.4000	0.0000	14.160	2.4000	24.000	0.0000	0.0000
4	-4.0091E-05	-3.6840E-03	-674.36	-877.27	-77.840	-803.03	-21.830	-239.64	1645.7	7.8279E+06	7.8279E+06
x(M)	10.560	0.0000	0.0000	6.0000	8.4000	0.0000	14.160	2.4000	24.000	0.0000	0.0000
5	-3.5638E-05	-3.6360E-03	-577.53	-773.59	-64.935	-674.28	-19.782	-189.38	767.29	7.8279E+06	7.8279E+06
x(M)	11.040	0.0000	0.0000	6.2400	8.8800	0.0000	14.160	2.4000	24.000	0.0000	0.0000
6	-3.8574E-05	-3.5880E-03	-636.13	-817.88	-72.503	-732.06	-21.219	-213.91	145.18	7.8279E+06	7.8279E+06
x(M)	10.800	0.0000	0.0000	6.2400	8.6400	0.0000	14.160	2.4000	24.000	0.0000	0.0000
7	-3.9975E-05	-3.6840E-03	-654.10	-897.81	-78.262	-827.71	-21.355	-250.47	2908.2	7.8279E+06	7.8279E+06
x(M)	10.560	0.0000	0.0000	6.0000	8.4000	0.0000	14.160	2.4000	24.000	0.0000	0.0000
8	-3.6125E-05	-3.6360E-03	-564.91	-797.85	-66.182	-702.13	-19.634	-200.67	2109.4	7.8279E+06	7.8279E+06
x(M)	11.040	0.0000	0.0000	6.2400	8.8800	0.0000	14.160	2.4000	24.000	0.0000	0.0000
9	-3.8774E-05	-3.5880E-03	-620.70	-841.11	-73.517	-759.57	-20.905	-225.63	1231.0	7.8279E+06	7.8279E+06
x(M)	10.560	0.0000	0.0000	6.0000	8.4000	0.0000	14.160	2.4000	24.000	0.0000	0.0000
10	-4.4580E-05	-3.6840E-03	-770.06	-1068.7	-99.300	-1044.1	-22.371	-344.83	3828.4	7.8279E+06	7.8279E+06
x(M)	9.6000	0.0000	0.0000	5.5200	7.6800	0.0000	10.560	2.4000	24.000	0.0000	0.0000
11	-4.4328E-05	-3.6360E-03	-722.45	-1008.5	-92.170	-959.73	-20.587	-307.48	3226.1	7.8279E+06	7.8279E+06
x(M)	9.8400	0.0000	0.0000	5.7600	7.6800	0.0000	10.800	2.4000	24.000	0.0000	0.0000
12	-4.4763E-05	-3.5880E-03	-754.91	-1025.0	-96.979	-989.47	-21.724	-324.62	2573.1	7.8279E+06	7.8279E+06

APPALTATORE: Consorzio Soci   	ITINERARIO NAPOLI – BARI RADDOPPIO TRATTA APICE – ORSARA I LOTTO FUNZIONALE APICE – HIRPINIA				
PROGETTAZIONE: Mandataria Mandanti   					
PROGETTO ESECUTIVO RELAZIONE DI CALCOLO FONDAZIONI PILE DA P17 A P20					
COMMESSA IF1N	LOTTO 01 E ZZ	CODIFICA RG	DOCUMENTO MD0000 001	REV. B	FOGLIO 98 di 143

x(M)	9.8400	0.0000	0.0000	5.7600	7.6800	0.0000	10.560	2.4000	24.000	0.0000	0.0000
Min. Pile N.	-4.4763E-05	-3.6840E-03	-770.06	-1068.7	-99.300	-1044.1	-23.181	-344.83	145.18	7.8279E+06	7.8279E+06
	12	1	10	10	10	10	1	10	6	1	1

* MAXIMUM VALUES AND LOCATIONS *

PILE	DISPL. y-DIR M	DISPL. z-DIR M	MOMENT z-DIR KN- M	MOMENT y-DIR KN- M	SHEAR y-DIR KN	SHEAR z-DIR KN	SOIL REACT y-DIR KN/ M	SOIL REACT z-DIR KN/ M	TOTAL STRESS KN/ M**2	FLEX. RIG. z-DIR M**2	FLEX. RIG. y-DIR M**2
*****	*****	*****	*****	*****	*****	*****	*****	*****	*****	*****	*****
1	1.6605E-03	9.2888E-05	404.44	2134.9	332.34	191.88	108.64	56.547	7114.0	7.8279E+06	7.8279E+06
x(M)	0.0000	10.560	5.7600	0.0000	0.0000	8.6400	2.4000	14.160	0.0000	0.0000	0.0000
2	1.6605E-03	8.0801E-05	365.77	1858.0	285.17	158.25	88.398	50.521	6558.3	7.8279E+06	7.8279E+06
x(M)	0.0000	11.280	6.0000	0.0000	0.0000	9.1200	2.4000	14.160	0.0000	0.0000	0.0000
3	1.6605E-03	8.7243E-05	390.76	1968.9	315.66	174.92	101.16	53.466	7799.2	7.8279E+06	7.8279E+06
x(M)	0.0000	10.800	5.7600	0.0000	0.0000	8.6400	2.4000	14.160	0.0000	0.0000	0.0000
4	1.6125E-03	8.9946E-05	381.00	2057.2	302.70	181.78	98.216	55.086	8179.6	7.8279E+06	7.8279E+06
x(M)	0.0000	10.800	5.7600	0.0000	0.0000	8.6400	2.4000	14.160	0.0000	0.0000	0.0000
5	1.6125E-03	7.7028E-05	342.13	1772.1	256.21	148.25	78.672	48.283	6392.4	7.8279E+06	7.8279E+06
x(M)	0.0000	11.520	6.0000	0.0000	0.0000	9.3600	2.4000	14.160	0.0000	0.0000	0.0000
6	1.6125E-03	8.3536E-05	365.70	1882.0	284.61	163.98	90.285	51.522	6140.9	7.8279E+06	7.8279E+06
x(M)	0.0000	11.040	5.7600	0.0000	0.0000	8.8800	2.4000	14.160	0.0000	0.0000	0.0000
7	1.5645E-03	9.2753E-05	377.73	2110.6	298.71	189.38	99.006	56.295	9577.1	7.8279E+06	7.8279E+06
x(M)	0.0000	10.800	5.5200	0.0000	0.0000	8.6400	2.4000	14.160	0.0000	0.0000	0.0000
8	1.5645E-03	8.0628E-05	341.95	1834.6	255.35	156.08	80.390	50.042	7902.7	7.8279E+06	7.8279E+06
x(M)	0.0000	11.280	5.7600	0.0000	0.0000	9.1200	2.4000	14.160	0.0000	0.0000	0.0000
9	1.5645E-03	8.6832E-05	364.48	1942.3	282.72	172.10	91.844	53.023	7385.0	7.8279E+06	7.8279E+06
x(M)	0.0000	10.800	5.7600	0.0000	0.0000	8.8800	2.4000	14.160	0.0000	0.0000	0.0000
10	1.5166E-03	1.1173E-04	433.24	2547.1	364.69	250.12	131.60	57.697	1.1859E+04	7.8279E+06	7.8279E+06
x(M)	0.0000	9.8400	5.2800	0.0000	0.0000	7.9200	2.4000	10.560	0.0000	0.0000	0.0000
11	1.5166E-03	1.0873E-04	413.75	2370.6	339.30	230.73	119.01	52.171	1.0706E+04	7.8279E+06	7.8279E+06
x(M)	0.0000	10.000	5.2800	0.0000	0.0000	7.9200	2.4000	10.800	0.0000	0.0000	0.0000
12	1.5166E-03	1.0876E-04	427.11	2411.1	356.86	237.88	127.61	54.315	1.0198E+04	7.8279E+06	7.8279E+06
x(M)	0.0000	9.8400	5.2800	0.0000	0.0000	7.9200	2.4000	10.800	0.0000	0.0000	0.0000
Max. Pile N.	1.6605E-03	1.1173E-04	433.24	2547.1	364.69	250.12	131.60	57.697	1.1859E+04	7.8279E+06	7.8279E+06
	1	10	10	10	10	10	10	10	10	1	1

LOAD CASE : 4
CASE NAME : Load Case
LOAD TYPE : Special, Sp

REDUCTION FACTORS FOR CLOSELY-SPACED PILE GROUPS, COMBINED Y AND Z DIRECTIONS
ESTIMATED USING MOVEMENT IN THE DIRECTION OF PILE CAP DISPLACEMENTS

GROUP NO	P-FACTOR	Y-FACTOR
1	0.8322	1.0000
2	0.7774	1.0000
3	0.8661	1.0000
4	0.5681	1.0000
5	0.4960	1.0000
6	0.6160	1.0000
7	0.5378	1.0000
8	0.4672	1.0000
9	0.5882	1.0000
10	0.5845	1.0000
11	0.5090	1.0000
12	0.6318	1.0000

* TABLE L * COMPUTATION ON PILE CAP

* EQUIVALENT CONCENTRATED LOAD AT ORIGIN *

VERT. LOAD, KN	HOR. LOAD Y, KN	HOR. LOAD Z, KN
27728.0	-3347.30	9692.10
MOMENT X, KN- M	MOMENT Y, KN- M	MOMENT Z, KN- M
-376.000	1.29067E+05	40803.9

* DISPLACEMENT OF GROUPED PILE FOUNDATION AT ORIGIN *

VERTICAL, M	HORIZONTAL Y, M	HORIZONTAL Z, M
1.20804E-03	-1.44758E-03	3.57696E-03
ANGLE ROT. X, RAD	ANGLE ROT. Y, RAD	ANGLE ROT. Z, RAD
-1.03932E-05	2.67923E-04	1.62182E-04

APPALTATORE: Consorzio  Soci  		ITINERARIO NAPOLI – BARI RADDOPPIO TRATTA APICE – ORSARA I LOTTO FUNZIONALE APICE – HIRPINIA					
PROGETTAZIONE: Mandataria  Mandanti  							
PROGETTO ESECUTIVO RELAZIONE DI CALCOLO FONDAZIONI PILE DA P17 A P20							

THE GLOBAL STRUCTURAL COORDINATE SYSTEM

* PILE TOP DISPLACEMENTS *

PILE GROUP	DISP. X, M	DISP. Y, M	DISP. Z, M	ROT. X,RAD	ROT. Y,RAD	ROT. Z,RAD
*****	*****	*****	*****	*****	*****	*****
1	2.2867E-03	-1.3774E-03	3.5302E-03	-1.0393E-05	2.6792E-04	1.6218E-04
2	3.0165E-03	-1.3774E-03	3.5770E-03	-1.0393E-05	2.6792E-04	1.6218E-04
3	3.7463E-03	-1.3774E-03	3.6237E-03	-1.0393E-05	2.6792E-04	1.6218E-04
4	1.0811E-03	-1.4242E-03	3.5302E-03	-1.0393E-05	2.6792E-04	1.6218E-04
5	1.8109E-03	-1.4242E-03	3.5770E-03	-1.0393E-05	2.6792E-04	1.6218E-04
6	2.5407E-03	-1.4242E-03	3.6237E-03	-1.0393E-05	2.6792E-04	1.6218E-04
7	-1.2460E-04	-1.4710E-03	3.5302E-03	-1.0393E-05	2.6792E-04	1.6218E-04
8	6.0522E-04	-1.4710E-03	3.5770E-03	-1.0393E-05	2.6792E-04	1.6218E-04
9	1.3350E-03	-1.4710E-03	3.6237E-03	-1.0393E-05	2.6792E-04	1.6218E-04
10	-1.3303E-03	-1.5177E-03	3.5302E-03	-1.0393E-05	2.6792E-04	1.6218E-04
11	-6.0044E-04	-1.5177E-03	3.5770E-03	-1.0393E-05	2.6792E-04	1.6218E-04
12	1.2938E-04	-1.5177E-03	3.6237E-03	-1.0393E-05	2.6792E-04	1.6218E-04
MINIMUM	-1.3303E-03	-1.5177E-03	3.5302E-03	-1.0393E-05	2.6792E-04	1.6218E-04
Pile N.	10	10	1	1	1	1
MAXIMUM	3.7463E-03	-1.3774E-03	3.6237E-03	-1.0393E-05	2.6792E-04	1.6218E-04
Pile N.	3	1	3	1	1	1

* PILE TOP REACTIONS *

PILE GROUP	FOR. X, KN	FOR. Y, KN	FOR. Z, KN	MOM X, KN- M	MOM Y, KN- M	MOM Z, KN- M
*****	*****	*****	*****	*****	*****	*****
1	4560.3	-324.93	980.10	-4.0496	-2374.2	-679.71
2	5632.1	-308.77	950.12	-4.0496	-2333.2	-649.93
3	6618.4	-330.76	1030.2	-4.0496	-2500.7	-691.01
4	2183.7	-257.92	751.43	-4.0496	-1910.1	-560.22
5	3622.3	-232.47	693.28	-4.0496	-1800.9	-508.49
6	4989.1	-270.42	812.74	-4.0496	-2063.5	-586.39
7	-252.85	-260.44	723.93	-4.0496	-1849.9	-576.80
8	1245.8	-233.88	665.25	-4.0496	-1738.0	-522.11
9	2684.4	-274.70	787.70	-4.0496	-2009.2	-606.96
10	-2618.5	-289.48	765.66	-4.0496	-1933.7	-647.41
11	-1205.8	-260.89	705.40	-4.0496	-1820.9	-589.26
12	268.99	-302.65	826.30	-4.0496	-2085.5	-675.01
MINIMUM	-2618.5	-330.76	665.25	-4.0496	-2500.7	-691.01
Pile N.	10	3	8	1	3	3
MAXIMUM	6618.4	-232.47	1030.2	-4.0496	-1738.0	-508.49
Pile N.	3	5	3	1	8	5

THE PILE COORDINATE SYSTEM (LOCAL AXES)

* PILE TOP DISPLACEMENTS *

PILE GROUP	DISP. x, M	DISP. y, M	DISP. z, M	ROT. x,RAD	ROT. y,RAD	ROT. z,RAD
*****	*****	*****	*****	*****	*****	*****
1	2.2867E-03	-1.3774E-03	3.5302E-03	-1.0393E-05	2.6792E-04	1.6218E-04
2	3.0165E-03	-1.3774E-03	3.5770E-03	-1.0393E-05	2.6792E-04	1.6218E-04
3	3.7463E-03	-1.3774E-03	3.6237E-03	-1.0393E-05	2.6792E-04	1.6218E-04
4	1.0811E-03	-1.4242E-03	3.5302E-03	-1.0393E-05	2.6792E-04	1.6218E-04
5	1.8109E-03	-1.4242E-03	3.5770E-03	-1.0393E-05	2.6792E-04	1.6218E-04
6	2.5407E-03	-1.4242E-03	3.6237E-03	-1.0393E-05	2.6792E-04	1.6218E-04
7	-1.2460E-04	-1.4710E-03	3.5302E-03	-1.0393E-05	2.6792E-04	1.6218E-04
8	6.0522E-04	-1.4710E-03	3.5770E-03	-1.0393E-05	2.6792E-04	1.6218E-04
9	1.3350E-03	-1.4710E-03	3.6237E-03	-1.0393E-05	2.6792E-04	1.6218E-04
10	-1.3303E-03	-1.5177E-03	3.5302E-03	-1.0393E-05	2.6792E-04	1.6218E-04
11	-6.0044E-04	-1.5177E-03	3.5770E-03	-1.0393E-05	2.6792E-04	1.6218E-04
12	1.2938E-04	-1.5177E-03	3.6237E-03	-1.0393E-05	2.6792E-04	1.6218E-04
MINIMUM	-1.3303E-03	-1.5177E-03	3.5302E-03	-1.0393E-05	2.6792E-04	1.6218E-04
Pile N.	10	10	1	1	1	1
MAXIMUM	3.7463E-03	-1.3774E-03	3.6237E-03	-1.0393E-05	2.6792E-04	1.6218E-04
Pile N.	3	1	3	1	1	1

* PILE TOP REACTIONS *

PILE GROUP	AXIAL, KN	LAT. y, KN	LAT. z, KN	MOM x, KN- M	MOM y, KN- M	MOM z, KN- M
*****	*****	*****	*****	*****	*****	*****
1	4560.3	-324.93	980.10	-4.0496	-2374.2	-679.71
2	5632.1	-308.77	950.12	-4.0496	-2333.2	-649.93
3	6618.4	-330.76	1030.2	-4.0496	-2500.7	-691.01
4	2183.7	-257.92	751.43	-4.0496	-1910.1	-560.22
5	3622.3	-232.47	693.28	-4.0496	-1800.9	-508.49
6	4989.1	-270.42	812.74	-4.0496	-2063.5	-586.39
7	-252.85	-260.44	723.93	-4.0496	-1849.9	-576.80
8	1245.8	-233.88	665.25	-4.0496	-1738.0	-522.11
9	2684.4	-274.70	787.70	-4.0496	-2009.2	-606.96
10	-2618.5	-289.48	765.66	-4.0496	-1933.7	-647.41
11	-1205.8	-260.89	705.40	-4.0496	-1820.9	-589.26

APPALTATORE:

Consorzio

Soci



ITINERARIO NAPOLI – BARI

PROGETTAZIONE:

Mandatario

Mandanti



RADDOPPIO TRATTA APICE – ORSARA
I LOTTO FUNZIONALE APICE – HIRPINIA

PROGETTO ESECUTIVO

RELAZIONE DI CALCOLO FONDAZIONI PILE DA P17 A P20

COMMESSA IF1N	LOTTO 01 E ZZ	CODIFICA RG	DOCUMENTO MD0000 001	REV. B	FOGLIO 100 di 143
------------------	------------------	----------------	-------------------------	-----------	-------------------------

12	268.99	-302.65	826.30	-4.0496	-2085.5	-675.01
MINIMUM	-2618.5	-330.76	665.25	-4.0496	-2500.7	-691.01
Pile N.	10	3	8	1	3	3
MAXIMUM	6618.4	-232.47	1030.2	-4.0496	-1738.0	-508.49
Pile N.	3	5	3	1	8	5

PILE GROUP	STRESS, KN/ M**2
*****	*****
1	1.0034E+04
2	1.0497E+04
3	1.1575E+04
4	7243.2
5	7697.5
6	9297.7
7	5991.2
8	6182.0
9	7853.6
10	7636.3
11	6458.4
12	6767.9
MINIMUM	5991.2
Pile N.	7
MAXIMUM	1.1575E+04
Pile N.	3

* EFFECTS FOR LATERALLY LOADED PILE *

* MINIMUM VALUES AND LOCATIONS *

PILE	DISPL. y-DIR M	DISPL. z-DIR M	MOMENT z-DIR KN- M	MOMENT y-DIR KN- M	SHEAR y-DIR KN	SHEAR z-DIR KN	SOIL REACT y-DIR KN/ M	SOIL REACT z-DIR KN/ M	TOTAL STRESS KN/ M**2	FLEX. RIG. z-DIR KN- M**2	FLEX. RIG. y-DIR KN- M**2
*****	*****	*****	*****	*****	*****	*****	*****	*****	*****	*****	*****
1	-1.3774E-03	-1.0797E-04	-391.08	-2374.2	-324.98	-235.68	-117.62	-53.794	2580.6	7.8279E+06	7.8279E+06
x(M)	0.0000	9.8400	5.2800	0.0000	7.9200	2.4000	10.560	24.000	24.000	0.0000	0.0000
2	-1.3774E-03	-1.0797E-04	-378.90	-2333.2	-308.82	-228.97	-109.62	-51.729	3187.1	7.8279E+06	7.8279E+06
x(M)	0.0000	10.800	5.2800	0.0000	7.9200	2.4000	10.800	24.000	24.000	0.0000	0.0000
3	-1.3774E-03	-1.1066E-04	-395.61	-2500.7	-330.83	-247.13	-120.62	-56.886	3745.3	7.8279E+06	7.8279E+06
x(M)	0.0000	9.8400	5.2800	0.0000	7.6800	2.4000	10.560	24.000	24.000	0.0000	0.0000
4	-1.4242E-03	-8.7225E-05	-334.35	-1910.1	-257.94	-171.46	-84.670	-52.799	1235.7	7.8279E+06	7.8279E+06
x(M)	0.0000	10.800	5.7600	0.0000	8.6400	2.4000	14.160	24.000	0.0000	0.0000	
5	-1.4242E-03	-8.0740E-05	-313.58	-1800.9	-232.50	-155.03	-73.915	-49.772	2049.8	7.8279E+06	7.8279E+06
x(M)	0.0000	11.280	5.7600	0.0000	9.1200	2.4000	14.160	24.000	0.0000	0.0000	
6	-1.4242E-03	-9.2342E-05	-345.00	-2063.5	-270.47	-186.82	-90.330	-55.710	2823.3	7.8279E+06	7.8279E+06
x(M)	0.0000	10.800	5.5200	0.0000	8.6400	2.4000	14.160	24.000	24.000	0.0000	0.0000
7	-1.4710E-03	-8.3823E-05	-336.25	-1849.9	-260.43	-163.28	-83.390	-51.238	143.08	7.8279E+06	7.8279E+06
x(M)	0.0000	11.040	5.7600	0.0000	8.8800	2.4000	14.160	24.000	0.0000	0.0000	
8	-1.4710E-03	-7.7113E-05	-314.03	-1738.0	-233.89	-146.98	-72.443	-47.974	704.98	7.8279E+06	7.8279E+06
x(M)	0.0000	11.280	6.0000	0.0000	9.3600	2.4000	14.160	24.000	0.0000	0.0000	
9	-1.4710E-03	-8.9543E-05	-348.24	-2009.2	-274.72	-179.15	-89.706	-54.506	1519.0	7.8279E+06	7.8279E+06
x(M)	0.0000	10.800	5.7600	0.0000	8.6400	2.4000	14.160	24.000	0.0000	0.0000	
10	-1.5177E-03	-8.7454E-05	-359.59	-1933.7	-289.45	-173.96	-93.525	-53.174	1481.8	7.8279E+06	7.8279E+06
x(M)	0.0000	10.800	5.7600	0.0000	8.6400	2.4000	14.160	24.000	0.0000	0.0000	
11	-1.5177E-03	-8.0747E-05	-336.25	-1820.9	-260.88	-156.78	-81.463	-50.160	682.34	7.8279E+06	7.8279E+06
x(M)	0.0000	11.280	5.7600	0.0000	9.1200	2.4000	14.160	24.000	0.0000	0.0000	
12	-1.5177E-03	-9.2525E-05	-370.35	-2085.5	-302.66	-189.01	-99.485	-55.863	152.22	7.8279E+06	7.8279E+06
x(M)	0.0000	10.560	5.7600	0.0000	8.6400	2.4000	14.160	24.000	0.0000	0.0000	
Min.	-1.5177E-03	-1.1066E-04	-395.61	-2500.7	-330.83	-247.13	-120.62	-56.886	143.08	7.8279E+06	7.8279E+06
Pile N.	10	3	3	3	3	3	3	3	7	1	1

* MAXIMUM VALUES AND LOCATIONS *

PILE	DISPL. y-DIR M	DISPL. z-DIR M	MOMENT z-DIR KN- M	MOMENT y-DIR KN- M	SHEAR y-DIR KN	SHEAR z-DIR KN	SOIL REACT y-DIR KN/ M	SOIL REACT z-DIR KN/ M	TOTAL STRESS KN/ M**2	FLEX. RIG. z-DIR KN- M**2	FLEX. RIG. y-DIR KN- M**2
*****	*****	*****	*****	*****	*****	*****	*****	*****	*****	*****	*****
1	4.0915E-05	3.5302E-03	679.71	1016.4	88.891	980.27	19.832	324.73	1.0034E+04	7.8279E+06	7.8279E+06
x(M)	9.6000	0.0000	0.0000	5.5200	7.6800	0.0000	10.560	2.4000	0.0000	0.0000	0.0000
2	4.0621E-05	3.5770E-03	649.93	999.05	84.653	950.32	18.809	307.32	1.0497E+04	7.8279E+06	7.8279E+06
x(M)	9.8400	0.0000	0.0000	5.7600	7.6800	0.0000	10.560	2.4000	0.0000	0.0000	0.0000
3	4.0769E-05	3.6237E-03	691.01	1056.8	90.592	1030.4	20.320	342.95	1.1575E+04	7.8279E+06	7.8279E+06
x(M)	9.6000	0.0000	0.0000	5.5200	7.6800	0.0000	10.560	2.4000	0.0000	0.0000	0.0000
4	3.5997E-05	3.5302E-03	560.22	834.20	67.705	751.49	19.207	225.11	7243.2	7.8279E+06	7.8279E+06
x(M)	10.560	0.0000	0.0000	6.0000	8.4000	0.0000	14.160	2.4000	0.0000	0.0000	0.0000
5	3.3459E-05	3.5770E-03	508.49	790.10	60.798	693.38	18.028	199.67	7697.5	7.8279E+06	7.8279E+06
x(M)	11.040	0.0000	0.0000	6.2400	8.6400	0.0000	14.160	2.4000	0.0000	0.0000	0.0000
6	3.6823E-05	3.6237E-03	586.39	885.28	71.383	812.90	19.515	247.27	9297.7	7.8279E+06	7.8279E+06
x(M)	10.560	0.0000	0.0000	6.0000	8.4000	0.0000	14.160	2.4000	0.0000	0.0000	0.0000
7	3.5864E-05	3.5302E-03	576.80	810.62	66.883	723.92	19.532	213.25	5991.2	7.8279E+06	7.8279E+06
x(M)	10.800	0.0000	0.0000	6.0000	8.6400	0.0000	14.160	2.4000	0.0000	0.0000	0.0000
8	3.3134E-05	3.5770E-03	522.11	765.85	59.777	665.28	18.203	188.21	6182.0	7.8279E+06	7.8279E+06
x(M)	11.040	0.0000	0.0000	6.2400	8.8800	0.0000	14.160	2.4000	0.0000	0.0000	0.0000
9	3.7025E-05	3.6237E-03	606.96	864.47	71.123	787.78	20.011	236.20	7853.6	7.8279E+06	7.8279E+06
x(M)	10.560	0.0000	0.0000	6.0000	8.4000	0.0000	14.160	2.4000	0.0000	0.0000	0.0000
10	3.8159E-05	3.5302E-03	647.41	842.20	73.335	765.58	21.000	230.20	7636.3	7.8279E+06	7.8279E+06

APPALTATORE: Consorzio Soci   	ITINERARIO NAPOLI – BARI RADDOPPIO TRATTA APICE – ORSARA I LOTTO FUNZIONALE APICE – HIRPINIA
PROGETTAZIONE: Mandataria Mandanti   	
PROGETTO ESECUTIVO RELAZIONE DI CALCOLO FONDAZIONI PILE DA P17 A P20	
	COMMESSA LOTTO CODIFICA DOCUMENTO REV. FOGLIO IF1N 01 E ZZ RG MD0000 001 B 101 di 143

x(M)	10.560	0.0000	0.0000	6.0000	8.4000	0.0000	14.160	2.4000	0.0000	0.0000	0.0000
11	3.5328E-05	3.5770E-03	589.26	796.54	65.605	705.37	19.681	203.69	6458.4	7.8279E+06	7.8279E+06
x(M)	11.040	0.0000	0.0000	6.2400	8.8800	0.0000	14.160	2.4000	0.0000	0.0000	0.0000
12	3.9064E-05	3.6237E-03	675.01	892.40	77.259	826.31	21.274	252.15	6767.9	7.8279E+06	7.8279E+06
x(M)	10.560	0.0000	0.0000	6.0000	8.4000	0.0000	14.160	2.4000	0.0000	0.0000	0.0000
Max.	4.0915E-05	3.6237E-03	691.01	1056.8	90.592	1030.4	21.274	342.95	1.1575E+04	7.8279E+06	7.8279E+06
Pile N.	1	3	3	3	3	3	12	3	3	1	1

LOAD CASE : 5
CASE NAME : Load Case
LOAD TYPE : Special, Sp

REDUCTION FACTORS FOR CLOSELY-SPACED PILE GROUPS, COMBINED Y AND Z DIRECTIONS
ESTIMATED USING MOVEMENT IN THE DIRECTION OF PILE CAP DISPLACEMENTS

GROUP NO	P-FACTOR	Y-FACTOR
1	0.6949	1.0000
2	0.6661	1.0000
3	0.8661	1.0000
4	0.5259	1.0000
5	0.4955	1.0000
6	0.7350	1.0000
7	0.5130	1.0000
8	0.4841	1.0000
9	0.7258	1.0000
10	0.5845	1.0000
11	0.5519	1.0000
12	0.7803	1.0000

* TABLE L * COMPUTATION ON PILE CAP

* EQUIVALENT CONCENTRATED LOAD AT ORIGIN *

VERT. LOAD, KN	HOR. LOAD Y, KN	HOR. LOAD Z, KN
45370.0	-3410.00	2907.30
MOMENT X, KN- M	MOMENT Y, KN- M	MOMENT Z, KN- M
113.000	38894.3	40423.9

* DISPLACEMENT OF GROUPED PILE FOUNDATION AT ORIGIN *

VERTICAL, M	HORIZONTAL Y, M	HORIZONTAL Z, M
1.92352E-03	-1.12484E-03	8.17867E-04
ANGLE ROT. X, RAD	ANGLE ROT. Y, RAD	ANGLE ROT. Z, RAD
1.60371E-06	8.23785E-05	1.57302E-04







THE GLOBAL STRUCTURAL COORDINATE SYSTEM

* PILE TOP DISPLACEMENTS *

PILE GROUP	DISP. X, M	DISP. Y, M	DISP. Z, M	ROT. X, RAD	ROT. Y, RAD	ROT. Z, RAD
*****	*****	*****	*****	*****	*****	*****
1	1.7717E-03	-1.1357E-03	8.2508E-04	1.6037E-06	8.2378E-05	1.5730E-04
2	2.4796E-03	-1.1357E-03	8.1787E-04	1.6037E-06	8.2378E-05	1.5730E-04
3	3.1874E-03	-1.1357E-03	8.1065E-04	1.6037E-06	8.2378E-05	1.5730E-04
4	1.4010E-03	-1.1285E-03	8.2508E-04	1.6037E-06	8.2378E-05	1.5730E-04
5	2.1089E-03	-1.1285E-03	8.1787E-04	1.6037E-06	8.2378E-05	1.5730E-04
6	2.8167E-03	-1.1285E-03	8.1065E-04	1.6037E-06	8.2378E-05	1.5730E-04
7	1.0303E-03	-1.1212E-03	8.2508E-04	1.6037E-06	8.2378E-05	1.5730E-04
8	1.7382E-03	-1.1212E-03	8.1787E-04	1.6037E-06	8.2378E-05	1.5730E-04
9	2.4460E-03	-1.1212E-03	8.1065E-04	1.6037E-06	8.2378E-05	1.5730E-04
10	6.5961E-04	-1.1140E-03	8.2508E-04	1.6037E-06	8.2378E-05	1.5730E-04
11	1.3675E-03	-1.1140E-03	8.1787E-04	1.6037E-06	8.2378E-05	1.5730E-04
12	2.0753E-03	-1.1140E-03	8.1065E-04	1.6037E-06	8.2378E-05	1.5730E-04
MINIMUM	6.5961E-04	-1.1357E-03	8.1065E-04	1.6037E-06	8.2378E-05	1.5730E-04
Pile N.	10	1	3	1	1	1
MAXIMUM	3.1874E-03	-1.1140E-03	8.2508E-04	1.6037E-06	8.2378E-05	1.5730E-04
Pile N.	3	10	1	1	1	1

* PILE TOP REACTIONS *

PILE GROUP	FOR. X, KN	FOR. Y, KN	FOR. Z, KN	MOM X, KN- M	MOM Y, KN- M	MOM Z, KN- M
*****	*****	*****	*****	*****	*****	*****
1	3545.2	-305.07	258.59	0.6249	-573.36	-585.46

APPALTATORE: Consorzio Soci   	ITINERARIO NAPOLI – BARI RADDOPPIO TRATTA APICE – ORSARA I LOTTO FUNZIONALE APICE – HIRPINIA				
PROGETTAZIONE: Mandataria Mandanti   					
PROGETTO ESECUTIVO RELAZIONE DI CALCOLO FONDAZIONI PILE DA P17 A P20					
COMMESSA IF1N	LOTTO 01 E ZZ	CODIFICA RG	DOCUMENTO MD0000 001	REV. B	FOGLIO 102 di 143

2	4906.5	-297.50	249.55	0.6249	-554.93	-572.89
3	5863.1	-348.02	285.75	0.6249	-614.94	-659.62
4	2814.4	-255.72	221.42	0.6249	-506.39	-495.11
5	4209.7	-246.66	211.51	0.6249	-485.85	-479.25
6	5362.2	-312.99	261.05	0.6249	-572.40	-596.98
7	2083.7	-249.66	218.68	0.6249	-501.17	-481.15
8	3479.0	-241.04	209.08	0.6249	-481.17	-466.04
9	4861.2	-307.95	259.59	0.6249	-569.77	-585.14
10	1353.0	-267.85	235.76	0.6249	-532.21	-510.77
11	2748.3	-258.75	225.56	0.6249	-511.37	-495.14
12	4143.6	-318.80	270.76	0.6249	-589.00	-600.39
MINIMUM	1353.0	-348.02	209.08	0.6249	-614.94	-659.62
Pile N.	10	3	8	1	3	3
MAXIMUM	5863.1	-241.04	285.75	0.6249	-481.17	-466.04
Pile N.	3	8	3	1	8	8

THE PILE COORDINATE SYSTEM (LOCAL AXES)

* PILE TOP DISPLACEMENTS *

PILE GROUP	DISP. x, M	DISP. y, M	DISP. z, M	ROT. x,RAD	ROT. y,RAD	ROT. z,RAD
1	1.7717E-03	-1.1357E-03	8.2508E-04	1.6037E-06	8.2378E-05	1.5730E-04
2	2.4796E-03	-1.1357E-03	8.1787E-04	1.6037E-06	8.2378E-05	1.5730E-04
3	3.1874E-03	-1.1357E-03	8.1065E-04	1.6037E-06	8.2378E-05	1.5730E-04
4	1.4010E-03	-1.1285E-03	8.2508E-04	1.6037E-06	8.2378E-05	1.5730E-04
5	2.1089E-03	-1.1285E-03	8.1787E-04	1.6037E-06	8.2378E-05	1.5730E-04
6	2.8167E-03	-1.1285E-03	8.1065E-04	1.6037E-06	8.2378E-05	1.5730E-04
7	1.0303E-03	-1.1212E-03	8.2508E-04	1.6037E-06	8.2378E-05	1.5730E-04
8	1.7382E-03	-1.1212E-03	8.1787E-04	1.6037E-06	8.2378E-05	1.5730E-04
9	2.4460E-03	-1.1212E-03	8.1065E-04	1.6037E-06	8.2378E-05	1.5730E-04
10	6.5961E-04	-1.1140E-03	8.2508E-04	1.6037E-06	8.2378E-05	1.5730E-04
11	1.3675E-03	-1.1140E-03	8.1787E-04	1.6037E-06	8.2378E-05	1.5730E-04
12	2.0753E-03	-1.1140E-03	8.1065E-04	1.6037E-06	8.2378E-05	1.5730E-04
MINIMUM	6.5961E-04	-1.1357E-03	8.1065E-04	1.6037E-06	8.2378E-05	1.5730E-04
Pile N.	10	1	3	1	1	1
MAXIMUM	3.1874E-03	-1.1140E-03	8.2508E-04	1.6037E-06	8.2378E-05	1.5730E-04
Pile N.	3	10	1	1	1	1

* PILE TOP REACTIONS *

PILE GROUP	AXIAL, KN	LAT. y, KN	LAT. z, KN	MOM x, KN- M	MOM y, KN- M	MOM z, KN- M
1	3545.2	-305.07	258.59	0.6249	-573.36	-585.46
2	4906.5	-297.50	249.55	0.6249	-554.93	-572.89
3	5863.1	-348.02	285.75	0.6249	-614.94	-659.62
4	2814.4	-255.72	221.42	0.6249	-506.39	-495.11
5	4209.7	-246.66	211.51	0.6249	-485.85	-479.25
6	5362.2	-312.99	261.05	0.6249	-572.40	-596.98
7	2083.7	-249.66	218.68	0.6249	-501.17	-481.15
8	3479.0	-241.04	209.08	0.6249	-481.17	-466.04
9	4861.2	-307.95	259.59	0.6249	-569.77	-585.14
10	1353.0	-267.85	235.76	0.6249	-532.21	-510.77
11	2748.3	-258.75	225.56	0.6249	-511.37	-495.14
12	4143.6	-318.80	270.76	0.6249	-589.00	-600.39
MINIMUM	1353.0	-348.02	209.08	0.6249	-614.94	-659.62
Pile N.	10	3	8	1	3	3
MAXIMUM	5863.1	-241.04	285.75	0.6249	-481.17	-466.04
Pile N.	3	8	3	1	8	8

PILE GROUP STRESS, KN/ M**2

1	4479.3
2	5183.7
3	6039.5
4	3730.1
5	4441.9
6	5530.5
7	3275.9
8	3990.4
9	5215.8
10	2991.9
11	3703.5
12	4883.2
MINIMUM	2991.9
Pile N.	10
MAXIMUM	6039.5
Pile N.	3

* EFFECTS FOR LATERALLY LOADED PILE *

* MINIMUM VALUES AND LOCATIONS *

APPALTATORE:

Consorzio

Soci



ITINERARIO NAPOLI – BARI

PROGETTAZIONE:

Mandatario

Mandanti



RADDOPPIO TRATTA APICE – ORSARA
I LOTTO FUNZIONALE APICE – HIRPINIA

PROGETTO ESECUTIVO

RELAZIONE DI CALCOLO FONDAZIONI PILE DA P17 A P20

COMMESSA IF1N	LOTTO 01 E ZZ	CODIFICA RG	DOCUMENTO MD0000 001	REV. B	FOGLIO 103 di 143
------------------	------------------	----------------	-------------------------	-----------	-------------------------

PILE	DISPL. y-DIR M	DISPL. z-DIR M	MOMENT z-DIR KN- M	MOMENT y-DIR KN- M	SHEAR y-DIR KN	SHEAR z-DIR KN	SOIL REACT y-DIR KN/ M	SOIL REACT z-DIR KN/ M	TOTAL STRESS KN/ M**2	FLEX. RIG. z-DIR KN- M**2	FLEX. RIG. y-DIR KN- M**2
*****	*****	*****	*****	*****	*****	*****	*****	*****	*****	*****	*****
1	-1.1357E-03	-3.3533E-05	-385.19	-573.36	-305.10	-68.403	-132.74	-22.889	2006.1	7.8279E+06	7.8279E+06
x (M)	0.0000	9.1200	4.8000	0.0000	0.0000	6.9600	2.4000	7.9200	24.000	0.0000	0.0000
2	-1.1357E-03	-3.3527E-05	-379.87	-554.93	-297.54	-66.020	-127.99	-21.337	2776.5	7.8279E+06	7.8279E+06
x (M)	0.0000	9.3600	4.8000	0.0000	0.0000	6.9600	2.4000	7.9200	24.000	0.0000	0.0000
3	-1.1357E-03	-3.1376E-05	-417.82	-614.94	-348.08	-77.802	-162.13	-30.721	3317.8	7.8279E+06	7.8279E+06
x (M)	0.0000	8.8800	4.5600	0.0000	0.0000	6.7200	2.4000	7.9200	24.000	0.0000	0.0000
4	-1.1285E-03	-3.4925E-05	-347.17	-506.39	-255.74	-57.012	-102.61	-13.776	1592.6	7.8279E+06	7.8279E+06
x (M)	0.0000	9.6000	5.0400	0.0000	0.0000	7.2000	2.4000	7.9200	24.000	0.0000	0.0000
5	-1.1285E-03	-3.4826E-05	-340.61	-485.85	-246.69	-54.385	-97.361	-12.058	2382.2	7.8279E+06	7.8279E+06
x (M)	0.0000	9.6000	5.0400	0.0000	0.0000	7.2000	2.4000	7.9200	24.000	0.0000	0.0000
6	-1.1285E-03	-3.2662E-05	-391.19	-572.40	-313.04	-69.936	-139.25	-24.726	3034.4	7.8279E+06	7.8279E+06
x (M)	0.0000	9.1200	4.8000	0.0000	0.0000	6.9600	2.4000	7.9200	24.000	0.0000	0.0000
7	-1.1212E-03	-3.5005E-05	-342.26	-501.17	-249.67	-56.083	-99.729	-13.063	1179.1	7.8279E+06	7.8279E+06
x (M)	0.0000	9.6000	5.0400	0.0000	0.0000	7.2000	2.4000	7.9200	24.000	0.0000	0.0000
8	-1.1212E-03	-3.4866E-05	-335.98	-481.17	-241.06	-53.548	-94.769	-11.430	1968.7	7.8279E+06	7.8279E+06
x (M)	0.0000	9.6000	5.0400	0.0000	0.0000	7.4400	2.4000	7.9200	24.000	0.0000	0.0000
9	-1.1212E-03	-3.2758E-05	-387.24	-569.77	-307.99	-69.421	-136.89	-24.318	2750.9	7.8279E+06	7.8279E+06
x (M)	0.0000	9.1200	4.8000	0.0000	0.0000	6.9600	2.4000	7.9200	24.000	0.0000	0.0000
10	-1.1140E-03	-3.4507E-05	-356.17	-532.21	-267.86	-61.086	-111.61	-17.122	765.65	7.8279E+06	7.8279E+06
x (M)	0.0000	9.3600	4.8000	0.0000	0.0000	7.2000	2.4000	7.9200	24.000	0.0000	0.0000
11	-1.1140E-03	-3.4469E-05	-349.25	-511.37	-258.77	-58.473	-106.14	-15.309	1555.2	7.8279E+06	7.8279E+06
x (M)	0.0000	9.6000	4.8000	0.0000	0.0000	7.2000	2.4000	7.9200	24.000	0.0000	0.0000
12	-1.1140E-03	-3.2221E-05	-395.31	-589.00	-318.84	-72.668	-145.20	-26.957	2344.8	7.8279E+06	7.8279E+06
x (M)	0.0000	9.1200	4.5600	0.0000	0.0000	6.9600	2.4000	7.9200	24.000	0.0000	0.0000
Min.	-1.1357E-03	-3.5005E-05	-417.82	-614.94	-348.08	-77.802	-162.13	-30.721	765.65	7.8279E+06	7.8279E+06
Pile N.	1	7	3	3	3	3	3	3	10	1	1

* MAXIMUM VALUES AND LOCATIONS *

PILE	DISPL. y-DIR M	DISPL. z-DIR M	MOMENT z-DIR KN- M	MOMENT y-DIR KN- M	SHEAR y-DIR KN	SHEAR z-DIR KN	SOIL REACT y-DIR KN/ M	SOIL REACT z-DIR KN/ M	TOTAL STRESS KN/ M**2	FLEX. RIG. z-DIR KN- M**2	FLEX. RIG. y-DIR KN- M**2
*****	*****	*****	*****	*****	*****	*****	*****	*****	*****	*****	*****
1	4.4894E-05	8.2508E-04	585.46	282.24	93.318	258.62	33.472	103.35	4479.3	7.8279E+06	7.8279E+06
x (M)	9.1200	0.0000	0.0000	5.0400	6.7200	0.0000	7.9200	2.4000	0.0000	0.0000	0.0000
2	4.5393E-05	8.1787E-04	572.89	275.81	90.967	249.60	31.724	98.648	5183.7	7.8279E+06	7.8279E+06
x (M)	9.1200	0.0000	0.0000	5.0400	6.9600	0.0000	7.9200	2.4000	0.0000	0.0000	0.0000
3	4.2495E-05	8.1065E-04	659.62	300.52	107.88	285.81	43.873	123.52	6039.5	7.8279E+06	7.8279E+06
x (M)	8.8800	0.0000	0.0000	4.8000	6.7200	0.0000	7.9200	2.4000	0.0000	0.0000	0.0000
4	4.6900E-05	8.2508E-04	495.11	256.19	77.557	221.44	21.975	80.648	3730.1	7.8279E+06	7.8279E+06
x (M)	9.3600	0.0000	0.0000	5.2800	6.9600	0.0000	7.9200	2.4000	0.0000	0.0000	0.0000
5	4.7291E-05	8.1787E-04	479.25	248.95	74.831	211.54	19.894	75.758	4441.9	7.8279E+06	7.8279E+06
x (M)	9.6000	0.0000	0.0000	5.2800	7.2000	0.0000	7.9200	2.4000	0.0000	0.0000	0.0000
6	4.4072E-05	8.1065E-04	596.98	283.18	96.717	261.10	36.049	107.02	5530.5	7.8279E+06	7.8279E+06
x (M)	8.8800	0.0000	0.0000	5.0400	6.7200	0.0000	7.9200	2.4000	0.0000	0.0000	0.0000
7	4.6728E-05	8.2508E-04	481.15	254.17	75.820	218.69	21.018	79.031	3275.9	7.8279E+06	7.8279E+06
x (M)	9.3600	0.0000	0.0000	5.2800	6.9600	0.0000	7.9200	2.4000	0.0000	0.0000	0.0000
8	4.7136E-05	8.1787E-04	466.04	247.11	73.326	209.11	19.050	74.351	3990.4	7.8279E+06	7.8279E+06
x (M)	9.6000	0.0000	0.0000	5.2800	7.2000	0.0000	7.9200	2.4000	0.0000	0.0000	0.0000
9	4.3907E-05	8.1065E-04	585.14	282.18	95.381	259.63	35.343	106.06	5215.8	7.8279E+06	7.8279E+06
x (M)	9.1200	0.0000	0.0000	5.0400	6.7200	0.0000	7.9200	2.4000	0.0000	0.0000	0.0000
10	4.5494E-05	8.2508E-04	510.77	265.81	82.182	235.77	25.925	89.107	2991.9	7.8279E+06	7.8279E+06
x (M)	9.3600	0.0000	0.0000	5.0400	6.9600	0.0000	7.9200	2.4000	0.0000	0.0000	0.0000
11	4.6047E-05	8.1787E-04	495.14	258.53	79.341	225.58	23.813	83.898	3703.5	7.8279E+06	7.8279E+06
x (M)	9.3600	0.0000	0.0000	5.2800	6.9600	0.0000	7.9200	2.4000	0.0000	0.0000	0.0000
12	4.2886E-05	8.1065E-04	600.39	289.82	99.362	270.79	38.428	113.38	4883.2	7.8279E+06	7.8279E+06
x (M)	8.8800	0.0000	0.0000	4.8000	6.7200	0.0000	7.9200	2.4000	0.0000	0.0000	0.0000
Max.	4.7291E-05	8.2508E-04	659.62	300.52	107.88	285.81	43.873	123.52	6039.5	7.8279E+06	7.8279E+06
Pile N.	5	1	3	3	3	3	3	3	3	1	1

LOAD CASE : 6
CASE NAME : Load Case
LOAD TYPE : Special, Sp

REDUCTION FACTORS FOR CLOSELY-SPACED PILE GROUPS, COMBINED Y AND Z DIRECTIONS
ESTIMATED USING MOVEMENT IN THE DIRECTION OF PILE CAP DISPLACEMENTS

GROUP NO	P-FACTOR	Y-FACTOR
1	0.7821	1.0000
2	0.5525	1.0000
3	0.5845	1.0000
4	0.7274	1.0000
5	0.4843	1.0000
6	0.5126	1.0000
7	0.7364	1.0000
8	0.4955	1.0000
9	0.5253	1.0000
10	0.8661	1.0000

APPALTATORE: Consorzio  Soci  	ITINERARIO NAPOLI – BARI RADDOPPIO TRATTA APICE – ORSARA I LOTTO FUNZIONALE APICE – HIRPINIA											
PROGETTAZIONE: Mandataria  Mandanti  												
PROGETTO ESECUTIVO RELAZIONE DI CALCOLO FONDAZIONI PILE DA P17 A P20												
<table border="1" style="width: 100%; border-collapse: collapse;"> <tr> <td style="width: 15%;">COMMESSA</td> <td style="width: 15%;">LOTTO</td> <td style="width: 15%;">CODIFICA</td> <td style="width: 15%;">DOCUMENTO</td> <td style="width: 15%;">REV.</td> <td style="width: 15%;">FOGLIO</td> </tr> <tr> <td>IF1N</td> <td>01 E ZZ</td> <td>RG</td> <td>MD0000 001</td> <td>B</td> <td>104 di 143</td> </tr> </table>	COMMESSA	LOTTO	CODIFICA	DOCUMENTO	REV.	FOGLIO	IF1N	01 E ZZ	RG	MD0000 001	B	104 di 143
COMMESSA	LOTTO	CODIFICA	DOCUMENTO	REV.	FOGLIO							
IF1N	01 E ZZ	RG	MD0000 001	B	104 di 143							

11	0.6644	1.0000
12	0.6929	1.0000

* TABLE L * COMPUTATION ON PILE CAP

* EQUIVALENT CONCENTRATED LOAD AT ORIGIN *

VERT. LOAD, KN	HOR. LOAD Y, KN	HOR. LOAD Z, KN
17293.0	3471.60	-2907.30
MOMENT X, KN- M	MOMENT Y, KN- M	MOMENT Z, KN- M
-113.000	-38705.2	-41060.8

* DISPLACEMENT OF GROUPED PILE FOUNDATION AT ORIGIN *

VERTICAL, M	HORIZONTAL Y, M	HORIZONTAL Z, M
7.12682E-04	1.10985E-03	-7.94681E-04
ANGLE ROT. X, RAD	ANGLE ROT. Y, RAD	ANGLE ROT. Z, RAD
3.90100E-07	-7.43593E-05	-1.47666E-04

THE GLOBAL STRUCTURAL COORDINATE SYSTEM

* PILE TOP DISPLACEMENTS *

PILE GROUP	DISP. X, M	DISP. Y, M	DISP. Z, M	ROT. X, RAD	ROT. Y, RAD	ROT. Z, RAD
*****	*****	*****	*****	*****	*****	*****
1	8.7525E-04	1.1072E-03	-7.9293E-04	3.9010E-07	-7.4359E-05	-1.4767E-04
2	2.1076E-04	1.1072E-03	-7.9468E-04	3.9010E-07	-7.4359E-05	-1.4767E-04
3	-4.5374E-04	1.1072E-03	-7.9644E-04	3.9010E-07	-7.4359E-05	-1.4767E-04
4	1.2099E-03	1.1090E-03	-7.9293E-04	3.9010E-07	-7.4359E-05	-1.4767E-04
5	5.4537E-04	1.1090E-03	-7.9468E-04	3.9010E-07	-7.4359E-05	-1.4767E-04
6	-1.1912E-04	1.1090E-03	-7.9644E-04	3.9010E-07	-7.4359E-05	-1.4767E-04
7	1.5445E-03	1.1107E-03	-7.9293E-04	3.9010E-07	-7.4359E-05	-1.4767E-04
8	8.7999E-04	1.1107E-03	-7.9468E-04	3.9010E-07	-7.4359E-05	-1.4767E-04
9	2.1549E-04	1.1107E-03	-7.9644E-04	3.9010E-07	-7.4359E-05	-1.4767E-04
10	1.8791E-03	1.1125E-03	-7.9293E-04	3.9010E-07	-7.4359E-05	-1.4767E-04
11	1.2146E-03	1.1125E-03	-7.9468E-04	3.9010E-07	-7.4359E-05	-1.4767E-04
12	5.5011E-04	1.1125E-03	-7.9644E-04	3.9010E-07	-7.4359E-05	-1.4767E-04
MINIMUM	-4.5374E-04	1.1072E-03	-7.9644E-04	3.9010E-07	-7.4359E-05	-1.4767E-04
Pile N.	3	1	3	1	1	1
MAXIMUM	1.8791E-03	1.1125E-03	-7.9293E-04	3.9010E-07	-7.4359E-05	-1.4767E-04
Pile N.	10	10	1	1	1	1

* PILE TOP REACTIONS *

PILE GROUP	FOR. X, KN	FOR. Y, KN	FOR. Z, KN	MOM X, KN- M	MOM Y, KN- M	MOM Z, KN- M
*****	*****	*****	*****	*****	*****	*****
1	1778.1	327.64	-272.55	0.1520	605.15	637.22
2	438.18	266.75	-225.44	0.1520	521.83	530.24
3	-920.73	276.02	-233.43	0.1520	536.68	546.30
4	2437.7	314.51	-261.68	0.1520	586.41	615.71
5	1127.8	246.94	-209.29	0.1520	492.15	495.18
6	-241.73	255.66	-216.80	0.1520	506.40	510.57
7	3097.2	317.37	-263.31	0.1520	589.42	621.61
8	1787.4	250.80	-211.84	0.1520	497.07	503.14
9	448.03	259.90	-219.65	0.1520	511.82	519.19
10	3756.8	349.73	-287.85	0.1520	631.86	677.57
11	2447.0	299.31	-249.37	0.1520	565.40	590.75
12	1137.2	306.97	-256.10	0.1520	577.66	603.57
MINIMUM	-920.73	246.94	-287.85	0.1520	492.15	495.18
Pile N.	3	5	10	1	5	5
MAXIMUM	3756.8	349.73	-209.29	0.1520	631.86	677.57
Pile N.	10	10	5	1	10	10

THE PILE COORDINATE SYSTEM (LOCAL AXES)

* PILE TOP DISPLACEMENTS *

PILE GROUP	DISP. x, M	DISP. y, M	DISP. z, M	ROT. x, RAD	ROT. y, RAD	ROT. z, RAD
*****	*****	*****	*****	*****	*****	*****
1	8.7525E-04	1.1072E-03	-7.9293E-04	3.9010E-07	-7.4359E-05	-1.4767E-04
2	2.1076E-04	1.1072E-03	-7.9468E-04	3.9010E-07	-7.4359E-05	-1.4767E-04
3	-4.5374E-04	1.1072E-03	-7.9644E-04	3.9010E-07	-7.4359E-05	-1.4767E-04
4	1.2099E-03	1.1090E-03	-7.9293E-04	3.9010E-07	-7.4359E-05	-1.4767E-04
5	5.4537E-04	1.1090E-03	-7.9468E-04	3.9010E-07	-7.4359E-05	-1.4767E-04

APPALTATORE:

Consorzio

Soci



ITINERARIO NAPOLI – BARI

PROGETTAZIONE:

Mandataria

Mandanti



**RADDOPPIO TRATTA APICE – ORSARA
I LOTTO FUNZIONALE APICE – HIRPINIA**

PROGETTO ESECUTIVO

RELAZIONE DI CALCOLO FONDAZIONI PILE DA P17 A P20

COMMESSA IF1N	LOTTO 01 E ZZ	CODIFICA RG	DOCUMENTO MD0000 001	REV. B	FOGLIO 105 di 143
------------------	------------------	----------------	-------------------------	-----------	-------------------------

6	-1.1912E-04	1.1090E-03	-7.9644E-04	3.9010E-07	-7.4359E-05	-1.4767E-04
7	1.5445E-04	1.1107E-03	-7.9293E-04	3.9010E-07	-7.4359E-05	-1.4767E-04
8	8.7999E-03	1.1107E-03	-7.9468E-04	3.9010E-07	-7.4359E-05	-1.4767E-04
9	2.1549E-04	1.1107E-03	-7.9644E-04	3.9010E-07	-7.4359E-05	-1.4767E-04
10	1.8791E-04	1.1125E-03	-7.9293E-04	3.9010E-07	-7.4359E-05	-1.4767E-04
11	1.2146E-03	1.1125E-03	-7.9468E-04	3.9010E-07	-7.4359E-05	-1.4767E-04
12	5.5011E-04	1.1125E-03	-7.9644E-04	3.9010E-07	-7.4359E-05	-1.4767E-04
MINIMUM	-4.5374E-04	1.1072E-03	-7.9644E-04	3.9010E-07	-7.4359E-05	-1.4767E-04
Pile N.	3	1	3	1	1	1
MAXIMUM	1.8791E-03	1.1125E-03	-7.9293E-04	3.9010E-07	-7.4359E-05	-1.4767E-04
Pile N.	10	10	1	1	1	1

* PILE TOP REACTIONS *

PILE GROUP	AXIAL, KN	LAT. y, KN	LAT. z, KN	MOM x, KN- M	MOM y, KN- M	MOM z, KN- M
1	1778.1	327.64	-272.55	0.1520	605.15	637.22
2	438.18	266.75	-225.44	0.1520	521.83	530.24
3	-920.73	276.02	-233.43	0.1520	536.68	546.30
4	2437.7	314.51	-261.68	0.1520	586.41	615.71
5	1127.8	246.94	-209.29	0.1520	492.15	495.18
6	-241.73	255.66	-216.80	0.1520	506.40	510.57
7	3097.2	317.37	-263.31	0.1520	589.42	621.61
8	1787.4	250.80	-211.84	0.1520	497.07	503.14
9	448.03	259.90	-219.65	0.1520	511.82	519.19
10	3756.8	349.73	-287.85	0.1520	631.86	677.57
11	2447.0	299.31	-249.37	0.1520	565.40	590.75
12	1137.2	306.97	-256.10	0.1520	577.66	603.57
MINIMUM	-920.73	246.94	-287.85	0.1520	492.15	495.18
Pile N.	3	5	10	1	5	5
MAXIMUM	3756.8	349.73	-209.29	0.1520	631.86	677.57
Pile N.	10	10	5	1	10	10

PILE GROUP STRESS, KN/ M**2

1	3658.4
2	2493.2
3	2832.3
4	3945.6
5	2745.3
6	2307.1
7	4338.0
8	3146.0
9	2453.9
10	4922.1
11	3852.6
12	3165.0
MINIMUM	2307.1
Pile N.	6
MAXIMUM	4922.1
Pile N.	10

* EFFECTS FOR LATERALLY LOADED PILE *

* MINIMUM VALUES AND LOCATIONS *

PILE	DISPL.		MOMENT		SHEAR		SOIL REACT		TOTAL STRESS	FLEX. RIG.	
	y-DIR	z-DIR	y-DIR	z-DIR	y-DIR	z-DIR	y-DIR	z-DIR		z-DIR	y-DIR
	M	M	KN- M	KN- M	KN	KN	KN/ M	KN/ M	KN/ M**2	KN- M**2	KN- M**2
1	-4.2697E-05	-7.9293E-04	-637.22	-283.69	-98.508	-272.56	-37.759	-112.59	1006.2	7.8279E+06	7.8279E+06
x(M)	8.8800	0.0000	0.0000	5.0400	6.7200	0.0000	7.9200	2.4000	24.000	0.0000	0.0000
2	-4.5760E-05	-7.9468E-04	-530.24	-251.68	-78.465	-225.44	-22.925	-82.702	247.96	7.8279E+06	7.8279E+06
x(M)	9.3600	0.0000	0.0000	5.2800	6.9600	0.0000	7.9200	2.4000	24.000	0.0000	0.0000
3	-4.5295E-05	-7.9644E-04	-546.30	-256.97	-81.365	-233.42	-25.066	-87.192	521.03	7.8279E+06	7.8279E+06
x(M)	9.3600	0.0000	0.0000	5.2800	6.9600	0.0000	7.9200	2.4000	24.000	0.0000	0.0000
4	-4.3530E-05	-7.9293E-04	-615.71	-276.71	-94.055	-261.70	-34.530	-105.51	1379.4	7.8279E+06	7.8279E+06
x(M)	9.1200	0.0000	0.0000	5.0400	6.7200	0.0000	7.9200	2.4000	24.000	0.0000	0.0000
5	-4.6591E-05	-7.9468E-04	-495.18	-240.40	-72.322	-209.30	-18.094	-73.389	638.23	7.8279E+06	7.8279E+06
x(M)	9.6000	0.0000	0.0000	5.2800	7.2000	0.0000	7.9200	2.4000	24.000	0.0000	0.0000
6	-4.6176E-05	-7.9644E-04	-510.57	-245.71	-74.811	-216.80	-20.068	-77.426	136.79	7.8279E+06	7.8279E+06
x(M)	9.3600	0.0000	0.0000	5.2800	7.2000	0.0000	7.9200	2.4000	24.000	0.0000	0.0000
7	-4.3476E-05	-7.9293E-04	-621.61	-277.87	-95.011	-263.34	-35.139	-106.61	1752.7	7.8279E+06	7.8279E+06
x(M)	9.1200	0.0000	0.0000	5.0400	6.7200	0.0000	7.9200	2.4000	24.000	0.0000	0.0000
8	-4.6554E-05	-7.9468E-04	-503.14	-242.34	-73.498	-211.85	-18.926	-74.873	1011.5	7.8279E+06	7.8279E+06
x(M)	9.6000	0.0000	0.0000	5.2800	7.2000	0.0000	7.9200	2.4000	24.000	0.0000	0.0000
9	-4.6165E-05	-7.9644E-04	-519.19	-247.80	-76.080	-219.65	-21.002	-79.110	253.53	7.8279E+06	7.8279E+06
x(M)	9.3600	0.0000	0.0000	5.2800	7.2000	0.0000	7.9200	2.4000	24.000	0.0000	0.0000
10	-4.1784E-05	-7.9293E-04	-677.57	-294.59	-105.66	-287.89	-42.748	-123.02	2125.9	7.8279E+06	7.8279E+06
x(M)	8.8000	0.0000	0.0000	4.8000	6.7200	0.0000	7.9200	2.4000	24.000	0.0000	0.0000
11	-4.4573E-05	-7.9468E-04	-590.75	-268.43	-88.930	-249.39	-30.581	-97.421	1384.7	7.8279E+06	7.8279E+06
x(M)	9.1200	0.0000	0.0000	5.0400	6.9600	0.0000	7.9200	2.4000	24.000	0.0000	0.0000
12	-4.4134E-05	-7.9644E-04	-603.57	-272.99	-91.132	-256.11	-32.337	-101.36	643.51	7.8279E+06	7.8279E+06
x(M)	9.1200	0.0000	0.0000	5.0400	6.9600	0.0000	7.9200	2.4000	24.000	0.0000	0.0000

APPALTATORE:

Consorzio

Soci



ITINERARIO NAPOLI – BARI

PROGETTAZIONE:

Mandataria

Mandanti

RADDOPPIO TRATTA APICE – ORSARA
I LOTTO FUNZIONALE APICE – HIRPINIA

PROGETTO ESECUTIVO

RELAZIONE DI CALCOLO FONDAZIONI PILE DA P17 A P20

COMMESSA	LOTTO	CODIFICA	DOCUMENTO	REV.	FOGLIO
IF1N	01 E ZZ	RG	MD0000 001	B	106 di 143

Min. Pile N.	-4.6591E-05	-7.9644E-04	-677.57	-294.59	-105.66	-287.89	-42.748	-123.02	136.79	7.8279E+06	7.8279E+06
	5	3	10	10	10	10	10	10	6	1	1

* MAXIMUM VALUES AND LOCATIONS *

PILE	DISPL. y-DIR M	DISPL. z-DIR M	MOMENT z-DIR KN- M	MOMENT y-DIR KN- M	SHEAR y-DIR KN	SHEAR z-DIR KN	SOIL REACT y-DIR KN/ M	SOIL REACT z-DIR KN/ M	TOTAL STRESS KN/ M**2	FLEX. RIG. z-DIR KN- M**2	FLEX. RIG. y-DIR KN- M**2
*****	*****	*****	*****	*****	*****	*****	*****	*****	*****	*****	*****
1	1.1072E-03	3.1623E-05	392.20	605.15	327.65	71.143	146.65	26.041	3658.4	7.8279E+06	7.8279E+06
x(M)	0.0000	9.1200	4.8000	0.0000	0.0000	6.9600	2.4000	7.9200	0.0000	0.0000	0.0000
2	1.1072E-03	3.3530E-05	346.72	521.83	266.75	56.743	107.26	14.363	2493.2	7.8279E+06	7.8279E+06
x(M)	0.0000	9.6000	5.0400	0.0000	0.0000	7.2000	2.4000	7.9200	0.0000	0.0000	0.0000
3	1.1072E-03	3.3328E-05	353.20	536.68	276.01	58.922	112.83	16.076	2832.3	7.8279E+06	7.8279E+06
x(M)	0.0000	9.3600	4.8000	0.0000	0.0000	7.2000	2.4000	7.9200	0.0000	0.0000	0.0000
4	1.1090E-03	3.2127E-05	383.04	586.41	314.53	67.937	137.65	23.448	3945.6	7.8279E+06	7.8279E+06
x(M)	0.0000	9.1200	4.8000	0.0000	0.0000	6.9600	2.4000	7.9200	0.0000	0.0000	0.0000
5	1.1090E-03	3.3847E-05	331.96	492.15	246.95	52.063	95.308	10.963	2745.3	7.8279E+06	7.8279E+06
x(M)	0.0000	9.6000	5.0400	0.0000	0.0000	7.4400	2.4000	14.160	0.0000	0.0000	0.0000
6	1.1090E-03	3.3806E-05	338.37	506.40	255.66	54.003	100.32	12.119	2307.1	7.8279E+06	7.8279E+06
x(M)	0.0000	9.6000	5.0400	0.0000	0.0000	7.2000	2.4000	7.9200	0.0000	0.0000	0.0000
7	1.1107E-03	3.2061E-05	385.29	589.42	317.40	68.501	139.37	23.891	4338.0	7.8279E+06	7.8279E+06
x(M)	0.0000	9.1200	4.8000	0.0000	0.0000	6.9600	2.4000	7.9200	0.0000	0.0000	0.0000
8	1.1107E-03	3.3843E-05	335.10	497.07	250.81	52.797	97.438	11.198	3146.0	7.8279E+06	7.8279E+06
x(M)	0.0000	9.6000	5.0400	0.0000	0.0000	7.4400	2.4000	7.9200	0.0000	0.0000	0.0000
9	1.1107E-03	3.3762E-05	341.75	511.82	259.90	54.937	102.72	12.839	2453.9	7.8279E+06	7.8279E+06
x(M)	0.0000	9.6000	5.0400	0.0000	0.0000	7.2000	2.4000	7.9200	0.0000	0.0000	0.0000
10	1.1125E-03	3.0853E-05	409.18	631.86	349.77	76.110	161.26	29.845	4922.1	7.8279E+06	7.8279E+06
x(M)	0.0000	8.8800	4.5600	0.0000	0.0000	6.7200	2.4000	7.9200	0.0000	0.0000	0.0000
11	1.1125E-03	3.2727E-05	371.89	565.40	299.33	64.014	127.22	20.313	3852.6	7.8279E+06	7.8279E+06
x(M)	0.0000	9.3600	4.8000	0.0000	0.0000	6.9600	2.4000	7.9200	0.0000	0.0000	0.0000
12	1.1125E-03	3.2486E-05	377.34	577.66	306.98	65.938	132.05	21.736	3165.0	7.8279E+06	7.8279E+06
x(M)	0.0000	9.1200	4.8000	0.0000	0.0000	6.9600	2.4000	7.9200	0.0000	0.0000	0.0000
Max. Pile N.	1.1125E-03	3.3847E-05	409.18	631.86	349.77	76.110	161.26	29.845	4922.1	7.8279E+06	7.8279E+06
	10	5	10	10	10	10	10	10	10	1	1

LOAD CASE : 7
CASE NAME : Load Case
LOAD TYPE : Special, Sp

REDUCTION FACTORS FOR CLOSELY-SPACED PILE GROUPS, COMBINED Y AND Z DIRECTIONS
ESTIMATED USING MOVEMENT IN THE DIRECTION OF PILE CAP DISPLACEMENTS

GROUP NO	P-FACTOR	Y-FACTOR
1	0.6339	1.0000
2	0.5096	1.0000
3	0.5845	1.0000
4	0.5902	1.0000
5	0.4675	1.0000
6	0.5375	1.0000
7	0.6176	1.0000
8	0.4960	1.0000
9	0.5675	1.0000
10	0.8661	1.0000
11	0.7761	1.0000
12	0.8306	1.0000

* TABLE L * COMPUTATION ON PILE CAP

* EQUIVALENT CONCENTRATED LOAD AT ORIGIN *

VERT. LOAD, KN	HOR. LOAD Y, KN	HOR. LOAD Z, KN
26180.0	3471.60	-9692.10
MOMENT X, KN- M	MOMENT Y, KN- M	MOMENT Z, KN- M
-376.000	-1.29059E+05	-41104.8

* DISPLACEMENT OF GROUPED PILE FOUNDATION AT ORIGIN *

VERTICAL, M	HORIZONTAL Y, M	HORIZONTAL Z, M
1.13695E-03	1.48683E-03	-3.57597E-03
ANGLE ROT. X, RAD	ANGLE ROT. Y, RAD	ANGLE ROT. Z, RAD
-1.04972E-05	-2.66671E-04	-1.63036E-04

THE GLOBAL STRUCTURAL COORDINATE SYSTEM

APPALTATORE: Consorzio Soci   		ITINERARIO NAPOLI – BARI RADDOPPIO TRATTA APICE – ORSARA I LOTTO FUNZIONALE APICE – HIRPINIA
PROGETTAZIONE: Mandataria Mandanti   		
PROGETTO ESECUTIVO RELAZIONE DI CALCOLO FONDAZIONI PILE DA P17 A P20		

* PILE TOP DISPLACEMENTS *

PILE GROUP	DISP. X, M	DISP. Y, M	DISP. Z, M	ROT. X,RAD	ROT. Y,RAD	ROT. Z,RAD
1	7.0583E-05	1.5577E-03	-3.6232E-03	-1.0497E-05	-2.6667E-04	-1.6304E-04
2	-6.6308E-04	1.5577E-03	-3.5760E-03	-1.0497E-05	-2.6667E-04	-1.6304E-04
3	-1.3967E-03	1.5577E-03	-3.5287E-03	-1.0497E-05	-2.6667E-04	-1.6304E-04
4	1.2706E-03	1.5104E-03	-3.6232E-03	-1.0497E-05	-2.6667E-04	-1.6304E-04
5	5.3694E-04	1.5104E-03	-3.5760E-03	-1.0497E-05	-2.6667E-04	-1.6304E-04
6	-1.9673E-04	1.5104E-03	-3.5287E-03	-1.0497E-05	-2.6667E-04	-1.6304E-04
7	2.4706E-03	1.4632E-03	-3.6232E-03	-1.0497E-05	-2.6667E-04	-1.6304E-04
8	1.7370E-03	1.4632E-03	-3.5760E-03	-1.0497E-05	-2.6667E-04	-1.6304E-04
9	1.0033E-03	1.4632E-03	-3.5287E-03	-1.0497E-05	-2.6667E-04	-1.6304E-04
10	3.6706E-03	1.4160E-03	-3.6232E-03	-1.0497E-05	-2.6667E-04	-1.6304E-04
11	2.9370E-03	1.4160E-03	-3.5760E-03	-1.0497E-05	-2.6667E-04	-1.6304E-04
12	2.2033E-03	1.4160E-03	-3.5287E-03	-1.0497E-05	-2.6667E-04	-1.6304E-04
MINIMUM	-1.3967E-03	1.4160E-03	-3.6232E-03	-1.0497E-05	-2.6667E-04	-1.6304E-04
Pile N.	3	10	1	1	1	1
MAXIMUM	3.6706E-03	1.5577E-03	-3.5287E-03	-1.0497E-05	-2.6667E-04	-1.6304E-04
Pile N.	10	1	3	1	1	1

* PILE TOP REACTIONS *

PILE GROUP	FOR. X, KN	FOR. Y, KN	FOR. Z, KN	MOM X, KN- M	MOM Y, KN- M	MOM Z, KN- M
1	146.75	313.88	-827.96	-4.0902	2091.2	706.79
2	-1327.1	270.27	-705.67	-4.0902	1823.5	617.16
3	-2747.2	299.55	-765.24	-4.0902	1934.9	676.80
4	2557.4	285.30	-789.34	-4.0902	2014.9	637.35
5	1111.2	242.56	-665.26	-4.0902	1740.1	548.39
6	-399.20	269.79	-723.28	-4.0902	1850.5	604.55
7	4894.4	281.09	-814.10	-4.0902	2068.6	616.84
8	3476.6	241.32	-693.09	-4.0902	1802.5	535.06
9	2030.5	267.45	-750.64	-4.0902	1910.4	588.30
10	6516.1	343.32	-1030.1	-4.0902	2503.1	725.33
11	5524.6	320.21	-948.87	-4.0902	2333.2	682.09
12	4395.9	336.87	-978.55	-4.0902	2373.5	712.82
MINIMUM	-2747.2	241.32	-1030.1	-4.0902	1740.1	535.06
Pile N.	3	8	10	1	5	8
MAXIMUM	6516.1	343.32	-665.26	-4.0902	2503.1	725.33
Pile N.	10	10	5	1	10	10

THE PILE COORDINATE SYSTEM (LOCAL AXES)

* PILE TOP DISPLACEMENTS *

PILE GROUP	DISP. x, M	DISP. y, M	DISP. z, M	ROT. x,RAD	ROT. y,RAD	ROT. z,RAD
1	7.0583E-05	1.5577E-03	-3.6232E-03	-1.0497E-05	-2.6667E-04	-1.6304E-04
2	-6.6308E-04	1.5577E-03	-3.5760E-03	-1.0497E-05	-2.6667E-04	-1.6304E-04
3	-1.3967E-03	1.5577E-03	-3.5287E-03	-1.0497E-05	-2.6667E-04	-1.6304E-04
4	1.2706E-03	1.5104E-03	-3.6232E-03	-1.0497E-05	-2.6667E-04	-1.6304E-04
5	5.3694E-04	1.5104E-03	-3.5760E-03	-1.0497E-05	-2.6667E-04	-1.6304E-04
6	-1.9673E-04	1.5104E-03	-3.5287E-03	-1.0497E-05	-2.6667E-04	-1.6304E-04
7	2.4706E-03	1.4632E-03	-3.6232E-03	-1.0497E-05	-2.6667E-04	-1.6304E-04
8	1.7370E-03	1.4632E-03	-3.5760E-03	-1.0497E-05	-2.6667E-04	-1.6304E-04
9	1.0033E-03	1.4632E-03	-3.5287E-03	-1.0497E-05	-2.6667E-04	-1.6304E-04
10	3.6706E-03	1.4160E-03	-3.6232E-03	-1.0497E-05	-2.6667E-04	-1.6304E-04
11	2.9370E-03	1.4160E-03	-3.5760E-03	-1.0497E-05	-2.6667E-04	-1.6304E-04
12	2.2033E-03	1.4160E-03	-3.5287E-03	-1.0497E-05	-2.6667E-04	-1.6304E-04
MINIMUM	-1.3967E-03	1.4160E-03	-3.6232E-03	-1.0497E-05	-2.6667E-04	-1.6304E-04
Pile N.	3	10	1	1	1	1
MAXIMUM	3.6706E-03	1.5577E-03	-3.5287E-03	-1.0497E-05	-2.6667E-04	-1.6304E-04
Pile N.	10	1	3	1	1	1

* PILE TOP REACTIONS *

PILE GROUP	AXIAL, KN	LAT. y, KN	LAT. z, KN	MOM x, KN- M	MOM y, KN- M	MOM z, KN- M
1	146.75	313.88	-827.96	-4.0902	2091.2	706.79
2	-1327.1	270.27	-705.67	-4.0902	1823.5	617.16
3	-2747.2	299.55	-765.24	-4.0902	1934.9	676.80
4	2557.4	285.30	-789.34	-4.0902	2014.9	637.35
5	1111.2	242.56	-665.26	-4.0902	1740.1	548.39
6	-399.20	269.79	-723.28	-4.0902	1850.5	604.55
7	4894.4	281.09	-814.10	-4.0902	2068.6	616.84
8	3476.6	241.32	-693.09	-4.0902	1802.5	535.06
9	2030.5	267.45	-750.64	-4.0902	1910.4	588.30
10	6516.1	343.32	-1030.1	-4.0902	2503.1	725.33
11	5524.6	320.21	-948.87	-4.0902	2333.2	682.09
12	4395.9	336.87	-978.55	-4.0902	2373.5	712.82

APPALDATTORE:					
Consorzio	Soci				
			ITINERARIO NAPOLI – BARI		
PROGETTAZIONE:					
Mandataria	Mandanti				
			RADDOPPIO TRATTA APICE – ORSARA I LOTTO FUNZIONALE APICE – HIRPINIA		
PROGETTO ESECUTIVO	COMMESSA	LOTTO	CODIFICA	DOCUMENTO	REV.
RELAZIONE DI CALCOLO FONDAZIONI PILE DA P17 A P20	IF1N	01 E ZZ	RG	MD0000 001	B
					FOGLIO 108 di 143

MINIMUM	-2747.2	241.32	-1030.1	-4.0902	1740.1	535.06
Pile N.	3	8	10	1	5	8
MAXIMUM	6516.1	343.32	-665.26	-4.0902	2503.1	725.33
Pile N.	10	10	5	1	10	10

PILE GROUP	STRESS, KN/ M**2
*****	*****
1	6745.0
2	6561.1
3	7741.1
4	7825.1
5	6135.1
6	6101.3
7	9284.6
8	7642.1
9	7181.9
10	1.1553E+04
11	1.0463E+04
12	9967.0

MINIMUM	6101.3
Pile N.	6
MAXIMUM	1.1553E+04
Pile N.	10

* EFFECTS FOR LATERALLY LOADED PILE *

* MINIMUM VALUES AND LOCATIONS *

PILE	DISPL.	DISPL.	MOMENT	MOMENT	SHEAR	SHEAR	SOIL REACT	SOIL REACT	TOTAL	FLEX. RIG.	FLEX. RIG.
	y-Dir	z-Dir	z-Dir	y-Dir	y-Dir	z-Dir	y-Dir	z-Dir	STRESS	z-Dir	y-Dir
	M	M	KN- M	KN- M	KN	KN	KN/ M	KN/ M	KN/ M**2	KN- M**2	KN- M**2
*****	*****	*****	*****	*****	*****	*****	*****	*****	*****	*****	*****
1	-4.0011E-05	-3.6232E-03	-706.79	-892.73	-79.471	-827.97	-21.963	-252.54	83.042	7.8279E+06	7.8279E+06
x(M)	10.560	0.0000	0.0000	6.0000	8.4000	0.0000	14.160	2.4000	24.000	0.0000	0.0000
2	-3.6093E-05	-3.5760E-03	-617.16	-795.84	-67.320	-705.64	-20.277	-203.54	750.96	7.8279E+06	7.8279E+06
x(M)	11.040	0.0000	0.0000	6.2400	8.8800	0.0000	14.160	2.4000	24.000	0.0000	0.0000
3	-3.8976E-05	-3.5287E-03	-676.80	-840.90	-75.192	-765.16	-21.638	-229.75	1554.6	7.8279E+06	7.8279E+06
x(M)	10.560	0.0000	0.0000	6.0000	8.4000	0.0000	14.160	2.4000	24.000	0.0000	0.0000
4	-3.7903E-05	-3.6232E-03	-637.35	-864.81	-73.163	-789.42	-20.668	-236.58	1447.2	7.8279E+06	7.8279E+06
x(M)	10.560	0.0000	0.0000	6.0000	8.4000	0.0000	14.160	2.4000	24.000	0.0000	0.0000
5	-3.3795E-05	-3.5760E-03	-548.39	-764.91	-61.296	-665.29	-18.758	-187.97	628.82	7.8279E+06	7.8279E+06
x(M)	11.040	0.0000	0.0000	6.2400	8.8800	0.0000	14.160	2.4000	24.000	0.0000	0.0000
6	-3.6628E-05	-3.5287E-03	-604.55	-809.08	-68.578	-723.27	-20.136	-212.73	225.90	7.8279E+06	7.8279E+06
x(M)	10.800	0.0000	0.0000	6.0000	8.6400	0.0000	14.160	2.4000	24.000	0.0000	0.0000
7	-3.7741E-05	-3.6232E-03	-616.84	-885.42	-73.486	-814.26	-20.176	-247.54	2769.7	7.8279E+06	7.8279E+06
x(M)	10.560	0.0000	0.0000	6.0000	8.4000	0.0000	14.160	2.4000	24.000	0.0000	0.0000
8	-3.4189E-05	-3.5760E-03	-535.06	-789.03	-62.385	-693.19	-18.598	-199.33	1967.4	7.8279E+06	7.8279E+06
x(M)	11.040	0.0000	0.0000	6.2400	8.8800	0.0000	14.160	2.4000	24.000	0.0000	0.0000
9	-3.6778E-05	-3.5287E-03	-588.30	-832.60	-69.450	-750.70	-19.822	-224.51	1149.0	7.8279E+06	7.8279E+06
x(M)	10.560	0.0000	0.0000	6.0000	8.4000	0.0000	14.160	2.4000	24.000	0.0000	0.0000
10	-4.1907E-05	-3.6232E-03	-725.33	-1055.8	-93.229	-1030.3	-20.954	-342.46	3687.4	7.8279E+06	7.8279E+06
x(M)	9.6000	0.0000	0.0000	5.5200	7.6800	0.0000	10.560	2.4000	24.000	0.0000	0.0000
11	-4.1731E-05	-3.5760E-03	-682.09	-997.36	-86.907	-949.06	-19.350	-306.34	3126.3	7.8279E+06	7.8279E+06
x(M)	9.8400	0.0000	0.0000	5.7600	7.6800	0.0000	10.560	2.4000	24.000	0.0000	0.0000
12	-4.2070E-05	-3.5287E-03	-712.82	-1014.3	-91.343	-978.70	-20.417	-323.58	2487.6	7.8279E+06	7.8279E+06
x(M)	9.8400	0.0000	0.0000	5.5200	7.6800	0.0000	10.560	2.4000	24.000	0.0000	0.0000
Min.	-4.2070E-05	-3.6232E-03	-725.33	-1055.8	-93.229	-1030.3	-21.963	-342.46	83.042	7.8279E+06	7.8279E+06
Pile N.	12	1	10	10	10	10	1	10	1	1	1

* MAXIMUM VALUES AND LOCATIONS *

PILE	DISPL.	DISPL.	MOMENT	MOMENT	SHEAR	SHEAR	SOIL REACT	SOIL REACT	TOTAL	FLEX. RIG.	FLEX. RIG.
	y-Dir	z-Dir	z-Dir	y-Dir	y-Dir	z-Dir	y-Dir	z-Dir	STRESS	z-Dir	y-Dir
	M	M	KN- M	KN- M	KN	KN	KN/ M	KN/ M	KN/ M**2	KN- M**2	KN- M**2
*****	*****	*****	*****	*****	*****	*****	*****	*****	*****	*****	*****
1	1.5577E-03	9.2376E-05	380.39	2091.2	313.88	189.17	102.63	55.875	6745.0	7.8279E+06	7.8279E+06
x(M)	0.0000	10.560	5.7600	0.0000	0.0000	8.6400	2.4000	14.160	0.0000	0.0000	0.0000
2	1.5577E-03	8.0507E-05	344.73	1823.5	270.26	156.60	83.868	50.099	6561.1	7.8279E+06	7.8279E+06
x(M)	0.0000	11.280	6.0000	0.0000	0.0000	9.1200	2.4000	14.160	0.0000	0.0000	0.0000
3	1.5577E-03	8.7119E-05	368.67	1934.9	299.52	173.55	96.177	53.073	7741.1	7.8279E+06	7.8279E+06
x(M)	0.0000	10.800	5.7600	0.0000	0.0000	8.6400	2.4000	14.160	0.0000	0.0000	0.0000
4	1.5104E-03	8.9410E-05	357.78	2014.9	285.33	179.30	92.624	54.506	7825.1	7.8279E+06	7.8279E+06
x(M)	0.0000	10.800	5.7600	0.0000	0.0000	8.6400	2.4000	14.160	0.0000	0.0000	0.0000
5	1.5104E-03	7.6826E-05	322.11	1740.1	242.57	146.76	74.599	47.904	6135.1	7.8279E+06	7.8279E+06
x(M)	0.0000	11.280	6.0000	0.0000	0.0000	9.3600	2.4000	14.160	0.0000	0.0000	0.0000
6	1.5104E-03	8.3476E-05	344.70	1850.5	269.78	162.83	85.782	51.136	6101.3	7.8279E+06	7.8279E+06
x(M)	0.0000	11.040	5.7600	0.0000	0.0000	8.8800	2.4000	14.160	0.0000	0.0000	0.0000
7	1.4632E-03	9.2191E-05	354.34	2068.6	281.13	186.91	93.294	55.698	9284.6	7.8279E+06	7.8279E+06
x(M)	0.0000	10.800	5.5200	0.0000	0.0000	8.6400	2.4000	14.160	0.0000	0.0000	0.0000
8	1.4632E-03	8.0455E-05	321.58	1802.5	241.35	154.72	76.148	49.687	7642.1	7.8279E+06	7.8279E+06
x(M)	0.0000	11.280	5.7600	0.0000	0.0000	9.1200	2.4000	14.160	0.0000	0.0000	0.0000
9	1.4632E-03	8.6847E-05	343.01	1910.4	267.47	170.94	87.147	52.682	7181.9	7.8279E+06	7.8279E+06
x(M)	0.0000	10.800	5.7600	0.0000	0.0000	8.6400	2.4000	14.160	0.0000	0.0000	0.0000
10	1.4160E-03	1.1052E-04	406.48	2503.1	343.39	246.84	124.36	56.861	1.1553E+04	7.8279E+06	7.8279E+06
x(M)	0.0000	9.8400	5.2800	0.0000	0.0000	7.6800	2.4000	10.560	0.0000	0.0000	0.0000
11	1.4160E-03	1.0776E-04	388.84	2333.2	320.27	228.47	112.83	51.615	1.0463E+04	7.8279E+06	7.8279E+06

APPALTATORE: Consorzio Soci   	ITINERARIO NAPOLI – BARI RADDOPPIO TRATTA APICE – ORSARA I LOTTO FUNZIONALE APICE – HIRPINIA				
PROGETTAZIONE: Mandataria Mandanti   					
PROGETTO ESECUTIVO RELAZIONE DI CALCOLO FONDAZIONI PILE DA P17 A P20					
COMMESSA IF1N	LOTTO 01 E ZZ	CODIFICA RG	DOCUMENTO MD0000 001	REV. B	FOGLIO 109 di 143

x(M)	0.0000	10.080	5.2800	0.0000	0.0000	7.9200	2.4000	10.800	0.0000	0.0000	0.0000
12	1.4160E-03	1.0777E-04	401.44	2373.5	336.91	235.22	121.04	53.667	9967.0	7.8279E+06	7.8279E+06
x(M)	0.0000	9.8400	5.2800	0.0000	0.0000	7.9200	2.4000	10.560	0.0000	0.0000	0.0000
Max.	1.5577E-03	1.1052E-04	406.48	2503.1	343.39	246.84	124.36	56.861	1.1553E+04	7.8279E+06	7.8279E+06
Pile N.	1	10	10	10	10	10	10	10	10	1	1

LOAD CASE : 8
CASE NAME : Load Case
LOAD TYPE : Special, Sp

REDUCTION FACTORS FOR CLOSELY-SPACED PILE GROUPS, COMBINED Y AND Z DIRECTIONS
ESTIMATED USING MOVEMENT IN THE DIRECTION OF PILE CAP DISPLACEMENTS

GROUP NO	P-FACTOR	Y-FACTOR
1	0.8344	1.0000
2	0.7792	1.0000
3	0.8661	1.0000
4	0.5688	1.0000
5	0.4960	1.0000
6	0.6137	1.0000
7	0.5383	1.0000
8	0.4669	1.0000
9	0.5855	1.0000
10	0.5845	1.0000
11	0.5082	1.0000
12	0.6289	1.0000

* TABLE L * COMPUTATION ON PILE CAP

* EQUIVALENT CONCENTRATED LOAD AT ORIGIN *

VERT. LOAD, KN	HOR. LOAD Y, KN	HOR. LOAD Z, KN
35891.0	-3236.20	9608.50
MOMENT X, KN- M	MOMENT Y, KN- M	MOMENT Z, KN- M
376.000	1.31347E+05	38291.0

* DISPLACEMENT OF GROUPED PILE FOUNDATION AT ORIGIN *

VERTICAL, M	HORIZONTAL Y, M	HORIZONTAL Z, M
1.59500E-03	-1.39786E-03	3.58718E-03
ANGLE ROT. X, RAD	ANGLE ROT. Y, RAD	ANGLE ROT. Z, RAD
-4.69647E-06	2.81299E-04	1.57714E-04

THE GLOBAL STRUCTURAL COORDINATE SYSTEM

* PILE TOP DISPLACEMENTS *

PILE GROUP	DISP. X, M	DISP. Y, M	DISP. Z, M	ROT. X, RAD	ROT. Y, RAD	ROT. Z, RAD
1	2.7841E-03	-1.3662E-03	3.5660E-03	-4.6965E-06	2.8130E-04	1.5771E-04
2	3.4938E-03	-1.3662E-03	3.5872E-03	-4.6965E-06	2.8130E-04	1.5771E-04
3	4.2035E-03	-1.3662E-03	3.6083E-03	-4.6965E-06	2.8130E-04	1.5771E-04
4	1.5182E-03	-1.3873E-03	3.5660E-03	-4.6965E-06	2.8130E-04	1.5771E-04
5	2.2279E-03	-1.3873E-03	3.5872E-03	-4.6965E-06	2.8130E-04	1.5771E-04
6	2.9376E-03	-1.3873E-03	3.6083E-03	-4.6965E-06	2.8130E-04	1.5771E-04
7	2.5237E-04	-1.4084E-03	3.5660E-03	-4.6965E-06	2.8130E-04	1.5771E-04
8	9.6208E-04	-1.4084E-03	3.5872E-03	-4.6965E-06	2.8130E-04	1.5771E-04
9	1.6718E-03	-1.4084E-03	3.6083E-03	-4.6965E-06	2.8130E-04	1.5771E-04
10	-1.0135E-03	-1.4296E-03	3.5660E-03	-4.6965E-06	2.8130E-04	1.5771E-04
11	-3.0377E-04	-1.4296E-03	3.5872E-03	-4.6965E-06	2.8130E-04	1.5771E-04
12	4.0595E-04	-1.4296E-03	3.6083E-03	-4.6965E-06	2.8130E-04	1.5771E-04
MINIMUM	-1.0135E-03	-1.4296E-03	3.5660E-03	-4.6965E-06	2.8130E-04	1.5771E-04
Pile N.	10	10	1	1	1	1
MAXIMUM	4.2035E-03	-1.3662E-03	3.6083E-03	-4.6965E-06	2.8130E-04	1.5771E-04
Pile N.	3	1	3	1	1	1

* PILE TOP REACTIONS *

PILE GROUP	FOR. X, KN	FOR. Y, KN	FOR. Z, KN	MOM X, KN- M	MOM Y, KN- M	MOM Z, KN- M
1	5318.0	-325.61	980.05	-1.8300	-2355.0	-688.39
2	6277.1	-310.13	943.13	-1.8300	-2292.9	-659.93
3	7236.2	-332.32	1014.4	-1.8300	-2435.2	-701.46

APPALTATORE: Consorzio  Soci  		ITINERARIO NAPOLI – BARI RADDOPPIO TRATTA APICE – ORSARA I LOTTO FUNZIONALE APICE – HIRPINIA				
PROGETTAZIONE: Mandataria  Mandanti  						
PROGETTO ESECUTIVO RELAZIONE DI CALCOLO FONDAZIONI PILE DA P17 A P20						
COMMESSA	LOTTO	CODIFICA	DOCUMENTO	REV.	FOGLIO	
IF1N	01 E ZZ	RG	MD0000 001	B	110 di 143	

4	3045.4	-251.61	750.65	-1.8300	-1890.5	-547.61
5	4444.4	-227.18	686.95	-1.8300	-1763.7	-498.04
6	5525.5	-264.19	798.43	-1.8300	-2002.5	-573.95
7	524.69	-247.70	723.54	-1.8300	-1831.2	-544.17
8	1949.2	-222.72	659.39	-1.8300	-1701.8	-492.87
9	3348.2	-261.56	773.86	-1.8300	-1949.5	-573.57
10	-2005.3	-268.95	765.78	-1.8300	-1915.8	-591.90
11	-616.40	-242.58	699.62	-1.8300	-1784.6	-538.51
12	843.99	-281.64	812.68	-1.8300	-2026.0	-618.59
MINIMUM	-2005.3	-332.32	659.39	-1.8300	-2435.2	-701.46
Pile N.	10	3	8	1	3	3
MAXIMUM	7236.2	-222.72	1014.4	-1.8300	-1701.8	-492.87
Pile N.	3	8	3	1	8	8

THE PILE COORDINATE SYSTEM (LOCAL AXES)

* PILE TOP DISPLACEMENTS *

PILE GROUP	DISP. x, M	DISP. y, M	DISP. z, M	ROT. x, RAD	ROT. y, RAD	ROT. z, RAD
*****	*****	*****	*****	*****	*****	*****
1	2.7841E-03	-1.3662E-03	3.5660E-03	-4.6965E-06	2.8130E-04	1.5771E-04
2	3.4938E-03	-1.3662E-03	3.5872E-03	-4.6965E-06	2.8130E-04	1.5771E-04
3	4.2035E-03	-1.3662E-03	3.6083E-03	-4.6965E-06	2.8130E-04	1.5771E-04
4	1.5182E-03	-1.3873E-03	3.5660E-03	-4.6965E-06	2.8130E-04	1.5771E-04
5	2.2279E-03	-1.3873E-03	3.5872E-03	-4.6965E-06	2.8130E-04	1.5771E-04
6	2.9376E-03	-1.3873E-03	3.6083E-03	-4.6965E-06	2.8130E-04	1.5771E-04
7	2.5237E-04	-1.4084E-03	3.5660E-03	-4.6965E-06	2.8130E-04	1.5771E-04
8	9.6208E-04	-1.4084E-03	3.5872E-03	-4.6965E-06	2.8130E-04	1.5771E-04
9	1.6718E-03	-1.4084E-03	3.6083E-03	-4.6965E-06	2.8130E-04	1.5771E-04
10	-1.0135E-03	-1.4296E-03	3.5660E-03	-4.6965E-06	2.8130E-04	1.5771E-04
11	-3.0377E-04	-1.4296E-03	3.5872E-03	-4.6965E-06	2.8130E-04	1.5771E-04
12	4.0595E-04	-1.4296E-03	3.6083E-03	-4.6965E-06	2.8130E-04	1.5771E-04
MINIMUM	-1.0135E-03	-1.4296E-03	3.5660E-03	-4.6965E-06	2.8130E-04	1.5771E-04
Pile N.	10	10	1	1	1	1
MAXIMUM	4.2035E-03	-1.3662E-03	3.6083E-03	-4.6965E-06	2.8130E-04	1.5771E-04
Pile N.	3	1	3	1	1	1

* PILE TOP REACTIONS *

PILE GROUP	AXIAL, KN	LAT. y, KN	LAT. z, KN	MOM x, KN- M	MOM y, KN- M	MOM z, KN- M
*****	*****	*****	*****	*****	*****	*****
1	5318.0	-325.61	980.05	-1.8300	-2355.0	-688.39
2	6277.1	-310.13	943.13	-1.8300	-2292.9	-659.93
3	7236.2	-332.32	1014.4	-1.8300	-2435.2	-701.46
4	3045.4	-251.61	750.65	-1.8300	-1890.5	-547.61
5	4444.4	-227.18	686.95	-1.8300	-1763.7	-498.04
6	5525.5	-264.19	798.43	-1.8300	-2002.5	-573.95
7	524.69	-247.70	723.54	-1.8300	-1831.2	-544.17
8	1949.2	-222.72	659.39	-1.8300	-1701.8	-492.87
9	3348.2	-261.56	773.86	-1.8300	-1949.5	-573.57
10	-2005.3	-268.95	765.78	-1.8300	-1915.8	-591.90
11	-616.40	-242.58	699.62	-1.8300	-1784.6	-538.51
12	843.99	-281.64	812.68	-1.8300	-2026.0	-618.59
MINIMUM	-2005.3	-332.32	659.39	-1.8300	-2435.2	-701.46
Pile N.	10	3	8	1	3	3
MAXIMUM	7236.2	-222.72	1014.4	-1.8300	-1701.8	-492.87
Pile N.	3	8	3	1	8	8

PILE GROUP STRESS, KN/ M**2

PILE GROUP	STRESS, KN/ M**2
*****	*****
1	1.0414E+04
2	1.0753E+04
3	1.1743E+04
4	7663.5
5	8046.1
6	9413.8
7	6062.3
8	6450.3
9	8027.7
10	7186.4
11	5974.6
12	6870.8
MINIMUM	5974.6
Pile N.	11
MAXIMUM	1.1743E+04
Pile N.	3

* EFFECTS FOR LATERALLY LOADED PILE *

* MINIMUM VALUES AND LOCATIONS *

PILE	DISPL.	DISPL.	MOMENT	MOMENT	SHEAR	SHEAR	SOIL REACT	SOIL REACT	TOTAL	FLEX. RIG.	FLEX. RIG.
------	--------	--------	--------	--------	-------	-------	------------	------------	-------	------------	------------

APPALTATORE: Consorzio Soci   	ITINERARIO NAPOLI – BARI RADDOPPIO TRATTA APICE – ORSARA I LOTTO FUNZIONALE APICE – HIRPINIA				
PROGETTAZIONE: Mandataria Mandanti   					
PROGETTO ESECUTIVO RELAZIONE DI CALCOLO FONDAZIONI PILE DA P17 A P20					
COMMESSA IF1N	LOTTO 01 E ZZ	CODIFICA RG	DOCUMENTO MD0000 001	REV. B	FOGLIO 111 di 143

	y-Dir M	z-Dir M	z-Dir KN- M	y-Dir KN- M	y-Dir KN	z-Dir KN	y-Dir KN/ M	z-Dir KN/ M	STRESS KN/ M**2	z-Dir KN- M**2	y-Dir KN- M**2
*****	*****	*****	*****	*****	*****	*****	*****	*****	*****	*****	*****
1	-1.3662E-03	-1.0902E-04	-388.47	-2355.0	-325.66	-237.75	-117.21	-54.295	3009.4	7.8279E+06	7.8279E+06
x(M)	0.0000	9.8400	5.2800	0.0000	0.0000	7.6800	2.4000	10.560	24.000	0.0000	0.0000
2	-1.3662E-03	-1.0850E-04	-376.84	-2292.9	-310.19	-229.84	-109.58	-51.883	3552.1	7.8279E+06	7.8279E+06
x(M)	0.0000	10.000	5.2800	0.0000	0.0000	7.9200	2.4000	10.800	24.000	0.0000	0.0000
3	-1.3662E-03	-1.1047E-04	-393.77	-2435.2	-332.39	-246.57	-120.71	-56.525	4094.9	7.8279E+06	7.8279E+06
x(M)	0.0000	9.8400	5.2800	0.0000	0.0000	7.6800	2.4000	10.560	24.000	0.0000	0.0000
4	-1.3873E-03	-8.8727E-05	-326.20	-1890.5	-251.64	-173.64	-82.551	-53.008	1723.4	7.8279E+06	7.8279E+06
x(M)	0.0000	10.800	5.7600	0.0000	0.0000	8.6400	2.4000	14.160	24.000	0.0000	0.0000
5	-1.3873E-03	-8.1909E-05	-306.34	-1763.7	-227.22	-156.08	-72.230	-49.729	2515.0	7.8279E+06	7.8279E+06
x(M)	0.0000	11.280	5.7600	0.0000	0.0000	9.1200	2.4000	14.160	24.000	0.0000	0.0000
6	-1.3873E-03	-9.3215E-05	-336.95	-2002.5	-264.24	-186.47	-88.248	-55.211	3126.8	7.8279E+06	7.8279E+06
x(M)	0.0000	10.560	5.5200	0.0000	0.0000	8.6400	2.4000	14.160	24.000	0.0000	0.0000
7	-1.4084E-03	-8.5344E-05	-322.66	-1831.2	-247.71	-165.40	-79.700	-51.508	296.91	7.8279E+06	7.8279E+06
x(M)	0.0000	11.040	5.7600	0.0000	0.0000	8.8800	2.4000	14.160	24.000	0.0000	0.0000
8	-1.4084E-03	-7.8502E-05	-301.74	-1701.8	-222.73	-148.11	-69.375	-47.984	1103.0	7.8279E+06	7.8279E+06
x(M)	0.0000	11.280	5.7600	0.0000	0.0000	9.1200	2.4000	14.160	24.000	0.0000	0.0000
9	-1.4084E-03	-9.0430E-05	-334.38	-1949.5	-261.59	-179.04	-85.869	-54.099	1894.7	7.8279E+06	7.8279E+06
x(M)	0.0000	10.800	5.7600	0.0000	0.0000	8.6400	2.4000	14.160	24.000	0.0000	0.0000
10	-1.4296E-03	-8.9110E-05	-339.38	-1915.8	-268.93	-176.27	-87.703	-53.494	1134.8	7.8279E+06	7.8279E+06
x(M)	0.0000	10.800	5.7600	0.0000	0.0000	8.6400	2.4000	14.160	24.000	0.0000	0.0000
11	-1.4296E-03	-8.2222E-05	-318.08	-1784.6	-242.58	-157.90	-76.529	-50.197	348.81	7.8279E+06	7.8279E+06
x(M)	0.0000	11.040	5.7600	0.0000	0.0000	8.8800	2.4000	14.160	24.000	0.0000	0.0000
12	-1.4296E-03	-9.3616E-05	-350.11	-2026.0	-281.65	-189.04	-93.496	-55.013	477.60	7.8279E+06	7.8279E+06
x(M)	0.0000	10.560	5.5200	0.0000	0.0000	8.4000	2.4000	14.160	24.000	0.0000	0.0000
Min.	-1.4296E-03	-1.1047E-04	-393.77	-2435.2	-332.39	-246.57	-120.71	-56.525	296.91	7.8279E+06	7.8279E+06
Pile N.	10	3	3	3	3	3	3	3	7	1	1

* MAXIMUM VALUES AND LOCATIONS *

PILE	DISPL. y-Dir M	DISPL. z-Dir M	MOMENT z-Dir KN- M	MOMENT y-Dir KN- M	SHEAR y-Dir KN	SHEAR z-Dir KN	SOIL REACT y-Dir KN/ M	SOIL REACT z-Dir KN/ M	TOTAL STRESS KN/ M**2	FLEX. RIG. z-Dir KN- M**2	FLEX. RIG. y-Dir KN- M**2
*****	*****	*****	*****	*****	*****	*****	*****	*****	*****	*****	*****
1	4.0685E-05	3.5661E-03	688.39	1026.7	88.541	980.24	19.789	326.51	1.0414E+04	7.8279E+06	7.8279E+06
x(M)	9.6000	0.0000	0.0000	5.5200	7.6800	0.0000	10.560	2.4000	0.0000	0.0000	0.0000
2	4.0513E-05	3.5872E-03	659.93	1002.5	84.515	943.35	18.796	307.42	1.0753E+04	7.8279E+06	7.8279E+06
x(M)	9.8400	0.0000	0.0000	5.7600	7.6800	0.0000	10.560	2.4000	0.0000	0.0000	0.0000
3	4.0719E-05	3.6083E-03	701.46	1053.8	90.416	1014.7	20.283	340.75	1.1743E+04	7.8279E+06	7.8279E+06
x(M)	9.6000	0.0000	0.0000	5.5200	7.6800	0.0000	10.560	2.4000	0.0000	0.0000	0.0000
4	3.5228E-05	3.5661E-03	547.61	843.34	66.208	750.74	18.744	226.31	7663.5	7.8279E+06	7.8279E+06
x(M)	10.560	0.0000	0.0000	6.0000	8.4000	0.0000	14.160	2.4000	0.0000	0.0000	0.0000
5	3.2882E-05	3.5872E-03	498.04	793.90	59.576	687.07	17.643	199.53	8046.1	7.8279E+06	7.8279E+06
x(M)	10.800	0.0000	0.0000	6.2400	8.6400	0.0000	14.160	2.4000	0.0000	0.0000	0.0000
6	3.6239E-05	3.6083E-03	573.95	882.56	69.879	798.60	19.138	245.09	9413.8	7.8279E+06	7.8279E+06
x(M)	10.320	0.0000	0.0000	6.0000	8.4000	0.0000	14.160	2.4000	0.0000	0.0000	0.0000
7	3.4593E-05	3.5661E-03	544.17	820.16	64.265	723.55	18.658	214.58	6062.3	7.8279E+06	7.8279E+06
x(M)	10.800	0.0000	0.0000	6.0000	8.6400	0.0000	14.160	2.4000	0.0000	0.0000	0.0000
8	3.2134E-05	3.5872E-03	492.87	770.14	57.569	659.44	17.441	188.20	6450.3	7.8279E+06	7.8279E+06
x(M)	11.040	0.0000	0.0000	6.2400	8.8800	0.0000	14.160	2.4000	0.0000	0.0000	0.0000
9	3.5912E-05	3.6083E-03	573.57	862.37	68.421	773.96	19.205	234.21	8027.7	7.8279E+06	7.8279E+06
x(M)	10.560	0.0000	0.0000	6.0000	8.4000	0.0000	14.160	2.4000	0.0000	0.0000	0.0000
10	3.6286E-05	3.5661E-03	591.90	851.91	69.281	765.73	19.653	231.79	7186.4	7.8279E+06	7.8279E+06
x(M)	10.560	0.0000	0.0000	6.0000	8.4000	0.0000	14.160	2.4000	0.0000	0.0000	0.0000
11	3.3779E-05	3.5872E-03	538.51	800.66	62.127	699.61	18.485	203.79	5974.6	7.8279E+06	7.8279E+06
x(M)	10.800	0.0000	0.0000	6.2400	8.6400	0.0000	14.160	2.4000	0.0000	0.0000	0.0000
12	3.7343E-05	3.6083E-03	618.59	890.25	73.034	812.71	19.827	250.35	6870.8	7.8279E+06	7.8279E+06
x(M)	10.320	0.0000	0.0000	6.0000	8.4000	0.0000	14.160	2.4000	0.0000	0.0000	0.0000
Max.	4.0719E-05	3.6083E-03	701.46	1053.8	90.416	1014.7	20.283	340.75	1.1743E+04	7.8279E+06	7.8279E+06
Pile N.	3	3	3	3	3	3	3	3	3	1	1

LOAD CASE : 9
CASE NAME : Load Case
LOAD TYPE : Special, Sp

REDUCTION FACTORS FOR CLOSELY-SPACED PILE GROUPS, COMBINED Y AND Z DIRECTIONS
ESTIMATED USING MOVEMENT IN THE DIRECTION OF PILE CAP DISPLACEMENTS

GROUP NO	P-FACTOR	Y-FACTOR
1	0.8554	1.0000
2	0.5756	1.0000
3	0.5845	1.0000
4	0.7954	1.0000
5	0.4937	1.0000
6	0.4978	1.0000
7	0.7965	1.0000
8	0.4951	1.0000
9	0.4996	1.0000
10	0.8661	1.0000
11	0.5911	1.0000
12	0.6001	1.0000

APPALTATORE: Consorzio Soci   	ITINERARIO NAPOLI – BARI RADDOPPIO TRATTA APICE – ORSARA I LOTTO FUNZIONALE APICE – HIRPINIA
PROGETTAZIONE: Mandataria Mandanti   	
PROGETTO ESECUTIVO RELAZIONE DI CALCOLO FONDAZIONI PILE DA P17 A P20	

* TABLE L * COMPUTATION ON PILE CAP

* EQUIVALENT CONCENTRATED LOAD AT ORIGIN *

VERT. LOAD, KN 28377.0	HOR. LOAD Y, KN 11902.0	HOR. LOAD Z, KN -2956.80
MOMENT X, KN- M -162.000	MOMENT Y, KN- M -38027.0	MOMENT Z, KN- M -1.41876E+05

* DISPLACEMENT OF GROUPED PILE FOUNDATION AT ORIGIN *

VERTICAL, M 1.34939E-03	HORIZONTAL Y, M 5.45267E-03	HORIZONTAL Z, M -1.18471E-03
ANGLE ROT. X,RAD 7.48438E-06	ANGLE ROT. Y,RAD -8.75949E-05	ANGLE ROT. Z,RAD -5.81231E-04

THE GLOBAL STRUCTURAL COORDINATE SYSTEM

* PILE TOP DISPLACEMENTS *

PILE GROUP	DISP. X, M	DISP. Y, M	DISP. Z, M	ROT. X,RAD	ROT. Y,RAD	ROT. Z,RAD
*****	*****	*****	*****	*****	*****	*****
1	3.3737E-03	5.4021E-03	-1.1510E-03	7.4844E-06	-8.7595E-05	-5.8123E-04
2	7.5813E-04	5.4021E-03	-1.1847E-03	7.4844E-06	-8.7595E-05	-5.8123E-04
3	-1.8574E-03	5.4021E-03	-1.2184E-03	7.4844E-06	-8.7595E-05	-5.8123E-04
4	3.7678E-03	5.4358E-03	-1.1510E-03	7.4844E-06	-8.7595E-05	-5.8123E-04
5	1.1523E-03	5.4358E-03	-1.1847E-03	7.4844E-06	-8.7595E-05	-5.8123E-04
6	-1.4632E-03	5.4358E-03	-1.2184E-03	7.4844E-06	-8.7595E-05	-5.8123E-04
7	4.1620E-03	5.4695E-03	-1.1510E-03	7.4844E-06	-8.7595E-05	-5.8123E-04
8	1.5465E-03	5.4695E-03	-1.1847E-03	7.4844E-06	-8.7595E-05	-5.8123E-04
9	-1.0691E-03	5.4695E-03	-1.2184E-03	7.4844E-06	-8.7595E-05	-5.8123E-04
10	4.5562E-03	5.5032E-03	-1.1510E-03	7.4844E-06	-8.7595E-05	-5.8123E-04
11	1.9407E-03	5.5032E-03	-1.1847E-03	7.4844E-06	-8.7595E-05	-5.8123E-04
12	-6.7488E-04	5.5032E-03	-1.2184E-03	7.4844E-06	-8.7595E-05	-5.8123E-04
MINIMUM	-1.8574E-03	5.4021E-03	-1.2184E-03	7.4844E-06	-8.7595E-05	-5.8123E-04
Pile N.	3	1	3	1	1	1
MAXIMUM	4.5562E-03	5.5032E-03	-1.1510E-03	7.4844E-06	-8.7595E-05	-5.8123E-04
Pile N.	10	10	1	1	1	1

* PILE TOP REACTIONS *

PILE GROUP	FOR. X, KN	FOR. Y, KN	FOR. Z, KN	MOM X, KN- M	MOM Y, KN- M	MOM Z, KN- M
*****	*****	*****	*****	*****	*****	*****
1	6114.8	1212.5	-292.41	2.9162	718.71	2668.5
2	1547.2	919.53	-233.19	2.9162	605.94	2075.7
3	-3639.0	932.32	-244.89	2.9162	637.11	2092.5
4	6647.5	1160.2	-277.94	2.9162	690.42	2578.6
5	2324.2	827.82	-209.24	2.9162	554.73	1892.2
6	-2875.9	835.39	-218.82	2.9162	581.45	1898.5
7	7180.2	1168.6	-277.47	2.9162	689.59	2605.7
8	3101.2	834.73	-209.04	2.9162	554.53	1916.4
9	-2112.9	842.71	-218.70	2.9162	581.42	1923.5
10	7561.5	1246.0	-292.55	2.9162	719.29	2766.3
11	3878.2	954.61	-235.39	2.9162	611.26	2178.4
12	-1349.9	967.59	-247.14	2.9162	642.53	2195.4
MINIMUM	-3639.0	827.82	-292.55	2.9162	554.53	1892.2
Pile N.	3	5	10	1	8	5
MAXIMUM	7561.5	1246.0	-209.04	2.9162	719.29	2766.3
Pile N.	10	10	8	1	10	10

THE PILE COORDINATE SYSTEM (LOCAL AXES)

* PILE TOP DISPLACEMENTS *

PILE GROUP	DISP. x, M	DISP. y, M	DISP. z, M	ROT. x,RAD	ROT. y,RAD	ROT. z,RAD
*****	*****	*****	*****	*****	*****	*****
1	3.3737E-03	5.4021E-03	-1.1510E-03	7.4844E-06	-8.7595E-05	-5.8123E-04
2	7.5813E-04	5.4021E-03	-1.1847E-03	7.4844E-06	-8.7595E-05	-5.8123E-04
3	-1.8574E-03	5.4021E-03	-1.2184E-03	7.4844E-06	-8.7595E-05	-5.8123E-04
4	3.7678E-03	5.4358E-03	-1.1510E-03	7.4844E-06	-8.7595E-05	-5.8123E-04
5	1.1523E-03	5.4358E-03	-1.1847E-03	7.4844E-06	-8.7595E-05	-5.8123E-04
6	-1.4632E-03	5.4358E-03	-1.2184E-03	7.4844E-06	-8.7595E-05	-5.8123E-04
7	4.1620E-03	5.4695E-03	-1.1510E-03	7.4844E-06	-8.7595E-05	-5.8123E-04

APPALTATORE: Consorzio Soci   		ITINERARIO NAPOLI – BARI RADDOPPIO TRATTA APICE – ORSARA I LOTTO FUNZIONALE APICE – HIRPINIA			
PROGETTAZIONE: Mandataria Mandanti   					
PROGETTO ESECUTIVO RELAZIONE DI CALCOLO FONDAZIONI PILE DA P17 A P20					
COMMESSA	LOTTO	CODIFICA	DOCUMENTO	REV.	FOGLIO
IF1N	01 E ZZ	RG	MD0000 001	B	113 di 143

8	1.5465E-03	5.4695E-03	-1.1847E-03	7.4844E-06	-8.7595E-05	-5.8123E-04
9	-1.0691E-03	5.4695E-03	-1.2184E-03	7.4844E-06	-8.7595E-05	-5.8123E-04
10	4.5562E-03	5.5032E-03	-1.1510E-03	7.4844E-06	-8.7595E-05	-5.8123E-04
11	1.9407E-03	5.5032E-03	-1.1847E-03	7.4844E-06	-8.7595E-05	-5.8123E-04
12	-6.7488E-04	5.5032E-03	-1.2184E-03	7.4844E-06	-8.7595E-05	-5.8123E-04
MINIMUM	-1.8574E-03	5.4021E-03	-1.2184E-03	7.4844E-06	-8.7595E-05	-5.8123E-04
Pile N.	3	1	3	1	1	1
MAXIMUM	4.5562E-03	5.5032E-03	-1.1510E-03	7.4844E-06	-8.7595E-05	-5.8123E-04
Pile N.	10	10	1	1	1	1

* PILE TOP REACTIONS *

PILE GROUP	AXIAL, KN	LAT. y, KN	LAT. z, KN	MOM x, KN- M	MOM y, KN- M	MOM z, KN- M
1	6114.8	1212.5	-292.41	2.9162	718.71	2668.5
2	1547.2	919.53	-233.19	2.9162	605.94	2075.7
3	-3639.0	932.32	-244.89	2.9162	637.11	2092.5
4	6647.5	1160.2	-277.94	2.9162	690.42	2578.6
5	2324.2	827.82	-209.24	2.9162	554.73	1892.2
6	-2875.9	835.39	-218.82	2.9162	581.45	1898.5
7	7180.2	1168.6	-277.47	2.9162	689.59	2605.7
8	3101.2	834.73	-209.04	2.9162	554.53	1916.4
9	-2112.9	842.71	-218.70	2.9162	581.42	1923.5
10	7561.5	1246.0	-292.55	2.9162	719.29	2766.3
11	3878.2	954.61	-235.39	2.9162	611.26	2178.4
12	-1349.9	967.59	-247.14	2.9162	642.53	2195.4
MINIMUM	-3639.0	827.82	-292.55	2.9162	554.53	1892.2
Pile N.	3	5	10	1	8	5
MAXIMUM	7561.5	1246.0	-209.04	2.9162	719.29	2766.3
Pile N.	10	10	8	1	10	10

PILE GROUP STRESS, KN/ M**2

1	1.1801E+04
2	7401.6
3	8660.8
4	1.1818E+04
5	7266.4
6	7620.0
7	1.2198E+04
8	7775.9
9	7260.4
10	1.2905E+04
11	9023.1
12	7667.7
MINIMUM	7260.4
Pile N.	9
MAXIMUM	1.2905E+04
Pile N.	10

* EFFECTS FOR LATERALLY LOADED PILE *

* MINIMUM VALUES AND LOCATIONS *

PILE	DISPL. y-DIR	DISPL. z-DIR	MOMENT z-DIR	MOMENT y-DIR	SHEAR y-DIR	SHEAR z-DIR	SOIL REACT y-DIR	SOIL REACT z-DIR	TOTAL STRESS	FLEX. RIG. z-DIR	FLEX. RIG. y-DIR
*****	*****	*****	*****	*****	*****	*****	*****	*****	*****	*****	*****
	M	M	KN- M	KN- M	KN	KN	KN/ M	KN/ M	KN/ M**2	KN- M**2	KN- M**2
1	-1.4152E-04	-1.1510E-03	-2668.5	-310.04	-321.20	-292.48	-74.522	-92.417	3460.3	7.8279E+06	7.8279E+06
x(M)	10.080	0.0000	0.0000	5.7600	8.1600	0.0000	10.800	2.4000	24.000	0.0000	0.0000
2	-1.1998E-04	-1.1847E-03	-2075.7	-265.45	-240.08	-233.21	-65.434	-65.648	875.54	7.8279E+06	7.8279E+06
x(M)	10.800	0.0000	0.0000	6.2400	8.8800	0.0000	14.160	2.4000	24.000	0.0000	0.0000
3	-1.1970E-04	-1.2184E-03	-2092.5	-274.57	-241.23	-244.86	-65.704	-68.710	2059.2	7.8279E+06	7.8279E+06
x(M)	10.800	0.0000	0.0000	6.2400	8.8800	0.0000	14.160	2.4000	24.000	0.0000	0.0000
4	-1.3911E-04	-1.1510E-03	-2578.6	-299.33	-308.77	-278.01	-70.528	-86.013	3761.7	7.8279E+06	7.8279E+06
x(M)	10.080	0.0000	0.0000	5.7600	8.1600	0.0000	14.160	2.4000	24.000	0.0000	0.0000
5	-1.1145E-04	-1.1847E-03	-1892.2	-246.05	-214.37	-209.26	-61.222	-56.546	1315.2	7.8279E+06	7.8279E+06
x(M)	11.280	0.0000	0.0000	6.4800	9.1200	0.0000	14.160	2.4000	24.000	0.0000	0.0000
6	-1.1063E-04	-1.2184E-03	-1898.5	-253.60	-214.11	-218.80	-61.324	-58.796	1627.4	7.8279E+06	7.8279E+06
x(M)	11.280	0.0000	0.0000	6.4800	9.1200	0.0000	14.160	2.4000	24.000	0.0000	0.0000
7	-1.3956E-04	-1.1510E-03	-2605.7	-299.01	-310.58	-277.54	-71.165	-85.841	4063.2	7.8279E+06	7.8279E+06
x(M)	10.080	0.0000	0.0000	5.7600	8.1600	0.0000	14.160	2.4000	24.000	0.0000	0.0000
8	-1.1187E-04	-1.1847E-03	-1916.4	-245.99	-215.81	-209.07	-61.609	-56.516	1754.9	7.8279E+06	7.8279E+06
x(M)	11.280	0.0000	0.0000	6.4800	9.1200	0.0000	14.160	2.4000	24.000	0.0000	0.0000
9	-1.1109E-04	-1.2184E-03	-1923.5	-253.60	-215.65	-218.68	-61.730	-58.797	1195.7	7.8279E+06	7.8279E+06
x(M)	11.280	0.0000	0.0000	6.4800	9.1200	0.0000	14.160	2.4000	24.000	0.0000	0.0000
10	-1.4348E-04	-1.1510E-03	-2766.3	-310.23	-328.90	-292.63	-76.543	-92.584	4278.9	7.8279E+06	7.8279E+06
x(M)	10.080	0.0000	0.0000	5.7600	8.1600	0.0000	10.800	2.4000	24.000	0.0000	0.0000
11	-1.2252E-04	-1.1847E-03	-2178.4	-267.48	-248.31	-235.43	-67.129	-66.657	2194.6	7.8279E+06	7.8279E+06
x(M)	10.800	0.0000	0.0000	6.2400	8.8800	0.0000	14.160	2.4000	24.000	0.0000	0.0000
12	-1.2220E-04	-1.2184E-03	-2195.4	-276.63	-249.43	-247.13	-67.386	-69.743	763.89	7.8279E+06	7.8279E+06
x(M)	10.800	0.0000	0.0000	6.2400	8.8800	0.0000	14.160	2.4000	24.000	0.0000	0.0000
Min.	-1.4348E-04	-1.2184E-03	-2766.3	-310.23	-328.90	-292.63	-76.543	-92.584	763.89	7.8279E+06	7.8279E+06
Pile N.	10	3	10	10	10	10	10	10	12	1	1

APPALTATORE: Consorzio Soci   	ITINERARIO NAPOLI – BARI RADDOPPIO TRATTA APICE – ORSARA I LOTTO FUNZIONALE APICE – HIRPINIA				
PROGETTAZIONE: Mandataria Mandanti   					
PROGETTO ESECUTIVO RELAZIONE DI CALCOLO FONDAZIONI PILE DA P17 A P20					
COMMESSA IF1N	LOTTO 01 E ZZ	CODIFICA RG	DOCUMENTO MD0000 001	REV. B	FOGLIO 114 di 143

* MAXIMUM VALUES AND LOCATIONS *

PILE	DISPL. y-DIR M	DISPL. z-DIR M	MOMENT z-DIR KN- M	MOMENT y-DIR KN- M	SHEAR y-DIR KN	SHEAR z-DIR KN	SOIL REACT y-DIR KN/ M	SOIL REACT z-DIR KN/ M	TOTAL STRESS KN/ M**2	FLEX. RIG. z-DIR KN- M**2	FLEX. RIG. y-DIR KN- M**2
*****	*****	*****	*****	*****	*****	*****	*****	*****	*****	*****	*****
1	5.4022E-03	3.0556E-05	1439.1	718.71	1212.8	71.227	410.01	16.496	1.1801E+04	7.8279E+06	7.8279E+06
x(M)	0.0000	10.000	5.5200	0.0000	0.0000	8.1600	2.4000	10.800	0.0000	0.0000	0.0000
2	5.4022E-03	2.5675E-05	1200.8	605.94	919.58	53.617	281.28	15.700	7401.6	7.8279E+06	7.8279E+06
x(M)	0.0000	11.040	6.0000	0.0000	0.0000	9.1200	2.4000	14.160	0.0000	0.0000	0.0000
3	5.4022E-03	2.6339E-05	1206.6	637.11	932.20	55.515	285.26	16.310	8660.8	7.8279E+06	7.8279E+06
x(M)	0.0000	11.040	5.7600	0.0000	0.0000	9.1200	2.4000	14.160	0.0000	0.0000	0.0000
4	5.4358E-03	2.9728E-05	1399.6	690.42	1160.5	67.510	384.30	16.547	1.1818E+04	7.8279E+06	7.8279E+06
x(M)	0.0000	10.320	5.5200	0.0000	0.0000	8.4000	2.4000	14.160	0.0000	0.0000	0.0000
5	5.4358E-03	2.3389E-05	1124.7	554.73	827.89	47.335	243.90	14.416	7266.4	7.8279E+06	7.8279E+06
x(M)	0.0000	11.520	6.0000	0.0000	0.0000	9.3600	2.4000	14.160	0.0000	0.0000	0.0000
6	5.4358E-03	2.3846E-05	1126.1	581.45	835.31	48.682	245.70	14.922	7620.0	7.8279E+06	7.8279E+06
x(M)	0.0000	11.520	6.0000	0.0000	0.0000	9.6000	2.4000	14.160	0.0000	0.0000	0.0000
7	5.4695E-03	2.9638E-05	1407.0	689.59	1168.8	67.434	386.37	16.557	1.2198E+04	7.8279E+06	7.8279E+06
x(M)	0.0000	10.320	5.5200	0.0000	0.0000	8.4000	2.4000	14.160	0.0000	0.0000	0.0000
8	5.4695E-03	2.3357E-05	1131.3	554.53	834.82	47.356	245.59	14.397	7775.9	7.8279E+06	7.8279E+06
x(M)	0.0000	11.520	6.0000	0.0000	0.0000	9.3600	2.4000	14.160	0.0000	0.0000	0.0000
9	5.4695E-03	2.3821E-05	1133.0	581.42	842.65	48.726	247.54	14.908	7260.4	7.8279E+06	7.8279E+06
x(M)	0.0000	11.520	6.0000	0.0000	0.0000	9.6000	2.4000	14.160	0.0000	0.0000	0.0000
10	5.5032E-03	3.0393E-05	1467.6	719.29	1246.3	71.416	419.95	16.596	1.2905E+04	7.8279E+06	7.8279E+06
x(M)	0.0000	10.000	5.5200	0.0000	0.0000	8.1600	2.4000	10.800	0.0000	0.0000	0.0000
11	5.5032E-03	2.5828E-05	1232.5	611.26	954.74	54.411	292.06	15.751	9023.1	7.8279E+06	7.8279E+06
x(M)	0.0000	11.040	6.0000	0.0000	0.0000	9.1200	2.4000	14.160	0.0000	0.0000	0.0000
12	5.5032E-03	2.6489E-05	1238.0	642.53	967.55	56.323	296.09	16.357	7667.7	7.8279E+06	7.8279E+06
x(M)	0.0000	11.040	5.7600	0.0000	0.0000	9.1200	2.4000	14.160	0.0000	0.0000	0.0000
Max.	5.5032E-03	3.0556E-05	1467.6	719.29	1246.3	71.416	419.95	16.596	1.2905E+04	7.8279E+06	7.8279E+06
Pile N.	10	1	10	10	10	10	10	10	10	1	1

LOAD CASE : 10
CASE NAME : Load Case
LOAD TYPE : Special, Sp

REDUCTION FACTORS FOR CLOSELY-SPACED PILE GROUPS, COMBINED Y AND Z DIRECTIONS
ESTIMATED USING MOVEMENT IN THE DIRECTION OF PILE CAP DISPLACEMENTS

GROUP NO	P-FACTOR	Y-FACTOR
1	0.6012	1.0000
2	0.5920	1.0000
3	0.8661	1.0000
4	0.4999	1.0000
5	0.4952	1.0000
6	0.7958	1.0000
7	0.4980	1.0000
8	0.4936	1.0000
9	0.7946	1.0000
10	0.5845	1.0000
11	0.5754	1.0000
12	0.8546	1.0000

* TABLE L * COMPUTATION ON PILE CAP

* EQUIVALENT CONCENTRATED LOAD AT ORIGIN *

VERT. LOAD, KN	HOR. LOAD Y, KN	HOR. LOAD Z, KN
35345.0	-11365.2	2907.30
MOMENT X, KN- M	MOMENT Y, KN- M	MOMENT Z, KN- M
113.000	38729.3	1.34624E+05

* DISPLACEMENT OF GROUPED PILE FOUNDATION AT ORIGIN *

VERTICAL, M	HORIZONTAL Y, M	HORIZONTAL Z, M
1.68871E-03	-5.17039E-03	1.16578E-03
ANGLE ROT. X, RAD	ANGLE ROT. Y, RAD	ANGLE ROT. Z, RAD
1.06014E-05	9.19635E-05	5.67374E-04

THE GLOBAL STRUCTURAL COORDINATE SYSTEM

* PILE TOP DISPLACEMENTS *

APPALTATORE:

Consorzio

Soci



ITINERARIO NAPOLI – BARI

PROGETTAZIONE:

Mandataria

Mandanti



RADDOPPIO TRATTA APICE – ORSARA
I LOTTO FUNZIONALE APICE – HIRPINIA

PROGETTO ESECUTIVO

RELAZIONE DI CALCOLO FONDAZIONI PILE DA P17 A P20

COMMESSA IF1N	LOTTO 01 E ZZ	CODIFICA RG	DOCUMENTO MD0000 001	REV. B	FOGLIO 115 di 143
------------------	------------------	----------------	-------------------------	-----------	-------------------------

PILE GROUP	DISP. X, M	DISP. Y, M	DISP. Z, M	ROT. X,RAD	ROT. Y,RAD	ROT. Z,RAD
*****	*****	*****	*****	*****	*****	*****
1	-2.4372E-04	-5.2420E-03	1.2135E-03	1.0601E-05	9.1963E-05	5.6737E-04
2	2.3095E-03	-5.2420E-03	1.1658E-03	1.0601E-05	9.1963E-05	5.6737E-04
3	4.8626E-03	-5.2420E-03	1.1181E-03	1.0601E-05	9.1963E-05	5.6737E-04
4	-6.5756E-04	-5.1942E-03	1.2135E-03	1.0601E-05	9.1963E-05	5.6737E-04
5	1.8956E-03	-5.1942E-03	1.1658E-03	1.0601E-05	9.1963E-05	5.6737E-04
6	4.4488E-03	-5.1942E-03	1.1181E-03	1.0601E-05	9.1963E-05	5.6737E-04
7	-1.0714E-03	-5.1465E-03	1.2135E-03	1.0601E-05	9.1963E-05	5.6737E-04
8	1.4818E-03	-5.1465E-03	1.1658E-03	1.0601E-05	9.1963E-05	5.6737E-04
9	4.0350E-03	-5.1465E-03	1.1181E-03	1.0601E-05	9.1963E-05	5.6737E-04
10	-1.4852E-03	-5.0988E-03	1.2135E-03	1.0601E-05	9.1963E-05	5.6737E-04
11	1.0680E-03	-5.0988E-03	1.1658E-03	1.0601E-05	9.1963E-05	5.6737E-04
12	3.6211E-03	-5.0988E-03	1.1181E-03	1.0601E-05	9.1963E-05	5.6737E-04
MINIMUM	-1.4852E-03	-5.2420E-03	1.1181E-03	1.0601E-05	9.1963E-05	5.6737E-04
Pile N.	10	1	3	1	1	1
MAXIMUM	4.8626E-03	-5.0988E-03	1.2135E-03	1.0601E-05	9.1963E-05	5.6737E-04
Pile N.	3	10	1	1	1	1

* PILE TOP REACTIONS *

PILE GROUP	FOR. X, KN	FOR. Y, KN	FOR. Z, KN	MOM X, KN- M	MOM Y, KN- M	MOM Z, KN- M
*****	*****	*****	*****	*****	*****	*****
1	-494.56	-928.07	246.79	4.1308	-631.97	-2077.8
2	4605.1	-915.74	231.25	4.1308	-589.13	-2061.7
3	7692.5	-1194.9	282.50	4.1308	-679.89	-2620.0
4	-1316.4	-804.72	218.42	4.1308	-571.35	-1806.9
5	3789.4	-797.09	205.32	4.1308	-533.66	-1800.1
6	7515.6	-1116.2	268.00	4.1308	-651.79	-2454.2
7	-2117.4	-794.82	218.77	4.1308	-571.92	-1773.1
8	2973.7	-787.63	205.75	4.1308	-534.38	-1767.1
9	7008.5	-1104.4	268.76	4.1308	-653.22	-2416.2
10	-2918.5	-883.88	245.13	4.1308	-627.90	-1945.8
11	2157.9	-871.85	229.64	4.1308	-585.17	-1930.2
12	6449.2	-1165.9	286.97	4.1308	-691.44	-2530.3
MINIMUM	-2918.5	-1194.9	205.32	4.1308	-691.44	-2620.0
Pile N.	10	3	5	1	12	3
MAXIMUM	7692.5	-787.63	286.97	4.1308	-533.66	-1767.1
Pile N.	3	8	12	1	5	8

THE PILE COORDINATE SYSTEM (LOCAL AXES)

* PILE TOP DISPLACEMENTS *

PILE GROUP	DISP. x, M	DISP. y, M	DISP. z, M	ROT. x,RAD	ROT. y,RAD	ROT. z,RAD
*****	*****	*****	*****	*****	*****	*****
1	-2.4372E-04	-5.2420E-03	1.2135E-03	1.0601E-05	9.1963E-05	5.6737E-04
2	2.3095E-03	-5.2420E-03	1.1658E-03	1.0601E-05	9.1963E-05	5.6737E-04
3	4.8626E-03	-5.2420E-03	1.1181E-03	1.0601E-05	9.1963E-05	5.6737E-04
4	-6.5756E-04	-5.1942E-03	1.2135E-03	1.0601E-05	9.1963E-05	5.6737E-04
5	1.8956E-03	-5.1942E-03	1.1658E-03	1.0601E-05	9.1963E-05	5.6737E-04
6	4.4488E-03	-5.1942E-03	1.1181E-03	1.0601E-05	9.1963E-05	5.6737E-04
7	-1.0714E-03	-5.1465E-03	1.2135E-03	1.0601E-05	9.1963E-05	5.6737E-04
8	1.4818E-03	-5.1465E-03	1.1658E-03	1.0601E-05	9.1963E-05	5.6737E-04
9	4.0350E-03	-5.1465E-03	1.1181E-03	1.0601E-05	9.1963E-05	5.6737E-04
10	-1.4852E-03	-5.0988E-03	1.2135E-03	1.0601E-05	9.1963E-05	5.6737E-04
11	1.0680E-03	-5.0988E-03	1.1658E-03	1.0601E-05	9.1963E-05	5.6737E-04
12	3.6211E-03	-5.0988E-03	1.1181E-03	1.0601E-05	9.1963E-05	5.6737E-04
MINIMUM	-1.4852E-03	-5.2420E-03	1.1181E-03	1.0601E-05	9.1963E-05	5.6737E-04
Pile N.	10	1	3	1	1	1
MAXIMUM	4.8626E-03	-5.0988E-03	1.2135E-03	1.0601E-05	9.1963E-05	5.6737E-04
Pile N.	3	10	1	1	1	1

* PILE TOP REACTIONS *

PILE GROUP	AXIAL, KN	LAT. y, KN	LAT. z, KN	MOM x, KN- M	MOM y, KN- M	MOM z, KN- M
*****	*****	*****	*****	*****	*****	*****
1	-494.56	-928.07	246.79	4.1308	-631.97	-2077.8
2	4605.1	-915.74	231.25	4.1308	-589.13	-2061.7
3	7692.5	-1194.9	282.50	4.1308	-679.89	-2620.0
4	-1316.4	-804.72	218.42	4.1308	-571.35	-1806.9
5	3789.4	-797.09	205.32	4.1308	-533.66	-1800.1
6	7515.6	-1116.2	268.00	4.1308	-651.79	-2454.2
7	-2117.4	-794.82	218.77	4.1308	-571.92	-1773.1
8	2973.7	-787.63	205.75	4.1308	-534.38	-1767.1
9	7008.5	-1104.4	268.76	4.1308	-653.22	-2416.2
10	-2918.5	-883.88	245.13	4.1308	-627.90	-1945.8
11	2157.9	-871.85	229.64	4.1308	-585.17	-1930.2
12	6449.2	-1165.9	286.97	4.1308	-691.44	-2530.3
MINIMUM	-2918.5	-1194.9	205.32	4.1308	-691.44	-2620.0
Pile N.	10	3	5	1	12	3

APPALTATORE:

Consorzio

Soci



ITINERARIO NAPOLI – BARI

PROGETTAZIONE:

Mandataria

Mandanti



RADDOPPIO TRATTA APICE – ORSARA
I LOTTO FUNZIONALE APICE – HIRPINIA

PROGETTO ESECUTIVO

RELAZIONE DI CALCOLO FONDAZIONI PILE DA P17 A P20

COMMESSA IF1N	LOTTO 01 E ZZ	CODIFICA RG	DOCUMENTO MD0000 001	REV. B	FOGLIO 116 di 143
------------------	------------------	----------------	-------------------------	-----------	-------------------------

MAXIMUM Pile N.	7692.5 3	-787.63 8	286.97 12	4.1308 1	-533.66 5	-1767.1 8
--------------------	-------------	--------------	--------------	-------------	--------------	--------------

PILE GROUP *****	STRESS, KN/ M**2 *****
1	6834.3
2	9077.5
3	1.2522E+04
4	6464.5
5	7810.8
6	1.1917E+04
7	6821.1
8	7254.5
9	1.1520E+04
10	7822.3
11	7308.4
12	1.1566E+04

MINIMUM Pile N.	6464.5 4
MAXIMUM Pile N.	1.2522E+04 3

* EFFECTS FOR LATERALLY LOADED PILE *

* MINIMUM VALUES AND LOCATIONS *

PILE	DISPL. y-DIR M	DISPL. z-DIR M	MOMENT z-DIR KN- M	MOMENT y-DIR KN- M	SHEAR y-DIR KN	SHEAR z-DIR KN	SOIL REACT y-DIR KN/ M	SOIL REACT z-DIR KN/ M	TOTAL STRESS KN/ M**2	FLEX. RIG. z-DIR KN- M**2	FLEX. RIG. y-DIR KN- M**2
*****	*****	*****	*****	*****	*****	*****	*****	*****	*****	*****	*****
1	-5.2419E-03	-2.7382E-05	-1196.2	-631.97	-928.05	-57.309	-288.04	-16.530	279.86	7.8279E+06	7.8279E+06
x (M)	0.0000	11.040	5.7600	0.0000	0.0000	8.8800	2.4000	14.160	24.000	0.0000	0.0000
2	-5.2419E-03	-2.6403E-05	-1190.8	-589.13	-915.89	-54.657	-284.13	-15.676	2606.0	7.8279E+06	7.8279E+06
x (M)	0.0000	11.040	5.7600	0.0000	0.0000	8.8800	2.4000	14.160	24.000	0.0000	0.0000
3	-5.2419E-03	-3.0160E-05	-1414.3	-679.89	-1195.2	-69.773	-408.13	-16.229	4353.1	7.8279E+06	7.8279E+06
x (M)	0.0000	10.000	5.5200	0.0000	0.0000	8.1600	2.4000	10.800	24.000	0.0000	0.0000
4	-5.1942E-03	-2.4651E-05	-1092.0	-571.35	-804.69	-49.528	-240.05	-15.102	744.91	7.8279E+06	7.8279E+06
x (M)	0.0000	11.520	6.0000	0.0000	0.0000	9.3600	2.4000	14.160	24.000	0.0000	0.0000
5	-5.1942E-03	-2.3895E-05	-1090.4	-533.66	-797.19	-47.513	-238.12	-14.376	2144.4	7.8279E+06	7.8279E+06
x (M)	0.0000	11.520	6.0000	0.0000	0.0000	9.3600	2.4000	14.160	24.000	0.0000	0.0000
6	-5.1942E-03	-2.9621E-05	-1353.5	-651.79	-1116.5	-66.396	-374.44	-15.598	4253.0	7.8279E+06	7.8279E+06
x (M)	0.0000	10.320	5.5200	0.0000	0.0000	8.1600	2.4000	14.160	24.000	0.0000	0.0000
7	-5.1465E-03	-2.4733E-05	-1083.0	-571.92	-794.76	-49.548	-237.71	-15.140	1198.2	7.8279E+06	7.8279E+06
x (M)	0.0000	11.520	6.0000	0.0000	0.0000	9.3600	2.4000	14.160	24.000	0.0000	0.0000
8	-5.1465E-03	-2.3982E-05	-1081.6	-534.38	-787.71	-47.553	-235.94	-14.417	1682.7	7.8279E+06	7.8279E+06
x (M)	0.0000	11.520	6.0000	0.0000	0.0000	9.3600	2.4000	14.160	24.000	0.0000	0.0000
9	-5.1465E-03	-2.9773E-05	-1343.4	-653.22	-1104.6	-66.579	-371.62	-15.579	3966.0	7.8279E+06	7.8279E+06
x (M)	0.0000	10.320	5.5200	0.0000	0.0000	8.1600	2.4000	14.160	24.000	0.0000	0.0000
10	-5.0988E-03	-2.7449E-05	-1157.6	-627.90	-883.80	-56.649	-275.28	-16.555	1651.5	7.8279E+06	7.8279E+06
x (M)	0.0000	11.040	5.7600	0.0000	0.0000	8.8800	2.4000	14.160	24.000	0.0000	0.0000
11	-5.0988E-03	-2.6467E-05	-1152.3	-585.17	-871.92	-54.017	-271.45	-15.698	1221.1	7.8279E+06	7.8279E+06
x (M)	0.0000	11.040	5.7600	0.0000	0.0000	8.8800	2.4000	14.160	24.000	0.0000	0.0000
12	-5.0988E-03	-3.2461E-05	-1405.3	-691.44	-1166.2	-73.064	-397.24	-16.872	3649.5	7.8279E+06	7.8279E+06
x (M)	0.0000	9.8400	5.5200	0.0000	0.0000	7.9200	2.4000	10.800	24.000	0.0000	0.0000
Min. Pile N.	-5.2419E-03 1	-3.2461E-05 12	-1414.3 3	-691.44 12	-1195.2 3	-73.064 12	-408.13 3	-16.872 12	279.86 1	7.8279E+06 1	7.8279E+06 1

* MAXIMUM VALUES AND LOCATIONS *

PILE	DISPL. y-DIR M	DISPL. z-DIR M	MOMENT z-DIR KN- M	MOMENT y-DIR KN- M	SHEAR y-DIR KN	SHEAR z-DIR KN	SOIL REACT y-DIR KN/ M	SOIL REACT z-DIR KN/ M	TOTAL STRESS KN/ M**2	FLEX. RIG. z-DIR KN- M**2	FLEX. RIG. y-DIR KN- M**2
*****	*****	*****	*****	*****	*****	*****	*****	*****	*****	*****	*****
1	1.2063E-04	1.2135E-03	2077.8	278.90	242.85	246.79	65.260	70.790	6834.3	7.8279E+06	7.8279E+06
x (M)	10.800	0.0000	0.0000	6.2400	8.6400	0.0000	14.160	2.4000	0.0000	0.0000	0.0000
2	1.2105E-04	1.1658E-03	2061.7	266.32	241.69	231.29	64.995	66.720	9077.5	7.8279E+06	7.8279E+06
x (M)	10.800	0.0000	0.0000	6.2400	8.6400	0.0000	14.160	2.4000	0.0000	0.0000	0.0000
3	1.3938E-04	1.1181E-03	2620.0	304.10	317.18	282.58	73.566	91.204	1.2522E+04	7.8279E+06	7.8279E+06
x (M)	10.080	0.0000	0.0000	5.7600	7.9200	0.0000	10.800	2.4000	0.0000	0.0000	0.0000
4	1.0946E-04	1.2135E-03	1806.9	255.89	209.10	218.41	59.680	59.709	6464.5	7.8279E+06	7.8279E+06
x (M)	11.280	0.0000	0.0000	6.2400	9.1200	0.0000	14.160	2.4000	0.0000	0.0000	0.0000
5	1.1026E-04	1.1658E-03	1800.1	245.24	209.20	205.35	59.575	56.586	7810.8	7.8279E+06	7.8279E+06
x (M)	11.280	0.0000	0.0000	6.2400	9.1200	0.0000	14.160	2.4000	0.0000	0.0000	0.0000
6	1.3656E-04	1.1181E-03	2454.2	293.71	299.03	268.08	68.043	84.626	1.1917E+04	7.8279E+06	7.8279E+06
x (M)	10.080	0.0000	0.0000	5.7600	8.1600	0.0000	10.800	2.4000	0.0000	0.0000	0.0000
7	1.0894E-04	1.2135E-03	1773.1	256.12	207.18	218.76	59.144	59.791	6821.1	7.8279E+06	7.8279E+06
x (M)	11.280	0.0000	0.0000	6.2400	9.1200	0.0000	14.160	2.4000	0.0000	0.0000	0.0000
8	1.0977E-04	1.1658E-03	1767.1	245.54	207.38	205.77	59.059	56.697	7254.5	7.8279E+06	7.8279E+06
x (M)	11.280	0.0000	0.0000	6.2400	9.1200	0.0000	14.160	2.4000	0.0000	0.0000	0.0000
9	1.3594E-04	1.1181E-03	2416.2	294.29	296.57	268.83	67.476	84.926	1.1520E+04	7.8279E+06	7.8279E+06
x (M)	10.080	0.0000	0.0000	5.7600	8.1600	0.0000	10.800	2.4000	0.0000	0.0000	0.0000
10	1.1800E-04	1.2135E-03	1945.8	277.45	233.28	245.10	63.132	69.959	7822.3	7.8279E+06	7.8279E+06
x (M)	10.800	0.0000	0.0000	6.2400	8.6400	0.0000	14.160	2.4000	0.0000	0.0000	0.0000
11	1.1840E-04	1.1658E-03	1930.2	264.91	232.13	229.66	62.861	65.915	7308.4	7.8279E+06	7.8279E+06
x (M)	10.800	0.0000	0.0000	6.2400	8.6400	0.0000	14.160	2.4000	0.0000	0.0000	0.0000
12	1.4571E-04	1.1181E-03	2530.3	312.02	322.07	287.04	73.970	91.746	1.1566E+04	7.8279E+06	7.8279E+06

APPALTATORE: Consorzio Soci 	ITINERARIO NAPOLI – BARI RADDOPPIO TRATTA APICE – ORSARA I LOTTO FUNZIONALE APICE – HIRPINIA				
PROGETTAZIONE: Mandataria Mandanti 					
PROGETTO ESECUTIVO RELAZIONE DI CALCOLO FONDAZIONI PILE DA P17 A P20					
COMMESSA IF1N	LOTTO 01 E ZZ	CODIFICA RG	DOCUMENTO MD0000 001	REV. B	FOGLIO 117 di 143

x(M)	9.8400	0.0000	0.0000	5.7600	7.6800	0.0000	10.560	2.4000	0.0000	0.0000	0.0000
Max. Pile N.	1.4571E-04 12	1.2135E-03 1	2620.0 3	312.02 12	322.07 12	287.04 12	73.970 12	91.746 12	1.2522E+04 3	7.8279E+06 1	7.8279E+06 1

LOAD CASE : 11
CASE NAME : Load Case
LOAD TYPE : Special, Sp

REDUCTION FACTORS FOR CLOSELY-SPACED PILE GROUPS, COMBINED Y AND Z DIRECTIONS
ESTIMATED USING MOVEMENT IN THE DIRECTION OF PILE CAP DISPLACEMENTS

GROUP NO	P-FACTOR	Y-FACTOR
1	0.8497	1.0000
2	0.5738	1.0000
3	0.5845	1.0000
4	0.7901	1.0000
5	0.4929	1.0000
6	0.4990	1.0000
7	0.7918	1.0000
8	0.4952	1.0000
9	0.5017	1.0000
10	0.8661	1.0000
11	0.5974	1.0000
12	0.6081	1.0000

* TABLE L * COMPUTATION ON PILE CAP

* EQUIVALENT CONCENTRATED LOAD AT ORIGIN *

VERT. LOAD, KN	HOR. LOAD Y, KN	HOR. LOAD Z, KN
47171.5	3534.00	-1098.00
MOMENT X, KN- M	MOMENT Y, KN- M	MOMENT Z, KN- M
-361.000	-19625.0	-48642.0

* DISPLACEMENT OF GROUPED PILE FOUNDATION AT ORIGIN *

VERTICAL, M	HORIZONTAL Y, M	HORIZONTAL Z, M
2.01226E-03	1.19767E-03	-3.25328E-04
ANGLE ROT. X, RAD	ANGLE ROT. Y, RAD	ANGLE ROT. Z, RAD
-4.40662E-07	-4.07914E-05	-1.86709E-04

THE GLOBAL STRUCTURAL COORDINATE SYSTEM

* PILE TOP DISPLACEMENTS *

PILE GROUP	DISP. X, M	DISP. Y, M	DISP. Z, M	ROT. X, RAD	ROT. Y, RAD	ROT. Z, RAD
1	2.5771E-03	1.2006E-03	-3.2731E-04	-4.4066E-07	-4.0791E-05	-1.8671E-04
2	1.7369E-03	1.2006E-03	-3.2533E-04	-4.4066E-07	-4.0791E-05	-1.8671E-04
3	8.9673E-04	1.2006E-03	-3.2335E-04	-4.4066E-07	-4.0791E-05	-1.8671E-04
4	2.7607E-03	1.1987E-03	-3.2731E-04	-4.4066E-07	-4.0791E-05	-1.8671E-04
5	1.9205E-03	1.1987E-03	-3.2533E-04	-4.4066E-07	-4.0791E-05	-1.8671E-04
6	1.0803E-03	1.1987E-03	-3.2335E-04	-4.4066E-07	-4.0791E-05	-1.8671E-04
7	2.9442E-03	1.1967E-03	-3.2731E-04	-4.4066E-07	-4.0791E-05	-1.8671E-04
8	2.1040E-03	1.1967E-03	-3.2533E-04	-4.4066E-07	-4.0791E-05	-1.8671E-04
9	1.2638E-03	1.1967E-03	-3.2335E-04	-4.4066E-07	-4.0791E-05	-1.8671E-04
10	3.1278E-03	1.1947E-03	-3.2731E-04	-4.4066E-07	-4.0791E-05	-1.8671E-04
11	2.2876E-03	1.1947E-03	-3.2533E-04	-4.4066E-07	-4.0791E-05	-1.8671E-04
12	1.4474E-03	1.1947E-03	-3.2335E-04	-4.4066E-07	-4.0791E-05	-1.8671E-04
MINIMUM Pile N.	3	10	1	1	1	1
MAXIMUM Pile N.	10	1	3	1	1	1

* PILE TOP REACTIONS *

PILE GROUP	FOR. X, KN	FOR. Y, KN	FOR. Z, KN	MOM X, KN- M	MOM Y, KN- M	MOM Z, KN- M
1	5038.3	354.13	-109.43	-0.1717	218.63	621.28
2	3476.6	278.79	-86.499	-0.1717	177.97	492.01
3	1820.4	282.34	-86.718	-0.1717	177.39	497.54
4	5286.4	338.05	-105.00	-0.1717	211.18	593.71
5	3838.4	252.96	-79.161	-0.1717	164.76	445.46

APPALTATORE: Consorzio  Soci  		ITINERARIO NAPOLI – BARI RADDOPPIO TRATTA APICE – ORSARA I LOTTO FUNZIONALE APICE – HIRPINIA					
PROGETTAZIONE: Mandataria  Mandanti  							
PROGETTO ESECUTIVO RELAZIONE DI CALCOLO FONDAZIONI PILE DA P17 A P20							
		COMMESSA	LOTTO	CODIFICA	DOCUMENTO	REV.	FOGLIO
		IF1N	01 E ZZ	RG	MD0000 001	B	118 di 143

6	2182.2	255.24	-79.072	-0.1717	163.67	448.84
7	5534.5	337.68	-105.17	-0.1717	211.50	592.33
8	4200.2	253.01	-79.397	-0.1717	165.24	444.96
9	2544.1	255.42	-79.345	-0.1717	164.21	448.57
10	5782.5	355.68	-110.75	-0.1717	220.96	621.54
11	4562.0	283.62	-88.638	-0.1717	181.91	498.62
12	2905.9	287.09	-88.820	-0.1717	181.26	503.96
MINIMUM	1820.4	252.96	-110.75	-0.1717	163.67	444.96
Pile N.	3	5	10	1	6	8
MAXIMUM	5782.5	355.68	-79.072	-0.1717	220.96	621.54
Pile N.	10	10	6	1	10	10

THE PILE COORDINATE SYSTEM (LOCAL AXES)

* PILE TOP DISPLACEMENTS *

PILE GROUP	DISP. x, M	DISP. y, M	DISP. z, M	ROT. x,RAD	ROT. y,RAD	ROT. z,RAD
*****	*****	*****	*****	*****	*****	*****
1	2.5771E-03	1.2006E-03	-3.2731E-04	-4.4066E-07	-4.0791E-05	-1.8671E-04
2	1.7369E-03	1.2006E-03	-3.2533E-04	-4.4066E-07	-4.0791E-05	-1.8671E-04
3	8.9673E-04	1.2006E-03	-3.2335E-04	-4.4066E-07	-4.0791E-05	-1.8671E-04
4	2.7607E-03	1.1987E-03	-3.2731E-04	-4.4066E-07	-4.0791E-05	-1.8671E-04
5	1.9205E-03	1.1987E-03	-3.2533E-04	-4.4066E-07	-4.0791E-05	-1.8671E-04
6	1.0803E-03	1.1987E-03	-3.2335E-04	-4.4066E-07	-4.0791E-05	-1.8671E-04
7	2.9442E-03	1.1967E-03	-3.2731E-04	-4.4066E-07	-4.0791E-05	-1.8671E-04
8	2.1040E-03	1.1967E-03	-3.2533E-04	-4.4066E-07	-4.0791E-05	-1.8671E-04
9	1.2638E-03	1.1967E-03	-3.2335E-04	-4.4066E-07	-4.0791E-05	-1.8671E-04
10	3.1278E-03	1.1947E-03	-3.2731E-04	-4.4066E-07	-4.0791E-05	-1.8671E-04
11	2.2876E-03	1.1947E-03	-3.2533E-04	-4.4066E-07	-4.0791E-05	-1.8671E-04
12	1.4474E-03	1.1947E-03	-3.2335E-04	-4.4066E-07	-4.0791E-05	-1.8671E-04
MINIMUM	8.9673E-04	1.1947E-03	-3.2731E-04	-4.4066E-07	-4.0791E-05	-1.8671E-04
Pile N.	3	10	1	1	1	1
MAXIMUM	3.1278E-03	1.2006E-03	-3.2335E-04	-4.4066E-07	-4.0791E-05	-1.8671E-04
Pile N.	10	1	3	1	1	1

* PILE TOP REACTIONS *

PILE GROUP	AXIAL, KN	LAT. y, KN	LAT. z, KN	MOM x, KN- M	MOM y, KN- M	MOM z, KN- M
*****	*****	*****	*****	*****	*****	*****
1	5038.3	354.13	-109.43	-0.1717	218.63	621.28
2	3476.6	278.79	-86.499	-0.1717	177.97	492.01
3	1820.4	282.34	-86.718	-0.1717	177.39	497.54
4	5286.4	338.05	-105.00	-0.1717	211.18	593.71
5	3838.4	252.96	-79.161	-0.1717	164.76	445.46
6	2182.2	255.24	-79.072	-0.1717	163.67	448.84
7	5534.5	337.68	-105.17	-0.1717	211.50	592.33
8	4200.2	253.01	-79.397	-0.1717	165.24	444.96
9	2544.1	255.42	-79.345	-0.1717	164.21	448.57
10	5782.5	355.68	-110.75	-0.1717	220.96	621.54
11	4562.0	283.62	-88.638	-0.1717	181.91	498.62
12	2905.9	287.09	-88.820	-0.1717	181.26	503.96
MINIMUM	1820.4	252.96	-110.75	-0.1717	163.67	444.96
Pile N.	3	5	10	1	6	8
MAXIMUM	5782.5	355.68	-79.072	-0.1717	220.96	621.54
Pile N.	10	10	6	1	10	10

PILE GROUP STRESS, KN/ M**2

*****	*****
1	4838.9
2	3546.4
3	2624.3
4	4893.3
5	3605.5
6	2676.8
7	5030.1
8	3809.4
9	2881.3
10	5263.1
11	4183.5
12	3260.8
MINIMUM	2624.3
Pile N.	3
MAXIMUM	5263.1
Pile N.	10

* EFFECTS FOR Laterally Loaded Pile *

* MINIMUM VALUES AND LOCATIONS *

PILE	DISPL. y-DIR M	DISPL. z-DIR M	MOMENT z-DIR KN- M	MOMENT y-DIR KN- M	SHEAR y-DIR KN	SHEAR z-DIR KN	SOIL REACT y-DIR KN/ M	SOIL REACT z-DIR KN/ M	TOTAL STRESS KN/ M**2	FLEX. RIG. z-DIR KN- M**2	FLEX. RIG. y-DIR KN- M**2
------	----------------	----------------	--------------------	--------------------	----------------	----------------	------------------------	------------------------	-----------------------	---------------------------	---------------------------

APPALTATORE: Consorzio Soci   		ITINERARIO NAPOLI – BARI RADDOPPIO TRATTA APICE – ORSARA I LOTTO FUNZIONALE APICE – HIRPINIA					
PROGETTAZIONE: Mandataria Mandanti   							
PROGETTO ESECUTIVO RELAZIONE DI CALCOLO FONDAZIONI PILE DA P17 A P20		COMMESSA IF1N	LOTTO 01 E ZZ	CODIFICA RG	DOCUMENTO MD0000 001	REV. B	FOGLIO 119 di 143

*****	*****	*****	*****	*****	*****	*****	*****	*****	*****	*****	*****	*****
1	-4.5704E-05	-3.2731E-04	-621.28	-123.78	-117.76	-109.45	-48.411	-50.628	2851.1	7.8279E+06	7.8279E+06	0.0000
x (M)	8.6400	0.0000	0.0000	4.5600	6.4800	0.0000	7.9200	2.4000	24.000	0.0000	0.0000	0.0000
2	-5.0362E-05	-3.2533E-04	-492.01	-106.61	-91.289	-86.508	-30.659	-35.413	1967.3	7.8279E+06	7.8279E+06	0.0000
x (M)	9.1200	0.0000	0.0000	4.8000	6.7200	0.0000	7.9200	2.4000	24.000	0.0000	0.0000	0.0000
3	-5.0123E-05	-3.2334E-04	-497.54	-106.67	-92.312	-86.723	-31.367	-35.751	1030.1	7.8279E+06	7.8279E+06	0.0000
x (M)	9.1200	0.0000	0.0000	4.8000	6.7200	0.0000	7.9200	2.4000	24.000	0.0000	0.0000	0.0000
4	-4.6557E-05	-3.2731E-04	-593.71	-120.44	-112.25	-105.02	-44.914	-47.512	2991.5	7.8279E+06	7.8279E+06	0.0000
x (M)	8.6400	0.0000	0.0000	4.5600	6.4800	0.0000	7.9200	2.4000	24.000	0.0000	0.0000	0.0000
5	-5.1621E-05	-3.2533E-04	-445.46	-101.20	-82.757	-79.171	-24.685	-30.905	2172.1	7.8279E+06	7.8279E+06	0.0000
x (M)	9.3600	0.0000	0.0000	5.0400	6.9600	0.0000	7.9200	2.4000	24.000	0.0000	0.0000	0.0000
6	-5.1451E-05	-3.2334E-04	-448.84	-100.98	-83.294	-79.077	-25.087	-31.026	1234.9	7.8279E+06	7.8279E+06	0.0000
x (M)	9.3600	0.0000	0.0000	5.0400	6.9600	0.0000	7.9200	2.4000	24.000	0.0000	0.0000	0.0000
7	-4.6469E-05	-3.2731E-04	-592.33	-120.60	-112.30	-105.19	-44.983	-47.644	3131.9	7.8279E+06	7.8279E+06	0.0000
x (M)	8.6400	0.0000	0.0000	4.5600	6.4800	0.0000	7.9200	2.4000	24.000	0.0000	0.0000	0.0000
8	-5.1525E-05	-3.2533E-04	-444.96	-101.40	-82.921	-79.408	-24.873	-31.060	2376.8	7.8279E+06	7.8279E+06	0.0000
x (M)	9.3600	0.0000	0.0000	5.0400	6.9600	0.0000	7.9200	2.4000	24.000	0.0000	0.0000	0.0000
9	-5.1346E-05	-3.2334E-04	-448.57	-101.21	-83.499	-79.351	-25.306	-31.203	1439.6	7.8279E+06	7.8279E+06	0.0000
x (M)	9.3600	0.0000	0.0000	5.0400	6.9600	0.0000	7.9200	2.4000	24.000	0.0000	0.0000	0.0000
10	-4.5241E-05	-3.2731E-04	-621.54	-124.84	-118.81	-110.77	-49.203	-51.621	3272.2	7.8279E+06	7.8279E+06	0.0000
x (M)	8.6400	0.0000	0.0000	4.5600	6.4800	0.0000	7.9200	2.4000	24.000	0.0000	0.0000	0.0000
11	-4.9770E-05	-3.2533E-04	-498.62	-108.36	-93.540	-88.650	-32.345	-36.816	2581.6	7.8279E+06	7.8279E+06	0.0000
x (M)	9.1200	0.0000	0.0000	4.8000	6.7200	0.0000	7.9200	2.4000	24.000	0.0000	0.0000	0.0000
12	-4.9518E-05	-3.2334E-04	-503.96	-108.37	-94.518	-88.828	-33.030	-37.139	1644.4	7.8279E+06	7.8279E+06	0.0000
x (M)	9.1200	0.0000	0.0000	4.8000	6.7200	0.0000	7.9200	2.4000	24.000	0.0000	0.0000	0.0000
Min.	-5.1621E-05	-3.2731E-04	-621.54	-124.84	-118.81	-110.77	-49.203	-51.621	1030.1	7.8279E+06	7.8279E+06	0.0000
Pile N.	5	1	10	10	10	10	10	10	3	1	1	1

* MAXIMUM VALUES AND LOCATIONS *

PILE	DISPL. y-DIR	DISPL. z-DIR	MOMENT KN-M	MOMENT y-DIR KN-M	SHEAR y-DIR KN	SHEAR z-DIR KN	SOIL REACT y-DIR KN/M	SOIL REACT z-DIR KN/M	TOTAL STRESS KN/M**2	FLEX. RIG. KN-M**2	FLEX. RIG. y-DIR KN-M**2
*****	*****	*****	*****	*****	*****	*****	*****	*****	*****	*****	*****
1	1.2006E-03	1.2761E-05	452.98	218.63	354.17	32.090	175.55	13.058	4838.9	7.8279E+06	7.8279E+06
x (M)	0.0000	8.8800	4.3200	0.0000	0.0000	6.4800	2.4000	7.9200	0.0000	0.0000	0.0000
2	1.2006E-03	1.3830E-05	393.57	177.97	278.81	24.677	123.51	7.7697	3546.4	7.8279E+06	7.8279E+06
x (M)	0.0000	9.3600	4.8000	0.0000	0.0000	6.9600	2.4000	7.9200	0.0000	0.0000	0.0000
3	1.2006E-03	1.3673E-05	396.00	177.39	282.35	24.794	125.64	7.9420	2624.3	7.8279E+06	7.8279E+06
x (M)	0.0000	9.3600	4.5600	0.0000	0.0000	6.9600	2.4000	7.9200	0.0000	0.0000	0.0000
4	1.1987E-03	1.3040E-05	440.92	211.18	338.10	30.695	164.35	12.039	4893.3	7.8279E+06	7.8279E+06
x (M)	0.0000	8.8800	4.5600	0.0000	0.0000	6.7200	2.4000	7.9200	0.0000	0.0000	0.0000
5	1.1987E-03	1.4119E-05	373.24	164.76	252.99	22.280	6.0321	107.49	3605.5	7.8279E+06	7.8279E+06
x (M)	0.0000	9.3600	4.8000	0.0000	0.0000	7.2000	2.4000	7.9200	0.0000	0.0000	0.0000
6	1.1987E-03	1.3997E-05	374.73	163.67	255.25	22.302	108.73	6.1293	2676.8	7.8279E+06	7.8279E+06
x (M)	0.0000	9.3600	4.8000	0.0000	0.0000	6.9600	2.4000	7.9200	0.0000	0.0000	0.0000
7	1.1967E-03	1.3038E-05	440.69	211.50	337.73	30.755	164.45	12.080	5030.1	7.8279E+06	7.8279E+06
x (M)	0.0000	8.8800	4.5600	0.0000	0.0000	6.7200	2.4000	7.9200	0.0000	0.0000	0.0000
8	1.1967E-03	1.4123E-05	373.38	165.24	253.04	22.361	107.79	6.0931	3809.4	7.8279E+06	7.8279E+06
x (M)	0.0000	9.3600	4.8000	0.0000	0.0000	6.9600	2.4000	7.9200	0.0000	0.0000	0.0000
9	1.1967E-03	1.3999E-05	374.97	164.21	255.44	22.402	109.12	6.1992	2881.3	7.8279E+06	7.8279E+06
x (M)	0.0000	9.3600	4.8000	0.0000	0.0000	6.9600	2.4000	7.9200	0.0000	0.0000	0.0000
10	1.1947E-03	1.2704E-05	454.68	220.96	355.73	32.582	177.87	13.363	5263.1	7.8279E+06	7.8279E+06
x (M)	0.0000	8.6400	4.3200	0.0000	0.0000	6.4800	2.4000	7.9200	0.0000	0.0000	0.0000
11	1.1947E-03	1.3759E-05	397.90	181.91	283.66	25.380	127.60	8.2962	4183.5	7.8279E+06	7.8279E+06
x (M)	0.0000	9.1200	4.5600	0.0000	0.0000	6.9600	2.4000	7.9200	0.0000	0.0000	0.0000
12	1.1947E-03	1.3617E-05	400.40	181.26	287.11	25.480	129.70	8.4595	3260.8	7.8279E+06	7.8279E+06
x (M)	0.0000	9.1200	4.5600	0.0000	0.0000	6.9600	2.4000	7.9200	0.0000	0.0000	0.0000
Max.	1.2006E-03	1.4123E-05	454.68	220.96	355.73	32.582	177.87	13.363	5263.1	7.8279E+06	7.8279E+06
Pile N.	1	8	10	10	10	10	10	10	10	1	1

LOAD CASE : 12
CASE NAME : Load Case
LOAD TYPE : Special, Sp

REDUCTION FACTORS FOR CLOSELY-SPACED PILE GROUPS, COMBINED Y AND Z DIRECTIONS
ESTIMATED USING MOVEMENT IN THE DIRECTION OF PILE CAP DISPLACEMENTS

GROUP NO	P-FACTOR	Y-FACTOR
1	0.7263	1.0000
2	0.5357	1.0000
3	0.5845	1.0000
4	0.6758	1.0000
5	0.4776	1.0000
6	0.5228	1.0000
7	0.6913	1.0000
8	0.4957	1.0000
9	0.5426	1.0000
10	0.8661	1.0000
11	0.7113	1.0000
12	0.7511	1.0000

APPALTATORE: Consorzio Soci   	ITINERARIO NAPOLI – BARI RADDOPPIO TRATTA APICE – ORSARA I LOTTO FUNZIONALE APICE – HIRPINIA				
PROGETTAZIONE: Mandataria Mandanti   					
PROGETTO ESECUTIVO RELAZIONE DI CALCOLO FONDAZIONI PILE DA P17 A P20					
COMMESSA IF1N	LOTTO 01 E ZZ	CODIFICA RG	DOCUMENTO MD0000 001	REV. B	FOGLIO 120 di 143

* TABLE L * COMPUTATION ON PILE CAP

* EQUIVALENT CONCENTRATED LOAD AT ORIGIN *

VERT. LOAD, KN 50691.5	HOR. LOAD Y, KN 1340.00	HOR. LOAD Z, KN -1635.00
MOMENT X, KN- M -5.00000	MOMENT Y, KN- M -28879.5	MOMENT Z, KN- M -16178.0

* DISPLACEMENT OF GROUPED PILE FOUNDATION AT ORIGIN *

VERTICAL, M 2.13139E-03	HORIZONTAL Y, M 3.87623E-04	HORIZONTAL Z, M -4.24126E-04
ANGLE ROT. X,RAD -2.07057E-07	ANGLE ROT. Y,RAD -5.70395E-05	ANGLE ROT. Z,RAD -6.21608E-05

THE GLOBAL STRUCTURAL COORDINATE SYSTEM

* PILE TOP DISPLACEMENTS *

PILE GROUP	DISP. X, M	DISP. Y, M	DISP. Z, M	ROT. X,RAD	ROT. Y,RAD	ROT. Z,RAD
*****	*****	*****	*****	*****	*****	*****
1	2.0261E-03	3.8902E-04	-4.2506E-04	-2.0706E-07	-5.7040E-05	-6.2161E-05
2	1.7464E-03	3.8902E-04	-4.2413E-04	-2.0706E-07	-5.7040E-05	-6.2161E-05
3	1.4666E-03	3.8902E-04	-4.2319E-04	-2.0706E-07	-5.7040E-05	-6.2161E-05
4	2.2828E-03	3.8809E-04	-4.2506E-04	-2.0706E-07	-5.7040E-05	-6.2161E-05
5	2.0031E-03	3.8809E-04	-4.2413E-04	-2.0706E-07	-5.7040E-05	-6.2161E-05
6	1.7233E-03	3.8809E-04	-4.2319E-04	-2.0706E-07	-5.7040E-05	-6.2161E-05
7	2.5394E-03	3.8716E-04	-4.2506E-04	-2.0706E-07	-5.7040E-05	-6.2161E-05
8	2.2597E-03	3.8716E-04	-4.2413E-04	-2.0706E-07	-5.7040E-05	-6.2161E-05
9	1.9800E-03	3.8716E-04	-4.2319E-04	-2.0706E-07	-5.7040E-05	-6.2161E-05
10	2.7961E-03	3.8623E-04	-4.2506E-04	-2.0706E-07	-5.7040E-05	-6.2161E-05
11	2.5164E-03	3.8623E-04	-4.2413E-04	-2.0706E-07	-5.7040E-05	-6.2161E-05
12	2.2367E-03	3.8623E-04	-4.2319E-04	-2.0706E-07	-5.7040E-05	-6.2161E-05
MINIMUM	1.4666E-03	3.8623E-04	-4.2506E-04	-2.0706E-07	-5.7040E-05	-6.2161E-05
Pile N.	3	10	1	1	1	1
MAXIMUM	2.7961E-03	3.8902E-04	-4.2319E-04	-2.0706E-07	-5.7040E-05	-6.2161E-05
Pile N.	10	1	3	1	1	1

* PILE TOP REACTIONS *

PILE GROUP	FOR. X, KN	FOR. Y, KN	FOR. Z, KN	MOM X, KN- M	MOM Y, KN- M	MOM Z, KN- M
*****	*****	*****	*****	*****	*****	*****
1	4046.6	122.73	-148.73	-0.080679	286.56	212.49
2	3495.2	102.12	-124.35	-0.080679	244.24	177.42
3	2943.8	107.80	-130.49	-0.080679	254.48	187.14
4	4552.5	117.06	-142.71	-0.080679	276.47	202.67
5	4001.1	94.740	-116.24	-0.080679	229.94	164.18
6	3449.8	100.25	-122.25	-0.080679	240.15	173.78
7	4987.4	118.20	-144.60	-0.080679	279.74	204.22
8	4507.1	96.538	-118.81	-0.080679	234.61	167.05
9	3955.7	102.16	-124.96	-0.080679	245.00	176.77
10	5334.3	134.66	-164.44	-0.080679	312.80	230.94
11	4956.3	119.84	-146.60	-0.080679	282.71	206.54
12	4461.7	123.90	-150.83	-0.080679	289.31	213.20
MINIMUM	2943.8	94.740	-164.44	-0.080679	229.94	164.18
Pile N.	3	5	10	1	5	5
MAXIMUM	5334.3	134.66	-116.24	-0.080679	312.80	230.94
Pile N.	10	10	5	1	10	10

THE PILE COORDINATE SYSTEM (LOCAL AXES)

* PILE TOP DISPLACEMENTS *

PILE GROUP	DISP. x, M	DISP. y, M	DISP. z, M	ROT. x,RAD	ROT. y,RAD	ROT. z,RAD
*****	*****	*****	*****	*****	*****	*****
1	2.0261E-03	3.8902E-04	-4.2506E-04	-2.0706E-07	-5.7040E-05	-6.2161E-05
2	1.7464E-03	3.8902E-04	-4.2413E-04	-2.0706E-07	-5.7040E-05	-6.2161E-05
3	1.4666E-03	3.8902E-04	-4.2319E-04	-2.0706E-07	-5.7040E-05	-6.2161E-05
4	2.2828E-03	3.8809E-04	-4.2506E-04	-2.0706E-07	-5.7040E-05	-6.2161E-05
5	2.0031E-03	3.8809E-04	-4.2413E-04	-2.0706E-07	-5.7040E-05	-6.2161E-05
6	1.7233E-03	3.8809E-04	-4.2319E-04	-2.0706E-07	-5.7040E-05	-6.2161E-05
7	2.5394E-03	3.8716E-04	-4.2506E-04	-2.0706E-07	-5.7040E-05	-6.2161E-05
8	2.2597E-03	3.8716E-04	-4.2413E-04	-2.0706E-07	-5.7040E-05	-6.2161E-05
9	1.9800E-03	3.8716E-04	-4.2319E-04	-2.0706E-07	-5.7040E-05	-6.2161E-05

APPALTATORE: Consorzio Soci   	ITINERARIO NAPOLI – BARI RADDOPPIO TRATTA APICE – ORSARA I LOTTO FUNZIONALE APICE – HIRPINIA					
PROGETTAZIONE: Mandataria Mandanti   						
PROGETTO ESECUTIVO RELAZIONE DI CALCOLO FONDAZIONI PILE DA P17 A P20						
	COMMESSA IF1N	LOTTO 01 E ZZ	CODIFICA RG	DOCUMENTO MD0000 001	REV. B	FOGLIO 121 di 143

10	2.7961E-03	3.8623E-04	-4.2506E-04	-2.0706E-07	-5.7040E-05	-6.2161E-05
11	2.5164E-03	3.8623E-04	-4.2413E-04	-2.0706E-07	-5.7040E-05	-6.2161E-05
12	2.2367E-03	3.8623E-04	-4.2319E-04	-2.0706E-07	-5.7040E-05	-6.2161E-05
MINIMUM	1.4666E-03	3.8623E-04	-4.2506E-04	-2.0706E-07	-5.7040E-05	-6.2161E-05
Pile N.	3	10	1	1	1	1
MAXIMUM	2.7961E-03	3.8902E-04	-4.2319E-04	-2.0706E-07	-5.7040E-05	-6.2161E-05
Pile N.	10	1	3	1	1	1

* PILE TOP REACTIONS *

PILE GROUP	AXIAL, KN	LAT. y, KN	LAT. z, KN	MOM x, KN- M	MOM y, KN- M	MOM z, KN- M
*****	*****	*****	*****	*****	*****	*****
1	4046.6	122.73	-148.73	-0.080679	286.56	212.49
2	3495.2	102.12	-124.35	-0.080679	244.24	177.42
3	2943.8	107.80	-130.49	-0.080679	254.48	187.14
4	4552.5	117.06	-142.71	-0.080679	276.47	202.67
5	4001.1	94.740	-116.24	-0.080679	229.94	164.18
6	3449.8	100.25	-122.25	-0.080679	240.15	173.78
7	4987.4	118.20	-144.60	-0.080679	279.74	204.22
8	4507.1	96.538	-118.81	-0.080679	234.61	167.05
9	3955.7	102.16	-124.96	-0.080679	245.00	176.77
10	5334.3	134.66	-164.44	-0.080679	312.80	230.94
11	4956.3	119.84	-146.60	-0.080679	282.71	206.54
12	4461.7	123.90	-150.83	-0.080679	289.31	213.20
MINIMUM	2943.8	94.740	-164.44	-0.080679	229.94	164.18
Pile N.	3	5	10	1	5	5
MAXIMUM	5334.3	134.66	-116.24	-0.080679	312.80	230.94
Pile N.	10	10	5	1	10	10

PILE GROUP	STRESS, KN/ M**2
*****	*****
1	3366.6
2	2889.0
3	2619.2
4	3610.8
5	3116.9
6	2846.8
7	3867.6
8	3419.7
9	3150.3
10	4192.1
11	3861.4
12	3609.4
MINIMUM	2619.2
Pile N.	3
MAXIMUM	4192.1
Pile N.	10

* EFFECTS FOR LATERALLY LOADED PILE *

* MINIMUM VALUES AND LOCATIONS *

PILE	DISPL. y-DIR	DISPL. z-DIR	MOMENT z-DIR	MOMENT y-DIR	SHEAR y-DIR	SHEAR z-DIR	SOIL REACT y-DIR	SOIL REACT z-DIR	TOTAL STRESS	FLEX. RIG. z-DIR	FLEX. RIG. y-DIR
*****	*****	*****	*****	*****	*****	*****	*****	*****	*****	*****	*****
1	-1.6612E-05	-4.2506E-04	-212.49	-169.77	-39.426	-148.75	-15.652	-78.958	2289.9	7.8279E+06	7.8279E+06
x(M)	8.6400	0.0000	0.0000	4.3200	6.2400	0.0000	7.9200	2.4000	24.000	0.0000	0.0000
2	-1.7899E-05	-4.2413E-04	-177.42	-150.48	-32.098	-124.36	-11.340	-60.259	1977.9	7.8279E+06	7.8279E+06
x(M)	8.8800	0.0000	0.0000	4.5600	6.4800	0.0000	7.9200	2.4000	24.000	0.0000	0.0000
3	-1.7557E-05	-4.2319E-04	-187.14	-155.30	-34.045	-130.50	-12.527	-64.968	1665.9	7.8279E+06	7.8279E+06
x(M)	8.8800	0.0000	0.0000	4.5600	6.4800	0.0000	7.9200	2.4000	24.000	0.0000	0.0000
4	-1.6930E-05	-4.2506E-04	-202.67	-164.93	-37.468	-142.73	-14.573	-74.165	2576.2	7.8279E+06	7.8279E+06
x(M)	8.6400	0.0000	0.0000	4.3200	6.2400	0.0000	7.9200	2.4000	24.000	0.0000	0.0000
5	-1.8238E-05	-4.2413E-04	-164.18	-143.87	-29.584	-116.25	-9.8398	-54.443	2264.2	7.8279E+06	7.8279E+06
x(M)	9.1200	0.0000	0.0000	4.5600	6.7200	0.0000	7.9200	2.4000	24.000	0.0000	0.0000
6	-1.7939E-05	-4.2319E-04	-173.78	-148.78	-31.503	-122.26	-11.001	-58.880	1952.2	7.8279E+06	7.8279E+06
x(M)	8.8800	0.0000	0.0000	4.5600	6.4800	0.0000	7.9200	2.4000	24.000	0.0000	0.0000
7	-1.6786E-05	-4.2506E-04	-204.22	-166.50	-37.994	-144.62	-14.877	-75.700	2822.3	7.8279E+06	7.8279E+06
x(M)	8.6400	0.0000	0.0000	4.3200	6.2400	0.0000	7.9200	2.4000	24.000	0.0000	0.0000
8	-1.8068E-05	-4.2413E-04	-167.05	-146.04	-30.310	-118.83	-10.304	-56.307	2550.5	7.8279E+06	7.8279E+06
x(M)	9.1200	0.0000	0.0000	4.5600	6.4800	0.0000	7.9200	2.4000	24.000	0.0000	0.0000
9	-1.7778E-05	-4.2319E-04	-176.77	-151.00	-32.274	-124.97	-11.486	-60.901	2238.5	7.8279E+06	7.8279E+06
x(M)	8.8800	0.0000	0.0000	4.5600	6.4800	0.0000	7.9200	2.4000	24.000	0.0000	0.0000
10	-1.5647E-05	-4.2506E-04	-230.94	-182.05	-43.950	-164.46	-18.165	-92.190	3018.6	7.8279E+06	7.8279E+06
x(M)	8.4000	0.0000	0.0000	4.3200	6.0000	0.0000	7.9200	2.4000	24.000	0.0000	0.0000
11	-1.6604E-05	-4.2413E-04	-206.54	-168.15	-38.668	-146.62	-15.265	-77.509	2804.7	7.8279E+06	7.8279E+06
x(M)	8.6400	0.0000	0.0000	4.3200	6.2400	0.0000	7.9200	2.4000	24.000	0.0000	0.0000
12	-1.6356E-05	-4.2319E-04	-213.20	-171.51	-40.094	-150.85	-16.059	-81.125	2524.8	7.8279E+06	7.8279E+06
x(M)	8.4000	0.0000	0.0000	4.3200	6.2400	0.0000	7.9200	2.4000	24.000	0.0000	0.0000
Min.	-1.8238E-05	-4.2506E-04	-230.94	-182.05	-43.950	-164.46	-18.165	-92.190	1665.9	7.8279E+06	7.8279E+06
Pile N.	5	1	10	10	10	10	10	10	3	1	1

* MAXIMUM VALUES AND LOCATIONS *

APPALTATORE: Consorzio Soci   	ITINERARIO NAPOLI – BARI RADDOPPIO TRATTA APICE – ORSARA I LOTTO FUNZIONALE APICE – HIRPINIA				
PROGETTAZIONE: Mandataria Mandanti   					
PROGETTO ESECUTIVO RELAZIONE DI CALCOLO FONDAZIONI PILE DA P17 A P20					
COMMESSA IF1N	LOTTO 01 E ZZ	CODIFICA RG	DOCUMENTO MD0000 001	REV. B	FOGLIO 122 di 143

PILE	DISPL. y-DIR M	DISPL. z-DIR M	MOMENT z-DIR KN- M	MOMENT y-DIR KN- M	SHEAR y-DIR KN	SHEAR z-DIR KN	SOIL REACT y-DIR KN/ M	SOIL REACT z-DIR KN/ M	TOTAL STRESS KN/ M**2	FLEX. RIG. z-DIR KN- M**2	FLEX. RIG. y-DIR KN- M**2
*****	*****	*****	*****	*****	*****	*****	*****	*****	*****	*****	*****
1	3.8902E-04	1.8448E-05	155.69	286.56	122.74	42.785	68.950	16.976	3366.6	7.8279E+06	7.8279E+06
x(M)	0.0000	8.6400	4.3200	0.0000	0.0000	6.4800	2.4000	7.9200	0.0000	0.0000	0.0000
2	3.8902E-04	1.9649E-05	138.67	244.24	102.13	34.622	52.703	11.915	2889.0	7.8279E+06	7.8279E+06
x(M)	0.0000	9.1200	4.3200	0.0000	0.0000	6.7200	2.4000	7.9200	0.0000	0.0000	0.0000
3	3.8902E-04	1.9300E-05	143.45	254.48	107.80	36.715	56.997	13.270	2619.2	7.8279E+06	7.8279E+06
x(M)	0.0000	8.8800	4.3200	0.0000	0.0000	6.4800	2.4000	7.9200	0.0000	0.0000	0.0000
4	3.8809E-04	1.8782E-05	151.24	276.47	117.08	40.825	64.544	15.749	3610.8	7.8279E+06	7.8279E+06
x(M)	0.0000	8.6400	4.3200	0.0000	0.0000	6.4800	2.4000	7.9200	0.0000	0.0000	0.0000
5	3.8809E-04	2.0023E-05	132.52	229.94	94.750	32.012	47.445	10.191	3116.9	7.8279E+06	7.8279E+06
x(M)	0.0000	9.1200	4.5600	0.0000	0.0000	6.7200	2.4000	7.9200	0.0000	0.0000	0.0000
6	3.8809E-04	1.9700E-05	137.11	240.15	100.26	33.995	51.472	11.524	2846.8	7.8279E+06	7.8279E+06
x(M)	0.0000	9.1200	4.3200	0.0000	0.0000	6.7200	2.4000	7.9200	0.0000	0.0000	0.0000
7	3.8716E-04	1.8694E-05	152.22	279.74	118.21	41.466	65.680	16.145	3867.6	7.8279E+06	7.8279E+06
x(M)	0.0000	8.6400	4.3200	0.0000	0.0000	6.4800	2.4000	7.9200	0.0000	0.0000	0.0000
8	3.8716E-04	1.9935E-05	134.04	234.61	96.550	32.874	48.922	10.751	3419.7	7.8279E+06	7.8279E+06
x(M)	0.0000	9.1200	4.5600	0.0000	0.0000	6.7200	2.4000	7.9200	0.0000	0.0000	0.0000
9	3.8716E-04	1.9564E-05	138.84	245.00	102.17	34.877	53.079	12.113	3150.3	7.8279E+06	7.8279E+06
x(M)	0.0000	9.1200	4.3200	0.0000	0.0000	6.7200	2.4000	7.9200	0.0000	0.0000	0.0000
10	3.8623E-04	1.7559E-05	165.64	312.80	134.68	48.393	79.807	20.085	4192.1	7.8279E+06	7.8279E+06
x(M)	0.0000	8.4000	4.0800	0.0000	0.0000	6.2400	2.4000	7.9200	0.0000	0.0000	0.0000
11	3.8623E-04	1.8524E-05	153.54	282.71	119.86	42.173	67.229	16.609	3861.4	7.8279E+06	7.8279E+06
x(M)	0.0000	8.6400	4.3200	0.0000	0.0000	6.4800	2.4000	7.9200	0.0000	0.0000	0.0000
12	3.8623E-04	1.8202E-05	156.68	289.31	123.91	43.699	70.573	17.510	3609.4	7.8279E+06	7.8279E+06
x(M)	0.0000	8.6400	4.3200	0.0000	0.0000	6.2400	2.4000	7.9200	0.0000	0.0000	0.0000
Max.	3.8902E-04	2.0023E-05	165.64	312.80	134.68	48.393	79.807	20.085	4192.1	7.8279E+06	7.8279E+06
Pile N.	1	5	10	10	10	10	10	10	10	1	1

LOAD CASE : 13
CASE NAME : Load Case
LOAD TYPE : Special, Sp

REDUCTION FACTORS FOR CLOSELY-SPACED PILE GROUPS, COMBINED Y AND Z DIRECTIONS
ESTIMATED USING MOVEMENT IN THE DIRECTION OF PILE CAP DISPLACEMENTS

GROUP NO	P-FACTOR	Y-FACTOR
1	0.7622	1.0000
2	0.5464	1.0000
3	0.5845	1.0000
4	0.7090	1.0000
5	0.4819	1.0000
6	0.5164	1.0000
7	0.7202	1.0000
8	0.4955	1.0000
9	0.5317	1.0000
10	0.8661	1.0000
11	0.6820	1.0000
12	0.7148	1.0000

* TABLE L * COMPUTATION ON PILE CAP

* EQUIVALENT CONCENTRATED LOAD AT ORIGIN *

VERT. LOAD, KN	HOR. LOAD Y, KN	HOR. LOAD Z, KN
50691.5	1750.00	-1635.00
MOMENT X , KN- M	MOMENT Y, KN- M	MOMENT Z, KN- M
-5.00000	-28879.5	-21225.0

* DISPLACEMENT OF GROUPED PILE FOUNDATION AT ORIGIN *

VERTICAL , M	HORIZONTAL Y, M	HORIZONTAL Z, M
2.13696E-03	5.19315E-04	-4.36758E-04
ANGLE ROT. X,RAD	ANGLE ROT. Y,RAD	ANGLE ROT. Z,RAD
1.63600E-07	-5.81156E-05	-8.20419E-05

THE GLOBAL STRUCTURAL COORDINATE SYSTEM

* PILE TOP DISPLACEMENTS *

PILE GROUP DISP. X, M DISP. Y, M DISP. Z, M ROT. X,RAD ROT. Y,RAD ROT. Z,RAD

APPALTATORE: Consorzio  Soci  		ITINERARIO NAPOLI – BARI RADDOPPIO TRATTA APICE – ORSARA I LOTTO FUNZIONALE APICE – HIRPINIA					
PROGETTAZIONE: Mandataria  Mandanti  							
PROGETTO ESECUTIVO RELAZIONE DI CALCOLO FONDAZIONI PILE DA P17 A P20						COMMESSA IF1N	LOTTO 01 E ZZ

*****	*****	*****	*****	*****	*****	*****
1	2.1139E-03	5.1821E-04	-4.3602E-04	1.6360E-07	-5.8116E-05	-8.2042E-05
2	1.7447E-03	5.1821E-04	-4.3676E-04	1.6360E-07	-5.8116E-05	-8.2042E-05
3	1.3755E-03	5.1821E-04	-4.3749E-04	1.6360E-07	-5.8116E-05	-8.2042E-05
4	2.3754E-03	5.1895E-04	-4.3602E-04	1.6360E-07	-5.8116E-05	-8.2042E-05
5	2.0062E-03	5.1895E-04	-4.3676E-04	1.6360E-07	-5.8116E-05	-8.2042E-05
6	1.6370E-03	5.1895E-04	-4.3749E-04	1.6360E-07	-5.8116E-05	-8.2042E-05
7	2.6369E-03	5.1968E-04	-4.3602E-04	1.6360E-07	-5.8116E-05	-8.2042E-05
8	2.2677E-03	5.1968E-04	-4.3676E-04	1.6360E-07	-5.8116E-05	-8.2042E-05
9	1.8985E-03	5.1968E-04	-4.3749E-04	1.6360E-07	-5.8116E-05	-8.2042E-05
10	2.8984E-03	5.2042E-04	-4.3602E-04	1.6360E-07	-5.8116E-05	-8.2042E-05
11	2.5292E-03	5.2042E-04	-4.3676E-04	1.6360E-07	-5.8116E-05	-8.2042E-05
12	2.1601E-03	5.2042E-04	-4.3749E-04	1.6360E-07	-5.8116E-05	-8.2042E-05
MINIMUM	1.3755E-03	5.1821E-04	-4.3749E-04	1.6360E-07	-5.8116E-05	-8.2042E-05
Pile N.	3	1	3	1	1	1
MAXIMUM	2.8984E-03	5.2042E-04	-4.3602E-04	1.6360E-07	-5.8116E-05	-8.2042E-05
Pile N.	10	10	1	1	1	1

* PILE TOP REACTIONS *

PILE GROUP	FOR. X, KN	FOR. Y, KN	FOR. Z, KN	MOM X, KN- M	MOM Y, KN- M	MOM Z, KN- M
*****	*****	*****	*****	*****	*****	*****
1	4219.6	163.20	-151.92	0.063746	293.55	284.16
2	3491.9	133.45	-125.66	0.063746	248.69	233.51
3	2764.1	139.09	-131.06	0.063746	258.35	243.15
4	4735.1	156.57	-145.68	0.063746	283.11	273.54
5	4007.3	123.73	-116.65	0.063746	232.76	216.83
6	3279.6	129.15	-121.83	0.063746	242.19	226.26
7	5119.1	158.36	-146.94	0.063746	285.30	276.95
8	4522.8	126.13	-118.52	0.063746	236.19	221.47
9	3795.1	131.75	-123.88	0.063746	245.90	231.21
10	5472.6	177.06	-163.18	0.063746	312.40	308.21
11	4973.6	153.55	-142.70	0.063746	278.41	269.16
12	4310.6	157.96	-147.00	0.063746	285.92	276.45
MINIMUM	2764.1	123.73	-163.18	0.063746	232.76	216.83
Pile N.	3	5	10	1	5	5
MAXIMUM	5472.6	177.06	-116.65	0.063746	312.40	308.21
Pile N.	10	10	5	1	10	10

THE PILE COORDINATE SYSTEM (LOCAL AXES)

* PILE TOP DISPLACEMENTS *

PILE GROUP	DISP. x, M	DISP. y, M	DISP. z, M	ROT. x,RAD	ROT. y,RAD	ROT. z,RAD
*****	*****	*****	*****	*****	*****	*****
1	2.1139E-03	5.1821E-04	-4.3602E-04	1.6360E-07	-5.8116E-05	-8.2042E-05
2	1.7447E-03	5.1821E-04	-4.3676E-04	1.6360E-07	-5.8116E-05	-8.2042E-05
3	1.3755E-03	5.1821E-04	-4.3749E-04	1.6360E-07	-5.8116E-05	-8.2042E-05
4	2.3754E-03	5.1895E-04	-4.3602E-04	1.6360E-07	-5.8116E-05	-8.2042E-05
5	2.0062E-03	5.1895E-04	-4.3676E-04	1.6360E-07	-5.8116E-05	-8.2042E-05
6	1.6370E-03	5.1895E-04	-4.3749E-04	1.6360E-07	-5.8116E-05	-8.2042E-05
7	2.6369E-03	5.1968E-04	-4.3602E-04	1.6360E-07	-5.8116E-05	-8.2042E-05
8	2.2677E-03	5.1968E-04	-4.3676E-04	1.6360E-07	-5.8116E-05	-8.2042E-05
9	1.8985E-03	5.1968E-04	-4.3749E-04	1.6360E-07	-5.8116E-05	-8.2042E-05
10	2.8984E-03	5.2042E-04	-4.3602E-04	1.6360E-07	-5.8116E-05	-8.2042E-05
11	2.5292E-03	5.2042E-04	-4.3676E-04	1.6360E-07	-5.8116E-05	-8.2042E-05
12	2.1601E-03	5.2042E-04	-4.3749E-04	1.6360E-07	-5.8116E-05	-8.2042E-05
MINIMUM	1.3755E-03	5.1821E-04	-4.3749E-04	1.6360E-07	-5.8116E-05	-8.2042E-05
Pile N.	3	1	3	1	1	1
MAXIMUM	2.8984E-03	5.2042E-04	-4.3602E-04	1.6360E-07	-5.8116E-05	-8.2042E-05
Pile N.	10	10	1	1	1	1

* PILE TOP REACTIONS *

PILE GROUP	AXIAL, KN	LAT. y, KN	LAT. z, KN	MOM x, KN- M	MOM y, KN- M	MOM z, KN- M
*****	*****	*****	*****	*****	*****	*****
1	4219.6	163.20	-151.92	0.063746	293.55	284.16
2	3491.9	133.45	-125.66	0.063746	248.69	233.51
3	2764.1	139.09	-131.06	0.063746	258.35	243.15
4	4735.1	156.57	-145.68	0.063746	283.11	273.54
5	4007.3	123.73	-116.65	0.063746	232.76	216.83
6	3279.6	129.15	-121.83	0.063746	242.19	226.26
7	5119.1	158.36	-146.94	0.063746	285.30	276.95
8	4522.8	126.13	-118.52	0.063746	236.19	221.47
9	3795.1	131.75	-123.88	0.063746	245.90	231.21
10	5472.6	177.06	-163.18	0.063746	312.40	308.21
11	4973.6	153.55	-142.70	0.063746	278.41	269.16
12	4310.6	157.96	-147.00	0.063746	285.92	276.45
MINIMUM	2764.1	123.73	-163.18	0.063746	232.76	216.83
Pile N.	3	5	10	1	5	5
MAXIMUM	5472.6	177.06	-116.65	0.063746	312.40	308.21
Pile N.	10	10	5	1	10	10

APPALDATTORE: Consorzio  Soci  		ITINERARIO NAPOLI – BARI					
PROGETTAZIONE: Mandataria  Mandanti  		RADDOPPIO TRATTA APICE – ORSARA I LOTTO FUNZIONALE APICE – HIRPINIA					
PROGETTO ESECUTIVO RELAZIONE DI CALCOLO FONDAZIONI PILE DA P17 A P20		COMMESSA IF1N	LOTTO 01 E ZZ	CODIFICA RG	DOCUMENTO MD0000 001	REV. B	FOGLIO 124 di 143

PILE GROUP	STRESS, KN/ M**2
*****	*****
1	3620.8
2	3005.5
3	2634.9
4	3867.6
5	3227.7
6	2856.2
7	4096.9
8	3536.6
9	3166.3
10	4421.3
11	3983.2
12	3639.6
MINIMUM	2634.9
Pile N.	3
MAXIMUM	4421.3
Pile N.	10

* EFFECTS FOR Laterally LOADED PILE *
* MINIMUM VALUES AND LOCATIONS *

PILE	DISPL. y-DIR	DISPL. z-DIR	MOMENT z-DIR	MOMENT y-DIR	SHEAR y-DIR	SHEAR z-DIR	SOIL REACT y-DIR	SOIL REACT z-DIR	TOTAL STRESS	FLEX. RIG. z-DIR	FLEX. RIG. y-DIR
	M	M	KN- M	KN- M	KN	KN	KN/ M	KN/ M	KN/ M**2	KN- M**2	KN- M**2
1	-2.1558E-05	-4.3602E-04	-284.16	-173.37	-52.863	-151.94	-21.262	-78.846	2387.8	7.8279E+06	7.8279E+06
x(M)	8.6400	0.0000	0.0000	4.3200	6.2400	0.0000	7.9200	2.4000	24.000	0.0000	0.0000
2	-2.3405E-05	-4.3676E-04	-233.51	-152.90	-42.259	-125.67	-14.896	-58.866	1976.0	7.8279E+06	7.8279E+06
x(M)	8.8800	0.0000	0.0000	4.5600	6.4800	0.0000	7.9200	2.4000	24.000	0.0000	0.0000
3	-2.3075E-05	-4.3749E-04	-243.15	-157.19	-44.240	-131.07	-16.108	-62.610	1564.2	7.8279E+06	7.8279E+06
x(M)	8.8800	0.0000	0.0000	4.5600	6.4800	0.0000	7.9200	2.4000	24.000	0.0000	0.0000
4	-2.2071E-05	-4.3602E-04	-273.54	-168.58	-50.381	-145.70	-19.859	-73.960	2679.5	7.8279E+06	7.8279E+06
x(M)	8.6400	0.0000	0.0000	4.5600	6.2400	0.0000	7.9200	2.4000	24.000	0.0000	0.0000
5	-2.4002E-05	-4.3676E-04	-216.83	-145.75	-38.920	-116.66	-12.729	-52.594	2267.7	7.8279E+06	7.8279E+06
x(M)	9.1200	0.0000	0.0000	4.8000	6.7200	0.0000	7.9200	2.4000	24.000	0.0000	0.0000
6	-2.3675E-05	-4.3749E-04	-226.26	-149.72	-40.683	-121.84	-13.898	-56.040	1855.9	7.8279E+06	7.8279E+06
x(M)	9.1200	0.0000	0.0000	4.5600	6.7200	0.0000	7.9200	2.4000	24.000	0.0000	0.0000
7	-2.2010E-05	-4.3602E-04	-276.95	-169.55	-51.009	-146.96	-20.199	-74.958	2896.8	7.8279E+06	7.8279E+06
x(M)	8.6400	0.0000	0.0000	4.5600	6.2400	0.0000	7.9200	2.4000	24.000	0.0000	0.0000
8	-2.3926E-05	-4.3676E-04	-221.47	-147.24	-39.705	-118.54	-13.220	-53.900	2559.4	7.8279E+06	7.8279E+06
x(M)	9.1200	0.0000	0.0000	4.8000	6.7200	0.0000	7.9200	2.4000	24.000	0.0000	0.0000
9	-2.3579E-05	-4.3749E-04	-231.21	-151.45	-41.548	-123.89	-14.434	-57.499	2147.6	7.8279E+06	7.8279E+06
x(M)	8.8800	0.0000	0.0000	4.5600	6.4800	0.0000	7.9200	2.4000	24.000	0.0000	0.0000
10	-2.0868E-05	-4.3602E-04	-308.21	-182.30	-57.726	-163.20	-23.944	-88.033	3096.8	7.8279E+06	7.8279E+06
x(M)	8.4000	0.0000	0.0000	4.3200	6.2400	0.0000	7.9200	2.4000	24.000	0.0000	0.0000
11	-2.2363E-05	-4.3676E-04	-269.16	-166.39	-49.227	-142.72	-19.137	-71.529	2814.5	7.8279E+06	7.8279E+06
x(M)	8.6400	0.0000	0.0000	4.5600	6.4800	0.0000	7.9200	2.4000	24.000	0.0000	0.0000
12	-2.2074E-05	-4.3749E-04	-276.45	-169.55	-50.742	-147.02	-20.048	-74.674	2439.3	7.8279E+06	7.8279E+06
x(M)	8.6400	0.0000	0.0000	4.5600	6.2400	0.0000	7.9200	2.4000	24.000	0.0000	0.0000
Min.	-2.4002E-05	-4.3749E-04	-308.21	-182.30	-57.726	-163.20	-23.944	-88.033	1564.2	7.8279E+06	7.8279E+06
Pile N.	5	3	10	10	10	10	10	10	3	1	1

* MAXIMUM VALUES AND LOCATIONS *

PILE	DISPL. y-DIR	DISPL. z-DIR	MOMENT z-DIR	MOMENT y-DIR	SHEAR y-DIR	SHEAR z-DIR	SOIL REACT y-DIR	SOIL REACT z-DIR	TOTAL STRESS	FLEX. RIG. z-DIR	FLEX. RIG. y-DIR
	M	M	KN- M	KN- M	KN	KN	KN/ M	KN/ M	KN/ M**2	KN- M**2	KN- M**2
1	5.1821E-04	1.8458E-05	206.52	293.55	163.21	44.313	89.514	17.787	3620.8	7.8279E+06	7.8279E+06
x(M)	0.0000	8.6400	4.3200	0.0000	0.0000	6.4800	2.4000	7.9200	0.0000	0.0000	0.0000
2	5.1821E-04	1.9906E-05	182.10	248.69	133.46	35.368	66.609	12.079	3005.5	7.8279E+06	7.8279E+06
x(M)	0.0000	9.1200	4.5600	0.0000	0.0000	6.7200	2.4000	7.9200	0.0000	0.0000	0.0000
3	5.1821E-04	1.9671E-05	186.58	258.35	139.10	37.036	70.715	13.187	2634.9	7.8279E+06	7.8279E+06
x(M)	0.0000	8.8800	4.3200	0.0000	0.0000	6.7200	2.4000	7.9200	0.0000	0.0000	0.0000
4	5.1895E-04	1.8802E-05	201.26	283.11	156.59	42.264	84.100	16.498	3867.6	7.8279E+06	7.8279E+06
x(M)	0.0000	8.6400	4.3200	0.0000	0.0000	6.4800	2.4000	7.9200	0.0000	0.0000	0.0000
5	5.1895E-04	2.0280E-05	174.19	232.76	123.74	32.396	59.593	10.123	3227.7	7.8279E+06	7.8279E+06
x(M)	0.0000	9.1200	4.5600	0.0000	0.0000	6.7200	2.4000	7.9200	0.0000	0.0000	0.0000
6	5.1895E-04	2.0126E-05	178.59	242.19	129.16	34.053	63.383	11.184	2856.2	7.8279E+06	7.8279E+06
x(M)	0.0000	9.1200	4.5600	0.0000	0.0000	6.7200	2.4000	7.9200	0.0000	0.0000	0.0000
7	5.1968E-04	1.8736E-05	202.72	285.30	158.39	42.715	85.395	16.780	4096.9	7.8279E+06	7.8279E+06
x(M)	0.0000	8.6400	4.3200	0.0000	0.0000	6.4800	2.4000	7.9200	0.0000	0.0000	0.0000
8	5.1968E-04	2.0223E-05	176.21	236.19	126.14	33.060	61.193	10.551	3536.6	7.8279E+06	7.8279E+06
x(M)	0.0000	9.1200	4.5600	0.0000	0.0000	6.7200	2.4000	7.9200	0.0000	0.0000	0.0000
9	5.1968E-04	2.0038E-05	180.74	245.90	131.77	34.762	65.159	11.651	3166.3	7.8279E+06	7.8279E+06
x(M)	0.0000	9.1200	4.5600	0.0000	0.0000	6.7200	2.4000	7.9200	0.0000	0.0000	0.0000
10	5.2042E-04	1.7784E-05	217.30	312.40	177.09	48.361	100.54	20.115	4421.3	7.8279E+06	7.8279E+06
x(M)	0.0000	8.4000	4.3200	0.0000	0.0000	6.2400	7.9200	2.4000	24.000	0.0000	0.0000
11	5.2042E-04	1.9004E-05	198.77	278.41	153.57	41.220	81.452	15.830	3983.2	7.8279E+06	7.8279E+06
x(M)	0.0000	8.8800	4.3200	0.0000	0.0000	6.4800	7.9200	2.4000	24.000	0.0000	0.0000
12	5.2042E-04	1.8822E-05	202.29	285.92	157.98	42.594	84.872	16.674	3639.6	7.8279E+06	7.8279E+06
x(M)	0.0000	8.6400	4.3200	0.0000	0.0000	6.4800	2.4000	7.9200	0.0000	0.0000	0.0000

APPALTATORE: Consorzio Soci   	ITINERARIO NAPOLI – BARI RADDOPPIO TRATTA APICE – ORSARA I LOTTO FUNZIONALE APICE – HIRPINIA
PROGETTAZIONE: Mandataria Mandanti   	
PROGETTO ESECUTIVO RELAZIONE DI CALCOLO FONDAZIONI PILE DA P17 A P20	COMMESSA IF1N LOTTO 01 E ZZ CODIFICA RG DOCUMENTO MD0000 001 REV. B FOGLIO 125 di 143

Max. Pile N.	5.2042E-04 10	2.0280E-05 5	217.30 10	312.40 10	177.09 10	48.361 10	100.54 10	20.115 10	4421.3 10	7.8279E+06 1	7.8279E+06 1
--------------	------------------	-----------------	--------------	--------------	--------------	--------------	--------------	--------------	--------------	-----------------	-----------------

LOAD CASE : 14
CASE NAME : Load Case
LOAD TYPE : Special, Sp

REDUCTION FACTORS FOR CLOSELY-SPACED PILE GROUPS, COMBINED Y AND Z DIRECTIONS
ESTIMATED USING MOVEMENT IN THE DIRECTION OF PILE CAP DISPLACEMENTS

GROUP NO	P-FACTOR	Y-FACTOR
1	0.6009	1.0000
2	0.5008	1.0000
3	0.5845	1.0000
4	0.5596	1.0000
5	0.4641	1.0000
6	0.5422	1.0000
7	0.5918	1.0000
8	0.4961	1.0000
9	0.5754	1.0000
10	0.8661	1.0000
11	0.7960	1.0000
12	0.8548	1.0000

* TABLE L * COMPUTATION ON PILE CAP

* EQUIVALENT CONCENTRATED LOAD AT ORIGIN *

VERT. LOAD, KN 34888.5	HOR. LOAD Y, KN 255.000	HOR. LOAD Z, KN -1282.00
MOMENT X, KN- M 0.00000	MOMENT Y, KN- M -22314.0	MOMENT Z, KN- M -3133.50

* DISPLACEMENT OF GROUPED PILE FOUNDATION AT ORIGIN *

VERTICAL, M 1.44816E-03	HORIZONTAL Y, M 6.87528E-05	HORIZONTAL Z, M -3.07537E-04
ANGLE ROT. X, RAD -3.40536E-07	ANGLE ROT. Y, RAD -4.13809E-05	ANGLE ROT. Z, RAD -1.11739E-05

THE GLOBAL STRUCTURAL COORDINATE SYSTEM

* PILE TOP DISPLACEMENTS *

PILE GROUP	DISP. X, M	DISP. Y, M	DISP. Z, M	ROT. X, RAD	ROT. Y, RAD	ROT. Z, RAD
1	1.2191E-03	7.1051E-05	-3.0907E-04	-3.4054E-07	-4.1381E-05	-1.1174E-05
2	1.1688E-03	7.1051E-05	-3.0754E-04	-3.4054E-07	-4.1381E-05	-1.1174E-05
3	1.1186E-03	7.1051E-05	-3.0600E-04	-3.4054E-07	-4.1381E-05	-1.1174E-05
4	1.4053E-03	6.9519E-05	-3.0907E-04	-3.4054E-07	-4.1381E-05	-1.1174E-05
5	1.3551E-03	6.9519E-05	-3.0754E-04	-3.4054E-07	-4.1381E-05	-1.1174E-05
6	1.3048E-03	6.9519E-05	-3.0600E-04	-3.4054E-07	-4.1381E-05	-1.1174E-05
7	1.5915E-03	6.7987E-05	-3.0907E-04	-3.4054E-07	-4.1381E-05	-1.1174E-05
8	1.5413E-03	6.7987E-05	-3.0754E-04	-3.4054E-07	-4.1381E-05	-1.1174E-05
9	1.4910E-03	6.7987E-05	-3.0600E-04	-3.4054E-07	-4.1381E-05	-1.1174E-05
10	1.7778E-03	6.6454E-05	-3.0907E-04	-3.4054E-07	-4.1381E-05	-1.1174E-05
11	1.7275E-03	6.6454E-05	-3.0754E-04	-3.4054E-07	-4.1381E-05	-1.1174E-05
12	1.6772E-03	6.6454E-05	-3.0600E-04	-3.4054E-07	-4.1381E-05	-1.1174E-05
MINIMUM Pile N.	3	10	1	1	1	1
MAXIMUM Pile N.	10	1	3	1	1	1

* PILE TOP REACTIONS *

PILE GROUP	FOR. X, KN	FOR. Y, KN	FOR. Z, KN	MOM X, KN- M	MOM Y, KN- M	MOM Z, KN- M
1	2455.9	22.273	-106.48	-0.1327	205.53	39.029
2	2356.8	19.935	-94.985	-0.1327	185.04	35.030
3	2257.7	21.906	-103.21	-0.1327	198.60	38.403
4	2823.0	20.557	-102.14	-0.1327	198.14	35.453
5	2723.8	18.316	-90.784	-0.1327	177.69	31.585
6	2624.7	20.165	-98.756	-0.1327	190.98	34.779
7	3190.0	20.471	-105.50	-0.1327	203.94	34.640

APPALTATORE: Consorzio  Soci  				ITINERARIO NAPOLI – BARI RADDOPPIO TRATTA APICE – ORSARA I LOTTO FUNZIONALE APICE – HIRPINIA					
PROGETTAZIONE: Mandataria  Mandanti  									
PROGETTO ESECUTIVO RELAZIONE DI CALCOLO FONDAZIONI PILE DA P17 A P20									

8	3090.9	18.359	-94.421	-0.1327	184.13	31.031
9	2991.8	20.123	-102.23	-0.1327	196.99	34.047
10	3557.1	24.765	-131.12	-0.1327	246.52	40.966
11	3458.0	23.554	-124.12	-0.1327	234.37	39.016
12	3358.8	24.576	-128.26	-0.1327	240.36	40.657
MINIMUM	2257.7	18.316	-131.12	-0.1327	177.69	31.031
Pile N.	3	5	10	1	5	8
MAXIMUM	3557.1	24.765	-90.784	-0.1327	246.52	40.966
Pile N.	10	10	5	1	10	10

THE PILE COORDINATE SYSTEM (LOCAL AXES)

* PILE TOP DISPLACEMENTS *

PILE GROUP	DISP. x, M	DISP. y, M	DISP. z, M	ROT. x,RAD	ROT. y,RAD	ROT. z,RAD
*****	*****	*****	*****	*****	*****	*****
1	1.2191E-03	7.1051E-05	-3.0907E-04	-3.4054E-07	-4.1381E-05	-1.1174E-05
2	1.1688E-03	7.1051E-05	-3.0754E-04	-3.4054E-07	-4.1381E-05	-1.1174E-05
3	1.1186E-03	7.1051E-05	-3.0600E-04	-3.4054E-07	-4.1381E-05	-1.1174E-05
4	1.4053E-03	6.9519E-05	-3.0907E-04	-3.4054E-07	-4.1381E-05	-1.1174E-05
5	1.3551E-03	6.9519E-05	-3.0754E-04	-3.4054E-07	-4.1381E-05	-1.1174E-05
6	1.3048E-03	6.9519E-05	-3.0600E-04	-3.4054E-07	-4.1381E-05	-1.1174E-05
7	1.5915E-03	6.7987E-05	-3.0907E-04	-3.4054E-07	-4.1381E-05	-1.1174E-05
8	1.5413E-03	6.7987E-05	-3.0754E-04	-3.4054E-07	-4.1381E-05	-1.1174E-05
9	1.4910E-03	6.7987E-05	-3.0600E-04	-3.4054E-07	-4.1381E-05	-1.1174E-05
10	1.7778E-03	6.6454E-05	-3.0907E-04	-3.4054E-07	-4.1381E-05	-1.1174E-05
11	1.7275E-03	6.6454E-05	-3.0754E-04	-3.4054E-07	-4.1381E-05	-1.1174E-05
12	1.6772E-03	6.6454E-05	-3.0600E-04	-3.4054E-07	-4.1381E-05	-1.1174E-05
MINIMUM	1.1186E-03	6.6454E-05	-3.0907E-04	-3.4054E-07	-4.1381E-05	-1.1174E-05
Pile N.	3	10	1	1	1	1
MAXIMUM	1.7778E-03	7.1051E-05	-3.0600E-04	-3.4054E-07	-4.1381E-05	-1.1174E-05
Pile N.	10	1	3	1	1	1

* PILE TOP REACTIONS *

PILE GROUP	AXIAL, KN	LAT. y, KN	LAT. z, KN	MOM x, KN- M	MOM y, KN- M	MOM z, KN- M
*****	*****	*****	*****	*****	*****	*****
1	2455.9	22.273	-106.48	-0.1327	205.53	39.029
2	2356.8	19.935	-94.985	-0.1327	185.04	35.030
3	2257.7	21.906	-103.21	-0.1327	198.60	38.403
4	2823.0	20.557	-102.14	-0.1327	198.14	35.453
5	2723.8	18.316	-90.784	-0.1327	177.69	31.585
6	2624.7	20.165	-98.756	-0.1327	190.98	34.779
7	3190.0	20.471	-105.50	-0.1327	203.94	34.640
8	3090.9	18.359	-94.421	-0.1327	184.13	31.031
9	2991.8	20.123	-102.23	-0.1327	196.99	34.047
10	3557.1	24.765	-131.12	-0.1327	246.52	40.966
11	3458.0	23.554	-124.12	-0.1327	234.37	39.016
12	3358.8	24.576	-128.26	-0.1327	240.36	40.657
MINIMUM	2257.7	18.316	-131.12	-0.1327	177.69	31.031
Pile N.	3	5	10	1	5	8
MAXIMUM	3557.1	24.765	-90.784	-0.1327	246.52	40.966
Pile N.	10	10	5	1	10	10

PILE GROUP STRESS, KN/ M**2

PILE GROUP	STRESS, KN/ M**2
*****	*****
1	2021.1
2	1902.0
3	1888.1
4	2205.0
5	2086.1
6	2071.2
7	2429.5
8	2312.6
9	2296.4
10	2767.1
11	2673.9
12	2636.5
MINIMUM	1888.1
Pile N.	3
MAXIMUM	2767.1
Pile N.	10

* EFFECTS FOR LATERALLY LOADED PILE *

* MINIMUM VALUES AND LOCATIONS *

PILE	DISPL. y-DIR	DISPL. z-DIR	MOMENT z-DIR	MOMENT y-DIR	SHEAR y-DIR	SHEAR z-DIR	SOIL REACT y-DIR	SOIL REACT z-DIR	TOTAL STRESS	FLEX. RIG. z-DIR	FLEX. RIG. y-DIR
*****	*****	*****	*****	*****	*****	*****	*****	*****	*****	*****	*****
1	-3.2738E-06	-3.0907E-04	-39.029	-119.47	-6.6264	-106.49	-2.4917	-61.290	1389.8	7.8279E+06	7.8279E+06

APPALTATORE: Consorzio Soci   		ITINERARIO NAPOLI – BARI RADDOPPIO TRATTA APICE – ORSARA I LOTTO FUNZIONALE APICE – HIRPINIA					
PROGETTAZIONE: Mandataria Mandanti   							
PROGETTO ESECUTIVO RELAZIONE DI CALCOLO FONDAZIONI PILE DA P17 A P20							
		COMMESSA IF1N	LOTTO 01 E ZZ	CODIFICA RG	DOCUMENTO MD0000 001	REV. B	FOGLIO 127 di 143

x(M)	8.6400	0.0000	0.0000	4.3200	6.2400	0.0000	7.9200	2.4000	24.000	0.0000	0.0000
2	-3.4009E-06	-3.0754E-04	-35.030	-110.20	-5.8402	-94.992	-2.0347	-51.918	1333.7	7.8279E+06	7.8279E+06
x(M)	8.8800	0.0000	0.0000	4.5600	6.4800	0.0000	7.9200	2.4000	24.000	0.0000	0.0000
3	-3.2934E-06	-3.0600E-04	-38.403	-116.98	-6.4958	-103.22	-2.4200	-59.091	1277.6	7.8279E+06	7.8279E+06
x(M)	8.6400	0.0000	0.0000	4.3200	6.2400	0.0000	7.9200	2.4000	24.000	0.0000	0.0000
4	-3.2499E-06	-3.0907E-04	-35.453	-116.00	-6.1766	-102.14	-2.2685	-57.591	1597.5	7.8279E+06	7.8279E+06
x(M)	8.6400	0.0000	0.0000	4.3200	6.2400	0.0000	7.9200	2.4000	24.000	0.0000	0.0000
5	-3.3689E-06	-3.0754E-04	-31.585	-106.96	-5.4329	-90.792	-1.8267	-48.547	1541.4	7.8279E+06	7.8279E+06
x(M)	8.8800	0.0000	0.0000	4.5600	6.4800	0.0000	7.9200	2.4000	24.000	0.0000	0.0000
6	-3.2706E-06	-3.0600E-04	-34.779	-113.38	-6.0405	-98.764	-2.1911	-55.327	1485.3	7.8279E+06	7.8279E+06
x(M)	8.8800	0.0000	0.0000	4.3200	6.4800	0.0000	7.9200	2.4000	24.000	0.0000	0.0000
7	-3.1390E-06	-3.0907E-04	-34.640	-118.73	-6.3016	-105.51	-2.3611	-60.474	1805.2	7.8279E+06	7.8279E+06
x(M)	8.6400	0.0000	0.0000	4.3200	6.2400	0.0000	7.9200	2.4000	24.000	0.0000	0.0000
8	-3.2593E-06	-3.0754E-04	-31.031	-109.81	-5.5785	-94.430	-1.9476	-51.486	1749.1	7.8279E+06	7.8279E+06
x(M)	8.8800	0.0000	0.0000	4.5600	6.4800	0.0000	7.9200	2.4000	24.000	0.0000	0.0000
9	-3.1588E-06	-3.0600E-04	-34.047	-116.23	-6.1775	-102.24	-2.2930	-58.278	1693.0	7.8279E+06	7.8279E+06
x(M)	8.6400	0.0000	0.0000	4.3200	6.2400	0.0000	7.9200	2.4000	24.000	0.0000	0.0000
10	-2.7516E-06	-3.0907E-04	-40.966	-138.94	-7.9737	-131.14	-3.2349	-84.033	2012.9	7.8279E+06	7.8279E+06
x(M)	8.1600	0.0000	0.0000	4.0800	6.0000	0.0000	7.9200	2.4000	24.000	0.0000	0.0000
11	-2.8244E-06	-3.0754E-04	-39.016	-133.43	-7.5441	-124.13	-3.0291	-77.693	1956.8	7.8279E+06	7.8279E+06
x(M)	8.1600	0.0000	0.0000	4.0800	6.0000	0.0000	7.9200	2.4000	24.000	0.0000	0.0000
12	-2.7634E-06	-3.0600E-04	-40.657	-136.82	-7.9057	-128.28	-3.2026	-82.078	1900.7	7.8279E+06	7.8279E+06
x(M)	8.1600	0.0000	0.0000	4.0800	6.0000	0.0000	7.9200	2.4000	24.000	0.0000	0.0000
Min.	-3.4009E-06	-3.0907E-04	-40.966	-138.94	-7.9737	-131.14	-3.2349	-84.033	1277.6	7.8279E+06	7.8279E+06
Pile N.	2	1	10	10	10	10	10	10	3	1	1

* MAXIMUM VALUES AND LOCATIONS *

PILE	DISPL. y-DIR	DISPL. z-DIR	MOMENT z-DIR	MOMENT y-DIR	SHEAR y-DIR	SHEAR z-DIR	SOIL REACT y-DIR	SOIL REACT z-DIR	TOTAL STRESS	FLEX. RIG. z-DIR	FLEX. RIG. y-DIR
	M	M	KN- M	KN- M	KN	KN	KN/ M	KN/ M	KN/ M**2	KN- M**2	KN- M**2
*****	*****	*****	*****	*****	*****	*****	*****	*****	*****	*****	*****
1	7.1051E-05	1.4339E-05	27.596	205.53	22.274	28.562	13.494	10.651	2021.1	7.8279E+06	7.8279E+06
x(M)	0.0000	8.6400	4.0800	0.0000	0.0000	6.4800	2.4000	7.9200	0.0000	0.0000	0.0000
2	7.1051E-05	1.4760E-05	25.704	185.04	19.937	24.951	11.494	8.5091	1902.0	7.8279E+06	7.8279E+06
x(M)	0.0000	9.1200	4.3200	0.0000	0.0000	6.4800	2.4000	7.9200	0.0000	0.0000	0.0000
3	7.1051E-05	1.4279E-05	27.299	198.60	21.907	27.750	13.171	10.230	1888.1	7.8279E+06	7.8279E+06
x(M)	0.0000	8.8800	4.3200	0.0000	0.0000	6.4800	2.4000	7.9200	0.0000	0.0000	0.0000
4	6.9519E-05	1.4574E-05	26.294	198.14	20.558	27.188	12.321	9.8139	2205.0	7.8279E+06	7.8279E+06
x(M)	0.0000	8.8800	4.3200	0.0000	0.0000	6.4800	2.4000	7.9200	0.0000	0.0000	0.0000
5	6.9519E-05	1.4953E-05	24.450	177.69	18.317	23.654	10.443	7.6868	2086.1	7.8279E+06	7.8279E+06
x(M)	0.0000	9.1200	4.3200	0.0000	0.0000	6.7200	2.4000	7.9200	0.0000	0.0000	0.0000
6	6.9519E-05	1.4509E-05	25.976	190.98	20.167	26.328	11.983	9.3666	2071.2	7.8279E+06	7.8279E+06
x(M)	0.0000	8.8800	4.3200	0.0000	0.0000	6.4800	2.4000	7.9200	0.0000	0.0000	0.0000
7	6.7987E-05	1.4398E-05	26.347	203.94	20.473	28.279	12.569	10.476	2429.5	7.8279E+06	7.8279E+06
x(M)	0.0000	8.8800	4.0800	0.0000	0.0000	6.4800	2.4000	7.9200	0.0000	0.0000	0.0000
8	6.7987E-05	1.4794E-05	24.585	184.13	18.360	24.790	10.758	8.4120	2312.6	7.8279E+06	7.8279E+06
x(M)	0.0000	9.1200	4.3200	0.0000	0.0000	6.4800	2.4000	7.9200	0.0000	0.0000	0.0000
9	6.7987E-05	1.4338E-05	26.045	196.99	20.125	27.462	12.262	10.052	2296.4	7.8279E+06	7.8279E+06
x(M)	0.0000	8.8800	4.0800	0.0000	0.0000	6.4800	2.4000	7.9200	0.0000	0.0000	0.0000
10	6.6454E-05	1.3035E-05	29.998	246.52	24.768	36.885	16.981	15.180	2767.1	7.8279E+06	7.8279E+06
x(M)	0.0000	8.1600	3.8400	0.0000	0.0000	6.0000	2.4000	7.9200	0.0000	0.0000	0.0000
11	6.6454E-05	1.3308E-05	29.010	234.37	23.556	34.605	15.790	14.053	2673.9	7.8279E+06	7.8279E+06
x(M)	0.0000	8.4000	4.0800	0.0000	0.0000	6.2400	2.4000	7.9200	0.0000	0.0000	0.0000
12	6.6454E-05	1.2941E-05	29.835	240.36	24.578	36.185	16.791	14.861	2636.5	7.8279E+06	7.8279E+06
x(M)	0.0000	8.1600	3.8400	0.0000	0.0000	6.0000	2.4000	7.9200	0.0000	0.0000	0.0000
Max.	7.1051E-05	1.4953E-05	29.998	246.52	24.768	36.885	16.981	15.180	2767.1	7.8279E+06	7.8279E+06
Pile N.	1	5	10	10	10	10	10	10	10	1	1

LOAD CASE : 15
CASE NAME : Load Case
LOAD TYPE : Special, Sp

REDUCTION FACTORS FOR CLOSELY-SPACED PILE GROUPS, COMBINED Y AND Z DIRECTIONS
ESTIMATED USING MOVEMENT IN THE DIRECTION OF PILE CAP DISPLACEMENTS

GROUP NO	P-FACTOR	Y-FACTOR
1	0.7219	1.0000
2	0.5344	1.0000
3	0.5845	1.0000
4	0.6717	1.0000
5	0.4771	1.0000
6	0.5235	1.0000
7	0.6877	1.0000
8	0.4957	1.0000
9	0.5439	1.0000
10	0.8661	1.0000
11	0.7147	1.0000
12	0.7554	1.0000

* TABLE L * COMPUTATION ON PILE CAP

APPALTATORE: Consorzio Soci   	ITINERARIO NAPOLI – BARI RADDOPPIO TRATTA APICE – ORSARA I LOTTO FUNZIONALE APICE – HIRPINIA
PROGETTAZIONE: Mandataria Mandanti   	
PROGETTO ESECUTIVO RELAZIONE DI CALCOLO FONDAZIONI PILE DA P17 A P20	

* EQUIVALENT CONCENTRATED LOAD AT ORIGIN *

VERT. LOAD, KN 46423.5	HOR. LOAD Y, KN 1152.00	HOR. LOAD Z, KN -1320.00
MOMENT X, KN- M 0.00000	MOMENT Y, KN- M -30912.0	MOMENT Z, KN- M -13935.0

* DISPLACEMENT OF GROUPED PILE FOUNDATION AT ORIGIN *

VERTICAL, M 1.93907E-03	HORIZONTAL Y, M 3.17821E-04	HORIZONTAL Z, M -3.58894E-04
ANGLE ROT. X,RAD -2.46410E-07	ANGLE ROT. Y,RAD -5.63699E-05	ANGLE ROT. Z,RAD -5.09598E-05

THE GLOBAL STRUCTURAL COORDINATE SYSTEM

* PILE TOP DISPLACEMENTS *

PILE GROUP	DISP. X, M	DISP. Y, M	DISP. Z, M	ROT. X,RAD	ROT. Y,RAD	ROT. Z,RAD
1	1.7879E-03	3.1948E-04	-3.6000E-04	-2.4641E-07	-5.6370E-05	-5.0960E-05
2	1.5586E-03	3.1948E-04	-3.5889E-04	-2.4641E-07	-5.6370E-05	-5.0960E-05
3	1.3293E-03	3.1948E-04	-3.5779E-04	-2.4641E-07	-5.6370E-05	-5.0960E-05
4	2.0416E-03	3.1837E-04	-3.6000E-04	-2.4641E-07	-5.6370E-05	-5.0960E-05
5	1.8122E-03	3.1837E-04	-3.5889E-04	-2.4641E-07	-5.6370E-05	-5.0960E-05
6	1.5829E-03	3.1837E-04	-3.5779E-04	-2.4641E-07	-5.6370E-05	-5.0960E-05
7	2.2952E-03	3.1727E-04	-3.6000E-04	-2.4641E-07	-5.6370E-05	-5.0960E-05
8	2.0659E-03	3.1727E-04	-3.5889E-04	-2.4641E-07	-5.6370E-05	-5.0960E-05
9	1.8366E-03	3.1727E-04	-3.5779E-04	-2.4641E-07	-5.6370E-05	-5.0960E-05
10	2.5489E-03	3.1616E-04	-3.6000E-04	-2.4641E-07	-5.6370E-05	-5.0960E-05
11	2.3196E-03	3.1616E-04	-3.5889E-04	-2.4641E-07	-5.6370E-05	-5.0960E-05
12	2.0903E-03	3.1616E-04	-3.5779E-04	-2.4641E-07	-5.6370E-05	-5.0960E-05
MINIMUM	1.3293E-03	3.1616E-04	-3.6000E-04	-2.4641E-07	-5.6370E-05	-5.0960E-05
Pile N.	3	10	1	1	1	1
MAXIMUM	2.5489E-03	3.1948E-04	-3.5779E-04	-2.4641E-07	-5.6370E-05	-5.0960E-05
Pile N.	10	1	3	1	1	1

* PILE TOP REACTIONS *

PILE GROUP	FOR. X, KN	FOR. Y, KN	FOR. Z, KN	MOM X, KN- M	MOM Y, KN- M	MOM Z, KN- M
1	3577.0	105.39	-120.21	-0.096012	211.13	182.65
2	3125.0	87.969	-99.910	-0.096012	176.23	153.14
3	2673.0	92.977	-105.02	-0.096012	184.48	161.69
4	4077.0	100.38	-115.19	-0.096012	202.84	173.86
5	3625.0	81.558	-93.223	-0.096012	164.64	141.57
6	3173.0	86.426	-98.233	-0.096012	172.86	150.01
7	4577.1	101.23	-116.84	-0.096012	205.67	174.83
8	4125.0	83.013	-95.452	-0.096012	168.61	143.72
9	3673.0	87.961	-100.57	-0.096012	176.97	152.25
10	5000.2	115.40	-133.84	-0.096012	233.63	197.57
11	4625.0	103.08	-119.05	-0.096012	208.83	177.39
12	4173.0	106.61	-122.47	-0.096012	213.90	183.16
MINIMUM	2673.0	81.558	-133.84	-0.096012	164.64	141.57
Pile N.	3	5	10	1	5	5
MAXIMUM	5000.2	115.40	-93.223	-0.096012	233.63	197.57
Pile N.	10	10	5	1	10	10

THE PILE COORDINATE SYSTEM (LOCAL AXES)

* PILE TOP DISPLACEMENTS *

PILE GROUP	DISP. x, M	DISP. y, M	DISP. z, M	ROT. x,RAD	ROT. y,RAD	ROT. z,RAD
1	1.7879E-03	3.1948E-04	-3.6000E-04	-2.4641E-07	-5.6370E-05	-5.0960E-05
2	1.5586E-03	3.1948E-04	-3.5889E-04	-2.4641E-07	-5.6370E-05	-5.0960E-05
3	1.3293E-03	3.1948E-04	-3.5779E-04	-2.4641E-07	-5.6370E-05	-5.0960E-05
4	2.0416E-03	3.1837E-04	-3.6000E-04	-2.4641E-07	-5.6370E-05	-5.0960E-05
5	1.8122E-03	3.1837E-04	-3.5889E-04	-2.4641E-07	-5.6370E-05	-5.0960E-05
6	1.5829E-03	3.1837E-04	-3.5779E-04	-2.4641E-07	-5.6370E-05	-5.0960E-05
7	2.2952E-03	3.1727E-04	-3.6000E-04	-2.4641E-07	-5.6370E-05	-5.0960E-05
8	2.0659E-03	3.1727E-04	-3.5889E-04	-2.4641E-07	-5.6370E-05	-5.0960E-05
9	1.8366E-03	3.1727E-04	-3.5779E-04	-2.4641E-07	-5.6370E-05	-5.0960E-05
10	2.5489E-03	3.1616E-04	-3.6000E-04	-2.4641E-07	-5.6370E-05	-5.0960E-05
11	2.3196E-03	3.1616E-04	-3.5889E-04	-2.4641E-07	-5.6370E-05	-5.0960E-05

APPALTATORE: Consorzio Soci   			ITINERARIO NAPOLI – BARI RADDOPPIO TRATTA APICE – ORSARA I LOTTO FUNZIONALE APICE – HIRPINIA					
PROGETTAZIONE: Mandataria Mandanti   								
PROGETTO ESECUTIVO RELAZIONE DI CALCOLO FONDAZIONI PILE DA P17 A P20							COMMESSA IF1N	LOTTO 01 E ZZ

12	2.0903E-03	3.1616E-04	-3.5779E-04	-2.4641E-07	-5.6370E-05	-5.0960E-05
MINIMUM	1.3293E-03	3.1616E-04	-3.6000E-04	-2.4641E-07	-5.6370E-05	-5.0960E-05
Pile N.	3	10	1	1	1	1
MAXIMUM	2.5489E-03	3.1948E-04	-3.5779E-04	-2.4641E-07	-5.6370E-05	-5.0960E-05
Pile N.	10	1	3	1	1	1

*** PILE TOP REACTIONS ***

PILE GROUP	AXIAL, KN	LAT. y, KN	LAT. z, KN	MOM x, KN- M	MOM y, KN- M	MOM z, KN- M
1	3577.0	105.39	-120.21	-0.096012	211.13	182.65
2	3125.0	87.969	-99.910	-0.096012	176.23	153.14
3	2673.0	92.977	-105.02	-0.096012	184.48	161.69
4	4077.0	100.38	-115.19	-0.096012	202.84	173.86
5	3625.0	81.558	-93.223	-0.096012	164.64	141.57
6	3173.0	86.426	-98.233	-0.096012	172.86	150.01
7	4577.1	101.23	-116.84	-0.096012	205.67	174.83
8	4125.0	83.013	-95.452	-0.096012	168.61	143.72
9	3673.0	87.961	-100.57	-0.096012	176.97	152.25
10	5000.2	115.40	-133.84	-0.096012	233.63	197.57
11	4625.0	103.08	-119.05	-0.096012	208.83	177.39
12	4173.0	106.61	-122.47	-0.096012	213.90	183.16
MINIMUM	2673.0	81.558	-133.84	-0.096012	164.64	141.57
Pile N.	3	5	10	1	5	5
MAXIMUM	5000.2	115.40	-93.223	-0.096012	233.63	197.57
Pile N.	10	10	5	1	10	10

PILE GROUP STRESS, KN/ M2**

1	2866.7
2	2473.0
3	2252.9
4	3113.4
5	2706.7
6	2486.3
7	3404.8
8	3003.0
9	2783.1
10	3752.9
11	3444.2
12	3211.4
MINIMUM	2252.9
Pile N.	3
MAXIMUM	3752.9
Pile N.	10





*** EFFECTS FOR LATERALLY LOADED PILE ***

*** MINIMUM VALUES AND LOCATIONS ***

PILE	DISPL. y-DIR	DISPL. z-DIR	MOMENT z-DIR	MOMENT y-DIR	SHEAR y-DIR	SHEAR z-DIR	SOIL REACT y-DIR	SOIL REACT z-DIR	TOTAL STRESS	FLEX. RIG. z-DIR	FLEX. RIG. y-DIR
*****	M	M	KN- M	KN- M	KN	KN	KN/ M	KN/ M	KN/ M**2	KN- M**2	KN- M**2
1	-1.3890E-05	-3.6000E-04	-182.65	-147.59	-33.151	-120.22	-13.143	-69.930	2024.2	7.8279E+06	7.8279E+06
x(M)	8.4000	0.0000	0.0000	4.0800	6.2400	0.0000	7.9200	2.4000	24.000	0.0000	0.0000
2	-1.4941E-05	-3.5889E-04	-153.14	-130.93	-27.007	-99.918	-9.6405	-53.512	1768.4	7.8279E+06	7.8279E+06
x(M)	8.8800	0.0000	0.0000	4.3200	6.4800	0.0000	7.9200	2.4000	24.000	0.0000	0.0000
3	-1.4641E-05	-3.5778E-04	-161.69	-135.21	-28.662	-105.03	-10.650	-57.757	1512.6	7.8279E+06	7.8279E+06
x(M)	8.6400	0.0000	0.0000	4.3200	6.4800	0.0000	7.9200	2.4000	24.000	0.0000	0.0000
4	-1.4111E-05	-3.6000E-04	-173.86	-143.44	-31.503	-115.20	-12.246	-65.713	2307.1	7.8279E+06	7.8279E+06
x(M)	8.6400	0.0000	0.0000	4.3200	6.2400	0.0000	7.9200	2.4000	24.000	0.0000	0.0000
5	-1.5194E-05	-3.5889E-04	-141.57	-125.23	-24.905	-93.233	-8.4044	-48.425	2051.3	7.8279E+06	7.8279E+06
x(M)	8.8800	0.0000	0.0000	4.3200	6.4800	0.0000	7.9200	2.4000	24.000	0.0000	0.0000
6	-1.4955E-05	-3.5778E-04	-150.01	-129.56	-26.560	-98.242	-9.3948	-52.434	1795.6	7.8279E+06	7.8279E+06
x(M)	8.8800	0.0000	0.0000	4.3200	6.4800	0.0000	7.9200	2.4000	24.000	0.0000	0.0000
7	-1.3966E-05	-3.6000E-04	-174.83	-144.78	-31.922	-116.86	-12.492	-67.144	2590.1	7.8279E+06	7.8279E+06
x(M)	8.4000	0.0000	0.0000	4.0800	6.2400	0.0000	7.9200	2.4000	24.000	0.0000	0.0000
8	-1.5061E-05	-3.5889E-04	-143.72	-127.18	-25.518	-95.462	-8.7924	-50.145	2334.3	7.8279E+06	7.8279E+06
x(M)	8.8800	0.0000	0.0000	4.3200	6.4800	0.0000	7.9200	2.4000	24.000	0.0000	0.0000
9	-1.4787E-05	-3.5778E-04	-152.25	-131.55	-27.183	-100.58	-9.7962	-54.292	2078.5	7.8279E+06	7.8279E+06
x(M)	8.8800	0.0000	0.0000	4.3200	6.4800	0.0000	7.9200	2.4000	24.000	0.0000	0.0000
10	-1.3018E-05	-3.6000E-04	-197.57	-158.93	-37.135	-133.86	-15.210	-82.124	2829.5	7.8279E+06	7.8279E+06
x(M)	8.1600	0.0000	0.0000	4.0800	6.0000	0.0000	7.9200	2.4000	24.000	0.0000	0.0000
11	-1.3788E-05	-3.5889E-04	-177.39	-146.73	-32.655	-119.06	-12.913	-69.299	2617.2	7.8279E+06	7.8279E+06
x(M)	8.4000	0.0000	0.0000	4.0800	6.2400	0.0000	7.9200	2.4000	24.000	0.0000	0.0000
12	-1.3576E-05	-3.5778E-04	-183.16	-149.66	-33.844	-122.48	-13.571	-72.507	2361.4	7.8279E+06	7.8279E+06
x(M)	8.4000	0.0000	0.0000	4.0800	6.2400	0.0000	7.9200	2.4000	24.000	0.0000	0.0000
Min.	-1.5194E-05	-3.6000E-04	-197.57	-158.93	-37.135	-133.86	-15.210	-82.124	1512.6	7.8279E+06	7.8279E+06
Pile N.	5	1	10	10	10	10	10	10	3	1	1

*** MAXIMUM VALUES AND LOCATIONS ***

PILE	DISPL.	DISPL.	MOMENT	MOMENT	SHEAR	SHEAR	SOIL REACT	SOIL REACT	TOTAL	FLEX. RIG.	FLEX. RIG.
------	--------	--------	--------	--------	-------	-------	------------	------------	-------	------------	------------

APPALTATORE: Consorzio Soci   	ITINERARIO NAPOLI – BARI RADDOPPIO TRATTA APICE – ORSARA I LOTTO FUNZIONALE APICE – HIRPINIA				
PROGETTAZIONE: Mandataria Mandanti   					
PROGETTO ESECUTIVO RELAZIONE DI CALCOLO FONDAZIONI PILE DA P17 A P20					
COMMESSA IF1N	LOTTO 01 E ZZ	CODIFICA RG	DOCUMENTO MD0000 001	REV. B	FOGLIO 130 di 143

	y-DIR M	z-DIR M	z-DIR KN- M	y-DIR KN- M	y-DIR KN	z-DIR KN	y-DIR KN/ M	z-DIR KN/ M	STRESS KN/ M**2	z-DIR KN- M**2	y-DIR KN- M**2
*****	*****	*****	*****	*****	*****	*****	*****	*****	*****	*****	*****
1	3.1948E-04	1.5671E-05	131.12	211.13	105.40	37.333	61.721	14.800	2866.7	7.8279E+06	7.8279E+06
x(M)	0.0000	8.4000	4.0800	0.0000	0.0000	6.2400	2.4000	7.9200	0.0000	0.0000	0.0000
2	3.1948E-04	1.6795E-05	116.67	176.23	87.976	30.304	47.414	10.796	2473.0	7.8279E+06	7.8279E+06
x(M)	0.0000	8.8800	4.3200	0.0000	0.0000	6.4800	2.4000	7.9200	0.0000	0.0000	0.0000
3	3.1948E-04	1.6403E-05	120.80	184.48	92.984	32.081	51.383	11.905	2252.9	7.8279E+06	7.8279E+06
x(M)	0.0000	8.6400	4.3200	0.0000	0.0000	6.4800	2.4000	7.9200	0.0000	0.0000	0.0000
4	3.1838E-04	1.5984E-05	126.96	202.84	100.39	35.578	57.736	13.826	3113.4	7.8279E+06	7.8279E+06
x(M)	0.0000	8.6400	4.0800	0.0000	0.0000	6.2400	2.4000	7.9200	0.0000	0.0000	0.0000
5	3.1838E-04	1.7134E-05	111.28	164.64	81.566	28.011	42.710	9.4218	2706.7	7.8279E+06	7.8279E+06
x(M)	0.0000	9.1200	4.3200	0.0000	0.0000	6.4800	2.4000	7.9200	0.0000	0.0000	0.0000
6	3.1838E-04	1.6815E-05	115.41	172.86	86.433	29.809	46.434	10.521	2486.3	7.8279E+06	7.8279E+06
x(M)	0.0000	8.8800	4.3200	0.0000	0.0000	6.4800	2.4000	7.9200	0.0000	0.0000	0.0000
7	3.1727E-04	1.5881E-05	127.81	205.67	101.25	36.177	58.726	14.155	3404.8	7.8279E+06	7.8279E+06
x(M)	0.0000	8.6400	4.0800	0.0000	0.0000	6.2400	2.4000	7.9200	0.0000	0.0000	0.0000
8	3.1727E-04	1.7041E-05	112.63	168.61	83.022	28.800	44.026	9.8881	3003.0	7.8279E+06	7.8279E+06
x(M)	0.0000	8.8800	4.3200	0.0000	0.0000	6.4800	2.4000	7.9200	0.0000	0.0000	0.0000
9	3.1727E-04	1.6691E-05	116.79	176.97	87.969	30.615	47.862	11.006	2783.1	7.8279E+06	7.8279E+06
x(M)	0.0000	8.8800	4.3200	0.0000	0.0000	6.4800	2.4000	7.9200	0.0000	0.0000	0.0000
10	3.1616E-04	1.4860E-05	139.66	233.63	115.42	42.244	71.513	17.338	3752.9	7.8279E+06	7.8279E+06
x(M)	0.0000	8.1600	4.0800	0.0000	0.0000	6.0000	2.4000	7.9200	0.0000	0.0000	0.0000
11	3.1616E-04	1.5677E-05	129.46	208.83	103.09	37.335	60.578	14.644	3444.2	7.8279E+06	7.8279E+06
x(M)	0.0000	8.4000	4.0800	0.0000	0.0000	6.2400	2.4000	7.9200	0.0000	0.0000	0.0000
12	3.1616E-04	1.5392E-05	132.39	213.90	106.62	38.285	63.639	15.352	3211.4	7.8279E+06	7.8279E+06
x(M)	0.0000	8.4000	4.0800	0.0000	0.0000	6.2400	2.4000	7.9200	0.0000	0.0000	0.0000
Max.	3.1948E-04	1.7134E-05	139.66	233.63	115.42	42.244	71.513	17.338	3752.9	7.8279E+06	7.8279E+06
Pile N.	1	5	10	10	10	10	10	10	10	1	1

LOAD CASE : 16
CASE NAME : Load Case
LOAD TYPE : Special, Sp

REDUCTION FACTORS FOR CLOSELY-SPACED PILE GROUPS, COMBINED Y AND Z DIRECTIONS
ESTIMATED USING MOVEMENT IN THE DIRECTION OF PILE CAP DISPLACEMENTS

GROUP NO	P-FACTOR	Y-FACTOR
1	0.8497	1.0000
2	0.5738	1.0000
3	0.5845	1.0000
4	0.7901	1.0000
5	0.4929	1.0000
6	0.4990	1.0000
7	0.7918	1.0000
8	0.4952	1.0000
9	0.5017	1.0000
10	0.8661	1.0000
11	0.5974	1.0000
12	0.6081	1.0000

* TABLE L * COMPUTATION ON PILE CAP

* EQUIVALENT CONCENTRATED LOAD AT ORIGIN *

VERT. LOAD, KN	HOR. LOAD Y, KN	HOR. LOAD Z, KN
47171.5	3534.00	-1098.00
MOMENT X, KN- M	MOMENT Y, KN- M	MOMENT Z, KN- M
-361.000	-19625.0	-48642.0

* DISPLACEMENT OF GROUPED PILE FOUNDATION AT ORIGIN *

VERTICAL, M	HORIZONTAL Y, M	HORIZONTAL Z, M
2.01226E-03	1.19767E-03	-3.25328E-04
ANGLE ROT. X,RAD	ANGLE ROT. Y,RAD	ANGLE ROT. Z,RAD
-4.40662E-07	-4.07914E-05	-1.86709E-04

THE GLOBAL STRUCTURAL COORDINATE SYSTEM

* PILE TOP DISPLACEMENTS *

PILE GROUP	DISP. X, M	DISP. Y, M	DISP. Z, M	ROT. X,RAD	ROT. Y,RAD	ROT. Z,RAD
*****	*****	*****	*****	*****	*****	*****
1	2.5771E-03	1.2006E-03	-3.2731E-04	-4.4066E-07	-4.0791E-05	-1.8671E-04

APPALTATORE:

Consorzio

Soci



ITINERARIO NAPOLI – BARI

PROGETTAZIONE:

Mandataria

Mandanti



RADDOPPIO TRATTA APICE – ORSARA
I LOTTO FUNZIONALE APICE – HIRPINIA

PROGETTO ESECUTIVO

RELAZIONE DI CALCOLO FONDAZIONI PILE DA P17 A P20

COMMESSA IF1N	LOTTO 01 E ZZ	CODIFICA RG	DOCUMENTO MD0000 001	REV. B	FOGLIO 131 di 143
------------------	------------------	----------------	-------------------------	-----------	-------------------------

2	1.7369E-03	1.2006E-03	-3.2533E-04	-4.4066E-07	-4.0791E-05	-1.8671E-04
3	8.9673E-04	1.2006E-03	-3.2335E-04	-4.4066E-07	-4.0791E-05	-1.8671E-04
4	2.7607E-03	1.1987E-03	-3.2731E-04	-4.4066E-07	-4.0791E-05	-1.8671E-04
5	1.9205E-03	1.1987E-03	-3.2533E-04	-4.4066E-07	-4.0791E-05	-1.8671E-04
6	1.0803E-03	1.1987E-03	-3.2335E-04	-4.4066E-07	-4.0791E-05	-1.8671E-04
7	2.9442E-03	1.1967E-03	-3.2731E-04	-4.4066E-07	-4.0791E-05	-1.8671E-04
8	2.1040E-03	1.1967E-03	-3.2533E-04	-4.4066E-07	-4.0791E-05	-1.8671E-04
9	1.2638E-03	1.1967E-03	-3.2335E-04	-4.4066E-07	-4.0791E-05	-1.8671E-04
10	3.1278E-03	1.1947E-03	-3.2731E-04	-4.4066E-07	-4.0791E-05	-1.8671E-04
11	2.2876E-03	1.1947E-03	-3.2533E-04	-4.4066E-07	-4.0791E-05	-1.8671E-04
12	1.4474E-03	1.1947E-03	-3.2335E-04	-4.4066E-07	-4.0791E-05	-1.8671E-04

MINIMUM	8.9673E-04	1.1947E-03	-3.2731E-04	-4.4066E-07	-4.0791E-05	-1.8671E-04
Pile N.	3	10	1	1	1	1
MAXIMUM	3.1278E-03	1.2006E-03	-3.2335E-04	-4.4066E-07	-4.0791E-05	-1.8671E-04
Pile N.	10	1	3	1	1	1

* PILE TOP REACTIONS *

PILE GROUP	FOR. X, KN	FOR. Y, KN	FOR. Z, KN	MOM X, KN- M	MOM Y, KN- M	MOM Z, KN- M
*****	*****	*****	*****	*****	*****	*****
1	5038.3	354.13	-109.43	-0.1717	218.63	621.28
2	3476.6	278.79	-86.499	-0.1717	177.97	492.01
3	1820.4	282.34	-86.718	-0.1717	177.39	497.54
4	5286.4	338.05	-105.00	-0.1717	211.18	593.71
5	3838.4	252.96	-79.161	-0.1717	164.76	445.46
6	2182.2	255.24	-79.072	-0.1717	163.67	448.84
7	5534.5	337.68	-105.17	-0.1717	211.50	592.33
8	4200.2	253.01	-79.397	-0.1717	165.24	444.96
9	2544.1	255.42	-79.345	-0.1717	164.21	448.57
10	5782.5	355.68	-110.75	-0.1717	220.96	621.54
11	4562.0	283.62	-88.638	-0.1717	181.91	498.62
12	2905.9	287.09	-88.820	-0.1717	181.26	503.96
MINIMUM	1820.4	252.96	-110.75	-0.1717	163.67	444.96
Pile N.	3	5	10	1	6	8
MAXIMUM	5782.5	355.68	-79.072	-0.1717	220.96	621.54
Pile N.	10	10	6	1	10	10

THE PILE COORDINATE SYSTEM (LOCAL AXES)

* PILE TOP DISPLACEMENTS *

PILE GROUP	DISP. x, M	DISP. y, M	DISP. z, M	ROT. x,RAD	ROT. y,RAD	ROT. z,RAD
*****	*****	*****	*****	*****	*****	*****
1	2.5771E-03	1.2006E-03	-3.2731E-04	-4.4066E-07	-4.0791E-05	-1.8671E-04
2	1.7369E-03	1.2006E-03	-3.2533E-04	-4.4066E-07	-4.0791E-05	-1.8671E-04
3	8.9673E-04	1.2006E-03	-3.2335E-04	-4.4066E-07	-4.0791E-05	-1.8671E-04
4	2.7607E-03	1.1987E-03	-3.2731E-04	-4.4066E-07	-4.0791E-05	-1.8671E-04
5	1.9205E-03	1.1987E-03	-3.2533E-04	-4.4066E-07	-4.0791E-05	-1.8671E-04
6	1.0803E-03	1.1987E-03	-3.2335E-04	-4.4066E-07	-4.0791E-05	-1.8671E-04
7	2.9442E-03	1.1967E-03	-3.2731E-04	-4.4066E-07	-4.0791E-05	-1.8671E-04
8	2.1040E-03	1.1967E-03	-3.2533E-04	-4.4066E-07	-4.0791E-05	-1.8671E-04
9	1.2638E-03	1.1967E-03	-3.2335E-04	-4.4066E-07	-4.0791E-05	-1.8671E-04
10	3.1278E-03	1.1947E-03	-3.2731E-04	-4.4066E-07	-4.0791E-05	-1.8671E-04
11	2.2876E-03	1.1947E-03	-3.2533E-04	-4.4066E-07	-4.0791E-05	-1.8671E-04
12	1.4474E-03	1.1947E-03	-3.2335E-04	-4.4066E-07	-4.0791E-05	-1.8671E-04
MINIMUM	8.9673E-04	1.1947E-03	-3.2731E-04	-4.4066E-07	-4.0791E-05	-1.8671E-04
Pile N.	3	10	1	1	1	1
MAXIMUM	3.1278E-03	1.2006E-03	-3.2335E-04	-4.4066E-07	-4.0791E-05	-1.8671E-04
Pile N.	10	1	3	1	1	1

* PILE TOP REACTIONS *

PILE GROUP	AXIAL, KN	LAT. y, KN	LAT. z, KN	MOM x, KN- M	MOM y, KN- M	MOM z, KN- M
*****	*****	*****	*****	*****	*****	*****
1	5038.3	354.13	-109.43	-0.1717	218.63	621.28
2	3476.6	278.79	-86.499	-0.1717	177.97	492.01
3	1820.4	282.34	-86.718	-0.1717	177.39	497.54
4	5286.4	338.05	-105.00	-0.1717	211.18	593.71
5	3838.4	252.96	-79.161	-0.1717	164.76	445.46
6	2182.2	255.24	-79.072	-0.1717	163.67	448.84
7	5534.5	337.68	-105.17	-0.1717	211.50	592.33
8	4200.2	253.01	-79.397	-0.1717	165.24	444.96
9	2544.1	255.42	-79.345	-0.1717	164.21	448.57
10	5782.5	355.68	-110.75	-0.1717	220.96	621.54
11	4562.0	283.62	-88.638	-0.1717	181.91	498.62
12	2905.9	287.09	-88.820	-0.1717	181.26	503.96
MINIMUM	1820.4	252.96	-110.75	-0.1717	163.67	444.96
Pile N.	3	5	10	1	6	8
MAXIMUM	5782.5	355.68	-79.072	-0.1717	220.96	621.54
Pile N.	10	10	6	1	10	10

PILE GROUP STRESS, KN/ M**2

APPALTATORE: Consorzio Soci   		ITINERARIO NAPOLI – BARI RADDOPPIO TRATTA APICE – ORSARA I LOTTO FUNZIONALE APICE – HIRPINIA					
PROGETTAZIONE: Mandataria Mandanti   							
PROGETTO ESECUTIVO RELAZIONE DI CALCOLO FONDAZIONI PILE DA P17 A P20		COMMESSA	LOTTO	CODIFICA	DOCUMENTO	REV.	FOGLIO
		IF1N	01 E ZZ	RG	MD0000 001	B	133 di 143

***** SUMMARY FOR LOAD CASES AND COMBINATIONS *****

***** LOAD CASES RESULTS *****

LOAD CASE : 1

* TABLE L * COMPUTATION ON PILE CAP

* EQUIVALENT CONCENTRATED LOAD AT ORIGIN *

LOAD X, KN	LOAD Y, KN	LOAD Z, KN	MOM X, KN- M	MOM Y, KN- M	MOM Z, KN- M
28377.0	11902.0	-2956.80	-162.000	-38027.0	-1.41876E+05

* DISPLACEMENT OF GROUPED PILE FOUNDATION AT ORIGIN *

DISP X, M	DISP Y, M	DISP Z, M	ROT X,RAD	ROT Y,RAD	ROT Z,RAD
1.34939E-03	5.45267E-03	-1.18471E-03	7.48438E-06	-8.75949E-05	-5.81231E-04

* PILE TOP DISPLACEMENTS, GLOBAL *

	DISP. X, M	DISP. Y, M	DISP. Z, M	ROT. X,RAD	ROT. Y,RAD	ROT. Z,RAD
MINIMUM	-1.8574E-03	5.4021E-03	-1.2184E-03	7.4844E-06	-8.7595E-05	-5.8123E-04
Pile N.	3	1	3	1	1	1
MAXIMUM	4.5562E-03	5.5032E-03	-1.1510E-03	7.4844E-06	-8.7595E-05	-5.8123E-04
Pile N.	10	10	1	1	1	1

* PILE TOP REACTIONS, GLOBAL *

	FOR. X, KN	FOR. Y, KN	FOR. Z, KN	MOM X, KN- M	MOM Y, KN- M	MOM Z, KN- M
MINIMUM	-3639.0	827.82	-292.55	2.9162	554.53	1892.2
Pile N.	3	5	10	1	8	5
MAXIMUM	7561.5	1246.0	-209.04	2.9162	719.29	2766.3
Pile N.	10	10	8	1	10	10

* PILE TOP DISPLACEMENTS, LOCAL *

	DISP. x, M	DISP. y, M	DISP. z, M	ROT. x,RAD	ROT. y,RAD	ROT. z,RAD
MINIMUM	-1.8574E-03	5.4021E-03	-1.2184E-03	7.4844E-06	-8.7595E-05	-5.8123E-04
Pile N.	3	1	3	1	1	1
MAXIMUM	4.5562E-03	5.5032E-03	-1.1510E-03	7.4844E-06	-8.7595E-05	-5.8123E-04
Pile N.	10	10	1	1	1	1

* PILE TOP REACTIONS, LOCAL *

	AXIAL, KN	LAT. y, KN	LAT. z, KN	MOM x, KN- M	MOM y, KN- M	MOM z, KN- M
MINIMUM	-3639.0	827.82	-292.55	2.9162	554.53	1892.2
Pile N.	3	5	10	1	8	5
MAXIMUM	7561.5	1246.0	-209.04	2.9162	719.29	2766.3
Pile N.	10	10	8	1	10	10

* EFFECTS FOR LATERALLY LOADED PILE *

PILE	DISPL. y-DIR M	DISPL. z-DIR M	MOMENT z-DIR KN- M	MOMENT y-DIR KN- M	SHEAR y-DIR KN	SHEAR z-DIR KN	SOIL REACT y-DIR KN/ M	SOIL REACT z-DIR KN/ M	TOTAL STRESS KN/ M**2
Min.	-1.4348E-04	-1.2184E-03	-2766.3	-310.23	-328.90	-292.63	-76.543	-92.584	763.89
Pile N.	10	3	10	10	10	10	10	10	12
Max.	5.5032E-03	3.0556E-05	1467.6	719.29	1246.3	71.416	419.95	16.596	1.2905E+04
Pile N.	10	1	10	10	10	10	10	10	10

LOAD CASE : 2

* TABLE L * COMPUTATION ON PILE CAP

* EQUIVALENT CONCENTRATED LOAD AT ORIGIN *

LOAD X, KN	LOAD Y, KN	LOAD Z, KN	MOM X, KN- M	MOM Y, KN- M	MOM Z, KN- M
35345.0	-11365.2	2907.30	113.000	38729.3	1.34624E+05

* DISPLACEMENT OF GROUPED PILE FOUNDATION AT ORIGIN *

DISP X, M	DISP Y, M	DISP Z, M	ROT X,RAD	ROT Y,RAD	ROT Z,RAD
1.68871E-03	-5.17039E-03	1.16578E-03	1.06014E-05	9.19635E-05	5.67374E-04

* PILE TOP DISPLACEMENTS, GLOBAL *

	DISP. X, M	DISP. Y, M	DISP. Z, M	ROT. X,RAD	ROT. Y,RAD	ROT. Z,RAD
MINIMUM	-1.4852E-03	-5.2420E-03	1.1181E-03	1.0601E-05	9.1963E-05	5.6737E-04
Pile N.	10	1	3	1	1	1
MAXIMUM	4.8626E-03	-5.0988E-03	1.2135E-03	1.0601E-05	9.1963E-05	5.6737E-04
Pile N.	3	10	1	1	1	1

* PILE TOP REACTIONS, GLOBAL *

	FOR. X, KN	FOR. Y, KN	FOR. Z, KN	MOM X, KN- M	MOM Y, KN- M	MOM Z, KN- M
MINIMUM	-2918.5	-1194.9	205.32	4.1308	-691.44	-2620.0

APPALTATORE:				ITINERARIO NAPOLI – BARI RADDOPPIO TRATTA APICE – ORSARA I LOTTO FUNZIONALE APICE – HIRPINIA					
Consorzio		Soci							
		 							
PROGETTAZIONE:									
Mandataria		Mandanti							
		 							
PROGETTO ESECUTIVO				COMMESSA	LOTTO	CODIFICA	DOCUMENTO	REV.	FOGLIO
RELAZIONE DI CALCOLO FONDAZIONI PILE DA P17 A P20				IF1N	01 E ZZ	RG	MD0000 001	B	134 di 143

Pile N.	10	3	5	1	12	3
MAXIMUM	7692.5	-787.63	286.97	4.1308	-533.66	-1767.1
Pile N.	3	8	12	1	5	8

* PILE TOP DISPLACEMENTS, LOCAL *

	DISP. x, M	DISP. y, M	DISP. z, M	ROT. x,RAD	ROT. y,RAD	ROT. z,RAD
MINIMUM	-1.4852E-03	-5.2420E-03	1.1181E-03	1.0601E-05	9.1963E-05	5.6737E-04
Pile N.	10	1	3	1	1	1
MAXIMUM	4.8626E-03	-5.0988E-03	1.2135E-03	1.0601E-05	9.1963E-05	5.6737E-04
Pile N.	3	10	1	1	1	1

* PILE TOP REACTIONS, LOCAL *

	AXIAL, KN	LAT. y, KN	LAT. z, KN	MOM x, KN- M	MOM y, KN- M	MOM z, KN- M
MINIMUM	-2918.5	-1194.9	205.32	4.1308	-691.44	-2620.0
Pile N.	10	3	5	1	12	3
MAXIMUM	7692.5	-787.63	286.97	4.1308	-533.66	-1767.1
Pile N.	3	8	12	1	5	8

* EFFECTS FOR LATERALLY LOADED PILE *

PILE	DISPL. y-DIR M	DISPL. z-DIR M	MOMENT z-DIR KN- M	MOMENT y-DIR KN- M	SHEAR y-DIR KN	SHEAR z-DIR KN	SOIL REACT y-DIR KN/ M	SOIL REACT z-DIR KN/ M	TOTAL STRESS KN/ M**2
Min.	-5.2419E-03	-3.2461E-05	-1414.3	-691.44	-1195.2	-73.064	-408.13	-16.872	279.86
Pile N.	1	12	3	12	3	12	3	12	1
Max.	1.4571E-04	1.2135E-03	2620.0	312.02	322.07	287.04	73.970	91.746	1.2522E+04
Pile N.	12	1	3	12	12	12	12	12	3

LOAD CASE : 3

* TABLE L * COMPUTATION ON PILE CAP

* EQUIVALENT CONCENTRATED LOAD AT ORIGIN *

LOAD X, KN	LOAD Y, KN	LOAD Z, KN	MOM X, KN- M	MOM Y, KN- M	MOM Z, KN- M
28863.0	3674.00	-9824.10	-377.000	-1.27379E+05	-43553.4

* DISPLACEMENT OF GROUPED PILE FOUNDATION AT ORIGIN *

DISP X, M	DISP Y, M	DISP Z, M	ROT X,RAD	ROT Y,RAD	ROT Z,RAD
1.26268E-03	1.58851E-03	-3.63599E-03	-1.06592E-05	-2.67380E-04	-1.75002E-04

* PILE TOP DISPLACEMENTS, GLOBAL *

	DISP. X, M	DISP. Y, M	DISP. Z, M	ROT. X,RAD	ROT. Y,RAD	ROT. Z,RAD
MINIMUM	-1.3296E-03	1.5166E-03	-3.6840E-03	-1.0659E-05	-2.6738E-04	-1.7500E-04
Pile N.	3	10	1	1	1	1
MAXIMUM	3.8550E-03	1.6605E-03	-3.5880E-03	-1.0659E-05	-2.6738E-04	-1.7500E-04
Pile N.	10	1	3	1	1	1

* PILE TOP REACTIONS, GLOBAL *

	FOR. X, KN	FOR. Y, KN	FOR. Z, KN	MOM X, KN- M	MOM Y, KN- M	MOM Z, KN- M
MINIMUM	-2617.3	255.32	-1043.8	-4.1533	1772.1	564.91
Pile N.	3	8	10	1	5	8
MAXIMUM	6765.3	364.61	-674.25	-4.1533	2547.1	770.06
Pile N.	10	10	5	1	10	10

* PILE TOP DISPLACEMENTS, LOCAL *

	DISP. x, M	DISP. y, M	DISP. z, M	ROT. x,RAD	ROT. y,RAD	ROT. z,RAD
MINIMUM	-1.3296E-03	1.5166E-03	-3.6840E-03	-1.0659E-05	-2.6738E-04	-1.7500E-04
Pile N.	3	10	1	1	1	1
MAXIMUM	3.8550E-03	1.6605E-03	-3.5880E-03	-1.0659E-05	-2.6738E-04	-1.7500E-04
Pile N.	10	1	3	1	1	1

* PILE TOP REACTIONS, LOCAL *

	AXIAL, KN	LAT. y, KN	LAT. z, KN	MOM x, KN- M	MOM y, KN- M	MOM z, KN- M
MINIMUM	-2617.3	255.32	-1043.8	-4.1533	1772.1	564.91
Pile N.	3	8	10	1	5	8
MAXIMUM	6765.3	364.61	-674.25	-4.1533	2547.1	770.06
Pile N.	10	10	5	1	10	10

* EFFECTS FOR LATERALLY LOADED PILE *

PILE	DISPL. y-DIR M	DISPL. z-DIR M	MOMENT z-DIR KN- M	MOMENT y-DIR KN- M	SHEAR y-DIR KN	SHEAR z-DIR KN	SOIL REACT y-DIR KN/ M	SOIL REACT z-DIR KN/ M	TOTAL STRESS KN/ M**2
Min.	-4.4763E-05	-3.6840E-03	-770.06	-1068.7	-99.300	-1044.1	-23.181	-344.83	145.18
Pile N.	12	1	10	10	10	10	10	10	6
Max.	1.6605E-03	1.1173E-04	433.24	2547.1	364.69	250.12	131.60	57.697	1.1859E+04
Pile N.	1	10	10	10	10	10	10	10	10

LOAD CASE : 4

APPALDATTORE: Consorzio Soci 		ITINERARIO NAPOLI – BARI RADDOPPIO TRATTA APICE – ORSARA I LOTTO FUNZIONALE APICE – HIRPINIA					
PROGETTAZIONE: Mandataria Mandanti 							
PROGETTO ESECUTIVO RELAZIONE DI CALCOLO FONDAZIONI PILE DA P17 A P20							COMMESSA IF1N

* TABLE L * COMPUTATION ON PILE CAP

* EQUIVALENT CONCENTRATED LOAD AT ORIGIN *

LOAD X, KN	LOAD Y, KN	LOAD Z, KN	MOM X, KN- M	MOM Y, KN- M	MOM Z, KN- M
27728.0	-3347.30	9692.10	-376.000	1.29067E+05	40803.9

* DISPLACEMENT OF GROUPED PILE FOUNDATION AT ORIGIN *

DISP X, M	DISP Y, M	DISP Z, M	ROT X,RAD	ROT Y,RAD	ROT Z,RAD
1.20804E-03	-1.44758E-03	3.57696E-03	-1.03932E-05	2.67923E-04	1.62182E-04

* PILE TOP DISPLACEMENTS, GLOBAL *

	DISP. X, M	DISP. Y, M	DISP. Z, M	ROT. X,RAD	ROT. Y,RAD	ROT. Z,RAD
MINIMUM	-1.3303E-03	-1.5177E-03	3.5302E-03	-1.0393E-05	2.6792E-04	1.6218E-04
Pile N.	10	10	1	1	1	1
MAXIMUM	3.7463E-03	-1.3774E-03	3.6237E-03	-1.0393E-05	2.6792E-04	1.6218E-04
Pile N.	3	1	3	1	1	1

* PILE TOP REACTIONS, GLOBAL *

	FOR. X, KN	FOR. Y, KN	FOR. Z, KN	MOM X, KN- M	MOM Y, KN- M	MOM Z, KN- M
MINIMUM	-2618.5	-330.76	665.25	-4.0496	-2500.7	-691.01
Pile N.	10	3	8	1	3	3
MAXIMUM	6618.4	-232.47	1030.2	-4.0496	-1738.0	-508.49
Pile N.	3	5	3	1	8	5

* PILE TOP DISPLACEMENTS, LOCAL *

	DISP. x, M	DISP. y, M	DISP. z, M	ROT. x,RAD	ROT. y,RAD	ROT. z,RAD
MINIMUM	-1.3303E-03	-1.5177E-03	3.5302E-03	-1.0393E-05	2.6792E-04	1.6218E-04
Pile N.	10	10	1	1	1	1
MAXIMUM	3.7463E-03	-1.3774E-03	3.6237E-03	-1.0393E-05	2.6792E-04	1.6218E-04
Pile N.	3	1	3	1	1	1

* PILE TOP REACTIONS, LOCAL *

	AXIAL, KN	LAT. y, KN	LAT. z, KN	MOM x, KN- M	MOM y, KN- M	MOM z, KN- M
MINIMUM	-2618.5	-330.76	665.25	-4.0496	-2500.7	-691.01
Pile N.	10	3	8	1	3	3
MAXIMUM	6618.4	-232.47	1030.2	-4.0496	-1738.0	-508.49
Pile N.	3	5	3	1	8	5

* EFFECTS FOR LATERALLY LOADED PILE *

PILE	DISPL. y-DIR	DISPL. z-DIR	MOMENT z-DIR	MOMENT y-DIR	SHEAR y-DIR	SHEAR z-DIR	SOIL REACT y-DIR	SOIL REACT z-DIR	TOTAL STRESS
	M	M	KN- M	KN- M	KN	KN	KN/ M	KN/ M	KN/ M**2
Min.	-1.5177E-03	-1.1066E-04	-395.61	-2500.7	-330.83	-247.13	-120.62	-56.886	143.08
Pile N.	10	3	3	3	3	3	3	3	7
Max.	4.0915E-05	3.6237E-03	691.01	1056.8	90.592	1030.4	21.274	342.95	1.1575E+04
Pile N.	1	3	3	3	3	3	12	3	3

LOAD CASE : 5

* TABLE L * COMPUTATION ON PILE CAP

* EQUIVALENT CONCENTRATED LOAD AT ORIGIN *

LOAD X, KN	LOAD Y, KN	LOAD Z, KN	MOM X, KN- M	MOM Y, KN- M	MOM Z, KN- M
45370.0	-3410.00	2907.30	113.000	38894.3	40423.9

* DISPLACEMENT OF GROUPED PILE FOUNDATION AT ORIGIN *

DISP X, M	DISP Y, M	DISP Z, M	ROT X,RAD	ROT Y,RAD	ROT Z,RAD
1.92352E-03	-1.12484E-03	8.17867E-04	1.60371E-06	8.23785E-05	1.57302E-04

* PILE TOP DISPLACEMENTS, GLOBAL *

	DISP. X, M	DISP. Y, M	DISP. Z, M	ROT. X,RAD	ROT. Y,RAD	ROT. Z,RAD
MINIMUM	6.5961E-04	-1.1357E-03	8.1065E-04	1.6037E-06	8.2378E-05	1.5730E-04
Pile N.	10	1	3	1	1	1
MAXIMUM	3.1874E-03	-1.1140E-03	8.2508E-04	1.6037E-06	8.2378E-05	1.5730E-04
Pile N.	3	10	1	1	1	1

* PILE TOP REACTIONS, GLOBAL *

	FOR. X, KN	FOR. Y, KN	FOR. Z, KN	MOM X, KN- M	MOM Y, KN- M	MOM Z, KN- M
MINIMUM	1353.0	-348.02	209.08	0.6249	-614.94	-659.62
Pile N.	10	3	8	1	3	3
MAXIMUM	5863.1	-241.04	285.75	0.6249	-481.17	-466.04
Pile N.	3	8	3	1	8	8

* PILE TOP DISPLACEMENTS, LOCAL *

	DISP. x, M	DISP. y, M	DISP. z, M	ROT. x,RAD	ROT. y,RAD	ROT. z,RAD
MINIMUM	6.5961E-04	-1.1357E-03	8.1065E-04	1.6037E-06	8.2378E-05	1.5730E-04
Pile N.	10	1	3	1	1	1
MAXIMUM	3.1874E-03	-1.1140E-03	8.2508E-04	1.6037E-06	8.2378E-05	1.5730E-04
Pile N.	3	10	1	1	1	1

APPALTATORE:

Consorzio

Soci



ITINERARIO NAPOLI – BARI

PROGETTAZIONE:

Mandataria

Mandanti



RADDOPPIO TRATTA APICE – ORSARA
I LOTTO FUNZIONALE APICE – HIRPINIA

PROGETTO ESECUTIVO

RELAZIONE DI CALCOLO FONDAZIONI PILE DA P17 A P20

COMMESSA IF1N	LOTTO 01 E ZZ	CODIFICA RG	DOCUMENTO MD0000 001	REV. B	FOGLIO 136 di 143
------------------	------------------	----------------	-------------------------	-----------	-------------------------

* PILE TOP REACTIONS, LOCAL *

	AXIAL, KN	LAT. y, KN	LAT. z, KN	MOM x, KN- M	MOM y, KN- M	MOM z, KN- M
MINIMUM	1353.0	-348.02	209.08	0.6249	-614.94	-659.62
Pile N.	10	3	8	1	3	3
MAXIMUM	5863.1	-241.04	285.75	0.6249	-481.17	-466.04
Pile N.	3	8	3	1	8	8

* EFFECTS FOR LATERALLY LOADED PILE *

PILE	DISPL. y-DIR M	DISPL. z-DIR M	MOMENT KN- M	MOMENT KN- M	SHEAR y-DIR KN	SHEAR z-DIR KN	SOIL REACT y-DIR KN/ M	SOIL REACT z-DIR KN/ M	TOTAL STRESS KN/ M**2
Min.	-1.1357E-03	-3.5005E-05	-417.82	-614.94	-348.08	-77.802	-162.13	-30.721	765.65
Pile N.	1	7	3	3	3	3	3	3	10
Max.	4.7291E-05	8.2508E-04	659.62	300.52	107.88	285.81	43.873	123.52	6039.5
Pile N.	5	1	3	3	3	3	3	3	3

LOAD CASE : 6

* TABLE L * COMPUTATION ON PILE CAP

* EQUIVALENT CONCENTRATED LOAD AT ORIGIN *

LOAD X, KN	LOAD Y, KN	LOAD Z, KN	MOM X, KN- M	MOM Y, KN- M	MOM Z, KN- M
17293.0	3471.60	-2907.30	-113.000	-38705.2	-41060.8

* DISPLACEMENT OF GROUPED PILE FOUNDATION AT ORIGIN *

DISP X, M	DISP Y, M	DISP Z, M	ROT X,RAD	ROT Y,RAD	ROT Z,RAD
7.12682E-04	1.10985E-03	-7.94681E-04	3.90100E-07	-7.43593E-05	-1.47666E-04

* PILE TOP DISPLACEMENTS, GLOBAL *

	DISP. X, M	DISP. Y, M	DISP. Z, M	ROT. X,RAD	ROT. Y,RAD	ROT. Z,RAD
MINIMUM	-4.5374E-04	1.1072E-03	-7.9644E-04	3.9010E-07	-7.4359E-05	-1.4767E-04
Pile N.	3	1	3	1	1	1
MAXIMUM	1.8791E-03	1.1125E-03	-7.9293E-04	3.9010E-07	-7.4359E-05	-1.4767E-04
Pile N.	10	10	1	1	1	1

* PILE TOP REACTIONS, GLOBAL *

	FOR. X, KN	FOR. Y, KN	FOR. Z, KN	MOM X, KN- M	MOM Y, KN- M	MOM Z, KN- M
MINIMUM	-920.73	246.94	-287.85	0.1520	492.15	495.18
Pile N.	3	5	10	1	5	5
MAXIMUM	3756.8	349.73	-209.29	0.1520	631.86	677.57
Pile N.	10	10	5	1	10	10

* PILE TOP DISPLACEMENTS, LOCAL *

	DISP. x, M	DISP. y, M	DISP. z, M	ROT. x,RAD	ROT. y,RAD	ROT. z,RAD
MINIMUM	-4.5374E-04	1.1072E-03	-7.9644E-04	3.9010E-07	-7.4359E-05	-1.4767E-04
Pile N.	3	1	3	1	1	1
MAXIMUM	1.8791E-03	1.1125E-03	-7.9293E-04	3.9010E-07	-7.4359E-05	-1.4767E-04
Pile N.	10	10	1	1	1	1

* PILE TOP REACTIONS, LOCAL *

	AXIAL, KN	LAT. y, KN	LAT. z, KN	MOM x, KN- M	MOM y, KN- M	MOM z, KN- M
MINIMUM	-920.73	246.94	-287.85	0.1520	492.15	495.18
Pile N.	3	5	10	1	5	5
MAXIMUM	3756.8	349.73	-209.29	0.1520	631.86	677.57
Pile N.	10	10	5	1	10	10

* EFFECTS FOR LATERALLY LOADED PILE *

PILE	DISPL. y-DIR M	DISPL. z-DIR M	MOMENT KN- M	MOMENT KN- M	SHEAR y-DIR KN	SHEAR z-DIR KN	SOIL REACT y-DIR KN/ M	SOIL REACT z-DIR KN/ M	TOTAL STRESS KN/ M**2
Min.	-4.6591E-05	-7.9644E-04	-677.57	-294.59	-105.66	-287.89	-42.748	-123.02	136.79
Pile N.	5	3	10	10	10	10	10	10	6
Max.	1.1125E-03	3.3847E-05	409.18	631.86	349.77	76.110	161.26	29.845	4922.1
Pile N.	10	5	10	10	10	10	10	10	10

LOAD CASE : 7

* TABLE L * COMPUTATION ON PILE CAP

* EQUIVALENT CONCENTRATED LOAD AT ORIGIN *

LOAD X, KN	LOAD Y, KN	LOAD Z, KN	MOM X, KN- M	MOM Y, KN- M	MOM Z, KN- M
26180.0	3471.60	-9692.10	-376.000	-1.29059E+05	-41104.8

* DISPLACEMENT OF GROUPED PILE FOUNDATION AT ORIGIN *

DISP X, M	DISP Y, M	DISP Z, M	ROT X,RAD	ROT Y,RAD	ROT Z,RAD
1.13695E-03	1.48683E-03	-3.57597E-03	-1.04972E-05	-2.66671E-04	-1.63036E-04

* PILE TOP DISPLACEMENTS, GLOBAL *

APPALTATORE:

Consorzio

Soci



ITINERARIO NAPOLI – BARI

PROGETTAZIONE:

Mandataria

Mandanti



RADDOPPIO TRATTA APICE – ORSARA
I LOTTO FUNZIONALE APICE – HIRPINIA

PROGETTO ESECUTIVO

RELAZIONE DI CALCOLO FONDAZIONI PILE DA P17 A P20

COMMESSA IF1N	LOTTO 01 E ZZ	CODIFICA RG	DOCUMENTO MD0000 001	REV. B	FOGLIO 137 di 143
------------------	------------------	----------------	-------------------------	-----------	-------------------------

	DISP. X, M	DISP. Y, M	DISP. Z, M	ROT. X,RAD	ROT. Y,RAD	ROT. Z,RAD
MINIMUM	-1.3967E-03	1.4160E-03	-3.6232E-03	-1.0497E-05	-2.6667E-04	-1.6304E-04
Pile N.	3	10	1	1	1	1
MAXIMUM	3.6706E-03	1.5577E-03	-3.5287E-03	-1.0497E-05	-2.6667E-04	-1.6304E-04
Pile N.	10	1	3	1	1	1

* PILE TOP REACTIONS, GLOBAL *

	FOR. X, KN	FOR. Y, KN	FOR. Z, KN	MOM X, KN- M	MOM Y, KN- M	MOM Z, KN- M
MINIMUM	-2747.2	241.32	-1030.1	-4.0902	1740.1	535.06
Pile N.	3	8	10	1	5	8
MAXIMUM	6516.1	343.32	-665.26	-4.0902	2503.1	725.33
Pile N.	10	10	5	1	10	10

* PILE TOP DISPLACEMENTS, LOCAL *

	DISP. X, M	DISP. y, M	DISP. z, M	ROT. x,RAD	ROT. y,RAD	ROT. z,RAD
MINIMUM	-1.3967E-03	1.4160E-03	-3.6232E-03	-1.0497E-05	-2.6667E-04	-1.6304E-04
Pile N.	3	10	1	1	1	1
MAXIMUM	3.6706E-03	1.5577E-03	-3.5287E-03	-1.0497E-05	-2.6667E-04	-1.6304E-04
Pile N.	10	1	3	1	1	1

* PILE TOP REACTIONS, LOCAL *

	AXIAL, KN	LAT. y, KN	LAT. z, KN	MOM x, KN- M	MOM y, KN- M	MOM z, KN- M
MINIMUM	-2747.2	241.32	-1030.1	-4.0902	1740.1	535.06
Pile N.	3	8	10	1	5	8
MAXIMUM	6516.1	343.32	-665.26	-4.0902	2503.1	725.33
Pile N.	10	10	5	1	10	10

* EFFECTS FOR LATERALLY LOADED PILE *

PILE	DISPL. y-DIR M	DISPL. z-DIR M	MOMENT z-DIR KN- M	MOMENT y-DIR KN- M	SHEAR y-DIR KN	SHEAR z-DIR KN	SOIL REACT y-DIR KN/ M	SOIL REACT z-DIR KN/ M	TOTAL STRESS KN/ M**2
Min.	-4.2070E-05	-3.6232E-03	-725.33	-1055.8	-93.229	-1030.3	-21.963	-342.46	83.042
Pile N.	12	1	10	10	10	10	10	10	1
Max.	1.5577E-03	1.1052E-04	406.48	2503.1	343.39	246.84	124.36	56.861	1.1553E+04
Pile N.	1	10	10	10	10	10	10	10	10

LOAD CASE : 8

* TABLE L * COMPUTATION ON PILE CAP

* EQUIVALENT CONCENTRATED LOAD AT ORIGIN *

LOAD X, KN	LOAD Y, KN	LOAD Z, KN	MOM X, KN- M	MOM Y, KN- M	MOM Z, KN- M
35891.0	-3236.20	9608.50	376.000	1.31347E+05	38291.0

* DISPLACEMENT OF GROUPED PILE FOUNDATION AT ORIGIN *

DISP X, M	DISP Y, M	DISP Z, M	ROT X,RAD	ROT Y,RAD	ROT Z,RAD
1.59500E-03	-1.39786E-03	3.58718E-03	-4.69647E-06	2.81299E-04	1.57714E-04

* PILE TOP DISPLACEMENTS, GLOBAL *

	DISP. X, M	DISP. Y, M	DISP. Z, M	ROT. X,RAD	ROT. Y,RAD	ROT. Z,RAD
MINIMUM	-1.0135E-03	-1.4296E-03	3.5660E-03	-4.6965E-06	2.8130E-04	1.5771E-04
Pile N.	10	10	1	1	1	1
MAXIMUM	4.2035E-03	-1.3662E-03	3.6083E-03	-4.6965E-06	2.8130E-04	1.5771E-04
Pile N.	3	1	3	1	1	1

* PILE TOP REACTIONS, GLOBAL *

	FOR. X, KN	FOR. Y, KN	FOR. Z, KN	MOM X, KN- M	MOM Y, KN- M	MOM Z, KN- M
MINIMUM	-2005.3	-332.32	659.39	-1.8300	-2435.2	-701.46
Pile N.	10	3	8	1	3	3
MAXIMUM	7236.2	-222.72	1014.4	-1.8300	-1701.8	-492.87
Pile N.	3	8	3	1	8	8

* PILE TOP DISPLACEMENTS, LOCAL *

	DISP. X, M	DISP. y, M	DISP. z, M	ROT. x,RAD	ROT. y,RAD	ROT. z,RAD
MINIMUM	-1.0135E-03	-1.4296E-03	3.5660E-03	-4.6965E-06	2.8130E-04	1.5771E-04
Pile N.	10	10	1	1	1	1
MAXIMUM	4.2035E-03	-1.3662E-03	3.6083E-03	-4.6965E-06	2.8130E-04	1.5771E-04
Pile N.	3	1	3	1	1	1

* PILE TOP REACTIONS, LOCAL *

	AXIAL, KN	LAT. y, KN	LAT. z, KN	MOM x, KN- M	MOM y, KN- M	MOM z, KN- M
MINIMUM	-2005.3	-332.32	659.39	-1.8300	-2435.2	-701.46
Pile N.	10	3	8	1	3	3
MAXIMUM	7236.2	-222.72	1014.4	-1.8300	-1701.8	-492.87
Pile N.	3	8	3	1	8	8

* EFFECTS FOR LATERALLY LOADED PILE *

APPALTATORE:

Consorzio

Soci



ITINERARIO NAPOLI – BARI

PROGETTAZIONE:

Mandatario

Mandanti

RADDOPPIO TRATTA APICE – ORSARA
I LOTTO FUNZIONALE APICE – HIRPINIA

PROGETTO ESECUTIVO

RELAZIONE DI CALCOLO FONDAZIONI PILE DA P17 A P20

COMMESSA	LOTTO	CODIFICA	DOCUMENTO	REV.	FOGLIO
IF1N	01 E ZZ	RG	MD0000 001	B	138 di 143

PILE	DISPL. y-DIR M	DISPL. z-DIR M	MOMENT z-DIR KN- M	MOMENT y-DIR KN- M	SHEAR y-DIR KN	SHEAR z-DIR KN	SOIL REACT y-DIR KN/ M	SOIL REACT z-DIR KN/ M	TOTAL STRESS KN/ M**2
*****	*****	*****	*****	*****	*****	*****	*****	*****	*****
Min.	-1.4296E-03	-1.1047E-04	-393.77	-2435.2	-332.39	-246.57	-120.71	-56.525	296.91
Pile N.	10	3	3	3	3	3	3	3	7
Max.	4.0719E-05	3.6083E-03	701.46	1053.8	90.416	1014.7	20.283	340.75	1.1743E+04
Pile N.	3	3	3	3	3	3	3	3	3

LOAD CASE : 9

* TABLE L * COMPUTATION ON PILE CAP

* EQUIVALENT CONCENTRATED LOAD AT ORIGIN *

LOAD X, KN	LOAD Y, KN	LOAD Z, KN	MOM X, KN- M	MOM Y, KN- M	MOM Z, KN- M
28377.0	11902.0	-2956.80	-162.000	-38027.0	-1.41876E+05

* DISPLACEMENT OF GROUPED PILE FOUNDATION AT ORIGIN *

DISP X, M	DISP Y, M	DISP Z, M	ROT X,RAD	ROT Y,RAD	ROT Z,RAD
1.34939E-03	5.45267E-03	-1.18471E-03	7.48438E-06	-8.75949E-05	-5.81231E-04

* PILE TOP DISPLACEMENTS, GLOBAL *

	DISP. X, M	DISP. Y, M	DISP. Z, M	ROT. X,RAD	ROT. Y,RAD	ROT. Z,RAD
*****	*****	*****	*****	*****	*****	*****
MINIMUM	-1.8574E-03	5.4021E-03	-1.2184E-03	7.4844E-06	-8.7595E-05	-5.8123E-04
Pile N.	3	1	3	1	1	1
MAXIMUM	4.5562E-03	5.5032E-03	-1.1510E-03	7.4844E-06	-8.7595E-05	-5.8123E-04
Pile N.	10	10	1	1	1	1

* PILE TOP REACTIONS, GLOBAL *

	FOR. X, KN	FOR. Y, KN	FOR. Z, KN	MOM X, KN- M	MOM Y, KN- M	MOM Z, KN- M
*****	*****	*****	*****	*****	*****	*****
MINIMUM	-3639.0	827.82	-292.55	2.9162	554.53	1892.2
Pile N.	3	5	10	1	8	5
MAXIMUM	7561.5	1246.0	-209.04	2.9162	719.29	2766.3
Pile N.	10	10	8	1	10	10

* PILE TOP DISPLACEMENTS, LOCAL *

	DISP. x, M	DISP. y, M	DISP. z, M	ROT. x,RAD	ROT. y,RAD	ROT. z,RAD
*****	*****	*****	*****	*****	*****	*****
MINIMUM	-1.8574E-03	5.4021E-03	-1.2184E-03	7.4844E-06	-8.7595E-05	-5.8123E-04
Pile N.	3	1	3	1	1	1
MAXIMUM	4.5562E-03	5.5032E-03	-1.1510E-03	7.4844E-06	-8.7595E-05	-5.8123E-04
Pile N.	10	10	1	1	1	1

* PILE TOP REACTIONS, LOCAL *

	AXIAL, KN	LAT. y, KN	LAT. z, KN	MOM x, KN- M	MOM y, KN- M	MOM z, KN- M
*****	*****	*****	*****	*****	*****	*****
MINIMUM	-3639.0	827.82	-292.55	2.9162	554.53	1892.2
Pile N.	3	5	10	1	8	5
MAXIMUM	7561.5	1246.0	-209.04	2.9162	719.29	2766.3
Pile N.	10	10	8	1	10	10

* EFFECTS FOR LATERALLY LOADED PILE *

PILE	DISPL. y-DIR M	DISPL. z-DIR M	MOMENT z-DIR KN- M	MOMENT y-DIR KN- M	SHEAR y-DIR KN	SHEAR z-DIR KN	SOIL REACT y-DIR KN/ M	SOIL REACT z-DIR KN/ M	TOTAL STRESS KN/ M**2
*****	*****	*****	*****	*****	*****	*****	*****	*****	*****
Min.	-1.4348E-04	-1.2184E-03	-2766.3	-310.23	-328.90	-292.63	-76.543	-92.584	763.89
Pile N.	10	3	10	10	10	10	10	10	12
Max.	5.5032E-03	3.0556E-05	1467.6	719.29	1246.3	71.416	419.95	16.596	1.2905E+04
Pile N.	10	1	10	10	10	10	10	10	10

LOAD CASE : 10

* TABLE L * COMPUTATION ON PILE CAP

* EQUIVALENT CONCENTRATED LOAD AT ORIGIN *

LOAD X, KN	LOAD Y, KN	LOAD Z, KN	MOM X, KN- M	MOM Y, KN- M	MOM Z, KN- M
35345.0	-11365.2	2907.30	113.000	38729.3	1.34624E+05

* DISPLACEMENT OF GROUPED PILE FOUNDATION AT ORIGIN *

DISP X, M	DISP Y, M	DISP Z, M	ROT X,RAD	ROT Y,RAD	ROT Z,RAD
1.68871E-03	-5.17039E-03	1.16578E-03	1.06014E-05	9.19635E-05	5.67374E-04

* PILE TOP DISPLACEMENTS, GLOBAL *

	DISP. X, M	DISP. Y, M	DISP. Z, M	ROT. X,RAD	ROT. Y,RAD	ROT. Z,RAD
*****	*****	*****	*****	*****	*****	*****
MINIMUM	-1.4852E-03	-5.2420E-03	1.1181E-03	1.0601E-05	9.1963E-05	5.6737E-04
Pile N.	10	1	3	1	1	1
MAXIMUM	4.8626E-03	-5.0988E-03	1.2135E-03	1.0601E-05	9.1963E-05	5.6737E-04
Pile N.	3	10	1	1	1	1

* PILE TOP REACTIONS, GLOBAL *

	FOR. X, KN	FOR. Y, KN	FOR. Z, KN	MOM X, KN- M	MOM Y, KN- M	MOM Z, KN- M
*****	*****	*****	*****	*****	*****	*****
MINIMUM	-2918.5	-1194.9	205.32	4.1308	-691.44	-2620.0

APPALTATORE:

Consorzio



Soci



ITINERARIO NAPOLI – BARI

PROGETTAZIONE:

Mandataria



Mandanti

RADDOPPIO TRATTA APICE – ORSARA
I LOTTO FUNZIONALE APICE – HIRPINIA

PROGETTO ESECUTIVO

RELAZIONE DI CALCOLO FONDAZIONI PILE DA P17 A P20

COMMESSA
IF1NLOTTO
01 E ZZCODIFICA
RGDOCUMENTO
MD0000 001REV.
BFOGLIO
139 di
143

Pile N.	10	3	5	1	12	3
MAXIMUM	7692.5	-787.63	286.97	4.1308	-533.66	-1767.1
Pile N.	3	8	12	1	5	8

* PILE TOP DISPLACEMENTS, LOCAL *

	DISP. x, M	DISP. y, M	DISP. z, M	ROT. x,RAD	ROT. y,RAD	ROT. z,RAD
MINIMUM	-1.4852E-03	-5.2420E-03	1.1181E-03	1.0601E-05	9.1963E-05	5.6737E-04
Pile N.	10	1	3	1	1	1
MAXIMUM	4.8626E-03	-5.0988E-03	1.2135E-03	1.0601E-05	9.1963E-05	5.6737E-04
Pile N.	3	10	1	1	1	1

* PILE TOP REACTIONS, LOCAL *

	AXIAL, KN	LAT. y, KN	LAT. z, KN	MOM x, KN- M	MOM y, KN- M	MOM z, KN- M
MINIMUM	-2918.5	-1194.9	205.32	4.1308	-691.44	-2620.0
Pile N.	10	3	5	1	12	3
MAXIMUM	7692.5	-787.63	286.97	4.1308	-533.66	-1767.1
Pile N.	3	8	12	1	5	8

* EFFECTS FOR LATERALLY LOADED PILE *

PILE	DISPL. y-DIR M	DISPL. z-DIR M	MOMENT z-DIR KN- M	MOMENT y-DIR KN- M	SHEAR y-DIR KN	SHEAR z-DIR KN	SOIL REACT y-DIR KN/ M	SOIL REACT z-DIR KN/ M	TOTAL STRESS KN/ M**2
Min.	-5.2419E-03	-3.2461E-05	-1414.3	-691.44	-1195.2	-73.064	-408.13	-16.872	279.86
Pile N.	1	12	3	12	3	12	3	12	1
Max.	1.4571E-04	1.2135E-03	2620.0	312.02	322.07	287.04	73.970	91.746	1.2522E+04
Pile N.	12	1	3	12	12	12	12	12	3

LOAD CASE : 11

* TABLE L * COMPUTATION ON PILE CAP

* EQUIVALENT CONCENTRATED LOAD AT ORIGIN *

LOAD X, KN	LOAD Y, KN	LOAD Z, KN	MOM X, KN- M	MOM Y, KN- M	MOM Z, KN- M
47171.5	3534.00	-1098.00	-361.000	-19625.0	-48642.0

* DISPLACEMENT OF GROUPED PILE FOUNDATION AT ORIGIN *

DISP X, M	DISP Y, M	DISP Z, M	ROT X,RAD	ROT Y,RAD	ROT Z,RAD
2.01226E-03	1.19767E-03	-3.25328E-04	-4.40662E-07	-4.07914E-05	-1.86709E-04

* PILE TOP DISPLACEMENTS, GLOBAL *

	DISP. X, M	DISP. Y, M	DISP. Z, M	ROT. X,RAD	ROT. Y,RAD	ROT. Z,RAD
MINIMUM	8.9673E-04	1.1947E-03	-3.2731E-04	-4.4066E-07	-4.0791E-05	-1.8671E-04
Pile N.	3	10	1	1	1	1
MAXIMUM	3.1278E-03	1.2006E-03	-3.2335E-04	-4.4066E-07	-4.0791E-05	-1.8671E-04
Pile N.	10	1	3	1	1	1

* PILE TOP REACTIONS, GLOBAL *

	FOR. X, KN	FOR. Y, KN	FOR. Z, KN	MOM X, KN- M	MOM Y, KN- M	MOM Z, KN- M
MINIMUM	1820.4	252.96	-110.75	-0.1717	163.67	444.96
Pile N.	3	5	10	1	6	8
MAXIMUM	5782.5	355.68	-79.072	-0.1717	220.96	621.54
Pile N.	10	10	6	1	10	10

* PILE TOP DISPLACEMENTS, LOCAL *

	DISP. x, M	DISP. y, M	DISP. z, M	ROT. x,RAD	ROT. y,RAD	ROT. z,RAD
MINIMUM	8.9673E-04	1.1947E-03	-3.2731E-04	-4.4066E-07	-4.0791E-05	-1.8671E-04
Pile N.	3	10	1	1	1	1
MAXIMUM	3.1278E-03	1.2006E-03	-3.2335E-04	-4.4066E-07	-4.0791E-05	-1.8671E-04
Pile N.	10	1	3	1	1	1

* PILE TOP REACTIONS, LOCAL *

	AXIAL, KN	LAT. y, KN	LAT. z, KN	MOM x, KN- M	MOM y, KN- M	MOM z, KN- M
MINIMUM	1820.4	252.96	-110.75	-0.1717	163.67	444.96
Pile N.	3	5	10	1	6	8
MAXIMUM	5782.5	355.68	-79.072	-0.1717	220.96	621.54
Pile N.	10	10	6	1	10	10

* EFFECTS FOR LATERALLY LOADED PILE *

PILE	DISPL. y-DIR M	DISPL. z-DIR M	MOMENT z-DIR KN- M	MOMENT y-DIR KN- M	SHEAR y-DIR KN	SHEAR z-DIR KN	SOIL REACT y-DIR KN/ M	SOIL REACT z-DIR KN/ M	TOTAL STRESS KN/ M**2
Min.	-5.1621E-05	-3.2731E-04	-621.54	-124.84	-118.81	-110.77	-49.203	-51.621	1030.1
Pile N.	5	1	10	10	10	10	10	10	3
Max.	1.2006E-03	1.4123E-05	454.68	220.96	355.73	32.582	177.87	13.363	5263.1
Pile N.	1	8	10	10	10	10	10	10	10

LOAD CASE : 12

APPALTATORE: Consorzio Soci   	ITINERARIO NAPOLI – BARI RADDOPPIO TRATTA APICE – ORSARA I LOTTO FUNZIONALE APICE – HIRPINIA
PROGETTAZIONE: Mandataria Mandanti   	
PROGETTO ESECUTIVO RELAZIONE DI CALCOLO FONDAZIONI PILE DA P17 A P20	COMMESSA IF1N LOTTO 01 E ZZ CODIFICA RG DOCUMENTO MD0000 001 REV. B FOGLIO 140 di 143

* TABLE L * COMPUTATION ON PILE CAP

* EQUIVALENT CONCENTRATED LOAD AT ORIGIN *

LOAD X, KN	LOAD Y, KN	LOAD Z, KN	MOM X, KN- M	MOM Y, KN- M	MOM Z, KN- M
50691.5	1340.00	-1635.00	-5.00000	-28879.5	-16178.0

* DISPLACEMENT OF GROUPED PILE FOUNDATION AT ORIGIN *

DISP X, M	DISP Y, M	DISP Z, M	ROT X,RAD	ROT Y,RAD	ROT Z,RAD
2.13139E-03	3.87623E-04	-4.24126E-04	-2.07057E-07	-5.70395E-05	-6.21608E-05

* PILE TOP DISPLACEMENTS, GLOBAL *

	DISP. X, M	DISP. Y, M	DISP. Z, M	ROT. X,RAD	ROT. Y,RAD	ROT. Z,RAD
MINIMUM	1.4666E-03	3.8623E-04	-4.2506E-04	-2.0706E-07	-5.7040E-05	-6.2161E-05
Pile N.	3	10	1	1	1	1
MAXIMUM	2.7961E-03	3.8902E-04	-4.2319E-04	-2.0706E-07	-5.7040E-05	-6.2161E-05
Pile N.	10	1	3	1	1	1

* PILE TOP REACTIONS, GLOBAL *

	FOR. X, KN	FOR. Y, KN	FOR. Z, KN	MOM X, KN- M	MOM Y, KN- M	MOM Z, KN- M
MINIMUM	2943.8	94.740	-164.44	-0.080679	229.94	164.18
Pile N.	3	5	10	1	5	5
MAXIMUM	5334.3	134.66	-116.24	-0.080679	312.80	230.94
Pile N.	10	10	5	1	10	10

* PILE TOP DISPLACEMENTS, LOCAL *

	DISP. x, M	DISP. y, M	DISP. z, M	ROT. x,RAD	ROT. y,RAD	ROT. z,RAD
MINIMUM	1.4666E-03	3.8623E-04	-4.2506E-04	-2.0706E-07	-5.7040E-05	-6.2161E-05
Pile N.	3	10	1	1	1	1
MAXIMUM	2.7961E-03	3.8902E-04	-4.2319E-04	-2.0706E-07	-5.7040E-05	-6.2161E-05
Pile N.	10	1	3	1	1	1

* PILE TOP REACTIONS, LOCAL *

	AXIAL, KN	LAT. y, KN	LAT. z, KN	MOM x, KN- M	MOM y, KN- M	MOM z, KN- M
MINIMUM	2943.8	94.740	-164.44	-0.080679	229.94	164.18
Pile N.	3	5	10	1	5	5
MAXIMUM	5334.3	134.66	-116.24	-0.080679	312.80	230.94
Pile N.	10	10	5	1	10	10

* EFFECTS FOR LATERALLY LOADED PILE *

PILE	DISPL. y-DIR M	DISPL. z-DIR M	MOMENT z-DIR KN- M	MOMENT y-DIR KN- M	SHEAR y-DIR KN	SHEAR z-DIR KN	SOIL REACT y-DIR KN/ M	SOIL REACT z-DIR KN/ M	TOTAL STRESS KN/ M**2
Min.	-1.8238E-05	-4.2506E-04	-230.94	-182.05	-43.950	-164.46	-18.165	-92.190	1665.9
Pile N.	5	1	10	10	10	10	10	10	3
Max.	3.8902E-04	2.0023E-05	165.64	312.80	134.68	48.393	79.807	20.085	4192.1
Pile N.	1	5	10	10	10	10	10	10	10

LOAD CASE : 13

* TABLE L * COMPUTATION ON PILE CAP

* EQUIVALENT CONCENTRATED LOAD AT ORIGIN *

LOAD X, KN	LOAD Y, KN	LOAD Z, KN	MOM X, KN- M	MOM Y, KN- M	MOM Z, KN- M
50691.5	1750.00	-1635.00	-5.00000	-28879.5	-21225.0

* DISPLACEMENT OF GROUPED PILE FOUNDATION AT ORIGIN *

DISP X, M	DISP Y, M	DISP Z, M	ROT X,RAD	ROT Y,RAD	ROT Z,RAD
2.13696E-03	5.19315E-04	-4.36758E-04	1.63600E-07	-5.81156E-05	-8.20419E-05

* PILE TOP DISPLACEMENTS, GLOBAL *

	DISP. X, M	DISP. Y, M	DISP. Z, M	ROT. X,RAD	ROT. Y,RAD	ROT. Z,RAD
MINIMUM	1.3755E-03	5.1821E-04	-4.3749E-04	1.6360E-07	-5.8116E-05	-8.2042E-05
Pile N.	3	1	3	1	1	1
MAXIMUM	2.8984E-03	5.2042E-04	-4.3602E-04	1.6360E-07	-5.8116E-05	-8.2042E-05
Pile N.	10	10	1	1	1	1

* PILE TOP REACTIONS, GLOBAL *

	FOR. X, KN	FOR. Y, KN	FOR. Z, KN	MOM X, KN- M	MOM Y, KN- M	MOM Z, KN- M
MINIMUM	2764.1	123.73	-163.18	0.063746	232.76	216.83
Pile N.	3	5	10	1	5	5
MAXIMUM	5472.6	177.06	-116.65	0.063746	312.40	308.21
Pile N.	10	10	5	1	10	10

* PILE TOP DISPLACEMENTS, LOCAL *

	DISP. x, M	DISP. y, M	DISP. z, M	ROT. x,RAD	ROT. y,RAD	ROT. z,RAD
MINIMUM	1.3755E-03	5.1821E-04	-4.3749E-04	1.6360E-07	-5.8116E-05	-8.2042E-05
Pile N.	3	1	3	1	1	1
MAXIMUM	2.8984E-03	5.2042E-04	-4.3602E-04	1.6360E-07	-5.8116E-05	-8.2042E-05
Pile N.	10	10	1	1	1	1

APPALTATORE:

Consorzio

Soci



ITINERARIO NAPOLI – BARI

PROGETTAZIONE:

Mandataria

Mandanti



RADDOPPIO TRATTA APICE – ORSARA
I LOTTO FUNZIONALE APICE – HIRPINIA

PROGETTO ESECUTIVO

RELAZIONE DI CALCOLO FONDAZIONI PILE DA P17 A P20

COMMESSA IF1N	LOTTO 01 E ZZ	CODIFICA RG	DOCUMENTO MD0000 001	REV. B	FOGLIO 141 di 143
------------------	------------------	----------------	-------------------------	-----------	-------------------------

* PILE TOP REACTIONS, LOCAL *

	AXIAL, KN	LAT. y, KN	LAT. z, KN	MOM x, KN- M	MOM y, KN- M	MOM z, KN- M
MINIMUM	2764.1	123.73	-163.18	0.063746	232.76	216.83
Pile N.	3	5	10	1	5	5
MAXIMUM	5472.6	177.06	-116.65	0.063746	312.40	308.21
Pile N.	10	10	5	1	10	10

* EFFECTS FOR LATERALLY LOADED PILE *

PILE	DISPL. y-DIR	DISPL. z-DIR	MOMENT z-DIR	MOMENT y-DIR	SHEAR y-DIR	SHEAR z-DIR	SOIL REACT y-DIR	SOIL REACT z-DIR	TOTAL STRESS
	M	M	KN- M	KN- M	KN	KN	KN/ M	KN/ M	KN/ M**2
Min.	-2.4002E-05	-4.3749E-04	-308.21	-182.30	-57.726	-163.20	-23.944	-88.033	1564.2
Pile N.	5	3	10	10	10	10	10	10	3
Max.	5.2042E-04	2.0280E-05	217.30	312.40	177.09	48.361	100.54	20.115	4421.3
Pile N.	10	5	10	10	10	10	10	10	10

LOAD CASE : 14

* TABLE L * COMPUTATION ON PILE CAP

* EQUIVALENT CONCENTRATED LOAD AT ORIGIN *

LOAD X, KN	LOAD Y, KN	LOAD Z, KN	MOM X, KN- M	MOM Y, KN- M	MOM Z, KN- M
34888.5	255.000	-1282.00	0.00000	-22314.0	-3133.50

* DISPLACEMENT OF GROUPED PILE FOUNDATION AT ORIGIN *

DISP X, M	DISP Y, M	DISP Z, M	ROT X,RAD	ROT Y,RAD	ROT Z,RAD
1.44816E-03	6.87528E-05	-3.07537E-04	-3.40536E-07	-4.13809E-05	-1.11739E-05

* PILE TOP DISPLACEMENTS, GLOBAL *

	DISP. X, M	DISP. Y, M	DISP. Z, M	ROT. X,RAD	ROT. Y,RAD	ROT. Z,RAD
MINIMUM	1.1186E-03	6.6454E-05	-3.0907E-04	-3.4054E-07	-4.1381E-05	-1.1174E-05
Pile N.	3	10	1	1	1	1
MAXIMUM	1.7778E-03	7.1051E-05	-3.0600E-04	-3.4054E-07	-4.1381E-05	-1.1174E-05
Pile N.	10	1	3	1	1	1

* PILE TOP REACTIONS, GLOBAL *

	FOR. X, KN	FOR. Y, KN	FOR. Z, KN	MOM X, KN- M	MOM Y, KN- M	MOM Z, KN- M
MINIMUM	2257.7	18.316	-131.12	-0.1327	177.69	31.031
Pile N.	3	5	10	1	5	8
MAXIMUM	3557.1	24.765	-90.784	-0.1327	246.52	40.966
Pile N.	10	10	5	1	10	10

* PILE TOP DISPLACEMENTS, LOCAL *

	DISP. x, M	DISP. y, M	DISP. z, M	ROT. x,RAD	ROT. y,RAD	ROT. z,RAD
MINIMUM	1.1186E-03	6.6454E-05	-3.0907E-04	-3.4054E-07	-4.1381E-05	-1.1174E-05
Pile N.	3	10	1	1	1	1
MAXIMUM	1.7778E-03	7.1051E-05	-3.0600E-04	-3.4054E-07	-4.1381E-05	-1.1174E-05
Pile N.	10	1	3	1	1	1

* PILE TOP REACTIONS, LOCAL *

	AXIAL, KN	LAT. y, KN	LAT. z, KN	MOM x, KN- M	MOM y, KN- M	MOM z, KN- M
MINIMUM	2257.7	18.316	-131.12	-0.1327	177.69	31.031
Pile N.	3	5	10	1	5	8
MAXIMUM	3557.1	24.765	-90.784	-0.1327	246.52	40.966
Pile N.	10	10	5	1	10	10

* EFFECTS FOR LATERALLY LOADED PILE *

PILE	DISPL. y-DIR	DISPL. z-DIR	MOMENT z-DIR	MOMENT y-DIR	SHEAR y-DIR	SHEAR z-DIR	SOIL REACT y-DIR	SOIL REACT z-DIR	TOTAL STRESS
	M	M	KN- M	KN- M	KN	KN	KN/ M	KN/ M	KN/ M**2
Min.	-3.4009E-06	-3.0907E-04	-40.966	-138.94	-7.9737	-131.14	-3.2349	-84.033	1277.6
Pile N.	2	1	10	10	10	10	10	10	3
Max.	7.1051E-05	1.4953E-05	29.998	246.52	24.768	36.885	16.981	15.180	2767.1
Pile N.	1	5	10	10	10	10	10	10	10

LOAD CASE : 15

* TABLE L * COMPUTATION ON PILE CAP

* EQUIVALENT CONCENTRATED LOAD AT ORIGIN *

LOAD X, KN	LOAD Y, KN	LOAD Z, KN	MOM X, KN- M	MOM Y, KN- M	MOM Z, KN- M
46423.5	1152.00	-1320.00	0.00000	-30912.0	-13935.0

* DISPLACEMENT OF GROUPED PILE FOUNDATION AT ORIGIN *

DISP X, M	DISP Y, M	DISP Z, M	ROT X,RAD	ROT Y,RAD	ROT Z,RAD
1.93907E-03	3.17821E-04	-3.58894E-04	-2.46410E-07	-5.63699E-05	-5.09598E-05

* PILE TOP DISPLACEMENTS, GLOBAL *

APPALTATORE: Consorzio Soci   		ITINERARIO NAPOLI – BARI RADDOPPIO TRATTA APICE – ORSARA I LOTTO FUNZIONALE APICE – HIRPINIA			
PROGETTAZIONE: Mandataria Mandanti   					
PROGETTO ESECUTIVO RELAZIONE DI CALCOLO FONDAZIONI PILE DA P17 A P20					
COMMESSA	LOTTO	CODIFICA	DOCUMENTO	REV.	FOGLIO
IF1N	01 E ZZ	RG	MD0000 001	B	142 di 143

	DISP. X, M	DISP. Y, M	DISP. Z, M	ROT. X,RAD	ROT. Y,RAD	ROT. Z,RAD
MINIMUM	1.3293E-03	3.1616E-04	-3.6000E-04	-2.4641E-07	-5.6370E-05	-5.0960E-05
Pile N.	3	10	1	1	1	1
MAXIMUM	2.5489E-03	3.1948E-04	-3.5779E-04	-2.4641E-07	-5.6370E-05	-5.0960E-05
Pile N.	10	1	3	1	1	1

* PILE TOP REACTIONS, GLOBAL *						
	FOR. X, KN	FOR. Y, KN	FOR. Z, KN	MOM X, KN- M	MOM Y, KN- M	MOM Z, KN- M
MINIMUM	2673.0	81.558	-133.84	-0.096012	164.64	141.57
Pile N.	3	5	10	1	5	5
MAXIMUM	5000.2	115.40	-93.223	-0.096012	233.63	197.57
Pile N.	10	10	5	1	10	10

* PILE TOP DISPLACEMENTS, LOCAL *						
	DISP. X, M	DISP. Y, M	DISP. z, M	ROT. x,RAD	ROT. y,RAD	ROT. z,RAD
MINIMUM	1.3293E-03	3.1616E-04	-3.6000E-04	-2.4641E-07	-5.6370E-05	-5.0960E-05
Pile N.	3	10	1	1	1	1
MAXIMUM	2.5489E-03	3.1948E-04	-3.5779E-04	-2.4641E-07	-5.6370E-05	-5.0960E-05
Pile N.	10	1	3	1	1	1

* PILE TOP REACTIONS, LOCAL *						
	AXIAL, KN	LAT. y, KN	LAT. z, KN	MOM x, KN- M	MOM y, KN- M	MOM z, KN- M
MINIMUM	2673.0	81.558	-133.84	-0.096012	164.64	141.57
Pile N.	3	5	10	1	5	5
MAXIMUM	5000.2	115.40	-93.223	-0.096012	233.63	197.57
Pile N.	10	10	5	1	10	10

* EFFECTS FOR LATERALLY LOADED PILE *

PILE	DISPL. y-DIR M	DISPL. z-DIR M	MOMENT z-DIR KN- M	MOMENT y-DIR KN- M	SHEAR y-DIR KN	SHEAR z-DIR KN	SOIL REACT y-DIR KN/ M	SOIL REACT z-DIR KN/ M	TOTAL STRESS KN/ M**2
Min.	-1.5194E-05	-3.6000E-04	-197.57	-158.93	-37.135	-133.86	-15.210	-82.124	1512.6
Pile N.	5	1	10	10	10	10	10	10	3
Max.	3.1948E-04	1.7134E-05	139.66	233.63	115.42	42.244	71.513	17.338	3752.9
Pile N.	1	5	10	10	10	10	10	10	10

LOAD CASE : 16

* TABLE L * COMPUTATION ON PILE CAP

* EQUIVALENT CONCENTRATED LOAD AT ORIGIN *

LOAD X, KN	LOAD Y, KN	LOAD Z, KN	MOM X, KN- M	MOM Y, KN- M	MOM Z, KN- M
47171.5	3534.00	-1098.00	-361.000	-19625.0	-48642.0

* DISPLACEMENT OF GROUPED PILE FOUNDATION AT ORIGIN *

DISP X, M	DISP Y, M	DISP Z, M	ROT X,RAD	ROT Y,RAD	ROT Z,RAD
2.01226E-03	1.19767E-03	-3.25328E-04	-4.40662E-07	-4.07914E-05	-1.86709E-04



* PILE TOP DISPLACEMENTS, GLOBAL *						
	DISP. X, M	DISP. Y, M	DISP. Z, M	ROT. X,RAD	ROT. Y,RAD	ROT. Z,RAD
MINIMUM	8.9673E-04	1.1947E-03	-3.2731E-04	-4.4066E-07	-4.0791E-05	-1.8671E-04
Pile N.	3	10	1	1	1	1
MAXIMUM	3.1278E-03	1.2006E-03	-3.2335E-04	-4.4066E-07	-4.0791E-05	-1.8671E-04
Pile N.	10	1	3	1	1	1

* PILE TOP REACTIONS, GLOBAL *						
	FOR. X, KN	FOR. Y, KN	FOR. Z, KN	MOM X, KN- M	MOM Y, KN- M	MOM Z, KN- M
MINIMUM	1820.4	252.96	-110.75	-0.1717	163.67	444.96
Pile N.	3	5	10	1	6	8
MAXIMUM	5782.5	355.68	-79.072	-0.1717	220.96	621.54
Pile N.	10	10	6	1	10	10

* PILE TOP DISPLACEMENTS, LOCAL *						
	DISP. X, M	DISP. Y, M	DISP. z, M	ROT. x,RAD	ROT. y,RAD	ROT. z,RAD
MINIMUM	8.9673E-04	1.1947E-03	-3.2731E-04	-4.4066E-07	-4.0791E-05	-1.8671E-04
Pile N.	3	10	1	1	1	1
MAXIMUM	3.1278E-03	1.2006E-03	-3.2335E-04	-4.4066E-07	-4.0791E-05	-1.8671E-04
Pile N.	10	1	3	1	1	1

* PILE TOP REACTIONS, LOCAL *						
	AXIAL, KN	LAT. y, KN	LAT. z, KN	MOM x, KN- M	MOM y, KN- M	MOM z, KN- M
MINIMUM	1820.4	252.96	-110.75	-0.1717	163.67	444.96
Pile N.	3	5	10	1	6	8
MAXIMUM	5782.5	355.68	-79.072	-0.1717	220.96	621.54
Pile N.	10	10	6	1	10	10

* EFFECTS FOR LATERALLY LOADED PILE *

APPALTATORE: Consorzio  Soci  	ITINERARIO NAPOLI – BARI RADDOPPIO TRATTA APICE – ORSARA I LOTTO FUNZIONALE APICE – HIRPINIA					
PROGETTAZIONE: Mandataria  Mandanti  						
PROGETTO ESECUTIVO RELAZIONE DI CALCOLO FONDAZIONI PILE DA P17 A P20	COMMESSA IF1N	LOTTO 01 E ZZ	CODIFICA RG	DOCUMENTO MD0000 001	REV. B	FOGLIO 143 di 143

PILE	DISPL. y-DIR M	DISPL. z-DIR M	MOMENT z-DIR KN- M	MOMENT y-DIR KN- M	SHEAR y-DIR KN	SHEAR z-DIR KN	SOIL REACT y-DIR KN/ M	SOIL REACT z-DIR KN/ M	TOTAL STRESS KN/ M**2
*****	*****	*****	*****	*****	*****	*****	*****	*****	*****
Min.	-5.1621E-05	-3.2731E-04	-621.54	-124.84	-118.81	-110.77	-49.203	-51.621	1030.1
Pile N.	5	1	10	10	10	10	10	10	3
Max.	1.2006E-03	1.4123E-05	454.68	220.96	355.73	32.582	177.87	13.363	5263.1
Pile N.	1	8	10	10	10	10	10	10	10