

COMMITTENTE:



DIREZIONE LAVORI:



APPALTATORE:
CONSORZIO:



SOCI:



PROGETTAZIONE:
MANDATARIA:



MANDANTI:



PROGETTO ESECUTIVO

ITINERARIO NAPOLI - BARI RADDOPPIO TRATTA APICE - ORSARA I LOTTO FUNZIONALE APICE - HIRPINIA

VIADOTTI

VI04 - VIADOTTO UFITA APICE DA KM 16+713 A KM 17+418

RELAZIONE DI CALCOLO FONDAZIONI PILE DA P7 A P16

APPALTATORE	DIRETTORE DELLA PROGETTAZIONE	PROGETTISTA
Consorzio HIRPINIA AV Il Direttore Tecnico Ing. Vincenzo Moriello 10/06/2020	Il Responsabile integrazione fra le varie prestazioni specialistiche Ing. G. Cassani	Alpina S.p.A. Ing. Paolo Galvanin

COMMESSA LOTTO FASE ENTE TIPO DOC. OPERA/DISCIPLINA Progr. REV. SCALA:

IF28	01	E	ZZ	CL	VI0403	007	B	-
------	----	---	----	----	--------	-----	---	---

Rev.	Descrizione	Redatto	Data	Verificato	Data	Approvato	Data	Autorizzato Data
A	Emissione per consegna	P.Pazzaglia	21/02/2020	L.Zanelotti	21/02/2020	M.Vernaleone	21/02/2020	P.Galvanin
B	Recepimento Istruttorie	P.Pazzaglia	10/06/2020	L.Zanelotti	10/06/2020	M.Vernaleone	10/06/2020	
								10/06/2020

File: IF2801EZZCLVI0403007B

n. Elab.:

APPALTATORE: <u>Consorzio</u> HIRPINIA AV	<u>Soci</u> SALINI IMPREGILO S.P.A. ASTALDI S.P.A.	ITINERARIO NAPOLI – BARI RADDOPPIO TRATTA APICE – ORSARA I LOTTO FUNZIONALE APICE – HIRPINIA				
PROGETTAZIONE: <u>Mandatario</u> ROCKSOIL S.P.A.	<u>Mandanti</u> NET ENGINEERING S.P.A. ALPINA S.P.A.					
PROGETTO ESECUTIVO RELAZIONE DI CALCOLO FONDAZIONI PILE DA P7 A P16	COMMESSA IF28	LOTTO 01	CODIFICA E ZZ CL	DOCUMENTO VI0403 007	REV. B	FOGLIO 2 di 144

Indice

1	INTRODUZIONE	4
2	DOCUMENTI DI RIFERIMENTO E NORMATIVA.....	5
2.1	DOCUMENTI DI RIFERIMENTO.....	5
2.2	NORMATIVA E STRANDARD DI RIFERIMENTO	6
2.3	SOFTWARE	6
3	MATERIALI.....	7
3.1	ACCIAIO	7
3.1.1	ACCIAIO PER ARMATURA STRUTTURE IN C.A.	7
3.1.2	PROFILATI E PIASTRE METALLICHE	7
3.2	CALCESTRUZZO.....	7
3.2.1	CALCESTRUZZO MAGRO PER GETTI DI LIVELLAMENTO	7
3.2.2	CALCESTRUZZO PALI, DIAFRAMMI DI FONDAZIONE, CORDOLI E OPERE PROVVISORIALI	7
3.2.3	CALCESTRUZZO PER FONDAZIONI PILE E SPALLE	7
4	DESCRIZIONE DELLE FONDAZIONI E STRATIGRAFIA DI PROGETTO	9
4.1	DESCRIZIONE DEL SISTEMA FONDAZIONALE	9
4.2	STRATIGRAFIA DI RIFERIMENTO.....	9
5	CRITERI DI VERIFICA.....	10
6	SCARICHI DI FONDAZIONE	11
6.1	SCARICHI ALLA BASE DELLA PILA.....	11
6.1.1	COMBINAZIONI DELLE AZIONI AGLI STATI LIMITE ULTIMI SISMICI.....	11
6.1.2	COMBINAZIONI DELLE AZIONI AGLI STATI LIMITE ULTIMI STATICI (SLU)	12
6.1.3	COMBINAZIONI DELLE AZIONI AGLI STATI LIMITE DI ESERCIZIO (SLE).....	12
6.2	SCARICHI A INTRADOSSO PLINTO.....	13
6.2.1	COMBINAZIONI DELLE AZIONI AGLI STATI LIMITE ULTIMI SISMICI (SLV).....	13
6.2.2	COMBINAZIONI DELLE AZIONI AGLI STATI LIMITE ULTIMI STATICI (SLU)	14
6.2.3	COMBINAZIONI DELLE AZIONI AGLI STATI LIMITE DI ESERCIZIO (SLE).....	14
7	ANALISI DELL'INTERAZIONE FONDAZIONE-TERRENO	15
7.1	DESCRIZIONE DEL MODELLO DI CALCOLO GROUP	15
7.2	SINTESI DEI RISULTATI AGLI STATI LIMITE DI ESERCIZIO (SLE)	21
7.2.1	SPOSTAMENTI.....	23
7.3	SINTESI DEI RISULTATI AGLI STATI LIMITE ULTIMI STATICI (SLU)	24
7.4	SINTESI DEI RISULTATI AGLI STATI LIMITE ULTIMI SISMICI (SLV)	26

APPALTATORE: Consorzio Soci   	ITINERARIO NAPOLI – BARI RADDOPPIO TRATTA APICE – ORSARA I LOTTO FUNZIONALE APICE – HIRPINIA																	
PROGETTAZIONE: Mandataria Mandanti   	<table border="1" style="width: 100%; border-collapse: collapse;"> <tr> <td style="width: 16.6%;">COMMESSA</td> <td style="width: 16.6%;">LOTTO</td> <td style="width: 16.6%;">CODIFICA</td> <td style="width: 16.6%;">DOCUMENTO</td> <td style="width: 16.6%;">REV.</td> <td style="width: 16.6%;">FOGLIO</td> </tr> <tr> <td>IF1N</td> <td>01 E ZZ</td> <td>RG</td> <td>MD0000 001</td> <td>B</td> <td>3 di 144</td> </tr> </table>						COMMESSA	LOTTO	CODIFICA	DOCUMENTO	REV.	FOGLIO	IF1N	01 E ZZ	RG	MD0000 001	B	3 di 144
COMMESSA	LOTTO	CODIFICA	DOCUMENTO	REV.	FOGLIO													
IF1N	01 E ZZ	RG	MD0000 001	B	3 di 144													

8	VERIFICA DEI PALI DI FONDAZIONE	29
8.1.1	SHEMI ARMATURA E INCIDENZA DEL PALO	33
9	VERIFICHE ALLO SLU DI TIPO GEOTECNICO	36
9.1	VERIFICA DI CAPACITÀ PORTANTE DEL PALO SINGOLO	36
9.1.1	CAPACITÀ PORTANTE VERTICALE DEL PALO SINGOLO	36
9.1.2	VERIFICA DI CAPACITÀ PORTANTE VERTICALE DEL GRUPPO DI PALI.....	41
9.1.3	VERIFICA DI CAPACITÀ PORTANTE ORIZZONTALE DEL GRUPPO DI PALI	42
10	DIMENSIONAMENTO E VERIFICA DEL PLINTO DI FONDAZIONE [P7 ÷P16]	43
10.1	DESCRIZIONE DEL MODELLO	43
10.1.1	COMBINAZIONI E CARICHI	45
10.2	SOLLECITAZIONI.....	48
10.2.1	SOLLECITAZIONI SLV.....	48
10.2.2	SOLLECITAZIONI SLU	51
10.2.3	SOLLECITAZIONI SLE.....	53
10.3	VERIFICHE SLU/SLE	54
10.3.1	SOLLECITAZIONI DI VERIFICA	54
10.3.2	VERIFICHE A FLESSIONE E TAGLIO.....	58
10.4	VERIFICA PUNZONAMENTO	73
10.5	VERIFICA TIRANTE-PUNTO.....	74
10.6	STIMA INCIDENZE DI ARMATURA.....	76
11	ALLEGATO: TABULATI GROUP.....	77
11.1	PILA SLE.....	77
11.2	PILA SLU – SLV.....	91

APPALTATORE: <u>Consorzio</u> <u>Soci</u> HIRPINIA AV SALINI IMPREGILO S.P.A. ASTALDI S.P.A	ITINERARIO NAPOLI – BARI RADDOPPIO TRATTA APICE – ORSARA I LOTTO FUNZIONALE APICE – HIRPINIA					
PROGETTAZIONE: <u>Mandatario</u> <u>Mandanti</u> ROCKSOIL S.P.A NET ENGINEERING S.P.A. ALPINA S.P.A.						
PROGETTO ESECUTIVO RELAZIONE DI CALCOLO FONDAZIONI PILE DA P7 A P16	COMMESSA IF28	LOTTO 01	CODIFICA E ZZ CL	DOCUMENTO VI0403 007	REV. B	FOGLIO 4 di 144

1 INTRODUZIONE

Nell'ambito della redazione del Progetto Esecutivo della tratta Apice - Orsara del Lotto 1 Apice – Irpinia - potenziamento della linea ferroviaria Napoli – Bari, la presente relazione riporta i risultati del dimensionamento e verifiche delle fondazioni – plinto su pali – delle pile da P7 a P16 del Viadotto VI04 denominato Viadotto Ufita Apice.

Le pile sostengono le campate di luce 25m, costituite da n. 4 cassoncini/travi in c.a.p. affiancati e solidarizzati da una soletta in c.a. gettata in opera.

Considerate le caratteristiche geometriche, le condizioni geotecniche e l'entità dei carichi agenti, le analisi sono sviluppate in riferimento alla pila P12.

Per quanto riguarda i criteri di verifica adottati per le analisi del sistema di fondazione adottato si rimanda al documento IF2801EZZRBVI0003001: Viadotti ferroviari – Relazione sui criteri di calcolo delle fondazioni.

APPALTATORE: Consorzio Soci   	ITINERARIO NAPOLI – BARI RADDOPPIO TRATTA APICE – ORSARA I LOTTO FUNZIONALE APICE – HIRPINIA																	
PROGETTAZIONE: Mandataria Mandanti   	<table border="1" style="width: 100%; border-collapse: collapse;"> <tr> <td style="width: 16.6%;">COMMESSA</td> <td style="width: 16.6%;">LOTTO</td> <td style="width: 16.6%;">CODIFICA</td> <td style="width: 16.6%;">DOCUMENTO</td> <td style="width: 16.6%;">REV.</td> <td style="width: 16.6%;">FOGLIO</td> </tr> <tr> <td>IF1N</td> <td>01 E ZZ</td> <td>RG</td> <td>MD0000 001</td> <td>B</td> <td>5 di 144</td> </tr> </table>						COMMESSA	LOTTO	CODIFICA	DOCUMENTO	REV.	FOGLIO	IF1N	01 E ZZ	RG	MD0000 001	B	5 di 144
COMMESSA	LOTTO	CODIFICA	DOCUMENTO	REV.	FOGLIO													
IF1N	01 E ZZ	RG	MD0000 001	B	5 di 144													
PROGETTO ESECUTIVO RELAZIONE DI CALCOLO FONDAZIONI PILE DA P7 A P16																		

2 Documenti di riferimento e normativa

2.1 DOCUMENTI DI RIFERIMENTO

- 1) IF2801EZZRGVI0000001 - Relazione Tecnico-Descrittiva delle Opere Civili - Viadotti VI01, VI02, VI03 e VI04;
- 2) IF2801EZZRBVI0003001 - Relazione sui criteri di calcolo delle fondazioni;
- 3) IF2801EZZRBOC0101001 - Relazione Geotecnica Generale;
- 4) IF2801EZZF6OC0101001 - Profilo geologico - Tratta all'aperto Isca Girasole, da pk 0+000 a 2+705;
- 5) IF2801EZZF6OC0101002 - Profilo geologico - Tratta all'aperto valle Ufita, da pk 4+695 a pk 5+090;
- 6) IF2801EZZF6OC0101003 - Profilo geologico - Tratta all'aperto Castel del Fiego, da pk 9+550 a pk 10+090;
- 7) IF2801EZZF6OC0101004 - Profilo geologico - Tratta all'aperto Iscalonga, da pk 16+610 a pk 18+700;
- 8) IF2801EZZRBOC0301001 - Relazione Sismica generale;
- 9) IF2801EZZP9VI0400000 - Pianta fondazioni e sezioni (tav. 1 di 6)
- 10) IF2801EZZP9VI0400001 - Pianta fondazioni e sezioni (tav. 2 di 6)
- 11) IF2801EZZP9VI0400002 - Pianta fondazioni e sezioni (tav. 3 di 6)
- 12) IF2801EZZP9VI0400003 - Pianta fondazioni e sezioni (tav. 4 di 6)
- 13) IF2801EZZP9VI0400004 - Pianta fondazioni e sezioni (tav. 5 di 6)
- 14) IF2801EZZP9VI0400005 - Pianta fondazioni e sezioni (tav. 6 di 6)
- 15) IF2801EZZP9VI0400006 - Pianta impalcato e prospetto (tav. 1 di 6)
- 16) IF2801EZZP9VI0400007 - Pianta impalcato e prospetto (tav. 2 di 6)
- 17) IF2801EZZP9VI0400008 - Pianta impalcato e prospetto (tav. 3 di 6)
- 18) IF2801EZZP9VI0400009 - Pianta impalcato e prospetto (tav. 4 di 6)
- 19) IF2801EZZP9VI0400010 - Pianta impalcato e prospetto (tav. 5 di 6)
- 20) IF2801EZZP9VI0400011 - Pianta impalcato e prospetto (tav. 6 di 6)
- 21) IF2801EZZCLVI0404001 - Spalla A: Relazione di calcolo strutture in elevazione
- 22) IF2801EZZCLVI0405001 - Pile P1, P2, P21, P22, P23 e P24: Relazione di calcolo strutture in elevazione
- 23) IF2801EZZCLVI0405002 - Pila P3: Relazione di calcolo strutture in elevazione
- 24) IF2801EZZCLVI0405003 - Pila P4 : Relazione di calcolo strutture in elevazione
- 25) IF2801EZZCLVI0405004 - Pila P5: Relazione di calcolo strutture in elevazione
- 26) IF2801EZZCLVI0405005 - Pila P6: Relazione di calcolo strutture in elevazione
- 27) IF2801EZZCLVI0405006 - Pila da P7 a P16: Relazione di calcolo strutture in elevazione
- 28) IF2801EZZCLVI0405007 - Pile da P17 a P20: Relazione di calcolo strutture in elevazione
- 29) IF2801EZZCLVI0404002 - Spalla B: Relazione di calcolo strutture in elevazione

APPALTATORE: Consorzio Soci   	ITINERARIO NAPOLI – BARI RADDOPPIO TRATTA APICE – ORSARA I LOTTO FUNZIONALE APICE – HIRPINIA																	
PROGETTAZIONE: Mandataria Mandanti   	<table border="1" style="width: 100%; border-collapse: collapse;"> <tr> <td style="width: 16.6%;">COMMESSA</td> <td style="width: 16.6%;">LOTTO</td> <td style="width: 16.6%;">CODIFICA</td> <td style="width: 16.6%;">DOCUMENTO</td> <td style="width: 16.6%;">REV.</td> <td style="width: 16.6%;">FOGLIO</td> </tr> <tr> <td>IF1N</td> <td>01 E ZZ</td> <td>RG</td> <td>MD0000 001</td> <td>B</td> <td>6 di 144</td> </tr> </table>						COMMESSA	LOTTO	CODIFICA	DOCUMENTO	REV.	FOGLIO	IF1N	01 E ZZ	RG	MD0000 001	B	6 di 144
COMMESSA	LOTTO	CODIFICA	DOCUMENTO	REV.	FOGLIO													
IF1N	01 E ZZ	RG	MD0000 001	B	6 di 144													

- 30) IF2801EZZCLVI0403001 - Relazione di calcolo fondazioni spalla A e spalla B
- 31) IF2801EZZCLVI0403002 - Relazione di calcolo fondazioni pile Pile P1, P2, P21, P22,P23 e P24
- 32) IF2801EZZCLVI0403003 - Relazione di calcolo fondazioni pile P3 e P6
- 33) IF2801EZZCLVI0403004 - Relazione di calcolo fondazioni pile P4 e P5
- 34) IF2801EZZCLVI0403007 - Relazione di calcolo fondazioni pile da P7 a P16
- 35) IF2801EZZCLVI0403008 - Relazione di calcolo fondazioni pile da P17 a P20.

2.2 **NORMATIVA E STRANDARD DI RIFERIMENTO**

- 36) Decreto Ministeriale del 14/01/2008: “Approvazione delle Nuove Norma Tecniche per le Costruzioni”, G.U. n.29 del 04/02/2008, Supplemento Ordinario n.30;
- 37) Circolare 01/02/2009, n.617 - Istruzione per l'applicazione delle “Nuove Norme Tecniche per le Costruzioni” di cui al D.M. 14/01/2008;
- 38) DM 06/05/2008 - “Integrazione al DM 14/01/2008 di approvazione delle Nuove Norme Tecniche per le Costruzioni”;
- 39) RFI DTC SI MA IFS 001 A - “Manuale di progettazione delle opere civili”;
- 40) RFI DTC SI SP IFS 001 A - “Capitolato generale tecnico d'appalto delle opere civili”;
- 41) UNI EN 1997-1: Eurocodice 7 - Progettazione Geotecnica - Parte 1: Regole generali;
- 42) UNI EN 1998-5: Eurocodice 8 - Progettazione delle strutture per la resistenza sismica - Parte 5: Fondazioni, strutture di contenimento ed aspetti geotecnici;
- 43) Caltrans. Guidelines on Foundation Loading and Deformation Due to Liquefaction Induced Lateral Spreading. California Department of Transportation, Sacramento, California, 2012;
- 44) JRA (2002) – Specifications for Highway Bridges, JapanRoad Association. Part V: Seismic Design.

2.3 **SOFTWARE**

- 45) Lpile, Ensoft Inc, versione 2016, release n. 9;
- 46) Group, Ensoft Inc, versione 2016, release n.10;
- 47) GeoStru, RC-SEC, Calcolo di sezioni in Cemento Armato;
- 48) Pozzi J – Pozzi di fondazione o di stabilizzazione – VOL. 4, T. Collotta 2010.

APPALTATORE: Consorzio Soci   	ITINERARIO NAPOLI – BARI RADDOPPIO TRATTA APICE – ORSARA I LOTTO FUNZIONALE APICE – HIRPINIA																	
PROGETTAZIONE: Mandataria Mandanti   	<table border="1" style="width: 100%; border-collapse: collapse;"> <tr> <td style="width: 16.6%;">COMMESSA</td> <td style="width: 16.6%;">LOTTO</td> <td style="width: 16.6%;">CODIFICA</td> <td style="width: 16.6%;">DOCUMENTO</td> <td style="width: 16.6%;">REV.</td> <td style="width: 16.6%;">FOGLIO</td> </tr> <tr> <td>IF1N</td> <td>01 E ZZ</td> <td>RG</td> <td>MD0000 001</td> <td>B</td> <td>7 di 144</td> </tr> </table>						COMMESSA	LOTTO	CODIFICA	DOCUMENTO	REV.	FOGLIO	IF1N	01 E ZZ	RG	MD0000 001	B	7 di 144
COMMESSA	LOTTO	CODIFICA	DOCUMENTO	REV.	FOGLIO													
IF1N	01 E ZZ	RG	MD0000 001	B	7 di 144													
PROGETTO ESECUTIVO RELAZIONE DI CALCOLO FONDAZIONI PILE DA P7 A P16																		

3 Materiali

Il progetto strutturale delle fondazioni prevede l'uso dei materiali con le caratteristiche meccaniche minime riportate nei paragrafi seguenti.

3.1 ACCIAIO

3.1.1 Acciaio per armatura strutture in c.a.

Barre ad aderenza migliorata, saldabile, tipo B450C dotato delle seguenti caratteristiche meccaniche:

- tensione caratteristica di rottura: $f_{tk} \geq 540$ MPa
- tensione caratteristica di snervamento: $f_{yk} \geq 450$ MPa
- allungamento caratteristico: ≥ 7.5 %
- rapporto tensione di rottura/ tensione di snervamento: $1.15 \leq f_{tk}/f_{yk} < 1.35$

3.1.2 Profilati e piastre metalliche

- - Acciaio tipo: EN 10025-S275 JR
- - Tensione di rottura a trazione: $f_{tk} \geq 430$ MPa
- - Tensione di snervamento: $f_{yk} \geq 275$ MPa

3.2 CALCESTRUZZO

3.2.1 Calcestruzzo magro per getti di livellamento

- Classe di resistenza: C12/15
- classe di esposizione: X0

3.2.2 Calcestruzzo pali, diaframmi di fondazione, cordoli e opere provvisionali

- Classe di resistenza: C25/30
- classe di consistenza: S4
- classe di esposizione: XC2
- dimensione massima dell'inerte: $D_{max} = 32$ mm
- copriferro minimo: $C_{f,min} \geq 60$ mm

3.2.3 Calcestruzzo per fondazioni pile e spalle

- Classe di resistenza: C28/35
- classe di consistenza: S4
- classe di esposizione: XC2

APPALTATORE: Consorzio Soci   	ITINERARIO NAPOLI – BARI RADDOPPIO TRATTA APICE – ORSARA I LOTTO FUNZIONALE APICE – HIRPINIA																	
PROGETTAZIONE: Mandataria Mandanti   	<table border="1" style="width: 100%; border-collapse: collapse;"> <tr> <td style="width: 16.6%;">COMMESSA</td> <td style="width: 16.6%;">LOTTO</td> <td style="width: 16.6%;">CODIFICA</td> <td style="width: 16.6%;">DOCUMENTO</td> <td style="width: 16.6%;">REV.</td> <td style="width: 16.6%;">FOGLIO</td> </tr> <tr> <td style="text-align: center;">IF1N</td> <td style="text-align: center;">01 E ZZ</td> <td style="text-align: center;">RG</td> <td style="text-align: center;">MD0000 001</td> <td style="text-align: center;">B</td> <td style="text-align: center;">8 di 144</td> </tr> </table>						COMMESSA	LOTTO	CODIFICA	DOCUMENTO	REV.	FOGLIO	IF1N	01 E ZZ	RG	MD0000 001	B	8 di 144
COMMESSA	LOTTO	CODIFICA	DOCUMENTO	REV.	FOGLIO													
IF1N	01 E ZZ	RG	MD0000 001	B	8 di 144													
PROGETTO ESECUTIVO RELAZIONE DI CALCOLO FONDAZIONI PILE DA P7 A P16																		

- dimensione massima dell'inerte:
 $D_{max} = 25 \text{ mm}$
- copriferro minimo:
 $C_{f,min} \geq 40 \text{ mm}$

APPALTATORE: Consorzio Soci   	ITINERARIO NAPOLI – BARI RADDOPPIO TRATTA APICE – ORSARA I LOTTO FUNZIONALE APICE – HIRPINIA					
PROGETTAZIONE: Mandataria Mandanti   						
PROGETTO ESECUTIVO RELAZIONE DI CALCOLO FONDAZIONI PILE DA P7 A P16	COMMESSA IF1N	LOTTO 01 E ZZ	CODIFICA RG	DOCUMENTO MD0000 001	REV. B	FOGLIO 9 di 144

4 DESCRIZIONE DELLE FONDAZIONI E STRATIGRAFIA DI PROGETTO

4.1 DESCRIZIONE DEL SISTEMA FONDAZIONALE

La fondazione della pila P12 è costituita da: un plinto a sezione rettangolare di dimensioni 12.0 m x 16.5 m² e altezza di 2.5 m posto su n.12 pali trivellati di diametro $\varnothing = 1500$ mm e lunghezza L = 33.0 m.

4.2 STRATIGRAFIA DI RIFERIMENTO

In accordo con quanto riportato nella Relazione Geotecnica Generale - ref. 3), la stratigrafia e i parametri geotecnici di riferimento sono riportati nella seguente Tabella 1 unitamente alla portanza limite laterale e di base dei diaframmi.

La quota piano campagna di riferimento è ca. 153.0 m s.l.m.. Si considera la profondità della testa del palo da p.c. di ca. 5.5 m.

STRATIGRAFIA da quota testa palo				PARAMETRI GEOTECNICI DI RIFERIMENTO			PORTANZA LIMITE DEGLI ELEMENTI FONDAZIONE	
DA	A	ΔH	UNITA' DI RIFERIMENTO	γ	φ	Cu	qs	qb
[m]	[m]	[m]		[kN/m ³]	[°]	[kPa]	[kPa]	[kPa]
0,0	4,80	4,80	ALL-G	19	38	-	68	-
4,8	16,80	12,00	BNA3	20.5	33	-	85	-
16,8	20,80	4,00	BNA3	20.5		205	107.38	3037.3
20,8	25,8	5,00	BNA3	20.5		240	116.19	3286.3
25,8	30,8	5,00	BNA3	20.5		280	125.5	3400
30,8	50,0	...	BNA3	20.5		300	129.9	3400

Tabella 1 Stratigrafia e parametri geotecnici di riferimento

La falda è assunta alla profondità di 1m da quota testa palo.

APPALTATORE: Consorzio Soci   	ITINERARIO NAPOLI – BARI RADDOPPIO TRATTA APICE – ORSARA I LOTTO FUNZIONALE APICE – HIRPINIA																	
PROGETTAZIONE: Mandataria Mandanti   	<table border="1" style="width: 100%; border-collapse: collapse;"> <tr> <td style="width: 16.6%;">COMMESSA</td> <td style="width: 16.6%;">LOTTO</td> <td style="width: 16.6%;">CODIFICA</td> <td style="width: 16.6%;">DOCUMENTO</td> <td style="width: 16.6%;">REV.</td> <td style="width: 16.6%;">FOGLIO</td> </tr> <tr> <td style="text-align: center;">IF1N</td> <td style="text-align: center;">01 E ZZ</td> <td style="text-align: center;">RG</td> <td style="text-align: center;">MD0000 001</td> <td style="text-align: center;">B</td> <td style="text-align: center;">10 di 144</td> </tr> </table>						COMMESSA	LOTTO	CODIFICA	DOCUMENTO	REV.	FOGLIO	IF1N	01 E ZZ	RG	MD0000 001	B	10 di 144
COMMESSA	LOTTO	CODIFICA	DOCUMENTO	REV.	FOGLIO													
IF1N	01 E ZZ	RG	MD0000 001	B	10 di 144													
PROGETTO ESECUTIVO RELAZIONE DI CALCOLO FONDAZIONI PILE DA P7 A P16																		

5 CRITERI DI VERIFICA

Per ogni stato limite ultimo deve essere rispettata la condizione:

$$Ed \leq Rd;$$

dove Ed è il valore di progetto dell'azione o dell'effetto dell'azione e Rd è il valore di progetto della resistenza.

Le verifiche sono sviluppate secondo l'approccio 2:

combinazione: A1+M1+R3,

in cui è previsto un'unica combinazione di gruppi di coefficienti, da adottare sia nelle verifiche strutturali (STR) sia nelle verifiche geotecniche (GEO).

Per maggiori dettagli sui criteri di calcolo e verifica si rimanda alla relazione ref. 2).

Per le verifiche a fessurazione si ricorda che sono svolte per condizioni ambientali ordinarie e armature poco sensibili (vedasi § 9.3.1 di ref. 2)).

APPALTATORE: Consorzio Soci 	ITINERARIO NAPOLI – BARI RADDOPPIO TRATTA APICE – ORSARA I LOTTO FUNZIONALE APICE – HIRPINIA					
PROGETTAZIONE: Mandataria Mandanti 						
PROGETTO ESECUTIVO RELAZIONE DI CALCOLO FONDAZIONI PILE DA P7 A P16	COMMESSA IF1N	LOTTO 01 E ZZ	CODIFICA RG	DOCUMENTO MD0000 001	REV. B	FOGLIO 11 di 144

6 SCARICHI DI FONDAZIONE

Di seguito si esaminano gli scarichi a quota spiccato pila, derivanti dall'analisi strutturale complessiva del viadotto, e si valutano le azioni ad intradosso plinto considerando i trasporti delle azioni di taglio, e i contributi addizionali, in termini di azioni permanenti, dovuti ai pesi propri del plinto di fondazione e del terreno di ricoprimento definitivo.

6.1 SCARICHI ALLA BASE DELLA PILA

Di seguito si riportano gli scarichi alla base della pila per le combinazioni di carico sismiche (SLV), statiche (SLU) e di esercizio (SLE).

Nella **Figura 6-1** la convenzione dei segni assunta per le pile.



Figura 6-1: Sistema di riferimento proprio delle pile

6.1.1 Combinazioni delle azioni agli stati limite ultimi sismici

Nella seguente **Tabella 2** si riportano le combinazioni di carico più gravose agli stati limite ultimi (SLV) in presenza di sisma.

Tali carichi sono stati ottenuti considerando la struttura in elevazione in classe di duttilità B (fattore di struttura $q=1.5$). Per il dimensionamento e le verifiche del sistema fondazione le azioni da considerare sono le resistenze degli elementi strutturali soprastanti, con il limite, in accordo alle NTC 2008 (ref. 36)), che il fattore di amplificazione non superi $\gamma_{Rd} = 1.1$.

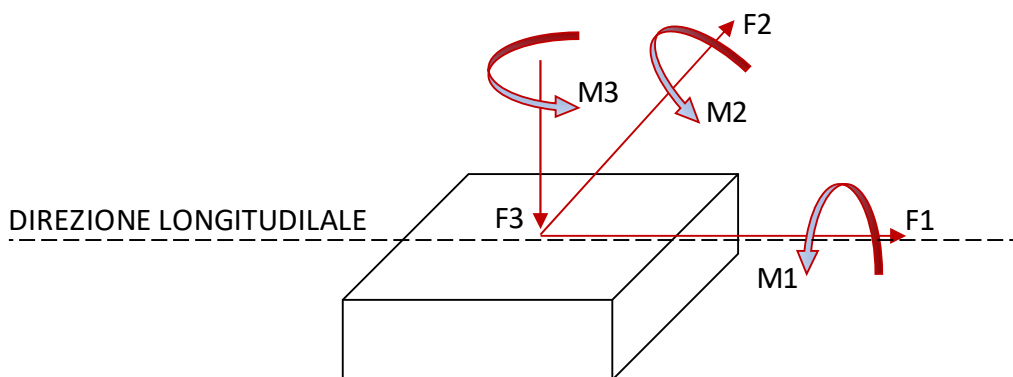
APPALTATORE: Consorzio  Soci  	ITINERARIO NAPOLI – BARI RADDOPPIO TRATTA APICE – ORSARA I LOTTO FUNZIONALE APICE – HIRPINIA
PROGETTAZIONE: Mandataria  Mandanti  	
PROGETTO ESECUTIVO RELAZIONE DI CALCOLO FONDAZIONI PILE DA P7 A P16	COMMESSA IF1N LOTTO 01 E ZZ CODIFICA RG DOCUMENTO MD0000 001 REV. B FOGLIO 12 di 144

Sollecitazioni estradosso fondazione SLV							
sollecitazione	combinazione	F1	F2	F3	M1	M2	M3
		KN	KN	KN	KN-m	KN-m	kN-m
MAX F1	slu-SISMA6	12425	3381	12412	-44765	156032	172
MIN F1	slu-SISMA1	-11889	-3332	20741	47108	-150783	-123
MAX F2	slu-SISMA32	3830	11239	12897	-154473	48617	410
MIN F2	slu-SISMA28	-3505	-11107	20741	157024	-44410	-409
MAX F3	slu-SISMA48	-3566	-3332	32355	47288	-45332	-123
MIN F3	slu-SISMA41	3629	3332	-260	-47055	45866	123
MAX M1	slu-SISMA26	-4704	-14658	21287	210752	-59339	409
MIN M1	slu-SISMA21	4919	14734	10215	-208259	62164	-409
MAX M2	slu-SISMA6	12425	3381	12412	-44765	156032	172
MIN M2	slu-SISMA1	-11889	-3332	20741	47108	-150783	-123

Tabella 2: Combinazioni sismiche SLV: azioni agenti a base pila

6.1.2 Combinazioni delle azioni agli stati limite ultimi statici (SLU)

Nella seguente Tabella 3 si riportano le combinazioni agli stati limite ultimi statici (SLU); i carichi sono amplificati con i coefficienti parziali A1.

Sollecitazioni estradosso fondazione SLU-STR							
sollecitazione	combinazione	F1	F2	F3	M1	M2	M3
		KN	KN	KN	KN-m	KN-m	kN-m
MAX F1	slu60	3534	1146	27354	-21371	52175	361
MAX F2	slu26	1340	1683	30875	-31162	17517	5
MAX F3	slu52	1750	1683	30875	-31162	22974	5
MIN F3	slu25	255	1362	14704	-24677	3388	0
MAX M1	slu63	1152	1368	26606	-32882	15088	0
MAX M2	slu60	3534	1146	27354	-21371	52175	361

Tabella 3: Combinazioni statiche SLU-A1: azioni agenti a base pila

6.1.3 Combinazioni delle azioni agli stati limite di esercizio (SLE)

Nella seguente Tabella 4 si riportano le combinazioni di carico caratteristiche impiegate per gli stati limite di esercizio (SLE).

Sollecitazioni estradosso fondazione SLE-RARA							
sollecitazione	combinazione	F1	F2	F3	M1	M2	M3
		KN	KN	KN	KN-m	KN-m	kN-m
MAX F3	SLE-RARA44	-1201	-1142	21926	21151	-15762	-3

APPALTATORE: Consorzio  Soci  	ITINERARIO NAPOLI – BARI RADDOPPIO TRATTA APICE – ORSARA I LOTTO FUNZIONALE APICE – HIRPINIA
PROGETTAZIONE: Mandataria  Mandanti  	
PROGETTO ESECUTIVO RELAZIONE DI CALCOLO FONDAZIONI PILE DA P7 A P16	COMMESSA IF1N LOTTO 01 E ZZ CODIFICA RG DOCUMENTO MD0000 001 REV. B FOGLIO 13 di 144

MIN F3	SLE-RARA25	-170	-908	14704	16451	-2258	0
MAX M1	SLE-RARA55	-791	-925	18982	22337	-10360	0
MAX M2	SLE-RARA85	-2437	-770	19498	14371	-35983	-248

Tabella 4: Combinazioni di esercizio SLE: azioni agenti a base pila

6.2 SCARICHI A INTRADOSSO PLINTO

6.2.1 Combinazioni delle azioni agli stati limite ultimi sismici (SLV)

Nella Tabella 6 si riportano le combinazioni di carico agli stati limite ultimi (SLV) in presenza dell'azione sismica, ottenute:

- amplificando le azioni di taglio e i momenti a base pila del coefficiente $\gamma_{Rd} = 1.1$;
- considerando il trasporto dei momenti da spiccato pila a intradosso plinto;
- aggiungendo il peso proprio del plinto e del terreno di ricoprimento (Tabella 5).

plinto	B trasv	16.5	m
	L long	12	m
	H	2.5	m
ricoprimento	h	1	m
	peso plinto	12375.0	kN
	peso rinterro	3960.0	kN

Tabella 5: Plinto: caratteristiche geometriche

Sollecitazioni intradosso fondazione SLV							
sollecitazione	combinazione	F1	F2	F3	M1	M2	M3
		KN	KN	KN	KN-m	KN-m	kN-m
MAX F1	slu-SISMA6	12425	3381	28747	-53219	187093	172
MIN F1	slu-SISMA1	-11889	-3332	37076	55437	-180505	-123
MAX F2	slu-SISMA32	3830	11239	29232	-182570	58192	410
MIN F2	slu-SISMA28	-3505	-11107	37076	184791	-53172	-409
MAX F3	slu-SISMA48	-3566	-3332	48690	55618	-54248	-123
MIN F3	slu-SISMA41	3629	3332	16075	-55384	54938	123
MAX M1	slu-SISMA26	-4704	-14658	37622	247398	-71098	409
MIN M1	slu-SISMA21	4919	14734	26550	-245095	74460	-409
MAX M2	slu-SISMA6	12425	3381	28747	-53219	187093	172
MIN M2	slu-SISMA1	-11889	-3332	37076	55437	-180505	-123

Tabella 6: Combinazioni sismiche SLV: azioni agenti ad intradosso plinto

APPALTATORE: Consorzio Soci   	ITINERARIO NAPOLI – BARI RADDOPPIO TRATTA APICE – ORSARA I LOTTO FUNZIONALE APICE – HIRPINIA
PROGETTAZIONE: Mandataria Mandanti   	
PROGETTO ESECUTIVO RELAZIONE DI CALCOLO FONDAZIONI PILE DA P7 A P16	COMMESSA LOTTO CODIFICA DOCUMENTO REV. FOGLIO IF1N 01 E ZZ RG MD0000 001 B 14 di 144

6.2.2 Combinazioni delle azioni agli stati limite ultimi statici (SLU)

Nella **Tabella 7** si riportano gli scarichi per gli stati limite ultimi statici (SLU), ottenuti:

- considerando il trasporto dei momenti da spiccato pila a intradosso plinto;
- aggiungendo il peso proprio del plinto e del terreno di ricoprimento (**Tabella 5**), fattorizzati per il fattore 1.3.

Sollecitazioni intradosso fondazione SLU-STR							
sollecitazione	combinazione	F1	F2	F3	M1	M2	M3
		KN	KN	KN	KN-m	KN-m	kN-m
MAX F1	slu60	3534	1146	48590	-24236	61010	361
MAX F2	slu26	1340	1683	52111	-35370	20867	5
MAX F3	slu52	1750	1683	52111	-35370	27349	5
MIN F3	slu25	255	1362	35940	-28082	4026	0
MAX M1	slu63	1152	1368	47842	-36302	17968	0
MAX M2	slu60	3534	1146	48590	-24236	61010	361

Tabella 7: Combinazioni di statiche SLU-A1: azioni agenti ad intradosso plinto

6.2.3 Combinazioni delle azioni agli stati limite di esercizio (SLE)

Nella **Tabella 8** si riportano le combinazioni di carico caratteristiche impiegate per gli stati limite di esercizio ottenute:

- considerando il trasporto dei momenti da spiccato pila a intradosso plinto;
- aggiungendo il peso proprio del plinto e del terreno di ricoprimento (**Tabella 5**).

Sollecitazioni estradosso fondazione SLE-RARA							
sollecitazione	combinazione	F1	F2	F3	M1	M2	M3
		KN	KN	KN	KN-m	KN-m	kN-m
MAX F3	SLE-RARA44	-1201	-1142	38261	24006	-18765	-3
MIN F3	SLE-RARA25	-170	-908	31039	18721	-2683	0
MAX M1	SLE-RARA55	-791	-925	35317	24650	-12338	0
MAX M2	SLE-RARA85	-2437	-770	35833	16296	-42076	-248

Tabella 8: Combinazioni di esercizio SLE: azioni agenti ad intradosso plinto

APPALTATORE: Consorzio Soci   	ITINERARIO NAPOLI – BARI RADDOPPIO TRATTA APICE – ORSARA I LOTTO FUNZIONALE APICE – HIRPINIA																	
PROGETTAZIONE: Mandataria Mandanti   	<table border="1" style="width: 100%; border-collapse: collapse;"> <tr> <td style="width: 16.6%;">COMMESSA</td> <td style="width: 16.6%;">LOTTO</td> <td style="width: 16.6%;">CODIFICA</td> <td style="width: 16.6%;">DOCUMENTO</td> <td style="width: 16.6%;">REV.</td> <td style="width: 16.6%;">FOGLIO</td> </tr> <tr> <td>IF1N</td> <td>01 E ZZ</td> <td>RG</td> <td>MD0000 001</td> <td>B</td> <td>15 di 144</td> </tr> </table>						COMMESSA	LOTTO	CODIFICA	DOCUMENTO	REV.	FOGLIO	IF1N	01 E ZZ	RG	MD0000 001	B	15 di 144
COMMESSA	LOTTO	CODIFICA	DOCUMENTO	REV.	FOGLIO													
IF1N	01 E ZZ	RG	MD0000 001	B	15 di 144													
PROGETTO ESECUTIVO RELAZIONE DI CALCOLO FONDAZIONI PILE DA P7 A P16																		

7 ANALISI DELL'INTERAZIONE FONDAZIONE-TERRENO

L'analisi di interazione terreno-fondazione è stata sviluppata con il software GROUP della Ensoft.

Il programma considera che il comportamento di un palo soggetto ad azioni orizzontali all'interno di un gruppo differisce da quello di un palo singolo ed isolato. In un gruppo di pali caricato da azioni orizzontali i fenomeni di interazione reciproca palo – terreno – palo determinano, complessivamente, una diminuzione della rigidità del sistema.

La diversità di comportamento si manifesta mediante un differente valore dello sforzo di taglio agente in testa a ciascun palo, differenti valori di momento flettente, diversa ubicazione del valore massimo di momento al variare della profondità (nell'ipotesi in cui il vincolo in testa al palo non sia un incastro). La modalità di risposta di ciascun palo è funzione essenzialmente dalla posizione geometrica che questo occupa all'interno del gruppo. Precisamente, la risposta del singolo palo all'interno del gruppo è condizionata:

- dalla fila di appartenenza all'interno del gruppo (effetto ombra o shadowing);
- dalla posizione all'interno della singola fila (effetto di bordo).

7.1 DESCRIZIONE DEL MODELLO DI CALCOLO GROUP

Il modello di calcolo è stato costruito nel seguente modo:

APPALTATORE: Consorzio Soci   	ITINERARIO NAPOLI – BARI RADDOPPIO TRATTA APICE – ORSARA I LOTTO FUNZIONALE APICE – HIRPINIA												
PROGETTAZIONE: Mandataria Mandanti   													
PROGETTO ESECUTIVO RELAZIONE DI CALCOLO FONDAZIONI PILE DA P7 A P16	<table border="1" style="width: 100%; border-collapse: collapse;"> <tr> <td style="text-align: center;">COMMESSA</td> <td style="text-align: center;">LOTTO</td> <td style="text-align: center;">CODIFICA</td> <td style="text-align: center;">DOCUMENTO</td> <td style="text-align: center;">REV.</td> <td style="text-align: center;">FOGLIO</td> </tr> <tr> <td style="text-align: center;">IF1N</td> <td style="text-align: center;">01 E ZZ</td> <td style="text-align: center;">RG</td> <td style="text-align: center;">MD0000 001</td> <td style="text-align: center;">B</td> <td style="text-align: center;">16 di 144</td> </tr> </table>	COMMESSA	LOTTO	CODIFICA	DOCUMENTO	REV.	FOGLIO	IF1N	01 E ZZ	RG	MD0000 001	B	16 di 144
COMMESSA	LOTTO	CODIFICA	DOCUMENTO	REV.	FOGLIO								
IF1N	01 E ZZ	RG	MD0000 001	B	16 di 144								



Figura 7-1: Vista frontale del modello GROUPv2016

APPALTATORE: Consorzio Soci   	ITINERARIO NAPOLI – BARI RADDOPPIO TRATTA APICE – ORSARA I LOTTO FUNZIONALE APICE – HIRPINIA																	
PROGETTAZIONE: Mandataria Mandanti   	<table border="1" style="width: 100%; border-collapse: collapse;"> <tr> <td style="width: 16.6%;">COMMESSA</td> <td style="width: 16.6%;">LOTTO</td> <td style="width: 16.6%;">CODIFICA</td> <td style="width: 16.6%;">DOCUMENTO</td> <td style="width: 16.6%;">REV.</td> <td style="width: 16.6%;">FOGLIO</td> </tr> <tr> <td>IF1N</td> <td>01 E ZZ</td> <td>RG</td> <td>MD0000 001</td> <td>B</td> <td>17 di 144</td> </tr> </table>						COMMESSA	LOTTO	CODIFICA	DOCUMENTO	REV.	FOGLIO	IF1N	01 E ZZ	RG	MD0000 001	B	17 di 144
COMMESSA	LOTTO	CODIFICA	DOCUMENTO	REV.	FOGLIO													
IF1N	01 E ZZ	RG	MD0000 001	B	17 di 144													
PROGETTO ESECUTIVO RELAZIONE DI CALCOLO FONDAZIONI PILE DA P7 A P16																		

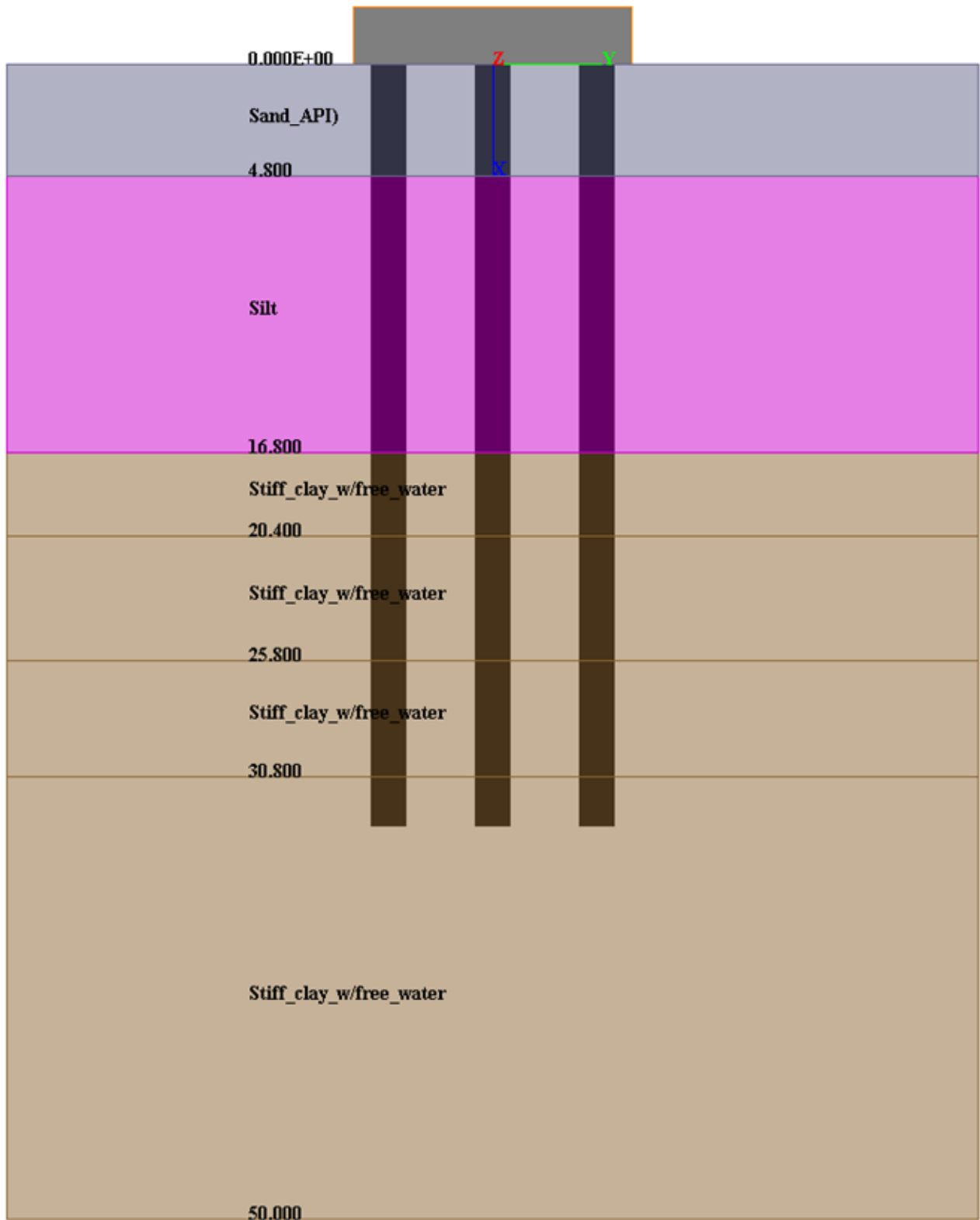

Figura 7-2: Vista in pianta del modello GROUPv2016

In accordo al § 4.2 nelle seguenti Figura 7-3 ÷ Figura 7-9 si riporta il modello stratigrafico di calcolo e i parametri geotecnici assegnati ai singoli strati. I parametri di rigidità del terreno sono stati assunti in accordo ai criteri illustrati nella relazione al ref. 2), § 8.1.1 per le “stiff clays with free water”.

APPALTATORE: Consorzio Soci 		ITINERARIO NAPOLI – BARI RADDOPPIO TRATTA APICE – ORSARA I LOTTO FUNZIONALE APICE – HIRPINIA					
PROGETTAZIONE: Mandataria Mandanti 							
PROGETTO ESECUTIVO RELAZIONE DI CALCOLO FONDAZIONI PILE DA P7 A P16		COMMESSA IF1N	LOTTO 01 E ZZ	CODIFICA RG	DOCUMENTO MD0000 001	REV. B	FOGLIO 18 di 144

Layer	Soil Type	Depth for Top of Soil Layer (m)	Depth for Bottom of Soil Layer (m)	Properties of Layer
1	API Sand (O'Neil)	0	4.8	1: API Sand
2	Silt (cemented c-phi)	4.8	16.8	2: Cemented c-phi Soil
3	Stiff Clay with Free Water (Reese)	16.8	20.4	3: Stiff Clay with Free Water
4	Stiff Clay with Free Water (Reese)	20.4	25.8	4: Stiff Clay with Free Water
5	Stiff Clay with Free Water (Reese)	25.8	30.8	5: Stiff Clay with Free Water
6	Stiff Clay with Free Water (Reese)	30.8	50	6: Stiff Clay with Free Water

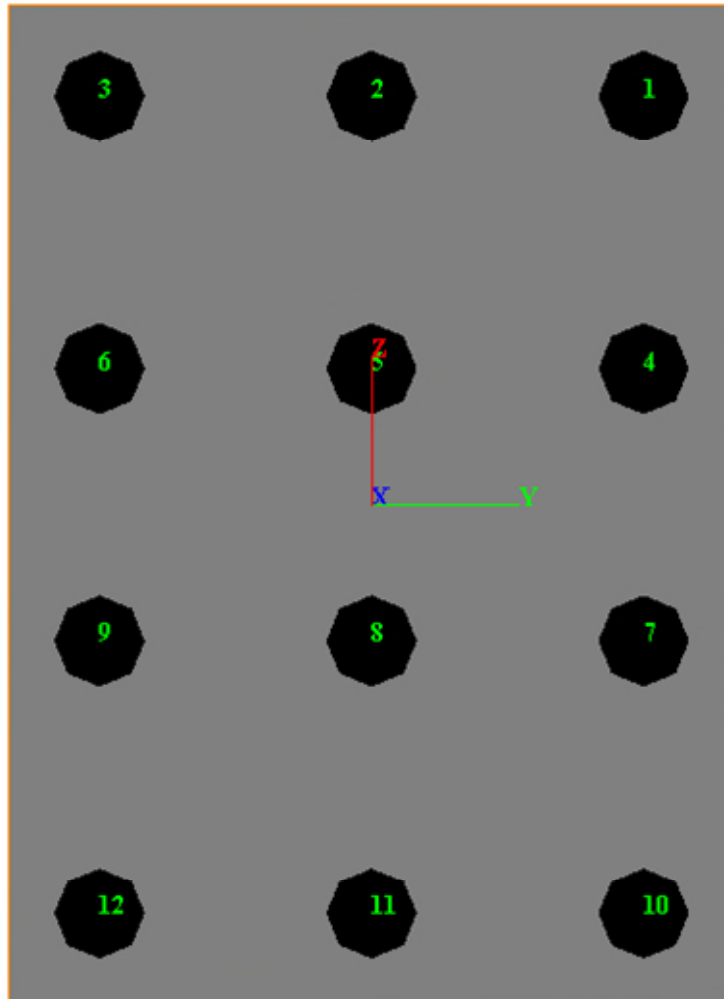
Figura 7-3: Modello stratigrafico GROUP V2016

1=Top, 2=Bottom	Effective Unit Weight (kN/m ³)	Friction Angle (DEG.)	p-y Modulus, k (kN/m ³)	Ultimate Unit Side Friction (kN/m ²)	Ultimate Unit Tip Resistance (kN/m ²)
1	9	38	34000	68	0
2	9	38	34000	68	0

A linear interpolation with depth will be used to compute values between the top and bottom of the layer.

p-y Modulus, k:
 - Always check recommended value in Geotechnical Investigation Reports.
 - Program will help to estimate value for p-y Modulus, k, if zero input value is entered.

Ultimate Unit Side Friction and Ultimate Unit Tip Resistance:
 - The program uses Ultimate Unit Side Friction to generate t-z curves.
 - The program uses Ultimate Unit Tip Resistance to generate q-w curves.
 - Always check recommended values in Geotechnical Investigation Reports.
 - Program will help to estimate values for Ultimate Unit Side Friction and Ultimate Unit Tip Resistance if zero input values are entered.

Figura 7-4: Layer no.1 (ALL-G)

1=Top, 2=Bottom	Effective Unit Weight (kN/m ³)	Undrained Cohesion, c (kN/m ²)	Friction Angle (DEG.)	p-y Modulus, k (kN/m ³)	Strain Factor E50	Ultimate Unit Side Friction (kN/m ²)	Ultimate Unit Tip Resistance (kN/m ²)
1	10.5	10	32	125000	0.007	85	2780
2	10.5	10	32	125000	0.007	85	2780

This p-y model requires non-zero values for both cohesion and friction angle.
 A linear interpolation with depth will be used to compute values between the top and bottom of the layer.

Ultimate Unit Side Friction and Ultimate Unit Tip Resistance:
 - The program uses Ultimate Unit Side Friction to generate t-z curves.
 - The program uses Ultimate Unit Tip Resistance to generate q-w curves.
 - Always check recommended values in Geotechnical Investigation Reports.
 - Program will help to estimate values for Ultimate Unit Side Friction and Ultimate Unit Tip Resistance if zero input values are entered.

(K=89000 per analisi SLE)

Figura 7-5: Layer no.2 (BNA3)

APPALTATORE: Consorzio Soci   	ITINERARIO NAPOLI – BARI RADDOPPIO TRATTA APICE – ORSARA I LOTTO FUNZIONALE APICE – HIRPINIA
PROGETTAZIONE: Mandataria Mandanti   	
PROGETTO ESECUTIVO RELAZIONE DI CALCOLO FONDAZIONI PILE DA P7 A P16	COMMESSA LOTTO CODIFICA DOCUMENTO REV. FOGLIO IF1N 01 E ZZ RG MD0000 001 B 19 di 144

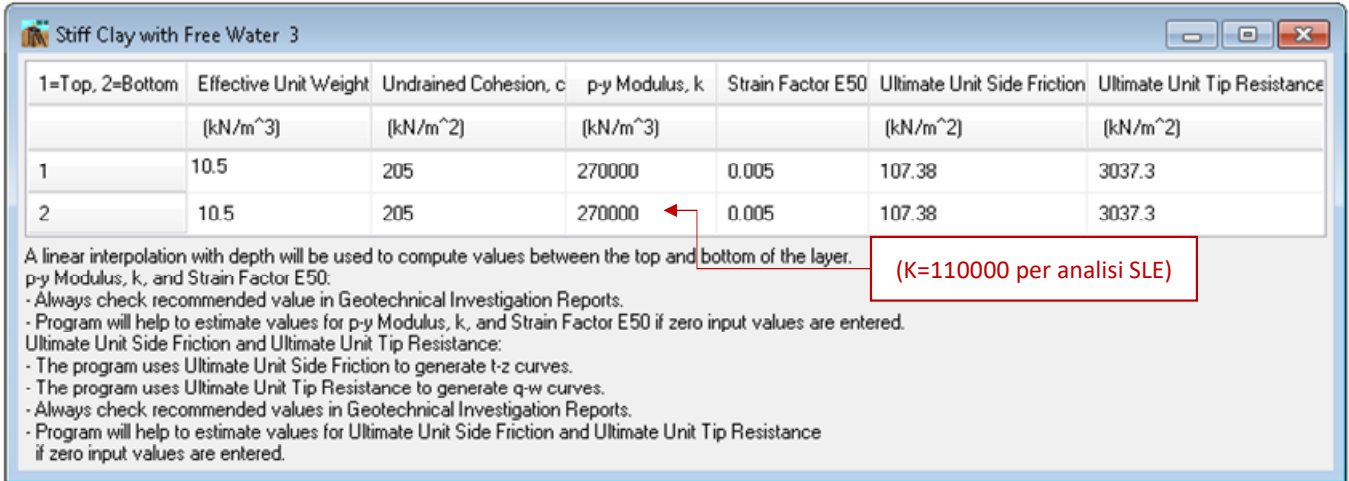

1=Top, 2=Bottom	Effective Unit Weight (kN/m ³)	Undrained Cohesion, c (kN/m ²)	p-y Modulus, k (kN/m ³)	Strain Factor E50	Ultimate Unit Side Friction (kN/m ²)	Ultimate Unit Tip Resistance (kN/m ²)
1	10.5	205	270000	0.005	107.38	3037.3
2	10.5	205	270000	0.005	107.38	3037.3

A linear interpolation with depth will be used to compute values between the top and bottom of the layer.
 p-y Modulus, k, and Strain Factor E50:
 - Always check recommended value in Geotechnical Investigation Reports.
 - Program will help to estimate values for p-y Modulus, k, and Strain Factor E50 if zero input values are entered.
 Ultimate Unit Side Friction and Ultimate Unit Tip Resistance:
 - The program uses Ultimate Unit Side Friction to generate t-z curves.
 - The program uses Ultimate Unit Tip Resistance to generate q-w curves.
 - Always check recommended values in Geotechnical Investigation Reports.
 - Program will help to estimate values for Ultimate Unit Side Friction and Ultimate Unit Tip Resistance if zero input values are entered.

Figura 7-6: Layer no.3 (BNA3)

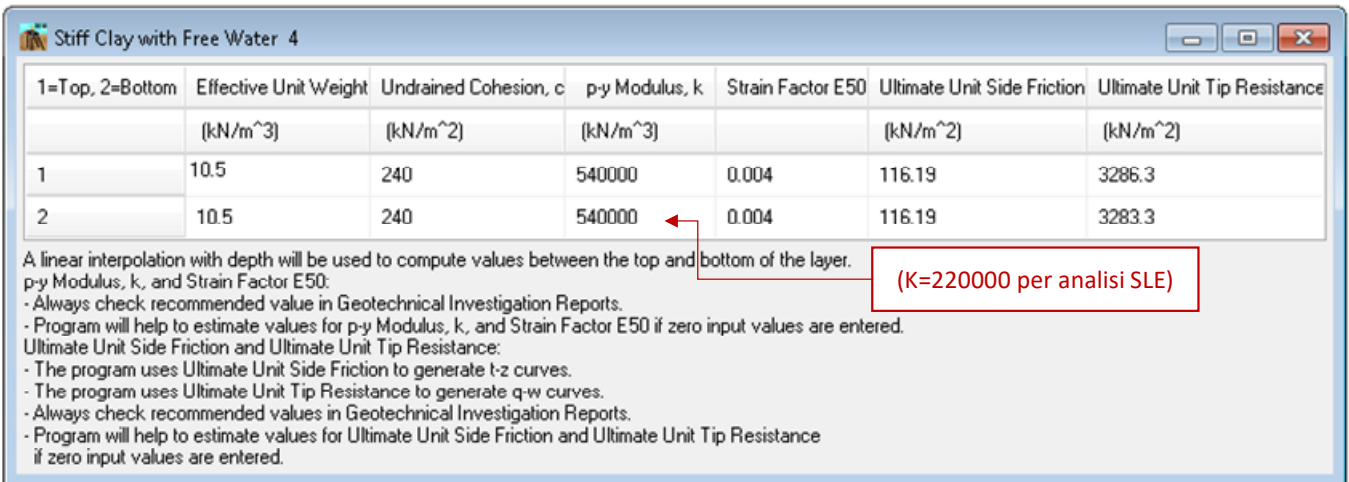

1=Top, 2=Bottom	Effective Unit Weight (kN/m ³)	Undrained Cohesion, c (kN/m ²)	p-y Modulus, k (kN/m ³)	Strain Factor E50	Ultimate Unit Side Friction (kN/m ²)	Ultimate Unit Tip Resistance (kN/m ²)
1	10.5	240	540000	0.004	116.19	3286.3
2	10.5	240	540000	0.004	116.19	3283.3

A linear interpolation with depth will be used to compute values between the top and bottom of the layer.
 p-y Modulus, k, and Strain Factor E50:
 - Always check recommended value in Geotechnical Investigation Reports.
 - Program will help to estimate values for p-y Modulus, k, and Strain Factor E50 if zero input values are entered.
 Ultimate Unit Side Friction and Ultimate Unit Tip Resistance:
 - The program uses Ultimate Unit Side Friction to generate t-z curves.
 - The program uses Ultimate Unit Tip Resistance to generate q-w curves.
 - Always check recommended values in Geotechnical Investigation Reports.
 - Program will help to estimate values for Ultimate Unit Side Friction and Ultimate Unit Tip Resistance if zero input values are entered.

Figura 7-7: Layer no.4 (BNA3)

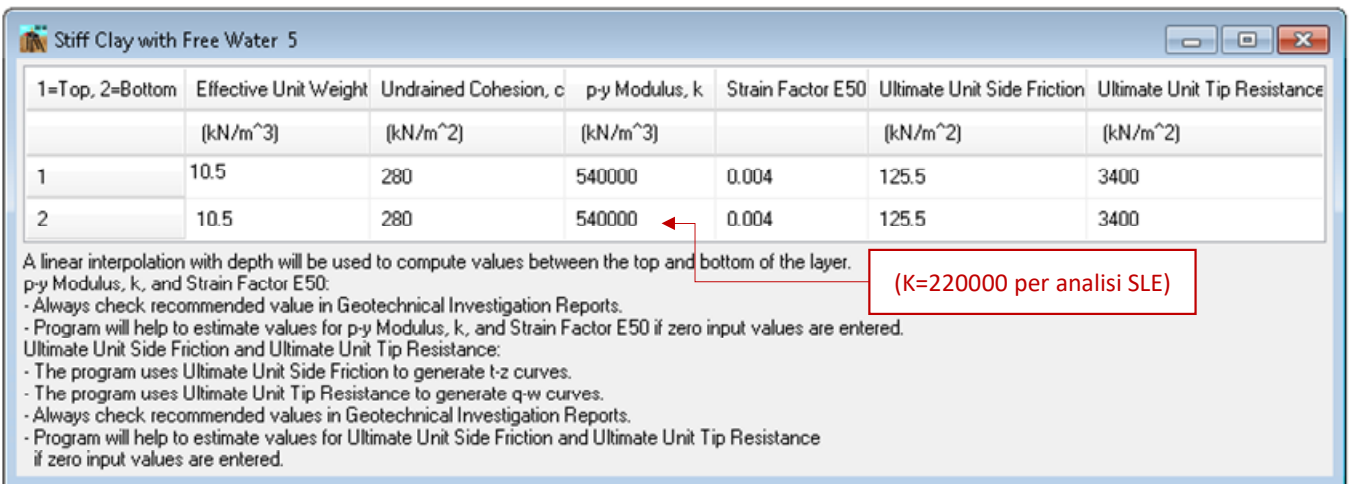

1=Top, 2=Bottom	Effective Unit Weight (kN/m ³)	Undrained Cohesion, c (kN/m ²)	p-y Modulus, k (kN/m ³)	Strain Factor E50	Ultimate Unit Side Friction (kN/m ²)	Ultimate Unit Tip Resistance (kN/m ²)
1	10.5	280	540000	0.004	125.5	3400
2	10.5	280	540000	0.004	125.5	3400

A linear interpolation with depth will be used to compute values between the top and bottom of the layer.
 p-y Modulus, k, and Strain Factor E50:
 - Always check recommended value in Geotechnical Investigation Reports.
 - Program will help to estimate values for p-y Modulus, k, and Strain Factor E50 if zero input values are entered.
 Ultimate Unit Side Friction and Ultimate Unit Tip Resistance:
 - The program uses Ultimate Unit Side Friction to generate t-z curves.
 - The program uses Ultimate Unit Tip Resistance to generate q-w curves.
 - Always check recommended values in Geotechnical Investigation Reports.
 - Program will help to estimate values for Ultimate Unit Side Friction and Ultimate Unit Tip Resistance if zero input values are entered.

Figura 7-8: Layer no.5 (BNA3)

APPALTATORE: Consorzio Soci   	ITINERARIO NAPOLI – BARI RADDOPPIO TRATTA APICE – ORSARA I LOTTO FUNZIONALE APICE – HIRPINIA
PROGETTAZIONE: Mandataria Mandanti   	
PROGETTO ESECUTIVO RELAZIONE DI CALCOLO FONDAZIONI PILE DA P7 A P16	COMMESSA IF1N LOTTO 01 E ZZ CODIFICA RG DOCUMENTO MD0000 001 REV. B FOGLIO 20 di 144

Stiff Clay with Free Water 6

1=Top, 2=Bottom	Effective Unit Weight (kN/m ³)	Undrained Cohesion, c (kN/m ²)	p-y Modulus, k (kN/m ³)	Strain Factor E50	Ultimate Unit Side Friction (kN/m ²)	Ultimate Unit Tip Resistance (kN/m ²)
1	10.5	300	540000	0.004	129.9	3400
2	10.5	300	540000	0.004	129.9	3400

A linear interpolation with depth will be used to compute values between the top and bottom of the layer.
 p-y Modulus, k, and Strain Factor E50:
 - Always check recommended value in Geotechnical Investigation Reports.
 - Program will help to estimate values for p-y Modulus, k, and Strain Factor E50 if zero input values are entered.
 Ultimate Unit Side Friction and Ultimate Unit Tip Resistance:
 - The program uses Ultimate Unit Side Friction to generate t-z curves.
 - The program uses Ultimate Unit Tip Resistance to generate q-w curves.
 - Always check recommended values in Geotechnical Investigation Reports.
 - Program will help to estimate values for Ultimate Unit Side Friction and Ultimate Unit Tip Resistance if zero input values are entered.

(K=220000 per analisi SLE)

Figura 7-9: Layer no.6 (BNA3)

APPALTATORE: Consorzio Soci   	ITINERARIO NAPOLI – BARI RADDOPPIO TRATTA APICE – ORSARA I LOTTO FUNZIONALE APICE – HIRPINIA																	
PROGETTAZIONE: Mandataria Mandanti   	<table border="1" style="width: 100%; border-collapse: collapse;"> <tr> <td style="width: 16.6%;">COMMESSA</td> <td style="width: 16.6%;">LOTTO</td> <td style="width: 16.6%;">CODIFICA</td> <td style="width: 16.6%;">DOCUMENTO</td> <td style="width: 16.6%;">REV.</td> <td style="width: 16.6%;">FOGLIO</td> </tr> <tr> <td>IF1N</td> <td>01 E ZZ</td> <td>RG</td> <td>MD0000 001</td> <td>B</td> <td>21 di 144</td> </tr> </table>						COMMESSA	LOTTO	CODIFICA	DOCUMENTO	REV.	FOGLIO	IF1N	01 E ZZ	RG	MD0000 001	B	21 di 144
COMMESSA	LOTTO	CODIFICA	DOCUMENTO	REV.	FOGLIO													
IF1N	01 E ZZ	RG	MD0000 001	B	21 di 144													
PROGETTO ESECUTIVO RELAZIONE DI CALCOLO FONDAZIONI PILE DA P7 A P16																		

7.2 SINTESI DEI RISULTATI AGLI STATI LIMITE DI ESERCIZIO (SLE)

Si riassumono nel seguito le sollecitazioni massime di sforzo assiale, taglio e momento, agenti in testa ai pali.

Si ricorda che per le analisi allo SLE (vedasi Ref. 2)) sono stati utilizzati per le curve p-y i coefficienti di rigidezza del terreno suggeriti dal programma per carichi ciclici; facendo riferimento alle Figura 7-4 e Figura 7-9 sono stati utilizzati i valori evidenziati di lato.

SLE	FOR. X, KN	FOR.H, KN	MOM, KN-M	MOM X, KN- M
	*****	*****	*****	*****
max	4686,9	265,9	548,4	1,2
min	1250,8	65,0	163,5	-0,2

Tabella 9: Sollecitazioni allo SLE massime e minime per i pali di fondazione

Nelle seguenti figure sono diagrammati l'andamento con la profondità del momento flettente e del taglio relativi alle combinazioni in cui tali sollecitazioni risultano massime.

APPALTATORE: Consorzio Soci   	ITINERARIO NAPOLI – BARI RADDOPPIO TRATTA APICE – ORSARA I LOTTO FUNZIONALE APICE – HIRPINIA												
PROGETTAZIONE: Mandataria Mandanti   													
PROGETTO ESECUTIVO RELAZIONE DI CALCOLO FONDAZIONI PILE DA P7 A P16	<table border="1" style="width: 100%; border-collapse: collapse;"> <tr> <td style="text-align: center;">COMMESSA</td> <td style="text-align: center;">LOTTO</td> <td style="text-align: center;">CODIFICA</td> <td style="text-align: center;">DOCUMENTO</td> <td style="text-align: center;">REV.</td> <td style="text-align: center;">FOGLIO</td> </tr> <tr> <td style="text-align: center;">IF1N</td> <td style="text-align: center;">01 E ZZ</td> <td style="text-align: center;">RG</td> <td style="text-align: center;">MD0000 001</td> <td style="text-align: center;">B</td> <td style="text-align: center;">22 di 144</td> </tr> </table>	COMMESSA	LOTTO	CODIFICA	DOCUMENTO	REV.	FOGLIO	IF1N	01 E ZZ	RG	MD0000 001	B	22 di 144
COMMESSA	LOTTO	CODIFICA	DOCUMENTO	REV.	FOGLIO								
IF1N	01 E ZZ	RG	MD0000 001	B	22 di 144								



Figura 7-10: Combinazioni SLE: Andamento con la profondità del momento (combo SLE4 max M2).

APPALTATORE: Consorzio Soci 			ITINERARIO NAPOLI – BARI RADDOPPIO TRATTA APICE – ORSARA I LOTTO FUNZIONALE APICE – HIRPINIA						
PROGETTAZIONE: Mandataria Mandanti 			COMMESSA IF1N		LOTTO 01 E ZZ	CODIFICA RG	DOCUMENTO MD0000 001	REV. B	FOGLIO 23 di 144
PROGETTO ESECUTIVO RELAZIONE DI CALCOLO FONDAZIONI PILE DA P7 A P16									

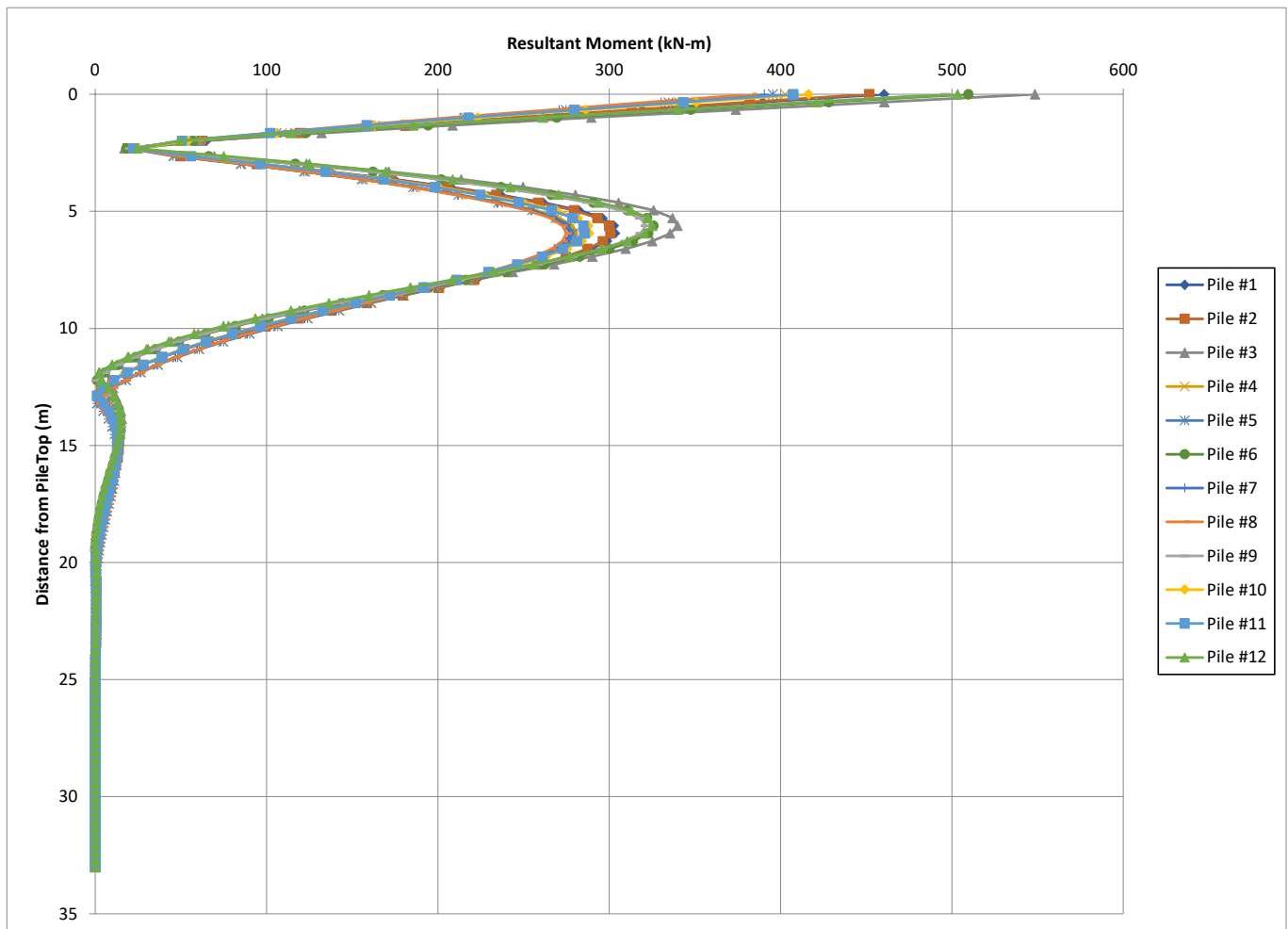

Figura 7-11: Combinazioni SLE: Andamento con la profondità del taglio (combo SLE4 max M2).

7.2.1 Spostamenti

Nella Tabella 7-10 si riportano gli spostamenti e le rotazioni ad intradosso plinto e sommità pila.

Gli spostamenti orizzontali (direzione y-2) e direzione z-3) tengono già conto dell'interazione fra pali e sono quindi rappresentativi degli spostamenti orizzontali del gruppo di pali; lo spostamento verticale non tiene conto dell'effetto gruppo.

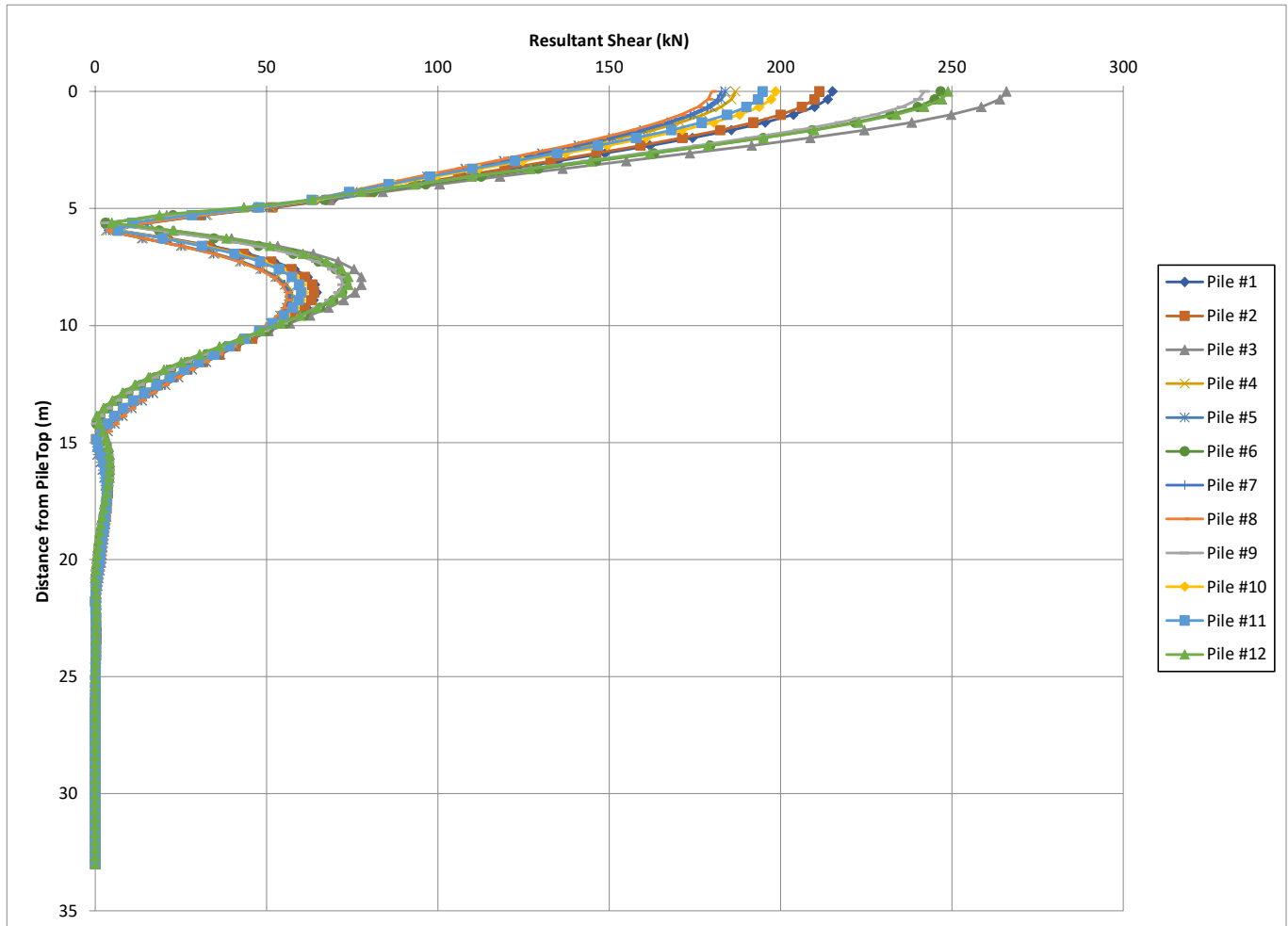
Il coefficiente amplificativo del cedimento verticale per effetto gruppo E_G viene valutato in accordo a Mandolini et al. (2005) ed è riportato in Tabella 7-11.

VERTICAL , M	HORIZONTAL Y, M	HORIZONTAL Z, M	ANGLE ROT. X,RAD	ANGLE ROT. Y,RAD	ANGLE ROT. Z,RAD	Ppostamento testa pila - sle			
						H pila (m)	asse Y (mm)	asse Z (mm)	asse X (mm)
0,00148778	-0,000567141	0,000484319	2,06714E-07	4,30408E-05	6,43564E-05	14,7	-1,513	1,117	3,713
0,00119365	-8,15508E-05	0,000387485	-4,82689E-07	3,36686E-05	9,19637E-06		-0,217	0,882	2,979
0,00136788	-0,000373919	0,00041748	-2,76307E-07	4,30209E-05	4,23308E-05		-0,996	1,050	3,414
0,00139184	-0,00118216	0,000326319	3,39811E-06	2,86265E-05	0,000141127		-3,257	0,747	3,474

Tabella 7-10: Combinazioni SLE: spostamenti e rotazioni ad intradosso plinto.

APPALTATORE: Consorzio Soci   	ITINERARIO NAPOLI – BARI RADDOPPIO TRATTA APICE – ORSARA I LOTTO FUNZIONALE APICE – HIRPINIA
PROGETTAZIONE: Mandataria Mandanti   	
PROGETTO ESECUTIVO RELAZIONE DI CALCOLO FONDAZIONI PILE DA P7 A P16	COMMESSA IF1N LOTTO 01 E ZZ CODIFICA RG DOCUMENTO MD0000 001 REV. B FOGLIO 24 di 144

DATI FONDAZIONE		
Larghezza plinto	12	m
Profondità plinto	16,5	m
Diametro palo	1,5	m
Lunghezza palo	33	m
interasse palo	4,5	m
numero pali	12	-
Coefficiente R	1,2792	-
Coefficiente RG	0,208	-
Coeff. amplificazione cedimento del gruppo EG	2,50	-

Tabella 7-11: Coefficiente amplificativo del cedimento verticale per effetto gruppo.

7.3 SINTESI DEI RISULTATI AGLI STATI LIMITE ULTIMI STATICI (SLU)

Si riassumono nel seguito le sollecitazioni massime di sforzo assiale, taglio e momento, agenti in testa ai pali.

SLU	FOR. X, KN	FOR.H, KN	MOM, KN-M	MOM X, KN- M
	*****	*****	*****	*****
max	6540,8	374,3	763,8	0,1
min	1537,4	98,3	246,2	-0,2

Tabella 12: Sollecitazioni allo SLU massime e minime per i pali di fondazione

Nelle seguenti figure sono diagrammati l'andamento con la profondità del momento flettente e del taglio relativi alle combinazioni in cui tali sollecitazioni risultano massime.

APPALTATORE: Consorzio Soci 		ITINERARIO NAPOLI – BARI RADDOPPIO TRATTA APICE – ORSARA I LOTTO FUNZIONALE APICE – HIRPINIA					
PROGETTAZIONE: Mandataria Mandanti 							
PROGETTO ESECUTIVO RELAZIONE DI CALCOLO FONDAZIONI PILE DA P7 A P16		COMMESSA IF1N	LOTTO 01 E ZZ	CODIFICA RG	DOCUMENTO MD0000 001	REV. B	FOGLIO 25 di 144



Figura 7-12: Combinazioni statica SLU: Andamento con la profondità del momento (combo SLU11 max F1).

APPALTATORE: Consorzio Soci 			ITINERARIO NAPOLI – BARI RADDOPPIO TRATTA APICE – ORSARA I LOTTO FUNZIONALE APICE – HIRPINIA							
PROGETTAZIONE: Mandataria Mandanti 			PROGETTO ESECUTIVO RELAZIONE DI CALCOLO FONDAZIONI PILE DA P7 A P16		COMMESSA IF1N	LOTTO 01 E ZZ	CODIFICA RG	DOCUMENTO MD0000 001	REV. B	FOGLIO 26 di 144

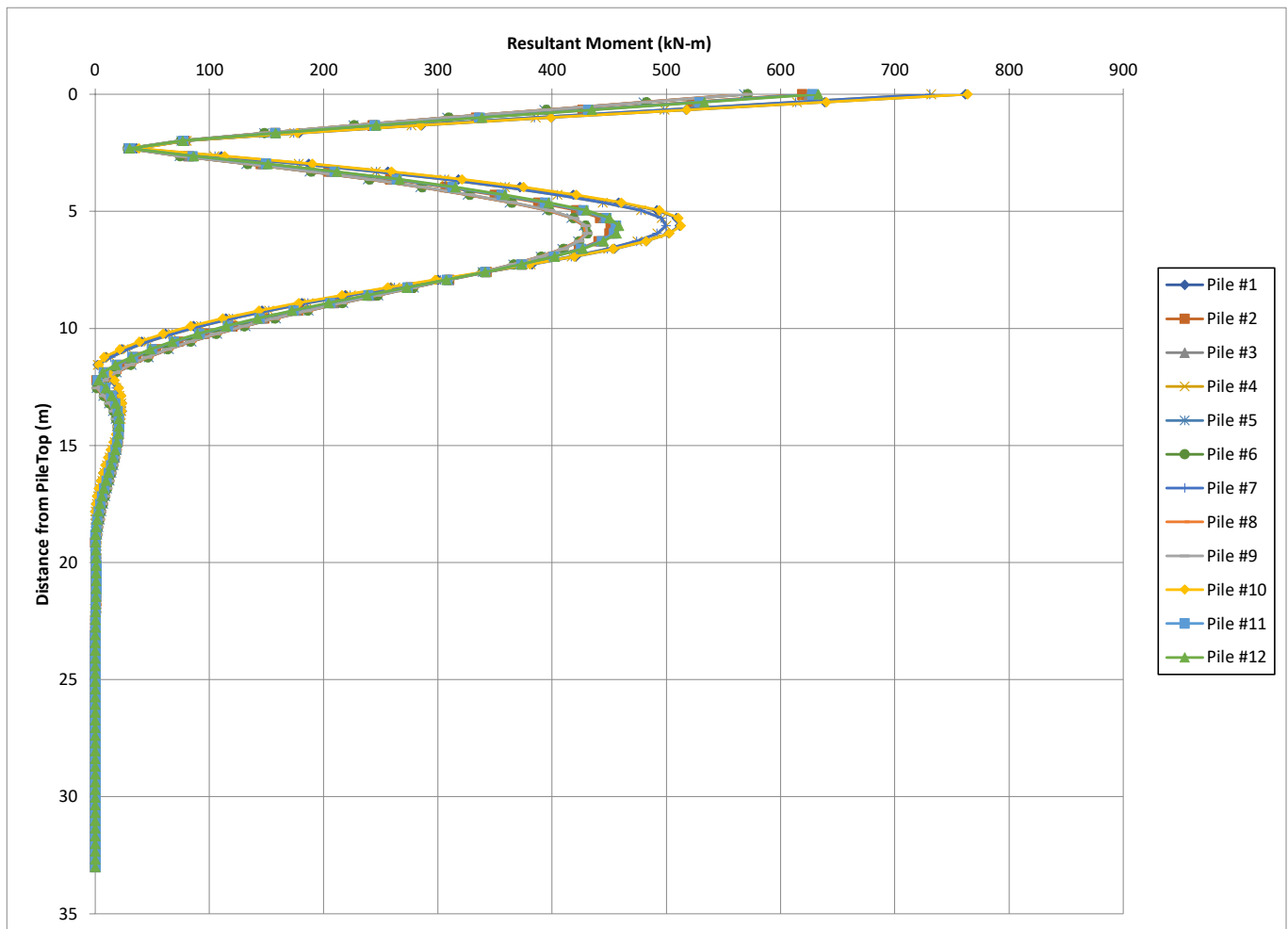

Figura 7-13: Combinazioni statica SLU: Andamento con la profondità del taglio (combo SLU11 max F1).

7.4 SINTESI DEI RISULTATI AGLI STATI LIMITE ULTIMI SISMICI (SLV)

Si riassumono nel seguito le sollecitazioni massime di sforzo assiale, taglio e momento, agenti in testa ai pali.

SLV	FOR. X, KN	FOR.H, KN	MOM, KN-M	MOM X, KN- M
max	10964,0	1585,2	3954,7	3,0
min	-6653,2	347,1	839,0	-4,8

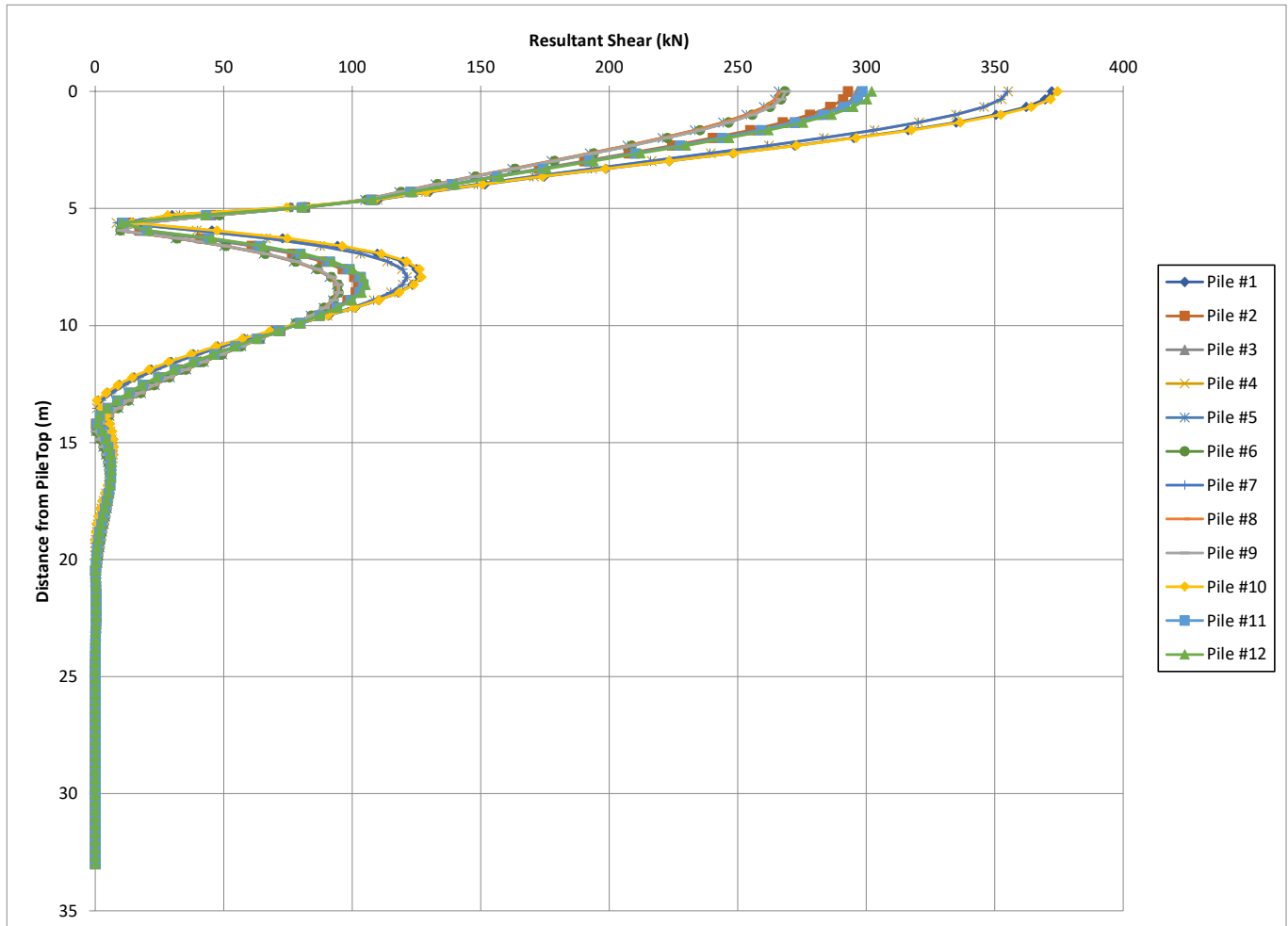
Tabella 13: Sollecitazioni allo SLV massime e minime per i pali di fondazione

Nelle seguenti figure sono diagrammati l'andamento con la profondità del momento flettente e del taglio relativi alle combinazioni in cui tali sollecitazioni risultano massime.

APPALTATORE: Consorzio Soci 		ITINERARIO NAPOLI – BARI RADDOPPIO TRATTA APICE – ORSARA I LOTTO FUNZIONALE APICE – HIRPINIA											
PROGETTAZIONE: Mandataria Mandanti 		COMMESSA IF1N		LOTTO 01 E ZZ		CODIFICA RG		DOCUMENTO MD0000 001		REV. B		FOGLIO 27 di 144	
PROGETTO ESECUTIVO RELAZIONE DI CALCOLO FONDAZIONI PILE DA P7 A P16													



Figura 7-14: Combinazioni sismica SLV: Andamento con la profondità del momento (combo SLV8 MIN M1).

APPALTATORE: Consorzio Soci 		ITINERARIO NAPOLI – BARI RADDOPPIO TRATTA APICE – ORSARA I LOTTO FUNZIONALE APICE – HIRPINIA											
PROGETTAZIONE: Mandataria Mandanti 		COMMESSA IF1N		LOTTO 01 E ZZ		CODIFICA RG		DOCUMENTO MD0000 001		REV. B		FOGLIO 28 di 144	
PROGETTO ESECUTIVO RELAZIONE DI CALCOLO FONDAZIONI PILE DA P7 A P16													

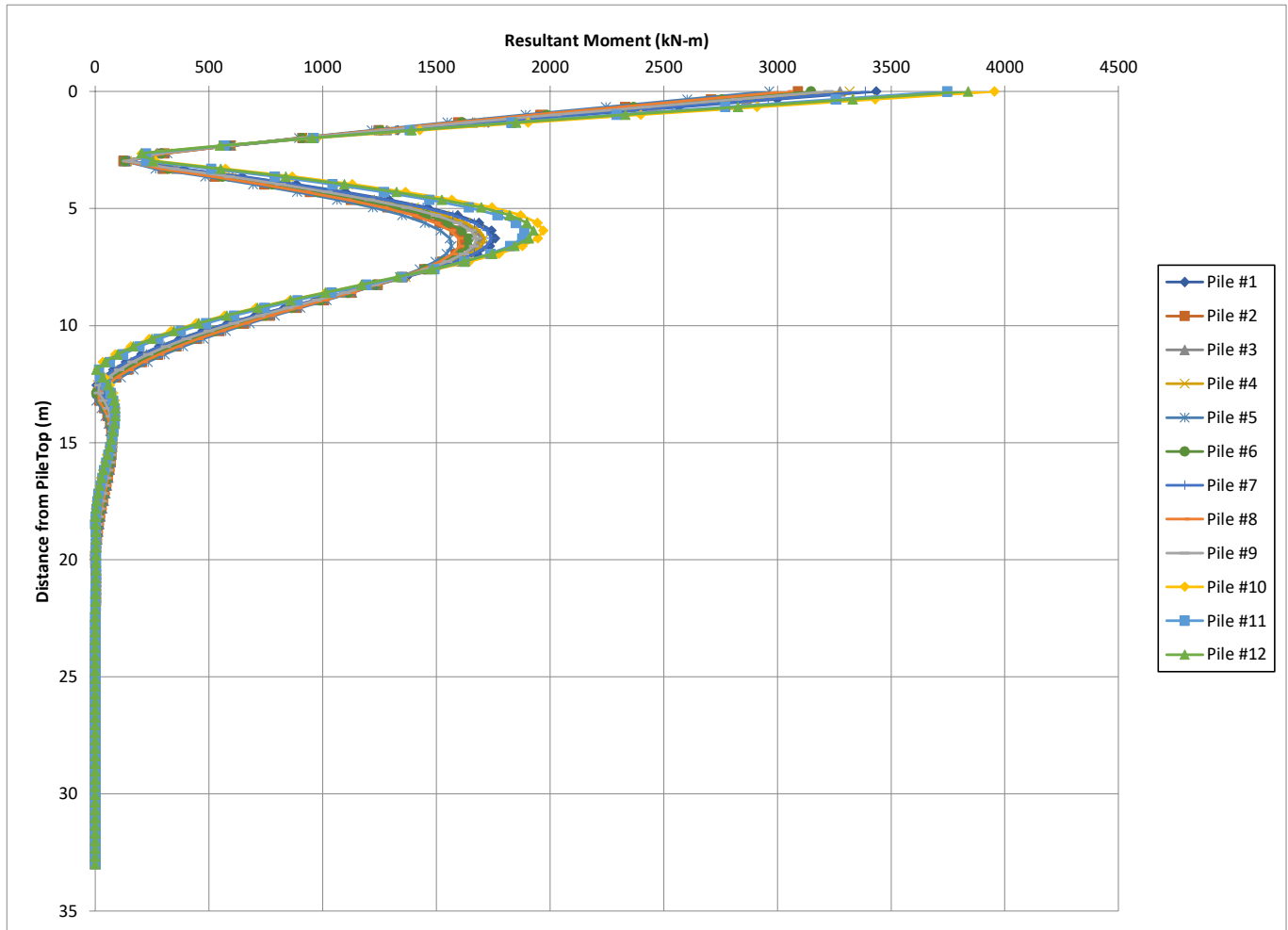

Figura 7-15: Combinazioni sismica SLV: Andamento con la profondità del taglio (combo SLV8 MIN M1).

APPALTATORE: Consorzio Soci   	ITINERARIO NAPOLI – BARI RADDOPPIO TRATTA APICE – ORSARA I LOTTO FUNZIONALE APICE – HIRPINIA					
PROGETTAZIONE: Mandataria Mandanti   						
PROGETTO ESECUTIVO RELAZIONE DI CALCOLO FONDAZIONI PILE DA P7 A P16	COMMESSA IF1N	LOTTO 01 E ZZ	CODIFICA RG	DOCUMENTO MD0000 001	REV. B	FOGLIO 29 di 144

8 VERIFICA DEI PALI DI FONDAZIONE

Nel seguito di riportano le verifiche strutturali dei pali di fondazione.

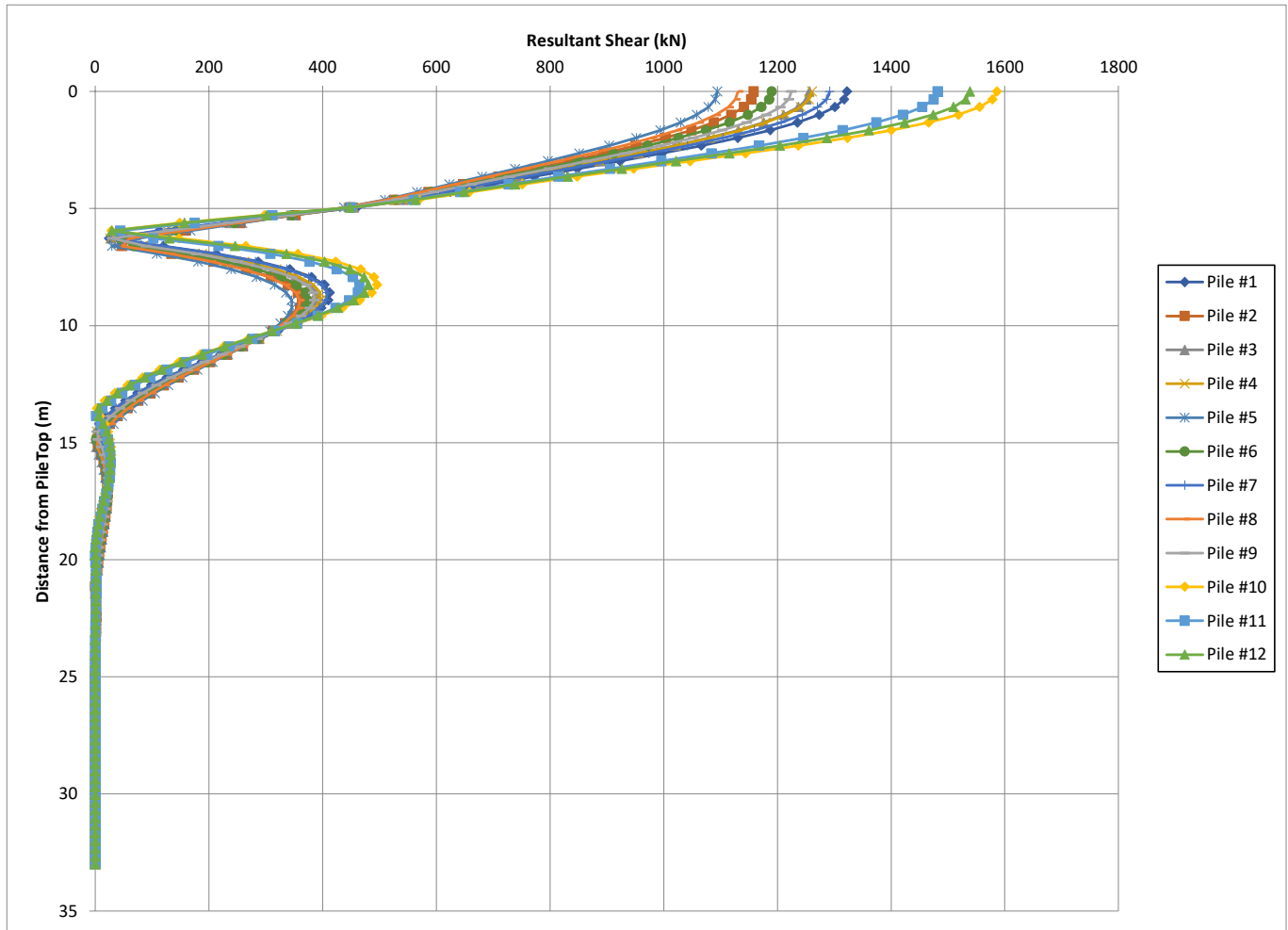
Le sollecitazioni massime agenti lungo il fusto del palo sono riassunte nella **Tabella 14**.

LOAD CASE :	PILE GROUP	FOR. X, KN	FOR. Y, KN	FOR. Z, KN	MOM X, KN- M	MOM Y, KN- M	MOM Z, KN- M	FOR.H, KN	MOM, KN-M
*****	*****	*****	*****	*****	*****	*****	*****		
SLV-8	3	-6653,2	410,93	-1187,5	-2,4265	3138,2	938,91	1256,59	3275,65
SLV-8	10	10253	492,48	-1506,8	-2,4265	3805,5	1076,2	1585,24	3954,75

LOAD CASE :	PILE GROUP	FOR. X, KN	FOR. Y, KN	FOR. Z, KN	MOM X, KN- M	MOM Y, KN- M	MOM Z, KN- M	FOR.H, KN	MOM, KN-M
*****	*****	*****	*****	*****	*****	*****	*****		
SLE-4.00	3					-166,68	-522,5		548,44
SLE-4.00	10	1250,8	-	-	-	-	-		-

Tabella 14: Sollecitazioni massime agenti nel palo

Nel seguito si riportano le verifiche strutturali del palo trivellato di diametro $\varnothing = 1500\text{mm}$ in cls – C25/30 e lunghezza L33m. Per le verifiche si considerano le sollecitazioni risultanti. Sono risultate più severe le verifiche in presenza di trazione.

In riferimento all'andamento dei momenti lungo il fusto del palo- Momenti Figura 7-14 e Taglio Figura 7-15- sono state previste n. 3 ordini di armature principali:

1. L'armatura massima:
 - o ferri correnti: corona esterna n.26 $\varnothing 30$;
 - o ferri correnti: corona interna n.26 $\varnothing 26$;
 - o staffatura: spirale $\varnothing 14$ passo 10.

2. L'armatura media:
 - o ferri correnti: corona esterna n.26 $\varnothing 30$;
 - o ferri correnti: corona interna n.13 $\varnothing 26$;
 - o staffatura: spirale $\varnothing 14$ passo 20.

3. L'armatura minima:
 - o ferri correnti: corona esterna n.26 $\varnothing 24$;
 - o staffatura: spirale $\varnothing 14$ passo 20.

Le verifiche strutturali del palo sono soddisfatte; di seguito le schede di calcolo.

APPALTATORE: Consorzio HirpiniaAV Soci salini impregilo ASTALDI	ITINERARIO NAPOLI – BARI RADDOPPIO TRATTA APICE – ORSARA I LOTTO FUNZIONALE APICE – HIRPINIA
PROGETTAZIONE: Mandataria ROKSOJL Mandanti NETENGINEERING Alpina	
PROGETTO ESECUTIVO RELAZIONE DI CALCOLO FONDAZIONI PILE DA P7 A P16	
COMMESSA IF1N LOTTO 01 E ZZ CODIFICA RG DOCUMENTO MD0000 001 REV. B FOGLIO 30 di 144	

geometria				
sezione trasversale				
D	c	d	passo	interferro
[cm]	[cm]	[cm]	[cm]	[cm]
150	6,0	141,1	16,0	13,0
armatura longitudinale				
n _{barre}	φ	r _i	A _{sl}	c _i
	[mm]	[cm]	[cm ²]	[cm]
26	30	66,10	183,78	8,90
26	26	59,30	138,04	15,70
armatura a taglio				
Tipo	φ	p	A _{sw}	
	[mm]	[cm]	[cm ²]	
spirale	14	10	3,08	

sollecitazioni e risultati	
SLE	SLU
M _{Ek} 543,6 [kNm]	M _{Ed} 3275,6 [kNm]
N _{Ek} -1244,3 [kN]	N _{Ed} 6653,2 [kN]
	V _{Ed} 1585,2 [kN]
momento di cracking	presso-flessione
M _{cr} 1235,6 [kNm]	M _{Rd} 3521,9 [kNm]
quota asse neutro	FS 1,08
y _n 99,03 [cm]	taglio
tensioni e fessure	V _{Rdc} -215,9 [kN]
σ _{c,min} -1,9 [MPa]	predisporre armatura a taglio
σ _{s,min} -25,6 [MPa]	
σ _{s,max} 11,9 [MPa]	
	V _{Rds} 1926,5 [kN]
k ₂ 0,5	V _{Rdmax} 4480,7 [kN]
ε _{sm-ε_{cm}} - [%]	θ 30,0 [°]
S _{r,max} - [cm]	sezione duttile
W _k - [mm]	a _i 92,1 [cm]

materiali			
calcestruzzo		acciaio	
R _{ck}	30 [MPa]	f _{yk}	450 [MPa]
f _{ck}	24,9 [MPa]	γ _s	1,15
γ _c	1,5	f _{yd}	391,3 [MPa]
α _{cc}	0,85	E _s	200000 [MPa]
f _{cd}	14,1 [MPa]	ε _{uk}	10 [‰]
v	0,5		
ε _{c2}	2,0 [‰]		
ε _{cu2}	3,5 [‰]		
α _e	15,0		
k _t	0,6		
		valori limite	
k ₁	0,8	0,55 f _{ck}	13,7 [MPa]
k ₃	3,4	0,75 f _{yk}	337,5 [MPa]
k ₄	0,425	W _{k,lim}	0,2 [mm]



Tabella 8-15: Verifica del palo D=1500mm; armatura massima

APPALTATORE: Consorzio HirpiniaAV Soci salini impregilo ASTALDI		ITINERARIO NAPOLI – BARI RADDOPPIO TRATTA APICE – ORSARA I LOTTO FUNZIONALE APICE – HIRPINIA					
PROGETTAZIONE: Mandataria ROKSOJL Mandanti NETENGINEERING Alpina							
PROGETTO ESECUTIVO RELAZIONE DI CALCOLO FONDAZIONI PILE DA P7 A P16		COMMESSA IF1N	LOTTO 01 E ZZ	CODIFICA RG	DOCUMENTO MD0000 001	REV. B	FOGLIO 31 di 144

geometria				
sezione trasversale				
D	c	d	passo	interferro
[cm]	[cm]	[cm]	[cm]	[cm]
150	6,0	141,1	16,0	13,0
armatura longitudinale				
n _{barre}	φ	r _i	A _{sl}	c _i
	[mm]	[cm]	[cm ²]	[cm]
26	30	66,10	183,78	8,90
13	26	59,30	69,02	15,70
armatura a taglio				
Tipo	φ	p	A _{sw}	
	[mm]	[cm]	[cm ²]	
spirale	14	20	3,08	

sollecitazioni e risultati	
SLE	SLU
M _{Ek} 543,6 [kNm]	M _{Ed} 1352,2 [kNm]
N _{Ek} -1244,3 [kN]	N _{Ed} 6653,2 [kN]
momento di cracking	
M _{cr} 1129,7 [kNm]	
quota asse neutro	
y _n 95,56 [cm]	
tensioni e fessure	
σ _{c,min} -2,1 [MPa]	
σ _{s,min} -28,2 [MPa]	
σ _{s,max} 14,8 [MPa]	
prezzo-flessione	
M _{Rd} 2026,1 [kNm]	
FS 1,50	
taglio	
V _{Rdc} -272,0 [kN]	
predisporre armatura a taglio	
V _{Rds} 962,5 [kN]	
V _{Rdmax} 4480,7 [kN]	
θ 30,0 [°]	
sezione duttile	
a _l 90,1 [cm]	

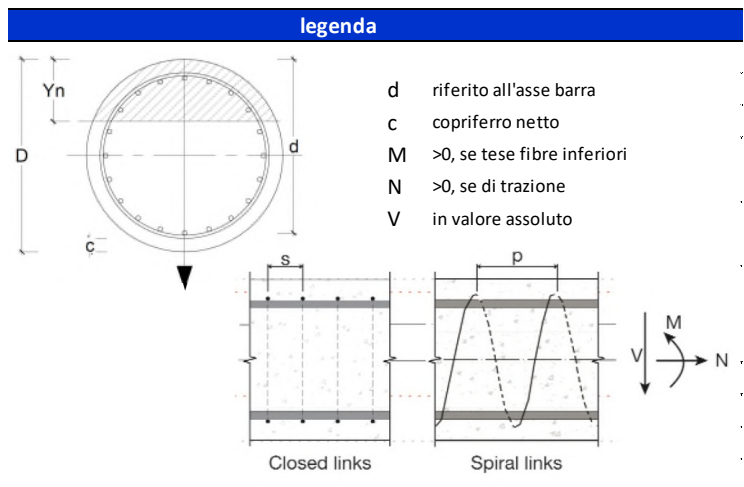
materiali			
calcestruzzo		acciaio	
R _{ck}	30 [MPa]	f _{yk}	450 [MPa]
f _{ck}	24,9 [MPa]	γ _s	1,15
γ _c	1,5	f _{yd}	391,3 [MPa]
α _{cc}	0,85	E _s	200000 [MPa]
f _{cd}	14,1 [MPa]	ε _{uk}	10 [‰]
v	0,5		
ε _{c2}	2,0 [‰]		
ε _{cu2}	3,5 [‰]		
α _e	15,0		
k _t	0,6		
k ₁	0,8		
k ₃	3,4		
k ₄	0,425		
		valori limite	
		0,55 f _{ck}	13,7 [MPa]
		0,75 f _{yk}	337,5 [MPa]
		w _{k,lim}	0,2 [mm]



Tabella 8-16: Verifica del palo D=1500mm; armatura media

APPALTATORE: Consorzio HirpiniaAV Soci salini impregilo ASTALDI	ITINERARIO NAPOLI – BARI RADDOPPIO TRATTA APICE – ORSARA I LOTTO FUNZIONALE APICE – HIRPINIA
PROGETTAZIONE: Mandataria ROKSOJL Mandanti NETENGINEERING Alpina	
PROGETTO ESECUTIVO RELAZIONE DI CALCOLO FONDAZIONI PILE DA P7 A P16	
COMMESSA IF1N LOTTO 01 E ZZ CODIFICA RG DOCUMENTO MD0000 001 REV. B FOGLIO 32 di 144	

geometria				
sezione trasversale				
D	c	d	passo	interferro
[cm]	[cm]	[cm]	[cm]	[cm]
150	6,0	141,4	16,0	13,6
armatura longitudinale				
n _{barre}	φ	r _i	A _{sl}	c _i
	[mm]	[cm]	[cm ²]	[cm]
26	24	66,40	117,62	8,60
61,20				
armatura a taglio				
Tipo	φ	ρ	A _{sw}	
	[mm]	[cm]	[cm ²]	
spirale	14	20	3,08	

sollecitazioni e risultati	
SLE	SLU
M _{Ek} 543,6 [kNm]	M _{Ed} 100,0 [kNm]
N _{Ek} -1244,3 [kN]	N _{Ed} 3614,3 [kN]
momento di cracking	V _{Ed} 490,2 [kN]
M _{cr} 1141,1 [kNm]	presso-flessione
quota asse neutro	M _{Rd} 643,5 [kNm]
y _n 95,41 [cm]	FS 6,43
tensioni e fessure	taglio
σ _{c,min} -2,2 [MPa]	V _{Rdc} 7,3 [kN]
σ _{s,min} -30,4 [MPa]	predisporre armatura a taglio
σ _{s,max} 16,0 [MPa]	
	V _{Rds} 964,5 [kN]
k ₂ 0,5	V _{Rdmax} 4490,3 [kN]
ε _{sm-ε_{cm}} - [%]	θ 30,0 [°]
S _{r,max} - [cm]	sezione duttile
W _k - [mm]	a _i 90,3 [cm]

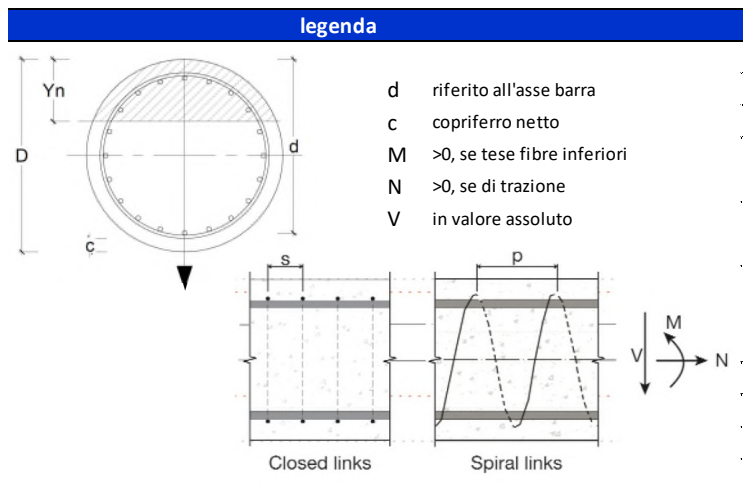
materiali			
calcestruzzo		acciaio	
R _{ck}	30 [MPa]	f _{yk}	450 [MPa]
f _{ck}	24,9 [MPa]	γ _s	1,15
γ _c	1,5	f _{yd}	391,3 [MPa]
α _{cc}	0,85	E _s	200000 [MPa]
f _{cd}	14,1 [MPa]	ε _{uk}	10 [‰]
v	0,5		
ε _{c2}	2,0 [‰]		
ε _{cu2}	3,5 [‰]		
α _e	15,0		
k _t	0,6		
k ₁	0,8		
k ₃	3,4		
k ₄	0,425		
		valori limite	
		0,55 f _{ck}	13,7 [MPa]
		0,75 f _{yk}	337,5 [MPa]
		W _{k,lim}	0,2 [mm]



Tabella 8-17: Verifica del palo D=1500mm; armatura minima

APPALTATORE: Consorzio HirpiniaAV Soci salini impregilo ASTALDI		ITINERARIO NAPOLI – BARI					
PROGETTAZIONE: Mandataria ROKSOJL Mandanti NETENGINEERING Alpina		RADDOPPIO TRATTA APICE – ORSARA I LOTTO FUNZIONALE APICE – HIRPINIA					
PROGETTO ESECUTIVO RELAZIONE DI CALCOLO FONDAZIONI PILE DA P7 A P16		COMMESSA IF1N	LOTTO 01 E ZZ	CODIFICA RG	DOCUMENTO MD0000 001	REV. B	FOGLIO 34 di 144

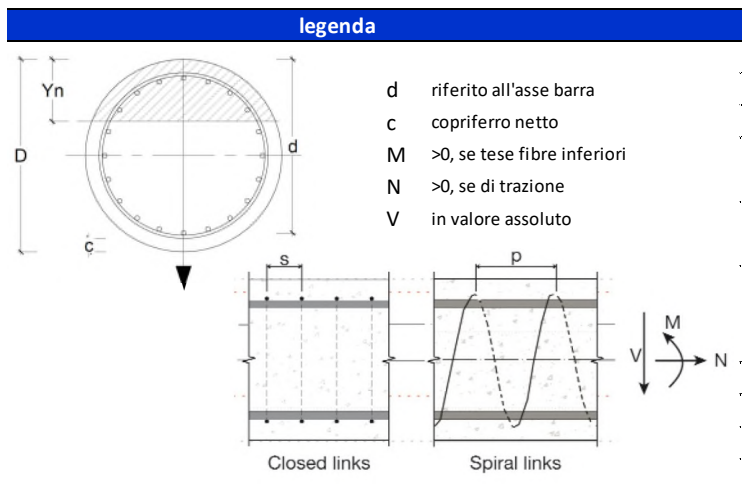

Figura 8-1: VI04 P12 Schema armatura gabbie

APPALTATORE: Consorzio HirpiniaAV Soci salini impregilo ASTALDI		ITINERARIO NAPOLI – BARI					
PROGETTAZIONE: Mandataria ROKSOJL Mandanti NETENGINEERING Alpina		RADDOPPIO TRATTA APICE – ORSARA I LOTTO FUNZIONALE APICE – HIRPINIA					
PROGETTO ESECUTIVO RELAZIONE DI CALCOLO FONDAZIONI PILE DA P7 A P16		COMMESSA IF1N	LOTTO 01 E ZZ	CODIFICA RG	DOCUMENTO MD0000 001	REV. B	FOGLIO 35 di 144

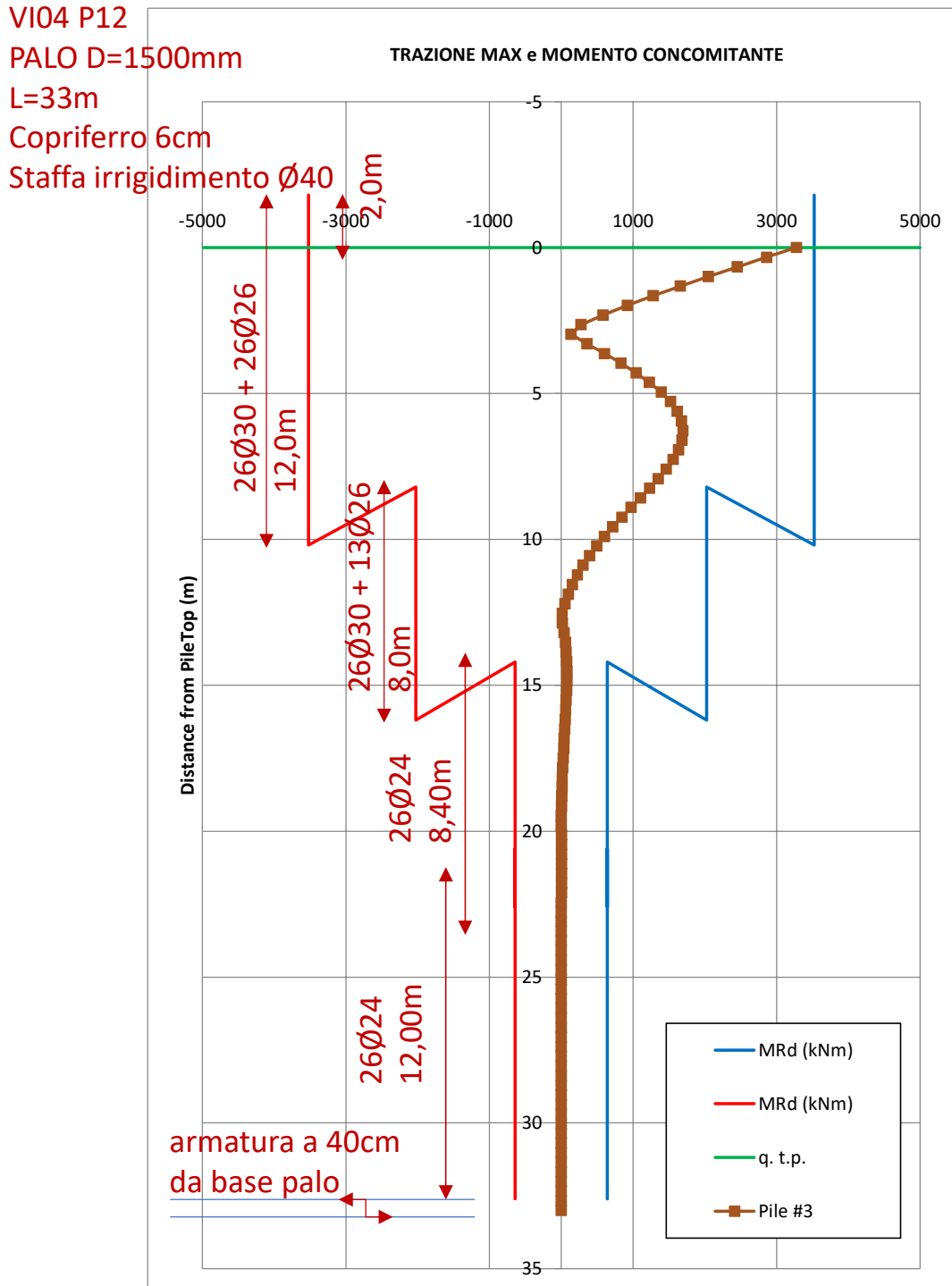

Figura 8-2: VI04 P12 Schema armatura a taglio

APPALTATORE: Consorzio Soci 	ITINERARIO NAPOLI – BARI RADDOPPIO TRATTA APICE – ORSARA I LOTTO FUNZIONALE APICE – HIRPINIA					
PROGETTAZIONE: Mandataria Mandanti 						
PROGETTO ESECUTIVO RELAZIONE DI CALCOLO FONDAZIONI PILE DA P7 A P16	COMMESSA IF1N	LOTTO 01 E ZZ	CODIFICA RG	DOCUMENTO MD0000 001	REV. B	FOGLIO 36 di 144

9 VERIFICHE ALLO SLU DI TIPO GEOTECNICO

9.1 VERIFICA DI CAPACITÀ PORTANTE DEL PALO SINGOLO

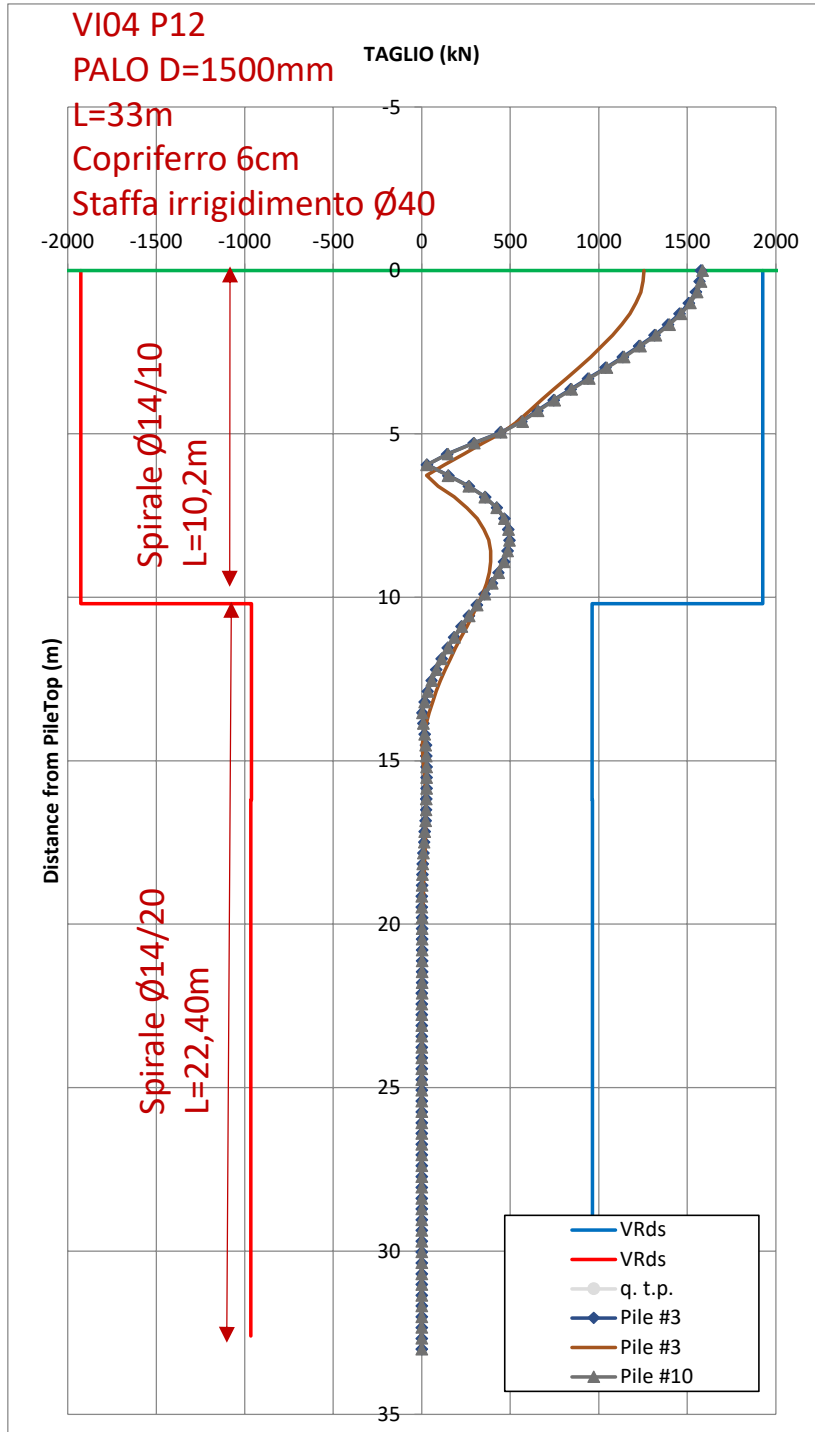
La verifica di capacità portante verticale per il singolo palo è stata condotta in accordo ai criteri esposti nel documento di cui al ref. 2).

Di seguito si riporta, per i pali di fondazione di lunghezza $L = 33$ m, la capacità portante a compressione ($R_{c,d}$) e a trazione ($R_{t,d}$), secondo l'approccio 2 ($A1+M1+R3$).

I carichi assiali massimi agenti sui pali sono riassunti nella seguente tabella:

Massima compressione, N_{dc} , max [kN]	10964,0 (SLV)
Massima trazione, N_{dt} , max [kN]	-6653,2 (SLV)

Tabella 19: Combinazione SLU e SLV: Sollecitazioni massime di compressione e trazione

Si verifica inoltre che lo sforzo assiale massimo in esercizio (Tabella 19) sia inferiore della resistenza laterale di calcolo ($R_{c,s,k}$) divisa per un fattore pari a 1.25.

Massima compressione, N_{dcSLE} , max [kN]	4686,9 (SLE)
--	--------------

Tabella 20: Combinazione SLE: Sollecitazione massima di compressione

In Tabella 9-21 si riporta, per i pali di lunghezza 33.0 m, la capacità portante a compressione ($R_{c,d}$) e a trazione ($R_{t,d}$) del palo isolato secondo l'Approccio 2 ($A1+M1+R3$).

Combinazione SLU A1+M1+R3 (metodo AGI)							Comb. SLU A1+M1+R3 (metodo AGI)				
L palo	Q I-c,k	Q b-c,k	Q I-c,d	Q b-c,d	ΔW palo	Q _{c,d}	L palo	Q I-t,k	Q I-t,d	ΔW palo	Q _{t,d}
m	kN	kN	kN	kN	kN	kN	m	kN	kN	kN	kN
33,0	15439,1	6388,1	8950,22	3154,60	1137,16	10968	33,0	15439,1	8234,20	874,74	9108,9

Tabella 9-21: Capacità portante a compressione e a trazione dei pali di fondazione secondo l'Approccio 2 ($A1+M1+R3$).

9.1.1 Capacità portante verticale del palo singolo

Stratigrafia e parametri geotecnici

Dati di input		
Diametro Palo	1.5	m
Sovraccarico efficace	112,8	kPa
HW da testa palo	1	m
γ acqua	10	kN/m ³
ΔZ palo da p.c. originario	5,5	m
N° diametri per qb	4	(-)
L palo fuori terra	0	(m)
Peso calcestruzzo	25	kN/m ³

APPALTATORE: Consorzio Soci   		ITINERARIO NAPOLI – BARI RADDOPPIO TRATTA APICE – ORSARA I LOTTO FUNZIONALE APICE – HIRPINIA					
PROGETTAZIONE: Mandataria Mandanti   							
PROGETTO ESECUTIVO RELAZIONE DI CALCOLO FONDAZIONI PILE DA P7 A P16							

Pressione max sul cls.	11.34	MPa
-------------------------------	--------------	------------







Caratteristiche del terreno													
Profondità (m)		Strato	Terreno	γ_{tot}	Nspt		c_u (kPa)		$\Delta-z$	ϕ°		Nq	
da	a	No.	(S,SL,G,A)	kN/m3	da	a	da	a	(m)	da	a	da	a
0,0	4,80	1	S	19,0					1,00	38	38	24,18	24,18
4,8	16,80	2	S	20,5					1,00	33	33	11,95	11,95
16,8	20,80	3	A	20,5			205	205	1,00				
20,8	25,8	4	A	20,5			240	240	1,00				
25,8	30,8	5	A	20,5			280	280	1,00				
30,8	50,0	6	A	20,5			300	300	1,00				

Verticali di indagine	ξ_3	ξ_4
5	1.50	1.34

Scelta di ξ	ξ
3	1.5

APPALTATORE: Consorzio Soci   	ITINERARIO NAPOLI – BARI RADDOPPIO TRATTA APICE – ORSARA I LOTTO FUNZIONALE APICE – HIRPINIA
PROGETTAZIONE: Mandataria Mandanti   	
PROGETTO ESECUTIVO RELAZIONE DI CALCOLO FONDAZIONI PILE DA P7 A P16	COMMESSA LOTTO CODIFICA DOCUMENTO REV. FOGLIO IF1N 01 E ZZ RG MD0000 001 B 38 di 144

Combinazione SLE (metodo AGI)						
L palo	τ_s calcolo	Q_{ub} calcolo	$R_{c,s,k}$	$R_{c,b,k}$	ΔW palo	$Q_{c,s,k}/1.25$
m	kPa	kPa	kN	kN	kN	kN
1,0	57,3	1003,2	270,1	1772,7	26,5	189,5
2,0	63,9	2006,3	571,0	3545,5	53,0	403,8
3,0	68,1	2597,0	891,9	4589,2	79,5	634,0
4,0	72,3	2302,6	1232,6	4069,0	106,0	880,1
4,8	76,1	2067,1	1519,5	3652,8	127,2	1088,4
4,8	77,8	2067,1	1519,5	3652,8	127,2	1088,4
5,0	62,6	2008,2	1578,6	3548,8	132,5	1130,3
6,0	65,0	2133,7	1884,7	3770,5	159,0	1348,8
7,0	68,9	2259,1	2209,5	3992,2	185,6	1582,0
8,0	72,8	2384,6	2552,8	4214,0	212,1	1830,2
9,0	76,8	2510,1	2914,6	4435,7	238,6	2093,1
10,0	80,7	2635,6	3295,0	4657,4	265,1	2370,9
11,0	84,7	2761,0	3693,9	4879,2	291,6	2663,6
12,0	88,6	2886,5	4111,4	5100,9	318,1	2971,0
13,0	92,5	3012,0	4547,5	5322,6	344,6	3293,4
14,0	96,5	3018,3	5002,0	5333,8	371,1	3630,5
15,0	100,4	3024,6	5475,2	5345,0	397,6	3982,5
16,0	104,3	3031,0	5966,9	5356,1	424,1	4349,4
16,8	107,9	3036,0	6373,6	5365,1	445,3	4653,6
16,8	109,5	3036,0	6373,6	5365,1	445,3	4653,6
17,0	107,4	3037,3	6474,8	5367,3	450,6	4729,2
18,0	107,4	3037,3	6980,8	5367,3	477,1	5107,5
19,0	107,4	3037,3	7486,9	5367,3	503,6	5485,9
20,0	107,4	3037,3	7992,9	5367,3	530,1	5864,2
20,8	107,4	3037,3	8397,7	5367,3	551,3	6166,8
20,8	107,4	3037,3	8397,7	5367,3	551,3	6166,8
21,0	116,2	3049,1	8507,2	5388,3	556,7	6249,1
22,0	116,2	3108,4	9054,8	5493,1	583,2	6660,7
23,0	116,2	3167,7	9602,3	5597,8	609,7	7072,2
24,0	116,2	3227,0	10149,8	5702,6	636,2	7483,7
25,0	116,2	3286,3	10697,4	5807,4	662,7	7895,2
25,8	116,2	3286,3	11135,4	5807,4	683,9	8224,4
25,8	116,2	3286,3	11135,4	5807,4	683,9	8224,4
26,0	125,5	3298,9	11253,7	5829,6	689,2	8313,7
27,0	125,5	3361,6	11845,1	5940,4	715,7	8760,4
28,0	125,5	3424,3	12436,5	6051,2	742,2	9207,0
29,0	125,5	3487,0	13027,9	6162,0	768,7	9653,6
30,0	125,5	3549,6	13619,3	6272,7	795,2	10100,2
30,8	125,5	3549,6	14092,4	6272,7	816,4	10457,5
30,8	125,5	3549,6	14092,4	6272,7	816,4	10457,5
31,0	129,9	3555,6	14214,8	6283,2	821,7	10550,1
32,0	129,9	3585,2	14827,0	6335,6	848,2	11013,3
33,0	129,9	3614,9	15439,1	6388,1	874,7	11476,6
34,0	129,9	3644,6	16051,3	6440,5	901,2	11939,8
35,0	129,9	3674,2	16663,4	6492,9	927,8	12403,0
36,0	129,9	3674,2	17275,6	6492,9	954,3	12866,2
37,0	129,9	3674,2	17887,8	6492,9	980,8	13329,4
38,0	129,9	3674,2	18499,9	6492,9	1007,3	13792,7
39,0	129,9	3674,2	19112,1	6492,9	1033,8	14255,9
40,0	129,9	3674,2	19724,2	6492,9	1060,3	14719,1

APPALTATORE: Consorzio Soci   	ITINERARIO NAPOLI – BARI RADDOPPIO TRATTA APICE – ORSARA I LOTTO FUNZIONALE APICE – HIRPINIA
PROGETTAZIONE: Mandataria Mandanti   	
PROGETTO ESECUTIVO RELAZIONE DI CALCOLO FONDAZIONI PILE DA P7 A P16	

Combinazione SLU A1+M1+R3 (metodo AGI)						
L palo	Q I-c,k	Q b-c,k	Q I-c,d	Q b-c,d	ΔW palo	Qc,d
m	kN	kN	kN	kN	kN	kN
1,0	270,1	1772,7	156,55	875,43	34,46	998
2,0	571,0	3545,5	331,03	1750,86	68,92	2013
3,0	891,9	4589,2	517,04	2266,27	103,38	2680
4,0	1232,6	4069,0	714,57	2009,38	137,84	2586
4,8	1519,5	3652,8	880,90	1803,86	165,40	2519
4,8	1519,5	3652,8	880,90	1803,86	165,40	2519
5,0	1578,6	3548,8	915,11	1752,48	172,30	2495
6,0	1884,7	3770,5	1092,60	1861,98	206,76	2748
7,0	2209,5	3992,2	1280,86	1971,48	241,22	3011
8,0	2552,8	4214,0	1479,86	2080,98	275,67	3285
9,0	2914,6	4435,7	1689,62	2190,47	310,13	3570
10,0	3295,0	4657,4	1910,14	2299,97	344,59	3866
11,0	3693,9	4879,2	2141,40	2409,47	379,05	4172
12,0	4111,4	5100,9	2383,43	2518,97	413,51	4489
13,0	4547,5	5322,6	2636,20	2628,46	447,97	4817
14,0	5002,0	5333,8	2899,73	2633,98	482,43	5051
15,0	5475,2	5345,0	3174,02	2639,49	516,89	5297
16,0	5966,9	5356,1	3459,06	2645,00	551,35	5553
16,8	6373,6	5365,1	3694,84	2649,41	578,92	5765
16,8	6373,6	5365,1	3694,84	2649,41	578,92	5765
17,0	6474,8	5367,3	3753,51	2650,52	585,81	5818
18,0	6980,8	5367,3	4046,86	2650,52	620,27	6077
19,0	7486,9	5367,3	4340,21	2650,52	654,73	6336
20,0	7992,9	5367,3	4633,56	2650,52	689,19	6595
20,8	8397,7	5367,3	4868,25	2650,52	716,75	6802
20,8	8397,7	5367,3	4868,25	2650,52	716,75	6802
21,0	8507,2	5388,3	4931,73	2660,87	723,65	6869
22,0	9054,8	5493,1	5249,14	2712,62	758,11	7204
23,0	9602,3	5597,8	5566,55	2764,37	792,56	7538
24,0	10149,8	5702,6	5883,95	2816,12	827,02	7873
25,0	10697,4	5807,4	6201,36	2867,87	861,48	8208
25,8	11135,4	5807,4	6455,29	2867,87	889,05	8434
25,8	11135,4	5807,4	6455,29	2867,87	889,05	8434
26,0	11253,7	5829,6	6523,86	2878,81	895,94	8507
27,0	11845,1	5940,4	6866,70	2933,52	930,40	8870
28,0	12436,5	6051,2	7209,54	2988,23	964,86	9233
29,0	13027,9	6162,0	7552,38	3042,94	999,32	9596
30,0	13619,3	6272,7	7895,22	3097,65	1033,78	9959
30,8	14092,4	6272,7	8169,49	3097,65	1061,35	10206
30,8	14092,4	6272,7	8169,49	3097,65	1061,35	10206
31,0	14214,8	6283,2	8240,47	3102,83	1068,24	10275
32,0	14827,0	6335,6	8595,34	3128,72	1102,70	10621
33,0	15439,1	6388,1	8950,22	3154,60	1137,16	10968
34,0	16051,3	6440,5	9305,09	3180,49	1171,62	11314
35,0	16663,4	6492,9	9659,96	3206,37	1206,08	11660
36,0	17275,6	6492,9	10014,84	3206,37	1240,54	11981
37,0	17887,8	6492,9	10369,71	3206,37	1275,00	12301
38,0	18499,9	6492,9	10724,59	3206,37	1309,46	12622
39,0	19112,1	6492,9	11079,46	3206,37	1343,91	12942
40,0	19724,2	6492,9	11434,33	3206,37	1378,37	13262

Comb. SLU A1+M1+R3 (metodo AGI)				
L palo	Q I-t,k	Q I-t,d	ΔW palo	Qt,d
m	kN	kN	kN	kN
1,0	270,1	144,03	26,51	171
2,0	571,0	304,55	53,01	358
3,0	891,9	475,68	79,52	555
4,0	1232,6	657,41	106,03	763
4,8	1519,5	810,43	127,23	938
4,8	1519,5	810,43	127,23	938
5,0	1578,6	841,90	132,54	974
6,0	1884,7	1005,20	159,04	1164
7,0	2209,5	1178,39	185,55	1364
8,0	2552,8	1361,47	212,06	1574
9,0	2914,6	1554,45	238,56	1793
10,0	3295,0	1757,32	265,07	2022
11,0	3693,9	1970,09	291,58	2262
12,0	4111,4	2192,75	318,09	2511
13,0	4547,5	2425,31	344,59	2770
14,0	5002,0	2667,76	371,10	3039
15,0	5475,2	2920,10	397,61	3318
16,0	5966,9	3182,34	424,12	3606
16,8	6373,6	3399,25	445,32	3845
16,8	6373,6	3399,25	445,32	3845
17,0	6474,8	3453,23	450,62	3904
18,0	6980,8	3723,11	477,13	4200
19,0	7486,9	3992,99	503,64	4497
20,0	7992,9	4262,88	530,14	4793
20,8	8397,7	4478,79	551,35	5030
20,8	8397,7	4478,79	551,35	5030
21,0	8507,2	4537,19	556,65	5094
22,0	9054,8	4829,21	583,16	5412
23,0	9602,3	5121,22	609,67	5731
24,0	10149,8	5413,24	636,17	6049
25,0	10697,4	5705,25	662,68	6368
25,8	11135,4	5938,87	683,89	6623
25,8	11135,4	5938,87	683,89	6623
26,0	11253,7	6001,95	689,19	6691
27,0	11845,1	6317,36	715,69	7033
28,0	12436,5	6632,78	742,20	7375
29,0	13027,9	6948,19	768,71	7717
30,0	13619,3	7263,60	795,22	8059
30,8	14092,4	7515,93	816,42	8332
30,8	14092,4	7515,93	816,42	8332
31,0	14214,8	7581,23	821,72	8403
32,0	14827,0	7907,72	848,23	8756
33,0	15439,1	8234,20	874,74	9109
34,0	16051,3	8560,68	901,24	9462
35,0	16663,4	8887,17	927,75	9815
36,0	17275,6	9213,65	954,26	10168
37,0	17887,8	9540,13	980,77	10521
38,0	18499,9	9866,62	1007,27	10874
39,0	19112,1	10193,10	1033,78	11227
40,0	19724,2	10519,59	1060,29	11580

APPALTATORE: Consorzio Soci   	ITINERARIO NAPOLI – BARI					
PROGETTAZIONE: Mandataria Mandanti   	RADDOPPIO TRATTA APICE – ORSARA I LOTTO FUNZIONALE APICE – HIRPINIA					
PROGETTO ESECUTIVO RELAZIONE DI CALCOLO FONDAZIONI PILE DA P7 A P16	COMMESSA IF1N	LOTTO 01 E ZZ	CODIFICA RG	DOCUMENTO MD0000 001	REV. B	FOGLIO 40 di 144

VI04 - pila P12
 Capacità portante A1+M1+R3
 Palo D=1500mm



Figura 9-1: Capacità portante del palo singolo

APPALTATORE: Consorzio  Soci  	ITINERARIO NAPOLI – BARI RADDOPPIO TRATTA APICE – ORSARA I LOTTO FUNZIONALE APICE – HIRPINIA					
PROGETTAZIONE: Mandataria  Mandanti  						
PROGETTO ESECUTIVO RELAZIONE DI CALCOLO FONDAZIONI PILE DA P7 A P16	COMMESSA IF1N	LOTTO 01 E ZZ	CODIFICA RG	DOCUMENTO MD0000 001	REV. B	FOGLIO 41 di 144

9.1.2 Verifica di capacità portante verticale del gruppo di pali

La verifica di capacità portante verticale del blocco è stata condotta in accordo ai criteri descritti nel documento di cui al Ref. 2) §7.1.

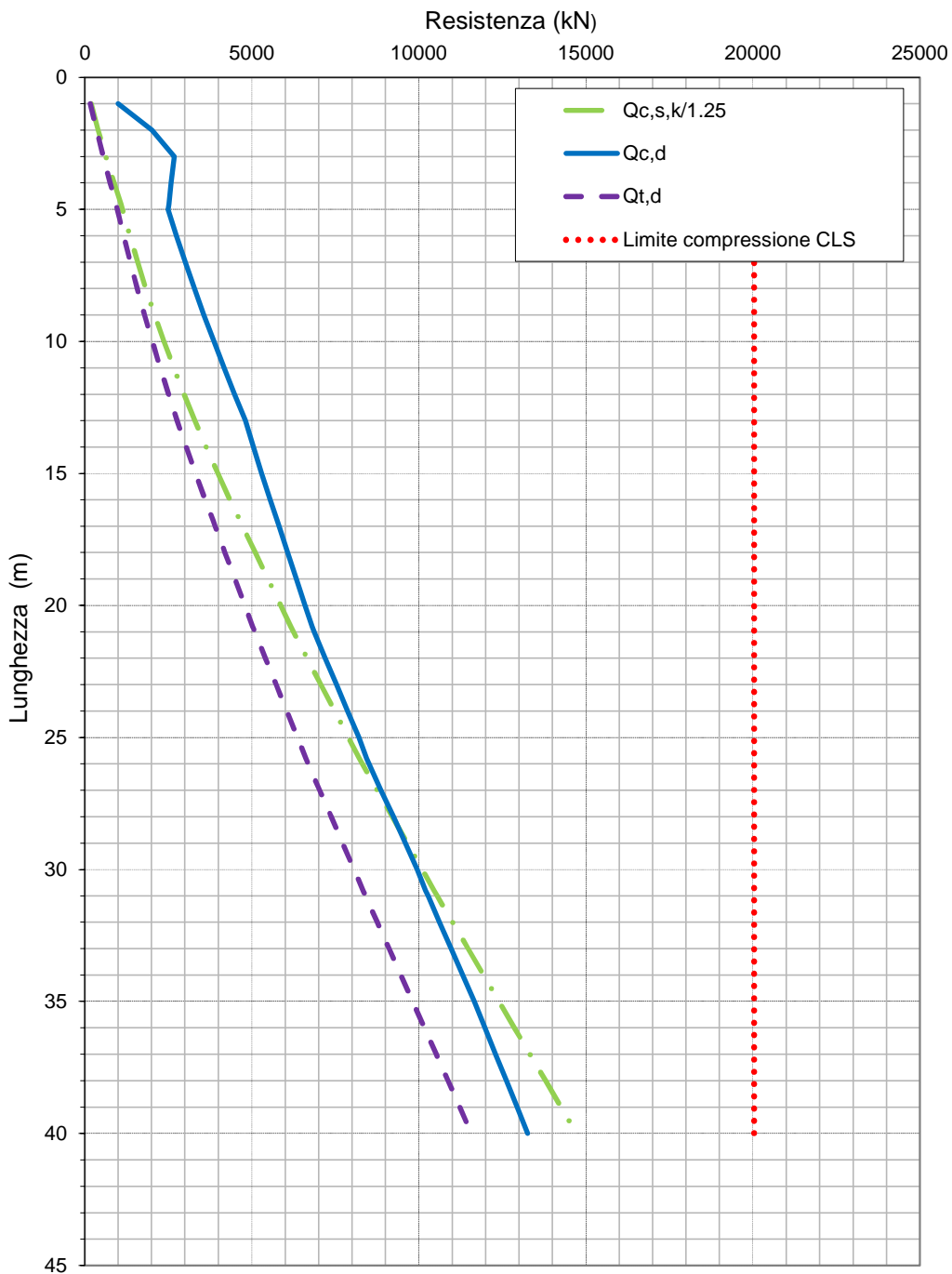
Nella seguente tabella si riporta la capacità portante del blocco valutata secondo l'Approccio 2 (A1+M1+R3).

CAPACITA' PORTANTE VERTICALE GRUPPI DI PALI				
B	10,5		m	larghezza pozzo
L	15		m	lunghezza pozzo
D	33		m	profondità pozzo
i	4,5		m	interasse pali
n°	12			numero dei pali
γ_R cap.port.	2,3			coefficiente sicurezza globale per capacità portante
ξ_3	1,5			fattore di correlazione in base alle verticali indagate
γ_s	1,15			coefficiente di resistenza laterale
γ_b	1,35			coefficiente di resistenza base
$Cu_{b,calc}$	300		kPa	coesione non drenata di calcolo, base
$Cu_{b,d}$	148		kPa	coesione non drenata di progetto, base
$Cu_{s,i}$	200	300	kPa	coesione strato i
d_i	30,8	2,2	m	altezza strato i-esimo
$Cu_{s,calc}$	207		kPa	coesione non drenata di calcolo, laterale
$Cu_{s,d}$	120		kPa	coesione non drenata di progetto, laterale
A_s	1683		m ²	area laterale
A_b	158		m ²	area base
S_{block}	1			fattore forma
N_c	5,14			fattore di portanza alla base
$R_{block,c,d}$	139828		kN	resistenza di progetto
Valutazione alternativa dell'Area di Base				
$A_{b,diafr}$	21,20575		m ²	area di impronta dei soli pali o pannelli
$R_{punz,c,d}$	94690		kN	Resistenza di progetto con area di base
Verifica:				
N slu, max	52110,5		kN	
FSblock	2,68		ok	
FSpunz	1,82		ok	

Tabella 22: Capacità portante del blocco (Approccio 2: A1+M1+R3)

APPALTATORE: Consorzio HirpiniaAV Soci salini impregilo ASTALDI	ITINERARIO NAPOLI – BARI RADDOPPIO TRATTA APICE – ORSARA I LOTTO FUNZIONALE APICE – HIRPINIA					
PROGETTAZIONE: Mandataria ROKSOJL Mandanti NETENGINEERING Alpina						
PROGETTO ESECUTIVO RELAZIONE DI CALCOLO FONDAZIONI PILE DA P7 A P16	COMMESSA IF1N	LOTTO 01 E ZZ	CODIFICA RG	DOCUMENTO MD0000 001	REV. B	FOGLIO 42 di 144

9.1.3 Verifica di capacità portante orizzontale del gruppo di pali

La verifica di capacità portante orizzontale del gruppo di pali è stata condotta con i criteri descritti nel documento di cui al Ref. 2) §6.2, con i metodi basati sulle curve p-y.

Considerata la presenza di successioni stratigrafiche abbastanza articolate, con contrasti di rigidezza anche marcati e caratteristiche diverse delle varie unità geotecniche, si è fatto uso del programma FEM non lineare LPile, considerando negli strati di terreno curve p-y non lineari, definibili lungo il fuso del palo, e opportunamente ridotte secondo il coefficiente parziale $\xi \times \gamma_T$.

Si ricava una curva "pushover" del palo singolo: incrementando progressivamente il carico orizzontale applicato alla testa del palo, fino al raggiungimento del collasso, vale a dire della completa plasticizzazione del terreno. Tale plasticizzazione si rende "visibile" attraverso il cambiamento del comportamento deformativo del palo stesso, al raggiungimento del "plateau" di resistenza.

Nella seguente Figura 9-2 è illustrata la curva push-over ottenuta per il palo in oggetto, con il vincolo di invastro, al crescere dell'azione H applicata alla testa dello stesso.

Il taglio massimo agente è pari a $T_{longSLV} = 1585,2\text{kN}$.

La verifica a capacità portante orizzontale risulta soddisfatta, poiché il carico limite $H_{lim} = 5478.0\text{ kN}$ risulta superiore al valore di progetto.



Figura 9-2: Analisi push-over palo

APPALTATORE: Consorzio Soci 	ITINERARIO NAPOLI – BARI RADDOPPIO TRATTA APICE – ORSARA I LOTTO FUNZIONALE APICE – HIRPINIA																	
PROGETTAZIONE: Mandataria Mandanti 	<table border="1" style="width: 100%; border-collapse: collapse;"> <tr> <td style="width: 16.6%;">COMMESSA</td> <td style="width: 16.6%;">LOTTO</td> <td style="width: 16.6%;">CODIFICA</td> <td style="width: 16.6%;">DOCUMENTO</td> <td style="width: 16.6%;">REV.</td> <td style="width: 16.6%;">FOGLIO</td> </tr> <tr> <td>IF1N</td> <td>01 E ZZ</td> <td>RG</td> <td>MD0000 001</td> <td>B</td> <td>43 di 144</td> </tr> </table>						COMMESSA	LOTTO	CODIFICA	DOCUMENTO	REV.	FOGLIO	IF1N	01 E ZZ	RG	MD0000 001	B	43 di 144
COMMESSA	LOTTO	CODIFICA	DOCUMENTO	REV.	FOGLIO													
IF1N	01 E ZZ	RG	MD0000 001	B	43 di 144													
PROGETTO ESECUTIVO RELAZIONE DI CALCOLO FONDAZIONI PILE DA P7 A P16																		

10 DIMENSIONAMENTO E VERIFICA DEL PLINTO DI FONDAZIONE [P7 ÷ P16]

10.1 DESCRIZIONE DEL MODELLO

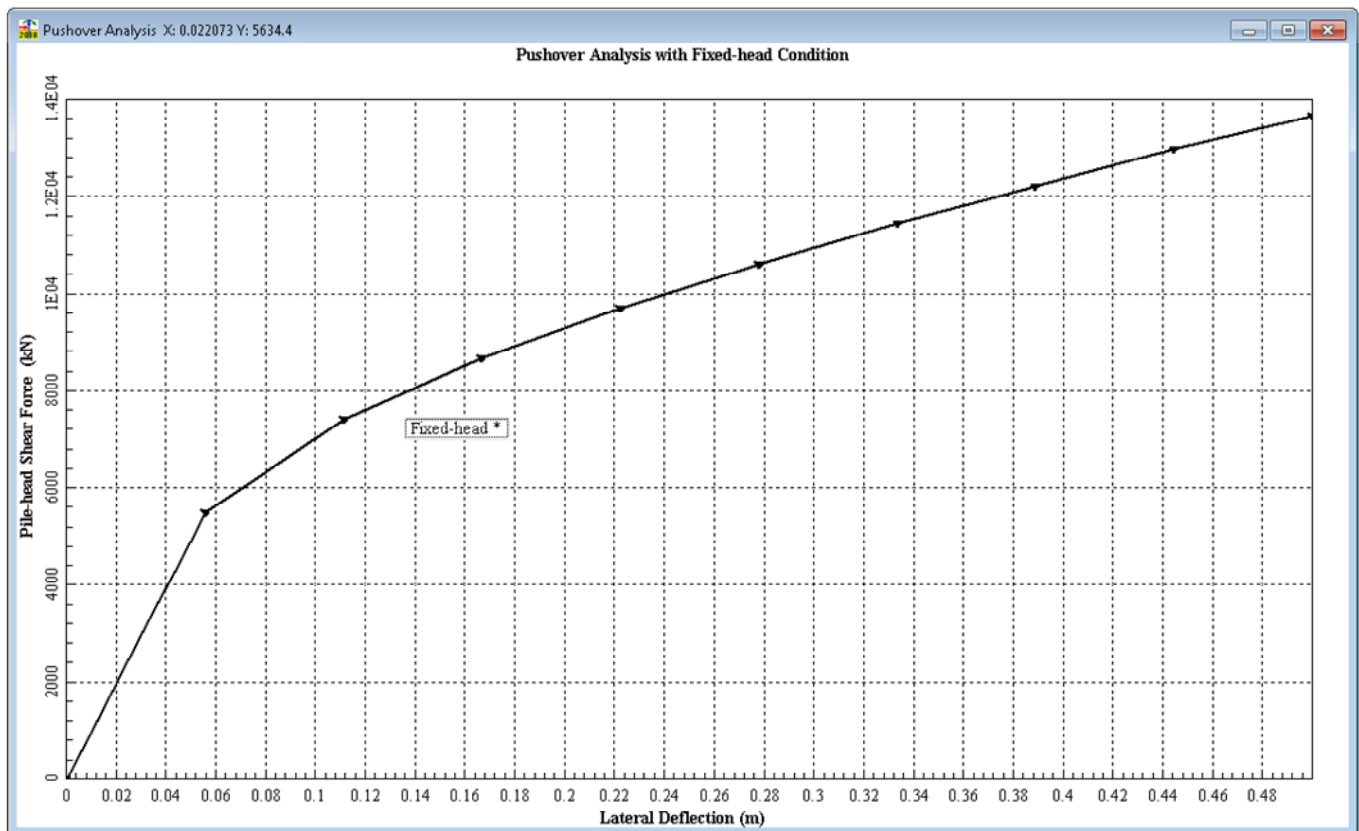
La platea di fondazione ha le seguenti dimensioni 16 m x 12 m x 2,5 m, con un ricoprimento minimo di 1 m; la platea presenta 12 pali.

Il dimensionamento a flessione e taglio del plinto di fondazione viene fatta a filo della pila, in modo da valutare le massime sollecitazioni, **Figura 10.1**.



Figura 10.1 Pianta del plinto

La platea di fondazione è stata modellata mediante il software SAP2000, con elementi shell.

APPALTATORE: Consorzio Soci   	ITINERARIO NAPOLI – BARI RADDOPPIO TRATTA APICE – ORSARA I LOTTO FUNZIONALE APICE – HIRPINIA																	
PROGETTAZIONE: Mandataria Mandanti   	<table border="1" style="width: 100%; border-collapse: collapse;"> <tr> <td style="width: 16.6%;">COMMESSA</td> <td style="width: 16.6%;">LOTTO</td> <td style="width: 16.6%;">CODIFICA</td> <td style="width: 16.6%;">DOCUMENTO</td> <td style="width: 16.6%;">REV.</td> <td style="width: 16.6%;">FOGLIO</td> </tr> <tr> <td style="text-align: center;">IF1N</td> <td style="text-align: center;">01 E ZZ</td> <td style="text-align: center;">RG</td> <td style="text-align: center;">MD0000 001</td> <td style="text-align: center;">B</td> <td style="text-align: center;">44 di 144</td> </tr> </table>						COMMESSA	LOTTO	CODIFICA	DOCUMENTO	REV.	FOGLIO	IF1N	01 E ZZ	RG	MD0000 001	B	44 di 144
COMMESSA	LOTTO	CODIFICA	DOCUMENTO	REV.	FOGLIO													
IF1N	01 E ZZ	RG	MD0000 001	B	44 di 144													
PROGETTO ESECUTIVO RELAZIONE DI CALCOLO FONDAZIONI PILE DA P7 A P16																		

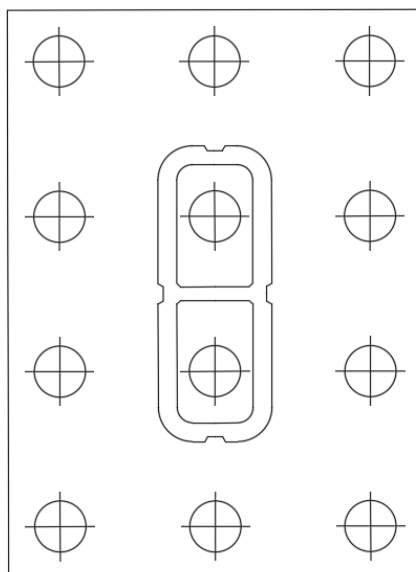

Figura 10.2 Modello numerico

A partire dalle azioni interne delle fondazioni profonde, definiti precedentemente, è stato possibile caricare la platea in esame, considerando il carico concentrato proveniente dalle differenti combinazioni per ogni palo nel proprio baricentro.

La platea è stata vincolata in corrispondenza del fusto pila attraverso dei vincoli traslazionali che non interrompono la continuità del momento, **Figura 10.3**.

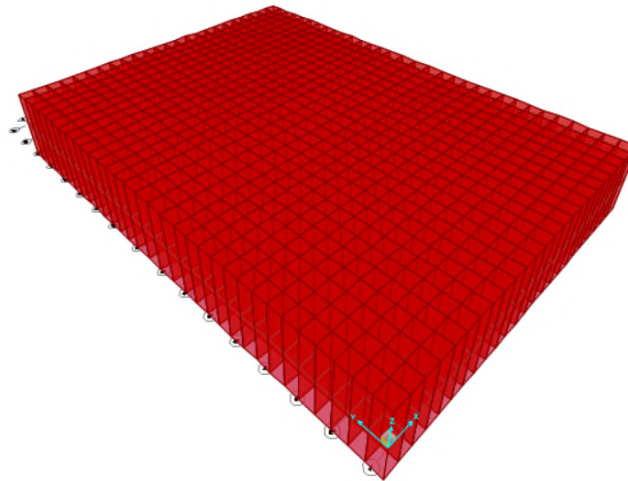

Figura 10.3 Modello numerico con le condizioni al contorno

APPALTATORE: Consorzio  Soci  	ITINERARIO NAPOLI – BARI					
PROGETTAZIONE: Mandataria  Mandanti  	RADDOPPIO TRATTA APICE – ORSARA I LOTTO FUNZIONALE APICE – HIRPINIA					
PROGETTO ESECUTIVO RELAZIONE DI CALCOLO FONDAZIONI PILE DA P7 A P16	COMMESSA IF1N	LOTTO 01 E ZZ	CODIFICA RG	DOCUMENTO MD0000 001	REV. B	FOGLIO 45 di 144

10.1.1 Combinazioni e carichi

Le combinazioni introdotte nel modello numerico ad elementi finiti sono caratterizzate da non avere coefficienti di amplificazione per i vari Stati Limite, in quanto gli scarichi dei pali considerano già tale amplificazione.

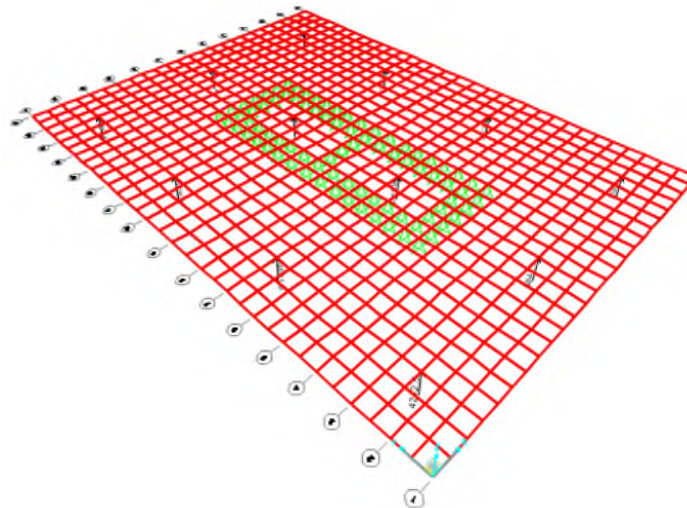
Sono state considerate:

- 10 Combinazioni SLV, stato limite di salvaguardia della vita;
- 6 Combinazioni SLU, stato limite ultimo;
- 4 Combinazioni SLE-R, stato limite di esercizio caratteristico.

Gli scarichi sui pali sono stati quelli determinati attraverso il software Group come definito al paragrafo 7.1.

Ai carichi sopra citati, viene aggiunto il carico distribuito dato dal terreno di ricoprimento minimo, considerando tale carico permanente non strutturale.

Di seguito sono esplicitati i carichi provenienti dai pali:

Point load	Combination	F [kN]	Point load	Combination	F [kN]
Palo1	Pali SLE1	3190,3	Palo1	Pali SLE3	3147,5
Palo2	Pali SLE1	3782,9	Palo2	Pali SLE3	3537,3
Palo3	Pali SLE1	4375,4	Palo3	Pali SLE3	3927
Palo4	Pali SLE1	2794	Palo4	Pali SLE3	2751,4
Palo5	Pali SLE1	3386,6	Palo5	Pali SLE3	3141,1
Palo6	Pali SLE1	3979,1	Palo6	Pali SLE3	3530,9
Palo7	Pali SLE1	2397,7	Palo7	Pali SLE3	2355,3
Palo8	Pali SLE1	2990,3	Palo8	Pali SLE3	2745
Palo9	Pali SLE1	3582,8	Palo9	Pali SLE3	3134,8
Palo10	Pali SLE1	2001,4	Palo10	Pali SLE3	1959,1
Palo11	Pali SLE1	2594	Palo11	Pali SLE3	2348,9
Palo12	Pali SLE1	3186,5	Palo12	Pali SLE3	2738,7
Palo1	Pali SLE2	2966,9	Palo1	Pali SLE4	2088,1
Palo2	Pali SLE2	3051,6	Palo2	Pali SLE4	3387,5
Palo3	Pali SLE2	3136,3	Palo3	Pali SLE4	4686,9
Palo4	Pali SLE2	2656,9	Palo4	Pali SLE4	1822,6
Palo5	Pali SLE2	2741,6	Palo5	Pali SLE4	3123,9
Palo6	Pali SLE2	2826,3	Palo6	Pali SLE4	4423,4
Palo7	Pali SLE2	2346,9	Palo7	Pali SLE4	1536,7
Palo8	Pali SLE2	2431,6	Palo8	Pali SLE4	2860,3
Palo9	Pali SLE2	2516,3	Palo9	Pali SLE4	4159,8
Palo10	Pali SLE2	2036,9	Palo10	Pali SLE4	1250,8
Palo11	Pali SLE2	2121,6	Palo11	Pali SLE4	2596,7
Palo12	Pali SLE2	2206,2	Palo12	Pali SLE4	3896,2

APPALTATORE: Consorzio  Soci  		ITINERARIO NAPOLI – BARI RADDOPPIO TRATTA APICE – ORSARA I LOTTO FUNZIONALE APICE – HIRPINIA					
PROGETTAZIONE: Mandataria  Mandanti  							
PROGETTO ESECUTIVO RELAZIONE DI CALCOLO FONDAZIONI PILE DA P7 A P16		COMMESSA IF1N	LOTTO 01 E ZZ	CODIFICA RG	DOCUMENTO MD0000 001	REV. B	FOGLIO 46 di 144

SLU					
Point load	Combination	F [kN]	Point load	Combination	F [kN]
Palo1	Pali SLU1	5348,7	Palo1	Pali SLU4	2424,7
Palo2	Pali SLU1	3455,1	Palo2	Pali SLU4	2297,7
Palo3	Pali SLU1	1537,4	Palo3	Pali SLU4	2170,7
Palo4	Pali SLU1	5746,1	Palo4	Pali SLU4	2889,6
Palo5	Pali SLU1	3852,5	Palo5	Pali SLU4	2762,6
Palo6	Pali SLU1	1958,9	Palo6	Pali SLU4	2635,6
Palo7	Pali SLU1	6143,4	Palo7	Pali SLU4	3354,4
Palo8	Pali SLU1	4249,9	Palo8	Pali SLU4	3227,4
Palo9	Pali SLU1	2356,3	Palo9	Pali SLU4	3100,4
Palo10	Pali SLU1	6540,8	Palo10	Pali SLU4	3819,3
Palo11	Pali SLU1	4647,2	Palo11	Pali SLU4	3692,3
Palo12	Pali SLU1	2753,7	Palo12	Pali SLU4	3565,3
Palo1	Pali SLU2	4126	Palo1	Pali SLU5	3679
Palo2	Pali SLU2	3466,8	Palo2	Pali SLU5	3111,6
Palo3	Pali SLU2	2807,6	Palo3	Pali SLU5	2544,1
Palo4	Pali SLU2	4709,9	Palo4	Pali SLU5	4262,5
Palo5	Pali SLU2	4050,7	Palo5	Pali SLU5	3695,1
Palo6	Pali SLU2	3391,4	Palo6	Pali SLU5	3127,6
Palo7	Pali SLU2	5293,7	Palo7	Pali SLU5	4846
Palo8	Pali SLU2	4634,5	Palo8	Pali SLU5	4278,6
Palo9	Pali SLU2	3975,3	Palo9	Pali SLU5	3711,1
Palo10	Pali SLU2	5877,6	Palo10	Pali SLU5	5429,5
Palo11	Pali SLU2	5218,4	Palo11	Pali SLU5	4862,1
Palo12	Pali SLU2	4559,2	Palo12	Pali SLU5	4294,7
Palo1	Pali SLU3	4330,2	Palo1	Pali SLU6	5348,7
Palo2	Pali SLU3	3466,9	Palo2	Pali SLU6	3455,1
Palo3	Pali SLU3	2603,5	Palo3	Pali SLU6	1537,4
Palo4	Pali SLU3	4914	Palo4	Pali SLU6	5746,1
Palo5	Pali SLU3	4050,7	Palo5	Pali SLU6	3852,5
Palo6	Pali SLU3	3187,3	Palo6	Pali SLU6	1958,9
Palo7	Pali SLU3	5497,9	Palo7	Pali SLU6	6143,4
Palo8	Pali SLU3	4634,5	Palo8	Pali SLU6	4249,9
Palo9	Pali SLU3	3771,1	Palo9	Pali SLU6	2356,3
Palo10	Pali SLU3	6081,7	Palo10	Pali SLU6	6540,8
Palo11	Pali SLU3	5218,3	Palo11	Pali SLU6	4647,2
Palo12	Pali SLU3	4354,9	Palo12	Pali SLU6	2753,7

APPALTATORE: Consorzio Soci   			ITINERARIO NAPOLI – BARI					
PROGETTAZIONE: Mandataria Mandanti   			RADDOPPIO TRATTA APICE – ORSARA I LOTTO FUNZIONALE APICE – HIRPINIA					
PROGETTO ESECUTIVO RELAZIONE DI CALCOLO FONDAZIONI PILE DA P7 A P16			COMMESSA IF1N	LOTTO 01 E ZZ	CODIFICA RG	DOCUMENTO MD0000 001	REV. B	FOGLIO 47 di 144

SLV					
Point load	Combination	F [kN]	Point load	Combination	F [kN]
Palo1	Pali SLV1	7027,9	Palo1	Pali SLV6	1710,8
Palo2	Pali SLV1	1021,8	Palo2	Pali SLV6	-95,618
Palo3	Pali SLV1	-5100	Palo3	Pali SLV6	-1863,3
Palo4	Pali SLV1	8000,1	Palo4	Pali SLV6	2627,5
Palo5	Pali SLV1	2058,3	Palo5	Pali SLV6	885,9
Palo6	Pali SLV1	-4129,9	Palo6	Pali SLV6	-908,72
Palo7	Pali SLV1	8769,5	Palo7	Pali SLV6	3533,6
Palo8	Pali SLV1	3030,5	Palo8	Pali SLV6	1867
Palo9	Pali SLV1	-3159,9	Palo9	Pali SLV6	60,96
Palo10	Pali SLV1	9416	Palo10	Pali SLV6	4439,8
Palo11	Pali SLV1	4002,6	Palo11	Pali SLV6	2773,1
Palo12	Pali SLV1	-2189,9	Palo12	Pali SLV6	1043,9
Palo1	Pali SLV2	-1185,4	Palo1	Pali SLV7	7475,3
Palo2	Pali SLV2	4816,3	Palo2	Pali SLV7	9368,9
Palo3	Pali SLV2	9850	Palo3	Pali SLV7	10964
Palo4	Pali SLV2	-2245	Palo4	Pali SLV7	3138,6
Palo5	Pali SLV2	3786,5	Palo5	Pali SLV7	5536,9
Palo6	Pali SLV2	9165,2	Palo6	Pali SLV7	7935,2
Palo7	Pali SLV2	-3272,6	Palo7	Pali SLV7	-1435,1
Palo8	Pali SLV2	2756,6	Palo8	Pali SLV7	1145,5
Palo9	Pali SLV2	8480,3	Palo9	Pali SLV7	3598,5
Palo10	Pali SLV2	-4300,2	Palo10	Pali SLV7	-5777,7
Palo11	Pali SLV2	1716,6	Palo11	Pali SLV7	-3384,6
Palo12	Pali SLV2	7507,5	Palo12	Pali SLV7	-943,41
Palo1	Pali SLV3	-417,8	Palo1	Pali SLV8	-1731,2
Palo2	Pali SLV3	-2342,1	Palo2	Pali SLV8	-4192,2
Palo3	Pali SLV3	-4183,1	Palo3	Pali SLV8	-6653,2
Palo4	Pali SLV3	2836,7	Palo4	Pali SLV8	2748,1
Palo5	Pali SLV3	919,21	Palo5	Pali SLV8	149,18
Palo6	Pali SLV3	-1066,7	Palo6	Pali SLV8	-2434,8
Palo7	Pali SLV3	5920	Palo7	Pali SLV8	6975,6
Palo8	Pali SLV3	4074,9	Palo8	Pali SLV8	4509,2
Palo9	Pali SLV3	2229,8	Palo9	Pali SLV8	2042,9
Palo10	Pali SLV3	8790,1	Palo10	Pali SLV8	10253
Palo11	Pali SLV3	7158,1	Palo11	Pali SLV8	8612,9
Palo12	Pali SLV3	5313	Palo12	Pali SLV8	6270,4
Palo1	Pali SLV4	6183,7	Palo1	Pali SLV9	7027,9
Palo2	Pali SLV4	7895,5	Palo2	Pali SLV9	1021,8
Palo3	Pali SLV4	9191,9	Palo3	Pali SLV9	-5100
Palo4	Pali SLV4	3048,3	Palo4	Pali SLV9	8000,1

APPALTATORE: Consorzio Soci 			ITINERARIO NAPOLI – BARI					
PROGETTAZIONE: Mandataria Mandanti 			RADDOPPIO TRATTA APICE – ORSARA I LOTTO FUNZIONALE APICE – HIRPINIA					
PROGETTO ESECUTIVO RELAZIONE DI CALCOLO FONDAZIONI PILE DA P7 A P16			COMMESSA IF1N	LOTTO 01 E ZZ	CODIFICA RG	DOCUMENTO MD0000 001	REV. B	FOGLIO 48 di 144

Palo5	Pali SLV4	4760,2	Palo5	Pali SLV9	2058,3
Palo6	Pali SLV4	6472	Palo6	Pali SLV9	-4129,9
Palo7	Pali SLV4	-247,28	Palo7	Pali SLV9	8769,5
Palo8	Pali SLV4	1606	Palo8	Pali SLV9	3030,5
Palo9	Pali SLV4	3336,6	Palo9	Pali SLV9	-3159,9
Palo10	Pali SLV4	-3470,4	Palo10	Pali SLV9	9416
Palo11	Pali SLV4	-1762,3	Palo11	Pali SLV9	4002,6
Palo12	Pali SLV4	61,828	Palo12	Pali SLV9	-2189,9
Palo1	Pali SLV5	3763,5	Palo1	Pali SLV10	-1185,4
Palo2	Pali SLV5	5475,2	Palo2	Pali SLV10	4816,3
Palo3	Pali SLV5	7186,9	Palo3	Pali SLV10	9850
Palo4	Pali SLV5	2822,6	Palo4	Pali SLV10	-2245
Palo5	Pali SLV5	4534,3	Palo5	Pali SLV10	3786,5
Palo6	Pali SLV5	6246	Palo6	Pali SLV10	9165,2
Palo7	Pali SLV5	1881,8	Palo7	Pali SLV10	-3272,6
Palo8	Pali SLV5	3593,5	Palo8	Pali SLV10	2756,6
Palo9	Pali SLV5	5305,2	Palo9	Pali SLV10	8480,3
Palo10	Pali SLV5	864,18	Palo10	Pali SLV10	-4300,2
Palo11	Pali SLV5	2652,6	Palo11	Pali SLV10	1716,6
Palo12	Pali SLV5	4364,3	Palo12	Pali SLV10	7507,5

10.2 SOLLECITAZIONI

10.2.1 Sollecitazioni SLV



Figura 10.4 M11 max SLV



Figura 10.5 M11 min SLV

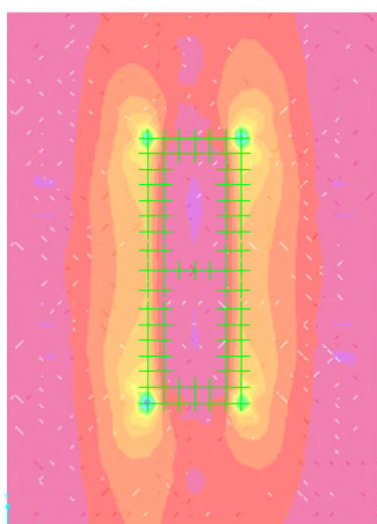

APPALTATORE:

Consorzio

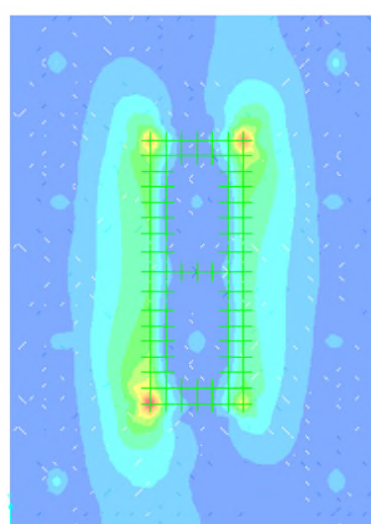
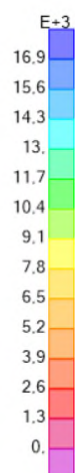
Soci



PROGETTAZIONE:

Mandataria

Mandanti



ITINERARIO NAPOLI – BARI

RADDOPPIO TRATTA APICE – ORSARA I LOTTO FUNZIONALE APICE – HIRPINIA

PROGETTO ESECUTIVO

RELAZIONE DI CALCOLO FONDAZIONI PILE DA P7 A P16

COMMESSA
IF1N

LOTTO
01 E ZZ

CODIFICA
RG

DOCUMENTO
MD0000 001

REV.
B

FOGLIO
49 di 144



Figura 10.6 M22 max SLV



Figura 10.7 M22 min SLV

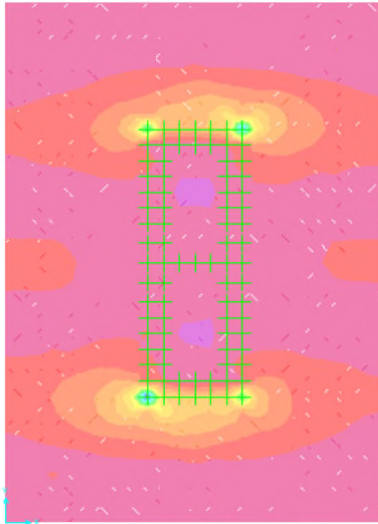

Figura 10.8 M12 max SLV

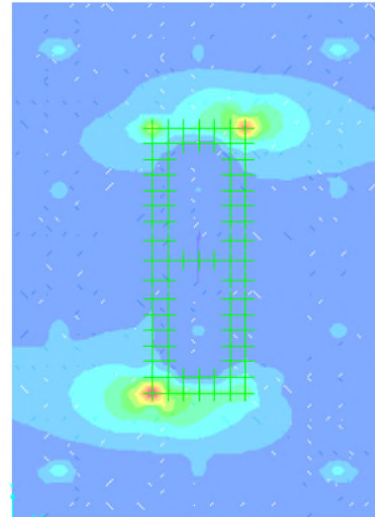

Figura 10.9 M12 min SLV

APPALTATORE:

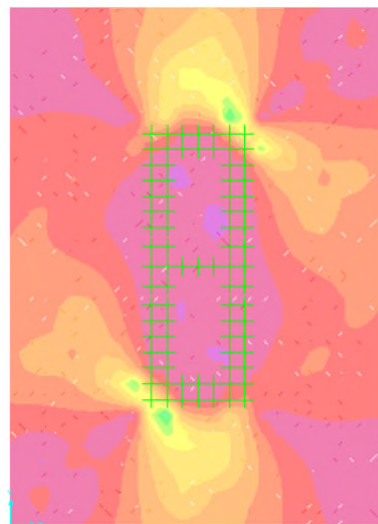
Consorzio

Soci

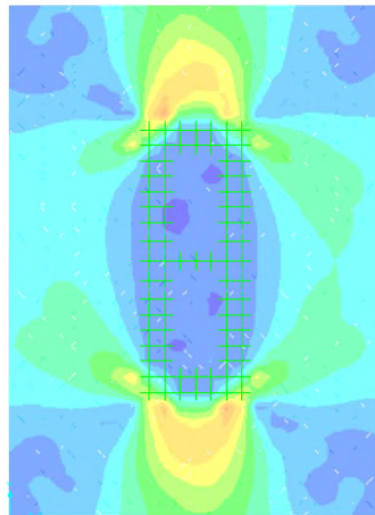

PROGETTAZIONE:

Mandataria

Mandanti



ITINERARIO NAPOLI – BARI

RADDOPPIO TRATTA APICE – ORSARA I LOTTO FUNZIONALE APICE – HIRPINIA

PROGETTO ESECUTIVO

RELAZIONE DI CALCOLO FONDAZIONI PILE DA P7 A P16

COMMESSA
IF1N

LOTTO
01 E ZZ

CODIFICA
RG

DOCUMENTO
MD0000 001

REV.
B

FOGLIO
50 di 144



Figura 10.10 V13 max SLV



Figura 10.11 V13 min SLV

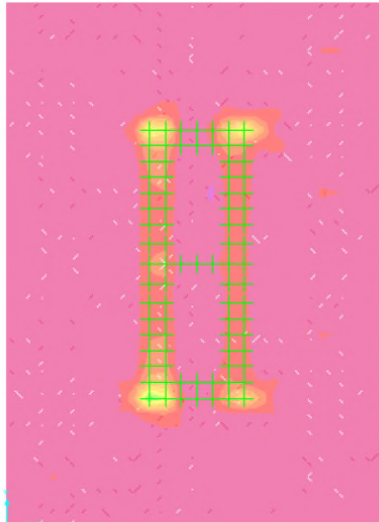

Figura 10.12 V23 max SLV

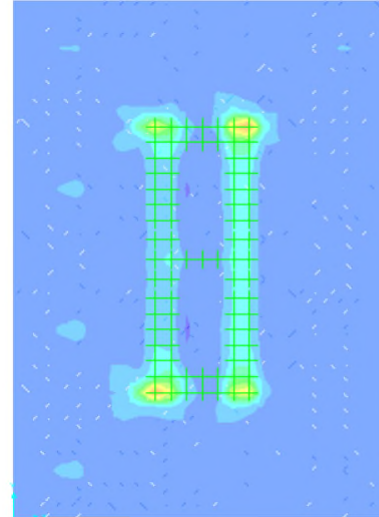

Figura 10.13 V23 min SLV

APPALTATORE: Consorzio Soci 		ITINERARIO NAPOLI – BARI RADDOPPIO TRATTA APICE – ORSARA I LOTTO FUNZIONALE APICE – HIRPINIA											
PROGETTAZIONE: Mandataria Mandanti 		COMMESSA IF1N		LOTTO 01 E ZZ		CODIFICA RG		DOCUMENTO MD0000 001		REV. B		FOGLIO 51 di 144	
PROGETTO ESECUTIVO RELAZIONE DI CALCOLO FONDAZIONI PILE DA P7 A P16													

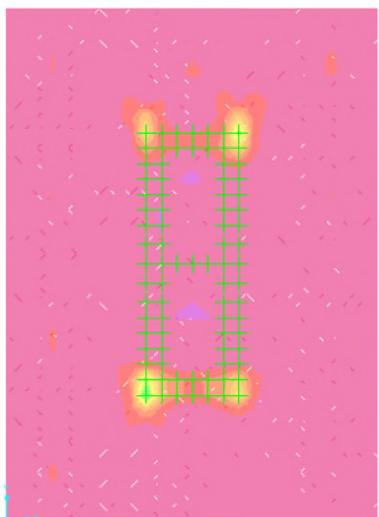
10.2.2 Sollecitazioni SLU

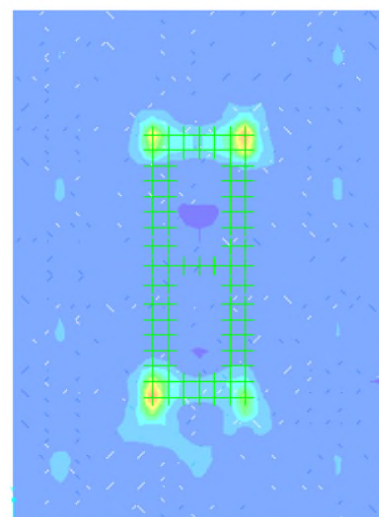

Figura 10.14 M11 max SLU



Figura 10.15 M11 min SLU

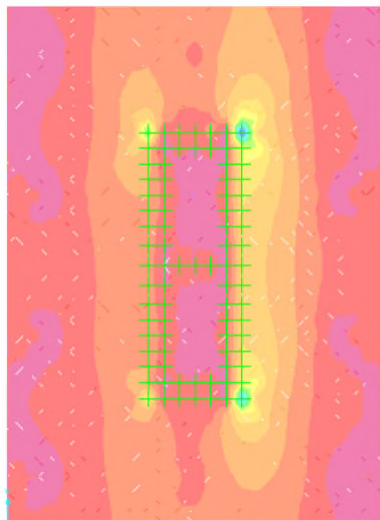

Figura 10.16 M22 max SLU

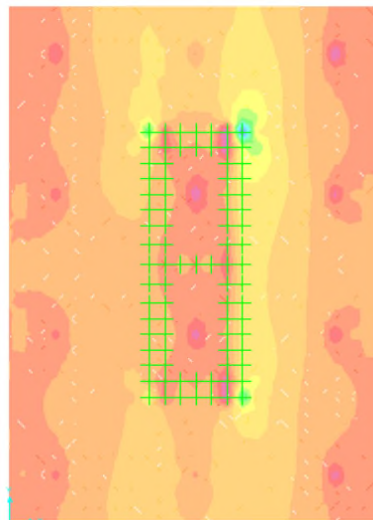

Figura 10.17 M22 min SLU

APPALTATORE:

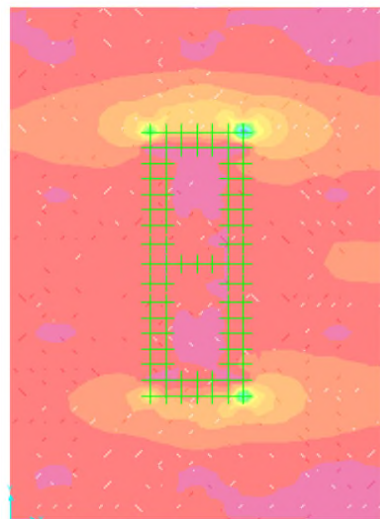
Consorzio

Soci

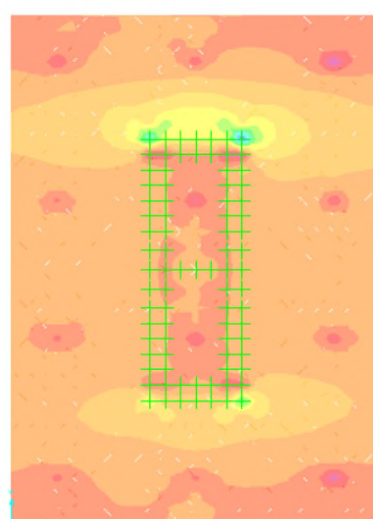

PROGETTAZIONE:

Mandataria

Mandanti



ITINERARIO NAPOLI – BARI

RADDOPPIO TRATTA APICE – ORSARA I LOTTO FUNZIONALE APICE – HIRPINIA

PROGETTO ESECUTIVO

RELAZIONE DI CALCOLO FONDAZIONI PILE DA P7 A P16

COMMESSA
IF1N

LOTTO
01 E ZZ

CODIFICA
RG

DOCUMENTO
MD0000 001

REV.
B

FOGLIO
52 di 144



Figura 10.18 M12 max SLU



Figura 10.19 M12 min SLU

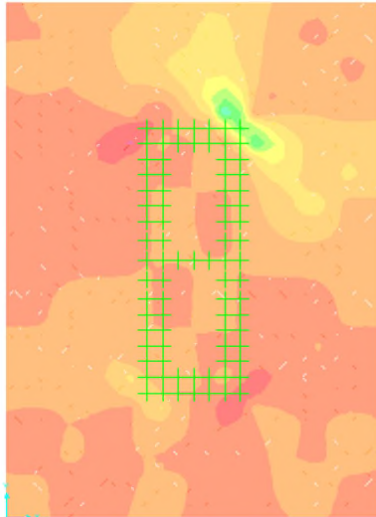

Figura 10.20 V13 max SLU

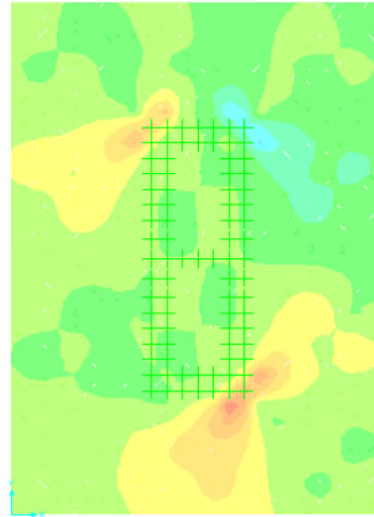

Figura 10.21 V13 min SLU

APPALTATORE:

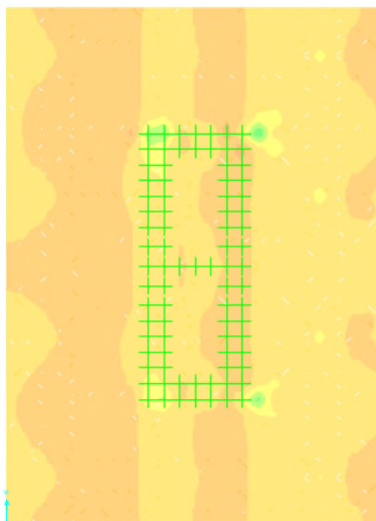
Consorzio

Soci

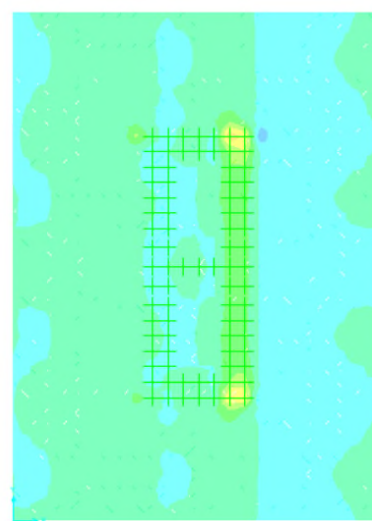

PROGETTAZIONE:

Mandataria

Mandanti



ITINERARIO NAPOLI – BARI

RADDOPPIO TRATTA APICE – ORSARA
I LOTTO FUNZIONALE APICE – HIRPINIA

PROGETTO ESECUTIVO

RELAZIONE DI CALCOLO FONDAZIONI PILE DA P7 A P16

COMMESSA
IF1N

LOTTO
01 E ZZ

CODIFICA
RG

DOCUMENTO
MD0000 001

REV.
B

FOGLIO
53 di 144



Figura 10.22 V23 max SLU



Figura 10.23 V23 min SLU

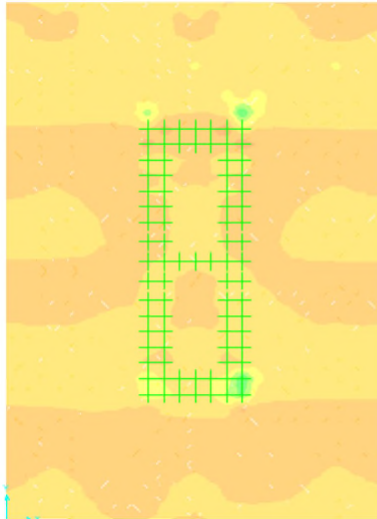

10.2.3 Sollecitazioni SLE

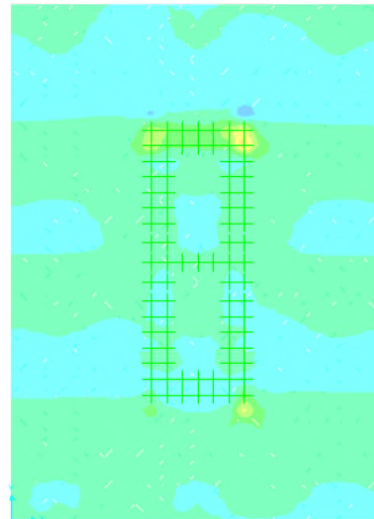
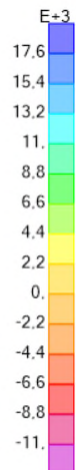
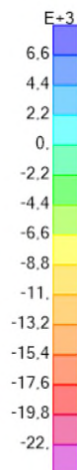

Figura 10.24 M11 max SLE



Figura 10.25 M11 min SLE

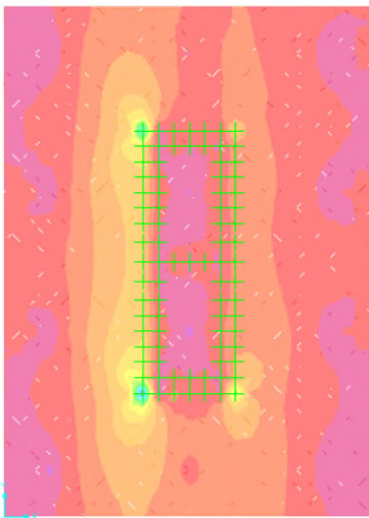

APPALTATORE: Consorzio Soci 		ITINERARIO NAPOLI – BARI RADDOPPIO TRATTA APICE – ORSARA I LOTTO FUNZIONALE APICE – HIRPINIA						
PROGETTAZIONE: Mandataria Mandanti 		COMMESSA IF1N		LOTTO 01 E ZZ	CODIFICA RG	DOCUMENTO MD0000 001	REV. B	FOGLIO 54 di 144
PROGETTO ESECUTIVO RELAZIONE DI CALCOLO FONDAZIONI PILE DA P7 A P16								

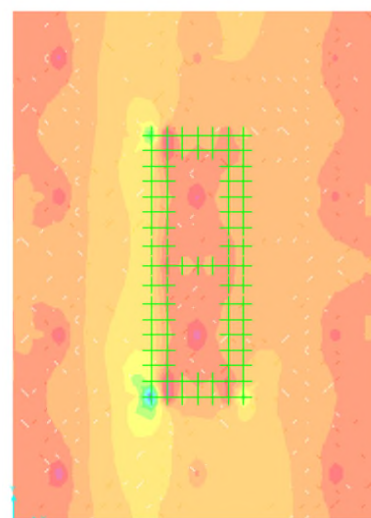
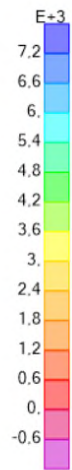

Figura 10.26 M22 max SLE



Figura 10.27 M22 min SLE

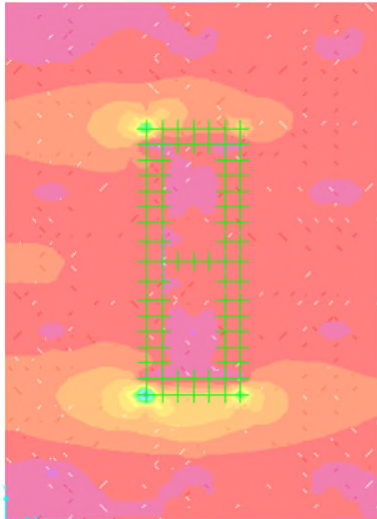

Figura 10.28 M12 max SLE

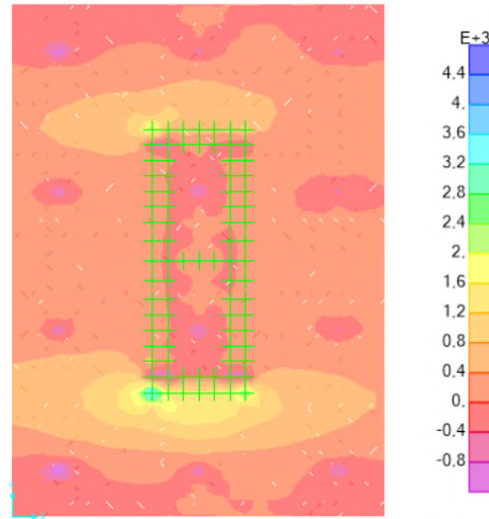

Figura 10.29 M12 min SLE

10.3 VERIFICHE SLU/SLE

10.3.1 Sollecitazioni di verifica

A partire dallo stato di sollecitazione determinato attraverso il software, sono state definite section-cut di 1m sul filo della pila nelle due direzioni.

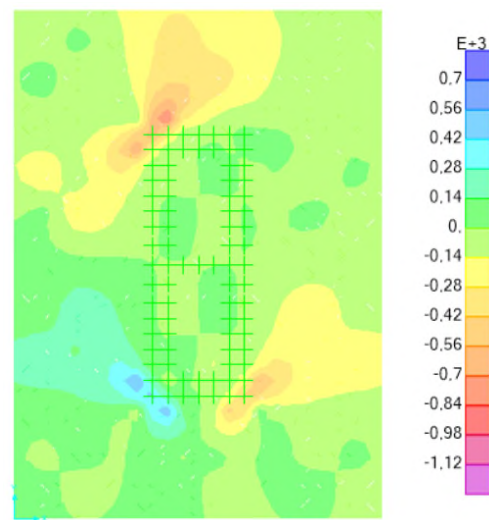
La definizione delle section-cut permette attraverso il post-processing definire la sollecitazione media su un metro di piastra, ciò al fine di by-passare la concentrazione delle azioni su porzioni infinitesime di piastra, che sono dovuti alla schematizzazione dei vincoli come puntuali.

Quindi le azioni interne sono definite secondo sezioni come indicato nelle seguenti immagini:

APPALTATORE: Consorzio Soci 	ITINERARIO NAPOLI – BARI RADDOPPIO TRATTA APICE – ORSARA I LOTTO FUNZIONALE APICE – HIRPINIA
PROGETTAZIONE: Mandataria Mandanti 	
PROGETTO ESECUTIVO RELAZIONE DI CALCOLO FONDAZIONI PILE DA P7 A P16	COMMESSA LOTTO CODIFICA DOCUMENTO REV. FOGLIO IF1N 01 E ZZ RG MD0000 001 B 55 di 144



Figura 10.30 Definizione delle Section-cut

A partire dalle azioni così definite è possibile involuppare geometricamente secondo i due assi di simmetria del plinto di fondazione in modo da garantire la copertura massima delle azioni sollecitanti, in aggiunta ad uno schema d'armatura doppiamente simmetrico.

Di seguito sono riportati i vari involuppi geometrici:

Longitudinale	Trasversale
Max (L1, L16, L17, L32)	Max (T1, T12, T13, T24)
Max (L2, L15, L18, L31)	Max (T2, T11, T14, T23)
Max (L3, L14, L19, L30)	Max (T3, T10, T15, T22)
Max (L4, L13, L20, L29)	Max (T4, T9, T16, T21)
Max (L5, L12, L21, L28)	Max (T5, T8, T17, T20)
Max (L6, L11, L22, L27)	Max (T6, T7, T18, T19)
Max (L7, L10, L23, L26)	
Max (L8, L9, L24, L25)	

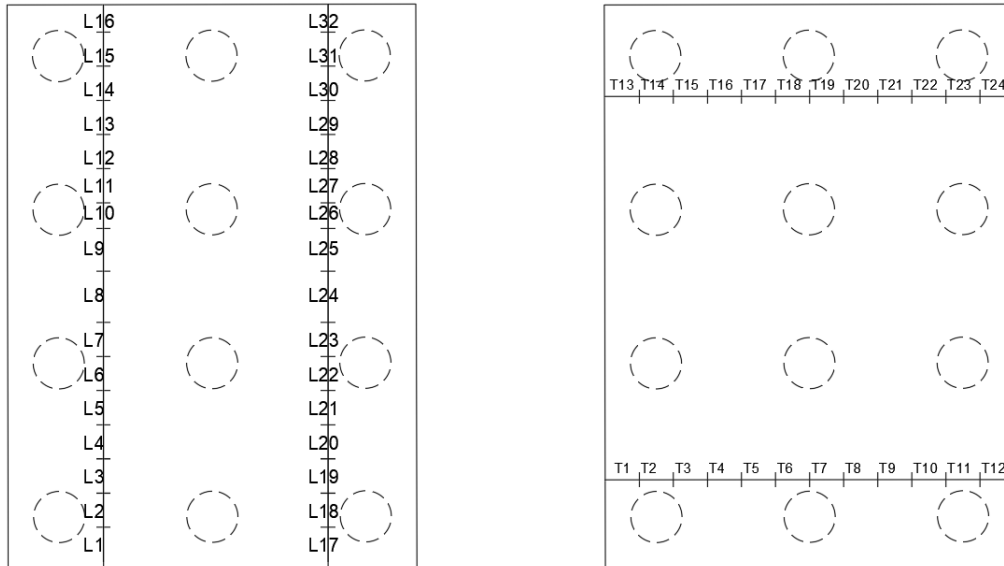
Il momento torcente è stato sommato in modulo a fine di massimizzare l'effetto della flessione.

APPALTATORE: Consorzio  Soci  		ITINERARIO NAPOLI – BARI RADDOPPIO TRATTA APICE – ORSARA I LOTTO FUNZIONALE APICE – HIRPINIA					
PROGETTAZIONE: Mandataria  Mandanti  							
PROGETTO ESECUTIVO RELAZIONE DI CALCOLO FONDAZIONI PILE DA P7 A P16		COMMESSA IF1N	LOTTO 01 E ZZ	CODIFICA RG	DOCUMENTO MD0000 001	REV. B	FOGLIO 56 di 144

Di seguito sono riportate le sollecitazioni ai vari stati limite.

	EnvSLV	M		V		
		min	max	min	max	
	Longitudinale	1	-5106,11	3917,058	-685,212	
	2	-5735,91	4516,052	-838,077	618,885	max(L2,L15,L18,L31)
	3	-6999,33	5456,896	-1767,06	1314,489	max(L3,L14,L19,L30)
	4	-7174,91	5610,765	-6733,37	7596,964	max(L4,L13,L20,L29)
	5	-14085,1	10295,53	-4746,77	6255,89	max(L5,L12,L21,L28)
	6	-7832,14	5364,652	-1994,88	1472,339	max(L6,L11,L22,L27)
	7	-6208,18	4148,531	-1439,38	1218,974	max(L7,L10,L23,L26)
	8	-6872,4	4573,479	-1695,38	1508,522	max(L8,L9,L24,L25)

	EnvSLV	M		V		
		min	max	min	max	
	Trasversale	1	-2536,52	3397,085	-839,042	
	2	-3004,47	3988,571	-882,763	657,454	max(T2,T11,T14,T23)
	3	-3785,71	5013,96	-1327,97	990,205	max(T3,T10,T15,T22)
	4	-5689,69	6647,795	-3690,19	2805,183	max(T4,T9,T16,T21)
	5	-7584,56	10394,28	-6210,76	7275,75	max(T5,T8,T17,T20)
	6	-8280,5	10803,77	-3594	2818,959	max(T6,T7,T18,T19)

	EnvSLU	M		V		
		min	max	min	max	
	Longitudinale	1	-2423,47	-972,642	-374,678	
	2	-2680,4	-1006,18	-448,651	179,801	max(L2,L15,L18,L31)
	3	-3151,28	-1037,44	-976,739	155,524	max(L3,L14,L19,L30)
	4	-4310,85	-846,838	-2497,61	3152,72	max(L4,L13,L20,L29)
	5	-6583,58	-865,785	-2780,84	1925,303	max(L5,L12,L21,L28)
	6	-4628,15	-400,62	-1149,94	91,439	max(L6,L11,L22,L27)
	7	-3639,02	-356,052	-827,645	195,688	max(L7,L10,L23,L26)
	8	-3919,61	-489,454	-1017,07	372,991	max(L8,L19,L24,L25)

	EnvSLU	M		V		
		min	max	min	max	
	Trasversale	1	-1126,81	1734,412	-403,996	
	2	-1351,43	2011,501	-432,516	189,21	max(T2,T11,T14,T23)
	3	-1733,24	2550,433	-647,595	228,799	max(T3,T10,T15,T22)
	4	-2465,96	3479,972	-1673,7	795,794	max(T4,T9,T16,T21)
	5	-3252,22	5868,65	-1795,98	7893,159	max(T5,T8,T17,T20)
	6	-2589,21	4006,018	-1160,34	-210,085	max(T6,T7,T18,T19)

APPALTATORE: Consorzio  Soci  		ITINERARIO NAPOLI – BARI RADDOPPIO TRATTA APICE – ORSARA I LOTTO FUNZIONALE APICE – HIRPINIA					
PROGETTAZIONE: Mandataria  Mandanti  							
PROGETTO ESECUTIVO RELAZIONE DI CALCOLO FONDAZIONI PILE DA P7 A P16		COMMESSA IF1N	LOTTO 01 E ZZ	CODIFICA RG	DOCUMENTO MD0000 001	REV. B	FOGLIO 57 di 144

	EnvSLE	M		
		min	max	
	Longitudinale	1	-1761,23	
	2	-2002,09	-647,707	max(L2,L15,L18,L31)
	3	-2568,25	-571,491	max(L3,L14,L19,L30)
	4	-2915,13	-306,176	max(L4,L13,L20,L29)
	5	-5286,41	-273,169	max(L5,L12,L21,L28)
	6	-2680,17	-169,355	max(L6,L11,L22,L27)
	7	-2221,58	-165,835	max(L7,L10,L23,L26)
	8	-2479,84	-253,239	max(L8,L19,L24,L25)

	EnvSLE	M		
		min	max	
	Trasversale	1	-727,185	
	2	-850,702	1251,762	max(T2,T11,T14,T23)
	3	-1074,59	1522,167	max(T3,T10,T15,T22)
	4	-2023,18	1568,545	max(T4,T9,T16,T21)
	5	-2219,44	3288,761	max(T5,T8,T17,T20)
	6	-1897,62	3472,012	max(T6,T7,T18,T19)

Inviluppando SLU ed SLV, per le verifiche agli stati limite ultimi si ottiene:

	EnvSLV/SLU	M		V		
		min	max	min	max	
	Longitudinale	1	-5106,11	3917,058	-685,212	
	2	-5735,91	4516,052	-838,077	618,885	max(L2,L15,L18,L31)
	3	-6999,33	5456,896	-1767,06	1314,489	max(L3,L14,L19,L30)
	4	-7174,91	5610,765	-6733,37	7596,964	max(L4,L13,L20,L29)
	5	-14085,1	10295,53	-4746,77	6255,89	max(L5,L12,L21,L28)
	6	-7832,14	5364,652	-1994,88	1472,339	max(L6,L11,L22,L27)
	7	-6208,18	4148,531	-1439,38	1218,974	max(L7,L10,L23,L26)
	8	-6872,4	4573,479	-1695,38	1508,522	max(L8,L19,L24,L25)

	EnvSLV/SLU	M		V		
		min	max	min	max	
	Trasversale	1	-2536,52	3397,085	-839,042	
	2	-3004,47	3988,571	-882,763	657,454	max(T2,T11,T14,T23)
	3	-3785,71	5013,96	-1327,97	990,205	max(T3,T10,T15,T22)
	4	-5689,69	6647,795	-3690,19	2805,183	max(T4,T9,T16,T21)
	5	-7584,56	10394,28	-6210,76	7275,75	max(T5,T8,T17,T20)
	6	-8280,5	10803,77	-3594	2818,959	max(T6,T7,T18,T19)

APPALTATORE: Consorzio HirpiniaAV Soci salini impregilo ASTALDI	ITINERARIO NAPOLI – BARI RADDOPPIO TRATTA APICE – ORSARA I LOTTO FUNZIONALE APICE – HIRPINIA
PROGETTAZIONE: Mandataria ROKSOJL Mandanti NETENGINEERING Alpina	
PROGETTO ESECUTIVO RELAZIONE DI CALCOLO FONDAZIONI PILE DA P7 A P16	
COMMESSA IF1N LOTTO 01 E ZZ CODIFICA RG DOCUMENTO MD0000 001 REV. B FOGLIO 58 di 144	

10.3.2 Verifiche a flessione e taglio

I criteri di verifica per gli stati limite ultimi e per gli stati limite di esercizio (fessurazione e limiti tensionali) sono stati esplicitati in precedenza.

Caratteristiche materiali e parametri di verifica sono sintetizzati di seguito:

materiali			
calcestruzzo		acciaio	
R _{ck}	35 [MPa]	f _{yk}	450 [MPa]
f _{ck}	29,1 [MPa]	γ _s	1,15
γ _c	1,5	f _{yd}	391,3 [MPa]
α _{cc}	0,85	E _s	210000 [MPa]
f _{cd}	16,5 [MPa]	ε _{uk}	75 [%]
ν	0,530		
ε _{c2}	2,0 [%]		
ε _{cu2}	3,5 [%]		
α _e	15,0		
k _t	0,4		
		valori limite	
k ₁	0,8	0,45 f _{ck}	13,1 [MPa]
k ₃	3,4	0,8 f _{yk}	360,0 [MPa]
k ₄	0,425	w _{k,lim}	0,2 [mm]

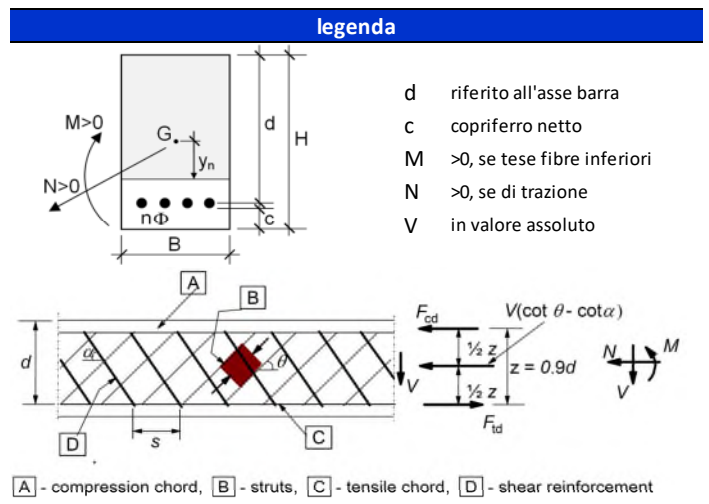

L'armatura base è composta da una maglia di $\phi 32$ con passo 15cm, la quale viene aggiunto un raffittimento nelle zone maggiormente sollecitate, a passo 30cm. L'armatura in direzione trasversale è posta sopra la longitudinale motivo per cui nelle seguenti verifiche si ha un copriferro maggiore nelle armature trasversali. Si considera che gli spilli non siano legati alle barre più interne, motivo per cui non sono considerate nel calcolo del copriferro.

A favore di sicurezza nelle seguenti verifiche si considera solo lo strato più esterno di armatura compressa.

APPALTATORE: Consorzio HirpiniaAV Soci salini impregilo ASTALDI	ITINERARIO NAPOLI – BARI RADDOPPIO TRATTA APICE – ORSARA I LOTTO FUNZIONALE APICE – HIRPINIA					
PROGETTAZIONE: Mandataria SOJL Mandanti NETENGINEERING Alpina						
PROGETTO ESECUTIVO RELAZIONE DI CALCOLO FONDAZIONI PILE DA P7 A P16	COMMESSA IF1N	LOTTO 01 E ZZ	CODIFICA RG	DOCUMENTO MD0000 001	REV. B	FOGLIO 59 di 144

Sezione 1 longitudinale:

- *verifica armature inferiori:*

geometria				
sezione trasversale				
B	H	c	d	z
[cm]	[cm]	[cm]	[cm]	[cm]
100	250	5,0	243,4	219,1
armatura longitudinale				
nbarre	φ	d	Asl	
	[mm]	[cm]	[cm ²]	
6,66667	32	6,6	53,62	
10	32	243,4	80,42	
armatura a taglio				
nbracci	φ	s	α	Asw
	[mm]	[cm]	[°]	[cm ²]
3,33333	16	60	90	6,70

- *verifica armature superiore:*

geometria				
sezione trasversale				
B	H	c	d	z
[cm]	[cm]	[cm]	[cm]	[cm]
100	250	5,0	243,4	219,1
armatura longitudinale				
nbarre	φ	d	Asl	
	[mm]	[cm]	[cm ²]	
10	32	6,6	80,42	
6,66667	32	243,4	53,62	
armatura a taglio				
nbracci	φ	s	α	Asw
	[mm]	[cm]	[°]	[cm ²]
3,33333	16	60	90	6,70

sollecitazioni e risultati	
SLE	SLU
MEk 1762,00 [kNm]	MEd 5101,00 [kNm]
NEk 0 [kN]	NEd 0 [kN]
tensioni e fessure	
Mdec 0,0 [kNm]	
Mcr 2996,4 [kNm]	
yn -65,21 [cm]	
σ _{c,min} -2,1 [MPa]	
σ _{s,min} -28,1 [MPa]	
σ _{s,max} 96,9 [MPa]	
k ₂ 0,5	
ε _{sm} -ε _{cm} - [%o]	
S _{r,max} - [cm]	
w _k - [mm]	
presso-flessione	
MRd 7479,7 [kNm]	
FS 1,47	
taglio	
VRdc 798,7 [kN]	
non serve armatura a taglio	
VRds 1912,1 [kN]	
VRdmax 7655,9 [kN]	
θ 26,6 [°]	
sezione duttile	
ai 243,4 [cm]	

sollecitazioni e risultati	
SLE	SLU
MEk 0,00 [kNm]	MEd 3918,00 [kNm]
NEk 0 [kN]	NEd 0 [kN]
VEd 686,00 [kN]	
tensioni e fessure	
Mdec 0,0 [kNm]	
Mcr -2996,4 [kNm]	
yn 65,21 [cm]	
σ _{c,min} 0,0 [MPa]	
σ _{s,min} 0,0 [MPa]	
σ _{s,max} 0,0 [MPa]	
k ₂ 0,5	
ε _{sm} -ε _{cm} - [%o]	
S _{r,max} - [cm]	
w _k - [mm]	
presso-flessione	
MRd 5001,7 [kNm]	
FS 1,28	
taglio	
VRdc 697,7 [kN]	
non serve armatura a taglio	
VRds 1912,1 [kN]	
VRdmax 7655,9 [kN]	
θ 26,6 [°]	
sezione duttile	
ai 243,4 [cm]	

APPALTATORE: Consorzio HirpiniaAV Soci salini impregilo ASTALDI	ITINERARIO NAPOLI – BARI RADDOPPIO TRATTA APICE – ORSARA I LOTTO FUNZIONALE APICE – HIRPINIA					
PROGETTAZIONE: Mandataria SOJL Mandanti NETENGINEERING Alpina						
PROGETTO ESECUTIVO RELAZIONE DI CALCOLO FONDAZIONI PILE DA P7 A P16	COMMESSA IF1N	LOTTO 01 E ZZ	CODIFICA RG	DOCUMENTO MD0000 001	REV. B	FOGLIO 60 di 144

Sezione 2 longitudinale:

- *verifica armature inferiori:*

geometria				
sezione trasversale				
B	H	c	d	z
[cm]	[cm]	[cm]	[cm]	[cm]
100	250	5,0	243,4	219,1
armatura longitudinale				
nbarre	φ	d	Asl	
	[mm]	[cm]	[cm ²]	
6,66667	32	6,6	53,62	
10	32	243,4	80,42	
armatura a taglio				
nbracci	φ	s	α	Asw
	[mm]	[cm]	[°]	[cm ²]
3,33333	16	60	90	6,70

- *verifica armature superiore:*

geometria				
sezione trasversale				
B	H	c	d	z
[cm]	[cm]	[cm]	[cm]	[cm]
100	250	5,0	243,4	219,1
armatura longitudinale				
nbarre	φ	d	Asl	
	[mm]	[cm]	[cm ²]	
10	32	6,6	80,42	
6,66667	32	243,4	53,62	
armatura a taglio				
nbracci	φ	s	α	Asw
	[mm]	[cm]	[°]	[cm ²]
3,33333	16	60	90	6,70

sollecitazioni e risultati	
SLE	SLU
MEk 2003,00 [kNm]	MEd 5736,00 [kNm]
NEk 0 [kN]	NEd 0 [kN]
tensioni e fessure	
Mdec 0,0 [kNm]	
Mcr 2996,4 [kNm]	
yn -65,21 [cm]	
σc,min -2,4 [MPa]	
σs,min -31,9 [MPa]	
σs,max 110,2 [MPa]	
k2 0,5	
εsm-εcm - [%o]	
Sr,max - [cm]	
Wk - [mm]	
presso-flessione	
MRd 7479,7 [kNm]	
FS 1,30	
taglio	
VRdc 798,7 [kN]	
predisporre armatura a taglio	
VRds 1912,1 [kN]	
VRdmax 7655,9 [kN]	
θ 26,6 [°]	
sezione duttile	
ai 218,7 [cm]	

sollecitazioni e risultati	
SLE	SLU
MEk 0,00 [kNm]	MEd 4517,00 [kNm]
NEk 0 [kN]	NEd 0 [kN]
VEd 838,00 [kN]	
tensioni e fessure	
Mdec 0,0 [kNm]	
Mcr -2996,4 [kNm]	
yn 65,21 [cm]	
σc,min 0,0 [MPa]	
σs,min 0,0 [MPa]	
σs,max 0,0 [MPa]	
k2 0,5	
εsm-εcm - [%o]	
Sr,max - [cm]	
Wk - [mm]	
presso-flessione	
MRd 5001,7 [kNm]	
FS 1,11	
taglio	
VRdc 697,7 [kN]	
predisporre armatura a taglio	
VRds 1912,1 [kN]	
VRdmax 7655,9 [kN]	
θ 26,6 [°]	
sezione duttile	
ai 218,7 [cm]	

APPALTATORE: Consorzio HirpiniaAV Soci salini impregilo ASTALDI	ITINERARIO NAPOLI – BARI RADDOPPIO TRATTA APICE – ORSARA I LOTTO FUNZIONALE APICE – HIRPINIA					
PROGETTAZIONE: Mandataria ROKSOJL Mandanti NETENGINEERING Alpina						
PROGETTO ESECUTIVO RELAZIONE DI CALCOLO FONDAZIONI PILE DA P7 A P16	COMMESSA IF1N	LOTTO 01 E ZZ	CODIFICA RG	DOCUMENTO MD0000 001	REV. B	FOGLIO 61 di 144

Sezione 3 longitudinale:

- *verifica armature inferiori:*

geometria				
sezione trasversale				
B	H	c	d	z
[cm]	[cm]	[cm]	[cm]	[cm]
100	250	5,0	243,4	219,1
armatura longitudinale				
nbarre	φ	d	Asl	
	[mm]	[cm]	[cm ²]	
6,66667	32	6,6	53,62	
10	32	243,4	80,42	
armatura a taglio				
nbracci	φ	s	α	Asw
	[mm]	[cm]	[°]	[cm ²]
3,33333	16	60	90	6,70

- *verifica armature superiore:*

geometria				
sezione trasversale				
B	H	c	d	z
[cm]	[cm]	[cm]	[cm]	[cm]
100	250	5,0	243,4	219,1
armatura longitudinale				
nbarre	φ	d	Asl	
	[mm]	[cm]	[cm ²]	
10	32	6,6	80,42	
10	32	243,4	80,42	
armatura a taglio				
nbracci	φ	s	α	Asw
	[mm]	[cm]	[°]	[cm ²]
3,33333	16	60	90	6,70

sollecitazioni e risultati	
SLE	SLU
MEk 2569,00 [kNm]	MEd 7000,00 [kNm]
NEk 0 [kN]	NEd 0 [kN]
VEd 1768,00 [kN]	
tensioni e fessure	
Mdec 0,0 [kNm]	
Mcr 2996,4 [kNm]	
yn -65,21 [cm]	
σc,min -3,1 [MPa]	
σs,min -40,9 [MPa]	
σs,max 141,3 [MPa]	
k2 0,5	
εsm-εcm - [%o]	
Sr,max - [cm]	
Wk - [mm]	
presso-flessione	
MRd 7479,7 [kNm]	
FS 1,07	
taglio	
VRdc 798,7 [kN]	
predisporre armatura a taglio	
VRds 1912,1 [kN]	
VRdmax 7655,9 [kN]	
θ 26,6 [°]	
sezione duttile	
ai 218,7 [cm]	

sollecitazioni e risultati	
SLE	SLU
MEk 0,00 [kNm]	MEd 5457,00 [kNm]
NEk 0 [kN]	NEd 0 [kN]
VEd 1768,00 [kN]	
tensioni e fessure	
Mdec 0,0 [kNm]	
Mcr -3057,6 [kNm]	
yn 67,80 [cm]	
σc,min 0,0 [MPa]	
σs,min 0,0 [MPa]	
σs,max 0,0 [MPa]	
k2 0,5	
εsm-εcm - [%o]	
Sr,max - [cm]	
Wk - [mm]	
presso-flessione	
MRd 7484,2 [kNm]	
FS 1,37	
taglio	
VRdc 798,7 [kN]	
predisporre armatura a taglio	
VRds 1912,1 [kN]	
VRdmax 7655,9 [kN]	
θ 26,6 [°]	
sezione duttile	
ai 218,7 [cm]	

APPALTATORE: Consorzio HirpiniaAV Soci salini impregilo ASTALDI	ITINERARIO NAPOLI – BARI RADDOPPIO TRATTA APICE – ORSARA I LOTTO FUNZIONALE APICE – HIRPINIA					
PROGETTAZIONE: Mandataria ROKSOJL Mandanti NETENGINEERING Alpina						
PROGETTO ESECUTIVO RELAZIONE DI CALCOLO FONDAZIONI PILE DA P7 A P16	COMMESSA IF1N	LOTTO 01 E ZZ	CODIFICA RG	DOCUMENTO MD0000 001	REV. B	FOGLIO 62 di 144

Sezione 4 longitudinale:

- *verifica armature inferiori:*

geometria				
sezione trasversale				
B	H	c	d	z
[cm]	[cm]	[cm]	[cm]	[cm]
100	250	5,0	243,4	219,1
armatura longitudinale				
nbarre	φ	d	Asl	
	[mm]	[cm]	[cm ²]	
10	32	6,6	80,42	
10	32	243,4	80,42	
armatura a taglio				
nbracci	φ	s	α	Asw
	[mm]	[cm]	[°]	[cm ²]
3,33333	16	15	90	6,70

- *verifica armature superiore:*

geometria				
sezione trasversale				
B	H	c	d	z
[cm]	[cm]	[cm]	[cm]	[cm]
100	250	5,0	243,4	219,1
armatura longitudinale				
nbarre	φ	d	Asl	
	[mm]	[cm]	[cm ²]	
10	32	6,6	80,42	
10	32	243,4	80,42	
armatura a taglio				
nbracci	φ	s	α	Asw
	[mm]	[cm]	[°]	[cm ²]
3,33333	16	15	90	6,70

sollecitazioni e risultati	
SLE	SLU
MEk 2915,00 [kNm]	MEd 7174,00 [kNm]
NEk 0 [kN]	NEd 0 [kN]
tensioni e fessure	
Mdec 0,0 [kNm]	
Mcr 3057,6 [kNm]	
yn -67,80 [cm]	
σ _{c,min} -3,3 [MPa]	
σ _{s,min} -43,3 [MPa]	
σ _{s,max} 159,2 [MPa]	
k ₂ 0,5	
ε _{sm} -ε _{cm} - [%o]	
S _{r,max} - [cm]	
w _k - [mm]	
presso-flessione	
MRd 7484,2 [kNm]	
FS 1,04	
taglio	
VRdc 798,7 [kN]	
predisporre armatura a taglio	
VRds 7648,3 [kN]	
VRdmax 7655,9 [kN]	
θ 26,6 [°]	
sezione duttile	
ai 218,7 [cm]	

sollecitazioni e risultati	
SLE	SLU
MEk 0,00 [kNm]	MEd 5611,00 [kNm]
NEk 0 [kN]	NEd 0 [kN]
tensioni e fessure	
Mdec 0,0 [kNm]	
Mcr -3057,6 [kNm]	
yn 67,80 [cm]	
σ _{c,min} 0,0 [MPa]	
σ _{s,min} 0,0 [MPa]	
σ _{s,max} 0,0 [MPa]	
k ₂ 0,5	
ε _{sm} -ε _{cm} - [%o]	
S _{r,max} - [cm]	
w _k - [mm]	
presso-flessione	
MRd 7484,2 [kNm]	
FS 1,33	
taglio	
VRdc 798,7 [kN]	
predisporre armatura a taglio	
VRds 7648,3 [kN]	
VRdmax 7655,9 [kN]	
θ 26,6 [°]	
sezione duttile	
ai 218,7 [cm]	

APPALTATORE: Consorzio HirpiniaAV Soci salini impregio ASTALDI	ITINERARIO NAPOLI – BARI RADDOPPIO TRATTA APICE – ORSARA I LOTTO FUNZIONALE APICE – HIRPINIA					
PROGETTAZIONE: Mandataria SOJL Mandanti NETENGINEERING Alpina						
PROGETTO ESECUTIVO RELAZIONE DI CALCOLO FONDAZIONI PILE DA P7 A P16	COMMESSA IF1N	LOTTO 01 E ZZ	CODIFICA RG	DOCUMENTO MD0000 001	REV. B	FOGLIO 63 di 144

Sezione 5 longitudinale:

- *verifica armature inferiori:*

geometria				
sezione trasversale				
B	H	c	d	z
[cm]	[cm]	[cm]	[cm]	[cm]
100	250	5,0	241,3	217,1
armatura longitudinale				
nbarre	φ	d	Asl	
	[mm]	[cm]	[cm ²]	
13,3333	32	6,6	107,23	
6,66667	32	237,0	53,62	
13,3333	32	243,4	107,23	
armatura a taglio				
nbracci	φ	s	α	Asw
	[mm]	[cm]	[°]	[cm ²]
3,33333	16	15	90	6,70

- *verifica armature superiore:*

geometria				
sezione trasversale				
B	H	c	d	z
[cm]	[cm]	[cm]	[cm]	[cm]
100	250	5,0	242,1	217,9
armatura longitudinale				
nbarre	φ	d	Asl	
	[mm]	[cm]	[cm ²]	
13,3333	32	6,6	107,23	
3,33333	32	237,0	26,81	
13,3333	32	243,4	107,23	
armatura a taglio				
nbracci	φ	s	α	Asw
	[mm]	[cm]	[°]	[cm ²]
3,33333	16	15	90	6,70

sollecitazioni e risultati	
SLE	SLU
MEk 5287,00 [kNm]	MEd 14086,00 [kNm]
NEk 0 [kN]	NEd 0 [kN]
tensioni e fessure	
Mdec 0,0 [kNm]	
Mcr 3511,9 [kNm]	
yn -49,14 [cm]	
σ _{c,min} -4,5 [MPa]	
σ _{s,min} -62,2 [MPa]	
σ _{s,max} 150,5 [MPa]	
k ₂ 0,5	
ε _{sm} -ε _{cm} 0,55 [‰]	
S _{r,max} 25,3 [cm]	
w _k 0,140 [mm]	
presso-flessione	
MRd 14764,5 [kNm]	
FS 1,05	
taglio	
VRdc 1001,4 [kN]	
predisporre armatura a taglio	
VRds 6575,6 [kN]	
VRdmax 8207,7 [kN]	
θ 30,0 [°]	
sezione duttile	
ai 188,0 [cm]	

sollecitazioni e risultati	
SLE	SLU
MEk 0,00 [kNm]	MEd 10296,00 [kNm]
NEk 0 [kN]	NEd 0 [kN]
tensioni e fessure	
Mdec 0,0 [kNm]	
Mcr -3305,1 [kNm]	
yn 63,94 [cm]	
σ _{c,min} 0,0 [MPa]	
σ _{s,min} 0,0 [MPa]	
σ _{s,max} 0,0 [MPa]	
k ₂ 0,5	
ε _{sm} -ε _{cm} - [‰]	
S _{r,max} - [cm]	
w _k - [mm]	
presso-flessione	
MRd 12373,8 [kNm]	
FS 1,20	
taglio	
VRdc 944,2 [kN]	
predisporre armatura a taglio	
VRds 6598,8 [kN]	
VRdmax 8236,7 [kN]	
θ 30,0 [°]	
sezione duttile	
ai 188,7 [cm]	

APPALTATORE: Consorzio Soci   	ITINERARIO NAPOLI – BARI RADDOPPIO TRATTA APICE – ORSARA I LOTTO FUNZIONALE APICE – HIRPINIA					
PROGETTAZIONE: Mandataria Mandanti   						
PROGETTO ESECUTIVO RELAZIONE DI CALCOLO FONDAZIONI PILE DA P7 A P16	COMMESSA IF1N	LOTTO 01 E ZZ	CODIFICA RG	DOCUMENTO MD0000 001	REV. B	FOGLIO 64 di 144

Sezione 6 longitudinale:

- *verifica armature inferiori:*

geometria				
sezione trasversale				
B	H	c	d	z
[cm]	[cm]	[cm]	[cm]	[cm]
100	250	5,0	243,4	219,1
armatura longitudinale				
nbarre	φ	d	Asl	
	[mm]	[cm]	[cm ²]	
10	32	6,6	80,42	
13,3333	32	243,4	107,23	
armatura a taglio				
nbracci	φ	s	α	Asw
	[mm]	[cm]	[°]	[cm ²]
3,33333	16	30	90	6,70

- *verifica armature superiore:*

geometria				
sezione trasversale				
B	H	c	d	z
[cm]	[cm]	[cm]	[cm]	[cm]
100	250	5,0	243,4	219,1
armatura longitudinale				
nbarre	φ	d	Asl	
	[mm]	[cm]	[cm ²]	
13,3333	32	6,6	107,23	
10	32	243,4	80,42	
armatura a taglio				
nbracci	φ	s	α	Asw
	[mm]	[cm]	[°]	[cm ²]
3,33333	16	30	90	6,70

sollecitazioni e risultati	
SLE	SLU
MEk 2681,00 [kNm]	MEd 7833,00 [kNm]
NEk 0 [kN]	NEd 0 [kN]
tensioni e fessure	
Mdec 0,0 [kNm]	
Mcr 3196,8 [kNm]	
presso-flessione	
	MRd 9962,4 [kNm]
	FS 1,27
taglio	
	VRdc 879,1 [kN]
	predisporre armatura a taglio
	VRds 3316,8 [kN]
	VRdmax 8280,2 [kN]
	θ 30,0 [°]
	sezione duttile
	ai 189,7 [cm]

sollecitazioni e risultati	
SLE	SLU
MEk 0,00 [kNm]	MEd 5364,00 [kNm]
NEk 0 [kN]	NEd 0 [kN]
tensioni e fessure	
Mdec 0,0 [kNm]	
Mcr -3196,8 [kNm]	
presso-flessione	
	MRd 7484,9 [kNm]
	FS 1,40
taglio	
	VRdc 798,7 [kN]
	predisporre armatura a taglio
	VRds 3316,8 [kN]
	VRdmax 8280,2 [kN]
	θ 30,0 [°]
	sezione duttile
	ai 189,7 [cm]

APPALTATORE: Consorzio HirpiniaAV Soci salini impregilo ASTALDI	ITINERARIO NAPOLI – BARI RADDOPPIO TRATTA APICE – ORSARA I LOTTO FUNZIONALE APICE – HIRPINIA					
PROGETTAZIONE: Mandataria SOJL Mandanti NETENGINEERING Alpina						
PROGETTO ESECUTIVO RELAZIONE DI CALCOLO FONDAZIONI PILE DA P7 A P16	COMMESSA IF1N	LOTTO 01 E ZZ	CODIFICA RG	DOCUMENTO MD0000 001	REV. B	FOGLIO 65 di 144

Sezione 7 longitudinale:

- *verifica armature inferiori:*

geometria				
sezione trasversale				
B	H	c	d	z
[cm]	[cm]	[cm]	[cm]	[cm]
100	250	5,0	243,4	219,1
armatura longitudinale				
nbarre	φ	d	Asl	
	[mm]	[cm]	[cm ²]	
6,66667	32	6,6	53,62	
10	32	243,4	80,42	
armatura a taglio				
nbracci	φ	s	α	Asw
	[mm]	[cm]	[°]	[cm ²]
3,33333	16	30	90	6,70

- *verifica armature superiore:*

geometria				
sezione trasversale				
B	H	c	d	z
[cm]	[cm]	[cm]	[cm]	[cm]
100	250	5,0	243,4	219,1
armatura longitudinale				
nbarre	φ	d	Asl	
	[mm]	[cm]	[cm ²]	
10	32	6,6	80,42	
6,66667	32	243,4	53,62	
armatura a taglio				
nbracci	φ	s	α	Asw
	[mm]	[cm]	[°]	[cm ²]
3,33333	16	30	90	6,70

sollecitazioni e risultati	
SLE	SLU
MEk 2222,00 [kNm]	MEd 6209,00 [kNm]
NEk 0 [kN]	NEd 0 [kN]
tensioni e fessure	
Mdec 0,0 [kNm]	
Mcr 2996,4 [kNm]	
presso-flessione	
	MRd 7479,7 [kNm]
	FS 1,20
taglio	
	VRdc 798,7 [kN]
	predisporre armatura a taglio
	VRds 3316,8 [kN]
	VRdmax 8280,2 [kN]
	θ 30,0 [°]
	sezione duttile
	ai 189,7 [cm]

sollecitazioni e risultati	
SLE	SLU
MEk 0,00 [kNm]	MEd 4149,00 [kNm]
NEk 0 [kN]	NEd 0 [kN]
tensioni e fessure	
Mdec 0,0 [kNm]	
Mcr -2996,4 [kNm]	
presso-flessione	
	MRd 5001,7 [kNm]
	FS 1,21
taglio	
	VRdc 697,7 [kN]
	predisporre armatura a taglio
	VRds 3316,8 [kN]
	VRdmax 8280,2 [kN]
	θ 30,0 [°]
	sezione duttile
	ai 189,7 [cm]

APPALTATORE: Consorzio HirpiniaAV Soci salini impregilo ASTALDI	ITINERARIO NAPOLI – BARI RADDOPPIO TRATTA APICE – ORSARA I LOTTO FUNZIONALE APICE – HIRPINIA					
PROGETTAZIONE: Mandataria SOJL Mandanti NETENGINEERING Alpina						
PROGETTO ESECUTIVO RELAZIONE DI CALCOLO FONDAZIONI PILE DA P7 A P16	COMMESSA IF1N	LOTTO 01 E ZZ	CODIFICA RG	DOCUMENTO MD0000 001	REV. B	FOGLIO 66 di 144

Sezione 8 longitudinale:

- *verifica armature inferiori:*

geometria				
sezione trasversale				
B	H	c	d	z
[cm]	[cm]	[cm]	[cm]	[cm]
100	250	5,0	243,4	219,1
armatura longitudinale				
nbarre	φ	d	Asl	
	[mm]	[cm]	[cm ²]	
6,66667	32	6,6	53,62	
10	32	243,4	80,42	
armatura a taglio				
nbracci	φ	s	α	Asw
	[mm]	[cm]	[°]	[cm ²]
3,33333	16	30	90	6,70

- *verifica armature superiore:*

geometria				
sezione trasversale				
B	H	c	d	z
[cm]	[cm]	[cm]	[cm]	[cm]
100	250	5,0	243,4	219,1
armatura longitudinale				
nbarre	φ	d	Asl	
	[mm]	[cm]	[cm ²]	
10	32	6,6	80,42	
6,66667	32	243,4	53,62	
armatura a taglio				
nbracci	φ	s	α	Asw
	[mm]	[cm]	[°]	[cm ²]
3,33333	16	30	90	6,70

sollecitazioni e risultati	
SLE	SLU
MEk 2480,00 [kNm]	MEd 6873,00 [kNm]
NEk 0 [kN]	NEd 0 [kN]
tensioni e fessure	
Mdec 0,0 [kNm]	
Mcr 2996,4 [kNm]	
yn -65,21 [cm]	
σc,min -3,0 [MPa]	
σs,min -39,5 [MPa]	
σs,max 136,4 [MPa]	
k2 0,5	
εsm-εcm - [%o]	
Sr,max - [cm]	
Wk - [mm]	
presso-flessione	
MRd 7479,7 [kNm]	
FS 1,09	
taglio	
VRdc 798,7 [kN]	
predisporre armatura a taglio	
VRds 3316,8 [kN]	
VRdmax 8280,2 [kN]	
θ 30,0 [°]	
sezione duttile	
ai 189,7 [cm]	

sollecitazioni e risultati	
SLE	SLU
MEk 0,00 [kNm]	MEd 4574,00 [kNm]
NEk 0 [kN]	NEd 0 [kN]
VEd 1696,00 [kN]	
tensioni e fessure	
Mdec 0,0 [kNm]	
Mcr -2996,4 [kNm]	
yn 65,21 [cm]	
σc,min 0,0 [MPa]	
σs,min 0,0 [MPa]	
σs,max 0,0 [MPa]	
k2 0,5	
εsm-εcm - [%o]	
Sr,max - [cm]	
Wk - [mm]	
presso-flessione	
MRd 5001,7 [kNm]	
FS 1,09	
taglio	
VRdc 697,7 [kN]	
predisporre armatura a taglio	
VRds 3316,8 [kN]	
VRdmax 8280,2 [kN]	
θ 30,0 [°]	
sezione duttile	
ai 189,7 [cm]	

APPALTATORE: Consorzio HirpiniaAV Soci salini impregilo ASTALDI	ITINERARIO NAPOLI – BARI RADDOPPIO TRATTA APICE – ORSARA I LOTTO FUNZIONALE APICE – HIRPINIA					
PROGETTAZIONE: Mandataria SOJL Mandanti NETENGINEERING Alpina						
PROGETTO ESECUTIVO RELAZIONE DI CALCOLO FONDAZIONI PILE DA P7 A P16	COMMESSA IF1N	LOTTO 01 E ZZ	CODIFICA RG	DOCUMENTO MD0000 001	REV. B	FOGLIO 67 di 144

Sezione 1 trasversale:

- *verifica armature inferiori:*

geometria				
sezione trasversale				
B	H	c	d	z
[cm]	[cm]	[cm]	[cm]	[cm]
100	250	8,2	240,2	216,2
armatura longitudinale				
nbarre	ϕ	d	Asl	
	[mm]	[cm]	[cm ²]	
6,66667	32	9,8	53,62	
6,66667	32	240,2	53,62	
armatura a taglio				
nbracci	ϕ	s	α	Asw
	[mm]	[cm]	[°]	[cm ²]
3,33333	16	60	90	6,70

- *verifica armature superiore:*

geometria				
sezione trasversale				
B	H	c	d	z
[cm]	[cm]	[cm]	[cm]	[cm]
100	250	8,2	240,2	216,2
armatura longitudinale				
nbarre	ϕ	d	Asl	
	[mm]	[cm]	[cm ²]	
6,66667	32	9,8	53,62	
6,66667	32	240,2	53,62	
armatura a taglio				
nbracci	ϕ	s	α	Asw
	[mm]	[cm]	[°]	[cm ²]
3,33333	16	60	90	6,70

sollecitazioni e risultati		
SLE	SLU	
MEk 727,00 [kNm]	MEd 2537,00 [kNm]	
NEk 0 [kN]	NEd 0 [kN]	
VEk	VEd 840,00 [kN]	
tensioni e fessure		
Mdec 0,0 [kNm]	MRd 4910,2 [kNm]	
Mcr 2837,5 [kNm]	FS 1,94	
yn -75,66 [cm]	taglio	
$\sigma_{c,min}$ -1,0 [MPa]	VRdc 692,6 [kN]	predisporre armatura a taglio
$\sigma_{s,min}$ -12,5 [MPa]	VRds 1636,6 [kN]	
$\sigma_{s,max}$ 60,2 [MPa]	VRdmax 8171,4 [kN]	
k ₂ 0,5	θ 30,0 [°]	sezione duttile
$\epsilon_{sm-\epsilon_{cm}}$ - [%o]	ai 187,2 [cm]	
Sr,max - [cm]		
Wk - [mm]		

sollecitazioni e risultati		
SLE	SLU	
MEk 1076,00 [kNm]	MEd 3398,00 [kNm]	
NEk 0 [kN]	NEd 0 [kN]	
VEk	VEd 840,00 [kN]	
tensioni e fessure		
Mdec 0,0 [kNm]	MRd 4910,2 [kNm]	
Mcr 2837,5 [kNm]	FS 1,45	
yn -75,66 [cm]	taglio	
$\sigma_{c,min}$ -1,5 [MPa]	VRdc 692,6 [kN]	predisporre armatura a taglio
$\sigma_{s,min}$ -18,5 [MPa]	VRds 1636,6 [kN]	
$\sigma_{s,max}$ 89,1 [MPa]	VRdmax 8171,4 [kN]	
k ₂ 0,5	θ 30,0 [°]	sezione duttile
$\epsilon_{sm-\epsilon_{cm}}$ - [%o]	ai 187,2 [cm]	
Sr,max - [cm]		
Wk - [mm]		

APPALTATORE: Consorzio HirpiniaAV Soci salini impregilo ASTALDI	ITINERARIO NAPOLI – BARI RADDOPPIO TRATTA APICE – ORSARA I LOTTO FUNZIONALE APICE – HIRPINIA					
PROGETTAZIONE: Mandataria SOJL Mandanti NETENGINEERING Alpina						
PROGETTO ESECUTIVO RELAZIONE DI CALCOLO FONDAZIONI PILE DA P7 A P16	COMMESSA IF1N	LOTTO 01 E ZZ	CODIFICA RG	DOCUMENTO MD0000 001	REV. B	FOGLIO 68 di 144

Sezione 2 trasversale:

- *verifica armature inferiori:*

geometria				
sezione trasversale				
B	H	c	d	z
[cm]	[cm]	[cm]	[cm]	[cm]
100	250	8,2	240,2	216,2
armatura longitudinale				
nbarre	φ	d	Asl	
	[mm]	[cm]	[cm ²]	
6,66667	32	9,8	53,62	
6,66667	32	240,2	53,62	
armatura a taglio				
nbracci	φ	s	α	Asw
	[mm]	[cm]	[°]	[cm ²]
3,33333	16	60	90	6,70

- *verifica armature superiore:*

geometria				
sezione trasversale				
B	H	c	d	z
[cm]	[cm]	[cm]	[cm]	[cm]
100	250	8,2	240,2	216,2
armatura longitudinale				
nbarre	φ	d	Asl	
	[mm]	[cm]	[cm ²]	
6,66667	32	9,8	53,62	
6,66667	32	240,2	53,62	
armatura a taglio				
nbracci	φ	s	α	Asw
	[mm]	[cm]	[°]	[cm ²]
3,33333	16	60	90	6,70

sollecitazioni e risultati	
SLE	SLU
MEk 851,00 [kNm]	MEd 3005,00 [kNm]
NEk 0 [kN]	NEd 0 [kN]
tensioni e fessure	
Mdec 0,0 [kNm]	
Mcr 2837,5 [kNm]	
yn -75,66 [cm]	
σc,min -1,2 [MPa]	
σs,min -14,6 [MPa]	
σs,max 70,5 [MPa]	
k2 0,5	
εsm-εcm - [%o]	
Sr,max - [cm]	
Wk - [mm]	
presso-flessione	
MRd 4910,2 [kNm]	
FS 1,63	
taglio	
VRdc 692,6 [kN]	
predisporre armatura a taglio	
VRds 1636,6 [kN]	
VRdmax 8171,4 [kN]	
θ 30,0 [°]	
sezione duttile	
ai 187,2 [cm]	

sollecitazioni e risultati	
SLE	SLU
MEk 1252,00 [kNm]	MEd 3989,00 [kNm]
NEk 0 [kN]	NEd 0 [kN]
VEd 882,00 [kN]	
tensioni e fessure	
Mdec 0,0 [kNm]	
Mcr 2837,5 [kNm]	
yn -75,66 [cm]	
σc,min -1,8 [MPa]	
σs,min -21,5 [MPa]	
σs,max 103,7 [MPa]	
k2 0,5	
εsm-εcm - [%o]	
Sr,max - [cm]	
Wk - [mm]	
presso-flessione	
MRd 4910,2 [kNm]	
FS 1,23	
taglio	
VRdc 692,6 [kN]	
predisporre armatura a taglio	
VRds 1636,6 [kN]	
VRdmax 8171,4 [kN]	
θ 30,0 [°]	
sezione duttile	
ai 187,2 [cm]	

APPALTATORE: Consorzio HirpiniaAV Soci salini impregilo ASTALDI	ITINERARIO NAPOLI – BARI RADDOPPIO TRATTA APICE – ORSARA I LOTTO FUNZIONALE APICE – HIRPINIA					
PROGETTAZIONE: Mandataria ROKSOJL Mandanti NETENGINEERING Alpina						
PROGETTO ESECUTIVO RELAZIONE DI CALCOLO FONDAZIONI PILE DA P7 A P16	COMMESSA IF1N	LOTTO 01 E ZZ	CODIFICA RG	DOCUMENTO MD0000 001	REV. B	FOGLIO 69 di 144

Sezione 3 trasversale:

- *verifica armature inferiori:*

geometria				
sezione trasversale				
B	H	c	d	z
[cm]	[cm]	[cm]	[cm]	[cm]
100	250	8,2	240,2	216,2
armatura longitudinale				
nbarre	φ	d	Asl	
	[mm]	[cm]	[cm ²]	
10	32	9,8	80,42	
10	32	240,2	80,42	
armatura a taglio				
nbracci	φ	s	α	Asw
	[mm]	[cm]	[°]	[cm ²]
3,33333	16	60	90	6,70

- *verifica armature superiore:*

geometria				
sezione trasversale				
B	H	c	d	z
[cm]	[cm]	[cm]	[cm]	[cm]
100	250	8,2	240,2	216,2
armatura longitudinale				
nbarre	φ	d	Asl	
	[mm]	[cm]	[cm ²]	
10	32	9,8	80,42	
10	32	240,2	80,42	
armatura a taglio				
nbracci	φ	s	α	Asw
	[mm]	[cm]	[°]	[cm ²]
3,33333	16	60	90	6,70

sollecitazioni e risultati	
SLE	SLU
MEk 1075,00 [kNm]	MEd 3786,00 [kNm]
NEk 0 [kN]	NEd 0 [kN]
tensioni e fessure	
Mdec 0,0 [kNm]	
Mcr 3025,8 [kNm]	
yn -67,80 [cm]	
σc,min -1,2 [MPa]	
σs,min -15,5 [MPa]	
σs,max 59,8 [MPa]	
k2 0,5	
εsm-εcm - [%o]	
Sr,max - [cm]	
Wk - [mm]	
presso-flessione	
MRd 7323,8 [kNm]	
FS 1,93	
taglio	
VRdc 792,8 [kN]	
predisporre armatura a taglio	
VRds 1636,6 [kN]	
VRdmax 8171,4 [kN]	
θ 30,0 [°]	
sezione duttile	
ai 187,2 [cm]	

sollecitazioni e risultati	
SLE	SLU
MEk 1523,00 [kNm]	MEd 5014,00 [kNm]
NEk 0 [kN]	NEd 0 [kN]
VEd 1327,00 [kN]	
tensioni e fessure	
Mdec 0,0 [kNm]	
Mcr 3025,8 [kNm]	
yn -67,80 [cm]	
σc,min -1,8 [MPa]	
σs,min -21,9 [MPa]	
σs,max 84,7 [MPa]	
k2 0,5	
εsm-εcm - [%o]	
Sr,max - [cm]	
Wk - [mm]	
presso-flessione	
MRd 7323,8 [kNm]	
FS 1,46	
taglio	
VRdc 792,8 [kN]	
predisporre armatura a taglio	
VRds 1636,6 [kN]	
VRdmax 8171,4 [kN]	
θ 30,0 [°]	
sezione duttile	
ai 187,2 [cm]	

APPALTATORE: Consorzio HirpiniaAV Soci salini impregilo ASTALDI	ITINERARIO NAPOLI – BARI RADDOPPIO TRATTA APICE – ORSARA I LOTTO FUNZIONALE APICE – HIRPINIA					
PROGETTAZIONE: Mandataria ROKSOJL Mandanti NETENGINEERING Alpina						
PROGETTO ESECUTIVO RELAZIONE DI CALCOLO FONDAZIONI PILE DA P7 A P16	COMMESSA IF1N	LOTTO 01 E ZZ	CODIFICA RG	DOCUMENTO MD0000 001	REV. B	FOGLIO 70 di 144

Sezione 4 trasversale:

- *verifica armature inferiori:*

geometria				
sezione trasversale				
B	H	c	d	z
[cm]	[cm]	[cm]	[cm]	[cm]
100	250	8,2	240,2	216,2
armatura longitudinale				
nbarre	φ	d	Asl	
	[mm]	[cm]	[cm ²]	
10	32	9,8	80,42	
10	32	240,2	80,42	
armatura a taglio				
nbracci	φ	s	α	Asw
	[mm]	[cm]	[°]	[cm ²]
3,33333	16	30	90	6,70

- *verifica armature superiore:*

geometria				
sezione trasversale				
B	H	c	d	z
[cm]	[cm]	[cm]	[cm]	[cm]
100	250	8,2	240,2	216,2
armatura longitudinale				
nbarre	φ	d	Asl	
	[mm]	[cm]	[cm ²]	
10	32	9,8	80,42	
10	32	240,2	80,42	
armatura a taglio				
nbracci	φ	s	α	Asw
	[mm]	[cm]	[°]	[cm ²]
3,33333	16	30	90	6,70

sollecitazioni e risultati	
SLE	SLU
MEk 2024,00 [kNm]	MEd 5690,00 [kNm]
NEk 0 [kN]	NEd 0 [kN]
VEd 3691,00 [kN]	
tensioni e fessure	
Mdec 0,0 [kNm]	
Mcr 3025,8 [kNm]	
yn -67,80 [cm]	
σc,min -2,3 [MPa]	
σs,min -29,2 [MPa]	
σs,max 112,6 [MPa]	
k ₂ 0,5	
εsm-εcm - [%o]	
Sr,max - [cm]	
Wk - [mm]	
presso-flessione	
MRd 7323,8 [kNm]	
FS 1,29	
taglio	
VRdc 792,8 [kN]	
predisporre armatura a taglio	
VRds 4052,7 [kN]	
VRdmax 7228,0 [kN]	
θ 25,0 [°]	
sezione duttile	
ai 231,8 [cm]	

sollecitazioni e risultati	
SLE	SLU
MEk 1569,00 [kNm]	MEd 6647,00 [kNm]
NEk 0 [kN]	NEd 0 [kN]
VEd 3691,00 [kN]	
tensioni e fessure	
Mdec 0,0 [kNm]	
Mcr 3025,8 [kNm]	
yn -67,80 [cm]	
σc,min -1,8 [MPa]	
σs,min -22,6 [MPa]	
σs,max 87,3 [MPa]	
k ₂ 0,5	
εsm-εcm - [%o]	
Sr,max - [cm]	
Wk - [mm]	
presso-flessione	
MRd 7323,8 [kNm]	
FS 1,10	
taglio	
VRdc 792,8 [kN]	
predisporre armatura a taglio	
VRds 4052,7 [kN]	
VRdmax 7228,0 [kN]	
θ 25,0 [°]	
sezione duttile	
ai 231,8 [cm]	

APPALTATORE: Consorzio HirpiniaAV Soci salini impregilo ASTALDI	ITINERARIO NAPOLI – BARI RADDOPPIO TRATTA APICE – ORSARA I LOTTO FUNZIONALE APICE – HIRPINIA					
PROGETTAZIONE: Mandataria SOJL Mandanti NETENGINEERING Alpina						
PROGETTO ESECUTIVO RELAZIONE DI CALCOLO FONDAZIONI PILE DA P7 A P16	COMMESSA IF1N	LOTTO 01 E ZZ	CODIFICA RG	DOCUMENTO MD0000 001	REV. B	FOGLIO 71 di 144

Sezione 5 trasversale:

- *verifica armature inferiori:*

geometria				
sezione trasversale				
B	H	c	d	z
[cm]	[cm]	[cm]	[cm]	[cm]
100	250	8,2	238,9	215,0
armatura longitudinale				
nbarre	φ	d	Asl	
	[mm]	[cm]	[cm ²]	
13,3333	32	9,8	107,23	
3,33333	32	233,8	26,81	
13,3333	32	240,2	107,23	
armatura a taglio				
nbracci	φ	s	α	Asw
	[mm]	[cm]	[°]	[cm ²]
3,33333	16	15	90	6,70

- *verifica armature superiore:*

geometria				
sezione trasversale				
B	H	c	d	z
[cm]	[cm]	[cm]	[cm]	[cm]
100	250	8,2	238,9	215,0
armatura longitudinale				
nbarre	φ	d	Asl	
	[mm]	[cm]	[cm ²]	
13,3333	32	9,8	107,23	
3,33333	32	233,8	26,81	
13,3333	32	240,2	107,23	
armatura a taglio				
nbracci	φ	s	α	Asw
	[mm]	[cm]	[°]	[cm ²]
3,33333	16	15	90	6,70

sollecitazioni e risultati	
SLE	SLU
MEk 2219,00 [kNm]	MEd 7585,00 [kNm]
NEk 0 [kN]	NEd 0 [kN]
tensioni e fessure	
Mdec 0,0 [kNm]	
Mcr 3335,3 [kNm]	
yn -55,21 [cm]	
σ _{c,min} -2,1 [MPa]	
σ _{s,min} -26,8 [MPa]	
σ _{s,max} 76,0 [MPa]	
k ₂ 0,5	
ε _{sm} -ε _{cm} - [%o]	
S _{r,max} - [cm]	
w _k - [mm]	
presso-flessione	
MRd 12082,3 [kNm]	
FS 1,59	
taglio	
VRdc 937,2 [kN]	
predisporre armatura a taglio	
VRds 7378,4 [kN]	
VRdmax 7592,8 [kN]	
θ 27,0 [°]	
sezione duttile	
ai 211,0 [cm]	

sollecitazioni e risultati	
SLE	SLU
MEk 3289,00 [kNm]	MEd 10395,00 [kNm]
NEk 0 [kN]	NEd 0 [kN]
tensioni e fessure	
Mdec 0,0 [kNm]	
Mcr 3335,3 [kNm]	
yn -55,21 [cm]	
σ _{c,min} -3,1 [MPa]	
σ _{s,min} -39,7 [MPa]	
σ _{s,max} 112,6 [MPa]	
k ₂ 0,5	
ε _{sm} -ε _{cm} - [%o]	
S _{r,max} - [cm]	
w _k - [mm]	
presso-flessione	
MRd 12082,3 [kNm]	
FS 1,16	
taglio	
VRdc 937,2 [kN]	
predisporre armatura a taglio	
VRds 7378,4 [kN]	
VRdmax 7592,8 [kN]	
θ 27,0 [°]	
sezione duttile	
ai 211,0 [cm]	

APPALTATORE: Consorzio HirpiniaAV Soci salini impregilo ASTALDI	ITINERARIO NAPOLI – BARI RADDOPPIO TRATTA APICE – ORSARA I LOTTO FUNZIONALE APICE – HIRPINIA					
PROGETTAZIONE: Mandataria ROKSOJL Mandanti NETENGINEERING Alpina						
PROGETTO ESECUTIVO RELAZIONE DI CALCOLO FONDAZIONI PILE DA P7 A P16	COMMESSA IF1N	LOTTO 01 E ZZ	CODIFICA RG	DOCUMENTO MD0000 001	REV. B	FOGLIO 72 di 144

Sezione 6 trasversale:

- *verifica armature inferiori:*

geometria				
sezione trasversale				
B	H	c	d	z
[cm]	[cm]	[cm]	[cm]	[cm]
100	250	8,2	238,9	215,0
armatura longitudinale				
nbarre	φ	d	Asl	
	[mm]	[cm]	[cm ²]	
13,3333	32	9,8	107,23	
3,33333	32	233,8	26,81	
13,3333	32	240,2	107,23	
armatura a taglio				
nbracci	φ	s	α	Asw
	[mm]	[cm]	[°]	[cm ²]
3,33333	16	15	90	6,70

- *verifica armature superiore:*

geometria				
sezione trasversale				
B	H	c	d	z
[cm]	[cm]	[cm]	[cm]	[cm]
100	250	8,2	238,9	215,0
armatura longitudinale				
nbarre	φ	d	Asl	
	[mm]	[cm]	[cm ²]	
13,3333	32	9,8	107,23	
3,33333	32	233,8	26,81	
13,3333	32	240,2	107,23	
armatura a taglio				
nbracci	φ	s	α	Asw
	[mm]	[cm]	[°]	[cm ²]
3,33333	16	15	90	6,70

sollecitazioni e risultati	
SLE	SLU
MEk 3473,00 [kNm]	MEd 8281,00 [kNm]
NEk 0 [kN]	NEd 0 [kN]
tensioni e fessure	
Mdec 0,0 [kNm]	
Mcr 3335,3 [kNm]	
yn -55,21 [cm]	
σ _{c,min} -3,2 [MPa]	
σ _{s,min} -41,9 [MPa]	
σ _{s,max} 118,9 [MPa]	
k ₂ 0,5	
ε _{sm} -ε _{cm} 0,35 [‰]	
S _{r,max} 41,1 [cm]	
w _k 0,146 [mm]	
presso-flessione	
MRd 12082,3 [kNm]	
FS 1,46	
taglio	
VRdc 937,2 [kN]	
predisporre armatura a taglio	
VRds 7378,4 [kN]	
VRdmax 7592,8 [kN]	
θ 27,0 [°]	
sezione duttile	
ai 211,0 [cm]	

sollecitazioni e risultati	
SLE	SLU
MEk 1898,00 [kNm]	MEd 10804,00 [kNm]
NEk 0 [kN]	NEd 0 [kN]
tensioni e fessure	
Mdec 0,0 [kNm]	
Mcr 3335,3 [kNm]	
yn -55,21 [cm]	
σ _{c,min} -1,8 [MPa]	
σ _{s,min} -22,9 [MPa]	
σ _{s,max} 65,0 [MPa]	
k ₂ 0,5	
ε _{sm} -ε _{cm} - [‰]	
S _{r,max} - [cm]	
w _k - [mm]	
presso-flessione	
MRd 12082,3 [kNm]	
FS 1,12	
taglio	
VRdc 937,2 [kN]	
predisporre armatura a taglio	
VRds 7378,4 [kN]	
VRdmax 7592,8 [kN]	
θ 27,0 [°]	
sezione duttile	
ai 211,0 [cm]	

APPALTATORE: Consorzio Soci   	ITINERARIO NAPOLI – BARI RADDOPPIO TRATTA APICE – ORSARA I LOTTO FUNZIONALE APICE – HIRPINIA					
PROGETTAZIONE: Mandataria Mandanti   						
PROGETTO ESECUTIVO RELAZIONE DI CALCOLO FONDAZIONI PILE DA P7 A P16	COMMESSA IF1N	LOTTO 01 E ZZ	CODIFICA RG	DOCUMENTO MD0000 001	REV. B	FOGLIO 73 di 144

10.4 VERIFICA PUNZONAMENTO

La verifica a punzonamento viene eseguita in prima istanza trascurando la presenza di armatura e considerando l'azione assiale massima di compressione agente sui pali e ipotizzando di questa sia riferita ad un palo di bordo.

La verifica è eseguita sul perimetro del palo, u_0 , e sul perimetro composto dal quadrato di lato 3,75m che traccia l'interasse tra i pali, u_1 .

- Verifica su u_0 :

$$v_{ED,0} = \frac{\beta N_{ED}}{u_0 H} \leq v_{RD,max} = 0,5 v f_{cd}$$

- Verifica su u_1 :

$$v_{ED,1} = \frac{N_{ED}}{u_1 H} \leq v_{RD,max} = 0,5 f_{ctd}$$

Caratteristiche meccaniche			
R_{ck}	resistenza cubica a compressione caratteristica	35	MPa
f_{ck}	resistenza cilindrica a compressione caratteristica	29,1	MPa
f_{cd}	resistenza cilindrica a compressione di progetto	16,5	MPa
f_{ctd}	resistenza cilindrica a trazione di progetto	1,32	MPa
v	$0,6 \times (1 - f_{ck} / 250)$	0,53	[-]
Caratteristiche geometriche			
D_{palo}	diametro palo	1,5	m
u_0	perimetro palo	4,7	m
H_{plinto}	altezza plinto	2,5	m
u_1	perimetro interno posto ad interasse pali di bordo	7,5	m
β	fattore di posizione del palo	1,5	[-]
Sollecitazione			
N_{Ed}	azione assiale sollecitante	10964,0	kN
Verifica su u_0			
$v_{Ed,0}$	sforzo agente su u_0	1,40	MPa
$v_{Rd,0}$	sforzo resistente su u_0	4,36	MPa
FS	fattore di sicurezza	3,13	[-]
Verifica su u_1			
$v_{Ed,1}$	sforzo agente su u_1	0,58	MPa
$v_{Rd,1}$	sforzo resistente su u_1	0,66	MPa
FS	fattore di sicurezza	1,13	[-]

APPALTATORE: Consorzio <u>Soci</u>   	ITINERARIO NAPOLI – BARI RADDOPPIO TRATTA APICE – ORSARA I LOTTO FUNZIONALE APICE – HIRPINIA																	
PROGETTAZIONE: <u>Mandataria</u> <u>Mandanti</u>   							<table border="1" style="width: 100%; border-collapse: collapse;"> <tr> <td style="width: 16.6%;">COMMESSA</td> <td style="width: 16.6%;">LOTTO</td> <td style="width: 16.6%;">CODIFICA</td> <td style="width: 16.6%;">DOCUMENTO</td> <td style="width: 16.6%;">REV.</td> <td style="width: 16.6%;">FOGLIO</td> </tr> <tr> <td>IF1N</td> <td>01 E ZZ</td> <td>RG</td> <td>MD0000 001</td> <td>B</td> <td>74 di 144</td> </tr> </table>						COMMESSA	LOTTO	CODIFICA	DOCUMENTO	REV.	FOGLIO
COMMESSA	LOTTO	CODIFICA	DOCUMENTO	REV.	FOGLIO													
IF1N	01 E ZZ	RG	MD0000 001	B	74 di 144													
PROGETTO ESECUTIVO RELAZIONE DI CALCOLO FONDAZIONI PILE DA P7 A P16																		

10.5 VERIFICA TIRANTE-PUNTONE

La verifica tirante-puntone viene eseguita considerando le sollecitazioni del palo più sollecitato, i quali risulta avere un carico allo SLV, ed è di 7693 kN. Tale verifica viene eseguita secondo l'EC2.

Il riferimento per le dimensioni sono quelle in pianta dell'area che interessa il singolo palo, quindi l'armatura di verifica di riferimento è su base di 2.65m.

APPALTATORE: Consorzio Soci 	ITINERARIO NAPOLI – BARI RADDOPPIO TRATTA APICE – ORSARA I LOTTO FUNZIONALE APICE – HIRPINIA
PROGETTAZIONE: Mandataria Mandanti 	
PROGETTO ESECUTIVO RELAZIONE DI CALCOLO FONDAZIONI PILE DA P7 A P16	COMMESSA LOTTO CODIFICA DOCUMENTO REV. FOGLIO IF1N 01 E ZZ RG MD0000 001 B 75 di 144

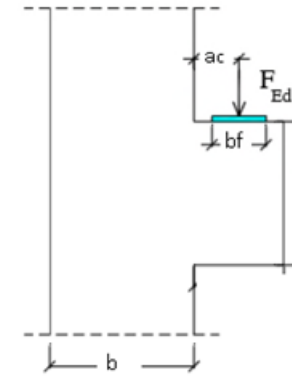
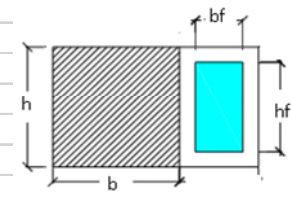
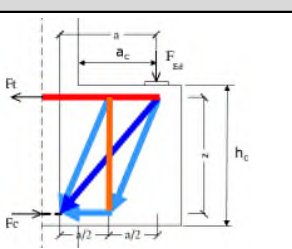
SQUAT CANTILEVER VERIFICATION BY STRUT AND TIE MODEL					
Norm: [1] UNI EN 1992-1-1:2005					
MATERIAL PROPERTIES					
Concrete					
Characteristic cube strength	R_{ck}	=	35	N/mm ²	
Characteristic cylinder strength	f_{ck}	=	29	N/mm ²	
Partial safety factor for concrete	γ_c	=	1,50		
Coefficient for long-term effects	α_{cc}	=	0,85		
Design value of compression resistance	f_{cd}	=	16,46	N/mm ² $f_{cd} = f_{ck} \alpha_{cc} / \gamma_c$	
Steel					
Characteristic yield strength of reinforcement	f_{yk}	=	450	N/mm ²	
Partial safety factor for steel	γ_s	=	1,15	N/mm ²	
Design yield strength of reinforcement	f_{yd}	=	391	N/mm ² $f_{yd} = f_{yk} / \gamma_s$	
DEFINITION OF GEOMETRY					
Overall depth of a cantilever cross-section	h_c	=	3000	mm	
Distance between force and column	a_c	=	2600	mm	
Overall width of a column cross-section	b	=	3000	mm	
Overall depth of a column cross-section	h	=	3000	mm	
Concrete cover of a cantilever cross-section	d'	=	50	mm	
Width plate on acting force	b_f	=	1200	mm	
Depth plate on acting force	h_f	=	2650	mm	
Effective depth of a cantilever cross-section	d	=	2950	mm	
Internal arm	z	=	2900	mm	
Area of the primary tensile reinforcement	A_s	=	28417	mm ²	
Dimameter of stirrups	ϕ_{sw}	=	16	mm	
Number of arms	n_b	=	8,83	mm	
Number of the stirrups	n	=	8,83	mm	
Area of the secondary reinforcement	$A_{s,ink}$	=	15688	mm ²	
CASE $a_c > h_c/2$					
YES!!					
					
NODE DESIGN RESISTANCE					
	k_1	=	1,00		
	k_2	=	0,85		
	k_3	=	0,75		
	v'	=	1,04		
Resistance of node face 1	$\sigma_{1RD,max}$	=	17,1	N/mm ²	
Resistance of node face 2	$\sigma_{2RD,max}$	=	14,5	kN	
Resistance of node face 3	$\sigma_{3RD,max}$	=	12,8	kN	
					
ACTION FORCES ON NODES					
Acting force	F_{Ed}	=	10964	kN	
	x_1	=	213,52	mm	
	y_1	=	590,00	mm	
Principal Traction Force	F_t	=	10233,42	kN	
Compression Force	F_c	=	5116,71	kN	
Stresses on node 1	$\sigma_{1,Ed}$	=	1,45	N/mm ²	
Stresses on node 2	$\sigma_{2,Ed}$	=	3,45	N/mm ²	
Secondary Traction Force	F_{Wd}	=	3167,613	kN	
					
CHECKS					
Chech nodes 1	$Ed / \sigma_{1RD,max}$	=	0,08	< 1	CHECKED
	$A_{s,min} / A_s$	=	0,92	< 1	CHECKED
	$A_s * k_1 / A_{s,ink}$	=	0,45	< 1	CHECKED
	$k_{,min} / A_{s,ink}$	=	0,52	< 1	CHECKED
Chech nodes 2	$Ed / \sigma_{2RD,max}$	=	0,24	< 1	CHECKED

APPALTATORE: Consorzio Soci   	ITINERARIO NAPOLI – BARI RADDOPPIO TRATTA APICE – ORSARA I LOTTO FUNZIONALE APICE – HIRPINIA
PROGETTAZIONE: Mandataria Mandanti   	
PROGETTO ESECUTIVO RELAZIONE DI CALCOLO FONDAZIONI PILE DA P7 A P16	COMMESSA LOTTO CODIFICA DOCUMENTO REV. FOGLIO IF1N 01 E ZZ RG MD0000 001 B 76 di 144

10.6 STIMA INCIDENZE DI ARMATURA

Nella seguente tabella si riporta la stima delle incidenze di armatura per i plinti in oggetto

Tabella ferri						
VI04- PILE 7-16- FONDAZIONE						
POS.	N.	DIAM.	LUNG. (cm)	P.U.	LUNG. TOT. (cm)	PESO (kg)
1	113	32	1192	6.313	134696	8504
2	22	32	920	6.313	20240	1278
3	35	32	920	6.313	32200	2033
4	41	32	1192	6.313	48872	3085
5	41	24	192	3.551	7872	280
6	14	32	920	6.313	12880	813
7	81	32	1192	6.313	96552	6095
8	324	32	572	6.313	185328	11700
9	81	32	1800	6.313	145800	9205
10	40	32	520	6.313	20800	1313
11	41	32	1800	6.313	73800	4659
12	41	24	192	3.551	7872	280
13	40	32	520	6.313	20800	1313
14	81	32	1800	6.313	145800	9205
15	32	20	900	2.466	28800	710
16	32	20	500	2.466	16000	395
17	28	20	466	2.466	13048	322
18	32	24	728	3.551	23296	827
19	976	16	332	1.578	324032	5114
1 elev	149	26	466	4.168	69434	2894
2 elev	149	26	596	4.168	88804	3701
TOTALE Kg.						73725

mc **495.00**

Kg/mc **160.00**

(Comprensiva armature di confezionamento)

APPALTATORE: <u>Consorzio</u> <u>Soci</u> HIRPINIA AV SALINI IMPREGILO S.P.A. ASTALDI S.P.A.	ITINERARIO NAPOLI – BARI					
PROGETTAZIONE: <u>Mandatario</u> <u>Mandanti</u> ROCKSOIL S.P.A. NET ENGINEERING S.P.A. ALPINA S.P.A.	RADDOPPIO TRATTA APICE – ORSARA I LOTTO FUNZIONALE APICE – HIRPINIA					
PROGETTO ESECUTIVO RELAZIONE DI CALCOLO FONDAZIONI PILE DA P7 A P16	COMMESSA IF28	LOTTO 01	CODIFICA E ZZ CL	DOCUMENTO VI0403 007	REV. B	FOGLIO 77 di 144

11 ALLEGATO: TABULATI GROUP

11.1 PILA SLE

=====

GROUP for Windows, Version 2016.10.13

Serial Number : 228330872

Analysis of A Group of Piles
Subjected to Axial and Lateral Loading

(c) Copyright ENSOFT, Inc., 1987-2015
All Rights Reserved

=====

Time and Date of Analysis

Date: July 06, 2020 Time: 14:36:58

***** COMPUTATION RESULTS *****

New Group

***** LOAD CASES RESULTS *****

LOAD CASE : 1
CASE NAME : Load Case
LOAD TYPE : Special, Sp

REDUCTION FACTORS FOR CLOSELY-SPACED PILE GROUPS, COMBINED Y AND Z DIRECTIONS
ESTIMATED USING MOVEMENT IN THE DIRECTION OF PILE CAP DISPLACEMENTS

GROUP NO	P-FACTOR	Y-FACTOR
1	0.7169	1.0000
2	0.6837	1.0000
3	0.8661	1.0000
4	0.5324	1.0000
5	0.4955	1.0000
6	0.7186	1.0000
7	0.5167	1.0000
8	0.4816	1.0000
9	0.7071	1.0000
10	0.5845	1.0000
11	0.5458	1.0000
12	0.7602	1.0000

* TABLE L * COMPUTATION ON PILE CAP

* EQUIVALENT CONCENTRATED LOAD AT ORIGIN *

VERT. LOAD, KN 38261.0	HOR. LOAD Y, KN -1201.00	HOR. LOAD Z, KN 1142.00
MOMENT X, KN- M 3.00000	MOMENT Y, KN- M 24006.0	MOMENT Z, KN- M 18765.0

* DISPLACEMENT OF GROUPED PILE FOUNDATION AT ORIGIN *

APPALTATORE:

Consorzio

Soci



ITINERARIO NAPOLI – BARI

PROGETTAZIONE:

Mandataria

Mandanti



RADDOPPIO TRATTA APICE – ORSARA
I LOTTO FUNZIONALE APICE – HIRPINIA

PROGETTO ESECUTIVO

RELAZIONE DI CALCOLO FONDAZIONI PILE DA P7 A P16

COMMESSA
IF1N

LOTTO
01 E ZZ

CODIFICA
RG

DOCUMENTO
MD0000 001

REV.
B

FOGLIO
78 di 144

VERTICAL , M 1.48778E-03	HORIZONTAL Y, M -5.67141E-04	HORIZONTAL Z, M 4.84319E-04
ANGLE ROT. X,RAD 2.06714E-07	ANGLE ROT. Y,RAD 4.30408E-05	ANGLE ROT. Z,RAD 6.43564E-05

THE GLOBAL STRUCTURAL COORDINATE SYSTEM

* PILE TOP DISPLACEMENTS *

PILE GROUP	DISP. X, M	DISP. Y, M	DISP. Z, M	ROT. X,RAD	ROT. Y,RAD	ROT. Z,RAD
*****	*****	*****	*****	*****	*****	*****
1	1.4887E-03	-5.6854E-04	4.8525E-04	2.0671E-07	4.3041E-05	6.4356E-05
2	1.7783E-03	-5.6854E-04	4.8432E-04	2.0671E-07	4.3041E-05	6.4356E-05
3	2.0679E-03	-5.6854E-04	4.8339E-04	2.0671E-07	4.3041E-05	6.4356E-05
4	1.2950E-03	-5.6761E-04	4.8525E-04	2.0671E-07	4.3041E-05	6.4356E-05
5	1.5846E-03	-5.6761E-04	4.8432E-04	2.0671E-07	4.3041E-05	6.4356E-05
6	1.8742E-03	-5.6761E-04	4.8339E-04	2.0671E-07	4.3041E-05	6.4356E-05
7	1.1013E-03	-5.6667E-04	4.8525E-04	2.0671E-07	4.3041E-05	6.4356E-05
8	1.3909E-03	-5.6667E-04	4.8432E-04	2.0671E-07	4.3041E-05	6.4356E-05
9	1.6805E-03	-5.6667E-04	4.8339E-04	2.0671E-07	4.3041E-05	6.4356E-05
10	9.0765E-04	-5.6574E-04	4.8525E-04	2.0671E-07	4.3041E-05	6.4356E-05
11	1.1972E-03	-5.6574E-04	4.8432E-04	2.0671E-07	4.3041E-05	6.4356E-05
12	1.4869E-03	-5.6574E-04	4.8339E-04	2.0671E-07	4.3041E-05	6.4356E-05
MINIMUM	9.0765E-04	-5.6854E-04	4.8339E-04	2.0671E-07	4.3041E-05	6.4356E-05
Pile N.	10	1	3	1	1	1
MAXIMUM	2.0679E-03	-5.6574E-04	4.8525E-04	2.0671E-07	4.3041E-05	6.4356E-05
Pile N.	3	10	1	1	1	1

* PILE TOP REACTIONS *

PILE GROUP	FOR. X, KN	FOR. Y, KN	FOR. Z, KN	MOM X, KN- M	MOM Y, KN- M	MOM Z, KN- M
*****	*****	*****	*****	*****	*****	*****
1	3190.3	-109.05	103.23	0.070953	-244.31	-231.17
2	3782.9	-105.77	100.00	0.070953	-238.17	-225.33
3	4375.4	-122.85	115.10	0.070953	-265.16	-255.80
4	2794.0	-90.035	86.204	0.070953	-212.21	-195.56
5	3386.6	-85.966	82.279	0.070953	-204.36	-187.84
6	3979.1	-108.89	102.80	0.070953	-243.02	-230.71
7	2397.7	-88.140	84.682	0.070953	-209.20	-191.58
8	2990.3	-84.224	80.891	0.070953	-201.57	-184.12
9	3582.8	-107.54	101.82	0.070953	-241.18	-227.90
10	2001.4	-95.143	91.285	0.070953	-221.86	-204.51
11	2594.0	-91.031	87.299	0.070953	-214.03	-196.86
12	3186.5	-112.35	106.41	0.070953	-249.49	-236.15
MINIMUM	2001.4	-122.85	80.891	0.070953	-265.16	-255.80
Pile N.	10	3	8	1	3	3
MAXIMUM	4375.4	-84.224	115.10	0.070953	-201.57	-184.12
Pile N.	3	8	3	1	8	8

THE PILE COORDINATE SYSTEM (LOCAL AXES)

* PILE TOP DISPLACEMENTS *

PILE GROUP	DISP. x, M	DISP. y, M	DISP. z, M	ROT. x,RAD	ROT. y,RAD	ROT. z,RAD
*****	*****	*****	*****	*****	*****	*****
1	1.4887E-03	-5.6854E-04	4.8525E-04	2.0671E-07	4.3041E-05	6.4356E-05
2	1.7783E-03	-5.6854E-04	4.8432E-04	2.0671E-07	4.3041E-05	6.4356E-05
3	2.0679E-03	-5.6854E-04	4.8339E-04	2.0671E-07	4.3041E-05	6.4356E-05
4	1.2950E-03	-5.6761E-04	4.8525E-04	2.0671E-07	4.3041E-05	6.4356E-05
5	1.5846E-03	-5.6761E-04	4.8432E-04	2.0671E-07	4.3041E-05	6.4356E-05
6	1.8742E-03	-5.6761E-04	4.8339E-04	2.0671E-07	4.3041E-05	6.4356E-05
7	1.1013E-03	-5.6667E-04	4.8525E-04	2.0671E-07	4.3041E-05	6.4356E-05
8	1.3909E-03	-5.6667E-04	4.8432E-04	2.0671E-07	4.3041E-05	6.4356E-05
9	1.6805E-03	-5.6667E-04	4.8339E-04	2.0671E-07	4.3041E-05	6.4356E-05
10	9.0765E-04	-5.6574E-04	4.8525E-04	2.0671E-07	4.3041E-05	6.4356E-05
11	1.1972E-03	-5.6574E-04	4.8432E-04	2.0671E-07	4.3041E-05	6.4356E-05
12	1.4869E-03	-5.6574E-04	4.8339E-04	2.0671E-07	4.3041E-05	6.4356E-05
MINIMUM	9.0765E-04	-5.6854E-04	4.8339E-04	2.0671E-07	4.3041E-05	6.4356E-05
Pile N.	10	1	3	1	1	1
MAXIMUM	2.0679E-03	-5.6574E-04	4.8525E-04	2.0671E-07	4.3041E-05	6.4356E-05
Pile N.	3	10	1	1	1	1

* PILE TOP REACTIONS *

PILE GROUP	AXIAL, KN	LAT. y, KN	LAT. z, KN	MOM x, KN- M	MOM y, KN- M	MOM z, KN- M
*****	*****	*****	*****	*****	*****	*****
1	3190.3	-109.05	103.23	0.070953	-244.31	-231.17
2	3782.9	-105.77	100.00	0.070953	-238.17	-225.33
3	4375.4	-122.85	115.10	0.070953	-265.16	-255.80
4	2794.0	-90.035	86.204	0.070953	-212.21	-195.56

APPALTATORE:

Consorzio

Soci



ITINERARIO NAPOLI – BARI

PROGETTAZIONE:

Mandataria

Mandanti



RADDOPPIO TRATTA APICE – ORSARA
I LOTTO FUNZIONALE APICE – HIRPINIA

PROGETTO ESECUTIVO

RELAZIONE DI CALCOLO FONDAZIONI PILE DA P7 A P16

COMMESSA	LOTTO	CODIFICA	DOCUMENTO	REV.	FOGLIO
IF1N	01 E ZZ	RG	MD0000 001	B	79 di 144

5	3386.6	-85.966	82.279	0.070953	-204.36	-187.84
6	3979.1	-108.89	102.80	0.070953	-243.02	-230.71
7	2397.7	-88.140	84.682	0.070953	-209.20	-191.58
8	2990.3	-84.224	80.891	0.070953	-201.57	-184.12
9	3582.8	-107.54	101.82	0.070953	-241.18	-227.90
10	2001.4	-95.143	91.285	0.070953	-221.86	-204.51
11	2594.0	-91.031	87.299	0.070953	-214.03	-196.86
12	3186.5	-112.35	106.41	0.070953	-249.49	-236.15
MINIMUM	2001.4	-122.85	80.891	0.070953	-265.16	-255.80
Pile N.	10	3	8	1	3	3
MAXIMUM	4375.4	-84.224	115.10	0.070953	-201.57	-184.12
Pile N.	3	8	3	1	8	8

PILE GROUP STRESS, KN/ M**2

1	2820.4
2	3130.2
3	3587.9
4	2452.0
5	2754.1
6	3263.1
7	2212.9
8	2516.1
9	3028.9
10	2043.2
11	2345.5
12	2840.0
MINIMUM	2043.2
Pile N.	10
MAXIMUM	3587.9
Pile N.	3

* EFFECTS FOR LATERALLY LOADED PILE *

* MINIMUM VALUES AND LOCATIONS *

PILE	DISPL. y-DIR M	DISPL. z-DIR M	MOMENT z-DIR KN- M	MOMENT y-DIR KN- M	SHEAR y-DIR KN	SHEAR z-DIR KN	SOIL REACT y-DIR KN/ M	SOIL REACT z-DIR KN/ M	TOTAL STRESS KN/ M**2	FLEX. RIG. z-DIR KN- M**2	FLEX. RIG. y-DIR KN- M**2
1	-5.6854E-04	-1.0832E-05	-145.70	-244.31	-109.07	-27.876	-34.522	-6.6979	1805.3	7.8279E+06	7.8279E+06
x(M)	0.0000	10.560	5.6100	0.0000	0.0000	8.5800	4.9500	10.890	33.000	0.0000	0.0000
2	-5.6854E-04	-1.0854E-05	-143.31	-238.17	-105.79	-27.144	-33.468	-6.4483	2140.7	7.8279E+06	7.8279E+06
x(M)	0.0000	10.560	5.6100	0.0000	0.0000	8.5800	4.9500	10.890	33.000	0.0000	0.0000
3	-5.6854E-04	-1.0665E-05	-155.41	-265.16	-122.87	-30.838	-38.896	-7.6935	2476.0	7.8279E+06	7.8279E+06
x(M)	0.0000	10.230	5.6100	0.0000	0.0000	8.2500	4.9500	10.560	33.000	0.0000	0.0000
4	-5.6761E-04	-1.0999E-05	-131.58	-212.21	-90.047	-23.676	-28.241	-5.3382	1581.1	7.8279E+06	7.8279E+06
x(M)	0.0000	10.890	5.9400	0.0000	0.0000	8.9100	4.9500	11.550	33.000	0.0000	0.0000
5	-5.6761E-04	-1.1056E-05	-128.41	-204.36	-85.979	-22.711	-26.872	-5.0543	1916.4	7.8279E+06	7.8279E+06
x(M)	0.0000	11.220	5.9400	0.0000	0.0000	8.9100	4.9500	11.550	33.000	0.0000	0.0000
6	-5.6761E-04	-1.0794E-05	-145.61	-243.02	-108.91	-27.812	-34.489	-6.6866	2251.7	7.8279E+06	7.8279E+06
x(M)	0.0000	10.560	5.6100	0.0000	0.0000	8.5800	4.9500	10.890	33.000	0.0000	0.0000
7	-5.6668E-04	-1.1019E-05	-130.02	-209.20	-88.150	-23.281	-27.606	-5.2222	1356.8	7.8279E+06	7.8279E+06
x(M)	0.0000	11.220	5.9400	0.0000	0.0000	8.9100	4.9500	11.550	33.000	0.0000	0.0000
8	-5.6668E-04	-1.1073E-05	-126.92	-201.57	-84.236	-22.331	-26.285	-4.9410	1692.1	7.8279E+06	7.8279E+06
x(M)	0.0000	11.220	5.9400	0.0000	0.0000	8.9100	4.9500	11.550	33.000	0.0000	0.0000
9	-5.6668E-04	-1.0806E-05	-144.53	-241.18	-107.56	-27.571	-34.055	-6.6038	2027.5	7.8279E+06	7.8279E+06
x(M)	0.0000	10.560	5.6100	0.0000	0.0000	8.5800	4.9500	10.890	33.000	0.0000	0.0000
10	-5.6575E-04	-1.0960E-05	-135.28	-221.86	-95.151	-24.857	-29.964	-5.7341	1132.6	7.8279E+06	7.8279E+06
x(M)	0.0000	10.890	5.9400	0.0000	0.0000	8.9100	4.9500	11.220	33.000	0.0000	0.0000
11	-5.6575E-04	-1.0976E-05	-132.24	-214.03	-91.042	-23.944	-28.596	-5.4201	1467.9	7.8279E+06	7.8279E+06
x(M)	0.0000	10.890	5.9400	0.0000	0.0000	8.9100	4.9500	11.550	33.000	0.0000	0.0000
12	-5.6575E-04	-1.0712E-05	-147.94	-249.49	-112.37	-28.628	-35.598	-6.9587	1803.2	7.8279E+06	7.8279E+06
x(M)	0.0000	10.560	5.6100	0.0000	0.0000	8.2500	4.9500	10.890	33.000	0.0000	0.0000
Min. Pile N.	-5.6854E-04 1	-1.1073E-05 8	-155.41 3	-265.16 3	-122.87 3	-30.838 3	-38.896 3	-7.6935 3	1132.6 10	7.8279E+06 1	7.8279E+06 1

* MAXIMUM VALUES AND LOCATIONS *

PILE	DISPL. y-DIR M	DISPL. z-DIR M	MOMENT z-DIR KN- M	MOMENT y-DIR KN- M	SHEAR y-DIR KN	SHEAR z-DIR KN	SOIL REACT y-DIR KN/ M	SOIL REACT z-DIR KN/ M	TOTAL STRESS KN/ M**2	FLEX. RIG. z-DIR KN- M**2	FLEX. RIG. y-DIR KN- M**2
1	1.2583E-05	4.8525E-04	231.17	125.86	32.125	103.25	7.6695	32.113	2820.4	7.8279E+06	7.8279E+06
x(M)	10.230	0.0000	0.0000	5.9400	8.2500	0.0000	10.890	4.9500	0.0000	0.0000	0.0000
2	1.2643E-05	4.8432E-04	225.33	123.62	31.281	100.02	7.4204	31.062	3130.2	7.8279E+06	7.8279E+06
x(M)	10.560	0.0000	0.0000	5.9400	8.2500	0.0000	10.890	4.9500	0.0000	0.0000	0.0000
3	1.2407E-05	4.8339E-04	255.80	133.54	35.546	115.13	8.8409	35.979	3587.9	7.8279E+06	7.8279E+06
x(M)	9.9000	0.0000	0.0000	5.6100	8.2500	0.0000	10.560	4.9500	0.0000	0.0000	0.0000
4	1.2855E-05	4.8525E-04	195.56	113.33	27.226	86.216	6.1307	26.366	2452.0	7.8279E+06	7.8279E+06
x(M)	10.890	0.0000	0.0000	6.2700	8.5800	0.0000	11.220	4.9500	0.0000	0.0000	0.0000
5	1.2907E-05	4.8432E-04	187.84	110.44	26.200	82.293	5.8012	25.035	2754.1	7.8279E+06	7.8279E+06
x(M)	10.890	0.0000	0.0000	6.2700	8.9100	0.0000	11.550	4.9500	0.0000	0.0000	0.0000
6	1.2574E-05	4.8339E-04	230.71	125.47	32.135	102.82	7.6732	31.998	3263.1	7.8279E+06	7.8279E+06
x(M)	10.230	0.0000	0.0000	5.9400	8.2500	0.0000	10.890	4.9500	0.0000	0.0000	0.0000

APPALTATORE: Consorzio Soci 	ITINERARIO NAPOLI – BARI RADDOPPIO TRATTA APICE – ORSARA I LOTTO FUNZIONALE APICE – HIRPINIA				
PROGETTAZIONE: Mandataria Mandanti 					
PROGETTO ESECUTIVO RELAZIONE DI CALCOLO FONDAZIONI PILE DA P7 A P16					
COMMESSA IF1N	LOTTO 01 E ZZ	CODIFICA RG	DOCUMENTO MD0000 001	REV. B	FOGLIO 80 di 144

	7	1.2852E-05	4.8525E-04	191.58	112.21	26.701	84.693	5.9750	25.837	2212.9	7.8279E+06	7.8279E+06
x(M)		10.890	0.0000	0.0000	6.2700	8.9100	0.0000	11.220	4.9500	0.0000	0.0000	0.0000
	8	1.2882E-05	4.8432E-04	184.12	109.37	25.754	80.903	5.6723	24.548	2516.1	7.8279E+06	7.8279E+06
x(M)		10.890	0.0000	0.0000	6.2700	8.9100	0.0000	11.550	4.9500	0.0000	0.0000	0.0000
	9	1.2548E-05	4.8339E-04	227.90	124.78	31.778	101.84	7.5719	31.670	3028.9	7.8279E+06	7.8279E+06
x(M)		10.230	0.0000	0.0000	5.9400	8.2500	0.0000	10.890	4.9500	0.0000	0.0000	0.0000
	10	1.2682E-05	4.8525E-04	204.51	117.18	28.581	91.294	6.5442	28.092	2043.2	7.8279E+06	7.8279E+06
x(M)		10.560	0.0000	0.0000	5.9400	8.5800	0.0000	11.220	4.9500	0.0000	0.0000	0.0000
	11	1.2781E-05	4.8432E-04	196.86	114.06	27.520	87.311	6.2264	26.752	2345.5	7.8279E+06	7.8279E+06
x(M)		10.890	0.0000	0.0000	5.9400	8.5800	0.0000	11.220	4.9500	0.0000	0.0000	0.0000
	12	1.2499E-05	4.8339E-04	236.15	127.80	33.012	106.43	7.9839	33.172	2840.0	7.8279E+06	7.8279E+06
x(M)		10.230	0.0000	0.0000	5.9400	8.2500	0.0000	10.560	4.9500	0.0000	0.0000	0.0000
Max.		1.2907E-05	4.8525E-04	255.80	133.54	35.546	115.13	8.8409	35.979	3587.9	7.8279E+06	7.8279E+06
Pile N.		5	1	3	3	3	3	3	3	3	1	1

LOAD CASE : 2
CASE NAME : Load Case
LOAD TYPE : Special, Sp

REDUCTION FACTORS FOR CLOSELY-SPACED PILE GROUPS, COMBINED Y AND Z DIRECTIONS
ESTIMATED USING MOVEMENT IN THE DIRECTION OF PILE CAP DISPLACEMENTS

GROUP NO	P-FACTOR	Y-FACTOR
1	0.8560	1.0000
2	0.7970	1.0000
3	0.8661	1.0000
4	0.5758	1.0000
5	0.4961	1.0000
6	0.5904	1.0000
7	0.5425	1.0000
8	0.4640	1.0000
9	0.5580	1.0000
10	0.5845	1.0000
11	0.5003	1.0000
12	0.5992	1.0000

* TABLE L * COMPUTATION ON PILE CAP

* EQUIVALENT CONCENTRATED LOAD AT ORIGIN *

VERT. LOAD, KN	HOR. LOAD Y, KN	HOR. LOAD Z, KN
31039.0	-170.000	908.000
MOMENT X, KN- M	MOMENT Y, KN- M	MOMENT Z, KN- M
0.00000	18721.0	2683.00

* DISPLACEMENT OF GROUPED PILE FOUNDATION AT ORIGIN *

VERTICAL, M	HORIZONTAL Y, M	HORIZONTAL Z, M
1.19365E-03	-8.15508E-05	3.87485E-04
ANGLE ROT. X, RAD	ANGLE ROT. Y, RAD	ANGLE ROT. Z, RAD
-4.82689E-07	3.36686E-05	9.19637E-06

THE GLOBAL STRUCTURAL COORDINATE SYSTEM

* PILE TOP DISPLACEMENTS *

PILE GROUP	DISP. X, M	DISP. Y, M	DISP. Z, M	ROT. X, RAD	ROT. Y, RAD	ROT. Z, RAD
*****	*****	*****	*****	*****	*****	*****
1	1.3795E-03	-7.8293E-05	3.8531E-04	-4.8269E-07	3.3669E-05	9.1964E-06
2	1.4209E-03	-7.8293E-05	3.8749E-04	-4.8269E-07	3.3669E-05	9.1964E-06
3	1.4623E-03	-7.8293E-05	3.8966E-04	-4.8269E-07	3.3669E-05	9.1964E-06
4	1.2280E-03	-8.0465E-05	3.8531E-04	-4.8269E-07	3.3669E-05	9.1964E-06
5	1.2694E-03	-8.0465E-05	3.8749E-04	-4.8269E-07	3.3669E-05	9.1964E-06
6	1.3108E-03	-8.0465E-05	3.8966E-04	-4.8269E-07	3.3669E-05	9.1964E-06
7	1.0765E-03	-8.2637E-05	3.8531E-04	-4.8269E-07	3.3669E-05	9.1964E-06
8	1.1179E-03	-8.2637E-05	3.8749E-04	-4.8269E-07	3.3669E-05	9.1964E-06
9	1.1593E-03	-8.2637E-05	3.8966E-04	-4.8269E-07	3.3669E-05	9.1964E-06
10	9.2500E-04	-8.4809E-05	3.8531E-04	-4.8269E-07	3.3669E-05	9.1964E-06
11	9.6638E-04	-8.4809E-05	3.8749E-04	-4.8269E-07	3.3669E-05	9.1964E-06
12	1.0078E-03	-8.4809E-05	3.8966E-04	-4.8269E-07	3.3669E-05	9.1964E-06
MINIMUM	9.2500E-04	-8.4809E-05	3.8531E-04	-4.8269E-07	3.3669E-05	9.1964E-06
Pile N.	10	10	1	1	1	1
MAXIMUM	1.4623E-03	-7.8293E-05	3.8966E-04	-4.8269E-07	3.3669E-05	9.1964E-06

APPALTATORE:

Consorzio

Soci



ITINERARIO NAPOLI – BARI

RADDOPPIO TRATTA APICE – ORSARA
I LOTTO FUNZIONALE APICE – HIRPINIA

PROGETTAZIONE:

Mandatario

Mandanti



PROGETTO ESECUTIVO

RELAZIONE DI CALCOLO FONDAZIONI PILE DA P7 A P16

COMMESSA
IF1NLOTTO
01 E ZZCODIFICA
RGDOCUMENTO
MD0000 001REV.
BFOGLIO
81 di 144

Pile N. 3 1 3 1 1 1

* PILE TOP REACTIONS *

PILE GROUP	FOR. X, KN	FOR. Y, KN	FOR. Z, KN	MOM X, KN- M	MOM Y, KN- M	MOM Z, KN- M
1	2966.9	-16.516	91.812	-0.1657	-212.87	-33.654
2	3051.6	-15.778	88.586	-0.1657	-207.88	-32.365
3	3136.3	-16.638	93.844	-0.1657	-217.99	-33.870
4	2656.9	-13.370	72.236	-0.1657	-176.91	-28.693
5	2741.6	-12.154	66.518	-0.1657	-166.47	-26.380
6	2826.3	-13.584	74.465	-0.1657	-182.49	-29.100
7	2346.9	-13.414	69.692	-0.1657	-171.99	-29.433
8	2431.6	-12.143	63.887	-0.1657	-161.23	-26.980
9	2516.3	-13.654	71.981	-0.1657	-177.71	-29.895
10	2036.9	-14.630	72.930	-0.1657	-178.16	-32.392
11	2121.6	-13.262	66.891	-0.1657	-167.13	-29.782
12	2206.2	-14.858	75.159	-0.1657	-183.74	-32.823
MINIMUM	2036.9	-16.638	63.887	-0.1657	-217.99	-33.870
Pile N.	10	3	8	1	3	3
MAXIMUM	3136.3	-12.143	93.844	-0.1657	-161.23	-26.380
Pile N.	3	8	3	1	8	5

THE PILE COORDINATE SYSTEM (LOCAL AXES)

* PILE TOP DISPLACEMENTS *

PILE GROUP	DISP. x, M	DISP. y, M	DISP. z, M	ROT. x, RAD	ROT. y, RAD	ROT. z, RAD
1	1.3795E-03	-7.8293E-05	3.8531E-04	-4.8269E-07	3.3669E-05	9.1964E-06
2	1.4209E-03	-7.8293E-05	3.8749E-04	-4.8269E-07	3.3669E-05	9.1964E-06
3	1.4623E-03	-7.8293E-05	3.8966E-04	-4.8269E-07	3.3669E-05	9.1964E-06
4	1.2280E-03	-8.0465E-05	3.8531E-04	-4.8269E-07	3.3669E-05	9.1964E-06
5	1.2694E-03	-8.0465E-05	3.8749E-04	-4.8269E-07	3.3669E-05	9.1964E-06
6	1.3108E-03	-8.0465E-05	3.8966E-04	-4.8269E-07	3.3669E-05	9.1964E-06
7	1.0765E-03	-8.2637E-05	3.8531E-04	-4.8269E-07	3.3669E-05	9.1964E-06
8	1.1179E-03	-8.2637E-05	3.8749E-04	-4.8269E-07	3.3669E-05	9.1964E-06
9	1.1593E-03	-8.2637E-05	3.8966E-04	-4.8269E-07	3.3669E-05	9.1964E-06
10	9.2500E-04	-8.4809E-05	3.8531E-04	-4.8269E-07	3.3669E-05	9.1964E-06
11	9.6638E-04	-8.4809E-05	3.8749E-04	-4.8269E-07	3.3669E-05	9.1964E-06
12	1.0078E-03	-8.4809E-05	3.8966E-04	-4.8269E-07	3.3669E-05	9.1964E-06
MINIMUM	9.2500E-04	-8.4809E-05	3.8531E-04	-4.8269E-07	3.3669E-05	9.1964E-06
Pile N.	10	10	1	1	1	1
MAXIMUM	1.4623E-03	-7.8293E-05	3.8966E-04	-4.8269E-07	3.3669E-05	9.1964E-06
Pile N.	3	1	3	1	1	1

* PILE TOP REACTIONS *

PILE GROUP	AXIAL, KN	LAT. y, KN	LAT. z, KN	MOM x, KN- M	MOM y, KN- M	MOM z, KN- M
1	2966.9	-16.516	91.812	-0.1657	-212.87	-33.654
2	3051.6	-15.778	88.586	-0.1657	-207.88	-32.365
3	3136.3	-16.638	93.844	-0.1657	-217.99	-33.870
4	2656.9	-13.370	72.236	-0.1657	-176.91	-28.693
5	2741.6	-12.154	66.518	-0.1657	-166.47	-26.380
6	2826.3	-13.584	74.465	-0.1657	-182.49	-29.100
7	2346.9	-13.414	69.692	-0.1657	-171.99	-29.433
8	2431.6	-12.143	63.887	-0.1657	-161.23	-26.980
9	2516.3	-13.654	71.981	-0.1657	-177.71	-29.895
10	2036.9	-14.630	72.930	-0.1657	-178.16	-32.392
11	2121.6	-13.262	66.891	-0.1657	-167.13	-29.782
12	2206.2	-14.858	75.159	-0.1657	-183.74	-32.823
MINIMUM	2036.9	-16.638	63.887	-0.1657	-217.99	-33.870
Pile N.	10	3	8	1	3	3
MAXIMUM	3136.3	-12.143	93.844	-0.1657	-161.23	-26.380
Pile N.	3	8	3	1	8	5

PILE GROUP STRESS, KN/ M**2

PILE GROUP	STRESS, KN/ M**2
1	2329.4
2	2361.8
3	2440.6
4	2044.4
5	2060.1
6	2157.1
7	1854.7
8	1869.3
9	1967.8
10	1699.2
11	1712.9
12	1811.8
MINIMUM	1699.2

APPALDATTORE:

Consorzio

Soci



ITINERARIO NAPOLI – BARI

PROGETTAZIONE:

Mandataria

Mandanti



RADDOPPIO TRATTA APICE – ORSARA
I LOTTO FUNZIONALE APICE – HIRPINIA

PROGETTO ESECUTIVO

RELAZIONE DI CALCOLO FONDAZIONI PILE DA P7 A P16

COMMESSA IF1N	LOTTO 01 E ZZ	CODIFICA RG	DOCUMENTO MD0000 001	REV. B	FOGLIO 82 di 144
------------------	------------------	----------------	-------------------------	-----------	---------------------

Pile N. 10
MAXIMUM 2440.6
Pile N. 3

* EFFECTS FOR Laterally Loaded PILE *

* MINIMUM VALUES AND LOCATIONS *

PILE	DISPL. y-Dir M	DISPL. z-Dir M	MOMENT z-Dir KN- M	MOMENT y-Dir KN- M	SHEAR y-Dir KN	SHEAR z-Dir KN	SOIL REACT y-Dir KN/ M	SOIL REACT z-Dir KN/ M	TOTAL STRESS KN/ M**2	FLEX. RIG. z-Dir KN- M**2	FLEX. RIG. y-Dir KN- M**2
*****	*****	*****	*****	*****	*****	*****	*****	*****	*****	*****	*****
1	-7.8293E-05	-8.5060E-06	-21.275	-212.87	-16.518	-24.434	-5.2363	-6.0823	1678.9	7.8279E+06	7.8279E+06
x(M)	0.0000	10.230	5.6100	0.0000	0.0000	8.2500	4.9500	10.560	33.000	0.0000	0.0000
2	-7.8293E-05	-8.5842E-06	-20.780	-207.88	-15.700	-23.619	-5.0072	-5.7861	1726.8	7.8279E+06	7.8279E+06
x(M)	0.0000	10.230	5.6100	0.0000	0.0000	8.2500	4.9500	10.560	33.000	0.0000	0.0000
3	-7.8293E-05	-8.5987E-06	-21.357	-217.99	-16.640	-24.890	-5.2741	-6.2114	1774.8	7.8279E+06	7.8279E+06
x(M)	0.0000	10.230	5.6100	0.0000	0.0000	8.2500	4.9500	10.560	33.000	0.0000	0.0000
4	-8.0465E-05	-8.7215E-06	-19.144	-176.91	-13.372	-19.620	-4.2089	-4.5074	1503.5	7.8279E+06	7.8279E+06
x(M)	0.0000	10.890	5.9400	0.0000	0.0000	8.9100	4.9500	11.220	33.000	0.0000	0.0000
5	-8.0465E-05	-8.8448E-06	-18.205	-166.47	-12.156	-18.194	-3.7998	-4.0516	1551.4	7.8279E+06	7.8279E+06
x(M)	0.0000	11.220	5.9400	0.0000	0.0000	8.9100	4.9500	11.550	33.000	0.0000	0.0000
6	-8.0465E-05	-8.8102E-06	-19.304	-182.49	-13.586	-20.120	-4.2807	-4.6530	1599.3	7.8279E+06	7.8279E+06
x(M)	0.0000	10.890	5.9400	0.0000	0.0000	8.9100	4.9500	11.220	33.000	0.0000	0.0000
7	-8.2637E-05	-8.7320E-06	-19.290	-171.99	-13.415	-19.006	-4.1976	-4.2997	1328.1	7.8279E+06	7.8279E+06
x(M)	0.0000	10.890	5.9400	0.0000	0.0000	8.9100	4.9500	11.550	33.000	0.0000	0.0000
8	-8.2637E-05	-8.8687E-06	-18.268	-161.23	-12.144	-17.494	-3.7661	-3.8378	1376.0	7.8279E+06	7.8279E+06
x(M)	0.0000	11.220	5.9400	0.0000	0.0000	9.2400	4.9500	11.550	33.000	0.0000	0.0000
9	-8.2637E-05	-8.8312E-06	-19.476	-177.71	-13.656	-19.532	-4.2790	-4.4472	1423.9	7.8279E+06	7.8279E+06
x(M)	0.0000	10.890	5.9400	0.0000	0.0000	8.9100	4.9500	11.220	33.000	0.0000	0.0000
10	-8.4809E-05	-8.7077E-06	-20.322	-178.16	-14.632	-19.763	-4.5800	-4.5584	1152.6	7.8279E+06	7.8279E+06
x(M)	0.0000	10.890	5.9400	0.0000	0.0000	8.9100	4.9500	11.220	33.000	0.0000	0.0000
11	-8.4809E-05	-8.8325E-06	-19.262	-167.13	-13.263	-18.273	-4.1179	-4.0758	1200.6	7.8279E+06	7.8279E+06
x(M)	0.0000	11.220	5.9400	0.0000	0.0000	8.9100	4.9500	11.550	33.000	0.0000	0.0000
12	-8.4809E-05	-8.7939E-06	-20.492	-183.74	-14.860	-20.276	-4.6565	-4.7030	1248.5	7.8279E+06	7.8279E+06
x(M)	0.0000	10.890	5.9400	0.0000	0.0000	8.5800	4.9500	11.220	33.000	0.0000	0.0000
Min.	-8.4809E-05	-8.8687E-06	-21.357	-217.99	-16.640	-24.890	-5.2741	-6.2114	1152.6	7.8279E+06	7.8279E+06
Pile N.	10	8	3	3	3	3	3	3	10	1	1







* MAXIMUM VALUES AND LOCATIONS *

PILE	DISPL. y-Dir M	DISPL. z-Dir M	MOMENT z-Dir KN- M	MOMENT y-Dir KN- M	SHEAR y-Dir KN	SHEAR z-Dir KN	SOIL REACT y-Dir KN/ M	SOIL REACT z-Dir KN/ M	TOTAL STRESS KN/ M**2	FLEX. RIG. z-Dir KN- M**2	FLEX. RIG. y-Dir KN- M**2
*****	*****	*****	*****	*****	*****	*****	*****	*****	*****	*****	*****
1	1.7070E-06	3.8531E-04	33.654	106.05	4.8448	91.826	1.2016	28.637	2329.4	7.8279E+06	7.8279E+06
x(M)	9.9000	0.0000	0.0000	5.6100	8.2500	0.0000	10.560	4.9500	0.0000	0.0000	0.0000
2	1.7218E-06	3.8748E-04	32.365	104.19	4.6730	88.600	1.1423	27.592	2361.8	7.8279E+06	7.8279E+06
x(M)	10.230	0.0000	0.0000	5.9400	8.2500	0.0000	10.560	4.9500	0.0000	0.0000	0.0000
3	1.7072E-06	3.8966E-04	33.870	107.75	4.8773	93.858	1.2113	29.262	2440.6	7.8279E+06	7.8279E+06
x(M)	9.9000	0.0000	0.0000	5.6100	7.9200	0.0000	10.560	4.9500	0.0000	0.0000	0.0000
4	1.8061E-06	3.8531E-04	28.693	92.598	4.0328	72.246	0.9209	22.175	2044.4	7.8279E+06	7.8279E+06
x(M)	10.890	0.0000	0.0000	5.9400	8.5800	0.0000	11.220	4.9500	0.0000	0.0000	0.0000
5	1.8288E-06	3.8748E-04	26.380	88.488	3.7120	66.527	0.8219	20.182	2060.1	7.8279E+06	7.8279E+06
x(M)	10.890	0.0000	0.0000	6.2700	8.9100	0.0000	11.550	4.9500	0.0000	0.0000	0.0000
6	1.8058E-06	3.8966E-04	29.100	94.544	4.0893	74.476	0.9376	22.881	2157.1	7.8279E+06	7.8279E+06
x(M)	10.560	0.0000	0.0000	5.9400	8.5800	0.0000	11.220	4.9500	0.0000	0.0000	0.0000
7	1.8681E-06	3.8531E-04	29.433	90.626	4.0085	69.700	0.9065	21.302	1854.7	7.8279E+06	7.8279E+06
x(M)	10.890	0.0000	0.0000	6.2700	8.5800	0.0000	11.220	4.9500	0.0000	0.0000	0.0000
8	1.8855E-06	3.8748E-04	26.980	86.457	3.6831	63.895	0.8054	19.266	1869.3	7.8279E+06	7.8279E+06
x(M)	11.220	0.0000	0.0000	6.2700	8.9100	0.0000	11.550	4.9500	0.0000	0.0000	0.0000
9	1.8633E-06	3.8966E-04	29.895	92.595	4.0747	71.990	0.9263	22.030	1967.8	7.8279E+06	7.8279E+06
x(M)	10.890	0.0000	0.0000	5.9400	8.5800	0.0000	11.220	4.9500	0.0000	0.0000	0.0000
10	1.9021E-06	3.8531E-04	32.392	93.096	4.2970	72.937	0.9856	22.404	1699.2	7.8279E+06	7.8279E+06
x(M)	10.890	0.0000	0.0000	5.9400	8.5800	0.0000	11.220	4.9500	0.0000	0.0000	0.0000
11	1.9233E-06	3.8748E-04	29.782	88.732	3.9429	66.898	0.8755	20.304	1712.9	7.8279E+06	7.8279E+06
x(M)	10.890	0.0000	0.0000	6.2700	8.9100	0.0000	11.550	4.9500	0.0000	0.0000	0.0000
12	1.8998E-06	3.8966E-04	32.823	95.035	4.3570	75.168	1.0032	23.109	1811.8	7.8279E+06	7.8279E+06
x(M)	10.560	0.0000	0.0000	5.9400	8.5800	0.0000	11.220	4.9500	0.0000	0.0000	0.0000
Max.	1.9233E-06	3.8966E-04	33.870	107.75	4.8773	93.858	1.2113	29.262	2440.6	7.8279E+06	7.8279E+06
Pile N.	11	3	3	3	3	3	3	3	3	1	1

LOAD CASE : 3
CASE NAME : Load Case
LOAD TYPE : Special, Sp

REDUCTION FACTORS FOR CLOSELY-SPACED PILE GROUPS, COMBINED Y AND Z DIRECTIONS
ESTIMATED USING MOVEMENT IN THE DIRECTION OF PILE CAP DISPLACEMENTS

GROUP NO	P-FACTOR	Y-FACTOR
1	0.7538	1.0000
2	0.7135	1.0000
3	0.8661	1.0000

APPALTATORE: Consorzio  Soci  	ITINERARIO NAPOLI – BARI RADDOPPIO TRATTA APICE – ORSARA I LOTTO FUNZIONALE APICE – HIRPINIA												
PROGETTAZIONE: Mandataria  Mandanti  													
PROGETTO ESECUTIVO RELAZIONE DI CALCOLO FONDAZIONI PILE DA P7 A P16	<table border="0"> <tr> <td>COMMESSA</td> <td>LOTTO</td> <td>CODIFICA</td> <td>DOCUMENTO</td> <td>REV.</td> <td>FOGLIO</td> </tr> <tr> <td>IF1N</td> <td>01 E ZZ</td> <td>RG</td> <td>MD0000 001</td> <td>B</td> <td>83 di 144</td> </tr> </table>	COMMESSA	LOTTO	CODIFICA	DOCUMENTO	REV.	FOGLIO	IF1N	01 E ZZ	RG	MD0000 001	B	83 di 144
COMMESSA	LOTTO	CODIFICA	DOCUMENTO	REV.	FOGLIO								
IF1N	01 E ZZ	RG	MD0000 001	B	83 di 144								

4	0.5435	1.0000
5	0.4957	1.0000
6	0.6890	1.0000
7	0.5232	1.0000
8	0.4773	1.0000
9	0.6732	1.0000
10	0.5845	1.0000
11	0.5349	1.0000
12	0.7235	1.0000

* TABLE L * COMPUTATION ON PILE CAP

* EQUIVALENT CONCENTRATED LOAD AT ORIGIN *

VERT. LOAD, KN	HOR. LOAD Y, KN	HOR. LOAD Z, KN
35317.0	-791.000	925.000
MOMENT X, KN- M	MOMENT Y, KN- M	MOMENT Z, KN- M
0.00000	24650.0	12338.0

* DISPLACEMENT OF GROUPED PILE FOUNDATION AT ORIGIN *

VERTICAL, M	HORIZONTAL Y, M	HORIZONTAL Z, M
1.36788E-03	-3.73919E-04	4.17480E-04
ANGLE ROT. X, RAD	ANGLE ROT. Y, RAD	ANGLE ROT. Z, RAD
-2.76307E-07	4.30209E-05	4.23308E-05

THE GLOBAL STRUCTURAL COORDINATE SYSTEM

* PILE TOP DISPLACEMENTS *

PILE GROUP	DISP. X, M	DISP. Y, M	DISP. Z, M	ROT. X, RAD	ROT. Y, RAD	ROT. Z, RAD
*****	*****	*****	*****	*****	*****	*****
1	1.4678E-03	-3.7205E-04	4.1624E-04	-2.7631E-07	4.3021E-05	4.2331E-05
2	1.6583E-03	-3.7205E-04	4.1748E-04	-2.7631E-07	4.3021E-05	4.2331E-05
3	1.8488E-03	-3.7205E-04	4.1872E-04	-2.7631E-07	4.3021E-05	4.2331E-05
4	1.2742E-03	-3.7330E-04	4.1624E-04	-2.7631E-07	4.3021E-05	4.2331E-05
5	1.4647E-03	-3.7330E-04	4.1748E-04	-2.7631E-07	4.3021E-05	4.2331E-05
6	1.6552E-03	-3.7330E-04	4.1872E-04	-2.7631E-07	4.3021E-05	4.2331E-05
7	1.0806E-03	-3.7454E-04	4.1624E-04	-2.7631E-07	4.3021E-05	4.2331E-05
8	1.2711E-03	-3.7454E-04	4.1748E-04	-2.7631E-07	4.3021E-05	4.2331E-05
9	1.4616E-03	-3.7454E-04	4.1872E-04	-2.7631E-07	4.3021E-05	4.2331E-05
10	8.8700E-04	-3.7578E-04	4.1624E-04	-2.7631E-07	4.3021E-05	4.2331E-05
11	1.0775E-03	-3.7578E-04	4.1748E-04	-2.7631E-07	4.3021E-05	4.2331E-05
12	1.2680E-03	-3.7578E-04	4.1872E-04	-2.7631E-07	4.3021E-05	4.2331E-05
MINIMUM	8.8700E-04	-3.7578E-04	4.1624E-04	-2.7631E-07	4.3021E-05	4.2331E-05
Pile N.	10	10	1	1	1	1
MAXIMUM	1.8488E-03	-3.7205E-04	4.1872E-04	-2.7631E-07	4.3021E-05	4.2331E-05
Pile N.	3	1	3	1	1	1

* PILE TOP REACTIONS *

PILE GROUP	FOR. X, KN	FOR. Y, KN	FOR. Z, KN	MOM X, KN- M	MOM Y, KN- M	MOM Z, KN- M
*****	*****	*****	*****	*****	*****	*****
1	3147.5	-73.523	86.025	-0.094841	-190.27	-154.61
2	3537.3	-70.979	83.465	-0.094841	-186.11	-150.09
3	3927.0	-80.254	94.535	-0.094841	-206.30	-166.55
4	2751.4	-60.021	70.169	-0.094841	-160.85	-130.12
5	3141.1	-56.576	66.521	-0.094841	-154.23	-123.56
6	3530.9	-69.770	82.020	-0.094841	-183.88	-148.31
7	2355.3	-58.906	68.546	-0.094841	-157.68	-128.32
8	2745.0	-55.530	64.987	-0.094841	-151.17	-121.84
9	3134.8	-69.112	80.862	-0.094841	-181.71	-147.48
10	1959.1	-63.555	73.475	-0.094841	-167.03	-137.46
11	2348.9	-60.044	69.801	-0.094841	-160.47	-130.87
12	2738.7	-72.730	84.595	-0.094841	-188.47	-154.40
MINIMUM	1959.1	-80.254	64.987	-0.094841	-206.30	-166.55
Pile N.	10	3	8	1	3	3
MAXIMUM	3927.0	-55.530	94.535	-0.094841	-151.17	-121.84
Pile N.	3	8	3	1	8	8

THE PILE COORDINATE SYSTEM (LOCAL AXES)

* PILE TOP DISPLACEMENTS *

APPALTATORE:

Consorzio

Soci



ITINERARIO NAPOLI – BARI

PROGETTAZIONE:

Mandataria

Mandanti



RADDOPPIO TRATTA APICE – ORSARA
I LOTTO FUNZIONALE APICE – HIRPINIA

PROGETTO ESECUTIVO

RELAZIONE DI CALCOLO FONDAZIONI PILE DA P7 A P16

COMMESSA	LOTTO	CODIFICA	DOCUMENTO	REV.	FOGLIO
IF1N	01 E ZZ	RG	MD0000 001	B	84 di 144

PILE GROUP	DISP. x, M	DISP. y, M	DISP. z, M	ROT. x,RAD	ROT. y,RAD	ROT. z,RAD
*****	*****	*****	*****	*****	*****	*****
1	1.4678E-03	-3.7205E-04	4.1624E-04	-2.7631E-07	4.3021E-05	4.2331E-05
2	1.6583E-03	-3.7205E-04	4.1748E-04	-2.7631E-07	4.3021E-05	4.2331E-05
3	1.8488E-03	-3.7205E-04	4.1872E-04	-2.7631E-07	4.3021E-05	4.2331E-05
4	1.2742E-03	-3.7330E-04	4.1624E-04	-2.7631E-07	4.3021E-05	4.2331E-05
5	1.4647E-03	-3.7330E-04	4.1748E-04	-2.7631E-07	4.3021E-05	4.2331E-05
6	1.6552E-03	-3.7330E-04	4.1872E-04	-2.7631E-07	4.3021E-05	4.2331E-05
7	1.0806E-03	-3.7454E-04	4.1624E-04	-2.7631E-07	4.3021E-05	4.2331E-05
8	1.2711E-03	-3.7454E-04	4.1748E-04	-2.7631E-07	4.3021E-05	4.2331E-05
9	1.4616E-03	-3.7454E-04	4.1872E-04	-2.7631E-07	4.3021E-05	4.2331E-05
10	8.8700E-04	-3.7578E-04	4.1624E-04	-2.7631E-07	4.3021E-05	4.2331E-05
11	1.0775E-03	-3.7578E-04	4.1748E-04	-2.7631E-07	4.3021E-05	4.2331E-05
12	1.2680E-03	-3.7578E-04	4.1872E-04	-2.7631E-07	4.3021E-05	4.2331E-05
MINIMUM	8.8700E-04	-3.7578E-04	4.1624E-04	-2.7631E-07	4.3021E-05	4.2331E-05
Pile N.	10	10	1	1	1	1
MAXIMUM	1.8488E-03	-3.7205E-04	4.1872E-04	-2.7631E-07	4.3021E-05	4.2331E-05
Pile N.	3	1	3	1	1	1

* PILE TOP REACTIONS *

PILE GROUP	AXIAL, KN	LAT. y, KN	LAT. z, KN	MOM x, KN- M	MOM y, KN- M	MOM z, KN- M
*****	*****	*****	*****	*****	*****	*****
1	3147.5	-73.523	86.025	-0.094841	-190.27	-154.61
2	3537.3	-70.979	83.465	-0.094841	-186.11	-150.09
3	3927.0	-80.254	94.535	-0.094841	-206.30	-166.55
4	2751.4	-60.021	70.169	-0.094841	-160.85	-130.12
5	3141.1	-56.576	66.521	-0.094841	-154.23	-123.56
6	3530.9	-69.770	82.020	-0.094841	-183.88	-148.31
7	2355.3	-58.906	68.546	-0.094841	-157.68	-128.32
8	2745.0	-55.530	64.987	-0.094841	-151.17	-121.84
9	3134.8	-69.112	80.862	-0.094841	-181.71	-147.48
10	1959.1	-63.555	73.475	-0.094841	-167.03	-137.46
11	2348.9	-60.044	69.801	-0.094841	-160.47	-130.87
12	2738.7	-72.730	84.595	-0.094841	-188.47	-154.40
MINIMUM	1959.1	-80.254	64.987	-0.094841	-206.30	-166.55
Pile N.	10	3	8	1	3	3
MAXIMUM	3927.0	-55.530	94.535	-0.094841	-151.17	-121.84
Pile N.	3	8	3	1	8	8

PILE GROUP STRESS, KN/ M**2

PILE GROUP	STRESS, KN/ M**2
*****	*****
1	2521.0
2	2723.3
3	3022.4
4	2181.4
5	2373.9
6	2711.1
7	1946.4
8	2139.4
9	2480.2
10	1761.5
11	1954.1
12	2285.1
MINIMUM	1761.5
Pile N.	10
MAXIMUM	3022.4
Pile N.	3

* EFFECTS FOR LATERALLY LOADED PILE *

* MINIMUM VALUES AND LOCATIONS *

PILE	DISPL. y-DIR	DISPL. z-DIR	MOMENT z-DIR	MOMENT y-DIR	SHEAR y-DIR	SHEAR z-DIR	SOIL REACT y-DIR	SOIL REACT z-DIR	TOTAL STRESS	FLEX. RIG. z-DIR	FLEX. RIG. y-DIR
*****	*****	*****	*****	*****	*****	*****	*****	*****	*****	*****	*****
	M	M	KN- M	KN- M	KN	KN	KN/ M	KN/ M	KN/ M**2	KN- M**2	KN- M**2
1	-3.7205E-04	-9.2052E-06	-97.015	-190.27	-73.534	-24.326	-23.283	-5.8728	1781.1	7.8279E+06	7.8279E+06
x(M)	0.0000	10.230	5.6100	0.0000	0.0000	8.2500	4.9500	10.560	33.000	0.0000	0.0000
2	-3.7205E-04	-9.2662E-06	-95.192	-186.11	-70.990	-23.649	-22.471	-5.6684	2001.7	7.8279E+06	7.8279E+06
x(M)	0.0000	10.560	5.6100	0.0000	0.0000	8.2500	4.9500	10.890	33.000	0.0000	0.0000
3	-3.7205E-04	-9.1724E-06	-101.67	-206.30	-80.268	-26.402	-25.401	-6.5753	2222.2	7.8279E+06	7.8279E+06
x(M)	0.0000	10.230	5.6100	0.0000	0.0000	8.2500	4.9500	10.560	33.000	0.0000	0.0000
4	-3.7330E-04	-9.4203E-06	-87.145	-160.85	-60.028	-20.291	-18.836	-4.5979	1557.0	7.8279E+06	7.8279E+06
x(M)	0.0000	10.890	5.9400	0.0000	0.0000	8.9100	4.9500	11.220	33.000	0.0000	0.0000
5	-3.7330E-04	-9.4788E-06	-84.455	-154.23	-56.584	-19.398	-17.676	-4.3047	1777.5	7.8279E+06	7.8279E+06
x(M)	0.0000	11.220	5.9400	0.0000	0.0000	8.9100	4.9500	11.550	33.000	0.0000	0.0000
6	-3.7330E-04	-9.3333E-06	-94.350	-183.88	-69.781	-23.286	-22.070	-5.5434	1998.1	7.8279E+06	7.8279E+06
x(M)	0.0000	10.560	5.6100	0.0000	0.0000	8.5800	4.9500	10.890	33.000	0.0000	0.0000
7	-3.7454E-04	-9.4304E-06	-86.317	-157.68	-58.912	-19.889	-18.441	-4.4571	1332.8	7.8279E+06	7.8279E+06
x(M)	0.0000	10.890	5.9400	0.0000	0.0000	8.9100	4.9500	11.220	33.000	0.0000	0.0000
8	-3.7454E-04	-9.5157E-06	-83.625	-151.17	-55.537	-18.991	-17.299	-4.1833	1553.4	7.8279E+06	7.8279E+06
x(M)	0.0000	11.220	5.9400	0.0000	0.0000	8.9100	4.9500	11.550	33.000	0.0000	0.0000
9	-3.7454E-04	-9.3495E-06	-93.883	-181.71	-69.121	-23.002	-21.842	-5.4450	1773.9	7.8279E+06	7.8279E+06
x(M)	0.0000	10.560	5.6100	0.0000	0.0000	8.5800	4.9500	10.890	33.000	0.0000	0.0000

APPALTATORE: Consorzio Soci   		ITINERARIO NAPOLI – BARI					
PROGETTAZIONE: Mandataria Mandanti   		RADDOPPIO TRATTA APICE – ORSARA I LOTTO FUNZIONALE APICE – HIRPINIA					
PROGETTO ESECUTIVO RELAZIONE DI CALCOLO FONDAZIONI PILE DA P7 A P16		COMMESSA IF1N	LOTTO 01 E ZZ	CODIFICA RG	DOCUMENTO MD0000 001	REV. B	FOGLIO 85 di 144

10	-3.7578E-04	-9.3517E-06	-89.895	-167.03	-63.560	-21.145	-19.984	-4.8577	1108.6	7.8279E+06	7.8279E+06
x(M)	0.0000	10.890	5.9400	0.0000	0.0000	8.5800	4.9500	11.220	33.000	0.0000	0.0000
11	-3.7578E-04	-9.4518E-06	-87.263	-160.47	-60.051	-20.183	-18.810	-4.5521	1329.2	7.8279E+06	7.8279E+06
x(M)	0.0000	10.890	5.9400	0.0000	0.0000	8.9100	4.9500	11.220	33.000	0.0000	0.0000
12	-3.7578E-04	-9.2703E-06	-96.620	-188.47	-72.739	-23.900	-23.001	-5.7399	1549.8	7.8279E+06	7.8279E+06
x(M)	0.0000	10.560	5.6100	0.0000	0.0000	8.2500	4.9500	10.890	33.000	0.0000	0.0000
Min. Pile N.	-3.7578E-04	-9.5157E-06	-101.67	-206.30	-80.268	-26.402	-25.401	-6.5753	1108.6	7.8279E+06	7.8279E+06
	10	8	3	3	3	3	3	3	10	1	1

* MAXIMUM VALUES AND LOCATIONS *

PILE	DISPL. y-DIR M	DISPL. z-DIR M	MOMENT KN- M	MOMENT y-DIR KN- M	SHEAR y-DIR KN	SHEAR z-DIR KN	SOIL REACT y-DIR KN/ M	SOIL REACT z-DIR KN/ M	TOTAL STRESS KN/ M**2	FLEX. RIG. z-DIR KN- M**2	FLEX. RIG. y-DIR KN- M**2
*****	*****	*****	*****	*****	*****	*****	*****	*****	*****	*****	*****
1	8.2237E-06	4.1624E-04	154.61	108.84	21.611	86.037	5.2160	27.043	2521.0	7.8279E+06	7.8279E+06
x(M)	10.230	0.0000	0.0000	5.6100	8.2500	0.0000	10.560	4.9500	0.0000	0.0000	0.0000
2	8.2389E-06	4.1748E-04	150.09	107.15	20.968	83.479	5.0014	26.209	2723.3	7.8279E+06	7.8279E+06
x(M)	10.230	0.0000	0.0000	5.9400	8.2500	0.0000	10.890	4.9500	0.0000	0.0000	0.0000
3	8.1161E-06	4.1872E-04	166.55	114.98	23.243	94.552	5.7804	29.737	3022.4	7.8279E+06	7.8279E+06
x(M)	9.9000	0.0000	0.0000	5.6100	8.2500	0.0000	10.560	4.9500	0.0000	0.0000	0.0000
4	8.4390E-06	4.1624E-04	130.12	97.459	18.120	70.178	4.0966	21.789	2181.4	7.8279E+06	7.8279E+06
x(M)	10.890	0.0000	0.0000	5.9400	8.5800	0.0000	11.220	4.9500	0.0000	0.0000	0.0000
5	8.4865E-06	4.1748E-04	123.56	94.614	17.229	66.531	3.8152	20.534	2373.9	7.8279E+06	7.8279E+06
x(M)	10.890	0.0000	0.0000	5.9400	8.9100	0.0000	11.550	4.9500	0.0000	0.0000	0.0000
6	8.2903E-06	4.1872E-04	148.31	106.28	20.626	82.033	4.8978	25.727	2711.1	7.8279E+06	7.8279E+06
x(M)	10.560	0.0000	0.0000	5.9400	8.2500	0.0000	10.890	4.9500	0.0000	0.0000	0.0000
7	8.4883E-06	4.1624E-04	128.32	96.153	17.779	68.554	3.9899	21.232	1946.4	7.8279E+06	7.8279E+06
x(M)	10.890	0.0000	0.0000	5.9400	8.5800	0.0000	11.220	4.9500	0.0000	0.0000	0.0000
8	8.5173E-06	4.1748E-04	121.84	93.316	16.942	64.996	3.7252	20.003	2139.4	7.8279E+06	7.8279E+06
x(M)	11.220	0.0000	0.0000	5.9400	8.9100	0.0000	11.550	4.9500	0.0000	0.0000	0.0000
9	8.3400E-06	4.1872E-04	147.48	105.47	20.412	80.874	4.8315	25.342	2480.2	7.8279E+06	7.8279E+06
x(M)	10.560	0.0000	0.0000	5.9400	8.2500	0.0000	10.890	4.9500	0.0000	0.0000	0.0000
10	8.4215E-06	4.1624E-04	137.46	99.937	18.995	73.482	4.3509	22.895	1761.5	7.8279E+06	7.8279E+06
x(M)	10.560	0.0000	0.0000	5.9400	8.5800	0.0000	11.220	4.9500	0.0000	0.0000	0.0000
11	8.5035E-06	4.1748E-04	130.87	97.202	18.071	69.809	4.0738	21.643	1954.1	7.8279E+06	7.8279E+06
x(M)	10.890	0.0000	0.0000	5.9400	8.5800	0.0000	11.220	4.9500	0.0000	0.0000	0.0000
12	8.3125E-06	4.1872E-04	154.40	107.95	21.342	84.606	5.1023	26.558	2285.1	7.8279E+06	7.8279E+06
x(M)	10.230	0.0000	0.0000	5.9400	8.2500	0.0000	10.890	4.9500	0.0000	0.0000	0.0000
Max. Pile N.	8.5173E-06	4.1872E-04	166.55	114.98	23.243	94.552	5.7804	29.737	3022.4	7.8279E+06	7.8279E+06
	8	3	3	3	3	3	3	3	3	1	1

LOAD CASE : 4
CASE NAME : Load Case
LOAD TYPE : Special, Sp

REDUCTION FACTORS FOR CLOSELY-SPACED PILE GROUPS, COMBINED Y AND Z DIRECTIONS
ESTIMATED USING MOVEMENT IN THE DIRECTION OF PILE CAP DISPLACEMENTS

GROUP NO	P-FACTOR	Y-FACTOR
1	0.6088	1.0000
2	0.5979	1.0000
3	0.8661	1.0000
4	0.5019	1.0000
5	0.4952	1.0000
6	0.7914	1.0000
7	0.4991	1.0000
8	0.4929	1.0000
9	0.7897	1.0000
10	0.5845	1.0000
11	0.5736	1.0000
12	0.8492	1.0000

* TABLE L * COMPUTATION ON PILE CAP

* EQUIVALENT CONCENTRATED LOAD AT ORIGIN *

VERT. LOAD, KN	HOR. LOAD Y, KN	HOR. LOAD Z, KN
35833.0	-2437.00	770.000
MOMENT X, KN- M	MOMENT Y, KN- M	MOMENT Z, KN- M
248.000	16296.0	42076.0

* DISPLACEMENT OF GROUPED PILE FOUNDATION AT ORIGIN *

VERTICAL, M	HORIZONTAL Y, M	HORIZONTAL Z, M
1.39184E-03	-1.18216E-03	3.26319E-04

APPALTATORE:

Consorzio



Soci



ITINERARIO NAPOLI – BARI

RADDOPPIO TRATTA APICE – ORSARA
I LOTTO FUNZIONALE APICE – HIRPINIA

PROGETTAZIONE:

Mandatario



Mandanti



PROGETTO ESECUTIVO

RELAZIONE DI CALCOLO FONDAZIONI PILE DA P7 A P16

COMMESSA
IF1NLOTTO
01 E ZZCODIFICA
RGDOCUMENTO
MD0000 001REV.
BFOGLIO
86 di 144

ANGLE ROT. X,RAD ANGLE ROT. Y,RAD ANGLE ROT. Z,RAD
3.39811E-06 2.86265E-05 1.41127E-04

THE GLOBAL STRUCTURAL COORDINATE SYSTEM

* PILE TOP DISPLACEMENTS *

PILE GROUP	DISP. X, M	DISP. Y, M	DISP. Z, M	ROT. X,RAD	ROT. Y,RAD	ROT. Z,RAD
*****	*****	*****	*****	*****	*****	*****
1	9.5000E-04	-1.2051E-03	3.4161E-04	3.3981E-06	2.8627E-05	1.4113E-04
2	1.5851E-03	-1.2051E-03	3.2632E-04	3.3981E-06	2.8627E-05	1.4113E-04
3	2.2201E-03	-1.2051E-03	3.1103E-04	3.3981E-06	2.8627E-05	1.4113E-04
4	8.2118E-04	-1.1898E-03	3.4161E-04	3.3981E-06	2.8627E-05	1.4113E-04
5	1.4563E-03	-1.1898E-03	3.2632E-04	3.3981E-06	2.8627E-05	1.4113E-04
6	2.0913E-03	-1.1898E-03	3.1103E-04	3.3981E-06	2.8627E-05	1.4113E-04
7	6.9236E-04	-1.1745E-03	3.4161E-04	3.3981E-06	2.8627E-05	1.4113E-04
8	1.3274E-03	-1.1745E-03	3.2632E-04	3.3981E-06	2.8627E-05	1.4113E-04
9	1.9625E-03	-1.1745E-03	3.1103E-04	3.3981E-06	2.8627E-05	1.4113E-04
10	5.6354E-04	-1.1592E-03	3.4161E-04	3.3981E-06	2.8627E-05	1.4113E-04
11	1.1986E-03	-1.1592E-03	3.2632E-04	3.3981E-06	2.8627E-05	1.4113E-04
12	1.8337E-03	-1.1592E-03	3.1103E-04	3.3981E-06	2.8627E-05	1.4113E-04
MINIMUM	5.6354E-04	-1.2051E-03	3.1103E-04	3.3981E-06	2.8627E-05	1.4113E-04
Pile N.	10	1	3	1	1	1
MAXIMUM	2.2201E-03	-1.1592E-03	3.4161E-04	3.3981E-06	2.8627E-05	1.4113E-04
Pile N.	3	10	1	1	1	1

* PILE TOP REACTIONS *

PILE GROUP	FOR. X, KN	FOR. Y, KN	FOR. Z, KN	MOM X, KN- M	MOM Y, KN- M	MOM Z, KN- M
*****	*****	*****	*****	*****	*****	*****
1	2088.1	-204.38	67.119	1.1664	-165.55	-429.62
2	3387.5	-201.85	62.345	1.1664	-151.94	-425.38
3	4686.9	-255.63	73.083	1.1664	-166.68	-522.50
4	1822.6	-176.95	59.783	1.1664	-151.35	-372.98
5	3123.9	-175.23	55.632	1.1664	-138.94	-370.15
6	4423.4	-236.74	69.188	1.1664	-159.73	-483.94
7	1536.7	-172.74	59.601	1.1664	-150.97	-360.23
8	2860.3	-171.14	55.488	1.1664	-138.63	-357.65
9	4159.8	-231.82	69.110	1.1664	-159.56	-469.84
10	1250.8	-187.43	65.549	1.1664	-162.47	-383.28
11	2596.7	-184.96	60.842	1.1664	-148.99	-379.17
12	3896.2	-238.14	72.259	1.1664	-165.14	-475.41
MINIMUM	1250.8	-255.63	55.488	1.1664	-166.68	-522.50
Pile N.	10	3	8	1	3	3
MAXIMUM	4686.9	-171.14	73.083	1.1664	-138.63	-357.65
Pile N.	3	8	3	1	8	8

THE PILE COORDINATE SYSTEM (LOCAL AXES)

* PILE TOP DISPLACEMENTS *

PILE GROUP	DISP. x, M	DISP. y, M	DISP. z, M	ROT. x,RAD	ROT. y,RAD	ROT. z,RAD
*****	*****	*****	*****	*****	*****	*****
1	9.5000E-04	-1.2051E-03	3.4161E-04	3.3981E-06	2.8627E-05	1.4113E-04
2	1.5851E-03	-1.2051E-03	3.2632E-04	3.3981E-06	2.8627E-05	1.4113E-04
3	2.2201E-03	-1.2051E-03	3.1103E-04	3.3981E-06	2.8627E-05	1.4113E-04
4	8.2118E-04	-1.1898E-03	3.4161E-04	3.3981E-06	2.8627E-05	1.4113E-04
5	1.4563E-03	-1.1898E-03	3.2632E-04	3.3981E-06	2.8627E-05	1.4113E-04
6	2.0913E-03	-1.1898E-03	3.1103E-04	3.3981E-06	2.8627E-05	1.4113E-04
7	6.9236E-04	-1.1745E-03	3.4161E-04	3.3981E-06	2.8627E-05	1.4113E-04
8	1.3274E-03	-1.1745E-03	3.2632E-04	3.3981E-06	2.8627E-05	1.4113E-04
9	1.9625E-03	-1.1745E-03	3.1103E-04	3.3981E-06	2.8627E-05	1.4113E-04
10	5.6354E-04	-1.1592E-03	3.4161E-04	3.3981E-06	2.8627E-05	1.4113E-04
11	1.1986E-03	-1.1592E-03	3.2632E-04	3.3981E-06	2.8627E-05	1.4113E-04
12	1.8337E-03	-1.1592E-03	3.1103E-04	3.3981E-06	2.8627E-05	1.4113E-04
MINIMUM	5.6354E-04	-1.2051E-03	3.1103E-04	3.3981E-06	2.8627E-05	1.4113E-04
Pile N.	10	1	3	1	1	1
MAXIMUM	2.2201E-03	-1.1592E-03	3.4161E-04	3.3981E-06	2.8627E-05	1.4113E-04
Pile N.	3	10	1	1	1	1

* PILE TOP REACTIONS *

PILE GROUP	AXIAL, KN	LAT. y, KN	LAT. z, KN	MOM x, KN- M	MOM y, KN- M	MOM z, KN- M
*****	*****	*****	*****	*****	*****	*****
1	2088.1	-204.38	67.119	1.1664	-165.55	-429.62
2	3387.5	-201.85	62.345	1.1664	-151.94	-425.38
3	4686.9	-255.63	73.083	1.1664	-166.68	-522.50
4	1822.6	-176.95	59.783	1.1664	-151.35	-372.98
5	3123.9	-175.23	55.632	1.1664	-138.94	-370.15
6	4423.4	-236.74	69.188	1.1664	-159.73	-483.94

APPALTATORE:

Consorzio

Soci



ITINERARIO NAPOLI – BARI

PROGETTAZIONE:

Mandatario

Mandanti



RADDOPPIO TRATTA APICE – ORSARA
I LOTTO FUNZIONALE APICE – HIRPINIA

PROGETTO ESECUTIVO

RELAZIONE DI CALCOLO FONDAZIONI PILE DA P7 A P16

COMMESSA LOTTO CODIFICA DOCUMENTO REV. FOGLIO
IF1N 01 E ZZ RG MD0000 001 B 87 di 144

7	1536.7	-172.74	59.601	1.1664	-150.97	-360.23
8	2860.3	-171.14	55.488	1.1664	-138.63	-357.65
9	4159.8	-231.82	69.110	1.1664	-159.56	-469.84
10	1250.8	-187.43	65.549	1.1664	-162.47	-383.28
11	2596.7	-184.96	60.842	1.1664	-148.99	-379.17
12	3896.2	-238.14	72.259	1.1664	-165.14	-475.41
MINIMUM	1250.8	-255.63	55.488	1.1664	-166.68	-522.50
Pile N.	10	3	8	1	3	3
MAXIMUM	4686.9	-171.14	73.083	1.1664	-138.63	-357.65
Pile N.	3	8	3	1	8	8

PILE GROUP STRESS, KN/ M**2

*****	*****
1	2571.1
2	3280.2
3	4307.5
4	2246.2
5	2961.0
6	4041.2
7	2048.4
8	2776.3
9	3851.5
10	1964.2
11	2699.0
12	3723.7
MINIMUM	1964.2
Pile N.	10
MAXIMUM	4307.5
Pile N.	3

* EFFECTS FOR LATERALLY LOADED PILE *

* MINIMUM VALUES AND LOCATIONS *

PILE	DISPL. y-DIR M	DISPL. z-DIR M	MOMENT KN- M	MOMENT y-DIR KN- M	SHEAR y-DIR KN	SHEAR z-DIR KN	SOIL REACT y-DIR KN/ M	SOIL REACT z-DIR KN/ M	TOTAL STRESS KN/ M**2	FLEX. RIG. z-DIR KN- M**2	FLEX. RIG. y-DIR KN- M**2
*****	*****	*****	*****	*****	*****	*****	*****	*****	*****	*****	*****
1	-1.2051E-03	-7.7060E-06	-291.56	-165.55	-204.40	-17.969	-64.793	-4.1824	1181.6	7.8279E+06	7.8279E+06
x(M)	0.0000	10.890	5.9400	0.0000	0.0000	8.5800	4.9500	11.220	33.000	0.0000	0.0000
2	-1.2051E-03	-7.3699E-06	-289.97	-151.94	-201.88	-16.964	-63.993	-3.9316	1916.9	7.8279E+06	7.8279E+06
x(M)	0.0000	10.890	5.9400	0.0000	0.0000	8.5800	4.9500	11.220	33.000	0.0000	0.0000
3	-1.2051E-03	-6.8532E-06	-328.85	-166.68	-255.68	-19.796	-81.292	-4.9372	2652.3	7.8279E+06	7.8279E+06
x(M)	0.0000	10.230	5.6100	0.0000	0.0000	8.2500	4.9500	10.560	33.000	0.0000	0.0000
4	-1.1898E-03	-7.7910E-06	-269.96	-151.35	-176.96	-16.165	-55.752	-3.6103	1031.4	7.8279E+06	7.8279E+06
x(M)	0.0000	11.220	5.9400	0.0000	0.0000	8.9100	4.9500	11.550	33.000	0.0000	0.0000
5	-1.1898E-03	-7.4499E-06	-268.83	-138.94	-175.25	-15.302	-3.4058	1767.8	7.8279E+06	7.8279E+06	
x(M)	0.0000	11.220	5.9400	0.0000	0.0000	8.9100	4.9500	11.550	33.000	0.0000	0.0000
6	-1.1898E-03	-6.8914E-06	-314.99	-159.73	-236.78	-18.836	-75.438	-4.6053	2503.1	7.8279E+06	7.8279E+06
x(M)	0.0000	10.230	5.6100	0.0000	0.0000	8.2500	4.9500	10.560	33.000	0.0000	0.0000
7	-1.1745E-03	-7.7917E-06	-265.91	-150.97	-172.75	-16.109	-54.505	-3.5939	869.61	7.8279E+06	7.8279E+06
x(M)	0.0000	11.220	5.9400	0.0000	0.0000	8.9100	4.9500	11.550	33.000	0.0000	0.0000
8	-1.1745E-03	-7.4504E-06	-264.87	-138.63	-171.16	-15.257	-54.008	-3.3926	1618.6	7.8279E+06	7.8279E+06
x(M)	0.0000	11.220	5.9400	0.0000	0.0000	8.9100	4.9500	11.550	33.000	0.0000	0.0000
9	-1.1745E-03	-6.8899E-06	-310.54	-159.56	-231.86	-18.809	-73.940	-4.5961	2354.0	7.8279E+06	7.8279E+06
x(M)	0.0000	10.230	5.6100	0.0000	0.0000	8.2500	4.9500	10.560	33.000	0.0000	0.0000
10	-1.1592E-03	-7.7226E-06	-276.24	-162.47	-187.44	-17.569	-59.600	-4.0505	707.81	7.8279E+06	7.8279E+06
x(M)	0.0000	10.890	5.9400	0.0000	0.0000	8.9100	4.9500	11.220	33.000	0.0000	0.0000
11	-1.1592E-03	-7.3856E-06	-274.67	-148.99	-184.98	-16.577	-58.822	-3.8045	1469.5	7.8279E+06	7.8279E+06
x(M)	0.0000	10.890	5.9400	0.0000	0.0000	8.9100	4.9500	11.220	33.000	0.0000	0.0000
12	-1.1592E-03	-6.8614E-06	-313.65	-165.14	-238.18	-19.578	-75.939	-4.8629	2204.8	7.8279E+06	7.8279E+06
x(M)	0.0000	10.230	5.6100	0.0000	0.0000	8.2500	4.9500	10.560	33.000	0.0000	0.0000
Min.	-1.2051E-03	-7.7917E-06	-328.85	-166.68	-255.68	-19.796	-81.292	-4.9372	707.81	7.8279E+06	7.8279E+06
Pile N.	1	7	3	3	3	3	3	3	10	1	1

* MAXIMUM VALUES AND LOCATIONS *

PILE	DISPL. y-DIR M	DISPL. z-DIR M	MOMENT KN- M	MOMENT y-DIR KN- M	SHEAR y-DIR KN	SHEAR z-DIR KN	SOIL REACT y-DIR KN/ M	SOIL REACT z-DIR KN/ M	TOTAL STRESS KN/ M**2	FLEX. RIG. z-DIR KN- M**2	FLEX. RIG. y-DIR KN- M**2
*****	*****	*****	*****	*****	*****	*****	*****	*****	*****	*****	*****
1	2.7007E-05	3.4161E-04	429.62	83.881	62.107	67.126	14.334	20.663	2571.1	7.8279E+06	7.8279E+06
x(M)	10.560	0.0000	0.0000	5.9400	8.5800	0.0000	10.890	4.9500	0.0000	0.0000	0.0000
2	2.7066E-05	3.2632E-04	425.38	79.496	61.586	62.356	14.144	19.242	3280.2	7.8279E+06	7.8279E+06
x(M)	10.560	0.0000	0.0000	5.9400	8.5800	0.0000	10.890	4.9500	0.0000	0.0000	0.0000
3	2.6312E-05	3.1103E-04	522.50	85.808	75.167	73.100	18.672	22.924	4307.5	7.8279E+06	7.8279E+06
x(M)	9.9000	0.0000	0.0000	5.6100	7.9200	0.0000	10.560	4.9500	0.0000	0.0000	0.0000
4	2.7022E-05	3.4161E-04	372.98	78.446	55.011	59.789	12.218	18.133	2246.2	7.8279E+06	7.8279E+06
x(M)	10.890	0.0000	0.0000	6.2700	8.9100	0.0000	11.220	4.9500	0.0000	0.0000	0.0000
5	2.7080E-05	3.2632E-04	370.15	74.437	54.697	55.641	12.102	16.930	2961.0	7.8279E+06	7.8279E+06
x(M)	10.890	0.0000	0.0000	6.2700	8.9100	0.0000	11.220	4.9500	0.0000	0.0000	0.0000
6	2.6208E-05	3.1103E-04	483.94	83.145	70.768	69.203	17.272	21.674	4041.2	7.8279E+06	7.8279E+06
x(M)	10.230	0.0000	0.0000	5.9400	8.2500	0.0000	10.560	4.9500	0.0000	0.0000	0.0000
7	2.6681E-05	3.4161E-04	360.23	78.292	54.092	59.606	11.997	18.066	2048.4	7.8279E+06	7.8279E+06
x(M)	10.890	0.0000	0.0000	6.2700	8.5800	0.0000	11.220	4.9500	0.0000	0.0000	0.0000

APPALTATORE:

Consorzio

Soci



ITINERARIO NAPOLI – BARI

PROGETTAZIONE:

Mandataria

Mandanti



RADDOPPIO TRATTA APICE – ORSARA
I LOTTO FUNZIONALE APICE – HIRPINIA

PROGETTO ESECUTIVO

RELAZIONE DI CALCOLO FONDAZIONI PILE DA P7 A P16

COMMESSA LOTTO CODIFICA DOCUMENTO REV. FOGLIO
IF1N 01 E ZZ RG MD0000 001 B 88 di 144

	8	2.6740E-05	3.2632E-04	357.65	74.314	53.799	55.497	11.891	16.876	2776.3	7.8279E+06	7.8279E+06
x(M)		10.890	0.0000	0.0000	6.2700	8.9100	0.0000	11.220	4.9500	0.0000	0.0000	0.0000
	9	2.5863E-05	3.1103E-04	469.84	83.083	69.692	69.124	16.999	21.645	3851.5	7.8279E+06	7.8279E+06
x(M)		10.230	0.0000	0.0000	5.9400	8.2500	0.0000	10.560	4.9500	0.0000	0.0000	0.0000
	10	2.6014E-05	3.4161E-04	383.28	82.628	58.272	65.553	13.308	20.113	1964.2	7.8279E+06	7.8279E+06
x(M)		10.560	0.0000	0.0000	5.9400	8.5800	0.0000	11.220	4.9500	0.0000	0.0000	0.0000
	11	2.6066E-05	3.2632E-04	379.17	78.294	57.756	60.851	13.151	18.717	2699.0	7.8279E+06	7.8279E+06
x(M)		10.560	0.0000	0.0000	5.9400	8.5800	0.0000	11.220	4.9500	0.0000	0.0000	0.0000
	12	2.5311E-05	3.1103E-04	475.41	85.197	71.320	72.273	17.636	22.650	3723.7	7.8279E+06	7.8279E+06
x(M)		9.9000	0.0000	0.0000	5.6100	7.9200	0.0000	10.560	4.9500	0.0000	0.0000	0.0000
Max.	2.7080E-05	3.4161E-04	522.50	85.808	75.167	73.100	18.672	22.924	4307.5	7.8279E+06	7.8279E+06	
Pile N.	5	1	3	3	3	3	3	3	3	1	1	

***** SUMMARY FOR LOAD CASES AND COMBINATIONS *****

***** LOAD CASES RESULTS *****

LOAD CASE : 1

* TABLE L * COMPUTATION ON PILE CAP

* EQUIVALENT CONCENTRATED LOAD AT ORIGIN *

LOAD X, KN	LOAD Y, KN	LOAD Z, KN	MOM X, KN- M	MOM Y, KN- M	MOM Z, KN- M
30261.0	-1201.00	1142.00	3.00000	24006.0	18765.0

* DISPLACEMENT OF GROUPED PILE FOUNDATION AT ORIGIN *

DISP X, M	DISP Y, M	DISP Z, M	ROT X,RAD	ROT Y,RAD	ROT Z,RAD
1.48778E-03	-5.67141E-04	4.84319E-04	2.06714E-07	4.30408E-05	6.43564E-05

* PILE TOP DISPLACEMENTS, GLOBAL *

	DISP. X, M	DISP. Y, M	DISP. Z, M	ROT. X,RAD	ROT. Y,RAD	ROT. Z,RAD
MINIMUM	9.0765E-04	-5.6854E-04	4.8339E-04	2.0671E-07	4.3041E-05	6.4356E-05
Pile N.	10	1	3	1	1	1
MAXIMUM	2.0679E-03	-5.6574E-04	4.8525E-04	2.0671E-07	4.3041E-05	6.4356E-05
Pile N.	3	10	1	1	1	1

* PILE TOP REACTIONS, GLOBAL *

	FOR. X, KN	FOR. Y, KN	FOR. Z, KN	MOM X, KN- M	MOM Y, KN- M	MOM Z, KN- M
MINIMUM	2001.4	-122.85	80.891	0.070953	-265.16	-255.80
Pile N.	10	3	8	1	3	3
MAXIMUM	4375.4	-84.224	115.10	0.070953	-201.57	-184.12
Pile N.	3	8	3	1	8	8

* PILE TOP DISPLACEMENTS, LOCAL *

	DISP. x, M	DISP. y, M	DISP. z, M	ROT. x,RAD	ROT. y,RAD	ROT. z,RAD
MINIMUM	9.0765E-04	-5.6854E-04	4.8339E-04	2.0671E-07	4.3041E-05	6.4356E-05
Pile N.	10	1	3	1	1	1
MAXIMUM	2.0679E-03	-5.6574E-04	4.8525E-04	2.0671E-07	4.3041E-05	6.4356E-05
Pile N.	3	10	1	1	1	1

* PILE TOP REACTIONS, LOCAL *

	AXIAL, KN	LAT. y, KN	LAT. z, KN	MOM x, KN- M	MOM y, KN- M	MOM z, KN- M
MINIMUM	2001.4	-122.85	80.891	0.070953	-265.16	-255.80
Pile N.	10	3	8	1	3	3
MAXIMUM	4375.4	-84.224	115.10	0.070953	-201.57	-184.12
Pile N.	3	8	3	1	8	8

* EFFECTS FOR LATERALLY LOADED PILE *

PILE	DISPL. y-DIR	DISPL. z-DIR	MOMENT z-DIR	MOMENT y-DIR	SHEAR y-DIR	SHEAR z-DIR	SOIL REACT y-DIR	SOIL REACT z-DIR	TOTAL STRESS
	M	M	KN- M	KN- M	KN	KN	KN/ M	KN/ M	KN/ M**2
*****	*****	*****	*****	*****	*****	*****	*****	*****	*****
Min.	-5.6854E-04	-1.1073E-05	-155.41	-265.16	-122.87	-30.838	-38.896	-7.6935	1132.6
Pile N.	1	8	3	3	3	3	3	3	10
Max.	1.2907E-05	4.8525E-04	255.80	133.54	35.546	115.13	8.8409	35.979	3587.9
Pile N.	5	1	3	3	3	3	3	3	3

LOAD CASE : 2

* TABLE L * COMPUTATION ON PILE CAP

* EQUIVALENT CONCENTRATED LOAD AT ORIGIN *

LOAD X, KN	LOAD Y, KN	LOAD Z, KN	MOM X, KN- M	MOM Y, KN- M	MOM Z, KN- M
31039.0	-170.000	908.000	0.00000	18721.0	2683.00

* DISPLACEMENT OF GROUPED PILE FOUNDATION AT ORIGIN *

DISP X, M	DISP Y, M	DISP Z, M	ROT X,RAD	ROT Y,RAD	ROT Z,RAD
1.19365E-03	-8.15508E-05	3.87485E-04	-4.82689E-07	3.36686E-05	9.19637E-06

APPALTATORE:

Consorzio



Soci



ITINERARIO NAPOLI – BARI

PROGETTAZIONE:

Mandataria



Mandanti

RADDOPPIO TRATTA APICE – ORSARA
I LOTTO FUNZIONALE APICE – HIRPINIA

PROGETTO ESECUTIVO

RELAZIONE DI CALCOLO FONDAZIONI PILE DA P7 A P16

COMMESSA
IF1NLOTTO
01 E ZZCODIFICA
RGDOCUMENTO
MD0000 001REV.
BFOGLIO
89 di 144

* PILE TOP DISPLACEMENTS, GLOBAL *

	DISP. X, M	DISP. Y, M	DISP. Z, M	ROT. X,RAD	ROT. Y,RAD	ROT. Z,RAD
MINIMUM	9.2500E-04	-8.4809E-05	3.8531E-04	-4.8269E-07	3.3669E-05	9.1964E-06
Pile N.	10	10	1	1	1	1
MAXIMUM	1.4623E-03	-7.8293E-05	3.8966E-04	-4.8269E-07	3.3669E-05	9.1964E-06
Pile N.	3	1	3	1	1	1

* PILE TOP REACTIONS, GLOBAL *

	FOR. X, KN	FOR. Y, KN	FOR. Z, KN	MOM X, KN- M	MOM Y, KN- M	MOM Z, KN- M
MINIMUM	2036.9	-16.638	63.887	-0.1657	-217.99	-33.870
Pile N.	10	3	8	1	3	3
MAXIMUM	3136.3	-12.143	93.844	-0.1657	-161.23	-26.380
Pile N.	3	8	3	1	8	5

* PILE TOP DISPLACEMENTS, LOCAL *

	DISP. X, M	DISP. Y, M	DISP. z, M	ROT. x,RAD	ROT. y,RAD	ROT. z,RAD
MINIMUM	9.2500E-04	-8.4809E-05	3.8531E-04	-4.8269E-07	3.3669E-05	9.1964E-06
Pile N.	10	10	1	1	1	1
MAXIMUM	1.4623E-03	-7.8293E-05	3.8966E-04	-4.8269E-07	3.3669E-05	9.1964E-06
Pile N.	3	1	3	1	1	1

* PILE TOP REACTIONS, LOCAL *

	AXIAL, KN	LAT. y, KN	LAT. z, KN	MOM x, KN- M	MOM y, KN- M	MOM z, KN- M
MINIMUM	2036.9	-16.638	63.887	-0.1657	-217.99	-33.870
Pile N.	10	3	8	1	3	3
MAXIMUM	3136.3	-12.143	93.844	-0.1657	-161.23	-26.380
Pile N.	3	8	3	1	8	5

* EFFECTS FOR LATERALLY LOADED PILE *

PILE	DISPL. y-DIR	DISPL. z-DIR	MOMENT z-DIR	MOMENT y-DIR	SHEAR y-DIR	SHEAR z-DIR	SOIL REACT y-DIR	SOIL REACT z-DIR	TOTAL STRESS
	M	M	KN- M	KN- M	KN	KN	KN/ M	KN/ M	KN/ M**2
Min.	-8.4809E-05	-8.8687E-06	-21.357	-217.99	-16.640	-24.890	-5.2741	-6.2114	1152.6
Pile N.	10	8	3	3	3	3	3	3	10
Max.	1.9233E-06	3.8966E-04	33.870	107.75	4.8773	93.858	1.2113	29.262	2440.6
Pile N.	11	3	3	3	3	3	3	3	3

LOAD CASE : 3

* TABLE L * COMPUTATION ON PILE CAP

* EQUIVALENT CONCENTRATED LOAD AT ORIGIN *

LOAD X, KN	LOAD Y, KN	LOAD Z, KN	MOM X, KN- M	MOM Y, KN- M	MOM Z, KN- M
35317.0	-791.000	925.000	0.00000	24650.0	12338.0

* DISPLACEMENT OF GROUPED PILE FOUNDATION AT ORIGIN *

DISP X, M	DISP Y, M	DISP Z, M	ROT X,RAD	ROT Y,RAD	ROT Z,RAD
1.36788E-03	-3.73919E-04	4.17480E-04	-2.76307E-07	4.30209E-05	4.23308E-05

* PILE TOP DISPLACEMENTS, GLOBAL *

	DISP. X, M	DISP. Y, M	DISP. Z, M	ROT. X,RAD	ROT. Y,RAD	ROT. Z,RAD
MINIMUM	8.8700E-04	-3.7578E-04	4.1624E-04	-2.7631E-07	4.3021E-05	4.2331E-05
Pile N.	10	10	1	1	1	1
MAXIMUM	1.8488E-03	-3.7205E-04	4.1872E-04	-2.7631E-07	4.3021E-05	4.2331E-05
Pile N.	3	1	3	1	1	1

* PILE TOP REACTIONS, GLOBAL *

	FOR. X, KN	FOR. Y, KN	FOR. Z, KN	MOM X, KN- M	MOM Y, KN- M	MOM Z, KN- M
MINIMUM	1959.1	-80.254	64.987	-0.094841	-206.30	-166.55
Pile N.	10	3	8	1	3	3
MAXIMUM	3927.0	-55.530	94.535	-0.094841	-151.17	-121.84
Pile N.	3	8	3	1	8	8

* PILE TOP DISPLACEMENTS, LOCAL *

	DISP. X, M	DISP. Y, M	DISP. z, M	ROT. x,RAD	ROT. y,RAD	ROT. z,RAD
MINIMUM	8.8700E-04	-3.7578E-04	4.1624E-04	-2.7631E-07	4.3021E-05	4.2331E-05
Pile N.	10	10	1	1	1	1
MAXIMUM	1.8488E-03	-3.7205E-04	4.1872E-04	-2.7631E-07	4.3021E-05	4.2331E-05
Pile N.	3	1	3	1	1	1

* PILE TOP REACTIONS, LOCAL *

	AXIAL, KN	LAT. y, KN	LAT. z, KN	MOM x, KN- M	MOM y, KN- M	MOM z, KN- M
MINIMUM	1959.1	-80.254	64.987	-0.094841	-206.30	-166.55
Pile N.	10	3	8	1	3	3
MAXIMUM	3927.0	-55.530	94.535	-0.094841	-151.17	-121.84
Pile N.	3	8	3	1	8	8

APPALTATORE: Consorzio Soci   		ITINERARIO NAPOLI – BARI RADDOPPIO TRATTA APICE – ORSARA I LOTTO FUNZIONALE APICE – HIRPINIA					
PROGETTAZIONE: Mandataria Mandanti   							
PROGETTO ESECUTIVO RELAZIONE DI CALCOLO FONDAZIONI PILE DA P7 A P16							

* EFFECTS FOR LATERALLY LOADED PILE *

PILE	DISPL. y-DIR M	DISPL. z-DIR M	MOMENT z-DIR KN- M	MOMENT y-DIR KN- M	SHEAR y-DIR KN	SHEAR z-DIR KN	SOIL REACT y-DIR KN/ M	SOIL REACT z-DIR KN/ M	TOTAL STRESS KN/ M**2
*****	*****	*****	*****	*****	*****	*****	*****	*****	*****
Min.	-3.7578E-04	-9.5157E-06	-101.67	-206.30	-80.268	-26.402	-25.401	-6.5753	1108.6
Pile N.	10	8	3	3	3	3	3	3	10
Max.	8.5173E-06	4.1872E-04	166.55	114.98	23.243	94.552	5.7804	29.737	3022.4
Pile N.	8	3	3	3	3	3	3	3	3

LOAD CASE : 4

* TABLE L * COMPUTATION ON PILE CAP

* EQUIVALENT CONCENTRATED LOAD AT ORIGIN *

LOAD X, KN	LOAD Y, KN	LOAD Z, KN	MOM X, KN- M	MOM Y, KN- M	MOM Z, KN- M
35833.0	-2437.00	770.000	248.000	16296.0	42076.0

* DISPLACEMENT OF GROUPED PILE FOUNDATION AT ORIGIN *

DISP X, M	DISP Y, M	DISP Z, M	ROT X,RAD	ROT Y,RAD	ROT Z,RAD
1.39184E-03	-1.18216E-03	3.26319E-04	3.39811E-06	2.86265E-05	1.41127E-04

* PILE TOP DISPLACEMENTS, GLOBAL *

	DISP. X, M	DISP. Y, M	DISP. Z, M	ROT. X,RAD	ROT. Y,RAD	ROT. Z,RAD
MINIMUM	5.6354E-04	-1.2051E-03	3.1103E-04	3.3981E-06	2.8627E-05	1.4113E-04
Pile N.	10	1	3	1	1	1
MAXIMUM	2.2201E-03	-1.1592E-03	3.4161E-04	3.3981E-06	2.8627E-05	1.4113E-04
Pile N.	3	10	1	1	1	1

* PILE TOP REACTIONS, GLOBAL *

	FOR. X, KN	FOR. Y, KN	FOR. Z, KN	MOM X, KN- M	MOM Y, KN- M	MOM Z, KN- M
MINIMUM	1250.8	-255.63	55.488	1.1664	-166.68	-522.50
Pile N.	10	3	8	1	3	3
MAXIMUM	4686.9	-171.14	73.083	1.1664	-138.63	-357.65
Pile N.	3	8	3	1	8	8

* PILE TOP DISPLACEMENTS, LOCAL *

	DISP. x, M	DISP. y, M	DISP. z, M	ROT. x,RAD	ROT. y,RAD	ROT. z,RAD
MINIMUM	5.6354E-04	-1.2051E-03	3.1103E-04	3.3981E-06	2.8627E-05	1.4113E-04
Pile N.	10	1	3	1	1	1
MAXIMUM	2.2201E-03	-1.1592E-03	3.4161E-04	3.3981E-06	2.8627E-05	1.4113E-04
Pile N.	3	10	1	1	1	1

* PILE TOP REACTIONS, LOCAL *

	AXIAL, KN	LAT. y, KN	LAT. z, KN	MOM x, KN- M	MOM y, KN- M	MOM z, KN- M
MINIMUM	1250.8	-255.63	55.488	1.1664	-166.68	-522.50
Pile N.	10	3	8	1	3	3
MAXIMUM	4686.9	-171.14	73.083	1.1664	-138.63	-357.65
Pile N.	3	8	3	1	8	8

* EFFECTS FOR LATERALLY LOADED PILE *

PILE	DISPL. y-DIR M	DISPL. z-DIR M	MOMENT z-DIR KN- M	MOMENT y-DIR KN- M	SHEAR y-DIR KN	SHEAR z-DIR KN	SOIL REACT y-DIR KN/ M	SOIL REACT z-DIR KN/ M	TOTAL STRESS KN/ M**2
*****	*****	*****	*****	*****	*****	*****	*****	*****	*****
Min.	-1.2051E-03	-7.7917E-06	-328.85	-166.68	-255.68	-19.796	-81.292	-4.9372	707.81
Pile N.	1	7	3	3	3	3	3	3	10
Max.	2.7080E-05	3.4161E-04	522.50	85.808	75.167	73.100	18.672	22.924	4307.5
Pile N.	5	1	3	3	3	3	3	3	3

APPALTATORE: <u>Consorzio</u> HIRPINIA AV	<u>Soci</u> SALINI IMPREGILO S.P.A. ASTALDI S.P.A.	ITINERARIO NAPOLI – BARI RADDOPPIO TRATTA APICE – ORSARA I LOTTO FUNZIONALE APICE – HIRPINIA				
PROGETTAZIONE: <u>Mandatario</u> ROCKSOIL S.P.A.	<u>Mandanti</u> NET ENGINEERING S.P.A. ALPINA S.P.A.					
PROGETTO ESECUTIVO RELAZIONE DI CALCOLO FONDAZIONI PILE DA P7 A P16	COMMESSA IF28	LOTTO 01	CODIFICA E ZZ CL	DOCUMENTO VI0403 007	REV. B	FOGLIO 91 di 144

11.2 PILA SLU – SLV

=====

GROUP for Windows, Version 2016.10.13

Serial Number : 228330872

Analysis of A Group of Piles
Subjected to Axial and Lateral Loading

(c) Copyright ENSOFT, Inc., 1987-2015
All Rights Reserved

=====

Time and Date of Analysis

Date: July 06, 2020 Time: 14:32:26

***** COMPUTATION RESULTS *****

New Group

***** LOAD CASES RESULTS *****

LOAD CASE : 1
CASE NAME : Load Case
LOAD TYPE : Special, Sp

REDUCTION FACTORS FOR CLOSELY-SPACED PILE GROUPS, COMBINED Y AND Z DIRECTIONS
ESTIMATED USING MOVEMENT IN THE DIRECTION OF PILE CAP DISPLACEMENTS

GROUP NO	P-FACTOR	Y-FACTOR
1	0.8536	1.0000
2	0.5750	1.0000
3	0.5845	1.0000
4	0.7937	1.0000
5	0.4934	1.0000
6	0.4982	1.0000
7	0.7950	1.0000
8	0.4952	1.0000
9	0.5003	1.0000
10	0.8661	1.0000
11	0.5931	1.0000
12	0.6026	1.0000

* TABLE L * COMPUTATION ON PILE CAP

* EQUIVALENT CONCENTRATED LOAD AT ORIGIN *

VERT. LOAD, KN	HOR. LOAD Y, KN	HOR. LOAD Z, KN
28747.0	12425.0	-3381.00
MOMENT X, KN- M	MOMENT Y, KN- M	MOMENT Z, KN- M
-172.000	-53219.0	-1.87093E+05

* DISPLACEMENT OF GROUPED PILE FOUNDATION AT ORIGIN *

VERTICAL, M	HORIZONTAL Y, M	HORIZONTAL Z, M
1.17303E-03	5.90506E-03	-1.39195E-03
ANGLE ROT. X, RAD	ANGLE ROT. Y, RAD	ANGLE ROT. Z, RAD

APPALTATORE:

Consorzio

Soci



ITINERARIO NAPOLI – BARI

RADDOPPIO TRATTA APICE – ORSARA
I LOTTO FUNZIONALE APICE – HIRPINIA

PROGETTAZIONE:

Mandataria

Mandanti



PROGETTO ESECUTIVO

RELAZIONE DI CALCOLO FONDAZIONI PILE DA P7 A P16

COMMESSA
IF1NLOTTO
01 E ZZCODIFICA
RGDOCUMENTO
MD0000 001REV.
BFOGLIO
92 di 144

6.56852E-06 -1.05582E-04 -6.45304E-04

THE GLOBAL STRUCTURAL COORDINATE SYSTEM

* PILE TOP DISPLACEMENTS *

PILE GROUP	DISP. X, M	DISP. Y, M	DISP. Z, M	ROT. X,RAD	ROT. Y,RAD	ROT. Z,RAD
1	3.3642E-03	5.8607E-03	-1.3624E-03	6.5685E-06	-1.0558E-04	-6.4530E-04
2	4.6036E-04	5.8607E-03	-1.3920E-03	6.5685E-06	-1.0558E-04	-6.4530E-04
3	-2.4435E-03	5.8607E-03	-1.4215E-03	6.5685E-06	-1.0558E-04	-6.4530E-04
4	3.8393E-03	5.8903E-03	-1.3624E-03	6.5685E-06	-1.0558E-04	-6.4530E-04
5	9.3547E-04	5.8903E-03	-1.3920E-03	6.5685E-06	-1.0558E-04	-6.4530E-04
6	-1.9684E-03	5.8903E-03	-1.4215E-03	6.5685E-06	-1.0558E-04	-6.4530E-04
7	4.3145E-03	5.9198E-03	-1.3624E-03	6.5685E-06	-1.0558E-04	-6.4530E-04
8	1.4106E-03	5.9198E-03	-1.3920E-03	6.5685E-06	-1.0558E-04	-6.4530E-04
9	-1.4933E-03	5.9198E-03	-1.4215E-03	6.5685E-06	-1.0558E-04	-6.4530E-04
10	4.7896E-03	5.9494E-03	-1.3624E-03	6.5685E-06	-1.0558E-04	-6.4530E-04
11	1.8857E-03	5.9494E-03	-1.3920E-03	6.5685E-06	-1.0558E-04	-6.4530E-04
12	-1.0182E-03	5.9494E-03	-1.4215E-03	6.5685E-06	-1.0558E-04	-6.4530E-04
MINIMUM	-2.4435E-03	5.8607E-03	-1.4215E-03	6.5685E-06	-1.0558E-04	-6.4530E-04
Pile N.	3	1	3	1	1	1
MAXIMUM	4.7896E-03	5.9494E-03	-1.3624E-03	6.5685E-06	-1.0558E-04	-6.4530E-04
Pile N.	10	10	1	1	1	1

* PILE TOP REACTIONS *

PILE GROUP	FOR. X, KN	FOR. Y, KN	FOR. Z, KN	MOM X, KN- M	MOM Y, KN- M	MOM Z, KN- M
1	7027.9	1236.3	-328.08	2.2546	812.26	2705.3
2	1021.8	967.18	-267.79	2.2546	703.96	2188.6
3	-5100.0	981.49	-278.98	2.2546	732.41	2205.1
4	8000.1	1188.0	-313.76	2.2546	786.03	2629.0
5	2058.3	882.45	-244.03	2.2546	656.32	2031.1
6	-4129.9	892.01	-253.35	2.2546	681.10	2038.6
7	8769.5	1196.3	-313.64	2.2546	786.07	2655.8
8	3030.5	889.63	-244.12	2.2546	656.86	2055.7
9	-3159.9	899.62	-253.54	2.2546	681.85	2064.1
10	9416.0	1269.9	-329.59	2.2546	815.86	2801.5
11	4002.6	1003.8	-271.44	2.2546	712.29	2292.3
12	-2189.9	1018.3	-282.69	2.2546	740.84	2308.8
MINIMUM	-5100.0	882.45	-329.59	2.2546	656.32	2031.1
Pile N.	3	5	10	1	5	5
MAXIMUM	9416.0	1269.9	-244.03	2.2546	815.86	2801.5
Pile N.	10	10	5	1	10	10

THE PILE COORDINATE SYSTEM (LOCAL AXES)

* PILE TOP DISPLACEMENTS *

PILE GROUP	DISP. x, M	DISP. y, M	DISP. z, M	ROT. x,RAD	ROT. y,RAD	ROT. z,RAD
1	3.3642E-03	5.8607E-03	-1.3624E-03	6.5685E-06	-1.0558E-04	-6.4530E-04
2	4.6036E-04	5.8607E-03	-1.3920E-03	6.5685E-06	-1.0558E-04	-6.4530E-04
3	-2.4435E-03	5.8607E-03	-1.4215E-03	6.5685E-06	-1.0558E-04	-6.4530E-04
4	3.8393E-03	5.8903E-03	-1.3624E-03	6.5685E-06	-1.0558E-04	-6.4530E-04
5	9.3547E-04	5.8903E-03	-1.3920E-03	6.5685E-06	-1.0558E-04	-6.4530E-04
6	-1.9684E-03	5.8903E-03	-1.4215E-03	6.5685E-06	-1.0558E-04	-6.4530E-04
7	4.3145E-03	5.9198E-03	-1.3624E-03	6.5685E-06	-1.0558E-04	-6.4530E-04
8	1.4106E-03	5.9198E-03	-1.3920E-03	6.5685E-06	-1.0558E-04	-6.4530E-04
9	-1.4933E-03	5.9198E-03	-1.4215E-03	6.5685E-06	-1.0558E-04	-6.4530E-04
10	4.7896E-03	5.9494E-03	-1.3624E-03	6.5685E-06	-1.0558E-04	-6.4530E-04
11	1.8857E-03	5.9494E-03	-1.3920E-03	6.5685E-06	-1.0558E-04	-6.4530E-04
12	-1.0182E-03	5.9494E-03	-1.4215E-03	6.5685E-06	-1.0558E-04	-6.4530E-04
MINIMUM	-2.4435E-03	5.8607E-03	-1.4215E-03	6.5685E-06	-1.0558E-04	-6.4530E-04
Pile N.	3	1	3	1	1	1
MAXIMUM	4.7896E-03	5.9494E-03	-1.3624E-03	6.5685E-06	-1.0558E-04	-6.4530E-04
Pile N.	10	10	1	1	1	1

* PILE TOP REACTIONS *

PILE GROUP	AXIAL, KN	LAT. y, KN	LAT. z, KN	MOM x, KN- M	MOM y, KN- M	MOM z, KN- M
1	7027.9	1236.3	-328.08	2.2546	812.26	2705.3
2	1021.8	967.18	-267.79	2.2546	703.96	2188.6
3	-5100.0	981.49	-278.98	2.2546	732.41	2205.1
4	8000.1	1188.0	-313.76	2.2546	786.03	2629.0
5	2058.3	882.45	-244.03	2.2546	656.32	2031.1
6	-4129.9	892.01	-253.35	2.2546	681.10	2038.6
7	8769.5	1196.3	-313.64	2.2546	786.07	2655.8
8	3030.5	889.63	-244.12	2.2546	656.86	2055.7

APPALTATORE:

Consorzio

Soci



ITINERARIO NAPOLI – BARI

PROGETTAZIONE:

Mandataria

Mandanti



RADDOPPIO TRATTA APICE – ORSARA
I LOTTO FUNZIONALE APICE – HIRPINIA

PROGETTO ESECUTIVO

RELAZIONE DI CALCOLO FONDAZIONI PILE DA P7 A P16

COMMESSA	LOTTO	CODIFICA	DOCUMENTO	REV.	FOGLIO
IF1N	01 E ZZ	RG	MD0000 001	B	93 di 144

9	-3159.9	899.62	-253.54	2.2546	681.85	2064.1
10	9416.0	1269.9	-329.59	2.2546	815.86	2801.5
11	4002.6	1003.8	-271.44	2.2546	712.29	2292.3
12	-2189.9	1018.3	-282.69	2.2546	740.84	2308.8
MINIMUM	-5100.0	882.45	-329.59	2.2546	656.32	2031.1
Pile N.	3	5	10	1	5	5
MAXIMUM	9416.0	1269.9	-244.03	2.2546	815.86	2801.5
Pile N.	10	10	5	1	10	10

PILE GROUP STRESS, KN/ M**2

*****	*****
1	1.2502E+04
2	7516.8
3	9898.5
4	1.2809E+04
5	7606.7
6	8823.8
7	1.3321E+04
8	8228.2
9	8348.7
10	1.4135E+04
11	9509.6
12	8557.2
MINIMUM	7516.8
Pile N.	2
MAXIMUM	1.4135E+04
Pile N.	10

* EFFECTS FOR LATERALLY LOADED PILE *

* MINIMUM VALUES AND LOCATIONS *

PILE	DISPL. y-DIR M	DISPL. z-DIR M	MOMENT KN- M	MOMENT y-DIR KN- M	SHEAR y-DIR KN	SHEAR z-DIR KN	SOIL REACT y-DIR KN/ M	SOIL REACT z-DIR KN/ M	TOTAL STRESS KN/ M**2	FLEX. RIG. z-DIR KN- M**2	FLEX. RIG. y-DIR KN- M**2
*****	*****	*****	*****	*****	*****	*****	*****	*****	*****	*****	*****
1	-1.1797E-04	-1.3624E-03	-2705.3	-406.02	-421.91	-328.20	-112.81	-107.63	3977.0	7.8279E+06	7.8279E+06
x(M)	9.9000	0.0000	0.0000	5.9400	7.9200	0.0000	10.230	4.9500	33.000	0.0000	0.0000
2	-1.1994E-04	-1.3919E-03	-2188.6	-360.58	-337.04	-267.81	-83.197	-79.443	578.21	7.8279E+06	7.8279E+06
x(M)	10.560	0.0000	0.0000	6.2700	8.5800	0.0000	10.890	5.9400	33.000	0.0000	0.0000
3	-1.1903E-04	-1.4215E-03	-2205.1	-370.36	-338.39	-278.90	-83.788	-82.634	2886.0	7.8279E+06	7.8279E+06
x(M)	10.560	0.0000	0.0000	6.2700	8.5800	0.0000	10.890	5.9400	33.000	0.0000	0.0000
4	-1.1931E-04	-1.3624E-03	-2629.0	-395.90	-406.39	-313.89	-107.54	-100.58	4527.1	7.8279E+06	7.8279E+06
x(M)	9.9000	0.0000	0.0000	5.9400	7.9200	0.0000	10.230	4.9500	33.000	0.0000	0.0000
5	-1.2128E-04	-1.3919E-03	-2031.1	-340.98	-310.69	-244.06	-74.352	-69.976	1164.8	7.8279E+06	7.8279E+06
x(M)	10.890	0.0000	0.0000	6.2700	8.5800	0.0000	11.220	5.9400	33.000	0.0000	0.0000
6	-1.2038E-04	-1.4215E-03	-2038.6	-349.33	-310.70	-253.29	-74.478	-72.412	2337.1	7.8279E+06	7.8279E+06
x(M)	10.890	0.0000	0.0000	6.2700	8.5800	0.0000	11.220	5.9400	33.000	0.0000	0.0000
7	-1.1991E-04	-1.3624E-03	-2655.8	-395.93	-408.94	-313.78	-108.27	-100.26	4962.5	7.8279E+06	7.8279E+06
x(M)	9.9000	0.0000	0.0000	5.9400	7.9200	0.0000	10.230	4.9500	33.000	0.0000	0.0000
8	-1.2191E-04	-1.3919E-03	-2055.7	-341.26	-313.07	-244.16	-74.983	-69.877	1714.9	7.8279E+06	7.8279E+06
x(M)	10.890	0.0000	0.0000	6.2700	8.5800	0.0000	11.220	5.9400	33.000	0.0000	0.0000
9	-1.2100E-04	-1.4215E-03	-2064.1	-349.70	-313.20	-253.49	-75.143	-72.349	1788.1	7.8279E+06	7.8279E+06
x(M)	10.890	0.0000	0.0000	6.2700	8.5800	0.0000	11.220	5.9400	33.000	0.0000	0.0000
10	-1.1965E-04	-1.3624E-03	-2801.5	-407.41	-432.32	-329.75	-115.93	-107.52	5328.4	7.8279E+06	7.8279E+06
x(M)	9.9000	0.0000	0.0000	5.9400	7.9200	0.0000	10.230	4.9500	33.000	0.0000	0.0000
11	-1.2151E-04	-1.3919E-03	-2292.3	-363.98	-348.58	-271.50	-86.598	-80.402	2265.0	7.8279E+06	7.8279E+06
x(M)	10.560	0.0000	0.0000	6.2700	8.5800	0.0000	10.890	5.9400	33.000	0.0000	0.0000
12	-1.2057E-04	-1.4215E-03	-2308.8	-373.77	-349.83	-282.66	-87.162	-83.601	1239.2	7.8279E+06	7.8279E+06
x(M)	10.560	0.0000	0.0000	6.2700	8.5800	0.0000	10.890	5.9400	33.000	0.0000	0.0000
Min.	-1.2191E-04	-1.4215E-03	-2801.5	-407.41	-432.32	-329.75	-115.93	-107.63	578.21	7.8279E+06	7.8279E+06
Pile N.	8	3	10	10	10	10	10	1	2	1	1

* MAXIMUM VALUES AND LOCATIONS *

PILE	DISPL. y-DIR M	DISPL. z-DIR M	MOMENT KN- M	MOMENT y-DIR KN- M	SHEAR y-DIR KN	SHEAR z-DIR KN	SOIL REACT y-DIR KN/ M	SOIL REACT z-DIR KN/ M	TOTAL STRESS KN/ M**2	FLEX. RIG. z-DIR KN- M**2	FLEX. RIG. y-DIR KN- M**2
*****	*****	*****	*****	*****	*****	*****	*****	*****	*****	*****	*****
1	5.8607E-03	2.8088E-05	1699.3	812.26	1236.7	101.25	415.82	27.255	1.2502E+04	7.8279E+06	7.8279E+06
x(M)	0.0000	9.9000	5.6100	0.0000	0.0000	8.2500	4.9500	10.230	0.0000	0.0000	0.0000
2	5.8607E-03	2.9122E-05	1476.4	703.96	967.23	82.855	293.07	20.531	7516.8	7.8279E+06	7.8279E+06
x(M)	0.0000	10.560	5.9400	0.0000	0.0000	8.5800	4.9500	10.890	0.0000	0.0000	0.0000
3	5.8607E-03	2.9585E-05	1482.7	732.41	981.25	85.144	297.16	21.175	9898.5	7.8279E+06	7.8279E+06
x(M)	0.0000	10.560	5.9400	0.0000	0.0000	8.5800	4.9500	10.890	0.0000	0.0000	0.0000
4	5.8903E-03	2.8066E-05	1662.3	786.03	1188.4	97.458	391.14	25.702	1.2809E+04	7.8279E+06	7.8279E+06
x(M)	0.0000	9.9000	5.6100	0.0000	0.0000	8.2500	4.9500	10.230	0.0000	0.0000	0.0000
5	5.8903E-03	2.9349E-05	1402.2	656.32	882.53	76.105	257.37	18.276	7606.7	7.8279E+06	7.8279E+06
x(M)	0.0000	10.890	6.2700	0.0000	0.0000	8.9100	5.9400	11.220	0.0000	0.0000	0.0000
6	5.8903E-03	2.9801E-05	1404.3	681.10	891.83	77.874	259.34	18.739	8823.8	7.8279E+06	7.8279E+06
x(M)	0.0000	10.890	6.2700	0.0000	0.0000	8.9100	5.9400	11.220	0.0000	0.0000	0.0000
7	5.9198E-03	2.8062E-05	1671.1	786.07	1196.8	97.541	392.61	25.736	1.3321E+04	7.8279E+06	7.8279E+06
x(M)	0.0000	9.9000	5.6100	0.0000	0.0000	8.2500	4.9500	10.230	0.0000	0.0000	0.0000
8	5.9198E-03	2.9352E-05	1411.0	656.86	889.76	76.270	258.92	18.333	8228.2	7.8279E+06	7.8279E+06
x(M)	0.0000	10.890	6.2700	0.0000	0.0000	8.9100	5.9400	11.220	0.0000	0.0000	0.0000

APPALTATORE: Consorzio Soci   	ITINERARIO NAPOLI – BARI RADDOPPIO TRATTA APICE – ORSARA I LOTTO FUNZIONALE APICE – HIRPINIA				
PROGETTAZIONE: Mandataria Mandanti   					
PROGETTO ESECUTIVO RELAZIONE DI CALCOLO FONDAZIONI PILE DA P7 A P16					
COMMESSA IF1N	LOTTO 01 E ZZ	CODIFICA RG	DOCUMENTO MD0000 001	REV. B	FOGLIO 94 di 144

9	5.9198E-03	2.9803E-05	1413.3	681.85	899.48	78.072	261.03	18.806	8348.7	7.8279E+06	7.8279E+06
x(M)	0.0000	10.890	6.2700	0.0000	0.0000	8.9100	5.9400	11.220	0.0000	0.0000	0.0000
10	5.9494E-03	2.8058E-05	1732.8	815.86	1270.5	101.99	424.08	27.560	1.4135E+04	7.8279E+06	7.8279E+06
x(M)	0.0000	9.9000	5.6100	0.0000	0.0000	8.2500	4.9500	10.230	0.0000	0.0000	0.0000
11	5.9494E-03	2.9118E-05	1514.7	712.29	1004.0	84.412	303.47	21.062	9509.6	7.8279E+06	7.8279E+06
x(M)	0.0000	10.560	5.9400	0.0000	0.0000	8.5800	4.9500	10.890	0.0000	0.0000	0.0000
12	5.9494E-03	2.9575E-05	1520.9	740.84	1018.2	86.714	307.57	21.709	8557.2	7.8279E+06	7.8279E+06
x(M)	0.0000	10.560	5.9400	0.0000	0.0000	8.5800	4.9500	10.890	0.0000	0.0000	0.0000
Max. Pile N.	5.9494E-03	2.9803E-05	1732.8	815.86	1270.5	101.99	424.08	27.560	1.4135E+04	7.8279E+06	7.8279E+06
	10	9	10	10	10	10	10	10	10	1	1

LOAD CASE : 2
CASE NAME : Load Case
LOAD TYPE : Special, Sp

REDUCTION FACTORS FOR CLOSELY-SPACED PILE GROUPS, COMBINED Y AND Z DIRECTIONS
ESTIMATED USING MOVEMENT IN THE DIRECTION OF PILE CAP DISPLACEMENTS

GROUP NO	P-FACTOR	Y-FACTOR
1	0.6041	1.0000
2	0.5943	1.0000
3	0.8661	1.0000
4	0.5007	1.0000
5	0.4952	1.0000
6	0.7941	1.0000
7	0.4984	1.0000
8	0.4933	1.0000
9	0.7927	1.0000
10	0.5845	1.0000
11	0.5747	1.0000
12	0.8525	1.0000

* TABLE L * COMPUTATION ON PILE CAP

* EQUIVALENT CONCENTRATED LOAD AT ORIGIN *

VERT. LOAD, KN	HOR. LOAD Y, KN	HOR. LOAD Z, KN
37076.0	-11889.0	3332.00
MOMENT X, KN- M	MOMENT Y, KN- M	MOMENT Z, KN- M
123.000	55437.0	1.80505E+05

* DISPLACEMENT OF GROUPED PILE FOUNDATION AT ORIGIN *

VERTICAL, M	HORIZONTAL Y, M	HORIZONTAL Z, M
1.52840E-03	-5.65539E-03	1.38949E-03
ANGLE ROT. X, RAD	ANGLE ROT. Y, RAD	ANGLE ROT. Z, RAD
8.70564E-06	1.11849E-04	6.27824E-04

THE GLOBAL STRUCTURAL COORDINATE SYSTEM

* PILE TOP DISPLACEMENTS *

PILE GROUP	DISP. X, M	DISP. Y, M	DISP. Z, M	ROT. X, RAD	ROT. Y, RAD	ROT. Z, RAD
1	-5.4183E-04	-5.7142E-03	1.4287E-03	8.7056E-06	1.1185E-04	6.2782E-04
2	2.2834E-03	-5.7142E-03	1.3895E-03	8.7056E-06	1.1185E-04	6.2782E-04
3	5.1086E-03	-5.7142E-03	1.3503E-03	8.7056E-06	1.1185E-04	6.2782E-04
4	-1.0451E-03	-5.6750E-03	1.4287E-03	8.7056E-06	1.1185E-04	6.2782E-04
5	1.7801E-03	-5.6750E-03	1.3895E-03	8.7056E-06	1.1185E-04	6.2782E-04
6	4.6053E-03	-5.6750E-03	1.3503E-03	8.7056E-06	1.1185E-04	6.2782E-04
7	-1.5485E-03	-5.6358E-03	1.4287E-03	8.7056E-06	1.1185E-04	6.2782E-04
8	1.2767E-03	-5.6358E-03	1.3895E-03	8.7056E-06	1.1185E-04	6.2782E-04
9	4.1019E-03	-5.6358E-03	1.3503E-03	8.7056E-06	1.1185E-04	6.2782E-04
10	-2.0518E-03	-5.5966E-03	1.4287E-03	8.7056E-06	1.1185E-04	6.2782E-04
11	7.7342E-04	-5.5966E-03	1.3895E-03	8.7056E-06	1.1185E-04	6.2782E-04
12	3.5986E-03	-5.5966E-03	1.3503E-03	8.7056E-06	1.1185E-04	6.2782E-04
MINIMUM Pile N.	-2.0518E-03	-5.7142E-03	1.3503E-03	8.7056E-06	1.1185E-04	6.2782E-04
	10	1	3	1	1	1
MAXIMUM Pile N.	5.1086E-03	-5.5966E-03	1.4287E-03	8.7056E-06	1.1185E-04	6.2782E-04
	3	10	1	1	1	1

* PILE TOP REACTIONS *

APPALTATORE:

Consorzio

Soci



ITINERARIO NAPOLI – BARI

PROGETTAZIONE:

Mandataria

Mandanti



RADDOPPIO TRATTA APICE – ORSARA
I LOTTO FUNZIONALE APICE – HIRPINIA

PROGETTO ESECUTIVO

RELAZIONE DI CALCOLO FONDAZIONI PILE DA P7 A P16

COMMESSA IF1N	LOTTO 01 E ZZ	CODIFICA RG	DOCUMENTO MD0000 001	REV. B	FOGLIO 95 di 144
------------------	------------------	----------------	-------------------------	-----------	---------------------

PILE GROUP *****	FOR. X, KN *****	FOR. Y, KN *****	FOR. Z, KN *****	MOM X, KN- M *****	MOM Y, KN- M *****	MOM Z, KN- M *****
1	-1185.4	-979.46	281.64	2.9882	-727.17	-2204.3
2	4816.3	-965.44	267.82	2.9882	-690.64	-2188.0
3	9850.0	-1220.2	322.04	2.9882	-782.85	-2673.2
4	-2245.0	-861.89	252.25	2.9882	-667.89	-1959.3
5	3786.5	-852.08	240.47	2.9882	-635.35	-1950.7
6	9165.2	-1145.7	306.24	2.9882	-753.43	-2522.7
7	-3272.6	-852.17	252.11	2.9882	-667.23	-1926.8
8	2756.6	-842.83	240.44	2.9882	-634.91	-1919.1
9	8480.3	-1134.6	306.41	2.9882	-753.55	-2487.9
10	-4300.2	-935.31	277.85	2.9882	-718.59	-2077.6
11	1716.6	-921.47	264.11	2.9882	-682.23	-2061.5
12	7507.5	-1177.8	320.63	2.9882	-779.50	-2551.5
MINIMUM	-4300.2	-1220.2	240.44	2.9882	-782.85	-2673.2
Pile N.	10	3	8	1	3	3
MAXIMUM	9850.0	-842.83	322.04	2.9882	-634.91	-1919.1
Pile N.	3	8	3	1	8	8

THE PILE COORDINATE SYSTEM (LOCAL AXES)

* PILE TOP DISPLACEMENTS *

PILE GROUP *****	DISP. x, M *****	DISP. y, M *****	DISP. z, M *****	ROT. x,RAD *****	ROT. y,RAD *****	ROT. z,RAD *****
1	-5.4183E-04	-5.7142E-03	1.4287E-03	8.7056E-06	1.1185E-04	6.2782E-04
2	2.2834E-03	-5.7142E-03	1.3895E-03	8.7056E-06	1.1185E-04	6.2782E-04
3	5.1086E-03	-5.7142E-03	1.3503E-03	8.7056E-06	1.1185E-04	6.2782E-04
4	-1.0451E-03	-5.6750E-03	1.4287E-03	8.7056E-06	1.1185E-04	6.2782E-04
5	1.7801E-03	-5.6750E-03	1.3895E-03	8.7056E-06	1.1185E-04	6.2782E-04
6	4.6053E-03	-5.6750E-03	1.3503E-03	8.7056E-06	1.1185E-04	6.2782E-04
7	-1.5485E-03	-5.6358E-03	1.4287E-03	8.7056E-06	1.1185E-04	6.2782E-04
8	1.2767E-03	-5.6358E-03	1.3895E-03	8.7056E-06	1.1185E-04	6.2782E-04
9	4.1019E-03	-5.6358E-03	1.3503E-03	8.7056E-06	1.1185E-04	6.2782E-04
10	-2.0518E-03	-5.5966E-03	1.4287E-03	8.7056E-06	1.1185E-04	6.2782E-04
11	7.7342E-04	-5.5966E-03	1.3895E-03	8.7056E-06	1.1185E-04	6.2782E-04
12	3.5986E-03	-5.5966E-03	1.3503E-03	8.7056E-06	1.1185E-04	6.2782E-04
MINIMUM	-2.0518E-03	-5.7142E-03	1.3503E-03	8.7056E-06	1.1185E-04	6.2782E-04
Pile N.	10	1	3	1	1	1
MAXIMUM	5.1086E-03	-5.5966E-03	1.4287E-03	8.7056E-06	1.1185E-04	6.2782E-04
Pile N.	3	10	1	1	1	1

* PILE TOP REACTIONS *

PILE GROUP *****	AXIAL, KN *****	LAT. y, KN *****	LAT. z, KN *****	MOM x, KN- M *****	MOM y, KN- M *****	MOM z, KN- M *****
1	-1185.4	-979.46	281.64	2.9882	-727.17	-2204.3
2	4816.3	-965.44	267.82	2.9882	-690.64	-2188.0
3	9850.0	-1220.2	322.04	2.9882	-782.85	-2673.2
4	-2245.0	-861.89	252.25	2.9882	-667.89	-1959.3
5	3786.5	-852.08	240.47	2.9882	-635.35	-1950.7
6	9165.2	-1145.7	306.24	2.9882	-753.43	-2522.7
7	-3272.6	-852.17	252.11	2.9882	-667.23	-1926.8
8	2756.6	-842.83	240.44	2.9882	-634.91	-1919.1
9	8480.3	-1134.6	306.41	2.9882	-753.55	-2487.9
10	-4300.2	-935.31	277.85	2.9882	-718.59	-2077.6
11	1716.6	-921.47	264.11	2.9882	-682.23	-2061.5
12	7507.5	-1177.8	320.63	2.9882	-779.50	-2551.5
MINIMUM	-4300.2	-1220.2	240.44	2.9882	-782.85	-2673.2
Pile N.	10	3	8	1	3	3
MAXIMUM	9850.0	-842.83	322.04	2.9882	-634.91	-1919.1
Pile N.	3	8	3	1	8	8

PILE GROUP STRESS, KN/ M**2

PILE GROUP *****	STRESS, KN/ M**2 *****
1	7676.1
2	9650.2
3	1.3981E+04
4	7517.8
5	8334.4
6	1.3132E+04
7	8006.0
8	7660.7
9	1.2644E+04
10	9068.2
11	7524.9
12	1.2300E+04
MINIMUM	7517.8
Pile N.	4
MAXIMUM	1.3981E+04
Pile N.	3

APPALTATORE:

Consorzio

Soci



ITINERARIO NAPOLI – BARI

PROGETTAZIONE:

Mandatario

Mandanti



RADDOPPIO TRATTA APICE – ORSARA
I LOTTO FUNZIONALE APICE – HIRPINIA

PROGETTO ESECUTIVO

RELAZIONE DI CALCOLO FONDAZIONI PILE DA P7 A P16

COMMESSA IF1N	LOTTO 01 E ZZ	CODIFICA RG	DOCUMENTO MD0000 001	REV. B	FOGLIO 96 di 144
------------------	------------------	----------------	-------------------------	-----------	---------------------

* EFFECTS FOR LATERALLY LOADED PILE *

* MINIMUM VALUES AND LOCATIONS *

PILE	DISPL. y-DIR M	DISPL. z-DIR M	MOMENT z-DIR KN- M	MOMENT y-DIR KN- M	SHEAR y-DIR KN	SHEAR z-DIR KN	SOIL REACT y-DIR KN/ M	SOIL REACT z-DIR KN/ M	TOTAL STRESS KN/ M**2	FLEX. RIG. z-DIR KN- M**2	FLEX. RIG. y-DIR KN- M**2
*****	*****	*****	*****	*****	*****	*****	*****	*****	*****	*****	*****
1	-5.7142E-03	-2.9833E-05	-1469.4	-727.17	-979.41	-87.365	-303.33	-21.858	670.78	7.8279E+06	7.8279E+06
x (M)	0.0000	10.560	5.9400	0.0000	0.0000	8.5800	4.9500	10.890	33.000	0.0000	0.0000
2	-5.7142E-03	-2.9163E-05	-1463.3	-690.64	-965.66	-84.388	-299.31	-21.040	2725.5	7.8279E+06	7.8279E+06
x (M)	0.0000	10.560	5.9400	0.0000	0.0000	8.5800	4.9500	10.890	33.000	0.0000	0.0000
3	-5.7142E-03	-2.7860E-05	-1672.1	-782.85	-1220.8	-100.90	-417.91	-27.249	5574.0	7.8279E+06	7.8279E+06
x (M)	0.0000	9.9000	5.6100	0.0000	0.0000	7.9200	4.9500	10.230	33.000	0.0000	0.0000
4	-5.6750E-03	-3.0057E-05	-1361.0	-667.89	-861.80	-78.498	-255.55	-18.907	1270.4	7.8279E+06	7.8279E+06
x (M)	0.0000	10.890	5.9400	0.0000	0.0000	8.9100	4.9500	11.220	33.000	0.0000	0.0000
5	-5.6750E-03	-2.9389E-05	-1358.0	-635.35	-852.24	-76.076	-253.44	-18.282	2142.7	7.8279E+06	7.8279E+06
x (M)	0.0000	10.890	5.9400	0.0000	0.0000	8.9100	5.9400	11.220	33.000	0.0000	0.0000
6	-5.6750E-03	-2.7925E-05	-1609.3	-753.43	-1146.2	-96.435	-386.25	-25.466	5186.4	7.8279E+06	7.8279E+06
x (M)	0.0000	9.9000	5.6100	0.0000	0.0000	4.9500	10.230	33.000	33.000	0.0000	0.0000
7	-5.6358E-03	-3.0065E-05	-1350.2	-667.23	-852.04	-78.304	-253.67	-18.839	1851.9	7.8279E+06	7.8279E+06
x (M)	0.0000	10.890	5.9400	0.0000	0.0000	8.9100	4.9500	11.220	33.000	0.0000	0.0000
8	-5.6358E-03	-2.9397E-05	-1347.5	-634.91	-842.94	-75.917	-251.64	-18.226	1559.9	7.8279E+06	7.8279E+06
x (M)	0.0000	10.890	5.9400	0.0000	0.0000	8.9100	4.9500	11.220	33.000	0.0000	0.0000
9	-5.6358E-03	-2.7942E-05	-1598.0	-753.55	-1135.0	-96.375	-384.39	-25.438	4798.9	7.8279E+06	7.8279E+06
x (M)	0.0000	9.9000	5.6100	0.0000	0.0000	8.2500	4.9500	10.230	33.000	0.0000	0.0000
10	-5.5966E-03	-2.9894E-05	-1423.8	-718.59	-935.12	-85.756	-291.57	-21.305	2433.4	7.8279E+06	7.8279E+06
x (M)	0.0000	10.560	5.9400	0.0000	0.0000	8.5800	4.9500	10.890	33.000	0.0000	0.0000
11	-5.5966E-03	-2.9221E-05	-1417.7	-682.23	-921.54	-82.812	-287.57	-20.497	971.42	7.8279E+06	7.8279E+06
x (M)	0.0000	10.560	5.9400	0.0000	0.0000	8.5800	4.9500	10.890	33.000	0.0000	0.0000
12	-5.5966E-03	-2.7930E-05	-1630.5	-779.50	-1178.2	-100.08	-408.17	-26.948	4248.4	7.8279E+06	7.8279E+06
x (M)	0.0000	9.9000	5.6100	0.0000	0.0000	7.9200	4.9500	10.230	33.000	0.0000	0.0000
Min.	-5.7142E-03	-3.0065E-05	-1672.1	-782.85	-1220.8	-100.90	-417.91	-27.249	670.78	7.8279E+06	7.8279E+06
Pile N.	1	7	3	3	3	3	3	3	1	1	1

* MAXIMUM VALUES AND LOCATIONS *

PILE	DISPL. y-DIR M	DISPL. z-DIR M	MOMENT z-DIR KN- M	MOMENT y-DIR KN- M	SHEAR y-DIR KN	SHEAR z-DIR KN	SOIL REACT y-DIR KN/ M	SOIL REACT z-DIR KN/ M	TOTAL STRESS KN/ M**2	FLEX. RIG. z-DIR KN- M**2	FLEX. RIG. y-DIR KN- M**2
*****	*****	*****	*****	*****	*****	*****	*****	*****	*****	*****	*****
1	1.1654E-04	1.4287E-03	2204.3	376.20	337.55	281.62	84.077	85.011	7676.1	7.8279E+06	7.8279E+06
x (M)	10.230	0.0000	0.0000	6.2700	8.5800	0.0000	10.890	5.9400	0.0000	0.0000	0.0000
2	1.1728E-04	1.3895E-03	2188.0	363.59	336.22	267.89	83.507	81.004	9650.2	7.8279E+06	7.8279E+06
x (M)	10.560	0.0000	0.0000	6.2700	8.5800	0.0000	10.890	5.9400	0.0000	0.0000	0.0000
3	1.1542E-04	1.3503E-03	2673.2	403.30	416.78	322.21	111.56	108.04	1.3981E+04	7.8279E+06	7.8279E+06
x (M)	9.9000	0.0000	0.0000	5.9400	7.9200	0.0000	10.230	4.9500	0.0000	0.0000	0.0000
4	1.1676E-04	1.4287E-03	1959.3	352.18	301.76	252.22	72.227	73.650	7517.8	7.8279E+06	7.8279E+06
x (M)	10.560	0.0000	0.0000	6.2700	8.5800	0.0000	11.220	5.9400	0.0000	0.0000	0.0000
5	1.1756E-04	1.3895E-03	1950.7	341.10	301.49	240.52	72.033	70.460	8334.4	7.8279E+06	7.8279E+06
x (M)	10.560	0.0000	0.0000	6.2700	8.5800	0.0000	11.220	5.9400	0.0000	0.0000	0.0000
6	1.1559E-04	1.3503E-03	2522.7	392.07	393.46	306.38	103.98	100.85	1.3132E+04	7.8279E+06	7.8279E+06
x (M)	9.9000	0.0000	0.0000	5.9400	7.9200	0.0000	10.230	4.9500	0.0000	0.0000	0.0000
7	1.1595E-04	1.4287E-03	1926.8	351.87	298.75	252.07	71.428	73.813	8006.0	7.8279E+06	7.8279E+06
x (M)	10.560	0.0000	0.0000	6.2700	8.5800	0.0000	11.220	5.9400	0.0000	0.0000	0.0000
8	1.1675E-04	1.3895E-03	1919.1	340.89	298.60	240.47	71.271	70.658	7660.7	7.8279E+06	7.8279E+06
x (M)	10.560	0.0000	0.0000	6.2700	8.5800	0.0000	11.220	5.9400	0.0000	0.0000	0.0000
9	1.1482E-04	1.3503E-03	2487.9	392.13	390.31	306.55	103.07	101.33	1.2644E+04	7.8279E+06	7.8279E+06
x (M)	9.9000	0.0000	0.0000	5.9400	7.9200	0.0000	10.230	4.9500	0.0000	0.0000	0.0000
10	1.1434E-04	1.4287E-03	2077.6	372.80	324.27	277.78	80.228	84.273	9068.2	7.8279E+06	7.8279E+06
x (M)	10.560	0.0000	0.0000	6.2700	8.5800	0.0000	10.890	5.9400	0.0000	0.0000	0.0000
11	1.1523E-04	1.3895E-03	2061.5	360.24	322.89	264.13	79.640	80.270	7524.9	7.8279E+06	7.8279E+06
x (M)	10.560	0.0000	0.0000	6.2700	8.5800	0.0000	10.890	5.9400	0.0000	0.0000	0.0000
12	1.1324E-04	1.3503E-03	2551.5	402.11	404.28	320.75	107.84	108.61	1.2300E+04	7.8279E+06	7.8279E+06
x (M)	9.9000	0.0000	0.0000	5.9400	7.9200	0.0000	10.230	4.9500	0.0000	0.0000	0.0000
Max.	1.1756E-04	1.4287E-03	2673.2	403.30	416.78	322.21	111.56	108.61	1.3981E+04	7.8279E+06	7.8279E+06
Pile N.	5	1	3	3	3	3	3	12	3	1	1

LOAD CASE : 3
CASE NAME : Load Case
LOAD TYPE : Special, Sp

REDUCTION FACTORS FOR CLOSELY-SPACED PILE GROUPS, COMBINED Y AND Z DIRECTIONS
ESTIMATED USING MOVEMENT IN THE DIRECTION OF PILE CAP DISPLACEMENTS

GROUP NO	P-FACTOR	Y-FACTOR
1	0.6310	1.0000
2	0.5088	1.0000
3	0.5845	1.0000
4	0.5874	1.0000
5	0.4672	1.0000
6	0.5380	1.0000
7	0.6153	1.0000

APPALTATORE: Consorzio Soci   	ITINERARIO NAPOLI – BARI RADDOPPIO TRATTA APICE – ORSARA I LOTTO FUNZIONALE APICE – HIRPINIA				
PROGETTAZIONE: Mandataria Mandanti   					
PROGETTO ESECUTIVO RELAZIONE DI CALCOLO FONDAZIONI PILE DA P7 A P16					
COMMESSA IF1N	LOTTO 01 E ZZ	CODIFICA RG	DOCUMENTO MD0000 001	REV. B	FOGLIO 97 di 144

8	0.4960	1.0000
9	0.5683	1.0000
10	0.8661	1.0000
11	0.7780	1.0000
12	0.8329	1.0000

* TABLE L * COMPUTATION ON PILE CAP

* EQUIVALENT CONCENTRATED LOAD AT ORIGIN *

VERT. LOAD, KN 29232.0	HOR. LOAD Y, KN 3830.00	HOR. LOAD Z, KN -11239.0
MOMENT X, KN- M -410.000	MOMENT Y, KN- M -1.82570E+05	MOMENT Z, KN- M -58192.0

* DISPLACEMENT OF GROUPED PILE FOUNDATION AT ORIGIN *

VERTICAL, M 1.16757E-03	HORIZONTAL Y, M 1.81842E-03	HORIZONTAL Z, M -4.54148E-03
ANGLE ROT. X, RAD -1.05617E-05	ANGLE ROT. Y, RAD -3.34858E-04	ANGLE ROT. Z, RAD -2.00387E-04

THE GLOBAL STRUCTURAL COORDINATE SYSTEM

* PILE TOP DISPLACEMENTS *

PILE GROUP	DISP. X, M	DISP. Y, M	DISP. Z, M	ROT. X, RAD	ROT. Y, RAD	ROT. Z, RAD
*****	*****	*****	*****	*****	*****	*****
1	-1.9098E-04	1.8897E-03	-4.5890E-03	-1.0562E-05	-3.3486E-04	-2.0039E-04
2	-1.0927E-03	1.8897E-03	-4.5415E-03	-1.0562E-05	-3.3486E-04	-2.0039E-04
3	-1.9945E-03	1.8897E-03	-4.4940E-03	-1.0562E-05	-3.3486E-04	-2.0039E-04
4	1.3159E-03	1.8422E-03	-4.5890E-03	-1.0562E-05	-3.3486E-04	-2.0039E-04
5	4.1414E-04	1.8422E-03	-4.5415E-03	-1.0562E-05	-3.3486E-04	-2.0039E-04
6	-4.8760E-04	1.8422E-03	-4.4940E-03	-1.0562E-05	-3.3486E-04	-2.0039E-04
7	2.8227E-03	1.7947E-03	-4.5890E-03	-1.0562E-05	-3.3486E-04	-2.0039E-04
8	1.9210E-03	1.7947E-03	-4.5415E-03	-1.0562E-05	-3.3486E-04	-2.0039E-04
9	1.0193E-03	1.7947E-03	-4.4940E-03	-1.0562E-05	-3.3486E-04	-2.0039E-04
10	4.3296E-03	1.7471E-03	-4.5890E-03	-1.0562E-05	-3.3486E-04	-2.0039E-04
11	3.4279E-03	1.7471E-03	-4.5415E-03	-1.0562E-05	-3.3486E-04	-2.0039E-04
12	2.5261E-03	1.7471E-03	-4.4940E-03	-1.0562E-05	-3.3486E-04	-2.0039E-04
MINIMUM	-1.9945E-03	1.7471E-03	-4.5890E-03	-1.0562E-05	-3.3486E-04	-2.0039E-04
Pile N.	3	10	1	1	1	1
MAXIMUM	4.3296E-03	1.8897E-03	-4.4940E-03	-1.0562E-05	-3.3486E-04	-2.0039E-04
Pile N.	10	1	3	1	1	1

* PILE TOP REACTIONS *

PILE GROUP	FOR. X, KN	FOR. Y, KN	FOR. Z, KN	MOM X, KN- M	MOM Y, KN- M	MOM Z, KN- M
*****	*****	*****	*****	*****	*****	*****
1	-417.80	343.62	-960.82	-3.6253	2500.3	783.23
2	-2342.1	301.11	-837.13	-3.6253	2238.8	699.35
3	-4183.1	329.51	-898.73	-3.6253	2345.7	754.09
4	2836.7	315.70	-919.94	-3.6253	2424.8	716.66
5	919.21	273.79	-794.46	-3.6253	2155.9	632.76
6	-1066.7	300.52	-854.71	-3.6253	2262.7	685.03
7	5920.0	311.85	-944.00	-3.6253	2476.1	696.10
8	4074.9	272.63	-822.00	-3.6253	2216.6	618.58
9	2229.8	298.27	-881.26	-3.6253	2319.7	668.05
10	8790.1	371.20	-1153.0	-3.6253	2873.9	791.29
11	7158.1	347.81	-1070.9	-3.6253	2704.8	748.33
12	5313.0	363.98	-1102.1	-3.6253	2744.0	776.59
MINIMUM	-4183.1	272.63	-1153.0	-3.6253	2155.9	618.58
Pile N.	3	8	10	1	5	8
MAXIMUM	8790.1	371.20	-794.46	-3.6253	2873.9	791.29
Pile N.	10	10	5	1	10	10

THE PILE COORDINATE SYSTEM (LOCAL AXES)

* PILE TOP DISPLACEMENTS *

PILE GROUP	DISP. x, M	DISP. y, M	DISP. z, M	ROT. x, RAD	ROT. y, RAD	ROT. z, RAD
*****	*****	*****	*****	*****	*****	*****
1	-1.9098E-04	1.8897E-03	-4.5890E-03	-1.0562E-05	-3.3486E-04	-2.0039E-04
2	-1.0927E-03	1.8897E-03	-4.5415E-03	-1.0562E-05	-3.3486E-04	-2.0039E-04

APPALTATORE:

Consorzio

Soci



ITINERARIO NAPOLI – BARI

PROGETTAZIONE:

Mandatario

Mandanti



RADDOPPIO TRATTA APICE – ORSARA
I LOTTO FUNZIONALE APICE – HIRPINIA

PROGETTO ESECUTIVO

RELAZIONE DI CALCOLO FONDAZIONI PILE DA P7 A P16

COMMESSA LOTTO CODIFICA DOCUMENTO REV. FOGLIO
IF1N 01 E ZZ RG MD0000 001 B 98 di 144

3	-1.9945E-03	1.8897E-03	-4.4940E-03	-1.0562E-05	-3.3486E-04	-2.0039E-04
4	1.3159E-03	1.8422E-03	-4.5890E-03	-1.0562E-05	-3.3486E-04	-2.0039E-04
5	4.1414E-04	1.8422E-03	-4.5415E-03	-1.0562E-05	-3.3486E-04	-2.0039E-04
6	-4.8760E-04	1.8422E-03	-4.4940E-03	-1.0562E-05	-3.3486E-04	-2.0039E-04
7	2.8227E-04	1.7947E-03	-4.5890E-03	-1.0562E-05	-3.3486E-04	-2.0039E-04
8	1.9210E-03	1.7947E-03	-4.5415E-03	-1.0562E-05	-3.3486E-04	-2.0039E-04
9	1.0193E-03	1.7947E-03	-4.4940E-03	-1.0562E-05	-3.3486E-04	-2.0039E-04
10	4.3296E-03	1.7471E-03	-4.5890E-03	-1.0562E-05	-3.3486E-04	-2.0039E-04
11	3.4279E-03	1.7471E-03	-4.5415E-03	-1.0562E-05	-3.3486E-04	-2.0039E-04
12	2.5261E-03	1.7471E-03	-4.4940E-03	-1.0562E-05	-3.3486E-04	-2.0039E-04

MINIMUM	-1.9945E-03	1.7471E-03	-4.5890E-03	-1.0562E-05	-3.3486E-04	-2.0039E-04
Pile N.	3	10	1	1	1	1
MAXIMUM	4.3296E-03	1.8897E-03	-4.4940E-03	-1.0562E-05	-3.3486E-04	-2.0039E-04
Pile N.	10	1	3	1	1	1

* PILE TOP REACTIONS *

PILE GROUP	AXIAL, KN	LAT. y, KN	LAT. z, KN	MOM x, KN- M	MOM y, KN- M	MOM z, KN- M
1	-417.80	343.62	-960.82	-3.6253	2500.3	783.23
2	-2342.1	301.11	-837.13	-3.6253	2238.8	699.35
3	-4183.1	329.51	-898.73	-3.6253	2345.7	754.09
4	2836.7	315.70	-919.94	-3.6253	2424.8	716.66
5	919.21	273.79	-794.46	-3.6253	2155.9	632.76
6	-1066.7	300.52	-854.71	-3.6253	2262.7	685.03
7	5920.0	311.85	-944.00	-3.6253	2476.1	696.10
8	4074.9	272.63	-822.00	-3.6253	2216.6	618.58
9	2229.8	298.27	-881.26	-3.6253	2319.7	668.05
10	8790.1	371.20	-1153.0	-3.6253	2873.9	791.29
11	7158.1	347.81	-1070.9	-3.6253	2704.8	748.33
12	5313.0	363.98	-1102.1	-3.6253	2744.0	776.59
MINIMUM	-4183.1	272.63	-1153.0	-3.6253	2155.9	618.58
Pile N.	3	8	10	1	5	8
MAXIMUM	8790.1	371.20	-794.46	-3.6253	2873.9	791.29
Pile N.	10	10	5	1	10	10

PILE GROUP	STRESS, KN/ M**2
1	8144.2
2	8404.0
3	9803.5
4	9236.5
5	7301.2
6	7738.6
7	1.1113E+04
8	9251.5
9	8547.3
10	1.3971E+04
11	1.2520E+04
12	1.1613E+04
MINIMUM	7301.2
Pile N.	5
MAXIMUM	1.3971E+04
Pile N.	10

* EFFECTS FOR LATERALLY LOADED PILE *

* MINIMUM VALUES AND LOCATIONS *

PILE	DISPL. y-DIR	DISPL. z-DIR	MOMENT z-DIR	MOMENT y-DIR	SHEAR y-DIR	SHEAR z-DIR	SOIL REACT y-DIR	SOIL REACT z-DIR	TOTAL STRESS	FLEX. RIG. z-DIR	FLEX. RIG. y-DIR
*****	*****	*****	*****	*****	*****	*****	*****	*****	*****	*****	*****
	M	M	KN- M	KN- M	KN	KN	KN/ M	KN/ M	KN/ M**2	KN- M**2	KN- M**2
1	-3.8958E-05	-4.5890E-03	-783.23	-1240.2	-115.61	-960.79	-29.084	-300.80	236.43	7.8279E+06	7.8279E+06
x(M)	10.230	0.0000	0.0000	5.9400	8.2500	0.0000	10.560	4.9500	33.000	0.0000	0.0000
2	-3.9296E-05	-4.5415E-03	-699.35	-1138.1	-102.47	-837.02	-24.594	-247.78	1325.3	7.8279E+06	7.8279E+06
x(M)	10.560	0.0000	0.0000	6.2700	8.5800	0.0000	10.890	5.9400	33.000	0.0000	0.0000
3	-3.8996E-05	-4.4940E-03	-754.09	-1182.5	-110.67	-898.52	-27.387	-278.19	2367.2	7.8279E+06	7.8279E+06
x(M)	10.560	0.0000	0.0000	6.2700	8.5800	0.0000	10.890	4.9500	33.000	0.0000	0.0000
4	-3.8087E-05	-4.5890E-03	-716.66	-1211.6	-108.26	-920.08	-26.816	-282.96	1605.2	7.8279E+06	7.8279E+06
x(M)	10.560	0.0000	0.0000	6.2700	8.5800	0.0000	10.890	4.9500	33.000	0.0000	0.0000
5	-3.8579E-05	-4.5415E-03	-632.76	-1103.5	-95.012	-794.50	-22.512	-231.77	520.17	7.8279E+06	7.8279E+06
x(M)	10.890	0.0000	0.0000	6.2700	8.5800	0.0000	11.220	5.9400	33.000	0.0000	0.0000
6	-3.8384E-05	-4.4940E-03	-685.03	-1150.9	-103.20	-854.66	-25.099	-258.94	603.64	7.8279E+06	7.8279E+06
x(M)	10.560	0.0000	0.0000	6.2700	8.5800	0.0000	10.890	4.9500	33.000	0.0000	0.0000
7	-3.7202E-05	-4.5890E-03	-696.10	-1231.3	-108.35	-944.31	-27.087	-295.68	3350.0	7.8279E+06	7.8279E+06
x(M)	10.230	0.0000	0.0000	6.2700	8.2500	0.0000	10.560	4.9500	33.000	0.0000	0.0000
8	-3.7561E-05	-4.5415E-03	-618.58	-1130.2	-96.064	-822.20	-22.915	-243.75	2305.9	7.8279E+06	7.8279E+06
x(M)	10.560	0.0000	0.0000	6.2700	8.5800	0.0000	10.890	5.9400	33.000	0.0000	0.0000
9	-3.7266E-05	-4.4940E-03	-668.05	-1173.7	-103.51	-881.37	-25.462	-272.74	1261.8	7.8279E+06	7.8279E+06
x(M)	10.560	0.0000	0.0000	6.2700	8.5800	0.0000	10.890	4.9500	33.000	0.0000	0.0000
10	-3.5426E-05	-4.5890E-03	-791.29	-1392.6	-127.58	-1153.5	-34.084	-400.38	4974.2	7.8279E+06	7.8279E+06
x(M)	9.5700	0.0000	0.0000	5.9400	7.9200	0.0000	9.9000	4.9500	33.000	0.0000	0.0000
11	-3.5828E-05	-4.5415E-03	-748.33	-1329.9	-120.09	-1071.3	-31.536	-362.71	4050.7	7.8279E+06	7.8279E+06
x(M)	9.9000	0.0000	0.0000	5.9400	7.9200	0.0000	10.230	4.9500	33.000	0.0000	0.0000

APPALTATORE: Consorzio Soci   		ITINERARIO NAPOLI – BARI RADDOPPIO TRATTA APICE – ORSARA I LOTTO FUNZIONALE APICE – HIRPINIA					
PROGETTAZIONE: Mandataria Mandanti   							
PROGETTO ESECUTIVO RELAZIONE DI CALCOLO FONDAZIONI PILE DA P7 A P16							
		COMMESSA IF1N	LOTTO 01 E ZZ	CODIFICA RG	DOCUMENTO MD0000 001	REV. B	FOGLIO 99 di 144

12	-3.5554E-05	-4.4940E-03	-776.59	-1345.7	-124.79	-1102.4	-33.107	-383.29	3006.6	7.8279E+06	7.8279E+06
x(M)	9.9000	0.0000	0.0000	5.9400	7.9200	0.0000	10.230	4.9500	33.000	0.0000	0.0000
Min. Pile N.	-3.9296E-05	-4.5890E-03	-791.29	-1392.6	-127.58	-1153.5	-34.084	-400.38	236.43	7.8279E+06	7.8279E+06
	2	1	10	10	10	10	10	10	1	1	1

* MAXIMUM VALUES AND LOCATIONS *

PILE	DISPL. y-DIR	DISPL. z-DIR	MOMENT z-DIR	MOMENT y-DIR	SHEAR y-DIR	SHEAR z-DIR	SOIL REACT y-DIR	SOIL REACT z-DIR	TOTAL STRESS	FLEX. RIG. z-DIR	FLEX. RIG. y-DIR
	M	M	KN- M	KN- M	KN	KN	KN/ M	KN/ M	KN/ M**2	KN- M**2	KN- M**2
*****	*****	*****	*****	*****	*****	*****	*****	*****	*****	*****	*****
1	1.8897E-03	9.6560E-05	498.06	2500.3	343.62	290.69	111.10	73.308	8144.2	7.8279E+06	7.8279E+06
x(M)	0.0000	10.560	5.9400	0.0000	0.0000	8.5800	4.9500	10.890	0.0000	0.0000	0.0000
2	1.8897E-03	9.6474E-05	460.70	2238.8	301.08	254.29	92.286	61.466	8404.0	7.8279E+06	7.8279E+06
x(M)	0.0000	10.890	5.9400	0.0000	0.0000	8.9100	4.9500	11.220	0.0000	0.0000	0.0000
3	1.8897E-03	9.4867E-05	485.53	2345.7	329.44	272.03	105.39	67.573	9803.5	7.8279E+06	7.8279E+06
x(M)	0.0000	10.560	5.9400	0.0000	0.0000	8.5800	4.9500	10.890	0.0000	0.0000	0.0000
4	1.8422E-03	9.7430E-05	473.21	2424.8	315.75	280.16	100.85	69.698	9236.5	7.8279E+06	7.8279E+06
x(M)	0.0000	10.560	5.9400	0.0000	0.0000	8.5800	4.9500	10.890	0.0000	0.0000	0.0000
5	1.8422E-03	9.7020E-05	435.05	2155.9	273.80	243.11	82.689	57.582	7301.2	7.8279E+06	7.8279E+06
x(M)	0.0000	10.890	6.2700	0.0000	0.0000	8.9100	4.9500	11.220	0.0000	0.0000	0.0000
6	1.8422E-03	9.5183E-05	459.24	2262.7	300.50	259.75	94.660	63.445	7738.6	7.8279E+06	7.8279E+06
x(M)	0.0000	10.890	5.9400	0.0000	0.0000	8.5800	4.9500	11.220	0.0000	0.0000	0.0000
7	1.7947E-03	9.7418E-05	467.96	2476.1	311.94	288.23	101.64	72.359	1.1113E+04	7.8279E+06	7.8279E+06
x(M)	0.0000	10.560	5.9400	0.0000	0.0000	8.5800	4.9500	10.890	0.0000	0.0000	0.0000
8	1.7947E-03	9.7318E-05	433.31	2216.6	272.69	252.22	84.378	60.637	9251.5	7.8279E+06	7.8279E+06
x(M)	0.0000	10.890	5.9400	0.0000	0.0000	8.9100	4.9500	11.220	0.0000	0.0000	0.0000
9	1.7947E-03	9.5609E-05	455.87	2319.7	298.30	269.15	96.164	66.460	8547.3	7.8279E+06	7.8279E+06
x(M)	0.0000	10.560	5.9400	0.0000	0.0000	8.5800	4.9500	10.890	0.0000	0.0000	0.0000
10	1.7471E-03	9.6060E-05	513.22	2873.9	371.35	348.07	132.83	94.085	1.3971E+04	7.8279E+06	7.8279E+06
x(M)	0.0000	9.9000	5.6100	0.0000	0.0000	8.2500	4.9500	10.230	0.0000	0.0000	0.0000
11	1.7471E-03	9.5146E-05	494.78	2704.8	347.92	325.58	121.81	85.417	1.2520E+04	7.8279E+06	7.8279E+06
x(M)	0.0000	10.230	5.6100	0.0000	0.0000	8.2500	4.9500	10.230	0.0000	0.0000	0.0000
12	1.7471E-03	9.4073E-05	507.03	2744.0	364.06	333.37	130.46	89.190	1.1613E+04	7.8279E+06	7.8279E+06
x(M)	0.0000	9.9000	5.6100	0.0000	0.0000	8.2500	4.9500	10.230	0.0000	0.0000	0.0000
Max. Pile N.	1.8897E-03	9.7430E-05	513.22	2873.9	371.35	348.07	132.83	94.085	1.3971E+04	7.8279E+06	7.8279E+06
	1	4	10	10	10	10	10	10	10	1	1

LOAD CASE : 4
CASE NAME : Load Case
LOAD TYPE : Special, Sp

REDUCTION FACTORS FOR CLOSELY-SPACED PILE GROUPS, COMBINED Y AND Z DIRECTIONS
ESTIMATED USING MOVEMENT IN THE DIRECTION OF PILE CAP DISPLACEMENTS

GROUP NO	P-FACTOR	Y-FACTOR
1	0.8372	1.0000
2	0.7816	1.0000
3	0.8661	1.0000
4	0.5697	1.0000
5	0.4960	1.0000
6	0.6107	1.0000
7	0.5388	1.0000
8	0.4666	1.0000
9	0.5820	1.0000
10	0.5845	1.0000
11	0.5072	1.0000
12	0.6251	1.0000



* TABLE L * COMPUTATION ON PILE CAP

* EQUIVALENT CONCENTRATED LOAD AT ORIGIN *

VERT. LOAD, KN	HOR. LOAD Y, KN	HOR. LOAD Z, KN
37076.0	-3505.00	11107.0
MOMENT X, KN- M	MOMENT Y, KN- M	MOMENT Z, KN- M
409.000	1.84791E+05	53172.0

* DISPLACEMENT OF GROUPED PILE FOUNDATION AT ORIGIN *

VERTICAL, M	HORIZONTAL Y, M	HORIZONTAL Z, M
1.48975E-03	-1.66840E-03	4.51337E-03
ANGLE ROT. X, RAD	ANGLE ROT. Y, RAD	ANGLE ROT. Z, RAD
-4.04229E-06	3.40520E-04	1.85914E-04

APPALTATORE: Consorzio  Soci  		ITINERARIO NAPOLI – BARI RADDOPPIO TRATTA APICE – ORSARA I LOTTO FUNZIONALE APICE – HIRPINIA					
PROGETTAZIONE: Mandataria  Mandanti  							
PROGETTO ESECUTIVO RELAZIONE DI CALCOLO FONDAZIONI PILE DA P7 A P16							COMMESSA IF1N

THE GLOBAL STRUCTURAL COORDINATE SYSTEM

* PILE TOP DISPLACEMENTS *

PILE GROUP	DISP. X, M	DISP. Y, M	DISP. Z, M	ROT. X,RAD	ROT. Y,RAD	ROT. Z,RAD
1	2.9517E-03	-1.6411E-03	4.4952E-03	-4.0423E-06	3.4052E-04	1.8591E-04
2	3.7883E-03	-1.6411E-03	4.5134E-03	-4.0423E-06	3.4052E-04	1.8591E-04
3	4.6249E-03	-1.6411E-03	4.5316E-03	-4.0423E-06	3.4052E-04	1.8591E-04
4	1.4193E-03	-1.6593E-03	4.4952E-03	-4.0423E-06	3.4052E-04	1.8591E-04
5	2.2559E-03	-1.6593E-03	4.5134E-03	-4.0423E-06	3.4052E-04	1.8591E-04
6	3.0925E-03	-1.6593E-03	4.5316E-03	-4.0423E-06	3.4052E-04	1.8591E-04
7	-1.1303E-04	-1.6775E-03	4.4952E-03	-4.0423E-06	3.4052E-04	1.8591E-04
8	7.2358E-04	-1.6775E-03	4.5134E-03	-4.0423E-06	3.4052E-04	1.8591E-04
9	1.5602E-03	-1.6775E-03	4.5316E-03	-4.0423E-06	3.4052E-04	1.8591E-04
10	-1.6454E-03	-1.6957E-03	4.4952E-03	-4.0423E-06	3.4052E-04	1.8591E-04
11	-8.0876E-04	-1.6957E-03	4.5134E-03	-4.0423E-06	3.4052E-04	1.8591E-04
12	2.7856E-05	-1.6957E-03	4.5316E-03	-4.0423E-06	3.4052E-04	1.8591E-04
MINIMUM	-1.6454E-03	-1.6957E-03	4.4952E-03	-4.0423E-06	3.4052E-04	1.8591E-04
Pile N.	10	10	1	1	1	1
MAXIMUM	4.6249E-03	-1.6411E-03	4.5316E-03	-4.0423E-06	3.4052E-04	1.8591E-04
Pile N.	3	1	3	1	1	1

* PILE TOP REACTIONS *

PILE GROUP	FOR. X, KN	FOR. Y, KN	FOR. Z, KN	MOM X, KN- M	MOM Y, KN- M	MOM Z, KN- M
1	6183.7	-345.30	1101.2	-1.3875	-2730.0	-741.80
2	7895.5	-330.23	1061.8	-1.3875	-2665.9	-715.50
3	9191.9	-351.66	1131.9	-1.3875	-2802.3	-754.64
4	3048.3	-275.95	879.12	-1.3875	-2304.1	-617.01
5	4760.2	-252.16	812.79	-1.3875	-2178.7	-571.19
6	6472.0	-287.31	922.62	-1.3875	-2404.8	-640.58
7	-247.28	-271.55	852.41	-1.3875	-2246.9	-612.28
8	1606.0	-247.19	785.14	-1.3875	-2117.9	-564.76
9	3336.6	-283.99	898.41	-1.3875	-2353.3	-638.27
10	-3470.4	-291.23	895.96	-1.3875	-2328.8	-654.32
11	-1762.3	-265.80	826.95	-1.3875	-2198.8	-605.49
12	61.828	-302.63	938.79	-1.3875	-2427.8	-677.98
MINIMUM	-3470.4	-351.66	785.14	-1.3875	-2802.3	-754.64
Pile N.	10	3	8	1	3	3
MAXIMUM	9191.9	-247.19	1131.9	-1.3875	-2117.9	-564.76
Pile N.	3	8	3	1	8	8

THE PILE COORDINATE SYSTEM (LOCAL AXES)

* PILE TOP DISPLACEMENTS *

PILE GROUP	DISP. x, M	DISP. y, M	DISP. z, M	ROT. x,RAD	ROT. y,RAD	ROT. z,RAD
1	2.9517E-03	-1.6411E-03	4.4952E-03	-4.0423E-06	3.4052E-04	1.8591E-04
2	3.7883E-03	-1.6411E-03	4.5134E-03	-4.0423E-06	3.4052E-04	1.8591E-04
3	4.6249E-03	-1.6411E-03	4.5316E-03	-4.0423E-06	3.4052E-04	1.8591E-04
4	1.4193E-03	-1.6593E-03	4.4952E-03	-4.0423E-06	3.4052E-04	1.8591E-04
5	2.2559E-03	-1.6593E-03	4.5134E-03	-4.0423E-06	3.4052E-04	1.8591E-04
6	3.0925E-03	-1.6593E-03	4.5316E-03	-4.0423E-06	3.4052E-04	1.8591E-04
7	-1.1303E-04	-1.6775E-03	4.4952E-03	-4.0423E-06	3.4052E-04	1.8591E-04
8	7.2358E-04	-1.6775E-03	4.5134E-03	-4.0423E-06	3.4052E-04	1.8591E-04
9	1.5602E-03	-1.6775E-03	4.5316E-03	-4.0423E-06	3.4052E-04	1.8591E-04
10	-1.6454E-03	-1.6957E-03	4.4952E-03	-4.0423E-06	3.4052E-04	1.8591E-04
11	-8.0876E-04	-1.6957E-03	4.5134E-03	-4.0423E-06	3.4052E-04	1.8591E-04
12	2.7856E-05	-1.6957E-03	4.5316E-03	-4.0423E-06	3.4052E-04	1.8591E-04
MINIMUM	-1.6454E-03	-1.6957E-03	4.4952E-03	-4.0423E-06	3.4052E-04	1.8591E-04
Pile N.	10	10	1	1	1	1
MAXIMUM	4.6249E-03	-1.6411E-03	4.5316E-03	-4.0423E-06	3.4052E-04	1.8591E-04
Pile N.	3	1	3	1	1	1

* PILE TOP REACTIONS *

PILE GROUP	AXIAL, KN	LAT. y, KN	LAT. z, KN	MOM x, KN- M	MOM y, KN- M	MOM z, KN- M
1	6183.7	-345.30	1101.2	-1.3875	-2730.0	-741.80
2	7895.5	-330.23	1061.8	-1.3875	-2665.9	-715.50
3	9191.9	-351.66	1131.9	-1.3875	-2802.3	-754.64
4	3048.3	-275.95	879.12	-1.3875	-2304.1	-617.01
5	4760.2	-252.16	812.79	-1.3875	-2178.7	-571.19
6	6472.0	-287.31	922.62	-1.3875	-2404.8	-640.58
7	-247.28	-271.55	852.41	-1.3875	-2246.9	-612.28
8	1606.0	-247.19	785.14	-1.3875	-2117.9	-564.76
9	3336.6	-283.99	898.41	-1.3875	-2353.3	-638.27
10	-3470.4	-291.23	895.96	-1.3875	-2328.8	-654.32

APPALTATORE:

Consorzio

Soci



ITINERARIO NAPOLI – BARI

PROGETTAZIONE:

Mandatario

Mandanti



RADDOPPIO TRATTA APICE – ORSARA
I LOTTO FUNZIONALE APICE – HIRPINIA

PROGETTO ESECUTIVO

RELAZIONE DI CALCOLO FONDAZIONI PILE DA P7 A P16

COMMESSA IF1N	LOTTO 01 E ZZ	CODIFICA RG	DOCUMENTO MD0000 001	REV. B	FOGLIO 101 di 144
------------------	------------------	----------------	-------------------------	-----------	-------------------------

11	-1762.3	-265.80	826.95	-1.3875	-2198.8	-605.49
12	61.828	-302.63	938.79	-1.3875	-2427.8	-677.98
MINIMUM Pile N.	-3470.4 10	-351.66 3	785.14 8	-1.3875 1	-2802.3 3	-754.64 3
MAXIMUM Pile N.	9191.9 3	-247.19 8	1131.9 3	-1.3875 1	-2117.9 8	-564.76 8

PILE GROUP STRESS, KN/ M**2

1	1.2037E+04
2	1.2799E+04
3	1.3960E+04
4	8924.0
5	9491.4
6	1.1173E+04
7	7168.4
8	7524.0
9	9247.0
10	9264.3
11	7880.4
12	7642.7
MINIMUM Pile N.	7168.4 7
MAXIMUM Pile N.	1.3960E+04 3

* EFFECTS FOR Laterally LOADED PILE *

* MINIMUM VALUES AND LOCATIONS *

PILE	DISPL. y-DIR M	DISPL. z-DIR M	MOMENT z-DIR KN- M	MOMENT y-DIR KN- M	SHEAR y-DIR KN	SHEAR z-DIR KN	SOIL REACT y-DIR KN/ M	SOIL REACT z-DIR KN/ M	TOTAL STRESS KN/ M**2	FLEX. RIG. z-DIR KN- M**2	FLEX. RIG. y-DIR KN- M**2
1	-1.6411E-03	-9.4133E-05	-477.98	-2730.0	-345.40	-334.16	-124.50	-89.545	3499.3	7.8279E+06	-124.50
x(M)	0.0000	9.9000	5.6100	0.0000	0.0000	8.2500	4.9500	10.230	33.000	0.0000	0.0000
2	-1.6411E-03	-9.4704E-05	-466.78	-2665.9	-330.35	-324.28	-116.73	-85.234	4468.0	7.8279E+06	7.8279E+06
x(M)	0.0000	9.9000	5.6100	0.0000	0.0000	8.2500	4.9500	10.230	33.000	0.0000	0.0000
3	-1.6411E-03	-9.4895E-05	-483.46	-2802.3	-351.80	-343.67	-127.42	-92.793	5201.5	7.8279E+06	7.8279E+06
x(M)	0.0000	9.9000	5.6100	0.0000	0.0000	7.9200	4.9500	10.230	33.000	0.0000	0.0000
4	-1.6593E-03	-9.5739E-05	-422.27	-2304.1	-275.99	-269.68	-89.693	-66.616	1725.0	7.8279E+06	7.8279E+06
x(M)	0.0000	10.560	5.9400	0.0000	0.0000	8.5800	4.9500	10.890	33.000	0.0000	0.0000
5	-1.6593E-03	-9.6876E-05	-401.62	-2178.7	-252.22	-250.70	-78.888	-60.269	2693.7	7.8279E+06	7.8279E+06
x(M)	0.0000	10.890	5.9400	0.0000	0.0000	8.9100	4.9500	11.220	33.000	0.0000	0.0000
6	-1.6593E-03	-9.6358E-05	-432.50	-2404.8	-287.39	-283.38	-94.862	-71.005	3662.4	7.8279E+06	7.8279E+06
x(M)	0.0000	10.560	5.9400	0.0000	0.0000	8.5800	4.9500	10.890	33.000	0.0000	0.0000
7	-1.6775E-03	-9.5383E-05	-418.55	-2246.9	-271.55	-260.25	-86.534	-63.506	139.93	7.8279E+06	7.8279E+06
x(M)	0.0000	10.560	5.9400	0.0000	0.0000	8.5800	4.9500	11.220	33.000	0.0000	0.0000
8	-1.6775E-03	-9.6666E-05	-396.40	-2117.9	-247.21	-241.59	-75.733	-57.209	908.82	7.8279E+06	7.8279E+06
x(M)	0.0000	10.890	5.9400	0.0000	0.0000	8.9100	4.9500	11.220	33.000	0.0000	0.0000
9	-1.6775E-03	-9.6405E-05	-430.06	-2353.3	-284.03	-275.24	-92.175	-68.310	1888.1	7.8279E+06	7.8279E+06
x(M)	0.0000	10.560	5.9400	0.0000	0.0000	8.5800	4.9500	10.890	33.000	0.0000	0.0000
10	-1.6957E-03	-9.5029E-05	-435.35	-2328.8	-291.18	-272.24	-94.479	-67.606	1963.9	7.8279E+06	7.8279E+06
x(M)	0.0000	10.560	5.9400	0.0000	0.0000	8.5800	4.9500	10.890	33.000	0.0000	0.0000
11	-1.6957E-03	-9.6090E-05	-413.54	-2198.8	-265.77	-252.40	-82.853	-60.959	997.27	7.8279E+06	7.8279E+06
x(M)	0.0000	10.890	5.9400	0.0000	0.0000	8.9100	4.9500	11.220	33.000	0.0000	0.0000
12	-1.6957E-03	-9.5560E-05	-445.56	-2427.8	-302.63	-285.60	-99.696	-71.856	34.988	7.8279E+06	7.8279E+06
x(M)	0.0000	10.560	5.9400	0.0000	0.0000	8.5800	4.9500	10.890	33.000	0.0000	0.0000
Min. Pile N.	-1.6957E-03 10	-9.6876E-05 5	-483.46 3	-2802.3 3	-351.80 3	-343.67 3	-127.42 3	-92.793 3	34.988 12	7.8279E+06 1	7.8279E+06 1

* MAXIMUM VALUES AND LOCATIONS *

PILE	DISPL. y-DIR M	DISPL. z-DIR M	MOMENT z-DIR KN- M	MOMENT y-DIR KN- M	SHEAR y-DIR KN	SHEAR z-DIR KN	SOIL REACT y-DIR KN/ M	SOIL REACT z-DIR KN/ M	TOTAL STRESS KN/ M**2	FLEX. RIG. z-DIR KN- M**2	FLEX. RIG. y-DIR KN- M**2
1	3.3450E-05	4.4952E-03	741.80	1347.5	117.84	1101.5	31.294	386.09	1.2037E+04	7.8279E+06	7.8279E+06
x(M)	9.9000	0.0000	0.0000	5.9400	7.9200	0.0000	10.230	4.9500	0.0000	0.0000	0.0000
2	3.3749E-05	4.5134E-03	715.50	1323.5	113.46	1062.2	29.820	363.98	1.2799E+04	7.8279E+06	7.8279E+06
x(M)	9.9000	0.0000	0.0000	5.9400	7.9200	0.0000	10.230	4.9500	0.0000	0.0000	0.0000
3	3.3380E-05	4.5316E-03	754.64	1374.0	120.20	1132.4	32.114	399.10	1.3960E+04	7.8279E+06	7.8279E+06
x(M)	9.5700	0.0000	0.0000	5.9400	7.9200	0.0000	9.9000	4.9500	0.0000	0.0000	0.0000
4	3.4496E-05	4.4952E-03	617.01	1174.7	95.915	879.27	23.605	274.52	8924.0	7.8279E+06	7.8279E+06
x(M)	10.560	0.0000	0.0000	6.2700	8.5800	0.0000	10.890	4.9500	0.0000	0.0000	0.0000
5	3.4850E-05	4.5134E-03	571.19	1124.0	89.027	813.01	21.237	243.27	9491.4	7.8279E+06	7.8279E+06
x(M)	10.560	0.0000	0.0000	6.2700	8.5800	0.0000	10.890	5.9400	0.0000	0.0000	0.0000
6	3.4519E-05	4.5316E-03	640.58	1213.5	99.989	922.94	24.949	293.16	1.1173E+04	7.8279E+06	7.8279E+06
x(M)	10.230	0.0000	0.0000	5.9400	8.2500	0.0000	10.560	4.9500	0.0000	0.0000	0.0000
7	3.4991E-05	4.4952E-03	612.28	1151.9	94.031	852.39	22.873	260.90	7168.4	7.8279E+06	7.8279E+06
x(M)	10.560	0.0000	0.0000	6.2700	8.5800	0.0000	10.890	4.9500	0.0000	0.0000	0.0000
8	3.5205E-05	4.5134E-03	564.76	1097.4	86.600	785.21	20.483	231.45	7524.0	7.8279E+06	7.8279E+06
x(M)	10.890	0.0000	0.0000	6.2700	8.5800	0.0000	11.220	5.9400	0.0000	0.0000	0.0000
9	3.4778E-05	4.5316E-03	638.27	1192.6	98.113	898.58	24.250	280.60	9247.0	7.8279E+06	7.8279E+06
x(M)	10.230	0.0000	0.0000	6.2700	8.5800	0.0000	10.890	4.9500	0.0000	0.0000	0.0000

APPALTATORE: Consorzio Soci   	ITINERARIO NAPOLI – BARI RADDOPPIO TRATTA APICE – ORSARA I LOTTO FUNZIONALE APICE – HIRPINIA
PROGETTAZIONE: Mandataria Mandanti   	
PROGETTO ESECUTIVO RELAZIONE DI CALCOLO FONDAZIONI PILE DA P7 A P16	
	COMMESSA IF1N LOTTO 01 E ZZ CODIFICA RG DOCUMENTO MD0000 001 REV. B FOGLIO 103 di 144

1	3763.5	-322.56	299.28	0.6268	-744.41	-694.49
2	5475.2	-313.46	289.00	0.6268	-723.35	-678.93
3	7186.9	-363.57	329.43	0.6268	-793.89	-768.32
4	2822.6	-268.76	254.25	0.6268	-659.31	-592.03
5	4534.3	-257.59	242.40	0.6268	-634.32	-571.58
6	6246.0	-324.32	298.03	0.6268	-737.38	-695.94
7	1881.8	-262.23	250.32	0.6268	-651.33	-576.52
8	3593.5	-251.69	238.98	0.6268	-627.24	-557.15
9	5305.2	-319.21	295.74	0.6268	-732.86	-683.42
10	864.18	-281.25	269.11	0.6268	-687.09	-609.17
11	2652.6	-270.19	257.14	0.6268	-662.25	-589.35
12	4364.3	-331.18	308.31	0.6268	-755.30	-701.30
MINIMUM	864.18	-363.57	238.98	0.6268	-793.89	-768.32
Pile N.	10	3	8	1	3	3
MAXIMUM	7186.9	-251.69	329.43	0.6268	-627.24	-557.15
Pile N.	3	8	3	1	8	8

THE PILE COORDINATE SYSTEM (LOCAL AXES)

* PILE TOP DISPLACEMENTS *

PILE GROUP	DISP. x, M	DISP. y, M	DISP. z, M	ROT. x,RAD	ROT. y,RAD	ROT. z,RAD
*****	*****	*****	*****	*****	*****	*****
1	1.7688E-03	-1.6336E-03	1.3066E-03	1.8260E-06	1.0218E-04	1.8590E-04
2	2.6054E-03	-1.6336E-03	1.2984E-03	1.8260E-06	1.0218E-04	1.8590E-04
3	3.4419E-03	-1.6336E-03	1.2902E-03	1.8260E-06	1.0218E-04	1.8590E-04
4	1.3090E-03	-1.6253E-03	1.3066E-03	1.8260E-06	1.0218E-04	1.8590E-04
5	2.1456E-03	-1.6253E-03	1.2984E-03	1.8260E-06	1.0218E-04	1.8590E-04
6	2.9821E-03	-1.6253E-03	1.2902E-03	1.8260E-06	1.0218E-04	1.8590E-04
7	8.4918E-04	-1.6171E-03	1.3066E-03	1.8260E-06	1.0218E-04	1.8590E-04
8	1.6857E-03	-1.6171E-03	1.2984E-03	1.8260E-06	1.0218E-04	1.8590E-04
9	2.5223E-03	-1.6171E-03	1.2902E-03	1.8260E-06	1.0218E-04	1.8590E-04
10	3.8935E-04	-1.6089E-03	1.3066E-03	1.8260E-06	1.0218E-04	1.8590E-04
11	1.2259E-03	-1.6089E-03	1.2984E-03	1.8260E-06	1.0218E-04	1.8590E-04
12	2.0624E-03	-1.6089E-03	1.2902E-03	1.8260E-06	1.0218E-04	1.8590E-04
MINIMUM	3.8935E-04	-1.6336E-03	1.2902E-03	1.8260E-06	1.0218E-04	1.8590E-04
Pile N.	10	1	3	1	1	1
MAXIMUM	3.4419E-03	-1.6089E-03	1.3066E-03	1.8260E-06	1.0218E-04	1.8590E-04
Pile N.	3	10	1	1	1	1

* PILE TOP REACTIONS *

PILE GROUP	AXIAL, KN	LAT. y, KN	LAT. z, KN	MOM x, KN- M	MOM y, KN- M	MOM z, KN- M
*****	*****	*****	*****	*****	*****	*****
1	3763.5	-322.56	299.28	0.6268	-744.41	-694.49
2	5475.2	-313.46	289.00	0.6268	-723.35	-678.93
3	7186.9	-363.57	329.43	0.6268	-793.89	-768.32
4	2822.6	-268.76	254.25	0.6268	-659.31	-592.03
5	4534.3	-257.59	242.40	0.6268	-634.32	-571.58
6	6246.0	-324.32	298.03	0.6268	-737.38	-695.94
7	1881.8	-262.23	250.32	0.6268	-651.33	-576.52
8	3593.5	-251.69	238.98	0.6268	-627.24	-557.15
9	5305.2	-319.21	295.74	0.6268	-732.86	-683.42
10	864.18	-281.25	269.11	0.6268	-687.09	-609.17
11	2652.6	-270.19	257.14	0.6268	-662.25	-589.35
12	4364.3	-331.18	308.31	0.6268	-755.30	-701.30
MINIMUM	864.18	-363.57	238.98	0.6268	-793.89	-768.32
Pile N.	10	3	8	1	3	3
MAXIMUM	7186.9	-251.69	329.43	0.6268	-627.24	-557.15
Pile N.	3	8	3	1	8	8

PILE GROUP STRESS, KN/ M**2

*****	*****
1	5202.3
2	6092.4
3	7401.3
4	4271.6
5	5142.9
6	6594.6
7	3690.1
8	4565.5
9	6026.4
10	3260.3
11	4176.6
12	5580.3
MINIMUM	3260.3
Pile N.	10
MAXIMUM	7401.3
Pile N.	3

* EFFECTS FOR Laterally LOADED PILE *

APPALTATORE:

Consorzio

Soci



ITINERARIO NAPOLI – BARI

PROGETTAZIONE:

Mandatario

Mandanti



RADDOPPIO TRATTA APICE – ORSARA
I LOTTO FUNZIONALE APICE – HIRPINIA

PROGETTO ESECUTIVO

RELAZIONE DI CALCOLO FONDAZIONI PILE DA P7 A P16

COMMESSA IF1N	LOTTO 01 E ZZ	CODIFICA RG	DOCUMENTO MD0000 001	REV. B	FOGLIO 104 di 144
------------------	------------------	----------------	-------------------------	-----------	-------------------------

* MINIMUM VALUES AND LOCATIONS *

PILE	DISPL. y-DIR M	DISPL. z-DIR M	MOMENT z-DIR KN- M	MOMENT y-DIR KN- M	SHEAR y-DIR KN	SHEAR z-DIR KN	SOIL REACT y-DIR KN/ M	SOIL REACT z-DIR KN/ M	TOTAL STRESS KN/ M**2	FLEX. RIG. z-DIR KN- M**2	FLEX. RIG. y-DIR KN- M**2
*****	*****	*****	*****	*****	*****	*****	*****	*****	*****	*****	*****
1	-1.6336E-03	-2.8000E-05	-456.63	-744.41	-322.61	-89.575	-128.94	-23.063	2129.7	7.8279E+06	7.8279E+06
x(M)	0.0000	10.230	5.6100	0.0000	0.0000	8.2500	4.9500	10.560	33.000	0.0000	0.0000
2	-1.6336E-03	-2.8000E-05	-450.01	-723.35	-313.53	-86.911	-125.16	-22.196	3098.3	7.8279E+06	7.8279E+06
x(M)	0.0000	10.230	5.6100	0.0000	0.0000	8.2500	4.9500	10.560	33.000	0.0000	0.0000
3	-1.6336E-03	-2.7224E-05	-486.87	-793.89	-363.68	-98.440	-146.19	-26.442	4067.0	7.8279E+06	7.8279E+06
x(M)	0.0000	9.9000	5.6100	0.0000	0.0000	7.9200	4.9500	10.230	33.000	0.0000	0.0000
4	-1.6253E-03	-2.8646E-05	-413.10	-659.31	-268.80	-76.563	-105.73	-18.568	1597.3	7.8279E+06	7.8279E+06
x(M)	0.0000	10.560	5.9400	0.0000	0.0000	8.5800	4.9500	10.890	33.000	0.0000	0.0000
5	-1.6253E-03	-2.8543E-05	-404.54	-634.32	-257.65	-73.331	-101.00	-17.549	2565.9	7.8279E+06	7.8279E+06
x(M)	0.0000	10.890	5.9400	0.0000	0.0000	8.5800	4.9500	11.220	33.000	0.0000	0.0000
6	-1.6253E-03	-2.7580E-05	-457.99	-737.38	-324.41	-89.642	-129.94	-23.165	3534.5	7.8279E+06	7.8279E+06
x(M)	0.0000	10.230	5.6100	0.0000	0.0000	8.2500	4.9500	10.560	33.000	0.0000	0.0000
7	-1.6171E-03	-2.8639E-05	-407.15	-651.33	-262.25	-75.321	-103.05	-18.142	1064.9	7.8279E+06	7.8279E+06
x(M)	0.0000	10.560	5.9400	0.0000	0.0000	8.5800	4.9500	10.890	33.000	0.0000	0.0000
8	-1.6171E-03	-2.8625E-05	-398.87	-627.24	-251.73	-72.155	-98.496	-17.213	2033.5	7.8279E+06	7.8279E+06
x(M)	0.0000	10.890	5.9400	0.0000	0.0000	8.5800	4.9500	11.220	33.000	0.0000	0.0000
9	-1.6171E-03	-2.7622E-05	-453.29	-732.86	-319.28	-88.901	-127.84	-22.920	3002.1	7.8279E+06	7.8279E+06
x(M)	0.0000	10.230	5.6100	0.0000	0.0000	8.2500	4.9500	10.560	33.000	0.0000	0.0000
10	-1.6089E-03	-2.8348E-05	-421.21	-687.09	-281.26	-80.571	-111.40	-19.959	489.03	7.8279E+06	7.8279E+06
x(M)	0.0000	10.560	5.6100	0.0000	0.0000	8.5800	4.9500	10.890	33.000	0.0000	0.0000
11	-1.6089E-03	-2.8395E-05	-413.01	-662.25	-270.22	-77.478	-106.68	-18.939	1501.1	7.8279E+06	7.8279E+06
x(M)	0.0000	10.560	5.9400	0.0000	0.0000	8.5800	4.9500	10.890	33.000	0.0000	0.0000
12	-1.6089E-03	-2.7440E-05	-461.30	-755.30	-331.25	-92.202	-132.93	-24.162	2469.7	7.8279E+06	7.8279E+06
x(M)	0.0000	9.9000	5.6100	0.0000	0.0000	8.2500	4.9500	10.230	33.000	0.0000	0.0000
Min.	-1.6336E-03	-2.8646E-05	-486.87	-793.89	-363.68	-98.440	-146.19	-26.442	489.03	7.8279E+06	7.8279E+06
Pile N.	1	4	3	3	3	3	3	3	10	1	1

* MAXIMUM VALUES AND LOCATIONS *

PILE	DISPL. y-DIR M	DISPL. z-DIR M	MOMENT z-DIR KN- M	MOMENT y-DIR KN- M	SHEAR y-DIR KN	SHEAR z-DIR KN	SOIL REACT y-DIR KN/ M	SOIL REACT z-DIR KN/ M	TOTAL STRESS KN/ M**2	FLEX. RIG. z-DIR KN- M**2	FLEX. RIG. y-DIR KN- M**2
*****	*****	*****	*****	*****	*****	*****	*****	*****	*****	*****	*****
1	3.4343E-05	1.3066E-03	694.49	374.71	108.03	299.34	27.780	116.21	5202.3	7.8279E+06	7.8279E+06
x(M)	9.9000	0.0000	0.0000	5.9400	7.9200	0.0000	10.230	4.9500	0.0000	0.0000	0.0000
2	3.4453E-05	1.2984E-03	678.93	366.97	105.73	289.08	26.829	111.96	6092.4	7.8279E+06	7.8279E+06
x(M)	9.9000	0.0000	0.0000	5.9400	8.2500	0.0000	10.230	4.9500	0.0000	0.0000	0.0000
3	3.3750E-05	1.2902E-03	768.32	394.59	120.65	329.55	32.270	129.57	7401.3	7.8279E+06	7.8279E+06
x(M)	9.5700	0.0000	0.0000	5.6100	7.9200	0.0000	9.9000	4.9500	0.0000	0.0000	0.0000
4	3.4956E-05	1.3066E-03	592.03	339.91	92.023	254.29	22.274	96.139	4271.6	7.8279E+06	7.8279E+06
x(M)	10.560	0.0000	0.0000	5.9400	8.2500	0.0000	10.890	4.9500	0.0000	0.0000	0.0000
5	3.5303E-05	1.2984E-03	571.58	330.04	89.080	242.46	21.245	91.163	5142.9	7.8279E+06	7.8279E+06
x(M)	10.560	0.0000	0.0000	6.2700	8.5800	0.0000	10.890	4.9500	0.0000	0.0000	0.0000
6	3.4185E-05	1.2902E-03	695.94	372.63	109.13	298.13	28.197	116.09	6594.6	7.8279E+06	7.8279E+06
x(M)	9.9000	0.0000	0.0000	5.9400	7.9200	0.0000	10.230	4.9500	0.0000	0.0000	0.0000
7	3.4871E-05	1.3066E-03	576.52	336.46	90.169	250.35	21.695	94.389	3690.1	7.8279E+06	7.8279E+06
x(M)	10.560	0.0000	0.0000	5.9400	8.5800	0.0000	10.890	4.9500	0.0000	0.0000	0.0000
8	3.5168E-05	1.2984E-03	557.15	327.22	87.323	239.03	20.691	89.558	4565.5	7.8279E+06	7.8279E+06
x(M)	10.560	0.0000	0.0000	6.2700	8.5800	0.0000	10.890	4.9500	0.0000	0.0000	0.0000
9	3.4014E-05	1.2902E-03	683.42	370.87	107.57	295.82	27.709	115.04	6026.4	7.8279E+06	7.8279E+06
x(M)	9.9000	0.0000	0.0000	5.9400	7.9200	0.0000	10.230	4.9500	0.0000	0.0000	0.0000
10	3.4324E-05	1.3066E-03	609.17	351.65	96.051	269.13	23.669	102.69	3260.3	7.8279E+06	7.8279E+06
x(M)	10.230	0.0000	0.0000	5.9400	8.2500	0.0000	10.560	4.9500	0.0000	0.0000	0.0000
11	3.4483E-05	1.2984E-03	589.35	341.79	92.833	257.18	22.549	97.612	4176.6	7.8279E+06	7.8279E+06
x(M)	10.230	0.0000	0.0000	5.9400	8.2500	0.0000	10.890	4.9500	0.0000	0.0000	0.0000
12	3.3567E-05	1.2902E-03	701.30	379.14	111.28	308.38	29.047	120.43	5580.3	7.8279E+06	7.8279E+06
x(M)	9.9000	0.0000	0.0000	5.9400	7.9200	0.0000	10.230	4.9500	0.0000	0.0000	0.0000
Max.	3.5303E-05	1.3066E-03	768.32	394.59	120.65	329.55	32.270	129.57	7401.3	7.8279E+06	7.8279E+06
Pile N.	5	1	3	3	3	3	3	3	3	1	1

LOAD CASE : 6
CASE NAME : Load Case
LOAD TYPE : Special, Sp

REDUCTION FACTORS FOR CLOSELY-SPACED PILE GROUPS, COMBINED Y AND Z DIRECTIONS
ESTIMATED USING MOVEMENT IN THE DIRECTION OF PILE CAP DISPLACEMENTS

GROUP NO	P-FACTOR	Y-FACTOR
1	0.7699	1.0000
2	0.5488	1.0000
3	0.5845	1.0000
4	0.7162	1.0000
5	0.4828	1.0000
6	0.5149	1.0000
7	0.7265	1.0000
8	0.4955	1.0000
9	0.5293	1.0000

APPALTATORE: Consorzio  Soci  	ITINERARIO NAPOLI – BARI RADDOPPIO TRATTA APICE – ORSARA I LOTTO FUNZIONALE APICE – HIRPINIA												
PROGETTAZIONE: Mandataria  Mandanti  													
PROGETTO ESECUTIVO RELAZIONE DI CALCOLO FONDAZIONI PILE DA P7 A P16	<table border="1"> <tr> <td>COMMESSA</td> <td>LOTTO</td> <td>CODIFICA</td> <td>DOCUMENTO</td> <td>REV.</td> <td>FOGLIO</td> </tr> <tr> <td>IF1N</td> <td>01 E ZZ</td> <td>RG</td> <td>MD0000 001</td> <td>B</td> <td>105 di 144</td> </tr> </table>	COMMESSA	LOTTO	CODIFICA	DOCUMENTO	REV.	FOGLIO	IF1N	01 E ZZ	RG	MD0000 001	B	105 di 144
COMMESSA	LOTTO	CODIFICA	DOCUMENTO	REV.	FOGLIO								
IF1N	01 E ZZ	RG	MD0000 001	B	105 di 144								

10	0.8661	1.0000
11	0.6753	1.0000
12	0.7064	1.0000

* TABLE L * COMPUTATION ON PILE CAP

* EQUIVALENT CONCENTRATED LOAD AT ORIGIN *

VERT. LOAD, KN	HOR. LOAD Y, KN	HOR. LOAD Z, KN
16075.0	3629.00	-3332.00
MOMENT X, KN- M	MOMENT Y, KN- M	MOMENT Z, KN- M
-123.000	-55384.0	-54938.0

* DISPLACEMENT OF GROUPED PILE FOUNDATION AT ORIGIN *

VERTICAL, M	HORIZONTAL Y, M	HORIZONTAL Z, M
6.20558E-04	1.62318E-03	-1.28487E-03
ANGLE ROT. X, RAD	ANGLE ROT. Y, RAD	ANGLE ROT. Z, RAD
9.56329E-08	-9.84096E-05	-1.81003E-04

THE GLOBAL STRUCTURAL COORDINATE SYSTEM

* PILE TOP DISPLACEMENTS *

PILE GROUP	DISP. X, M	DISP. Y, M	DISP. Z, M	ROT. X, RAD	ROT. Y, RAD	ROT. Z, RAD
*****	*****	*****	*****	*****	*****	*****
1	7.7081E-04	1.6225E-03	-1.2844E-03	9.5633E-08	-9.8410E-05	-1.8100E-04
2	-4.3707E-05	1.6225E-03	-1.2849E-03	9.5633E-08	-9.8410E-05	-1.8100E-04
3	-8.5822E-04	1.6225E-03	-1.2853E-03	9.5633E-08	-9.8410E-05	-1.8100E-04
4	1.2136E-03	1.6230E-03	-1.2844E-03	9.5633E-08	-9.8410E-05	-1.8100E-04
5	3.9914E-04	1.6230E-03	-1.2849E-03	9.5633E-08	-9.8410E-05	-1.8100E-04
6	-4.1538E-04	1.6230E-03	-1.2853E-03	9.5633E-08	-9.8410E-05	-1.8100E-04
7	1.6565E-03	1.6234E-03	-1.2844E-03	9.5633E-08	-9.8410E-05	-1.8100E-04
8	8.4198E-04	1.6234E-03	-1.2849E-03	9.5633E-08	-9.8410E-05	-1.8100E-04
9	2.7465E-05	1.6234E-03	-1.2853E-03	9.5633E-08	-9.8410E-05	-1.8100E-04
10	2.0993E-03	1.6238E-03	-1.2844E-03	9.5633E-08	-9.8410E-05	-1.8100E-04
11	1.2848E-03	1.6238E-03	-1.2849E-03	9.5633E-08	-9.8410E-05	-1.8100E-04
12	4.7031E-04	1.6238E-03	-1.2853E-03	9.5633E-08	-9.8410E-05	-1.8100E-04
MINIMUM	-8.5822E-04	1.6225E-03	-1.2853E-03	9.5633E-08	-9.8410E-05	-1.8100E-04
Pile N.	3	1	3	1	1	1
MAXIMUM	2.0993E-03	1.6238E-03	-1.2844E-03	9.5633E-08	-9.8410E-05	-1.8100E-04
Pile N.	10	10	1	1	1	1

* PILE TOP REACTIONS *

PILE GROUP	FOR. X, KN	FOR. Y, KN	FOR. Z, KN	MOM X, KN- M	MOM Y, KN- M	MOM Z, KN- M
*****	*****	*****	*****	*****	*****	*****
1	1710.8	340.83	-310.74	0.032825	766.05	734.25
2	-95.618	278.46	-257.23	0.032825	666.00	619.52
3	-1863.3	289.60	-266.93	0.032825	684.06	639.54
4	2627.5	326.26	-298.15	0.032825	743.54	708.91
5	885.90	257.56	-239.10	0.032825	631.01	580.23
6	-908.72	268.12	-248.31	0.032825	648.57	599.64
7	3533.6	329.02	-300.42	0.032825	748.01	714.46
8	1867.0	261.53	-242.45	0.032825	637.97	588.52
9	60.960	272.66	-252.15	0.032825	656.36	608.89
10	4439.8	365.62	-331.61	0.032825	804.16	779.36
11	2773.1	315.15	-288.53	0.032825	726.06	689.24
12	1043.9	324.18	-296.38	0.032825	740.05	704.70
MINIMUM	-1863.3	257.56	-331.61	0.032825	631.01	580.23
Pile N.	3	5	10	1	5	5
MAXIMUM	4439.8	365.62	-239.10	0.032825	804.16	779.36
Pile N.	10	10	5	1	10	10

THE PILE COORDINATE SYSTEM (LOCAL AXES)

* PILE TOP DISPLACEMENTS *

PILE GROUP	DISP. x, M	DISP. y, M	DISP. z, M	ROT. x, RAD	ROT. y, RAD	ROT. z, RAD
*****	*****	*****	*****	*****	*****	*****
1	7.7081E-04	1.6225E-03	-1.2844E-03	9.5633E-08	-9.8410E-05	-1.8100E-04
2	-4.3707E-05	1.6225E-03	-1.2849E-03	9.5633E-08	-9.8410E-05	-1.8100E-04
3	-8.5822E-04	1.6225E-03	-1.2853E-03	9.5633E-08	-9.8410E-05	-1.8100E-04
4	1.2136E-03	1.6230E-03	-1.2844E-03	9.5633E-08	-9.8410E-05	-1.8100E-04

APPALTATORE:

Consorzio

Soci



ITINERARIO NAPOLI – BARI

PROGETTAZIONE:

Mandataria

Mandanti



RADDOPPIO TRATTA APICE – ORSARA
I LOTTO FUNZIONALE APICE – HIRPINIA

PROGETTO ESECUTIVO

RELAZIONE DI CALCOLO FONDAZIONI PILE DA P7 A P16

COMMESSA IF1N	LOTTO 01 E ZZ	CODIFICA RG	DOCUMENTO MD0000 001	REV. B	FOGLIO 106 di 144
------------------	------------------	----------------	-------------------------	-----------	-------------------------

5	3.9914E-04	1.6230E-03	-1.2849E-03	9.5633E-08	-9.8410E-05	-1.8100E-04
6	-4.1538E-04	1.6230E-03	-1.2853E-03	9.5633E-08	-9.8410E-05	-1.8100E-04
7	1.6565E-04	1.6234E-03	-1.2844E-03	9.5633E-08	-9.8410E-05	-1.8100E-04
8	8.4198E-04	1.6234E-03	-1.2849E-03	9.5633E-08	-9.8410E-05	-1.8100E-04
9	2.7465E-05	1.6234E-03	-1.2853E-03	9.5633E-08	-9.8410E-05	-1.8100E-04
10	2.0993E-03	1.6238E-03	-1.2844E-03	9.5633E-08	-9.8410E-05	-1.8100E-04
11	1.2848E-03	1.6238E-03	-1.2849E-03	9.5633E-08	-9.8410E-05	-1.8100E-04
12	4.7031E-04	1.6238E-03	-1.2853E-03	9.5633E-08	-9.8410E-05	-1.8100E-04
MINIMUM	-8.5822E-04	1.6225E-03	-1.2853E-03	9.5633E-08	-9.8410E-05	-1.8100E-04
Pile N.	3	1	3	1	1	1
MAXIMUM	2.0993E-03	1.6238E-03	-1.2844E-03	9.5633E-08	-9.8410E-05	-1.8100E-04
Pile N.	10	10	1	1	1	1

* PILE TOP REACTIONS *

PILE GROUP	AXIAL, KN	LAT. y, KN	LAT. z, KN	MOM x, KN- M	MOM y, KN- M	MOM z, KN- M
*****	*****	*****	*****	*****	*****	*****
1	1710.8	340.83	-310.74	0.032825	766.05	734.25
2	-95.618	278.46	-257.23	0.032825	666.00	619.52
3	-1863.3	289.60	-266.93	0.032825	684.06	639.54
4	2627.5	326.26	-298.15	0.032825	743.54	708.91
5	885.90	257.56	-239.10	0.032825	631.01	580.23
6	-908.72	268.12	-248.31	0.032825	648.57	599.64
7	3533.6	329.02	-300.42	0.032825	748.01	714.46
8	1867.0	261.53	-242.45	0.032825	637.97	588.52
9	60.960	272.66	-252.15	0.032825	656.36	608.89
10	4439.8	365.62	-331.61	0.032825	804.16	779.36
11	2773.1	315.15	-288.53	0.032825	726.06	689.24
12	1043.9	324.18	-296.38	0.032825	740.05	704.70
MINIMUM	-1863.3	257.56	-331.61	0.032825	631.01	580.23
Pile N.	3	5	10	1	5	5
MAXIMUM	4439.8	365.62	-239.10	0.032825	804.16	779.36
Pile N.	10	10	5	1	10	10

PILE GROUP STRESS, KN/ M**2

PILE GROUP	STRESS, KN/ M**2
*****	*****
1	4170.6
2	2799.3
3	3880.7
4	4587.4
5	3088.5
6	3180.1
7	5121.5
8	3676.1
9	2736.6
10	5892.2
11	4590.7
12	3674.9
MINIMUM	2736.6
Pile N.	9
MAXIMUM	5892.2
Pile N.	10

* EFFECTS FOR LATERALLY LOADED PILE *

* MINIMUM VALUES AND LOCATIONS *

PILE	DISPL. y-DIR	DISPL. z-DIR	MOMENT z-DIR	MOMENT y-DIR	SHEAR y-DIR	SHEAR z-DIR	SOIL REACT y-DIR	SOIL REACT z-DIR	TOTAL STRESS	FLEX. RIG. z-DIR	FLEX. RIG. y-DIR
*****	*****	*****	*****	*****	*****	*****	*****	*****	*****	*****	*****
1	-3.3841E-05	-1.2844E-03	-734.25	-378.46	-112.47	-310.76	-29.399	-121.08	968.14	7.8279E+06	7.8279E+06
x(M)	9.9000	0.0000	0.0000	5.9400	7.9200	0.0000	10.230	4.9500	33.000	0.0000	0.0000
2	-3.4680E-05	-1.2849E-03	-619.52	-338.61	-93.667	-257.23	-22.805	-97.350	54.109	7.8279E+06	7.8279E+06
x(M)	10.230	0.0000	0.0000	5.9400	8.2500	0.0000	10.890	4.9500	33.000	0.0000	0.0000
3	-3.4559E-05	-1.2853E-03	-639.54	-346.14	-96.931	-266.91	-23.893	-101.59	1054.4	7.8279E+06	7.8279E+06
x(M)	10.230	0.0000	0.0000	5.9400	8.2500	0.0000	10.560	4.9500	33.000	0.0000	0.0000
4	-3.4088E-05	-1.2844E-03	-708.91	-370.14	-108.09	-298.19	-27.876	-115.67	1486.9	7.8279E+06	7.8279E+06
x(M)	9.9000	0.0000	0.0000	5.9400	7.9200	0.0000	10.230	4.9500	33.000	0.0000	0.0000
5	-3.5223E-05	-1.2849E-03	-580.23	-324.28	-87.704	-239.11	-20.777	-89.295	501.32	7.8279E+06	7.8279E+06
x(M)	10.560	0.0000	0.0000	6.2700	8.5800	0.0000	10.890	4.9500	33.000	0.0000	0.0000
6	-3.4959E-05	-1.2853E-03	-599.64	-331.03	-90.564	-248.30	-21.786	-93.351	514.23	7.8279E+06	7.8279E+06
x(M)	10.560	0.0000	0.0000	5.9400	8.5800	0.0000	10.890	4.9500	33.000	0.0000	0.0000
7	-3.4094E-05	-1.2844E-03	-714.46	-371.88	-109.09	-300.47	-28.214	-116.70	1999.6	7.8279E+06	7.8279E+06
x(M)	9.9000	0.0000	0.0000	5.9400	7.9200	0.0000	10.230	4.9500	33.000	0.0000	0.0000
8	-3.5199E-05	-1.2849E-03	-588.52	-327.06	-89.004	-242.48	-21.223	-90.869	1056.5	7.8279E+06	7.8279E+06
x(M)	10.560	0.0000	0.0000	6.2700	8.5800	0.0000	10.890	4.9500	33.000	0.0000	0.0000
9	-3.4883E-05	-1.2853E-03	-608.89	-334.41	-91.926	-252.15	-22.250	-95.058	34.496	7.8279E+06	7.8279E+06
x(M)	10.560	0.0000	0.0000	5.9400	8.5800	0.0000	10.890	4.9500	33.000	0.0000	0.0000
10	-3.3494E-05	-1.2844E-03	-779.36	-393.39	-120.00	-331.69	-32.078	-130.11	2512.4	7.8279E+06	7.8279E+06
x(M)	9.5700	0.0000	0.0000	5.6100	7.9200	0.0000	9.9000	4.9500	33.000	0.0000	0.0000
11	-3.4169E-05	-1.2849E-03	-689.24	-363.41	-105.05	-288.57	-26.655	-111.45	1569.3	7.8279E+06	7.8279E+06
x(M)	9.9000	0.0000	0.0000	5.9400	8.2500	0.0000	10.560	4.9500	33.000	0.0000	0.0000
12	-3.4080E-05	-1.2853E-03	-704.70	-368.70	-107.29	-296.40	-27.561	-114.79	590.71	7.8279E+06	7.8279E+06
x(M)	9.9000	0.0000	0.0000	5.9400	8.2500	0.0000	10.230	4.9500	33.000	0.0000	0.0000

APPALTATORE: Consorzio Soci   		ITINERARIO NAPOLI – BARI RADDOPPIO TRATTA APICE – ORSARA I LOTTO FUNZIONALE APICE – HIRPINIA			
PROGETTAZIONE: Mandataria Mandanti   					
PROGETTO ESECUTIVO RELAZIONE DI CALCOLO FONDAZIONI PILE DA P7 A P16					
COMMESSA	LOTTO	CODIFICA	DOCUMENTO	REV.	FOGLIO
IF1N	01 E ZZ	RG	MD0000 001	B	107 di 144

Min. -3.5223E-05 -1.2853E-03 -779.36 -393.39 -120.00 -331.69 -32.078 -130.11 34.496 7.8279E+06 7.8279E+06
Pile N. 5 3 10 10 10 10 10 10 9 1 1

* MAXIMUM VALUES AND LOCATIONS *

PILE	DISPL. y-DIR M	DISPL. z-DIR M	MOMENT z-DIR KN- M	MOMENT y-DIR KN- M	SHEAR y-DIR KN	SHEAR z-DIR KN	SOIL REACT y-DIR KN/ M	SOIL REACT z-DIR KN/ M	TOTAL STRESS KN/ M**2	FLEX. RIG. z-DIR KN- M**2	FLEX. RIG. y-DIR KN- M**2
1	1.6225E-03	2.7290E-05	466.43	766.05	340.86	91.990	136.21	24.105	4170.6	7.8279E+06	7.8279E+06
x(M)	0.0000	9.9000	5.6100	0.0000	0.0000	8.2500	4.9500	10.230	0.0000	0.0000	0.0000
2	1.6225E-03	2.8060E-05	417.52	666.00	278.46	76.702	109.27	18.753	2799.3	7.8279E+06	7.8279E+06
x(M)	0.0000	10.560	5.9400	0.0000	0.0000	8.5800	4.9500	10.890	0.0000	0.0000	0.0000
3	1.6225E-03	2.7854E-05	425.64	684.06	289.58	79.242	114.04	19.631	3880.7	7.8279E+06	7.8279E+06
x(M)	0.0000	10.560	5.9400	0.0000	0.0000	8.5800	4.9500	10.890	0.0000	0.0000	0.0000
4	1.6230E-03	2.7491E-05	455.84	743.54	326.30	88.665	130.12	22.879	4587.4	7.8279E+06	7.8279E+06
x(M)	0.0000	10.230	5.6100	0.0000	0.0000	8.2500	4.9500	10.560	0.0000	0.0000	0.0000
5	1.6230E-03	2.8297E-05	400.86	631.01	257.58	71.379	100.18	17.042	3088.5	7.8279E+06	7.8279E+06
x(M)	0.0000	10.890	5.9400	0.0000	0.0000	8.9100	4.9500	11.220	0.0000	0.0000	0.0000
6	1.6230E-03	2.8111E-05	409.17	648.57	268.11	74.008	104.74	17.821	3180.1	7.8279E+06	7.8279E+06
x(M)	0.0000	10.560	5.9400	0.0000	0.0000	8.5800	4.9500	10.890	0.0000	0.0000	0.0000
7	1.6234E-03	2.7453E-05	458.20	748.01	329.08	89.397	131.34	23.121	5121.5	7.8279E+06	7.8279E+06
x(M)	0.0000	10.230	5.6100	0.0000	0.0000	8.2500	4.9500	10.560	0.0000	0.0000	0.0000
8	1.6234E-03	2.8225E-05	404.47	637.97	261.55	72.527	102.00	17.374	3676.1	7.8279E+06	7.8279E+06
x(M)	0.0000	10.890	5.9400	0.0000	0.0000	8.5800	4.9500	11.220	0.0000	0.0000	0.0000
9	1.6234E-03	2.8126E-05	413.02	656.36	272.66	75.227	106.71	18.239	2736.6	7.8279E+06	7.8279E+06
x(M)	0.0000	10.560	5.9400	0.0000	0.0000	8.5800	4.9500	10.890	0.0000	0.0000	0.0000
10	1.6238E-03	2.7105E-05	484.59	804.16	365.69	98.055	146.61	26.362	5892.2	7.8279E+06	7.8279E+06
x(M)	0.0000	9.9000	5.6100	0.0000	0.0000	7.9200	4.9500	10.230	0.0000	0.0000	0.0000
11	1.6238E-03	2.7688E-05	447.32	726.06	315.19	85.915	125.38	21.942	4590.7	7.8279E+06	7.8279E+06
x(M)	0.0000	10.230	5.6100	0.0000	0.0000	8.2500	4.9500	10.560	0.0000	0.0000	0.0000
12	1.6238E-03	2.7526E-05	453.90	740.05	324.20	87.985	129.13	22.652	3674.9	7.8279E+06	7.8279E+06
x(M)	0.0000	10.230	5.6100	0.0000	0.0000	8.2500	4.9500	10.560	0.0000	0.0000	0.0000
Max. Pile N.	1.6238E-03 10	2.8297E-05 5	484.59 10	804.16 10	365.69 10	98.055 10	146.61 10	26.362 10	5892.2 10	7.8279E+06 1	7.8279E+06 1

LOAD CASE : 7
CASE NAME : Load Case
LOAD TYPE : Special, Sp

REDUCTION FACTORS FOR CLOSELY-SPACED PILE GROUPS, COMBINED Y AND Z DIRECTIONS
ESTIMATED USING MOVEMENT IN THE DIRECTION OF PILE CAP DISPLACEMENTS

GROUP NO	P-FACTOR	Y-FACTOR
1	0.8363	1.0000
2	0.7808	1.0000
3	0.8661	1.0000
4	0.5694	1.0000
5	0.4960	1.0000
6	0.6117	1.0000
7	0.5386	1.0000
8	0.4667	1.0000
9	0.5832	1.0000
10	0.5845	1.0000
11	0.5075	1.0000
12	0.6264	1.0000

* TABLE L * COMPUTATION ON PILE CAP

* EQUIVALENT CONCENTRATED LOAD AT ORIGIN *

VERT. LOAD, KN	HOR. LOAD Y, KN	HOR. LOAD Z, KN
37622.0	-4704.00	14658.0
MOMENT X, KN- M	MOMENT Y, KN- M	MOMENT Z, KN- M
-409.000	2.47398E+05	71098.0

* DISPLACEMENT OF GROUPED PILE FOUNDATION AT ORIGIN *

VERTICAL, M	HORIZONTAL Y, M	HORIZONTAL Z, M
1.57583E-03	-2.36351E-03	6.27798E-03
ANGLE ROT. X,RAD	ANGLE ROT. Y,RAD	ANGLE ROT. Z,RAD
-1.38525E-05	4.70988E-04	2.60469E-04

THE GLOBAL STRUCTURAL COORDINATE SYSTEM

APPALTATORE:

Consorzio

Soci



ITINERARIO NAPOLI – BARI

PROGETTAZIONE:

Mandatario

Mandanti



RADDOPPIO TRATTA APICE – ORSARA
I LOTTO FUNZIONALE APICE – HIRPINIA

PROGETTO ESECUTIVO

RELAZIONE DI CALCOLO FONDAZIONI PILE DA P7 A P16

COMMESSA IF1N	LOTTO 01 E ZZ	CODIFICA RG	DOCUMENTO MD0000 001	REV. B	FOGLIO 108 di 144
------------------	------------------	----------------	-------------------------	-----------	-------------------------

* PILE TOP DISPLACEMENTS *

PILE GROUP	DISP. X, M	DISP. Y, M	DISP. Z, M	ROT. X,RAD	ROT. Y,RAD	ROT. Z,RAD
*****	*****	*****	*****	*****	*****	*****
1	3.5829E-03	-2.2700E-03	6.2156E-03	-1.3852E-05	4.7099E-04	2.6047E-04
2	4.7550E-03	-2.2700E-03	6.2780E-03	-1.3852E-05	4.7099E-04	2.6047E-04
3	5.9271E-03	-2.2700E-03	6.3403E-03	-1.3852E-05	4.7099E-04	2.6047E-04
4	1.4634E-03	-2.3323E-03	6.2156E-03	-1.3852E-05	4.7099E-04	2.6047E-04
5	2.6355E-03	-2.3323E-03	6.2780E-03	-1.3852E-05	4.7099E-04	2.6047E-04
6	3.8077E-03	-2.3323E-03	6.3403E-03	-1.3852E-05	4.7099E-04	2.6047E-04
7	-6.5601E-04	-2.3947E-03	6.2156E-03	-1.3852E-05	4.7099E-04	2.6047E-04
8	5.1610E-04	-2.3947E-03	6.2780E-03	-1.3852E-05	4.7099E-04	2.6047E-04
9	1.6882E-03	-2.3947E-03	6.3403E-03	-1.3852E-05	4.7099E-04	2.6047E-04
10	-2.7755E-03	-2.4570E-03	6.2156E-03	-1.3852E-05	4.7099E-04	2.6047E-04
11	-1.6033E-03	-2.4570E-03	6.2780E-03	-1.3852E-05	4.7099E-04	2.6047E-04
12	-4.3123E-04	-2.4570E-03	6.3403E-03	-1.3852E-05	4.7099E-04	2.6047E-04
MINIMUM	-2.7755E-03	-2.4570E-03	6.2156E-03	-1.3852E-05	4.7099E-04	2.6047E-04
Pile N.	10	10	1	1	1	1
MAXIMUM	5.9271E-03	-2.2700E-03	6.3403E-03	-1.3852E-05	4.7099E-04	2.6047E-04
Pile N.	3	1	3	1	1	1

* PILE TOP REACTIONS *

PILE GROUP	FOR. X, KN	FOR. Y, KN	FOR. Z, KN	MOM X, KN- M	MOM Y, KN- M	MOM Z, KN- M
*****	*****	*****	*****	*****	*****	*****
1	7475.3	-450.04	1448.8	-4.7548	-3636.3	-967.48
2	9368.9	-429.06	1403.9	-4.7548	-3575.3	-930.01
3	1.0964E+04	-457.37	1509.0	-4.7548	-3796.1	-983.22
4	3138.6	-366.62	1151.0	-4.7548	-3050.7	-825.44
5	5536.9	-333.67	1068.8	-4.7548	-2904.2	-761.16
6	7935.2	-381.04	1225.0	-4.7548	-3243.4	-857.17
7	-1435.1	-369.40	1115.6	-4.7548	-2970.4	-845.75
8	1145.5	-335.07	1032.1	-4.7548	-2819.1	-777.91
9	3598.5	-385.66	1192.5	-4.7548	-3170.3	-881.70
10	-5777.7	-405.88	1174.6	-4.7548	-3081.8	-933.11
11	-3384.6	-369.26	1088.9	-4.7548	-2929.1	-861.68
12	-943.41	-420.92	1247.9	-4.7548	-3272.6	-966.15
MINIMUM	-5777.7	-457.37	1032.1	-4.7548	-3796.1	-983.22
Pile N.	10	3	8	1	3	3
MAXIMUM	1.0964E+04	-333.67	1509.0	-4.7548	-2819.1	-761.16
Pile N.	3	5	3	1	8	5

THE PILE COORDINATE SYSTEM (LOCAL AXES)

* PILE TOP DISPLACEMENTS *

PILE GROUP	DISP. x, M	DISP. y, M	DISP. z, M	ROT. x,RAD	ROT. y,RAD	ROT. z,RAD
*****	*****	*****	*****	*****	*****	*****
1	3.5829E-03	-2.2700E-03	6.2156E-03	-1.3852E-05	4.7099E-04	2.6047E-04
2	4.7550E-03	-2.2700E-03	6.2780E-03	-1.3852E-05	4.7099E-04	2.6047E-04
3	5.9271E-03	-2.2700E-03	6.3403E-03	-1.3852E-05	4.7099E-04	2.6047E-04
4	1.4634E-03	-2.3323E-03	6.2156E-03	-1.3852E-05	4.7099E-04	2.6047E-04
5	2.6355E-03	-2.3323E-03	6.2780E-03	-1.3852E-05	4.7099E-04	2.6047E-04
6	3.8077E-03	-2.3323E-03	6.3403E-03	-1.3852E-05	4.7099E-04	2.6047E-04
7	-6.5601E-04	-2.3947E-03	6.2156E-03	-1.3852E-05	4.7099E-04	2.6047E-04
8	5.1610E-04	-2.3947E-03	6.2780E-03	-1.3852E-05	4.7099E-04	2.6047E-04
9	1.6882E-03	-2.3947E-03	6.3403E-03	-1.3852E-05	4.7099E-04	2.6047E-04
10	-2.7755E-03	-2.4570E-03	6.2156E-03	-1.3852E-05	4.7099E-04	2.6047E-04
11	-1.6033E-03	-2.4570E-03	6.2780E-03	-1.3852E-05	4.7099E-04	2.6047E-04
12	-4.3123E-04	-2.4570E-03	6.3403E-03	-1.3852E-05	4.7099E-04	2.6047E-04
MINIMUM	-2.7755E-03	-2.4570E-03	6.2156E-03	-1.3852E-05	4.7099E-04	2.6047E-04
Pile N.	10	10	1	1	1	1
MAXIMUM	5.9271E-03	-2.2700E-03	6.3403E-03	-1.3852E-05	4.7099E-04	2.6047E-04
Pile N.	3	1	3	1	1	1

* PILE TOP REACTIONS *

PILE GROUP	AXIAL, KN	LAT. y, KN	LAT. z, KN	MOM x, KN- M	MOM y, KN- M	MOM z, KN- M
*****	*****	*****	*****	*****	*****	*****
1	7475.3	-450.04	1448.8	-4.7548	-3636.3	-967.48
2	9368.9	-429.06	1403.9	-4.7548	-3575.3	-930.01
3	1.0964E+04	-457.37	1509.0	-4.7548	-3796.1	-983.22
4	3138.6	-366.62	1151.0	-4.7548	-3050.7	-825.44
5	5536.9	-333.67	1068.8	-4.7548	-2904.2	-761.16
6	7935.2	-381.04	1225.0	-4.7548	-3243.4	-857.17
7	-1435.1	-369.40	1115.6	-4.7548	-2970.4	-845.75
8	1145.5	-335.07	1032.1	-4.7548	-2819.1	-777.91
9	3598.5	-385.66	1192.5	-4.7548	-3170.3	-881.70
10	-5777.7	-405.88	1174.6	-4.7548	-3081.8	-933.11
11	-3384.6	-369.26	1088.9	-4.7548	-2929.1	-861.68
12	-943.41	-420.92	1247.9	-4.7548	-3272.6	-966.15

APPALTATORE:

Consorzio

Soci



ITINERARIO NAPOLI – BARI

PROGETTAZIONE:

Mandatario

Mandanti



RADDOPPIO TRATTA APICE – ORSARA
I LOTTO FUNZIONALE APICE – HIRPINIA

PROGETTO ESECUTIVO

RELAZIONE DI CALCOLO FONDAZIONI PILE DA P7 A P16

COMMESSA IF1N	LOTTO 01 E ZZ	CODIFICA RG	DOCUMENTO MD0000 001	REV. B	FOGLIO 109 di 144
------------------	------------------	----------------	-------------------------	-----------	-------------------------

MINIMUM	-5777.7	-457.37	1032.1	-4.7548	-3796.1	-983.22
Pile N.	10	3	8	1	3	3
MAXIMUM	1.0964E+04	-333.67	1509.0	-4.7548	-2819.1	-761.16
Pile N.	3	5	3	1	8	5

PILE GROUP STRESS, KN/ M**2

*****	*****
1	1.5587E+04
2	1.6451E+04
3	1.8039E+04
4	1.1314E+04
5	1.2194E+04
6	1.4615E+04
7	1.0133E+04
8	9474.4
9	1.1968E+04
10	1.2987E+04
11	1.1130E+04
12	1.0832E+04

MINIMUM	9474.4
Pile N.	8
MAXIMUM	1.8039E+04
Pile N.	3

* EFFECTS FOR LATERALLY LOADED PILE *

* MINIMUM VALUES AND LOCATIONS *

PILE	DISPL. y-DIR M	DISPL. z-DIR M	MOMENT z-DIR KN- M	MOMENT y-DIR KN- M	SHEAR y-DIR KN	SHEAR z-DIR KN	SOIL REACT y-DIR KN/ M	SOIL REACT z-DIR KN/ M	TOTAL STRESS KN/ M**2	FLEX. RIG. z-DIR KN- M**2	FLEX. RIG. y-DIR KN- M**2
*****	*****	*****	*****	*****	*****	*****	*****	*****	*****	*****	*****
1	-2.2700E-03	-1.2460E-04	-634.66	-3636.3	-450.19	-449.89	-136.54	-120.22	4230.2	7.8279E+06	7.8279E+06
x(M)	0.0000	9.9000	5.6100	0.0000	0.0000	8.2500	4.9500	10.230	33.000	0.0000	0.0000
2	-2.2700E-03	-1.2692E-04	-618.84	-3575.3	-429.24	-437.17	-127.56	-115.71	5301.7	7.8279E+06	7.8279E+06
x(M)	0.0000	10.230	5.9400	0.0000	0.0000	8.2500	4.9500	10.560	33.000	0.0000	0.0000
3	-2.2700E-03	-1.2729E-04	-641.39	-3796.1	-457.59	-468.51	-138.56	-126.43	6204.2	7.8279E+06	7.8279E+06
x(M)	0.0000	9.9000	5.6100	0.0000	0.0000	8.2500	4.9500	10.230	33.000	0.0000	0.0000
4	-2.3323E-03	-1.2640E-04	-568.32	-3050.7	-366.68	-360.50	-100.73	-89.363	1776.1	7.8279E+06	7.8279E+06
x(M)	0.0000	10.890	5.9400	0.0000	0.0000	8.9100	5.9400	11.220	33.000	0.0000	0.0000
5	-2.3323E-03	-1.2862E-04	-541.08	-2904.2	-333.76	-337.62	-89.050	-81.256	3133.3	7.8279E+06	7.8279E+06
x(M)	0.0000	10.890	6.2700	0.0000	0.0000	8.9100	5.9400	11.220	33.000	0.0000	0.0000
6	-2.3323E-03	-1.2909E-04	-582.74	-3243.4	-381.19	-383.94	-105.72	-96.741	4490.4	7.8279E+06	7.8279E+06
x(M)	0.0000	10.560	5.9400	0.0000	0.0000	8.5800	4.9500	10.890	33.000	0.0000	0.0000
7	-2.3947E-03	-1.2639E-04	-572.59	-2970.4	-369.38	-348.46	-99.610	-85.437	812.13	7.8279E+06	7.8279E+06
x(M)	0.0000	10.890	6.2700	0.0000	0.0000	8.9100	5.9400	11.220	33.000	0.0000	0.0000
8	-2.3947E-03	-1.2838E-04	-543.31	-2819.1	-335.09	-324.22	-88.062	-77.358	648.23	7.8279E+06	7.8279E+06
x(M)	0.0000	11.220	6.2700	0.0000	0.0000	9.2400	5.9400	11.550	33.000	0.0000	0.0000
9	-2.3947E-03	-1.2835E-04	-587.41	-3170.3	-385.73	-372.24	-104.88	-92.722	2036.4	7.8279E+06	7.8279E+06
x(M)	0.0000	10.890	5.9400	0.0000	0.0000	8.9100	4.9500	11.220	33.000	0.0000	0.0000
10	-2.4570E-03	-1.2487E-04	-604.82	-3081.8	-405.77	-362.87	-110.34	-90.362	3269.5	7.8279E+06	7.8279E+06
x(M)	0.0000	10.890	6.2700	0.0000	0.0000	8.9100	4.9500	11.220	33.000	0.0000	0.0000
11	-2.4570E-03	-1.2730E-04	-575.25	-2929.1	-369.20	-339.33	-97.730	-82.099	1915.3	7.8279E+06	7.8279E+06
x(M)	0.0000	10.890	6.2700	0.0000	0.0000	8.9100	5.9400	11.220	33.000	0.0000	0.0000
12	-2.4570E-03	-1.2782E-04	-619.44	-3272.6	-420.90	-386.35	-115.56	-97.817	533.86	7.8279E+06	7.8279E+06
x(M)	0.0000	10.560	5.9400	0.0000	0.0000	8.5800	4.9500	10.890	33.000	0.0000	0.0000
Min.	-2.4570E-03	-1.2909E-04	-641.39	-3796.1	-457.59	-468.51	-138.56	-126.43	533.86	7.8279E+06	7.8279E+06
Pile N.	10	6	3	3	3	3	3	3	12	1	1

* MAXIMUM VALUES AND LOCATIONS *

PILE	DISPL. y-DIR M	DISPL. z-DIR M	MOMENT z-DIR KN- M	MOMENT y-DIR KN- M	SHEAR y-DIR KN	SHEAR z-DIR KN	SOIL REACT y-DIR KN/ M	SOIL REACT z-DIR KN/ M	TOTAL STRESS KN/ M**2	FLEX. RIG. z-DIR KN- M**2	FLEX. RIG. y-DIR KN- M**2
*****	*****	*****	*****	*****	*****	*****	*****	*****	*****	*****	*****
1	4.4464E-05	6.2156E-03	967.48	1802.5	157.11	1449.4	42.076	425.49	1.5587E+04	7.8279E+06	7.8279E+06
x(M)	9.9000	0.0000	0.0000	5.9400	7.9200	0.0000	10.230	4.9500	0.0000	0.0000	0.0000
2	4.4513E-05	6.2780E-03	930.01	1773.7	151.51	1404.6	39.859	402.66	1.6451E+04	7.8279E+06	7.8279E+06
x(M)	9.9000	0.0000	0.0000	5.9400	8.2500	0.0000	10.230	4.9500	0.0000	0.0000	0.0000
3	4.4319E-05	6.3403E-03	983.22	1860.4	160.34	1509.9	43.180	442.47	1.8039E+04	7.8279E+06	7.8279E+06
x(M)	9.9000	0.0000	0.0000	5.9400	7.9200	0.0000	10.230	4.9500	0.0000	0.0000	0.0000
4	4.6393E-05	6.2156E-03	825.44	1565.2	130.35	1151.3	32.174	310.16	1.1314E+04	7.8279E+06	7.8279E+06
x(M)	10.560	0.0000	0.0000	6.2700	8.5800	0.0000	10.890	6.2700	0.0000	0.0000	0.0000
5	4.6700E-05	6.2780E-03	761.16	1501.8	120.51	1069.1	28.967	280.82	1.2194E+04	7.8279E+06	7.8279E+06
x(M)	10.890	0.0000	0.0000	6.0000	8.9100	0.0000	11.220	6.2700	0.0000	0.0000	0.0000
6	4.6195E-05	6.3403E-03	857.17	1638.8	135.79	1225.5	34.010	331.98	1.4615E+04	7.8279E+06	7.8279E+06
x(M)	10.560	0.0000	0.0000	6.2700	8.5800	0.0000	10.890	5.9400	0.0000	0.0000	0.0000
7	4.7428E-05	6.2156E-03	845.75	1529.6	129.28	1115.5	31.516	296.97	1.0133E+04	7.8279E+06	7.8279E+06
x(M)	10.560	0.0000	0.0000	6.2700	8.5800	0.0000	11.220	6.2700	0.0000	0.0000	0.0000
8	4.7842E-05	6.2780E-03	777.91	1466.6	119.44	1032.1	28.284	267.64	9474.4	7.8279E+06	7.8279E+06
x(M)	10.890	0.0000	0.0000	6.0000	8.9100	0.0000	11.220	6.2700	0.0000	0.0000	0.0000
9	4.7466E-05	6.3403E-03	881.70	1607.3	135.64	1192.8	33.673	319.25	1.1968E+04	7.8279E+06	7.8279E+06
x(M)	10.560	0.0000	0.0000	6.2700	8.5800	0.0000	10.890	5.9400	0.0000	0.0000	0.0000
10	4.8482E-05	6.2156E-03	933.11	1575.4	139.02	1174.2	34.526	315.56	1.2987E+04	7.8279E+06	7.8279E+06
x(M)	10.560	0.0000	0.0000	6.2700	8.5800	0.0000	10.890	5.9400	0.0000	0.0000	0.0000

APPALTATORE: Consorzio Soci   	ITINERARIO NAPOLI – BARI RADDOPPIO TRATTA APICE – ORSARA I LOTTO FUNZIONALE APICE – HIRPINIA					
PROGETTAZIONE: Mandataria Mandanti   						
PROGETTO ESECUTIVO RELAZIONE DI CALCOLO FONDAZIONI PILE DA P7 A P16						
	COMMESSA IF1N	LOTTO 01 E ZZ	CODIFICA RG	DOCUMENTO MD0000 001	REV. B	FOGLIO 110 di 144

	11	4.8789E-05	6.2780E-03	861.68	1508.8	128.31	1088.6	30.992	284.98	1.1130E+04	7.8279E+06	7.8279E+06
x(M)		10.890	0.0000	0.0000	6.6000	8.9100	0.0000	11.220	6.2700	0.0000	0.0000	0.0000
	12	4.8311E-05	6.3403E-03	966.15	1647.9	144.70	1247.8	36.435	337.09	1.0832E+04	7.8279E+06	7.8279E+06
x(M)		10.560	0.0000	0.0000	6.2700	8.5800	0.0000	10.890	5.9400	0.0000	0.0000	0.0000
Max. Pile N.		4.8789E-05	6.3403E-03	983.22	1860.4	160.34	1509.9	43.180	442.47	1.8039E+04	7.8279E+06	7.8279E+06
		11	3	3	3	3	3	3	3	3	1	1

LOAD CASE : 8
CASE NAME : Load Case
LOAD TYPE : Special, Sp

REDUCTION FACTORS FOR CLOSELY-SPACED PILE GROUPS, COMBINED Y AND Z DIRECTIONS
ESTIMATED USING MOVEMENT IN THE DIRECTION OF PILE CAP DISPLACEMENTS

GROUP NO	P-FACTOR	Y-FACTOR
1	0.6293	1.0000
2	0.5083	1.0000
3	0.5845	1.0000
4	0.5859	1.0000
5	0.4670	1.0000
6	0.5382	1.0000
7	0.6140	1.0000
8	0.4960	1.0000
9	0.5687	1.0000
10	0.8661	1.0000
11	0.7790	1.0000
12	0.8341	1.0000

* TABLE L * COMPUTATION ON PILE CAP

* EQUIVALENT CONCENTRATED LOAD AT ORIGIN *

VERT. LOAD, KN	HOR. LOAD Y, KN	HOR. LOAD Z, KN
26550.0	4919.00	-14734.0
MOMENT X, KN- M	MOMENT Y, KN- M	MOMENT Z, KN- M
409.000	-2.45095E+05	-74460.0

* DISPLACEMENT OF GROUPED PILE FOUNDATION AT ORIGIN *

VERTICAL, M	HORIZONTAL Y, M	HORIZONTAL Z, M
1.10025E-03	2.45522E-03	-6.26797E-03
ANGLE ROT. X, RAD	ANGLE ROT. Y, RAD	ANGLE ROT. Z, RAD
-7.06929E-06	-4.59131E-04	-2.67859E-04

THE GLOBAL STRUCTURAL COORDINATE SYSTEM

* PILE TOP DISPLACEMENTS *

PILE GROUP	DISP. X, M	DISP. Y, M	DISP. Z, M	ROT. X, RAD	ROT. Y, RAD	ROT. Z, RAD
1	-7.9351E-04	2.5029E-03	-6.2998E-03	-7.0693E-06	-4.5913E-04	-2.6786E-04
2	-1.9989E-03	2.5029E-03	-6.2680E-03	-7.0693E-06	-4.5913E-04	-2.6786E-04
3	-3.2042E-03	2.5029E-03	-6.2362E-03	-7.0693E-06	-4.5913E-04	-2.6786E-04
4	1.2726E-03	2.4711E-03	-6.2998E-03	-7.0693E-06	-4.5913E-04	-2.6786E-04
5	6.7210E-05	2.4711E-03	-6.2680E-03	-7.0693E-06	-4.5913E-04	-2.6786E-04
6	-1.1382E-03	2.4711E-03	-6.2362E-03	-7.0693E-06	-4.5913E-04	-2.6786E-04
7	3.3387E-03	2.4393E-03	-6.2998E-03	-7.0693E-06	-4.5913E-04	-2.6786E-04
8	2.1333E-03	2.4393E-03	-6.2680E-03	-7.0693E-06	-4.5913E-04	-2.6786E-04
9	9.2793E-04	2.4393E-03	-6.2362E-03	-7.0693E-06	-4.5913E-04	-2.6786E-04
10	5.4047E-03	2.4075E-03	-6.2998E-03	-7.0693E-06	-4.5913E-04	-2.6786E-04
11	4.1994E-03	2.4075E-03	-6.2680E-03	-7.0693E-06	-4.5913E-04	-2.6786E-04
12	2.9940E-03	2.4075E-03	-6.2362E-03	-7.0693E-06	-4.5913E-04	-2.6786E-04
MINIMUM	-3.2042E-03	2.4075E-03	-6.2998E-03	-7.0693E-06	-4.5913E-04	-2.6786E-04
Pile N.	3	10	1	1	1	1
MAXIMUM	5.4047E-03	2.5029E-03	-6.2362E-03	-7.0693E-06	-4.5913E-04	-2.6786E-04
Pile N.	10	1	3	1	1	1

* PILE TOP REACTIONS *

PILE GROUP	FOR. X, KN	FOR. Y, KN	FOR. Z, KN	MOM X, KN- M	MOM Y, KN- M	MOM Z, KN- M
1	-1731.2	428.34	-1251.3	-2.4265	3292.8	976.84
2	-4192.2	374.53	-1096.0	-2.4265	2965.5	868.11

APPALTATORE:

Consorzio

Soci



ITINERARIO NAPOLI – BARI

PROGETTAZIONE:

Mandatario

Mandanti



RADDOPPIO TRATTA APICE – ORSARA
I LOTTO FUNZIONALE APICE – HIRPINIA

PROGETTO ESECUTIVO

RELAZIONE DI CALCOLO FONDAZIONI PILE DA P7 A P16

COMMESSA	LOTTO	CODIFICA	DOCUMENTO	REV.	FOGLIO
IF1N	01 E ZZ	RG	MD0000 001	B	111 di 144

3	-6653.2	410.93	-1187.5	-2.4265	3138.2	938.91
4	2748.1	400.06	-1195.6	-2.4265	3189.6	915.32
5	149.18	346.37	-1038.2	-2.4265	2852.7	805.07
6	-2434.8	381.09	-1127.2	-2.4265	3023.8	873.65
7	6975.6	403.19	-1227.0	-2.4265	3260.4	915.22
8	4509.2	352.01	-1074.2	-2.4265	2936.3	811.35
9	2042.9	385.93	-1162.2	-2.4265	3103.1	877.51
10	1.0253E+04	492.48	-1506.8	-2.4265	3805.5	1076.2
11	8612.9	461.07	-1407.6	-2.4265	3605.4	1017.0
12	6270.4	483.00	-1460.4	-2.4265	3690.6	1055.9
MINIMUM	-6653.2	346.37	-1506.8	-2.4265	2852.7	805.07
Pile N.	3	5	10	1	5	5
MAXIMUM	1.0253E+04	492.48	-1038.2	-2.4265	3805.5	1076.2
Pile N.	10	10	5	1	10	10

THE PILE COORDINATE SYSTEM (LOCAL AXES)

* PILE TOP DISPLACEMENTS *

PILE GROUP	DISP. x, M	DISP. y, M	DISP. z, M	ROT. x,RAD	ROT. y,RAD	ROT. z,RAD
1	-7.9351E-04	2.5029E-03	-6.2998E-03	-7.0693E-06	-4.5913E-04	-2.6786E-04
2	-1.9989E-03	2.5029E-03	-6.2680E-03	-7.0693E-06	-4.5913E-04	-2.6786E-04
3	-3.2042E-03	2.5029E-03	-6.2362E-03	-7.0693E-06	-4.5913E-04	-2.6786E-04
4	1.2726E-03	2.4711E-03	-6.2998E-03	-7.0693E-06	-4.5913E-04	-2.6786E-04
5	6.7210E-05	2.4711E-03	-6.2680E-03	-7.0693E-06	-4.5913E-04	-2.6786E-04
6	-1.1382E-03	2.4711E-03	-6.2362E-03	-7.0693E-06	-4.5913E-04	-2.6786E-04
7	3.3387E-03	2.4393E-03	-6.2998E-03	-7.0693E-06	-4.5913E-04	-2.6786E-04
8	2.1333E-03	2.4393E-03	-6.2680E-03	-7.0693E-06	-4.5913E-04	-2.6786E-04
9	9.2793E-04	2.4393E-03	-6.2362E-03	-7.0693E-06	-4.5913E-04	-2.6786E-04
10	5.4047E-03	2.4075E-03	-6.2998E-03	-7.0693E-06	-4.5913E-04	-2.6786E-04
11	4.1994E-03	2.4075E-03	-6.2680E-03	-7.0693E-06	-4.5913E-04	-2.6786E-04
12	2.9940E-03	2.4075E-03	-6.2362E-03	-7.0693E-06	-4.5913E-04	-2.6786E-04
MINIMUM	-3.2042E-03	2.4075E-03	-6.2998E-03	-7.0693E-06	-4.5913E-04	-2.6786E-04
Pile N.	3	10	1	1	1	1
MAXIMUM	5.4047E-03	2.5029E-03	-6.2362E-03	-7.0693E-06	-4.5913E-04	-2.6786E-04
Pile N.	10	1	3	1	1	1

* PILE TOP REACTIONS *

PILE GROUP	AXIAL, KN	LAT. y, KN	LAT. z, KN	MOM x, KN- M	MOM y, KN- M	MOM z, KN- M
1	-1731.2	428.34	-1251.3	-2.4265	3292.8	976.84
2	-4192.2	374.53	-1096.0	-2.4265	2965.5	868.11
3	-6653.2	410.93	-1187.5	-2.4265	3138.2	938.91
4	2748.1	400.06	-1195.6	-2.4265	3189.6	915.32
5	149.18	346.37	-1038.2	-2.4265	2852.7	805.07
6	-2434.8	381.09	-1127.2	-2.4265	3023.8	873.65
7	6975.6	403.19	-1227.0	-2.4265	3260.4	915.22
8	4509.2	352.01	-1074.2	-2.4265	2936.3	811.35
9	2042.9	385.93	-1162.2	-2.4265	3103.1	877.51
10	1.0253E+04	492.48	-1506.8	-2.4265	3805.5	1076.2
11	8612.9	461.07	-1407.6	-2.4265	3605.4	1017.0
12	6270.4	483.00	-1460.4	-2.4265	3690.6	1055.9
MINIMUM	-6653.2	346.37	-1506.8	-2.4265	2852.7	805.07
Pile N.	3	5	10	1	5	5
MAXIMUM	1.0253E+04	492.48	-1038.2	-2.4265	3805.5	1076.2
Pile N.	10	10	5	1	10	10

PILE GROUP	STRESS, KN/ M**2
1	1.1346E+04
2	1.1698E+04
3	1.3651E+04
4	1.1570E+04
5	9030.2
6	1.0877E+04
7	1.4168E+04
8	1.1746E+04
9	1.0889E+04
10	1.7738E+04
11	1.6180E+04
12	1.5134E+04
MINIMUM	9030.2
Pile N.	5
MAXIMUM	1.7738E+04
Pile N.	10

* EFFECTS FOR LATERALLY LOADED PILE *

* MINIMUM VALUES AND LOCATIONS *

APPALTATORE:

Consorzio

Soci



ITINERARIO NAPOLI – BARI

PROGETTAZIONE:

Mandatario

Mandanti



RADDOPPIO TRATTA APICE – ORSARA
I LOTTO FUNZIONALE APICE – HIRPINIA

PROGETTO ESECUTIVO

RELAZIONE DI CALCOLO FONDAZIONI PILE DA P7 A P16

COMMESSA IF1N	LOTTO 01 E ZZ	CODIFICA RG	DOCUMENTO MD0000 001	REV. B	FOGLIO 112 di 144
------------------	------------------	----------------	-------------------------	-----------	-------------------------

PILE	DISPL. y-DIR M	DISPL. z-DIR M	MOMENT z-DIR KN- M	MOMENT y-DIR KN- M	SHEAR y-DIR KN	SHEAR z-DIR KN	SOIL REACT y-DIR KN/ M	SOIL REACT z-DIR KN/ M	TOTAL STRESS KN/ M**2	FLEX. RIG. z-DIR KN- M**2	FLEX. RIG. y-DIR KN- M**2
*****	*****	*****	*****	*****	*****	*****	*****	*****	*****	*****	*****
1	-4.9114E-05	-6.2998E-03	-976.84	-1642.1	-147.52	-1251.2	-37.169	-337.85	979.65	7.8279E+06	7.8279E+06
x(M)	10.560	0.0000	0.0000	6.2700	8.5800	0.0000	10.890	5.9400	33.000	0.0000	0.0000
2	-4.9574E-05	-6.2680E-03	-868.11	-1508.9	-130.49	-1095.8	-31.528	-285.91	2372.3	7.8279E+06	7.8279E+06
x(M)	10.890	0.0000	0.0000	6.6000	8.9100	0.0000	11.220	6.2700	33.000	0.0000	0.0000
3	-4.9218E-05	-6.2362E-03	-938.91	-1580.9	-141.16	-1187.0	-35.058	-317.08	3764.9	7.8279E+06	7.8279E+06
x(M)	10.560	0.0000	0.0000	6.2700	8.5800	0.0000	10.890	6.2700	33.000	0.0000	0.0000
4	-4.8924E-05	-6.2998E-03	-915.32	-1601.0	-140.25	-1195.7	-34.853	-319.68	1555.1	7.8279E+06	7.8279E+06
x(M)	10.560	0.0000	0.0000	6.2700	8.5800	0.0000	10.890	6.2700	33.000	0.0000	0.0000
5	-4.9241E-05	-6.2680E-03	-805.07	-1465.3	-123.09	-1038.2	-29.151	-268.10	84.416	7.8279E+06	7.8279E+06
x(M)	10.890	0.0000	0.0000	6.6000	8.9100	0.0000	11.220	6.2700	33.000	0.0000	0.0000
6	-4.8769E-05	-6.2362E-03	-873.65	-1533.6	-133.02	-1127.0	-32.457	-298.05	1377.8	7.8279E+06	7.8279E+06
x(M)	10.560	0.0000	0.0000	6.2700	8.5800	0.0000	11.220	6.2700	33.000	0.0000	0.0000
7	-4.8291E-05	-6.2998E-03	-915.22	-1631.5	-142.41	-1227.5	-35.708	-331.84	3947.4	7.8279E+06	7.8279E+06
x(M)	10.560	0.0000	0.0000	6.2700	8.5800	0.0000	10.890	5.9400	33.000	0.0000	0.0000
8	-4.8763E-05	-6.2680E-03	-811.35	-1500.0	-126.03	-1074.5	-30.295	-280.89	2551.7	7.8279E+06	7.8279E+06
x(M)	10.890	0.0000	0.0000	6.6000	8.9100	0.0000	11.220	6.2700	33.000	0.0000	0.0000
9	-4.8385E-05	-6.2362E-03	-877.51	-1568.7	-136.07	-1162.4	-33.589	-310.91	1156.0	7.8279E+06	7.8279E+06
x(M)	10.560	0.0000	0.0000	6.2700	8.5800	0.0000	10.890	6.2700	33.000	0.0000	0.0000
10	-4.7050E-05	-6.2998E-03	-1076.2	-1849.3	-170.32	-1507.7	-45.937	-440.09	5802.0	7.8279E+06	7.8279E+06
x(M)	9.9000	0.0000	0.0000	5.9400	7.9200	0.0000	10.230	4.9500	33.000	0.0000	0.0000
11	-4.7140E-05	-6.2680E-03	-1017.0	-1769.0	-160.82	-1408.2	-42.248	-400.53	4873.9	7.8279E+06	7.8279E+06
x(M)	9.9000	0.0000	0.0000	5.9400	8.2500	0.0000	10.230	4.9500	33.000	0.0000	0.0000
12	-4.7078E-05	-6.2362E-03	-1055.9	-1805.6	-166.50	-1460.8	-44.584	-424.10	3548.3	7.8279E+06	7.8279E+06
x(M)	9.9000	0.0000	0.0000	5.9400	8.2500	0.0000	10.230	4.9500	33.000	0.0000	0.0000
Min.	-4.9574E-05	-6.2998E-03	-1076.2	-1849.3	-170.32	-1507.7	-45.937	-440.09	84.416	7.8279E+06	7.8279E+06
Pile N.	2	1	10	10	10	10	10	10	5	1	1

* MAXIMUM VALUES AND LOCATIONS *

PILE	DISPL. y-DIR M	DISPL. z-DIR M	MOMENT z-DIR KN- M	MOMENT y-DIR KN- M	SHEAR y-DIR KN	SHEAR z-DIR KN	SOIL REACT y-DIR KN/ M	SOIL REACT z-DIR KN/ M	TOTAL STRESS KN/ M**2	FLEX. RIG. z-DIR KN- M**2	FLEX. RIG. y-DIR KN- M**2
*****	*****	*****	*****	*****	*****	*****	*****	*****	*****	*****	*****
1	2.5029E-03	1.2704E-04	631.58	3292.8	428.30	385.27	117.81	97.653	1.1346E+04	7.8279E+06	7.8279E+06
x(M)	0.0000	10.560	5.9400	0.0000	0.0000	8.5800	4.9500	10.890	0.0000	0.0000	0.0000
2	2.5029E-03	1.2701E-04	585.23	2965.5	374.46	339.26	98.900	82.120	1.1698E+04	7.8279E+06	7.8279E+06
x(M)	0.0000	10.890	6.2700	0.0000	0.0000	8.9100	5.9400	11.220	0.0000	0.0000	0.0000
3	2.5029E-03	1.2528E-04	614.45	3138.2	410.80	364.44	111.21	90.795	1.3651E+04	7.8279E+06	7.8279E+06
x(M)	0.0000	10.890	6.2700	0.0000	0.0000	8.9100	4.9500	11.220	0.0000	0.0000	0.0000
4	2.4711E-03	1.2751E-04	607.02	3189.6	400.11	371.12	108.71	92.536	1.1570E+04	7.8279E+06	7.8279E+06
x(M)	0.0000	10.890	5.9400	0.0000	0.0000	8.9100	4.9500	11.220	0.0000	0.0000	0.0000
5	2.4711E-03	1.2808E-04	560.05	2852.7	346.37	324.02	90.670	77.320	9030.2	7.8279E+06	7.8279E+06
x(M)	0.0000	11.220	6.2700	0.0000	0.0000	9.2400	5.9400	11.550	0.0000	0.0000	0.0000
6	2.4711E-03	1.2667E-04	589.70	3023.8	381.04	349.57	102.08	85.720	1.0877E+04	7.8279E+06	7.8279E+06
x(M)	0.0000	10.890	6.2700	0.0000	0.0000	8.9100	5.9400	11.220	0.0000	0.0000	0.0000
7	2.4393E-03	1.2819E-04	610.49	3260.4	403.32	382.40	111.43	96.451	1.4168E+04	7.8279E+06	7.8279E+06
x(M)	0.0000	10.560	5.9400	0.0000	0.0000	8.5800	4.9500	10.890	0.0000	0.0000	0.0000
8	2.4393E-03	1.2816E-04	565.71	2936.3	352.09	336.93	93.406	81.134	1.1746E+04	7.8279E+06	7.8279E+06
x(M)	0.0000	10.890	6.2700	0.0000	0.0000	8.9100	5.9400	11.550	0.0000	0.0000	0.0000
9	2.4393E-03	1.2672E-04	593.27	3103.1	385.97	361.60	104.91	89.654	1.0889E+04	7.8279E+06	7.8279E+06
x(M)	0.0000	10.890	6.2700	0.0000	0.0000	8.9100	4.9500	11.220	0.0000	0.0000	0.0000
10	2.4075E-03	1.2640E-04	680.97	3805.5	492.71	465.80	148.27	125.68	1.7738E+04	7.8279E+06	7.8279E+06
x(M)	0.0000	9.9000	5.6100	0.0000	0.0000	8.2500	4.9500	10.230	0.0000	0.0000	0.0000
11	2.4075E-03	1.2667E-04	656.88	3605.4	461.26	435.86	135.71	115.42	1.6180E+04	7.8279E+06	7.8279E+06
x(M)	0.0000	10.230	5.9400	0.0000	0.0000	8.2500	4.9500	10.560	0.0000	0.0000	0.0000
12	2.4075E-03	1.2494E-04	672.22	3690.6	483.13	450.59	144.67	120.32	1.5134E+04	7.8279E+06	7.8279E+06
x(M)	0.0000	10.230	5.9400	0.0000	0.0000	8.2500	4.9500	10.560	0.0000	0.0000	0.0000
Max.	2.5029E-03	1.2819E-04	680.97	3805.5	492.71	465.80	148.27	125.68	1.7738E+04	7.8279E+06	7.8279E+06
Pile N.	1	7	10	10	10	10	10	10	10	1	1

LOAD CASE : 9
CASE NAME : Load Case
LOAD TYPE : Special, Sp

REDUCTION FACTORS FOR CLOSELY-SPACED PILE GROUPS, COMBINED Y AND Z DIRECTIONS
ESTIMATED USING MOVEMENT IN THE DIRECTION OF PILE CAP DISPLACEMENTS

GROUP NO	P-FACTOR	Y-FACTOR
1	0.8536	1.0000
2	0.5750	1.0000
3	0.5845	1.0000
4	0.7937	1.0000
5	0.4934	1.0000
6	0.4982	1.0000
7	0.7950	1.0000
8	0.4952	1.0000
9	0.5003	1.0000
10	0.8661	1.0000
11	0.5931	1.0000

APPALTATORE: Consorzio Soci   	ITINERARIO NAPOLI – BARI RADDOPPIO TRATTA APICE – ORSARA I LOTTO FUNZIONALE APICE – HIRPINIA
PROGETTAZIONE: Mandataria Mandanti   	
PROGETTO ESECUTIVO RELAZIONE DI CALCOLO FONDAZIONI PILE DA P7 A P16	

12 0.6026 1.0000

* TABLE L * COMPUTATION ON PILE CAP

* EQUIVALENT CONCENTRATED LOAD AT ORIGIN *

VERT. LOAD, KN 28747.0	HOR. LOAD Y, KN 12425.0	HOR. LOAD Z, KN -3381.00
MOMENT X, KN- M -172.000	MOMENT Y, KN- M -53219.0	MOMENT Z, KN- M -1.87093E+05

* DISPLACEMENT OF GROUPED PILE FOUNDATION AT ORIGIN *

VERTICAL, M 1.17303E-03	HORIZONTAL Y, M 5.90506E-03	HORIZONTAL Z, M -1.39195E-03
ANGLE ROT. X,RAD 6.56852E-06	ANGLE ROT. Y,RAD -1.05582E-04	ANGLE ROT. Z,RAD -6.45304E-04

THE GLOBAL STRUCTURAL COORDINATE SYSTEM

* PILE TOP DISPLACEMENTS *

PILE GROUP	DISP. X, M	DISP. Y, M	DISP. Z, M	ROT. X,RAD	ROT. Y,RAD	ROT. Z,RAD
1	3.3642E-03	5.8607E-03	-1.3624E-03	6.5685E-06	-1.0558E-04	-6.4530E-04
2	4.6036E-04	5.8607E-03	-1.3920E-03	6.5685E-06	-1.0558E-04	-6.4530E-04
3	-2.4435E-03	5.8607E-03	-1.4215E-03	6.5685E-06	-1.0558E-04	-6.4530E-04
4	3.8393E-03	5.8903E-03	-1.3624E-03	6.5685E-06	-1.0558E-04	-6.4530E-04
5	9.3547E-04	5.8903E-03	-1.3920E-03	6.5685E-06	-1.0558E-04	-6.4530E-04
6	-1.9684E-03	5.8903E-03	-1.4215E-03	6.5685E-06	-1.0558E-04	-6.4530E-04
7	4.3145E-03	5.9198E-03	-1.3624E-03	6.5685E-06	-1.0558E-04	-6.4530E-04
8	1.4106E-03	5.9198E-03	-1.3920E-03	6.5685E-06	-1.0558E-04	-6.4530E-04
9	-1.4933E-03	5.9198E-03	-1.4215E-03	6.5685E-06	-1.0558E-04	-6.4530E-04
10	4.7896E-03	5.9494E-03	-1.3624E-03	6.5685E-06	-1.0558E-04	-6.4530E-04
11	1.8857E-03	5.9494E-03	-1.3920E-03	6.5685E-06	-1.0558E-04	-6.4530E-04
12	-1.0182E-03	5.9494E-03	-1.4215E-03	6.5685E-06	-1.0558E-04	-6.4530E-04
MINIMUM	-2.4435E-03	5.8607E-03	-1.4215E-03	6.5685E-06	-1.0558E-04	-6.4530E-04
Pile N.	3	1	3	1	1	1
MAXIMUM	4.7896E-03	5.9494E-03	-1.3624E-03	6.5685E-06	-1.0558E-04	-6.4530E-04
Pile N.	10	10	1	1	1	1

* PILE TOP REACTIONS *

PILE GROUP	FOR. X, KN	FOR. Y, KN	FOR. Z, KN	MOM X, KN- M	MOM Y, KN- M	MOM Z, KN- M
1	7027.9	1236.3	-328.08	2.2546	812.26	2705.3
2	1021.8	967.18	-267.79	2.2546	703.96	2188.6
3	-5100.0	981.49	-278.98	2.2546	732.41	2205.1
4	8000.1	1188.0	-313.76	2.2546	786.03	2629.0
5	2058.3	882.45	-244.03	2.2546	656.32	2031.1
6	-4129.9	892.01	-253.35	2.2546	681.10	2038.6
7	8769.5	1196.3	-313.64	2.2546	786.07	2655.8
8	3030.5	889.63	-244.12	2.2546	656.86	2055.7
9	-3159.9	899.62	-253.54	2.2546	681.85	2064.1
10	9416.0	1269.9	-329.59	2.2546	815.86	2801.5
11	4002.6	1003.8	-271.44	2.2546	712.29	2292.3
12	-2189.9	1018.3	-282.69	2.2546	740.84	2308.8
MINIMUM	-5100.0	882.45	-329.59	2.2546	656.32	2031.1
Pile N.	3	5	10	1	5	5
MAXIMUM	9416.0	1269.9	-244.03	2.2546	815.86	2801.5
Pile N.	10	10	5	1	10	10

THE PILE COORDINATE SYSTEM (LOCAL AXES)

* PILE TOP DISPLACEMENTS *

PILE GROUP	DISP. x, M	DISP. y, M	DISP. z, M	ROT. x,RAD	ROT. y,RAD	ROT. z,RAD
1	3.3642E-03	5.8607E-03	-1.3624E-03	6.5685E-06	-1.0558E-04	-6.4530E-04
2	4.6036E-04	5.8607E-03	-1.3920E-03	6.5685E-06	-1.0558E-04	-6.4530E-04
3	-2.4435E-03	5.8607E-03	-1.4215E-03	6.5685E-06	-1.0558E-04	-6.4530E-04
4	3.8393E-03	5.8903E-03	-1.3624E-03	6.5685E-06	-1.0558E-04	-6.4530E-04
5	9.3547E-04	5.8903E-03	-1.3920E-03	6.5685E-06	-1.0558E-04	-6.4530E-04
6	-1.9684E-03	5.8903E-03	-1.4215E-03	6.5685E-06	-1.0558E-04	-6.4530E-04

APPALTATORE:

Consorzio

Soci



ITINERARIO NAPOLI – BARI

PROGETTAZIONE:

Mandatario

Mandanti

RADDOPPIO TRATTA APICE – ORSARA
I LOTTO FUNZIONALE APICE – HIRPINIA

PROGETTO ESECUTIVO

RELAZIONE DI CALCOLO FONDAZIONI PILE DA P7 A P16

COMMESSA	LOTTO	CODIFICA	DOCUMENTO	REV.	FOGLIO
IF1N	01 E ZZ	RG	MD0000 001	B	114 di 144

7	4.3145E-03	5.9198E-03	-1.3624E-03	6.5685E-06	-1.0558E-04	-6.4530E-04
8	1.4106E-03	5.9198E-03	-1.3920E-03	6.5685E-06	-1.0558E-04	-6.4530E-04
9	-1.4933E-03	5.9198E-03	-1.4215E-03	6.5685E-06	-1.0558E-04	-6.4530E-04
10	4.7896E-03	5.9494E-03	-1.3624E-03	6.5685E-06	-1.0558E-04	-6.4530E-04
11	1.8857E-03	5.9494E-03	-1.3920E-03	6.5685E-06	-1.0558E-04	-6.4530E-04
12	-1.0182E-03	5.9494E-03	-1.4215E-03	6.5685E-06	-1.0558E-04	-6.4530E-04
MINIMUM	-2.4435E-03	5.8607E-03	-1.4215E-03	6.5685E-06	-1.0558E-04	-6.4530E-04
Pile N.	3	1	3	1	1	1
MAXIMUM	4.7896E-03	5.9494E-03	-1.3624E-03	6.5685E-06	-1.0558E-04	-6.4530E-04
Pile N.	10	10	1	1	1	1

* PILE TOP REACTIONS *

PILE GROUP	AXIAL, KN	LAT. y, KN	LAT. z, KN	MOM x, KN- M	MOM y, KN- M	MOM z, KN- M
1	7027.9	1236.3	-328.08	2.2546	812.26	2705.3
2	1021.8	967.18	-267.79	2.2546	703.96	2188.6
3	-5100.0	981.49	-278.98	2.2546	732.41	2205.1
4	8000.1	1188.0	-313.76	2.2546	786.03	2629.0
5	2058.3	882.45	-244.03	2.2546	656.32	2031.1
6	-4129.9	892.01	-253.35	2.2546	681.10	2038.6
7	8769.5	1196.3	-313.64	2.2546	786.07	2655.8
8	3030.5	889.63	-244.12	2.2546	656.86	2055.7
9	-3159.9	899.62	-253.54	2.2546	681.85	2064.1
10	9416.0	1269.9	-329.59	2.2546	815.86	2801.5
11	4002.6	1003.8	-271.44	2.2546	712.29	2292.3
12	-2189.9	1018.3	-282.69	2.2546	740.84	2308.8
MINIMUM	-5100.0	882.45	-329.59	2.2546	656.32	2031.1
Pile N.	3	5	10	1	5	5
MAXIMUM	9416.0	1269.9	-244.03	2.2546	815.86	2801.5
Pile N.	10	10	5	1	10	10

* PILE GROUP STRESS, KN/ M**2

1	1.2502E+04
2	7516.8
3	9898.5
4	1.2809E+04
5	7606.7
6	8823.8
7	1.3321E+04
8	8228.2
9	8348.7
10	1.4135E+04
11	9509.6
12	8557.2
MINIMUM	7516.8
Pile N.	2
MAXIMUM	1.4135E+04
Pile N.	10

* EFFECTS FOR LATERALLY LOADED PILE *

* MINIMUM VALUES AND LOCATIONS *

PILE	DISPL. y-DIR	DISPL. z-DIR	MOMENT z-DIR	MOMENT y-DIR	SHEAR y-DIR	SHEAR z-DIR	SOIL REACT y-DIR	SOIL REACT z-DIR	TOTAL STRESS	FLEX. RIG. z-DIR	FLEX. RIG. y-DIR
*****	*****	*****	*****	*****	*****	*****	*****	*****	*****	*****	*****
1	-1.1797E-04	-1.3624E-03	-2705.3	-406.02	-421.91	-328.20	-112.81	-107.63	3977.0	7.8279E+06	7.8279E+06
x(M)	9.9000	0.0000	0.0000	5.9400	7.9200	0.0000	10.230	4.9500	33.000	0.0000	0.0000
2	-1.1994E-04	-1.3919E-03	-2188.6	-360.58	-337.04	-267.81	-83.197	-79.443	578.21	7.8279E+06	7.8279E+06
x(M)	10.560	0.0000	0.0000	6.2700	8.5800	0.0000	10.890	5.9400	33.000	0.0000	0.0000
3	-1.1903E-04	-1.4215E-03	-2205.1	-370.36	-338.39	-278.90	-83.788	-82.634	2886.0	7.8279E+06	7.8279E+06
x(M)	10.560	0.0000	0.0000	6.2700	8.5800	0.0000	10.890	5.9400	33.000	0.0000	0.0000
4	-1.1931E-04	-1.3624E-03	-2629.0	-395.90	-406.39	-313.89	-107.54	-100.58	4527.1	7.8279E+06	7.8279E+06
x(M)	9.9000	0.0000	0.0000	5.9400	7.9200	0.0000	10.230	4.9500	33.000	0.0000	0.0000
5	-1.2128E-04	-1.3919E-03	-2031.1	-340.98	-310.69	-244.06	-74.352	-69.976	1164.8	7.8279E+06	7.8279E+06
x(M)	10.890	0.0000	0.0000	6.2700	8.5800	0.0000	11.220	5.9400	33.000	0.0000	0.0000
6	-1.2038E-04	-1.4215E-03	-2038.6	-349.33	-310.70	-253.29	-74.478	-72.412	2337.1	7.8279E+06	7.8279E+06
x(M)	10.890	0.0000	0.0000	6.2700	8.5800	0.0000	11.220	5.9400	33.000	0.0000	0.0000
7	-1.1991E-04	-1.3624E-03	-2655.8	-395.93	-408.94	-313.78	-108.27	-100.26	4962.5	7.8279E+06	7.8279E+06
x(M)	9.9000	0.0000	0.0000	5.9400	7.9200	0.0000	10.230	4.9500	33.000	0.0000	0.0000
8	-1.2191E-04	-1.3919E-03	-2055.7	-341.26	-313.07	-244.16	-74.983	-69.877	1714.9	7.8279E+06	7.8279E+06
x(M)	10.890	0.0000	0.0000	6.2700	8.5800	0.0000	11.220	5.9400	33.000	0.0000	0.0000
9	-1.2100E-04	-1.4215E-03	-2064.1	-349.70	-313.20	-253.49	-75.143	-72.349	1788.1	7.8279E+06	7.8279E+06
x(M)	10.890	0.0000	0.0000	6.2700	8.5800	0.0000	11.220	5.9400	33.000	0.0000	0.0000
10	-1.1965E-04	-1.3624E-03	-2801.5	-407.41	-432.32	-329.75	-115.93	-107.52	5328.4	7.8279E+06	7.8279E+06
x(M)	9.9000	0.0000	0.0000	5.9400	7.9200	0.0000	10.230	4.9500	33.000	0.0000	0.0000
11	-1.2151E-04	-1.3919E-03	-2292.3	-363.98	-348.55	-271.50	-86.598	-80.402	2265.0	7.8279E+06	7.8279E+06
x(M)	10.560	0.0000	0.0000	6.2700	8.5800	0.0000	10.890	5.9400	33.000	0.0000	0.0000
12	-1.2057E-04	-1.4215E-03	-2308.8	-373.77	-349.83	-282.66	-87.162	-83.601	1239.2	7.8279E+06	7.8279E+06
x(M)	10.560	0.0000	0.0000	6.2700	8.5800	0.0000	10.890	5.9400	33.000	0.0000	0.0000
Min.	-1.2191E-04	-1.4215E-03	-2801.5	-407.41	-432.32	-329.75	-115.93	-107.63	578.21	7.8279E+06	7.8279E+06

APPALTATORE: Consorzio Soci   	ITINERARIO NAPOLI – BARI RADDOPPIO TRATTA APICE – ORSARA I LOTTO FUNZIONALE APICE – HIRPINIA
PROGETTAZIONE: Mandataria Mandanti   	
PROGETTO ESECUTIVO RELAZIONE DI CALCOLO FONDAZIONI PILE DA P7 A P16	
COMMESSA IF1N LOTTO 01 E ZZ CODIFICA RG DOCUMENTO MD0000 001 REV. B FOGLIO 115 di 144	

PILE	DISPL. y-DIR	DISPL. z-DIR	MOMENT z-DIR	MOMENT y-DIR	SHEAR y-DIR	SHEAR z-DIR	SOIL REACT y-DIR	SOIL REACT z-DIR	TOTAL STRESS	FLEX. RIG. z-DIR	FLEX. RIG. y-DIR
	M	M	KN- M	KN- M	KN	KN	KN/ M	KN/ M	KN/ M**2	KN- M**2	KN- M**2
*****	*****	*****	*****	*****	*****	*****	*****	*****	*****	*****	*****
1	5.8607E-03	2.8088E-05	1699.3	812.26	1236.7	101.25	415.82	27.255	1.2502E+04	7.8279E+06	7.8279E+06
x(M)	0.0000	9.9000	5.6100	0.0000	0.0000	8.2500	4.9500	10.230	0.0000	0.0000	0.0000
2	5.8607E-03	2.9122E-05	1476.4	703.96	967.23	82.855	293.07	20.531	7516.8	7.8279E+06	7.8279E+06
x(M)	0.0000	10.560	5.9400	0.0000	0.0000	8.5800	4.9500	10.890	0.0000	0.0000	0.0000
3	5.8607E-03	2.9585E-05	1482.7	732.41	981.25	85.144	297.16	21.175	9898.5	7.8279E+06	7.8279E+06
x(M)	0.0000	10.560	5.9400	0.0000	0.0000	8.5800	4.9500	10.890	0.0000	0.0000	0.0000
4	5.8903E-03	2.8066E-05	1662.3	786.03	1188.4	97.458	391.14	25.702	1.2809E+04	7.8279E+06	7.8279E+06
x(M)	0.0000	9.9000	5.6100	0.0000	0.0000	8.2500	4.9500	10.230	0.0000	0.0000	0.0000
5	5.8903E-03	2.9349E-05	1402.2	656.32	882.53	76.105	257.37	18.276	7606.7	7.8279E+06	7.8279E+06
x(M)	0.0000	10.890	6.2700	0.0000	0.0000	8.9100	5.9400	11.220	0.0000	0.0000	0.0000
6	5.8903E-03	2.9801E-05	1404.3	681.10	891.83	77.874	259.34	18.739	8823.8	7.8279E+06	7.8279E+06
x(M)	0.0000	10.890	6.2700	0.0000	0.0000	8.9100	5.9400	11.220	0.0000	0.0000	0.0000
7	5.9198E-03	2.8062E-05	1671.1	786.07	1196.8	97.541	392.61	25.736	1.3321E+04	7.8279E+06	7.8279E+06
x(M)	0.0000	9.9000	5.6100	0.0000	0.0000	8.2500	4.9500	10.230	0.0000	0.0000	0.0000
8	5.9198E-03	2.9352E-05	1411.0	656.86	889.76	76.270	258.92	18.333	8228.2	7.8279E+06	7.8279E+06
x(M)	0.0000	10.890	6.2700	0.0000	0.0000	8.9100	5.9400	11.220	0.0000	0.0000	0.0000
9	5.9198E-03	2.9803E-05	1413.3	681.85	899.48	78.072	261.03	18.806	8348.7	7.8279E+06	7.8279E+06
x(M)	0.0000	10.890	6.2700	0.0000	0.0000	8.9100	5.9400	11.220	0.0000	0.0000	0.0000
10	5.9494E-03	2.8058E-05	1732.8	815.86	1270.5	101.99	424.08	27.560	1.4135E+04	7.8279E+06	7.8279E+06
x(M)	0.0000	9.9000	5.6100	0.0000	0.0000	8.2500	4.9500	10.230	0.0000	0.0000	0.0000
11	5.9494E-03	2.9118E-05	1514.7	712.29	1004.0	84.412	303.47	21.062	9509.6	7.8279E+06	7.8279E+06
x(M)	0.0000	10.560	5.9400	0.0000	0.0000	8.5800	4.9500	10.890	0.0000	0.0000	0.0000
12	5.9494E-03	2.9575E-05	1520.9	740.84	1018.2	86.714	307.57	21.709	8557.2	7.8279E+06	7.8279E+06
x(M)	0.0000	10.560	5.9400	0.0000	0.0000	8.5800	4.9500	10.890	0.0000	0.0000	0.0000
Max.	5.9494E-03	2.9803E-05	1732.8	815.86	1270.5	101.99	424.08	27.560	1.4135E+04	7.8279E+06	7.8279E+06
Pile N.	10	9	10	10	10	10	10	10	10	1	1

LOAD CASE : 10
CASE NAME : Load Case
LOAD TYPE : Special, Sp

REDUCTION FACTORS FOR CLOSELY-SPACED PILE GROUPS, COMBINED Y AND Z DIRECTIONS
ESTIMATED USING MOVEMENT IN THE DIRECTION OF PILE CAP DISPLACEMENTS

GROUP NO	P-FACTOR	Y-FACTOR
1	0.6041	1.0000
2	0.5943	1.0000
3	0.8661	1.0000
4	0.5007	1.0000
5	0.4952	1.0000
6	0.7941	1.0000
7	0.4984	1.0000
8	0.4933	1.0000
9	0.7927	1.0000
10	0.5845	1.0000
11	0.5747	1.0000
12	0.8525	1.0000

* TABLE L * COMPUTATION ON PILE CAP

* EQUIVALENT CONCENTRATED LOAD AT ORIGIN *

VERT. LOAD, KN	HOR. LOAD Y, KN	HOR. LOAD Z, KN
37076.0	-11889.0	3332.00
MOMENT X, KN- M	MOMENT Y, KN- M	MOMENT Z, KN- M
123.000	55437.0	1.80505E+05

* DISPLACEMENT OF GROUPED PILE FOUNDATION AT ORIGIN *

VERTICAL, M	HORIZONTAL Y, M	HORIZONTAL Z, M
1.52840E-03	-5.65539E-03	1.38949E-03
ANGLE ROT. X, RAD	ANGLE ROT. Y, RAD	ANGLE ROT. Z, RAD
8.70564E-06	1.11849E-04	6.27824E-04

THE GLOBAL STRUCTURAL COORDINATE SYSTEM

APPALTATORE:

Consorzio

Soci



ITINERARIO NAPOLI – BARI

RADDOPPIO TRATTA APICE – ORSARA
I LOTTO FUNZIONALE APICE – HIRPINIA

PROGETTAZIONE:

Mandatario

Mandanti



PROGETTO ESECUTIVO

RELAZIONE DI CALCOLO FONDAZIONI PILE DA P7 A P16

COMMESSA IF1N	LOTTO 01 E ZZ	CODIFICA RG	DOCUMENTO MD0000 001	REV. B	FOGLIO 116 di 144
------------------	------------------	----------------	-------------------------	-----------	-------------------------

* PILE TOP DISPLACEMENTS *

PILE GROUP	DISP. X, M	DISP. Y, M	DISP. Z, M	ROT. X,RAD	ROT. Y,RAD	ROT. Z,RAD
*****	*****	*****	*****	*****	*****	*****
1	-5.4183E-04	-5.7142E-03	1.4287E-03	8.7056E-06	1.1185E-04	6.2782E-04
2	2.2834E-03	-5.7142E-03	1.3895E-03	8.7056E-06	1.1185E-04	6.2782E-04
3	5.1086E-03	-5.7142E-03	1.3503E-03	8.7056E-06	1.1185E-04	6.2782E-04
4	-1.0451E-03	-5.6750E-03	1.4287E-03	8.7056E-06	1.1185E-04	6.2782E-04
5	1.7801E-03	-5.6750E-03	1.3895E-03	8.7056E-06	1.1185E-04	6.2782E-04
6	4.6053E-03	-5.6750E-03	1.3503E-03	8.7056E-06	1.1185E-04	6.2782E-04
7	-1.5485E-03	-5.6358E-03	1.4287E-03	8.7056E-06	1.1185E-04	6.2782E-04
8	1.2767E-03	-5.6358E-03	1.3895E-03	8.7056E-06	1.1185E-04	6.2782E-04
9	4.1019E-03	-5.6358E-03	1.3503E-03	8.7056E-06	1.1185E-04	6.2782E-04
10	-2.0518E-03	-5.5966E-03	1.4287E-03	8.7056E-06	1.1185E-04	6.2782E-04
11	7.7342E-04	-5.5966E-03	1.3895E-03	8.7056E-06	1.1185E-04	6.2782E-04
12	3.5986E-03	-5.5966E-03	1.3503E-03	8.7056E-06	1.1185E-04	6.2782E-04
MINIMUM	-2.0518E-03	-5.7142E-03	1.3503E-03	8.7056E-06	1.1185E-04	6.2782E-04
Pile N.	10	1	3	1	1	1
MAXIMUM	5.1086E-03	-5.5966E-03	1.4287E-03	8.7056E-06	1.1185E-04	6.2782E-04
Pile N.	3	10	1	1	1	1

* PILE TOP REACTIONS *

PILE GROUP	FOR. X, KN	FOR. Y, KN	FOR. Z, KN	MOM X, KN- M	MOM Y, KN- M	MOM Z, KN- M
*****	*****	*****	*****	*****	*****	*****
1	-1185.4	-979.46	281.64	2.9882	-727.17	-2204.3
2	4816.3	-965.44	267.82	2.9882	-690.64	-2188.0
3	9850.0	-1220.2	322.04	2.9882	-782.85	-2673.2
4	-2245.0	-861.89	252.25	2.9882	-667.89	-1959.3
5	3786.5	-852.08	240.47	2.9882	-635.35	-1950.7
6	9165.2	-1145.7	306.24	2.9882	-753.43	-2522.7
7	-3272.6	-852.17	252.11	2.9882	-667.23	-1926.8
8	2756.6	-842.83	240.44	2.9882	-634.91	-1919.1
9	8480.3	-1134.6	306.41	2.9882	-753.55	-2487.9
10	-4300.2	-935.31	277.85	2.9882	-718.59	-2077.6
11	1716.6	-921.47	264.11	2.9882	-682.23	-2061.5
12	7507.5	-1177.8	320.63	2.9882	-779.50	-2551.5
MINIMUM	-4300.2	-1220.2	240.44	2.9882	-782.85	-2673.2
Pile N.	10	3	8	1	3	3
MAXIMUM	9850.0	-842.83	322.04	2.9882	-634.91	-1919.1
Pile N.	3	8	3	1	8	8

THE PILE COORDINATE SYSTEM (LOCAL AXES)

* PILE TOP DISPLACEMENTS *

PILE GROUP	DISP. x, M	DISP. y, M	DISP. z, M	ROT. x,RAD	ROT. y,RAD	ROT. z,RAD
*****	*****	*****	*****	*****	*****	*****
1	-5.4183E-04	-5.7142E-03	1.4287E-03	8.7056E-06	1.1185E-04	6.2782E-04
2	2.2834E-03	-5.7142E-03	1.3895E-03	8.7056E-06	1.1185E-04	6.2782E-04
3	5.1086E-03	-5.7142E-03	1.3503E-03	8.7056E-06	1.1185E-04	6.2782E-04
4	-1.0451E-03	-5.6750E-03	1.4287E-03	8.7056E-06	1.1185E-04	6.2782E-04
5	1.7801E-03	-5.6750E-03	1.3895E-03	8.7056E-06	1.1185E-04	6.2782E-04
6	4.6053E-03	-5.6750E-03	1.3503E-03	8.7056E-06	1.1185E-04	6.2782E-04
7	-1.5485E-03	-5.6358E-03	1.4287E-03	8.7056E-06	1.1185E-04	6.2782E-04
8	1.2767E-03	-5.6358E-03	1.3895E-03	8.7056E-06	1.1185E-04	6.2782E-04
9	4.1019E-03	-5.6358E-03	1.3503E-03	8.7056E-06	1.1185E-04	6.2782E-04
10	-2.0518E-03	-5.5966E-03	1.4287E-03	8.7056E-06	1.1185E-04	6.2782E-04
11	7.7342E-04	-5.5966E-03	1.3895E-03	8.7056E-06	1.1185E-04	6.2782E-04
12	3.5986E-03	-5.5966E-03	1.3503E-03	8.7056E-06	1.1185E-04	6.2782E-04
MINIMUM	-2.0518E-03	-5.7142E-03	1.3503E-03	8.7056E-06	1.1185E-04	6.2782E-04
Pile N.	10	1	3	1	1	1
MAXIMUM	5.1086E-03	-5.5966E-03	1.4287E-03	8.7056E-06	1.1185E-04	6.2782E-04
Pile N.	3	10	1	1	1	1

* PILE TOP REACTIONS *

PILE GROUP	AXIAL, KN	LAT. y, KN	LAT. z, KN	MOM x, KN- M	MOM y, KN- M	MOM z, KN- M
*****	*****	*****	*****	*****	*****	*****
1	-1185.4	-979.46	281.64	2.9882	-727.17	-2204.3
2	4816.3	-965.44	267.82	2.9882	-690.64	-2188.0
3	9850.0	-1220.2	322.04	2.9882	-782.85	-2673.2
4	-2245.0	-861.89	252.25	2.9882	-667.89	-1959.3
5	3786.5	-852.08	240.47	2.9882	-635.35	-1950.7
6	9165.2	-1145.7	306.24	2.9882	-753.43	-2522.7
7	-3272.6	-852.17	252.11	2.9882	-667.23	-1926.8
8	2756.6	-842.83	240.44	2.9882	-634.91	-1919.1
9	8480.3	-1134.6	306.41	2.9882	-753.55	-2487.9
10	-4300.2	-935.31	277.85	2.9882	-718.59	-2077.6
11	1716.6	-921.47	264.11	2.9882	-682.23	-2061.5
12	7507.5	-1177.8	320.63	2.9882	-779.50	-2551.5
MINIMUM	-4300.2	-1220.2	240.44	2.9882	-782.85	-2673.2

APPALTATORE:

Consorzio

Soci



ITINERARIO NAPOLI – BARI

PROGETTAZIONE:

Mandataria

Mandanti



RADDOPPIO TRATTA APICE – ORSARA
I LOTTO FUNZIONALE APICE – HIRPINIA

PROGETTO ESECUTIVO

RELAZIONE DI CALCOLO FONDAZIONI PILE DA P7 A P16

COMMESSA IF1N	LOTTO 01 E ZZ	CODIFICA RG	DOCUMENTO MD0000 001	REV. B	FOGLIO 117 di 144
------------------	------------------	----------------	-------------------------	-----------	-------------------------

Pile N.	10	3	8	1	3	3
MAXIMUM	9850.0	-842.83	322.04	2.9882	-634.91	-1919.1
Pile N.	3	8	3	1	8	8

PILE GROUP	STRESS, KN/ M**2
1	7676.1
2	9650.2
3	1.3981E+04
4	7517.8
5	8334.4
6	1.3132E+04
7	8006.0
8	7660.7
9	1.2644E+04
10	9068.2
11	7524.9
12	1.2300E+04

MINIMUM	7517.8
Pile N.	4
MAXIMUM	1.3981E+04
Pile N.	3

* EFFECTS FOR LATERALLY LOADED PILE *

* MINIMUM VALUES AND LOCATIONS *

PILE	DISPL. y-DIR	DISPL. z-DIR	MOMENT z-DIR	MOMENT y-DIR	SHEAR y-DIR	SHEAR z-DIR	SOIL REACT y-DIR	SOIL REACT z-DIR	TOTAL STRESS	FLEX. RIG. z-DIR	FLEX. RIG. y-DIR
	M	M	KN- M	KN- M	KN	KN	KN/ M	KN/ M	KN/ M**2	KN- M**2	KN- M**2
1	-5.7142E-03	-2.9833E-05	-1469.4	-727.17	-979.41	-87.365	-303.33	-21.858	670.78	7.8279E+06	7.8279E+06
x(M)	0.0000	10.560	5.9400	0.0000	0.0000	8.5800	4.9500	10.890	33.000	0.0000	0.0000
2	-5.7142E-03	-2.9163E-05	-1463.3	-690.64	-965.66	-84.388	-299.31	-21.040	2725.5	7.8279E+06	7.8279E+06
x(M)	0.0000	10.560	5.9400	0.0000	0.0000	8.5800	4.9500	10.890	33.000	0.0000	0.0000
3	-5.7142E-03	-2.7860E-05	-1672.1	-782.85	-1220.8	-100.90	-417.91	-27.249	5574.0	7.8279E+06	7.8279E+06
x(M)	0.0000	9.9000	5.6100	0.0000	0.0000	7.9200	4.9500	10.230	33.000	0.0000	0.0000
4	-5.6750E-03	-3.0057E-05	-1361.0	-667.89	-861.80	-78.498	-255.55	-18.907	1270.4	7.8279E+06	7.8279E+06
x(M)	0.0000	10.890	5.9400	0.0000	0.0000	8.9100	4.9500	11.220	33.000	0.0000	0.0000
5	-5.6750E-03	-2.9389E-05	-1358.0	-635.35	-852.24	-76.076	-253.44	-18.282	2142.7	7.8279E+06	7.8279E+06
x(M)	0.0000	10.890	5.9400	0.0000	0.0000	8.9100	4.9500	11.220	33.000	0.0000	0.0000
6	-5.6750E-03	-2.7925E-05	-1609.3	-753.43	-1146.2	-96.435	-386.25	-25.466	5186.4	7.8279E+06	7.8279E+06
x(M)	0.0000	9.9000	5.6100	0.0000	0.0000	8.2500	4.9500	10.230	33.000	0.0000	0.0000
7	-5.6358E-03	-3.0065E-05	-1350.2	-667.23	-852.04	-78.304	-253.67	-18.839	1851.9	7.8279E+06	7.8279E+06
x(M)	0.0000	10.890	5.9400	0.0000	0.0000	8.9100	4.9500	11.220	33.000	0.0000	0.0000
8	-5.6358E-03	-2.9397E-05	-1347.5	-634.91	-842.94	-75.917	-251.64	-18.226	1559.9	7.8279E+06	7.8279E+06
x(M)	0.0000	10.890	5.9400	0.0000	0.0000	8.9100	4.9500	11.220	33.000	0.0000	0.0000
9	-5.6358E-03	-2.7942E-05	-1598.0	-753.55	-1135.0	-96.375	-384.39	-25.438	4798.9	7.8279E+06	7.8279E+06
x(M)	0.0000	9.9000	5.6100	0.0000	0.0000	8.2500	4.9500	10.230	33.000	0.0000	0.0000
10	-5.5966E-03	-2.9894E-05	-1423.8	-718.59	-935.12	-85.756	-291.57	-21.305	2433.4	7.8279E+06	7.8279E+06
x(M)	0.0000	10.560	5.9400	0.0000	0.0000	8.5800	4.9500	10.890	33.000	0.0000	0.0000
11	-5.5966E-03	-2.9221E-05	-1417.7	-682.23	-921.54	-82.812	-287.57	-20.497	971.42	7.8279E+06	7.8279E+06
x(M)	0.0000	10.560	5.9400	0.0000	0.0000	8.5800	4.9500	10.890	33.000	0.0000	0.0000
12	-5.5966E-03	-2.7930E-05	-1630.5	-779.50	-1178.2	-100.08	-408.17	-26.948	4248.4	7.8279E+06	7.8279E+06
x(M)	0.0000	10.560	5.6100	0.0000	0.0000	7.9200	4.9500	10.230	33.000	0.0000	0.0000
Min.	-5.7142E-03	-3.0065E-05	-1672.1	-782.85	-1220.8	-100.90	-417.91	-27.249	670.78	7.8279E+06	7.8279E+06
Pile N.	1	7	3	3	3	3	3	3	1	1	1

* MAXIMUM VALUES AND LOCATIONS *

PILE	DISPL. y-DIR	DISPL. z-DIR	MOMENT z-DIR	MOMENT y-DIR	SHEAR y-DIR	SHEAR z-DIR	SOIL REACT y-DIR	SOIL REACT z-DIR	TOTAL STRESS	FLEX. RIG. z-DIR	FLEX. RIG. y-DIR
	M	M	KN- M	KN- M	KN	KN	KN/ M	KN/ M	KN/ M**2	KN- M**2	KN- M**2
1	1.1654E-04	1.4287E-03	2204.3	376.20	337.55	281.62	84.077	85.011	7676.1	7.8279E+06	7.8279E+06
x(M)	10.230	0.0000	0.0000	6.2700	8.5800	0.0000	10.890	5.9400	0.0000	0.0000	0.0000
2	1.1728E-04	1.3895E-03	2188.0	363.59	336.22	267.89	83.507	81.004	9650.2	7.8279E+06	7.8279E+06
x(M)	10.560	0.0000	0.0000	6.2700	8.5800	0.0000	10.890	5.9400	0.0000	0.0000	0.0000
3	1.1542E-04	1.3503E-03	2673.2	403.30	416.78	322.21	111.56	108.04	1.3981E+04	7.8279E+06	7.8279E+06
x(M)	9.9000	0.0000	0.0000	5.9400	7.9200	0.0000	10.230	4.9500	0.0000	0.0000	0.0000
4	1.1676E-04	1.4287E-03	1959.3	352.18	301.76	252.22	72.227	73.650	7517.8	7.8279E+06	7.8279E+06
x(M)	10.560	0.0000	0.0000	6.2700	8.5800	0.0000	11.220	5.9400	0.0000	0.0000	0.0000
5	1.1756E-04	1.3895E-03	1950.7	341.10	301.49	240.52	72.033	70.460	8334.4	7.8279E+06	7.8279E+06
x(M)	10.560	0.0000	0.0000	6.2700	8.5800	0.0000	11.220	5.9400	0.0000	0.0000	0.0000
6	1.1559E-04	1.3503E-03	2522.7	392.07	393.46	306.38	103.98	100.85	1.3132E+04	7.8279E+06	7.8279E+06
x(M)	9.9000	0.0000	0.0000	5.9400	7.9200	0.0000	10.230	4.9500	0.0000	0.0000	0.0000
7	1.1595E-04	1.4287E-03	1926.8	351.87	298.75	252.07	71.428	73.813	8006.0	7.8279E+06	7.8279E+06
x(M)	10.560	0.0000	0.0000	6.2700	8.5800	0.0000	11.220	5.9400	0.0000	0.0000	0.0000
8	1.1675E-04	1.3895E-03	1919.1	340.89	298.60	240.47	71.271	70.658	7660.7	7.8279E+06	7.8279E+06
x(M)	10.560	0.0000	0.0000	6.2700	8.5800	0.0000	11.220	5.9400	0.0000	0.0000	0.0000
9	1.1482E-04	1.3503E-03	2487.9	392.13	390.31	306.55	103.07	101.33	1.2644E+04	7.8279E+06	7.8279E+06
x(M)	9.9000	0.0000	0.0000	5.9400	7.9200	0.0000	10.230	4.9500	0.0000	0.0000	0.0000
10	1.1434E-04	1.4287E-03	2077.6	372.80	324.27	277.78	80.228	84.273	9068.2	7.8279E+06	7.8279E+06
x(M)	10.560	0.0000	0.0000	6.2700	8.5800	0.0000	10.890	5.9400	0.0000	0.0000	0.0000
11	1.1523E-04	1.3895E-03	2061.5	360.24	322.89	264.13	79.640	80.270	7524.9	7.8279E+06	7.8279E+06
x(M)	10.560	0.0000	0.0000	6.2700	8.5800	0.0000	10.890	5.9400	0.0000	0.0000	0.0000

APPALTATORE: Consorzio Soci   	ITINERARIO NAPOLI – BARI RADDOPPIO TRATTA APICE – ORSARA I LOTTO FUNZIONALE APICE – HIRPINIA					
PROGETTAZIONE: Mandataria Mandanti   						
PROGETTO ESECUTIVO RELAZIONE DI CALCOLO FONDAZIONI PILE DA P7 A P16						
	COMMESSA IF1N	LOTTO 01 E ZZ	CODIFICA RG	DOCUMENTO MD0000 001	REV. B	FOGLIO 118 di 144

12	1.1324E-04	1.3503E-03	2551.5	402.11	404.28	320.75	107.84	108.61	1.2300E+04	7.8279E+06	7.8279E+06
x(M)	9.9000	0.0000	0.0000	5.9400	7.9200	0.0000	10.230	4.9500	0.0000	0.0000	0.0000
Max. Pile N.	1.1756E-04	1.4287E-03	2673.2	403.30	416.78	322.21	111.56	108.61	1.3981E+04	7.8279E+06	7.8279E+06
	5	1	3	3	3	3	3	12	3	1	1

LOAD CASE : 11
CASE NAME : Load Case
LOAD TYPE : Special, Sp

REDUCTION FACTORS FOR CLOSELY-SPACED PILE GROUPS, COMBINED Y AND Z DIRECTIONS
ESTIMATED USING MOVEMENT IN THE DIRECTION OF PILE CAP DISPLACEMENTS

GROUP NO	P-FACTOR	Y-FACTOR
1	0.8486	1.0000
2	0.5734	1.0000
3	0.5845	1.0000
4	0.7891	1.0000
5	0.4928	1.0000
6	0.4993	1.0000
7	0.7909	1.0000
8	0.4952	1.0000
9	0.5021	1.0000
10	0.8661	1.0000
11	0.5986	1.0000
12	0.6096	1.0000

* TABLE L * COMPUTATION ON PILE CAP

* EQUIVALENT CONCENTRATED LOAD AT ORIGIN *

VERT. LOAD, KN	HOR. LOAD Y, KN	HOR. LOAD Z, KN
48590.0	3534.00	-1146.00
MOMENT X, KN- M	MOMENT Y, KN- M	MOMENT Z, KN- M
-361.000	-24236.0	-61010.0

* DISPLACEMENT OF GROUPED PILE FOUNDATION AT ORIGIN *

VERTICAL, M	HORIZONTAL Y, M	HORIZONTAL Z, M
1.90943E-03	1.66807E-03	-4.69439E-04
ANGLE ROT. X, RAD	ANGLE ROT. Y, RAD	ANGLE ROT. Z, RAD
-5.25939E-07	-4.31575E-05	-2.05653E-04

THE GLOBAL STRUCTURAL COORDINATE SYSTEM

* PILE TOP DISPLACEMENTS *

PILE GROUP	DISP. X, M	DISP. Y, M	DISP. Z, M	ROT. X, RAD	ROT. Y, RAD	ROT. Z, RAD
1	2.5435E-03	1.6716E-03	-4.7181E-04	-5.2594E-07	-4.3158E-05	-2.0565E-04
2	1.6181E-03	1.6716E-03	-4.6944E-04	-5.2594E-07	-4.3158E-05	-2.0565E-04
3	6.9268E-04	1.6716E-03	-4.6707E-04	-5.2594E-07	-4.3158E-05	-2.0565E-04
4	2.7378E-03	1.6692E-03	-4.7181E-04	-5.2594E-07	-4.3158E-05	-2.0565E-04
5	1.8123E-03	1.6692E-03	-4.6944E-04	-5.2594E-07	-4.3158E-05	-2.0565E-04
6	8.8689E-04	1.6692E-03	-4.6707E-04	-5.2594E-07	-4.3158E-05	-2.0565E-04
7	2.9320E-03	1.6669E-03	-4.7181E-04	-5.2594E-07	-4.3158E-05	-2.0565E-04
8	2.0065E-03	1.6669E-03	-4.6944E-04	-5.2594E-07	-4.3158E-05	-2.0565E-04
9	1.0811E-03	1.6669E-03	-4.6707E-04	-5.2594E-07	-4.3158E-05	-2.0565E-04
10	3.1262E-03	1.6645E-03	-4.7181E-04	-5.2594E-07	-4.3158E-05	-2.0565E-04
11	2.2007E-03	1.6645E-03	-4.6944E-04	-5.2594E-07	-4.3158E-05	-2.0565E-04
12	1.2753E-03	1.6645E-03	-4.6707E-04	-5.2594E-07	-4.3158E-05	-2.0565E-04
MINIMUM Pile N.	3	10	1	1	1	1
MAXIMUM Pile N.	10	1	3	1	1	1

* PILE TOP REACTIONS *

PILE GROUP	FOR. X, KN	FOR. Y, KN	FOR. Z, KN	MOM X, KN- M	MOM Y, KN- M	MOM Z, KN- M
1	5348.7	354.23	-114.00	-0.1805	263.94	714.71
2	3455.1	278.49	-90.315	-0.1805	219.81	578.50
3	1537.4	282.23	-90.800	-0.1805	219.70	584.42
4	5746.1	337.87	-109.26	-0.1805	255.64	685.66

APPALTATORE: Consorzio  Soci  		ITINERARIO NAPOLI – BARI RADDOPPIO TRATTA APICE – ORSARA I LOTTO FUNZIONALE APICE – HIRPINIA			
PROGETTAZIONE: Mandataria  Mandanti  					
PROGETTO ESECUTIVO RELAZIONE DI CALCOLO FONDAZIONI PILE DA P7 A P16					
COMMESSA	LOTTO	CODIFICA	DOCUMENTO	REV.	FOGLIO
IF1N	01 E ZZ	RG	MD0000 001	B	119 di 144

5	3852.5	252.77	-82.677	-0.1805	205.20	529.53
6	1958.9	255.24	-82.827	-0.1805	204.50	533.22
7	6143.4	337.51	-109.38	-0.1805	255.91	684.37
8	4249.9	252.87	-82.887	-0.1805	205.66	529.17
9	2356.3	255.47	-83.078	-0.1805	205.05	533.11
10	6540.8	356.11	-115.29	-0.1805	266.34	715.83
11	4647.2	283.78	-92.517	-0.1805	224.12	586.55
12	2753.7	287.43	-92.964	-0.1805	223.92	592.24
MINIMUM	1537.4	252.77	-115.29	-0.1805	204.50	529.17
Pile N.	3	5	10	1	6	8
MAXIMUM	6540.8	356.11	-82.677	-0.1805	266.34	715.83
Pile N.	10	10	5	1	10	10

THE PILE COORDINATE SYSTEM (LOCAL AXES)

* PILE TOP DISPLACEMENTS *

PILE GROUP	DISP. x, M	DISP. y, M	DISP. z, M	ROT. x, RAD	ROT. y, RAD	ROT. z, RAD
1	2.5435E-03	1.6716E-03	-4.7181E-04	-5.2594E-07	-4.3158E-05	-2.0565E-04
2	1.6181E-03	1.6716E-03	-4.6944E-04	-5.2594E-07	-4.3158E-05	-2.0565E-04
3	6.9268E-04	1.6716E-03	-4.6707E-04	-5.2594E-07	-4.3158E-05	-2.0565E-04
4	2.7378E-03	1.6692E-03	-4.7181E-04	-5.2594E-07	-4.3158E-05	-2.0565E-04
5	1.8123E-03	1.6692E-03	-4.6944E-04	-5.2594E-07	-4.3158E-05	-2.0565E-04
6	8.8689E-04	1.6692E-03	-4.6707E-04	-5.2594E-07	-4.3158E-05	-2.0565E-04
7	2.9320E-03	1.6669E-03	-4.7181E-04	-5.2594E-07	-4.3158E-05	-2.0565E-04
8	2.0065E-03	1.6669E-03	-4.6944E-04	-5.2594E-07	-4.3158E-05	-2.0565E-04
9	1.0811E-03	1.6669E-03	-4.6707E-04	-5.2594E-07	-4.3158E-05	-2.0565E-04
10	3.1262E-03	1.6645E-03	-4.7181E-04	-5.2594E-07	-4.3158E-05	-2.0565E-04
11	2.2007E-03	1.6645E-03	-4.6944E-04	-5.2594E-07	-4.3158E-05	-2.0565E-04
12	1.2753E-03	1.6645E-03	-4.6707E-04	-5.2594E-07	-4.3158E-05	-2.0565E-04
MINIMUM	6.9268E-04	1.6645E-03	-4.7181E-04	-5.2594E-07	-4.3158E-05	-2.0565E-04
Pile N.	3	10	1	1	1	1
MAXIMUM	3.1262E-03	1.6716E-03	-4.6707E-04	-5.2594E-07	-4.3158E-05	-2.0565E-04
Pile N.	10	1	3	1	1	1

* PILE TOP REACTIONS *

PILE GROUP	AXIAL, KN	LAT. y, KN	LAT. z, KN	MOM x, KN- M	MOM y, KN- M	MOM z, KN- M
1	5348.7	354.23	-114.00	-0.1805	263.94	714.71
2	3455.1	278.49	-90.315	-0.1805	219.81	578.50
3	1537.4	282.23	-90.800	-0.1805	219.70	584.42
4	5746.1	337.87	-109.26	-0.1805	255.64	685.66
5	3852.5	252.77	-82.677	-0.1805	205.20	529.53
6	1958.9	255.24	-82.827	-0.1805	204.50	533.22
7	6143.4	337.51	-109.38	-0.1805	255.91	684.37
8	4249.9	252.87	-82.887	-0.1805	205.66	529.17
9	2356.3	255.47	-83.078	-0.1805	205.05	533.11
10	6540.8	356.11	-115.29	-0.1805	266.34	715.83
11	4647.2	283.78	-92.517	-0.1805	224.12	586.55
12	2753.7	287.43	-92.964	-0.1805	223.92	592.24
MINIMUM	1537.4	252.77	-115.29	-0.1805	204.50	529.17
Pile N.	3	5	10	1	6	8
MAXIMUM	6540.8	356.11	-82.677	-0.1805	266.34	715.83
Pile N.	10	10	5	1	10	10

PILE GROUP	STRESS, KN/ M**2
1	5326.2
2	3822.9
3	2754.3
4	5460.1
5	3894.0
6	2832.1
7	5681.6
8	4118.4
9	3057.3
10	6006.5
11	4524.9
12	3469.2
MINIMUM	2754.3
Pile N.	3
MAXIMUM	6006.5
Pile N.	10

* EFFECTS FOR LATERALLY LOADED PILE *

* MINIMUM VALUES AND LOCATIONS *

PILE	DISPL. y-DIR	DISPL. z-DIR	MOMENT z-DIR	MOMENT y-DIR	SHEAR y-DIR	SHEAR z-DIR	SOIL REACT y-DIR	SOIL REACT z-DIR	TOTAL STRESS	FLEX. RIG. z-DIR	FLEX. RIG. y-DIR
------	--------------	--------------	--------------	--------------	-------------	-------------	------------------	------------------	--------------	------------------	------------------

APPALTATORE:

Consorzio

Soci



ITINERARIO NAPOLI – BARI

PROGETTAZIONE:

Mandatario

Mandanti



RADDOPPIO TRATTA APICE – ORSARA
I LOTTO FUNZIONALE APICE – HIRPINIA

PROGETTO ESECUTIVO

RELAZIONE DI CALCOLO FONDAZIONI PILE DA P7 A P16

COMMESSA IF1N	LOTTO 01 E ZZ	CODIFICA RG	DOCUMENTO MD0000 001	REV. B	FOGLIO 120 di 144
------------------	------------------	----------------	-------------------------	-----------	-------------------------

	M	M	KN- M	KN- M	KN	KN	KN/ M	KN/ M	KN/ M**2	KN- M**2	KN- M**2
*****	*****	*****	*****	*****	*****	*****	*****	*****	*****	*****	*****
1	-3.4437E-05	-4.7181E-04	-714.71	-142.01	-121.03	-114.03	-32.217	-44.984	3026.7	7.8279E+06	7.8279E+06
x(M)	9.5700	0.0000	0.0000	5.6100	7.9200	0.0000	9.9000	4.9500	33.000	0.0000	0.0000
2	-3.5744E-05	-4.6944E-04	-578.50	-124.34	-98.457	-90.331	-24.142	-34.802	1955.2	7.8279E+06	7.8279E+06
x(M)	10.230	0.0000	0.0000	5.9400	8.2500	0.0000	10.560	4.9500	33.000	0.0000	0.0000
3	-3.5617E-05	-4.6707E-04	-584.42	-124.41	-99.322	-90.807	-24.457	-35.030	870.00	7.8279E+06	7.8279E+06
x(M)	10.230	0.0000	0.0000	5.9400	8.2500	0.0000	10.560	4.9500	33.000	0.0000	0.0000
4	-3.4577E-05	-4.7181E-04	-685.66	-138.63	-116.51	-109.29	-30.475	-43.006	3251.6	7.8279E+06	7.8279E+06
x(M)	9.9000	0.0000	0.0000	5.6100	7.9200	0.0000	10.230	4.9500	33.000	0.0000	0.0000
5	-3.6159E-05	-4.6944E-04	-529.53	-118.11	-90.507	-82.694	-21.557	-31.427	2180.1	7.8279E+06	7.8279E+06
x(M)	10.560	0.0000	0.0000	5.9400	8.5800	0.0000	10.890	4.9500	33.000	0.0000	0.0000
6	-3.6032E-05	-4.6707E-04	-533.22	-117.97	-90.966	-82.836	-21.729	-31.512	1108.5	7.8279E+06	7.8279E+06
x(M)	10.560	0.0000	0.0000	5.9400	8.5800	0.0000	10.890	4.9500	33.000	0.0000	0.0000
7	-3.4521E-05	-4.7181E-04	-684.37	-138.75	-116.50	-109.42	-30.481	-43.064	3476.5	7.8279E+06	7.8279E+06
x(M)	9.9000	0.0000	0.0000	5.6100	7.9200	0.0000	10.230	4.9500	33.000	0.0000	0.0000
8	-3.6098E-05	-4.6944E-04	-529.17	-118.32	-90.611	-82.905	-21.607	-31.529	2404.9	7.8279E+06	7.8279E+06
x(M)	10.560	0.0000	0.0000	5.9400	8.5800	0.0000	10.890	4.9500	33.000	0.0000	0.0000
9	-3.5965E-05	-4.6707E-04	-533.11	-118.21	-91.107	-83.088	-21.791	-31.631	1333.4	7.8279E+06	7.8279E+06
x(M)	10.560	0.0000	0.0000	5.9400	8.5800	0.0000	10.890	4.9500	33.000	0.0000	0.0000
10	-3.4275E-05	-4.7181E-04	-715.83	-142.99	-121.75	-115.32	-32.597	-45.535	3701.3	7.8279E+06	7.8279E+06
x(M)	9.5700	0.0000	0.0000	5.6100	7.9200	0.0000	9.9000	4.9500	33.000	0.0000	0.0000
11	-3.5472E-05	-4.6944E-04	-586.55	-126.13	-100.34	-92.539	-24.835	-35.797	2629.8	7.8279E+06	7.8279E+06
x(M)	10.230	0.0000	0.0000	5.9400	8.2500	0.0000	10.560	4.9500	33.000	0.0000	0.0000
12	-3.5330E-05	-4.6707E-04	-592.24	-126.15	-101.15	-92.977	-25.130	-36.006	1558.3	7.8279E+06	7.8279E+06
x(M)	10.230	0.0000	0.0000	5.9400	8.2500	0.0000	10.560	4.9500	33.000	0.0000	0.0000
Min.	-3.6159E-05	-4.7181E-04	-715.83	-142.99	-121.75	-115.32	-32.597	-45.535	870.00	7.8279E+06	7.8279E+06
Pile N.	5	1	10	10	10	10	10	10	3	1	1

* MAXIMUM VALUES AND LOCATIONS *

PILE	DISPL. y-DIR	DISPL. z-DIR	MOMENT z-DIR	MOMENT y-DIR	SHEAR y-DIR	SHEAR z-DIR	SOIL REACT y-DIR	SOIL REACT z-DIR	TOTAL STRESS	FLEX. RIG. z-DIR	FLEX. RIG. y-DIR
	M	M	KN- M	KN- M	KN	KN	KN/ M	KN/ M	KN/ M**2	KN- M**2	KN- M**2
*****	*****	*****	*****	*****	*****	*****	*****	*****	*****	*****	*****
1	1.6716E-03	9.8743E-06	491.65	263.94	354.32	35.161	142.91	9.3836	5326.2	7.8279E+06	7.8279E+06
x(M)	0.0000	9.9000	5.6100	0.0000	0.0000	7.9200	4.9500	10.230	0.0000	0.0000	0.0000
2	1.6716E-03	1.0129E-05	434.10	219.81	278.53	28.297	111.06	6.9740	3822.9	7.8279E+06	7.8279E+06
x(M)	0.0000	10.560	5.6100	0.0000	0.0000	8.5800	4.9500	10.890	0.0000	0.0000	0.0000
3	1.6716E-03	1.0035E-05	436.71	219.70	282.25	28.371	112.55	7.0170	2754.3	7.8279E+06	7.8279E+06
x(M)	0.0000	10.230	5.6100	0.0000	0.0000	8.5800	4.9500	10.890	0.0000	0.0000	0.0000
4	1.6693E-03	9.9632E-06	480.32	255.64	337.95	33.775	136.29	8.9131	5460.1	7.8279E+06	7.8279E+06
x(M)	0.0000	9.9000	5.6100	0.0000	0.0000	7.9200	4.9500	10.230	0.0000	0.0000	0.0000
5	1.6693E-03	1.0267E-05	412.64	205.20	252.82	26.129	99.989	6.2220	3894.0	7.8279E+06	7.8279E+06
x(M)	0.0000	10.560	5.9400	0.0000	0.0000	8.5800	4.9500	10.890	0.0000	0.0000	0.0000
6	1.6693E-03	1.0190E-05	414.15	204.50	255.26	26.135	100.94	6.2438	2832.1	7.8279E+06	7.8279E+06
x(M)	0.0000	10.560	5.9400	0.0000	0.0000	8.5800	4.9500	10.890	0.0000	0.0000	0.0000
7	1.6669E-03	9.9644E-06	479.96	255.91	337.60	33.829	136.19	8.9307	5681.6	7.8279E+06	7.8279E+06
x(M)	0.0000	9.9000	5.6100	0.0000	0.0000	7.9200	4.9500	10.230	0.0000	0.0000	0.0000
8	1.6669E-03	1.0270E-05	412.68	205.66	252.91	26.208	100.10	6.2488	4118.4	7.8279E+06	7.8279E+06
x(M)	0.0000	10.560	5.9400	0.0000	0.0000	8.5800	4.9500	10.890	0.0000	0.0000	0.0000
9	1.6669E-03	1.0192E-05	414.29	205.05	255.49	26.226	101.12	6.2746	3057.3	7.8279E+06	7.8279E+06
x(M)	0.0000	10.560	5.9400	0.0000	0.0000	8.5800	4.9500	10.890	0.0000	0.0000	0.0000
10	1.6645E-03	9.8508E-06	492.43	266.34	356.20	35.577	143.77	9.5204	6006.5	7.8279E+06	7.8279E+06
x(M)	0.0000	9.9000	5.6100	0.0000	0.0000	7.9200	4.9500	10.230	0.0000	0.0000	0.0000
11	1.6645E-03	1.0116E-05	438.52	224.12	283.84	28.984	113.55	7.2004	4524.9	7.8279E+06	7.8279E+06
x(M)	0.0000	10.230	5.6100	0.0000	0.0000	8.2500	4.9500	10.560	0.0000	0.0000	0.0000
12	1.6645E-03	1.0040E-05	440.99	223.92	287.46	29.088	114.99	7.2557	3469.2	7.8279E+06	7.8279E+06
x(M)	0.0000	10.230	5.6100	0.0000	0.0000	8.2500	4.9500	10.560	0.0000	0.0000	0.0000
Max.	1.6716E-03	1.0270E-05	492.43	266.34	356.20	35.577	143.77	9.5204	6006.5	7.8279E+06	7.8279E+06
Pile N.	1	8	10	10	10	10	10	10	10	1	1

LOAD CASE : 12
CASE NAME : Load Case
LOAD TYPE : Special, Sp

REDUCTION FACTORS FOR CLOSELY-SPACED PILE GROUPS, COMBINED Y AND Z DIRECTIONS
ESTIMATED USING MOVEMENT IN THE DIRECTION OF PILE CAP DISPLACEMENTS

GROUP NO	P-FACTOR	Y-FACTOR
1	0.7225	1.0000
2	0.5346	1.0000
3	0.5845	1.0000
4	0.6722	1.0000
5	0.4772	1.0000
6	0.5234	1.0000
7	0.6882	1.0000
8	0.4957	1.0000
9	0.5438	1.0000
10	0.8661	1.0000
11	0.7143	1.0000
12	0.7548	1.0000

APPALTATORE: Consorzio  Soci  	ITINERARIO NAPOLI – BARI RADDOPPIO TRATTA APICE – ORSARA I LOTTO FUNZIONALE APICE – HIRPINIA												
PROGETTAZIONE: Mandataria  Mandanti  													
PROGETTO ESECUTIVO RELAZIONE DI CALCOLO FONDAZIONI PILE DA P7 A P16		<table border="1" style="width: 100%; border-collapse: collapse;"> <tr> <td style="width: 15%;">COMMESSA</td> <td style="width: 15%;">LOTTO</td> <td style="width: 15%;">CODIFICA</td> <td style="width: 15%;">DOCUMENTO</td> <td style="width: 15%;">REV.</td> <td style="width: 15%;">FOGLIO</td> </tr> <tr> <td>IF1N</td> <td>01 E ZZ</td> <td>RG</td> <td>MD0000 001</td> <td>B</td> <td>121 di 144</td> </tr> </table>	COMMESSA	LOTTO	CODIFICA	DOCUMENTO	REV.	FOGLIO	IF1N	01 E ZZ	RG	MD0000 001	B
COMMESSA	LOTTO	CODIFICA	DOCUMENTO	REV.	FOGLIO								
IF1N	01 E ZZ	RG	MD0000 001	B	121 di 144								

* TABLE L * COMPUTATION ON PILE CAP

* EQUIVALENT CONCENTRATED LOAD AT ORIGIN *

VERT. LOAD, KN 52111.0	HOR. LOAD Y, KN 1340.00	HOR. LOAD Z, KN -1683.00
MOMENT X, KN- M -5.00000	MOMENT Y, KN- M -35370.0	MOMENT Z, KN- M -20867.0

* DISPLACEMENT OF GROUPED PILE FOUNDATION AT ORIGIN *

VERTICAL, M 2.05185E-03	HORIZONTAL Y, M 6.13811E-04	HORIZONTAL Z, M -6.90389E-04
ANGLE ROT. X, RAD -4.04048E-07	ANGLE ROT. Y, RAD -6.34109E-05	ANGLE ROT. Z, RAD -7.15946E-05

THE GLOBAL STRUCTURAL COORDINATE SYSTEM

* PILE TOP DISPLACEMENTS *

PILE GROUP	DISP. X, M	DISP. Y, M	DISP. Z, M	ROT. X, RAD	ROT. Y, RAD	ROT. Z, RAD
*****	*****	*****	*****	*****	*****	*****
1	1.9460E-03	6.1654E-04	-6.9221E-04	-4.0405E-07	-6.3411E-05	-7.1595E-05
2	1.6238E-03	6.1654E-04	-6.9039E-04	-4.0405E-07	-6.3411E-05	-7.1595E-05
3	1.3016E-03	6.1654E-04	-6.8857E-04	-4.0405E-07	-6.3411E-05	-7.1595E-05
4	2.2314E-03	6.1472E-04	-6.9221E-04	-4.0405E-07	-6.3411E-05	-7.1595E-05
5	1.9092E-03	6.1472E-04	-6.9039E-04	-4.0405E-07	-6.3411E-05	-7.1595E-05
6	1.5870E-03	6.1472E-04	-6.8857E-04	-4.0405E-07	-6.3411E-05	-7.1595E-05
7	2.5167E-03	6.1290E-04	-6.9221E-04	-4.0405E-07	-6.3411E-05	-7.1595E-05
8	2.1945E-03	6.1290E-04	-6.9039E-04	-4.0405E-07	-6.3411E-05	-7.1595E-05
9	1.8723E-03	6.1290E-04	-6.8857E-04	-4.0405E-07	-6.3411E-05	-7.1595E-05
10	2.8020E-03	6.1108E-04	-6.9221E-04	-4.0405E-07	-6.3411E-05	-7.1595E-05
11	2.4799E-03	6.1108E-04	-6.9039E-04	-4.0405E-07	-6.3411E-05	-7.1595E-05
12	2.1577E-03	6.1108E-04	-6.8857E-04	-4.0405E-07	-6.3411E-05	-7.1595E-05
MINIMUM	1.3016E-03	6.1108E-04	-6.9221E-04	-4.0405E-07	-6.3411E-05	-7.1595E-05
Pile N.	3	10	1	1	1	1
MAXIMUM	2.8020E-03	6.1654E-04	-6.8857E-04	-4.0405E-07	-6.3411E-05	-7.1595E-05
Pile N.	10	1	3	1	1	1

* PILE TOP REACTIONS *

PILE GROUP	FOR. X, KN	FOR. Y, KN	FOR. Z, KN	MOM X, KN- M	MOM Y, KN- M	MOM Z, KN- M
*****	*****	*****	*****	*****	*****	*****
1	4126.0	122.59	-152.82	-0.1387	360.81	259.75
2	3466.8	102.09	-127.92	-0.1387	313.83	222.09
3	2807.6	107.86	-134.28	-0.1387	325.19	232.75
4	4709.9	116.75	-146.50	-0.1387	349.45	248.75
5	4050.7	94.763	-119.72	-0.1387	298.07	207.65
6	3391.4	100.33	-125.91	-0.1387	309.38	218.16
7	5293.7	117.84	-148.46	-0.1387	353.14	250.21
8	4634.5	96.494	-122.34	-0.1387	303.30	210.53
9	3975.3	102.17	-128.67	-0.1387	314.79	221.16
10	5877.6	134.93	-169.63	-0.1387	390.94	279.64
11	5218.4	120.01	-151.16	-0.1387	357.41	253.43
12	4559.2	124.18	-155.59	-0.1387	364.60	260.69
MINIMUM	2807.6	94.763	-169.63	-0.1387	298.07	207.65
Pile N.	3	5	10	1	5	5
MAXIMUM	5877.6	134.93	-119.72	-0.1387	390.94	279.64
Pile N.	10	10	5	1	10	10

THE PILE COORDINATE SYSTEM (LOCAL AXES)

* PILE TOP DISPLACEMENTS *

PILE GROUP	DISP. x, M	DISP. y, M	DISP. z, M	ROT. x, RAD	ROT. y, RAD	ROT. z, RAD
*****	*****	*****	*****	*****	*****	*****
1	1.9460E-03	6.1654E-04	-6.9221E-04	-4.0405E-07	-6.3411E-05	-7.1595E-05
2	1.6238E-03	6.1654E-04	-6.9039E-04	-4.0405E-07	-6.3411E-05	-7.1595E-05
3	1.3016E-03	6.1654E-04	-6.8857E-04	-4.0405E-07	-6.3411E-05	-7.1595E-05
4	2.2314E-03	6.1472E-04	-6.9221E-04	-4.0405E-07	-6.3411E-05	-7.1595E-05
5	1.9092E-03	6.1472E-04	-6.9039E-04	-4.0405E-07	-6.3411E-05	-7.1595E-05
6	1.5870E-03	6.1472E-04	-6.8857E-04	-4.0405E-07	-6.3411E-05	-7.1595E-05
7	2.5167E-03	6.1290E-04	-6.9221E-04	-4.0405E-07	-6.3411E-05	-7.1595E-05
8	2.1945E-03	6.1290E-04	-6.9039E-04	-4.0405E-07	-6.3411E-05	-7.1595E-05

APPALTATORE: Consorzio Soci   		ITINERARIO NAPOLI – BARI RADDOPPIO TRATTA APICE – ORSARA I LOTTO FUNZIONALE APICE – HIRPINIA			
PROGETTAZIONE: Mandataria Mandanti   					
PROGETTO ESECUTIVO RELAZIONE DI CALCOLO FONDAZIONI PILE DA P7 A P16					
COMMESSA	LOTTO	CODIFICA	DOCUMENTO	REV.	FOGLIO
IF1N	01 E ZZ	RG	MD0000 001	B	122 di 144

9	1.8723E-03	6.1290E-04	-6.8857E-04	-4.0405E-07	-6.3411E-05	-7.1595E-05
10	2.8020E-03	6.1108E-04	-6.9221E-04	-4.0405E-07	-6.3411E-05	-7.1595E-05
11	2.4799E-03	6.1108E-04	-6.9039E-04	-4.0405E-07	-6.3411E-05	-7.1595E-05
12	2.1577E-03	6.1108E-04	-6.8857E-04	-4.0405E-07	-6.3411E-05	-7.1595E-05
MINIMUM	1.3016E-03	6.1108E-04	-6.9221E-04	-4.0405E-07	-6.3411E-05	-7.1595E-05
Pile N.	3	10	1	1	1	1
MAXIMUM	2.8020E-03	6.1654E-04	-6.8857E-04	-4.0405E-07	-6.3411E-05	-7.1595E-05
Pile N.	10	1	3	1	1	1

* PILE TOP REACTIONS *

PILE GROUP	AXIAL, KN	LAT. y, KN	LAT. z, KN	MOM x, KN- M	MOM y, KN- M	MOM z, KN- M
1	4126.0	122.59	-152.82	-0.1387	360.81	259.75
2	3466.8	102.09	-127.92	-0.1387	313.83	222.09
3	2807.6	107.86	-134.28	-0.1387	325.19	232.75
4	4709.9	116.75	-146.50	-0.1387	349.45	248.75
5	4050.7	94.763	-119.72	-0.1387	298.07	207.65
6	3391.4	100.33	-125.91	-0.1387	309.38	218.16
7	5293.7	117.84	-148.46	-0.1387	353.14	250.21
8	4634.5	96.494	-122.34	-0.1387	303.30	210.53
9	3975.3	102.17	-128.67	-0.1387	314.79	221.16
10	5877.6	134.93	-169.63	-0.1387	390.94	279.64
11	5218.4	120.01	-151.16	-0.1387	357.41	253.43
12	4559.2	124.18	-155.59	-0.1387	364.60	260.69
MINIMUM	2807.6	94.763	-169.63	-0.1387	298.07	207.65
Pile N.	3	5	10	1	5	5
MAXIMUM	5877.6	134.93	-119.72	-0.1387	390.94	279.64
Pile N.	10	10	5	1	10	10

PILE GROUP	STRESS, KN/ M**2
1	3676.6
2	3122.1
3	2795.7
4	3959.8
5	3388.6
6	3061.7
7	4301.8
8	3736.9
9	3410.6
10	4776.7
11	4275.3
12	3932.7
MINIMUM	2795.7
Pile N.	3
MAXIMUM	4776.7
Pile N.	10

* EFFECTS FOR Laterally LOADED PILE *

* MINIMUM VALUES AND LOCATIONS *

PILE	DISPL. y-DIR	DISPL. z-DIR	MOMENT z-DIR	MOMENT y-DIR	SHEAR y-DIR	SHEAR z-DIR	SOIL REACT y-DIR	SOIL REACT z-DIR	TOTAL STRESS	FLEX. RIG. z-DIR	FLEX. RIG. y-DIR
*****	*****	*****	*****	*****	*****	*****	*****	*****	*****	*****	*****
	M	M	KN- M	KN- M	KN	KN	KN/ M	KN/ M	KN/ M**2	KN- M**2	KN- M**2
1	-1.2943E-05	-6.9221E-04	-259.75	-197.29	-41.203	-152.85	-10.632	-59.656	2334.8	7.8279E+06	7.8279E+06
x(M)	9.9000	0.0000	0.0000	5.6100	7.9200	0.0000	10.230	4.9500	33.000	0.0000	0.0000
2	-1.3239E-05	-6.9039E-04	-222.09	-178.65	-35.083	-127.94	-8.4921	-48.831	1961.8	7.8279E+06	7.8279E+06
x(M)	10.560	0.0000	0.0000	5.9400	8.2500	0.0000	10.890	4.9500	33.000	0.0000	0.0000
3	-1.3180E-05	-6.8857E-04	-232.75	-183.50	-36.853	-134.30	-9.0814	-51.659	1588.8	7.8279E+06	7.8279E+06
x(M)	10.230	0.0000	0.0000	5.9400	8.2500	0.0000	10.560	4.9500	33.000	0.0000	0.0000
4	-1.2958E-05	-6.9221E-04	-248.75	-193.02	-39.541	-146.54	-10.020	-56.962	2665.2	7.8279E+06	7.8279E+06
x(M)	9.9000	0.0000	0.0000	5.9400	8.2500	0.0000	10.230	4.9500	33.000	0.0000	0.0000
5	-1.3387E-05	-6.9039E-04	-207.65	-171.79	-32.976	-119.75	-7.7920	-45.201	2292.2	7.8279E+06	7.8279E+06
x(M)	10.560	0.0000	0.0000	5.9400	8.5800	0.0000	10.890	4.9500	33.000	0.0000	0.0000
6	-1.3240E-05	-6.8857E-04	-218.16	-176.87	-34.550	-125.93	-8.3397	-47.977	1919.2	7.8279E+06	7.8279E+06
x(M)	10.560	0.0000	0.0000	5.9400	8.2500	0.0000	10.890	4.9500	33.000	0.0000	0.0000
7	-1.2916E-05	-6.9221E-04	-250.21	-194.44	-39.880	-148.50	-10.182	-57.820	2995.6	7.8279E+06	7.8279E+06
x(M)	9.9000	0.0000	0.0000	5.9400	8.2500	0.0000	10.230	4.9500	33.000	0.0000	0.0000
8	-1.3308E-05	-6.9039E-04	-210.53	-174.12	-33.535	-122.37	-7.9986	-46.387	2622.6	7.8279E+06	7.8279E+06
x(M)	10.560	0.0000	0.0000	5.9400	8.5800	0.0000	10.890	4.9500	33.000	0.0000	0.0000
9	-1.3160E-05	-6.8857E-04	-221.16	-179.20	-35.218	-128.70	-8.5383	-49.218	2249.6	7.8279E+06	7.8279E+06
x(M)	10.230	0.0000	0.0000	5.9400	8.2500	0.0000	10.890	4.9500	33.000	0.0000	0.0000
10	-1.2603E-05	-6.9221E-04	-279.64	-209.76	-44.958	-169.67	-12.028	-66.746	3326.0	7.8279E+06	7.8279E+06
x(M)	9.5700	0.0000	0.0000	5.6100	7.9200	0.0000	9.9000	4.9500	33.000	0.0000	0.0000
11	-1.2848E-05	-6.9039E-04	-253.43	-196.09	-40.584	-151.20	-10.446	-59.010	2953.0	7.8279E+06	7.8279E+06
x(M)	9.9000	0.0000	0.0000	5.9400	7.9200	0.0000	10.230	4.9500	33.000	0.0000	0.0000
12	-1.2772E-05	-6.8857E-04	-260.69	-199.20	-41.822	-155.63	-10.877	-60.904	2580.0	7.8279E+06	7.8279E+06
x(M)	9.9000	0.0000	0.0000	5.6100	7.9200	0.0000	10.230	4.9500	33.000	0.0000	0.0000
Min.	-1.3387E-05	-6.9221E-04	-279.64	-209.76	-44.958	-169.67	-12.028	-66.746	1588.8	7.8279E+06	7.8279E+06
Pile N.	5	1	10	10	10	10	10	10	3	1	1

APPALTATORE: Consorzio Soci   		ITINERARIO NAPOLI – BARI RADDOPPIO TRATTA APICE – ORSARA I LOTTO FUNZIONALE APICE – HIRPINIA			
PROGETTAZIONE: Mandataria Mandanti   					
PROGETTO ESECUTIVO RELAZIONE DI CALCOLO FONDAZIONI PILE DA P7 A P16					
COMMESSA	LOTTO	CODIFICA	DOCUMENTO	REV.	FOGLIO
IF1N	01 E ZZ	RG	MD0000 001	B	123 di 144

* MAXIMUM VALUES AND LOCATIONS *

PILE	DISPL.	DISPL.	MOMENT	MOMENT	SHEAR	SHEAR	SOIL REACT	SOIL REACT	TOTAL	FLEX. RIG.	FLEX. RIG.
	y-DIR	z-DIR	z-DIR	y-DIR	y-DIR	z-DIR	y-DIR	z-DIR	STRESS	z-DIR	y-DIR
	M	M	KN- M	KN- M	KN	KN	KN/ M	KN/ M	KN/ M**2	KN- M**2	KN- M**2
*****	*****	*****	*****	*****	*****	*****	*****	*****	*****	*****	*****
1	6.1654E-04	1.4657E-05	173.31	360.81	122.61	47.312	48.838	12.195	3676.6	7.8279E+06	7.8279E+06
x (M)	0.0000	9.9000	5.6100	0.0000	0.0000	8.2500	4.9500	10.230	0.0000	0.0000	0.0000
2	6.1654E-04	1.5028E-05	157.01	313.83	102.11	40.150	40.061	9.7510	3122.1	7.8279E+06	7.8279E+06
x (M)	0.0000	10.560	5.9400	0.0000	0.0000	8.5800	4.9500	10.890	0.0000	0.0000	0.0000
3	6.1654E-04	1.4816E-05	161.49	325.19	107.87	41.876	42.546	10.358	2795.7	7.8279E+06	7.8279E+06
x (M)	0.0000	10.230	5.6100	0.0000	0.0000	8.5800	4.9500	10.890	0.0000	0.0000	0.0000
4	6.1472E-04	1.4798E-05	168.78	349.45	116.77	45.593	46.422	11.602	3959.8	7.8279E+06	7.8279E+06
x (M)	0.0000	10.230	5.6100	0.0000	0.0000	8.2500	4.9500	10.560	0.0000	0.0000	0.0000
5	6.1472E-04	1.5108E-05	151.00	298.07	94.781	37.750	36.906	8.9441	3388.6	7.8279E+06	7.8279E+06
x (M)	0.0000	10.560	5.9400	0.0000	0.0000	8.5800	4.9500	11.220	0.0000	0.0000	0.0000
6	6.1472E-04	1.5011E-05	155.49	309.38	100.34	39.589	39.327	9.5681	3061.7	7.8279E+06	7.8279E+06
x (M)	0.0000	10.560	5.9400	0.0000	0.0000	8.5800	4.9500	10.890	0.0000	0.0000	0.0000
7	6.1290E-04	1.4759E-05	169.57	353.14	117.87	46.180	46.928	11.801	4301.8	7.8279E+06	7.8279E+06
x (M)	0.0000	10.230	5.6100	0.0000	0.0000	8.2500	4.9500	10.560	0.0000	0.0000	0.0000
8	6.1290E-04	1.5113E-05	152.40	303.30	96.515	38.583	37.720	9.2022	3736.9	7.8279E+06	7.8279E+06
x (M)	0.0000	10.560	5.9400	0.0000	0.0000	8.5800	4.9500	10.890	0.0000	0.0000	0.0000
9	6.1290E-04	1.4967E-05	156.86	314.79	102.19	40.409	40.181	9.8509	3410.6	7.8279E+06	7.8279E+06
x (M)	0.0000	10.560	5.9400	0.0000	0.0000	8.5800	4.9500	10.890	0.0000	0.0000	0.0000
10	6.1108E-04	1.4445E-05	181.66	390.94	134.96	52.170	53.992	13.959	4776.7	7.8279E+06	7.8279E+06
x (M)	0.0000	9.9000	5.6100	0.0000	0.0000	7.9200	4.9500	10.230	0.0000	0.0000	0.0000
11	6.1108E-04	1.4632E-05	171.08	357.41	120.04	46.939	47.863	12.067	4275.3	7.8279E+06	7.8279E+06
x (M)	0.0000	9.9000	5.6100	0.0000	0.0000	8.2500	4.9500	10.560	0.0000	0.0000	0.0000
12	6.1108E-04	1.4566E-05	174.09	364.60	124.20	48.085	49.581	12.559	3932.7	7.8279E+06	7.8279E+06
x (M)	0.0000	9.9000	5.6100	0.0000	0.0000	8.2500	4.9500	10.230	0.0000	0.0000	0.0000
Max.	6.1654E-04	1.5113E-05	181.66	390.94	134.96	52.170	53.992	13.959	4776.7	7.8279E+06	7.8279E+06
Pile N.	1	8	10	10	10	10	10	10	10	1	1

LOAD CASE : 13
CASE NAME : Load Case
LOAD TYPE : Special, Sp

REDUCTION FACTORS FOR CLOSELY-SPACED PILE GROUPS, COMBINED Y AND Z DIRECTIONS
ESTIMATED USING MOVEMENT IN THE DIRECTION OF PILE CAP DISPLACEMENTS

GROUP NO	P-FACTOR	Y-FACTOR
1	0.7591	1.0000
2	0.5455	1.0000
3	0.5845	1.0000
4	0.7062	1.0000
5	0.4815	1.0000
6	0.5169	1.0000
7	0.7178	1.0000
8	0.4955	1.0000
9	0.5327	1.0000
10	0.8661	1.0000
11	0.6845	1.0000
12	0.7179	1.0000

* TABLE L * COMPUTATION ON PILE CAP

* EQUIVALENT CONCENTRATED LOAD AT ORIGIN *

VERT. LOAD, KN	HOR. LOAD Y, KN	HOR. LOAD Z, KN
52111.0	1750.00	-1683.00
MOMENT X, KN- M	MOMENT Y, KN- M	MOMENT Z, KN- M
-5.00000	-35370.0	-27349.0

* DISPLACEMENT OF GROUPED PILE FOUNDATION AT ORIGIN *

VERTICAL, M	HORIZONTAL Y, M	HORIZONTAL Z, M
2.05185E-03	8.01227E-04	-6.89519E-04
ANGLE ROT. X, RAD	ANGLE ROT. Y, RAD	ANGLE ROT. Z, RAD
1.99104E-07	-6.34059E-05	-9.37668E-05

THE GLOBAL STRUCTURAL COORDINATE SYSTEM

* PILE TOP DISPLACEMENTS *

APPALTATORE:

Consorzio

Soci



ITINERARIO NAPOLI – BARI

PROGETTAZIONE:

Mandatario

Mandanti



**RADDOPPIO TRATTA APICE – ORSARA
I LOTTO FUNZIONALE APICE – HIRPINIA**

PROGETTO ESECUTIVO

RELAZIONE DI CALCOLO FONDAZIONI PILE DA P7 A P16

COMMESSA IF1N	LOTTO 01 E ZZ	CODIFICA RG	DOCUMENTO MD0000 001	REV. B	FOGLIO 124 di 144
------------------	------------------	----------------	-------------------------	-----------	-------------------------

PILE GROUP *****	DISP. X, M *****	DISP. Y, M *****	DISP. Z, M *****	ROT. X,RAD *****	ROT. Y,RAD *****	ROT. Z,RAD *****
1	2.0458E-03	7.9988E-04	-6.8862E-04	1.9910E-07	-6.3406E-05	-9.3767E-05
2	1.6239E-03	7.9988E-04	-6.8952E-04	1.9910E-07	-6.3406E-05	-9.3767E-05
3	1.2019E-03	7.9988E-04	-6.9041E-04	1.9910E-07	-6.3406E-05	-9.3767E-05
4	2.3311E-03	8.0078E-04	-6.8862E-04	1.9910E-07	-6.3406E-05	-9.3767E-05
5	1.9092E-03	8.0078E-04	-6.8952E-04	1.9910E-07	-6.3406E-05	-9.3767E-05
6	1.4872E-03	8.0078E-04	-6.9041E-04	1.9910E-07	-6.3406E-05	-9.3767E-05
7	2.6165E-03	8.0167E-04	-6.8862E-04	1.9910E-07	-6.3406E-05	-9.3767E-05
8	2.1945E-03	8.0167E-04	-6.8952E-04	1.9910E-07	-6.3406E-05	-9.3767E-05
9	1.7726E-03	8.0167E-04	-6.9041E-04	1.9910E-07	-6.3406E-05	-9.3767E-05
10	2.9018E-03	8.0257E-04	-6.8862E-04	1.9910E-07	-6.3406E-05	-9.3767E-05
11	2.4798E-03	8.0257E-04	-6.8952E-04	1.9910E-07	-6.3406E-05	-9.3767E-05
12	2.0579E-03	8.0257E-04	-6.9041E-04	1.9910E-07	-6.3406E-05	-9.3767E-05
MINIMUM Pile N.	1.2019E-03 3	7.9988E-04 1	-6.9041E-04 3	1.9910E-07 1	-6.3406E-05 1	-9.3767E-05 1
MAXIMUM Pile N.	2.9018E-03 10	8.0257E-04 10	-6.8862E-04 1	1.9910E-07 1	-6.3406E-05 1	-9.3767E-05 1

* PILE TOP REACTIONS *

PILE GROUP *****	FOR. X, KN *****	FOR. Y, KN *****	FOR. Z, KN *****	MOM X, KN- M *****	MOM Y, KN- M *****	MOM Z, KN- M *****
1	4330.2	163.02	-156.09	0.068341	365.52	341.93
2	3466.9	133.33	-129.16	0.068341	315.97	287.74
3	2603.5	139.17	-134.76	0.068341	326.69	298.42
4	4914.0	156.19	-149.61	0.068341	353.98	330.28
5	4050.7	123.69	-120.10	0.068341	298.59	269.85
6	3187.3	129.27	-125.45	0.068341	309.07	280.29
7	5497.9	157.96	-150.98	0.068341	356.57	333.90
8	4634.5	126.05	-122.07	0.068341	302.54	274.81
9	3771.1	131.84	-127.60	0.068341	313.32	285.59
10	6081.7	177.36	-168.36	0.068341	387.49	368.29
11	5218.3	153.75	-147.17	0.068341	349.90	326.60
12	4354.9	158.37	-151.65	0.068341	358.17	334.67
MINIMUM Pile N.	2603.5 3	123.69 5	-168.36 10	0.068341 1	298.59 5	269.85 5
MAXIMUM Pile N.	6081.7 10	177.36 10	-120.10 5	0.068341 1	387.49 10	368.29 10

THE PILE COORDINATE SYSTEM (LOCAL AXES)

* PILE TOP DISPLACEMENTS *

PILE GROUP *****	DISP. x, M *****	DISP. y, M *****	DISP. z, M *****	ROT. x,RAD *****	ROT. y,RAD *****	ROT. z,RAD *****
1	2.0458E-03	7.9988E-04	-6.8862E-04	1.9910E-07	-6.3406E-05	-9.3767E-05
2	1.6239E-03	7.9988E-04	-6.8952E-04	1.9910E-07	-6.3406E-05	-9.3767E-05
3	1.2019E-03	7.9988E-04	-6.9041E-04	1.9910E-07	-6.3406E-05	-9.3767E-05
4	2.3311E-03	8.0078E-04	-6.8862E-04	1.9910E-07	-6.3406E-05	-9.3767E-05
5	1.9092E-03	8.0078E-04	-6.8952E-04	1.9910E-07	-6.3406E-05	-9.3767E-05
6	1.4872E-03	8.0078E-04	-6.9041E-04	1.9910E-07	-6.3406E-05	-9.3767E-05
7	2.6165E-03	8.0167E-04	-6.8862E-04	1.9910E-07	-6.3406E-05	-9.3767E-05
8	2.1945E-03	8.0167E-04	-6.8952E-04	1.9910E-07	-6.3406E-05	-9.3767E-05
9	1.7726E-03	8.0167E-04	-6.9041E-04	1.9910E-07	-6.3406E-05	-9.3767E-05
10	2.9018E-03	8.0257E-04	-6.8862E-04	1.9910E-07	-6.3406E-05	-9.3767E-05
11	2.4798E-03	8.0257E-04	-6.8952E-04	1.9910E-07	-6.3406E-05	-9.3767E-05
12	2.0579E-03	8.0257E-04	-6.9041E-04	1.9910E-07	-6.3406E-05	-9.3767E-05
MINIMUM Pile N.	1.2019E-03 3	7.9988E-04 1	-6.9041E-04 3	1.9910E-07 1	-6.3406E-05 1	-9.3767E-05 1
MAXIMUM Pile N.	2.9018E-03 10	8.0257E-04 10	-6.8862E-04 1	1.9910E-07 1	-6.3406E-05 1	-9.3767E-05 1

* PILE TOP REACTIONS *

PILE GROUP *****	AXIAL, KN *****	LAT. y, KN *****	LAT. z, KN *****	MOM x, KN- M *****	MOM y, KN- M *****	MOM z, KN- M *****
1	4330.2	163.02	-156.09	0.068341	365.52	341.93
2	3466.9	133.33	-129.16	0.068341	315.97	287.74
3	2603.5	139.17	-134.76	0.068341	326.69	298.42
4	4914.0	156.19	-149.61	0.068341	353.98	330.28
5	4050.7	123.69	-120.10	0.068341	298.59	269.85
6	3187.3	129.27	-125.45	0.068341	309.07	280.29
7	5497.9	157.96	-150.98	0.068341	356.57	333.90
8	4634.5	126.05	-122.07	0.068341	302.54	274.81
9	3771.1	131.84	-127.60	0.068341	313.32	285.59
10	6081.7	177.36	-168.36	0.068341	387.49	368.29
11	5218.3	153.75	-147.17	0.068341	349.90	326.60
12	4354.9	158.37	-151.65	0.068341	358.17	334.67
MINIMUM Pile N.	2603.5 3	123.69 5	-168.36 10	0.068341 1	298.59 5	269.85 5
MAXIMUM Pile N.	6081.7 10	177.36 10	-120.10 5	0.068341 1	387.49 10	368.29 10

APPALTATORE:

Consorzio

Soci



ITINERARIO NAPOLI – BARI

PROGETTAZIONE:

Mandataria

Mandanti



RADDOPPIO TRATTA APICE – ORSARA
I LOTTO FUNZIONALE APICE – HIRPINIA

PROGETTO ESECUTIVO

RELAZIONE DI CALCOLO FONDAZIONI PILE DA P7 A P16

COMMESSA IF1N	LOTTO 01 E ZZ	CODIFICA RG	DOCUMENTO MD0000 001	REV. B	FOGLIO 125 di 144
------------------	------------------	----------------	-------------------------	-----------	-------------------------

Pile N. 10 10 5 1 10 10

PILE GROUP STRESS, KN/ M**2

1	3961.0
2	3251.6
3	2808.7
4	4241.9
5	3506.9
6	3062.9
7	4585.5
8	3856.1
9	3413.5
10	5055.0
11	4397.5
12	3943.8

MINIMUM 2808.7
Pile N. 3
MAXIMUM 5055.0
Pile N. 10

* EFFECTS FOR LATERALLY LOADED PILE *

* MINIMUM VALUES AND LOCATIONS *

PILE	DISPL. y-DIR M	DISPL. z-DIR M	MOMENT z-DIR KN- M	MOMENT y-DIR KN- M	SHEAR y-DIR KN	SHEAR z-DIR KN	SOIL REACT y-DIR KN/ M	SOIL REACT z-DIR KN/ M	TOTAL STRESS KN/ M**2	FLEX. RIG. z-DIR KN- M**2	FLEX. RIG. y-DIR KN- M**2
1	-1.6703E-05	-6.8862E-04	-341.93	-199.59	-54.901	-156.12	-14.292	-61.137	2450.4	7.8279E+06	7.8279E+06
x(M)	9.9000	0.0000	0.0000	5.6100	7.9200	0.0000	10.230	4.9500	33.000	0.0000	0.0000
2	-1.7164E-05	-6.8952E-04	-287.74	-179.63	-46.013	-129.19	-11.158	-49.421	1961.8	7.8279E+06	7.8279E+06
x(M)	10.230	0.0000	0.0000	5.9400	8.2500	0.0000	10.890	4.9500	33.000	0.0000	0.0000
3	-1.7090E-05	-6.9041E-04	-298.42	-184.02	-47.767	-134.78	-11.769	-51.846	1473.3	7.8279E+06	7.8279E+06
x(M)	10.230	0.0000	0.0000	5.9400	8.2500	0.0000	10.560	4.9500	33.000	0.0000	0.0000
4	-1.6845E-05	-6.8862E-04	-330.28	-194.86	-52.830	-149.65	-13.567	-58.396	2780.8	7.8279E+06	7.8279E+06
x(M)	9.9000	0.0000	0.0000	5.9400	7.9200	0.0000	10.230	4.9500	33.000	0.0000	0.0000
5	-1.7424E-05	-6.8952E-04	-269.85	-172.11	-43.137	-120.13	-10.216	-45.410	2292.2	7.8279E+06	7.8279E+06
x(M)	10.560	0.0000	0.0000	5.9400	8.5800	0.0000	10.890	4.9500	33.000	0.0000	0.0000
6	-1.7270E-05	-6.9041E-04	-280.29	-176.61	-44.685	-125.47	-10.759	-47.746	1803.6	7.8279E+06	7.8279E+06
x(M)	10.560	0.0000	0.0000	5.9400	8.5800	0.0000	10.890	4.9500	33.000	0.0000	0.0000
7	-1.6854E-05	-6.8862E-04	-333.90	-195.84	-53.405	-151.03	-13.761	-58.999	3111.2	7.8279E+06	7.8279E+06
x(M)	9.9000	0.0000	0.0000	5.9400	7.9200	0.0000	10.230	4.9500	33.000	0.0000	0.0000
8	-1.7406E-05	-6.8952E-04	-274.81	-173.87	-43.852	-122.10	-10.459	-46.305	2622.6	7.8279E+06	7.8279E+06
x(M)	10.560	0.0000	0.0000	5.9400	8.5800	0.0000	10.890	4.9500	33.000	0.0000	0.0000
9	-1.7220E-05	-6.9041E-04	-285.59	-178.45	-45.517	-127.62	-11.008	-48.718	2134.0	7.8279E+06	7.8279E+06
x(M)	10.560	0.0000	0.0000	5.9400	8.2500	0.0000	10.890	4.9500	33.000	0.0000	0.0000
10	-1.6557E-05	-6.8862E-04	-368.29	-208.61	-59.071	-168.41	-15.803	-66.301	3441.5	7.8279E+06	7.8279E+06
x(M)	9.5700	0.0000	0.0000	5.6100	7.9200	0.0000	9.9000	4.9500	33.000	0.0000	0.0000
11	-1.6915E-05	-6.8952E-04	-326.60	-193.30	-52.084	-147.20	-13.276	-57.338	2953.0	7.8279E+06	7.8279E+06
x(M)	9.9000	0.0000	0.0000	5.9400	8.2500	0.0000	10.230	4.9500	33.000	0.0000	0.0000
12	-1.6856E-05	-6.9041E-04	-334.67	-196.36	-53.430	-151.68	-13.768	-59.220	2464.4	7.8279E+06	7.8279E+06
x(M)	9.9000	0.0000	0.0000	5.9400	7.9200	0.0000	10.230	4.9500	33.000	0.0000	0.0000
Min.	-1.7424E-05	-6.9041E-04	-368.29	-208.61	-59.071	-168.41	-15.803	-66.301	1473.3	7.8279E+06	7.8279E+06
Pile N.	5	3	10	10	10	10	10	10	3	1	1

* MAXIMUM VALUES AND LOCATIONS *

PILE	DISPL. y-DIR M	DISPL. z-DIR M	MOMENT z-DIR KN- M	MOMENT y-DIR KN- M	SHEAR y-DIR KN	SHEAR z-DIR KN	SOIL REACT y-DIR KN/ M	SOIL REACT z-DIR KN/ M	TOTAL STRESS KN/ M**2	FLEX. RIG. z-DIR KN- M**2	FLEX. RIG. y-DIR KN- M**2
1	7.9988E-04	1.4560E-05	228.27	365.52	163.05	48.216	65.127	12.614	3961.0	7.8279E+06	7.8279E+06
x(M)	0.0000	9.9000	5.6100	0.0000	0.0000	8.2500	4.9500	10.230	0.0000	0.0000	0.0000
2	7.9988E-04	1.4977E-05	204.83	315.97	133.35	40.521	52.481	9.8848	3251.6	7.8279E+06	7.8279E+06
x(M)	0.0000	10.560	5.9400	0.0000	0.0000	8.5800	4.9500	10.890	0.0000	0.0000	0.0000
3	7.9988E-04	1.4853E-05	209.43	326.69	139.18	41.994	54.983	10.387	2808.7	7.8279E+06	7.8279E+06
x(M)	0.0000	10.230	5.6100	0.0000	0.0000	8.5800	4.9500	10.890	0.0000	0.0000	0.0000
4	8.0078E-04	1.4613E-05	223.36	353.98	156.23	46.526	62.287	11.939	4241.9	7.8279E+06	7.8279E+06
x(M)	0.0000	10.230	5.6100	0.0000	0.0000	8.2500	4.9500	10.560	0.0000	0.0000	0.0000
5	8.0078E-04	1.5089E-05	197.21	298.59	123.71	37.892	48.268	8.9878	3506.9	7.8279E+06	7.8279E+06
x(M)	0.0000	10.560	5.9400	0.0000	0.0000	8.5800	4.9500	11.220	0.0000	0.0000	0.0000
6	8.0078E-04	1.5063E-05	201.66	309.07	129.29	39.432	50.684	9.5022	3062.9	7.8279E+06	7.8279E+06
x(M)	0.0000	10.560	5.9400	0.0000	0.0000	8.5800	4.9500	10.890	0.0000	0.0000	0.0000
7	8.0167E-04	1.4597E-05	224.83	356.57	158.00	46.932	63.033	12.075	4585.5	7.8279E+06	7.8279E+06
x(M)	0.0000	9.9000	5.6100	0.0000	0.0000	8.2500	4.9500	10.230	0.0000	0.0000	0.0000
8	8.0167E-04	1.5093E-05	199.29	302.54	126.08	38.525	49.304	9.1876	3856.1	7.8279E+06	7.8279E+06
x(M)	0.0000	10.560	5.9400	0.0000	0.0000	8.5800	4.9500	10.890	0.0000	0.0000	0.0000
9	8.0167E-04	1.5037E-05	203.83	313.32	131.86	40.086	51.805	9.7279	3413.5	7.8279E+06	7.8279E+06
x(M)	0.0000	10.560	5.9400	0.0000	0.0000	8.5800	4.9500	10.890	0.0000	0.0000	0.0000
10	8.0257E-04	1.4367E-05	238.65	387.49	177.41	51.883	70.996	13.881	5055.0	7.8279E+06	7.8279E+06
x(M)	0.0000	9.9000	5.6100	0.0000	0.0000	7.9200	4.9500	10.230	0.0000	0.0000	0.0000
11	8.0257E-04	1.4708E-05	221.65	349.90	153.78	45.855	61.240	11.706	4397.5	7.8279E+06	7.8279E+06
x(M)	0.0000	10.230	5.6100	0.0000	0.0000	8.2500	4.9500	10.560	0.0000	0.0000	0.0000
12	8.0257E-04	1.4621E-05	225.06	358.17	158.40	47.035	63.158	12.102	3943.8	7.8279E+06	7.8279E+06
x(M)	0.0000	9.9000	5.6100	0.0000	0.0000	8.2500	4.9500	10.560	0.0000	0.0000	0.0000

APPALTATORE: Consorzio Soci   	ITINERARIO NAPOLI – BARI RADDOPPIO TRATTA APICE – ORSARA I LOTTO FUNZIONALE APICE – HIRPINIA				
PROGETTAZIONE: Mandataria Mandanti   					
PROGETTO ESECUTIVO RELAZIONE DI CALCOLO FONDAZIONI PILE DA P7 A P16					
COMMESSA IF1N	LOTTO 01 E ZZ	CODIFICA RG	DOCUMENTO MD0000 001	REV. B	FOGLIO 126 di 144

Max.	8.0257E-04	1.5093E-05	238.65	387.49	177.41	51.883	70.996	13.881	5055.0	7.8279E+06	7.8279E+06
Pile N.	10	8	10	10	10	10	10	10	10	1	1

LOAD CASE : 14
CASE NAME : Load Case
LOAD TYPE : Special, Sp

REDUCTION FACTORS FOR CLOSELY-SPACED PILE GROUPS, COMBINED Y AND Z DIRECTIONS
ESTIMATED USING MOVEMENT IN THE DIRECTION OF PILE CAP DISPLACEMENTS

GROUP NO	P-FACTOR	Y-FACTOR
1	0.5993	1.0000
2	0.5004	1.0000
3	0.5845	1.0000
4	0.5581	1.0000
5	0.4640	1.0000
6	0.5425	1.0000
7	0.5905	1.0000
8	0.4961	1.0000
9	0.5758	1.0000
10	0.8661	1.0000
11	0.7969	1.0000
12	0.8559	1.0000

* TABLE L * COMPUTATION ON PILE CAP

* EQUIVALENT CONCENTRATED LOAD AT ORIGIN *

VERT. LOAD, KN	HOR. LOAD Y, KN	HOR. LOAD Z, KN
35940.0	255.000	-1362.00
MOMENT X, KN- M	MOMENT Y, KN- M	MOMENT Z, KN- M
0.00000	-28082.0	-4026.00

* DISPLACEMENT OF GROUPED PILE FOUNDATION AT ORIGIN *

VERTICAL, M	HORIZONTAL Y, M	HORIZONTAL Z, M
1.39325E-03	1.18422E-04	-5.60687E-04
ANGLE ROT. X, RAD	ANGLE ROT. Y, RAD	ANGLE ROT. Z, RAD
-6.60749E-07	-5.04881E-05	-1.37923E-05

THE GLOBAL STRUCTURAL COORDINATE SYSTEM

* PILE TOP DISPLACEMENTS *

PILE GROUP	DISP. X, M	DISP. Y, M	DISP. Z, M	ROT. X, RAD	ROT. Y, RAD	ROT. Z, RAD
*****	*****	*****	*****	*****	*****	*****
1	1.1145E-03	1.2288E-04	-5.6366E-04	-6.6075E-07	-5.0488E-05	-1.3792E-05
2	1.0524E-03	1.2288E-04	-5.6069E-04	-6.6075E-07	-5.0488E-05	-1.3792E-05
3	9.9039E-04	1.2288E-04	-5.5771E-04	-6.6075E-07	-5.0488E-05	-1.3792E-05
4	1.3417E-03	1.1991E-04	-5.6366E-04	-6.6075E-07	-5.0488E-05	-1.3792E-05
5	1.2797E-03	1.1991E-04	-5.6069E-04	-6.6075E-07	-5.0488E-05	-1.3792E-05
6	1.2176E-03	1.1991E-04	-5.5771E-04	-6.6075E-07	-5.0488E-05	-1.3792E-05
7	1.5689E-03	1.1694E-04	-5.6366E-04	-6.6075E-07	-5.0488E-05	-1.3792E-05
8	1.5068E-03	1.1694E-04	-5.6069E-04	-6.6075E-07	-5.0488E-05	-1.3792E-05
9	1.4448E-03	1.1694E-04	-5.5771E-04	-6.6075E-07	-5.0488E-05	-1.3792E-05
10	1.7961E-03	1.1396E-04	-5.6366E-04	-6.6075E-07	-5.0488E-05	-1.3792E-05
11	1.7340E-03	1.1396E-04	-5.6069E-04	-6.6075E-07	-5.0488E-05	-1.3792E-05
12	1.6720E-03	1.1396E-04	-5.5771E-04	-6.6075E-07	-5.0488E-05	-1.3792E-05
MINIMUM	9.9039E-04	1.1396E-04	-5.6366E-04	-6.6075E-07	-5.0488E-05	-1.3792E-05
Pile N.	3	10	1	1	1	1
MAXIMUM	1.7961E-03	1.2288E-04	-5.5771E-04	-6.6075E-07	-5.0488E-05	-1.3792E-05
Pile N.	10	1	3	1	1	1

* PILE TOP REACTIONS *

PILE GROUP	FOR. X, KN	FOR. Y, KN	FOR. Z, KN	MOM X, KN- M	MOM Y, KN- M	MOM Z, KN- M
*****	*****	*****	*****	*****	*****	*****
1	2424.7	22.250	-112.82	-0.2268	274.90	48.903
2	2297.7	19.955	-100.94	-0.2268	251.28	44.580
3	2170.7	21.923	-109.62	-0.2268	266.91	48.286
4	2889.6	20.516	-108.25	-0.2268	266.35	44.716
5	2762.6	18.336	-96.597	-0.2268	242.86	40.558
6	2635.6	20.169	-104.95	-0.2268	258.14	44.055

APPALTATORE:

Consorzio

Soci



ITINERARIO NAPOLI – BARI

PROGETTAZIONE:

Mandatario

Mandanti



RADDOPPIO TRATTA APICE – ORSARA
I LOTTO FUNZIONALE APICE – HIRPINIA

PROGETTO ESECUTIVO

RELAZIONE DI CALCOLO FONDAZIONI PILE DA P7 A P16

COMMESSA IF1N	LOTTO 01 E ZZ	CODIFICA RG	DOCUMENTO MD0000 001	REV. B	FOGLIO 128 di 144
------------------	------------------	----------------	-------------------------	-----------	-------------------------

	1	-2.6240E-06	-5.6366E-04	-48.903	-151.73	-7.4642	-112.84	-1.8503	-43.347	1372.1	7.8279E+06	7.8279E+06
x(M)		10.230	0.0000	0.0000	5.9400	8.2500	0.0000	10.560	4.9500	33.000	0.0000	0.0000
	2	-2.6635E-06	-5.6069E-04	-44.580	-141.95	-6.7705	-100.95	-1.6182	-38.158	1300.2	7.8279E+06	7.8279E+06
x(M)		10.560	0.0000	0.0000	5.9400	8.5800	0.0000	10.890	4.9500	33.000	0.0000	0.0000
	3	-2.6281E-06	-5.5771E-04	-48.286	-148.79	-7.3621	-109.63	-1.8148	-42.060	1228.4	7.8279E+06	7.8279E+06
x(M)		10.230	0.0000	0.0000	5.9400	8.2500	0.0000	10.560	4.9500	33.000	0.0000	0.0000
	4	-2.5705E-06	-5.6366E-04	-44.716	-148.20	-6.9928	-108.27	-1.7046	-41.346	1635.2	7.8279E+06	7.8279E+06
x(M)		10.230	0.0000	0.0000	5.9400	8.2500	0.0000	10.560	4.9500	33.000	0.0000	0.0000
	5	-2.6129E-06	-5.6069E-04	-40.558	-138.22	-6.3379	-96.611	-1.4865	-36.232	1563.3	7.8279E+06	7.8279E+06
x(M)		10.560	0.0000	0.0000	5.9400	8.5800	0.0000	10.890	4.9500	33.000	0.0000	0.0000
	6	-2.5713E-06	-5.5771E-04	-44.055	-145.14	-6.8801	-104.97	-1.6692	-40.015	1491.4	7.8279E+06	7.8279E+06
x(M)		10.230	0.0000	0.0000	5.9400	8.2500	0.0000	10.890	4.9500	33.000	0.0000	0.0000
	7	-2.4977E-06	-5.6366E-04	-43.561	-151.02	-7.0219	-111.82	-1.7340	-42.920	1898.2	7.8279E+06	7.8279E+06
x(M)		10.230	0.0000	0.0000	5.9400	8.2500	0.0000	10.560	4.9500	33.000	0.0000	0.0000
	8	-2.5343E-06	-5.6069E-04	-39.679	-141.55	-6.3878	-100.39	-1.5237	-37.929	1826.4	7.8279E+06	7.8279E+06
x(M)		10.560	0.0000	0.0000	5.9400	8.5800	0.0000	10.890	4.9500	33.000	0.0000	0.0000
	9	-2.5021E-06	-5.5771E-04	-42.978	-148.08	-6.9254	-108.61	-1.7004	-41.633	1754.5	7.8279E+06	7.8279E+06
x(M)		10.230	0.0000	0.0000	5.9400	8.2500	0.0000	10.560	4.9500	33.000	0.0000	0.0000
	10	-2.3438E-06	-5.6366E-04	-50.311	-171.01	-8.3428	-139.51	-2.2326	-54.728	2161.3	7.8279E+06	7.8279E+06
x(M)		9.5700	0.0000	0.0000	5.6100	7.9200	0.0000	9.9000	4.9500	33.000	0.0000	0.0000
	11	-2.3564E-06	-5.6069E-04	-48.177	-165.41	-7.9992	-132.01	-2.0967	-51.649	2089.4	7.8279E+06	7.8279E+06
x(M)		9.9000	0.0000	0.0000	5.6100	7.9200	0.0000	10.230	4.9500	33.000	0.0000	0.0000
	12	-2.3449E-06	-5.5771E-04	-50.003	-168.43	-8.2934	-136.62	-2.2121	-53.600	2017.6	7.8279E+06	7.8279E+06
x(M)		9.5700	0.0000	0.0000	5.6100	7.9200	0.0000	9.9000	4.9500	33.000	0.0000	0.0000
Min.		-2.6635E-06	-5.6366E-04	-50.311	-171.01	-8.3428	-139.51	-2.2326	-54.728	1228.4	7.8279E+06	7.8279E+06
Pile N.		2	1	10	10	10	10	10	10	3	1	1

* MAXIMUM VALUES AND LOCATIONS *

PILE	DISPL. y-DIR M	DISPL. z-DIR M	MOMENT z-DIR KN- M	MOMENT y-DIR KN- M	SHEAR y-DIR KN	SHEAR z-DIR KN	SOIL REACT y-DIR KN/ M	SOIL REACT z-DIR KN/ M	TOTAL STRESS KN/ M**2	FLEX. RIG. z-DIR KN- M**2	FLEX. RIG. y-DIR KN- M**2	
*****	*****	*****	*****	*****	*****	*****	*****	*****	*****	*****	*****	
1	1.2288E-04	1.2133E-05	32.504	274.90	22.253	34.827	8.7423	8.6558	2214.8	7.8279E+06	7.8279E+06	
x(M)	0.0000	10.230	5.6100	0.0000	0.0000	8.2500	4.9500	10.560	0.0000	0.0000	0.0000	
2	1.2288E-04	1.2249E-05	30.712	251.28	19.957	31.486	7.7428	7.5266	2070.4	7.8279E+06	7.8279E+06	
x(M)	0.0000	10.560	5.9400	0.0000	0.0000	8.5800	4.9500	10.890	0.0000	0.0000	0.0000	
3	1.2288E-04	1.1998E-05	32.251	266.91	21.925	33.961	8.5995	8.4015	2047.0	7.8279E+06	7.8279E+06	
x(M)	0.0000	10.230	5.9400	0.0000	0.0000	8.5800	4.9500	10.890	0.0000	0.0000	0.0000	
4	1.1991E-04	1.2223E-05	30.968	266.35	20.519	33.584	8.0532	8.2335	2450.3	7.8279E+06	7.8279E+06	
x(M)	0.0000	10.560	5.9400	0.0000	0.0000	8.5800	4.9500	10.890	0.0000	0.0000	0.0000	
5	1.1991E-04	1.2317E-05	29.202	242.86	18.339	30.173	7.0993	7.1271	2306.4	7.8279E+06	7.8279E+06	
x(M)	0.0000	10.890	5.9400	0.0000	0.0000	8.5800	4.9500	11.220	0.0000	0.0000	0.0000	
6	1.1991E-04	1.2123E-05	30.695	258.14	20.171	32.706	7.9011	7.9692	2281.8	7.8279E+06	7.8279E+06	
x(M)	0.0000	10.560	5.9400	0.0000	0.0000	8.5800	4.9500	10.890	0.0000	0.0000	0.0000	
7	1.1694E-04	1.2145E-05	30.723	273.13	20.415	34.561	8.0684	8.5672	2733.0	7.8279E+06	7.8279E+06	
x(M)	0.0000	10.230	5.6100	0.0000	0.0000	8.5800	4.9500	10.890	0.0000	0.0000	0.0000	
8	1.1694E-04	1.2263E-05	29.056	250.33	18.351	31.361	7.1725	7.4806	2591.3	7.8279E+06	7.8279E+06	
x(M)	0.0000	10.560	5.9400	0.0000	0.0000	8.5800	4.9500	10.890	0.0000	0.0000	0.0000	
9	1.1694E-04	1.2036E-05	30.458	265.13	20.106	33.729	7.9339	8.3202	2565.1	7.8279E+06	7.8279E+06	
x(M)	0.0000	10.560	5.6100	0.0000	0.0000	8.5800	4.9500	10.890	0.0000	0.0000	0.0000	
10	1.1396E-04	1.1765E-05	33.767	323.23	24.803	42.506	9.9333	11.381	3148.6	7.8279E+06	7.8279E+06	
x(M)	0.0000	9.9000	5.6100	0.0000	0.0000	7.9200	4.9500	10.230	0.0000	0.0000	0.0000	
11	1.1396E-04	1.1822E-05	32.932	308.95	23.568	40.356	9.4352	10.671	3033.1	7.8279E+06	7.8279E+06	
x(M)	0.0000	9.9000	5.6100	0.0000	0.0000	7.9200	4.9500	10.230	0.0000	0.0000	0.0000	
12	1.1396E-04	1.1651E-05	33.648	315.95	24.628	41.747	9.8625	11.157	2983.0	7.8279E+06	7.8279E+06	
x(M)	0.0000	9.9000	5.6100	0.0000	0.0000	7.9200	4.9500	10.230	0.0000	0.0000	0.0000	
Max.		1.2288E-04	1.2317E-05	33.767	323.23	24.803	42.506	9.9333	11.381	3148.6	7.8279E+06	7.8279E+06
Pile N.		1	5	10	10	10	10	10	10	10	1	1

LOAD CASE : 15
CASE NAME : Load Case
LOAD TYPE : Special, Sp

REDUCTION FACTORS FOR CLOSELY-SPACED PILE GROUPS, COMBINED Y AND Z DIRECTIONS
ESTIMATED USING MOVEMENT IN THE DIRECTION OF PILE CAP DISPLACEMENTS

GROUP NO	P-FACTOR	Y-FACTOR
1	0.7217	1.0000
2	0.5343	1.0000
3	0.5845	1.0000
4	0.6715	1.0000
5	0.4771	1.0000
6	0.5235	1.0000
7	0.6876	1.0000
8	0.4957	1.0000
9	0.5440	1.0000
10	0.8661	1.0000
11	0.7149	1.0000
12	0.7556	1.0000

APPALTATORE: Consorzio Soci   	ITINERARIO NAPOLI – BARI RADDOPPIO TRATTA APICE – ORSARA I LOTTO FUNZIONALE APICE – HIRPINIA
PROGETTAZIONE: Mandataria Mandanti   	
PROGETTO ESECUTIVO RELAZIONE DI CALCOLO FONDAZIONI PILE DA P7 A P16	COMMESSA IF1N LOTTO 01 E ZZ CODIFICA RG DOCUMENTO MD0000 001 REV. B FOGLIO 129 di 144

* TABLE L * COMPUTATION ON PILE CAP

* EQUIVALENT CONCENTRATED LOAD AT ORIGIN *

VERT. LOAD, KN 47842.0	HOR. LOAD Y, KN 1152.00	HOR. LOAD Z, KN -1368.00
MOMENT X, KN- M 0.00000	MOMENT Y, KN- M -36302.0	MOMENT Z, KN- M -17968.0

* DISPLACEMENT OF GROUPED PILE FOUNDATION AT ORIGIN *

VERTICAL, M 1.87798E-03	HORIZONTAL Y, M 5.27751E-04	HORIZONTAL Z, M -5.96808E-04
ANGLE ROT. X, RAD -3.88648E-07	ANGLE ROT. Y, RAD -6.33721E-05	ANGLE ROT. Z, RAD -6.16273E-05

THE GLOBAL STRUCTURAL COORDINATE SYSTEM

* PILE TOP DISPLACEMENTS *

PILE GROUP	DISP. X, M	DISP. Y, M	DISP. Z, M	ROT. X, RAD	ROT. Y, RAD	ROT. Z, RAD
*****	*****	*****	*****	*****	*****	*****
1	1.7275E-03	5.3038E-04	-5.9856E-04	-3.8865E-07	-6.3372E-05	-6.1627E-05
2	1.4502E-03	5.3038E-04	-5.9681E-04	-3.8865E-07	-6.3372E-05	-6.1627E-05
3	1.1729E-03	5.3038E-04	-5.9506E-04	-3.8865E-07	-6.3372E-05	-6.1627E-05
4	2.0127E-03	5.2863E-04	-5.9856E-04	-3.8865E-07	-6.3372E-05	-6.1627E-05
5	1.7354E-03	5.2863E-04	-5.9681E-04	-3.8865E-07	-6.3372E-05	-6.1627E-05
6	1.4581E-03	5.2863E-04	-5.9506E-04	-3.8865E-07	-6.3372E-05	-6.1627E-05
7	2.2979E-03	5.2688E-04	-5.9856E-04	-3.8865E-07	-6.3372E-05	-6.1627E-05
8	2.0206E-03	5.2688E-04	-5.9681E-04	-3.8865E-07	-6.3372E-05	-6.1627E-05
9	1.7433E-03	5.2688E-04	-5.9506E-04	-3.8865E-07	-6.3372E-05	-6.1627E-05
10	2.5831E-03	5.2513E-04	-5.9856E-04	-3.8865E-07	-6.3372E-05	-6.1627E-05
11	2.3057E-03	5.2513E-04	-5.9681E-04	-3.8865E-07	-6.3372E-05	-6.1627E-05
12	2.0284E-03	5.2513E-04	-5.9506E-04	-3.8865E-07	-6.3372E-05	-6.1627E-05
MINIMUM	1.1729E-03	5.2513E-04	-5.9856E-04	-3.8865E-07	-6.3372E-05	-6.1627E-05
Pile N.	3	10	1	1	1	1
MAXIMUM	2.5831E-03	5.3038E-04	-5.9506E-04	-3.8865E-07	-6.3372E-05	-6.1627E-05
Pile N.	10	1	3	1	1	1

* PILE TOP REACTIONS *

PILE GROUP	FOR. X, KN	FOR. Y, KN	FOR. Z, KN	MOM X, KN- M	MOM Y, KN- M	MOM Z, KN- M
*****	*****	*****	*****	*****	*****	*****
1	3679.0	105.43	-124.50	-0.1334	277.08	223.21
2	3111.6	87.823	-103.67	-0.1334	238.01	190.89
3	2544.1	92.803	-108.94	-0.1334	247.26	200.10
4	4262.5	100.35	-119.22	-0.1334	267.66	213.59
5	3695.1	81.485	-96.848	-0.1334	225.02	178.34
6	3127.6	86.286	-101.97	-0.1334	234.22	187.42
7	4846.0	101.25	-120.87	-0.1334	270.74	214.69
8	4278.6	82.937	-99.041	-0.1334	229.37	180.69
9	3711.1	87.829	-104.28	-0.1334	238.72	189.87
10	5429.5	115.93	-138.66	-0.1334	302.28	239.91
11	4862.1	103.15	-123.18	-0.1334	274.30	217.49
12	4294.7	106.74	-126.82	-0.1334	280.07	223.75
MINIMUM	2544.1	81.485	-138.66	-0.1334	225.02	178.34
Pile N.	3	5	10	1	5	5
MAXIMUM	5429.5	115.93	-96.848	-0.1334	302.28	239.91
Pile N.	10	10	5	1	10	10

THE PILE COORDINATE SYSTEM (LOCAL AXES)

* PILE TOP DISPLACEMENTS *

PILE GROUP	DISP. x, M	DISP. y, M	DISP. z, M	ROT. x, RAD	ROT. y, RAD	ROT. z, RAD
*****	*****	*****	*****	*****	*****	*****
1	1.7275E-03	5.3038E-04	-5.9856E-04	-3.8865E-07	-6.3372E-05	-6.1627E-05
2	1.4502E-03	5.3038E-04	-5.9681E-04	-3.8865E-07	-6.3372E-05	-6.1627E-05
3	1.1729E-03	5.3038E-04	-5.9506E-04	-3.8865E-07	-6.3372E-05	-6.1627E-05
4	2.0127E-03	5.2863E-04	-5.9856E-04	-3.8865E-07	-6.3372E-05	-6.1627E-05
5	1.7354E-03	5.2863E-04	-5.9681E-04	-3.8865E-07	-6.3372E-05	-6.1627E-05
6	1.4581E-03	5.2863E-04	-5.9506E-04	-3.8865E-07	-6.3372E-05	-6.1627E-05
7	2.2979E-03	5.2688E-04	-5.9856E-04	-3.8865E-07	-6.3372E-05	-6.1627E-05
8	2.0206E-03	5.2688E-04	-5.9681E-04	-3.8865E-07	-6.3372E-05	-6.1627E-05
9	1.7433E-03	5.2688E-04	-5.9506E-04	-3.8865E-07	-6.3372E-05	-6.1627E-05
10	2.5831E-03	5.2513E-04	-5.9856E-04	-3.8865E-07	-6.3372E-05	-6.1627E-05

APPALTATORE:

Consorzio

Soci



ITINERARIO NAPOLI – BARI

PROGETTAZIONE:

Mandataria

Mandanti



RADDOPPIO TRATTA APICE – ORSARA
I LOTTO FUNZIONALE APICE – HIRPINIA

PROGETTO ESECUTIVO

RELAZIONE DI CALCOLO FONDAZIONI PILE DA P7 A P16

COMMESSA IF1N	LOTTO 01 E ZZ	CODIFICA RG	DOCUMENTO MD0000 001	REV. B	FOGLIO 130 di 144
------------------	------------------	----------------	-------------------------	-----------	-------------------------

11	2.3057E-03	5.2513E-04	-5.9681E-04	-3.8865E-07	-6.3372E-05	-6.1627E-05
12	2.0284E-03	5.2513E-04	-5.9506E-04	-3.8865E-07	-6.3372E-05	-6.1627E-05
MINIMUM	1.1729E-03	5.2513E-04	-5.9856E-04	-3.8865E-07	-6.3372E-05	-6.1627E-05
Pile N.	3	10	1	1	1	1
MAXIMUM	2.5831E-03	5.3038E-04	-5.9506E-04	-3.8865E-07	-6.3372E-05	-6.1627E-05
Pile N.	10	1	3	1	1	1

* PILE TOP REACTIONS *

PILE GROUP	AXIAL, KN	LAT. y, KN	LAT. z, KN	MOM x, KN- M	MOM y, KN- M	MOM z, KN- M
1	3679.0	105.43	-124.50	-0.1334	277.08	223.21
2	3111.6	87.823	-103.67	-0.1334	238.01	190.89
3	2544.1	92.803	-108.94	-0.1334	247.26	200.10
4	4262.5	100.35	-119.22	-0.1334	267.66	213.59
5	3695.1	81.485	-96.848	-0.1334	225.02	178.34
6	3127.6	86.286	-101.97	-0.1334	234.22	187.42
7	4846.0	101.25	-120.87	-0.1334	270.74	214.69
8	4278.6	82.937	-99.041	-0.1334	229.37	180.69
9	3711.1	87.829	-104.28	-0.1334	238.72	189.87
10	5429.5	115.93	-138.66	-0.1334	302.28	239.91
11	4862.1	103.15	-123.18	-0.1334	274.30	217.49
12	4294.7	106.74	-126.82	-0.1334	280.07	223.75
MINIMUM	2544.1	81.485	-138.66	-0.1334	225.02	178.34
Pile N.	3	5	10	1	5	5
MAXIMUM	5429.5	115.93	-96.848	-0.1334	302.28	239.91
Pile N.	10	10	5	1	10	10

PILE GROUP STRESS, KN/ M**2

1	3155.7
2	2681.6
3	2399.7
4	3445.6
5	2957.5
6	2675.2
7	3785.1
8	3302.4
9	3020.6
10	4237.2
11	3807.9
12	3512.2
MINIMUM	2399.7
Pile N.	3
MAXIMUM	4237.2
Pile N.	10

* EFFECTS FOR LATERALLY LOADED PILE *

* MINIMUM VALUES AND LOCATIONS *

PILE	DISPL.		MOMENT		SHEAR		SOIL REACT		TOTAL STRESS	FLEX. RIG.	
	y-DIR	z-DIR	y-DIR	z-DIR	y-DIR	z-DIR	y-DIR	z-DIR		KN- M**2	KN- M**2
1	-1.1131E-05	-5.9856E-04	-223.21	-169.16	-35.411	-124.53	-9.1354	-49.126	2081.9	7.8279E+06	7.8279E+06
x(M)	9.9000	0.0000	0.0000	5.6100	7.9200	0.0000	10.230	4.9500	33.000	0.0000	0.0000
2	-1.1385E-05	-5.9681E-04	-190.89	-152.96	-30.163	-103.69	-7.3007	-40.174	1760.8	7.8279E+06	7.8279E+06
x(M)	10.560	0.0000	0.0000	5.9400	8.2500	0.0000	10.890	4.9500	33.000	0.0000	0.0000
3	-1.1335E-05	-5.9506E-04	-200.10	-156.87	-31.695	-108.96	-7.8102	-42.498	1439.7	7.8279E+06	7.8279E+06
x(M)	10.230	0.0000	0.0000	5.9400	8.2500	0.0000	10.560	4.9500	33.000	0.0000	0.0000
4	-1.1138E-05	-5.9856E-04	-213.59	-165.12	-33.972	-119.24	-8.6061	-46.899	2412.1	7.8279E+06	7.8279E+06
x(M)	9.9000	0.0000	0.0000	5.6100	8.2500	0.0000	10.230	4.9500	33.000	0.0000	0.0000
5	-1.1508E-05	-5.9681E-04	-178.34	-147.38	-28.344	-96.866	-6.6971	-37.182	2091.0	7.8279E+06	7.8279E+06
x(M)	10.560	0.0000	0.0000	5.9400	8.5800	0.0000	10.890	4.9500	33.000	0.0000	0.0000
6	-1.1382E-05	-5.9506E-04	-187.42	-151.48	-29.708	-101.98	-7.1707	-39.463	1769.9	7.8279E+06	7.8279E+06
x(M)	10.560	0.0000	0.0000	5.9400	8.2500	0.0000	10.890	4.9500	33.000	0.0000	0.0000
7	-1.1099E-05	-5.9856E-04	-214.69	-166.47	-34.253	-120.89	-8.7431	-47.613	2742.3	7.8279E+06	7.8279E+06
x(M)	9.9000	0.0000	0.0000	5.6100	8.2500	0.0000	10.230	4.9500	33.000	0.0000	0.0000
8	-1.1435E-05	-5.9681E-04	-180.69	-149.29	-28.817	-99.062	-6.8731	-38.165	2421.2	7.8279E+06	7.8279E+06
x(M)	10.560	0.0000	0.0000	5.9400	8.5800	0.0000	10.890	4.9500	33.000	0.0000	0.0000
9	-1.1310E-05	-5.9506E-04	-189.87	-153.38	-30.272	-104.30	-7.3392	-40.492	2100.1	7.8279E+06	7.8279E+06
x(M)	10.230	0.0000	0.0000	5.9400	8.2500	0.0000	10.890	4.9500	33.000	0.0000	0.0000
10	-1.0826E-05	-5.9856E-04	-239.91	-179.45	-38.616	-138.70	-10.331	-55.020	3072.5	7.8279E+06	7.8279E+06
x(M)	9.5700	0.0000	0.0000	5.6100	7.9200	0.0000	9.9000	4.9500	33.000	0.0000	0.0000
11	-1.1036E-05	-5.9681E-04	-217.49	-168.14	-34.879	-123.21	-8.9788	-48.621	2751.4	7.8279E+06	7.8279E+06
x(M)	9.9000	0.0000	0.0000	5.6100	7.9200	0.0000	10.230	4.9500	33.000	0.0000	0.0000
12	-1.0971E-05	-5.9506E-04	-223.75	-170.69	-35.946	-126.84	-9.3498	-50.161	2430.3	7.8279E+06	7.8279E+06
x(M)	9.9000	0.0000	0.0000	5.6100	7.9200	0.0000	10.230	4.9500	33.000	0.0000	0.0000
Min.	-1.1508E-05	-5.9856E-04	-239.91	-179.45	-38.616	-138.70	-10.331	-55.020	1439.7	7.8279E+06	7.8279E+06
Pile N.	5	1	10	10	10	10	10	10	3	1	1

* MAXIMUM VALUES AND LOCATIONS *

APPALTATORE:

Consorzio

Soci



ITINERARIO NAPOLI – BARI

PROGETTAZIONE:

Mandatario

Mandanti



RADDOPPIO TRATTA APICE – ORSARA
I LOTTO FUNZIONALE APICE – HIRPINIA

PROGETTO ESECUTIVO

RELAZIONE DI CALCOLO FONDAZIONI PILE DA P7 A P16

COMMESSA IF1N	LOTTO 01 E ZZ	CODIFICA RG	DOCUMENTO MD0000 001	REV. B	FOGLIO 132 di 144
------------------	------------------	----------------	-------------------------	-----------	-------------------------

1	2.5435E-03	1.6716E-03	-4.7181E-04	-5.2594E-07	-4.3158E-05	-2.0565E-04
2	1.6181E-03	1.6716E-03	-4.6944E-04	-5.2594E-07	-4.3158E-05	-2.0565E-04
3	6.9268E-04	1.6716E-03	-4.6707E-04	-5.2594E-07	-4.3158E-05	-2.0565E-04
4	2.7378E-03	1.6692E-03	-4.7181E-04	-5.2594E-07	-4.3158E-05	-2.0565E-04
5	1.8123E-03	1.6692E-03	-4.6944E-04	-5.2594E-07	-4.3158E-05	-2.0565E-04
6	8.8689E-04	1.6692E-03	-4.6707E-04	-5.2594E-07	-4.3158E-05	-2.0565E-04
7	2.9320E-03	1.6669E-03	-4.7181E-04	-5.2594E-07	-4.3158E-05	-2.0565E-04
8	2.0065E-03	1.6669E-03	-4.6944E-04	-5.2594E-07	-4.3158E-05	-2.0565E-04
9	1.0811E-03	1.6669E-03	-4.6707E-04	-5.2594E-07	-4.3158E-05	-2.0565E-04
10	3.1262E-03	1.6645E-03	-4.7181E-04	-5.2594E-07	-4.3158E-05	-2.0565E-04
11	2.2007E-03	1.6645E-03	-4.6944E-04	-5.2594E-07	-4.3158E-05	-2.0565E-04
12	1.2753E-03	1.6645E-03	-4.6707E-04	-5.2594E-07	-4.3158E-05	-2.0565E-04

MINIMUM	6.9268E-04	1.6645E-03	-4.7181E-04	-5.2594E-07	-4.3158E-05	-2.0565E-04
Pile N.	3	10	1	1	1	1
MAXIMUM	3.1262E-03	1.6716E-03	-4.6707E-04	-5.2594E-07	-4.3158E-05	-2.0565E-04
Pile N.	10	1	3	1	1	1

* PILE TOP REACTIONS *

PILE GROUP	FOR. X, KN	FOR. Y, KN	FOR. Z, KN	MOM X, KN- M	MOM Y, KN- M	MOM Z, KN- M
1	5348.7	354.23	-114.00	-0.1805	263.94	714.71
2	3455.1	278.49	-90.315	-0.1805	219.81	578.50
3	1537.4	282.23	-90.800	-0.1805	219.70	584.42
4	5746.1	337.87	-109.26	-0.1805	255.64	685.66
5	3852.5	252.77	-82.677	-0.1805	205.20	529.53
6	1958.9	255.24	-82.827	-0.1805	204.50	533.22
7	6143.4	337.51	-109.38	-0.1805	255.91	684.37
8	4249.9	252.87	-82.887	-0.1805	205.66	529.17
9	2356.3	255.47	-83.078	-0.1805	205.05	533.11
10	6540.8	356.11	-115.29	-0.1805	266.34	715.83
11	4647.2	283.78	-92.517	-0.1805	224.12	586.55
12	2753.7	287.43	-92.964	-0.1805	223.92	592.24
MINIMUM	1537.4	252.77	-115.29	-0.1805	204.50	529.17
Pile N.	3	5	10	1	6	8
MAXIMUM	6540.8	356.11	-82.677	-0.1805	266.34	715.83
Pile N.	10	10	5	1	10	10

THE PILE COORDINATE SYSTEM (LOCAL AXES)

* PILE TOP DISPLACEMENTS *

PILE GROUP	DISP. x, M	DISP. y, M	DISP. z, M	ROT. x,RAD	ROT. y,RAD	ROT. z,RAD
1	2.5435E-03	1.6716E-03	-4.7181E-04	-5.2594E-07	-4.3158E-05	-2.0565E-04
2	1.6181E-03	1.6716E-03	-4.6944E-04	-5.2594E-07	-4.3158E-05	-2.0565E-04
3	6.9268E-04	1.6716E-03	-4.6707E-04	-5.2594E-07	-4.3158E-05	-2.0565E-04
4	2.7378E-03	1.6692E-03	-4.7181E-04	-5.2594E-07	-4.3158E-05	-2.0565E-04
5	1.8123E-03	1.6692E-03	-4.6944E-04	-5.2594E-07	-4.3158E-05	-2.0565E-04
6	8.8689E-04	1.6692E-03	-4.6707E-04	-5.2594E-07	-4.3158E-05	-2.0565E-04
7	2.9320E-03	1.6669E-03	-4.7181E-04	-5.2594E-07	-4.3158E-05	-2.0565E-04
8	2.0065E-03	1.6669E-03	-4.6944E-04	-5.2594E-07	-4.3158E-05	-2.0565E-04
9	1.0811E-03	1.6669E-03	-4.6707E-04	-5.2594E-07	-4.3158E-05	-2.0565E-04
10	3.1262E-03	1.6645E-03	-4.7181E-04	-5.2594E-07	-4.3158E-05	-2.0565E-04
11	2.2007E-03	1.6645E-03	-4.6944E-04	-5.2594E-07	-4.3158E-05	-2.0565E-04
12	1.2753E-03	1.6645E-03	-4.6707E-04	-5.2594E-07	-4.3158E-05	-2.0565E-04
MINIMUM	6.9268E-04	1.6645E-03	-4.7181E-04	-5.2594E-07	-4.3158E-05	-2.0565E-04
Pile N.	3	10	1	1	1	1
MAXIMUM	3.1262E-03	1.6716E-03	-4.6707E-04	-5.2594E-07	-4.3158E-05	-2.0565E-04
Pile N.	10	1	3	1	1	1

* PILE TOP REACTIONS *

PILE GROUP	AXIAL, KN	LAT. y, KN	LAT. z, KN	MOM x, KN- M	MOM y, KN- M	MOM z, KN- M
1	5348.7	354.23	-114.00	-0.1805	263.94	714.71
2	3455.1	278.49	-90.315	-0.1805	219.81	578.50
3	1537.4	282.23	-90.800	-0.1805	219.70	584.42
4	5746.1	337.87	-109.26	-0.1805	255.64	685.66
5	3852.5	252.77	-82.677	-0.1805	205.20	529.53
6	1958.9	255.24	-82.827	-0.1805	204.50	533.22
7	6143.4	337.51	-109.38	-0.1805	255.91	684.37
8	4249.9	252.87	-82.887	-0.1805	205.66	529.17
9	2356.3	255.47	-83.078	-0.1805	205.05	533.11
10	6540.8	356.11	-115.29	-0.1805	266.34	715.83
11	4647.2	283.78	-92.517	-0.1805	224.12	586.55
12	2753.7	287.43	-92.964	-0.1805	223.92	592.24
MINIMUM	1537.4	252.77	-115.29	-0.1805	204.50	529.17
Pile N.	3	5	10	1	6	8
MAXIMUM	6540.8	356.11	-82.677	-0.1805	266.34	715.83
Pile N.	10	10	5	1	10	10

APPALTATORE:

Consorzio

Soci



ITINERARIO NAPOLI – BARI

PROGETTAZIONE:

Mandataria

Mandanti



RADDOPPIO TRATTA APICE – ORSARA
I LOTTO FUNZIONALE APICE – HIRPINIA

PROGETTO ESECUTIVO

RELAZIONE DI CALCOLO FONDAZIONI PILE DA P7 A P16

COMMESSA IF1N	LOTTO 01 E ZZ	CODIFICA RG	DOCUMENTO MD0000 001	REV. B	FOGLIO 133 di 144
------------------	------------------	----------------	-------------------------	-----------	-------------------------

PILE GROUP STRESS, KN/ M**2

*****	*****
1	5326.2
2	3822.9
3	2754.3
4	5460.1
5	3894.0
6	2832.1
7	5681.6
8	4118.4
9	3057.3
10	6006.5
11	4524.9
12	3469.2

MINIMUM 2754.3
Pile N. 3
MAXIMUM 6006.5
Pile N. 10

* EFFECTS FOR LATERALLY LOADED PILE *

* MINIMUM VALUES AND LOCATIONS *

PILE	DISPL. y-DIR M	DISPL. z-DIR M	MOMENT z-DIR KN- M	MOMENT y-DIR KN- M	SHEAR y-DIR KN	SHEAR z-DIR KN	SOIL REACT y-DIR KN/ M	SOIL REACT z-DIR KN/ M	TOTAL STRESS KN/ M**2	FLEX. RIG. z-DIR KN- M**2	FLEX. RIG. y-DIR KN- M**2
*****	*****	*****	*****	*****	*****	*****	*****	*****	*****	*****	*****
1	-3.4437E-05	-4.7181E-04	-714.71	-142.01	-121.03	-114.03	-32.217	-44.984	3026.7	7.8279E+06	7.8279E+06
x(M)	9.5700	0.0000	0.0000	5.6100	7.9200	0.0000	9.9000	4.9500	33.000	0.0000	0.0000
2	-3.5744E-05	-4.6944E-04	-578.50	-124.34	-98.457	-90.331	-24.142	-34.802	1955.2	7.8279E+06	7.8279E+06
x(M)	10.230	0.0000	0.0000	5.9400	8.2500	0.0000	10.560	4.9500	33.000	0.0000	0.0000
3	-3.5617E-05	-4.6707E-04	-584.42	-124.41	-99.322	-90.807	-24.457	-35.030	870.00	7.8279E+06	7.8279E+06
x(M)	10.230	0.0000	0.0000	5.9400	8.2500	0.0000	10.560	4.9500	33.000	0.0000	0.0000
4	-3.4577E-05	-4.7181E-04	-685.66	-138.63	-116.51	-109.29	-30.475	-43.006	3251.6	7.8279E+06	7.8279E+06
x(M)	9.9000	0.0000	0.0000	5.6100	7.9200	0.0000	10.230	4.9500	33.000	0.0000	0.0000
5	-3.6159E-05	-4.6944E-04	-529.53	-118.11	-90.507	-82.694	-21.557	-31.427	2180.1	7.8279E+06	7.8279E+06
x(M)	10.560	0.0000	0.0000	5.9400	8.5800	0.0000	10.890	4.9500	33.000	0.0000	0.0000
6	-3.6032E-05	-4.6707E-04	-533.22	-117.97	-90.966	-82.836	-21.729	-31.512	1108.5	7.8279E+06	7.8279E+06
x(M)	10.560	0.0000	0.0000	5.9400	8.5800	0.0000	10.890	4.9500	33.000	0.0000	0.0000
7	-3.4521E-05	-4.7181E-04	-684.37	-138.75	-116.50	-109.42	-30.481	-43.064	3476.5	7.8279E+06	7.8279E+06
x(M)	9.9000	0.0000	0.0000	5.6100	7.9200	0.0000	10.230	4.9500	33.000	0.0000	0.0000
8	-3.6098E-05	-4.6944E-04	-529.17	-118.32	-90.611	-82.905	-21.607	-31.529	2404.9	7.8279E+06	7.8279E+06
x(M)	10.560	0.0000	0.0000	5.9400	8.5800	0.0000	10.890	4.9500	33.000	0.0000	0.0000
9	-3.5965E-05	-4.6707E-04	-533.11	-118.21	-91.107	-83.088	-21.791	-31.631	1333.4	7.8279E+06	7.8279E+06
x(M)	10.560	0.0000	0.0000	5.9400	8.5800	0.0000	10.890	4.9500	33.000	0.0000	0.0000
10	-3.4275E-05	-4.7181E-04	-715.83	-142.99	-121.75	-115.32	-32.597	-45.535	3701.3	7.8279E+06	7.8279E+06
x(M)	9.5700	0.0000	0.0000	5.6100	7.9200	0.0000	9.9000	4.9500	33.000	0.0000	0.0000
11	-3.5472E-05	-4.6944E-04	-586.55	-126.13	-100.34	-92.539	-24.835	-35.797	2629.8	7.8279E+06	7.8279E+06
x(M)	10.230	0.0000	0.0000	5.9400	8.2500	0.0000	10.560	4.9500	33.000	0.0000	0.0000
12	-3.5330E-05	-4.6707E-04	-592.24	-126.15	-101.15	-92.977	-25.130	-36.006	1558.3	7.8279E+06	7.8279E+06
x(M)	10.230	0.0000	0.0000	5.9400	8.2500	0.0000	10.560	4.9500	33.000	0.0000	0.0000
Min.	-3.6159E-05	-4.7181E-04	-715.83	-142.99	-121.75	-115.32	-32.597	-45.535	870.00	7.8279E+06	7.8279E+06
Pile N.	5	1	10	10	10	10	10	10	3	1	1

* MAXIMUM VALUES AND LOCATIONS *

PILE	DISPL. y-DIR M	DISPL. z-DIR M	MOMENT z-DIR KN- M	MOMENT y-DIR KN- M	SHEAR y-DIR KN	SHEAR z-DIR KN	SOIL REACT y-DIR KN/ M	SOIL REACT z-DIR KN/ M	TOTAL STRESS KN/ M**2	FLEX. RIG. z-DIR KN- M**2	FLEX. RIG. y-DIR KN- M**2
*****	*****	*****	*****	*****	*****	*****	*****	*****	*****	*****	*****
1	1.6716E-03	9.8743E-06	491.65	263.94	354.32	35.161	142.91	9.3836	5326.2	7.8279E+06	7.8279E+06
x(M)	0.0000	9.9000	5.6100	0.0000	0.0000	7.9200	4.9500	10.230	0.0000	0.0000	0.0000
2	1.6716E-03	1.0129E-05	434.10	219.81	278.53	28.297	111.06	6.9740	3822.9	7.8279E+06	7.8279E+06
x(M)	0.0000	10.560	5.6100	0.0000	0.0000	8.5800	4.9500	10.890	0.0000	0.0000	0.0000
3	1.6716E-03	1.0035E-05	436.71	219.70	282.25	28.371	112.55	7.0170	2754.3	7.8279E+06	7.8279E+06
x(M)	0.0000	10.230	5.6100	0.0000	0.0000	8.5800	4.9500	10.890	0.0000	0.0000	0.0000
4	1.6693E-03	9.9632E-06	480.32	255.64	337.95	33.775	136.29	8.9131	5460.1	7.8279E+06	7.8279E+06
x(M)	0.0000	9.9000	5.6100	0.0000	0.0000	7.9200	4.9500	10.230	0.0000	0.0000	0.0000
5	1.6693E-03	1.0267E-05	412.64	205.20	252.82	26.129	99.989	6.2220	3894.0	7.8279E+06	7.8279E+06
x(M)	0.0000	10.560	5.9400	0.0000	0.0000	8.5800	4.9500	10.890	0.0000	0.0000	0.0000
6	1.6693E-03	1.0190E-05	414.15	204.50	255.26	26.135	100.94	6.2438	2832.1	7.8279E+06	7.8279E+06
x(M)	0.0000	10.560	5.9400	0.0000	0.0000	8.5800	4.9500	10.890	0.0000	0.0000	0.0000
7	1.6669E-03	9.9644E-06	479.96	255.91	337.60	33.829	136.19	8.9307	5681.6	7.8279E+06	7.8279E+06
x(M)	0.0000	9.9000	5.6100	0.0000	0.0000	7.9200	4.9500	10.230	0.0000	0.0000	0.0000
8	1.6669E-03	1.0270E-05	412.68	205.66	252.91	26.208	100.10	6.2488	4118.4	7.8279E+06	7.8279E+06
x(M)	0.0000	10.560	5.9400	0.0000	0.0000	8.5800	4.9500	10.890	0.0000	0.0000	0.0000
9	1.6669E-03	1.0192E-05	414.29	205.05	255.49	26.226	101.12	6.2746	3057.3	7.8279E+06	7.8279E+06
x(M)	0.0000	10.560	5.9400	0.0000	0.0000	8.5800	4.9500	10.890	0.0000	0.0000	0.0000
10	1.6645E-03	9.8508E-06	492.43	266.34	356.20	35.577	143.77	9.5204	6006.5	7.8279E+06	7.8279E+06
x(M)	0.0000	9.9000	5.6100	0.0000	0.0000	7.9200	4.9500	10.230	0.0000	0.0000	0.0000
11	1.6645E-03	1.0116E-05	438.52	224.12	283.84	28.984	113.55	7.2004	4524.9	7.8279E+06	7.8279E+06
x(M)	0.0000	10.230	5.6100	0.0000	0.0000	8.2500	4.9500	10.560	0.0000	0.0000	0.0000
12	1.6645E-03	1.0040E-05	440.99	223.92	287.46	29.088	114.99	7.2557	3469.2	7.8279E+06	7.8279E+06
x(M)	0.0000	10.230	5.6100	0.0000	0.0000	8.2500	4.9500	10.560	0.0000	0.0000	0.0000
Max.	1.6716E-03	1.0270E-05	492.43	266.34	356.20	35.577	143.77	9.5204	6006.5	7.8279E+06	7.8279E+06

APPALTATORE: Consorzio Soci   					ITINERARIO NAPOLI – BARI RADDOPPIO TRATTA APICE – ORSARA I LOTTO FUNZIONALE APICE – HIRPINIA						
PROGETTAZIONE: Mandataria Mandanti   											
PROGETTO ESECUTIVO RELAZIONE DI CALCOLO FONDAZIONI PILE DA P7 A P16											

Pile N. 1 8 10 10 10 10 10 10 10 1 1

***** SUMMARY FOR LOAD CASES AND COMBINATIONS *****

***** LOAD CASES RESULTS *****

LOAD CASE : 1

* TABLE L * COMPUTATION ON PILE CAP

* EQUIVALENT CONCENTRATED LOAD AT ORIGIN *

LOAD X, KN	LOAD Y, KN	LOAD Z, KN	MOM X, KN- M	MOM Y, KN- M	MOM Z, KN- M
28747.0	12425.0	-3381.00	-172.000	-53219.0	-1.87093E+05

* DISPLACEMENT OF GROUPED PILE FOUNDATION AT ORIGIN *

DISP X, M	DISP Y, M	DISP Z, M	ROT X,RAD	ROT Y,RAD	ROT Z,RAD
1.17303E-03	5.90506E-03	-1.39195E-03	6.56852E-06	-1.05582E-04	-6.45304E-04

* PILE TOP DISPLACEMENTS, GLOBAL *

	DISP. X, M	DISP. Y, M	DISP. Z, M	ROT. X,RAD	ROT. Y,RAD	ROT. Z,RAD
MINIMUM	-2.4435E-03	5.8607E-03	-1.4215E-03	6.5685E-06	-1.0558E-04	-6.4530E-04
Pile N.	3	1	3	1	1	1
MAXIMUM	4.7896E-03	5.9494E-03	-1.3624E-03	6.5685E-06	-1.0558E-04	-6.4530E-04
Pile N.	10	10	1	1	1	1

* PILE TOP REACTIONS, GLOBAL *

	FOR. X, KN	FOR. Y, KN	FOR. Z, KN	MOM X, KN- M	MOM Y, KN- M	MOM Z, KN- M
MINIMUM	-5100.0	882.45	-329.59	2.2546	656.32	2031.1
Pile N.	3	5	10	1	5	5
MAXIMUM	9416.0	1269.9	-244.03	2.2546	815.86	2801.5
Pile N.	10	10	5	1	10	10

* PILE TOP DISPLACEMENTS, LOCAL *

	DISP. x, M	DISP. y, M	DISP. z, M	ROT. x,RAD	ROT. y,RAD	ROT. z,RAD
MINIMUM	-2.4435E-03	5.8607E-03	-1.4215E-03	6.5685E-06	-1.0558E-04	-6.4530E-04
Pile N.	3	1	3	1	1	1
MAXIMUM	4.7896E-03	5.9494E-03	-1.3624E-03	6.5685E-06	-1.0558E-04	-6.4530E-04
Pile N.	10	10	1	1	1	1

* PILE TOP REACTIONS, LOCAL *

	AXIAL, KN	LAT. y, KN	LAT. z, KN	MOM x, KN- M	MOM y, KN- M	MOM z, KN- M
MINIMUM	-5100.0	882.45	-329.59	2.2546	656.32	2031.1
Pile N.	3	5	10	1	5	5
MAXIMUM	9416.0	1269.9	-244.03	2.2546	815.86	2801.5
Pile N.	10	10	5	1	10	10

* EFFECTS FOR LATERALLY LOADED PILE *

PILE	DISPL. y-DIR M	DISPL. z-DIR M	MOMENT z-DIR KN- M	MOMENT y-DIR KN- M	SHEAR y-DIR KN	SHEAR z-DIR KN	SOIL REACT y-DIR KN/ M	SOIL REACT z-DIR KN/ M	TOTAL STRESS KN/ M**2
Min.	-1.2191E-04	-1.4215E-03	-2801.5	-407.41	-432.32	-329.75	-115.93	-107.63	578.21
Pile N.	8	3	10	10	10	10	10	1	2
Max.	5.9494E-03	2.9803E-05	1732.8	815.86	1270.5	101.99	424.08	27.560	1.4135E+04
Pile N.	10	9	10	10	10	10	10	10	10

LOAD CASE : 2

* TABLE L * COMPUTATION ON PILE CAP

* EQUIVALENT CONCENTRATED LOAD AT ORIGIN *

LOAD X, KN	LOAD Y, KN	LOAD Z, KN	MOM X, KN- M	MOM Y, KN- M	MOM Z, KN- M
37076.0	-11889.0	3332.00	123.000	55437.0	1.80505E+05

* DISPLACEMENT OF GROUPED PILE FOUNDATION AT ORIGIN *

DISP X, M	DISP Y, M	DISP Z, M	ROT X,RAD	ROT Y,RAD	ROT Z,RAD
1.52840E-03	-5.65539E-03	1.38949E-03	8.70564E-06	1.11849E-04	6.27824E-04

* PILE TOP DISPLACEMENTS, GLOBAL *

	DISP. X, M	DISP. Y, M	DISP. Z, M	ROT. X,RAD	ROT. Y,RAD	ROT. Z,RAD
MINIMUM	-2.0518E-03	-5.7142E-03	1.3503E-03	8.7056E-06	1.1185E-04	6.2782E-04
Pile N.	10	1	3	1	1	1
MAXIMUM	5.1086E-03	-5.5966E-03	1.4287E-03	8.7056E-06	1.1185E-04	6.2782E-04
Pile N.	3	10	1	1	1	1

* PILE TOP REACTIONS, GLOBAL *

	FOR. X, KN	FOR. Y, KN	FOR. Z, KN	MOM X, KN- M	MOM Y, KN- M	MOM Z, KN- M
MINIMUM	-5100.0	882.45	-329.59	2.2546	656.32	2031.1
Pile N.	3	5	10	1	5	5
MAXIMUM	9416.0	1269.9	-244.03	2.2546	815.86	2801.5
Pile N.	10	10	5	1	10	10

APPALTATORE: Consorzio Soci   		ITINERARIO NAPOLI – BARI RADDOPPIO TRATTA APICE – ORSARA I LOTTO FUNZIONALE APICE – HIRPINIA			
PROGETTAZIONE: Mandataria Mandanti   					
PROGETTO ESECUTIVO RELAZIONE DI CALCOLO FONDAZIONI PILE DA P7 A P16					
COMMESSA	LOTTO	CODIFICA	DOCUMENTO	REV.	FOGLIO
IF1N	01 E ZZ	RG	MD0000 001	B	135 di 144

MINIMUM	-4300.2	-1220.2	240.44	2.9882	-782.85	-2673.2
Pile N.	10	3	8	1	3	3
MAXIMUM	9850.0	-842.83	322.04	2.9882	-634.91	-1919.1
Pile N.	3	8	3	1	8	8

* PILE TOP DISPLACEMENTS, LOCAL *

	DISP. x, M	DISP. y, M	DISP. z, M	ROT. x,RAD	ROT. y,RAD	ROT. z,RAD
MINIMUM	-2.0518E-03	-5.7142E-03	1.3503E-03	8.7056E-06	1.1185E-04	6.2782E-04
Pile N.	10	1	3	1	1	1
MAXIMUM	5.1086E-03	-5.5966E-03	1.4287E-03	8.7056E-06	1.1185E-04	6.2782E-04
Pile N.	3	10	1	1	1	1

* PILE TOP REACTIONS, LOCAL *

	AXIAL, KN	LAT. y, KN	LAT. z, KN	MOM x, KN- M	MOM y, KN- M	MOM z, KN- M
MINIMUM	-4300.2	-1220.2	240.44	2.9882	-782.85	-2673.2
Pile N.	10	3	8	1	3	3
MAXIMUM	9850.0	-842.83	322.04	2.9882	-634.91	-1919.1
Pile N.	3	8	3	1	8	8

* EFFECTS FOR LATERALLY LOADED PILE *

PILE	DISPL. y-DIR M	DISPL. z-DIR M	MOMENT z-DIR KN- M	MOMENT y-DIR KN- M	SHEAR y-DIR KN	SHEAR z-DIR KN	SOIL REACT y-DIR KN/ M	SOIL REACT z-DIR KN/ M	TOTAL STRESS KN/ M**2
Min.	-5.7142E-03	-3.0065E-05	-1672.1	-782.85	-1220.8	-100.90	-417.91	-27.249	670.78
Pile N.	1	7	3	3	3	3	3	3	1
Max.	1.1756E-04	1.4287E-03	2673.2	403.30	416.78	322.21	111.56	108.61	1.3981E+04
Pile N.	5	1	3	3	3	3	12	3	3

LOAD CASE : 3

* TABLE L * COMPUTATION ON PILE CAP

* EQUIVALENT CONCENTRATED LOAD AT ORIGIN *

LOAD X, KN	LOAD Y, KN	LOAD Z, KN	MOM X, KN- M	MOM Y, KN- M	MOM Z, KN- M
29232.0	3830.00	-11239.0	-410.000	-1.82570E+05	-58192.0

* DISPLACEMENT OF GROUPED PILE FOUNDATION AT ORIGIN *

DISP X, M	DISP Y, M	DISP Z, M	ROT X,RAD	ROT Y,RAD	ROT Z,RAD
1.16757E-03	1.81842E-03	-4.54148E-03	-1.05617E-05	-3.34858E-04	-2.00387E-04

* PILE TOP DISPLACEMENTS, GLOBAL *

	DISP. X, M	DISP. Y, M	DISP. Z, M	ROT. X,RAD	ROT. Y,RAD	ROT. Z,RAD
MINIMUM	-1.9945E-03	1.7471E-03	-4.5890E-03	-1.0562E-05	-3.3486E-04	-2.0039E-04
Pile N.	3	10	1	1	1	1
MAXIMUM	4.3296E-03	1.8897E-03	-4.4940E-03	-1.0562E-05	-3.3486E-04	-2.0039E-04
Pile N.	10	1	3	1	1	1

* PILE TOP REACTIONS, GLOBAL *

	FOR. X, KN	FOR. Y, KN	FOR. Z, KN	MOM X, KN- M	MOM Y, KN- M	MOM Z, KN- M
MINIMUM	-4183.1	272.63	-1153.0	-3.6253	2155.9	618.58
Pile N.	3	8	10	1	5	8
MAXIMUM	8790.1	371.20	-794.46	-3.6253	2873.9	791.29
Pile N.	10	10	5	1	10	10

* PILE TOP DISPLACEMENTS, LOCAL *

	DISP. x, M	DISP. y, M	DISP. z, M	ROT. x,RAD	ROT. y,RAD	ROT. z,RAD
MINIMUM	-1.9945E-03	1.7471E-03	-4.5890E-03	-1.0562E-05	-3.3486E-04	-2.0039E-04
Pile N.	3	10	1	1	1	1
MAXIMUM	4.3296E-03	1.8897E-03	-4.4940E-03	-1.0562E-05	-3.3486E-04	-2.0039E-04
Pile N.	10	1	3	1	1	1

* PILE TOP REACTIONS, LOCAL *

	AXIAL, KN	LAT. y, KN	LAT. z, KN	MOM x, KN- M	MOM y, KN- M	MOM z, KN- M
MINIMUM	-4183.1	272.63	-1153.0	-3.6253	2155.9	618.58
Pile N.	3	8	10	1	5	8
MAXIMUM	8790.1	371.20	-794.46	-3.6253	2873.9	791.29
Pile N.	10	10	5	1	10	10

* EFFECTS FOR LATERALLY LOADED PILE *

PILE	DISPL. y-DIR M	DISPL. z-DIR M	MOMENT z-DIR KN- M	MOMENT y-DIR KN- M	SHEAR y-DIR KN	SHEAR z-DIR KN	SOIL REACT y-DIR KN/ M	SOIL REACT z-DIR KN/ M	TOTAL STRESS KN/ M**2
Min.	-3.9296E-05	-4.5890E-03	-791.29	-1392.6	-127.58	-1153.5	-34.084	-400.38	236.43
Pile N.	2	1	10	10	10	10	10	10	1
Max.	1.8897E-03	9.7430E-05	513.22	2873.9	371.35	348.07	132.83	94.085	1.3971E+04
Pile N.	1	4	10	10	10	10	10	10	10

LOAD CASE : 4

APPALTATORE:

Consorzio

Soci



ITINERARIO NAPOLI – BARI

PROGETTAZIONE:

Mandataria

Mandanti



RADDOPPIO TRATTA APICE – ORSARA
I LOTTO FUNZIONALE APICE – HIRPINIA

PROGETTO ESECUTIVO

RELAZIONE DI CALCOLO FONDAZIONI PILE DA P7 A P16

COMMESSA IF1N	LOTTO 01 E ZZ	CODIFICA RG	DOCUMENTO MD0000 001	REV. B	FOGLIO 136 di 144
------------------	------------------	----------------	-------------------------	-----------	-------------------------

* TABLE L * COMPUTATION ON PILE CAP

* EQUIVALENT CONCENTRATED LOAD AT ORIGIN *

LOAD X, KN	LOAD Y, KN	LOAD Z, KN	MOM X, KN- M	MOM Y, KN- M	MOM Z, KN- M
37076.0	-3505.00	11107.0	409.000	1.84791E+05	53172.0

* DISPLACEMENT OF GROUPED PILE FOUNDATION AT ORIGIN *

DISP X, M	DISP Y, M	DISP Z, M	ROT X,RAD	ROT Y,RAD	ROT Z,RAD
1.48975E-03	-1.66840E-03	4.51337E-03	-4.04229E-06	3.40520E-04	1.85914E-04

* PILE TOP DISPLACEMENTS, GLOBAL *

	DISP. X, M	DISP. Y, M	DISP. Z, M	ROT. X,RAD	ROT. Y,RAD	ROT. Z,RAD
MINIMUM	-1.6454E-03	-1.6957E-03	4.4952E-03	-4.0423E-06	3.4052E-04	1.8591E-04
Pile N.	10	10	1	1	1	1
MAXIMUM	4.6249E-03	-1.6411E-03	4.5316E-03	-4.0423E-06	3.4052E-04	1.8591E-04
Pile N.	3	1	3	1	1	1

* PILE TOP REACTIONS, GLOBAL *

	FOR. X, KN	FOR. Y, KN	FOR. Z, KN	MOM X, KN- M	MOM Y, KN- M	MOM Z, KN- M
MINIMUM	-3470.4	-351.66	785.14	-1.3875	-2802.3	-754.64
Pile N.	10	3	8	1	3	3
MAXIMUM	9191.9	-247.19	1131.9	-1.3875	-2117.9	-564.76
Pile N.	3	8	3	1	8	8

* PILE TOP DISPLACEMENTS, LOCAL *

	DISP. x, M	DISP. y, M	DISP. z, M	ROT. x,RAD	ROT. y,RAD	ROT. z,RAD
MINIMUM	-1.6454E-03	-1.6957E-03	4.4952E-03	-4.0423E-06	3.4052E-04	1.8591E-04
Pile N.	10	10	1	1	1	1
MAXIMUM	4.6249E-03	-1.6411E-03	4.5316E-03	-4.0423E-06	3.4052E-04	1.8591E-04
Pile N.	3	1	3	1	1	1

* PILE TOP REACTIONS, LOCAL *

	AXIAL, KN	LAT. y, KN	LAT. z, KN	MOM x, KN- M	MOM y, KN- M	MOM z, KN- M
MINIMUM	-3470.4	-351.66	785.14	-1.3875	-2802.3	-754.64
Pile N.	10	3	8	1	3	3
MAXIMUM	9191.9	-247.19	1131.9	-1.3875	-2117.9	-564.76
Pile N.	3	8	3	1	8	8

* EFFECTS FOR LATERALLY LOADED PILE *

PILE	DISPL. y-DIR M	DISPL. z-DIR M	MOMENT z-DIR KN- M	MOMENT y-DIR KN- M	SHEAR y-DIR KN	SHEAR z-DIR KN	SOIL REACT y-DIR KN/ M	SOIL REACT z-DIR KN/ M	TOTAL STRESS KN/ M**2
*****	*****	*****	*****	*****	*****	*****	*****	*****	*****
Min.	-1.6957E-03	-9.6876E-05	-483.46	-2802.3	-351.80	-343.67	-127.42	-92.793	34.988
Pile N.	10	5	3	3	3	3	3	3	12
Max.	3.5374E-05	4.5316E-03	754.64	1374.0	120.20	1132.4	32.114	399.10	1.3960E+04
Pile N.	11	3	3	3	3	3	3	3	3

LOAD CASE : 5

* TABLE L * COMPUTATION ON PILE CAP

* EQUIVALENT CONCENTRATED LOAD AT ORIGIN *

LOAD X, KN	LOAD Y, KN	LOAD Z, KN	MOM X, KN- M	MOM Y, KN- M	MOM Z, KN- M
48690.0	-3566.00	3332.00	123.000	55618.0	54248.0

* DISPLACEMENT OF GROUPED PILE FOUNDATION AT ORIGIN *

DISP X, M	DISP Y, M	DISP Z, M	ROT X,RAD	ROT Y,RAD	ROT Z,RAD
1.91564E-03	-1.62123E-03	1.29842E-03	1.82602E-06	1.02184E-04	1.85899E-04

* PILE TOP DISPLACEMENTS, GLOBAL *

	DISP. X, M	DISP. Y, M	DISP. Z, M	ROT. X,RAD	ROT. Y,RAD	ROT. Z,RAD
MINIMUM	3.8935E-04	-1.6336E-03	1.2902E-03	1.8260E-06	1.0218E-04	1.8590E-04
Pile N.	10	1	3	1	1	1
MAXIMUM	3.4419E-03	-1.6089E-03	1.3066E-03	1.8260E-06	1.0218E-04	1.8590E-04
Pile N.	3	10	1	1	1	1

* PILE TOP REACTIONS, GLOBAL *

	FOR. X, KN	FOR. Y, KN	FOR. Z, KN	MOM X, KN- M	MOM Y, KN- M	MOM Z, KN- M
MINIMUM	864.18	-363.57	238.98	0.6268	-793.89	-768.32
Pile N.	10	3	8	1	3	3
MAXIMUM	7186.9	-251.69	329.43	0.6268	-627.24	-557.15
Pile N.	3	8	3	1	8	8

* PILE TOP DISPLACEMENTS, LOCAL *

	DISP. x, M	DISP. y, M	DISP. z, M	ROT. x,RAD	ROT. y,RAD	ROT. z,RAD
MINIMUM	3.8935E-04	-1.6336E-03	1.2902E-03	1.8260E-06	1.0218E-04	1.8590E-04
Pile N.	10	1	3	1	1	1
MAXIMUM	3.4419E-03	-1.6089E-03	1.3066E-03	1.8260E-06	1.0218E-04	1.8590E-04

APPALTATORE:

Consorzio

Soci



ITINERARIO NAPOLI – BARI

PROGETTAZIONE:

Mandataria

Mandanti



RADDOPPIO TRATTA APICE – ORSARA
I LOTTO FUNZIONALE APICE – HIRPINIA

PROGETTO ESECUTIVO

RELAZIONE DI CALCOLO FONDAZIONI PILE DA P7 A P16

COMMESSA IF1N	LOTTO 01 E ZZ	CODIFICA RG	DOCUMENTO MD0000 001	REV. B	FOGLIO 137 di 144
------------------	------------------	----------------	-------------------------	-----------	-------------------------

Pile N. 3 10 1 1 1 1

* PILE TOP REACTIONS, LOCAL *

	AXIAL, KN	LAT. y, KN	LAT. z, KN	MOM x, KN- M	MOM y, KN- M	MOM z, KN- M
MINIMUM	864.18	-363.57	238.98	0.6268	-793.89	-768.32
Pile N.	10	3	8	1	3	3
MAXIMUM	7186.9	-251.69	329.43	0.6268	-627.24	-557.15
Pile N.	3	8	3	1	8	8

* EFFECTS FOR LATERALLY LOADED PILE *

PILE	DISPL. y-DIR M	DISPL. z-DIR M	MOMENT z-DIR KN- M	MOMENT y-DIR KN- M	SHEAR y-DIR KN	SHEAR z-DIR KN	SOIL REACT y-DIR KN/ M	SOIL REACT z-DIR KN/ M	TOTAL STRESS KN/ M**2
Min.	-1.6336E-03	-2.8646E-05	-486.87	-793.89	-363.68	-98.440	-146.19	-26.442	489.03
Pile N.	1	4	3	3	3	3	3	3	10
Max.	3.5303E-05	1.3066E-03	768.32	394.59	120.65	329.55	32.270	129.57	7401.3
Pile N.	5	1	3	3	3	3	3	3	3

LOAD CASE : 6

* TABLE L * COMPUTATION ON PILE CAP

* EQUIVALENT CONCENTRATED LOAD AT ORIGIN *

LOAD X, KN	LOAD Y, KN	LOAD Z, KN	MOM X, KN- M	MOM Y, KN- M	MOM Z, KN- M
16075.0	3629.00	-3332.00	-123.000	-55384.0	-54938.0

* DISPLACEMENT OF GROUPED PILE FOUNDATION AT ORIGIN *

DISP X, M	DISP Y, M	DISP Z, M	ROT X,RAD	ROT Y,RAD	ROT Z,RAD
6.20558E-04	1.62318E-03	-1.28487E-03	9.56329E-08	-9.84096E-05	-1.81003E-04

* PILE TOP DISPLACEMENTS, GLOBAL *

	DISP. X, M	DISP. Y, M	DISP. Z, M	ROT. X,RAD	ROT. Y,RAD	ROT. Z,RAD
MINIMUM	-8.5822E-04	1.6225E-03	-1.2853E-03	9.5633E-08	-9.8410E-05	-1.8100E-04
Pile N.	3	1	3	1	1	1
MAXIMUM	2.0993E-03	1.6238E-03	-1.2844E-03	9.5633E-08	-9.8410E-05	-1.8100E-04
Pile N.	10	10	1	1	1	1

* PILE TOP REACTIONS, GLOBAL *

	FOR. X, KN	FOR. Y, KN	FOR. Z, KN	MOM X, KN- M	MOM Y, KN- M	MOM Z, KN- M
MINIMUM	-1863.3	257.56	-331.61	0.032825	631.01	580.23
Pile N.	3	5	10	1	5	5
MAXIMUM	4439.8	365.62	-239.10	0.032825	804.16	779.36
Pile N.	10	10	5	1	10	10

* PILE TOP DISPLACEMENTS, LOCAL *

	DISP. x, M	DISP. y, M	DISP. z, M	ROT. x,RAD	ROT. y,RAD	ROT. z,RAD
MINIMUM	-8.5822E-04	1.6225E-03	-1.2853E-03	9.5633E-08	-9.8410E-05	-1.8100E-04
Pile N.	3	1	3	1	1	1
MAXIMUM	2.0993E-03	1.6238E-03	-1.2844E-03	9.5633E-08	-9.8410E-05	-1.8100E-04
Pile N.	10	10	1	1	1	1

* PILE TOP REACTIONS, LOCAL *

	AXIAL, KN	LAT. y, KN	LAT. z, KN	MOM x, KN- M	MOM y, KN- M	MOM z, KN- M
MINIMUM	-1863.3	257.56	-331.61	0.032825	631.01	580.23
Pile N.	3	5	10	1	5	5
MAXIMUM	4439.8	365.62	-239.10	0.032825	804.16	779.36
Pile N.	10	10	5	1	10	10

* EFFECTS FOR LATERALLY LOADED PILE *

PILE	DISPL. y-DIR M	DISPL. z-DIR M	MOMENT z-DIR KN- M	MOMENT y-DIR KN- M	SHEAR y-DIR KN	SHEAR z-DIR KN	SOIL REACT y-DIR KN/ M	SOIL REACT z-DIR KN/ M	TOTAL STRESS KN/ M**2
Min.	-3.5223E-05	-1.2853E-03	-779.36	-393.39	-120.00	-331.69	-32.078	-130.11	34.496
Pile N.	5	3	10	10	10	10	10	10	9
Max.	1.6238E-03	2.8297E-05	484.59	804.16	365.69	98.055	146.61	26.362	5892.2
Pile N.	10	5	10	10	10	10	10	10	10

LOAD CASE : 7

* TABLE L * COMPUTATION ON PILE CAP

* EQUIVALENT CONCENTRATED LOAD AT ORIGIN *

LOAD X, KN	LOAD Y, KN	LOAD Z, KN	MOM X, KN- M	MOM Y, KN- M	MOM Z, KN- M
37622.0	-4704.00	14658.0	-409.000	2.47398E+05	71098.0

* DISPLACEMENT OF GROUPED PILE FOUNDATION AT ORIGIN *

DISP X, M	DISP Y, M	DISP Z, M	ROT X,RAD	ROT Y,RAD	ROT Z,RAD
1.57583E-03	-2.36351E-03	6.27798E-03	-1.38525E-05	4.70988E-04	2.60469E-04

APPALTATORE: Consorzio Soci 		ITINERARIO NAPOLI – BARI RADDOPPIO TRATTA APICE – ORSARA I LOTTO FUNZIONALE APICE – HIRPINIA
PROGETTAZIONE: Mandataria Mandanti 		
PROGETTO ESECUTIVO RELAZIONE DI CALCOLO FONDAZIONI PILE DA P7 A P16		

* PILE TOP DISPLACEMENTS, GLOBAL *

	DISP. X, M	DISP. Y, M	DISP. Z, M	ROT. X,RAD	ROT. Y,RAD	ROT. Z,RAD
MINIMUM	-2.7755E-03	-2.4570E-03	6.2156E-03	-1.3852E-05	4.7099E-04	2.6047E-04
Pile N.	10	10	1	1	1	1
MAXIMUM	5.9271E-03	-2.2700E-03	6.3403E-03	-1.3852E-05	4.7099E-04	2.6047E-04
Pile N.	3	1	3	1	1	1

* PILE TOP REACTIONS, GLOBAL *

	FOR. X, KN	FOR. Y, KN	FOR. Z, KN	MOM X, KN- M	MOM Y, KN- M	MOM Z, KN- M
MINIMUM	-5777.7	-457.37	1032.1	-4.7548	-3796.1	-983.22
Pile N.	10	3	8	1	3	3
MAXIMUM	1.0964E+04	-333.67	1509.0	-4.7548	-2819.1	-761.16
Pile N.	3	5	3	1	8	5

* PILE TOP DISPLACEMENTS, LOCAL *

	DISP. x, M	DISP. y, M	DISP. z, M	ROT. x,RAD	ROT. y,RAD	ROT. z,RAD
MINIMUM	-2.7755E-03	-2.4570E-03	6.2156E-03	-1.3852E-05	4.7099E-04	2.6047E-04
Pile N.	10	10	1	1	1	1
MAXIMUM	5.9271E-03	-2.2700E-03	6.3403E-03	-1.3852E-05	4.7099E-04	2.6047E-04
Pile N.	3	1	3	1	1	1

* PILE TOP REACTIONS, LOCAL *

	AXIAL, KN	LAT. y, KN	LAT. z, KN	MOM x, KN- M	MOM y, KN- M	MOM z, KN- M
MINIMUM	-5777.7	-457.37	1032.1	-4.7548	-3796.1	-983.22
Pile N.	10	3	8	1	3	3
MAXIMUM	1.0964E+04	-333.67	1509.0	-4.7548	-2819.1	-761.16
Pile N.	3	5	3	1	8	5

* EFFECTS FOR LATERALLY LOADED PILE *

PILE	DISPL. y-DIR M	DISPL. z-DIR M	MOMENT z-DIR KN- M	MOMENT y-DIR KN- M	SHEAR y-DIR KN	SHEAR z-DIR KN	SOIL REACT y-DIR KN/ M	SOIL REACT z-DIR KN/ M	TOTAL STRESS KN/ M**2
Min.	-2.4570E-03	-1.2909E-04	-641.39	-3796.1	-457.59	-468.51	-138.56	-126.43	533.86
Pile N.	10	6	3	3	3	3	3	3	12
Max.	4.8789E-05	6.3403E-03	983.22	1860.4	160.34	1509.9	43.180	442.47	1.8039E+04
Pile N.	11	3	3	3	3	3	3	3	3

LOAD CASE : 8

* TABLE L * COMPUTATION ON PILE CAP

* EQUIVALENT CONCENTRATED LOAD AT ORIGIN *

LOAD X, KN	LOAD Y, KN	LOAD Z, KN	MOM X, KN- M	MOM Y, KN- M	MOM Z, KN- M
26550.0	4919.00	-14734.0	409.000	-2.45095E+05	-74460.0

* DISPLACEMENT OF GROUPED PILE FOUNDATION AT ORIGIN *

DISP X, M	DISP Y, M	DISP Z, M	ROT X,RAD	ROT Y,RAD	ROT Z,RAD
1.10025E-03	2.45522E-03	-6.26797E-03	-7.06929E-06	-4.59131E-04	-2.67859E-04

* PILE TOP DISPLACEMENTS, GLOBAL *

	DISP. X, M	DISP. Y, M	DISP. Z, M	ROT. X,RAD	ROT. Y,RAD	ROT. Z,RAD
MINIMUM	-3.2042E-03	2.4075E-03	-6.2998E-03	-7.0693E-06	-4.5913E-04	-2.6786E-04
Pile N.	3	10	1	1	1	1
MAXIMUM	5.4047E-03	2.5029E-03	-6.2362E-03	-7.0693E-06	-4.5913E-04	-2.6786E-04
Pile N.	10	1	3	1	1	1

* PILE TOP REACTIONS, GLOBAL *

	FOR. X, KN	FOR. Y, KN	FOR. Z, KN	MOM X, KN- M	MOM Y, KN- M	MOM Z, KN- M
MINIMUM	-6653.2	346.37	-1506.8	-2.4265	2852.7	805.07
Pile N.	3	5	10	1	5	5
MAXIMUM	1.0253E+04	492.48	-1038.2	-2.4265	3805.5	1076.2
Pile N.	10	10	5	1	10	10

* PILE TOP DISPLACEMENTS, LOCAL *

	DISP. x, M	DISP. y, M	DISP. z, M	ROT. x,RAD	ROT. y,RAD	ROT. z,RAD
MINIMUM	-3.2042E-03	2.4075E-03	-6.2998E-03	-7.0693E-06	-4.5913E-04	-2.6786E-04
Pile N.	3	10	1	1	1	1
MAXIMUM	5.4047E-03	2.5029E-03	-6.2362E-03	-7.0693E-06	-4.5913E-04	-2.6786E-04
Pile N.	10	1	3	1	1	1

* PILE TOP REACTIONS, LOCAL *

	AXIAL, KN	LAT. y, KN	LAT. z, KN	MOM x, KN- M	MOM y, KN- M	MOM z, KN- M
MINIMUM	-6653.2	346.37	-1506.8	-2.4265	2852.7	805.07
Pile N.	3	5	10	1	5	5
MAXIMUM	1.0253E+04	492.48	-1038.2	-2.4265	3805.5	1076.2
Pile N.	10	10	5	1	10	10

* EFFECTS FOR LATERALLY LOADED PILE *

APPALTATORE: Consorzio Soci   		ITINERARIO NAPOLI – BARI RADDOPPIO TRATTA APICE – ORSARA I LOTTO FUNZIONALE APICE – HIRPINIA
PROGETTAZIONE: Mandataria Mandanti   		
PROGETTO ESECUTIVO RELAZIONE DI CALCOLO FONDAZIONI PILE DA P7 A P16		

MINIMUM	-4300.2	-1220.2	240.44	2.9882	-782.85	-2673.2
Pile N.	10	3	8	1	3	3
MAXIMUM	9850.0	-842.83	322.04	2.9882	-634.91	-1919.1
Pile N.	3	8	3	1	8	8

* PILE TOP DISPLACEMENTS, LOCAL *

	DISP. x, M	DISP. y, M	DISP. z, M	ROT. x,RAD	ROT. y,RAD	ROT. z,RAD
MINIMUM	-2.0518E-03	-5.7142E-03	1.3503E-03	8.7056E-06	1.1185E-04	6.2782E-04
Pile N.	10	1	3	1	1	1
MAXIMUM	5.1086E-03	-5.5966E-03	1.4287E-03	8.7056E-06	1.1185E-04	6.2782E-04
Pile N.	3	10	1	1	1	1

* PILE TOP REACTIONS, LOCAL *

	AXIAL, KN	LAT. y, KN	LAT. z, KN	MOM x, KN- M	MOM y, KN- M	MOM z, KN- M
MINIMUM	-4300.2	-1220.2	240.44	2.9882	-782.85	-2673.2
Pile N.	10	3	8	1	3	3
MAXIMUM	9850.0	-842.83	322.04	2.9882	-634.91	-1919.1
Pile N.	3	8	3	1	8	8

* EFFECTS FOR LATERALLY LOADED PILE *

PILE	DISPL. y-DIR M	DISPL. z-DIR M	MOMENT KN- M	MOMENT KN- M	SHEAR y-DIR KN	SHEAR z-DIR KN	SOIL REACT y-DIR KN/ M	SOIL REACT z-DIR KN/ M	TOTAL STRESS KN/ M**2
Min.	-5.7142E-03	-3.0065E-05	-1672.1	-782.85	-1220.8	-100.90	-417.91	-27.249	670.78
Pile N.	1	7	3	3	3	3	3	3	1
Max.	1.1756E-04	1.4287E-03	2673.2	403.30	416.78	322.21	111.56	108.61	1.3981E+04
Pile N.	5	1	3	3	3	3	12	3	3

LOAD CASE : 11

* TABLE L * COMPUTATION ON PILE CAP

* EQUIVALENT CONCENTRATED LOAD AT ORIGIN *

LOAD X, KN	LOAD Y, KN	LOAD Z, KN	MOM X, KN- M	MOM Y, KN- M	MOM Z, KN- M
48590.0	3534.00	-1146.00	-361.000	-24236.0	-61010.0

* DISPLACEMENT OF GROUPED PILE FOUNDATION AT ORIGIN *

DISP X, M	DISP Y, M	DISP Z, M	ROT X,RAD	ROT Y,RAD	ROT Z,RAD
1.90943E-03	1.66807E-03	-4.69439E-04	-5.25939E-07	-4.31575E-05	-2.05653E-04

* PILE TOP DISPLACEMENTS, GLOBAL *

	DISP. X, M	DISP. Y, M	DISP. Z, M	ROT. X,RAD	ROT. Y,RAD	ROT. Z,RAD
MINIMUM	6.9268E-04	1.6645E-03	-4.7181E-04	-5.2594E-07	-4.3158E-05	-2.0565E-04
Pile N.	3	10	1	1	1	1
MAXIMUM	3.1262E-03	1.6716E-03	-4.6707E-04	-5.2594E-07	-4.3158E-05	-2.0565E-04
Pile N.	10	1	3	1	1	1

* PILE TOP REACTIONS, GLOBAL *

	FOR. X, KN	FOR. Y, KN	FOR. Z, KN	MOM X, KN- M	MOM Y, KN- M	MOM Z, KN- M
MINIMUM	1537.4	252.77	-115.29	-0.1805	204.50	529.17
Pile N.	3	5	10	1	6	8
MAXIMUM	6540.8	356.11	-82.677	-0.1805	266.34	715.83
Pile N.	10	10	5	1	10	10

* PILE TOP DISPLACEMENTS, LOCAL *

	DISP. x, M	DISP. y, M	DISP. z, M	ROT. x,RAD	ROT. y,RAD	ROT. z,RAD
MINIMUM	6.9268E-04	1.6645E-03	-4.7181E-04	-5.2594E-07	-4.3158E-05	-2.0565E-04
Pile N.	3	10	1	1	1	1
MAXIMUM	3.1262E-03	1.6716E-03	-4.6707E-04	-5.2594E-07	-4.3158E-05	-2.0565E-04
Pile N.	10	1	3	1	1	1

* PILE TOP REACTIONS, LOCAL *

	AXIAL, KN	LAT. y, KN	LAT. z, KN	MOM x, KN- M	MOM y, KN- M	MOM z, KN- M
MINIMUM	1537.4	252.77	-115.29	-0.1805	204.50	529.17
Pile N.	3	5	10	1	6	8
MAXIMUM	6540.8	356.11	-82.677	-0.1805	266.34	715.83
Pile N.	10	10	5	1	10	10

* EFFECTS FOR LATERALLY LOADED PILE *

PILE	DISPL. y-DIR M	DISPL. z-DIR M	MOMENT KN- M	MOMENT KN- M	SHEAR y-DIR KN	SHEAR z-DIR KN	SOIL REACT y-DIR KN/ M	SOIL REACT z-DIR KN/ M	TOTAL STRESS KN/ M**2
Min.	-3.6159E-05	-4.7181E-04	-715.83	-142.99	-121.75	-115.32	-32.597	-45.535	870.00
Pile N.	5	1	10	10	10	10	10	10	3
Max.	1.6716E-03	1.0270E-05	492.43	266.34	356.20	35.577	143.77	9.5204	6006.5
Pile N.	1	8	10	10	10	10	10	10	10

LOAD CASE : 12

APPALTATORE:

Consorzio

Soci



ITINERARIO NAPOLI – BARI

PROGETTAZIONE:

Mandataria

Mandanti

RADDOPPIO TRATTA APICE – ORSARA
I LOTTO FUNZIONALE APICE – HIRPINIA

PROGETTO ESECUTIVO

RELAZIONE DI CALCOLO FONDAZIONI PILE DA P7 A P16

COMMESSA	LOTTO	CODIFICA	DOCUMENTO	REV.	FOGLIO
IF1N	01 E ZZ	RG	MD0000 001	B	141 di 144

* TABLE L * COMPUTATION ON PILE CAP

* EQUIVALENT CONCENTRATED LOAD AT ORIGIN *

LOAD X, KN	LOAD Y, KN	LOAD Z, KN	MOM X, KN- M	MOM Y, KN- M	MOM Z, KN- M
52111.0	1340.00	-1683.00	-5.00000	-35370.0	-20867.0

* DISPLACEMENT OF GROUPED PILE FOUNDATION AT ORIGIN *

DISP X, M	DISP Y, M	DISP Z, M	ROT X,RAD	ROT Y,RAD	ROT Z,RAD
2.05185E-03	6.13811E-04	-6.90389E-04	-4.04048E-07	-6.34109E-05	-7.15946E-05

* PILE TOP DISPLACEMENTS, GLOBAL *

	DISP. X, M	DISP. Y, M	DISP. Z, M	ROT. X,RAD	ROT. Y,RAD	ROT. Z,RAD
MINIMUM	1.3016E-03	6.1108E-04	-6.9221E-04	-4.0405E-07	-6.3411E-05	-7.1595E-05
Pile N.	3	10	1	1	1	1
MAXIMUM	2.8020E-03	6.1654E-04	-6.8857E-04	-4.0405E-07	-6.3411E-05	-7.1595E-05
Pile N.	10	1	3	1	1	1

* PILE TOP REACTIONS, GLOBAL *

	FOR. X, KN	FOR. Y, KN	FOR. Z, KN	MOM X, KN- M	MOM Y, KN- M	MOM Z, KN- M
MINIMUM	2807.6	94.763	-169.63	-0.1387	298.07	207.65
Pile N.	3	5	10	1	5	5
MAXIMUM	5877.6	134.93	-119.72	-0.1387	390.94	279.64
Pile N.	10	10	5	1	10	10

* PILE TOP DISPLACEMENTS, LOCAL *

	DISP. x, M	DISP. y, M	DISP. z, M	ROT. x,RAD	ROT. y,RAD	ROT. z,RAD
MINIMUM	1.3016E-03	6.1108E-04	-6.9221E-04	-4.0405E-07	-6.3411E-05	-7.1595E-05
Pile N.	3	10	1	1	1	1
MAXIMUM	2.8020E-03	6.1654E-04	-6.8857E-04	-4.0405E-07	-6.3411E-05	-7.1595E-05
Pile N.	10	1	3	1	1	1

* PILE TOP REACTIONS, LOCAL *

	AXIAL, KN	LAT. y, KN	LAT. z, KN	MOM x, KN- M	MOM y, KN- M	MOM z, KN- M
MINIMUM	2807.6	94.763	-169.63	-0.1387	298.07	207.65
Pile N.	3	5	10	1	5	5
MAXIMUM	5877.6	134.93	-119.72	-0.1387	390.94	279.64
Pile N.	10	10	5	1	10	10

* EFFECTS FOR LATERALLY LOADED PILE *

PILE	DISPL. y-DIR M	DISPL. z-DIR M	MOMENT z-DIR KN- M	MOMENT y-DIR KN- M	SHEAR y-DIR KN	SHEAR z-DIR KN	SOIL REACT y-DIR KN/ M	SOIL REACT z-DIR KN/ M	TOTAL STRESS KN/ M**2
*****	*****	*****	*****	*****	*****	*****	*****	*****	*****
Min.	-1.3387E-05	-6.9221E-04	-279.64	-209.76	-44.958	-169.67	-12.028	-66.746	1588.8
Pile N.	5	1	10	10	10	10	10	10	3
Max.	6.1654E-04	1.5113E-05	181.66	390.94	134.96	52.170	53.992	13.959	4776.7
Pile N.	1	8	10	10	10	10	10	10	10

LOAD CASE : 13

* TABLE L * COMPUTATION ON PILE CAP

* EQUIVALENT CONCENTRATED LOAD AT ORIGIN *

LOAD X, KN	LOAD Y, KN	LOAD Z, KN	MOM X, KN- M	MOM Y, KN- M	MOM Z, KN- M
52111.0	1750.00	-1683.00	-5.00000	-35370.0	-27349.0

* DISPLACEMENT OF GROUPED PILE FOUNDATION AT ORIGIN *

DISP X, M	DISP Y, M	DISP Z, M	ROT X,RAD	ROT Y,RAD	ROT Z,RAD
2.05185E-03	8.01227E-04	-6.89519E-04	1.99104E-07	-6.34059E-05	-9.37668E-05

* PILE TOP DISPLACEMENTS, GLOBAL *

	DISP. X, M	DISP. Y, M	DISP. Z, M	ROT. X,RAD	ROT. Y,RAD	ROT. Z,RAD
MINIMUM	1.2019E-03	7.9988E-04	-6.9041E-04	1.9910E-07	-6.3406E-05	-9.3767E-05
Pile N.	3	1	3	1	1	1
MAXIMUM	2.9018E-03	8.0257E-04	-6.8862E-04	1.9910E-07	-6.3406E-05	-9.3767E-05
Pile N.	10	10	1	1	1	1

* PILE TOP REACTIONS, GLOBAL *

	FOR. X, KN	FOR. Y, KN	FOR. Z, KN	MOM X, KN- M	MOM Y, KN- M	MOM Z, KN- M
MINIMUM	2603.5	123.69	-168.36	0.068341	298.59	269.85
Pile N.	3	5	10	1	5	5
MAXIMUM	6081.7	177.36	-120.10	0.068341	387.49	368.29
Pile N.	10	10	5	1	10	10

* PILE TOP DISPLACEMENTS, LOCAL *

	DISP. x, M	DISP. y, M	DISP. z, M	ROT. x,RAD	ROT. y,RAD	ROT. z,RAD
MINIMUM	1.2019E-03	7.9988E-04	-6.9041E-04	1.9910E-07	-6.3406E-05	-9.3767E-05
Pile N.	3	1	3	1	1	1
MAXIMUM	2.9018E-03	8.0257E-04	-6.8862E-04	1.9910E-07	-6.3406E-05	-9.3767E-05
Pile N.	10	10	1	1	1	1

APPALDATTORE: Consorzio Soci   	ITINERARIO NAPOLI – BARI RADDOPPIO TRATTA APICE – ORSARA I LOTTO FUNZIONALE APICE – HIRPINIA
PROGETTAZIONE: Mandataria Mandanti   	
PROGETTO ESECUTIVO RELAZIONE DI CALCOLO FONDAZIONI PILE DA P7 A P16	
COMMESSA IF1N LOTTO 01 E ZZ CODIFICA RG DOCUMENTO MD0000 001 REV. B FOGLIO 142 di 144	

Pile N.	10	10	1	1	1	1
* PILE TOP REACTIONS, LOCAL *						
	AXIAL, KN	LAT. y, KN	LAT. z, KN	MOM x, KN- M	MOM y, KN- M	MOM z, KN- M
	*****	*****	*****	*****	*****	*****
MINIMUM	2603.5	123.69	-168.36	0.068341	298.59	269.85
Pile N.	3	5	10	1	5	5
MAXIMUM	6081.7	177.36	-120.10	0.068341	387.49	368.29
Pile N.	10	10	5	1	10	10

*** EFFECTS FOR LATERALLY LOADED PILE ***

PILE	DISPL. y-DIR	DISPL. z-DIR	MOMENT z-DIR	MOMENT y-DIR	SHEAR y-DIR	SHEAR z-DIR	SOIL REACT y-DIR	SOIL REACT z-DIR	TOTAL STRESS
	M	M	KN- M	KN- M	KN	KN	KN/ M	KN/ M	KN/ M**2
*****	*****	*****	*****	*****	*****	*****	*****	*****	*****
Min.	-1.7424E-05	-6.9041E-04	-368.29	-208.61	-59.071	-168.41	-15.803	-66.301	1473.3
Pile N.	5	3	10	10	10	10	10	10	3
Max.	8.0257E-04	1.5093E-05	238.65	387.49	177.41	51.883	70.996	13.881	5055.0
Pile N.	10	8	10	10	10	10	10	10	10

LOAD CASE : 14

*** TABLE L * COMPUTATION ON PILE CAP**

*** EQUIVALENT CONCENTRATED LOAD AT ORIGIN ***

LOAD X, KN	LOAD Y, KN	LOAD Z, KN	MOM X, KN- M	MOM Y, KN- M	MOM Z, KN- M
35940.0	255.000	-1362.00	0.00000	-28082.0	-4026.00

*** DISPLACEMENT OF GROUPED PILE FOUNDATION AT ORIGIN ***

DISP X, M	DISP Y, M	DISP Z, M	ROT X,RAD	ROT Y,RAD	ROT Z,RAD
1.39325E-03	1.18422E-04	-5.60687E-04	-6.60749E-07	-5.04881E-05	-1.37923E-05

*** PILE TOP DISPLACEMENTS, GLOBAL ***

	DISP. X, M	DISP. Y, M	DISP. Z, M	ROT. X,RAD	ROT. Y,RAD	ROT. Z,RAD
	*****	*****	*****	*****	*****	*****
MINIMUM	9.9039E-04	1.1396E-04	-5.6366E-04	-6.6075E-07	-5.0488E-05	-1.3792E-05
Pile N.	3	10	1	1	1	1
MAXIMUM	1.7961E-03	1.2288E-04	-5.5771E-04	-6.6075E-07	-5.0488E-05	-1.3792E-05
Pile N.	10	1	3	1	1	1

*** PILE TOP REACTIONS, GLOBAL ***

	FOR. X, KN	FOR. Y, KN	FOR. Z, KN	MOM X, KN- M	MOM Y, KN- M	MOM Z, KN- M
	*****	*****	*****	*****	*****	*****
MINIMUM	2170.7	18.336	-139.48	-0.2268	242.86	39.679
Pile N.	3	5	10	1	5	8
MAXIMUM	3819.3	24.799	-96.597	-0.2268	323.23	50.311
Pile N.	10	10	5	1	10	10

*** PILE TOP DISPLACEMENTS, LOCAL ***

	DISP. x, M	DISP. y, M	DISP. z, M	ROT. x,RAD	ROT. y,RAD	ROT. z,RAD
	*****	*****	*****	*****	*****	*****
MINIMUM	9.9039E-04	1.1396E-04	-5.6366E-04	-6.6075E-07	-5.0488E-05	-1.3792E-05
Pile N.	3	10	1	1	1	1
MAXIMUM	1.7961E-03	1.2288E-04	-5.5771E-04	-6.6075E-07	-5.0488E-05	-1.3792E-05
Pile N.	10	1	3	1	1	1

*** PILE TOP REACTIONS, LOCAL ***

	AXIAL, KN	LAT. y, KN	LAT. z, KN	MOM x, KN- M	MOM y, KN- M	MOM z, KN- M
	*****	*****	*****	*****	*****	*****
MINIMUM	2170.7	18.336	-139.48	-0.2268	242.86	39.679
Pile N.	3	5	10	1	5	8
MAXIMUM	3819.3	24.799	-96.597	-0.2268	323.23	50.311
Pile N.	10	10	5	1	10	10

*** EFFECTS FOR LATERALLY LOADED PILE ***

PILE	DISPL. y-DIR	DISPL. z-DIR	MOMENT z-DIR	MOMENT y-DIR	SHEAR y-DIR	SHEAR z-DIR	SOIL REACT y-DIR	SOIL REACT z-DIR	TOTAL STRESS
	M	M	KN- M	KN- M	KN	KN	KN/ M	KN/ M	KN/ M**2
*****	*****	*****	*****	*****	*****	*****	*****	*****	*****
Min.	-2.6635E-06	-5.6366E-04	-50.311	-171.01	-8.3428	-139.51	-2.2326	-54.728	1228.4
Pile N.	2	1	10	10	10	10	10	10	3
Max.	1.2288E-04	1.2317E-05	33.767	323.23	24.803	42.506	9.9333	11.381	3148.6
Pile N.	1	5	10	10	10	10	10	10	10

LOAD CASE : 15

*** TABLE L * COMPUTATION ON PILE CAP**

*** EQUIVALENT CONCENTRATED LOAD AT ORIGIN ***

LOAD X, KN	LOAD Y, KN	LOAD Z, KN	MOM X, KN- M	MOM Y, KN- M	MOM Z, KN- M
47842.0	1152.00	-1368.00	0.00000	-36302.0	-17968.0

*** DISPLACEMENT OF GROUPED PILE FOUNDATION AT ORIGIN ***

DISP X, M	DISP Y, M	DISP Z, M	ROT X,RAD	ROT Y,RAD	ROT Z,RAD
1.87798E-03	5.27751E-04	-5.96808E-04	-3.88648E-07	-6.33721E-05	-6.16273E-05

APPALTATORE: Consorzio Soci   		ITINERARIO NAPOLI – BARI RADDOPPIO TRATTA APICE – ORSARA I LOTTO FUNZIONALE APICE – HIRPINIA
PROGETTAZIONE: Mandataria Mandanti   		
PROGETTO ESECUTIVO RELAZIONE DI CALCOLO FONDAZIONI PILE DA P7 A P16		

* PILE TOP DISPLACEMENTS, GLOBAL *

	DISP. X, M	DISP. Y, M	DISP. Z, M	ROT. X,RAD	ROT. Y,RAD	ROT. Z,RAD
MINIMUM	1.1729E-03	5.2513E-04	-5.9856E-04	-3.8865E-07	-6.3372E-05	-6.1627E-05
Pile N.	3	10	1	1	1	1
MAXIMUM	2.5831E-03	5.3038E-04	-5.9506E-04	-3.8865E-07	-6.3372E-05	-6.1627E-05
Pile N.	10	1	3	1	1	1

* PILE TOP REACTIONS, GLOBAL *

	FOR. X, KN	FOR. Y, KN	FOR. Z, KN	MOM X, KN- M	MOM Y, KN- M	MOM Z, KN- M
MINIMUM	2544.1	81.485	-138.66	-0.1334	225.02	178.34
Pile N.	3	5	10	1	5	5
MAXIMUM	5429.5	115.93	-96.848	-0.1334	302.28	239.91
Pile N.	10	10	5	1	10	10

* PILE TOP DISPLACEMENTS, LOCAL *

	DISP. x, M	DISP. y, M	DISP. z, M	ROT. x,RAD	ROT. y,RAD	ROT. z,RAD
MINIMUM	1.1729E-03	5.2513E-04	-5.9856E-04	-3.8865E-07	-6.3372E-05	-6.1627E-05
Pile N.	3	10	1	1	1	1
MAXIMUM	2.5831E-03	5.3038E-04	-5.9506E-04	-3.8865E-07	-6.3372E-05	-6.1627E-05
Pile N.	10	1	3	1	1	1

* PILE TOP REACTIONS, LOCAL *

	AXIAL, KN	LAT. y, KN	LAT. z, KN	MOM x, KN- M	MOM y, KN- M	MOM z, KN- M
MINIMUM	2544.1	81.485	-138.66	-0.1334	225.02	178.34
Pile N.	3	5	10	1	5	5
MAXIMUM	5429.5	115.93	-96.848	-0.1334	302.28	239.91
Pile N.	10	10	5	1	10	10

* EFFECTS FOR LATERALLY LOADED PILE *

PILE	DISPL. y-DIR M	DISPL. z-DIR M	MOMENT z-DIR KN- M	MOMENT y-DIR KN- M	SHEAR y-DIR KN	SHEAR z-DIR KN	SOIL REACT y-DIR KN/ M	SOIL REACT z-DIR KN/ M	TOTAL STRESS KN/ M**2
Min.	-1.1508E-05	-5.9856E-04	-239.91	-179.45	-38.616	-138.70	-10.331	-55.020	1439.7
Pile N.	5	1	10	10	10	10	10	10	3
Max.	5.3037E-04	1.3019E-05	156.07	302.28	115.96	44.499	46.366	11.891	4237.2
Pile N.	1	5	10	10	10	10	10	10	10

LOAD CASE : 16

* TABLE L * COMPUTATION ON PILE CAP

* EQUIVALENT CONCENTRATED LOAD AT ORIGIN *

LOAD X, KN	LOAD Y, KN	LOAD Z, KN	MOM X, KN- M	MOM Y, KN- M	MOM Z, KN- M
48590.0	3534.00	-1146.00	-361.000	-24236.0	-61010.0

* DISPLACEMENT OF GROUPED PILE FOUNDATION AT ORIGIN *

DISP X, M	DISP Y, M	DISP Z, M	ROT X,RAD	ROT Y,RAD	ROT Z,RAD
1.90943E-03	1.66807E-03	-4.69439E-04	-5.25939E-07	-4.31575E-05	-2.05653E-04

* PILE TOP DISPLACEMENTS, GLOBAL *

	DISP. X, M	DISP. Y, M	DISP. Z, M	ROT. X,RAD	ROT. Y,RAD	ROT. Z,RAD
MINIMUM	6.9268E-04	1.6645E-03	-4.7181E-04	-5.2594E-07	-4.3158E-05	-2.0565E-04
Pile N.	3	10	1	1	1	1
MAXIMUM	3.1262E-03	1.6716E-03	-4.6707E-04	-5.2594E-07	-4.3158E-05	-2.0565E-04
Pile N.	10	1	3	1	1	1

* PILE TOP REACTIONS, GLOBAL *

	FOR. X, KN	FOR. Y, KN	FOR. Z, KN	MOM X, KN- M	MOM Y, KN- M	MOM Z, KN- M
MINIMUM	1537.4	252.77	-115.29	-0.1805	204.50	529.17
Pile N.	3	5	10	1	6	8
MAXIMUM	6540.8	356.11	-82.677	-0.1805	266.34	715.83
Pile N.	10	10	5	1	10	10

* PILE TOP DISPLACEMENTS, LOCAL *

	DISP. x, M	DISP. y, M	DISP. z, M	ROT. x,RAD	ROT. y,RAD	ROT. z,RAD
MINIMUM	6.9268E-04	1.6645E-03	-4.7181E-04	-5.2594E-07	-4.3158E-05	-2.0565E-04
Pile N.	3	10	1	1	1	1
MAXIMUM	3.1262E-03	1.6716E-03	-4.6707E-04	-5.2594E-07	-4.3158E-05	-2.0565E-04
Pile N.	10	1	3	1	1	1

* PILE TOP REACTIONS, LOCAL *

	AXIAL, KN	LAT. y, KN	LAT. z, KN	MOM x, KN- M	MOM y, KN- M	MOM z, KN- M
MINIMUM	1537.4	252.77	-115.29	-0.1805	204.50	529.17
Pile N.	3	5	10	1	6	8
MAXIMUM	6540.8	356.11	-82.677	-0.1805	266.34	715.83
Pile N.	10	10	5	1	10	10

* EFFECTS FOR LATERALLY LOADED PILE *

APPALTATORE: Consorzio  Soci  	ITINERARIO NAPOLI – BARI RADDOPPIO TRATTA APICE – ORSARA I LOTTO FUNZIONALE APICE – HIRPINIA					
PROGETTAZIONE: Mandataria  Mandanti  						
PROGETTO ESECUTIVO RELAZIONE DI CALCOLO FONDAZIONI PILE DA P7 A P16	COMMESSA IF1N	LOTTO 01 E ZZ	CODIFICA RG	DOCUMENTO MD0000 001	REV. B	FOGLIO 144 di 144

PILE	DISPL. y-DIR M	DISPL. z-DIR M	MOMENT z-DIR KN- M	MOMENT y-DIR KN- M	SHEAR y-DIR KN	SHEAR z-DIR KN	SOIL REACT y-DIR KN/ M	SOIL REACT z-DIR KN/ M	TOTAL STRESS KN/ M**2
*****	*****	*****	*****	*****	*****	*****	*****	*****	*****
Min.	-3.6159E-05	-4.7181E-04	-715.83	-142.99	-121.75	-115.32	-32.597	-45.535	870.00
Pile N.	5	1	10	10	10	10	10	10	3
Max.	1.6716E-03	1.0270E-05	492.43	266.34	356.20	35.577	143.77	9.5204	6006.5
Pile N.	1	8	10	10	10	10	10	10	10