



<u>Committente</u>	Consorzio HirpiniaAV
<u>Indagine</u>	I lotto funzionale Apice-Hirpinia
<u>Sondaggio</u>	SN04
<u>Campione</u>	C1
<u>Profondità</u>	5.50 ÷ 6.00 m
<u>Data apertura</u>	15/10/19
<u>Operatore</u>	Alfredo Ponzo

Diametro (mm):	85
Lunghezza (mm):	470
Data di apertura:	15/10/2019

<b>Stato del Campione</b>	Indisturbato	x
	Parzialmente Rimaneggiato	
	Rimaneggiato	

**Descrizione:** Argilla grigia con presenza di concrezioni calcaree disfatte. Presenza di zone indurite marnose. Tracce di ossidazione . contenuto d'acqua non omogeneo nel campione

<b>Colore</b>	Grigio scuro				
<b>Plasticità</b>	<input type="checkbox"/> Non Plastico	<input type="checkbox"/> Bassa	<input type="checkbox"/> Media alta	<input checked="" type="checkbox"/> Elevata	
<b>Addensamento (Terreni granulari)</b>	<input type="checkbox"/> Molto sciolto ( $D_r=0.0\div 0.2$ )	<input type="checkbox"/> Sciolto ( $D_r=0.2\div 0.4$ )	<input type="checkbox"/> Medio ( $D_r=0.4\div 0.6$ )	<input type="checkbox"/> Denso ( $D_r=0.6\div 0.8$ )	<input type="checkbox"/> Molto denso ( $D_r=0.8\div 1.0$ )
<b>Consistenza (Terreni coesivi)</b>	<input type="checkbox"/> Molto molle ( $I_c < 0.0$ )	<input type="checkbox"/> Molle ( $I_c=0.0\div 0.5$ )	<input type="checkbox"/> Media ( $I_c=0.5\div 1.0$ )	<input checked="" type="checkbox"/> Consistente ( $I_c > 1.0$ )	<input type="checkbox"/> Molto consist. ( $I_c >> 1.0$ )
<b>Grado di umidità</b>	<input type="checkbox"/> Asciutto	<input type="checkbox"/> Poco Umido	<input checked="" type="checkbox"/> Umido	<input type="checkbox"/> Molto Umido	
<b>Alterazione</b>	<input checked="" type="checkbox"/> Assente	<input type="checkbox"/> Debole	<input type="checkbox"/> Media	<input type="checkbox"/> Elevata	
<b>Struttura</b>	<input type="checkbox"/> Omogenea	<input type="checkbox"/> Stratificata	<input type="checkbox"/> Scagliosa	<input type="checkbox"/> Laminata	<input type="checkbox"/> Caotica
<b>Fratturazione</b>	<input checked="" type="checkbox"/> Assente	<input type="checkbox"/> Moderata	<input type="checkbox"/> Elevata		
<b>Cementazione</b>	<input checked="" type="checkbox"/> Assente	<input type="checkbox"/> Debole	<input type="checkbox"/> Media	<input type="checkbox"/> Elevata	

Proprietà fisiche			Proprietà meccaniche	
n,γ,w	X		Pocket=4.0 kg/cm <sup>2</sup> 32 cm Pocket > 5 kg/cm <sup>2</sup> 15 cm	Compressione uniassiale
Analisi granulometrica	X	TX-UU		
Limiti	X	TX-CIU		
CaCO <sub>3</sub>		TX-CID		
Sostanze organiche		TX-Ciclica		<input checked="" type="checkbox"/>
Peso specifico del solido		Taglio anulare		
Proctor		Taglio diretto		
CBR		RC TS		<input checked="" type="checkbox"/>
Altro _____		Altro _____		



Università degli Studi di Napoli Federico II  
Dipartimento di Ingegneria Civile, Edile ed Ambientale  
Laboratorio di Geotecnica

<u>Committente</u>	Consorzio HirpiniaAV
<u>Indagine</u>	I lotto funzionale Apice-Hirpinia
<u>Sondaggio</u>	SN04
<u>Campione</u>	C1
<u>Profondità</u>	5.50 ÷ 6.00 m
<u>Data apertura</u>	15/10/19
<u>Operatore</u>	Alfredo Ponzio

FOTO CAMPIONE

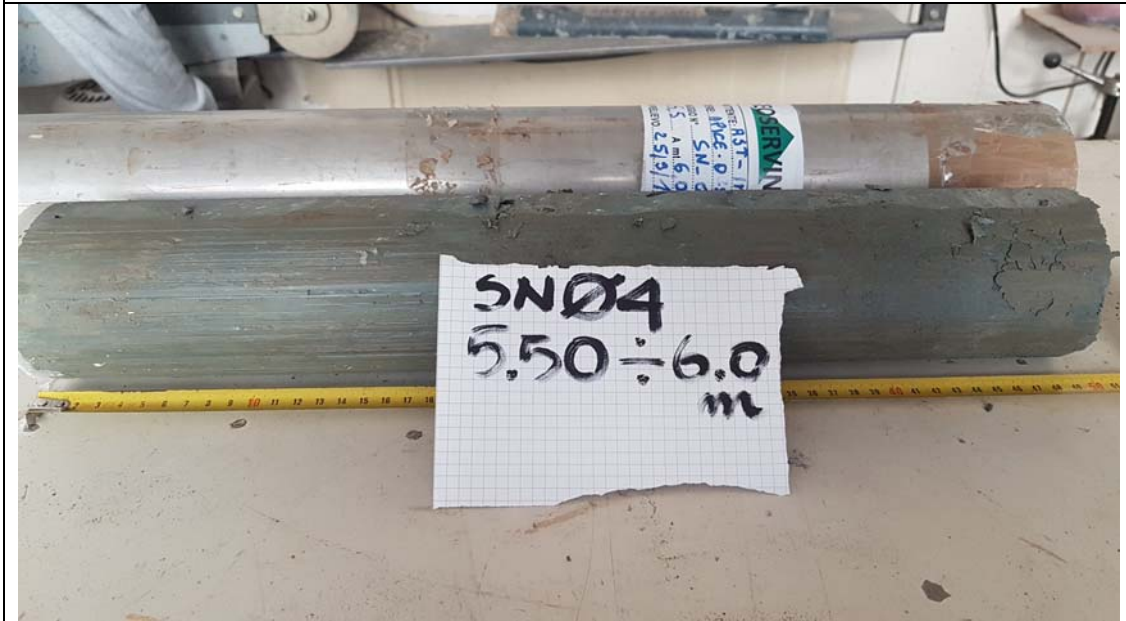

Il responsabile della sperimentazione  
Prof. Ing. Anna d'Onofrio

*Anna d'Onofrio*



Università degli Studi di Napoli  
 Dipartimento di Ingegneria Civile, Edile e Ambientale  
 Laboratorio di Geotecnica

Committente	Consorzio HirpiniaAV
Indagine	I lotto funzionale Apice-Hirpinia
Sondaggio	SN04
Campione	C1
Profondità	5.50 ÷ 6.00 m
Data	22/10/2019
Operatore	Alfredo Ponzo

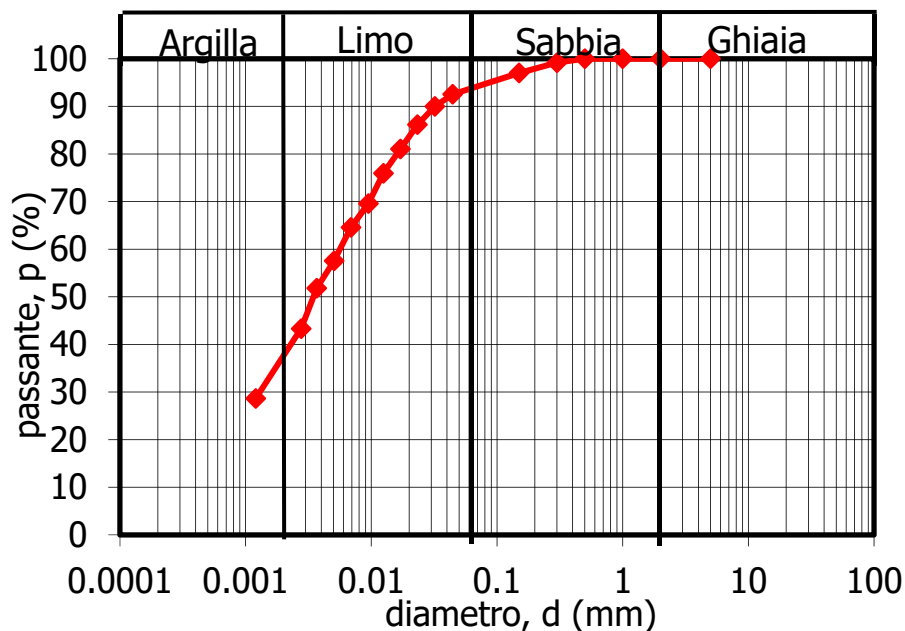

Curva granulometrica	
diametro (mm)	passante (%)
0.30	99.19
0.15	97.01
0.04	92.54
0.03	89.99
0.02	86.16
0.02	81.06
0.012	75.96
0.009	69.58
0.007	64.58
0.005	57.56
0.004	51.82
0.003	43.31
0.001	28.65

**Limo con argilla debolmente sabbioso**

peso secco totale (g)	peso secco sediment. (g)
61.51	61.51

STACCIATURA			SEDIMENTAZIONE		
d (mm)	peso trattenuto (g)	peso passante (g)	tempo (min)	temperatura (°C)	lettura areometro (g/cm <sup>3</sup> )
0.50	0.00	61.51		25.5	
0.30	0.50	61.01	0.5	25.5	1.037
0.15	1.84	59.67	1	25.5	1.036
			2	25.5	1.0345
			4	25.5	1.0325
			8	25.5	1.0305
			15	25.5	1.028
			30	25.75	1.026
			60	25.75	1.02325
			120	25.75	1.021
			240	23.5	1.018
			1440	23.5	1.01225

Gs= 2.757

%<0.075mm	%ghiaia	% sabbia	%limo	%argilla	D <sub>max</sub> (mm)	D <sub>60</sub> (mm)	D <sub>10</sub> (mm)
95	0	7	54	39	0.50	0.0055	

Normativa di riferimento : ASTM 422/90

il responsabile della sperimentazione

prof. Ing. Anna d'Onofrio







Committente	Consorzio HirpiniaAV
Indagine	I lotto funzionale Apice-Hirpinia
Sondaggio	SN04
Campione	C1
Profondità	5.50-6.00
Data	15/10/2019
Operatore	Alfredo Ponzo

LIMITE DI PLASTICITA'				
pesafiltro n°	Tara	Peso lordo umido (P <sub>u</sub> )	Peso lordo secco (P <sub>s</sub> )	Contenuto d'acqua (w)
[-]	[gr]	[gr]	[gr]	[-]
20	15.55	50.95	44.63	0.217
<b>w<sub>P</sub></b>				0.217

LIMITE DI LIQUIDITA' (Metodo di Casagrande ASTM)					
Pesafiltro n°	N° colpi (N)	Tara (P <sub>c</sub> )	Peso lordo umido (P <sub>u</sub> )	Peso lordo secco (P <sub>s</sub> )	Contenuto d'acqua (w)
[-]	[-]	[g]	[g]	[g]	[g]
126	10	11.36	42.53	30.79	0.604
119	14	10.49	42.98	31.02	0.583
147	19	11.77	39.91	29.87	0.555
131	30	10.92	39.14	29.4	0.527
25	<b>Limite di liquidità ASTM (w<sub>L</sub>)</b>				0.537

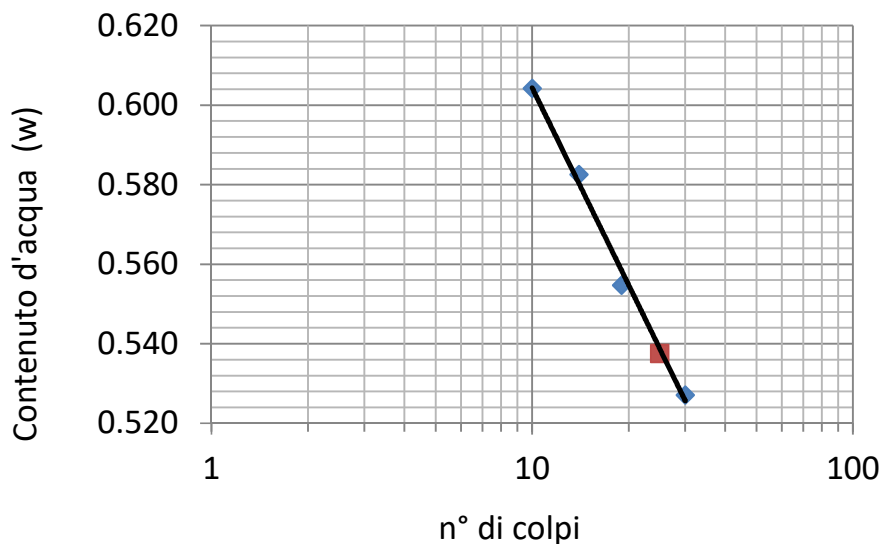

Indice di plasticità (I <sub>p</sub> )	Frazione argillosa CF (d < 2 μm)	Indice di attività (I <sub>A</sub> )
[%]	[%]	[-]
32.01	39.000	0.82

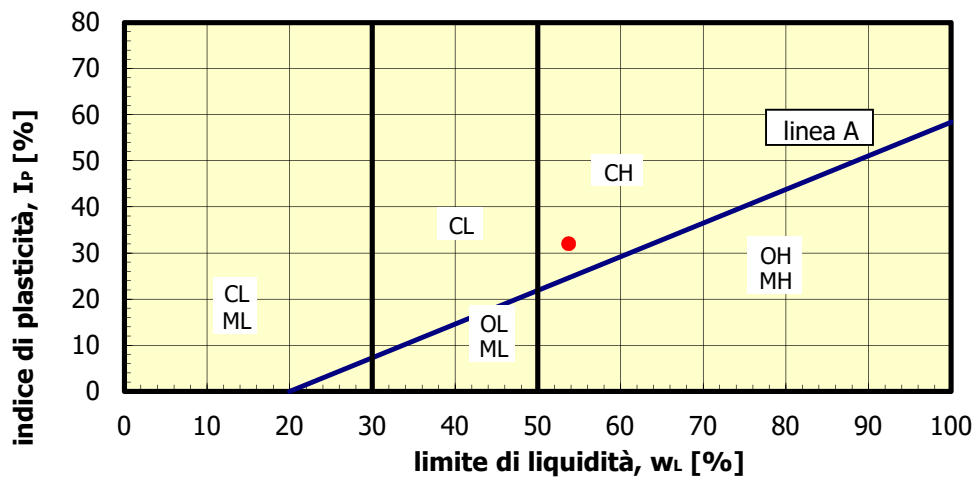

ML	Limi inorganici da bassa a media plasticità	M = limi
CL	Argille inorganiche da bassa a media plasticità	C = argille
OL	Limi e argille organiche di bassa plasticità	O = sostanze organiche
MH	Limi inorganici di alta plasticità	L = bassa plasticità
CH	Argille inorganiche di alta plasticità	H = alta plasticità
OH	Argille organiche da media ad alta plasticità	

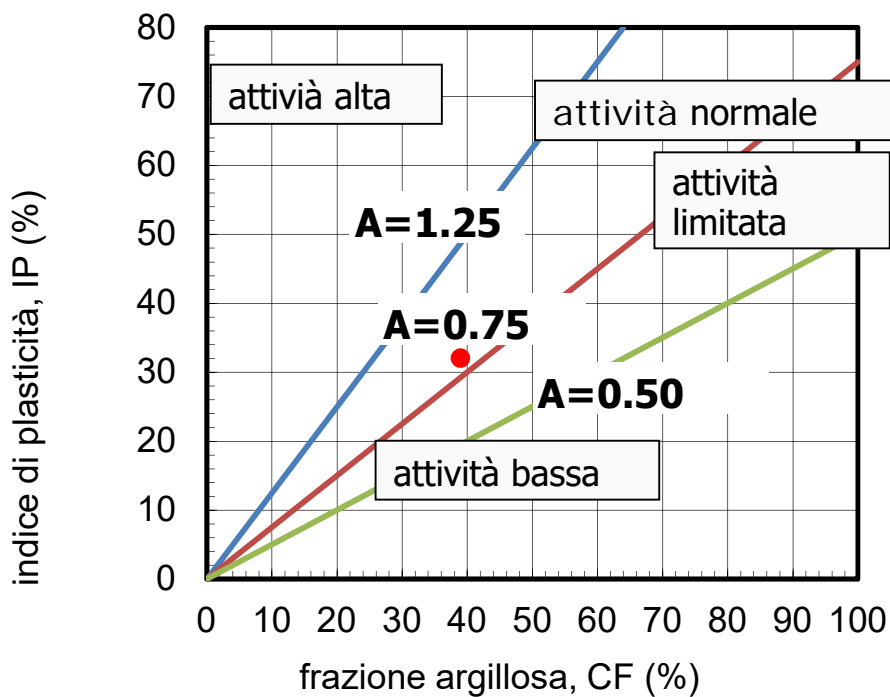

CONSISTENZA TERRENO A GRANA FINE		
$w_L$	$I_p$	$I_c$
[-]	[-]	[-]
53.744	32.01	1.67
COMPATTEZZA TERRENO A GRANA GROSSA		
$e_{max}$	$e_{min}$	$D_r$
[-]	[-]	[-]



Università degli Studi di Napoli  
Dipartimento di Ingegneria Civile, Edile e Ambientale  
Laboratorio di Geotecnica

Committente	Consorzio HirpiniaAV
Indagine	Apice-Hirpinia
Sondaggio	SN03
Campione	C2
Profondità	9.00-9.30
Data	14/10/2019
Operatore	Alfredo Ponzo

Peso specifico del solido	
Peso specifico dell'acqua ( $\gamma_w$ ) (g/cm <sup>3</sup> )	1.000
picnometro n°	xx
Peso picnometro ( $P_p$ ) (g)	42.54
Peso picnometro + acqua ( $P_{pw}$ ) (g)	140.180
Volume picnometro ( $V_p$ ) (cm <sup>3</sup> )	97.64
Peso picnometro + terreno ( $P_{ps}$ ) (g)	62.76
Peso terreno ( $P_s$ )	20.22
Peso picnometro + terreno + acqua ( $P_{psw}$ ) (g)	153.000
Volume acqua aggiunta ( $V_w$ ) (cm <sup>3</sup> )	90.24
Volume terreno ( $V_s$ ) (cm <sup>3</sup> )	7.400
Peso specifico del terreno ( $\gamma_s$ ) (kN/m <sup>3</sup> )	26.794

Caratteristiche Fisiche Generali			
pesafiltro n°		175	199
Peso contenitore ( $P_c$ ) (g)	29.43	11.61	11.36
Diametro (D) (mm)	35.46		
Altezza (H) (mm)	71.86		
Volume (V) (cm <sup>3</sup> )	70.93		
Peso lordo umido ( $P_u$ ) (g)	186.17	49.97	53.44
Peso lordo secco ( $P_s$ ) (g)	164.16	44.74	48.2
Contenuto d'acqua (w)	0.16	0.16	0.14
Peso umido unità di volume ( $\gamma$ ) (kN/m <sup>3</sup> )	21.67		
Peso secco unità di volume ( $\gamma_d$ ) (kN/m <sup>3</sup> )	18.63		
Peso specifico del solido ( $\gamma_s$ ) (kN/m <sup>3</sup> )	26.79		
Porosità (n)	0.30		
Indice dei vuoti (e)	0.44		
Grado di Saturazione ( $S_r$ )	1.02		



Università degli Studi di Napoli Federico II  
Dipartimento di Ingegneria Idraulica,  
Geotecnica ed Ambientale

Prova Compressione Triassiale n.		Celle n.
Prova tipo	TXC	
Committente	Consorzio Hirpinia AV	
Indagine	I lotto funzionale Apice-Hirpinia	
Sondaggio	SN04	
Campione	1	
Profondità	5.50 ÷ 6.00 m	

Condizioni inizio prova			Consolidazione		Condizioni fine prova			
altezza ho	mm	76.20	Pressione di cella $\sigma_c$	kPa	280	altezza h	mm	77.50
diámetro d	mm	37.90	Contropressione $u_0$	kPa	200	diámetro d	mm	37.90
peso umido iniziale	g	189.10	Tensione effettiva $\sigma'_c$	kPa	80	Pesafiltro n° 37	g	14.41
Peso specifico $\gamma_s$	kN/m <sup>3</sup>	27.04				Pf + prov. umido	g	208.96
<b>Peso secco dell'udv <math>\gamma_d</math></b>	kN/m <sup>3</sup>	18.56				Pf + prov.secco	g	177.02
<b>Contenuto d'acqua w</b>		0.163				Peso specifico $\gamma_s$	kN/m <sup>3</sup>	27.04
<b>Peso umido dell'udv <math>\gamma</math></b>	kN/m <sup>3</sup>	21.58				<b>Peso secco dell'udv <math>\gamma_d</math></b>	kN/m <sup>3</sup>	18.25
<b>Indice dei vuoti e</b>		0.457				<b>Contenuto d'acqua w</b>		0.196
<b>Grado di saturazione Sr</b>		1.0				<b>Peso umido dell'udv <math>\gamma</math></b>	kN/m <sup>3</sup>	21.83
						<b>Indice dei vuoti e</b>		0.482
						<b>Grado di saturazione Sr</b>		1.0

Prova triassiale ciclica SN04-C1			
ensione di confinamento (kPa)		80	
deviatore ciclico (kPa)		95	
frequenza (hz)		0.00625	
tempo	cella di carico	$\Delta u$	LVDT
(min)	kN	(kPa)	$\delta$ (mm)
0.00	0.006	196	0.0204
0.02	0.006	196	0.0204
0.03	0.006	196	0.0204
0.05	0.008	196.2	0.0231
0.07	0.011	196.3	0.0275
0.08	0.012	196.5	0.0311
0.10	0.014	196.7	0.0311
0.12	0.016	196.9	0.0346
0.13	0.016	196.9	0.0373
0.15	0.017	197.1	0.0408
0.17	0.019	197.3	0.0444
0.18	0.022	197.5	0.0479
0.20	0.022	197.7	0.0506
0.22	0.024	197.9	0.0533
0.23	0.026	198.1	0.0533
0.25	0.026	198.1	0.0559
0.27	0.026	198.3	0.0568
0.28	0.027	198.4	0.0586
0.30	0.028	198.6	0.0604
0.32	0.028	198.7	0.0621
0.33	0.028	198.8	0.0621
0.35	0.029	199	0.0621
0.37	0.029	199	0.063
0.38	0.029	199.1	0.063
0.40	0.029	199.2	0.063
0.42	0.028	199.2	0.063
0.43	0.028	199.3	0.063
0.45	0.028	199.3	0.0612
0.47	0.026	199.2	0.0595
0.48	0.025	199.3	0.0586
0.50	0.024	199.2	0.0568
0.52	0.022	199.1	0.0568
0.53	0.021	199.1	0.0541
0.55	0.021	199.1	0.0524
0.57	0.02	199	0.0497
0.58	0.017	198.8	0.047
0.60	0.015	198.7	0.0444
0.63	0.014	198.6	0.0408
0.65	0.011	198.3	0.0408
0.67	0.009	198.3	0.0373
0.68	0.009	198.2	0.0337
0.70	0.008	198	0.0302
0.70	0.005	197.7	0.0249
0.72	0.003	197.5	0.0222
0.73	0.002	197.3	0.0178
0.75	-0.001	197	0.0178
0.77	-0.003	196.7	0.0133
0.78	-0.003	196.7	0.0098
0.80	-0.004	196.5	0.0062
0.82	-0.007	196.2	0.0027
0.83	-0.009	196	-0.0009
0.85	-0.01	195.7	-0.0036
0.87	-0.011	195.4	-0.0036
0.88	-0.013	195.2	-0.0062
0.90	-0.013	195.2	-0.0089
0.92	-0.014	195	-0.0107

Prova triassiale ciclica SN04-C1			
pressione di confinamento (kPa)		80	
deviatore ciclico (kPa)		95	
frequenza (hz)		0.00625	
tempo	cella di carico	$\Delta u$	LVDT
(min)	kN	(kPa)	$\delta$ (mm)
0.93	-0.015	194.7	-0.0133
0.95	-0.016	194.5	-0.0151
0.97	-0.016	194.3	-0.016
0.98	-0.017	194.2	-0.016
1.00	-0.017	194	-0.0178
1.02	-0.017	194	-0.0186
1.03	-0.017	193.9	-0.0186
1.05	-0.017	193.8	-0.0186
1.07	-0.017	193.7	-0.0178
1.08	-0.016	193.6	-0.0178
1.10	-0.016	193.6	-0.0169
1.12	-0.015	193.5	-0.0169
1.13	-0.014	193.5	-0.0151
1.15	-0.014	193.6	-0.0133
1.17	-0.012	193.6	-0.0133
1.18	-0.011	193.6	-0.0115
1.20	-0.011	193.6	-0.0098
1.22	-0.01	193.8	-0.0071
1.23	-0.007	193.9	-0.0044
1.25	-0.006	193.9	-0.0027
1.27	-0.004	194.1	0.0018
1.28	-0.001	194.3	0.0018
1.30	0	194.3	0.0044
1.32	0	194.4	0.008
1.33	0.002	194.7	0.0124
1.35	0.006	194.9	0.016
1.37	0.006	195	0.0186
1.38	0.008	195.3	0.024
1.40	0.012	195.6	0.024
1.42	0.013	195.6	0.0284
1.43	0.013	195.8	0.0311
1.45	0.014	196.1	0.0355
1.47	0.017	196.3	0.0391
1.48	0.019	196.5	0.0426
1.50	0.02	196.8	0.0453
1.52	0.023	197	0.0453
1.53	0.023	197	0.0488
1.55	0.023	197.2	0.0506
1.57	0.024	197.4	0.0533
1.58	0.026	197.7	0.0559
1.60	0.027	197.9	0.0577
1.62	0.027	198	0.0595
1.63	0.028	198.2	0.0595
1.65	0.029	198.2	0.0612
1.67	0.029	198.4	0.0621
1.68	0.029	198.5	0.0621
1.70	0.029	198.6	0.0621
1.72	0.029	198.7	0.063
1.73	0.028	198.8	0.063
1.75	0.028	198.9	0.063
1.77	0.028	198.9	0.063
1.78	0.028	198.9	0.0621
1.80	0.026	199	0.0595
1.82	0.025	198.9	0.0577
1.83	0.024	198.9	0.0568
1.85	0.024	198.9	0.0559
1.87	0.022	198.8	0.0533
1.88	0.02	198.8	0.0515

Prova triassiale ciclica SN04-C1			
pressione di confinamento (kPa)		80	
deviatore ciclico (kPa)		95	
frequenza (hz)		0.00625	
tempo	cella di carico	$\Delta u$	LVDT
(min)	kN	(kPa)	$\delta$ (mm)
1.90	0.019	198.7	0.0479
1.92	0.016	198.5	0.0479
1.93	0.014	198.4	0.0453
1.95	0.014	198.4	0.0426
1.97	0.013	198.3	0.0391
1.98	0.011	198	0.0355
2.00	0.008	197.9	0.032
2.02	0.007	197.7	0.0284
2.03	0.005	197.4	0.0231
2.05	0.002	197.2	0.0231
2.07	0.001	197.2	0.0195
2.10	0.001	197	0.0169
2.12	-0.001	196.7	0.0124
2.13	-0.005	196.5	0.008
2.15	-0.005	196.3	0.0053
2.15	-0.007	196	0.0009
2.17	-0.01	195.7	0.0009
2.18	-0.01	195.7	-0.0027
2.20	-0.01	195.5	-0.0053
2.22	-0.011	195.2	-0.008
2.23	-0.014	194.9	-0.0107
2.25	-0.014	194.7	-0.0115
2.27	-0.015	194.5	-0.0142
2.28	-0.016	194.3	-0.0142
2.30	-0.017	194.3	-0.016
2.32	-0.017	194.2	-0.0169
2.33	-0.017	194	-0.0178
2.35	-0.017	193.9	-0.0178
2.37	-0.017	193.8	-0.0186
2.38	-0.017	193.7	-0.0186
2.40	-0.017	193.6	-0.0186
2.42	-0.016	193.6	-0.0186
2.43	-0.016	193.5	-0.0178
2.45	-0.016	193.5	-0.0169
2.47	-0.014	193.5	-0.0151
2.48	-0.014	193.5	-0.0142
2.50	-0.012	193.6	-0.0115
2.52	-0.011	193.6	-0.0115
2.53	-0.009	193.6	-0.0107
2.55	-0.009	193.7	-0.008
2.57	-0.006	193.9	-0.0053
2.58	-0.005	193.9	-0.0036
2.60	-0.005	194	-0.0009
2.62	-0.003	194.1	0.0027
2.63	0	194.3	0.0062
2.65	0.001	194.5	0.0089
2.67	0.002	194.7	0.0124
2.68	0.006	194.9	0.0124
2.70	0.008	195.1	0.0169
2.72	0.008	195.1	0.0204
2.73	0.009	195.4	0.024
2.75	0.012	195.7	0.0302
2.77	0.014	195.9	0.0328
2.78	0.015	196.1	0.0364
2.80	0.017	196.4	0.0364
2.82	0.02	196.6	0.0399
2.83	0.02	196.6	0.0435
2.85	0.02	196.8	0.047

Prova triassiale ciclica SN04-C1			
pressione di confinamento (kPa)		80	
deviatore ciclico (kPa)		95	
frequenza (hz)		0.00625	
tempo	cella di carico	$\Delta u$	LVDT
(min)	kN	(kPa)	$\delta$ (mm)
2.87	0.022	197.1	0.0497
2.88	0.024	197.3	0.0524
2.90	0.025	197.5	0.055
2.92	0.026	197.7	0.0568
2.93	0.027	197.9	0.0568
2.95	0.028	197.9	0.0586
2.97	0.028	198.1	0.0595
2.98	0.028	198.3	0.0604
3.00	0.029	198.4	0.0621
3.02	0.029	198.5	0.0621
3.03	0.029	198.7	0.063
3.05	0.029	198.7	0.063
3.07	0.029	198.7	0.063
3.08	0.029	198.8	0.063
3.10	0.028	198.9	0.0621
3.12	0.027	198.9	0.0604
3.13	0.026	199	0.0595
3.15	0.025	199	0.0586
3.17	0.023	198.9	0.0586
3.18	0.022	198.9	0.0559
3.20	0.022	198.9	0.0541
3.22	0.021	198.8	0.0515
3.23	0.018	198.6	0.0488
3.25	0.017	198.6	0.0462
3.27	0.016	198.4	0.0426
3.28	0.012	198.2	0.0391
3.30	0.012	198.2	0.0373
3.32	0.011	198	0.0346
3.33	0.006	197.7	0.0346
3.35	0.006	197.7	0.0293
3.37	0.006	197.6	0.0275
3.38	0.005	197.4	0.0222
3.40	0.001	197.1	0.0178
3.42	0	196.9	0.0151
3.43	-0.002	196.6	0.0107
3.45	-0.005	196.4	0.0107
3.47	-0.006	196.4	0.0062
3.48	-0.006	196.1	0.0027
3.50	-0.007	195.9	0
3.52	-0.01	195.6	-0.0044
3.55	-0.011	195.4	-0.0062
3.57	-0.012	195.1	-0.0089
3.58	-0.014	194.8	-0.0089
3.60	-0.015	194.8	-0.0115
3.60	-0.015	194.7	-0.0133
3.62	-0.015	194.5	-0.0151
3.63	-0.016	194.3	-0.0169
3.65	-0.017	194.1	-0.0178
3.67	-0.017	194	-0.0186
3.68	-0.017	193.8	-0.0186
3.70	-0.017	193.8	-0.0186
3.72	-0.017	193.7	-0.0186
3.73	-0.017	193.6	-0.0186
3.75	-0.017	193.6	-0.0186
3.77	-0.016	193.5	-0.0178
3.78	-0.015	193.5	-0.0169
3.80	-0.014	193.5	-0.0169
3.82	-0.013	193.5	-0.0151



Prova triassiale ciclica SN04-C1			
pressione di confinamento (kPa)		80	
deviatore ciclico (kPa)		95	
frequenza (hz)		0.00625	
tempo	cella di carico	$\Delta u$	LVDT
(min)	kN	(kPa)	$\delta$ (mm)
3.83	-0.013	193.5	-0.0142
3.85	-0.012	193.6	-0.0115
3.87	-0.01	193.7	-0.0098
3.88	-0.008	193.8	-0.0071
3.90	-0.007	193.8	-0.0044
3.92	-0.006	194	-0.0018
3.93	-0.002	194.2	-0.0018
3.95	-0.002	194.2	0.0018
3.97	-0.002	194.3	0.0044
3.98	0	194.5	0.008
4.00	0.003	194.7	0.0124
4.02	0.005	194.9	0.0151
4.03	0.006	195	0.0178
4.05	0.009	195.3	0.0213
4.07	0.01	195.5	0.0249
4.08	0.011	195.8	0.0302
4.10	0.015	196	0.0302
4.12	0.016	196	0.0346
4.13	0.016	196.2	0.0382
4.15	0.017	196.5	0.0417
4.17	0.021	196.8	0.0453
4.18	0.021	197	0.047
4.20	0.022	197.2	0.0506
4.22	0.025	197.4	0.0506
4.23	0.025	197.4	0.0533
4.25	0.025	197.6	0.055
4.27	0.026	197.8	0.0577
4.28	0.027	198	0.0586
4.30	0.027	198.2	0.0595
4.32	0.028	198.3	0.0612
4.33	0.029	198.5	0.0612
4.35	0.029	198.5	0.0621
4.37	0.029	198.6	0.0621
4.38	0.029	198.7	0.063
4.40	0.029	198.8	0.063
4.42	0.028	198.9	0.063
4.43	0.028	199	0.0621
4.45	0.027	199	0.0621
4.47	0.026	199	0.0604
4.48	0.026	199	0.0586
4.50	0.025	199	0.0568
4.52	0.022	198.9	0.0541
4.53	0.022	198.9	0.0533
4.55	0.02	198.8	0.0497
4.57	0.017	198.6	0.0497
4.58	0.016	198.6	0.047
4.60	0.016	198.5	0.0453
4.62	0.015	198.4	0.0417
4.63	0.012	198.2	0.0382
4.65	0.01	198.1	0.0355
4.67	0.009	197.9	0.0311
4.68	0.006	197.6	0.0311
4.70	0.004	197.4	0.0275
4.72	0.004	197.4	0.0231
4.73	0	197	0.0186
4.75	-0.001	196.8	0.0169
4.77	-0.001	196.8	0.0133
4.78	-0.003	196.6	0.0089

Prova triassiale ciclica SN04-C1			
pressione di confinamento (kPa)		80	
deviatore ciclico (kPa)		95	
frequenza (hz)		0.00625	
tempo	cella di carico	$\Delta u$	LVDT
(min)	kN	(kPa)	$\delta$ (mm)
4.80	-0.005	196.3	0.0044
4.82	-0.007	196	0.0009
4.83	-0.008	195.8	-0.0018
4.85	-0.01	195.5	-0.0018
4.87	-0.012	195.2	-0.0053
4.88	-0.012	195.2	-0.0071
4.90	-0.013	195	-0.0098
4.92	-0.014	194.8	-0.0124
4.93	-0.015	194.6	-0.0142
4.95	-0.016	194.4	-0.0151
4.97	-0.016	194.2	-0.0169
5.00	-0.017	194.1	-0.0169
5.02	-0.017	194.1	-0.0178
5.03	-0.017	193.9	-0.0186
5.05	-0.017	193.8	-0.0186
5.05	-0.017	193.7	-0.0186
5.07	-0.017	193.6	-0.0186
5.08	-0.017	193.6	-0.0186
5.10	-0.016	193.5	-0.0186
5.12	-0.015	193.5	-0.0178
5.13	-0.015	193.5	-0.0169
5.15	-0.014	193.5	-0.0151
5.17	-0.012	193.6	-0.0133
5.18	-0.011	193.6	-0.0115
5.20	-0.01	193.7	-0.0098
5.22	-0.008	193.8	-0.0098
5.23	-0.007	193.8	-0.0071
5.25	-0.007	193.9	-0.0044
5.27	-0.005	194	-0.0009
5.28	-0.002	194.2	0.0036
5.30	-0.001	194.4	0.0053
5.32	0.001	194.6	0.0098
5.33	0.005	194.8	0.0098
5.35	0.005	194.8	0.0142
5.37	0.005	195	0.0169
5.38	0.007	195.2	0.0213
5.40	0.011	195.5	0.0257
5.42	0.012	195.7	0.0293
5.43	0.013	195.9	0.0337
5.45	0.016	196.2	0.0337
5.47	0.018	196.5	0.0408
5.48	0.018	196.6	0.0426
5.50	0.02	196.9	0.0426
5.52	0.022	197.1	0.0462
5.53	0.022	197.1	0.0488
5.55	0.023	197.3	0.0515
5.57	0.025	197.6	0.0541
5.58	0.026	197.8	0.0559
5.60	0.026	197.9	0.0577
5.62	0.027	198.1	0.0595
5.63	0.028	198.3	0.0595
5.65	0.028	198.3	0.0604
5.67	0.028	198.4	0.0612
5.68	0.029	198.6	0.0621
5.70	0.029	198.7	0.0621
5.72	0.029	198.8	0.063
5.73	0.029	198.9	0.0621
5.75	0.028	199	0.0621

Prova triassiale ciclica SN04-C1			
pressione di confinamento (kPa)		80	
deviatore ciclico (kPa)		95	
frequenza (hz)		0.00625	
tempo	cella di carico	$\Delta u$	LVDT
(min)	kN	(kPa)	$\delta$ (mm)
5.77	0.027	199	0.0621
5.78	0.027	199	0.0604
5.80	0.026	199	0.0595
5.82	0.025	199	0.0577
5.83	0.024	199	0.0568
5.85	0.023	198.9	0.0541
5.87	0.02	198.9	0.0541
5.88	0.019	198.9	0.0524
5.90	0.019	198.8	0.0506
5.92	0.018	198.7	0.047
5.93	0.015	198.5	0.0426
5.95	0.014	198.4	0.0399
5.97	0.012	198.2	0.0373
5.98	0.009	198	0.0373
6.00	0.008	198	0.0328
6.02	0.008	197.9	0.0302
6.03	0.006	197.7	0.0257
6.05	0.002	197.4	0.0213
6.07	0.002	197.2	0.0178
6.08	0	197	0.0133
6.10	-0.004	196.7	0.0133
6.12	-0.005	196.7	0.0089
6.13	-0.005	196.4	0.0062
6.15	-0.006	196.2	0.0027
6.17	-0.009	195.9	-0.0018
6.18	-0.01	195.7	-0.0044
6.20	-0.01	195.5	-0.0062
6.22	-0.012	195.2	-0.0089
6.23	-0.014	194.9	-0.0107
6.25	-0.014	194.8	-0.0124
6.27	-0.015	194.6	-0.0124
6.28	-0.016	194.4	-0.0142
6.30	-0.016	194.4	-0.016
6.32	-0.016	194.2	-0.0178
6.33	-0.017	194.1	-0.0186
6.35	-0.017	193.9	-0.0195
6.37	-0.017	193.8	-0.0186
6.38	-0.017	193.7	-0.0186
6.40	-0.016	193.7	-0.0186
6.42	-0.016	193.7	-0.0186
6.43	-0.016	193.6	-0.0186
6.47	-0.016	193.6	-0.0169
6.48	-0.014	193.6	-0.016
6.50	-0.014	193.6	-0.0142
6.52	-0.013	193.6	-0.0124
6.52	-0.01	193.7	-0.0124
6.53	-0.009	193.7	-0.0107
6.55	-0.009	193.8	-0.008
6.57	-0.008	193.9	-0.0062
6.58	-0.005	194	-0.0027
6.60	-0.004	194.1	0
6.62	-0.002	194.3	0.0036
6.63	0.001	194.5	0.0036
6.65	0.002	194.5	0.0071
6.67	0.002	194.6	0.0107
6.68	0.004	194.9	0.0142
6.70	0.007	195.1	0.0186
6.72	0.008	195.3	0.0222

Prova triassiale ciclica SN04-C1			
pressione di confinamento (kPa)		80	
deviatore ciclico (kPa)		95	
frequenza (hz)		0.00625	
tempo	cella di carico	$\Delta u$	LVDT
(min)	kN	(kPa)	$\delta$ (mm)
6.73	0.01	195.6	0.0275
6.75	0.013	195.9	0.0275
6.77	0.014	195.9	0.0311
6.78	0.014	196.1	0.0337
6.80	0.016	196.3	0.0382
6.82	0.019	196.6	0.0426
6.83	0.02	196.8	0.0444
6.85	0.021	197.1	0.0479
6.87	0.024	197.3	0.0479
6.88	0.024	197.3	0.0515
6.90	0.024	197.5	0.0533
6.92	0.026	197.9	0.0559
6.93	0.027	198.1	0.0568
6.95	0.027	198.1	0.0586
6.97	0.027	198.2	0.0595
6.98	0.028	198.4	0.0604
7.00	0.029	198.6	0.0612
7.02	0.029	198.7	0.0621
7.03	0.029	198.8	0.0621
7.05	0.029	198.9	0.0621
7.07	0.029	198.9	0.063
7.08	0.029	199	0.0621
7.10	0.028	199	0.0612
7.12	0.027	199.1	0.0604
7.13	0.026	199.1	0.0586
7.15	0.025	199	0.0568
7.17	0.023	199	0.0568
7.18	0.023	199	0.055
7.20	0.022	199	0.0533
7.22	0.021	198.9	0.0515
7.23	0.018	198.8	0.0479
7.25	0.017	198.7	0.0453
7.27	0.015	198.5	0.0426
7.28	0.012	198.4	0.0426
7.30	0.011	198.4	0.0391
7.32	0.011	198.2	0.0364
7.33	0.01	198	0.032
7.35	0.006	197.8	0.0284
7.37	0.005	197.6	0.024
7.38	0.003	197.3	0.0195
7.40	0	197.1	0.0195
7.42	-0.001	197.1	0.016
7.43	-0.001	196.9	0.0124
7.45	-0.003	196.6	0.0089
7.47	-0.006	196.4	0.0044
7.48	-0.007	196.2	0.0009
7.50	-0.008	195.8	-0.0027
7.52	-0.011	195.6	-0.0027
7.53	-0.012	195.6	-0.0062
7.55	-0.012	195.4	-0.008
7.57	-0.013	195.1	-0.0107
7.58	-0.015	194.9	-0.0124
7.60	-0.015	194.7	-0.0142
7.62	-0.016	194.5	-0.016
7.63	-0.017	194.3	-0.016
7.65	-0.017	194.2	-0.0178
7.67	-0.017	194	-0.0186
7.68	-0.017	193.9	-0.0186

Prova triassiale ciclica SN04-C1			
pressione di confinamento (kPa)		80	
deviatore ciclico (kPa)		95	
frequenza (hz)		0.00625	
tempo	cella di carico	$\Delta u$	LVDT
(min)	kN	(kPa)	$\delta$ (mm)
7.70	-0.017	193.9	-0.0195
7.72	-0.017	193.8	-0.0195
7.73	-0.017	193.7	-0.0195
7.75	-0.017	193.6	-0.0186
7.77	-0.016	193.6	-0.0178
7.78	-0.015	193.6	-0.0169
7.80	-0.014	193.6	-0.0169
7.82	-0.013	193.6	-0.0151
7.83	-0.013	193.6	-0.0142
7.85	-0.012	193.7	-0.0124
7.87	-0.01	193.8	-0.0098
7.90	-0.009	193.8	-0.008
7.92	-0.007	193.9	-0.0053
7.93	-0.005	194.1	-0.0053
7.95	-0.003	194.1	-0.0018
7.97	-0.003	194.2	0.0009
7.97	-0.002	194.4	0.0044
7.98	0.002	194.6	0.0089
8.00	0.003	194.7	0.0115
8.02	0.004	194.9	0.0151
8.03	0.008	195.2	0.0151
8.05	0.009	195.5	0.0195
8.07	0.009	195.5	0.0231
8.08	0.011	195.7	0.0284
8.10	0.014	196	0.0328
8.12	0.015	196.2	0.0355
8.13	0.017	196.5	0.0391
8.15	0.019	196.7	0.0391
8.17	0.021	197	0.0426
8.18	0.021	197	0.0462
8.20	0.022	197.2	0.0488
8.22	0.024	197.4	0.0515
8.23	0.025	197.6	0.0541
8.25	0.026	197.8	0.0559
8.27	0.026	198	0.0577
8.28	0.028	198.2	0.0577
8.30	0.028	198.2	0.0595
8.32	0.028	198.4	0.0604
8.33	0.028	198.5	0.0612
8.35	0.029	198.7	0.0621
8.37	0.029	198.8	0.0621
8.38	0.029	198.9	0.0621
8.40	0.029	199	0.0621
8.42	0.029	199.1	0.0621
8.43	0.028	199.1	0.0612
8.45	0.026	199.1	0.0612
8.47	0.025	199.1	0.0595
8.48	0.025	199.1	0.0586
8.50	0.025	199.1	0.0559
8.52	0.022	199	0.0541
8.53	0.022	199	0.0533
8.55	0.02	198.9	0.0497
8.57	0.018	198.8	0.0497
8.58	0.016	198.8	0.047
8.60	0.016	198.7	0.0444
8.62	0.015	198.6	0.0417
8.63	0.012	198.3	0.0382
8.65	0.01	198.2	0.0346

Prova triassiale ciclica SN04-C1			
pressione di confinamento (kPa)		80	
deviatore ciclico (kPa)		95	
frequenza (hz)		0.00625	
tempo	cella di carico	$\Delta u$	LVDT
(min)	kN	(kPa)	$\delta$ (mm)
8.67	0.009	198	0.0302
8.68	0.005	197.7	0.0302
8.70	0.004	197.5	0.0257
8.72	0.004	197.5	0.0222
8.73	0.003	197.3	0.0186
8.75	-0.001	197.1	0.0142
8.77	-0.002	196.8	0.0107
8.78	-0.004	196.6	0.0062
8.80	-0.006	196.3	0.0062
8.82	-0.008	196.1	0.0027
8.83	-0.008	196.1	0
8.85	-0.009	195.8	-0.0036
8.87	-0.011	195.5	-0.0071
8.88	-0.013	195.3	-0.0089
8.90	-0.013	195.1	-0.0115
8.92	-0.014	194.8	-0.0133
8.93	-0.016	194.6	-0.0133
8.95	-0.016	194.6	-0.0151
8.97	-0.016	194.4	-0.0169
8.98	-0.017	194.3	-0.0178
9.00	-0.017	194.1	-0.0186
9.02	-0.017	194	-0.0195
9.03	-0.017	193.9	-0.0195
9.05	-0.017	193.8	-0.0195
9.07	-0.017	193.8	-0.0195
9.08	-0.017	193.7	-0.0186
9.10	-0.016	193.6	-0.0186
9.12	-0.015	193.6	-0.0178
9.13	-0.015	193.6	-0.0169
9.15	-0.014	193.6	-0.0151
9.17	-0.012	193.7	-0.0133
9.18	-0.011	193.7	-0.0124
9.20	-0.01	193.8	-0.0089
9.22	-0.007	193.9	-0.0089
9.23	-0.006	193.9	-0.0062
9.25	-0.006	194	-0.0044
9.27	-0.005	194.1	-0.0009
9.28	-0.002	194.3	0.0027
9.30	-0.001	194.4	0.0044
9.32	0.001	194.6	0.0098
9.33	0.004	194.9	0.0098
9.37	0.006	195.1	0.0133
9.38	0.006	195.1	0.0169
9.40	0.007	195.3	0.0204
9.42	0.011	195.6	0.0249
9.42	0.012	195.8	0.0284
9.43	0.013	196	0.0328
9.45	0.016	196.3	0.0328
9.47	0.018	196.6	0.0373
9.48	0.018	196.6	0.0399
9.50	0.019	196.8	0.0435
9.52	0.021	197.1	0.047
9.53	0.023	197.3	0.0497
9.55	0.024	197.5	0.0524
9.57	0.025	197.7	0.0524
9.58	0.026	197.9	0.055
9.60	0.026	197.9	0.0568
9.62	0.027	198.1	0.0586

Prova triassiale ciclica SN04-C1			
pressione di confinamento (kPa)		80	
deviatore ciclico (kPa)		95	
frequenza (hz)		0.00625	
tempo	cella di carico	$\Delta u$	LVDT
(min)	kN	(kPa)	$\delta$ (mm)
9.63	0.028	198.3	0.0604
9.65	0.028	198.5	0.0604
9.67	0.029	198.6	0.0612
9.68	0.029	198.7	0.0612
9.70	0.029	198.8	0.0621
9.72	0.029	198.8	0.0621
9.73	0.029	198.9	0.0621
9.75	0.029	199	0.0621
9.77	0.028	199.1	0.0612
9.78	0.027	199.1	0.0604
9.80	0.026	199.1	0.0586
9.82	0.024	199.1	0.0568
9.83	0.024	199.1	0.0568
9.85	0.023	199.1	0.0541
9.87	0.021	199	0.0541
9.88	0.019	199	0.0515
9.90	0.019	198.9	0.0497
9.92	0.018	198.8	0.0462
9.93	0.015	198.6	0.0435
9.95	0.014	198.5	0.0408
9.97	0.012	198.4	0.0373
9.98	0.009	198.1	0.0373
10.00	0.008	198.1	0.0328
10.02	0.008	198	0.0311
10.03	0.006	197.8	0.0249
10.05	0.002	197.5	0.0204
10.07	0.001	197.3	0.0178
10.08	0	197.1	0.0142
10.10	-0.004	196.8	0.0142
10.12	-0.004	196.8	0.0098
10.13	-0.004	196.6	0.0062
10.15	-0.006	196.3	0.0018
10.17	-0.009	196	-0.0018
10.18	-0.01	195.8	-0.0044
10.20	-0.011	195.5	-0.008
10.22	-0.013	195.2	-0.008
10.23	-0.014	195.2	-0.0098
10.25	-0.014	195	-0.0124
10.27	-0.015	194.8	-0.0142
10.28	-0.016	194.6	-0.016
10.30	-0.016	194.4	-0.0169
10.32	-0.016	194.3	-0.0178
10.33	-0.017	194.1	-0.0178
10.35	-0.017	194	-0.0186
10.37	-0.017	194	-0.0186
10.38	-0.017	193.9	-0.0195
10.40	-0.017	193.8	-0.0186
10.42	-0.017	193.7	-0.0186
10.43	-0.016	193.7	-0.0178
10.45	-0.015	193.7	-0.0178
10.47	-0.014	193.7	-0.016
10.48	-0.014	193.7	-0.0151
10.50	-0.013	193.7	-0.0142
10.52	-0.011	193.8	-0.0115
10.53	-0.01	193.9	-0.0107
10.55	-0.009	193.9	-0.0071
10.57	-0.007	194	-0.0053
10.58	-0.005	194.1	-0.0027

Prova triassiale ciclica SN04-C1			
pressione di confinamento (kPa)		80	
deviatore ciclico (kPa)		95	
frequenza (hz)		0.00625	
tempo	cella di carico	$\Delta u$	LVDT
(min)	kN	(kPa)	$\delta$ (mm)
10.60	-0.004	194.2	0
10.62	-0.002	194.4	0.0027
10.63	0.001	194.6	0.0027
10.65	0.002	194.6	0.0071
10.67	0.002	194.8	0.0098
10.68	0.004	195	0.0142
10.70	0.007	195.2	0.0186
10.72	0.008	195.4	0.0213
10.73	0.01	195.7	0.0257
10.75	0.014	196	0.0257
10.77	0.015	196	0.0311
10.80	0.015	196.2	0.0337
10.82	0.016	196.4	0.0373
10.83	0.019	196.7	0.0417
10.85	0.02	196.9	0.0444
10.87	0.021	197.2	0.0479
10.88	0.024	197.4	0.0479
10.90	0.024	197.4	0.0506
10.92	0.024	197.6	0.0533
10.93	0.025	197.8	0.055
10.95	0.027	198.1	0.0577
10.95	0.027	198.2	0.0586
10.97	0.028	198.4	0.0604
10.98	0.029	198.6	0.0604
11.00	0.029	198.6	0.0612
11.02	0.029	198.7	0.0612
11.03	0.029	198.8	0.0621
11.05	0.029	198.9	0.0621
11.07	0.029	199	0.0621
11.08	0.028	199.1	0.0612
11.10	0.027	199.2	0.0612
11.12	0.027	199.2	0.0604
11.13	0.027	199.2	0.0595
11.15	0.026	199.2	0.0577
11.17	0.024	199.1	0.0559
11.18	0.023	199.1	0.0541
11.20	0.022	199	0.0524
11.22	0.02	198.9	0.0524
11.23	0.017	198.8	0.0488
11.25	0.017	198.8	0.0462
11.27	0.016	198.7	0.0435
11.28	0.012	198.4	0.0408
11.30	0.012	198.4	0.0391
11.32	0.012	198.3	0.0355
11.33	0.009	198.1	0.0311
11.35	0.006	197.9	0.0284
11.37	0.005	197.7	0.0231
11.38	0.003	197.4	0.0186
11.40	0	197.2	0.0186
11.42	0	197.2	0.0151
11.43	-0.001	197	0.0107
11.45	-0.004	196.7	0.0071
11.47	-0.006	196.4	0.0036
11.48	-0.007	196.2	0
11.50	-0.008	195.9	-0.0036
11.52	-0.011	195.6	-0.0036
11.53	-0.011	195.6	-0.0071
11.55	-0.012	195.4	-0.0089



Prova triassiale ciclica SN04-C1			
pressione di confinamento (kPa)		80	
deviatore ciclico (kPa)		95	
frequenza (hz)		0.00625	
tempo	cella di carico	$\Delta u$	LVDT
(min)	kN	(kPa)	$\delta$ (mm)
11.57	-0.013	195.2	-0.0115
11.58	-0.015	194.9	-0.0133
11.60	-0.015	194.7	-0.0151
11.62	-0.016	194.6	-0.0169
11.63	-0.016	194.4	-0.0169
11.65	-0.017	194.4	-0.0178
11.67	-0.017	194.2	-0.0186
11.68	-0.017	194.1	-0.0195
11.70	-0.017	194	-0.0195
11.72	-0.017	193.9	-0.0195
11.73	-0.017	193.8	-0.0195
11.75	-0.016	193.8	-0.0195
11.77	-0.016	193.8	-0.0186
11.78	-0.016	193.7	-0.0178
11.80	-0.015	193.7	-0.0169
11.82	-0.013	193.7	-0.0151
11.83	-0.012	193.8	-0.0133
11.85	-0.011	193.8	-0.0115
11.87	-0.009	193.9	-0.0115
11.88	-0.008	193.9	-0.0098
11.90	-0.008	193.9	-0.0071
11.92	-0.007	194.1	-0.0044
11.93	-0.003	194.3	-0.0009
11.95	-0.002	194.4	0.0018
11.97	-0.001	194.6	0.0062
11.98	0.003	194.8	0.0062
12.00	0.004	195	0.0115
12.02	0.004	195.1	0.0151
12.03	0.008	195.4	0.0151
12.05	0.009	195.4	0.0195
12.07	0.009	195.6	0.0222
12.08	0.011	195.8	0.0275
12.10	0.014	196.1	0.032
12.12	0.016	196.3	0.0346
12.13	0.016	196.5	0.0382
12.15	0.019	196.8	0.0382
12.17	0.021	197.1	0.0426
12.18	0.021	197.1	0.0453
12.20	0.022	197.3	0.0479
12.22	0.023	197.5	0.0515
12.23	0.025	197.8	0.0541
12.27	0.026	197.9	0.0559
12.28	0.027	198.2	0.0577
12.30	0.028	198.3	0.0577
12.32	0.028	198.3	0.0595
12.33	0.028	198.5	0.0595
12.35	0.028	198.6	0.0604
12.37	0.029	198.8	0.0612
12.38	0.029	198.9	0.0612
12.40	0.029	199	0.0612
12.42	0.029	199.1	0.0612
12.43	0.028	199.1	0.0612
12.45	0.028	199.2	0.0612
12.47	0.027	199.2	0.0604
12.48	0.026	199.2	0.0586
12.48	0.025	199.2	0.0577
12.50	0.024	199.1	0.055
12.52	0.022	199.1	0.055

Prova triassiale ciclica SN04-C1			
pressione di confinamento (kPa)		80	
deviatore ciclico (kPa)		95	
frequenza (hz)		0.00625	
tempo	cella di carico	$\Delta u$	LVDT
(min)	kN	(kPa)	$\delta$ (mm)
12.53	0.021	199.1	0.0533
12.55	0.021	199.1	0.0515
12.57	0.019	198.9	0.0479
12.58	0.016	198.8	0.0453
12.60	0.016	198.7	0.0426
12.62	0.014	198.5	0.0391
12.63	0.011	198.4	0.0391
12.65	0.009	198.4	0.0355
12.67	0.009	198.2	0.0328
12.68	0.008	198	0.0284
12.70	0.004	197.7	0.0231
12.72	0.003	197.6	0.0204
12.73	0.002	197.3	0.0169
12.75	0	197.1	0.0142
12.77	-0.002	196.9	0.0107
12.78	-0.003	196.7	0.0062
12.80	-0.007	196.4	0.0062
12.82	-0.008	196.4	0.0018
12.83	-0.008	196.1	-0.0009
12.85	-0.009	195.9	-0.0044
12.87	-0.011	195.6	-0.0071
12.88	-0.012	195.4	-0.0098
12.90	-0.013	195.1	-0.0124
12.92	-0.015	194.9	-0.0124
12.93	-0.015	194.7	-0.0142
12.95	-0.015	194.7	-0.016
12.97	-0.016	194.5	-0.0169
12.98	-0.016	194.4	-0.0186
13.00	-0.017	194.2	-0.0195
13.02	-0.017	194.1	-0.0195
13.03	-0.017	194	-0.0195
13.05	-0.017	193.9	-0.0195
13.07	-0.017	193.9	-0.0195
13.08	-0.017	193.8	-0.0195
13.10	-0.016	193.8	-0.0186
13.12	-0.015	193.7	-0.0178
13.13	-0.015	193.7	-0.016
13.15	-0.013	193.8	-0.016
13.17	-0.012	193.8	-0.0151
13.18	-0.012	193.8	-0.0133
13.20	-0.011	193.8	-0.0107
13.22	-0.009	194	-0.0089
13.23	-0.007	194.1	-0.0062
13.25	-0.006	194.2	-0.0027
13.27	-0.004	194.4	0
13.28	-0.001	194.5	0
13.30	-0.001	194.5	0.0036
13.32	0	194.6	0.0071
13.33	0.002	194.9	0.0107
13.35	0.005	195.1	0.0142
13.37	0.006	195.3	0.0186
13.38	0.009	195.6	0.0222
13.40	0.012	195.9	0.0222
13.42	0.012	195.9	0.0275
13.43	0.013	196.1	0.0311
13.45	0.016	196.5	0.0346
13.47	0.018	196.5	0.0364
13.48	0.018	196.7	0.0399

Prova triassiale ciclica SN04-C1			
pressione di confinamento (kPa)		80	
deviatore ciclico (kPa)		95	
frequenza (hz)		0.00625	
tempo	cella di carico	$\Delta u$	LVDT
(min)	kN	(kPa)	$\delta$ (mm)
13.50	0.019	197	0.0435
13.52	0.022	197.2	0.0462
13.53	0.022	197.4	0.0497
13.55	0.024	197.7	0.0515
13.57	0.026	197.9	0.0515
13.58	0.026	197.9	0.0541
13.60	0.026	198.1	0.0559
13.62	0.027	198.2	0.0577
13.63	0.028	198.5	0.0595
13.65	0.028	198.6	0.0595
13.67	0.028	198.7	0.0612
13.68	0.029	198.9	0.0612
13.70	0.029	198.9	0.0612
13.73	0.029	199	0.0612
13.75	0.029	199.1	0.0612
13.77	0.029	199.2	0.0612
13.78	0.028	199.2	0.0604
13.80	0.027	199.2	0.0595
13.82	0.025	199.2	0.0595
13.83	0.024	199.2	0.0586
13.85	0.024	199.2	0.0568
13.87	0.024	199.2	0.055
13.88	0.022	199.1	0.0524
13.90	0.02	199	0.0497
13.92	0.019	199	0.047
13.93	0.016	198.8	0.047
13.93	0.014	198.7	0.0444
13.95	0.014	198.7	0.0417
13.97	0.013	198.5	0.0382
13.98	0.01	198.3	0.0337
14.00	0.008	198.1	0.0311
14.02	0.007	198	0.0257
14.03	0.004	197.7	0.0257
14.05	0.002	197.5	0.0222
14.07	0.002	197.5	0.0186
14.08	0.001	197.3	0.0151
14.10	-0.002	197	0.0107
14.12	-0.004	196.7	0.0071
14.13	-0.005	196.5	0.0036
14.15	-0.008	196.2	0.0036
14.17	-0.01	196	-0.0009
14.18	-0.01	195.8	-0.0053
14.20	-0.011	195.6	-0.0053
14.22	-0.013	195.3	-0.008
14.23	-0.013	195.3	-0.0107
14.25	-0.014	195.1	-0.0124
14.27	-0.015	194.8	-0.0151
14.28	-0.016	194.6	-0.0169
14.30	-0.016	194.5	-0.0178
14.32	-0.016	194.3	-0.0178
14.33	-0.017	194.2	-0.0186
14.35	-0.017	194.2	-0.0195
14.37	-0.017	194.1	-0.0204
14.38	-0.017	194	-0.0204
14.40	-0.017	193.9	-0.0204
14.42	-0.017	193.8	-0.0195
14.43	-0.016	193.8	-0.0178
14.45	-0.014	193.8	-0.0178

Prova triassiale ciclica SN04-C1			
pressione di confinamento (kPa)		80	
deviatore ciclico (kPa)		95	
frequenza (hz)		0.00625	
tempo	cella di carico	$\Delta u$	LVDT
(min)	kN	(kPa)	$\delta$ (mm)
14.47	-0.014	193.8	-0.0169
14.48	-0.014	193.8	-0.016
14.50	-0.013	193.8	-0.0151
14.52	-0.011	193.9	-0.0124
14.53	-0.01	193.9	-0.0107
14.55	-0.009	194.1	-0.008
14.57	-0.006	194.2	-0.008
14.58	-0.005	194.2	-0.0053
14.60	-0.005	194.3	-0.0027
14.62	-0.003	194.5	0.0009
14.63	0	194.6	0.0044
14.65	0.001	194.8	0.008
14.67	0.003	195	0.0124
14.68	0.007	195.2	0.0124
14.70	0.007	195.2	0.0169
14.72	0.007	195.4	0.0195
14.73	0.009	195.7	0.0231
14.75	0.012	196	0.0284
14.77	0.014	196.2	0.032
14.78	0.015	196.5	0.0355
14.80	0.018	196.7	0.0355
14.82	0.019	196.7	0.0399
14.83	0.019	196.9	0.0417
14.85	0.02	197.2	0.0462
14.87	0.023	197.4	0.0488
14.88	0.024	197.6	0.0506
14.90	0.024	197.8	0.0541
14.92	0.025	198	0.055
14.93	0.027	198.2	0.0568
14.95	0.027	198.4	0.0586
14.97	0.028	198.6	0.0586
14.98	0.029	198.7	0.0595
15.00	0.029	198.7	0.0604
15.02	0.029	198.9	0.0612
15.03	0.029	199	0.0621
15.05	0.029	199.1	0.0612
15.07	0.029	199.2	0.0621
15.08	0.028	199.3	0.0612
15.10	0.027	199.3	0.0612
15.12	0.027	199.3	0.0604
15.13	0.027	199.3	0.0586
15.17	0.025	199.3	0.0577
15.18	0.024	199.3	0.0559
15.20	0.023	199.2	0.0541
15.22	0.022	199.1	0.0515
15.23	0.019	199	0.0515
15.25	0.018	199	0.0488
15.27	0.018	199	0.047
15.28	0.016	198.8	0.0435
15.30	0.013	198.7	0.0399
15.32	0.012	198.5	0.0373
15.33	0.011	198.3	0.0328
15.35	0.007	198.1	0.0328
15.37	0.006	198.1	0.0293
15.38	0.006	198	0.0249
15.38	0.005	197.7	0.0204
15.40	0	197.4	0.016
15.42	0	197.2	0.0133

Prova triassiale ciclica SN04-C1			
pressione di confinamento (kPa)		80	
deviatore ciclico (kPa)		95	
frequenza (hz)		0.00625	
tempo	cella di carico	$\Delta u$	LVDT
(min)	kN	(kPa)	$\delta$ (mm)
15.43	-0.002	197	0.0098
15.45	-0.005	196.7	0.0098
15.47	-0.006	196.7	0.0053
15.48	-0.006	196.5	0.0018
15.50	-0.007	196.2	-0.0018
15.52	-0.01	195.9	-0.0053
15.53	-0.011	195.7	-0.008
15.55	-0.012	195.4	-0.0098
15.57	-0.014	195.2	-0.0098
15.58	-0.015	195.2	-0.0124
15.60	-0.015	195	-0.0142
15.62	-0.015	194.8	-0.016
15.63	-0.017	194.6	-0.0178
15.65	-0.017	194.4	-0.0186
15.67	-0.017	194.3	-0.0195
15.68	-0.017	194.2	-0.0195
15.70	-0.017	194	-0.0195
15.72	-0.017	193.9	-0.0204
15.73	-0.017	193.9	-0.0204
15.75	-0.016	193.8	-0.0204
15.77	-0.016	193.8	-0.0195
15.78	-0.016	193.8	-0.0186
15.80	-0.015	193.8	-0.0178
15.82	-0.013	193.8	-0.016
15.83	-0.013	193.8	-0.0142
15.85	-0.011	193.9	-0.0142
15.87	-0.009	194	-0.0115
15.88	-0.009	194	-0.0098
15.90	-0.008	194	-0.0071
15.92	-0.006	194.2	-0.0036
15.93	-0.004	194.4	-0.0009
15.95	-0.002	194.5	0.0027
15.97	0	194.7	0.0062
15.98	0.003	194.9	0.0062
16.00	0.003	194.9	0.0098
16.02	0.004	195	0.0133
16.03	0.006	195.4	0.0178
16.05	0.009	195.6	0.0213
16.07	0.01	195.8	0.0249
16.08	0.012	196.1	0.0293
16.10	0.015	196.4	0.0293
16.12	0.016	196.4	0.0337
16.13	0.016	196.5	0.0364
16.15	0.017	196.8	0.0399
16.17	0.021	197.1	0.0444
16.18	0.021	197.3	0.0462
16.20	0.022	197.5	0.0497
16.22	0.025	197.8	0.0497
16.23	0.025	197.8	0.0524
16.25	0.025	197.9	0.0541
16.27	0.026	198.2	0.0568
16.28	0.028	198.4	0.0586
16.30	0.028	198.5	0.0586
16.32	0.028	198.7	0.0595
16.33	0.029	198.8	0.0595
16.35	0.029	198.8	0.0612
16.37	0.029	199.1	0.0612
16.38	0.029	199.1	0.0612

Prova triassiale ciclica SN04-C1			
pressione di confinamento (kPa)		80	
deviatore ciclico (kPa)		95	
frequenza (hz)		0.00625	
tempo	cella di carico	$\Delta u$	LVDT
(min)	kN	(kPa)	$\delta$ (mm)
16.40	0.029	199.1	0.0612
16.42	0.029	199.2	0.0612
16.43	0.028	199.3	0.0604
16.45	0.026	199.3	0.0595
16.47	0.026	199.3	0.0586
16.48	0.025	199.3	0.0568
16.50	0.023	199.3	0.0568
16.52	0.022	199.3	0.0541
16.53	0.022	199.2	0.0533
16.55	0.021	199.2	0.0506
16.57	0.019	199	0.0479
16.58	0.017	198.9	0.0453
16.60	0.016	198.8	0.0417
16.63	0.013	198.6	0.0417
16.65	0.011	198.5	0.0382
16.67	0.011	198.5	0.0355
16.68	0.01	198.3	0.0311
16.70	0.007	198	0.0275
16.72	0.005	197.9	0.024
16.73	0.003	197.7	0.0195
16.75	0.001	197.4	0.0195
16.77	-0.002	197.1	0.0151
16.78	-0.002	197.1	0.0107
16.80	-0.003	196.9	0.008
16.82	-0.005	196.6	0.0036
16.83	-0.007	196.4	0
16.83	-0.008	196.1	-0.0036
16.85	-0.01	195.8	-0.0062
16.87	-0.012	195.6	-0.0062
16.88	-0.012	195.6	-0.0089
16.90	-0.013	195.4	-0.0115
16.92	-0.014	195.1	-0.0133
16.93	-0.015	194.9	-0.0151
16.95	-0.016	194.7	-0.0169
16.97	-0.016	194.5	-0.0178
16.98	-0.017	194.4	-0.0178
17.00	-0.017	194.4	-0.0195
17.02	-0.017	194.3	-0.0195
17.03	-0.017	194.1	-0.0204
17.05	-0.017	194	-0.0204
17.07	-0.017	193.9	-0.0204
17.08	-0.017	193.9	-0.0195
17.10	-0.016	193.8	-0.0195
17.12	-0.016	193.8	-0.0186
17.13	-0.014	193.8	-0.016
17.15	-0.012	193.9	-0.016
17.17	-0.012	193.9	-0.0151
17.18	-0.012	193.9	-0.0142
17.20	-0.011	194	-0.0115
17.22	-0.008	194.1	-0.0089
17.23	-0.007	194.1	-0.0062
17.25	-0.006	194.3	-0.0036
17.27	-0.002	194.5	-0.0036
17.28	-0.001	194.5	0
17.30	-0.001	194.6	0.0027
17.32	0	194.8	0.0062
17.33	0.004	195	0.0107
17.35	0.004	195.2	0.0142

Prova triassiale ciclica SN04-C1			
pressione di confinamento (kPa)		80	
deviatore ciclico (kPa)		95	
frequenza (hz)		0.00625	
tempo	cella di carico	$\Delta u$	LVDT
(min)	kN	(kPa)	$\delta$ (mm)
17.37	0.006	195.4	0.0178
17.38	0.01	195.7	0.0178
17.40	0.011	195.7	0.0231
17.42	0.011	195.9	0.0257
17.43	0.012	196.2	0.0311
17.45	0.016	196.5	0.0346
17.47	0.017	196.7	0.0373
17.48	0.018	196.9	0.0408
17.50	0.021	197.2	0.0408
17.52	0.022	197.4	0.0453
17.53	0.022	197.4	0.047
17.55	0.023	197.6	0.0497
17.57	0.024	197.8	0.0524
17.58	0.026	198	0.055
17.60	0.026	198.2	0.0568
17.62	0.027	198.4	0.0568
17.63	0.028	198.6	0.0586
17.65	0.028	198.6	0.0595
17.67	0.028	198.7	0.0604
17.68	0.029	198.9	0.0604
17.70	0.029	199	0.0612
17.72	0.029	199.1	0.0612
17.73	0.029	199.2	0.0612
17.75	0.028	199.3	0.0612
17.77	0.027	199.3	0.0612
17.78	0.027	199.3	0.0595
17.80	0.026	199.3	0.0586
17.82	0.024	199.3	0.0568
17.83	0.024	199.3	0.0559
17.85	0.024	199.3	0.0541
17.87	0.021	199.2	0.0515
17.88	0.02	199.2	0.0506
17.90	0.019	199	0.047
17.92	0.016	198.9	0.047
17.93	0.015	198.9	0.0435
17.95	0.015	198.8	0.0408
17.97	0.013	198.6	0.0373
17.98	0.01	198.4	0.0337
18.00	0.009	198.3	0.0302
18.02	0.007	198.1	0.0249
18.03	0.003	197.8	0.0249
18.07	0.002	197.8	0.0213
18.08	0.002	197.6	0.0186
18.10	0.001	197.4	0.0142
18.12	-0.003	197.1	0.0098
18.13	-0.004	196.9	0.0071
18.15	-0.005	196.6	0.0027
18.17	-0.008	196.3	0.0027
18.18	-0.009	196.3	-0.0018
18.20	-0.009	196.1	-0.0036
18.22	-0.01	195.9	-0.0071
18.23	-0.012	195.6	-0.0098
18.25	-0.013	195.3	-0.0115
18.27	-0.014	195.1	-0.0142
18.28	-0.015	194.9	-0.0142
18.30	-0.016	194.7	-0.016
18.30	-0.016	194.7	-0.0178
18.32	-0.016	194.5	-0.0186

Prova triassiale ciclica SN04-C1			
pressione di confinamento (kPa)		80	
deviatore ciclico (kPa)		95	
frequenza (hz)		0.00625	
tempo	cella di carico	$\Delta u$	LVDT
(min)	kN	(kPa)	$\delta$ (mm)
18.33	-0.017	194.4	-0.0195
18.35	-0.017	194.2	-0.0204
18.37	-0.017	194.1	-0.0204
18.38	-0.017	194	-0.0195
18.40	-0.017	193.9	-0.0195
18.42	-0.017	193.9	-0.0204
18.43	-0.016	193.9	-0.0195
18.45	-0.015	193.9	-0.0178
18.47	-0.015	193.9	-0.0178
18.48	-0.014	193.9	-0.016
18.50	-0.012	194	-0.0142
18.52	-0.01	194	-0.0142
18.53	-0.009	194	-0.0107
18.55	-0.009	194.1	-0.008
18.57	-0.006	194.2	-0.008
18.58	-0.005	194.2	-0.0053
18.60	-0.005	194.3	-0.0027
18.62	-0.003	194.6	0.0009
18.63	0	194.7	0.0044
18.65	0.001	194.9	0.0071
18.67	0.003	195.1	0.0115
18.68	0.006	195.3	0.0115
18.70	0.007	195.3	0.016
18.72	0.007	195.6	0.0195
18.73	0.009	195.8	0.0231
18.75	0.012	196.1	0.0284
18.77	0.014	196.3	0.0311
18.78	0.015	196.6	0.0355
18.80	0.018	196.8	0.0355
18.82	0.019	196.8	0.0399
18.83	0.019	197	0.0426
18.85	0.02	197.3	0.0453
18.87	0.023	197.5	0.0488
18.88	0.024	197.7	0.0506
18.90	0.025	197.9	0.0541
18.92	0.026	198.2	0.0541
18.93	0.027	198.2	0.0559
18.95	0.027	198.3	0.0568
18.97	0.027	198.5	0.0586
18.98	0.028	198.7	0.0604
19.00	0.029	198.8	0.0604
19.02	0.029	199	0.0612
19.03	0.029	199.1	0.0612
19.05	0.029	199.1	0.0612
19.07	0.029	199.2	0.0612
19.08	0.028	199.3	0.0612
19.10	0.028	199.3	0.0604
19.12	0.027	199.3	0.0595
19.13	0.026	199.4	0.0577
19.15	0.024	199.3	0.0577
19.17	0.023	199.3	0.0559
19.18	0.023	199.3	0.0541
19.20	0.023	199.3	0.0524
19.22	0.02	199.2	0.0497
19.23	0.019	199.1	0.0479
19.25	0.017	199	0.0444
19.27	0.014	198.8	0.0408
19.28	0.014	198.7	0.0391



Prova triassiale ciclica SN04-C1			
pressione di confinamento (kPa)		80	
deviatore ciclico (kPa)		95	
frequenza (hz)		0.00625	
tempo	cella di carico	$\Delta u$	LVDT
(min)	kN	(kPa)	$\delta$ (mm)
19.30	0.012	198.6	0.0355
19.32	0.01	198.3	0.0355
19.33	0.007	198.2	0.032
19.35	0.007	198.2	0.0293
19.37	0.006	198	0.024
19.38	0.003	197.7	0.0195
19.40	0.001	197.5	0.0169
19.42	0	197.3	0.0124
19.43	-0.003	197	0.0124
19.45	-0.005	196.7	0.008
19.47	-0.005	196.7	0.0044
19.48	-0.006	196.5	0.0009
19.50	-0.008	196.2	-0.0027
19.53	-0.01	196	-0.0053
19.55	-0.011	195.8	-0.008
19.57	-0.012	195.5	-0.0115
19.58	-0.014	195.2	-0.0115
19.60	-0.015	195.2	-0.0133
19.62	-0.015	195	-0.0151
19.63	-0.015	194.8	-0.0169
19.65	-0.016	194.6	-0.0186
19.67	-0.017	194.5	-0.0195
19.68	-0.017	194.3	-0.0195
19.70	-0.017	194.2	-0.0195
19.72	-0.017	194.2	-0.0204
19.73	-0.017	194.1	-0.0204
19.75	-0.017	194	-0.0204
19.75	-0.017	193.9	-0.0204
19.78	-0.016	193.9	-0.0195
19.78	-0.015	193.9	-0.0186
19.80	-0.014	193.9	-0.0186
19.82	-0.013	193.9	-0.0169
19.83	-0.013	193.9	-0.016
19.85	-0.012	193.9	-0.0133
19.87	-0.01	194	-0.0115
19.88	-0.009	194.1	-0.0089
19.90	-0.007	194.3	-0.0062
19.92	-0.004	194.4	-0.0062
19.93	-0.004	194.4	-0.0036
19.95	-0.004	194.5	0
19.97	-0.002	194.7	0.0036
19.98	0.002	194.9	0.008
20.00	0.003	195.1	0.0098
20.02	0.003	195.2	0.0124
20.03	0.007	195.5	0.0169
20.05	0.008	195.7	0.0204
20.07	0.01	196	0.0249
20.08	0.014	196.2	0.0249
20.10	0.014	196.2	0.0302
20.12	0.014	196.4	0.0328
20.13	0.016	196.7	0.0364
20.15	0.019	196.9	0.0408
20.17	0.02	197.1	0.0435
20.18	0.021	197.4	0.0462
20.20	0.023	197.6	0.0462
20.22	0.024	197.6	0.0497
20.23	0.024	197.9	0.0515
20.25	0.025	198	0.0541

Prova triassiale ciclica SN04-C1			
pressione di confinamento (kPa)		80	
deviatore ciclico (kPa)		95	
frequenza (hz)		0.00625	
tempo	cella di carico	$\Delta u$	LVDT
(min)	kN	(kPa)	$\delta$ (mm)
20.27	0.027	198.3	0.0559
20.28	0.027	198.5	0.0577
20.30	0.028	198.6	0.0586
20.32	0.028	198.8	0.0586
20.33	0.029	198.9	0.0595
20.35	0.029	198.9	0.0604
20.37	0.029	199.1	0.0612
20.38	0.029	199.2	0.0612
20.40	0.029	199.3	0.0612
20.42	0.029	199.3	0.0604
20.43	0.028	199.4	0.0595
20.45	0.026	199.4	0.0595
20.47	0.026	199.4	0.0586
20.48	0.026	199.4	0.0577
20.50	0.024	199.3	0.055
20.52	0.022	199.3	0.0533
20.53	0.022	199.3	0.0515
20.55	0.02	199.2	0.0488
20.57	0.017	199	0.0488
20.58	0.017	199	0.0462
20.60	0.017	199	0.0435
20.62	0.015	198.8	0.0399
20.63	0.011	198.6	0.0364
20.65	0.011	198.5	0.0328
20.67	0.009	198.2	0.0293
20.68	0.005	198	0.0293
20.70	0.004	198	0.024
20.72	0.003	197.6	0.0186
20.73	0.001	197.4	0.0186
20.75	-0.001	197.4	0.016
20.77	-0.001	197.2	0.0115
20.78	-0.002	197	0.0071
20.80	-0.006	196.7	0.0027
20.82	-0.007	196.4	0
20.83	-0.008	196.2	-0.0036
20.85	-0.011	195.9	-0.0036
20.87	-0.012	195.7	-0.0071
20.88	-0.012	195.7	-0.0089
20.90	-0.012	195.5	-0.0115
20.92	-0.014	195.2	-0.0142
20.93	-0.015	195	-0.016
20.97	-0.016	194.8	-0.0178
20.98	-0.016	194.6	-0.0178
21.00	-0.017	194.4	-0.0186
21.02	-0.017	194.4	-0.0195
21.03	-0.017	194.3	-0.0204
21.05	-0.017	194.2	-0.0204
21.07	-0.017	194.1	-0.0204
21.08	-0.017	194	-0.0204
21.10	-0.017	193.9	-0.0204
21.12	-0.016	193.9	-0.0195
21.13	-0.016	193.9	-0.0195
21.15	-0.015	193.9	-0.0178
21.15	-0.014	194	-0.016
21.17	-0.012	194	-0.0151
21.18	-0.011	194	-0.0133
21.20	-0.01	194.1	-0.0107
21.22	-0.007	194.2	-0.0107

Prova triassiale ciclica SN04-C1			
pressione di confinamento (kPa)		80	
deviatore ciclico (kPa)		95	
frequenza (hz)		0.00625	
tempo	cella di carico	$\Delta u$	LVDT
(min)	kN	(kPa)	$\delta$ (mm)
21.23	-0.007	194.2	-0.008
21.25	-0.007	194.3	-0.0053
21.27	-0.005	194.5	-0.0018
21.28	-0.002	194.6	0.0009
21.30	-0.001	194.8	0.0044
21.32	0.001	195	0.0089
21.33	0.004	195.2	0.0089
21.35	0.004	195.2	0.0124
21.37	0.005	195.4	0.016
21.38	0.008	195.7	0.0195
21.40	0.011	196	0.024
21.42	0.012	196.2	0.0275
21.43	0.013	196.4	0.0311
21.45	0.016	196.7	0.0355
21.47	0.017	196.8	0.0382
21.48	0.018	197.1	0.0408
21.50	0.021	197.3	0.0408
21.52	0.022	197.3	0.0444
21.53	0.022	197.5	0.047
21.55	0.023	197.8	0.0497
21.57	0.025	198	0.0524
21.58	0.026	198.2	0.0541
21.60	0.026	198.4	0.0559
21.62	0.027	198.6	0.0559
21.63	0.028	198.6	0.0577
21.65	0.028	198.7	0.0586
21.67	0.029	198.9	0.0604
21.68	0.029	199	0.0604
21.70	0.029	199.1	0.0604
21.72	0.029	199.2	0.0604
21.73	0.028	199.3	0.0604
21.75	0.028	199.3	0.0604
21.77	0.028	199.4	0.0604
21.78	0.027	199.4	0.0586
21.80	0.026	199.4	0.0577
21.82	0.025	199.4	0.0568
21.83	0.024	199.4	0.0541
21.85	0.022	199.3	0.0541
21.87	0.021	199.3	0.0524
21.88	0.021	199.3	0.0497
21.90	0.019	199.2	0.047
21.92	0.016	199	0.0444
21.93	0.015	198.9	0.0417
21.95	0.014	198.8	0.0382
21.97	0.011	198.6	0.0382
21.98	0.009	198.6	0.0346
22.00	0.009	198.4	0.032
22.02	0.008	198.2	0.0275
22.03	0.005	198	0.0231
22.05	0.003	197.8	0.0195
22.07	0.002	197.6	0.0151
22.08	-0.002	197.3	0.0151
22.10	-0.003	197	0.0107
22.12	-0.003	197	0.0071
22.13	-0.004	196.8	0.0036
22.15	-0.007	196.5	0
22.17	-0.009	196.3	-0.0027
22.18	-0.009	196.1	-0.0053

Prova triassiale ciclica SN04-C1			
pressione di confinamento (kPa)		80	
deviatore ciclico (kPa)		95	
frequenza (hz)		0.00625	
tempo	cella di carico	$\Delta u$	LVDT
(min)	kN	(kPa)	$\delta$ (mm)
22.20	-0.011	195.8	-0.008
22.22	-0.012	195.6	-0.0107
22.23	-0.013	195.4	-0.0124
22.25	-0.014	195.1	-0.0124
22.27	-0.016	194.9	-0.0151
22.28	-0.016	194.9	-0.0169
22.30	-0.016	194.7	-0.0178
22.32	-0.017	194.5	-0.0195
22.33	-0.017	194.4	-0.0204
22.35	-0.017	194.3	-0.0204
22.37	-0.017	194.2	-0.0204
22.38	-0.017	194.1	-0.0204
22.40	-0.017	194.1	-0.0213
22.43	-0.017	194	-0.0204
22.45	-0.016	193.9	-0.0204
22.47	-0.015	193.9	-0.0186
22.48	-0.015	193.9	-0.0178
22.48	-0.014	193.9	-0.016
22.50	-0.011	194	-0.016
22.52	-0.011	194	-0.0142
22.53	-0.011	194	-0.0124
22.55	-0.01	194.1	-0.0098
22.57	-0.006	194.3	-0.0071
22.58	-0.006	194.4	-0.0053
22.60	-0.004	194.5	-0.0018
22.62	-0.001	194.7	-0.0018
22.63	0	194.9	0.0018
22.65	0	194.9	0.0053
22.67	0.002	195	0.0089
22.68	0.005	195.3	0.0133
22.70	0.007	195.5	0.0169
22.72	0.008	195.7	0.0213
22.73	0.012	196.1	0.0213
22.75	0.013	196.2	0.0257
22.77	0.013	196.2	0.0293
22.78	0.014	196.5	0.0328
22.80	0.017	196.8	0.0373
22.82	0.019	197	0.0399
22.83	0.02	197.2	0.0435
22.85	0.022	197.5	0.0435
22.87	0.023	197.7	0.047
22.88	0.023	197.7	0.0488
22.90	0.025	198.1	0.0515
22.92	0.026	198.3	0.0533
22.93	0.026	198.3	0.055
22.95	0.027	198.4	0.0568
22.97	0.027	198.7	0.0586
22.98	0.028	198.8	0.0595
23.00	0.029	199	0.0604
23.02	0.029	199.1	0.0604
23.03	0.029	199.2	0.0604
23.05	0.029	199.2	0.0604
23.07	0.029	199.3	0.0612
23.08	0.029	199.4	0.0612
23.10	0.028	199.4	0.0604
23.12	0.027	199.5	0.0586
23.13	0.026	199.5	0.0568
23.15	0.024	199.4	0.0568

Prova triassiale ciclica SN04-C1			
pressione di confinamento (kPa)		80	
deviatore ciclico (kPa)		95	
frequenza (hz)		0.00625	
tempo	cella di carico	$\Delta u$	LVDT
(min)	kN	(kPa)	$\delta$ (mm)
23.17	0.024	199.4	0.055
23.18	0.024	199.4	0.0533
23.20	0.022	199.4	0.0515
23.22	0.02	199.2	0.0488
23.23	0.019	199.2	0.047
23.25	0.017	199	0.0435
23.27	0.014	198.9	0.0435
23.28	0.013	198.9	0.0399
23.30	0.013	198.8	0.0373
23.32	0.011	198.6	0.0337
23.33	0.007	198.3	0.0293
23.35	0.007	198.2	0.0257
23.37	0.005	198	0.0213
23.38	0.001	197.7	0.0213
23.40	0.001	197.7	0.0169
23.42	0.001	197.5	0.0142
23.43	-0.001	197.3	0.0098
23.45	-0.005	197	0.0062
23.47	-0.005	196.7	0.0036
23.48	-0.007	196.5	-0.0009
23.50	-0.01	196.2	-0.0009
23.52	-0.01	196.2	-0.0044
23.53	-0.01	196	-0.0071
23.55	-0.011	195.7	-0.0098
23.57	-0.014	195.5	-0.0124
23.58	-0.014	195.2	-0.0142
23.60	-0.015	195	-0.016
23.62	-0.016	194.8	-0.0186
23.63	-0.016	194.7	-0.0186
23.65	-0.017	194.5	-0.0195
23.67	-0.017	194.4	-0.0195
23.68	-0.017	194.3	-0.0204
23.70	-0.017	194.3	-0.0204
23.72	-0.017	194.1	-0.0213
23.73	-0.017	194.1	-0.0213
23.75	-0.017	194	-0.0204
23.77	-0.016	194	-0.0195
23.78	-0.015	194	-0.0186
23.80	-0.014	194	-0.0186
23.82	-0.013	194	-0.0169
23.83	-0.013	194	-0.016
23.85	-0.012	194	-0.0133
23.87	-0.01	194.1	-0.0115
23.90	-0.009	194.2	-0.0089
23.92	-0.007	194.3	-0.0062
23.93	-0.004	194.5	-0.0062
23.95	-0.004	194.5	-0.0036
23.95	-0.004	194.6	-0.0009
23.97	-0.002	194.8	0.0027
23.98	0.002	195	0.0071
24.00	0.003	195.1	0.0107
24.02	0.004	195.4	0.0142
24.03	0.008	195.7	0.0142
24.05	0.009	195.7	0.0186
24.07	0.009	195.9	0.0213
24.08	0.011	196.1	0.0257
24.10	0.014	196.4	0.0311
24.12	0.015	196.6	0.0337

Prova triassiale ciclica SN04-C1			
pressione di confinamento (kPa)		80	
deviatore ciclico (kPa)		95	
frequenza (hz)		0.00625	
tempo	cella di carico	$\Delta u$	LVDT
(min)	kN	(kPa)	$\delta$ (mm)
24.13	0.017	196.9	0.0382
24.15	0.02	197.1	0.0382
24.17	0.021	197.1	0.0417
24.18	0.021	197.3	0.0444
24.20	0.022	197.6	0.0479
24.22	0.024	197.8	0.0506
24.23	0.024	198	0.0524
24.25	0.026	198.2	0.055
24.27	0.027	198.5	0.055
24.28	0.027	198.5	0.0568
24.30	0.027	198.6	0.0577
24.32	0.028	198.8	0.0586
24.33	0.028	198.9	0.0595
24.35	0.029	199.1	0.0604
24.37	0.029	199.2	0.0604
24.38	0.029	199.3	0.0604
24.40	0.029	199.4	0.0604
24.42	0.028	199.4	0.0604
24.43	0.028	199.5	0.0604
24.45	0.026	199.5	0.0595
24.47	0.026	199.5	0.0586
24.48	0.026	199.5	0.0568
24.50	0.024	199.4	0.0541
24.52	0.023	199.4	0.0533
24.53	0.022	199.4	0.0506
24.55	0.019	199.2	0.0506
24.57	0.018	199.2	0.0479
24.58	0.018	199.2	0.0453
24.60	0.016	199.1	0.0426
24.62	0.014	198.8	0.0391
24.63	0.012	198.7	0.0364
24.65	0.011	198.6	0.0328
24.67	0.007	198.3	0.0328
24.68	0.006	198.1	0.0284
24.70	0.006	198.1	0.0249
24.72	0.005	197.9	0.0204
24.73	0.001	197.6	0.016
24.75	-0.001	197.4	0.0124
24.77	-0.002	197.2	0.0089
24.78	-0.005	196.9	0.0089
24.80	-0.006	196.6	0.0044
24.82	-0.006	196.6	0.0009
24.83	-0.007	196.4	-0.0027
24.85	-0.01	196.1	-0.0062
24.87	-0.012	195.9	-0.0089
24.88	-0.012	195.7	-0.0107
24.90	-0.014	195.4	-0.0107
24.92	-0.015	195.1	-0.0133
24.93	-0.015	195.1	-0.016
24.95	-0.015	195	-0.0169
24.97	-0.016	194.8	-0.0186
24.98	-0.017	194.6	-0.0195
25.00	-0.017	194.5	-0.0204
25.02	-0.017	194.3	-0.0213
25.03	-0.017	194.2	-0.0213
25.05	-0.017	194.2	-0.0213
25.07	-0.017	194.1	-0.0213
25.08	-0.016	194	-0.0204

Prova triassiale ciclica SN04-C1			
pressione di confinamento (kPa)		80	
deviatore ciclico (kPa)		95	
frequenza (hz)		0.00625	
tempo	cella di carico	$\Delta u$	LVDT
(min)	kN	(kPa)	$\delta$ (mm)
25.10	-0.016	194	-0.0204
25.12	-0.016	194	-0.0195
25.13	-0.015	194	-0.0178
25.15	-0.013	194	-0.0169
25.17	-0.012	194	-0.0151
25.18	-0.011	194.1	-0.0133
25.20	-0.009	194.2	-0.0133
25.22	-0.008	194.2	-0.0115
25.23	-0.008	194.2	-0.0089
25.25	-0.007	194.4	-0.0053
25.27	-0.003	194.6	-0.0018
25.28	-0.002	194.7	0.0009
25.30	-0.001	194.9	0.0044
25.33	0.003	195.1	0.0044
25.35	0.004	195.1	0.008
25.37	0.004	195.2	0.0115
25.38	0.005	195.6	0.016
25.40	0.009	195.8	0.0204
25.40	0.01	196	0.024
25.42	0.012	196.3	0.0284
25.43	0.015	196.5	0.0284
25.45	0.016	196.5	0.0328
25.47	0.016	196.7	0.0355
25.48	0.017	197	0.0391
25.50	0.02	197.2	0.0426
25.52	0.021	197.4	0.0453
25.53	0.022	197.7	0.0488
25.55	0.025	197.9	0.0488
25.57	0.025	197.9	0.0515
25.58	0.025	198.1	0.0533
25.60	0.026	198.3	0.0559
25.62	0.028	198.6	0.0577
25.63	0.028	198.7	0.0586
25.65	0.028	198.8	0.0586
25.67	0.029	199	0.0586
25.68	0.029	199	0.0604
25.70	0.029	199.1	0.0604
25.72	0.029	199.2	0.0604
25.73	0.028	199.3	0.0604
25.75	0.028	199.4	0.0604
25.77	0.028	199.5	0.0595
25.78	0.027	199.5	0.0595
25.80	0.026	199.5	0.0568
25.82	0.025	199.6	0.0559
25.83	0.024	199.5	0.0559
25.85	0.022	199.4	0.0541
25.87	0.022	199.4	0.0515
25.88	0.021	199.4	0.0488
25.90	0.019	199.2	0.0462
25.92	0.017	199.1	0.0444
25.93	0.016	199	0.0408
25.95	0.013	198.8	0.0408
25.97	0.011	198.6	0.0373
25.98	0.011	198.6	0.0346
26.00	0.01	198.5	0.0311
26.02	0.007	198.2	0.0257
26.03	0.004	198	0.0222
26.05	0.003	197.9	0.0178

Prova triassiale ciclica SN04-C1			
pressione di confinamento (kPa)		80	
deviatore ciclico (kPa)		95	
frequenza (hz)		0.00625	
tempo	cella di carico	$\Delta u$	LVDT
(min)	kN	(kPa)	$\delta$ (mm)
26.07	0.001	197.6	0.0142
26.08	-0.002	197.3	0.0142
26.10	-0.002	197.3	0.0107
26.12	-0.003	197.1	0.0062
26.13	-0.005	196.8	0.0027
26.15	-0.007	196.6	-0.0009
26.17	-0.008	196.3	-0.0044
26.18	-0.01	196	-0.0071
26.20	-0.012	195.8	-0.0071
26.22	-0.012	195.8	-0.0098
26.23	-0.012	195.6	-0.0115
26.25	-0.014	195.3	-0.0151
26.27	-0.015	195.1	-0.0169
26.28	-0.016	194.9	-0.0178
26.30	-0.016	194.7	-0.0195
26.32	-0.017	194.6	-0.0195
26.33	-0.017	194.6	-0.0204
26.35	-0.017	194.4	-0.0204
26.37	-0.017	194.3	-0.0213
26.38	-0.017	194.2	-0.0213
26.40	-0.017	194.1	-0.0204
26.42	-0.017	194.1	-0.0204
26.43	-0.016	194	-0.0204
26.45	-0.015	194	-0.0195
26.47	-0.015	194	-0.0186
26.48	-0.014	194	-0.0169
26.50	-0.012	194.1	-0.0151
26.52	-0.011	194.1	-0.0133
26.53	-0.01	194.2	-0.0115
26.55	-0.009	194.2	-0.0098
26.57	-0.007	194.3	-0.0071
26.58	-0.006	194.5	-0.0044
26.60	-0.003	194.6	-0.0044
26.62	-0.001	194.6	-0.0009
26.63	-0.001	194.8	0.0018
26.65	0	194.9	0.0053
26.67	0.003	195.2	0.0098
26.68	0.005	195.4	0.0133
26.70	0.006	195.6	0.0169
26.72	0.01	195.9	0.0169
26.73	0.011	195.9	0.0213
26.75	0.011	196.1	0.024
26.77	0.012	196.3	0.0302
26.80	0.016	196.7	0.0346
26.82	0.017	196.9	0.0373
26.83	0.018	197.1	0.0408
26.85	0.021	197.4	0.0408
26.85	0.022	197.6	0.0444
26.87	0.022	197.6	0.0462
26.88	0.023	197.8	0.0488
26.90	0.024	198	0.0524
26.92	0.026	198.3	0.0541
26.93	0.026	198.4	0.0559
26.95	0.027	198.6	0.0577
26.97	0.028	198.8	0.0577
26.98	0.028	198.8	0.0586
27.00	0.028	198.9	0.0595
27.02	0.029	199.1	0.0604



Prova triassiale ciclica SN04-C1			
pressione di confinamento (kPa)		80	
deviatore ciclico (kPa)		95	
frequenza (hz)		0.00625	
tempo	cella di carico	$\Delta u$	LVDT
(min)	kN	(kPa)	$\delta$ (mm)
27.03	0.029	199.2	0.0604
27.05	0.029	199.3	0.0604
27.07	0.029	199.4	0.0604
27.08	0.028	199.5	0.0604
27.10	0.027	199.5	0.0595
27.12	0.027	199.6	0.0586
27.13	0.026	199.6	0.0568
27.15	0.025	199.5	0.0559
27.17	0.024	199.6	0.055
27.18	0.023	199.5	0.0524
27.20	0.02	199.4	0.0524
27.22	0.019	199.4	0.0497
27.23	0.019	199.3	0.0479
27.25	0.016	199.1	0.0444
27.27	0.015	199.1	0.0435
27.28	0.015	199	0.0399
27.30	0.013	198.8	0.0364
27.32	0.01	198.6	0.0328
27.33	0.009	198.5	0.0293
27.35	0.007	198.2	0.0249
27.37	0.004	198	0.0249
27.38	0.002	198	0.0204
27.40	0.002	197.8	0.0178
27.42	0.001	197.5	0.0133
27.43	-0.003	197.2	0.0089
27.45	-0.004	197	0.0053
27.47	-0.005	196.8	0.0018
27.48	-0.008	196.5	0.0018
27.50	-0.009	196.5	-0.0027
27.52	-0.009	196.3	-0.0044
27.53	-0.01	196	-0.008
27.55	-0.013	195.7	-0.0115
27.57	-0.014	195.5	-0.0133
27.58	-0.014	195.3	-0.0151
27.60	-0.015	195.1	-0.0151
27.62	-0.016	194.9	-0.0169
27.63	-0.016	194.9	-0.0186
27.65	-0.016	194.7	-0.0195
27.67	-0.017	194.6	-0.0204
27.68	-0.017	194.4	-0.0204
27.70	-0.017	194.3	-0.0213
27.72	-0.017	194.2	-0.0213
27.73	-0.017	194.1	-0.0213
27.75	-0.016	194.1	-0.0213
27.77	-0.016	194.1	-0.0204
27.78	-0.016	194.1	-0.0195
27.80	-0.014	194.1	-0.0178
27.82	-0.014	194	-0.0169
27.83	-0.013	194.1	-0.0151
27.85	-0.01	194.2	-0.0151
27.87	-0.01	194.2	-0.0133
27.88	-0.01	194.2	-0.0115
27.90	-0.008	194.4	-0.0089
27.92	-0.005	194.5	-0.0053
27.93	-0.004	194.6	-0.0027
27.95	-0.003	194.8	0.0009
27.97	0.001	195	0.0009
27.98	0.002	195.2	0.0071

Prova triassiale ciclica SN04-C1			
pressione di confinamento (kPa)		80	
deviatore ciclico (kPa)		95	
frequenza (hz)		0.00625	
tempo	cella di carico	$\Delta u$	LVDT
(min)	kN	(kPa)	$\delta$ (mm)
28.00	0.003	195.3	0.0107
28.02	0.006	195.6	0.0107
28.03	0.007	195.6	0.0142
28.05	0.007	195.8	0.0178
28.07	0.009	196	0.0222
28.08	0.013	196.3	0.0275
28.10	0.014	196.5	0.0302
28.12	0.015	196.7	0.0346
28.13	0.018	197	0.0346
28.15	0.019	197	0.0382
28.17	0.019	197.2	0.0408
28.18	0.02	197.4	0.0444
28.20	0.023	197.7	0.0479
28.23	0.024	197.9	0.0497
28.25	0.025	198.1	0.0524
28.27	0.026	198.4	0.0524
28.28	0.027	198.6	0.055
28.30	0.027	198.6	0.0559
28.30	0.027	198.7	0.0577
28.32	0.028	198.9	0.0586
28.33	0.028	199	0.0595
28.35	0.029	199.2	0.0604
28.37	0.029	199.3	0.0604
28.38	0.029	199.4	0.0604
28.40	0.029	199.4	0.0604
28.42	0.029	199.5	0.0604
28.43	0.028	199.6	0.0586
28.45	0.027	199.6	0.0577
28.47	0.026	199.6	0.0568
28.48	0.025	199.6	0.055
28.50	0.023	199.5	0.055
28.52	0.022	199.5	0.0533
28.53	0.022	199.5	0.0515
28.55	0.021	199.4	0.0488
28.57	0.018	199.2	0.0462
28.58	0.017	199.2	0.0444
28.60	0.016	199	0.0408
28.62	0.012	198.8	0.0408
28.63	0.011	198.8	0.0364
28.65	0.011	198.7	0.0337
28.67	0.01	198.5	0.0302
28.68	0.006	198.3	0.0249
28.70	0.005	198.1	0.0222
28.72	0.004	197.9	0.0195
28.73	0.001	197.7	0.0151
28.75	0	197.5	0.0124
28.77	-0.002	197.2	0.008
28.78	-0.005	196.9	0.008
28.80	-0.006	196.9	0.0036
28.82	-0.006	196.7	0.0009
28.83	-0.007	196.5	-0.0027
28.85	-0.01	196.2	-0.0071
28.87	-0.011	196	-0.0089
28.88	-0.012	195.7	-0.0115
28.90	-0.014	195.4	-0.0115
28.92	-0.015	195.4	-0.0142
28.93	-0.015	195.2	-0.016
28.95	-0.015	195	-0.0178

Prova triassiale ciclica SN04-C1			
pressione di confinamento (kPa)		80	
deviatore ciclico (kPa)		95	
frequenza (hz)		0.00625	
tempo	cella di carico	$\Delta u$	LVDT
(min)	kN	(kPa)	$\delta$ (mm)
28.97	-0.016	194.8	-0.0195
28.98	-0.017	194.7	-0.0204
29.00	-0.017	194.5	-0.0213
29.02	-0.017	194.4	-0.0213
29.03	-0.017	194.3	-0.0213
29.05	-0.017	194.3	-0.0213
29.07	-0.017	194.2	-0.0213
29.08	-0.017	194.1	-0.0213
29.10	-0.016	194.1	-0.0204
29.12	-0.015	194.1	-0.0195
29.13	-0.014	194.1	-0.0195
29.15	-0.013	194.1	-0.0178
29.17	-0.013	194.1	-0.0169
29.18	-0.012	194.1	-0.0142
29.20	-0.01	194.2	-0.0124
29.22	-0.008	194.3	-0.0098
29.23	-0.007	194.4	-0.0071
29.25	-0.006	194.6	-0.0044
29.27	-0.002	194.7	-0.0044
29.28	-0.002	194.7	-0.0009
29.30	-0.002	194.8	0.0018
29.32	0	195.1	0.0053
29.33	0.004	195.3	0.0098
29.35	0.004	195.5	0.0124
29.37	0.006	195.8	0.0169
29.38	0.01	196	0.0169
29.40	0.011	196	0.0213
29.42	0.011	196.2	0.024
29.43	0.015	196.7	0.0293
29.45	0.016	196.7	0.032
29.47	0.016	196.9	0.0355
29.48	0.018	197.1	0.0391
29.50	0.021	197.4	0.0426
29.52	0.021	197.6	0.0453
29.53	0.022	197.8	0.0479
29.55	0.025	198.1	0.0479
29.57	0.025	198.1	0.0515
29.58	0.025	198.2	0.0533
29.60	0.026	198.5	0.055
29.62	0.027	198.7	0.0568
29.63	0.028	198.8	0.0577
29.65	0.028	199	0.0586
29.67	0.029	199.1	0.0586
29.70	0.029	199.1	0.0595
29.72	0.029	199.2	0.0595
29.73	0.029	199.3	0.0595
29.75	0.029	199.4	0.0595
29.75	0.028	199.6	0.0595
29.77	0.028	199.6	0.0586
29.78	0.026	199.6	0.0586
29.80	0.025	199.6	0.0568
29.82	0.025	199.6	0.0568
29.83	0.025	199.6	0.0541
29.85	0.023	199.6	0.0524
29.87	0.021	199.5	0.0506
29.88	0.02	199.4	0.0479
29.90	0.018	199.2	0.0479
29.92	0.016	199.1	0.0453

Prova triassiale ciclica SN04-C1			
pressione di confinamento (kPa)		80	
deviatore ciclico (kPa)		95	
frequenza (hz)		0.00625	
tempo	cella di carico	$\Delta u$	LVDT
(min)	kN	(kPa)	$\delta$ (mm)
29.93	0.016	199.1	0.0417
29.95	0.015	199	0.0391
29.97	0.012	198.8	0.0355
29.98	0.01	198.7	0.0328
30.00	0.009	198.5	0.0284
30.02	0.006	198.2	0.0284
30.03	0.004	198	0.024
30.05	0.004	198	0.0204
30.07	0.003	197.9	0.0169
30.08	0	197.5	0.0124
30.10	-0.003	197.3	0.008
30.12	-0.004	197.1	0.0044
30.13	-0.006	196.8	0.0044
30.15	-0.008	196.5	0.0009
30.17	-0.009	196.3	-0.0044
30.18	-0.01	196.1	-0.0044
30.20	-0.012	195.9	-0.0071
30.22	-0.012	195.9	-0.0107
30.23	-0.012	195.7	-0.0133
30.25	-0.014	195.4	-0.0151
30.27	-0.015	195.1	-0.0169
30.28	-0.016	195	-0.0186
30.30	-0.016	194.8	-0.0195
30.32	-0.017	194.6	-0.0195
30.33	-0.017	194.6	-0.0204
30.35	-0.017	194.5	-0.0213
30.37	-0.017	194.4	-0.0213
30.38	-0.017	194.3	-0.0213
30.40	-0.017	194.2	-0.0213
30.42	-0.016	194.1	-0.0204
30.43	-0.016	194.1	-0.0204
30.45	-0.015	194.1	-0.0204
30.47	-0.015	194.1	-0.0186
30.48	-0.014	194.1	-0.0178
30.50	-0.012	194.1	-0.016
30.52	-0.011	194.2	-0.0142
30.53	-0.01	194.3	-0.0115
30.55	-0.007	194.4	-0.0115
30.57	-0.007	194.4	-0.0089
30.58	-0.007	194.4	-0.0071
30.60	-0.005	194.6	-0.0036
30.62	-0.002	194.8	0
30.63	-0.001	194.9	0.0027
30.65	0.001	195.1	0.0071
30.67	0.005	195.4	0.0071
30.68	0.005	195.4	0.0115
30.70	0.005	195.6	0.0142
30.72	0.007	195.8	0.0186
30.73	0.011	196.1	0.0231
30.75	0.012	196.3	0.0249
30.77	0.013	196.5	0.0302
30.78	0.017	196.8	0.0302
30.80	0.018	196.8	0.0346
30.82	0.018	197	0.0382
30.83	0.019	197.3	0.0417
30.85	0.022	197.6	0.0453
30.87	0.023	197.8	0.047
30.88	0.024	198	0.0497

Prova triassiale ciclica SN04-C1			
pressione di confinamento (kPa)		80	
deviatore ciclico (kPa)		95	
frequenza (hz)		0.00625	
tempo	cella di carico	$\Delta u$	LVDT
(min)	kN	(kPa)	$\delta$ (mm)
30.90	0.025	198.2	0.0515
30.92	0.026	198.4	0.0533
30.93	0.027	198.5	0.0559
30.95	0.028	198.8	0.0559
30.97	0.028	198.9	0.0577
30.98	0.028	198.9	0.0577
31.00	0.028	199.1	0.0595
31.02	0.029	199.2	0.0595
31.03	0.029	199.3	0.0595
31.05	0.029	199.4	0.0604
31.07	0.029	199.5	0.0604
31.08	0.028	199.6	0.0604
31.10	0.028	199.6	0.0595
31.12	0.027	199.7	0.0577
31.13	0.026	199.6	0.0559
31.17	0.025	199.6	0.055
31.18	0.024	199.6	0.0533
31.20	0.022	199.5	0.0515
31.20	0.02	199.4	0.0515
31.22	0.02	199.4	0.0488
31.23	0.02	199.4	0.047
31.25	0.018	199.2	0.0435
31.27	0.015	199.1	0.0408
31.28	0.014	199	0.0382
31.30	0.012	198.8	0.0337
31.32	0.009	198.6	0.0337
31.33	0.008	198.6	0.0302
31.35	0.008	198.4	0.0275
31.37	0.006	198.2	0.0231
31.38	0.002	197.9	0.0178
31.40	0.002	197.8	0.0151
31.42	0	197.5	0.0107
31.43	-0.004	197.2	0.0107
31.45	-0.004	197.2	0.0071
31.47	-0.004	197	0.0036
31.48	-0.006	196.7	-0.0009
31.50	-0.009	196.4	-0.0044
31.52	-0.01	196.2	-0.0071
31.53	-0.011	196	-0.0098
31.55	-0.013	195.7	-0.0098
31.57	-0.014	195.7	-0.0124
31.58	-0.014	195.5	-0.0142
31.60	-0.014	195.2	-0.0169
31.62	-0.016	195	-0.0186
31.63	-0.016	194.9	-0.0195
31.65	-0.016	194.7	-0.0204
31.67	-0.017	194.5	-0.0213
31.68	-0.017	194.4	-0.0213
31.70	-0.017	194.3	-0.0222
31.72	-0.017	194.2	-0.0222
31.73	-0.017	194.2	-0.0213
31.75	-0.017	194.2	-0.0213
31.77	-0.016	194.1	-0.0204
31.78	-0.015	194.1	-0.0195
31.80	-0.014	194.1	-0.0186
31.82	-0.014	194.1	-0.0169
31.83	-0.012	194.1	-0.0169
31.85	-0.011	194.1	-0.0151

Prova triassiale ciclica SN04-C1			
pressione di confinamento (kPa)		80	
deviatore ciclico (kPa)		95	
frequenza (hz)		0.00625	
tempo	cella di carico	$\Delta u$	LVDT
(min)	kN	(kPa)	$\delta$ (mm)
31.87	-0.011	194.2	-0.0142
31.88	-0.01	194.3	-0.0107
31.90	-0.007	194.4	-0.008
31.92	-0.006	194.5	-0.0053
31.93	-0.004	194.7	-0.0018
31.95	-0.001	194.9	-0.0018
31.97	0	195	0.0009
31.98	0	195	0.0036
32.00	0.002	195.2	0.0089
32.02	0.005	195.5	0.0124
32.03	0.007	195.7	0.016
32.05	0.008	195.9	0.0195
32.07	0.011	196.2	0.0195
32.08	0.013	196.4	0.024
32.10	0.013	196.4	0.0284
32.12	0.014	196.6	0.0328
32.13	0.017	197	0.0364
32.15	0.019	197.2	0.0399
32.17	0.02	197.4	0.0426
32.18	0.021	197.6	0.0426
32.20	0.024	197.9	0.0453
32.22	0.024	197.9	0.0488
32.23	0.024	198.1	0.0515
32.25	0.025	198.3	0.0533
32.27	0.027	198.5	0.055
32.28	0.027	198.7	0.0559
32.30	0.028	198.8	0.0559
32.32	0.028	199	0.0577
32.33	0.029	199.1	0.0595
32.35	0.029	199.3	0.0595
32.37	0.029	199.4	0.0595
32.38	0.028	199.4	0.0595
32.40	0.028	199.5	0.0595
32.42	0.028	199.6	0.0595
32.43	0.028	199.6	0.0595
32.45	0.027	199.7	0.0577
32.47	0.026	199.7	0.0559
32.48	0.025	199.7	0.0559
32.50	0.023	199.7	0.055
32.52	0.023	199.6	0.0533
32.53	0.022	199.6	0.0506
32.55	0.02	199.4	0.0479
32.57	0.019	199.4	0.0462
32.60	0.017	199.2	0.0426
32.62	0.014	199.1	0.0426
32.63	0.013	199.1	0.0391
32.65	0.013	198.9	0.0364
32.67	0.011	198.7	0.0328
32.67	0.008	198.5	0.0293
32.68	0.007	198.4	0.0249
32.70	0.005	198.1	0.0204
32.72	0.001	197.9	0.0204
32.73	0.001	197.9	0.016
32.75	0.001	197.7	0.0133
32.77	-0.001	197.4	0.0089
32.78	-0.005	197.1	0.0044
32.80	-0.005	196.9	0.0018
32.82	-0.007	196.7	-0.0018

Prova triassiale ciclica SN04-C1			
pressione di confinamento (kPa)		80	
deviatore ciclico (kPa)		95	
frequenza (hz)		0.00625	
tempo	cella di carico	$\Delta u$	LVDT
(min)	kN	(kPa)	$\delta$ (mm)
32.83	-0.01	196.4	-0.0018
32.85	-0.01	196.4	-0.0062
32.87	-0.01	196.1	-0.008
32.88	-0.011	195.9	-0.0107
32.90	-0.014	195.6	-0.0133
32.92	-0.014	195.4	-0.0151
32.93	-0.015	195.2	-0.0169
32.95	-0.016	195	-0.0169
32.97	-0.017	195	-0.0195
32.98	-0.017	194.8	-0.0204
33.00	-0.017	194.7	-0.0204
33.02	-0.017	194.5	-0.0213
33.03	-0.017	194.4	-0.0213
33.05	-0.017	194.3	-0.0222
33.07	-0.017	194.2	-0.0222
33.08	-0.017	194.1	-0.0213
33.10	-0.016	194.1	-0.0204
33.12	-0.015	194.1	-0.0204
33.13	-0.014	194.1	-0.0195
33.15	-0.014	194.1	-0.0178
33.17	-0.013	194.1	-0.0169
33.18	-0.012	194.2	-0.0151
33.20	-0.01	194.3	-0.0124
33.22	-0.009	194.3	-0.0107
33.23	-0.007	194.5	-0.0071
33.25	-0.004	194.6	-0.0071
33.27	-0.003	194.6	-0.0044
33.28	-0.003	194.7	-0.0018
33.30	-0.001	194.9	0.0027
33.32	0.001	195.1	0.0053
33.33	0.002	195.3	0.0089
33.35	0.005	195.6	0.0133
33.37	0.008	195.8	0.0133
33.38	0.009	195.8	0.0178
33.40	0.009	196	0.0204
33.42	0.011	196.3	0.0249
33.43	0.014	196.6	0.0302
33.45	0.015	196.8	0.0328
33.47	0.017	197.1	0.0373
33.48	0.02	197.3	0.0373
33.50	0.02	197.3	0.0408
33.52	0.02	197.5	0.0435
33.53	0.022	197.7	0.047
33.55	0.024	198	0.0497
33.57	0.025	198.2	0.0515
33.58	0.025	198.4	0.0533
33.60	0.027	198.6	0.0533
33.62	0.028	198.6	0.055
33.63	0.028	198.8	0.0568
33.65	0.028	198.9	0.0577
33.67	0.029	199.1	0.0586
33.68	0.029	199.2	0.0595
33.70	0.029	199.3	0.0595
33.72	0.029	199.5	0.0595
33.73	0.029	199.5	0.0595
33.75	0.029	199.6	0.0595
33.77	0.028	199.6	0.0586
33.78	0.027	199.7	0.0577

Prova triassiale ciclica SN04-C1			
pressione di confinamento (kPa)		80	
deviatore ciclico (kPa)		95	
frequenza (hz)		0.00625	
tempo	cella di carico	$\Delta u$	LVDT
(min)	kN	(kPa)	$\delta$ (mm)
33.80	0.026	199.7	0.0568
33.82	0.026	199.7	0.0559
33.83	0.024	199.7	0.0533
33.85	0.022	199.6	0.0524
33.87	0.022	199.6	0.0497
33.88	0.019	199.4	0.0497
33.90	0.017	199.4	0.047
33.92	0.017	199.3	0.0444
33.93	0.016	199.2	0.0417
33.95	0.013	199	0.0382
33.97	0.012	198.9	0.0355
33.98	0.011	198.7	0.0311
34.00	0.007	198.5	0.0311
34.02	0.006	198.5	0.0275
34.03	0.006	198.3	0.0231
34.07	0.004	198.1	0.0186
34.08	0.001	197.8	0.0151
34.10	0	197.6	0.0115
34.12	-0.002	197.4	0.0071
34.12	-0.005	197	0.0071
34.13	-0.006	197	0.0036
34.15	-0.006	196.8	0
34.17	-0.007	196.6	-0.0036
34.18	-0.01	196.3	-0.0071
34.20	-0.011	196.1	-0.0098
34.22	-0.012	195.9	-0.0124
34.23	-0.014	195.6	-0.0124
34.25	-0.015	195.3	-0.0142
34.27	-0.015	195.3	-0.0169
34.28	-0.015	195.1	-0.0186
34.30	-0.016	194.9	-0.0195
34.32	-0.017	194.8	-0.0204
34.33	-0.017	194.6	-0.0213
34.35	-0.017	194.5	-0.0213
34.37	-0.017	194.4	-0.0213
34.38	-0.017	194.4	-0.0222
34.40	-0.017	194.3	-0.0222
34.42	-0.017	194.2	-0.0213
34.43	-0.016	194.2	-0.0204
34.45	-0.015	194.1	-0.0195
34.47	-0.014	194.2	-0.0186
34.48	-0.013	194.2	-0.0186
34.50	-0.012	194.2	-0.0169
34.52	-0.011	194.2	-0.0142
34.53	-0.009	194.3	-0.0142
34.55	-0.008	194.3	-0.0124
34.57	-0.008	194.4	-0.0098
34.58	-0.007	194.5	-0.0062
34.60	-0.004	194.7	-0.0036
34.62	-0.002	194.8	0
34.63	-0.001	195	0.0036
34.65	0.002	195.2	0.0036
34.67	0.004	195.2	0.0071
34.68	0.004	195.4	0.0107
34.70	0.005	195.7	0.0151
34.72	0.009	196	0.0186
34.73	0.01	196.1	0.0222
34.75	0.012	196.4	0.0275



Prova triassiale ciclica SN04-C1			
pressione di confinamento (kPa)		80	
deviatore ciclico (kPa)		95	
frequenza (hz)		0.00625	
tempo	cella di carico	$\Delta u$	LVDT
(min)	kN	(kPa)	$\delta$ (mm)
34.77	0.015	196.7	0.0275
34.78	0.016	196.7	0.032
34.80	0.016	196.9	0.0346
34.82	0.017	197.1	0.0382
34.83	0.021	197.4	0.0417
34.85	0.021	197.6	0.0444
34.87	0.022	197.9	0.0479
34.88	0.025	198.1	0.0479
34.90	0.025	198.1	0.0506
34.92	0.025	198.3	0.0524
34.93	0.026	198.5	0.0541
34.95	0.027	198.7	0.0559
34.97	0.028	198.9	0.0577
34.98	0.028	199	0.0586
35.00	0.029	199.2	0.0586
35.02	0.029	199.2	0.0595
35.03	0.029	199.3	0.0595
35.05	0.029	199.4	0.0595
35.07	0.029	199.5	0.0595
35.08	0.028	199.6	0.0595
35.10	0.028	199.7	0.0586
35.12	0.026	199.7	0.0586
35.13	0.025	199.7	0.0568
35.15	0.025	199.7	0.0559
35.17	0.025	199.7	0.0541
35.18	0.022	199.6	0.0515
35.20	0.021	199.6	0.0506
35.22	0.02	199.5	0.0479
35.23	0.018	199.3	0.0479
35.25	0.016	199.2	0.0426
35.27	0.016	199.2	0.0399
35.28	0.013	199	0.0399
35.30	0.011	199	0.0364
35.32	0.011	198.8	0.0337
35.33	0.01	198.6	0.0302
35.35	0.006	198.4	0.0249
35.37	0.005	198.2	0.0213
35.38	0.004	198	0.0178
35.40	0	197.7	0.0178
35.42	-0.001	197.7	0.0133
35.43	-0.001	197.5	0.0098
35.45	-0.003	197.2	0.0053
35.47	-0.006	196.9	0.0018
35.50	-0.007	196.7	-0.0018
35.52	-0.008	196.5	-0.0053
35.53	-0.01	196.2	-0.0053
35.55	-0.012	195.9	-0.0089
35.57	-0.012	195.9	-0.0107
35.57	-0.012	195.8	-0.0133
35.58	-0.014	195.5	-0.0151
35.62	-0.015	195.2	-0.0169
35.63	-0.015	195.1	-0.0186
35.65	-0.016	194.9	-0.0186
35.65	-0.017	194.7	-0.0204
35.67	-0.017	194.7	-0.0213
35.68	-0.017	194.6	-0.0213
35.70	-0.017	194.4	-0.0222
35.72	-0.017	194.4	-0.0222

Prova triassiale ciclica SN04-C1			
pressione di confinamento (kPa)		80	
deviatore ciclico (kPa)		95	
frequenza (hz)		0.00625	
tempo	cella di carico	$\Delta u$	LVDT
(min)	kN	(kPa)	$\delta$ (mm)
35.73	-0.017	194.3	-0.0222
35.75	-0.017	194.2	-0.0213
35.77	-0.015	194.2	-0.0213
35.78	-0.015	194.2	-0.0204
35.80	-0.015	194.1	-0.0195
35.82	-0.014	194.2	-0.0186
35.83	-0.012	194.2	-0.016
35.85	-0.011	194.2	-0.0151
35.87	-0.01	194.3	-0.0124
35.88	-0.008	194.4	-0.0124
35.90	-0.007	194.4	-0.0098
35.92	-0.007	194.5	-0.0071
35.93	-0.005	194.7	-0.0036
35.95	-0.001	194.9	0
35.97	-0.001	195	0.0027
35.98	0	195.2	0.0044
36.00	0.003	195.4	0.0089
36.02	0.004	195.6	0.0124
36.03	0.006	195.9	0.016
36.05	0.01	196.1	0.016
36.07	0.011	196.1	0.0213
36.08	0.011	196.3	0.024
36.10	0.012	196.5	0.0293
36.12	0.016	196.8	0.0328
36.13	0.017	197	0.0364
36.15	0.018	197.3	0.0399
36.17	0.021	197.5	0.0399
36.18	0.022	197.5	0.0435
36.20	0.022	197.7	0.0453
36.22	0.023	198	0.0488
36.23	0.025	198.2	0.0515
36.25	0.026	198.4	0.0533
36.27	0.027	198.6	0.055
36.28	0.027	198.8	0.055
36.30	0.028	198.8	0.0568
36.32	0.028	198.9	0.0577
36.33	0.028	199.1	0.0586
36.35	0.029	199.2	0.0595
36.37	0.029	199.3	0.0595
36.38	0.029	199.5	0.0595
36.40	0.029	199.6	0.0595
36.42	0.028	199.7	0.0595
36.43	0.028	199.7	0.0595
36.45	0.027	199.7	0.0577
36.47	0.026	199.7	0.0559
36.48	0.025	199.7	0.055
36.50	0.024	199.7	0.0533
36.52	0.022	199.6	0.0533
36.53	0.021	199.5	0.0515
36.55	0.021	199.5	0.0497
36.57	0.02	199.4	0.047
36.58	0.017	199.3	0.0435
36.60	0.015	199.2	0.0408
36.62	0.014	199	0.0373
36.63	0.011	198.8	0.0373
36.65	0.009	198.6	0.0328
36.67	0.009	198.6	0.0302
36.68	0.008	198.5	0.0257

Prova triassiale ciclica SN04-C1			
pressione di confinamento (kPa)		80	
deviatore ciclico (kPa)		95	
frequenza (hz)		0.00625	
tempo	cella di carico	$\Delta u$	LVDT
(min)	kN	(kPa)	$\delta$ (mm)
36.70	0.004	198.1	0.0222
36.72	0.004	198.1	0.0195
36.73	0.002	197.9	0.016
36.75	0	197.6	0.0115
36.77	-0.003	197.3	0.008
36.78	-0.004	197.1	0.0044
36.80	-0.006	196.8	0
36.82	-0.008	196.6	0
36.83	-0.008	196.6	-0.0027
36.85	-0.009	196.4	-0.0062
36.87	-0.011	196.1	-0.0098
36.88	-0.013	195.8	-0.0124
36.90	-0.013	195.6	-0.0142
36.92	-0.014	195.4	-0.016
36.93	-0.016	195.1	-0.016
36.97	-0.016	195.1	-0.0186
36.98	-0.016	195	-0.0195
37.00	-0.016	194.8	-0.0204
37.02	-0.017	194.7	-0.0213
37.03	-0.017	194.5	-0.0222
37.05	-0.017	194.4	-0.0222
37.07	-0.017	194.3	-0.0222
37.08	-0.017	194.3	-0.0222
37.10	-0.017	194.2	-0.0222
37.10	-0.016	194.2	-0.0213
37.12	-0.015	194.2	-0.0204
37.13	-0.014	194.2	-0.0186
37.15	-0.014	194.2	-0.0178
37.17	-0.012	194.2	-0.0178
37.18	-0.011	194.2	-0.016
37.20	-0.011	194.3	-0.0133
37.22	-0.009	194.4	-0.0115
37.23	-0.007	194.5	-0.0089
37.25	-0.006	194.6	-0.0062
37.27	-0.004	194.8	-0.0027
37.28	-0.001	195	-0.0027
37.30	0	195	0.0009
37.32	0	195.1	0.0036
37.33	0.001	195.3	0.008
37.35	0.005	195.6	0.0124
37.37	0.006	195.8	0.0151
37.38	0.008	196	0.0195
37.40	0.011	196.3	0.0195
37.42	0.013	196.5	0.0275
37.43	0.014	196.7	0.0302
37.45	0.016	196.9	0.0302
37.47	0.018	197.2	0.0337
37.48	0.018	197.2	0.0373
37.50	0.019	197.4	0.0408
37.52	0.022	197.7	0.0444
37.53	0.023	197.9	0.047
37.55	0.023	198.1	0.0497
37.57	0.025	198.3	0.0497
37.58	0.027	198.5	0.0524
37.60	0.027	198.5	0.0541
37.62	0.027	198.7	0.055
37.63	0.027	198.9	0.0568
37.65	0.028	199	0.0577

Prova triassiale ciclica SN04-C1			
pressione di confinamento (kPa)		80	
deviatore ciclico (kPa)		95	
frequenza (hz)		0.00625	
tempo	cella di carico	$\Delta u$	LVDT
(min)	kN	(kPa)	$\delta$ (mm)
37.67	0.029	199.2	0.0586
37.68	0.029	199.3	0.0595
37.70	0.029	199.4	0.0595
37.72	0.029	199.4	0.0595
37.73	0.029	199.6	0.0595
37.75	0.028	199.7	0.0595
37.77	0.028	199.7	0.0586
37.78	0.027	199.8	0.0577
37.80	0.026	199.8	0.0559
37.82	0.024	199.7	0.0559
37.83	0.023	199.7	0.0541
37.85	0.023	199.7	0.0533
37.87	0.022	199.6	0.0506
37.88	0.02	199.5	0.0479
37.90	0.019	199.5	0.0453
37.92	0.017	199.3	0.0417
37.93	0.014	199.1	0.0417
37.95	0.013	199.1	0.0391
37.97	0.013	199	0.0355
37.98	0.012	198.8	0.032
38.00	0.008	198.6	0.0284
38.02	0.007	198.4	0.0249
38.03	0.005	198.2	0.0204
38.05	0.001	197.9	0.0204
38.07	0.001	197.9	0.016
38.08	0.001	197.8	0.0124
38.10	-0.001	197.5	0.0089
38.12	-0.004	197.2	0.0044
38.13	-0.006	197	0.0009
38.15	-0.006	196.7	-0.0018
38.17	-0.008	196.5	-0.0044
38.18	-0.01	196.3	-0.0071
38.20	-0.011	196.1	-0.0107
38.22	-0.013	195.8	-0.0107
38.23	-0.014	195.6	-0.0133
38.25	-0.014	195.6	-0.0151
38.27	-0.015	195.3	-0.0169
38.28	-0.016	195.1	-0.0195
38.30	-0.016	194.9	-0.0204
38.32	-0.017	194.8	-0.0213
38.33	-0.017	194.6	-0.0213
38.35	-0.017	194.5	-0.0222
38.37	-0.017	194.5	-0.0222
38.40	-0.017	194.4	-0.0222
38.42	-0.017	194.3	-0.0222
38.43	-0.017	194.2	-0.0222
38.45	-0.016	194.2	-0.0213
38.47	-0.015	194.2	-0.0195
38.47	-0.014	194.2	-0.0195
38.48	-0.013	194.2	-0.0186
38.50	-0.013	194.2	-0.0178
38.52	-0.012	194.3	-0.0151
38.53	-0.01	194.4	-0.0133
38.55	-0.009	194.4	-0.0115
38.57	-0.007	194.6	-0.008
38.58	-0.004	194.7	-0.008
38.60	-0.003	194.7	-0.0044
38.62	-0.003	194.8	-0.0027

Prova triassiale ciclica SN04-C1			
pressione di confinamento (kPa)		80	
deviatore ciclico (kPa)		95	
frequenza (hz)		0.00625	
tempo	cella di carico	$\Delta u$	LVDT
(min)	kN	(kPa)	$\delta$ (mm)
38.63	-0.002	195	0.0018
38.65	0.002	195.2	0.0053
38.67	0.002	195.4	0.0089
38.68	0.004	195.7	0.0124
38.70	0.008	195.9	0.0124
38.72	0.009	195.9	0.0178
38.73	0.009	196.1	0.0204
38.75	0.011	196.4	0.024
38.77	0.014	196.6	0.0293
38.78	0.015	196.8	0.0328
38.80	0.017	197.1	0.0364
38.82	0.02	197.4	0.0364
38.83	0.021	197.4	0.0399
38.85	0.021	197.6	0.0426
38.87	0.022	197.8	0.0462
38.88	0.024	198.1	0.0488
38.90	0.024	198.2	0.0497
38.92	0.025	198.4	0.0524
38.93	0.027	198.7	0.055
38.95	0.027	198.8	0.0559
38.97	0.028	199	0.0568
38.98	0.028	199.1	0.0568
39.00	0.029	199.1	0.0577
39.02	0.029	199.3	0.0586
39.03	0.029	199.4	0.0595
39.05	0.029	199.5	0.0595
39.07	0.029	199.6	0.0595
39.08	0.028	199.7	0.0586
39.10	0.028	199.7	0.0586
39.12	0.026	199.8	0.0577
39.13	0.026	199.8	0.0568
39.15	0.026	199.8	0.0559
39.17	0.024	199.7	0.0533
39.18	0.022	199.7	0.0515
39.20	0.022	199.6	0.0497
39.22	0.02	199.5	0.0497
39.23	0.017	199.4	0.047
39.25	0.017	199.4	0.0444
39.27	0.016	199.3	0.0408
39.28	0.014	199.1	0.0382
39.30	0.011	198.9	0.0346
39.32	0.011	198.8	0.0311
39.33	0.008	198.5	0.0257
39.35	0.005	198.3	0.0257
39.37	0.005	198.3	0.0222
39.38	0.004	198.1	0.0195
39.40	0.002	197.9	0.0151
39.42	-0.001	197.6	0.0107
39.43	-0.002	197.4	0.0062
39.45	-0.004	197.1	0.0027
39.47	-0.007	196.8	0.0027
39.48	-0.007	196.8	-0.0009
39.50	-0.007	196.6	-0.0036
39.52	-0.009	196.3	-0.0071
39.53	-0.012	196.1	-0.0098
39.55	-0.012	195.9	-0.0124
39.57	-0.013	195.7	-0.0142
39.58	-0.015	195.4	-0.0142

Prova triassiale ciclica SN04-C1			
pressione di confinamento (kPa)		80	
deviatore ciclico (kPa)		95	
frequenza (hz)		0.00625	
tempo	cella di carico	$\Delta u$	LVDT
(min)	kN	(kPa)	$\delta$ (mm)
39.60	-0.016	195.2	-0.0186
39.62	-0.016	195.1	-0.0195
39.63	-0.016	194.9	-0.0195
39.65	-0.017	194.9	-0.0204
39.67	-0.017	194.7	-0.0213
39.68	-0.017	194.6	-0.0222
39.70	-0.017	194.4	-0.0222
39.72	-0.017	194.3	-0.0231
39.73	-0.017	194.3	-0.0222
39.75	-0.016	194.2	-0.0222
39.77	-0.015	194.2	-0.0222
39.78	-0.015	194.2	-0.0213
39.80	-0.015	194.2	-0.0204
39.82	-0.014	194.2	-0.0186
39.83	-0.012	194.2	-0.0169
39.87	-0.011	194.3	-0.0151
39.88	-0.009	194.4	-0.0151
39.90	-0.008	194.4	-0.0124
39.92	-0.008	194.5	-0.0107
39.92	-0.007	194.6	-0.0071
39.93	-0.004	194.7	-0.0036
39.95	-0.002	194.9	-0.0018
39.97	-0.001	195	0.0027
39.98	0.002	195.3	0.0027
40.00	0.004	195.3	0.0062
40.02	0.004	195.5	0.0098
40.03	0.005	195.7	0.0133
40.05	0.009	196	0.0178
40.07	0.01	196.2	0.0213
40.08	0.012	196.4	0.0257
40.10	0.015	196.8	0.0257
40.12	0.017	196.9	0.0311
40.13	0.017	196.9	0.0337
40.15	0.017	197.2	0.0373
40.17	0.02	197.5	0.0408
40.18	0.022	197.7	0.0435
40.20	0.022	197.9	0.0462
40.22	0.024	198.1	0.0462
40.23	0.026	198.4	0.0497
40.25	0.026	198.4	0.0515
40.27	0.026	198.5	0.0533
40.28	0.027	198.7	0.0559
40.30	0.028	198.9	0.0568
40.32	0.028	199.1	0.0577
40.33	0.028	199.2	0.0577
40.35	0.029	199.3	0.0586
40.37	0.029	199.5	0.0586
40.38	0.029	199.6	0.0586
40.40	0.029	199.7	0.0586
40.42	0.028	199.7	0.0586
40.43	0.028	199.8	0.0586
40.45	0.027	199.8	0.0568
40.47	0.026	199.8	0.0559
40.48	0.025	199.8	0.055
40.50	0.024	199.7	0.0524
40.52	0.022	199.7	0.0524
40.53	0.021	199.7	0.0506
40.55	0.021	199.6	0.0479

Prova triassiale ciclica SN04-C1			
pressione di confinamento (kPa)		80	
deviatore ciclico (kPa)		95	
frequenza (hz)		0.00625	
tempo	cella di carico	$\Delta u$	LVDT
(min)	kN	(kPa)	$\delta$ (mm)
40.57	0.02	199.5	0.0453
40.58	0.016	199.3	0.0426
40.60	0.016	199.2	0.0399
40.62	0.014	199.1	0.0364
40.63	0.01	198.9	0.0364
40.65	0.01	198.9	0.0328
40.67	0.01	198.7	0.0293
40.68	0.008	198.5	0.0249
40.70	0.004	198.3	0.0213
40.72	0.003	198.1	0.0178
40.73	0.002	197.8	0.0133
40.75	-0.002	197.5	0.0133
40.77	-0.003	197.5	0.0089
40.78	-0.003	197.3	0.0053
40.80	-0.005	197.1	0.0018
40.82	-0.007	196.8	-0.0018
40.83	-0.008	196.6	-0.0044
40.85	-0.01	196.3	-0.0089
40.87	-0.013	196	-0.0089
40.88	-0.013	196	-0.0115
40.90	-0.013	195.8	-0.0133
40.92	-0.013	195.6	-0.016
40.93	-0.015	195.3	-0.0178
40.95	-0.016	195.1	-0.0195
40.97	-0.016	195	-0.0204
40.98	-0.017	194.8	-0.0204
41.00	-0.017	194.8	-0.0213
41.02	-0.017	194.7	-0.0222
41.03	-0.017	194.5	-0.0222
41.05	-0.017	194.3	-0.0222
41.07	-0.017	194.3	-0.0222
41.08	-0.017	194.2	-0.0222
41.10	-0.016	194.2	-0.0213
41.12	-0.015	194.2	-0.0204
41.13	-0.015	194.2	-0.0195
41.15	-0.013	194.2	-0.0195
41.17	-0.012	194.3	-0.0178
41.18	-0.012	194.3	-0.016
41.20	-0.011	194.3	-0.0133
41.22	-0.009	194.4	-0.0115
41.23	-0.007	194.6	-0.0089
41.25	-0.006	194.6	-0.0062
41.27	-0.004	194.8	-0.0027
41.28	-0.001	195	-0.0027
41.30	0	195	0
41.33	0	195.1	0.0036
41.35	0.002	195.4	0.008
41.37	0.005	195.7	0.0115
41.37	0.006	195.8	0.0151
41.38	0.008	196.1	0.0195
41.40	0.012	196.4	0.0195
41.42	0.012	196.4	0.024
41.43	0.012	196.5	0.0275
41.45	0.014	196.8	0.032
41.47	0.018	197.1	0.0355
41.48	0.018	197.3	0.0382
41.50	0.02	197.5	0.0426
41.52	0.023	197.8	0.0426

Prova triassiale ciclica SN04-C1			
pressione di confinamento (kPa)		80	
deviatore ciclico (kPa)		95	
frequenza (hz)		0.00625	
tempo	cella di carico	$\Delta u$	LVDT
(min)	kN	(kPa)	$\delta$ (mm)
41.53	0.023	197.8	0.0453
41.55	0.023	198	0.0479
41.57	0.024	198.2	0.0506
41.58	0.026	198.5	0.0524
41.60	0.027	198.6	0.0541
41.62	0.027	198.8	0.0559
41.63	0.028	199	0.0559
41.65	0.029	199	0.0568
41.67	0.029	199.1	0.0577
41.68	0.028	199.3	0.0577
41.70	0.028	199.4	0.0586
41.72	0.029	199.5	0.0586
41.73	0.029	199.6	0.0595
41.75	0.028	199.7	0.0595
41.77	0.027	199.7	0.0586
41.78	0.027	199.8	0.0568
41.80	0.026	199.8	0.0568
41.82	0.025	199.8	0.0559
41.83	0.025	199.8	0.0541
41.85	0.024	199.8	0.0524
41.87	0.022	199.7	0.0497
41.88	0.02	199.6	0.0479
41.90	0.019	199.5	0.0444
41.92	0.016	199.3	0.0444
41.93	0.014	199.2	0.0408
41.95	0.014	199.2	0.0391
41.97	0.013	199	0.0355
41.98	0.01	198.8	0.0311
42.00	0.008	198.6	0.0284
42.02	0.007	198.5	0.0231
42.03	0.004	198.2	0.0231
42.05	0.002	198	0.0195
42.07	0.002	198	0.016
42.08	0.001	197.8	0.0115
42.10	-0.002	197.5	0.0071
42.12	-0.004	197.2	0.0044
42.13	-0.005	197	0
42.15	-0.007	196.7	0
42.17	-0.009	196.5	-0.0036
42.18	-0.009	196.5	-0.0062
42.20	-0.01	196.2	-0.0098
42.22	-0.012	196	-0.0124
42.23	-0.014	195.7	-0.0151
42.25	-0.014	195.5	-0.016
42.27	-0.015	195.2	-0.0186
42.28	-0.016	195	-0.0186
42.30	-0.016	195	-0.0204
42.32	-0.016	194.9	-0.0213
42.33	-0.017	194.8	-0.0222
42.35	-0.017	194.6	-0.0222
42.37	-0.017	194.5	-0.0222
42.38	-0.017	194.4	-0.0222
42.40	-0.017	194.3	-0.0222
42.42	-0.016	194.3	-0.0222
42.43	-0.016	194.3	-0.0222
42.45	-0.016	194.2	-0.0213
42.47	-0.014	194.3	-0.0195
42.48	-0.014	194.2	-0.0186



Prova triassiale ciclica SN04-C1			
pressione di confinamento (kPa)		80	
deviatore ciclico (kPa)		95	
frequenza (hz)		0.00625	
tempo	cella di carico	$\Delta u$	LVDT
(min)	kN	(kPa)	$\delta$ (mm)
42.50	-0.012	194.3	-0.016
42.52	-0.011	194.3	-0.0151
42.53	-0.01	194.4	-0.0133
42.55	-0.009	194.5	-0.0107
42.57	-0.006	194.6	-0.0107
42.58	-0.005	194.6	-0.008
42.60	-0.005	194.7	-0.0053
42.62	-0.004	194.9	-0.0018
42.63	0	195.1	0.0018
42.65	0.001	195.2	0.0044
42.67	0.002	195.4	0.0089
42.68	0.006	195.7	0.0089
42.70	0.008	195.9	0.0133
42.72	0.008	195.9	0.016
42.73	0.009	196.1	0.0204
42.77	0.012	196.4	0.0249
42.78	0.014	196.7	0.0293
42.80	0.015	196.9	0.0328
42.82	0.017	197.2	0.0328
42.83	0.02	197.4	0.0364
42.83	0.02	197.4	0.0399
42.85	0.02	197.6	0.0435
42.87	0.023	197.9	0.0462
42.88	0.024	198.1	0.0488
42.90	0.025	198.3	0.0506
42.92	0.026	198.5	0.0506
42.93	0.027	198.7	0.0533
42.95	0.027	198.7	0.055
42.97	0.027	198.9	0.0559
42.98	0.028	199.1	0.0577
43.00	0.029	199.2	0.0586
43.02	0.029	199.4	0.0586
43.03	0.029	199.5	0.0586
43.05	0.029	199.6	0.0586
43.07	0.029	199.6	0.0586
43.08	0.029	199.7	0.0586
43.10	0.028	199.8	0.0586
43.12	0.027	199.8	0.0568
43.13	0.026	199.8	0.0559
43.15	0.025	199.8	0.0541
43.17	0.023	199.7	0.0541
43.18	0.022	199.7	0.0515
43.20	0.022	199.7	0.0506
43.22	0.021	199.6	0.0479
43.23	0.018	199.5	0.0453
43.25	0.018	199.4	0.0444
43.27	0.017	199.3	0.0408
43.28	0.013	199.1	0.0373
43.30	0.012	199	0.0346
43.32	0.011	198.8	0.0302
43.33	0.007	198.5	0.0302
43.35	0.006	198.5	0.0257
43.37	0.006	198.4	0.0231
43.38	0.004	198.1	0.0186
43.40	0.001	197.9	0.0142
43.42	0	197.7	0.0107
43.43	-0.002	197.4	0.0071
43.45	-0.005	197.1	0.0071

Prova triassiale ciclica SN04-C1			
pressione di confinamento (kPa)		80	
deviatore ciclico (kPa)		95	
frequenza (hz)		0.00625	
tempo	cella di carico	$\Delta u$	LVDT
(min)	kN	(kPa)	$\delta$ (mm)
43.47	-0.006	197.1	0.0027
43.48	-0.006	196.9	-0.0009
43.50	-0.007	196.7	-0.0044
43.52	-0.01	196.4	-0.008
43.53	-0.011	196.2	-0.0107
43.55	-0.012	195.9	-0.0133
43.57	-0.014	195.6	-0.0133
43.58	-0.015	195.6	-0.016
43.60	-0.015	195.4	-0.0169
43.62	-0.015	195.2	-0.0186
43.63	-0.016	195	-0.0204
43.65	-0.017	194.9	-0.0213
43.67	-0.017	194.7	-0.0222
43.68	-0.017	194.6	-0.0222
43.70	-0.017	194.6	-0.0222
43.72	-0.017	194.5	-0.0231
43.73	-0.017	194.4	-0.0231
43.75	-0.017	194.3	-0.0222
43.77	-0.016	194.3	-0.0213
43.78	-0.015	194.3	-0.0204
43.80	-0.014	194.3	-0.0204
43.82	-0.013	194.3	-0.0186
43.83	-0.013	194.3	-0.0178
43.85	-0.012	194.3	-0.016
43.87	-0.01	194.4	-0.0133
43.88	-0.008	194.5	-0.0115
43.90	-0.007	194.6	-0.0089
43.92	-0.005	194.8	-0.0089
43.93	-0.002	194.9	-0.0053
43.95	-0.002	194.9	-0.0018
43.97	0	195.2	0.0027
43.98	0.002	195.4	0.0027
44.00	0.002	195.4	0.0053
44.02	0.003	195.6	0.0107
44.03	0.006	195.9	0.0151
44.05	0.009	196.1	0.0186
44.07	0.01	196.3	0.0213
44.08	0.012	196.6	0.0257
44.10	0.015	196.8	0.0257
44.12	0.016	196.8	0.0302
44.13	0.016	197	0.0337
44.15	0.017	197.3	0.0373
44.17	0.021	197.5	0.0408
44.18	0.021	197.7	0.0435
44.20	0.022	198	0.047
44.23	0.025	198.2	0.047
44.25	0.025	198.2	0.0506
44.27	0.025	198.4	0.0515
44.28	0.026	198.6	0.0533
44.28	0.027	198.8	0.055
44.30	0.028	199	0.0568
44.32	0.028	199.2	0.0577
44.33	0.029	199.3	0.0577
44.35	0.029	199.3	0.0586
44.37	0.029	199.4	0.0595
44.38	0.029	199.6	0.0595
44.40	0.029	199.7	0.0586
44.42	0.028	199.7	0.0586

Prova triassiale ciclica SN04-C1			
pressione di confinamento (kPa)		80	
deviatore ciclico (kPa)		95	
frequenza (hz)		0.00625	
tempo	cella di carico	$\Delta u$	LVDT
(min)	kN	(kPa)	$\delta$ (mm)
44.43	0.028	199.8	0.0577
44.45	0.026	199.8	0.0577
44.47	0.026	199.8	0.0559
44.48	0.026	199.8	0.0559
44.50	0.025	199.8	0.0533
44.52	0.022	199.7	0.0506
44.53	0.022	199.7	0.0497
44.55	0.02	199.6	0.047
44.57	0.017	199.4	0.047
44.58	0.016	199.4	0.0435
44.60	0.016	199.4	0.0408
44.62	0.015	199.2	0.0373
44.63	0.011	199	0.0346
44.65	0.01	198.9	0.0311
44.67	0.009	198.7	0.0275
44.68	0.005	198.4	0.0222
44.70	0.005	198.3	0.0204
44.72	0.004	198.1	0.0169
44.73	0	197.8	0.0169
44.75	-0.001	197.8	0.0124
44.77	-0.001	197.6	0.0098
44.78	-0.003	197.3	0.0053
44.80	-0.006	197	0.0009
44.82	-0.007	196.8	-0.0018
44.83	-0.008	196.6	-0.0062
44.85	-0.011	196.3	-0.0062
44.87	-0.012	196.1	-0.0098
44.88	-0.012	196.1	-0.0115
44.90	-0.013	195.9	-0.0133
44.92	-0.014	195.6	-0.016
44.93	-0.015	195.4	-0.0178
44.95	-0.016	195.2	-0.0195
44.97	-0.016	195	-0.0195
44.98	-0.017	194.8	-0.0204
45.00	-0.017	194.8	-0.0222
45.02	-0.017	194.7	-0.0222
45.03	-0.017	194.6	-0.0222
45.05	-0.017	194.5	-0.0222
45.07	-0.017	194.4	-0.0231
45.08	-0.017	194.3	-0.0222
45.10	-0.016	194.3	-0.0222
45.12	-0.015	194.3	-0.0213
45.13	-0.015	194.3	-0.0195
45.15	-0.014	194.3	-0.0186
45.17	-0.012	194.3	-0.0169
45.18	-0.011	194.3	-0.0151
45.20	-0.01	194.4	-0.0133
45.22	-0.007	194.6	-0.0133
45.23	-0.007	194.6	-0.0107
45.25	-0.007	194.6	-0.008
45.27	-0.005	194.8	-0.0044
45.28	-0.002	195	-0.0009
45.30	-0.001	195.1	0.0018
45.32	0.001	195.3	0.0053
45.33	0.004	195.6	0.0053
45.35	0.005	195.6	0.0098
45.37	0.005	195.8	0.0124
45.38	0.007	196	0.0169

Prova triassiale ciclica SN04-C1			
pressione di confinamento (kPa)		80	
deviatore ciclico (kPa)		95	
frequenza (hz)		0.00625	
tempo	cella di carico	$\Delta u$	LVDT
(min)	kN	(kPa)	$\delta$ (mm)
45.40	0.011	196.3	0.0222
45.42	0.012	196.5	0.0249
45.43	0.012	196.7	0.0284
45.45	0.016	196.9	0.032
45.47	0.017	197.1	0.0346
45.48	0.018	197.4	0.0391
45.50	0.02	197.7	0.0391
45.52	0.022	197.9	0.0426
45.53	0.022	197.9	0.0453
45.55	0.023	198.1	0.0479
45.57	0.024	198.3	0.0506
45.58	0.026	198.6	0.0524
45.60	0.027	198.7	0.0541
45.62	0.027	198.9	0.0541
45.63	0.028	199.1	0.0559
45.67	0.028	199.1	0.0568
45.68	0.028	199.2	0.0577
45.70	0.029	199.4	0.0586
45.72	0.029	199.5	0.0586
45.73	0.029	199.6	0.0586
45.73	0.029	199.7	0.0586
45.75	0.028	199.8	0.0586
45.77	0.028	199.8	0.0586
45.78	0.028	199.8	0.0577
45.80	0.026	199.8	0.0559
45.82	0.024	199.8	0.0541
45.83	0.024	199.8	0.0533
45.85	0.023	199.8	0.0506
45.87	0.02	199.7	0.0506
45.88	0.019	199.7	0.0479
45.90	0.019	199.6	0.0462
45.92	0.018	199.4	0.0435
45.93	0.015	199.3	0.0399
45.95	0.014	199.2	0.0364
45.97	0.012	199	0.0328
45.98	0.008	198.8	0.0328
46.00	0.008	198.8	0.0293
46.02	0.008	198.6	0.0257
46.03	0.006	198.4	0.0222
46.05	0.003	198.1	0.0178
46.07	0.001	197.9	0.0142
46.08	0	197.7	0.0098
46.10	-0.004	197.4	0.0098
46.12	-0.005	197.4	0.0053
46.13	-0.006	197	0
46.15	-0.007	196.7	0
46.17	-0.009	196.7	-0.0027
46.18	-0.009	196.5	-0.0053
46.20	-0.01	196.3	-0.0098
46.22	-0.013	196	-0.0124
46.23	-0.013	195.8	-0.0142
46.25	-0.014	195.6	-0.0169
46.27	-0.016	195.3	-0.0169
46.28	-0.016	195.1	-0.0186
46.30	-0.016	195.1	-0.0195
46.32	-0.017	194.9	-0.0213
46.33	-0.017	194.8	-0.0222
46.35	-0.017	194.7	-0.0222

Prova triassiale ciclica SN04-C1			
pressione di confinamento (kPa)		80	
deviatore ciclico (kPa)		95	
frequenza (hz)		0.00625	
tempo	cella di carico	$\Delta u$	LVDT
(min)	kN	(kPa)	$\delta$ (mm)
46.37	-0.017	194.5	-0.0222
46.38	-0.017	194.4	-0.0222
46.40	-0.017	194.4	-0.0231
46.42	-0.017	194.4	-0.0231
46.43	-0.016	194.3	-0.0213
46.45	-0.015	194.3	-0.0204
46.47	-0.014	194.3	-0.0195
46.48	-0.014	194.3	-0.0186
46.50	-0.013	194.3	-0.016
46.52	-0.01	194.4	-0.016
46.53	-0.01	194.4	-0.0142
46.55	-0.01	194.5	-0.0124
46.57	-0.008	194.6	-0.0098
46.58	-0.005	194.7	-0.0062
46.60	-0.004	194.8	-0.0036
46.62	-0.002	195.1	0
46.63	0.001	195.2	0
46.65	0.002	195.2	0.0036
46.67	0.002	195.4	0.0071
46.68	0.004	195.7	0.0107
46.70	0.007	195.9	0.0151
46.72	0.008	196.1	0.0186
46.73	0.01	196.4	0.0222
46.75	0.013	196.6	0.0222
46.77	0.014	196.6	0.0275
46.78	0.014	196.8	0.0311
46.80	0.016	197.1	0.0346
46.82	0.019	197.4	0.0382
46.83	0.02	197.6	0.0408
46.85	0.021	197.8	0.0453
46.87	0.024	198.1	0.047
46.88	0.023	198.2	0.0488
46.90	0.025	198.5	0.0515
46.92	0.026	198.7	0.0515
46.93	0.027	198.7	0.0541
46.95	0.027	198.8	0.055
46.97	0.028	199	0.0568
46.98	0.028	199.2	0.0577
47.00	0.029	199.3	0.0586
47.02	0.029	199.5	0.0586
47.03	0.028	199.6	0.0586
47.05	0.028	199.6	0.0586
47.07	0.028	199.7	0.0586
47.08	0.028	199.8	0.0586
47.10	0.028	199.8	0.0586
47.13	0.027	199.8	0.0568
47.15	0.027	199.9	0.0559
47.17	0.024	199.8	0.0559
47.18	0.024	199.8	0.0533
47.18	0.024	199.8	0.0524
47.20	0.022	199.8	0.0497
47.22	0.02	199.7	0.047
47.23	0.018	199.6	0.0453
47.25	0.017	199.5	0.0417
47.27	0.014	199.3	0.0417
47.28	0.013	199.3	0.0391
47.30	0.013	199.1	0.0364
47.32	0.012	199	0.0328

Prova triassiale ciclica SN04-C1			
pressione di confinamento (kPa)		80	
deviatore ciclico (kPa)		95	
frequenza (hz)		0.00625	
tempo	cella di carico	$\Delta u$	LVDT
(min)	kN	(kPa)	$\delta$ (mm)
47.33	0.008	198.7	0.0284
47.35	0.007	198.6	0.0249
47.37	0.005	198.4	0.0204
47.38	0.002	198.1	0.0204
47.40	0	198.1	0.016
47.42	0	197.9	0.0124
47.43	-0.001	197.6	0.0089
47.45	-0.004	197.3	0.0036
47.47	-0.006	197.1	0.0009
47.48	-0.007	196.9	-0.0027
47.50	-0.009	196.6	-0.0027
47.52	-0.011	196.3	-0.0071
47.53	-0.011	196.3	-0.0098
47.55	-0.011	196.1	-0.0115
47.57	-0.013	195.9	-0.0142
47.58	-0.014	195.6	-0.0169
47.60	-0.015	195.4	-0.0178
47.62	-0.016	195.2	-0.0195
47.63	-0.016	195	-0.0204
47.65	-0.016	194.9	-0.0213
47.67	-0.017	194.7	-0.0213
47.68	-0.017	194.6	-0.0222
47.70	-0.017	194.6	-0.0231
47.72	-0.017	194.5	-0.0231
47.73	-0.017	194.4	-0.0231
47.75	-0.017	194.3	-0.0222
47.77	-0.016	194.3	-0.0213
47.78	-0.015	194.3	-0.0204
47.80	-0.014	194.3	-0.0204
47.82	-0.014	194.3	-0.0195
47.83	-0.013	194.3	-0.0178
47.85	-0.012	194.4	-0.0151
47.87	-0.01	194.5	-0.0133
47.88	-0.009	194.5	-0.0107
47.90	-0.007	194.7	-0.008
47.92	-0.004	194.8	-0.008
47.93	-0.004	194.8	-0.0053
47.95	-0.003	194.9	-0.0018
47.97	-0.001	195.2	0.0018
47.98	0.002	195.4	0.0053
48.00	0.002	195.5	0.0089
48.02	0.005	195.8	0.0124
48.03	0.008	196	0.0124
48.05	0.009	196	0.0169
48.07	0.009	196.2	0.0204
48.08	0.011	196.5	0.024
48.10	0.014	196.7	0.0284
48.12	0.015	197	0.032
48.13	0.017	197.3	0.0364
48.15	0.02	197.5	0.0364
48.17	0.02	197.5	0.0399
48.18	0.02	197.7	0.0426
48.20	0.022	198	0.0453
48.22	0.024	198.2	0.0488
48.23	0.024	198.4	0.0506
48.25	0.026	198.6	0.0533
48.27	0.027	198.8	0.0533
48.28	0.027	198.8	0.055

Prova triassiale ciclica SN04-C1			
pressione di confinamento (kPa)		80	
deviatore ciclico (kPa)		95	
frequenza (hz)		0.00625	
tempo	cella di carico	$\Delta u$	LVDT
(min)	kN	(kPa)	$\delta$ (mm)
48.30	0.027	199	0.0559
48.32	0.029	199.3	0.0577
48.33	0.029	199.3	0.0586
48.35	0.029	199.4	0.0586
48.37	0.029	199.6	0.0586
48.38	0.029	199.7	0.0586
48.40	0.029	199.8	0.0586
48.42	0.028	199.8	0.0586
48.43	0.028	199.9	0.0586
48.45	0.026	199.9	0.0577
48.47	0.026	199.9	0.0568
48.48	0.026	199.9	0.055
48.50	0.024	199.8	0.0524
48.52	0.023	199.8	0.0515
48.53	0.022	199.8	0.0488
48.55	0.019	199.7	0.0488
48.58	0.017	199.6	0.0462
48.60	0.017	199.6	0.0435
48.62	0.016	199.4	0.0408
48.63	0.014	199.2	0.0373
48.63	0.012	199.1	0.0346
48.65	0.01	198.9	0.0311
48.67	0.008	198.7	0.0311
48.68	0.005	198.5	0.0257
48.70	0.005	198.5	0.0222
48.72	0.004	198.3	0.0178
48.73	0.002	198	0.0142
48.75	-0.001	197.8	0.0107
48.77	-0.002	197.5	0.0062
48.78	-0.005	197.2	0.0062
48.80	-0.007	197	0.0027
48.82	-0.007	197	-0.0009
48.83	-0.007	196.8	-0.0044
48.85	-0.009	196.5	-0.008
48.87	-0.012	196.2	-0.0107
48.88	-0.012	196	-0.0133
48.90	-0.013	195.8	-0.016
48.92	-0.015	195.5	-0.016
48.93	-0.015	195.5	-0.0178
48.95	-0.015	195.3	-0.0186
48.97	-0.016	195.1	-0.0204
48.98	-0.017	194.9	-0.0222
49.00	-0.017	194.8	-0.0222
49.02	-0.017	194.7	-0.0231
49.03	-0.017	194.6	-0.0231
49.05	-0.017	194.5	-0.0231
49.07	-0.017	194.4	-0.0231
49.08	-0.016	194.3	-0.0231
49.10	-0.015	194.3	-0.0222
49.12	-0.015	194.3	-0.0213
49.13	-0.015	194.3	-0.0204
49.15	-0.013	194.3	-0.0186
49.17	-0.012	194.3	-0.0178
49.18	-0.012	194.4	-0.0151
49.20	-0.009	194.5	-0.0151
49.22	-0.008	194.5	-0.0124
49.23	-0.008	194.6	-0.0107
49.25	-0.007	194.7	-0.008

Prova triassiale ciclica SN04-C1			
pressione di confinamento (kPa)		80	
deviatore ciclico (kPa)		95	
frequenza (hz)		0.00625	
tempo	cella di carico	$\Delta u$	LVDT
(min)	kN	(kPa)	$\delta$ (mm)
49.27	-0.003	194.8	-0.0044
49.28	-0.003	195	-0.0018
49.30	-0.001	195.2	0.0018
49.32	0.003	195.4	0.0018
49.33	0.004	195.4	0.0062
49.35	0.004	195.6	0.0098
49.37	0.005	195.8	0.0133
49.38	0.009	196.1	0.0178
49.40	0.01	196.3	0.0213
49.42	0.012	196.5	0.0257
49.43	0.014	196.8	0.0257
49.45	0.016	197.1	0.0302
49.47	0.016	197.1	0.0337
49.48	0.017	197.2	0.0373
49.50	0.02	197.6	0.0408
49.52	0.022	197.8	0.0435
49.53	0.022	198	0.0462
49.55	0.024	198.3	0.0462
49.57	0.025	198.5	0.0497
49.58	0.025	198.5	0.0515
49.60	0.026	198.6	0.0533
49.62	0.027	198.8	0.055
49.63	0.028	199	0.0568
49.65	0.028	199.2	0.0568
49.67	0.028	199.3	0.0577
49.68	0.029	199.5	0.0577
49.70	0.029	199.5	0.0586
49.72	0.029	199.6	0.0586
49.73	0.029	199.7	0.0586
49.75	0.029	199.8	0.0586
49.77	0.028	199.8	0.0577
49.78	0.027	199.9	0.0568
49.80	0.026	199.9	0.0559
49.82	0.025	199.9	0.0541
49.83	0.024	199.8	0.0524
49.85	0.022	199.8	0.0524
49.87	0.021	199.8	0.0506
49.88	0.021	199.7	0.0488
49.90	0.02	199.7	0.0453
49.92	0.017	199.5	0.0426
49.93	0.015	199.3	0.0399
49.95	0.014	199.2	0.0364
49.97	0.011	199	0.0364
49.98	0.009	198.8	0.0328
50.00	0.009	198.8	0.0293
50.03	0.008	198.7	0.0249
50.05	0.004	198.4	0.0204
50.07	0.003	198.2	0.0178
50.08	0.002	198	0.0133
50.08	-0.001	197.7	0.0133
50.10	-0.003	197.5	0.0089
50.12	-0.003	197.5	0.0053
50.13	-0.004	197.2	0.0018
50.15	-0.007	196.9	-0.0027
50.17	-0.009	196.7	-0.0053
50.18	-0.01	196.5	-0.0089
50.20	-0.011	196.2	-0.0089
50.22	-0.013	195.9	-0.0115



Prova triassiale ciclica SN04-C1			
pressione di confinamento (kPa)		80	
deviatore ciclico (kPa)		95	
frequenza (hz)		0.00625	
tempo	cella di carico	$\Delta u$	LVDT
(min)	kN	(kPa)	$\delta$ (mm)
50.23	-0.013	195.9	-0.0142
50.25	-0.014	195.7	-0.016
50.27	-0.015	195.5	-0.0178
50.28	-0.016	195.2	-0.0195
50.30	-0.016	195.1	-0.0204
50.32	-0.016	194.9	-0.0213
50.33	-0.017	194.8	-0.0213
50.35	-0.017	194.8	-0.0222
50.37	-0.017	194.7	-0.0231
50.38	-0.017	194.6	-0.0231
50.40	-0.017	194.5	-0.0231
50.42	-0.016	194.4	-0.0222
50.43	-0.016	194.4	-0.0213
50.45	-0.015	194.4	-0.0213
50.47	-0.014	194.4	-0.0204
50.48	-0.014	194.3	-0.0195
50.50	-0.012	194.4	-0.0178
50.52	-0.011	194.4	-0.0169
50.53	-0.011	194.4	-0.0142
50.55	-0.01	194.5	-0.0124
50.57	-0.007	194.7	-0.0089
50.58	-0.006	194.8	-0.0071
50.60	-0.004	194.9	-0.0036
50.62	-0.001	195.1	-0.0036
50.63	0	195.1	0
50.65	0	195.2	0.0027
50.67	0.002	195.5	0.0071
50.68	0.005	195.8	0.0115
50.70	0.006	195.9	0.0142
50.72	0.008	196.2	0.0186
50.73	0.012	196.5	0.0186
50.75	0.013	196.5	0.0231
50.77	0.013	196.6	0.0257
50.78	0.014	196.9	0.0311
50.80	0.017	197.2	0.0355
50.82	0.019	197.4	0.0382
50.83	0.019	197.6	0.0417
50.85	0.022	197.9	0.0417
50.87	0.024	198.1	0.0453
50.88	0.024	198.1	0.047
50.90	0.024	198.3	0.0497
50.92	0.026	198.6	0.0524
50.93	0.027	198.7	0.0541
50.95	0.027	198.9	0.0559
50.97	0.028	199.1	0.0559
50.98	0.029	199.3	0.0568
51.00	0.029	199.3	0.0577
51.02	0.028	199.4	0.0577
51.03	0.029	199.6	0.0586
51.05	0.029	199.7	0.0586
51.07	0.029	199.8	0.0586
51.08	0.028	199.8	0.0586
51.10	0.027	199.8	0.0586
51.12	0.027	199.8	0.0568
51.13	0.027	199.9	0.0559
51.15	0.025	199.8	0.0541
51.17	0.023	199.8	0.0524
51.18	0.023	199.8	0.0515

Prova triassiale ciclica SN04-C1			
pressione di confinamento (kPa)		80	
deviatore ciclico (kPa)		95	
frequenza (hz)		0.00625	
tempo	cella di carico	$\Delta u$	LVDT
(min)	kN	(kPa)	$\delta$ (mm)
51.20	0.022	199.7	0.0488
51.22	0.019	199.6	0.0453
51.23	0.019	199.6	0.0444
51.25	0.017	199.4	0.0417
51.27	0.014	199.3	0.0417
51.28	0.013	199.3	0.0382
51.30	0.013	199.2	0.0355
51.32	0.012	199	0.032
51.33	0.008	198.7	0.0275
51.35	0.007	198.6	0.024
51.37	0.006	198.4	0.0195
51.38	0.002	198.1	0.0195
51.40	0.001	198.1	0.0151
51.42	0.001	197.9	0.0124
51.43	-0.001	197.7	0.008
51.45	-0.005	197.4	0.0036
51.47	-0.005	197.1	0.0009
51.50	-0.007	196.9	-0.0036
51.52	-0.009	196.6	-0.0036
51.53	-0.011	196.4	-0.0071
51.55	-0.011	196.4	-0.0098
51.55	-0.011	196.2	-0.0124
51.57	-0.013	195.9	-0.0151
51.58	-0.014	195.7	-0.0169
51.60	-0.015	195.4	-0.0186
51.62	-0.016	195.2	-0.0186
51.63	-0.017	195	-0.0204
51.65	-0.017	195	-0.0213
51.67	-0.017	194.9	-0.0222
51.68	-0.017	194.7	-0.0231
51.70	-0.017	194.6	-0.0231
51.72	-0.017	194.5	-0.0231
51.73	-0.017	194.5	-0.0231
51.75	-0.016	194.4	-0.0231
51.77	-0.016	194.4	-0.0222
51.78	-0.016	194.4	-0.0213
51.80	-0.015	194.4	-0.0204
51.82	-0.013	194.4	-0.0186
51.83	-0.013	194.4	-0.0178
51.85	-0.011	194.5	-0.0151
51.87	-0.009	194.6	-0.0151
51.88	-0.008	194.6	-0.0124
51.90	-0.008	194.6	-0.0098
51.92	-0.006	194.8	-0.0071
51.93	-0.003	194.9	-0.0044
51.95	-0.003	195	-0.0018
51.97	-0.002	195.2	0.0009
51.98	0.001	195.4	0.0044
52.00	0.002	195.6	0.0071
52.02	0.004	195.9	0.0124
52.03	0.009	196.1	0.0124
52.05	0.009	196.1	0.0169
52.07	0.009	196.3	0.0204
52.08	0.011	196.5	0.024
52.10	0.014	196.8	0.0284
52.12	0.015	197	0.032
52.13	0.016	197.3	0.0355
52.15	0.02	197.5	0.0355

Prova triassiale ciclica SN04-C1			
pressione di confinamento (kPa)		80	
deviatore ciclico (kPa)		95	
frequenza (hz)		0.00625	
tempo	cella di carico	$\Delta u$	LVDT
(min)	kN	(kPa)	$\delta$ (mm)
52.17	0.02	197.5	0.0399
52.18	0.02	197.7	0.0417
52.20	0.022	198	0.0453
52.22	0.024	198.2	0.0488
52.23	0.025	198.4	0.0506
52.25	0.026	198.6	0.0524
52.27	0.027	198.8	0.0524
52.28	0.027	198.8	0.055
52.30	0.027	199	0.0559
52.32	0.028	199.2	0.0568
52.33	0.029	199.3	0.0577
52.35	0.029	199.5	0.0586
52.37	0.029	199.6	0.0586
52.38	0.029	199.7	0.0586
52.40	0.028	199.7	0.0586
52.42	0.028	199.8	0.0586
52.43	0.028	199.9	0.0586
52.45	0.027	199.9	0.0568
52.47	0.026	199.9	0.0559
52.48	0.025	199.9	0.0541
52.50	0.023	199.8	0.0541
52.52	0.022	199.8	0.0524
52.53	0.022	199.8	0.0506
52.55	0.021	199.8	0.0479
52.57	0.018	199.6	0.0444
52.58	0.017	199.5	0.0426
52.60	0.015	199.4	0.0391
52.62	0.013	199.2	0.0391
52.63	0.011	199	0.0355
52.65	0.011	199	0.0328
52.67	0.01	198.9	0.0293
52.68	0.006	198.5	0.024
52.70	0.006	198.5	0.0222
52.72	0.004	198.3	0.0178
52.73	0.001	198	0.0142
52.75	-0.001	197.8	0.0107
52.77	-0.002	197.6	0.0062
52.78	-0.005	197.2	0.0062
52.80	-0.006	197	0.0018
52.82	-0.006	197	-0.0009
52.83	-0.008	196.8	-0.0044
52.85	-0.009	196.5	-0.008
52.87	-0.011	196.3	-0.0107
52.88	-0.012	196	-0.0133
52.90	-0.014	195.8	-0.0133
52.93	-0.015	195.6	-0.016
52.95	-0.015	195.6	-0.0178
52.97	-0.015	195.4	-0.0195
52.98	-0.016	195.1	-0.0204
53.00	-0.017	195	-0.0222
53.00	-0.017	194.8	-0.0222
53.02	-0.017	194.7	-0.0222
53.03	-0.017	194.6	-0.0222
53.05	-0.017	194.6	-0.0231
53.07	-0.017	194.5	-0.0231
53.08	-0.017	194.4	-0.0231
53.10	-0.016	194.4	-0.0222
53.12	-0.015	194.4	-0.0213

Prova triassiale ciclica SN04-C1			
pressione di confinamento (kPa)		80	
deviatore ciclico (kPa)		95	
frequenza (hz)		0.00625	
tempo	cella di carico	$\Delta u$	LVDT
(min)	kN	(kPa)	$\delta$ (mm)
53.13	-0.015	194.4	-0.0195
53.15	-0.013	194.4	-0.0195
53.17	-0.012	194.4	-0.0178
53.18	-0.012	194.4	-0.0169
53.20	-0.011	194.5	-0.0142
53.22	-0.008	194.6	-0.0115
53.23	-0.007	194.7	-0.0089
53.25	-0.006	194.9	-0.0062
53.27	-0.002	195	-0.0062
53.28	-0.002	195	-0.0027
53.30	-0.002	195.1	0
53.32	0	195.4	0.0036
53.33	0.004	195.6	0.008
53.35	0.005	195.8	0.0115
53.37	0.006	196.1	0.0151
53.38	0.01	196.3	0.0151
53.40	0.011	196.5	0.0213
53.42	0.011	196.7	0.0249
53.43	0.015	197	0.0249
53.45	0.016	197	0.0302
53.47	0.016	197.2	0.0337
53.48	0.017	197.4	0.0373
53.50	0.021	197.7	0.0408
53.52	0.021	197.9	0.0435
53.53	0.022	198.1	0.047
53.55	0.025	198.4	0.047
53.57	0.025	198.4	0.0497
53.58	0.025	198.5	0.0515
53.60	0.026	198.7	0.0533
53.62	0.027	199	0.055
53.63	0.027	199.1	0.0559
53.65	0.028	199.3	0.0577
53.67	0.029	199.4	0.0577
53.68	0.029	199.4	0.0586
53.70	0.029	199.6	0.0586
53.72	0.029	199.7	0.0586
53.73	0.029	199.8	0.0586
53.75	0.028	199.8	0.0586
53.77	0.028	199.9	0.0568
53.78	0.026	199.9	0.0568
53.80	0.026	199.9	0.0559
53.82	0.026	199.9	0.055
53.83	0.025	199.9	0.0533
53.85	0.022	199.8	0.0506
53.87	0.021	199.8	0.0488
53.88	0.02	199.8	0.0462
53.90	0.017	199.6	0.0462
53.92	0.017	199.6	0.0435
53.93	0.017	199.5	0.0417
53.95	0.015	199.3	0.0373
53.97	0.011	199.1	0.0337
53.98	0.01	199	0.0311
54.00	0.009	198.8	0.0275
54.02	0.006	198.6	0.0275
54.03	0.004	198.4	0.0222
54.05	0.004	198.4	0.0186
54.07	0.003	198.2	0.0151
54.08	-0.001	197.8	0.0107

Prova triassiale ciclica SN04-C1			
pressione di confinamento (kPa)		80	
deviatore ciclico (kPa)		95	
frequenza (hz)		0.00625	
tempo	cella di carico	$\Delta u$	LVDT
(min)	kN	(kPa)	$\delta$ (mm)
54.10	-0.003	197.6	0.0071
54.12	-0.003	197.4	0.0036
54.13	-0.006	197.1	-0.0009
54.15	-0.007	196.9	-0.0027
54.17	-0.008	196.7	-0.0062
54.18	-0.01	196.3	-0.0062
54.20	-0.012	196.1	-0.0098
54.22	-0.012	196.1	-0.0124
54.23	-0.013	195.9	-0.0142
54.25	-0.014	195.7	-0.0169
54.27	-0.015	195.5	-0.0186
54.28	-0.016	195.3	-0.0195
54.30	-0.016	195.1	-0.0213
54.32	-0.017	194.9	-0.0213
54.33	-0.017	194.9	-0.0222
54.35	-0.017	194.8	-0.0222
54.37	-0.017	194.7	-0.0231
54.40	-0.017	194.5	-0.024
54.42	-0.017	194.5	-0.0231
54.43	-0.017	194.4	-0.0222
54.45	-0.016	194.4	-0.0222
54.45	-0.015	194.4	-0.0213
54.47	-0.015	194.4	-0.0204
54.48	-0.014	194.4	-0.0195
54.50	-0.012	194.4	-0.0178
54.52	-0.011	194.4	-0.016
54.53	-0.01	194.5	-0.0133
54.55	-0.007	194.7	-0.0133
54.57	-0.007	194.7	-0.0107
54.58	-0.007	194.7	-0.0089
54.60	-0.005	194.9	-0.0053
54.62	-0.001	195.1	-0.0018
54.63	-0.001	195.2	0.0009
54.65	0.001	195.5	0.0053
54.67	0.005	195.7	0.0053
54.68	0.005	195.7	0.0098
54.70	0.005	195.9	0.0124
54.72	0.007	196.2	0.0169
54.73	0.011	196.4	0.0222
54.75	0.011	196.6	0.024
54.77	0.013	196.8	0.0293
54.78	0.017	197.1	0.0293
54.80	0.018	197.1	0.0337
54.82	0.018	197.3	0.0364
54.83	0.019	197.6	0.0399
54.85	0.022	197.9	0.0435
54.87	0.022	198	0.0453
54.88	0.023	198.2	0.0479
54.90	0.025	198.5	0.0497
54.92	0.026	198.7	0.0515
54.93	0.026	198.8	0.0541
54.95	0.027	199.1	0.0541
54.97	0.028	199.2	0.0559
54.98	0.028	199.2	0.0568
55.00	0.028	199.4	0.0577
55.02	0.029	199.5	0.0577
55.03	0.029	199.7	0.0586
55.05	0.029	199.8	0.0586

Prova triassiale ciclica SN04-C1			
pressione di confinamento (kPa)		80	
deviatore ciclico (kPa)		95	
frequenza (hz)		0.00625	
tempo	cella di carico	$\Delta u$	LVDT
(min)	kN	(kPa)	$\delta$ (mm)
55.07	0.029	199.8	0.0586
55.08	0.028	199.9	0.0586
55.10	0.028	199.9	0.0577
55.12	0.027	199.9	0.0568
55.13	0.026	199.9	0.055
55.15	0.025	199.9	0.0533
55.17	0.024	199.9	0.0524
55.18	0.023	199.8	0.0506
55.20	0.021	199.8	0.0506
55.22	0.019	199.8	0.0479
55.23	0.019	199.7	0.0462
55.25	0.018	199.6	0.0426
55.27	0.015	199.4	0.0391
55.28	0.014	199.3	0.0373
55.30	0.013	199.1	0.0328
55.32	0.009	198.9	0.0328
55.33	0.008	198.9	0.0293
55.35	0.008	198.7	0.0249
55.37	0.006	198.5	0.0213
55.38	0.002	198.3	0.0169
55.40	0.002	198.1	0.0142
55.42	0	197.8	0.0098
55.43	-0.004	197.5	0.0098
55.45	-0.005	197.5	0.0053
55.47	-0.005	197.3	0.0018
55.48	-0.006	197	-0.0018
55.50	-0.009	196.8	-0.0053
55.52	-0.01	196.5	-0.008
55.53	-0.011	196.3	-0.0115
55.55	-0.013	196	-0.0115
55.57	-0.014	195.8	-0.0142
55.58	-0.014	195.6	-0.0169
55.60	-0.015	195.4	-0.0169
55.62	-0.016	195.2	-0.0186
55.63	-0.016	195.2	-0.0204
55.65	-0.017	195	-0.0222
55.67	-0.017	194.9	-0.0222
55.68	-0.017	194.7	-0.0231
55.70	-0.017	194.6	-0.0231
55.72	-0.017	194.5	-0.0231
55.73	-0.017	194.5	-0.0231
55.75	-0.017	194.5	-0.0231
55.77	-0.016	194.4	-0.0222
55.78	-0.016	194.4	-0.0213
55.80	-0.014	194.4	-0.0195
55.83	-0.013	194.4	-0.0186
55.85	-0.012	194.5	-0.0169
55.87	-0.01	194.5	-0.0169
55.88	-0.01	194.5	-0.0151
55.90	-0.01	194.6	-0.0133
55.90	-0.008	194.7	-0.0107
55.92	-0.005	194.8	-0.0071
55.93	-0.004	194.9	-0.0044
55.95	-0.003	195.1	-0.0009
55.97	0.001	195.4	-0.0009
55.98	0.002	195.4	0.0027
56.00	0.002	195.5	0.0062
56.02	0.004	195.8	0.0107

Prova triassiale ciclica SN04-C1			
pressione di confinamento (kPa)		80	
deviatore ciclico (kPa)		95	
frequenza (hz)		0.00625	
tempo	cella di carico	$\Delta u$	LVDT
(min)	kN	(kPa)	$\delta$ (mm)
56.03	0.007	196	0.0151
56.05	0.008	196.2	0.0178
56.07	0.01	196.5	0.0222
56.08	0.014	196.7	0.0222
56.10	0.014	196.7	0.0275
56.12	0.014	196.9	0.0311
56.13	0.016	197.2	0.0346
56.15	0.019	197.5	0.0382
56.17	0.02	197.7	0.0408
56.18	0.021	197.9	0.0444
56.20	0.024	198.2	0.0444
56.22	0.024	198.2	0.047
56.23	0.024	198.4	0.0497
56.25	0.025	198.6	0.0524
56.27	0.027	198.8	0.0533
56.28	0.027	199	0.055
56.30	0.028	199.1	0.0559
56.32	0.028	199.3	0.0568
56.33	0.028	199.4	0.0577
56.35	0.029	199.6	0.0586
56.37	0.029	199.7	0.0586
56.38	0.029	199.7	0.0586
56.40	0.029	199.8	0.0586
56.42	0.029	199.9	0.0586
56.43	0.028	199.9	0.0577
56.45	0.027	199.9	0.0568
56.47	0.026	200	0.055
56.48	0.025	199.9	0.055
56.50	0.023	199.9	0.0533
56.52	0.023	199.9	0.0515
56.53	0.022	199.9	0.0497
56.55	0.02	199.8	0.047
56.57	0.018	199.7	0.0444
56.58	0.017	199.6	0.0417
56.60	0.015	199.4	0.0417
56.62	0.012	199.2	0.0382
56.63	0.012	199.2	0.0355
56.65	0.011	199.1	0.032
56.67	0.009	198.8	0.0284
56.68	0.006	198.6	0.024
56.70	0.005	198.5	0.0195
56.72	0.003	198.2	0.0195
56.73	0	198	0.016
56.75	0	198	0.0115
56.77	-0.001	197.8	0.008
56.78	-0.004	197.4	0.0036
56.80	-0.006	197.2	0
56.82	-0.007	197	-0.0036
56.83	-0.009	196.6	-0.0036
56.85	-0.011	196.4	-0.0071
56.87	-0.011	196.4	-0.0098
56.88	-0.012	196.2	-0.0124
56.90	-0.013	195.9	-0.0151
56.92	-0.015	195.7	-0.0169
56.93	-0.015	195.6	-0.0186
56.95	-0.016	195.3	-0.0204
56.97	-0.017	195.1	-0.0204
56.98	-0.017	195.1	-0.0213

Prova triassiale ciclica SN04-C1			
pressione di confinamento (kPa)		80	
deviatore ciclico (kPa)		95	
frequenza (hz)		0.00625	
tempo	cella di carico	$\Delta u$	LVDT
(min)	kN	(kPa)	$\delta$ (mm)
57.00	-0.017	194.9	-0.0222
57.02	-0.017	194.8	-0.0231
57.03	-0.017	194.7	-0.0231
57.05	-0.017	194.6	-0.0231
57.07	-0.017	194.5	-0.0231
57.08	-0.017	194.4	-0.0231
57.10	-0.016	194.4	-0.0222
57.12	-0.015	194.4	-0.0204
57.13	-0.014	194.4	-0.0204
57.15	-0.013	194.4	-0.0195
57.17	-0.013	194.4	-0.0186
57.18	-0.012	194.5	-0.016
57.20	-0.01	194.5	-0.0142
57.22	-0.009	194.6	-0.0124
57.23	-0.007	194.7	-0.0089
57.25	-0.004	194.9	-0.0089
57.27	-0.003	194.9	-0.0053
57.30	-0.003	195	-0.0027
57.32	-0.002	195.2	0.0009
57.33	0.002	195.4	0.0044
57.35	0.003	195.6	0.008
57.35	0.004	195.9	0.0124
57.37	0.009	196.1	0.0124
57.38	0.009	196.1	0.0169
57.40	0.009	196.3	0.0186
57.42	0.011	196.5	0.0231
57.43	0.014	196.8	0.0284
57.45	0.015	197	0.0311
57.47	0.016	197.3	0.0355
57.48	0.02	197.6	0.0355
57.50	0.02	197.8	0.0399
57.52	0.02	197.8	0.0417
57.53	0.022	198	0.0453
57.55	0.024	198.3	0.0479
57.57	0.025	198.5	0.0497
57.58	0.026	198.7	0.0524
57.60	0.027	198.9	0.0524
57.62	0.027	199.1	0.0541
57.63	0.027	199.1	0.0559
57.65	0.028	199.2	0.0568
57.67	0.029	199.4	0.0577
57.68	0.029	199.6	0.0586
57.70	0.029	199.7	0.0586
57.72	0.029	199.8	0.0586
57.73	0.029	199.8	0.0586
57.75	0.029	199.8	0.0586
57.77	0.027	200	0.0568
57.78	0.026	200	0.0568
57.80	0.026	200	0.0559
57.82	0.026	200	0.055
57.83	0.024	199.9	0.0524
57.85	0.023	199.9	0.0506
57.87	0.021	199.8	0.0488
57.88	0.02	199.8	0.0462
57.90	0.017	199.6	0.0462
57.92	0.016	199.6	0.0435
57.93	0.016	199.6	0.0408
57.95	0.015	199.4	0.0373



Prova triassiale ciclica SN04-C1			
pressione di confinamento (kPa)		80	
deviatore ciclico (kPa)		95	
frequenza (hz)		0.00625	
tempo	cella di carico	$\Delta u$	LVDT
(min)	kN	(kPa)	$\delta$ (mm)
57.97	0.011	199.2	0.0337
57.98	0.011	199	0.0302
58.00	0.009	198.8	0.0257
58.02	0.005	198.6	0.0257
58.03	0.004	198.6	0.0213
58.05	0.004	198.4	0.0186
58.07	0.003	198.1	0.0142
58.08	-0.001	197.8	0.0098
58.10	-0.002	197.7	0.0071
58.12	-0.003	197.4	0.0036
58.13	-0.007	197.1	0.0036
58.15	-0.008	197.1	-0.0009
58.17	-0.008	196.9	-0.0036
58.18	-0.009	196.6	-0.0071
58.20	-0.011	196.4	-0.0107
58.22	-0.012	196.1	-0.0124
58.23	-0.013	195.9	-0.0151
58.25	-0.015	195.7	-0.0151
58.27	-0.015	195.7	-0.0178
58.28	-0.015	195.5	-0.0186
58.30	-0.016	195.2	-0.0204
58.32	-0.017	195.1	-0.0222
58.33	-0.017	194.9	-0.0231
58.35	-0.017	194.8	-0.0231
58.37	-0.017	194.7	-0.0231
58.38	-0.017	194.6	-0.0231
58.40	-0.017	194.6	-0.0231
58.42	-0.017	194.5	-0.0231
58.43	-0.016	194.5	-0.0222
58.45	-0.015	194.4	-0.0213
58.47	-0.015	194.4	-0.0195
58.48	-0.013	194.5	-0.0178
58.50	-0.012	194.4	-0.0169
58.52	-0.011	194.5	-0.0151
58.53	-0.009	194.6	-0.0151
58.55	-0.008	194.7	-0.0124
58.57	-0.008	194.7	-0.0107
58.58	-0.007	194.8	-0.0071
58.60	-0.004	195	-0.0036
58.62	-0.002	195.1	-0.0009
58.63	-0.001	195.3	0.0027
58.65	0.002	195.6	0.0027
58.67	0.004	195.8	0.0062
58.68	0.004	195.8	0.0098
58.70	0.006	196	0.0142
58.72	0.008	196.2	0.0178
58.73	0.011	196.5	0.0213
58.77	0.012	196.7	0.0257
58.78	0.014	196.9	0.0302
58.80	0.017	197.2	0.0302
58.80	0.017	197.2	0.0337
58.82	0.018	197.4	0.0373
58.83	0.019	197.7	0.0408
58.85	0.022	197.9	0.0444
58.87	0.022	198.1	0.047
58.88	0.024	198.4	0.0497
58.90	0.026	198.6	0.0497
58.92	0.026	198.6	0.0515

Prova triassiale ciclica SN04-C1			
pressione di confinamento (kPa)		80	
deviatore ciclico (kPa)		95	
frequenza (hz)		0.00625	
tempo	cella di carico	$\Delta u$	LVDT
(min)	kN	(kPa)	$\delta$ (mm)
58.93	0.026	198.8	0.0533
58.95	0.027	199	0.055
58.97	0.028	199.2	0.0559
58.98	0.028	199.3	0.0568
59.00	0.029	199.4	0.0577
59.02	0.029	199.6	0.0577
59.03	0.029	199.6	0.0586
59.05	0.029	199.7	0.0586
59.07	0.029	199.8	0.0586
59.08	0.028	199.9	0.0586
59.10	0.028	199.9	0.0577
59.12	0.027	199.9	0.0559
59.13	0.025	199.9	0.0559
59.15	0.024	199.9	0.0541
59.17	0.024	199.9	0.0533
59.18	0.023	199.9	0.0515
59.20	0.021	199.8	0.0488
59.22	0.02	199.8	0.047
59.23	0.019	199.7	0.0453
59.25	0.017	199.6	0.0426
59.27	0.015	199.5	0.0399
59.28	0.014	199.3	0.0364
59.30	0.011	199.1	0.0364
59.32	0.009	198.9	0.032
59.33	0.009	198.9	0.0293
59.35	0.008	198.8	0.024
59.37	0.005	198.5	0.0204
59.38	0.003	198.3	0.0178
59.40	0.002	198.1	0.0133
59.42	-0.002	197.8	0.0133
59.43	-0.003	197.6	0.0089
59.45	-0.003	197.6	0.0053
59.47	-0.005	197.3	0.0009
59.48	-0.007	197	-0.0027
59.50	-0.009	196.8	-0.0053
59.52	-0.009	196.5	-0.0089
59.53	-0.012	196.2	-0.0089
59.55	-0.013	196	-0.0115
59.57	-0.013	196	-0.0142
59.58	-0.014	195.8	-0.016
59.60	-0.015	195.6	-0.0186
59.62	-0.016	195.4	-0.0195
59.63	-0.016	195.2	-0.0213
59.65	-0.017	195	-0.0222
59.67	-0.017	194.8	-0.0222
59.68	-0.017	194.8	-0.0231
59.70	-0.017	194.7	-0.0231
59.72	-0.017	194.6	-0.0231
59.73	-0.017	194.6	-0.0231
59.75	-0.016	194.5	-0.0222
59.77	-0.016	194.5	-0.0213
59.78	-0.015	194.4	-0.0213
59.80	-0.014	194.4	-0.0204
59.82	-0.014	194.4	-0.0195
59.83	-0.013	194.5	-0.0178
59.85	-0.011	194.5	-0.0151
59.87	-0.01	194.6	-0.0142
59.88	-0.009	194.7	-0.0115

Prova triassiale ciclica SN04-C1			
pressione di confinamento (kPa)		80	
deviatore ciclico (kPa)		95	
frequenza (hz)		0.00625	
tempo	cella di carico	$\Delta u$	LVDT
(min)	kN	(kPa)	$\delta$ (mm)
59.90	-0.006	194.8	-0.0115
59.92	-0.005	194.8	-0.008
59.93	-0.003	195	-0.0036
59.95	-0.002	195.2	-0.0036
59.97	0	195.2	-0.0009
59.98	0	195.3	0.0027
60.00	0.001	195.6	0.0071
60.02	0.006	195.9	0.0115
60.03	0.006	196	0.0142
60.05	0.008	196.3	0.0186
60.07	0.012	196.6	0.0186
60.08	0.012	196.6	0.0231
60.10	0.012	196.7	0.0257
60.12	0.014	197	0.0311
60.13	0.018	197.3	0.0355
60.15	0.018	197.5	0.0382
60.17	0.02	197.7	0.0417
60.20	0.022	198	0.0417
60.22	0.023	198.2	0.0444
60.23	0.023	198.2	0.047
60.25	0.024	198.4	0.0497
60.27	0.026	198.7	0.0524
60.27	0.026	198.8	0.0533
60.28	0.027	199	0.055
60.30	0.028	199.2	0.055
60.32	0.028	199.4	0.0568
60.33	0.028	199.4	0.0577
60.35	0.029	199.5	0.0586
60.37	0.029	199.6	0.0586
60.38	0.029	199.7	0.0586
60.40	0.029	199.8	0.0586
60.42	0.028	199.9	0.0586
60.43	0.027	199.9	0.0586
60.45	0.027	199.9	0.0577
60.47	0.027	200	0.0559
60.48	0.025	199.9	0.0541
60.50	0.024	199.9	0.0524
60.52	0.023	199.9	0.0506
60.53	0.021	199.8	0.0506
60.55	0.019	199.7	0.0479
60.57	0.019	199.7	0.0462
60.58	0.018	199.7	0.0435
60.60	0.016	199.4	0.0399
60.62	0.013	199.3	0.0364
60.63	0.012	199.2	0.0337
60.65	0.01	198.9	0.0302
60.67	0.007	198.7	0.0257
60.68	0.007	198.6	0.0231
60.70	0.005	198.3	0.0195
60.72	0.002	198.1	0.0195
60.73	0.002	198.1	0.0151
60.75	0	198	0.0115
60.77	-0.001	197.6	0.008
60.78	-0.004	197.4	0.0036
60.80	-0.005	197.2	0.0009
60.82	-0.007	196.9	-0.0036
60.83	-0.01	196.6	-0.0036
60.85	-0.01	196.6	-0.0071

Prova triassiale ciclica SN04-C1			
pressione di confinamento (kPa)		80	
deviatore ciclico (kPa)		95	
frequenza (hz)		0.00625	
tempo	cella di carico	$\Delta u$	LVDT
(min)	kN	(kPa)	$\delta$ (mm)
60.87	-0.01	196.4	-0.0098
60.88	-0.011	196.1	-0.0124
60.90	-0.014	195.9	-0.0151
60.92	-0.014	195.7	-0.0169
60.93	-0.015	195.5	-0.0186
60.95	-0.017	195.2	-0.0186
60.97	-0.016	195.2	-0.0204
60.98	-0.016	195.1	-0.0213
61.00	-0.017	195	-0.0222
61.02	-0.017	194.8	-0.0231
61.03	-0.017	194.7	-0.0231
61.05	-0.017	194.6	-0.0231
61.07	-0.017	194.5	-0.0231
61.08	-0.016	194.5	-0.0231
61.10	-0.016	194.5	-0.0222
61.12	-0.016	194.4	-0.0213
61.13	-0.015	194.4	-0.0204
61.15	-0.013	194.4	-0.0186
61.17	-0.013	194.5	-0.0169
61.18	-0.011	194.6	-0.0169
61.20	-0.01	194.6	-0.0151
61.22	-0.01	194.6	-0.0124
61.23	-0.008	194.7	-0.0098
61.25	-0.005	194.9	-0.0062
61.27	-0.004	195	-0.0044
61.28	-0.003	195.1	0
61.30	0.001	195.4	0
61.32	0.002	195.6	0.0036
61.33	0.002	195.6	0.0062
61.35	0.004	195.8	0.0107
61.37	0.006	196.1	0.0151
61.38	0.009	196.3	0.0186
61.40	0.01	196.4	0.0222
61.42	0.012	196.7	0.0249
61.43	0.014	196.9	0.0284
61.45	0.015	197.1	0.0328
61.47	0.017	197.4	0.0328
61.48	0.02	197.6	0.0364
61.50	0.02	197.6	0.0399
61.52	0.021	197.8	0.0435
61.53	0.022	198.1	0.0462
61.55	0.024	198.3	0.0488
61.57	0.025	198.5	0.0515
61.58	0.026	198.8	0.0533
61.60	0.027	199	0.0533
61.62	0.027	199	0.055
61.63	0.027	199.1	0.0559
61.67	0.028	199.3	0.0577
61.68	0.029	199.4	0.0586
61.70	0.029	199.6	0.0595
61.72	0.029	199.7	0.0595
61.72	0.029	199.8	0.0595
61.73	0.029	199.8	0.0595
61.75	0.029	199.9	0.0595
61.77	0.028	199.9	0.0586
61.78	0.026	200	0.0568
61.80	0.026	200	0.0559
61.82	0.025	200	0.0541

Prova triassiale ciclica SN04-C1			
pressione di confinamento (kPa)		80	
deviatore ciclico (kPa)		95	
frequenza (hz)		0.00625	
tempo	cella di carico	$\Delta u$	LVDT
(min)	kN	(kPa)	$\delta$ (mm)
61.83	0.023	199.9	0.0541
61.85	0.022	199.9	0.0524
61.87	0.022	199.9	0.0506
61.88	0.021	199.8	0.0479
61.90	0.018	199.7	0.0462
61.92	0.017	199.6	0.0435
61.93	0.016	199.5	0.0408
61.95	0.012	199.3	0.0408
61.97	0.011	199.3	0.0364
61.98	0.011	199.1	0.0337
62.00	0.01	198.9	0.0293
62.02	0.006	198.7	0.0249
62.03	0.005	198.5	0.0213
62.05	0.004	198.3	0.0178
62.07	-0.001	198	0.0178
62.08	-0.001	198	0.0124
62.10	-0.001	197.8	0.0098
62.12	-0.005	197.3	0.0062
62.13	-0.006	197.3	0.0036
62.15	-0.006	197.1	0.0009
62.17	-0.007	196.8	-0.0036
62.18	-0.01	196.5	-0.0071
62.20	-0.011	196.3	-0.0098
62.22	-0.012	196.1	-0.0124
62.23	-0.014	195.8	-0.0124
62.25	-0.015	195.6	-0.0151
62.27	-0.015	195.6	-0.0169
62.28	-0.015	195.4	-0.0186
62.30	-0.016	195.2	-0.0195
62.32	-0.017	195	-0.0204
62.33	-0.017	194.9	-0.0222
62.35	-0.017	194.7	-0.0222
62.37	-0.017	194.6	-0.0222
62.38	-0.017	194.6	-0.0222
62.40	-0.017	194.6	-0.0222
62.42	-0.017	194.5	-0.0222
62.43	-0.016	194.4	-0.0213
62.45	-0.015	194.4	-0.0204
62.47	-0.015	194.4	-0.0186
62.48	-0.013	194.5	-0.0186
62.50	-0.012	194.5	-0.0169
62.52	-0.012	194.5	-0.0151
62.53	-0.011	194.6	-0.0133
62.55	-0.008	194.7	-0.0107
62.57	-0.007	194.7	-0.008
62.58	-0.006	194.9	-0.0053
62.60	-0.002	195.1	-0.0053
62.62	-0.002	195.1	-0.0018
62.63	-0.002	195.2	0.0009
62.65	0	195.4	0.0044
62.67	0.003	195.7	0.008
62.68	0.004	195.8	0.0124
62.70	0.006	196.1	0.016
62.72	0.01	196.4	0.016
62.73	0.011	196.4	0.0213
62.75	0.011	196.6	0.024
62.77	0.013	196.8	0.0284
62.78	0.016	197.1	0.0328

Prova triassiale ciclica SN04-C1			
pressione di confinamento (kPa)		80	
deviatore ciclico (kPa)		95	
frequenza (hz)		0.00625	
tempo	cella di carico	$\Delta u$	LVDT
(min)	kN	(kPa)	$\delta$ (mm)
62.80	0.017	197.3	0.0355
62.82	0.018	197.5	0.0399
62.83	0.021	197.8	0.0399
62.85	0.022	198	0.0453
62.87	0.022	198.2	0.047
62.88	0.024	198.4	0.047
62.90	0.025	198.6	0.0497
62.92	0.025	198.6	0.0515
62.93	0.026	198.8	0.0541
62.95	0.027	199	0.0559
62.97	0.028	199.2	0.0568
62.98	0.028	199.4	0.0586
63.00	0.029	199.5	0.0586
63.02	0.029	199.7	0.0586
63.03	0.029	199.7	0.0595
63.05	0.029	199.8	0.0595
63.07	0.029	199.8	0.0595
63.10	0.029	199.9	0.0595
63.12	0.028	200	0.0577
63.13	0.027	200	0.0559
63.15	0.025	200	0.0559
63.17	0.025	200	0.055
63.17	0.025	200	0.0541
63.18	0.023	199.9	0.0515
63.20	0.021	199.8	0.0497
63.22	0.02	199.8	0.0479
63.23	0.019	199.7	0.0444
63.25	0.016	199.5	0.0444
63.27	0.015	199.5	0.0417
63.28	0.015	199.4	0.0382
63.30	0.013	199.2	0.0346
63.32	0.01	199	0.0311
63.33	0.008	198.9	0.0275
63.35	0.007	198.6	0.024
63.37	0.004	198.4	0.024
63.38	0.002	198.4	0.0195
63.40	0.002	198.2	0.016
63.42	0.001	197.9	0.0115
63.43	-0.003	197.6	0.0062
63.45	-0.004	197.4	0.0036
63.47	-0.005	197.1	0
63.48	-0.009	196.8	0
63.50	-0.009	196.8	-0.0044
63.52	-0.009	196.6	-0.0062
63.53	-0.01	196.4	-0.0098
63.55	-0.013	196.1	-0.0133
63.57	-0.013	195.9	-0.0151
63.58	-0.014	195.8	-0.016
63.60	-0.015	195.5	-0.0178
63.62	-0.016	195.3	-0.0195
63.63	-0.016	195.1	-0.0213
63.65	-0.017	194.9	-0.0213
63.67	-0.017	194.9	-0.0222
63.68	-0.017	194.8	-0.0231
63.70	-0.017	194.7	-0.0231
63.72	-0.017	194.6	-0.0231
63.73	-0.017	194.5	-0.0231
63.75	-0.017	194.4	-0.0222

Prova triassiale ciclica SN04-C1			
pressione di confinamento (kPa)		80	
deviatore ciclico (kPa)		95	
frequenza (hz)		0.00625	
tempo	cella di carico	$\Delta u$	LVDT
(min)	kN	(kPa)	$\delta$ (mm)
63.77	-0.016	194.4	-0.0222
63.78	-0.015	194.4	-0.0213
63.80	-0.015	194.4	-0.0204
63.82	-0.014	194.4	-0.0186
63.83	-0.013	194.5	-0.0178
63.85	-0.011	194.5	-0.016
63.87	-0.01	194.5	-0.0133
63.88	-0.008	194.7	-0.0133
63.90	-0.006	194.8	-0.0107
63.92	-0.006	194.8	-0.008
63.93	-0.005	194.9	-0.0044
63.95	-0.003	195.1	-0.0018
63.97	0	195.3	0.0018
63.98	0.001	195.4	0.0053
64.00	0.003	195.7	0.0089
64.02	0.006	195.9	0.0089
64.03	0.006	195.9	0.0124
64.05	0.007	196.1	0.0169
64.07	0.01	196.4	0.0213
64.08	0.013	196.6	0.0249
64.10	0.013	196.8	0.0284
64.12	0.015	197.1	0.0328
64.13	0.019	197.4	0.0328
64.15	0.019	197.4	0.0373
64.17	0.019	197.6	0.0391
64.18	0.02	197.8	0.0426
64.20	0.023	198.1	0.0462
64.22	0.024	198.3	0.0479
64.23	0.024	198.5	0.0506
64.25	0.027	198.8	0.0506
64.27	0.027	198.8	0.0533
64.28	0.027	198.9	0.0541
64.30	0.028	199.3	0.0559
64.32	0.028	199.3	0.0568
64.33	0.028	199.4	0.0577
64.35	0.029	199.6	0.0586
64.37	0.029	199.7	0.0586
64.38	0.029	199.8	0.0586
64.40	0.029	199.8	0.0586
64.42	0.028	199.9	0.0586
64.43	0.027	199.9	0.0577
64.45	0.027	200	0.0577
64.47	0.026	200	0.055
64.48	0.024	199.9	0.0533
64.50	0.024	199.9	0.0533
64.52	0.023	199.9	0.0506
64.53	0.021	199.8	0.0506
64.57	0.019	199.8	0.0479
64.58	0.019	199.8	0.0462
64.60	0.018	199.7	0.0426
64.62	0.015	199.5	0.0399
64.62	0.014	199.3	0.0373
64.63	0.012	199.2	0.0337
64.65	0.009	199	0.0337
64.67	0.007	198.8	0.0293
64.68	0.007	198.8	0.0257
64.70	0.006	198.6	0.0213
64.72	0.003	198.3	0.0178

Prova triassiale ciclica SN04-C1			
pressione di confinamento (kPa)		80	
deviatore ciclico (kPa)		95	
frequenza (hz)		0.00625	
tempo	cella di carico	$\Delta u$	LVDT
(min)	kN	(kPa)	$\delta$ (mm)
64.73	0.001	198.1	0.0142
64.75	0	197.9	0.0098
64.77	-0.004	197.6	0.0098
64.78	-0.005	197.4	0.0053
64.80	-0.005	197.4	0.0027
64.82	-0.006	197.2	-0.0009
64.83	-0.009	196.8	-0.0053
64.85	-0.01	196.6	-0.008
64.87	-0.011	196.4	-0.0107
64.88	-0.013	196.1	-0.0107
64.90	-0.014	195.9	-0.0133
64.92	-0.014	195.9	-0.016
64.93	-0.015	195.7	-0.0178
64.95	-0.016	195.4	-0.0195
64.97	-0.017	195.2	-0.0213
64.98	-0.017	195.1	-0.0222
65.00	-0.017	194.9	-0.0222
65.02	-0.017	194.8	-0.0222
65.03	-0.017	194.7	-0.0231
65.05	-0.017	194.6	-0.0231
65.07	-0.017	194.5	-0.0231
65.08	-0.017	194.5	-0.0231
65.10	-0.017	194.4	-0.0231
65.12	-0.016	194.4	-0.0213
65.13	-0.014	194.4	-0.0204
65.15	-0.013	194.4	-0.0186
65.17	-0.012	194.5	-0.0169
65.18	-0.01	194.6	-0.0169
65.20	-0.01	194.6	-0.0151
65.22	-0.01	194.6	-0.0124
65.23	-0.008	194.7	-0.0098
65.25	-0.005	194.9	-0.0071
65.27	-0.004	195	-0.0044
65.28	-0.003	195.1	-0.0009
65.30	0.001	195.4	-0.0009
65.32	0.002	195.4	0.0027
65.33	0.002	195.6	0.0053
65.35	0.003	195.8	0.0098
65.37	0.007	196.1	0.0142
65.38	0.008	196.2	0.0178
65.40	0.01	196.5	0.0222
65.42	0.013	196.8	0.0222
65.43	0.015	197	0.0275
65.45	0.015	197	0.0302
65.47	0.016	197.2	0.0337
65.48	0.019	197.5	0.0382
65.50	0.02	197.7	0.0408
65.52	0.021	197.9	0.0435
65.53	0.023	198.2	0.0435
65.55	0.025	198.4	0.0462
65.57	0.025	198.4	0.0488
65.58	0.025	198.6	0.0515
65.60	0.026	198.8	0.0524
65.62	0.027	199	0.055
65.63	0.028	199.2	0.0559
65.65	0.028	199.4	0.0568
65.67	0.029	199.5	0.0568
65.68	0.029	199.5	0.0577



Prova triassiale ciclica SN04-C1			
pressione di confinamento (kPa)		80	
deviatore ciclico (kPa)		95	
frequenza (hz)		0.00625	
tempo	cella di carico	$\Delta u$	LVDT
(min)	kN	(kPa)	$\delta$ (mm)
65.70	0.029	199.6	0.0577
65.72	0.029	199.8	0.0577
65.73	0.028	199.8	0.0577
65.75	0.028	199.9	0.0577
65.77	0.028	200	0.0577
65.78	0.027	200	0.0568
65.80	0.026	200	0.055
65.82	0.025	200	0.0533
65.83	0.023	199.9	0.0533
65.85	0.022	199.9	0.0506
65.87	0.022	199.9	0.0497
65.88	0.021	199.8	0.047
65.90	0.019	199.7	0.0444
65.92	0.017	199.6	0.0417
65.93	0.016	199.5	0.0382
65.95	0.013	199.3	0.0382
65.97	0.011	199.3	0.0355
65.98	0.011	199.1	0.032
66.02	0.01	199	0.0284
66.03	0.006	198.7	0.0231
66.05	0.005	198.5	0.0204
66.07	0.003	198.3	0.016
66.07	0	198	0.016
66.08	-0.001	198	0.0115
66.10	-0.001	197.8	0.0089
66.12	-0.002	197.6	0.0044
66.13	-0.006	197.3	0
66.15	-0.007	197	-0.0027
66.17	-0.008	196.8	-0.0062
66.18	-0.01	196.5	-0.0062
66.20	-0.012	196.3	-0.0098
66.22	-0.012	196.3	-0.0124
66.23	-0.013	196.1	-0.0151
66.25	-0.014	195.8	-0.0169
66.27	-0.015	195.6	-0.0186
66.28	-0.016	195.4	-0.0195
66.30	-0.016	195.2	-0.0213
66.32	-0.017	195	-0.0213
66.33	-0.017	195	-0.0222
66.35	-0.017	194.9	-0.0231
66.37	-0.017	194.8	-0.0231
66.38	-0.017	194.7	-0.0231
66.40	-0.017	194.6	-0.0231
66.42	-0.017	194.5	-0.0222
66.43	-0.016	194.5	-0.0222
66.45	-0.016	194.5	-0.0222
66.47	-0.015	194.5	-0.0204
66.48	-0.013	194.5	-0.0186
66.50	-0.012	194.5	-0.0186
66.52	-0.012	194.5	-0.0169
66.53	-0.011	194.6	-0.0151
66.55	-0.008	194.7	-0.0124
66.57	-0.007	194.8	-0.0098
66.58	-0.006	194.9	-0.0071
66.60	-0.002	195.1	-0.0071
66.62	-0.002	195.1	-0.0036
66.63	-0.002	195.2	0
66.65	0	195.5	0.0036

Prova triassiale ciclica SN04-C1			
pressione di confinamento (kPa)		80	
deviatore ciclico (kPa)		95	
frequenza (hz)		0.00625	
tempo	cella di carico	$\Delta u$	LVDT
(min)	kN	(kPa)	$\delta$ (mm)
66.67	0.004	195.7	0.008
66.68	0.004	195.9	0.0107
66.70	0.006	196.1	0.0151
66.72	0.01	196.4	0.0151
66.73	0.011	196.4	0.0195
66.75	0.011	196.6	0.0231
66.77	0.012	196.9	0.0275
66.78	0.016	197.1	0.032
66.80	0.017	197.3	0.0346
66.82	0.018	197.6	0.0382
66.83	0.021	197.8	0.0382
66.85	0.022	197.8	0.0417
66.87	0.022	198	0.0444
66.88	0.023	198.3	0.047
66.90	0.025	198.5	0.0497
66.92	0.025	198.7	0.0515
66.93	0.026	198.9	0.0541
66.95	0.027	199.1	0.0541
66.97	0.028	199.1	0.055
66.98	0.028	199.3	0.0568
67.00	0.028	199.4	0.0577
67.02	0.029	199.6	0.0577
67.03	0.029	199.7	0.0577
67.05	0.029	199.8	0.0577
67.07	0.028	199.9	0.0577
67.08	0.028	199.9	0.0577
67.10	0.028	200	0.0577
67.12	0.027	200	0.0559
67.13	0.026	200	0.055
67.15	0.025	200	0.0541
67.17	0.024	200	0.0515
67.18	0.022	199.9	0.0515
67.20	0.021	199.8	0.0479
67.22	0.02	199.8	0.0462
67.23	0.018	199.7	0.0462
67.25	0.016	199.6	0.0435
67.27	0.016	199.6	0.0408
67.28	0.015	199.4	0.0373
67.30	0.012	199.2	0.0328
67.32	0.01	199	0.0302
67.33	0.009	198.9	0.0257
67.35	0.006	198.6	0.0257
67.37	0.004	198.4	0.0222
67.38	0.004	198.4	0.0186
67.40	0.003	198.2	0.0142
67.42	0	197.9	0.0098
67.43	-0.003	197.7	0.0062
67.47	-0.004	197.5	0.0027
67.48	-0.006	197.2	-0.0009
67.50	-0.008	196.9	-0.0009
67.52	-0.008	196.9	-0.0044
67.52	-0.009	196.7	-0.008
67.53	-0.011	196.4	-0.0115
67.55	-0.013	196.1	-0.0142
67.57	-0.013	196	-0.016
67.58	-0.014	195.7	-0.0178
67.60	-0.016	195.5	-0.0178
67.62	-0.016	195.5	-0.0195

Prova triassiale ciclica SN04-C1			
pressione di confinamento (kPa)		80	
deviatore ciclico (kPa)		95	
frequenza (hz)		0.00625	
tempo	cella di carico	$\Delta u$	LVDT
(min)	kN	(kPa)	$\delta$ (mm)
67.63	-0.016	195.3	-0.0204
67.65	-0.016	195.1	-0.0222
67.67	-0.017	195	-0.0231
67.68	-0.017	194.8	-0.0231
67.70	-0.017	194.7	-0.024
67.72	-0.017	194.6	-0.024
67.73	-0.017	194.6	-0.024
67.75	-0.017	194.5	-0.0231
67.77	-0.016	194.5	-0.0222
67.78	-0.015	194.5	-0.0213
67.80	-0.015	194.5	-0.0204
67.82	-0.013	194.5	-0.0186
67.83	-0.011	194.6	-0.0186
67.85	-0.011	194.6	-0.0169
67.87	-0.011	194.6	-0.0151
67.88	-0.009	194.7	-0.0124
67.90	-0.007	194.8	-0.0098
67.92	-0.006	194.9	-0.0071
67.93	-0.004	195.1	-0.0036
67.95	-0.002	195.2	-0.0018
67.97	-0.001	195.3	0.0009
67.98	0.001	195.6	0.0053
68.00	0.005	195.8	0.0053
68.02	0.005	195.8	0.0089
68.03	0.005	196	0.0124
68.05	0.007	196.2	0.0169
68.07	0.011	196.5	0.0213
68.08	0.012	196.7	0.024
68.10	0.013	196.9	0.0293
68.12	0.017	197.2	0.0293
68.13	0.018	197.2	0.0337
68.15	0.018	197.4	0.0364
68.17	0.019	197.7	0.0399
68.18	0.021	197.9	0.0426
68.20	0.023	198.1	0.0453
68.22	0.023	198.3	0.0479
68.23	0.025	198.6	0.0479
68.25	0.027	198.8	0.0515
68.27	0.027	198.8	0.0524
68.28	0.026	199	0.0541
68.30	0.027	199.2	0.055
68.32	0.028	199.4	0.0568
68.33	0.029	199.5	0.0577
68.35	0.029	199.7	0.0577
68.37	0.029	199.8	0.0586
68.38	0.029	199.8	0.0586
68.40	0.029	199.9	0.0586
68.42	0.029	199.9	0.0586
68.43	0.028	200	0.0577
68.45	0.027	200	0.0559
68.47	0.026	200	0.0559
68.48	0.024	200	0.0541
68.50	0.024	200	0.0533
68.52	0.023	200	0.0506
68.53	0.022	199.9	0.0488
68.55	0.02	199.8	0.0462
68.57	0.019	199.8	0.0435
68.58	0.017	199.6	0.0408

Prova triassiale ciclica SN04-C1			
pressione di confinamento (kPa)		80	
deviatore ciclico (kPa)		95	
frequenza (hz)		0.00625	
tempo	cella di carico	$\Delta u$	LVDT
(min)	kN	(kPa)	$\delta$ (mm)
68.60	0.014	199.4	0.0408
68.62	0.014	199.4	0.0373
68.63	0.013	199.3	0.0337
68.65	0.009	199	0.0302
68.67	0.009	199	0.0293
68.68	0.007	198.8	0.024
68.70	0.006	198.5	0.0204
68.72	0.003	198.3	0.0169
68.73	0.001	198.1	0.0124
68.75	-0.001	197.8	0.008
68.77	-0.004	197.5	0.008
68.78	-0.004	197.5	0.0044
68.80	-0.004	197.4	0.0018
68.82	-0.006	197.1	-0.0027
68.83	-0.009	196.8	-0.0062
68.85	-0.01	196.6	-0.0089
68.87	-0.011	196.3	-0.0115
68.88	-0.013	196.1	-0.0115
68.90	-0.014	196.1	-0.0151
68.93	-0.014	195.9	-0.016
68.95	-0.015	195.6	-0.0186
68.97	-0.016	195.4	-0.0204
68.98	-0.016	195.2	-0.0213
69.00	-0.017	195.1	-0.0231
69.02	-0.017	194.9	-0.0231
69.03	-0.017	194.9	-0.0231
69.05	-0.017	194.8	-0.024
69.05	-0.017	194.7	-0.024
69.07	-0.017	194.6	-0.024
69.08	-0.017	194.5	-0.0231
69.10	-0.016	194.5	-0.0222
69.12	-0.015	194.5	-0.0222
69.13	-0.014	194.5	-0.0213
69.15	-0.014	194.5	-0.0204
69.17	-0.013	194.5	-0.0186
69.18	-0.011	194.5	-0.0169
69.20	-0.01	194.6	-0.0142
69.22	-0.009	194.7	-0.0115
69.23	-0.006	194.9	-0.0115
69.25	-0.005	194.9	-0.0089
69.27	-0.005	194.9	-0.0062
69.28	-0.003	195.2	-0.0027
69.30	0	195.4	0.0018
69.32	0.001	195.5	0.0044
69.33	0.003	195.8	0.008
69.35	0.007	196	0.008
69.37	0.007	196	0.0124
69.38	0.009	196.4	0.0178
69.40	0.011	196.6	0.0178
69.42	0.012	196.6	0.0204
69.43	0.012	196.8	0.0249
69.45	0.014	197	0.0302
69.47	0.017	197.3	0.0346
69.48	0.019	197.6	0.0373
69.50	0.02	197.8	0.0408
69.52	0.022	198.1	0.0408
69.53	0.023	198.3	0.0444
69.55	0.023	198.3	0.047

Prova triassiale ciclica SN04-C1			
pressione di confinamento (kPa)		80	
deviatore ciclico (kPa)		95	
frequenza (hz)		0.00625	
tempo	cella di carico	$\Delta u$	LVDT
(min)	kN	(kPa)	$\delta$ (mm)
69.57	0.024	198.5	0.0488
69.58	0.025	198.7	0.0506
69.60	0.027	198.9	0.0524
69.62	0.027	199.1	0.055
69.63	0.028	199.3	0.055
69.65	0.029	199.4	0.0559
69.67	0.029	199.4	0.0568
69.68	0.029	199.6	0.0568
69.70	0.029	199.7	0.0577
69.72	0.029	199.8	0.0577
69.73	0.029	199.9	0.0577
69.75	0.028	200	0.0577
69.77	0.027	200	0.0568
69.78	0.027	200	0.0559
69.80	0.027	200	0.055
69.82	0.025	200	0.0533
69.83	0.024	200	0.0524
69.85	0.023	199.9	0.0497
69.87	0.021	199.8	0.0497
69.88	0.019	199.8	0.047
69.90	0.019	199.8	0.0444
69.92	0.018	199.7	0.0417
69.93	0.016	199.5	0.0391
69.95	0.013	199.3	0.0364
69.97	0.012	199.2	0.0328
69.98	0.01	199	0.0284
70.00	0.007	198.8	0.0284
70.02	0.007	198.8	0.024
70.03	0.006	198.6	0.0213
70.05	0.004	198.3	0.0169
70.07	0.001	198.1	0.0124
70.08	0	197.9	0.0098
70.10	-0.002	197.6	0.0053
70.12	-0.005	197.4	0.0009
70.13	-0.005	197.2	-0.0009
70.15	-0.007	196.9	-0.0036
70.17	-0.01	196.7	-0.0036
70.18	-0.01	196.7	-0.008
70.20	-0.01	196.5	-0.0107
70.22	-0.011	196.2	-0.0133
70.23	-0.014	196	-0.016
70.25	-0.014	195.8	-0.0178
70.27	-0.015	195.6	-0.0195
70.28	-0.016	195.3	-0.0195
70.30	-0.016	195.3	-0.0213
70.32	-0.016	195.1	-0.0222
70.33	-0.017	195	-0.0231
70.37	-0.017	194.8	-0.024
70.38	-0.017	194.7	-0.024
70.40	-0.017	194.6	-0.024
70.42	-0.017	194.5	-0.024
70.43	-0.016	194.5	-0.024
70.43	-0.016	194.5	-0.0231
70.45	-0.016	194.5	-0.0222
70.47	-0.014	194.5	-0.0204
70.48	-0.013	194.5	-0.0195
70.50	-0.013	194.5	-0.0178
70.52	-0.01	194.6	-0.0178

Prova triassiale ciclica SN04-C1			
pressione di confinamento (kPa)		80	
deviatore ciclico (kPa)		95	
frequenza (hz)		0.00625	
tempo	cella di carico	$\Delta u$	LVDT
(min)	kN	(kPa)	$\delta$ (mm)
70.53	-0.009	194.6	-0.016
70.55	-0.009	194.7	-0.0142
70.57	-0.008	194.7	-0.0115
70.58	-0.005	194.9	-0.008
70.60	-0.004	195	-0.0053
70.62	-0.003	195.2	-0.0018
70.63	0.001	195.4	-0.0018
70.65	0.002	195.4	0.0018
70.67	0.002	195.6	0.0053
70.68	0.004	195.8	0.0098
70.70	0.007	196.1	0.0133
70.72	0.009	196.3	0.0169
70.73	0.01	196.5	0.0204
70.75	0.013	196.8	0.0204
70.77	0.015	197	0.0249
70.78	0.015	197	0.0293
70.80	0.016	197.2	0.0337
70.82	0.019	197.5	0.0373
70.83	0.02	197.7	0.0399
70.85	0.02	197.9	0.0417
70.87	0.022	198.2	0.0444
70.88	0.024	198.4	0.047
70.90	0.025	198.6	0.0497
70.92	0.026	198.8	0.0497
70.93	0.027	199	0.0524
70.95	0.027	199	0.0533
70.97	0.028	199.2	0.055
70.98	0.028	199.3	0.0559
71.00	0.028	199.5	0.0568
71.02	0.029	199.7	0.0577
71.03	0.029	199.8	0.0577
71.05	0.029	199.9	0.0577
71.07	0.029	199.9	0.0577
71.08	0.029	199.9	0.0577
71.10	0.028	200	0.0568
71.12	0.027	200	0.0559
71.13	0.026	200	0.0541
71.15	0.025	200	0.0533
71.17	0.023	200	0.0533
71.18	0.022	200	0.0515
71.20	0.022	200	0.0497
71.22	0.021	199.9	0.047
71.23	0.018	199.8	0.0435
71.25	0.017	199.7	0.0417
71.27	0.016	199.6	0.0382
71.28	0.012	199.3	0.0382
71.30	0.011	199.3	0.0346
71.32	0.011	199.2	0.032
71.33	0.01	199	0.0284
71.35	0.006	198.7	0.0231
71.37	0.005	198.6	0.0204
71.38	0.004	198.4	0.016
71.40	0	198.1	0.016
71.42	-0.002	198.1	0.0115
71.43	-0.002	197.8	0.008
71.45	-0.002	197.6	0.0044
71.47	-0.006	197.3	0
71.48	-0.007	197.1	-0.0027

Prova triassiale ciclica SN04-C1			
pressione di confinamento (kPa)		80	
deviatore ciclico (kPa)		95	
frequenza (hz)		0.00625	
tempo	cella di carico	$\Delta u$	LVDT
(min)	kN	(kPa)	$\delta$ (mm)
71.50	-0.008	196.8	-0.0071
71.52	-0.011	196.5	-0.0071
71.53	-0.012	196.3	-0.0107
71.55	-0.012	196.3	-0.0124
71.57	-0.014	195.9	-0.0151
71.58	-0.014	195.7	-0.016
71.60	-0.014	195.7	-0.0178
71.62	-0.015	195.5	-0.0204
71.63	-0.016	195.2	-0.0213
71.65	-0.017	195.1	-0.0222
71.67	-0.017	194.9	-0.0231
71.68	-0.017	194.8	-0.0231
71.70	-0.017	194.7	-0.0231
71.72	-0.017	194.7	-0.024
71.73	-0.017	194.6	-0.024
71.75	-0.017	194.5	-0.0231
71.77	-0.016	194.5	-0.0231
71.78	-0.015	194.5	-0.0213
71.80	-0.014	194.5	-0.0213
71.83	-0.013	194.5	-0.0195
71.85	-0.013	194.5	-0.0186
71.87	-0.012	194.5	-0.016
71.88	-0.01	194.6	-0.0151
71.88	-0.008	194.7	-0.0124
71.90	-0.007	194.8	-0.0098
71.92	-0.005	195	-0.0098
71.93	-0.003	195.1	-0.0062
71.95	-0.003	195.1	-0.0036
71.97	-0.002	195.2	0.0009
71.98	0.001	195.6	0.0044
72.00	0.003	195.7	0.0071
72.02	0.004	195.9	0.0107
72.03	0.007	196.2	0.0107
72.05	0.01	196.4	0.0151
72.07	0.01	196.4	0.0186
72.08	0.011	196.6	0.0231
72.10	0.014	196.9	0.0284
72.12	0.016	197.1	0.0311
72.13	0.017	197.3	0.0346
72.15	0.019	197.7	0.0382
72.17	0.021	197.9	0.0382
72.18	0.021	197.9	0.0417
72.20	0.022	198.1	0.0453
72.22	0.023	198.3	0.0479
72.23	0.025	198.6	0.0497
72.25	0.026	198.7	0.0524
72.27	0.026	199	0.0541
72.28	0.027	199.2	0.055
72.30	0.028	199.3	0.0559
72.32	0.028	199.5	0.0568
72.33	0.029	199.6	0.0568
72.35	0.029	199.6	0.0577
72.37	0.029	199.7	0.0577
72.38	0.029	199.8	0.0577
72.40	0.029	199.9	0.0577
72.42	0.028	200	0.0577
72.43	0.028	200	0.0559
72.45	0.026	200	0.0559

Prova triassiale ciclica SN04-C1			
pressione di confinamento (kPa)		80	
deviatore ciclico (kPa)		95	
frequenza (hz)		0.00625	
tempo	cella di carico	$\Delta u$	LVDT
(min)	kN	(kPa)	$\delta$ (mm)
72.47	0.026	200	0.055
72.48	0.026	200	0.0541
72.50	0.025	200	0.0524
72.52	0.022	199.9	0.0497
72.53	0.021	199.9	0.0479
72.55	0.02	199.8	0.0453
72.57	0.017	199.7	0.0453
72.58	0.017	199.7	0.0426
72.60	0.017	199.6	0.0408
72.62	0.015	199.4	0.0373
72.63	0.011	199.2	0.0328
72.65	0.01	199.1	0.0302
72.67	0.009	198.9	0.0249
72.68	0.005	198.7	0.0249
72.70	0.004	198.7	0.0213
72.72	0.004	198.5	0.0178
72.73	0.003	198.2	0.0133
72.75	-0.001	197.9	0.0089
72.77	-0.002	197.7	0.0062
72.78	-0.004	197.4	0.0018
72.80	-0.007	197.1	0.0018
72.82	-0.008	197.1	-0.0027
72.83	-0.008	196.9	-0.0053
72.85	-0.009	196.6	-0.0089
72.87	-0.012	196.4	-0.0115
72.88	-0.012	196.2	-0.0142
72.90	-0.013	196	-0.0169
72.92	-0.015	195.7	-0.0169
72.93	-0.015	195.7	-0.0186
72.95	-0.015	195.6	-0.0195
72.97	-0.016	195.3	-0.0213
72.98	-0.017	195.1	-0.0222
73.00	-0.017	195	-0.0231
73.02	-0.017	194.8	-0.024
73.03	-0.017	194.7	-0.024
73.05	-0.017	194.6	-0.024
73.07	-0.017	194.6	-0.024
73.08	-0.016	194.5	-0.024
73.10	-0.015	194.5	-0.0231
73.12	-0.015	194.5	-0.0222
73.13	-0.015	194.4	-0.0213
73.15	-0.013	194.5	-0.0195
73.17	-0.012	194.5	-0.0186
73.18	-0.011	194.5	-0.016
73.20	-0.009	194.7	-0.016
73.22	-0.008	194.7	-0.0133
73.23	-0.008	194.7	-0.0115
73.27	-0.007	194.8	-0.008
73.28	-0.004	195	-0.0044
73.30	-0.002	195.2	-0.0027
73.32	-0.001	195.4	0.0018
73.33	0.002	195.6	0.0018
73.33	0.004	195.8	0.0053
73.35	0.004	195.8	0.0089
73.37	0.005	196	0.0124
73.38	0.009	196.3	0.0169
73.40	0.01	196.5	0.0204
73.42	0.012	196.7	0.0249



Prova triassiale ciclica SN04-C1			
pressione di confinamento (kPa)		80	
deviatore ciclico (kPa)		95	
frequenza (hz)		0.00625	
tempo	cella di carico	$\Delta u$	LVDT
(min)	kN	(kPa)	$\delta$ (mm)
73.43	0.014	197	0.0249
73.45	0.016	197.2	0.0293
73.47	0.016	197.2	0.0328
73.48	0.017	197.4	0.0364
73.50	0.02	197.8	0.0408
73.52	0.021	198	0.0426
73.53	0.022	198.2	0.0462
73.55	0.024	198.4	0.0462
73.57	0.026	198.7	0.0488
73.58	0.026	198.7	0.0506
73.60	0.026	198.8	0.0524
73.62	0.027	199	0.0541
73.63	0.028	199.2	0.0559
73.65	0.028	199.4	0.0568
73.67	0.029	199.5	0.0577
73.68	0.029	199.7	0.0577
73.70	0.029	199.7	0.0577
73.72	0.029	199.8	0.0577
73.73	0.028	199.9	0.0577
73.75	0.028	199.9	0.0577
73.77	0.028	200	0.0577
73.78	0.027	200	0.0559
73.80	0.025	200	0.0541
73.82	0.025	200	0.0533
73.83	0.024	200	0.0515
73.85	0.022	199.9	0.0515
73.87	0.021	199.9	0.0488
73.88	0.021	199.9	0.047
73.90	0.02	199.8	0.0444
73.92	0.016	199.6	0.0408
73.93	0.015	199.6	0.0391
73.95	0.014	199.4	0.0355
73.97	0.011	199.2	0.0355
73.98	0.01	199.2	0.032
74.00	0.01	199	0.0293
74.02	0.008	198.8	0.024
74.03	0.004	198.6	0.0195
74.05	0.003	198.4	0.016
74.07	0.002	198.2	0.0124
74.08	-0.002	197.8	0.0124
74.10	-0.003	197.8	0.008
74.12	-0.003	197.6	0.0053
74.13	-0.004	197.4	0.0009
74.15	-0.007	197.1	-0.0036
74.17	-0.009	196.8	-0.0062
74.18	-0.009	196.6	-0.0089
74.20	-0.012	196.3	-0.0089
74.22	-0.013	196.1	-0.0124
74.23	-0.013	196.1	-0.0142
74.25	-0.014	195.9	-0.0169
74.27	-0.015	195.7	-0.0195
74.28	-0.016	195.4	-0.0204
74.30	-0.016	195.2	-0.0213
74.32	-0.017	195.1	-0.0213
74.33	-0.017	194.9	-0.0222
74.35	-0.017	194.9	-0.0231
74.37	-0.017	194.8	-0.0231
74.38	-0.017	194.7	-0.024

Prova triassiale ciclica SN04-C1			
pressione di confinamento (kPa)		80	
deviatore ciclico (kPa)		95	
frequenza (hz)		0.00625	
tempo	cella di carico	$\Delta u$	LVDT
(min)	kN	(kPa)	$\delta$ (mm)
74.40	-0.017	194.6	-0.024
74.42	-0.017	194.5	-0.0231
74.43	-0.016	194.5	-0.0222
74.45	-0.015	194.5	-0.0222
74.47	-0.014	194.5	-0.0204
74.48	-0.014	194.5	-0.0195
74.50	-0.012	194.5	-0.0195
74.52	-0.011	194.5	-0.0178
74.53	-0.011	194.6	-0.016
74.55	-0.009	194.7	-0.0124
74.57	-0.006	194.8	-0.0098
74.58	-0.006	194.9	-0.008
74.60	-0.004	195.1	-0.0044
74.62	-0.001	195.3	-0.0044
74.63	0	195.3	0
74.65	0	195.4	0.0027
74.67	0.002	195.7	0.0062
74.68	0.005	195.9	0.0107
74.70	0.006	196.1	0.0142
74.73	0.008	196.4	0.0186
74.75	0.012	196.6	0.0186
74.77	0.012	196.6	0.0231
74.78	0.012	196.8	0.0257
74.78	0.014	197.1	0.0311
74.80	0.018	197.4	0.0346
74.82	0.018	197.5	0.0382
74.83	0.02	197.8	0.0408
74.85	0.022	198.1	0.0408
74.87	0.023	198.3	0.0444
74.88	0.023	198.3	0.047
74.90	0.024	198.5	0.0497
74.92	0.026	198.7	0.0524
74.93	0.027	198.9	0.0533
74.95	0.027	199.1	0.0541
74.97	0.028	199.3	0.0541
74.98	0.028	199.4	0.0559
75.00	0.028	199.4	0.0568
75.02	0.029	199.6	0.0577
75.03	0.029	199.7	0.0577
75.05	0.029	199.8	0.0577
75.07	0.029	199.9	0.0577
75.08	0.028	200	0.0577
75.10	0.027	200	0.0577
75.12	0.027	200	0.0568
75.13	0.027	200	0.055
75.15	0.025	200	0.0533
75.17	0.023	200	0.0515
75.18	0.023	200	0.0506
75.20	0.022	199.9	0.0479
75.22	0.02	199.8	0.0462
75.23	0.019	199.8	0.0444
75.25	0.017	199.6	0.0408
75.27	0.014	199.5	0.0408
75.28	0.013	199.5	0.0373
75.30	0.013	199.3	0.0346
75.32	0.011	199.1	0.0311
75.33	0.007	198.9	0.0257
75.35	0.007	198.7	0.0231

Prova triassiale ciclica SN04-C1			
pressione di confinamento (kPa)		80	
deviatore ciclico (kPa)		95	
frequenza (hz)		0.00625	
tempo	cella di carico	$\Delta u$	LVDT
(min)	kN	(kPa)	$\delta$ (mm)
75.37	0.005	198.5	0.0186
75.38	0.001	198.2	0.0186
75.40	0.001	198.2	0.0142
75.42	0.001	198.1	0.0115
75.43	-0.001	197.8	0.0071
75.45	-0.005	197.5	0.0027
75.47	-0.005	197.3	0
75.48	-0.006	197	-0.0036
75.50	-0.01	196.7	-0.0036
75.52	-0.01	196.7	-0.008
75.53	-0.01	196.5	-0.0098
75.55	-0.011	196.3	-0.0133
75.57	-0.014	196	-0.016
75.58	-0.014	195.8	-0.0169
75.60	-0.015	195.6	-0.0195
75.62	-0.016	195.4	-0.0195
75.63	-0.016	195.4	-0.0213
75.65	-0.016	195.2	-0.0222
75.67	-0.017	195	-0.0231
75.68	-0.017	194.9	-0.024
75.70	-0.017	194.8	-0.024
75.72	-0.017	194.7	-0.024
75.73	-0.017	194.6	-0.024
75.75	-0.016	194.6	-0.024
75.77	-0.016	194.5	-0.0231
75.78	-0.016	194.5	-0.0222
75.80	-0.015	194.5	-0.0204
75.82	-0.014	194.5	-0.0195
75.83	-0.012	194.5	-0.0178
75.85	-0.011	194.6	-0.0178
75.87	-0.009	194.6	-0.016
75.88	-0.009	194.7	-0.0133
75.90	-0.008	194.8	-0.0107
75.92	-0.005	195	-0.008
75.93	-0.005	195	-0.0062
75.95	-0.003	195.1	-0.0027
75.97	0	195.4	0.0009
75.98	0.001	195.6	0.0036
76.00	0.002	195.7	0.008
76.02	0.006	196	0.008
76.03	0.008	196.2	0.0115
76.05	0.008	196.2	0.016
76.07	0.009	196.4	0.0195
76.08	0.012	196.7	0.024
76.10	0.014	196.9	0.0275
76.12	0.015	197.2	0.032
76.13	0.018	197.5	0.032
76.15	0.019	197.7	0.0355
76.17	0.019	197.7	0.0382
76.20	0.02	197.9	0.0417
76.22	0.022	198.2	0.0453
76.23	0.024	198.4	0.0479
76.23	0.025	198.6	0.0497
76.25	0.026	198.8	0.0497
76.27	0.027	199	0.0524
76.28	0.027	199	0.0533
76.30	0.027	199.2	0.055
76.32	0.028	199.4	0.0559

Prova triassiale ciclica SN04-C1			
pressione di confinamento (kPa)		80	
deviatore ciclico (kPa)		95	
frequenza (hz)		0.00625	
tempo	cella di carico	$\Delta u$	LVDT
(min)	kN	(kPa)	$\delta$ (mm)
76.33	0.028	199.5	0.0577
76.35	0.029	199.7	0.0577
76.37	0.029	199.8	0.0577
76.38	0.029	199.9	0.0586
76.40	0.029	199.9	0.0577
76.42	0.028	199.9	0.0577
76.43	0.028	200	0.0568
76.45	0.026	200	0.055
76.47	0.026	200	0.0541
76.48	0.025	200	0.0524
76.50	0.023	200	0.0524
76.52	0.022	200	0.0506
76.53	0.022	199.9	0.0497
76.55	0.021	199.8	0.0462
76.57	0.018	199.8	0.0435
76.58	0.017	199.7	0.0417
76.60	0.016	199.5	0.0382
76.62	0.012	199.3	0.0382
76.63	0.011	199.3	0.0346
76.65	0.01	199	0.0302
76.67	0.008	198.8	0.0302
76.68	0.006	198.8	0.0249
76.70	0.006	198.7	0.0213
76.72	0.005	198.4	0.0169
76.73	0.001	198.1	0.0124
76.75	0	197.9	0.0098
76.77	-0.002	197.7	0.0053
76.78	-0.005	197.4	0.0053
76.80	-0.006	197.4	0.0009
76.82	-0.006	197.2	-0.0018
76.83	-0.007	196.9	-0.0053
76.85	-0.01	196.6	-0.0089
76.87	-0.011	196.4	-0.0115
76.88	-0.012	196.2	-0.0142
76.90	-0.014	195.9	-0.0142
76.92	-0.015	195.9	-0.0169
76.93	-0.015	195.7	-0.0186
76.95	-0.015	195.6	-0.0195
76.97	-0.016	195.3	-0.0213
76.98	-0.017	195.1	-0.0231
77.00	-0.017	195	-0.024
77.02	-0.017	194.8	-0.024
77.03	-0.017	194.8	-0.024
77.05	-0.017	194.7	-0.024
77.07	-0.017	194.6	-0.024
77.08	-0.017	194.5	-0.024
77.10	-0.016	194.5	-0.0231
77.12	-0.015	194.5	-0.0222
77.13	-0.014	194.5	-0.0222
77.15	-0.013	194.5	-0.0204
77.17	-0.013	194.5	-0.0195
77.18	-0.012	194.5	-0.0178
77.20	-0.01	194.7	-0.0151
77.22	-0.008	194.7	-0.0133
77.23	-0.007	194.8	-0.0107
77.25	-0.005	195	-0.0107
77.27	-0.003	195.1	-0.0071
77.28	-0.003	195.1	-0.0044

Prova triassiale ciclica SN04-C1			
pressione di confinamento (kPa)		80	
deviatore ciclico (kPa)		95	
frequenza (hz)		0.00625	
tempo	cella di carico	$\Delta u$	LVDT
(min)	kN	(kPa)	$\delta$ (mm)
77.30	-0.002	195.3	-0.0009
77.32	0.001	195.6	0.0027
77.33	0.003	195.7	0.0062
77.35	0.004	195.9	0.0107
77.37	0.007	196.2	0.0151
77.38	0.009	196.4	0.0169
77.40	0.01	196.5	0.0204
77.42	0.012	196.8	0.0249
77.43	0.015	197.1	0.0249
77.45	0.015	197.1	0.0293
77.47	0.016	197.3	0.0328
77.48	0.018	197.6	0.0364
77.50	0.02	197.8	0.0399
77.52	0.021	198	0.0426
77.53	0.023	198.3	0.0462
77.55	0.024	198.5	0.0462
77.57	0.024	198.5	0.0479
77.58	0.025	198.7	0.0506
77.60	0.026	198.9	0.0524
77.63	0.028	199.1	0.0541
77.65	0.028	199.3	0.055
77.67	0.028	199.4	0.0559
77.68	0.028	199.6	0.0559
77.70	0.029	199.6	0.0559
77.70	0.029	199.7	0.0568
77.72	0.029	199.8	0.0568
77.73	0.029	199.9	0.0568
77.75	0.028	200	0.0568
77.77	0.028	200	0.0559
77.78	0.026	200	0.0559
77.80	0.026	200	0.0541
77.82	0.026	200	0.0541
77.83	0.025	200	0.0515
77.85	0.022	199.9	0.0497
77.87	0.022	199.9	0.0479
77.88	0.02	199.8	0.0453
77.90	0.017	199.7	0.0453
77.92	0.016	199.7	0.0417
77.93	0.016	199.6	0.0391
77.95	0.015	199.4	0.0364
77.97	0.011	199.2	0.0328
77.98	0.011	199.1	0.0293
78.00	0.009	198.9	0.0249
78.02	0.005	198.6	0.0249
78.03	0.004	198.6	0.0204
78.05	0.004	198.5	0.0178
78.07	0.002	198.2	0.0124
78.08	-0.001	197.9	0.0089
78.10	-0.002	197.7	0.0062
78.12	-0.002	197.6	0.0036
78.13	-0.006	197.2	-0.0009
78.15	-0.007	197	-0.0036
78.17	-0.008	196.8	-0.008
78.18	-0.011	196.5	-0.008
78.20	-0.012	196.5	-0.0098
78.22	-0.012	196.3	-0.0133
78.23	-0.012	196.1	-0.016
78.25	-0.014	195.8	-0.0186

Prova triassiale ciclica SN04-C1			
pressione di confinamento (kPa)		80	
deviatore ciclico (kPa)		95	
frequenza (hz)		0.00625	
tempo	cella di carico	$\Delta u$	LVDT
(min)	kN	(kPa)	$\delta$ (mm)
78.27	-0.015	195.6	-0.0204
78.28	-0.016	195.4	-0.0213
78.30	-0.017	195.2	-0.0213
78.32	-0.017	195	-0.0231
78.33	-0.017	195	-0.024
78.35	-0.017	194.9	-0.024
78.37	-0.017	194.8	-0.024
78.38	-0.017	194.7	-0.0249
78.40	-0.017	194.6	-0.0249
78.42	-0.017	194.5	-0.0249
78.43	-0.016	194.5	-0.024
78.45	-0.016	194.5	-0.0231
78.47	-0.015	194.5	-0.0213
78.48	-0.013	194.5	-0.0204
78.50	-0.012	194.5	-0.0195
78.52	-0.011	194.6	-0.0169
78.53	-0.01	194.7	-0.0169
78.55	-0.008	194.8	-0.0142
78.57	-0.008	194.8	-0.0124
78.58	-0.006	194.9	-0.0089
78.60	-0.004	195.1	-0.0053
78.62	-0.002	195.2	-0.0027
78.63	-0.001	195.4	0.0009
78.65	0.002	195.7	0.0009
78.67	0.004	195.8	0.0044
78.68	0.004	195.8	0.008
78.70	0.006	196	0.0124
78.72	0.008	196.3	0.0169
78.73	0.011	196.5	0.0195
78.75	0.012	196.7	0.024
78.77	0.014	197	0.0284
78.78	0.017	197.3	0.0284
78.80	0.017	197.3	0.032
78.82	0.018	197.5	0.0355
78.83	0.021	197.9	0.0391
78.85	0.021	197.9	0.0408
78.87	0.022	198.2	0.0444
78.88	0.023	198.4	0.047
78.90	0.025	198.6	0.0497
78.92	0.026	198.8	0.0506
78.93	0.026	199	0.0524
78.95	0.028	199.2	0.0524
78.97	0.028	199.2	0.0541
78.98	0.028	199.3	0.055
79.00	0.029	199.5	0.0568
79.02	0.029	199.7	0.0568
79.03	0.029	199.8	0.0568
79.05	0.029	199.9	0.0568
79.07	0.028	200	0.0568
79.10	0.028	200	0.0568
79.12	0.028	200	0.0568
79.13	0.027	200.1	0.0559
79.15	0.026	200.1	0.0541
79.15	0.025	200.1	0.0533
79.17	0.024	200	0.0506
79.18	0.022	199.9	0.0506
79.20	0.021	199.9	0.0488
79.22	0.021	199.9	0.047

Prova triassiale ciclica SN04-C1			
pressione di confinamento (kPa)		80	
deviatore ciclico (kPa)		95	
frequenza (hz)		0.00625	
tempo	cella di carico	$\Delta u$	LVDT
(min)	kN	(kPa)	$\delta$ (mm)
79.23	0.02	199.8	0.0444
79.25	0.017	199.7	0.0408
79.27	0.015	199.6	0.0382
79.28	0.014	199.4	0.0355
79.30	0.011	199.2	0.0355
79.32	0.009	199.2	0.0311
79.33	0.009	199	0.0284
79.35	0.008	198.8	0.0231
79.37	0.005	198.6	0.0195
79.38	0.003	198.4	0.016
79.40	0.002	198.2	0.0115
79.42	-0.002	197.8	0.0115
79.43	-0.003	197.6	0.0071
79.45	-0.003	197.6	0.0036
79.47	-0.005	197.4	0
79.48	-0.007	197.1	-0.0036
79.50	-0.009	196.8	-0.0071
79.52	-0.01	196.6	-0.0107
79.53	-0.012	196.3	-0.0107
79.55	-0.013	196.1	-0.016
79.57	-0.013	195.9	-0.0169
79.58	-0.014	195.7	-0.0169
79.60	-0.015	195.5	-0.0186
79.62	-0.015	195.5	-0.0204
79.63	-0.016	195.3	-0.0222
79.65	-0.017	195.1	-0.024
79.67	-0.017	195	-0.024
79.68	-0.017	194.8	-0.024
79.70	-0.017	194.7	-0.024
79.72	-0.017	194.6	-0.024
79.73	-0.017	194.6	-0.024
79.75	-0.017	194.5	-0.024
79.77	-0.016	194.5	-0.024
79.78	-0.015	194.5	-0.0222
79.80	-0.014	194.5	-0.0204
79.82	-0.013	194.5	-0.0204
79.83	-0.012	194.6	-0.0195
79.85	-0.012	194.6	-0.0178
79.87	-0.011	194.6	-0.016
79.88	-0.009	194.7	-0.0133
79.90	-0.007	194.8	-0.0107
79.92	-0.006	194.9	-0.008
79.93	-0.004	195.1	-0.0044
79.95	-0.001	195.3	-0.0044
79.97	-0.001	195.3	-0.0009
79.98	0	195.4	0.0018
80.00	0.002	195.7	0.0062
80.02	0.005	195.9	0.0098
80.03	0.006	196.1	0.0142
80.05	0.009	196.4	0.0178
80.07	0.012	196.6	0.0178
80.08	0.012	196.6	0.0213
80.10	0.013	196.8	0.0257
80.12	0.015	197.2	0.0302
80.13	0.018	197.4	0.0337
80.15	0.018	197.6	0.0373
80.17	0.02	197.9	0.0408
80.18	0.023	198.1	0.0408

Prova triassiale ciclica SN04-C1			
pressione di confinamento (kPa)		80	
deviatore ciclico (kPa)		95	
frequenza (hz)		0.00625	
tempo	cella di carico	$\Delta u$	LVDT
(min)	kN	(kPa)	$\delta$ (mm)
80.20	0.023	198.1	0.0435
80.22	0.023	198.3	0.0462
80.23	0.024	198.5	0.0479
80.25	0.026	198.8	0.0506
80.27	0.026	198.9	0.0524
80.28	0.027	199.1	0.0541
80.30	0.028	199.3	0.055
80.32	0.028	199.4	0.055
80.33	0.028	199.6	0.0568
80.35	0.029	199.7	0.0568
80.37	0.029	199.7	0.0568
80.38	0.029	199.8	0.0568
80.40	0.029	199.9	0.0568
80.42	0.028	200	0.0568
80.43	0.028	200.1	0.0559
80.45	0.027	200.1	0.0541
80.47	0.025	200	0.0541
80.48	0.024	200	0.0533
80.50	0.024	200	0.0515
80.53	0.024	200	0.0497
80.55	0.021	199.9	0.0479
80.57	0.02	199.9	0.0462
80.58	0.019	199.8	0.0426
80.60	0.016	199.6	0.0426
80.60	0.015	199.6	0.0391
80.62	0.015	199.5	0.0364
80.63	0.013	199.3	0.0328
80.65	0.01	199.1	0.0293
80.67	0.009	198.9	0.0249
80.68	0.007	198.7	0.0204
80.70	0.003	198.5	0.0204
80.72	0.002	198.5	0.0169
80.73	0.002	198.3	0.0142
80.75	0.001	198	0.0098
80.77	-0.003	197.7	0.0053
80.78	-0.004	197.5	0.0018
80.80	-0.005	197.3	-0.0018
80.82	-0.008	197	-0.0018
80.83	-0.009	197	-0.0053
80.85	-0.009	196.7	-0.008
80.87	-0.01	196.5	-0.0115
80.88	-0.013	196.2	-0.0151
80.90	-0.013	196	-0.016
80.92	-0.014	195.8	-0.0186
80.93	-0.015	195.6	-0.0186
80.95	-0.016	195.4	-0.0204
80.97	-0.016	195.4	-0.0213
80.98	-0.016	195.2	-0.0231
81.00	-0.017	194.9	-0.024
81.02	-0.017	194.9	-0.0249
81.03	-0.017	194.8	-0.0249
81.05	-0.017	194.7	-0.0249
81.07	-0.017	194.6	-0.0249
81.08	-0.017	194.5	-0.0249
81.10	-0.016	194.5	-0.0231
81.12	-0.015	194.5	-0.0231
81.13	-0.014	194.5	-0.0222
81.15	-0.014	194.5	-0.0213



Prova triassiale ciclica SN04-C1			
pressione di confinamento (kPa)		80	
deviatore ciclico (kPa)		95	
frequenza (hz)		0.00625	
tempo	cella di carico	$\Delta u$	LVDT
(min)	kN	(kPa)	$\delta$ (mm)
81.17	-0.013	194.5	-0.0186
81.18	-0.011	194.6	-0.0178
81.20	-0.01	194.6	-0.0151
81.22	-0.009	194.8	-0.0133
81.23	-0.006	194.9	-0.0133
81.25	-0.005	194.9	-0.0098
81.27	-0.005	195	-0.0071
81.28	-0.003	195.2	-0.0036
81.30	0	195.4	0
81.32	0.001	195.6	0.0036
81.33	0.002	195.8	0.0071
81.35	0.006	196	0.0071
81.37	0.007	196	0.0107
81.38	0.007	196.2	0.0142
81.40	0.009	196.5	0.0186
81.42	0.013	196.8	0.0231
81.43	0.014	196.9	0.0275
81.45	0.015	197.2	0.0311
81.47	0.018	197.5	0.0311
81.48	0.019	197.5	0.0355
81.50	0.019	197.7	0.0373
81.52	0.02	198	0.0408
81.53	0.023	198.2	0.0444
81.55	0.023	198.4	0.0462
81.57	0.025	198.6	0.0497
81.58	0.027	198.9	0.0497
81.60	0.027	198.9	0.0515
81.62	0.027	199	0.0524
81.63	0.027	199.2	0.0541
81.65	0.028	199.4	0.0559
81.67	0.029	199.6	0.0559
81.68	0.029	199.7	0.0568
81.70	0.029	199.8	0.0568
81.72	0.029	199.8	0.0568
81.73	0.029	200	0.0568
81.75	0.028	200	0.0568
81.77	0.027	200	0.0568
81.78	0.027	200.1	0.0559
81.80	0.026	200.1	0.0541
81.82	0.025	200	0.0524
81.83	0.024	200.1	0.0506
81.85	0.023	200	0.0488
81.87	0.02	199.9	0.0488
81.88	0.02	199.9	0.0462
81.90	0.02	199.8	0.0444
81.92	0.018	199.7	0.0408
81.93	0.015	199.6	0.0373
81.95	0.014	199.4	0.0355
81.97	0.012	199.3	0.032
82.00	0.01	199	0.032
82.02	0.007	198.8	0.0284
82.03	0.007	198.8	0.024
82.05	0.006	198.7	0.0195
82.05	0.003	198.4	0.0151
82.07	0.001	198.2	0.0115
82.08	0	198	0.0089
82.10	-0.002	197.6	0.0089
82.12	-0.005	197.4	0.0036

Prova triassiale ciclica SN04-C1			
pressione di confinamento (kPa)		80	
deviatore ciclico (kPa)		95	
frequenza (hz)		0.00625	
tempo	cella di carico	$\Delta u$	LVDT
(min)	kN	(kPa)	$\delta$ (mm)
82.13	-0.005	197.4	0
82.15	-0.006	197.2	-0.0036
82.17	-0.008	196.9	-0.0071
82.18	-0.01	196.6	-0.0107
82.20	-0.011	196.4	-0.0124
82.22	-0.012	196.1	-0.0124
82.23	-0.014	195.9	-0.016
82.25	-0.014	195.9	-0.0178
82.27	-0.015	195.7	-0.0195
82.28	-0.016	195.5	-0.0213
82.30	-0.016	195.2	-0.0222
82.32	-0.017	195.1	-0.024
82.33	-0.017	195	-0.0249
82.35	-0.017	194.8	-0.0249
82.37	-0.017	194.8	-0.0249
82.38	-0.017	194.7	-0.0249
82.40	-0.017	194.6	-0.0249
82.42	-0.017	194.6	-0.024
82.43	-0.016	194.5	-0.024
82.45	-0.015	194.5	-0.0231
82.47	-0.015	194.5	-0.0222
82.48	-0.013	194.5	-0.0204
82.50	-0.013	194.5	-0.0186
82.52	-0.01	194.6	-0.0186
82.53	-0.009	194.6	-0.0169
82.55	-0.009	194.7	-0.0151
82.57	-0.008	194.8	-0.0115
82.58	-0.005	194.9	-0.0089
82.60	-0.004	195	-0.0062
82.62	-0.003	195.2	-0.0027
82.63	0.001	195.4	-0.0027
82.65	0.002	195.4	0.0018
82.67	0.002	195.6	0.0044
82.68	0.003	195.9	0.008
82.70	0.007	196.1	0.0124
82.72	0.008	196.3	0.016
82.73	0.01	196.6	0.0213
82.75	0.014	196.8	0.0213
82.77	0.015	196.8	0.0249
82.78	0.015	197	0.0284
82.80	0.015	197.3	0.032
82.82	0.019	197.6	0.0364
82.83	0.02	197.8	0.0391
82.85	0.021	198	0.0426
82.87	0.024	198.3	0.0426
82.88	0.024	198.3	0.0462
82.90	0.024	198.5	0.047
82.92	0.025	198.7	0.0497
82.93	0.027	198.9	0.0524
82.95	0.027	199.1	0.0533
82.97	0.028	199.2	0.0541
82.98	0.028	199.4	0.0541
83.00	0.029	199.4	0.055
83.02	0.029	199.6	0.0559
83.03	0.029	199.7	0.0568
83.05	0.029	199.8	0.0568
83.07	0.029	199.9	0.0568
83.08	0.028	200	0.0568

Prova triassiale ciclica SN04-C1			
pressione di confinamento (kPa)		80	
deviatore ciclico (kPa)		95	
frequenza (hz)		0.00625	
tempo	cella di carico	$\Delta u$	LVDT
(min)	kN	(kPa)	$\delta$ (mm)
83.10	0.028	200	0.0568
83.12	0.026	200	0.055
83.13	0.026	200	0.0541
83.15	0.026	200	0.0533
83.17	0.024	200	0.0515
83.18	0.022	199.9	0.0488
83.20	0.022	199.9	0.0479
83.22	0.021	199.8	0.0462
83.23	0.018	199.8	0.0426
83.25	0.017	199.7	0.0408
83.27	0.016	199.5	0.0373
83.28	0.012	199.3	0.0373
83.30	0.011	199.3	0.0337
83.32	0.011	199.2	0.0302
83.33	0.01	198.9	0.0257
83.35	0.006	198.7	0.0222
83.37	0.005	198.6	0.0186
83.38	0.004	198.3	0.0151
83.40	0	198	0.0151
83.43	-0.001	198	0.0098
83.45	-0.001	197.8	0.0071
83.47	-0.003	197.5	0.0027
83.48	-0.006	197.3	-0.0018
83.50	-0.007	197.1	-0.0044
83.50	-0.008	196.8	-0.008
83.52	-0.011	196.5	-0.008
83.53	-0.011	196.5	-0.0115
83.55	-0.011	196.3	-0.0133
83.57	-0.013	196	-0.016
83.58	-0.015	195.8	-0.0186
83.60	-0.015	195.6	-0.0204
83.62	-0.015	195.4	-0.0213
83.63	-0.016	195.2	-0.0213
83.65	-0.017	195.2	-0.0231
83.67	-0.017	195	-0.024
83.68	-0.017	194.9	-0.024
83.70	-0.017	194.8	-0.0249
83.72	-0.017	194.7	-0.0249
83.73	-0.017	194.6	-0.0249
83.75	-0.016	194.5	-0.0249
83.77	-0.016	194.5	-0.024
83.78	-0.016	194.5	-0.0231
83.80	-0.015	194.5	-0.0222
83.82	-0.013	194.5	-0.0204
83.83	-0.012	194.5	-0.0186
83.85	-0.011	194.6	-0.0169
83.87	-0.009	194.7	-0.0169
83.88	-0.008	194.7	-0.0142
83.90	-0.008	194.8	-0.0124
83.92	-0.005	195	-0.0089
83.93	-0.003	195.1	-0.008
83.95	-0.003	195.1	-0.0044
83.97	-0.002	195.3	-0.0009
83.98	0.002	195.6	0.0027
84.00	0.003	195.7	0.0062
84.02	0.004	195.9	0.0098
84.03	0.008	196.2	0.0098
84.05	0.01	196.4	0.0151

Prova triassiale ciclica SN04-C1			
pressione di confinamento (kPa)		80	
deviatore ciclico (kPa)		95	
frequenza (hz)		0.00625	
tempo	cella di carico	$\Delta u$	LVDT
(min)	kN	(kPa)	$\delta$ (mm)
84.07	0.01	196.4	0.0178
84.08	0.011	196.6	0.0213
84.10	0.013	196.9	0.0257
84.12	0.016	197.1	0.0302
84.13	0.017	197.3	0.0337
84.15	0.019	197.6	0.0337
84.17	0.021	197.9	0.0373
84.18	0.021	197.9	0.0399
84.20	0.022	198.1	0.0435
84.22	0.023	198.4	0.0462
84.23	0.025	198.6	0.0488
84.25	0.025	198.8	0.0506
84.27	0.026	199	0.0524
84.28	0.028	199.2	0.0524
84.30	0.028	199.2	0.0541
84.32	0.028	199.3	0.055
84.33	0.028	199.5	0.0559
84.35	0.029	199.6	0.0568
84.37	0.029	199.8	0.0568
84.38	0.029	199.8	0.0568
84.40	0.029	199.9	0.0568
84.42	0.028	199.9	0.0568
84.43	0.028	200	0.0559
84.45	0.027	200	0.055
84.47	0.026	200	0.0541
84.48	0.025	200	0.0524
84.50	0.024	200	0.0506
84.52	0.022	199.9	0.0506
84.53	0.021	199.9	0.0479
84.55	0.021	199.9	0.0462
84.57	0.02	199.8	0.0435
84.58	0.016	199.7	0.0399
84.60	0.016	199.6	0.0382
84.62	0.014	199.3	0.0337
84.63	0.01	199.1	0.0302
84.65	0.01	199	0.0284
84.67	0.009	198.9	0.0249
84.68	0.005	198.6	0.0249
84.70	0.004	198.6	0.0204
84.72	0.004	198.4	0.0169
84.73	0.002	198.2	0.0124
84.75	-0.002	197.9	0.008
84.77	-0.002	197.8	0.0053
84.78	-0.003	197.4	0.0009
84.80	-0.007	197.1	0.0009
84.82	-0.007	197.1	-0.0027
84.83	-0.007	196.9	-0.0053
84.85	-0.009	196.7	-0.0089
84.87	-0.012	196.4	-0.0124
84.90	-0.012	196.2	-0.0151
84.92	-0.013	196	-0.0169
84.93	-0.015	195.7	-0.0169
84.95	-0.015	195.7	-0.0195
84.95	-0.015	195.5	-0.0213
84.97	-0.016	195.3	-0.0222
84.98	-0.017	195.1	-0.024
85.00	-0.017	195	-0.024
85.02	-0.017	194.8	-0.0249

Prova triassiale ciclica SN04-C1			
pressione di confinamento (kPa)		80	
deviatore ciclico (kPa)		95	
frequenza (hz)		0.00625	
tempo	cella di carico	$\Delta u$	LVDT
(min)	kN	(kPa)	$\delta$ (mm)
85.03	-0.017	194.7	-0.0249
85.05	-0.017	194.6	-0.0249
85.07	-0.017	194.6	-0.0249
85.08	-0.017	194.5	-0.0249
85.10	-0.016	194.5	-0.024
85.12	-0.015	194.5	-0.0231
85.13	-0.015	194.5	-0.0222
85.15	-0.013	194.5	-0.0222
85.17	-0.011	194.6	-0.0204
85.18	-0.011	194.6	-0.0186
85.20	-0.011	194.6	-0.016
85.22	-0.009	194.7	-0.0142
85.23	-0.007	194.8	-0.0115
85.25	-0.006	194.9	-0.0089
85.27	-0.004	195.1	-0.0053
85.28	-0.001	195.3	-0.0053
85.30	-0.001	195.3	-0.0018
85.32	0	195.4	0.0018
85.33	0.002	195.7	0.0062
85.35	0.005	195.9	0.0098
85.37	0.006	196.1	0.0133
85.38	0.007	196.3	0.0151
85.40	0.01	196.6	0.0186
85.42	0.011	196.8	0.0231
85.43	0.014	197.1	0.0293
85.45	0.017	197.3	0.0293
85.47	0.017	197.3	0.032
85.48	0.018	197.5	0.0355
85.50	0.019	197.8	0.0391
85.52	0.022	198	0.0408
85.53	0.022	198.2	0.0435
85.55	0.024	198.4	0.047
85.57	0.026	198.7	0.047
85.58	0.026	198.7	0.0497
85.60	0.026	198.9	0.0515
85.62	0.027	199.1	0.0533
85.63	0.028	199.2	0.0541
85.65	0.028	199.4	0.055
85.67	0.028	199.6	0.055
85.68	0.029	199.7	0.055
85.70	0.029	199.7	0.0559
85.72	0.029	199.8	0.0559
85.73	0.029	199.9	0.0559
85.75	0.028	200	0.0559
85.77	0.028	200	0.0559
85.78	0.027	200	0.0541
85.80	0.025	200	0.0541
85.82	0.025	200	0.0524
85.83	0.025	200	0.0515
85.85	0.024	200	0.0488
85.87	0.021	199.9	0.0462
85.88	0.02	199.8	0.0453
85.90	0.019	199.8	0.0417
85.92	0.016	199.6	0.0417
85.93	0.015	199.6	0.0391
85.95	0.015	199.5	0.0364
85.97	0.013	199.3	0.032
85.98	0.01	199.1	0.0284

Prova triassiale ciclica SN04-C1			
pressione di confinamento (kPa)		80	
deviatore ciclico (kPa)		95	
frequenza (hz)		0.00625	
tempo	cella di carico	$\Delta u$	LVDT
(min)	kN	(kPa)	$\delta$ (mm)
86.00	0.008	198.9	0.0249
86.02	0.007	198.7	0.0204
86.03	0.004	198.5	0.0204
86.05	0.002	198.3	0.0169
86.07	0.002	198.3	0.0142
86.08	-0.001	197.8	0.0089
86.10	-0.003	197.6	0.0062
86.12	-0.003	197.6	0.0036
86.13	-0.004	197.4	-0.0009
86.15	-0.007	197	-0.0044
86.17	-0.009	196.8	-0.008
86.18	-0.01	196.6	-0.0107
86.20	-0.011	196.3	-0.0107
86.22	-0.013	196.1	-0.0142
86.23	-0.013	196.1	-0.0169
86.25	-0.014	195.9	-0.0178
86.27	-0.015	195.6	-0.0204
86.28	-0.016	195.4	-0.0222
86.30	-0.016	195.2	-0.0231
86.32	-0.017	195.1	-0.024
86.33	-0.017	194.9	-0.024
86.37	-0.017	194.9	-0.0257
86.38	-0.017	194.8	-0.0257
86.40	-0.017	194.7	-0.0257
86.40	-0.017	194.6	-0.0257
86.42	-0.016	194.5	-0.0249
86.43	-0.016	194.5	-0.0249
86.45	-0.015	194.5	-0.0249
86.47	-0.014	194.5	-0.0231
86.48	-0.014	194.5	-0.0222
86.50	-0.013	194.5	-0.0195
86.52	-0.011	194.6	-0.0178
86.53	-0.01	194.6	-0.016
86.55	-0.009	194.8	-0.0133
86.57	-0.006	194.9	-0.0133
86.58	-0.005	194.9	-0.0107
86.60	-0.005	195	-0.0071
86.62	-0.003	195.2	-0.0044
86.63	0	195.4	-0.0009
86.65	0.001	195.5	0.0027
86.67	0.003	195.8	0.0071
86.68	0.006	196	0.0071
86.70	0.007	196	0.0107
86.72	0.007	196.2	0.0142
86.73	0.009	196.5	0.0186
86.75	0.013	196.7	0.0231
86.77	0.014	196.9	0.0257
86.78	0.015	197.2	0.0302
86.80	0.018	197.4	0.0302
86.82	0.019	197.6	0.0364
86.83	0.019	197.9	0.0391
86.85	0.022	198.1	0.0391
86.87	0.023	198.1	0.0417
86.88	0.023	198.3	0.0453
86.90	0.024	198.5	0.0479
86.92	0.026	198.8	0.0506
86.93	0.027	199	0.0515
86.95	0.027	199.1	0.0533

Prova triassiale ciclica SN04-C1			
pressione di confinamento (kPa)		80	
deviatore ciclico (kPa)		95	
frequenza (hz)		0.00625	
tempo	cella di carico	$\Delta u$	LVDT
(min)	kN	(kPa)	$\delta$ (mm)
86.97	0.028	199.3	0.0533
86.98	0.028	199.3	0.0541
87.00	0.028	199.5	0.055
87.02	0.029	199.6	0.0559
87.03	0.029	199.7	0.0559
87.05	0.029	199.8	0.0559
87.07	0.029	199.9	0.0559
87.08	0.028	200	0.0559
87.10	0.027	200	0.0559
87.12	0.027	200	0.055
87.13	0.026	200.1	0.0533
87.15	0.025	200	0.0515
87.17	0.024	200	0.0497
87.18	0.023	200	0.0488
87.20	0.021	199.9	0.0488
87.22	0.019	199.8	0.0453
87.23	0.019	199.8	0.0435
87.25	0.018	199.7	0.0399
87.27	0.015	199.6	0.0373
87.28	0.013	199.4	0.0346
87.30	0.012	199.3	0.0311
87.32	0.01	199	0.0311
87.33	0.007	198.8	0.0275
87.35	0.007	198.8	0.0231
87.37	0.006	198.7	0.0195
87.38	0.004	198.4	0.0151
87.40	0.001	198.1	0.0115
87.42	0	197.9	0.008
87.43	-0.003	197.6	0.008
87.45	-0.005	197.4	0.0036
87.47	-0.005	197.4	0
87.48	-0.006	197.2	-0.0036
87.50	-0.008	196.8	-0.0071
87.52	-0.01	196.6	-0.0107
87.53	-0.011	196.4	-0.0142
87.55	-0.012	196.2	-0.0151
87.57	-0.013	196	-0.0169
87.58	-0.014	195.8	-0.0186
87.60	-0.015	195.5	-0.0213
87.62	-0.016	195.3	-0.0213
87.63	-0.016	195.3	-0.0231
87.65	-0.016	195.1	-0.024
87.67	-0.017	195	-0.0249
87.68	-0.017	194.8	-0.0249
87.70	-0.017	194.7	-0.0257
87.72	-0.017	194.6	-0.0257
87.73	-0.017	194.5	-0.0257
87.75	-0.016	194.5	-0.0257
87.77	-0.016	194.5	-0.0249
87.80	-0.016	194.4	-0.024
87.82	-0.014	194.5	-0.0231
87.83	-0.014	194.5	-0.0213
87.85	-0.013	194.5	-0.0195
87.87	-0.01	194.6	-0.0195
87.87	-0.01	194.6	-0.0169
87.88	-0.01	194.6	-0.0151
87.90	-0.008	194.8	-0.0124
87.92	-0.005	194.9	-0.0089

Prova triassiale ciclica SN04-C1			
pressione di confinamento (kPa)		80	
deviatore ciclico (kPa)		95	
frequenza (hz)		0.00625	
tempo	cella di carico	$\Delta u$	LVDT
(min)	kN	(kPa)	$\delta$ (mm)
87.93	-0.004	195	-0.0071
87.95	-0.003	195.2	-0.0027
87.97	0.001	195.4	-0.0027
87.98	0.002	195.4	0.0009
88.00	0.002	195.6	0.0036
88.02	0.003	195.8	0.008
88.03	0.007	196.1	0.0124
88.05	0.009	196.3	0.0151
88.07	0.01	196.5	0.0186
88.08	0.013	196.8	0.0186
88.10	0.015	196.8	0.024
88.12	0.015	197	0.0284
88.13	0.016	197.2	0.032
88.15	0.019	197.5	0.0355
88.17	0.02	197.7	0.0382
88.18	0.021	198	0.0417
88.20	0.023	198.3	0.0417
88.22	0.024	198.5	0.0444
88.23	0.024	198.5	0.0462
88.25	0.025	198.7	0.0497
88.27	0.027	199.1	0.0515
88.28	0.027	199.1	0.0524
88.30	0.027	199.2	0.0533
88.32	0.028	199.4	0.0541
88.33	0.029	199.6	0.055
88.35	0.029	199.7	0.0559
88.37	0.029	199.8	0.0559
88.38	0.029	199.9	0.0559
88.40	0.029	199.9	0.0559
88.42	0.029	200	0.0559
88.43	0.028	200	0.055
88.45	0.027	200	0.0541
88.47	0.026	200.1	0.0524
88.48	0.025	200	0.0515
88.50	0.023	200	0.0515
88.52	0.022	200	0.0488
88.53	0.022	199.9	0.0479
88.55	0.021	199.9	0.0453
88.57	0.018	199.8	0.0417
88.58	0.017	199.7	0.0399
88.60	0.016	199.5	0.0355
88.62	0.013	199.3	0.0355
88.63	0.011	199.3	0.0328
88.65	0.011	199.2	0.0293
88.67	0.01	199	0.0249
88.68	0.006	198.7	0.0213
88.70	0.005	198.6	0.0178
88.72	0.004	198.3	0.0142
88.73	0	198.1	0.0142
88.75	-0.001	198.1	0.0089
88.77	-0.001	197.8	0.0062
88.78	-0.003	197.6	0.0027
88.80	-0.006	197.3	-0.0018
88.82	-0.007	197.1	-0.0044
88.83	-0.008	196.8	-0.0089
88.85	-0.011	196.5	-0.0089
88.87	-0.012	196.5	-0.0124
88.88	-0.012	196.3	-0.0142



Prova triassiale ciclica SN04-C1			
pressione di confinamento (kPa)		80	
deviatore ciclico (kPa)		95	
frequenza (hz)		0.00625	
tempo	cella di carico	$\Delta u$	LVDT
(min)	kN	(kPa)	$\delta$ (mm)
88.90	-0.012	196.1	-0.0169
88.92	-0.014	195.8	-0.0195
88.93	-0.016	195.6	-0.0213
88.95	-0.016	195.4	-0.0222
88.97	-0.016	195.2	-0.0222
88.98	-0.017	195.1	-0.0231
89.00	-0.017	194.9	-0.0257
89.02	-0.017	194.8	-0.0257
89.03	-0.017	194.7	-0.0257
89.05	-0.017	194.7	-0.0257
89.07	-0.017	194.6	-0.0257
89.08	-0.017	194.5	-0.0257
89.10	-0.016	194.5	-0.0249
89.12	-0.015	194.4	-0.0231
89.13	-0.014	194.5	-0.0231
89.15	-0.013	194.5	-0.0222
89.17	-0.013	194.5	-0.0204
89.18	-0.012	194.5	-0.0186
89.20	-0.011	194.6	-0.0169
89.22	-0.008	194.7	-0.0142
89.23	-0.007	194.8	-0.0124
89.27	-0.006	195	-0.0089
89.28	-0.002	195.1	-0.0089
89.30	-0.002	195.1	-0.0053
89.32	-0.002	195.2	-0.0027
89.32	0	195.5	0.0009
89.33	0.004	195.7	0.0053
89.35	0.005	195.9	0.008
89.37	0.007	196.2	0.0124
89.38	0.01	196.4	0.0124
89.40	0.011	196.4	0.0169
89.42	0.011	196.6	0.0204
89.43	0.012	196.9	0.024
89.45	0.016	197.1	0.0293
89.47	0.017	197.3	0.032
89.48	0.018	197.6	0.0355
89.50	0.021	197.9	0.0355
89.52	0.022	197.9	0.0391
89.53	0.022	198.1	0.0417
89.55	0.023	198.3	0.0453
89.57	0.025	198.5	0.0479
89.58	0.026	198.7	0.0488
89.60	0.026	198.9	0.0506
89.62	0.027	199.1	0.0506
89.63	0.028	199.1	0.0524
89.65	0.028	199.3	0.0541
89.67	0.028	199.4	0.0541
89.68	0.029	199.6	0.055
89.70	0.029	199.7	0.0559
89.72	0.029	199.8	0.0559
89.73	0.029	199.9	0.055
89.75	0.028	200	0.055
89.77	0.027	200	0.0541
89.78	0.026	200	0.0541
89.80	0.025	200	0.0533
89.82	0.025	200	0.0515
89.83	0.025	200	0.0497
89.85	0.023	199.9	0.0479

Prova triassiale ciclica SN04-C1			
pressione di confinamento (kPa)		80	
deviatore ciclico (kPa)		95	
frequenza (hz)		0.00625	
tempo	cella di carico	$\Delta u$	LVDT
(min)	kN	(kPa)	$\delta$ (mm)
89.87	0.021	199.9	0.0462
89.88	0.02	199.8	0.0435
89.90	0.017	199.7	0.0435
89.92	0.016	199.7	0.0399
89.93	0.016	199.6	0.0382
89.95	0.015	199.4	0.0337
89.97	0.011	199.2	0.0302
89.98	0.01	199.1	0.0275
90.00	0.009	198.9	0.0231
90.02	0.005	198.6	0.0231
90.03	0.004	198.6	0.0186
90.05	0.004	198.5	0.016
90.07	0.003	198.2	0.0115
90.08	-0.001	197.9	0.0071
90.10	-0.002	197.7	0.0044
90.12	-0.003	197.5	0
90.13	-0.007	197.2	0
90.15	-0.008	197.2	-0.0044
90.17	-0.008	196.9	-0.0071
90.18	-0.009	196.7	-0.0107
90.20	-0.011	196.4	-0.0142
90.22	-0.013	196.2	-0.0169
90.23	-0.013	196	-0.0186
90.25	-0.015	195.7	-0.0186
90.27	-0.015	195.5	-0.0204
90.28	-0.015	195.5	-0.0222
90.30	-0.016	195.3	-0.024
90.32	-0.017	195.1	-0.0249
90.33	-0.017	195	-0.0257
90.35	-0.017	194.8	-0.0257
90.37	-0.017	194.7	-0.0257
90.38	-0.017	194.6	-0.0266
90.40	-0.017	194.6	-0.0266
90.42	-0.017	194.5	-0.0266
90.43	-0.016	194.5	-0.0249
90.45	-0.015	194.5	-0.024
90.47	-0.015	194.4	-0.024
90.48	-0.014	194.5	-0.0222
90.50	-0.012	194.5	-0.0204
90.52	-0.012	194.5	-0.0195
90.53	-0.01	194.6	-0.016
90.55	-0.007	194.7	-0.016
90.57	-0.007	194.7	-0.0142
90.58	-0.007	194.8	-0.0115
90.60	-0.005	195	-0.008
90.62	-0.001	195.2	-0.0044
90.63	-0.001	195.3	-0.0018
90.65	0.001	195.6	0.0018
90.67	0.005	195.8	0.0018
90.70	0.005	195.8	0.0062
90.72	0.005	196	0.0089
90.73	0.007	196.3	0.0142
90.75	0.011	196.5	0.0178
90.77	0.012	196.7	0.0213
90.77	0.013	197	0.0257
90.78	0.017	197.2	0.0257
90.80	0.017	197.2	0.0311
90.82	0.017	197.4	0.0337

Prova triassiale ciclica SN04-C1			
pressione di confinamento (kPa)		80	
deviatore ciclico (kPa)		95	
frequenza (hz)		0.00625	
tempo	cella di carico	$\Delta u$	LVDT
(min)	kN	(kPa)	$\delta$ (mm)
90.83	0.019	197.7	0.0373
90.85	0.022	197.9	0.0399
90.87	0.022	198.2	0.0426
90.88	0.023	198.4	0.0453
90.90	0.026	198.6	0.0453
90.92	0.026	198.6	0.0479
90.93	0.026	198.8	0.0497
90.95	0.027	199	0.0515
90.97	0.028	199.2	0.0533
90.98	0.028	199.3	0.0541
91.00	0.028	199.5	0.0541
91.02	0.029	199.7	0.0541
91.03	0.029	199.7	0.055
91.05	0.029	199.8	0.055
91.07	0.029	199.8	0.055
91.08	0.029	199.9	0.055
91.10	0.027	200	0.0541
91.12	0.027	200	0.0533
91.13	0.025	200	0.0533
91.15	0.024	200	0.0515
91.17	0.023	200	0.0488
91.18	0.022	199.9	0.0488
91.20	0.021	199.9	0.047
91.22	0.021	199.9	0.0453
91.23	0.02	199.8	0.0417
91.25	0.017	199.6	0.0391
91.27	0.015	199.5	0.0364
91.28	0.014	199.4	0.0328
91.30	0.011	199.1	0.0328
91.32	0.01	199	0.0293
91.33	0.01	199	0.0249
91.35	0.008	198.8	0.0204
91.37	0.004	198.5	0.0169
91.38	0.003	198.3	0.0133
91.40	0.002	198.1	0.0098
91.42	-0.001	197.8	0.0098
91.43	-0.004	197.6	0.0053
91.45	-0.004	197.6	0.0018
91.47	-0.004	197.4	-0.0018
91.48	-0.007	197	-0.0062
91.50	-0.008	196.8	-0.0089
91.52	-0.01	196.6	-0.0124
91.53	-0.012	196.3	-0.0124
91.55	-0.013	196.1	-0.0151
91.57	-0.013	196.1	-0.0178
91.58	-0.014	195.8	-0.0195
91.60	-0.015	195.6	-0.0222
91.62	-0.016	195.4	-0.0231
91.63	-0.016	195.2	-0.024
91.65	-0.017	195	-0.0249
91.67	-0.017	194.9	-0.0249
91.68	-0.017	194.9	-0.0266
91.70	-0.017	194.8	-0.0266
91.72	-0.017	194.6	-0.0266
91.73	-0.017	194.6	-0.0266
91.75	-0.017	194.5	-0.0266
91.77	-0.016	194.5	-0.0249
91.78	-0.015	194.5	-0.0249

Prova triassiale ciclica SN04-C1			
pressione di confinamento (kPa)		80	
deviatore ciclico (kPa)		95	
frequenza (hz)		0.00625	
tempo	cella di carico	$\Delta u$	LVDT
(min)	kN	(kPa)	$\delta$ (mm)
91.80	-0.014	194.5	-0.024
91.82	-0.014	194.5	-0.0231
91.83	-0.013	194.5	-0.0213
91.85	-0.011	194.5	-0.0195
91.87	-0.01	194.6	-0.0178
91.88	-0.009	194.7	-0.0151
91.90	-0.006	194.9	-0.0115
91.92	-0.006	194.9	-0.0107
91.93	-0.004	195	-0.0071
91.95	-0.001	195.2	-0.0071
91.97	0	195.4	-0.0036
91.98	0	195.4	-0.0009
92.00	0.002	195.6	0.0036
92.02	0.005	195.9	0.008
92.03	0.007	196.1	0.0107
92.05	0.008	196.3	0.0151
92.07	0.011	196.6	0.0151
92.08	0.013	196.8	0.0186
92.10	0.013	196.8	0.0222
92.12	0.014	197	0.0275
92.13	0.016	197.3	0.0311
92.17	0.019	197.5	0.0346
92.18	0.02	197.7	0.0382
92.20	0.022	198	0.0408
92.22	0.023	198.3	0.0408
92.22	0.023	198.3	0.0435
92.23	0.024	198.5	0.0462
92.25	0.025	198.7	0.0488
92.27	0.027	198.9	0.0506
92.28	0.027	199.1	0.0515
92.30	0.028	199.2	0.0533
92.32	0.028	199.4	0.0533
92.33	0.028	199.4	0.0541
92.35	0.029	199.6	0.055
92.37	0.029	199.7	0.055
92.38	0.029	199.8	0.055
92.40	0.029	199.9	0.055
92.42	0.028	199.9	0.055
92.43	0.027	200	0.055
92.45	0.026	200	0.0533
92.47	0.026	200	0.0524
92.48	0.026	200	0.0506
92.50	0.024	200	0.0488
92.52	0.023	199.9	0.047
92.53	0.022	199.8	0.0444
92.55	0.019	199.8	0.0444
92.57	0.018	199.8	0.0426
92.58	0.018	199.7	0.0399
92.60	0.016	199.5	0.0364
92.62	0.013	199.3	0.0328
92.63	0.012	199.2	0.0302
92.65	0.011	199.1	0.0284
92.67	0.008	198.9	0.0231
92.68	0.007	198.7	0.0204
92.70	0.005	198.4	0.016
92.72	0.001	198.2	0.016
92.73	0.001	198.2	0.0115
92.75	0.001	198	0.008

Prova triassiale ciclica SN04-C1			
pressione di confinamento (kPa)		80	
deviatore ciclico (kPa)		95	
frequenza (hz)		0.00625	
tempo	cella di carico	$\Delta u$	LVDT
(min)	kN	(kPa)	$\delta$ (mm)
92.77	-0.001	197.7	0.0044
92.78	-0.005	197.4	-0.0009
92.80	-0.005	197.2	-0.0036
92.82	-0.007	197	-0.0071
92.83	-0.01	196.7	-0.0071
92.85	-0.01	196.7	-0.0107
92.87	-0.01	196.5	-0.0133
92.88	-0.012	196.2	-0.016
92.90	-0.014	195.9	-0.0186
92.92	-0.014	195.8	-0.0204
92.93	-0.015	195.6	-0.0231
92.95	-0.016	195.3	-0.0231
92.97	-0.017	195.3	-0.024
92.98	-0.017	195.1	-0.0249
93.00	-0.017	195	-0.0257
93.02	-0.017	194.8	-0.0266
93.03	-0.017	194.7	-0.0266
93.05	-0.017	194.6	-0.0266
93.07	-0.017	194.5	-0.0266
93.08	-0.016	194.5	-0.0266
93.10	-0.016	194.5	-0.0266
93.12	-0.016	194.5	-0.0249
93.13	-0.015	194.4	-0.024
93.15	-0.013	194.5	-0.0222
93.17	-0.012	194.5	-0.0204
93.18	-0.011	194.6	-0.0204
93.20	-0.009	194.6	-0.0186
93.22	-0.009	194.6	-0.0169
93.23	-0.008	194.7	-0.0142
93.25	-0.006	194.9	-0.0107
93.27	-0.004	195	-0.008
93.28	-0.002	195.2	-0.0044
93.30	0	195.4	-0.0009
93.32	0.003	195.6	-0.0009
93.33	0.003	195.6	0.0027
93.35	0.006	196	0.0089
93.37	0.007	196.2	0.0089
93.38	0.009	196.2	0.0115
93.40	0.009	196.4	0.016
93.42	0.011	196.7	0.0195
93.43	0.014	196.9	0.024
93.45	0.015	197.1	0.0284
93.47	0.017	197.4	0.032
93.48	0.02	197.7	0.032
93.50	0.02	197.7	0.0355
93.52	0.02	197.9	0.0382
93.53	0.022	198.1	0.0417
93.55	0.024	198.3	0.0444
93.57	0.025	198.5	0.0462
93.58	0.025	198.7	0.0488
93.62	0.027	199	0.0488
93.63	0.027	199	0.0506
93.65	0.027	199.1	0.0515
93.67	0.028	199.3	0.0533
93.67	0.029	199.5	0.0541
93.68	0.029	199.6	0.0541
93.70	0.029	199.7	0.055
93.72	0.029	199.8	0.055

Prova triassiale ciclica SN04-C1			
pressione di confinamento (kPa)		80	
deviatore ciclico (kPa)		95	
frequenza (hz)		0.00625	
tempo	cella di carico	$\Delta u$	LVDT
(min)	kN	(kPa)	$\delta$ (mm)
93.73	0.029	199.8	0.055
93.75	0.029	199.9	0.055
93.77	0.028	199.9	0.0541
93.78	0.026	200	0.0524
93.80	0.026	200	0.0515
93.82	0.025	200	0.0497
93.83	0.023	199.9	0.0497
93.85	0.022	199.9	0.0479
93.87	0.022	199.9	0.0462
93.88	0.021	199.8	0.0435
93.90	0.018	199.7	0.0408
93.92	0.017	199.6	0.0382
93.93	0.016	199.5	0.0355
93.95	0.012	199.3	0.0355
93.97	0.011	199.3	0.032
93.98	0.011	199.1	0.0284
94.00	0.01	199	0.024
94.02	0.006	198.7	0.0195
94.03	0.005	198.5	0.0169
94.05	0.004	198.3	0.0124
94.07	0	198	0.0124
94.08	-0.001	197.8	0.0053
94.10	-0.002	197.6	0.0018
94.12	-0.005	197.3	0.0018
94.13	-0.006	197.1	-0.0018
94.15	-0.006	197.1	-0.0044
94.17	-0.007	196.9	-0.0089
94.18	-0.01	196.5	-0.0115
94.20	-0.011	196.3	-0.0142
94.22	-0.012	196.1	-0.0178
94.23	-0.014	195.8	-0.0178
94.25	-0.015	195.6	-0.0195
94.27	-0.015	195.6	-0.0213
94.28	-0.015	195.4	-0.024
94.30	-0.016	195.2	-0.0249
94.32	-0.017	195	-0.0257
94.33	-0.017	194.9	-0.0266
94.35	-0.017	194.8	-0.0266
94.37	-0.017	194.7	-0.0266
94.38	-0.017	194.7	-0.0266
94.40	-0.017	194.6	-0.0275
94.42	-0.017	194.5	-0.0266
94.43	-0.016	194.5	-0.0257
94.45	-0.015	194.4	-0.0249
94.47	-0.015	194.4	-0.0231
94.48	-0.013	194.5	-0.0231
94.50	-0.012	194.5	-0.0222
94.52	-0.012	194.5	-0.0204
94.53	-0.011	194.6	-0.0178
94.55	-0.008	194.7	-0.0151
94.57	-0.007	194.7	-0.0133
94.58	-0.006	194.9	-0.0098
94.60	-0.002	195.1	-0.0098
94.62	-0.002	195.1	-0.0062
94.63	-0.002	195.2	-0.0044
94.65	0	195.4	0
94.67	0.004	195.7	0.0044
94.68	0.004	195.8	0.008

Prova triassiale ciclica SN04-C1			
pressione di confinamento (kPa)		80	
deviatore ciclico (kPa)		95	
frequenza (hz)		0.00625	
tempo	cella di carico	$\Delta u$	LVDT
(min)	kN	(kPa)	$\delta$ (mm)
94.70	0.006	196.1	0.0115
94.72	0.01	196.4	0.0115
94.73	0.011	196.4	0.0169
94.75	0.011	196.6	0.0195
94.77	0.012	196.8	0.0231
94.78	0.016	197.1	0.0284
94.80	0.017	197.3	0.0311
94.82	0.017	197.5	0.0337
94.83	0.02	197.8	0.0373
94.85	0.021	198	0.0399
94.87	0.022	198.2	0.0435
94.88	0.025	198.5	0.0435
94.90	0.025	198.5	0.0462
94.92	0.025	198.6	0.047
94.93	0.026	198.8	0.0497
94.95	0.027	199	0.0515
94.97	0.028	199.2	0.0524
94.98	0.028	199.4	0.0533
95.00	0.028	199.5	0.0533
95.02	0.029	199.5	0.0541
95.03	0.029	199.7	0.0541
95.07	0.029	199.8	0.0541
95.08	0.029	199.8	0.055
95.10	0.029	199.9	0.0541
95.12	0.028	200	0.0533
95.12	0.026	200	0.0533
95.13	0.025	200	0.0515
95.15	0.025	200	0.0506
95.17	0.025	200	0.0488
95.18	0.023	199.9	0.047
95.20	0.021	199.9	0.0453
95.22	0.02	199.8	0.0426
95.23	0.018	199.7	0.0426
95.25	0.016	199.6	0.0399
95.27	0.016	199.6	0.0373
95.28	0.015	199.4	0.0337
95.30	0.012	199.2	0.0302
95.32	0.01	199.1	0.0257
95.33	0.009	198.9	0.0222
95.35	0.006	198.6	0.0222
95.37	0.004	198.4	0.0178
95.38	0.004	198.4	0.0142
95.40	0.003	198.2	0.0107
95.42	0	197.9	0.0062
95.43	-0.003	197.7	0.0027
95.45	-0.004	197.5	-0.0009
95.47	-0.006	197.1	-0.0009
95.48	-0.008	196.9	-0.0053
95.50	-0.008	196.9	-0.008
95.52	-0.009	196.7	-0.0115
95.53	-0.012	196.2	-0.0142
95.55	-0.012	196.2	-0.016
95.57	-0.013	196	-0.0186
95.58	-0.014	195.7	-0.0213
95.60	-0.015	195.5	-0.0231
95.62	-0.016	195.3	-0.024
95.63	-0.016	195.1	-0.0249
95.65	-0.017	194.9	-0.0249

Prova triassiale ciclica SN04-C1			
pressione di confinamento (kPa)		80	
deviatore ciclico (kPa)		95	
frequenza (hz)		0.00625	
tempo	cella di carico	$\Delta u$	LVDT
(min)	kN	(kPa)	$\delta$ (mm)
95.67	-0.017	194.9	-0.0257
95.68	-0.017	194.8	-0.0266
95.70	-0.017	194.7	-0.0266
95.72	-0.017	194.6	-0.0266
95.73	-0.017	194.5	-0.0266
95.75	-0.017	194.4	-0.0266
95.77	-0.015	194.4	-0.0266
95.78	-0.015	194.4	-0.0257
95.80	-0.015	194.4	-0.0249
95.82	-0.014	194.4	-0.0231
95.83	-0.012	194.5	-0.0213
95.85	-0.011	194.5	-0.0195
95.87	-0.01	194.5	-0.0169
95.88	-0.007	194.7	-0.0169
95.90	-0.006	194.8	-0.0142
95.92	-0.006	194.8	-0.0124
95.93	-0.005	194.9	-0.0089
95.95	-0.002	195.1	-0.0053
95.97	0	195.3	-0.0027
95.98	0.001	195.4	0.0018
96.00	0.004	195.7	0.0018
96.02	0.006	195.9	0.0053
96.03	0.006	195.9	0.0089
96.05	0.007	196.1	0.0124
96.07	0.01	196.4	0.0169
96.08	0.012	196.7	0.0204
96.10	0.014	196.9	0.0249
96.12	0.016	197.2	0.0249
96.13	0.018	197.4	0.0293
96.15	0.018	197.4	0.032
96.17	0.019	197.6	0.0364
96.18	0.021	197.9	0.0391
96.20	0.023	198.1	0.0426
96.22	0.024	198.3	0.0444
96.23	0.025	198.6	0.0444
96.25	0.027	198.8	0.047
96.27	0.027	198.9	0.0497
96.28	0.027	199.1	0.0515
96.30	0.028	199.3	0.0515
96.32	0.029	199.3	0.0524
96.33	0.029	199.4	0.0533
96.35	0.029	199.6	0.0541
96.37	0.029	199.7	0.0541
96.38	0.029	199.8	0.0541
96.40	0.029	199.9	0.0541
96.42	0.028	200	0.0541
96.43	0.027	200	0.0541
96.45	0.027	200	0.0533
96.47	0.027	200	0.0515
96.48	0.025	200	0.0497
96.50	0.024	200	0.0488
96.53	0.023	199.9	0.0462
96.55	0.02	199.8	0.0462
96.57	0.02	199.8	0.0444
96.58	0.02	199.8	0.0426
96.58	0.018	199.7	0.0382
96.60	0.015	199.4	0.0355
96.62	0.014	199.3	0.0328



Prova triassiale ciclica SN04-C1			
pressione di confinamento (kPa)		80	
deviatore ciclico (kPa)		95	
frequenza (hz)		0.00625	
tempo	cella di carico	$\Delta u$	LVDT
(min)	kN	(kPa)	$\delta$ (mm)
96.63	0.012	199.2	0.0293
96.65	0.009	198.9	0.0293
96.67	0.007	198.9	0.024
96.68	0.007	198.8	0.0213
96.70	0.006	198.6	0.0178
96.72	0.003	198.3	0.0133
96.73	0.001	198.1	0.0098
96.75	0	197.9	0.0053
96.77	-0.003	197.5	0.0053
96.78	-0.005	197.3	0.0009
96.80	-0.005	197.3	-0.0027
96.82	-0.006	197.1	-0.0053
96.83	-0.008	196.8	-0.0089
96.85	-0.01	196.5	-0.0124
96.87	-0.011	196.3	-0.0151
96.88	-0.013	196.1	-0.0151
96.90	-0.014	195.8	-0.0178
96.92	-0.014	195.8	-0.0204
96.93	-0.015	195.6	-0.0222
96.95	-0.015	195.4	-0.024
96.97	-0.016	195.2	-0.0249
96.98	-0.017	195	-0.0266
97.00	-0.017	194.9	-0.0266
97.02	-0.017	194.7	-0.0275
97.03	-0.017	194.6	-0.0275
97.05	-0.017	194.5	-0.0275
97.07	-0.017	194.5	-0.0275
97.08	-0.016	194.5	-0.0266
97.10	-0.016	194.4	-0.0266
97.12	-0.016	194.4	-0.0249
97.13	-0.014	194.4	-0.024
97.15	-0.014	194.4	-0.0231
97.17	-0.013	194.4	-0.0213
97.18	-0.01	194.5	-0.0213
97.20	-0.01	194.5	-0.0186
97.22	-0.01	194.5	-0.0169
97.23	-0.008	194.7	-0.0142
97.25	-0.005	194.8	-0.0107
97.27	-0.004	195	-0.0089
97.28	-0.003	195.2	-0.0044
97.30	0.001	195.4	-0.0044
97.32	0.002	195.4	-0.0009
97.33	0.002	195.6	0.0018
97.35	0.003	195.8	0.0062
97.37	0.007	196	0.0107
97.38	0.008	196.2	0.0142
97.40	0.01	196.5	0.0178
97.42	0.014	196.7	0.0178
97.43	0.014	196.7	0.0222
97.45	0.014	196.9	0.0249
97.47	0.016	197.2	0.0302
97.48	0.019	197.5	0.0337
97.50	0.02	197.7	0.0364
97.52	0.021	197.9	0.0399
97.53	0.024	198.2	0.0399
97.55	0.024	198.2	0.0435
97.57	0.024	198.4	0.0453
97.58	0.025	198.6	0.0479

Prova triassiale ciclica SN04-C1			
pressione di confinamento (kPa)		80	
deviatore ciclico (kPa)		95	
frequenza (hz)		0.00625	
tempo	cella di carico	$\Delta u$	LVDT
(min)	kN	(kPa)	$\delta$ (mm)
97.60	0.027	198.8	0.0497
97.62	0.027	199	0.0506
97.63	0.028	199.2	0.0524
97.65	0.028	199.3	0.0524
97.67	0.029	199.3	0.0533
97.68	0.029	199.5	0.0541
97.70	0.029	199.6	0.0541
97.72	0.029	199.8	0.0541
97.73	0.029	199.8	0.0541
97.75	0.028	199.9	0.0541
97.77	0.028	199.9	0.0541
97.78	0.027	200	0.0524
97.80	0.026	200	0.0515
97.82	0.025	200	0.0515
97.83	0.023	199.9	0.0497
97.85	0.023	199.9	0.0479
97.87	0.022	199.9	0.0453
97.88	0.021	199.8	0.0435
97.90	0.018	199.7	0.0408
97.92	0.017	199.6	0.0382
97.93	0.015	199.4	0.0346
97.97	0.012	199.3	0.0346
97.98	0.012	199.3	0.0311
98.00	0.012	199.1	0.0275
98.02	0.009	198.8	0.0231
98.03	0.006	198.6	0.0195
98.03	0.005	198.5	0.016
98.05	0.003	198.2	0.0124
98.07	0	198	0.0124
98.08	-0.001	198	0.008
98.10	-0.001	197.8	0.0044
98.12	-0.003	197.4	0.0009
98.13	-0.006	197.2	-0.0036
98.15	-0.007	197	-0.0071
98.17	-0.008	196.7	-0.0107
98.18	-0.011	196.4	-0.0107
98.20	-0.011	196.4	-0.0133
98.22	-0.011	196.2	-0.016
98.23	-0.013	196	-0.0186
98.25	-0.015	195.7	-0.0213
98.27	-0.015	195.5	-0.0222
98.28	-0.016	195.3	-0.024
98.30	-0.017	195.1	-0.024
98.32	-0.017	195.1	-0.0249
98.33	-0.017	195	-0.0257
98.35	-0.017	194.8	-0.0266
98.37	-0.017	194.7	-0.0266
98.38	-0.017	194.6	-0.0266
98.40	-0.017	194.5	-0.0266
98.42	-0.016	194.4	-0.0266
98.43	-0.016	194.4	-0.0257
98.45	-0.015	194.4	-0.0249
98.47	-0.014	194.4	-0.0249
98.48	-0.013	194.4	-0.024
98.50	-0.013	194.4	-0.0222
98.52	-0.012	194.5	-0.0204
98.53	-0.009	194.6	-0.0178
98.55	-0.009	194.6	-0.016

Prova triassiale ciclica SN04-C1			
pressione di confinamento (kPa)		80	
deviatore ciclico (kPa)		95	
frequenza (hz)		0.00625	
tempo	cella di carico	$\Delta u$	LVDT
(min)	kN	(kPa)	$\delta$ (mm)
98.57	-0.007	194.7	-0.0124
98.58	-0.004	194.9	-0.0124
98.60	-0.003	194.9	-0.0098
98.62	-0.003	195	-0.0071
98.63	-0.002	195.2	-0.0027
98.65	0.002	195.4	0.0009
98.67	0.003	195.6	0.0036
98.68	0.004	195.8	0.008
98.70	0.008	196.1	0.008
98.72	0.009	196.3	0.0124
98.73	0.009	196.3	0.016
98.75	0.011	196.5	0.0204
98.77	0.014	196.8	0.0249
98.78	0.015	197	0.0284
98.80	0.017	197.3	0.032
98.82	0.019	197.6	0.032
98.83	0.021	197.8	0.0355
98.85	0.021	197.8	0.0382
98.87	0.022	198	0.0417
98.88	0.024	198.3	0.0444
98.90	0.025	198.5	0.047
98.92	0.026	198.7	0.0488
98.93	0.027	198.9	0.0488
98.95	0.028	199.1	0.0506
98.97	0.028	199.1	0.0515
98.98	0.028	199.2	0.0524
99.00	0.029	199.4	0.0541
99.02	0.029	199.5	0.0541
99.03	0.029	199.7	0.055
99.05	0.029	199.8	0.055
99.07	0.029	199.8	0.055
99.08	0.028	199.8	0.055
99.10	0.028	199.9	0.0541
99.12	0.027	199.9	0.0533
99.13	0.025	199.9	0.0515
99.15	0.025	199.9	0.0506
99.17	0.024	199.9	0.0479
99.18	0.023	199.9	0.047
99.20	0.022	199.8	0.0462
99.22	0.02	199.8	0.0426
99.23	0.017	199.6	0.0426
99.25	0.016	199.6	0.0399
99.27	0.016	199.6	0.0373
99.28	0.015	199.4	0.0337
99.30	0.011	199.1	0.0302
99.32	0.011	199	0.0275
99.33	0.009	198.8	0.0222
99.35	0.005	198.6	0.0222
99.37	0.004	198.6	0.0178
99.38	0.004	198.4	0.0151
99.40	0.003	198.1	0.0115
99.43	-0.001	197.9	0.0062
99.45	-0.002	197.7	0.0036
99.47	-0.004	197.4	-0.0009
99.48	-0.007	197.1	-0.0009
99.48	-0.008	197.1	-0.0053
99.50	-0.008	196.9	-0.008
99.52	-0.009	196.6	-0.0115

Prova triassiale ciclica SN04-C1			
pressione di confinamento (kPa)		80	
deviatore ciclico (kPa)		95	
frequenza (hz)		0.00625	
tempo	cella di carico	$\Delta u$	LVDT
(min)	kN	(kPa)	$\delta$ (mm)
99.53	-0.012	196.3	-0.0151
99.55	-0.012	196.1	-0.0169
99.57	-0.013	195.9	-0.0195
99.58	-0.015	195.6	-0.0195
99.60	-0.015	195.6	-0.0222
99.62	-0.015	195.4	-0.0231
99.63	-0.016	195.2	-0.024
99.65	-0.017	195	-0.0257
99.67	-0.017	194.9	-0.0266
99.68	-0.017	194.8	-0.0266
99.70	-0.017	194.7	-0.0266
99.72	-0.017	194.6	-0.0266
99.73	-0.017	194.6	-0.0266
99.75	-0.017	194.5	-0.0266
99.77	-0.016	194.4	-0.0266
99.78	-0.015	194.4	-0.0249
99.80	-0.014	194.4	-0.024
99.82	-0.014	194.5	-0.0222
99.83	-0.011	194.5	-0.0222
99.85	-0.011	194.5	-0.0204
99.87	-0.011	194.5	-0.0186
99.88	-0.008	194.7	-0.016
99.90	-0.007	194.7	-0.0151
99.92	-0.007	194.8	-0.0124
99.93	-0.005	195	-0.0089
99.95	-0.002	195.1	-0.0053
99.97	-0.001	195.3	-0.0027
99.98	0.001	195.6	0.0009
100.00	0.004	195.8	0.0009
100.02	0.005	195.8	0.0053
100.03	0.005	195.9	0.0089
100.05	0.007	196.2	0.0133
100.07	0.011	196.5	0.0178
100.08	0.012	196.6	0.0204
100.10	0.014	196.9	0.0249
100.12	0.017	197.2	0.0249
100.13	0.017	197.2	0.0293
100.15	0.017	197.4	0.0328
100.17	0.019	197.6	0.0364
100.18	0.022	197.9	0.0399
100.20	0.022	198.1	0.0417
100.22	0.024	198.3	0.0453
100.23	0.026	198.6	0.0453
100.25	0.026	198.6	0.047
100.27	0.026	198.7	0.0497
100.28	0.027	198.9	0.0506
100.30	0.028	199.1	0.0515
100.32	0.028	199.3	0.0533
100.33	0.029	199.4	0.0541
100.35	0.029	199.6	0.0541
100.37	0.029	199.6	0.0541
100.38	0.029	199.7	0.0541
100.40	0.029	199.8	0.0541
100.42	0.028	199.9	0.0541
100.43	0.028	199.9	0.0533
100.45	0.027	200	0.0524
100.47	0.025	199.9	0.0524
100.48	0.024	199.9	0.0506

Prova triassiale ciclica SN04-C1			
pressione di confinamento (kPa)		80	
deviatore ciclico (kPa)		95	
frequenza (hz)		0.00625	
tempo	cella di carico	$\Delta u$	LVDT
(min)	kN	(kPa)	$\delta$ (mm)
100.50	0.024	199.9	0.0488
100.52	0.023	199.9	0.047
100.53	0.022	199.8	0.0453
100.55	0.02	199.8	0.0426
100.57	0.019	199.7	0.0399
100.58	0.016	199.5	0.0399
100.60	0.014	199.4	0.0364
100.62	0.013	199.3	0.032
100.63	0.012	199.1	0.032
100.65	0.009	198.9	0.0293
100.67	0.009	198.9	0.0249
100.68	0.008	198.7	0.0204
100.70	0.005	198.4	0.016
100.72	0.003	198.2	0.0124
100.73	0.002	198	0.0089
100.75	-0.001	197.7	0.0089
100.77	-0.004	197.5	0.0044
100.78	-0.004	197.5	0.0009
100.80	-0.004	197.3	-0.0027
100.82	-0.007	197	-0.0071
100.83	-0.009	196.7	-0.0098
100.87	-0.01	196.5	-0.0133
100.88	-0.011	196.2	-0.0133
100.90	-0.013	196	-0.016
100.92	-0.013	196	-0.0195
100.93	-0.014	195.8	-0.0213
100.93	-0.015	195.6	-0.0231
100.95	-0.016	195.3	-0.024
100.97	-0.016	195.1	-0.0249
100.98	-0.017	195	-0.0266
101.00	-0.017	194.8	-0.0266
101.02	-0.017	194.8	-0.0266
101.03	-0.017	194.7	-0.0275
101.05	-0.017	194.6	-0.0275
101.07	-0.017	194.5	-0.0275
101.08	-0.017	194.4	-0.0275
101.10	-0.016	194.4	-0.0257
101.12	-0.015	194.4	-0.0257
101.13	-0.014	194.4	-0.0249
101.15	-0.014	194.4	-0.024
101.17	-0.013	194.4	-0.0222
101.18	-0.011	194.5	-0.0204
101.20	-0.01	194.5	-0.0186
101.22	-0.009	194.7	-0.0151
101.23	-0.006	194.8	-0.0151
101.25	-0.005	194.8	-0.0124
101.27	-0.005	194.9	-0.0098
101.28	-0.004	195	-0.0071
101.30	0	195.2	-0.0027
101.32	0.001	195.4	0
101.33	0.002	195.6	0.0036
101.35	0.006	195.9	0.008
101.37	0.007	196.1	0.0107
101.38	0.008	196.3	0.0142
101.40	0.011	196.6	0.0142
101.42	0.013	196.7	0.0186
101.43	0.013	196.7	0.0222
101.45	0.014	197	0.0257

Prova triassiale ciclica SN04-C1			
pressione di confinamento (kPa)		80	
deviatore ciclico (kPa)		95	
frequenza (hz)		0.00625	
tempo	cella di carico	$\Delta u$	LVDT
(min)	kN	(kPa)	$\delta$ (mm)
101.47	0.017	197.3	0.0302
101.48	0.019	197.5	0.0328
101.50	0.02	197.7	0.0364
101.52	0.022	198	0.0364
101.53	0.023	198.2	0.0399
101.55	0.023	198.2	0.0426
101.57	0.024	198.4	0.0453
101.58	0.026	198.7	0.0479
101.60	0.027	198.8	0.0488
101.62	0.027	199	0.0506
101.63	0.028	199.2	0.0524
101.65	0.029	199.3	0.0524
101.67	0.029	199.3	0.0533
101.68	0.029	199.5	0.0533
101.70	0.029	199.6	0.0533
101.72	0.029	199.7	0.0533
101.73	0.028	199.8	0.0533
101.75	0.028	199.9	0.0533
101.77	0.027	199.9	0.0533
101.78	0.026	199.9	0.0533
101.80	0.026	199.9	0.0515
101.82	0.026	199.9	0.0497
101.83	0.023	199.9	0.0479
101.85	0.023	199.9	0.047
101.87	0.022	199.8	0.0444
101.88	0.019	199.7	0.0444
101.90	0.018	199.7	0.0417
101.92	0.018	199.7	0.0391
101.93	0.016	199.5	0.0355
101.95	0.013	199.3	0.032
101.97	0.012	199.2	0.0293
101.98	0.011	199	0.0249
102.00	0.007	198.7	0.0249
102.02	0.006	198.7	0.0204
102.03	0.006	198.6	0.0178
102.05	0.004	198.3	0.0133
102.07	0	198.1	0.0089
102.08	0	197.9	0.0071
102.10	-0.001	197.7	0.0027
102.12	-0.004	197.4	-0.0009
102.13	-0.006	197.2	-0.0036
102.15	-0.006	196.9	-0.0071
102.17	-0.009	196.6	-0.0071
102.18	-0.011	196.4	-0.0115
102.20	-0.011	196.4	-0.0142
102.22	-0.011	196.2	-0.0169
102.23	-0.013	195.9	-0.0195
102.25	-0.014	195.7	-0.0213
102.27	-0.015	195.5	-0.0231
102.28	-0.016	195.2	-0.0231
102.30	-0.017	195.1	-0.0249
102.33	-0.017	195.1	-0.0266
102.35	-0.017	194.9	-0.0266
102.37	-0.017	194.8	-0.0275
102.38	-0.017	194.7	-0.0275
102.38	-0.017	194.5	-0.0275
102.40	-0.017	194.5	-0.0275
102.42	-0.016	194.4	-0.0275

Prova triassiale ciclica SN04-C1			
pressione di confinamento (kPa)		80	
deviatore ciclico (kPa)		95	
frequenza (hz)		0.00625	
tempo	cella di carico	$\Delta u$	LVDT
(min)	kN	(kPa)	$\delta$ (mm)
102.43	-0.016	194.4	-0.0275
102.45	-0.016	194.4	-0.0266
102.47	-0.015	194.4	-0.0249
102.48	-0.013	194.4	-0.0231
102.50	-0.012	194.4	-0.0222
102.52	-0.012	194.5	-0.0204
102.53	-0.009	194.6	-0.0204
102.55	-0.008	194.6	-0.0178
102.57	-0.008	194.6	-0.0151
102.58	-0.007	194.8	-0.0124
102.60	-0.003	194.9	-0.0089
102.62	-0.003	195.1	-0.0062
102.63	-0.001	195.3	-0.0027
102.65	0.003	195.6	-0.0027
102.67	0.004	195.6	0.0018
102.68	0.004	195.7	0.0044
102.70	0.005	195.9	0.0089
102.72	0.009	196.2	0.0133
102.73	0.01	196.4	0.016
102.75	0.012	196.6	0.0213
102.77	0.015	196.9	0.0213
102.78	0.016	196.9	0.0249
102.80	0.017	197.4	0.0311
102.82	0.019	197.6	0.0311
102.83	0.021	197.6	0.0337
102.85	0.021	197.8	0.0373
102.87	0.021	198	0.0399
102.88	0.024	198.3	0.0435
102.90	0.025	198.5	0.0453
102.92	0.025	198.7	0.0479
102.93	0.027	198.9	0.0479
102.95	0.028	199.1	0.0497
102.97	0.028	199.1	0.0506
102.98	0.028	199.2	0.0515
103.00	0.028	199.4	0.0524
103.02	0.029	199.6	0.0533
103.03	0.029	199.7	0.0533
103.05	0.029	199.8	0.0541
103.07	0.029	199.8	0.0541
103.08	0.028	199.8	0.0533
103.10	0.028	199.9	0.0533
103.12	0.027	199.9	0.0515
103.13	0.026	199.9	0.0506
103.15	0.025	199.9	0.0488
103.17	0.024	199.9	0.047
103.18	0.022	199.8	0.047
103.20	0.021	199.8	0.0453
103.22	0.021	199.8	0.0435
103.23	0.02	199.7	0.0399
103.25	0.016	199.5	0.0364
103.27	0.016	199.4	0.0346
103.28	0.014	199.2	0.0311
103.30	0.011	199	0.0311
103.32	0.01	199	0.0275
103.33	0.01	198.9	0.0231
103.35	0.008	198.6	0.0186
103.37	0.004	198.4	0.0151
103.38	0.003	198.3	0.0124

Prova triassiale ciclica SN04-C1			
pressione di confinamento (kPa)		80	
deviatore ciclico (kPa)		95	
frequenza (hz)		0.00625	
tempo	cella di carico	$\Delta u$	LVDT
(min)	kN	(kPa)	$\delta$ (mm)
103.40	0.002	197.9	0.008
103.42	-0.002	197.7	0.008
103.43	-0.003	197.7	0.0036
103.45	-0.003	197.5	0
103.47	-0.004	197.2	-0.0036
103.48	-0.008	196.9	-0.008
103.50	-0.008	196.7	-0.0107
103.52	-0.01	196.5	-0.0142
103.53	-0.011	196.2	-0.016
103.55	-0.012	196	-0.0178
103.57	-0.013	195.8	-0.0204
103.58	-0.015	195.6	-0.0204
103.60	-0.015	195.6	-0.0231
103.62	-0.015	195.4	-0.024
103.63	-0.016	195.2	-0.0257
103.65	-0.017	195	-0.0266
103.67	-0.017	194.8	-0.0275
103.68	-0.017	194.7	-0.0275
103.70	-0.017	194.6	-0.0275
103.72	-0.017	194.6	-0.0284
103.73	-0.017	194.5	-0.0284
103.75	-0.017	194.4	-0.0275
103.77	-0.016	194.4	-0.0266
103.80	-0.015	194.3	-0.0257
103.82	-0.014	194.3	-0.024
103.83	-0.013	194.4	-0.024
103.83	-0.011	194.4	-0.0231
103.85	-0.011	194.4	-0.0213
103.87	-0.011	194.4	-0.0195
103.88	-0.009	194.6	-0.0169
103.90	-0.007	194.7	-0.0142
103.92	-0.006	194.8	-0.0115
103.93	-0.004	195	-0.0115
103.95	-0.001	195.1	-0.008
103.97	-0.001	195.1	-0.0053
103.98	0	195.3	-0.0009
104.00	0.003	195.6	0.0027
104.02	0.005	195.8	0.0062
104.03	0.006	196	0.0098
104.05	0.009	196.3	0.0142
104.07	0.012	196.5	0.0142
104.08	0.013	196.5	0.0178
104.10	0.013	196.7	0.0213
104.12	0.015	197	0.0249
104.13	0.017	197.2	0.0302
104.15	0.018	197.4	0.0328
104.17	0.02	197.7	0.0364
104.18	0.023	198	0.0364
104.20	0.023	198	0.0399
104.22	0.023	198.1	0.0417
104.23	0.024	198.4	0.0444
104.25	0.027	198.6	0.0479
104.27	0.027	198.8	0.0488
104.28	0.027	199	0.0506
104.30	0.028	199.1	0.0515
104.32	0.028	199.3	0.0515
104.33	0.028	199.4	0.0524
104.35	0.029	199.6	0.0524



Prova triassiale ciclica SN04-C1			
pressione di confinamento (kPa)		80	
deviatore ciclico (kPa)		95	
frequenza (hz)		0.00625	
tempo	cella di carico	$\Delta u$	LVDT
(min)	kN	(kPa)	$\delta$ (mm)
104.37	0.029	199.6	0.0533
104.38	0.029	199.7	0.0533
104.40	0.029	199.8	0.0533
104.42	0.028	199.9	0.0533
104.43	0.028	199.9	0.0524
104.45	0.027	199.9	0.0515
104.47	0.025	199.9	0.0515
104.48	0.025	199.9	0.0497
104.50	0.025	199.9	0.0488
104.52	0.023	199.9	0.0462
104.53	0.021	199.8	0.0435
104.55	0.02	199.7	0.0417
104.57	0.019	199.7	0.0391
104.58	0.016	199.5	0.0391
104.60	0.015	199.4	0.0364
104.62	0.015	199.4	0.0337
104.63	0.013	199.2	0.0302
104.65	0.01	199	0.0249
104.67	0.009	198.8	0.0222
104.68	0.007	198.6	0.0178
104.70	0.003	198.3	0.0178
104.72	0.002	198.3	0.0133
104.73	0.002	198.2	0.0107
104.75	0.001	197.9	0.0062
104.77	-0.003	197.6	0.0018
104.78	-0.004	197.4	-0.0018
104.80	-0.005	197.1	-0.0053
104.82	-0.008	196.8	-0.0053
104.83	-0.009	196.6	-0.0089
104.85	-0.009	196.6	-0.0115
104.87	-0.01	196.4	-0.0151
104.88	-0.013	196.1	-0.0178
104.90	-0.014	195.9	-0.0204
104.92	-0.014	195.7	-0.0222
104.93	-0.015	195.4	-0.0222
104.95	-0.016	195.2	-0.024
104.97	-0.017	195	-0.0257
104.98	-0.016	194.9	-0.0257
105.00	-0.017	194.8	-0.0266
105.02	-0.017	194.8	-0.0275
105.03	-0.017	194.6	-0.0284
105.05	-0.017	194.5	-0.0284
105.07	-0.017	194.4	-0.0284
105.08	-0.017	194.4	-0.0275
105.10	-0.016	194.4	-0.0266
105.12	-0.015	194.3	-0.0266
105.13	-0.014	194.3	-0.0257
105.15	-0.014	194.3	-0.024
105.17	-0.013	194.4	-0.0222
105.18	-0.011	194.4	-0.0204
105.20	-0.01	194.5	-0.0186
105.23	-0.009	194.6	-0.016
105.25	-0.006	194.8	-0.016
105.27	-0.005	194.8	-0.0133
105.28	-0.005	194.8	-0.0107
105.30	-0.004	195	-0.0071
105.30	0	195.2	-0.0027
105.32	0.001	195.4	0

Prova triassiale ciclica SN04-C1			
pressione di confinamento (kPa)		80	
deviatore ciclico (kPa)		95	
frequenza (hz)		0.00625	
tempo	cella di carico	$\Delta u$	LVDT
(min)	kN	(kPa)	$\delta$ (mm)
105.33	0.003	195.7	0.0036
105.35	0.006	195.9	0.0036
105.37	0.007	195.9	0.008
105.38	0.007	196.1	0.0115
105.40	0.009	196.4	0.0151
105.42	0.013	196.6	0.0195
105.43	0.013	196.8	0.0231
105.45	0.015	197.1	0.0284
105.47	0.019	197.3	0.0284
105.48	0.019	197.3	0.032
105.50	0.019	197.5	0.0346
105.52	0.02	197.8	0.0382
105.53	0.023	198	0.0408
105.55	0.023	198.2	0.0435
105.57	0.025	198.5	0.0462
105.58	0.027	198.7	0.0462
105.60	0.027	198.7	0.0488
105.62	0.027	198.9	0.0497
105.63	0.027	199.1	0.0506
105.65	0.028	199.2	0.0524
105.67	0.029	199.4	0.0533
105.68	0.029	199.6	0.0541
105.70	0.029	199.7	0.0541
105.72	0.029	199.7	0.0541
105.73	0.029	199.8	0.0541
105.75	0.028	199.9	0.0541
105.77	0.027	199.9	0.0533
105.78	0.027	199.9	0.0524
105.80	0.026	199.9	0.0506
105.82	0.025	199.9	0.0488
105.83	0.024	199.9	0.0479
105.85	0.023	199.9	0.0453
105.87	0.021	199.8	0.0453
105.88	0.02	199.8	0.0435
105.90	0.02	199.7	0.0408
105.92	0.018	199.6	0.0373
105.93	0.015	199.4	0.0346
105.95	0.014	199.3	0.032
105.97	0.012	199.1	0.0284
105.98	0.009	198.9	0.0284
106.00	0.008	198.9	0.0231
106.02	0.008	198.7	0.0204
106.03	0.006	198.5	0.016
106.05	0.002	198.2	0.0124
106.07	0.002	198	0.0089
106.08	0	197.8	0.0044
106.10	-0.004	197.5	0.0044
106.12	-0.005	197.3	0
106.13	-0.005	197.3	-0.0027
106.15	-0.006	197	-0.0062
106.17	-0.008	196.7	-0.0098
106.18	-0.01	196.5	-0.0133
106.20	-0.011	196.3	-0.016
106.22	-0.013	196	-0.016
106.23	-0.014	195.8	-0.0186
106.25	-0.014	195.8	-0.0204
106.27	-0.015	195.6	-0.0231
106.28	-0.016	195.3	-0.0249

Prova triassiale ciclica SN04-C1			
pressione di confinamento (kPa)		80	
deviatore ciclico (kPa)		95	
frequenza (hz)		0.00625	
tempo	cella di carico	$\Delta u$	LVDT
(min)	kN	(kPa)	$\delta$ (mm)
106.30	-0.017	195.1	-0.0266
106.32	-0.017	195	-0.0266
106.33	-0.017	194.8	-0.0275
106.35	-0.017	194.7	-0.0275
106.37	-0.017	194.7	-0.0275
106.38	-0.017	194.6	-0.0275
106.40	-0.017	194.5	-0.0275
106.42	-0.017	194.4	-0.0275
106.43	-0.016	194.4	-0.0275
106.45	-0.016	194.3	-0.0266
106.47	-0.014	194.3	-0.0249
106.48	-0.014	194.3	-0.024
106.50	-0.013	194.4	-0.0222
106.52	-0.01	194.5	-0.0222
106.53	-0.009	194.5	-0.0195
106.55	-0.009	194.5	-0.0178
106.57	-0.008	194.6	-0.0151
106.58	-0.005	194.8	-0.0115
106.60	-0.004	194.9	-0.0089
106.62	-0.002	195.1	-0.0053
106.63	0.001	195.3	-0.0053
106.65	0.002	195.3	-0.0018
106.67	0.002	195.5	0.0018
106.70	0.004	195.8	0.0053
106.72	0.007	196	0.0098
106.73	0.008	196.2	0.0133
106.75	0.01	196.4	0.0169
106.75	0.014	196.7	0.0169
106.77	0.014	196.7	0.0213
106.78	0.014	196.9	0.0249
106.80	0.016	197.1	0.0293
106.82	0.019	197.4	0.0328
106.83	0.02	197.6	0.0355
106.85	0.021	197.9	0.0391
106.87	0.024	198.1	0.0391
106.88	0.024	198.1	0.0426
106.90	0.024	198.3	0.0444
106.92	0.025	198.6	0.047
106.93	0.027	198.8	0.0488
106.95	0.027	199	0.0497
106.97	0.028	199.1	0.0515
106.98	0.028	199.3	0.0515
107.00	0.029	199.3	0.0524
107.02	0.029	199.4	0.0533
107.03	0.029	199.6	0.0533
107.05	0.029	199.7	0.0533
107.07	0.029	199.8	0.0533
107.08	0.028	199.8	0.0524
107.10	0.027	199.8	0.0524
107.12	0.027	199.8	0.0515
107.13	0.027	199.9	0.0506
107.15	0.024	199.9	0.0488
107.17	0.024	199.9	0.0479
107.18	0.024	199.9	0.047
107.20	0.022	199.8	0.0444
107.22	0.02	199.7	0.0417
107.23	0.018	199.6	0.0399
107.25	0.017	199.6	0.0364

Prova triassiale ciclica SN04-C1			
pressione di confinamento (kPa)		80	
deviatore ciclico (kPa)		95	
frequenza (hz)		0.00625	
tempo	cella di carico	$\Delta u$	LVDT
(min)	kN	(kPa)	$\delta$ (mm)
107.27	0.014	199.3	0.0364
107.28	0.013	199.3	0.0328
107.30	0.013	199.2	0.0302
107.32	0.011	199	0.0257
107.33	0.008	198.8	0.0213
107.35	0.006	198.6	0.0186
107.37	0.005	198.4	0.0151
107.38	0.002	198.1	0.0151
107.40	0	197.9	0.0107
107.42	0	197.9	0.0071
107.43	-0.001	197.7	0.0027
107.45	-0.004	197.3	-0.0018
107.47	-0.006	197.1	-0.0053
107.48	-0.006	196.9	-0.0089
107.50	-0.009	196.6	-0.0089
107.52	-0.011	196.3	-0.0124
107.53	-0.011	196.3	-0.0151
107.55	-0.012	196.1	-0.0178
107.57	-0.013	195.9	-0.0204
107.58	-0.014	195.6	-0.0222
107.60	-0.015	195.4	-0.024
107.62	-0.016	195.1	-0.024
107.63	-0.017	195	-0.0257
107.65	-0.017	195	-0.0266
107.67	-0.017	194.9	-0.0275
107.68	-0.017	194.7	-0.0284
107.70	-0.017	194.6	-0.0284
107.72	-0.017	194.5	-0.0284
107.73	-0.017	194.4	-0.0284
107.75	-0.016	194.4	-0.0284
107.77	-0.016	194.4	-0.0275
107.78	-0.016	194.3	-0.0266
107.80	-0.015	194.3	-0.0257
107.82	-0.013	194.3	-0.024
107.83	-0.012	194.3	-0.0222
107.85	-0.011	194.4	-0.0204
107.87	-0.009	194.5	-0.0204
107.88	-0.008	194.6	-0.0169
107.90	-0.007	194.7	-0.0142
107.92	-0.005	194.8	-0.0142
107.93	-0.003	194.8	-0.0115
107.95	-0.003	194.9	-0.008
107.97	-0.002	195.2	-0.0044
107.98	0.002	195.4	0
108.00	0.003	195.6	0.0027
108.02	0.005	195.8	0.0062
108.03	0.008	196.1	0.0062
108.05	0.009	196.1	0.0107
108.07	0.009	196.2	0.0142
108.08	0.011	196.5	0.0186
108.10	0.014	196.8	0.0231
108.13	0.015	197	0.0257
108.15	0.017	197.3	0.0311
108.17	0.02	197.5	0.0311
108.18	0.021	197.5	0.0346
108.20	0.021	197.7	0.0373
108.20	0.022	198	0.0399
108.22	0.024	198.2	0.0426

Prova triassiale ciclica SN04-C1			
pressione di confinamento (kPa)		80	
deviatore ciclico (kPa)		95	
frequenza (hz)		0.00625	
tempo	cella di carico	$\Delta u$	LVDT
(min)	kN	(kPa)	$\delta$ (mm)
108.23	0.024	198.4	0.0444
108.25	0.025	198.6	0.047
108.27	0.028	198.8	0.047
108.28	0.028	198.8	0.0497
108.30	0.028	199	0.0506
108.32	0.028	199.2	0.0515
108.33	0.029	199.3	0.0524
108.35	0.029	199.5	0.0533
108.37	0.029	199.6	0.0533
108.38	0.029	199.7	0.0533
108.40	0.028	199.7	0.0533
108.42	0.028	199.8	0.0533
108.43	0.028	199.8	0.0524
108.45	0.027	199.9	0.0515
108.47	0.026	199.8	0.0497
108.48	0.025	199.9	0.0488
108.50	0.024	199.8	0.0488
108.52	0.022	199.8	0.047
108.53	0.022	199.8	0.0453
108.55	0.021	199.7	0.0417
108.57	0.018	199.6	0.0391
108.58	0.017	199.5	0.0364
108.60	0.015	199.4	0.0328
108.62	0.014	199.2	0.0311
108.63	0.012	199.1	0.0284
108.65	0.011	198.9	0.024
108.67	0.007	198.6	0.024
108.68	0.006	198.5	0.0204
108.70	0.006	198.5	0.0169
108.72	0.004	198.3	0.0124
108.73	0.001	198	0.008
108.75	-0.001	197.7	0.0044
108.77	-0.002	197.5	0.0018
108.78	-0.004	197.2	0.0018
108.80	-0.007	197	-0.0027
108.82	-0.007	197	-0.0062
108.83	-0.007	196.8	-0.0098
108.85	-0.01	196.4	-0.0133
108.87	-0.011	196.2	-0.016
108.88	-0.012	196	-0.0186
108.90	-0.014	195.7	-0.0186
108.92	-0.015	195.5	-0.0213
108.93	-0.015	195.5	-0.0231
108.95	-0.016	195.3	-0.0249
108.97	-0.016	195.1	-0.0257
108.98	-0.017	194.9	-0.0275
109.00	-0.017	194.8	-0.0275
109.02	-0.017	194.7	-0.0284
109.03	-0.017	194.5	-0.0284
109.05	-0.017	194.5	-0.0284
109.07	-0.017	194.4	-0.0284
109.08	-0.017	194.4	-0.0284
109.10	-0.016	194.3	-0.0275
109.12	-0.015	194.3	-0.0257
109.13	-0.015	194.3	-0.0249
109.15	-0.013	194.3	-0.0249
109.17	-0.012	194.3	-0.024
109.18	-0.012	194.3	-0.0222

Prova triassiale ciclica SN04-C1			
pressione di confinamento (kPa)		80	
deviatore ciclico (kPa)		95	
frequenza (hz)		0.00625	
tempo	cella di carico	$\Delta u$	LVDT
(min)	kN	(kPa)	$\delta$ (mm)
109.20	-0.011	194.4	-0.0195
109.22	-0.008	194.5	-0.0169
109.23	-0.007	194.6	-0.0151
109.25	-0.006	194.7	-0.0115
109.27	-0.003	194.9	-0.0115
109.28	-0.001	195.1	-0.008
109.30	-0.001	195.1	-0.0053
109.32	0	195.2	-0.0018
109.33	0.004	195.7	0.0027
109.35	0.004	195.7	0.0044
109.37	0.005	195.9	0.0089
109.38	0.009	196.2	0.0133
109.40	0.011	196.4	0.016
109.42	0.011	196.6	0.0195
109.43	0.015	196.9	0.0195
109.45	0.016	197.1	0.024
109.47	0.016	197.1	0.0284
109.48	0.017	197.3	0.032
109.50	0.02	197.6	0.0355
109.52	0.021	197.8	0.0382
109.53	0.022	198	0.0408
109.55	0.024	198.3	0.0408
109.57	0.026	198.5	0.0444
109.60	0.026	198.5	0.047
109.62	0.026	198.7	0.0479
109.63	0.027	198.9	0.0497
109.65	0.028	199.1	0.0506
109.65	0.028	199.2	0.0515
109.67	0.029	199.4	0.0533
109.68	0.029	199.5	0.0533
109.70	0.029	199.5	0.0533
109.72	0.029	199.6	0.0533
109.73	0.029	199.7	0.0533
109.75	0.028	199.8	0.0533
109.77	0.028	199.8	0.0524
109.78	0.027	199.9	0.0506
109.80	0.025	199.9	0.0506
109.82	0.025	199.9	0.0497
109.83	0.025	199.8	0.0488
109.85	0.023	199.8	0.0462
109.87	0.021	199.8	0.0444
109.88	0.02	199.7	0.0417
109.90	0.019	199.6	0.0391
109.92	0.016	199.4	0.0391
109.93	0.015	199.4	0.0355
109.95	0.015	199.3	0.0328
109.97	0.013	199.1	0.0293
109.98	0.01	198.9	0.0249
110.00	0.009	198.8	0.0213
110.02	0.007	198.5	0.0178
110.03	0.003	198.3	0.0178
110.05	0.002	198.3	0.0133
110.07	0.002	197.9	0.008
110.08	-0.002	197.6	0.008
110.10	-0.003	197.6	0.0036
110.12	-0.003	197.4	0.0009
110.13	-0.004	197.2	-0.0044
110.15	-0.007	196.9	-0.008

Prova triassiale ciclica SN04-C1			
pressione di confinamento (kPa)		80	
deviatore ciclico (kPa)		95	
frequenza (hz)		0.00625	
tempo	cella di carico	$\Delta u$	LVDT
(min)	kN	(kPa)	$\delta$ (mm)
110.17	-0.009	196.6	-0.0107
110.18	-0.01	196.4	-0.0142
110.20	-0.012	196.1	-0.0142
110.22	-0.013	195.9	-0.0169
110.23	-0.013	195.9	-0.0195
110.25	-0.014	195.7	-0.0213
110.27	-0.015	195.4	-0.0231
110.28	-0.016	195.2	-0.0249
110.30	-0.016	195	-0.0257
110.32	-0.017	194.9	-0.0257
110.33	-0.017	194.7	-0.0275
110.35	-0.017	194.7	-0.0275
110.37	-0.017	194.6	-0.0284
110.38	-0.017	194.5	-0.0293
110.40	-0.017	194.4	-0.0284
110.42	-0.016	194.3	-0.0275
110.43	-0.016	194.3	-0.0275
110.45	-0.015	194.3	-0.0275
110.47	-0.014	194.3	-0.0266
110.48	-0.014	194.3	-0.0249
110.50	-0.013	194.4	-0.0222
110.52	-0.011	194.4	-0.0204
110.53	-0.01	194.4	-0.0195
110.55	-0.009	194.6	-0.0169
110.57	-0.006	194.7	-0.0169
110.58	-0.005	194.7	-0.0133
110.60	-0.005	194.8	-0.0107
110.62	-0.003	195	-0.0071
110.63	0	195.2	-0.0044
110.65	0.001	195.3	-0.0009
110.67	0.003	195.6	0.0036
110.68	0.006	195.8	0.0036
110.70	0.007	195.8	0.008
110.72	0.007	196	0.0115
110.73	0.009	196.3	0.0151
110.75	0.013	196.6	0.0195
110.77	0.014	196.7	0.0222
110.78	0.015	197	0.0275
110.80	0.017	197.2	0.0293
110.82	0.018	197.4	0.0328
110.83	0.019	197.7	0.0355
110.85	0.023	197.9	0.0355
110.87	0.023	197.9	0.0391
110.88	0.023	198.1	0.0417
110.90	0.024	198.3	0.0444
110.92	0.026	198.6	0.047
110.93	0.027	198.8	0.0488
110.95	0.027	198.9	0.0506
110.97	0.028	199.1	0.0506
110.98	0.029	199.3	0.0515
111.00	0.029	199.3	0.0524
111.02	0.029	199.4	0.0524
111.05	0.029	199.6	0.0533
111.07	0.029	199.7	0.0533
111.08	0.029	199.8	0.0533
111.10	0.028	199.8	0.0533
111.10	0.027	199.8	0.0524
111.12	0.027	199.8	0.0515

Prova triassiale ciclica SN04-C1			
pressione di confinamento (kPa)		80	
deviatore ciclico (kPa)		95	
frequenza (hz)		0.00625	
tempo	cella di carico	$\Delta u$	LVDT
(min)	kN	(kPa)	$\delta$ (mm)
111.13	0.026	199.9	0.0497
111.15	0.025	199.8	0.0488
111.17	0.024	199.8	0.047
111.18	0.023	199.8	0.0453
111.20	0.022	199.7	0.0435
111.22	0.019	199.6	0.0435
111.23	0.018	199.6	0.0399
111.25	0.018	199.6	0.0382
111.27	0.016	199.3	0.0346
111.28	0.013	199.2	0.0311
111.30	0.012	199.1	0.0284
111.32	0.011	198.8	0.024
111.33	0.006	198.6	0.024
111.35	0.006	198.6	0.0195
111.37	0.006	198.5	0.0169
111.38	0.005	198.2	0.0133
111.40	0	198	0.008
111.42	0	197.8	0.0053
111.43	-0.002	197.5	0.0009
111.45	-0.006	197.2	0.0009
111.47	-0.006	197.2	-0.0036
111.48	-0.006	197	-0.0062
111.50	-0.007	196.7	-0.0098
111.52	-0.01	196.4	-0.0133
111.53	-0.01	196.3	-0.0151
111.55	-0.012	196	-0.0178
111.57	-0.013	195.8	-0.0204
111.58	-0.015	195.6	-0.0222
111.60	-0.015	195.4	-0.024
111.62	-0.016	195.1	-0.024
111.63	-0.016	195.1	-0.0257
111.65	-0.016	195	-0.0266
111.67	-0.017	194.8	-0.0275
111.68	-0.017	194.6	-0.0284
111.70	-0.017	194.5	-0.0284
111.72	-0.017	194.4	-0.0284
111.73	-0.017	194.4	-0.0284
111.75	-0.016	194.3	-0.0284
111.77	-0.016	194.3	-0.0275
111.78	-0.016	194.3	-0.0266
111.80	-0.015	194.3	-0.0249
111.82	-0.013	194.3	-0.024
111.83	-0.013	194.3	-0.0222
111.85	-0.01	194.4	-0.0222
111.87	-0.009	194.5	-0.0195
111.88	-0.009	194.5	-0.0178
111.90	-0.008	194.6	-0.0151
111.92	-0.006	194.8	-0.0115
111.93	-0.004	194.9	-0.0098
111.95	-0.002	195	-0.0062
111.97	0	195.2	-0.0062
111.98	0.003	195.5	-0.0027
112.00	0.003	195.5	0.0009
112.02	0.003	195.6	0.0044
112.03	0.006	195.9	0.0089
112.05	0.009	196.1	0.0133
112.07	0.01	196.3	0.016
112.08	0.012	196.6	0.0204



Prova triassiale ciclica SN04-C1			
pressione di confinamento (kPa)		80	
deviatore ciclico (kPa)		95	
frequenza (hz)		0.00625	
tempo	cella di carico	$\Delta u$	LVDT
(min)	kN	(kPa)	$\delta$ (mm)
112.10	0.015	196.9	0.0204
112.12	0.016	196.9	0.024
112.13	0.016	197	0.0284
112.15	0.017	197.3	0.032
112.17	0.021	197.6	0.0355
112.18	0.021	197.8	0.0373
112.20	0.023	198.1	0.0408
112.22	0.024	198.3	0.0408
112.23	0.025	198.5	0.0462
112.25	0.026	198.7	0.0479
112.27	0.027	198.8	0.0479
112.28	0.027	198.8	0.0488
112.30	0.027	199	0.0506
112.32	0.028	199.2	0.0515
112.33	0.028	199.3	0.0524
112.35	0.029	199.5	0.0533
112.37	0.029	199.6	0.0533
112.38	0.029	199.7	0.0533
112.40	0.028	199.7	0.0533
112.42	0.028	199.8	0.0533
112.43	0.028	199.8	0.0524
112.45	0.027	199.8	0.0515
112.47	0.026	199.9	0.0497
112.50	0.025	199.8	0.0479
112.52	0.024	199.8	0.0479
112.53	0.022	199.8	0.047
112.55	0.022	199.8	0.0444
112.55	0.021	199.7	0.0417
112.57	0.018	199.6	0.0391
112.58	0.017	199.5	0.0373
112.60	0.016	199.3	0.0337
112.62	0.013	199.1	0.0337
112.63	0.011	199.1	0.0302
112.65	0.011	199	0.0275
112.67	0.01	198.8	0.0222
112.68	0.006	198.6	0.0186
112.70	0.005	198.4	0.0151
112.72	0.004	198.2	0.0115
112.73	0	197.9	0.0115
112.75	-0.001	197.6	0.0071
112.77	-0.001	197.6	0.0036
112.78	-0.003	197.4	-0.0009
112.80	-0.006	197.1	-0.0044
112.82	-0.007	196.9	-0.0071
112.83	-0.008	196.7	-0.0115
112.85	-0.01	196.3	-0.0115
112.87	-0.012	196.1	-0.0151
112.88	-0.012	196.1	-0.0178
112.90	-0.013	195.9	-0.0195
112.92	-0.014	195.6	-0.0222
112.93	-0.015	195.4	-0.024
112.95	-0.016	195.2	-0.0257
112.97	-0.016	195	-0.0266
112.98	-0.017	194.8	-0.0275
113.00	-0.017	194.7	-0.0275
113.02	-0.017	194.6	-0.0284
113.03	-0.017	194.5	-0.0284
113.05	-0.017	194.5	-0.0284

Prova triassiale ciclica SN04-C1			
pressione di confinamento (kPa)		80	
deviatore ciclico (kPa)		95	
frequenza (hz)		0.00625	
tempo	cella di carico	$\Delta u$	LVDT
(min)	kN	(kPa)	$\delta$ (mm)
113.07	-0.017	194.4	-0.0284
113.08	-0.017	194.3	-0.0284
113.10	-0.016	194.3	-0.0275
113.12	-0.015	194.3	-0.0266
113.13	-0.015	194.3	-0.0249
113.15	-0.013	194.3	-0.0249
113.17	-0.012	194.3	-0.024
113.18	-0.012	194.3	-0.0222
113.20	-0.011	194.4	-0.0195
113.22	-0.008	194.5	-0.0169
113.23	-0.007	194.6	-0.0151
113.25	-0.006	194.8	-0.0115
113.27	-0.002	194.9	-0.0115
113.28	-0.002	194.9	-0.008
113.30	-0.002	195	-0.0053
113.32	0	195.3	-0.0009
113.33	0.004	195.5	0.0027
113.35	0.005	195.7	0.0062
113.37	0.006	195.9	0.0098
113.38	0.01	196.2	0.0098
113.40	0.011	196.2	0.0142
113.42	0.011	196.4	0.0178
113.43	0.012	196.7	0.0222
113.45	0.016	196.9	0.0257
113.47	0.017	197.1	0.0302
113.48	0.018	197.4	0.0337
113.50	0.021	197.7	0.0337
113.52	0.022	197.7	0.0373
113.53	0.022	197.9	0.0391
113.55	0.023	198.1	0.0417
113.57	0.025	198.3	0.0453
113.58	0.026	198.5	0.047
113.60	0.026	198.7	0.0488
113.62	0.027	198.9	0.0488
113.63	0.028	199.1	0.0506
113.65	0.028	199.1	0.0515
113.67	0.028	199.2	0.0524
113.68	0.029	199.5	0.0524
113.70	0.029	199.5	0.0533
113.72	0.029	199.6	0.0533
113.73	0.029	199.7	0.0533
113.75	0.028	199.8	0.0533
113.77	0.027	199.8	0.0524
113.78	0.027	199.8	0.0506
113.80	0.025	199.8	0.0506
113.82	0.025	199.8	0.0497
113.83	0.025	199.8	0.0479
113.85	0.023	199.8	0.0462
113.87	0.021	199.7	0.0435
113.88	0.02	199.7	0.0417
113.90	0.019	199.5	0.0382
113.92	0.015	199.4	0.0382
113.93	0.015	199.4	0.0355
113.97	0.015	199.3	0.0328
113.98	0.013	199.1	0.0293
114.00	0.01	198.9	0.0249
114.02	0.009	198.7	0.0213
114.02	0.007	198.5	0.0178

Prova triassiale ciclica SN04-C1			
pressione di confinamento (kPa)		80	
deviatore ciclico (kPa)		95	
frequenza (hz)		0.00625	
tempo	cella di carico	$\Delta u$	LVDT
(min)	kN	(kPa)	$\delta$ (mm)
114.03	0.003	198.2	0.0178
114.05	0.002	198.2	0.0133
114.07	0.002	198.1	0.0107
114.08	0.001	197.8	0.0062
114.10	-0.003	197.5	0.0018
114.12	-0.004	197.3	-0.0018
114.13	-0.005	197	-0.0053
114.15	-0.008	196.7	-0.0053
114.17	-0.009	196.7	-0.0089
114.18	-0.009	196.5	-0.0115
114.20	-0.01	196.2	-0.0151
114.22	-0.013	196	-0.0186
114.23	-0.013	195.8	-0.0204
114.25	-0.014	195.6	-0.0222
114.27	-0.016	195.3	-0.0222
114.28	-0.016	195.3	-0.0249
114.30	-0.016	195.1	-0.0257
114.32	-0.016	195	-0.0266
114.33	-0.017	194.8	-0.0275
114.35	-0.017	194.6	-0.0284
114.37	-0.017	194.5	-0.0284
114.38	-0.017	194.5	-0.0284
114.40	-0.017	194.5	-0.0284
114.42	-0.016	194.3	-0.0275
114.43	-0.016	194.2	-0.0275
114.45	-0.015	194.2	-0.0266
114.47	-0.015	194.2	-0.0257
114.48	-0.014	194.2	-0.024
114.50	-0.012	194.3	-0.0222
114.52	-0.011	194.3	-0.0213
114.53	-0.01	194.4	-0.0186
114.55	-0.008	194.5	-0.0186
114.57	-0.006	194.7	-0.016
114.58	-0.006	194.7	-0.0133
114.60	-0.005	194.7	-0.0107
114.62	-0.002	195	-0.0071
114.63	0	195.1	-0.0036
114.65	0.001	195.3	0
114.67	0.004	195.6	0
114.68	0.006	195.8	0.0044
114.70	0.006	195.8	0.008
114.72	0.007	196	0.0107
114.73	0.01	196.3	0.016
114.75	0.013	196.5	0.0195
114.77	0.013	196.7	0.0231
114.78	0.016	197	0.0275
114.80	0.018	197.2	0.0275
114.82	0.018	197.2	0.0311
114.83	0.019	197.5	0.0346
114.85	0.021	197.7	0.0382
114.87	0.023	198	0.0408
114.88	0.024	198.2	0.0435
114.90	0.025	198.4	0.0453
114.92	0.026	198.6	0.0453
114.93	0.027	198.6	0.0479
114.95	0.027	198.8	0.0488
114.97	0.027	199	0.0506
114.98	0.028	199.1	0.0515

Prova triassiale ciclica SN04-C1			
pressione di confinamento (kPa)		80	
deviatore ciclico (kPa)		95	
frequenza (hz)		0.00625	
tempo	cella di carico	$\Delta u$	LVDT
(min)	kN	(kPa)	$\delta$ (mm)
115.00	0.029	199.3	0.0524
115.02	0.029	199.4	0.0533
115.03	0.029	199.6	0.0533
115.05	0.029	199.6	0.0533
115.07	0.029	199.7	0.0533
115.08	0.029	199.8	0.0533
115.10	0.028	199.8	0.0524
115.12	0.027	199.8	0.0515
115.13	0.026	199.8	0.0497
115.15	0.024	199.8	0.0479
115.17	0.024	199.8	0.047
115.18	0.023	199.8	0.0453
115.20	0.021	199.7	0.0453
115.22	0.02	199.7	0.0426
115.23	0.02	199.6	0.0408
115.25	0.018	199.5	0.0373
115.27	0.015	199.3	0.0337
115.28	0.014	199.2	0.032
115.30	0.013	199	0.0284
115.32	0.009	198.8	0.0284
115.33	0.008	198.8	0.0231
115.35	0.008	198.6	0.0204
115.37	0.006	198.4	0.016
115.40	0.002	198.1	0.0115
115.42	0.001	198	0.0089
115.43	0	197.7	0.0044
115.45	-0.004	197.4	0.0044
115.47	-0.005	197.2	0
115.47	-0.005	197.2	-0.0027
115.48	-0.006	197	-0.0071
115.50	-0.009	196.6	-0.0107
115.52	-0.01	196.4	-0.0133
115.53	-0.011	196.2	-0.0169
115.55	-0.013	195.9	-0.0169
115.57	-0.014	195.7	-0.0195
115.58	-0.014	195.7	-0.0213
115.60	-0.015	195.5	-0.0231
115.62	-0.016	195.2	-0.0249
115.63	-0.017	195	-0.0266
115.65	-0.017	194.9	-0.0266
115.67	-0.017	194.7	-0.0275
115.68	-0.017	194.6	-0.0275
115.70	-0.017	194.6	-0.0284
115.72	-0.017	194.5	-0.0284
115.73	-0.017	194.4	-0.0284
115.75	-0.017	194.3	-0.0284
115.77	-0.016	194.3	-0.0275
115.78	-0.015	194.3	-0.0266
115.80	-0.014	194.3	-0.0266
115.82	-0.013	194.3	-0.0249
115.83	-0.013	194.3	-0.0231
115.85	-0.012	194.4	-0.0213
115.87	-0.009	194.4	-0.0186
115.88	-0.009	194.5	-0.0178
115.90	-0.008	194.6	-0.0151
115.92	-0.005	194.7	-0.0124
115.93	-0.004	194.8	-0.0098
115.95	-0.003	195	-0.0062

Prova triassiale ciclica SN04-C1			
pressione di confinamento (kPa)		80	
deviatore ciclico (kPa)		95	
frequenza (hz)		0.00625	
tempo	cella di carico	$\Delta u$	LVDT
(min)	kN	(kPa)	$\delta$ (mm)
115.97	0.001	195.2	-0.0062
115.98	0.002	195.2	-0.0027
116.00	0.002	195.4	0.0009
116.02	0.003	195.7	0.0044
116.03	0.007	195.9	0.0089
116.05	0.008	196.1	0.0124
116.07	0.01	196.3	0.0169
116.08	0.013	196.6	0.0169
116.10	0.014	196.6	0.0213
116.12	0.014	196.8	0.024
116.13	0.016	197	0.0293
116.15	0.019	197.3	0.0328
116.17	0.02	197.5	0.0355
116.18	0.021	197.8	0.0391
116.20	0.023	198	0.0391
116.22	0.024	198	0.0417
116.23	0.024	198.2	0.0444
116.25	0.025	198.4	0.0462
116.27	0.027	198.7	0.0488
116.28	0.027	198.9	0.0497
116.30	0.028	199	0.0506
116.32	0.028	199.2	0.0506
116.33	0.029	199.3	0.0524
116.35	0.029	199.3	0.0533
116.37	0.029	199.5	0.0533
116.38	0.029	199.6	0.0533
116.40	0.029	199.7	0.0533
116.42	0.028	199.8	0.0524
116.43	0.027	199.8	0.0524
116.45	0.027	199.8	0.0515
116.47	0.027	199.8	0.0506
116.48	0.026	199.8	0.0488
116.50	0.024	199.8	0.047
116.52	0.022	199.7	0.0453
116.53	0.021	199.7	0.0435
116.55	0.02	199.6	0.0408
116.57	0.017	199.4	0.0408
116.58	0.016	199.4	0.0382
116.60	0.015	199.2	0.0337
116.62	0.013	199.1	0.0337
116.63	0.012	199.1	0.0311
116.65	0.012	199	0.0257
116.67	0.01	198.7	0.0222
116.68	0.006	198.5	0.0178
116.70	0.005	198.3	0.0151
116.72	0.003	198	0.0107
116.73	0	197.8	0.0107
116.75	-0.001	197.8	0.0062
116.77	-0.001	197.6	0.0036
116.78	-0.003	197.3	-0.0009
116.80	-0.006	197	-0.0053
116.82	-0.007	196.8	-0.008
116.83	-0.008	196.5	-0.0115
116.87	-0.011	196.2	-0.0115
116.88	-0.012	196.2	-0.0151
116.90	-0.012	196	-0.0178
116.92	-0.012	195.8	-0.0195
116.92	-0.014	195.6	-0.0222

Prova triassiale ciclica SN04-C1			
pressione di confinamento (kPa)		80	
deviatore ciclico (kPa)		95	
frequenza (hz)		0.00625	
tempo	cella di carico	$\Delta u$	LVDT
(min)	kN	(kPa)	$\delta$ (mm)
116.93	-0.015	195.3	-0.024
116.95	-0.016	195.1	-0.0249
116.97	-0.017	194.9	-0.0249
116.98	-0.017	194.9	-0.0266
117.00	-0.017	194.8	-0.0275
117.02	-0.017	194.6	-0.0275
117.03	-0.017	194.5	-0.0284
117.05	-0.017	194.4	-0.0293
117.07	-0.017	194.3	-0.0284
117.08	-0.016	194.3	-0.0284
117.10	-0.015	194.2	-0.0275
117.12	-0.015	194.2	-0.0266
117.13	-0.015	194.2	-0.0257
117.15	-0.014	194.2	-0.024
117.17	-0.012	194.3	-0.0231
117.18	-0.012	194.3	-0.0204
117.20	-0.009	194.4	-0.0204
117.22	-0.008	194.5	-0.0186
117.23	-0.008	194.5	-0.016
117.25	-0.006	194.6	-0.0124
117.27	-0.004	194.8	-0.0098
117.28	-0.002	195	-0.0062
117.30	-0.001	195.1	-0.0036
117.32	0.002	195.4	0.0009
117.33	0.003	195.5	0.0027
117.35	0.004	195.7	0.0062
117.37	0.007	196	0.0107
117.38	0.01	196.2	0.0107
117.40	0.01	196.2	0.0142
117.42	0.011	196.4	0.0178
117.43	0.013	196.7	0.0222
117.45	0.016	196.9	0.0257
117.47	0.017	197.1	0.0302
117.48	0.018	197.4	0.0337
117.50	0.021	197.6	0.0337
117.52	0.022	197.6	0.0373
117.53	0.022	197.9	0.0399
117.55	0.023	198.1	0.0426
117.57	0.025	198.3	0.0453
117.58	0.026	198.5	0.0462
117.60	0.026	198.7	0.0488
117.62	0.028	198.9	0.0488
117.63	0.028	198.9	0.0506
117.65	0.028	199.1	0.0506
117.67	0.028	199.2	0.0524
117.68	0.029	199.4	0.0533
117.70	0.029	199.5	0.0533
117.72	0.029	199.6	0.0533
117.73	0.029	199.7	0.0533
117.75	0.028	199.7	0.0533
117.77	0.028	199.8	0.0524
117.78	0.027	199.8	0.0515
117.80	0.026	199.8	0.0497
117.82	0.025	199.8	0.0488
117.83	0.024	199.8	0.047
117.85	0.022	199.7	0.047
117.87	0.021	199.7	0.0444
117.88	0.021	199.7	0.0426

Prova triassiale ciclica SN04-C1			
pressione di confinamento (kPa)		80	
deviatore ciclico (kPa)		95	
frequenza (hz)		0.00625	
tempo	cella di carico	$\Delta u$	LVDT
(min)	kN	(kPa)	$\delta$ (mm)
117.90	0.02	199.6	0.0399
117.92	0.017	199.4	0.0364
117.93	0.015	199.3	0.0346
117.95	0.014	199.1	0.0311
117.97	0.011	198.9	0.0311
117.98	0.009	198.7	0.0257
118.00	0.009	198.7	0.0231
118.02	0.008	198.6	0.0195
118.03	0.005	198.3	0.0151
118.05	0.003	198.1	0.0115
118.07	0.002	198	0.0098
118.08	0	197.7	0.0053
118.10	-0.002	197.4	0.0018
118.12	-0.003	197.2	-0.0018
118.13	-0.006	196.9	-0.0018
118.15	-0.008	196.7	-0.0062
118.17	-0.008	196.7	-0.0089
118.18	-0.009	196.4	-0.0133
118.20	-0.011	196.1	-0.016
118.22	-0.012	195.9	-0.0186
118.23	-0.013	195.7	-0.0204
118.25	-0.014	195.4	-0.0204
118.27	-0.016	195.2	-0.0231
118.30	-0.016	195.2	-0.0249
118.32	-0.016	195	-0.0266
118.33	-0.017	194.9	-0.0266
118.35	-0.017	194.7	-0.0284
118.37	-0.017	194.6	-0.0284
118.37	-0.017	194.5	-0.0284
118.38	-0.017	194.4	-0.0284
118.40	-0.017	194.4	-0.0284
118.42	-0.017	194.3	-0.0284
118.43	-0.016	194.2	-0.0275
118.45	-0.015	194.2	-0.0266
118.47	-0.015	194.2	-0.0257
118.48	-0.014	194.2	-0.024
118.50	-0.011	194.3	-0.024
118.52	-0.011	194.3	-0.0222
118.53	-0.011	194.3	-0.0204
118.55	-0.01	194.4	-0.0178
118.57	-0.006	194.6	-0.0151
118.58	-0.006	194.6	-0.0124
118.60	-0.005	194.8	-0.0089
118.62	-0.001	195	-0.0089
118.63	0	195	-0.0053
118.65	0	195.1	-0.0018
118.67	0.002	195.4	0.0018
118.68	0.005	195.7	0.0062
118.70	0.006	195.8	0.0089
118.72	0.008	196	0.0133
118.73	0.012	196.3	0.0133
118.75	0.013	196.5	0.0178
118.77	0.013	196.5	0.0204
118.78	0.016	197	0.0249
118.80	0.018	197.2	0.0275
118.82	0.018	197.2	0.0311
118.83	0.019	197.4	0.0346
118.85	0.021	197.7	0.0382

Prova triassiale ciclica SN04-C1			
pressione di confinamento (kPa)		80	
deviatore ciclico (kPa)		95	
frequenza (hz)		0.00625	
tempo	cella di carico	$\Delta u$	LVDT
(min)	kN	(kPa)	$\delta$ (mm)
118.87	0.023	197.9	0.0408
118.88	0.024	198.2	0.0435
118.90	0.025	198.4	0.0435
118.92	0.026	198.6	0.0453
118.93	0.026	198.6	0.0479
118.95	0.027	198.8	0.0488
118.97	0.027	199	0.0506
118.98	0.029	199.1	0.0524
119.00	0.029	199.3	0.0524
119.02	0.029	199.4	0.0524
119.03	0.029	199.5	0.0524
119.05	0.029	199.5	0.0533
119.07	0.029	199.6	0.0533
119.08	0.028	199.7	0.0533
119.10	0.028	199.8	0.0524
119.12	0.027	199.8	0.0515
119.13	0.026	199.8	0.0497
119.15	0.024	199.8	0.0497
119.17	0.023	199.8	0.0479
119.18	0.023	199.8	0.0462
119.20	0.022	199.7	0.0444
119.22	0.02	199.6	0.0417
119.23	0.019	199.5	0.0391
119.25	0.017	199.3	0.0355
119.27	0.014	199.2	0.0355
119.28	0.013	199.2	0.0328
119.30	0.013	199.1	0.0302
119.32	0.012	198.9	0.0257
119.33	0.008	198.7	0.0213
119.35	0.007	198.5	0.0186
119.37	0.005	198.3	0.0142
119.38	0.002	198	0.0142
119.40	0.001	198	0.0098
119.42	0.001	197.8	0.0071
119.43	-0.001	197.5	0.0027
119.45	-0.004	197.2	-0.0018
119.47	-0.006	197	-0.0053
119.48	-0.007	196.8	-0.0089
119.50	-0.009	196.5	-0.0124
119.52	-0.01	196.3	-0.0142
119.53	-0.011	196.1	-0.0169
119.55	-0.013	195.8	-0.0169
119.57	-0.014	195.6	-0.0195
119.58	-0.014	195.6	-0.0213
119.60	-0.015	195.4	-0.0231
119.62	-0.016	195.1	-0.0257
119.63	-0.016	194.9	-0.0266
119.65	-0.017	194.8	-0.0275
119.67	-0.017	194.6	-0.0275
119.68	-0.017	194.5	-0.0284
119.70	-0.017	194.5	-0.0284
119.72	-0.017	194.4	-0.0284
119.73	-0.017	194.3	-0.0284
119.77	-0.016	194.2	-0.0275
119.78	-0.016	194.2	-0.0266
119.80	-0.015	194.2	-0.0257
119.82	-0.014	194.2	-0.0257
119.82	-0.014	194.2	-0.0249



Prova triassiale ciclica SN04-C1			
pressione di confinamento (kPa)		80	
deviatore ciclico (kPa)		95	
frequenza (hz)		0.00625	
tempo	cella di carico	$\Delta u$	LVDT
(min)	kN	(kPa)	$\delta$ (mm)
119.83	-0.013	194.2	-0.0222
119.85	-0.011	194.3	-0.0213
119.87	-0.01	194.4	-0.0195
119.88	-0.009	194.4	-0.0169
119.90	-0.007	194.6	-0.0142
119.92	-0.005	194.7	-0.0142
119.93	-0.003	194.7	-0.0107
119.95	-0.003	194.8	-0.008
119.97	-0.002	195	-0.0044
119.98	0.002	195.2	-0.0009
120.00	0.003	195.4	0.0027
120.02	0.004	195.7	0.0062
120.03	0.008	195.9	0.0062
120.05	0.009	195.9	0.0107
120.07	0.009	196.1	0.0142
120.08	0.011	196.4	0.0186
120.10	0.014	196.7	0.0231
120.12	0.015	196.9	0.0257
120.13	0.017	197.2	0.0302
120.15	0.02	197.4	0.0302
120.17	0.021	197.4	0.0346
120.18	0.021	197.6	0.0373
120.20	0.022	197.9	0.0399
120.22	0.024	198.1	0.0426
120.23	0.025	198.3	0.0453
120.25	0.025	198.5	0.0462
120.27	0.027	198.7	0.0488
120.28	0.027	198.8	0.0497
120.30	0.028	199	0.0515
120.32	0.029	199.2	0.0515
120.33	0.029	199.2	0.0524
120.35	0.029	199.3	0.0524
120.37	0.029	199.4	0.0533
120.38	0.029	199.6	0.0533
120.40	0.029	199.7	0.0533
120.42	0.028	199.8	0.0524
120.43	0.027	199.8	0.0524
120.45	0.026	199.8	0.0515
120.47	0.026	199.8	0.0506
120.48	0.026	199.8	0.0488
120.50	0.024	199.8	0.047
120.52	0.023	199.7	0.0453
120.53	0.022	199.7	0.0426
120.55	0.019	199.5	0.0426
120.57	0.017	199.4	0.0408
120.58	0.017	199.4	0.0382
120.60	0.016	199.3	0.0355
120.62	0.014	199.1	0.032
120.63	0.011	199	0.0284
120.65	0.011	198.8	0.024
120.67	0.008	198.5	0.024
120.68	0.005	198.4	0.0195
120.70	0.005	198.4	0.016
120.72	0.004	198.2	0.0124
120.73	0.002	197.9	0.0089
120.75	-0.001	197.7	0.0044
120.77	-0.002	197.5	0.0009
120.78	-0.004	197.2	-0.0027

Prova triassiale ciclica SN04-C1			
pressione di confinamento (kPa)		80	
deviatore ciclico (kPa)		95	
frequenza (hz)		0.00625	
tempo	cella di carico	$\Delta u$	LVDT
(min)	kN	(kPa)	$\delta$ (mm)
120.80	-0.007	196.9	-0.0027
120.82	-0.007	196.9	-0.0071
120.83	-0.007	196.7	-0.0098
120.85	-0.009	196.3	-0.0133
120.87	-0.011	196.1	-0.016
120.88	-0.012	195.9	-0.0186
120.90	-0.013	195.7	-0.0204
120.92	-0.015	195.4	-0.0204
120.93	-0.015	195.4	-0.0231
120.95	-0.016	195	-0.0249
120.97	-0.016	194.9	-0.0249
120.98	-0.017	194.9	-0.0257
121.00	-0.017	194.7	-0.0275
121.02	-0.017	194.6	-0.0284
121.03	-0.017	194.4	-0.0284
121.05	-0.017	194.3	-0.0284
121.07	-0.017	194.3	-0.0284
121.08	-0.016	194.2	-0.0284
121.10	-0.016	194.2	-0.0275
121.12	-0.016	194.2	-0.0266
121.13	-0.015	194.2	-0.0257
121.15	-0.013	194.2	-0.024
121.17	-0.012	194.2	-0.0231
121.18	-0.012	194.3	-0.0204
121.20	-0.009	194.4	-0.0204
121.23	-0.008	194.4	-0.0186
121.25	-0.008	194.5	-0.016
121.27	-0.007	194.6	-0.0133
121.27	-0.004	194.7	-0.0098
121.28	-0.002	194.9	-0.0071
121.30	-0.001	195	-0.0036
121.32	0.002	195.3	-0.0036
121.33	0.004	195.5	0.0009
121.35	0.004	195.5	0.0036
121.37	0.005	195.7	0.008
121.38	0.009	196	0.0124
121.40	0.01	196.2	0.0151
121.42	0.012	196.4	0.0195
121.43	0.015	196.7	0.0195
121.45	0.016	197	0.024
121.47	0.016	197	0.0284
121.48	0.018	197.2	0.032
121.50	0.02	197.5	0.0355
121.52	0.021	197.7	0.0373
121.53	0.022	197.9	0.0408
121.55	0.024	198.2	0.0408
121.57	0.025	198.4	0.0435
121.58	0.025	198.4	0.0453
121.60	0.026	198.6	0.0479
121.62	0.027	198.8	0.0497
121.63	0.028	198.9	0.0506
121.65	0.028	199.1	0.0506
121.67	0.028	199.2	0.0506
121.68	0.029	199.4	0.0524
121.70	0.029	199.5	0.0524
121.72	0.029	199.6	0.0533
121.73	0.029	199.7	0.0533
121.75	0.028	199.7	0.0524

Prova triassiale ciclica SN04-C1			
pressione di confinamento (kPa)		80	
deviatore ciclico (kPa)		95	
frequenza (hz)		0.00625	
tempo	cella di carico	$\Delta u$	LVDT
(min)	kN	(kPa)	$\delta$ (mm)
121.77	0.028	199.7	0.0515
121.78	0.027	199.8	0.0515
121.80	0.026	199.8	0.0497
121.82	0.025	199.8	0.0488
121.83	0.024	199.7	0.0462
121.85	0.022	199.7	0.0462
121.87	0.021	199.7	0.0444
121.88	0.021	199.6	0.0426
121.90	0.02	199.5	0.0391
121.92	0.016	199.3	0.0355
121.93	0.016	199.2	0.0337
121.95	0.014	199	0.0302
121.97	0.01	198.9	0.0302
121.98	0.009	198.9	0.0249
122.00	0.009	198.7	0.0222
122.02	0.008	198.5	0.0186
122.03	0.005	198.3	0.0142
122.05	0.003	198.1	0.0115
122.07	0.002	197.8	0.0071
122.08	-0.002	197.5	0.0071
122.10	-0.003	197.5	0.0018
122.12	-0.003	197.3	-0.0009
122.13	-0.005	197	-0.0053
122.15	-0.007	196.8	-0.0089
122.17	-0.008	196.5	-0.0115
122.18	-0.01	196.2	-0.0142
122.20	-0.012	196	-0.0142
122.22	-0.013	196	-0.0178
122.23	-0.013	195.8	-0.0204
122.25	-0.014	195.6	-0.0231
122.27	-0.015	195.3	-0.0249
122.28	-0.016	195.1	-0.0257
122.30	-0.016	194.9	-0.0275
122.32	-0.017	194.7	-0.0275
122.33	-0.017	194.7	-0.0284
122.35	-0.017	194.6	-0.0293
122.37	-0.017	194.5	-0.0293
122.38	-0.017	194.4	-0.0293
122.40	-0.017	194.3	-0.0293
122.42	-0.017	194.2	-0.0293
122.43	-0.016	194.1	-0.0284
122.45	-0.015	194.1	-0.0275
122.47	-0.015	194.1	-0.0257
122.48	-0.013	194.2	-0.0257
122.50	-0.012	194.2	-0.024
122.52	-0.012	194.2	-0.0231
122.53	-0.011	194.2	-0.0204
122.55	-0.009	194.4	-0.0186
122.57	-0.007	194.5	-0.016
122.58	-0.006	194.6	-0.0133
122.60	-0.003	194.8	-0.0133
122.62	-0.001	194.9	-0.0098
122.63	-0.001	194.9	-0.0062
122.67	0	195	-0.0027
122.68	0.003	195.4	0.0018
122.70	0.005	195.6	0.0044
122.72	0.006	195.8	0.0089
122.73	0.009	196.1	0.0089

Prova triassiale ciclica SN04-C1			
pressione di confinamento (kPa)		80	
deviatore ciclico (kPa)		95	
frequenza (hz)		0.00625	
tempo	cella di carico	$\Delta u$	LVDT
(min)	kN	(kPa)	$\delta$ (mm)
122.73	0.011	196.3	0.0133
122.75	0.011	196.3	0.016
122.77	0.013	196.5	0.0213
122.78	0.015	196.8	0.0249
122.80	0.017	197	0.0293
122.82	0.018	197.2	0.032
122.83	0.02	197.5	0.0355
122.85	0.022	197.8	0.0355
122.87	0.023	197.8	0.0382
122.88	0.023	197.9	0.0408
122.90	0.024	198.2	0.0435
122.92	0.026	198.4	0.0453
122.93	0.026	198.6	0.047
122.95	0.027	198.8	0.0488
122.97	0.028	198.9	0.0488
122.98	0.029	198.9	0.0506
123.00	0.029	199.1	0.0515
123.02	0.029	199.2	0.0515
123.03	0.028	199.4	0.0515
123.05	0.029	199.5	0.0515
123.07	0.028	199.6	0.0515
123.08	0.028	199.7	0.0515
123.10	0.027	199.7	0.0515
123.12	0.027	199.7	0.0506
123.13	0.025	199.7	0.0488
123.15	0.025	199.7	0.0479
123.17	0.025	199.7	0.047
123.18	0.024	199.7	0.0444
123.20	0.021	199.6	0.0426
123.22	0.02	199.5	0.0399
123.23	0.019	199.4	0.0373
123.25	0.015	199.2	0.0373
123.27	0.015	199.2	0.0337
123.28	0.015	199.1	0.032
123.30	0.013	199	0.0284
123.32	0.01	198.8	0.0231
123.33	0.009	198.6	0.0204
123.35	0.007	198.4	0.016
123.37	0.003	198.1	0.016
123.38	0.002	198.1	0.0115
123.40	0.002	197.9	0.0089
123.42	0.001	197.7	0.0053
123.43	-0.002	197.4	0.0009
123.45	-0.004	197.2	-0.0027
123.47	-0.005	196.9	-0.0071
123.48	-0.008	196.6	-0.0071
123.50	-0.009	196.4	-0.0107
123.52	-0.009	196.4	-0.0133
123.53	-0.01	196.2	-0.0169
123.55	-0.012	195.8	-0.0204
123.57	-0.014	195.6	-0.0213
123.58	-0.014	195.4	-0.024
123.60	-0.015	195.1	-0.024
123.62	-0.016	194.9	-0.0257
123.63	-0.016	194.9	-0.0266
123.65	-0.017	194.8	-0.0275
123.67	-0.017	194.6	-0.0284
123.68	-0.017	194.5	-0.0293

Prova triassiale ciclica SN04-C1			
pressione di confinamento (kPa)		80	
deviatore ciclico (kPa)		95	
frequenza (hz)		0.00625	
tempo	cella di carico	$\Delta u$	LVDT
(min)	kN	(kPa)	$\delta$ (mm)
123.70	-0.017	194.4	-0.0293
123.72	-0.017	194.3	-0.0293
123.73	-0.017	194.2	-0.0293
123.75	-0.017	194.2	-0.0293
123.77	-0.016	194.1	-0.0284
123.78	-0.015	194.1	-0.0275
123.80	-0.014	194.1	-0.0257
123.82	-0.014	194.1	-0.0249
123.83	-0.012	194.2	-0.0231
123.85	-0.01	194.3	-0.0231
123.87	-0.009	194.3	-0.0195
123.88	-0.009	194.4	-0.0178
123.90	-0.006	194.5	-0.0178
123.92	-0.005	194.5	-0.0151
123.93	-0.005	194.6	-0.0115
123.95	-0.003	194.8	-0.008
123.97	0	195	-0.0044
123.98	0.001	195.1	-0.0018
124.00	0.002	195.4	0.0027
124.02	0.006	195.7	0.0027
124.03	0.007	195.7	0.0062
124.05	0.007	195.8	0.0098
124.07	0.009	196.1	0.0142
124.08	0.013	196.4	0.0186
124.10	0.013	196.5	0.0213
124.13	0.015	196.8	0.0257
124.15	0.019	197.1	0.0257
124.17	0.019	197.1	0.0311
124.18	0.019	197.3	0.0337
124.18	0.02	197.5	0.0364
124.20	0.023	197.8	0.0399
124.22	0.024	198	0.0417
124.23	0.025	198.2	0.0453
124.25	0.027	198.5	0.0453
124.27	0.027	198.5	0.047
124.28	0.027	198.6	0.0479
124.30	0.027	198.8	0.0497
124.32	0.028	199	0.0515
124.33	0.029	199.1	0.0524
124.35	0.029	199.2	0.0515
124.37	0.029	199.3	0.0515
124.38	0.028	199.4	0.0524
124.40	0.028	199.4	0.0524
124.42	0.028	199.6	0.0524
124.43	0.028	199.6	0.0515
124.45	0.027	199.7	0.0506
124.47	0.026	199.7	0.0488
124.48	0.025	199.6	0.0488
124.50	0.023	199.6	0.047
124.52	0.023	199.6	0.0453
124.53	0.022	199.6	0.0435
124.55	0.02	199.4	0.0408
124.57	0.018	199.3	0.0382
124.58	0.017	199.2	0.0346
124.60	0.016	199.1	0.0337
124.62	0.014	199	0.0311
124.63	0.012	198.8	0.0257
124.65	0.01	198.6	0.0222

Prova triassiale ciclica SN04-C1			
pressione di confinamento (kPa)		80	
deviatore ciclico (kPa)		95	
frequenza (hz)		0.00625	
tempo	cella di carico	$\Delta u$	LVDT
(min)	kN	(kPa)	$\delta$ (mm)
124.67	0.007	198.4	0.0222
124.68	0.007	198.4	0.0186
124.70	0.006	198.2	0.0151
124.72	0.004	197.9	0.0115
124.73	0.001	197.7	0.0071
124.75	0	197.5	0.0036
124.77	-0.002	197.2	-0.0009
124.78	-0.005	197	-0.0009
124.80	-0.006	197	-0.0044
124.82	-0.006	196.7	-0.0071
124.83	-0.007	196.5	-0.0107
124.85	-0.01	196.2	-0.0142
124.87	-0.011	196	-0.0169
124.88	-0.012	195.7	-0.0195
124.90	-0.014	195.4	-0.0195
124.92	-0.015	195.4	-0.0222
124.93	-0.015	195.2	-0.024
124.95	-0.015	195	-0.0257
124.97	-0.016	194.8	-0.0266
124.98	-0.017	194.7	-0.0275
125.00	-0.017	194.5	-0.0293
125.02	-0.017	194.4	-0.0293
125.03	-0.017	194.4	-0.0293
125.05	-0.017	194.3	-0.0293
125.07	-0.017	194.2	-0.0293
125.08	-0.017	194.1	-0.0293
125.10	-0.016	194.1	-0.0284
125.12	-0.015	194	-0.0266
125.13	-0.014	194.1	-0.0266
125.15	-0.013	194.1	-0.0257
125.17	-0.013	194.1	-0.0249
125.18	-0.012	194.1	-0.0222
125.20	-0.01	194.2	-0.0204
125.22	-0.008	194.3	-0.0178
125.23	-0.007	194.4	-0.0151
125.25	-0.005	194.6	-0.0151
125.27	-0.003	194.7	-0.0124
125.28	-0.003	194.7	-0.0089
125.30	-0.002	194.8	-0.0053
125.32	0.002	195.2	-0.0018
125.33	0.002	195.2	0
125.35	0.004	195.4	0.0044
125.37	0.007	195.7	0.008
125.38	0.009	195.9	0.0115
125.40	0.01	196.1	0.016
125.42	0.013	196.4	0.016
125.43	0.015	196.6	0.0195
125.45	0.015	196.6	0.0231
125.47	0.016	196.8	0.0275
125.48	0.018	197.1	0.032
125.50	0.02	197.4	0.0346
125.52	0.021	197.6	0.0382
125.53	0.023	197.9	0.0382
125.57	0.025	198.1	0.0408
125.58	0.025	198.1	0.0435
125.60	0.025	198.3	0.0453
125.62	0.026	198.5	0.0479
125.63	0.027	198.7	0.0488

Prova triassiale ciclica SN04-C1			
pressione di confinamento (kPa)		80	
deviatore ciclico (kPa)		95	
frequenza (hz)		0.00625	
tempo	cella di carico	$\Delta u$	LVDT
(min)	kN	(kPa)	$\delta$ (mm)
125.63	0.028	198.8	0.0497
125.65	0.028	199	0.0506
125.67	0.029	199.1	0.0506
125.68	0.029	199.1	0.0515
125.70	0.029	199.3	0.0524
125.72	0.029	199.4	0.0524
125.73	0.029	199.5	0.0524
125.75	0.028	199.6	0.0515
125.77	0.028	199.6	0.0506
125.78	0.026	199.6	0.0506
125.80	0.025	199.6	0.0497
125.82	0.025	199.6	0.0479
125.83	0.025	199.6	0.0462
125.85	0.023	199.6	0.0444
125.87	0.021	199.5	0.0426
125.88	0.021	199.4	0.0399
125.90	0.018	199.3	0.0399
125.92	0.016	199.3	0.0373
125.93	0.016	199.2	0.0346
125.95	0.015	199	0.0311
125.97	0.012	198.8	0.0275
125.98	0.01	198.7	0.024
126.00	0.009	198.5	0.0195
126.02	0.005	198.2	0.0195
126.03	0.004	198	0.0124
126.05	0.003	197.9	0.0098
126.07	0.001	197.6	0.0098
126.08	-0.002	197.4	0.0062
126.10	-0.002	197.4	0.0027
126.12	-0.003	197.2	-0.0018
126.13	-0.005	196.8	-0.0053
126.15	-0.007	196.6	-0.0089
126.17	-0.008	196.4	-0.0124
126.18	-0.01	196.1	-0.0124
126.20	-0.012	195.8	-0.016
126.22	-0.012	195.8	-0.0186
126.23	-0.012	195.6	-0.0204
126.25	-0.014	195.3	-0.0231
126.27	-0.015	195.1	-0.0249
126.28	-0.016	194.9	-0.0266
126.30	-0.016	194.7	-0.0275
126.32	-0.017	194.6	-0.0275
126.33	-0.017	194.6	-0.0284
126.35	-0.017	194.4	-0.0293
126.37	-0.017	194.3	-0.0293
126.38	-0.017	194.2	-0.0302
126.40	-0.017	194.1	-0.0302
126.42	-0.017	194.1	-0.0284
126.43	-0.015	194.1	-0.0284
126.45	-0.015	194.1	-0.0275
126.47	-0.015	194	-0.0266
126.48	-0.014	194	-0.0257
126.50	-0.012	194.1	-0.024
126.52	-0.011	194.1	-0.0222
126.53	-0.011	194.2	-0.0204
126.55	-0.007	194.3	-0.0204
126.57	-0.007	194.3	-0.0169
126.58	-0.007	194.4	-0.0151

Prova triassiale ciclica SN04-C1			
pressione di confinamento (kPa)		80	
deviatore ciclico (kPa)		95	
frequenza (hz)		0.00625	
tempo	cella di carico	$\Delta u$	LVDT
(min)	kN	(kPa)	$\delta$ (mm)
126.60	-0.005	194.5	-0.0115
126.62	-0.001	194.7	-0.0071
126.63	-0.001	194.8	-0.0044
126.65	0.001	195.1	-0.0009
126.67	0.005	195.3	-0.0009
126.68	0.005	195.3	0.0027
126.70	0.005	195.5	0.0062
126.72	0.007	195.8	0.0107
126.73	0.011	196	0.0151
126.75	0.012	196.2	0.0178
126.77	0.013	196.5	0.0222
126.78	0.015	196.7	0.024
126.80	0.017	196.9	0.0284
126.82	0.018	197.1	0.032
126.83	0.021	197.4	0.032
126.85	0.022	197.6	0.0355
126.87	0.022	197.6	0.0382
126.88	0.023	197.8	0.0408
126.90	0.025	198.1	0.0435
126.92	0.026	198.3	0.0453
126.93	0.026	198.5	0.047
126.95	0.027	198.7	0.047
126.97	0.028	198.9	0.0488
126.98	0.028	198.9	0.0506
127.00	0.029	199	0.0506
127.03	0.029	199.1	0.0515
127.05	0.029	199.2	0.0515
127.07	0.029	199.3	0.0515
127.08	0.029	199.4	0.0515
127.08	0.028	199.5	0.0515
127.10	0.028	199.5	0.0515
127.12	0.027	199.6	0.0506
127.13	0.026	199.6	0.0488
127.15	0.025	199.6	0.0479
127.17	0.024	199.6	0.0453
127.18	0.022	199.4	0.0453
127.20	0.021	199.4	0.0435
127.22	0.021	199.4	0.0408
127.23	0.02	199.3	0.0391
127.25	0.017	199.1	0.0355
127.27	0.015	199	0.0328
127.28	0.014	198.9	0.0293
127.30	0.011	198.7	0.0293
127.32	0.009	198.5	0.0249
127.33	0.009	198.5	0.0222
127.35	0.008	198.3	0.0186
127.37	0.005	198.1	0.0142
127.38	0.003	197.9	0.0098
127.40	0.002	197.7	0.0062
127.42	-0.001	197.3	0.0062
127.43	-0.004	197.1	0.0027
127.45	-0.004	197.1	-0.0018
127.47	-0.004	196.9	-0.0044
127.48	-0.008	196.4	-0.0089
127.50	-0.008	196.4	-0.0107
127.52	-0.009	196.2	-0.0142
127.53	-0.011	195.9	-0.0169
127.55	-0.013	195.6	-0.0195



Prova triassiale ciclica SN04-C1			
pressione di confinamento (kPa)		80	
deviatore ciclico (kPa)		95	
frequenza (hz)		0.00625	
tempo	cella di carico	$\Delta u$	LVDT
(min)	kN	(kPa)	$\delta$ (mm)
127.57	-0.013	195.4	-0.0213
127.58	-0.014	195.2	-0.024
127.60	-0.016	194.9	-0.024
127.62	-0.016	194.9	-0.0257
127.63	-0.016	194.8	-0.0266
127.65	-0.017	194.6	-0.0284
127.67	-0.017	194.4	-0.0293
127.68	-0.017	194.3	-0.0293
127.70	-0.017	194.2	-0.0293
127.72	-0.017	194.1	-0.0293
127.73	-0.017	194.1	-0.0293
127.75	-0.017	194	-0.0293
127.77	-0.016	194	-0.0284
127.78	-0.015	193.9	-0.0275
127.80	-0.015	193.9	-0.0266
127.82	-0.014	194	-0.0249
127.83	-0.012	194	-0.0249
127.85	-0.011	194	-0.0231
127.87	-0.011	194.1	-0.0213
127.88	-0.01	194.1	-0.0186
127.90	-0.007	194.3	-0.016
127.92	-0.006	194.4	-0.0133
127.93	-0.004	194.5	-0.0098
127.95	-0.001	194.7	-0.0098
127.97	0	194.9	-0.0062
127.98	0	194.9	-0.0036
128.00	0.002	195	0
128.02	0.005	195.4	0.0044
128.03	0.007	195.6	0.008
128.05	0.008	195.8	0.0124
128.07	0.012	196.1	0.0124
128.08	0.013	196.3	0.0169
128.10	0.013	196.3	0.0195
128.12	0.014	196.5	0.024
128.13	0.017	196.8	0.0284
128.15	0.018	197	0.0311
128.17	0.02	197.2	0.0355
128.18	0.022	197.6	0.0355
128.20	0.024	197.8	0.0382
128.22	0.024	198	0.0426
128.23	0.025	198.1	0.0426
128.25	0.026	198.4	0.0444
128.27	0.026	198.4	0.047
128.28	0.027	198.5	0.0488
128.30	0.028	198.7	0.0506
128.32	0.028	198.9	0.0506
128.33	0.029	199	0.0515
128.35	0.029	199.2	0.0515
128.37	0.029	199.3	0.0515
128.38	0.029	199.3	0.0524
128.40	0.029	199.4	0.0524
128.42	0.028	199.4	0.0524
128.43	0.028	199.5	0.0515
128.47	0.027	199.6	0.0497
128.48	0.026	199.5	0.0488
128.50	0.024	199.5	0.0488
128.52	0.024	199.5	0.047
128.53	0.024	199.5	0.0453

Prova triassiale ciclica SN04-C1			
pressione di confinamento (kPa)		80	
deviatore ciclico (kPa)		95	
frequenza (hz)		0.00625	
tempo	cella di carico	$\Delta u$	LVDT
(min)	kN	(kPa)	$\delta$ (mm)
128.53	0.022	199.4	0.0435
128.55	0.02	199.3	0.0408
128.57	0.019	199.2	0.0391
128.58	0.017	199.1	0.0355
128.60	0.014	198.9	0.0355
128.62	0.013	198.9	0.032
128.63	0.013	198.8	0.0293
128.65	0.011	198.6	0.0249
128.67	0.008	198.4	0.0204
128.68	0.007	198.2	0.0178
128.70	0.005	198	0.0133
128.72	0.002	197.7	0.0133
128.73	0	197.7	0.0089
128.75	0	197.5	0.0053
128.77	-0.001	197.2	0.0018
128.78	-0.004	197	-0.0018
128.80	-0.005	196.8	-0.0053
128.82	-0.007	196.5	-0.0089
128.83	-0.01	196.2	-0.0089
128.85	-0.01	196.2	-0.0133
128.87	-0.01	196	-0.016
128.88	-0.011	195.7	-0.0186
128.90	-0.014	195.4	-0.0213
128.92	-0.014	195.2	-0.0222
128.93	-0.015	195	-0.0249
128.95	-0.016	194.8	-0.0266
128.97	-0.017	194.6	-0.0275
128.98	-0.017	194.5	-0.0275
129.00	-0.017	194.4	-0.0275
129.02	-0.017	194.4	-0.0284
129.03	-0.017	194.2	-0.0293
129.05	-0.017	194.1	-0.0293
129.07	-0.017	194	-0.0293
129.08	-0.016	193.9	-0.0293
129.10	-0.016	193.9	-0.0284
129.12	-0.015	193.9	-0.0284
129.13	-0.014	193.9	-0.0266
129.15	-0.014	193.9	-0.0257
129.17	-0.013	193.9	-0.024
129.18	-0.011	194	-0.0222
129.20	-0.01	194.1	-0.0204
129.22	-0.009	194.1	-0.0178
129.23	-0.006	194.3	-0.0178
129.25	-0.005	194.4	-0.0151
129.27	-0.005	194.4	-0.0124
129.28	-0.003	194.5	-0.0089
129.30	-0.001	194.8	-0.0044
129.32	0.001	194.9	-0.0018
129.33	0.002	195.1	0.0018
129.35	0.006	195.4	0.0018
129.37	0.008	195.6	0.0062
129.38	0.008	195.6	0.0098
129.40	0.009	195.8	0.0142
129.42	0.012	196.1	0.0186
129.43	0.014	196.4	0.0213
129.45	0.015	196.6	0.0249
129.47	0.017	196.9	0.0249
129.48	0.02	197.1	0.0302

Prova triassiale ciclica SN04-C1			
pressione di confinamento (kPa)		80	
deviatore ciclico (kPa)		95	
frequenza (hz)		0.00625	
tempo	cella di carico	$\Delta u$	LVDT
(min)	kN	(kPa)	$\delta$ (mm)
129.50	0.02	197.1	0.0337
129.52	0.02	197.3	0.0364
129.53	0.022	197.6	0.0391
129.55	0.024	197.8	0.0417
129.57	0.025	198	0.0444
129.58	0.026	198.3	0.0444
129.60	0.027	198.5	0.047
129.62	0.027	198.5	0.0479
129.63	0.027	198.6	0.0488
129.65	0.028	198.8	0.0506
129.67	0.029	198.9	0.0515
129.68	0.029	199.1	0.0515
129.70	0.029	199.2	0.0524
129.72	0.029	199.3	0.0524
129.73	0.029	199.4	0.0524
129.75	0.028	199.4	0.0515
129.77	0.027	199.5	0.0515
129.78	0.026	199.5	0.0506
129.80	0.026	199.5	0.0497
129.82	0.026	199.5	0.0479
129.83	0.024	199.5	0.0462
129.85	0.023	199.4	0.0444
129.87	0.022	199.3	0.0417
129.88	0.019	199.2	0.0417
129.90	0.018	199.2	0.0391
129.93	0.018	199.1	0.0364
129.95	0.017	199	0.0337
129.97	0.013	198.8	0.0302
129.98	0.012	198.7	0.0275
129.98	0.01	198.4	0.0222
130.00	0.007	198.3	0.0222
130.02	0.006	198.3	0.0186
130.03	0.006	198.1	0.016
130.05	0.004	197.8	0.0115
130.07	0.001	197.6	0.0071
130.08	0	197.4	0.0036
130.10	-0.002	197.1	-0.0009
130.12	-0.005	196.8	-0.0009
130.13	-0.006	196.8	-0.0044
130.15	-0.006	196.6	-0.0071
130.17	-0.007	196.3	-0.0107
130.18	-0.01	196.1	-0.0151
130.20	-0.011	195.8	-0.0169
130.22	-0.012	195.6	-0.0195
130.23	-0.014	195.3	-0.0195
130.25	-0.015	195.3	-0.0222
130.27	-0.015	195.1	-0.024
130.28	-0.015	194.9	-0.0249
130.30	-0.016	194.7	-0.0266
130.32	-0.017	194.5	-0.0275
130.33	-0.017	194.4	-0.0293
130.35	-0.017	194.3	-0.0293
130.37	-0.017	194.2	-0.0293
130.38	-0.017	194.2	-0.0293
130.40	-0.017	194	-0.0293
130.42	-0.016	193.9	-0.0293
130.43	-0.016	193.9	-0.0284
130.45	-0.016	193.9	-0.0275

Prova triassiale ciclica SN04-C1			
pressione di confinamento (kPa)		80	
deviatore ciclico (kPa)		95	
frequenza (hz)		0.00625	
tempo	cella di carico	$\Delta u$	LVDT
(min)	kN	(kPa)	$\delta$ (mm)
130.47	-0.015	193.9	-0.0257
130.48	-0.013	193.9	-0.0249
130.50	-0.013	193.9	-0.024
130.52	-0.011	194	-0.024
130.53	-0.009	194.1	-0.0213
130.55	-0.009	194.1	-0.0195
130.57	-0.008	194.2	-0.0169
130.58	-0.006	194.3	-0.0133
130.60	-0.004	194.5	-0.0107
130.62	-0.002	194.6	-0.0071
130.63	0	194.8	-0.0071
130.65	0.003	195	-0.0036
130.67	0.003	195	0
130.68	0.003	195.2	0.0036
130.70	0.006	195.5	0.008
130.72	0.009	195.7	0.0115
130.73	0.01	195.9	0.0151
130.75	0.012	196.2	0.0195
130.77	0.015	196.5	0.0195
130.78	0.016	196.5	0.0231
130.80	0.016	196.7	0.0275
130.82	0.017	197	0.0311
130.83	0.02	197.2	0.0346
130.85	0.021	197.4	0.0373
130.87	0.022	197.7	0.0399
130.88	0.024	197.9	0.0399
130.90	0.025	197.9	0.0435
130.92	0.025	198.1	0.0453
130.93	0.026	198.3	0.047
130.95	0.028	198.5	0.0497
130.97	0.028	198.7	0.0497
130.98	0.028	198.8	0.0506
131.00	0.029	199	0.0506
131.02	0.029	199	0.0515
131.03	0.029	199.1	0.0524
131.05	0.029	199.2	0.0524
131.07	0.029	199.3	0.0524
131.08	0.028	199.4	0.0515
131.10	0.028	199.4	0.0506
131.12	0.026	199.4	0.0497
131.13	0.026	199.5	0.0488
131.15	0.025	199.4	0.047
131.17	0.023	199.4	0.047
131.18	0.022	199.4	0.0453
131.20	0.022	199.4	0.0444
131.22	0.021	199.3	0.0408
131.23	0.019	199.2	0.0382
131.25	0.017	199.1	0.0364
131.27	0.016	198.9	0.032
131.28	0.012	198.7	0.032
131.30	0.011	198.7	0.0284
131.32	0.011	198.6	0.0249
131.33	0.01	198.4	0.0213
131.35	0.006	198.2	0.0169
131.37	0.005	198	0.0142
131.40	0.004	197.8	0.0107
131.42	0	197.5	0.0107
131.43	-0.001	197.3	0.0062

Prova triassiale ciclica SN04-C1			
pressione di confinamento (kPa)		80	
deviatore ciclico (kPa)		95	
frequenza (hz)		0.00625	
tempo	cella di carico	$\Delta u$	LVDT
(min)	kN	(kPa)	$\delta$ (mm)
131.45	-0.001	197.3	0.0027
131.45	-0.003	197	-0.0018
131.47	-0.006	196.7	-0.0053
131.48	-0.007	196.5	-0.0089
131.50	-0.008	196.2	-0.0124
131.52	-0.011	195.9	-0.0124
131.53	-0.012	195.7	-0.016
131.55	-0.012	195.7	-0.0178
131.57	-0.013	195.5	-0.0195
131.58	-0.014	195.2	-0.0231
131.60	-0.015	195	-0.0249
131.62	-0.015	194.8	-0.0257
131.63	-0.016	194.6	-0.0257
131.65	-0.017	194.4	-0.0275
131.67	-0.017	194.4	-0.0284
131.68	-0.017	194.3	-0.0284
131.70	-0.017	194.2	-0.0293
131.72	-0.017	194.1	-0.0293
131.73	-0.017	194	-0.0293
131.75	-0.017	193.9	-0.0293
131.77	-0.016	193.9	-0.0284
131.78	-0.016	193.9	-0.0284
131.80	-0.015	193.9	-0.0257
131.82	-0.014	194	-0.0249
131.83	-0.012	194	-0.0231
131.85	-0.011	194	-0.0213
131.87	-0.01	194	-0.0195
131.88	-0.008	194.1	-0.0178
131.90	-0.007	194.2	-0.016
131.92	-0.006	194.4	-0.0124
131.93	-0.003	194.5	-0.0124
131.95	-0.002	194.5	-0.0089
131.97	-0.002	194.7	-0.0062
131.98	0	194.9	-0.0027
132.00	0.003	195.1	0.0018
132.02	0.005	195.3	0.0053
132.03	0.006	195.6	0.0098
132.05	0.01	195.8	0.0098
132.07	0.011	195.8	0.0133
132.08	0.011	196	0.0169
132.10	0.013	196.3	0.0204
132.12	0.016	196.5	0.0249
132.13	0.017	196.8	0.0293
132.15	0.018	197	0.0328
132.17	0.021	197.3	0.0328
132.18	0.022	197.3	0.0364
132.20	0.022	197.5	0.0391
132.22	0.023	197.8	0.0417
132.23	0.025	198	0.0444
132.25	0.026	198.2	0.0462
132.27	0.026	198.4	0.0479
132.28	0.028	198.6	0.0479
132.30	0.028	198.6	0.0497
132.32	0.028	198.7	0.0506
132.33	0.028	198.9	0.0515
132.35	0.029	199	0.0515
132.37	0.029	199.1	0.0524
132.38	0.029	199.2	0.0524

Prova triassiale ciclica SN04-C1			
pressione di confinamento (kPa)		80	
deviatore ciclico (kPa)		95	
frequenza (hz)		0.00625	
tempo	cella di carico	$\Delta u$	LVDT
(min)	kN	(kPa)	$\delta$ (mm)
132.40	0.029	199.3	0.0524
132.42	0.028	199.3	0.0524
132.43	0.028	199.4	0.0515
132.45	0.027	199.4	0.0506
132.47	0.026	199.4	0.0488
132.48	0.025	199.4	0.0479
132.50	0.024	199.4	0.0462
132.52	0.022	199.3	0.0462
132.53	0.021	199.3	0.0444
132.55	0.021	199.3	0.0426
132.57	0.02	199.2	0.0391
132.58	0.016	199	0.0355
132.60	0.016	199	0.0346
132.62	0.015	198.9	0.0311
132.63	0.012	198.6	0.0275
132.65	0.01	198.5	0.024
132.67	0.009	198.3	0.0195
132.68	0.006	198	0.0195
132.70	0.004	197.8	0.0151
132.72	0.004	197.8	0.0124
132.73	0.002	197.6	0.0089
132.75	0	197.3	0.0044
132.77	-0.003	197.1	0.0009
132.78	-0.003	196.9	-0.0027
132.80	-0.006	196.6	-0.0027
132.83	-0.008	196.3	-0.0071
132.85	-0.008	196.3	-0.0107
132.87	-0.009	196.1	-0.0133
132.88	-0.01	195.8	-0.0169
132.90	-0.013	195.6	-0.0195
132.90	-0.013	195.3	-0.0222
132.92	-0.014	195	-0.024
132.93	-0.016	194.8	-0.024
132.95	-0.016	194.8	-0.0257
132.97	-0.016	194.7	-0.0266
132.98	-0.016	194.5	-0.0275
133.00	-0.017	194.4	-0.0284
133.02	-0.017	194.2	-0.0293
133.03	-0.017	194.1	-0.0293
133.05	-0.017	194	-0.0293
133.07	-0.017	194	-0.0293
133.08	-0.017	193.9	-0.0293
133.10	-0.016	193.9	-0.0284
133.12	-0.015	193.9	-0.0275
133.13	-0.015	193.8	-0.0266
133.15	-0.014	193.9	-0.0249
133.17	-0.012	193.9	-0.0249
133.18	-0.01	193.9	-0.0231
133.20	-0.01	194	-0.0213
133.22	-0.01	194	-0.0186
133.23	-0.007	194.2	-0.016
133.25	-0.006	194.3	-0.0133
133.27	-0.004	194.4	-0.0098
133.28	-0.001	194.6	-0.0098
133.30	0	194.8	-0.0044
133.32	0.001	194.9	-0.0009
133.33	0.004	195.1	-0.0009
133.35	0.005	195.4	0.0027

Prova triassiale ciclica SN04-C1			
pressione di confinamento (kPa)		80	
deviatore ciclico (kPa)		95	
frequenza (hz)		0.00625	
tempo	cella di carico	$\Delta u$	LVDT
(min)	kN	(kPa)	$\delta$ (mm)
133.37	0.005	195.4	0.0062
133.38	0.007	195.6	0.0107
133.40	0.011	195.9	0.0151
133.42	0.012	196.1	0.0178
133.43	0.013	196.3	0.0222
133.45	0.016	196.6	0.0222
133.47	0.018	196.8	0.0275
133.48	0.018	196.8	0.0302
133.50	0.019	197.1	0.0337
133.52	0.021	197.4	0.0373
133.53	0.023	197.6	0.0391
133.55	0.023	197.7	0.0417
133.57	0.025	198	0.0417
133.58	0.027	198.2	0.0444
133.60	0.027	198.2	0.047
133.62	0.027	198.4	0.0488
133.63	0.028	198.6	0.0497
133.65	0.028	198.8	0.0506
133.67	0.029	198.9	0.0515
133.68	0.029	199	0.0524
133.70	0.029	199.1	0.0524
133.72	0.029	199.1	0.0524
133.73	0.029	199.2	0.0524
133.75	0.029	199.3	0.0524
133.77	0.028	199.4	0.0515
133.78	0.027	199.4	0.0497
133.80	0.026	199.4	0.0479
133.82	0.024	199.4	0.0479
133.83	0.023	199.4	0.047
133.85	0.023	199.4	0.0453
133.87	0.023	199.3	0.0435
133.88	0.02	199.2	0.0408
133.90	0.019	199.1	0.0382
133.92	0.017	199	0.0346
133.93	0.014	198.8	0.0346
133.95	0.013	198.8	0.032
133.97	0.013	198.7	0.0293
133.98	0.011	198.5	0.024
134.00	0.007	198.3	0.0204
134.02	0.007	198.1	0.0169
134.03	0.005	197.9	0.0133
134.05	0.003	197.7	0.0115
134.07	0.002	197.5	0.008
134.08	0	197.3	0.0036
134.10	-0.004	197	0.0036
134.12	-0.005	197	-0.0009
134.13	-0.005	196.7	-0.0044
134.15	-0.006	196.5	-0.008
134.17	-0.009	196.2	-0.0115
134.18	-0.01	196	-0.0142
134.20	-0.011	195.8	-0.0169
134.22	-0.013	195.4	-0.0169
134.23	-0.014	195.2	-0.0204
134.25	-0.014	195.2	-0.0222
134.27	-0.015	195	-0.024
134.30	-0.016	194.8	-0.0257
134.32	-0.016	194.6	-0.0275
134.33	-0.017	194.4	-0.0275

Prova triassiale ciclica SN04-C1			
pressione di confinamento (kPa)		80	
deviatore ciclico (kPa)		95	
frequenza (hz)		0.00625	
tempo	cella di carico	$\Delta u$	LVDT
(min)	kN	(kPa)	$\delta$ (mm)
134.35	-0.017	194.3	-0.0275
134.35	-0.017	194.2	-0.0293
134.37	-0.017	194.2	-0.0293
134.38	-0.017	194	-0.0293
134.40	-0.017	193.9	-0.0293
134.42	-0.017	193.9	-0.0293
134.43	-0.016	193.9	-0.0284
134.45	-0.015	193.8	-0.0275
134.47	-0.014	193.9	-0.0275
134.48	-0.013	193.9	-0.0257
134.50	-0.013	193.8	-0.0249
134.52	-0.012	193.9	-0.0222
134.53	-0.01	194	-0.0204
134.55	-0.009	194.1	-0.0178
134.57	-0.007	194.2	-0.0151
134.58	-0.004	194.4	-0.0151
134.60	-0.003	194.4	-0.0115
134.62	-0.003	194.5	-0.0089
134.63	-0.002	194.7	-0.0053
134.65	0.002	194.9	-0.0018
134.67	0.003	195	0.0018
134.68	0.004	195.3	0.0053
134.70	0.008	195.6	0.0053
134.72	0.009	195.6	0.0098
134.73	0.009	195.8	0.0133
134.75	0.013	196.2	0.0169
134.77	0.014	196.2	0.0195
134.78	0.014	196.4	0.0222
134.80	0.016	196.7	0.0275
134.82	0.019	197	0.032
134.83	0.02	197.1	0.0346
134.85	0.021	197.4	0.0373
134.87	0.024	197.6	0.0373
134.88	0.024	197.6	0.0408
134.90	0.024	197.8	0.0426
134.92	0.025	198.1	0.0453
134.93	0.027	198.3	0.047
134.95	0.027	198.5	0.0488
134.97	0.028	198.6	0.0497
134.98	0.028	198.8	0.0497
135.00	0.029	198.8	0.0506
135.02	0.029	198.9	0.0515
135.03	0.029	199.1	0.0515
135.05	0.029	199.2	0.0515
135.07	0.028	199.2	0.0515
135.08	0.028	199.3	0.0515
135.10	0.028	199.4	0.0515
135.12	0.026	199.4	0.0506
135.13	0.026	199.4	0.0497
135.15	0.026	199.4	0.0479
135.17	0.024	199.3	0.0462
135.18	0.022	199.3	0.0444
135.20	0.022	199.3	0.0417
135.22	0.02	199.1	0.0417
135.23	0.017	199	0.0391
135.25	0.017	199	0.0373
135.27	0.016	198.9	0.0337
135.28	0.014	198.7	0.0302



Prova triassiale ciclica SN04-C1			
pressione di confinamento (kPa)		80	
deviatore ciclico (kPa)		95	
frequenza (hz)		0.00625	
tempo	cella di carico	$\Delta u$	LVDT
(min)	kN	(kPa)	$\delta$ (mm)
135.30	0.011	198.6	0.0275
135.32	0.01	198.4	0.0231
135.33	0.008	198.2	0.0195
135.35	0.005	198	0.0195
135.37	0.004	198	0.0151
135.38	0.004	197.8	0.0124
135.40	0.002	197.5	0.0089
135.42	-0.001	197.3	0.0044
135.43	-0.002	197.1	0
135.45	-0.004	196.8	-0.0036
135.47	-0.007	196.5	-0.0036
135.48	-0.007	196.3	-0.0098
135.50	-0.008	196.1	-0.0124
135.52	-0.011	195.8	-0.0124
135.53	-0.012	195.8	-0.0151
135.55	-0.012	195.6	-0.0178
135.57	-0.012	195.3	-0.0204
135.58	-0.015	195	-0.0231
135.60	-0.015	194.9	-0.0249
135.62	-0.016	194.7	-0.0266
135.63	-0.017	194.5	-0.0266
135.65	-0.017	194.5	-0.0284
135.67	-0.017	194.3	-0.0284
135.68	-0.017	194.2	-0.0293
135.70	-0.017	194.1	-0.0293
135.73	-0.017	194	-0.0293
135.75	-0.017	193.9	-0.0293
135.77	-0.016	193.8	-0.0293
135.78	-0.016	193.8	-0.0284
135.80	-0.016	193.8	-0.0284
135.80	-0.015	193.8	-0.0266
135.82	-0.014	193.8	-0.0257
135.83	-0.012	193.9	-0.0231
135.85	-0.011	193.9	-0.0213
135.87	-0.009	194	-0.0213
135.88	-0.008	194	-0.0195
135.90	-0.008	194.1	-0.0169
135.92	-0.007	194.2	-0.0142
135.93	-0.003	194.4	-0.0107
135.95	-0.002	194.5	-0.0089
135.97	-0.001	194.6	-0.0044
135.98	0.002	194.9	-0.0044
136.00	0.004	195.1	-0.0009
136.02	0.004	195.1	0.0027
136.03	0.005	195.2	0.0071
136.05	0.009	195.6	0.0115
136.07	0.01	195.8	0.0142
136.08	0.012	196	0.0186
136.10	0.015	196.3	0.0186
136.12	0.016	196.6	0.0231
136.13	0.016	196.6	0.0257
136.15	0.017	196.8	0.0311
136.17	0.02	197.1	0.0346
136.18	0.022	197.3	0.0373
136.20	0.022	197.5	0.0391
136.22	0.023	197.7	0.0408
136.23	0.025	197.9	0.0435
136.25	0.026	198.1	0.0462

Prova triassiale ciclica SN04-C1			
pressione di confinamento (kPa)		80	
deviatore ciclico (kPa)		95	
frequenza (hz)		0.00625	
tempo	cella di carico	$\Delta u$	LVDT
(min)	kN	(kPa)	$\delta$ (mm)
136.27	0.027	198.3	0.0479
136.28	0.028	198.5	0.0479
136.30	0.028	198.5	0.0497
136.32	0.028	198.7	0.0506
136.33	0.029	198.8	0.0515
136.35	0.029	198.9	0.0515
136.37	0.029	199.1	0.0515
136.38	0.029	199.2	0.0524
136.40	0.029	199.3	0.0524
136.42	0.028	199.3	0.0524
136.43	0.028	199.3	0.0515
136.45	0.027	199.3	0.0506
136.47	0.025	199.3	0.0488
136.48	0.025	199.4	0.0479
136.50	0.024	199.3	0.0453
136.52	0.022	199.2	0.0453
136.53	0.021	199.2	0.0435
136.55	0.021	199.2	0.0417
136.57	0.02	199.1	0.0391
136.58	0.016	198.9	0.0355
136.60	0.016	198.9	0.0328
136.62	0.014	198.7	0.0293
136.63	0.01	198.5	0.0293
136.65	0.01	198.5	0.0249
136.67	0.01	198.3	0.0222
136.68	0.008	198.1	0.0178
136.70	0.004	197.9	0.0142
136.72	0.003	197.7	0.0107
136.73	0.002	197.4	0.0062
136.75	-0.002	197.1	0.0062
136.77	-0.003	197.1	0.0018
136.78	-0.003	196.9	-0.0009
136.80	-0.004	196.7	-0.0053
136.82	-0.007	196.4	-0.0089
136.83	-0.009	196.1	-0.0115
136.85	-0.009	195.9	-0.0151
136.87	-0.012	195.6	-0.0151
136.88	-0.013	195.4	-0.0178
136.90	-0.013	195.4	-0.0204
136.92	-0.014	195.1	-0.0231
136.93	-0.016	194.7	-0.0249
136.95	-0.016	194.7	-0.0257
136.97	-0.016	194.6	-0.0275
136.98	-0.016	194.4	-0.0284
137.00	-0.017	194.2	-0.0293
137.02	-0.017	194.1	-0.0293
137.03	-0.017	194	-0.0302
137.05	-0.017	193.9	-0.0302
137.07	-0.017	193.9	-0.0302
137.08	-0.017	193.8	-0.0293
137.10	-0.016	193.8	-0.0284
137.12	-0.015	193.7	-0.0275
137.13	-0.014	193.7	-0.0266
137.15	-0.014	193.8	-0.0249
137.17	-0.011	193.8	-0.0249
137.20	-0.011	193.8	-0.0231
137.22	-0.011	193.8	-0.0213
137.23	-0.009	194	-0.0186

Prova triassiale ciclica SN04-C1			
pressione di confinamento (kPa)		80	
deviatore ciclico (kPa)		95	
frequenza (hz)		0.00625	
tempo	cella di carico	$\Delta u$	LVDT
(min)	kN	(kPa)	$\delta$ (mm)
137.25	-0.006	194.1	-0.016
137.25	-0.006	194.2	-0.0133
137.27	-0.004	194.3	-0.0098
137.28	-0.001	194.5	-0.0098
137.30	0	194.5	-0.0062
137.32	0	194.6	-0.0036
137.33	0.002	194.9	0.0009
137.35	0.006	195.1	0.0053
137.37	0.006	195.3	0.008
137.38	0.008	195.6	0.0124
137.40	0.012	195.9	0.0124
137.42	0.013	195.9	0.0169
137.43	0.013	196.1	0.0204
137.45	0.014	196.4	0.024
137.47	0.017	196.6	0.0284
137.48	0.019	196.8	0.0311
137.50	0.02	197.1	0.0346
137.52	0.022	197.3	0.0346
137.53	0.023	197.3	0.0382
137.55	0.023	197.5	0.0408
137.57	0.024	197.7	0.0435
137.58	0.026	198	0.0453
137.60	0.027	198.2	0.047
137.62	0.027	198.4	0.0488
137.63	0.028	198.5	0.0488
137.65	0.029	198.5	0.0506
137.67	0.029	198.8	0.0515
137.68	0.029	199	0.0515
137.70	0.029	199.1	0.0515
137.72	0.029	199.1	0.0515
137.73	0.029	199.2	0.0524
137.75	0.028	199.2	0.0515
137.77	0.028	199.3	0.0515
137.78	0.027	199.3	0.0497
137.80	0.026	199.3	0.0479
137.82	0.024	199.3	0.0479
137.83	0.023	199.3	0.0462
137.85	0.023	199.3	0.0444
137.87	0.022	199.2	0.0426
137.88	0.02	199.1	0.0399
137.90	0.019	199	0.0382
137.92	0.017	198.9	0.0346
137.93	0.014	198.7	0.0346
137.95	0.013	198.7	0.032
137.97	0.013	198.6	0.0293
137.98	0.011	198.4	0.0249
138.00	0.008	198.2	0.0204
138.02	0.007	198	0.0169
138.03	0.005	197.8	0.0133
138.05	0.002	197.5	0.0133
138.07	0.001	197.5	0.0089
138.08	0.001	197.3	0.0053
138.10	-0.001	197	0.0009
138.12	-0.005	196.7	-0.0036
138.13	-0.005	196.5	-0.0062
138.15	-0.007	196.2	-0.0098
138.17	-0.01	196	-0.0098
138.18	-0.01	196	-0.0133

Prova triassiale ciclica SN04-C1			
pressione di confinamento (kPa)		80	
deviatore ciclico (kPa)		95	
frequenza (hz)		0.00625	
tempo	cella di carico	$\Delta u$	LVDT
(min)	kN	(kPa)	$\delta$ (mm)
138.20	-0.01	195.8	-0.016
138.22	-0.012	195.5	-0.0186
138.23	-0.014	195.2	-0.0213
138.25	-0.014	195	-0.0231
138.27	-0.015	194.8	-0.0257
138.28	-0.016	194.6	-0.0257
138.30	-0.017	194.6	-0.0266
138.32	-0.017	194.4	-0.0275
138.33	-0.017	194.3	-0.0284
138.35	-0.017	194.1	-0.0293
138.37	-0.017	194	-0.0293
138.38	-0.017	193.9	-0.0293
138.40	-0.017	193.8	-0.0293
138.42	-0.017	193.8	-0.0293
138.43	-0.016	193.7	-0.0284
138.45	-0.015	193.7	-0.0284
138.47	-0.014	193.7	-0.0266
138.48	-0.014	193.7	-0.0257
138.50	-0.013	193.7	-0.024
138.52	-0.011	193.8	-0.0222
138.53	-0.01	193.9	-0.0204
138.55	-0.009	193.9	-0.0178
138.57	-0.006	194.1	-0.0178
138.58	-0.005	194.2	-0.0151
138.60	-0.005	194.2	-0.0124
138.62	-0.004	194.3	-0.0089
138.65	-0.001	194.6	-0.0053
138.67	0.001	194.7	-0.0018
138.68	0.003	194.9	0.0027
138.70	0.005	195.2	0.0027
138.70	0.008	195.4	0.0062
138.72	0.008	195.4	0.0098
138.73	0.009	195.6	0.0133
138.75	0.011	195.9	0.0178
138.77	0.014	196.2	0.0222
138.78	0.015	196.4	0.0257
138.80	0.017	196.7	0.0302
138.82	0.02	196.9	0.0302
138.83	0.02	196.9	0.0337
138.85	0.021	197.1	0.0364
138.87	0.022	197.4	0.0391
138.88	0.024	197.6	0.0417
138.90	0.025	197.8	0.0444
138.92	0.026	198.1	0.0462
138.93	0.027	198.2	0.0462
138.95	0.027	198.2	0.0479
138.97	0.027	198.4	0.0488
138.98	0.028	198.6	0.0506
139.00	0.029	198.7	0.0515
139.02	0.029	198.9	0.0524
139.03	0.029	199	0.0524
139.05	0.029	199.1	0.0524
139.07	0.029	199.1	0.0524
139.08	0.029	199.2	0.0515
139.10	0.028	199.2	0.0506
139.12	0.026	199.3	0.0506
139.13	0.026	199.3	0.0497
139.15	0.026	199.3	0.0479

Prova triassiale ciclica SN04-C1			
pressione di confinamento (kPa)		80	
deviatore ciclico (kPa)		95	
frequenza (hz)		0.00625	
tempo	cella di carico	$\Delta u$	LVDT
(min)	kN	(kPa)	$\delta$ (mm)
139.17	0.024	199.2	0.0462
139.18	0.023	199.2	0.0444
139.20	0.022	199.2	0.0417
139.22	0.019	199	0.0417
139.23	0.018	199	0.0399
139.25	0.018	199	0.0373
139.27	0.016	198.8	0.0337
139.28	0.014	198.6	0.0311
139.30	0.012	198.5	0.0275
139.32	0.01	198.3	0.0222
139.33	0.007	198	0.0222
139.35	0.006	197.9	0.0186
139.37	0.006	197.9	0.016
139.38	0.005	197.7	0.0115
139.40	0.001	197.4	0.0071
139.42	-0.001	197.2	0.0036
139.43	-0.002	197	0
139.45	-0.005	196.6	0
139.47	-0.006	196.4	-0.0036
139.48	-0.006	196.4	-0.0071
139.50	-0.007	196.2	-0.0107
139.52	-0.01	195.8	-0.0142
139.53	-0.011	195.6	-0.0169
139.55	-0.012	195.4	-0.0195
139.57	-0.014	195.1	-0.0195
139.58	-0.015	194.9	-0.0222
139.60	-0.015	194.9	-0.024
139.62	-0.015	194.7	-0.0249
139.63	-0.016	194.5	-0.0266
139.65	-0.017	194.3	-0.0284
139.67	-0.017	194.2	-0.0284
139.68	-0.017	194	-0.0293
139.70	-0.017	193.9	-0.0293
139.72	-0.017	193.9	-0.0293
139.73	-0.017	193.8	-0.0293
139.75	-0.017	193.8	-0.0293
139.77	-0.016	193.7	-0.0284
139.78	-0.015	193.7	-0.0275
139.80	-0.014	193.7	-0.0257
139.82	-0.013	193.7	-0.0257
139.83	-0.012	193.7	-0.0231
139.85	-0.011	193.8	-0.0213
139.87	-0.009	193.9	-0.0213
139.88	-0.008	193.9	-0.0195
139.90	-0.008	193.9	-0.0169
139.92	-0.007	194.1	-0.0142
139.93	-0.003	194.3	-0.0107
139.95	-0.002	194.4	-0.008
139.97	-0.001	194.6	-0.0044
139.98	0.003	194.8	-0.0044
140.00	0.004	194.8	0
140.02	0.004	194.9	0.0027
140.03	0.005	195.2	0.0071
140.05	0.009	195.5	0.0115
140.07	0.01	195.7	0.0142
140.10	0.012	195.9	0.0186
140.12	0.015	196.2	0.0186
140.13	0.016	196.2	0.0231

Prova triassiale ciclica SN04-C1			
pressione di confinamento (kPa)		80	
deviatore ciclico (kPa)		95	
frequenza (hz)		0.00625	
tempo	cella di carico	$\Delta u$	LVDT
(min)	kN	(kPa)	$\delta$ (mm)
140.15	0.016	196.4	0.0275
140.15	0.017	196.7	0.0311
140.17	0.02	197	0.0346
140.18	0.021	197.2	0.0373
140.20	0.022	197.4	0.0399
140.22	0.024	197.6	0.0399
140.23	0.025	197.6	0.0435
140.25	0.025	197.8	0.0453
140.27	0.026	198.1	0.047
140.28	0.027	198.3	0.0488
140.30	0.028	198.4	0.0497
140.32	0.028	198.6	0.0506
140.33	0.029	198.7	0.0506
140.35	0.029	198.9	0.0515
140.37	0.029	198.9	0.0515
140.38	0.029	199	0.0524
140.40	0.029	199.1	0.0524
140.42	0.028	199.2	0.0515
140.43	0.027	199.2	0.0506
140.45	0.026	199.2	0.0506
140.47	0.025	199.2	0.0497
140.48	0.025	199.2	0.0488
140.50	0.025	199.2	0.0462
140.52	0.023	199.1	0.0444
140.53	0.021	199.1	0.0426
140.55	0.02	199	0.0399
140.57	0.019	198.9	0.0382
140.58	0.017	198.8	0.0364
140.60	0.016	198.7	0.0328
140.62	0.014	198.5	0.0293
140.63	0.01	198.3	0.0293
140.65	0.01	198.3	0.0249
140.67	0.01	198.2	0.0222
140.68	0.008	197.9	0.0178
140.70	0.004	197.7	0.0142
140.72	0.004	197.6	0.0107
140.73	0.001	197.3	0.0062
140.75	-0.002	197	0.0062
140.77	-0.003	197	0.0018
140.78	-0.003	196.8	-0.0018
140.80	-0.004	196.5	-0.0044
140.82	-0.007	196.2	-0.0089
140.83	-0.008	196	-0.0115
140.85	-0.01	195.7	-0.0151
140.87	-0.012	195.4	-0.0151
140.88	-0.013	195.4	-0.0186
140.90	-0.013	195.2	-0.0204
140.92	-0.014	195	-0.0231
140.93	-0.015	194.8	-0.0249
140.95	-0.016	194.6	-0.0257
140.97	-0.016	194.4	-0.0266
140.98	-0.017	194.2	-0.0266
141.00	-0.017	194.2	-0.0284
141.02	-0.017	194.1	-0.0293
141.03	-0.017	194	-0.0293
141.05	-0.017	193.9	-0.0302
141.07	-0.017	193.8	-0.0293
141.08	-0.017	193.7	-0.0284

Prova triassiale ciclica SN04-C1			
pressione di confinamento (kPa)		80	
deviatore ciclico (kPa)		95	
frequenza (hz)		0.00625	
tempo	cella di carico	$\Delta u$	LVDT
(min)	kN	(kPa)	$\delta$ (mm)
141.10	-0.016	193.7	-0.0284
141.12	-0.015	193.7	-0.0275
141.13	-0.015	193.7	-0.0266
141.15	-0.014	193.7	-0.0249
141.17	-0.012	193.7	-0.0231
141.18	-0.011	193.7	-0.0222
141.20	-0.01	193.8	-0.0195
141.22	-0.008	194	-0.0195
141.23	-0.006	194	-0.0169
141.25	-0.006	194	-0.0151
141.27	-0.005	194.2	-0.0107
141.28	-0.002	194.4	-0.0071
141.30	0	194.5	-0.0044
141.32	0	194.6	-0.0027
141.33	0.003	194.9	0.0009
141.35	0.005	195.1	0.0044
141.37	0.006	195.2	0.0089
141.38	0.009	195.6	0.0089
141.40	0.011	195.8	0.0133
141.42	0.011	195.8	0.0169
141.43	0.013	196	0.0204
141.45	0.015	196.3	0.0249
141.47	0.017	196.6	0.0293
141.48	0.018	196.8	0.032
141.50	0.02	197	0.0355
141.52	0.022	197.3	0.0355
141.53	0.023	197.3	0.0391
141.57	0.023	197.5	0.0408
141.58	0.024	197.7	0.0435
141.60	0.026	197.9	0.0462
141.62	0.026	198.1	0.047
141.62	0.027	198.3	0.0488
141.63	0.028	198.5	0.0488
141.65	0.028	198.5	0.0506
141.67	0.028	198.6	0.0506
141.68	0.028	198.7	0.0515
141.70	0.029	198.9	0.0524
141.72	0.029	199	0.0524
141.73	0.029	199.1	0.0524
141.75	0.028	199.2	0.0524
141.77	0.027	199.2	0.0515
141.78	0.027	199.2	0.0506
141.80	0.027	199.2	0.0497
141.82	0.025	199.2	0.0479
141.83	0.024	199.2	0.0462
141.85	0.023	199.1	0.0444
141.87	0.021	199	0.0444
141.88	0.019	199	0.0417
141.90	0.019	199	0.0399
141.92	0.018	198.8	0.0364
141.93	0.015	198.7	0.0328
141.95	0.014	198.6	0.0311
141.97	0.012	198.4	0.0257
141.98	0.009	198.2	0.0257
142.00	0.008	198.2	0.0222
142.02	0.006	197.8	0.0169
142.03	0.004	197.6	0.0169
142.05	0.003	197.6	0.0142

Prova triassiale ciclica SN04-C1			
pressione di confinamento (kPa)		80	
deviatore ciclico (kPa)		95	
frequenza (hz)		0.00625	
tempo	cella di carico	$\Delta u$	LVDT
(min)	kN	(kPa)	$\delta$ (mm)
142.07	0.003	197.4	0.0098
142.08	0.001	197.2	0.0044
142.10	-0.003	196.9	0
142.12	-0.004	196.7	-0.0027
142.13	-0.005	196.4	-0.0062
142.15	-0.008	196.1	-0.0062
142.17	-0.009	195.9	-0.0098
142.18	-0.009	195.9	-0.0133
142.20	-0.01	195.7	-0.016
142.22	-0.012	195.3	-0.0195
142.23	-0.014	195.1	-0.0213
142.25	-0.014	194.9	-0.0231
142.27	-0.015	194.7	-0.0231
142.28	-0.016	194.5	-0.0249
142.30	-0.016	194.5	-0.0266
142.32	-0.016	194.3	-0.0275
142.33	-0.017	194.1	-0.0284
142.35	-0.017	194	-0.0293
142.37	-0.017	193.9	-0.0293
142.38	-0.017	193.8	-0.0293
142.40	-0.017	193.7	-0.0293
142.42	-0.017	193.7	-0.0293
142.43	-0.016	193.7	-0.0284
142.45	-0.015	193.7	-0.0266
142.47	-0.014	193.6	-0.0257
142.48	-0.014	193.6	-0.0249
142.50	-0.012	193.7	-0.0249
142.52	-0.01	193.8	-0.0231
142.53	-0.01	193.8	-0.0213
142.55	-0.01	193.8	-0.0186
142.57	-0.007	194	-0.0151
142.58	-0.005	194.1	-0.0133
142.60	-0.004	194.2	-0.0098
142.62	-0.002	194.4	-0.0098
142.63	0.001	194.6	-0.0062
142.65	0.001	194.6	-0.0027
142.67	0.002	194.7	0.0009
142.68	0.004	195	0.0044
142.70	0.007	195.2	0.008
142.72	0.008	195.4	0.0124
142.73	0.011	195.8	0.0124
142.75	0.013	196	0.0204
142.77	0.014	196.2	0.0231
142.78	0.016	196.4	0.0275
142.80	0.018	196.7	0.0275
142.82	0.018	196.7	0.0302
142.83	0.019	196.8	0.0337
142.85	0.021	197.1	0.0373
142.87	0.023	197.4	0.0399
142.88	0.024	197.6	0.0426
142.90	0.025	197.8	0.0444
142.92	0.026	198	0.0444
142.93	0.027	198	0.047
142.95	0.027	198.2	0.0488
142.97	0.028	198.4	0.0506
143.00	0.029	198.5	0.0515
143.02	0.029	198.7	0.0515
143.03	0.029	198.8	0.0524



Prova triassiale ciclica SN04-C1			
pressione di confinamento (kPa)		80	
deviatore ciclico (kPa)		95	
frequenza (hz)		0.00625	
tempo	cella di carico	$\Delta u$	LVDT
(min)	kN	(kPa)	$\delta$ (mm)
143.05	0.029	198.9	0.0524
143.07	0.028	198.9	0.0524
143.07	0.028	199	0.0524
143.08	0.028	199.1	0.0524
143.10	0.028	199.1	0.0515
143.12	0.027	199.2	0.0506
143.13	0.026	199.2	0.0488
143.15	0.024	199.1	0.0488
143.17	0.024	199.1	0.047
143.18	0.024	199.1	0.0462
143.20	0.022	199.1	0.0435
143.22	0.02	199	0.0408
143.23	0.019	198.9	0.0391
143.25	0.017	198.8	0.0355
143.27	0.014	198.6	0.0355
143.28	0.013	198.6	0.032
143.30	0.013	198.5	0.0293
143.32	0.012	198.3	0.0249
143.33	0.008	198.1	0.0204
143.35	0.006	197.9	0.0178
143.37	0.006	197.7	0.0142
143.38	0.002	197.4	0.0142
143.40	0	197.2	0.0089
143.42	0	197.2	0.0062
143.43	-0.001	197	0.0027
143.45	-0.004	196.6	-0.0027
143.47	-0.006	196.4	-0.0053
143.48	-0.006	196.3	-0.008
143.50	-0.008	195.9	-0.0115
143.52	-0.01	195.7	-0.0142
143.53	-0.011	195.5	-0.0178
143.55	-0.013	195.1	-0.0178
143.57	-0.014	194.9	-0.0204
143.58	-0.014	194.9	-0.0222
143.60	-0.014	194.7	-0.024
143.62	-0.015	194.5	-0.0257
143.63	-0.016	194.3	-0.0266
143.65	-0.017	194.2	-0.0284
143.67	-0.017	194	-0.0284
143.68	-0.017	193.9	-0.0284
143.70	-0.017	193.9	-0.0293
143.72	-0.017	193.8	-0.0293
143.73	-0.017	193.7	-0.0293
143.75	-0.017	193.6	-0.0293
143.77	-0.016	193.6	-0.0284
143.78	-0.015	193.6	-0.0266
143.80	-0.014	193.6	-0.0266
143.82	-0.013	193.6	-0.0257
143.83	-0.013	193.6	-0.024
143.85	-0.012	193.7	-0.0222
143.87	-0.01	193.8	-0.0195
143.88	-0.009	193.8	-0.0178
143.90	-0.007	193.9	-0.0151
143.92	-0.004	194.1	-0.0151
143.93	-0.004	194.1	-0.0115
143.95	-0.004	194.2	-0.0089
143.97	-0.001	194.4	-0.0053
143.98	0.002	194.6	-0.0018

Prova triassiale ciclica SN04-C1			
pressione di confinamento (kPa)		80	
deviatore ciclico (kPa)		95	
frequenza (hz)		0.00625	
tempo	cella di carico	$\Delta u$	LVDT
(min)	kN	(kPa)	$\delta$ (mm)
144.00	0.002	194.8	0.0018
144.02	0.004	195	0.0062
144.03	0.009	195.3	0.0062
144.05	0.009	195.3	0.0107
144.07	0.009	195.5	0.0133
144.08	0.011	195.7	0.0178
144.10	0.014	196	0.0222
144.12	0.015	196.2	0.0249
144.13	0.017	196.5	0.0302
144.15	0.02	196.8	0.0302
144.17	0.021	196.8	0.0337
144.18	0.021	197	0.0364
144.20	0.023	197.4	0.0391
144.22	0.024	197.6	0.0408
144.23	0.024	197.6	0.0426
144.25	0.025	197.8	0.0453
144.27	0.026	198	0.047
144.28	0.027	198.2	0.0488
144.30	0.028	198.4	0.0506
144.32	0.028	198.6	0.0506
144.33	0.029	198.7	0.0515
144.35	0.029	198.7	0.0524
144.37	0.029	198.8	0.0524
144.38	0.029	198.9	0.0524
144.40	0.028	199	0.0524
144.42	0.028	199.1	0.0515
144.43	0.028	199.1	0.0515
144.47	0.026	199.1	0.0506
144.48	0.026	199.1	0.0497
144.50	0.026	199.2	0.0479
144.52	0.024	199.1	0.0462
144.52	0.023	199.1	0.0453
144.53	0.022	199	0.0417
144.55	0.019	198.9	0.0417
144.57	0.017	198.8	0.0399
144.58	0.017	198.8	0.0373
144.60	0.017	198.7	0.0346
144.62	0.014	198.5	0.0311
144.63	0.012	198.4	0.0275
144.65	0.01	198.2	0.0231
144.67	0.008	197.9	0.0231
144.68	0.006	197.8	0.0195
144.70	0.006	197.8	0.016
144.72	0.004	197.6	0.0124
144.73	0.002	197.3	0.008
144.75	-0.001	197	0.0044
144.77	-0.002	196.8	0
144.78	-0.004	196.5	0
144.80	-0.006	196.3	-0.0036
144.82	-0.006	196.3	-0.0071
144.83	-0.008	196	-0.0115
144.85	-0.01	195.7	-0.0142
144.87	-0.011	195.5	-0.0169
144.88	-0.012	195.2	-0.0195
144.90	-0.013	194.9	-0.0222
144.92	-0.015	194.7	-0.024
144.93	-0.015	194.6	-0.0249
144.95	-0.016	194.4	-0.0257

Prova triassiale ciclica SN04-C1			
pressione di confinamento (kPa)		80	
deviatore ciclico (kPa)		95	
frequenza (hz)		0.00625	
tempo	cella di carico	$\Delta u$	LVDT
(min)	kN	(kPa)	$\delta$ (mm)
144.97	-0.017	194.2	-0.0257
144.98	-0.017	194.2	-0.0275
145.00	-0.017	194.1	-0.0284
145.02	-0.017	193.9	-0.0293
145.03	-0.017	193.8	-0.0293
145.05	-0.017	193.7	-0.0293
145.07	-0.017	193.6	-0.0293
145.08	-0.016	193.6	-0.0293
145.10	-0.016	193.6	-0.0284
145.12	-0.016	193.5	-0.0275
145.13	-0.015	193.5	-0.0266
145.15	-0.013	193.6	-0.0249
145.17	-0.013	193.6	-0.0231
145.18	-0.012	193.7	-0.0213
145.20	-0.009	193.8	-0.0213
145.22	-0.008	193.8	-0.0186
145.23	-0.008	193.8	-0.0169
145.25	-0.007	194	-0.0133
145.27	-0.004	194.1	-0.0098
145.28	-0.003	194.2	-0.0071
145.30	-0.001	194.4	-0.0036
145.32	0.003	194.7	-0.0036
145.33	0.004	194.7	0
145.35	0.004	194.8	0.0036
145.37	0.005	195	0.008
145.38	0.009	195.3	0.0115
145.40	0.01	195.6	0.0151
145.42	0.012	195.8	0.0195
145.43	0.015	196.1	0.0195
145.45	0.016	196.1	0.0231
145.47	0.016	196.3	0.0275
145.48	0.017	196.5	0.0311
145.50	0.02	196.8	0.0346
145.52	0.021	197	0.0373
145.53	0.022	197.2	0.0399
145.55	0.024	197.5	0.0399
145.57	0.026	197.7	0.0435
145.58	0.026	197.7	0.0453
145.60	0.026	197.9	0.047
145.62	0.027	198.1	0.0488
145.63	0.028	198.3	0.0497
145.65	0.028	198.4	0.0506
145.67	0.028	198.6	0.0515
145.68	0.029	198.7	0.0524
145.70	0.029	198.8	0.0524
145.72	0.029	198.9	0.0524
145.73	0.028	199	0.0524
145.75	0.028	199	0.0524
145.77	0.028	199.1	0.0515
145.78	0.027	199.1	0.0506
145.80	0.026	199.1	0.0497
145.82	0.025	199.1	0.0479
145.83	0.024	199	0.0453
145.85	0.022	199	0.0453
145.87	0.021	199	0.0435
145.90	0.021	199	0.0417
145.92	0.02	198.8	0.0391
145.93	0.016	198.7	0.0355

Prova triassiale ciclica SN04-C1			
pressione di confinamento (kPa)		80	
deviatore ciclico (kPa)		95	
frequenza (hz)		0.00625	
tempo	cella di carico	$\Delta u$	LVDT
(min)	kN	(kPa)	$\delta$ (mm)
145.95	0.015	198.6	0.0337
145.97	0.014	198.4	0.0302
145.97	0.01	198.2	0.0302
145.98	0.01	198.2	0.0249
146.00	0.01	198.1	0.0222
146.02	0.008	197.9	0.0178
146.03	0.004	197.6	0.0133
146.05	0.003	197.4	0.0107
146.07	0.002	197.2	0.0062
146.08	-0.002	196.9	0.0062
146.10	-0.003	196.9	0.0018
146.12	-0.003	196.7	-0.0009
146.13	-0.004	196.4	-0.0053
146.15	-0.007	196.1	-0.0089
146.17	-0.008	195.9	-0.0115
146.18	-0.01	195.6	-0.0151
146.20	-0.012	195.3	-0.0151
146.22	-0.013	195.3	-0.0178
146.23	-0.013	195.1	-0.0195
146.25	-0.014	194.9	-0.0222
146.27	-0.016	194.6	-0.0249
146.28	-0.016	194.5	-0.0257
146.30	-0.016	194.3	-0.0275
146.32	-0.017	194.1	-0.0275
146.33	-0.017	194.1	-0.0275
146.35	-0.017	194	-0.0284
146.37	-0.017	193.9	-0.0293
146.38	-0.017	193.7	-0.0293
146.40	-0.017	193.7	-0.0293
146.42	-0.017	193.6	-0.0293
146.43	-0.016	193.5	-0.0284
146.45	-0.015	193.5	-0.0275
146.47	-0.015	193.5	-0.0257
146.48	-0.013	193.5	-0.0257
146.50	-0.012	193.6	-0.024
146.52	-0.012	193.6	-0.0231
146.53	-0.011	193.6	-0.0204
146.55	-0.009	193.8	-0.0186
146.57	-0.007	193.9	-0.016
146.58	-0.006	193.9	-0.0124
146.60	-0.003	194.1	-0.0124
146.62	-0.001	194.3	-0.0089
146.63	-0.001	194.3	-0.0062
146.65	0	194.4	-0.0027
146.67	0.002	194.7	0.0009
146.68	0.005	194.9	0.0053
146.70	0.006	195.1	0.0089
146.72	0.009	195.4	0.0133
146.73	0.012	195.7	0.0133
146.75	0.012	195.7	0.0169
146.77	0.012	195.8	0.0204
146.78	0.015	196.1	0.0249
146.80	0.017	196.4	0.0293
146.82	0.019	196.6	0.032
146.83	0.02	196.9	0.0346
146.85	0.022	197.1	0.0346
146.87	0.023	197.1	0.0382
146.88	0.023	197.3	0.0408

Prova triassiale ciclica SN04-C1			
pressione di confinamento (kPa)		80	
deviatore ciclico (kPa)		95	
frequenza (hz)		0.00625	
tempo	cella di carico	$\Delta u$	LVDT
(min)	kN	(kPa)	$\delta$ (mm)
146.90	0.024	197.5	0.0435
146.92	0.026	197.8	0.0462
146.93	0.026	198	0.047
146.95	0.027	198.1	0.0497
146.97	0.028	198.3	0.0497
146.98	0.028	198.3	0.0506
147.00	0.028	198.5	0.0515
147.02	0.029	198.6	0.0515
147.03	0.029	198.7	0.0524
147.05	0.029	198.8	0.0524
147.07	0.029	198.9	0.0524
147.08	0.028	199	0.0524
147.10	0.027	199	0.0506
147.12	0.027	199.1	0.0497
147.13	0.026	199.1	0.0497
147.15	0.024	199.1	0.0488
147.17	0.024	199.1	0.047
147.18	0.024	199	0.0453
147.20	0.021	199	0.0426
147.22	0.02	198.9	0.0408
147.23	0.019	198.8	0.0373
147.25	0.016	198.6	0.0373
147.27	0.014	198.6	0.0346
147.28	0.014	198.5	0.032
147.30	0.013	198.4	0.0293
147.32	0.01	198.2	0.024
147.33	0.008	198	0.0204
147.37	0.007	197.8	0.0169
147.38	0.004	197.5	0.0169
147.40	0.002	197.3	0.0124
147.42	0.002	197.3	0.0098
147.42	0.001	197.1	0.0053
147.43	-0.002	196.8	0.0009
147.45	-0.004	196.6	-0.0027
147.47	-0.005	196.3	-0.0062
147.48	-0.008	196	-0.0062
147.50	-0.009	195.8	-0.0098
147.52	-0.009	195.8	-0.0133
147.53	-0.01	195.5	-0.016
147.55	-0.012	195.2	-0.0195
147.57	-0.014	195	-0.0213
147.58	-0.014	194.8	-0.0231
147.60	-0.015	194.5	-0.0231
147.62	-0.016	194.4	-0.0249
147.63	-0.016	194.4	-0.0266
147.65	-0.016	194.2	-0.0275
147.67	-0.017	194	-0.0284
147.68	-0.017	193.9	-0.0293
147.70	-0.017	193.8	-0.0293
147.72	-0.017	193.7	-0.0293
147.73	-0.017	193.6	-0.0293
147.75	-0.016	193.6	-0.0293
147.77	-0.016	193.6	-0.0284
147.78	-0.016	193.5	-0.0275
147.80	-0.015	193.5	-0.0257
147.82	-0.013	193.5	-0.0249
147.83	-0.013	193.6	-0.0231
147.85	-0.011	193.6	-0.0222

Prova triassiale ciclica SN04-C1			
pressione di confinamento (kPa)		80	
deviatore ciclico (kPa)		95	
frequenza (hz)		0.00625	
tempo	cella di carico	$\Delta u$	LVDT
(min)	kN	(kPa)	$\delta$ (mm)
147.87	-0.01	193.6	-0.0204
147.88	-0.009	193.8	-0.0178
147.90	-0.006	193.9	-0.0178
147.92	-0.005	193.9	-0.0142
147.93	-0.005	194	-0.0115
147.95	-0.004	194.2	-0.008
147.97	0	194.4	-0.0044
147.98	0.001	194.5	-0.0009
148.00	0.003	194.7	0.0027
148.02	0.006	195	0.0027
148.03	0.007	195	0.0062
148.05	0.007	195.1	0.0098
148.07	0.009	195.4	0.0142
148.08	0.013	195.7	0.0186
148.10	0.014	195.9	0.0222
148.12	0.015	196.2	0.0257
148.13	0.018	196.5	0.0257
148.15	0.019	196.5	0.0311
148.17	0.019	196.7	0.0328
148.18	0.02	196.9	0.0373
148.20	0.023	197.2	0.0399
148.22	0.024	197.4	0.0417
148.23	0.025	197.6	0.0444
148.25	0.026	197.8	0.0444
148.27	0.027	198	0.047
148.28	0.027	198	0.0479
148.30	0.027	198.2	0.0497
148.32	0.028	198.4	0.0506
148.33	0.029	198.5	0.0515
148.35	0.029	198.6	0.0524
148.37	0.029	198.8	0.0524
148.38	0.029	198.9	0.0524
148.40	0.029	198.9	0.0524
148.42	0.029	199	0.0524
148.43	0.028	199	0.0515
148.45	0.027	199	0.0506
148.47	0.026	199	0.0488
148.48	0.025	199	0.047
148.50	0.023	199	0.047
148.52	0.022	199	0.0453
148.53	0.022	199	0.0435
148.55	0.019	198.8	0.0408
148.57	0.018	198.8	0.0399
148.58	0.018	198.7	0.0373
148.60	0.016	198.6	0.0337
148.62	0.013	198.4	0.0311
148.63	0.012	198.3	0.0284
148.65	0.011	198.1	0.0231
148.67	0.007	197.8	0.0231
148.68	0.006	197.8	0.0195
148.70	0.006	197.7	0.0169
148.72	0.005	197.4	0.0115
148.73	0.001	197.2	0.008
148.75	0	197	0.0044
148.77	-0.002	196.7	0
148.78	-0.005	196.4	0
148.80	-0.006	196.4	-0.0036
148.83	-0.006	196.2	-0.0071

Prova triassiale ciclica SN04-C1			
pressione di confinamento (kPa)		80	
deviatore ciclico (kPa)		95	
frequenza (hz)		0.00625	
tempo	cella di carico	$\Delta u$	LVDT
(min)	kN	(kPa)	$\delta$ (mm)
148.85	-0.007	195.9	-0.0107
148.87	-0.01	195.6	-0.0142
148.87	-0.011	195.4	-0.0169
148.88	-0.012	195.1	-0.0195
148.90	-0.014	194.8	-0.0195
148.92	-0.015	194.6	-0.0222
148.93	-0.015	194.6	-0.024
148.95	-0.015	194.5	-0.0257
148.97	-0.016	194.2	-0.0275
148.98	-0.017	194.1	-0.0284
149.00	-0.017	193.9	-0.0284
149.02	-0.017	193.8	-0.0284
149.03	-0.017	193.7	-0.0284
149.05	-0.017	193.7	-0.0293
149.07	-0.017	193.6	-0.0293
149.08	-0.017	193.6	-0.0284
149.10	-0.016	193.5	-0.0275
149.12	-0.015	193.5	-0.0275
149.13	-0.015	193.5	-0.0257
149.15	-0.013	193.5	-0.0257
149.17	-0.012	193.5	-0.024
149.18	-0.012	193.5	-0.0222
149.20	-0.011	193.6	-0.0204
149.22	-0.008	193.7	-0.0178
149.23	-0.007	193.8	-0.016
149.25	-0.006	194	-0.0124
149.27	-0.003	194.1	-0.0124
149.28	-0.002	194.3	-0.0071
149.30	-0.001	194.4	-0.0036
149.32	0.002	194.6	-0.0036
149.33	0.004	194.6	0
149.35	0.004	194.8	0.0036
149.37	0.005	195	0.0071
149.38	0.009	195.3	0.0124
149.40	0.011	195.5	0.0151
149.42	0.011	195.8	0.0186
149.43	0.015	196	0.0186
149.45	0.016	196	0.0231
149.47	0.016	196.2	0.0275
149.48	0.017	196.5	0.0311
149.50	0.02	196.8	0.0346
149.52	0.021	197	0.0373
149.53	0.022	197.2	0.0408
149.55	0.025	197.5	0.0408
149.57	0.025	197.5	0.0435
149.58	0.025	197.7	0.0453
149.60	0.026	197.8	0.047
149.62	0.027	198.1	0.0488
149.63	0.028	198.2	0.0497
149.65	0.028	198.4	0.0506
149.67	0.029	198.5	0.0506
149.68	0.029	198.7	0.0515
149.70	0.029	198.7	0.0524
149.72	0.029	198.8	0.0524
149.73	0.029	198.9	0.0524
149.75	0.028	198.9	0.0524
149.77	0.028	199	0.0515
149.78	0.027	199	0.0515

Prova triassiale ciclica SN04-C1			
pressione di confinamento (kPa)		80	
deviatore ciclico (kPa)		95	
frequenza (hz)		0.00625	
tempo	cella di carico	$\Delta u$	LVDT
(min)	kN	(kPa)	$\delta$ (mm)
149.80	0.025	199	0.0497
149.82	0.025	199	0.0479
149.83	0.025	199	0.047
149.85	0.023	199	0.0444
149.87	0.021	198.9	0.0426
149.88	0.02	198.8	0.0408
149.90	0.018	198.7	0.0408
149.92	0.016	198.5	0.0373
149.93	0.016	198.5	0.0346
149.95	0.015	198.4	0.0311
149.97	0.012	198.2	0.0275
149.98	0.01	198	0.024
150.00	0.009	197.9	0.0204
150.02	0.007	197.7	0.0178
150.03	0.005	197.5	0.0151
150.05	0.003	197.3	0.0107
150.07	0.001	197	0.0071
150.08	-0.002	196.8	0.0071
150.10	-0.003	196.8	0.0027
150.12	-0.003	196.6	-0.0009
150.13	-0.004	196.3	-0.0053
150.15	-0.008	196	-0.0089
150.17	-0.008	195.8	-0.0115
150.18	-0.01	195.5	-0.0151
150.20	-0.012	195.2	-0.0151
150.22	-0.013	195.2	-0.0178
150.23	-0.013	195	-0.0204
150.27	-0.014	194.7	-0.0222
150.28	-0.015	194.5	-0.0249
150.30	-0.016	194.3	-0.0257
150.32	-0.016	194.2	-0.0266
150.33	-0.017	194	-0.0266
150.33	-0.017	194	-0.0284
150.35	-0.017	193.9	-0.0284
150.37	-0.017	193.7	-0.0293
150.38	-0.017	193.6	-0.0293
150.40	-0.017	193.5	-0.0293
150.42	-0.017	193.5	-0.0284
150.43	-0.016	193.4	-0.0284
150.45	-0.015	193.4	-0.0275
150.47	-0.015	193.4	-0.0266
150.48	-0.014	193.4	-0.0249
150.50	-0.012	193.5	-0.0231
150.52	-0.011	193.5	-0.0222
150.53	-0.01	193.6	-0.0195
150.55	-0.008	193.7	-0.0195
150.57	-0.006	193.7	-0.0169
150.58	-0.006	193.8	-0.0142
150.60	-0.005	193.9	-0.0107
150.62	-0.002	194.1	-0.0071
150.63	0	194.3	-0.0044
150.65	0.001	194.4	-0.0009
150.67	0.004	194.7	-0.0009
150.68	0.006	194.9	0.0036
150.70	0.006	194.9	0.0062
150.72	0.007	195.1	0.0115
150.73	0.011	195.6	0.0151
150.75	0.011	195.6	0.0178



Prova triassiale ciclica SN04-C1			
pressione di confinamento (kPa)		80	
deviatore ciclico (kPa)		95	
frequenza (hz)		0.00625	
tempo	cella di carico	$\Delta u$	LVDT
(min)	kN	(kPa)	$\delta$ (mm)
150.77	0.013	195.8	0.0213
150.78	0.015	196.1	0.0249
150.80	0.017	196.3	0.0293
150.82	0.018	196.6	0.0328
150.83	0.02	196.9	0.0328
150.85	0.022	197.1	0.0364
150.87	0.022	197.1	0.0391
150.88	0.023	197.3	0.0408
150.90	0.024	197.5	0.0444
150.92	0.026	197.7	0.0462
150.93	0.026	197.9	0.0479
150.95	0.027	198.1	0.0497
150.97	0.028	198.3	0.0497
150.98	0.029	198.3	0.0506
151.00	0.029	198.4	0.0515
151.02	0.029	198.5	0.0515
151.03	0.029	198.7	0.0524
151.05	0.029	198.8	0.0524
151.07	0.029	198.9	0.0524
151.08	0.028	198.9	0.0524
151.10	0.027	198.9	0.0515
151.12	0.027	199	0.0506
151.13	0.027	199	0.0497
151.15	0.025	199	0.0479
151.17	0.024	199	0.0462
151.18	0.023	198.9	0.0435
151.20	0.02	198.8	0.0435
151.22	0.019	198.8	0.0417
151.23	0.019	198.7	0.0399
151.25	0.018	198.6	0.0364
151.27	0.016	198.5	0.0337
151.28	0.014	198.3	0.0311
151.30	0.012	198.2	0.0275
151.32	0.009	197.9	0.0275
151.33	0.007	197.8	0.0222
151.35	0.007	197.8	0.0186
151.37	0.006	197.6	0.0151
151.38	0.003	197.3	0.0115
151.40	0.001	197.1	0.008
151.42	0	196.9	0.0036
151.43	-0.003	196.5	0.0036
151.45	-0.005	196.3	-0.0009
151.47	-0.006	196.1	-0.0062
151.48	-0.007	195.9	-0.0062
151.50	-0.009	195.6	-0.0089
151.52	-0.009	195.6	-0.0124
151.53	-0.01	195.4	-0.016
151.55	-0.012	195	-0.0186
151.57	-0.014	194.8	-0.0213
151.58	-0.014	194.6	-0.0231
151.60	-0.015	194.4	-0.0249
151.62	-0.016	194.2	-0.0249
151.63	-0.016	194.2	-0.0266
151.65	-0.016	194.1	-0.0275
151.67	-0.017	193.9	-0.0284
151.68	-0.017	193.8	-0.0293
151.70	-0.017	193.6	-0.0293
151.73	-0.017	193.5	-0.0293

Prova triassiale ciclica SN04-C1			
pressione di confinamento (kPa)		80	
deviatore ciclico (kPa)		95	
frequenza (hz)		0.00625	
tempo	cella di carico	$\Delta u$	LVDT
(min)	kN	(kPa)	$\delta$ (mm)
151.75	-0.017	193.5	-0.0293
151.77	-0.016	193.5	-0.0293
151.78	-0.016	193.4	-0.0284
151.78	-0.016	193.4	-0.0275
151.80	-0.014	193.4	-0.0257
151.82	-0.014	193.4	-0.0249
151.83	-0.013	193.4	-0.0231
151.85	-0.01	193.5	-0.0231
151.87	-0.01	193.5	-0.0204
151.88	-0.01	193.5	-0.0186
151.90	-0.008	193.7	-0.0151
151.92	-0.005	193.8	-0.0124
151.93	-0.004	193.9	-0.0107
151.95	-0.003	194.1	-0.0071
151.97	0.001	194.3	-0.0071
151.98	0.002	194.3	-0.0027
152.00	0.002	194.5	0
152.02	0.003	194.7	0.0044
152.03	0.007	195	0.0089
152.05	0.008	195.2	0.0115
152.07	0.01	195.5	0.016
152.08	0.013	195.7	0.016
152.10	0.015	195.7	0.0204
152.12	0.015	196	0.024
152.13	0.016	196.2	0.0284
152.15	0.019	196.5	0.032
152.17	0.02	196.7	0.0346
152.18	0.021	196.9	0.0382
152.20	0.022	197.1	0.0399
152.22	0.024	197.3	0.0417
152.23	0.025	197.5	0.0444
152.25	0.026	197.8	0.0444
152.27	0.027	198	0.047
152.28	0.027	198	0.0479
152.30	0.027	198.1	0.0497
152.32	0.028	198.3	0.0515
152.33	0.029	198.4	0.0524
152.35	0.029	198.6	0.0524
152.37	0.029	198.7	0.0524
152.38	0.029	198.8	0.0533
152.40	0.029	198.8	0.0524
152.42	0.029	198.9	0.0524
152.43	0.028	198.9	0.0515
152.45	0.027	198.9	0.0506
152.47	0.026	199	0.0497
152.48	0.025	199	0.0479
152.50	0.023	198.9	0.0479
152.52	0.022	198.9	0.0462
152.53	0.022	198.9	0.0444
152.55	0.021	198.7	0.0408
152.57	0.018	198.6	0.0382
152.58	0.017	198.6	0.0364
152.60	0.016	198.4	0.0328
152.62	0.012	198.2	0.0328
152.63	0.011	198.2	0.0293
152.65	0.011	198.1	0.0257
152.67	0.01	197.9	0.0213
152.68	0.006	197.6	0.0178

Prova triassiale ciclica SN04-C1			
pressione di confinamento (kPa)		80	
deviatore ciclico (kPa)		95	
frequenza (hz)		0.00625	
tempo	cella di carico	$\Delta u$	LVDT
(min)	kN	(kPa)	$\delta$ (mm)
152.70	0.005	197.5	0.0142
152.72	0.003	197.2	0.0107
152.73	0	197	0.0107
152.75	-0.001	197	0.0062
152.77	-0.001	196.8	0.0027
152.78	-0.002	196.5	-0.0009
152.80	-0.006	196.2	-0.0053
152.82	-0.007	196	-0.008
152.83	-0.008	195.7	-0.0124
152.85	-0.011	195.4	-0.0124
152.87	-0.012	195.4	-0.016
152.88	-0.012	195.1	-0.0178
152.90	-0.013	194.9	-0.0204
152.92	-0.015	194.7	-0.0222
152.93	-0.015	194.5	-0.024
152.95	-0.015	194.3	-0.0249
152.97	-0.016	194.1	-0.0266
152.98	-0.017	194	-0.0275
153.00	-0.017	193.8	-0.0284
153.02	-0.017	193.7	-0.0284
153.03	-0.017	193.7	-0.0284
153.05	-0.017	193.6	-0.0284
153.07	-0.017	193.5	-0.0284
153.08	-0.017	193.4	-0.0284
153.10	-0.016	193.4	-0.0275
153.12	-0.016	193.4	-0.0266
153.13	-0.014	193.4	-0.0266
153.17	-0.013	193.4	-0.0249
153.18	-0.013	193.4	-0.024
153.20	-0.012	193.4	-0.0213
153.22	-0.01	193.5	-0.0195
153.23	-0.009	193.6	-0.0178
153.23	-0.007	193.7	-0.0151
153.25	-0.005	193.9	-0.0151
153.27	-0.003	193.9	-0.0115
153.28	-0.003	194	-0.0089
153.30	-0.002	194.1	-0.0053
153.32	0.001	194.4	-0.0018
153.33	0.003	194.5	0.0018
153.35	0.004	194.7	0.0062
153.37	0.008	195	0.0062
153.38	0.009	195.2	0.0107
153.40	0.009	195.2	0.0133
153.42	0.011	195.5	0.0178
153.43	0.014	195.8	0.0222
153.45	0.015	196	0.0249
153.47	0.017	196.2	0.0293
153.48	0.019	196.5	0.0293
153.50	0.021	196.8	0.0337
153.52	0.021	196.8	0.0364
153.53	0.022	197	0.0391
153.55	0.024	197.2	0.0417
153.57	0.025	197.4	0.0444
153.58	0.026	197.6	0.047
153.60	0.027	197.8	0.047
153.62	0.027	198	0.0479
153.63	0.028	198.2	0.0497
153.65	0.028	198.3	0.0497

Prova triassiale ciclica SN04-C1			
pressione di confinamento (kPa)		80	
deviatore ciclico (kPa)		95	
frequenza (hz)		0.00625	
tempo	cella di carico	$\Delta u$	LVDT
(min)	kN	(kPa)	$\delta$ (mm)
153.67	0.029	198.5	0.0515
153.68	0.029	198.5	0.0524
153.70	0.029	198.6	0.0524
153.72	0.029	198.7	0.0524
153.73	0.029	198.8	0.0524
153.75	0.028	198.9	0.0524
153.77	0.027	198.9	0.0515
153.78	0.026	198.9	0.0515
153.80	0.025	198.9	0.0497
153.82	0.025	198.9	0.0488
153.83	0.024	198.9	0.047
153.85	0.023	198.9	0.0453
153.87	0.022	198.8	0.0435
153.88	0.02	198.7	0.0399
153.90	0.017	198.6	0.0399
153.92	0.017	198.6	0.0373
153.93	0.017	198.5	0.0346
153.95	0.015	198.3	0.0311
153.97	0.011	198.1	0.0275
153.98	0.01	198	0.024
154.00	0.009	197.8	0.0204
154.02	0.005	197.5	0.0204
154.03	0.004	197.5	0.016
154.05	0.004	197.4	0.0133
154.07	0.003	197.1	0.0089
154.08	-0.001	196.8	0.0044
154.10	-0.002	196.6	0.0009
154.12	-0.004	196.3	-0.0027
154.13	-0.007	196	-0.0027
154.15	-0.007	196	-0.0071
154.17	-0.007	195.8	-0.0098
154.18	-0.009	195.5	-0.0133
154.20	-0.012	195.2	-0.0169
154.22	-0.012	195	-0.0195
154.23	-0.013	194.7	-0.0222
154.25	-0.015	194.5	-0.0222
154.27	-0.015	194.5	-0.024
154.28	-0.015	194.3	-0.0249
154.30	-0.016	194.2	-0.0266
154.32	-0.017	194	-0.0275
154.33	-0.017	193.8	-0.0284
154.35	-0.017	193.7	-0.0293
154.37	-0.017	193.6	-0.0293
154.38	-0.017	193.5	-0.0293
154.40	-0.017	193.4	-0.0293
154.42	-0.017	193.3	-0.0293
154.43	-0.016	193.3	-0.0293
154.45	-0.016	193.3	-0.0275
154.47	-0.015	193.3	-0.0266
154.48	-0.014	193.3	-0.0249
154.50	-0.012	193.3	-0.024
154.52	-0.011	193.4	-0.0213
154.53	-0.01	193.5	-0.0213
154.55	-0.007	193.6	-0.0195
154.57	-0.007	193.6	-0.0169
154.58	-0.007	193.7	-0.0142
154.60	-0.004	193.9	-0.0107
154.63	-0.002	194	-0.008

Prova triassiale ciclica SN04-C1			
pressione di confinamento (kPa)		80	
deviatore ciclico (kPa)		95	
frequenza (hz)		0.00625	
tempo	cella di carico	$\Delta u$	LVDT
(min)	kN	(kPa)	$\delta$ (mm)
154.65	-0.001	194.1	-0.0036
154.67	0.002	194.4	-0.0036
154.68	0.004	194.6	0
154.68	0.004	194.6	0.0036
154.70	0.005	194.7	0.008
154.72	0.008	195.1	0.0115
154.73	0.011	195.3	0.016
154.75	0.012	195.5	0.0186
154.77	0.013	195.8	0.0222
154.78	0.017	196.1	0.0222
154.80	0.017	196.1	0.0275
154.82	0.017	196.3	0.0311
154.83	0.019	196.5	0.0346
154.85	0.022	196.8	0.0373
154.87	0.022	197	0.0399
154.88	0.023	197.2	0.0426
154.90	0.026	197.5	0.0426
154.92	0.026	197.5	0.0453
154.93	0.026	197.6	0.0462
154.95	0.027	197.9	0.0488
154.97	0.028	198	0.0497
154.98	0.028	198.2	0.0506
155.00	0.029	198.3	0.0515
155.02	0.029	198.5	0.0515
155.03	0.029	198.5	0.0524
155.05	0.029	198.6	0.0524
155.07	0.029	198.7	0.0524
155.08	0.029	198.8	0.0524
155.10	0.028	198.8	0.0515
155.12	0.027	198.9	0.0506
155.13	0.026	198.8	0.0488
155.15	0.025	198.9	0.0479
155.17	0.024	198.8	0.0453
155.18	0.022	198.7	0.0453
155.20	0.021	198.7	0.0435
155.22	0.021	198.7	0.0417
155.23	0.019	198.6	0.0391
155.25	0.017	198.4	0.0355
155.27	0.015	198.3	0.0337
155.28	0.014	198.2	0.0293
155.30	0.011	198	0.0293
155.32	0.009	198	0.0257
155.33	0.009	197.8	0.0222
155.35	0.008	197.6	0.0178
155.37	0.005	197.3	0.0142
155.38	0.003	197.2	0.0107
155.40	0.001	196.9	0.0062
155.42	-0.002	196.6	0.0062
155.43	-0.003	196.4	0.0027
155.45	-0.003	196.4	-0.0009
155.47	-0.004	196.2	-0.0044
155.48	-0.007	195.9	-0.0089
155.50	-0.009	195.6	-0.0115
155.52	-0.01	195.4	-0.0142
155.53	-0.012	195.1	-0.0142
155.55	-0.013	194.8	-0.0178
155.57	-0.013	194.8	-0.0195
155.58	-0.014	194.7	-0.0213

Prova triassiale ciclica SN04-C1			
pressione di confinamento (kPa)		80	
deviatore ciclico (kPa)		95	
frequenza (hz)		0.00625	
tempo	cella di carico	$\Delta u$	LVDT
(min)	kN	(kPa)	$\delta$ (mm)
155.60	-0.015	194.4	-0.024
155.62	-0.016	194.2	-0.0257
155.63	-0.016	194.1	-0.0266
155.65	-0.017	193.9	-0.0275
155.67	-0.017	193.7	-0.0275
155.68	-0.017	193.7	-0.0284
155.70	-0.017	193.6	-0.0284
155.72	-0.017	193.5	-0.0293
155.73	-0.017	193.4	-0.0293
155.75	-0.016	193.4	-0.0284
155.77	-0.016	193.3	-0.0275
155.78	-0.015	193.3	-0.0275
155.80	-0.014	193.3	-0.0266
155.82	-0.013	193.3	-0.024
155.83	-0.012	193.3	-0.024
155.85	-0.011	193.3	-0.0231
155.87	-0.011	193.4	-0.0204
155.88	-0.01	193.5	-0.0178
155.90	-0.006	193.6	-0.0151
155.92	-0.006	193.7	-0.0133
155.93	-0.004	193.9	-0.0089
155.95	-0.001	194.1	-0.0089
155.97	0	194.1	-0.0053
155.98	0	194.2	-0.0027
156.00	0.002	194.4	0.0009
156.02	0.005	194.7	0.0053
156.03	0.006	194.8	0.0089
156.05	0.008	195.1	0.0133
156.08	0.012	195.4	0.0133
156.10	0.013	195.4	0.0169
156.12	0.013	195.6	0.0195
156.13	0.014	195.8	0.024
156.13	0.017	196.1	0.0293
156.15	0.018	196.4	0.032
156.17	0.02	196.6	0.0355
156.18	0.022	196.9	0.0355
156.20	0.023	197.1	0.0391
156.22	0.023	197.1	0.0408
156.23	0.024	197.3	0.0444
156.25	0.026	197.5	0.0462
156.27	0.027	197.7	0.0479
156.28	0.027	197.9	0.0497
156.30	0.028	198.1	0.0497
156.32	0.029	198.2	0.0506
156.33	0.029	198.2	0.0515
156.35	0.029	198.4	0.0524
156.37	0.029	198.5	0.0524
156.38	0.029	198.6	0.0524
156.40	0.029	198.7	0.0524
156.42	0.028	198.8	0.0524
156.43	0.027	198.8	0.0524
156.45	0.027	198.8	0.0515
156.47	0.026	198.8	0.0497
156.48	0.025	198.8	0.0479
156.50	0.024	198.8	0.0462
156.52	0.023	198.7	0.0453
156.53	0.022	198.7	0.0426
156.55	0.019	198.6	0.0399

Prova triassiale ciclica SN04-C1			
pressione di confinamento (kPa)		80	
deviatore ciclico (kPa)		95	
frequenza (hz)		0.00625	
tempo	cella di carico	$\Delta u$	LVDT
(min)	kN	(kPa)	$\delta$ (mm)
156.57	0.019	198.5	0.0382
156.58	0.017	198.4	0.0355
156.60	0.014	198.2	0.0355
156.62	0.013	198.2	0.032
156.63	0.013	198.1	0.0293
156.65	0.011	197.9	0.0249
156.67	0.008	197.7	0.0213
156.68	0.007	197.5	0.0178
156.70	0.005	197.3	0.0142
156.72	0.002	197	0.0142
156.73	0.001	197	0.0098
156.75	0.001	196.8	0.0062
156.77	-0.001	196.5	0.0018
156.78	-0.005	196.3	-0.0027
156.80	-0.005	196.1	-0.0053
156.82	-0.006	195.8	-0.0089
156.83	-0.01	195.5	-0.0089
156.85	-0.01	195.5	-0.0133
156.87	-0.01	195.2	-0.0151
156.88	-0.011	195	-0.0178
156.90	-0.014	194.7	-0.0204
156.92	-0.014	194.6	-0.0222
156.93	-0.015	194.3	-0.024
156.95	-0.016	194.1	-0.024
156.97	-0.017	194.1	-0.0257
156.98	-0.017	194	-0.0266
157.00	-0.017	193.8	-0.0275
157.02	-0.017	193.7	-0.0284
157.03	-0.017	193.6	-0.0284
157.05	-0.017	193.5	-0.0284
157.07	-0.017	193.4	-0.0284
157.08	-0.016	193.4	-0.0284
157.10	-0.016	193.3	-0.0275
157.12	-0.015	193.3	-0.0257
157.13	-0.014	193.3	-0.0257
157.15	-0.013	193.3	-0.024
157.17	-0.013	193.3	-0.0222
157.18	-0.011	193.4	-0.0222
157.20	-0.009	193.5	-0.0204
157.22	-0.009	193.5	-0.0186
157.23	-0.008	193.5	-0.016
157.25	-0.006	193.7	-0.0124
157.27	-0.004	193.8	-0.0098
157.28	-0.004	193.9	-0.008
157.30	-0.001	194.2	-0.0044
157.32	0.001	194.3	-0.0009
157.33	0.002	194.5	0.0036
157.35	0.005	194.8	0.0071
157.37	0.008	195	0.0071
157.38	0.008	195	0.0115
157.40	0.009	195.1	0.0151
157.42	0.012	195.5	0.0195
157.43	0.014	195.7	0.0222
157.45	0.015	195.9	0.0275
157.47	0.017	196.2	0.0311
157.48	0.02	196.5	0.0311
157.50	0.02	196.5	0.0346
157.53	0.02	196.7	0.0373

Prova triassiale ciclica SN04-C1			
pressione di confinamento (kPa)		80	
deviatore ciclico (kPa)		95	
frequenza (hz)		0.00625	
tempo	cella di carico	$\Delta u$	LVDT
(min)	kN	(kPa)	$\delta$ (mm)
157.55	0.022	197	0.0408
157.57	0.024	197.2	0.0426
157.58	0.025	197.4	0.0453
157.58	0.026	197.6	0.047
157.60	0.027	197.8	0.047
157.62	0.027	197.8	0.0497
157.63	0.027	197.9	0.0506
157.65	0.028	198.1	0.0515
157.67	0.029	198.3	0.0524
157.68	0.029	198.4	0.0524
157.70	0.029	198.5	0.0533
157.72	0.029	198.6	0.0533
157.73	0.028	198.6	0.0533
157.75	0.028	198.7	0.0533
157.77	0.028	198.8	0.0524
157.78	0.027	198.8	0.0515
157.80	0.026	198.8	0.0497
157.82	0.025	198.8	0.0479
157.83	0.023	198.8	0.0479
157.85	0.022	198.8	0.0462
157.87	0.022	198.7	0.0453
157.88	0.021	198.6	0.0417
157.90	0.018	198.5	0.0391
157.92	0.017	198.4	0.0373
157.93	0.016	198.3	0.0337
157.95	0.012	198.1	0.0337
157.97	0.011	197.9	0.0302
157.98	0.011	197.9	0.0275
158.00	0.007	197.6	0.0222
158.02	0.006	197.4	0.0204
158.03	0.006	197.4	0.0178
158.05	0.004	197.2	0.0133
158.07	0.001	196.9	0.0089
158.08	-0.001	196.7	0.0053
158.10	-0.002	196.5	0.0018
158.12	-0.005	196.2	0.0018
158.13	-0.007	195.9	-0.0027
158.15	-0.007	195.9	-0.0062
158.17	-0.007	195.7	-0.0089
158.18	-0.009	195.4	-0.0133
158.20	-0.012	195.1	-0.016
158.22	-0.012	194.9	-0.0178
158.23	-0.013	194.6	-0.0178
158.25	-0.015	194.4	-0.0204
158.27	-0.015	194.4	-0.0231
158.28	-0.015	194.3	-0.024
158.30	-0.016	194.1	-0.0257
158.32	-0.017	193.9	-0.0266
158.33	-0.017	193.7	-0.0275
158.35	-0.017	193.6	-0.0275
158.37	-0.017	193.5	-0.0275
158.38	-0.017	193.5	-0.0275
158.40	-0.017	193.4	-0.0275
158.42	-0.017	193.3	-0.0275
158.43	-0.016	193.3	-0.0266
158.45	-0.015	193.2	-0.0257
158.47	-0.014	193.3	-0.024
158.48	-0.013	193.3	-0.024



Prova triassiale ciclica SN04-C1			
pressione di confinamento (kPa)		80	
deviatore ciclico (kPa)		95	
frequenza (hz)		0.00625	
tempo	cella di carico	$\Delta u$	LVDT
(min)	kN	(kPa)	$\delta$ (mm)
158.50	-0.012	193.3	-0.0222
158.52	-0.012	193.3	-0.0213
158.53	-0.011	193.4	-0.0186
158.55	-0.008	193.5	-0.0169
158.57	-0.007	193.6	-0.0142
158.58	-0.006	193.7	-0.0115
158.60	-0.002	193.9	-0.0115
158.62	-0.002	193.9	-0.0071
158.63	-0.002	194	-0.0044
158.65	0	194.2	0
158.67	0.004	194.5	0.0036
158.68	0.005	194.6	0.0062
158.70	0.006	194.9	0.0107
158.72	0.01	195.1	0.0151
158.73	0.01	195.3	0.0169
158.75	0.012	195.6	0.0213
158.77	0.015	195.8	0.0213
158.78	0.016	195.8	0.0249
158.80	0.016	196	0.0284
158.82	0.017	196.3	0.0328
158.83	0.02	196.6	0.0364
158.85	0.021	196.8	0.0382
158.87	0.022	197	0.0417
158.88	0.024	197.2	0.0417
158.90	0.026	197.4	0.0444
158.92	0.026	197.4	0.0462
158.93	0.026	197.6	0.0488
158.95	0.027	197.8	0.0506
158.97	0.028	198	0.0515
159.00	0.028	198.2	0.0524
159.02	0.029	198.3	0.0524
159.03	0.029	198.4	0.0533
159.05	0.029	198.4	0.0533
159.05	0.029	198.6	0.0541
159.07	0.029	198.6	0.0541
159.08	0.028	198.7	0.0533
159.10	0.028	198.8	0.0524
159.12	0.027	198.8	0.0515
159.13	0.025	198.8	0.0515
159.15	0.024	198.8	0.0497
159.17	0.024	198.8	0.0488
159.18	0.024	198.7	0.047
159.20	0.021	198.7	0.0444
159.22	0.02	198.6	0.0426
159.23	0.019	198.5	0.0391
159.25	0.016	198.4	0.0391
159.27	0.015	198.4	0.0364
159.28	0.015	198.3	0.0337
159.30	0.013	198	0.0302
159.32	0.009	197.8	0.0249
159.33	0.009	197.7	0.0222
159.35	0.007	197.5	0.0186
159.37	0.003	197.2	0.0186
159.38	0.002	197.2	0.0142
159.40	0.002	197	0.0107
159.42	0.001	196.7	0.0062
159.43	-0.003	196.5	0.0027
159.45	-0.004	196.3	-0.0009

Prova triassiale ciclica SN04-C1			
pressione di confinamento (kPa)		80	
deviatore ciclico (kPa)		95	
frequenza (hz)		0.00625	
tempo	cella di carico	$\Delta u$	LVDT
(min)	kN	(kPa)	$\delta$ (mm)
159.47	-0.004	196.1	-0.0027
159.48	-0.007	195.8	-0.0071
159.50	-0.008	195.6	-0.0098
159.52	-0.009	195.2	-0.0133
159.53	-0.012	195	-0.0133
159.55	-0.013	195	-0.0169
159.57	-0.013	194.8	-0.0186
159.58	-0.013	194.6	-0.0204
159.60	-0.015	194.3	-0.0231
159.62	-0.016	194.1	-0.024
159.63	-0.016	194	-0.0257
159.65	-0.017	193.8	-0.0257
159.67	-0.017	193.8	-0.0266
159.68	-0.017	193.7	-0.0266
159.70	-0.017	193.5	-0.0275
159.72	-0.017	193.4	-0.0275
159.73	-0.017	193.3	-0.0275
159.75	-0.017	193.3	-0.0266
159.77	-0.016	193.3	-0.0266
159.78	-0.015	193.2	-0.0257
159.80	-0.015	193.2	-0.0249
159.82	-0.014	193.2	-0.0231
159.83	-0.012	193.3	-0.0213
159.85	-0.011	193.3	-0.0204
159.87	-0.01	193.4	-0.0178
159.88	-0.008	193.5	-0.0178
159.90	-0.006	193.6	-0.0151
159.92	-0.006	193.6	-0.0124
159.93	-0.005	193.7	-0.0098
159.95	-0.003	193.9	-0.0062
159.97	0	194.1	-0.0036
159.98	0.001	194.2	0
160.00	0.004	194.5	0.0053
160.02	0.006	194.7	0.0053
160.03	0.006	194.7	0.008
160.05	0.007	194.9	0.0124
160.07	0.01	195.2	0.0169
160.08	0.012	195.5	0.0204
160.10	0.014	195.7	0.024
160.12	0.015	196	0.0284
160.13	0.018	196.2	0.0284
160.15	0.019	196.2	0.032
160.17	0.019	196.4	0.0355
160.18	0.022	196.9	0.0391
160.20	0.023	196.9	0.0408
160.22	0.023	197.1	0.0426
160.23	0.024	197.3	0.0453
160.25	0.026	197.5	0.0479
160.27	0.027	197.7	0.0497
160.28	0.027	197.9	0.0506
160.30	0.028	198.1	0.0506
160.32	0.029	198.1	0.0524
160.33	0.029	198.2	0.0533
160.35	0.029	198.4	0.0533
160.37	0.029	198.5	0.0541
160.38	0.029	198.6	0.0541
160.40	0.029	198.7	0.0541
160.43	0.028	198.7	0.0541

Prova triassiale ciclica SN04-C1			
pressione di confinamento (kPa)		80	
deviatore ciclico (kPa)		95	
frequenza (hz)		0.00625	
tempo	cella di carico	$\Delta u$	LVDT
(min)	kN	(kPa)	$\delta$ (mm)
160.45	0.027	198.7	0.0533
160.47	0.027	198.8	0.0524
160.48	0.027	198.8	0.0515
160.50	0.025	198.8	0.0497
160.50	0.024	198.8	0.0479
160.52	0.023	198.7	0.0462
160.53	0.021	198.6	0.0462
160.55	0.019	198.6	0.0435
160.57	0.019	198.6	0.0417
160.58	0.018	198.5	0.0382
160.60	0.016	198.3	0.0355
160.62	0.014	198.2	0.0328
160.63	0.012	198	0.0284
160.65	0.009	197.8	0.0284
160.67	0.008	197.6	0.024
160.68	0.008	197.6	0.0213
160.70	0.006	197.4	0.0169
160.72	0.003	197.1	0.0133
160.73	0.001	196.9	0.0098
160.75	0	196.7	0.0053
160.77	-0.003	196.4	0.0053
160.78	-0.005	196.1	0.0009
160.80	-0.005	196.1	-0.0018
160.82	-0.006	195.9	-0.0053
160.83	-0.008	195.6	-0.0089
160.85	-0.01	195.3	-0.0124
160.87	-0.011	195.1	-0.0151
160.88	-0.012	194.8	-0.0151
160.90	-0.014	194.6	-0.0195
160.92	-0.014	194.4	-0.0204
160.93	-0.015	194.2	-0.0231
160.95	-0.016	194	-0.0231
160.97	-0.016	194	-0.024
160.98	-0.016	193.9	-0.0249
161.00	-0.017	193.7	-0.0257
161.02	-0.017	193.6	-0.0266
161.03	-0.017	193.5	-0.0266
161.05	-0.017	193.4	-0.0266
161.07	-0.017	193.3	-0.0266
161.08	-0.016	193.3	-0.0266
161.10	-0.016	193.2	-0.0257
161.12	-0.016	193.2	-0.0249
161.13	-0.014	193.2	-0.024
161.15	-0.013	193.3	-0.0222
161.17	-0.012	193.3	-0.0204
161.18	-0.011	193.3	-0.0204
161.20	-0.01	193.3	-0.0186
161.22	-0.01	193.4	-0.016
161.23	-0.008	193.6	-0.0133
161.25	-0.005	193.7	-0.0107
161.27	-0.004	193.8	-0.008
161.28	-0.002	194	-0.0044
161.30	0.001	194.2	-0.0044
161.32	0.002	194.2	-0.0009
161.33	0.002	194.3	0.0018
161.35	0.003	194.6	0.0062
161.37	0.007	194.8	0.0107
161.38	0.008	195	0.0142

Prova triassiale ciclica SN04-C1			
pressione di confinamento (kPa)		80	
deviatore ciclico (kPa)		95	
frequenza (hz)		0.00625	
tempo	cella di carico	$\Delta u$	LVDT
(min)	kN	(kPa)	$\delta$ (mm)
161.40	0.01	195.3	0.0178
161.42	0.014	195.6	0.0178
161.43	0.015	195.6	0.0222
161.45	0.015	195.8	0.0249
161.47	0.016	196	0.0302
161.48	0.019	196.3	0.0346
161.50	0.02	196.5	0.0373
161.52	0.021	196.8	0.0399
161.53	0.023	197	0.0399
161.55	0.024	197	0.0426
161.57	0.024	197.2	0.0453
161.58	0.025	197.4	0.0479
161.60	0.027	197.7	0.0497
161.62	0.027	197.8	0.0506
161.63	0.028	198	0.0524
161.65	0.027	198.1	0.0524
161.67	0.028	198.3	0.0533
161.68	0.028	198.4	0.0541
161.70	0.029	198.5	0.0541
161.72	0.029	198.5	0.0541
161.73	0.029	198.6	0.0541
161.75	0.029	198.7	0.0541
161.77	0.028	198.8	0.0533
161.78	0.027	198.8	0.0524
161.80	0.026	198.8	0.0506
161.82	0.025	198.8	0.0506
161.83	0.023	198.7	0.0497
161.85	0.023	198.7	0.0479
161.87	0.022	198.7	0.0453
161.90	0.021	198.6	0.0435
161.92	0.018	198.5	0.0408
161.93	0.017	198.4	0.0382
161.95	0.015	198.2	0.0337
161.95	0.012	198.1	0.0337
161.97	0.012	198.1	0.0311
161.98	0.012	197.9	0.0284
162.00	0.009	197.7	0.0231
162.02	0.006	197.5	0.0195
162.03	0.005	197.3	0.016
162.05	0.003	197	0.016
162.07	0	196.8	0.0124
162.08	0	196.8	0.008
162.10	-0.001	196.6	0.0044
162.12	-0.003	196.3	0
162.13	-0.006	196	-0.0036
162.15	-0.007	195.8	-0.0062
162.17	-0.009	195.5	-0.0107
162.18	-0.011	195.2	-0.0107
162.20	-0.011	195.2	-0.0133
162.22	-0.012	195	-0.016
162.23	-0.013	194.7	-0.0186
162.25	-0.015	194.5	-0.0204
162.27	-0.015	194.3	-0.0222
162.28	-0.016	194.1	-0.024
162.30	-0.017	193.9	-0.024
162.32	-0.017	193.9	-0.0249
162.33	-0.017	193.8	-0.0257
162.35	-0.017	193.5	-0.0266

Prova triassiale ciclica SN04-C1			
pressione di confinamento (kPa)		80	
deviatore ciclico (kPa)		95	
frequenza (hz)		0.00625	
tempo	cella di carico	$\Delta u$	LVDT
(min)	kN	(kPa)	$\delta$ (mm)
162.37	-0.017	193.5	-0.0266
162.38	-0.017	193.4	-0.0266
162.40	-0.017	193.3	-0.0266
162.42	-0.017	193.3	-0.0266
162.43	-0.016	193.2	-0.0257
162.45	-0.015	193.2	-0.0249
162.47	-0.014	193.2	-0.0249
162.48	-0.013	193.2	-0.0231
162.50	-0.013	193.2	-0.0213
162.52	-0.012	193.3	-0.0195
162.53	-0.01	193.4	-0.0178
162.55	-0.009	193.4	-0.0151
162.57	-0.007	193.6	-0.0124
162.58	-0.005	193.7	-0.0124
162.60	-0.003	193.7	-0.0098
162.62	-0.003	193.8	-0.0062
162.63	-0.002	194	-0.0027
162.65	0.002	194.2	0.0009
162.67	0.003	194.4	0.0044
162.68	0.005	194.6	0.008
162.70	0.008	194.9	0.008
162.72	0.009	194.9	0.0124
162.73	0.009	195.1	0.016
162.75	0.011	195.3	0.0204
162.77	0.014	195.7	0.024
162.78	0.015	195.9	0.0284
162.80	0.017	196.1	0.032
162.82	0.019	196.4	0.032
162.83	0.021	196.6	0.0355
162.85	0.021	196.6	0.0382
162.87	0.022	196.8	0.0417
162.88	0.024	197.1	0.0444
162.90	0.025	197.3	0.0462
162.92	0.026	197.5	0.0488
162.93	0.027	197.7	0.0506
162.95	0.028	197.9	0.0506
162.97	0.028	197.9	0.0524
162.98	0.028	198.1	0.0533
163.00	0.028	198.2	0.0533
163.02	0.029	198.4	0.0541
163.03	0.029	198.5	0.0541
163.05	0.029	198.6	0.055
163.07	0.028	198.7	0.055
163.08	0.028	198.7	0.0541
163.10	0.028	198.8	0.0533
163.12	0.027	198.8	0.0533
163.13	0.025	198.8	0.0524
163.15	0.025	198.8	0.0506
163.17	0.025	198.8	0.0488
163.18	0.022	198.7	0.047
163.20	0.022	198.7	0.0453
163.22	0.02	198.6	0.0417
163.23	0.017	198.4	0.0417
163.25	0.016	198.4	0.0391
163.27	0.016	198.3	0.0373
163.28	0.015	198.2	0.0337
163.30	0.011	198	0.0302
163.33	0.011	197.9	0.0275

Prova triassiale ciclica SN04-C1			
pressione di confinamento (kPa)		80	
deviatore ciclico (kPa)		95	
frequenza (hz)		0.00625	
tempo	cella di carico	$\Delta u$	LVDT
(min)	kN	(kPa)	$\delta$ (mm)
163.35	0.009	197.7	0.0222
163.37	0.005	197.4	0.0222
163.38	0.004	197.4	0.0178
163.40	0.004	197.2	0.0151
163.40	0.003	197	0.0115
163.42	0	196.7	0.0071
163.43	-0.002	196.5	0.0027
163.45	-0.004	196.3	-0.0009
163.47	-0.006	195.9	-0.0009
163.48	-0.008	195.7	-0.0044
163.50	-0.008	195.7	-0.0071
163.52	-0.009	195.5	-0.0115
163.53	-0.011	195.1	-0.0151
163.55	-0.013	194.9	-0.0169
163.57	-0.013	194.7	-0.0195
163.58	-0.014	194.4	-0.0213
163.60	-0.016	194.2	-0.0213
163.62	-0.016	194.2	-0.0231
163.63	-0.016	194.1	-0.024
163.65	-0.016	193.9	-0.0257
163.67	-0.017	193.7	-0.0257
163.68	-0.017	193.6	-0.0266
163.70	-0.017	193.5	-0.0266
163.72	-0.017	193.4	-0.0266
163.73	-0.017	193.4	-0.0266
163.75	-0.017	193.3	-0.0257
163.77	-0.016	193.3	-0.0257
163.78	-0.015	193.3	-0.0249
163.80	-0.015	193.2	-0.0231
163.82	-0.014	193.2	-0.0222
163.83	-0.013	193.2	-0.0213
163.85	-0.011	193.3	-0.0195
163.87	-0.01	193.4	-0.0169
163.88	-0.007	193.5	-0.0169
163.90	-0.007	193.5	-0.0142
163.92	-0.007	193.6	-0.0124
163.93	-0.005	193.8	-0.0089
163.95	-0.002	193.9	-0.0053
163.97	-0.001	194.1	-0.0027
163.98	0.001	194.3	0.0018
164.00	0.004	194.5	0.0018
164.02	0.005	194.5	0.0062
164.03	0.005	194.7	0.0098
164.05	0.007	194.9	0.0142
164.07	0.011	195.2	0.0186
164.08	0.012	195.4	0.0213
164.10	0.014	195.7	0.0249
164.12	0.016	196	0.0249
164.13	0.018	196	0.0302
164.15	0.018	196.2	0.0328
164.17	0.019	196.4	0.0364
164.18	0.021	196.7	0.0399
164.20	0.023	196.9	0.0426
164.22	0.024	197.1	0.0453
164.23	0.025	197.4	0.0453
164.25	0.026	197.6	0.047
164.27	0.026	197.6	0.0488
164.28	0.026	197.8	0.0506

Prova triassiale ciclica SN04-C1			
pressione di confinamento (kPa)		80	
deviatore ciclico (kPa)		95	
frequenza (hz)		0.00625	
tempo	cella di carico	$\Delta u$	LVDT
(min)	kN	(kPa)	$\delta$ (mm)
164.30	0.027	198	0.0524
164.32	0.029	198.1	0.0541
164.33	0.029	198.3	0.0541
164.35	0.029	198.4	0.0541
164.37	0.029	198.5	0.055
164.38	0.029	198.5	0.055
164.40	0.028	198.6	0.055
164.42	0.028	198.7	0.0541
164.43	0.028	198.7	0.0541
164.45	0.027	198.8	0.0524
164.47	0.026	198.8	0.0524
164.48	0.024	198.7	0.0506
164.50	0.024	198.7	0.0497
164.52	0.023	198.7	0.0479
164.53	0.021	198.6	0.0453
164.55	0.02	198.6	0.0444
164.57	0.02	198.5	0.0426
164.58	0.018	198.4	0.0382
164.60	0.015	198.3	0.0355
164.62	0.014	198.1	0.0328
164.63	0.012	198	0.0293
164.65	0.009	197.8	0.0293
164.67	0.008	197.8	0.0249
164.68	0.008	197.6	0.0213
164.70	0.006	197.3	0.0178
164.72	0.002	197.1	0.0133
164.73	0.002	196.9	0.0107
164.75	0	196.6	0.0053
164.77	-0.004	196.3	0.0053
164.80	-0.005	196.3	0.0018
164.82	-0.005	196.1	-0.0018
164.83	-0.006	195.8	-0.0044
164.85	-0.009	195.6	-0.0089
164.85	-0.01	195.3	-0.0115
164.87	-0.011	195	-0.0142
164.88	-0.013	194.8	-0.0142
164.90	-0.014	194.8	-0.0186
164.92	-0.014	194.5	-0.0195
164.93	-0.013	194.4	-0.0222
164.95	-0.017	194.2	-0.0231
164.97	-0.016	194	-0.024
164.98	-0.016	193.8	-0.0257
165.00	-0.017	193.7	-0.0257
165.02	-0.017	193.7	-0.0266
165.03	-0.017	193.5	-0.0266
165.05	-0.017	193.4	-0.0266
165.07	-0.018	193.3	-0.0266
165.08	-0.016	193.3	-0.0266
165.10	-0.015	193.2	-0.0249
165.12	-0.016	193.2	-0.0249
165.13	-0.015	193.2	-0.024
165.15	-0.015	193.2	-0.0213
165.17	-0.014	193.3	-0.0204
165.18	-0.01	193.4	-0.0169
165.20	-0.01	193.4	-0.0169
165.22	-0.009	193.5	-0.0142
165.23	-0.007	193.6	-0.0142
165.25	-0.004	193.6	-0.0133

Prova triassiale ciclica SN04-C1			
pressione di confinamento (kPa)		80	
deviatore ciclico (kPa)		95	
frequenza (hz)		0.00625	
tempo	cella di carico	$\Delta u$	LVDT
(min)	kN	(kPa)	$\delta$ (mm)
165.27	-0.003	193.9	-0.0071
165.28	-0.002	194	-0.0071
165.30	0	194	-0.0044
165.32	0	194.1	-0.0009
165.33	0.001	194.3	0.0036
165.35	0.006	194.6	0.008
165.37	0.006	194.7	0.0107
165.38	0.008	195	0.0151
165.40	0.012	195.3	0.0151
165.42	0.012	195.5	0.0195
165.43	0.012	195.5	0.0213
165.45	0.015	195.8	0.0293
165.47	0.018	196.1	0.0328
165.48	0.019	196.3	0.0355
165.50	0.02	196.5	0.0373
165.52	0.021	196.8	0.0373
165.53	0.024	197.1	0.0399
165.55	0.024	197.1	0.0444
165.57	0.024	197.2	0.0462
165.58	0.025	197.5	0.0488
165.60	0.027	197.7	0.0506
165.62	0.027	197.8	0.0515
165.63	0.027	198	0.0515
165.65	0.029	198.2	0.0515
165.67	0.029	198.2	0.055
165.68	0.029	198.3	0.0541
165.70	0.029	198.4	0.055
165.72	0.028	198.5	0.055
165.73	0.029	198.6	0.055
165.75	0.028	198.7	0.055
165.77	0.027	198.8	0.055
165.78	0.027	198.8	0.0541
165.80	0.027	198.8	0.0515
165.82	0.026	198.8	0.0506
165.83	0.023	198.7	0.0488
165.85	0.023	198.7	0.0479
165.87	0.022	198.6	0.0453
165.88	0.019	198.5	0.0453
165.90	0.018	198.5	0.0426
165.92	0.018	198.5	0.0408
165.93	0.017	198.3	0.0373
165.95	0.014	198.1	0.0346
165.97	0.012	198	0.0311
165.98	0.011	197.8	0.0275
166.00	0.009	197.6	0.0231
166.02	0.006	197.5	0.0204
166.03	0.005	197.3	0.0169
166.05	0.002	197	0.0169
166.07	0	196.8	0.0124
166.08	0	196.8	0.0089
166.10	-0.001	196.5	0.0044
166.12	-0.004	196.2	0.0009
166.13	-0.006	196	-0.0027
166.15	-0.007	195.8	-0.0062
166.17	-0.009	195.5	-0.0062
166.18	-0.011	195.2	-0.0098
166.20	-0.011	195.2	-0.0124
166.22	-0.012	195	-0.0151



Prova triassiale ciclica SN04-C1			
pressione di confinamento (kPa)		80	
deviatore ciclico (kPa)		95	
frequenza (hz)		0.00625	
tempo	cella di carico	$\Delta u$	LVDT
(min)	kN	(kPa)	$\delta$ (mm)
166.23	-0.013	194.7	-0.0178
166.27	-0.014	194.5	-0.0195
166.28	-0.015	194.3	-0.0222
166.30	-0.016	194.1	-0.024
166.30	-0.017	193.9	-0.024
166.32	-0.017	193.9	-0.0249
166.33	-0.017	193.7	-0.0257
166.35	-0.017	193.6	-0.0257
166.37	-0.017	193.5	-0.0257
166.38	-0.017	193.4	-0.0257
166.40	-0.017	193.3	-0.0257
166.42	-0.016	193.3	-0.0257
166.43	-0.016	193.3	-0.0249
166.45	-0.016	193.2	-0.0249
166.47	-0.015	193.2	-0.0231
166.48	-0.014	193.2	-0.0222
166.50	-0.012	193.3	-0.0204
166.52	-0.012	193.3	-0.0186
166.53	-0.009	193.4	-0.0186
166.55	-0.008	193.4	-0.016
166.57	-0.008	193.5	-0.0133
166.58	-0.007	193.6	-0.0107
166.60	-0.004	193.8	-0.0071
166.62	-0.002	193.9	-0.0044
166.63	-0.001	194.1	-0.0009
166.65	0.003	194.3	-0.0009
166.67	0.003	194.3	0.0027
166.68	0.003	194.5	0.0062
166.70	0.005	194.7	0.0107
166.72	0.009	195	0.0151
166.73	0.009	195.1	0.0169
166.75	0.011	195.4	0.0204
166.77	0.014	195.7	0.0249
166.78	0.015	195.9	0.0284
166.80	0.016	196.2	0.0328
166.82	0.02	196.4	0.0328
166.83	0.02	196.4	0.0364
166.85	0.02	196.6	0.0391
166.87	0.022	196.9	0.0426
166.88	0.024	197.1	0.0453
166.90	0.025	197.3	0.047
166.92	0.025	197.5	0.0488
166.93	0.027	197.8	0.0488
166.95	0.028	197.9	0.0515
166.97	0.028	197.9	0.0524
166.98	0.028	198.1	0.0533
167.00	0.028	198.2	0.0541
167.02	0.029	198.4	0.055
167.03	0.029	198.5	0.055
167.05	0.029	198.6	0.055
167.07	0.028	198.7	0.055
167.08	0.028	198.7	0.055
167.10	0.028	198.7	0.055
167.12	0.027	198.7	0.0533
167.13	0.026	198.7	0.0524
167.15	0.025	198.8	0.0515
167.17	0.024	198.7	0.0515
167.18	0.022	198.6	0.0488

Prova triassiale ciclica SN04-C1			
pressione di confinamento (kPa)		80	
deviatore ciclico (kPa)		95	
frequenza (hz)		0.00625	
tempo	cella di carico	$\Delta u$	LVDT
(min)	kN	(kPa)	$\delta$ (mm)
167.20	0.022	198.6	0.047
167.22	0.021	198.6	0.0444
167.23	0.019	198.5	0.0417
167.25	0.016	198.3	0.0382
167.27	0.015	198.2	0.0355
167.28	0.014	198	0.0328
167.30	0.011	197.9	0.0328
167.32	0.01	197.9	0.0293
167.33	0.01	197.7	0.0257
167.35	0.007	197.4	0.0204
167.37	0.004	197.3	0.0178
167.38	0.004	197.1	0.0142
167.40	0.001	196.8	0.0098
167.42	-0.002	196.6	0.0098
167.43	-0.002	196.3	0.0036
167.45	-0.004	196.1	0
167.47	-0.006	195.9	0
167.48	-0.007	195.9	-0.0036
167.50	-0.007	195.6	-0.0071
167.52	-0.009	195.3	-0.0107
167.53	-0.012	195	-0.0142
167.55	-0.012	194.8	-0.016
167.57	-0.013	194.6	-0.0186
167.58	-0.015	194.4	-0.0186
167.60	-0.015	194.4	-0.0213
167.62	-0.015	194.2	-0.0222
167.63	-0.016	194	-0.024
167.65	-0.017	193.8	-0.0249
167.67	-0.017	193.7	-0.0249
167.70	-0.017	193.5	-0.0257
167.72	-0.017	193.4	-0.0257
167.73	-0.017	193.4	-0.0257
167.75	-0.017	193.3	-0.0257
167.77	-0.017	193.2	-0.0257
167.77	-0.016	193.2	-0.0249
167.78	-0.015	193.2	-0.024
167.80	-0.015	193.2	-0.0222
167.82	-0.012	193.2	-0.0222
167.83	-0.012	193.2	-0.0213
167.85	-0.012	193.2	-0.0195
167.87	-0.011	193.3	-0.0169
167.88	-0.008	193.5	-0.0142
167.90	-0.007	193.5	-0.0124
167.92	-0.006	193.6	-0.0089
167.93	-0.003	193.8	-0.0089
167.95	-0.001	194	-0.0053
167.97	-0.001	194	-0.0027
167.98	0	194.1	0.0009
168.00	0.003	194.4	0.0053
168.02	0.005	194.6	0.008
168.03	0.006	194.8	0.0124
168.05	0.01	195.1	0.0124
168.07	0.011	195.3	0.0169
168.08	0.011	195.3	0.0195
168.10	0.012	195.5	0.024
168.12	0.015	195.8	0.0293
168.13	0.017	196.1	0.032
168.15	0.018	196.3	0.0355

Prova triassiale ciclica SN04-C1			
pressione di confinamento (kPa)		80	
deviatore ciclico (kPa)		95	
frequenza (hz)		0.00625	
tempo	cella di carico	$\Delta u$	LVDT
(min)	kN	(kPa)	$\delta$ (mm)
168.17	0.02	196.5	0.0382
168.18	0.021	196.7	0.0399
168.20	0.022	196.9	0.0426
168.22	0.024	197.2	0.0462
168.23	0.026	197.4	0.0462
168.25	0.026	197.4	0.0488
168.27	0.026	197.6	0.0506
168.28	0.027	197.8	0.0524
168.30	0.029	198	0.0541
168.32	0.028	198.1	0.0541
168.33	0.028	198.3	0.0541
168.35	0.029	198.4	0.0541
168.37	0.029	198.4	0.055
168.38	0.029	198.5	0.055
168.40	0.029	198.6	0.055
168.42	0.028	198.7	0.055
168.43	0.027	198.8	0.0541
168.45	0.027	198.7	0.0533
168.47	0.025	198.8	0.0533
168.48	0.025	198.8	0.0515
168.50	0.025	198.8	0.0506
168.52	0.024	198.7	0.0479
168.53	0.021	198.6	0.0462
168.55	0.02	198.6	0.0444
168.57	0.019	198.4	0.0408
168.58	0.016	198.3	0.0408
168.60	0.015	198.3	0.0373
168.62	0.015	198.2	0.0346
168.63	0.013	198	0.0311
168.65	0.01	197.8	0.0275
168.67	0.009	197.7	0.0231
168.68	0.007	197.4	0.0195
168.70	0.004	197.2	0.0195
168.72	0.002	197.2	0.016
168.73	0.002	197	0.0124
168.75	0.001	196.7	0.008
168.77	-0.003	196.5	0.0036
168.78	-0.004	196.2	0.0009
168.80	-0.005	196	-0.0027
168.82	-0.008	195.7	-0.0027
168.83	-0.009	195.7	-0.0062
168.85	-0.009	195.4	-0.0089
168.87	-0.01	195.1	-0.0124
168.88	-0.012	194.9	-0.016
168.90	-0.014	194.6	-0.0178
168.92	-0.014	194.5	-0.0195
168.93	-0.015	194.3	-0.0204
168.95	-0.016	194.1	-0.0222
168.97	-0.016	193.9	-0.024
168.98	-0.017	193.7	-0.024
169.00	-0.017	193.6	-0.0249
169.02	-0.017	193.6	-0.0257
169.03	-0.017	193.5	-0.0257
169.05	-0.017	193.4	-0.0257
169.07	-0.017	193.3	-0.0257
169.08	-0.016	193.2	-0.0249
169.10	-0.016	193.2	-0.024
169.12	-0.015	193.2	-0.024

Prova triassiale ciclica SN04-C1			
pressione di confinamento (kPa)		80	
deviatore ciclico (kPa)		95	
frequenza (hz)		0.00625	
tempo	cella di carico	$\Delta u$	LVDT
(min)	kN	(kPa)	$\delta$ (mm)
169.13	-0.014	193.2	-0.024
169.17	-0.014	193.2	-0.0222
169.18	-0.013	193.2	-0.0204
169.20	-0.011	193.3	-0.0186
169.22	-0.01	193.3	-0.016
169.22	-0.009	193.4	-0.0142
169.23	-0.006	193.6	-0.0142
169.25	-0.005	193.6	-0.0107
169.27	-0.005	193.7	-0.0089
169.28	-0.003	193.8	-0.0053
169.30	0	194	-0.0018
169.32	0.001	194.2	0.0018
169.33	0.003	194.4	0.0053
169.35	0.006	194.7	0.0053
169.37	0.007	194.7	0.0098
169.38	0.007	194.8	0.0133
169.40	0.009	195.1	0.0178
169.42	0.013	195.4	0.0222
169.43	0.014	195.6	0.0257
169.45	0.015	195.9	0.0302
169.47	0.018	196.2	0.0302
169.48	0.019	196.2	0.0337
169.50	0.019	196.4	0.0364
169.52	0.021	196.6	0.0399
169.53	0.023	196.9	0.0426
169.55	0.024	197.1	0.0453
169.57	0.025	197.3	0.0479
169.58	0.026	197.5	0.0479
169.60	0.027	197.5	0.0497
169.62	0.028	197.9	0.0524
169.63	0.028	198	0.0524
169.65	0.028	198	0.0533
169.67	0.028	198.2	0.0541
169.68	0.029	198.3	0.055
169.70	0.029	198.4	0.055
169.72	0.029	198.5	0.055
169.73	0.029	198.6	0.055
169.75	0.028	198.7	0.055
169.77	0.027	198.7	0.055
169.78	0.027	198.7	0.0541
169.80	0.026	198.7	0.0524
169.82	0.025	198.7	0.0506
169.83	0.024	198.7	0.0497
169.85	0.023	198.7	0.047
169.87	0.02	198.6	0.047
169.88	0.02	198.6	0.0453
169.90	0.02	198.5	0.0435
169.92	0.018	198.4	0.0399
169.93	0.015	198.2	0.0364
169.95	0.014	198.1	0.0337
169.97	0.012	197.9	0.0302
169.98	0.009	197.7	0.0302
170.00	0.008	197.7	0.0257
170.02	0.008	197.6	0.0222
170.03	0.006	197.3	0.0186
170.05	0.003	197.1	0.0142
170.07	0.001	196.9	0.0107
170.08	0	196.6	0.0062

Prova triassiale ciclica SN04-C1			
pressione di confinamento (kPa)		80	
deviatore ciclico (kPa)		95	
frequenza (hz)		0.00625	
tempo	cella di carico	$\Delta u$	LVDT
(min)	kN	(kPa)	$\delta$ (mm)
170.10	-0.004	196.3	0.0062
170.12	-0.005	196.3	0.0027
170.13	-0.005	196.1	-0.0009
170.15	-0.006	195.9	-0.0044
170.17	-0.009	195.6	-0.008
170.18	-0.01	195.2	-0.0107
170.20	-0.011	195	-0.0133
170.22	-0.013	194.8	-0.0133
170.23	-0.014	194.5	-0.016
170.25	-0.014	194.5	-0.0186
170.27	-0.015	194.3	-0.0204
170.28	-0.016	194.1	-0.0222
170.30	-0.017	193.9	-0.0231
170.32	-0.017	193.8	-0.024
170.33	-0.017	193.6	-0.0249
170.35	-0.017	193.5	-0.0257
170.37	-0.017	193.4	-0.0257
170.38	-0.017	193.3	-0.0257
170.40	-0.017	193.2	-0.0257
170.42	-0.016	193.2	-0.0257
170.43	-0.016	193.2	-0.0249
170.45	-0.015	193.1	-0.024
170.47	-0.014	193.1	-0.0222
170.48	-0.014	193.1	-0.0213
170.50	-0.013	193.2	-0.0195
170.52	-0.01	193.3	-0.0195
170.53	-0.01	193.3	-0.0178
170.55	-0.01	193.3	-0.016
170.57	-0.008	193.5	-0.0124
170.60	-0.005	193.6	-0.0098
170.62	-0.004	193.7	-0.0062
170.63	-0.003	193.9	-0.0036
170.65	0.001	194.1	-0.0036
170.67	0.002	194.1	0
170.67	0.002	194.2	0.0036
170.68	0.004	194.5	0.0071
170.70	0.007	194.7	0.0115
170.72	0.008	194.9	0.0151
170.73	0.01	195.2	0.0195
170.75	0.014	195.5	0.0195
170.77	0.014	195.5	0.024
170.78	0.014	195.7	0.0275
170.80	0.016	196	0.032
170.82	0.019	196.2	0.0355
170.83	0.02	196.4	0.0382
170.85	0.021	196.7	0.0417
170.87	0.024	197	0.0417
170.88	0.024	197	0.0444
170.90	0.024	197.2	0.047
170.92	0.025	197.4	0.0488
170.93	0.027	197.6	0.0515
170.95	0.027	197.8	0.0524
170.97	0.028	197.9	0.0541
170.98	0.028	198.1	0.0541
171.00	0.029	198.2	0.055
171.02	0.029	198.2	0.055
171.03	0.029	198.4	0.0559
171.05	0.029	198.5	0.0559

Prova triassiale ciclica SN04-C1			
pressione di confinamento (kPa)		80	
deviatore ciclico (kPa)		95	
frequenza (hz)		0.00625	
tempo	cella di carico	$\Delta u$	LVDT
(min)	kN	(kPa)	$\delta$ (mm)
171.07	0.029	198.6	0.0559
171.08	0.028	198.6	0.0559
171.10	0.028	198.7	0.055
171.12	0.027	198.7	0.0541
171.13	0.026	198.8	0.0524
171.15	0.025	198.7	0.0524
171.17	0.023	198.7	0.0506
171.18	0.023	198.7	0.0488
171.20	0.022	198.6	0.047
171.22	0.02	198.5	0.0444
171.23	0.018	198.4	0.0417
171.25	0.017	198.3	0.0391
171.27	0.015	198.1	0.0355
171.28	0.012	198	0.0355
171.30	0.012	198	0.0328
171.32	0.011	197.9	0.0293
171.33	0.009	197.6	0.0249
171.35	0.006	197.4	0.0213
171.37	0.005	197.2	0.0169
171.38	0.003	196.9	0.0133
171.40	0	196.7	0.0133
171.42	0	196.7	0.0098
171.43	-0.001	196.5	0.0053
171.45	-0.003	196.2	0.0018
171.47	-0.006	195.9	-0.0027
171.48	-0.007	195.7	-0.0053
171.50	-0.008	195.4	-0.0089
171.52	-0.011	195.1	-0.0089
171.53	-0.011	195.1	-0.0115
171.55	-0.011	194.9	-0.0142
171.57	-0.012	194.6	-0.0169
171.58	-0.015	194.4	-0.0195
171.60	-0.015	194.2	-0.0204
171.62	-0.016	194	-0.0222
171.63	-0.017	193.8	-0.0222
171.65	-0.017	193.8	-0.024
171.67	-0.017	193.7	-0.0249
171.68	-0.017	193.6	-0.0249
171.70	-0.017	193.4	-0.0257
171.72	-0.017	193.3	-0.0257
171.73	-0.017	193.3	-0.0257
171.75	-0.016	193.2	-0.0257
171.77	-0.016	193.2	-0.0249
171.78	-0.016	193.2	-0.024
171.80	-0.014	193.1	-0.0231
171.82	-0.013	193.1	-0.0222
171.83	-0.013	193.1	-0.0204
171.85	-0.012	193.2	-0.0186
171.87	-0.01	193.3	-0.016
171.88	-0.009	193.4	-0.0142
171.90	-0.007	193.5	-0.0115
171.92	-0.005	193.7	-0.0115
171.93	-0.003	193.7	-0.0089
171.95	-0.003	193.8	-0.0053
171.97	-0.002	193.9	-0.0018
171.98	0.002	194.2	0.0027
172.00	0.003	194.3	0.0053
172.02	0.004	194.5	0.0089

Prova triassiale ciclica SN04-C1			
pressione di confinamento (kPa)		80	
deviatore ciclico (kPa)		95	
frequenza (hz)		0.00625	
tempo	cella di carico	$\Delta u$	LVDT
(min)	kN	(kPa)	$\delta$ (mm)
172.03	0.008	194.8	0.0089
172.07	0.009	194.8	0.0142
172.08	0.009	195	0.0169
172.10	0.011	195.2	0.0213
172.12	0.014	195.6	0.0257
172.12	0.015	195.8	0.0293
172.13	0.016	196	0.0328
172.15	0.019	196.3	0.0328
172.17	0.021	196.5	0.0373
172.18	0.021	196.5	0.0391
172.20	0.022	196.8	0.0435
172.22	0.024	197	0.0453
172.23	0.025	197.2	0.0479
172.25	0.026	197.4	0.0506
172.27	0.027	197.6	0.0506
172.28	0.028	197.8	0.0515
172.30	0.028	197.8	0.0533
172.32	0.028	198	0.0541
172.33	0.028	198.1	0.055
172.35	0.029	198.3	0.0559
172.37	0.029	198.4	0.0559
172.38	0.029	198.5	0.0559
172.40	0.028	198.6	0.0559
172.42	0.028	198.6	0.0559
172.43	0.028	198.7	0.055
172.45	0.027	198.7	0.0541
172.47	0.026	198.7	0.0533
172.48	0.025	198.7	0.0515
172.50	0.024	198.7	0.0497
172.52	0.022	198.6	0.0497
172.53	0.022	198.6	0.0462
172.55	0.02	198.5	0.0435
172.57	0.017	198.3	0.0435
172.58	0.016	198.3	0.0408
172.60	0.016	198.3	0.0382
172.62	0.015	198.1	0.0346
172.63	0.011	197.9	0.0311
172.65	0.01	197.8	0.0284
172.67	0.009	197.6	0.024
172.68	0.005	197.3	0.024
172.70	0.004	197.3	0.0195
172.72	0.004	197.1	0.0169
172.73	0.003	196.9	0.0124
172.75	-0.001	196.6	0.008
172.77	-0.002	196.4	0.0044
172.78	-0.003	196.2	0.0009
172.80	-0.007	195.8	0.0009
172.82	-0.008	195.8	-0.0036
172.83	-0.008	195.6	-0.0062
172.85	-0.009	195.4	-0.0098
172.87	-0.011	195	-0.0133
172.88	-0.013	194.8	-0.0151
172.90	-0.013	194.6	-0.0178
172.92	-0.014	194.3	-0.0178
172.93	-0.016	194.1	-0.0195
172.95	-0.016	194.1	-0.0213
172.97	-0.016	194	-0.0222
172.98	-0.017	193.8	-0.024

Prova triassiale ciclica SN04-C1			
pressione di confinamento (kPa)		80	
deviatore ciclico (kPa)		95	
frequenza (hz)		0.00625	
tempo	cella di carico	$\Delta u$	LVDT
(min)	kN	(kPa)	$\delta$ (mm)
173.00	-0.017	193.6	-0.0249
173.02	-0.017	193.5	-0.0249
173.03	-0.017	193.4	-0.0249
173.05	-0.017	193.3	-0.0257
173.07	-0.017	193.3	-0.0249
173.08	-0.017	193.2	-0.0249
173.10	-0.016	193.2	-0.024
173.12	-0.015	193.2	-0.0231
173.13	-0.015	193.1	-0.0213
173.15	-0.013	193.2	-0.0213
173.17	-0.011	193.2	-0.0204
173.18	-0.011	193.2	-0.0186
173.20	-0.011	193.2	-0.0169
173.22	-0.009	193.4	-0.0142
173.23	-0.007	193.5	-0.0115
173.25	-0.006	193.6	-0.0089
173.27	-0.005	193.7	-0.0071
173.28	-0.002	193.9	-0.0036
173.30	-0.001	194	0
173.32	0.001	194.2	0.0036
173.33	0.004	194.4	0.0036
173.35	0.004	194.4	0.008
173.37	0.005	194.6	0.0115
173.38	0.008	194.9	0.016
173.40	0.011	195.1	0.0195
173.42	0.012	195.4	0.0222
173.43	0.013	195.7	0.0257
173.45	0.016	195.9	0.0257
173.47	0.018	195.9	0.0311
173.50	0.018	196.1	0.0346
173.52	0.019	196.4	0.0382
173.53	0.022	196.7	0.0417
173.55	0.022	196.9	0.0435
173.57	0.023	197.1	0.0462
173.57	0.026	197.3	0.0462
173.58	0.026	197.3	0.0497
173.60	0.026	197.5	0.0506
173.62	0.027	197.7	0.0524
173.63	0.028	197.9	0.0541
173.65	0.028	198.1	0.055
173.67	0.029	198.2	0.0559
173.68	0.029	198.3	0.0559
173.70	0.029	198.3	0.0559
173.72	0.029	198.4	0.0559
173.73	0.029	198.5	0.0559
173.75	0.028	198.6	0.0559
173.77	0.028	198.7	0.055
173.78	0.027	198.7	0.0541
173.80	0.025	198.7	0.0541
173.82	0.024	198.7	0.0524
173.83	0.024	198.7	0.0515
173.85	0.024	198.6	0.0488
173.87	0.021	198.6	0.047
173.88	0.02	198.5	0.0444
173.90	0.019	198.4	0.0417
173.92	0.015	198.2	0.0417
173.93	0.015	198.2	0.0382
173.95	0.015	198.1	0.0364



Prova triassiale ciclica SN04-C1			
pressione di confinamento (kPa)		80	
deviatore ciclico (kPa)		95	
frequenza (hz)		0.00625	
tempo	cella di carico	$\Delta u$	LVDT
(min)	kN	(kPa)	$\delta$ (mm)
173.97	0.013	198	0.0328
173.98	0.01	197.6	0.0293
174.00	0.01	197.6	0.0275
174.02	0.008	197.5	0.0222
174.03	0.005	197.2	0.0178
174.05	0.003	197	0.0151
174.07	0.001	196.8	0.0107
174.08	-0.002	196.5	0.0107
174.10	-0.003	196.3	0.0062
174.12	-0.003	196.3	0.0036
174.13	-0.004	196	-0.0009
174.15	-0.007	195.7	-0.0044
174.17	-0.009	195.4	-0.008
174.18	-0.01	195.2	-0.0107
174.20	-0.012	194.9	-0.0107
174.22	-0.013	194.7	-0.0133
174.23	-0.013	194.7	-0.016
174.25	-0.013	194.5	-0.0178
174.27	-0.015	194.2	-0.0204
174.28	-0.016	194	-0.0222
174.30	-0.016	193.9	-0.0222
174.32	-0.017	193.7	-0.0222
174.33	-0.017	193.5	-0.024
174.35	-0.017	193.5	-0.0249
174.37	-0.017	193.4	-0.0249
174.38	-0.017	193.3	-0.0249
174.40	-0.017	193.2	-0.0249
174.42	-0.017	193.2	-0.024
174.43	-0.016	193.2	-0.0231
174.45	-0.015	193.1	-0.0231
174.47	-0.014	193.1	-0.0222
174.48	-0.014	193.1	-0.0213
174.50	-0.013	193.1	-0.0195
174.52	-0.011	193.2	-0.0178
174.53	-0.01	193.3	-0.016
174.55	-0.009	193.4	-0.0133
174.57	-0.006	193.5	-0.0133
174.58	-0.005	193.5	-0.0098
174.60	-0.005	193.6	-0.008
174.62	-0.004	193.8	-0.0036
174.63	0	194	0
174.65	0.001	194.1	0.0027
174.67	0.003	194.4	0.0062
174.68	0.006	194.6	0.0062
174.70	0.007	194.8	0.0133
174.72	0.008	195	0.016
174.73	0.012	195.2	0.016
174.75	0.012	195.2	0.0204
174.77	0.012	195.4	0.024
174.78	0.014	195.8	0.0293
174.80	0.018	196	0.0337
174.82	0.018	196.2	0.0355
174.83	0.02	196.5	0.0399
174.85	0.023	196.8	0.0399
174.87	0.023	196.8	0.0426
174.88	0.023	196.9	0.0453
174.90	0.024	197.2	0.0479
174.92	0.026	197.4	0.0497

Prova triassiale ciclica SN04-C1			
pressione di confinamento (kPa)		80	
deviatore ciclico (kPa)		95	
frequenza (hz)		0.00625	
tempo	cella di carico	$\Delta u$	LVDT
(min)	kN	(kPa)	$\delta$ (mm)
174.93	0.027	197.6	0.0515
174.97	0.027	197.8	0.0524
174.98	0.028	197.9	0.0524
175.00	0.029	197.9	0.0533
175.02	0.029	198.1	0.055
175.02	0.029	198.2	0.055
175.03	0.029	198.3	0.0559
175.05	0.029	198.4	0.0559
175.07	0.028	198.5	0.0559
175.08	0.028	198.6	0.0559
175.10	0.028	198.6	0.0559
175.12	0.028	198.7	0.055
175.13	0.026	198.7	0.0533
175.15	0.025	198.6	0.0515
175.17	0.024	198.6	0.0506
175.18	0.023	198.6	0.0479
175.20	0.021	198.5	0.0479
175.22	0.019	198.4	0.0462
175.23	0.019	198.4	0.0435
175.25	0.018	198.4	0.0408
175.27	0.016	198.2	0.0373
175.28	0.013	198	0.0346
175.30	0.012	197.9	0.0302
175.32	0.01	197.6	0.0257
175.33	0.007	197.4	0.0257
175.35	0.007	197.4	0.0231
175.37	0.006	197.3	0.0195
175.38	0.004	197	0.0151
175.40	0.001	196.8	0.0107
175.42	0	196.6	0.0071
175.43	-0.003	196.2	0.0036
175.45	-0.004	196.1	0.0018
175.47	-0.005	195.9	-0.0018
175.48	-0.006	195.6	-0.0044
175.50	-0.01	195.3	-0.0044
175.52	-0.01	195.3	-0.0089
175.53	-0.01	195.1	-0.0115
175.55	-0.011	194.8	-0.0142
175.57	-0.014	194.6	-0.0169
175.58	-0.014	194.4	-0.0186
175.60	-0.015	194.1	-0.0204
175.62	-0.017	193.9	-0.0204
175.63	-0.017	193.9	-0.0231
175.65	-0.017	193.8	-0.0231
175.67	-0.016	193.6	-0.024
175.68	-0.017	193.5	-0.0249
175.70	-0.017	193.4	-0.0249
175.72	-0.017	193.3	-0.0257
175.73	-0.017	193.2	-0.0257
175.75	-0.016	193.2	-0.0249
175.77	-0.016	193.2	-0.024
175.78	-0.015	193.1	-0.0231
175.80	-0.015	193.1	-0.0231
175.82	-0.014	193.1	-0.0213
175.83	-0.013	193.2	-0.0186
175.85	-0.01	193.3	-0.0186
175.87	-0.009	193.3	-0.0169
175.88	-0.009	193.3	-0.0151

Prova triassiale ciclica SN04-C1			
pressione di confinamento (kPa)		80	
deviatore ciclico (kPa)		95	
frequenza (hz)		0.00625	
tempo	cella di carico	$\Delta u$	LVDT
(min)	kN	(kPa)	$\delta$ (mm)
175.90	-0.008	193.4	-0.0115
175.92	-0.005	193.6	-0.0089
175.93	-0.004	193.7	-0.0062
175.95	-0.002	193.8	-0.0018
175.97	0.001	194.1	-0.0018
175.98	0.002	194.1	0.0009
176.00	0.002	194.2	0.0044
176.02	0.004	194.4	0.008
176.03	0.007	194.7	0.0124
176.05	0.008	194.9	0.016
176.07	0.01	195.1	0.0204
176.08	0.013	195.4	0.0204
176.10	0.015	195.7	0.024
176.12	0.015	195.7	0.0284
176.13	0.016	195.9	0.032
176.15	0.02	196.4	0.0355
176.17	0.02	196.4	0.0382
176.18	0.02	196.6	0.0408
176.20	0.022	196.8	0.0435
176.22	0.024	197	0.0462
176.23	0.025	197.2	0.0479
176.25	0.026	197.5	0.0479
176.27	0.027	197.7	0.0506
176.28	0.027	197.7	0.0515
176.30	0.027	197.8	0.0533
176.32	0.028	198	0.055
176.33	0.029	198.2	0.0559
176.35	0.029	198.3	0.0559
176.37	0.029	198.4	0.0559
176.38	0.029	198.5	0.0559
176.40	0.028	198.5	0.0559
176.43	0.028	198.6	0.0559
176.45	0.028	198.7	0.0559
176.47	0.027	198.7	0.0541
176.48	0.026	198.7	0.0533
176.48	0.025	198.7	0.0515
176.50	0.023	198.6	0.0515
176.52	0.022	198.6	0.0497
176.53	0.022	198.6	0.0479
176.55	0.021	198.5	0.0444
176.57	0.018	198.4	0.0426
176.58	0.017	198.3	0.0399
176.60	0.016	198.1	0.0364
176.62	0.012	197.9	0.0364
176.63	0.011	197.9	0.0328
176.65	0.011	197.8	0.0302
176.67	0.01	197.6	0.0257
176.68	0.006	197.4	0.0213
176.70	0.005	197.2	0.0186
176.72	0.004	197	0.0142
176.73	-0.001	196.7	0.0142
176.75	-0.001	196.7	0.0098
176.77	-0.001	196.5	0.0071
176.78	-0.002	196.2	0.0027
176.80	-0.006	195.9	-0.0018
176.82	-0.007	195.7	-0.0044
176.83	-0.008	195.4	-0.008
176.85	-0.011	195.1	-0.008

Prova triassiale ciclica SN04-C1			
pressione di confinamento (kPa)		80	
deviatore ciclico (kPa)		95	
frequenza (hz)		0.00625	
tempo	cella di carico	$\Delta u$	LVDT
(min)	kN	(kPa)	$\delta$ (mm)
176.87	-0.011	195.1	-0.0115
176.88	-0.012	194.7	-0.0151
176.90	-0.013	194.5	-0.0151
176.92	-0.014	194.3	-0.0169
176.93	-0.014	194.3	-0.0195
176.95	-0.015	194.1	-0.0213
176.97	-0.016	193.9	-0.0231
176.98	-0.017	193.7	-0.024
177.00	-0.017	193.5	-0.0249
177.02	-0.017	193.4	-0.0249
177.03	-0.017	193.3	-0.0249
177.05	-0.017	193.3	-0.0249
177.07	-0.017	193.2	-0.0249
177.08	-0.017	193.1	-0.0249
177.10	-0.016	193.1	-0.024
177.12	-0.015	193.1	-0.0231
177.13	-0.014	193.1	-0.0213
177.15	-0.013	193.1	-0.0213
177.17	-0.012	193.1	-0.0204
177.18	-0.012	193.1	-0.0186
177.20	-0.011	193.2	-0.0169
177.22	-0.008	193.3	-0.0133
177.23	-0.007	193.4	-0.0115
177.25	-0.006	193.6	-0.0089
177.27	-0.003	193.7	-0.0089
177.28	-0.002	193.7	-0.0053
177.30	-0.002	193.9	-0.0018
177.32	0	194	0.0018
177.33	0.004	194.3	0.0053
177.35	0.004	194.4	0.0089
177.37	0.006	194.7	0.0133
177.38	0.01	195	0.0133
177.40	0.011	195	0.0178
177.42	0.011	195.1	0.0204
177.43	0.012	195.4	0.0249
177.45	0.016	195.8	0.0302
177.47	0.017	195.9	0.0328
177.48	0.018	196.2	0.0364
177.50	0.021	196.5	0.0364
177.52	0.022	196.7	0.0399
177.53	0.022	196.7	0.0426
177.55	0.023	196.9	0.0453
177.57	0.025	197.1	0.0479
177.58	0.026	197.4	0.0497
177.60	0.026	197.5	0.0515
177.62	0.027	197.7	0.0533
177.63	0.028	197.9	0.0541
177.65	0.028	198	0.055
177.67	0.029	198.2	0.055
177.68	0.029	198.3	0.0559
177.70	0.029	198.3	0.0559
177.72	0.029	198.4	0.0559
177.73	0.029	198.5	0.0559
177.75	0.029	198.6	0.0559
177.77	0.028	198.7	0.055
177.78	0.027	198.7	0.0533
177.80	0.025	198.6	0.0533
177.82	0.025	198.6	0.0524

Prova triassiale ciclica SN04-C1			
pressione di confinamento (kPa)		80	
deviatore ciclico (kPa)		95	
frequenza (hz)		0.00625	
tempo	cella di carico	$\Delta u$	LVDT
(min)	kN	(kPa)	$\delta$ (mm)
177.83	0.025	198.6	0.0515
177.87	0.024	198.6	0.0488
177.88	0.021	198.5	0.047
177.90	0.02	198.5	0.0444
177.92	0.019	198.3	0.0408
177.93	0.016	198.2	0.0408
177.93	0.015	198.2	0.0382
177.95	0.015	198.1	0.0364
177.97	0.013	197.9	0.032
177.98	0.009	197.7	0.0284
178.00	0.009	197.6	0.0249
178.02	0.007	197.3	0.0204
178.03	0.003	197.1	0.0204
178.05	0.002	197.1	0.0169
178.07	0.002	196.9	0.0133
178.08	0.001	196.6	0.0089
178.10	-0.003	196.3	0.0044
178.12	-0.004	196.1	0.0018
178.13	-0.005	195.9	-0.0018
178.15	-0.008	195.6	-0.0018
178.17	-0.009	195.6	-0.0053
178.18	-0.009	195.3	-0.0089
178.20	-0.01	195	-0.0115
178.22	-0.013	194.8	-0.0151
178.23	-0.013	194.6	-0.0169
178.25	-0.014	194.4	-0.0195
178.27	-0.015	194.1	-0.0195
178.28	-0.016	193.9	-0.0213
178.30	-0.016	193.9	-0.0222
178.32	-0.016	193.8	-0.0231
178.33	-0.017	193.5	-0.024
178.35	-0.017	193.5	-0.0249
178.37	-0.017	193.4	-0.0249
178.38	-0.017	193.3	-0.0249
178.40	-0.017	193.2	-0.0249
178.42	-0.017	193.1	-0.024
178.43	-0.016	193.1	-0.0231
178.45	-0.015	193.1	-0.0231
178.47	-0.014	193.1	-0.0222
178.48	-0.014	193.1	-0.0213
178.50	-0.013	193.1	-0.0195
178.52	-0.011	193.2	-0.0178
178.53	-0.01	193.2	-0.016
178.55	-0.009	193.3	-0.0133
178.57	-0.006	193.5	-0.0133
178.58	-0.005	193.5	-0.0107
178.60	-0.005	193.6	-0.008
178.62	-0.003	193.8	-0.0044
178.63	0	194	0
178.65	0.001	194.1	0.0027
178.67	0.003	194.3	0.0062
178.68	0.006	194.5	0.0062
178.70	0.007	194.5	0.0107
178.72	0.007	194.7	0.0142
178.73	0.009	195	0.0186
178.75	0.012	195.3	0.0222
178.77	0.013	195.5	0.0257
178.78	0.015	195.8	0.0311

Prova triassiale ciclica SN04-C1			
pressione di confinamento (kPa)		80	
deviatore ciclico (kPa)		95	
frequenza (hz)		0.00625	
tempo	cella di carico	$\Delta u$	LVDT
(min)	kN	(kPa)	$\delta$ (mm)
178.80	0.018	196.1	0.0311
178.82	0.019	196.1	0.0346
178.83	0.019	196.3	0.0373
178.85	0.02	196.5	0.0408
178.87	0.023	196.7	0.0435
178.88	0.024	197	0.0462
178.90	0.025	197.2	0.0488
178.92	0.026	197.4	0.0488
178.93	0.027	197.4	0.0506
178.95	0.027	197.6	0.0524
178.97	0.027	197.8	0.0533
178.98	0.028	197.9	0.055
179.00	0.029	198.1	0.0559
179.02	0.029	198.2	0.0559
179.03	0.029	198.3	0.0559
179.05	0.029	198.3	0.0559
179.07	0.028	198.5	0.0559
179.08	0.028	198.6	0.0559
179.10	0.027	198.6	0.0559
179.12	0.027	198.6	0.055
179.13	0.026	198.7	0.0541
179.15	0.025	198.6	0.0524
179.17	0.024	198.6	0.0506
179.18	0.023	198.6	0.0488
179.20	0.021	198.5	0.0488
179.22	0.019	198.4	0.0462
179.23	0.019	198.4	0.0435
179.25	0.018	198.3	0.0408
179.27	0.016	198.1	0.0382
179.28	0.014	198	0.0346
179.30	0.012	197.9	0.0311
179.33	0.009	197.6	0.0311
179.35	0.007	197.4	0.0275
179.37	0.007	197.4	0.0231
179.38	0.006	197.3	0.0204
179.38	0.003	197	0.016
179.40	0.001	196.8	0.0124
179.42	0	196.6	0.008
179.43	-0.003	196.2	0.008
179.45	-0.005	196	0.0036
179.47	-0.005	196	0
179.48	-0.006	195.8	-0.0036
179.50	-0.008	195.4	-0.0071
179.52	-0.01	195.1	-0.0098
179.53	-0.011	194.9	-0.0133
179.55	-0.012	194.6	-0.016
179.57	-0.014	194.4	-0.016
179.58	-0.015	194.4	-0.0178
179.60	-0.015	194.2	-0.0195
179.62	-0.015	194	-0.0213
179.63	-0.017	193.8	-0.0231
179.65	-0.017	193.7	-0.024
179.67	-0.017	193.6	-0.024
179.68	-0.017	193.4	-0.024
179.70	-0.017	193.4	-0.0249
179.72	-0.017	193.3	-0.0249
179.73	-0.017	193.2	-0.0249
179.75	-0.017	193.1	-0.0249

Prova triassiale ciclica SN04-C1			
pressione di confinamento (kPa)		80	
deviatore ciclico (kPa)		95	
frequenza (hz)		0.00625	
tempo	cella di carico	$\Delta u$	LVDT
(min)	kN	(kPa)	$\delta$ (mm)
179.77	-0.016	193.1	-0.024
179.78	-0.015	193	-0.0231
179.80	-0.015	193	-0.0231
179.82	-0.014	193	-0.0213
179.83	-0.013	193.1	-0.0186
179.85	-0.01	193.2	-0.0186
179.87	-0.01	193.2	-0.0169
179.88	-0.01	193.2	-0.0151
179.90	-0.008	193.3	-0.0124
179.92	-0.005	193.5	-0.0089
179.93	-0.004	193.6	-0.0062
179.95	-0.003	193.8	-0.0027
179.97	0.001	194	-0.0027
179.98	0.002	194.1	0.0009
180.00	0.002	194.1	0.0036
180.02	0.003	194.3	0.008
180.03	0.007	194.6	0.0124
180.05	0.009	194.8	0.016
180.07	0.01	195	0.0195
180.08	0.013	195.4	0.0195
180.10	0.015	195.6	0.024
180.12	0.015	195.6	0.0284
180.13	0.016	195.8	0.0328
180.15	0.019	196.1	0.0364
180.17	0.02	196.4	0.0391
180.18	0.021	196.6	0.0417
180.20	0.023	196.8	0.0417
180.22	0.025	197.1	0.0444
180.23	0.025	197.1	0.047
180.25	0.025	197.3	0.0497
180.27	0.026	197.5	0.0515
180.28	0.027	197.7	0.0533
180.30	0.028	197.8	0.0541
180.32	0.028	198	0.0541
180.33	0.029	198.1	0.055
180.35	0.029	198.1	0.0559
180.37	0.029	198.3	0.0559
180.38	0.029	198.4	0.0568
180.40	0.029	198.5	0.0568
180.42	0.029	198.6	0.0559
180.43	0.028	198.6	0.055
180.45	0.026	198.6	0.055
180.47	0.026	198.6	0.0533
180.48	0.026	198.6	0.0524
180.50	0.024	198.6	0.0506
180.52	0.022	198.5	0.0488
180.53	0.022	198.5	0.0479
180.55	0.021	198.4	0.0453
180.57	0.018	198.3	0.0426
180.58	0.017	198.2	0.0399
180.60	0.016	198.1	0.0364
180.62	0.012	197.9	0.0364
180.63	0.011	197.9	0.0328
180.65	0.011	197.8	0.0302
180.67	0.01	197.5	0.0257
180.68	0.006	197.3	0.0213
180.70	0.005	197.1	0.0186
180.72	0.004	196.9	0.0142

Prova triassiale ciclica SN04-C1			
pressione di confinamento (kPa)		80	
deviatore ciclico (kPa)		95	
frequenza (hz)		0.00625	
tempo	cella di carico	$\Delta u$	LVDT
(min)	kN	(kPa)	$\delta$ (mm)
180.73	0	196.6	0.0142
180.77	-0.001	196.6	0.0098
180.78	-0.001	196.4	0.0062
180.80	-0.003	196.1	0.0027
180.82	-0.006	195.9	-0.0018
180.83	-0.006	195.7	-0.0044
180.83	-0.008	195.3	-0.0089
180.85	-0.011	195	-0.0089
180.87	-0.012	195	-0.0115
180.88	-0.012	194.8	-0.0133
180.90	-0.013	194.6	-0.016
180.92	-0.015	194.3	-0.0186
180.93	-0.015	194.2	-0.0195
180.95	-0.016	194	-0.0213
180.97	-0.016	193.8	-0.0213
180.98	-0.017	193.6	-0.0231
181.00	-0.017	193.6	-0.024
181.02	-0.017	193.5	-0.024
181.03	-0.017	193.4	-0.0249
181.05	-0.017	193.3	-0.0249
181.07	-0.017	193.2	-0.0249
181.08	-0.017	193.1	-0.0249
181.10	-0.016	193.1	-0.024
181.12	-0.016	193.1	-0.0231
181.13	-0.015	193	-0.0222
181.15	-0.014	193.1	-0.0204
181.17	-0.012	193.1	-0.0186
181.18	-0.011	193.1	-0.0169
181.20	-0.01	193.3	-0.0142
181.22	-0.007	193.4	-0.0142
181.23	-0.006	193.4	-0.0107
181.25	-0.006	193.5	-0.008
181.27	-0.003	193.7	-0.008
181.28	-0.002	193.7	-0.0044
181.30	-0.002	193.8	-0.0018
181.32	0	194.1	0.0027
181.33	0.004	194.3	0.0062
181.35	0.005	194.4	0.0098
181.37	0.006	194.7	0.0133
181.38	0.01	194.9	0.0133
181.40	0.011	194.9	0.0178
181.42	0.011	195.1	0.0213
181.43	0.012	195.4	0.0257
181.45	0.016	195.7	0.0302
181.47	0.017	195.9	0.0328
181.48	0.018	196.2	0.0364
181.50	0.021	196.4	0.0364
181.52	0.022	196.4	0.0399
181.53	0.022	196.7	0.0426
181.55	0.023	196.9	0.0453
181.57	0.025	197.1	0.0479
181.58	0.026	197.3	0.0497
181.60	0.026	197.5	0.0515
181.62	0.027	197.7	0.0515
181.63	0.028	197.7	0.0533
181.65	0.028	197.9	0.0541
181.67	0.028	198	0.055
181.68	0.029	198.2	0.0559



Prova triassiale ciclica SN04-C1			
pressione di confinamento (kPa)		80	
deviatore ciclico (kPa)		95	
frequenza (hz)		0.00625	
tempo	cella di carico	$\Delta u$	LVDT
(min)	kN	(kPa)	$\delta$ (mm)
181.70	0.029	198.3	0.0568
181.72	0.029	198.4	0.0568
181.73	0.029	198.5	0.0568
181.75	0.028	198.5	0.0568
181.77	0.028	198.5	0.0559
181.78	0.027	198.6	0.0541
181.80	0.026	198.6	0.0533
181.82	0.025	198.6	0.0524
181.83	0.024	198.6	0.0497
181.85	0.022	198.5	0.0497
181.87	0.021	198.4	0.0479
181.88	0.021	198.4	0.0462
181.90	0.02	198.4	0.0435
181.92	0.017	198.2	0.0399
181.93	0.015	198.1	0.0373
181.95	0.014	198	0.0346
181.97	0.012	197.7	0.0311
181.98	0.01	197.6	0.0284
182.00	0.009	197.5	0.024
182.02	0.006	197.2	0.024
182.03	0.004	197	0.0204
182.05	0.004	197	0.0169
182.07	0.003	196.8	0.0124
182.08	0	196.5	0.0089
182.10	-0.003	196.2	0.0044
182.12	-0.004	196	0.0018
182.13	-0.005	195.7	-0.0018
182.15	-0.008	195.4	-0.0018
182.17	-0.008	195.4	-0.0062
182.18	-0.009	195.2	-0.0089
182.20	-0.011	194.9	-0.0124
182.23	-0.013	194.7	-0.0151
182.25	-0.013	194.5	-0.0169
182.27	-0.014	194.2	-0.0186
182.28	-0.016	194	-0.0186
182.28	-0.016	194	-0.0204
182.30	-0.016	193.9	-0.0222
182.32	-0.016	193.7	-0.0231
182.33	-0.017	193.5	-0.024
182.35	-0.017	193.4	-0.0249
182.37	-0.017	193.3	-0.0249
182.38	-0.017	193.2	-0.0249
182.40	-0.017	193.2	-0.0249
182.42	-0.017	193.1	-0.0249
182.43	-0.016	193.1	-0.024
182.45	-0.015	193.1	-0.0231
182.47	-0.015	193	-0.0222
182.48	-0.014	193.1	-0.0204
182.50	-0.011	193.1	-0.0204
182.52	-0.011	193.1	-0.0186
182.53	-0.011	193.1	-0.0169
182.55	-0.009	193.2	-0.0142
182.57	-0.006	193.4	-0.0115
182.58	-0.006	193.5	-0.0089
182.60	-0.004	193.6	-0.0053
182.62	-0.001	193.8	-0.0053
182.63	0	193.8	-0.0018
182.65	0	194	0.0009

Prova triassiale ciclica SN04-C1			
pressione di confinamento (kPa)		80	
deviatore ciclico (kPa)		95	
frequenza (hz)		0.00625	
tempo	cella di carico	$\Delta u$	LVDT
(min)	kN	(kPa)	$\delta$ (mm)
182.67	0.002	194.2	0.0053
182.68	0.005	194.4	0.0089
182.70	0.006	194.6	0.0124
182.72	0.007	194.7	0.0151
182.73	0.01	195	0.0186
182.75	0.012	195.2	0.0222
182.77	0.013	195.5	0.0275
182.78	0.016	195.8	0.0275
182.80	0.018	196	0.032
182.82	0.018	196	0.0346
182.83	0.019	196.3	0.0382
182.85	0.021	196.6	0.0417
182.87	0.023	196.8	0.0435
182.88	0.024	197	0.047
182.90	0.025	197.2	0.047
182.92	0.026	197.4	0.0488
182.93	0.026	197.4	0.0506
182.95	0.027	197.6	0.0524
182.97	0.027	197.8	0.0541
182.98	0.029	198	0.055
183.00	0.029	198.1	0.0559
183.02	0.029	198.2	0.0559
183.03	0.029	198.3	0.0559
183.05	0.029	198.3	0.0559
183.07	0.029	198.4	0.0559
183.08	0.029	198.5	0.0559
183.10	0.028	198.6	0.0559
183.12	0.027	198.6	0.0541
183.13	0.026	198.6	0.0533
183.15	0.024	198.6	0.0533
183.17	0.023	198.6	0.0515
183.18	0.023	198.5	0.0497
183.20	0.022	198.5	0.0479
183.22	0.02	198.4	0.0453
183.23	0.019	198.3	0.0426
183.25	0.017	198.1	0.0391
183.27	0.014	198	0.0391
183.28	0.013	198	0.0355
183.30	0.013	197.9	0.0337
183.32	0.011	197.7	0.0293
183.33	0.007	197.4	0.0249
183.35	0.007	197.3	0.0213
183.37	0.005	197	0.0178
183.38	0.002	196.8	0.0178
183.40	0.001	196.8	0.0133
183.42	-0.001	196.4	0.008
183.43	-0.003	196.2	0.008
183.45	-0.004	196.2	0.0044
183.47	-0.004	195.9	0.0009
183.48	-0.006	195.7	-0.0036
183.50	-0.009	195.3	-0.0071
183.52	-0.01	195.1	-0.0098
183.53	-0.011	194.8	-0.0133
183.55	-0.013	194.6	-0.0133
183.57	-0.014	194.6	-0.016
183.58	-0.014	194.4	-0.0178
183.60	-0.014	194.2	-0.0195
183.62	-0.016	193.9	-0.0222

Prova triassiale ciclica SN04-C1			
pressione di confinamento (kPa)		80	
deviatore ciclico (kPa)		95	
frequenza (hz)		0.00625	
tempo	cella di carico	$\Delta u$	LVDT
(min)	kN	(kPa)	$\delta$ (mm)
183.63	-0.016	193.8	-0.0231
183.65	-0.017	193.6	-0.024
183.68	-0.017	193.5	-0.024
183.70	-0.017	193.5	-0.024
183.72	-0.017	193.3	-0.0249
183.73	-0.017	193.2	-0.0249
183.73	-0.017	193.1	-0.0249
183.75	-0.016	193.1	-0.024
183.77	-0.016	193	-0.0231
183.78	-0.015	193	-0.0231
183.80	-0.014	193	-0.0222
183.82	-0.014	193	-0.0213
183.83	-0.013	193	-0.0195
183.85	-0.012	193.1	-0.0178
183.87	-0.01	193.2	-0.016
183.88	-0.009	193.2	-0.0133
183.90	-0.007	193.4	-0.0133
183.92	-0.005	193.5	-0.0107
183.93	-0.005	193.5	-0.008
183.95	-0.003	193.6	-0.0044
183.97	-0.001	193.9	-0.0009
183.98	0.002	194	0.0027
184.00	0.003	194.2	0.0071
184.02	0.005	194.5	0.0071
184.03	0.008	194.7	0.0107
184.05	0.008	194.7	0.0142
184.07	0.009	194.9	0.0186
184.08	0.011	195.2	0.0222
184.10	0.014	195.5	0.0275
184.12	0.015	195.7	0.0293
184.13	0.017	196	0.0337
184.15	0.02	196.2	0.0373
184.17	0.02	196.4	0.0391
184.18	0.021	196.6	0.0426
184.20	0.024	196.9	0.0426
184.22	0.024	196.9	0.0453
184.23	0.024	197.1	0.047
184.25	0.025	197.3	0.0497
184.27	0.027	197.5	0.0515
184.28	0.027	197.7	0.0533
184.30	0.028	197.8	0.0541
184.32	0.029	198	0.0541
184.33	0.029	198	0.055
184.35	0.029	198.1	0.0559
184.37	0.029	198.2	0.0568
184.38	0.029	198.4	0.0568
184.40	0.029	198.5	0.0568
184.42	0.029	198.6	0.0559
184.43	0.027	198.6	0.0559
184.45	0.026	198.6	0.055
184.47	0.026	198.6	0.0541
184.48	0.026	198.6	0.0524
184.50	0.024	198.6	0.0506
184.52	0.023	198.5	0.0488
184.53	0.022	198.5	0.0462
184.55	0.019	198.3	0.0462
184.57	0.018	198.3	0.0435
184.58	0.018	198.3	0.0408

Prova triassiale ciclica SN04-C1			
pressione di confinamento (kPa)		80	
deviatore ciclico (kPa)		95	
frequenza (hz)		0.00625	
tempo	cella di carico	$\Delta u$	LVDT
(min)	kN	(kPa)	$\delta$ (mm)
184.60	0.016	198.1	0.0382
184.62	0.014	197.9	0.0346
184.63	0.012	197.8	0.032
184.65	0.011	197.7	0.0284
184.67	0.007	197.4	0.0284
184.68	0.006	197.2	0.0231
184.70	0.006	197.2	0.0204
184.72	0.004	197	0.016
184.73	0.001	196.7	0.0115
184.75	-0.001	196.5	0.0089
184.77	-0.002	196.3	0.0044
184.78	-0.005	195.9	0.0044
184.80	-0.007	195.7	0
184.82	-0.007	195.7	-0.0027
184.83	-0.007	195.5	-0.0062
184.85	-0.01	195.1	-0.0098
184.87	-0.011	194.9	-0.0124
184.88	-0.012	194.7	-0.0142
184.90	-0.013	194.4	-0.0169
184.92	-0.014	194.2	-0.0186
184.93	-0.015	194.1	-0.0204
184.95	-0.016	193.8	-0.0204
184.97	-0.017	193.7	-0.0222
184.98	-0.017	193.7	-0.0231
185.00	-0.017	193.5	-0.024
185.02	-0.017	193.4	-0.0249
185.03	-0.017	193.3	-0.0249
185.05	-0.017	193.2	-0.0249
185.07	-0.017	193.1	-0.0249
185.08	-0.016	193	-0.0249
185.10	-0.016	193	-0.024
185.13	-0.016	193	-0.0231
185.15	-0.015	193	-0.0222
185.17	-0.013	193	-0.0204
185.18	-0.012	193	-0.0186
185.20	-0.011	193.1	-0.0169
185.20	-0.009	193.2	-0.0169
185.22	-0.008	193.2	-0.0142
185.23	-0.008	193.3	-0.0124
185.25	-0.007	193.4	-0.0098
185.27	-0.004	193.6	-0.0062
185.28	-0.002	193.7	-0.0036
185.30	-0.001	193.9	0
185.32	0.002	194.1	0
185.33	0.004	194.1	0.0044
185.35	0.004	194.3	0.008
185.37	0.005	194.5	0.0115
185.38	0.01	194.8	0.016
185.40	0.01	195	0.0195
185.42	0.011	195.3	0.0231
185.43	0.015	195.6	0.0231
185.45	0.016	195.6	0.0284
185.47	0.016	195.8	0.0311
185.48	0.017	196	0.0346
185.50	0.021	196.3	0.0391
185.52	0.021	196.5	0.0408
185.53	0.022	196.7	0.0444
185.55	0.025	197	0.0444

Prova triassiale ciclica SN04-C1			
pressione di confinamento (kPa)		80	
deviatore ciclico (kPa)		95	
frequenza (hz)		0.00625	
tempo	cella di carico	$\Delta u$	LVDT
(min)	kN	(kPa)	$\delta$ (mm)
185.57	0.025	197	0.0479
185.58	0.025	197.2	0.0497
185.60	0.027	197.6	0.0506
185.62	0.027	197.6	0.0524
185.63	0.027	197.7	0.0533
185.65	0.028	197.9	0.0541
185.67	0.028	198	0.055
185.68	0.029	198.2	0.0559
185.70	0.029	198.3	0.0568
185.72	0.029	198.4	0.0568
185.73	0.029	198.5	0.0568
185.75	0.029	198.5	0.0568
185.77	0.028	198.6	0.0559
185.78	0.027	198.6	0.0541
185.80	0.026	198.6	0.0533
185.82	0.025	198.6	0.0524
185.83	0.024	198.5	0.0524
185.85	0.022	198.5	0.0497
185.87	0.022	198.5	0.0479
185.88	0.021	198.4	0.0453
185.90	0.019	198.3	0.0426
185.92	0.017	198.2	0.0399
185.93	0.016	198.1	0.0373
185.95	0.013	197.8	0.0337
185.97	0.01	197.7	0.0337
185.98	0.01	197.7	0.0302
186.00	0.01	197.5	0.0257
186.02	0.007	197.3	0.0213
186.03	0.004	197.1	0.0178
186.05	0.004	196.9	0.0151
186.07	0.001	196.6	0.0107
186.08	-0.002	196.4	0.0107
186.10	-0.002	196.4	0.0062
186.12	-0.003	196.2	0.0027
186.13	-0.005	195.8	-0.0009
186.15	-0.007	195.6	-0.0044
186.17	-0.008	195.3	-0.0071
186.18	-0.01	195	-0.0107
186.20	-0.012	194.8	-0.0107
186.22	-0.012	194.8	-0.0133
186.23	-0.012	194.6	-0.0151
186.25	-0.014	194.3	-0.0186
186.27	-0.016	194.1	-0.0204
186.28	-0.016	193.9	-0.0213
186.30	-0.016	193.7	-0.0231
186.32	-0.017	193.6	-0.0231
186.33	-0.017	193.4	-0.024
186.35	-0.017	193.3	-0.0249
186.37	-0.017	193.2	-0.0249
186.38	-0.017	193.2	-0.0249
186.40	-0.017	193.1	-0.0249
186.42	-0.017	193.1	-0.024
186.43	-0.016	193	-0.0231
186.45	-0.015	193	-0.0231
186.47	-0.014	193	-0.0213
186.48	-0.012	193	-0.0213
186.50	-0.012	193	-0.0195
186.52	-0.012	193	-0.0178

Prova triassiale ciclica SN04-C1			
pressione di confinamento (kPa)		80	
deviatore ciclico (kPa)		95	
frequenza (hz)		0.00625	
tempo	cella di carico	$\Delta u$	LVDT
(min)	kN	(kPa)	$\delta$ (mm)
186.53	-0.011	193.1	-0.016
186.55	-0.008	193.2	-0.0133
186.57	-0.007	193.3	-0.0115
186.60	-0.006	193.4	-0.008
186.62	-0.003	193.6	-0.008
186.63	-0.002	193.6	-0.0044
186.65	-0.002	193.8	-0.0018
186.65	0	193.9	0.0027
186.67	0.003	194.2	0.0062
186.68	0.005	194.4	0.0089
186.70	0.006	194.6	0.0133
186.72	0.01	194.9	0.0133
186.73	0.011	195.1	0.0178
186.75	0.011	195.1	0.0213
186.77	0.013	195.3	0.0249
186.78	0.015	195.6	0.0302
186.80	0.017	195.9	0.0328
186.82	0.018	196.1	0.0373
186.83	0.021	196.4	0.0373
186.85	0.022	196.6	0.0399
186.87	0.022	196.6	0.0426
186.88	0.023	196.8	0.0462
186.90	0.024	197.1	0.0479
186.92	0.026	197.3	0.0506
186.93	0.026	197.4	0.0515
186.95	0.027	197.6	0.0515
186.97	0.028	197.8	0.0533
186.98	0.028	197.8	0.055
187.00	0.029	198	0.0559
187.02	0.029	198.1	0.0559
187.03	0.029	198.2	0.0559
187.05	0.029	198.3	0.0559
187.07	0.028	198.4	0.0559
187.08	0.028	198.5	0.0559
187.10	0.028	198.6	0.0559
187.12	0.027	198.6	0.0541
187.13	0.025	198.5	0.0541
187.15	0.025	198.5	0.0524
187.17	0.025	198.6	0.0515
187.18	0.024	198.5	0.0488
187.20	0.021	198.4	0.0462
187.22	0.02	198.4	0.0453
187.23	0.019	198.3	0.0417
187.25	0.016	198.1	0.0417
187.27	0.015	198.1	0.0391
187.28	0.015	198	0.0364
187.30	0.013	197.8	0.032
187.32	0.009	197.6	0.0284
187.33	0.009	197.5	0.0249
187.35	0.007	197.3	0.0213
187.37	0.004	197	0.0213
187.38	0.002	197	0.0169
187.40	0.002	196.8	0.0142
187.42	0.001	196.6	0.0098
187.43	-0.002	196.2	0.0053
187.45	-0.004	196	0.0018
187.47	-0.005	195.8	-0.0018
187.48	-0.008	195.4	-0.0018

Prova triassiale ciclica SN04-C1			
pressione di confinamento (kPa)		80	
deviatore ciclico (kPa)		95	
frequenza (hz)		0.00625	
tempo	cella di carico	$\Delta u$	LVDT
(min)	kN	(kPa)	$\delta$ (mm)
187.50	-0.009	195.2	-0.0062
187.52	-0.009	195.2	-0.0089
187.53	-0.01	195	-0.0115
187.55	-0.012	194.7	-0.0142
187.57	-0.014	194.4	-0.0169
187.58	-0.014	194.3	-0.0186
187.60	-0.015	194	-0.0186
187.62	-0.016	193.8	-0.0204
187.63	-0.016	193.8	-0.0222
187.65	-0.016	193.7	-0.0231
187.67	-0.017	193.5	-0.024
187.68	-0.017	193.4	-0.0249
187.70	-0.017	193.3	-0.0249
187.72	-0.017	193.2	-0.0249
187.73	-0.017	193.1	-0.0249
187.75	-0.016	193.1	-0.024
187.77	-0.016	193	-0.024
187.78	-0.015	193	-0.0231
187.80	-0.014	193	-0.0222
187.82	-0.014	193	-0.0213
187.83	-0.014	193	-0.0195
187.85	-0.011	193.1	-0.0169
187.87	-0.01	193.1	-0.0151
187.88	-0.009	193.2	-0.0133
187.90	-0.006	193.4	-0.0133
187.92	-0.005	193.4	-0.0098
187.93	-0.005	193.4	-0.0071
187.95	-0.003	193.6	-0.0036
187.97	0	193.8	0
187.98	0.001	194	0.0027
188.00	0.002	194.2	0.0071
188.03	0.006	194.5	0.0071
188.05	0.007	194.5	0.0115
188.07	0.007	194.6	0.0142
188.08	0.009	194.9	0.0186
188.10	0.012	195.1	0.0231
188.10	0.013	195.4	0.0257
188.12	0.015	195.6	0.0311
188.13	0.018	196	0.0311
188.15	0.02	196.2	0.0355
188.17	0.02	196.2	0.0382
188.18	0.02	196.4	0.0408
188.20	0.022	196.6	0.0435
188.22	0.024	196.9	0.0462
188.23	0.025	197.1	0.0488
188.25	0.026	197.3	0.0488
188.27	0.027	197.5	0.0515
188.28	0.027	197.5	0.0524
188.30	0.028	197.7	0.0541
188.32	0.028	197.8	0.055
188.33	0.029	198	0.0559
188.35	0.029	198.1	0.0568
188.37	0.029	198.2	0.0568
188.38	0.029	198.3	0.0568
188.40	0.029	198.3	0.0568
188.42	0.029	198.4	0.0568
188.43	0.028	198.5	0.0559
188.45	0.026	198.5	0.055

Prova triassiale ciclica SN04-C1			
pressione di confinamento (kPa)		80	
deviatore ciclico (kPa)		95	
frequenza (hz)		0.00625	
tempo	cella di carico	$\Delta u$	LVDT
(min)	kN	(kPa)	$\delta$ (mm)
188.47	0.026	198.5	0.0541
188.48	0.025	198.5	0.0515
188.50	0.023	198.5	0.0497
188.52	0.023	198.5	0.0488
188.53	0.022	198.4	0.0462
188.55	0.019	198.3	0.0462
188.57	0.018	198.3	0.0435
188.58	0.018	198.2	0.0417
188.60	0.016	198.1	0.0382
188.62	0.013	197.9	0.0346
188.63	0.012	197.8	0.032
188.65	0.011	197.6	0.0284
188.67	0.007	197.3	0.0284
188.68	0.006	197.3	0.0231
188.70	0.006	197.2	0.0204
188.72	0.004	197	0.016
188.73	0.001	196.7	0.0124
188.75	-0.001	196.4	0.0089
188.77	-0.002	196.2	0.0044
188.78	-0.005	195.9	0.0044
188.80	-0.006	195.9	0
188.82	-0.006	195.7	-0.0027
188.83	-0.007	195.4	-0.0062
188.85	-0.01	195.1	-0.0098
188.87	-0.011	194.8	-0.0124
188.88	-0.012	194.6	-0.0151
188.90	-0.013	194.4	-0.0151
188.92	-0.015	194.1	-0.0169
188.93	-0.015	194.1	-0.0195
188.95	-0.015	194	-0.0213
188.97	-0.016	193.8	-0.0222
188.98	-0.017	193.6	-0.0231
189.00	-0.017	193.5	-0.024
189.02	-0.017	193.3	-0.024
189.03	-0.017	193.2	-0.0249
189.05	-0.017	193.2	-0.0249
189.07	-0.017	193.1	-0.0249
189.08	-0.017	193	-0.0249
189.10	-0.016	193	-0.024
189.12	-0.015	193	-0.0231
189.13	-0.015	193	-0.0213
189.15	-0.013	193	-0.0213
189.17	-0.012	193	-0.0195
189.18	-0.012	193	-0.0178
189.20	-0.011	193.1	-0.016
189.22	-0.008	193.2	-0.0133
189.23	-0.007	193.3	-0.0107
189.25	-0.007	193.4	-0.0098
189.27	-0.004	193.5	-0.0062
189.28	-0.003	193.7	-0.0036
189.30	-0.001	193.8	0
189.32	0.003	194.1	0
189.33	0.004	194.1	0.0044
189.35	0.004	194.2	0.008
189.37	0.005	194.5	0.0124
189.38	0.009	194.7	0.016
189.40	0.01	194.9	0.0195
189.42	0.011	195.2	0.0231



Prova triassiale ciclica SN04-C1			
pressione di confinamento (kPa)		80	
deviatore ciclico (kPa)		95	
frequenza (hz)		0.00625	
tempo	cella di carico	$\Delta u$	LVDT
(min)	kN	(kPa)	$\delta$ (mm)
189.43	0.015	195.5	0.0231
189.45	0.016	195.5	0.0284
189.47	0.016	195.7	0.0311
189.50	0.017	196	0.0355
189.52	0.021	196.3	0.0391
189.53	0.021	196.4	0.0408
189.55	0.022	196.7	0.0444
189.55	0.024	196.9	0.0444
189.57	0.026	197.2	0.0479
189.58	0.026	197.2	0.0497
189.60	0.026	197.3	0.0506
189.62	0.027	197.6	0.0533
189.63	0.028	197.7	0.0541
189.65	0.028	197.9	0.055
189.67	0.029	198	0.055
189.68	0.029	198.1	0.0559
189.70	0.029	198.1	0.0568
189.72	0.029	198.3	0.0568
189.73	0.029	198.4	0.0568
189.75	0.028	198.4	0.0559
189.77	0.028	198.5	0.055
189.78	0.026	198.5	0.055
189.80	0.026	198.5	0.0541
189.82	0.026	198.5	0.0533
189.83	0.024	198.5	0.0497
189.85	0.023	198.4	0.0488
189.87	0.021	198.4	0.047
189.88	0.021	198.3	0.0453
189.90	0.018	198.2	0.0453
189.92	0.016	198	0.0417
189.93	0.016	198	0.0391
189.95	0.013	197.8	0.0355
189.97	0.011	197.6	0.0337
189.98	0.011	197.6	0.0311
190.00	0.01	197.5	0.0257
190.02	0.007	197.2	0.0222
190.03	0.004	197	0.0186
190.05	0.003	196.8	0.0151
190.07	0.001	196.5	0.0151
190.08	-0.002	196.3	0.0107
190.10	-0.002	196.3	0.0071
190.12	-0.003	196.1	0.0027
190.13	-0.005	195.8	-0.0009
190.15	-0.007	195.5	-0.0044
190.17	-0.008	195.2	-0.008
190.18	-0.01	194.9	-0.008
190.20	-0.012	194.7	-0.0115
190.22	-0.012	194.7	-0.0142
190.23	-0.013	194.5	-0.016
190.25	-0.014	194.2	-0.0178
190.27	-0.015	194	-0.0204
190.28	-0.016	193.9	-0.0213
190.30	-0.016	193.7	-0.0231
190.32	-0.017	193.5	-0.0231
190.33	-0.017	193.5	-0.024
190.35	-0.017	193.4	-0.024
190.37	-0.017	193.3	-0.0249
190.38	-0.017	193.2	-0.0249

Prova triassiale ciclica SN04-C1			
pressione di confinamento (kPa)		80	
deviatore ciclico (kPa)		95	
frequenza (hz)		0.00625	
tempo	cella di carico	$\Delta u$	LVDT
(min)	kN	(kPa)	$\delta$ (mm)
190.40	-0.017	193.1	-0.0249
190.42	-0.016	193	-0.024
190.43	-0.015	193	-0.024
190.45	-0.015	193	-0.0231
190.47	-0.015	193	-0.0222
190.48	-0.014	193	-0.0204
190.50	-0.012	193	-0.0195
190.52	-0.011	193	-0.0169
190.53	-0.01	193.1	-0.0151
190.55	-0.007	193.3	-0.0151
190.57	-0.007	193.3	-0.0124
190.58	-0.007	193.3	-0.0098
190.60	-0.005	193.5	-0.0071
190.62	-0.002	193.7	-0.0027
190.63	-0.001	193.8	0
190.65	0.001	194	0.0036
190.67	0.005	194.2	0.0036
190.68	0.005	194.4	0.0098
190.70	0.006	194.6	0.0133
190.72	0.01	194.8	0.0133
190.73	0.011	194.8	0.0178
190.75	0.011	195	0.0204
190.77	0.013	195.3	0.0257
190.78	0.016	195.6	0.0302
190.80	0.017	195.8	0.0328
190.82	0.018	196.1	0.0373
190.83	0.021	196.4	0.0373
190.85	0.022	196.4	0.0408
190.87	0.022	196.6	0.0426
190.88	0.023	196.8	0.0453
190.90	0.025	197	0.0479
190.93	0.026	197.2	0.0497
190.95	0.026	197.4	0.0524
190.97	0.027	197.6	0.0524
190.98	0.028	197.8	0.0533
191.00	0.028	197.8	0.055
191.00	0.029	197.9	0.0559
191.02	0.029	198.1	0.0559
191.03	0.029	198.2	0.0568
191.05	0.029	198.3	0.0568
191.07	0.029	198.4	0.0568
191.08	0.028	198.5	0.0568
191.10	0.028	198.5	0.0559
191.12	0.027	198.5	0.0541
191.13	0.026	198.5	0.0533
191.15	0.025	198.5	0.0524
191.17	0.024	198.5	0.0515
191.18	0.023	198.4	0.0488
191.20	0.021	198.3	0.0488
191.22	0.02	198.3	0.0462
191.23	0.02	198.3	0.0444
191.25	0.018	198.1	0.0408
191.27	0.014	198	0.0373
191.28	0.014	197.9	0.0355
191.30	0.012	197.7	0.032
191.32	0.009	197.5	0.032
191.33	0.008	197.5	0.0275
191.35	0.008	197.3	0.024

Prova triassiale ciclica SN04-C1			
pressione di confinamento (kPa)		80	
deviatore ciclico (kPa)		95	
frequenza (hz)		0.00625	
tempo	cella di carico	$\Delta u$	LVDT
(min)	kN	(kPa)	$\delta$ (mm)
191.37	0.006	197.1	0.0204
191.38	0.002	196.8	0.016
191.40	0.002	196.7	0.0124
191.42	0	196.3	0.008
191.43	-0.003	196.2	0.0053
191.45	-0.004	196	0.0027
191.47	-0.005	195.7	-0.0018
191.48	-0.008	195.4	-0.0018
191.50	-0.009	195.4	-0.0053
191.52	-0.009	195.1	-0.008
191.53	-0.01	194.8	-0.0115
191.55	-0.013	194.6	-0.0142
191.57	-0.013	194.4	-0.016
191.58	-0.014	194.2	-0.0186
191.60	-0.015	194	-0.0186
191.62	-0.016	194	-0.0204
191.63	-0.016	193.8	-0.0222
191.65	-0.017	193.6	-0.0231
191.67	-0.017	193.5	-0.024
191.68	-0.017	193.3	-0.0249
191.70	-0.017	193.2	-0.0249
191.72	-0.017	193.1	-0.0249
191.73	-0.017	193	-0.0249
191.75	-0.017	193	-0.0249
191.77	-0.016	193	-0.0231
191.78	-0.015	193	-0.0222
191.80	-0.014	193	-0.0213
191.82	-0.014	193	-0.0204
191.83	-0.012	193.1	-0.0178
191.85	-0.01	193.1	-0.0178
191.87	-0.01	193.1	-0.016
191.88	-0.01	193.1	-0.0142
191.90	-0.008	193.3	-0.0107
191.92	-0.005	193.4	-0.008
191.93	-0.004	193.5	-0.0062
191.95	-0.002	193.7	-0.0018
191.97	0.001	193.9	-0.0018
191.98	0.002	193.9	0.0009
192.00	0.002	194	0.0053
192.02	0.004	194.3	0.0098
192.03	0.007	194.5	0.0133
192.05	0.008	194.7	0.0169
192.07	0.01	195	0.0204
192.08	0.013	195.2	0.0204
192.10	0.014	195.2	0.024
192.12	0.014	195.5	0.0284
192.13	0.018	196	0.0328
192.15	0.019	196	0.0346
192.17	0.019	196.2	0.0373
192.18	0.02	196.4	0.0408
192.20	0.023	196.7	0.0444
192.22	0.023	196.9	0.0462
192.23	0.024	197.1	0.0488
192.25	0.027	197.3	0.0488
192.27	0.027	197.3	0.0515
192.28	0.027	197.5	0.0524
192.30	0.027	197.7	0.0541
192.32	0.028	197.8	0.055

Prova triassiale ciclica SN04-C1			
pressione di confinamento (kPa)		80	
deviatore ciclico (kPa)		95	
frequenza (hz)		0.00625	
tempo	cella di carico	$\Delta u$	LVDT
(min)	kN	(kPa)	$\delta$ (mm)
192.33	0.028	198	0.0559
192.35	0.029	198.1	0.0568
192.37	0.029	198.2	0.0568
192.40	0.029	198.2	0.0568
192.42	0.029	198.3	0.0568
192.43	0.028	198.4	0.0568
192.45	0.028	198.5	0.0559
192.45	0.027	198.5	0.055
192.47	0.026	198.5	0.0533
192.48	0.025	198.5	0.0533
192.50	0.023	198.5	0.0515
192.52	0.023	198.5	0.0497
192.53	0.022	198.4	0.0479
192.55	0.02	198.3	0.0453
192.57	0.018	198.2	0.0426
192.58	0.017	198.1	0.0399
192.60	0.015	197.9	0.0399
192.62	0.013	197.8	0.0364
192.63	0.013	197.8	0.0337
192.65	0.011	197.7	0.0302
192.67	0.009	197.4	0.0249
192.68	0.006	197.2	0.0213
192.70	0.005	197	0.0178
192.72	0.003	196.7	0.0178
192.73	0	196.5	0.0142
192.75	0	196.5	0.0107
192.77	-0.001	196.3	0.0062
192.78	-0.004	196	0.0027
192.80	-0.006	195.7	-0.0009
192.82	-0.007	195.5	-0.0044
192.83	-0.009	195.1	-0.008
192.85	-0.011	194.9	-0.008
192.87	-0.012	194.7	-0.0133
192.88	-0.012	194.5	-0.0151
192.90	-0.014	194.3	-0.0151
192.92	-0.014	194.3	-0.0169
192.93	-0.014	194.1	-0.0186
192.95	-0.015	193.9	-0.0213
192.97	-0.017	193.7	-0.0231
192.98	-0.017	193.5	-0.0231
193.00	-0.017	193.4	-0.024
193.02	-0.017	193.2	-0.024
193.03	-0.017	193.2	-0.024
193.05	-0.017	193.1	-0.0249
193.07	-0.017	193.1	-0.0249
193.08	-0.017	193	-0.024
193.10	-0.016	193	-0.0231
193.12	-0.016	192.9	-0.0222
193.13	-0.014	192.9	-0.0222
193.15	-0.013	192.9	-0.0204
193.17	-0.013	193	-0.0195
193.18	-0.012	193	-0.0178
193.20	-0.01	193.1	-0.0151
193.22	-0.009	193.1	-0.0133
193.23	-0.007	193.3	-0.0098
193.25	-0.005	193.4	-0.0098
193.27	-0.003	193.4	-0.0071
193.28	-0.003	193.6	-0.0044

Prova triassiale ciclica SN04-C1			
pressione di confinamento (kPa)		80	
deviatore ciclico (kPa)		95	
frequenza (hz)		0.00625	
tempo	cella di carico	$\Delta u$	LVDT
(min)	kN	(kPa)	$\delta$ (mm)
193.30	-0.002	193.7	-0.0009
193.32	0.001	193.9	0.0027
193.33	0.003	194.1	0.0062
193.35	0.004	194.3	0.0107
193.37	0.007	194.6	0.0107
193.38	0.01	194.8	0.0151
193.40	0.01	194.8	0.0178
193.42	0.011	195	0.0222
193.43	0.013	195.3	0.0257
193.45	0.016	195.6	0.0311
193.47	0.017	195.8	0.0337
193.48	0.019	196.1	0.0337
193.50	0.021	196.4	0.0373
193.52	0.021	196.4	0.0408
193.53	0.022	196.6	0.0435
193.55	0.023	196.8	0.0462
193.57	0.025	197	0.0488
193.58	0.026	197.2	0.0506
193.60	0.026	197.4	0.0524
193.62	0.027	197.6	0.0533
193.63	0.028	197.8	0.0541
193.65	0.028	197.9	0.055
193.67	0.029	198.1	0.055
193.68	0.029	198.1	0.0559
193.70	0.029	198.2	0.0559
193.72	0.029	198.3	0.0568
193.73	0.029	198.4	0.0568
193.75	0.028	198.5	0.0568
193.77	0.028	198.5	0.055
193.78	0.026	198.5	0.055
193.80	0.026	198.5	0.0541
193.82	0.026	198.5	0.0533
193.83	0.024	198.5	0.0506
193.87	0.023	198.4	0.0488
193.88	0.021	198.4	0.047
193.90	0.02	198.3	0.0444
193.90	0.017	198.2	0.0444
193.92	0.017	198.2	0.0417
193.93	0.017	198.1	0.0391
193.95	0.015	197.9	0.0355
193.97	0.011	197.7	0.032
193.98	0.011	197.6	0.0293
194.00	0.009	197.3	0.024
194.02	0.005	197.1	0.024
194.03	0.004	197.1	0.0195
194.05	0.004	196.9	0.0169
194.07	0.002	196.7	0.0133
194.08	-0.001	196.4	0.0089
194.10	-0.002	196.2	0.0062
194.12	-0.004	195.9	0.0009
194.13	-0.007	195.6	0.0009
194.15	-0.008	195.6	-0.0036
194.17	-0.008	195.4	-0.0053
194.18	-0.009	195.1	-0.0089
194.20	-0.011	194.8	-0.0124
194.22	-0.012	194.6	-0.0142
194.23	-0.013	194.4	-0.0169
194.25	-0.015	194.1	-0.0169

Prova triassiale ciclica SN04-C1			
pressione di confinamento (kPa)		80	
deviatore ciclico (kPa)		95	
frequenza (hz)		0.00625	
tempo	cella di carico	$\Delta u$	LVDT
(min)	kN	(kPa)	$\delta$ (mm)
194.27	-0.016	193.9	-0.0195
194.28	-0.016	193.9	-0.0204
194.30	-0.016	193.8	-0.0222
194.32	-0.017	193.5	-0.0231
194.33	-0.017	193.5	-0.024
194.35	-0.017	193.3	-0.024
194.37	-0.017	193.2	-0.024
194.38	-0.017	193.1	-0.0249
194.40	-0.017	193	-0.024
194.42	-0.017	193	-0.024
194.43	-0.015	192.9	-0.024
194.45	-0.015	192.9	-0.0231
194.47	-0.015	192.9	-0.0213
194.48	-0.014	192.9	-0.0204
194.50	-0.012	193	-0.0186
194.52	-0.011	193	-0.0169
194.53	-0.01	193.1	-0.0142
194.55	-0.007	193.2	-0.0142
194.57	-0.006	193.2	-0.0115
194.58	-0.006	193.3	-0.0098
194.60	-0.005	193.5	-0.0062
194.62	-0.002	193.6	-0.0036
194.63	-0.001	193.8	0
194.65	0.001	194	0.0036
194.67	0.004	194.2	0.0036
194.68	0.005	194.2	0.008
194.70	0.005	194.4	0.0107
194.72	0.007	194.7	0.0151
194.73	0.011	194.9	0.0195
194.75	0.012	195.1	0.0231
194.77	0.013	195.4	0.0284
194.78	0.017	195.7	0.0284
194.80	0.018	195.7	0.032
194.82	0.018	195.9	0.0346
194.83	0.019	196.2	0.0382
194.85	0.022	196.4	0.0417
194.87	0.022	196.6	0.0444
194.88	0.023	196.9	0.047
194.90	0.026	197.1	0.047
194.92	0.026	197.1	0.0497
194.93	0.026	197.3	0.0515
194.95	0.027	197.5	0.0524
194.97	0.028	197.7	0.0541
194.98	0.028	197.8	0.055
195.00	0.029	198	0.0559
195.02	0.029	198.1	0.0559
195.03	0.029	198.1	0.0559
195.05	0.029	198.3	0.0559
195.07	0.029	198.4	0.0559
195.08	0.028	198.5	0.0559
195.10	0.028	198.5	0.0559
195.12	0.027	198.5	0.0541
195.13	0.026	198.5	0.0524
195.15	0.025	198.5	0.0524
195.17	0.024	198.5	0.0497
195.18	0.022	198.4	0.0497
195.20	0.021	198.3	0.0479
195.22	0.021	198.3	0.0462

Prova triassiale ciclica SN04-C1			
pressione di confinamento (kPa)		80	
deviatore ciclico (kPa)		95	
frequenza (hz)		0.00625	
tempo	cella di carico	$\Delta u$	LVDT
(min)	kN	(kPa)	$\delta$ (mm)
195.23	0.019	198.3	0.0426
195.25	0.017	198.1	0.0399
195.27	0.015	198	0.0373
195.30	0.014	197.9	0.0337
195.32	0.011	197.6	0.0337
195.33	0.009	197.5	0.0311
195.35	0.009	197.5	0.0275
195.37	0.008	197.3	0.0231
195.37	0.005	197	0.0186
195.38	0.002	196.8	0.0151
195.40	0.002	196.6	0.0115
195.42	-0.001	196.3	0.0115
195.43	-0.004	196.1	0.0071
195.45	-0.004	196.1	0.0036
195.47	-0.005	195.9	0
195.48	-0.006	195.5	-0.0036
195.50	-0.009	195.2	-0.0071
195.52	-0.01	195	-0.0107
195.53	-0.011	194.7	-0.0133
195.55	-0.013	194.5	-0.0133
195.57	-0.013	194.5	-0.016
195.58	-0.014	194.3	-0.0178
195.60	-0.015	194.1	-0.0204
195.62	-0.016	193.9	-0.0213
195.63	-0.016	193.7	-0.0222
195.65	-0.017	193.6	-0.0231
195.67	-0.017	193.4	-0.0231
195.68	-0.017	193.4	-0.024
195.70	-0.017	193.3	-0.0249
195.72	-0.017	193.2	-0.0249
195.73	-0.017	193.1	-0.0249
195.75	-0.017	193	-0.024
195.77	-0.016	193	-0.0231
195.78	-0.015	192.9	-0.0231
195.80	-0.014	192.9	-0.0222
195.82	-0.014	192.9	-0.0204
195.83	-0.011	193	-0.0204
195.85	-0.011	193	-0.0186
195.87	-0.011	193	-0.0169
195.88	-0.01	193.1	-0.0142
195.90	-0.007	193.3	-0.0115
195.92	-0.006	193.4	-0.0089
195.93	-0.004	193.5	-0.0053
195.95	-0.001	193.7	-0.0053
195.97	0	193.9	-0.0009
195.98	0	193.9	0.0018
196.00	0.002	194	0.0053
196.02	0.005	194.3	0.0098
196.03	0.007	194.5	0.0133
196.05	0.008	194.7	0.0169
196.07	0.011	195	0.0169
196.08	0.013	195.2	0.0204
196.10	0.013	195.2	0.024
196.12	0.014	195.4	0.0293
196.13	0.017	195.8	0.0328
196.15	0.019	196	0.0355
196.17	0.02	196.2	0.0391
196.18	0.022	196.5	0.0391

Prova triassiale ciclica SN04-C1			
pressione di confinamento (kPa)		80	
deviatore ciclico (kPa)		95	
frequenza (hz)		0.00625	
tempo	cella di carico	$\Delta u$	LVDT
(min)	kN	(kPa)	$\delta$ (mm)
196.20	0.023	196.7	0.0426
196.22	0.023	196.7	0.0453
196.23	0.024	196.9	0.0479
196.25	0.026	197.2	0.0497
196.27	0.027	197.4	0.0515
196.28	0.027	197.5	0.0533
196.30	0.028	197.7	0.0541
196.32	0.029	197.9	0.0541
196.33	0.028	197.9	0.055
196.35	0.028	198	0.0559
196.37	0.029	198.1	0.0559
196.38	0.029	198.2	0.0559
196.40	0.029	198.3	0.0559
196.42	0.028	198.4	0.0559
196.43	0.027	198.5	0.0559
196.45	0.026	198.5	0.055
196.47	0.026	198.5	0.0541
196.48	0.026	198.5	0.0524
196.50	0.023	198.4	0.0506
196.52	0.023	198.5	0.0497
196.53	0.022	198.4	0.0479
196.55	0.02	198.3	0.0453
196.57	0.019	198.2	0.0426
196.58	0.017	198.1	0.0399
196.60	0.014	197.9	0.0399
196.62	0.013	197.9	0.0364
196.63	0.013	197.8	0.0337
196.65	0.011	197.6	0.0293
196.67	0.008	197.4	0.0249
196.68	0.007	197.2	0.0222
196.70	0.005	197	0.0186
196.72	0.002	196.7	0.0186
196.73	0.001	196.7	0.0133
196.77	0.001	196.5	0.0107
196.78	-0.001	196.3	0.0062
196.80	-0.004	196	0.0018
196.82	-0.005	195.8	-0.0009
196.82	-0.007	195.5	-0.0053
196.83	-0.009	195.1	-0.0053
196.85	-0.01	194.9	-0.0089
196.87	-0.01	194.9	-0.0107
196.88	-0.011	194.7	-0.0142
196.90	-0.013	194.4	-0.0169
196.92	-0.015	194.2	-0.0186
196.93	-0.015	194	-0.0204
196.95	-0.016	193.8	-0.0204
196.97	-0.017	193.6	-0.0213
196.98	-0.017	193.6	-0.0231
197.00	-0.017	193.5	-0.024
197.02	-0.017	193.3	-0.0249
197.03	-0.017	193.2	-0.0249
197.05	-0.017	193.1	-0.0249
197.07	-0.017	193	-0.0249
197.08	-0.016	193	-0.0249
197.10	-0.015	193	-0.024
197.12	-0.015	192.9	-0.0231
197.13	-0.015	193	-0.0222
197.15	-0.013	193	-0.0204



Prova triassiale ciclica SN04-C1			
pressione di confinamento (kPa)		80	
deviatore ciclico (kPa)		95	
frequenza (hz)		0.00625	
tempo	cella di carico	$\Delta u$	LVDT
(min)	kN	(kPa)	$\delta$ (mm)
197.17	-0.012	193	-0.0195
197.18	-0.012	193	-0.0169
197.20	-0.009	193.1	-0.0169
197.22	-0.008	193.2	-0.0133
197.23	-0.008	193.3	-0.0107
197.25	-0.004	193.4	-0.0107
197.27	-0.004	193.4	-0.0071
197.28	-0.004	193.5	-0.0044
197.30	-0.002	193.7	-0.0009
197.32	0.002	194	0.0027
197.33	0.002	194.1	0.0062
197.35	0.004	194.4	0.0107
197.37	0.009	194.6	0.0107
197.38	0.009	194.6	0.0151
197.40	0.009	194.8	0.0178
197.42	0.011	195	0.0222
197.43	0.014	195.3	0.0257
197.45	0.015	195.6	0.0302
197.47	0.017	195.8	0.0337
197.48	0.02	196.1	0.0337
197.50	0.02	196.1	0.0373
197.52	0.02	196.3	0.0399
197.53	0.022	196.5	0.0435
197.55	0.024	196.8	0.0462
197.57	0.025	197	0.0488
197.58	0.025	197.2	0.0506
197.60	0.027	197.4	0.0506
197.62	0.028	197.4	0.0524
197.63	0.028	197.6	0.0541
197.65	0.028	197.8	0.055
197.67	0.028	197.9	0.0559
197.68	0.029	198.1	0.0559
197.70	0.029	198.2	0.0559
197.72	0.029	198.3	0.0559
197.73	0.028	198.4	0.0559
197.75	0.028	198.4	0.0568
197.77	0.028	198.4	0.0559
197.78	0.027	198.4	0.0541
197.80	0.026	198.4	0.0533
197.82	0.025	198.5	0.0524
197.83	0.024	198.4	0.0524
197.85	0.022	198.4	0.0497
197.87	0.022	198.4	0.0488
197.88	0.021	198.3	0.0453
197.90	0.019	198.2	0.0426
197.92	0.016	198.1	0.0399
197.93	0.016	198	0.0373
197.95	0.013	197.7	0.0337
197.97	0.012	197.6	0.032
197.98	0.011	197.5	0.0293
198.00	0.008	197.3	0.024
198.02	0.005	197.1	0.024
198.03	0.005	197.1	0.0204
198.05	0.004	196.9	0.0169
198.07	0.002	196.6	0.0124
198.08	-0.001	196.3	0.0089
198.10	-0.002	196.2	0.0044
198.12	-0.004	195.8	0.0009

Prova triassiale ciclica SN04-C1			
pressione di confinamento (kPa)		80	
deviatore ciclico (kPa)		95	
frequenza (hz)		0.00625	
tempo	cella di carico	$\Delta u$	LVDT
(min)	kN	(kPa)	$\delta$ (mm)
198.13	-0.007	195.6	0.0009
198.15	-0.007	195.6	-0.0027
198.17	-0.007	195.3	-0.0062
198.20	-0.009	195	-0.0098
198.22	-0.012	194.7	-0.0124
198.23	-0.012	194.5	-0.0151
198.25	-0.013	194.3	-0.0169
198.27	-0.015	194.1	-0.0169
198.27	-0.015	194.1	-0.0195
198.28	-0.015	193.9	-0.0204
198.30	-0.016	193.7	-0.0222
198.32	-0.017	193.5	-0.0231
198.33	-0.017	193.4	-0.024
198.35	-0.017	193.3	-0.024
198.37	-0.017	193.2	-0.024
198.38	-0.017	193.2	-0.024
198.40	-0.017	193.1	-0.024
198.42	-0.017	193	-0.024
198.43	-0.016	192.9	-0.0231
198.45	-0.015	192.9	-0.0222
198.47	-0.015	192.9	-0.0204
198.48	-0.013	193	-0.0204
198.50	-0.012	193	-0.0195
198.52	-0.012	193	-0.0178
198.53	-0.011	193	-0.0151
198.55	-0.008	193.2	-0.0133
198.57	-0.007	193.2	-0.0107
198.58	-0.006	193.3	-0.0071
198.60	-0.003	193.6	-0.0071
198.62	-0.001	193.7	-0.0044
198.63	-0.001	193.7	-0.0009
198.65	0	193.8	0.0027
198.67	0.004	194.2	0.0062
198.68	0.004	194.2	0.0089
198.70	0.005	194.4	0.0124
198.72	0.008	194.7	0.016
198.73	0.01	194.9	0.0195
198.75	0.012	195.1	0.024
198.77	0.014	195.5	0.024
198.78	0.017	195.7	0.0293
198.80	0.017	195.7	0.0328
198.82	0.018	195.9	0.0355
198.83	0.019	196.2	0.0391
198.85	0.022	196.5	0.0426
198.87	0.022	196.7	0.0453
198.88	0.024	196.9	0.0479
198.90	0.026	197.1	0.0479
198.92	0.026	197.1	0.0497
198.93	0.026	197.3	0.0515
198.95	0.027	197.5	0.0533
198.97	0.028	197.7	0.055
198.98	0.028	197.8	0.0559
199.00	0.029	198	0.0559
199.02	0.029	198.1	0.0559
199.03	0.029	198.1	0.0568
199.05	0.029	198.2	0.0568
199.07	0.029	198.3	0.0568
199.08	0.029	198.4	0.0568

Prova triassiale ciclica SN04-C1			
pressione di confinamento (kPa)		80	
deviatore ciclico (kPa)		95	
frequenza (hz)		0.00625	
tempo	cella di carico	$\Delta u$	LVDT
(min)	kN	(kPa)	$\delta$ (mm)
199.10	0.028	198.5	0.0559
199.12	0.027	198.5	0.0541
199.13	0.025	198.5	0.0541
199.15	0.025	198.5	0.0533
199.17	0.025	198.5	0.0515
199.18	0.023	198.4	0.0497
199.20	0.021	198.4	0.047
199.22	0.02	198.3	0.0453
199.23	0.019	198.1	0.0426
199.25	0.016	198	0.0426
199.27	0.015	198	0.0391
199.28	0.015	197.9	0.0373
199.30	0.013	197.7	0.0328
199.32	0.01	197.5	0.0293
199.33	0.009	197.4	0.0257
199.35	0.007	197.1	0.0213
199.37	0.003	196.9	0.0213
199.38	0.002	196.9	0.0169
199.40	0.001	196.5	0.0115
199.42	-0.001	196.3	0.0115
199.43	-0.003	196.3	0.0089
199.45	-0.003	196.1	0.0044
199.47	-0.004	195.8	0
199.48	-0.008	195.4	-0.0044
199.50	-0.008	195.2	-0.0062
199.52	-0.01	194.9	-0.0098
199.53	-0.012	194.7	-0.0098
199.55	-0.013	194.7	-0.0133
199.57	-0.013	194.5	-0.0151
199.58	-0.014	194.2	-0.0178
199.60	-0.015	194	-0.0195
199.62	-0.016	193.8	-0.0213
199.63	-0.016	193.7	-0.0222
199.67	-0.017	193.5	-0.0222
199.68	-0.017	193.5	-0.0231
199.70	-0.017	193.3	-0.024
199.72	-0.017	193.2	-0.024
199.72	-0.017	193.1	-0.024
199.73	-0.017	193	-0.024
199.75	-0.017	193	-0.0231
199.77	-0.015	193	-0.0231
199.78	-0.015	192.9	-0.0222
199.80	-0.015	192.9	-0.0222
199.82	-0.014	192.9	-0.0204
199.83	-0.013	193	-0.0186
199.85	-0.011	193	-0.0169
199.87	-0.01	193	-0.0142
199.88	-0.008	193.2	-0.0142
199.90	-0.006	193.3	-0.0115
199.92	-0.006	193.3	-0.0098
199.93	-0.005	193.4	-0.0062
199.95	-0.003	193.6	-0.0027
199.97	0	193.8	0
199.98	0.001	193.9	0.0036
200.00	0.003	194.2	0.0071
200.02	0.006	194.4	0.0071
200.03	0.006	194.4	0.0115
200.05	0.007	194.6	0.0151

Prova triassiale ciclica SN04-C1			
pressione di confinamento (kPa)		80	
deviatore ciclico (kPa)		95	
frequenza (hz)		0.00625	
tempo	cella di carico	$\Delta u$	LVDT
(min)	kN	(kPa)	$\delta$ (mm)
200.07	0.01	194.9	0.0195
200.08	0.012	195.1	0.0231
200.10	0.013	195.3	0.0275
200.12	0.016	195.7	0.032
200.13	0.018	195.9	0.0355
200.15	0.019	196.1	0.0373
200.17	0.02	196.3	0.0399
200.18	0.022	196.6	0.0399
200.20	0.023	196.6	0.0426
200.22	0.023	196.8	0.0453
200.23	0.024	197	0.0479
200.25	0.026	197.2	0.0506
200.27	0.027	197.4	0.0524
200.28	0.027	197.6	0.0533
200.30	0.028	197.8	0.0533
200.32	0.028	197.8	0.055
200.33	0.028	197.9	0.0559
200.35	0.029	198	0.0559
200.37	0.029	198.2	0.0568
200.38	0.029	198.3	0.0568
200.40	0.029	198.4	0.0568
200.42	0.028	198.4	0.0568
200.43	0.027	198.4	0.0568
200.45	0.027	198.5	0.0559
200.47	0.026	198.5	0.0541
200.48	0.025	198.5	0.0524
200.50	0.024	198.5	0.0515
200.52	0.023	198.4	0.0488
200.53	0.021	198.3	0.0488
200.55	0.019	198.3	0.0462
200.57	0.019	198.2	0.0444
200.58	0.018	198.1	0.0417
200.60	0.015	197.9	0.0373
200.62	0.013	197.8	0.0346
200.63	0.012	197.7	0.032
200.65	0.009	197.5	0.032
200.67	0.008	197.3	0.0284
200.68	0.008	197.3	0.024
200.70	0.006	197.1	0.0204
200.72	0.003	196.8	0.016
200.73	0.001	196.6	0.0124
200.75	0	196.4	0.008
200.77	-0.003	196.1	0.008
200.78	-0.005	195.8	0.0044
200.80	-0.005	195.8	0.0009
200.82	-0.006	195.6	-0.0027
200.83	-0.008	195.2	-0.0062
200.85	-0.01	195	-0.0098
200.87	-0.01	194.8	-0.0115
200.88	-0.012	194.5	-0.0142
200.90	-0.014	194.3	-0.0169
200.92	-0.014	194.1	-0.0186
200.93	-0.015	193.9	-0.0204
200.95	-0.016	193.7	-0.0204
200.97	-0.016	193.7	-0.0222
200.98	-0.017	193.6	-0.0231
201.00	-0.017	193.4	-0.024
201.02	-0.017	193.3	-0.024

Prova triassiale ciclica SN04-C1			
pressione di confinamento (kPa)		80	
deviatore ciclico (kPa)		95	
frequenza (hz)		0.00625	
tempo	cella di carico	$\Delta u$	LVDT
(min)	kN	(kPa)	$\delta$ (mm)
201.03	-0.017	193.2	-0.024
201.05	-0.017	193.1	-0.0249
201.07	-0.017	193	-0.0249
201.08	-0.016	193	-0.0249
201.12	-0.016	192.9	-0.024
201.13	-0.016	192.9	-0.0231
201.15	-0.014	192.9	-0.0213
201.17	-0.014	192.9	-0.0204
201.17	-0.013	193	-0.0186
201.18	-0.01	193	-0.0186
201.20	-0.01	193	-0.016
201.22	-0.01	193.1	-0.0151
201.23	-0.008	193.2	-0.0115
201.25	-0.005	193.4	-0.008
201.27	-0.004	193.5	-0.0053
201.28	-0.003	193.6	-0.0018
201.30	0.001	193.8	-0.0018
201.32	0.002	193.8	0.0018
201.33	0.002	194	0.0044
201.35	0.003	194.2	0.0089
201.37	0.007	194.5	0.0133
201.38	0.008	194.6	0.016
201.40	0.01	194.9	0.0204
201.42	0.014	195.2	0.0204
201.43	0.014	195.2	0.0249
201.45	0.014	195.4	0.0284
201.47	0.016	195.7	0.0328
201.48	0.019	196	0.0364
201.50	0.02	196.2	0.0391
201.52	0.021	196.4	0.0426
201.53	0.023	196.7	0.0426
201.55	0.024	196.7	0.0453
201.57	0.024	196.9	0.0479
201.58	0.026	197.3	0.0497
201.60	0.027	197.5	0.0515
201.62	0.027	197.5	0.0524
201.63	0.027	197.6	0.0541
201.65	0.028	197.8	0.0559
201.67	0.029	198	0.0559
201.68	0.029	198.1	0.0559
201.70	0.029	198.2	0.0559
201.72	0.029	198.3	0.0568
201.73	0.029	198.3	0.0568
201.75	0.028	198.4	0.0568
201.77	0.028	198.4	0.0559
201.78	0.027	198.5	0.055
201.80	0.026	198.5	0.0533
201.82	0.025	198.5	0.0515
201.83	0.023	198.4	0.0515
201.85	0.022	198.4	0.0497
201.87	0.022	198.4	0.0488
201.88	0.021	198.3	0.0453
201.90	0.018	198.2	0.0426
201.92	0.017	198.1	0.0399
201.93	0.016	197.9	0.0373
201.95	0.012	197.7	0.0373
201.97	0.011	197.7	0.0337
201.98	0.011	197.6	0.0311

Prova triassiale ciclica SN04-C1			
pressione di confinamento (kPa)		80	
deviatore ciclico (kPa)		95	
frequenza (hz)		0.00625	
tempo	cella di carico	$\Delta u$	LVDT
(min)	kN	(kPa)	$\delta$ (mm)
202.00	0.01	197.4	0.0257
202.02	0.006	197.1	0.0222
202.03	0.005	197	0.0186
202.05	0.003	196.7	0.0142
202.07	0	196.5	0.0142
202.08	-0.001	196.5	0.0107
202.10	-0.001	196.3	0.0062
202.12	-0.003	196	0.0027
202.13	-0.006	195.7	-0.0009
202.15	-0.007	195.5	-0.0036
202.17	-0.008	195.2	-0.008
202.18	-0.011	194.9	-0.008
202.20	-0.012	194.9	-0.0115
202.22	-0.012	194.7	-0.0133
202.23	-0.013	194.4	-0.016
202.25	-0.015	194.2	-0.0186
202.27	-0.015	194	-0.0195
202.28	-0.016	193.8	-0.0213
202.30	-0.017	193.6	-0.0231
202.32	-0.017	193.5	-0.0231
202.33	-0.017	193.3	-0.024
202.35	-0.017	193.2	-0.024
202.37	-0.017	193.1	-0.0249
202.38	-0.017	193.1	-0.0249
202.40	-0.017	193	-0.0249
202.42	-0.017	192.9	-0.024
202.43	-0.016	192.9	-0.0231
202.45	-0.015	192.9	-0.0222
202.47	-0.014	192.9	-0.0222
202.48	-0.013	192.9	-0.0213
202.50	-0.013	192.9	-0.0195
202.52	-0.012	192.9	-0.0178
202.53	-0.01	193	-0.0151
202.57	-0.008	193.1	-0.0133
202.58	-0.007	193.2	-0.0107
202.60	-0.005	193.4	-0.0107
202.62	-0.003	193.5	-0.0071
202.62	-0.003	193.5	-0.0044
202.63	-0.002	193.7	-0.0009
202.65	0.001	193.9	0.0027
202.67	0.004	194.1	0.0062
202.68	0.004	194.2	0.0107
202.70	0.007	194.6	0.0142
202.72	0.01	194.8	0.0142
202.73	0.01	194.8	0.0186
202.75	0.011	195	0.0222
202.77	0.013	195.3	0.0257
202.78	0.016	195.6	0.0311
202.80	0.017	195.8	0.0337
202.82	0.018	196.1	0.0373
202.83	0.021	196.3	0.0373
202.85	0.022	196.3	0.0408
202.87	0.022	196.5	0.0435
202.88	0.023	196.7	0.0462
202.90	0.025	197	0.0488
202.92	0.025	197.2	0.0506
202.93	0.026	197.4	0.0524
202.95	0.028	197.6	0.0524

Prova triassiale ciclica SN04-C1			
pressione di confinamento (kPa)		80	
deviatore ciclico (kPa)		95	
frequenza (hz)		0.00625	
tempo	cella di carico	$\Delta u$	LVDT
(min)	kN	(kPa)	$\delta$ (mm)
202.97	0.028	197.6	0.0541
202.98	0.028	197.7	0.055
203.00	0.028	197.9	0.0559
203.02	0.029	198	0.0568
203.03	0.029	198.1	0.0568
203.05	0.029	198.2	0.0568
203.07	0.029	198.3	0.0568
203.08	0.029	198.4	0.0568
203.10	0.028	198.4	0.055
203.12	0.026	198.5	0.055
203.13	0.025	198.5	0.0541
203.15	0.025	198.5	0.0533
203.17	0.024	198.5	0.0515
203.18	0.022	198.4	0.0497
203.20	0.022	198.4	0.0479
203.22	0.02	198.3	0.0444
203.23	0.017	198.1	0.0444
203.25	0.016	198.1	0.0426
203.27	0.016	198	0.0391
203.28	0.015	197.9	0.0355
203.30	0.011	197.7	0.032
203.32	0.01	197.5	0.0293
203.33	0.009	197.3	0.0249
203.35	0.005	197.1	0.0249
203.37	0.004	197.1	0.0204
203.38	0.004	196.9	0.0178
203.40	0.003	196.7	0.0133
203.42	-0.001	196.4	0.0089
203.43	-0.002	196.2	0.0053
203.45	-0.004	195.9	0.0018
203.47	-0.007	195.6	0.0018
203.48	-0.007	195.6	-0.0027
203.50	-0.007	195.4	-0.0053
203.52	-0.009	195.1	-0.0089
203.53	-0.011	194.8	-0.0124
203.55	-0.013	194.5	-0.0142
203.57	-0.013	194.4	-0.0169
203.58	-0.015	194.1	-0.0169
203.60	-0.015	193.9	-0.0186
203.62	-0.015	193.9	-0.0195
203.63	-0.016	193.7	-0.0222
203.65	-0.017	193.5	-0.0231
203.67	-0.017	193.4	-0.024
203.68	-0.017	193.3	-0.024
203.70	-0.017	193.2	-0.024
203.72	-0.017	193	-0.024
203.73	-0.017	193	-0.024
203.75	-0.016	192.9	-0.024
203.77	-0.016	192.9	-0.024
203.78	-0.015	192.9	-0.0231
203.80	-0.015	192.8	-0.0222
203.82	-0.014	192.9	-0.0204
203.83	-0.012	192.9	-0.0186
203.85	-0.011	193	-0.0169
203.87	-0.01	193	-0.0151
203.88	-0.007	193.2	-0.0151
203.90	-0.007	193.2	-0.0115
203.92	-0.007	193.2	-0.0098

Prova triassiale ciclica SN04-C1			
pressione di confinamento (kPa)		80	
deviatore ciclico (kPa)		95	
frequenza (hz)		0.00625	
tempo	cella di carico	$\Delta u$	LVDT
(min)	kN	(kPa)	$\delta$ (mm)
203.93	-0.005	193.4	-0.0062
203.95	-0.001	193.6	-0.0027
203.97	-0.001	193.7	0
203.98	0	193.9	0.0036
204.00	0.005	194.2	0.0036
204.03	0.005	194.2	0.008
204.05	0.005	194.3	0.0115
204.07	0.007	194.6	0.016
204.08	0.011	194.9	0.0204
204.08	0.012	195	0.0231
204.10	0.013	195.3	0.0275
204.12	0.017	195.6	0.0275
204.13	0.017	195.6	0.032
204.15	0.017	195.8	0.0346
204.17	0.019	196.1	0.0391
204.18	0.022	196.4	0.0426
204.20	0.022	196.6	0.0444
204.22	0.023	196.8	0.047
204.23	0.026	197	0.047
204.25	0.026	197	0.0497
204.27	0.026	197.2	0.0515
204.28	0.027	197.4	0.0533
204.30	0.028	197.6	0.055
204.32	0.028	197.8	0.0559
204.33	0.028	197.9	0.0559
204.35	0.029	198	0.0559
204.37	0.029	198.2	0.0568
204.38	0.029	198.2	0.0568
204.40	0.029	198.3	0.0568
204.42	0.029	198.3	0.0568
204.43	0.028	198.4	0.0559
204.45	0.027	198.4	0.0541
204.47	0.026	198.4	0.0541
204.48	0.024	198.4	0.0515
204.50	0.024	198.4	0.0506
204.52	0.023	198.3	0.0506
204.53	0.021	198.3	0.0488
204.55	0.021	198.3	0.0462
204.57	0.02	198.2	0.0435
204.58	0.017	198	0.0408
204.60	0.015	197.9	0.0382
204.62	0.014	197.8	0.0346
204.63	0.012	197.6	0.0346
204.65	0.009	197.4	0.0311
204.67	0.009	197.4	0.0275
204.68	0.008	197.2	0.0231
204.70	0.005	197	0.0195
204.72	0.003	196.8	0.016
204.73	0.002	196.6	0.0115
204.75	-0.001	196.2	0.0115
204.77	-0.004	196	0.0071
204.78	-0.004	196	0.0036
204.80	-0.005	195.8	0
204.82	-0.006	195.4	-0.0036
204.83	-0.009	195.2	-0.0062
204.85	-0.01	194.9	-0.0098
204.87	-0.012	194.6	-0.0133
204.88	-0.013	194.4	-0.0133



Prova triassiale ciclica SN04-C1			
pressione di confinamento (kPa)		80	
deviatore ciclico (kPa)		95	
frequenza (hz)		0.00625	
tempo	cella di carico	$\Delta u$	LVDT
(min)	kN	(kPa)	$\delta$ (mm)
204.90	-0.013	194.4	-0.0151
204.92	-0.014	194.2	-0.0169
204.93	-0.015	194	-0.0195
204.95	-0.016	193.8	-0.0213
204.97	-0.016	193.6	-0.0222
204.98	-0.017	193.5	-0.0231
205.00	-0.017	193.3	-0.0231
205.02	-0.017	193.3	-0.024
205.03	-0.017	193.2	-0.024
205.05	-0.017	193.1	-0.024
205.07	-0.017	193	-0.024
205.08	-0.017	192.9	-0.024
205.10	-0.016	192.9	-0.0231
205.12	-0.015	192.9	-0.0231
205.13	-0.014	192.9	-0.0213
205.15	-0.014	192.9	-0.0213
205.17	-0.013	193	-0.0186
205.18	-0.011	193	-0.0169
205.20	-0.01	193	-0.0142
205.22	-0.009	193.2	-0.0115
205.23	-0.007	193.2	-0.0107
205.25	-0.006	193.3	-0.008
205.27	-0.005	193.5	-0.0044
205.28	0	193.7	-0.0044
205.30	0	193.7	-0.0009
205.32	0	193.8	0.0018
205.33	0.002	194.1	0.0062
205.35	0.006	194.3	0.0098
205.37	0.006	194.4	0.0133
205.38	0.008	194.7	0.0178
205.40	0.012	195	0.0178
205.42	0.013	195	0.0222
205.43	0.013	195.2	0.0249
205.47	0.014	195.4	0.0302
205.48	0.017	195.8	0.0337
205.50	0.018	196	0.0364
205.52	0.02	196.2	0.0399
205.53	0.022	196.5	0.0399
205.53	0.023	196.5	0.0435
205.55	0.023	196.7	0.0453
205.57	0.024	196.9	0.0488
205.58	0.026	197.1	0.0506
205.60	0.026	197.3	0.0515
205.62	0.027	197.5	0.0541
205.63	0.028	197.7	0.0541
205.65	0.029	197.7	0.055
205.67	0.029	197.8	0.0559
205.68	0.029	198	0.0559
205.70	0.029	198.1	0.0568
205.72	0.029	198.2	0.0568
205.73	0.028	198.3	0.0568
205.75	0.028	198.4	0.0568
205.77	0.027	198.4	0.0568
205.78	0.027	198.4	0.0559
205.80	0.026	198.4	0.0541
205.82	0.025	198.4	0.0524
205.83	0.023	198.4	0.0506
205.85	0.023	198.4	0.0497

Prova triassiale ciclica SN04-C1			
pressione di confinamento (kPa)		80	
deviatore ciclico (kPa)		95	
frequenza (hz)		0.00625	
tempo	cella di carico	$\Delta u$	LVDT
(min)	kN	(kPa)	$\delta$ (mm)
205.87	0.021	198.3	0.0462
205.88	0.019	198.2	0.0462
205.90	0.018	198.2	0.0444
205.92	0.018	198.1	0.0417
205.93	0.014	197.8	0.0382
205.95	0.013	197.8	0.0364
205.97	0.013	197.7	0.0337
205.98	0.012	197.5	0.0311
206.00	0.008	197.3	0.0257
206.02	0.007	197.1	0.0222
206.03	0.005	196.9	0.0186
206.05	0.002	196.6	0.0186
206.07	0.001	196.6	0.0142
206.08	0.001	196.4	0.0107
206.10	-0.001	196.2	0.0062
206.12	-0.005	195.9	0.0018
206.13	-0.005	195.7	-0.0009
206.15	-0.006	195.4	-0.0036
206.17	-0.01	195	-0.0036
206.18	-0.01	195	-0.008
206.20	-0.01	194.8	-0.0107
206.22	-0.011	194.6	-0.0133
206.23	-0.014	194.3	-0.0169
206.25	-0.014	194.1	-0.0178
206.27	-0.015	193.9	-0.0204
206.28	-0.016	193.7	-0.0204
206.30	-0.017	193.7	-0.0213
206.32	-0.017	193.6	-0.0222
206.33	-0.017	193.4	-0.0231
206.35	-0.017	193.3	-0.024
206.37	-0.017	193.2	-0.024
206.38	-0.017	193.1	-0.0249
206.40	-0.017	193	-0.0249
206.42	-0.016	193	-0.0249
206.43	-0.016	192.9	-0.024
206.45	-0.016	192.9	-0.0222
206.47	-0.014	192.9	-0.0204
206.48	-0.013	192.9	-0.0195
206.50	-0.012	192.9	-0.0178
206.52	-0.01	193	-0.0178
206.53	-0.009	193	-0.016
206.55	-0.009	193.1	-0.0142
206.57	-0.008	193.1	-0.0107
206.58	-0.005	193.3	-0.008
206.60	-0.005	193.4	-0.0062
206.62	-0.003	193.6	-0.0027
206.63	0.001	193.8	-0.0027
206.65	0.002	193.8	0.0018
206.67	0.004	194.1	0.0071
206.68	0.005	194.3	0.0071
206.70	0.007	194.5	0.0107
206.72	0.007	194.5	0.0142
206.73	0.009	194.8	0.0186
206.75	0.013	195.1	0.024
206.77	0.014	195.3	0.0275
206.78	0.015	195.5	0.0311
206.80	0.018	195.8	0.0311
206.82	0.019	196	0.0355

Prova triassiale ciclica SN04-C1			
pressione di confinamento (kPa)		80	
deviatore ciclico (kPa)		95	
frequenza (hz)		0.00625	
tempo	cella di carico	$\Delta u$	LVDT
(min)	kN	(kPa)	$\delta$ (mm)
206.83	0.019	196	0.0373
206.85	0.02	196.3	0.0408
206.87	0.022	196.6	0.0444
206.88	0.024	196.8	0.047
206.90	0.025	197	0.0497
206.93	0.026	197.2	0.0497
206.95	0.027	197.4	0.0515
206.97	0.027	197.4	0.0533
206.98	0.028	197.6	0.0541
206.98	0.028	197.7	0.055
207.00	0.029	197.9	0.0559
207.02	0.029	198	0.0568
207.03	0.029	198.1	0.0568
207.05	0.029	198.2	0.0568
207.07	0.029	198.2	0.0568
207.08	0.029	198.3	0.0568
207.10	0.028	198.4	0.0559
207.12	0.027	198.4	0.0541
207.13	0.026	198.4	0.0541
207.15	0.025	198.4	0.0524
207.17	0.023	198.4	0.0524
207.18	0.022	198.4	0.0497
207.20	0.022	198.3	0.0488
207.22	0.021	198.3	0.0462
207.23	0.018	198.1	0.0426
207.25	0.017	198	0.0408
207.27	0.016	197.9	0.0373
207.28	0.012	197.7	0.0373
207.30	0.011	197.7	0.0337
207.32	0.011	197.6	0.0311
207.33	0.01	197.3	0.0257
207.35	0.006	197.1	0.0222
207.37	0.005	197	0.0195
207.38	0.003	196.7	0.0151
207.40	0.001	196.5	0.0124
207.42	0	196.3	0.0098
207.43	-0.001	196	0.0053
207.45	-0.006	195.7	0.0053
207.47	-0.006	195.7	0
207.48	-0.006	195.5	-0.0018
207.50	-0.007	195.2	-0.0062
207.52	-0.01	194.9	-0.0089
207.53	-0.011	194.7	-0.0115
207.55	-0.012	194.5	-0.0142
207.57	-0.014	194.2	-0.0142
207.58	-0.015	194.2	-0.0169
207.60	-0.015	194	-0.0186
207.62	-0.016	193.9	-0.0213
207.63	-0.016	193.6	-0.0222
207.65	-0.017	193.5	-0.0231
207.67	-0.017	193.3	-0.0231
207.68	-0.017	193.2	-0.0231
207.70	-0.017	193.2	-0.024
207.72	-0.017	193.1	-0.0249
207.73	-0.017	193	-0.024
207.75	-0.017	192.9	-0.024
207.77	-0.016	192.9	-0.0231
207.78	-0.015	192.9	-0.0222

Prova triassiale ciclica SN04-C1			
pressione di confinamento (kPa)		80	
deviatore ciclico (kPa)		95	
frequenza (hz)		0.00625	
tempo	cella di carico	$\Delta u$	LVDT
(min)	kN	(kPa)	$\delta$ (mm)
207.80	-0.014	192.9	-0.0222
207.82	-0.013	192.9	-0.0204
207.83	-0.013	192.9	-0.0195
207.85	-0.012	192.9	-0.0169
207.87	-0.01	193	-0.0151
207.88	-0.008	193.1	-0.0124
207.90	-0.007	193.2	-0.0098
207.92	-0.005	193.4	-0.0098
207.93	-0.003	193.5	-0.0071
207.95	-0.003	193.5	-0.0044
207.97	-0.001	193.6	0
207.98	0.001	193.9	0.0036
208.00	0.003	194	0.0062
208.02	0.005	194.2	0.0107
208.03	0.007	194.5	0.0107
208.05	0.01	194.7	0.0151
208.07	0.01	194.7	0.0178
208.08	0.011	194.9	0.0222
208.10	0.014	195.3	0.0275
208.12	0.016	195.5	0.0311
208.13	0.016	195.7	0.0328
208.15	0.018	196	0.0364
208.17	0.02	196.2	0.0399
208.18	0.021	196.4	0.0426
208.20	0.023	196.7	0.0453
208.22	0.025	196.9	0.0453
208.23	0.025	196.9	0.0479
208.25	0.025	197.1	0.0497
208.27	0.026	197.3	0.0524
208.28	0.028	197.5	0.0541
208.30	0.028	197.6	0.0541
208.32	0.028	197.8	0.0559
208.33	0.029	197.9	0.0559
208.37	0.029	197.9	0.0568
208.38	0.029	198.1	0.0568
208.40	0.029	198.2	0.0568
208.42	0.029	198.3	0.0568
208.43	0.028	198.4	0.0568
208.43	0.028	198.4	0.0559
208.45	0.026	198.4	0.0559
208.47	0.026	198.4	0.0541
208.48	0.026	198.4	0.0533
208.50	0.024	198.4	0.0515
208.52	0.022	198.3	0.0497
208.53	0.022	198.3	0.0479
208.55	0.02	198.2	0.0444
208.57	0.017	198.1	0.0444
208.58	0.016	198.1	0.0417
208.60	0.016	198	0.0391
208.62	0.015	197.8	0.0364
208.63	0.011	197.6	0.032
208.65	0.01	197.5	0.0293
208.67	0.009	197.3	0.0249
208.68	0.005	197	0.0249
208.70	0.004	197	0.0204
208.72	0.004	196.9	0.0178
208.73	0.003	196.6	0.0133
208.75	-0.001	196.3	0.0089

Prova triassiale ciclica SN04-C1			
pressione di confinamento (kPa)		80	
deviatore ciclico (kPa)		95	
frequenza (hz)		0.00625	
tempo	cella di carico	$\Delta u$	LVDT
(min)	kN	(kPa)	$\delta$ (mm)
208.77	-0.002	196.1	0.0062
208.78	-0.004	195.9	0.0018
208.80	-0.007	195.6	0.0018
208.82	-0.007	195.3	-0.0027
208.83	-0.007	195.3	-0.0044
208.85	-0.01	194.8	-0.008
208.87	-0.012	194.6	-0.0107
208.88	-0.012	194.6	-0.0124
208.90	-0.013	194.4	-0.016
208.92	-0.014	194.1	-0.0186
208.93	-0.015	193.9	-0.0195
208.95	-0.016	193.7	-0.0204
208.97	-0.016	193.6	-0.0204
208.98	-0.017	193.4	-0.0222
209.00	-0.017	193.4	-0.0231
209.02	-0.017	193.2	-0.024
209.03	-0.017	193.1	-0.024
209.05	-0.017	193	-0.024
209.07	-0.017	192.9	-0.024
209.08	-0.017	192.9	-0.0231
209.10	-0.016	192.9	-0.0231
209.12	-0.015	192.9	-0.0231
209.13	-0.015	192.8	-0.0213
209.15	-0.014	192.9	-0.0204
209.17	-0.012	192.9	-0.0186
209.18	-0.011	192.9	-0.0169
209.20	-0.01	193	-0.0142
209.22	-0.007	193.1	-0.0142
209.23	-0.007	193.1	-0.0115
209.25	-0.007	193.2	-0.0089
209.27	-0.005	193.4	-0.0062
209.28	-0.002	193.6	-0.0027
209.30	-0.001	193.7	0.0009
209.32	0.001	193.9	0.0044
209.33	0.005	194.1	0.0044
209.35	0.005	194.1	0.0089
209.37	0.005	194.3	0.0115
209.38	0.007	194.6	0.016
209.40	0.011	194.8	0.0204
209.42	0.012	195	0.0231
209.43	0.013	195.3	0.0284
209.45	0.017	195.6	0.0284
209.47	0.017	195.6	0.0328
209.48	0.017	195.8	0.0355
209.50	0.019	196.1	0.0391
209.52	0.022	196.3	0.0426
209.53	0.023	196.6	0.0444
209.55	0.024	196.8	0.047
209.57	0.026	197	0.0497
209.58	0.025	197.2	0.0506
209.60	0.026	197.4	0.0524
209.62	0.028	197.6	0.0524
209.63	0.028	197.6	0.0541
209.65	0.028	197.7	0.055
209.67	0.028	197.9	0.0559
209.68	0.029	198	0.0568
209.70	0.029	198.1	0.0568
209.72	0.029	198.2	0.0568

Prova triassiale ciclica SN04-C1			
pressione di confinamento (kPa)		80	
deviatore ciclico (kPa)		95	
frequenza (hz)		0.00625	
tempo	cella di carico	$\Delta u$	LVDT
(min)	kN	(kPa)	$\delta$ (mm)
209.73	0.029	198.3	0.0568
209.75	0.028	198.3	0.0568
209.77	0.028	198.4	0.0559
209.78	0.027	198.4	0.055
209.80	0.026	198.4	0.0541
209.83	0.025	198.4	0.0524
209.85	0.024	198.4	0.0506
209.87	0.022	198.3	0.0506
209.88	0.021	198.3	0.0479
209.88	0.021	198.3	0.0462
209.90	0.02	198.2	0.0435
209.92	0.017	198	0.0408
209.93	0.016	197.9	0.0391
209.95	0.014	197.8	0.0346
209.97	0.011	197.5	0.0346
209.98	0.009	197.4	0.0311
210.00	0.009	197.4	0.0275
210.02	0.008	197.2	0.024
210.03	0.005	196.9	0.0195
210.05	0.003	196.7	0.016
210.07	0.002	196.5	0.0115
210.08	-0.002	196.2	0.0115
210.10	-0.003	196	0.0071
210.12	-0.003	196	0.0044
210.13	-0.004	195.8	0.0009
210.15	-0.007	195.4	-0.0036
210.17	-0.009	195.1	-0.0062
210.18	-0.009	194.9	-0.0098
210.20	-0.012	194.6	-0.0098
210.22	-0.013	194.4	-0.0124
210.23	-0.013	194.4	-0.0151
210.25	-0.014	194.2	-0.0178
210.27	-0.015	193.9	-0.0195
210.28	-0.016	193.8	-0.0213
210.30	-0.016	193.6	-0.0222
210.32	-0.016	193.4	-0.0231
210.33	-0.017	193.3	-0.0231
210.35	-0.017	193.1	-0.024
210.37	-0.017	193	-0.024
210.38	-0.017	192.9	-0.024
210.40	-0.017	192.9	-0.0249
210.42	-0.017	192.9	-0.0249
210.43	-0.016	192.9	-0.0231
210.45	-0.015	192.8	-0.0222
210.47	-0.014	192.8	-0.0204
210.48	-0.013	192.8	-0.0195
210.50	-0.011	192.9	-0.0195
210.52	-0.011	192.9	-0.0178
210.53	-0.011	192.9	-0.016
210.55	-0.009	193	-0.0133
210.57	-0.006	193.2	-0.0107
210.58	-0.006	193.2	-0.008
210.60	-0.004	193.4	-0.0044
210.62	-0.001	193.6	-0.0044
210.63	0	193.6	-0.0009
210.65	0	193.7	0.0027
210.67	0.002	194	0.0062
210.68	0.005	194.2	0.0098

Prova triassiale ciclica SN04-C1			
pressione di confinamento (kPa)		80	
deviatore ciclico (kPa)		95	
frequenza (hz)		0.00625	
tempo	cella di carico	$\Delta u$	LVDT
(min)	kN	(kPa)	$\delta$ (mm)
210.70	0.006	194.4	0.0133
210.72	0.008	194.7	0.0178
210.73	0.012	194.9	0.0178
210.75	0.013	194.9	0.0222
210.77	0.013	195.1	0.0257
210.78	0.014	195.4	0.0302
210.80	0.018	195.7	0.0337
210.82	0.018	195.9	0.0373
210.83	0.02	196.2	0.0399
210.85	0.022	196.4	0.0399
210.87	0.023	196.4	0.0435
210.88	0.023	196.6	0.0453
210.90	0.024	196.9	0.0479
210.92	0.026	197.1	0.0506
210.93	0.026	197.3	0.0515
210.95	0.027	197.5	0.0541
210.97	0.028	197.6	0.0541
210.98	0.029	197.6	0.055
211.00	0.029	197.8	0.0559
211.02	0.029	198	0.0568
211.03	0.029	198	0.0568
211.05	0.029	198.2	0.0568
211.07	0.028	198.3	0.0568
211.08	0.028	198.3	0.0568
211.10	0.028	198.4	0.0568
211.12	0.027	198.4	0.055
211.13	0.025	198.4	0.055
211.15	0.024	198.4	0.0533
211.17	0.024	198.4	0.0524
211.18	0.024	198.4	0.0506
211.20	0.021	198.3	0.0479
211.22	0.02	198.2	0.0462
211.23	0.019	198.1	0.0426
211.25	0.016	198	0.0426
211.27	0.014	197.8	0.0391
211.30	0.014	197.8	0.0373
211.32	0.013	197.7	0.0337
211.33	0.01	197.5	0.0302
211.33	0.008	197.3	0.0257
211.35	0.007	197.1	0.0222
211.37	0.004	196.8	0.0178
211.38	0.002	196.6	0.0178
211.40	0.002	196.6	0.0142
211.42	0.001	196.4	0.0098
211.43	-0.002	196.1	0.0062
211.45	-0.004	195.9	0.0027
211.47	-0.005	195.7	-0.0009
211.48	-0.007	195.3	-0.0053
211.50	-0.01	195	-0.0053
211.52	-0.01	195	-0.008
211.53	-0.01	194.8	-0.0107
211.55	-0.011	194.5	-0.0133
211.57	-0.014	194.3	-0.016
211.58	-0.014	194.1	-0.0178
211.60	-0.015	193.9	-0.0195
211.62	-0.016	193.7	-0.0195
211.63	-0.016	193.7	-0.0213
211.65	-0.016	193.5	-0.0222

Prova triassiale ciclica SN04-C1			
pressione di confinamento (kPa)		80	
deviatore ciclico (kPa)		95	
frequenza (hz)		0.00625	
tempo	cella di carico	$\Delta u$	LVDT
(min)	kN	(kPa)	$\delta$ (mm)
211.67	-0.017	193.4	-0.0231
211.68	-0.017	193.2	-0.024
211.70	-0.017	193.1	-0.024
211.72	-0.017	193	-0.024
211.73	-0.017	192.9	-0.024
211.75	-0.016	192.9	-0.0231
211.77	-0.016	192.8	-0.0231
211.78	-0.015	192.8	-0.0231
211.80	-0.014	192.8	-0.0222
211.82	-0.014	192.8	-0.0204
211.83	-0.013	192.9	-0.0186
211.85	-0.011	192.9	-0.0169
211.87	-0.01	193	-0.0151
211.88	-0.009	193.1	-0.0124
211.90	-0.006	193.2	-0.0124
211.92	-0.005	193.2	-0.0089
211.93	-0.005	193.3	-0.0071
211.95	-0.004	193.5	-0.0036
211.97	0	193.7	0.0009
211.98	0.001	193.8	0.0027
212.00	0.002	194	0.0071
212.02	0.006	194.3	0.0071
212.03	0.008	194.3	0.0124
212.05	0.008	194.5	0.0151
212.07	0.009	194.7	0.0186
212.08	0.012	195	0.0231
212.10	0.014	195.2	0.0275
212.12	0.015	195.4	0.0311
212.13	0.018	195.8	0.0311
212.15	0.019	196	0.0355
212.17	0.019	196	0.0382
212.18	0.02	196.2	0.0417
212.20	0.023	196.5	0.0444
212.22	0.024	196.7	0.047
212.23	0.025	196.9	0.0488
212.25	0.026	197.2	0.0488
212.27	0.027	197.4	0.0515
212.28	0.027	197.4	0.0533
212.30	0.027	197.5	0.0541
212.32	0.028	197.7	0.055
212.33	0.029	197.8	0.0559
212.35	0.029	198	0.0568
212.37	0.029	198.1	0.0568
212.38	0.028	198.2	0.0568
212.40	0.028	198.2	0.0568
212.42	0.028	198.3	0.0568
212.43	0.028	198.3	0.0559
212.45	0.027	198.3	0.055
212.47	0.026	198.4	0.0541
212.48	0.026	198.4	0.0524
212.50	0.023	198.3	0.0506
212.52	0.023	198.3	0.0497
212.53	0.022	198.2	0.047
212.55	0.019	198.1	0.047
212.57	0.018	198.1	0.0444
212.58	0.018	198.1	0.0426
212.60	0.017	197.9	0.0391
212.62	0.013	197.7	0.0355



Prova triassiale ciclica SN04-C1			
pressione di confinamento (kPa)		80	
deviatore ciclico (kPa)		95	
frequenza (hz)		0.00625	
tempo	cella di carico	$\Delta u$	LVDT
(min)	kN	(kPa)	$\delta$ (mm)
212.63	0.012	197.6	0.032
212.65	0.011	197.4	0.0284
212.67	0.007	197.2	0.0284
212.68	0.006	197.2	0.024
212.70	0.006	197	0.0213
212.73	0.004	196.8	0.0169
212.75	0.001	196.5	0.0124
212.77	0	196.3	0.0089
212.78	-0.002	196	0.0053
212.80	-0.005	195.7	0.0053
212.80	-0.006	195.7	0.0009
212.82	-0.006	195.5	-0.0018
212.83	-0.007	195.2	-0.0062
212.85	-0.01	194.9	-0.0089
212.87	-0.011	194.7	-0.0115
212.88	-0.012	194.5	-0.0151
212.90	-0.014	194.2	-0.0151
212.92	-0.015	194	-0.0178
212.93	-0.015	194	-0.0186
212.95	-0.015	193.8	-0.0204
212.97	-0.016	193.6	-0.0213
212.98	-0.017	193.4	-0.0231
213.00	-0.017	193.3	-0.0231
213.02	-0.017	193.2	-0.0231
213.03	-0.017	193	-0.024
213.05	-0.017	193	-0.024
213.07	-0.017	193	-0.024
213.08	-0.017	192.9	-0.024
213.10	-0.016	192.9	-0.0231
213.12	-0.015	192.8	-0.0213
213.13	-0.014	192.8	-0.0204
213.15	-0.012	192.9	-0.0204
213.17	-0.012	192.9	-0.0186
213.18	-0.012	192.9	-0.0169
213.20	-0.009	193	-0.0151
213.22	-0.008	193	-0.0142
213.23	-0.008	193.1	-0.0115
213.25	-0.006	193.2	-0.008
213.27	-0.003	193.4	-0.0053
213.28	-0.002	193.5	-0.0027
213.30	-0.001	193.7	0.0009
213.32	0.002	193.9	0.0009
213.33	0.004	193.9	0.0053
213.35	0.004	194.1	0.0089
213.37	0.005	194.4	0.0124
213.38	0.009	194.6	0.0178
213.40	0.01	194.8	0.0204
213.42	0.012	195.1	0.024
213.43	0.015	195.4	0.024
213.45	0.016	195.4	0.0293
213.47	0.016	195.6	0.0328
213.48	0.017	195.8	0.0355
213.50	0.021	196.1	0.0399
213.52	0.021	196.3	0.0417
213.53	0.022	196.5	0.0453
213.55	0.025	196.8	0.0453
213.57	0.025	196.8	0.0479
213.58	0.025	197	0.0497

Prova triassiale ciclica SN04-C1			
pressione di confinamento (kPa)		80	
deviatore ciclico (kPa)		95	
frequenza (hz)		0.00625	
tempo	cella di carico	$\Delta u$	LVDT
(min)	kN	(kPa)	$\delta$ (mm)
213.60	0.026	197.2	0.0524
213.62	0.027	197.4	0.0533
213.63	0.028	197.6	0.055
213.65	0.028	197.7	0.0559
213.67	0.029	197.9	0.0559
213.68	0.029	197.9	0.0559
213.70	0.029	198	0.0568
213.72	0.029	198.1	0.0568
213.73	0.029	198.2	0.0568
213.75	0.028	198.3	0.0568
213.77	0.028	198.3	0.0559
213.78	0.026	198.3	0.0559
213.80	0.026	198.4	0.0541
213.82	0.026	198.4	0.0533
213.83	0.025	198.3	0.0515
213.85	0.023	198.3	0.0488
213.87	0.021	198.2	0.0479
213.88	0.02	198.2	0.0453
213.90	0.018	198	0.0453
213.92	0.016	197.9	0.0417
213.93	0.015	197.8	0.0373
213.95	0.014	197.7	0.0373
213.97	0.011	197.5	0.0346
213.98	0.011	197.5	0.032
214.00	0.01	197.3	0.0275
214.02	0.007	197	0.0222
214.03	0.005	196.9	0.0186
214.05	0.003	196.7	0.0151
214.07	0.001	196.4	0.0151
214.08	-0.002	196.1	0.0107
214.10	-0.002	196.1	0.0071
214.12	-0.003	195.9	0.0036
214.13	-0.005	195.6	0
214.15	-0.007	195.3	-0.0036
214.17	-0.008	195.1	-0.0071
214.20	-0.01	194.7	-0.0071
214.22	-0.012	194.5	-0.0107
214.23	-0.012	194.5	-0.0133
214.25	-0.012	194.4	-0.0151
214.25	-0.014	194.1	-0.0178
214.27	-0.015	193.9	-0.0195
214.28	-0.016	193.7	-0.0213
214.30	-0.016	193.5	-0.0222
214.32	-0.017	193.3	-0.0222
214.33	-0.017	193.3	-0.0231
214.35	-0.017	193.2	-0.024
214.37	-0.017	193.1	-0.024
214.38	-0.017	193	-0.024
214.40	-0.017	192.9	-0.024
214.42	-0.016	192.8	-0.0231
214.43	-0.015	192.8	-0.0231
214.45	-0.015	192.8	-0.0222
214.47	-0.015	192.8	-0.0213
214.48	-0.014	192.8	-0.0195
214.50	-0.012	192.9	-0.0186
214.52	-0.011	192.9	-0.0169
214.53	-0.01	193	-0.0142
214.55	-0.007	193.1	-0.0142

Prova triassiale ciclica SN04-C1			
pressione di confinamento (kPa)		80	
deviatore ciclico (kPa)		95	
frequenza (hz)		0.00625	
tempo	cella di carico	$\Delta u$	LVDT
(min)	kN	(kPa)	$\delta$ (mm)
214.57	-0.007	193.1	-0.0115
214.58	-0.007	193.2	-0.0089
214.60	-0.005	193.4	-0.0062
214.62	-0.001	193.5	-0.0018
214.63	-0.001	193.6	0.0009
214.65	0.001	193.9	0.0044
214.67	0.003	194	0.0071
214.68	0.004	194.2	0.0098
214.70	0.006	194.4	0.0142
214.72	0.01	194.7	0.0142
214.73	0.011	194.7	0.0186
214.75	0.011	194.9	0.0213
214.77	0.012	195.1	0.0257
214.78	0.016	195.4	0.0311
214.80	0.017	195.7	0.0337
214.82	0.018	195.9	0.0373
214.83	0.021	196.2	0.0373
214.85	0.022	196.2	0.0408
214.87	0.022	196.4	0.0435
214.88	0.023	196.6	0.0462
214.90	0.025	196.9	0.0488
214.92	0.026	197.1	0.0506
214.93	0.026	197.3	0.0524
214.95	0.027	197.5	0.0524
214.97	0.028	197.6	0.0541
214.98	0.028	197.6	0.055
215.00	0.028	197.8	0.0559
215.02	0.029	197.9	0.0568
215.03	0.029	198	0.0568
215.05	0.029	198.1	0.0568
215.07	0.028	198.2	0.0568
215.08	0.028	198.3	0.0568
215.10	0.027	198.3	0.0568
215.12	0.027	198.3	0.0559
215.13	0.027	198.4	0.055
215.15	0.025	198.3	0.0524
215.17	0.024	198.4	0.0515
215.18	0.023	198.3	0.0488
215.20	0.02	198.2	0.0488
215.22	0.02	198.2	0.0462
215.23	0.02	198.1	0.0444
215.25	0.018	198	0.0417
215.27	0.014	197.8	0.0373
215.28	0.014	197.7	0.0355
215.30	0.012	197.5	0.032
215.32	0.009	197.3	0.032
215.33	0.007	197.3	0.0275
215.35	0.007	197.2	0.0249
215.37	0.006	197	0.0204
215.38	0.002	196.7	0.016
215.40	0.002	196.6	0.0142
215.42	0.001	196.3	0.0098
215.43	-0.003	196	0.0053
215.45	-0.004	195.8	0.0027
215.47	-0.005	195.6	-0.0009
215.48	-0.008	195.2	-0.0009
215.50	-0.009	195.2	-0.0053
215.52	-0.009	195	-0.008

Prova triassiale ciclica SN04-C1			
pressione di confinamento (kPa)		80	
deviatore ciclico (kPa)		95	
frequenza (hz)		0.00625	
tempo	cella di carico	$\Delta u$	LVDT
(min)	kN	(kPa)	$\delta$ (mm)
215.53	-0.01	194.7	-0.0107
215.55	-0.012	194.5	-0.0133
215.57	-0.013	194.2	-0.016
215.58	-0.014	194	-0.0178
215.60	-0.016	193.8	-0.0178
215.63	-0.016	193.6	-0.0204
215.65	-0.016	193.6	-0.0213
215.67	-0.016	193.5	-0.0222
215.68	-0.017	193.3	-0.0231
215.70	-0.017	193.2	-0.024
215.70	-0.017	193.1	-0.024
215.72	-0.017	193	-0.024
215.73	-0.017	192.9	-0.024
215.75	-0.017	192.9	-0.024
215.77	-0.016	192.8	-0.0231
215.78	-0.015	192.8	-0.0222
215.80	-0.014	192.8	-0.0213
215.82	-0.014	192.8	-0.0195
215.83	-0.012	192.9	-0.0178
215.85	-0.01	192.9	-0.0178
215.87	-0.01	192.9	-0.016
215.88	-0.01	193	-0.0142
215.90	-0.008	193.1	-0.0115
215.92	-0.005	193.2	-0.008
215.93	-0.004	193.3	-0.0053
215.95	-0.002	193.6	-0.0018
215.97	0.001	193.7	-0.0018
215.98	0.002	193.7	0.0018
216.00	0.002	193.9	0.0053
216.02	0.004	194.2	0.0089
216.03	0.007	194.4	0.0133
216.05	0.008	194.6	0.0169
216.07	0.01	194.9	0.0213
216.08	0.013	195.1	0.0213
216.10	0.014	195.3	0.0284
216.12	0.015	195.6	0.0311
216.13	0.018	195.8	0.0311
216.15	0.019	195.8	0.0346
216.17	0.019	196	0.0382
216.18	0.02	196.3	0.0417
216.20	0.023	196.5	0.0444
216.22	0.023	196.7	0.047
216.23	0.025	196.9	0.0497
216.25	0.026	197.2	0.0497
216.27	0.027	197.2	0.0515
216.28	0.027	197.4	0.0533
216.30	0.027	197.5	0.0541
216.32	0.028	197.7	0.0559
216.33	0.029	197.8	0.0568
216.35	0.029	198	0.0568
216.37	0.029	198.1	0.0568
216.38	0.029	198.1	0.0568
216.40	0.029	198.2	0.0568
216.42	0.029	198.3	0.0568
216.43	0.028	198.3	0.0559
216.45	0.027	198.3	0.055
216.47	0.026	198.4	0.0533
216.48	0.024	198.3	0.0533

Prova triassiale ciclica SN04-C1			
pressione di confinamento (kPa)		80	
deviatore ciclico (kPa)		95	
frequenza (hz)		0.00625	
tempo	cella di carico	$\Delta u$	LVDT
(min)	kN	(kPa)	$\delta$ (mm)
216.50	0.023	198.3	0.0515
216.52	0.023	198.3	0.0506
216.53	0.022	198.3	0.0479
216.55	0.02	198.1	0.0453
216.57	0.018	198.1	0.0435
216.58	0.017	198	0.0399
216.60	0.014	197.8	0.0399
216.62	0.013	197.6	0.0373
216.63	0.013	197.6	0.0346
216.65	0.011	197.5	0.0302
216.67	0.009	197.2	0.0257
216.68	0.006	197	0.0222
216.70	0.005	196.9	0.0186
216.72	0.002	196.6	0.0186
216.73	0	196.4	0.0142
216.75	0	196.4	0.0115
216.77	-0.001	196.2	0.0071
216.78	-0.004	195.8	0.0027
216.80	-0.006	195.6	-0.0009
216.82	-0.007	195.3	-0.0044
216.83	-0.009	195	-0.0071
216.85	-0.01	194.8	-0.0098
216.87	-0.011	194.6	-0.0115
216.88	-0.012	194.3	-0.0151
216.90	-0.014	194.1	-0.0151
216.92	-0.014	194.1	-0.0178
216.93	-0.015	193.9	-0.0186
216.95	-0.015	193.7	-0.0204
216.97	-0.016	193.5	-0.0222
216.98	-0.017	193.3	-0.0231
217.00	-0.017	193.2	-0.0231
217.02	-0.017	193.1	-0.0231
217.03	-0.017	193.1	-0.024
217.05	-0.017	193	-0.024
217.07	-0.017	192.9	-0.024
217.10	-0.017	192.8	-0.0231
217.12	-0.016	192.8	-0.0231
217.13	-0.015	192.8	-0.0213
217.15	-0.014	192.8	-0.0213
217.15	-0.013	192.8	-0.0204
217.17	-0.013	192.8	-0.0186
217.18	-0.012	192.9	-0.0169
217.20	-0.01	192.9	-0.0151
217.22	-0.009	193	-0.0124
217.23	-0.007	193.2	-0.0098
217.25	-0.004	193.3	-0.0098
217.27	-0.003	193.3	-0.0062
217.28	-0.003	193.4	-0.0036
217.30	-0.002	193.6	0
217.32	0.002	193.8	0.0036
217.33	0.003	194	0.0071
217.35	0.004	194.2	0.0115
217.37	0.008	194.5	0.0115
217.38	0.009	194.5	0.016
217.40	0.009	194.6	0.0186
217.42	0.011	194.9	0.0231
217.43	0.014	195.1	0.0275
217.45	0.015	195.4	0.0311

Prova triassiale ciclica SN04-C1			
pressione di confinamento (kPa)		80	
deviatore ciclico (kPa)		95	
frequenza (hz)		0.00625	
tempo	cella di carico	$\Delta u$	LVDT
(min)	kN	(kPa)	$\delta$ (mm)
217.47	0.017	195.7	0.0346
217.48	0.02	196	0.0346
217.50	0.021	196	0.0382
217.52	0.021	196.2	0.0408
217.53	0.022	196.4	0.0444
217.55	0.024	196.7	0.047
217.57	0.025	196.9	0.0488
217.58	0.025	197	0.0506
217.60	0.027	197.3	0.0524
217.62	0.027	197.4	0.0541
217.63	0.028	197.6	0.055
217.65	0.028	197.8	0.055
217.67	0.029	197.9	0.0559
217.68	0.029	197.9	0.0568
217.70	0.029	198	0.0568
217.72	0.029	198.1	0.0577
217.73	0.029	198.2	0.0568
217.75	0.028	198.3	0.0568
217.77	0.027	198.3	0.0568
217.78	0.026	198.3	0.0559
217.80	0.026	198.3	0.0541
217.82	0.026	198.4	0.0533
217.83	0.025	198.3	0.0515
217.85	0.022	198.3	0.0497
217.87	0.022	198.2	0.0479
217.88	0.02	198.1	0.0453
217.90	0.017	198	0.0453
217.92	0.016	198	0.0426
217.93	0.016	197.9	0.0399
217.95	0.015	197.7	0.0364
217.97	0.011	197.5	0.0328
217.98	0.011	197.4	0.0302
218.00	0.009	197.2	0.0249
218.02	0.005	196.9	0.0249
218.03	0.004	196.9	0.0204
218.05	0.004	196.8	0.0178
218.07	0.003	196.5	0.0133
218.08	-0.001	196.2	0.0089
218.10	-0.002	196	0.0062
218.12	-0.003	195.8	0.0018
218.13	-0.007	195.4	0.0018
218.15	-0.007	195.4	-0.0027
218.17	-0.007	195.2	-0.0053
218.18	-0.009	194.9	-0.0089
218.20	-0.012	194.6	-0.0115
218.22	-0.012	194.4	-0.0133
218.23	-0.013	194.2	-0.016
218.25	-0.015	194	-0.016
218.27	-0.015	194	-0.0186
218.28	-0.016	193.6	-0.0204
218.30	-0.016	193.4	-0.0204
218.32	-0.017	193.4	-0.0222
218.33	-0.017	193.3	-0.0231
218.35	-0.017	193.2	-0.024
218.37	-0.017	193	-0.024
218.38	-0.017	192.9	-0.024
218.40	-0.017	192.8	-0.024
218.42	-0.016	192.8	-0.024

Prova triassiale ciclica SN04-C1			
pressione di confinamento (kPa)		80	
deviatore ciclico (kPa)		95	
frequenza (hz)		0.00625	
tempo	cella di carico	$\Delta u$	LVDT
(min)	kN	(kPa)	$\delta$ (mm)
218.43	-0.015	192.8	-0.0231
218.45	-0.015	192.8	-0.0222
218.47	-0.015	192.7	-0.0213
218.48	-0.014	192.8	-0.0195
218.50	-0.012	192.8	-0.0186
218.52	-0.011	192.8	-0.016
218.55	-0.009	193	-0.016
218.57	-0.008	193	-0.0142
218.58	-0.008	193	-0.0115
218.60	-0.007	193.1	-0.0089
218.60	-0.004	193.3	-0.0053
218.62	-0.002	193.5	-0.0027
218.63	-0.001	193.6	0.0009
218.65	0.002	193.9	0.0009
218.67	0.004	194	0.0053
218.68	0.004	194	0.008
218.70	0.005	194.2	0.0124
218.72	0.009	194.5	0.0169
218.73	0.011	194.7	0.0204
218.75	0.012	194.9	0.024
218.77	0.014	195.2	0.024
218.78	0.017	195.5	0.0284
218.80	0.017	195.5	0.032
218.82	0.017	195.7	0.0355
218.83	0.019	196	0.0391
218.85	0.022	196.3	0.0426
218.87	0.022	196.5	0.0453
218.88	0.024	196.7	0.0479
218.90	0.026	197	0.0479
218.92	0.026	197	0.0497
218.93	0.026	197.1	0.0515
218.95	0.027	197.4	0.0541
218.97	0.028	197.5	0.055
218.98	0.028	197.7	0.055
219.00	0.029	197.8	0.0559
219.02	0.029	197.9	0.0568
219.03	0.029	198.1	0.0568
219.05	0.029	198.2	0.0568
219.07	0.029	198.3	0.0568
219.08	0.028	198.3	0.0568
219.10	0.028	198.3	0.0568
219.12	0.027	198.4	0.055
219.13	0.026	198.4	0.0541
219.15	0.025	198.4	0.0524
219.17	0.024	198.3	0.0506
219.18	0.022	198.2	0.0506
219.20	0.021	198.2	0.0488
219.22	0.021	198.2	0.047
219.23	0.02	198.1	0.0435
219.25	0.017	198	0.0408
219.27	0.015	197.8	0.0382
219.28	0.014	197.7	0.0346
219.30	0.01	197.5	0.0346
219.32	0.01	197.5	0.0311
219.33	0.01	197.3	0.0284
219.35	0.008	197.1	0.0231
219.37	0.004	196.9	0.0186
219.38	0.003	196.7	0.016

Prova triassiale ciclica SN04-C1			
pressione di confinamento (kPa)		80	
deviatore ciclico (kPa)		95	
frequenza (hz)		0.00625	
tempo	cella di carico	$\Delta u$	LVDT
(min)	kN	(kPa)	$\delta$ (mm)
219.40	0.002	196.5	0.0124
219.42	-0.002	196.1	0.0124
219.43	-0.003	196.1	0.008
219.45	-0.003	195.9	0.0044
219.47	-0.004	195.7	0
219.48	-0.007	195.3	-0.0036
219.50	-0.009	195.1	-0.0062
219.52	-0.01	194.8	-0.0098
219.53	-0.012	194.6	-0.0098
219.55	-0.013	194.3	-0.0124
219.57	-0.013	194.3	-0.0151
219.58	-0.014	194.1	-0.0169
219.60	-0.015	193.9	-0.0195
219.62	-0.016	193.7	-0.0213
219.63	-0.016	193.5	-0.0222
219.65	-0.017	193.4	-0.0222
219.67	-0.017	193.2	-0.0231
219.68	-0.017	193.2	-0.0231
219.70	-0.017	193.1	-0.024
219.72	-0.017	193	-0.024
219.73	-0.017	192.9	-0.024
219.75	-0.017	192.8	-0.024
219.77	-0.016	192.8	-0.0231
219.78	-0.015	192.8	-0.0222
219.80	-0.014	192.7	-0.0204
219.82	-0.013	192.8	-0.0204
219.83	-0.012	192.8	-0.0195
219.85	-0.012	192.8	-0.0178
219.87	-0.011	192.8	-0.016
219.88	-0.009	193	-0.0133
219.90	-0.007	193.1	-0.0107
219.92	-0.006	193.2	-0.0071
219.93	-0.004	193.4	-0.0044
219.95	-0.001	193.6	-0.0044
219.97	0	193.6	-0.0009
220.00	0	193.7	0.0027
220.02	0.002	193.9	0.0062
220.03	0.005	194.2	0.0098
220.05	0.006	194.3	0.0133
220.05	0.008	194.6	0.0178
220.07	0.012	194.8	0.0178
220.08	0.012	194.8	0.0222
220.10	0.012	195	0.0249
220.12	0.014	195.4	0.0302
220.13	0.018	195.7	0.0346
220.15	0.019	195.9	0.0373
220.17	0.02	196.1	0.0399
220.18	0.022	196.4	0.0399
220.20	0.023	196.4	0.0435
220.22	0.023	196.6	0.0453
220.23	0.024	196.8	0.0488
220.25	0.026	197	0.0506
220.27	0.027	197.2	0.0524
220.28	0.027	197.4	0.0541
220.30	0.028	197.6	0.0541
220.32	0.028	197.6	0.055
220.33	0.028	197.7	0.0559
220.35	0.029	197.9	0.0568



Prova triassiale ciclica SN04-C1			
pressione di confinamento (kPa)		80	
deviatore ciclico (kPa)		95	
frequenza (hz)		0.00625	
tempo	cella di carico	$\Delta u$	LVDT
(min)	kN	(kPa)	$\delta$ (mm)
220.37	0.029	198	0.0568
220.38	0.029	198.1	0.0568
220.40	0.029	198.2	0.0568
220.42	0.028	198.3	0.0568
220.43	0.027	198.3	0.0568
220.45	0.027	198.3	0.0559
220.47	0.025	198.3	0.0541
220.48	0.025	198.3	0.0533
220.50	0.025	198.3	0.0524
220.52	0.023	198.3	0.0497
220.53	0.021	198.2	0.0479
220.55	0.02	198.1	0.0453
220.57	0.019	198.1	0.0426
220.58	0.016	197.9	0.0426
220.60	0.014	197.8	0.0399
220.62	0.014	197.8	0.0373
220.63	0.013	197.6	0.0337
220.65	0.01	197.4	0.0293
220.67	0.008	197.2	0.0257
220.68	0.007	197	0.0222
220.70	0.004	196.8	0.0222
220.72	0.002	196.5	0.0178
220.73	0.002	196.5	0.0142
220.75	0.001	196.3	0.0107
220.77	-0.002	196	0.0062
220.78	-0.004	195.8	0.0027
220.80	-0.005	195.6	-0.0009
220.82	-0.007	195.2	-0.0009
220.83	-0.01	194.9	-0.0044
220.85	-0.01	194.9	-0.008
220.87	-0.01	194.7	-0.0107
220.88	-0.012	194.4	-0.0133
220.90	-0.014	194.2	-0.016
220.92	-0.014	194	-0.0178
220.93	-0.015	193.8	-0.0195
220.95	-0.016	193.6	-0.0195
220.97	-0.017	193.6	-0.0213
220.98	-0.017	193.5	-0.0222
221.00	-0.017	193.3	-0.0231
221.02	-0.017	193.1	-0.024
221.03	-0.017	193	-0.024
221.05	-0.017	192.9	-0.024
221.07	-0.017	192.9	-0.024
221.08	-0.016	192.9	-0.024
221.10	-0.016	192.8	-0.0231
221.12	-0.016	192.8	-0.0222
221.13	-0.014	192.8	-0.0204
221.15	-0.014	192.8	-0.0195
221.17	-0.013	192.8	-0.0178
221.18	-0.01	192.9	-0.016
221.20	-0.01	192.9	-0.0151
221.22	-0.009	193	-0.0124
221.23	-0.006	193.2	-0.0124
221.25	-0.005	193.2	-0.0098
221.27	-0.005	193.3	-0.0062
221.28	-0.003	193.5	-0.0027
221.30	0	193.6	0.0009
221.32	0.001	193.8	0.0036

Prova triassiale ciclica SN04-C1			
pressione di confinamento (kPa)		80	
deviatore ciclico (kPa)		95	
frequenza (hz)		0.00625	
tempo	cella di carico	$\Delta u$	LVDT
(min)	kN	(kPa)	$\delta$ (mm)
221.33	0.003	194	0.008
221.35	0.007	194.2	0.008
221.37	0.007	194.2	0.0124
221.38	0.007	194.4	0.0151
221.40	0.009	194.7	0.0195
221.42	0.013	194.9	0.0231
221.43	0.014	195.1	0.0275
221.47	0.015	195.4	0.0311
221.48	0.018	195.7	0.0311
221.50	0.019	195.7	0.0355
221.52	0.019	195.9	0.0382
221.52	0.02	196.2	0.0417
221.53	0.023	196.4	0.0444
221.55	0.024	196.7	0.047
221.57	0.024	196.9	0.0497
221.58	0.026	197.1	0.0497
221.60	0.027	197.3	0.0524
221.62	0.027	197.3	0.0533
221.63	0.027	197.4	0.055
221.65	0.028	197.6	0.0559
221.67	0.029	197.8	0.0568
221.68	0.029	197.9	0.0568
221.70	0.029	198	0.0568
221.72	0.029	198.1	0.0568
221.73	0.029	198.1	0.0568
221.75	0.028	198.2	0.0568
221.77	0.028	198.2	0.0559
221.78	0.027	198.3	0.055
221.80	0.026	198.3	0.0541
221.82	0.025	198.3	0.0524
221.83	0.023	198.2	0.0524
221.85	0.022	198.2	0.0506
221.87	0.022	198.2	0.0488
221.88	0.021	198.1	0.0462
221.90	0.018	198	0.0435
221.92	0.017	197.9	0.0417
221.93	0.017	197.8	0.0391
221.95	0.013	197.7	0.0364
221.97	0.012	197.5	0.0328
221.98	0.011	197.3	0.0284
222.00	0.007	197.1	0.0284
222.02	0.006	197.1	0.024
222.03	0.006	196.9	0.0213
222.05	0.004	196.7	0.0169
222.07	0.001	196.4	0.0124
222.08	-0.001	196.2	0.0098
222.10	-0.002	196	0.0053
222.12	-0.005	195.7	0.0053
222.13	-0.006	195.7	0.0018
222.15	-0.006	195.4	-0.0018
222.17	-0.007	195.1	-0.0053
222.18	-0.01	194.8	-0.0089
222.20	-0.011	194.6	-0.0115
222.22	-0.012	194.4	-0.0142
222.23	-0.014	194.1	-0.0142
222.25	-0.014	194.1	-0.0169
222.27	-0.014	193.9	-0.0186
222.28	-0.016	193.7	-0.0204

Prova triassiale ciclica SN04-C1			
pressione di confinamento (kPa)		80	
deviatore ciclico (kPa)		95	
frequenza (hz)		0.00625	
tempo	cella di carico	$\Delta u$	LVDT
(min)	kN	(kPa)	$\delta$ (mm)
222.30	-0.016	193.5	-0.0222
222.32	-0.017	193.4	-0.0222
222.33	-0.017	193.2	-0.0231
222.35	-0.017	193.1	-0.0231
222.37	-0.017	193	-0.024
222.38	-0.017	193	-0.024
222.40	-0.017	192.9	-0.024
222.42	-0.017	192.8	-0.0231
222.43	-0.016	192.8	-0.0231
222.45	-0.015	192.7	-0.0213
222.47	-0.014	192.8	-0.0213
222.48	-0.013	192.8	-0.0204
222.50	-0.013	192.8	-0.0186
222.52	-0.012	192.8	-0.0169
222.53	-0.01	192.9	-0.0151
222.55	-0.008	193	-0.0124
222.57	-0.007	193.1	-0.0098
222.58	-0.005	193.3	-0.0071
222.60	-0.003	193.4	-0.0071
222.62	-0.003	193.4	-0.0036
222.63	-0.002	193.5	0
222.65	0.002	193.9	0.0036
222.67	0.004	193.9	0.0053
222.68	0.004	194.1	0.0089
222.70	0.005	194.3	0.0124
222.72	0.009	194.6	0.0169
222.73	0.01	194.7	0.0204
222.75	0.012	195	0.024
222.77	0.015	195.3	0.024
222.78	0.016	195.3	0.0302
222.80	0.016	195.5	0.0328
222.82	0.017	195.8	0.0364
222.83	0.02	196.1	0.0399
222.85	0.021	196.3	0.0417
222.87	0.022	196.6	0.0453
222.90	0.025	196.8	0.0453
222.92	0.025	196.8	0.0479
222.93	0.025	196.9	0.0506
222.95	0.026	197.1	0.0524
222.97	0.027	197.4	0.0541
222.97	0.027	197.5	0.055
222.98	0.028	197.7	0.0559
223.00	0.029	197.8	0.0559
223.02	0.029	197.8	0.0568
223.03	0.029	197.9	0.0568
223.05	0.029	198.1	0.0568
223.07	0.029	198.2	0.0568
223.08	0.028	198.3	0.0568
223.10	0.028	198.3	0.0559
223.12	0.026	198.3	0.0559
223.13	0.026	198.3	0.055
223.15	0.026	198.3	0.0533
223.17	0.025	198.3	0.0515
223.18	0.023	198.2	0.0488
223.20	0.021	198.2	0.047
223.22	0.02	198.1	0.0453
223.23	0.018	197.9	0.0453
223.25	0.016	197.9	0.0426

Prova triassiale ciclica SN04-C1			
pressione di confinamento (kPa)		80	
deviatore ciclico (kPa)		95	
frequenza (hz)		0.00625	
tempo	cella di carico	$\Delta u$	LVDT
(min)	kN	(kPa)	$\delta$ (mm)
223.27	0.016	197.8	0.0399
223.28	0.015	197.7	0.0364
223.30	0.011	197.5	0.0328
223.32	0.011	197.4	0.0302
223.33	0.009	197.2	0.0249
223.35	0.005	196.9	0.0249
223.37	0.004	196.7	0.0186
223.38	0.003	196.6	0.0151
223.40	0	196.3	0.0151
223.42	-0.001	196.3	0.0107
223.43	-0.001	196.1	0.008
223.45	-0.002	195.9	0.0036
223.47	-0.006	195.5	-0.0009
223.48	-0.007	195.2	-0.0027
223.50	-0.008	195	-0.0071
223.52	-0.011	194.7	-0.0071
223.53	-0.012	194.5	-0.0107
223.55	-0.012	194.5	-0.0133
223.57	-0.013	194.3	-0.0151
223.58	-0.014	194	-0.0178
223.60	-0.015	193.8	-0.0195
223.62	-0.016	193.6	-0.0213
223.63	-0.016	193.4	-0.0213
223.65	-0.017	193.3	-0.0222
223.67	-0.017	193.3	-0.0231
223.68	-0.017	193.1	-0.024
223.70	-0.017	193	-0.024
223.72	-0.017	192.9	-0.024
223.73	-0.017	192.8	-0.024
223.75	-0.016	192.8	-0.0231
223.77	-0.015	192.8	-0.0231
223.78	-0.015	192.8	-0.0222
223.80	-0.015	192.7	-0.0213
223.82	-0.014	192.8	-0.0195
223.83	-0.012	192.8	-0.0186
223.85	-0.011	192.8	-0.0169
223.87	-0.01	192.9	-0.0142
223.88	-0.007	193	-0.0142
223.90	-0.006	193	-0.0115
223.92	-0.006	193.1	-0.0089
223.93	-0.005	193.3	-0.0062
223.95	-0.002	193.4	-0.0027
223.97	-0.001	193.6	0.0009
223.98	0.001	193.8	0.0044
224.00	0.005	194	0.0044
224.02	0.005	194	0.0089
224.03	0.005	194.2	0.0115
224.05	0.007	194.5	0.016
224.07	0.011	194.7	0.0204
224.08	0.012	194.9	0.024
224.10	0.014	195.2	0.0293
224.12	0.015	195.4	0.0311
224.13	0.017	195.7	0.0346
224.15	0.018	195.9	0.0382
224.17	0.021	196.2	0.0382
224.18	0.022	196.2	0.0417
224.20	0.022	196.4	0.0435
224.22	0.023	196.6	0.0462

Prova triassiale ciclica SN04-C1			
pressione di confinamento (kPa)		80	
deviatore ciclico (kPa)		95	
frequenza (hz)		0.00625	
tempo	cella di carico	$\Delta u$	LVDT
(min)	kN	(kPa)	$\delta$ (mm)
224.23	0.025	196.8	0.0488
224.25	0.026	197	0.0506
224.27	0.026	197.2	0.0524
224.28	0.028	197.4	0.0524
224.30	0.028	197.4	0.0541
224.32	0.028	197.6	0.055
224.33	0.028	197.7	0.0559
224.37	0.029	197.9	0.0559
224.38	0.029	198	0.0568
224.40	0.029	198.1	0.0568
224.42	0.029	198.2	0.0568
224.42	0.028	198.2	0.0568
224.43	0.028	198.3	0.0568
224.45	0.027	198.3	0.055
224.47	0.026	198.3	0.0541
224.48	0.025	198.3	0.0533
224.50	0.024	198.3	0.0506
224.52	0.021	198.2	0.0506
224.53	0.021	198.1	0.0479
224.55	0.021	198.1	0.047
224.57	0.02	198.1	0.0435
224.58	0.017	197.9	0.0408
224.60	0.015	197.8	0.0382
224.62	0.014	197.7	0.0355
224.63	0.011	197.4	0.0355
224.65	0.009	197.3	0.032
224.67	0.009	197.3	0.0284
224.68	0.008	197.1	0.024
224.70	0.005	196.8	0.0195
224.72	0.003	196.6	0.016
224.73	0.002	196.4	0.0115
224.75	-0.001	196.1	0.0115
224.77	-0.003	195.9	0.008
224.78	-0.003	195.9	0.0044
224.80	-0.004	195.6	0.0009
224.82	-0.008	195.1	-0.0036
224.83	-0.008	195.1	-0.0053
224.85	-0.009	194.8	-0.0089
224.87	-0.011	194.5	-0.0115
224.88	-0.013	194.3	-0.0142
224.90	-0.013	194.1	-0.016
224.92	-0.014	193.9	-0.0186
224.93	-0.016	193.7	-0.0186
224.95	-0.016	193.7	-0.0204
224.97	-0.016	193.5	-0.0213
224.98	-0.016	193.4	-0.0222
225.00	-0.017	193.2	-0.0231
225.02	-0.017	193.1	-0.0231
225.03	-0.017	193	-0.024
225.05	-0.017	192.9	-0.024
225.07	-0.017	192.9	-0.024
225.08	-0.017	192.8	-0.024
225.10	-0.016	192.7	-0.0231
225.12	-0.015	192.7	-0.0222
225.13	-0.015	192.7	-0.0204
225.15	-0.014	192.7	-0.0195
225.17	-0.011	192.8	-0.0195
225.18	-0.011	192.8	-0.0178

Prova triassiale ciclica SN04-C1			
pressione di confinamento (kPa)		80	
deviatore ciclico (kPa)		95	
frequenza (hz)		0.00625	
tempo	cella di carico	$\Delta u$	LVDT
(min)	kN	(kPa)	$\delta$ (mm)
225.20	-0.011	192.8	-0.016
225.22	-0.009	192.9	-0.0133
225.23	-0.007	193.1	-0.0107
225.25	-0.006	193.1	-0.008
225.27	-0.004	193.3	-0.0044
225.28	-0.001	193.5	-0.0044
225.30	0	193.5	-0.0009
225.32	0	193.7	0.0018
225.33	0.002	193.9	0.0053
225.35	0.006	194.1	0.0107
225.37	0.006	194.3	0.0133
225.38	0.008	194.6	0.0178
225.40	0.012	194.8	0.0178
225.42	0.013	194.8	0.0222
225.43	0.013	195	0.0257
225.45	0.014	195.3	0.0302
225.47	0.017	195.6	0.0337
225.48	0.018	195.8	0.0364
225.50	0.02	196.1	0.0399
225.52	0.023	196.3	0.0399
225.53	0.023	196.3	0.0435
225.55	0.024	196.7	0.047
225.57	0.025	196.9	0.047
225.58	0.026	196.9	0.0497
225.60	0.026	197.1	0.0515
225.62	0.027	197.3	0.0533
225.63	0.028	197.5	0.055
225.65	0.028	197.6	0.0559
225.67	0.029	197.8	0.0568
225.68	0.029	197.9	0.0568
225.70	0.029	197.9	0.0568
225.72	0.029	198	0.0568
225.73	0.029	198.1	0.0568
225.75	0.028	198.2	0.0568
225.77	0.028	198.3	0.0559
225.80	0.027	198.3	0.055
225.82	0.026	198.3	0.055
225.83	0.024	198.3	0.0533
225.85	0.024	198.3	0.0515
225.87	0.023	198.2	0.0497
225.87	0.022	198.2	0.0479
225.88	0.02	198.1	0.0462
225.90	0.019	198	0.0426
225.92	0.016	197.8	0.0426
225.93	0.014	197.7	0.0391
225.95	0.014	197.7	0.0364
225.97	0.013	197.6	0.0328
225.98	0.011	197.3	0.0302
226.00	0.008	197.1	0.0257
226.02	0.007	197	0.0222
226.03	0.004	196.7	0.0178
226.05	0.002	196.5	0.0178
226.07	0.002	196.5	0.0142
226.08	0.001	196.3	0.0107
226.10	-0.001	196	0.0062
226.12	-0.004	195.7	0.0027
226.13	-0.005	195.5	-0.0009
226.15	-0.007	195.1	-0.0036

Prova triassiale ciclica SN04-C1			
pressione di confinamento (kPa)		80	
deviatore ciclico (kPa)		95	
frequenza (hz)		0.00625	
tempo	cella di carico	$\Delta u$	LVDT
(min)	kN	(kPa)	$\delta$ (mm)
226.17	-0.01	194.9	-0.0036
226.18	-0.01	194.9	-0.008
226.20	-0.01	194.7	-0.0107
226.22	-0.011	194.4	-0.0133
226.23	-0.014	194.2	-0.016
226.25	-0.014	194	-0.0178
226.27	-0.015	193.8	-0.0195
226.28	-0.016	193.6	-0.0204
226.30	-0.016	193.4	-0.0213
226.32	-0.016	193.3	-0.0231
226.33	-0.017	193.1	-0.0231
226.35	-0.017	193.1	-0.024
226.37	-0.017	193	-0.024
226.38	-0.017	192.9	-0.024
226.40	-0.017	192.8	-0.024
226.42	-0.017	192.7	-0.0231
226.43	-0.016	192.7	-0.0222
226.45	-0.015	192.7	-0.0222
226.47	-0.014	192.7	-0.0213
226.48	-0.014	192.7	-0.0204
226.50	-0.013	192.7	-0.0186
226.52	-0.011	192.8	-0.016
226.53	-0.01	192.8	-0.0151
226.55	-0.009	192.9	-0.0115
226.57	-0.006	193.1	-0.0115
226.58	-0.005	193.2	-0.0089
226.60	-0.005	193.2	-0.0062
226.62	-0.004	193.3	-0.0027
226.63	-0.001	193.6	0.0009
226.65	0.001	193.7	0.0036
226.67	0.003	193.9	0.008
226.68	0.006	194.2	0.008
226.70	0.008	194.4	0.0115
226.72	0.008	194.4	0.0151
226.73	0.009	194.6	0.0186
226.75	0.012	194.9	0.0231
226.77	0.014	195.1	0.0275
226.78	0.015	195.3	0.032
226.80	0.017	195.7	0.0355
226.82	0.02	195.9	0.0355
226.83	0.02	195.9	0.0391
226.85	0.021	196.1	0.0417
226.87	0.022	196.4	0.0444
226.88	0.024	196.6	0.047
226.90	0.024	196.8	0.0488
226.92	0.026	197	0.0515
226.93	0.027	197.2	0.0515
226.95	0.027	197.2	0.0533
226.97	0.027	197.4	0.0541
226.98	0.028	197.6	0.0559
227.00	0.029	197.7	0.0568
227.02	0.029	197.8	0.0568
227.03	0.029	198	0.0568
227.05	0.029	198.1	0.0577
227.07	0.029	198.2	0.0577
227.08	0.028	198.2	0.0568
227.10	0.027	198.3	0.0568
227.12	0.026	198.3	0.0559

Prova triassiale ciclica SN04-C1			
pressione di confinamento (kPa)		80	
deviatore ciclico (kPa)		95	
frequenza (hz)		0.00625	
tempo	cella di carico	$\Delta u$	LVDT
(min)	kN	(kPa)	$\delta$ (mm)
227.13	0.026	198.3	0.055
227.15	0.026	198.3	0.0533
227.17	0.024	198.2	0.0515
227.18	0.023	198.2	0.0497
227.20	0.022	198.2	0.047
227.22	0.019	198	0.047
227.23	0.018	198	0.0444
227.27	0.018	198	0.0417
227.28	0.016	197.8	0.0391
227.30	0.013	197.6	0.0355
227.32	0.012	197.5	0.0337
227.32	0.011	197.3	0.0293
227.33	0.007	197.1	0.0293
227.35	0.006	197.1	0.024
227.37	0.006	196.9	0.0213
227.38	0.005	196.7	0.0178
227.40	0.001	196.4	0.0124
227.42	0	196.2	0.0098
227.43	-0.002	196	0.0053
227.45	-0.005	195.6	0.0053
227.47	-0.006	195.4	0.0009
227.48	-0.006	195.4	-0.0018
227.50	-0.007	195.1	-0.0053
227.52	-0.01	194.8	-0.0089
227.53	-0.011	194.6	-0.0115
227.55	-0.012	194.4	-0.0142
227.57	-0.014	194.1	-0.0142
227.58	-0.015	193.9	-0.0169
227.60	-0.015	193.9	-0.0186
227.62	-0.015	193.7	-0.0204
227.63	-0.016	193.5	-0.0213
227.65	-0.017	193.3	-0.0231
227.67	-0.017	193.2	-0.0231
227.68	-0.017	193	-0.024
227.70	-0.017	192.9	-0.024
227.72	-0.017	192.9	-0.024
227.73	-0.017	192.8	-0.024
227.75	-0.016	192.7	-0.024
227.77	-0.015	192.7	-0.0231
227.78	-0.015	192.7	-0.0222
227.80	-0.015	192.7	-0.0213
227.82	-0.013	192.7	-0.0195
227.83	-0.013	192.7	-0.0178
227.85	-0.011	192.8	-0.016
227.87	-0.009	192.9	-0.016
227.88	-0.008	192.9	-0.0133
227.90	-0.008	192.9	-0.0115
227.92	-0.006	193.1	-0.008
227.93	-0.004	193.2	-0.0053
227.95	-0.002	193.4	-0.0018
227.97	-0.001	193.6	0.0018
227.98	0.003	193.8	0.0018
228.00	0.004	193.8	0.0053
228.02	0.004	194	0.0089
228.03	0.005	194.2	0.0133
228.05	0.009	194.5	0.0169
228.07	0.01	194.6	0.0195
228.08	0.012	194.9	0.024



Prova triassiale ciclica SN04-C1			
pressione di confinamento (kPa)		80	
deviatore ciclico (kPa)		95	
frequenza (hz)		0.00625	
tempo	cella di carico	$\Delta u$	LVDT
(min)	kN	(kPa)	$\delta$ (mm)
228.10	0.015	195.2	0.024
228.12	0.016	195.2	0.0293
228.13	0.016	195.4	0.0328
228.15	0.017	195.7	0.0364
228.17	0.021	196	0.0399
228.18	0.021	196.2	0.0426
228.20	0.022	196.4	0.0453
228.22	0.024	196.7	0.0453
228.23	0.025	196.7	0.0479
228.25	0.025	196.9	0.0497
228.27	0.026	197.1	0.0524
228.28	0.027	197.3	0.0541
228.30	0.028	197.4	0.055
228.32	0.028	197.6	0.0559
228.33	0.029	197.7	0.0559
228.35	0.029	197.7	0.0568
228.37	0.029	197.9	0.0568
228.38	0.029	198	0.0568
228.40	0.029	198.1	0.0568
228.42	0.028	198.2	0.0568
228.43	0.028	198.2	0.0559
228.45	0.027	198.2	0.055
228.47	0.026	198.3	0.0541
228.48	0.025	198.3	0.0524
228.50	0.023	198.2	0.0524
228.52	0.022	198.2	0.0506
228.53	0.022	198.2	0.0488
228.55	0.021	198.1	0.0462
228.57	0.019	198	0.0435
228.58	0.016	197.8	0.0408
228.60	0.016	197.8	0.0382
228.62	0.014	197.5	0.0346
228.63	0.011	197.4	0.0346
228.65	0.011	197.4	0.0311
228.67	0.01	197.2	0.0275
228.68	0.007	197	0.0231
228.70	0.004	196.8	0.0195
228.73	0.003	196.6	0.016
228.75	0.001	196.3	0.0115
228.77	-0.002	196.1	0.0115
228.77	-0.002	196.1	0.008
228.78	-0.003	195.8	0.0036
228.80	-0.005	195.5	0
228.82	-0.008	195.2	-0.0036
228.83	-0.008	195	-0.0071
228.85	-0.01	194.7	-0.0098
228.87	-0.012	194.4	-0.0098
228.88	-0.013	194.4	-0.0124
228.90	-0.013	194.2	-0.0151
228.92	-0.014	194	-0.0178
228.93	-0.016	193.8	-0.0195
228.95	-0.016	193.6	-0.0204
228.97	-0.016	193.4	-0.0213
228.98	-0.017	193.3	-0.0213
229.00	-0.017	193.3	-0.0231
229.02	-0.017	193.1	-0.0231
229.03	-0.017	193	-0.024
229.05	-0.017	192.9	-0.024

Prova triassiale ciclica SN04-C1			
pressione di confinamento (kPa)		80	
deviatore ciclico (kPa)		95	
frequenza (hz)		0.00625	
tempo	cella di carico	$\Delta u$	LVDT
(min)	kN	(kPa)	$\delta$ (mm)
229.07	-0.017	192.8	-0.024
229.08	-0.017	192.7	-0.0231
229.10	-0.015	192.7	-0.0231
229.12	-0.015	192.7	-0.0222
229.13	-0.015	192.7	-0.0213
229.15	-0.014	192.7	-0.0195
229.17	-0.012	192.8	-0.0178
229.18	-0.012	192.8	-0.0169
229.20	-0.011	192.8	-0.0151
229.22	-0.009	192.9	-0.0124
229.23	-0.007	193	-0.0107
229.25	-0.006	193.1	-0.0071
229.27	-0.003	193.3	-0.0071
229.28	-0.001	193.4	-0.0036
229.30	-0.001	193.4	-0.0018
229.32	0	193.6	0.0027
229.33	0.003	193.9	0.0071
229.35	0.005	194.1	0.0098
229.37	0.006	194.2	0.0142
229.38	0.009	194.6	0.0142
229.40	0.011	194.8	0.0186
229.42	0.011	194.8	0.0222
229.43	0.013	195	0.0257
229.45	0.015	195.3	0.0311
229.47	0.017	195.6	0.0337
229.48	0.018	195.8	0.0373
229.50	0.02	196.1	0.0373
229.52	0.022	196.3	0.0408
229.53	0.022	196.3	0.0435
229.55	0.023	196.5	0.0462
229.57	0.024	196.8	0.0488
229.58	0.026	197	0.0506
229.60	0.026	197.1	0.0533
229.62	0.027	197.4	0.0533
229.63	0.028	197.5	0.0541
229.65	0.028	197.5	0.0559
229.67	0.029	197.7	0.0559
229.68	0.028	197.8	0.0568
229.70	0.029	197.9	0.0568
229.72	0.029	198	0.0568
229.73	0.028	198.1	0.0568
229.75	0.028	198.2	0.0568
229.77	0.027	198.2	0.0568
229.78	0.027	198.2	0.0559
229.80	0.026	198.2	0.0541
229.82	0.025	198.2	0.0533
229.83	0.024	198.2	0.0515
229.85	0.023	198.2	0.0488
229.87	0.02	198.1	0.0488
229.88	0.02	198.1	0.047
229.90	0.018	197.9	0.0426
229.92	0.016	197.8	0.0426
229.93	0.015	197.8	0.0408
229.95	0.015	197.7	0.0373
229.97	0.013	197.5	0.0328
229.98	0.009	197.3	0.0293
230.00	0.009	197.1	0.0257
230.02	0.007	196.9	0.0213

Prova triassiale ciclica SN04-C1			
pressione di confinamento (kPa)		80	
deviatore ciclico (kPa)		95	
frequenza (hz)		0.00625	
tempo	cella di carico	$\Delta u$	LVDT
(min)	kN	(kPa)	$\delta$ (mm)
230.03	0.003	196.7	0.0213
230.05	0.003	196.7	0.0178
230.07	0.003	196.5	0.0142
230.08	0.001	196.2	0.0098
230.10	-0.003	195.9	0.0053
230.12	-0.004	195.7	0.0027
230.13	-0.005	195.4	-0.0009
230.17	-0.009	195.1	-0.0009
230.18	-0.009	195.1	-0.0053
230.20	-0.009	194.9	-0.0071
230.22	-0.01	194.6	-0.0107
230.23	-0.013	194.3	-0.0142
230.23	-0.013	194.1	-0.0151
230.25	-0.014	193.9	-0.0178
230.27	-0.015	193.7	-0.0178
230.28	-0.016	193.7	-0.0195
230.30	-0.016	193.5	-0.0213
230.32	-0.016	193.4	-0.0222
230.33	-0.017	193.2	-0.0231
230.35	-0.017	193	-0.024
230.37	-0.017	192.9	-0.024
230.38	-0.017	192.8	-0.024
230.40	-0.017	192.8	-0.024
230.42	-0.017	192.8	-0.024
230.43	-0.016	192.7	-0.0231
230.45	-0.015	192.7	-0.0222
230.47	-0.014	192.7	-0.0213
230.48	-0.014	192.7	-0.0195
230.50	-0.012	192.8	-0.0195
230.52	-0.011	192.8	-0.0178
230.53	-0.011	192.8	-0.016
230.55	-0.009	192.9	-0.0124
230.57	-0.007	193	-0.0107
230.58	-0.006	193.1	-0.008
230.60	-0.005	193.3	-0.0044
230.62	-0.001	193.5	-0.0044
230.63	0.001	193.6	0.0027
230.65	0.001	193.7	0.0053
230.67	0.004	194	0.0053
230.68	0.005	194.1	0.008
230.70	0.005	194.1	0.0115
230.72	0.007	194.4	0.016
230.73	0.01	194.7	0.0204
230.75	0.012	194.9	0.024
230.77	0.014	195.1	0.0284
230.78	0.016	195.4	0.0284
230.80	0.018	195.7	0.032
230.82	0.018	195.7	0.0355
230.83	0.019	195.9	0.0391
230.85	0.021	196.2	0.0426
230.87	0.023	196.4	0.0444
230.88	0.023	196.6	0.047
230.90	0.025	196.9	0.047
230.92	0.027	197.1	0.0506
230.93	0.027	197.1	0.0524
230.95	0.027	197.2	0.0533
230.97	0.027	197.4	0.055
230.98	0.028	197.6	0.0559

Prova triassiale ciclica SN04-C1			
pressione di confinamento (kPa)		80	
deviatore ciclico (kPa)		95	
frequenza (hz)		0.00625	
tempo	cella di carico	$\Delta u$	LVDT
(min)	kN	(kPa)	$\delta$ (mm)
231.00	0.029	197.7	0.0568
231.02	0.029	197.8	0.0568
231.03	0.029	198	0.0568
231.05	0.029	198	0.0568
231.07	0.029	198.1	0.0577
231.08	0.028	198.2	0.0568
231.10	0.027	198.2	0.0559
231.12	0.027	198.2	0.055
231.13	0.026	198.2	0.0533
231.15	0.024	198.2	0.0533
231.17	0.024	198.2	0.0515
231.18	0.024	198.2	0.0506
231.20	0.022	198.1	0.0479
231.22	0.019	198	0.0453
231.23	0.019	198	0.0426
231.25	0.017	197.8	0.0391
231.27	0.014	197.6	0.0391
231.28	0.014	197.6	0.0373
231.30	0.013	197.5	0.0337
231.32	0.011	197.3	0.0302
231.33	0.008	197.1	0.0257
231.35	0.007	196.9	0.0222
231.37	0.005	196.8	0.0204
231.38	0.003	196.6	0.0169
231.40	0.002	196.4	0.0133
231.42	0	196	0.0089
231.43	-0.004	195.8	0.0089
231.45	-0.005	195.8	0.0044
231.47	-0.005	195.6	0.0009
231.48	-0.006	195.2	-0.0027
231.50	-0.009	195	-0.0062
231.52	-0.009	194.7	-0.0089
231.53	-0.011	194.4	-0.0124
231.55	-0.013	194.2	-0.0124
231.57	-0.014	194.2	-0.0151
231.58	-0.014	194	-0.0169
231.60	-0.015	193.8	-0.0186
231.63	-0.016	193.6	-0.0204
231.65	-0.016	193.4	-0.0213
231.67	-0.017	193.3	-0.0222
231.68	-0.017	193.1	-0.0222
231.68	-0.017	193.1	-0.0231
231.70	-0.017	193	-0.024
231.72	-0.017	192.9	-0.024
231.73	-0.017	192.8	-0.024
231.75	-0.017	192.7	-0.024
231.77	-0.016	192.7	-0.0231
231.78	-0.015	192.7	-0.0231
231.80	-0.014	192.7	-0.0213
231.82	-0.014	192.7	-0.0204
231.83	-0.013	192.7	-0.0178
231.85	-0.01	192.8	-0.016
231.87	-0.01	192.8	-0.0151
231.88	-0.009	192.9	-0.0124
231.90	-0.006	193.1	-0.0124
231.92	-0.005	193.1	-0.0089
231.93	-0.005	193.2	-0.0071
231.95	-0.003	193.4	-0.0027

Prova triassiale ciclica SN04-C1			
pressione di confinamento (kPa)		80	
deviatore ciclico (kPa)		95	
frequenza (hz)		0.00625	
tempo	cella di carico	$\Delta u$	LVDT
(min)	kN	(kPa)	$\delta$ (mm)
231.97	0	193.5	0.0009
231.98	0.001	193.7	0.0036
232.00	0.002	193.9	0.008
232.02	0.006	194.1	0.008
232.03	0.007	194.1	0.0115
232.05	0.007	194.3	0.0151
232.07	0.009	194.6	0.0195
232.08	0.013	194.8	0.024
232.10	0.013	195	0.0257
232.12	0.014	195.2	0.0302
232.13	0.017	195.6	0.0337
232.15	0.019	195.8	0.0364
232.17	0.02	196	0.0399
232.18	0.022	196.3	0.0399
232.20	0.023	196.5	0.0435
232.22	0.023	196.5	0.0453
232.23	0.024	196.7	0.0488
232.25	0.026	197	0.0515
232.27	0.027	197.1	0.0524
232.28	0.027	197.3	0.0533
232.30	0.028	197.5	0.0533
232.32	0.028	197.7	0.055
232.33	0.028	197.7	0.0559
232.35	0.029	197.8	0.0568
232.37	0.029	197.9	0.0568
232.38	0.029	198	0.0568
232.40	0.029	198.1	0.0568
232.42	0.028	198.2	0.0568
232.43	0.027	198.2	0.0568
232.45	0.026	198.2	0.0559
232.47	0.026	198.2	0.055
232.48	0.026	198.2	0.0533
232.50	0.024	198.2	0.0515
232.52	0.023	198.2	0.0497
232.53	0.022	198.1	0.047
232.55	0.019	198	0.047
232.57	0.018	198	0.0444
232.58	0.018	197.9	0.0417
232.60	0.016	197.7	0.0391
232.62	0.013	197.6	0.0355
232.63	0.012	197.5	0.0328
232.65	0.011	197.2	0.0293
232.67	0.007	197	0.0293
232.68	0.006	197	0.024
232.70	0.006	196.8	0.0213
232.72	0.005	196.6	0.0169
232.73	0.001	196.3	0.0124
232.75	0	196.1	0.0089
232.77	-0.002	195.8	0.0044
232.78	-0.006	195.6	0.0044
232.80	-0.006	195.6	0.0009
232.82	-0.007	195.1	-0.0036
232.83	-0.009	194.8	-0.0036
232.85	-0.01	194.8	-0.0071
232.87	-0.01	194.6	-0.0098
232.88	-0.011	194.4	-0.0133
232.90	-0.014	194.1	-0.016
232.92	-0.015	193.9	-0.0178

Prova triassiale ciclica SN04-C1			
pressione di confinamento (kPa)		80	
deviatore ciclico (kPa)		95	
frequenza (hz)		0.00625	
tempo	cella di carico	$\Delta u$	LVDT
(min)	kN	(kPa)	$\delta$ (mm)
232.93	-0.015	193.7	-0.0195
232.95	-0.016	193.5	-0.0195
232.97	-0.017	193.5	-0.0213
232.98	-0.017	193.3	-0.0222
233.00	-0.017	193.2	-0.0231
233.02	-0.017	193	-0.024
233.03	-0.017	192.9	-0.024
233.07	-0.017	192.8	-0.024
233.08	-0.017	192.7	-0.024
233.10	-0.016	192.7	-0.024
233.12	-0.016	192.7	-0.0231
233.13	-0.016	192.6	-0.0222
233.13	-0.014	192.7	-0.0204
233.15	-0.013	192.7	-0.0195
233.17	-0.013	192.7	-0.0178
233.18	-0.011	192.8	-0.0178
233.20	-0.009	192.8	-0.016
233.22	-0.009	192.8	-0.0133
233.23	-0.008	192.9	-0.0107
233.25	-0.006	193.1	-0.008
233.27	-0.004	193.2	-0.0053
233.28	-0.002	193.3	-0.0018
233.30	0	193.6	0.0018
233.32	0.003	193.8	0.0018
233.33	0.003	193.8	0.0053
233.35	0.004	193.9	0.0089
233.37	0.006	194.2	0.0124
233.38	0.008	194.4	0.016
233.40	0.01	194.6	0.0213
233.42	0.013	194.9	0.0257
233.43	0.015	195.2	0.0257
233.45	0.015	195.2	0.0293
233.47	0.016	195.4	0.0328
233.48	0.018	195.7	0.0355
233.50	0.02	196	0.0399
233.52	0.021	196.2	0.0426
233.53	0.023	196.4	0.0462
233.55	0.024	196.6	0.047
233.57	0.025	196.8	0.0488
233.58	0.025	197	0.0506
233.60	0.027	197.2	0.0506
233.62	0.027	197.2	0.0533
233.63	0.027	197.4	0.0541
233.65	0.028	197.5	0.0559
233.67	0.029	197.7	0.0568
233.68	0.029	197.8	0.0568
233.70	0.029	198	0.0568
233.72	0.028	198.1	0.0568
233.73	0.028	198.1	0.0568
233.75	0.028	198.1	0.0568
233.77	0.028	198.2	0.0559
233.78	0.027	198.2	0.0559
233.80	0.026	198.2	0.0541
233.82	0.025	198.2	0.0524
233.83	0.023	198.2	0.0524
233.85	0.022	198.2	0.0497
233.87	0.022	198.2	0.0488
233.88	0.021	198	0.0453

Prova triassiale ciclica SN04-C1			
pressione di confinamento (kPa)		80	
deviatore ciclico (kPa)		95	
frequenza (hz)		0.00625	
tempo	cella di carico	$\Delta u$	LVDT
(min)	kN	(kPa)	$\delta$ (mm)
233.90	0.018	197.9	0.0426
233.92	0.017	197.9	0.0408
233.93	0.016	197.7	0.0373
233.95	0.012	197.5	0.0373
233.97	0.011	197.5	0.0337
233.98	0.011	197.4	0.0311
234.00	0.01	197.1	0.0275
234.02	0.006	196.9	0.0222
234.03	0.005	196.8	0.0186
234.05	0.004	196.5	0.0151
234.07	0	196.2	0.0151
234.08	-0.001	196.2	0.0107
234.10	-0.001	196	0.0071
234.12	-0.003	195.7	0.0036
234.13	-0.006	195.4	-0.0009
234.15	-0.007	195.2	-0.0036
234.17	-0.008	194.9	-0.0071
234.18	-0.011	194.6	-0.0071
234.20	-0.012	194.6	-0.0107
234.22	-0.012	194.4	-0.0124
234.23	-0.012	194.2	-0.0151
234.25	-0.015	193.9	-0.0178
234.27	-0.015	193.7	-0.0195
234.28	-0.015	193.6	-0.0204
234.30	-0.016	193.4	-0.0222
234.32	-0.017	193.2	-0.0222
234.33	-0.017	193.1	-0.024
234.35	-0.017	192.9	-0.024
234.37	-0.017	192.9	-0.024
234.38	-0.017	192.8	-0.024
234.40	-0.017	192.7	-0.024
234.42	-0.017	192.7	-0.024
234.43	-0.016	192.7	-0.0231
234.45	-0.015	192.6	-0.0222
234.47	-0.014	192.6	-0.0222
234.48	-0.013	192.7	-0.0204
234.50	-0.013	192.7	-0.0195
234.53	-0.012	192.7	-0.0169
234.55	-0.01	192.8	-0.0151
234.57	-0.008	192.9	-0.0124
234.58	-0.007	192.9	-0.0098
234.58	-0.005	193.1	-0.0098
234.60	-0.003	193.3	-0.0071
234.62	-0.003	193.3	-0.0044
234.63	-0.002	193.4	-0.0009
234.65	0.001	193.7	0.0036
234.67	0.004	193.8	0.0071
234.68	0.004	194	0.0098
234.70	0.007	194.3	0.0098
234.72	0.01	194.5	0.0142
234.73	0.01	194.5	0.0186
234.75	0.011	194.7	0.0222
234.77	0.013	195	0.0275
234.78	0.016	195.2	0.0311
234.80	0.017	195.5	0.0346
234.82	0.019	195.8	0.0382
234.83	0.021	196.1	0.0382
234.85	0.022	196.1	0.0417

Prova triassiale ciclica SN04-C1			
pressione di confinamento (kPa)		80	
deviatore ciclico (kPa)		95	
frequenza (hz)		0.00625	
tempo	cella di carico	$\Delta u$	LVDT
(min)	kN	(kPa)	$\delta$ (mm)
234.87	0.022	196.3	0.0444
234.88	0.023	196.5	0.0462
234.90	0.025	196.7	0.0488
234.92	0.025	196.9	0.0497
234.93	0.026	197.2	0.0533
234.95	0.028	197.3	0.0533
234.97	0.028	197.3	0.055
234.98	0.028	197.6	0.0559
235.00	0.029	197.7	0.0559
235.02	0.029	197.7	0.0568
235.03	0.029	197.9	0.0568
235.05	0.029	198	0.0568
235.07	0.028	198.1	0.0568
235.08	0.028	198.2	0.0568
235.10	0.028	198.2	0.0559
235.12	0.026	198.2	0.0559
235.13	0.026	198.2	0.0541
235.15	0.026	198.2	0.0533
235.17	0.025	198.2	0.0515
235.18	0.022	198.1	0.0497
235.20	0.021	198.1	0.0479
235.22	0.02	198	0.0453
235.23	0.017	197.9	0.0453
235.25	0.016	197.9	0.0426
235.27	0.016	197.8	0.0391
235.28	0.015	197.6	0.0364
235.30	0.011	197.4	0.0328
235.32	0.011	197.3	0.0293
235.33	0.009	197	0.0249
235.35	0.005	196.8	0.0249
235.37	0.004	196.8	0.0204
235.38	0.004	196.6	0.0169
235.40	0.003	196.4	0.0133
235.42	-0.001	196.1	0.0089
235.43	-0.002	195.9	0.0062
235.45	-0.004	195.6	0.0018
235.47	-0.007	195.3	0.0018
235.48	-0.007	195.3	-0.0018
235.50	-0.007	195	-0.0044
235.52	-0.009	194.8	-0.0089
235.53	-0.012	194.5	-0.0124
235.55	-0.012	194.3	-0.0142
235.57	-0.013	194.1	-0.016
235.58	-0.015	193.8	-0.016
235.60	-0.016	193.8	-0.0186
235.62	-0.016	193.6	-0.0195
235.63	-0.016	193.5	-0.0213
235.65	-0.017	193.3	-0.0222
235.67	-0.017	193.1	-0.0231
235.68	-0.017	193	-0.024
235.70	-0.017	192.9	-0.024
235.72	-0.017	192.8	-0.024
235.73	-0.017	192.7	-0.024
235.75	-0.016	192.6	-0.024
235.77	-0.016	192.6	-0.0231
235.78	-0.016	192.6	-0.0222
235.80	-0.015	192.6	-0.0204
235.82	-0.014	192.6	-0.0195



Prova triassiale ciclica SN04-C1			
pressione di confinamento (kPa)		80	
deviatore ciclico (kPa)		95	
frequenza (hz)		0.00625	
tempo	cella di carico	$\Delta u$	LVDT
(min)	kN	(kPa)	$\delta$ (mm)
235.83	-0.012	192.7	-0.0186
235.85	-0.011	192.7	-0.016
235.87	-0.009	192.8	-0.016
235.88	-0.008	192.9	-0.0142
235.90	-0.008	192.9	-0.0115
235.92	-0.007	193	-0.0089
235.93	-0.004	193.2	-0.0053
235.97	-0.002	193.3	-0.0018
235.98	-0.001	193.5	0.0009
236.00	0.001	193.7	0.0044
236.02	0.004	193.9	0.0044
236.03	0.005	193.9	0.0089
236.03	0.005	194.1	0.0115
236.05	0.007	194.4	0.016
236.07	0.011	194.6	0.0204
236.08	0.012	194.8	0.024
236.10	0.013	195.1	0.0284
236.12	0.017	195.4	0.0284
236.13	0.018	195.4	0.032
236.15	0.018	195.6	0.0355
236.17	0.019	195.9	0.0391
236.18	0.022	196.1	0.0417
236.20	0.022	196.3	0.0444
236.22	0.023	196.6	0.047
236.23	0.026	196.8	0.047
236.25	0.026	196.8	0.0497
236.27	0.026	197	0.0515
236.28	0.027	197.2	0.0533
236.30	0.028	197.4	0.0541
236.32	0.028	197.5	0.0559
236.33	0.028	197.7	0.0559
236.35	0.029	197.8	0.0559
236.37	0.029	197.8	0.0568
236.38	0.029	197.9	0.0568
236.40	0.028	198	0.0568
236.42	0.028	198.1	0.0568
236.43	0.028	198.2	0.0559
236.45	0.027	198.2	0.0541
236.47	0.026	198.2	0.0541
236.48	0.025	198.2	0.0524
236.50	0.024	198.2	0.0506
236.52	0.022	198.1	0.0506
236.53	0.021	198.1	0.0488
236.55	0.021	198.1	0.047
236.57	0.019	198	0.0435
236.58	0.017	197.8	0.0408
236.60	0.015	197.7	0.0382
236.62	0.014	197.6	0.0355
236.63	0.011	197.3	0.0355
236.65	0.009	197.2	0.0311
236.67	0.009	197.2	0.0275
236.68	0.008	197	0.0231
236.70	0.005	196.7	0.0195
236.72	0.003	196.5	0.016
236.73	0.002	196.3	0.0115
236.75	-0.001	196	0.0115
236.77	-0.003	195.8	0.0071
236.78	-0.003	195.8	0.0044

Prova triassiale ciclica SN04-C1			
pressione di confinamento (kPa)		80	
deviatore ciclico (kPa)		95	
frequenza (hz)		0.00625	
tempo	cella di carico	$\Delta u$	LVDT
(min)	kN	(kPa)	$\delta$ (mm)
236.80	-0.004	195.5	0
236.82	-0.007	195.2	-0.0036
236.83	-0.009	194.9	-0.0071
236.85	-0.01	194.7	-0.0098
236.87	-0.011	194.4	-0.0098
236.88	-0.013	194.2	-0.0124
236.90	-0.013	194.2	-0.0151
236.92	-0.014	194	-0.0169
236.93	-0.015	193.7	-0.0195
236.95	-0.016	193.5	-0.0213
236.97	-0.016	193.4	-0.0222
236.98	-0.017	193.2	-0.0231
237.00	-0.017	193.1	-0.0231
237.02	-0.017	193.1	-0.024
237.03	-0.017	192.9	-0.024
237.05	-0.017	192.8	-0.024
237.07	-0.017	192.7	-0.024
237.08	-0.017	192.7	-0.024
237.10	-0.016	192.7	-0.0222
237.12	-0.015	192.6	-0.0222
237.13	-0.014	192.6	-0.0213
237.15	-0.014	192.6	-0.0204
237.17	-0.012	192.7	-0.0186
237.18	-0.011	192.7	-0.0178
237.20	-0.011	192.7	-0.016
237.22	-0.01	192.8	-0.0133
237.23	-0.007	193	-0.0107
237.25	-0.006	193	-0.008
237.27	-0.004	193.3	-0.0044
237.28	-0.001	193.4	-0.0044
237.30	0	193.4	-0.0009
237.32	0	193.6	0.0018
237.33	0.002	193.8	0.0062
237.35	0.005	194	0.0098
237.37	0.007	194.2	0.0133
237.38	0.008	194.4	0.0169
237.40	0.012	194.7	0.0169
237.43	0.012	194.7	0.0213
237.45	0.012	194.9	0.0249
237.47	0.014	195.2	0.0293
237.48	0.017	195.5	0.0337
237.48	0.019	195.7	0.0364
237.50	0.02	196	0.0399
237.52	0.022	196.2	0.0399
237.53	0.023	196.2	0.0435
237.55	0.023	196.4	0.0453
237.57	0.024	196.7	0.0479
237.58	0.026	196.9	0.0506
237.60	0.026	197.1	0.0515
237.62	0.027	197.2	0.0541
237.63	0.028	197.4	0.0541
237.65	0.028	197.4	0.055
237.67	0.028	197.6	0.0559
237.68	0.029	197.7	0.0568
237.70	0.029	197.8	0.0568
237.72	0.029	197.9	0.0568
237.73	0.028	198	0.0568
237.75	0.028	198.1	0.0568

Prova triassiale ciclica SN04-C1			
pressione di confinamento (kPa)		80	
deviatore ciclico (kPa)		95	
frequenza (hz)		0.00625	
tempo	cella di carico	$\Delta u$	LVDT
(min)	kN	(kPa)	$\delta$ (mm)
237.77	0.027	198.2	0.0568
237.78	0.027	198.2	0.055
237.80	0.027	198.2	0.0541
237.82	0.025	198.2	0.0524
237.83	0.024	198.1	0.0515
237.85	0.023	198.1	0.0488
237.87	0.021	198	0.0488
237.88	0.019	197.9	0.0462
237.90	0.018	197.9	0.0426
237.92	0.017	197.8	0.0426
237.93	0.014	197.6	0.0399
237.95	0.014	197.6	0.0373
237.97	0.013	197.5	0.0337
237.98	0.01	197.2	0.0293
238.00	0.008	197	0.0257
238.02	0.007	196.9	0.0222
238.03	0.004	196.6	0.0222
238.05	0.002	196.4	0.0178
238.07	0.002	196.4	0.0142
238.08	0.001	196.2	0.0107
238.10	-0.002	195.9	0.0062
238.12	-0.004	195.6	0.0027
238.13	-0.005	195.4	-0.0018
238.15	-0.007	195	-0.0053
238.17	-0.01	194.8	-0.0053
238.18	-0.01	194.8	-0.0089
238.20	-0.01	194.6	-0.0107
238.22	-0.012	194.3	-0.0142
238.23	-0.014	194.1	-0.016
238.25	-0.014	193.9	-0.0178
238.27	-0.015	193.6	-0.0195
238.28	-0.016	193.5	-0.0195
238.30	-0.017	193.5	-0.0213
238.32	-0.017	193.3	-0.0231
238.33	-0.017	193.1	-0.024
238.35	-0.017	193	-0.024
238.37	-0.017	192.9	-0.024
238.38	-0.017	192.8	-0.024
238.40	-0.017	192.7	-0.024
238.42	-0.016	192.7	-0.024
238.43	-0.016	192.6	-0.0231
238.45	-0.016	192.6	-0.0222
238.47	-0.014	192.6	-0.0213
238.48	-0.014	192.6	-0.0195
238.50	-0.013	192.7	-0.0178
238.52	-0.01	192.7	-0.0178
238.53	-0.009	192.7	-0.016
238.55	-0.009	192.8	-0.0142
238.57	-0.008	192.9	-0.0115
238.58	-0.005	193.1	-0.008
238.60	-0.004	193.2	-0.0053
238.62	-0.002	193.4	-0.0018
238.63	0	193.5	0
238.65	0.001	193.6	0.0036
238.67	0.003	193.9	0.0071
238.68	0.006	194.1	0.0071
238.70	0.007	194.1	0.0115
238.72	0.007	194.3	0.0151

Prova triassiale ciclica SN04-C1			
pressione di confinamento (kPa)		80	
deviatore ciclico (kPa)		95	
frequenza (hz)		0.00625	
tempo	cella di carico	$\Delta u$	LVDT
(min)	kN	(kPa)	$\delta$ (mm)
238.73	0.009	194.6	0.0195
238.75	0.013	194.8	0.0231
238.77	0.013	195	0.0275
238.78	0.015	195.3	0.0311
238.80	0.019	195.6	0.0311
238.82	0.019	195.6	0.0355
238.83	0.019	195.8	0.0382
238.85	0.02	196.1	0.0408
238.87	0.023	196.3	0.0444
238.90	0.024	196.5	0.047
238.92	0.025	196.8	0.0497
238.93	0.026	197	0.0497
238.93	0.027	197	0.0515
238.95	0.027	197.1	0.0533
238.97	0.028	197.3	0.0541
238.98	0.028	197.5	0.0559
239.00	0.029	197.7	0.0559
239.02	0.029	197.8	0.0559
239.03	0.029	197.9	0.0559
239.05	0.029	197.9	0.0568
239.07	0.029	198	0.0568
239.08	0.028	198.1	0.0568
239.10	0.028	198.1	0.0559
239.12	0.027	198.2	0.055
239.13	0.026	198.2	0.0533
239.15	0.024	198.1	0.0533
239.17	0.023	198.1	0.0515
239.18	0.023	198.1	0.0506
239.20	0.022	198.1	0.0479
239.22	0.02	197.9	0.0453
239.23	0.018	197.9	0.0426
239.25	0.017	197.8	0.0399
239.27	0.015	197.6	0.0399
239.28	0.013	197.5	0.0373
239.30	0.013	197.5	0.0337
239.32	0.011	197.3	0.0302
239.33	0.008	197.1	0.0257
239.35	0.007	196.9	0.0222
239.37	0.006	196.8	0.0195
239.38	0.004	196.5	0.016
239.40	0.001	196.3	0.0124
239.42	0	196.1	0.0089
239.43	-0.003	195.7	0.0089
239.45	-0.005	195.5	0.0036
239.47	-0.005	195.5	0.0009
239.48	-0.006	195.2	-0.0027
239.50	-0.008	194.9	-0.0062
239.52	-0.01	194.7	-0.0098
239.53	-0.011	194.4	-0.0124
239.55	-0.013	194.1	-0.0151
239.57	-0.014	194	-0.0151
239.58	-0.014	194	-0.0169
239.60	-0.015	193.8	-0.0186
239.62	-0.016	193.5	-0.0204
239.63	-0.017	193.3	-0.0222
239.65	-0.017	193.2	-0.0231
239.67	-0.017	193.1	-0.024
239.68	-0.017	192.9	-0.024

Prova triassiale ciclica SN04-C1			
pressione di confinamento (kPa)		80	
deviatore ciclico (kPa)		95	
frequenza (hz)		0.00625	
tempo	cella di carico	$\Delta u$	LVDT
(min)	kN	(kPa)	$\delta$ (mm)
239.70	-0.017	192.9	-0.0249
239.72	-0.017	192.8	-0.024
239.73	-0.017	192.7	-0.024
239.75	-0.016	192.7	-0.024
239.77	-0.016	192.6	-0.0231
239.78	-0.015	192.6	-0.0213
239.80	-0.014	192.6	-0.0213
239.82	-0.013	192.6	-0.0204
239.83	-0.013	192.6	-0.0195
239.85	-0.012	192.7	-0.0169
239.87	-0.009	192.8	-0.0151
239.88	-0.009	192.8	-0.0124
239.90	-0.007	193	-0.0098
239.92	-0.004	193.1	-0.0098
239.93	-0.004	193.1	-0.0062
239.95	-0.004	193.2	-0.0044
239.97	-0.002	193.4	0
239.98	0.002	193.7	0.0036
240.00	0.003	193.8	0.0071
240.02	0.004	194	0.0107
240.03	0.008	194.3	0.0107
240.05	0.009	194.3	0.0151
240.07	0.009	194.5	0.0186
240.08	0.013	194.9	0.0222
240.10	0.014	195.1	0.0249
240.12	0.014	195.1	0.0284
240.13	0.016	195.4	0.0328
240.15	0.019	195.7	0.0364
240.17	0.02	195.9	0.0391
240.18	0.021	196.1	0.0426
240.20	0.023	196.4	0.0426
240.22	0.024	196.6	0.0453
240.23	0.024	196.6	0.0479
240.25	0.025	196.8	0.0506
240.27	0.027	197.1	0.0524
240.28	0.027	197.2	0.0533
240.30	0.028	197.4	0.055
240.33	0.028	197.6	0.055
240.35	0.029	197.7	0.0559
240.37	0.029	197.7	0.0568
240.38	0.029	197.8	0.0568
240.40	0.029	197.9	0.0568
240.40	0.028	198	0.0568
240.42	0.028	198.1	0.0568
240.43	0.028	198.1	0.0559
240.45	0.026	198.2	0.0559
240.47	0.026	198.2	0.0541
240.48	0.026	198.2	0.0533
240.50	0.025	198.1	0.0515
240.52	0.022	198.1	0.0488
240.53	0.021	198.1	0.047
240.55	0.02	197.9	0.0444
240.57	0.017	197.8	0.0444
240.58	0.016	197.8	0.0417
240.60	0.016	197.7	0.0399
240.62	0.015	197.5	0.0364
240.63	0.011	197.3	0.032
240.65	0.01	197.2	0.0293

Prova triassiale ciclica SN04-C1			
pressione di confinamento (kPa)		80	
deviatore ciclico (kPa)		95	
frequenza (hz)		0.00625	
tempo	cella di carico	$\Delta u$	LVDT
(min)	kN	(kPa)	$\delta$ (mm)
240.67	0.009	197	0.0249
240.68	0.005	196.8	0.0249
240.70	0.004	196.8	0.0204
240.72	0.004	196.6	0.0178
240.73	0.003	196.3	0.0133
240.75	-0.001	196.1	0.0089
240.77	-0.002	195.8	0.0062
240.78	-0.003	195.6	0.0018
240.80	-0.007	195.2	-0.0027
240.82	-0.007	195	-0.0044
240.83	-0.008	194.8	-0.0071
240.85	-0.011	194.5	-0.0071
240.87	-0.011	194.5	-0.0107
240.88	-0.011	194.3	-0.0124
240.90	-0.013	194.1	-0.016
240.92	-0.015	193.8	-0.0178
240.93	-0.015	193.6	-0.0195
240.95	-0.016	193.5	-0.0213
240.97	-0.017	193.3	-0.0213
240.98	-0.017	193.3	-0.0222
241.00	-0.017	193.1	-0.0231
241.02	-0.017	193	-0.024
241.03	-0.017	192.9	-0.024
241.05	-0.017	192.8	-0.024
241.07	-0.017	192.7	-0.024
241.08	-0.016	192.6	-0.024
241.10	-0.016	192.6	-0.0231
241.12	-0.016	192.6	-0.0222
241.13	-0.015	192.6	-0.0213
241.15	-0.013	192.6	-0.0195
241.17	-0.012	192.6	-0.0186
241.18	-0.011	192.7	-0.016
241.20	-0.01	192.8	-0.016
241.22	-0.008	192.9	-0.0142
241.23	-0.008	192.9	-0.0115
241.25	-0.006	193	-0.008
241.27	-0.004	193.2	-0.0053
241.28	-0.002	193.3	-0.0027
241.30	-0.001	193.4	0.0018
241.32	0.001	193.7	0.0018
241.33	0.004	193.9	0.0044
241.35	0.004	193.9	0.0089
241.37	0.006	194.1	0.0124
241.38	0.008	194.4	0.0169
241.40	0.011	194.6	0.0204
241.42	0.012	194.8	0.024
241.43	0.014	195.1	0.0293
241.45	0.017	195.3	0.0293
241.47	0.017	195.3	0.0328
241.48	0.017	195.6	0.0355
241.50	0.019	195.9	0.0391
241.52	0.022	196.1	0.0426
241.53	0.022	196.3	0.0444
241.55	0.023	196.5	0.0462
241.57	0.025	196.7	0.0488
241.58	0.026	196.9	0.0506
241.60	0.026	197.1	0.0533
241.62	0.028	197.3	0.0533

Prova triassiale ciclica SN04-C1			
pressione di confinamento (kPa)		80	
deviatore ciclico (kPa)		95	
frequenza (hz)		0.00625	
tempo	cella di carico	$\Delta u$	LVDT
(min)	kN	(kPa)	$\delta$ (mm)
241.63	0.028	197.3	0.0541
241.65	0.028	197.5	0.055
241.67	0.028	197.6	0.0559
241.68	0.029	197.8	0.0568
241.70	0.029	197.9	0.0568
241.72	0.029	198	0.0568
241.73	0.029	198.1	0.0568
241.75	0.028	198.1	0.0568
241.77	0.028	198.1	0.0568
241.80	0.027	198.2	0.055
241.82	0.026	198.2	0.0541
241.83	0.025	198.2	0.0524
241.85	0.024	198.1	0.0506
241.85	0.022	198.1	0.0506
241.87	0.021	198.1	0.0488
241.88	0.021	198	0.0462
241.90	0.02	197.9	0.0435
241.92	0.017	197.8	0.0408
241.93	0.016	197.7	0.0391
241.95	0.014	197.5	0.0346
241.97	0.011	197.3	0.0346
241.98	0.009	197.3	0.0311
242.00	0.009	197.1	0.0284
242.02	0.008	197	0.0231
242.03	0.005	196.7	0.0195
242.05	0.003	196.5	0.016
242.07	0.002	196.3	0.0124
242.08	-0.002	196	0.0124
242.10	-0.003	195.7	0.008
242.12	-0.003	195.7	0.0044
242.13	-0.004	195.5	0.0009
242.15	-0.007	195.1	-0.0027
242.17	-0.008	194.9	-0.0062
242.18	-0.01	194.7	-0.0098
242.20	-0.012	194.4	-0.0098
242.22	-0.013	194.2	-0.0133
242.23	-0.013	194.2	-0.0151
242.25	-0.015	193.7	-0.0169
242.27	-0.015	193.6	-0.0186
242.28	-0.015	193.6	-0.0195
242.30	-0.016	193.4	-0.0213
242.32	-0.017	193.2	-0.0231
242.33	-0.017	193.1	-0.0231
242.35	-0.017	192.9	-0.024
242.37	-0.017	192.8	-0.024
242.38	-0.017	192.7	-0.024
242.40	-0.017	192.7	-0.024
242.42	-0.017	192.7	-0.024
242.43	-0.016	192.6	-0.0231
242.45	-0.015	192.6	-0.0222
242.47	-0.014	192.6	-0.0204
242.48	-0.013	192.6	-0.0186
242.50	-0.012	192.6	-0.0186
242.52	-0.011	192.6	-0.0178
242.53	-0.011	192.7	-0.016
242.55	-0.01	192.8	-0.0133
242.57	-0.006	192.9	-0.0098
242.58	-0.006	193	-0.0071

Prova triassiale ciclica SN04-C1			
pressione di confinamento (kPa)		80	
deviatore ciclico (kPa)		95	
frequenza (hz)		0.00625	
tempo	cella di carico	$\Delta u$	LVDT
(min)	kN	(kPa)	$\delta$ (mm)
242.60	-0.004	193.2	-0.0044
242.62	-0.001	193.4	-0.0044
242.63	0	193.4	-0.0009
242.65	0	193.5	0.0018
242.67	0.002	193.7	0.0053
242.68	0.005	194	0.0098
242.70	0.006	194.2	0.0133
242.72	0.008	194.4	0.0178
242.73	0.012	194.7	0.0178
242.75	0.013	194.7	0.0222
242.77	0.013	194.9	0.0257
242.78	0.014	195.1	0.0302
242.80	0.017	195.4	0.0337
242.82	0.018	195.7	0.0373
242.83	0.02	196	0.0399
242.85	0.023	196.2	0.0399
242.87	0.023	196.2	0.0435
242.88	0.023	196.4	0.0462
242.90	0.024	196.6	0.0488
242.92	0.026	196.8	0.0506
242.93	0.026	197	0.0524
242.95	0.027	197.2	0.0533
242.97	0.028	197.4	0.0533
242.98	0.028	197.5	0.0559
243.00	0.028	197.7	0.0568
243.02	0.029	197.8	0.0568
243.03	0.029	197.8	0.0568
243.05	0.029	197.9	0.0568
243.07	0.029	198	0.0568
243.08	0.028	198.1	0.0568
243.10	0.028	198.1	0.0559
243.12	0.027	198.1	0.055
243.13	0.026	198.2	0.055
243.15	0.024	198.2	0.0533
243.17	0.024	198.1	0.0524
243.18	0.024	198.1	0.0497
243.20	0.021	198	0.0479
243.23	0.02	198	0.0453
243.25	0.019	197.9	0.0426
243.27	0.016	197.7	0.0426
243.28	0.014	197.7	0.0399
243.30	0.014	197.6	0.0373
243.30	0.013	197.4	0.0337
243.32	0.01	197.2	0.0293
243.33	0.009	197.1	0.0257
243.35	0.007	196.8	0.0222
243.37	0.004	196.6	0.0222
243.38	0.002	196.4	0.0178
243.40	0.002	196.4	0.0142
243.42	0.001	196.2	0.0098
243.43	-0.002	195.8	0.0062
243.45	-0.004	195.6	0.0027
243.47	-0.005	195.3	-0.0018
243.48	-0.008	195	-0.0018
243.50	-0.01	194.8	-0.0053
243.52	-0.01	194.8	-0.008
243.53	-0.01	194.6	-0.0107
243.55	-0.012	194.3	-0.0142



Prova triassiale ciclica SN04-C1			
pressione di confinamento (kPa)		80	
deviatore ciclico (kPa)		95	
frequenza (hz)		0.00625	
tempo	cella di carico	$\Delta u$	LVDT
(min)	kN	(kPa)	$\delta$ (mm)
243.57	-0.014	194	-0.016
243.58	-0.014	193.8	-0.0178
243.60	-0.015	193.6	-0.0178
243.62	-0.016	193.4	-0.0195
243.63	-0.016	193.4	-0.0213
243.65	-0.017	193.3	-0.0222
243.67	-0.017	193.1	-0.0231
243.68	-0.017	193	-0.024
243.70	-0.017	192.8	-0.024
243.72	-0.017	192.7	-0.024
243.73	-0.017	192.7	-0.024
243.75	-0.017	192.6	-0.0231
243.77	-0.016	192.6	-0.0222
243.78	-0.015	192.6	-0.0222
243.80	-0.014	192.6	-0.0213
243.82	-0.014	192.5	-0.0204
243.83	-0.013	192.6	-0.0186
243.85	-0.011	192.7	-0.0169
243.87	-0.01	192.7	-0.0151
243.88	-0.009	192.8	-0.0115
243.90	-0.006	193	-0.0115
243.92	-0.005	193	-0.0089
243.93	-0.005	193.1	-0.0062
243.95	-0.003	193.3	-0.0036
243.97	0	193.4	0
243.98	0.001	193.6	0.0036
244.00	0.003	193.8	0.0071
244.02	0.006	194.1	0.0071
244.03	0.008	194.1	0.0124
244.05	0.008	194.2	0.016
244.07	0.009	194.5	0.0195
244.08	0.013	194.8	0.0231
244.10	0.013	194.9	0.0275
244.12	0.015	195.3	0.032
244.13	0.019	195.6	0.032
244.15	0.019	195.6	0.0364
244.17	0.019	195.8	0.0382
244.18	0.02	196	0.0417
244.20	0.023	196.3	0.0444
244.22	0.024	196.5	0.047
244.23	0.025	196.7	0.0497
244.25	0.026	196.9	0.0497
244.27	0.027	196.9	0.0524
244.28	0.027	197.1	0.0533
244.30	0.027	197.3	0.0541
244.32	0.028	197.5	0.055
244.33	0.028	197.6	0.0559
244.35	0.029	197.7	0.0568
244.37	0.029	197.9	0.0568
244.38	0.029	197.9	0.0568
244.40	0.029	198	0.0568
244.42	0.029	198	0.0568
244.43	0.027	198.1	0.0559
244.45	0.027	198.1	0.0559
244.47	0.026	198.1	0.0541
244.48	0.025	198.1	0.0524
244.50	0.024	198.1	0.0506
244.52	0.023	198.1	0.0488

Prova triassiale ciclica SN04-C1			
pressione di confinamento (kPa)		80	
deviatore ciclico (kPa)		95	
frequenza (hz)		0.00625	
tempo	cella di carico	$\Delta u$	LVDT
(min)	kN	(kPa)	$\delta$ (mm)
244.53	0.021	198	0.0488
244.55	0.019	197.9	0.047
244.57	0.019	197.9	0.0444
244.58	0.018	197.8	0.0417
244.60	0.016	197.6	0.0382
244.62	0.013	197.5	0.0355
244.63	0.012	197.3	0.032
244.65	0.009	197.1	0.032
244.67	0.007	196.9	0.0275
244.70	0.007	196.9	0.024
244.72	0.007	196.8	0.0204
244.73	0.003	196.5	0.016
244.75	0.001	196.3	0.0124
244.75	0	196	0.008
244.77	-0.003	195.7	0.008
244.78	-0.005	195.5	0.0044
244.80	-0.005	195.5	0.0009
244.82	-0.006	195.2	-0.0036
244.83	-0.008	194.9	-0.0062
244.85	-0.01	194.6	-0.0098
244.87	-0.011	194.4	-0.0124
244.88	-0.013	194.1	-0.0124
244.90	-0.014	193.9	-0.0151
244.92	-0.014	193.9	-0.0169
244.93	-0.014	193.7	-0.0186
244.95	-0.016	193.5	-0.0204
244.97	-0.016	193.3	-0.0213
244.98	-0.017	193.2	-0.0231
245.00	-0.017	193	-0.0231
245.02	-0.017	192.9	-0.0231
245.03	-0.017	192.9	-0.024
245.05	-0.017	192.8	-0.024
245.07	-0.017	192.7	-0.024
245.08	-0.016	192.6	-0.024
245.10	-0.016	192.6	-0.0231
245.12	-0.015	192.6	-0.0222
245.13	-0.014	192.6	-0.0222
245.15	-0.013	192.6	-0.0204
245.17	-0.012	192.6	-0.0186
245.18	-0.011	192.6	-0.0186
245.20	-0.01	192.6	-0.0169
245.22	-0.01	192.7	-0.0142
245.23	-0.008	192.8	-0.0115
245.25	-0.005	193	-0.008
245.27	-0.004	193.1	-0.0053
245.28	-0.003	193.3	-0.0018
245.30	0.001	193.5	-0.0018
245.32	0.002	193.5	0.0018
245.33	0.002	193.6	0.0053
245.35	0.004	193.9	0.0089
245.37	0.007	194.1	0.0133
245.38	0.008	194.3	0.016
245.40	0.01	194.6	0.0204
245.42	0.013	194.9	0.0204
245.43	0.014	194.9	0.0249
245.45	0.014	195.1	0.0293
245.47	0.016	195.4	0.0328
245.48	0.019	195.6	0.0373

Prova triassiale ciclica SN04-C1			
pressione di confinamento (kPa)		80	
deviatore ciclico (kPa)		95	
frequenza (hz)		0.00625	
tempo	cella di carico	$\Delta u$	LVDT
(min)	kN	(kPa)	$\delta$ (mm)
245.50	0.02	195.9	0.0399
245.52	0.021	196.1	0.0426
245.53	0.023	196.4	0.0426
245.55	0.024	196.4	0.0462
245.57	0.024	196.5	0.0479
245.58	0.025	196.8	0.0497
245.60	0.027	197	0.0524
245.62	0.027	197.2	0.0533
245.63	0.028	197.3	0.055
245.65	0.029	197.5	0.055
245.67	0.029	197.5	0.0559
245.68	0.029	197.6	0.0568
245.70	0.029	197.8	0.0568
245.72	0.029	197.9	0.0568
245.73	0.029	198	0.0568
245.75	0.028	198.1	0.0568
245.77	0.027	198.1	0.0568
245.78	0.026	198.1	0.055
245.80	0.026	198.1	0.0541
245.82	0.026	198.1	0.0524
245.83	0.024	198.1	0.0506
245.85	0.022	198	0.0488
245.87	0.022	198	0.047
245.88	0.019	197.9	0.0444
245.90	0.019	197.8	0.0435
245.92	0.017	197.7	0.0399
245.93	0.014	197.5	0.0399
245.95	0.013	197.4	0.0364
245.97	0.013	197.4	0.0346
245.98	0.011	197.3	0.0293
246.00	0.009	197	0.0257
246.02	0.006	196.8	0.0213
246.03	0.005	196.6	0.0186
246.05	0.002	196.4	0.0186
246.07	0	196.1	0.0142
246.08	0	196.1	0.0107
246.10	-0.001	195.9	0.0071
246.12	-0.004	195.6	0.0027
246.15	-0.006	195.3	-0.0009
246.17	-0.006	195.1	-0.0044
246.18	-0.009	194.8	-0.0044
246.20	-0.011	194.5	-0.008
246.20	-0.011	194.5	-0.0107
246.22	-0.011	194.3	-0.0133
246.23	-0.013	194	-0.016
246.25	-0.014	193.8	-0.0178
246.27	-0.015	193.6	-0.0195
246.28	-0.016	193.4	-0.0195
246.30	-0.017	193.2	-0.0222
246.32	-0.017	193.2	-0.0231
246.33	-0.017	193.1	-0.0231
246.35	-0.017	192.9	-0.024
246.37	-0.017	192.8	-0.024
246.38	-0.017	192.7	-0.024
246.40	-0.017	192.7	-0.024
246.42	-0.016	192.6	-0.024
246.43	-0.016	192.6	-0.024
246.45	-0.016	192.6	-0.0222

Prova triassiale ciclica SN04-C1			
pressione di confinamento (kPa)		80	
deviatore ciclico (kPa)		95	
frequenza (hz)		0.00625	
tempo	cella di carico	$\Delta u$	LVDT
(min)	kN	(kPa)	$\delta$ (mm)
246.47	-0.015	192.6	-0.0213
246.48	-0.013	192.6	-0.0195
246.50	-0.013	192.6	-0.0178
246.52	-0.011	192.7	-0.016
246.53	-0.009	192.8	-0.016
246.55	-0.008	192.8	-0.0133
246.57	-0.008	192.8	-0.0115
246.58	-0.006	193	-0.008
246.60	-0.003	193.1	-0.0053
246.62	-0.002	193.3	-0.0027
246.63	-0.002	193.4	-0.0009
246.65	0.001	193.6	0.0027
246.67	0.003	193.7	0.0062
246.68	0.004	194	0.0107
246.70	0.008	194.2	0.0107
246.72	0.009	194.2	0.0151
246.73	0.009	194.4	0.0186
246.75	0.011	194.7	0.0222
246.77	0.014	195	0.0275
246.78	0.015	195.2	0.0311
246.80	0.017	195.5	0.0346
246.82	0.02	195.8	0.0346
246.83	0.02	195.8	0.0382
246.85	0.02	196	0.0408
246.87	0.022	196.2	0.0435
246.88	0.024	196.5	0.0462
246.90	0.025	196.7	0.0488
246.92	0.026	196.9	0.0515
246.93	0.027	197.1	0.0515
246.95	0.028	197.1	0.0533
246.97	0.028	197.2	0.0541
246.98	0.028	197.4	0.055
247.00	0.028	197.6	0.0559
247.02	0.029	197.7	0.0568
247.03	0.029	197.8	0.0568
247.05	0.029	197.9	0.0568
247.07	0.028	197.9	0.0568
247.08	0.028	198	0.0568
247.10	0.028	198.1	0.0559
247.12	0.027	198.1	0.055
247.13	0.026	198.1	0.0541
247.15	0.025	198.1	0.0515
247.17	0.023	198	0.0515
247.18	0.022	198	0.0497
247.20	0.022	198	0.0479
247.22	0.021	197.9	0.0462
247.23	0.018	197.8	0.0435
247.25	0.017	197.7	0.0408
247.27	0.016	197.6	0.0373
247.28	0.012	197.4	0.0373
247.30	0.011	197.4	0.0337
247.32	0.011	197.2	0.0311
247.33	0.007	196.9	0.0275
247.35	0.006	196.9	0.024
247.37	0.006	196.7	0.0213
247.38	0.005	196.5	0.0169
247.40	0.001	196.2	0.0124
247.42	0	196	0.0089

Prova triassiale ciclica SN04-C1			
pressione di confinamento (kPa)		80	
deviatore ciclico (kPa)		95	
frequenza (hz)		0.00625	
tempo	cella di carico	$\Delta u$	LVDT
(min)	kN	(kPa)	$\delta$ (mm)
247.43	-0.002	195.8	0.0044
247.45	-0.005	195.4	0.0044
247.47	-0.006	195.4	0.0009
247.48	-0.006	195.2	-0.0018
247.50	-0.007	194.9	-0.0053
247.52	-0.01	194.6	-0.0089
247.53	-0.011	194.4	-0.0124
247.55	-0.012	194.2	-0.0142
247.57	-0.014	193.9	-0.0142
247.60	-0.015	193.9	-0.0169
247.62	-0.015	193.7	-0.0186
247.63	-0.015	193.5	-0.0204
247.65	-0.016	193.3	-0.0222
247.65	-0.017	193.1	-0.0231
247.67	-0.017	193	-0.0231
247.68	-0.017	192.9	-0.0231
247.70	-0.017	192.8	-0.0231
247.72	-0.017	192.8	-0.024
247.73	-0.017	192.7	-0.024
247.75	-0.017	192.6	-0.024
247.77	-0.016	192.6	-0.0231
247.78	-0.015	192.5	-0.0213
247.80	-0.014	192.6	-0.0213
247.82	-0.013	192.6	-0.0195
247.83	-0.013	192.6	-0.0186
247.85	-0.012	192.6	-0.0169
247.87	-0.01	192.7	-0.0151
247.88	-0.009	192.8	-0.0133
247.90	-0.007	192.9	-0.0098
247.92	-0.005	193.1	-0.0098
247.93	-0.003	193.2	-0.0071
247.95	-0.003	193.2	-0.0036
247.97	-0.002	193.3	0
247.98	0.001	193.6	0.0036
248.00	0.003	193.7	0.0062
248.02	0.005	193.9	0.0107
248.03	0.008	194.2	0.0107
248.05	0.01	194.4	0.0151
248.07	0.011	194.6	0.0213
248.08	0.012	194.8	0.0213
248.10	0.014	195.1	0.024
248.12	0.014	195.1	0.0284
248.13	0.016	195.3	0.0328
248.15	0.018	195.6	0.0364
248.17	0.02	195.9	0.0399
248.18	0.021	196.1	0.0426
248.20	0.023	196.3	0.0453
248.22	0.025	196.6	0.0453
248.23	0.025	196.6	0.0479
248.25	0.025	196.8	0.0497
248.27	0.026	197	0.0524
248.28	0.028	197.2	0.0541
248.30	0.028	197.3	0.0541
248.32	0.028	197.5	0.0559
248.33	0.029	197.6	0.0559
248.35	0.029	197.6	0.0568
248.37	0.029	197.8	0.0568
248.38	0.029	197.9	0.0568

Prova triassiale ciclica SN04-C1			
pressione di confinamento (kPa)		80	
deviatore ciclico (kPa)		95	
frequenza (hz)		0.00625	
tempo	cella di carico	$\Delta u$	LVDT
(min)	kN	(kPa)	$\delta$ (mm)
248.40	0.029	198	0.0568
248.42	0.028	198	0.0568
248.43	0.028	198.1	0.0559
248.45	0.026	198.1	0.0559
248.47	0.025	198.1	0.0541
248.48	0.025	198.1	0.0533
248.50	0.025	198.1	0.0515
248.52	0.023	198	0.0497
248.53	0.021	198	0.0479
248.55	0.02	197.9	0.0444
248.57	0.017	197.8	0.0444
248.58	0.016	197.8	0.0426
248.60	0.016	197.7	0.0399
248.62	0.015	197.5	0.0364
248.63	0.011	197.3	0.0328
248.65	0.01	197.2	0.0302
248.67	0.009	197	0.0249
248.68	0.005	196.7	0.0249
248.70	0.004	196.7	0.0204
248.72	0.004	196.5	0.0178
248.73	0.002	196.3	0.0133
248.75	-0.001	196	0.0089
248.77	-0.002	195.8	0.0062
248.78	-0.003	195.5	0.0027
248.80	-0.005	195.2	0
248.82	-0.007	195	-0.0027
248.83	-0.008	194.8	-0.0071
248.85	-0.011	194.5	-0.0071
248.87	-0.012	194.5	-0.0107
248.88	-0.012	194.3	-0.0133
248.90	-0.013	194	-0.0151
248.92	-0.014	193.8	-0.0178
248.93	-0.015	193.6	-0.0195
248.95	-0.016	193.4	-0.0204
248.97	-0.016	193.2	-0.0204
248.98	-0.017	193.2	-0.0222
249.00	-0.017	193.1	-0.0231
249.02	-0.017	192.9	-0.0231
249.03	-0.017	192.8	-0.024
249.07	-0.017	192.7	-0.024
249.08	-0.017	192.6	-0.0231
249.10	-0.016	192.6	-0.0231
249.12	-0.015	192.5	-0.0231
249.12	-0.015	192.5	-0.0222
249.13	-0.015	192.5	-0.0213
249.15	-0.014	192.5	-0.0195
249.17	-0.012	192.6	-0.0178
249.18	-0.011	192.6	-0.016
249.20	-0.009	192.7	-0.016
249.22	-0.007	192.8	-0.0133
249.23	-0.007	192.8	-0.0115
249.25	-0.007	192.9	-0.0089
249.27	-0.005	193.1	-0.0062
249.28	-0.002	193.3	-0.0018
249.30	-0.001	193.4	0.0018
249.32	0.002	193.6	0.0053
249.33	0.004	193.8	0.0053
249.35	0.004	193.8	0.0089

Prova triassiale ciclica SN04-C1			
pressione di confinamento (kPa)		80	
deviatore ciclico (kPa)		95	
frequenza (hz)		0.00625	
tempo	cella di carico	$\Delta u$	LVDT
(min)	kN	(kPa)	$\delta$ (mm)
249.37	0.005	194	0.0124
249.38	0.008	194.3	0.0169
249.40	0.011	194.5	0.0213
249.42	0.012	194.7	0.024
249.43	0.014	195	0.0284
249.45	0.017	195.2	0.0284
249.47	0.017	195.2	0.0328
249.48	0.017	195.5	0.0346
249.50	0.019	195.8	0.0382
249.52	0.022	196	0.0426
249.53	0.022	196.2	0.0444
249.55	0.023	196.4	0.047
249.57	0.025	196.6	0.0488
249.58	0.026	196.9	0.0506
249.60	0.026	197.1	0.0524
249.62	0.028	197.2	0.0524
249.63	0.028	197.2	0.0541
249.65	0.028	197.4	0.055
249.67	0.028	197.5	0.0559
249.68	0.028	197.7	0.0559
249.70	0.029	197.8	0.0568
249.72	0.029	197.9	0.0568
249.73	0.028	198	0.0568
249.75	0.028	198	0.0568
249.77	0.028	198.1	0.0568
249.78	0.027	198.1	0.055
249.80	0.026	198.1	0.0541
249.82	0.025	198.1	0.0533
249.83	0.024	198.1	0.0515
249.85	0.022	198	0.0515
249.87	0.021	198	0.0488
249.88	0.021	197.9	0.0462
249.90	0.019	197.8	0.0435
249.92	0.016	197.7	0.0408
249.93	0.016	197.6	0.0382
249.95	0.014	197.4	0.0346
249.97	0.01	197.2	0.0346
249.98	0.009	197.2	0.0302
250.00	0.009	197.1	0.0284
250.02	0.008	196.9	0.0231
250.03	0.005	196.6	0.0195
250.05	0.003	196.4	0.016
250.07	0.002	196.2	0.0115
250.08	-0.002	195.9	0.0115
250.10	-0.003	195.9	0.0071
250.12	-0.003	195.7	0.0044
250.13	-0.004	195.4	0
250.15	-0.008	195	-0.0036
250.17	-0.009	194.8	-0.0062
250.18	-0.009	194.6	-0.0089
250.20	-0.012	194.3	-0.0089
250.22	-0.013	194.3	-0.0124
250.23	-0.013	194.1	-0.0151
250.25	-0.015	193.7	-0.0169
250.27	-0.015	193.5	-0.0186
250.28	-0.015	193.5	-0.0204
250.30	-0.016	193.3	-0.0213
250.32	-0.017	193.1	-0.0222

Prova triassiale ciclica SN04-C1			
pressione di confinamento (kPa)		80	
deviatore ciclico (kPa)		95	
frequenza (hz)		0.00625	
tempo	cella di carico	$\Delta u$	LVDT
(min)	kN	(kPa)	$\delta$ (mm)
250.33	-0.017	193	-0.0231
250.35	-0.018	192.8	-0.024
250.37	-0.018	192.7	-0.024
250.38	-0.017	192.6	-0.0249
250.40	-0.017	192.6	-0.024
250.42	-0.016	192.6	-0.0231
250.43	-0.016	192.5	-0.0222
250.45	-0.015	192.5	-0.0222
250.47	-0.015	192.5	-0.0213
250.50	-0.013	192.6	-0.0213
250.52	-0.012	192.6	-0.0195
250.53	-0.012	192.6	-0.0178
250.55	-0.011	192.6	-0.0151
250.57	-0.008	192.7	-0.0124
250.57	-0.007	192.8	-0.0107
250.58	-0.006	192.9	-0.0071
250.60	-0.003	193.2	-0.0071
250.62	-0.001	193.3	-0.0036
250.63	-0.001	193.3	-0.0009
250.65	0	193.4	0.0027
250.67	0.003	193.7	0.0062
250.68	0.005	193.9	0.0098
250.70	0.006	194.1	0.0142
250.72	0.01	194.4	0.0142
250.73	0.011	194.6	0.0186
250.75	0.011	194.6	0.0222
250.77	0.013	194.8	0.0257
250.78	0.015	195.1	0.0302
250.80	0.017	195.4	0.0337
250.82	0.018	195.6	0.0373
250.83	0.021	195.9	0.0373
250.85	0.022	196.1	0.0408
250.87	0.022	196.1	0.0435
250.88	0.023	196.3	0.0462
250.90	0.024	196.6	0.0488
250.92	0.026	196.8	0.0506
250.93	0.026	197	0.0524
250.95	0.027	197.2	0.0541
250.97	0.028	197.3	0.055
250.98	0.028	197.5	0.0559
251.00	0.028	197.6	0.0559
251.02	0.029	197.8	0.0559
251.03	0.029	197.8	0.0568
251.05	0.029	197.9	0.0568
251.07	0.029	197.9	0.0568
251.08	0.028	198	0.0568
251.10	0.028	198.1	0.0559
251.12	0.027	198.1	0.055
251.13	0.025	198.1	0.055
251.15	0.024	198.1	0.0533
251.17	0.024	198.1	0.0524
251.18	0.024	198.1	0.0497
251.20	0.021	198	0.0479
251.22	0.02	197.9	0.0462
251.23	0.019	197.8	0.0426
251.25	0.016	197.6	0.0426
251.27	0.015	197.6	0.0399
251.28	0.015	197.5	0.0364



Prova triassiale ciclica SN04-C1			
pressione di confinamento (kPa)		80	
deviatore ciclico (kPa)		95	
frequenza (hz)		0.00625	
tempo	cella di carico	$\Delta u$	LVDT
(min)	kN	(kPa)	$\delta$ (mm)
251.30	0.013	197.3	0.0337
251.32	0.01	197.1	0.0293
251.33	0.008	197	0.0249
251.35	0.007	196.8	0.0213
251.37	0.004	196.5	0.0213
251.38	0.003	196.5	0.0178
251.40	0.003	196.3	0.0142
251.42	0.001	196	0.0098
251.43	-0.003	195.8	0.0053
251.45	-0.004	195.6	0.0027
251.47	-0.005	195.2	-0.0009
251.48	-0.008	194.9	-0.0009
251.50	-0.009	194.9	-0.0044
251.52	-0.009	194.7	-0.008
251.53	-0.01	194.4	-0.0107
251.55	-0.013	194.2	-0.0142
251.57	-0.013	194	-0.016
251.58	-0.014	193.7	-0.0178
251.60	-0.016	193.5	-0.0178
251.62	-0.016	193.5	-0.0195
251.63	-0.016	193.4	-0.0213
251.65	-0.016	193.2	-0.0222
251.67	-0.017	193	-0.0231
251.68	-0.017	192.9	-0.024
251.70	-0.017	192.8	-0.024
251.72	-0.017	192.7	-0.024
251.73	-0.017	192.6	-0.024
251.75	-0.017	192.5	-0.0231
251.77	-0.015	192.5	-0.0231
251.78	-0.015	192.5	-0.0222
251.80	-0.015	192.5	-0.0213
251.82	-0.014	192.5	-0.0204
251.83	-0.012	192.5	-0.0178
251.85	-0.011	192.6	-0.0169
251.87	-0.01	192.6	-0.0142
251.88	-0.007	192.8	-0.0142
251.90	-0.006	192.8	-0.0115
251.92	-0.006	192.9	-0.0089
251.93	-0.005	193	-0.0062
251.97	-0.002	193.2	-0.0027
251.98	-0.001	193.3	0
252.00	0.001	193.5	0.0044
252.02	0.004	193.8	0.0044
252.02	0.006	194	0.0089
252.03	0.006	194	0.0115
252.05	0.007	194.2	0.016
252.07	0.011	194.5	0.0204
252.08	0.012	194.7	0.0231
252.10	0.013	194.9	0.0284
252.12	0.016	195.2	0.0284
252.13	0.018	195.5	0.032
252.15	0.018	195.5	0.0355
252.17	0.019	195.7	0.0391
252.18	0.021	196	0.0426
252.20	0.023	196.2	0.0453
252.22	0.023	196.4	0.047
252.23	0.025	196.7	0.047
252.25	0.026	196.9	0.0497

Prova triassiale ciclica SN04-C1			
pressione di confinamento (kPa)		80	
deviatore ciclico (kPa)		95	
frequenza (hz)		0.00625	
tempo	cella di carico	$\Delta u$	LVDT
(min)	kN	(kPa)	$\delta$ (mm)
252.27	0.026	196.9	0.0515
252.28	0.027	197	0.0541
252.30	0.028	197.3	0.055
252.32	0.028	197.4	0.0559
252.33	0.029	197.6	0.0568
252.35	0.029	197.7	0.0568
252.37	0.029	197.8	0.0568
252.38	0.029	197.8	0.0568
252.40	0.029	197.9	0.0568
252.42	0.028	198	0.0568
252.43	0.027	198	0.0568
252.45	0.027	198.1	0.0559
252.47	0.027	198.1	0.0541
252.48	0.025	198.1	0.0533
252.50	0.024	198.1	0.0515
252.52	0.023	198	0.0497
252.53	0.02	197.9	0.0497
252.55	0.02	197.9	0.047
252.57	0.02	197.9	0.0453
252.58	0.018	197.7	0.0417
252.60	0.015	197.6	0.0382
252.62	0.014	197.4	0.0355
252.63	0.012	197.2	0.032
252.65	0.009	197.1	0.032
252.67	0.008	197.1	0.0284
252.68	0.008	196.9	0.024
252.70	0.006	196.6	0.0204
252.72	0.003	196.4	0.016
252.73	0.001	196.2	0.0133
252.75	0	195.9	0.0089
252.77	-0.004	195.7	0.0089
252.78	-0.005	195.7	0.0044
252.80	-0.005	195.4	0.0009
252.82	-0.006	195.1	-0.0027
252.83	-0.009	194.8	-0.0062
252.85	-0.01	194.6	-0.0089
252.87	-0.011	194.3	-0.0115
252.88	-0.013	194.1	-0.0115
252.90	-0.013	194.1	-0.0142
252.92	-0.013	193.9	-0.016
252.93	-0.014	193.6	-0.0186
252.95	-0.017	193.4	-0.0213
252.97	-0.016	193.3	-0.0213
252.98	-0.017	193.1	-0.0222
253.00	-0.017	193	-0.0222
253.02	-0.017	193	-0.0231
253.03	-0.017	192.9	-0.0231
253.05	-0.017	192.7	-0.024
253.07	-0.017	192.7	-0.0231
253.08	-0.017	192.6	-0.0231
253.10	-0.016	192.5	-0.0222
253.12	-0.015	192.5	-0.0222
253.13	-0.014	192.5	-0.0213
253.15	-0.013	192.5	-0.0195
253.17	-0.012	192.5	-0.0195
253.18	-0.011	192.5	-0.0178
253.20	-0.011	192.6	-0.016
253.22	-0.01	192.7	-0.0124

Prova triassiale ciclica SN04-C1			
pressione di confinamento (kPa)		80	
deviatore ciclico (kPa)		95	
frequenza (hz)		0.00625	
tempo	cella di carico	$\Delta u$	LVDT
(min)	kN	(kPa)	$\delta$ (mm)
253.23	-0.007	192.8	-0.0098
253.25	-0.005	192.9	-0.008
253.27	-0.004	193	-0.0044
253.28	-0.001	193.3	-0.0044
253.30	0	193.4	-0.0009
253.32	0	193.4	0.0018
253.33	0.002	193.6	0.0062
253.35	0.005	193.9	0.0107
253.37	0.006	194.1	0.0133
253.40	0.008	194.3	0.0178
253.42	0.011	194.6	0.0178
253.43	0.013	194.8	0.0222
253.45	0.013	194.8	0.0257
253.47	0.014	195	0.0302
253.47	0.017	195.3	0.0337
253.48	0.019	195.6	0.0373
253.50	0.02	195.8	0.0408
253.52	0.022	196.1	0.0408
253.53	0.024	196.3	0.0444
253.55	0.024	196.3	0.0462
253.57	0.024	196.5	0.0488
253.58	0.025	196.8	0.0506
253.60	0.027	197	0.0524
253.62	0.027	197.1	0.0541
253.63	0.028	197.3	0.0541
253.65	0.028	197.5	0.055
253.67	0.028	197.5	0.0559
253.68	0.029	197.6	0.0568
253.70	0.029	197.7	0.0577
253.72	0.029	197.8	0.0577
253.73	0.029	197.9	0.0577
253.75	0.029	198	0.0568
253.77	0.027	198	0.0568
253.78	0.026	198	0.0559
253.80	0.026	198.1	0.055
253.82	0.026	198.1	0.0533
253.83	0.024	198	0.0515
253.85	0.023	198	0.0497
253.87	0.022	197.9	0.0479
253.88	0.019	197.8	0.0444
253.90	0.019	197.8	0.0435
253.92	0.017	197.7	0.0408
253.93	0.014	197.5	0.0408
253.95	0.013	197.4	0.0373
253.97	0.013	197.4	0.0355
253.98	0.012	197.2	0.0302
254.00	0.008	197	0.0257
254.02	0.007	196.8	0.0222
254.03	0.005	196.6	0.0186
254.05	0.002	196.3	0.0186
254.07	0	196.1	0.0151
254.08	0	196.1	0.0115
254.10	-0.001	195.9	0.0071
254.12	-0.004	195.5	0.0027
254.13	-0.006	195.2	-0.0009
254.15	-0.007	195	-0.0044
254.17	-0.009	194.7	-0.0044
254.18	-0.011	194.5	-0.0071

Prova triassiale ciclica SN04-C1			
pressione di confinamento (kPa)		80	
deviatore ciclico (kPa)		95	
frequenza (hz)		0.00625	
tempo	cella di carico	$\Delta u$	LVDT
(min)	kN	(kPa)	$\delta$ (mm)
254.20	-0.011	194.5	-0.0098
254.22	-0.011	194.3	-0.0124
254.23	-0.013	194	-0.016
254.25	-0.015	193.8	-0.0178
254.27	-0.015	193.6	-0.0195
254.28	-0.016	193.4	-0.0204
254.30	-0.017	193.2	-0.0204
254.32	-0.017	193.2	-0.0222
254.33	-0.017	193.1	-0.0231
254.35	-0.017	192.9	-0.0231
254.37	-0.017	192.8	-0.024
254.38	-0.017	192.7	-0.024
254.40	-0.017	192.6	-0.024
254.42	-0.016	192.6	-0.024
254.43	-0.016	192.6	-0.0231
254.45	-0.016	192.5	-0.0222
254.47	-0.015	192.5	-0.0204
254.48	-0.013	192.5	-0.0186
254.50	-0.013	192.5	-0.0178
254.52	-0.011	192.6	-0.016
254.53	-0.009	192.7	-0.016
254.55	-0.008	192.7	-0.0133
254.57	-0.008	192.8	-0.0115
254.58	-0.006	192.9	-0.008
254.60	-0.003	193.1	-0.0053
254.62	-0.003	193.2	-0.0036
254.63	-0.002	193.3	0
254.65	0.002	193.5	0.0044
254.67	0.003	193.7	0.0071
254.68	0.004	193.9	0.0115
254.70	0.008	194.2	0.0115
254.72	0.009	194.2	0.0151
254.73	0.009	194.4	0.0186
254.75	0.011	194.6	0.0222
254.77	0.014	194.9	0.0275
254.78	0.015	195.1	0.0311
254.80	0.017	195.4	0.0346
254.82	0.02	195.7	0.0346
254.83	0.021	195.7	0.0382
254.87	0.021	195.9	0.0408
254.88	0.022	196.1	0.0444
254.90	0.024	196.4	0.047
254.92	0.025	196.6	0.0488
254.92	0.026	196.8	0.0515
254.93	0.027	197	0.0515
254.95	0.028	197.2	0.0533
254.97	0.028	197.2	0.0541
254.98	0.028	197.3	0.055
255.00	0.029	197.5	0.0559
255.02	0.029	197.6	0.0568
255.03	0.029	197.7	0.0568
255.05	0.029	197.9	0.0568
255.07	0.028	197.9	0.0568
255.08	0.028	197.9	0.0568
255.10	0.028	198	0.0568
255.12	0.027	198	0.055
255.13	0.026	198	0.0533
255.15	0.025	198	0.0524

Prova triassiale ciclica SN04-C1			
pressione di confinamento (kPa)		80	
deviatore ciclico (kPa)		95	
frequenza (hz)		0.00625	
tempo	cella di carico	$\Delta u$	LVDT
(min)	kN	(kPa)	$\delta$ (mm)
255.17	0.024	198	0.0524
255.18	0.022	198	0.0506
255.20	0.022	198	0.0488
255.22	0.021	197.9	0.0462
255.23	0.019	197.8	0.0435
255.25	0.017	197.6	0.0408
255.27	0.015	197.5	0.0373
255.28	0.013	197.3	0.0346
255.30	0.011	197.2	0.0346
255.32	0.01	197.2	0.0311
255.33	0.008	196.8	0.0249
255.35	0.006	196.7	0.0249
255.37	0.004	196.7	0.0222
255.38	0.004	196.5	0.0178
255.40	0.003	196.2	0.0133
255.42	-0.001	195.9	0.0098
255.43	-0.002	195.7	0.0062
255.45	-0.004	195.4	0.0018
255.47	-0.007	195.1	0.0018
255.48	-0.008	195.1	-0.0027
255.50	-0.008	194.9	-0.0053
255.52	-0.009	194.6	-0.0089
255.53	-0.012	194.3	-0.0115
255.55	-0.012	194.1	-0.0133
255.57	-0.013	193.9	-0.016
255.58	-0.015	193.7	-0.016
255.60	-0.015	193.7	-0.0186
255.62	-0.015	193.5	-0.0204
255.63	-0.016	193.3	-0.0213
255.65	-0.017	193.1	-0.0222
255.67	-0.017	193	-0.0231
255.68	-0.017	192.9	-0.0231
255.70	-0.017	192.7	-0.0231
255.72	-0.017	192.7	-0.024
255.73	-0.017	192.6	-0.024
255.75	-0.017	192.6	-0.0231
255.77	-0.016	192.5	-0.0222
255.78	-0.015	192.5	-0.0213
255.80	-0.015	192.5	-0.0204
255.82	-0.013	192.5	-0.0204
255.83	-0.012	192.5	-0.0186
255.85	-0.012	192.5	-0.0178
255.87	-0.011	192.6	-0.0151
255.88	-0.008	192.7	-0.0124
255.90	-0.007	192.8	-0.0107
255.92	-0.006	192.9	-0.0071
255.93	-0.003	193.1	-0.0071
255.95	-0.001	193.3	-0.0036
255.97	-0.001	193.3	-0.0009
255.98	0	193.4	0.0027
256.00	0.003	193.7	0.0071
256.02	0.005	193.9	0.0098
256.03	0.006	194	0.0142
256.05	0.01	194.3	0.0186
256.07	0.011	194.5	0.0204
256.08	0.011	194.7	0.024
256.10	0.014	195	0.024
256.12	0.017	195.3	0.0293

Prova triassiale ciclica SN04-C1			
pressione di confinamento (kPa)		80	
deviatore ciclico (kPa)		95	
frequenza (hz)		0.00625	
tempo	cella di carico	$\Delta u$	LVDT
(min)	kN	(kPa)	$\delta$ (mm)
256.13	0.017	195.3	0.0328
256.15	0.018	195.5	0.0364
256.17	0.019	195.8	0.0399
256.18	0.022	196	0.0426
256.20	0.022	196.2	0.0453
256.22	0.024	196.5	0.0453
256.23	0.026	196.7	0.0479
256.25	0.026	196.7	0.0506
256.27	0.026	196.9	0.0524
256.28	0.027	197.1	0.0541
256.30	0.028	197.3	0.055
256.33	0.028	197.4	0.0559
256.35	0.028	197.6	0.0568
256.37	0.029	197.7	0.0568
256.37	0.029	197.7	0.0577
256.38	0.029	197.8	0.0577
256.40	0.029	197.9	0.0577
256.42	0.029	198	0.0577
256.43	0.028	198	0.0559
256.45	0.027	198	0.0541
256.47	0.025	198	0.0541
256.48	0.025	198	0.0533
256.50	0.025	198.1	0.0524
256.52	0.024	198	0.0497
256.53	0.022	197.9	0.0479
256.55	0.02	197.8	0.0453
256.57	0.019	197.7	0.0426
256.58	0.016	197.6	0.0426
256.60	0.015	197.6	0.0399
256.62	0.015	197.5	0.0373
256.63	0.013	197.3	0.0337
256.65	0.009	197.1	0.0302
256.67	0.009	197	0.0275
256.68	0.007	196.8	0.0213
256.70	0.003	196.5	0.0213
256.72	0.002	196.3	0.0178
256.73	0.002	196.3	0.0142
256.75	0.001	196.1	0.0107
256.77	-0.002	195.7	0.0062
256.78	-0.004	195.5	0.0027
256.80	-0.005	195.3	0.0009
256.82	-0.006	195	-0.0027
256.83	-0.009	194.8	-0.0062
256.85	-0.009	194.5	-0.0098
256.87	-0.012	194.2	-0.0098
256.88	-0.013	194	-0.0133
256.90	-0.013	194	-0.0151
256.92	-0.014	193.8	-0.0169
256.93	-0.015	193.6	-0.0186
256.95	-0.016	193.4	-0.0204
256.97	-0.016	193.2	-0.0213
256.98	-0.017	193.1	-0.0222
257.00	-0.017	192.9	-0.0222
257.02	-0.017	192.9	-0.0231
257.03	-0.017	192.8	-0.0231
257.05	-0.017	192.7	-0.024
257.07	-0.017	192.6	-0.024
257.08	-0.017	192.5	-0.0222

Prova triassiale ciclica SN04-C1			
pressione di confinamento (kPa)		80	
deviatore ciclico (kPa)		95	
frequenza (hz)		0.00625	
tempo	cella di carico	$\Delta u$	LVDT
(min)	kN	(kPa)	$\delta$ (mm)
257.10	-0.016	192.5	-0.0222
257.12	-0.015	192.5	-0.0222
257.13	-0.015	192.5	-0.0213
257.15	-0.014	192.5	-0.0195
257.17	-0.013	192.6	-0.0178
257.18	-0.011	192.6	-0.016
257.20	-0.01	192.6	-0.0142
257.22	-0.008	192.8	-0.0115
257.23	-0.006	192.9	-0.0115
257.25	-0.006	192.9	-0.0089
257.27	-0.005	193	-0.0053
257.28	-0.003	193.2	-0.0027
257.30	0	193.4	0.0009
257.32	0.001	193.5	0.0044
257.33	0.003	193.8	0.008
257.35	0.006	194	0.008
257.37	0.007	194	0.0124
257.38	0.007	194.2	0.016
257.40	0.009	194.4	0.0195
257.42	0.013	194.7	0.024
257.43	0.013	194.9	0.0275
257.45	0.015	195.2	0.032
257.47	0.018	195.4	0.032
257.48	0.019	195.4	0.0355
257.50	0.02	195.9	0.0408
257.52	0.022	196.1	0.0408
257.53	0.023	196.1	0.0435
257.55	0.023	196.3	0.0453
257.57	0.024	196.6	0.0479
257.58	0.026	196.8	0.0506
257.60	0.026	197	0.0524
257.62	0.027	197.1	0.0541
257.63	0.028	197.3	0.0541
257.65	0.028	197.3	0.0559
257.67	0.028	197.5	0.0559
257.68	0.029	197.6	0.0568
257.70	0.029	197.8	0.0577
257.72	0.029	197.9	0.0577
257.73	0.029	198	0.0568
257.77	0.028	198	0.0568
257.78	0.027	198	0.0568
257.80	0.027	198.1	0.0559
257.82	0.026	198.1	0.0541
257.83	0.025	198	0.0533
257.83	0.024	198	0.0515
257.85	0.023	198	0.0488
257.87	0.021	197.9	0.0488
257.88	0.019	197.9	0.0462
257.90	0.019	197.8	0.0444
257.92	0.018	197.7	0.0417
257.93	0.015	197.5	0.0382
257.95	0.014	197.4	0.0355
257.97	0.012	197.3	0.032
257.98	0.009	197	0.032
258.00	0.007	196.9	0.0284
258.02	0.007	196.9	0.024
258.03	0.006	196.7	0.0204
258.05	0.003	196.4	0.016

Prova triassiale ciclica SN04-C1			
pressione di confinamento (kPa)		80	
deviatore ciclico (kPa)		95	
frequenza (hz)		0.00625	
tempo	cella di carico	$\Delta u$	LVDT
(min)	kN	(kPa)	$\delta$ (mm)
258.07	0.001	196.2	0.0124
258.08	0	196	0.0089
258.10	-0.003	195.6	0.0089
258.12	-0.005	195.4	0.0044
258.13	-0.005	195.4	0.0018
258.15	-0.006	195.1	-0.0027
258.17	-0.009	194.8	-0.0062
258.18	-0.01	194.6	-0.0089
258.20	-0.011	194.3	-0.0124
258.22	-0.013	194	-0.0124
258.23	-0.014	193.8	-0.0169
258.25	-0.014	193.7	-0.0186
258.27	-0.015	193.4	-0.0195
258.28	-0.016	193.3	-0.0195
258.30	-0.016	193.3	-0.0213
258.32	-0.017	193.1	-0.0222
258.33	-0.017	193	-0.0231
258.35	-0.017	192.8	-0.0231
258.37	-0.017	192.7	-0.024
258.38	-0.017	192.6	-0.024
258.40	-0.017	192.5	-0.024
258.42	-0.016	192.5	-0.024
258.43	-0.016	192.5	-0.0231
258.45	-0.016	192.5	-0.0213
258.47	-0.014	192.5	-0.0204
258.48	-0.014	192.4	-0.0195
258.50	-0.013	192.5	-0.0178
258.52	-0.01	192.6	-0.0178
258.53	-0.01	192.6	-0.0151
258.55	-0.01	192.6	-0.0133
258.57	-0.008	192.8	-0.0107
258.58	-0.005	192.9	-0.0071
258.60	-0.004	193	-0.0044
258.62	-0.003	193.2	-0.0009
258.63	0.001	193.4	-0.0009
258.65	0.002	193.4	0.0027
258.67	0.002	193.6	0.0053
258.68	0.004	193.8	0.0098
258.70	0.007	194.1	0.0142
258.72	0.008	194.2	0.0169
258.73	0.01	194.5	0.0213
258.75	0.014	194.8	0.0213
258.77	0.014	194.8	0.0257
258.78	0.014	195	0.0293
258.80	0.016	195.3	0.0337
258.82	0.019	195.6	0.0373
258.83	0.02	195.8	0.0399
258.85	0.021	196	0.0435
258.87	0.024	196.3	0.0435
258.88	0.024	196.3	0.0462
258.90	0.024	196.5	0.0479
258.92	0.025	196.7	0.0506
258.93	0.027	196.9	0.0524
258.95	0.027	197.1	0.0541
258.97	0.028	197.3	0.055
258.98	0.028	197.4	0.0559
259.00	0.028	197.6	0.0568
259.02	0.029	197.7	0.0568



Prova triassiale ciclica SN04-C1			
pressione di confinamento (kPa)		80	
deviatore ciclico (kPa)		95	
frequenza (hz)		0.00625	
tempo	cella di carico	$\Delta u$	LVDT
(min)	kN	(kPa)	$\delta$ (mm)
259.03	0.029	197.8	0.0568
259.05	0.029	197.9	0.0577
259.07	0.029	197.9	0.0577
259.08	0.029	198	0.0577
259.10	0.028	198	0.0568
259.12	0.027	198.1	0.055
259.13	0.026	198.1	0.0541
259.15	0.024	198	0.0541
259.17	0.023	198	0.0524
259.18	0.023	198	0.0506
259.20	0.022	198	0.0488
259.23	0.02	197.9	0.0462
259.25	0.018	197.8	0.0435
259.27	0.017	197.7	0.0408
259.28	0.015	197.5	0.0408
259.28	0.013	197.4	0.0373
259.30	0.013	197.4	0.0346
259.32	0.011	197.2	0.0302
259.33	0.009	196.9	0.0257
259.35	0.006	196.7	0.0231
259.37	0.005	196.6	0.0186
259.38	0.003	196.3	0.0151
259.40	0	196	0.0151
259.42	0	196	0.0107
259.43	-0.001	195.9	0.0071
259.45	-0.003	195.5	0.0036
259.47	-0.006	195.2	-0.0009
259.48	-0.007	195	-0.0036
259.50	-0.008	194.7	-0.0071
259.52	-0.011	194.4	-0.0071
259.53	-0.012	194.4	-0.0107
259.55	-0.012	194.2	-0.0124
259.57	-0.012	194	-0.0151
259.58	-0.015	193.7	-0.0178
259.60	-0.015	193.6	-0.0186
259.62	-0.016	193.3	-0.0213
259.63	-0.017	193.2	-0.0213
259.65	-0.017	193.2	-0.0222
259.67	-0.017	193	-0.0231
259.68	-0.017	192.8	-0.0231
259.70	-0.017	192.8	-0.024
259.72	-0.017	192.7	-0.024
259.73	-0.017	192.6	-0.024
259.75	-0.017	192.5	-0.0231
259.77	-0.016	192.5	-0.0222
259.78	-0.015	192.4	-0.0213
259.80	-0.014	192.5	-0.0213
259.82	-0.013	192.5	-0.0204
259.83	-0.013	192.5	-0.0186
259.85	-0.012	192.5	-0.0169
259.87	-0.01	192.6	-0.0142
259.88	-0.009	192.7	-0.0124
259.90	-0.007	192.8	-0.0089
259.92	-0.004	193	-0.0089
259.93	-0.003	193	-0.0053
259.95	-0.003	193.1	-0.0036
259.97	-0.002	193.3	0
259.98	0.002	193.5	0.0036

Prova triassiale ciclica SN04-C1			
pressione di confinamento (kPa)		80	
deviatore ciclico (kPa)		95	
frequenza (hz)		0.00625	
tempo	cella di carico	$\Delta u$	LVDT
(min)	kN	(kPa)	$\delta$ (mm)
260.00	0.003	193.6	0.0071
260.02	0.005	193.9	0.0115
260.03	0.009	194.1	0.0115
260.05	0.009	194.1	0.016
260.07	0.009	194.3	0.0178
260.08	0.011	194.5	0.0222
260.10	0.014	194.8	0.0275
260.12	0.015	195	0.0311
260.13	0.017	195.3	0.0346
260.15	0.02	195.7	0.0346
260.17	0.021	195.7	0.0391
260.18	0.021	195.9	0.0408
260.20	0.022	196.1	0.0444
260.22	0.024	196.3	0.047
260.23	0.025	196.6	0.0488
260.25	0.026	196.8	0.0515
260.27	0.027	197	0.0515
260.28	0.027	197.1	0.0533
260.30	0.027	197.1	0.0541
260.32	0.028	197.3	0.0559
260.33	0.029	197.5	0.0568
260.35	0.029	197.6	0.0568
260.37	0.029	197.7	0.0568
260.38	0.029	197.8	0.0568
260.40	0.029	197.9	0.0568
260.42	0.028	198	0.0568
260.43	0.027	198	0.0568
260.45	0.026	198	0.0559
260.47	0.026	198	0.055
260.48	0.026	198.1	0.0533
260.50	0.024	198	0.0515
260.52	0.022	198	0.0497
260.53	0.022	197.9	0.0479
260.55	0.02	197.8	0.0453
260.57	0.017	197.7	0.0453
260.58	0.017	197.7	0.0426
260.60	0.016	197.6	0.0391
260.62	0.014	197.4	0.0355
260.63	0.011	197.2	0.0328
260.67	0.01	197.1	0.0284
260.68	0.008	196.8	0.0249
260.70	0.005	196.6	0.0249
260.72	0.005	196.6	0.0213
260.73	0.005	196.5	0.0178
260.73	0.002	196.1	0.0133
260.75	-0.001	195.9	0.0089
260.77	-0.002	195.7	0.0044
260.78	-0.004	195.4	0.0018
260.80	-0.007	195.1	0.0018
260.82	-0.008	195.1	-0.0018
260.83	-0.008	194.9	-0.0053
260.85	-0.009	194.6	-0.008
260.87	-0.011	194.3	-0.0115
260.88	-0.012	194.1	-0.0142
260.90	-0.013	193.9	-0.016
260.92	-0.015	193.6	-0.016
260.93	-0.015	193.6	-0.0186
260.95	-0.015	193.5	-0.0195

Prova triassiale ciclica SN04-C1			
pressione di confinamento (kPa)		80	
deviatore ciclico (kPa)		95	
frequenza (hz)		0.00625	
tempo	cella di carico	$\Delta u$	LVDT
(min)	kN	(kPa)	$\delta$ (mm)
260.97	-0.016	193.3	-0.0213
260.98	-0.017	193.1	-0.0222
261.00	-0.017	192.9	-0.0231
261.02	-0.017	192.8	-0.0231
261.03	-0.017	192.7	-0.0231
261.05	-0.017	192.7	-0.0231
261.07	-0.017	192.6	-0.0231
261.08	-0.017	192.6	-0.0231
261.10	-0.016	192.5	-0.0222
261.12	-0.015	192.5	-0.0213
261.13	-0.014	192.5	-0.0204
261.15	-0.014	192.5	-0.0195
261.17	-0.013	192.5	-0.0186
261.18	-0.012	192.5	-0.016
261.20	-0.009	192.7	-0.016
261.22	-0.008	192.7	-0.0133
261.23	-0.008	192.7	-0.0115
261.25	-0.007	192.9	-0.008
261.27	-0.003	193	-0.0044
261.28	-0.003	193.1	-0.0018
261.30	-0.001	193.3	0.0018
261.32	0.003	193.6	0.0018
261.33	0.004	193.6	0.0062
261.35	0.004	193.7	0.0089
261.37	0.006	193.9	0.0133
261.38	0.009	194.2	0.0178
261.40	0.01	194.4	0.0204
261.42	0.012	194.6	0.0249
261.43	0.015	194.9	0.0249
261.45	0.016	195.2	0.0293
261.47	0.016	195.2	0.0328
261.48	0.017	195.4	0.0364
261.50	0.02	195.7	0.0399
261.52	0.021	195.9	0.0426
261.53	0.022	196.2	0.0453
261.55	0.024	196.4	0.0453
261.57	0.025	196.6	0.0479
261.58	0.025	196.6	0.0497
261.60	0.026	196.8	0.0524
261.62	0.027	197	0.0541
261.63	0.028	197.2	0.055
261.65	0.028	197.4	0.0568
261.67	0.028	197.5	0.0568
261.68	0.029	197.6	0.0568
261.70	0.029	197.6	0.0568
261.72	0.029	197.7	0.0568
261.73	0.029	197.8	0.0568
261.75	0.028	197.9	0.0568
261.77	0.028	198	0.0568
261.78	0.027	198	0.055
261.80	0.026	198	0.055
261.82	0.026	198	0.0541
261.83	0.025	198	0.0515
261.85	0.023	197.9	0.0497
261.87	0.021	197.9	0.0479
261.88	0.021	197.8	0.047
261.90	0.019	197.7	0.0435
261.92	0.016	197.6	0.0408

Prova triassiale ciclica SN04-C1			
pressione di confinamento (kPa)		80	
deviatore ciclico (kPa)		95	
frequenza (hz)		0.00625	
tempo	cella di carico	$\Delta u$	LVDT
(min)	kN	(kPa)	$\delta$ (mm)
261.93	0.016	197.5	0.0382
261.95	0.014	197.3	0.0355
261.97	0.01	197.1	0.0355
261.98	0.01	197.1	0.0311
262.00	0.01	197	0.0284
262.02	0.008	196.7	0.024
262.03	0.004	196.5	0.0195
262.05	0.003	196.3	0.0169
262.07	0.002	196.1	0.0124
262.08	-0.002	195.8	0.0124
262.10	-0.003	195.8	0.008
262.13	-0.003	195.6	0.0044
262.15	-0.005	195.2	0.0009
262.17	-0.007	194.9	-0.0027
262.18	-0.008	194.7	-0.0062
262.18	-0.01	194.5	-0.0098
262.20	-0.012	194.2	-0.0098
262.22	-0.013	194.2	-0.0124
262.23	-0.013	194	-0.0142
262.25	-0.013	193.8	-0.016
262.27	-0.015	193.6	-0.0186
262.28	-0.016	193.4	-0.0204
262.30	-0.016	193.2	-0.0213
262.32	-0.017	193	-0.0213
262.33	-0.017	193	-0.0222
262.35	-0.017	192.9	-0.0231
262.37	-0.017	192.8	-0.0231
262.38	-0.017	192.7	-0.0231
262.40	-0.017	192.6	-0.0231
262.42	-0.016	192.5	-0.0231
262.43	-0.016	192.5	-0.0231
262.45	-0.015	192.5	-0.0222
262.47	-0.015	192.5	-0.0213
262.48	-0.014	192.5	-0.0195
262.50	-0.012	192.5	-0.0178
262.52	-0.011	192.6	-0.016
262.53	-0.01	192.6	-0.0142
262.55	-0.007	192.7	-0.0142
262.57	-0.007	192.8	-0.0107
262.58	-0.007	192.8	-0.0089
262.60	-0.003	193.1	-0.0053
262.62	-0.001	193.2	-0.0036
262.63	-0.001	193.2	-0.0009
262.65	0	193.4	0.0036
262.67	0.003	193.7	0.0071
262.68	0.005	193.8	0.0107
262.70	0.006	194	0.0142
262.72	0.009	194.3	0.0142
262.73	0.012	194.5	0.0186
262.75	0.012	194.5	0.0222
262.77	0.012	194.7	0.0257
262.78	0.015	195	0.0311
262.80	0.017	195.3	0.0337
262.82	0.018	195.5	0.0382
262.83	0.02	195.8	0.0382
262.85	0.022	196.1	0.0417
262.87	0.022	196.1	0.0444
262.88	0.023	196.3	0.0462

Prova triassiale ciclica SN04-C1			
pressione di confinamento (kPa)		80	
deviatore ciclico (kPa)		95	
frequenza (hz)		0.00625	
tempo	cella di carico	$\Delta u$	LVDT
(min)	kN	(kPa)	$\delta$ (mm)
262.90	0.024	196.5	0.0488
262.92	0.026	196.7	0.0515
262.93	0.026	196.9	0.0524
262.95	0.027	197.1	0.0541
262.97	0.028	197.3	0.0541
262.98	0.028	197.3	0.0559
263.00	0.028	197.4	0.0568
263.02	0.029	197.6	0.0568
263.03	0.029	197.7	0.0568
263.05	0.029	197.8	0.0577
263.07	0.029	197.9	0.0577
263.08	0.028	198	0.0577
263.10	0.027	198	0.0568
263.12	0.027	198	0.0559
263.13	0.026	198	0.0541
263.15	0.025	198	0.0524
263.17	0.024	198	0.0515
263.18	0.023	197.9	0.0497
263.20	0.02	197.8	0.0497
263.22	0.02	197.8	0.047
263.23	0.02	197.8	0.0444
263.25	0.018	197.6	0.0417
263.27	0.015	197.5	0.0382
263.28	0.014	197.4	0.0355
263.30	0.013	197.1	0.032
263.32	0.009	197	0.0284
263.33	0.008	196.8	0.0257
263.35	0.007	196.6	0.0222
263.37	0.003	196.4	0.0222
263.38	0.002	196.4	0.0178
263.40	0.002	196.2	0.0142
263.42	0.001	196	0.0107
263.43	-0.003	195.7	0.0062
263.45	-0.004	195.4	0.0036
263.47	-0.005	195.1	-0.0009
263.48	-0.009	194.8	-0.0009
263.50	-0.009	194.8	-0.0053
263.52	-0.009	194.6	-0.0071
263.53	-0.01	194.4	-0.0107
263.55	-0.013	194.1	-0.0133
263.58	-0.013	193.9	-0.0151
263.60	-0.014	193.7	-0.0178
263.62	-0.016	193.4	-0.0178
263.63	-0.016	193.3	-0.0195
263.63	-0.016	193.3	-0.0213
263.65	-0.016	193.1	-0.0213
263.67	-0.017	192.9	-0.0231
263.68	-0.017	192.8	-0.0231
263.70	-0.017	192.7	-0.0231
263.72	-0.017	192.6	-0.0231
263.73	-0.017	192.5	-0.0231
263.75	-0.017	192.5	-0.0231
263.77	-0.016	192.5	-0.0222
263.78	-0.016	192.5	-0.0213
263.80	-0.015	192.5	-0.0204
263.82	-0.014	192.5	-0.0195
263.83	-0.012	192.5	-0.0169
263.85	-0.01	192.6	-0.0169

Prova triassiale ciclica SN04-C1			
pressione di confinamento (kPa)		80	
deviatore ciclico (kPa)		95	
frequenza (hz)		0.00625	
tempo	cella di carico	$\Delta u$	LVDT
(min)	kN	(kPa)	$\delta$ (mm)
263.87	-0.009	192.6	-0.0151
263.88	-0.009	192.6	-0.0133
263.90	-0.008	192.8	-0.0107
263.92	-0.005	192.9	-0.0071
263.93	-0.004	193	-0.0044
263.95	-0.003	193.2	-0.0018
263.97	0.001	193.4	-0.0018
263.98	0.002	193.4	0.0027
264.00	0.002	193.5	0.0053
264.02	0.004	193.8	0.0098
264.03	0.007	194	0.0142
264.05	0.008	194.2	0.0169
264.07	0.009	194.4	0.0195
264.08	0.013	194.6	0.024
264.10	0.013	194.8	0.0275
264.12	0.015	195.1	0.032
264.13	0.018	195.4	0.032
264.15	0.019	195.4	0.0364
264.17	0.019	195.6	0.0382
264.18	0.02	195.9	0.0417
264.20	0.023	196.1	0.0462
264.22	0.024	196.4	0.0479
264.23	0.024	196.6	0.0497
264.25	0.026	196.8	0.0497
264.27	0.027	196.8	0.0515
264.28	0.027	197	0.0533
264.30	0.028	197.2	0.055
264.32	0.028	197.3	0.0559
264.33	0.029	197.5	0.0568
264.35	0.029	197.6	0.0568
264.37	0.029	197.7	0.0568
264.38	0.028	197.8	0.0568
264.40	0.028	197.8	0.0568
264.42	0.028	197.9	0.0568
264.43	0.028	198	0.0568
264.45	0.027	198	0.0559
264.47	0.026	198	0.0541
264.48	0.024	198	0.0541
264.50	0.022	197.9	0.0524
264.52	0.022	197.9	0.0497
264.53	0.022	197.9	0.0479
264.55	0.02	197.8	0.0462
264.57	0.018	197.7	0.0435
264.58	0.017	197.6	0.0408
264.60	0.015	197.4	0.0408
264.62	0.013	197.3	0.0373
264.63	0.013	197.3	0.0346
264.65	0.012	197.1	0.0311
264.67	0.008	196.9	0.0257
264.68	0.006	196.7	0.0231
264.70	0.005	196.5	0.0186
264.72	0.002	196.2	0.0186
264.73	0	196	0.0151
264.75	0	196	0.0115
264.77	-0.003	195.5	0.008
264.78	-0.005	195.3	0.0053
264.80	-0.005	195.3	0.0027
264.82	-0.006	195	-0.0018

Prova triassiale ciclica SN04-C1			
pressione di confinamento (kPa)		80	
deviatore ciclico (kPa)		95	
frequenza (hz)		0.00625	
tempo	cella di carico	$\Delta u$	LVDT
(min)	kN	(kPa)	$\delta$ (mm)
264.83	-0.008	194.7	-0.0062
264.85	-0.01	194.5	-0.0098
264.87	-0.011	194.3	-0.0124
264.88	-0.013	194	-0.0124
264.90	-0.014	193.8	-0.0142
264.92	-0.014	193.8	-0.016
264.93	-0.014	193.6	-0.0178
264.95	-0.016	193.3	-0.0204
264.97	-0.017	193.2	-0.0213
264.98	-0.017	193	-0.0222
265.00	-0.017	192.9	-0.0231
265.03	-0.017	192.7	-0.0231
265.05	-0.017	192.7	-0.0231
265.07	-0.017	192.6	-0.024
265.08	-0.017	192.5	-0.0231
265.08	-0.016	192.5	-0.0231
265.10	-0.016	192.4	-0.0222
265.12	-0.015	192.4	-0.0213
265.13	-0.014	192.4	-0.0213
265.15	-0.013	192.4	-0.0204
265.17	-0.013	192.4	-0.0186
265.18	-0.012	192.5	-0.016
265.20	-0.01	192.6	-0.0142
265.22	-0.009	192.6	-0.0124
265.23	-0.007	192.8	-0.0098
265.25	-0.004	192.9	-0.0098
265.27	-0.003	192.9	-0.0062
265.28	-0.003	193	-0.0036
265.30	-0.002	193.2	0
265.32	0.002	193.4	0.0044
265.33	0.003	193.6	0.0071
265.35	0.004	193.9	0.0115
265.37	0.009	194.1	0.0115
265.38	0.009	194.1	0.016
265.40	0.009	194.3	0.0186
265.42	0.011	194.6	0.0231
265.43	0.014	194.8	0.0284
265.45	0.015	195	0.0311
265.47	0.016	195.3	0.0346
265.48	0.02	195.6	0.0346
265.50	0.021	195.8	0.0408
265.52	0.021	196	0.0435
265.53	0.023	196.3	0.0435
265.55	0.024	196.3	0.0462
265.57	0.024	196.5	0.0479
265.58	0.025	196.7	0.0506
265.60	0.027	196.9	0.0524
265.62	0.027	197.1	0.0541
265.63	0.028	197.2	0.0559
265.65	0.028	197.4	0.0559
265.67	0.029	197.5	0.0568
265.68	0.029	197.5	0.0577
265.70	0.029	197.7	0.0577
265.72	0.029	197.8	0.0577
265.73	0.029	197.9	0.0577
265.75	0.028	197.9	0.0568
265.77	0.027	198	0.0559
265.78	0.026	198	0.0559

Prova triassiale ciclica SN04-C1			
pressione di confinamento (kPa)		80	
deviatore ciclico (kPa)		95	
frequenza (hz)		0.00625	
tempo	cella di carico	$\Delta u$	LVDT
(min)	kN	(kPa)	$\delta$ (mm)
265.80	0.026	198	0.055
265.82	0.026	198	0.0533
265.83	0.024	198	0.0515
265.85	0.022	197.9	0.0497
265.87	0.022	197.9	0.0479
265.88	0.02	197.8	0.0453
265.90	0.017	197.6	0.0453
265.92	0.016	197.6	0.0426
265.93	0.016	197.6	0.0399
265.95	0.015	197.4	0.0373
265.97	0.011	197.2	0.0328
265.98	0.011	197.1	0.0302
266.00	0.009	196.8	0.0257
266.02	0.005	196.6	0.0257
266.03	0.004	196.6	0.0213
266.05	0.004	196.4	0.0186
266.07	0.002	196.1	0.0142
266.08	-0.001	195.9	0.0098
266.10	-0.002	195.7	0.0062
266.12	-0.004	195.3	0.0027
266.13	-0.007	195.1	0.0027
266.15	-0.007	195.1	-0.0018
266.17	-0.007	194.9	-0.0044
266.18	-0.009	194.6	-0.008
266.20	-0.011	194.3	-0.0107
266.22	-0.012	194.1	-0.0133
266.23	-0.013	193.9	-0.0142
266.25	-0.015	193.7	-0.0169
266.27	-0.015	193.5	-0.0186
266.28	-0.016	193.3	-0.0195
266.30	-0.016	193.1	-0.0195
266.32	-0.017	193.1	-0.0213
266.33	-0.017	192.9	-0.0222
266.35	-0.017	192.8	-0.0231
266.37	-0.017	192.7	-0.0231
266.38	-0.017	192.6	-0.0231
266.40	-0.017	192.5	-0.0231
266.42	-0.016	192.5	-0.0231
266.43	-0.016	192.5	-0.0222
266.45	-0.016	192.4	-0.0222
266.47	-0.015	192.4	-0.0204
266.50	-0.013	192.4	-0.0186
266.52	-0.013	192.4	-0.0178
266.53	-0.011	192.5	-0.0151
266.55	-0.009	192.6	-0.0151
266.55	-0.008	192.6	-0.0124
266.57	-0.008	192.7	-0.0107
266.58	-0.006	192.8	-0.0071
266.60	-0.004	193	-0.0044
266.62	-0.002	193.1	-0.0018
266.63	-0.001	193.3	0.0018
266.65	0.002	193.5	0.0018
266.67	0.004	193.5	0.0062
266.68	0.004	193.7	0.0089
266.70	0.005	193.9	0.0124
266.72	0.007	194.1	0.0151
266.73	0.008	194.2	0.0178
266.75	0.01	194.5	0.0213



Prova triassiale ciclica SN04-C1			
pressione di confinamento (kPa)		80	
deviatore ciclico (kPa)		95	
frequenza (hz)		0.00625	
tempo	cella di carico	$\Delta u$	LVDT
(min)	kN	(kPa)	$\delta$ (mm)
266.77	0.014	194.8	0.0213
266.78	0.015	194.8	0.0257
266.80	0.015	195	0.0302
266.82	0.016	195.2	0.0337
266.83	0.019	195.5	0.0373
266.85	0.02	195.7	0.0399
266.87	0.021	196	0.0435
266.88	0.023	196.2	0.0435
266.90	0.024	196.5	0.0462
266.92	0.024	196.5	0.0488
266.93	0.025	196.6	0.0506
266.95	0.027	197	0.0533
266.97	0.027	197	0.0541
266.98	0.028	197.2	0.055
267.00	0.028	197.4	0.0568
267.02	0.029	197.5	0.0568
267.03	0.029	197.6	0.0577
267.05	0.029	197.7	0.0577
267.07	0.029	197.9	0.0577
267.08	0.029	197.9	0.0577
267.10	0.028	197.9	0.0577
267.12	0.027	198	0.0568
267.13	0.027	198	0.0559
267.15	0.026	198	0.0541
267.17	0.025	198	0.0533
267.18	0.023	198	0.0533
267.20	0.022	198	0.0515
267.22	0.022	197.9	0.0497
267.23	0.021	197.8	0.047
267.25	0.018	197.7	0.0444
267.27	0.017	197.6	0.0417
267.28	0.015	197.4	0.0382
267.30	0.012	197.3	0.0382
267.32	0.011	197.3	0.0346
267.33	0.011	197.1	0.032
267.35	0.01	196.9	0.0284
267.37	0.006	196.7	0.0231
267.38	0.005	196.5	0.0195
267.40	0.003	196.2	0.016
267.42	0	196	0.016
267.43	-0.001	196	0.0107
267.45	-0.001	195.8	0.0071
267.47	-0.003	195.4	0.0036
267.48	-0.006	195.2	0
267.50	-0.006	194.9	-0.0027
267.52	-0.008	194.6	-0.0071
267.53	-0.011	194.4	-0.0071
267.55	-0.012	194.4	-0.0107
267.57	-0.012	194.2	-0.0124
267.58	-0.013	193.9	-0.0151
267.60	-0.015	193.7	-0.0178
267.62	-0.015	193.5	-0.0186
267.63	-0.016	193.3	-0.0204
267.65	-0.017	193.1	-0.0204
267.67	-0.017	193.1	-0.0222
267.68	-0.017	192.8	-0.0231
267.70	-0.017	192.7	-0.0231
267.72	-0.017	192.7	-0.0231

Prova triassiale ciclica SN04-C1			
pressione di confinamento (kPa)		80	
deviatore ciclico (kPa)		95	
frequenza (hz)		0.00625	
tempo	cella di carico	$\Delta u$	LVDT
(min)	kN	(kPa)	$\delta$ (mm)
267.73	-0.017	192.6	-0.0231
267.75	-0.017	192.5	-0.0231
267.77	-0.016	192.4	-0.0231
267.78	-0.016	192.4	-0.0222
267.80	-0.015	192.3	-0.0213
267.82	-0.014	192.4	-0.0213
267.83	-0.013	192.4	-0.0204
267.85	-0.013	192.4	-0.0186
267.87	-0.012	192.5	-0.0169
267.88	-0.01	192.5	-0.0142
267.90	-0.009	192.6	-0.0115
267.93	-0.007	192.7	-0.0089
267.95	-0.004	192.9	-0.0089
267.97	-0.003	192.9	-0.0062
267.98	-0.003	193	-0.0036
268.00	-0.002	193.2	0
268.00	0.002	193.4	0.0044
268.02	0.003	193.6	0.0071
268.03	0.005	193.7	0.0115
268.05	0.008	194	0.0115
268.07	0.009	194.2	0.0151
268.08	0.009	194.2	0.0186
268.10	0.011	194.5	0.0222
268.12	0.014	194.8	0.0284
268.13	0.015	195	0.0311
268.15	0.017	195.2	0.0346
268.17	0.02	195.6	0.0346
268.18	0.021	195.8	0.0391
268.20	0.021	195.8	0.0417
268.22	0.022	196	0.0444
268.23	0.024	196.3	0.047
268.25	0.025	196.5	0.0488
268.27	0.026	196.7	0.0515
268.28	0.027	196.9	0.0515
268.30	0.028	197.1	0.0533
268.32	0.028	197.1	0.055
268.33	0.028	197.2	0.0559
268.35	0.029	197.4	0.0559
268.37	0.028	197.5	0.0568
268.38	0.029	197.6	0.0568
268.40	0.029	197.7	0.0577
268.42	0.029	197.8	0.0577
268.43	0.028	197.9	0.0568
268.45	0.028	198	0.0559
268.47	0.026	198	0.0559
268.48	0.026	198	0.055
268.50	0.026	198	0.0533
268.52	0.024	197.9	0.0515
268.53	0.022	197.9	0.0497
268.55	0.022	197.8	0.0479
268.57	0.02	197.7	0.0453
268.58	0.017	197.6	0.0453
268.60	0.016	197.6	0.0417
268.62	0.016	197.5	0.0399
268.63	0.015	197.4	0.0364
268.65	0.011	197.2	0.0328
268.67	0.011	197.1	0.0302
268.68	0.009	196.8	0.0249

Prova triassiale ciclica SN04-C1			
pressione di confinamento (kPa)		80	
deviatore ciclico (kPa)		95	
frequenza (hz)		0.00625	
tempo	cella di carico	$\Delta u$	LVDT
(min)	kN	(kPa)	$\delta$ (mm)
268.70	0.005	196.6	0.0249
268.72	0.004	196.4	0.0204
268.73	0.004	196.4	0.0186
268.75	0.003	196.2	0.0142
268.77	0	195.9	0.0098
268.78	-0.002	195.6	0.0062
268.80	-0.004	195.4	0.0018
268.82	-0.006	195	0.0018
268.83	-0.008	194.8	-0.0018
268.85	-0.008	194.8	-0.0053
268.87	-0.009	194.6	-0.008
268.88	-0.011	194.3	-0.0107
268.90	-0.013	194	-0.0133
268.92	-0.013	193.8	-0.0151
268.93	-0.014	193.6	-0.0151
268.95	-0.016	193.4	-0.0178
268.97	-0.016	193.4	-0.0204
268.98	-0.016	193.2	-0.0204
269.00	-0.017	193	-0.0222
269.02	-0.017	192.9	-0.0231
269.03	-0.017	192.7	-0.0231
269.05	-0.017	192.6	-0.0231
269.07	-0.017	192.5	-0.0231
269.08	-0.017	192.5	-0.024
269.10	-0.017	192.5	-0.0231
269.12	-0.016	192.4	-0.0222
269.13	-0.015	192.4	-0.0213
269.15	-0.015	192.3	-0.0204
269.17	-0.014	192.4	-0.0195
269.18	-0.012	192.4	-0.0178
269.20	-0.011	192.4	-0.016
269.22	-0.01	192.5	-0.0142
269.23	-0.008	192.6	-0.0142
269.25	-0.006	192.6	-0.0115
269.27	-0.006	192.7	-0.0089
269.28	-0.005	192.9	-0.0053
269.30	-0.002	193.1	-0.0018
269.32	-0.001	193.2	0.0009
269.33	0.001	193.4	0.0044
269.35	0.004	193.6	0.0044
269.37	0.006	193.6	0.0089
269.40	0.006	193.8	0.0124
269.42	0.007	194	0.016
269.43	0.011	194.3	0.0204
269.45	0.012	194.5	0.024
269.45	0.013	194.8	0.0293
269.47	0.017	195.1	0.0293
269.48	0.017	195.1	0.0328
269.50	0.017	195.3	0.0355
269.52	0.019	195.6	0.0399
269.53	0.022	195.9	0.0426
269.55	0.023	196.1	0.0453
269.57	0.024	196.3	0.0479
269.58	0.025	196.5	0.0479
269.60	0.026	196.7	0.0506
269.62	0.026	196.7	0.0524
269.63	0.027	196.9	0.0541
269.65	0.028	197.1	0.0559

Prova triassiale ciclica SN04-C1			
pressione di confinamento (kPa)		80	
deviatore ciclico (kPa)		95	
frequenza (hz)		0.00625	
tempo	cella di carico	$\Delta u$	LVDT
(min)	kN	(kPa)	$\delta$ (mm)
269.67	0.028	197.3	0.0559
269.68	0.028	197.4	0.0568
269.70	0.028	197.5	0.0568
269.72	0.029	197.7	0.0568
269.73	0.029	197.7	0.0577
269.75	0.029	197.7	0.0577
269.77	0.029	197.8	0.0577
269.78	0.028	197.9	0.0568
269.80	0.027	197.9	0.055
269.82	0.026	197.9	0.0533
269.83	0.024	197.9	0.0533
269.85	0.023	197.9	0.0506
269.87	0.023	197.9	0.0497
269.88	0.021	197.8	0.0497
269.90	0.02	197.8	0.0479
269.92	0.02	197.7	0.0453
269.93	0.018	197.5	0.0417
269.95	0.015	197.4	0.0382
269.97	0.014	197.3	0.0355
269.98	0.012	197.1	0.032
270.00	0.009	196.9	0.032
270.02	0.008	196.9	0.0284
270.03	0.008	196.7	0.024
270.05	0.006	196.5	0.0204
270.07	0.003	196.3	0.0169
270.08	0.001	196.1	0.0133
270.10	0	195.7	0.0089
270.12	-0.003	195.5	0.0089
270.13	-0.005	195.5	0.0053
270.15	-0.005	195.2	0.0018
270.17	-0.006	194.9	-0.0027
270.18	-0.009	194.7	-0.0071
270.20	-0.01	194.5	-0.0089
270.22	-0.011	194.2	-0.0107
270.23	-0.013	193.9	-0.0107
270.25	-0.013	193.9	-0.0133
270.27	-0.013	193.8	-0.016
270.28	-0.015	193.5	-0.0186
270.30	-0.016	193.3	-0.0204
270.32	-0.016	193.1	-0.0213
270.33	-0.017	193	-0.0222
270.35	-0.017	192.8	-0.0222
270.37	-0.017	192.8	-0.0231
270.38	-0.017	192.7	-0.0231
270.40	-0.017	192.6	-0.0231
270.42	-0.017	192.5	-0.0231
270.43	-0.017	192.4	-0.0231
270.45	-0.016	192.4	-0.0213
270.47	-0.015	192.4	-0.0213
270.48	-0.014	192.4	-0.0204
270.50	-0.014	192.4	-0.0195
270.52	-0.013	192.4	-0.0178
270.53	-0.011	192.5	-0.016
270.55	-0.01	192.5	-0.0142
270.57	-0.009	192.6	-0.0107
270.58	-0.006	192.8	-0.0089
270.60	-0.006	192.8	-0.0071
270.62	-0.004	193	-0.0036

Prova triassiale ciclica SN04-C1			
pressione di confinamento (kPa)		80	
deviatore ciclico (kPa)		95	
frequenza (hz)		0.00625	
tempo	cella di carico	$\Delta u$	LVDT
(min)	kN	(kPa)	$\delta$ (mm)
270.63	-0.001	193.2	-0.0036
270.65	0	193.2	0
270.67	0	193.3	0.0027
270.68	0.002	193.5	0.0062
270.70	0.005	193.8	0.0107
270.72	0.007	193.9	0.0142
270.73	0.008	194.2	0.0178
270.75	0.011	194.5	0.0178
270.77	0.013	194.5	0.0222
270.78	0.013	194.6	0.0257
270.80	0.014	194.9	0.0293
270.83	0.017	195.2	0.0346
270.85	0.019	195.4	0.0373
270.87	0.02	195.7	0.0408
270.88	0.022	195.9	0.0408
270.90	0.023	195.9	0.0444
270.90	0.023	196.2	0.0462
270.92	0.024	196.4	0.0479
270.93	0.025	196.6	0.0506
270.95	0.027	196.8	0.0533
270.97	0.028	197	0.055
270.98	0.028	197.2	0.055
271.00	0.028	197.2	0.0559
271.02	0.028	197.3	0.0568
271.03	0.028	197.5	0.0568
271.05	0.029	197.6	0.0577
271.07	0.029	197.7	0.0577
271.08	0.029	197.8	0.0577
271.10	0.028	197.9	0.0577
271.12	0.027	197.9	0.0568
271.13	0.027	197.9	0.0559
271.15	0.026	197.9	0.055
271.17	0.025	197.9	0.0533
271.18	0.024	197.9	0.0524
271.20	0.023	197.9	0.0497
271.22	0.021	197.7	0.0497
271.23	0.019	197.6	0.047
271.25	0.019	197.6	0.0444
271.27	0.018	197.6	0.0426
271.28	0.016	197.4	0.0391
271.30	0.013	197.3	0.0355
271.32	0.012	197.1	0.0337
271.33	0.011	197	0.0311
271.35	0.008	196.8	0.0275
271.37	0.007	196.6	0.0231
271.38	0.004	196.4	0.0186
271.40	0.002	196.1	0.0186
271.42	0.002	196.1	0.0151
271.43	0.001	196	0.0107
271.45	-0.002	195.6	0.0062
271.47	-0.004	195.3	0.0036
271.48	-0.005	195.1	0
271.50	-0.007	194.8	-0.0036
271.52	-0.01	194.5	-0.0036
271.53	-0.01	194.5	-0.0071
271.55	-0.01	194.3	-0.0098
271.57	-0.011	194	-0.0124
271.58	-0.013	193.8	-0.016

Prova triassiale ciclica SN04-C1			
pressione di confinamento (kPa)		80	
deviatore ciclico (kPa)		95	
frequenza (hz)		0.00625	
tempo	cella di carico	$\Delta u$	LVDT
(min)	kN	(kPa)	$\delta$ (mm)
271.60	-0.015	193.6	-0.0169
271.62	-0.015	193.4	-0.0186
271.63	-0.016	193.2	-0.0186
271.65	-0.017	193.2	-0.0204
271.67	-0.017	193	-0.0222
271.68	-0.017	192.9	-0.0222
271.70	-0.017	192.7	-0.0231
271.72	-0.017	192.6	-0.0231
271.73	-0.017	192.5	-0.0231
271.75	-0.017	192.5	-0.0231
271.77	-0.016	192.5	-0.0231
271.78	-0.016	192.4	-0.0222
271.80	-0.016	192.3	-0.0222
271.82	-0.014	192.4	-0.0204
271.83	-0.014	192.3	-0.0195
271.85	-0.013	192.4	-0.0169
271.87	-0.01	192.5	-0.0169
271.88	-0.009	192.5	-0.0151
271.90	-0.009	192.5	-0.0133
271.92	-0.008	192.7	-0.0107
271.93	-0.005	192.8	-0.0071
271.95	-0.004	192.9	-0.0044
271.97	-0.002	193.1	-0.0009
271.98	0.001	193.3	-0.0009
272.00	0.002	193.3	0.0027
272.02	0.002	193.4	0.0062
272.03	0.006	193.9	0.0098
272.05	0.007	193.9	0.0124
272.07	0.007	194	0.016
272.08	0.009	194.3	0.0204
272.10	0.012	194.6	0.024
272.12	0.014	194.8	0.0284
272.13	0.015	195	0.032
272.15	0.018	195.3	0.032
272.17	0.019	195.3	0.0364
272.18	0.019	195.5	0.0391
272.20	0.021	195.8	0.0417
272.22	0.022	196	0.0444
272.23	0.024	196.3	0.0479
272.25	0.025	196.5	0.0497
272.27	0.026	196.7	0.0497
272.30	0.027	196.7	0.0524
272.32	0.027	196.9	0.0533
272.33	0.027	197.1	0.0559
272.35	0.028	197.3	0.0568
272.35	0.029	197.4	0.0568
272.37	0.029	197.5	0.0577
272.38	0.029	197.7	0.0577
272.40	0.029	197.7	0.0577
272.42	0.029	197.7	0.0577
272.43	0.028	197.8	0.0568
272.45	0.027	197.9	0.0568
272.47	0.027	197.9	0.0559
272.48	0.026	197.9	0.0541
272.50	0.025	197.9	0.0541
272.52	0.023	197.9	0.0524
272.53	0.023	197.9	0.0515
272.55	0.022	197.8	0.0488

Prova triassiale ciclica SN04-C1			
pressione di confinamento (kPa)		80	
deviatore ciclico (kPa)		95	
frequenza (hz)		0.00625	
tempo	cella di carico	$\Delta u$	LVDT
(min)	kN	(kPa)	$\delta$ (mm)
272.57	0.02	197.7	0.0462
272.58	0.019	197.6	0.0444
272.60	0.017	197.5	0.0408
272.62	0.014	197.3	0.0408
272.63	0.013	197.2	0.0373
272.65	0.013	197.2	0.0346
272.67	0.011	197	0.0311
272.68	0.008	196.8	0.0257
272.70	0.007	196.6	0.0231
272.72	0.005	196.4	0.0195
272.73	0.002	196.1	0.0195
272.75	0	195.9	0.0151
272.77	-0.001	195.7	0.0098
272.78	-0.002	195.5	0.0098
272.80	-0.005	195.2	0.0062
272.82	-0.005	195.2	0.0018
272.83	-0.006	195	-0.0018
272.85	-0.008	194.6	-0.0053
272.87	-0.01	194.4	-0.0089
272.88	-0.011	194.2	-0.0115
272.90	-0.013	193.9	-0.0142
272.92	-0.014	193.7	-0.0142
272.93	-0.014	193.7	-0.0169
272.95	-0.015	193.5	-0.0178
272.97	-0.016	193.3	-0.0195
272.98	-0.016	193.1	-0.0213
273.00	-0.017	192.9	-0.0222
273.02	-0.017	192.8	-0.0222
273.03	-0.017	192.7	-0.0222
273.05	-0.017	192.7	-0.0231
273.07	-0.017	192.5	-0.0231
273.08	-0.017	192.4	-0.0231
273.10	-0.016	192.4	-0.0231
273.12	-0.016	192.4	-0.0222
273.13	-0.015	192.3	-0.0204
273.15	-0.014	192.3	-0.0204
273.17	-0.013	192.3	-0.0195
273.18	-0.013	192.3	-0.0178
273.20	-0.012	192.4	-0.016
273.22	-0.01	192.5	-0.0142
273.23	-0.009	192.6	-0.0115
273.25	-0.007	192.7	-0.0089
273.27	-0.004	192.8	-0.0089
273.28	-0.003	192.8	-0.0053
273.30	-0.003	193	-0.0027
273.32	-0.002	193.2	0
273.33	0.002	193.4	0.0044
273.35	0.003	193.5	0.008
273.37	0.004	193.8	0.0115
273.38	0.008	194	0.0115
273.40	0.009	194	0.016
273.42	0.009	194.2	0.0195
273.43	0.011	194.5	0.024
273.45	0.015	194.7	0.0284
273.47	0.015	194.9	0.0311
273.48	0.017	195.2	0.0355
273.50	0.019	195.5	0.0373
273.52	0.02	195.7	0.0399

Prova triassiale ciclica SN04-C1			
pressione di confinamento (kPa)		80	
deviatore ciclico (kPa)		95	
frequenza (hz)		0.00625	
tempo	cella di carico	$\Delta u$	LVDT
(min)	kN	(kPa)	$\delta$ (mm)
273.53	0.021	196	0.0435
273.55	0.023	196.2	0.0435
273.57	0.024	196.2	0.0462
273.58	0.024	196.4	0.0488
273.60	0.025	196.6	0.0506
273.62	0.027	196.8	0.0524
273.63	0.027	197	0.0541
273.65	0.028	197.1	0.0559
273.67	0.029	197.3	0.0559
273.68	0.029	197.3	0.0568
273.70	0.029	197.5	0.0568
273.72	0.029	197.6	0.0577
273.73	0.029	197.7	0.0577
273.77	0.029	197.8	0.0577
273.78	0.028	197.8	0.0568
273.80	0.027	197.9	0.0568
273.80	0.026	197.9	0.0559
273.82	0.026	197.9	0.0541
273.83	0.026	197.9	0.0541
273.85	0.024	197.9	0.0524
273.87	0.023	197.8	0.0497
273.88	0.021	197.8	0.0479
273.90	0.019	197.7	0.0479
273.92	0.017	197.6	0.0453
273.93	0.017	197.6	0.0417
273.95	0.016	197.5	0.0399
273.97	0.014	197.3	0.0364
273.98	0.012	197.1	0.0337
274.00	0.011	197	0.0293
274.02	0.007	196.7	0.0293
274.03	0.006	196.5	0.024
274.05	0.006	196.5	0.0213
274.07	0.004	196.3	0.0169
274.08	0.001	196	0.0124
274.10	-0.001	195.8	0.0098
274.12	-0.002	195.6	0.0062
274.13	-0.004	195.2	0.0062
274.15	-0.006	195	0.0027
274.17	-0.006	195	-0.0018
274.18	-0.007	194.7	-0.0044
274.20	-0.01	194.4	-0.0089
274.22	-0.011	194.2	-0.0115
274.23	-0.012	194	-0.0124
274.25	-0.013	193.8	-0.0151
274.27	-0.014	193.6	-0.0169
274.28	-0.015	193.4	-0.0195
274.30	-0.016	193.1	-0.0204
274.32	-0.017	193	-0.0204
274.33	-0.017	193	-0.0213
274.35	-0.017	192.8	-0.0222
274.37	-0.017	192.7	-0.0231
274.38	-0.018	192.6	-0.024
274.40	-0.017	192.5	-0.0231
274.42	-0.017	192.4	-0.0231
274.43	-0.016	192.3	-0.0231
274.45	-0.016	192.3	-0.0222
274.47	-0.016	192.3	-0.0213
274.48	-0.015	192.4	-0.0204



Prova triassiale ciclica SN04-C1			
pressione di confinamento (kPa)		80	
deviatore ciclico (kPa)		95	
frequenza (hz)		0.00625	
tempo	cella di carico	$\Delta u$	LVDT
(min)	kN	(kPa)	$\delta$ (mm)
274.50	-0.013	192.3	-0.0195
274.52	-0.012	192.3	-0.0178
274.53	-0.011	192.4	-0.016
274.55	-0.009	192.5	-0.016
274.57	-0.008	192.5	-0.0133
274.58	-0.008	192.6	-0.0107
274.60	-0.006	192.7	-0.008
274.62	-0.004	192.9	-0.0044
274.63	-0.002	193	-0.0009
274.65	-0.001	193.2	0.0027
274.67	0.002	193.4	0.0027
274.68	0.004	193.4	0.0053
274.70	0.004	193.6	0.0089
274.72	0.005	193.8	0.0133
274.73	0.009	194.1	0.0169
274.75	0.01	194.3	0.0213
274.77	0.012	194.6	0.0249
274.78	0.015	194.9	0.0249
274.80	0.016	194.9	0.0302
274.82	0.016	195	0.0328
274.83	0.017	195.3	0.0373
274.85	0.02	195.6	0.0408
274.87	0.022	195.9	0.0435
274.88	0.022	196.1	0.0462
274.90	0.024	196.3	0.0462
274.92	0.025	196.3	0.0479
274.93	0.026	196.7	0.0524
274.95	0.027	196.9	0.0524
274.97	0.027	196.9	0.0533
274.98	0.027	197.1	0.055
275.00	0.028	197.2	0.0559
275.02	0.029	197.4	0.0568
275.03	0.029	197.5	0.0577
275.05	0.029	197.6	0.0577
275.07	0.029	197.7	0.0577
275.08	0.028	197.7	0.0577
275.10	0.028	197.8	0.0568
275.12	0.028	197.9	0.0568
275.13	0.027	197.9	0.0559
275.15	0.026	197.9	0.055
275.17	0.026	197.9	0.0533
275.20	0.023	197.9	0.0533
275.22	0.023	197.9	0.0515
275.23	0.023	197.8	0.0497
275.25	0.021	197.8	0.047
275.27	0.019	197.6	0.0435
275.27	0.017	197.5	0.0408
275.28	0.015	197.4	0.0382
275.30	0.013	197.2	0.0382
275.32	0.011	197	0.0346
275.33	0.011	197	0.032
275.35	0.01	196.9	0.0284
275.37	0.006	196.6	0.024
275.38	0.005	196.4	0.0204
275.40	0.004	196.2	0.016
275.42	0.001	195.9	0.016
275.43	-0.002	195.7	0.0124
275.45	-0.002	195.7	0.0089

Prova triassiale ciclica SN04-C1			
pressione di confinamento (kPa)		80	
deviatore ciclico (kPa)		95	
frequenza (hz)		0.00625	
tempo	cella di carico	$\Delta u$	LVDT
(min)	kN	(kPa)	$\delta$ (mm)
275.47	-0.003	195.5	0.0044
275.48	-0.005	195.1	0
275.50	-0.007	194.8	-0.0036
275.52	-0.009	194.6	-0.0062
275.53	-0.01	194.3	-0.0098
275.55	-0.012	194.1	-0.0098
275.57	-0.012	194.1	-0.0124
275.58	-0.013	193.9	-0.0151
275.60	-0.014	193.6	-0.0178
275.62	-0.015	193.4	-0.0186
275.63	-0.016	193.2	-0.0204
275.65	-0.016	193	-0.0213
275.67	-0.017	192.9	-0.0222
275.68	-0.018	192.7	-0.0231
275.70	-0.017	192.6	-0.0231
275.72	-0.017	192.5	-0.0231
275.73	-0.017	192.5	-0.0231
275.75	-0.017	192.4	-0.0231
275.77	-0.017	192.4	-0.0231
275.78	-0.016	192.3	-0.0222
275.80	-0.015	192.3	-0.0204
275.82	-0.014	192.3	-0.0195
275.83	-0.013	192.3	-0.0195
275.85	-0.012	192.3	-0.0186
275.87	-0.012	192.4	-0.016
275.88	-0.011	192.4	-0.0142
275.90	-0.008	192.5	-0.0115
275.92	-0.007	192.6	-0.0089
275.93	-0.006	192.8	-0.0062
275.95	-0.002	192.9	-0.0062
275.97	-0.001	192.9	-0.0027
275.98	-0.001	193.1	0
276.00	0	193.3	0.0036
276.02	0.004	193.5	0.008
276.03	0.005	193.7	0.0107
276.05	0.006	193.9	0.016
276.07	0.01	194.2	0.016
276.08	0.011	194.2	0.0195
276.10	0.011	194.4	0.0231
276.12	0.012	194.6	0.0275
276.13	0.016	194.9	0.032
276.15	0.017	195.1	0.0346
276.17	0.018	195.4	0.0382
276.18	0.021	195.7	0.0382
276.20	0.022	195.7	0.0417
276.22	0.022	195.9	0.0444
276.23	0.023	196.1	0.047
276.25	0.025	196.4	0.0497
276.27	0.026	196.6	0.0515
276.28	0.026	196.8	0.0533
276.30	0.027	197	0.0533
276.32	0.028	197.2	0.055
276.33	0.028	197.2	0.0559
276.35	0.028	197.3	0.0568
276.37	0.029	197.4	0.0577
276.38	0.029	197.6	0.0577
276.40	0.029	197.7	0.0577
276.42	0.029	197.8	0.0577

Prova triassiale ciclica SN04-C1			
pressione di confinamento (kPa)		80	
deviatore ciclico (kPa)		95	
frequenza (hz)		0.00625	
tempo	cella di carico	$\Delta u$	LVDT
(min)	kN	(kPa)	$\delta$ (mm)
276.43	0.028	197.8	0.0577
276.45	0.028	197.9	0.0568
276.47	0.027	197.9	0.055
276.48	0.025	197.9	0.055
276.50	0.025	197.9	0.0541
276.52	0.025	197.9	0.0524
276.53	0.024	197.8	0.0506
276.55	0.021	197.8	0.0488
276.57	0.02	197.7	0.0462
276.58	0.019	197.6	0.0435
276.60	0.016	197.4	0.0435
276.62	0.014	197.4	0.0408
276.63	0.014	197.3	0.0373
276.67	0.013	197.1	0.0337
276.68	0.01	196.9	0.0302
276.70	0.009	196.8	0.0257
276.72	0.007	196.5	0.0222
276.72	0.003	196.3	0.0222
276.73	0.002	196.3	0.0178
276.75	0.002	196.1	0.0151
276.77	0.001	195.8	0.0107
276.78	-0.003	195.6	0.0062
276.80	-0.004	195.3	0.0036
276.82	-0.005	195	-0.0009
276.83	-0.009	194.7	-0.0009
276.85	-0.009	194.7	-0.0044
276.87	-0.009	194.5	-0.0071
276.88	-0.01	194.2	-0.0107
276.90	-0.013	194	-0.0133
276.92	-0.013	193.8	-0.0151
276.93	-0.014	193.6	-0.0178
276.95	-0.016	193.3	-0.0178
276.97	-0.016	193.3	-0.0195
276.98	-0.016	193.2	-0.0204
277.00	-0.016	193	-0.0213
277.02	-0.017	192.8	-0.0222
277.03	-0.017	192.7	-0.0231
277.05	-0.017	192.6	-0.0231
277.07	-0.017	192.5	-0.0231
277.08	-0.017	192.4	-0.0231
277.10	-0.017	192.4	-0.0231
277.12	-0.016	192.3	-0.0222
277.13	-0.015	192.3	-0.0213
277.15	-0.015	192.3	-0.0213
277.17	-0.014	192.3	-0.0186
277.18	-0.013	192.3	-0.0178
277.20	-0.011	192.4	-0.016
277.22	-0.01	192.4	-0.0133
277.23	-0.008	192.6	-0.0133
277.25	-0.006	192.7	-0.0107
277.27	-0.006	192.7	-0.008
277.28	-0.005	192.8	-0.0053
277.30	-0.002	193	-0.0018
277.32	0	193.2	0.0009
277.33	0.001	193.3	0.0044
277.35	0.004	193.6	0.0044
277.37	0.006	193.8	0.0089
277.38	0.006	193.8	0.0124

Prova triassiale ciclica SN04-C1			
pressione di confinamento (kPa)		80	
deviatore ciclico (kPa)		95	
frequenza (hz)		0.00625	
tempo	cella di carico	$\Delta u$	LVDT
(min)	kN	(kPa)	$\delta$ (mm)
277.40	0.007	194	0.0169
277.42	0.01	194.3	0.0204
277.43	0.012	194.5	0.024
277.45	0.014	194.7	0.0293
277.47	0.016	195	0.0293
277.48	0.018	195.2	0.0328
277.50	0.018	195.2	0.0364
277.52	0.019	195.5	0.0399
277.53	0.021	195.8	0.0426
277.55	0.023	196	0.0453
277.57	0.023	196.2	0.0479
277.58	0.025	196.5	0.0506
277.60	0.027	196.7	0.0506
277.62	0.027	196.7	0.0524
277.63	0.027	196.8	0.0541
277.65	0.028	197	0.0559
277.67	0.028	197.2	0.0568
277.68	0.029	197.4	0.0568
277.70	0.029	197.5	0.0577
277.72	0.029	197.6	0.0577
277.73	0.029	197.6	0.0577
277.75	0.029	197.7	0.0577
277.77	0.029	197.8	0.0577
277.78	0.028	197.9	0.0568
277.80	0.027	197.9	0.0559
277.82	0.026	197.9	0.0541
277.83	0.024	197.9	0.0541
277.85	0.023	197.8	0.0515
277.87	0.023	197.8	0.0497
277.88	0.02	197.7	0.0497
277.90	0.02	197.7	0.0479
277.92	0.02	197.7	0.0453
277.93	0.018	197.5	0.0417
277.95	0.015	197.4	0.0391
277.97	0.014	197.3	0.0364
277.98	0.012	197.1	0.0328
278.00	0.009	196.9	0.0328
278.02	0.008	196.9	0.0284
278.03	0.008	196.7	0.0249
278.05	0.006	196.5	0.0204
278.07	0.002	196.2	0.016
278.10	0.001	196	0.0133
278.12	0	195.8	0.0089
278.13	-0.004	195.4	0.0089
278.15	-0.004	195.4	0.0053
278.17	-0.004	195.2	0.0027
278.17	-0.006	194.9	-0.0018
278.18	-0.009	194.6	-0.0062
278.20	-0.01	194.4	-0.008
278.22	-0.011	194.1	-0.0115
278.23	-0.013	193.9	-0.0115
278.25	-0.014	193.9	-0.0142
278.27	-0.014	193.7	-0.016
278.28	-0.014	193.5	-0.0178
278.30	-0.016	193.2	-0.0204
278.32	-0.016	193.1	-0.0213
278.33	-0.017	192.9	-0.0222
278.35	-0.017	192.8	-0.0222

Prova triassiale ciclica SN04-C1			
pressione di confinamento (kPa)		80	
deviatore ciclico (kPa)		95	
frequenza (hz)		0.00625	
tempo	cella di carico	$\Delta u$	LVDT
(min)	kN	(kPa)	$\delta$ (mm)
278.37	-0.017	192.6	-0.0231
278.38	-0.017	192.6	-0.0231
278.40	-0.017	192.5	-0.0231
278.42	-0.017	192.4	-0.0231
278.43	-0.016	192.4	-0.0231
278.45	-0.016	192.3	-0.0222
278.47	-0.015	192.3	-0.0222
278.48	-0.014	192.3	-0.0213
278.50	-0.014	192.3	-0.0195
278.52	-0.013	192.3	-0.0178
278.53	-0.011	192.4	-0.016
278.55	-0.01	192.5	-0.0142
278.57	-0.009	192.5	-0.0115
278.58	-0.008	192.6	-0.0098
278.60	-0.005	192.7	-0.0071
278.62	-0.004	192.8	-0.0044
278.63	-0.002	193.1	-0.0009
278.65	0.001	193.2	-0.0009
278.67	0.002	193.2	0.0018
278.68	0.002	193.4	0.0062
278.70	0.004	193.6	0.0098
278.72	0.007	193.9	0.0142
278.73	0.008	194	0.0178
278.75	0.01	194.3	0.0213
278.77	0.013	194.6	0.0213
278.78	0.014	194.6	0.0275
278.80	0.014	194.8	0.0293
278.82	0.016	195.1	0.0337
278.83	0.019	195.4	0.0373
278.85	0.02	195.6	0.0399
278.87	0.021	195.8	0.0426
278.88	0.024	196.1	0.0426
278.90	0.024	196.1	0.047
278.92	0.024	196.3	0.0479
278.93	0.025	196.5	0.0506
278.95	0.027	196.8	0.0533
278.97	0.027	196.9	0.0541
278.98	0.028	197.1	0.0559
279.00	0.029	197.2	0.0559
279.02	0.029	197.2	0.0568
279.03	0.029	197.4	0.0568
279.05	0.029	197.5	0.0568
279.07	0.028	197.6	0.0568
279.08	0.028	197.7	0.0568
279.10	0.028	197.8	0.0568
279.12	0.027	197.8	0.0568
279.13	0.027	197.8	0.0559
279.15	0.027	197.9	0.0559
279.17	0.026	197.9	0.0533
279.18	0.024	197.8	0.0515
279.20	0.023	197.8	0.0497
279.22	0.022	197.7	0.047
279.23	0.019	197.6	0.047
279.25	0.018	197.6	0.0453
279.27	0.018	197.5	0.0426
279.28	0.016	197.4	0.0391
279.30	0.013	197.2	0.0355
279.32	0.013	197.1	0.0346

Prova triassiale ciclica SN04-C1			
pressione di confinamento (kPa)		80	
deviatore ciclico (kPa)		95	
frequenza (hz)		0.00625	
tempo	cella di carico	$\Delta u$	LVDT
(min)	kN	(kPa)	$\delta$ (mm)
279.33	0.011	196.9	0.0302
279.35	0.008	196.7	0.0257
279.37	0.007	196.6	0.0231
279.38	0.005	196.3	0.0186
279.40	0.002	196.1	0.0186
279.42	0	195.8	0.0151
279.43	0	195.8	0.0115
279.45	-0.001	195.6	0.0071
279.47	-0.004	195.3	0.0036
279.48	-0.006	195	0
279.50	-0.007	194.8	-0.0036
279.52	-0.009	194.5	-0.0036
279.53	-0.011	194.2	-0.0071
279.57	-0.011	194.2	-0.0098
279.58	-0.011	194	-0.0124
279.60	-0.013	193.7	-0.0151
279.62	-0.015	193.5	-0.0169
279.62	-0.015	193.4	-0.0178
279.63	-0.016	193.1	-0.0204
279.65	-0.016	193	-0.0204
279.67	-0.017	193	-0.0213
279.68	-0.017	192.8	-0.0222
279.70	-0.017	192.7	-0.0231
279.72	-0.017	192.6	-0.0231
279.73	-0.017	192.5	-0.0231
279.75	-0.017	192.4	-0.0231
279.77	-0.016	192.3	-0.0231
279.78	-0.015	192.3	-0.0222
279.80	-0.015	192.3	-0.0213
279.82	-0.015	192.2	-0.0204
279.83	-0.014	192.3	-0.0195
279.85	-0.012	192.3	-0.0178
279.87	-0.012	192.4	-0.016
279.88	-0.009	192.5	-0.016
279.90	-0.008	192.5	-0.0124
279.92	-0.008	192.5	-0.0107
279.93	-0.007	192.7	-0.008
279.95	-0.003	192.8	-0.0044
279.97	-0.003	192.9	-0.0018
279.98	-0.001	193.2	0.0018
280.00	0.003	193.4	0.0018
280.02	0.004	193.5	0.008
280.03	0.004	193.7	0.0115
280.05	0.008	193.9	0.0115
280.07	0.009	193.9	0.0151
280.08	0.009	194.1	0.0186
280.10	0.011	194.4	0.0231
280.12	0.014	194.7	0.0284
280.13	0.015	194.9	0.0311
280.15	0.016	195.1	0.0346
280.17	0.02	195.4	0.0346
280.18	0.02	195.4	0.0391
280.20	0.02	195.7	0.0417
280.22	0.022	195.9	0.0444
280.23	0.024	196.2	0.047
280.25	0.025	196.4	0.0488
280.27	0.026	196.6	0.0515
280.28	0.027	196.8	0.0515

Prova triassiale ciclica SN04-C1			
pressione di confinamento (kPa)		80	
deviatore ciclico (kPa)		95	
frequenza (hz)		0.00625	
tempo	cella di carico	$\Delta u$	LVDT
(min)	kN	(kPa)	$\delta$ (mm)
280.30	0.027	196.8	0.0533
280.32	0.027	197	0.055
280.33	0.028	197.1	0.0559
280.35	0.029	197.3	0.0568
280.37	0.029	197.4	0.0577
280.38	0.029	197.5	0.0577
280.40	0.029	197.7	0.0577
280.42	0.028	197.7	0.0577
280.43	0.028	197.7	0.0577
280.45	0.028	197.8	0.0568
280.47	0.027	197.8	0.0559
280.48	0.026	197.8	0.0541
280.50	0.025	197.9	0.0533
280.52	0.023	197.8	0.0533
280.53	0.022	197.7	0.0506
280.55	0.022	197.7	0.0497
280.57	0.021	197.7	0.047
280.58	0.019	197.5	0.0435
280.60	0.017	197.4	0.0417
280.62	0.016	197.3	0.0382
280.63	0.013	197.1	0.0382
280.65	0.011	197	0.0346
280.67	0.011	197	0.032
280.68	0.009	196.8	0.0275
280.70	0.006	196.5	0.0231
280.72	0.005	196.4	0.0204
280.73	0.003	196.2	0.016
280.75	0	195.8	0.0115
280.77	-0.001	195.7	0.0098
280.78	-0.002	195.4	0.0062
280.80	-0.004	195.1	0.0062
280.82	-0.007	194.8	0.0018
280.83	-0.007	194.8	-0.0018
280.85	-0.007	194.6	-0.0044
280.87	-0.009	194.3	-0.0089
280.88	-0.012	194.1	-0.0115
280.90	-0.012	193.9	-0.0133
280.92	-0.013	193.6	-0.016
280.93	-0.015	193.4	-0.016
280.95	-0.015	193.4	-0.0178
280.97	-0.015	193.2	-0.0186
281.00	-0.016	193	-0.0204
281.02	-0.017	192.9	-0.0222
281.03	-0.017	192.7	-0.0222
281.05	-0.017	192.6	-0.0231
281.07	-0.017	192.5	-0.0231
281.07	-0.017	192.5	-0.0231
281.08	-0.017	192.4	-0.0231
281.10	-0.017	192.3	-0.0231
281.12	-0.016	192.3	-0.0222
281.13	-0.015	192.2	-0.0213
281.15	-0.015	192.3	-0.0195
281.17	-0.013	192.3	-0.0195
281.18	-0.012	192.3	-0.0186
281.20	-0.012	192.3	-0.0169
281.22	-0.011	192.4	-0.0142
281.23	-0.008	192.5	-0.0115
281.25	-0.007	192.6	-0.0098

Prova triassiale ciclica SN04-C1			
pressione di confinamento (kPa)		80	
deviatore ciclico (kPa)		95	
frequenza (hz)		0.00625	
tempo	cella di carico	$\Delta u$	LVDT
(min)	kN	(kPa)	$\delta$ (mm)
281.27	-0.006	192.7	-0.0062
281.28	-0.003	192.9	-0.0062
281.30	-0.001	192.9	-0.0036
281.32	-0.001	193	0
281.33	0	193.2	0.0036
281.35	0.004	193.4	0.0071
281.37	0.005	193.6	0.0107
281.38	0.006	193.8	0.0142
281.40	0.01	194.1	0.0142
281.42	0.011	194.1	0.0195
281.43	0.011	194.3	0.0222
281.45	0.012	194.6	0.0275
281.47	0.016	194.9	0.032
281.48	0.017	195.1	0.0346
281.50	0.017	195.3	0.0364
281.52	0.02	195.6	0.0399
281.53	0.021	195.8	0.0426
281.55	0.022	196	0.0462
281.57	0.025	196.3	0.0462
281.58	0.025	196.5	0.0488
281.60	0.025	196.5	0.0506
281.62	0.026	196.7	0.0524
281.63	0.027	196.9	0.0541
281.65	0.028	197	0.055
281.67	0.028	197.2	0.0559
281.68	0.029	197.3	0.0559
281.70	0.029	197.5	0.0568
281.72	0.029	197.5	0.0577
281.73	0.029	197.6	0.0577
281.75	0.029	197.7	0.0577
281.77	0.028	197.8	0.0577
281.78	0.028	197.8	0.0568
281.80	0.027	197.8	0.0559
281.82	0.025	197.8	0.0559
281.83	0.025	197.8	0.0541
281.85	0.025	197.8	0.0524
281.87	0.024	197.8	0.0506
281.88	0.021	197.7	0.0479
281.90	0.02	197.7	0.0462
281.92	0.019	197.5	0.0435
281.93	0.016	197.4	0.0435
281.95	0.015	197.4	0.0399
281.97	0.015	197.3	0.0373
281.98	0.013	197	0.0337
282.00	0.01	196.9	0.0302
282.02	0.009	196.7	0.0257
282.03	0.007	196.5	0.0222
282.05	0.004	196.2	0.0222
282.07	0.002	196.2	0.0186
282.08	0.002	196	0.0142
282.10	0.001	195.8	0.0107
282.12	-0.003	195.5	0.0062
282.13	-0.004	195.2	0.0036
282.15	-0.005	194.9	-0.0009
282.17	-0.009	194.7	-0.0009
282.18	-0.009	194.7	-0.0044
282.20	-0.01	194.2	-0.0089
282.22	-0.012	194	-0.0089



Prova triassiale ciclica SN04-C1			
pressione di confinamento (kPa)		80	
deviatore ciclico (kPa)		95	
frequenza (hz)		0.00625	
tempo	cella di carico	$\Delta u$	LVDT
(min)	kN	(kPa)	$\delta$ (mm)
282.23	-0.013	194	-0.0115
282.25	-0.013	193.8	-0.0142
282.27	-0.014	193.6	-0.0169
282.28	-0.015	193.3	-0.0186
282.30	-0.016	193.1	-0.0195
282.32	-0.016	193	-0.0213
282.33	-0.017	192.8	-0.0213
282.35	-0.017	192.7	-0.0222
282.37	-0.017	192.7	-0.0231
282.38	-0.017	192.5	-0.0231
282.40	-0.017	192.4	-0.0231
282.42	-0.017	192.3	-0.0231
282.43	-0.016	192.3	-0.0222
282.47	-0.016	192.3	-0.0222
282.48	-0.015	192.2	-0.0213
282.50	-0.015	192.2	-0.0204
282.52	-0.014	192.2	-0.0186
282.52	-0.012	192.3	-0.0178
282.53	-0.011	192.3	-0.016
282.55	-0.01	192.4	-0.0133
282.57	-0.008	192.5	-0.0133
282.58	-0.006	192.6	-0.0115
282.60	-0.006	192.6	-0.008
282.62	-0.005	192.7	-0.0053
282.63	-0.003	193	-0.0018
282.65	0	193.1	0.0009
282.67	0.001	193.3	0.0044
282.68	0.003	193.5	0.0044
282.70	0.006	193.7	0.0089
282.72	0.006	193.7	0.0124
282.73	0.007	193.9	0.0169
282.75	0.01	194.2	0.0204
282.77	0.012	194.4	0.024
282.78	0.013	194.6	0.0284
282.80	0.015	195	0.0328
282.82	0.018	195.2	0.0328
282.83	0.019	195.2	0.0364
282.85	0.019	195.4	0.0391
282.87	0.021	195.7	0.0426
282.88	0.023	196	0.0453
282.90	0.024	196.2	0.047
282.92	0.025	196.4	0.0497
282.93	0.027	196.6	0.0524
282.95	0.027	196.8	0.0533
282.97	0.027	196.9	0.0541
282.98	0.028	197.1	0.0541
283.00	0.028	197.1	0.055
283.02	0.028	197.3	0.0559
283.03	0.029	197.4	0.0568
283.05	0.029	197.5	0.0577
283.07	0.029	197.6	0.0577
283.08	0.029	197.7	0.0577
283.10	0.028	197.8	0.0577
283.12	0.027	197.8	0.0568
283.13	0.027	197.8	0.0559
283.15	0.026	197.8	0.055
283.17	0.025	197.8	0.0533
283.18	0.024	197.8	0.0515

Prova triassiale ciclica SN04-C1			
pressione di confinamento (kPa)		80	
deviatore ciclico (kPa)		95	
frequenza (hz)		0.00625	
tempo	cella di carico	$\Delta u$	LVDT
(min)	kN	(kPa)	$\delta$ (mm)
283.20	0.023	197.8	0.0497
283.22	0.021	197.7	0.0497
283.23	0.019	197.7	0.047
283.25	0.019	197.6	0.0453
283.27	0.018	197.5	0.0417
283.28	0.015	197.3	0.0391
283.30	0.014	197.2	0.0364
283.32	0.012	197	0.0328
283.33	0.009	196.8	0.0328
283.35	0.008	196.8	0.0284
283.37	0.008	196.6	0.0249
283.38	0.006	196.4	0.0213
283.40	0.002	196.2	0.0169
283.42	0.002	196	0.0133
283.43	0	195.7	0.0089
283.45	-0.003	195.4	0.0089
283.47	-0.005	195.4	0.0044
283.48	-0.005	195.1	0.0018
283.50	-0.006	194.9	-0.0018
283.52	-0.008	194.6	-0.0053
283.53	-0.01	194.3	-0.008
283.55	-0.011	194.1	-0.0115
283.57	-0.013	193.8	-0.0115
283.58	-0.014	193.8	-0.0142
283.60	-0.014	193.6	-0.016
283.62	-0.014	193.4	-0.0178
283.63	-0.016	193.2	-0.0195
283.65	-0.016	193	-0.0204
283.67	-0.017	192.9	-0.0222
283.68	-0.017	192.7	-0.0222
283.70	-0.017	192.6	-0.0231
283.72	-0.017	192.5	-0.0231
283.73	-0.017	192.4	-0.0231
283.75	-0.017	192.3	-0.0231
283.77	-0.017	192.3	-0.0231
283.78	-0.016	192.2	-0.0222
283.80	-0.015	192.3	-0.0213
283.82	-0.014	192.2	-0.0204
283.83	-0.014	192.2	-0.0186
283.85	-0.012	192.3	-0.0186
283.87	-0.01	192.3	-0.0169
283.88	-0.01	192.3	-0.0151
283.90	-0.009	192.4	-0.0124
283.93	-0.008	192.6	-0.0098
283.95	-0.005	192.7	-0.0071
283.97	-0.004	192.8	-0.0036
283.98	-0.002	193	0
283.98	0.001	193.2	0
284.00	0.002	193.2	0.0027
284.02	0.002	193.3	0.0062
284.03	0.003	193.6	0.0098
284.05	0.007	193.8	0.0142
284.07	0.008	194	0.0178
284.08	0.01	194.3	0.0222
284.10	0.013	194.5	0.0222
284.12	0.014	194.5	0.0275
284.13	0.014	194.7	0.0302
284.15	0.016	195	0.0337

Prova triassiale ciclica SN04-C1			
pressione di confinamento (kPa)		80	
deviatore ciclico (kPa)		95	
frequenza (hz)		0.00625	
tempo	cella di carico	$\Delta u$	LVDT
(min)	kN	(kPa)	$\delta$ (mm)
284.17	0.019	195.3	0.0373
284.18	0.02	195.5	0.0408
284.20	0.021	195.8	0.0435
284.22	0.024	196.1	0.0435
284.23	0.024	196.1	0.047
284.25	0.024	196.3	0.0479
284.27	0.025	196.5	0.0515
284.28	0.027	196.7	0.0533
284.30	0.027	196.9	0.0541
284.32	0.028	197	0.0559
284.33	0.028	197.2	0.0559
284.35	0.029	197.2	0.0568
284.37	0.029	197.3	0.0568
284.38	0.029	197.5	0.0577
284.40	0.029	197.5	0.0577
284.42	0.029	197.7	0.0577
284.43	0.028	197.7	0.0577
284.45	0.028	197.8	0.0568
284.47	0.027	197.8	0.0559
284.48	0.026	197.8	0.055
284.50	0.024	197.8	0.055
284.52	0.023	197.8	0.0524
284.53	0.023	197.8	0.0506
284.55	0.022	197.7	0.0488
284.57	0.02	197.6	0.0462
284.58	0.019	197.5	0.0444
284.60	0.017	197.4	0.0408
284.62	0.015	197.2	0.0408
284.63	0.013	197.1	0.0373
284.65	0.013	197.1	0.0346
284.67	0.011	197	0.0302
284.68	0.009	196.7	0.0257
284.70	0.006	196.5	0.0231
284.72	0.005	196.3	0.0195
284.73	0.002	196.1	0.0195
284.75	0	195.8	0.0151
284.77	0	195.8	0.0115
284.78	-0.001	195.6	0.008
284.80	-0.004	195.2	0.0036
284.82	-0.005	195	0.0009
284.83	-0.006	194.8	-0.0036
284.85	-0.009	194.4	-0.0036
284.87	-0.011	194.2	-0.0071
284.88	-0.011	194.2	-0.0098
284.90	-0.012	194	-0.0124
284.92	-0.013	193.7	-0.0151
284.93	-0.015	193.5	-0.0169
284.95	-0.015	193.3	-0.0186
284.97	-0.016	193.1	-0.0204
284.98	-0.017	192.9	-0.0204
285.00	-0.017	192.9	-0.0222
285.02	-0.017	192.8	-0.0222
285.03	-0.017	192.6	-0.0231
285.05	-0.017	192.5	-0.0231
285.07	-0.017	192.4	-0.0231
285.08	-0.017	192.3	-0.0231
285.10	-0.016	192.3	-0.0231
285.12	-0.016	192.2	-0.0213

Prova triassiale ciclica SN04-C1			
pressione di confinamento (kPa)		80	
deviatore ciclico (kPa)		95	
frequenza (hz)		0.00625	
tempo	cella di carico	$\Delta u$	LVDT
(min)	kN	(kPa)	$\delta$ (mm)
285.13	-0.015	192.2	-0.0213
285.15	-0.014	192.2	-0.0213
285.17	-0.013	192.2	-0.0195
285.18	-0.013	192.2	-0.0178
285.20	-0.012	192.3	-0.016
285.22	-0.009	192.4	-0.0133
285.23	-0.009	192.4	-0.0115
285.25	-0.008	192.6	-0.0089
285.27	-0.004	192.7	-0.0089
285.28	-0.003	192.7	-0.0062
285.30	-0.003	192.9	-0.0027
285.32	-0.002	193.1	0.0009
285.33	0.002	193.2	0.0044
285.37	0.003	193.4	0.008
285.38	0.004	193.7	0.0115
285.40	0.008	193.9	0.0115
285.42	0.009	193.9	0.016
285.43	0.009	194.1	0.0195
285.43	0.011	194.3	0.0231
285.45	0.014	194.6	0.0275
285.47	0.015	194.8	0.0311
285.48	0.017	195.1	0.0355
285.50	0.02	195.4	0.0355
285.52	0.021	195.4	0.0391
285.53	0.021	195.6	0.0417
285.55	0.022	195.8	0.0444
285.57	0.024	196.1	0.047
285.58	0.025	196.3	0.0497
285.60	0.025	196.5	0.0515
285.62	0.027	196.7	0.0515
285.63	0.028	196.9	0.0541
285.65	0.028	196.9	0.055
285.67	0.028	197.1	0.0559
285.68	0.028	197.2	0.0568
285.70	0.029	197.4	0.0577
285.72	0.029	197.5	0.0577
285.73	0.029	197.6	0.0577
285.75	0.028	197.7	0.0577
285.77	0.028	197.7	0.0577
285.78	0.028	197.8	0.0568
285.80	0.027	197.8	0.0559
285.82	0.026	197.8	0.055
285.83	0.025	197.8	0.0533
285.85	0.024	197.8	0.0524
285.87	0.023	197.7	0.0506
285.88	0.022	197.7	0.0479
285.90	0.02	197.5	0.0444
285.92	0.017	197.4	0.0444
285.93	0.017	197.4	0.0426
285.95	0.016	197.3	0.0399
285.97	0.015	197.2	0.0364
285.98	0.011	197	0.0328
286.00	0.011	196.9	0.0302
286.02	0.008	196.6	0.0249
286.03	0.005	196.4	0.0249
286.05	0.005	196.4	0.0213
286.07	0.004	196.2	0.0178
286.08	0.002	195.9	0.0133

Prova triassiale ciclica SN04-C1			
pressione di confinamento (kPa)		80	
deviatore ciclico (kPa)		95	
frequenza (hz)		0.00625	
tempo	cella di carico	$\Delta u$	LVDT
(min)	kN	(kPa)	$\delta$ (mm)
286.10	-0.001	195.7	0.0098
286.12	-0.002	195.5	0.0062
286.13	-0.004	195.1	0.0027
286.15	-0.006	194.9	0.0027
286.17	-0.008	194.9	-0.0018
286.18	-0.008	194.6	-0.0044
286.20	-0.009	194.3	-0.0071
286.22	-0.012	194.1	-0.0107
286.23	-0.012	193.9	-0.0133
286.25	-0.013	193.7	-0.0151
286.27	-0.015	193.4	-0.0151
286.28	-0.015	193.4	-0.0178
286.30	-0.015	193.2	-0.0186
286.32	-0.016	193.1	-0.0204
286.33	-0.017	192.9	-0.0213
286.35	-0.017	192.7	-0.0222
286.37	-0.017	192.6	-0.0231
286.38	-0.017	192.5	-0.0231
286.40	-0.017	192.5	-0.0231
286.42	-0.017	192.4	-0.0231
286.43	-0.017	192.3	-0.0222
286.45	-0.016	192.3	-0.0222
286.47	-0.015	192.2	-0.0213
286.48	-0.015	192.2	-0.0195
286.50	-0.013	192.3	-0.0195
286.52	-0.012	192.3	-0.0178
286.53	-0.012	192.3	-0.0169
286.55	-0.011	192.3	-0.0142
286.57	-0.008	192.5	-0.0115
286.58	-0.008	192.5	-0.0107
286.60	-0.006	192.6	-0.008
286.62	-0.004	192.8	-0.0044
286.63	-0.002	192.9	-0.0018
286.65	-0.001	193.1	0.0018
286.67	0.002	193.3	0.0018
286.68	0.004	193.5	0.0062
286.70	0.004	193.5	0.0089
286.72	0.005	193.7	0.0133
286.73	0.008	194	0.0178
286.75	0.011	194.2	0.0213
286.77	0.012	194.4	0.0249
286.78	0.014	194.7	0.0293
286.80	0.016	194.9	0.0293
286.83	0.016	194.9	0.0328
286.85	0.018	195.1	0.0373
286.87	0.02	195.5	0.0399
286.88	0.022	195.8	0.0426
286.88	0.022	196	0.0462
286.90	0.024	196.2	0.0488
286.92	0.026	196.4	0.0488
286.93	0.026	196.4	0.0515
286.95	0.026	196.6	0.0524
286.97	0.027	196.8	0.0541
286.98	0.028	197	0.0559
287.00	0.028	197.1	0.0559
287.02	0.028	197.3	0.0568
287.03	0.029	197.4	0.0568
287.05	0.029	197.4	0.0577

Prova triassiale ciclica SN04-C1			
pressione di confinamento (kPa)		80	
deviatore ciclico (kPa)		95	
frequenza (hz)		0.00625	
tempo	cella di carico	$\Delta u$	LVDT
(min)	kN	(kPa)	$\delta$ (mm)
287.07	0.029	197.5	0.0577
287.08	0.029	197.6	0.0577
287.10	0.029	197.7	0.0577
287.12	0.027	197.8	0.0559
287.13	0.026	197.8	0.055
287.15	0.025	197.8	0.055
287.17	0.024	197.8	0.0541
287.18	0.024	197.8	0.0524
287.20	0.024	197.7	0.0506
287.22	0.021	197.6	0.0488
287.23	0.02	197.6	0.0462
287.25	0.019	197.4	0.0435
287.27	0.016	197.3	0.0435
287.28	0.015	197.2	0.0382
287.30	0.014	197.1	0.0355
287.32	0.011	196.9	0.0355
287.33	0.01	196.9	0.032
287.35	0.01	196.8	0.0284
287.37	0.008	196.5	0.024
287.38	0.004	196.3	0.0195
287.40	0.003	196.1	0.0169
287.42	0.002	195.8	0.0124
287.43	-0.002	195.6	0.0124
287.45	-0.003	195.6	0.008
287.47	-0.003	195.3	0.0053
287.48	-0.004	195	0.0009
287.50	-0.008	194.7	-0.0036
287.52	-0.009	194.5	-0.0053
287.53	-0.01	194.3	-0.0089
287.55	-0.012	194	-0.0089
287.57	-0.013	194	-0.0115
287.58	-0.013	193.8	-0.0142
287.60	-0.014	193.6	-0.016
287.62	-0.015	193.3	-0.0186
287.63	-0.016	193.2	-0.0195
287.65	-0.016	193	-0.0204
287.67	-0.017	192.8	-0.0204
287.68	-0.017	192.8	-0.0222
287.70	-0.017	192.7	-0.0231
287.72	-0.017	192.5	-0.0231
287.73	-0.017	192.4	-0.0231
287.75	-0.017	192.3	-0.0231
287.77	-0.016	192.3	-0.0222
287.78	-0.016	192.3	-0.0222
287.80	-0.015	192.3	-0.0213
287.82	-0.015	192.2	-0.0204
287.83	-0.014	192.2	-0.0195
287.85	-0.012	192.3	-0.0178
287.87	-0.011	192.3	-0.016
287.88	-0.01	192.4	-0.0133
287.90	-0.007	192.5	-0.0133
287.92	-0.007	192.6	-0.0107
287.93	-0.007	192.6	-0.0089
287.95	-0.005	192.7	-0.0053
287.97	-0.002	192.9	-0.0018
287.98	-0.001	193.1	0.0009
288.00	0.001	193.2	0.0053
288.02	0.004	193.5	0.0089

Prova triassiale ciclica SN04-C1			
pressione di confinamento (kPa)		80	
deviatore ciclico (kPa)		95	
frequenza (hz)		0.00625	
tempo	cella di carico	$\Delta u$	LVDT
(min)	kN	(kPa)	$\delta$ (mm)
288.03	0.005	193.6	0.0107
288.05	0.006	193.8	0.0151
288.07	0.009	194.1	0.0151
288.08	0.011	194.3	0.0195
288.10	0.011	194.3	0.0231
288.12	0.013	194.5	0.0275
288.13	0.015	194.8	0.0311
288.15	0.017	195.1	0.0346
288.17	0.018	195.3	0.0382
288.18	0.02	195.6	0.0382
288.20	0.022	195.9	0.0417
288.22	0.022	195.9	0.0444
288.23	0.023	196.1	0.047
288.27	0.024	196.3	0.0497
288.28	0.026	196.5	0.0515
288.30	0.026	196.7	0.0533
288.32	0.027	196.9	0.0533
288.33	0.028	197.1	0.055
288.33	0.028	197.1	0.0559
288.35	0.028	197.2	0.0568
288.37	0.028	197.3	0.0568
288.38	0.029	197.5	0.0577
288.40	0.029	197.6	0.0577
288.42	0.029	197.7	0.0577
288.43	0.028	197.7	0.0577
288.45	0.027	197.7	0.0568
288.47	0.027	197.8	0.0559
288.48	0.026	197.8	0.0541
288.50	0.025	197.7	0.0533
288.52	0.024	197.8	0.0515
288.53	0.023	197.7	0.0488
288.55	0.02	197.6	0.0488
288.57	0.019	197.6	0.047
288.58	0.019	197.5	0.0453
288.60	0.018	197.4	0.0417
288.62	0.015	197.2	0.0391
288.63	0.014	197.1	0.0364
288.65	0.012	197	0.0328
288.67	0.009	196.7	0.0328
288.68	0.008	196.7	0.0284
288.70	0.008	196.6	0.0249
288.72	0.006	196.4	0.0204
288.73	0.002	196.1	0.0169
288.75	0.002	196	0.0142
288.77	0.001	195.7	0.0107
288.78	-0.003	195.4	0.0062
288.80	-0.004	195.2	0.0036
288.82	-0.005	194.9	-0.0009
288.83	-0.008	194.6	-0.0009
288.85	-0.009	194.6	-0.0044
288.87	-0.009	194.4	-0.0071
288.88	-0.01	194.1	-0.0098
288.90	-0.013	193.9	-0.0133
288.92	-0.013	193.7	-0.0151
288.93	-0.014	193.4	-0.0178
288.95	-0.016	193.2	-0.0178
288.97	-0.016	193.2	-0.0195
288.98	-0.016	193	-0.0204

Prova triassiale ciclica SN04-C1			
pressione di confinamento (kPa)		80	
deviatore ciclico (kPa)		95	
frequenza (hz)		0.00625	
tempo	cella di carico	$\Delta u$	LVDT
(min)	kN	(kPa)	$\delta$ (mm)
289.00	-0.016	192.9	-0.0213
289.02	-0.017	192.7	-0.0222
289.03	-0.017	192.6	-0.0231
289.05	-0.017	192.5	-0.0231
289.07	-0.017	192.4	-0.0231
289.08	-0.017	192.3	-0.0231
289.10	-0.017	192.3	-0.0231
289.12	-0.016	192.2	-0.0222
289.13	-0.015	192.2	-0.0213
289.15	-0.014	192.2	-0.0204
289.17	-0.013	192.2	-0.0178
289.18	-0.012	192.3	-0.0169
289.20	-0.01	192.3	-0.0169
289.22	-0.01	192.3	-0.0151
289.23	-0.01	192.4	-0.0124
289.25	-0.007	192.5	-0.0098
289.27	-0.005	192.7	-0.0071
289.28	-0.004	192.8	-0.0036
289.30	-0.002	193	0
289.32	0.001	193.2	0
289.33	0.001	193.2	0.0027
289.35	0.002	193.3	0.0062
289.37	0.004	193.6	0.0107
289.38	0.007	193.8	0.0142
289.40	0.008	194	0.0178
289.42	0.01	194.3	0.0222
289.43	0.013	194.5	0.0222
289.45	0.014	194.5	0.0257
289.47	0.016	194.9	0.032
289.48	0.017	195.1	0.032
289.50	0.019	195.1	0.0346
289.52	0.019	195.4	0.0382
289.53	0.02	195.7	0.0426
289.55	0.023	196	0.0453
289.57	0.024	196.1	0.047
289.58	0.024	196.4	0.0497
289.60	0.027	196.6	0.0497
289.62	0.027	196.6	0.0524
289.63	0.027	196.8	0.0533
289.65	0.027	196.9	0.055
289.67	0.028	197.1	0.0559
289.68	0.029	197.3	0.0568
289.70	0.029	197.4	0.0568
289.73	0.029	197.5	0.0568
289.75	0.028	197.6	0.0568
289.77	0.028	197.6	0.0577
289.78	0.028	197.7	0.0568
289.78	0.028	197.8	0.0568
289.80	0.027	197.8	0.0559
289.82	0.026	197.8	0.0541
289.83	0.025	197.7	0.0524
289.85	0.023	197.7	0.0524
289.87	0.023	197.7	0.0506
289.88	0.022	197.7	0.0488
289.90	0.021	197.6	0.0462
289.92	0.018	197.4	0.0435
289.93	0.017	197.4	0.0417
289.95	0.015	197.2	0.0382



Prova triassiale ciclica SN04-C1			
pressione di confinamento (kPa)		80	
deviatore ciclico (kPa)		95	
frequenza (hz)		0.00625	
tempo	cella di carico	$\Delta u$	LVDT
(min)	kN	(kPa)	$\delta$ (mm)
289.97	0.012	197	0.0382
289.98	0.011	197	0.0346
290.00	0.011	196.9	0.0311
290.02	0.01	196.7	0.0275
290.03	0.006	196.4	0.0231
290.05	0.005	196.3	0.0195
290.07	0.003	196	0.0151
290.08	0	195.7	0.0151
290.10	-0.001	195.7	0.0107
290.12	-0.001	195.6	0.008
290.13	-0.003	195.2	0.0036
290.15	-0.006	194.9	0
290.17	-0.007	194.7	-0.0027
290.18	-0.008	194.4	-0.0062
290.20	-0.011	194.2	-0.0098
290.22	-0.011	194	-0.0115
290.23	-0.012	193.7	-0.0142
290.25	-0.014	193.5	-0.0142
290.27	-0.015	193.5	-0.016
290.28	-0.015	193.3	-0.0178
290.30	-0.015	193.1	-0.0195
290.32	-0.016	192.9	-0.0213
290.33	-0.017	192.8	-0.0222
290.35	-0.017	192.6	-0.0222
290.37	-0.017	192.5	-0.0222
290.38	-0.017	192.5	-0.0231
290.40	-0.017	192.4	-0.0231
290.42	-0.017	192.3	-0.0231
290.43	-0.017	192.2	-0.0231
290.45	-0.016	192.2	-0.0213
290.47	-0.015	192.2	-0.0204
290.48	-0.014	192.2	-0.0204
290.50	-0.013	192.2	-0.0195
290.52	-0.013	192.2	-0.0178
290.53	-0.012	192.2	-0.016
290.55	-0.01	192.4	-0.0142
290.57	-0.008	192.4	-0.0115
290.58	-0.007	192.5	-0.0089
290.60	-0.005	192.7	-0.0089
290.62	-0.003	192.8	-0.0062
290.63	-0.003	192.8	-0.0027
290.65	-0.002	193	0
290.67	0.001	193.2	0.0036
290.68	0.003	193.4	0.0071
290.70	0.004	193.5	0.0115
290.72	0.008	193.9	0.0115
290.73	0.01	194.1	0.016
290.75	0.01	194.1	0.0186
290.77	0.011	194.2	0.0231
290.78	0.014	194.6	0.0284
290.80	0.016	194.8	0.032
290.82	0.017	195	0.0355
290.83	0.019	195.3	0.0355
290.85	0.021	195.6	0.0391
290.87	0.021	195.6	0.0417
290.88	0.022	195.8	0.0444
290.90	0.023	196.1	0.047
290.92	0.025	196.3	0.0497

Prova triassiale ciclica SN04-C1			
pressione di confinamento (kPa)		80	
deviatore ciclico (kPa)		95	
frequenza (hz)		0.00625	
tempo	cella di carico	$\Delta u$	LVDT
(min)	kN	(kPa)	$\delta$ (mm)
290.93	0.025	196.5	0.0506
290.95	0.026	196.7	0.0524
290.97	0.027	196.8	0.0541
290.98	0.028	197	0.055
291.00	0.028	197.1	0.0559
291.02	0.029	197.3	0.0559
291.03	0.029	197.3	0.0568
291.05	0.029	197.4	0.0568
291.07	0.029	197.5	0.0577
291.08	0.029	197.6	0.0577
291.10	0.028	197.7	0.0577
291.12	0.028	197.8	0.0568
291.13	0.026	197.8	0.0568
291.15	0.025	197.8	0.055
291.18	0.025	197.8	0.0541
291.20	0.025	197.8	0.0524
291.22	0.023	197.7	0.0506
291.23	0.021	197.6	0.0479
291.23	0.02	197.6	0.0453
291.25	0.018	197.4	0.0453
291.27	0.016	197.4	0.0435
291.28	0.016	197.3	0.0399
291.30	0.015	197.2	0.0373
291.32	0.012	197	0.0328
291.33	0.01	196.8	0.0302
291.35	0.009	196.7	0.0257
291.37	0.005	196.4	0.0257
291.38	0.004	196.2	0.0213
291.40	0.004	196.2	0.0186
291.42	0.003	196	0.0142
291.43	-0.001	195.7	0.0098
291.45	-0.003	195.4	0.0062
291.47	-0.003	195.2	0.0036
291.48	-0.006	194.8	0.0036
291.50	-0.008	194.6	-0.0009
291.52	-0.008	194.6	-0.0044
291.53	-0.009	194.4	-0.008
291.55	-0.011	194.1	-0.0107
291.57	-0.013	193.8	-0.0133
291.58	-0.013	193.6	-0.016
291.60	-0.015	193.4	-0.016
291.62	-0.015	193.2	-0.0178
291.63	-0.015	193.2	-0.0195
291.65	-0.017	192.8	-0.0222
291.67	-0.017	192.7	-0.0222
291.68	-0.017	192.7	-0.0222
291.70	-0.017	192.6	-0.0231
291.72	-0.017	192.4	-0.0231
291.73	-0.017	192.3	-0.0231
291.75	-0.017	192.3	-0.0231
291.77	-0.017	192.2	-0.0222
291.78	-0.015	192.2	-0.0222
291.80	-0.015	192.2	-0.0213
291.82	-0.015	192.1	-0.0204
291.83	-0.014	192.2	-0.0186
291.85	-0.012	192.2	-0.0169
291.87	-0.011	192.2	-0.016
291.88	-0.01	192.3	-0.0133

Prova triassiale ciclica SN04-C1			
pressione di confinamento (kPa)		80	
deviatore ciclico (kPa)		95	
frequenza (hz)		0.00625	
tempo	cella di carico	$\Delta u$	LVDT
(min)	kN	(kPa)	$\delta$ (mm)
291.90	-0.007	192.5	-0.0133
291.92	-0.006	192.5	-0.0107
291.93	-0.006	192.5	-0.008
291.95	-0.005	192.7	-0.0053
291.97	-0.002	192.9	-0.0018
291.98	-0.001	193	0.0009
292.00	0.001	193.2	0.0053
292.02	0.004	193.5	0.0053
292.03	0.006	193.6	0.0089
292.05	0.006	193.6	0.0124
292.07	0.007	193.8	0.0169
292.08	0.011	194.1	0.0213
292.10	0.012	194.3	0.024
292.12	0.013	194.6	0.0293
292.13	0.017	194.9	0.0293
292.15	0.018	195.1	0.0328
292.17	0.018	195.1	0.0355
292.18	0.019	195.3	0.0391
292.20	0.021	195.7	0.0426
292.22	0.023	195.9	0.0453
292.23	0.023	196.1	0.0479
292.25	0.025	196.3	0.0479
292.27	0.026	196.5	0.0506
292.28	0.026	196.5	0.0524
292.30	0.027	196.7	0.0541
292.32	0.028	196.9	0.055
292.33	0.028	197.1	0.0568
292.35	0.029	197.2	0.0568
292.37	0.029	197.3	0.0568
292.38	0.029	197.4	0.0577
292.40	0.029	197.6	0.0577
292.42	0.028	197.6	0.0577
292.43	0.028	197.7	0.0577
292.45	0.027	197.7	0.0577
292.47	0.027	197.7	0.0559
292.48	0.027	197.8	0.055
292.50	0.025	197.8	0.0533
292.52	0.024	197.7	0.0524
292.53	0.023	197.7	0.0497
292.55	0.021	197.6	0.0497
292.57	0.019	197.6	0.047
292.58	0.019	197.5	0.0453
292.60	0.018	197.4	0.0417
292.63	0.015	197.3	0.0391
292.65	0.014	197.1	0.0364
292.67	0.012	197	0.0328
292.68	0.009	196.7	0.0328
292.68	0.007	196.6	0.0293
292.70	0.007	196.6	0.0249
292.72	0.006	196.3	0.0213
292.73	0.003	196.1	0.0169
292.75	0.001	195.9	0.0133
292.77	0	195.7	0.0089
292.78	-0.003	195.3	0.0089
292.80	-0.005	195	0.0053
292.82	-0.005	195	0.0018
292.83	-0.006	194.8	-0.0018
292.85	-0.008	194.5	-0.0053

Prova triassiale ciclica SN04-C1			
pressione di confinamento (kPa)		80	
deviatore ciclico (kPa)		95	
frequenza (hz)		0.00625	
tempo	cella di carico	$\Delta u$	LVDT
(min)	kN	(kPa)	$\delta$ (mm)
292.87	-0.01	194.2	-0.0089
292.88	-0.011	194	-0.0115
292.90	-0.013	193.7	-0.0115
292.92	-0.014	193.5	-0.0142
292.93	-0.014	193.5	-0.016
292.95	-0.015	193.3	-0.0178
292.97	-0.016	193.1	-0.0195
292.98	-0.016	192.9	-0.0204
293.00	-0.017	192.8	-0.0213
293.02	-0.017	192.6	-0.0222
293.03	-0.017	192.5	-0.0222
293.05	-0.017	192.5	-0.0231
293.07	-0.017	192.4	-0.0231
293.08	-0.017	192.3	-0.0231
293.10	-0.016	192.3	-0.0222
293.12	-0.016	192.2	-0.0222
293.13	-0.016	192.1	-0.0213
293.15	-0.014	192.2	-0.0195
293.17	-0.014	192.1	-0.0186
293.18	-0.012	192.2	-0.0169
293.20	-0.01	192.3	-0.0169
293.22	-0.01	192.3	-0.0151
293.23	-0.01	192.3	-0.0124
293.25	-0.008	192.5	-0.0098
293.27	-0.005	192.6	-0.0071
293.28	-0.004	192.7	-0.0036
293.30	-0.002	192.9	-0.0009
293.32	0.001	193.1	-0.0009
293.33	0.002	193.1	0.0027
293.35	0.002	193.3	0.0062
293.37	0.003	193.5	0.0098
293.38	0.007	193.8	0.0142
293.40	0.008	193.9	0.0178
293.42	0.01	194.2	0.0222
293.43	0.013	194.5	0.0222
293.45	0.015	194.5	0.0275
293.47	0.015	194.7	0.0302
293.48	0.016	194.9	0.0337
293.50	0.019	195.2	0.0382
293.52	0.02	195.4	0.0408
293.53	0.021	195.8	0.0435
293.55	0.024	196	0.0435
293.57	0.024	196	0.047
293.58	0.024	196.2	0.0488
293.60	0.025	196.4	0.0515
293.62	0.027	196.6	0.0533
293.63	0.027	196.8	0.0541
293.65	0.027	196.9	0.0559
293.67	0.029	197.1	0.0559
293.68	0.029	197.1	0.0568
293.70	0.029	197.2	0.0568
293.72	0.029	197.4	0.0577
293.73	0.029	197.5	0.0577
293.75	0.029	197.6	0.0577
293.77	0.028	197.7	0.0577
293.78	0.028	197.7	0.0577
293.80	0.026	197.7	0.0568
293.82	0.026	197.7	0.055

Prova triassiale ciclica SN04-C1			
pressione di confinamento (kPa)		80	
deviatore ciclico (kPa)		95	
frequenza (hz)		0.00625	
tempo	cella di carico	$\Delta u$	LVDT
(min)	kN	(kPa)	$\delta$ (mm)
293.83	0.025	197.7	0.0533
293.85	0.023	197.7	0.0533
293.87	0.023	197.7	0.0506
293.88	0.022	197.7	0.0488
293.90	0.02	197.5	0.0462
293.92	0.018	197.4	0.0444
293.93	0.017	197.3	0.0408
293.95	0.015	197.2	0.0408
293.97	0.013	197	0.0382
293.98	0.013	197	0.0346
294.00	0.011	196.9	0.0311
294.02	0.009	196.6	0.0275
294.03	0.006	196.4	0.0231
294.05	0.005	196.3	0.0195
294.07	0.002	195.9	0.0195
294.10	0	195.7	0.0151
294.12	0	195.7	0.0115
294.13	-0.001	195.5	0.008
294.15	-0.004	195.1	0.0036
294.15	-0.006	194.9	0
294.17	-0.007	194.7	-0.0036
294.18	-0.009	194.4	-0.0036
294.20	-0.011	194.1	-0.0071
294.22	-0.011	194.1	-0.0098
294.23	-0.012	193.9	-0.0124
294.25	-0.013	193.6	-0.0151
294.27	-0.015	193.4	-0.0169
294.28	-0.015	193.2	-0.0186
294.30	-0.016	193	-0.0204
294.32	-0.017	192.9	-0.0204
294.33	-0.017	192.9	-0.0213
294.35	-0.017	192.7	-0.0222
294.37	-0.017	192.5	-0.0231
294.38	-0.017	192.4	-0.0231
294.40	-0.017	192.3	-0.0231
294.42	-0.017	192.3	-0.0222
294.43	-0.016	192.2	-0.0222
294.45	-0.015	192.2	-0.0222
294.47	-0.015	192.2	-0.0213
294.48	-0.015	192.1	-0.0204
294.50	-0.013	192.2	-0.0186
294.52	-0.013	192.2	-0.0169
294.53	-0.011	192.3	-0.0151
294.55	-0.009	192.3	-0.0124
294.57	-0.009	192.4	-0.0115
294.58	-0.007	192.5	-0.008
294.60	-0.004	192.7	-0.008
294.62	-0.003	192.7	-0.0053
294.63	-0.003	192.8	-0.0036
294.65	-0.002	192.9	0.0009
294.67	0.001	193.2	0.0044
294.68	0.003	193.3	0.008
294.70	0.004	193.5	0.0115
294.72	0.008	193.8	0.0115
294.73	0.01	194	0.016
294.75	0.01	194	0.0195
294.77	0.011	194.2	0.0231
294.78	0.014	194.5	0.0284

Prova triassiale ciclica SN04-C1			
pressione di confinamento (kPa)		80	
deviatore ciclico (kPa)		95	
frequenza (hz)		0.00625	
tempo	cella di carico	$\Delta u$	LVDT
(min)	kN	(kPa)	$\delta$ (mm)
294.80	0.015	194.7	0.0311
294.82	0.017	195	0.0355
294.83	0.019	195.3	0.0355
294.85	0.021	195.6	0.0391
294.87	0.021	195.6	0.0426
294.88	0.022	195.8	0.0444
294.90	0.023	196	0.047
294.92	0.025	196.3	0.0497
294.93	0.025	196.4	0.0524
294.95	0.027	196.7	0.0541
294.97	0.028	196.8	0.0541
294.98	0.028	196.8	0.055
295.00	0.028	197	0.0559
295.02	0.028	197.2	0.0568
295.03	0.029	197.3	0.0577
295.05	0.029	197.4	0.0577
295.07	0.029	197.5	0.0577
295.08	0.029	197.6	0.0577
295.10	0.028	197.6	0.0577
295.12	0.028	197.7	0.0577
295.13	0.027	197.7	0.0559
295.15	0.026	197.7	0.0541
295.17	0.025	197.7	0.0533
295.18	0.024	197.7	0.0515
295.20	0.022	197.6	0.0515
295.22	0.021	197.6	0.0497
295.23	0.021	197.6	0.0479
295.25	0.019	197.5	0.0444
295.27	0.017	197.3	0.0417
295.28	0.016	197.2	0.0391
295.30	0.015	197.1	0.0373
295.32	0.012	196.9	0.0337
295.33	0.01	196.8	0.0302
295.35	0.009	196.6	0.0257
295.37	0.005	196.3	0.0257
295.38	0.004	196.3	0.0213
295.40	0.004	196.1	0.0186
295.42	0.003	195.9	0.0142
295.43	-0.001	195.6	0.0107
295.45	-0.002	195.4	0.0071
295.47	-0.003	195.1	0.0027
295.48	-0.006	194.8	0.0027
295.50	-0.008	194.5	-0.0009
295.53	-0.008	194.5	-0.0044
295.55	-0.009	194.3	-0.0071
295.57	-0.011	194	-0.0107
295.58	-0.013	193.8	-0.0133
295.60	-0.013	193.6	-0.0151
295.60	-0.014	193.3	-0.0151
295.62	-0.016	193.1	-0.0178
295.63	-0.016	193.1	-0.0186
295.65	-0.016	193	-0.0204
295.67	-0.017	192.8	-0.0222
295.68	-0.017	192.6	-0.0231
295.70	-0.017	192.5	-0.0231
295.72	-0.017	192.4	-0.0231
295.73	-0.017	192.3	-0.0231
295.75	-0.017	192.3	-0.0231

Prova triassiale ciclica SN04-C1			
pressione di confinamento (kPa)		80	
deviatore ciclico (kPa)		95	
frequenza (hz)		0.00625	
tempo	cella di carico	$\Delta u$	LVDT
(min)	kN	(kPa)	$\delta$ (mm)
295.77	-0.017	192.2	-0.0231
295.78	-0.016	192.2	-0.0213
295.80	-0.015	192.1	-0.0213
295.82	-0.015	192.1	-0.0195
295.83	-0.014	192.2	-0.0186
295.85	-0.012	192.2	-0.0186
295.87	-0.011	192.2	-0.0169
295.88	-0.011	192.2	-0.0142
295.90	-0.009	192.4	-0.0124
295.92	-0.007	192.5	-0.0098
295.93	-0.006	192.6	-0.0071
295.95	-0.004	192.8	-0.0036
295.97	-0.001	193	-0.0036
295.98	0	193	0
296.00	0.002	193.2	0.0053
296.02	0.004	193.4	0.0053
296.03	0.005	193.4	0.008
296.05	0.005	193.6	0.0124
296.07	0.007	193.9	0.0169
296.08	0.011	194.1	0.0213
296.10	0.012	194.3	0.024
296.12	0.013	194.6	0.0293
296.13	0.017	194.9	0.0293
296.15	0.018	194.9	0.0337
296.17	0.018	195.1	0.0364
296.18	0.019	195.4	0.0399
296.20	0.022	195.7	0.0435
296.22	0.022	195.8	0.0453
296.23	0.023	196.1	0.0479
296.25	0.025	196.3	0.0479
296.27	0.026	196.3	0.0506
296.28	0.026	196.5	0.0524
296.30	0.027	196.7	0.0541
296.32	0.028	196.9	0.0559
296.33	0.029	197.1	0.0568
296.35	0.029	197.2	0.0568
296.37	0.028	197.3	0.0568
296.38	0.029	197.4	0.0568
296.40	0.029	197.4	0.0577
296.42	0.029	197.5	0.0577
296.43	0.028	197.6	0.0577
296.45	0.027	197.7	0.0568
296.47	0.027	197.7	0.0559
296.48	0.026	197.7	0.0541
296.50	0.024	197.7	0.0541
296.52	0.024	197.7	0.0533
296.53	0.024	197.7	0.0515
296.55	0.022	197.6	0.0488
296.57	0.02	197.5	0.0462
296.58	0.019	197.4	0.0435
296.60	0.017	197.2	0.0408
296.62	0.014	197.1	0.0408
296.63	0.014	197.1	0.0373
296.65	0.013	197	0.0346
296.67	0.011	196.7	0.0311
296.68	0.008	196.6	0.0275
296.70	0.007	196.4	0.0222
296.72	0.005	196.1	0.0186

Prova triassiale ciclica SN04-C1			
pressione di confinamento (kPa)		80	
deviatore ciclico (kPa)		95	
frequenza (hz)		0.00625	
tempo	cella di carico	$\Delta u$	LVDT
(min)	kN	(kPa)	$\delta$ (mm)
296.73	0.002	195.9	0.0151
296.75	0.001	195.7	0.0124
296.77	-0.001	195.4	0.0089
296.78	-0.004	195.2	0.0089
296.80	-0.004	195.2	0.0053
296.82	-0.004	195	0.0018
296.83	-0.006	194.6	-0.0018
296.85	-0.009	194.4	-0.0062
296.87	-0.01	194.2	-0.008
296.88	-0.011	193.9	-0.0107
296.90	-0.013	193.6	-0.0107
296.92	-0.014	193.6	-0.0142
296.93	-0.014	193.5	-0.016
296.95	-0.015	193.2	-0.0178
296.97	-0.016	193	-0.0195
297.00	-0.016	192.9	-0.0213
297.02	-0.017	192.7	-0.0222
297.03	-0.017	192.5	-0.0222
297.05	-0.017	192.5	-0.0231
297.05	-0.017	192.4	-0.0231
297.07	-0.017	192.3	-0.0231
297.08	-0.017	192.2	-0.0231
297.10	-0.016	192.2	-0.0222
297.12	-0.016	192.1	-0.0213
297.13	-0.015	192.1	-0.0213
297.15	-0.014	192.1	-0.0204
297.17	-0.014	192.1	-0.0195
297.18	-0.013	192.1	-0.0178
297.20	-0.011	192.2	-0.0151
297.22	-0.01	192.3	-0.0142
297.23	-0.009	192.4	-0.0107
297.25	-0.006	192.5	-0.0107
297.27	-0.005	192.5	-0.008
297.28	-0.005	192.6	-0.0053
297.30	-0.003	192.8	-0.0018
297.32	0	193	0.0018
297.33	0.001	193.2	0.0044
297.35	0.002	193.3	0.008
297.37	0.006	193.6	0.008
297.38	0.008	193.8	0.0124
297.40	0.008	193.8	0.016
297.42	0.009	194	0.0204
297.43	0.012	194.3	0.0249
297.45	0.014	194.5	0.0284
297.47	0.014	194.7	0.0311
297.48	0.016	195	0.0346
297.50	0.019	195.2	0.0373
297.52	0.02	195.4	0.0408
297.53	0.022	195.8	0.0408
297.55	0.024	196	0.0444
297.57	0.024	196	0.047
297.58	0.024	196.2	0.0488
297.60	0.026	196.4	0.0515
297.62	0.027	196.6	0.0533
297.63	0.027	196.8	0.055
297.65	0.028	197	0.0559
297.67	0.029	197.1	0.0559
297.68	0.029	197.1	0.0568



Prova triassiale ciclica SN04-C1			
pressione di confinamento (kPa)		80	
deviatore ciclico (kPa)		95	
frequenza (hz)		0.00625	
tempo	cella di carico	$\Delta u$	LVDT
(min)	kN	(kPa)	$\delta$ (mm)
297.70	0.029	197.2	0.0568
297.72	0.029	197.4	0.0577
297.73	0.029	197.5	0.0577
297.75	0.029	197.6	0.0577
297.77	0.028	197.7	0.0577
297.78	0.027	197.7	0.0577
297.80	0.026	197.7	0.0559
297.82	0.026	197.7	0.055
297.83	0.026	197.7	0.0541
297.85	0.024	197.7	0.0524
297.87	0.023	197.7	0.0506
297.88	0.022	197.6	0.0479
297.90	0.019	197.5	0.0479
297.92	0.018	197.5	0.0453
297.93	0.018	197.4	0.0426
297.95	0.016	197.3	0.0399
297.97	0.013	197.1	0.0364
297.98	0.012	196.9	0.0337
298.00	0.011	196.8	0.0302
298.02	0.007	196.5	0.0302
298.03	0.006	196.5	0.0249
298.05	0.006	196.3	0.0222
298.07	0.004	196.1	0.0178
298.08	0.001	195.8	0.0133
298.10	0	195.6	0.0107
298.12	-0.002	195.3	0.0062
298.13	-0.005	195	0.0062
298.15	-0.006	194.8	0.0018
298.17	-0.006	194.8	-0.0009
298.18	-0.009	194.3	-0.0053
298.20	-0.01	194.1	-0.0071
298.22	-0.01	194.1	-0.0089
298.23	-0.011	193.8	-0.0124
298.25	-0.013	193.5	-0.0151
298.27	-0.015	193.3	-0.0169
298.28	-0.015	193.2	-0.0186
298.30	-0.016	193	-0.0186
298.32	-0.016	192.8	-0.0204
298.33	-0.016	192.8	-0.0213
298.35	-0.017	192.6	-0.0222
298.37	-0.017	192.5	-0.0222
298.38	-0.017	192.4	-0.0231
298.40	-0.017	192.3	-0.0231
298.43	-0.017	192.2	-0.0231
298.45	-0.016	192.2	-0.0231
298.47	-0.015	192.2	-0.0222
298.48	-0.015	192.1	-0.0213
298.50	-0.015	192.1	-0.0204
298.50	-0.014	192.1	-0.0186
298.52	-0.012	192.2	-0.0169
298.53	-0.011	192.2	-0.0151
298.55	-0.009	192.3	-0.0151
298.57	-0.008	192.3	-0.0124
298.58	-0.008	192.4	-0.0107
298.60	-0.007	192.5	-0.008
298.62	-0.004	192.7	-0.0044
298.63	-0.002	192.8	-0.0018
298.65	-0.001	193	0.0027

Prova triassiale ciclica SN04-C1			
pressione di confinamento (kPa)		80	
deviatore ciclico (kPa)		95	
frequenza (hz)		0.00625	
tempo	cella di carico	$\Delta u$	LVDT
(min)	kN	(kPa)	$\delta$ (mm)
298.67	0.003	193.2	0.0027
298.68	0.003	193.2	0.0062
298.70	0.003	193.4	0.0098
298.72	0.005	193.6	0.0133
298.73	0.009	193.9	0.0178
298.75	0.01	194.1	0.0213
298.77	0.012	194.3	0.0249
298.78	0.015	194.6	0.0249
298.80	0.016	194.8	0.0302
298.82	0.016	194.8	0.0328
298.83	0.017	195	0.0364
298.85	0.02	195.4	0.0408
298.87	0.021	195.6	0.0435
298.88	0.022	195.8	0.0453
298.90	0.024	196.1	0.0453
298.92	0.025	196.3	0.0506
298.93	0.026	196.5	0.0524
298.95	0.027	196.7	0.0524
298.97	0.028	196.9	0.0533
298.98	0.028	196.9	0.055
299.00	0.028	197	0.0559
299.02	0.028	197.2	0.0568
299.03	0.029	197.3	0.0577
299.05	0.029	197.4	0.0577
299.07	0.029	197.5	0.0577
299.08	0.029	197.6	0.0577
299.10	0.028	197.6	0.0577
299.12	0.028	197.7	0.0577
299.13	0.027	197.7	0.0559
299.15	0.026	197.7	0.0541
299.17	0.025	197.7	0.0541
299.18	0.024	197.6	0.0515
299.20	0.022	197.6	0.0515
299.22	0.021	197.6	0.0497
299.23	0.021	197.6	0.0479
299.25	0.02	197.4	0.0453
299.27	0.016	197.3	0.0417
299.28	0.016	197.2	0.0391
299.30	0.014	197	0.0355
299.32	0.01	196.8	0.0355
299.33	0.01	196.8	0.032
299.35	0.01	196.7	0.0284
299.37	0.008	196.4	0.024
299.38	0.004	196.2	0.0204
299.40	0.003	196	0.0169
299.42	0.002	195.8	0.0124
299.43	-0.002	195.5	0.0124
299.45	-0.003	195.5	0.0089
299.47	-0.003	195.2	0.0053
299.48	-0.004	195	0.0018
299.50	-0.008	194.6	-0.0027
299.52	-0.008	194.4	-0.0053
299.53	-0.009	194.2	-0.0089
299.55	-0.012	193.9	-0.0089
299.57	-0.013	193.7	-0.0124
299.58	-0.013	193.7	-0.0133
299.60	-0.013	193.5	-0.016
299.62	-0.015	193.2	-0.0178

Prova triassiale ciclica SN04-C1			
pressione di confinamento (kPa)		80	
deviatore ciclico (kPa)		95	
frequenza (hz)		0.00625	
tempo	cella di carico	$\Delta u$	LVDT
(min)	kN	(kPa)	$\delta$ (mm)
299.63	-0.016	193	-0.0195
299.65	-0.016	192.9	-0.0204
299.67	-0.016	192.7	-0.0213
299.68	-0.017	192.6	-0.0222
299.70	-0.017	192.4	-0.0231
299.72	-0.017	192.3	-0.0231
299.73	-0.017	192.2	-0.0231
299.75	-0.017	192.2	-0.0231
299.77	-0.017	192.2	-0.0231
299.78	-0.016	192.1	-0.0213
299.80	-0.015	192.1	-0.0213
299.82	-0.014	192.1	-0.0195
299.83	-0.014	192.1	-0.0186
299.85	-0.011	192.2	-0.0186
299.87	-0.011	192.2	-0.016
299.90	-0.011	192.2	-0.0151
299.92	-0.01	192.3	-0.0124
299.93	-0.007	192.4	-0.0098
299.95	-0.006	192.5	-0.0071
299.95	-0.004	192.7	-0.0036
299.97	-0.001	192.9	-0.0036
299.98	0	192.9	0
300.00	0	193	0.0027
300.02	0.002	193.2	0.0071
300.03	0.006	193.5	0.0115
300.05	0.006	193.7	0.0142
300.07	0.008	193.9	0.0186
300.08	0.012	194.2	0.0186
300.10	0.013	194.2	0.0231
300.12	0.013	194.4	0.0257
300.13	0.014	194.6	0.0302
300.15	0.017	194.9	0.0346
300.17	0.019	195.1	0.0382
300.18	0.02	195.4	0.0408
300.20	0.022	195.7	0.0408
300.22	0.024	195.9	0.0444
300.23	0.024	195.9	0.047
300.25	0.024	196.1	0.0497
300.27	0.025	196.3	0.0515
300.28	0.027	196.6	0.0533
300.30	0.027	196.7	0.0541
300.32	0.028	196.9	0.0541
300.33	0.029	197.1	0.0559
300.35	0.029	197.1	0.0577
300.37	0.028	197.3	0.0577
300.38	0.029	197.4	0.0577
300.40	0.029	197.4	0.0577
300.42	0.029	197.5	0.0577
300.43	0.029	197.6	0.0577
300.45	0.028	197.7	0.0577
300.47	0.027	197.7	0.0559
300.48	0.026	197.7	0.0541
300.50	0.024	197.7	0.0541
300.52	0.023	197.7	0.0533
300.53	0.023	197.7	0.0515
300.55	0.022	197.6	0.0488
300.57	0.02	197.5	0.047
300.58	0.019	197.4	0.0444

Prova triassiale ciclica SN04-C1			
pressione di confinamento (kPa)		80	
deviatore ciclico (kPa)		95	
frequenza (hz)		0.00625	
tempo	cella di carico	$\Delta u$	LVDT
(min)	kN	(kPa)	$\delta$ (mm)
300.60	0.017	197.3	0.0417
300.62	0.014	197.1	0.0417
300.63	0.013	197.1	0.0382
300.65	0.013	197	0.0355
300.67	0.012	196.8	0.032
300.68	0.008	196.6	0.0275
300.70	0.007	196.4	0.024
300.72	0.005	196.2	0.0195
300.73	0.002	195.9	0.0195
300.75	0.001	195.9	0.0151
300.77	0.001	195.7	0.0115
300.78	-0.001	195.4	0.008
300.80	-0.004	195.1	0.0036
300.82	-0.005	194.9	0.0009
300.83	-0.007	194.6	-0.0036
300.85	-0.01	194.3	-0.0036
300.87	-0.011	194.3	-0.0071
300.88	-0.011	194.1	-0.0089
300.90	-0.011	193.8	-0.0124
300.92	-0.014	193.6	-0.0151
300.93	-0.014	193.4	-0.016
300.95	-0.015	193.2	-0.0186
300.97	-0.016	193	-0.0186
300.98	-0.017	193	-0.0195
301.00	-0.017	192.8	-0.0213
301.02	-0.017	192.7	-0.0213
301.03	-0.017	192.5	-0.0222
301.05	-0.017	192.4	-0.0231
301.07	-0.017	192.3	-0.0231
301.08	-0.017	192.2	-0.0222
301.10	-0.017	192.1	-0.0222
301.12	-0.016	192.1	-0.0213
301.13	-0.015	192.1	-0.0213
301.15	-0.014	192.1	-0.0204
301.17	-0.014	192.1	-0.0186
301.18	-0.013	192.1	-0.0178
301.20	-0.011	192.2	-0.0151
301.22	-0.01	192.2	-0.0142
301.23	-0.009	192.3	-0.0107
301.25	-0.006	192.5	-0.0107
301.27	-0.005	192.6	-0.008
301.28	-0.005	192.6	-0.0053
301.30	-0.004	192.7	-0.0018
301.32	0	193	0.0018
301.33	0.001	193.1	0.0044
301.37	0.003	193.3	0.0089
301.38	0.005	193.6	0.0089
301.40	0.008	193.8	0.0124
301.40	0.008	193.8	0.016
301.42	0.009	194	0.0195
301.43	0.012	194.3	0.024
301.45	0.014	194.5	0.0284
301.47	0.015	194.7	0.0328
301.48	0.018	195	0.0328
301.50	0.02	195.3	0.0364
301.52	0.02	195.3	0.0391
301.53	0.02	195.5	0.0426
301.55	0.022	195.8	0.0453

Prova triassiale ciclica SN04-C1			
pressione di confinamento (kPa)		80	
deviatore ciclico (kPa)		95	
frequenza (hz)		0.00625	
tempo	cella di carico	$\Delta u$	LVDT
(min)	kN	(kPa)	$\delta$ (mm)
301.57	0.024	196	0.0479
301.58	0.025	196.2	0.0506
301.60	0.026	196.5	0.0524
301.62	0.027	196.7	0.0524
301.63	0.027	196.7	0.0541
301.65	0.027	196.8	0.055
301.67	0.028	197	0.0559
301.68	0.029	197.1	0.0577
301.70	0.029	197.3	0.0577
301.72	0.029	197.4	0.0577
301.73	0.029	197.5	0.0577
301.75	0.029	197.5	0.0577
301.77	0.029	197.6	0.0577
301.78	0.028	197.6	0.0577
301.80	0.027	197.6	0.0559
301.82	0.026	197.7	0.055
301.83	0.026	197.7	0.0541
301.85	0.024	197.7	0.0524
301.87	0.022	197.6	0.0506
301.88	0.022	197.6	0.0479
301.90	0.02	197.5	0.0479
301.92	0.017	197.3	0.0462
301.93	0.017	197.3	0.0435
301.95	0.017	197.3	0.0399
301.97	0.014	197	0.0364
301.98	0.012	196.9	0.0337
302.00	0.011	196.8	0.0302
302.02	0.007	196.5	0.0302
302.03	0.006	196.3	0.0249
302.05	0.006	196.3	0.0222
302.07	0.004	196.1	0.0178
302.08	0.001	195.8	0.0142
302.10	-0.001	195.6	0.0107
302.12	-0.002	195.3	0.0062
302.13	-0.005	195	0.0062
302.15	-0.006	194.7	0.0027
302.17	-0.006	194.7	-0.0009
302.18	-0.007	194.5	-0.0044
302.20	-0.01	194.2	-0.008
302.22	-0.011	194	-0.0107
302.23	-0.012	193.8	-0.0133
302.25	-0.013	193.5	-0.0133
302.27	-0.015	193.3	-0.0151
302.28	-0.015	193.3	-0.0178
302.30	-0.015	193.1	-0.0186
302.32	-0.016	192.9	-0.0204
302.33	-0.017	192.7	-0.0213
302.35	-0.017	192.6	-0.0222
302.37	-0.017	192.5	-0.0222
302.38	-0.017	192.4	-0.0222
302.40	-0.017	192.4	-0.0222
302.42	-0.017	192.3	-0.0222
302.43	-0.017	192.2	-0.0222
302.45	-0.016	192.1	-0.0213
302.47	-0.015	192.1	-0.0204
302.48	-0.015	192.1	-0.0186
302.50	-0.013	192.1	-0.0186
302.52	-0.012	192.1	-0.0178

Prova triassiale ciclica SN04-C1			
pressione di confinamento (kPa)		80	
deviatore ciclico (kPa)		95	
frequenza (hz)		0.00625	
tempo	cella di carico	$\Delta u$	LVDT
(min)	kN	(kPa)	$\delta$ (mm)
302.53	-0.011	192.2	-0.0151
302.55	-0.01	192.3	-0.0151
302.57	-0.008	192.3	-0.0133
302.58	-0.008	192.4	-0.0107
302.60	-0.007	192.5	-0.0071
302.62	-0.004	192.7	-0.0044
302.63	-0.002	192.8	-0.0018
302.65	-0.001	192.9	0.0027
302.67	0.002	193.2	0.0027
302.68	0.004	193.4	0.0062
302.70	0.004	193.4	0.0089
302.72	0.005	193.6	0.0133
302.73	0.009	193.8	0.0178
302.75	0.01	194	0.0213
302.77	0.012	194.3	0.0249
302.80	0.015	194.6	0.0249
302.82	0.016	194.8	0.0302
302.83	0.016	194.8	0.0337
302.85	0.017	195	0.0373
302.87	0.02	195.4	0.0408
302.87	0.022	195.6	0.0435
302.88	0.022	195.8	0.047
302.90	0.024	196.1	0.047
302.92	0.025	196.3	0.0497
302.93	0.025	196.3	0.0506
302.95	0.026	196.5	0.0524
302.97	0.027	196.7	0.0541
302.98	0.028	196.9	0.0559
303.00	0.028	197	0.0568
303.02	0.029	197.2	0.0568
303.03	0.029	197.3	0.0577
303.05	0.029	197.3	0.0577
303.07	0.029	197.4	0.0577
303.08	0.029	197.5	0.0577
303.10	0.028	197.6	0.0577
303.12	0.027	197.6	0.0568
303.13	0.026	197.6	0.055
303.15	0.025	197.6	0.055
303.17	0.025	197.6	0.0541
303.18	0.025	197.6	0.0533
303.20	0.023	197.6	0.0506
303.22	0.021	197.5	0.0488
303.23	0.02	197.5	0.0462
303.25	0.019	197.3	0.0435
303.27	0.016	197.2	0.0408
303.28	0.015	197.1	0.0391
303.30	0.014	197	0.0355
303.32	0.01	196.8	0.0355
303.33	0.01	196.8	0.032
303.35	0.01	196.6	0.0293
303.37	0.008	196.4	0.024
303.38	0.004	196.2	0.0204
303.40	0.004	196	0.0169
303.42	0.002	195.7	0.0124
303.43	-0.002	195.4	0.0124
303.45	-0.003	195.4	0.008
303.47	-0.003	195.2	0.0053
303.48	-0.004	194.8	0.0009

Prova triassiale ciclica SN04-C1			
pressione di confinamento (kPa)		80	
deviatore ciclico (kPa)		95	
frequenza (hz)		0.00625	
tempo	cella di carico	$\Delta u$	LVDT
(min)	kN	(kPa)	$\delta$ (mm)
303.50	-0.008	194.6	-0.0027
303.52	-0.008	194.4	-0.0053
303.53	-0.01	194.1	-0.0089
303.55	-0.012	193.8	-0.0089
303.57	-0.013	193.8	-0.0115
303.58	-0.013	193.6	-0.0133
303.60	-0.014	193.4	-0.016
303.62	-0.015	193.2	-0.0178
303.63	-0.016	193	-0.0186
303.65	-0.016	192.8	-0.0204
303.67	-0.017	192.6	-0.0204
303.68	-0.017	192.6	-0.0222
303.70	-0.017	192.5	-0.0222
303.72	-0.017	192.4	-0.0222
303.73	-0.017	192.3	-0.0222
303.75	-0.017	192.2	-0.0222
303.77	-0.017	192.1	-0.0222
303.78	-0.016	192.1	-0.0222
303.80	-0.015	192.1	-0.0213
303.82	-0.015	192.1	-0.0204
303.83	-0.014	192.1	-0.0186
303.85	-0.013	192.1	-0.0169
303.87	-0.011	192.2	-0.0151
303.88	-0.01	192.2	-0.0124
303.90	-0.008	192.4	-0.0124
303.92	-0.006	192.5	-0.0098
303.93	-0.006	192.5	-0.008
303.95	-0.005	192.6	-0.0053
303.97	-0.002	192.8	-0.0009
303.98	0	192.9	0.0018
304.00	0.001	193.1	0.0053
304.02	0.002	193.3	0.0071
304.03	0.005	193.5	0.0107
304.05	0.006	193.7	0.0151
304.07	0.009	194	0.0151
304.08	0.012	194.2	0.0195
304.10	0.012	194.2	0.0231
304.12	0.012	194.4	0.0275
304.13	0.015	194.7	0.032
304.15	0.017	194.9	0.0355
304.17	0.018	195.1	0.0391
304.18	0.02	195.5	0.0417
304.20	0.022	195.7	0.0417
304.22	0.022	195.7	0.0444
304.23	0.023	195.9	0.047
304.27	0.024	196.2	0.0497
304.28	0.026	196.4	0.0524
304.30	0.026	196.6	0.0541
304.32	0.027	196.7	0.055
304.32	0.028	196.9	0.055
304.33	0.029	196.9	0.0568
304.35	0.029	197.1	0.0577
304.37	0.029	197.2	0.0577
304.38	0.029	197.3	0.0577
304.40	0.029	197.4	0.0586
304.42	0.029	197.5	0.0586
304.43	0.028	197.6	0.0586
304.45	0.027	197.6	0.0577

Prova triassiale ciclica SN04-C1			
pressione di confinamento (kPa)		80	
deviatore ciclico (kPa)		95	
frequenza (hz)		0.00625	
tempo	cella di carico	$\Delta u$	LVDT
(min)	kN	(kPa)	$\delta$ (mm)
304.47	0.027	197.6	0.0568
304.48	0.027	197.7	0.055
304.50	0.025	197.6	0.0541
304.52	0.024	197.6	0.0524
304.53	0.023	197.6	0.0497
304.55	0.02	197.5	0.0497
304.57	0.019	197.5	0.0479
304.58	0.019	197.4	0.0462
304.60	0.018	197.3	0.0426
304.62	0.015	197.1	0.0399
304.63	0.014	197	0.0373
304.65	0.012	196.9	0.0328
304.67	0.009	196.6	0.0328
304.68	0.007	196.5	0.0293
304.70	0.007	196.5	0.0257
304.72	0.006	196.3	0.0213
304.73	0.003	196	0.0169
304.75	0.001	195.7	0.0142
304.77	0	195.6	0.0098
304.78	-0.003	195.2	0.0098
304.80	-0.005	194.9	0.0053
304.82	-0.005	194.9	0.0027
304.83	-0.008	194.5	-0.0009
304.85	-0.009	194.2	-0.0036
304.87	-0.009	194.2	-0.0062
304.88	-0.01	194	-0.0098
304.90	-0.012	193.7	-0.0124
304.92	-0.014	193.5	-0.0151
304.93	-0.014	193.3	-0.0169
304.95	-0.015	193.1	-0.0186
304.97	-0.016	192.9	-0.0186
304.98	-0.016	192.9	-0.0195
305.00	-0.017	192.7	-0.0204
305.02	-0.017	192.6	-0.0222
305.03	-0.017	192.4	-0.0222
305.05	-0.017	192.3	-0.0222
305.07	-0.017	192.2	-0.0222
305.08	-0.017	192.1	-0.0222
305.10	-0.016	192.1	-0.0222
305.12	-0.016	192.1	-0.0222
305.13	-0.016	192.1	-0.0204
305.15	-0.014	192.1	-0.0195
305.17	-0.014	192.1	-0.0186
305.18	-0.012	192.1	-0.016
305.20	-0.01	192.2	-0.016
305.22	-0.009	192.2	-0.0142
305.23	-0.009	192.2	-0.0124
305.25	-0.008	192.4	-0.0098
305.27	-0.005	192.5	-0.0062
305.28	-0.004	192.6	-0.0044
305.30	-0.003	192.8	0
305.32	0.001	193	0
305.33	0.002	193	0.0036
305.35	0.002	193.2	0.0062
305.37	0.004	193.4	0.0107
305.38	0.007	193.6	0.0151
305.40	0.009	193.8	0.0178
305.42	0.01	194.1	0.0222



Prova triassiale ciclica SN04-C1			
pressione di confinamento (kPa)		80	
deviatore ciclico (kPa)		95	
frequenza (hz)		0.00625	
tempo	cella di carico	$\Delta u$	LVDT
(min)	kN	(kPa)	$\delta$ (mm)
305.43	0.013	194.3	0.0222
305.45	0.014	194.3	0.0275
305.47	0.014	194.6	0.0302
305.48	0.016	194.8	0.0346
305.50	0.019	195.1	0.0382
305.52	0.02	195.3	0.0408
305.53	0.021	195.6	0.0444
305.55	0.023	195.9	0.047
305.57	0.024	196	0.0479
305.58	0.025	196.2	0.0506
305.60	0.026	196.5	0.0506
305.62	0.027	196.7	0.0533
305.63	0.027	196.7	0.055
305.65	0.027	196.8	0.055
305.67	0.028	197	0.0568
305.70	0.029	197.1	0.0577
305.72	0.029	197.3	0.0577
305.73	0.029	197.4	0.0577
305.75	0.029	197.5	0.0577
305.77	0.029	197.5	0.0577
305.77	0.029	197.6	0.0577
305.78	0.028	197.6	0.0577
305.80	0.026	197.6	0.0559
305.82	0.026	197.7	0.055
305.83	0.025	197.6	0.0533
305.85	0.023	197.6	0.0533
305.87	0.022	197.6	0.0515
305.88	0.022	197.6	0.0497
305.90	0.021	197.5	0.047
305.92	0.018	197.4	0.0444
305.93	0.017	197.3	0.0417
305.95	0.016	197.1	0.0391
305.97	0.012	196.9	0.0391
305.98	0.011	196.9	0.0355
306.00	0.011	196.8	0.0328
306.02	0.01	196.5	0.0275
306.03	0.006	196.3	0.0231
306.05	0.005	196.2	0.0204
306.07	0.003	195.9	0.0169
306.08	0	195.7	0.0169
306.10	-0.001	195.7	0.0124
306.12	-0.001	195.4	0.0089
306.13	-0.002	195.1	0.0053
306.15	-0.006	194.8	0.0009
306.17	-0.007	194.6	-0.0027
306.18	-0.008	194.3	-0.0062
306.20	-0.011	194	-0.0062
306.22	-0.012	194	-0.0098
306.23	-0.012	193.8	-0.0115
306.25	-0.012	193.6	-0.0133
306.27	-0.015	193.3	-0.016
306.28	-0.015	193.2	-0.0178
306.30	-0.015	193	-0.0186
306.32	-0.016	192.8	-0.0204
306.33	-0.017	192.6	-0.0213
306.35	-0.017	192.5	-0.0222
306.37	-0.017	192.4	-0.0222
306.38	-0.017	192.4	-0.0222

Prova triassiale ciclica SN04-C1			
pressione di confinamento (kPa)		80	
deviatore ciclico (kPa)		95	
frequenza (hz)		0.00625	
tempo	cella di carico	$\Delta u$	LVDT
(min)	kN	(kPa)	$\delta$ (mm)
306.40	-0.017	192.3	-0.0231
306.42	-0.017	192.2	-0.0222
306.43	-0.016	192.1	-0.0222
306.45	-0.016	192.1	-0.0213
306.47	-0.015	192.1	-0.0204
306.48	-0.014	192.1	-0.0204
306.50	-0.013	192.1	-0.0186
306.52	-0.013	192.1	-0.0178
306.53	-0.012	192.1	-0.016
306.55	-0.01	192.2	-0.0133
306.57	-0.008	192.3	-0.0107
306.58	-0.007	192.4	-0.0089
306.60	-0.005	192.6	-0.0089
306.62	-0.003	192.6	-0.0053
306.63	-0.003	192.7	-0.0027
306.65	-0.002	192.8	0.0009
306.67	0.002	193.1	0.0053
306.68	0.003	193.2	0.008
306.70	0.004	193.5	0.0115
306.72	0.008	193.7	0.0115
306.73	0.009	193.7	0.016
306.75	0.009	193.9	0.0195
306.77	0.011	194.1	0.024
306.78	0.014	194.4	0.0293
306.80	0.015	194.6	0.032
306.82	0.016	194.9	0.0355
306.83	0.019	195.2	0.0355
306.85	0.021	195.4	0.0399
306.87	0.021	195.4	0.0426
306.88	0.022	195.7	0.0453
306.90	0.023	195.9	0.0479
306.92	0.025	196.2	0.0506
306.93	0.025	196.3	0.0524
306.95	0.026	196.6	0.0524
306.97	0.027	196.7	0.0541
306.98	0.027	196.7	0.055
307.00	0.029	197.1	0.0568
307.02	0.029	197.2	0.0577
307.03	0.029	197.2	0.0577
307.05	0.029	197.3	0.0577
307.07	0.029	197.4	0.0577
307.08	0.029	197.5	0.0577
307.10	0.028	197.6	0.0577
307.12	0.028	197.6	0.0568
307.13	0.026	197.6	0.0568
307.17	0.026	197.6	0.0559
307.18	0.026	197.7	0.0541
307.20	0.024	197.6	0.0524
307.22	0.022	197.6	0.0506
307.22	0.021	197.5	0.0488
307.23	0.02	197.4	0.0462
307.25	0.017	197.3	0.0462
307.27	0.017	197.3	0.0435
307.28	0.017	197.2	0.0408
307.30	0.015	197	0.0373
307.32	0.011	196.8	0.0337
307.33	0.011	196.7	0.0302
307.35	0.009	196.5	0.0257

Prova triassiale ciclica SN04-C1			
pressione di confinamento (kPa)		80	
deviatore ciclico (kPa)		95	
frequenza (hz)		0.00625	
tempo	cella di carico	$\Delta u$	LVDT
(min)	kN	(kPa)	$\delta$ (mm)
307.37	0.005	196.2	0.0257
307.38	0.004	196.2	0.0213
307.40	0.004	196.1	0.0186
307.42	0.002	195.8	0.0151
307.43	-0.001	195.5	0.0107
307.45	-0.002	195.2	0.0071
307.47	-0.003	194.9	0.0027
307.48	-0.007	194.7	0.0027
307.50	-0.008	194.7	-0.0018
307.52	-0.008	194.4	-0.0036
307.53	-0.009	194.2	-0.0071
307.55	-0.012	193.9	-0.0107
307.57	-0.012	193.7	-0.0124
307.58	-0.013	193.5	-0.0151
307.60	-0.015	193.2	-0.0151
307.62	-0.015	193.2	-0.0178
307.63	-0.015	193.1	-0.0186
307.65	-0.016	192.9	-0.0204
307.67	-0.017	192.7	-0.0213
307.68	-0.017	192.5	-0.0222
307.70	-0.017	192.4	-0.0222
307.72	-0.017	192.3	-0.0222
307.73	-0.017	192.2	-0.0222
307.75	-0.017	192.1	-0.0222
307.77	-0.016	192.1	-0.0222
307.78	-0.015	192	-0.0222
307.80	-0.015	192	-0.0213
307.82	-0.015	192	-0.0204
307.83	-0.014	192	-0.0186
307.85	-0.012	192.1	-0.0169
307.87	-0.012	192.1	-0.0151
307.88	-0.009	192.2	-0.0151
307.90	-0.008	192.3	-0.0124
307.92	-0.008	192.3	-0.0107
307.93	-0.007	192.4	-0.0071
307.95	-0.004	192.6	-0.0044
307.97	-0.002	192.7	-0.0009
307.98	-0.001	192.9	0.0027
308.00	0.002	193.1	0.0027
308.02	0.005	193.3	0.0062
308.03	0.005	193.3	0.0098
308.05	0.005	193.5	0.0133
308.07	0.008	193.8	0.0178
308.08	0.011	194	0.0213
308.10	0.011	194.2	0.0249
308.12	0.014	194.5	0.0302
308.13	0.017	194.8	0.0302
308.15	0.017	194.8	0.0337
308.17	0.017	195	0.0373
308.18	0.019	195.3	0.0408
308.20	0.022	195.6	0.0435
308.22	0.022	195.8	0.0462
308.23	0.024	196	0.0488
308.25	0.026	196.2	0.0488
308.27	0.026	196.2	0.0515
308.28	0.026	196.4	0.0533
308.30	0.027	196.6	0.055
308.32	0.028	196.8	0.0559

Prova triassiale ciclica SN04-C1			
pressione di confinamento (kPa)		80	
deviatore ciclico (kPa)		95	
frequenza (hz)		0.00625	
tempo	cella di carico	$\Delta u$	LVDT
(min)	kN	(kPa)	$\delta$ (mm)
308.33	0.028	197	0.0568
308.35	0.028	197.1	0.0577
308.37	0.029	197.2	0.0577
308.38	0.029	197.2	0.0586
308.40	0.029	197.3	0.0586
308.42	0.029	197.4	0.0586
308.43	0.028	197.5	0.0577
308.45	0.027	197.6	0.0568
308.47	0.027	197.6	0.0559
308.48	0.026	197.6	0.055
308.50	0.025	197.6	0.0541
308.52	0.024	197.6	0.0524
308.53	0.022	197.5	0.0524
308.55	0.021	197.5	0.0497
308.57	0.021	197.5	0.0479
308.58	0.02	197.3	0.0444
308.62	0.016	197.2	0.0417
308.63	0.016	197.1	0.0391
308.65	0.014	196.9	0.0355
308.67	0.011	196.7	0.0355
308.67	0.009	196.7	0.032
308.68	0.009	196.6	0.0293
308.70	0.008	196.4	0.024
308.72	0.004	196.1	0.0204
308.73	0.003	196	0.0178
308.75	0.002	195.7	0.0133
308.77	-0.002	195.4	0.0133
308.78	-0.003	195.4	0.0089
308.80	-0.003	195.1	0.0053
308.82	-0.004	194.9	0.0018
308.83	-0.007	194.6	-0.0027
308.85	-0.009	194.4	-0.0053
308.87	-0.01	194.1	-0.0089
308.88	-0.012	193.8	-0.0089
308.90	-0.012	193.8	-0.0115
308.92	-0.012	193.6	-0.0133
308.93	-0.014	193.4	-0.016
308.95	-0.015	193.1	-0.0178
308.97	-0.016	193	-0.0195
308.98	-0.016	192.8	-0.0204
309.00	-0.017	192.6	-0.0204
309.02	-0.017	192.5	-0.0222
309.03	-0.017	192.5	-0.0222
309.05	-0.017	192.3	-0.0222
309.07	-0.017	192.2	-0.0222
309.08	-0.017	192.1	-0.0222
309.10	-0.017	192.1	-0.0222
309.12	-0.016	192.1	-0.0222
309.13	-0.015	192	-0.0213
309.15	-0.015	192	-0.0204
309.17	-0.014	192	-0.0186
309.18	-0.012	192.1	-0.016
309.20	-0.012	192.1	-0.016
309.22	-0.011	192.1	-0.0133
309.23	-0.009	192.3	-0.0115
309.25	-0.006	192.4	-0.0089
309.27	-0.006	192.5	-0.0062
309.28	-0.004	192.7	-0.0027

Prova triassiale ciclica SN04-C1			
pressione di confinamento (kPa)		80	
deviatore ciclico (kPa)		95	
frequenza (hz)		0.00625	
tempo	cella di carico	$\Delta u$	LVDT
(min)	kN	(kPa)	$\delta$ (mm)
309.30	-0.001	192.8	-0.0027
309.32	-0.001	192.8	0
309.33	0	193	0.0036
309.35	0.002	193.2	0.008
309.37	0.005	193.4	0.0115
309.38	0.006	193.6	0.0151
309.40	0.009	193.9	0.0195
309.42	0.011	194.1	0.0195
309.43	0.012	194.1	0.0231
309.45	0.012	194.3	0.0275
309.47	0.015	194.6	0.0311
309.48	0.017	194.9	0.0346
309.50	0.018	195.1	0.0382
309.52	0.02	195.4	0.0408
309.53	0.022	195.7	0.0408
309.55	0.023	195.7	0.0444
309.57	0.023	195.8	0.0462
309.58	0.024	196.1	0.0497
309.60	0.026	196.3	0.0515
309.62	0.026	196.5	0.0533
309.63	0.027	196.7	0.055
309.65	0.028	196.9	0.055
309.67	0.029	196.9	0.0559
309.68	0.029	197	0.0568
309.70	0.029	197.1	0.0577
309.72	0.029	197.3	0.0577
309.73	0.029	197.4	0.0577
309.75	0.028	197.5	0.0577
309.77	0.028	197.6	0.0577
309.78	0.027	197.6	0.0577
309.80	0.027	197.6	0.0568
309.82	0.026	197.6	0.055
309.83	0.025	197.6	0.0541
309.85	0.024	197.6	0.0524
309.87	0.023	197.5	0.0497
309.88	0.02	197.4	0.0497
309.90	0.02	197.4	0.047
309.92	0.018	197.3	0.0444
309.93	0.017	197.2	0.0444
309.95	0.015	197.2	0.0417
309.97	0.015	197.1	0.0382
309.98	0.013	196.9	0.0337
310.00	0.01	196.7	0.0302
310.02	0.009	196.5	0.0275
310.03	0.007	196.3	0.0231
310.07	0.004	196	0.0231
310.08	0.002	195.8	0.0186
310.10	0.002	195.8	0.0151
310.12	0.001	195.6	0.0115
310.12	-0.002	195.2	0.0071
310.13	-0.004	195	0.0044
310.15	-0.005	194.8	0
310.17	-0.008	194.4	0
310.18	-0.009	194.2	-0.0036
310.20	-0.009	194.2	-0.0071
310.22	-0.01	194	-0.0098
310.23	-0.012	193.7	-0.0124
310.25	-0.013	193.5	-0.0142

Prova triassiale ciclica SN04-C1			
pressione di confinamento (kPa)		80	
deviatore ciclico (kPa)		95	
frequenza (hz)		0.00625	
tempo	cella di carico	$\Delta u$	LVDT
(min)	kN	(kPa)	$\delta$ (mm)
310.27	-0.014	193.3	-0.0169
310.28	-0.015	193	-0.0169
310.30	-0.016	192.9	-0.0186
310.32	-0.016	192.9	-0.0195
310.33	-0.017	192.7	-0.0213
310.35	-0.017	192.6	-0.0213
310.37	-0.017	192.4	-0.0222
310.38	-0.017	192.3	-0.0222
310.40	-0.017	192.2	-0.0222
310.42	-0.017	192.1	-0.0222
310.43	-0.016	192.1	-0.0222
310.45	-0.016	192.1	-0.0222
310.47	-0.016	192	-0.0204
310.48	-0.014	192	-0.0195
310.50	-0.013	192	-0.0178
310.52	-0.013	192.1	-0.016
310.53	-0.01	192.2	-0.016
310.55	-0.01	192.2	-0.0142
310.57	-0.01	192.2	-0.0124
310.58	-0.008	192.4	-0.0098
310.60	-0.005	192.5	-0.0062
310.62	-0.004	192.6	-0.0036
310.63	-0.002	192.8	0
310.65	0	192.9	0.0018
310.67	0.001	193	0.0053
310.68	0.002	193.3	0.0089
310.70	0.007	193.5	0.0089
310.72	0.007	193.5	0.0133
310.73	0.007	193.7	0.016
310.75	0.009	193.9	0.0204
310.77	0.013	194.2	0.0249
310.78	0.013	194.4	0.0284
310.80	0.015	194.7	0.0328
310.82	0.018	195	0.0328
310.83	0.019	195.2	0.0364
310.85	0.019	195.2	0.0399
310.87	0.02	195.4	0.0426
310.88	0.023	195.7	0.0462
310.90	0.024	196	0.0479
310.92	0.025	196.1	0.0506
310.93	0.026	196.4	0.0506
310.95	0.027	196.6	0.0533
310.97	0.027	196.6	0.0541
310.98	0.027	196.8	0.0559
311.00	0.028	196.9	0.0568
311.02	0.029	197.1	0.0577
311.03	0.029	197.2	0.0577
311.05	0.029	197.3	0.0586
311.07	0.029	197.4	0.0586
311.08	0.029	197.4	0.0586
311.10	0.029	197.5	0.0586
311.12	0.028	197.6	0.0568
311.13	0.026	197.6	0.0559
311.15	0.026	197.6	0.055
311.17	0.025	197.6	0.0533
311.18	0.023	197.5	0.0533
311.20	0.022	197.5	0.0515
311.22	0.022	197.5	0.0497

Prova triassiale ciclica SN04-C1			
pressione di confinamento (kPa)		80	
deviatore ciclico (kPa)		95	
frequenza (hz)		0.00625	
tempo	cella di carico	$\Delta u$	LVDT
(min)	kN	(kPa)	$\delta$ (mm)
311.23	0.021	197.4	0.047
311.25	0.018	197.3	0.0444
311.27	0.017	197.2	0.0417
311.28	0.016	197.1	0.0391
311.30	0.012	196.9	0.0391
311.32	0.011	196.9	0.0355
311.33	0.011	196.8	0.0328
311.35	0.01	196.5	0.0284
311.37	0.006	196.3	0.0231
311.38	0.006	196.2	0.0222
311.40	0.004	196	0.0178
311.42	0.001	195.7	0.0142
311.43	0	195.5	0.0107
311.45	-0.002	195.2	0.0062
311.47	-0.005	194.9	0.0062
311.48	-0.006	194.9	0.0027
311.50	-0.006	194.7	0
311.53	-0.007	194.4	-0.0044
311.55	-0.01	194.1	-0.008
311.57	-0.011	193.9	-0.0107
311.58	-0.012	193.7	-0.0124
311.58	-0.014	193.4	-0.0124
311.60	-0.015	193.2	-0.0151
311.62	-0.015	193.2	-0.0178
311.63	-0.015	193	-0.0186
311.65	-0.016	192.8	-0.0204
311.67	-0.017	192.6	-0.0213
311.68	-0.017	192.5	-0.0222
311.70	-0.017	192.4	-0.0222
311.72	-0.017	192.2	-0.0222
311.73	-0.017	192.2	-0.0222
311.75	-0.017	192.2	-0.0222
311.77	-0.017	192.1	-0.0222
311.78	-0.016	192.1	-0.0213
311.80	-0.015	192	-0.0204
311.82	-0.014	192.1	-0.0204
311.83	-0.013	192.1	-0.0186
311.85	-0.013	192.1	-0.0178
311.87	-0.012	192.1	-0.016
311.88	-0.01	192.2	-0.0133
311.90	-0.008	192.3	-0.0115
311.92	-0.007	192.4	-0.008
311.93	-0.005	192.5	-0.008
311.95	-0.003	192.7	-0.0053
311.97	-0.003	192.7	-0.0018
311.98	-0.002	192.8	0.0009
312.00	0.001	193	0.0044
312.02	0.003	193.2	0.008
312.03	0.004	193.4	0.0124
312.05	0.007	193.7	0.0169
312.07	0.01	193.9	0.0169
312.08	0.01	193.9	0.0204
312.10	0.012	194.4	0.0257
312.12	0.015	194.6	0.0257
312.13	0.016	194.6	0.0302
312.15	0.016	194.8	0.0337
312.17	0.018	195.1	0.0373
312.18	0.02	195.3	0.0408

Prova triassiale ciclica SN04-C1			
pressione di confinamento (kPa)		80	
deviatore ciclico (kPa)		95	
frequenza (hz)		0.00625	
tempo	cella di carico	$\Delta u$	LVDT
(min)	kN	(kPa)	$\delta$ (mm)
312.20	0.021	195.6	0.0435
312.22	0.022	195.8	0.0462
312.23	0.025	196.1	0.0462
312.25	0.025	196.1	0.0488
312.27	0.025	196.2	0.0506
312.28	0.026	196.5	0.0533
312.30	0.027	196.7	0.055
312.32	0.028	196.8	0.0559
312.33	0.028	197	0.0568
312.35	0.029	197.1	0.0568
312.37	0.029	197.1	0.0577
312.38	0.029	197.2	0.0577
312.40	0.029	197.4	0.0586
312.42	0.029	197.5	0.0586
312.43	0.028	197.5	0.0577
312.45	0.028	197.6	0.0568
312.47	0.026	197.6	0.0568
312.48	0.026	197.6	0.0559
312.50	0.026	197.6	0.055
312.52	0.025	197.6	0.0524
312.53	0.023	197.5	0.0506
312.55	0.021	197.5	0.0488
312.57	0.02	197.4	0.0462
312.58	0.018	197.3	0.0462
312.60	0.016	197.2	0.0435
312.62	0.016	197.2	0.0408
312.63	0.015	197	0.0382
312.65	0.012	196.8	0.0337
312.67	0.01	196.7	0.0311
312.68	0.009	196.5	0.0257
312.70	0.006	196.2	0.0257
312.72	0.004	196	0.0222
312.73	0.004	196	0.0186
312.75	0.002	195.8	0.0142
312.77	0	195.5	0.0107
312.78	-0.002	195.2	0.0071
312.80	-0.004	195	0.0036
312.82	-0.006	194.6	0
312.83	-0.007	194.5	-0.0027
312.85	-0.008	194.3	-0.0053
312.87	-0.01	193.9	-0.0089
312.88	-0.012	193.7	-0.0089
312.90	-0.012	193.7	-0.0115
312.92	-0.013	193.5	-0.0142
312.93	-0.014	193.3	-0.016
312.97	-0.016	193.1	-0.0178
312.98	-0.016	192.9	-0.0195
313.00	-0.016	192.7	-0.0204
313.02	-0.017	192.5	-0.0204
313.03	-0.017	192.5	-0.0213
313.03	-0.017	192.4	-0.0222
313.05	-0.017	192.3	-0.0222
313.07	-0.017	192.2	-0.0222
313.08	-0.017	192.1	-0.0222
313.10	-0.017	192	-0.0222
313.12	-0.015	192	-0.0222
313.13	-0.015	192	-0.0204
313.15	-0.015	192	-0.0195



Prova triassiale ciclica SN04-C1			
pressione di confinamento (kPa)		80	
deviatore ciclico (kPa)		95	
frequenza (hz)		0.00625	
tempo	cella di carico	$\Delta u$	LVDT
(min)	kN	(kPa)	$\delta$ (mm)
313.17	-0.014	192	-0.0186
313.18	-0.012	192	-0.0169
313.20	-0.011	192.1	-0.0151
313.22	-0.01	192.2	-0.0133
313.23	-0.007	192.3	-0.0133
313.25	-0.007	192.3	-0.0098
313.27	-0.007	192.4	-0.0071
313.28	-0.005	192.6	-0.0044
313.30	-0.002	192.8	-0.0009
313.32	0	192.9	0.0027
313.33	0.001	193.1	0.0062
313.35	0.004	193.3	0.0062
313.37	0.005	193.3	0.0098
313.38	0.005	193.5	0.0133
313.40	0.007	193.7	0.0178
313.42	0.011	194	0.0213
313.43	0.012	194.2	0.0249
313.45	0.014	194.4	0.0302
313.47	0.017	194.7	0.0302
313.48	0.018	194.7	0.0337
313.50	0.018	194.9	0.0364
313.52	0.019	195.2	0.0399
313.53	0.021	195.5	0.0426
313.55	0.023	195.7	0.0462
313.57	0.023	195.9	0.0479
313.58	0.025	196.1	0.0497
313.60	0.026	196.3	0.0524
313.62	0.026	196.5	0.0541
313.63	0.027	196.7	0.0541
313.65	0.028	196.9	0.055
313.67	0.028	196.9	0.0568
313.68	0.028	197	0.0568
313.70	0.029	197.2	0.0577
313.72	0.029	197.3	0.0577
313.73	0.029	197.4	0.0586
313.75	0.029	197.5	0.0586
313.77	0.028	197.5	0.0586
313.78	0.027	197.5	0.0577
313.80	0.027	197.6	0.0568
313.82	0.026	197.6	0.055
313.83	0.025	197.6	0.0541
313.85	0.024	197.6	0.0524
313.87	0.023	197.5	0.0497
313.88	0.02	197.4	0.0497
313.90	0.02	197.4	0.0479
313.92	0.02	197.4	0.0453
313.93	0.018	197.2	0.0426
313.95	0.015	197.1	0.0391
313.97	0.014	197	0.0364
313.98	0.012	196.7	0.0328
314.00	0.009	196.5	0.0328
314.02	0.008	196.5	0.0293
314.03	0.008	196.4	0.0249
314.05	0.006	196.1	0.0213
314.07	0.003	195.9	0.0178
314.08	0.001	195.7	0.0142
314.10	0	195.4	0.0107
314.12	-0.004	195.1	0.0107

Prova triassiale ciclica SN04-C1			
pressione di confinamento (kPa)		80	
deviatore ciclico (kPa)		95	
frequenza (hz)		0.00625	
tempo	cella di carico	$\Delta u$	LVDT
(min)	kN	(kPa)	$\delta$ (mm)
314.13	-0.005	195.1	0.0053
314.15	-0.005	194.9	0.0027
314.17	-0.006	194.6	-0.0018
314.18	-0.009	194.3	-0.0053
314.20	-0.01	194.1	-0.008
314.22	-0.011	193.8	-0.0107
314.23	-0.013	193.6	-0.0107
314.25	-0.014	193.6	-0.0133
314.27	-0.015	193.2	-0.0169
314.28	-0.015	193	-0.0169
314.30	-0.016	193	-0.0186
314.32	-0.016	192.8	-0.0195
314.33	-0.016	192.6	-0.0213
314.35	-0.017	192.5	-0.0222
314.37	-0.017	192.3	-0.0222
314.38	-0.017	192.2	-0.0222
314.40	-0.017	192.2	-0.0222
314.43	-0.017	192.2	-0.0222
314.45	-0.017	192.1	-0.0222
314.47	-0.016	192	-0.0213
314.48	-0.015	192	-0.0204
314.48	-0.014	192	-0.0195
314.50	-0.014	192	-0.0178
314.52	-0.012	192.1	-0.0178
314.53	-0.011	192.1	-0.016
314.55	-0.011	192.1	-0.0142
314.57	-0.01	192.2	-0.0115
314.58	-0.007	192.3	-0.0089
314.60	-0.005	192.4	-0.0062
314.62	-0.004	192.5	-0.0036
314.63	-0.001	192.8	-0.0036
314.65	0	192.9	0
314.67	0	192.9	0.0036
314.68	0.002	193.1	0.0071
314.70	0.005	193.4	0.0115
314.72	0.007	193.6	0.0142
314.73	0.008	193.8	0.0186
314.75	0.012	194.1	0.0186
314.77	0.013	194.3	0.0231
314.78	0.013	194.3	0.0275
314.80	0.014	194.5	0.0311
314.82	0.017	194.8	0.0346
314.83	0.018	195	0.0382
314.85	0.02	195.3	0.0417
314.87	0.022	195.6	0.0417
314.88	0.023	195.8	0.0453
314.90	0.023	195.8	0.047
314.92	0.024	196	0.0497
314.93	0.026	196.3	0.0515
314.95	0.027	196.5	0.0533
314.97	0.027	196.6	0.055
314.98	0.028	196.8	0.055
315.00	0.029	196.9	0.0568
315.02	0.029	197.1	0.0577
315.03	0.029	197.2	0.0577
315.05	0.029	197.3	0.0577
315.07	0.029	197.3	0.0577
315.08	0.029	197.4	0.0577

Prova triassiale ciclica SN04-C1			
pressione di confinamento (kPa)		80	
deviatore ciclico (kPa)		95	
frequenza (hz)		0.00625	
tempo	cella di carico	$\Delta u$	LVDT
(min)	kN	(kPa)	$\delta$ (mm)
315.10	0.028	197.5	0.0577
315.12	0.028	197.6	0.0577
315.13	0.027	197.6	0.0559
315.15	0.026	197.6	0.0541
315.17	0.024	197.6	0.0541
315.18	0.024	197.6	0.0533
315.20	0.024	197.5	0.0515
315.22	0.022	197.5	0.0488
315.23	0.019	197.4	0.0462
315.25	0.019	197.3	0.0444
315.27	0.017	197.1	0.0408
315.28	0.014	197	0.0408
315.30	0.013	197	0.0382
315.32	0.013	196.9	0.0355
315.33	0.012	196.6	0.032
315.35	0.008	196.4	0.0275
315.37	0.007	196.3	0.0231
315.38	0.005	196	0.0195
315.40	0.002	195.8	0.0195
315.42	0.001	195.8	0.0151
315.43	0.001	195.6	0.0115
315.45	-0.001	195.2	0.008
315.47	-0.004	195	0.0044
315.48	-0.005	194.7	0.0009
315.50	-0.007	194.5	-0.0036
315.52	-0.01	194.2	-0.0036
315.53	-0.01	194.2	-0.0071
315.55	-0.01	194	-0.0089
315.57	-0.011	193.7	-0.0115
315.58	-0.014	193.5	-0.0151
315.60	-0.014	193.3	-0.016
315.62	-0.015	193.1	-0.0186
315.63	-0.016	192.8	-0.0186
315.65	-0.017	192.8	-0.0204
315.67	-0.017	192.7	-0.0213
315.68	-0.017	192.5	-0.0213
315.70	-0.017	192.4	-0.0222
315.72	-0.017	192.3	-0.0222
315.73	-0.017	192.2	-0.0222
315.75	-0.017	192.1	-0.0222
315.77	-0.016	192	-0.0222
315.78	-0.016	192	-0.0213
315.80	-0.015	192	-0.0213
315.82	-0.014	192	-0.0204
315.83	-0.014	192	-0.0195
315.87	-0.013	192	-0.0169
315.88	-0.011	192.1	-0.0151
315.90	-0.01	192.1	-0.0133
315.92	-0.009	192.2	-0.0107
315.93	-0.006	192.4	-0.0107
315.93	-0.005	192.5	-0.008
315.95	-0.005	192.5	-0.0053
315.97	-0.003	192.6	-0.0018
315.98	-0.001	192.8	0.0009
316.00	0.001	193	0.0044
316.02	0.003	193.2	0.0089
316.03	0.006	193.5	0.0089
316.05	0.008	193.7	0.0133

Prova triassiale ciclica SN04-C1			
pressione di confinamento (kPa)		80	
deviatore ciclico (kPa)		95	
frequenza (hz)		0.00625	
tempo	cella di carico	$\Delta u$	LVDT
(min)	kN	(kPa)	$\delta$ (mm)
316.07	0.008	193.7	0.0169
316.08	0.009	193.9	0.0204
316.10	0.012	194.2	0.024
316.12	0.014	194.4	0.0293
316.13	0.015	194.6	0.0328
316.15	0.017	194.9	0.0328
316.17	0.02	195.1	0.0364
316.18	0.02	195.1	0.0399
316.20	0.02	195.4	0.0426
316.22	0.022	195.7	0.0462
316.23	0.024	195.9	0.0488
316.25	0.025	196.1	0.0515
316.27	0.026	196.3	0.0533
316.28	0.027	196.5	0.0533
316.30	0.027	196.5	0.0541
316.32	0.027	196.7	0.0559
316.33	0.028	196.9	0.0568
316.35	0.029	197	0.0577
316.37	0.029	197.1	0.0586
316.38	0.029	197.3	0.0586
316.40	0.029	197.4	0.0586
316.42	0.029	197.4	0.0586
316.43	0.028	197.5	0.0577
316.45	0.027	197.6	0.0568
316.47	0.026	197.6	0.0568
316.48	0.026	197.6	0.0559
316.50	0.026	197.6	0.0541
316.52	0.024	197.5	0.0524
316.53	0.023	197.5	0.0506
316.55	0.022	197.4	0.0479
316.57	0.019	197.3	0.0479
316.58	0.018	197.3	0.0453
316.60	0.018	197.3	0.0435
316.62	0.016	197.1	0.0399
316.63	0.013	196.9	0.0364
316.65	0.012	196.8	0.0337
316.67	0.01	196.6	0.0302
316.68	0.007	196.4	0.0302
316.70	0.006	196.4	0.0257
316.72	0.006	196.2	0.0222
316.73	0.004	195.9	0.0178
316.75	0.001	195.7	0.0142
316.77	0	195.4	0.0107
316.78	-0.002	195.1	0.0062
316.80	-0.005	194.8	0.0062
316.82	-0.006	194.8	0.0018
316.83	-0.006	194.6	-0.0009
316.85	-0.007	194.3	-0.0044
316.87	-0.011	194	-0.008
316.88	-0.011	193.8	-0.0098
316.90	-0.012	193.6	-0.0124
316.92	-0.014	193.3	-0.0124
316.93	-0.015	193.3	-0.0151
316.95	-0.015	193.2	-0.0169
316.97	-0.015	193	-0.0186
316.98	-0.016	192.7	-0.0204
317.00	-0.017	192.6	-0.0213
317.02	-0.017	192.5	-0.0213

Prova triassiale ciclica SN04-C1			
pressione di confinamento (kPa)		80	
deviatore ciclico (kPa)		95	
frequenza (hz)		0.00625	
tempo	cella di carico	$\Delta u$	LVDT
(min)	kN	(kPa)	$\delta$ (mm)
317.03	-0.017	192.3	-0.0213
317.05	-0.017	192.3	-0.0222
317.07	-0.017	192.2	-0.0222
317.08	-0.017	192.1	-0.0222
317.10	-0.016	192.1	-0.0213
317.12	-0.016	192	-0.0213
317.13	-0.015	192	-0.0204
317.15	-0.014	192	-0.0204
317.17	-0.013	192	-0.0186
317.18	-0.012	192	-0.0169
317.20	-0.011	192.1	-0.0169
317.22	-0.01	192.1	-0.0151
317.23	-0.01	192.1	-0.0124
317.25	-0.008	192.3	-0.0098
317.27	-0.005	192.4	-0.0062
317.28	-0.004	192.5	-0.0044
317.30	-0.003	192.7	0
317.33	0.001	192.9	0
317.35	0.002	192.9	0.0036
317.37	0.002	193	0.0062
317.38	0.003	193.3	0.0107
317.38	0.007	193.5	0.0151
317.40	0.008	193.7	0.0186
317.42	0.01	194	0.0222
317.43	0.013	194.3	0.0222
317.45	0.014	194.3	0.0257
317.47	0.014	194.5	0.0302
317.48	0.016	194.7	0.0346
317.50	0.02	195	0.0391
317.52	0.02	195.2	0.0408
317.53	0.021	195.5	0.0435
317.55	0.023	195.8	0.0435
317.57	0.024	195.8	0.047
317.58	0.024	196	0.0488
317.60	0.025	196.2	0.0515
317.62	0.027	196.4	0.0533
317.63	0.027	196.6	0.055
317.65	0.028	196.7	0.0568
317.67	0.029	196.9	0.0568
317.68	0.029	196.9	0.0577
317.70	0.029	197	0.0577
317.72	0.029	197.2	0.0577
317.73	0.028	197.3	0.0577
317.75	0.028	197.4	0.0577
317.77	0.028	197.5	0.0577
317.78	0.028	197.5	0.0577
317.80	0.027	197.5	0.0577
317.82	0.027	197.5	0.0559
317.83	0.025	197.5	0.0541
317.85	0.024	197.5	0.0524
317.87	0.023	197.5	0.0506
317.88	0.022	197.4	0.0488
317.90	0.019	197.3	0.0462
317.92	0.018	197.2	0.0444
317.93	0.017	197.1	0.0417
317.95	0.014	197	0.0417
317.97	0.013	197	0.0382
317.98	0.013	196.8	0.0355

Prova triassiale ciclica SN04-C1			
pressione di confinamento (kPa)		80	
deviatore ciclico (kPa)		95	
frequenza (hz)		0.00625	
tempo	cella di carico	$\Delta u$	LVDT
(min)	kN	(kPa)	$\delta$ (mm)
318.00	0.012	196.7	0.032
318.02	0.008	196.4	0.0275
318.03	0.007	196.2	0.024
318.05	0.005	196.1	0.0195
318.07	0.002	195.8	0.0195
318.08	0	195.6	0.0151
318.10	0	195.6	0.0124
318.12	-0.001	195.3	0.008
318.13	-0.004	194.9	0.0044
318.15	-0.005	194.7	0.0018
318.17	-0.007	194.5	-0.0027
318.18	-0.009	194.2	-0.0027
318.20	-0.011	193.9	-0.0062
318.22	-0.011	193.9	-0.0098
318.23	-0.012	193.7	-0.0115
318.25	-0.013	193.4	-0.0142
318.27	-0.014	193.2	-0.016
318.28	-0.015	193	-0.0178
318.30	-0.016	192.8	-0.0178
318.32	-0.017	192.7	-0.0195
318.33	-0.017	192.7	-0.0204
318.35	-0.017	192.5	-0.0213
318.37	-0.017	192.4	-0.0222
318.38	-0.017	192.2	-0.0222
318.40	-0.017	192.1	-0.0222
318.42	-0.017	192.1	-0.0222
318.43	-0.016	192	-0.0222
318.45	-0.016	192	-0.0213
318.47	-0.015	192	-0.0204
318.48	-0.015	192	-0.0195
318.50	-0.013	192	-0.0178
318.52	-0.012	192	-0.0169
318.53	-0.011	192.1	-0.0142
318.55	-0.009	192.2	-0.0142
318.57	-0.008	192.2	-0.0124
318.58	-0.008	192.2	-0.0098
318.60	-0.006	192.4	-0.0071
318.62	-0.003	192.6	-0.0036
318.63	-0.002	192.7	-0.0009
318.65	-0.002	192.8	0.0009
318.67	0.001	193	0.0044
318.68	0.003	193.2	0.008
318.70	0.004	193.4	0.0124
318.72	0.009	193.7	0.0124
318.73	0.009	193.7	0.0169
318.75	0.009	193.8	0.0195
318.77	0.011	194.1	0.024
318.80	0.014	194.4	0.0293
318.82	0.015	194.6	0.032
318.83	0.017	194.9	0.0364
318.83	0.02	195.1	0.0364
318.85	0.021	195.1	0.0408
318.87	0.021	195.4	0.0426
318.88	0.022	195.6	0.0453
318.90	0.024	195.9	0.0479
318.92	0.025	196.1	0.0506
318.93	0.025	196.3	0.0524
318.95	0.027	196.5	0.0524

Prova triassiale ciclica SN04-C1			
pressione di confinamento (kPa)		80	
deviatore ciclico (kPa)		95	
frequenza (hz)		0.00625	
tempo	cella di carico	$\Delta u$	LVDT
(min)	kN	(kPa)	$\delta$ (mm)
318.97	0.028	196.5	0.0541
318.98	0.028	196.7	0.0559
319.00	0.028	196.8	0.0568
319.02	0.028	197	0.0568
319.03	0.029	197.1	0.0577
319.05	0.029	197.2	0.0586
319.07	0.029	197.3	0.0586
319.08	0.029	197.4	0.0586
319.10	0.029	197.4	0.0586
319.12	0.028	197.5	0.0568
319.13	0.027	197.5	0.0559
319.15	0.026	197.5	0.055
319.17	0.025	197.5	0.0533
319.18	0.024	197.4	0.0533
319.20	0.022	197.4	0.0515
319.22	0.022	197.4	0.0497
319.23	0.021	197.4	0.0479
319.25	0.019	197.2	0.0444
319.27	0.017	197.1	0.0417
319.28	0.016	197	0.0391
319.30	0.013	196.8	0.0391
319.32	0.011	196.7	0.0355
319.33	0.011	196.7	0.0328
319.35	0.007	196.3	0.0284
319.37	0.006	196.1	0.0257
319.38	0.006	196.1	0.0222
319.40	0.004	195.9	0.0186
319.42	0.002	195.6	0.0142
319.43	-0.001	195.4	0.0107
319.45	-0.002	195.1	0.0071
319.47	-0.004	194.8	0.0027
319.48	-0.007	194.6	0.0027
319.50	-0.007	194.6	-0.0009
319.52	-0.008	194.3	-0.0044
319.53	-0.009	194	-0.0071
319.55	-0.011	193.8	-0.0098
319.57	-0.012	193.6	-0.0133
319.58	-0.014	193.3	-0.0151
319.60	-0.015	193.1	-0.0151
319.62	-0.015	193.1	-0.0169
319.63	-0.015	192.9	-0.0186
319.65	-0.016	192.7	-0.0195
319.67	-0.017	192.6	-0.0213
319.68	-0.017	192.4	-0.0213
319.70	-0.017	192.3	-0.0222
319.72	-0.017	192.2	-0.0222
319.73	-0.017	192.2	-0.0222
319.75	-0.017	192.1	-0.0222
319.77	-0.017	192	-0.0213
319.78	-0.016	192	-0.0213
319.80	-0.015	192	-0.0204
319.82	-0.015	191.9	-0.0195
319.83	-0.013	192	-0.0195
319.85	-0.012	192	-0.0178
319.87	-0.012	192	-0.016
319.88	-0.011	192.1	-0.0133
319.90	-0.008	192.2	-0.0107
319.92	-0.007	192.3	-0.008

Prova triassiale ciclica SN04-C1			
pressione di confinamento (kPa)		80	
deviatore ciclico (kPa)		95	
frequenza (hz)		0.00625	
tempo	cella di carico	$\Delta u$	LVDT
(min)	kN	(kPa)	$\delta$ (mm)
319.93	-0.006	192.4	-0.0053
319.95	-0.002	192.6	-0.0053
319.97	-0.002	192.6	-0.0018
319.98	-0.002	192.7	0
320.00	0	193	0.0044
320.02	0.004	193.2	0.0089
320.03	0.005	193.3	0.0115
320.05	0.006	193.6	0.016
320.07	0.01	193.8	0.016
320.08	0.011	194	0.0222
320.10	0.011	194.2	0.0257
320.12	0.015	194.5	0.0257
320.13	0.016	194.5	0.0302
320.15	0.016	194.7	0.0337
320.17	0.017	195	0.0373
320.18	0.021	195.2	0.0408
320.20	0.021	195.4	0.0435
320.23	0.022	195.7	0.0462
320.25	0.025	196	0.0462
320.27	0.025	196	0.0488
320.28	0.025	196.2	0.0506
320.30	0.026	196.4	0.0533
320.30	0.027	196.6	0.055
320.32	0.028	196.7	0.0559
320.33	0.028	196.9	0.0568
320.35	0.029	197.1	0.0568
320.37	0.029	197.1	0.0577
320.38	0.029	197.2	0.0586
320.40	0.029	197.3	0.0586
320.42	0.029	197.4	0.0586
320.43	0.028	197.5	0.0586
320.45	0.027	197.5	0.0568
320.47	0.027	197.5	0.0568
320.48	0.025	197.5	0.0559
320.50	0.025	197.5	0.0541
320.52	0.024	197.5	0.0524
320.53	0.023	197.4	0.0506
320.55	0.021	197.4	0.0488
320.57	0.02	197.3	0.0462
320.58	0.018	197.2	0.0462
320.60	0.016	197.1	0.0435
320.62	0.016	197.1	0.0408
320.63	0.015	197	0.0382
320.65	0.012	196.7	0.0337
320.67	0.01	196.6	0.0311
320.68	0.009	196.4	0.0275
320.70	0.006	196.2	0.0275
320.72	0.004	195.9	0.0222
320.73	0.004	195.9	0.0186
320.75	0.002	195.7	0.0151
320.77	0	195.4	0.0107
320.78	-0.003	195.1	0.0071
320.80	-0.004	194.9	0.0036
320.82	-0.005	194.7	0.0018
320.83	-0.007	194.4	-0.0018
320.85	-0.008	194.2	-0.0053
320.87	-0.01	193.9	-0.0089
320.88	-0.012	193.6	-0.0089



Prova triassiale ciclica SN04-C1			
pressione di confinamento (kPa)		80	
deviatore ciclico (kPa)		95	
frequenza (hz)		0.00625	
tempo	cella di carico	$\Delta u$	LVDT
(min)	kN	(kPa)	$\delta$ (mm)
320.90	-0.012	193.6	-0.0115
320.92	-0.013	193.4	-0.0142
320.93	-0.014	193.2	-0.016
320.95	-0.016	193	-0.0178
320.97	-0.016	192.8	-0.0186
320.98	-0.016	192.7	-0.0204
321.00	-0.017	192.5	-0.0204
321.02	-0.017	192.5	-0.0213
321.03	-0.017	192.4	-0.0222
321.05	-0.017	192.2	-0.0222
321.07	-0.017	192.1	-0.0222
321.08	-0.017	192	-0.0222
321.10	-0.016	192	-0.0213
321.12	-0.015	192	-0.0213
321.13	-0.015	192	-0.0204
321.15	-0.015	191.9	-0.0204
321.17	-0.014	191.9	-0.0186
321.18	-0.012	192	-0.0169
321.20	-0.011	192	-0.0151
321.22	-0.01	192.1	-0.0124
321.23	-0.007	192.2	-0.0124
321.25	-0.006	192.2	-0.0098
321.27	-0.006	192.3	-0.008
321.28	-0.005	192.4	-0.0044
321.30	-0.002	192.7	-0.0009
321.32	0	192.8	0.0018
321.33	0.001	192.9	0.0062
321.35	0.004	193.2	0.0062
321.37	0.006	193.4	0.0107
321.38	0.006	193.4	0.0133
321.40	0.007	193.6	0.0178
321.42	0.01	193.9	0.0213
321.43	0.012	194.1	0.0249
321.45	0.013	194.3	0.0293
321.47	0.016	194.6	0.0293
321.48	0.018	194.9	0.0337
321.50	0.018	194.9	0.0373
321.52	0.019	195.1	0.0399
321.53	0.022	195.6	0.0435
321.55	0.022	195.6	0.0453
321.57	0.023	195.8	0.0479
321.58	0.025	196.1	0.0506
321.60	0.026	196.3	0.0524
321.62	0.026	196.4	0.0541
321.63	0.027	196.7	0.055
321.65	0.028	196.8	0.055
321.67	0.028	196.8	0.0568
321.70	0.028	196.9	0.0568
321.72	0.029	197.1	0.0577
321.73	0.029	197.2	0.0586
321.75	0.029	197.3	0.0586
321.75	0.029	197.4	0.0586
321.77	0.028	197.5	0.0586
321.78	0.027	197.5	0.0577
321.80	0.027	197.5	0.0568
321.82	0.027	197.5	0.0559
321.83	0.025	197.5	0.0541
321.85	0.024	197.5	0.0524

Prova triassiale ciclica SN04-C1			
pressione di confinamento (kPa)		80	
deviatore ciclico (kPa)		95	
frequenza (hz)		0.00625	
tempo	cella di carico	$\Delta u$	LVDT
(min)	kN	(kPa)	$\delta$ (mm)
321.87	0.023	197.4	0.0497
321.88	0.02	197.4	0.0497
321.90	0.019	197.4	0.0479
321.92	0.019	197.3	0.0462
321.93	0.018	197.2	0.0426
321.95	0.015	197	0.0399
321.97	0.014	196.9	0.0373
321.98	0.012	196.7	0.0328
322.00	0.009	196.5	0.0328
322.02	0.007	196.5	0.0293
322.03	0.007	196.3	0.0257
322.05	0.006	196.1	0.0222
322.07	0.003	195.9	0.0178
322.08	0.001	195.6	0.0142
322.10	0	195.4	0.0098
322.12	-0.004	195	0.0098
322.13	-0.005	194.8	0.0053
322.15	-0.005	194.8	0.0027
322.17	-0.006	194.6	-0.0009
322.18	-0.009	194.3	-0.0053
322.20	-0.01	194	-0.0071
322.22	-0.011	193.8	-0.0107
322.23	-0.013	193.5	-0.0107
322.25	-0.014	193.3	-0.0133
322.27	-0.014	193.1	-0.016
322.28	-0.015	192.9	-0.0178
322.30	-0.016	192.7	-0.0178
322.32	-0.016	192.7	-0.0195
322.33	-0.017	192.6	-0.0213
322.35	-0.017	192.4	-0.0213
322.37	-0.017	192.3	-0.0222
322.38	-0.017	192.2	-0.0222
322.40	-0.017	192.1	-0.0222
322.42	-0.017	192	-0.0222
322.43	-0.016	192	-0.0222
322.45	-0.016	192	-0.0213
322.47	-0.015	191.9	-0.0204
322.48	-0.014	191.9	-0.0186
322.50	-0.014	191.9	-0.0178
322.52	-0.012	192	-0.016
322.53	-0.01	192	-0.016
322.55	-0.009	192	-0.0142
322.57	-0.009	192.1	-0.0115
322.58	-0.008	192.2	-0.0089
322.60	-0.005	192.4	-0.0062
322.62	-0.004	192.5	-0.0036
322.63	-0.002	192.7	0
322.65	0.001	192.9	0
322.67	0.002	192.9	0.0036
322.68	0.002	193	0.0062
322.70	0.004	193.3	0.0107
322.72	0.007	193.5	0.0151
322.73	0.008	193.7	0.0178
322.75	0.01	194	0.0222
322.77	0.014	194.2	0.0222
322.78	0.014	194.2	0.0275
322.80	0.014	194.4	0.0311
322.82	0.016	194.7	0.0346

Prova triassiale ciclica SN04-C1			
pressione di confinamento (kPa)		80	
deviatore ciclico (kPa)		95	
frequenza (hz)		0.00625	
tempo	cella di carico	$\Delta u$	LVDT
(min)	kN	(kPa)	$\delta$ (mm)
322.83	0.019	195	0.0391
322.85	0.02	195.2	0.0408
322.87	0.021	195.4	0.0435
322.88	0.024	195.7	0.0435
322.90	0.024	195.7	0.047
322.92	0.024	195.9	0.0488
322.93	0.025	196.1	0.0515
322.95	0.027	196.4	0.0541
322.97	0.027	196.6	0.055
322.98	0.028	196.7	0.0559
323.00	0.028	196.9	0.0568
323.02	0.029	197	0.0577
323.03	0.029	197.1	0.0586
323.05	0.029	197.2	0.0586
323.07	0.029	197.2	0.0586
323.08	0.029	197.4	0.0586
323.10	0.028	197.5	0.0577
323.13	0.028	197.5	0.0577
323.15	0.027	197.5	0.0568
323.17	0.026	197.5	0.055
323.18	0.025	197.5	0.055
323.20	0.023	197.5	0.0533
323.20	0.023	197.5	0.0524
323.22	0.023	197.4	0.0497
323.23	0.02	197.3	0.047
323.25	0.018	197.2	0.0453
323.27	0.017	197.1	0.0417
323.28	0.014	196.9	0.0417
323.30	0.013	196.9	0.0382
323.32	0.013	196.8	0.0355
323.33	0.012	196.7	0.032
323.35	0.008	196.4	0.0284
323.37	0.007	196.2	0.0249
323.38	0.006	196	0.0204
323.40	0.002	195.7	0.0204
323.42	0.001	195.7	0.016
323.43	0.001	195.5	0.0124
323.45	-0.001	195.2	0.008
323.47	-0.004	194.9	0.0044
323.48	-0.005	194.7	0.0018
323.50	-0.007	194.4	-0.0027
323.52	-0.01	194.1	-0.0027
323.53	-0.011	194.1	-0.0062
323.55	-0.011	193.9	-0.0089
323.57	-0.011	193.7	-0.0115
323.58	-0.013	193.4	-0.0142
323.60	-0.014	193.2	-0.016
323.62	-0.015	193	-0.0178
323.63	-0.016	192.8	-0.0178
323.65	-0.017	192.6	-0.0195
323.67	-0.017	192.6	-0.0204
323.68	-0.017	192.5	-0.0213
323.70	-0.017	192.3	-0.0222
323.72	-0.017	192.2	-0.0222
323.73	-0.017	192.1	-0.0222
323.75	-0.017	192	-0.0231
323.77	-0.017	192	-0.0222
323.78	-0.016	191.9	-0.0213

Prova triassiale ciclica SN04-C1			
pressione di confinamento (kPa)		80	
deviatore ciclico (kPa)		95	
frequenza (hz)		0.00625	
tempo	cella di carico	$\Delta u$	LVDT
(min)	kN	(kPa)	$\delta$ (mm)
323.80	-0.015	191.9	-0.0213
323.82	-0.014	191.9	-0.0195
323.83	-0.014	191.9	-0.0186
323.85	-0.013	191.9	-0.0169
323.87	-0.011	192	-0.0151
323.88	-0.01	192	-0.0133
323.90	-0.009	192.1	-0.0107
323.92	-0.007	192.3	-0.0107
323.93	-0.005	192.4	-0.008
323.95	-0.005	192.4	-0.0053
323.97	-0.004	192.5	-0.0018
323.98	-0.001	192.8	0.0018
324.00	0.002	193	0.0053
324.02	0.003	193.1	0.0089
324.03	0.005	193.4	0.0133
324.05	0.008	193.6	0.0133
324.07	0.008	193.6	0.0169
324.08	0.009	193.8	0.0204
324.10	0.011	194.1	0.024
324.12	0.014	194.3	0.0293
324.13	0.015	194.5	0.032
324.15	0.017	194.8	0.0355
324.17	0.02	195	0.0355
324.18	0.02	195	0.0399
324.20	0.02	195.2	0.0417
324.22	0.022	195.6	0.0453
324.23	0.024	195.8	0.0479
324.25	0.024	196	0.0497
324.27	0.025	196.2	0.0524
324.28	0.027	196.4	0.0524
324.30	0.028	196.4	0.0541
324.32	0.028	196.6	0.055
324.33	0.028	196.8	0.0559
324.35	0.029	196.9	0.0568
324.37	0.029	197.1	0.0577
324.38	0.029	197.2	0.0577
324.40	0.029	197.3	0.0577
324.42	0.029	197.3	0.0586
324.43	0.028	197.4	0.0577
324.45	0.027	197.5	0.0577
324.47	0.026	197.5	0.0568
324.48	0.026	197.5	0.055
324.50	0.026	197.5	0.0541
324.52	0.024	197.5	0.0524
324.53	0.023	197.4	0.0515
324.55	0.022	197.4	0.0479
324.57	0.019	197.2	0.0479
324.60	0.017	197.2	0.0453
324.62	0.017	197.2	0.0435
324.63	0.016	197	0.0399
324.65	0.014	196.8	0.0373
324.65	0.012	196.7	0.0346
324.67	0.011	196.5	0.0302
324.68	0.007	196.3	0.0302
324.70	0.006	196.1	0.0249
324.72	0.006	196.1	0.0222
324.73	0.004	195.9	0.0186
324.75	0.001	195.6	0.0142

Prova triassiale ciclica SN04-C1			
pressione di confinamento (kPa)		80	
deviatore ciclico (kPa)		95	
frequenza (hz)		0.00625	
tempo	cella di carico	$\Delta u$	LVDT
(min)	kN	(kPa)	$\delta$ (mm)
324.77	0	195.4	0.0107
324.78	-0.002	195.1	0.0062
324.80	-0.005	194.8	0.0062
324.82	-0.006	194.5	0.0018
324.83	-0.006	194.5	-0.0009
324.85	-0.007	194.3	-0.0036
324.87	-0.01	194	-0.0071
324.88	-0.011	193.8	-0.0107
324.90	-0.012	193.6	-0.0133
324.92	-0.014	193.3	-0.0133
324.93	-0.015	193.1	-0.0151
324.95	-0.015	193.1	-0.0169
324.97	-0.015	192.9	-0.0186
324.98	-0.016	192.7	-0.0195
325.00	-0.017	192.5	-0.0213
325.02	-0.017	192.4	-0.0213
325.03	-0.017	192.3	-0.0222
325.05	-0.017	192.2	-0.0222
325.07	-0.017	192.2	-0.0222
325.08	-0.017	192.1	-0.0222
325.10	-0.017	192	-0.0222
325.12	-0.016	192	-0.0213
325.13	-0.015	191.9	-0.0204
325.15	-0.014	191.9	-0.0186
325.17	-0.013	192	-0.0178
325.18	-0.012	191.9	-0.016
325.20	-0.012	192	-0.0151
325.22	-0.009	192.1	-0.0151
325.23	-0.008	192.1	-0.0124
325.25	-0.008	192.2	-0.0098
325.27	-0.007	192.3	-0.0071
325.28	-0.003	192.5	-0.0036
325.30	-0.002	192.6	-0.0009
325.32	-0.001	192.8	0.0027
325.33	0.003	193	0.0027
325.35	0.004	193	0.0071
325.37	0.004	193.2	0.0098
325.38	0.005	193.4	0.0142
325.40	0.009	193.7	0.0186
325.42	0.01	193.9	0.0213
325.43	0.012	194.1	0.0257
325.45	0.015	194.4	0.0257
325.47	0.016	194.4	0.0311
325.48	0.016	194.6	0.0337
325.50	0.017	194.9	0.0373
325.52	0.02	195.1	0.0408
325.53	0.021	195.4	0.0435
325.55	0.022	195.6	0.0462
325.57	0.024	195.9	0.0462
325.58	0.025	195.9	0.0488
325.60	0.025	196.1	0.0506
325.62	0.026	196.3	0.0533
325.63	0.027	196.5	0.055
325.65	0.028	196.6	0.0559
325.67	0.028	196.8	0.0568
325.68	0.028	196.9	0.0568
325.70	0.028	196.9	0.0568
325.72	0.028	197.1	0.0577

Prova triassiale ciclica SN04-C1			
pressione di confinamento (kPa)		80	
deviatore ciclico (kPa)		95	
frequenza (hz)		0.00625	
tempo	cella di carico	$\Delta u$	LVDT
(min)	kN	(kPa)	$\delta$ (mm)
325.73	0.029	197.2	0.0577
325.75	0.028	197.3	0.0577
325.77	0.029	197.4	0.0577
325.78	0.028	197.4	0.0568
325.80	0.026	197.4	0.0568
325.82	0.025	197.5	0.0559
325.83	0.025	197.5	0.0541
325.85	0.025	197.4	0.0524
325.87	0.023	197.4	0.0506
325.88	0.021	197.3	0.0488
325.90	0.02	197.3	0.047
325.92	0.02	197.2	0.0462
325.93	0.017	197.1	0.0426
325.95	0.016	197	0.0391
325.97	0.013	196.8	0.0391
325.98	0.011	196.6	0.0355
326.00	0.011	196.6	0.032
326.03	0.01	196.4	0.0293
326.05	0.007	196.2	0.024
326.07	0.005	196	0.0204
326.08	0.003	195.8	0.0169
326.10	0.001	195.4	0.0169
326.10	-0.002	195.2	0.0124
326.12	-0.002	195.2	0.0089
326.13	-0.003	195	0.0053
326.15	-0.005	194.6	0.0018
326.17	-0.007	194.4	-0.0018
326.18	-0.008	194.2	-0.0062
326.20	-0.011	193.9	-0.0089
326.22	-0.012	193.7	-0.0089
326.23	-0.012	193.7	-0.0115
326.25	-0.013	193.4	-0.0133
326.27	-0.014	193.2	-0.0151
326.28	-0.015	193	-0.0178
326.30	-0.016	192.8	-0.0195
326.32	-0.017	192.6	-0.0213
326.33	-0.017	192.5	-0.0213
326.35	-0.017	192.5	-0.0213
326.37	-0.017	192.3	-0.0222
326.38	-0.017	192.2	-0.0222
326.40	-0.017	192.1	-0.0222
326.42	-0.017	192	-0.0222
326.43	-0.017	191.9	-0.0213
326.45	-0.016	191.9	-0.0213
326.47	-0.015	191.9	-0.0204
326.48	-0.015	191.9	-0.0195
326.50	-0.014	191.9	-0.0186
326.52	-0.012	192	-0.0169
326.53	-0.011	192	-0.0151
326.55	-0.01	192.1	-0.0124
326.57	-0.007	192.2	-0.0124
326.58	-0.006	192.2	-0.0098
326.60	-0.006	192.3	-0.0071
326.62	-0.003	192.6	-0.0044
326.63	-0.002	192.6	-0.0027
326.65	-0.002	192.7	0.0009
326.67	0	192.9	0.0044
326.68	0.004	193.1	0.008

Prova triassiale ciclica SN04-C1			
pressione di confinamento (kPa)		80	
deviatore ciclico (kPa)		95	
frequenza (hz)		0.00625	
tempo	cella di carico	$\Delta u$	LVDT
(min)	kN	(kPa)	$\delta$ (mm)
326.70	0.004	193.3	0.0115
326.72	0.006	193.6	0.016
326.73	0.01	193.8	0.016
326.75	0.011	193.8	0.0204
326.77	0.011	194	0.0231
326.78	0.013	194.2	0.0284
326.80	0.016	194.5	0.032
326.82	0.017	194.7	0.0346
326.83	0.018	194.9	0.0382
326.85	0.021	195.2	0.0382
326.87	0.022	195.2	0.0417
326.88	0.022	195.5	0.0444
326.90	0.023	195.7	0.047
326.92	0.025	196	0.0497
326.93	0.026	196.2	0.0515
326.95	0.026	196.4	0.0533
326.97	0.027	196.6	0.0533
326.98	0.028	196.7	0.0559
327.00	0.028	196.7	0.0568
327.02	0.029	196.9	0.0568
327.03	0.029	197	0.0577
327.05	0.029	197.1	0.0586
327.07	0.029	197.2	0.0586
327.08	0.029	197.3	0.0586
327.10	0.028	197.4	0.0586
327.12	0.028	197.4	0.0577
327.13	0.028	197.4	0.0568
327.15	0.026	197.4	0.055
327.17	0.025	197.4	0.0541
327.18	0.024	197.4	0.0524
327.20	0.022	197.3	0.0524
327.22	0.02	197.3	0.0497
327.23	0.02	197.3	0.0479
327.25	0.019	197.2	0.0453
327.27	0.018	197.1	0.0426
327.28	0.015	196.9	0.0391
327.30	0.014	196.8	0.0364
327.32	0.012	196.6	0.0337
327.33	0.009	196.4	0.0337
327.35	0.008	196.2	0.0257
327.37	0.007	196.1	0.0231
327.38	0.004	195.9	0.0231
327.40	0.002	195.9	0.0195
327.42	0.002	195.7	0.0151
327.43	0.001	195.4	0.0115
327.45	-0.002	195.1	0.008
327.47	-0.004	194.8	0.0044
327.50	-0.005	194.5	0.0009
327.52	-0.008	194.3	0.0009
327.53	-0.009	194.3	-0.0036
327.55	-0.009	194.1	-0.0062
327.55	-0.01	193.8	-0.0098
327.57	-0.013	193.5	-0.0124
327.58	-0.013	193.3	-0.0142
327.60	-0.014	193.1	-0.016
327.62	-0.016	192.9	-0.016
327.63	-0.016	192.9	-0.0186
327.65	-0.016	192.7	-0.0195

Prova triassiale ciclica SN04-C1			
pressione di confinamento (kPa)		80	
deviatore ciclico (kPa)		95	
frequenza (hz)		0.00625	
tempo	cella di carico	$\Delta u$	LVDT
(min)	kN	(kPa)	$\delta$ (mm)
327.67	-0.017	192.6	-0.0204
327.68	-0.017	192.4	-0.0213
327.70	-0.017	192.3	-0.0222
327.72	-0.017	192.1	-0.0222
327.73	-0.017	192	-0.0222
327.75	-0.017	192	-0.0222
327.77	-0.017	192	-0.0222
327.78	-0.016	191.9	-0.0213
327.80	-0.015	191.9	-0.0204
327.82	-0.015	191.8	-0.0195
327.83	-0.014	191.9	-0.0178
327.85	-0.012	191.9	-0.0178
327.87	-0.011	191.9	-0.016
327.88	-0.011	192	-0.0142
327.90	-0.01	192.1	-0.0115
327.92	-0.007	192.2	-0.0089
327.93	-0.006	192.3	-0.0062
327.95	-0.004	192.5	-0.0027
327.97	-0.001	192.7	-0.0027
327.98	0	192.7	0
328.00	0	192.8	0.0036
328.02	0.002	193.1	0.008
328.03	0.005	193.3	0.0115
328.05	0.006	193.5	0.0151
328.07	0.008	193.7	0.0195
328.08	0.01	193.9	0.0213
328.10	0.012	194.1	0.0249
328.12	0.014	194.4	0.0302
328.13	0.017	194.6	0.0302
328.15	0.017	194.6	0.0337
328.17	0.017	194.8	0.0364
328.18	0.019	195.1	0.0408
328.20	0.022	195.4	0.0444
328.22	0.022	195.6	0.0453
328.23	0.023	195.8	0.0488
328.25	0.025	196.1	0.0488
328.27	0.026	196.1	0.0506
328.28	0.026	196.3	0.0533
328.30	0.027	196.5	0.0541
328.32	0.027	196.7	0.0559
328.33	0.028	196.8	0.0568
328.35	0.029	197	0.0577
328.37	0.029	197.1	0.0577
328.38	0.029	197.1	0.0586
328.40	0.029	197.2	0.0586
328.42	0.029	197.3	0.0586
328.43	0.028	197.4	0.0577
328.45	0.027	197.4	0.0568
328.47	0.027	197.5	0.0559
328.48	0.026	197.5	0.0559
328.50	0.024	197.5	0.055
328.52	0.024	197.4	0.0533
328.53	0.024	197.4	0.0515
328.55	0.022	197.4	0.0488
328.57	0.02	197.3	0.047
328.58	0.019	197.2	0.0444
328.60	0.016	197	0.0444
328.62	0.015	197	0.0408



Prova triassiale ciclica SN04-C1			
pressione di confinamento (kPa)		80	
deviatore ciclico (kPa)		95	
frequenza (hz)		0.00625	
tempo	cella di carico	$\Delta u$	LVDT
(min)	kN	(kPa)	$\delta$ (mm)
328.63	0.015	196.9	0.0382
328.65	0.013	196.7	0.0346
328.67	0.01	196.5	0.0311
328.68	0.009	196.3	0.0284
328.70	0.007	196.1	0.0231
328.72	0.003	195.9	0.0231
328.73	0.002	195.9	0.0186
328.75	0.002	195.7	0.016
328.77	0.001	195.4	0.0115
328.78	-0.002	195.1	0.008
328.80	-0.004	194.9	0.0044
328.82	-0.005	194.7	0.0009
328.83	-0.007	194.4	-0.0018
328.85	-0.008	194.2	-0.0044
328.87	-0.01	193.9	-0.0089
328.88	-0.012	193.6	-0.0089
328.90	-0.013	193.4	-0.0115
328.92	-0.013	193.4	-0.0133
328.93	-0.014	193.2	-0.0151
328.97	-0.015	192.9	-0.0178
328.98	-0.016	192.8	-0.0195
329.00	-0.016	192.6	-0.0204
329.02	-0.017	192.4	-0.0204
329.02	-0.017	192.3	-0.0213
329.03	-0.017	192.3	-0.0222
329.05	-0.017	192.2	-0.0222
329.07	-0.017	192.1	-0.0222
329.08	-0.017	192	-0.0222
329.10	-0.017	191.9	-0.0213
329.12	-0.016	191.9	-0.0213
329.13	-0.015	191.9	-0.0213
329.15	-0.015	191.9	-0.0195
329.17	-0.014	191.8	-0.0178
329.18	-0.012	191.9	-0.0169
329.20	-0.011	192	-0.0151
329.22	-0.01	192	-0.0124
329.23	-0.008	192.1	-0.0124
329.25	-0.006	192.3	-0.0098
329.27	-0.006	192.3	-0.0071
329.28	-0.005	192.3	-0.0044
329.30	-0.003	192.6	-0.0009
329.32	0	192.7	0.0018
329.33	0.001	192.9	0.0062
329.35	0.004	193.2	0.0062
329.37	0.006	193.3	0.0098
329.38	0.006	193.3	0.0133
329.40	0.007	193.5	0.0178
329.42	0.01	193.8	0.0213
329.43	0.012	194.1	0.024
329.45	0.013	194.3	0.0293
329.47	0.016	194.6	0.0337
329.48	0.019	194.8	0.0337
329.50	0.019	194.8	0.0373
329.52	0.02	195.2	0.0408
329.53	0.022	195.5	0.0408
329.55	0.022	195.5	0.0435
329.57	0.022	195.7	0.047
329.58	0.025	196	0.0506

Prova triassiale ciclica SN04-C1			
pressione di confinamento (kPa)		80	
deviatore ciclico (kPa)		95	
frequenza (hz)		0.00625	
tempo	cella di carico	$\Delta u$	LVDT
(min)	kN	(kPa)	$\delta$ (mm)
329.60	0.027	196.2	0.0524
329.62	0.026	196.3	0.0533
329.63	0.027	196.6	0.055
329.65	0.028	196.7	0.055
329.67	0.028	196.7	0.0559
329.68	0.028	196.9	0.0568
329.70	0.029	197	0.0586
329.72	0.029	197.1	0.0586
329.73	0.029	197.3	0.0586
329.75	0.029	197.4	0.0577
329.77	0.027	197.4	0.0577
329.78	0.027	197.4	0.0568
329.80	0.027	197.4	0.0568
329.82	0.026	197.4	0.0559
329.83	0.025	197.4	0.0541
329.85	0.024	197.4	0.0524
329.87	0.023	197.4	0.0497
329.88	0.02	197.3	0.0497
329.90	0.02	197.3	0.0479
329.92	0.02	197.2	0.0462
329.93	0.018	197	0.0426
329.95	0.015	196.9	0.0391
329.97	0.014	196.8	0.0364
329.98	0.012	196.6	0.032
330.00	0.008	196.4	0.032
330.02	0.008	196.4	0.0284
330.03	0.008	196.2	0.0249
330.05	0.006	196	0.0222
330.07	0.003	195.8	0.0178
330.08	0.002	195.6	0.0142
330.10	0	195.2	0.0098
330.12	-0.004	194.9	0.0098
330.13	-0.004	194.9	0.0053
330.15	-0.004	194.7	0.0027
330.17	-0.006	194.4	-0.0018
330.18	-0.009	194.1	-0.0053
330.20	-0.01	193.9	-0.008
330.22	-0.011	193.6	-0.0107
330.23	-0.013	193.4	-0.0107
330.25	-0.014	193.2	-0.0151
330.27	-0.014	193	-0.0169
330.28	-0.016	192.8	-0.0169
330.30	-0.016	192.8	-0.0186
330.32	-0.016	192.7	-0.0195
330.33	-0.016	192.5	-0.0204
330.35	-0.017	192.3	-0.0222
330.37	-0.017	192.2	-0.0222
330.40	-0.017	192.1	-0.0222
330.42	-0.017	192	-0.0222
330.43	-0.017	192	-0.0222
330.45	-0.017	191.9	-0.0222
330.47	-0.016	191.9	-0.0213
330.47	-0.015	191.8	-0.0204
330.48	-0.014	191.8	-0.0186
330.50	-0.013	191.8	-0.0178
330.52	-0.011	191.9	-0.0178
330.53	-0.011	191.9	-0.016
330.55	-0.011	191.9	-0.0142

Prova triassiale ciclica SN04-C1			
pressione di confinamento (kPa)		80	
deviatore ciclico (kPa)		95	
frequenza (hz)		0.00625	
tempo	cella di carico	$\Delta u$	LVDT
(min)	kN	(kPa)	$\delta$ (mm)
330.57	-0.01	192.1	-0.0115
330.58	-0.007	192.2	-0.0089
330.60	-0.006	192.3	-0.0062
330.62	-0.004	192.5	-0.0027
330.63	0	192.7	-0.0027
330.65	0	192.7	0.0009
330.67	0	192.8	0.0036
330.68	0.002	193	0.008
330.70	0.005	193.2	0.0115
330.72	0.006	193.4	0.0151
330.73	0.008	193.7	0.0195
330.75	0.012	193.9	0.0195
330.77	0.013	193.9	0.024
330.78	0.013	194.1	0.0275
330.80	0.014	194.4	0.0311
330.82	0.017	194.7	0.0355
330.83	0.018	194.9	0.0382
330.85	0.02	195.1	0.0417
330.87	0.023	195.4	0.0417
330.88	0.023	195.4	0.0453
330.90	0.023	195.7	0.047
330.92	0.024	195.9	0.0497
330.93	0.026	196.1	0.0524
330.95	0.027	196.3	0.0541
330.97	0.027	196.5	0.055
330.98	0.028	196.7	0.0559
331.00	0.029	196.8	0.0568
331.02	0.028	196.9	0.0568
331.03	0.028	197.1	0.0568
331.05	0.029	197.2	0.0577
331.07	0.029	197.2	0.0577
331.08	0.029	197.3	0.0577
331.10	0.029	197.3	0.0586
331.12	0.028	197.4	0.0577
331.13	0.027	197.5	0.0559
331.15	0.025	197.4	0.0559
331.17	0.024	197.4	0.0541
331.18	0.024	197.4	0.0533
331.20	0.024	197.4	0.0515
331.22	0.022	197.3	0.0497
331.23	0.02	197.2	0.047
331.25	0.019	197.2	0.0435
331.27	0.016	197	0.0435
331.28	0.015	196.8	0.0408
331.30	0.015	196.8	0.0391
331.32	0.013	196.7	0.0346
331.33	0.01	196.5	0.0311
331.35	0.008	196.3	0.0275
331.37	0.007	196.2	0.0222
331.38	0.004	195.9	0.0222
331.40	0.001	195.6	0.0186
331.42	0.001	195.6	0.0151
331.43	0.001	195.4	0.0124
331.45	-0.001	195	0.008
331.47	-0.004	194.8	0.0044
331.48	-0.005	194.6	0.0009
331.50	-0.007	194.3	0.0009
331.52	-0.01	194	-0.0036

Prova triassiale ciclica SN04-C1			
pressione di confinamento (kPa)		80	
deviatore ciclico (kPa)		95	
frequenza (hz)		0.00625	
tempo	cella di carico	$\Delta u$	LVDT
(min)	kN	(kPa)	$\delta$ (mm)
331.53	-0.01	194	-0.0071
331.55	-0.01	193.8	-0.0089
331.57	-0.012	193.5	-0.0124
331.58	-0.014	193.3	-0.0142
331.60	-0.014	193.1	-0.016
331.62	-0.015	192.9	-0.0186
331.63	-0.017	192.7	-0.0186
331.65	-0.017	192.7	-0.0204
331.67	-0.016	192.5	-0.0204
331.68	-0.017	192.4	-0.0213
331.70	-0.017	192.2	-0.0222
331.72	-0.017	192.1	-0.0222
331.73	-0.017	192	-0.0222
331.75	-0.017	191.9	-0.0222
331.77	-0.017	191.8	-0.0222
331.78	-0.016	191.8	-0.0204
331.80	-0.015	191.8	-0.0204
331.82	-0.014	191.8	-0.0195
331.83	-0.014	191.8	-0.0186
331.87	-0.013	191.9	-0.0169
331.88	-0.011	191.9	-0.0151
331.90	-0.01	192	-0.0124
331.92	-0.009	192.1	-0.0107
331.92	-0.006	192.2	-0.0107
331.93	-0.005	192.2	-0.008
331.95	-0.005	192.3	-0.0053
331.97	-0.004	192.5	-0.0018
331.98	0	192.7	0.0018
332.00	0.001	192.9	0.0053
332.02	0.003	193.1	0.0098
332.03	0.006	193.3	0.0098
332.05	0.007	193.3	0.0133
332.07	0.007	193.5	0.0169
332.08	0.009	193.8	0.0204
332.10	0.013	194	0.0249
332.12	0.014	194.2	0.0293
332.13	0.015	194.5	0.0328
332.15	0.018	194.8	0.0328
332.17	0.019	194.8	0.0373
332.18	0.019	195	0.0391
332.20	0.02	195.3	0.0426
332.22	0.023	195.6	0.0453
332.23	0.024	195.8	0.0479
332.25	0.025	196	0.0515
332.27	0.026	196.2	0.0515
332.28	0.027	196.2	0.0533
332.30	0.027	196.4	0.0541
332.32	0.027	196.6	0.0559
332.33	0.028	196.7	0.0568
332.35	0.029	196.9	0.0577
332.37	0.029	197	0.0577
332.38	0.029	197.1	0.0577
332.40	0.029	197.1	0.0586
332.42	0.029	197.2	0.0586
332.43	0.028	197.4	0.0586
332.45	0.027	197.4	0.0586
332.47	0.027	197.4	0.0568
332.48	0.027	197.5	0.0559

Prova triassiale ciclica SN04-C1			
pressione di confinamento (kPa)		80	
deviatore ciclico (kPa)		95	
frequenza (hz)		0.00625	
tempo	cella di carico	$\Delta u$	LVDT
(min)	kN	(kPa)	$\delta$ (mm)
332.50	0.025	197.4	0.0541
332.52	0.024	197.4	0.0524
332.53	0.023	197.4	0.0506
332.55	0.021	197.3	0.0506
332.57	0.019	197.3	0.0479
332.58	0.019	197.2	0.0462
332.60	0.018	197.1	0.0435
332.62	0.015	196.9	0.0399
332.63	0.014	196.8	0.0373
332.65	0.012	196.7	0.0328
332.67	0.009	196.4	0.0328
332.68	0.007	196.2	0.0293
332.70	0.007	196.2	0.0249
332.72	0.006	196.1	0.0213
332.73	0.003	195.8	0.0178
332.75	0.002	195.6	0.0142
332.77	0	195.2	0.0107
332.78	-0.003	194.9	0.0107
332.80	-0.005	194.7	0.0062
332.82	-0.005	194.7	0.0027
332.83	-0.006	194.5	-0.0018
332.85	-0.009	194.2	-0.0053
332.87	-0.01	193.9	-0.008
332.88	-0.011	193.7	-0.0107
332.90	-0.012	193.4	-0.0107
332.92	-0.014	193.2	-0.0124
332.93	-0.014	193.2	-0.0151
332.95	-0.015	193	-0.0178
332.97	-0.016	192.8	-0.0195
332.98	-0.016	192.6	-0.0204
333.00	-0.017	192.5	-0.0213
333.02	-0.017	192.3	-0.0213
333.03	-0.017	192.2	-0.0222
333.05	-0.017	192.2	-0.0222
333.07	-0.017	192.1	-0.0222
333.08	-0.017	192	-0.0222
333.10	-0.017	191.9	-0.0213
333.12	-0.016	191.9	-0.0204
333.13	-0.015	191.9	-0.0204
333.15	-0.014	191.9	-0.0186
333.17	-0.014	191.8	-0.0178
333.18	-0.012	191.9	-0.0178
333.20	-0.01	192	-0.016
333.22	-0.01	192	-0.0142
333.23	-0.009	192	-0.0115
333.25	-0.007	192.2	-0.0089
333.27	-0.005	192.3	-0.0062
333.30	-0.004	192.4	-0.0036
333.32	-0.002	192.6	0
333.33	0.001	192.8	0
333.35	0.001	192.8	0.0036
333.37	0.002	192.9	0.0071
333.37	0.004	193.2	0.0115
333.38	0.007	193.4	0.0151
333.40	0.008	193.6	0.0186
333.42	0.01	193.9	0.0231
333.43	0.014	194.1	0.0231
333.45	0.014	194.1	0.0275

Prova triassiale ciclica SN04-C1			
pressione di confinamento (kPa)		80	
deviatore ciclico (kPa)		95	
frequenza (hz)		0.00625	
tempo	cella di carico	$\Delta u$	LVDT
(min)	kN	(kPa)	$\delta$ (mm)
333.47	0.014	194.3	0.0311
333.48	0.016	194.6	0.0346
333.50	0.019	194.9	0.0382
333.52	0.019	195.1	0.0399
333.53	0.021	195.4	0.0444
333.55	0.024	195.7	0.0444
333.57	0.024	195.7	0.0479
333.58	0.024	195.8	0.0497
333.60	0.025	196.1	0.0524
333.62	0.027	196.3	0.0541
333.63	0.027	196.5	0.055
333.65	0.027	196.7	0.0559
333.67	0.028	196.8	0.0559
333.68	0.029	196.8	0.0577
333.70	0.029	197	0.0577
333.72	0.029	197.1	0.0586
333.73	0.029	197.2	0.0586
333.75	0.029	197.3	0.0586
333.77	0.028	197.4	0.0586
333.78	0.027	197.4	0.0586
333.80	0.026	197.4	0.0568
333.82	0.026	197.4	0.0559
333.83	0.026	197.4	0.0541
333.85	0.024	197.4	0.0533
333.87	0.023	197.3	0.0506
333.88	0.022	197.3	0.0479
333.90	0.02	197.2	0.047
333.92	0.019	197.1	0.0444
333.93	0.017	197	0.0417
333.95	0.014	196.8	0.0417
333.97	0.013	196.8	0.0391
333.98	0.013	196.7	0.0355
334.00	0.012	196.5	0.032
334.02	0.007	196.3	0.0275
334.03	0.007	196.1	0.024
334.05	0.006	195.9	0.0204
334.07	0.001	195.6	0.0204
334.08	0.001	195.6	0.016
334.10	0.001	195.4	0.0133
334.12	-0.001	195.1	0.0089
334.13	-0.005	194.8	0.0036
334.15	-0.005	194.6	0.0018
334.17	-0.006	194.3	-0.0027
334.18	-0.01	194	-0.0027
334.20	-0.011	194	-0.0062
334.22	-0.011	193.8	-0.0089
334.23	-0.011	193.6	-0.0115
334.25	-0.013	193.3	-0.0142
334.27	-0.014	193.1	-0.016
334.28	-0.015	192.9	-0.0178
334.30	-0.016	192.7	-0.0178
334.32	-0.017	192.5	-0.0195
334.33	-0.017	192.5	-0.0204
334.35	-0.017	192.4	-0.0213
334.37	-0.017	192.2	-0.0213
334.38	-0.017	192.1	-0.0222
334.40	-0.017	192	-0.0222
334.42	-0.017	191.9	-0.0222

Prova triassiale ciclica SN04-C1			
pressione di confinamento (kPa)		80	
deviatore ciclico (kPa)		95	
frequenza (hz)		0.00625	
tempo	cella di carico	$\Delta u$	LVDT
(min)	kN	(kPa)	$\delta$ (mm)
334.43	-0.016	191.9	-0.0222
334.45	-0.016	191.9	-0.0213
334.47	-0.016	191.8	-0.0204
334.48	-0.015	191.8	-0.0186
334.50	-0.013	191.8	-0.0178
334.52	-0.012	191.9	-0.0151
334.53	-0.011	192	-0.0133
334.55	-0.009	192	-0.0133
334.57	-0.009	192	-0.0124
334.58	-0.008	192.1	-0.0089
334.60	-0.006	192.3	-0.0062
334.62	-0.003	192.4	-0.0036
334.63	-0.003	192.5	-0.0018
334.65	-0.002	192.7	0.0018
334.67	0.002	192.9	0.0053
334.68	0.003	193	0.0089
334.70	0.005	193.3	0.0124
334.72	0.008	193.5	0.0124
334.73	0.009	193.5	0.0169
334.77	0.009	193.7	0.0204
334.78	0.011	194	0.024
334.80	0.014	194.2	0.0293
334.82	0.015	194.4	0.032
334.82	0.017	194.7	0.0364
334.83	0.02	195	0.0364
334.85	0.02	195	0.0399
334.87	0.02	195.2	0.0426
334.88	0.022	195.5	0.0453
334.90	0.024	195.7	0.0479
334.92	0.025	195.9	0.0506
334.93	0.026	196.1	0.0524
334.95	0.027	196.4	0.0524
334.97	0.027	196.4	0.0541
334.98	0.027	196.5	0.055
335.00	0.028	196.7	0.0568
335.02	0.029	196.9	0.0577
335.03	0.029	197	0.0577
335.05	0.029	197.1	0.0586
335.07	0.029	197.2	0.0586
335.08	0.028	197.2	0.0586
335.10	0.028	197.3	0.0586
335.12	0.028	197.4	0.0577
335.13	0.027	197.4	0.0568
335.15	0.026	197.4	0.055
335.17	0.025	197.4	0.0541
335.18	0.023	197.4	0.0541
335.20	0.022	197.4	0.0524
335.22	0.022	197.3	0.0497
335.23	0.021	197.2	0.047
335.25	0.018	197.1	0.0444
335.27	0.017	197	0.0426
335.28	0.016	196.9	0.0391
335.30	0.012	196.7	0.0391
335.32	0.011	196.7	0.0355
335.33	0.01	196.4	0.0311
335.35	0.008	196.2	0.0311
335.37	0.006	196.2	0.0275
335.38	0.006	196	0.0222

Prova triassiale ciclica SN04-C1			
pressione di confinamento (kPa)		80	
deviatore ciclico (kPa)		95	
frequenza (hz)		0.00625	
tempo	cella di carico	$\Delta u$	LVDT
(min)	kN	(kPa)	$\delta$ (mm)
335.40	0.005	195.8	0.0186
335.42	0.001	195.5	0.0142
335.43	0	195.2	0.0107
335.45	-0.002	195	0.0071
335.47	-0.005	194.7	0.0071
335.48	-0.006	194.4	0.0027
335.50	-0.006	194.4	0
335.52	-0.007	194.2	-0.0036
335.53	-0.01	193.9	-0.008
335.55	-0.011	193.7	-0.0098
335.57	-0.012	193.5	-0.0124
335.58	-0.014	193.2	-0.0124
335.60	-0.015	193	-0.0151
335.62	-0.015	193	-0.0169
335.63	-0.015	192.8	-0.0186
335.65	-0.016	192.6	-0.0195
335.67	-0.017	192.4	-0.0213
335.68	-0.017	192.3	-0.0222
335.70	-0.017	192.2	-0.0222
335.72	-0.017	192.1	-0.0222
335.73	-0.017	192.1	-0.0222
335.75	-0.017	192	-0.0222
335.77	-0.017	191.9	-0.0222
335.78	-0.016	191.9	-0.0213
335.80	-0.016	191.8	-0.0204
335.82	-0.014	191.9	-0.0204
335.83	-0.013	191.9	-0.0186
335.85	-0.013	191.9	-0.0178
335.87	-0.012	191.9	-0.0151
335.88	-0.01	192	-0.0124
335.90	-0.008	192.1	-0.0098
335.92	-0.007	192.2	-0.008
335.93	-0.005	192.3	-0.0053
335.95	-0.003	192.5	-0.0053
335.97	-0.003	192.5	-0.0027
335.98	-0.002	192.6	0.0018
336.00	0.001	192.9	0.0053
336.02	0.003	193	0.0089
336.03	0.004	193.2	0.0124
336.05	0.007	193.5	0.0169
336.07	0.01	193.7	0.0204
336.08	0.01	193.9	0.0222
336.10	0.012	194.1	0.0257
336.12	0.015	194.4	0.0257
336.13	0.016	194.4	0.0302
336.15	0.016	194.6	0.0337
336.17	0.017	194.9	0.0373
336.18	0.02	195.1	0.0408
336.22	0.021	195.3	0.0444
336.23	0.023	195.6	0.047
336.25	0.025	195.9	0.047
336.27	0.025	195.9	0.0497
336.27	0.025	196	0.0515
336.28	0.026	196.3	0.0533
336.30	0.028	196.5	0.055
336.32	0.028	196.6	0.0559
336.33	0.028	196.8	0.0577
336.35	0.029	196.9	0.0577



Prova triassiale ciclica SN04-C1			
pressione di confinamento (kPa)		80	
deviatore ciclico (kPa)		95	
frequenza (hz)		0.00625	
tempo	cella di carico	$\Delta u$	LVDT
(min)	kN	(kPa)	$\delta$ (mm)
336.37	0.029	196.9	0.0577
336.38	0.029	197	0.0577
336.40	0.029	197.1	0.0586
336.42	0.029	197.2	0.0586
336.43	0.028	197.3	0.0586
336.45	0.028	197.4	0.0577
336.47	0.026	197.4	0.0577
336.48	0.026	197.4	0.0559
336.50	0.026	197.4	0.055
336.52	0.024	197.4	0.0524
336.53	0.023	197.3	0.0506
336.55	0.021	197.3	0.0488
336.57	0.02	197.2	0.0462
336.58	0.017	197	0.0462
336.60	0.016	197	0.0435
336.62	0.016	197	0.0417
336.63	0.014	196.8	0.0364
336.65	0.011	196.6	0.0337
336.67	0.01	196.4	0.032
336.68	0.009	196.3	0.0275
336.70	0.005	196	0.0275
336.72	0.004	196	0.0222
336.73	0.004	195.8	0.0195
336.75	0.002	195.6	0.0151
336.77	0	195.2	0.0115
336.78	-0.002	195	0.008
336.80	-0.003	194.8	0.0053
336.82	-0.006	194.5	0.0009
336.83	-0.007	194.3	-0.0018
336.85	-0.008	194.1	-0.0053
336.87	-0.011	193.8	-0.0053
336.88	-0.012	193.5	-0.0089
336.90	-0.012	193.5	-0.0115
336.92	-0.013	193.3	-0.0133
336.93	-0.014	193.1	-0.016
336.95	-0.015	192.9	-0.0169
336.97	-0.015	192.7	-0.0186
336.98	-0.017	192.5	-0.0186
337.00	-0.017	192.4	-0.0204
337.02	-0.017	192.4	-0.0213
337.03	-0.017	192.2	-0.0222
337.05	-0.017	192.1	-0.0222
337.07	-0.017	192	-0.0222
337.08	-0.017	191.9	-0.0222
337.10	-0.017	191.9	-0.0222
337.12	-0.016	191.8	-0.0213
337.13	-0.016	191.8	-0.0204
337.15	-0.015	191.8	-0.0186
337.17	-0.014	191.8	-0.0178
337.18	-0.012	191.9	-0.016
337.20	-0.012	191.9	-0.0151
337.22	-0.01	192	-0.0124
337.23	-0.007	192.1	-0.0124
337.25	-0.007	192.1	-0.0098
337.27	-0.006	192.2	-0.0062
337.28	-0.004	192.4	-0.0036
337.30	-0.002	192.5	-0.0009
337.32	-0.001	192.6	0.0027

Prova triassiale ciclica SN04-C1			
pressione di confinamento (kPa)		80	
deviatore ciclico (kPa)		95	
frequenza (hz)		0.00625	
tempo	cella di carico	$\Delta u$	LVDT
(min)	kN	(kPa)	$\delta$ (mm)
337.33	0.001	192.9	0.0071
337.35	0.004	193.1	0.0071
337.37	0.004	193.1	0.0107
337.38	0.005	193.3	0.0142
337.40	0.008	193.6	0.0186
337.42	0.011	193.8	0.0222
337.43	0.012	194	0.0249
337.45	0.013	194.3	0.0293
337.47	0.016	194.5	0.0293
337.48	0.018	194.5	0.0337
337.50	0.018	194.8	0.0373
337.52	0.021	195.2	0.0399
337.53	0.022	195.2	0.0426
337.55	0.022	195.4	0.0453
337.57	0.023	195.7	0.0479
337.58	0.025	196	0.0506
337.60	0.026	196.1	0.0515
337.62	0.026	196.3	0.0533
337.63	0.027	196.5	0.0533
337.67	0.028	196.5	0.0559
337.68	0.028	196.7	0.0568
337.70	0.028	196.8	0.0577
337.72	0.029	197	0.0577
337.72	0.029	197.1	0.0586
337.73	0.029	197.2	0.0586
337.75	0.029	197.3	0.0586
337.77	0.028	197.3	0.0586
337.78	0.028	197.3	0.0577
337.80	0.027	197.4	0.0559
337.82	0.026	197.4	0.055
337.83	0.025	197.4	0.0541
337.85	0.024	197.4	0.0524
337.87	0.022	197.3	0.0524
337.88	0.021	197.3	0.0506
337.90	0.021	197.2	0.0479
337.92	0.019	197.1	0.0453
337.93	0.016	197	0.0426
337.95	0.015	196.9	0.0399
337.97	0.014	196.8	0.0364
337.98	0.011	196.5	0.0364
338.00	0.009	196.4	0.0328
338.02	0.009	196.4	0.0302
338.03	0.008	196.2	0.0249
338.05	0.005	195.9	0.0204
338.07	0.003	195.7	0.0178
338.08	0.002	195.5	0.0142
338.10	-0.001	195.1	0.0142
338.12	-0.004	194.9	0.0089
338.13	-0.004	194.9	0.0053
338.15	-0.005	194.7	0.0018
338.17	-0.007	194.3	-0.0018
338.18	-0.008	194.1	-0.0044
338.20	-0.009	193.9	-0.008
338.22	-0.012	193.6	-0.008
338.23	-0.013	193.4	-0.0133
338.25	-0.013	193.2	-0.0142
338.27	-0.014	193	-0.016
338.28	-0.016	192.8	-0.016

Prova triassiale ciclica SN04-C1			
pressione di confinamento (kPa)		80	
deviatore ciclico (kPa)		95	
frequenza (hz)		0.00625	
tempo	cella di carico	$\Delta u$	LVDT
(min)	kN	(kPa)	$\delta$ (mm)
338.30	-0.016	192.8	-0.0186
338.32	-0.016	192.6	-0.0195
338.33	-0.017	192.4	-0.0204
338.35	-0.017	192.3	-0.0213
338.37	-0.017	192.1	-0.0213
338.38	-0.017	192	-0.0222
338.40	-0.017	191.9	-0.0222
338.42	-0.017	191.9	-0.0222
338.43	-0.017	191.8	-0.0222
338.45	-0.016	191.8	-0.0213
338.47	-0.015	191.8	-0.0195
338.48	-0.014	191.8	-0.0186
338.50	-0.014	191.8	-0.0178
338.52	-0.012	191.8	-0.0178
338.53	-0.011	191.8	-0.016
338.55	-0.011	191.9	-0.0142
338.57	-0.01	192	-0.0115
338.58	-0.007	192.1	-0.0089
338.60	-0.006	192.2	-0.0062
338.62	-0.004	192.4	-0.0027
338.63	-0.001	192.6	-0.0027
338.65	0	192.7	0.0009
338.67	0	192.7	0.0036
338.68	0.001	192.9	0.0071
338.70	0.005	193.2	0.0115
338.72	0.006	193.3	0.0151
338.73	0.008	193.6	0.0195
338.75	0.011	193.9	0.0195
338.77	0.013	194.1	0.024
338.78	0.013	194.1	0.0275
338.80	0.014	194.3	0.0311
338.82	0.016	194.6	0.0346
338.83	0.019	194.8	0.0391
338.85	0.02	195	0.0426
338.87	0.022	195.3	0.0426
338.88	0.023	195.6	0.0444
338.90	0.023	195.6	0.047
338.92	0.024	195.8	0.0497
338.93	0.025	196.1	0.0524
338.95	0.027	196.2	0.0541
338.97	0.027	196.4	0.055
338.98	0.027	196.6	0.0559
339.00	0.028	196.7	0.0568
339.02	0.029	196.9	0.0577
339.03	0.029	197	0.0586
339.05	0.029	197.1	0.0586
339.07	0.029	197.1	0.0586
339.08	0.029	197.2	0.0586
339.10	0.028	197.3	0.0586
339.13	0.028	197.3	0.0586
339.15	0.027	197.4	0.0568
339.17	0.026	197.4	0.055
339.18	0.024	197.4	0.055
339.18	0.023	197.4	0.0533
339.20	0.023	197.3	0.0524
339.22	0.023	197.2	0.0497
339.23	0.02	197.2	0.047
339.25	0.018	197.1	0.0453

Prova triassiale ciclica SN04-C1			
pressione di confinamento (kPa)		80	
deviatore ciclico (kPa)		95	
frequenza (hz)		0.00625	
tempo	cella di carico	$\Delta u$	LVDT
(min)	kN	(kPa)	$\delta$ (mm)
339.27	0.017	196.9	0.0426
339.28	0.014	196.8	0.0426
339.30	0.013	196.8	0.0391
339.32	0.013	196.7	0.0355
339.33	0.011	196.5	0.032
339.35	0.008	196.2	0.0284
339.37	0.007	196.1	0.024
339.38	0.005	195.8	0.0204
339.40	0.001	195.6	0.0204
339.42	0.001	195.6	0.016
339.43	0.001	195.3	0.0124
339.45	-0.001	195	0.008
339.47	-0.005	194.7	0.0036
339.48	-0.006	194.5	0.0009
339.50	-0.007	194.3	-0.0018
339.52	-0.009	194	-0.0018
339.53	-0.01	194	-0.0053
339.55	-0.01	193.8	-0.0089
339.57	-0.012	193.5	-0.0115
339.58	-0.014	193.2	-0.0142
339.60	-0.014	193	-0.016
339.62	-0.015	192.8	-0.0178
339.63	-0.017	192.6	-0.0178
339.65	-0.017	192.6	-0.0195
339.67	-0.017	192.5	-0.0204
339.68	-0.017	192.3	-0.0213
339.70	-0.017	192.2	-0.0213
339.72	-0.017	192.1	-0.0222
339.73	-0.017	192	-0.0222
339.75	-0.017	191.9	-0.0222
339.77	-0.017	191.8	-0.0213
339.78	-0.016	191.8	-0.0204
339.80	-0.015	191.8	-0.0204
339.82	-0.014	191.8	-0.0195
339.83	-0.014	191.7	-0.0178
339.85	-0.013	191.8	-0.016
339.87	-0.011	191.9	-0.0142
339.88	-0.01	191.9	-0.0124
339.90	-0.009	192	-0.0098
339.92	-0.006	192.2	-0.0098
339.93	-0.005	192.3	-0.0071
339.95	-0.005	192.3	-0.0044
339.97	-0.003	192.4	-0.0009
339.98	-0.001	192.6	0.0018
340.00	0.001	192.8	0.0053
340.02	0.002	193	0.0098
340.03	0.006	193.3	0.0098
340.05	0.008	193.5	0.0142
340.07	0.008	193.5	0.0169
340.08	0.009	193.6	0.0213
340.10	0.012	193.9	0.0257
340.12	0.014	194.2	0.0293
340.13	0.015	194.4	0.0337
340.15	0.017	194.7	0.0337
340.17	0.02	194.9	0.0373
340.18	0.02	194.9	0.0408
340.20	0.02	195.1	0.0435
340.22	0.022	195.4	0.0462

Prova triassiale ciclica SN04-C1			
pressione di confinamento (kPa)		80	
deviatore ciclico (kPa)		95	
frequenza (hz)		0.00625	
tempo	cella di carico	$\Delta u$	LVDT
(min)	kN	(kPa)	$\delta$ (mm)
340.23	0.024	195.7	0.0488
340.25	0.024	195.9	0.0506
340.27	0.026	196.1	0.0533
340.28	0.027	196.3	0.0533
340.30	0.027	196.3	0.055
340.32	0.028	196.5	0.0568
340.33	0.028	196.7	0.0577
340.35	0.029	196.8	0.0586
340.37	0.029	196.9	0.0586
340.38	0.029	197.1	0.0586
340.40	0.029	197.2	0.0586
340.42	0.028	197.3	0.0586
340.43	0.028	197.3	0.0586
340.45	0.028	197.4	0.0586
340.47	0.027	197.4	0.0577
340.48	0.027	197.4	0.0568
340.50	0.025	197.4	0.0541
340.52	0.024	197.3	0.0533
340.53	0.023	197.3	0.0515
340.57	0.022	197.2	0.0488
340.58	0.019	197.1	0.0488
340.60	0.018	197.1	0.0462
340.62	0.018	197	0.0435
340.63	0.017	196.9	0.0408
340.63	0.013	196.7	0.0364
340.65	0.012	196.6	0.0346
340.67	0.011	196.3	0.0302
340.68	0.007	196.1	0.0302
340.70	0.006	196.1	0.0257
340.72	0.006	196	0.0231
340.73	0.004	195.7	0.0186
340.75	0	195.4	0.0142
340.77	0	195.2	0.0107
340.78	-0.002	194.9	0.0071
340.80	-0.005	194.6	0.0071
340.82	-0.006	194.6	0.0036
340.83	-0.006	194.4	0
340.85	-0.007	194.1	-0.0036
340.87	-0.011	193.8	-0.0071
340.88	-0.011	193.7	-0.0098
340.90	-0.012	193.4	-0.0124
340.92	-0.014	193.1	-0.0124
340.93	-0.014	193.1	-0.0151
340.95	-0.014	193	-0.016
340.97	-0.015	192.8	-0.0178
340.98	-0.017	192.6	-0.0195
341.00	-0.017	192.4	-0.0204
341.02	-0.017	192.3	-0.0213
341.03	-0.017	192.1	-0.0213
341.05	-0.017	192.1	-0.0213
341.07	-0.017	192	-0.0222
341.08	-0.017	191.9	-0.0222
341.10	-0.016	191.9	-0.0213
341.12	-0.016	191.8	-0.0204
341.13	-0.015	191.8	-0.0195
341.15	-0.014	191.8	-0.0178
341.17	-0.014	191.8	-0.0169
341.18	-0.012	191.8	-0.0151

Prova triassiale ciclica SN04-C1			
pressione di confinamento (kPa)		80	
deviatore ciclico (kPa)		95	
frequenza (hz)		0.00625	
tempo	cella di carico	$\Delta u$	LVDT
(min)	kN	(kPa)	$\delta$ (mm)
341.20	-0.01	191.9	-0.0151
341.22	-0.009	191.9	-0.0133
341.23	-0.009	191.9	-0.0115
341.25	-0.008	192.1	-0.0089
341.27	-0.005	192.2	-0.0062
341.28	-0.004	192.3	-0.0036
341.30	-0.003	192.5	0.0009
341.32	0.001	192.7	0.0009
341.33	0.002	192.7	0.0044
341.35	0.002	192.9	0.0071
341.37	0.004	193.1	0.0115
341.38	0.007	193.3	0.0151
341.40	0.008	193.5	0.0186
341.42	0.01	193.7	0.0231
341.43	0.013	194	0.0231
341.45	0.015	194.3	0.0284
341.47	0.015	194.3	0.0311
341.48	0.016	194.5	0.0346
341.50	0.019	194.8	0.0391
341.52	0.02	195	0.0417
341.53	0.021	195.2	0.0453
341.55	0.023	195.6	0.0453
341.57	0.024	195.8	0.0479
341.58	0.024	195.8	0.0497
341.60	0.025	196	0.0524
341.62	0.026	196.2	0.0541
341.63	0.027	196.4	0.055
341.65	0.028	196.6	0.0568
341.67	0.028	196.7	0.0577
341.68	0.029	196.9	0.0577
341.70	0.029	196.9	0.0586
341.72	0.029	197	0.0586
341.73	0.029	197.1	0.0586
341.75	0.029	197.2	0.0586
341.77	0.028	197.3	0.0586
341.78	0.028	197.3	0.0577
341.80	0.026	197.3	0.0577
341.82	0.025	197.3	0.0559
341.83	0.025	197.3	0.055
341.85	0.025	197.3	0.0533
341.87	0.022	197.2	0.0515
341.88	0.022	197.3	0.0506
341.90	0.021	197.1	0.0479
341.92	0.018	197	0.0444
341.93	0.017	197	0.0426
341.95	0.016	196.8	0.0399
341.97	0.012	196.6	0.0399
341.98	0.011	196.6	0.0355
342.00	0.011	196.5	0.0328
342.03	0.01	196.2	0.0293
342.05	0.006	196	0.024
342.07	0.005	195.9	0.0213
342.08	0.003	195.6	0.0169
342.08	0	195.3	0.0169
342.10	-0.001	195.3	0.0124
342.12	-0.001	195.1	0.0098
342.13	-0.003	194.8	0.0053
342.15	-0.006	194.5	0.0018

Prova triassiale ciclica SN04-C1			
pressione di confinamento (kPa)		80	
deviatore ciclico (kPa)		95	
frequenza (hz)		0.00625	
tempo	cella di carico	$\Delta u$	LVDT
(min)	kN	(kPa)	$\delta$ (mm)
342.17	-0.006	194.3	-0.0009
342.18	-0.008	194	-0.0053
342.20	-0.011	193.7	-0.0053
342.22	-0.012	193.7	-0.0089
342.23	-0.012	193.5	-0.0107
342.25	-0.013	193.3	-0.0133
342.27	-0.015	193	-0.016
342.28	-0.015	192.8	-0.0169
342.30	-0.015	192.7	-0.0178
342.32	-0.016	192.5	-0.0178
342.33	-0.017	192.5	-0.0195
342.35	-0.017	192.3	-0.0204
342.37	-0.017	192.2	-0.0213
342.38	-0.017	192.1	-0.0213
342.40	-0.017	192	-0.0213
342.42	-0.017	191.9	-0.0213
342.43	-0.016	191.8	-0.0213
342.45	-0.016	191.8	-0.0213
342.47	-0.016	191.8	-0.0204
342.48	-0.015	191.8	-0.0186
342.50	-0.013	191.8	-0.0169
342.52	-0.013	191.8	-0.016
342.53	-0.012	191.9	-0.0133
342.55	-0.009	192	-0.0133
342.57	-0.008	192	-0.0115
342.58	-0.008	192.1	-0.0089
342.60	-0.005	192.3	-0.0053
342.62	-0.003	192.3	-0.0044
342.63	-0.003	192.4	-0.0018
342.65	-0.002	192.6	0.0018
342.67	0.002	192.8	0.0053
342.68	0.003	193	0.0089
342.70	0.004	193.2	0.0133
342.72	0.008	193.5	0.0133
342.73	0.009	193.6	0.0178
342.75	0.009	193.6	0.0204
342.77	0.011	193.9	0.0249
342.78	0.014	194.2	0.0302
342.80	0.016	194.4	0.0328
342.82	0.017	194.6	0.0364
342.83	0.019	194.9	0.0364
342.85	0.021	195.1	0.0399
342.87	0.021	195.1	0.0435
342.88	0.022	195.4	0.0462
342.90	0.024	195.7	0.0488
342.92	0.025	195.9	0.0506
342.93	0.026	196.1	0.0541
342.95	0.027	196.3	0.0541
342.97	0.028	196.5	0.0559
342.98	0.028	196.5	0.0568
343.00	0.028	196.6	0.0568
343.02	0.028	196.8	0.0577
343.03	0.028	196.9	0.0586
343.05	0.029	197	0.0586
343.07	0.029	197.1	0.0586
343.08	0.029	197.2	0.0586
343.10	0.029	197.2	0.0586
343.12	0.028	197.3	0.0586

Prova triassiale ciclica SN04-C1			
pressione di confinamento (kPa)		80	
deviatore ciclico (kPa)		95	
frequenza (hz)		0.00625	
tempo	cella di carico	$\Delta u$	LVDT
(min)	kN	(kPa)	$\delta$ (mm)
343.13	0.027	197.3	0.0568
343.15	0.026	197.3	0.0559
343.17	0.025	197.3	0.0541
343.18	0.024	197.3	0.0524
343.20	0.022	197.2	0.0524
343.22	0.022	197.2	0.0506
343.23	0.021	197.2	0.047
343.25	0.019	197	0.0453
343.27	0.017	196.9	0.0426
343.28	0.016	196.8	0.0399
343.30	0.014	196.6	0.0364
343.32	0.011	196.4	0.0328
343.33	0.01	196.3	0.0311
343.35	0.009	196.1	0.0275
343.37	0.005	195.9	0.0275
343.38	0.004	195.9	0.0231
343.40	0.004	195.7	0.0195
343.42	0.002	195.4	0.0151
343.43	-0.001	195.1	0.0115
343.47	-0.002	194.9	0.008
343.48	-0.004	194.6	0.0036
343.50	-0.007	194.4	0.0036
343.52	-0.007	194.4	0
343.53	-0.007	194.2	-0.0027
343.53	-0.009	193.8	-0.0062
343.55	-0.012	193.6	-0.0098
343.57	-0.012	193.4	-0.0124
343.58	-0.013	193.1	-0.0142
343.60	-0.015	192.9	-0.0142
343.62	-0.015	192.9	-0.016
343.63	-0.015	192.8	-0.0169
343.65	-0.016	192.5	-0.0195
343.67	-0.017	192.4	-0.0204
343.68	-0.017	192.2	-0.0213
343.70	-0.017	192.1	-0.0213
343.72	-0.017	192	-0.0213
343.73	-0.017	192	-0.0213
343.75	-0.017	191.9	-0.0213
343.77	-0.017	191.8	-0.0213
343.78	-0.016	191.8	-0.0204
343.80	-0.015	191.8	-0.0195
343.82	-0.015	191.8	-0.0178
343.83	-0.013	191.8	-0.0178
343.85	-0.012	191.8	-0.0169
343.87	-0.012	191.8	-0.0151
343.88	-0.011	191.9	-0.0124
343.90	-0.008	192	-0.0107
343.92	-0.007	192.1	-0.008
343.93	-0.006	192.2	-0.0053
343.95	-0.003	192.4	-0.0053
343.97	-0.002	192.4	-0.0018
343.98	-0.002	192.5	0.0009
344.00	0	192.8	0.0053
344.02	0.004	193	0.0089
344.03	0.005	193.1	0.0124
344.05	0.006	193.4	0.016
344.07	0.009	193.6	0.0186
344.08	0.01	193.7	0.0222



Prova triassiale ciclica SN04-C1			
pressione di confinamento (kPa)		80	
deviatore ciclico (kPa)		95	
frequenza (hz)		0.00625	
tempo	cella di carico	$\Delta u$	LVDT
(min)	kN	(kPa)	$\delta$ (mm)
344.10	0.012	194	0.0275
344.12	0.015	194.3	0.0275
344.13	0.016	194.3	0.0311
344.15	0.016	194.5	0.0346
344.17	0.017	194.7	0.0382
344.18	0.02	195	0.0417
344.20	0.021	195.2	0.0444
344.22	0.022	195.5	0.047
344.23	0.024	195.8	0.047
344.25	0.025	196	0.0497
344.27	0.025	196	0.0515
344.28	0.026	196.1	0.0533
344.30	0.027	196.4	0.055
344.32	0.028	196.5	0.0568
344.33	0.028	196.7	0.0577
344.35	0.029	196.8	0.0577
344.37	0.029	196.9	0.0586
344.38	0.029	196.9	0.0586
344.40	0.029	197.1	0.0586
344.42	0.029	197.2	0.0586
344.43	0.028	197.3	0.0586
344.45	0.028	197.3	0.0577
344.47	0.027	197.3	0.0577
344.48	0.026	197.3	0.0568
344.50	0.026	197.3	0.0559
344.52	0.024	197.3	0.0533
344.53	0.023	197.2	0.0515
344.55	0.021	197.2	0.0497
344.57	0.021	197.1	0.047
344.58	0.018	196.9	0.047
344.60	0.016	196.9	0.0435
344.62	0.016	196.9	0.0417
344.63	0.015	196.8	0.0382
344.65	0.012	196.5	0.0346
344.67	0.01	196.4	0.0311
344.68	0.009	196.2	0.0275
344.70	0.006	195.9	0.0275
344.72	0.004	195.7	0.0231
344.73	0.004	195.7	0.0195
344.75	0.002	195.5	0.016
344.77	0	195.1	0.0115
344.78	-0.003	194.9	0.008
344.80	-0.003	194.7	0.0053
344.82	-0.005	194.5	0.0027
344.83	-0.007	194.2	-0.0009
344.85	-0.008	194	-0.0036
344.87	-0.009	193.7	-0.0071
344.88	-0.012	193.5	-0.0071
344.90	-0.013	193.5	-0.0115
344.93	-0.013	193.3	-0.0133
344.95	-0.014	193	-0.0151
344.97	-0.015	192.8	-0.0169
344.98	-0.016	192.6	-0.0186
344.98	-0.017	192.4	-0.0204
345.00	-0.017	192.3	-0.0204
345.02	-0.017	192.3	-0.0213
345.03	-0.017	192.2	-0.0213
345.05	-0.017	192	-0.0213

Prova triassiale ciclica SN04-C1			
pressione di confinamento (kPa)		80	
deviatore ciclico (kPa)		95	
frequenza (hz)		0.00625	
tempo	cella di carico	$\Delta u$	LVDT
(min)	kN	(kPa)	$\delta$ (mm)
345.07	-0.017	191.9	-0.0213
345.08	-0.017	191.8	-0.0213
345.10	-0.017	191.8	-0.0213
345.12	-0.015	191.7	-0.0213
345.13	-0.015	191.7	-0.0204
345.15	-0.015	191.7	-0.0195
345.17	-0.014	191.7	-0.0178
345.18	-0.012	191.8	-0.016
345.20	-0.011	191.8	-0.0142
345.22	-0.01	191.9	-0.0115
345.23	-0.007	192	-0.0115
345.25	-0.007	192	-0.0098
345.27	-0.007	192.1	-0.0071
345.28	-0.005	192.2	-0.0036
345.30	-0.001	192.5	0
345.32	-0.001	192.6	0.0027
345.33	0.001	192.8	0.0071
345.35	0.005	193	0.0071
345.37	0.006	193	0.0115
345.38	0.006	193.2	0.0142
345.40	0.007	193.4	0.0178
345.42	0.01	193.7	0.0213
345.43	0.012	193.9	0.0249
345.45	0.014	194.2	0.0311
345.47	0.017	194.4	0.0311
345.48	0.017	194.4	0.0346
345.50	0.019	194.9	0.0391
345.52	0.02	195.1	0.0391
345.53	0.022	195.1	0.0417
345.55	0.022	195.3	0.0453
345.57	0.023	195.6	0.0479
345.58	0.025	195.9	0.0506
345.60	0.026	196	0.0524
345.62	0.026	196.2	0.055
345.63	0.028	196.4	0.055
345.65	0.028	196.6	0.0568
345.67	0.028	196.6	0.0568
345.68	0.028	196.7	0.0577
345.70	0.029	196.9	0.0586
345.72	0.029	197	0.0586
345.73	0.029	197.1	0.0586
345.75	0.029	197.2	0.0586
345.77	0.028	197.3	0.0586
345.78	0.028	197.3	0.0586
345.80	0.027	197.3	0.0568
345.82	0.026	197.3	0.0559
345.83	0.025	197.3	0.055
345.85	0.024	197.3	0.0524
345.87	0.022	197.2	0.0506
345.88	0.021	197.1	0.0506
345.90	0.021	197.1	0.0488
345.92	0.02	197.1	0.0462
345.93	0.017	196.9	0.0426
345.95	0.014	196.8	0.0399
345.97	0.014	196.7	0.0373
345.98	0.012	196.4	0.0328
346.00	0.009	196.3	0.0328
346.02	0.009	196.3	0.0293

Prova triassiale ciclica SN04-C1			
pressione di confinamento (kPa)		80	
deviatore ciclico (kPa)		95	
frequenza (hz)		0.00625	
tempo	cella di carico	$\Delta u$	LVDT
(min)	kN	(kPa)	$\delta$ (mm)
346.03	0.007	196.1	0.0249
346.05	0.005	195.8	0.0213
346.07	0.002	195.6	0.0178
346.08	0.002	195.4	0.0142
346.10	-0.001	195	0.0098
346.12	-0.004	194.8	0.0098
346.13	-0.004	194.8	0.0062
346.15	-0.005	194.6	0.0018
346.17	-0.007	194.3	-0.0018
346.18	-0.009	194	-0.0044
346.20	-0.01	193.8	-0.008
346.22	-0.011	193.5	-0.0107
346.23	-0.013	193.3	-0.0133
346.25	-0.014	193.1	-0.0142
346.27	-0.014	192.9	-0.016
346.28	-0.016	192.7	-0.016
346.30	-0.016	192.7	-0.0178
346.32	-0.016	192.5	-0.0186
346.33	-0.017	192.3	-0.0204
346.35	-0.017	192.2	-0.0213
346.37	-0.017	192	-0.0222
346.40	-0.017	191.9	-0.0222
346.42	-0.017	191.9	-0.0222
346.43	-0.016	191.9	-0.0213
346.43	-0.016	191.8	-0.0213
346.45	-0.016	191.7	-0.0204
346.47	-0.015	191.7	-0.0195
346.48	-0.015	191.7	-0.0186
346.50	-0.014	191.7	-0.0169
346.52	-0.011	191.8	-0.0169
346.53	-0.011	191.8	-0.0151
346.55	-0.011	191.8	-0.0133
346.57	-0.009	191.9	-0.0107
346.58	-0.006	192.1	-0.008
346.60	-0.006	192.1	-0.0053
346.62	-0.004	192.3	-0.0018
346.63	-0.001	192.5	-0.0018
346.65	0	192.5	0.0009
346.67	0	192.6	0.0044
346.68	0.002	192.8	0.008
346.70	0.005	193.1	0.0124
346.72	0.006	193.3	0.016
346.73	0.008	193.5	0.0195
346.75	0.012	193.8	0.0195
346.77	0.012	193.8	0.024
346.78	0.012	194	0.0257
346.80	0.014	194.3	0.032
346.82	0.017	194.6	0.0364
346.83	0.019	194.8	0.0391
346.85	0.02	195	0.0426
346.87	0.022	195.2	0.0426
346.88	0.023	195.2	0.0453
346.90	0.023	195.5	0.0479
346.92	0.024	195.7	0.0506
346.93	0.026	196	0.0533
346.95	0.027	196.2	0.0541
346.97	0.027	196.3	0.055
346.98	0.027	196.5	0.0568

Prova triassiale ciclica SN04-C1			
pressione di confinamento (kPa)		80	
deviatore ciclico (kPa)		95	
frequenza (hz)		0.00625	
tempo	cella di carico	$\Delta u$	LVDT
(min)	kN	(kPa)	$\delta$ (mm)
347.00	0.028	196.7	0.0568
347.02	0.028	196.8	0.0577
347.03	0.029	197	0.0577
347.05	0.029	197	0.0586
347.07	0.029	197.1	0.0586
347.08	0.029	197.2	0.0595
347.10	0.029	197.2	0.0586
347.12	0.028	197.3	0.0586
347.13	0.027	197.3	0.0568
347.15	0.025	197.3	0.0568
347.17	0.024	197.3	0.055
347.18	0.024	197.3	0.0541
347.20	0.024	197.3	0.0515
347.22	0.022	197.2	0.0497
347.23	0.02	197.1	0.0479
347.25	0.019	197	0.0444
347.27	0.017	196.9	0.0444
347.28	0.014	196.7	0.0417
347.30	0.014	196.7	0.0382
347.32	0.013	196.6	0.0355
347.33	0.011	196.4	0.032
347.35	0.008	196.2	0.0284
347.37	0.007	196	0.024
347.38	0.005	195.7	0.0195
347.40	0.002	195.5	0.0195
347.42	0.002	195.5	0.016
347.43	0.001	195.2	0.0124
347.45	-0.001	194.9	0.008
347.47	-0.005	194.7	0.0044
347.48	-0.005	194.5	0.0018
347.50	-0.007	194.2	-0.0018
347.52	-0.01	193.9	-0.0018
347.53	-0.01	193.9	-0.0053
347.55	-0.01	193.7	-0.0089
347.57	-0.011	193.4	-0.0115
347.58	-0.014	193.2	-0.0142
347.60	-0.014	193	-0.016
347.62	-0.015	192.8	-0.0178
347.63	-0.016	192.6	-0.0178
347.65	-0.016	192.6	-0.0195
347.67	-0.016	192.4	-0.0204
347.68	-0.017	192.1	-0.0213
347.70	-0.017	192.1	-0.0213
347.72	-0.017	192	-0.0222
347.73	-0.017	191.9	-0.0222
347.75	-0.017	191.8	-0.0222
347.77	-0.016	191.7	-0.0213
347.78	-0.016	191.7	-0.0204
347.80	-0.015	191.7	-0.0204
347.83	-0.014	191.7	-0.0195
347.85	-0.014	191.7	-0.0186
347.87	-0.013	191.7	-0.0169
347.88	-0.011	191.8	-0.0142
347.90	-0.01	191.9	-0.0124
347.90	-0.009	191.9	-0.0098
347.92	-0.006	192.1	-0.0098
347.93	-0.005	192.1	-0.0071
347.95	-0.005	192.2	-0.0036

Prova triassiale ciclica SN04-C1			
pressione di confinamento (kPa)		80	
deviatore ciclico (kPa)		95	
frequenza (hz)		0.00625	
tempo	cella di carico	$\Delta u$	LVDT
(min)	kN	(kPa)	$\delta$ (mm)
347.97	-0.003	192.4	-0.0009
347.98	0	192.6	0.0027
348.00	0.001	192.7	0.0062
348.02	0.003	192.9	0.0098
348.03	0.006	193.2	0.0098
348.05	0.007	193.2	0.0133
348.07	0.007	193.4	0.0169
348.08	0.009	193.7	0.0213
348.10	0.013	193.9	0.0275
348.12	0.014	194.1	0.0302
348.13	0.015	194.4	0.0337
348.15	0.018	194.6	0.0337
348.17	0.019	194.6	0.0364
348.18	0.019	194.9	0.0399
348.20	0.02	195.1	0.0435
348.22	0.023	195.4	0.0462
348.23	0.024	195.6	0.0488
348.25	0.024	195.9	0.0515
348.27	0.027	196.1	0.0515
348.28	0.027	196.1	0.0541
348.30	0.027	196.3	0.055
348.32	0.027	196.4	0.0559
348.33	0.028	196.6	0.0577
348.35	0.029	196.8	0.0586
348.37	0.029	196.9	0.0586
348.38	0.029	197	0.0586
348.40	0.029	197	0.0586
348.42	0.029	197.2	0.0586
348.43	0.028	197.3	0.0586
348.45	0.027	197.3	0.0586
348.47	0.027	197.3	0.0577
348.48	0.026	197.4	0.0559
348.50	0.025	197.3	0.055
348.52	0.024	197.3	0.0533
348.53	0.023	197.3	0.0506
348.55	0.021	197.1	0.0506
348.57	0.019	197.1	0.0488
348.58	0.019	197.1	0.047
348.60	0.018	197	0.0435
348.62	0.015	196.8	0.0399
348.63	0.013	196.7	0.0373
348.65	0.012	196.5	0.0337
348.67	0.009	196.3	0.0337
348.68	0.007	196.1	0.0302
348.70	0.007	196.1	0.0275
348.72	0.006	195.9	0.0222
348.73	0.003	195.6	0.0186
348.75	0.001	195.4	0.0151
348.77	0	195.2	0.0115
348.78	-0.003	194.8	0.0115
348.80	-0.005	194.6	0.0071
348.82	-0.005	194.6	0.0027
348.83	-0.006	194.4	0
348.85	-0.008	194	-0.0036
348.87	-0.01	193.8	-0.0071
348.88	-0.011	193.6	-0.0098
348.90	-0.012	193.3	-0.0124
348.92	-0.014	193.1	-0.0124

Prova triassiale ciclica SN04-C1			
pressione di confinamento (kPa)		80	
deviatore ciclico (kPa)		95	
frequenza (hz)		0.00625	
tempo	cella di carico	$\Delta u$	LVDT
(min)	kN	(kPa)	$\delta$ (mm)
348.93	-0.014	193.1	-0.0151
348.95	-0.015	192.9	-0.016
348.97	-0.016	192.7	-0.0178
348.98	-0.017	192.5	-0.0195
349.00	-0.017	192.4	-0.0204
349.02	-0.017	192.2	-0.0213
349.03	-0.017	192.1	-0.0213
349.05	-0.017	192.1	-0.0213
349.07	-0.017	192	-0.0222
349.08	-0.017	191.9	-0.0213
349.10	-0.017	191.8	-0.0213
349.12	-0.016	191.8	-0.0204
349.13	-0.015	191.7	-0.0186
349.15	-0.014	191.7	-0.0186
349.17	-0.014	191.7	-0.0178
349.18	-0.013	191.8	-0.0151
349.20	-0.01	191.8	-0.0151
349.22	-0.009	191.8	-0.0133
349.23	-0.009	191.9	-0.0107
349.25	-0.008	192	-0.008
349.27	-0.005	192.2	-0.0053
349.30	-0.004	192.3	-0.0027
349.32	-0.003	192.5	0.0009
349.33	0.001	192.7	0.0009
349.35	0.002	192.7	0.0044
349.35	0.002	192.8	0.008
349.37	0.004	193	0.0115
349.38	0.007	193.3	0.0151
349.40	0.008	193.5	0.0195
349.42	0.01	193.7	0.0231
349.43	0.013	194	0.0231
349.45	0.014	194	0.0284
349.47	0.014	194.2	0.0311
349.48	0.015	194.5	0.0346
349.50	0.019	194.8	0.0391
349.52	0.02	195	0.0417
349.53	0.021	195.2	0.0453
349.55	0.023	195.5	0.0453
349.57	0.024	195.5	0.0479
349.58	0.024	195.7	0.0497
349.60	0.025	195.9	0.0524
349.62	0.027	196.2	0.0541
349.63	0.027	196.3	0.055
349.65	0.028	196.5	0.0568
349.67	0.028	196.7	0.0568
349.68	0.029	196.7	0.0577
349.70	0.029	196.8	0.0586
349.72	0.029	196.9	0.0586
349.73	0.029	197	0.0586
349.75	0.029	197.1	0.0586
349.77	0.028	197.2	0.0586
349.78	0.027	197.2	0.0586
349.80	0.026	197.3	0.0577
349.82	0.026	197.3	0.0568
349.83	0.026	197.3	0.055
349.85	0.024	197.2	0.0533
349.87	0.022	197.2	0.0515
349.88	0.022	197.2	0.0497

Prova triassiale ciclica SN04-C1			
pressione di confinamento (kPa)		80	
deviatore ciclico (kPa)		95	
frequenza (hz)		0.00625	
tempo	cella di carico	$\Delta u$	LVDT
(min)	kN	(kPa)	$\delta$ (mm)
349.90	0.02	197.1	0.0479
349.92	0.019	197	0.0462
349.93	0.017	196.9	0.0417
349.95	0.014	196.7	0.0417
349.97	0.012	196.6	0.0382
349.98	0.012	196.6	0.0364
350.00	0.011	196.4	0.0328
350.02	0.009	196.2	0.0293
350.03	0.006	196	0.0249
350.05	0.005	195.8	0.0213
350.07	0.003	195.5	0.0169
350.08	0	195.2	0.0169
350.10	0	195.2	0.0124
350.12	-0.001	195	0.0089
350.13	-0.004	194.7	0.0053
350.15	-0.006	194.5	0.0018
350.17	-0.006	194.2	-0.0018
350.18	-0.009	193.9	-0.0053
350.20	-0.011	193.7	-0.0053
350.22	-0.011	193.7	-0.008
350.23	-0.011	193.5	-0.0107
350.25	-0.013	193.2	-0.0142
350.27	-0.015	193	-0.016
350.28	-0.015	192.8	-0.0178
350.30	-0.016	192.6	-0.0186
350.32	-0.017	192.4	-0.0186
350.33	-0.017	192.4	-0.0195
350.35	-0.017	192.2	-0.0213
350.37	-0.017	192.1	-0.0213
350.38	-0.017	192	-0.0222
350.40	-0.017	191.9	-0.0222
350.42	-0.017	191.8	-0.0213
350.43	-0.016	191.8	-0.0213
350.45	-0.016	191.8	-0.0204
350.47	-0.016	191.7	-0.0195
350.48	-0.015	191.7	-0.0186
350.50	-0.013	191.8	-0.0178
350.52	-0.013	191.8	-0.016
350.53	-0.011	191.9	-0.0133
350.55	-0.009	191.9	-0.0133
350.57	-0.008	191.9	-0.0107
350.58	-0.007	192.1	-0.008
350.60	-0.005	192.2	-0.008
350.62	-0.004	192.2	-0.0053
350.63	-0.004	192.3	-0.0018
350.65	-0.002	192.6	0.0018
350.67	0.002	192.8	0.0062
350.68	0.003	192.9	0.0098
350.70	0.005	193.2	0.0133
350.73	0.008	193.4	0.0133
350.75	0.009	193.4	0.0169
350.77	0.009	193.6	0.0204
350.78	0.011	193.9	0.0249
350.80	0.014	194.1	0.0293
350.80	0.015	194.3	0.0328
350.82	0.017	194.6	0.0364
350.83	0.02	194.8	0.0364
350.85	0.021	194.8	0.0408

Prova triassiale ciclica SN04-C1			
pressione di confinamento (kPa)		80	
deviatore ciclico (kPa)		95	
frequenza (hz)		0.00625	
tempo	cella di carico	$\Delta u$	LVDT
(min)	kN	(kPa)	$\delta$ (mm)
350.87	0.021	195	0.0435
350.88	0.021	195.3	0.0453
350.90	0.024	195.6	0.0488
350.92	0.025	195.8	0.0506
350.93	0.026	196	0.0533
350.95	0.027	196.2	0.0533
350.97	0.027	196.2	0.055
350.98	0.027	196.4	0.0559
351.00	0.028	196.6	0.0568
351.02	0.028	196.7	0.0577
351.03	0.029	196.8	0.0586
351.05	0.029	197	0.0586
351.07	0.029	197.1	0.0586
351.08	0.029	197.1	0.0586
351.10	0.029	197.2	0.0586
351.12	0.028	197.2	0.0586
351.13	0.027	197.2	0.0568
351.15	0.026	197.3	0.0559
351.17	0.025	197.3	0.0541
351.18	0.023	197.2	0.0541
351.20	0.022	197.2	0.0524
351.22	0.022	197.2	0.0506
351.23	0.021	197.1	0.0479
351.25	0.018	197	0.0453
351.27	0.017	196.9	0.0426
351.28	0.015	196.7	0.0391
351.30	0.012	196.5	0.0391
351.32	0.011	196.4	0.0337
351.33	0.011	196.3	0.0311
351.35	0.008	196.1	0.0311
351.37	0.006	195.9	0.0275
351.38	0.006	195.9	0.0231
351.40	0.004	195.7	0.0186
351.42	0.001	195.3	0.0142
351.43	-0.001	195.1	0.0107
351.45	-0.002	194.9	0.0071
351.47	-0.005	194.6	0.0071
351.48	-0.006	194.3	0.0036
351.50	-0.006	194.3	0.0009
351.52	-0.007	194.1	-0.0036
351.53	-0.01	193.8	-0.0071
351.55	-0.011	193.6	-0.0089
351.57	-0.012	193.3	-0.0115
351.58	-0.014	193.1	-0.0115
351.60	-0.015	192.9	-0.0142
351.62	-0.015	192.9	-0.016
351.63	-0.015	192.7	-0.0178
351.65	-0.016	192.5	-0.0195
351.67	-0.017	192.3	-0.0204
351.68	-0.017	192.2	-0.0213
351.70	-0.017	192.1	-0.0213
351.72	-0.017	191.9	-0.0213
351.73	-0.017	191.9	-0.0213
351.75	-0.017	191.8	-0.0213
351.77	-0.017	191.8	-0.0213
351.78	-0.016	191.7	-0.0204
351.80	-0.015	191.7	-0.0195
351.82	-0.014	191.7	-0.0178



Prova triassiale ciclica SN04-C1			
pressione di confinamento (kPa)		80	
deviatore ciclico (kPa)		95	
frequenza (hz)		0.00625	
tempo	cella di carico	$\Delta u$	LVDT
(min)	kN	(kPa)	$\delta$ (mm)
351.83	-0.013	191.7	-0.0178
351.85	-0.012	191.7	-0.0169
351.87	-0.012	191.8	-0.0151
351.88	-0.011	191.8	-0.0124
351.90	-0.008	192	-0.0107
351.92	-0.008	192	-0.008
351.93	-0.006	192.2	-0.0044
351.95	-0.002	192.4	-0.0044
351.97	-0.001	192.4	-0.0009
351.98	-0.001	192.5	0.0018
352.00	0	192.7	0.0053
352.02	0.004	192.9	0.0098
352.03	0.004	193.1	0.0124
352.05	0.005	193.2	0.0142
352.07	0.009	193.5	0.0186
352.08	0.01	193.7	0.0222
352.10	0.012	193.9	0.0275
352.12	0.015	194.2	0.0275
352.13	0.016	194.2	0.0311
352.15	0.016	194.4	0.0346
352.17	0.017	194.6	0.0382
352.20	0.02	194.9	0.0417
352.22	0.021	195.1	0.0435
352.23	0.022	195.4	0.047
352.25	0.025	195.7	0.047
352.25	0.025	195.7	0.0506
352.27	0.025	195.9	0.0515
352.28	0.026	196.1	0.0533
352.30	0.027	196.3	0.0559
352.32	0.028	196.5	0.0568
352.33	0.028	196.6	0.0586
352.35	0.029	196.8	0.0586
352.37	0.029	196.8	0.0595
352.38	0.029	196.9	0.0595
352.40	0.029	197	0.0595
352.42	0.029	197.1	0.0595
352.43	0.028	197.2	0.0595
352.45	0.028	197.3	0.0577
352.47	0.026	197.3	0.0577
352.48	0.025	197.3	0.0568
352.50	0.025	197.3	0.0559
352.52	0.025	197.3	0.0533
352.53	0.023	197.2	0.0515
352.55	0.022	197.2	0.0497
352.57	0.02	197.1	0.047
352.58	0.017	196.9	0.047
352.60	0.016	196.8	0.0435
352.62	0.016	196.8	0.0417
352.63	0.015	196.7	0.0391
352.65	0.012	196.4	0.0346
352.67	0.01	196.3	0.032
352.68	0.009	196.2	0.0275
352.70	0.005	195.9	0.0275
352.72	0.004	195.7	0.0231
352.73	0.004	195.7	0.0204
352.75	0.003	195.5	0.016
352.77	-0.001	194.9	0.0115
352.78	-0.001	194.9	0.0098

Prova triassiale ciclica SN04-C1			
pressione di confinamento (kPa)		80	
deviatore ciclico (kPa)		95	
frequenza (hz)		0.00625	
tempo	cella di carico	$\Delta u$	LVDT
(min)	kN	(kPa)	$\delta$ (mm)
352.80	-0.003	194.7	0.0053
352.82	-0.006	194.4	0.0018
352.83	-0.007	194.2	-0.0009
352.85	-0.008	194	-0.0044
352.87	-0.01	193.6	-0.0044
352.88	-0.012	193.4	-0.008
352.90	-0.012	193.4	-0.0107
352.92	-0.013	193.2	-0.0124
352.93	-0.014	193	-0.0151
352.95	-0.015	192.7	-0.0169
352.97	-0.016	192.6	-0.0186
352.98	-0.016	192.4	-0.0186
353.00	-0.017	192.2	-0.0195
353.02	-0.017	192.2	-0.0204
353.03	-0.017	192.1	-0.0204
353.05	-0.017	192	-0.0213
353.07	-0.017	191.9	-0.0213
353.08	-0.017	191.8	-0.0213
353.10	-0.017	191.7	-0.0204
353.12	-0.016	191.7	-0.0204
353.13	-0.016	191.7	-0.0195
353.15	-0.015	191.7	-0.0178
353.17	-0.014	191.7	-0.0169
353.18	-0.012	191.8	-0.0151
353.20	-0.011	191.8	-0.0142
353.22	-0.01	191.9	-0.0115
353.23	-0.007	192	-0.0115
353.25	-0.006	192	-0.0089
353.27	-0.006	192.1	-0.0062
353.28	-0.005	192.2	-0.0036
353.30	-0.002	192.4	0
353.32	-0.001	192.5	0.0036
353.33	0.001	192.8	0.0071
353.35	0.004	193	0.0071
353.37	0.005	193	0.0107
353.38	0.005	193.2	0.0142
353.40	0.007	193.4	0.0186
353.42	0.011	193.7	0.0231
353.43	0.012	193.9	0.0257
353.45	0.013	194.2	0.0311
353.47	0.017	194.4	0.0311
353.48	0.017	194.4	0.0346
353.50	0.019	194.8	0.0391
353.52	0.02	195	0.0391
353.53	0.022	195	0.0426
353.55	0.022	195.3	0.0462
353.57	0.023	195.6	0.0488
353.58	0.025	195.8	0.0515
353.60	0.026	196	0.0524
353.62	0.026	196.2	0.055
353.65	0.028	196.4	0.055
353.67	0.028	196.4	0.0568
353.68	0.028	196.5	0.0577
353.70	0.029	196.7	0.0586
353.70	0.029	196.8	0.0586
353.72	0.029	197	0.0595
353.73	0.029	197.1	0.0595
353.75	0.028	197.2	0.0595

Prova triassiale ciclica SN04-C1			
pressione di confinamento (kPa)		80	
deviatore ciclico (kPa)		95	
frequenza (hz)		0.00625	
tempo	cella di carico	$\Delta u$	LVDT
(min)	kN	(kPa)	$\delta$ (mm)
353.77	0.028	197.2	0.0595
353.78	0.028	197.2	0.0586
353.80	0.027	197.3	0.0577
353.82	0.025	197.3	0.0559
353.83	0.025	197.3	0.055
353.85	0.024	197.2	0.0533
353.87	0.022	197.2	0.0533
353.88	0.021	197.2	0.0506
353.90	0.021	197.1	0.0488
353.92	0.02	197	0.0462
353.93	0.017	196.9	0.0435
353.95	0.015	196.8	0.0408
353.97	0.014	196.6	0.0373
353.98	0.011	196.4	0.0373
354.00	0.009	196.4	0.0337
354.02	0.009	196.2	0.0302
354.03	0.008	196.1	0.0257
354.05	0.005	195.8	0.0222
354.07	0.003	195.6	0.0186
354.08	0.002	195.3	0.0142
354.10	-0.002	195	0.0142
354.12	-0.003	195	0.0098
354.13	-0.003	194.8	0.0062
354.15	-0.004	194.5	0.0027
354.17	-0.007	194.2	-0.0009
354.18	-0.008	194	-0.0036
354.20	-0.01	193.8	-0.0071
354.22	-0.012	193.5	-0.0098
354.23	-0.012	193.3	-0.0115
354.25	-0.013	193.1	-0.0133
354.27	-0.014	192.8	-0.0133
354.28	-0.016	192.6	-0.016
354.30	-0.016	192.6	-0.0178
354.32	-0.016	192.5	-0.0186
354.33	-0.017	192.3	-0.0204
354.35	-0.017	192.2	-0.0204
354.37	-0.017	192	-0.0204
354.38	-0.017	191.9	-0.0213
354.40	-0.017	191.8	-0.0213
354.42	-0.017	191.8	-0.0213
354.43	-0.017	191.7	-0.0213
354.45	-0.016	191.7	-0.0195
354.47	-0.015	191.7	-0.0186
354.48	-0.015	191.7	-0.0178
354.50	-0.014	191.7	-0.016
354.52	-0.012	191.8	-0.016
354.53	-0.011	191.8	-0.0142
354.55	-0.011	191.8	-0.0124
354.57	-0.009	191.9	-0.0098
354.58	-0.006	192	-0.0071
354.60	-0.006	192.1	-0.0053
354.62	-0.004	192.3	-0.0018
354.63	-0.001	192.5	-0.0018
354.65	0	192.5	0.0018
354.67	0	192.6	0.0044
354.68	0.002	192.8	0.0089
354.70	0.006	193.1	0.0133
354.72	0.006	193.2	0.016

Prova triassiale ciclica SN04-C1			
pressione di confinamento (kPa)		80	
deviatore ciclico (kPa)		95	
frequenza (hz)		0.00625	
tempo	cella di carico	$\Delta u$	LVDT
(min)	kN	(kPa)	$\delta$ (mm)
354.73	0.008	193.5	0.0204
354.75	0.012	193.8	0.0204
354.77	0.013	193.8	0.024
354.78	0.013	194	0.0284
354.80	0.014	194.2	0.032
354.82	0.018	194.5	0.0364
354.83	0.018	194.7	0.0391
354.85	0.02	195	0.0426
354.87	0.022	195.2	0.0426
354.88	0.023	195.2	0.0462
354.90	0.023	195.5	0.0479
354.92	0.024	195.7	0.0515
354.93	0.026	196	0.0541
354.95	0.027	196.2	0.055
354.97	0.027	196.3	0.0559
354.98	0.027	196.5	0.0568
355.00	0.028	196.7	0.0577
355.02	0.029	196.8	0.0586
355.03	0.029	196.9	0.0586
355.05	0.029	196.9	0.0595
355.07	0.029	197	0.0595
355.10	0.029	197.1	0.0595
355.12	0.029	197.2	0.0595
355.13	0.028	197.3	0.0586
355.15	0.027	197.3	0.0568
355.15	0.026	197.3	0.0568
355.17	0.024	197.2	0.0559
355.18	0.024	197.2	0.0541
355.20	0.024	197.2	0.0524
355.22	0.022	197.2	0.0506
355.23	0.02	197.1	0.0479
355.25	0.019	197	0.0453
355.27	0.016	196.8	0.0453
355.28	0.014	196.7	0.0417
355.30	0.014	196.7	0.0391
355.32	0.013	196.6	0.0364
355.33	0.011	196.3	0.0328
355.35	0.008	196.1	0.0293
355.37	0.007	196	0.024
355.38	0.004	195.7	0.024
355.40	0.002	195.5	0.0204
355.42	0.002	195.5	0.0169
355.43	0.001	195.2	0.0124
355.45	-0.002	194.9	0.0089
355.47	-0.004	194.6	0.0053
355.48	-0.005	194.4	0.0018
355.50	-0.007	194.1	0.0018
355.52	-0.01	193.8	-0.0018
355.53	-0.01	193.8	-0.0053
355.55	-0.01	193.6	-0.0089
355.57	-0.012	193.3	-0.0115
355.58	-0.014	193.1	-0.0133
355.60	-0.014	192.9	-0.0151
355.62	-0.015	192.7	-0.0169
355.63	-0.016	192.5	-0.0169
355.65	-0.016	192.5	-0.0186
355.67	-0.017	192.2	-0.0204
355.68	-0.017	192.1	-0.0204

Prova triassiale ciclica SN04-C1			
pressione di confinamento (kPa)		80	
deviatore ciclico (kPa)		95	
frequenza (hz)		0.00625	
tempo	cella di carico	$\Delta u$	LVDT
(min)	kN	(kPa)	$\delta$ (mm)
355.70	-0.017	192.1	-0.0204
355.72	-0.017	192	-0.0213
355.73	-0.017	191.9	-0.0213
355.75	-0.017	191.8	-0.0213
355.77	-0.017	191.7	-0.0204
355.78	-0.016	191.6	-0.0195
355.80	-0.015	191.6	-0.0195
355.82	-0.014	191.6	-0.0186
355.83	-0.014	191.6	-0.0178
355.85	-0.013	191.7	-0.016
355.87	-0.011	191.7	-0.0133
355.88	-0.01	191.8	-0.0115
355.90	-0.009	191.9	-0.0089
355.92	-0.006	192.1	-0.0089
355.93	-0.005	192.1	-0.0062
355.95	-0.005	192.1	-0.0036
355.97	-0.003	192.4	-0.0009
355.98	0	192.5	0.0036
356.00	0.001	192.7	0.0062
356.02	0.003	192.9	0.0107
356.03	0.006	193.1	0.0107
356.05	0.007	193.1	0.0142
356.07	0.007	193.3	0.0178
356.08	0.009	193.6	0.0213
356.10	0.013	193.9	0.0275
356.12	0.013	194.1	0.0302
356.13	0.015	194.3	0.0337
356.15	0.018	194.6	0.0337
356.17	0.019	194.6	0.0382
356.18	0.019	194.8	0.0399
356.20	0.02	195.1	0.0444
356.22	0.023	195.3	0.047
356.23	0.024	195.6	0.0488
356.25	0.024	195.8	0.0515
356.27	0.027	196	0.0515
356.28	0.027	196	0.0541
356.30	0.027	196.2	0.055
356.32	0.027	196.4	0.0568
356.33	0.028	196.6	0.0577
356.35	0.029	196.7	0.0586
356.37	0.029	196.8	0.0586
356.38	0.029	196.9	0.0586
356.40	0.029	197.1	0.0595
356.42	0.029	197.2	0.0595
356.43	0.028	197.2	0.0595
356.45	0.027	197.2	0.0586
356.47	0.027	197.2	0.0577
356.48	0.027	197.3	0.0568
356.50	0.025	197.3	0.055
356.52	0.024	197.2	0.0541
356.53	0.023	197.2	0.0515
356.57	0.021	197.1	0.0515
356.58	0.019	197.1	0.0488
356.60	0.019	197	0.047
356.62	0.018	196.9	0.0435
356.62	0.015	196.7	0.0408
356.63	0.014	196.6	0.0382
356.65	0.012	196.5	0.0337

Prova triassiale ciclica SN04-C1			
pressione di confinamento (kPa)		80	
deviatore ciclico (kPa)		95	
frequenza (hz)		0.00625	
tempo	cella di carico	$\Delta u$	LVDT
(min)	kN	(kPa)	$\delta$ (mm)
356.67	0.009	196.2	0.0337
356.68	0.007	196	0.0302
356.70	0.007	196	0.0257
356.72	0.006	195.9	0.0231
356.73	0.003	195.6	0.0186
356.75	0.001	195.3	0.0151
356.77	0	195.1	0.0107
356.78	-0.003	194.8	0.0107
356.80	-0.005	194.5	0.0071
356.82	-0.005	194.5	0.0036
356.83	-0.006	194.3	0
356.85	-0.008	194	-0.0036
356.87	-0.01	193.8	-0.0062
356.88	-0.011	193.5	-0.0098
356.90	-0.012	193.2	-0.0115
356.92	-0.014	193	-0.0115
356.93	-0.015	193	-0.0142
356.95	-0.015	192.8	-0.016
356.97	-0.015	192.6	-0.0178
356.98	-0.017	192.4	-0.0195
357.00	-0.017	192.3	-0.0204
357.02	-0.017	192.1	-0.0204
357.03	-0.017	192	-0.0204
357.05	-0.017	192	-0.0204
357.07	-0.017	191.9	-0.0213
357.08	-0.017	191.8	-0.0213
357.10	-0.017	191.7	-0.0213
357.12	-0.016	191.7	-0.0204
357.13	-0.015	191.7	-0.0195
357.15	-0.015	191.6	-0.0186
357.17	-0.013	191.6	-0.0169
357.18	-0.012	191.7	-0.0151
357.20	-0.01	191.8	-0.0151
357.22	-0.01	191.8	-0.0133
357.23	-0.01	191.8	-0.0107
357.25	-0.008	191.9	-0.008
357.27	-0.005	192.1	-0.0053
357.28	-0.004	192.2	-0.0027
357.30	-0.002	192.4	0.0009
357.32	0.001	192.6	0.0009
357.33	0.002	192.6	0.0053
357.35	0.002	192.7	0.008
357.37	0.004	193	0.0115
357.38	0.007	193.2	0.016
357.40	0.008	193.4	0.0186
357.42	0.01	193.7	0.0231
357.43	0.014	193.9	0.0231
357.45	0.014	193.9	0.0284
357.47	0.014	194.1	0.0311
357.48	0.016	194.4	0.0355
357.50	0.019	194.7	0.0391
357.52	0.02	194.9	0.0417
357.53	0.021	195.1	0.0453
357.55	0.023	195.4	0.0453
357.57	0.024	195.4	0.0479
357.58	0.024	195.7	0.0506
357.60	0.025	195.9	0.0533
357.62	0.027	196.1	0.055

Prova triassiale ciclica SN04-C1			
pressione di confinamento (kPa)		80	
deviatore ciclico (kPa)		95	
frequenza (hz)		0.00625	
tempo	cella di carico	$\Delta u$	LVDT
(min)	kN	(kPa)	$\delta$ (mm)
357.63	0.027	196.3	0.0559
357.65	0.027	196.4	0.0568
357.67	0.028	196.6	0.0568
357.68	0.029	196.8	0.0577
357.70	0.029	196.8	0.0586
357.72	0.029	196.9	0.0595
357.73	0.029	197	0.0595
357.75	0.029	197.1	0.0595
357.77	0.028	197.2	0.0586
357.78	0.027	197.2	0.0586
357.80	0.026	197.2	0.0577
357.82	0.026	197.2	0.0568
357.83	0.026	197.2	0.055
357.85	0.023	197.2	0.0533
357.87	0.023	197.2	0.0524
357.88	0.022	197.2	0.0506
357.90	0.02	197	0.0479
357.92	0.018	196.9	0.0462
357.93	0.017	196.9	0.0426
357.95	0.015	196.6	0.0426
357.97	0.012	196.5	0.0391
358.00	0.012	196.5	0.0364
358.02	0.011	196.4	0.0328
358.03	0.009	196.1	0.0293
358.05	0.006	195.9	0.0249
358.07	0.005	195.8	0.0204
358.07	0.003	195.4	0.0169
358.08	0	195.1	0.0169
358.10	-0.001	195.1	0.0133
358.12	-0.001	194.9	0.0098
358.13	-0.003	194.6	0.0062
358.15	-0.006	194.4	0.0018
358.17	-0.007	194.2	-0.0009
358.18	-0.008	193.9	-0.0044
358.20	-0.011	193.6	-0.0044
358.22	-0.012	193.6	-0.008
358.23	-0.012	193.4	-0.0098
358.25	-0.013	193.2	-0.0133
358.27	-0.015	192.9	-0.0151
358.28	-0.015	192.7	-0.016
358.30	-0.015	192.5	-0.0178
358.32	-0.016	192.4	-0.0178
358.33	-0.017	192.4	-0.0195
358.35	-0.017	192.2	-0.0204
358.37	-0.017	192.1	-0.0213
358.38	-0.017	192	-0.0213
358.40	-0.017	191.9	-0.0213
358.42	-0.017	191.8	-0.0204
358.43	-0.016	191.7	-0.0204
358.45	-0.016	191.7	-0.0204
358.47	-0.016	191.7	-0.0195
358.48	-0.015	191.7	-0.0186
358.50	-0.013	191.7	-0.0169
358.52	-0.012	191.7	-0.016
358.53	-0.012	191.7	-0.0133
358.55	-0.009	191.9	-0.0133
358.57	-0.008	191.9	-0.0107
358.58	-0.007	192	-0.0071

Prova triassiale ciclica SN04-C1			
pressione di confinamento (kPa)		80	
deviatore ciclico (kPa)		95	
frequenza (hz)		0.00625	
tempo	cella di carico	$\Delta u$	LVDT
(min)	kN	(kPa)	$\delta$ (mm)
358.60	-0.005	192.1	-0.0071
358.62	-0.003	192.1	-0.0053
358.63	-0.003	192.3	-0.0018
358.65	-0.002	192.4	0.0027
358.67	0.001	192.7	0.0062
358.68	0.003	192.8	0.0089
358.70	0.004	193	0.0142
358.72	0.008	193.3	0.0142
358.73	0.009	193.5	0.0186
358.75	0.009	193.5	0.0204
358.77	0.011	193.7	0.0249
358.78	0.014	194	0.0302
358.80	0.016	194.3	0.0328
358.82	0.017	194.5	0.0364
358.83	0.019	194.8	0.0364
358.85	0.021	195	0.0408
358.87	0.021	195	0.0435
358.88	0.022	195.2	0.0462
358.90	0.023	195.6	0.0488
358.92	0.025	195.8	0.0515
358.93	0.025	195.9	0.0533
358.95	0.027	196.2	0.055
358.97	0.028	196.3	0.055
358.98	0.028	196.3	0.0568
359.00	0.028	196.5	0.0577
359.02	0.028	196.7	0.0586
359.03	0.029	196.8	0.0595
359.05	0.029	196.9	0.0595
359.07	0.029	197	0.0595
359.08	0.029	197.1	0.0595
359.10	0.028	197.1	0.0595
359.12	0.028	197.2	0.0595
359.13	0.027	197.2	0.0577
359.15	0.026	197.2	0.0559
359.17	0.025	197.2	0.055
359.18	0.024	197.2	0.0533
359.20	0.022	197.1	0.0533
359.22	0.021	197.1	0.0515
359.23	0.021	197.1	0.0497
359.25	0.02	196.9	0.0462
359.27	0.016	196.8	0.0426
359.28	0.016	196.7	0.0408
359.30	0.014	196.5	0.0373
359.32	0.012	196.4	0.0355
359.33	0.01	196.3	0.032
359.35	0.009	196	0.0284
359.37	0.005	195.8	0.0284
359.38	0.004	195.8	0.0231
359.40	0.004	195.6	0.0195
359.42	0.002	195.3	0.016
359.43	-0.001	195	0.0115
359.47	-0.002	194.8	0.008
359.48	-0.004	194.5	0.0044
359.50	-0.007	194.3	0.0044
359.52	-0.008	194.3	0.0009
359.52	-0.008	194	-0.0027
359.53	-0.009	193.8	-0.0053
359.55	-0.012	193.5	-0.0089



Prova triassiale ciclica SN04-C1			
pressione di confinamento (kPa)		80	
deviatore ciclico (kPa)		95	
frequenza (hz)		0.00625	
tempo	cella di carico	$\Delta u$	LVDT
(min)	kN	(kPa)	$\delta$ (mm)
359.57	-0.012	193.3	-0.0107
359.58	-0.013	193.1	-0.0133
359.60	-0.015	192.8	-0.0133
359.62	-0.015	192.8	-0.016
359.63	-0.015	192.7	-0.0169
359.65	-0.016	192.5	-0.0186
359.67	-0.017	192.3	-0.0195
359.68	-0.017	192.1	-0.0204
359.70	-0.017	192	-0.0213
359.72	-0.017	191.9	-0.0213
359.73	-0.017	191.9	-0.0213
359.75	-0.017	191.8	-0.0213
359.77	-0.017	191.7	-0.0204
359.78	-0.016	191.7	-0.0204
359.80	-0.015	191.7	-0.0195
359.82	-0.015	191.6	-0.0178
359.83	-0.013	191.7	-0.0178
359.85	-0.012	191.7	-0.016
359.87	-0.012	191.7	-0.0151
359.88	-0.011	191.8	-0.0124
359.90	-0.008	191.9	-0.0098
359.92	-0.007	192	-0.0071
359.93	-0.006	192.1	-0.0044
359.95	-0.003	192.3	-0.0044
359.97	-0.002	192.4	-0.0018
359.98	-0.002	192.4	0.0009
360.00	0	192.6	0.0053
360.02	0.003	192.9	0.0098
360.03	0.005	193	0.0124
360.05	0.006	193.2	0.0151
360.07	0.008	193.4	0.0186
360.08	0.01	193.6	0.0231
360.10	0.012	193.9	0.0275
360.12	0.014	194.2	0.0275
360.13	0.016	194.4	0.0311
360.15	0.016	194.4	0.0346
360.17	0.017	194.6	0.0382
360.18	0.02	194.9	0.0426
360.20	0.022	195.1	0.0444
360.22	0.022	195.4	0.047
360.23	0.024	195.7	0.047
360.25	0.026	195.9	0.0497
360.27	0.026	195.9	0.0524
360.28	0.026	196.1	0.0541
360.30	0.027	196.2	0.0559
360.32	0.028	196.4	0.0577
360.33	0.028	196.6	0.0577
360.35	0.028	196.7	0.0586
360.37	0.029	196.9	0.0586
360.38	0.029	196.9	0.0586
360.40	0.029	197	0.0595
360.42	0.029	197	0.0595
360.43	0.028	197.1	0.0595
360.45	0.028	197.2	0.0586
360.47	0.027	197.2	0.0568
360.48	0.025	197.2	0.0568
360.50	0.025	197.2	0.055
360.52	0.025	197.2	0.0541

Prova triassiale ciclica SN04-C1			
pressione di confinamento (kPa)		80	
deviatore ciclico (kPa)		95	
frequenza (hz)		0.00625	
tempo	cella di carico	$\Delta u$	LVDT
(min)	kN	(kPa)	$\delta$ (mm)
360.53	0.024	197.2	0.0524
360.55	0.021	197.1	0.0506
360.57	0.02	197	0.0479
360.58	0.019	196.9	0.0453
360.60	0.016	196.8	0.0453
360.62	0.015	196.8	0.0417
360.63	0.015	196.7	0.0391
360.65	0.013	196.4	0.0355
360.67	0.01	196.2	0.032
360.68	0.009	196.1	0.0284
360.70	0.007	195.8	0.024
360.72	0.003	195.6	0.024
360.73	0.002	195.6	0.0195
360.75	0.001	195.2	0.0142
360.77	-0.001	194.9	0.0142
360.78	-0.003	194.9	0.0115
360.80	-0.003	194.7	0.0071
360.82	-0.005	194.4	0.0027
360.83	-0.008	194.1	-0.0009
360.85	-0.008	193.9	-0.0036
360.87	-0.01	193.7	-0.0071
360.90	-0.012	193.4	-0.0071
360.92	-0.013	193.4	-0.0107
360.93	-0.013	193.2	-0.0124
360.95	-0.014	192.9	-0.0142
360.97	-0.015	192.7	-0.016
360.97	-0.016	192.5	-0.0178
360.98	-0.016	192.4	-0.0195
361.00	-0.017	192.2	-0.0195
361.02	-0.017	192.2	-0.0204
361.03	-0.017	192	-0.0213
361.05	-0.017	191.9	-0.0213
361.07	-0.017	191.8	-0.0213
361.08	-0.017	191.7	-0.0213
361.10	-0.017	191.7	-0.0204
361.12	-0.016	191.6	-0.0204
361.13	-0.015	191.6	-0.0195
361.15	-0.015	191.6	-0.0186
361.17	-0.014	191.6	-0.0178
361.18	-0.013	191.7	-0.016
361.20	-0.011	191.7	-0.0142
361.22	-0.01	191.8	-0.0115
361.23	-0.007	191.9	-0.0115
361.25	-0.007	191.9	-0.0089
361.27	-0.007	192	-0.0062
361.28	-0.005	192.1	-0.0027
361.30	-0.002	192.3	0
361.32	-0.001	192.5	0.0027
361.33	0.001	192.7	0.0071
361.35	0.004	192.9	0.0071
361.37	0.006	192.9	0.0115
361.38	0.006	193.1	0.0142
361.40	0.007	193.3	0.0186
361.42	0.011	193.6	0.0231
361.43	0.012	193.8	0.0257
361.45	0.013	194	0.0302
361.47	0.016	194.3	0.0302
361.48	0.018	194.5	0.0373

Prova triassiale ciclica SN04-C1			
pressione di confinamento (kPa)		80	
deviatore ciclico (kPa)		95	
frequenza (hz)		0.00625	
tempo	cella di carico	$\Delta u$	LVDT
(min)	kN	(kPa)	$\delta$ (mm)
361.50	0.018	194.7	0.0399
361.52	0.02	195	0.0399
361.53	0.022	195.2	0.0435
361.55	0.022	195.2	0.0453
361.57	0.023	195.4	0.0488
361.58	0.025	195.7	0.0506
361.60	0.026	195.9	0.0533
361.62	0.026	196.1	0.055
361.63	0.028	196.3	0.055
361.65	0.028	196.5	0.0568
361.67	0.028	196.5	0.0577
361.68	0.029	196.7	0.0586
361.70	0.029	196.8	0.0586
361.72	0.029	196.9	0.0586
361.73	0.029	197	0.0586
361.75	0.028	197.1	0.0586
361.77	0.028	197.2	0.0586
361.78	0.028	197.2	0.0586
361.80	0.027	197.2	0.0577
361.82	0.026	197.2	0.0559
361.83	0.025	197.2	0.055
361.85	0.024	197.2	0.0533
361.87	0.023	197.1	0.0506
361.88	0.02	197	0.0506
361.90	0.02	197	0.0488
361.92	0.02	197	0.0462
361.93	0.018	196.8	0.0435
361.95	0.015	196.7	0.0399
361.97	0.014	196.6	0.0373
361.98	0.012	196.3	0.0337
362.00	0.009	196.1	0.0337
362.02	0.009	196.1	0.0302
362.03	0.008	196	0.0257
362.05	0.005	195.7	0.0222
362.07	0.002	195.5	0.0178
362.08	0.001	195.2	0.0142
362.10	0	195	0.0107
362.12	-0.004	194.7	0.0107
362.13	-0.004	194.7	0.0062
362.15	-0.004	194.5	0.0036
362.17	-0.006	194.2	0
362.18	-0.009	193.9	-0.0036
362.20	-0.01	193.7	-0.0062
362.22	-0.011	193.4	-0.0089
362.23	-0.013	193.2	-0.0115
362.25	-0.013	193	-0.0133
362.27	-0.014	192.8	-0.0151
362.28	-0.016	192.6	-0.0151
362.30	-0.016	192.6	-0.0178
362.32	-0.016	192.4	-0.0178
362.33	-0.016	192.2	-0.0195
362.37	-0.017	192.1	-0.0204
362.38	-0.017	192	-0.0213
362.40	-0.017	191.8	-0.0213
362.42	-0.017	191.7	-0.0213
362.42	-0.017	191.7	-0.0213
362.43	-0.017	191.7	-0.0204
362.45	-0.016	191.6	-0.0204

Prova triassiale ciclica SN04-C1			
pressione di confinamento (kPa)		80	
deviatore ciclico (kPa)		95	
frequenza (hz)		0.00625	
tempo	cella di carico	$\Delta u$	LVDT
(min)	kN	(kPa)	$\delta$ (mm)
362.47	-0.015	191.6	-0.0195
362.48	-0.014	191.6	-0.0186
362.50	-0.014	191.6	-0.0169
362.52	-0.011	191.7	-0.0169
362.53	-0.011	191.7	-0.0142
362.55	-0.011	191.7	-0.0133
362.57	-0.01	191.8	-0.0107
362.58	-0.006	191.9	-0.0071
362.60	-0.006	192	-0.0053
362.62	-0.004	192.2	-0.0018
362.63	-0.001	192.4	-0.0018
362.65	0	192.4	0.0018
362.67	0	192.5	0.0044
362.68	0.002	192.8	0.0089
362.70	0.006	193	0.0124
362.72	0.006	193.2	0.016
362.73	0.008	193.4	0.0204
362.75	0.012	193.7	0.0204
362.77	0.013	193.7	0.0249
362.78	0.013	193.9	0.0284
362.80	0.014	194.1	0.032
362.82	0.017	194.4	0.0364
362.83	0.018	194.6	0.0391
362.85	0.02	194.9	0.0426
362.87	0.022	195.1	0.0426
362.88	0.023	195.4	0.0462
362.90	0.023	195.4	0.0479
362.92	0.024	195.6	0.0506
362.93	0.026	196	0.0533
362.95	0.026	196	0.0541
362.97	0.027	196.2	0.0559
362.98	0.028	196.4	0.0568
363.00	0.028	196.6	0.0577
363.02	0.029	196.7	0.0586
363.03	0.029	196.8	0.0586
363.05	0.029	196.9	0.0586
363.07	0.029	196.9	0.0595
363.08	0.029	197	0.0595
363.10	0.028	197.1	0.0595
363.12	0.028	197.2	0.0586
363.13	0.027	197.2	0.0577
363.15	0.026	197.2	0.0559
363.17	0.024	197.2	0.0559
363.18	0.023	197.2	0.0541
363.20	0.023	197.2	0.0533
363.22	0.022	197.1	0.0506
363.23	0.02	197	0.0479
363.25	0.019	196.9	0.0453
363.27	0.017	196.8	0.0426
363.28	0.014	196.6	0.0426
363.30	0.013	196.6	0.0391
363.32	0.013	196.5	0.0364
363.33	0.011	196.3	0.0328
363.35	0.008	196.1	0.0293
363.37	0.007	195.9	0.0249
363.38	0.005	195.7	0.0213
363.40	0.001	195.4	0.0213
363.42	0.001	195.4	0.0169

Prova triassiale ciclica SN04-C1			
pressione di confinamento (kPa)		80	
deviatore ciclico (kPa)		95	
frequenza (hz)		0.00625	
tempo	cella di carico	$\Delta u$	LVDT
(min)	kN	(kPa)	$\delta$ (mm)
363.43	0.001	195.1	0.0133
363.45	-0.001	194.9	0.0098
363.47	-0.005	194.6	0.0053
363.48	-0.005	194.4	0.0018
363.50	-0.006	194.1	-0.0009
363.52	-0.01	193.8	-0.0009
363.53	-0.011	193.8	-0.0053
363.55	-0.011	193.6	-0.008
363.57	-0.011	193.3	-0.0107
363.58	-0.014	193.1	-0.0133
363.60	-0.014	192.9	-0.0142
363.62	-0.015	192.7	-0.0169
363.63	-0.016	192.5	-0.0169
363.65	-0.017	192.5	-0.0186
363.67	-0.017	192.2	-0.0195
363.68	-0.017	192	-0.0195
363.70	-0.017	191.9	-0.0204
363.72	-0.017	191.9	-0.0204
363.73	-0.017	191.8	-0.0213
363.75	-0.017	191.7	-0.0213
363.77	-0.017	191.7	-0.0204
363.78	-0.016	191.6	-0.0195
363.80	-0.015	191.6	-0.0195
363.83	-0.014	191.6	-0.0186
363.85	-0.014	191.6	-0.0169
363.87	-0.013	191.6	-0.016
363.87	-0.011	191.7	-0.0133
363.88	-0.01	191.7	-0.0124
363.90	-0.009	191.8	-0.0098
363.92	-0.007	192	-0.0098
363.93	-0.004	192.1	-0.0071
363.95	-0.004	192.1	-0.0036
363.97	-0.003	192.2	0
363.98	-0.001	192.5	0.0027
364.00	0.002	192.6	0.0062
364.02	0.003	192.8	0.0107
364.03	0.005	193.1	0.0142
364.05	0.008	193.3	0.0142
364.07	0.008	193.3	0.0186
364.08	0.009	193.5	0.0213
364.10	0.011	193.8	0.0257
364.12	0.014	194	0.0302
364.13	0.015	194.2	0.0337
364.15	0.017	194.6	0.0382
364.17	0.02	194.8	0.0382
364.18	0.02	194.8	0.0408
364.20	0.021	195	0.0444
364.22	0.022	195.2	0.047
364.23	0.024	195.5	0.0488
364.25	0.024	195.7	0.0515
364.27	0.026	196	0.0541
364.28	0.027	196.2	0.0541
364.30	0.027	196.2	0.0559
364.32	0.027	196.3	0.0568
364.33	0.028	196.5	0.0577
364.35	0.029	196.6	0.0586
364.37	0.029	196.8	0.0595
364.38	0.029	196.9	0.0595

Prova triassiale ciclica SN04-C1			
pressione di confinamento (kPa)		80	
deviatore ciclico (kPa)		95	
frequenza (hz)		0.00625	
tempo	cella di carico	$\Delta u$	LVDT
(min)	kN	(kPa)	$\delta$ (mm)
364.40	0.029	197	0.0595
364.42	0.029	197.1	0.0595
364.43	0.028	197.2	0.0586
364.45	0.027	197.2	0.0586
364.47	0.027	197.2	0.0577
364.48	0.027	197.2	0.0577
364.50	0.026	197.2	0.055
364.52	0.024	197.2	0.0533
364.53	0.023	197.1	0.0515
364.55	0.022	197.1	0.0497
364.57	0.019	197	0.0497
364.58	0.018	197	0.047
364.60	0.018	196.9	0.0444
364.62	0.016	196.7	0.0417
364.63	0.013	196.5	0.0382
364.65	0.012	196.4	0.0355
364.67	0.011	196.2	0.0311
364.68	0.007	196	0.0311
364.70	0.006	196	0.0257
364.72	0.006	195.8	0.0231
364.73	0.004	195.6	0.0195
364.75	0.001	195.3	0.0151
364.77	0	195	0.0124
364.78	-0.002	194.7	0.008
364.80	-0.005	194.5	0.008
364.82	-0.006	194.5	0.0036
364.83	-0.006	194.3	0.0009
364.85	-0.007	194	-0.0027
364.87	-0.011	193.7	-0.0071
364.88	-0.011	193.5	-0.0089
364.90	-0.012	193.2	-0.0115
364.92	-0.014	193	-0.0115
364.93	-0.015	193	-0.0133
364.95	-0.015	192.8	-0.016
364.97	-0.015	192.6	-0.0169
364.98	-0.017	192.4	-0.0186
365.00	-0.016	192.3	-0.0195
365.02	-0.017	192.1	-0.0204
365.03	-0.017	192	-0.0204
365.05	-0.017	192	-0.0213
365.07	-0.017	191.9	-0.0213
365.08	-0.017	191.8	-0.0213
365.10	-0.017	191.7	-0.0204
365.12	-0.016	191.6	-0.0195
365.13	-0.016	191.6	-0.0195
365.15	-0.015	191.6	-0.0178
365.17	-0.014	191.6	-0.0169
365.18	-0.012	191.6	-0.0151
365.20	-0.01	191.7	-0.0151
365.22	-0.009	191.8	-0.0124
365.23	-0.009	191.8	-0.0107
365.27	-0.008	191.9	-0.008
365.28	-0.005	192	-0.0053
365.30	-0.004	192.2	-0.0027
365.32	-0.002	192.3	0.0018
365.33	0.001	192.5	0.0018
365.33	0.002	192.7	0.0044
365.35	0.002	192.7	0.0071

Prova triassiale ciclica SN04-C1			
pressione di confinamento (kPa)		80	
deviatore ciclico (kPa)		95	
frequenza (hz)		0.00625	
tempo	cella di carico	$\Delta u$	LVDT
(min)	kN	(kPa)	$\delta$ (mm)
365.37	0.003	192.9	0.0115
365.38	0.007	193.2	0.016
365.40	0.009	193.4	0.0186
365.42	0.01	193.6	0.0231
365.43	0.013	193.9	0.0231
365.45	0.015	194.1	0.0284
365.47	0.015	194.1	0.032
365.48	0.016	194.3	0.0355
365.50	0.019	194.6	0.0391
365.52	0.02	194.8	0.0426
365.53	0.021	195.1	0.0453
365.55	0.023	195.3	0.0453
365.57	0.024	195.6	0.0479
365.58	0.024	195.6	0.0506
365.60	0.025	195.8	0.0524
365.62	0.026	196	0.0541
365.63	0.028	196.2	0.0568
365.65	0.028	196.4	0.0577
365.67	0.028	196.6	0.0577
365.68	0.029	196.7	0.0586
365.70	0.029	196.7	0.0586
365.72	0.029	196.8	0.0595
365.73	0.029	196.9	0.0595
365.75	0.029	197	0.0595
365.77	0.028	197.1	0.0595
365.78	0.027	197.1	0.0595
365.80	0.026	197.2	0.0577
365.82	0.026	197.2	0.0568
365.83	0.025	197.2	0.055
365.85	0.023	197.1	0.0541
365.87	0.022	197.1	0.0533
365.88	0.022	197.1	0.0515
365.90	0.021	197	0.0488
365.92	0.018	196.9	0.0462
365.93	0.017	196.8	0.0435
365.95	0.016	196.6	0.0399
365.97	0.012	196.5	0.0399
365.98	0.011	196.5	0.0364
366.00	0.011	196.3	0.0337
366.02	0.009	196.1	0.0293
366.03	0.006	195.9	0.0249
366.05	0.005	195.7	0.0222
366.07	0.004	195.4	0.0186
366.08	0	195.1	0.0186
366.10	-0.001	195.1	0.0133
366.12	-0.001	194.9	0.0107
366.13	-0.003	194.6	0.0062
366.15	-0.006	194.3	0.0018
366.17	-0.007	194.1	-0.0009
366.18	-0.008	193.8	-0.0044
366.20	-0.011	193.6	-0.0044
366.22	-0.012	193.6	-0.008
366.23	-0.012	193.4	-0.0098
366.25	-0.012	193.1	-0.0124
366.27	-0.015	192.9	-0.0151
366.28	-0.015	192.7	-0.016
366.30	-0.016	192.5	-0.0178
366.32	-0.017	192.3	-0.0178

Prova triassiale ciclica SN04-C1			
pressione di confinamento (kPa)		80	
deviatore ciclico (kPa)		95	
frequenza (hz)		0.00625	
tempo	cella di carico	$\Delta u$	LVDT
(min)	kN	(kPa)	$\delta$ (mm)
366.33	-0.017	192.3	-0.0195
366.35	-0.017	192.1	-0.0195
366.37	-0.017	192	-0.0204
366.38	-0.017	191.9	-0.0213
366.40	-0.017	191.8	-0.0213
366.42	-0.017	191.7	-0.0213
366.43	-0.016	191.7	-0.0213
366.45	-0.016	191.7	-0.0204
366.47	-0.016	191.6	-0.0195
366.48	-0.015	191.6	-0.0178
366.50	-0.013	191.6	-0.0169
366.52	-0.012	191.6	-0.0151
366.53	-0.011	191.7	-0.0133
366.55	-0.009	191.8	-0.0133
366.57	-0.008	191.9	-0.0089
366.58	-0.007	191.9	-0.0071
366.60	-0.005	192.1	-0.0071
366.62	-0.003	192.2	-0.0044
366.63	-0.003	192.2	-0.0009
366.65	-0.002	192.4	0.0027
366.67	0.001	192.6	0.0062
366.68	0.003	192.8	0.0098
366.70	0.004	193	0.0133
366.73	0.007	193.3	0.0133
366.75	0.01	193.5	0.0178
366.77	0.01	193.5	0.0213
366.78	0.011	193.7	0.0249
366.78	0.013	194	0.0302
366.80	0.016	194.2	0.0337
366.82	0.017	194.4	0.0373
366.83	0.019	194.7	0.0408
366.85	0.021	195	0.0408
366.87	0.021	195	0.0444
366.88	0.022	195.2	0.0462
366.90	0.023	195.4	0.0488
366.92	0.025	195.7	0.0515
366.93	0.026	195.9	0.0533
366.95	0.027	196.1	0.055
366.97	0.028	196.3	0.055
366.98	0.028	196.3	0.0568
367.00	0.028	196.4	0.0577
367.02	0.028	196.6	0.0586
367.03	0.029	196.7	0.0586
367.05	0.029	196.8	0.0595
367.07	0.029	196.9	0.0595
367.08	0.028	197	0.0595
367.10	0.028	197	0.0595
367.12	0.028	197.1	0.0595
367.13	0.027	197.2	0.0577
367.15	0.026	197.1	0.0568
367.17	0.025	197.2	0.0559
367.18	0.024	197.1	0.0533
367.20	0.022	197	0.0533
367.22	0.021	197	0.0515
367.23	0.021	197	0.0497
367.25	0.02	196.9	0.0462
367.27	0.016	196.7	0.0426
367.28	0.015	196.6	0.0408



Prova triassiale ciclica SN04-C1			
pressione di confinamento (kPa)		80	
deviatore ciclico (kPa)		95	
frequenza (hz)		0.00625	
tempo	cella di carico	$\Delta u$	LVDT
(min)	kN	(kPa)	$\delta$ (mm)
367.30	0.014	196.5	0.0373
367.32	0.013	196.4	0.0364
367.33	0.01	196.2	0.0328
367.35	0.009	196	0.0284
367.37	0.006	195.8	0.0284
367.38	0.004	195.6	0.024
367.40	0.004	195.6	0.0204
367.42	0.003	195.3	0.0169
367.43	0	195	0.0124
367.45	-0.002	194.8	0.0089
367.47	-0.004	194.5	0.0053
367.48	-0.006	194.2	0.0053
367.50	-0.008	194	0.0009
367.52	-0.008	194	-0.0018
367.53	-0.009	193.8	-0.0053
367.55	-0.011	193.4	-0.008
367.57	-0.013	193.2	-0.0107
367.58	-0.013	193	-0.0133
367.60	-0.014	192.8	-0.0133
367.62	-0.016	192.6	-0.0151
367.63	-0.016	192.6	-0.0169
367.65	-0.016	192.4	-0.0186
367.67	-0.017	192.2	-0.0195
367.68	-0.017	192.1	-0.0204
367.70	-0.017	191.9	-0.0204
367.72	-0.017	191.8	-0.0213
367.73	-0.017	191.7	-0.0213
367.75	-0.017	191.7	-0.0213
367.77	-0.017	191.7	-0.0204
367.78	-0.016	191.6	-0.0195
367.80	-0.015	191.6	-0.0186
367.82	-0.015	191.6	-0.0178
367.83	-0.014	191.6	-0.016
367.85	-0.011	191.7	-0.016
367.87	-0.011	191.7	-0.0142
367.88	-0.011	191.7	-0.0124
367.90	-0.01	191.8	-0.0098
367.92	-0.007	191.9	-0.0071
367.93	-0.006	192	-0.0044
367.95	-0.004	192.2	-0.0009
367.97	-0.001	192.4	-0.0009
367.98	0	192.4	0.0027
368.00	0	192.5	0.0053
368.02	0.004	192.9	0.0089
368.03	0.005	192.9	0.0107
368.05	0.005	193.1	0.0142
368.07	0.007	193.3	0.0186
368.08	0.011	193.6	0.0231
368.10	0.012	193.8	0.0257
368.12	0.013	194	0.0311
368.13	0.017	194.3	0.0311
368.17	0.017	194.3	0.0355
368.18	0.017	194.5	0.0382
368.20	0.019	194.7	0.0417
368.22	0.022	195	0.0453
368.23	0.022	195.2	0.047
368.23	0.023	195.5	0.0497
368.25	0.025	195.8	0.0497

Prova triassiale ciclica SN04-C1			
pressione di confinamento (kPa)		80	
deviatore ciclico (kPa)		95	
frequenza (hz)		0.00625	
tempo	cella di carico	$\Delta u$	LVDT
(min)	kN	(kPa)	$\delta$ (mm)
368.27	0.026	196	0.0524
368.28	0.026	196	0.0541
368.30	0.027	196.1	0.0559
368.32	0.028	196.3	0.0577
368.33	0.028	196.5	0.0586
368.35	0.029	196.6	0.0586
368.37	0.029	196.8	0.0586
368.38	0.029	196.9	0.0595
368.40	0.029	196.9	0.0595
368.42	0.029	197	0.0595
368.43	0.028	197.1	0.0595
368.45	0.028	197.1	0.0586
368.47	0.027	197.2	0.0568
368.48	0.026	197.1	0.0559
368.50	0.024	197.1	0.0559
368.52	0.024	197.1	0.0541
368.53	0.024	197.1	0.0524
368.55	0.022	197	0.0506
368.57	0.02	196.9	0.0488
368.58	0.019	196.9	0.0462
368.60	0.017	196.7	0.0426
368.62	0.014	196.6	0.0426
368.63	0.013	196.6	0.0391
368.65	0.013	196.4	0.0364
368.67	0.011	196.2	0.0328
368.68	0.008	196	0.0293
368.70	0.007	195.9	0.0249
368.72	0.005	195.6	0.0213
368.73	0.001	195.3	0.0213
368.75	0.001	195.1	0.0142
368.77	0	194.9	0.0115
368.78	-0.004	194.6	0.0115
368.80	-0.004	194.6	0.0071
368.82	-0.004	194.4	0.0044
368.83	-0.006	194.1	0
368.85	-0.009	193.8	-0.0044
368.87	-0.01	193.6	-0.0062
368.88	-0.011	193.4	-0.0089
368.90	-0.013	193.1	-0.0089
368.92	-0.014	193.1	-0.0124
368.93	-0.014	192.9	-0.0142
368.95	-0.015	192.7	-0.016
368.97	-0.016	192.5	-0.0178
368.98	-0.016	192.3	-0.0186
369.00	-0.017	192.2	-0.0195
369.02	-0.017	192	-0.0195
369.03	-0.017	191.9	-0.0204
369.05	-0.017	191.9	-0.0213
369.07	-0.017	191.8	-0.0213
369.08	-0.017	191.7	-0.0213
369.10	-0.016	191.6	-0.0204
369.12	-0.016	191.6	-0.0195
369.13	-0.015	191.6	-0.0195
369.15	-0.014	191.6	-0.0186
369.17	-0.014	191.6	-0.0169
369.18	-0.013	191.6	-0.016
369.20	-0.012	191.6	-0.0142
369.22	-0.01	191.7	-0.0115

Prova triassiale ciclica SN04-C1			
pressione di confinamento (kPa)		80	
deviatore ciclico (kPa)		95	
frequenza (hz)		0.00625	
tempo	cella di carico	$\Delta u$	LVDT
(min)	kN	(kPa)	$\delta$ (mm)
369.23	-0.009	191.8	-0.0089
369.25	-0.007	191.9	-0.0089
369.27	-0.004	192.1	-0.0062
369.28	-0.004	192.1	-0.0036
369.30	-0.003	192.2	-0.0009
369.32	-0.001	192.4	0.0036
369.33	0.002	192.6	0.0062
369.35	0.002	192.7	0.0098
369.37	0.005	193	0.0098
369.38	0.008	193.2	0.0142
369.40	0.008	193.2	0.0178
369.42	0.009	193.4	0.0222
369.43	0.011	193.7	0.0257
369.45	0.014	194	0.0302
369.47	0.015	194.2	0.0337
369.48	0.016	194.4	0.0364
369.50	0.019	194.6	0.0391
369.52	0.02	194.8	0.0426
369.53	0.021	195.1	0.0453
369.55	0.023	195.4	0.0453
369.57	0.024	195.4	0.0488
369.58	0.024	195.6	0.0506
369.60	0.025	195.8	0.0524
369.63	0.027	196	0.055
369.65	0.027	196.2	0.0559
369.67	0.028	196.4	0.0577
369.68	0.028	196.6	0.0577
369.68	0.029	196.6	0.0586
369.70	0.029	196.7	0.0586
369.72	0.029	196.8	0.0595
369.73	0.029	196.9	0.0595
369.75	0.029	197	0.0595
369.77	0.029	197.1	0.0595
369.78	0.027	197.1	0.0595
369.80	0.026	197.1	0.0577
369.82	0.026	197.1	0.0568
369.83	0.025	197.1	0.055
369.85	0.024	197.1	0.0541
369.87	0.023	197.1	0.0524
369.88	0.022	197	0.0497
369.90	0.019	196.9	0.0497
369.92	0.018	196.8	0.047
369.93	0.018	196.8	0.0453
369.95	0.017	196.7	0.0417
369.97	0.014	196.5	0.0382
369.98	0.012	196.3	0.0355
370.00	0.011	196.2	0.032
370.02	0.007	195.9	0.032
370.03	0.005	195.7	0.0275
370.05	0.005	195.7	0.0231
370.07	0.004	195.6	0.0195
370.08	0.001	195.2	0.0151
370.10	-0.001	195	0.0124
370.12	-0.002	194.7	0.008
370.13	-0.005	194.4	0.008
370.15	-0.006	194.2	0.0036
370.17	-0.006	194.2	0.0009
370.18	-0.007	194	-0.0027

Prova triassiale ciclica SN04-C1			
pressione di confinamento (kPa)		80	
deviatore ciclico (kPa)		95	
frequenza (hz)		0.00625	
tempo	cella di carico	$\Delta u$	LVDT
(min)	kN	(kPa)	$\delta$ (mm)
370.20	-0.011	193.4	-0.0062
370.22	-0.011	193.4	-0.008
370.23	-0.011	193.2	-0.0107
370.25	-0.013	193	-0.0133
370.27	-0.015	192.8	-0.0151
370.28	-0.015	192.6	-0.0169
370.30	-0.016	192.4	-0.0169
370.32	-0.017	192.2	-0.0178
370.33	-0.017	192.2	-0.0195
370.35	-0.017	192.1	-0.0204
370.37	-0.017	191.9	-0.0204
370.38	-0.017	191.8	-0.0213
370.40	-0.017	191.7	-0.0213
370.42	-0.017	191.6	-0.0204
370.43	-0.016	191.6	-0.0204
370.45	-0.016	191.6	-0.0195
370.47	-0.016	191.5	-0.0195
370.48	-0.015	191.5	-0.0178
370.50	-0.013	191.6	-0.016
370.52	-0.012	191.6	-0.0151
370.53	-0.011	191.7	-0.0124
370.55	-0.009	191.7	-0.0124
370.57	-0.008	191.7	-0.0107
370.58	-0.008	191.8	-0.0089
370.60	-0.007	192	-0.0053
370.62	-0.004	192.1	-0.0027
370.63	-0.002	192.3	0.0009
370.65	-0.001	192.5	0.0044
370.67	0.002	192.7	0.0044
370.68	0.004	192.7	0.008
370.70	0.004	192.8	0.0115
370.72	0.005	193.1	0.0151
370.73	0.009	193.3	0.0204
370.75	0.01	193.5	0.0231
370.77	0.012	193.8	0.0275
370.78	0.015	194	0.0275
370.80	0.016	194	0.032
370.82	0.016	194.3	0.0355
370.83	0.017	194.5	0.0391
370.85	0.021	194.8	0.0435
370.87	0.021	195	0.0453
370.88	0.022	195.3	0.0479
370.90	0.025	195.5	0.0479
370.92	0.025	195.5	0.0506
370.93	0.026	195.9	0.0541
370.95	0.027	196.1	0.0541
370.97	0.027	196.1	0.055
370.98	0.027	196.3	0.0568
371.00	0.028	196.5	0.0586
371.02	0.029	196.6	0.0586
371.03	0.029	196.7	0.0595
371.07	0.029	196.9	0.0595
371.08	0.029	197	0.0595
371.10	0.028	197	0.0595
371.12	0.028	197	0.0595
371.13	0.028	197.1	0.0595
371.13	0.027	197.1	0.0577
371.15	0.026	197.1	0.0568

Prova triassiale ciclica SN04-C1			
pressione di confinamento (kPa)		80	
deviatore ciclico (kPa)		95	
frequenza (hz)		0.00625	
tempo	cella di carico	$\Delta u$	LVDT
(min)	kN	(kPa)	$\delta$ (mm)
371.17	0.025	197.1	0.055
371.18	0.023	197.1	0.055
371.20	0.022	197.1	0.0533
371.22	0.022	197.1	0.0515
371.23	0.021	197	0.0488
371.25	0.018	196.8	0.0462
371.27	0.017	196.8	0.0435
371.28	0.016	196.6	0.0399
371.30	0.012	196.4	0.0399
371.32	0.011	196.3	0.0364
371.33	0.011	196.3	0.0337
371.35	0.01	196.1	0.0311
371.37	0.007	195.8	0.0257
371.38	0.005	195.6	0.0222
371.40	0.004	195.4	0.0186
371.42	0	195.1	0.0186
371.43	-0.001	194.9	0.0142
371.45	-0.001	194.9	0.0107
371.47	-0.003	194.6	0.0062
371.48	-0.006	194.3	0.0027
371.50	-0.007	194.1	-0.0009
371.52	-0.008	193.8	-0.0044
371.53	-0.011	193.5	-0.0044
371.55	-0.012	193.3	-0.008
371.57	-0.012	193.3	-0.0098
371.58	-0.013	193.1	-0.0115
371.60	-0.014	192.8	-0.0142
371.62	-0.015	192.6	-0.016
371.63	-0.016	192.5	-0.0178
371.65	-0.016	192.3	-0.0186
371.67	-0.017	192.1	-0.0195
371.68	-0.017	192	-0.0195
371.70	-0.017	191.9	-0.0204
371.72	-0.017	191.7	-0.0204
371.73	-0.017	191.7	-0.0204
371.75	-0.017	191.6	-0.0213
371.77	-0.017	191.6	-0.0204
371.78	-0.016	191.5	-0.0195
371.80	-0.015	191.5	-0.0186
371.82	-0.015	191.5	-0.0178
371.83	-0.013	191.6	-0.0178
371.85	-0.012	191.6	-0.016
371.87	-0.012	191.6	-0.0142
371.88	-0.011	191.7	-0.0115
371.90	-0.008	191.8	-0.0098
371.92	-0.007	191.8	-0.0071
371.93	-0.006	192	-0.0036
371.95	-0.002	192.2	-0.0036
371.97	-0.002	192.2	-0.0009
371.98	-0.002	192.3	0.0018
372.00	0	192.5	0.0062
372.02	0.003	192.7	0.0098
372.03	0.005	192.9	0.0124
372.05	0.006	193.1	0.0169
372.07	0.009	193.4	0.0169
372.08	0.011	193.6	0.0213
372.10	0.011	193.6	0.0249
372.12	0.013	193.8	0.0293

Prova triassiale ciclica SN04-C1			
pressione di confinamento (kPa)		80	
deviatore ciclico (kPa)		95	
frequenza (hz)		0.00625	
tempo	cella di carico	$\Delta u$	LVDT
(min)	kN	(kPa)	$\delta$ (mm)
372.13	0.015	194.1	0.0337
372.15	0.017	194.3	0.0373
372.17	0.018	194.6	0.0399
372.18	0.02	194.9	0.0399
372.20	0.022	195.1	0.0435
372.22	0.022	195.1	0.0462
372.23	0.023	195.3	0.0488
372.25	0.025	195.6	0.0515
372.27	0.026	195.8	0.0533
372.28	0.026	196	0.055
372.30	0.027	196.2	0.055
372.32	0.028	196.4	0.0577
372.33	0.028	196.4	0.0586
372.35	0.028	196.5	0.0586
372.37	0.029	196.7	0.0595
372.38	0.029	196.8	0.0595
372.40	0.029	196.9	0.0595
372.42	0.029	197	0.0595
372.43	0.028	197.1	0.0595
372.45	0.028	197.1	0.0586
372.47	0.027	197.1	0.0577
372.48	0.025	197.1	0.0577
372.50	0.025	197.1	0.0559
372.53	0.025	197.1	0.055
372.55	0.024	197.1	0.0524
372.57	0.021	197	0.0506
372.58	0.02	197	0.0479
372.58	0.019	196.8	0.0453
372.60	0.015	196.7	0.0453
372.62	0.015	196.7	0.0426
372.63	0.015	196.6	0.0399
372.65	0.013	196.4	0.0364
372.67	0.009	196.2	0.032
372.68	0.009	196	0.0293
372.70	0.007	195.7	0.0249
372.72	0.004	195.5	0.0249
372.73	0.002	195.5	0.0204
372.75	0.002	195.3	0.0169
372.77	0	195	0.0124
372.78	-0.003	194.7	0.0089
372.80	-0.004	194.5	0.0062
372.82	-0.005	194.2	0.0018
372.83	-0.008	194	0.0018
372.85	-0.009	194	-0.0018
372.87	-0.009	193.7	-0.0044
372.88	-0.01	193.5	-0.008
372.90	-0.013	193.2	-0.0107
372.92	-0.013	193	-0.0124
372.93	-0.014	192.8	-0.0151
372.95	-0.016	192.5	-0.0151
372.97	-0.016	192.5	-0.0169
372.98	-0.016	192.4	-0.0178
373.00	-0.017	192.2	-0.0195
373.02	-0.017	192.1	-0.0204
373.03	-0.017	191.9	-0.0204
373.05	-0.017	191.8	-0.0204
373.07	-0.017	191.7	-0.0204
373.08	-0.017	191.7	-0.0204

Prova triassiale ciclica SN04-C1			
pressione di confinamento (kPa)		80	
deviatore ciclico (kPa)		95	
frequenza (hz)		0.00625	
tempo	cella di carico	$\Delta u$	LVDT
(min)	kN	(kPa)	$\delta$ (mm)
373.10	-0.016	191.6	-0.0204
373.12	-0.016	191.5	-0.0204
373.13	-0.015	191.5	-0.0195
373.15	-0.015	191.5	-0.0186
373.17	-0.014	191.5	-0.0169
373.18	-0.012	191.6	-0.0151
373.20	-0.011	191.6	-0.0133
373.22	-0.01	191.7	-0.0107
373.23	-0.007	191.8	-0.0107
373.25	-0.006	191.9	-0.008
373.27	-0.006	191.9	-0.0062
373.28	-0.005	192	-0.0027
373.30	-0.002	192.2	0.0009
373.32	0	192.4	0.0036
373.33	0.001	192.5	0.0071
373.35	0.004	192.8	0.0071
373.37	0.006	193	0.0115
373.38	0.006	193	0.0142
373.40	0.007	193.2	0.0186
373.42	0.01	193.5	0.0231
373.43	0.012	193.7	0.0275
373.45	0.014	193.9	0.0311
373.47	0.016	194.2	0.0346
373.48	0.018	194.4	0.0346
373.50	0.018	194.4	0.0382
373.52	0.019	194.7	0.0417
373.53	0.021	195	0.0453
373.55	0.023	195.2	0.0479
373.57	0.023	195.4	0.0497
373.58	0.024	195.7	0.0524
373.60	0.027	195.9	0.0524
373.62	0.027	195.9	0.0541
373.63	0.027	196.1	0.0559
373.65	0.027	196.2	0.0568
373.67	0.029	196.4	0.0586
373.68	0.029	196.6	0.0586
373.70	0.028	196.7	0.0595
373.72	0.029	196.8	0.0595
373.73	0.029	196.8	0.0595
373.75	0.029	196.9	0.0595
373.77	0.028	197	0.0595
373.78	0.028	197.1	0.0595
373.80	0.027	197.1	0.0586
373.82	0.026	197.1	0.0568
373.83	0.024	197.1	0.055
373.85	0.024	197.1	0.0541
373.87	0.023	197	0.0524
373.88	0.02	196.9	0.0524
373.90	0.02	196.9	0.0497
373.92	0.02	196.9	0.0479
373.93	0.018	196.7	0.0444
373.95	0.015	196.6	0.0408
373.97	0.014	196.5	0.0382
374.00	0.012	196.3	0.0346
374.02	0.009	196.1	0.0346
374.03	0.008	196.1	0.0311
374.05	0.008	195.9	0.0284
374.05	0.006	195.7	0.0231

Prova triassiale ciclica SN04-C1			
pressione di confinamento (kPa)		80	
deviatore ciclico (kPa)		95	
frequenza (hz)		0.00625	
tempo	cella di carico	$\Delta u$	LVDT
(min)	kN	(kPa)	$\delta$ (mm)
374.07	0.002	195.4	0.0195
374.08	0.002	195.2	0.016
374.10	0	194.9	0.0115
374.12	-0.003	194.6	0.0115
374.13	-0.005	194.6	0.008
374.15	-0.005	194.4	0.0044
374.17	-0.006	194.2	0
374.18	-0.009	193.9	-0.0036
374.20	-0.01	193.6	-0.0053
374.22	-0.011	193.4	-0.0089
374.23	-0.013	193.1	-0.0089
374.25	-0.014	193.1	-0.0115
374.27	-0.014	192.9	-0.0133
374.28	-0.014	192.7	-0.0151
374.30	-0.016	192.5	-0.0169
374.32	-0.017	192.3	-0.0186
374.33	-0.017	192.1	-0.0195
374.35	-0.017	192	-0.0195
374.37	-0.017	191.9	-0.0195
374.38	-0.017	191.9	-0.0204
374.40	-0.017	191.7	-0.0204
374.42	-0.017	191.7	-0.0204
374.43	-0.017	191.6	-0.0204
374.45	-0.016	191.5	-0.0186
374.47	-0.015	191.5	-0.0186
374.48	-0.014	191.5	-0.0178
374.50	-0.014	191.5	-0.0169
374.52	-0.013	191.6	-0.0151
374.53	-0.011	191.7	-0.0133
374.55	-0.01	191.7	-0.0115
374.57	-0.01	191.7	-0.0107
374.58	-0.007	191.8	-0.0071
374.60	-0.005	192	-0.0044
374.62	-0.004	192.1	-0.0018
374.63	-0.002	192.3	0.0018
374.65	0.001	192.5	0.0018
374.67	0.001	192.5	0.0053
374.68	0.002	192.6	0.0089
374.70	0.004	192.9	0.0133
374.72	0.007	193.1	0.0169
374.73	0.008	193.3	0.0204
374.75	0.011	193.6	0.024
374.77	0.013	193.8	0.024
374.78	0.013	193.8	0.0284
374.80	0.014	194	0.032
374.82	0.016	194.3	0.0364
374.83	0.019	194.6	0.0399
374.85	0.02	194.8	0.0435
374.87	0.022	195.1	0.047
374.88	0.024	195.3	0.047
374.90	0.024	195.3	0.0497
374.92	0.024	195.6	0.0506
374.93	0.025	195.8	0.0524
374.95	0.027	196	0.055
374.97	0.027	196.1	0.0559
374.98	0.028	196.3	0.0577
375.00	0.028	196.5	0.0577
375.02	0.029	196.5	0.0586



Prova triassiale ciclica SN04-C1			
pressione di confinamento (kPa)		80	
deviatore ciclico (kPa)		95	
frequenza (hz)		0.00625	
tempo	cella di carico	$\Delta u$	LVDT
(min)	kN	(kPa)	$\delta$ (mm)
375.03	0.029	196.6	0.0586
375.05	0.029	196.7	0.0595
375.07	0.028	196.9	0.0595
375.08	0.028	197	0.0595
375.10	0.028	197	0.0595
375.12	0.028	197.1	0.0595
375.13	0.027	197.1	0.0586
375.15	0.027	197.1	0.0568
375.17	0.026	197.1	0.0559
375.18	0.024	197.1	0.0541
375.20	0.023	197	0.0515
375.22	0.022	196.9	0.0497
375.23	0.019	196.8	0.0497
375.25	0.018	196.8	0.047
375.27	0.018	196.7	0.0444
375.28	0.014	196.5	0.0408
375.30	0.013	196.5	0.0391
375.32	0.013	196.4	0.0364
375.33	0.011	196.2	0.0328
375.35	0.008	196	0.0293
375.37	0.007	195.8	0.0257
375.38	0.005	195.5	0.0213
375.40	0.002	195.2	0.0213
375.43	0	195.2	0.0169
375.45	0	195	0.0133
375.47	-0.001	194.7	0.0098
375.48	-0.004	194.4	0.0062
375.50	-0.005	194.2	0.0027
375.50	-0.007	194	-0.0018
375.52	-0.01	193.7	-0.0018
375.53	-0.01	193.7	-0.0053
375.55	-0.01	193.5	-0.0071
375.57	-0.011	193.2	-0.0098
375.58	-0.014	193	-0.0133
375.60	-0.014	192.8	-0.0142
375.62	-0.015	192.6	-0.016
375.63	-0.016	192.4	-0.016
375.65	-0.017	192.4	-0.0178
375.67	-0.017	192.2	-0.0195
375.68	-0.017	192.1	-0.0195
375.70	-0.017	191.9	-0.0204
375.72	-0.017	191.8	-0.0204
375.73	-0.017	191.7	-0.0213
375.75	-0.017	191.6	-0.0213
375.77	-0.016	191.6	-0.0204
375.78	-0.016	191.6	-0.0204
375.80	-0.016	191.5	-0.0186
375.82	-0.015	191.5	-0.0178
375.83	-0.014	191.5	-0.0169
375.85	-0.012	191.6	-0.0142
375.87	-0.01	191.7	-0.0142
375.88	-0.009	191.7	-0.0124
375.90	-0.009	191.7	-0.0107
375.92	-0.008	191.8	-0.008
375.93	-0.006	192	-0.0044
375.95	-0.004	192.1	-0.0027
375.97	-0.002	192.2	0.0009
375.98	0	192.5	0.0009

Prova triassiale ciclica SN04-C1			
pressione di confinamento (kPa)		80	
deviatore ciclico (kPa)		95	
frequenza (hz)		0.00625	
tempo	cella di carico	$\Delta u$	LVDT
(min)	kN	(kPa)	$\delta$ (mm)
376.00	0.002	192.6	0.0044
376.02	0.004	192.8	0.0107
376.03	0.005	193	0.0107
376.05	0.007	193.2	0.0133
376.07	0.007	193.2	0.0178
376.08	0.009	193.4	0.0222
376.10	0.012	193.7	0.0275
376.12	0.014	193.9	0.0311
376.13	0.015	194.1	0.0346
376.15	0.017	194.4	0.0382
376.17	0.02	194.6	0.0382
376.18	0.02	194.6	0.0408
376.20	0.021	194.9	0.0444
376.22	0.022	195.2	0.0462
376.23	0.024	195.4	0.0497
376.25	0.025	195.6	0.0524
376.27	0.026	195.9	0.0541
376.28	0.027	196.1	0.0541
376.30	0.027	196.1	0.0559
376.32	0.027	196.2	0.0568
376.33	0.028	196.4	0.0577
376.35	0.028	196.5	0.0586
376.37	0.029	196.7	0.0595
376.38	0.029	196.8	0.0595
376.40	0.029	196.9	0.0595
376.42	0.029	196.9	0.0595
376.43	0.029	197	0.0595
376.45	0.028	197	0.0595
376.47	0.027	197.1	0.0577
376.48	0.026	197.1	0.0568
376.50	0.025	197.1	0.055
376.52	0.023	197	0.055
376.53	0.022	197	0.0533
376.55	0.022	197	0.0515
376.57	0.021	196.9	0.0488
376.58	0.018	196.8	0.0462
376.60	0.017	196.7	0.0435
376.62	0.016	196.5	0.0399
376.63	0.012	196.3	0.0399
376.65	0.011	196.3	0.0364
376.67	0.011	196.2	0.0337
376.68	0.009	196	0.0302
376.70	0.006	195.8	0.0249
376.72	0.005	195.6	0.0222
376.73	0.004	195.3	0.0186
376.75	0.001	195.1	0.016
376.77	0	194.9	0.0124
376.78	-0.002	194.6	0.008
376.80	-0.006	194.3	0.008
376.82	-0.006	194.3	0.0036
376.83	-0.006	194.1	0.0009
376.85	-0.007	193.8	-0.0027
376.87	-0.01	193.6	-0.0062
376.90	-0.011	193.4	-0.0089
376.92	-0.012	193.1	-0.0107
376.93	-0.014	192.9	-0.0107
376.95	-0.015	192.9	-0.0133
376.95	-0.015	192.7	-0.0151

Prova triassiale ciclica SN04-C1			
pressione di confinamento (kPa)		80	
deviatore ciclico (kPa)		95	
frequenza (hz)		0.00625	
tempo	cella di carico	$\Delta u$	LVDT
(min)	kN	(kPa)	$\delta$ (mm)
376.97	-0.015	192.5	-0.0169
376.98	-0.016	192.3	-0.0186
377.00	-0.017	192.1	-0.0186
377.02	-0.017	192	-0.0195
377.03	-0.017	191.8	-0.0195
377.05	-0.017	191.7	-0.0204
377.07	-0.017	191.7	-0.0204
377.08	-0.017	191.6	-0.0204
377.10	-0.017	191.6	-0.0204
377.12	-0.016	191.5	-0.0195
377.13	-0.015	191.5	-0.0178
377.15	-0.014	191.5	-0.0178
377.17	-0.013	191.5	-0.0169
377.18	-0.013	191.5	-0.0151
377.20	-0.012	191.5	-0.0133
377.22	-0.01	191.7	-0.0115
377.23	-0.008	191.7	-0.0089
377.25	-0.007	191.8	-0.0071
377.27	-0.006	192	-0.0036
377.28	-0.002	192.2	-0.0036
377.30	-0.002	192.2	0
377.32	-0.002	192.3	0.0027
377.33	0	192.5	0.0062
377.35	0.004	192.7	0.0098
377.37	0.005	192.9	0.0133
377.38	0.006	193.2	0.0178
377.40	0.01	193.4	0.0178
377.42	0.011	193.4	0.0222
377.43	0.011	193.6	0.0249
377.45	0.012	193.9	0.0302
377.47	0.016	194.1	0.0346
377.48	0.016	194.3	0.0364
377.50	0.017	194.5	0.0391
377.52	0.02	194.8	0.0426
377.53	0.021	195	0.0453
377.55	0.022	195.2	0.0488
377.57	0.025	195.5	0.0488
377.58	0.025	195.5	0.0515
377.60	0.025	195.7	0.0524
377.62	0.026	195.9	0.055
377.63	0.028	196.1	0.0568
377.65	0.028	196.3	0.0577
377.67	0.028	196.4	0.0586
377.68	0.029	196.6	0.0586
377.70	0.029	196.6	0.0595
377.72	0.029	196.7	0.0595
377.73	0.029	196.8	0.0595
377.75	0.029	196.9	0.0595
377.77	0.028	197	0.0595
377.78	0.027	197.1	0.0586
377.80	0.027	197.1	0.0586
377.82	0.025	197.1	0.0577
377.83	0.025	197.1	0.0568
377.85	0.025	197.1	0.0541
377.87	0.023	197	0.0524
377.88	0.021	197	0.0506
377.90	0.02	196.9	0.0479
377.92	0.017	196.7	0.0479

Prova triassiale ciclica SN04-C1			
pressione di confinamento (kPa)		80	
deviatore ciclico (kPa)		95	
frequenza (hz)		0.00625	
tempo	cella di carico	$\Delta u$	LVDT
(min)	kN	(kPa)	$\delta$ (mm)
377.93	0.016	196.6	0.0444
377.95	0.016	196.6	0.0435
377.97	0.015	196.5	0.0399
377.98	0.012	196.3	0.0355
378.00	0.01	196.1	0.0328
378.02	0.009	196	0.0284
378.03	0.006	195.7	0.0284
378.05	0.003	195.5	0.0231
378.07	0.003	195.5	0.0204
378.08	0.002	195.2	0.0169
378.10	0	194.9	0.0133
378.12	-0.003	194.7	0.0089
378.13	-0.004	194.5	0.0053
378.15	-0.006	194.1	0.0018
378.17	-0.008	193.9	0.0018
378.18	-0.009	193.7	-0.0036
378.20	-0.01	193.5	-0.0053
378.22	-0.012	193.2	-0.0053
378.23	-0.013	193.2	-0.0089
378.25	-0.013	193	-0.0115
378.27	-0.014	192.8	-0.0133
378.28	-0.015	192.6	-0.016
378.30	-0.016	192.4	-0.0169
378.33	-0.016	192.2	-0.0178
378.35	-0.017	192	-0.0178
378.37	-0.017	192	-0.0195
378.38	-0.017	191.9	-0.0195
378.40	-0.017	191.8	-0.0204
378.40	-0.017	191.7	-0.0204
378.43	-0.017	191.6	-0.0204
378.43	-0.016	191.5	-0.0195
378.45	-0.016	191.5	-0.0195
378.47	-0.015	191.5	-0.0186
378.48	-0.015	191.5	-0.0178
378.50	-0.014	191.5	-0.016
378.52	-0.012	191.5	-0.0151
378.53	-0.011	191.6	-0.0124
378.55	-0.01	191.7	-0.0107
378.57	-0.008	191.8	-0.0107
378.58	-0.006	191.8	-0.008
378.60	-0.006	191.9	-0.0053
378.62	-0.005	192	-0.0027
378.63	-0.002	192.2	0.0009
378.65	-0.001	192.4	0.0044
378.67	0.001	192.6	0.008
378.68	0.005	192.8	0.008
378.70	0.006	192.8	0.0124
378.72	0.006	193	0.0151
378.73	0.007	193.2	0.0195
378.75	0.011	193.5	0.024
378.77	0.012	193.7	0.0275
378.78	0.013	193.9	0.032
378.80	0.017	194.2	0.032
378.82	0.017	194.2	0.0355
378.83	0.017	194.4	0.0382
378.85	0.019	194.7	0.0417
378.87	0.022	194.9	0.0462
378.88	0.023	195.1	0.0488

Prova triassiale ciclica SN04-C1			
pressione di confinamento (kPa)		80	
deviatore ciclico (kPa)		95	
frequenza (hz)		0.00625	
tempo	cella di carico	$\Delta u$	LVDT
(min)	kN	(kPa)	$\delta$ (mm)
378.90	0.024	195.4	0.0506
378.92	0.025	195.7	0.0524
378.93	0.026	195.8	0.0541
378.95	0.026	196	0.055
378.97	0.027	196.2	0.055
378.98	0.028	196.2	0.0568
379.00	0.028	196.4	0.0586
379.02	0.028	196.5	0.0586
379.03	0.029	196.7	0.0595
379.05	0.029	196.8	0.0604
379.07	0.029	196.9	0.0604
379.08	0.029	197	0.0604
379.10	0.028	197.1	0.0604
379.12	0.028	197.1	0.0595
379.13	0.027	197.1	0.0586
379.15	0.026	197.1	0.0568
379.17	0.025	197.1	0.0559
379.18	0.024	197.1	0.0533
379.20	0.022	197	0.0533
379.22	0.021	196.9	0.0515
379.23	0.021	196.9	0.0497
379.25	0.02	196.8	0.0479
379.27	0.017	196.7	0.0444
379.28	0.015	196.6	0.0408
379.30	0.014	196.5	0.0382
379.32	0.011	196.2	0.0382
379.33	0.009	196.1	0.0346
379.35	0.009	196.1	0.0311
379.37	0.008	195.9	0.0275
379.38	0.005	195.6	0.0222
379.40	0.003	195.4	0.0195
379.42	0.001	195.1	0.0151
379.43	-0.001	194.8	0.0115
379.45	-0.003	194.6	0.0115
379.47	-0.003	194.6	0.008
379.48	-0.004	194.4	0.0036
379.50	-0.007	194	0
379.52	-0.009	193.8	-0.0036
379.53	-0.01	193.6	-0.0062
379.55	-0.011	193.3	-0.0089
379.57	-0.013	193	-0.0089
379.58	-0.014	193	-0.0115
379.60	-0.014	192.8	-0.0133
379.62	-0.014	192.6	-0.0151
379.63	-0.016	192.4	-0.0169
379.65	-0.016	192.3	-0.0178
379.67	-0.017	192.1	-0.0186
379.68	-0.017	191.9	-0.0195
379.70	-0.017	191.8	-0.0204
379.72	-0.017	191.7	-0.0204
379.73	-0.017	191.6	-0.0204
379.75	-0.017	191.6	-0.0204
379.77	-0.017	191.5	-0.0204
379.80	-0.016	191.5	-0.0195
379.82	-0.015	191.5	-0.0178
379.83	-0.014	191.4	-0.0169
379.85	-0.014	191.5	-0.016
379.85	-0.012	191.5	-0.016

Prova triassiale ciclica SN04-C1			
pressione di confinamento (kPa)		80	
deviatore ciclico (kPa)		95	
frequenza (hz)		0.00625	
tempo	cella di carico	$\Delta u$	LVDT
(min)	kN	(kPa)	$\delta$ (mm)
379.87	-0.011	191.5	-0.0142
379.88	-0.011	191.6	-0.0124
379.90	-0.01	191.7	-0.0098
379.92	-0.006	191.8	-0.0062
379.93	-0.006	191.9	-0.0044
379.95	-0.004	192.1	-0.0009
379.97	-0.001	192.3	-0.0009
379.98	0	192.3	0.0027
380.00	0	192.4	0.0053
380.02	0.001	192.6	0.0089
380.03	0.005	192.9	0.0133
380.05	0.006	193	0.016
380.07	0.008	193.3	0.0213
380.08	0.012	193.6	0.0213
380.10	0.013	193.6	0.0257
380.12	0.013	193.8	0.0293
380.13	0.014	194	0.0328
380.15	0.017	194.3	0.0373
380.17	0.019	194.5	0.0399
380.18	0.02	194.7	0.0435
380.20	0.022	195	0.0435
380.22	0.023	195.2	0.0462
380.23	0.023	195.2	0.0488
380.25	0.024	195.5	0.0515
380.27	0.026	195.8	0.0541
380.28	0.026	195.9	0.055
380.30	0.027	196.1	0.0568
380.32	0.028	196.3	0.0568
380.33	0.029	196.5	0.0586
380.35	0.029	196.5	0.0595
380.37	0.028	196.7	0.0595
380.38	0.028	196.8	0.0595
380.40	0.028	196.8	0.0604
380.42	0.029	196.9	0.0604
380.43	0.029	197	0.0604
380.45	0.028	197.1	0.0595
380.47	0.027	197.1	0.0577
380.48	0.026	197.1	0.0568
380.50	0.024	197.1	0.0568
380.52	0.024	197.1	0.055
380.53	0.024	197.1	0.0533
380.55	0.022	196.9	0.0506
380.57	0.02	196.9	0.0488
380.58	0.019	196.8	0.0453
380.60	0.017	196.6	0.0426
380.62	0.014	196.5	0.0426
380.63	0.013	196.5	0.0399
380.65	0.013	196.4	0.0373
380.67	0.011	196.2	0.0337
380.68	0.008	195.9	0.0302
380.70	0.007	195.8	0.0257
380.72	0.005	195.5	0.0222
380.73	0.002	195.2	0.0222
380.75	0	195.2	0.0178
380.77	0	195	0.0142
380.78	-0.001	194.8	0.0107
380.80	-0.004	194.5	0.0062
380.82	-0.005	194.3	0.0027

Prova triassiale ciclica SN04-C1			
pressione di confinamento (kPa)		80	
deviatore ciclico (kPa)		95	
frequenza (hz)		0.00625	
tempo	cella di carico	$\Delta u$	LVDT
(min)	kN	(kPa)	$\delta$ (mm)
380.83	-0.007	193.9	-0.0009
380.85	-0.01	193.7	-0.0009
380.87	-0.01	193.7	-0.0044
380.88	-0.01	193.5	-0.0071
380.90	-0.012	193.2	-0.0098
380.92	-0.014	192.9	-0.0133
380.93	-0.015	192.8	-0.0142
380.95	-0.015	192.6	-0.016
380.97	-0.016	192.4	-0.016
380.98	-0.017	192.4	-0.0169
381.00	-0.017	192.2	-0.0186
381.02	-0.017	192	-0.0195
381.03	-0.017	191.9	-0.0204
381.05	-0.017	191.8	-0.0204
381.07	-0.017	191.7	-0.0204
381.08	-0.017	191.6	-0.0204
381.10	-0.016	191.5	-0.0195
381.12	-0.016	191.5	-0.0195
381.13	-0.015	191.5	-0.0195
381.15	-0.014	191.5	-0.0178
381.17	-0.014	191.5	-0.0169
381.18	-0.013	191.5	-0.0151
381.20	-0.011	191.6	-0.0124
381.22	-0.01	191.6	-0.0115
381.23	-0.009	191.7	-0.0089
381.27	-0.006	191.9	-0.0089
381.28	-0.005	191.9	-0.0062
381.30	-0.005	192	-0.0036
381.30	-0.003	192.2	0
381.32	0	192.3	0.0036
381.33	0.001	192.5	0.0062
381.35	0.003	192.7	0.0107
381.37	0.006	192.9	0.0107
381.38	0.008	192.9	0.0151
381.40	0.008	193.1	0.0186
381.42	0.009	193.4	0.0222
381.43	0.012	193.7	0.0275
381.45	0.014	193.9	0.0302
381.47	0.015	194.1	0.0346
381.48	0.018	194.4	0.0346
381.50	0.019	194.6	0.0391
381.52	0.019	194.6	0.0408
381.53	0.02	194.8	0.0444
381.55	0.022	195.1	0.047
381.57	0.024	195.4	0.0497
381.58	0.024	195.6	0.0524
381.60	0.026	195.8	0.0524
381.62	0.027	196	0.055
381.63	0.027	196	0.0559
381.65	0.027	196.2	0.0568
381.67	0.028	196.4	0.0586
381.68	0.029	196.5	0.0595
381.70	0.029	196.6	0.0604
381.72	0.029	196.8	0.0604
381.73	0.029	196.9	0.0604
381.75	0.029	196.9	0.0604
381.77	0.029	197	0.0604
381.78	0.028	197	0.0595

Prova triassiale ciclica SN04-C1			
pressione di confinamento (kPa)		80	
deviatore ciclico (kPa)		95	
frequenza (hz)		0.00625	
tempo	cella di carico	$\Delta u$	LVDT
(min)	kN	(kPa)	$\delta$ (mm)
381.80	0.027	197	0.0586
381.82	0.026	197.1	0.0568
381.83	0.026	197.1	0.0559
381.85	0.024	197	0.0541
381.87	0.023	197	0.0524
381.88	0.022	196.9	0.0506
381.90	0.019	196.8	0.0506
381.92	0.018	196.8	0.047
381.93	0.018	196.7	0.0453
381.95	0.016	196.6	0.0426
381.97	0.013	196.4	0.0391
381.98	0.012	196.3	0.0364
382.00	0.011	196.1	0.032
382.02	0.007	195.8	0.032
382.03	0.006	195.8	0.0284
382.05	0.006	195.7	0.024
382.07	0.004	195.4	0.0204
382.08	0.001	195.1	0.016
382.10	0	194.9	0.0133
382.12	-0.002	194.6	0.0089
382.13	-0.006	194.3	0.0089
382.15	-0.006	194.3	0.0044
382.17	-0.006	194.1	0.0018
382.18	-0.007	193.9	-0.0018
382.20	-0.011	193.6	-0.0062
382.22	-0.011	193.4	-0.008
382.23	-0.012	193.1	-0.0107
382.25	-0.014	192.9	-0.0107
382.27	-0.015	192.9	-0.0133
382.28	-0.015	192.7	-0.0151
382.30	-0.015	192.5	-0.0169
382.32	-0.016	192.3	-0.0178
382.33	-0.017	192.1	-0.0186
382.35	-0.017	192	-0.0195
382.37	-0.017	191.8	-0.0195
382.38	-0.017	191.7	-0.0204
382.40	-0.017	191.7	-0.0204
382.42	-0.017	191.6	-0.0195
382.43	-0.017	191.6	-0.0195
382.45	-0.016	191.5	-0.0186
382.47	-0.016	191.5	-0.0178
382.48	-0.014	191.5	-0.0169
382.50	-0.013	191.5	-0.0169
382.52	-0.013	191.5	-0.0151
382.53	-0.012	191.5	-0.0133
382.55	-0.009	191.7	-0.0107
382.57	-0.008	191.7	-0.0098
382.58	-0.008	191.8	-0.008
382.60	-0.006	191.9	-0.0044
382.62	-0.004	192.1	-0.0018
382.63	-0.002	192.2	0.0009
382.65	-0.001	192.4	0.0044
382.67	0.003	192.6	0.0044
382.70	0.004	192.6	0.0089
382.72	0.004	192.7	0.0115
382.73	0.005	193	0.016
382.75	0.009	193.3	0.0204
382.77	0.01	193.5	0.024



Prova triassiale ciclica SN04-C1			
pressione di confinamento (kPa)		80	
deviatore ciclico (kPa)		95	
frequenza (hz)		0.00625	
tempo	cella di carico	$\Delta u$	LVDT
(min)	kN	(kPa)	$\delta$ (mm)
382.77	0.012	193.8	0.0284
382.78	0.015	194	0.0284
382.80	0.016	194	0.0328
382.82	0.016	194.2	0.0355
382.83	0.017	194.5	0.0391
382.85	0.021	194.7	0.0435
382.87	0.022	194.9	0.0462
382.88	0.022	195.2	0.0479
382.90	0.024	195.4	0.0479
382.92	0.025	195.4	0.0506
382.93	0.025	195.7	0.0533
382.95	0.026	195.9	0.055
382.97	0.027	196.1	0.0568
382.98	0.028	196.3	0.0577
383.00	0.028	196.4	0.0595
383.02	0.029	196.6	0.0595
383.03	0.029	196.6	0.0595
383.05	0.029	196.7	0.0595
383.07	0.029	196.8	0.0604
383.08	0.029	196.9	0.0604
383.10	0.028	197	0.0604
383.12	0.028	197	0.0586
383.13	0.026	197	0.0586
383.15	0.025	197	0.0577
383.17	0.025	197	0.0559
383.18	0.025	197	0.0541
383.20	0.023	197	0.0524
383.22	0.021	196.9	0.0506
383.23	0.02	196.8	0.0488
383.25	0.018	196.7	0.0488
383.27	0.016	196.6	0.0435
383.28	0.015	196.5	0.0408
383.30	0.013	196.3	0.0408
383.32	0.012	196.3	0.0373
383.33	0.012	196.2	0.0346
383.35	0.01	196	0.0302
383.37	0.006	195.7	0.0249
383.38	0.005	195.6	0.0222
383.40	0.004	195.3	0.0186
383.42	0	195	0.0186
383.43	-0.001	194.8	0.0142
383.45	-0.001	194.8	0.0107
383.47	-0.003	194.5	0.0071
383.48	-0.006	194.2	0.0027
383.50	-0.007	194	0
383.52	-0.008	193.8	-0.0036
383.53	-0.011	193.5	-0.0036
383.55	-0.012	193.2	-0.0071
383.57	-0.012	193.2	-0.0089
383.58	-0.012	193	-0.0115
383.60	-0.014	192.8	-0.0142
383.62	-0.015	192.5	-0.016
383.63	-0.016	192.4	-0.0169
383.65	-0.016	192.2	-0.0169
383.67	-0.017	192	-0.0186
383.68	-0.017	192	-0.0195
383.70	-0.017	191.9	-0.0204
383.72	-0.017	191.8	-0.0204

Prova triassiale ciclica SN04-C1			
pressione di confinamento (kPa)		80	
deviatore ciclico (kPa)		95	
frequenza (hz)		0.00625	
tempo	cella di carico	$\Delta u$	LVDT
(min)	kN	(kPa)	$\delta$ (mm)
383.73	-0.017	191.7	-0.0204
383.75	-0.017	191.6	-0.0195
383.77	-0.016	191.5	-0.0195
383.78	-0.016	191.5	-0.0195
383.80	-0.016	191.5	-0.0186
383.82	-0.015	191.5	-0.0178
383.83	-0.013	191.5	-0.0151
383.85	-0.012	191.5	-0.0142
383.87	-0.012	191.6	-0.0133
383.88	-0.01	191.7	-0.0133
383.90	-0.008	191.8	-0.0107
383.92	-0.008	191.8	-0.008
383.93	-0.006	191.9	-0.0044
383.95	-0.004	192.1	-0.0018
383.97	-0.002	192.2	0.0009
383.98	-0.001	192.3	0.0053
384.00	0.002	192.6	0.0089
384.02	0.003	192.7	0.0107
384.03	0.005	192.9	0.0142
384.05	0.007	193.2	0.0142
384.07	0.01	193.4	0.0186
384.08	0.01	193.4	0.0222
384.10	0.011	193.6	0.0257
384.12	0.013	193.9	0.0302
384.13	0.016	194.1	0.0337
384.17	0.016	194.3	0.0373
384.18	0.019	194.6	0.0417
384.20	0.021	194.9	0.0417
384.22	0.022	194.9	0.0444
384.22	0.022	195	0.047
384.23	0.023	195.3	0.0497
384.25	0.025	195.6	0.0524
384.27	0.026	195.8	0.0541
384.28	0.026	196	0.0559
384.30	0.027	196.2	0.0559
384.32	0.028	196.2	0.0568
384.33	0.028	196.3	0.0586
384.35	0.028	196.5	0.0595
384.37	0.029	196.6	0.0595
384.38	0.029	196.7	0.0595
384.40	0.029	196.8	0.0604
384.42	0.028	196.9	0.0604
384.43	0.028	196.9	0.0595
384.45	0.028	197	0.0595
384.47	0.027	197	0.0577
384.48	0.026	197	0.0568
384.50	0.025	197	0.055
384.52	0.024	197	0.0541
384.53	0.022	196.9	0.0541
384.55	0.021	196.9	0.0515
384.57	0.021	196.9	0.0497
384.58	0.02	196.8	0.047
384.60	0.016	196.6	0.0435
384.62	0.016	196.5	0.0417
384.63	0.014	196.3	0.0382
384.65	0.011	196.2	0.0382
384.67	0.01	196.2	0.0337
384.68	0.01	196	0.0311

Prova triassiale ciclica SN04-C1			
pressione di confinamento (kPa)		80	
deviatore ciclico (kPa)		95	
frequenza (hz)		0.00625	
tempo	cella di carico	$\Delta u$	LVDT
(min)	kN	(kPa)	$\delta$ (mm)
384.70	0.008	195.8	0.0275
384.72	0.005	195.5	0.0222
384.73	0.003	195.3	0.0186
384.75	0.002	195.1	0.0169
384.77	-0.001	194.9	0.0133
384.78	-0.002	194.6	0.0098
384.80	-0.003	194.4	0.0053
384.82	-0.007	194	0.0053
384.83	-0.007	194	0.0009
384.85	-0.007	193.8	-0.0009
384.87	-0.009	193.6	-0.0053
384.88	-0.012	193.3	-0.008
384.90	-0.012	193.1	-0.0107
384.92	-0.014	192.9	-0.0133
384.93	-0.015	192.6	-0.0133
384.95	-0.015	192.6	-0.0151
384.97	-0.015	192.5	-0.016
384.98	-0.016	192.3	-0.0178
385.00	-0.017	192.1	-0.0186
385.02	-0.017	191.9	-0.0186
385.03	-0.017	191.8	-0.0195
385.05	-0.018	191.7	-0.0195
385.07	-0.017	191.7	-0.0204
385.08	-0.017	191.6	-0.0204
385.10	-0.017	191.5	-0.0195
385.12	-0.016	191.5	-0.0186
385.13	-0.015	191.5	-0.0178
385.15	-0.014	191.4	-0.0169
385.17	-0.013	191.5	-0.0169
385.18	-0.012	191.5	-0.0151
385.20	-0.012	191.5	-0.0142
385.22	-0.011	191.6	-0.0115
385.23	-0.008	191.7	-0.0089
385.25	-0.007	191.8	-0.0062
385.27	-0.006	191.9	-0.0027
385.28	-0.002	192.1	-0.0027
385.30	-0.002	192.1	0
385.32	-0.002	192.2	0.0027
385.33	0	192.4	0.0062
385.35	0.003	192.7	0.0098
385.37	0.005	192.8	0.0133
385.38	0.006	193	0.0186
385.40	0.01	193.3	0.0186
385.42	0.011	193.5	0.0222
385.43	0.011	193.5	0.0257
385.45	0.014	194	0.0302
385.47	0.016	194.2	0.0328
385.48	0.016	194.2	0.0355
385.50	0.017	194.4	0.0391
385.52	0.02	194.7	0.0435
385.53	0.022	194.9	0.0462
385.55	0.022	195.1	0.0488
385.57	0.024	195.4	0.0488
385.60	0.025	195.7	0.0515
385.62	0.025	195.7	0.0533
385.63	0.026	195.9	0.055
385.65	0.027	196.1	0.0568
385.67	0.028	196.3	0.0586

Prova triassiale ciclica SN04-C1			
pressione di confinamento (kPa)		80	
deviatore ciclico (kPa)		95	
frequenza (hz)		0.00625	
tempo	cella di carico	$\Delta u$	LVDT
(min)	kN	(kPa)	$\delta$ (mm)
385.67	0.028	196.4	0.0595
385.68	0.029	196.5	0.0595
385.70	0.029	196.7	0.0604
385.72	0.029	196.7	0.0604
385.73	0.029	196.8	0.0604
385.75	0.029	196.9	0.0604
385.77	0.028	197	0.0595
385.78	0.027	197	0.0586
385.80	0.027	197	0.0586
385.82	0.025	197	0.0577
385.83	0.025	197	0.0568
385.85	0.025	197	0.0541
385.87	0.023	196.9	0.0533
385.88	0.021	196.9	0.0506
385.90	0.02	196.8	0.0488
385.92	0.019	196.7	0.0462
385.93	0.015	196.5	0.0462
385.95	0.014	196.5	0.0417
385.97	0.014	196.5	0.0399
385.98	0.013	196.3	0.0364
386.00	0.01	196.1	0.0328
386.02	0.009	195.9	0.0293
386.03	0.007	195.7	0.0249
386.05	0.004	195.4	0.0249
386.07	0.003	195.4	0.0213
386.08	0.003	195.2	0.0178
386.10	0	194.9	0.0124
386.12	-0.003	194.6	0.0089
386.13	-0.004	194.4	0.0062
386.15	-0.005	194.1	0.0027
386.17	-0.008	193.8	0.0027
386.18	-0.009	193.6	-0.0036
386.20	-0.009	193.4	-0.0062
386.22	-0.012	193.1	-0.0062
386.23	-0.013	193.1	-0.0089
386.25	-0.013	192.9	-0.0115
386.27	-0.014	192.7	-0.0142
386.28	-0.016	192.5	-0.016
386.30	-0.016	192.3	-0.0169
386.32	-0.016	192.1	-0.0186
386.33	-0.017	192	-0.0186
386.35	-0.017	192	-0.0195
386.37	-0.017	191.8	-0.0195
386.38	-0.017	191.7	-0.0204
386.40	-0.017	191.6	-0.0204
386.42	-0.017	191.5	-0.0204
386.43	-0.017	191.5	-0.0195
386.45	-0.015	191.4	-0.0195
386.47	-0.015	191.4	-0.0186
386.48	-0.015	191.4	-0.0186
386.50	-0.014	191.4	-0.016
386.52	-0.012	191.5	-0.0142
386.53	-0.011	191.5	-0.0133
386.55	-0.01	191.5	-0.0107
386.57	-0.007	191.7	-0.0107
386.58	-0.007	191.7	-0.008
386.60	-0.007	191.8	-0.0062
386.62	-0.005	191.9	-0.0027

Prova triassiale ciclica SN04-C1			
pressione di confinamento (kPa)		80	
deviatore ciclico (kPa)		95	
frequenza (hz)		0.00625	
tempo	cella di carico	$\Delta u$	LVDT
(min)	kN	(kPa)	$\delta$ (mm)
386.63	-0.002	192.1	0.0009
386.65	-0.001	192.3	0.0036
386.67	0.001	192.4	0.008
386.68	0.004	192.7	0.008
386.70	0.006	192.9	0.0115
386.72	0.006	192.9	0.0151
386.73	0.007	193.1	0.0195
386.75	0.011	193.4	0.024
386.77	0.012	193.6	0.0275
386.78	0.013	193.8	0.032
386.80	0.016	194.1	0.032
386.82	0.018	194.3	0.0355
386.83	0.018	194.3	0.0391
386.85	0.019	194.6	0.0417
386.87	0.021	194.9	0.0453
386.88	0.023	195.1	0.0479
386.90	0.023	195.3	0.0506
386.92	0.024	195.6	0.0515
386.93	0.025	195.8	0.0533
386.95	0.026	195.9	0.0559
386.97	0.027	196.2	0.0559
386.98	0.028	196.3	0.0577
387.00	0.028	196.3	0.0586
387.02	0.029	196.5	0.0595
387.03	0.029	196.6	0.0595
387.07	0.029	196.7	0.0604
387.08	0.029	196.8	0.0604
387.10	0.029	196.9	0.0604
387.12	0.028	197	0.0604
387.12	0.027	197	0.0595
387.13	0.027	197	0.0586
387.15	0.026	197	0.0568
387.17	0.025	197	0.0559
387.18	0.024	197	0.0541
387.20	0.023	196.9	0.0515
387.22	0.02	196.8	0.0515
387.23	0.02	196.8	0.0497
387.25	0.02	196.8	0.0479
387.27	0.018	196.6	0.0444
387.28	0.015	196.5	0.0408
387.30	0.014	196.4	0.0382
387.32	0.012	196.2	0.0355
387.33	0.009	196	0.0355
387.35	0.008	196	0.0311
387.37	0.008	195.8	0.0284
387.38	0.006	195.5	0.0231
387.40	0.002	195.2	0.0186
387.42	0.001	195	0.016
387.43	0	194.8	0.0115
387.45	-0.004	194.5	0.0115
387.47	-0.005	194.5	0.0071
387.48	-0.005	194.3	0.0044
387.50	-0.006	194	0.0009
387.52	-0.009	193.7	-0.0027
387.53	-0.009	193.5	-0.0053
387.55	-0.011	193.3	-0.0089
387.57	-0.014	193	-0.0089
387.58	-0.014	193	-0.0115

Prova triassiale ciclica SN04-C1			
pressione di confinamento (kPa)		80	
deviatore ciclico (kPa)		95	
frequenza (hz)		0.00625	
tempo	cella di carico	$\Delta u$	LVDT
(min)	kN	(kPa)	$\delta$ (mm)
387.60	-0.014	192.8	-0.0133
387.62	-0.014	192.6	-0.0151
387.63	-0.016	192.4	-0.0169
387.65	-0.016	192.2	-0.0178
387.67	-0.017	192	-0.0186
387.68	-0.017	191.9	-0.0195
387.70	-0.017	191.7	-0.0204
387.72	-0.017	191.6	-0.0204
387.73	-0.017	191.5	-0.0204
387.75	-0.017	191.5	-0.0204
387.77	-0.017	191.5	-0.0195
387.78	-0.016	191.4	-0.0186
387.80	-0.016	191.4	-0.0186
387.82	-0.014	191.4	-0.0169
387.83	-0.014	191.4	-0.016
387.85	-0.012	191.5	-0.0133
387.87	-0.01	191.5	-0.0133
387.88	-0.01	191.5	-0.0115
387.90	-0.01	191.6	-0.0098
387.92	-0.008	191.8	-0.0071
387.93	-0.005	191.9	-0.0036
387.95	-0.004	192	-0.0018
387.97	-0.002	192.2	0.0018
387.98	0	192.3	0.0018
388.00	0.002	192.3	0.0053
388.02	0.002	192.5	0.0089
388.03	0.004	192.7	0.0124
388.05	0.007	193	0.0169
388.07	0.008	193.2	0.0204
388.08	0.01	193.5	0.0249
388.10	0.014	193.7	0.0249
388.12	0.014	193.7	0.0293
388.13	0.014	193.9	0.0328
388.15	0.016	194.2	0.0364
388.17	0.019	194.5	0.0399
388.18	0.02	194.6	0.0435
388.20	0.021	194.9	0.0462
388.22	0.024	195.2	0.0462
388.23	0.024	195.2	0.0497
388.25	0.024	195.4	0.0515
388.27	0.025	195.7	0.0541
388.28	0.027	195.9	0.0559
388.30	0.027	196	0.0568
388.32	0.028	196.2	0.0586
388.33	0.028	196.4	0.0586
388.35	0.029	196.4	0.0595
388.37	0.029	196.6	0.0595
388.38	0.028	196.7	0.0595
388.40	0.028	196.7	0.0604
388.42	0.028	196.9	0.0604
388.43	0.029	196.9	0.0604
388.45	0.028	197	0.0595
388.47	0.027	197	0.0586
388.50	0.026	197	0.0568
388.52	0.024	197	0.0568
388.53	0.023	197	0.055
388.55	0.023	197	0.0541
388.57	0.022	196.9	0.0515

Prova triassiale ciclica SN04-C1			
pressione di confinamento (kPa)		80	
deviatore ciclico (kPa)		95	
frequenza (hz)		0.00625	
tempo	cella di carico	$\Delta u$	LVDT
(min)	kN	(kPa)	$\delta$ (mm)
388.57	0.02	196.8	0.0488
388.58	0.019	196.7	0.047
388.60	0.017	196.6	0.0435
388.62	0.014	196.4	0.0435
388.63	0.013	196.4	0.0408
388.65	0.013	196.3	0.0373
388.67	0.012	196.1	0.0346
388.68	0.008	195.9	0.0302
388.70	0.006	195.7	0.0257
388.72	0.005	195.5	0.0222
388.73	0.002	195.1	0.0222
388.75	0	195.1	0.0178
388.77	0	194.9	0.0142
388.78	-0.001	194.7	0.0107
388.80	-0.004	194.4	0.0062
388.82	-0.005	194.2	0.0036
388.83	-0.007	193.9	-0.0009
388.85	-0.01	193.6	-0.0009
388.87	-0.01	193.6	-0.0044
388.88	-0.01	193.4	-0.0071
388.90	-0.011	193.2	-0.0098
388.92	-0.014	192.9	-0.0124
388.93	-0.014	192.7	-0.0133
388.95	-0.015	192.5	-0.016
388.97	-0.016	192.3	-0.016
388.98	-0.017	192.3	-0.0178
389.00	-0.017	192.1	-0.0186
389.02	-0.017	192	-0.0195
389.03	-0.017	191.8	-0.0204
389.05	-0.017	191.7	-0.0204
389.07	-0.017	191.6	-0.0195
389.08	-0.017	191.5	-0.0195
389.10	-0.016	191.4	-0.0195
389.12	-0.016	191.4	-0.0186
389.13	-0.014	191.4	-0.0186
389.15	-0.014	191.4	-0.0169
389.17	-0.014	191.4	-0.0169
389.18	-0.013	191.4	-0.0142
389.20	-0.011	191.5	-0.0124
389.22	-0.01	191.5	-0.0107
389.23	-0.009	191.6	-0.0089
389.25	-0.006	191.8	-0.0089
389.27	-0.005	191.8	-0.0062
389.28	-0.005	191.9	-0.0027
389.30	-0.003	192	0.0009
389.32	0	192.3	0.0044
389.33	0.001	192.4	0.0071
389.35	0.003	192.6	0.0115
389.37	0.006	192.9	0.0115
389.38	0.007	193.1	0.0151
389.40	0.007	193.1	0.0186
389.42	0.009	193.3	0.0231
389.43	0.013	193.6	0.0284
389.45	0.014	193.8	0.0311
389.47	0.015	194	0.0346
389.48	0.018	194.3	0.0346
389.50	0.019	194.5	0.0391
389.52	0.019	194.5	0.0408

Prova triassiale ciclica SN04-C1			
pressione di confinamento (kPa)		80	
deviatore ciclico (kPa)		95	
frequenza (hz)		0.00625	
tempo	cella di carico	$\Delta u$	LVDT
(min)	kN	(kPa)	$\delta$ (mm)
389.53	0.02	194.8	0.0453
389.55	0.023	195	0.0479
389.57	0.024	195.2	0.0506
389.58	0.025	195.5	0.0524
389.60	0.026	195.8	0.0524
389.62	0.027	196	0.055
389.63	0.027	196	0.0559
389.65	0.028	196.1	0.0577
389.67	0.028	196.3	0.0586
389.68	0.029	196.4	0.0595
389.70	0.029	196.6	0.0595
389.72	0.029	196.7	0.0595
389.73	0.029	196.8	0.0604
389.75	0.029	196.8	0.0604
389.77	0.029	196.9	0.0604
389.78	0.028	196.9	0.0595
389.80	0.026	197	0.0577
389.82	0.026	197	0.0568
389.83	0.026	197	0.0559
389.85	0.024	197	0.0541
389.87	0.023	197	0.0533
389.88	0.022	196.9	0.0506
389.90	0.019	196.7	0.0506
389.92	0.018	196.7	0.0479
389.93	0.018	196.7	0.0453
389.97	0.016	196.5	0.0426
389.98	0.013	196.3	0.0391
390.00	0.012	196.2	0.0355
390.02	0.011	196	0.032
390.02	0.007	195.8	0.032
390.03	0.006	195.8	0.0275
390.05	0.006	195.6	0.0249
390.07	0.004	195.3	0.0204
390.08	0.001	195	0.016
390.10	0	194.8	0.0124
390.12	-0.002	194.5	0.0089
390.13	-0.005	194.2	0.0089
390.15	-0.006	194.2	0.0044
390.17	-0.006	194	0.0018
390.18	-0.008	193.7	-0.0027
390.20	-0.01	193.5	-0.0053
390.22	-0.011	193.3	-0.008
390.23	-0.012	193	-0.0107
390.25	-0.014	192.8	-0.0107
390.27	-0.015	192.8	-0.0133
390.28	-0.015	192.6	-0.0151
390.30	-0.015	192.4	-0.0169
390.32	-0.016	192.2	-0.0178
390.33	-0.017	192	-0.0186
390.35	-0.017	191.9	-0.0195
390.37	-0.017	191.7	-0.0195
390.38	-0.017	191.7	-0.0204
390.40	-0.017	191.6	-0.0204
390.42	-0.017	191.5	-0.0204
390.43	-0.017	191.5	-0.0195
390.45	-0.016	191.4	-0.0186
390.47	-0.015	191.4	-0.0178
390.48	-0.014	191.4	-0.0178



Prova triassiale ciclica SN04-C1			
pressione di confinamento (kPa)		80	
deviatore ciclico (kPa)		95	
frequenza (hz)		0.00625	
tempo	cella di carico	$\Delta u$	LVDT
(min)	kN	(kPa)	$\delta$ (mm)
390.50	-0.013	191.4	-0.0169
390.52	-0.013	191.4	-0.0151
390.53	-0.011	191.5	-0.0133
390.55	-0.01	191.5	-0.0124
390.57	-0.01	191.6	-0.0107
390.58	-0.008	191.7	-0.0071
390.60	-0.005	191.8	-0.0044
390.62	-0.004	191.9	-0.0018
390.63	-0.002	192.1	0.0018
390.65	0	192.3	0.0018
390.67	0.002	192.5	0.0053
390.68	0.002	192.5	0.0089
390.70	0.004	192.7	0.0124
390.72	0.007	192.9	0.0169
390.73	0.009	193.2	0.0204
390.75	0.01	193.3	0.0231
390.77	0.013	193.6	0.0231
390.78	0.015	193.9	0.0293
390.80	0.015	193.9	0.0328
390.82	0.016	194.1	0.0364
390.83	0.018	194.4	0.0399
390.85	0.02	194.6	0.0435
390.87	0.021	194.8	0.0453
390.88	0.023	195.1	0.0488
390.90	0.025	195.4	0.0488
390.92	0.025	195.4	0.0515
390.93	0.025	195.6	0.0533
390.95	0.026	195.8	0.055
390.97	0.027	196	0.0568
390.98	0.028	196.2	0.0577
391.00	0.028	196.3	0.0586
391.02	0.029	196.5	0.0586
391.03	0.029	196.5	0.0595
391.05	0.029	196.6	0.0595
391.07	0.029	196.7	0.0604
391.08	0.029	196.8	0.0604
391.10	0.029	196.8	0.0595
391.12	0.028	196.9	0.0586
391.13	0.026	196.9	0.0586
391.15	0.025	196.9	0.0568
391.17	0.025	197	0.0559
391.18	0.024	196.9	0.0541
391.20	0.023	196.9	0.0533
391.22	0.022	196.8	0.0506
391.23	0.02	196.7	0.0479
391.25	0.017	196.6	0.0479
391.27	0.016	196.5	0.0426
391.28	0.016	196.4	0.0408
391.30	0.012	196.2	0.0408
391.32	0.012	196.2	0.0373
391.33	0.012	196.1	0.0346
391.35	0.01	195.8	0.0302
391.37	0.005	195.6	0.0249
391.38	0.005	195.5	0.0222
391.40	0.003	195.2	0.0186
391.43	0	194.9	0.0186
391.45	-0.001	194.9	0.0142
391.47	-0.001	194.7	0.0107

Prova triassiale ciclica SN04-C1			
pressione di confinamento (kPa)		80	
deviatore ciclico (kPa)		95	
frequenza (hz)		0.00625	
tempo	cella di carico	$\Delta u$	LVDT
(min)	kN	(kPa)	$\delta$ (mm)
391.47	-0.003	194.4	0.0062
391.48	-0.006	194.1	0.0027
391.50	-0.007	193.9	0
391.52	-0.008	193.6	-0.0036
391.53	-0.011	193.4	-0.0036
391.55	-0.011	193.4	-0.0071
391.57	-0.011	193.2	-0.0089
391.58	-0.012	192.9	-0.0124
391.60	-0.015	192.6	-0.0142
391.62	-0.015	192.5	-0.016
391.63	-0.016	192.3	-0.0178
391.65	-0.017	192.1	-0.0178
391.67	-0.017	192.1	-0.0186
391.68	-0.017	191.9	-0.0195
391.70	-0.017	191.8	-0.0195
391.72	-0.017	191.7	-0.0204
391.73	-0.017	191.6	-0.0204
391.75	-0.017	191.5	-0.0204
391.77	-0.016	191.4	-0.0204
391.78	-0.016	191.4	-0.0195
391.80	-0.016	191.4	-0.0186
391.82	-0.015	191.4	-0.0169
391.83	-0.013	191.4	-0.016
391.85	-0.013	191.4	-0.0142
391.87	-0.011	191.5	-0.0115
391.88	-0.009	191.6	-0.0115
391.90	-0.008	191.6	-0.0098
391.92	-0.008	191.7	-0.008
391.93	-0.007	191.8	-0.0053
391.95	-0.004	192	-0.0018
391.97	-0.002	192.1	0.0009
391.98	-0.001	192.2	0.0044
392.00	0.001	192.4	0.0071
392.02	0.003	192.6	0.0098
392.03	0.004	192.8	0.0142
392.05	0.007	193.1	0.0142
392.07	0.01	193.3	0.0186
392.08	0.01	193.3	0.0222
392.10	0.011	193.5	0.0275
392.12	0.013	193.8	0.0311
392.13	0.016	194	0.0346
392.15	0.016	194.2	0.0373
392.17	0.019	194.5	0.0373
392.18	0.021	194.8	0.0417
392.20	0.021	194.8	0.0444
392.22	0.022	195	0.0479
392.23	0.023	195.2	0.0497
392.25	0.025	195.5	0.0524
392.27	0.026	195.7	0.0541
392.28	0.026	195.9	0.0559
392.30	0.028	196.1	0.0559
392.32	0.028	196.1	0.0577
392.33	0.028	196.2	0.0586
392.35	0.029	196.4	0.0595
392.37	0.029	196.5	0.0595
392.38	0.029	196.7	0.0604
392.40	0.028	196.8	0.0604
392.42	0.028	196.8	0.0604

Prova triassiale ciclica SN04-C1			
pressione di confinamento (kPa)		80	
deviatore ciclico (kPa)		95	
frequenza (hz)		0.00625	
tempo	cella di carico	$\Delta u$	LVDT
(min)	kN	(kPa)	$\delta$ (mm)
392.43	0.028	196.8	0.0604
392.45	0.028	196.9	0.0595
392.47	0.027	197	0.0586
392.48	0.026	196.9	0.0577
392.50	0.025	196.9	0.0559
392.52	0.024	196.9	0.0533
392.53	0.021	196.8	0.0533
392.55	0.021	196.8	0.0515
392.57	0.021	196.8	0.0506
392.58	0.02	196.7	0.0479
392.60	0.017	196.6	0.0444
392.62	0.016	196.5	0.0417
392.63	0.014	196.3	0.0382
392.65	0.01	196.1	0.0382
392.67	0.01	196.1	0.0346
392.68	0.01	195.9	0.032
392.70	0.008	195.7	0.0284
392.72	0.004	195.4	0.0231
392.73	0.004	195.2	0.0204
392.75	0.002	195	0.016
392.77	-0.001	194.8	0.0124
392.78	-0.002	194.6	0.0098
392.80	-0.004	194.3	0.0053
392.82	-0.007	194	0.0053
392.83	-0.008	194	0.0009
392.87	-0.008	193.7	-0.0009
392.88	-0.009	193.5	-0.0044
392.90	-0.012	193.2	-0.008
392.92	-0.012	193	-0.0098
392.93	-0.013	192.8	-0.0124
392.93	-0.015	192.5	-0.0124
392.95	-0.016	192.4	-0.0151
392.97	-0.016	192.4	-0.016
392.98	-0.016	192.2	-0.0169
393.00	-0.016	192	-0.0186
393.02	-0.017	191.8	-0.0195
393.03	-0.017	191.7	-0.0204
393.05	-0.017	191.6	-0.0204
393.07	-0.017	191.5	-0.0204
393.08	-0.017	191.5	-0.0204
393.10	-0.017	191.4	-0.0195
393.12	-0.016	191.4	-0.0186
393.13	-0.015	191.4	-0.0186
393.15	-0.015	191.4	-0.0169
393.17	-0.013	191.4	-0.0169
393.18	-0.012	191.4	-0.0151
393.20	-0.012	191.4	-0.0133
393.22	-0.011	191.4	-0.0107
393.23	-0.009	191.6	-0.0089
393.25	-0.007	191.7	-0.0062
393.27	-0.006	191.8	-0.0044
393.28	-0.004	192	-0.0044
393.30	-0.001	192.2	0
393.32	-0.001	192.2	0.0027
393.33	0	192.3	0.0062
393.35	0.003	192.6	0.0107
393.37	0.005	192.8	0.0142
393.38	0.006	192.9	0.0178

Prova triassiale ciclica SN04-C1			
pressione di confinamento (kPa)		80	
deviatore ciclico (kPa)		95	
frequenza (hz)		0.00625	
tempo	cella di carico	$\Delta u$	LVDT
(min)	kN	(kPa)	$\delta$ (mm)
393.40	0.009	193.2	0.0178
393.42	0.011	193.4	0.0222
393.43	0.011	193.4	0.0257
393.45	0.014	193.9	0.032
393.47	0.016	194.1	0.032
393.48	0.016	194.1	0.0355
393.50	0.017	194.3	0.0399
393.52	0.02	194.6	0.0435
393.53	0.022	194.9	0.0462
393.55	0.022	195.1	0.0479
393.57	0.024	195.4	0.0515
393.58	0.026	195.6	0.0515
393.60	0.026	195.6	0.0541
393.62	0.026	195.8	0.0559
393.63	0.027	196	0.0568
393.65	0.028	196.2	0.0586
393.67	0.028	196.3	0.0586
393.68	0.028	196.5	0.0595
393.70	0.029	196.6	0.0595
393.72	0.029	196.6	0.0604
393.73	0.029	196.7	0.0604
393.75	0.029	196.8	0.0604
393.77	0.029	196.9	0.0604
393.78	0.028	196.9	0.0595
393.80	0.027	197	0.0577
393.82	0.025	197	0.0577
393.83	0.025	197	0.0568
393.85	0.025	196.9	0.0559
393.87	0.024	196.9	0.0541
393.88	0.021	196.8	0.0515
393.90	0.02	196.8	0.0479
393.92	0.019	196.7	0.0453
393.93	0.015	196.5	0.0453
393.95	0.015	196.5	0.0426
393.97	0.015	196.4	0.0408
393.98	0.014	196.2	0.0373
394.00	0.01	196	0.0328
394.02	0.008	195.8	0.0293
394.03	0.007	195.6	0.0257
394.05	0.004	195.4	0.0257
394.07	0.002	195.4	0.0213
394.08	0.002	195.1	0.0186
394.10	0.001	194.8	0.0142
394.12	-0.002	194.5	0.0098
394.13	-0.004	194.3	0.0071
394.15	-0.005	194	0.0027
394.17	-0.008	193.8	-0.0018
394.18	-0.008	193.6	-0.0027
394.20	-0.01	193.3	-0.0062
394.22	-0.013	193.1	-0.0062
394.23	-0.013	193.1	-0.0098
394.25	-0.013	192.9	-0.0115
394.27	-0.014	192.7	-0.0133
394.28	-0.015	192.4	-0.0151
394.30	-0.016	192.2	-0.0169
394.33	-0.016	192.1	-0.0178
394.35	-0.017	191.9	-0.0178
394.37	-0.017	191.9	-0.0186

Prova triassiale ciclica SN04-C1			
pressione di confinamento (kPa)		80	
deviatore ciclico (kPa)		95	
frequenza (hz)		0.00625	
tempo	cella di carico	$\Delta u$	LVDT
(min)	kN	(kPa)	$\delta$ (mm)
394.38	-0.017	191.8	-0.0195
394.38	-0.017	191.6	-0.0195
394.40	-0.017	191.5	-0.0204
394.42	-0.017	191.5	-0.0204
394.43	-0.017	191.4	-0.0195
394.45	-0.015	191.4	-0.0195
394.47	-0.015	191.4	-0.0186
394.48	-0.015	191.4	-0.0169
394.50	-0.014	191.3	-0.016
394.52	-0.012	191.4	-0.0142
394.53	-0.012	191.4	-0.0124
394.55	-0.01	191.5	-0.0098
394.57	-0.007	191.6	-0.0098
394.58	-0.006	191.6	-0.0071
394.60	-0.006	191.7	-0.0053
394.62	-0.005	191.9	-0.0018
394.63	-0.002	192.1	0.0018
394.65	-0.001	192.2	0.0044
394.67	0.001	192.4	0.008
394.68	0.005	192.6	0.008
394.70	0.005	192.6	0.0124
394.72	0.005	192.8	0.0151
394.73	0.007	193	0.0195
394.75	0.012	193.3	0.0249
394.77	0.011	193.5	0.0275
394.78	0.013	193.8	0.032
394.80	0.017	194.1	0.032
394.82	0.017	194.1	0.0364
394.83	0.017	194.3	0.0391
394.85	0.02	194.5	0.0435
394.87	0.022	194.8	0.0462
394.88	0.023	195	0.0479
394.90	0.023	195.2	0.0506
394.92	0.024	195.5	0.0515
394.93	0.026	195.7	0.0541
394.95	0.027	195.9	0.0559
394.97	0.028	196.1	0.0559
394.98	0.028	196.2	0.0577
395.00	0.028	196.2	0.0586
395.02	0.029	196.4	0.0595
395.03	0.029	196.5	0.0604
395.05	0.029	196.6	0.0604
395.07	0.029	196.8	0.0604
395.08	0.028	196.8	0.0604
395.10	0.028	196.9	0.0604
395.12	0.028	196.9	0.0604
395.13	0.027	197	0.0586
395.15	0.026	196.9	0.0577
395.17	0.025	196.9	0.0559
395.18	0.024	196.9	0.0541
395.20	0.023	196.8	0.0541
395.22	0.02	196.8	0.0524
395.23	0.02	196.8	0.0497
395.25	0.019	196.7	0.047
395.27	0.017	196.6	0.0444
395.28	0.015	196.4	0.0417
395.30	0.014	196.3	0.0382
395.32	0.012	196.1	0.0382

Prova triassiale ciclica SN04-C1			
pressione di confinamento (kPa)		80	
deviatore ciclico (kPa)		95	
frequenza (hz)		0.00625	
tempo	cella di carico	$\Delta u$	LVDT
(min)	kN	(kPa)	$\delta$ (mm)
395.33	0.009	195.9	0.0346
395.35	0.009	195.9	0.032
395.37	0.008	195.7	0.0275
395.38	0.005	195.4	0.0231
395.40	0.002	195.2	0.0195
395.42	0.001	195	0.016
395.43	-0.001	194.7	0.0115
395.45	-0.003	194.4	0.0115
395.47	-0.003	194.4	0.008
395.48	-0.004	194.2	0.0036
395.50	-0.006	193.9	0
395.52	-0.009	193.6	-0.0036
395.53	-0.01	193.4	-0.0062
395.55	-0.011	193.1	-0.0089
395.57	-0.013	192.9	-0.0089
395.58	-0.014	192.9	-0.0115
395.60	-0.014	192.7	-0.0124
395.62	-0.016	192.3	-0.0151
395.63	-0.016	192.3	-0.016
395.65	-0.016	192.1	-0.0169
395.67	-0.016	192	-0.0186
395.68	-0.017	191.8	-0.0195
395.70	-0.017	191.7	-0.0195
395.72	-0.017	191.6	-0.0195
395.73	-0.017	191.5	-0.0195
395.77	-0.017	191.5	-0.0195
395.78	-0.017	191.4	-0.0195
395.80	-0.016	191.4	-0.0186
395.82	-0.015	191.4	-0.0178
395.83	-0.014	191.3	-0.0169
395.83	-0.014	191.3	-0.0151
395.85	-0.012	191.4	-0.0151
395.87	-0.011	191.4	-0.0133
395.88	-0.011	191.4	-0.0115
395.90	-0.009	191.5	-0.0089
395.92	-0.007	191.7	-0.0062
395.93	-0.005	191.8	-0.0036
395.95	-0.004	191.9	-0.0009
395.97	-0.001	192.1	-0.0009
395.98	0	192.3	0.0027
396.00	0	192.3	0.0053
396.02	0.002	192.4	0.0098
396.03	0.005	192.7	0.0142
396.05	0.007	192.9	0.0169
396.07	0.008	193.1	0.0204
396.08	0.011	193.4	0.0204
396.10	0.013	193.6	0.0257
396.12	0.013	193.6	0.0302
396.13	0.014	193.8	0.0337
396.15	0.017	194.1	0.0373
396.17	0.018	194.4	0.0399
396.18	0.02	194.6	0.0435
396.20	0.022	194.9	0.0435
396.22	0.024	195.1	0.047
396.23	0.024	195.1	0.0497
396.25	0.024	195.3	0.0524
396.27	0.026	195.6	0.0541
396.28	0.027	195.8	0.0559

Prova triassiale ciclica SN04-C1			
pressione di confinamento (kPa)		80	
deviatore ciclico (kPa)		95	
frequenza (hz)		0.00625	
tempo	cella di carico	$\Delta u$	LVDT
(min)	kN	(kPa)	$\delta$ (mm)
396.30	0.027	196	0.0568
396.32	0.028	196.1	0.0586
396.33	0.028	196.3	0.0586
396.35	0.029	196.5	0.0604
396.37	0.029	196.6	0.0604
396.38	0.029	196.7	0.0604
396.40	0.028	196.7	0.0604
396.42	0.028	196.8	0.0604
396.43	0.028	196.9	0.0604
396.45	0.028	196.9	0.0604
396.47	0.027	196.9	0.0586
396.48	0.026	196.9	0.0568
396.50	0.024	196.9	0.0568
396.52	0.023	196.9	0.055
396.53	0.023	196.9	0.0533
396.55	0.022	196.9	0.0515
396.57	0.02	196.8	0.0497
396.58	0.019	196.7	0.047
396.60	0.017	196.5	0.0435
396.62	0.014	196.3	0.0435
396.63	0.013	196.3	0.0399
396.65	0.013	196.2	0.0373
396.67	0.011	196	0.0337
396.68	0.007	195.8	0.0293
396.70	0.007	195.7	0.0257
396.72	0.005	195.3	0.0222
396.73	0.001	195.1	0.0222
396.75	0.001	195.1	0.0178
396.77	0.001	194.9	0.0142
396.78	-0.001	194.6	0.0107
396.80	-0.004	194.3	0.0062
396.82	-0.005	194.1	0.0036
396.83	-0.006	193.8	0
396.85	-0.01	193.5	0
396.87	-0.01	193.5	-0.0044
396.88	-0.01	193.3	-0.0062
396.90	-0.011	193.1	-0.0098
396.92	-0.014	192.8	-0.0124
396.93	-0.014	192.6	-0.0133
396.95	-0.015	192.4	-0.016
396.97	-0.016	192.2	-0.016
396.98	-0.017	192.2	-0.0169
397.00	-0.017	192	-0.0178
397.02	-0.017	191.9	-0.0186
397.03	-0.017	191.8	-0.0195
397.05	-0.017	191.6	-0.0204
397.07	-0.017	191.5	-0.0204
397.08	-0.017	191.4	-0.0204
397.10	-0.016	191.4	-0.0195
397.12	-0.016	191.3	-0.0186
397.13	-0.015	191.3	-0.0186
397.15	-0.014	191.3	-0.0178
397.17	-0.014	191.3	-0.016
397.18	-0.013	191.3	-0.0142
397.20	-0.011	191.4	-0.0124
397.23	-0.01	191.5	-0.0107
397.25	-0.009	191.5	-0.008
397.27	-0.006	191.7	-0.008

Prova triassiale ciclica SN04-C1			
pressione di confinamento (kPa)		80	
deviatore ciclico (kPa)		95	
frequenza (hz)		0.00625	
tempo	cella di carico	$\Delta u$	LVDT
(min)	kN	(kPa)	$\delta$ (mm)
397.28	-0.005	191.8	-0.0053
397.28	-0.005	191.8	-0.0027
397.30	-0.003	191.9	0.0009
397.32	0	192.2	0.0044
397.33	0.001	192.4	0.0071
397.35	0.003	192.5	0.0115
397.37	0.005	192.8	0.0115
397.38	0.008	193	0.0151
397.40	0.008	193	0.0186
397.42	0.009	193.2	0.0231
397.43	0.012	193.5	0.0284
397.45	0.014	193.8	0.032
397.47	0.015	193.9	0.0346
397.48	0.017	194.3	0.0346
397.50	0.02	194.5	0.0391
397.52	0.02	194.5	0.0417
397.53	0.021	194.7	0.0453
397.55	0.022	195	0.0479
397.57	0.024	195.2	0.0506
397.58	0.025	195.4	0.0524
397.60	0.026	195.7	0.0541
397.62	0.027	195.9	0.0541
397.63	0.027	195.9	0.0568
397.65	0.028	196	0.0577
397.67	0.028	196.2	0.0595
397.68	0.029	196.4	0.0595
397.70	0.029	196.5	0.0595
397.72	0.028	196.6	0.0604
397.73	0.028	196.7	0.0604
397.75	0.028	196.7	0.0604
397.77	0.028	196.8	0.0604
397.78	0.028	196.9	0.0604
397.80	0.026	196.9	0.0586
397.82	0.026	196.9	0.0586
397.83	0.026	196.9	0.0568
397.85	0.023	196.9	0.0541
397.87	0.023	196.9	0.0533
397.88	0.022	196.8	0.0506
397.90	0.019	196.7	0.0506
397.92	0.018	196.7	0.0479
397.93	0.018	196.6	0.0453
397.95	0.016	196.4	0.0417
397.97	0.013	196.3	0.0391
397.98	0.012	196.2	0.0364
398.00	0.011	195.9	0.032
398.02	0.007	195.7	0.032
398.03	0.006	195.7	0.0284
398.05	0.006	195.5	0.0249
398.07	0.004	195.2	0.0204
398.08	0.001	195	0.016
398.10	0	194.8	0.0133
398.12	-0.002	194.5	0.0089
398.13	-0.005	194.2	0.0089
398.15	-0.006	194.2	0.0044
398.17	-0.006	194	0.0018
398.18	-0.007	193.7	-0.0018
398.20	-0.01	193.4	-0.0053
398.22	-0.011	193.2	-0.008



Prova triassiale ciclica SN04-C1			
pressione di confinamento (kPa)		80	
deviatore ciclico (kPa)		95	
frequenza (hz)		0.00625	
tempo	cella di carico	$\Delta u$	LVDT
(min)	kN	(kPa)	$\delta$ (mm)
398.23	-0.012	193	-0.0107
398.25	-0.014	192.7	-0.0107
398.27	-0.015	192.5	-0.0133
398.28	-0.015	192.5	-0.0151
398.30	-0.015	192.3	-0.016
398.32	-0.016	192.1	-0.0169
398.33	-0.017	191.9	-0.0186
398.35	-0.017	191.8	-0.0195
398.37	-0.017	191.7	-0.0195
398.38	-0.017	191.6	-0.0204
398.40	-0.017	191.6	-0.0204
398.42	-0.017	191.4	-0.0195
398.43	-0.017	191.4	-0.0195
398.45	-0.016	191.4	-0.0186
398.47	-0.015	191.3	-0.0178
398.48	-0.014	191.4	-0.0178
398.50	-0.013	191.4	-0.016
398.52	-0.013	191.4	-0.0151
398.53	-0.011	191.4	-0.0124
398.55	-0.01	191.5	-0.0124
398.57	-0.01	191.5	-0.0107
398.58	-0.008	191.6	-0.0071
398.60	-0.006	191.8	-0.0044
398.62	-0.004	191.9	-0.0009
398.63	-0.002	192	0.0018
398.65	0	192.3	0.0053
398.68	0.002	192.4	0.0053
398.70	0.002	192.4	0.0089
398.72	0.004	192.6	0.0133
398.73	0.006	192.9	0.0169
398.73	0.009	193.1	0.0204
398.75	0.01	193.3	0.0249
398.77	0.012	193.6	0.0293
398.78	0.015	193.8	0.0293
398.80	0.016	193.8	0.0328
398.82	0.016	194.1	0.0364
398.83	0.018	194.3	0.0399
398.85	0.02	194.6	0.0435
398.87	0.021	194.8	0.0462
398.88	0.022	195	0.0479
398.90	0.024	195.2	0.0479
398.92	0.025	195.2	0.0515
398.93	0.025	195.5	0.0533
398.95	0.026	195.7	0.055
398.97	0.028	195.9	0.0577
398.98	0.028	196.1	0.0577
399.00	0.028	196.3	0.0595
399.02	0.029	196.4	0.0595
399.03	0.029	196.4	0.0604
399.05	0.029	196.5	0.0604
399.07	0.029	196.6	0.0604
399.08	0.029	196.7	0.0604
399.10	0.028	196.8	0.0604
399.12	0.028	196.9	0.0586
399.13	0.026	196.9	0.0586
399.15	0.025	196.9	0.0577
399.17	0.025	196.9	0.0568
399.18	0.024	196.9	0.055

Prova triassiale ciclica SN04-C1			
pressione di confinamento (kPa)		80	
deviatore ciclico (kPa)		95	
frequenza (hz)		0.00625	
tempo	cella di carico	$\Delta u$	LVDT
(min)	kN	(kPa)	$\delta$ (mm)
399.20	0.023	196.8	0.0533
399.22	0.021	196.8	0.0506
399.23	0.02	196.7	0.0479
399.25	0.017	196.5	0.0453
399.27	0.017	196.5	0.0444
399.28	0.016	196.4	0.0399
399.30	0.012	196.2	0.0399
399.32	0.011	196.2	0.0373
399.33	0.011	196	0.0346
399.35	0.01	195.9	0.0311
399.37	0.006	195.6	0.0257
399.38	0.005	195.4	0.0231
399.40	0.004	195.1	0.0195
399.42	0	194.8	0.0195
399.43	-0.001	194.6	0.0142
399.45	-0.001	194.6	0.0115
399.47	-0.002	194.4	0.008
399.48	-0.006	194.1	0.0027
399.50	-0.007	193.8	0
399.52	-0.008	193.6	-0.0036
399.53	-0.01	193.3	-0.0036
399.55	-0.012	193.1	-0.0071
399.57	-0.012	193.1	-0.0089
399.58	-0.013	192.8	-0.0115
399.60	-0.014	192.6	-0.0142
399.62	-0.015	192.4	-0.0151
399.63	-0.016	192.2	-0.0169
399.65	-0.016	192	-0.0169
399.67	-0.017	191.9	-0.0186
399.68	-0.017	191.9	-0.0195
399.70	-0.017	191.7	-0.0195
399.72	-0.017	191.6	-0.0195
399.73	-0.017	191.5	-0.0195
399.75	-0.017	191.4	-0.0195
399.77	-0.017	191.4	-0.0195
399.78	-0.015	191.3	-0.0195
399.80	-0.015	191.3	-0.0186
399.82	-0.015	191.3	-0.0178
399.83	-0.014	191.3	-0.016
399.85	-0.012	191.4	-0.0142
399.87	-0.011	191.4	-0.0124
399.88	-0.01	191.5	-0.0107
399.90	-0.007	191.6	-0.0107
399.92	-0.007	191.6	-0.008
399.93	-0.007	191.7	-0.0053
399.95	-0.005	191.9	-0.0018
399.97	-0.002	192	0.0018
399.98	-0.001	192.2	0.0044
400.00	0	192.3	0.0062
400.02	0.003	192.5	0.0098
400.03	0.004	192.7	0.0133
400.05	0.006	192.9	0.0178
400.07	0.01	193.2	0.0178
400.08	0.011	193.2	0.0222
400.10	0.011	193.4	0.0249
400.13	0.012	193.7	0.0302
400.15	0.016	193.9	0.0346
400.17	0.017	194.1	0.0373

Prova triassiale ciclica SN04-C1			
pressione di confinamento (kPa)		80	
deviatore ciclico (kPa)		95	
frequenza (hz)		0.00625	
tempo	cella di carico	$\Delta u$	LVDT
(min)	kN	(kPa)	$\delta$ (mm)
400.18	0.018	194.4	0.0408
400.18	0.021	194.6	0.0408
400.20	0.022	194.6	0.0444
400.22	0.022	194.9	0.047
400.23	0.023	195.1	0.0488
400.25	0.025	195.3	0.0524
400.27	0.026	195.6	0.0541
400.28	0.026	195.8	0.0559
400.30	0.027	196	0.0559
400.32	0.028	196.2	0.0577
400.33	0.028	196.2	0.0586
400.35	0.028	196.3	0.0586
400.37	0.029	196.4	0.0595
400.38	0.029	196.5	0.0604
400.40	0.029	196.7	0.0604
400.42	0.029	196.8	0.0604
400.43	0.028	196.8	0.0604
400.45	0.028	196.8	0.0604
400.47	0.027	196.9	0.0586
400.48	0.026	196.8	0.0568
400.50	0.025	196.8	0.0559
400.52	0.024	196.8	0.0541
400.53	0.022	196.7	0.0541
400.55	0.02	196.7	0.0515
400.57	0.02	196.7	0.0497
400.58	0.019	196.6	0.047
400.60	0.017	196.4	0.0444
400.62	0.015	196.3	0.0417
400.63	0.014	196.2	0.0382
400.65	0.012	196	0.0346
400.67	0.009	195.8	0.0346
400.68	0.009	195.8	0.0311
400.70	0.006	195.4	0.0249
400.72	0.004	195.2	0.0249
400.73	0.004	195.2	0.0222
400.75	0.003	195	0.0169
400.77	0	194.7	0.0133
400.78	-0.003	194.4	0.0089
400.80	-0.004	194.2	0.0053
400.82	-0.005	193.9	0.0027
400.83	-0.008	193.7	0.0027
400.85	-0.009	193.7	-0.0018
400.87	-0.009	193.5	-0.0044
400.88	-0.01	193.2	-0.0071
400.90	-0.012	192.9	-0.0098
400.92	-0.014	192.7	-0.0124
400.93	-0.014	192.5	-0.0142
400.95	-0.016	192.3	-0.0142
400.97	-0.016	192.3	-0.016
400.98	-0.016	192.1	-0.0169
401.00	-0.016	191.9	-0.0186
401.02	-0.017	191.8	-0.0195
401.03	-0.017	191.6	-0.0195
401.05	-0.017	191.5	-0.0195
401.07	-0.017	191.4	-0.0195
401.08	-0.017	191.4	-0.0195
401.10	-0.017	191.4	-0.0195
401.12	-0.016	191.3	-0.0186

Prova triassiale ciclica SN04-C1			
pressione di confinamento (kPa)		80	
deviatore ciclico (kPa)		95	
frequenza (hz)		0.00625	
tempo	cella di carico	$\Delta u$	LVDT
(min)	kN	(kPa)	$\delta$ (mm)
401.13	-0.015	191.3	-0.0178
401.15	-0.014	191.3	-0.0169
401.17	-0.014	191.3	-0.0151
401.18	-0.012	191.3	-0.0151
401.20	-0.011	191.3	-0.0133
401.22	-0.011	191.4	-0.0115
401.23	-0.009	191.5	-0.0089
401.25	-0.007	191.6	-0.0062
401.27	-0.006	191.7	-0.0036
401.28	-0.004	191.8	-0.0009
401.30	-0.001	192.1	-0.0009
401.32	0	192.2	0.0027
401.33	0	192.2	0.0062
401.35	0.002	192.4	0.0098
401.37	0.005	192.7	0.0142
401.38	0.006	192.8	0.0169
401.40	0.008	193	0.0213
401.42	0.011	193.4	0.0213
401.43	0.013	193.6	0.0302
401.45	0.014	193.8	0.032
401.47	0.016	194	0.032
401.48	0.018	194.3	0.0355
401.50	0.018	194.3	0.0391
401.52	0.019	194.5	0.0426
401.53	0.021	194.8	0.0453
401.55	0.023	195	0.0479
401.57	0.023	195.2	0.0506
401.60	0.025	195.5	0.0533
401.62	0.026	195.7	0.0533
401.63	0.027	195.7	0.055
401.65	0.027	195.9	0.0568
401.65	0.027	196.1	0.0577
401.67	0.028	196.2	0.0586
401.68	0.029	196.4	0.0595
401.70	0.029	196.5	0.0604
401.72	0.029	196.6	0.0604
401.73	0.029	196.6	0.0604
401.75	0.029	196.7	0.0604
401.77	0.028	196.8	0.0604
401.78	0.028	196.8	0.0595
401.80	0.027	196.9	0.0586
401.82	0.026	196.9	0.0568
401.83	0.025	196.9	0.0568
401.85	0.023	196.9	0.0559
401.87	0.023	196.8	0.0541
401.88	0.022	196.8	0.0515
401.90	0.02	196.7	0.0497
401.92	0.019	196.6	0.047
401.93	0.017	196.4	0.0435
401.95	0.014	196.3	0.0435
401.97	0.013	196.3	0.0408
401.98	0.013	196.2	0.0382
402.00	0.012	196	0.0337
402.02	0.007	195.7	0.0293
402.03	0.007	195.6	0.0257
402.05	0.005	195.3	0.0222
402.07	0.001	195	0.0222
402.08	0.001	195	0.0178

Prova triassiale ciclica SN04-C1			
pressione di confinamento (kPa)		80	
deviatore ciclico (kPa)		95	
frequenza (hz)		0.00625	
tempo	cella di carico	$\Delta u$	LVDT
(min)	kN	(kPa)	$\delta$ (mm)
402.10	0.001	194.8	0.0142
402.12	-0.001	194.6	0.0107
402.13	-0.004	194.3	0.0062
402.15	-0.005	194	0.0036
402.17	-0.007	193.8	0.0009
402.18	-0.008	193.6	-0.0018
402.20	-0.009	193.4	-0.0044
402.22	-0.011	193.1	-0.008
402.23	-0.013	192.8	-0.008
402.25	-0.014	192.6	-0.0107
402.27	-0.014	192.6	-0.0124
402.28	-0.014	192.4	-0.0151
402.30	-0.016	192.2	-0.0169
402.32	-0.016	192	-0.0178
402.33	-0.017	191.9	-0.0186
402.35	-0.017	191.7	-0.0186
402.37	-0.017	191.6	-0.0195
402.38	-0.017	191.6	-0.0195
402.40	-0.017	191.5	-0.0204
402.42	-0.017	191.4	-0.0195
402.43	-0.016	191.3	-0.0195
402.45	-0.016	191.3	-0.0186
402.47	-0.015	191.3	-0.0178
402.48	-0.014	191.3	-0.0178
402.50	-0.013	191.3	-0.0169
402.52	-0.013	191.3	-0.0151
402.53	-0.012	191.3	-0.0133
402.55	-0.01	191.4	-0.0107
402.57	-0.009	191.5	-0.0089
402.58	-0.007	191.6	-0.0062
402.60	-0.004	191.8	-0.0062
402.62	-0.003	191.8	-0.0027
402.63	-0.003	191.9	0.0009
402.65	-0.002	192.1	0.0044
402.67	0.002	192.3	0.008
402.68	0.003	192.5	0.0107
402.70	0.004	192.7	0.0151
402.72	0.008	193	0.0151
402.73	0.009	193	0.0186
402.75	0.009	193.1	0.0222
402.77	0.011	193.4	0.0275
402.78	0.014	193.7	0.0311
402.80	0.015	193.9	0.0346
402.82	0.017	194.1	0.0382
402.83	0.02	194.4	0.0382
402.85	0.02	194.4	0.0417
402.87	0.02	194.6	0.0444
402.88	0.023	195.1	0.0479
402.90	0.024	195.1	0.0497
402.92	0.024	195.3	0.0515
402.93	0.025	195.5	0.0541
402.95	0.027	195.8	0.0559
402.97	0.027	196	0.0577
402.98	0.028	196.1	0.0586
403.00	0.028	196.3	0.0586
403.03	0.029	196.4	0.0595
403.05	0.029	196.4	0.0595
403.07	0.029	196.5	0.0604

Prova triassiale ciclica SN04-C1			
pressione di confinamento (kPa)		80	
deviatore ciclico (kPa)		95	
frequenza (hz)		0.00625	
tempo	cella di carico	$\Delta u$	LVDT
(min)	kN	(kPa)	$\delta$ (mm)
403.08	0.029	196.6	0.0604
403.10	0.029	196.7	0.0604
403.10	0.028	196.8	0.0604
403.12	0.028	196.9	0.0595
403.13	0.026	196.9	0.0595
403.15	0.026	196.9	0.0577
403.17	0.026	196.9	0.0568
403.18	0.024	196.8	0.055
403.20	0.022	196.8	0.0524
403.22	0.022	196.8	0.0506
403.23	0.02	196.6	0.0479
403.25	0.017	196.5	0.0479
403.27	0.017	196.5	0.0453
403.28	0.017	196.4	0.0426
403.30	0.014	196.2	0.0391
403.32	0.012	196.1	0.0364
403.33	0.01	195.9	0.0328
403.35	0.008	195.6	0.0284
403.37	0.005	195.4	0.0284
403.38	0.005	195.4	0.024
403.40	0.004	195.2	0.0213
403.42	0.002	194.9	0.016
403.43	-0.001	194.7	0.0124
403.45	-0.002	194.5	0.0098
403.47	-0.004	194.1	0.0053
403.48	-0.006	193.9	0.0053
403.50	-0.007	193.9	0.0018
403.52	-0.007	193.7	-0.0009
403.53	-0.009	193.4	-0.0053
403.55	-0.012	193.1	-0.0089
403.57	-0.012	192.9	-0.0098
403.58	-0.013	192.7	-0.0124
403.60	-0.015	192.4	-0.0124
403.62	-0.015	192.3	-0.016
403.63	-0.016	192.1	-0.0169
403.65	-0.017	191.9	-0.0169
403.67	-0.017	191.9	-0.0186
403.68	-0.017	191.8	-0.0186
403.70	-0.017	191.6	-0.0195
403.72	-0.017	191.5	-0.0204
403.73	-0.017	191.4	-0.0204
403.75	-0.017	191.4	-0.0195
403.77	-0.016	191.3	-0.0195
403.78	-0.015	191.3	-0.0186
403.80	-0.015	191.3	-0.0178
403.82	-0.015	191.2	-0.0178
403.83	-0.014	191.3	-0.016
403.85	-0.012	191.3	-0.0142
403.87	-0.012	191.4	-0.0124
403.88	-0.009	191.5	-0.0124
403.90	-0.008	191.5	-0.0098
403.92	-0.008	191.5	-0.008
403.93	-0.007	191.7	-0.0044
403.95	-0.003	191.8	-0.0009
403.97	-0.002	192	0.0018
403.98	-0.001	192.2	0.0053
404.00	0.003	192.4	0.0053
404.02	0.004	192.4	0.0089

Prova triassiale ciclica SN04-C1			
pressione di confinamento (kPa)		80	
deviatore ciclico (kPa)		95	
frequenza (hz)		0.00625	
tempo	cella di carico	$\Delta u$	LVDT
(min)	kN	(kPa)	$\delta$ (mm)
404.03	0.004	192.5	0.0124
404.05	0.005	192.8	0.016
404.07	0.009	193.1	0.0213
404.08	0.01	193.2	0.024
404.10	0.012	193.5	0.0293
404.12	0.015	193.8	0.0293
404.13	0.016	193.8	0.0328
404.15	0.016	194	0.0364
404.17	0.017	194.2	0.0399
404.18	0.021	194.5	0.0435
404.20	0.021	194.7	0.0453
404.22	0.022	194.9	0.0488
404.23	0.025	195.2	0.0488
404.25	0.025	195.2	0.0515
404.27	0.025	195.4	0.0533
404.28	0.026	195.6	0.055
404.30	0.027	195.9	0.0568
404.32	0.028	196	0.0577
404.33	0.028	196.2	0.0595
404.35	0.029	196.3	0.0595
404.37	0.029	196.5	0.0604
404.38	0.029	196.6	0.0604
404.40	0.029	196.7	0.0604
404.42	0.028	196.8	0.0604
404.43	0.028	196.8	0.0604
404.45	0.028	196.8	0.0595
404.47	0.027	196.8	0.0586
404.50	0.025	196.8	0.0568
404.52	0.025	196.9	0.0559
404.53	0.024	196.8	0.0541
404.55	0.022	196.8	0.0541
404.55	0.021	196.8	0.0524
404.57	0.021	196.7	0.0506
404.58	0.02	196.6	0.0479
404.60	0.017	196.4	0.0444
404.62	0.016	196.3	0.0417
404.63	0.014	196.1	0.0382
404.65	0.01	196	0.0382
404.67	0.01	196	0.0346
404.68	0.01	195.8	0.032
404.70	0.008	195.6	0.0284
404.72	0.004	195.3	0.0231
404.73	0.003	195.1	0.0195
404.75	0.002	194.8	0.0151
404.77	-0.002	194.6	0.0151
404.78	-0.003	194.6	0.0107
404.80	-0.003	194.4	0.008
404.82	-0.004	194.1	0.0044
404.83	-0.007	193.8	0
404.85	-0.008	193.6	-0.0027
404.87	-0.01	193.3	-0.0062
404.88	-0.012	193	-0.0062
404.90	-0.013	193	-0.0089
404.92	-0.013	192.8	-0.0107
404.93	-0.014	192.6	-0.0133
404.95	-0.015	192.4	-0.0151
404.97	-0.016	192.2	-0.0169
404.98	-0.016	192	-0.0178

Prova triassiale ciclica SN04-C1			
pressione di confinamento (kPa)		80	
deviatore ciclico (kPa)		95	
frequenza (hz)		0.00625	
tempo	cella di carico	$\Delta u$	LVDT
(min)	kN	(kPa)	$\delta$ (mm)
405.00	-0.017	191.8	-0.0178
405.02	-0.017	191.8	-0.0186
405.03	-0.017	191.7	-0.0195
405.05	-0.017	191.6	-0.0195
405.07	-0.017	191.4	-0.0195
405.08	-0.017	191.4	-0.0195
405.10	-0.017	191.3	-0.0195
405.12	-0.016	191.2	-0.0186
405.13	-0.015	191.2	-0.0178
405.15	-0.015	191.2	-0.0169
405.17	-0.013	191.3	-0.0169
405.18	-0.012	191.3	-0.0151
405.20	-0.012	191.3	-0.0133
405.22	-0.011	191.3	-0.0115
405.23	-0.009	191.5	-0.0089
405.25	-0.007	191.6	-0.0062
405.27	-0.006	191.7	-0.0027
405.28	-0.003	191.9	-0.0027
405.30	-0.001	192.1	0.0009
405.32	-0.001	192.1	0.0036
405.33	0	192.2	0.0062
405.35	0.002	192.4	0.0107
405.37	0.005	192.7	0.0142
405.38	0.006	192.8	0.0178
405.40	0.009	193.1	0.0222
405.42	0.012	193.3	0.0222
405.43	0.013	193.3	0.0257
405.45	0.013	193.5	0.0302
405.47	0.015	193.8	0.0337
405.48	0.017	194.1	0.0373
405.50	0.018	194.3	0.0408
405.52	0.02	194.6	0.0435
405.53	0.022	194.8	0.0435
405.55	0.023	194.8	0.0479
405.57	0.023	195	0.0497
405.58	0.024	195.2	0.0524
405.60	0.026	195.5	0.055
405.62	0.026	195.7	0.0559
405.63	0.027	195.9	0.0568
405.65	0.028	196.1	0.0568
405.67	0.028	196.1	0.0586
405.68	0.028	196.2	0.0595
405.70	0.029	196.4	0.0595
405.72	0.029	196.5	0.0604
405.73	0.028	196.6	0.0604
405.75	0.028	196.7	0.0604
405.77	0.028	196.8	0.0604
405.78	0.028	196.8	0.0595
405.80	0.027	196.9	0.0586
405.82	0.026	196.8	0.0586
405.83	0.024	196.8	0.0568
405.85	0.024	196.8	0.0559
405.87	0.024	196.8	0.0541
405.88	0.021	196.7	0.0515
405.90	0.02	196.7	0.0497
405.93	0.019	196.6	0.0462
405.95	0.016	196.4	0.0462
405.97	0.015	196.4	0.0435



Prova triassiale ciclica SN04-C1			
pressione di confinamento (kPa)		80	
deviatore ciclico (kPa)		95	
frequenza (hz)		0.00625	
tempo	cella di carico	$\Delta u$	LVDT
(min)	kN	(kPa)	$\delta$ (mm)
405.98	0.015	196.3	0.0408
406.00	0.013	196.1	0.0373
406.00	0.01	195.9	0.0337
406.02	0.008	195.7	0.0311
406.03	0.007	195.5	0.0257
406.05	0.004	195.2	0.0257
406.07	0.002	195	0.0213
406.08	0.002	195	0.0178
406.10	0.001	194.8	0.0133
406.12	-0.003	194.4	0.0098
406.13	-0.004	194.2	0.0062
406.15	-0.005	194	0.0027
406.17	-0.008	193.7	0.0027
406.18	-0.009	193.4	-0.0009
406.20	-0.009	193.4	-0.0036
406.22	-0.01	193.2	-0.0071
406.23	-0.012	192.9	-0.0098
406.25	-0.014	192.7	-0.0115
406.27	-0.014	192.5	-0.0133
406.28	-0.015	192.3	-0.0133
406.30	-0.016	192.1	-0.0151
406.32	-0.016	192.1	-0.0178
406.33	-0.017	191.9	-0.0186
406.35	-0.017	191.8	-0.0186
406.37	-0.017	191.6	-0.0195
406.38	-0.017	191.5	-0.0195
406.40	-0.017	191.4	-0.0195
406.42	-0.017	191.3	-0.0195
406.43	-0.017	191.3	-0.0195
406.45	-0.016	191.3	-0.0186
406.47	-0.016	191.3	-0.0178
406.48	-0.014	191.3	-0.0169
406.50	-0.013	191.2	-0.0151
406.52	-0.012	191.3	-0.0142
406.53	-0.012	191.3	-0.0124
406.55	-0.01	191.4	-0.0098
406.57	-0.008	191.5	-0.0098
406.58	-0.006	191.6	-0.0071
406.60	-0.006	191.6	-0.0053
406.62	-0.005	191.7	-0.0018
406.63	-0.003	192	0.0018
406.65	0	192.1	0.0053
406.67	0.001	192.2	0.0089
406.68	0.003	192.5	0.0124
406.70	0.006	192.7	0.0124
406.72	0.006	192.7	0.016
406.73	0.007	192.9	0.0195
406.75	0.01	193.2	0.0231
406.77	0.012	193.5	0.0284
406.78	0.013	193.6	0.032
406.80	0.015	193.9	0.0355
406.82	0.019	194.2	0.0355
406.83	0.019	194.2	0.0399
406.85	0.019	194.4	0.0417
406.87	0.02	194.7	0.0453
406.88	0.023	194.9	0.0488
406.90	0.024	195.1	0.0506
406.92	0.024	195.4	0.0533

Prova triassiale ciclica SN04-C1			
pressione di confinamento (kPa)		80	
deviatore ciclico (kPa)		95	
frequenza (hz)		0.00625	
tempo	cella di carico	$\Delta u$	LVDT
(min)	kN	(kPa)	$\delta$ (mm)
406.93	0.026	195.6	0.0533
406.95	0.027	195.6	0.055
406.97	0.027	195.8	0.0568
406.98	0.027	196	0.0577
407.00	0.028	196.1	0.0595
407.02	0.029	196.3	0.0604
407.03	0.029	196.4	0.0604
407.05	0.029	196.5	0.0604
407.07	0.029	196.5	0.0604
407.08	0.029	196.6	0.0604
407.10	0.028	196.7	0.0604
407.12	0.028	196.8	0.0595
407.13	0.027	196.8	0.0586
407.15	0.026	196.8	0.0568
407.17	0.024	196.8	0.0568
407.18	0.023	196.8	0.055
407.20	0.023	196.7	0.0541
407.22	0.023	196.7	0.0524
407.23	0.02	196.6	0.0497
407.25	0.019	196.5	0.047
407.27	0.018	196.5	0.0453
407.28	0.015	196.3	0.0426
407.30	0.014	196.2	0.0399
407.32	0.012	196	0.0355
407.33	0.009	195.8	0.0355
407.35	0.007	195.8	0.032
407.37	0.007	195.6	0.0293
407.40	0.006	195.4	0.024
407.42	0.002	195.1	0.0195
407.43	0.001	194.9	0.0169
407.45	0	194.6	0.0124
407.45	-0.004	194.3	0.0124
407.47	-0.005	194.1	0.008
407.48	-0.005	194.1	0.0053
407.50	-0.006	193.8	0.0018
407.52	-0.009	193.5	-0.0027
407.53	-0.01	193.3	-0.0053
407.55	-0.011	193.1	-0.008
407.57	-0.013	192.8	-0.008
407.58	-0.014	192.6	-0.0107
407.60	-0.014	192.6	-0.0124
407.62	-0.014	192.4	-0.0151
407.63	-0.016	192.2	-0.0169
407.65	-0.017	192	-0.0178
407.67	-0.017	191.8	-0.0186
407.68	-0.017	191.7	-0.0186
407.70	-0.017	191.6	-0.0195
407.72	-0.017	191.6	-0.0195
407.73	-0.017	191.5	-0.0195
407.75	-0.017	191.4	-0.0195
407.77	-0.016	191.3	-0.0195
407.78	-0.016	191.2	-0.0186
407.80	-0.015	191.2	-0.0169
407.82	-0.014	191.2	-0.0169
407.83	-0.014	191.2	-0.016
407.85	-0.013	191.2	-0.0142
407.87	-0.012	191.3	-0.0124
407.88	-0.01	191.4	-0.0107

Prova triassiale ciclica SN04-C1			
pressione di confinamento (kPa)		80	
deviatore ciclico (kPa)		95	
frequenza (hz)		0.00625	
tempo	cella di carico	$\Delta u$	LVDT
(min)	kN	(kPa)	$\delta$ (mm)
407.90	-0.009	191.5	-0.008
407.92	-0.007	191.6	-0.0053
407.93	-0.005	191.8	-0.0053
407.95	-0.003	191.8	-0.0027
407.97	-0.002	192	0.0027
407.98	0	192.2	0.0027
408.00	0.002	192.2	0.0053
408.02	0.002	192.3	0.0089
408.03	0.003	192.6	0.0133
408.05	0.007	192.8	0.0178
408.07	0.008	193	0.0213
408.08	0.01	193.3	0.0257
408.10	0.014	193.5	0.0257
408.12	0.014	193.5	0.0302
408.13	0.014	193.7	0.0328
408.15	0.015	194	0.0364
408.17	0.019	194.3	0.0408
408.18	0.02	194.5	0.0435
408.20	0.021	194.7	0.047
408.22	0.024	195	0.047
408.23	0.024	195	0.0497
408.25	0.024	195.2	0.0515
408.27	0.025	195.5	0.0533
408.28	0.027	195.7	0.0559
408.30	0.027	195.9	0.0568
408.32	0.028	196	0.0586
408.33	0.029	196.2	0.0586
408.35	0.029	196.2	0.0595
408.37	0.029	196.3	0.0604
408.38	0.029	196.5	0.0604
408.40	0.028	196.6	0.0604
408.42	0.029	196.7	0.0604
408.43	0.028	196.8	0.0604
408.45	0.028	196.8	0.0604
408.47	0.027	196.8	0.0595
408.48	0.027	196.8	0.0586
408.50	0.026	196.8	0.0568
408.52	0.024	196.8	0.055
408.53	0.023	196.7	0.0533
408.55	0.022	196.7	0.0506
408.57	0.019	196.5	0.0506
408.58	0.018	196.5	0.0479
408.60	0.018	196.5	0.0462
408.62	0.017	196.3	0.0426
408.63	0.013	196.1	0.0391
408.65	0.012	196	0.0364
408.67	0.011	195.9	0.0328
408.68	0.007	195.6	0.0328
408.70	0.006	195.4	0.0257
408.72	0.005	195.2	0.0231
408.73	0.002	195	0.0231
408.75	0	194.7	0.0186
408.77	0	194.7	0.0151
408.78	-0.001	194.5	0.0115
408.80	-0.004	194.2	0.0071
408.82	-0.005	193.9	0.0044
408.83	-0.006	193.7	0
408.87	-0.01	193.4	0

Prova triassiale ciclica SN04-C1			
pressione di confinamento (kPa)		80	
deviatore ciclico (kPa)		95	
frequenza (hz)		0.00625	
tempo	cella di carico	$\Delta u$	LVDT
(min)	kN	(kPa)	$\delta$ (mm)
408.88	-0.011	193.2	-0.0044
408.90	-0.011	193.2	-0.0062
408.90	-0.011	192.9	-0.0089
408.92	-0.014	192.7	-0.0115
408.93	-0.014	192.5	-0.0133
408.95	-0.015	192.3	-0.0142
408.97	-0.016	192.1	-0.0142
408.98	-0.017	191.9	-0.0169
409.00	-0.017	191.9	-0.0186
409.02	-0.017	191.8	-0.0186
409.03	-0.017	191.6	-0.0186
409.05	-0.017	191.5	-0.0195
409.07	-0.017	191.4	-0.0195
409.08	-0.017	191.3	-0.0195
409.10	-0.016	191.3	-0.0195
409.12	-0.016	191.3	-0.0186
409.13	-0.015	191.2	-0.0178
409.15	-0.014	191.2	-0.016
409.17	-0.013	191.2	-0.0151
409.18	-0.013	191.3	-0.0133
409.20	-0.011	191.4	-0.0133
409.22	-0.009	191.4	-0.0115
409.23	-0.009	191.4	-0.0098
409.25	-0.008	191.5	-0.0071
409.27	-0.006	191.7	-0.0044
409.28	-0.004	191.8	-0.0009
409.30	-0.002	191.9	0.0027
409.32	0.001	192.2	0.0027
409.33	0.002	192.3	0.0062
409.35	0.002	192.3	0.0089
409.37	0.003	192.5	0.0133
409.38	0.006	192.8	0.0169
409.40	0.009	193	0.0213
409.42	0.01	193.2	0.0249
409.43	0.011	193.4	0.0275
409.45	0.014	193.7	0.0311
409.47	0.015	193.9	0.0355
409.48	0.017	194.2	0.0391
409.50	0.02	194.4	0.0391
409.52	0.021	194.4	0.0417
409.53	0.021	194.6	0.0453
409.55	0.022	194.8	0.0479
409.57	0.024	195.1	0.0497
409.58	0.024	195.3	0.0524
409.60	0.025	195.6	0.055
409.62	0.027	195.8	0.055
409.63	0.028	195.8	0.0568
409.65	0.028	196	0.0577
409.67	0.028	196.1	0.0595
409.68	0.029	196.3	0.0595
409.70	0.029	196.4	0.0604
409.72	0.029	196.5	0.0604
409.73	0.029	196.6	0.0604
409.75	0.028	196.6	0.0604
409.77	0.028	196.7	0.0604
409.78	0.028	196.8	0.0595
409.80	0.027	196.8	0.0586
409.82	0.026	196.8	0.0577

Prova triassiale ciclica SN04-C1			
pressione di confinamento (kPa)		80	
deviatore ciclico (kPa)		95	
frequenza (hz)		0.00625	
tempo	cella di carico	$\Delta u$	LVDT
(min)	kN	(kPa)	$\delta$ (mm)
409.83	0.025	196.8	0.0559
409.85	0.023	196.7	0.0559
409.87	0.022	196.7	0.0541
409.88	0.022	196.7	0.0524
409.90	0.021	196.6	0.0497
409.92	0.018	196.5	0.047
409.93	0.017	196.4	0.0444
409.95	0.016	196.2	0.0417
409.97	0.012	196	0.0417
409.98	0.011	196	0.0373
410.00	0.011	195.9	0.0346
410.02	0.01	195.7	0.0311
410.03	0.006	195.5	0.0257
410.05	0.005	195.3	0.0231
410.07	0.004	195	0.0186
410.08	-0.001	194.7	0.0186
410.10	-0.001	194.7	0.0142
410.12	-0.001	194.5	0.0115
410.13	-0.003	194.2	0.0071
410.15	-0.006	193.9	0.0027
410.17	-0.006	193.8	0.0009
410.18	-0.008	193.5	-0.0027
410.20	-0.011	193.2	-0.0053
410.22	-0.011	193	-0.008
410.23	-0.012	192.8	-0.0107
410.25	-0.014	192.5	-0.0107
410.27	-0.014	192.5	-0.0124
410.30	-0.014	192.3	-0.0133
410.32	-0.015	192.1	-0.016
410.33	-0.017	191.9	-0.0178
410.35	-0.017	191.8	-0.0186
410.37	-0.017	191.7	-0.0186
410.37	-0.017	191.5	-0.0186
410.38	-0.017	191.5	-0.0195
410.40	-0.017	191.4	-0.0195
410.42	-0.017	191.3	-0.0195
410.43	-0.016	191.3	-0.0195
410.45	-0.016	191.2	-0.0186
410.47	-0.015	191.2	-0.0178
410.48	-0.014	191.2	-0.0178
410.50	-0.013	191.2	-0.016
410.52	-0.013	191.2	-0.0142
410.53	-0.012	191.3	-0.0133
410.55	-0.01	191.4	-0.0107
410.57	-0.009	191.4	-0.0089
410.58	-0.007	191.6	-0.0053
410.60	-0.004	191.7	-0.0053
410.62	-0.003	191.7	-0.0018
410.63	-0.003	191.8	0.0009
410.65	-0.002	192	0.0044
410.67	0.002	192.2	0.008
410.68	0.003	192.4	0.0107
410.70	0.004	192.6	0.0151
410.72	0.008	192.9	0.0151
410.73	0.01	192.9	0.0195
410.75	0.01	193.1	0.0231
410.77	0.011	193.3	0.0257
410.78	0.014	193.6	0.0311

Prova triassiale ciclica SN04-C1			
pressione di confinamento (kPa)		80	
deviatore ciclico (kPa)		95	
frequenza (hz)		0.00625	
tempo	cella di carico	$\Delta u$	LVDT
(min)	kN	(kPa)	$\delta$ (mm)
410.80	0.015	193.8	0.0346
410.82	0.016	194	0.0382
410.83	0.02	194.3	0.0382
410.85	0.021	194.3	0.0426
410.87	0.021	194.5	0.0453
410.88	0.023	195	0.0479
410.90	0.024	195.2	0.0497
410.92	0.024	195.2	0.0515
410.93	0.025	195.4	0.0541
410.95	0.026	195.7	0.0559
410.97	0.028	195.9	0.0577
410.98	0.028	196	0.0586
411.00	0.028	196.2	0.0586
411.02	0.028	196.3	0.0595
411.03	0.028	196.3	0.0604
411.05	0.029	196.5	0.0604
411.07	0.029	196.6	0.0604
411.08	0.029	196.7	0.0604
411.10	0.029	196.7	0.0604
411.12	0.028	196.8	0.0604
411.13	0.026	196.8	0.0595
411.15	0.026	196.8	0.0586
411.17	0.026	196.8	0.0568
411.18	0.024	196.7	0.055
411.20	0.022	196.7	0.0533
411.22	0.021	196.7	0.0506
411.23	0.02	196.5	0.0506
411.25	0.018	196.4	0.0479
411.27	0.018	196.4	0.0462
411.28	0.016	196.3	0.0426
411.30	0.014	196.1	0.0391
411.32	0.011	196	0.0364
411.33	0.011	195.8	0.032
411.35	0.008	195.6	0.032
411.37	0.005	195.3	0.0284
411.38	0.005	195.3	0.0249
411.40	0.004	195.1	0.0204
411.42	0.002	194.8	0.0169
411.43	-0.001	194.6	0.0133
411.45	-0.002	194.4	0.0098
411.47	-0.005	194.1	0.0053
411.48	-0.007	193.8	0.0053
411.50	-0.007	193.8	0.0018
411.52	-0.008	193.6	-0.0018
411.53	-0.009	193.3	-0.0044
411.55	-0.012	193	-0.008
411.57	-0.012	192.8	-0.0098
411.58	-0.013	192.6	-0.0115
411.60	-0.015	192.3	-0.0142
411.62	-0.015	192.2	-0.0151
411.63	-0.016	192	-0.0169
411.65	-0.017	191.8	-0.0169
411.67	-0.017	191.8	-0.0178
411.68	-0.017	191.7	-0.0186
411.70	-0.017	191.5	-0.0195
411.72	-0.017	191.4	-0.0195
411.73	-0.017	191.3	-0.0195
411.77	-0.017	191.2	-0.0195

Prova triassiale ciclica SN04-C1			
pressione di confinamento (kPa)		80	
deviatore ciclico (kPa)		95	
frequenza (hz)		0.00625	
tempo	cella di carico	$\Delta u$	LVDT
(min)	kN	(kPa)	$\delta$ (mm)
411.78	-0.016	191.2	-0.0195
411.80	-0.016	191.2	-0.0186
411.82	-0.016	191.2	-0.0178
411.82	-0.015	191.2	-0.0169
411.83	-0.013	191.2	-0.0151
411.85	-0.012	191.2	-0.0133
411.87	-0.011	191.3	-0.0115
411.88	-0.009	191.4	-0.0115
411.90	-0.008	191.4	-0.0098
411.92	-0.008	191.4	-0.0071
411.93	-0.007	191.6	-0.0044
411.95	-0.003	191.8	0
411.97	-0.002	191.9	0.0018
411.98	-0.001	192	0.0053
412.00	0.003	192.3	0.0053
412.02	0.003	192.3	0.0089
412.03	0.003	192.4	0.0124
412.05	0.005	192.7	0.0169
412.07	0.009	192.9	0.0213
412.08	0.01	193.1	0.024
412.10	0.012	193.4	0.0293
412.12	0.015	193.7	0.0293
412.13	0.016	193.7	0.0337
412.15	0.016	193.9	0.0364
412.17	0.017	194.1	0.0399
412.18	0.02	194.4	0.0426
412.20	0.021	194.6	0.0453
412.22	0.022	194.8	0.0497
412.23	0.025	195.1	0.0497
412.25	0.025	195.1	0.0515
412.27	0.025	195.3	0.0533
412.28	0.026	195.6	0.0559
412.30	0.027	195.8	0.0577
412.32	0.028	196	0.0586
412.33	0.028	196.1	0.0595
412.35	0.029	196.3	0.0604
412.37	0.029	196.4	0.0604
412.38	0.029	196.5	0.0604
412.40	0.029	196.6	0.0604
412.42	0.028	196.6	0.0604
412.43	0.028	196.7	0.0604
412.45	0.028	196.8	0.0604
412.47	0.027	196.8	0.0586
412.48	0.026	196.8	0.0577
412.50	0.025	196.8	0.0559
412.52	0.023	196.7	0.0559
412.53	0.022	196.7	0.0541
412.55	0.022	196.7	0.0524
412.57	0.021	196.6	0.0497
412.58	0.019	196.5	0.047
412.60	0.017	196.4	0.0453
412.62	0.016	196.3	0.0417
412.63	0.012	196.1	0.0417
412.65	0.011	195.9	0.0382
412.67	0.011	195.9	0.0355
412.68	0.01	195.7	0.032
412.70	0.006	195.4	0.0275
412.72	0.005	195.2	0.024

Prova triassiale ciclica SN04-C1			
pressione di confinamento (kPa)		80	
deviatore ciclico (kPa)		95	
frequenza (hz)		0.00625	
tempo	cella di carico	$\Delta u$	LVDT
(min)	kN	(kPa)	$\delta$ (mm)
412.73	0.003	195	0.0186
412.75	0	194.7	0.0186
412.77	-0.001	194.5	0.0151
412.78	-0.001	194.5	0.0124
412.80	-0.003	194.3	0.008
412.82	-0.006	194	0.0044
412.83	-0.007	193.7	0.0018
412.85	-0.008	193.5	-0.0027
412.87	-0.011	193.2	-0.0027
412.88	-0.012	192.9	-0.0062
412.90	-0.012	192.9	-0.008
412.92	-0.012	192.7	-0.0107
412.93	-0.014	192.5	-0.0124
412.95	-0.015	192.3	-0.0151
412.97	-0.016	192.1	-0.016
412.98	-0.017	191.9	-0.016
413.00	-0.017	191.8	-0.0178
413.02	-0.017	191.8	-0.0186
413.03	-0.017	191.6	-0.0186
413.05	-0.017	191.4	-0.0186
413.07	-0.017	191.4	-0.0195
413.08	-0.017	191.3	-0.0195
413.10	-0.017	191.2	-0.0186
413.12	-0.016	191.2	-0.0178
413.13	-0.015	191.2	-0.0169
413.15	-0.015	191.2	-0.0169
413.17	-0.012	191.2	-0.016
413.20	-0.012	191.2	-0.0142
413.22	-0.012	191.2	-0.0124
413.23	-0.01	191.3	-0.0107
413.25	-0.009	191.4	-0.0089
413.27	-0.007	191.5	-0.0053
413.27	-0.005	191.7	-0.0053
413.28	-0.002	191.8	-0.0018
413.30	-0.002	191.8	0.0009
413.32	-0.002	191.9	0.0036
413.33	0	192.2	0.008
413.35	0.004	192.4	0.0115
413.37	0.004	192.5	0.0151
413.38	0.007	192.8	0.0186
413.40	0.01	193	0.0186
413.42	0.01	193	0.0222
413.43	0.011	193.3	0.0275
413.45	0.013	193.6	0.032
413.47	0.016	193.8	0.0355
413.48	0.016	194	0.0382
413.50	0.019	194.3	0.0417
413.52	0.021	194.5	0.0417
413.53	0.021	194.5	0.0453
413.55	0.022	194.7	0.0479
413.57	0.023	195	0.0506
413.58	0.025	195.2	0.0533
413.60	0.026	195.4	0.055
413.62	0.027	195.7	0.0568
413.63	0.027	195.9	0.0568
413.65	0.028	195.9	0.0577
413.67	0.028	196.1	0.0595
413.68	0.028	196.2	0.0604



Prova triassiale ciclica SN04-C1			
pressione di confinamento (kPa)		80	
deviatore ciclico (kPa)		95	
frequenza (hz)		0.00625	
tempo	cella di carico	$\Delta u$	LVDT
(min)	kN	(kPa)	$\delta$ (mm)
413.70	0.029	196.3	0.0612
413.72	0.029	196.5	0.0612
413.73	0.029	196.5	0.0612
413.75	0.029	196.7	0.0612
413.77	0.028	196.7	0.0612
413.78	0.027	196.8	0.0595
413.80	0.027	196.8	0.0595
413.82	0.026	196.8	0.0595
413.83	0.026	196.8	0.0577
413.85	0.025	196.8	0.0559
413.87	0.023	196.7	0.0541
413.88	0.021	196.7	0.0515
413.90	0.02	196.6	0.0488
413.92	0.017	196.4	0.0488
413.93	0.017	196.4	0.0462
413.95	0.017	196.4	0.0435
413.97	0.015	196.2	0.0399
413.98	0.011	196	0.0364
414.00	0.011	195.8	0.0346
414.02	0.009	195.6	0.0302
414.03	0.005	195.3	0.0302
414.05	0.004	195.3	0.0249
414.07	0.004	195.2	0.0222
414.08	0.003	194.9	0.0178
414.10	-0.001	194.6	0.0142
414.12	-0.002	194.4	0.0107
414.13	-0.004	194.1	0.0062
414.15	-0.007	193.9	0.0062
414.17	-0.008	193.9	0.0027
414.18	-0.008	193.6	-0.0009
414.20	-0.009	193.4	-0.0036
414.22	-0.011	193.1	-0.0062
414.23	-0.012	192.9	-0.0089
414.25	-0.013	192.6	-0.0115
414.27	-0.015	192.4	-0.0115
414.28	-0.016	192.4	-0.0142
414.30	-0.016	192.2	-0.0151
414.32	-0.016	192	-0.016
414.33	-0.016	191.9	-0.0169
414.35	-0.017	191.7	-0.0178
414.37	-0.017	191.6	-0.0186
414.38	-0.017	191.4	-0.0186
414.40	-0.017	191.4	-0.0186
414.42	-0.017	191.4	-0.0195
414.43	-0.017	191.3	-0.0186
414.45	-0.016	191.2	-0.0178
414.47	-0.015	191.2	-0.0169
414.48	-0.014	191.2	-0.0151
414.50	-0.013	191.2	-0.0142
414.52	-0.012	191.2	-0.0133
414.53	-0.012	191.2	-0.0115
414.55	-0.009	191.4	-0.0115
414.57	-0.008	191.5	-0.0089
414.58	-0.008	191.5	-0.0071
414.60	-0.007	191.6	-0.0036
414.62	-0.004	191.8	0
414.63	-0.002	191.9	0.0027
414.67	-0.001	192	0.0053

Prova triassiale ciclica SN04-C1			
pressione di confinamento (kPa)		80	
deviatore ciclico (kPa)		95	
frequenza (hz)		0.00625	
tempo	cella di carico	$\Delta u$	LVDT
(min)	kN	(kPa)	$\delta$ (mm)
414.68	0.002	192.3	0.0053
414.70	0.004	192.5	0.0098
414.72	0.004	192.5	0.0124
414.72	0.005	192.6	0.0169
414.73	0.008	193	0.0213
414.75	0.011	193.2	0.0249
414.77	0.012	193.4	0.0302
414.78	0.014	193.7	0.0302
414.80	0.016	193.9	0.0337
414.82	0.016	193.9	0.0364
414.83	0.017	194.1	0.0399
414.85	0.02	194.4	0.0453
414.87	0.022	194.6	0.047
414.88	0.022	194.8	0.0488
414.90	0.023	195.1	0.0488
414.92	0.026	195.4	0.0515
414.93	0.026	195.4	0.0541
414.95	0.026	195.6	0.0559
414.97	0.027	195.8	0.0577
414.98	0.028	196	0.0595
415.00	0.028	196.1	0.0604
415.02	0.029	196.2	0.0612
415.03	0.029	196.4	0.0612
415.05	0.029	196.4	0.0612
415.07	0.029	196.5	0.0612
415.08	0.029	196.6	0.0612
415.10	0.028	196.7	0.0612
415.12	0.028	196.7	0.0604
415.13	0.027	196.7	0.0586
415.15	0.025	196.8	0.0586
415.17	0.025	196.8	0.0568
415.18	0.025	196.8	0.0559
415.20	0.024	196.7	0.0541
415.22	0.021	196.6	0.0524
415.23	0.02	196.6	0.0497
415.25	0.02	196.5	0.0479
415.27	0.017	196.4	0.0453
415.28	0.016	196.2	0.0435
415.30	0.014	196.1	0.0399
415.32	0.01	195.9	0.0399
415.33	0.01	195.9	0.0355
415.35	0.01	195.7	0.032
415.37	0.008	195.5	0.0284
415.38	0.004	195.2	0.024
415.40	0.004	195	0.0213
415.42	0.002	194.7	0.0169
415.43	-0.002	194.4	0.0169
415.45	-0.003	194.4	0.0115
415.47	-0.003	194.2	0.0089
415.48	-0.004	194	0.0053
415.50	-0.008	193.7	0.0009
415.52	-0.008	193.5	-0.0018
415.53	-0.009	193.2	-0.0044
415.55	-0.012	192.9	-0.0044
415.57	-0.013	192.9	-0.008
415.58	-0.013	192.7	-0.0107
415.60	-0.014	192.5	-0.0124
415.62	-0.015	192.3	-0.0142

Prova triassiale ciclica SN04-C1			
pressione di confinamento (kPa)		80	
deviatore ciclico (kPa)		95	
frequenza (hz)		0.00625	
tempo	cella di carico	$\Delta u$	LVDT
(min)	kN	(kPa)	$\delta$ (mm)
415.63	-0.016	192.1	-0.016
415.65	-0.016	191.9	-0.0169
415.67	-0.017	191.8	-0.0169
415.68	-0.017	191.8	-0.0178
415.70	-0.017	191.6	-0.0186
415.72	-0.017	191.5	-0.0186
415.73	-0.017	191.4	-0.0186
415.75	-0.017	191.3	-0.0186
415.77	-0.017	191.2	-0.0186
415.78	-0.015	191.2	-0.0186
415.80	-0.015	191.2	-0.0178
415.82	-0.015	191.2	-0.0169
415.83	-0.014	191.2	-0.0151
415.85	-0.012	191.2	-0.0133
415.87	-0.011	191.3	-0.0115
415.88	-0.01	191.3	-0.0089
415.90	-0.008	191.5	-0.0089
415.92	-0.006	191.6	-0.0062
415.93	-0.006	191.6	-0.0044
415.95	-0.005	191.7	-0.0009
415.97	-0.001	192	0.0027
415.98	-0.001	192	0.0044
416.00	0	192.1	0.008
416.02	0.003	192.4	0.0115
416.03	0.005	192.6	0.0142
416.05	0.006	192.8	0.0186
416.07	0.009	193.1	0.0186
416.08	0.012	193.3	0.0231
416.12	0.012	193.3	0.0275
416.13	0.013	193.5	0.0311
416.15	0.015	193.8	0.0355
416.17	0.017	194	0.0382
416.17	0.018	194.2	0.0417
416.18	0.02	194.5	0.0417
416.20	0.022	194.7	0.0444
416.22	0.022	194.7	0.0479
416.23	0.023	194.9	0.0506
416.25	0.024	195.2	0.0533
416.27	0.026	195.4	0.055
416.28	0.026	195.7	0.0568
416.30	0.027	195.8	0.0568
416.32	0.028	196	0.0586
416.33	0.028	196	0.0595
416.35	0.028	196.2	0.0604
416.37	0.028	196.3	0.0604
416.38	0.029	196.4	0.0612
416.40	0.029	196.5	0.0612
416.42	0.029	196.6	0.0612
416.43	0.028	196.7	0.0612
416.45	0.027	196.7	0.0612
416.47	0.027	196.7	0.0604
416.48	0.027	196.7	0.0586
416.50	0.025	196.7	0.0577
416.52	0.024	196.7	0.055
416.53	0.023	196.6	0.0533
416.55	0.02	196.6	0.0533
416.57	0.019	196.6	0.0506
416.58	0.019	196.5	0.0479

Prova triassiale ciclica SN04-C1			
pressione di confinamento (kPa)		80	
deviatore ciclico (kPa)		95	
frequenza (hz)		0.00625	
tempo	cella di carico	$\Delta u$	LVDT
(min)	kN	(kPa)	$\delta$ (mm)
416.60	0.018	196.4	0.0453
416.62	0.015	196.2	0.0426
416.63	0.014	196.1	0.0408
416.65	0.013	195.9	0.0364
416.67	0.008	195.7	0.0364
416.68	0.008	195.5	0.0302
416.70	0.007	195.4	0.0275
416.72	0.004	195.1	0.0275
416.73	0.003	195.1	0.0222
416.75	0.003	194.9	0.0186
416.77	0.001	194.6	0.0142
416.78	-0.003	194.3	0.0098
416.80	-0.004	194.1	0.0071
416.82	-0.005	193.8	0.0036
416.83	-0.008	193.5	0.0036
416.85	-0.009	193.5	0
416.87	-0.009	193.3	-0.0027
416.88	-0.01	193.1	-0.0062
416.90	-0.013	192.8	-0.0089
416.92	-0.013	192.6	-0.0107
416.93	-0.014	192.4	-0.0133
416.95	-0.016	192.2	-0.0133
416.97	-0.016	192.2	-0.0151
416.98	-0.016	192	-0.016
417.00	-0.017	191.8	-0.0178
417.02	-0.017	191.7	-0.0186
417.03	-0.017	191.5	-0.0186
417.05	-0.017	191.4	-0.0195
417.07	-0.017	191.3	-0.0195
417.08	-0.017	191.3	-0.0195
417.10	-0.017	191.2	-0.0186
417.12	-0.016	191.2	-0.0178
417.13	-0.015	191.2	-0.0169
417.15	-0.014	191.2	-0.016
417.17	-0.014	191.2	-0.0142
417.18	-0.012	191.2	-0.0142
417.20	-0.01	191.3	-0.0124
417.22	-0.01	191.3	-0.0107
417.23	-0.01	191.3	-0.0089
417.25	-0.007	191.5	-0.0062
417.27	-0.006	191.6	-0.0036
417.28	-0.004	191.7	0
417.30	-0.001	192	0
417.32	0.001	192.1	0.0036
417.33	0.001	192.1	0.0071
417.35	0.002	192.3	0.0107
417.37	0.005	192.5	0.0142
417.38	0.007	192.7	0.0186
417.40	0.009	192.9	0.0222
417.42	0.011	193.2	0.0257
417.43	0.012	193.4	0.0284
417.45	0.013	193.6	0.032
417.47	0.016	193.9	0.032
417.48	0.018	194.1	0.0364
417.50	0.018	194.1	0.0399
417.52	0.019	194.3	0.0435
417.53	0.021	194.6	0.0462
417.57	0.023	194.8	0.0488

Prova triassiale ciclica SN04-C1			
pressione di confinamento (kPa)		80	
deviatore ciclico (kPa)		95	
frequenza (hz)		0.00625	
tempo	cella di carico	$\Delta u$	LVDT
(min)	kN	(kPa)	$\delta$ (mm)
417.58	0.023	195	0.0515
417.60	0.025	195.3	0.0515
417.62	0.026	195.6	0.0541
417.62	0.026	195.6	0.0559
417.63	0.027	195.7	0.0568
417.65	0.027	195.9	0.0586
417.67	0.028	196.1	0.0595
417.68	0.028	196.2	0.0604
417.70	0.029	196.4	0.0604
417.72	0.029	196.5	0.0612
417.73	0.029	196.5	0.0612
417.75	0.029	196.6	0.0612
417.77	0.029	196.7	0.0612
417.78	0.028	196.7	0.0604
417.80	0.027	196.7	0.0595
417.82	0.026	196.7	0.0577
417.83	0.024	196.7	0.0577
417.85	0.023	196.7	0.0559
417.87	0.023	196.7	0.0541
417.88	0.022	196.6	0.0524
417.90	0.02	196.5	0.0497
417.92	0.019	196.5	0.047
417.93	0.017	196.3	0.0444
417.95	0.014	196.1	0.0444
417.97	0.013	196.1	0.0408
417.98	0.013	196.1	0.0382
418.00	0.011	195.8	0.0346
418.02	0.008	195.6	0.0311
418.03	0.007	195.4	0.0275
418.05	0.005	195.1	0.0231
418.07	0.001	194.9	0.0231
418.08	0.001	194.9	0.0186
418.10	0.001	194.7	0.0151
418.12	-0.001	194.4	0.0107
418.13	-0.005	194.1	0.0071
418.15	-0.005	193.9	0.0053
418.17	-0.006	193.7	0.0018
418.18	-0.009	193.4	-0.0018
418.20	-0.01	193.2	-0.0044
418.22	-0.011	192.9	-0.008
418.23	-0.013	192.7	-0.008
418.25	-0.014	192.7	-0.0107
418.27	-0.014	192.5	-0.0124
418.28	-0.014	192.3	-0.0133
418.30	-0.016	192.1	-0.016
418.32	-0.016	191.9	-0.0169
418.33	-0.017	191.7	-0.0178
418.35	-0.017	191.6	-0.0178
418.37	-0.017	191.6	-0.0186
418.38	-0.017	191.5	-0.0195
418.40	-0.017	191.3	-0.0195
418.42	-0.017	191.3	-0.0195
418.43	-0.016	191.2	-0.0186
418.45	-0.016	191.2	-0.0178
418.47	-0.015	191.2	-0.0178
418.48	-0.014	191.2	-0.0169
418.50	-0.014	191.2	-0.016
418.52	-0.013	191.2	-0.0133

Prova triassiale ciclica SN04-C1			
pressione di confinamento (kPa)		80	
deviatore ciclico (kPa)		95	
frequenza (hz)		0.00625	
tempo	cella di carico	$\Delta u$	LVDT
(min)	kN	(kPa)	$\delta$ (mm)
418.53	-0.011	191.3	-0.0115
418.55	-0.01	191.3	-0.0098
418.57	-0.009	191.4	-0.0071
418.58	-0.006	191.5	-0.0071
418.60	-0.005	191.7	-0.0044
418.62	-0.005	191.7	-0.0018
418.63	-0.004	191.8	0.0009
418.65	0	192	0.0053
418.67	0.001	192.2	0.008
418.68	0.003	192.3	0.0124
418.70	0.005	192.6	0.0124
418.72	0.008	192.8	0.016
418.73	0.008	192.8	0.0195
418.75	0.009	193	0.0231
418.77	0.012	193.3	0.0284
418.78	0.014	193.5	0.032
418.80	0.015	193.8	0.0364
418.82	0.018	194.1	0.0364
418.83	0.02	194.3	0.0399
418.85	0.02	194.3	0.0426
418.87	0.022	194.7	0.0453
418.88	0.023	194.9	0.047
418.90	0.023	194.9	0.0497
418.92	0.024	195.1	0.0524
418.93	0.025	195.4	0.055
418.95	0.027	195.7	0.0568
418.97	0.027	195.8	0.0577
418.98	0.028	196	0.0586
419.00	0.029	196.2	0.0586
419.03	0.029	196.2	0.0604
419.05	0.029	196.3	0.0604
419.07	0.029	196.4	0.0604
419.08	0.029	196.5	0.0612
419.08	0.029	196.6	0.0612
419.10	0.028	196.7	0.0604
419.12	0.028	196.7	0.0604
419.13	0.026	196.7	0.0595
419.15	0.026	196.7	0.0586
419.17	0.026	196.8	0.0568
419.18	0.024	196.7	0.055
419.20	0.023	196.7	0.0541
419.22	0.022	196.6	0.0506
419.23	0.019	196.5	0.0506
419.25	0.018	196.5	0.0479
419.27	0.018	196.4	0.0462
419.28	0.016	196.3	0.0426
419.30	0.013	196.1	0.0399
419.32	0.012	196	0.0373
419.33	0.011	195.8	0.0337
419.35	0.007	195.5	0.0337
419.37	0.006	195.5	0.0293
419.38	0.006	195.3	0.0249
419.40	0.004	195.1	0.0213
419.42	0.001	194.8	0.0169
419.43	0	194.6	0.0142
419.45	-0.002	194.3	0.0098
419.47	-0.006	194	0.0098
419.48	-0.006	194	0.0053

Prova triassiale ciclica SN04-C1			
pressione di confinamento (kPa)		80	
deviatore ciclico (kPa)		95	
frequenza (hz)		0.00625	
tempo	cella di carico	$\Delta u$	LVDT
(min)	kN	(kPa)	$\delta$ (mm)
419.50	-0.006	193.8	0.0027
419.52	-0.007	193.5	-0.0009
419.53	-0.01	193.2	-0.0044
419.55	-0.011	193	-0.0071
419.57	-0.012	192.8	-0.0098
419.58	-0.014	192.5	-0.0124
419.60	-0.015	192.3	-0.0133
419.62	-0.015	192.2	-0.0151
419.63	-0.016	191.9	-0.0151
419.65	-0.017	191.8	-0.0169
419.67	-0.017	191.8	-0.0178
419.68	-0.017	191.6	-0.0178
419.70	-0.017	191.5	-0.0186
419.72	-0.017	191.4	-0.0186
419.73	-0.017	191.3	-0.0186
419.75	-0.017	191.2	-0.0186
419.77	-0.016	191.2	-0.0186
419.78	-0.016	191.2	-0.0186
419.80	-0.016	191.2	-0.0178
419.82	-0.014	191.2	-0.016
419.83	-0.013	191.2	-0.0151
419.85	-0.012	191.2	-0.0124
419.87	-0.011	191.3	-0.0124
419.88	-0.009	191.4	-0.0107
419.90	-0.009	191.4	-0.0089
419.92	-0.008	191.4	-0.0062
419.93	-0.006	191.6	-0.0036
419.95	-0.004	191.7	-0.0009
419.97	-0.002	191.9	0.0036
419.98	0	192.1	0.0036
420.00	0.002	192.3	0.0071
420.02	0.002	192.3	0.0098
420.03	0.004	192.4	0.0142
420.05	0.006	192.7	0.0178
420.07	0.009	192.9	0.0213
420.08	0.01	193.1	0.0249
420.10	0.012	193.4	0.0249
420.12	0.015	193.7	0.0302
420.13	0.015	193.7	0.0337
420.15	0.016	193.9	0.0373
420.17	0.018	194.2	0.0408
420.18	0.02	194.4	0.0435
420.20	0.021	194.6	0.047
420.22	0.023	194.9	0.047
420.23	0.025	195.1	0.0497
420.25	0.025	195.1	0.0524
420.27	0.025	195.3	0.0541
420.28	0.026	195.6	0.0559
420.30	0.027	195.8	0.0577
420.32	0.027	195.9	0.0586
420.33	0.028	196.1	0.0595
420.35	0.029	196.2	0.0604
420.37	0.029	196.4	0.0612
420.38	0.029	196.5	0.0612
420.40	0.029	196.6	0.0612
420.42	0.028	196.6	0.0612
420.43	0.028	196.6	0.0612
420.47	0.028	196.7	0.0604

Prova triassiale ciclica SN04-C1			
pressione di confinamento (kPa)		80	
deviatore ciclico (kPa)		95	
frequenza (hz)		0.00625	
tempo	cella di carico	$\Delta u$	LVDT
(min)	kN	(kPa)	$\delta$ (mm)
420.48	0.027	196.7	0.0595
420.50	0.026	196.8	0.0577
420.52	0.025	196.7	0.0568
420.53	0.023	196.7	0.0568
420.53	0.022	196.7	0.055
420.55	0.022	196.7	0.0524
420.57	0.021	196.6	0.0497
420.58	0.018	196.4	0.047
420.60	0.017	196.4	0.0453
420.62	0.016	196.2	0.0417
420.63	0.012	196	0.0417
420.65	0.011	196	0.0382
420.67	0.011	195.9	0.0355
420.68	0.009	195.7	0.0311
420.70	0.006	195.4	0.0275
420.72	0.005	195.2	0.024
420.73	0.004	194.9	0.0195
420.75	-0.001	194.7	0.0195
420.77	-0.001	194.7	0.0151
420.78	-0.001	194.5	0.0124
420.80	-0.002	194.2	0.008
420.82	-0.006	193.9	0.0036
420.83	-0.007	193.7	0.0009
420.85	-0.008	193.4	-0.0018
420.87	-0.011	193.1	-0.0018
420.88	-0.012	193.1	-0.0053
420.90	-0.012	192.9	-0.008
420.92	-0.013	192.7	-0.0107
420.93	-0.015	192.5	-0.0133
420.95	-0.015	192.3	-0.0142
420.97	-0.015	192.1	-0.016
420.98	-0.016	191.9	-0.016
421.00	-0.017	191.9	-0.0169
421.02	-0.017	191.7	-0.0178
421.03	-0.017	191.6	-0.0186
421.05	-0.017	191.4	-0.0195
421.07	-0.017	191.3	-0.0195
421.08	-0.017	191.2	-0.0195
421.10	-0.016	191.2	-0.0186
421.12	-0.016	191.2	-0.0178
421.13	-0.015	191.1	-0.0169
421.15	-0.014	191.2	-0.0169
421.17	-0.013	191.2	-0.016
421.18	-0.013	191.2	-0.0142
421.20	-0.012	191.2	-0.0124
421.22	-0.01	191.3	-0.0107
421.23	-0.008	191.4	-0.008
421.25	-0.008	191.4	-0.0053
421.27	-0.005	191.6	-0.0053
421.28	-0.003	191.8	-0.0027
421.30	-0.003	191.8	0.0009
421.32	-0.002	191.9	0.0044
421.33	0.001	192.2	0.008
421.35	0.003	192.3	0.0115
421.37	0.005	192.5	0.016
421.38	0.007	192.8	0.0195
421.40	0.01	193	0.0195
421.42	0.01	193	0.0231



Prova triassiale ciclica SN04-C1			
pressione di confinamento (kPa)		80	
deviatore ciclico (kPa)		95	
frequenza (hz)		0.00625	
tempo	cella di carico	$\Delta u$	LVDT
(min)	kN	(kPa)	$\delta$ (mm)
421.43	0.011	193.2	0.0275
421.45	0.013	193.5	0.0311
421.47	0.016	193.8	0.0355
421.48	0.017	194	0.0391
421.50	0.019	194.3	0.0417
421.52	0.021	194.5	0.0417
421.53	0.022	194.5	0.0453
421.55	0.022	194.7	0.0479
421.57	0.023	195	0.0506
421.58	0.025	195.2	0.0533
421.60	0.026	195.4	0.055
421.62	0.026	195.6	0.0568
421.63	0.028	195.8	0.0568
421.65	0.028	195.8	0.0586
421.67	0.028	196	0.0595
421.68	0.028	196.2	0.0595
421.70	0.029	196.3	0.0604
421.72	0.029	196.4	0.0612
421.73	0.029	196.5	0.0612
421.75	0.029	196.6	0.0612
421.77	0.028	196.7	0.0604
421.78	0.028	196.7	0.0604
421.80	0.026	196.7	0.0604
421.82	0.026	196.7	0.0586
421.83	0.026	196.7	0.0577
421.85	0.025	196.7	0.0559
421.87	0.022	196.6	0.0533
421.88	0.022	196.6	0.0515
421.90	0.02	196.5	0.0488
421.93	0.017	196.4	0.0488
421.95	0.016	196.4	0.0462
421.97	0.016	196.3	0.0435
421.98	0.015	196.1	0.0408
421.98	0.011	195.9	0.0364
422.00	0.01	195.8	0.0337
422.02	0.009	195.6	0.0302
422.03	0.005	195.3	0.0302
422.05	0.004	195.3	0.0249
422.07	0.004	195.1	0.0222
422.08	0.002	194.9	0.0178
422.10	-0.001	194.6	0.0133
422.12	-0.002	194.4	0.0107
422.13	-0.003	194.1	0.0071
422.15	-0.007	193.7	0.0071
422.17	-0.008	193.7	0.0027
422.18	-0.008	193.5	0
422.20	-0.009	193.3	-0.0036
422.22	-0.012	193	-0.0071
422.23	-0.012	192.8	-0.0089
422.25	-0.013	192.6	-0.0115
422.27	-0.015	192.3	-0.0115
422.28	-0.016	192.3	-0.0142
422.30	-0.016	192.1	-0.0151
422.32	-0.016	192	-0.0169
422.33	-0.017	191.8	-0.0178
422.35	-0.017	191.6	-0.0186
422.37	-0.017	191.5	-0.0186
422.38	-0.017	191.4	-0.0186

Prova triassiale ciclica SN04-C1			
pressione di confinamento (kPa)		80	
deviatore ciclico (kPa)		95	
frequenza (hz)		0.00625	
tempo	cella di carico	$\Delta u$	LVDT
(min)	kN	(kPa)	$\delta$ (mm)
422.40	-0.017	191.4	-0.0186
422.42	-0.017	191.3	-0.0195
422.43	-0.017	191.2	-0.0186
422.45	-0.016	191.2	-0.0178
422.47	-0.015	191.2	-0.0169
422.48	-0.014	191.2	-0.0151
422.50	-0.013	191.2	-0.0142
422.52	-0.012	191.2	-0.0133
422.53	-0.012	191.2	-0.0115
422.55	-0.009	191.3	-0.0115
422.57	-0.008	191.4	-0.0089
422.58	-0.008	191.4	-0.0071
422.60	-0.006	191.5	-0.0036
422.62	-0.004	191.7	-0.0009
422.63	-0.002	191.8	0.0027
422.65	-0.001	192	0.0062
422.67	0.002	192.2	0.0062
422.68	0.004	192.4	0.0098
422.70	0.004	192.4	0.0133
422.72	0.005	192.6	0.0169
422.73	0.008	192.9	0.0204
422.75	0.011	193.1	0.0249
422.77	0.012	193.3	0.0293
422.78	0.015	193.6	0.0293
422.80	0.017	193.8	0.0337
422.82	0.017	193.8	0.0373
422.83	0.017	194	0.0399
422.85	0.019	194.4	0.0435
422.87	0.021	194.6	0.0462
422.88	0.022	194.8	0.0488
422.90	0.024	195.1	0.0488
422.92	0.025	195.3	0.0515
422.93	0.025	195.3	0.0541
422.95	0.026	195.5	0.0559
422.97	0.027	195.7	0.0577
422.98	0.028	195.9	0.0595
423.00	0.028	196.1	0.0595
423.02	0.028	196.2	0.0604
423.03	0.029	196.3	0.0604
423.05	0.029	196.3	0.0612
423.07	0.029	196.4	0.0612
423.08	0.029	196.5	0.0612
423.10	0.029	196.6	0.0612
423.12	0.028	196.7	0.0595
423.13	0.027	196.7	0.0595
423.15	0.025	196.7	0.0595
423.17	0.025	196.7	0.0577
423.18	0.025	196.7	0.0568
423.20	0.024	196.7	0.0541
423.22	0.021	196.6	0.0515
423.23	0.021	196.5	0.0506
423.25	0.02	196.5	0.0479
423.27	0.017	196.3	0.0453
423.28	0.016	196.2	0.0426
423.30	0.014	196	0.0391
423.32	0.011	195.8	0.0391
423.33	0.009	195.8	0.0355
423.37	0.009	195.7	0.032

Prova triassiale ciclica SN04-C1			
pressione di confinamento (kPa)		80	
deviatore ciclico (kPa)		95	
frequenza (hz)		0.00625	
tempo	cella di carico	$\Delta u$	LVDT
(min)	kN	(kPa)	$\delta$ (mm)
423.38	0.008	195.4	0.0284
423.40	0.005	195.2	0.024
423.42	0.003	195	0.0204
423.43	0.002	194.7	0.016
423.43	-0.002	194.4	0.016
423.45	-0.003	194.2	0.0115
423.47	-0.003	194.2	0.0089
423.48	-0.004	194	0.0053
423.50	-0.007	193.7	0.0009
423.52	-0.009	193.4	-0.0018
423.53	-0.01	193.2	-0.0044
423.55	-0.012	192.9	-0.0044
423.57	-0.013	192.7	-0.008
423.58	-0.013	192.7	-0.0098
423.60	-0.014	192.5	-0.0133
423.62	-0.015	192.2	-0.0151
423.63	-0.016	192	-0.016
423.65	-0.016	191.9	-0.0169
423.67	-0.017	191.7	-0.0169
423.68	-0.017	191.6	-0.0178
423.70	-0.017	191.6	-0.0186
423.72	-0.017	191.4	-0.0195
423.73	-0.017	191.3	-0.0195
423.75	-0.017	191.3	-0.0195
423.77	-0.017	191.2	-0.0186
423.78	-0.016	191.2	-0.0186
423.80	-0.015	191.2	-0.0178
423.82	-0.015	191.2	-0.0169
423.83	-0.014	191.2	-0.0151
423.85	-0.012	191.2	-0.0133
423.87	-0.011	191.2	-0.0115
423.88	-0.01	191.3	-0.0098
423.90	-0.008	191.4	-0.0071
423.92	-0.006	191.5	-0.0071
423.93	-0.006	191.5	-0.0044
423.95	-0.003	191.8	0.0009
423.97	-0.002	191.9	0.0009
423.98	-0.002	191.9	0.0027
424.00	0	192	0.0071
424.02	0.002	192.3	0.0115
424.03	0.005	192.5	0.0151
424.05	0.006	192.7	0.0186
424.07	0.009	193	0.0222
424.08	0.012	193.2	0.0222
424.10	0.012	193.2	0.0257
424.12	0.012	193.4	0.0302
424.13	0.014	193.7	0.0346
424.15	0.017	193.9	0.0382
424.17	0.018	194.2	0.0408
424.18	0.02	194.5	0.0444
424.20	0.022	194.7	0.0444
424.22	0.023	194.7	0.0479
424.23	0.023	194.9	0.0506
424.25	0.024	195.1	0.0524
424.27	0.026	195.4	0.055
424.28	0.026	195.6	0.0568
424.30	0.027	195.8	0.0577
424.32	0.028	196	0.0577

Prova triassiale ciclica SN04-C1			
pressione di confinamento (kPa)		80	
deviatore ciclico (kPa)		95	
frequenza (hz)		0.00625	
tempo	cella di carico	$\Delta u$	LVDT
(min)	kN	(kPa)	$\delta$ (mm)
424.33	0.029	196	0.0586
424.35	0.029	196.1	0.0595
424.37	0.029	196.2	0.0604
424.38	0.029	196.4	0.0604
424.40	0.029	196.5	0.0604
424.42	0.028	196.6	0.0604
424.43	0.028	196.6	0.0604
424.45	0.028	196.6	0.0604
424.47	0.028	196.7	0.0595
424.48	0.026	196.7	0.0577
424.50	0.025	196.6	0.0559
424.52	0.024	196.6	0.055
424.53	0.023	196.6	0.0524
424.55	0.02	196.5	0.0524
424.57	0.02	196.5	0.0506
424.58	0.02	196.5	0.0488
424.60	0.018	196.3	0.0453
424.62	0.015	196.1	0.0417
424.63	0.014	196	0.0399
424.65	0.012	195.9	0.0355
424.67	0.009	195.7	0.0355
424.68	0.009	195.5	0.0302
424.70	0.007	195.3	0.0257
424.72	0.003	195	0.0257
424.73	0.002	194.8	0.0213
424.75	0.002	194.8	0.0186
424.77	0.001	194.6	0.0142
424.78	-0.003	194.3	0.0098
424.80	-0.004	194.1	0.0071
424.83	-0.005	193.8	0.0036
424.85	-0.008	193.5	0.0036
424.87	-0.009	193.3	0
424.88	-0.009	193.3	-0.0027
424.88	-0.01	193.1	-0.0062
424.90	-0.012	192.8	-0.0089
424.92	-0.014	192.6	-0.0115
424.93	-0.014	192.4	-0.0133
424.95	-0.015	192.1	-0.0133
424.97	-0.016	191.9	-0.0151
424.98	-0.016	191.9	-0.0169
425.00	-0.016	191.8	-0.0169
425.02	-0.017	191.6	-0.0178
425.03	-0.017	191.5	-0.0186
425.05	-0.017	191.4	-0.0195
425.07	-0.017	191.3	-0.0195
425.08	-0.017	191.2	-0.0195
425.10	-0.016	191.2	-0.0186
425.12	-0.016	191.2	-0.0186
425.13	-0.016	191.1	-0.0178
425.15	-0.014	191.1	-0.016
425.17	-0.014	191.1	-0.0151
425.18	-0.013	191.2	-0.0133
425.20	-0.01	191.2	-0.0133
425.22	-0.009	191.2	-0.0107
425.23	-0.009	191.3	-0.0089
425.25	-0.008	191.4	-0.0062
425.27	-0.005	191.5	-0.0036
425.28	-0.004	191.7	0

Prova triassiale ciclica SN04-C1			
pressione di confinamento (kPa)		80	
deviatore ciclico (kPa)		95	
frequenza (hz)		0.00625	
tempo	cella di carico	$\Delta u$	LVDT
(min)	kN	(kPa)	$\delta$ (mm)
425.30	-0.002	191.9	0.0027
425.32	0.001	192	0.0027
425.33	0.001	192	0.0062
425.35	0.001	192.2	0.0098
425.37	0.004	192.5	0.0142
425.38	0.008	192.7	0.0186
425.40	0.008	192.9	0.0213
425.42	0.009	193.1	0.0231
425.43	0.012	193.3	0.0275
425.45	0.013	193.5	0.0311
425.47	0.015	193.8	0.0364
425.48	0.019	194.1	0.0364
425.50	0.019	194.1	0.0399
425.52	0.019	194.2	0.0426
425.53	0.02	194.5	0.0462
425.55	0.023	194.7	0.0488
425.57	0.023	195	0.0506
425.58	0.025	195.2	0.0533
425.60	0.027	195.5	0.0533
425.62	0.027	195.5	0.0559
425.63	0.027	195.6	0.0577
425.65	0.027	195.8	0.0586
425.67	0.028	196	0.0595
425.68	0.029	196.2	0.0604
425.70	0.029	196.3	0.0604
425.72	0.029	196.4	0.0604
425.73	0.028	196.4	0.0604
425.75	0.028	196.5	0.0604
425.77	0.028	196.6	0.0604
425.78	0.028	196.6	0.0604
425.80	0.027	196.7	0.0595
425.82	0.026	196.7	0.0577
425.83	0.024	196.7	0.0577
425.85	0.023	196.7	0.0559
425.87	0.023	196.6	0.055
425.88	0.022	196.6	0.0524
425.90	0.02	196.5	0.0497
425.92	0.019	196.4	0.047
425.93	0.017	196.3	0.0444
425.95	0.014	196.1	0.0444
425.97	0.013	196.1	0.0417
425.98	0.013	196	0.0382
426.00	0.011	195.8	0.0346
426.02	0.008	195.5	0.0302
426.03	0.006	195.3	0.0275
426.05	0.005	195.1	0.0231
426.07	0.002	194.8	0.0231
426.08	0.001	194.6	0.0186
426.10	0.001	194.6	0.016
426.12	-0.001	194.4	0.0115
426.13	-0.005	193.9	0.0071
426.15	-0.005	193.9	0.0053
426.17	-0.006	193.7	0.0018
426.18	-0.009	193.3	-0.0018
426.20	-0.01	193.1	-0.0044
426.22	-0.011	192.9	-0.0071
426.23	-0.012	192.6	-0.0071
426.25	-0.014	192.4	-0.0098

Prova triassiale ciclica SN04-C1			
pressione di confinamento (kPa)		80	
deviatore ciclico (kPa)		95	
frequenza (hz)		0.00625	
tempo	cella di carico	$\Delta u$	LVDT
(min)	kN	(kPa)	$\delta$ (mm)
426.27	-0.014	192.4	-0.0124
426.30	-0.015	192.2	-0.0142
426.32	-0.016	192	-0.016
426.33	-0.016	191.8	-0.0169
426.33	-0.017	191.6	-0.0178
426.35	-0.017	191.5	-0.0178
426.37	-0.018	191.4	-0.0186
426.38	-0.018	191.4	-0.0195
426.40	-0.018	191.3	-0.0195
426.42	-0.017	191.2	-0.0186
426.43	-0.016	191.2	-0.0186
426.45	-0.016	191.1	-0.0178
426.47	-0.015	191.1	-0.0178
426.48	-0.014	191.1	-0.016
426.50	-0.014	191.1	-0.0151
426.52	-0.013	191.1	-0.0142
426.53	-0.012	191.2	-0.0115
426.55	-0.01	191.2	-0.0098
426.57	-0.009	191.3	-0.0071
426.58	-0.007	191.5	-0.0053
426.60	-0.004	191.6	-0.0053
426.62	-0.004	191.6	-0.0018
426.63	-0.004	191.7	0.0009
426.65	-0.001	191.9	0.0053
426.67	0.002	192.1	0.0089
426.68	0.003	192.3	0.0124
426.70	0.005	192.5	0.016
426.72	0.008	192.8	0.016
426.73	0.009	192.8	0.0195
426.75	0.009	193	0.0231
426.77	0.011	193.3	0.0284
426.78	0.014	193.5	0.032
426.80	0.015	193.7	0.0355
426.82	0.017	194	0.0391
426.83	0.02	194.2	0.0391
426.85	0.021	194.4	0.0453
426.87	0.021	194.6	0.047
426.88	0.023	194.9	0.047
426.90	0.024	194.9	0.0497
426.92	0.024	195.1	0.0524
426.93	0.025	195.4	0.055
426.95	0.027	195.6	0.0568
426.97	0.027	195.8	0.0577
426.98	0.028	195.9	0.0595
427.00	0.029	196.1	0.0595
427.02	0.029	196.1	0.0604
427.03	0.029	196.2	0.0604
427.05	0.029	196.4	0.0612
427.07	0.029	196.4	0.0612
427.08	0.028	196.5	0.0612
427.10	0.028	196.6	0.0612
427.12	0.027	196.6	0.0612
427.13	0.027	196.6	0.0604
427.15	0.027	196.7	0.0586
427.17	0.026	196.7	0.0568
427.18	0.024	196.6	0.055
427.20	0.023	196.6	0.0533
427.22	0.022	196.5	0.0515

Prova triassiale ciclica SN04-C1			
pressione di confinamento (kPa)		80	
deviatore ciclico (kPa)		95	
frequenza (hz)		0.00625	
tempo	cella di carico	$\Delta u$	LVDT
(min)	kN	(kPa)	$\delta$ (mm)
427.23	0.019	196.4	0.0515
427.25	0.018	196.4	0.0488
427.27	0.018	196.3	0.0462
427.28	0.016	196.2	0.0426
427.30	0.013	196	0.0399
427.32	0.012	195.9	0.0373
427.33	0.011	195.7	0.0337
427.35	0.007	195.4	0.0337
427.37	0.006	195.4	0.0293
427.38	0.006	195.2	0.0257
427.40	0.004	195	0.0213
427.42	0.001	194.7	0.0169
427.43	0	194.5	0.0142
427.45	-0.002	194.2	0.0089
427.47	-0.006	193.9	0.0089
427.48	-0.006	193.9	0.0053
427.50	-0.006	193.7	0.0027
427.52	-0.007	193.5	-0.0009
427.53	-0.011	193.2	-0.0053
427.55	-0.011	193	-0.0062
427.57	-0.012	192.7	-0.0089
427.58	-0.014	192.5	-0.0115
427.60	-0.014	192.3	-0.0124
427.62	-0.015	192.1	-0.0151
427.63	-0.016	191.9	-0.0151
427.65	-0.017	191.9	-0.016
427.67	-0.017	191.7	-0.0178
427.68	-0.017	191.6	-0.0186
427.70	-0.017	191.4	-0.0186
427.73	-0.017	191.3	-0.0186
427.75	-0.017	191.2	-0.0186
427.77	-0.017	191.2	-0.0186
427.78	-0.016	191.2	-0.0186
427.80	-0.016	191.1	-0.0178
427.80	-0.016	191	-0.0169
427.82	-0.014	191.1	-0.016
427.83	-0.014	191.1	-0.0142
427.85	-0.012	191.1	-0.0124
427.87	-0.01	191.2	-0.0124
427.88	-0.009	191.2	-0.0107
427.90	-0.009	191.3	-0.0089
427.92	-0.008	191.3	-0.0053
427.93	-0.005	191.5	-0.0027
427.95	-0.004	191.6	0
427.97	-0.002	191.8	0.0036
427.98	0.001	192	0.0036
428.00	0.002	192.2	0.0071
428.02	0.002	192.2	0.0098
428.03	0.003	192.4	0.0142
428.05	0.007	192.7	0.0186
428.07	0.009	192.8	0.0213
428.08	0.01	193	0.0257
428.10	0.013	193.3	0.0257
428.12	0.015	193.6	0.0302
428.13	0.015	193.6	0.0337
428.15	0.016	193.8	0.0373
428.17	0.019	194.1	0.0408
428.18	0.02	194.3	0.0444

Prova triassiale ciclica SN04-C1			
pressione di confinamento (kPa)		80	
deviatore ciclico (kPa)		95	
frequenza (hz)		0.00625	
tempo	cella di carico	$\Delta u$	LVDT
(min)	kN	(kPa)	$\delta$ (mm)
428.20	0.021	194.5	0.047
428.22	0.023	194.8	0.047
428.23	0.024	195	0.0497
428.25	0.024	195	0.0524
428.27	0.025	195.2	0.055
428.28	0.026	195.5	0.0568
428.30	0.027	195.7	0.0577
428.32	0.028	195.8	0.0586
428.33	0.028	196	0.0595
428.35	0.028	196.2	0.0604
428.37	0.029	196.3	0.0612
428.38	0.029	196.4	0.0612
428.40	0.029	196.5	0.0612
428.42	0.029	196.5	0.0612
428.43	0.029	196.6	0.0612
428.45	0.028	196.7	0.0612
428.47	0.027	196.7	0.0595
428.48	0.026	196.7	0.0586
428.50	0.025	196.6	0.0568
428.52	0.023	196.6	0.0568
428.53	0.022	196.6	0.055
428.55	0.022	196.6	0.0533
428.57	0.021	196.5	0.0506
428.58	0.018	196.4	0.0479
428.60	0.017	196.3	0.0453
428.62	0.015	196.1	0.0417
428.63	0.012	195.9	0.0417
428.65	0.011	195.9	0.0382
428.67	0.011	195.8	0.0355
428.68	0.01	195.6	0.032
428.70	0.006	195.3	0.0275
428.72	0.005	195.1	0.024
428.73	0.003	194.9	0.0195
428.75	0	194.6	0.0195
428.77	-0.001	194.6	0.0151
428.78	-0.001	194.4	0.0124
428.80	-0.003	194.1	0.008
428.82	-0.006	193.8	0.0036
428.83	-0.007	193.6	0.0018
428.85	-0.008	193.3	-0.0018
428.87	-0.011	193	-0.0018
428.88	-0.012	193	-0.0053
428.90	-0.012	192.8	-0.008
428.92	-0.013	192.5	-0.0107
428.93	-0.015	192.3	-0.0133
428.95	-0.015	192.1	-0.0142
428.97	-0.016	191.9	-0.016
428.98	-0.017	191.8	-0.016
429.00	-0.017	191.8	-0.0178
429.02	-0.017	191.6	-0.0178
429.03	-0.017	191.4	-0.0186
429.05	-0.017	191.4	-0.0186
429.07	-0.017	191.3	-0.0195
429.08	-0.017	191.2	-0.0186
429.10	-0.016	191.1	-0.0186
429.12	-0.016	191	-0.0178
429.13	-0.015	191	-0.0169
429.15	-0.014	191.1	-0.0169



Prova triassiale ciclica SN04-C1			
pressione di confinamento (kPa)		80	
deviatore ciclico (kPa)		95	
frequenza (hz)		0.00625	
tempo	cella di carico	$\Delta u$	LVDT
(min)	kN	(kPa)	$\delta$ (mm)
429.17	-0.013	191.1	-0.0151
429.20	-0.013	191.1	-0.0142
429.22	-0.012	191.1	-0.0124
429.23	-0.01	191.2	-0.0098
429.25	-0.009	191.2	-0.008
429.25	-0.007	191.4	-0.0044
429.27	-0.004	191.5	-0.0044
429.28	-0.004	191.5	-0.0018
429.30	-0.004	191.7	0.0009
429.32	-0.002	191.9	0.0044
429.33	0.002	192.1	0.0089
429.35	0.003	192.2	0.0115
429.37	0.004	192.4	0.016
429.38	0.008	192.7	0.016
429.40	0.009	192.7	0.0204
429.42	0.009	192.9	0.0231
429.43	0.011	193.1	0.0275
429.45	0.014	193.4	0.032
429.47	0.015	193.6	0.0355
429.48	0.017	193.9	0.0391
429.50	0.02	194.2	0.0391
429.52	0.02	194.2	0.0426
429.53	0.02	194.4	0.0453
429.55	0.021	194.6	0.0479
429.57	0.024	194.9	0.0515
429.58	0.025	195.1	0.0533
429.60	0.026	195.3	0.0559
429.62	0.027	195.5	0.0559
429.63	0.028	195.7	0.0577
429.65	0.028	195.7	0.0586
429.67	0.028	195.9	0.0595
429.68	0.028	196	0.0604
429.70	0.029	196.2	0.0612
429.72	0.029	196.3	0.0612
429.73	0.029	196.4	0.0612
429.75	0.029	196.5	0.0612
429.77	0.028	196.6	0.0612
429.78	0.028	196.6	0.0612
429.80	0.026	196.7	0.0604
429.82	0.026	196.7	0.0586
429.83	0.026	196.7	0.0577
429.85	0.024	196.6	0.0559
429.87	0.023	196.6	0.055
429.88	0.022	196.5	0.0515
429.90	0.019	196.4	0.0515
429.92	0.017	196.3	0.0488
429.93	0.017	196.3	0.047
429.95	0.017	196.2	0.0435
429.97	0.014	196	0.0399
429.98	0.011	195.8	0.0364
430.00	0.011	195.7	0.0337
430.02	0.008	195.4	0.0337
430.03	0.005	195.2	0.0302
430.05	0.005	195.2	0.0257
430.07	0.004	195	0.0213
430.08	0.002	194.7	0.0178
430.10	-0.001	194.4	0.0133
430.12	-0.002	194.2	0.0098

Prova triassiale ciclica SN04-C1			
pressione di confinamento (kPa)		80	
deviatore ciclico (kPa)		95	
frequenza (hz)		0.00625	
tempo	cella di carico	$\Delta u$	LVDT
(min)	kN	(kPa)	$\delta$ (mm)
430.13	-0.004	193.9	0.0062
430.15	-0.007	193.7	0.0062
430.17	-0.007	193.7	0.0027
430.18	-0.008	193.5	-0.0009
430.20	-0.009	193.1	-0.0044
430.22	-0.012	192.9	-0.0071
430.23	-0.012	192.7	-0.0089
430.25	-0.013	192.4	-0.0107
430.27	-0.015	192.2	-0.0107
430.28	-0.016	192.2	-0.0133
430.30	-0.016	192	-0.0151
430.32	-0.016	191.8	-0.0169
430.33	-0.017	191.7	-0.0178
430.35	-0.017	191.5	-0.0186
430.37	-0.017	191.4	-0.0186
430.38	-0.017	191.3	-0.0186
430.40	-0.017	191.3	-0.0186
430.42	-0.017	191.2	-0.0186
430.43	-0.017	191.1	-0.0186
430.45	-0.016	191.1	-0.0178
430.47	-0.016	191.1	-0.0169
430.48	-0.015	191.1	-0.016
430.50	-0.014	191.1	-0.0151
430.52	-0.012	191.1	-0.0133
430.53	-0.011	191.2	-0.0107
430.55	-0.009	191.2	-0.0107
430.57	-0.008	191.2	-0.0089
430.58	-0.008	191.3	-0.0062
430.60	-0.007	191.5	-0.0036
430.63	-0.004	191.6	0
430.65	-0.002	191.7	0.0027
430.67	-0.001	191.9	0.0062
430.68	0.002	192.2	0.0062
430.70	0.004	192.2	0.0098
430.70	0.004	192.3	0.0133
430.72	0.005	192.6	0.0178
430.73	0.009	192.8	0.0222
430.75	0.01	193	0.0249
430.77	0.011	193.2	0.0302
430.78	0.015	193.5	0.0302
430.80	0.016	193.5	0.0337
430.82	0.016	193.7	0.0364
430.83	0.017	194	0.0408
430.85	0.021	194.3	0.0444
430.87	0.021	194.5	0.0462
430.88	0.022	194.7	0.0488
430.90	0.025	195	0.0488
430.92	0.025	195	0.0515
430.93	0.025	195.1	0.0541
430.95	0.026	195.4	0.0559
430.97	0.027	195.6	0.0577
430.98	0.028	195.8	0.0595
431.00	0.028	196	0.0595
431.02	0.029	196.1	0.0595
431.03	0.029	196.2	0.0604
431.05	0.029	196.2	0.0612
431.07	0.029	196.3	0.0612
431.08	0.029	196.4	0.0612

Prova triassiale ciclica SN04-C1			
pressione di confinamento (kPa)		80	
deviatore ciclico (kPa)		95	
frequenza (hz)		0.00625	
tempo	cella di carico	$\Delta u$	LVDT
(min)	kN	(kPa)	$\delta$ (mm)
431.10	0.028	196.5	0.0612
431.12	0.028	196.6	0.0595
431.13	0.027	196.6	0.0586
431.15	0.025	196.6	0.0586
431.17	0.025	196.6	0.0577
431.18	0.025	196.6	0.0559
431.20	0.023	196.5	0.0541
431.22	0.021	196.5	0.0515
431.23	0.021	196.5	0.0506
431.25	0.02	196.3	0.0479
431.27	0.017	196.2	0.0453
431.28	0.016	196.1	0.0426
431.30	0.014	195.9	0.0391
431.32	0.01	195.7	0.0391
431.33	0.01	195.7	0.0355
431.35	0.01	195.6	0.032
431.37	0.008	195.3	0.0284
431.38	0.004	195	0.0231
431.40	0.003	194.9	0.0204
431.42	0.002	194.6	0.016
431.43	-0.002	194.3	0.016
431.45	-0.003	194.3	0.0115
431.47	-0.003	194.1	0.0089
431.48	-0.004	193.8	0.0053
431.50	-0.008	193.5	0.0009
431.52	-0.008	193.3	-0.0018
431.53	-0.009	193	-0.0044
431.55	-0.012	192.8	-0.0044
431.57	-0.013	192.8	-0.008
431.58	-0.013	192.6	-0.0098
431.60	-0.014	192.4	-0.0124
431.62	-0.015	192.1	-0.0142
431.63	-0.016	192	-0.0151
431.65	-0.016	191.8	-0.0169
431.67	-0.017	191.6	-0.0169
431.68	-0.017	191.6	-0.0178
431.70	-0.017	191.5	-0.0186
431.72	-0.017	191.4	-0.0186
431.73	-0.017	191.2	-0.0186
431.75	-0.017	191.2	-0.0186
431.77	-0.016	191.1	-0.0186
431.78	-0.016	191.1	-0.0186
431.80	-0.015	191.1	-0.0178
431.82	-0.015	191	-0.0169
431.83	-0.014	191	-0.0151
431.85	-0.012	191.1	-0.0133
431.87	-0.011	191.2	-0.0115
431.88	-0.01	191.2	-0.0098
431.90	-0.008	191.3	-0.0098
431.92	-0.006	191.3	-0.0062
431.93	-0.005	191.5	-0.0027
431.95	-0.003	191.6	-0.0027
431.97	-0.002	191.6	0
431.98	-0.002	191.8	0.0036
432.00	0	192	0.0071
432.02	0.004	192.2	0.0115
432.03	0.005	192.4	0.0142
432.05	0.006	192.6	0.0186

Prova triassiale ciclica SN04-C1			
pressione di confinamento (kPa)		80	
deviatore ciclico (kPa)		95	
frequenza (hz)		0.00625	
tempo	cella di carico	$\Delta u$	LVDT
(min)	kN	(kPa)	$\delta$ (mm)
432.07	0.01	192.9	0.0186
432.10	0.011	193.1	0.0231
432.12	0.011	193.1	0.0257
432.13	0.013	193.3	0.0311
432.15	0.015	193.6	0.0355
432.15	0.017	193.8	0.0382
432.17	0.018	194.1	0.0417
432.18	0.02	194.4	0.0417
432.20	0.022	194.6	0.0453
432.22	0.022	194.6	0.0479
432.23	0.023	194.8	0.0506
432.25	0.025	195	0.0533
432.27	0.026	195.2	0.055
432.28	0.027	195.5	0.0568
432.30	0.027	195.7	0.0568
432.32	0.028	195.9	0.0586
432.33	0.028	195.9	0.0595
432.35	0.028	196	0.0604
432.37	0.029	196.2	0.0612
432.38	0.029	196.3	0.0612
432.40	0.029	196.4	0.0612
432.42	0.029	196.5	0.0612
432.43	0.028	196.5	0.0612
432.45	0.027	196.5	0.0612
432.47	0.027	196.6	0.0595
432.48	0.026	196.6	0.0586
432.50	0.025	196.6	0.0568
432.52	0.024	196.6	0.0559
432.53	0.023	196.5	0.0533
432.55	0.02	196.4	0.0533
432.57	0.02	196.4	0.0515
432.58	0.02	196.4	0.0488
432.60	0.018	196.2	0.0462
432.62	0.014	196.1	0.0426
432.63	0.014	196	0.0399
432.65	0.013	195.7	0.0364
432.67	0.009	195.5	0.0328
432.68	0.008	195.4	0.0302
432.70	0.007	195.2	0.0257
432.72	0.003	194.9	0.0257
432.73	0.002	194.9	0.0222
432.75	0.002	194.8	0.0186
432.77	0.001	194.5	0.0151
432.78	-0.003	194.2	0.0107
432.80	-0.004	194	0.008
432.82	-0.005	193.7	0.0036
432.83	-0.008	193.4	0.0036
432.85	-0.009	193.4	-0.0009
432.87	-0.009	193.2	-0.0027
432.88	-0.01	192.9	-0.0053
432.90	-0.012	192.7	-0.0089
432.92	-0.013	192.4	-0.0107
432.93	-0.014	192.2	-0.0133
432.95	-0.015	192	-0.0133
432.97	-0.016	192	-0.0151
432.98	-0.016	191.8	-0.016
433.00	-0.016	191.7	-0.0169
433.02	-0.017	191.5	-0.0186

Prova triassiale ciclica SN04-C1			
pressione di confinamento (kPa)		80	
deviatore ciclico (kPa)		95	
frequenza (hz)		0.00625	
tempo	cella di carico	$\Delta u$	LVDT
(min)	kN	(kPa)	$\delta$ (mm)
433.03	-0.017	191.4	-0.0186
433.05	-0.017	191.3	-0.0186
433.07	-0.017	191.2	-0.0186
433.08	-0.017	191.1	-0.0186
433.10	-0.017	191.1	-0.0186
433.12	-0.016	191	-0.0178
433.13	-0.015	191	-0.0169
433.15	-0.014	191	-0.016
433.17	-0.014	191	-0.0142
433.18	-0.012	191.1	-0.0142
433.20	-0.011	191.2	-0.0124
433.22	-0.011	191.2	-0.0107
433.23	-0.009	191.2	-0.008
433.25	-0.007	191.4	-0.0053
433.27	-0.005	191.5	-0.0027
433.28	-0.004	191.6	0.0009
433.30	-0.002	191.8	0.0044
433.32	0.001	192	0.0044
433.33	0.001	192	0.0071
433.35	0.002	192.1	0.0115
433.37	0.004	192.4	0.0151
433.38	0.007	192.6	0.0186
433.40	0.008	192.8	0.0213
433.42	0.009	193	0.024
433.43	0.012	193.2	0.0293
433.45	0.014	193.4	0.0328
433.47	0.015	193.7	0.0364
433.48	0.018	194	0.0364
433.50	0.019	194	0.0399
433.53	0.019	194.2	0.0426
433.55	0.02	194.4	0.0462
433.57	0.023	194.7	0.0488
433.58	0.024	194.9	0.0515
433.60	0.025	195.1	0.0541
433.60	0.026	195.4	0.0541
433.62	0.027	195.4	0.0568
433.63	0.027	195.6	0.0577
433.65	0.027	195.7	0.0586
433.67	0.028	195.9	0.0604
433.68	0.028	196.1	0.0604
433.70	0.029	196.2	0.0612
433.72	0.029	196.3	0.0612
433.73	0.029	196.3	0.0621
433.75	0.029	196.4	0.0621
433.77	0.029	196.5	0.0612
433.78	0.028	196.6	0.0612
433.80	0.027	196.6	0.0604
433.82	0.026	196.6	0.0586
433.83	0.025	196.6	0.0586
433.85	0.023	196.5	0.0568
433.87	0.023	196.5	0.055
433.88	0.022	196.5	0.0524
433.90	0.02	196.4	0.0497
433.92	0.018	196.3	0.0479
433.93	0.017	196.2	0.0453
433.95	0.015	196	0.0453
433.97	0.012	195.9	0.0417
433.98	0.012	195.9	0.0391

Prova triassiale ciclica SN04-C1			
pressione di confinamento (kPa)		80	
deviatore ciclico (kPa)		95	
frequenza (hz)		0.00625	
tempo	cella di carico	$\Delta u$	LVDT
(min)	kN	(kPa)	$\delta$ (mm)
434.00	0.012	195.7	0.0355
434.02	0.009	195.4	0.0311
434.03	0.006	195.2	0.0275
434.05	0.005	195	0.0231
434.07	0.002	194.8	0.0231
434.08	0	194.5	0.0195
434.10	0	194.5	0.016
434.12	-0.003	194.1	0.0124
434.13	-0.005	193.9	0.0098
434.15	-0.005	193.9	0.0062
434.17	-0.006	193.6	0.0027
434.18	-0.008	193.3	-0.0009
434.20	-0.01	193.1	-0.0044
434.22	-0.011	192.8	-0.0062
434.23	-0.012	192.6	-0.0089
434.25	-0.014	192.3	-0.0089
434.27	-0.014	192.3	-0.0115
434.28	-0.015	192.1	-0.0133
434.30	-0.016	191.9	-0.016
434.32	-0.017	191.7	-0.0169
434.33	-0.017	191.6	-0.0169
434.35	-0.017	191.4	-0.0178
434.37	-0.017	191.3	-0.0178
434.38	-0.017	191.3	-0.0186
434.40	-0.017	191.2	-0.0186
434.42	-0.017	191.2	-0.0186
434.43	-0.017	191	-0.0186
434.45	-0.016	191	-0.0169
434.47	-0.015	191	-0.016
434.48	-0.014	191	-0.016
434.50	-0.013	191	-0.0151
434.52	-0.013	191	-0.0133
434.53	-0.012	191.1	-0.0115
434.55	-0.01	191.2	-0.0098
434.57	-0.009	191.2	-0.0071
434.58	-0.007	191.4	-0.0044
434.60	-0.004	191.5	-0.0044
434.62	-0.004	191.5	-0.0009
434.63	-0.004	191.6	0.0009
434.65	-0.002	191.8	0.0053
434.67	0.002	192	0.0089
434.68	0.003	192.2	0.0115
434.70	0.004	192.4	0.016
434.72	0.008	192.7	0.016
434.73	0.009	192.7	0.0195
434.75	0.009	192.9	0.0231
434.77	0.011	193.1	0.0284
434.78	0.014	193.4	0.0328
434.80	0.015	193.6	0.0355
434.82	0.017	193.8	0.0391
434.83	0.02	194.1	0.0391
434.85	0.02	194.3	0.0444
434.87	0.021	194.5	0.047
434.88	0.023	194.8	0.047
434.90	0.024	194.8	0.0506
434.92	0.024	195	0.0524
434.93	0.025	195.2	0.055
434.95	0.027	195.4	0.0568

Prova triassiale ciclica SN04-C1			
pressione di confinamento (kPa)		80	
deviatore ciclico (kPa)		95	
frequenza (hz)		0.00625	
tempo	cella di carico	$\Delta u$	LVDT
(min)	kN	(kPa)	$\delta$ (mm)
434.97	0.027	195.6	0.0577
435.00	0.028	195.8	0.0595
435.02	0.028	196	0.0595
435.03	0.029	196	0.0604
435.05	0.029	196.1	0.0612
435.05	0.029	196.2	0.0612
435.07	0.029	196.3	0.0612
435.08	0.029	196.4	0.0612
435.10	0.028	196.5	0.0604
435.12	0.027	196.5	0.0604
435.13	0.026	196.5	0.0595
435.15	0.026	196.6	0.0586
435.17	0.026	196.6	0.0577
435.18	0.024	196.5	0.0559
435.20	0.023	196.5	0.0541
435.22	0.022	196.5	0.0515
435.23	0.02	196.3	0.0515
435.25	0.017	196.2	0.0488
435.27	0.017	196.2	0.0462
435.28	0.016	196.1	0.0435
435.30	0.014	195.9	0.0399
435.32	0.012	195.8	0.0373
435.33	0.01	195.6	0.0328
435.35	0.007	195.3	0.0328
435.37	0.005	195.1	0.0293
435.38	0.005	195.1	0.0249
435.40	0.004	194.9	0.0213
435.42	0.002	194.6	0.0169
435.43	-0.001	194.4	0.0142
435.45	-0.002	194.2	0.0098
435.47	-0.004	193.8	0.0053
435.48	-0.007	193.6	0.0053
435.50	-0.007	193.6	0.0027
435.52	-0.008	193.4	-0.0009
435.53	-0.009	193	-0.0044
435.55	-0.012	192.8	-0.0071
435.57	-0.012	192.6	-0.0098
435.58	-0.013	192.4	-0.0107
435.60	-0.014	192.2	-0.0124
435.62	-0.015	192	-0.0142
435.63	-0.016	191.8	-0.016
435.65	-0.016	191.6	-0.016
435.67	-0.017	191.6	-0.0169
435.68	-0.017	191.5	-0.0186
435.70	-0.017	191.3	-0.0186
435.72	-0.017	191.2	-0.0186
435.73	-0.017	191.1	-0.0186
435.75	-0.017	191	-0.0186
435.77	-0.016	191	-0.0186
435.78	-0.015	191	-0.0178
435.80	-0.015	190.9	-0.0169
435.82	-0.015	190.9	-0.016
435.83	-0.013	191	-0.0142
435.85	-0.012	191	-0.0133
435.87	-0.012	191	-0.0115
435.88	-0.009	191.2	-0.0115
435.90	-0.008	191.2	-0.0089
435.92	-0.008	191.2	-0.0071

Prova triassiale ciclica SN04-C1			
pressione di confinamento (kPa)		80	
deviatore ciclico (kPa)		95	
frequenza (hz)		0.00625	
tempo	cella di carico	$\Delta u$	LVDT
(min)	kN	(kPa)	$\delta$ (mm)
435.93	-0.007	191.3	-0.0036
435.95	-0.004	191.5	-0.0009
435.97	-0.003	191.6	0.0027
435.98	-0.001	191.8	0.0062
436.00	0.003	192.1	0.0062
436.02	0.004	192.1	0.0098
436.03	0.004	192.2	0.0133
436.05	0.005	192.5	0.0178
436.07	0.009	192.7	0.0222
436.08	0.01	192.9	0.024
436.10	0.011	193.1	0.0293
436.12	0.015	193.4	0.0293
436.13	0.016	193.4	0.0337
436.15	0.016	193.6	0.0373
436.17	0.017	193.9	0.0399
436.18	0.02	194.2	0.0435
436.20	0.021	194.4	0.0462
436.22	0.022	194.6	0.0497
436.23	0.024	194.9	0.0497
436.25	0.026	194.9	0.0524
436.27	0.026	195.1	0.0541
436.28	0.026	195.3	0.0559
436.30	0.027	195.5	0.0577
436.32	0.027	195.7	0.0586
436.33	0.028	195.8	0.0595
436.35	0.028	196	0.0604
436.37	0.029	196.1	0.0612
436.38	0.029	196.2	0.0612
436.40	0.029	196.3	0.0612
436.42	0.029	196.4	0.0612
436.43	0.029	196.4	0.0612
436.47	0.028	196.5	0.0604
436.48	0.027	196.5	0.0595
436.50	0.026	196.5	0.0586
436.50	0.025	196.5	0.0568
436.52	0.023	196.5	0.0568
436.53	0.022	196.5	0.055
436.55	0.022	196.5	0.0533
436.57	0.021	196.4	0.0506
436.58	0.019	196.2	0.0479
436.60	0.017	196.1	0.0453
436.62	0.015	196	0.0417
436.63	0.013	195.8	0.0417
436.65	0.011	195.7	0.0382
436.67	0.011	195.7	0.0355
436.68	0.01	195.4	0.032
436.70	0.007	195.1	0.0284
436.72	0.004	195	0.024
436.73	0.003	194.8	0.0195
436.75	0.001	194.5	0.0195
436.77	-0.002	194.2	0.016
436.78	-0.002	194.2	0.0124
436.80	-0.003	194	0.008
436.82	-0.005	193.7	0.0053
436.83	-0.007	193.5	0.0009
436.85	-0.008	193.2	-0.0027
436.87	-0.01	192.9	-0.0027
436.88	-0.012	192.7	-0.0053



Prova triassiale ciclica SN04-C1			
pressione di confinamento (kPa)		80	
deviatore ciclico (kPa)		95	
frequenza (hz)		0.00625	
tempo	cella di carico	$\Delta u$	LVDT
(min)	kN	(kPa)	$\delta$ (mm)
436.90	-0.012	192.7	-0.008
436.92	-0.012	192.5	-0.0098
436.93	-0.014	192.2	-0.0124
436.95	-0.015	192	-0.0142
436.97	-0.016	191.8	-0.016
436.98	-0.016	191.7	-0.016
437.00	-0.017	191.5	-0.0169
437.02	-0.017	191.4	-0.0178
437.03	-0.017	191.2	-0.0178
437.05	-0.017	191.1	-0.0186
437.07	-0.017	191.1	-0.0186
437.08	-0.017	191	-0.0186
437.10	-0.017	191	-0.0186
437.12	-0.016	190.9	-0.0178
437.13	-0.015	190.9	-0.016
437.15	-0.014	190.9	-0.016
437.17	-0.013	190.9	-0.0151
437.18	-0.013	190.9	-0.0133
437.20	-0.012	191	-0.0124
437.22	-0.011	191.1	-0.0107
437.23	-0.008	191.2	-0.008
437.25	-0.007	191.2	-0.0053
437.27	-0.005	191.4	-0.0018
437.28	-0.003	191.6	-0.0018
437.30	-0.003	191.6	0.0009
437.32	-0.002	191.7	0.0044
437.33	0.001	192	0.008
437.35	0.003	192.1	0.0115
437.37	0.005	192.3	0.016
437.38	0.007	192.6	0.0195
437.40	0.01	192.8	0.0195
437.42	0.01	192.8	0.024
437.43	0.011	193	0.0284
437.45	0.013	193.3	0.032
437.47	0.016	193.5	0.0355
437.48	0.017	193.8	0.0391
437.50	0.018	194	0.0417
437.52	0.021	194.3	0.0417
437.53	0.021	194.3	0.0453
437.55	0.021	194.5	0.0479
437.57	0.023	194.7	0.0515
437.58	0.025	195	0.0541
437.60	0.025	195.2	0.055
437.62	0.026	195.4	0.0568
437.63	0.028	195.7	0.0568
437.65	0.028	195.7	0.0586
437.67	0.028	195.8	0.0595
437.68	0.029	195.9	0.0604
437.70	0.029	196.1	0.0612
437.72	0.029	196.2	0.0612
437.73	0.029	196.3	0.0612
437.75	0.028	196.4	0.0612
437.77	0.028	196.5	0.0612
437.78	0.028	196.5	0.0604
437.80	0.026	196.5	0.0604
437.82	0.026	196.5	0.0595
437.83	0.026	196.6	0.0586
437.85	0.025	196.5	0.0559

Prova triassiale ciclica SN04-C1			
pressione di confinamento (kPa)		80	
deviatore ciclico (kPa)		95	
frequenza (hz)		0.00625	
tempo	cella di carico	$\Delta u$	LVDT
(min)	kN	(kPa)	$\delta$ (mm)
437.87	0.022	196.5	0.0541
437.90	0.021	196.4	0.0524
437.92	0.02	196.3	0.0497
437.93	0.017	196.2	0.0497
437.95	0.016	196.2	0.047
437.97	0.016	196.1	0.0444
437.97	0.015	195.9	0.0408
437.98	0.011	195.8	0.0373
438.00	0.011	195.6	0.0346
438.02	0.009	195.3	0.0302
438.03	0.005	195.1	0.0302
438.05	0.004	195.1	0.0257
438.07	0.004	194.9	0.0222
438.08	0.002	194.6	0.0186
438.10	-0.001	194.4	0.0142
438.12	-0.002	194.2	0.0107
438.13	-0.003	193.8	0.0071
438.15	-0.007	193.6	0.0071
438.17	-0.008	193.6	0.0027
438.18	-0.008	193.4	0
438.20	-0.009	193.1	-0.0036
438.22	-0.012	192.8	-0.0062
438.23	-0.012	192.6	-0.0089
438.25	-0.013	192.4	-0.0115
438.27	-0.015	192.2	-0.0115
438.28	-0.015	192.2	-0.0133
438.30	-0.015	192	-0.0142
438.32	-0.016	191.8	-0.016
438.33	-0.017	191.6	-0.0169
438.35	-0.017	191.5	-0.0178
438.37	-0.017	191.3	-0.0178
438.38	-0.017	191.2	-0.0178
438.40	-0.017	191.2	-0.0186
438.42	-0.017	191.2	-0.0186
438.43	-0.017	191.1	-0.0186
438.45	-0.016	191	-0.0178
438.47	-0.015	191	-0.016
438.48	-0.015	191	-0.0151
438.50	-0.013	191	-0.0142
438.52	-0.013	191	-0.0133
438.53	-0.012	191	-0.0107
438.55	-0.009	191.2	-0.0107
438.57	-0.008	191.2	-0.008
438.58	-0.008	191.2	-0.0062
438.60	-0.006	191.3	-0.0027
438.62	-0.003	191.5	0
438.63	-0.002	191.6	0.0036
438.65	-0.001	191.9	0.0062
438.67	0.003	192.1	0.0062
438.68	0.004	192.1	0.0107
438.70	0.004	192.2	0.0133
438.72	0.005	192.5	0.0178
438.73	0.009	192.7	0.0222
438.75	0.01	192.9	0.0249
438.77	0.011	193.2	0.0293
438.78	0.015	193.4	0.0293
438.80	0.016	193.4	0.0346
438.82	0.016	193.7	0.0373

Prova triassiale ciclica SN04-C1			
pressione di confinamento (kPa)		80	
deviatore ciclico (kPa)		95	
frequenza (hz)		0.00625	
tempo	cella di carico	$\Delta u$	LVDT
(min)	kN	(kPa)	$\delta$ (mm)
438.83	0.017	193.9	0.0408
438.85	0.02	194.2	0.0444
438.87	0.022	194.4	0.047
438.88	0.022	194.6	0.0497
438.90	0.024	194.9	0.0497
438.92	0.025	194.9	0.0524
438.93	0.025	195.1	0.0541
438.95	0.026	195.3	0.0568
438.97	0.027	195.6	0.0586
438.98	0.028	195.7	0.0595
439.00	0.028	195.9	0.0595
439.02	0.028	196	0.0595
439.03	0.029	196.2	0.0604
439.05	0.029	196.2	0.0612
439.07	0.029	196.3	0.0612
439.08	0.029	196.4	0.0612
439.10	0.028	196.5	0.0612
439.12	0.028	196.5	0.0604
439.13	0.027	196.5	0.0604
439.15	0.025	196.5	0.0595
439.17	0.025	196.5	0.0577
439.18	0.024	196.5	0.0559
439.20	0.022	196.4	0.0541
439.22	0.022	196.4	0.0533
439.23	0.021	196.4	0.0506
439.25	0.019	196.2	0.0479
439.27	0.017	196.1	0.0453
439.28	0.016	196	0.0426
439.30	0.013	195.8	0.0391
439.32	0.011	195.7	0.0391
439.33	0.011	195.7	0.0355
439.37	0.01	195.5	0.032
439.38	0.007	195.2	0.0284
439.40	0.004	195	0.024
439.42	0.004	194.8	0.0204
439.42	0.001	194.5	0.016
439.43	-0.002	194.2	0.016
439.45	-0.003	194.2	0.0124
439.47	-0.003	194	0.0089
439.48	-0.004	193.7	0.0053
439.50	-0.007	193.5	0.0018
439.52	-0.008	193.2	-0.0018
439.53	-0.009	193	-0.0044
439.55	-0.012	192.7	-0.0044
439.57	-0.013	192.7	-0.0071
439.58	-0.013	192.5	-0.0098
439.60	-0.014	192.3	-0.0124
439.62	-0.016	192.1	-0.0142
439.63	-0.016	191.9	-0.0151
439.65	-0.016	191.7	-0.016
439.67	-0.017	191.5	-0.016
439.68	-0.017	191.5	-0.0178
439.70	-0.017	191.4	-0.0186
439.72	-0.017	191.3	-0.0186
439.73	-0.017	191.2	-0.0186
439.75	-0.017	191.1	-0.0186
439.77	-0.017	191	-0.0178
439.78	-0.015	191	-0.0178

Prova triassiale ciclica SN04-C1			
pressione di confinamento (kPa)		80	
deviatore ciclico (kPa)		95	
frequenza (hz)		0.00625	
tempo	cella di carico	$\Delta u$	LVDT
(min)	kN	(kPa)	$\delta$ (mm)
439.80	-0.015	191	-0.0169
439.82	-0.015	190.9	-0.016
439.83	-0.014	191	-0.0151
439.85	-0.012	191	-0.0133
439.87	-0.011	191.1	-0.0115
439.88	-0.01	191.2	-0.0089
439.90	-0.007	191.3	-0.0089
439.92	-0.006	191.3	-0.0062
439.93	-0.005	191.4	-0.0027
439.95	-0.004	191.6	-0.0027
439.97	-0.002	191.6	0.0009
439.98	-0.002	191.7	0.0036
440.00	0	191.9	0.008
440.02	0.003	192.2	0.0115
440.03	0.005	192.3	0.0151
440.05	0.006	192.5	0.0186
440.07	0.01	192.8	0.0186
440.08	0.011	193	0.0231
440.10	0.011	193	0.0257
440.12	0.012	193.2	0.032
440.13	0.015	193.6	0.0355
440.15	0.017	193.8	0.0391
440.17	0.018	194	0.0417
440.18	0.02	194.3	0.0417
440.20	0.022	194.5	0.0453
440.22	0.022	194.5	0.0479
440.23	0.023	194.7	0.0506
440.25	0.025	195	0.0541
440.27	0.026	195.2	0.0559
440.28	0.026	195.4	0.0568
440.30	0.027	195.6	0.0568
440.32	0.028	195.8	0.0586
440.33	0.028	195.8	0.0595
440.35	0.029	196	0.0612
440.37	0.029	196.1	0.0612
440.38	0.029	196.2	0.0612
440.40	0.029	196.3	0.0612
440.42	0.029	196.4	0.0612
440.43	0.028	196.5	0.0612
440.45	0.028	196.5	0.0612
440.47	0.027	196.5	0.0595
440.48	0.026	196.5	0.0586
440.50	0.025	196.5	0.0568
440.52	0.024	196.5	0.055
440.53	0.023	196.4	0.0533
440.55	0.02	196.3	0.0533
440.57	0.019	196.3	0.0506
440.58	0.019	196.3	0.0488
440.60	0.018	196.1	0.0462
440.62	0.015	196	0.0426
440.63	0.014	195.9	0.0399
440.65	0.012	195.7	0.0364
440.67	0.01	195.6	0.0346
440.68	0.009	195.4	0.0311
440.70	0.007	195.1	0.0275
440.72	0.004	194.8	0.0275
440.73	0.003	194.8	0.0231
440.75	0.003	194.7	0.0186

Prova triassiale ciclica SN04-C1			
pressione di confinamento (kPa)		80	
deviatore ciclico (kPa)		95	
frequenza (hz)		0.00625	
tempo	cella di carico	$\Delta u$	LVDT
(min)	kN	(kPa)	$\delta$ (mm)
440.77	0	194.4	0.0142
440.80	-0.003	194.1	0.0107
440.82	-0.004	193.9	0.0071
440.83	-0.005	193.6	0.0036
440.85	-0.008	193.3	0.0036
440.87	-0.009	193.3	0
440.87	-0.009	193.1	-0.0027
440.88	-0.01	192.8	-0.0062
440.90	-0.013	192.6	-0.0089
440.92	-0.013	192.4	-0.0107
440.93	-0.014	192.2	-0.0124
440.95	-0.016	191.9	-0.0124
440.97	-0.016	191.9	-0.0151
440.98	-0.016	191.8	-0.016
441.00	-0.017	191.6	-0.0169
441.02	-0.017	191.5	-0.0186
441.03	-0.017	191.3	-0.0186
441.05	-0.017	191.2	-0.0186
441.07	-0.017	191.1	-0.0186
441.08	-0.017	191.1	-0.0186
441.10	-0.017	191	-0.0186
441.12	-0.016	191	-0.0178
441.13	-0.015	191	-0.0169
441.15	-0.014	191	-0.0151
441.17	-0.014	191	-0.0142
441.18	-0.012	191	-0.0142
441.20	-0.011	191	-0.0124
441.22	-0.011	191.1	-0.0107
441.23	-0.009	191.2	-0.008
441.25	-0.007	191.3	-0.0053
441.27	-0.005	191.4	-0.0027
441.28	-0.004	191.5	0.0009
441.30	-0.001	191.7	0.0009
441.32	0	191.9	0.0044
441.33	0	191.9	0.0071
441.35	0.002	192.1	0.0107
441.37	0.005	192.3	0.0151
441.38	0.007	192.5	0.0178
441.40	0.007	192.7	0.0204
441.42	0.01	192.9	0.0249
441.43	0.012	193.2	0.0293
441.45	0.013	193.4	0.0337
441.47	0.016	193.7	0.0373
441.48	0.018	193.9	0.0373
441.50	0.018	193.9	0.0399
441.52	0.019	194.1	0.0435
441.53	0.021	194.4	0.047
441.55	0.023	194.6	0.0497
441.57	0.024	194.8	0.0524
441.58	0.025	195.1	0.0524
441.60	0.026	195.3	0.055
441.62	0.026	195.3	0.0568
441.63	0.027	195.5	0.0577
441.65	0.027	195.7	0.0595
441.67	0.028	195.9	0.0604
441.68	0.029	196	0.0612
441.70	0.029	196.1	0.0612
441.72	0.029	196.3	0.0612

Prova triassiale ciclica SN04-C1			
pressione di confinamento (kPa)		80	
deviatore ciclico (kPa)		95	
frequenza (hz)		0.00625	
tempo	cella di carico	$\Delta u$	LVDT
(min)	kN	(kPa)	$\delta$ (mm)
441.73	0.029	196.3	0.0612
441.75	0.029	196.4	0.0612
441.77	0.028	196.5	0.0612
441.78	0.027	196.5	0.0604
441.80	0.027	196.6	0.0595
441.82	0.026	196.5	0.0577
441.83	0.024	196.5	0.0577
441.85	0.024	196.5	0.0568
441.87	0.024	196.5	0.055
441.88	0.022	196.4	0.0524
441.90	0.02	196.3	0.0506
441.92	0.019	196.2	0.0479
441.93	0.017	196.1	0.0453
441.95	0.014	195.9	0.0453
441.97	0.013	195.9	0.0417
441.98	0.013	195.8	0.0391
442.00	0.012	195.6	0.0355
442.02	0.008	195.4	0.0311
442.03	0.007	195.2	0.0284
442.05	0.005	194.9	0.024
442.07	0.002	194.7	0.024
442.08	0.001	194.7	0.0195
442.10	-0.001	194.2	0.0133
442.12	-0.002	194	0.0133
442.13	-0.004	194	0.0107
442.15	-0.004	193.8	0.0062
442.17	-0.006	193.5	0.0027
442.18	-0.009	193.2	-0.0009
442.20	-0.009	193	-0.0036
442.22	-0.011	192.7	-0.0071
442.23	-0.014	192.5	-0.0071
442.27	-0.014	192.5	-0.0098
442.28	-0.014	192.3	-0.0115
442.30	-0.015	192.1	-0.0133
442.32	-0.016	191.9	-0.0151
442.32	-0.016	191.7	-0.016
442.33	-0.017	191.5	-0.0169
442.35	-0.017	191.4	-0.0169
442.37	-0.017	191.4	-0.0178
442.38	-0.017	191.3	-0.0186
442.40	-0.017	191.2	-0.0186
442.42	-0.017	191.1	-0.0186
442.43	-0.017	191	-0.0178
442.45	-0.016	191	-0.0169
442.47	-0.015	190.9	-0.0169
442.48	-0.014	190.9	-0.016
442.50	-0.014	190.9	-0.0151
442.52	-0.013	190.9	-0.0133
442.53	-0.011	191	-0.0115
442.55	-0.01	191.1	-0.0098
442.57	-0.009	191.2	-0.0062
442.58	-0.006	191.3	-0.0062
442.60	-0.005	191.5	-0.0036
442.62	-0.005	191.5	-0.0009
442.63	-0.003	191.6	0.0027
442.65	0	191.8	0.0062
442.67	0.001	192	0.0089
442.68	0.002	192.1	0.0124

Prova triassiale ciclica SN04-C1			
pressione di confinamento (kPa)		80	
deviatore ciclico (kPa)		95	
frequenza (hz)		0.00625	
tempo	cella di carico	$\Delta u$	LVDT
(min)	kN	(kPa)	$\delta$ (mm)
442.70	0.006	192.4	0.0124
442.72	0.008	192.6	0.0169
442.73	0.008	192.6	0.0204
442.75	0.009	192.8	0.024
442.77	0.012	193.1	0.0293
442.78	0.014	193.3	0.0328
442.80	0.015	193.6	0.0364
442.82	0.018	193.9	0.0364
442.83	0.019	194.1	0.0426
442.85	0.02	194.3	0.0453
442.87	0.022	194.5	0.0453
442.88	0.023	194.7	0.0479
442.90	0.023	194.7	0.0506
442.92	0.024	194.9	0.0533
442.93	0.026	195.2	0.0559
442.95	0.027	195.4	0.0577
442.97	0.027	195.6	0.0586
442.98	0.028	195.8	0.0586
443.00	0.029	196	0.0595
443.02	0.029	196	0.0612
443.03	0.029	196.1	0.0612
443.05	0.029	196.2	0.0612
443.07	0.028	196.3	0.0612
443.08	0.028	196.4	0.0612
443.10	0.028	196.5	0.0612
443.12	0.028	196.5	0.0612
443.13	0.028	196.5	0.0612
443.15	0.026	196.5	0.0586
443.17	0.025	196.5	0.0568
443.18	0.023	196.5	0.0559
443.20	0.023	196.5	0.0541
443.22	0.021	196.4	0.0515
443.23	0.019	196.3	0.0515
443.25	0.019	196.3	0.0497
443.27	0.018	196.2	0.0462
443.28	0.016	196	0.0435
443.30	0.013	195.9	0.0408
443.32	0.012	195.7	0.0373
443.33	0.011	195.5	0.0337
443.35	0.007	195.2	0.0337
443.37	0.006	195.2	0.0302
443.38	0.006	195.1	0.0257
443.40	0.004	194.8	0.0222
443.42	0.001	194.6	0.0178
443.43	0	194.4	0.0142
443.45	-0.002	194.1	0.0107
443.47	-0.005	193.8	0.0107
443.48	-0.006	193.8	0.0062
443.50	-0.006	193.6	0.0036
443.52	-0.008	193.3	0
443.53	-0.01	193	-0.0036
443.55	-0.011	192.8	-0.0062
443.57	-0.012	192.5	-0.0089
443.58	-0.014	192.4	-0.0107
443.60	-0.014	192.2	-0.0124
443.62	-0.015	192	-0.0142
443.63	-0.016	191.8	-0.0142
443.65	-0.016	191.8	-0.0151

Prova triassiale ciclica SN04-C1			
pressione di confinamento (kPa)		80	
deviatore ciclico (kPa)		95	
frequenza (hz)		0.00625	
tempo	cella di carico	$\Delta u$	LVDT
(min)	kN	(kPa)	$\delta$ (mm)
443.67	-0.016	191.6	-0.0169
443.68	-0.017	191.5	-0.0169
443.72	-0.017	191.3	-0.0178
443.73	-0.017	191.2	-0.0186
443.75	-0.017	191.1	-0.0186
443.77	-0.017	191	-0.0186
443.77	-0.016	191	-0.0178
443.78	-0.016	191	-0.0178
443.80	-0.016	190.9	-0.016
443.82	-0.014	190.9	-0.0151
443.83	-0.013	190.9	-0.0133
443.85	-0.013	191	-0.0124
443.87	-0.011	191.1	-0.0124
443.88	-0.009	191.1	-0.0098
443.90	-0.009	191.2	-0.0089
443.92	-0.008	191.2	-0.0053
443.93	-0.005	191.4	-0.0027
443.95	-0.004	191.5	0
443.97	-0.003	191.6	0.0036
443.98	0.001	191.9	0.0036
444.00	0.002	192	0.008
444.02	0.002	192	0.0107
444.03	0.004	192.2	0.0151
444.05	0.007	192.5	0.0186
444.07	0.009	192.7	0.0222
444.08	0.01	192.9	0.0257
444.10	0.013	193.2	0.0257
444.12	0.015	193.4	0.0311
444.13	0.015	193.4	0.0346
444.15	0.015	193.7	0.0373
444.17	0.018	194	0.0417
444.18	0.02	194.2	0.0444
444.20	0.021	194.4	0.0479
444.22	0.023	194.7	0.0479
444.23	0.025	194.9	0.0506
444.25	0.025	194.9	0.0533
444.27	0.025	195.1	0.055
444.28	0.027	195.6	0.0568
444.30	0.027	195.6	0.0577
444.32	0.027	195.7	0.0595
444.33	0.028	195.9	0.0604
444.35	0.029	196	0.0612
444.37	0.029	196.2	0.0621
444.38	0.029	196.3	0.0621
444.40	0.029	196.4	0.0621
444.42	0.029	196.4	0.0621
444.43	0.028	196.5	0.0612
444.45	0.028	196.5	0.0612
444.47	0.027	196.5	0.0604
444.48	0.026	196.6	0.0586
444.50	0.025	196.5	0.0568
444.52	0.023	196.5	0.0568
444.53	0.023	196.5	0.055
444.55	0.022	196.5	0.0533
444.57	0.02	196.3	0.0506
444.58	0.018	196.2	0.0479
444.60	0.017	196.2	0.0453
444.62	0.015	196	0.0426



Prova triassiale ciclica SN04-C1			
pressione di confinamento (kPa)		80	
deviatore ciclico (kPa)		95	
frequenza (hz)		0.00625	
tempo	cella di carico	$\Delta u$	LVDT
(min)	kN	(kPa)	$\delta$ (mm)
444.63	0.013	195.8	0.0426
444.65	0.013	195.8	0.0399
444.67	0.012	195.6	0.0364
444.68	0.009	195.3	0.032
444.70	0.006	195.1	0.0284
444.72	0.005	195	0.024
444.73	0.003	194.7	0.0195
444.75	0	194.4	0.0195
444.77	0	194.4	0.016
444.78	-0.001	194.3	0.0124
444.80	-0.004	193.9	0.008
444.82	-0.006	193.7	0.0044
444.83	-0.007	193.5	0.0009
444.85	-0.009	193.1	-0.0027
444.87	-0.011	192.9	-0.0027
444.88	-0.011	192.9	-0.0044
444.90	-0.011	192.7	-0.0071
444.92	-0.013	192.4	-0.0098
444.93	-0.015	192.2	-0.0124
444.95	-0.015	192	-0.0142
444.97	-0.016	191.8	-0.0151
444.98	-0.016	191.6	-0.0151
445.00	-0.017	191.6	-0.016
445.02	-0.017	191.3	-0.0178
445.03	-0.017	191.2	-0.0178
445.05	-0.017	191.2	-0.0178
445.07	-0.017	191.1	-0.0178
445.08	-0.017	191	-0.0178
445.10	-0.017	190.9	-0.0178
445.12	-0.016	190.9	-0.0169
445.13	-0.016	190.9	-0.016
445.17	-0.014	190.9	-0.016
445.18	-0.013	190.9	-0.0151
445.20	-0.013	190.9	-0.0133
445.22	-0.012	191	-0.0115
445.22	-0.01	191.1	-0.0089
445.23	-0.009	191.2	-0.0071
445.25	-0.007	191.3	-0.0044
445.27	-0.004	191.4	-0.0044
445.28	-0.003	191.4	-0.0009
445.30	-0.003	191.5	0.0018
445.32	-0.002	191.7	0.0053
445.33	0.002	191.9	0.0089
445.35	0.003	192.1	0.0115
445.37	0.004	192.3	0.016
445.38	0.008	192.6	0.016
445.40	0.009	192.6	0.0204
445.42	0.009	192.8	0.0231
445.43	0.011	193	0.0293
445.45	0.015	193.3	0.0328
445.47	0.015	193.5	0.0355
445.48	0.016	193.8	0.0391
445.50	0.02	194.1	0.0391
445.52	0.021	194.1	0.0435
445.53	0.021	194.3	0.0462
445.55	0.022	194.5	0.0497
445.57	0.024	194.7	0.0515
445.58	0.025	194.9	0.0533

Prova triassiale ciclica SN04-C1			
pressione di confinamento (kPa)		80	
deviatore ciclico (kPa)		95	
frequenza (hz)		0.00625	
tempo	cella di carico	$\Delta u$	LVDT
(min)	kN	(kPa)	$\delta$ (mm)
445.60	0.025	195.1	0.0559
445.62	0.027	195.4	0.0559
445.63	0.027	195.6	0.0577
445.65	0.027	195.6	0.0586
445.67	0.028	195.8	0.0604
445.68	0.028	195.9	0.0612
445.70	0.029	196.1	0.0612
445.72	0.029	196.2	0.0621
445.73	0.029	196.3	0.0621
445.75	0.029	196.4	0.0621
445.77	0.029	196.5	0.0621
445.78	0.027	196.5	0.0621
445.80	0.026	196.5	0.0604
445.82	0.026	196.5	0.0595
445.83	0.026	196.6	0.0586
445.85	0.024	196.5	0.0568
445.87	0.022	196.5	0.0541
445.88	0.022	196.4	0.0524
445.90	0.02	196.3	0.0524
445.92	0.017	196.2	0.0497
445.93	0.017	196.2	0.047
445.95	0.017	196.1	0.0453
445.97	0.014	195.9	0.0408
445.98	0.011	195.7	0.0373
446.00	0.011	195.6	0.0337
446.02	0.008	195.3	0.0337
446.03	0.005	195.1	0.0302
446.05	0.005	195.1	0.0257
446.07	0.004	194.9	0.0222
446.08	0.002	194.6	0.0186
446.10	-0.001	194.3	0.0151
446.12	-0.002	194.1	0.0107
446.13	-0.004	193.8	0.0107
446.15	-0.007	193.5	0.0062
446.17	-0.007	193.5	0.0027
446.18	-0.008	193.3	0
446.20	-0.009	193	-0.0027
446.22	-0.011	192.8	-0.0053
446.23	-0.012	192.6	-0.0089
446.25	-0.014	192.3	-0.0115
446.27	-0.015	192.1	-0.0115
446.28	-0.015	192.1	-0.0133
446.30	-0.015	191.9	-0.0142
446.32	-0.016	191.7	-0.016
446.33	-0.017	191.5	-0.0169
446.35	-0.017	191.4	-0.0178
446.37	-0.017	191.3	-0.0178
446.38	-0.017	191.2	-0.0178
446.40	-0.017	191.2	-0.0186
446.42	-0.017	191.1	-0.0186
446.43	-0.017	191	-0.0178
446.45	-0.016	191	-0.0169
446.47	-0.015	190.9	-0.016
446.48	-0.015	190.9	-0.0151
446.50	-0.013	190.9	-0.0142
446.52	-0.013	190.9	-0.0124
446.53	-0.011	191	-0.0107
446.55	-0.009	191.1	-0.0107

Prova triassiale ciclica SN04-C1			
pressione di confinamento (kPa)		80	
deviatore ciclico (kPa)		95	
frequenza (hz)		0.00625	
tempo	cella di carico	$\Delta u$	LVDT
(min)	kN	(kPa)	$\delta$ (mm)
446.57	-0.008	191.1	-0.008
446.58	-0.008	191.2	-0.0062
446.60	-0.007	191.3	-0.0036
446.63	-0.003	191.5	0
446.65	-0.003	191.6	0.0036
446.67	-0.001	191.8	0.0071
446.68	0.003	192	0.0071
446.68	0.004	192	0.0107
446.70	0.004	192.2	0.0142
446.72	0.005	192.4	0.0178
446.73	0.009	192.7	0.0222
446.75	0.01	192.9	0.0249
446.77	0.012	193.1	0.0302
446.78	0.015	193.4	0.0302
446.80	0.016	193.4	0.0346
446.82	0.016	193.6	0.0373
446.83	0.017	193.9	0.0408
446.85	0.02	194.2	0.0444
446.87	0.021	194.4	0.047
446.88	0.022	194.6	0.0506
446.90	0.025	194.9	0.0506
446.92	0.025	194.9	0.0533
446.93	0.025	195.1	0.055
446.95	0.026	195.2	0.0568
446.97	0.027	195.5	0.0586
446.98	0.028	195.7	0.0595
447.00	0.028	195.9	0.0604
447.02	0.028	196	0.0604
447.03	0.029	196	0.0612
447.05	0.029	196.1	0.0612
447.07	0.029	196.2	0.0621
447.08	0.029	196.3	0.0621
447.10	0.029	196.4	0.0621
447.12	0.028	196.5	0.0604
447.13	0.026	196.5	0.0604
447.15	0.026	196.5	0.0586
447.17	0.026	196.5	0.0577
447.18	0.024	196.5	0.0559
447.20	0.022	196.4	0.0541
447.22	0.022	196.4	0.0533
447.23	0.021	196.3	0.0506
447.25	0.018	196.2	0.047
447.27	0.017	196.1	0.0453
447.28	0.016	196	0.0417
447.30	0.012	195.8	0.0417
447.32	0.011	195.8	0.0382
447.33	0.011	195.6	0.0364
447.35	0.01	195.4	0.032
447.37	0.006	195.1	0.0275
447.38	0.005	194.9	0.024
447.40	0.003	194.7	0.0195
447.42	0	194.4	0.0195
447.43	-0.001	194.2	0.0151
447.45	-0.001	194.2	0.0124
447.47	-0.003	194	0.008
447.48	-0.006	193.6	0.0044
447.50	-0.007	193.4	0.0018
447.52	-0.008	193.2	-0.0027

Prova triassiale ciclica SN04-C1			
pressione di confinamento (kPa)		80	
deviatore ciclico (kPa)		95	
frequenza (hz)		0.00625	
tempo	cella di carico	$\Delta u$	LVDT
(min)	kN	(kPa)	$\delta$ (mm)
447.53	-0.01	192.9	-0.0027
447.55	-0.012	192.7	-0.0053
447.57	-0.012	192.7	-0.0071
447.58	-0.013	192.4	-0.0098
447.60	-0.014	192.2	-0.0124
447.62	-0.015	192	-0.0142
447.63	-0.015	191.8	-0.0151
447.65	-0.016	191.6	-0.0169
447.67	-0.017	191.4	-0.0169
447.68	-0.017	191.4	-0.0178
447.70	-0.017	191.3	-0.0186
447.72	-0.017	191.2	-0.0186
447.73	-0.017	191.1	-0.0186
447.75	-0.017	191	-0.0186
447.77	-0.017	191	-0.0178
447.78	-0.016	190.9	-0.0178
447.80	-0.015	190.9	-0.0169
447.82	-0.015	190.9	-0.016
447.83	-0.014	190.9	-0.0151
447.85	-0.012	191	-0.0124
447.87	-0.012	191	-0.0107
447.88	-0.01	191.1	-0.0089
447.90	-0.007	191.2	-0.0089
447.92	-0.007	191.3	-0.0044
447.93	-0.006	191.4	-0.0018
447.95	-0.003	191.6	-0.0018
447.97	-0.002	191.6	0.0009
447.98	-0.002	191.7	0.0044
448.00	0	191.9	0.0089
448.02	0.004	192.1	0.0124
448.03	0.004	192.3	0.0151
448.07	0.006	192.5	0.0195
448.08	0.01	192.8	0.0195
448.10	0.011	192.8	0.024
448.12	0.011	193	0.0275
448.13	0.012	193.2	0.032
448.13	0.016	193.5	0.0355
448.15	0.017	193.7	0.0382
448.17	0.018	193.9	0.0417
448.18	0.021	194.2	0.0417
448.20	0.022	194.2	0.0453
448.22	0.022	194.4	0.0479
448.23	0.023	194.7	0.0506
448.25	0.025	194.9	0.0533
448.27	0.026	195.1	0.055
448.28	0.027	195.4	0.0577
448.30	0.027	195.6	0.0577
448.32	0.028	195.7	0.0586
448.33	0.028	195.7	0.0595
448.35	0.028	195.9	0.0604
448.37	0.029	196	0.0612
448.38	0.029	196.1	0.0612
448.40	0.029	196.3	0.0612
448.42	0.029	196.4	0.0612
448.43	0.028	196.4	0.0621
448.45	0.028	196.4	0.0604
448.47	0.027	196.5	0.0604
448.48	0.026	196.4	0.0586

Prova triassiale ciclica SN04-C1			
pressione di confinamento (kPa)		80	
deviatore ciclico (kPa)		95	
frequenza (hz)		0.00625	
tempo	cella di carico	$\Delta u$	LVDT
(min)	kN	(kPa)	$\delta$ (mm)
448.50	0.025	196.4	0.0568
448.52	0.024	196.5	0.0559
448.53	0.023	196.4	0.0533
448.55	0.021	196.3	0.0533
448.57	0.021	196.3	0.0515
448.58	0.019	196.2	0.0479
448.60	0.017	196.1	0.0453
448.62	0.015	195.9	0.0426
448.63	0.014	195.8	0.0399
448.65	0.012	195.6	0.0364
448.67	0.01	195.5	0.0346
448.68	0.009	195.3	0.0311
448.70	0.007	195	0.0275
448.72	0.003	194.8	0.0275
448.73	0.002	194.8	0.0222
448.75	0.002	194.6	0.0195
448.77	0.001	194.3	0.0151
448.78	-0.003	194.1	0.0107
448.80	-0.004	193.9	0.008
448.82	-0.005	193.5	0.0044
448.83	-0.008	193.3	0.0044
448.85	-0.009	193.3	0
448.87	-0.009	193.1	-0.0027
448.88	-0.01	192.8	-0.0053
448.90	-0.013	192.5	-0.0089
448.92	-0.013	192.4	-0.0107
448.93	-0.014	192.1	-0.0124
448.95	-0.016	191.9	-0.0124
448.97	-0.016	191.9	-0.0142
448.98	-0.016	191.7	-0.0151
449.00	-0.016	191.5	-0.0169
449.02	-0.017	191.4	-0.0178
449.03	-0.017	191.2	-0.0186
449.05	-0.017	191.2	-0.0186
449.07	-0.017	191.1	-0.0186
449.08	-0.017	191.1	-0.0178
449.10	-0.017	191	-0.0178
449.12	-0.016	190.9	-0.0169
449.13	-0.015	190.9	-0.016
449.15	-0.014	190.9	-0.0151
449.17	-0.014	190.9	-0.0133
449.18	-0.011	191	-0.0133
449.20	-0.011	191	-0.0115
449.22	-0.011	191	-0.0098
449.23	-0.01	191.2	-0.008
449.25	-0.007	191.3	-0.0044
449.27	-0.006	191.3	-0.0018
449.28	-0.004	191.5	0.0009
449.30	-0.001	191.7	0.0009
449.32	0	191.7	0.0044
449.33	0	191.8	0.008
449.35	0.002	192.1	0.0115
449.37	0.006	192.3	0.016
449.38	0.006	192.4	0.0178
449.40	0.007	192.7	0.0213
449.42	0.011	192.9	0.0257
449.43	0.012	193.1	0.0302
449.45	0.013	193.4	0.0337

Prova triassiale ciclica SN04-C1			
pressione di confinamento (kPa)		80	
deviatore ciclico (kPa)		95	
frequenza (hz)		0.00625	
tempo	cella di carico	$\Delta u$	LVDT
(min)	kN	(kPa)	$\delta$ (mm)
449.47	0.017	193.6	0.0337
449.48	0.017	193.6	0.0373
449.50	0.017	193.8	0.0408
449.53	0.019	194.1	0.0444
449.55	0.022	194.4	0.0479
449.57	0.022	194.6	0.0497
449.58	0.023	194.8	0.0524
449.58	0.026	195	0.0524
449.60	0.026	195	0.055
449.62	0.026	195.2	0.0568
449.63	0.027	195.4	0.0577
449.65	0.028	195.7	0.0595
449.67	0.028	195.8	0.0604
449.68	0.029	195.9	0.0612
449.70	0.029	196.1	0.0612
449.72	0.029	196.1	0.0621
449.73	0.029	196.2	0.0621
449.75	0.029	196.3	0.0621
449.77	0.028	196.4	0.0621
449.78	0.028	196.4	0.0612
449.80	0.027	196.5	0.0595
449.82	0.025	196.5	0.0595
449.83	0.024	196.5	0.0586
449.85	0.024	196.4	0.0568
449.87	0.024	196.4	0.055
449.88	0.021	196.3	0.0533
449.90	0.02	196.3	0.0506
449.92	0.019	196.2	0.0479
449.93	0.016	196	0.0479
449.95	0.015	196	0.0444
449.97	0.015	195.9	0.0426
449.98	0.013	195.7	0.0382
450.00	0.01	195.5	0.0346
450.02	0.009	195.3	0.032
450.03	0.007	195.1	0.0284
450.05	0.004	194.8	0.0284
450.07	0.002	194.6	0.0231
450.08	0.002	194.6	0.0195
450.10	-0.001	194.2	0.0151
450.12	-0.003	193.9	0.0133
450.13	-0.003	193.9	0.0107
450.15	-0.004	193.7	0.0062
450.17	-0.007	193.4	0.0018
450.18	-0.009	193.1	-0.0009
450.20	-0.009	192.9	-0.0036
450.22	-0.012	192.6	-0.0036
450.23	-0.013	192.4	-0.0071
450.25	-0.013	192.4	-0.0089
450.27	-0.014	192.2	-0.0115
450.28	-0.015	192	-0.0133
450.30	-0.016	191.8	-0.0142
450.32	-0.016	191.6	-0.0151
450.33	-0.017	191.5	-0.0169
450.35	-0.017	191.3	-0.0169
450.37	-0.017	191.3	-0.0178
450.38	-0.017	191.2	-0.0178
450.40	-0.017	191.1	-0.0178
450.42	-0.017	191	-0.0178

Prova triassiale ciclica SN04-C1			
pressione di confinamento (kPa)		80	
deviatore ciclico (kPa)		95	
frequenza (hz)		0.00625	
tempo	cella di carico	$\Delta u$	LVDT
(min)	kN	(kPa)	$\delta$ (mm)
450.43	-0.017	190.9	-0.0169
450.45	-0.016	190.9	-0.016
450.47	-0.014	190.9	-0.016
450.48	-0.014	190.9	-0.0151
450.50	-0.014	190.9	-0.0142
450.52	-0.013	190.9	-0.0124
450.53	-0.011	191	-0.0107
450.55	-0.01	191	-0.0089
450.57	-0.009	191.2	-0.0062
450.58	-0.006	191.3	-0.0062
450.60	-0.005	191.3	-0.0036
450.62	-0.005	191.4	-0.0009
450.63	-0.004	191.6	0.0027
450.65	0	191.8	0.0062
450.67	0.001	191.9	0.0098
450.68	0.003	192.1	0.0133
450.70	0.006	192.4	0.0133
450.72	0.007	192.4	0.0178
450.73	0.007	192.5	0.0213
450.75	0.009	192.8	0.0249
450.77	0.013	193.1	0.0302
450.78	0.014	193.3	0.0328
450.80	0.015	193.5	0.0373
450.82	0.018	193.8	0.0408
450.83	0.019	194	0.0426
450.85	0.02	194.2	0.0462
450.87	0.023	194.5	0.0462
450.88	0.023	194.5	0.0488
450.90	0.023	194.7	0.0506
450.92	0.024	194.9	0.0533
450.93	0.026	195.1	0.0559
450.97	0.026	195.3	0.0577
450.98	0.027	195.6	0.0595
451.00	0.028	195.7	0.0595
451.02	0.029	195.9	0.0604
451.03	0.029	195.9	0.0612
451.03	0.029	196	0.0612
451.05	0.029	196.1	0.0621
451.07	0.029	196.2	0.0621
451.08	0.029	196.3	0.0621
451.10	0.028	196.4	0.0621
451.12	0.027	196.5	0.0621
451.13	0.027	196.5	0.0612
451.15	0.027	196.5	0.0595
451.17	0.025	196.4	0.0577
451.18	0.023	196.4	0.0559
451.20	0.023	196.4	0.0541
451.22	0.021	196.3	0.0524
451.23	0.019	196.2	0.0524
451.25	0.018	196.2	0.0497
451.27	0.018	196.1	0.047
451.28	0.016	196	0.0444
451.30	0.013	195.8	0.0408
451.32	0.012	195.7	0.0382
451.33	0.011	195.4	0.0346
451.35	0.007	195.2	0.0346
451.37	0.006	195.2	0.0302
451.38	0.006	195	0.0257

Prova triassiale ciclica SN04-C1			
pressione di confinamento (kPa)		80	
deviatore ciclico (kPa)		95	
frequenza (hz)		0.00625	
tempo	cella di carico	$\Delta u$	LVDT
(min)	kN	(kPa)	$\delta$ (mm)
451.40	0.004	194.7	0.0222
451.42	0.001	194.5	0.0178
451.43	0	194.3	0.0151
451.45	-0.002	194	0.0107
451.47	-0.005	193.7	0.0107
451.48	-0.006	193.7	0.0062
451.50	-0.006	193.5	0.0036
451.52	-0.007	193.2	0
451.53	-0.01	193	-0.0036
451.55	-0.011	192.7	-0.0053
451.57	-0.011	192.6	-0.0071
451.58	-0.014	192.3	-0.0098
451.60	-0.014	192.1	-0.0115
451.62	-0.015	191.9	-0.0133
451.63	-0.016	191.7	-0.0133
451.65	-0.017	191.7	-0.0151
451.67	-0.017	191.5	-0.016
451.68	-0.017	191.4	-0.0169
451.70	-0.017	191.3	-0.0169
451.72	-0.017	191.2	-0.0178
451.73	-0.017	191	-0.0178
451.75	-0.017	190.9	-0.0178
451.77	-0.016	190.9	-0.0178
451.78	-0.016	190.9	-0.0169
451.80	-0.016	190.9	-0.016
451.82	-0.015	190.9	-0.0151
451.83	-0.013	190.9	-0.0133
451.85	-0.013	190.9	-0.0115
451.87	-0.011	191	-0.0115
451.88	-0.009	191.1	-0.0098
451.90	-0.009	191.1	-0.008
451.92	-0.008	191.2	-0.0044
451.93	-0.005	191.3	-0.0018
451.95	-0.004	191.4	0.0009
451.97	-0.002	191.6	0.0044
451.98	0.001	191.8	0.0044
452.00	0.002	191.9	0.008
452.02	0.002	191.9	0.0115
452.03	0.003	192.1	0.0151
452.05	0.007	192.4	0.0186
452.07	0.009	192.6	0.0222
452.08	0.01	192.8	0.0275
452.10	0.013	193.1	0.0275
452.12	0.014	193.4	0.0311
452.13	0.014	193.4	0.0346
452.15	0.016	193.6	0.0382
452.17	0.019	193.9	0.0426
452.18	0.02	194.1	0.0453
452.20	0.021	194.3	0.0488
452.22	0.023	194.6	0.0488
452.23	0.024	194.8	0.0515
452.25	0.024	194.8	0.0533
452.27	0.025	195	0.055
452.28	0.027	195.4	0.0577
452.30	0.027	195.4	0.0586
452.32	0.027	195.6	0.0595
452.33	0.028	195.8	0.0604
452.35	0.029	195.9	0.0612



Prova triassiale ciclica SN04-C1			
pressione di confinamento (kPa)		80	
deviatore ciclico (kPa)		95	
frequenza (hz)		0.00625	
tempo	cella di carico	$\Delta u$	LVDT
(min)	kN	(kPa)	$\delta$ (mm)
452.37	0.029	196.1	0.0621
452.38	0.029	196.2	0.0621
452.40	0.029	196.3	0.0621
452.43	0.028	196.3	0.0621
452.45	0.028	196.4	0.0621
452.47	0.028	196.4	0.0621
452.48	0.027	196.5	0.0604
452.48	0.026	196.5	0.0595
452.50	0.025	196.5	0.0577
452.52	0.023	196.4	0.0577
452.53	0.022	196.4	0.0559
452.55	0.022	196.4	0.0541
452.57	0.021	196.3	0.0515
452.58	0.018	196.2	0.0479
452.60	0.017	196.1	0.0462
452.62	0.016	195.9	0.0435
452.63	0.012	195.7	0.0435
452.65	0.011	195.7	0.0399
452.67	0.011	195.6	0.0364
452.68	0.01	195.3	0.0328
452.70	0.006	195.1	0.0284
452.72	0.005	194.9	0.0249
452.73	0.004	194.6	0.0204
452.75	0	194.4	0.0204
452.77	-0.001	194.4	0.0169
452.78	-0.001	194.2	0.0133
452.80	-0.003	193.9	0.0089
452.82	-0.006	193.6	0.0053
452.83	-0.007	193.4	0.0018
452.85	-0.008	193.1	-0.0018
452.87	-0.011	192.8	-0.0018
452.88	-0.011	192.8	-0.0044
452.90	-0.011	192.6	-0.0062
452.92	-0.013	192.4	-0.0098
452.93	-0.015	192.1	-0.0115
452.95	-0.015	191.9	-0.0133
452.97	-0.016	191.8	-0.0142
452.98	-0.017	191.6	-0.0142
453.00	-0.017	191.4	-0.016
453.02	-0.017	191.3	-0.0169
453.03	-0.017	191.2	-0.0169
453.05	-0.017	191.2	-0.0178
453.07	-0.017	191.1	-0.0178
453.08	-0.017	191	-0.0178
453.10	-0.017	190.9	-0.0169
453.12	-0.016	190.9	-0.016
453.13	-0.015	190.8	-0.0151
453.15	-0.014	190.9	-0.0151
453.17	-0.013	190.9	-0.0142
453.18	-0.013	190.9	-0.0133
453.20	-0.012	190.9	-0.0107
453.22	-0.01	191	-0.0089
453.23	-0.008	191.1	-0.0062
453.25	-0.007	191.2	-0.0036
453.27	-0.005	191.3	-0.0036
453.28	-0.003	191.3	-0.0009
453.30	-0.003	191.5	0.0018
453.32	-0.002	191.6	0.0062

Prova triassiale ciclica SN04-C1			
pressione di confinamento (kPa)		80	
deviatore ciclico (kPa)		95	
frequenza (hz)		0.00625	
tempo	cella di carico	$\Delta u$	LVDT
(min)	kN	(kPa)	$\delta$ (mm)
453.33	0.002	191.9	0.0098
453.35	0.003	192.1	0.0124
453.37	0.004	192.3	0.0169
453.38	0.008	192.5	0.0169
453.40	0.01	192.7	0.0213
453.42	0.01	192.7	0.0249
453.43	0.011	192.9	0.0293
453.45	0.014	193.2	0.0328
453.47	0.015	193.4	0.0355
453.48	0.016	193.7	0.0399
453.50	0.02	194	0.0399
453.52	0.021	194	0.0435
453.53	0.021	194.2	0.0462
453.55	0.021	194.4	0.0488
453.57	0.023	194.7	0.0515
453.58	0.025	194.9	0.0541
453.60	0.026	195.1	0.0559
453.62	0.027	195.4	0.0559
453.63	0.028	195.5	0.0586
453.65	0.028	195.5	0.0595
453.67	0.028	195.7	0.0604
453.68	0.029	195.9	0.0612
453.70	0.029	196	0.0621
453.72	0.029	196.1	0.0621
453.73	0.028	196.2	0.0621
453.75	0.028	196.3	0.0621
453.77	0.028	196.4	0.0621
453.78	0.028	196.4	0.0621
453.80	0.026	196.4	0.0612
453.82	0.026	196.4	0.0595
453.83	0.026	196.5	0.0586
453.85	0.024	196.4	0.0568
453.87	0.023	196.4	0.055
453.90	0.022	196.3	0.0524
453.92	0.02	196.2	0.0524
453.93	0.017	196.1	0.0506
453.93	0.017	196.1	0.047
453.95	0.016	196	0.0444
453.97	0.014	195.8	0.0408
453.98	0.012	195.7	0.0382
454.00	0.011	195.5	0.0346
454.02	0.008	195.2	0.0346
454.03	0.005	195	0.0302
454.05	0.005	195	0.0275
454.07	0.004	194.8	0.0222
454.08	0.002	194.5	0.0186
454.10	-0.001	194.3	0.0142
454.12	-0.002	194.1	0.0107
454.13	-0.005	193.7	0.0107
454.15	-0.007	193.5	0.0071
454.17	-0.007	193.5	0.0036
454.18	-0.007	193.3	0
454.20	-0.01	192.9	-0.0027
454.22	-0.011	192.7	-0.0053
454.23	-0.012	192.5	-0.0089
454.25	-0.014	192.2	-0.0107
454.27	-0.015	192	-0.0107
454.28	-0.015	192	-0.0124

Prova triassiale ciclica SN04-C1			
pressione di confinamento (kPa)		80	
deviatore ciclico (kPa)		95	
frequenza (hz)		0.00625	
tempo	cella di carico	$\Delta u$	LVDT
(min)	kN	(kPa)	$\delta$ (mm)
454.30	-0.015	191.8	-0.0142
454.32	-0.016	191.6	-0.0151
454.33	-0.017	191.5	-0.0169
454.35	-0.017	191.3	-0.0178
454.37	-0.017	191.2	-0.0178
454.38	-0.017	191.1	-0.0178
454.40	-0.017	191.1	-0.0178
454.42	-0.017	191	-0.0178
454.43	-0.017	190.9	-0.0178
454.45	-0.016	190.9	-0.0169
454.47	-0.016	190.8	-0.016
454.48	-0.015	190.8	-0.0151
454.50	-0.013	190.8	-0.0133
454.52	-0.012	190.9	-0.0124
454.53	-0.012	191	-0.0107
454.55	-0.009	191	-0.0107
454.57	-0.008	191	-0.008
454.58	-0.008	191.1	-0.0053
454.60	-0.006	191.2	-0.0027
454.62	-0.004	191.4	0.0009
454.63	-0.003	191.5	0.0036
454.65	-0.001	191.7	0.0071
454.67	0.003	192	0.0071
454.68	0.004	192	0.0107
454.70	0.004	192.1	0.0142
454.72	0.005	192.4	0.0178
454.73	0.009	192.6	0.0222
454.75	0.01	192.8	0.0257
454.77	0.012	193.1	0.0302
454.78	0.015	193.3	0.0302
454.80	0.016	193.3	0.0346
454.82	0.016	193.5	0.0382
454.83	0.017	193.8	0.0417
454.85	0.02	194.1	0.0444
454.87	0.021	194.3	0.047
454.88	0.022	194.6	0.0506
454.90	0.025	194.8	0.0506
454.92	0.025	194.8	0.0533
454.93	0.025	195	0.0559
454.95	0.026	195.2	0.0577
454.97	0.027	195.4	0.0586
454.98	0.028	195.6	0.0595
455.00	0.028	195.8	0.0612
455.02	0.029	195.9	0.0612
455.03	0.029	195.9	0.0621
455.05	0.029	196	0.0621
455.07	0.029	196.2	0.0621
455.08	0.028	196.3	0.0621
455.10	0.028	196.4	0.0621
455.12	0.028	196.4	0.0621
455.13	0.027	196.4	0.0621
455.15	0.025	196.4	0.0604
455.17	0.025	196.4	0.0586
455.18	0.023	196.4	0.0568
455.20	0.022	196.4	0.0559
455.22	0.022	196.4	0.0541
455.23	0.021	196.3	0.0515
455.25	0.018	196.1	0.0488

Prova triassiale ciclica SN04-C1			
pressione di confinamento (kPa)		80	
deviatore ciclico (kPa)		95	
frequenza (hz)		0.00625	
tempo	cella di carico	$\Delta u$	LVDT
(min)	kN	(kPa)	$\delta$ (mm)
455.27	0.017	196	0.0462
455.28	0.016	195.9	0.0426
455.30	0.012	195.7	0.0426
455.33	0.011	195.7	0.0391
455.35	0.011	195.6	0.0364
455.37	0.01	195.3	0.0328
455.38	0.006	195.1	0.0284
455.40	0.005	194.9	0.0249
455.40	0.004	194.7	0.0213
455.42	0	194.4	0.0213
455.43	-0.001	194.4	0.0169
455.45	-0.001	194.2	0.0133
455.47	-0.003	193.9	0.0098
455.48	-0.006	193.6	0.0053
455.50	-0.007	193.4	0.0018
455.52	-0.008	193.1	-0.0018
455.53	-0.011	192.8	-0.0018
455.55	-0.012	192.8	-0.0044
455.57	-0.012	192.6	-0.0071
455.58	-0.013	192.4	-0.0098
455.60	-0.014	192.1	-0.0124
455.62	-0.015	191.9	-0.0133
455.63	-0.016	191.7	-0.0151
455.65	-0.017	191.6	-0.0151
455.67	-0.017	191.4	-0.0169
455.68	-0.017	191.4	-0.0169
455.70	-0.017	191.3	-0.0178
455.72	-0.017	191.2	-0.0178
455.73	-0.017	191	-0.0178
455.75	-0.017	190.9	-0.0178
455.77	-0.016	190.9	-0.0178
455.78	-0.015	190.9	-0.0169
455.80	-0.015	190.9	-0.016
455.82	-0.015	190.8	-0.0151
455.83	-0.014	190.9	-0.0142
455.85	-0.012	190.9	-0.0124
455.87	-0.012	190.9	-0.0107
455.88	-0.009	191	-0.0107
455.90	-0.007	191.2	-0.008
455.92	-0.007	191.2	-0.0044
455.93	-0.005	191.4	-0.0044
455.95	-0.003	191.5	-0.0018
455.97	-0.003	191.5	0.0018
455.98	-0.001	191.6	0.0062
456.00	0.001	191.9	0.0098
456.02	0.003	192	0.0124
456.03	0.004	192.2	0.016
456.05	0.007	192.5	0.016
456.07	0.01	192.7	0.0204
456.08	0.01	192.7	0.024
456.10	0.011	192.9	0.0293
456.12	0.013	193.2	0.0328
456.13	0.016	193.5	0.0364
456.15	0.017	193.7	0.0399
456.17	0.018	194	0.0426
456.18	0.021	194.2	0.0426
456.20	0.022	194.2	0.0453
456.22	0.022	194.4	0.0488

Prova triassiale ciclica SN04-C1			
pressione di confinamento (kPa)		80	
deviatore ciclico (kPa)		95	
frequenza (hz)		0.00625	
tempo	cella di carico	$\Delta u$	LVDT
(min)	kN	(kPa)	$\delta$ (mm)
456.23	0.024	194.7	0.0524
456.25	0.025	194.9	0.0541
456.27	0.026	195.1	0.0559
456.28	0.026	195.3	0.0577
456.30	0.027	195.5	0.0577
456.32	0.028	195.5	0.0595
456.33	0.028	195.7	0.0604
456.35	0.028	195.9	0.0612
456.37	0.029	196	0.0612
456.38	0.029	196.1	0.0621
456.40	0.029	196.2	0.0621
456.42	0.029	196.3	0.0621
456.43	0.028	196.3	0.0621
456.45	0.028	196.4	0.0621
456.47	0.027	196.4	0.0604
456.48	0.026	196.4	0.0586
456.50	0.026	196.4	0.0577
456.52	0.024	196.4	0.0559
456.53	0.022	196.3	0.0559
456.55	0.021	196.3	0.0533
456.57	0.021	196.3	0.0515
456.58	0.02	196.1	0.0497
456.60	0.017	196	0.0462
456.62	0.016	195.9	0.0435
456.63	0.014	195.7	0.0399
456.65	0.012	195.6	0.0382
456.67	0.011	195.4	0.0346
456.68	0.009	195.1	0.0311
456.70	0.005	194.9	0.0311
456.72	0.004	194.9	0.0257
456.73	0.004	194.8	0.0231
456.75	0.002	194.5	0.0186
456.77	-0.001	194.2	0.0151
456.80	-0.002	194	0.0115
456.82	-0.004	193.7	0.008
456.83	-0.007	193.5	0.008
456.85	-0.007	193.5	0.0027
456.85	-0.007	193.3	0.0009
456.87	-0.009	193	-0.0027
456.88	-0.012	192.7	-0.0062
456.90	-0.012	192.5	-0.008
456.92	-0.013	192.3	-0.0107
456.93	-0.015	192	-0.0107
456.95	-0.015	192	-0.0124
456.97	-0.015	191.8	-0.0133
456.98	-0.016	191.7	-0.0151
457.00	-0.017	191.5	-0.0169
457.02	-0.017	191.3	-0.0178
457.03	-0.017	191.2	-0.0178
457.05	-0.017	191.1	-0.0178
457.07	-0.017	191.1	-0.0178
457.08	-0.017	191	-0.0178
457.10	-0.017	190.9	-0.0178
457.12	-0.016	190.9	-0.0169
457.13	-0.015	190.8	-0.016
457.15	-0.015	190.9	-0.0151
457.17	-0.013	190.9	-0.0151
457.18	-0.012	190.9	-0.0133

Prova triassiale ciclica SN04-C1			
pressione di confinamento (kPa)		80	
deviatore ciclico (kPa)		95	
frequenza (hz)		0.00625	
tempo	cella di carico	$\Delta u$	LVDT
(min)	kN	(kPa)	$\delta$ (mm)
457.20	-0.012	190.9	-0.0115
457.22	-0.011	191	-0.0098
457.23	-0.008	191.1	-0.0071
457.25	-0.007	191.2	-0.0044
457.27	-0.006	191.3	-0.0018
457.28	-0.002	191.5	-0.0018
457.30	-0.002	191.5	0.0018
457.32	-0.002	191.6	0.0044
457.33	0	191.8	0.008
457.35	0.004	192.1	0.0124
457.37	0.005	192.2	0.0151
457.38	0.005	192.4	0.0178
457.40	0.009	192.6	0.0222
457.42	0.01	192.8	0.0249
457.43	0.012	193.1	0.0302
457.45	0.015	193.4	0.0302
457.47	0.017	193.6	0.0346
457.48	0.017	193.6	0.0382
457.50	0.017	193.8	0.0408
457.52	0.02	194.1	0.0444
457.53	0.021	194.3	0.047
457.55	0.022	194.5	0.0497
457.57	0.025	194.8	0.0497
457.58	0.025	195	0.0533
457.60	0.025	195	0.0541
457.62	0.026	195.2	0.0568
457.63	0.027	195.4	0.0586
457.65	0.028	195.6	0.0595
457.67	0.028	195.8	0.0604
457.68	0.029	195.9	0.0604
457.70	0.029	196.1	0.0612
457.72	0.029	196.1	0.0621
457.73	0.029	196.2	0.0621
457.75	0.029	196.3	0.0621
457.77	0.028	196.4	0.0612
457.78	0.028	196.4	0.0612
457.80	0.027	196.4	0.0612
457.82	0.026	196.4	0.0595
457.83	0.026	196.4	0.0586
457.85	0.024	196.4	0.0559
457.87	0.023	196.3	0.0533
457.88	0.021	196.3	0.0524
457.90	0.02	196.2	0.0497
457.92	0.018	196	0.0497
457.93	0.016	195.9	0.047
457.95	0.016	195.9	0.0444
457.97	0.015	195.8	0.0408
457.98	0.012	195.6	0.0373
458.00	0.009	195.4	0.0337
458.02	0.009	195.2	0.0311
458.03	0.006	195	0.0275
458.05	0.004	194.7	0.0275
458.07	0.002	194.7	0.0231
458.08	0	194.3	0.0169
458.10	-0.001	194.1	0.0169
458.12	-0.002	194.1	0.0142
458.13	-0.002	193.9	0.0107
458.15	-0.005	193.6	0.0053

Prova triassiale ciclica SN04-C1			
pressione di confinamento (kPa)		80	
deviatore ciclico (kPa)		95	
frequenza (hz)		0.00625	
tempo	cella di carico	$\Delta u$	LVDT
(min)	kN	(kPa)	$\delta$ (mm)
458.17	-0.008	193.3	0.0018
458.18	-0.008	193.1	-0.0009
458.20	-0.01	192.8	-0.0044
458.23	-0.012	192.6	-0.0044
458.25	-0.013	192.6	-0.008
458.27	-0.013	192.3	-0.0098
458.28	-0.014	192.1	-0.0115
458.30	-0.015	191.9	-0.0133
458.30	-0.015	191.7	-0.0151
458.32	-0.016	191.5	-0.0169
458.33	-0.017	191.4	-0.0169
458.35	-0.017	191.4	-0.0178
458.37	-0.017	191.2	-0.0178
458.38	-0.017	191.1	-0.0178
458.40	-0.017	191	-0.0178
458.42	-0.017	190.9	-0.0178
458.43	-0.016	190.9	-0.0169
458.45	-0.016	190.8	-0.0169
458.47	-0.015	190.8	-0.0169
458.48	-0.015	190.8	-0.016
458.50	-0.014	190.8	-0.0142
458.52	-0.012	190.9	-0.0124
458.53	-0.012	190.9	-0.0115
458.55	-0.011	191	-0.0089
458.57	-0.007	191.2	-0.0089
458.58	-0.006	191.2	-0.0053
458.60	-0.006	191.2	-0.0027
458.62	-0.005	191.3	0
458.63	-0.002	191.5	0.0036
458.65	-0.001	191.7	0.0053
458.67	0.001	191.9	0.0098
458.68	0.005	192.1	0.0098
458.70	0.006	192.1	0.0142
458.72	0.006	192.3	0.0169
458.73	0.007	192.5	0.0204
458.75	0.01	192.8	0.0249
458.77	0.012	193	0.0302
458.78	0.014	193.2	0.0346
458.80	0.017	193.5	0.0346
458.82	0.017	193.7	0.0391
458.83	0.018	193.9	0.0417
458.85	0.021	194.2	0.0417
458.87	0.022	194.2	0.0453
458.88	0.022	194.4	0.0479
458.90	0.023	194.6	0.0515
458.92	0.025	194.9	0.0541
458.93	0.026	195.1	0.055
458.95	0.026	195.2	0.0568
458.97	0.027	195.5	0.0568
458.98	0.028	195.7	0.0586
459.00	0.028	195.7	0.0604
459.02	0.028	195.8	0.0604
459.03	0.029	196	0.0612
459.05	0.029	196.1	0.0621
459.07	0.029	196.2	0.0621
459.08	0.029	196.3	0.0621
459.10	0.028	196.4	0.0621
459.12	0.028	196.4	0.0621

Prova triassiale ciclica SN04-C1			
ensione di confinamento (kPa)		80	
deviatore ciclico (kPa)		95	
frequenza (hz)		0.00625	
tempo	cella di carico	$\Delta u$	LVDT
(min)	kN	(kPa)	$\delta$ (mm)
459.13	0.027	196.4	0.0604
459.15	0.026	196.4	0.0586
459.17	0.025	196.4	0.0577
459.18	0.024	196.4	0.0559
459.20	0.022	196.3	0.0559
459.22	0.021	196.2	0.0541
459.23	0.021	196.2	0.0515
459.25	0.019	196.2	0.0479
459.27	0.017	196	0.0453
459.28	0.015	195.9	0.0435
459.30	0.014	195.8	0.0408
459.32	0.012	195.5	0.0408
459.33	0.009	195.3	0.0364
459.35	0.009	195.3	0.0328
459.37	0.008	195.1	0.0302
459.38	0.005	194.8	0.0249
459.40	0.003	194.6	0.0213
459.42	0.001	194.4	0.0169
459.43	-0.001	194.1	0.0133
459.45	-0.003	193.9	0.0133
459.47	-0.003	193.9	0.0098
459.48	-0.004	193.7	0.0062
459.50	-0.007	193.3	0.0018
459.52	-0.009	193.1	-0.0009
459.53	-0.01	192.9	-0.0044
459.55	-0.01	192.6	-0.0053
459.57	-0.013	192.4	-0.008
459.58	-0.013	192.2	-0.0098
459.60	-0.014	192	-0.0115
459.62	-0.015	191.8	-0.0115
459.63	-0.016	191.8	-0.0133
459.65	-0.016	191.6	-0.0151
459.67	-0.016	191.4	-0.016
459.70	-0.017	191.3	-0.0178
459.72	-0.017	191.2	-0.0178
459.73	-0.017	191	-0.0178
459.75	-0.017	190.9	-0.0178
459.75	-0.016	190.9	-0.0178
459.77	-0.016	190.8	-0.0169
459.78	-0.016	190.8	-0.0169
459.80	-0.015	190.8	-0.016
459.82	-0.015	190.8	-0.0142
459.83	-0.014	190.8	-0.0133
459.85	-0.011	190.9	-0.0133
459.87	-0.011	190.9	-0.0115
459.88	-0.011	190.9	-0.0098
459.90	-0.01	191	-0.0071
459.92	-0.006	191.2	-0.0036
459.93	-0.006	191.2	-0.0018
459.95	-0.004	191.4	0.0009
459.97	-0.001	191.6	0.0009
459.98	0	191.6	0.0053
460.00	0	191.7	0.008
460.02	0.002	191.9	0.0124
460.03	0.005	192.2	0.016
460.05	0.006	192.4	0.0195
460.07	0.008	192.6	0.0231
460.08	0.012	192.9	0.0231



Prova triassiale ciclica SN04-C1			
pressione di confinamento (kPa)		80	
deviatore ciclico (kPa)		95	
frequenza (hz)		0.00625	
tempo	cella di carico	$\Delta u$	LVDT
(min)	kN	(kPa)	$\delta$ (mm)
460.10	0.013	192.9	0.0284
460.12	0.013	193.1	0.032
460.13	0.014	193.3	0.0346
460.15	0.017	193.6	0.0391
460.17	0.018	193.8	0.0417
460.18	0.02	194.1	0.0462
460.20	0.023	194.3	0.0462
460.22	0.023	194.3	0.0506
460.23	0.023	194.5	0.0515
460.25	0.024	194.8	0.0533
460.27	0.026	195	0.055
460.28	0.026	195.2	0.0568
460.30	0.027	195.4	0.0595
460.32	0.028	195.6	0.0604
460.33	0.028	195.8	0.0612
460.35	0.029	195.9	0.0621
460.37	0.029	196	0.0621
460.38	0.029	196.2	0.0621
460.40	0.029	196.2	0.0621
460.42	0.029	196.2	0.0621
460.43	0.029	196.3	0.0621
460.45	0.028	196.4	0.0612
460.47	0.027	196.4	0.0595
460.48	0.025	196.4	0.0595
460.50	0.024	196.4	0.0577
460.52	0.024	196.4	0.0568
460.53	0.024	196.4	0.0559
460.55	0.022	196.2	0.0533
460.57	0.02	196.2	0.0506
460.58	0.019	196.1	0.0479
460.60	0.016	196	0.0479
460.62	0.014	195.8	0.0444
460.63	0.014	195.8	0.0417
460.65	0.014	195.7	0.0391
460.67	0.011	195.4	0.0355
460.68	0.008	195.2	0.032
460.70	0.007	195	0.0293
460.72	0.004	194.7	0.0293
460.73	0.002	194.5	0.024
460.75	0.002	194.5	0.0195
460.77	0	194.4	0.0151
460.78	-0.002	194	0.0115
460.80	-0.004	193.8	0.0089
460.82	-0.005	193.5	0.0053
460.83	-0.007	193.2	0.0053
460.85	-0.01	193	0.0009
460.87	-0.01	193	-0.0027
460.88	-0.01	192.8	-0.0044
460.90	-0.012	192.5	-0.008
460.92	-0.014	192.3	-0.0098
460.93	-0.014	192.1	-0.0115
460.95	-0.015	191.8	-0.0142
460.97	-0.017	191.7	-0.0142
460.98	-0.017	191.7	-0.016
461.00	-0.017	191.3	-0.0169
461.02	-0.017	191.2	-0.0169
461.03	-0.017	191.2	-0.0169
461.05	-0.017	191.1	-0.0178

Prova triassiale ciclica SN04-C1			
pressione di confinamento (kPa)		80	
deviatore ciclico (kPa)		95	
frequenza (hz)		0.00625	
tempo	cella di carico	$\Delta u$	LVDT
(min)	kN	(kPa)	$\delta$ (mm)
461.07	-0.017	190.9	-0.0186
461.08	-0.017	190.9	-0.0178
461.10	-0.016	190.8	-0.0178
461.12	-0.016	190.8	-0.0169
461.15	-0.015	190.8	-0.0169
461.17	-0.014	190.8	-0.0151
461.18	-0.014	190.8	-0.0142
461.20	-0.013	190.8	-0.0124
461.20	-0.011	190.9	-0.0107
461.22	-0.01	190.9	-0.0089
461.23	-0.009	191.1	-0.0062
461.25	-0.006	191.2	-0.0062
461.27	-0.005	191.2	-0.0027
461.28	-0.005	191.3	0
461.30	-0.003	191.5	0.0027
461.32	0	191.7	0.0062
461.33	0.001	191.8	0.0098
461.35	0.003	192.1	0.0133
461.37	0.006	192.3	0.0133
461.38	0.007	192.3	0.0178
461.40	0.007	192.5	0.0204
461.42	0.009	192.8	0.0249
461.43	0.013	193	0.0302
461.45	0.013	193.2	0.0328
461.47	0.015	193.5	0.0373
461.48	0.018	193.7	0.0373
461.50	0.019	193.7	0.0408
461.52	0.019	193.9	0.0444
461.53	0.021	194.2	0.047
461.55	0.023	194.5	0.0497
461.57	0.024	194.6	0.0524
461.58	0.024	194.9	0.055
461.60	0.027	195.1	0.055
461.62	0.027	195.1	0.0568
461.63	0.027	195.3	0.0577
461.65	0.027	195.5	0.0595
461.67	0.029	195.7	0.0612
461.68	0.028	195.8	0.0612
461.70	0.029	196	0.0621
461.72	0.029	196.1	0.0621
461.73	0.029	196.2	0.0621
461.75	0.029	196.3	0.0621
461.77	0.028	196.4	0.0621
461.78	0.027	196.4	0.0612
461.80	0.027	196.4	0.0604
461.82	0.027	196.4	0.0595
461.83	0.025	196.4	0.0568
461.85	0.023	196.4	0.0559
461.87	0.023	196.3	0.0541
461.88	0.021	196.2	0.0541
461.90	0.02	196.2	0.0524
461.92	0.02	196.1	0.0506
461.93	0.018	196	0.047
461.95	0.015	195.8	0.0426
461.97	0.014	195.8	0.0408
461.98	0.012	195.6	0.0373
462.00	0.009	195.3	0.0373
462.02	0.008	195.3	0.0337

Prova triassiale ciclica SN04-C1			
pressione di confinamento (kPa)		80	
deviatore ciclico (kPa)		95	
frequenza (hz)		0.00625	
tempo	cella di carico	$\Delta u$	LVDT
(min)	kN	(kPa)	$\delta$ (mm)
462.03	0.008	195.1	0.0311
462.05	0.006	194.9	0.0257
462.07	0.002	194.6	0.0213
462.08	0.001	194.4	0.0178
462.10	0	194.1	0.0133
462.12	-0.004	193.9	0.0133
462.13	-0.005	193.9	0.0098
462.15	-0.005	193.7	0.0071
462.17	-0.006	193.4	0.0027
462.18	-0.009	193.1	-0.0009
462.20	-0.01	192.9	-0.0036
462.22	-0.011	192.6	-0.0062
462.23	-0.013	192.3	-0.0062
462.25	-0.014	192.3	-0.0089
462.27	-0.014	192.2	-0.0107
462.28	-0.015	192	-0.0133
462.30	-0.016	191.7	-0.0142
462.32	-0.016	191.5	-0.0151
462.33	-0.017	191.4	-0.0169
462.35	-0.017	191.2	-0.0169
462.37	-0.017	191.2	-0.0178
462.38	-0.017	191.1	-0.0178
462.40	-0.017	191	-0.0178
462.42	-0.017	190.9	-0.0178
462.43	-0.017	190.9	-0.0178
462.45	-0.016	190.8	-0.016
462.47	-0.015	190.8	-0.016
462.48	-0.015	190.7	-0.0151
462.50	-0.013	190.8	-0.0124
462.52	-0.012	190.8	-0.0124
462.53	-0.01	190.9	-0.0115
462.55	-0.01	190.9	-0.0098
462.57	-0.009	191	-0.0071
462.60	-0.007	191.1	-0.0044
462.62	-0.006	191.2	-0.0027
462.63	-0.005	191.4	0.0009
462.65	-0.001	191.6	0.0009
462.65	0	191.7	0.0053
462.67	0	191.7	0.008
462.68	0.002	191.9	0.0124
462.70	0.005	192.2	0.016
462.72	0.006	192.4	0.0186
462.73	0.008	192.6	0.0231
462.75	0.011	192.9	0.0231
462.77	0.013	193.1	0.0284
462.78	0.013	193.1	0.0311
462.80	0.014	193.3	0.0355
462.82	0.017	193.6	0.0399
462.83	0.019	193.8	0.0426
462.85	0.02	194	0.0453
462.87	0.022	194.3	0.0453
462.88	0.023	194.5	0.0479
462.90	0.023	194.5	0.0506
462.92	0.024	194.7	0.0533
462.93	0.026	195	0.0559
462.95	0.027	195.2	0.0577
462.97	0.027	195.4	0.0586
462.98	0.028	195.6	0.0586

Prova triassiale ciclica SN04-C1			
pressione di confinamento (kPa)		80	
deviatore ciclico (kPa)		95	
frequenza (hz)		0.00625	
tempo	cella di carico	$\Delta u$	LVDT
(min)	kN	(kPa)	$\delta$ (mm)
463.00	0.029	195.8	0.0604
463.02	0.029	195.8	0.0612
463.03	0.029	195.9	0.0612
463.05	0.029	196	0.0621
463.07	0.028	196.1	0.0621
463.08	0.028	196.2	0.0621
463.10	0.028	196.3	0.0621
463.12	0.027	196.3	0.0621
463.13	0.027	196.3	0.0612
463.15	0.026	196.4	0.0595
463.17	0.025	196.3	0.0577
463.18	0.025	196.3	0.0577
463.20	0.023	196.3	0.055
463.22	0.022	196.2	0.0524
463.23	0.02	196.2	0.0515
463.25	0.019	196.1	0.0479
463.27	0.017	195.9	0.0444
463.28	0.014	195.8	0.0444
463.30	0.014	195.8	0.0408
463.32	0.013	195.7	0.0382
463.33	0.011	195.4	0.0355
463.35	0.008	195.1	0.032
463.37	0.007	195	0.0275
463.38	0.005	194.7	0.0231
463.40	0.001	194.5	0.0231
463.42	0.001	194.5	0.0186
463.43	0.001	194.3	0.016
463.45	-0.001	194	0.0124
463.47	-0.004	193.7	0.008
463.48	-0.005	193.5	0.0044
463.50	-0.007	193.2	0.0009
463.52	-0.01	192.9	0.0009
463.53	-0.01	192.9	-0.0027
463.55	-0.01	192.7	-0.0044
463.57	-0.012	192.4	-0.008
463.58	-0.013	192.2	-0.0098
463.60	-0.014	192	-0.0124
463.62	-0.015	191.8	-0.0142
463.63	-0.016	191.6	-0.0142
463.65	-0.016	191.6	-0.0151
463.67	-0.016	191.5	-0.016
463.68	-0.017	191.3	-0.0178
463.70	-0.017	191.2	-0.0178
463.72	-0.017	191	-0.0178
463.73	-0.017	190.9	-0.0178
463.75	-0.017	190.9	-0.0178
463.77	-0.016	190.9	-0.0178
463.78	-0.016	190.8	-0.0178
463.80	-0.016	190.8	-0.016
463.82	-0.014	190.8	-0.0151
463.83	-0.013	190.8	-0.0142
463.85	-0.013	190.8	-0.0115
463.87	-0.01	190.9	-0.0115
463.88	-0.009	190.9	-0.0098
463.90	-0.008	191	-0.0062
463.92	-0.007	191.1	-0.0062
463.93	-0.005	191.1	-0.0044
463.95	-0.005	191.2	-0.0009

Prova triassiale ciclica SN04-C1			
pressione di confinamento (kPa)		80	
deviatore ciclico (kPa)		95	
frequenza (hz)		0.00625	
tempo	cella di carico	$\Delta u$	LVDT
(min)	kN	(kPa)	$\delta$ (mm)
463.97	-0.003	191.4	0.0036
463.98	0	191.6	0.0071
464.00	0.001	191.7	0.0098
464.02	0.002	192	0.0133
464.03	0.006	192.2	0.0133
464.07	0.007	192.2	0.0169
464.08	0.007	192.4	0.0204
464.10	0.009	192.7	0.0249
464.12	0.013	192.9	0.0311
464.12	0.014	193.1	0.0337
464.13	0.015	193.4	0.0364
464.15	0.018	193.7	0.0364
464.17	0.019	193.7	0.0408
464.18	0.019	193.9	0.0435
464.20	0.02	194.1	0.047
464.22	0.023	194.4	0.0497
464.23	0.024	194.6	0.0524
464.25	0.025	194.8	0.0541
464.27	0.026	195	0.0541
464.28	0.027	195	0.0568
464.30	0.027	195.2	0.0586
464.32	0.027	195.4	0.0595
464.33	0.028	195.6	0.0604
464.35	0.029	195.8	0.0612
464.37	0.029	195.9	0.0621
464.38	0.029	196	0.0621
464.40	0.029	196	0.0621
464.42	0.029	196.1	0.0621
464.43	0.028	196.2	0.0621
464.45	0.028	196.3	0.0612
464.47	0.027	196.3	0.0604
464.48	0.026	196.3	0.0586
464.50	0.025	196.3	0.0586
464.52	0.023	196.3	0.0568
464.53	0.023	196.3	0.0559
464.55	0.022	196.2	0.0533
464.57	0.02	196.1	0.0515
464.58	0.018	196	0.0488
464.60	0.017	195.9	0.0453
464.62	0.015	195.8	0.0453
464.63	0.014	195.7	0.0408
464.65	0.012	195.5	0.0373
464.67	0.01	195.2	0.0373
464.68	0.007	195	0.0337
464.70	0.007	195	0.0302
464.72	0.006	194.8	0.0275
464.73	0.004	194.5	0.0222
464.75	0.001	194.3	0.0186
464.77	0	194.2	0.0142
464.78	-0.003	193.8	0.0098
464.80	-0.005	193.6	0.0098
464.82	-0.005	193.6	0.0062
464.83	-0.006	193.4	0.0036
464.85	-0.008	193.1	0
464.87	-0.01	192.8	-0.0036
464.88	-0.011	192.6	-0.0053
464.90	-0.012	192.3	-0.008
464.92	-0.014	192.1	-0.008

Prova triassiale ciclica SN04-C1			
pressione di confinamento (kPa)		80	
deviatore ciclico (kPa)		95	
frequenza (hz)		0.00625	
tempo	cella di carico	$\Delta u$	LVDT
(min)	kN	(kPa)	$\delta$ (mm)
464.93	-0.014	192.1	-0.0107
464.95	-0.014	191.9	-0.0124
464.97	-0.016	191.7	-0.0151
464.98	-0.017	191.5	-0.016
465.00	-0.017	191.3	-0.016
465.02	-0.017	191.2	-0.0169
465.03	-0.017	191.1	-0.0169
465.05	-0.017	191.1	-0.0178
465.07	-0.017	191	-0.0178
465.08	-0.017	190.9	-0.0178
465.10	-0.016	190.8	-0.0169
465.12	-0.016	190.8	-0.016
465.13	-0.015	190.7	-0.0151
465.15	-0.014	190.7	-0.0151
465.17	-0.013	190.7	-0.0142
465.18	-0.013	190.8	-0.0133
465.20	-0.012	190.9	-0.0107
465.22	-0.009	190.9	-0.008
465.23	-0.009	191	-0.0062
465.25	-0.007	191.1	-0.0036
465.27	-0.005	191.3	-0.0036
465.28	-0.003	191.3	-0.0009
465.30	-0.003	191.4	0.0027
465.32	-0.002	191.6	0.0062
465.33	0.002	191.8	0.0098
465.35	0.003	192	0.0124
465.37	0.004	192.1	0.0151
465.38	0.007	192.3	0.0186
465.40	0.008	192.5	0.0222
465.42	0.01	192.8	0.0284
465.43	0.014	193.1	0.0284
465.45	0.014	193.1	0.032
465.47	0.014	193.3	0.0346
465.50	0.016	193.6	0.0382
465.52	0.019	193.8	0.0426
465.53	0.02	194	0.0453
465.55	0.021	194.3	0.0479
465.57	0.023	194.5	0.0479
465.57	0.024	194.5	0.0515
465.58	0.024	194.7	0.0533
465.60	0.025	194.9	0.0559
465.62	0.027	195.1	0.0577
465.63	0.027	195.3	0.0586
465.65	0.027	195.6	0.0595
465.67	0.028	195.7	0.0595
465.68	0.029	195.7	0.0604
465.70	0.029	195.9	0.0621
465.72	0.029	196	0.0621
465.73	0.029	196.1	0.0621
465.75	0.029	196.2	0.0621
465.77	0.028	196.2	0.0621
465.78	0.027	196.3	0.0621
465.80	0.027	196.3	0.0612
465.82	0.027	196.3	0.0604
465.83	0.026	196.3	0.0577
465.85	0.024	196.3	0.0559
465.87	0.023	196.3	0.055
465.88	0.022	196.2	0.0524

Prova triassiale ciclica SN04-C1			
pressione di confinamento (kPa)		80	
deviatore ciclico (kPa)		95	
frequenza (hz)		0.00625	
tempo	cella di carico	$\Delta u$	LVDT
(min)	kN	(kPa)	$\delta$ (mm)
465.90	0.019	196.1	0.0524
465.92	0.018	196.1	0.0497
465.93	0.018	196	0.047
465.95	0.016	195.8	0.0435
465.97	0.013	195.7	0.0408
465.98	0.012	195.5	0.0382
466.00	0.011	195.2	0.0346
466.02	0.007	195	0.0346
466.03	0.006	195	0.0302
466.05	0.006	194.9	0.0275
466.07	0.004	194.6	0.0222
466.08	0	194.3	0.0178
466.10	0	194.2	0.016
466.12	-0.001	193.9	0.0124
466.13	-0.004	193.7	0.008
466.15	-0.005	193.4	0.0053
466.17	-0.007	193.2	0.0018
466.18	-0.01	192.9	0.0018
466.20	-0.011	192.9	-0.0027
466.22	-0.011	192.7	-0.0053
466.23	-0.011	192.5	-0.0071
466.25	-0.013	192.2	-0.0089
466.27	-0.014	192	-0.0115
466.28	-0.015	191.8	-0.0142
466.30	-0.016	191.5	-0.0142
466.32	-0.016	191.5	-0.016
466.33	-0.016	191.4	-0.016
466.35	-0.017	191.2	-0.0169
466.37	-0.017	191.1	-0.0178
466.38	-0.017	191	-0.0186
466.40	-0.017	190.9	-0.0178
466.42	-0.017	190.8	-0.0178
466.43	-0.016	190.8	-0.0178
466.45	-0.016	190.8	-0.0169
466.47	-0.016	190.7	-0.016
466.48	-0.014	190.7	-0.0142
466.50	-0.013	190.7	-0.0133
466.52	-0.012	190.8	-0.0115
466.53	-0.01	190.9	-0.0115
466.55	-0.009	190.9	-0.0098
466.57	-0.009	190.9	-0.008
466.58	-0.008	191	-0.0053
466.60	-0.005	191.2	-0.0018
466.62	-0.004	191.3	0
466.63	-0.002	191.5	0.0044
466.65	0.001	191.7	0.0044
466.67	0.002	191.7	0.0089
466.68	0.002	191.8	0.0107
466.70	0.003	192.1	0.0142
466.72	0.007	192.3	0.0186
466.73	0.008	192.5	0.0231
466.75	0.01	192.8	0.0284
466.77	0.014	193	0.0284
466.78	0.014	193	0.032
466.80	0.016	193.5	0.0364
466.82	0.017	193.7	0.0364
466.83	0.019	193.7	0.0399
466.85	0.019	193.9	0.0435

Prova triassiale ciclica SN04-C1			
pressione di confinamento (kPa)		80	
deviatore ciclico (kPa)		95	
frequenza (hz)		0.00625	
tempo	cella di carico	$\Delta u$	LVDT
(min)	kN	(kPa)	$\delta$ (mm)
466.87	0.02	194.1	0.047
466.88	0.023	194.4	0.0497
466.90	0.024	194.6	0.0524
466.92	0.024	194.9	0.0533
466.93	0.025	195.1	0.0533
466.97	0.027	195.3	0.055
466.98	0.027	195.3	0.0586
467.00	0.028	195.4	0.0604
467.02	0.029	195.6	0.0612
467.02	0.029	195.7	0.0612
467.03	0.028	195.9	0.0612
467.05	0.029	196	0.0612
467.07	0.028	196.1	0.0621
467.08	0.028	196.1	0.0621
467.10	0.028	196.2	0.0621
467.12	0.028	196.3	0.0621
467.13	0.027	196.3	0.0604
467.15	0.026	196.4	0.0586
467.17	0.025	196.3	0.0586
467.18	0.023	196.3	0.0577
467.20	0.023	196.3	0.0559
467.22	0.023	196.2	0.0541
467.23	0.021	196.1	0.0515
467.25	0.018	196	0.0488
467.27	0.017	195.9	0.0453
467.28	0.015	195.7	0.0453
467.30	0.012	195.6	0.0417
467.32	0.012	195.6	0.0391
467.33	0.011	195.4	0.0364
467.35	0.009	195.1	0.0328
467.37	0.007	194.9	0.0293
467.38	0.005	194.8	0.024
467.40	0.002	194.5	0.024
467.42	0	194.2	0.0195
467.43	0	194.2	0.016
467.45	-0.001	194	0.0124
467.47	-0.004	193.7	0.0089
467.48	-0.006	193.4	0.0053
467.50	-0.007	193.2	0.0009
467.52	-0.009	192.9	0.0009
467.53	-0.011	192.7	-0.0053
467.55	-0.011	192.5	-0.0071
467.57	-0.012	192.3	-0.0089
467.58	-0.014	192.1	-0.0089
467.60	-0.014	192.1	-0.0115
467.62	-0.015	191.9	-0.0142
467.63	-0.016	191.7	-0.0151
467.65	-0.016	191.5	-0.0151
467.67	-0.017	191.3	-0.0169
467.68	-0.017	191.2	-0.0169
467.70	-0.017	191	-0.0169
467.72	-0.017	191	-0.0178
467.73	-0.017	190.9	-0.0169
467.75	-0.017	190.8	-0.0178
467.77	-0.016	190.7	-0.0169
467.78	-0.016	190.7	-0.0169
467.80	-0.015	190.7	-0.016
467.82	-0.014	190.7	-0.016



Prova triassiale ciclica SN04-C1			
pressione di confinamento (kPa)		80	
deviatore ciclico (kPa)		95	
frequenza (hz)		0.00625	
tempo	cella di carico	$\Delta u$	LVDT
(min)	kN	(kPa)	$\delta$ (mm)
467.83	-0.013	190.7	-0.0142
467.85	-0.013	190.7	-0.0124
467.87	-0.012	190.8	-0.0107
467.88	-0.01	190.9	-0.0089
467.90	-0.009	190.9	-0.0062
467.92	-0.007	191.1	-0.0036
467.93	-0.004	191.2	-0.0036
467.95	-0.003	191.2	0
467.97	-0.003	191.3	0.0018
467.98	-0.002	191.5	0.0053
468.00	0.002	191.7	0.0098
468.02	0.003	191.9	0.0133
468.03	0.005	192.2	0.0169
468.05	0.008	192.4	0.0169
468.07	0.009	192.4	0.0204
468.08	0.009	192.6	0.024
468.10	0.011	192.9	0.0293
468.12	0.014	193.1	0.0328
468.13	0.015	193.4	0.0355
468.15	0.015	193.6	0.0382
468.17	0.02	193.9	0.0382
468.18	0.022	193.9	0.0453
468.20	0.022	194	0.0479
468.22	0.022	194.2	0.0497
468.23	0.023	194.5	0.0515
468.25	0.024	194.8	0.0533
468.27	0.024	195	0.055
468.28	0.027	195.2	0.0577
468.30	0.027	195.3	0.0586
468.32	0.028	195.5	0.0604
468.33	0.029	195.7	0.0604
468.35	0.029	195.7	0.0612
468.37	0.029	195.9	0.0621
468.40	0.029	196	0.0621
468.42	0.029	196.1	0.0621
468.43	0.029	196.2	0.0621
468.45	0.028	196.3	0.0612
468.47	0.027	196.3	0.0612
468.47	0.026	196.3	0.0604
468.48	0.026	196.4	0.0595
468.50	0.026	196.3	0.0577
468.52	0.024	196.3	0.0568
468.53	0.023	196.2	0.055
468.55	0.022	196.1	0.0533
468.57	0.019	196	0.0533
468.58	0.017	196	0.0497
468.60	0.017	196	0.0462
468.62	0.016	195.9	0.0444
468.63	0.014	195.7	0.0417
468.65	0.012	195.5	0.0382
468.67	0.01	195.3	0.0346
468.68	0.007	195	0.0346
468.70	0.006	195	0.0302
468.72	0.006	194.9	0.0275
468.73	0.004	194.6	0.0222
468.75	0.001	194.3	0.0186
468.77	0.001	194.1	0.016
468.78	-0.002	193.8	0.0107

Prova triassiale ciclica SN04-C1			
pressione di confinamento (kPa)		80	
deviatore ciclico (kPa)		95	
frequenza (hz)		0.00625	
tempo	cella di carico	$\Delta u$	LVDT
(min)	kN	(kPa)	$\delta$ (mm)
468.80	-0.007	193.6	0.0107
468.82	-0.007	193.6	0.0044
468.83	-0.007	193.4	0.0027
468.85	-0.007	193.1	0.0009
468.87	-0.01	192.8	-0.0027
468.88	-0.011	192.6	-0.0053
468.90	-0.012	192.3	-0.0089
468.92	-0.015	192.1	-0.0089
468.93	-0.015	192.1	-0.0115
468.95	-0.015	191.9	-0.0124
468.97	-0.015	191.7	-0.0142
468.98	-0.017	191.5	-0.016
469.00	-0.017	191.4	-0.0169
469.02	-0.017	191.2	-0.0169
469.03	-0.017	191.1	-0.0169
469.05	-0.017	191	-0.0178
469.07	-0.017	190.9	-0.0178
469.08	-0.017	190.8	-0.0178
469.10	-0.016	190.8	-0.0178
469.12	-0.016	190.7	-0.0169
469.13	-0.016	190.7	-0.016
469.15	-0.014	190.7	-0.0151
469.17	-0.014	190.7	-0.0142
469.18	-0.012	190.7	-0.0115
469.20	-0.01	190.8	-0.0115
469.22	-0.01	190.8	-0.0098
469.23	-0.01	190.9	-0.008
469.25	-0.008	191	-0.0044
469.27	-0.005	191.2	-0.0018
469.28	-0.004	191.3	0.0009
469.30	-0.002	191.4	0.0044
469.32	0	191.6	0.0044
469.33	0.002	191.6	0.008
469.35	0.002	191.8	0.0115
469.37	0.004	192	0.0151
469.38	0.007	192.3	0.0186
469.40	0.008	192.5	0.0222
469.42	0.01	192.7	0.0284
469.43	0.013	193	0.0284
469.45	0.014	193.2	0.0311
469.47	0.014	193.2	0.0346
469.48	0.016	193.4	0.0382
469.50	0.019	193.7	0.0417
469.52	0.02	193.9	0.0444
469.53	0.021	194.2	0.0479
469.55	0.023	194.4	0.0479
469.57	0.025	194.7	0.0515
469.58	0.025	194.7	0.0533
469.60	0.025	194.9	0.0559
469.62	0.026	195.1	0.0577
469.63	0.027	195.3	0.0586
469.65	0.028	195.5	0.0595
469.67	0.028	195.7	0.0612
469.68	0.029	195.8	0.0612
469.70	0.029	195.8	0.0621
469.72	0.029	196	0.0621
469.73	0.029	196.2	0.0621
469.75	0.029	196.2	0.0621

Prova triassiale ciclica SN04-C1			
pressione di confinamento (kPa)		80	
deviatore ciclico (kPa)		95	
frequenza (hz)		0.00625	
tempo	cella di carico	$\Delta u$	LVDT
(min)	kN	(kPa)	$\delta$ (mm)
469.77	0.029	196.2	0.0621
469.78	0.028	196.3	0.0621
469.80	0.027	196.3	0.0604
469.82	0.026	196.3	0.0595
469.83	0.025	196.3	0.0577
469.87	0.023	196.3	0.0577
469.88	0.022	196.3	0.0559
469.90	0.022	196.2	0.0541
469.92	0.021	196.1	0.0515
469.92	0.018	196	0.0488
469.93	0.017	195.9	0.0462
469.95	0.015	195.8	0.0426
469.97	0.012	195.6	0.0426
469.98	0.012	195.6	0.0399
470.00	0.012	195.4	0.0373
470.02	0.01	195.1	0.0328
470.03	0.006	194.9	0.0284
470.05	0.005	194.7	0.024
470.07	0.003	194.5	0.0204
470.08	0	194.2	0.0204
470.10	-0.001	194.2	0.0169
470.12	-0.001	194	0.0133
470.13	-0.003	193.7	0.0089
470.15	-0.006	193.4	0.0053
470.17	-0.007	193.2	0.0027
470.18	-0.008	192.9	-0.0009
470.20	-0.011	192.6	-0.0009
470.22	-0.011	192.6	-0.0044
470.23	-0.011	192.5	-0.0062
470.25	-0.013	192.2	-0.0098
470.27	-0.015	192	-0.0124
470.28	-0.015	191.8	-0.0133
470.30	-0.015	191.6	-0.0142
470.32	-0.016	191.4	-0.0142
470.33	-0.017	191.4	-0.016
470.35	-0.017	191.3	-0.016
470.37	-0.017	191.1	-0.0169
470.38	-0.017	191	-0.0178
470.40	-0.017	190.9	-0.0178
470.42	-0.017	190.8	-0.0178
470.43	-0.016	190.8	-0.0169
470.45	-0.016	190.7	-0.0169
470.47	-0.015	190.7	-0.0151
470.48	-0.014	190.7	-0.0151
470.50	-0.013	190.7	-0.0142
470.52	-0.013	190.7	-0.0124
470.53	-0.012	190.7	-0.0107
470.55	-0.01	190.8	-0.0089
470.57	-0.009	190.9	-0.0062
470.58	-0.007	191	-0.0027
470.60	-0.005	191.2	-0.0027
470.62	-0.003	191.2	-0.0009
470.63	-0.003	191.3	0.0018
470.65	-0.002	191.5	0.0053
470.67	0.002	191.7	0.0098
470.68	0.003	191.9	0.0124
470.70	0.005	192.1	0.0169
470.72	0.009	192.3	0.0169

Prova triassiale ciclica SN04-C1			
pressione di confinamento (kPa)		80	
deviatore ciclico (kPa)		95	
frequenza (hz)		0.00625	
tempo	cella di carico	$\Delta u$	LVDT
(min)	kN	(kPa)	$\delta$ (mm)
470.73	0.009	192.3	0.0213
470.75	0.009	192.5	0.0231
470.77	0.01	192.8	0.0293
470.78	0.014	193.1	0.0337
470.80	0.015	193.3	0.0364
470.82	0.017	193.6	0.0399
470.83	0.02	193.8	0.0399
470.85	0.021	193.8	0.0444
470.87	0.021	194	0.0462
470.88	0.022	194.2	0.0488
470.90	0.024	194.5	0.0515
470.92	0.025	194.7	0.0533
470.93	0.026	194.9	0.0568
470.95	0.027	195.2	0.0568
470.97	0.027	195.2	0.0586
470.98	0.027	195.4	0.0586
471.00	0.028	195.5	0.0604
471.02	0.029	195.7	0.0621
471.03	0.029	195.8	0.0621
471.05	0.029	196	0.0621
471.07	0.029	196.1	0.0621
471.08	0.029	196.2	0.0621
471.10	0.029	196.2	0.0621
471.12	0.028	196.2	0.0612
471.13	0.027	196.3	0.0604
471.15	0.026	196.3	0.0595
471.17	0.025	196.3	0.0577
471.18	0.024	196.2	0.0568
471.20	0.022	196.2	0.055
471.22	0.022	196.2	0.0524
471.23	0.02	196	0.0524
471.25	0.018	195.9	0.0497
471.27	0.018	195.9	0.0479
471.28	0.016	195.8	0.0444
471.30	0.014	195.6	0.0408
471.33	0.011	195.4	0.0382
471.35	0.011	195.3	0.0346
471.37	0.008	195	0.0346
471.37	0.005	194.8	0.0311
471.38	0.005	194.8	0.0275
471.40	0.004	194.6	0.0231
471.42	0.002	194.3	0.0186
471.43	-0.001	194.1	0.0151
471.45	-0.002	193.9	0.0107
471.47	-0.004	193.6	0.0071
471.48	-0.006	193.3	0.0071
471.50	-0.006	193.3	0.0044
471.52	-0.007	193.1	0
471.53	-0.01	192.8	-0.0036
471.55	-0.011	192.5	-0.0053
471.57	-0.012	192.3	-0.008
471.58	-0.014	192	-0.0107
471.60	-0.015	191.8	-0.0107
471.62	-0.015	191.8	-0.0124
471.63	-0.015	191.7	-0.0142
471.65	-0.016	191.5	-0.016
471.67	-0.017	191.3	-0.0169
471.68	-0.017	191.2	-0.0169

Prova triassiale ciclica SN04-C1			
pressione di confinamento (kPa)		80	
deviatore ciclico (kPa)		95	
frequenza (hz)		0.00625	
tempo	cella di carico	$\Delta u$	LVDT
(min)	kN	(kPa)	$\delta$ (mm)
471.70	-0.017	191	-0.0178
471.72	-0.017	190.9	-0.0178
471.73	-0.017	190.9	-0.0178
471.75	-0.017	190.8	-0.0178
471.77	-0.017	190.8	-0.0169
471.78	-0.016	190.7	-0.016
471.80	-0.015	190.7	-0.016
471.82	-0.015	190.7	-0.0142
471.83	-0.013	190.7	-0.0142
471.85	-0.012	190.7	-0.0124
471.87	-0.012	190.8	-0.0107
471.88	-0.009	190.9	-0.0089
471.90	-0.008	190.9	-0.008
471.92	-0.008	190.9	-0.0053
471.93	-0.007	191.1	-0.0027
471.95	-0.004	191.2	0.0009
471.97	-0.003	191.4	0.0036
471.98	-0.001	191.6	0.0071
472.00	0.003	191.8	0.0071
472.02	0.004	191.8	0.0115
472.03	0.004	192	0.0151
472.05	0.006	192.2	0.0186
472.07	0.009	192.5	0.0231
472.08	0.01	192.6	0.0257
472.10	0.011	193	0.0302
472.12	0.016	193.2	0.0302
472.13	0.016	193.2	0.0355
472.15	0.016	193.4	0.0382
472.17	0.018	193.7	0.0417
472.18	0.021	193.9	0.0453
472.20	0.021	194.1	0.047
472.22	0.022	194.4	0.0506
472.23	0.025	194.6	0.0506
472.25	0.025	194.6	0.0533
472.27	0.025	194.8	0.055
472.28	0.026	195	0.0568
472.30	0.027	195.2	0.0586
472.32	0.028	195.4	0.0604
472.33	0.028	195.6	0.0612
472.35	0.029	195.8	0.0612
472.37	0.029	195.8	0.0621
472.38	0.029	195.9	0.0621
472.40	0.029	196	0.0621
472.42	0.029	196.1	0.0621
472.43	0.028	196.2	0.0621
472.45	0.028	196.3	0.0604
472.47	0.026	196.2	0.0604
472.48	0.025	196.2	0.0595
472.50	0.025	196.3	0.0586
472.52	0.025	196.2	0.0568
472.53	0.023	196.2	0.055
472.55	0.021	196.1	0.0533
472.57	0.02	196.1	0.0506
472.58	0.018	195.9	0.0506
472.60	0.016	195.8	0.0479
472.62	0.015	195.7	0.0426
472.63	0.013	195.6	0.0426
472.65	0.011	195.4	0.0399

Prova triassiale ciclica SN04-C1			
pressione di confinamento (kPa)		80	
deviatore ciclico (kPa)		95	
frequenza (hz)		0.00625	
tempo	cella di carico	$\Delta u$	LVDT
(min)	kN	(kPa)	$\delta$ (mm)
472.67	0.011	195.4	0.0373
472.68	0.01	195.1	0.0328
472.70	0.006	194.9	0.0284
472.72	0.005	194.7	0.024
472.73	0.003	194.5	0.0204
472.77	0	194.2	0.0204
472.78	-0.001	194	0.016
472.80	-0.001	194	0.0133
472.82	-0.003	193.7	0.0098
472.83	-0.006	193.4	0.0053
472.83	-0.007	193.2	0.0018
472.85	-0.008	193	-0.0009
472.87	-0.01	192.6	-0.0009
472.88	-0.012	192.4	-0.0044
472.90	-0.012	192.4	-0.0071
472.92	-0.013	192.2	-0.0098
472.93	-0.014	191.9	-0.0115
472.95	-0.015	191.7	-0.0133
472.97	-0.016	191.6	-0.0142
472.98	-0.016	191.4	-0.0142
473.00	-0.017	191.2	-0.016
473.02	-0.017	191.2	-0.0169
473.03	-0.017	191.1	-0.0178
473.05	-0.017	191	-0.0178
473.07	-0.017	190.9	-0.0178
473.08	-0.017	190.8	-0.0178
473.10	-0.016	190.7	-0.0178
473.12	-0.016	190.7	-0.0169
473.13	-0.016	190.7	-0.0169
473.15	-0.015	190.6	-0.0151
473.17	-0.014	190.7	-0.0133
473.18	-0.012	190.7	-0.0124
473.20	-0.012	190.7	-0.0107
473.22	-0.01	190.9	-0.0089
473.23	-0.008	191	-0.0089
473.25	-0.006	191	-0.0053
473.27	-0.006	191	-0.0027
473.28	-0.005	191.2	0
473.30	-0.001	191.4	0.0036
473.32	-0.001	191.5	0.0062
473.33	0.001	191.8	0.0107
473.35	0.003	191.9	0.0124
473.37	0.004	192.1	0.016
473.38	0.006	192.3	0.0204
473.40	0.01	192.6	0.0204
473.42	0.011	192.6	0.0249
473.43	0.011	192.8	0.0284
473.45	0.013	193	0.0328
473.47	0.016	193.3	0.0373
473.48	0.017	193.5	0.0391
473.50	0.018	193.8	0.0426
473.52	0.021	194	0.0426
473.53	0.022	194	0.0462
473.55	0.022	194.3	0.0488
473.57	0.023	194.5	0.0515
473.58	0.025	194.7	0.0541
473.60	0.026	194.9	0.0559
473.62	0.026	195.1	0.0586

Prova triassiale ciclica SN04-C1			
pressione di confinamento (kPa)		80	
deviatore ciclico (kPa)		95	
frequenza (hz)		0.00625	
tempo	cella di carico	$\Delta u$	LVDT
(min)	kN	(kPa)	$\delta$ (mm)
473.63	0.028	195.3	0.0586
473.65	0.028	195.3	0.0595
473.67	0.028	195.5	0.0604
473.68	0.028	195.7	0.0612
473.70	0.029	195.8	0.0621
473.72	0.029	195.9	0.0621
473.73	0.029	196	0.0621
473.75	0.029	196.1	0.0621
473.77	0.028	196.1	0.0621
473.78	0.028	196.2	0.0621
473.80	0.027	196.2	0.0604
473.82	0.026	196.2	0.0595
473.83	0.025	196.2	0.0586
473.85	0.024	196.2	0.0559
473.87	0.022	196.1	0.0559
473.88	0.021	196.1	0.0541
473.90	0.021	196.1	0.0515
473.92	0.019	196	0.0488
473.93	0.016	195.8	0.0462
473.95	0.016	195.7	0.0444
473.97	0.014	195.6	0.0408
473.98	0.01	195.3	0.0408
474.00	0.009	195.3	0.0364
474.02	0.009	195.1	0.0337
474.03	0.008	194.9	0.0293
474.05	0.005	194.7	0.0249
474.07	0.003	194.5	0.0222
474.08	0.003	194.3	0.0195
474.10	0	194	0.0151
474.12	-0.002	193.8	0.0115
474.13	-0.004	193.6	0.008
474.15	-0.006	193.3	0.008
474.17	-0.008	193	0.0044
474.18	-0.008	193	0.0009
474.20	-0.009	192.8	-0.0027
474.23	-0.011	192.5	-0.0062
474.25	-0.013	192.3	-0.008
474.27	-0.013	192.1	-0.0098
474.28	-0.014	191.8	-0.0098
474.28	-0.016	191.6	-0.0124
474.30	-0.016	191.6	-0.0142
474.32	-0.016	191.5	-0.0151
474.33	-0.016	191.3	-0.0169
474.35	-0.017	191.2	-0.0169
474.37	-0.017	191	-0.0178
474.38	-0.017	190.9	-0.0178
474.40	-0.017	190.8	-0.0178
474.42	-0.017	190.8	-0.0178
474.43	-0.017	190.7	-0.0178
474.45	-0.016	190.7	-0.0169
474.47	-0.015	190.7	-0.016
474.48	-0.015	190.6	-0.0151
474.50	-0.013	190.7	-0.0124
474.52	-0.011	190.7	-0.0124
474.53	-0.011	190.7	-0.0107
474.55	-0.011	190.7	-0.0089
474.57	-0.009	190.9	-0.0062
474.58	-0.007	191	-0.0036

Prova triassiale ciclica SN04-C1			
pressione di confinamento (kPa)		80	
deviatore ciclico (kPa)		95	
frequenza (hz)		0.00625	
tempo	cella di carico	$\Delta u$	LVDT
(min)	kN	(kPa)	$\delta$ (mm)
474.60	-0.006	191.1	-0.0018
474.62	-0.004	191.3	0.0018
474.63	-0.001	191.5	0.0018
474.65	0	191.5	0.0053
474.67	0	191.6	0.008
474.68	0.002	191.8	0.0124
474.70	0.005	192	0.016
474.72	0.007	192.2	0.0195
474.73	0.009	192.5	0.024
474.75	0.011	192.7	0.024
474.77	0.013	192.7	0.0284
474.78	0.013	192.9	0.032
474.80	0.016	193.4	0.0355
474.82	0.018	193.4	0.0382
474.83	0.018	193.6	0.0408
474.85	0.019	193.9	0.0444
474.87	0.022	194.2	0.0479
474.88	0.022	194.3	0.0497
474.90	0.023	194.6	0.0524
474.92	0.026	194.8	0.0524
474.93	0.026	194.8	0.0559
474.95	0.026	195	0.0568
474.97	0.026	195.2	0.0577
474.98	0.028	195.4	0.0604
475.00	0.029	195.6	0.0612
475.02	0.029	195.7	0.0621
475.03	0.029	195.8	0.0621
475.05	0.029	195.8	0.0621
475.07	0.029	196	0.0621
475.08	0.029	196.1	0.0621
475.10	0.028	196.2	0.0621
475.12	0.028	196.2	0.0612
475.13	0.027	196.2	0.0604
475.15	0.025	196.2	0.0604
475.17	0.024	196.2	0.0586
475.18	0.024	196.3	0.0568
475.20	0.023	196.2	0.0541
475.22	0.021	196.1	0.0533
475.23	0.021	196.1	0.0515
475.25	0.019	195.9	0.0479
475.27	0.015	195.7	0.0479
475.28	0.015	195.7	0.0444
475.30	0.015	195.7	0.0426
475.32	0.013	195.5	0.0391
475.33	0.01	195.2	0.0355
475.35	0.009	195.1	0.032
475.37	0.007	194.8	0.0284
475.38	0.003	194.6	0.0284
475.40	0.002	194.6	0.0231
475.42	0.002	194.4	0.0195
475.43	0.001	194.1	0.0151
475.45	-0.003	193.8	0.0115
475.47	-0.004	193.6	0.0089
475.48	-0.005	193.3	0.0044
475.50	-0.008	193	0.0044
475.52	-0.009	192.8	-0.0009
475.53	-0.009	192.6	-0.0027
475.55	-0.012	192.4	-0.0027



Prova triassiale ciclica SN04-C1			
pressione di confinamento (kPa)		80	
deviatore ciclico (kPa)		95	
frequenza (hz)		0.00625	
tempo	cella di carico	$\Delta u$	LVDT
(min)	kN	(kPa)	$\delta$ (mm)
475.57	-0.013	192.4	-0.0071
475.58	-0.013	192.2	-0.0089
475.60	-0.014	192	-0.0115
475.62	-0.016	191.7	-0.0133
475.63	-0.016	191.5	-0.0142
475.67	-0.016	191.4	-0.0151
475.68	-0.017	191.2	-0.0151
475.70	-0.017	191.2	-0.0169
475.72	-0.017	191.1	-0.0169
475.73	-0.017	190.9	-0.0178
475.73	-0.017	190.8	-0.0178
475.75	-0.017	190.7	-0.0178
475.77	-0.017	190.7	-0.0169
475.78	-0.016	190.7	-0.0169
475.80	-0.015	190.7	-0.016
475.82	-0.015	190.6	-0.0151
475.83	-0.014	190.6	-0.0133
475.85	-0.012	190.7	-0.0124
475.87	-0.011	190.7	-0.0107
475.88	-0.01	190.8	-0.008
475.90	-0.008	190.9	-0.008
475.92	-0.006	190.9	-0.0053
475.93	-0.006	191	-0.0027
475.95	-0.005	191.2	0
475.97	-0.002	191.3	0.0036
475.98	-0.001	191.5	0.0062
476.00	0.001	191.7	0.0098
476.02	0.004	191.9	0.0098
476.03	0.006	192.1	0.0142
476.05	0.006	192.1	0.0169
476.07	0.007	192.3	0.0213
476.08	0.01	192.6	0.0257
476.10	0.012	192.8	0.0302
476.12	0.013	193	0.0337
476.13	0.016	193.3	0.0337
476.15	0.018	193.6	0.0373
476.17	0.018	193.6	0.0399
476.18	0.019	193.8	0.0444
476.20	0.021	194.1	0.047
476.22	0.023	194.3	0.0497
476.23	0.023	194.5	0.0524
476.25	0.025	194.8	0.055
476.27	0.026	194.9	0.0568
476.28	0.027	195.1	0.0586
476.30	0.027	195.3	0.0595
476.32	0.028	195.5	0.0595
476.33	0.028	195.5	0.0604
476.35	0.029	195.7	0.0612
476.37	0.029	195.8	0.0621
476.38	0.029	195.9	0.0621
476.40	0.029	196.1	0.0621
476.42	0.028	196.1	0.0621
476.43	0.028	196.2	0.0621
476.45	0.028	196.2	0.0621
476.47	0.028	196.2	0.0612
476.48	0.027	196.2	0.0595
476.50	0.025	196.2	0.0577
476.52	0.024	196.2	0.0559

Prova triassiale ciclica SN04-C1			
pressione di confinamento (kPa)		80	
deviatore ciclico (kPa)		95	
frequenza (hz)		0.00625	
tempo	cella di carico	$\Delta u$	LVDT
(min)	kN	(kPa)	$\delta$ (mm)
476.53	0.023	196.1	0.0541
476.55	0.02	196.1	0.0541
476.57	0.02	196.1	0.0515
476.58	0.02	196	0.0497
476.60	0.018	195.9	0.0462
476.62	0.015	195.7	0.0435
476.63	0.014	195.6	0.0408
476.65	0.012	195.4	0.0373
476.67	0.009	195.1	0.0373
476.68	0.008	195.1	0.0337
476.70	0.008	195	0.0311
476.72	0.006	194.7	0.0257
476.73	0.002	194.5	0.0204
476.75	0.001	194.3	0.0186
476.77	0	194	0.0151
476.78	-0.003	193.7	0.0151
476.80	-0.005	193.7	0.0107
476.82	-0.005	193.5	0.0071
476.83	-0.006	193.2	0.0027
476.85	-0.009	192.9	-0.0009
476.87	-0.01	192.7	-0.0027
476.88	-0.011	192.5	-0.0062
476.90	-0.013	192.2	-0.0062
476.92	-0.014	192.2	-0.0089
476.93	-0.014	192	-0.0115
476.95	-0.015	191.8	-0.0133
476.97	-0.016	191.6	-0.0142
476.98	-0.016	191.4	-0.0151
477.00	-0.016	191.3	-0.016
477.02	-0.017	191.1	-0.0169
477.03	-0.017	191	-0.0178
477.05	-0.017	190.9	-0.0178
477.07	-0.017	190.8	-0.0178
477.08	-0.017	190.8	-0.0178
477.10	-0.017	190.7	-0.0169
477.13	-0.016	190.7	-0.016
477.15	-0.015	190.7	-0.016
477.17	-0.014	190.6	-0.0151
477.18	-0.014	190.6	-0.0133
477.18	-0.012	190.7	-0.0133
477.20	-0.01	190.7	-0.0115
477.22	-0.01	190.7	-0.0098
477.23	-0.01	190.8	-0.0071
477.25	-0.007	191	-0.0044
477.27	-0.006	191	-0.0018
477.28	-0.004	191.2	0.0018
477.30	-0.001	191.4	0.0018
477.32	0	191.4	0.0053
477.33	0	191.6	0.008
477.35	0.002	191.8	0.0115
477.37	0.005	192	0.016
477.38	0.007	192.2	0.0195
477.40	0.008	192.4	0.024
477.42	0.012	192.7	0.024
477.43	0.013	192.7	0.0284
477.45	0.013	192.9	0.032
477.47	0.014	193.2	0.0355
477.48	0.017	193.5	0.0391

Prova triassiale ciclica SN04-C1			
pressione di confinamento (kPa)		80	
deviatore ciclico (kPa)		95	
frequenza (hz)		0.00625	
tempo	cella di carico	$\Delta u$	LVDT
(min)	kN	(kPa)	$\delta$ (mm)
477.50	0.019	193.7	0.0426
477.52	0.02	193.9	0.0462
477.53	0.022	194.2	0.0462
477.55	0.023	194.4	0.0488
477.57	0.023	194.4	0.0506
477.58	0.024	194.6	0.0533
477.60	0.025	194.8	0.0559
477.62	0.027	195	0.0577
477.63	0.027	195.2	0.0595
477.65	0.028	195.4	0.0595
477.67	0.028	195.6	0.0604
477.68	0.028	195.6	0.0612
477.70	0.029	195.9	0.0621
477.72	0.029	196	0.0621
477.73	0.029	196	0.0621
477.75	0.029	196.1	0.0621
477.77	0.028	196.2	0.0621
477.78	0.028	196.2	0.0612
477.80	0.027	196.2	0.0604
477.82	0.026	196.2	0.0604
477.83	0.024	196.2	0.0586
477.85	0.024	196.2	0.0568
477.87	0.023	196.2	0.055
477.88	0.022	196.1	0.0533
477.90	0.02	196	0.0515
477.92	0.019	196	0.0479
477.93	0.017	195.8	0.0479
477.95	0.014	195.6	0.0453
477.97	0.014	195.6	0.0417
477.98	0.013	195.5	0.0391
478.00	0.011	195.2	0.0355
478.02	0.008	195	0.032
478.03	0.007	194.9	0.0284
478.05	0.004	194.6	0.0231
478.07	0.001	194.3	0.0231
478.08	0.001	194.3	0.0195
478.10	0.001	194.2	0.016
478.12	-0.001	193.9	0.0124
478.13	-0.004	193.6	0.008
478.15	-0.005	193.4	0.0053
478.17	-0.007	193.1	0.0018
478.18	-0.01	192.8	0.0018
478.20	-0.01	192.8	-0.0018
478.22	-0.01	192.6	-0.0044
478.23	-0.012	192.3	-0.0071
478.25	-0.014	192.1	-0.0098
478.27	-0.014	191.9	-0.0115
478.28	-0.015	191.7	-0.0133
478.30	-0.016	191.5	-0.0133
478.32	-0.017	191.5	-0.0151
478.33	-0.017	191.3	-0.016
478.35	-0.017	191.2	-0.0169
478.37	-0.017	191	-0.0169
478.38	-0.017	190.9	-0.0178
478.40	-0.017	190.8	-0.0178
478.42	-0.017	190.7	-0.0178
478.43	-0.017	190.6	-0.0169
478.45	-0.016	190.6	-0.016

Prova triassiale ciclica SN04-C1			
pressione di confinamento (kPa)		80	
deviatore ciclico (kPa)		95	
frequenza (hz)		0.00625	
tempo	cella di carico	$\Delta u$	LVDT
(min)	kN	(kPa)	$\delta$ (mm)
478.47	-0.015	190.6	-0.016
478.48	-0.014	190.6	-0.0151
478.50	-0.014	190.6	-0.0142
478.52	-0.013	190.6	-0.0124
478.53	-0.011	190.7	-0.0107
478.57	-0.01	190.7	-0.008
478.58	-0.009	190.9	-0.0053
478.60	-0.006	191	-0.0053
478.62	-0.005	191	-0.0027
478.63	-0.005	191.2	-0.0009
478.63	-0.004	191.3	0.0027
478.65	0	191.5	0.0071
478.67	0.001	191.6	0.0098
478.68	0.003	191.9	0.0133
478.70	0.007	192.1	0.0133
478.72	0.007	192.1	0.0178
478.73	0.007	192.3	0.0204
478.75	0.009	192.6	0.0249
478.77	0.013	192.8	0.0302
478.78	0.014	193	0.0337
478.80	0.015	193.3	0.0373
478.82	0.019	193.6	0.0373
478.83	0.019	193.6	0.0417
478.85	0.019	193.8	0.0435
478.87	0.02	194.1	0.047
478.88	0.023	194.3	0.0506
478.90	0.023	194.5	0.0524
478.92	0.025	194.7	0.055
478.93	0.027	194.9	0.055
478.95	0.027	194.9	0.0577
478.97	0.027	195.1	0.0586
478.98	0.027	195.3	0.0604
479.00	0.029	195.5	0.0612
479.02	0.028	195.7	0.0612
479.03	0.029	195.8	0.0621
479.05	0.029	195.9	0.0621
479.07	0.029	195.9	0.063
479.08	0.029	196	0.063
479.10	0.029	196.1	0.0621
479.12	0.028	196.1	0.0612
479.13	0.027	196.2	0.0604
479.15	0.026	196.2	0.0595
479.17	0.025	196.2	0.0586
479.18	0.024	196.2	0.0568
479.20	0.023	196.2	0.055
479.22	0.021	196.1	0.055
479.23	0.019	196.1	0.0524
479.25	0.019	196	0.0506
479.27	0.018	195.9	0.047
479.28	0.015	195.7	0.0444
479.30	0.014	195.6	0.0417
479.32	0.012	195.4	0.0373
479.33	0.009	195.1	0.0373
479.35	0.007	195	0.0337
479.37	0.007	195	0.0302
479.38	0.006	194.7	0.0275
479.40	0.003	194.5	0.0222
479.42	0.001	194.3	0.0186

Prova triassiale ciclica SN04-C1			
pressione di confinamento (kPa)		80	
deviatore ciclico (kPa)		95	
frequenza (hz)		0.00625	
tempo	cella di carico	$\Delta u$	LVDT
(min)	kN	(kPa)	$\delta$ (mm)
479.43	0	194.1	0.0142
479.45	-0.004	193.7	0.0142
479.47	-0.005	193.5	0.0098
479.48	-0.005	193.5	0.0071
479.50	-0.006	193.2	0.0036
479.52	-0.009	192.9	-0.0009
479.53	-0.01	192.7	-0.0027
479.55	-0.011	192.5	-0.0053
479.57	-0.013	192.2	-0.0053
479.58	-0.014	192	-0.0089
479.60	-0.014	192	-0.0107
479.62	-0.015	191.8	-0.0124
479.63	-0.016	191.6	-0.0142
479.65	-0.016	191.4	-0.0151
479.67	-0.016	191.2	-0.016
479.68	-0.017	191.1	-0.016
479.70	-0.017	190.9	-0.0169
479.72	-0.017	190.9	-0.0178
479.73	-0.017	190.8	-0.0178
479.75	-0.017	190.8	-0.0178
479.77	-0.017	190.7	-0.0178
479.78	-0.016	190.6	-0.016
479.80	-0.015	190.6	-0.016
479.82	-0.013	190.6	-0.0142
479.83	-0.013	190.6	-0.0133
479.85	-0.013	190.6	-0.0115
479.87	-0.012	190.7	-0.0107
479.88	-0.01	190.8	-0.0089
479.90	-0.01	190.8	-0.0071
479.92	-0.007	190.9	-0.0044
479.93	-0.005	191.1	-0.0018
479.95	-0.005	191.2	0.0009
479.97	-0.002	191.4	0.0009
479.98	0	191.5	0.0044
480.00	0	191.5	0.008
480.03	0.002	191.7	0.0124
480.05	0.005	192	0.0169
480.07	0.007	192.2	0.0195
480.08	0.008	192.4	0.024
480.08	0.011	192.7	0.024
480.10	0.013	192.9	0.0284
480.12	0.013	192.9	0.0311
480.13	0.014	193.1	0.0355
480.15	0.017	193.4	0.0399
480.17	0.019	193.6	0.0426
480.18	0.02	193.9	0.0462
480.20	0.022	194.2	0.0462
480.22	0.023	194.4	0.0488
480.23	0.023	194.4	0.0515
480.25	0.024	194.6	0.0541
480.27	0.026	194.8	0.0568
480.28	0.027	195	0.0577
480.30	0.027	195.2	0.0595
480.32	0.028	195.4	0.0595
480.33	0.028	195.6	0.0604
480.35	0.028	195.6	0.0612
480.37	0.029	195.7	0.0621
480.38	0.029	195.8	0.063

Prova triassiale ciclica SN04-C1			
pressione di confinamento (kPa)		80	
deviatore ciclico (kPa)		95	
frequenza (hz)		0.00625	
tempo	cella di carico	$\Delta u$	LVDT
(min)	kN	(kPa)	$\delta$ (mm)
480.40	0.029	196	0.063
480.42	0.029	196.1	0.0621
480.43	0.028	196.1	0.0621
480.45	0.027	196.2	0.0612
480.47	0.027	196.2	0.0612
480.48	0.026	196.2	0.0595
480.50	0.026	196.1	0.0586
480.52	0.024	196.1	0.0559
480.53	0.023	196.1	0.0541
480.55	0.021	196	0.0541
480.57	0.019	195.9	0.0515
480.58	0.019	195.9	0.0506
480.60	0.016	195.7	0.047
480.62	0.015	195.6	0.0453
480.63	0.015	195.6	0.0435
480.65	0.013	195.4	0.0391
480.67	0.011	195.1	0.0355
480.68	0.008	194.9	0.032
480.70	0.007	194.8	0.0284
480.72	0.005	194.5	0.024
480.73	0.002	194.3	0.024
480.75	0.002	194.3	0.0195
480.77	0	194.1	0.016
480.78	-0.002	193.8	0.0115
480.80	-0.004	193.6	0.008
480.82	-0.005	193.3	0.0053
480.83	-0.007	193	0.0009
480.85	-0.01	192.8	0.0009
480.87	-0.01	192.8	-0.0027
480.88	-0.01	192.6	-0.0044
480.90	-0.012	192.3	-0.008
480.92	-0.014	192	-0.0098
480.93	-0.014	191.8	-0.0115
480.95	-0.015	191.6	-0.0133
480.97	-0.017	191.4	-0.0133
480.98	-0.017	191.4	-0.0151
481.00	-0.017	191.3	-0.016
481.02	-0.017	191.2	-0.016
481.03	-0.017	191	-0.0178
481.05	-0.017	190.9	-0.0178
481.07	-0.017	190.8	-0.0178
481.08	-0.017	190.7	-0.0178
481.10	-0.016	190.7	-0.0169
481.12	-0.016	190.6	-0.0169
481.13	-0.015	190.6	-0.0151
481.15	-0.014	190.6	-0.0142
481.17	-0.014	190.6	-0.0133
481.18	-0.013	190.7	-0.0115
481.20	-0.01	190.7	-0.0115
481.22	-0.01	190.7	-0.0089
481.23	-0.01	190.8	-0.0071
481.25	-0.008	191	-0.0044
481.27	-0.005	191.1	-0.0009
481.28	-0.004	191.2	0.0018
481.30	-0.002	191.4	0.0044
481.32	0	191.5	0.0044
481.33	0.002	191.7	0.0107
481.35	0.002	191.9	0.0133

Prova triassiale ciclica SN04-C1			
pressione di confinamento (kPa)		80	
deviatore ciclico (kPa)		95	
frequenza (hz)		0.00625	
tempo	cella di carico	$\Delta u$	LVDT
(min)	kN	(kPa)	$\delta$ (mm)
481.37	0.006	192.1	0.0133
481.38	0.007	192.1	0.0178
481.40	0.007	192.3	0.0213
481.42	0.009	192.5	0.0257
481.43	0.013	192.8	0.0302
481.45	0.013	193	0.0337
481.47	0.015	193.3	0.0373
481.50	0.019	193.6	0.0373
481.52	0.019	193.6	0.0417
481.53	0.019	193.7	0.0435
481.55	0.02	194	0.047
481.55	0.023	194.3	0.0506
481.57	0.024	194.5	0.0524
481.58	0.025	194.7	0.055
481.60	0.027	194.9	0.055
481.62	0.027	194.9	0.0568
481.63	0.027	195.1	0.0586
481.65	0.027	195.2	0.0595
481.67	0.029	195.5	0.0612
481.68	0.028	195.6	0.0612
481.70	0.028	195.8	0.0621
481.72	0.029	195.9	0.0621
481.73	0.029	195.9	0.0621
481.75	0.029	196	0.063
481.77	0.029	196.1	0.0621
481.78	0.028	196.1	0.0612
481.80	0.027	196.1	0.0604
481.82	0.026	196.2	0.0586
481.83	0.024	196.1	0.0586
481.85	0.024	196.1	0.0568
481.87	0.024	196.1	0.0559
481.88	0.022	196.1	0.0541
481.90	0.02	196	0.0515
481.92	0.019	195.9	0.0488
481.93	0.017	195.8	0.0453
481.95	0.014	195.6	0.0453
481.97	0.013	195.6	0.0426
481.98	0.013	195.4	0.0399
482.00	0.012	195.2	0.0364
482.02	0.008	195	0.032
482.03	0.007	194.8	0.0293
482.05	0.005	194.6	0.024
482.07	0.003	194.4	0.0222
482.08	0.001	194.2	0.0186
482.10	0	193.9	0.0142
482.12	-0.004	193.6	0.0142
482.13	-0.005	193.6	0.0098
482.15	-0.005	193.4	0.0071
482.17	-0.006	193.2	0.0036
482.18	-0.008	192.9	0
482.20	-0.01	192.6	-0.0027
482.22	-0.011	192.4	-0.0062
482.23	-0.013	192.1	-0.0062
482.25	-0.014	191.9	-0.0089
482.27	-0.014	191.9	-0.0098
482.28	-0.015	191.7	-0.0124
482.30	-0.016	191.5	-0.0142
482.32	-0.016	191.3	-0.0151

Prova triassiale ciclica SN04-C1			
pressione di confinamento (kPa)		80	
deviatore ciclico (kPa)		95	
frequenza (hz)		0.00625	
tempo	cella di carico	$\Delta u$	LVDT
(min)	kN	(kPa)	$\delta$ (mm)
482.33	-0.017	191.2	-0.0169
482.35	-0.017	191	-0.0169
482.37	-0.017	190.9	-0.0178
482.38	-0.017	190.9	-0.0169
482.40	-0.017	190.8	-0.0178
482.42	-0.017	190.7	-0.0169
482.43	-0.016	190.6	-0.0169
482.45	-0.016	190.6	-0.0169
482.47	-0.015	190.6	-0.0169
482.48	-0.014	190.6	-0.0151
482.50	-0.014	190.6	-0.0142
482.52	-0.013	190.6	-0.0115
482.53	-0.011	190.7	-0.0098
482.55	-0.01	190.7	-0.0089
482.57	-0.009	190.8	-0.0062
482.58	-0.006	191	-0.0062
482.60	-0.005	191.1	-0.0027
482.62	-0.005	191.1	-0.0009
482.63	-0.003	191.2	0.0036
482.65	0	191.4	0.0071
482.67	0.001	191.6	0.0098
482.68	0.003	191.8	0.0142
482.70	0.006	192.1	0.0142
482.72	0.008	192.3	0.0178
482.73	0.008	192.3	0.0213
482.75	0.009	192.4	0.0249
482.77	0.011	192.7	0.0293
482.78	0.014	193	0.0337
482.80	0.014	193.1	0.0355
482.82	0.016	193.4	0.0391
482.83	0.019	193.7	0.0435
482.85	0.02	193.8	0.0453
482.87	0.021	194.1	0.0479
482.88	0.024	194.4	0.0479
482.90	0.024	194.4	0.0515
482.93	0.024	194.5	0.0533
482.95	0.025	194.8	0.0559
482.97	0.027	195	0.0577
482.98	0.027	195.2	0.0595
483.00	0.028	195.3	0.0604
483.00	0.028	195.5	0.0604
483.02	0.028	195.5	0.0612
483.03	0.028	195.7	0.0621
483.05	0.029	195.8	0.0621
483.07	0.029	195.9	0.063
483.08	0.029	196	0.063
483.10	0.029	196.1	0.0621
483.12	0.027	196.1	0.0621
483.13	0.026	196.1	0.0612
483.15	0.026	196.2	0.0604
483.17	0.026	196.2	0.0586
483.18	0.023	196.1	0.0568
483.20	0.023	196.1	0.055
483.22	0.022	196	0.0533
483.23	0.019	195.9	0.0533
483.25	0.018	195.9	0.0497
483.27	0.018	195.8	0.047
483.28	0.016	195.7	0.0444



Prova triassiale ciclica SN04-C1			
pressione di confinamento (kPa)		80	
deviatore ciclico (kPa)		95	
frequenza (hz)		0.00625	
tempo	cella di carico	$\Delta u$	LVDT
(min)	kN	(kPa)	$\delta$ (mm)
483.30	0.013	195.5	0.0417
483.32	0.012	195.3	0.0391
483.33	0.011	195.1	0.0346
483.35	0.007	194.9	0.0346
483.37	0.006	194.9	0.032
483.38	0.006	194.7	0.0284
483.40	0.005	194.4	0.0231
483.42	0	194.1	0.0178
483.43	0	194	0.0151
483.45	-0.002	193.7	0.0107
483.47	-0.005	193.4	0.0107
483.48	-0.006	193.4	0.0062
483.50	-0.006	193.2	0.0036
483.52	-0.009	192.7	0
483.53	-0.01	192.7	-0.0009
483.55	-0.01	192.5	-0.0036
483.57	-0.011	192.2	-0.0071
483.58	-0.014	192	-0.0098
483.60	-0.015	191.8	-0.0115
483.62	-0.015	191.6	-0.0133
483.63	-0.016	191.4	-0.0133
483.65	-0.016	191.4	-0.0142
483.67	-0.016	191.2	-0.016
483.68	-0.017	191.1	-0.016
483.70	-0.017	190.9	-0.0169
483.72	-0.017	190.8	-0.0178
483.73	-0.017	190.7	-0.0178
483.75	-0.017	190.6	-0.0178
483.77	-0.016	190.6	-0.0169
483.78	-0.016	190.6	-0.016
483.80	-0.016	190.6	-0.0151
483.82	-0.014	190.6	-0.0142
483.83	-0.014	190.6	-0.0133
483.85	-0.012	190.6	-0.0107
483.87	-0.01	190.6	-0.0107
483.88	-0.009	190.6	-0.008
483.90	-0.009	190.7	-0.0071
483.92	-0.008	190.8	-0.0044
483.93	-0.005	191	-0.0018
483.95	-0.004	191.2	0.0009
483.97	-0.003	191.3	0.0053
483.98	0.001	191.5	0.0053
484.00	0.002	191.5	0.0089
484.02	0.002	191.6	0.0115
484.03	0.003	191.9	0.016
484.05	0.007	192.2	0.0204
484.07	0.008	192.3	0.0231
484.08	0.01	192.5	0.0284
484.10	0.013	192.9	0.0284
484.12	0.015	193.1	0.032
484.13	0.015	193.1	0.0355
484.15	0.016	193.3	0.0391
484.17	0.019	193.6	0.0435
484.18	0.02	193.8	0.0453
484.20	0.021	194	0.0497
484.22	0.023	194.3	0.0497
484.23	0.025	194.5	0.0541
484.25	0.024	194.7	0.055

Prova triassiale ciclica SN04-C1			
pressione di confinamento (kPa)		80	
deviatore ciclico (kPa)		95	
frequenza (hz)		0.00625	
tempo	cella di carico	$\Delta u$	LVDT
(min)	kN	(kPa)	$\delta$ (mm)
484.27	0.025	195	0.055
484.28	0.027	195.1	0.0559
484.30	0.027	195.1	0.0595
484.32	0.028	195.2	0.0612
484.33	0.029	195.4	0.0621
484.35	0.029	195.7	0.0621
484.37	0.028	195.9	0.0621
484.40	0.028	196	0.0621
484.42	0.028	196	0.0621
484.43	0.028	196	0.063
484.45	0.029	196.1	0.063
484.45	0.028	196.1	0.0621
484.47	0.027	196.2	0.0612
484.48	0.026	196.2	0.0595
484.50	0.025	196.2	0.0595
484.52	0.023	196.1	0.0577
484.53	0.023	196.1	0.0559
484.55	0.023	196.1	0.0541
484.57	0.02	195.9	0.0515
484.58	0.018	195.9	0.0488
484.60	0.017	195.8	0.0462
484.62	0.015	195.6	0.0435
484.63	0.012	195.4	0.0435
484.65	0.012	195.4	0.0399
484.67	0.012	195.2	0.0373
484.68	0.009	195	0.0328
484.70	0.006	194.8	0.0284
484.72	0.005	194.6	0.0249
484.73	0.003	194.3	0.0213
484.75	0	194.1	0.0213
484.77	-0.001	194.1	0.0178
484.78	-0.001	193.9	0.0133
484.80	-0.003	193.6	0.0098
484.82	-0.006	193.3	0.0062
484.83	-0.007	193.1	0.0027
484.85	-0.009	192.8	-0.0009
484.87	-0.011	192.6	-0.0009
484.88	-0.011	192.6	-0.0044
484.90	-0.011	192.4	-0.0062
484.92	-0.013	192.1	-0.0089
484.93	-0.015	191.9	-0.0107
484.95	-0.015	191.7	-0.0124
484.97	-0.016	191.4	-0.0142
484.98	-0.017	191.3	-0.0151
485.00	-0.016	191.2	-0.0151
485.02	-0.017	191	-0.0169
485.03	-0.017	190.9	-0.0169
485.05	-0.017	190.9	-0.0169
485.07	-0.017	190.8	-0.0178
485.08	-0.017	190.7	-0.0169
485.10	-0.017	190.6	-0.016
485.12	-0.016	190.6	-0.0151
485.13	-0.015	190.5	-0.0142
485.15	-0.014	190.5	-0.0142
485.17	-0.013	190.5	-0.0133
485.18	-0.013	190.6	-0.0115
485.20	-0.012	190.6	-0.0107
485.22	-0.01	190.7	-0.008

Prova triassiale ciclica SN04-C1			
pressione di confinamento (kPa)		80	
deviatore ciclico (kPa)		95	
frequenza (hz)		0.00625	
tempo	cella di carico	$\Delta u$	LVDT
(min)	kN	(kPa)	$\delta$ (mm)
485.23	-0.009	190.8	-0.0062
485.25	-0.007	190.9	-0.0027
485.27	-0.004	191.1	-0.0027
485.28	-0.004	191.1	0.0009
485.30	-0.004	191.2	0.0027
485.32	-0.002	191.4	0.0062
485.33	0.002	191.6	0.0107
485.35	0.003	191.8	0.0133
485.37	0.005	192	0.0178
485.38	0.008	192.2	0.0178
485.40	0.009	192.4	0.0213
485.42	0.009	192.4	0.0249
485.43	0.01	192.6	0.0284
485.45	0.014	192.9	0.0337
485.47	0.015	193.1	0.0373
485.48	0.017	193.4	0.0408
485.50	0.019	193.7	0.0408
485.52	0.021	193.9	0.0444
485.53	0.021	193.9	0.047
485.55	0.022	194.1	0.0497
485.57	0.023	194.4	0.0524
485.58	0.025	194.6	0.055
485.60	0.026	194.8	0.0577
485.62	0.027	195	0.0577
485.63	0.027	195.2	0.0595
485.65	0.027	195.2	0.0595
485.67	0.028	195.4	0.0612
485.68	0.029	195.7	0.0621
485.70	0.029	195.7	0.063
485.72	0.029	195.8	0.063
485.73	0.029	195.9	0.063
485.75	0.029	196	0.063
485.77	0.028	196.1	0.063
485.78	0.028	196.1	0.0612
485.80	0.026	196.1	0.0612
485.83	0.026	196.1	0.0604
485.85	0.025	196.2	0.0586
485.87	0.024	196.1	0.0568
485.88	0.023	196.1	0.055
485.90	0.022	196	0.0533
485.90	0.02	195.9	0.0506
485.92	0.017	195.8	0.0506
485.93	0.016	195.8	0.0479
485.95	0.016	195.7	0.0462
485.97	0.015	195.5	0.0426
485.98	0.012	195.3	0.0391
486.00	0.01	195.1	0.0355
486.02	0.009	194.9	0.0311
486.03	0.005	194.7	0.0311
486.05	0.004	194.7	0.0275
486.07	0.004	194.5	0.024
486.08	0.003	194.2	0.0195
486.10	-0.001	193.9	0.016
486.12	-0.002	193.7	0.0124
486.13	-0.004	193.4	0.008
486.15	-0.007	193.2	0.008
486.17	-0.008	193.2	0.0044
486.18	-0.008	193	0.0018

Prova triassiale ciclica SN04-C1			
pressione di confinamento (kPa)		80	
deviatore ciclico (kPa)		95	
frequenza (hz)		0.00625	
tempo	cella di carico	$\Delta u$	LVDT
(min)	kN	(kPa)	$\delta$ (mm)
486.20	-0.009	192.7	-0.0018
486.22	-0.011	192.4	-0.0044
486.23	-0.012	192.2	-0.008
486.25	-0.013	192	-0.0098
486.27	-0.015	191.7	-0.0098
486.28	-0.015	191.7	-0.0115
486.30	-0.015	191.6	-0.0124
486.32	-0.016	191.4	-0.0151
486.33	-0.017	191.2	-0.016
486.35	-0.017	191	-0.016
486.37	-0.017	190.9	-0.0169
486.38	-0.017	190.8	-0.0169
486.40	-0.017	190.8	-0.0169
486.42	-0.017	190.7	-0.0169
486.43	-0.016	190.6	-0.0169
486.45	-0.016	190.6	-0.016
486.47	-0.016	190.5	-0.0151
486.48	-0.015	190.5	-0.0142
486.50	-0.013	190.6	-0.0133
486.52	-0.013	190.6	-0.0115
486.53	-0.011	190.6	-0.0089
486.55	-0.009	190.7	-0.0089
486.57	-0.007	190.7	-0.0062
486.58	-0.007	190.8	-0.0044
486.60	-0.007	190.9	-0.0027
486.62	-0.004	191.1	0.0009
486.63	-0.003	191.2	0.0036
486.65	-0.001	191.4	0.008
486.67	0.003	191.6	0.008
486.68	0.004	191.6	0.0124
486.70	0.004	191.8	0.016
486.72	0.005	192	0.0195
486.73	0.009	192.3	0.0231
486.75	0.01	192.5	0.0257
486.77	0.011	192.8	0.0311
486.78	0.016	193.1	0.0311
486.80	0.016	193.1	0.0364
486.82	0.016	193.2	0.0391
486.83	0.018	193.5	0.0426
486.85	0.02	193.8	0.0453
486.87	0.021	194	0.047
486.88	0.022	194.2	0.0506
486.90	0.025	194.5	0.0506
486.92	0.026	194.5	0.0541
486.93	0.026	194.7	0.0559
486.95	0.026	194.9	0.0577
486.97	0.027	195.1	0.0595
486.98	0.028	195.2	0.0604
487.00	0.028	195.4	0.0612
487.02	0.029	195.6	0.0612
487.03	0.029	195.6	0.0621
487.05	0.029	195.7	0.063
487.07	0.029	195.8	0.063
487.08	0.029	196	0.063
487.10	0.029	196	0.063
487.12	0.028	196.1	0.0612
487.13	0.026	196.1	0.0612
487.15	0.026	196.1	0.0595

Prova triassiale ciclica SN04-C1			
pressione di confinamento (kPa)		80	
deviatore ciclico (kPa)		95	
frequenza (hz)		0.00625	
tempo	cella di carico	$\Delta u$	LVDT
(min)	kN	(kPa)	$\delta$ (mm)
487.17	0.025	196.1	0.0586
487.18	0.024	196.1	0.0586
487.20	0.022	196	0.0568
487.22	0.022	196	0.055
487.23	0.021	196	0.0524
487.25	0.019	195.8	0.0488
487.27	0.016	195.7	0.047
487.30	0.016	195.6	0.0444
487.32	0.013	195.4	0.0444
487.33	0.011	195.2	0.0408
487.35	0.011	195.2	0.0373
487.35	0.01	195.1	0.0337
487.37	0.007	194.8	0.0302
487.38	0.004	194.6	0.0257
487.40	0.003	194.4	0.0222
487.42	0.001	194.1	0.0222
487.43	-0.002	193.8	0.0178
487.45	-0.002	193.8	0.0142
487.47	-0.003	193.6	0.0098
487.48	-0.005	193.3	0.0062
487.50	-0.008	193.1	0.0027
487.52	-0.008	192.9	0
487.53	-0.01	192.5	-0.0036
487.55	-0.012	192.3	-0.0036
487.57	-0.012	192.3	-0.0062
487.58	-0.013	192.1	-0.008
487.60	-0.014	191.9	-0.0107
487.62	-0.015	191.6	-0.0115
487.63	-0.016	191.5	-0.0133
487.65	-0.016	191.2	-0.0151
487.67	-0.017	191.1	-0.0151
487.68	-0.017	191.1	-0.016
487.70	-0.017	191	-0.0169
487.72	-0.017	190.8	-0.0169
487.73	-0.017	190.7	-0.0169
487.75	-0.017	190.7	-0.0169
487.77	-0.016	190.6	-0.016
487.78	-0.015	190.6	-0.016
487.80	-0.015	190.6	-0.0151
487.82	-0.015	190.5	-0.0142
487.83	-0.014	190.6	-0.0133
487.85	-0.012	190.6	-0.0107
487.87	-0.012	190.6	-0.0098
487.88	-0.011	190.7	-0.008
487.90	-0.008	190.8	-0.0062
487.92	-0.007	190.8	-0.0036
487.93	-0.006	191	-0.0009
487.95	-0.002	191.2	-0.0009
487.97	-0.002	191.2	0.0036
487.98	-0.002	191.3	0.0062
488.00	0	191.5	0.0089
488.02	0.004	191.7	0.0133
488.03	0.005	191.9	0.016
488.05	0.006	192.1	0.0204
488.07	0.01	192.4	0.0204
488.08	0.011	192.4	0.0257
488.10	0.011	192.6	0.0284
488.12	0.012	192.9	0.0337

Prova triassiale ciclica SN04-C1			
pressione di confinamento (kPa)		80	
deviatore ciclico (kPa)		95	
frequenza (hz)		0.00625	
tempo	cella di carico	$\Delta u$	LVDT
(min)	kN	(kPa)	$\delta$ (mm)
488.13	0.016	193.1	0.0373
488.15	0.017	193.4	0.0399
488.17	0.018	193.6	0.0435
488.18	0.021	193.9	0.0435
488.20	0.022	193.9	0.047
488.22	0.022	194.1	0.0497
488.23	0.023	194.3	0.0524
488.25	0.025	194.6	0.055
488.27	0.026	194.8	0.0568
488.28	0.026	195	0.0586
488.30	0.028	195.2	0.0586
488.32	0.028	195.2	0.0604
488.33	0.028	195.3	0.0612
488.35	0.028	195.5	0.0621
488.37	0.029	195.7	0.063
488.38	0.029	195.8	0.063
488.40	0.029	195.9	0.063
488.42	0.028	196	0.063
488.43	0.028	196.1	0.063
488.45	0.028	196.1	0.063
488.47	0.027	196.1	0.0612
488.48	0.026	196.1	0.0604
488.50	0.025	196.1	0.0586
488.52	0.024	196.1	0.0568
488.53	0.022	196	0.0568
488.55	0.02	195.9	0.0541
488.57	0.02	195.9	0.0524
488.58	0.02	195.9	0.0497
488.60	0.016	195.6	0.047
488.62	0.016	195.6	0.0453
488.63	0.015	195.5	0.0426
488.65	0.012	195.2	0.0391
488.67	0.01	195.1	0.0364
488.68	0.009	194.9	0.032
488.70	0.005	194.6	0.032
488.72	0.004	194.5	0.0275
488.75	0.004	194.5	0.024
488.77	0.003	194.3	0.0204
488.78	0	193.9	0.016
488.80	-0.002	193.7	0.0124
488.80	-0.004	193.5	0.0089
488.82	-0.006	193.2	0.0089
488.83	-0.008	192.9	0.0044
488.85	-0.008	192.9	0.0018
488.87	-0.009	192.7	-0.0018
488.88	-0.011	192.4	-0.0044
488.90	-0.012	192.2	-0.0071
488.92	-0.013	192	-0.0098
488.93	-0.015	191.7	-0.0115
488.95	-0.016	191.5	-0.0115
488.97	-0.016	191.5	-0.0133
488.98	-0.016	191.4	-0.0142
489.00	-0.016	191.2	-0.0151
489.02	-0.017	191	-0.016
489.03	-0.017	190.9	-0.0169
489.05	-0.017	190.8	-0.0169
489.07	-0.017	190.7	-0.0169
489.08	-0.017	190.7	-0.0169

Prova triassiale ciclica SN04-C1			
pressione di confinamento (kPa)		80	
deviatore ciclico (kPa)		95	
frequenza (hz)		0.00625	
tempo	cella di carico	$\Delta u$	LVDT
(min)	kN	(kPa)	$\delta$ (mm)
489.10	-0.017	190.6	-0.0169
489.12	-0.016	190.6	-0.016
489.13	-0.015	190.6	-0.0151
489.15	-0.014	190.5	-0.0133
489.17	-0.014	190.6	-0.0124
489.18	-0.012	190.6	-0.0124
489.20	-0.011	190.6	-0.0107
489.22	-0.011	190.6	-0.0089
489.23	-0.009	190.8	-0.0062
489.25	-0.007	190.9	-0.0036
489.27	-0.006	191	-0.0009
489.28	-0.004	191.2	0.0027
489.30	-0.001	191.3	0.0027
489.32	0	191.5	0.008
489.33	0.001	191.6	0.0107
489.35	0.004	191.8	0.0107
489.37	0.005	191.8	0.0151
489.38	0.005	192	0.0186
489.40	0.007	192.3	0.0222
489.42	0.011	192.5	0.0275
489.43	0.012	192.7	0.0311
489.45	0.013	193	0.0346
489.47	0.016	193.2	0.0346
489.48	0.017	193.2	0.0382
489.50	0.017	193.4	0.0408
489.52	0.019	193.7	0.0453
489.53	0.022	194	0.0488
489.55	0.023	194.2	0.0506
489.57	0.023	194.4	0.0533
489.58	0.025	194.6	0.0533
489.60	0.026	194.8	0.0559
489.62	0.026	194.8	0.0577
489.63	0.027	195	0.0586
489.65	0.027	195.2	0.0604
489.67	0.029	195.4	0.0621
489.68	0.029	195.6	0.0621
489.70	0.029	195.7	0.0621
489.72	0.029	195.8	0.063
489.73	0.029	195.8	0.063
489.75	0.028	195.9	0.063
489.77	0.028	196	0.063
489.78	0.028	196.1	0.0621
489.80	0.027	196.1	0.0612
489.82	0.026	196.1	0.0612
489.83	0.024	196.1	0.0595
489.85	0.024	196.1	0.0577
489.87	0.024	196.1	0.0559
489.88	0.022	196	0.0541
489.90	0.02	195.9	0.0515
489.92	0.019	195.8	0.0488
489.93	0.017	195.6	0.0462
489.95	0.014	195.5	0.0462
489.97	0.014	195.5	0.0435
489.98	0.013	195.4	0.0399
490.00	0.011	195.1	0.0364
490.02	0.008	194.9	0.0328
490.03	0.007	194.7	0.0293
490.05	0.005	194.5	0.0249

Prova triassiale ciclica SN04-C1			
pressione di confinamento (kPa)		80	
deviatore ciclico (kPa)		95	
frequenza (hz)		0.00625	
tempo	cella di carico	$\Delta u$	LVDT
(min)	kN	(kPa)	$\delta$ (mm)
490.07	0.003	194.3	0.0231
490.08	0.002	194.1	0.0195
490.10	0	193.8	0.0151
490.12	-0.004	193.6	0.0151
490.13	-0.005	193.6	0.0107
490.15	-0.005	193.3	0.008
490.17	-0.006	193	0.0044
490.20	-0.009	192.8	0
490.22	-0.01	192.6	-0.0027
490.23	-0.011	192.3	-0.0053
490.25	-0.013	192	-0.0053
490.25	-0.014	192	-0.008
490.27	-0.014	191.9	-0.0098
490.28	-0.015	191.6	-0.0115
490.30	-0.016	191.4	-0.0133
490.32	-0.016	191.3	-0.0142
490.33	-0.017	191.1	-0.0151
490.35	-0.017	190.9	-0.0151
490.37	-0.017	190.9	-0.016
490.38	-0.017	190.8	-0.0169
490.40	-0.017	190.7	-0.0169
490.42	-0.017	190.6	-0.0169
490.43	-0.016	190.6	-0.016
490.45	-0.016	190.5	-0.0151
490.47	-0.015	190.5	-0.0151
490.48	-0.014	190.5	-0.0142
490.50	-0.014	190.5	-0.0133
490.52	-0.013	190.6	-0.0115
490.53	-0.011	190.6	-0.0089
490.55	-0.01	190.7	-0.0071
490.57	-0.009	190.7	-0.0053
490.58	-0.006	190.9	-0.0053
490.60	-0.005	191	-0.0027
490.62	-0.005	191	0
490.63	-0.003	191.2	0.0036
490.65	0	191.4	0.008
490.67	0.001	191.5	0.0107
490.68	0.003	191.7	0.0151
490.70	0.006	192	0.0151
490.72	0.008	192.2	0.0186
490.73	0.008	192.2	0.0222
490.75	0.009	192.4	0.0257
490.77	0.013	192.9	0.0311
490.78	0.013	192.9	0.0328
490.80	0.014	193.1	0.0373
490.82	0.017	193.4	0.0408
490.83	0.019	193.6	0.0435
490.85	0.019	193.8	0.0462
490.87	0.021	194.1	0.0497
490.88	0.024	194.3	0.0497
490.90	0.024	194.3	0.0524
490.92	0.024	194.5	0.0541
490.93	0.025	194.7	0.0568
490.95	0.027	194.9	0.0586
490.97	0.027	195.1	0.0604
490.98	0.028	195.3	0.0612
491.00	0.028	195.5	0.0612
491.02	0.029	195.5	0.0621



Prova triassiale ciclica SN04-C1			
pressione di confinamento (kPa)		80	
deviatore ciclico (kPa)		95	
frequenza (hz)		0.00625	
tempo	cella di carico	$\Delta u$	LVDT
(min)	kN	(kPa)	$\delta$ (mm)
491.03	0.029	195.7	0.063
491.05	0.029	195.8	0.063
491.07	0.029	195.9	0.063
491.08	0.028	196	0.063
491.10	0.028	196.1	0.063
491.12	0.027	196.1	0.063
491.13	0.027	196.1	0.0621
491.15	0.027	196.1	0.0612
491.17	0.026	196.1	0.0595
491.18	0.024	196.1	0.0577
491.20	0.023	196.1	0.0559
491.22	0.022	196	0.0533
491.23	0.019	195.9	0.0533
491.25	0.018	195.9	0.0506
491.27	0.018	195.8	0.0488
491.28	0.017	195.6	0.0453
491.30	0.013	195.4	0.0417
491.32	0.012	195.3	0.0391
491.33	0.011	195.1	0.0355
491.35	0.007	194.8	0.0355
491.37	0.006	194.8	0.0311
491.38	0.006	194.7	0.0284
491.40	0.005	194.5	0.024
491.42	0.001	194.2	0.0186
491.43	0	194	0.016
491.45	-0.002	193.7	0.0115
491.47	-0.005	193.4	0.0115
491.48	-0.006	193.2	0.008
491.50	-0.007	192.9	0.0027
491.52	-0.009	192.7	0.0027
491.53	-0.01	192.5	0
491.55	-0.01	192.5	-0.0036
491.57	-0.011	192.2	-0.0062
491.58	-0.013	192	-0.0089
491.60	-0.015	191.8	-0.0107
491.62	-0.015	191.6	-0.0124
491.63	-0.016	191.4	-0.0124
491.67	-0.017	191.2	-0.0142
491.68	-0.017	191.2	-0.0151
491.70	-0.017	191	-0.016
491.72	-0.017	190.9	-0.016
491.72	-0.017	190.8	-0.0169
491.73	-0.017	190.7	-0.0169
491.75	-0.017	190.6	-0.016
491.77	-0.016	190.6	-0.016
491.78	-0.016	190.6	-0.016
491.80	-0.016	190.5	-0.0151
491.82	-0.015	190.5	-0.0142
491.83	-0.013	190.5	-0.0124
491.85	-0.012	190.5	-0.0107
491.87	-0.011	190.6	-0.0089
491.88	-0.009	190.7	-0.0089
491.90	-0.008	190.7	-0.0071
491.92	-0.008	190.8	-0.0044
491.93	-0.007	191	-0.0018
491.95	-0.003	191.1	0.0018
491.97	-0.002	191.2	0.0053
491.98	-0.001	191.4	0.008

Prova triassiale ciclica SN04-C1			
pressione di confinamento (kPa)		80	
deviatore ciclico (kPa)		95	
frequenza (hz)		0.00625	
tempo	cella di carico	$\Delta u$	LVDT
(min)	kN	(kPa)	$\delta$ (mm)
492.00	0.003	191.6	0.008
492.02	0.004	191.6	0.0124
492.03	0.004	191.8	0.0151
492.05	0.005	192	0.0186
492.07	0.009	192.3	0.0231
492.08	0.01	192.5	0.0275
492.10	0.012	192.8	0.032
492.12	0.015	193	0.032
492.13	0.016	193	0.0364
492.15	0.016	193.2	0.0391
492.17	0.017	193.5	0.0426
492.18	0.021	193.8	0.0462
492.20	0.021	194	0.0488
492.22	0.022	194.2	0.0515
492.23	0.024	194.5	0.0541
492.25	0.025	194.6	0.055
492.27	0.026	194.8	0.0577
492.28	0.027	195	0.0577
492.30	0.027	195	0.0595
492.32	0.027	195.2	0.0604
492.33	0.028	195.4	0.0612
492.35	0.029	195.6	0.0621
492.37	0.029	195.7	0.063
492.38	0.029	195.8	0.063
492.40	0.029	195.9	0.063
492.42	0.029	195.9	0.063
492.43	0.029	196	0.063
492.45	0.028	196.1	0.0621
492.47	0.027	196.1	0.0612
492.48	0.026	196.1	0.0604
492.50	0.025	196.1	0.0577
492.52	0.023	196	0.0577
492.53	0.022	196	0.0559
492.55	0.022	196	0.055
492.57	0.021	196	0.0524
492.58	0.019	195.8	0.0497
492.60	0.017	195.7	0.047
492.62	0.016	195.6	0.0435
492.63	0.013	195.3	0.0435
492.65	0.011	195.2	0.0399
492.67	0.011	195.2	0.0373
492.68	0.01	195	0.0337
492.70	0.007	194.7	0.0293
492.72	0.005	194.6	0.0257
492.73	0.003	194.3	0.0222
492.75	0.001	194	0.0178
492.77	-0.002	193.8	0.0178
492.78	-0.002	193.8	0.0142
492.80	-0.003	193.6	0.0107
492.82	-0.005	193.3	0.0062
492.83	-0.007	193	0.0027
492.85	-0.008	192.8	-0.0009
492.87	-0.01	192.5	-0.0036
492.88	-0.012	192.3	-0.0036
492.90	-0.012	192.3	-0.0062
492.92	-0.013	192.1	-0.0089
492.93	-0.014	191.8	-0.0107
492.95	-0.015	191.6	-0.0124

Prova triassiale ciclica SN04-C1			
pressione di confinamento (kPa)		80	
deviatore ciclico (kPa)		95	
frequenza (hz)		0.00625	
tempo	cella di carico	$\Delta u$	LVDT
(min)	kN	(kPa)	$\delta$ (mm)
492.97	-0.015	191.4	-0.0133
492.98	-0.016	191.2	-0.0151
493.00	-0.017	191.1	-0.016
493.02	-0.017	190.9	-0.016
493.03	-0.017	190.8	-0.0169
493.05	-0.017	190.7	-0.0169
493.07	-0.017	190.7	-0.0169
493.10	-0.017	190.6	-0.0169
493.12	-0.017	190.5	-0.016
493.13	-0.016	190.5	-0.016
493.15	-0.015	190.5	-0.0142
493.17	-0.015	190.5	-0.0133
493.17	-0.013	190.5	-0.0133
493.18	-0.012	190.5	-0.0115
493.20	-0.012	190.5	-0.0107
493.22	-0.011	190.6	-0.0089
493.23	-0.008	190.7	-0.0053
493.25	-0.007	190.8	-0.0036
493.27	-0.006	190.9	-0.0009
493.28	-0.002	191.2	-0.0009
493.30	-0.002	191.3	0.0036
493.32	-0.002	191.3	0.0053
493.33	0	191.4	0.0089
493.35	0.003	191.7	0.0133
493.37	0.005	191.9	0.0169
493.38	0.006	192.1	0.0204
493.40	0.009	192.4	0.0204
493.42	0.011	192.6	0.0249
493.43	0.011	192.6	0.0293
493.45	0.012	192.8	0.0328
493.47	0.015	193.1	0.0364
493.48	0.018	193.4	0.0408
493.50	0.019	193.5	0.0444
493.52	0.021	193.8	0.0444
493.53	0.022	194.1	0.047
493.55	0.022	194.1	0.0497
493.57	0.023	194.3	0.0524
493.58	0.024	194.5	0.0541
493.60	0.026	194.7	0.0568
493.62	0.026	194.9	0.0586
493.63	0.027	195.1	0.0604
493.65	0.028	195.3	0.0604
493.67	0.028	195.3	0.0612
493.68	0.029	195.7	0.0621
493.70	0.029	195.8	0.0621
493.72	0.029	195.8	0.063
493.73	0.029	195.9	0.063
493.75	0.029	196	0.063
493.77	0.029	196.1	0.063
493.78	0.027	196.1	0.0621
493.80	0.027	196.1	0.0612
493.82	0.025	196.1	0.0612
493.83	0.025	196.1	0.0595
493.85	0.025	196.1	0.0577
493.87	0.024	196	0.0559
493.88	0.021	196	0.0541
493.90	0.02	195.9	0.0515
493.92	0.019	195.8	0.0488

Prova triassiale ciclica SN04-C1			
pressione di confinamento (kPa)		80	
deviatore ciclico (kPa)		95	
frequenza (hz)		0.00625	
tempo	cella di carico	$\Delta u$	LVDT
(min)	kN	(kPa)	$\delta$ (mm)
493.93	0.016	195.6	0.0488
493.95	0.015	195.6	0.0453
493.97	0.015	195.5	0.0426
493.98	0.013	195.3	0.0399
494.00	0.01	195.1	0.0355
494.02	0.009	194.9	0.0328
494.03	0.007	194.7	0.0284
494.05	0.004	194.4	0.0284
494.07	0.002	194.4	0.024
494.08	0.002	194.2	0.0204
494.10	0.001	194	0.0169
494.12	-0.003	193.7	0.0124
494.13	-0.004	193.5	0.0089
494.15	-0.005	193.2	0.0053
494.17	-0.008	192.9	0.0053
494.18	-0.009	192.9	0.0018
494.20	-0.009	192.7	-0.0009
494.22	-0.01	192.5	-0.0044
494.23	-0.013	192.2	-0.008
494.25	-0.014	192	-0.0089
494.27	-0.014	191.8	-0.0107
494.28	-0.015	191.5	-0.0107
494.30	-0.016	191.3	-0.0133
494.32	-0.016	191.3	-0.0142
494.33	-0.016	191.2	-0.0151
494.35	-0.017	191	-0.016
494.37	-0.017	190.9	-0.0169
494.38	-0.017	190.8	-0.0169
494.40	-0.017	190.7	-0.0169
494.42	-0.017	190.6	-0.0169
494.43	-0.016	190.5	-0.016
494.45	-0.016	190.5	-0.016
494.47	-0.015	190.5	-0.016
494.48	-0.015	190.5	-0.0151
494.50	-0.014	190.5	-0.0133
494.52	-0.013	190.5	-0.0115
494.53	-0.011	190.6	-0.0098
494.57	-0.01	190.6	-0.0071
494.58	-0.008	190.8	-0.0071
494.60	-0.006	190.9	-0.0044
494.62	-0.006	190.9	-0.0027
494.62	-0.005	191	0.0009
494.63	-0.002	191.2	0.0044
494.65	0	191.4	0.0071
494.67	0.001	191.5	0.0107
494.68	0.004	191.8	0.0107
494.70	0.006	192	0.0142
494.72	0.006	192	0.0178
494.73	0.007	192.2	0.0222
494.75	0.01	192.5	0.0275
494.77	0.013	192.7	0.0311
494.78	0.013	192.9	0.0337
494.80	0.015	193.2	0.0382
494.82	0.018	193.4	0.0382
494.83	0.018	193.4	0.0417
494.85	0.019	193.7	0.0453
494.87	0.021	194	0.0488
494.88	0.023	194.2	0.0506

Prova triassiale ciclica SN04-C1			
pressione di confinamento (kPa)		80	
deviatore ciclico (kPa)		95	
frequenza (hz)		0.00625	
tempo	cella di carico	$\Delta u$	LVDT
(min)	kN	(kPa)	$\delta$ (mm)
494.90	0.024	194.4	0.0533
494.92	0.025	194.6	0.055
494.93	0.026	194.8	0.055
494.95	0.027	194.8	0.0577
494.97	0.027	195	0.0586
494.98	0.027	195.2	0.0604
495.00	0.028	195.4	0.0612
495.02	0.029	195.5	0.0621
495.03	0.029	195.7	0.0621
495.05	0.029	195.8	0.0621
495.07	0.028	195.8	0.0621
495.08	0.028	195.9	0.0621
495.10	0.028	196	0.0621
495.12	0.028	196	0.0621
495.13	0.027	196.1	0.0604
495.15	0.026	196.1	0.0604
495.17	0.025	196.1	0.0586
495.18	0.024	196.1	0.0577
495.20	0.023	196	0.055
495.22	0.021	195.9	0.055
495.23	0.019	195.9	0.0524
495.25	0.019	195.9	0.0506
495.27	0.018	195.8	0.047
495.28	0.015	195.6	0.0444
495.30	0.013	195.4	0.0408
495.32	0.012	195.2	0.0382
495.33	0.01	195	0.0382
495.35	0.007	194.8	0.0346
495.37	0.007	194.8	0.0311
495.38	0.006	194.6	0.0275
495.40	0.003	194.3	0.0213
495.42	0.001	194.1	0.0186
495.43	0	193.9	0.016
495.45	-0.003	193.6	0.016
495.47	-0.005	193.3	0.0115
495.48	-0.005	193.3	0.008
495.50	-0.006	193.1	0.0044
495.52	-0.008	192.8	0
495.53	-0.01	192.6	-0.0027
495.55	-0.011	192.3	-0.0053
495.57	-0.012	192.1	-0.008
495.58	-0.014	191.8	-0.008
495.60	-0.015	191.8	-0.0098
495.62	-0.015	191.7	-0.0115
495.63	-0.015	191.5	-0.0133
495.65	-0.017	191.3	-0.0151
495.67	-0.017	191.1	-0.016
495.68	-0.017	191	-0.0169
495.70	-0.017	190.8	-0.0169
495.72	-0.017	190.8	-0.0169
495.73	-0.017	190.7	-0.0169
495.75	-0.017	190.6	-0.0169
495.77	-0.017	190.6	-0.0169
495.78	-0.016	190.5	-0.016
495.80	-0.015	190.5	-0.0142
495.82	-0.014	190.5	-0.0142
495.83	-0.013	190.5	-0.0133
495.85	-0.012	190.5	-0.0115

Prova triassiale ciclica SN04-C1			
pressione di confinamento (kPa)		80	
deviatore ciclico (kPa)		95	
frequenza (hz)		0.00625	
tempo	cella di carico	$\Delta u$	LVDT
(min)	kN	(kPa)	$\delta$ (mm)
495.87	-0.011	190.6	-0.0115
495.88	-0.01	190.6	-0.0098
495.90	-0.01	190.6	-0.0071
495.92	-0.008	190.8	-0.0044
495.93	-0.005	190.9	-0.0009
495.95	-0.004	191	0.0018
495.97	-0.003	191.2	0.0044
496.00	0.001	191.4	0.0044
496.02	0.002	191.4	0.0089
496.03	0.002	191.6	0.0124
496.05	0.004	191.8	0.016
496.07	0.007	192.1	0.0204
496.07	0.008	192.2	0.0231
496.08	0.01	192.5	0.0284
496.10	0.014	192.8	0.0284
496.12	0.014	192.8	0.0328
496.13	0.014	193	0.0355
496.15	0.016	193.2	0.0399
496.17	0.019	193.5	0.0426
496.18	0.02	193.7	0.0462
496.20	0.021	194	0.0488
496.22	0.023	194.2	0.0488
496.23	0.024	194.2	0.0515
496.25	0.024	194.4	0.0533
496.27	0.025	194.6	0.0568
496.28	0.027	194.9	0.0586
496.30	0.027	195	0.0595
496.32	0.028	195.2	0.0612
496.33	0.028	195.4	0.0612
496.35	0.029	195.6	0.0621
496.37	0.029	195.6	0.0621
496.38	0.029	195.7	0.063
496.40	0.029	195.8	0.063
496.42	0.029	195.9	0.063
496.43	0.028	196	0.063
496.45	0.028	196	0.063
496.47	0.026	196	0.0612
496.48	0.026	196	0.0604
496.50	0.025	196.1	0.0586
496.52	0.024	196	0.0568
496.53	0.022	196	0.055
496.55	0.022	195.9	0.0533
496.57	0.02	195.8	0.0506
496.58	0.017	195.7	0.0479
496.60	0.017	195.6	0.0462
496.62	0.015	195.4	0.0426
496.63	0.012	195.3	0.0426
496.65	0.012	195.3	0.0399
496.67	0.011	195.1	0.0364
496.68	0.009	194.9	0.0328
496.70	0.006	194.7	0.0293
496.72	0.005	194.5	0.0249
496.73	0.003	194.2	0.0213
496.75	0	194	0.0213
496.77	-0.001	194	0.0169
496.78	-0.001	193.8	0.0142
496.80	-0.003	193.5	0.0098
496.82	-0.006	193.2	0.0062

Prova triassiale ciclica SN04-C1			
pressione di confinamento (kPa)		80	
deviatore ciclico (kPa)		95	
frequenza (hz)		0.00625	
tempo	cella di carico	$\Delta u$	LVDT
(min)	kN	(kPa)	$\delta$ (mm)
496.83	-0.007	193	0.0027
496.85	-0.008	192.7	-0.0009
496.87	-0.011	192.4	-0.0009
496.88	-0.011	192.4	-0.0044
496.90	-0.011	192.2	-0.0062
496.92	-0.012	192	-0.0089
496.93	-0.015	191.7	-0.0115
496.95	-0.015	191.5	-0.0124
496.97	-0.015	191.4	-0.0133
496.98	-0.017	191.2	-0.0133
497.00	-0.017	191.2	-0.0151
497.02	-0.017	191	-0.016
497.03	-0.017	190.9	-0.0169
497.05	-0.017	190.8	-0.0169
497.07	-0.017	190.7	-0.0169
497.08	-0.017	190.6	-0.0169
497.10	-0.016	190.5	-0.0169
497.12	-0.015	190.5	-0.016
497.13	-0.015	190.5	-0.0151
497.15	-0.015	190.5	-0.0142
497.17	-0.013	190.5	-0.0124
497.18	-0.012	190.5	-0.0115
497.20	-0.012	190.6	-0.0098
497.22	-0.009	190.7	-0.0098
497.23	-0.008	190.7	-0.008
497.25	-0.008	190.7	-0.0053
497.27	-0.007	190.9	-0.0018
497.28	-0.004	191.1	0.0018
497.30	-0.002	191.2	0.0044
497.32	-0.001	191.4	0.008
497.33	0.001	191.5	0.0098
497.35	0.003	191.7	0.0133
497.37	0.004	191.9	0.0178
497.38	0.009	192.2	0.0178
497.40	0.009	192.2	0.0213
497.42	0.009	192.3	0.0249
497.43	0.011	192.6	0.0293
497.47	0.014	192.9	0.0337
497.48	0.015	193.1	0.0373
497.50	0.016	193.3	0.0399
497.52	0.02	193.6	0.0399
497.52	0.02	193.6	0.0444
497.53	0.02	193.8	0.047
497.55	0.022	194	0.0497
497.57	0.024	194.3	0.0533
497.58	0.025	194.5	0.055
497.60	0.025	194.7	0.0568
497.62	0.027	194.9	0.0568
497.63	0.027	195.1	0.0586
497.65	0.027	195.1	0.0595
497.67	0.028	195.3	0.0612
497.68	0.028	195.5	0.0621
497.70	0.029	195.6	0.0621
497.72	0.029	195.8	0.063
497.73	0.029	195.8	0.063
497.75	0.029	195.9	0.063
497.77	0.029	195.9	0.063
497.78	0.028	196	0.0621

Prova triassiale ciclica SN04-C1			
pressione di confinamento (kPa)		80	
deviatore ciclico (kPa)		95	
frequenza (hz)		0.00625	
tempo	cella di carico	$\Delta u$	LVDT
(min)	kN	(kPa)	$\delta$ (mm)
497.80	0.027	196	0.0612
497.82	0.026	196	0.0604
497.83	0.025	196	0.0586
497.85	0.024	196	0.0586
497.87	0.022	195.9	0.0568
497.88	0.022	195.9	0.0541
497.90	0.021	195.9	0.0524
497.92	0.019	195.7	0.0497
497.93	0.016	195.6	0.047
497.95	0.016	195.5	0.0435
497.97	0.013	195.3	0.0399
497.98	0.01	195.1	0.0399
498.00	0.01	195.1	0.0373
498.02	0.01	194.9	0.0337
498.03	0.006	194.5	0.0302
498.05	0.006	194.5	0.0275
498.07	0.004	194.4	0.0231
498.08	0.002	194	0.0186
498.10	-0.001	193.8	0.016
498.12	-0.002	193.6	0.0124
498.13	-0.004	193.3	0.0089
498.15	-0.007	193.1	0.0089
498.17	-0.008	193.1	0.0044
498.18	-0.008	192.8	0.0018
498.20	-0.009	192.6	-0.0018
498.22	-0.012	192.3	-0.0044
498.23	-0.012	192.1	-0.0071
498.25	-0.013	191.8	-0.0098
498.27	-0.015	191.6	-0.0098
498.28	-0.015	191.6	-0.0115
498.30	-0.015	191.4	-0.0133
498.32	-0.016	191.2	-0.0142
498.33	-0.017	191.1	-0.0151
498.35	-0.017	190.9	-0.016
498.37	-0.017	190.8	-0.0169
498.38	-0.017	190.7	-0.0169
498.40	-0.017	190.7	-0.0169
498.42	-0.017	190.6	-0.0169
498.43	-0.017	190.5	-0.0169
498.45	-0.016	190.5	-0.016
498.47	-0.015	190.4	-0.0151
498.48	-0.015	190.5	-0.0133
498.50	-0.013	190.5	-0.0133
498.52	-0.012	190.5	-0.0115
498.53	-0.012	190.5	-0.0098
498.55	-0.011	190.6	-0.008
498.57	-0.008	190.7	-0.0053
498.58	-0.007	190.8	-0.0036
498.60	-0.006	190.9	0
498.62	-0.003	191.1	0
498.63	-0.001	191.1	0.0027
498.65	-0.001	191.2	0.0062
498.67	0	191.4	0.0089
498.68	0.004	191.7	0.0133
498.70	0.005	191.8	0.0169
498.72	0.006	192.1	0.0213
498.73	0.01	192.3	0.0213
498.75	0.011	192.3	0.0249



Prova triassiale ciclica SN04-C1			
pressione di confinamento (kPa)		80	
deviatore ciclico (kPa)		95	
frequenza (hz)		0.00625	
tempo	cella di carico	$\Delta u$	LVDT
(min)	kN	(kPa)	$\delta$ (mm)
498.77	0.012	192.7	0.032
498.78	0.014	192.9	0.032
498.80	0.015	192.9	0.0346
498.82	0.015	193.2	0.0382
498.83	0.017	193.4	0.0417
498.85	0.021	193.7	0.0462
498.87	0.021	193.9	0.0479
498.88	0.022	194.2	0.0515
498.90	0.024	194.4	0.0515
498.93	0.025	194.4	0.0541
498.95	0.025	194.6	0.0559
498.97	0.026	194.8	0.0577
498.97	0.027	195	0.0595
498.98	0.028	195.2	0.0604
499.00	0.028	195.4	0.0612
499.02	0.029	195.6	0.0612
499.03	0.029	195.6	0.063
499.05	0.029	195.7	0.063
499.07	0.029	195.8	0.063
499.08	0.029	195.9	0.063
499.10	0.028	196	0.063
499.12	0.028	196	0.0612
499.13	0.027	196	0.0612
499.15	0.025	196	0.0604
499.17	0.025	196	0.0595
499.18	0.024	196	0.0577
499.20	0.023	196	0.055
499.22	0.021	195.9	0.0533
499.23	0.021	195.9	0.0515
499.25	0.018	195.7	0.0479
499.27	0.016	195.6	0.0479
499.28	0.016	195.6	0.0453
499.30	0.015	195.4	0.0417
499.32	0.013	195.2	0.0391
499.33	0.01	195	0.0355
499.35	0.009	194.8	0.032
499.37	0.006	194.6	0.0284
499.38	0.003	194.4	0.0284
499.40	0.002	194.4	0.024
499.42	0.002	194.2	0.0204
499.43	0.001	193.9	0.0169
499.45	-0.002	193.6	0.0124
499.47	-0.004	193.4	0.0089
499.48	-0.005	193.1	0.0053
499.50	-0.007	192.9	0.0027
499.52	-0.008	192.7	0
499.53	-0.01	192.4	-0.0036
499.55	-0.012	192.2	-0.0036
499.57	-0.013	192.2	-0.0062
499.58	-0.013	192	-0.008
499.60	-0.014	191.7	-0.0098
499.62	-0.015	191.5	-0.0124
499.63	-0.016	191.3	-0.0133
499.65	-0.016	191.2	-0.0151
499.67	-0.017	191	-0.0151
499.68	-0.017	191	-0.016
499.70	-0.017	190.9	-0.016
499.72	-0.017	190.7	-0.0169

Prova triassiale ciclica SN04-C1			
pressione di confinamento (kPa)		80	
deviatore ciclico (kPa)		95	
frequenza (hz)		0.00625	
tempo	cella di carico	$\Delta u$	LVDT
(min)	kN	(kPa)	$\delta$ (mm)
499.73	-0.017	190.6	-0.0169
499.75	-0.017	190.6	-0.0169
499.77	-0.017	190.5	-0.016
499.78	-0.015	190.5	-0.016
499.80	-0.015	190.5	-0.0151
499.82	-0.015	190.4	-0.0142
499.83	-0.014	190.4	-0.0124
499.85	-0.012	190.5	-0.0115
499.87	-0.011	190.5	-0.0098
499.88	-0.01	190.6	-0.0071
499.90	-0.008	190.7	-0.0071
499.92	-0.006	190.8	-0.0044
499.93	-0.006	190.8	-0.0027
499.95	-0.005	190.9	0.0009
499.97	-0.002	191.2	0.0044
499.98	0	191.3	0.0071
500.00	0.001	191.4	0.0115
500.02	0.004	191.7	0.0115
500.03	0.006	191.9	0.0151
500.05	0.006	191.9	0.0186
500.07	0.007	192.1	0.0222
500.08	0.01	192.4	0.0275
500.10	0.012	192.7	0.0311
500.12	0.014	192.9	0.0355
500.13	0.016	193.2	0.0355
500.15	0.018	193.4	0.0391
500.17	0.018	193.4	0.0417
500.18	0.019	193.6	0.0453
500.20	0.021	193.9	0.0479
500.22	0.023	194.1	0.0515
500.23	0.023	194.3	0.0524
500.25	0.024	194.5	0.055
500.27	0.026	194.7	0.0577
500.28	0.027	194.9	0.0586
500.30	0.027	195.1	0.0604
500.32	0.028	195.3	0.0604
500.33	0.028	195.3	0.0612
500.37	0.028	195.4	0.0621
500.38	0.029	195.6	0.063
500.40	0.029	195.7	0.063
500.42	0.029	195.8	0.063
500.43	0.029	195.9	0.063
500.43	0.028	196	0.063
500.45	0.027	196	0.063
500.47	0.027	196.1	0.0621
500.48	0.026	196.1	0.0604
500.50	0.025	196	0.0586
500.52	0.024	196	0.0577
500.53	0.023	196	0.055
500.55	0.021	195.9	0.055
500.57	0.019	195.9	0.0524
500.58	0.019	195.8	0.0506
500.60	0.018	195.7	0.0479
500.62	0.015	195.5	0.0444
500.63	0.014	195.4	0.0417
500.65	0.012	195.2	0.0382
500.67	0.009	194.9	0.0382
500.68	0.007	194.8	0.0346

Prova triassiale ciclica SN04-C1			
pressione di confinamento (kPa)		80	
deviatore ciclico (kPa)		95	
frequenza (hz)		0.00625	
tempo	cella di carico	$\Delta u$	LVDT
(min)	kN	(kPa)	$\delta$ (mm)
500.70	0.007	194.8	0.032
500.72	0.006	194.6	0.0275
500.73	0.003	194.3	0.0231
500.75	0.001	194.1	0.0195
500.77	0	193.9	0.0151
500.78	-0.003	193.5	0.0151
500.80	-0.005	193.3	0.0107
500.82	-0.005	193.3	0.008
500.83	-0.006	193.1	0.0044
500.85	-0.009	192.8	0.0009
500.87	-0.01	192.5	-0.0018
500.88	-0.011	192.3	-0.0053
500.90	-0.012	192	-0.0053
500.92	-0.014	191.8	-0.008
500.93	-0.014	191.8	-0.0107
500.95	-0.015	191.4	-0.0124
500.97	-0.016	191.2	-0.0124
500.98	-0.016	191.2	-0.0142
501.00	-0.016	191.1	-0.0151
501.02	-0.017	190.9	-0.016
501.03	-0.017	190.8	-0.0169
501.05	-0.017	190.7	-0.0169
501.07	-0.017	190.6	-0.0169
501.08	-0.017	190.5	-0.0169
501.10	-0.016	190.5	-0.016
501.12	-0.016	190.5	-0.016
501.13	-0.015	190.4	-0.0142
501.15	-0.014	190.4	-0.0133
501.17	-0.013	190.4	-0.0124
501.18	-0.013	190.5	-0.0107
501.20	-0.011	190.5	-0.0107
501.22	-0.01	190.5	-0.0089
501.23	-0.01	190.6	-0.0062
501.25	-0.008	190.7	-0.0036
501.27	-0.005	190.9	-0.0009
501.28	-0.004	191	0.0018
501.30	-0.003	191.2	0.0053
501.32	0.001	191.4	0.0053
501.33	0.002	191.4	0.0089
501.35	0.002	191.5	0.0115
501.37	0.004	191.7	0.016
501.38	0.007	192	0.0204
501.40	0.008	192.2	0.024
501.42	0.01	192.4	0.0284
501.43	0.013	192.7	0.0284
501.45	0.015	192.9	0.0328
501.47	0.015	192.9	0.0355
501.48	0.016	193.2	0.0391
501.50	0.019	193.5	0.0435
501.52	0.02	193.7	0.0453
501.53	0.021	193.9	0.0488
501.55	0.023	194.2	0.0488
501.57	0.025	194.4	0.0515
501.58	0.025	194.4	0.0541
501.60	0.025	194.6	0.0559
501.62	0.026	194.8	0.0577
501.63	0.027	195	0.0595
501.65	0.028	195.2	0.0612

Prova triassiale ciclica SN04-C1			
pressione di confinamento (kPa)		80	
deviatore ciclico (kPa)		95	
frequenza (hz)		0.00625	
tempo	cella di carico	$\Delta u$	LVDT
(min)	kN	(kPa)	$\delta$ (mm)
501.67	0.028	195.4	0.0621
501.68	0.029	195.5	0.0621
501.70	0.029	195.7	0.063
501.72	0.029	195.8	0.063
501.73	0.029	195.9	0.063
501.75	0.029	195.9	0.063
501.77	0.028	196	0.063
501.78	0.028	196	0.0621
501.80	0.027	196	0.0612
501.83	0.026	196.1	0.0604
501.85	0.025	196	0.0586
501.87	0.023	196	0.0586
501.88	0.022	196	0.0568
501.88	0.022	196	0.055
501.90	0.021	195.9	0.0524
501.92	0.018	195.7	0.0497
501.93	0.017	195.6	0.047
501.95	0.016	195.4	0.0444
501.97	0.012	195.2	0.0444
501.98	0.011	195.2	0.0408
502.00	0.011	195.1	0.0373
502.02	0.01	194.9	0.0337
502.03	0.006	194.7	0.0302
502.05	0.005	194.5	0.0257
502.07	0.003	194.2	0.0222
502.08	0	194	0.0222
502.10	-0.001	194	0.0178
502.12	-0.001	193.8	0.0142
502.13	-0.003	193.4	0.0107
502.15	-0.006	193.2	0.0062
502.17	-0.007	193	0.0036
502.18	-0.008	192.7	0
502.20	-0.011	192.4	0
502.22	-0.011	192.4	-0.0036
502.23	-0.011	192.2	-0.0053
502.25	-0.013	192	-0.008
502.27	-0.015	191.7	-0.0107
502.28	-0.015	191.5	-0.0124
502.30	-0.016	191.3	-0.0133
502.32	-0.016	191.2	-0.0133
502.33	-0.017	191.2	-0.0151
502.35	-0.017	191	-0.016
502.37	-0.017	190.9	-0.016
502.38	-0.017	190.7	-0.0169
502.40	-0.017	190.6	-0.0169
502.42	-0.017	190.6	-0.0169
502.43	-0.017	190.5	-0.016
502.45	-0.016	190.5	-0.0151
502.47	-0.015	190.4	-0.0142
502.48	-0.014	190.4	-0.0142
502.50	-0.013	190.5	-0.0133
502.52	-0.013	190.5	-0.0115
502.53	-0.012	190.5	-0.0098
502.55	-0.01	190.6	-0.008
502.57	-0.009	190.7	-0.0053
502.58	-0.008	190.8	-0.0027
502.60	-0.004	190.9	-0.0027
502.62	-0.003	191.1	0.0009

Prova triassiale ciclica SN04-C1			
pressione di confinamento (kPa)		80	
deviatore ciclico (kPa)		95	
frequenza (hz)		0.00625	
tempo	cella di carico	$\Delta u$	LVDT
(min)	kN	(kPa)	$\delta$ (mm)
502.63	-0.003	191.1	0.0027
502.65	-0.002	191.2	0.0071
502.67	0.001	191.5	0.0107
502.68	0.003	191.6	0.0142
502.70	0.004	191.8	0.0178
502.72	0.008	192.1	0.0178
502.73	0.009	192.3	0.0222
502.75	0.009	192.3	0.0249
502.77	0.011	192.5	0.0302
502.78	0.014	192.8	0.0346
502.80	0.016	193.1	0.0382
502.82	0.017	193.3	0.0408
502.83	0.019	193.6	0.0408
502.85	0.021	193.8	0.0444
502.87	0.021	193.8	0.047
502.88	0.022	194	0.0506
502.90	0.023	194.3	0.0533
502.92	0.025	194.5	0.055
502.93	0.026	194.7	0.0568
502.95	0.026	194.9	0.0586
502.97	0.028	195.1	0.0586
502.98	0.028	195.1	0.0604
503.00	0.028	195.2	0.0612
503.02	0.028	195.4	0.0621
503.03	0.029	195.6	0.063
503.05	0.029	195.7	0.063
503.07	0.029	195.8	0.063
503.08	0.028	195.9	0.063
503.10	0.028	195.9	0.063
503.12	0.027	196	0.0621
503.13	0.026	196	0.0621
503.15	0.025	196	0.0604
503.17	0.025	196.1	0.0595
503.18	0.025	196	0.0577
503.20	0.023	196	0.0559
503.22	0.022	195.9	0.0541
503.23	0.02	195.8	0.0515
503.27	0.017	195.7	0.0515
503.28	0.016	195.7	0.0479
503.30	0.016	195.6	0.0453
503.32	0.015	195.4	0.0426
503.33	0.011	195.2	0.0391
503.33	0.011	195	0.0364
503.35	0.009	194.8	0.032
503.37	0.005	194.6	0.032
503.38	0.004	194.6	0.0275
503.40	0.004	194.4	0.024
503.42	0.003	194.1	0.0204
503.43	-0.001	193.8	0.0151
503.45	-0.002	193.6	0.0124
503.47	-0.004	193.4	0.0089
503.48	-0.006	193.1	0.0089
503.50	-0.008	193.1	0.0053
503.52	-0.008	192.8	0.0018
503.53	-0.009	192.6	-0.0018
503.55	-0.011	192.3	-0.0053
503.57	-0.012	192.1	-0.0071
503.58	-0.013	191.9	-0.0089

Prova triassiale ciclica SN04-C1			
pressione di confinamento (kPa)		80	
deviatore ciclico (kPa)		95	
frequenza (hz)		0.00625	
tempo	cella di carico	$\Delta u$	LVDT
(min)	kN	(kPa)	$\delta$ (mm)
503.60	-0.015	191.6	-0.0089
503.62	-0.016	191.6	-0.0115
503.63	-0.016	191.4	-0.0133
503.65	-0.016	191.3	-0.0142
503.67	-0.017	191.1	-0.016
503.68	-0.017	190.9	-0.0169
503.70	-0.017	190.8	-0.0169
503.72	-0.017	190.7	-0.0169
503.73	-0.017	190.6	-0.0169
503.75	-0.017	190.6	-0.0169
503.77	-0.017	190.5	-0.016
503.78	-0.016	190.5	-0.016
503.80	-0.015	190.4	-0.0151
503.82	-0.015	190.4	-0.0133
503.83	-0.013	190.5	-0.0133
503.85	-0.012	190.5	-0.0107
503.87	-0.011	190.5	-0.0098
503.88	-0.009	190.6	-0.0098
503.90	-0.008	190.7	-0.0071
503.92	-0.008	190.7	-0.0053
503.93	-0.007	190.8	-0.0018
503.95	-0.004	191	0.0018
503.97	-0.002	191.2	0.0044
503.98	-0.001	191.3	0.008
504.00	0.002	191.5	0.008
504.02	0.004	191.7	0.0115
504.03	0.004	191.7	0.0151
504.05	0.005	191.9	0.0186
504.07	0.008	192.2	0.0231
504.08	0.011	192.4	0.0275
504.10	0.012	192.6	0.032
504.12	0.014	192.9	0.0355
504.13	0.017	193.1	0.0355
504.15	0.017	193.1	0.0391
504.17	0.017	193.4	0.0426
504.18	0.019	193.7	0.0462
504.20	0.022	193.9	0.0488
504.22	0.022	194.1	0.0515
504.23	0.024	194.3	0.0541
504.25	0.026	194.6	0.0541
504.27	0.026	194.6	0.0568
504.28	0.026	194.7	0.0577
504.30	0.027	194.9	0.0595
504.32	0.028	195.1	0.0612
504.33	0.028	195.3	0.0612
504.35	0.028	195.4	0.0621
504.37	0.029	195.6	0.0621
504.38	0.029	195.6	0.063
504.40	0.029	195.7	0.063
504.42	0.029	195.8	0.063
504.43	0.028	195.9	0.063
504.45	0.028	196	0.0621
504.47	0.027	196	0.0612
504.48	0.025	196	0.0612
504.50	0.025	196	0.0595
504.52	0.025	196	0.0577
504.53	0.023	195.9	0.0559
504.55	0.021	195.9	0.0541

Prova triassiale ciclica SN04-C1			
pressione di confinamento (kPa)		80	
deviatore ciclico (kPa)		95	
frequenza (hz)		0.00625	
tempo	cella di carico	$\Delta u$	LVDT
(min)	kN	(kPa)	$\delta$ (mm)
504.57	0.02	195.8	0.0524
504.58	0.02	195.8	0.0506
504.60	0.017	195.6	0.047
504.62	0.016	195.5	0.0453
504.63	0.014	195.3	0.0408
504.65	0.01	195.1	0.0408
504.67	0.01	195.1	0.0373
504.68	0.01	194.9	0.0346
504.70	0.008	194.7	0.0302
504.73	0.004	194.4	0.0257
504.75	0.003	194.3	0.0222
504.77	0.002	194.1	0.0186
504.78	-0.002	193.7	0.0186
504.78	-0.003	193.5	0.0142
504.80	-0.003	193.5	0.0115
504.82	-0.004	193.3	0.0071
504.83	-0.007	192.9	0.0036
504.85	-0.008	192.7	0
504.87	-0.01	192.5	-0.0036
504.88	-0.012	192.2	-0.0036
504.90	-0.013	192	-0.0062
504.92	-0.013	192	-0.008
504.93	-0.014	191.8	-0.0107
504.95	-0.015	191.5	-0.0124
504.97	-0.016	191.3	-0.0133
504.98	-0.016	191.2	-0.0151
505.00	-0.017	191	-0.0151
505.02	-0.017	190.9	-0.016
505.03	-0.017	190.9	-0.016
505.05	-0.017	190.7	-0.0169
505.07	-0.017	190.6	-0.0169
505.08	-0.017	190.5	-0.0169
505.10	-0.017	190.5	-0.016
505.12	-0.016	190.5	-0.016
505.13	-0.015	190.4	-0.0151
505.15	-0.015	190.4	-0.0142
505.17	-0.014	190.4	-0.0124
505.18	-0.013	190.5	-0.0115
505.20	-0.011	190.5	-0.0098
505.22	-0.01	190.6	-0.0071
505.23	-0.008	190.7	-0.0044
505.25	-0.006	190.8	-0.0044
505.27	-0.005	190.8	-0.0018
505.28	-0.005	190.9	0.0009
505.30	-0.001	191.2	0.0044
505.32	0	191.2	0.0062
505.33	0	191.4	0.0089
505.35	0.002	191.6	0.0124
505.37	0.005	191.8	0.0169
505.38	0.006	192	0.0204
505.40	0.008	192.3	0.024
505.42	0.012	192.5	0.024
505.43	0.013	192.5	0.0293
505.45	0.013	192.7	0.0328
505.47	0.014	193	0.0364
505.48	0.017	193.3	0.0408
505.50	0.018	193.5	0.0435
505.52	0.02	193.8	0.047

Prova triassiale ciclica SN04-C1			
pressione di confinamento (kPa)		80	
deviatore ciclico (kPa)		95	
frequenza (hz)		0.00625	
tempo	cella di carico	$\Delta u$	LVDT
(min)	kN	(kPa)	$\delta$ (mm)
505.53	0.023	194	0.047
505.55	0.023	194	0.0506
505.57	0.023	194.2	0.0524
505.58	0.024	194.4	0.055
505.60	0.026	194.7	0.0568
505.62	0.026	194.8	0.0586
505.63	0.027	195	0.0604
505.65	0.028	195.2	0.0604
505.67	0.029	195.2	0.0612
505.68	0.029	195.4	0.0621
505.70	0.029	195.5	0.063
505.72	0.029	195.7	0.063
505.73	0.029	195.8	0.063
505.75	0.029	195.9	0.063
505.77	0.028	195.9	0.063
505.78	0.027	195.9	0.063
505.80	0.027	196	0.0621
505.82	0.026	196	0.0604
505.83	0.025	196	0.0586
505.85	0.024	196	0.0577
505.87	0.023	195.9	0.055
505.88	0.021	195.8	0.055
505.90	0.019	195.8	0.0533
505.92	0.019	195.8	0.0506
505.93	0.018	195.6	0.0479
505.95	0.015	195.4	0.0453
505.97	0.014	195.3	0.0426
505.98	0.012	195.1	0.0382
506.00	0.009	194.9	0.0382
506.02	0.007	194.7	0.0346
506.03	0.006	194.5	0.0293
506.05	0.005	194.4	0.0293
506.07	0.002	194.1	0.0257
506.08	0.002	194.1	0.0213
506.10	0.001	193.9	0.0169
506.12	-0.002	193.6	0.0133
506.13	-0.004	193.4	0.0098
506.15	-0.005	193.1	0.0053
506.18	-0.008	192.8	0.0053
506.20	-0.009	192.6	0.0018
506.22	-0.009	192.6	-0.0009
506.23	-0.01	192.4	-0.0036
506.23	-0.012	192.1	-0.0071
506.25	-0.014	191.8	-0.0089
506.27	-0.014	191.7	-0.0107
506.28	-0.015	191.4	-0.0124
506.30	-0.016	191.2	-0.0124
506.32	-0.016	191.2	-0.0142
506.33	-0.016	191.1	-0.0151
506.35	-0.017	190.9	-0.016
506.37	-0.017	190.8	-0.0169
506.38	-0.017	190.7	-0.0169
506.40	-0.017	190.6	-0.0169
506.42	-0.017	190.5	-0.0169
506.43	-0.016	190.5	-0.0169
506.45	-0.016	190.4	-0.016
506.47	-0.016	190.4	-0.0151
506.48	-0.014	190.4	-0.0142



Prova triassiale ciclica SN04-C1			
pressione di confinamento (kPa)		80	
deviatore ciclico (kPa)		95	
frequenza (hz)		0.00625	
tempo	cella di carico	$\Delta u$	LVDT
(min)	kN	(kPa)	$\delta$ (mm)
506.50	-0.014	190.4	-0.0133
506.52	-0.013	190.5	-0.0107
506.53	-0.01	190.6	-0.0107
506.55	-0.009	190.6	-0.008
506.57	-0.009	190.6	-0.0062
506.58	-0.008	190.7	-0.0044
506.60	-0.005	190.8	-0.0009
506.62	-0.004	191	0.0018
506.63	-0.003	191.2	0.0053
506.65	0.001	191.4	0.0053
506.67	0.002	191.4	0.0098
506.68	0.002	191.5	0.0124
506.70	0.004	191.7	0.016
506.72	0.007	192	0.0204
506.73	0.008	192.2	0.0231
506.75	0.01	192.5	0.0284
506.77	0.012	192.6	0.0311
506.78	0.013	192.8	0.0337
506.80	0.015	193.1	0.0382
506.82	0.018	193.4	0.0382
506.83	0.019	193.4	0.0417
506.85	0.019	193.5	0.0444
506.87	0.02	193.8	0.0479
506.88	0.023	194.1	0.0515
506.90	0.024	194.3	0.0533
506.92	0.025	194.5	0.0559
506.93	0.026	194.7	0.0559
506.95	0.027	194.7	0.0577
506.97	0.027	194.9	0.0595
506.98	0.027	195.1	0.0604
507.00	0.028	195.3	0.0621
507.02	0.029	195.4	0.0621
507.03	0.029	195.6	0.063
507.05	0.029	195.7	0.063
507.07	0.029	195.8	0.063
507.08	0.029	195.8	0.063
507.10	0.029	195.9	0.063
507.12	0.028	196	0.0621
507.13	0.027	196	0.0612
507.15	0.026	196	0.0595
507.17	0.025	196	0.0577
507.18	0.023	195.9	0.0577
507.20	0.022	195.9	0.0568
507.22	0.022	195.9	0.055
507.23	0.021	195.8	0.0524
507.25	0.018	195.7	0.0497
507.27	0.017	195.6	0.047
507.28	0.015	195.4	0.0435
507.30	0.012	195.2	0.0435
507.32	0.012	195.2	0.0408
507.33	0.012	195.1	0.0373
507.35	0.01	194.8	0.0337
507.37	0.006	194.6	0.0302
507.38	0.005	194.4	0.0257
507.40	0.003	194.2	0.0213
507.42	0	193.9	0.0213
507.43	-0.001	193.9	0.0178
507.45	-0.001	193.7	0.0142

Prova triassiale ciclica SN04-C1			
pressione di confinamento (kPa)		80	
deviatore ciclico (kPa)		95	
frequenza (hz)		0.00625	
tempo	cella di carico	$\Delta u$	LVDT
(min)	kN	(kPa)	$\delta$ (mm)
507.47	-0.002	193.4	0.0107
507.48	-0.006	193.1	0.0062
507.50	-0.006	193	0.0044
507.52	-0.008	192.7	0.0009
507.53	-0.01	192.4	-0.0018
507.55	-0.011	192.2	-0.0036
507.57	-0.012	192	-0.0062
507.58	-0.014	191.7	-0.0062
507.60	-0.015	191.7	-0.0089
507.63	-0.015	191.5	-0.0115
507.65	-0.015	191.3	-0.0133
507.67	-0.017	191.2	-0.0151
507.68	-0.017	191	-0.0151
507.68	-0.017	190.9	-0.016
507.70	-0.017	190.7	-0.016
507.72	-0.017	190.7	-0.016
507.73	-0.017	190.6	-0.016
507.75	-0.017	190.5	-0.016
507.77	-0.017	190.5	-0.016
507.78	-0.016	190.4	-0.0151
507.80	-0.015	190.4	-0.0142
507.82	-0.014	190.4	-0.0142
507.83	-0.013	190.4	-0.0133
507.85	-0.013	190.4	-0.0115
507.87	-0.012	190.4	-0.0098
507.88	-0.01	190.5	-0.0071
507.90	-0.008	190.6	-0.0053
507.92	-0.007	190.7	-0.0027
507.93	-0.005	190.9	-0.0027
507.95	-0.003	191	0.0009
507.97	-0.003	191	0.0036
507.98	-0.002	191.2	0.0071
508.00	0.001	191.4	0.0107
508.02	0.003	191.6	0.0142
508.03	0.004	191.8	0.0178
508.05	0.007	192.1	0.0222
508.07	0.01	192.3	0.0222
508.08	0.011	192.3	0.0257
508.10	0.011	192.5	0.0293
508.12	0.013	192.8	0.0337
508.13	0.016	193	0.0373
508.15	0.017	193.2	0.0408
508.17	0.018	193.5	0.0444
508.18	0.021	193.7	0.0444
508.20	0.022	194	0.0497
508.22	0.022	194.1	0.0515
508.23	0.024	194.4	0.0515
508.25	0.025	194.4	0.0541
508.27	0.025	194.6	0.0559
508.28	0.026	194.8	0.0586
508.30	0.027	195	0.0604
508.32	0.028	195.1	0.0612
508.33	0.028	195.3	0.0621
508.35	0.029	195.5	0.0621
508.37	0.029	195.5	0.063
508.38	0.029	195.6	0.063
508.40	0.029	195.7	0.0639
508.42	0.029	195.8	0.063

Prova triassiale ciclica SN04-C1			
pressione di confinamento (kPa)		80	
deviatore ciclico (kPa)		95	
frequenza (hz)		0.00625	
tempo	cella di carico	$\Delta u$	LVDT
(min)	kN	(kPa)	$\delta$ (mm)
508.43	0.028	195.9	0.063
508.45	0.028	196	0.0621
508.47	0.026	195.9	0.0621
508.48	0.025	196	0.0604
508.50	0.025	196	0.0595
508.52	0.025	196	0.0586
508.53	0.023	195.9	0.0559
508.55	0.021	195.8	0.0541
508.57	0.021	195.8	0.0524
508.58	0.018	195.6	0.0524
508.60	0.016	195.5	0.0479
508.62	0.016	195.5	0.0462
508.63	0.015	195.4	0.0426
508.65	0.012	195.1	0.0391
508.67	0.01	195	0.0364
508.68	0.009	194.8	0.032
508.70	0.006	194.5	0.032
508.72	0.004	194.3	0.0284
508.73	0.004	194.3	0.0249
508.75	0.002	194.1	0.0204
508.77	-0.001	193.8	0.016
508.78	-0.002	193.6	0.0133
508.80	-0.004	193.4	0.0089
508.82	-0.006	193	0.0089
508.83	-0.008	192.8	0.0053
508.85	-0.008	192.8	0.0027
508.87	-0.009	192.6	-0.0009
508.88	-0.011	192.3	-0.0044
508.90	-0.013	192	-0.0062
508.92	-0.013	191.8	-0.008
508.93	-0.014	191.6	-0.0107
508.95	-0.015	191.4	-0.0115
508.97	-0.015	191.2	-0.0133
508.98	-0.016	191	-0.0133
509.00	-0.017	190.9	-0.0151
509.02	-0.017	190.9	-0.0151
509.03	-0.017	190.8	-0.016
509.05	-0.017	190.7	-0.016
509.07	-0.017	190.5	-0.016
509.10	-0.017	190.5	-0.016
509.12	-0.016	190.4	-0.0151
509.13	-0.015	190.4	-0.0151
509.15	-0.015	190.4	-0.0142
509.15	-0.015	190.4	-0.0142
509.17	-0.014	190.4	-0.0124
509.18	-0.012	190.4	-0.0107
509.20	-0.011	190.5	-0.0089
509.22	-0.01	190.6	-0.0071
509.23	-0.007	190.7	-0.0071
509.25	-0.006	190.7	-0.0036
509.27	-0.006	190.7	-0.0018
509.28	-0.005	190.9	0.0018
509.30	-0.001	191.1	0.0053
509.32	-0.001	191.2	0.008
509.33	0.001	191.5	0.0124
509.35	0.005	191.7	0.0124
509.37	0.005	191.7	0.016
509.38	0.005	191.8	0.0195

Prova triassiale ciclica SN04-C1			
pressione di confinamento (kPa)		80	
deviatore ciclico (kPa)		95	
frequenza (hz)		0.00625	
tempo	cella di carico	$\Delta u$	LVDT
(min)	kN	(kPa)	$\delta$ (mm)
509.40	0.007	192.1	0.0231
509.42	0.011	192.4	0.0284
509.43	0.012	192.6	0.032
509.45	0.013	192.8	0.0355
509.47	0.017	193.1	0.0355
509.48	0.017	193.1	0.0391
509.50	0.017	193.3	0.0426
509.52	0.019	193.6	0.0453
509.53	0.022	193.8	0.0488
509.55	0.023	194	0.0515
509.57	0.023	194.2	0.0541
509.58	0.026	194.5	0.0541
509.60	0.026	194.5	0.0568
509.62	0.026	194.7	0.0577
509.63	0.027	194.9	0.0595
509.65	0.028	195.1	0.0612
509.67	0.028	195.2	0.0621
509.68	0.029	195.4	0.063
509.70	0.029	195.6	0.063
509.72	0.029	195.7	0.0639
509.73	0.029	195.8	0.0639
509.75	0.029	195.9	0.0639
509.77	0.028	195.9	0.0639
509.78	0.028	195.9	0.063
509.80	0.027	196	0.0621
509.82	0.026	196	0.0604
509.83	0.025	196	0.0595
509.85	0.024	196	0.0568
509.87	0.022	195.9	0.0568
509.88	0.021	195.8	0.055
509.90	0.021	195.8	0.0533
509.92	0.02	195.7	0.0506
509.93	0.017	195.6	0.0479
509.95	0.015	195.4	0.0453
509.97	0.014	195.3	0.0417
509.98	0.012	195	0.0417
510.00	0.009	194.8	0.0382
510.02	0.009	194.8	0.0346
510.03	0.008	194.7	0.0311
510.05	0.005	194.4	0.0275
510.07	0.003	194.2	0.0231
510.08	0.002	194	0.0195
510.10	-0.001	193.7	0.0151
510.12	-0.004	193.4	0.0151
510.13	-0.004	193.4	0.0115
510.15	-0.005	193.2	0.0071
510.17	-0.006	192.9	0.0044
510.18	-0.009	192.6	0.0009
510.20	-0.01	192.4	-0.0018
510.22	-0.011	192.2	-0.0044
510.23	-0.013	191.9	-0.0044
510.25	-0.014	191.9	-0.0071
510.27	-0.014	191.8	-0.0089
510.28	-0.015	191.5	-0.0107
510.30	-0.016	191.3	-0.0124
510.32	-0.016	191.2	-0.0142
510.33	-0.017	191	-0.0151
510.35	-0.017	190.8	-0.0151

Prova triassiale ciclica SN04-C1			
pressione di confinamento (kPa)		80	
deviatore ciclico (kPa)		95	
frequenza (hz)		0.00625	
tempo	cella di carico	$\Delta u$	LVDT
(min)	kN	(kPa)	$\delta$ (mm)
510.37	-0.017	190.8	-0.016
510.38	-0.017	190.6	-0.0169
510.40	-0.017	190.5	-0.0169
510.42	-0.017	190.5	-0.0169
510.43	-0.017	190.4	-0.016
510.45	-0.016	190.3	-0.0151
510.47	-0.015	190.4	-0.0142
510.48	-0.014	190.3	-0.0133
510.50	-0.014	190.4	-0.0115
510.53	-0.012	190.4	-0.0115
510.55	-0.011	190.4	-0.0098
510.57	-0.011	190.5	-0.008
510.58	-0.01	190.5	-0.0062
510.60	-0.007	190.7	-0.0036
510.60	-0.006	190.8	-0.0009
510.62	-0.004	190.9	0.0027
510.63	-0.001	191.2	0.0027
510.65	0	191.3	0.0062
510.67	0	191.3	0.0089
510.68	0.002	191.4	0.0133
510.70	0.005	191.7	0.0169
510.72	0.007	191.9	0.0204
510.73	0.008	192.1	0.0249
510.75	0.011	192.4	0.0249
510.77	0.013	192.7	0.0293
510.78	0.013	192.7	0.0328
510.80	0.014	192.9	0.0364
510.82	0.017	193.2	0.0408
510.83	0.019	193.4	0.0435
510.85	0.02	193.6	0.047
510.87	0.022	193.9	0.047
510.88	0.023	194.1	0.0506
510.90	0.023	194.1	0.0524
510.92	0.024	194.3	0.055
510.93	0.026	194.6	0.0577
510.95	0.027	194.7	0.0586
510.97	0.027	194.9	0.0604
510.98	0.028	195.1	0.0604
511.00	0.029	195.3	0.0621
511.02	0.029	195.3	0.063
511.03	0.029	195.4	0.063
511.05	0.029	195.6	0.063
511.07	0.029	195.7	0.063
511.08	0.029	195.8	0.063
511.10	0.028	195.9	0.063
511.12	0.027	195.9	0.0621
511.13	0.027	196	0.0621
511.15	0.026	196	0.0604
511.17	0.024	195.9	0.0604
511.18	0.024	195.9	0.0586
511.20	0.024	195.9	0.0568
511.22	0.022	195.8	0.055
511.23	0.02	195.7	0.0524
511.25	0.019	195.7	0.0497
511.27	0.017	195.5	0.047
511.28	0.014	195.3	0.047
511.30	0.013	195.3	0.0435
511.32	0.013	195.2	0.0408

Prova triassiale ciclica SN04-C1			
pressione di confinamento (kPa)		80	
deviatore ciclico (kPa)		95	
frequenza (hz)		0.00625	
tempo	cella di carico	$\Delta u$	LVDT
(min)	kN	(kPa)	$\delta$ (mm)
511.33	0.011	194.9	0.0364
511.35	0.007	194.7	0.0328
511.37	0.007	194.6	0.0302
511.38	0.005	194.3	0.0249
511.40	0.001	194.1	0.0249
511.42	0.001	194.1	0.0213
511.43	0.001	193.9	0.0178
511.45	-0.001	193.6	0.0133
511.47	-0.004	193.3	0.0098
511.48	-0.005	193.1	0.0062
511.50	-0.006	192.8	0.0036
511.52	-0.01	192.6	0.0036
511.53	-0.01	192.6	-0.0009
511.55	-0.01	192.3	-0.0036
511.57	-0.012	192.1	-0.0062
511.58	-0.014	191.8	-0.0089
511.60	-0.014	191.6	-0.0098
511.62	-0.015	191.4	-0.0124
511.63	-0.016	191.2	-0.0124
511.65	-0.017	191.2	-0.0142
511.67	-0.017	191	-0.0151
511.68	-0.017	190.9	-0.0151
511.70	-0.017	190.8	-0.016
511.72	-0.017	190.6	-0.016
511.73	-0.017	190.5	-0.0169
511.75	-0.017	190.4	-0.0169
511.77	-0.016	190.4	-0.0169
511.78	-0.016	190.4	-0.016
511.80	-0.016	190.3	-0.0151
511.82	-0.014	190.4	-0.0133
511.83	-0.013	190.4	-0.0124
511.85	-0.013	190.3	-0.0115
511.87	-0.011	190.4	-0.0098
511.88	-0.01	190.5	-0.008
511.90	-0.009	190.5	-0.0044
511.92	-0.007	190.7	-0.0044
511.93	-0.005	190.8	-0.0018
511.95	-0.005	190.8	0
511.97	-0.004	191	0.0044
512.00	0	191.2	0.008
512.02	0.002	191.4	0.0107
512.03	0.003	191.5	0.0151
512.05	0.005	191.8	0.0151
512.05	0.008	192	0.0186
512.07	0.008	192	0.0222
512.08	0.009	192.2	0.0275
512.10	0.012	192.5	0.032
512.12	0.014	192.7	0.0346
512.13	0.015	193	0.0382
512.15	0.017	193.3	0.0382
512.17	0.02	193.5	0.0417
512.18	0.02	193.5	0.0453
512.20	0.021	193.7	0.0479
512.22	0.022	194	0.0515
512.23	0.024	194.2	0.0533
512.25	0.025	194.4	0.0559
512.27	0.026	194.6	0.0586
512.28	0.027	194.8	0.0586

Prova triassiale ciclica SN04-C1			
pressione di confinamento (kPa)		80	
deviatore ciclico (kPa)		95	
frequenza (hz)		0.00625	
tempo	cella di carico	$\Delta u$	LVDT
(min)	kN	(kPa)	$\delta$ (mm)
512.30	0.028	194.8	0.0595
512.32	0.028	195	0.0604
512.33	0.028	195.1	0.0621
512.35	0.029	195.3	0.063
512.37	0.029	195.5	0.063
512.38	0.029	195.6	0.063
512.40	0.029	195.7	0.063
512.42	0.029	195.7	0.063
512.43	0.029	195.8	0.063
512.45	0.028	195.9	0.063
512.47	0.027	195.9	0.0612
512.48	0.026	195.9	0.0604
512.50	0.025	195.9	0.0586
512.52	0.023	195.8	0.0586
512.53	0.022	195.8	0.0568
512.55	0.022	195.8	0.055
512.57	0.019	195.7	0.0524
512.58	0.018	195.7	0.0515
512.60	0.018	195.6	0.0488
512.62	0.017	195.4	0.0453
512.63	0.013	195.2	0.0417
512.65	0.012	195.1	0.0391
512.67	0.011	194.8	0.0355
512.68	0.006	194.6	0.0355
512.70	0.006	194.6	0.0311
512.72	0.006	194.5	0.0284
512.73	0.004	194.2	0.024
512.75	0.001	193.9	0.0195
512.77	0	193.7	0.0169
512.78	-0.002	193.4	0.0124
512.80	-0.006	193.2	0.0124
512.82	-0.006	193.2	0.008
512.83	-0.006	193	0.0044
512.85	-0.007	192.7	0.0018
512.87	-0.01	192.4	-0.0018
512.88	-0.011	192.2	-0.0044
512.90	-0.012	192	-0.0071
512.92	-0.014	191.7	-0.0071
512.93	-0.014	191.7	-0.0098
512.95	-0.014	191.5	-0.0107
512.97	-0.015	191.3	-0.0133
512.98	-0.017	191.1	-0.0142
513.00	-0.017	190.9	-0.0151
513.02	-0.017	190.8	-0.016
513.03	-0.017	190.7	-0.016
513.05	-0.017	190.7	-0.0169
513.07	-0.017	190.5	-0.0169
513.08	-0.017	190.5	-0.016
513.10	-0.017	190.4	-0.016
513.12	-0.016	190.4	-0.0151
513.13	-0.015	190.3	-0.0142
513.15	-0.014	190.3	-0.0142
513.17	-0.013	190.3	-0.0133
513.18	-0.013	190.4	-0.0115
513.20	-0.012	190.4	-0.0098
513.22	-0.01	190.5	-0.0071
513.23	-0.009	190.6	-0.0053
513.25	-0.007	190.7	-0.0018

Prova triassiale ciclica SN04-C1			
pressione di confinamento (kPa)		80	
deviatore ciclico (kPa)		95	
frequenza (hz)		0.00625	
tempo	cella di carico	$\Delta u$	LVDT
(min)	kN	(kPa)	$\delta$ (mm)
513.27	-0.005	190.8	-0.0018
513.28	-0.003	191	0.0036
513.30	-0.003	191.1	0.0053
513.32	0	191.3	0.0053
513.33	0.002	191.4	0.0089
513.35	0.002	191.4	0.0124
513.37	0.003	191.6	0.0169
513.38	0.007	191.9	0.0213
513.40	0.009	192.1	0.024
513.43	0.01	192.3	0.0284
513.45	0.013	192.6	0.0284
513.47	0.015	192.8	0.0328
513.48	0.015	192.8	0.0364
513.50	0.016	193.1	0.0399
513.50	0.019	193.3	0.0435
513.52	0.02	193.6	0.0462
513.53	0.021	193.8	0.0488
513.55	0.023	194.1	0.0488
513.57	0.024	194.3	0.0524
513.58	0.024	194.3	0.0541
513.60	0.025	194.5	0.0568
513.62	0.026	194.7	0.0586
513.63	0.027	194.9	0.0604
513.65	0.028	195	0.0612
513.67	0.028	195.2	0.0612
513.68	0.029	195.4	0.0621
513.70	0.029	195.4	0.063
513.72	0.029	195.5	0.063
513.73	0.029	195.6	0.0639
513.75	0.029	195.7	0.0639
513.77	0.028	195.8	0.063
513.78	0.028	195.9	0.063
513.80	0.026	195.9	0.0621
513.82	0.026	195.9	0.0612
513.83	0.026	195.9	0.0595
513.85	0.024	195.9	0.0577
513.87	0.022	195.8	0.0559
513.88	0.022	195.8	0.0533
513.90	0.02	195.6	0.0506
513.92	0.017	195.5	0.0506
513.93	0.017	195.5	0.0488
513.95	0.017	195.4	0.0462
513.97	0.015	195.2	0.0426
513.98	0.012	195	0.0391
514.00	0.01	194.9	0.0355
514.02	0.008	194.6	0.032
514.03	0.006	194.5	0.0302
514.05	0.005	194.3	0.0257
514.07	0.004	194.1	0.0222
514.08	0	193.8	0.0222
514.10	-0.001	193.8	0.0178
514.12	-0.001	193.6	0.0142
514.13	-0.003	193.3	0.0107
514.15	-0.006	193	0.0071
514.17	-0.007	192.8	0.0044
514.18	-0.008	192.5	0
514.20	-0.011	192.3	0
514.22	-0.011	192.3	-0.0036



Prova triassiale ciclica SN04-C1			
pressione di confinamento (kPa)		80	
deviatore ciclico (kPa)		95	
frequenza (hz)		0.00625	
tempo	cella di carico	$\Delta u$	LVDT
(min)	kN	(kPa)	$\delta$ (mm)
514.23	-0.011	192	-0.0053
514.25	-0.013	191.8	-0.008
514.27	-0.015	191.6	-0.0107
514.28	-0.015	191.4	-0.0115
514.30	-0.016	191.2	-0.0133
514.32	-0.017	191	-0.0133
514.33	-0.017	191	-0.0142
514.35	-0.017	190.9	-0.0151
514.37	-0.017	190.7	-0.016
514.38	-0.017	190.6	-0.016
514.40	-0.017	190.5	-0.016
514.42	-0.017	190.4	-0.016
514.43	-0.016	190.4	-0.016
514.45	-0.015	190.4	-0.0151
514.47	-0.015	190.3	-0.0142
514.48	-0.015	190.3	-0.0133
514.50	-0.014	190.3	-0.0124
514.52	-0.013	190.4	-0.0107
514.53	-0.011	190.4	-0.008
514.55	-0.009	190.5	-0.008
514.57	-0.008	190.5	-0.0062
514.58	-0.008	190.6	-0.0036
514.60	-0.006	190.7	-0.0009
514.62	-0.004	190.9	0.0027
514.63	-0.002	191	0.0053
514.65	-0.001	191.2	0.0089
514.67	0.003	191.4	0.0089
514.68	0.004	191.6	0.0124
514.70	0.004	191.6	0.016
514.72	0.005	191.8	0.0195
514.73	0.009	192.1	0.024
514.75	0.01	192.3	0.0284
514.77	0.011	192.4	0.0302
514.78	0.013	192.7	0.0346
514.80	0.016	193	0.0373
514.82	0.016	193.2	0.0408
514.83	0.019	193.5	0.0408
514.85	0.021	193.7	0.0444
514.87	0.021	193.7	0.0479
514.90	0.022	193.9	0.0515
514.92	0.024	194.2	0.0541
514.93	0.025	194.4	0.0559
514.95	0.026	194.5	0.0586
514.95	0.027	194.8	0.0586
514.97	0.028	195	0.0595
514.98	0.028	195	0.0604
515.00	0.028	195.1	0.0612
515.02	0.028	195.3	0.063
515.03	0.029	195.5	0.0639
515.05	0.029	195.6	0.0639
515.07	0.029	195.7	0.0639
515.08	0.029	195.8	0.0639
515.10	0.029	195.8	0.0639
515.12	0.028	195.9	0.063
515.13	0.027	195.9	0.0621
515.15	0.026	195.9	0.0604
515.17	0.025	195.9	0.0586
515.18	0.024	195.8	0.0568

Prova triassiale ciclica SN04-C1			
pressione di confinamento (kPa)		80	
deviatore ciclico (kPa)		95	
frequenza (hz)		0.00625	
tempo	cella di carico	$\Delta u$	LVDT
(min)	kN	(kPa)	$\delta$ (mm)
515.20	0.022	195.8	0.0568
515.22	0.022	195.8	0.055
515.23	0.021	195.7	0.0533
515.25	0.019	195.6	0.0506
515.27	0.017	195.4	0.0479
515.28	0.016	195.3	0.0444
515.30	0.014	195.1	0.0417
515.32	0.01	194.9	0.0417
515.33	0.01	194.9	0.0373
515.35	0.01	194.8	0.0346
515.37	0.007	194.5	0.0311
515.38	0.004	194.3	0.0275
515.40	0.004	194.1	0.0231
515.42	0.002	193.8	0.0195
515.43	-0.002	193.6	0.0195
515.45	-0.003	193.6	0.0151
515.47	-0.004	193.2	0.0098
515.48	-0.006	192.9	0.0098
515.50	-0.007	192.9	0.0062
515.52	-0.007	192.7	0.0036
515.53	-0.009	192.4	-0.0009
515.55	-0.012	192.1	-0.0044
515.57	-0.012	191.9	-0.0062
515.58	-0.013	191.7	-0.0089
515.60	-0.015	191.5	-0.0089
515.62	-0.015	191.5	-0.0115
515.63	-0.015	191.3	-0.0115
515.65	-0.016	191.1	-0.0133
515.67	-0.017	190.9	-0.0151
515.68	-0.017	190.8	-0.0151
515.70	-0.017	190.6	-0.016
515.72	-0.017	190.5	-0.016
515.73	-0.017	190.5	-0.016
515.75	-0.017	190.4	-0.016
515.77	-0.017	190.4	-0.0151
515.78	-0.016	190.4	-0.0142
515.80	-0.015	190.3	-0.0142
515.82	-0.015	190.3	-0.0124
515.83	-0.013	190.3	-0.0124
515.85	-0.012	190.3	-0.0115
515.87	-0.012	190.4	-0.0098
515.88	-0.011	190.4	-0.0071
515.90	-0.008	190.6	-0.0044
515.92	-0.007	190.6	-0.0027
515.93	-0.006	190.8	0.0009
515.95	-0.002	191	0.0009
515.97	-0.002	191	0.0044
515.98	-0.002	191.1	0.0071
516.00	0	191.3	0.0107
516.02	0.004	191.5	0.0142
516.03	0.004	191.7	0.0178
516.05	0.006	191.9	0.0222
516.07	0.01	192.2	0.0222
516.08	0.011	192.2	0.0257
516.10	0.011	192.4	0.0293
516.12	0.012	192.6	0.0337
516.13	0.015	192.9	0.0382
516.15	0.017	193.1	0.0417

Prova triassiale ciclica SN04-C1			
pressione di confinamento (kPa)		80	
deviatore ciclico (kPa)		95	
frequenza (hz)		0.00625	
tempo	cella di carico	$\Delta u$	LVDT
(min)	kN	(kPa)	$\delta$ (mm)
516.17	0.018	193.4	0.0453
516.18	0.021	193.6	0.0453
516.20	0.022	193.9	0.0506
516.22	0.023	194	0.0515
516.23	0.024	194.3	0.0515
516.25	0.025	194.5	0.0541
516.27	0.025	194.5	0.0568
516.28	0.026	194.7	0.0586
516.30	0.027	194.9	0.0604
516.32	0.028	195.1	0.0621
516.33	0.028	195.2	0.063
516.37	0.029	195.4	0.063
516.38	0.029	195.5	0.063
516.40	0.029	195.5	0.0639
516.40	0.029	195.7	0.0639
516.42	0.029	195.8	0.0639
516.43	0.029	195.8	0.0639
516.45	0.028	195.9	0.063
516.47	0.027	195.9	0.0612
516.48	0.025	195.9	0.0612
516.50	0.025	195.9	0.0604
516.52	0.025	195.9	0.0586
516.53	0.023	195.8	0.0568
516.55	0.021	195.8	0.0541
516.57	0.02	195.7	0.0533
516.58	0.019	195.6	0.0497
516.60	0.016	195.4	0.0497
516.62	0.015	195.4	0.047
516.63	0.015	195.3	0.0444
516.65	0.013	195.1	0.0408
516.67	0.01	194.9	0.0364
516.68	0.009	194.7	0.0337
516.70	0.007	194.5	0.0302
516.72	0.003	194.2	0.0302
516.73	0.002	194.2	0.0249
516.75	0.002	194.1	0.0222
516.77	0.001	193.8	0.0178
516.78	-0.003	193.5	0.0133
516.80	-0.004	193.3	0.0098
516.82	-0.005	193	0.0062
516.83	-0.008	192.7	0.0062
516.85	-0.009	192.7	0.0027
516.87	-0.009	192.5	0
516.88	-0.01	192.2	-0.0036
516.90	-0.013	192	-0.0062
516.92	-0.013	191.8	-0.008
516.93	-0.014	191.6	-0.0098
516.95	-0.015	191.4	-0.0115
516.97	-0.016	191.2	-0.0124
516.98	-0.016	191	-0.0133
517.00	-0.017	190.8	-0.0133
517.02	-0.017	190.8	-0.0151
517.03	-0.017	190.7	-0.016
517.05	-0.017	190.6	-0.016
517.07	-0.017	190.5	-0.016
517.08	-0.017	190.4	-0.016
517.10	-0.017	190.3	-0.0151
517.12	-0.016	190.3	-0.0151

Prova triassiale ciclica SN04-C1			
pressione di confinamento (kPa)		80	
deviatore ciclico (kPa)		95	
frequenza (hz)		0.00625	
tempo	cella di carico	$\Delta u$	LVDT
(min)	kN	(kPa)	$\delta$ (mm)
517.13	-0.015	190.3	-0.0142
517.15	-0.015	190.3	-0.0133
517.17	-0.014	190.3	-0.0115
517.18	-0.012	190.4	-0.0107
517.20	-0.011	190.4	-0.0089
517.22	-0.01	190.4	-0.0062
517.23	-0.007	190.6	-0.0062
517.25	-0.006	190.7	-0.0036
517.27	-0.006	190.7	-0.0018
517.28	-0.005	190.8	0.0018
517.30	-0.002	191	0.0053
517.32	0	191.2	0.008
517.33	0.001	191.3	0.0115
517.35	0.004	191.6	0.0115
517.37	0.006	191.8	0.016
517.38	0.006	191.8	0.0195
517.40	0.007	192	0.0231
517.42	0.01	192.3	0.0284
517.43	0.012	192.5	0.032
517.45	0.013	192.7	0.0355
517.47	0.016	193	0.0391
517.48	0.018	193.2	0.0391
517.50	0.019	193.2	0.0426
517.52	0.019	193.4	0.0453
517.53	0.02	193.7	0.0488
517.55	0.023	194	0.0515
517.57	0.024	194.2	0.0541
517.58	0.024	194.4	0.0568
517.60	0.026	194.6	0.0568
517.62	0.027	194.6	0.0586
517.63	0.027	194.8	0.0604
517.65	0.028	195.1	0.0612
517.67	0.028	195.1	0.0621
517.68	0.028	195.3	0.063
517.70	0.029	195.4	0.0639
517.72	0.029	195.6	0.0639
517.73	0.029	195.7	0.0639
517.75	0.029	195.8	0.0639
517.77	0.028	195.9	0.0639
517.80	0.027	195.9	0.0639
517.82	0.027	195.9	0.0621
517.83	0.027	195.9	0.0612
517.85	0.025	195.9	0.0595
517.87	0.024	195.9	0.0586
517.87	0.023	195.9	0.0559
517.88	0.021	195.7	0.0559
517.90	0.019	195.7	0.0541
517.92	0.019	195.7	0.0515
517.93	0.018	195.6	0.0488
517.95	0.015	195.4	0.0462
517.97	0.014	195.2	0.0435
517.98	0.012	195	0.0391
518.00	0.009	194.8	0.0391
518.02	0.008	194.8	0.0355
518.03	0.008	194.6	0.0328
518.05	0.006	194.4	0.0284
518.07	0.003	194.2	0.024
518.08	0.001	194	0.0204

Prova triassiale ciclica SN04-C1			
pressione di confinamento (kPa)		80	
deviatore ciclico (kPa)		95	
frequenza (hz)		0.00625	
tempo	cella di carico	$\Delta u$	LVDT
(min)	kN	(kPa)	$\delta$ (mm)
518.10	0	193.7	0.016
518.12	-0.003	193.4	0.016
518.13	-0.005	193.2	0.0124
518.15	-0.005	193.2	0.0089
518.17	-0.006	193	0.0053
518.18	-0.008	192.6	0.0018
518.20	-0.01	192.4	-0.0018
518.22	-0.011	192.2	-0.0036
518.23	-0.013	191.9	-0.0036
518.25	-0.014	191.7	-0.0071
518.27	-0.014	191.7	-0.0089
518.28	-0.015	191.5	-0.0107
518.30	-0.016	191.2	-0.0124
518.32	-0.017	191.1	-0.0142
518.33	-0.017	190.9	-0.0142
518.35	-0.017	190.8	-0.0142
518.37	-0.017	190.7	-0.0151
518.38	-0.017	190.5	-0.0151
518.40	-0.017	190.4	-0.016
518.42	-0.017	190.4	-0.016
518.43	-0.017	190.4	-0.016
518.45	-0.016	190.3	-0.0142
518.47	-0.016	190.3	-0.0133
518.48	-0.014	190.3	-0.0124
518.50	-0.014	190.3	-0.0115
518.52	-0.012	190.4	-0.0098
518.53	-0.01	190.4	-0.0098
518.55	-0.009	190.4	-0.008
518.57	-0.009	190.5	-0.0053
518.58	-0.008	190.6	-0.0027
518.60	-0.005	190.8	0
518.62	-0.004	190.9	0.0027
518.63	-0.003	191.1	0.0062
518.65	0.001	191.3	0.0062
518.67	0.002	191.3	0.0098
518.68	0.002	191.4	0.0133
518.70	0.004	191.7	0.0169
518.72	0.007	191.9	0.0213
518.73	0.008	192.1	0.0249
518.75	0.01	192.3	0.0293
518.77	0.013	192.6	0.0293
518.78	0.014	192.6	0.0337
518.80	0.014	192.8	0.0364
518.82	0.016	193.1	0.0408
518.83	0.019	193.3	0.0444
518.85	0.02	193.5	0.0462
518.87	0.021	193.8	0.0497
518.88	0.023	194	0.0497
518.90	0.024	194	0.0533
518.92	0.024	194.2	0.055
518.93	0.025	194.5	0.0577
518.95	0.026	194.7	0.0595
518.97	0.027	194.9	0.0612
518.98	0.028	195	0.0621
519.00	0.028	195.2	0.0621
519.02	0.029	195.4	0.063
519.03	0.029	195.4	0.063
519.05	0.029	195.5	0.0639

Prova triassiale ciclica SN04-C1			
pressione di confinamento (kPa)		80	
deviatore ciclico (kPa)		95	
frequenza (hz)		0.00625	
tempo	cella di carico	$\Delta u$	LVDT
(min)	kN	(kPa)	$\delta$ (mm)
519.07	0.029	195.6	0.0639
519.08	0.029	195.7	0.0639
519.10	0.029	195.8	0.0639
519.12	0.028	195.9	0.0639
519.13	0.027	195.9	0.0621
519.15	0.026	195.9	0.0612
519.17	0.025	195.9	0.0612
519.18	0.023	195.9	0.0595
519.20	0.023	195.9	0.0577
519.22	0.022	195.8	0.0559
519.23	0.021	195.7	0.0533
519.27	0.018	195.6	0.0506
519.28	0.017	195.5	0.0479
519.30	0.015	195.3	0.0479
519.32	0.012	195.1	0.0444
519.32	0.012	195.1	0.0408
519.33	0.012	195	0.0382
519.35	0.009	194.7	0.0346
519.37	0.006	194.5	0.0311
519.38	0.005	194.3	0.0257
519.40	0.002	194	0.0257
519.42	0	193.8	0.0222
519.43	0	193.8	0.0186
519.45	-0.001	193.6	0.0151
519.47	-0.004	193.3	0.0107
519.48	-0.006	193	0.0071
519.50	-0.006	192.8	0.0044
519.52	-0.009	192.5	0.0044
519.53	-0.011	192.3	0.0009
519.55	-0.011	192.3	-0.0027
519.57	-0.012	192.1	-0.0053
519.58	-0.013	191.8	-0.008
519.60	-0.014	191.6	-0.0098
519.62	-0.015	191.4	-0.0115
519.63	-0.016	191.2	-0.0115
519.65	-0.017	191	-0.0133
519.67	-0.017	191	-0.0142
519.68	-0.017	190.8	-0.0142
519.70	-0.017	190.7	-0.0151
519.72	-0.017	190.6	-0.016
519.73	-0.017	190.5	-0.016
519.75	-0.017	190.4	-0.016
519.77	-0.016	190.3	-0.016
519.78	-0.016	190.3	-0.0151
519.80	-0.016	190.3	-0.0142
519.82	-0.015	190.3	-0.0133
519.83	-0.013	190.3	-0.0115
519.85	-0.013	190.3	-0.0107
519.87	-0.012	190.4	-0.0089
519.88	-0.009	190.5	-0.0062
519.90	-0.009	190.5	-0.0044
519.92	-0.007	190.6	-0.0018
519.93	-0.004	190.8	-0.0018
519.95	-0.003	190.8	0.0018
519.97	-0.003	190.9	0.0036
519.98	-0.002	191.1	0.008
520.00	0.002	191.3	0.0115
520.02	0.003	191.5	0.0142

Prova triassiale ciclica SN04-C1			
pressione di confinamento (kPa)		80	
deviatore ciclico (kPa)		95	
frequenza (hz)		0.00625	
tempo	cella di carico	$\Delta u$	LVDT
(min)	kN	(kPa)	$\delta$ (mm)
520.03	0.004	191.7	0.0186
520.05	0.008	192	0.0186
520.07	0.009	192.2	0.0231
520.08	0.009	192.2	0.0257
520.10	0.011	192.4	0.0311
520.12	0.014	192.7	0.0355
520.13	0.015	192.9	0.0382
520.15	0.017	193.1	0.0417
520.17	0.019	193.4	0.0417
520.18	0.021	193.6	0.0453
520.20	0.021	193.6	0.0479
520.22	0.022	193.8	0.0515
520.23	0.024	194.1	0.0541
520.25	0.025	194.3	0.0568
520.27	0.026	194.5	0.0586
520.28	0.027	194.7	0.0586
520.30	0.028	194.9	0.0595
520.32	0.028	194.9	0.0612
520.33	0.028	195.1	0.0621
520.35	0.028	195.2	0.063
520.37	0.029	195.4	0.0639
520.38	0.029	195.6	0.0639
520.40	0.029	195.7	0.0639
520.42	0.028	195.7	0.0639
520.43	0.028	195.7	0.0639
520.45	0.028	195.8	0.063
520.47	0.027	195.8	0.0621
520.48	0.026	195.8	0.0604
520.50	0.025	195.8	0.0595
520.52	0.024	195.8	0.0577
520.53	0.022	195.7	0.0577
520.55	0.021	195.7	0.0541
520.57	0.02	195.6	0.0524
520.58	0.017	195.5	0.0524
520.60	0.016	195.5	0.0497
520.62	0.016	195.4	0.047
520.63	0.015	195.2	0.0435
520.65	0.011	195	0.0399
520.67	0.011	194.9	0.0364
520.70	0.009	194.6	0.0328
520.72	0.005	194.4	0.0328
520.73	0.004	194.4	0.0293
520.75	0.004	194.2	0.0249
520.77	0.003	194	0.0213
520.77	-0.001	193.7	0.0169
520.78	-0.002	193.5	0.0133
520.80	-0.004	193.2	0.0098
520.82	-0.007	192.9	0.0098
520.83	-0.008	192.9	0.0053
520.85	-0.008	192.7	0.0027
520.87	-0.009	192.4	0
520.88	-0.011	192.2	-0.0036
520.90	-0.012	191.9	-0.0062
520.92	-0.013	191.7	-0.008
520.93	-0.015	191.5	-0.008
520.95	-0.016	191.3	-0.0107
520.97	-0.016	191.3	-0.0115
520.98	-0.016	191.2	-0.0133

Prova triassiale ciclica SN04-C1			
pressione di confinamento (kPa)		80	
deviatore ciclico (kPa)		95	
frequenza (hz)		0.00625	
tempo	cella di carico	$\Delta u$	LVDT
(min)	kN	(kPa)	$\delta$ (mm)
521.00	-0.017	190.9	-0.0142
521.02	-0.017	190.8	-0.0151
521.03	-0.017	190.6	-0.0151
521.05	-0.017	190.5	-0.0151
521.07	-0.017	190.4	-0.0151
521.08	-0.017	190.4	-0.016
521.10	-0.017	190.4	-0.0151
521.12	-0.016	190.3	-0.0142
521.13	-0.015	190.3	-0.0133
521.15	-0.015	190.3	-0.0115
521.17	-0.013	190.3	-0.0115
521.18	-0.011	190.4	-0.0107
521.20	-0.011	190.4	-0.0089
521.22	-0.011	190.4	-0.0071
521.23	-0.009	190.5	-0.0044
521.25	-0.007	190.6	-0.0018
521.27	-0.006	190.7	0.0009
521.28	-0.004	191	0.0044
521.30	-0.002	191	0.0053
521.32	-0.001	191.2	0.0089
521.33	0.001	191.4	0.0124
521.35	0.004	191.6	0.0124
521.37	0.005	191.6	0.016
521.38	0.005	191.8	0.0195
521.40	0.007	192	0.024
521.42	0.011	192.3	0.0293
521.43	0.012	192.5	0.032
521.45	0.014	192.8	0.0355
521.47	0.017	193	0.0355
521.48	0.018	193	0.0399
521.50	0.018	193.2	0.0426
521.52	0.019	193.5	0.0462
521.53	0.022	193.7	0.0497
521.55	0.022	193.9	0.0515
521.57	0.023	194.1	0.0541
521.58	0.026	194.4	0.0541
521.60	0.026	194.4	0.0568
521.62	0.026	194.6	0.0586
521.63	0.027	194.8	0.0604
521.65	0.028	195	0.0621
521.67	0.028	195.1	0.0621
521.68	0.029	195.2	0.063
521.70	0.029	195.4	0.063
521.72	0.029	195.4	0.0639
521.73	0.029	195.6	0.0639
521.75	0.029	195.7	0.0639
521.77	0.028	195.8	0.0639
521.78	0.028	195.8	0.063
521.80	0.027	195.9	0.0621
521.82	0.026	195.8	0.0621
521.83	0.024	195.8	0.0604
521.85	0.024	195.8	0.0595
521.87	0.024	195.8	0.0577
521.88	0.021	195.7	0.055
521.90	0.02	195.6	0.0533
521.92	0.019	195.6	0.0497
521.93	0.016	195.4	0.0497
521.95	0.014	195.2	0.047



Prova triassiale ciclica SN04-C1			
pressione di confinamento (kPa)		80	
deviatore ciclico (kPa)		95	
frequenza (hz)		0.00625	
tempo	cella di carico	$\Delta u$	LVDT
(min)	kN	(kPa)	$\delta$ (mm)
521.97	0.014	195.2	0.0444
521.98	0.013	195.1	0.0408
522.00	0.009	194.7	0.0373
522.02	0.009	194.7	0.0355
522.03	0.008	194.5	0.0311
522.05	0.005	194.3	0.0275
522.07	0.003	194.1	0.0231
522.08	0.001	193.9	0.0195
522.10	-0.002	193.5	0.0195
522.12	-0.003	193.3	0.0151
522.13	-0.003	193.3	0.0124
522.17	-0.004	193.1	0.008
522.18	-0.007	192.8	0.0044
522.20	-0.009	192.5	0.0009
522.22	-0.01	192.3	-0.0009
522.22	-0.011	192	-0.0009
522.23	-0.013	191.8	-0.0044
522.25	-0.013	191.8	-0.0062
522.27	-0.014	191.6	-0.0089
522.28	-0.015	191.3	-0.0107
522.30	-0.016	191.2	-0.0124
522.32	-0.016	191	-0.0133
522.33	-0.017	190.8	-0.0142
522.35	-0.017	190.7	-0.0142
522.37	-0.017	190.7	-0.0151
522.38	-0.017	190.6	-0.0151
522.40	-0.017	190.5	-0.0151
522.42	-0.017	190.4	-0.0151
522.43	-0.016	190.3	-0.0151
522.45	-0.016	190.3	-0.0142
522.47	-0.015	190.3	-0.0142
522.48	-0.014	190.3	-0.0133
522.50	-0.014	190.2	-0.0115
522.52	-0.013	190.3	-0.0098
522.53	-0.011	190.3	-0.008
522.55	-0.01	190.4	-0.0062
522.57	-0.009	190.5	-0.0036
522.58	-0.006	190.7	-0.0036
522.60	-0.005	190.7	-0.0009
522.62	-0.005	190.7	0.0018
522.63	-0.003	190.9	0.0053
522.65	0	191.2	0.0089
522.67	0.001	191.3	0.0115
522.68	0.002	191.5	0.0151
522.70	0.006	191.7	0.0151
522.72	0.007	191.7	0.0204
522.73	0.009	192.1	0.0249
522.75	0.011	192.3	0.0249
522.77	0.012	192.3	0.0293
522.78	0.012	192.5	0.0328
522.80	0.014	192.8	0.0382
522.82	0.017	193.1	0.0417
522.83	0.019	193.3	0.0444
522.85	0.02	193.5	0.047
522.87	0.022	193.8	0.047
522.88	0.023	194	0.0506
522.90	0.023	194	0.0533
522.92	0.024	194.2	0.0559

Prova triassiale ciclica SN04-C1			
pressione di confinamento (kPa)		80	
deviatore ciclico (kPa)		95	
frequenza (hz)		0.00625	
tempo	cella di carico	$\Delta u$	LVDT
(min)	kN	(kPa)	$\delta$ (mm)
522.93	0.026	194.5	0.0586
522.95	0.027	194.7	0.0595
522.97	0.027	194.8	0.0604
522.98	0.028	195	0.0604
523.00	0.028	195.2	0.0621
523.02	0.028	195.2	0.063
523.03	0.029	195.3	0.0639
523.05	0.029	195.5	0.0648
523.07	0.029	195.6	0.0648
523.08	0.029	195.7	0.0648
523.10	0.028	195.8	0.0639
523.12	0.027	195.8	0.0639
523.13	0.026	195.8	0.063
523.15	0.026	195.8	0.0621
523.17	0.026	195.8	0.0604
523.18	0.024	195.8	0.0586
523.20	0.023	195.8	0.0568
523.22	0.022	195.7	0.055
523.23	0.019	195.6	0.055
523.25	0.018	195.6	0.0524
523.27	0.018	195.5	0.0497
523.28	0.017	195.3	0.0462
523.30	0.013	195.1	0.0426
523.32	0.012	195	0.0399
523.33	0.01	194.8	0.0364
523.35	0.007	194.5	0.0364
523.37	0.006	194.5	0.0328
523.38	0.006	194.4	0.0293
523.40	0.004	194.1	0.0249
523.42	0.001	193.9	0.0204
523.43	0	193.7	0.0169
523.45	-0.002	193.4	0.0133
523.47	-0.004	193.2	0.0107
523.48	-0.005	193	0.008
523.50	-0.007	192.7	0.0044
523.52	-0.01	192.4	0.0044
523.53	-0.01	192.4	0.0009
523.55	-0.01	192.2	-0.0018
523.57	-0.011	192	-0.0044
523.60	-0.014	191.7	-0.008
523.62	-0.014	191.5	-0.0089
523.63	-0.015	191.3	-0.0107
523.65	-0.016	191.1	-0.0107
523.67	-0.016	191.1	-0.0124
523.67	-0.016	190.9	-0.0133
523.68	-0.017	190.8	-0.0142
523.70	-0.017	190.6	-0.0151
523.72	-0.017	190.5	-0.0151
523.73	-0.017	190.4	-0.0151
523.75	-0.017	190.3	-0.0151
523.77	-0.016	190.3	-0.0151
523.78	-0.016	190.3	-0.0142
523.80	-0.016	190.2	-0.0133
523.82	-0.014	190.3	-0.0124
523.83	-0.014	190.3	-0.0115
523.85	-0.013	190.3	-0.0089
523.87	-0.011	190.4	-0.0089
523.88	-0.009	190.5	-0.0071

Prova triassiale ciclica SN04-C1			
pressione di confinamento (kPa)		80	
deviatore ciclico (kPa)		95	
frequenza (hz)		0.00625	
tempo	cella di carico	$\Delta u$	LVDT
(min)	kN	(kPa)	$\delta$ (mm)
523.90	-0.009	190.5	-0.0044
523.92	-0.008	190.5	-0.0018
523.93	-0.005	190.7	0.0009
523.95	-0.004	190.8	0.0027
523.97	-0.002	191	0.0071
523.98	0	191.2	0.0071
524.00	0.002	191.4	0.0107
524.02	0.002	191.4	0.0133
524.03	0.004	191.5	0.0178
524.05	0.006	191.8	0.0213
524.07	0.009	192	0.0249
524.08	0.01	192.2	0.0302
524.10	0.013	192.6	0.0302
524.12	0.015	192.8	0.0337
524.13	0.015	192.8	0.0373
524.15	0.016	193	0.0417
524.17	0.018	193.3	0.0444
524.18	0.02	193.5	0.0479
524.20	0.021	193.7	0.0497
524.22	0.022	193.9	0.0524
524.23	0.024	194.2	0.055
524.25	0.025	194.3	0.0568
524.27	0.026	194.6	0.0586
524.28	0.027	194.8	0.0586
524.30	0.027	194.8	0.0612
524.32	0.027	194.9	0.0621
524.33	0.028	195.1	0.063
524.35	0.029	195.2	0.0639
524.37	0.029	195.4	0.0639
524.38	0.029	195.6	0.0648
524.40	0.029	195.7	0.0648
524.42	0.029	195.7	0.0648
524.43	0.029	195.7	0.0648
524.45	0.028	195.8	0.0639
524.47	0.027	195.8	0.0621
524.48	0.026	195.9	0.0612
524.50	0.025	195.8	0.0595
524.52	0.023	195.8	0.0595
524.53	0.022	195.8	0.0577
524.55	0.022	195.8	0.0559
524.57	0.021	195.7	0.0533
524.58	0.018	195.5	0.0506
524.60	0.017	195.4	0.0488
524.62	0.016	195.3	0.0453
524.63	0.012	195	0.0453
524.65	0.011	195	0.0417
524.67	0.011	194.9	0.0391
524.68	0.01	194.7	0.0346
524.70	0.006	194.5	0.0311
524.72	0.005	194.3	0.0284
524.73	0.003	194	0.0231
524.75	0	193.7	0.0231
524.77	-0.001	193.5	0.0186
524.78	-0.001	193.5	0.016
524.80	-0.002	193.3	0.0115
524.82	-0.006	193	0.0071
524.83	-0.007	192.8	0.0044
524.85	-0.008	192.5	0.0018

Prova triassiale ciclica SN04-C1			
pressione di confinamento (kPa)		80	
deviatore ciclico (kPa)		95	
frequenza (hz)		0.00625	
tempo	cella di carico	$\Delta u$	LVDT
(min)	kN	(kPa)	$\delta$ (mm)
524.87	-0.01	192.2	0.0018
524.88	-0.012	192	-0.0018
524.90	-0.012	192	-0.0044
524.92	-0.014	191.6	-0.0062
524.93	-0.014	191.4	-0.008
524.95	-0.014	191.4	-0.0098
524.97	-0.015	191.2	-0.0115
524.98	-0.016	191	-0.0133
525.00	-0.017	190.8	-0.0142
525.02	-0.017	190.7	-0.0151
525.03	-0.017	190.6	-0.0151
525.07	-0.017	190.4	-0.0151
525.08	-0.017	190.4	-0.0151
525.10	-0.017	190.3	-0.0151
525.12	-0.017	190.3	-0.0151
525.12	-0.016	190.2	-0.0142
525.13	-0.015	190.2	-0.0133
525.15	-0.014	190.2	-0.0115
525.17	-0.012	190.3	-0.0115
525.18	-0.012	190.3	-0.0107
525.20	-0.012	190.3	-0.0089
525.22	-0.011	190.4	-0.0062
525.23	-0.008	190.5	-0.0036
525.25	-0.007	190.5	-0.0018
525.27	-0.006	190.7	0.0018
525.28	-0.003	190.9	0.0018
525.30	-0.002	190.9	0.0044
525.32	-0.002	191	0.0071
525.33	0	191.2	0.0115
525.35	0.004	191.4	0.0151
525.37	0.005	191.6	0.0178
525.38	0.006	191.8	0.0222
525.40	0.01	192.1	0.0222
525.42	0.011	192.1	0.0275
525.43	0.011	192.3	0.0302
525.45	0.012	192.5	0.0346
525.47	0.016	192.8	0.0391
525.48	0.017	193	0.0417
525.50	0.018	193.3	0.0453
525.52	0.021	193.5	0.0453
525.53	0.022	193.8	0.0488
525.55	0.022	193.8	0.0506
525.57	0.023	194	0.0541
525.58	0.025	194.3	0.0568
525.60	0.026	194.5	0.0586
525.62	0.026	194.6	0.0604
525.63	0.027	194.8	0.0612
525.65	0.028	195	0.0621
525.67	0.028	195.1	0.063
525.68	0.029	195.3	0.0639
525.70	0.029	195.4	0.0639
525.72	0.029	195.4	0.0639
525.73	0.029	195.6	0.0648
525.75	0.029	195.7	0.0648
525.77	0.028	195.8	0.0648
525.78	0.028	195.8	0.0639
525.80	0.027	195.8	0.0621
525.82	0.025	195.8	0.0621

Prova triassiale ciclica SN04-C1			
pressione di confinamento (kPa)		80	
deviatore ciclico (kPa)		95	
frequenza (hz)		0.00625	
tempo	cella di carico	$\Delta u$	LVDT
(min)	kN	(kPa)	$\delta$ (mm)
525.83	0.025	195.8	0.0612
525.85	0.025	195.8	0.0595
525.87	0.024	195.8	0.0577
525.88	0.021	195.7	0.055
525.90	0.02	195.6	0.0533
525.92	0.019	195.5	0.0506
525.93	0.016	195.3	0.0506
525.95	0.015	195.3	0.047
525.97	0.015	195.2	0.0444
525.98	0.013	195	0.0408
526.00	0.01	194.8	0.0373
526.02	0.009	194.6	0.0346
526.03	0.007	194.4	0.0311
526.05	0.003	194.2	0.0311
526.07	0.002	194.2	0.0257
526.08	0.002	194	0.0222
526.10	0.001	193.7	0.0178
526.12	-0.003	193.4	0.0133
526.13	-0.003	193.2	0.0107
526.15	-0.005	192.9	0.0071
526.17	-0.008	192.6	0.0071
526.18	-0.009	192.6	0.0027
526.20	-0.009	192.4	0.0009
526.22	-0.01	192.2	-0.0027
526.23	-0.013	191.9	-0.0053
526.25	-0.013	191.7	-0.0071
526.27	-0.014	191.5	-0.0098
526.28	-0.016	191.3	-0.0098
526.30	-0.016	191.3	-0.0115
526.32	-0.016	191.1	-0.0124
526.33	-0.016	190.9	-0.0133
526.35	-0.017	190.8	-0.0142
526.37	-0.017	190.6	-0.0151
526.38	-0.017	190.5	-0.0151
526.40	-0.017	190.4	-0.0151
526.42	-0.017	190.3	-0.0151
526.43	-0.017	190.3	-0.0142
526.45	-0.016	190.2	-0.0142
526.47	-0.015	190.2	-0.0133
526.48	-0.015	190.2	-0.0124
526.50	-0.014	190.2	-0.0115
526.53	-0.013	190.3	-0.0098
526.55	-0.011	190.3	-0.008
526.57	-0.01	190.4	-0.0062
526.58	-0.008	190.5	-0.0062
526.58	-0.006	190.6	-0.0036
526.60	-0.006	190.6	-0.0009
526.62	-0.005	190.7	0.0027
526.63	-0.002	190.9	0.0062
526.65	0	191.1	0.0089
526.67	0.001	191.2	0.0124
526.68	0.004	191.5	0.0124
526.70	0.006	191.7	0.0169
526.72	0.006	191.7	0.0204
526.73	0.007	191.9	0.024
526.75	0.01	192.2	0.0293
526.77	0.012	192.4	0.0328
526.78	0.013	192.6	0.0364

Prova triassiale ciclica SN04-C1			
pressione di confinamento (kPa)		80	
deviatore ciclico (kPa)		95	
frequenza (hz)		0.00625	
tempo	cella di carico	$\Delta u$	LVDT
(min)	kN	(kPa)	$\delta$ (mm)
526.80	0.016	192.9	0.0364
526.82	0.018	193.2	0.0399
526.83	0.018	193.2	0.0435
526.85	0.019	193.4	0.047
526.87	0.021	193.7	0.0497
526.88	0.023	193.9	0.0524
526.90	0.024	194.1	0.055
526.92	0.025	194.3	0.0577
526.93	0.026	194.5	0.0577
526.95	0.027	194.5	0.0595
526.97	0.027	194.7	0.0604
526.98	0.027	194.9	0.0621
527.00	0.028	195.1	0.063
527.02	0.029	195.2	0.0639
527.03	0.029	195.4	0.0639
527.05	0.029	195.5	0.0639
527.07	0.028	195.5	0.0639
527.08	0.028	195.7	0.0639
527.10	0.028	195.8	0.0639
527.12	0.028	195.8	0.0639
527.13	0.028	195.8	0.063
527.15	0.027	195.8	0.0612
527.17	0.025	195.8	0.0595
527.18	0.024	195.8	0.0586
527.20	0.023	195.8	0.0568
527.22	0.021	195.7	0.0568
527.23	0.019	195.7	0.0541
527.25	0.019	195.6	0.0524
527.27	0.018	195.5	0.0497
527.28	0.015	195.2	0.0462
527.30	0.014	195.1	0.0435
527.32	0.012	195	0.0391
527.33	0.009	194.7	0.0391
527.35	0.007	194.5	0.0355
527.37	0.007	194.5	0.0328
527.38	0.006	194.4	0.0284
527.40	0.003	194.1	0.024
527.42	0.001	193.8	0.0204
527.43	0	193.6	0.0169
527.45	-0.003	193.3	0.0169
527.47	-0.005	193.1	0.0124
527.48	-0.005	193.1	0.0089
527.50	-0.006	192.9	0.0053
527.52	-0.008	192.5	0.0018
527.53	-0.01	192.3	-0.0009
527.55	-0.011	192.1	-0.0036
527.57	-0.013	191.8	-0.0036
527.58	-0.014	191.6	-0.0062
527.60	-0.014	191.6	-0.008
527.62	-0.014	191.4	-0.0098
527.63	-0.015	191.2	-0.0115
527.65	-0.016	191	-0.0133
527.67	-0.017	190.8	-0.0142
527.68	-0.017	190.7	-0.0142
527.70	-0.017	190.6	-0.0142
527.72	-0.017	190.6	-0.0151
527.73	-0.017	190.4	-0.0151
527.75	-0.017	190.4	-0.0151

Prova triassiale ciclica SN04-C1			
pressione di confinamento (kPa)		80	
deviatore ciclico (kPa)		95	
frequenza (hz)		0.00625	
tempo	cella di carico	$\Delta u$	LVDT
(min)	kN	(kPa)	$\delta$ (mm)
527.77	-0.017	190.3	-0.0151
527.78	-0.016	190.3	-0.0142
527.80	-0.015	190.2	-0.0124
527.82	-0.014	190.2	-0.0115
527.83	-0.014	190.2	-0.0107
527.85	-0.013	190.2	-0.0089
527.87	-0.01	190.3	-0.0089
527.88	-0.009	190.3	-0.0071
527.90	-0.009	190.4	-0.0053
527.92	-0.008	190.5	-0.0027
527.93	-0.005	190.7	0.0009
527.97	-0.004	190.8	0.0027
527.98	-0.003	190.9	0.0071
528.00	0.001	191.2	0.0071
528.02	0.002	191.2	0.0107
528.03	0.002	191.3	0.0133
528.03	0.004	191.5	0.0178
528.05	0.007	191.8	0.0222
528.07	0.008	192	0.0249
528.08	0.01	192.2	0.0302
528.10	0.013	192.5	0.0302
528.12	0.014	192.5	0.0346
528.13	0.014	192.7	0.0373
528.15	0.016	192.9	0.0408
528.17	0.019	193.2	0.0453
528.18	0.02	193.4	0.047
528.20	0.021	193.7	0.0506
528.22	0.023	193.9	0.0506
528.23	0.024	194.1	0.0533
528.25	0.024	194.1	0.0559
528.27	0.025	194.3	0.0577
528.28	0.026	194.6	0.0604
528.30	0.028	194.8	0.0612
528.32	0.028	194.9	0.0621
528.33	0.028	195.1	0.0621
528.35	0.029	195.2	0.063
528.37	0.029	195.2	0.0639
528.38	0.029	195.4	0.0648
528.40	0.029	195.5	0.0648
528.42	0.029	195.6	0.0648
528.43	0.029	195.7	0.0639
528.45	0.028	195.8	0.063
528.47	0.026	195.8	0.063
528.48	0.026	195.8	0.0621
528.50	0.026	195.8	0.0612
528.52	0.024	195.7	0.0595
528.53	0.023	195.7	0.0577
528.55	0.022	195.7	0.055
528.57	0.021	195.6	0.0541
528.58	0.018	195.5	0.0506
528.60	0.017	195.4	0.0488
528.62	0.016	195.2	0.0453
528.63	0.012	195	0.0453
528.65	0.011	195	0.0417
528.67	0.011	194.9	0.0391
528.68	0.01	194.6	0.0346
528.70	0.006	194.4	0.0311
528.72	0.005	194.2	0.0275

Prova triassiale ciclica SN04-C1			
pressione di confinamento (kPa)		80	
deviatore ciclico (kPa)		95	
frequenza (hz)		0.00625	
tempo	cella di carico	$\Delta u$	LVDT
(min)	kN	(kPa)	$\delta$ (mm)
528.73	0.003	194	0.0231
528.75	0	193.7	0.0231
528.77	-0.001	193.7	0.0186
528.78	-0.001	193.5	0.016
528.80	-0.003	193.2	0.0115
528.82	-0.006	192.9	0.0071
528.83	-0.007	192.7	0.0044
528.85	-0.008	192.5	0.0009
528.87	-0.011	192.2	0.0009
528.88	-0.012	192.2	-0.0018
528.90	-0.012	192	-0.0036
528.92	-0.012	191.7	-0.0071
528.93	-0.015	191.5	-0.0089
528.95	-0.015	191.3	-0.0107
528.97	-0.016	191.1	-0.0124
528.98	-0.017	190.9	-0.0124
529.00	-0.017	190.9	-0.0133
529.02	-0.017	190.8	-0.0142
529.03	-0.017	190.6	-0.0151
529.05	-0.017	190.5	-0.0151
529.07	-0.017	190.4	-0.0151
529.08	-0.017	190.3	-0.0142
529.10	-0.016	190.3	-0.0142
529.12	-0.016	190.3	-0.0142
529.13	-0.016	190.2	-0.0133
529.15	-0.015	190.2	-0.0124
529.17	-0.014	190.3	-0.0107
529.18	-0.012	190.3	-0.0089
529.20	-0.011	190.3	-0.0071
529.22	-0.009	190.4	-0.0071
529.23	-0.008	190.4	-0.0044
529.25	-0.008	190.5	-0.0027
529.27	-0.005	190.7	0
529.28	-0.003	190.8	0.0018
529.30	-0.003	190.8	0.0044
529.32	-0.002	191	0.008
529.33	0.001	191.2	0.0115
529.35	0.003	191.4	0.0151
529.37	0.004	191.6	0.0186
529.38	0.007	191.9	0.0186
529.40	0.01	192.1	0.0231
529.43	0.01	192.1	0.0275
529.45	0.011	192.3	0.0311
529.47	0.013	192.6	0.0355
529.48	0.016	192.8	0.0391
529.48	0.017	193.1	0.0426
529.50	0.019	193.4	0.0462
529.52	0.021	193.6	0.0462
529.53	0.021	193.6	0.0488
529.55	0.022	193.8	0.0515
529.57	0.023	194	0.0541
529.58	0.025	194.3	0.0568
529.60	0.026	194.4	0.0577
529.62	0.026	194.7	0.0604
529.63	0.028	194.8	0.0604
529.65	0.028	194.8	0.0621
529.67	0.028	195	0.063
529.68	0.028	195.1	0.0639



Prova triassiale ciclica SN04-C1			
pressione di confinamento (kPa)		80	
deviatore ciclico (kPa)		95	
frequenza (hz)		0.00625	
tempo	cella di carico	$\Delta u$	LVDT
(min)	kN	(kPa)	$\delta$ (mm)
529.70	0.029	195.3	0.0639
529.72	0.029	195.4	0.0639
529.73	0.029	195.6	0.0648
529.75	0.029	195.7	0.0648
529.77	0.028	195.7	0.0648
529.78	0.028	195.8	0.0639
529.80	0.027	195.8	0.0621
529.82	0.026	195.8	0.0612
529.83	0.025	195.8	0.0604
529.85	0.024	195.7	0.0586
529.87	0.022	195.7	0.0586
529.88	0.021	195.7	0.0559
529.90	0.021	195.6	0.0541
529.92	0.019	195.5	0.0515
529.93	0.016	195.3	0.0479
529.95	0.016	195.2	0.0462
529.97	0.014	195	0.0426
529.98	0.01	194.8	0.0426
530.00	0.01	194.7	0.0364
530.02	0.009	194.6	0.0337
530.03	0.005	194.3	0.0337
530.05	0.004	194.3	0.0302
530.07	0.004	194.1	0.0257
530.08	0.003	193.9	0.0213
530.10	-0.001	193.6	0.0169
530.12	-0.002	193.4	0.0142
530.13	-0.004	193.1	0.0098
530.15	-0.006	192.8	0.0098
530.17	-0.008	192.8	0.0062
530.18	-0.008	192.6	0.0036
530.20	-0.009	192.4	0
530.22	-0.011	192.1	-0.0027
530.23	-0.012	191.9	-0.0053
530.25	-0.013	191.6	-0.008
530.27	-0.015	191.4	-0.008
530.28	-0.015	191.2	-0.0098
530.30	-0.015	191.2	-0.0115
530.32	-0.016	191	-0.0124
530.33	-0.017	190.8	-0.0142
530.35	-0.017	190.7	-0.0142
530.37	-0.017	190.6	-0.0151
530.38	-0.017	190.4	-0.0151
530.40	-0.017	190.4	-0.0151
530.42	-0.017	190.4	-0.0151
530.43	-0.017	190.3	-0.0151
530.45	-0.016	190.2	-0.0142
530.47	-0.015	190.2	-0.0133
530.48	-0.014	190.2	-0.0124
530.50	-0.014	190.2	-0.0107
530.52	-0.011	190.3	-0.0107
530.53	-0.011	190.3	-0.0089
530.55	-0.011	190.3	-0.0071
530.57	-0.01	190.4	-0.0044
530.58	-0.007	190.6	-0.0018
530.60	-0.006	190.7	0.0009
530.62	-0.004	190.8	0.0044
530.63	-0.001	191	0.0044
530.65	0	191	0.008

Prova triassiale ciclica SN04-C1			
pressione di confinamento (kPa)		80	
deviatore ciclico (kPa)		95	
frequenza (hz)		0.00625	
tempo	cella di carico	$\Delta u$	LVDT
(min)	kN	(kPa)	$\delta$ (mm)
530.67	0	191.1	0.0107
530.68	0.002	191.4	0.0142
530.70	0.006	191.6	0.0186
530.72	0.006	191.8	0.0213
530.73	0.007	191.9	0.024
530.75	0.011	192.2	0.0293
530.77	0.012	192.4	0.032
530.78	0.013	192.6	0.0364
530.80	0.017	192.9	0.0364
530.82	0.018	193.1	0.0399
530.83	0.018	193.1	0.0426
530.87	0.019	193.3	0.0462
530.88	0.022	193.7	0.0497
530.90	0.023	193.9	0.0524
530.92	0.023	194.1	0.055
530.93	0.025	194.3	0.055
530.93	0.027	194.5	0.0568
530.95	0.027	194.5	0.0595
530.97	0.027	194.7	0.0612
530.98	0.027	194.9	0.0621
531.00	0.028	195.1	0.063
531.02	0.028	195.2	0.0639
531.03	0.029	195.4	0.0639
531.05	0.029	195.5	0.0639
531.07	0.029	195.5	0.0639
531.08	0.029	195.6	0.0639
531.10	0.028	195.7	0.0639
531.12	0.028	195.7	0.0639
531.13	0.027	195.8	0.0621
531.15	0.026	195.7	0.0604
531.17	0.024	195.7	0.0604
531.18	0.023	195.7	0.0595
531.20	0.023	195.7	0.0577
531.22	0.022	195.6	0.0559
531.23	0.02	195.6	0.0533
531.25	0.019	195.5	0.0506
531.27	0.017	195.2	0.0479
531.28	0.014	195.1	0.0479
531.30	0.013	195.1	0.0444
531.32	0.013	195	0.0417
531.33	0.011	194.8	0.0382
531.35	0.007	194.6	0.0337
531.37	0.007	194.4	0.0311
531.38	0.005	194.1	0.0257
531.40	0.001	193.9	0.0257
531.42	0.001	193.9	0.0222
531.43	0.001	193.7	0.0186
531.45	-0.003	193.2	0.0151
531.47	-0.004	193.2	0.0124
531.48	-0.004	193	0.0089
531.50	-0.006	192.7	0.0053
531.52	-0.009	192.4	0.0018
531.53	-0.01	192.2	-0.0009
531.55	-0.011	192	-0.0036
531.57	-0.013	191.7	-0.0036
531.58	-0.014	191.7	-0.0062
531.60	-0.014	191.5	-0.008
531.62	-0.015	191.3	-0.0098

Prova triassiale ciclica SN04-C1			
pressione di confinamento (kPa)		80	
deviatore ciclico (kPa)		95	
frequenza (hz)		0.00625	
tempo	cella di carico	$\Delta u$	LVDT
(min)	kN	(kPa)	$\delta$ (mm)
531.63	-0.016	191.1	-0.0115
531.65	-0.016	190.9	-0.0124
531.67	-0.017	190.8	-0.0142
531.68	-0.017	190.6	-0.0142
531.70	-0.017	190.6	-0.0151
531.72	-0.017	190.5	-0.0151
531.73	-0.017	190.4	-0.0151
531.75	-0.017	190.3	-0.0151
531.77	-0.017	190.2	-0.0151
531.78	-0.016	190.2	-0.0142
531.80	-0.015	190.2	-0.0142
531.82	-0.014	190.2	-0.0124
531.83	-0.014	190.2	-0.0115
531.85	-0.013	190.2	-0.0098
531.87	-0.011	190.3	-0.008
531.88	-0.01	190.3	-0.0062
531.90	-0.009	190.4	-0.0036
531.92	-0.007	190.6	-0.0009
531.93	-0.005	190.7	-0.0009
531.95	-0.005	190.7	0.0018
531.97	-0.003	190.8	0.0053
531.98	-0.001	191	0.0089
532.00	0.002	191.2	0.0124
532.02	0.003	191.4	0.0151
532.03	0.005	191.6	0.0195
532.05	0.008	191.8	0.0195
532.07	0.009	191.8	0.0231
532.08	0.009	192	0.0275
532.10	0.011	192.3	0.0311
532.12	0.014	192.6	0.0355
532.13	0.015	192.8	0.0391
532.15	0.017	193.1	0.0426
532.17	0.02	193.3	0.0426
532.18	0.02	193.5	0.0479
532.20	0.021	193.8	0.0506
532.22	0.024	194	0.0506
532.23	0.024	194	0.0541
532.25	0.024	194.2	0.0559
532.27	0.025	194.4	0.0577
532.28	0.027	194.6	0.0604
532.30	0.027	194.8	0.0612
532.33	0.027	194.9	0.0621
532.35	0.028	195.1	0.0621
532.37	0.029	195.1	0.0639
532.38	0.029	195.2	0.0639
532.38	0.029	195.4	0.0639
532.40	0.029	195.5	0.0639
532.42	0.028	195.6	0.0639
532.43	0.028	195.7	0.0639
532.45	0.028	195.8	0.0639
532.47	0.027	195.8	0.063
532.48	0.027	195.8	0.0621
532.50	0.026	195.8	0.0604
532.52	0.024	195.7	0.0586
532.53	0.022	195.7	0.0568
532.55	0.022	195.6	0.055
532.57	0.019	195.5	0.055
532.58	0.018	195.4	0.0524

Prova triassiale ciclica SN04-C1			
pressione di confinamento (kPa)		80	
deviatore ciclico (kPa)		95	
frequenza (hz)		0.00625	
tempo	cella di carico	$\Delta u$	LVDT
(min)	kN	(kPa)	$\delta$ (mm)
532.60	0.018	195.4	0.0497
532.62	0.017	195.3	0.047
532.63	0.014	195	0.0426
532.65	0.012	194.9	0.0399
532.67	0.011	194.7	0.0373
532.68	0.007	194.5	0.0373
532.70	0.005	194.3	0.0328
532.72	0.005	194.3	0.0293
532.73	0.004	194.1	0.0249
532.75	0.001	193.8	0.0213
532.77	-0.001	193.6	0.0178
532.78	-0.002	193.4	0.0133
532.80	-0.005	193	0.0133
532.82	-0.007	192.8	0.0089
532.83	-0.007	192.8	0.0062
532.85	-0.007	192.6	0.0027
532.87	-0.009	192.3	-0.0009
532.88	-0.011	192	-0.0036
532.90	-0.012	191.8	-0.0062
532.92	-0.013	191.6	-0.0071
532.93	-0.015	191.4	-0.0098
532.95	-0.015	191.2	-0.0107
532.97	-0.016	191	-0.0107
532.98	-0.016	190.8	-0.0124
533.00	-0.016	190.8	-0.0133
533.02	-0.017	190.7	-0.0142
533.03	-0.017	190.5	-0.0151
533.05	-0.017	190.4	-0.016
533.07	-0.017	190.3	-0.0151
533.08	-0.017	190.2	-0.0151
533.10	-0.016	190.2	-0.0151
533.12	-0.016	190.2	-0.0142
533.13	-0.016	190.1	-0.0133
533.15	-0.015	190.1	-0.0124
533.17	-0.013	190.1	-0.0107
533.18	-0.012	190.2	-0.0098
533.20	-0.011	190.3	-0.0071
533.22	-0.009	190.3	-0.0071
533.23	-0.008	190.3	-0.0053
533.25	-0.008	190.4	-0.0027
533.27	-0.007	190.6	0
533.28	-0.003	190.7	0.0036
533.30	-0.002	190.9	0.0062
533.32	-0.001	191.1	0.0098
533.33	0.003	191.3	0.0098
533.35	0.004	191.3	0.0142
533.37	0.004	191.4	0.0169
533.38	0.005	191.6	0.0195
533.40	0.007	191.8	0.0222
533.42	0.009	192	0.0257
533.43	0.01	192.2	0.0302
533.45	0.014	192.5	0.0302
533.47	0.014	192.5	0.0346
533.48	0.014	192.7	0.0373
533.50	0.016	193	0.0408
533.52	0.019	193.2	0.0444
533.53	0.02	193.4	0.047
533.55	0.021	193.7	0.0506

Prova triassiale ciclica SN04-C1			
pressione di confinamento (kPa)		80	
deviatore ciclico (kPa)		95	
frequenza (hz)		0.00625	
tempo	cella di carico	$\Delta u$	LVDT
(min)	kN	(kPa)	$\delta$ (mm)
533.57	0.024	193.9	0.0506
533.58	0.024	193.9	0.0533
533.60	0.024	194.1	0.055
533.62	0.025	194.3	0.0577
533.63	0.027	194.6	0.0604
533.65	0.027	194.7	0.0612
533.67	0.028	194.9	0.0621
533.68	0.028	195	0.063
533.70	0.029	195.2	0.0639
533.72	0.029	195.3	0.0639
533.73	0.029	195.5	0.0639
533.75	0.029	195.5	0.0648
533.78	0.029	195.6	0.0648
533.80	0.029	195.7	0.0648
533.82	0.028	195.7	0.0639
533.83	0.027	195.8	0.063
533.83	0.026	195.8	0.0612
533.85	0.025	195.7	0.0612
533.87	0.023	195.7	0.0595
533.88	0.023	195.7	0.0577
533.90	0.022	195.7	0.0559
533.92	0.02	195.5	0.0533
533.93	0.019	195.4	0.0515
533.95	0.017	195.3	0.0479
533.97	0.014	195.1	0.0479
533.98	0.013	195	0.0444
534.00	0.013	195	0.0417
534.02	0.011	194.8	0.0382
534.03	0.009	194.6	0.0346
534.05	0.006	194.4	0.0311
534.07	0.005	194.2	0.0275
534.08	0.002	193.9	0.0275
534.10	0	193.7	0.0222
534.12	0	193.7	0.0195
534.13	-0.001	193.5	0.0151
534.15	-0.004	193.1	0.0115
534.17	-0.006	192.9	0.008
534.18	-0.007	192.7	0.0044
534.20	-0.009	192.4	0.0009
534.22	-0.011	192.1	0.0009
534.23	-0.011	192.1	-0.0018
534.25	-0.011	191.9	-0.0044
534.27	-0.013	191.6	-0.0071
534.28	-0.015	191.4	-0.0098
534.30	-0.015	191.2	-0.0107
534.32	-0.016	191	-0.0124
534.33	-0.017	190.9	-0.0124
534.35	-0.017	190.7	-0.0142
534.37	-0.017	190.6	-0.0142
534.38	-0.017	190.5	-0.0142
534.40	-0.017	190.5	-0.0151
534.42	-0.017	190.3	-0.0151
534.43	-0.017	190.3	-0.0151
534.45	-0.017	190.2	-0.0151
534.47	-0.016	190.1	-0.0142
534.48	-0.016	190.1	-0.0124
534.50	-0.014	190.1	-0.0124
534.52	-0.013	190.1	-0.0115

Prova triassiale ciclica SN04-C1			
pressione di confinamento (kPa)		80	
deviatore ciclico (kPa)		95	
frequenza (hz)		0.00625	
tempo	cella di carico	$\Delta u$	LVDT
(min)	kN	(kPa)	$\delta$ (mm)
534.53	-0.013	190.1	-0.0098
534.55	-0.012	190.2	-0.008
534.57	-0.009	190.3	-0.0062
534.58	-0.009	190.4	-0.0044
534.60	-0.007	190.5	-0.0009
534.62	-0.005	190.6	-0.0009
534.63	-0.003	190.6	0.0027
534.65	-0.003	190.8	0.0044
534.67	-0.002	190.9	0.008
534.68	0.001	191.2	0.0115
534.70	0.003	191.3	0.0151
534.72	0.004	191.5	0.0195
534.73	0.008	191.8	0.0195
534.75	0.009	191.8	0.0231
534.77	0.009	192	0.0275
534.78	0.011	192.2	0.032
534.80	0.014	192.5	0.0364
534.82	0.015	192.7	0.0391
534.83	0.017	193	0.0435
534.85	0.019	193.3	0.0435
534.87	0.021	193.5	0.0462
534.88	0.021	193.5	0.0488
534.90	0.022	193.7	0.0515
534.92	0.024	194	0.0541
534.93	0.025	194.2	0.0568
534.95	0.026	194.4	0.0586
534.97	0.027	194.6	0.0586
534.98	0.028	194.8	0.0604
535.00	0.028	194.8	0.0621
535.02	0.028	194.9	0.0621
535.03	0.028	195.1	0.063
535.05	0.029	195.2	0.0648
535.07	0.029	195.4	0.0648
535.08	0.029	195.5	0.0648
535.10	0.029	195.6	0.0648
535.12	0.029	195.7	0.0648
535.13	0.028	195.7	0.063
535.15	0.026	195.7	0.063
535.17	0.026	195.7	0.0621
535.18	0.025	195.7	0.0604
535.20	0.024	195.7	0.0586
535.23	0.022	195.6	0.0568
535.25	0.022	195.6	0.0559
535.27	0.02	195.5	0.0524
535.28	0.017	195.3	0.0524
535.30	0.016	195.3	0.0497
535.30	0.016	195.2	0.0479
535.32	0.015	195	0.0435
535.33	0.011	194.8	0.0399
535.35	0.01	194.7	0.0373
535.37	0.009	194.5	0.0337
535.38	0.005	194.2	0.0337
535.40	0.004	194.2	0.0293
535.42	0.004	194.1	0.0257
535.43	0.002	193.8	0.0213
535.45	-0.001	193.5	0.0178
535.47	-0.002	193.3	0.0142
535.48	-0.004	193	0.0098

Prova triassiale ciclica SN04-C1			
pressione di confinamento (kPa)		80	
deviatore ciclico (kPa)		95	
frequenza (hz)		0.00625	
tempo	cella di carico	$\Delta u$	LVDT
(min)	kN	(kPa)	$\delta$ (mm)
535.50	-0.007	192.8	0.0098
535.52	-0.007	192.8	0.0062
535.53	-0.007	192.5	0.0036
535.55	-0.009	192.2	0
535.57	-0.012	192	-0.0036
535.58	-0.012	191.8	-0.0053
535.60	-0.013	191.6	-0.0071
535.62	-0.015	191.3	-0.0071
535.63	-0.016	191.3	-0.0098
535.65	-0.016	191.2	-0.0107
535.67	-0.016	191	-0.0124
535.68	-0.017	190.8	-0.0133
535.70	-0.017	190.6	-0.0142
535.72	-0.017	190.5	-0.0151
535.73	-0.017	190.4	-0.0151
535.75	-0.017	190.4	-0.0151
535.77	-0.017	190.3	-0.0151
535.78	-0.017	190.2	-0.0151
535.80	-0.016	190.2	-0.0142
535.82	-0.016	190.1	-0.0133
535.83	-0.015	190.1	-0.0124
535.85	-0.014	190.1	-0.0107
535.87	-0.012	190.2	-0.0089
535.88	-0.011	190.2	-0.0071
535.90	-0.009	190.3	-0.0071
535.92	-0.008	190.3	-0.0053
535.93	-0.008	190.4	-0.0027
535.95	-0.007	190.5	0
535.97	-0.004	190.7	0.0027
535.98	-0.002	190.8	0.0062
536.00	-0.001	191	0.0098
536.02	0.002	191.2	0.0098
536.03	0.004	191.4	0.0133
536.05	0.004	191.4	0.016
536.07	0.005	191.6	0.0204
536.08	0.009	191.9	0.0249
536.10	0.01	192.1	0.0293
536.12	0.012	192.3	0.0328
536.13	0.015	192.6	0.0328
536.15	0.016	192.8	0.0373
536.17	0.016	192.8	0.0399
536.18	0.017	193	0.0435
536.20	0.02	193.4	0.047
536.22	0.022	193.6	0.0497
536.23	0.022	193.8	0.0524
536.25	0.024	194.1	0.0524
536.27	0.025	194.3	0.0559
536.28	0.025	194.3	0.0577
536.30	0.026	194.5	0.0595
536.32	0.027	194.7	0.0612
536.33	0.028	194.8	0.0621
536.35	0.028	195	0.063
536.37	0.029	195.1	0.0639
536.38	0.029	195.3	0.0639
536.40	0.029	195.3	0.0639
536.42	0.029	195.4	0.0639
536.43	0.028	195.5	0.0648
536.45	0.028	195.6	0.0648

Prova triassiale ciclica SN04-C1			
pressione di confinamento (kPa)		80	
deviatore ciclico (kPa)		95	
frequenza (hz)		0.00625	
tempo	cella di carico	$\Delta u$	LVDT
(min)	kN	(kPa)	$\delta$ (mm)
536.47	0.028	195.7	0.0639
536.48	0.027	195.7	0.0621
536.50	0.025	195.7	0.0621
536.52	0.025	195.7	0.0604
536.53	0.024	195.7	0.0586
536.55	0.022	195.6	0.0586
536.57	0.021	195.6	0.0568
536.58	0.021	195.6	0.0541
536.60	0.02	195.4	0.0515
536.62	0.016	195.2	0.0488
536.63	0.016	195.1	0.0462
536.65	0.014	195	0.0426
536.67	0.01	194.8	0.0426
536.70	0.01	194.8	0.0391
536.72	0.01	194.6	0.0364
536.73	0.008	194.4	0.032
536.75	0.004	194.2	0.0275
536.75	0.003	194	0.024
536.77	0.002	193.7	0.0204
536.78	-0.002	193.4	0.0204
536.80	-0.003	193.4	0.0151
536.82	-0.003	193.2	0.0133
536.83	-0.004	193	0.0089
536.85	-0.007	192.7	0.0044
536.87	-0.008	192.4	0.0027
536.88	-0.01	192.2	-0.0018
536.90	-0.012	191.9	-0.0018
536.92	-0.013	191.7	-0.0044
536.93	-0.013	191.7	-0.0062
536.95	-0.014	191.5	-0.008
536.97	-0.015	191.2	-0.0107
536.98	-0.016	191	-0.0124
537.00	-0.016	190.9	-0.0133
537.02	-0.017	190.7	-0.0133
537.03	-0.017	190.6	-0.0142
537.05	-0.017	190.6	-0.0142
537.07	-0.017	190.4	-0.0151
537.08	-0.017	190.3	-0.0151
537.10	-0.017	190.2	-0.0151
537.12	-0.017	190.2	-0.0142
537.13	-0.016	190.2	-0.0142
537.15	-0.015	190.1	-0.0133
537.17	-0.015	190.1	-0.0124
537.18	-0.014	190.1	-0.0107
537.20	-0.012	190.2	-0.0098
537.22	-0.011	190.2	-0.008
537.23	-0.01	190.3	-0.0053
537.25	-0.008	190.4	-0.0053
537.27	-0.006	190.5	-0.0009
537.28	-0.006	190.6	0.0018
537.30	-0.004	190.8	0.0044
537.32	-0.001	190.9	0.0044
537.33	-0.001	190.9	0.008
537.35	0	191.1	0.0115
537.37	0.003	191.3	0.0151
537.38	0.006	191.5	0.0186
537.40	0.006	191.7	0.0222
537.42	0.009	192	0.0275



Prova triassiale ciclica SN04-C1			
pressione di confinamento (kPa)		80	
deviatore ciclico (kPa)		95	
frequenza (hz)		0.00625	
tempo	cella di carico	$\Delta u$	LVDT
(min)	kN	(kPa)	$\delta$ (mm)
537.43	0.012	192.2	0.0275
537.45	0.013	192.2	0.0311
537.47	0.013	192.4	0.0346
537.48	0.014	192.7	0.0382
537.50	0.017	193	0.0417
537.52	0.018	193.2	0.0444
537.53	0.019	193.5	0.0479
537.55	0.023	193.7	0.0479
537.57	0.023	193.7	0.0515
537.58	0.023	193.9	0.0533
537.60	0.024	194.1	0.0568
537.62	0.026	194.3	0.0586
537.63	0.026	194.5	0.0604
537.65	0.027	194.7	0.0612
537.67	0.028	194.9	0.0612
537.68	0.028	194.9	0.063
537.70	0.028	195	0.0639
537.72	0.028	195.2	0.0639
537.73	0.029	195.3	0.0648
537.75	0.029	195.4	0.0648
537.77	0.029	195.6	0.0648
537.78	0.028	195.7	0.0648
537.80	0.027	195.7	0.0648
537.82	0.027	195.7	0.0639
537.83	0.027	195.7	0.0621
537.85	0.025	195.7	0.0604
537.87	0.024	195.7	0.0595
537.88	0.023	195.6	0.0568
537.90	0.021	195.5	0.0568
537.92	0.019	195.5	0.0541
537.93	0.019	195.4	0.0524
537.95	0.018	195.3	0.0497
537.97	0.015	195.1	0.0462
537.98	0.014	195	0.0435
538.00	0.013	194.9	0.0417
538.02	0.01	194.7	0.0373
538.03	0.009	194.5	0.0346
538.05	0.007	194.3	0.0311
538.07	0.003	194	0.0311
538.08	0.002	193.8	0.0257
538.10	0.002	193.8	0.0222
538.13	0.001	193.6	0.0178
538.15	-0.002	193.3	0.0142
538.17	-0.004	193.1	0.0107
538.18	-0.005	192.9	0.0071
538.20	-0.007	192.5	0.0071
538.20	-0.009	192.3	0.0036
538.22	-0.009	192.3	0.0009
538.23	-0.01	192.1	-0.0027
538.25	-0.012	191.8	-0.0053
538.27	-0.014	191.6	-0.0071
538.28	-0.014	191.3	-0.0089
538.30	-0.015	191.1	-0.0089
538.32	-0.016	190.9	-0.0107
538.33	-0.016	190.9	-0.0124
538.35	-0.017	190.8	-0.0133
538.37	-0.017	190.6	-0.0142
538.38	-0.017	190.5	-0.0151

Prova triassiale ciclica SN04-C1			
pressione di confinamento (kPa)		80	
deviatore ciclico (kPa)		95	
frequenza (hz)		0.00625	
tempo	cella di carico	$\Delta u$	LVDT
(min)	kN	(kPa)	$\delta$ (mm)
538.40	-0.017	190.4	-0.0151
538.42	-0.017	190.3	-0.0151
538.43	-0.017	190.2	-0.0151
538.45	-0.017	190.2	-0.0151
538.47	-0.016	190.1	-0.0142
538.48	-0.016	190.1	-0.0133
538.50	-0.015	190.1	-0.0124
538.52	-0.014	190.1	-0.0107
538.53	-0.013	190.2	-0.0089
538.55	-0.01	190.2	-0.0089
538.57	-0.009	190.2	-0.0071
538.58	-0.009	190.3	-0.0044
538.60	-0.008	190.4	-0.0018
538.62	-0.005	190.6	0.0009
538.63	-0.004	190.7	0.0036
538.65	-0.003	190.9	0.0071
538.67	0.001	191.1	0.0071
538.68	0.002	191.1	0.0107
538.70	0.002	191.2	0.0133
538.72	0.006	191.6	0.0178
538.73	0.007	191.6	0.0195
538.75	0.007	191.8	0.0231
538.77	0.009	192.1	0.0284
538.78	0.013	192.3	0.032
538.80	0.013	192.5	0.0355
538.82	0.015	192.8	0.0399
538.83	0.019	193.1	0.0399
538.85	0.019	193.1	0.0444
538.87	0.019	193.3	0.047
538.88	0.02	193.5	0.0497
538.90	0.023	193.8	0.0524
538.92	0.024	194	0.055
538.93	0.025	194.2	0.0577
538.95	0.027	194.4	0.0577
538.97	0.027	194.4	0.0595
538.98	0.027	194.6	0.0604
539.00	0.027	194.8	0.0612
539.02	0.028	195	0.063
539.03	0.029	195.1	0.0639
539.05	0.029	195.2	0.0639
539.07	0.029	195.4	0.0639
539.08	0.029	195.4	0.0648
539.10	0.029	195.5	0.0648
539.12	0.029	195.6	0.0648
539.13	0.028	195.7	0.0639
539.15	0.027	195.7	0.063
539.17	0.026	195.7	0.0612
539.18	0.025	195.7	0.0612
539.20	0.023	195.6	0.0595
539.22	0.023	195.6	0.0577
539.23	0.022	195.6	0.0559
539.25	0.02	195.5	0.0533
539.27	0.018	195.3	0.0515
539.28	0.017	195.2	0.0479
539.30	0.015	195	0.0444
539.32	0.012	194.9	0.0444
539.33	0.012	194.9	0.0417
539.35	0.011	194.8	0.0382

Prova triassiale ciclica SN04-C1			
pressione di confinamento (kPa)		80	
deviatore ciclico (kPa)		95	
frequenza (hz)		0.00625	
tempo	cella di carico	$\Delta u$	LVDT
(min)	kN	(kPa)	$\delta$ (mm)
539.37	0.009	194.5	0.0346
539.38	0.006	194.3	0.0311
539.40	0.005	194.1	0.0275
539.42	0.003	193.8	0.0231
539.43	0	193.6	0.0195
539.45	0	193.4	0.0169
539.47	-0.002	193.2	0.0133
539.48	-0.005	192.9	0.0133
539.50	-0.006	192.9	0.0098
539.52	-0.006	192.7	0.0062
539.53	-0.008	192.4	0.0027
539.55	-0.01	192.1	-0.0009
539.57	-0.011	191.9	-0.0027
539.60	-0.012	191.7	-0.0053
539.62	-0.014	191.4	-0.0053
539.63	-0.015	191.4	-0.008
539.65	-0.015	191.3	-0.0098
539.65	-0.015	191	-0.0107
539.67	-0.017	190.9	-0.0124
539.68	-0.017	190.7	-0.0133
539.70	-0.017	190.6	-0.0142
539.72	-0.017	190.4	-0.0142
539.73	-0.017	190.4	-0.0151
539.75	-0.017	190.3	-0.0151
539.77	-0.017	190.2	-0.0151
539.78	-0.017	190.2	-0.0142
539.80	-0.016	190.1	-0.0133
539.82	-0.015	190.1	-0.0124
539.83	-0.014	190.1	-0.0124
539.85	-0.013	190.1	-0.0115
539.87	-0.013	190.1	-0.0098
539.88	-0.012	190.2	-0.008
539.90	-0.01	190.3	-0.0062
539.92	-0.009	190.3	-0.0036
539.93	-0.007	190.4	-0.0009
539.95	-0.004	190.6	-0.0009
539.97	-0.003	190.6	0.0018
539.98	-0.003	190.7	0.0044
540.00	-0.002	190.9	0.0089
540.02	0.002	191.2	0.0124
540.03	0.003	191.3	0.016
540.05	0.005	191.5	0.0195
540.07	0.008	191.8	0.0195
540.08	0.01	192	0.0231
540.10	0.01	192	0.0275
540.12	0.011	192.2	0.0311
540.13	0.014	192.5	0.0355
540.15	0.015	192.7	0.0391
540.17	0.016	192.9	0.0426
540.18	0.018	193.2	0.0444
540.20	0.02	193.4	0.0479
540.22	0.021	193.6	0.0506
540.23	0.023	193.9	0.0506
540.25	0.024	194.1	0.0533
540.27	0.024	194.1	0.0559
540.28	0.025	194.3	0.0577
540.30	0.026	194.5	0.0604
540.32	0.028	194.7	0.0621

Prova triassiale ciclica SN04-C1			
pressione di confinamento (kPa)		80	
deviatore ciclico (kPa)		95	
frequenza (hz)		0.00625	
tempo	cella di carico	$\Delta u$	LVDT
(min)	kN	(kPa)	$\delta$ (mm)
540.33	0.028	194.9	0.0621
540.35	0.028	195	0.0621
540.37	0.029	195.2	0.0639
540.38	0.029	195.2	0.0639
540.40	0.029	195.3	0.0648
540.42	0.029	195.4	0.0648
540.43	0.029	195.5	0.0648
540.45	0.028	195.6	0.0648
540.47	0.028	195.7	0.063
540.48	0.026	195.7	0.063
540.50	0.026	195.7	0.0621
540.52	0.026	195.7	0.0612
540.53	0.025	195.7	0.0595
540.55	0.022	195.6	0.0568
540.57	0.022	195.6	0.055
540.58	0.021	195.4	0.0533
540.60	0.017	195.2	0.0533
540.62	0.016	195.2	0.0497
540.63	0.016	195.2	0.047
540.65	0.015	195	0.0435
540.67	0.011	194.8	0.0399
540.68	0.011	194.7	0.0373
540.70	0.009	194.4	0.0337
540.72	0.005	194.2	0.0337
540.73	0.004	194.2	0.0293
540.75	0.004	194.1	0.0257
540.77	0.003	193.8	0.0213
540.78	-0.001	193.5	0.0169
540.80	-0.002	193.3	0.0142
540.82	-0.004	193	0.0107
540.83	-0.007	192.7	0.0107
540.85	-0.008	192.7	0.0053
540.87	-0.008	192.5	0.0036
540.88	-0.009	192.2	0.0009
540.90	-0.012	192	-0.0027
540.92	-0.012	191.8	-0.0044
540.93	-0.013	191.5	-0.0071
540.95	-0.015	191.3	-0.0089
540.97	-0.015	191.2	-0.0107
540.98	-0.016	190.9	-0.0124
541.00	-0.017	190.8	-0.0124
541.03	-0.017	190.8	-0.0133
541.05	-0.017	190.6	-0.0142
541.07	-0.017	190.5	-0.0142
541.08	-0.017	190.4	-0.0142
541.10	-0.017	190.3	-0.0151
541.10	-0.017	190.2	-0.0151
541.12	-0.017	190.1	-0.0151
541.13	-0.016	190.1	-0.0142
541.15	-0.016	190.1	-0.0133
541.17	-0.015	190.1	-0.0115
541.18	-0.014	190.1	-0.0107
541.20	-0.012	190.1	-0.0089
541.22	-0.011	190.2	-0.0071
541.23	-0.01	190.3	-0.0071
541.25	-0.008	190.4	-0.0044
541.27	-0.008	190.4	-0.0027
541.28	-0.006	190.5	0

Prova triassiale ciclica SN04-C1			
pressione di confinamento (kPa)		80	
deviatore ciclico (kPa)		95	
frequenza (hz)		0.00625	
tempo	cella di carico	$\Delta u$	LVDT
(min)	kN	(kPa)	$\delta$ (mm)
541.30	-0.004	190.7	0.0036
541.32	-0.002	190.8	0.0062
541.33	-0.001	190.9	0.0098
541.35	0.002	191.2	0.0098
541.37	0.004	191.4	0.0133
541.38	0.004	191.4	0.0169
541.40	0.005	191.5	0.0213
541.42	0.008	191.9	0.0257
541.43	0.011	192.1	0.0302
541.45	0.012	192.3	0.0337
541.47	0.014	192.6	0.0337
541.48	0.017	192.8	0.0373
541.50	0.017	192.8	0.0408
541.52	0.017	193	0.0444
541.53	0.019	193.3	0.047
541.55	0.022	193.6	0.0506
541.57	0.022	193.8	0.0524
541.58	0.024	194	0.055
541.60	0.026	194.2	0.055
541.62	0.026	194.4	0.0595
541.63	0.026	194.6	0.0604
541.65	0.028	194.8	0.0604
541.67	0.028	194.8	0.0621
541.68	0.028	194.9	0.063
541.70	0.028	195.1	0.0639
541.72	0.029	195.2	0.0648
541.73	0.029	195.4	0.0648
541.75	0.029	195.5	0.0648
541.77	0.029	195.6	0.0648
541.78	0.028	195.6	0.0648
541.80	0.028	195.7	0.0639
541.82	0.027	195.7	0.063
541.83	0.026	195.7	0.0612
541.85	0.025	195.7	0.0604
541.87	0.024	195.6	0.0586
541.88	0.022	195.6	0.0586
541.90	0.021	195.6	0.0568
541.92	0.021	195.5	0.055
541.93	0.02	195.4	0.0515
541.95	0.016	195.2	0.0488
541.97	0.016	195.1	0.0462
541.98	0.014	194.9	0.0435
542.00	0.01	194.7	0.0435
542.02	0.01	194.7	0.0391
542.03	0.01	194.6	0.0364
542.05	0.008	194.4	0.032
542.07	0.004	194.1	0.0284
542.08	0.003	193.9	0.0249
542.10	0.002	193.7	0.0204
542.12	-0.002	193.4	0.0204
542.13	-0.003	193.4	0.016
542.15	-0.003	193.2	0.0133
542.17	-0.004	192.9	0.0089
542.18	-0.007	192.6	0.0053
542.20	-0.009	192.4	0.0027
542.22	-0.009	192.2	-0.0009
542.23	-0.012	191.9	-0.0009
542.25	-0.013	191.9	-0.0044

Prova triassiale ciclica SN04-C1			
pressione di confinamento (kPa)		80	
deviatore ciclico (kPa)		95	
frequenza (hz)		0.00625	
tempo	cella di carico	$\Delta u$	LVDT
(min)	kN	(kPa)	$\delta$ (mm)
542.27	-0.013	191.7	-0.0062
542.28	-0.014	191.4	-0.008
542.30	-0.015	191.2	-0.0107
542.32	-0.016	191	-0.0115
542.33	-0.016	190.8	-0.0133
542.35	-0.017	190.6	-0.0142
542.37	-0.017	190.5	-0.0142
542.38	-0.017	190.4	-0.0151
542.40	-0.017	190.3	-0.0151
542.42	-0.017	190.2	-0.0151
542.43	-0.017	190.2	-0.0151
542.45	-0.017	190.1	-0.0142
542.47	-0.016	190.1	-0.0133
542.50	-0.015	190.1	-0.0124
542.52	-0.015	190	-0.0115
542.53	-0.014	190.1	-0.0098
542.55	-0.011	190.1	-0.0098
542.55	-0.011	190.1	-0.0089
542.57	-0.011	190.2	-0.0062
542.58	-0.009	190.3	-0.0044
542.60	-0.007	190.4	-0.0018
542.62	-0.006	190.5	0.0009
542.63	-0.004	190.7	0.0044
542.65	-0.001	190.9	0.0044
542.67	0	190.9	0.008
542.68	0	191	0.0107
542.70	0.002	191.2	0.0142
542.72	0.005	191.5	0.0186
542.73	0.006	191.6	0.0222
542.75	0.008	191.9	0.0257
542.77	0.012	192.2	0.0257
542.78	0.012	192.2	0.0311
542.80	0.012	192.3	0.0346
542.82	0.014	192.6	0.0382
542.83	0.018	192.9	0.0426
542.85	0.018	193.1	0.0453
542.87	0.02	193.4	0.0488
542.88	0.022	193.6	0.0488
542.90	0.023	193.6	0.0515
542.92	0.023	193.8	0.0533
542.93	0.024	194.1	0.0559
542.95	0.026	194.3	0.0586
542.97	0.027	194.5	0.0604
542.98	0.027	194.6	0.0612
543.00	0.028	194.8	0.0612
543.02	0.028	194.8	0.063
543.03	0.028	195	0.063
543.05	0.028	195.1	0.0639
543.07	0.029	195.3	0.0648
543.08	0.029	195.4	0.0648
543.10	0.029	195.5	0.0648
543.12	0.029	195.6	0.0648
543.13	0.028	195.7	0.0639
543.15	0.027	195.7	0.0621
543.17	0.025	195.7	0.0621
543.18	0.024	195.7	0.0612
543.20	0.024	195.7	0.0595
543.22	0.024	195.6	0.0577

Prova triassiale ciclica SN04-C1			
pressione di confinamento (kPa)		80	
deviatore ciclico (kPa)		95	
frequenza (hz)		0.00625	
tempo	cella di carico	$\Delta u$	LVDT
(min)	kN	(kPa)	$\delta$ (mm)
543.23	0.021	195.5	0.0559
543.25	0.02	195.4	0.0541
543.27	0.019	195.4	0.0506
543.28	0.016	195.1	0.0506
543.30	0.014	195.1	0.0479
543.32	0.014	195	0.0453
543.33	0.013	194.9	0.0417
543.35	0.01	194.6	0.0382
543.37	0.009	194.5	0.0346
543.38	0.007	194.3	0.0302
543.40	0.004	194	0.0302
543.42	0.002	193.8	0.0257
543.43	0.002	193.8	0.0231
543.45	0.001	193.6	0.0186
543.47	-0.002	193.3	0.0142
543.48	-0.004	193	0.0115
543.50	-0.005	192.8	0.0071
543.52	-0.007	192.5	0.0071
543.53	-0.01	192.2	0.0036
543.55	-0.01	192.2	0.0009
543.57	-0.01	192	-0.0018
543.58	-0.012	191.7	-0.0044
543.60	-0.014	191.5	-0.0071
543.62	-0.014	191.3	-0.0089
543.63	-0.015	191.1	-0.0107
543.65	-0.016	190.9	-0.0107
543.67	-0.016	190.9	-0.0124
543.68	-0.017	190.7	-0.0133
543.70	-0.017	190.6	-0.0142
543.72	-0.017	190.4	-0.0142
543.73	-0.017	190.3	-0.0151
543.75	-0.017	190.2	-0.0151
543.77	-0.017	190.1	-0.0151
543.78	-0.016	190.1	-0.0151
543.80	-0.016	190	-0.0133
543.82	-0.015	190	-0.0133
543.83	-0.014	190	-0.0133
543.85	-0.014	190	-0.0115
543.87	-0.013	190.1	-0.0098
543.88	-0.011	190.1	-0.008
543.90	-0.01	190.1	-0.0053
543.92	-0.009	190.3	-0.0027
543.93	-0.006	190.5	-0.0027
543.97	-0.005	190.5	0
543.98	-0.005	190.5	0.0027
544.00	-0.004	190.8	0.0062
544.00	0	190.9	0.0098
544.02	0.001	191.1	0.0124
544.03	0.003	191.3	0.0169
544.05	0.007	191.5	0.0169
544.07	0.007	191.5	0.0213
544.08	0.007	191.7	0.0231
544.10	0.009	192	0.0284
544.12	0.013	192.2	0.0328
544.13	0.013	192.4	0.0364
544.15	0.015	192.7	0.0399
544.17	0.018	193	0.0399
544.18	0.019	193	0.0435

Prova triassiale ciclica SN04-C1			
pressione di confinamento (kPa)		80	
deviatore ciclico (kPa)		95	
frequenza (hz)		0.00625	
tempo	cella di carico	$\Delta u$	LVDT
(min)	kN	(kPa)	$\delta$ (mm)
544.20	0.019	193.2	0.0462
544.22	0.02	193.4	0.0488
544.23	0.023	193.7	0.0524
544.25	0.024	193.9	0.055
544.27	0.025	194.1	0.0568
544.28	0.026	194.3	0.0568
544.30	0.027	194.3	0.0595
544.32	0.027	194.5	0.0612
544.33	0.027	194.7	0.0621
544.35	0.029	194.9	0.0639
544.37	0.029	195	0.0639
544.38	0.028	195.2	0.0639
544.40	0.029	195.3	0.0639
544.42	0.029	195.4	0.0648
544.43	0.029	195.4	0.0648
544.45	0.028	195.5	0.0648
544.47	0.028	195.6	0.0648
544.48	0.027	195.6	0.063
544.50	0.026	195.6	0.0612
544.52	0.024	195.6	0.0595
544.53	0.024	195.6	0.0586
544.55	0.023	195.6	0.0568
544.57	0.021	195.4	0.0568
544.58	0.019	195.4	0.055
544.60	0.019	195.4	0.0524
544.62	0.018	195.2	0.0497
544.63	0.016	195.1	0.047
544.65	0.013	194.9	0.0435
544.67	0.012	194.8	0.0408
544.68	0.01	194.5	0.0408
544.70	0.007	194.3	0.0364
544.72	0.007	194.3	0.0328
544.73	0.006	194.2	0.0293
544.75	0.004	193.9	0.0249
544.77	0.001	193.7	0.0213
544.78	0	193.5	0.0178
544.80	-0.002	193.1	0.0133
544.82	-0.005	192.9	0.0133
544.83	-0.005	192.9	0.0098
544.85	-0.006	192.7	0.0062
544.87	-0.008	192.3	0.0027
544.88	-0.01	192.1	-0.0009
544.90	-0.011	191.9	-0.0027
544.92	-0.012	191.6	-0.0053
544.93	-0.014	191.4	-0.0053
544.95	-0.015	191.4	-0.008
544.97	-0.015	191.2	-0.0098
544.98	-0.015	191	-0.0115
545.00	-0.016	190.8	-0.0124
545.02	-0.017	190.7	-0.0133
545.03	-0.017	190.5	-0.0142
545.05	-0.017	190.4	-0.0142
545.07	-0.018	190.4	-0.0151
545.08	-0.018	190.3	-0.0151
545.10	-0.017	190.2	-0.0151
545.12	-0.016	190.1	-0.0142
545.13	-0.016	190.1	-0.0133
545.15	-0.015	190.1	-0.0124



Prova triassiale ciclica SN04-C1			
pressione di confinamento (kPa)		80	
deviatore ciclico (kPa)		95	
frequenza (hz)		0.00625	
tempo	cella di carico	$\Delta u$	LVDT
(min)	kN	(kPa)	$\delta$ (mm)
545.17	-0.014	190.1	-0.0124
545.18	-0.013	190.1	-0.0107
545.20	-0.013	190.1	-0.0098
545.22	-0.012	190.2	-0.008
545.23	-0.009	190.2	-0.0053
545.25	-0.009	190.3	-0.0036
545.27	-0.008	190.4	-0.0027
545.28	-0.005	190.5	0.0009
545.30	-0.004	190.6	0.0044
545.32	-0.002	190.8	0.008
545.33	0.001	191	0.008
545.35	0.002	191	0.0115
545.37	0.002	191.2	0.0142
545.40	0.004	191.4	0.0178
545.42	0.007	191.6	0.0222
545.43	0.008	191.8	0.0257
545.45	0.01	192.1	0.0302
545.47	0.014	192.4	0.0302
545.47	0.015	192.4	0.0346
545.48	0.015	192.6	0.0373
545.50	0.016	192.8	0.0408
545.52	0.019	193.1	0.0453
545.53	0.02	193.3	0.0479
545.55	0.021	193.5	0.0506
545.57	0.023	193.8	0.0506
545.58	0.024	193.8	0.0533
545.60	0.024	194	0.0559
545.62	0.025	194.2	0.0586
545.63	0.027	194.4	0.0604
545.65	0.027	194.6	0.0612
545.67	0.027	194.8	0.063
545.68	0.029	194.9	0.063
545.70	0.029	194.9	0.0639
545.72	0.029	195.1	0.0648
545.73	0.029	195.2	0.0648
545.75	0.029	195.3	0.0648
545.77	0.029	195.5	0.0648
545.78	0.028	195.6	0.0648
545.80	0.028	195.6	0.0648
545.82	0.026	195.6	0.0639
545.83	0.026	195.6	0.0621
545.85	0.025	195.6	0.0604
545.87	0.024	195.6	0.0595
545.88	0.023	195.5	0.0577
545.90	0.022	195.5	0.0559
545.92	0.019	195.3	0.0559
545.93	0.018	195.3	0.0524
545.95	0.018	195.2	0.0506
545.97	0.016	195.1	0.047
545.98	0.013	194.9	0.0435
546.00	0.013	194.8	0.0417
546.02	0.011	194.6	0.0382
546.03	0.008	194.4	0.0346
546.05	0.007	194.2	0.032
546.07	0.005	194.1	0.0275
546.08	0.002	193.8	0.0275
546.10	0.001	193.5	0.0231
546.12	0.001	193.5	0.0204

Prova triassiale ciclica SN04-C1			
pressione di confinamento (kPa)		80	
deviatore ciclico (kPa)		95	
frequenza (hz)		0.00625	
tempo	cella di carico	$\Delta u$	LVDT
(min)	kN	(kPa)	$\delta$ (mm)
546.13	-0.001	193.3	0.0151
546.15	-0.005	193	0.0107
546.17	-0.006	192.8	0.008
546.18	-0.007	192.6	0.0053
546.20	-0.009	192.2	0.0053
546.22	-0.011	192	0.0018
546.23	-0.011	192	-0.0009
546.25	-0.012	191.8	-0.0044
546.27	-0.014	191.5	-0.0071
546.28	-0.014	191.3	-0.0089
546.30	-0.015	191.1	-0.0098
546.32	-0.016	190.9	-0.0098
546.33	-0.017	190.7	-0.0115
546.35	-0.017	190.7	-0.0133
546.37	-0.017	190.6	-0.0142
546.38	-0.017	190.4	-0.0142
546.40	-0.017	190.3	-0.0151
546.42	-0.017	190.2	-0.0151
546.43	-0.017	190.1	-0.0142
546.45	-0.016	190.1	-0.0142
546.47	-0.016	190.1	-0.0142
546.48	-0.016	190	-0.0124
546.50	-0.014	190.1	-0.0115
546.52	-0.013	190.1	-0.0107
546.53	-0.013	190.1	-0.0089
546.55	-0.011	190.1	-0.0071
546.57	-0.009	190.2	-0.0071
546.58	-0.008	190.2	-0.0044
546.60	-0.008	190.3	-0.0027
546.62	-0.006	190.5	0.0009
546.63	-0.004	190.6	0.0036
546.65	-0.003	190.7	0.0062
546.67	-0.001	191	0.0107
546.68	0.003	191.2	0.0107
546.70	0.004	191.3	0.0169
546.72	0.004	191.5	0.0195
546.73	0.008	191.7	0.0195
546.75	0.009	191.7	0.024
546.77	0.009	191.9	0.0275
546.78	0.011	192.2	0.032
546.80	0.014	192.4	0.0355
546.82	0.015	192.6	0.0391
546.83	0.017	193	0.0426
546.87	0.02	193.2	0.0426
546.88	0.021	193.2	0.047
546.90	0.021	193.4	0.0488
546.92	0.022	193.6	0.0524
546.92	0.024	193.9	0.055
546.93	0.025	194.1	0.0568
546.95	0.025	194.3	0.0586
546.97	0.027	194.5	0.0586
546.98	0.028	194.5	0.0612
547.00	0.028	194.7	0.0621
547.02	0.028	194.8	0.063
547.03	0.029	195	0.0639
547.05	0.029	195.1	0.0648
547.07	0.029	195.2	0.0648
547.08	0.029	195.4	0.0648

Prova triassiale ciclica SN04-C1			
pressione di confinamento (kPa)		80	
deviatore ciclico (kPa)		95	
frequenza (hz)		0.00625	
tempo	cella di carico	$\Delta u$	LVDT
(min)	kN	(kPa)	$\delta$ (mm)
547.10	0.029	195.4	0.0648
547.12	0.029	195.5	0.0648
547.13	0.028	195.6	0.0639
547.15	0.027	195.6	0.063
547.17	0.026	195.6	0.0621
547.18	0.025	195.6	0.0604
547.20	0.023	195.5	0.0604
547.22	0.022	195.5	0.0586
547.23	0.022	195.5	0.0559
547.25	0.021	195.4	0.0541
547.27	0.018	195.2	0.0515
547.28	0.017	195.1	0.0488
547.30	0.016	195	0.0453
547.32	0.012	194.8	0.0453
547.33	0.011	194.8	0.0417
547.35	0.011	194.7	0.0391
547.37	0.01	194.4	0.0355
547.38	0.006	194.2	0.0311
547.40	0.005	194.1	0.0284
547.42	0.003	193.8	0.024
547.43	0	193.5	0.0195
547.45	0	193.4	0.0178
547.47	-0.002	193.1	0.0133
547.48	-0.005	192.8	0.0133
547.50	-0.006	192.8	0.0098
547.52	-0.006	192.6	0.0071
547.53	-0.007	192.4	0.0036
547.55	-0.01	192.1	0
547.57	-0.011	191.8	-0.0027
547.58	-0.012	191.6	-0.0053
547.60	-0.014	191.3	-0.0053
547.62	-0.015	191.3	-0.008
547.63	-0.015	191.2	-0.0098
547.65	-0.015	191	-0.0107
547.67	-0.016	190.8	-0.0124
547.68	-0.017	190.6	-0.0133
547.70	-0.017	190.5	-0.0142
547.72	-0.017	190.4	-0.0142
547.73	-0.017	190.2	-0.0142
547.75	-0.017	190.2	-0.0151
547.77	-0.017	190.1	-0.0151
547.78	-0.017	190.1	-0.0142
547.80	-0.016	190	-0.0133
547.82	-0.015	190	-0.0124
547.83	-0.014	190	-0.0124
547.85	-0.013	190	-0.0115
547.87	-0.013	190	-0.0098
547.88	-0.012	190.1	-0.008
547.90	-0.01	190.2	-0.0062
547.92	-0.008	190.2	-0.0036
547.93	-0.007	190.3	0
547.95	-0.005	190.5	0
547.97	-0.003	190.6	0.0027
547.98	-0.003	190.6	0.0053
548.00	-0.002	190.8	0.0089
548.02	0.001	191	0.0124
548.03	0.003	191.2	0.0151
548.05	0.004	191.4	0.0195

Prova triassiale ciclica SN04-C1			
pressione di confinamento (kPa)		80	
deviatore ciclico (kPa)		95	
frequenza (hz)		0.00625	
tempo	cella di carico	$\Delta u$	LVDT
(min)	kN	(kPa)	$\delta$ (mm)
548.07	0.007	191.7	0.024
548.08	0.01	191.9	0.024
548.10	0.01	191.9	0.0284
548.12	0.011	192.1	0.0311
548.13	0.013	192.4	0.0355
548.15	0.016	192.6	0.0391
548.17	0.016	192.8	0.0417
548.18	0.018	193	0.0453
548.20	0.02	193.3	0.0479
548.22	0.021	193.5	0.0497
548.23	0.022	193.8	0.0533
548.25	0.024	194	0.0533
548.27	0.026	194	0.0559
548.30	0.026	194.2	0.0577
548.32	0.026	194.4	0.0595
548.33	0.027	194.6	0.0612
548.35	0.028	194.7	0.063
548.37	0.028	194.9	0.0639
548.37	0.029	195.1	0.0639
548.38	0.029	195.1	0.0639
548.40	0.029	195.2	0.0648
548.42	0.029	195.3	0.0648
548.43	0.029	195.4	0.0648
548.45	0.028	195.5	0.0648
548.47	0.028	195.6	0.0639
548.48	0.027	195.6	0.0639
548.50	0.025	195.6	0.063
548.52	0.025	195.6	0.0612
548.53	0.025	195.6	0.0595
548.55	0.022	195.5	0.0577
548.57	0.022	195.4	0.0559
548.58	0.02	195.3	0.0533
548.60	0.018	195.2	0.0533
548.62	0.016	195.2	0.0506
548.63	0.016	195.1	0.0479
548.65	0.015	194.9	0.0444
548.67	0.011	194.7	0.0408
548.68	0.01	194.6	0.0382
548.70	0.009	194.4	0.0346
548.72	0.005	194.1	0.0346
548.73	0.004	194.1	0.0293
548.75	0.004	194	0.0257
548.77	0.003	193.7	0.0222
548.78	-0.001	193.4	0.0178
548.80	-0.002	193.2	0.0142
548.82	-0.004	192.9	0.0107
548.83	-0.006	192.7	0.0107
548.85	-0.008	192.7	0.0071
548.87	-0.008	192.4	0.0036
548.88	-0.011	191.9	0.0009
548.90	-0.012	191.9	-0.0018
548.92	-0.012	191.7	-0.0036
548.93	-0.013	191.5	-0.0062
548.95	-0.014	191.2	-0.008
548.97	-0.015	191.1	-0.0107
548.98	-0.016	190.9	-0.0115
549.00	-0.016	190.7	-0.0115
549.02	-0.017	190.5	-0.0124

Prova triassiale ciclica SN04-C1			
pressione di confinamento (kPa)		80	
deviatore ciclico (kPa)		95	
frequenza (hz)		0.00625	
tempo	cella di carico	$\Delta u$	LVDT
(min)	kN	(kPa)	$\delta$ (mm)
549.03	-0.017	190.5	-0.0133
549.05	-0.017	190.4	-0.0142
549.07	-0.017	190.3	-0.0142
549.08	-0.017	190.2	-0.0142
549.10	-0.017	190.1	-0.0142
549.12	-0.016	190	-0.0142
549.13	-0.015	190	-0.0142
549.15	-0.015	190	-0.0133
549.17	-0.015	190	-0.0124
549.18	-0.014	190	-0.0107
549.20	-0.013	190	-0.0089
549.22	-0.011	190.1	-0.0071
549.23	-0.009	190.2	-0.0071
549.25	-0.008	190.3	-0.0044
549.27	-0.008	190.3	-0.0027
549.28	-0.007	190.4	0
549.30	-0.004	190.6	0.0036
549.32	-0.002	190.7	0.0071
549.33	-0.001	190.9	0.0107
549.35	0.002	191.1	0.0107
549.37	0.004	191.3	0.0142
549.38	0.004	191.3	0.0169
549.40	0.005	191.5	0.0213
549.42	0.008	191.8	0.0249
549.43	0.011	192	0.0302
549.45	0.012	192.2	0.0337
549.47	0.014	192.5	0.0337
549.48	0.017	192.7	0.0373
549.50	0.017	192.7	0.0408
549.52	0.017	192.9	0.0444
549.53	0.019	193.2	0.047
549.55	0.021	193.5	0.0506
549.57	0.022	193.7	0.0541
549.58	0.024	193.9	0.0541
549.60	0.026	194.1	0.0577
549.62	0.026	194.3	0.0586
549.63	0.027	194.5	0.0612
549.65	0.028	194.7	0.0612
549.67	0.028	194.7	0.0621
549.68	0.028	194.9	0.063
549.70	0.029	195	0.0648
549.72	0.029	195.1	0.0648
549.73	0.029	195.3	0.0648
549.77	0.029	195.4	0.0648
549.78	0.028	195.5	0.0648
549.80	0.028	195.5	0.0648
549.82	0.028	195.6	0.0639
549.82	0.027	195.6	0.063
549.83	0.026	195.6	0.0621
549.85	0.025	195.6	0.0604
549.87	0.024	195.6	0.0586
549.88	0.022	195.5	0.0586
549.90	0.021	195.5	0.0568
549.92	0.021	195.4	0.055
549.93	0.02	195.2	0.0515
549.95	0.016	195.1	0.0488
549.97	0.015	195	0.047
549.98	0.014	194.8	0.0426

Prova triassiale ciclica SN04-C1			
pressione di confinamento (kPa)		80	
deviatore ciclico (kPa)		95	
frequenza (hz)		0.00625	
tempo	cella di carico	$\Delta u$	LVDT
(min)	kN	(kPa)	$\delta$ (mm)
550.00	0.011	194.6	0.0426
550.02	0.01	194.6	0.0391
550.03	0.01	194.5	0.0364
550.05	0.008	194.3	0.032
550.07	0.004	194	0.0284
550.08	0.003	193.8	0.024
550.10	0.002	193.6	0.0204
550.12	-0.002	193.3	0.0204
550.13	-0.003	193.3	0.016
550.15	-0.003	193.1	0.0133
550.17	-0.004	192.8	0.0089
550.18	-0.007	192.5	0.0053
550.20	-0.008	192.3	0.0027
550.22	-0.01	192	-0.0009
550.23	-0.012	191.8	-0.0009
550.25	-0.013	191.8	-0.0036
550.27	-0.013	191.5	-0.0053
550.28	-0.014	191.3	-0.008
550.30	-0.015	191.1	-0.0098
550.32	-0.016	190.9	-0.0115
550.33	-0.016	190.7	-0.0124
550.35	-0.017	190.6	-0.0133
550.37	-0.017	190.4	-0.0142
550.38	-0.017	190.3	-0.0142
550.40	-0.017	190.2	-0.0142
550.42	-0.017	190.2	-0.0142
550.43	-0.017	190.1	-0.0142
550.45	-0.017	190	-0.0142
550.47	-0.016	190	-0.0133
550.48	-0.015	190	-0.0124
550.50	-0.015	190	-0.0115
550.52	-0.013	190	-0.0115
550.53	-0.012	190	-0.0098
550.55	-0.012	190	-0.008
550.57	-0.011	190.1	-0.0062
550.58	-0.009	190.2	-0.0036
550.60	-0.007	190.3	-0.0009
550.62	-0.006	190.4	0.0018
550.63	-0.003	190.6	0.0018
550.65	-0.001	190.8	0.0053
550.67	-0.001	190.8	0.0089
550.68	0	190.9	0.0115
550.70	0.003	191.2	0.0151
550.72	0.005	191.3	0.0186
550.73	0.006	191.5	0.0231
550.75	0.009	191.9	0.0231
550.77	0.012	192.1	0.0284
550.78	0.012	192.1	0.032
550.80	0.012	192.3	0.0346
550.82	0.015	192.6	0.0391
550.83	0.017	192.8	0.0426
550.85	0.018	193	0.0453
550.87	0.02	193.3	0.0488
550.88	0.022	193.5	0.0488
550.90	0.022	193.5	0.0524
550.92	0.023	193.7	0.0541
550.93	0.024	194	0.0568
550.95	0.026	194.2	0.0595

Prova triassiale ciclica SN04-C1			
pressione di confinamento (kPa)		80	
deviatore ciclico (kPa)		95	
frequenza (hz)		0.00625	
tempo	cella di carico	$\Delta u$	LVDT
(min)	kN	(kPa)	$\delta$ (mm)
550.97	0.027	194.4	0.0604
550.98	0.027	194.6	0.0621
551.00	0.028	194.8	0.0621
551.02	0.029	194.8	0.063
551.03	0.029	194.9	0.0639
551.05	0.029	195	0.0648
551.07	0.029	195.2	0.0648
551.08	0.029	195.3	0.0648
551.10	0.029	195.4	0.0648
551.12	0.028	195.5	0.0648
551.13	0.028	195.6	0.0648
551.15	0.027	195.6	0.063
551.17	0.025	195.6	0.063
551.18	0.024	195.6	0.0612
551.22	0.024	195.6	0.0604
551.23	0.024	195.5	0.0586
551.25	0.021	195.4	0.0559
551.27	0.021	195.4	0.0541
551.27	0.019	195.2	0.0506
551.28	0.016	195	0.0506
551.30	0.015	195	0.0479
551.32	0.015	194.9	0.0453
551.33	0.013	194.7	0.0417
551.35	0.01	194.5	0.0382
551.37	0.009	194.4	0.0346
551.38	0.007	194.1	0.0311
551.40	0.003	193.9	0.0311
551.42	0.002	193.9	0.0257
551.43	0.002	193.7	0.0222
551.45	0	193.5	0.0186
551.47	-0.003	193.2	0.0151
551.48	-0.003	193	0.0124
551.50	-0.005	192.7	0.008
551.52	-0.008	192.4	0.008
551.53	-0.009	192.4	0.0044
551.55	-0.009	192.1	0.0018
551.57	-0.01	191.9	-0.0027
551.58	-0.013	191.6	-0.0053
551.60	-0.013	191.4	-0.0062
551.62	-0.014	191.2	-0.0089
551.63	-0.016	191	-0.0089
551.65	-0.016	191	-0.0107
551.67	-0.016	190.8	-0.0115
551.68	-0.016	190.6	-0.0133
551.70	-0.018	190.5	-0.0142
551.72	-0.017	190.3	-0.0142
551.73	-0.017	190.2	-0.0142
551.75	-0.017	190.1	-0.0142
551.77	-0.017	190.1	-0.0142
551.78	-0.016	190	-0.0142
551.80	-0.016	190	-0.0142
551.82	-0.015	190	-0.0133
551.83	-0.015	189.9	-0.0124
551.85	-0.014	189.9	-0.0107
551.87	-0.012	190	-0.0098
551.88	-0.012	190	-0.0071
551.90	-0.01	190.1	-0.0053
551.92	-0.007	190.2	-0.0053

Prova triassiale ciclica SN04-C1			
pressione di confinamento (kPa)		80	
deviatore ciclico (kPa)		95	
frequenza (hz)		0.00625	
tempo	cella di carico	$\Delta u$	LVDT
(min)	kN	(kPa)	$\delta$ (mm)
551.93	-0.006	190.2	-0.0018
551.95	-0.006	190.3	0
551.97	-0.005	190.5	0.0027
551.98	-0.002	190.7	0.0062
552.00	-0.001	190.8	0.0098
552.02	0.001	191	0.0133
552.03	0.005	191.2	0.0133
552.05	0.005	191.2	0.0178
552.07	0.005	191.4	0.0213
552.08	0.007	191.6	0.0249
552.10	0.011	191.9	0.0302
552.12	0.012	192.1	0.0328
552.13	0.013	192.4	0.0373
552.15	0.017	192.7	0.0373
552.17	0.018	192.9	0.0408
552.18	0.018	192.9	0.0435
552.20	0.019	193.1	0.0479
552.22	0.021	193.4	0.0506
552.23	0.023	193.6	0.0533
552.25	0.023	193.8	0.0559
552.27	0.025	194.1	0.0559
552.28	0.026	194.3	0.0577
552.30	0.026	194.3	0.0595
552.32	0.027	194.4	0.0612
552.33	0.028	194.6	0.063
552.35	0.029	194.8	0.0639
552.37	0.029	194.9	0.0648
552.38	0.029	195.1	0.0648
552.40	0.029	195.2	0.0648
552.42	0.029	195.2	0.0648
552.43	0.029	195.3	0.0648
552.45	0.028	195.4	0.0648
552.47	0.028	195.5	0.0648
552.48	0.027	195.5	0.063
552.50	0.026	195.5	0.0621
552.52	0.024	195.5	0.0604
552.53	0.024	195.5	0.0595
552.55	0.023	195.4	0.0577
552.57	0.021	195.3	0.0577
552.58	0.019	195.3	0.055
552.60	0.019	195.2	0.0524
552.62	0.018	195.1	0.0497
552.63	0.015	195	0.047
552.67	0.014	194.8	0.0444
552.68	0.012	194.6	0.0408
552.70	0.009	194.4	0.0408
552.72	0.008	194.4	0.0364
552.72	0.008	194.3	0.0337
552.73	0.006	194	0.0293
552.75	0.003	193.8	0.0249
552.77	0.001	193.6	0.0213
552.78	0	193.3	0.0169
552.80	-0.004	193	0.0169
552.82	-0.005	193	0.0133
552.83	-0.005	192.8	0.0098
552.85	-0.006	192.6	0.0062
552.87	-0.009	192.2	0.0027
552.88	-0.009	192.1	0



Prova triassiale ciclica SN04-C1			
pressione di confinamento (kPa)		80	
deviatore ciclico (kPa)		95	
frequenza (hz)		0.00625	
tempo	cella di carico	$\Delta u$	LVDT
(min)	kN	(kPa)	$\delta$ (mm)
552.90	-0.011	191.8	-0.0036
552.92	-0.014	191.5	-0.0036
552.93	-0.014	191.5	-0.0062
552.95	-0.014	191.3	-0.0071
552.97	-0.015	191.2	-0.0098
552.98	-0.016	190.9	-0.0107
553.00	-0.016	190.7	-0.0115
553.02	-0.016	190.6	-0.0133
553.03	-0.017	190.4	-0.0133
553.05	-0.017	190.4	-0.0142
553.07	-0.017	190.3	-0.0142
553.08	-0.017	190.2	-0.0142
553.10	-0.017	190.1	-0.0142
553.12	-0.017	190	-0.0133
553.13	-0.016	190	-0.0124
553.15	-0.015	190	-0.0124
553.17	-0.014	190	-0.0115
553.18	-0.014	190	-0.0107
553.20	-0.013	190	-0.0089
553.22	-0.011	190.1	-0.0071
553.23	-0.01	190.1	-0.0053
553.25	-0.01	190.1	-0.0044
553.27	-0.007	190.3	-0.0018
553.28	-0.006	190.4	0.0009
553.30	-0.004	190.5	0.0053
553.32	-0.001	190.8	0.0053
553.33	0	190.9	0.0089
553.35	0	190.9	0.0115
553.37	0.002	191.1	0.0151
553.38	0.005	191.3	0.0195
553.40	0.007	191.5	0.0231
553.42	0.008	191.7	0.0275
553.43	0.011	192	0.0275
553.45	0.013	192.3	0.032
553.47	0.013	192.3	0.0346
553.48	0.014	192.5	0.0382
553.50	0.017	192.8	0.0426
553.52	0.019	193	0.0453
553.53	0.02	193.2	0.0497
553.55	0.022	193.5	0.0497
553.57	0.023	193.7	0.0524
553.58	0.023	193.7	0.0541
553.60	0.024	193.9	0.0568
553.62	0.025	194.2	0.0586
553.63	0.027	194.4	0.0612
553.65	0.027	194.5	0.0621
553.67	0.028	194.7	0.0621
553.68	0.028	194.9	0.063
553.70	0.028	194.9	0.0648
553.72	0.028	195	0.0648
553.73	0.029	195.1	0.0648
553.75	0.029	195.2	0.0657
553.77	0.029	195.4	0.0657
553.78	0.029	195.5	0.0657
553.80	0.027	195.5	0.0657
553.82	0.027	195.5	0.0639
553.83	0.027	195.5	0.063
553.85	0.026	195.5	0.0612

Prova triassiale ciclica SN04-C1			
pressione di confinamento (kPa)		80	
deviatore ciclico (kPa)		95	
frequenza (hz)		0.00625	
tempo	cella di carico	$\Delta u$	LVDT
(min)	kN	(kPa)	$\delta$ (mm)
553.87	0.024	195.5	0.0595
553.88	0.023	195.4	0.0577
553.90	0.022	195.4	0.0559
553.92	0.019	195.2	0.0559
553.93	0.018	195.2	0.0524
553.95	0.018	195.1	0.0497
553.97	0.015	194.9	0.0479
553.98	0.013	194.9	0.0462
554.00	0.013	194.7	0.0426
554.02	0.011	194.6	0.0391
554.03	0.008	194.3	0.0355
554.05	0.007	194.2	0.0328
554.07	0.005	193.9	0.0284
554.08	0.001	193.7	0.0284
554.10	0	193.7	0.0222
554.13	0	193.5	0.0195
554.15	-0.001	193.2	0.016
554.17	-0.004	192.9	0.0115
554.18	-0.005	192.7	0.0089
554.18	-0.006	192.4	0.0053
554.20	-0.01	192.1	0.0053
554.22	-0.01	192.1	0.0009
554.23	-0.01	191.9	-0.0009
554.25	-0.012	191.7	-0.0044
554.27	-0.014	191.4	-0.0062
554.28	-0.015	191.2	-0.008
554.30	-0.015	191	-0.0098
554.32	-0.016	190.8	-0.0098
554.33	-0.017	190.8	-0.0115
554.35	-0.017	190.6	-0.0124
554.37	-0.017	190.5	-0.0133
554.38	-0.017	190.3	-0.0142
554.40	-0.017	190.2	-0.0142
554.42	-0.017	190.1	-0.0142
554.43	-0.017	190.1	-0.0142
554.45	-0.016	190	-0.0142
554.47	-0.016	190	-0.0133
554.48	-0.016	190	-0.0124
554.50	-0.015	190	-0.0115
554.52	-0.014	190	-0.0098
554.53	-0.012	190	-0.008
554.55	-0.011	190.1	-0.008
554.57	-0.009	190.2	-0.0062
554.58	-0.009	190.2	-0.0044
554.60	-0.008	190.2	-0.0018
554.62	-0.006	190.4	0.0018
554.63	-0.004	190.5	0.0044
554.65	-0.003	190.6	0.008
554.67	0	190.9	0.008
554.68	0.002	191.1	0.0115
554.70	0.003	191.2	0.0169
554.72	0.005	191.4	0.0204
554.73	0.008	191.7	0.0204
554.75	0.008	191.7	0.024
554.77	0.009	191.8	0.0293
554.78	0.011	192.2	0.0328
554.80	0.014	192.4	0.0364
554.82	0.015	192.6	0.0399

Prova triassiale ciclica SN04-C1			
pressione di confinamento (kPa)		80	
deviatore ciclico (kPa)		95	
frequenza (hz)		0.00625	
tempo	cella di carico	$\Delta u$	LVDT
(min)	kN	(kPa)	$\delta$ (mm)
554.83	0.017	192.9	0.0444
554.85	0.02	193.1	0.0444
554.87	0.02	193.1	0.047
554.88	0.02	193.3	0.0497
554.90	0.022	193.6	0.0533
554.92	0.024	193.8	0.0559
554.93	0.025	194	0.0577
554.95	0.026	194.3	0.0595
554.97	0.027	194.5	0.0595
554.98	0.027	194.5	0.0612
555.00	0.027	194.6	0.063
555.02	0.028	194.8	0.0639
555.03	0.029	194.9	0.0648
555.05	0.029	195.1	0.0648
555.07	0.029	195.2	0.0657
555.08	0.029	195.3	0.0657
555.10	0.028	195.3	0.0657
555.12	0.028	195.4	0.0657
555.13	0.028	195.5	0.0648
555.15	0.027	195.5	0.0639
555.17	0.026	195.5	0.0621
555.18	0.025	195.5	0.0612
555.20	0.023	195.4	0.0612
555.22	0.022	195.4	0.0586
555.23	0.022	195.4	0.0568
555.25	0.021	195.3	0.0541
555.27	0.018	195.2	0.0515
555.28	0.017	195.1	0.0497
555.30	0.016	195	0.047
555.32	0.013	194.8	0.047
555.33	0.011	194.8	0.0435
555.35	0.011	194.6	0.0399
555.37	0.01	194.4	0.0355
555.38	0.006	194.2	0.032
555.40	0.005	194	0.0293
555.42	0.004	193.7	0.024
555.43	0.001	193.6	0.0222
555.45	0	193.4	0.0186
555.47	-0.002	193.1	0.0142
555.48	-0.005	192.8	0.0142
555.50	-0.006	192.8	0.0098
555.52	-0.006	192.6	0.0071
555.53	-0.007	192.3	0.0036
555.57	-0.01	192	0
555.58	-0.011	191.8	-0.0018
555.60	-0.012	191.6	-0.0044
555.62	-0.014	191.3	-0.0044
555.63	-0.015	191.1	-0.0071
555.63	-0.015	191.1	-0.0089
555.65	-0.015	190.9	-0.0107
555.67	-0.016	190.7	-0.0115
555.68	-0.017	190.6	-0.0133
555.70	-0.017	190.4	-0.0133
555.72	-0.017	190.3	-0.0133
555.73	-0.017	190.2	-0.0142
555.75	-0.017	190.2	-0.0142
555.77	-0.017	190.1	-0.0142
555.78	-0.017	190	-0.0133

Prova triassiale ciclica SN04-C1			
pressione di confinamento (kPa)		80	
deviatore ciclico (kPa)		95	
frequenza (hz)		0.00625	
tempo	cella di carico	$\Delta u$	LVDT
(min)	kN	(kPa)	$\delta$ (mm)
555.80	-0.016	190	-0.0133
555.82	-0.015	189.9	-0.0115
555.83	-0.014	190	-0.0107
555.85	-0.012	190	-0.0107
555.87	-0.012	190	-0.0098
555.88	-0.012	190	-0.0071
555.90	-0.011	190.1	-0.0053
555.92	-0.008	190.2	-0.0027
555.93	-0.007	190.2	-0.0009
555.95	-0.006	190.4	0.0027
555.97	-0.003	190.6	0.0027
555.98	-0.002	190.6	0.0062
556.00	-0.002	190.7	0.0089
556.02	0	191	0.0124
556.03	0.004	191.2	0.0169
556.05	0.005	191.3	0.0195
556.07	0.006	191.6	0.024
556.08	0.01	191.8	0.024
556.10	0.011	191.8	0.0284
556.12	0.011	192	0.032
556.13	0.012	192.3	0.0355
556.15	0.016	192.6	0.0399
556.17	0.016	192.7	0.0417
556.18	0.017	193	0.0453
556.20	0.021	193.2	0.0488
556.22	0.021	193.4	0.0506
556.23	0.022	193.7	0.0533
556.25	0.025	193.9	0.0533
556.27	0.025	193.9	0.0568
556.28	0.025	194.1	0.0586
556.30	0.026	194.3	0.0604
556.32	0.027	194.5	0.0621
556.33	0.028	194.7	0.063
556.35	0.028	194.8	0.0639
556.37	0.029	195	0.0639
556.38	0.029	195.1	0.0648
556.40	0.029	195.1	0.0657
556.42	0.029	195.2	0.0657
556.43	0.029	195.4	0.0657
556.45	0.028	195.4	0.0657
556.47	0.028	195.5	0.0639
556.48	0.027	195.5	0.0639
556.50	0.025	195.5	0.063
556.52	0.025	195.5	0.0621
556.53	0.025	195.5	0.0604
556.55	0.023	195.4	0.0577
556.57	0.021	195.4	0.0559
556.58	0.02	195.3	0.0533
556.60	0.018	195.1	0.0506
556.62	0.016	195	0.0506
556.63	0.016	195	0.0479
556.65	0.014	194.9	0.0453
556.67	0.012	194.6	0.0417
556.68	0.01	194.5	0.0382
556.70	0.009	194.3	0.0346
556.72	0.006	194.1	0.0311
556.73	0.003	193.8	0.0311
556.75	0.003	193.8	0.0275

Prova triassiale ciclica SN04-C1			
pressione di confinamento (kPa)		80	
deviatore ciclico (kPa)		95	
frequenza (hz)		0.00625	
tempo	cella di carico	$\Delta u$	LVDT
(min)	kN	(kPa)	$\delta$ (mm)
556.77	0.002	193.7	0.0231
556.78	0	193.3	0.0186
556.80	-0.003	193.1	0.0151
556.82	-0.004	192.9	0.0115
556.83	-0.005	192.6	0.008
556.85	-0.008	192.3	0.008
556.87	-0.009	192.1	0.0027
556.88	-0.009	191.9	0
556.90	-0.012	191.6	0
556.92	-0.013	191.6	-0.0027
556.93	-0.013	191.4	-0.0053
556.95	-0.014	191.2	-0.0071
556.97	-0.015	191	-0.0098
556.98	-0.016	190.8	-0.0107
557.00	-0.016	190.7	-0.0124
557.03	-0.017	190.5	-0.0124
557.05	-0.017	190.5	-0.0133
557.07	-0.017	190.3	-0.0133
557.08	-0.017	190.2	-0.0142
557.08	-0.017	190.1	-0.0142
557.10	-0.017	190	-0.0142
557.12	-0.017	190	-0.0133
557.13	-0.015	189.9	-0.0133
557.15	-0.015	189.9	-0.0124
557.17	-0.015	189.9	-0.0115
557.18	-0.014	189.9	-0.0098
557.20	-0.013	190	-0.0089
557.22	-0.011	190	-0.0071
557.23	-0.01	190	-0.0044
557.25	-0.008	190.2	-0.0044
557.27	-0.007	190.3	-0.0018
557.28	-0.007	190.3	0
557.30	-0.005	190.4	0.0036
557.32	-0.002	190.6	0.0071
557.33	0	190.8	0.0107
557.35	0.001	190.9	0.0142
557.37	0.004	191.2	0.0142
557.38	0.006	191.4	0.0178
557.40	0.006	191.4	0.0213
557.42	0.007	191.6	0.0257
557.43	0.01	191.9	0.0302
557.45	0.012	192.1	0.0337
557.47	0.013	192.3	0.0373
557.48	0.016	192.6	0.0408
557.50	0.018	192.8	0.0408
557.52	0.019	192.8	0.0444
557.53	0.019	193	0.047
557.55	0.02	193.3	0.0506
557.57	0.023	193.6	0.0533
557.58	0.023	193.8	0.0559
557.60	0.025	194	0.0586
557.62	0.026	194.2	0.0604
557.63	0.026	194.4	0.0604
557.65	0.027	194.6	0.0621
557.67	0.028	194.7	0.0621
557.68	0.028	194.7	0.0639
557.70	0.028	194.9	0.0648
557.72	0.029	195	0.0657

Prova triassiale ciclica SN04-C1			
pressione di confinamento (kPa)		80	
deviatore ciclico (kPa)		95	
frequenza (hz)		0.00625	
tempo	cella di carico	$\Delta u$	LVDT
(min)	kN	(kPa)	$\delta$ (mm)
557.73	0.029	195.1	0.0657
557.75	0.029	195.2	0.0657
557.77	0.029	195.4	0.0657
557.78	0.028	195.5	0.0657
557.80	0.027	195.5	0.0657
557.82	0.027	195.5	0.0648
557.83	0.027	195.5	0.063
557.85	0.025	195.5	0.0612
557.87	0.024	195.5	0.0604
557.88	0.023	195.4	0.0568
557.90	0.021	195.3	0.0568
557.92	0.019	195.2	0.055
557.93	0.019	195.2	0.0533
557.95	0.018	195.1	0.0506
557.97	0.016	194.9	0.0479
557.98	0.014	194.8	0.0444
558.00	0.012	194.7	0.0408
558.02	0.009	194.4	0.0408
558.03	0.007	194.2	0.0373
558.05	0.007	194.2	0.0337
558.07	0.006	194.1	0.0302
558.08	0.003	193.8	0.0257
558.10	0.001	193.6	0.0222
558.12	0	193.4	0.0178
558.13	-0.003	193	0.0178
558.15	-0.005	192.8	0.0142
558.17	-0.005	192.8	0.0107
558.18	-0.006	192.6	0.0071
558.20	-0.008	192.3	0.0036
558.22	-0.01	192	0.0009
558.23	-0.011	191.8	-0.0027
558.25	-0.012	191.5	-0.0044
558.27	-0.014	191.3	-0.0044
558.28	-0.014	191.3	-0.0071
558.30	-0.015	191.1	-0.0089
558.32	-0.016	190.7	-0.0107
558.33	-0.016	190.7	-0.0115
558.35	-0.016	190.6	-0.0124
558.37	-0.017	190.4	-0.0133
558.38	-0.017	190.3	-0.0133
558.40	-0.017	190.1	-0.0142
558.42	-0.017	190.1	-0.0142
558.43	-0.017	190	-0.0142
558.47	-0.016	190	-0.0133
558.48	-0.016	189.9	-0.0124
558.50	-0.016	189.9	-0.0115
558.52	-0.014	189.9	-0.0107
558.53	-0.014	189.9	-0.0089
558.53	-0.012	190	-0.008
558.55	-0.01	190	-0.008
558.57	-0.009	190	-0.0062
558.58	-0.009	190.1	-0.0036
558.60	-0.008	190.2	-0.0009
558.62	-0.005	190.4	0.0027
558.63	-0.004	190.4	0.0044
558.65	-0.003	190.6	0.008
558.67	0.001	190.8	0.008
558.68	0.002	190.8	0.0124

Prova triassiale ciclica SN04-C1			
pressione di confinamento (kPa)		80	
deviatore ciclico (kPa)		95	
frequenza (hz)		0.00625	
tempo	cella di carico	$\Delta u$	LVDT
(min)	kN	(kPa)	$\delta$ (mm)
558.70	0.002	191	0.0151
558.72	0.004	191.2	0.0186
558.73	0.007	191.5	0.0231
558.75	0.008	191.6	0.0275
558.77	0.01	191.9	0.032
558.78	0.013	192.2	0.032
558.80	0.015	192.4	0.0355
558.82	0.015	192.4	0.0391
558.83	0.016	192.6	0.0426
558.85	0.019	192.9	0.0462
558.87	0.02	193.1	0.0488
558.88	0.021	193.3	0.0524
558.90	0.023	193.6	0.0524
558.92	0.024	193.9	0.055
558.93	0.024	193.9	0.0568
558.95	0.025	194	0.0595
558.97	0.026	194.3	0.0612
558.98	0.027	194.5	0.063
559.00	0.028	194.6	0.0639
559.02	0.028	194.8	0.0639
559.03	0.029	194.9	0.0648
559.05	0.029	195.1	0.0657
559.07	0.029	195.2	0.0657
559.08	0.029	195.3	0.0657
559.10	0.028	195.3	0.0657
559.12	0.028	195.4	0.0657
559.13	0.028	195.5	0.0657
559.15	0.027	195.5	0.0639
559.17	0.026	195.5	0.063
559.18	0.025	195.4	0.0604
559.20	0.023	195.4	0.0604
559.22	0.022	195.4	0.0595
559.23	0.022	195.4	0.0577
559.25	0.021	195.3	0.0559
559.27	0.019	195.2	0.0533
559.28	0.017	195	0.0497
559.30	0.016	194.9	0.047
559.32	0.012	194.7	0.047
559.33	0.011	194.7	0.0435
559.35	0.011	194.6	0.0408
559.37	0.01	194.4	0.0364
559.38	0.006	194.1	0.0328
559.40	0.005	194	0.0302
559.42	0.004	193.7	0.0249
559.43	0	193.4	0.0249
559.45	-0.001	193.4	0.0204
559.47	-0.001	193.2	0.0169
559.48	-0.002	193	0.0142
559.50	-0.006	192.7	0.0098
559.52	-0.007	192.5	0.0071
559.53	-0.008	192.2	0.0027
559.55	-0.011	191.9	0.0027
559.57	-0.012	191.9	0
559.58	-0.012	191.7	-0.0018
559.60	-0.013	191.5	-0.0053
559.62	-0.014	191.2	-0.0071
559.63	-0.015	191	-0.0089
559.65	-0.015	190.8	-0.0098

Prova triassiale ciclica SN04-C1			
pressione di confinamento (kPa)		80	
deviatore ciclico (kPa)		95	
frequenza (hz)		0.00625	
tempo	cella di carico	$\Delta u$	LVDT
(min)	kN	(kPa)	$\delta$ (mm)
559.67	-0.016	190.6	-0.0098
559.68	-0.017	190.5	-0.0124
559.70	-0.017	190.5	-0.0124
559.72	-0.017	190.3	-0.0133
559.73	-0.017	190.2	-0.0133
559.75	-0.017	190.1	-0.0133
559.77	-0.017	190	-0.0133
559.78	-0.016	190	-0.0124
559.80	-0.016	189.9	-0.0124
559.82	-0.015	189.9	-0.0115
559.83	-0.015	189.9	-0.0098
559.85	-0.013	189.9	-0.0098
559.87	-0.012	189.9	-0.0089
559.88	-0.012	189.9	-0.0071
559.90	-0.011	190	-0.0044
559.93	-0.009	190.1	-0.0027
559.95	-0.007	190.2	0
559.97	-0.006	190.4	0.0027
559.98	-0.003	190.5	0.0027
559.98	-0.001	190.5	0.0062
560.00	-0.001	190.7	0.0098
560.02	0	190.9	0.0124
560.03	0.003	191.1	0.0169
560.05	0.004	191.3	0.0204
560.07	0.006	191.5	0.024
560.08	0.01	191.8	0.024
560.10	0.011	191.8	0.0293
560.12	0.011	192	0.0328
560.13	0.012	192.3	0.0364
560.15	0.016	192.5	0.0399
560.17	0.017	192.7	0.0435
560.18	0.018	193	0.047
560.20	0.021	193.2	0.047
560.22	0.022	193.2	0.0506
560.23	0.022	193.4	0.0524
560.25	0.023	193.7	0.055
560.27	0.025	193.9	0.0577
560.28	0.025	194.1	0.0595
560.30	0.026	194.3	0.0621
560.32	0.028	194.5	0.0621
560.33	0.028	194.5	0.0639
560.35	0.028	194.7	0.0639
560.37	0.028	194.8	0.0648
560.38	0.029	195	0.0657
560.40	0.029	195.1	0.0657
560.42	0.029	195.2	0.0657
560.43	0.028	195.3	0.0657
560.45	0.028	195.4	0.0657
560.47	0.028	195.4	0.0657
560.48	0.027	195.4	0.0648
560.50	0.025	195.4	0.063
560.52	0.025	195.4	0.0621
560.53	0.025	195.4	0.0604
560.55	0.023	195.4	0.0586
560.57	0.021	195.3	0.0568
560.58	0.02	195.2	0.0541
560.60	0.018	195.1	0.0541
560.62	0.016	195	0.0515



Prova triassiale ciclica SN04-C1			
pressione di confinamento (kPa)		80	
deviatore ciclico (kPa)		95	
frequenza (hz)		0.00625	
tempo	cella di carico	$\Delta u$	LVDT
(min)	kN	(kPa)	$\delta$ (mm)
560.63	0.016	195	0.0488
560.65	0.015	194.9	0.0462
560.67	0.012	194.6	0.0426
560.68	0.01	194.4	0.0391
560.70	0.009	194.3	0.0355
560.72	0.006	194	0.0355
560.73	0.004	193.8	0.0311
560.75	0.004	193.8	0.0284
560.77	0.002	193.6	0.0231
560.78	0	193.3	0.0195
560.80	-0.003	193.1	0.0151
560.82	-0.004	192.9	0.0124
560.83	-0.006	192.5	0.0124
560.85	-0.008	192.3	0.008
560.87	-0.008	192.3	0.0044
560.88	-0.009	192.1	0.0018
560.90	-0.011	191.8	-0.0018
560.92	-0.013	191.5	-0.0036
560.93	-0.013	191.3	-0.0062
560.95	-0.014	191.1	-0.008
560.97	-0.016	190.9	-0.008
560.98	-0.016	190.9	-0.0098
561.00	-0.016	190.7	-0.0107
561.02	-0.016	190.6	-0.0115
561.03	-0.017	190.4	-0.0133
561.05	-0.017	190.3	-0.0133
561.07	-0.017	190.1	-0.0133
561.08	-0.017	190.1	-0.0133
561.10	-0.017	190.1	-0.0133
561.12	-0.017	190	-0.0133
561.13	-0.016	189.9	-0.0124
561.15	-0.015	189.9	-0.0115
561.17	-0.015	189.9	-0.0107
561.18	-0.014	189.9	-0.0089
561.20	-0.012	190	-0.0089
561.22	-0.011	190	-0.0071
561.23	-0.009	190.1	-0.0044
561.25	-0.008	190.1	-0.0044
561.27	-0.007	190.1	-0.0018
561.28	-0.007	190.2	0.0009
561.30	-0.005	190.4	0.0044
561.32	-0.002	190.6	0.0071
561.33	-0.001	190.7	0.0098
561.35	0.001	191	0.0142
561.37	0.005	191.2	0.0142
561.40	0.005	191.2	0.0186
561.42	0.005	191.3	0.0213
561.43	0.007	191.6	0.0257
561.43	0.011	191.9	0.0311
561.45	0.012	192.1	0.0337
561.47	0.013	192.3	0.0373
561.48	0.017	192.6	0.0373
561.50	0.018	192.6	0.0417
561.52	0.018	192.8	0.0453
561.53	0.019	193.1	0.0479
561.55	0.022	193.3	0.0515
561.57	0.023	193.5	0.0533
561.58	0.023	193.7	0.0559

Prova triassiale ciclica SN04-C1			
pressione di confinamento (kPa)		80	
deviatore ciclico (kPa)		95	
frequenza (hz)		0.00625	
tempo	cella di carico	$\Delta u$	LVDT
(min)	kN	(kPa)	$\delta$ (mm)
561.60	0.026	194	0.0559
561.62	0.026	194	0.0586
561.63	0.026	194.2	0.0604
561.65	0.027	194.4	0.0621
561.67	0.028	194.6	0.0639
561.68	0.028	194.7	0.0648
561.70	0.028	194.9	0.0648
561.72	0.029	195	0.0648
561.73	0.029	195	0.0657
561.75	0.029	195.1	0.0657
561.77	0.029	195.2	0.0657
561.78	0.029	195.4	0.0657
561.80	0.028	195.4	0.0648
561.82	0.027	195.4	0.0639
561.83	0.025	195.4	0.0639
561.85	0.024	195.4	0.0621
561.87	0.024	195.4	0.0612
561.88	0.023	195.4	0.0595
561.90	0.022	195.2	0.0568
561.92	0.02	195.2	0.055
561.93	0.019	195.1	0.0524
561.95	0.016	194.9	0.0488
561.97	0.015	194.8	0.047
561.98	0.014	194.7	0.0444
562.00	0.011	194.5	0.0444
562.02	0.009	194.3	0.0408
562.03	0.009	194.3	0.0373
562.05	0.008	194.2	0.0337
562.07	0.005	193.9	0.0302
562.08	0.003	193.7	0.0257
562.10	0.001	193.5	0.0213
562.12	-0.001	193.2	0.0213
562.13	-0.003	192.9	0.0178
562.15	-0.003	192.9	0.0142
562.17	-0.005	192.7	0.0098
562.18	-0.006	192.4	0.0062
562.20	-0.009	192.2	0.0036
562.22	-0.01	191.9	0.0009
562.23	-0.011	191.6	-0.0027
562.25	-0.013	191.4	-0.0027
562.27	-0.013	191.4	-0.0053
562.28	-0.014	191.2	-0.0071
562.30	-0.015	191	-0.0089
562.32	-0.016	190.8	-0.0107
562.33	-0.016	190.6	-0.0115
562.35	-0.017	190.5	-0.0124
562.37	-0.017	190.3	-0.0124
562.38	-0.017	190.3	-0.0133
562.40	-0.017	190.2	-0.0133
562.42	-0.017	190.1	-0.0133
562.43	-0.017	190	-0.0133
562.45	-0.016	189.9	-0.0124
562.47	-0.016	189.9	-0.0115
562.48	-0.015	189.9	-0.0115
562.50	-0.015	189.9	-0.0115
562.52	-0.015	189.9	-0.0098
562.53	-0.013	190	-0.008
562.55	-0.011	190	-0.0062

Prova triassiale ciclica SN04-C1			
pressione di confinamento (kPa)		80	
deviatore ciclico (kPa)		95	
frequenza (hz)		0.00625	
tempo	cella di carico	$\Delta u$	LVDT
(min)	kN	(kPa)	$\delta$ (mm)
562.57	-0.01	190	-0.0044
562.58	-0.009	190.2	-0.0018
562.60	-0.006	190.3	-0.0018
562.62	-0.005	190.3	0.0009
562.63	-0.005	190.4	0.0036
562.65	-0.003	190.6	0.0071
562.67	0	190.8	0.0107
562.68	0.001	190.9	0.0133
562.70	0.001	191.1	0.0151
562.72	0.005	191.3	0.0195
562.73	0.006	191.5	0.0231
562.75	0.008	191.7	0.0284
562.77	0.012	192	0.0284
562.78	0.012	192	0.0328
562.80	0.012	192.2	0.0355
562.83	0.014	192.4	0.0391
562.85	0.018	192.7	0.0435
562.87	0.018	192.9	0.0462
562.88	0.02	193.2	0.0497
562.90	0.022	193.4	0.0497
562.90	0.023	193.4	0.0524
562.92	0.023	193.6	0.055
562.93	0.024	193.9	0.0577
562.95	0.026	194.1	0.0604
562.97	0.027	194.3	0.0612
562.98	0.027	194.5	0.063
563.00	0.028	194.7	0.063
563.02	0.029	194.7	0.0639
563.03	0.029	194.8	0.0648
563.05	0.029	194.9	0.0657
563.07	0.029	195.1	0.0657
563.08	0.029	195.2	0.0657
563.10	0.029	195.3	0.0657
563.12	0.028	195.4	0.0657
563.13	0.028	195.4	0.0657
563.15	0.028	195.4	0.0648
563.17	0.026	195.4	0.063
563.18	0.025	195.4	0.0612
563.20	0.024	195.4	0.0604
563.22	0.023	195.4	0.0577
563.23	0.021	195.2	0.0577
563.25	0.02	195.2	0.0559
563.27	0.02	195.2	0.0541
563.28	0.018	195.1	0.0506
563.30	0.015	194.9	0.047
563.32	0.013	194.7	0.0444
563.33	0.012	194.6	0.0408
563.35	0.009	194.3	0.0408
563.37	0.007	194.2	0.0373
563.38	0.007	194.2	0.0346
563.40	0.006	194	0.0302
563.42	0.002	193.5	0.0257
563.43	0.002	193.5	0.024
563.45	0.001	193.4	0.0195
563.47	-0.002	193	0.016
563.48	-0.004	192.8	0.0124
563.50	-0.005	192.6	0.0089
563.52	-0.007	192.3	0.0053

Prova triassiale ciclica SN04-C1			
pressione di confinamento (kPa)		80	
deviatore ciclico (kPa)		95	
frequenza (hz)		0.00625	
tempo	cella di carico	$\Delta u$	LVDT
(min)	kN	(kPa)	$\delta$ (mm)
563.53	-0.01	192	0.0053
563.55	-0.01	192	0.0018
563.57	-0.01	191.8	-0.0009
563.58	-0.012	191.5	-0.0036
563.60	-0.014	191.3	-0.0062
563.62	-0.014	191.1	-0.008
563.63	-0.015	190.9	-0.0098
563.65	-0.016	190.7	-0.0098
563.67	-0.016	190.7	-0.0115
563.68	-0.016	190.5	-0.0124
563.70	-0.017	190.4	-0.0124
563.72	-0.017	190.2	-0.0133
563.73	-0.017	190.1	-0.0142
563.75	-0.017	190	-0.0133
563.77	-0.017	190	-0.0133
563.78	-0.016	190	-0.0133
563.80	-0.016	189.9	-0.0124
563.82	-0.016	189.9	-0.0115
563.83	-0.014	189.9	-0.0107
563.85	-0.013	189.9	-0.0089
563.87	-0.013	189.9	-0.0071
563.88	-0.01	190	-0.0071
563.90	-0.01	190	-0.0053
563.92	-0.01	190	-0.0036
563.93	-0.008	190.1	-0.0009
563.95	-0.005	190.3	0.0027
563.97	-0.004	190.4	0.0044
563.98	-0.003	190.6	0.0089
564.00	0.001	190.8	0.0089
564.02	0.002	191	0.0124
564.03	0.002	191	0.0151
564.05	0.003	191.2	0.0186
564.07	0.007	191.4	0.0231
564.08	0.009	191.6	0.0275
564.10	0.01	191.8	0.0311
564.12	0.013	192.1	0.0311
564.13	0.014	192.3	0.0382
564.15	0.015	192.5	0.0408
564.17	0.017	192.8	0.0408
564.18	0.019	193	0.0444
564.20	0.019	193	0.047
564.22	0.02	193.3	0.0506
564.23	0.023	193.5	0.0541
564.25	0.024	193.7	0.0559
564.27	0.024	193.9	0.0586
564.30	0.026	194.2	0.0586
564.32	0.027	194.4	0.0604
564.33	0.027	194.4	0.0621
564.35	0.027	194.5	0.063
564.35	0.028	194.7	0.0648
564.37	0.028	194.8	0.0648
564.38	0.029	195	0.0657
564.40	0.029	195.1	0.0657
564.42	0.029	195.2	0.0657
564.43	0.029	195.2	0.0657
564.45	0.029	195.3	0.0657
564.47	0.028	195.4	0.0657
564.48	0.027	195.4	0.0639

Prova triassiale ciclica SN04-C1			
pressione di confinamento (kPa)		80	
deviatore ciclico (kPa)		95	
frequenza (hz)		0.00625	
tempo	cella di carico	$\Delta u$	LVDT
(min)	kN	(kPa)	$\delta$ (mm)
564.50	0.026	195.4	0.063
564.52	0.025	195.4	0.0612
564.53	0.023	195.4	0.0612
564.55	0.022	195.4	0.0595
564.57	0.022	195.3	0.0577
564.58	0.021	195.2	0.055
564.60	0.018	195.1	0.0524
564.62	0.017	195	0.0497
564.63	0.016	194.8	0.047
564.65	0.012	194.6	0.047
564.67	0.011	194.6	0.0426
564.68	0.011	194.5	0.0399
564.70	0.01	194.3	0.0364
564.72	0.005	194.1	0.032
564.73	0.005	193.9	0.0302
564.75	0.004	193.6	0.0249
564.77	0	193.4	0.0249
564.78	-0.001	193.4	0.0204
564.80	-0.001	193.2	0.0178
564.82	-0.003	192.9	0.0133
564.83	-0.006	192.6	0.0098
564.85	-0.007	192.4	0.0062
564.87	-0.008	192.1	0.0036
564.88	-0.01	191.9	0.0018
564.90	-0.011	191.7	-0.0009
564.92	-0.012	191.5	-0.0044
564.93	-0.014	191.2	-0.0044
564.95	-0.015	191	-0.0062
564.97	-0.015	191	-0.008
564.98	-0.015	190.8	-0.0098
565.00	-0.016	190.6	-0.0115
565.02	-0.017	190.4	-0.0124
565.03	-0.017	190.3	-0.0124
565.05	-0.017	190.2	-0.0124
565.07	-0.017	190.1	-0.0133
565.08	-0.017	190.1	-0.0133
565.10	-0.017	190	-0.0133
565.12	-0.017	189.9	-0.0133
565.13	-0.016	189.9	-0.0124
565.15	-0.015	189.9	-0.0107
565.17	-0.014	189.9	-0.0107
565.18	-0.013	189.9	-0.0098
565.20	-0.013	189.9	-0.0089
565.22	-0.012	189.9	-0.0062
565.23	-0.01	190	-0.0044
565.25	-0.008	190.1	-0.0018
565.27	-0.007	190.2	0
565.28	-0.006	190.3	0.0027
565.30	-0.003	190.5	0.0027
565.32	-0.002	190.5	0.0062
565.33	-0.002	190.6	0.0098
565.35	0	190.9	0.0133
565.37	0.003	191.1	0.0169
565.38	0.005	191.2	0.0204
565.40	0.006	191.5	0.024
565.42	0.01	191.7	0.024
565.43	0.011	191.7	0.0293
565.45	0.011	191.9	0.0328

Prova triassiale ciclica SN04-C1			
pressione di confinamento (kPa)		80	
deviatore ciclico (kPa)		95	
frequenza (hz)		0.00625	
tempo	cella di carico	$\Delta u$	LVDT
(min)	kN	(kPa)	$\delta$ (mm)
565.47	0.013	192.2	0.0364
565.48	0.016	192.5	0.0399
565.50	0.017	192.7	0.0435
565.52	0.018	193	0.047
565.53	0.021	193.2	0.047
565.55	0.022	193.2	0.0506
565.57	0.022	193.4	0.0524
565.58	0.024	193.8	0.0559
565.60	0.025	193.8	0.0568
565.62	0.025	194	0.0595
565.63	0.026	194.2	0.0612
565.65	0.027	194.4	0.063
565.67	0.028	194.6	0.0639
565.68	0.028	194.8	0.0648
565.70	0.029	194.9	0.0648
565.73	0.029	194.9	0.0657
565.75	0.029	195	0.0657
565.77	0.029	195.1	0.0657
565.78	0.029	195.2	0.0657
565.80	0.028	195.3	0.0657
565.80	0.028	195.4	0.0648
565.82	0.027	195.4	0.0648
565.83	0.025	195.4	0.0639
565.85	0.025	195.4	0.0621
565.87	0.025	195.4	0.0604
565.88	0.023	195.3	0.0586
565.90	0.021	195.2	0.0568
565.92	0.02	195.2	0.0541
565.93	0.018	195	0.0541
565.95	0.016	194.9	0.0506
565.97	0.016	194.9	0.0488
565.98	0.015	194.8	0.0453
566.00	0.012	194.6	0.0417
566.02	0.01	194.4	0.0391
566.03	0.009	194.2	0.0355
566.05	0.006	194	0.0355
566.07	0.004	193.8	0.0311
566.08	0.004	193.8	0.0275
566.10	0.002	193.6	0.0231
566.12	-0.001	193.3	0.0186
566.13	-0.002	193	0.016
566.15	-0.004	192.8	0.0124
566.17	-0.006	192.5	0.0124
566.18	-0.008	192.2	0.0089
566.20	-0.008	192.2	0.0053
566.22	-0.009	192	0.0018
566.23	-0.011	191.7	-0.0009
566.25	-0.012	191.5	-0.0036
566.27	-0.013	191.3	-0.0053
566.28	-0.014	191	-0.0053
566.30	-0.016	190.8	-0.008
566.32	-0.016	190.7	-0.0107
566.33	-0.016	190.5	-0.0115
566.35	-0.017	190.4	-0.0115
566.37	-0.017	190.4	-0.0124
566.38	-0.017	190.2	-0.0133
566.40	-0.017	190.1	-0.0133
566.42	-0.017	190	-0.0133

Prova triassiale ciclica SN04-C1			
pressione di confinamento (kPa)		80	
deviatore ciclico (kPa)		95	
frequenza (hz)		0.00625	
tempo	cella di carico	$\Delta u$	LVDT
(min)	kN	(kPa)	$\delta$ (mm)
566.43	-0.017	189.9	-0.0133
566.45	-0.016	189.9	-0.0124
566.47	-0.015	189.8	-0.0124
566.48	-0.015	189.8	-0.0115
566.50	-0.015	189.8	-0.0107
566.52	-0.014	189.9	-0.0089
566.53	-0.012	189.9	-0.008
566.55	-0.011	189.9	-0.0053
566.57	-0.01	190	-0.0036
566.58	-0.007	190.1	-0.0036
566.60	-0.006	190.1	-0.0009
566.62	-0.006	190.2	0.0009
566.63	-0.005	190.4	0.0044
566.65	-0.002	190.6	0.008
566.67	-0.001	190.7	0.0107
566.68	0.001	190.9	0.0142
566.70	0.004	191.2	0.0142
566.72	0.005	191.2	0.0186
566.73	0.005	191.3	0.0213
566.75	0.007	191.6	0.0257
566.77	0.011	191.8	0.0311
566.78	0.012	192	0.0346
566.80	0.014	192.3	0.0382
566.82	0.017	192.6	0.0382
566.83	0.017	192.6	0.0417
566.85	0.017	192.8	0.0453
566.87	0.019	193.1	0.0488
566.88	0.022	193.3	0.0515
566.90	0.022	193.5	0.0541
566.92	0.023	193.7	0.0568
566.93	0.026	194	0.0568
566.95	0.026	194	0.0595
566.97	0.026	194.2	0.0612
566.98	0.027	194.3	0.0621
567.00	0.028	194.5	0.0639
567.02	0.028	194.7	0.0648
567.03	0.029	194.8	0.0657
567.05	0.029	195	0.0657
567.07	0.029	195.1	0.0657
567.08	0.029	195.2	0.0666
567.10	0.029	195.3	0.0666
567.12	0.028	195.4	0.0666
567.13	0.028	195.4	0.0657
567.15	0.027	195.4	0.0648
567.17	0.026	195.4	0.063
567.20	0.025	195.4	0.0621
567.22	0.024	195.4	0.0604
567.23	0.023	195.3	0.0604
567.25	0.021	195.2	0.0577
567.25	0.021	195.2	0.0559
567.27	0.02	195.1	0.0533
567.28	0.017	195	0.0506
567.30	0.015	194.9	0.047
567.32	0.014	194.7	0.0444
567.33	0.012	194.5	0.0444
567.35	0.009	194.3	0.0408
567.37	0.009	194.3	0.0373
567.38	0.008	194.2	0.0337

Prova triassiale ciclica SN04-C1			
pressione di confinamento (kPa)		80	
deviatore ciclico (kPa)		95	
frequenza (hz)		0.00625	
tempo	cella di carico	$\Delta u$	LVDT
(min)	kN	(kPa)	$\delta$ (mm)
567.40	0.005	193.9	0.0302
567.42	0.003	193.7	0.0257
567.43	0.002	193.5	0.0213
567.45	-0.001	193.2	0.0213
567.47	-0.004	192.9	0.0178
567.48	-0.004	192.9	0.0142
567.50	-0.004	192.7	0.0107
567.52	-0.007	192.4	0.0071
567.53	-0.009	192.1	0.0036
567.55	-0.01	191.9	0.0009
567.57	-0.011	191.6	0.0009
567.58	-0.013	191.4	-0.0027
567.60	-0.013	191.4	-0.0044
567.62	-0.014	191.2	-0.0071
567.63	-0.015	191	-0.0089
567.65	-0.016	190.8	-0.0098
567.67	-0.016	190.6	-0.0107
567.68	-0.017	190.4	-0.0115
567.70	-0.017	190.3	-0.0115
567.72	-0.017	190.3	-0.0133
567.73	-0.017	190.2	-0.0133
567.75	-0.017	190.1	-0.0133
567.77	-0.017	190	-0.0133
567.78	-0.017	189.9	-0.0133
567.80	-0.016	189.8	-0.0124
567.82	-0.015	189.8	-0.0115
567.83	-0.014	189.8	-0.0107
567.85	-0.014	189.8	-0.0089
567.87	-0.012	189.9	-0.0089
567.88	-0.011	189.9	-0.0071
567.90	-0.011	189.9	-0.0053
567.92	-0.01	190	-0.0027
567.93	-0.007	190.2	0
567.95	-0.006	190.2	0.0027
567.97	-0.004	190.4	0.0062
567.98	-0.001	190.6	0.0062
568.00	0	190.6	0.0098
568.02	0	190.8	0.0124
568.03	0.002	190.9	0.016
568.05	0.005	191.2	0.0204
568.07	0.007	191.4	0.0231
568.08	0.008	191.6	0.0284
568.10	0.012	191.9	0.0284
568.12	0.013	192.1	0.0328
568.13	0.013	192.1	0.0355
568.15	0.014	192.3	0.0399
568.17	0.017	192.6	0.0435
568.18	0.019	192.9	0.0462
568.20	0.02	193.1	0.0497
568.22	0.022	193.4	0.0497
568.23	0.023	193.6	0.0533
568.25	0.023	193.6	0.055
568.27	0.024	193.8	0.0577
568.28	0.026	194	0.0595
568.30	0.026	194.2	0.0612
568.32	0.027	194.4	0.063
568.33	0.028	194.6	0.063
568.35	0.029	194.7	0.0648



Prova triassiale ciclica SN04-C1			
pressione di confinamento (kPa)		80	
deviatore ciclico (kPa)		95	
frequenza (hz)		0.00625	
tempo	cella di carico	$\Delta u$	LVDT
(min)	kN	(kPa)	$\delta$ (mm)
568.37	0.029	194.7	0.0657
568.38	0.029	194.9	0.0657
568.40	0.029	195	0.0657
568.42	0.029	195.1	0.0657
568.43	0.029	195.2	0.0657
568.45	0.028	195.3	0.0657
568.47	0.027	195.4	0.0657
568.48	0.027	195.4	0.0648
568.50	0.026	195.4	0.063
568.52	0.025	195.4	0.063
568.53	0.025	195.4	0.0612
568.55	0.024	195.4	0.0586
568.57	0.022	195.2	0.0568
568.58	0.019	195.1	0.0541
568.60	0.019	195.1	0.0524
568.63	0.017	194.9	0.0488
568.65	0.014	194.7	0.0488
568.67	0.014	194.7	0.0462
568.68	0.013	194.6	0.0435
568.70	0.011	194.4	0.0399
568.70	0.008	194.2	0.0355
568.72	0.007	194	0.032
568.73	0.005	193.8	0.0284
568.75	0.002	193.5	0.0284
568.77	0.002	193.5	0.024
568.78	0.001	193.3	0.0195
568.80	-0.002	193	0.016
568.82	-0.004	192.8	0.0124
568.83	-0.005	192.6	0.0089
568.85	-0.007	192.2	0.0053
568.87	-0.01	192	0.0053
568.88	-0.01	192	0.0018
568.90	-0.01	191.8	0
568.92	-0.011	191.5	-0.0036
568.93	-0.014	191.3	-0.0062
568.95	-0.014	191.1	-0.0071
568.97	-0.015	190.9	-0.0089
568.98	-0.016	190.7	-0.0089
569.00	-0.017	190.7	-0.0107
569.02	-0.017	190.5	-0.0115
569.03	-0.017	190.4	-0.0124
569.05	-0.017	190.2	-0.0133
569.07	-0.017	190.1	-0.0133
569.08	-0.017	190	-0.0133
569.10	-0.017	189.9	-0.0133
569.12	-0.016	189.9	-0.0133
569.13	-0.016	189.9	-0.0124
569.15	-0.016	189.8	-0.0115
569.17	-0.014	189.8	-0.0107
569.18	-0.014	189.8	-0.0098
569.20	-0.013	189.9	-0.0071
569.22	-0.01	190	-0.0053
569.23	-0.01	190	-0.0036
569.25	-0.009	190.1	-0.0018
569.27	-0.006	190.2	-0.0018
569.28	-0.005	190.2	0.0009
569.30	-0.005	190.3	0.0036
569.32	-0.004	190.5	0.0071

Prova triassiale ciclica SN04-C1			
pressione di confinamento (kPa)		80	
deviatore ciclico (kPa)		95	
frequenza (hz)		0.00625	
tempo	cella di carico	$\Delta u$	LVDT
(min)	kN	(kPa)	$\delta$ (mm)
569.33	0	190.7	0.0107
569.35	0.001	190.8	0.0133
569.37	0.003	191	0.0178
569.38	0.006	191.3	0.0178
569.40	0.008	191.3	0.0222
569.42	0.008	191.5	0.0249
569.43	0.009	191.7	0.0302
569.45	0.013	192	0.0337
569.47	0.013	192.2	0.0364
569.48	0.015	192.4	0.0408
569.50	0.018	192.7	0.0408
569.52	0.019	193	0.0453
569.53	0.019	193	0.0479
569.55	0.021	193.2	0.0506
569.57	0.022	193.5	0.0541
569.58	0.024	193.7	0.0559
569.60	0.025	193.9	0.0586
569.62	0.026	194.1	0.0586
569.63	0.027	194.3	0.0604
569.65	0.027	194.3	0.0621
569.67	0.027	194.4	0.063
569.68	0.028	194.6	0.0648
569.70	0.029	194.8	0.0657
569.72	0.029	194.9	0.0657
569.73	0.029	195	0.0657
569.75	0.029	195.1	0.0657
569.77	0.029	195.1	0.0657
569.78	0.029	195.2	0.0657
569.80	0.028	195.3	0.0657
569.82	0.027	195.4	0.0639
569.83	0.026	195.4	0.063
569.85	0.025	195.4	0.0612
569.87	0.023	195.3	0.0612
569.88	0.022	195.3	0.0595
569.90	0.022	195.3	0.0577
569.92	0.021	195.1	0.055
569.93	0.018	195	0.0524
569.95	0.017	195	0.0506
569.97	0.017	194.8	0.0479
569.98	0.013	194.7	0.0453
570.00	0.012	194.6	0.0426
570.02	0.011	194.4	0.0382
570.03	0.007	194.1	0.0382
570.05	0.006	194.1	0.0337
570.07	0.006	193.9	0.0311
570.10	0.004	193.7	0.0275
570.12	0.001	193.4	0.0222
570.13	0	193.2	0.0195
570.15	-0.002	193	0.0151
570.15	-0.005	192.7	0.0151
570.17	-0.006	192.4	0.0107
570.18	-0.006	192.4	0.008
570.20	-0.007	192.2	0.0044
570.22	-0.01	191.9	0.0009
570.23	-0.011	191.7	-0.0018
570.25	-0.012	191.5	-0.0044
570.27	-0.014	191.2	-0.0044
570.28	-0.015	191	-0.0062

Prova triassiale ciclica SN04-C1			
pressione di confinamento (kPa)		80	
deviatore ciclico (kPa)		95	
frequenza (hz)		0.00625	
tempo	cella di carico	$\Delta u$	LVDT
(min)	kN	(kPa)	$\delta$ (mm)
570.30	-0.015	191	-0.0089
570.32	-0.015	190.8	-0.0098
570.33	-0.016	190.6	-0.0115
570.35	-0.017	190.4	-0.0124
570.37	-0.017	190.3	-0.0124
570.38	-0.017	190.1	-0.0124
570.40	-0.017	190	-0.0133
570.42	-0.017	190	-0.0133
570.43	-0.017	190	-0.0133
570.45	-0.017	189.9	-0.0124
570.47	-0.016	189.9	-0.0115
570.48	-0.015	189.8	-0.0107
570.50	-0.014	189.9	-0.0098
570.52	-0.012	189.9	-0.0098
570.53	-0.012	189.9	-0.008
570.55	-0.012	189.9	-0.0071
570.57	-0.01	190	-0.0044
570.58	-0.008	190.1	-0.0027
570.60	-0.007	190.1	0.0009
570.62	-0.005	190.3	0.0036
570.63	-0.003	190.5	0.0036
570.65	-0.003	190.5	0.0062
570.67	0	190.8	0.0115
570.68	0.002	190.9	0.0115
570.70	0.002	190.9	0.0142
570.72	0.003	191.1	0.0186
570.73	0.006	191.4	0.0231
570.75	0.009	191.6	0.0284
570.77	0.01	191.8	0.0311
570.78	0.012	192.1	0.0337
570.80	0.015	192.3	0.0337
570.82	0.016	192.3	0.0391
570.83	0.016	192.5	0.0417
570.85	0.017	192.8	0.0453
570.87	0.02	193.1	0.0488
570.88	0.021	193.3	0.0515
570.90	0.022	193.5	0.0541
570.92	0.024	193.8	0.0541
570.93	0.025	193.8	0.0568
570.95	0.025	193.9	0.0586
570.97	0.026	194.2	0.0612
570.98	0.027	194.4	0.0621
571.00	0.028	194.5	0.0639
571.02	0.028	194.7	0.0648
571.03	0.029	194.8	0.0648
571.05	0.029	194.8	0.0657
571.07	0.029	195	0.0657
571.08	0.029	195.1	0.0657
571.10	0.029	195.2	0.0657
571.12	0.028	195.2	0.0657
571.13	0.028	195.3	0.0648
571.15	0.027	195.4	0.0648
571.17	0.026	195.4	0.0639
571.18	0.026	195.4	0.0621
571.20	0.025	195.3	0.0604
571.22	0.022	195.2	0.0586
571.23	0.021	195.2	0.0568
571.25	0.02	195.1	0.0541

Prova triassiale ciclica SN04-C1			
pressione di confinamento (kPa)		80	
deviatore ciclico (kPa)		95	
frequenza (hz)		0.00625	
tempo	cella di carico	$\Delta u$	LVDT
(min)	kN	(kPa)	$\delta$ (mm)
571.27	0.018	195	0.0541
571.28	0.016	194.9	0.0515
571.30	0.016	194.9	0.0488
571.32	0.015	194.7	0.0453
571.33	0.012	194.5	0.0417
571.35	0.01	194.4	0.0391
571.37	0.009	194.2	0.0346
571.38	0.005	193.9	0.0346
571.40	0.004	193.7	0.0275
571.42	0.003	193.6	0.0249
571.43	0.001	193.3	0.0249
571.45	-0.001	193.1	0.0213
571.47	-0.001	193.1	0.0178
571.48	-0.002	192.9	0.0133
571.50	-0.006	192.5	0.0089
571.52	-0.007	192.3	0.0062
571.53	-0.008	192.1	0.0027
571.57	-0.01	191.8	0.0027
571.58	-0.012	191.5	0
571.60	-0.012	191.5	-0.0027
571.62	-0.013	191.3	-0.0053
571.62	-0.014	191.1	-0.008
571.63	-0.015	190.9	-0.0089
571.65	-0.016	190.7	-0.0107
571.67	-0.016	190.5	-0.0115
571.68	-0.017	190.3	-0.0115
571.70	-0.017	190.3	-0.0124
571.72	-0.017	190.2	-0.0133
571.73	-0.017	190.1	-0.0133
571.75	-0.017	190	-0.0133
571.77	-0.017	189.9	-0.0133
571.78	-0.017	189.8	-0.0133
571.80	-0.016	189.8	-0.0133
571.82	-0.015	189.8	-0.0124
571.83	-0.015	189.8	-0.0107
571.85	-0.014	189.8	-0.0098
571.87	-0.012	189.8	-0.008
571.88	-0.012	189.9	-0.0062
571.90	-0.01	189.9	-0.0036
571.92	-0.007	190.1	-0.0036
571.93	-0.006	190.1	-0.0009
571.95	-0.006	190.2	0.0009
571.97	-0.005	190.3	0.0044
571.98	-0.002	190.5	0.008
572.00	-0.001	190.6	0.0107
572.02	0.001	190.8	0.0142
572.03	0.004	191.1	0.0142
572.05	0.006	191.3	0.0186
572.07	0.006	191.3	0.0222
572.08	0.007	191.5	0.0257
572.10	0.011	191.8	0.0311
572.12	0.012	192	0.0337
572.13	0.013	192.1	0.0364
572.15	0.015	192.4	0.0399
572.17	0.017	192.7	0.0426
572.18	0.018	192.9	0.0462
572.20	0.02	193.2	0.0462
572.22	0.022	193.4	0.0506

Prova triassiale ciclica SN04-C1			
pressione di confinamento (kPa)		80	
deviatore ciclico (kPa)		95	
frequenza (hz)		0.00625	
tempo	cella di carico	$\Delta u$	LVDT
(min)	kN	(kPa)	$\delta$ (mm)
572.23	0.022	193.4	0.0533
572.25	0.023	193.6	0.055
572.27	0.025	193.8	0.0577
572.28	0.026	194.1	0.0595
572.30	0.026	194.2	0.0621
572.32	0.027	194.4	0.0621
572.33	0.028	194.6	0.063
572.35	0.028	194.6	0.0639
572.37	0.029	194.8	0.0648
572.38	0.029	194.9	0.0657
572.40	0.029	195	0.0657
572.42	0.029	195.1	0.0657
572.43	0.029	195.2	0.0657
572.45	0.028	195.3	0.0657
572.47	0.027	195.3	0.0657
572.48	0.027	195.3	0.0648
572.50	0.027	195.4	0.0639
572.52	0.025	195.3	0.0621
572.53	0.024	195.3	0.0604
572.55	0.023	195.2	0.0577
572.57	0.021	195.2	0.0577
572.58	0.02	195.2	0.0559
572.60	0.02	195.1	0.0533
572.62	0.018	194.9	0.0506
572.63	0.015	194.8	0.047
572.65	0.014	194.7	0.0444
572.67	0.012	194.5	0.0408
572.68	0.009	194.3	0.0408
572.70	0.007	194.3	0.0373
572.72	0.007	194.1	0.0346
572.73	0.006	193.9	0.0311
572.75	0.003	193.6	0.0257
572.77	0.001	193.4	0.0231
572.78	0	193.2	0.0186
572.80	-0.004	192.9	0.0186
572.82	-0.005	192.9	0.0142
572.83	-0.005	192.7	0.0115
572.85	-0.008	192.2	0.0071
572.87	-0.009	192.2	0.0053
572.88	-0.009	192	0.0027
572.90	-0.01	191.7	-0.0009
572.92	-0.012	191.4	-0.0036
572.93	-0.014	191.2	-0.0053
572.95	-0.014	191	-0.008
572.97	-0.015	190.8	-0.008
573.00	-0.016	190.6	-0.0098
573.02	-0.016	190.6	-0.0107
573.03	-0.017	190.5	-0.0115
573.05	-0.017	190.3	-0.0124
573.07	-0.017	190.2	-0.0133
573.07	-0.017	190	-0.0133
573.08	-0.017	189.9	-0.0133
573.10	-0.017	189.9	-0.0133
573.12	-0.017	189.9	-0.0133
573.13	-0.016	189.8	-0.0124
573.15	-0.015	189.8	-0.0115
573.17	-0.014	189.8	-0.0107
573.18	-0.014	189.8	-0.0089

Prova triassiale ciclica SN04-C1			
pressione di confinamento (kPa)		80	
deviatore ciclico (kPa)		95	
frequenza (hz)		0.00625	
tempo	cella di carico	$\Delta u$	LVDT
(min)	kN	(kPa)	$\delta$ (mm)
573.20	-0.012	189.9	-0.0089
573.22	-0.01	189.9	-0.0071
573.23	-0.01	189.9	-0.0053
573.25	-0.009	190	-0.0027
573.27	-0.008	190.1	0
573.28	-0.005	190.3	0.0027
573.30	-0.004	190.4	0.0062
573.32	-0.002	190.6	0.0098
573.33	0.001	190.7	0.0098
573.35	0.001	190.7	0.0133
573.37	0.002	190.9	0.016
573.38	0.004	191.2	0.0195
573.40	0.007	191.4	0.0231
573.42	0.008	191.6	0.0275
573.43	0.01	191.9	0.032
573.45	0.013	192.1	0.032
573.47	0.014	192.1	0.0355
573.48	0.014	192.3	0.0391
573.50	0.016	192.6	0.0426
573.52	0.019	192.8	0.0462
573.53	0.02	193	0.0488
573.55	0.021	193.3	0.0524
573.57	0.024	193.6	0.0524
573.58	0.024	193.7	0.0568
573.60	0.025	193.9	0.0586
573.62	0.026	194.1	0.0586
573.63	0.027	194.1	0.0604
573.65	0.027	194.3	0.0621
573.67	0.027	194.5	0.0639
573.68	0.028	194.7	0.0648
573.70	0.029	194.8	0.0657
573.72	0.029	194.9	0.0657
573.73	0.029	195.1	0.0657
573.75	0.029	195.1	0.0657
573.77	0.029	195.1	0.0657
573.78	0.028	195.2	0.0657
573.80	0.028	195.3	0.0657
573.82	0.027	195.4	0.0639
573.83	0.026	195.4	0.0621
573.85	0.025	195.3	0.0621
573.87	0.023	195.3	0.0612
573.88	0.023	195.3	0.0595
573.90	0.022	195.2	0.0568
573.92	0.02	195.1	0.0541
573.93	0.018	195	0.0524
573.95	0.017	194.9	0.0497
573.97	0.015	194.7	0.0497
573.98	0.012	194.6	0.0462
574.00	0.012	194.6	0.0435
574.02	0.011	194.5	0.0399
574.03	0.009	194.2	0.0364
574.05	0.006	194	0.0328
574.07	0.005	193.8	0.0284
574.08	0.002	193.5	0.0284
574.10	0	193.3	0.024
574.12	0	193.3	0.0204
574.13	-0.001	193.1	0.0169
574.15	-0.003	192.8	0.0133

Prova triassiale ciclica SN04-C1			
pressione di confinamento (kPa)		80	
deviatore ciclico (kPa)		95	
frequenza (hz)		0.00625	
tempo	cella di carico	$\Delta u$	LVDT
(min)	kN	(kPa)	$\delta$ (mm)
574.17	-0.006	192.5	0.0098
574.18	-0.007	192.3	0.0062
574.20	-0.009	192	0.0018
574.22	-0.011	191.7	0.0018
574.23	-0.011	191.7	-0.0009
574.25	-0.012	191.5	-0.0027
574.27	-0.013	191.3	-0.0053
574.28	-0.015	191	-0.0071
574.30	-0.015	190.9	-0.0089
574.32	-0.015	190.7	-0.0098
574.33	-0.017	190.5	-0.0115
574.35	-0.017	190.4	-0.0115
574.37	-0.017	190.2	-0.0124
574.38	-0.017	190.1	-0.0124
574.40	-0.017	190.1	-0.0133
574.42	-0.017	190	-0.0133
574.43	-0.017	189.9	-0.0133
574.47	-0.017	189.8	-0.0133
574.48	-0.016	189.8	-0.0124
574.50	-0.015	189.8	-0.0107
574.52	-0.014	189.8	-0.0107
574.52	-0.013	189.8	-0.0098
574.53	-0.013	189.8	-0.008
574.55	-0.012	189.8	-0.0062
574.57	-0.01	189.9	-0.0044
574.58	-0.009	190	-0.0027
574.60	-0.007	190.1	0.0009
574.62	-0.004	190.3	0.0009
574.63	-0.003	190.4	0.0036
574.65	-0.003	190.4	0.0062
574.67	-0.002	190.5	0.0098
574.68	0.001	190.8	0.0133
574.70	0.003	191	0.0169
574.72	0.005	191.2	0.0213
574.73	0.008	191.4	0.0213
574.75	0.01	191.7	0.0249
574.77	0.01	191.7	0.0293
574.78	0.011	191.9	0.0337
574.80	0.014	192.2	0.0373
574.82	0.016	192.4	0.0408
574.83	0.017	192.6	0.0435
574.85	0.019	192.9	0.0435
574.87	0.021	193.1	0.0479
574.88	0.021	193.1	0.0506
574.90	0.022	193.3	0.0533
574.92	0.023	193.6	0.0559
574.93	0.025	193.8	0.0586
574.95	0.026	194	0.0604
574.97	0.027	194.2	0.0604
574.98	0.028	194.4	0.0621
575.00	0.028	194.4	0.063
575.02	0.028	194.6	0.0648
575.03	0.029	194.9	0.0657
575.05	0.029	194.9	0.0657
575.07	0.029	195	0.0657
575.08	0.029	195.1	0.0657
575.10	0.029	195.2	0.0657
575.12	0.028	195.2	0.0657

Prova triassiale ciclica SN04-C1			
pressione di confinamento (kPa)		80	
deviatore ciclico (kPa)		95	
frequenza (hz)		0.00625	
tempo	cella di carico	$\Delta u$	LVDT
(min)	kN	(kPa)	$\delta$ (mm)
575.13	0.028	195.3	0.0648
575.15	0.026	195.3	0.0648
575.17	0.025	195.3	0.0639
575.18	0.025	195.4	0.0621
575.20	0.025	195.3	0.0604
575.22	0.022	195.2	0.0586
575.23	0.022	195.2	0.0568
575.25	0.02	195.1	0.0541
575.27	0.017	194.9	0.0541
575.28	0.016	194.9	0.0515
575.30	0.016	194.9	0.0488
575.32	0.015	194.7	0.0453
575.33	0.011	194.5	0.0417
575.35	0.01	194.4	0.0391
575.37	0.009	194.2	0.0346
575.38	0.005	193.9	0.0346
575.40	0.004	193.9	0.0311
575.42	0.004	193.7	0.0284
575.43	0.002	193.5	0.0231
575.45	-0.001	193.2	0.0195
575.47	-0.002	193	0.016
575.48	-0.004	192.7	0.0115
575.50	-0.007	192.4	0.0115
575.52	-0.008	192.4	0.0071
575.53	-0.008	192.2	0.0044
575.55	-0.009	192	0.0027
575.57	-0.011	191.7	-0.0009
575.58	-0.012	191.4	-0.0036
575.60	-0.013	191.3	-0.0053
575.62	-0.015	191	-0.0053
575.63	-0.016	190.8	-0.008
575.65	-0.016	190.8	-0.0089
575.67	-0.016	190.6	-0.0098
575.68	-0.017	190.5	-0.0115
575.70	-0.017	190.3	-0.0124
575.72	-0.017	190.2	-0.0133
575.73	-0.017	190	-0.0133
575.75	-0.017	189.9	-0.0133
575.77	-0.017	189.9	-0.0133
575.78	-0.017	189.8	-0.0124
575.80	-0.016	189.8	-0.0124
575.82	-0.015	189.8	-0.0115
575.83	-0.015	189.8	-0.0107
575.85	-0.014	189.8	-0.0089
575.87	-0.012	189.8	-0.0071
575.90	-0.011	189.9	-0.0062
575.92	-0.01	189.9	-0.0036
575.93	-0.008	190	-0.0036
575.95	-0.006	190	-0.0009
575.97	-0.006	190.2	0.0018
575.97	-0.005	190.3	0.0044
575.98	-0.002	190.5	0.008
576.00	-0.001	190.6	0.0107
576.02	0.001	190.8	0.0142
576.03	0.005	191.1	0.0142
576.05	0.005	191.1	0.0186
576.07	0.005	191.2	0.0222
576.08	0.007	191.5	0.0257



Prova triassiale ciclica SN04-C1			
pressione di confinamento (kPa)		80	
deviatore ciclico (kPa)		95	
frequenza (hz)		0.00625	
tempo	cella di carico	$\Delta u$	LVDT
(min)	kN	(kPa)	$\delta$ (mm)
576.10	0.011	191.8	0.0311
576.12	0.012	191.9	0.0337
576.13	0.013	192.2	0.0382
576.15	0.017	192.5	0.0382
576.17	0.017	192.5	0.0417
576.18	0.017	192.7	0.0453
576.20	0.019	192.9	0.0488
576.22	0.022	193.2	0.0515
576.23	0.022	193.4	0.0541
576.25	0.023	193.6	0.0568
576.27	0.026	193.9	0.0568
576.28	0.026	193.9	0.0595
576.30	0.026	194.1	0.0612
576.32	0.027	194.2	0.063
576.33	0.028	194.5	0.0639
576.35	0.028	194.6	0.0648
576.37	0.029	194.8	0.0657
576.38	0.029	194.9	0.0657
576.40	0.029	194.9	0.0657
576.42	0.029	195	0.0666
576.43	0.029	195.1	0.0666
576.45	0.028	195.2	0.0666
576.47	0.028	195.2	0.0657
576.48	0.027	195.3	0.0648
576.50	0.027	195.4	0.0639
576.52	0.025	195.3	0.0621
576.53	0.024	195.3	0.0604
576.55	0.023	195.2	0.0604
576.57	0.02	195.1	0.0586
576.58	0.02	195.1	0.0559
576.60	0.02	195.1	0.0533
576.62	0.017	194.9	0.0506
576.63	0.015	194.8	0.0479
576.65	0.014	194.7	0.0444
576.67	0.012	194.4	0.0408
576.68	0.009	194.2	0.0408
576.70	0.009	194.2	0.0373
576.72	0.007	194.1	0.0337
576.73	0.006	193.8	0.0302
576.75	0.002	193.6	0.0257
576.77	0.001	193.4	0.0222
576.78	0	193.1	0.0178
576.80	-0.004	192.8	0.0178
576.82	-0.004	192.8	0.0142
576.83	-0.005	192.6	0.0107
576.85	-0.006	192.3	0.0071
576.87	-0.009	192.1	0.0036
576.88	-0.009	191.9	0.0018
576.90	-0.011	191.6	-0.0018
576.92	-0.013	191.3	-0.0018
576.93	-0.014	191.3	-0.0044
576.95	-0.014	191.2	-0.0062
576.97	-0.015	190.9	-0.0089
576.98	-0.016	190.7	-0.0098
577.00	-0.016	190.5	-0.0107
577.02	-0.017	190.4	-0.0124
577.03	-0.018	190.2	-0.0124
577.05	-0.017	190.2	-0.0133

Prova triassiale ciclica SN04-C1			
pressione di confinamento (kPa)		80	
deviatore ciclico (kPa)		95	
frequenza (hz)		0.00625	
tempo	cella di carico	$\Delta u$	LVDT
(min)	kN	(kPa)	$\delta$ (mm)
577.07	-0.017	190.1	-0.0133
577.08	-0.017	190	-0.0133
577.10	-0.017	189.9	-0.0133
577.12	-0.017	189.8	-0.0124
577.13	-0.016	189.8	-0.0115
577.15	-0.015	189.8	-0.0115
577.17	-0.014	189.8	-0.0107
577.18	-0.014	189.8	-0.0098
577.20	-0.013	189.8	-0.008
577.22	-0.011	189.9	-0.0062
577.23	-0.011	189.9	-0.0053
577.25	-0.009	190	-0.0027
577.27	-0.006	190.1	0
577.28	-0.006	190.2	0.0027
577.30	-0.004	190.4	0.0062
577.32	-0.001	190.6	0.0062
577.33	0	190.7	0.0098
577.37	0	190.7	0.0124
577.38	0.002	190.9	0.0169
577.40	0.005	191.2	0.0204
577.42	0.007	191.3	0.0231
577.42	0.008	191.5	0.0284
577.43	0.011	191.8	0.0284
577.45	0.013	192.1	0.032
577.47	0.013	192.1	0.0364
577.48	0.014	192.3	0.0399
577.50	0.017	192.6	0.0435
577.52	0.019	192.8	0.047
577.53	0.02	193	0.0497
577.55	0.022	193.3	0.0524
577.57	0.023	193.5	0.0524
577.58	0.023	193.5	0.055
577.60	0.024	193.7	0.0577
577.62	0.025	194	0.0604
577.63	0.027	194.2	0.0621
577.65	0.027	194.4	0.063
577.67	0.028	194.5	0.0648
577.68	0.029	194.7	0.0648
577.70	0.029	194.7	0.0657
577.72	0.029	194.8	0.0657
577.73	0.029	194.9	0.0657
577.75	0.029	195	0.0657
577.77	0.028	195.1	0.0666
577.78	0.028	195.2	0.0657
577.80	0.028	195.3	0.0657
577.82	0.026	195.3	0.0657
577.83	0.026	195.3	0.0639
577.85	0.026	195.3	0.0621
577.87	0.024	195.3	0.0604
577.88	0.023	195.2	0.0586
577.90	0.022	195.1	0.0568
577.92	0.019	195	0.0568
577.93	0.018	195	0.0524
577.95	0.017	194.9	0.0497
577.97	0.014	194.7	0.0497
577.98	0.013	194.7	0.047
578.00	0.013	194.6	0.0435
578.02	0.011	194.4	0.0399

Prova triassiale ciclica SN04-C1			
pressione di confinamento (kPa)		80	
deviatore ciclico (kPa)		95	
frequenza (hz)		0.00625	
tempo	cella di carico	$\Delta u$	LVDT
(min)	kN	(kPa)	$\delta$ (mm)
578.03	0.008	194.2	0.0364
578.05	0.007	194	0.0337
578.07	0.006	193.8	0.0293
578.08	0.002	193.5	0.0293
578.10	0	193.3	0.024
578.12	0	193.3	0.0204
578.13	-0.001	193.1	0.016
578.15	-0.004	192.7	0.0124
578.17	-0.006	192.5	0.0098
578.18	-0.006	192.3	0.0062
578.20	-0.009	192	0.0062
578.22	-0.011	191.7	0.0027
578.23	-0.011	191.7	0
578.25	-0.012	191.5	-0.0027
578.27	-0.013	191.2	-0.0062
578.28	-0.015	191	-0.0071
578.30	-0.015	190.9	-0.0089
578.32	-0.016	190.7	-0.0089
578.33	-0.017	190.5	-0.0107
578.35	-0.017	190.5	-0.0124
578.37	-0.017	190.3	-0.0124
578.38	-0.017	190.2	-0.0124
578.40	-0.017	190.1	-0.0133
578.42	-0.017	190	-0.0133
578.43	-0.017	189.9	-0.0133
578.45	-0.016	189.8	-0.0133
578.47	-0.016	189.8	-0.0124
578.48	-0.016	189.8	-0.0124
578.50	-0.015	189.8	-0.0107
578.52	-0.013	189.8	-0.0089
578.53	-0.013	189.8	-0.008
578.55	-0.011	189.9	-0.0053
578.57	-0.009	190	-0.0053
578.58	-0.008	190	-0.0036
578.60	-0.008	190	-0.0009
578.62	-0.007	190.2	0.0018
578.63	-0.003	190.4	0.0053
578.65	-0.002	190.5	0.008
578.67	-0.001	190.7	0.0115
578.68	0.001	190.8	0.0133
578.70	0.002	191	0.0169
578.72	0.004	191.2	0.0204
578.73	0.008	191.5	0.0204
578.75	0.01	191.5	0.0249
578.77	0.01	191.7	0.0293
578.78	0.011	191.9	0.0328
578.80	0.014	192.2	0.0373
578.83	0.015	192.4	0.0399
578.85	0.017	192.6	0.0444
578.87	0.019	192.9	0.0444
578.87	0.021	193.2	0.0479
578.88	0.021	193.2	0.0506
578.90	0.022	193.4	0.0533
578.92	0.024	193.6	0.0559
578.93	0.025	193.8	0.0586
578.95	0.026	194	0.0604
578.97	0.026	194.2	0.0604
578.98	0.028	194.4	0.0612

Prova triassiale ciclica SN04-C1			
pressione di confinamento (kPa)		80	
deviatore ciclico (kPa)		95	
frequenza (hz)		0.00625	
tempo	cella di carico	$\Delta u$	LVDT
(min)	kN	(kPa)	$\delta$ (mm)
579.00	0.028	194.4	0.0639
579.02	0.028	194.6	0.0648
579.03	0.028	194.7	0.0648
579.05	0.029	194.9	0.0657
579.07	0.029	195	0.0666
579.08	0.029	195.1	0.0666
579.10	0.029	195.2	0.0666
579.12	0.029	195.2	0.0657
579.13	0.028	195.3	0.0657
579.15	0.027	195.3	0.0639
579.17	0.026	195.3	0.063
579.18	0.025	195.3	0.0612
579.20	0.024	195.2	0.0612
579.22	0.022	195.2	0.0595
579.23	0.022	195.2	0.0577
579.25	0.021	195.1	0.055
579.27	0.019	195	0.0524
579.28	0.017	194.9	0.0506
579.30	0.015	194.8	0.047
579.32	0.013	194.5	0.0435
579.33	0.011	194.4	0.0435
579.35	0.011	194.4	0.0399
579.37	0.009	194.2	0.0373
579.38	0.006	193.8	0.0337
579.40	0.004	193.8	0.0311
579.42	0.004	193.7	0.0275
579.43	0.002	193.4	0.0231
579.45	-0.001	193.1	0.0186
579.47	-0.002	192.9	0.016
579.48	-0.004	192.6	0.0124
579.50	-0.006	192.4	0.0124
579.52	-0.007	192.4	0.008
579.53	-0.007	192.2	0.0053
579.55	-0.009	191.9	0.0018
579.57	-0.011	191.6	-0.0009
579.58	-0.012	191.4	-0.0036
579.60	-0.013	191.2	-0.0062
579.62	-0.015	190.9	-0.0062
579.63	-0.015	190.9	-0.008
579.65	-0.015	190.7	-0.0098
579.67	-0.016	190.6	-0.0107
579.68	-0.017	190.4	-0.0115
579.70	-0.017	190.2	-0.0124
579.72	-0.017	190.1	-0.0133
579.73	-0.017	190	-0.0133
579.75	-0.017	190	-0.0133
579.77	-0.017	189.9	-0.0133
579.78	-0.017	189.9	-0.0124
579.80	-0.016	189.8	-0.0115
579.82	-0.015	189.8	-0.0107
579.83	-0.015	189.8	-0.0098
579.85	-0.013	189.8	-0.0098
579.87	-0.012	189.8	-0.008
579.88	-0.012	189.8	-0.0062
579.90	-0.011	189.9	-0.0044
579.92	-0.008	190	-0.0018
579.93	-0.007	190.1	0
579.95	-0.006	190.2	0.0036

Prova triassiale ciclica SN04-C1			
pressione di confinamento (kPa)		80	
deviatore ciclico (kPa)		95	
frequenza (hz)		0.00625	
tempo	cella di carico	$\Delta u$	LVDT
(min)	kN	(kPa)	$\delta$ (mm)
579.97	-0.003	190.4	0.0036
579.98	-0.001	190.4	0.0062
580.00	-0.001	190.6	0.0098
580.02	0	190.7	0.0133
580.03	0.004	191	0.0178
580.05	0.005	191.2	0.0204
580.07	0.006	191.4	0.024
580.08	0.01	191.6	0.024
580.10	0.011	191.6	0.0293
580.12	0.012	192.1	0.0355
580.13	0.014	192.3	0.0355
580.15	0.016	192.3	0.0382
580.17	0.016	192.5	0.0417
580.18	0.017	192.7	0.0462
580.20	0.02	193	0.0497
580.22	0.021	193.2	0.0515
580.23	0.022	193.5	0.055
580.27	0.024	193.7	0.055
580.28	0.025	193.9	0.0577
580.30	0.025	193.9	0.0595
580.32	0.026	194.1	0.0621
580.33	0.027	194.3	0.063
580.33	0.028	194.5	0.0648
580.35	0.028	194.7	0.0657
580.37	0.029	194.8	0.0657
580.38	0.029	194.9	0.0657
580.40	0.029	194.9	0.0666
580.42	0.029	195	0.0666
580.43	0.029	195.1	0.0666
580.45	0.029	195.2	0.0666
580.47	0.028	195.3	0.0657
580.48	0.027	195.3	0.0657
580.50	0.025	195.3	0.0639
580.52	0.025	195.3	0.063
580.53	0.025	195.3	0.0612
580.55	0.023	195.2	0.0595
580.57	0.021	195.1	0.0577
580.58	0.02	195.1	0.055
580.60	0.018	194.9	0.0515
580.62	0.016	194.8	0.0515
580.63	0.016	194.8	0.0497
580.65	0.015	194.7	0.0462
580.67	0.012	194.5	0.0426
580.68	0.01	194.3	0.0391
580.70	0.009	194.2	0.0355
580.72	0.007	193.9	0.0328
580.73	0.004	193.7	0.0328
580.75	0.002	193.7	0.0284
580.77	0.002	193.5	0.0249
580.78	0.001	193.2	0.0204
580.80	-0.003	192.9	0.016
580.82	-0.004	192.7	0.0133
580.83	-0.005	192.4	0.0089
580.85	-0.007	192.2	0.0071
580.87	-0.008	192	0.0044
580.88	-0.01	191.7	0.0009
580.90	-0.012	191.5	0.0009
580.92	-0.013	191.5	-0.0018

Prova triassiale ciclica SN04-C1			
pressione di confinamento (kPa)		80	
deviatore ciclico (kPa)		95	
frequenza (hz)		0.00625	
tempo	cella di carico	$\Delta u$	LVDT
(min)	kN	(kPa)	$\delta$ (mm)
580.93	-0.013	191.3	-0.0044
580.95	-0.014	191	-0.0062
580.97	-0.015	190.8	-0.008
580.98	-0.016	190.6	-0.0098
581.00	-0.016	190.5	-0.0107
581.02	-0.017	190.3	-0.0107
581.03	-0.017	190.3	-0.0115
581.05	-0.017	190.2	-0.0124
581.07	-0.017	190	-0.0133
581.08	-0.017	189.9	-0.0133
581.10	-0.017	189.8	-0.0124
581.12	-0.016	189.8	-0.0124
581.13	-0.016	189.8	-0.0124
581.15	-0.015	189.8	-0.0115
581.17	-0.015	189.7	-0.0107
581.18	-0.014	189.7	-0.0089
581.20	-0.012	189.8	-0.0071
581.22	-0.011	189.8	-0.0053
581.23	-0.01	189.9	-0.0027
581.25	-0.007	190	-0.0027
581.27	-0.006	190.1	-0.0009
581.28	-0.006	190.1	0.0009
581.30	-0.005	190.2	0.0044
581.32	-0.002	190.5	0.008
581.33	-0.001	190.6	0.0107
581.35	0.001	190.8	0.0151
581.37	0.004	191	0.0151
581.38	0.006	191.2	0.0186
581.40	0.006	191.2	0.0222
581.42	0.007	191.4	0.0257
581.43	0.01	191.7	0.0311
581.45	0.012	191.9	0.0346
581.47	0.013	192.1	0.0382
581.48	0.016	192.4	0.0417
581.50	0.018	192.7	0.0417
581.52	0.018	192.7	0.0453
581.53	0.019	192.9	0.0488
581.55	0.021	193.2	0.0524
581.57	0.023	193.4	0.0541
581.58	0.023	193.6	0.0559
581.60	0.024	193.8	0.0586
581.62	0.026	194	0.0604
581.63	0.027	194.2	0.0621
581.65	0.027	194.4	0.063
581.67	0.028	194.5	0.063
581.68	0.028	194.5	0.0648
581.70	0.028	194.7	0.0657
581.73	0.029	194.8	0.0666
581.75	0.029	195	0.0666
581.77	0.029	195.1	0.0666
581.78	0.029	195.2	0.0666
581.78	0.028	195.2	0.0666
581.80	0.027	195.2	0.0666
581.82	0.027	195.3	0.0648
581.83	0.026	195.3	0.0639
581.85	0.025	195.3	0.0621
581.87	0.024	195.3	0.0612
581.88	0.023	195.2	0.0586

Prova triassiale ciclica SN04-C1			
pressione di confinamento (kPa)		80	
deviatore ciclico (kPa)		95	
frequenza (hz)		0.00625	
tempo	cella di carico	$\Delta u$	LVDT
(min)	kN	(kPa)	$\delta$ (mm)
581.90	0.02	195.1	0.0586
581.92	0.019	195.1	0.0559
581.93	0.019	195	0.0541
581.95	0.018	194.9	0.0506
581.97	0.015	194.8	0.0479
581.98	0.014	194.6	0.0462
582.00	0.012	194.5	0.0417
582.02	0.009	194.3	0.0417
582.03	0.007	194.1	0.0382
582.05	0.007	194.1	0.0355
582.07	0.006	193.9	0.0311
582.08	0.003	193.6	0.0275
582.10	0.001	193.4	0.0222
582.12	0	193.2	0.0186
582.13	-0.002	192.9	0.0186
582.15	-0.005	192.6	0.0151
582.17	-0.005	192.6	0.0115
582.18	-0.006	192.4	0.008
582.20	-0.008	192.1	0.0044
582.22	-0.01	191.8	0.0018
582.23	-0.011	191.6	-0.0018
582.25	-0.013	191.3	-0.0018
582.27	-0.014	191.1	-0.0044
582.28	-0.014	191.1	-0.0062
582.30	-0.016	190.7	-0.0098
582.32	-0.016	190.6	-0.0098
582.33	-0.016	190.6	-0.0107
582.35	-0.016	190.4	-0.0107
582.37	-0.017	190.2	-0.0115
582.38	-0.017	190.1	-0.0124
582.40	-0.017	190	-0.0133
582.42	-0.017	189.9	-0.0133
582.43	-0.016	189.8	-0.0133
582.45	-0.016	189.8	-0.0124
582.47	-0.016	189.8	-0.0115
582.48	-0.016	189.7	-0.0115
582.50	-0.015	189.7	-0.0107
582.52	-0.014	189.7	-0.0089
582.53	-0.013	189.8	-0.0062
582.55	-0.01	189.9	-0.0062
582.57	-0.009	189.9	-0.0044
582.58	-0.009	189.9	-0.0027
582.60	-0.008	190.1	0
582.62	-0.005	190.2	0.0027
582.63	-0.004	190.3	0.0053
582.65	-0.003	190.5	0.0089
582.67	0.001	190.7	0.0089
582.68	0.002	190.7	0.0124
582.70	0.002	190.8	0.016
582.72	0.004	191	0.0195
582.73	0.007	191.3	0.024
582.75	0.008	191.5	0.0275
582.77	0.01	191.7	0.032
582.78	0.013	192	0.032
582.80	0.015	192.2	0.0364
582.82	0.015	192.2	0.0391
582.83	0.016	192.5	0.0426
582.85	0.019	192.8	0.0462

Prova triassiale ciclica SN04-C1			
pressione di confinamento (kPa)		80	
deviatore ciclico (kPa)		95	
frequenza (hz)		0.00625	
tempo	cella di carico	$\Delta u$	LVDT
(min)	kN	(kPa)	$\delta$ (mm)
582.87	0.02	193	0.0488
582.88	0.021	193.2	0.0524
582.90	0.023	193.5	0.0524
582.92	0.024	193.7	0.055
582.93	0.024	193.7	0.0577
582.95	0.025	193.9	0.0595
582.97	0.026	194.1	0.0621
582.98	0.028	194.3	0.063
583.00	0.028	194.5	0.0648
583.02	0.028	194.6	0.0657
583.03	0.029	194.8	0.0657
583.05	0.029	194.9	0.0666
583.07	0.029	195	0.0666
583.08	0.029	195.1	0.0666
583.10	0.028	195.1	0.0666
583.12	0.028	195.2	0.0666
583.13	0.028	195.3	0.0657
583.17	0.027	195.3	0.0648
583.18	0.026	195.3	0.0639
583.20	0.025	195.3	0.0621
583.22	0.023	195.2	0.0621
583.23	0.022	195.2	0.0595
583.23	0.022	195.2	0.0586
583.25	0.021	195.1	0.0559
583.27	0.018	195	0.0533
583.28	0.017	194.9	0.0506
583.30	0.016	194.8	0.0479
583.32	0.012	194.6	0.0479
583.33	0.011	194.6	0.0444
583.35	0.011	194.4	0.0417
583.37	0.01	194.3	0.0382
583.38	0.006	194	0.0337
583.40	0.005	193.8	0.0302
583.42	0.003	193.6	0.0257
583.43	0	193.3	0.0257
583.45	-0.001	193.1	0.0213
583.47	-0.001	193.1	0.0178
583.48	-0.003	192.8	0.0142
583.50	-0.005	192.5	0.0107
583.52	-0.007	192.3	0.0071
583.53	-0.008	192.1	0.0036
583.55	-0.01	191.7	0.0036
583.57	-0.012	191.5	0
583.58	-0.012	191.5	-0.0027
583.60	-0.013	191.3	-0.0044
583.62	-0.014	191	-0.0071
583.63	-0.015	190.8	-0.0089
583.65	-0.016	190.6	-0.0098
583.67	-0.016	190.5	-0.0107
583.68	-0.017	190.3	-0.0107
583.70	-0.017	190.3	-0.0124
583.72	-0.017	190.2	-0.0124
583.73	-0.017	190.1	-0.0124
583.75	-0.017	189.9	-0.0124
583.77	-0.017	189.9	-0.0124
583.78	-0.017	189.8	-0.0124
583.80	-0.016	189.7	-0.0115
583.82	-0.015	189.7	-0.0107



Prova triassiale ciclica SN04-C1			
pressione di confinamento (kPa)		80	
deviatore ciclico (kPa)		95	
frequenza (hz)		0.00625	
tempo	cella di carico	$\Delta u$	LVDT
(min)	kN	(kPa)	$\delta$ (mm)
583.83	-0.015	189.7	-0.0098
583.85	-0.012	189.7	-0.0098
583.87	-0.012	189.7	-0.008
583.88	-0.012	189.8	-0.0062
583.90	-0.011	189.9	-0.0044
583.92	-0.008	190	-0.0018
583.93	-0.007	190	0
583.95	-0.006	190.2	0.0036
583.97	-0.003	190.4	0.0036
583.98	-0.002	190.4	0.0071
584.00	-0.002	190.5	0.0107
584.02	0	190.7	0.0133
584.03	0.003	190.9	0.0169
584.05	0.005	191.2	0.0204
584.07	0.006	191.3	0.0249
584.08	0.01	191.6	0.0249
584.10	0.011	191.8	0.0293
584.12	0.011	191.8	0.0328
584.13	0.012	192	0.0364
584.15	0.016	192.3	0.0408
584.17	0.017	192.5	0.0435
584.18	0.018	192.8	0.0479
584.20	0.021	193.1	0.0479
584.22	0.022	193.3	0.0506
584.23	0.022	193.3	0.0533
584.25	0.023	193.5	0.0559
584.27	0.025	193.8	0.0586
584.28	0.026	194	0.0604
584.30	0.026	194.1	0.0621
584.32	0.027	194.4	0.0621
584.33	0.028	194.5	0.0639
584.35	0.028	194.5	0.0648
584.37	0.028	194.7	0.0657
584.38	0.029	194.8	0.0657
584.40	0.029	194.9	0.0666
584.42	0.029	195	0.0666
584.43	0.029	195.1	0.0666
584.45	0.028	195.2	0.0666
584.47	0.027	195.2	0.0657
584.48	0.027	195.3	0.0648
584.50	0.025	195.3	0.0648
584.52	0.024	195.3	0.063
584.53	0.024	195.3	0.0612
584.55	0.024	195.2	0.0595
584.57	0.021	195.1	0.0577
584.58	0.02	195.1	0.0559
584.60	0.019	195	0.0524
584.63	0.016	194.8	0.0524
584.65	0.015	194.8	0.0497
584.67	0.015	194.7	0.047
584.68	0.013	194.5	0.0435
584.68	0.01	194.3	0.0399
584.70	0.009	194.2	0.0373
584.72	0.007	193.9	0.032
584.73	0.004	193.7	0.032
584.75	0.002	193.7	0.0284
584.77	0.002	193.5	0.024
584.78	0.001	193.2	0.0204

Prova triassiale ciclica SN04-C1			
pressione di confinamento (kPa)		80	
deviatore ciclico (kPa)		95	
frequenza (hz)		0.00625	
tempo	cella di carico	$\Delta u$	LVDT
(min)	kN	(kPa)	$\delta$ (mm)
584.80	-0.003	192.9	0.016
584.82	-0.004	192.7	0.0133
584.83	-0.005	192.5	0.0098
584.85	-0.008	192.2	0.0098
584.87	-0.009	192.2	0.0053
584.88	-0.009	192	0.0036
584.90	-0.01	191.7	0
584.92	-0.013	191.4	-0.0027
584.93	-0.013	191.2	-0.0053
584.95	-0.014	191	-0.0071
584.97	-0.015	190.8	-0.0071
584.98	-0.016	190.8	-0.0089
585.00	-0.016	190.6	-0.0107
585.02	-0.016	190.4	-0.0115
585.03	-0.017	190.3	-0.0124
585.05	-0.017	190.1	-0.0124
585.07	-0.017	190	-0.0124
585.08	-0.017	189.9	-0.0124
585.10	-0.017	189.8	-0.0124
585.12	-0.017	189.8	-0.0124
585.13	-0.016	189.8	-0.0115
585.15	-0.016	189.8	-0.0115
585.17	-0.014	189.8	-0.0098
585.18	-0.014	189.7	-0.008
585.20	-0.012	189.8	-0.0062
585.22	-0.011	189.8	-0.0053
585.23	-0.01	189.9	-0.0036
585.25	-0.009	190	-0.0009
585.27	-0.006	190.2	-0.0009
585.28	-0.005	190.2	0.0018
585.30	-0.005	190.3	0.0044
585.32	-0.003	190.5	0.008
585.33	0	190.6	0.0115
585.35	0.001	190.8	0.0142
585.37	0.003	191	0.0186
585.38	0.006	191.2	0.0186
585.40	0.007	191.2	0.0222
585.42	0.007	191.4	0.0257
585.43	0.009	191.7	0.0302
585.45	0.013	191.9	0.0346
585.47	0.013	192.1	0.0382
585.48	0.015	192.4	0.0417
585.50	0.018	192.7	0.0417
585.52	0.019	192.7	0.0453
585.53	0.019	192.9	0.0479
585.55	0.02	193.2	0.0515
585.57	0.023	193.4	0.055
585.58	0.024	193.6	0.0568
585.60	0.025	193.8	0.0595
585.62	0.026	194	0.0595
585.63	0.027	194	0.0612
585.65	0.027	194.2	0.063
585.67	0.027	194.4	0.0639
585.68	0.029	194.6	0.0657
585.70	0.029	194.7	0.0657
585.72	0.029	194.9	0.0666
585.73	0.029	195	0.0666
585.75	0.029	195	0.0666

Prova triassiale ciclica SN04-C1			
pressione di confinamento (kPa)		80	
deviatore ciclico (kPa)		95	
frequenza (hz)		0.00625	
tempo	cella di carico	$\Delta u$	LVDT
(min)	kN	(kPa)	$\delta$ (mm)
585.77	0.029	195.1	0.0666
585.78	0.029	195.2	0.0666
585.80	0.028	195.2	0.0666
585.82	0.027	195.2	0.0648
585.83	0.026	195.3	0.063
585.85	0.024	195.2	0.063
585.87	0.023	195.2	0.0612
585.88	0.023	195.2	0.0604
585.90	0.022	195.2	0.0577
585.92	0.021	195.1	0.0559
585.93	0.018	195	0.0533
585.95	0.018	194.9	0.0515
585.97	0.016	194.7	0.0488
585.98	0.013	194.6	0.0453
586.00	0.013	194.5	0.0426
586.02	0.01	194.2	0.0426
586.03	0.007	194	0.0382
586.07	0.007	194	0.0346
586.08	0.006	193.9	0.0311
586.10	0.003	193.6	0.0275
586.12	0.001	193.4	0.0231
586.13	0	193.2	0.0195
586.13	-0.003	192.8	0.0195
586.15	-0.005	192.6	0.0151
586.17	-0.005	192.6	0.0115
586.18	-0.006	192.4	0.0089
586.20	-0.008	192.1	0.0044
586.22	-0.01	191.8	0.0018
586.23	-0.011	191.6	-0.0009
586.25	-0.012	191.3	-0.0036
586.27	-0.014	191.1	-0.0036
586.28	-0.014	191.1	-0.0053
586.30	-0.014	190.9	-0.0071
586.32	-0.015	190.7	-0.0089
586.33	-0.017	190.5	-0.0107
586.35	-0.017	190.4	-0.0115
586.37	-0.017	190.2	-0.0124
586.38	-0.017	190.1	-0.0124
586.40	-0.017	190.1	-0.0124
586.42	-0.017	190	-0.0124
586.43	-0.017	189.9	-0.0124
586.45	-0.017	189.8	-0.0124
586.47	-0.016	189.8	-0.0115
586.48	-0.015	189.7	-0.0107
586.50	-0.014	189.8	-0.0107
586.52	-0.013	189.8	-0.0089
586.53	-0.013	189.8	-0.0071
586.55	-0.012	189.8	-0.0053
586.57	-0.01	189.9	-0.0036
586.58	-0.009	190	-0.0009
586.60	-0.007	190.1	0.0018
586.62	-0.004	190.3	0.0018
586.63	-0.003	190.3	0.0044
586.65	-0.002	190.5	0.0089
586.67	0	190.7	0.0089
586.68	0.002	190.9	0.0115
586.70	0.002	190.9	0.0151
586.72	0.003	191	0.0195

Prova triassiale ciclica SN04-C1			
pressione di confinamento (kPa)		80	
deviatore ciclico (kPa)		95	
frequenza (hz)		0.00625	
tempo	cella di carico	$\Delta u$	LVDT
(min)	kN	(kPa)	$\delta$ (mm)
586.73	0.007	191.3	0.024
586.75	0.009	191.5	0.0284
586.77	0.01	191.7	0.032
586.78	0.013	192	0.032
586.80	0.015	192.3	0.0364
586.82	0.015	192.3	0.0399
586.83	0.016	192.5	0.0435
586.85	0.019	192.8	0.047
586.87	0.02	193	0.0497
586.88	0.021	193.2	0.0524
586.90	0.023	193.5	0.0524
586.92	0.024	193.7	0.055
586.93	0.024	193.7	0.0577
586.95	0.025	193.9	0.0604
586.97	0.026	194.1	0.0621
586.98	0.027	194.3	0.0639
587.00	0.028	194.5	0.0648
587.02	0.028	194.6	0.0657
587.03	0.029	194.8	0.0657
587.05	0.029	194.8	0.0666
587.07	0.029	194.9	0.0666
587.08	0.029	195	0.0666
587.10	0.029	195.1	0.0666
587.12	0.029	195.2	0.0666
587.13	0.028	195.2	0.0657
587.15	0.026	195.2	0.0657
587.17	0.026	195.2	0.0648
587.18	0.025	195.3	0.0621
587.20	0.024	195.2	0.0612
587.22	0.022	195.2	0.0595
587.23	0.022	195.1	0.0577
587.25	0.02	195	0.055
587.27	0.017	194.9	0.055
587.28	0.017	194.9	0.0515
587.30	0.017	194.8	0.0497
587.32	0.015	194.6	0.0462
587.33	0.011	194.4	0.0426
587.35	0.01	194.3	0.0399
587.37	0.009	194.1	0.0355
587.38	0.005	193.8	0.032
587.40	0.005	193.7	0.0302
587.42	0.003	193.5	0.0257
587.43	0	193.2	0.0257
587.45	-0.001	193.2	0.0213
587.47	-0.001	193	0.0178
587.48	-0.002	192.8	0.0142
587.50	-0.006	192.4	0.0107
587.53	-0.007	192.2	0.008
587.55	-0.008	192	0.0036
587.57	-0.011	191.7	0.0036
587.58	-0.012	191.5	0.0009
587.58	-0.012	191.5	-0.0018
587.60	-0.013	191.3	-0.0036
587.62	-0.014	191	-0.0062
587.63	-0.015	190.8	-0.008
587.65	-0.016	190.6	-0.0098
587.67	-0.016	190.4	-0.0107
587.68	-0.017	190.3	-0.0107

Prova triassiale ciclica SN04-C1			
pressione di confinamento (kPa)		80	
deviatore ciclico (kPa)		95	
frequenza (hz)		0.00625	
tempo	cella di carico	$\Delta u$	LVDT
(min)	kN	(kPa)	$\delta$ (mm)
587.70	-0.017	190.3	-0.0115
587.72	-0.017	190.1	-0.0124
587.73	-0.017	190	-0.0124
587.75	-0.017	189.9	-0.0124
587.77	-0.017	189.8	-0.0124
587.78	-0.016	189.8	-0.0115
587.80	-0.015	189.7	-0.0115
587.82	-0.015	189.7	-0.0107
587.83	-0.015	189.7	-0.0098
587.85	-0.014	189.8	-0.008
587.87	-0.012	189.8	-0.0062
587.88	-0.011	189.8	-0.0053
587.90	-0.011	189.9	-0.0036
587.92	-0.007	190	-0.0036
587.93	-0.006	190	0
587.95	-0.006	190.1	0.0027
587.97	-0.005	190.3	0.0053
587.98	-0.002	190.4	0.0089
588.00	-0.001	190.6	0.0115
588.02	0.001	190.8	0.0151
588.03	0.005	191	0.0151
588.05	0.005	191	0.0195
588.07	0.005	191.2	0.0222
588.08	0.007	191.5	0.0275
588.10	0.011	191.7	0.032
588.12	0.011	191.9	0.0337
588.13	0.013	192.1	0.0373
588.15	0.016	192.4	0.0417
588.17	0.017	192.6	0.0444
588.18	0.018	192.9	0.0479
588.20	0.021	193.1	0.0479
588.22	0.022	193.1	0.0515
588.23	0.022	193.3	0.0533
588.25	0.023	193.6	0.0559
588.27	0.025	193.8	0.0586
588.28	0.026	194	0.0604
588.30	0.026	194.2	0.063
588.32	0.027	194.4	0.063
588.33	0.028	194.4	0.0639
588.35	0.028	194.5	0.0648
588.37	0.029	194.7	0.0666
588.38	0.029	194.8	0.0666
588.40	0.029	195	0.0666
588.42	0.029	195.1	0.0666
588.43	0.028	195.2	0.0666
588.45	0.028	195.2	0.0666
588.47	0.028	195.2	0.0666
588.48	0.027	195.3	0.0657
588.50	0.026	195.3	0.0639
588.52	0.025	195.3	0.063
588.53	0.024	195.3	0.0612
588.55	0.022	195.2	0.0612
588.57	0.02	195.1	0.0586
588.58	0.02	195.1	0.0568
588.60	0.02	195	0.0541
588.62	0.017	194.9	0.0515
588.63	0.015	194.8	0.0488
588.65	0.014	194.6	0.0453

Prova triassiale ciclica SN04-C1			
pressione di confinamento (kPa)		80	
deviatore ciclico (kPa)		95	
frequenza (hz)		0.00625	
tempo	cella di carico	$\Delta u$	LVDT
(min)	kN	(kPa)	$\delta$ (mm)
588.67	0.011	194.4	0.0453
588.68	0.009	194.2	0.0417
588.70	0.009	194.2	0.0391
588.72	0.008	194.1	0.0346
588.73	0.005	193.8	0.0311
588.75	0.003	193.6	0.0275
588.77	0.002	193.4	0.0231
588.78	-0.001	193	0.0231
588.80	-0.003	192.8	0.0186
588.82	-0.003	192.8	0.0151
588.83	-0.006	192.4	0.0089
588.85	-0.008	192.1	0.0089
588.87	-0.008	192.1	0.0062
588.88	-0.009	191.9	0.0027
588.90	-0.011	191.6	-0.0009
588.92	-0.013	191.4	-0.0027
588.93	-0.013	191.2	-0.0053
588.95	-0.014	191	-0.0071
588.97	-0.016	190.7	-0.0071
589.00	-0.016	190.7	-0.0089
589.02	-0.016	190.6	-0.0098
589.03	-0.016	190.4	-0.0115
589.03	-0.017	190.2	-0.0115
589.05	-0.017	190.1	-0.0124
589.07	-0.017	190	-0.0124
589.08	-0.017	189.9	-0.0124
589.10	-0.017	189.9	-0.0124
589.12	-0.017	189.8	-0.0124
589.13	-0.016	189.8	-0.0107
589.15	-0.015	189.7	-0.0098
589.17	-0.014	189.7	-0.0089
589.18	-0.014	189.8	-0.008
589.20	-0.012	189.8	-0.008
589.22	-0.011	189.8	-0.0062
589.23	-0.011	189.8	-0.0044
589.25	-0.01	190	-0.0018
589.27	-0.006	190.1	0.0018
589.28	-0.006	190.2	0.0044
589.30	-0.004	190.3	0.0071
589.32	-0.001	190.5	0.0071
589.33	0	190.5	0.0107
589.35	0	190.7	0.0133
589.37	0.002	190.9	0.0169
589.38	0.005	191.2	0.0213
589.40	0.006	191.3	0.0249
589.42	0.008	191.6	0.0293
589.43	0.012	191.9	0.0293
589.45	0.013	191.9	0.0337
589.47	0.013	192	0.0364
589.48	0.014	192.3	0.0408
589.50	0.017	192.6	0.0444
589.52	0.018	192.8	0.047
589.53	0.02	193	0.0506
589.55	0.022	193.3	0.0541
589.57	0.023	193.5	0.055
589.58	0.023	193.7	0.0577
589.60	0.026	193.9	0.0577
589.62	0.026	193.9	0.0604

Prova triassiale ciclica SN04-C1			
pressione di confinamento (kPa)		80	
deviatore ciclico (kPa)		95	
frequenza (hz)		0.00625	
tempo	cella di carico	$\Delta u$	LVDT
(min)	kN	(kPa)	$\delta$ (mm)
589.63	0.026	194.1	0.0612
589.65	0.027	194.3	0.063
589.67	0.028	194.5	0.0648
589.68	0.029	194.6	0.0657
589.70	0.029	194.8	0.0666
589.72	0.029	194.9	0.0666
589.73	0.028	195	0.0666
589.75	0.028	195	0.0666
589.77	0.029	195.1	0.0675
589.78	0.028	195.2	0.0675
589.80	0.028	195.3	0.0666
589.82	0.027	195.3	0.0657
589.83	0.026	195.2	0.063
589.85	0.024	195.2	0.063
589.87	0.024	195.2	0.0612
589.88	0.023	195.2	0.0604
589.90	0.022	195.1	0.0586
589.92	0.02	195.1	0.0559
589.93	0.019	195	0.0533
589.95	0.017	194.8	0.0506
589.97	0.014	194.7	0.0506
589.98	0.013	194.7	0.047
590.00	0.013	194.6	0.0444
590.02	0.011	194.3	0.0408
590.03	0.007	194.1	0.0364
590.05	0.007	194	0.0337
590.07	0.005	193.7	0.0302
590.08	0.001	193.5	0.0302
590.10	0.001	193.5	0.0249
590.12	0.001	193.3	0.0222
590.13	-0.001	192.9	0.0178
590.15	-0.004	192.7	0.0142
590.17	-0.005	192.5	0.0098
590.18	-0.007	192.2	0.0071
590.20	-0.01	191.9	0.0071
590.22	-0.011	191.9	0.0027
590.23	-0.011	191.7	0.0009
590.25	-0.012	191.5	-0.0018
590.27	-0.014	191.2	-0.0044
590.28	-0.014	191	-0.0062
590.30	-0.014	190.8	-0.0071
590.32	-0.016	190.6	-0.0089
590.33	-0.016	190.5	-0.0098
590.35	-0.017	190.3	-0.0115
590.37	-0.017	190.2	-0.0115
590.38	-0.017	190.2	-0.0124
590.40	-0.017	190	-0.0124
590.43	-0.017	189.9	-0.0124
590.45	-0.017	189.8	-0.0115
590.47	-0.017	189.8	-0.0115
590.48	-0.016	189.8	-0.0107
590.50	-0.015	189.7	-0.0107
590.50	-0.014	189.7	-0.0098
590.52	-0.014	189.7	-0.0089
590.53	-0.013	189.8	-0.0071
590.55	-0.011	189.8	-0.0053
590.57	-0.01	189.9	-0.0027
590.58	-0.009	190	0

Prova triassiale ciclica SN04-C1			
pressione di confinamento (kPa)		80	
deviatore ciclico (kPa)		95	
frequenza (hz)		0.00625	
tempo	cella di carico	$\Delta u$	LVDT
(min)	kN	(kPa)	$\delta$ (mm)
590.60	-0.006	190.1	0
590.62	-0.005	190.1	0.0027
590.63	-0.005	190.2	0.0044
590.65	-0.004	190.5	0.0089
590.67	0	190.6	0.0124
590.68	0.001	190.8	0.0151
590.70	0.003	191	0.0186
590.72	0.006	191.2	0.0186
590.73	0.007	191.2	0.0231
590.75	0.007	191.4	0.0275
590.77	0.009	191.6	0.0311
590.78	0.012	191.9	0.0355
590.80	0.013	192.1	0.0382
590.82	0.015	192.4	0.0426
590.83	0.019	192.7	0.0426
590.85	0.019	192.7	0.0462
590.87	0.019	192.9	0.0488
590.88	0.02	193.1	0.0524
590.90	0.023	193.4	0.0559
590.92	0.024	193.6	0.0577
590.93	0.025	193.8	0.0604
590.95	0.026	194	0.0604
590.97	0.027	194	0.0621
590.98	0.027	194.2	0.063
591.00	0.027	194.4	0.0648
591.02	0.029	194.7	0.0657
591.03	0.029	194.7	0.0666
591.05	0.029	194.8	0.0675
591.07	0.029	195	0.0675
591.08	0.029	195.1	0.0675
591.10	0.028	195.2	0.0675
591.12	0.028	195.2	0.0675
591.13	0.027	195.3	0.0675
591.15	0.027	195.3	0.0657
591.17	0.027	195.3	0.0648
591.18	0.026	195.3	0.063
591.20	0.023	195.2	0.0612
591.22	0.023	195.2	0.0595
591.23	0.022	195.1	0.0577
591.25	0.019	195	0.0577
591.27	0.018	195	0.055
591.28	0.018	195	0.0524
591.30	0.016	194.8	0.0488
591.32	0.013	194.6	0.0462
591.33	0.012	194.5	0.0435
591.35	0.011	194.2	0.0391
591.37	0.007	194	0.0391
591.38	0.006	194	0.0355
591.40	0.006	193.9	0.0328
591.42	0.004	193.6	0.0284
591.43	0.001	193.4	0.024
591.45	0	193.2	0.0204
591.47	-0.002	192.9	0.016
591.48	-0.005	192.6	0.016
591.50	-0.006	192.6	0.0115
591.52	-0.006	192.4	0.0098
591.53	-0.007	192.1	0.0053
591.55	-0.01	191.8	0.0018



Prova triassiale ciclica SN04-C1			
pressione di confinamento (kPa)		80	
deviatore ciclico (kPa)		95	
frequenza (hz)		0.00625	
tempo	cella di carico	$\Delta u$	LVDT
(min)	kN	(kPa)	$\delta$ (mm)
591.57	-0.011	191.6	0
591.58	-0.012	191.4	-0.0027
591.60	-0.014	191.1	-0.0027
591.62	-0.015	191.1	-0.0053
591.63	-0.015	190.9	-0.0071
591.65	-0.015	190.7	-0.008
591.67	-0.016	190.6	-0.0089
591.68	-0.017	190.4	-0.0107
591.70	-0.017	190.2	-0.0115
591.72	-0.017	190.1	-0.0115
591.73	-0.017	190	-0.0115
591.75	-0.017	189.9	-0.0115
591.77	-0.017	189.8	-0.0115
591.78	-0.016	189.8	-0.0115
591.80	-0.016	189.8	-0.0115
591.82	-0.016	189.7	-0.0098
591.83	-0.014	189.7	-0.0089
591.85	-0.013	189.8	-0.008
591.87	-0.013	189.8	-0.0062
591.90	-0.011	189.9	-0.0062
591.92	-0.009	189.9	-0.0036
591.93	-0.009	189.9	-0.0018
591.95	-0.008	190	0
591.95	-0.005	190.2	0.0036
591.97	-0.004	190.3	0.0062
591.98	-0.003	190.4	0.0098
592.00	0	190.7	0.0098
592.02	0.002	190.9	0.0133
592.03	0.002	190.9	0.016
592.05	0.004	191	0.0204
592.07	0.007	191.3	0.0249
592.08	0.009	191.5	0.0293
592.10	0.01	191.7	0.0328
592.12	0.013	192	0.0328
592.13	0.015	192.3	0.0373
592.15	0.015	192.3	0.0399
592.17	0.016	192.5	0.0435
592.18	0.018	192.8	0.0479
592.20	0.02	193	0.0506
592.22	0.021	193.2	0.0533
592.23	0.022	193.5	0.0559
592.25	0.025	193.7	0.0559
592.27	0.025	193.7	0.0586
592.28	0.026	193.9	0.0612
592.30	0.027	194.1	0.063
592.32	0.027	194.3	0.0639
592.33	0.027	194.5	0.0657
592.35	0.028	194.7	0.0666
592.37	0.029	194.8	0.0666
592.38	0.029	194.8	0.0675
592.40	0.029	194.9	0.0675
592.42	0.029	195	0.0675
592.43	0.029	195.1	0.0675
592.45	0.028	195.2	0.0666
592.47	0.028	195.2	0.0666
592.48	0.027	195.3	0.0657
592.50	0.026	195.3	0.0639
592.52	0.025	195.3	0.063

Prova triassiale ciclica SN04-C1			
pressione di confinamento (kPa)		80	
deviatore ciclico (kPa)		95	
frequenza (hz)		0.00625	
tempo	cella di carico	$\Delta u$	LVDT
(min)	kN	(kPa)	$\delta$ (mm)
592.53	0.023	195.2	0.063
592.55	0.022	195.2	0.0612
592.57	0.022	195.2	0.0595
592.58	0.021	195.1	0.0568
592.60	0.018	195	0.0541
592.62	0.017	194.9	0.0515
592.63	0.016	194.7	0.0479
592.65	0.012	194.5	0.0479
592.67	0.011	194.5	0.0444
592.68	0.011	194.4	0.0417
592.70	0.01	194.2	0.0382
592.72	0.006	194	0.0337
592.73	0.005	193.8	0.0311
592.75	0.003	193.6	0.0275
592.77	0	193.3	0.0275
592.78	-0.001	193.3	0.0222
592.80	-0.001	193.1	0.0186
592.82	-0.003	192.8	0.0151
592.83	-0.006	192.5	0.0107
592.85	-0.007	192.3	0.008
592.87	-0.008	192.1	0.0053
592.88	-0.011	191.8	0.0053
592.90	-0.012	191.5	0.0018
592.92	-0.012	191.5	-0.0009
592.93	-0.012	191.3	-0.0036
592.95	-0.014	191.1	-0.0062
592.97	-0.015	190.8	-0.008
592.98	-0.016	190.7	-0.0089
593.00	-0.016	190.5	-0.0089
593.02	-0.017	190.3	-0.0107
593.03	-0.017	190.3	-0.0107
593.05	-0.017	190.2	-0.0115
593.07	-0.017	190	-0.0115
593.08	-0.017	189.9	-0.0124
593.10	-0.017	189.9	-0.0115
593.12	-0.016	189.8	-0.0115
593.13	-0.015	189.8	-0.0107
593.15	-0.015	189.8	-0.0107
593.17	-0.015	189.8	-0.0089
593.18	-0.013	189.8	-0.008
593.20	-0.012	189.8	-0.0071
593.22	-0.012	189.8	-0.0053
593.23	-0.011	189.9	-0.0036
593.25	-0.008	190	-0.0009
593.27	-0.007	190.1	0.0009
593.28	-0.006	190.2	0.0044
593.30	-0.003	190.4	0.0044
593.33	-0.002	190.4	0.008
593.35	-0.002	190.5	0.0107
593.37	0	190.8	0.0142
593.38	0.003	191	0.0178
593.40	0.005	191.2	0.0213
593.40	0.006	191.4	0.0257
593.42	0.01	191.6	0.0257
593.43	0.011	191.6	0.0311
593.45	0.011	191.8	0.0337
593.47	0.013	192.1	0.0382
593.48	0.016	192.4	0.0426

Prova triassiale ciclica SN04-C1			
pressione di confinamento (kPa)		80	
deviatore ciclico (kPa)		95	
frequenza (hz)		0.00625	
tempo	cella di carico	$\Delta u$	LVDT
(min)	kN	(kPa)	$\delta$ (mm)
593.50	0.017	192.6	0.0453
593.52	0.018	192.9	0.0479
593.53	0.021	193.1	0.0479
593.55	0.022	193.1	0.0515
593.57	0.022	193.3	0.0541
593.58	0.023	193.6	0.0568
593.60	0.025	193.8	0.0595
593.62	0.026	194	0.0612
593.63	0.026	194.2	0.063
593.65	0.028	194.4	0.063
593.67	0.028	194.4	0.0648
593.68	0.028	194.5	0.0657
593.70	0.029	194.7	0.0666
593.72	0.029	194.8	0.0675
593.73	0.029	194.9	0.0675
593.75	0.029	195	0.0675
593.77	0.028	195.1	0.0675
593.78	0.028	195.1	0.0675
593.80	0.028	195.2	0.0675
593.82	0.027	195.3	0.0657
593.83	0.026	195.2	0.0639
593.85	0.025	195.2	0.063
593.87	0.024	195.2	0.0612
593.88	0.022	195.2	0.0612
593.90	0.02	195.1	0.0595
593.92	0.019	195	0.0559
593.93	0.019	195	0.0559
593.95	0.016	194.8	0.0541
593.97	0.016	194.8	0.0506
593.98	0.015	194.7	0.047
594.00	0.012	194.5	0.0435
594.02	0.01	194.3	0.0399
594.03	0.009	194.1	0.0373
594.05	0.006	193.9	0.0373
594.07	0.004	193.7	0.0328
594.08	0.004	193.7	0.0293
594.10	0.002	193.5	0.0249
594.12	0	193.2	0.0204
594.13	-0.002	192.9	0.0178
594.15	-0.004	192.7	0.0133
594.17	-0.006	192.4	0.0098
594.18	-0.008	192.1	0.0098
594.20	-0.008	192.1	0.0062
594.22	-0.009	191.9	0.0036
594.23	-0.011	191.6	0
594.25	-0.013	191.4	-0.0027
594.27	-0.013	191.2	-0.0044
594.28	-0.014	191	-0.0062
594.30	-0.016	190.8	-0.0062
594.32	-0.016	190.8	-0.008
594.33	-0.016	190.6	-0.0089
594.35	-0.016	190.4	-0.0107
594.37	-0.017	190.3	-0.0115
594.38	-0.017	190.1	-0.0115
594.40	-0.017	190	-0.0124
594.42	-0.017	189.9	-0.0124
594.43	-0.017	189.9	-0.0115
594.45	-0.017	189.8	-0.0115

Prova triassiale ciclica SN04-C1			
pressione di confinamento (kPa)		80	
deviatore ciclico (kPa)		95	
frequenza (hz)		0.00625	
tempo	cella di carico	$\Delta u$	LVDT
(min)	kN	(kPa)	$\delta$ (mm)
594.47	-0.016	189.8	-0.0107
594.48	-0.015	189.8	-0.0098
594.50	-0.015	189.7	-0.0089
594.52	-0.014	189.8	-0.0071
594.53	-0.012	189.8	-0.0071
594.55	-0.011	189.8	-0.0053
594.57	-0.011	189.9	-0.0036
594.58	-0.01	190	-0.0018
594.60	-0.007	190.1	0.0018
594.62	-0.006	190.2	0.0036
594.63	-0.004	190.3	0.0071
594.65	-0.002	190.5	0.0089
594.67	-0.001	190.6	0.0115
594.68	0.001	190.8	0.0169
594.70	0.004	191.1	0.0169
594.72	0.006	191.2	0.0204
594.73	0.006	191.2	0.0231
594.75	0.007	191.5	0.0284
594.77	0.01	191.8	0.032
594.80	0.012	191.9	0.0355
594.82	0.014	192.2	0.0399
594.83	0.016	192.5	0.0399
594.85	0.018	192.7	0.0435
594.85	0.018	192.7	0.0462
594.87	0.019	192.9	0.0497
594.88	0.021	193.2	0.0533
594.90	0.023	193.4	0.055
594.92	0.024	193.6	0.0586
594.93	0.025	193.9	0.0586
594.95	0.026	194.1	0.0604
594.97	0.026	194.1	0.0621
594.98	0.027	194.3	0.0639
595.00	0.028	194.5	0.0648
595.02	0.028	194.6	0.0666
595.03	0.029	194.8	0.0666
595.05	0.029	194.9	0.0675
595.07	0.029	195	0.0675
595.08	0.029	195	0.0675
595.10	0.029	195.1	0.0675
595.12	0.029	195.2	0.0675
595.13	0.028	195.3	0.0666
595.15	0.027	195.3	0.0648
595.17	0.026	195.2	0.0639
595.18	0.024	195.2	0.0639
595.20	0.023	195.2	0.0621
595.22	0.023	195.2	0.0612
595.23	0.022	195.1	0.0586
595.25	0.02	195	0.0559
595.27	0.019	195	0.0533
595.28	0.017	194.8	0.0506
595.30	0.014	194.7	0.0506
595.32	0.013	194.7	0.047
595.33	0.013	194.5	0.0444
595.35	0.012	194.3	0.0408
595.37	0.008	194.1	0.0373
595.38	0.008	194	0.0355
595.40	0.006	193.8	0.0311
595.42	0.002	193.5	0.0275

Prova triassiale ciclica SN04-C1			
pressione di confinamento (kPa)		80	
deviatore ciclico (kPa)		95	
frequenza (hz)		0.00625	
tempo	cella di carico	$\Delta u$	LVDT
(min)	kN	(kPa)	$\delta$ (mm)
595.43	0.002	193.4	0.0231
595.45	0	193.1	0.0195
595.47	-0.004	192.8	0.0195
595.48	-0.005	192.8	0.016
595.50	-0.005	192.6	0.0124
595.52	-0.006	192.3	0.0089
595.53	-0.009	192	0.0053
595.55	-0.01	191.8	0.0027
595.57	-0.011	191.6	0
595.58	-0.013	191.3	0
595.60	-0.014	191.3	-0.0036
595.62	-0.014	191.1	-0.0053
595.63	-0.015	190.9	-0.0071
595.65	-0.016	190.7	-0.0089
595.67	-0.016	190.5	-0.0098
595.68	-0.017	190.3	-0.0107
595.70	-0.017	190.2	-0.0107
595.72	-0.017	190.2	-0.0115
595.73	-0.017	190.1	-0.0115
595.75	-0.017	190	-0.0115
595.77	-0.017	189.9	-0.0124
595.78	-0.016	189.8	-0.0115
595.80	-0.016	189.8	-0.0107
595.82	-0.015	189.8	-0.0107
595.83	-0.014	189.8	-0.0098
595.85	-0.014	189.8	-0.008
595.87	-0.013	189.8	-0.0062
595.88	-0.011	189.9	-0.0044
595.90	-0.01	189.9	-0.0027
595.92	-0.009	190	0
595.93	-0.006	190.1	0
595.95	-0.005	190.3	0.0018
595.97	-0.005	190.3	0.0053
595.98	-0.003	190.4	0.0089
596.00	-0.001	190.6	0.0115
596.02	0.001	190.8	0.0151
596.03	0.003	191	0.0186
596.05	0.006	191.2	0.0186
596.07	0.008	191.5	0.0231
596.08	0.008	191.5	0.0275
596.10	0.011	191.9	0.0328
596.12	0.012	192.1	0.0328
596.13	0.012	192.1	0.0364
596.15	0.014	192.3	0.0408
596.17	0.016	192.6	0.0444
596.18	0.019	192.8	0.0479
596.20	0.02	193	0.0506
596.22	0.021	193.3	0.0541
596.25	0.024	193.5	0.0541
596.27	0.024	193.5	0.0568
596.28	0.024	193.7	0.0586
596.30	0.025	194	0.0604
596.30	0.027	194.2	0.063
596.32	0.027	194.4	0.0639
596.33	0.028	194.5	0.0657
596.35	0.028	194.7	0.0657
596.37	0.029	194.7	0.0666
596.38	0.029	194.8	0.0666

Prova triassiale ciclica SN04-C1			
pressione di confinamento (kPa)		80	
deviatore ciclico (kPa)		95	
frequenza (hz)		0.00625	
tempo	cella di carico	$\Delta u$	LVDT
(min)	kN	(kPa)	$\delta$ (mm)
596.40	0.029	194.9	0.0675
596.42	0.029	195.1	0.0675
596.43	0.029	195.1	0.0675
596.45	0.028	195.2	0.0675
596.47	0.027	195.3	0.0675
596.48	0.027	195.3	0.0666
596.50	0.027	195.3	0.0648
596.52	0.026	195.3	0.0639
596.53	0.024	195.2	0.0612
596.55	0.023	195.2	0.0604
596.57	0.021	195.2	0.0577
596.58	0.019	195	0.0577
596.60	0.018	195	0.055
596.62	0.018	195	0.0524
596.63	0.016	194.8	0.0497
596.65	0.013	194.6	0.0462
596.67	0.012	194.5	0.0435
596.68	0.01	194.3	0.0391
596.70	0.007	194	0.0391
596.72	0.006	194	0.0355
596.73	0.006	193.9	0.0328
596.75	0.004	193.7	0.0293
596.77	0.001	193.4	0.024
596.78	0	193.2	0.0204
596.80	-0.002	192.9	0.016
596.82	-0.005	192.6	0.0124
596.83	-0.006	192.4	0.0107
596.85	-0.006	192.2	0.0071
596.87	-0.009	191.9	0.0071
596.88	-0.011	191.7	0.0036
596.90	-0.011	191.7	0.0009
596.92	-0.012	191.5	-0.0018
596.93	-0.013	191.2	-0.0044
596.95	-0.015	191	-0.0062
596.97	-0.015	190.8	-0.008
596.98	-0.016	190.6	-0.008
597.00	-0.017	190.4	-0.0089
597.02	-0.017	190.4	-0.0107
597.03	-0.017	190.3	-0.0115
597.05	-0.017	190.1	-0.0115
597.07	-0.017	190	-0.0124
597.08	-0.017	189.9	-0.0115
597.10	-0.017	189.8	-0.0115
597.12	-0.016	189.8	-0.0115
597.13	-0.016	189.8	-0.0115
597.15	-0.016	189.7	-0.0107
597.17	-0.015	189.7	-0.0089
597.18	-0.013	189.8	-0.008
597.20	-0.013	189.8	-0.0062
597.22	-0.011	189.9	-0.0044
597.23	-0.009	189.9	-0.0044
597.25	-0.008	189.9	-0.0018
597.27	-0.008	190	0
597.28	-0.006	190.2	0.0036
597.30	-0.003	190.3	0.0062
597.32	-0.002	190.4	0.0089
597.33	-0.001	190.6	0.0124
597.35	0.003	190.9	0.0124

Prova triassiale ciclica SN04-C1			
pressione di confinamento (kPa)		80	
deviatore ciclico (kPa)		95	
frequenza (hz)		0.00625	
tempo	cella di carico	$\Delta u$	LVDT
(min)	kN	(kPa)	$\delta$ (mm)
597.37	0.004	190.9	0.0169
597.38	0.004	191	0.0195
597.40	0.005	191.3	0.024
597.42	0.009	191.5	0.0293
597.43	0.01	191.7	0.032
597.45	0.011	192	0.0364
597.47	0.015	192.3	0.0364
597.48	0.016	192.3	0.0399
597.50	0.016	192.5	0.0435
597.52	0.017	192.7	0.047
597.53	0.02	193	0.0506
597.55	0.021	193.2	0.0524
597.57	0.022	193.4	0.0541
597.58	0.024	193.6	0.0568
597.60	0.025	193.8	0.0595
597.62	0.025	194	0.0612
597.63	0.027	194.3	0.0612
597.65	0.028	194.3	0.063
597.67	0.028	194.4	0.0648
597.70	0.028	194.6	0.0657
597.72	0.028	194.7	0.0666
597.73	0.029	194.9	0.0675
597.75	0.029	195	0.0675
597.75	0.029	195.1	0.0675
597.77	0.028	195.2	0.0675
597.78	0.028	195.2	0.0675
597.80	0.028	195.3	0.0666
597.82	0.027	195.3	0.0657
597.83	0.026	195.3	0.0648
597.85	0.025	195.3	0.063
597.87	0.024	195.2	0.0612
597.88	0.022	195.2	0.0612
597.90	0.021	195.2	0.0586
597.92	0.021	195.2	0.0568
597.93	0.02	195	0.0541
597.95	0.016	194.9	0.0515
597.97	0.016	194.8	0.0488
597.98	0.014	194.6	0.0453
598.00	0.01	194.4	0.0453
598.02	0.01	194.4	0.0417
598.03	0.01	194.3	0.0382
598.05	0.007	194	0.0346
598.07	0.004	193.8	0.0311
598.08	0.004	193.6	0.0284
598.10	0.001	193.3	0.0231
598.12	-0.002	193.1	0.0231
598.13	-0.003	193.1	0.0186
598.15	-0.003	192.8	0.0151
598.17	-0.004	192.5	0.0115
598.18	-0.007	192.3	0.008
598.20	-0.009	192	0.0044
598.22	-0.01	191.8	0.0018
598.23	-0.012	191.5	0.0018
598.25	-0.013	191.5	-0.0009
598.27	-0.014	191.1	-0.0044
598.28	-0.015	190.9	-0.0044
598.30	-0.015	190.9	-0.0062
598.32	-0.015	190.7	-0.008

Prova triassiale ciclica SN04-C1			
pressione di confinamento (kPa)		80	
deviatore ciclico (kPa)		95	
frequenza (hz)		0.00625	
tempo	cella di carico	$\Delta u$	LVDT
(min)	kN	(kPa)	$\delta$ (mm)
598.33	-0.016	190.5	-0.0098
598.35	-0.017	190.3	-0.0107
598.37	-0.017	190.2	-0.0115
598.38	-0.017	190.1	-0.0115
598.40	-0.017	190	-0.0115
598.42	-0.017	190	-0.0115
598.43	-0.017	189.9	-0.0115
598.45	-0.017	189.8	-0.0115
598.47	-0.016	189.8	-0.0107
598.48	-0.015	189.8	-0.0098
598.50	-0.015	189.7	-0.0089
598.52	-0.013	189.8	-0.0089
598.53	-0.012	189.8	-0.0071
598.55	-0.012	189.8	-0.0053
598.57	-0.011	189.9	-0.0027
598.58	-0.008	190	-0.0009
598.60	-0.007	190.1	0.0009
598.62	-0.006	190.2	0.0044
598.63	-0.003	190.4	0.0044
598.65	-0.002	190.4	0.008
598.67	-0.002	190.5	0.0107
598.68	0	190.7	0.0142
598.70	0.004	191	0.0186
598.72	0.005	191.2	0.0213
598.73	0.006	191.3	0.0257
598.75	0.01	191.6	0.0257
598.77	0.011	191.8	0.0302
598.78	0.011	191.8	0.0328
598.80	0.012	192	0.0373
598.82	0.016	192.3	0.0417
598.83	0.017	192.6	0.0444
598.85	0.018	192.8	0.0479
598.87	0.021	193.1	0.0479
598.88	0.022	193.3	0.0515
598.90	0.022	193.3	0.0541
598.92	0.023	193.5	0.0568
598.93	0.024	193.8	0.0595
598.95	0.026	194	0.0612
598.97	0.026	194.2	0.063
598.98	0.027	194.4	0.0639
599.00	0.028	194.5	0.0657
599.02	0.028	194.7	0.0666
599.03	0.029	194.8	0.0666
599.05	0.029	195	0.0666
599.07	0.029	195	0.0675
599.08	0.029	195.1	0.0675
599.10	0.029	195.2	0.0675
599.12	0.029	195.2	0.0675
599.13	0.028	195.3	0.0666
599.17	0.027	195.4	0.0648
599.18	0.025	195.3	0.0648
599.20	0.024	195.3	0.0639
599.22	0.024	195.3	0.063
599.22	0.024	195.3	0.0612
599.23	0.021	195.2	0.0586
599.25	0.02	195.1	0.0559
599.27	0.019	195	0.0533
599.28	0.016	194.8	0.0533



Prova triassiale ciclica SN04-C1			
pressione di confinamento (kPa)		80	
deviatore ciclico (kPa)		95	
frequenza (hz)		0.00625	
tempo	cella di carico	$\Delta u$	LVDT
(min)	kN	(kPa)	$\delta$ (mm)
599.30	0.014	194.8	0.0497
599.32	0.014	194.7	0.047
599.33	0.013	194.5	0.0444
599.35	0.01	194.3	0.0399
599.37	0.009	194.2	0.0373
599.38	0.007	193.9	0.0337
599.40	0.003	193.7	0.0337
599.42	0.002	193.7	0.0293
599.43	0.002	193.5	0.0257
599.45	0.001	193.2	0.0213
599.47	-0.003	193	0.0169
599.48	-0.004	192.7	0.0142
599.50	-0.005	192.5	0.0107
599.52	-0.008	192.2	0.0107
599.53	-0.009	192.2	0.0062
599.55	-0.009	192	0.0036
599.57	-0.01	191.7	0.0009
599.58	-0.012	191.4	-0.0027
599.60	-0.014	191.2	-0.0044
599.62	-0.014	191	-0.0062
599.63	-0.016	190.8	-0.0062
599.65	-0.016	190.6	-0.008
599.67	-0.016	190.6	-0.0089
599.68	-0.016	190.4	-0.0107
599.70	-0.017	190.3	-0.0115
599.72	-0.017	190.1	-0.0115
599.73	-0.017	190	-0.0124
599.75	-0.017	189.9	-0.0124
599.77	-0.017	189.8	-0.0115
599.78	-0.016	189.8	-0.0115
599.80	-0.016	189.7	-0.0107
599.82	-0.015	189.7	-0.0107
599.83	-0.015	189.7	-0.0098
599.85	-0.014	189.7	-0.008
599.87	-0.013	189.8	-0.0062
599.88	-0.011	189.9	-0.0044
599.90	-0.01	189.9	-0.0027
599.92	-0.008	190	0
599.93	-0.006	190.1	0
599.95	-0.005	190.1	0.0027
599.97	-0.005	190.2	0.0053
599.98	-0.003	190.5	0.008
600.00	0	190.6	0.0124
600.02	0.001	190.8	0.0151
600.03	0.003	191	0.0195
600.05	0.006	191.2	0.0195
600.07	0.007	191.2	0.0231
600.08	0.007	191.4	0.0275
600.10	0.009	191.7	0.032
600.12	0.012	191.9	0.0355
600.13	0.014	192.1	0.0391
600.15	0.015	192.5	0.0426
600.17	0.018	192.7	0.0426
600.18	0.019	192.7	0.0462
600.20	0.019	192.9	0.0488
600.22	0.02	193.2	0.0524
600.23	0.023	193.4	0.055
600.25	0.024	193.6	0.0577

Prova triassiale ciclica SN04-C1			
pressione di confinamento (kPa)		80	
deviatore ciclico (kPa)		95	
frequenza (hz)		0.00625	
tempo	cella di carico	$\Delta u$	LVDT
(min)	kN	(kPa)	$\delta$ (mm)
600.27	0.025	193.8	0.0595
600.28	0.026	194.1	0.0595
600.30	0.027	194.1	0.0621
600.32	0.027	194.2	0.063
600.33	0.027	194.4	0.0648
600.35	0.028	194.6	0.0666
600.37	0.029	194.7	0.0666
600.38	0.029	194.9	0.0675
600.40	0.029	195	0.0675
600.42	0.029	195	0.0675
600.43	0.029	195.1	0.0675
600.45	0.028	195.3	0.0675
600.47	0.027	195.3	0.0666
600.48	0.027	195.3	0.0666
600.50	0.027	195.4	0.0648
600.52	0.025	195.3	0.0639
600.53	0.024	195.3	0.0621
600.55	0.023	195.3	0.0595
600.57	0.021	195.2	0.0595
600.60	0.019	195.2	0.0577
600.62	0.019	195.1	0.055
600.63	0.018	195	0.0524
600.65	0.015	194.8	0.0488
600.67	0.014	194.7	0.047
600.67	0.012	194.5	0.0435
600.68	0.009	194.3	0.0435
600.70	0.007	194.1	0.0391
600.72	0.007	194.1	0.0364
600.73	0.006	193.9	0.0328
600.75	0.003	193.6	0.0284
600.77	0.001	193.4	0.024
600.78	0	193.2	0.0195
600.80	-0.003	192.9	0.0195
600.82	-0.005	192.6	0.016
600.83	-0.005	192.6	0.0124
600.85	-0.006	192.4	0.0089
600.87	-0.009	192.1	0.0053
600.88	-0.01	191.9	0.0027
600.90	-0.011	191.7	0
600.92	-0.012	191.4	0
600.93	-0.014	191.2	-0.0027
600.95	-0.014	191.2	-0.0053
600.97	-0.015	191	-0.0071
600.98	-0.016	190.7	-0.008
601.00	-0.017	190.5	-0.0098
601.02	-0.017	190.4	-0.0107
601.03	-0.017	190.2	-0.0107
601.05	-0.017	190.1	-0.0107
601.07	-0.017	190.1	-0.0115
601.08	-0.017	190	-0.0115
601.10	-0.017	189.9	-0.0115
601.12	-0.017	189.8	-0.0115
601.13	-0.016	189.8	-0.0107
601.15	-0.015	189.8	-0.0089
601.17	-0.014	189.8	-0.0089
601.18	-0.013	189.8	-0.0071
601.20	-0.013	189.8	-0.0053
601.22	-0.01	189.9	-0.0053

Prova triassiale ciclica SN04-C1			
pressione di confinamento (kPa)		80	
deviatore ciclico (kPa)		95	
frequenza (hz)		0.00625	
tempo	cella di carico	$\Delta u$	LVDT
(min)	kN	(kPa)	$\delta$ (mm)
601.23	-0.01	189.9	-0.0036
601.25	-0.01	189.9	-0.0018
601.27	-0.008	190.1	0.0009
601.28	-0.005	190.2	0.0044
601.30	-0.004	190.3	0.0071
601.32	-0.003	190.5	0.0098
601.33	0.001	190.7	0.0098
601.35	0.002	190.7	0.0133
601.37	0.002	190.9	0.0169
601.38	0.004	191.1	0.0213
601.40	0.007	191.4	0.0249
601.42	0.008	191.5	0.0293
601.43	0.01	191.8	0.0337
601.45	0.013	192.1	0.0337
601.47	0.014	192.1	0.0373
601.48	0.014	192.3	0.0408
601.50	0.016	192.5	0.0444
601.52	0.019	192.8	0.0479
601.53	0.02	193	0.0506
601.55	0.021	193.2	0.0533
601.57	0.023	193.5	0.0533
601.58	0.024	193.7	0.0559
601.60	0.024	193.7	0.0586
601.62	0.025	193.9	0.0612
601.63	0.026	194.2	0.063
601.65	0.027	194.3	0.0648
601.67	0.028	194.5	0.0657
601.68	0.028	194.7	0.0657
601.70	0.029	194.8	0.0666
601.72	0.029	194.8	0.0675
601.73	0.029	195	0.0675
601.75	0.029	195.1	0.0675
601.77	0.029	195.2	0.0675
601.78	0.029	195.2	0.0675
601.80	0.028	195.3	0.0666
601.82	0.026	195.3	0.0666
601.83	0.026	195.3	0.0657
601.85	0.026	195.3	0.0639
601.87	0.025	195.3	0.0621
601.88	0.022	195.2	0.0604
601.90	0.022	195.2	0.0586
601.92	0.021	195.1	0.0568
601.93	0.018	195	0.0541
601.95	0.017	194.9	0.0524
601.97	0.016	194.8	0.0488
601.98	0.012	194.6	0.0488
602.00	0.011	194.5	0.0453
602.02	0.011	194.5	0.0426
602.03	0.01	194.3	0.0382
602.07	0.006	194	0.0346
602.08	0.005	193.8	0.0311
602.10	0.004	193.6	0.0275
602.12	0	193.3	0.0275
602.12	-0.001	193.1	0.0222
602.13	-0.001	193.1	0.0195
602.15	-0.002	192.9	0.0151
602.17	-0.005	192.5	0.0107
602.18	-0.007	192.3	0.008

Prova triassiale ciclica SN04-C1			
pressione di confinamento (kPa)		80	
deviatore ciclico (kPa)		95	
frequenza (hz)		0.00625	
tempo	cella di carico	$\Delta u$	LVDT
(min)	kN	(kPa)	$\delta$ (mm)
602.20	-0.009	192.1	0.0044
602.22	-0.01	191.8	0.0044
602.23	-0.012	191.5	0.0018
602.25	-0.012	191.5	-0.0009
602.27	-0.013	191.3	-0.0036
602.28	-0.014	191.1	-0.0053
602.30	-0.015	190.9	-0.0071
602.32	-0.016	190.7	-0.0089
602.33	-0.016	190.5	-0.0098
602.35	-0.017	190.3	-0.0098
602.37	-0.017	190.3	-0.0107
602.38	-0.017	190.2	-0.0115
602.40	-0.017	190.1	-0.0115
602.42	-0.017	190	-0.0115
602.43	-0.017	189.9	-0.0115
602.45	-0.017	189.8	-0.0115
602.47	-0.016	189.8	-0.0115
602.48	-0.015	189.8	-0.0107
602.50	-0.015	189.8	-0.0098
602.52	-0.014	189.8	-0.008
602.53	-0.012	189.8	-0.0062
602.55	-0.011	189.9	-0.0044
602.57	-0.01	190	-0.0027
602.58	-0.007	190.1	-0.0027
602.60	-0.006	190.1	0.0009
602.62	-0.006	190.2	0.0027
602.63	-0.003	190.4	0.0053
602.65	-0.001	190.4	0.008
602.67	-0.001	190.6	0.0107
602.68	0	190.7	0.0142
602.70	0.004	191	0.0186
602.72	0.004	191.2	0.0213
602.73	0.006	191.4	0.0249
602.75	0.01	191.7	0.0249
602.77	0.011	191.7	0.0311
602.78	0.011	191.9	0.0337
602.80	0.013	192.1	0.0382
602.82	0.015	192.4	0.0417
602.83	0.017	192.6	0.0444
602.85	0.018	192.8	0.0479
602.87	0.021	193.1	0.0479
602.88	0.022	193.3	0.0524
602.90	0.022	193.3	0.0541
602.92	0.023	193.5	0.0568
602.93	0.025	193.8	0.0595
602.95	0.026	194	0.0612
602.97	0.026	194.2	0.063
602.98	0.028	194.4	0.063
603.00	0.028	194.5	0.0648
603.02	0.028	194.5	0.0657
603.03	0.029	194.7	0.0666
603.05	0.029	194.9	0.0666
603.07	0.029	195	0.0675
603.08	0.029	195.1	0.0675
603.10	0.029	195.2	0.0675
603.12	0.028	195.3	0.0675
603.13	0.028	195.3	0.0675
603.15	0.027	195.3	0.0657

Prova triassiale ciclica SN04-C1			
pressione di confinamento (kPa)		80	
deviatore ciclico (kPa)		95	
frequenza (hz)		0.00625	
tempo	cella di carico	$\Delta u$	LVDT
(min)	kN	(kPa)	$\delta$ (mm)
603.17	0.027	195.3	0.0648
603.18	0.024	195.3	0.063
603.20	0.024	195.3	0.0612
603.22	0.023	195.2	0.0586
603.23	0.02	195.1	0.0586
603.25	0.02	195.1	0.0577
603.27	0.02	195.1	0.055
603.28	0.018	194.9	0.0515
603.30	0.015	194.7	0.0488
603.32	0.014	194.7	0.0462
603.33	0.012	194.4	0.0426
603.35	0.009	194.2	0.0391
603.37	0.009	194.1	0.0364
603.38	0.007	193.9	0.0328
603.40	0.003	193.7	0.0328
603.42	0.002	193.7	0.0293
603.43	0.002	193.5	0.0249
603.45	0	193.2	0.0204
603.47	-0.003	192.9	0.0169
603.50	-0.004	192.7	0.0142
603.52	-0.005	192.4	0.0098
603.53	-0.009	192.1	0.0098
603.55	-0.009	192.1	0.0062
603.57	-0.009	191.9	0.0036
603.57	-0.01	191.7	0.0009
603.58	-0.013	191.4	-0.0027
603.60	-0.014	191.2	-0.0044
603.62	-0.014	191	-0.0062
603.63	-0.016	190.8	-0.0062
603.65	-0.016	190.8	-0.008
603.67	-0.016	190.6	-0.0089
603.68	-0.017	190.4	-0.0107
603.70	-0.017	190.3	-0.0115
603.72	-0.017	190.1	-0.0115
603.73	-0.017	190	-0.0115
603.75	-0.017	189.9	-0.0115
603.77	-0.017	189.9	-0.0124
603.78	-0.017	189.8	-0.0115
603.80	-0.016	189.8	-0.0107
603.82	-0.015	189.8	-0.0107
603.83	-0.015	189.8	-0.0098
603.85	-0.014	189.8	-0.0071
603.87	-0.012	189.8	-0.0071
603.88	-0.011	189.8	-0.0053
603.90	-0.011	189.9	-0.0044
603.92	-0.01	190	-0.0018
603.93	-0.007	190.1	0.0009
603.95	-0.006	190.2	0.0036
603.97	-0.004	190.4	0.0071
603.98	-0.001	190.6	0.0071
604.00	0	190.6	0.0107
604.02	0	190.7	0.0133
604.03	0.002	190.9	0.0169
604.05	0.005	191.2	0.0213
604.07	0.007	191.4	0.0249
604.08	0.008	191.6	0.0302
604.10	0.01	191.8	0.032
604.12	0.012	192	0.0355

Prova triassiale ciclica SN04-C1			
pressione di confinamento (kPa)		80	
deviatore ciclico (kPa)		95	
frequenza (hz)		0.00625	
tempo	cella di carico	$\Delta u$	LVDT
(min)	kN	(kPa)	$\delta$ (mm)
604.13	0.013	192.2	0.0391
604.15	0.017	192.5	0.0391
604.17	0.018	192.7	0.0435
604.18	0.018	192.7	0.0453
604.20	0.019	193	0.0488
604.22	0.021	193.2	0.0524
604.23	0.023	193.5	0.055
604.25	0.024	193.7	0.0577
604.27	0.025	193.9	0.0577
604.28	0.026	194.1	0.0604
604.30	0.026	194.1	0.0621
604.32	0.027	194.3	0.0639
604.33	0.028	194.5	0.0648
604.35	0.028	194.6	0.0657
604.37	0.029	194.8	0.0666
604.38	0.029	194.9	0.0666
604.40	0.029	195	0.0666
604.42	0.029	195	0.0675
604.43	0.029	195.1	0.0675
604.45	0.028	195.2	0.0675
604.47	0.028	195.3	0.0666
604.48	0.027	195.4	0.0657
604.50	0.026	195.4	0.0639
604.52	0.024	195.3	0.0639
604.53	0.023	195.3	0.0621
604.55	0.023	195.3	0.0604
604.57	0.022	195.2	0.0586
604.58	0.02	195.1	0.0559
604.60	0.019	195	0.0541
604.62	0.017	194.9	0.0506
604.63	0.014	194.7	0.0506
604.65	0.013	194.7	0.047
604.67	0.013	194.6	0.0453
604.68	0.011	194.4	0.0408
604.70	0.007	194.2	0.0364
604.72	0.006	194	0.0337
604.73	0.005	193.8	0.0302
604.75	0.002	193.5	0.0302
604.77	0.001	193.5	0.0257
604.78	0.001	193.3	0.0222
604.80	-0.001	193	0.0178
604.82	-0.005	192.7	0.0133
604.83	-0.005	192.6	0.0115
604.85	-0.006	192.3	0.0089
604.87	-0.009	192	0.0053
604.88	-0.01	191.8	0.0027
604.90	-0.011	191.6	-0.0009
604.92	-0.014	191.3	-0.0009
604.93	-0.014	191.3	-0.0036
604.97	-0.014	191.2	-0.0053
604.98	-0.014	190.9	-0.0071
605.00	-0.016	190.7	-0.0089
605.02	-0.016	190.5	-0.0098
605.02	-0.017	190.4	-0.0107
605.03	-0.017	190.2	-0.0107
605.05	-0.017	190.2	-0.0115
605.07	-0.017	190.1	-0.0124
605.08	-0.017	190	-0.0124

Prova triassiale ciclica SN04-C1			
pressione di confinamento (kPa)		80	
deviatore ciclico (kPa)		95	
frequenza (hz)		0.00625	
tempo	cella di carico	$\Delta u$	LVDT
(min)	kN	(kPa)	$\delta$ (mm)
605.10	-0.017	189.9	-0.0124
605.12	-0.016	189.8	-0.0115
605.13	-0.016	189.8	-0.0107
605.15	-0.015	189.8	-0.0107
605.17	-0.014	189.8	-0.0098
605.18	-0.014	189.8	-0.0089
605.20	-0.013	189.8	-0.0071
605.22	-0.011	189.9	-0.0044
605.23	-0.01	189.9	-0.0027
605.25	-0.009	190	0
605.27	-0.006	190.2	0
605.28	-0.005	190.3	0.0027
605.30	-0.005	190.3	0.0044
605.32	-0.003	190.4	0.0089
605.33	-0.001	190.7	0.0115
605.35	0.002	190.8	0.0142
605.37	0.002	191	0.0186
605.38	0.005	191.3	0.0186
605.40	0.008	191.5	0.0222
605.42	0.008	191.5	0.0257
605.43	0.009	191.6	0.0311
605.45	0.012	192	0.0346
605.47	0.014	192.2	0.0382
605.48	0.015	192.4	0.0417
605.50	0.018	192.7	0.0417
605.52	0.019	192.9	0.0462
605.53	0.02	193.1	0.0506
605.55	0.021	193.3	0.0533
605.57	0.023	193.6	0.0533
605.58	0.024	193.6	0.0559
605.60	0.024	193.8	0.0586
605.62	0.025	194	0.0604
605.63	0.027	194.2	0.0621
605.65	0.027	194.4	0.0639
605.67	0.028	194.6	0.0648
605.68	0.028	194.7	0.0648
605.70	0.028	194.7	0.0657
605.72	0.028	194.9	0.0666
605.73	0.029	195	0.0675
605.75	0.029	195.1	0.0675
605.77	0.029	195.2	0.0675
605.78	0.028	195.3	0.0675
605.80	0.027	195.4	0.0675
605.82	0.027	195.4	0.0657
605.83	0.027	195.4	0.0648
605.85	0.026	195.4	0.063
605.87	0.023	195.3	0.0612
605.88	0.023	195.3	0.0595
605.90	0.021	195.2	0.0577
605.92	0.019	195.1	0.0577
605.93	0.019	195.1	0.055
605.95	0.019	195	0.0524
605.97	0.017	194.8	0.0488
605.98	0.013	194.6	0.0453
606.00	0.012	194.5	0.0426
606.02	0.011	194.3	0.0391
606.03	0.007	194.1	0.0391
606.05	0.006	194.1	0.0355

Prova triassiale ciclica SN04-C1			
pressione di confinamento (kPa)		80	
deviatore ciclico (kPa)		95	
frequenza (hz)		0.00625	
tempo	cella di carico	$\Delta u$	LVDT
(min)	kN	(kPa)	$\delta$ (mm)
606.07	0.006	193.9	0.0328
606.08	0.005	193.7	0.0284
606.10	0.001	193.4	0.024
606.12	0	193.2	0.0204
606.13	-0.002	192.9	0.016
606.15	-0.005	192.6	0.016
606.17	-0.006	192.6	0.0115
606.18	-0.006	192.4	0.0089
606.20	-0.007	192.2	0.0053
606.22	-0.01	191.9	0.0027
606.23	-0.011	191.6	0
606.25	-0.012	191.4	-0.0027
606.27	-0.014	191.2	-0.0053
606.28	-0.014	191	-0.0071
606.30	-0.015	190.8	-0.008
606.32	-0.016	190.6	-0.008
606.33	-0.017	190.6	-0.0098
606.35	-0.017	190.4	-0.0107
606.37	-0.017	190.3	-0.0115
606.38	-0.017	190.2	-0.0124
606.40	-0.017	190	-0.0124
606.43	-0.017	189.9	-0.0124
606.45	-0.017	189.9	-0.0124
606.47	-0.016	189.9	-0.0124
606.47	-0.016	189.8	-0.0115
606.48	-0.016	189.8	-0.0107
606.50	-0.014	189.8	-0.0089
606.52	-0.013	189.8	-0.008
606.53	-0.013	189.8	-0.0062
606.55	-0.01	189.9	-0.0062
606.57	-0.009	190	-0.0044
606.58	-0.009	190	-0.0027
606.60	-0.008	190	0
606.62	-0.005	190.2	0.0036
606.63	-0.004	190.3	0.0062
606.65	-0.003	190.5	0.0098
606.67	0.001	190.7	0.0098
606.68	0.002	190.9	0.0133
606.70	0.002	190.9	0.016
606.72	0.003	191.1	0.0204
606.73	0.007	191.3	0.024
606.75	0.009	191.5	0.0284
606.77	0.01	191.7	0.032
606.78	0.013	192.1	0.032
606.80	0.015	192.3	0.0364
606.82	0.015	192.3	0.0399
606.83	0.016	192.5	0.0435
606.85	0.018	192.8	0.047
606.87	0.02	193	0.0497
606.88	0.021	193.2	0.0533
606.90	0.023	193.5	0.0559
606.92	0.025	193.7	0.0559
606.93	0.025	193.7	0.0586
606.95	0.025	193.9	0.0604
606.97	0.026	194.1	0.0621
606.98	0.028	194.3	0.0639
607.00	0.028	194.5	0.0648
607.02	0.028	194.7	0.0657



Prova triassiale ciclica SN04-C1			
pressione di confinamento (kPa)		80	
deviatore ciclico (kPa)		95	
frequenza (hz)		0.00625	
tempo	cella di carico	$\Delta u$	LVDT
(min)	kN	(kPa)	$\delta$ (mm)
607.03	0.028	194.8	0.0666
607.05	0.029	194.9	0.0675
607.07	0.029	195.1	0.0675
607.08	0.029	195.1	0.0675
607.10	0.028	195.1	0.0675
607.12	0.028	195.3	0.0675
607.13	0.028	195.3	0.0666
607.15	0.027	195.4	0.0657
607.17	0.026	195.4	0.0639
607.18	0.025	195.4	0.0621
607.20	0.023	195.3	0.0621
607.22	0.022	195.3	0.0604
607.23	0.022	195.2	0.0595
607.25	0.021	195.2	0.0559
607.27	0.018	195	0.0541
607.28	0.017	194.9	0.0515
607.30	0.016	194.8	0.0479
607.32	0.012	194.6	0.0479
607.33	0.011	194.6	0.0444
607.35	0.011	194.5	0.0417
607.37	0.01	194.3	0.0382
607.38	0.006	194	0.0337
607.40	0.005	193.8	0.0311
607.42	0.003	193.6	0.0257
607.43	-0.001	193.3	0.0257
607.45	-0.001	193.3	0.0213
607.47	-0.001	193.1	0.0186
607.48	-0.002	192.8	0.0151
607.50	-0.006	192.5	0.0107
607.52	-0.007	192.3	0.008
607.53	-0.008	192	0.0044
607.55	-0.011	191.8	0.0044
607.57	-0.012	191.8	0.0009
607.58	-0.012	191.6	-0.0009
607.60	-0.013	191.3	-0.0036
607.62	-0.014	191.1	-0.0062
607.63	-0.015	190.9	-0.0071
607.65	-0.016	190.7	-0.0098
607.67	-0.017	190.5	-0.0098
607.68	-0.017	190.5	-0.0107
607.70	-0.017	190.4	-0.0115
607.72	-0.017	190.1	-0.0115
607.73	-0.017	190.1	-0.0115
607.75	-0.017	190	-0.0124
607.77	-0.017	189.9	-0.0124
607.78	-0.017	189.8	-0.0115
607.80	-0.016	189.8	-0.0115
607.82	-0.016	189.8	-0.0107
607.83	-0.014	189.8	-0.0107
607.87	-0.013	189.8	-0.0089
607.88	-0.013	189.8	-0.0071
607.90	-0.012	189.8	-0.0053
607.92	-0.01	190	-0.0027
607.93	-0.008	190	-0.0009
607.93	-0.007	190.1	0.0018
607.95	-0.004	190.3	0.0018
607.97	-0.003	190.4	0.0053
607.98	-0.003	190.4	0.0071

Prova triassiale ciclica SN04-C1			
pressione di confinamento (kPa)		80	
deviatore ciclico (kPa)		95	
frequenza (hz)		0.00625	
tempo	cella di carico	$\Delta u$	LVDT
(min)	kN	(kPa)	$\delta$ (mm)
608.00	-0.002	190.5	0.0107
608.02	0.001	190.8	0.0142
608.03	0.003	191	0.0178
608.05	0.004	191.2	0.0222
608.07	0.007	191.5	0.0222
608.08	0.01	191.7	0.0275
608.10	0.01	191.7	0.0302
608.12	0.011	191.9	0.0346
608.13	0.013	192.2	0.0382
608.15	0.016	192.4	0.0417
608.17	0.016	192.6	0.0444
608.18	0.019	192.9	0.0488
608.20	0.021	193.1	0.0488
608.22	0.021	193.1	0.0524
608.23	0.022	193.4	0.0541
608.25	0.023	193.6	0.0568
608.27	0.025	193.9	0.0586
608.28	0.026	194	0.0612
608.30	0.027	194.2	0.063
608.32	0.028	194.4	0.063
608.33	0.028	194.4	0.0648
608.35	0.028	194.6	0.0657
608.37	0.028	194.7	0.0657
608.38	0.029	194.9	0.0666
608.40	0.029	195	0.0675
608.42	0.029	195.1	0.0675
608.43	0.029	195.2	0.0675
608.45	0.028	195.3	0.0666
608.47	0.028	195.4	0.0657
608.48	0.026	195.4	0.0657
608.50	0.025	195.4	0.0648
608.52	0.025	195.4	0.063
608.53	0.025	195.3	0.0621
608.55	0.023	195.3	0.0604
608.57	0.021	195.2	0.0577
608.58	0.02	195.1	0.055
608.60	0.017	195	0.055
608.62	0.017	195	0.0524
608.63	0.017	194.9	0.0497
608.65	0.015	194.7	0.047
608.67	0.011	194.5	0.0426
608.68	0.01	194.4	0.0399
608.70	0.009	194.1	0.0355
608.72	0.005	193.9	0.0355
608.73	0.004	193.9	0.032
608.75	0.004	193.7	0.0293
608.77	0.002	193.5	0.024
608.78	-0.001	193.2	0.0204
608.80	-0.002	193	0.0169
608.82	-0.003	192.7	0.0133
608.83	-0.007	192.4	0.0133
608.85	-0.008	192.4	0.0089
608.87	-0.008	192.2	0.0062
608.88	-0.009	191.9	0.0027
608.90	-0.011	191.7	0
608.92	-0.012	191.4	-0.0027
608.93	-0.013	191.2	-0.0053
608.95	-0.015	191	-0.0053

Prova triassiale ciclica SN04-C1			
pressione di confinamento (kPa)		80	
deviatore ciclico (kPa)		95	
frequenza (hz)		0.00625	
tempo	cella di carico	$\Delta u$	LVDT
(min)	kN	(kPa)	$\delta$ (mm)
608.97	-0.015	191	-0.0071
608.98	-0.015	190.8	-0.0089
609.00	-0.016	190.6	-0.0098
609.02	-0.017	190.4	-0.0107
609.03	-0.017	190.3	-0.0115
609.05	-0.017	190.2	-0.0124
609.07	-0.017	190.1	-0.0124
609.08	-0.017	190.1	-0.0124
609.10	-0.017	190	-0.0124
609.12	-0.016	189.9	-0.0115
609.13	-0.016	189.8	-0.0107
609.15	-0.015	189.8	-0.0107
609.17	-0.015	189.8	-0.0089
609.18	-0.014	189.8	-0.008
609.20	-0.012	189.8	-0.0062
609.22	-0.011	189.9	-0.0044
609.23	-0.009	190	-0.0044
609.25	-0.008	190	-0.0027
609.27	-0.008	190.1	0
609.28	-0.007	190.2	0.0027
609.30	-0.004	190.4	0.0062
609.33	-0.002	190.5	0.0089
609.35	-0.001	190.6	0.0124
609.37	0.003	190.9	0.0124
609.38	0.004	191.1	0.0169
609.38	0.004	191.1	0.0195
609.40	0.005	191.3	0.0231
609.42	0.009	191.6	0.0284
609.43	0.01	191.8	0.032
609.45	0.012	192	0.0355
609.47	0.015	192.3	0.0355
609.48	0.016	192.5	0.0399
609.50	0.016	192.5	0.0426
609.52	0.018	192.7	0.047
609.53	0.02	193	0.0497
609.55	0.021	193.2	0.0524
609.57	0.022	193.5	0.0559
609.58	0.024	193.7	0.0559
609.60	0.025	193.9	0.0577
609.62	0.025	193.9	0.0604
609.63	0.026	194.1	0.0621
609.65	0.027	194.4	0.063
609.67	0.028	194.5	0.0648
609.68	0.028	194.7	0.0657
609.70	0.029	194.8	0.0666
609.72	0.029	194.9	0.0666
609.73	0.029	194.9	0.0675
609.75	0.029	195.1	0.0675
609.77	0.029	195.2	0.0675
609.78	0.028	195.3	0.0666
609.80	0.027	195.3	0.0657
609.82	0.027	195.3	0.0648
609.83	0.025	195.3	0.0648
609.85	0.025	195.3	0.0639
609.87	0.025	195.3	0.0621
609.88	0.023	195.2	0.0604
609.90	0.021	195.2	0.0577
609.92	0.021	195.2	0.0568

Prova triassiale ciclica SN04-C1			
pressione di confinamento (kPa)		80	
deviatore ciclico (kPa)		95	
frequenza (hz)		0.00625	
tempo	cella di carico	$\Delta u$	LVDT
(min)	kN	(kPa)	$\delta$ (mm)
609.93	0.02	195	0.0541
609.95	0.016	194.9	0.0515
609.97	0.016	194.8	0.0488
609.98	0.014	194.6	0.0453
610.00	0.01	194.4	0.0453
610.02	0.009	194.4	0.0417
610.03	0.009	194.3	0.0382
610.05	0.008	194	0.0346
610.07	0.004	193.8	0.0311
610.08	0.003	193.6	0.0275
610.10	0.002	193.4	0.0222
610.12	-0.002	193.1	0.0222
610.13	-0.003	193.1	0.0186
610.15	-0.003	192.9	0.0151
610.17	-0.004	192.6	0.0107
610.18	-0.008	192.3	0.0071
610.20	-0.008	192.1	0.0044
610.22	-0.01	191.8	0.0018
610.23	-0.012	191.5	0.0018
610.25	-0.013	191.5	-0.0018
610.27	-0.013	191.4	-0.0036
610.28	-0.013	191.2	-0.0053
610.30	-0.015	190.9	-0.008
610.32	-0.016	190.7	-0.0089
610.33	-0.016	190.5	-0.0107
610.35	-0.017	190.4	-0.0107
610.37	-0.017	190.4	-0.0115
610.38	-0.017	190.2	-0.0115
610.40	-0.017	190.1	-0.0124
610.42	-0.017	190	-0.0124
610.43	-0.017	189.9	-0.0115
610.45	-0.017	189.8	-0.0115
610.47	-0.016	189.8	-0.0115
610.48	-0.015	189.8	-0.0107
610.50	-0.015	189.8	-0.0098
610.52	-0.014	189.8	-0.008
610.53	-0.012	189.8	-0.0071
610.55	-0.011	189.9	-0.0053
610.57	-0.01	190	-0.0027
610.58	-0.007	190.1	-0.0027
610.60	-0.006	190.1	0
610.62	-0.005	190.3	0.0036
610.63	-0.003	190.4	0.0036
610.65	-0.002	190.4	0.0062
610.67	-0.002	190.5	0.0098
610.68	0	190.7	0.0142
610.70	0.004	191	0.0186
610.72	0.005	191.2	0.0213
610.73	0.006	191.4	0.0249
610.77	0.01	191.7	0.0249
610.78	0.011	191.7	0.0302
610.80	0.011	191.9	0.0337
610.82	0.012	192.1	0.0373
610.83	0.016	192.4	0.0417
610.83	0.017	192.6	0.0444
610.85	0.018	192.8	0.0479
610.87	0.021	193.1	0.0479
610.88	0.022	193.4	0.0515

Prova triassiale ciclica SN04-C1			
pressione di confinamento (kPa)		80	
deviatore ciclico (kPa)		95	
frequenza (hz)		0.00625	
tempo	cella di carico	$\Delta u$	LVDT
(min)	kN	(kPa)	$\delta$ (mm)
610.90	0.022	193.4	0.0541
610.92	0.023	193.6	0.0568
610.93	0.025	193.8	0.0595
610.95	0.026	194	0.0612
610.97	0.026	194.2	0.063
610.98	0.027	194.4	0.063
611.00	0.028	194.6	0.0648
611.02	0.028	194.6	0.0657
611.03	0.028	194.7	0.0666
611.05	0.028	194.9	0.0666
611.07	0.029	195	0.0675
611.08	0.029	195.1	0.0675
611.10	0.029	195.2	0.0675
611.12	0.028	195.3	0.0675
611.13	0.027	195.3	0.0666
611.15	0.027	195.4	0.0657
611.17	0.027	195.3	0.0648
611.18	0.025	195.3	0.063
611.20	0.024	195.3	0.0612
611.22	0.023	195.2	0.0595
611.23	0.021	195.2	0.0595
611.25	0.019	195.2	0.0568
611.27	0.019	195.1	0.055
611.28	0.018	195	0.0524
611.30	0.015	194.8	0.0488
611.32	0.014	194.7	0.0462
611.33	0.012	194.5	0.0426
611.35	0.009	194.3	0.0391
611.37	0.008	194.2	0.0373
611.38	0.007	194	0.0328
611.40	0.003	193.7	0.0328
611.42	0.002	193.7	0.0293
611.43	0.002	193.5	0.0257
611.45	0.001	193.3	0.0213
611.47	-0.003	193	0.0169
611.48	-0.004	192.8	0.0142
611.50	-0.005	192.5	0.0107
611.52	-0.008	192.2	0.0107
611.53	-0.009	192.2	0.0071
611.55	-0.009	192	0.0036
611.57	-0.01	191.7	0.0009
611.58	-0.013	191.5	-0.0027
611.60	-0.014	191.3	-0.0044
611.62	-0.014	191.1	-0.0062
611.63	-0.016	190.8	-0.0062
611.65	-0.016	190.8	-0.008
611.67	-0.016	190.6	-0.0089
611.68	-0.017	190.5	-0.0107
611.70	-0.017	190.3	-0.0115
611.72	-0.017	190.2	-0.0115
611.73	-0.017	190.1	-0.0124
611.75	-0.017	190	-0.0124
611.77	-0.017	189.9	-0.0124
611.78	-0.017	189.9	-0.0115
611.80	-0.016	189.8	-0.0107
611.82	-0.015	189.8	-0.0098
611.83	-0.014	189.8	-0.0089
611.85	-0.014	189.8	-0.0071

Prova triassiale ciclica SN04-C1			
pressione di confinamento (kPa)		80	
deviatore ciclico (kPa)		95	
frequenza (hz)		0.00625	
tempo	cella di carico	$\Delta u$	LVDT
(min)	kN	(kPa)	$\delta$ (mm)
611.87	-0.012	189.9	-0.0053
611.88	-0.01	189.9	-0.0053
611.90	-0.01	189.9	-0.0044
611.92	-0.01	190	-0.0018
611.93	-0.008	190.2	0.0009
611.95	-0.005	190.3	0.0044
611.97	-0.004	190.4	0.0071
611.98	-0.003	190.6	0.0098
612.00	0.001	190.8	0.0098
612.02	0.002	190.8	0.0142
612.03	0.002	190.9	0.0169
612.05	0.004	191.2	0.0204
612.07	0.007	191.4	0.0249
612.08	0.007	191.5	0.0284
612.10	0.009	191.8	0.032
612.12	0.013	192	0.0355
612.13	0.013	192.2	0.0391
612.15	0.015	192.5	0.0426
612.17	0.018	192.8	0.0426
612.18	0.019	192.8	0.047
612.20	0.019	193	0.0497
612.23	0.02	193.2	0.0524
612.25	0.023	193.5	0.0559
612.27	0.024	193.7	0.0577
612.28	0.025	193.9	0.0604
612.28	0.026	194.1	0.0604
612.30	0.027	194.1	0.0621
612.32	0.027	194.3	0.0639
612.33	0.027	194.5	0.0648
612.35	0.028	194.7	0.0666
612.37	0.029	194.8	0.0675
612.38	0.029	195	0.0675
612.40	0.029	195.1	0.0675
612.42	0.029	195.1	0.0675
612.43	0.029	195.2	0.0675
612.45	0.029	195.3	0.0675
612.47	0.028	195.3	0.0666
612.48	0.027	195.4	0.0666
612.50	0.026	195.4	0.0639
612.52	0.025	195.4	0.0639
612.53	0.023	195.3	0.063
612.55	0.023	195.3	0.0612
612.57	0.022	195.3	0.0586
612.58	0.02	195.1	0.0568
612.60	0.018	195	0.0541
612.62	0.017	195	0.0506
612.63	0.015	194.8	0.0506
612.65	0.013	194.6	0.0479
612.67	0.013	194.6	0.0453
612.68	0.011	194.5	0.0417
612.70	0.009	194.2	0.0373
612.72	0.006	194	0.0346
612.73	0.005	193.8	0.0311
612.75	0.002	193.5	0.0311
612.77	0	193.3	0.0257
612.78	0	193.3	0.0231
612.80	-0.003	192.8	0.016
612.82	-0.005	192.6	0.016

Prova triassiale ciclica SN04-C1			
pressione di confinamento (kPa)		80	
deviatore ciclico (kPa)		95	
frequenza (hz)		0.00625	
tempo	cella di carico	$\Delta u$	LVDT
(min)	kN	(kPa)	$\delta$ (mm)
612.83	-0.005	192.6	0.0133
612.85	-0.006	192.4	0.0098
612.87	-0.008	192.1	0.0053
612.88	-0.01	191.8	0.0018
612.90	-0.011	191.6	0
612.92	-0.012	191.4	-0.0027
612.93	-0.014	191.2	-0.0027
612.95	-0.015	191.2	-0.0044
612.97	-0.015	191	-0.0062
612.98	-0.015	190.8	-0.008
613.00	-0.017	190.6	-0.0098
613.02	-0.017	190.4	-0.0107
613.03	-0.017	190.3	-0.0115
613.05	-0.017	190.1	-0.0115
613.07	-0.017	190.1	-0.0115
613.08	-0.017	190	-0.0115
613.10	-0.017	189.9	-0.0115
613.12	-0.017	189.9	-0.0115
613.13	-0.016	189.8	-0.0107
613.15	-0.015	189.8	-0.0098
613.17	-0.014	189.8	-0.0098
613.18	-0.013	189.8	-0.008
613.20	-0.013	189.8	-0.0071
613.22	-0.012	189.8	-0.0053
613.23	-0.01	190	-0.0027
613.25	-0.008	190.1	-0.0009
613.27	-0.007	190.1	0.0018
613.28	-0.005	190.3	0.0018
613.30	-0.003	190.4	0.0053
613.32	-0.003	190.4	0.0071
613.33	-0.002	190.6	0.0115
613.35	0.001	190.8	0.0151
613.37	0.004	191	0.0186
613.38	0.004	191.2	0.0213
613.40	0.007	191.5	0.0213
613.42	0.01	191.7	0.0257
613.43	0.01	191.7	0.0302
613.45	0.011	191.9	0.0337
613.47	0.014	192.2	0.0382
613.48	0.015	192.4	0.0408
613.50	0.016	192.6	0.0444
613.52	0.019	193	0.0444
613.53	0.021	193.2	0.0515
613.55	0.021	193.3	0.0533
613.57	0.023	193.6	0.0559
613.58	0.024	193.8	0.0559
613.60	0.024	193.8	0.0577
613.62	0.025	194	0.0604
613.63	0.026	194.2	0.0621
613.65	0.028	194.4	0.0639
613.68	0.028	194.6	0.0648
613.70	0.028	194.7	0.0657
613.72	0.029	194.9	0.0657
613.73	0.029	194.9	0.0666
613.73	0.029	195	0.0666
613.75	0.029	195.1	0.0666
613.77	0.029	195.2	0.0666
613.78	0.028	195.3	0.0666

Prova triassiale ciclica SN04-C1			
pressione di confinamento (kPa)		80	
deviatore ciclico (kPa)		95	
frequenza (hz)		0.00625	
tempo	cella di carico	$\Delta u$	LVDT
(min)	kN	(kPa)	$\delta$ (mm)
613.80	0.028	195.4	0.0657
613.82	0.026	195.4	0.0657
613.83	0.025	195.4	0.0639
613.85	0.025	195.4	0.063
613.87	0.025	195.4	0.0621
613.88	0.022	195.3	0.0595
613.90	0.021	195.2	0.0577
613.92	0.021	195.2	0.0559
613.93	0.017	195	0.0559
613.95	0.017	195	0.0524
613.97	0.017	194.9	0.0506
613.98	0.015	194.7	0.0462
614.00	0.011	194.5	0.0426
614.02	0.01	194.4	0.0399
614.03	0.009	194.2	0.0364
614.05	0.005	193.9	0.0364
614.07	0.004	193.9	0.032
614.08	0.004	193.8	0.0293
614.10	0.003	193.5	0.024
614.12	-0.001	193.2	0.0195
614.13	-0.002	193	0.0169
614.15	-0.004	192.8	0.0124
614.17	-0.007	192.4	0.0124
614.18	-0.008	192.4	0.008
614.20	-0.008	192.2	0.0062
614.22	-0.009	192	0.0027
614.23	-0.011	191.7	0
614.25	-0.012	191.5	-0.0027
614.27	-0.013	191.3	-0.0044
614.28	-0.015	191	-0.0071
614.30	-0.015	190.9	-0.008
614.32	-0.016	190.7	-0.0098
614.33	-0.017	190.5	-0.0098
614.35	-0.017	190.3	-0.0107
614.37	-0.017	190.3	-0.0115
614.38	-0.017	190.2	-0.0124
614.40	-0.017	190.1	-0.0124
614.42	-0.017	190	-0.0124
614.43	-0.017	189.9	-0.0124
614.45	-0.016	189.9	-0.0124
614.47	-0.015	189.8	-0.0115
614.48	-0.015	189.8	-0.0107
614.50	-0.015	189.8	-0.0098
614.52	-0.014	189.8	-0.008
614.53	-0.012	189.8	-0.0071
614.55	-0.011	189.9	-0.0053
614.57	-0.01	190	-0.0027
614.58	-0.007	190.1	-0.0027
614.60	-0.007	190.1	-0.0009
614.62	-0.007	190.2	0.0027
614.63	-0.004	190.4	0.0062
614.65	-0.002	190.5	0.0089
614.67	-0.001	190.6	0.0124
614.68	0.001	190.9	0.016
614.70	0.004	191.2	0.016
614.72	0.004	191.2	0.0195
614.73	0.005	191.3	0.0231
614.75	0.008	191.6	0.0284



Prova triassiale ciclica SN04-C1			
pressione di confinamento (kPa)		80	
deviatore ciclico (kPa)		95	
frequenza (hz)		0.00625	
tempo	cella di carico	$\Delta u$	LVDT
(min)	kN	(kPa)	$\delta$ (mm)
614.77	0.011	191.8	0.032
614.78	0.012	192	0.0346
614.80	0.014	192.3	0.0391
614.82	0.017	192.5	0.0391
614.83	0.017	192.5	0.0426
614.85	0.017	192.7	0.0453
614.87	0.019	193	0.0488
614.88	0.022	193.3	0.0524
614.90	0.022	193.5	0.055
614.92	0.024	193.7	0.0577
614.93	0.026	194	0.0577
614.95	0.026	194	0.0604
614.97	0.026	194.1	0.0621
614.98	0.028	194.5	0.063
615.00	0.028	194.5	0.0639
615.02	0.028	194.7	0.0657
615.03	0.028	194.8	0.0666
615.05	0.029	194.9	0.0666
615.07	0.029	195.1	0.0666
615.08	0.029	195.2	0.0675
615.10	0.028	195.3	0.0675
615.13	0.028	195.3	0.0675
615.15	0.028	195.4	0.0666
615.17	0.028	195.4	0.0657
615.18	0.026	195.4	0.0648
615.18	0.025	195.4	0.063
615.20	0.024	195.4	0.0612
615.22	0.022	195.3	0.0612
615.23	0.021	195.3	0.0595
615.25	0.021	195.2	0.0577
615.27	0.02	195.1	0.0541
615.28	0.016	194.9	0.0506
615.30	0.015	194.8	0.0488
615.32	0.014	194.7	0.0453
615.33	0.011	194.5	0.0453
615.35	0.009	194.3	0.0417
615.37	0.009	194.3	0.0391
615.38	0.008	194.2	0.0346
615.40	0.005	193.9	0.0311
615.42	0.003	193.7	0.0284
615.43	0.002	193.4	0.0231
615.45	-0.002	193.1	0.0231
615.47	-0.003	192.9	0.0186
615.48	-0.003	192.9	0.016
615.50	-0.005	192.7	0.0115
615.52	-0.007	192.3	0.0071
615.53	-0.009	192.1	0.0044
615.55	-0.01	191.9	0.0018
615.57	-0.012	191.6	0.0018
615.58	-0.013	191.4	-0.0009
615.60	-0.013	191.4	-0.0036
615.62	-0.014	191.2	-0.0053
615.63	-0.015	190.9	-0.0071
615.65	-0.016	190.7	-0.0089
615.67	-0.016	190.6	-0.0098
615.68	-0.017	190.4	-0.0107
615.70	-0.017	190.3	-0.0115
615.72	-0.017	190.1	-0.0124

Prova triassiale ciclica SN04-C1			
pressione di confinamento (kPa)		80	
deviatore ciclico (kPa)		95	
frequenza (hz)		0.00625	
tempo	cella di carico	$\Delta u$	LVDT
(min)	kN	(kPa)	$\delta$ (mm)
615.73	-0.017	190	-0.0124
615.75	-0.017	189.9	-0.0124
615.77	-0.017	189.9	-0.0124
615.78	-0.017	189.8	-0.0115
615.80	-0.016	189.8	-0.0107
615.82	-0.015	189.8	-0.0098
615.83	-0.014	189.8	-0.0089
615.85	-0.014	189.8	-0.0071
615.87	-0.011	189.9	-0.0071
615.88	-0.011	189.9	-0.0062
615.90	-0.011	189.9	-0.0036
615.92	-0.01	190	-0.0018
615.93	-0.006	190.1	0.0009
615.95	-0.006	190.2	0.0036
615.97	-0.004	190.4	0.0071
615.98	-0.001	190.6	0.0071
616.00	0	190.6	0.0107
616.02	0	190.8	0.0133
616.03	0.002	191	0.0169
616.05	0.005	191.2	0.0213
616.07	0.006	191.4	0.0249
616.08	0.008	191.6	0.0302
616.10	0.012	191.9	0.0302
616.12	0.013	191.9	0.0337
616.13	0.013	192.1	0.0373
616.15	0.014	192.3	0.0408
616.17	0.017	192.6	0.0444
616.18	0.018	192.9	0.0479
616.20	0.02	193.1	0.0506
616.22	0.022	193.4	0.0506
616.23	0.023	193.4	0.0541
616.25	0.023	193.6	0.0559
616.27	0.024	193.8	0.0586
616.28	0.026	194	0.0612
616.30	0.026	194.2	0.0621
616.32	0.027	194.4	0.0639
616.33	0.028	194.6	0.0639
616.35	0.029	194.7	0.0648
616.37	0.029	194.7	0.0657
616.38	0.029	194.9	0.0666
616.40	0.029	195	0.0666
616.42	0.029	195.1	0.0666
616.43	0.029	195.2	0.0666
616.45	0.028	195.3	0.0666
616.47	0.028	195.4	0.0666
616.48	0.027	195.4	0.0639
616.50	0.026	195.4	0.063
616.52	0.024	195.4	0.063
616.53	0.024	195.4	0.0612
616.55	0.023	195.4	0.0604
616.57	0.022	195.2	0.0577
616.60	0.02	195.1	0.0559
616.62	0.019	195.1	0.0533
616.63	0.017	194.9	0.0497
616.65	0.014	194.7	0.0497
616.65	0.013	194.7	0.047
616.67	0.013	194.6	0.0444
616.68	0.011	194.4	0.0408

Prova triassiale ciclica SN04-C1			
pressione di confinamento (kPa)		80	
deviatore ciclico (kPa)		95	
frequenza (hz)		0.00625	
tempo	cella di carico	$\Delta u$	LVDT
(min)	kN	(kPa)	$\delta$ (mm)
616.70	0.008	194.2	0.0364
616.72	0.007	194.1	0.0337
616.73	0.005	193.8	0.0293
616.75	0.002	193.6	0.0293
616.77	0.001	193.6	0.0249
616.78	0.001	193.4	0.0213
616.80	-0.001	193	0.0178
616.82	-0.005	192.8	0.0133
616.83	-0.005	192.6	0.0107
616.85	-0.007	192.3	0.0062
616.87	-0.01	192	0.0062
616.88	-0.01	192	0.0027
616.90	-0.01	191.8	0
616.92	-0.012	191.5	-0.0027
616.93	-0.014	191.3	-0.0053
616.95	-0.014	191.1	-0.0062
616.97	-0.015	190.9	-0.0089
616.98	-0.016	190.7	-0.0089
617.00	-0.017	190.7	-0.0098
617.02	-0.017	190.5	-0.0107
617.03	-0.017	190.4	-0.0115
617.05	-0.017	190.2	-0.0115
617.07	-0.017	190.1	-0.0124
617.08	-0.017	190	-0.0124
617.10	-0.017	189.9	-0.0124
617.12	-0.016	189.9	-0.0124
617.13	-0.016	189.9	-0.0115
617.15	-0.015	189.8	-0.0107
617.17	-0.014	189.8	-0.0098
617.18	-0.014	189.8	-0.0089
617.20	-0.013	189.8	-0.0071
617.22	-0.011	189.9	-0.0053
617.23	-0.01	190	-0.0036
617.25	-0.009	190	-0.0009
617.27	-0.006	190.2	-0.0009
617.28	-0.005	190.3	0.0018
617.30	-0.005	190.3	0.0044
617.32	-0.004	190.4	0.008
617.33	0	190.7	0.0115
617.35	0.001	190.8	0.0142
617.37	0.002	191	0.0186
617.38	0.006	191.3	0.0186
617.40	0.008	191.5	0.0231
617.42	0.008	191.5	0.0257
617.43	0.009	191.7	0.0311
617.45	0.012	192	0.0346
617.47	0.014	192.2	0.0382
617.48	0.015	192.4	0.0417
617.50	0.018	192.8	0.0417
617.52	0.019	193	0.0462
617.53	0.019	193	0.0479
617.55	0.02	193.2	0.0515
617.57	0.022	193.5	0.0541
617.58	0.024	193.7	0.0568
617.60	0.025	193.9	0.0595
617.62	0.026	194.1	0.0621
617.63	0.027	194.3	0.0621
617.65	0.027	194.3	0.063

Prova triassiale ciclica SN04-C1			
pressione di confinamento (kPa)		80	
deviatore ciclico (kPa)		95	
frequenza (hz)		0.00625	
tempo	cella di carico	$\Delta u$	LVDT
(min)	kN	(kPa)	$\delta$ (mm)
617.67	0.027	194.5	0.0648
617.68	0.028	194.7	0.0657
617.70	0.029	194.8	0.0666
617.72	0.029	194.9	0.0666
617.73	0.029	195.1	0.0666
617.75	0.029	195.2	0.0666
617.77	0.029	195.2	0.0666
617.78	0.029	195.3	0.0666
617.80	0.028	195.3	0.0666
617.82	0.027	195.4	0.0648
617.83	0.026	195.4	0.0639
617.85	0.025	195.3	0.0621
617.87	0.023	195.3	0.0621
617.88	0.022	195.2	0.0586
617.90	0.022	195.2	0.0568
617.92	0.019	195.1	0.0568
617.93	0.018	195.1	0.0541
617.95	0.018	195	0.0524
617.97	0.016	194.8	0.0488
617.98	0.013	194.7	0.0453
618.00	0.012	194.6	0.0426
618.03	0.01	194.3	0.0391
618.05	0.007	194.1	0.0391
618.07	0.006	194.1	0.0346
618.08	0.006	194	0.032
618.10	0.004	193.7	0.0284
618.10	0	193.4	0.0231
618.12	0	193.2	0.0204
618.13	-0.002	192.9	0.016
618.15	-0.005	192.7	0.016
618.17	-0.006	192.7	0.0115
618.18	-0.006	192.5	0.0089
618.20	-0.007	192.2	0.0044
618.22	-0.011	191.9	0.0018
618.23	-0.011	191.7	-0.0009
618.25	-0.012	191.4	-0.0036
618.27	-0.014	191.2	-0.0036
618.28	-0.015	191.2	-0.0062
618.30	-0.015	191	-0.0071
618.32	-0.015	190.8	-0.0089
618.33	-0.016	190.6	-0.0107
618.35	-0.017	190.4	-0.0115
618.37	-0.017	190.3	-0.0124
618.38	-0.017	190.1	-0.0124
618.40	-0.017	190.1	-0.0124
618.42	-0.017	190	-0.0133
618.43	-0.017	189.9	-0.0124
618.45	-0.017	189.9	-0.0124
618.47	-0.016	189.8	-0.0115
618.48	-0.015	189.8	-0.0098
618.50	-0.014	189.9	-0.0098
618.52	-0.013	189.9	-0.0089
618.53	-0.013	189.9	-0.008
618.55	-0.012	189.9	-0.0053
618.57	-0.01	190	-0.0036
618.58	-0.009	190.1	-0.0009
618.60	-0.007	190.2	0.0018
618.62	-0.005	190.3	0.0044

Prova triassiale ciclica SN04-C1			
pressione di confinamento (kPa)		80	
deviatore ciclico (kPa)		95	
frequenza (hz)		0.00625	
tempo	cella di carico	$\Delta u$	LVDT
(min)	kN	(kPa)	$\delta$ (mm)
618.63	-0.004	190.4	0.0062
618.65	-0.002	190.5	0.0089
618.67	0	190.8	0.0089
618.68	0.002	190.9	0.0124
618.70	0.002	190.9	0.016
618.72	0.004	191.1	0.0195
618.73	0.007	191.4	0.024
618.75	0.009	191.6	0.0284
618.77	0.01	191.8	0.032
618.78	0.013	192.1	0.0364
618.80	0.015	192.3	0.0364
618.82	0.015	192.3	0.0399
618.83	0.016	192.5	0.0426
618.85	0.018	192.8	0.047
618.87	0.02	193.1	0.0497
618.88	0.021	193.3	0.0524
618.90	0.022	193.5	0.055
618.92	0.024	193.8	0.055
618.93	0.025	193.8	0.0577
618.95	0.025	194	0.0595
618.97	0.026	194.2	0.0621
618.98	0.027	194.4	0.0639
619.00	0.028	194.5	0.0648
619.02	0.028	194.7	0.0657
619.03	0.029	194.8	0.0657
619.05	0.029	194.8	0.0666
619.07	0.029	195	0.0666
619.08	0.029	195.1	0.0666
619.10	0.029	195.2	0.0666
619.12	0.028	195.3	0.0666
619.13	0.028	195.4	0.0657
619.15	0.026	195.3	0.0657
619.17	0.026	195.3	0.0639
619.18	0.026	195.4	0.0639
619.20	0.025	195.4	0.0612
619.22	0.023	195.3	0.0595
619.23	0.021	195.2	0.0577
619.25	0.02	195.1	0.055
619.27	0.018	195	0.055
619.28	0.016	194.9	0.0524
619.30	0.016	194.9	0.0497
619.32	0.015	194.8	0.0462
619.33	0.011	194.4	0.0426
619.35	0.011	194.4	0.0408
619.37	0.01	194.3	0.0373
619.38	0.007	194	0.0337
619.40	0.005	193.8	0.0302
619.42	0.004	193.6	0.0257
619.43	0.001	193.3	0.0257
619.45	-0.002	193.1	0.0213
619.47	-0.002	193.1	0.0178
619.50	-0.003	192.9	0.0151
619.52	-0.005	192.5	0.0107
619.53	-0.007	192.3	0.0071
619.55	-0.008	192.1	0.0044
619.55	-0.01	191.8	0.0044
619.57	-0.012	191.5	0.0009
619.58	-0.012	191.5	-0.0018

Prova triassiale ciclica SN04-C1			
pressione di confinamento (kPa)		80	
deviatore ciclico (kPa)		95	
frequenza (hz)		0.00625	
tempo	cella di carico	$\Delta u$	LVDT
(min)	kN	(kPa)	$\delta$ (mm)
619.60	-0.013	191.3	-0.0036
619.62	-0.014	191.1	-0.0062
619.63	-0.016	190.9	-0.008
619.65	-0.016	190.7	-0.0089
619.67	-0.016	190.5	-0.0107
619.68	-0.017	190.4	-0.0107
619.70	-0.017	190.4	-0.0115
619.72	-0.017	190.2	-0.0115
619.73	-0.017	190.1	-0.0124
619.75	-0.017	190	-0.0124
619.77	-0.017	189.9	-0.0124
619.78	-0.016	189.9	-0.0115
619.80	-0.015	189.8	-0.0115
619.82	-0.015	189.8	-0.0107
619.83	-0.015	189.8	-0.0098
619.85	-0.014	189.8	-0.0089
619.87	-0.012	189.9	-0.0071
619.88	-0.011	189.9	-0.0044
619.90	-0.01	190	-0.0027
619.92	-0.008	190.1	-0.0027
619.93	-0.006	190.1	-0.0009
619.95	-0.006	190.2	0.0018
619.97	-0.005	190.4	0.0053
619.98	-0.002	190.5	0.0089
620.00	-0.001	190.7	0.0115
620.02	0.001	190.9	0.0151
620.03	0.004	191.1	0.0151
620.05	0.005	191.1	0.0195
620.07	0.007	191.5	0.0249
620.08	0.009	191.7	0.0249
620.10	0.011	191.7	0.0293
620.12	0.011	191.9	0.0328
620.13	0.012	192.2	0.0373
620.15	0.016	192.4	0.0417
620.17	0.017	192.6	0.0435
620.18	0.018	192.9	0.047
620.20	0.021	193.2	0.047
620.22	0.022	193.2	0.0515
620.23	0.022	193.4	0.0541
620.25	0.023	193.6	0.0568
620.27	0.025	193.8	0.0595
620.28	0.026	194.1	0.0612
620.30	0.026	194.3	0.063
620.32	0.027	194.4	0.063
620.33	0.028	194.4	0.0639
620.35	0.028	194.6	0.0657
620.37	0.029	194.8	0.0666
620.38	0.029	194.9	0.0666
620.40	0.029	195	0.0675
620.42	0.029	195.1	0.0675
620.43	0.028	195.2	0.0675
620.45	0.028	195.2	0.0675
620.47	0.028	195.3	0.0666
620.48	0.028	195.4	0.0657
620.50	0.026	195.4	0.0639
620.52	0.025	195.4	0.063
620.53	0.024	195.4	0.0612
620.55	0.023	195.2	0.0612

Prova triassiale ciclica SN04-C1			
pressione di confinamento (kPa)		80	
deviatore ciclico (kPa)		95	
frequenza (hz)		0.00625	
tempo	cella di carico	$\Delta u$	LVDT
(min)	kN	(kPa)	$\delta$ (mm)
620.57	0.02	195.2	0.0595
620.58	0.02	195.2	0.0568
620.60	0.02	195.1	0.0541
620.62	0.017	194.9	0.0515
620.63	0.015	194.8	0.0488
620.65	0.014	194.7	0.0453
620.67	0.011	194.5	0.0453
620.68	0.009	194.3	0.0417
620.70	0.009	194.3	0.0382
620.72	0.008	194.1	0.0346
620.73	0.005	193.9	0.0311
620.75	0.003	193.6	0.0275
620.77	0.001	193.5	0.0231
620.78	0	193.1	0.0186
620.80	-0.002	193	0.0169
620.82	-0.003	192.8	0.0142
620.83	-0.005	192.4	0.0098
620.85	-0.008	192.2	0.0098
620.87	-0.009	192.2	0.0062
620.88	-0.009	192	0.0036
620.90	-0.01	191.7	0
620.93	-0.013	191.4	-0.0027
620.95	-0.013	191.3	-0.0044
620.97	-0.014	191	-0.0062
620.98	-0.016	190.8	-0.0062
621.00	-0.016	190.8	-0.0089
621.00	-0.016	190.6	-0.0098
621.02	-0.016	190.5	-0.0107
621.03	-0.017	190.3	-0.0115
621.05	-0.017	190.2	-0.0115
621.07	-0.017	190.1	-0.0115
621.08	-0.017	190	-0.0115
621.10	-0.017	190	-0.0115
621.12	-0.017	189.9	-0.0115
621.13	-0.016	189.8	-0.0107
621.15	-0.015	189.8	-0.0107
621.17	-0.015	189.8	-0.0089
621.18	-0.014	189.8	-0.0071
621.20	-0.011	189.9	-0.0071
621.22	-0.011	189.9	-0.0053
621.23	-0.011	189.9	-0.0036
621.25	-0.01	190	-0.0018
621.27	-0.007	190.2	0.0009
621.28	-0.006	190.3	0.0036
621.30	-0.004	190.4	0.0071
621.32	-0.001	190.6	0.0071
621.33	0	190.6	0.0107
621.35	0	190.8	0.0133
621.37	0.002	191	0.0169
621.38	0.005	191.2	0.0213
621.40	0.006	191.4	0.024
621.42	0.008	191.7	0.0302
621.43	0.012	191.9	0.0302
621.45	0.013	191.9	0.0346
621.47	0.013	192.1	0.0364
621.48	0.014	192.4	0.0408
621.50	0.017	192.6	0.0444
621.52	0.018	192.9	0.0479

Prova triassiale ciclica SN04-C1			
pressione di confinamento (kPa)		80	
deviatore ciclico (kPa)		95	
frequenza (hz)		0.00625	
tempo	cella di carico	$\Delta u$	LVDT
(min)	kN	(kPa)	$\delta$ (mm)
621.53	0.019	193	0.0497
621.55	0.021	193.3	0.0524
621.57	0.022	193.5	0.055
621.58	0.023	193.7	0.0577
621.60	0.025	194	0.0577
621.62	0.026	194.2	0.0604
621.63	0.026	194.2	0.0621
621.65	0.027	194.4	0.063
621.67	0.028	194.6	0.0648
621.68	0.028	194.7	0.0657
621.70	0.029	194.9	0.0675
621.72	0.029	195	0.0675
621.73	0.029	195.1	0.0675
621.75	0.029	195.1	0.0675
621.77	0.029	195.2	0.0675
621.78	0.029	195.3	0.0675
621.80	0.028	195.4	0.0666
621.82	0.027	195.4	0.0648
621.83	0.026	195.4	0.0639
621.85	0.025	195.4	0.0639
621.87	0.023	195.4	0.0621
621.88	0.023	195.3	0.0612
621.90	0.022	195.3	0.0586
621.92	0.02	195.2	0.0568
621.93	0.019	195.1	0.0541
621.95	0.017	194.9	0.0506
621.97	0.014	194.8	0.0506
621.98	0.013	194.8	0.047
622.00	0.013	194.6	0.0444
622.02	0.011	194.4	0.0408
622.03	0.008	194.2	0.0373
622.05	0.007	194.1	0.0346
622.07	0.005	193.8	0.0302
622.08	0.001	193.6	0.0302
622.10	0.001	193.6	0.0249
622.12	0.001	193.4	0.0222
622.13	-0.001	193.1	0.0178
622.15	-0.004	192.8	0.0142
622.17	-0.006	192.6	0.0107
622.18	-0.006	192.3	0.0071
622.20	-0.01	192	0.0071
622.22	-0.01	192	0.0036
622.23	-0.01	191.8	0.0009
622.25	-0.013	191.3	-0.0009
622.27	-0.014	191.3	-0.0027
622.28	-0.014	191.2	-0.0044
622.30	-0.015	190.9	-0.0071
622.32	-0.016	190.7	-0.0089
622.33	-0.017	190.6	-0.0098
622.35	-0.017	190.4	-0.0107
622.37	-0.017	190.3	-0.0107
622.40	-0.017	190.1	-0.0115
622.42	-0.017	190.1	-0.0115
622.43	-0.017	190	-0.0115
622.45	-0.017	190	-0.0115
622.45	-0.016	189.9	-0.0107
622.47	-0.016	189.8	-0.0107
622.48	-0.015	189.8	-0.0107



Prova triassiale ciclica SN04-C1			
pressione di confinamento (kPa)		80	
deviatore ciclico (kPa)		95	
frequenza (hz)		0.00625	
tempo	cella di carico	$\Delta u$	LVDT
(min)	kN	(kPa)	$\delta$ (mm)
622.50	-0.014	189.8	-0.0089
622.52	-0.014	189.8	-0.008
622.53	-0.013	189.8	-0.0062
622.55	-0.012	189.9	-0.0044
622.57	-0.01	190	-0.0027
622.58	-0.009	190	0
622.60	-0.007	190.2	0.0027
622.62	-0.004	190.4	0.0027
622.63	-0.003	190.4	0.0053
622.65	-0.003	190.5	0.008
622.67	-0.002	190.7	0.0115
622.68	0.002	190.9	0.0151
622.70	0.002	191	0.0178
622.72	0.005	191.3	0.0222
622.73	0.008	191.5	0.0222
622.75	0.009	191.5	0.0275
622.77	0.009	191.7	0.0311
622.78	0.011	192	0.0346
622.80	0.014	192.2	0.0391
622.82	0.015	192.4	0.0417
622.83	0.017	192.7	0.0453
622.85	0.02	193	0.0453
622.87	0.02	193	0.0497
622.88	0.02	193.2	0.0524
622.90	0.022	193.5	0.055
622.92	0.024	193.7	0.0577
622.93	0.025	193.9	0.0595
622.95	0.026	194.1	0.0621
622.97	0.027	194.3	0.0639
622.98	0.027	194.5	0.0648
623.00	0.028	194.6	0.0657
623.02	0.028	194.8	0.0657
623.03	0.028	194.8	0.0666
623.05	0.028	194.9	0.0666
623.07	0.029	195	0.0675
623.08	0.029	195.2	0.0675
623.10	0.029	195.2	0.0675
623.12	0.028	195.4	0.0675
623.13	0.028	195.4	0.0675
623.15	0.026	195.4	0.0666
623.17	0.026	195.4	0.0657
623.18	0.026	195.4	0.0639
623.20	0.024	195.4	0.0621
623.22	0.023	195.4	0.0604
623.23	0.022	195.3	0.0586
623.25	0.02	195.1	0.0586
623.27	0.017	195	0.0559
623.28	0.017	195	0.0533
623.30	0.016	194.9	0.0497
623.32	0.014	194.7	0.047
623.33	0.012	194.6	0.0435
623.35	0.01	194.4	0.0399
623.37	0.008	194.2	0.0399
623.38	0.006	194	0.0364
623.40	0.006	194	0.0328
623.42	0.004	193.8	0.0293
623.43	0.001	193.5	0.024
623.45	-0.001	193.2	0.0204

Prova triassiale ciclica SN04-C1			
pressione di confinamento (kPa)		80	
deviatore ciclico (kPa)		95	
frequenza (hz)		0.00625	
tempo	cella di carico	$\Delta u$	LVDT
(min)	kN	(kPa)	$\delta$ (mm)
623.47	-0.002	193	0.0169
623.48	-0.005	192.7	0.0169
623.50	-0.006	192.5	0.0133
623.52	-0.006	192.5	0.0098
623.53	-0.007	192.3	0.0062
623.55	-0.01	191.9	0.0027
623.57	-0.011	191.7	0
623.58	-0.012	191.5	-0.0018
623.60	-0.014	191.2	-0.0018
623.62	-0.015	191	-0.0044
623.63	-0.015	191	-0.0062
623.65	-0.015	190.8	-0.008
623.67	-0.016	190.7	-0.0089
623.68	-0.017	190.5	-0.0107
623.70	-0.017	190.3	-0.0107
623.72	-0.017	190.2	-0.0115
623.73	-0.017	190.1	-0.0115
623.75	-0.017	190	-0.0115
623.77	-0.017	189.9	-0.0115
623.78	-0.016	189.9	-0.0115
623.80	-0.016	189.9	-0.0107
623.82	-0.016	189.8	-0.0098
623.83	-0.015	189.8	-0.0089
623.87	-0.013	189.8	-0.0071
623.88	-0.013	189.8	-0.0062
623.90	-0.011	189.9	-0.0036
623.90	-0.009	190	-0.0036
623.92	-0.008	190	-0.0018
623.93	-0.008	190.1	0.0009
623.95	-0.007	190.2	0.0036
623.97	-0.004	190.4	0.0062
623.98	-0.002	190.5	0.0089
624.00	-0.001	190.7	0.0133
624.02	0.002	190.9	0.0133
624.03	0.004	190.9	0.0169
624.05	0.004	191.1	0.0195
624.07	0.005	191.3	0.024
624.08	0.009	191.6	0.0293
624.10	0.01	191.8	0.0328
624.12	0.012	192	0.0364
624.13	0.015	192.3	0.0364
624.15	0.016	192.5	0.0408
624.17	0.016	192.5	0.0435
624.18	0.017	192.8	0.047
624.20	0.02	193.1	0.0506
624.22	0.022	193.3	0.0533
624.23	0.022	193.5	0.0559
624.25	0.024	193.8	0.0559
624.27	0.025	194	0.0586
624.28	0.025	194	0.0612
624.30	0.026	194.2	0.063
624.32	0.027	194.4	0.0648
624.33	0.028	194.5	0.0657
624.35	0.028	194.7	0.0666
624.37	0.029	194.9	0.0675
624.38	0.029	195	0.0675
624.40	0.029	195	0.0683
624.42	0.029	195.2	0.0683

Prova triassiale ciclica SN04-C1			
pressione di confinamento (kPa)		80	
deviatore ciclico (kPa)		95	
frequenza (hz)		0.00625	
tempo	cella di carico	$\Delta u$	LVDT
(min)	kN	(kPa)	$\delta$ (mm)
624.43	0.029	195.3	0.0683
624.45	0.028	195.3	0.0683
624.47	0.028	195.4	0.0675
624.48	0.028	195.4	0.0666
624.50	0.026	195.4	0.0648
624.52	0.025	195.4	0.0639
624.53	0.024	195.4	0.0621
624.55	0.022	195.3	0.0621
624.57	0.021	195.3	0.0604
624.58	0.021	195.2	0.0577
624.60	0.02	195.1	0.055
624.62	0.016	195	0.0524
624.63	0.016	194.9	0.0497
624.65	0.014	194.7	0.0462
624.67	0.01	194.5	0.0462
624.68	0.01	194.5	0.0426
624.70	0.01	194.4	0.0399
624.72	0.008	194.1	0.0355
624.73	0.004	193.9	0.032
624.75	0.003	193.7	0.0284
624.77	0.002	193.4	0.024
624.78	-0.002	193.2	0.024
624.80	-0.003	193.2	0.0195
624.82	-0.003	192.9	0.016
624.83	-0.004	192.7	0.0124
624.85	-0.007	192.4	0.0089
624.87	-0.008	192.2	0.0062
624.88	-0.01	191.9	0.0027
624.90	-0.012	191.6	0.0027
624.92	-0.013	191.4	0
624.93	-0.013	191.4	-0.0027
624.95	-0.013	191.2	-0.0044
624.97	-0.015	191	-0.0062
624.98	-0.016	190.8	-0.008
625.00	-0.016	190.6	-0.0089
625.02	-0.017	190.4	-0.0089
625.03	-0.017	190.3	-0.0098
625.05	-0.017	190.3	-0.0107
625.07	-0.017	190.2	-0.0107
625.08	-0.017	190.1	-0.0107
625.10	-0.017	190	-0.0107
625.12	-0.016	189.9	-0.0107
625.13	-0.016	189.9	-0.0107
625.15	-0.015	189.9	-0.0089
625.17	-0.015	189.8	-0.0071
625.18	-0.013	189.9	-0.0062
625.20	-0.012	189.9	-0.0062
625.22	-0.011	189.9	-0.0044
625.23	-0.011	189.9	-0.0027
625.25	-0.009	190.1	0
625.27	-0.007	190.2	0.0027
625.30	-0.006	190.3	0.0053
625.32	-0.004	190.5	0.008
625.33	-0.001	190.7	0.008
625.35	0	190.7	0.0115
625.37	0	190.8	0.0151
625.37	0.002	191	0.0186
625.38	0.005	191.3	0.0231

Prova triassiale ciclica SN04-C1			
pressione di confinamento (kPa)		80	
deviatore ciclico (kPa)		95	
frequenza (hz)		0.00625	
tempo	cella di carico	$\Delta u$	LVDT
(min)	kN	(kPa)	$\delta$ (mm)
625.40	0.007	191.4	0.0275
625.42	0.008	191.7	0.0311
625.43	0.012	191.9	0.0311
625.45	0.013	191.9	0.0355
625.47	0.013	192.2	0.0382
625.48	0.014	192.5	0.0417
625.50	0.017	192.7	0.0453
625.52	0.019	192.9	0.0488
625.53	0.02	193.1	0.0515
625.55	0.022	193.4	0.0515
625.57	0.023	193.4	0.055
625.58	0.023	193.6	0.0577
625.60	0.024	193.8	0.0604
625.62	0.026	194.1	0.063
625.63	0.027	194.3	0.0639
625.65	0.027	194.5	0.0657
625.67	0.028	194.6	0.0657
625.68	0.028	194.6	0.0666
625.70	0.028	194.8	0.0675
625.72	0.029	194.9	0.0683
625.73	0.029	195	0.0683
625.75	0.029	195.2	0.0683
625.77	0.029	195.2	0.0683
625.78	0.028	195.4	0.0683
625.80	0.027	195.4	0.0683
625.82	0.027	195.4	0.0666
625.83	0.026	195.4	0.0657
625.85	0.025	195.4	0.0648
625.87	0.024	195.4	0.063
625.88	0.024	195.4	0.0621
625.90	0.022	195.3	0.0595
625.92	0.02	195.2	0.0577
625.93	0.019	195.1	0.0541
625.95	0.016	194.9	0.0541
625.97	0.014	194.8	0.0515
625.98	0.014	194.8	0.0488
626.00	0.013	194.7	0.0453
626.02	0.011	194.4	0.0417
626.03	0.008	194.2	0.0391
626.05	0.007	194.1	0.0346
626.07	0.004	193.8	0.0302
626.08	0.002	193.6	0.0302
626.10	0.002	193.6	0.0275
626.12	0.001	193.4	0.0222
626.13	-0.002	193.1	0.0186
626.15	-0.005	192.8	0.0142
626.17	-0.005	192.6	0.0115
626.18	-0.007	192.3	0.008
626.20	-0.01	192	0.008
626.22	-0.01	192	0.0044
626.23	-0.01	191.8	0.0018
626.25	-0.012	191.5	-0.0009
626.27	-0.014	191.3	-0.0036
626.28	-0.014	191.2	-0.0044
626.30	-0.015	190.9	-0.0062
626.32	-0.017	190.7	-0.0062
626.33	-0.017	190.7	-0.008
626.35	-0.017	190.5	-0.0089

Prova triassiale ciclica SN04-C1			
pressione di confinamento (kPa)		80	
deviatore ciclico (kPa)		95	
frequenza (hz)		0.00625	
tempo	cella di carico	$\Delta u$	LVDT
(min)	kN	(kPa)	$\delta$ (mm)
626.37	-0.017	190.4	-0.0098
626.38	-0.017	190.3	-0.0098
626.40	-0.017	190.1	-0.0107
626.42	-0.017	190	-0.0107
626.43	-0.017	190	-0.0107
626.45	-0.016	190	-0.0107
626.47	-0.016	189.9	-0.0098
626.48	-0.015	189.9	-0.008
626.50	-0.014	189.9	-0.0071
626.52	-0.014	189.9	-0.0062
626.53	-0.012	190	-0.0044
626.55	-0.01	190	-0.0044
626.57	-0.009	190	-0.0018
626.58	-0.009	190.1	-0.0009
626.60	-0.006	190.3	0.0027
626.62	-0.005	190.3	0.0044
626.63	-0.005	190.4	0.0062
626.65	-0.003	190.6	0.0098
626.67	0	190.8	0.0133
626.68	0.001	190.9	0.0169
626.70	0.003	191.2	0.0204
626.72	0.006	191.4	0.0204
626.73	0.007	191.4	0.0249
626.77	0.007	191.5	0.0284
626.78	0.009	191.8	0.0328
626.80	0.013	192.1	0.0373
626.82	0.013	192.3	0.0391
626.82	0.015	192.5	0.0435
626.83	0.018	192.8	0.0435
626.85	0.019	192.8	0.0479
626.87	0.019	193	0.0506
626.88	0.02	193.3	0.0533
626.90	0.023	193.5	0.0568
626.92	0.024	193.7	0.0586
626.93	0.025	193.9	0.0612
626.95	0.026	194.2	0.0612
626.97	0.027	194.2	0.063
626.98	0.027	194.4	0.0648
627.00	0.028	194.5	0.0666
627.02	0.028	194.7	0.0675
627.03	0.029	194.9	0.0683
627.05	0.029	195	0.0683
627.07	0.029	195.1	0.0683
627.08	0.028	195.2	0.0683
627.10	0.028	195.2	0.0683
627.12	0.028	195.3	0.0683
627.13	0.028	195.4	0.0683
627.15	0.027	195.4	0.0675
627.17	0.026	195.4	0.0657
627.18	0.025	195.4	0.0639
627.20	0.023	195.4	0.0639
627.22	0.022	195.4	0.0621
627.23	0.022	195.3	0.0604
627.25	0.021	195.2	0.0577
627.27	0.018	195.1	0.055
627.28	0.017	195	0.0533
627.30	0.016	194.8	0.0497
627.32	0.012	194.7	0.0497

Prova triassiale ciclica SN04-C1			
pressione di confinamento (kPa)		80	
deviatore ciclico (kPa)		95	
frequenza (hz)		0.00625	
tempo	cella di carico	$\Delta u$	LVDT
(min)	kN	(kPa)	$\delta$ (mm)
627.33	0.011	194.5	0.0444
627.35	0.011	194.4	0.0417
627.37	0.007	194.2	0.0417
627.38	0.006	194.2	0.0373
627.40	0.006	194	0.0346
627.42	0.005	193.8	0.0311
627.43	0.001	193.5	0.0249
627.45	0	193.3	0.0222
627.47	-0.002	193	0.0186
627.48	-0.005	192.7	0.0186
627.50	-0.006	192.7	0.0142
627.52	-0.006	192.5	0.0107
627.53	-0.007	192.2	0.008
627.55	-0.01	191.9	0.0044
627.57	-0.011	191.7	0.0018
627.58	-0.012	191.5	-0.0009
627.60	-0.014	191.2	-0.0009
627.62	-0.015	191.2	-0.0036
627.63	-0.015	191	-0.0044
627.65	-0.015	190.9	-0.0062
627.67	-0.017	190.6	-0.008
627.68	-0.017	190.5	-0.0089
627.70	-0.017	190.3	-0.0098
627.72	-0.017	190.2	-0.0098
627.73	-0.017	190.2	-0.0098
627.75	-0.017	190.1	-0.0107
627.77	-0.017	190	-0.0098
627.78	-0.016	189.9	-0.0098
627.80	-0.016	189.9	-0.0089
627.82	-0.015	189.9	-0.008
627.83	-0.014	189.9	-0.008
627.85	-0.013	189.9	-0.0071
627.87	-0.013	189.9	-0.0053
627.88	-0.012	189.9	-0.0027
627.90	-0.01	190.1	-0.0009
627.92	-0.008	190.1	0.0009
627.93	-0.007	190.2	0.0036
627.95	-0.005	190.4	0.0036
627.97	-0.003	190.5	0.0062
627.98	-0.003	190.5	0.0098
628.00	-0.002	190.7	0.0133
628.02	0.001	190.9	0.0169
628.03	0.003	191.1	0.0204
628.05	0.004	191.3	0.024
628.07	0.006	191.5	0.0257
628.08	0.008	191.7	0.0302
628.10	0.01	191.9	0.0355
628.12	0.013	192.2	0.0355
628.13	0.015	192.4	0.0391
628.15	0.015	192.4	0.0426
628.17	0.016	192.6	0.0462
628.20	0.018	192.9	0.0497
628.22	0.02	193.2	0.0524
628.23	0.021	193.4	0.055
628.25	0.023	193.7	0.0586
628.27	0.025	193.9	0.0586
628.27	0.025	193.9	0.0604
628.28	0.025	194.1	0.063

Prova triassiale ciclica SN04-C1			
pressione di confinamento (kPa)		80	
deviatore ciclico (kPa)		95	
frequenza (hz)		0.00625	
tempo	cella di carico	$\Delta u$	LVDT
(min)	kN	(kPa)	$\delta$ (mm)
628.30	0.026	194.3	0.0648
628.32	0.027	194.5	0.0666
628.33	0.028	194.6	0.0675
628.35	0.028	194.8	0.0683
628.37	0.029	195	0.0683
628.38	0.029	195	0.0692
628.40	0.029	195.1	0.0692
628.42	0.029	195.2	0.0692
628.43	0.029	195.3	0.0692
628.45	0.029	195.4	0.0692
628.47	0.028	195.4	0.0683
628.48	0.026	195.4	0.0683
628.50	0.025	195.4	0.0666
628.52	0.025	195.4	0.0657
628.53	0.025	195.5	0.0639
628.55	0.023	195.4	0.0612
628.57	0.021	195.3	0.0604
628.58	0.02	195.2	0.0577
628.60	0.018	195.1	0.0577
628.62	0.016	195.1	0.055
628.63	0.016	195	0.0524
628.65	0.015	194.8	0.0488
628.67	0.011	194.6	0.0453
628.68	0.01	194.5	0.0426
628.70	0.009	194.3	0.0382
628.72	0.006	194	0.0382
628.73	0.004	194	0.0346
628.75	0.004	193.8	0.032
628.77	0.002	193.6	0.0275
628.78	-0.001	193.1	0.0222
628.80	-0.001	193.1	0.0204
628.82	-0.003	192.9	0.0169
628.83	-0.006	192.6	0.0133
628.85	-0.007	192.4	0.0098
628.87	-0.008	192.2	0.0062
628.88	-0.011	191.8	0.0062
628.90	-0.012	191.6	0.0036
628.92	-0.012	191.6	0.0009
628.93	-0.012	191.4	-0.0009
628.95	-0.014	191.2	-0.0036
628.97	-0.015	191	-0.0053
628.98	-0.016	190.8	-0.0062
629.00	-0.016	190.6	-0.0062
629.02	-0.017	190.4	-0.008
629.03	-0.017	190.4	-0.0089
629.05	-0.017	190.3	-0.0098
629.07	-0.017	190.2	-0.0098
629.08	-0.017	190.1	-0.0098
629.10	-0.017	190	-0.0098
629.12	-0.016	189.9	-0.0089
629.13	-0.015	189.9	-0.0089
629.15	-0.015	189.9	-0.008
629.17	-0.015	189.9	-0.0071
629.18	-0.014	189.9	-0.0062
629.20	-0.012	189.9	-0.0044
629.22	-0.012	189.9	-0.0018
629.23	-0.01	190.1	0
629.25	-0.007	190.2	0

Prova triassiale ciclica SN04-C1			
pressione di confinamento (kPa)		80	
deviatore ciclico (kPa)		95	
frequenza (hz)		0.00625	
tempo	cella di carico	$\Delta u$	LVDT
(min)	kN	(kPa)	$\delta$ (mm)
629.27	-0.007	190.2	0.0027
629.28	-0.007	190.3	0.0053
629.30	-0.005	190.5	0.008
629.32	-0.002	190.6	0.0115
629.33	-0.001	190.7	0.0151
629.35	0.001	191	0.0186
629.37	0.005	191.2	0.0186
629.38	0.005	191.2	0.0222
629.40	0.005	191.4	0.0257
629.42	0.007	191.7	0.0311
629.43	0.011	191.9	0.0355
629.45	0.012	192.1	0.0382
629.47	0.013	192.4	0.0417
629.48	0.017	192.6	0.0417
629.50	0.017	192.8	0.0479
629.52	0.018	193.1	0.0506
629.53	0.021	193.3	0.0506
629.55	0.021	193.3	0.0541
629.57	0.021	193.5	0.0559
629.58	0.023	193.7	0.0595
629.60	0.025	194	0.0621
629.62	0.026	194.2	0.0639
629.63	0.026	194.4	0.0648
629.67	0.027	194.6	0.0648
629.68	0.028	194.6	0.0666
629.70	0.028	194.7	0.0683
629.72	0.028	194.9	0.0692
629.72	0.029	195	0.0701
629.73	0.029	195.1	0.0701
629.75	0.029	195.2	0.0701
629.77	0.028	195.3	0.0701
629.78	0.028	195.3	0.0701
629.80	0.028	195.4	0.0701
629.82	0.028	195.5	0.0683
629.83	0.026	195.5	0.0666
629.85	0.025	195.5	0.0657
629.87	0.024	195.4	0.0639
629.88	0.022	195.3	0.0639
629.90	0.021	195.3	0.0612
629.92	0.021	195.3	0.0604
629.93	0.02	195.2	0.0568
629.95	0.017	195	0.0541
629.97	0.016	194.9	0.0515
629.98	0.014	194.8	0.0479
630.00	0.011	194.5	0.0479
630.02	0.009	194.5	0.0444
630.03	0.009	194.4	0.0417
630.05	0.008	194.2	0.0382
630.07	0.005	193.9	0.0346
630.08	0.003	193.7	0.0311
630.10	0.002	193.6	0.0257
630.12	-0.001	193.2	0.0257
630.13	-0.003	193	0.0222
630.15	-0.003	193	0.0186
630.17	-0.004	192.8	0.0142
630.18	-0.007	192.4	0.0107
630.20	-0.009	192.2	0.008
630.22	-0.01	192	0.0053



Prova triassiale ciclica SN04-C1			
pressione di confinamento (kPa)		80	
deviatore ciclico (kPa)		95	
frequenza (hz)		0.00625	
tempo	cella di carico	$\Delta u$	LVDT
(min)	kN	(kPa)	$\delta$ (mm)
630.23	-0.012	191.7	0.0018
630.25	-0.012	191.5	0.0009
630.27	-0.013	191.3	-0.0018
630.28	-0.015	191.1	-0.0018
630.30	-0.015	190.9	-0.0036
630.32	-0.015	190.9	-0.0053
630.33	-0.016	190.7	-0.0071
630.35	-0.017	190.5	-0.008
630.37	-0.017	190.4	-0.0089
630.38	-0.017	190.2	-0.0089
630.40	-0.017	190.1	-0.0089
630.42	-0.017	190	-0.0089
630.43	-0.017	190	-0.0089
630.45	-0.017	190	-0.0089
630.47	-0.016	189.9	-0.008
630.48	-0.015	189.9	-0.0071
630.50	-0.015	189.9	-0.0062
630.52	-0.014	189.9	-0.0044
630.53	-0.011	190	-0.0044
630.55	-0.011	190	-0.0027
630.57	-0.011	190	-0.0009
630.58	-0.009	190.1	0.0018
630.60	-0.007	190.2	0.0044
630.62	-0.006	190.3	0.0071
630.63	-0.004	190.5	0.0107
630.65	-0.001	190.7	0.0107
630.67	0	190.7	0.0133
630.68	0	190.8	0.0169
630.70	0.002	191.1	0.0204
630.72	0.005	191.3	0.0249
630.73	0.006	191.5	0.0284
630.75	0.008	191.8	0.0328
630.77	0.012	192	0.0328
630.78	0.012	192	0.0373
630.80	0.012	192.2	0.0399
630.82	0.014	192.5	0.0444
630.83	0.018	192.7	0.0479
630.85	0.018	192.9	0.0506
630.87	0.02	193.2	0.0541
630.88	0.023	193.5	0.0541
630.90	0.023	193.5	0.0577
630.92	0.023	193.6	0.0595
630.93	0.024	193.9	0.063
630.95	0.026	194.1	0.0648
630.97	0.027	194.3	0.0666
630.98	0.027	194.5	0.0666
631.00	0.027	194.6	0.0675
631.02	0.028	194.8	0.0692
631.03	0.028	194.9	0.0701
631.05	0.029	195.1	0.0701
631.07	0.029	195.2	0.071
631.10	0.029	195.2	0.071
631.12	0.029	195.3	0.071
631.13	0.029	195.4	0.071
631.15	0.028	195.5	0.0701
631.17	0.027	195.6	0.0692
631.17	0.026	195.5	0.0675
631.18	0.024	195.5	0.0675

Prova triassiale ciclica SN04-C1			
pressione di confinamento (kPa)		80	
deviatore ciclico (kPa)		95	
frequenza (hz)		0.00625	
tempo	cella di carico	$\Delta u$	LVDT
(min)	kN	(kPa)	$\delta$ (mm)
631.20	0.023	195.5	0.0657
631.22	0.023	195.4	0.0639
631.23	0.022	195.4	0.0621
631.25	0.02	195.2	0.0595
631.27	0.019	195.2	0.0577
631.28	0.017	195	0.0541
631.30	0.014	194.9	0.0541
631.32	0.013	194.9	0.0506
631.33	0.013	194.8	0.0479
631.35	0.011	194.5	0.0444
631.37	0.007	194.3	0.0399
631.38	0.007	194.2	0.0373
631.40	0.005	193.9	0.0337
631.42	0.001	193.6	0.0337
631.43	0.001	193.6	0.0293
631.45	0.001	193.5	0.0257
631.47	-0.001	193.1	0.0213
631.48	-0.005	192.9	0.0178
631.50	-0.005	192.7	0.0151
631.52	-0.006	192.4	0.0107
631.53	-0.01	192.1	0.0107
631.55	-0.01	192.1	0.0071
631.57	-0.01	191.9	0.0053
631.58	-0.011	191.6	0.0027
631.60	-0.014	191.4	0
631.62	-0.014	191.2	-0.0027
631.63	-0.015	191	-0.0044
631.65	-0.016	190.8	-0.0044
631.67	-0.017	190.8	-0.0053
631.68	-0.017	190.5	-0.0071
631.70	-0.017	190.3	-0.0071
631.72	-0.017	190.3	-0.008
631.73	-0.017	190.2	-0.008
631.75	-0.017	190.1	-0.008
631.77	-0.017	190	-0.008
631.78	-0.016	189.9	-0.008
631.80	-0.016	189.9	-0.0062
631.82	-0.015	189.9	-0.0062
631.83	-0.014	189.9	-0.0053
631.85	-0.014	189.9	-0.0044
631.87	-0.013	189.9	-0.0027
631.88	-0.011	190	-0.0009
631.90	-0.01	190	0.0009
631.92	-0.009	190.1	0.0036
631.93	-0.006	190.3	0.0036
631.95	-0.005	190.4	0.0071
631.97	-0.005	190.4	0.0089
631.98	-0.004	190.5	0.0115
632.00	-0.001	190.8	0.016
632.02	0.001	190.9	0.0186
632.03	0.003	191.1	0.0231
632.05	0.006	191.4	0.0275
632.07	0.008	191.6	0.0275
632.08	0.008	191.6	0.0302
632.10	0.009	191.8	0.0346
632.12	0.011	192.1	0.0382
632.13	0.014	192.3	0.0426
632.15	0.015	192.5	0.0444

Prova triassiale ciclica SN04-C1			
pressione di confinamento (kPa)		80	
deviatore ciclico (kPa)		95	
frequenza (hz)		0.00625	
tempo	cella di carico	$\Delta u$	LVDT
(min)	kN	(kPa)	$\delta$ (mm)
632.17	0.017	192.8	0.0488
632.18	0.02	193.1	0.0488
632.20	0.021	193.1	0.0524
632.22	0.021	193.3	0.055
632.23	0.022	193.6	0.0577
632.25	0.024	193.8	0.0612
632.27	0.025	194	0.063
632.28	0.025	194.2	0.0648
632.30	0.027	194.4	0.0648
632.32	0.028	194.4	0.0666
632.33	0.028	194.6	0.0675
632.35	0.028	194.7	0.0692
632.37	0.029	194.9	0.0692
632.38	0.029	195	0.0701
632.40	0.029	195.1	0.0701
632.42	0.029	195.3	0.0701
632.43	0.028	195.4	0.0701
632.45	0.028	195.5	0.0701
632.47	0.028	195.5	0.0701
632.48	0.027	195.5	0.0692
632.50	0.027	195.5	0.0683
632.52	0.026	195.5	0.0657
632.53	0.024	195.5	0.0648
632.57	0.023	195.4	0.063
632.58	0.022	195.4	0.0604
632.60	0.019	195.2	0.0604
632.62	0.018	195.2	0.0586
632.62	0.018	195.1	0.055
632.63	0.017	195	0.0524
632.65	0.013	194.8	0.0488
632.67	0.012	194.7	0.0462
632.68	0.01	194.5	0.0426
632.70	0.007	194.2	0.0426
632.72	0.006	194.2	0.0391
632.73	0.006	194.1	0.0355
632.75	0.004	193.9	0.032
632.77	0	193.6	0.0257
632.78	0	193.4	0.024
632.80	-0.002	193.1	0.0195
632.82	-0.005	192.8	0.0195
632.83	-0.006	192.8	0.0151
632.85	-0.006	192.6	0.0124
632.87	-0.007	192.3	0.0089
632.88	-0.01	192	0.0053
632.90	-0.011	191.8	0.0027
632.92	-0.012	191.6	0
632.93	-0.014	191.3	0
632.95	-0.015	191.2	-0.0018
632.97	-0.015	191.2	-0.0036
632.98	-0.015	190.9	-0.0053
633.00	-0.016	190.7	-0.0071
633.02	-0.017	190.5	-0.008
633.03	-0.017	190.4	-0.0089
633.05	-0.017	190.3	-0.0089
633.07	-0.017	190.2	-0.0089
633.08	-0.017	190.2	-0.0089
633.10	-0.017	190.1	-0.0089
633.12	-0.017	190	-0.0089

Prova triassiale ciclica SN04-C1			
pressione di confinamento (kPa)		80	
deviatore ciclico (kPa)		95	
frequenza (hz)		0.00625	
tempo	cella di carico	$\Delta u$	LVDT
(min)	kN	(kPa)	$\delta$ (mm)
633.13	-0.016	190	-0.008
633.15	-0.016	189.9	-0.0071
633.17	-0.015	189.9	-0.0062
633.18	-0.013	189.9	-0.0053
633.20	-0.013	189.9	-0.0036
633.22	-0.011	190.1	-0.0018
633.23	-0.009	190.1	-0.0018
633.25	-0.008	190.1	0.0009
633.27	-0.008	190.2	0.0036
633.28	-0.007	190.4	0.0062
633.30	-0.003	190.5	0.0098
633.32	-0.002	190.6	0.0124
633.33	-0.001	190.9	0.0151
633.35	0.003	191.1	0.0151
633.37	0.004	191.1	0.0195
633.38	0.004	191.2	0.0222
633.40	0.006	191.5	0.0275
633.42	0.009	191.7	0.0311
633.43	0.01	191.9	0.0346
633.45	0.012	192.2	0.0391
633.47	0.015	192.5	0.0391
633.48	0.016	192.5	0.0426
633.50	0.016	192.7	0.0453
633.52	0.017	192.9	0.0497
633.53	0.021	193.2	0.0533
633.55	0.021	193.4	0.055
633.57	0.023	193.6	0.0586
633.58	0.025	193.9	0.0586
633.60	0.025	193.9	0.0612
633.62	0.025	194.1	0.063
633.63	0.026	194.3	0.0648
633.65	0.027	194.5	0.0666
633.67	0.028	194.7	0.0675
633.68	0.028	194.8	0.0683
633.70	0.028	194.9	0.0683
633.72	0.029	195.1	0.0692
633.73	0.029	195.1	0.0701
633.75	0.029	195.2	0.0701
633.77	0.029	195.3	0.0701
633.78	0.029	195.4	0.0701
633.80	0.028	195.5	0.0683
633.82	0.027	195.5	0.0683
633.83	0.025	195.5	0.0675
633.85	0.025	195.5	0.0657
633.87	0.024	195.5	0.0639
633.88	0.022	195.4	0.0639
633.90	0.022	195.4	0.0621
633.92	0.021	195.4	0.0586
633.93	0.019	195.2	0.0559
633.95	0.016	195	0.0533
633.97	0.016	195	0.0515
633.98	0.014	194.8	0.0479
634.00	0.01	194.6	0.0479
634.03	0.009	194.6	0.0444
634.05	0.009	194.4	0.0408
634.07	0.008	194.2	0.0373
634.08	0.004	194	0.0337
634.08	0.003	193.8	0.0302

Prova triassiale ciclica SN04-C1			
pressione di confinamento (kPa)		80	
deviatore ciclico (kPa)		95	
frequenza (hz)		0.00625	
tempo	cella di carico	$\Delta u$	LVDT
(min)	kN	(kPa)	$\delta$ (mm)
634.10	0.002	193.5	0.0249
634.12	-0.002	193.2	0.0249
634.13	-0.003	193.2	0.0213
634.15	-0.003	193	0.0178
634.17	-0.004	192.7	0.0142
634.18	-0.008	192.5	0.0098
634.20	-0.008	192.3	0.0071
634.22	-0.01	192	0.0044
634.23	-0.012	191.7	0.0044
634.25	-0.012	191.7	0.0009
634.27	-0.012	191.5	-0.0009
634.28	-0.014	191.3	-0.0036
634.30	-0.016	191	-0.0053
634.32	-0.016	190.9	-0.0062
634.33	-0.016	190.7	-0.008
634.35	-0.017	190.5	-0.008
634.37	-0.017	190.5	-0.0089
634.38	-0.017	190.4	-0.0089
634.40	-0.017	190.2	-0.0098
634.42	-0.017	190.1	-0.0098
634.43	-0.017	190.1	-0.0098
634.45	-0.016	190	-0.0089
634.47	-0.016	190	-0.0089
634.48	-0.015	190	-0.008
634.50	-0.015	190	-0.0071
634.52	-0.014	189.9	-0.0053
634.53	-0.013	190	-0.0044
634.55	-0.011	190	-0.0018
634.57	-0.01	190.1	0
634.58	-0.008	190.3	0.0027
634.60	-0.007	190.3	0.0036
634.62	-0.006	190.4	0.0071
634.63	-0.003	190.6	0.0071
634.65	-0.001	190.7	0.0107
634.67	-0.001	190.7	0.0133
634.68	0	190.9	0.0169
634.70	0.003	191.2	0.0204
634.72	0.005	191.3	0.0231
634.73	0.006	191.5	0.0284
634.75	0.01	191.8	0.0284
634.77	0.011	192	0.0328
634.78	0.011	192	0.0364
634.80	0.013	192.2	0.0399
634.82	0.015	192.6	0.0435
634.83	0.017	192.8	0.047
634.85	0.018	193	0.0506
634.87	0.021	193.3	0.0541
634.88	0.022	193.5	0.0541
634.90	0.022	193.5	0.0559
634.92	0.023	193.7	0.0586
634.93	0.025	194	0.0621
634.95	0.026	194.2	0.0639
634.97	0.026	194.4	0.0648
634.98	0.027	194.6	0.0666
635.00	0.028	194.8	0.0666
635.02	0.029	194.8	0.0683
635.03	0.029	194.9	0.0692
635.05	0.029	195	0.0692

Prova triassiale ciclica SN04-C1			
pressione di confinamento (kPa)		80	
deviatore ciclico (kPa)		95	
frequenza (hz)		0.00625	
tempo	cella di carico	$\Delta u$	LVDT
(min)	kN	(kPa)	$\delta$ (mm)
635.07	0.029	195.1	0.0692
635.08	0.029	195.3	0.0692
635.10	0.028	195.4	0.0692
635.12	0.028	195.5	0.0692
635.13	0.027	195.5	0.0692
635.15	0.027	195.6	0.0683
635.17	0.026	195.6	0.0675
635.18	0.025	195.5	0.0657
635.20	0.024	195.5	0.0639
635.22	0.023	195.4	0.0621
635.23	0.021	195.4	0.0621
635.25	0.02	195.4	0.0604
635.27	0.02	195.3	0.0577
635.28	0.018	195.1	0.0541
635.30	0.015	194.9	0.0515
635.32	0.014	194.8	0.0488
635.33	0.013	194.7	0.047
635.35	0.01	194.5	0.0426
635.37	0.009	194.4	0.0399
635.38	0.007	194.2	0.0364
635.40	0.003	193.9	0.0364
635.42	0.002	193.9	0.032
635.43	0.002	193.7	0.0293
635.47	0.001	193.5	0.024
635.48	-0.003	193.1	0.0195
635.50	-0.004	192.9	0.016
635.52	-0.005	192.7	0.0124
635.53	-0.008	192.4	0.0124
635.53	-0.01	192.1	0.0089
635.55	-0.01	192.1	0.0062
635.57	-0.01	191.9	0.0036
635.58	-0.012	191.6	0
635.60	-0.013	191.4	-0.0018
635.62	-0.014	191.2	-0.0036
635.63	-0.015	191	-0.0036
635.65	-0.016	190.8	-0.0053
635.67	-0.016	190.8	-0.0071
635.68	-0.016	190.6	-0.008
635.70	-0.017	190.5	-0.0089
635.72	-0.017	190.3	-0.0098
635.73	-0.017	190.2	-0.0098
635.75	-0.017	190.1	-0.0098
635.77	-0.017	190	-0.0098
635.78	-0.016	190	-0.0089
635.80	-0.016	190	-0.0089
635.82	-0.016	190	-0.008
635.83	-0.014	190	-0.0062
635.85	-0.013	190	-0.0053
635.87	-0.013	190	-0.0036
635.88	-0.01	190.1	-0.0036
635.90	-0.009	190.1	-0.0018
635.92	-0.009	190.2	0.0009
635.93	-0.008	190.3	0.0036
635.95	-0.005	190.4	0.0062
635.97	-0.004	190.5	0.0089
635.98	-0.002	190.7	0.0124
636.00	0.001	190.9	0.0124
636.02	0.001	190.9	0.016

Prova triassiale ciclica SN04-C1			
pressione di confinamento (kPa)		80	
deviatore ciclico (kPa)		95	
frequenza (hz)		0.00625	
tempo	cella di carico	$\Delta u$	LVDT
(min)	kN	(kPa)	$\delta$ (mm)
636.03	0.001	191.1	0.0186
636.05	0.006	191.5	0.0231
636.07	0.007	191.5	0.0257
636.08	0.007	191.7	0.0302
636.10	0.009	191.9	0.0337
636.12	0.012	192.2	0.0373
636.13	0.013	192.4	0.0408
636.15	0.015	192.6	0.0453
636.17	0.018	192.9	0.0453
636.18	0.019	192.9	0.0488
636.20	0.019	193.1	0.0515
636.22	0.02	193.4	0.055
636.23	0.023	193.6	0.0577
636.25	0.024	193.8	0.0604
636.27	0.025	194.1	0.063
636.28	0.026	194.3	0.063
636.30	0.027	194.5	0.0648
636.32	0.027	194.5	0.0657
636.33	0.028	194.7	0.0675
636.35	0.028	194.8	0.0683
636.37	0.029	195	0.0692
636.38	0.029	195.1	0.0692
636.40	0.029	195.2	0.0692
636.42	0.028	195.4	0.0692
636.43	0.028	195.4	0.0692
636.45	0.028	195.4	0.0701
636.47	0.028	195.5	0.0692
636.48	0.027	195.6	0.0683
636.50	0.026	195.6	0.0666
636.52	0.025	195.5	0.0666
636.53	0.023	195.5	0.0648
636.55	0.023	195.5	0.063
636.57	0.022	195.4	0.0612
636.58	0.02	195.3	0.0586
636.60	0.018	195.2	0.0559
636.62	0.017	195.1	0.0533
636.63	0.015	194.9	0.0533
636.65	0.012	194.8	0.0506
636.67	0.012	194.8	0.047
636.68	0.011	194.6	0.0444
636.70	0.009	194.4	0.0408
636.72	0.006	194.2	0.0364
636.73	0.006	194	0.0337
636.75	0.003	193.7	0.0293
636.77	0	193.5	0.0249
636.78	0	193.3	0.0222
636.80	-0.002	193	0.0186
636.82	-0.005	192.8	0.0186
636.83	-0.006	192.8	0.0151
636.85	-0.006	192.6	0.0115
636.87	-0.007	192.3	0.0089
636.88	-0.01	192	0.0053
636.90	-0.011	191.8	0.0027
636.93	-0.012	191.5	0
636.95	-0.014	191.3	0
636.97	-0.015	191.3	-0.0018
636.98	-0.015	191.2	-0.0036
636.98	-0.015	190.9	-0.0053

Prova triassiale ciclica SN04-C1			
pressione di confinamento (kPa)		80	
deviatore ciclico (kPa)		95	
frequenza (hz)		0.00625	
tempo	cella di carico	$\Delta u$	LVDT
(min)	kN	(kPa)	$\delta$ (mm)
637.00	-0.017	190.7	-0.0071
637.02	-0.017	190.6	-0.008
637.03	-0.017	190.4	-0.008
637.05	-0.017	190.3	-0.008
637.07	-0.017	190.3	-0.0089
637.08	-0.017	190.2	-0.0089
637.10	-0.017	190.1	-0.0089
637.12	-0.016	190	-0.0089
637.13	-0.016	190	-0.008
637.15	-0.015	190	-0.0071
637.17	-0.014	190	-0.0071
637.18	-0.013	190	-0.0053
637.20	-0.013	190	-0.0036
637.22	-0.012	190	-0.0018
637.23	-0.01	190.1	0
637.25	-0.009	190.2	0.0027
637.27	-0.007	190.3	0.0053
637.28	-0.004	190.5	0.0053
637.30	-0.003	190.6	0.0089
637.32	-0.003	190.6	0.0107
637.33	-0.002	190.8	0.0142
637.35	0.001	191	0.0178
637.37	0.003	191.2	0.0213
637.38	0.005	191.4	0.0257
637.40	0.007	191.6	0.0257
637.42	0.01	191.9	0.0302
637.43	0.01	191.9	0.0346
637.45	0.011	192.1	0.0382
637.47	0.014	192.4	0.0417
637.48	0.015	192.6	0.0453
637.50	0.017	192.8	0.0497
637.52	0.018	193.1	0.0506
637.53	0.02	193.3	0.0541
637.55	0.021	193.5	0.0568
637.57	0.023	193.8	0.0568
637.58	0.024	194	0.0595
637.60	0.024	194	0.0621
637.62	0.025	194.2	0.0648
637.63	0.026	194.4	0.0666
637.65	0.027	194.6	0.0675
637.67	0.028	194.8	0.0692
637.68	0.028	194.9	0.0692
637.70	0.029	195	0.0701
637.72	0.029	195	0.071
637.73	0.029	195.2	0.071
637.75	0.029	195.3	0.071
637.77	0.029	195.4	0.071
637.78	0.028	195.5	0.071
637.80	0.028	195.6	0.0701
637.82	0.026	195.6	0.0701
637.83	0.025	195.6	0.0683
637.85	0.025	195.6	0.0675
637.87	0.024	195.6	0.0657
637.88	0.023	195.5	0.0639
637.90	0.022	195.4	0.0621
637.92	0.02	195.3	0.0586
637.93	0.017	195.2	0.0586
637.95	0.016	195.2	0.0568



Prova triassiale ciclica SN04-C1			
pressione di confinamento (kPa)		80	
deviatore ciclico (kPa)		95	
frequenza (hz)		0.00625	
tempo	cella di carico	$\Delta u$	LVDT
(min)	kN	(kPa)	$\delta$ (mm)
637.97	0.016	195.1	0.0541
637.98	0.015	194.9	0.0506
638.00	0.011	194.7	0.047
638.02	0.01	194.6	0.0444
638.03	0.009	194.3	0.0399
638.05	0.005	194.1	0.0399
638.07	0.004	194.1	0.0364
638.08	0.004	193.9	0.0328
638.10	0.003	193.7	0.0293
638.12	-0.001	193.4	0.024
638.13	-0.002	193.2	0.0213
638.15	-0.003	192.9	0.0169
638.17	-0.007	192.6	0.0169
638.18	-0.007	192.6	0.0133
638.20	-0.007	192.4	0.0107
638.22	-0.011	191.9	0.0062
638.23	-0.012	191.9	0.0044
638.25	-0.012	191.7	0.0027
638.27	-0.012	191.5	0
638.28	-0.014	191.2	-0.0018
638.30	-0.015	191	-0.0036
638.32	-0.016	190.9	-0.0053
638.33	-0.017	190.7	-0.0053
638.37	-0.017	190.7	-0.0071
638.38	-0.017	190.5	-0.0071
638.40	-0.017	190.4	-0.008
638.42	-0.017	190.3	-0.008
638.43	-0.017	190.2	-0.008
638.43	-0.017	190.1	-0.008
638.45	-0.016	190	-0.008
638.47	-0.015	190	-0.0071
638.48	-0.015	190	-0.0062
638.50	-0.015	190	-0.0062
638.52	-0.014	190	-0.0044
638.53	-0.012	190	-0.0027
638.55	-0.011	190.1	-0.0009
638.57	-0.009	190.2	-0.0009
638.58	-0.008	190.3	0.0018
638.60	-0.008	190.3	0.0036
638.62	-0.006	190.4	0.0071
638.63	-0.004	190.6	0.0098
638.65	-0.002	190.7	0.0124
638.67	-0.001	190.8	0.016
638.68	0.002	191.1	0.016
638.70	0.004	191.3	0.0204
638.72	0.004	191.3	0.0222
638.73	0.005	191.5	0.0284
638.75	0.009	191.8	0.0328
638.77	0.011	192	0.0355
638.78	0.012	192.2	0.0391
638.80	0.014	192.5	0.0435
638.82	0.017	192.7	0.0435
638.83	0.017	192.7	0.0462
638.85	0.017	192.9	0.0497
638.87	0.019	193.2	0.0533
638.88	0.022	193.5	0.0568
638.90	0.022	193.7	0.0586
638.92	0.023	193.9	0.0612

Prova triassiale ciclica SN04-C1			
pressione di confinamento (kPa)		80	
deviatore ciclico (kPa)		95	
frequenza (hz)		0.00625	
tempo	cella di carico	$\Delta u$	LVDT
(min)	kN	(kPa)	$\delta$ (mm)
638.93	0.025	194.1	0.0612
638.95	0.026	194.3	0.0648
638.97	0.027	194.5	0.0666
638.98	0.027	194.7	0.0666
639.00	0.028	194.7	0.0675
639.02	0.028	194.8	0.0683
639.03	0.029	195	0.0701
639.05	0.029	195.1	0.0701
639.07	0.029	195.2	0.0701
639.08	0.029	195.4	0.071
639.10	0.029	195.5	0.071
639.12	0.028	195.5	0.071
639.12	0.028	195.6	0.0701
639.13	0.027	195.6	0.0692
639.15	0.026	195.6	0.0675
639.17	0.025	195.6	0.0666
639.18	0.024	195.6	0.0648
639.20	0.022	195.5	0.0648
639.22	0.021	195.5	0.0621
639.23	0.021	195.4	0.0604
639.25	0.019	195.3	0.0577
639.27	0.017	195.1	0.055
639.28	0.016	195	0.0524
639.30	0.014	194.9	0.0488
639.32	0.011	194.7	0.0488
639.33	0.009	194.7	0.0444
639.35	0.009	194.5	0.0426
639.37	0.008	194.3	0.0382
639.38	0.004	194	0.0346
639.40	0.003	193.8	0.0311
639.42	0.002	193.6	0.0275
639.43	-0.002	193.3	0.0275
639.45	-0.003	193.1	0.0213
639.47	-0.003	193.1	0.0186
639.48	-0.005	192.9	0.0142
639.50	-0.007	192.5	0.0115
639.52	-0.009	192.3	0.008
639.53	-0.01	192.1	0.0053
639.55	-0.012	191.8	0.0053
639.57	-0.013	191.5	0.0018
639.58	-0.013	191.5	0
639.60	-0.014	191.3	-0.0018
639.62	-0.015	191.1	-0.0044
639.63	-0.016	190.9	-0.0053
639.65	-0.016	190.7	-0.0062
639.67	-0.017	190.6	-0.008
639.68	-0.017	190.4	-0.008
639.70	-0.017	190.3	-0.0089
639.72	-0.017	190.2	-0.0089
639.73	-0.017	190.1	-0.0089
639.75	-0.017	190.1	-0.0089
639.77	-0.017	190	-0.0089
639.78	-0.016	190	-0.008
639.80	-0.015	190	-0.0071
639.82	-0.015	189.9	-0.0062
639.83	-0.014	190	-0.0044
639.85	-0.011	190	-0.0044
639.87	-0.011	190	-0.0027

Prova triassiale ciclica SN04-C1			
pressione di confinamento (kPa)		80	
deviatore ciclico (kPa)		95	
frequenza (hz)		0.00625	
tempo	cella di carico	$\Delta u$	LVDT
(min)	kN	(kPa)	$\delta$ (mm)
639.88	-0.011	190.1	-0.0009
639.90	-0.01	190.2	0.0018
639.92	-0.007	190.3	0.0044
639.93	-0.006	190.4	0.0071
639.95	-0.004	190.6	0.0098
639.97	-0.001	190.8	0.0098
639.98	0	190.8	0.0142
640.02	0	190.9	0.0169
640.03	0.002	191.2	0.0204
640.05	0.005	191.4	0.024
640.07	0.007	191.5	0.0284
640.08	0.008	191.8	0.0328
640.08	0.012	192.1	0.0328
640.10	0.012	192.1	0.0373
640.12	0.012	192.3	0.0399
640.13	0.014	192.6	0.0435
640.15	0.018	192.8	0.0479
640.17	0.019	193	0.0506
640.18	0.02	193.3	0.0541
640.20	0.022	193.5	0.0541
640.22	0.023	193.5	0.0568
640.23	0.023	193.7	0.0586
640.25	0.024	194	0.0612
640.27	0.026	194.2	0.0639
640.28	0.026	194.4	0.0648
640.30	0.027	194.6	0.0675
640.32	0.028	194.8	0.0675
640.33	0.029	194.8	0.0683
640.35	0.029	194.9	0.0692
640.37	0.029	195.1	0.0701
640.38	0.029	195.2	0.0701
640.40	0.029	195.3	0.0701
640.42	0.028	195.4	0.0701
640.43	0.028	195.5	0.0701
640.45	0.028	195.6	0.0692
640.47	0.027	195.6	0.0675
640.48	0.025	195.6	0.0675
640.50	0.024	195.6	0.0666
640.52	0.024	195.6	0.0648
640.53	0.023	195.6	0.063
640.55	0.021	195.4	0.0612
640.57	0.021	195.4	0.0595
640.58	0.019	195.2	0.0559
640.60	0.016	195.1	0.0559
640.62	0.015	195.1	0.0524
640.63	0.015	195	0.0506
640.65	0.013	194.8	0.0462
640.67	0.009	194.6	0.0426
640.68	0.009	194.4	0.0399
640.70	0.007	194.2	0.0364
640.72	0.004	193.9	0.0364
640.73	0.002	193.9	0.032
640.75	0.002	193.7	0.0284
640.77	0.001	193.5	0.024
640.78	-0.003	193.2	0.0195
640.80	-0.004	193	0.0169
640.82	-0.005	192.8	0.0133
640.83	-0.007	192.4	0.0133

Prova triassiale ciclica SN04-C1			
pressione di confinamento (kPa)		80	
deviatore ciclico (kPa)		95	
frequenza (hz)		0.00625	
tempo	cella di carico	$\Delta u$	LVDT
(min)	kN	(kPa)	$\delta$ (mm)
640.85	-0.009	192.2	0.0098
640.87	-0.009	192.2	0.0062
640.88	-0.01	191.9	0.0036
640.90	-0.012	191.7	0
640.92	-0.014	191.4	-0.0018
640.93	-0.014	191.2	-0.0036
640.95	-0.015	191	-0.0036
640.97	-0.016	190.8	-0.0053
640.98	-0.016	190.8	-0.0062
641.00	-0.016	190.7	-0.008
641.02	-0.017	190.5	-0.0089
641.03	-0.017	190.4	-0.0089
641.05	-0.017	190.2	-0.0098
641.07	-0.017	190.1	-0.0098
641.08	-0.017	190.1	-0.0089
641.10	-0.017	190.1	-0.0089
641.12	-0.016	190	-0.0089
641.13	-0.015	190	-0.008
641.15	-0.015	190	-0.0071
641.17	-0.014	190	-0.0053
641.18	-0.013	190	-0.0036
641.20	-0.011	190.1	-0.0018
641.22	-0.01	190.1	0
641.23	-0.008	190.3	0.0027
641.25	-0.006	190.4	0.0027
641.27	-0.005	190.4	0.0053
641.28	-0.005	190.5	0.0071
641.30	-0.003	190.7	0.0115
641.32	0	190.9	0.0151
641.33	0.001	191	0.0178
641.35	0.003	191.2	0.0213
641.37	0.006	191.5	0.0213
641.38	0.007	191.5	0.0257
641.40	0.007	191.6	0.0302
641.42	0.009	191.9	0.0337
641.43	0.012	192.2	0.0373
641.45	0.013	192.4	0.0408
641.48	0.015	192.7	0.0453
641.50	0.018	192.9	0.0453
641.52	0.019	192.9	0.0488
641.53	0.019	193.1	0.0524
641.53	0.02	193.4	0.055
641.55	0.023	193.6	0.0577
641.57	0.024	193.9	0.0604
641.58	0.025	194.1	0.0621
641.60	0.027	194.3	0.0621
641.62	0.027	194.3	0.0648
641.63	0.027	194.5	0.0657
641.65	0.027	194.7	0.0675
641.67	0.028	194.8	0.0683
641.68	0.028	195	0.0692
641.70	0.029	195.1	0.0692
641.72	0.029	195.2	0.0692
641.73	0.029	195.2	0.0701
641.75	0.029	195.4	0.0701
641.77	0.029	195.5	0.0701
641.78	0.028	195.6	0.0692
641.80	0.027	195.6	0.0675

Prova triassiale ciclica SN04-C1			
pressione di confinamento (kPa)		80	
deviatore ciclico (kPa)		95	
frequenza (hz)		0.00625	
tempo	cella di carico	$\Delta u$	LVDT
(min)	kN	(kPa)	$\delta$ (mm)
641.82	0.026	195.6	0.0666
641.83	0.024	195.5	0.0648
641.85	0.024	195.6	0.0639
641.87	0.023	195.5	0.0621
641.88	0.021	195.4	0.0621
641.90	0.019	195.4	0.0595
641.92	0.019	195.3	0.0577
641.93	0.018	195.2	0.0541
641.95	0.015	195	0.0515
641.97	0.014	194.9	0.0488
641.98	0.012	194.7	0.0453
642.00	0.009	194.5	0.0453
642.02	0.008	194.5	0.0408
642.03	0.008	194.3	0.0382
642.05	0.006	194.1	0.0346
642.07	0.002	193.8	0.0302
642.08	0.001	193.6	0.0275
642.10	0	193.4	0.0222
642.12	-0.003	193.1	0.0222
642.13	-0.005	193.1	0.0178
642.15	-0.005	192.9	0.0151
642.17	-0.006	192.6	0.0115
642.18	-0.009	192.3	0.008
642.20	-0.01	192.1	0.0053
642.22	-0.011	191.9	0.0027
642.23	-0.013	191.6	0.0027
642.25	-0.014	191.4	-0.0009
642.27	-0.014	191.4	-0.0027
642.28	-0.014	191.2	-0.0044
642.30	-0.016	190.9	-0.0062
642.32	-0.016	190.8	-0.008
642.33	-0.017	190.6	-0.0089
642.35	-0.017	190.4	-0.0089
642.37	-0.017	190.3	-0.0098
642.38	-0.017	190.3	-0.0098
642.40	-0.017	190.2	-0.0098
642.42	-0.017	190.1	-0.0098
642.43	-0.016	190.1	-0.0089
642.45	-0.016	190	-0.008
642.47	-0.015	190	-0.008
642.48	-0.014	190	-0.0071
642.50	-0.014	190	-0.0062
642.52	-0.013	190	-0.0036
642.53	-0.011	190.1	-0.0027
642.55	-0.01	190.2	-0.0009
642.57	-0.009	190.2	0.0027
642.58	-0.007	190.3	0.0036
642.60	-0.006	190.4	0.0062
642.62	-0.004	190.5	0.0098
642.63	-0.002	190.8	0.0133
642.65	0.001	191	0.0133
642.67	0.001	191	0.016
642.68	0.002	191.2	0.0195
642.70	0.004	191.4	0.024
642.72	0.007	191.6	0.0284
642.73	0.009	191.8	0.032
642.75	0.01	192.1	0.0355
642.77	0.013	192.3	0.0355

Prova triassiale ciclica SN04-C1			
pressione di confinamento (kPa)		80	
deviatore ciclico (kPa)		95	
frequenza (hz)		0.00625	
tempo	cella di carico	$\Delta u$	LVDT
(min)	kN	(kPa)	$\delta$ (mm)
642.78	0.014	192.3	0.0391
642.80	0.014	192.5	0.0426
642.82	0.016	192.8	0.047
642.83	0.019	193	0.0497
642.85	0.02	193.3	0.0524
642.87	0.021	193.6	0.0559
642.88	0.024	193.8	0.0559
642.90	0.025	193.8	0.0595
642.92	0.025	194	0.0612
642.95	0.025	194.2	0.063
642.97	0.027	194.4	0.0657
642.98	0.027	194.6	0.0657
642.98	0.027	194.7	0.0675
643.00	0.028	194.9	0.0675
643.02	0.029	194.9	0.0692
643.03	0.029	195.1	0.0692
643.05	0.029	195.2	0.0692
643.07	0.029	195.3	0.0692
643.08	0.028	195.4	0.0692
643.10	0.028	195.5	0.0692
643.12	0.028	195.6	0.0692
643.13	0.026	195.6	0.0692
643.15	0.026	195.6	0.0675
643.17	0.026	195.6	0.0657
643.18	0.024	195.6	0.0639
643.20	0.023	195.5	0.063
643.22	0.022	195.5	0.0604
643.23	0.019	195.3	0.0604
643.25	0.018	195.3	0.0577
643.27	0.018	195.2	0.055
643.28	0.015	194.9	0.0524
643.30	0.013	194.9	0.0506
643.32	0.013	194.8	0.0479
643.33	0.011	194.6	0.0435
643.35	0.008	194.4	0.0399
643.37	0.007	194.2	0.0373
643.38	0.005	194	0.0337
643.40	0.002	193.7	0.0337
643.42	0	193.5	0.0293
643.43	0	193.5	0.0249
643.45	-0.001	193.3	0.0213
643.47	-0.004	193	0.0169
643.48	-0.006	192.7	0.0133
643.50	-0.007	192.5	0.0107
643.52	-0.009	192.2	0.0107
643.53	-0.011	191.9	0.0062
643.55	-0.011	191.9	0.0036
643.57	-0.011	191.8	0.0009
643.58	-0.013	191.5	-0.0009
643.60	-0.015	191.3	-0.0036
643.62	-0.015	191.1	-0.0044
643.63	-0.016	190.9	-0.0044
643.65	-0.017	190.7	-0.0062
643.67	-0.017	190.7	-0.0071
643.68	-0.017	190.6	-0.0089
643.70	-0.017	190.4	-0.0089
643.72	-0.017	190.3	-0.0089
643.73	-0.017	190.2	-0.0089

Prova triassiale ciclica SN04-C1			
pressione di confinamento (kPa)		80	
deviatore ciclico (kPa)		95	
frequenza (hz)		0.00625	
tempo	cella di carico	$\Delta u$	LVDT
(min)	kN	(kPa)	$\delta$ (mm)
643.75	-0.017	190.1	-0.0089
643.77	-0.016	190	-0.0089
643.78	-0.016	190	-0.008
643.80	-0.016	190	-0.0071
643.82	-0.015	190	-0.0062
643.83	-0.013	190	-0.0053
643.85	-0.012	190	-0.0027
643.87	-0.011	190.1	-0.0009
643.88	-0.009	190.2	-0.0009
643.90	-0.009	190.2	0.0009
643.92	-0.008	190.3	0.0027
643.93	-0.006	190.5	0.0062
643.95	-0.003	190.6	0.0098
643.97	-0.002	190.7	0.0124
643.98	0	190.9	0.016
644.00	0.002	191.2	0.016
644.02	0.003	191.3	0.0213
644.03	0.004	191.5	0.0249
644.05	0.008	191.7	0.0249
644.07	0.009	191.7	0.0293
644.08	0.009	191.9	0.0337
644.10	0.011	192.2	0.0373
644.12	0.014	192.4	0.0417
644.13	0.015	192.6	0.0444
644.15	0.017	192.9	0.0479
644.17	0.019	193.2	0.0479
644.18	0.021	193.2	0.0524
644.20	0.021	193.4	0.0541
644.22	0.022	193.7	0.0577
644.23	0.024	193.9	0.0604
644.25	0.025	194.1	0.0621
644.27	0.026	194.3	0.0639
644.28	0.027	194.5	0.0639
644.30	0.027	194.5	0.0666
644.32	0.027	194.7	0.0666
644.33	0.028	194.8	0.0683
644.35	0.028	195	0.0692
644.38	0.029	195.1	0.0701
644.40	0.029	195.3	0.0701
644.42	0.029	195.4	0.0701
644.43	0.028	195.4	0.0701
644.45	0.028	195.5	0.0701
644.45	0.028	195.6	0.0692
644.47	0.027	195.6	0.0683
644.48	0.026	195.6	0.0675
644.50	0.025	195.6	0.0648
644.52	0.023	195.6	0.0648
644.53	0.022	195.6	0.063
644.55	0.022	195.5	0.0621
644.57	0.021	195.4	0.0595
644.58	0.018	195.2	0.0559
644.60	0.017	195.1	0.0541
644.62	0.016	195	0.0506
644.63	0.013	194.8	0.0506
644.65	0.011	194.8	0.047
644.67	0.011	194.7	0.0444
644.68	0.01	194.5	0.0408
644.70	0.006	194.2	0.0364

Prova triassiale ciclica SN04-C1			
pressione di confinamento (kPa)		80	
deviatore ciclico (kPa)		95	
frequenza (hz)		0.00625	
tempo	cella di carico	$\Delta u$	LVDT
(min)	kN	(kPa)	$\delta$ (mm)
644.72	0.005	194.1	0.0337
644.73	0.003	193.9	0.0293
644.75	0	193.5	0.0249
644.77	0	193.4	0.0231
644.78	-0.002	193.2	0.0186
644.80	-0.005	192.8	0.0186
644.82	-0.007	192.6	0.0151
644.83	-0.007	192.6	0.0115
644.85	-0.007	192.4	0.0089
644.87	-0.01	192.1	0.0053
644.88	-0.011	191.9	0.0027
644.90	-0.012	191.6	0
644.92	-0.014	191.4	0
644.93	-0.015	191.2	-0.0027
644.95	-0.015	191.2	-0.0036
644.97	-0.016	191	-0.0053
644.98	-0.016	190.8	-0.0071
645.00	-0.017	190.6	-0.008
645.02	-0.017	190.5	-0.0089
645.03	-0.017	190.4	-0.0089
645.05	-0.017	190.2	-0.0089
645.07	-0.017	190.2	-0.0089
645.08	-0.017	190.2	-0.0089
645.10	-0.017	190.1	-0.0089
645.12	-0.016	190	-0.008
645.13	-0.015	190	-0.0062
645.15	-0.014	190	-0.0053
645.17	-0.012	190	-0.0053
645.18	-0.012	190	-0.0036
645.20	-0.012	190	-0.0027
645.22	-0.011	190.2	0
645.23	-0.008	190.3	0.0018
645.25	-0.007	190.3	0.0044
645.27	-0.006	190.5	0.0071
645.28	-0.003	190.7	0.0071
645.30	-0.002	190.7	0.0107
645.32	-0.002	190.8	0.0133
645.33	0	191.1	0.0169
645.35	0.003	191.3	0.0213
645.37	0.005	191.4	0.0249
645.38	0.006	191.7	0.0293
645.40	0.01	191.9	0.0293
645.42	0.011	191.9	0.0337
645.43	0.011	192.1	0.0373
645.45	0.013	192.4	0.0408
645.47	0.016	192.6	0.0453
645.48	0.016	192.8	0.047
645.50	0.018	193.1	0.0506
645.52	0.02	193.3	0.0533
645.53	0.021	193.5	0.0559
645.55	0.022	193.8	0.0586
645.57	0.025	194	0.0586
645.58	0.025	194	0.0612
645.60	0.025	194.2	0.063
645.62	0.026	194.4	0.0657
645.63	0.027	194.6	0.0666
645.65	0.028	194.8	0.0683
645.67	0.028	195	0.0692



Prova triassiale ciclica SN04-C1			
pressione di confinamento (kPa)		80	
deviatore ciclico (kPa)		95	
frequenza (hz)		0.00625	
tempo	cella di carico	$\Delta u$	LVDT
(min)	kN	(kPa)	$\delta$ (mm)
645.68	0.029	195.1	0.0692
645.70	0.029	195.1	0.0701
645.72	0.029	195.3	0.071
645.73	0.029	195.4	0.0701
645.75	0.029	195.5	0.0701
645.77	0.029	195.6	0.0701
645.78	0.028	195.6	0.0692
645.80	0.026	195.6	0.0692
645.82	0.025	195.6	0.0675
645.85	0.025	195.6	0.0666
645.87	0.025	195.6	0.0648
645.88	0.022	195.5	0.063
645.90	0.021	195.5	0.0612
645.90	0.02	195.4	0.0586
645.92	0.017	195.2	0.0586
645.93	0.016	195.2	0.0559
645.95	0.016	195.2	0.0541
645.97	0.015	195	0.0506
645.98	0.012	194.8	0.047
646.00	0.01	194.6	0.0435
646.02	0.009	194.4	0.0391
646.03	0.006	194.2	0.0391
646.05	0.004	194	0.0355
646.07	0.004	194	0.0328
646.08	0.003	193.8	0.0284
646.10	-0.001	193.5	0.024
646.12	-0.002	193.2	0.0204
646.13	-0.003	193	0.0169
646.15	-0.006	192.6	0.0169
646.17	-0.008	192.4	0.0133
646.18	-0.008	192.4	0.0098
646.20	-0.011	192	0.0053
646.22	-0.012	191.8	0.0044
646.23	-0.012	191.8	0.0027
646.25	-0.012	191.5	0
646.27	-0.014	191.3	-0.0027
646.28	-0.016	191.1	-0.0044
646.30	-0.016	190.9	-0.0053
646.32	-0.016	190.7	-0.0071
646.33	-0.017	190.6	-0.0071
646.35	-0.017	190.6	-0.008
646.37	-0.017	190.4	-0.008
646.38	-0.017	190.3	-0.0089
646.40	-0.017	190.2	-0.0089
646.42	-0.017	190.1	-0.0089
646.43	-0.017	190.1	-0.008
646.45	-0.016	190	-0.008
646.47	-0.015	190	-0.0071
646.48	-0.015	190	-0.0062
646.50	-0.014	190	-0.0044
646.52	-0.012	190.1	-0.0027
646.53	-0.011	190.1	-0.0009
646.55	-0.01	190.2	0.0009
646.57	-0.007	190.3	0.0009
646.58	-0.007	190.3	0.0036
646.60	-0.007	190.4	0.0062
646.62	-0.005	190.6	0.0089
646.63	-0.001	190.8	0.0133

Prova triassiale ciclica SN04-C1			
pressione di confinamento (kPa)		80	
deviatore ciclico (kPa)		95	
frequenza (hz)		0.00625	
tempo	cella di carico	$\Delta u$	LVDT
(min)	kN	(kPa)	$\delta$ (mm)
646.65	0	190.9	0.016
646.67	0.001	191.1	0.0195
646.68	0.005	191.3	0.0195
646.70	0.005	191.3	0.0231
646.72	0.005	191.5	0.0275
646.73	0.007	191.8	0.032
646.75	0.011	192	0.0364
646.77	0.012	192.2	0.0391
646.78	0.013	192.5	0.0426
646.80	0.017	192.8	0.0426
646.82	0.017	192.8	0.047
646.83	0.017	193	0.0497
646.85	0.019	193.2	0.0533
646.87	0.022	193.5	0.0568
646.88	0.022	193.7	0.0586
646.90	0.024	193.9	0.0612
646.92	0.026	194.2	0.0639
646.93	0.026	194.3	0.0648
646.95	0.027	194.5	0.0666
646.97	0.028	194.7	0.0666
646.98	0.028	194.7	0.0683
647.00	0.028	194.9	0.0692
647.02	0.028	195	0.0692
647.03	0.029	195.2	0.0701
647.05	0.029	195.3	0.071
647.07	0.029	195.4	0.071
647.08	0.029	195.5	0.071
647.10	0.028	195.6	0.0701
647.12	0.028	195.6	0.0701
647.13	0.028	195.7	0.0683
647.15	0.026	195.6	0.0675
647.17	0.025	195.7	0.0657
647.18	0.024	195.6	0.0639
647.20	0.022	195.5	0.0639
647.22	0.021	195.5	0.0621
647.23	0.021	195.5	0.0604
647.25	0.02	195.4	0.0577
647.28	0.018	195.2	0.055
647.30	0.015	195	0.0515
647.32	0.014	195	0.0479
647.33	0.011	194.7	0.0479
647.35	0.009	194.5	0.0444
647.35	0.009	194.5	0.0408
647.37	0.007	194.4	0.0373
647.38	0.005	194.1	0.0337
647.40	0.003	193.9	0.0311
647.42	0.002	193.7	0.0257
647.43	-0.001	193.3	0.0257
647.45	-0.004	193.1	0.0213
647.47	-0.004	193.1	0.0178
647.48	-0.005	192.9	0.0142
647.50	-0.007	192.6	0.0107
647.52	-0.009	192.3	0.008
647.53	-0.01	192.1	0.0044
647.55	-0.012	191.8	0.0044
647.57	-0.013	191.6	0.0018
647.58	-0.013	191.6	-0.0009
647.60	-0.014	191.4	-0.0027

Prova triassiale ciclica SN04-C1			
pressione di confinamento (kPa)		80	
deviatore ciclico (kPa)		95	
frequenza (hz)		0.00625	
tempo	cella di carico	$\Delta u$	LVDT
(min)	kN	(kPa)	$\delta$ (mm)
647.62	-0.015	191.2	-0.0044
647.63	-0.016	191	-0.0062
647.65	-0.016	190.8	-0.0071
647.67	-0.016	190.6	-0.008
647.68	-0.017	190.5	-0.0089
647.70	-0.017	190.3	-0.0098
647.72	-0.017	190.2	-0.0098
647.73	-0.017	190.2	-0.0098
647.75	-0.017	190.2	-0.0098
647.77	-0.017	190.1	-0.0089
647.78	-0.016	190.1	-0.0089
647.80	-0.015	190	-0.008
647.82	-0.014	190	-0.0062
647.83	-0.014	190	-0.0053
647.85	-0.012	190.1	-0.0053
647.87	-0.011	190.1	-0.0036
647.88	-0.011	190.1	-0.0018
647.90	-0.009	190.2	0.0009
647.92	-0.007	190.4	0.0036
647.93	-0.006	190.4	0.0062
647.95	-0.004	190.7	0.0098
647.97	-0.001	190.8	0.0098
647.98	0	190.8	0.0133
648.00	0	191	0.016
648.02	0.002	191.2	0.0195
648.03	0.005	191.4	0.024
648.05	0.006	191.6	0.0284
648.07	0.008	191.9	0.032
648.08	0.012	192.1	0.032
648.10	0.013	192.1	0.0364
648.12	0.013	192.3	0.0399
648.13	0.014	192.6	0.0435
648.15	0.018	192.9	0.047
648.17	0.018	193.1	0.0497
648.18	0.02	193.4	0.0533
648.20	0.023	193.6	0.0533
648.22	0.023	193.6	0.0559
648.23	0.023	193.8	0.0577
648.25	0.024	194.1	0.0612
648.27	0.026	194.3	0.0639
648.28	0.027	194.5	0.0648
648.30	0.027	194.7	0.0666
648.32	0.028	194.8	0.0666
648.33	0.028	194.8	0.0675
648.35	0.028	195	0.0683
648.37	0.029	195.2	0.0692
648.38	0.029	195.2	0.0692
648.40	0.029	195.4	0.0692
648.42	0.029	195.5	0.0692
648.43	0.028	195.6	0.0692
648.45	0.028	195.7	0.0683
648.47	0.027	195.7	0.0675
648.48	0.025	195.6	0.0675
648.50	0.024	195.6	0.0657
648.52	0.024	195.6	0.0639
648.53	0.023	195.6	0.0621
648.55	0.022	195.5	0.0604
648.57	0.02	195.4	0.0577

Prova triassiale ciclica SN04-C1			
pressione di confinamento (kPa)		80	
deviatore ciclico (kPa)		95	
frequenza (hz)		0.00625	
tempo	cella di carico	$\Delta u$	LVDT
(min)	kN	(kPa)	$\delta$ (mm)
648.58	0.019	195.3	0.0559
648.60	0.017	195.1	0.0559
648.62	0.014	195	0.0524
648.63	0.014	195	0.0497
648.65	0.013	194.9	0.0462
648.67	0.01	194.6	0.0417
648.68	0.008	194.5	0.0399
648.70	0.007	194.3	0.0364
648.72	0.004	194	0.0364
648.75	0.002	193.8	0.0311
648.77	0.002	193.8	0.0284
648.78	0.001	193.6	0.0231
648.80	-0.002	193.3	0.0186
648.80	-0.004	193	0.016
648.82	-0.005	192.8	0.0115
648.83	-0.007	192.5	0.0089
648.85	-0.01	192.2	0.0089
648.87	-0.01	192.2	0.0053
648.88	-0.01	192	0.0027
648.90	-0.012	191.7	0
648.92	-0.014	191.5	-0.0027
648.93	-0.014	191.3	-0.0036
648.95	-0.015	191.1	-0.0062
648.97	-0.017	190.9	-0.0062
648.98	-0.016	190.9	-0.008
649.00	-0.016	190.7	-0.008
649.02	-0.017	190.6	-0.0089
649.03	-0.017	190.4	-0.0098
649.05	-0.017	190.3	-0.0098
649.07	-0.017	190.2	-0.0098
649.08	-0.016	190.2	-0.0098
649.10	-0.016	190.1	-0.0098
649.12	-0.016	190	-0.0089
649.13	-0.015	190	-0.0089
649.15	-0.014	190	-0.0071
649.17	-0.014	190	-0.0062
649.18	-0.013	190.1	-0.0053
649.20	-0.011	190.1	-0.0027
649.22	-0.01	190.2	-0.0009
649.23	-0.009	190.3	0.0018
649.25	-0.006	190.4	0.0018
649.27	-0.005	190.4	0.0044
649.28	-0.005	190.5	0.0071
649.30	-0.004	190.7	0.0107
649.32	0	190.9	0.0142
649.33	0.001	191	0.0178
649.35	0.003	191.3	0.0213
649.37	0.007	191.5	0.0213
649.38	0.007	191.5	0.0257
649.40	0.007	191.7	0.0293
649.42	0.009	192	0.0328
649.43	0.012	192.3	0.0373
649.45	0.013	192.4	0.0399
649.47	0.015	192.7	0.0453
649.48	0.018	193	0.0453
649.50	0.019	193	0.0488
649.52	0.019	193.2	0.0515
649.53	0.02	193.5	0.055

Prova triassiale ciclica SN04-C1			
pressione di confinamento (kPa)		80	
deviatore ciclico (kPa)		95	
frequenza (hz)		0.00625	
tempo	cella di carico	$\Delta u$	LVDT
(min)	kN	(kPa)	$\delta$ (mm)
649.55	0.023	193.7	0.0577
649.57	0.023	193.9	0.0595
649.58	0.024	194.1	0.0621
649.60	0.026	194.4	0.0621
649.62	0.027	194.4	0.0639
649.63	0.027	194.5	0.0657
649.65	0.027	194.7	0.0666
649.67	0.028	194.9	0.0683
649.68	0.029	195	0.0683
649.70	0.029	195.2	0.0692
649.72	0.029	195.3	0.0692
649.73	0.029	195.3	0.0692
649.75	0.029	195.4	0.0692
649.77	0.028	195.6	0.0692
649.78	0.028	195.6	0.0683
649.80	0.027	195.6	0.0675
649.82	0.026	195.7	0.0666
649.83	0.024	195.6	0.0639
649.85	0.024	195.7	0.063
649.87	0.023	195.6	0.0612
649.88	0.021	195.5	0.0612
649.90	0.019	195.4	0.0595
649.92	0.019	195.4	0.0577
649.93	0.018	195.3	0.0541
649.95	0.015	195.1	0.0506
649.97	0.013	194.9	0.0479
649.98	0.012	194.8	0.0453
650.00	0.01	194.6	0.0453
650.02	0.007	194.4	0.0417
650.03	0.007	194.4	0.0373
650.05	0.006	194.2	0.0337
650.07	0.003	193.9	0.0302
650.08	0.001	193.7	0.0257
650.10	0	193.5	0.0222
650.12	-0.003	193.2	0.0222
650.13	-0.005	192.9	0.0178
650.15	-0.005	192.9	0.0151
650.17	-0.006	192.7	0.0107
650.20	-0.008	192.4	0.0071
650.22	-0.01	192.1	0.0044
650.23	-0.011	191.9	0.0018
650.25	-0.012	191.6	0.0018
650.25	-0.014	191.4	-0.0009
650.27	-0.014	191.4	-0.0036
650.28	-0.014	191.2	-0.0044
650.30	-0.016	191	-0.0071
650.32	-0.017	190.8	-0.008
650.33	-0.017	190.7	-0.0089
650.35	-0.017	190.5	-0.0089
650.37	-0.017	190.4	-0.0098
650.38	-0.017	190.4	-0.0098
650.40	-0.017	190.3	-0.0098
650.42	-0.017	190.2	-0.0098
650.43	-0.016	190.1	-0.0098
650.45	-0.016	190.1	-0.0089
650.47	-0.015	190.1	-0.008
650.48	-0.014	190.1	-0.008
650.50	-0.013	190.1	-0.0062

Prova triassiale ciclica SN04-C1			
pressione di confinamento (kPa)		80	
deviatore ciclico (kPa)		95	
frequenza (hz)		0.00625	
tempo	cella di carico	$\Delta u$	LVDT
(min)	kN	(kPa)	$\delta$ (mm)
650.52	-0.013	190.1	-0.0053
650.53	-0.012	190.2	-0.0036
650.55	-0.01	190.2	-0.0018
650.57	-0.01	190.3	0
650.58	-0.008	190.4	0.0027
650.60	-0.005	190.5	0.0062
650.62	-0.004	190.6	0.0089
650.63	-0.002	190.9	0.0115
650.65	0.001	191	0.0115
650.67	0.002	191	0.0151
650.68	0.002	191.2	0.0186
650.70	0.004	191.4	0.0222
650.72	0.007	191.7	0.0275
650.73	0.008	191.8	0.0311
650.75	0.01	192.1	0.0355
650.77	0.014	192.4	0.0355
650.78	0.014	192.4	0.0391
650.80	0.014	192.6	0.0417
650.82	0.016	192.9	0.0453
650.83	0.019	193.1	0.0488
650.85	0.02	193.4	0.0515
650.87	0.021	193.6	0.055
650.88	0.024	193.8	0.055
650.90	0.024	193.8	0.0586
650.92	0.024	194	0.0604
650.93	0.025	194.3	0.063
650.95	0.027	194.5	0.0648
650.97	0.027	194.6	0.0657
650.98	0.028	194.8	0.0675
651.00	0.028	195	0.0675
651.02	0.029	195	0.0683
651.03	0.029	195.1	0.0683
651.05	0.029	195.3	0.0683
651.07	0.028	195.4	0.0683
651.08	0.028	195.5	0.0683
651.10	0.028	195.6	0.0683
651.12	0.028	195.7	0.0683
651.13	0.026	195.7	0.0683
651.15	0.026	195.7	0.0666
651.17	0.026	195.7	0.0657
651.18	0.024	195.6	0.063
651.20	0.022	195.6	0.0612
651.22	0.022	195.6	0.0595
651.23	0.019	195.4	0.0595
651.25	0.018	195.4	0.0568
651.27	0.018	195.3	0.0541
651.28	0.015	195	0.0515
651.30	0.013	195	0.0497
651.32	0.013	194.9	0.047
651.33	0.011	194.7	0.0426
651.35	0.008	194.5	0.0391
651.37	0.007	194.3	0.0355
651.38	0.005	194.1	0.032
651.40	0.001	193.8	0.032
651.42	0.001	193.8	0.0275
651.43	0.001	193.6	0.024
651.45	-0.001	193.3	0.0195
651.47	-0.005	193	0.0151

Prova triassiale ciclica SN04-C1			
pressione di confinamento (kPa)		80	
deviatore ciclico (kPa)		95	
frequenza (hz)		0.00625	
tempo	cella di carico	$\Delta u$	LVDT
(min)	kN	(kPa)	$\delta$ (mm)
651.48	-0.006	192.8	0.0124
651.50	-0.007	192.6	0.0089
651.52	-0.01	192.3	0.0089
651.53	-0.01	192.3	0.0053
651.55	-0.01	192.1	0.0027
651.57	-0.011	191.8	0
651.58	-0.014	191.5	-0.0027
651.60	-0.014	191.3	-0.0044
651.62	-0.015	191.2	-0.0062
651.65	-0.016	190.9	-0.0062
651.67	-0.016	190.9	-0.008
651.68	-0.016	190.8	-0.0089
651.70	-0.017	190.6	-0.0098
651.70	-0.018	190.5	-0.0107
651.72	-0.017	190.4	-0.0107
651.73	-0.017	190.3	-0.0107
651.75	-0.017	190.2	-0.0107
651.77	-0.016	190.2	-0.0107
651.78	-0.016	190.2	-0.0098
651.80	-0.016	190.1	-0.008
651.82	-0.014	190.1	-0.0071
651.83	-0.014	190.1	-0.0062
651.85	-0.012	190.1	-0.0044
651.87	-0.01	190.2	-0.0044
651.88	-0.009	190.2	-0.0018
651.90	-0.009	190.3	0
651.92	-0.008	190.4	0.0036
651.93	-0.005	190.5	0.0053
651.95	-0.004	190.6	0.0071
651.97	-0.003	190.8	0.0115
651.98	0.001	191.1	0.0115
652.00	0.002	191.2	0.0178
652.02	0.003	191.3	0.0204
652.03	0.006	191.6	0.0204
652.05	0.007	191.8	0.0249
652.07	0.007	191.8	0.0293
652.08	0.009	192	0.0328
652.10	0.012	192.3	0.0364
652.12	0.014	192.5	0.0399
652.13	0.015	192.7	0.0444
652.15	0.018	193	0.0444
652.17	0.019	193.3	0.0479
652.18	0.019	193.3	0.0506
652.20	0.02	193.5	0.0541
652.22	0.023	193.8	0.0568
652.23	0.024	194	0.0586
652.25	0.025	194.2	0.0621
652.27	0.026	194.4	0.0621
652.28	0.027	194.6	0.0639
652.30	0.027	194.6	0.0648
652.32	0.027	194.8	0.0666
652.33	0.028	195	0.0675
652.35	0.029	195.1	0.0683
652.37	0.029	195.2	0.0692
652.38	0.029	195.4	0.0692
652.40	0.029	195.5	0.0692
652.42	0.029	195.5	0.0692
652.43	0.029	195.6	0.0692

Prova triassiale ciclica SN04-C1			
pressione di confinamento (kPa)		80	
deviatore ciclico (kPa)		95	
frequenza (hz)		0.00625	
tempo	cella di carico	$\Delta u$	LVDT
(min)	kN	(kPa)	$\delta$ (mm)
652.45	0.028	195.7	0.0683
652.47	0.027	195.7	0.0675
652.48	0.026	195.7	0.0648
652.50	0.024	195.7	0.0648
652.52	0.023	195.6	0.0639
652.53	0.023	195.6	0.0621
652.55	0.022	195.6	0.0604
652.57	0.021	195.5	0.0577
652.58	0.018	195.4	0.0559
652.60	0.017	195.3	0.0524
652.62	0.015	195	0.0524
652.63	0.012	194.9	0.0488
652.65	0.012	194.9	0.0462
652.67	0.012	194.8	0.0426
652.68	0.009	194.5	0.0391
652.70	0.006	194.3	0.0355
652.72	0.005	194.1	0.032
652.73	0.003	193.9	0.0275
652.75	0.001	193.7	0.0249
652.77	0	193.5	0.0213
652.78	-0.002	193.2	0.0169
652.80	-0.005	192.9	0.0169
652.82	-0.005	192.9	0.0142
652.83	-0.006	192.7	0.0107
652.85	-0.008	192.4	0.0071
652.87	-0.01	192.1	0.0036
652.88	-0.011	191.9	0.0009
652.90	-0.012	191.6	-0.0018
652.92	-0.014	191.4	-0.0018
652.93	-0.014	191.4	-0.0036
652.95	-0.015	191.2	-0.0053
652.97	-0.016	191	-0.0071
652.98	-0.017	190.8	-0.0089
653.00	-0.017	190.7	-0.0089
653.02	-0.017	190.5	-0.0098
653.03	-0.017	190.4	-0.0098
653.05	-0.017	190.4	-0.0107
653.07	-0.017	190.3	-0.0107
653.08	-0.017	190.2	-0.0098
653.12	-0.016	190.1	-0.0098
653.13	-0.016	190.1	-0.0098
653.15	-0.015	190.1	-0.008
653.17	-0.014	190.1	-0.008
653.17	-0.013	190.1	-0.0062
653.18	-0.013	190.1	-0.0053
653.20	-0.012	190.2	-0.0036
653.22	-0.01	190.2	-0.0018
653.23	-0.009	190.3	0.0009
653.25	-0.007	190.5	0.0036
653.27	-0.005	190.6	0.0036
653.28	-0.003	190.6	0.0062
653.30	-0.003	190.8	0.0098
653.32	-0.002	191	0.0133
653.33	0.002	191.2	0.0169
653.35	0.003	191.3	0.0204
653.37	0.004	191.6	0.024
653.38	0.008	191.8	0.024
653.40	0.009	191.8	0.0293



Prova triassiale ciclica SN04-C1			
pressione di confinamento (kPa)		80	
deviatore ciclico (kPa)		95	
frequenza (hz)		0.00625	
tempo	cella di carico	$\Delta u$	LVDT
(min)	kN	(kPa)	$\delta$ (mm)
653.42	0.009	192	0.032
653.43	0.011	192.3	0.0364
653.45	0.014	192.5	0.0408
653.47	0.015	192.7	0.0426
653.48	0.016	192.9	0.0453
653.50	0.019	193.2	0.0488
653.52	0.02	193.4	0.0515
653.53	0.021	193.7	0.055
653.55	0.023	193.9	0.055
653.57	0.024	193.9	0.0577
653.58	0.024	194.1	0.0604
653.60	0.025	194.3	0.0621
653.62	0.027	194.5	0.0648
653.63	0.027	194.7	0.0657
653.65	0.027	194.9	0.0666
653.67	0.029	195.1	0.0666
653.68	0.029	195.1	0.0683
653.70	0.029	195.2	0.0683
653.72	0.029	195.3	0.0692
653.73	0.029	195.5	0.0692
653.75	0.029	195.6	0.0692
653.77	0.028	195.7	0.0683
653.78	0.027	195.7	0.0683
653.80	0.027	195.7	0.0675
653.82	0.027	195.7	0.0666
653.83	0.026	195.7	0.0648
653.85	0.024	195.7	0.063
653.87	0.023	195.6	0.0612
653.88	0.022	195.6	0.0586
653.90	0.019	195.4	0.0586
653.92	0.018	195.3	0.0568
653.93	0.018	195.3	0.0541
653.95	0.016	195.2	0.0515
653.97	0.014	195	0.0479
653.98	0.012	194.9	0.0453
654.00	0.011	194.7	0.0408
654.02	0.007	194.4	0.0408
654.03	0.006	194.3	0.0364
654.05	0.006	194.3	0.0337
654.07	0.004	194	0.0302
654.08	0.001	193.7	0.0249
654.10	-0.001	193.5	0.0222
654.12	-0.002	193.3	0.0178
654.13	-0.005	193	0.0178
654.15	-0.006	192.8	0.0133
654.17	-0.006	192.8	0.0107
654.18	-0.009	192.3	0.0071
654.20	-0.01	192	0.0053
654.22	-0.01	192	0.0027
654.23	-0.011	191.8	0
654.25	-0.013	191.5	-0.0027
654.27	-0.015	191.3	-0.0044
654.28	-0.015	191.2	-0.0062
654.30	-0.016	190.9	-0.0062
654.32	-0.017	190.8	-0.008
654.33	-0.017	190.8	-0.0089
654.35	-0.017	190.6	-0.0098
654.37	-0.017	190.5	-0.0098

Prova triassiale ciclica SN04-C1			
pressione di confinamento (kPa)		80	
deviatore ciclico (kPa)		95	
frequenza (hz)		0.00625	
tempo	cella di carico	$\Delta u$	LVDT
(min)	kN	(kPa)	$\delta$ (mm)
654.38	-0.017	190.3	-0.0107
654.40	-0.017	190.3	-0.0107
654.42	-0.017	190.2	-0.0098
654.43	-0.016	190.1	-0.0098
654.45	-0.016	190.1	-0.0098
654.47	-0.016	190.1	-0.0089
654.48	-0.015	190.1	-0.008
654.50	-0.013	190.1	-0.0062
654.52	-0.012	190.1	-0.0044
654.55	-0.011	190.2	-0.0027
654.57	-0.009	190.3	-0.0027
654.58	-0.008	190.3	-0.0009
654.60	-0.008	190.4	0.0018
654.62	-0.007	190.5	0.0044
654.62	-0.003	190.7	0.008
654.63	-0.003	190.8	0.0107
654.65	-0.001	191.1	0.0142
654.67	0.003	191.3	0.0142
654.68	0.004	191.3	0.0186
654.70	0.004	191.4	0.0213
654.72	0.005	191.7	0.0257
654.73	0.009	191.9	0.0311
654.75	0.01	192.1	0.0337
654.77	0.011	192.4	0.0373
654.78	0.015	192.6	0.0373
654.80	0.016	192.6	0.0417
654.82	0.016	192.8	0.0444
654.83	0.017	193.1	0.0479
654.85	0.021	193.4	0.0524
654.87	0.021	193.6	0.0541
654.88	0.022	193.8	0.0568
654.90	0.025	194.1	0.0568
654.92	0.025	194.3	0.0612
654.93	0.025	194.4	0.063
654.95	0.027	194.6	0.063
654.97	0.027	194.6	0.0648
654.98	0.027	194.8	0.0657
655.00	0.028	195	0.0666
655.02	0.029	195.2	0.0683
655.03	0.029	195.3	0.0683
655.05	0.029	195.4	0.0683
655.07	0.029	195.6	0.0683
655.08	0.028	195.7	0.0683
655.10	0.028	195.7	0.0683
655.12	0.028	195.7	0.0683
655.13	0.027	195.7	0.0666
655.15	0.026	195.7	0.0657
655.17	0.025	195.8	0.0639
655.18	0.023	195.7	0.0639
655.20	0.022	195.6	0.0621
655.22	0.022	195.6	0.0604
655.23	0.021	195.6	0.0577
655.25	0.019	195.4	0.055
655.27	0.017	195.3	0.0533
655.28	0.016	195.2	0.0497
655.30	0.013	195	0.0497
655.32	0.011	194.8	0.047
655.33	0.011	194.8	0.0435

Prova triassiale ciclica SN04-C1			
pressione di confinamento (kPa)		80	
deviatore ciclico (kPa)		95	
frequenza (hz)		0.00625	
tempo	cella di carico	$\Delta u$	LVDT
(min)	kN	(kPa)	$\delta$ (mm)
655.35	0.009	194.6	0.0391
655.37	0.007	194.3	0.0355
655.38	0.005	194.2	0.0328
655.40	0.003	194	0.0284
655.42	0.001	193.7	0.0284
655.43	-0.002	193.4	0.024
655.45	-0.002	193.4	0.0204
655.47	-0.002	193.2	0.0169
655.48	-0.005	192.9	0.0124
655.50	-0.007	192.6	0.0089
655.52	-0.009	192.4	0.0062
655.53	-0.01	192.1	0.0062
655.55	-0.012	191.9	0.0027
655.57	-0.012	191.9	0
655.58	-0.013	191.7	-0.0018
655.60	-0.014	191.4	-0.0044
655.62	-0.015	191.2	-0.0062
655.63	-0.016	191	-0.0071
655.65	-0.016	190.9	-0.008
655.67	-0.017	190.7	-0.0098
655.68	-0.017	190.5	-0.0098
655.70	-0.017	190.4	-0.0107
655.72	-0.017	190.3	-0.0107
655.73	-0.017	190.3	-0.0107
655.75	-0.017	190.2	-0.0107
655.77	-0.017	190.2	-0.0098
655.78	-0.016	190.1	-0.0098
655.80	-0.015	190.1	-0.008
655.82	-0.015	190.1	-0.0071
655.83	-0.013	190.1	-0.0071
655.85	-0.012	190.1	-0.0053
655.87	-0.012	190.2	-0.0044
655.88	-0.011	190.2	-0.0027
655.90	-0.008	190.3	0.0009
655.92	-0.008	190.4	0.0027
655.93	-0.006	190.6	0.0062
655.95	-0.002	190.8	0.0062
655.97	-0.001	190.8	0.0098
655.98	-0.001	190.9	0.0124
656.02	0	191.1	0.016
656.03	0.003	191.3	0.0195
656.05	0.005	191.5	0.0231
656.07	0.006	191.7	0.0275
656.07	0.01	192	0.0275
656.08	0.011	192	0.032
656.10	0.011	192.2	0.0355
656.12	0.012	192.5	0.0391
656.13	0.016	192.7	0.0435
656.15	0.017	192.9	0.0462
656.17	0.018	193.2	0.0497
656.18	0.021	193.5	0.0497
656.20	0.022	193.5	0.0533
656.22	0.022	193.7	0.0559
656.23	0.023	193.9	0.0586
656.25	0.025	194.2	0.0612
656.27	0.026	194.3	0.063
656.28	0.026	194.6	0.0648
656.30	0.028	194.8	0.0648

Prova triassiale ciclica SN04-C1			
pressione di confinamento (kPa)		80	
deviatore ciclico (kPa)		95	
frequenza (hz)		0.00625	
tempo	cella di carico	$\Delta u$	LVDT
(min)	kN	(kPa)	$\delta$ (mm)
656.32	0.028	194.8	0.0657
656.33	0.028	194.9	0.0666
656.35	0.028	195.1	0.0675
656.37	0.029	195.2	0.0683
656.38	0.029	195.4	0.0683
656.40	0.029	195.5	0.0683
656.42	0.029	195.6	0.0692
656.43	0.028	195.7	0.0692
656.45	0.028	195.8	0.0675
656.47	0.027	195.7	0.0675
656.48	0.025	195.7	0.0666
656.50	0.025	195.7	0.0648
656.52	0.025	195.7	0.0639
656.53	0.023	195.7	0.0612
656.55	0.021	195.6	0.0595
656.57	0.021	195.6	0.0577
656.58	0.018	195.4	0.0541
656.60	0.016	195.2	0.0541
656.62	0.016	195.2	0.0524
656.63	0.015	195.1	0.0488
656.65	0.013	194.9	0.0453
656.67	0.01	194.7	0.0417
656.68	0.009	194.5	0.0382
656.70	0.006	194.3	0.0346
656.72	0.003	194.1	0.0346
656.73	0.003	194.1	0.0311
656.75	0.003	193.9	0.0275
656.77	0	193.5	0.0222
656.78	-0.002	193.3	0.0186
656.80	-0.004	193.1	0.0151
656.82	-0.006	192.8	0.0107
656.83	-0.008	192.5	0.0107
656.85	-0.008	192.5	0.008
656.87	-0.009	192.3	0.0053
656.88	-0.011	192	0.0018
656.90	-0.012	191.8	-0.0009
656.92	-0.013	191.6	-0.0027
656.93	-0.014	191.3	-0.0053
656.95	-0.016	191.1	-0.0053
656.97	-0.016	191.1	-0.0071
656.98	-0.016	191	-0.008
657.00	-0.017	190.8	-0.0089
657.02	-0.017	190.6	-0.0098
657.03	-0.017	190.5	-0.0107
657.05	-0.017	190.4	-0.0107
657.07	-0.017	190.3	-0.0107
657.08	-0.017	190.2	-0.0098
657.10	-0.017	190.1	-0.0098
657.12	-0.015	190.1	-0.0098
657.13	-0.015	190.1	-0.0089
657.15	-0.015	190.1	-0.008
657.17	-0.014	190.1	-0.0062
657.18	-0.012	190.2	-0.0044
657.20	-0.011	190.2	-0.0027
657.22	-0.01	190.3	-0.0009
657.23	-0.007	190.4	-0.0009
657.25	-0.006	190.4	0.0018
657.27	-0.006	190.5	0.0044

Prova triassiale ciclica SN04-C1			
pressione di confinamento (kPa)		80	
deviatore ciclico (kPa)		95	
frequenza (hz)		0.00625	
tempo	cella di carico	$\Delta u$	LVDT
(min)	kN	(kPa)	$\delta$ (mm)
657.28	-0.005	190.6	0.0071
657.30	-0.002	190.8	0.0107
657.32	-0.001	191	0.0133
657.33	0.001	191.2	0.0178
657.35	0.004	191.4	0.0178
657.37	0.005	191.4	0.0213
657.38	0.005	191.6	0.0249
657.40	0.007	191.8	0.0302
657.42	0.011	192.1	0.0337
657.45	0.012	192.3	0.0364
657.47	0.013	192.6	0.0408
657.48	0.017	192.8	0.0408
657.50	0.017	192.8	0.0444
657.52	0.017	193.1	0.047
657.52	0.019	193.3	0.0515
657.53	0.022	193.6	0.055
657.55	0.023	193.8	0.0568
657.57	0.023	194	0.0595
657.58	0.025	194.3	0.0595
657.60	0.026	194.3	0.0612
657.62	0.026	194.5	0.0639
657.63	0.027	194.7	0.0648
657.65	0.027	194.9	0.0666
657.67	0.028	195	0.0675
657.68	0.029	195.2	0.0683
657.70	0.029	195.3	0.0683
657.72	0.029	195.4	0.0683
657.73	0.029	195.4	0.0692
657.75	0.029	195.6	0.0692
657.77	0.029	195.7	0.0692
657.78	0.028	195.7	0.0683
657.80	0.027	195.8	0.0666
657.82	0.026	195.7	0.0657
657.83	0.025	195.8	0.0648
657.85	0.024	195.7	0.0621
657.87	0.022	195.7	0.0621
657.88	0.021	195.6	0.0604
657.90	0.021	195.6	0.0586
657.92	0.019	195.5	0.0559
657.93	0.017	195.3	0.0533
657.95	0.015	195.2	0.0506
657.97	0.014	195	0.047
657.98	0.011	194.8	0.047
658.00	0.009	194.6	0.0435
658.02	0.009	194.6	0.0399
658.03	0.008	194.5	0.0364
658.05	0.005	194.2	0.0328
658.07	0.002	194	0.0293
658.08	0.002	193.8	0.0249
658.10	-0.001	193.5	0.0204
658.12	-0.004	193.2	0.0204
658.13	-0.004	193.2	0.0169
658.15	-0.004	193	0.0133
658.17	-0.006	192.7	0.0098
658.18	-0.009	192.4	0.0062
658.20	-0.01	192.2	0.0036
658.22	-0.011	191.9	0
658.23	-0.013	191.7	0

Prova triassiale ciclica SN04-C1			
pressione di confinamento (kPa)		80	
deviatore ciclico (kPa)		95	
frequenza (hz)		0.00625	
tempo	cella di carico	$\Delta u$	LVDT
(min)	kN	(kPa)	$\delta$ (mm)
658.25	-0.013	191.7	-0.0027
658.27	-0.014	191.5	-0.0036
658.28	-0.015	191.3	-0.0053
658.30	-0.016	191.1	-0.0071
658.32	-0.017	190.9	-0.008
658.33	-0.017	190.8	-0.0098
658.35	-0.017	190.6	-0.0098
658.37	-0.017	190.6	-0.0098
658.38	-0.017	190.5	-0.0098
658.40	-0.017	190.4	-0.0107
658.42	-0.017	190.3	-0.0107
658.43	-0.017	190.2	-0.0098
658.45	-0.016	190.2	-0.0089
658.47	-0.015	190.2	-0.0089
658.48	-0.014	190.2	-0.008
658.50	-0.014	190.2	-0.0062
658.52	-0.013	190.2	-0.0053
658.53	-0.011	190.3	-0.0027
658.55	-0.01	190.3	-0.0018
658.57	-0.01	190.4	0
658.58	-0.007	190.5	0.0027
658.60	-0.006	190.6	0.0053
658.62	-0.004	190.8	0.0089
658.63	-0.001	191	0.0089
658.65	0	191	0.0124
658.67	0	191.1	0.0151
658.68	0.002	191.3	0.0186
658.70	0.005	191.5	0.0231
658.72	0.007	191.7	0.0257
658.73	0.008	192	0.0311
658.75	0.011	192.2	0.0311
658.77	0.013	192.2	0.0346
658.78	0.013	192.5	0.0382
658.80	0.014	192.7	0.0426
658.82	0.018	193	0.0462
658.83	0.019	193.2	0.0488
658.85	0.02	193.4	0.0524
658.87	0.022	193.7	0.0524
658.88	0.023	193.9	0.055
658.92	0.023	193.9	0.0577
658.93	0.024	194.1	0.0604
658.95	0.026	194.4	0.0621
658.97	0.027	194.6	0.0639
658.97	0.027	194.7	0.0657
658.98	0.028	194.9	0.0657
659.00	0.028	195.1	0.0675
659.02	0.028	195.1	0.0675
659.03	0.029	195.3	0.0683
659.05	0.029	195.4	0.0683
659.07	0.029	195.5	0.0683
659.08	0.029	195.6	0.0683
659.10	0.028	195.7	0.0683
659.12	0.027	195.7	0.0683
659.13	0.027	195.7	0.0675
659.15	0.027	195.8	0.0657
659.17	0.026	195.8	0.0648
659.18	0.024	195.7	0.063
659.20	0.023	195.7	0.0612

Prova triassiale ciclica SN04-C1			
pressione di confinamento (kPa)		80	
deviatore ciclico (kPa)		95	
frequenza (hz)		0.00625	
tempo	cella di carico	$\Delta u$	LVDT
(min)	kN	(kPa)	$\delta$ (mm)
659.22	0.022	195.6	0.0586
659.23	0.019	195.5	0.0586
659.25	0.018	195.5	0.0568
659.27	0.017	195.3	0.0524
659.28	0.015	195.1	0.0524
659.30	0.013	195.1	0.0497
659.32	0.013	195	0.0462
659.33	0.011	194.8	0.0426
659.35	0.008	194.6	0.0382
659.37	0.007	194.4	0.0355
659.38	0.005	194.2	0.032
659.40	0.001	193.9	0.032
659.42	0.001	193.9	0.0275
659.43	0.001	193.7	0.0231
659.45	-0.001	193.4	0.0195
659.47	-0.005	193.1	0.0151
659.48	-0.005	192.9	0.0124
659.50	-0.006	192.7	0.0089
659.52	-0.01	192.3	0.0089
659.53	-0.01	192.3	0.0044
659.55	-0.01	192.1	0.0018
659.57	-0.011	191.9	0
659.58	-0.014	191.6	-0.0036
659.60	-0.014	191.4	-0.0044
659.62	-0.015	191.2	-0.0062
659.63	-0.016	191	-0.0062
659.65	-0.016	191	-0.008
659.67	-0.016	190.9	-0.0089
659.68	-0.017	190.7	-0.0098
659.70	-0.017	190.6	-0.0107
659.72	-0.017	190.4	-0.0107
659.73	-0.017	190.3	-0.0107
659.75	-0.017	190.3	-0.0107
659.77	-0.016	190.2	-0.0098
659.78	-0.016	190.2	-0.0098
659.80	-0.016	190.2	-0.0089
659.82	-0.015	190.2	-0.008
659.83	-0.014	190.2	-0.0062
659.85	-0.013	190.2	-0.0044
659.87	-0.01	190.3	-0.0044
659.88	-0.009	190.3	-0.0018
659.90	-0.009	190.3	0
659.92	-0.008	190.4	0.0027
659.93	-0.006	190.6	0.0053
659.95	-0.004	190.8	0.008
659.97	-0.002	190.9	0.0115
659.98	0.001	191.2	0.0115
660.00	0.002	191.3	0.0178
660.02	0.003	191.4	0.0204
660.03	0.005	191.7	0.0204
660.05	0.008	191.9	0.024
660.07	0.008	191.9	0.0284
660.08	0.009	192.1	0.0328
660.10	0.012	192.4	0.0364
660.12	0.014	192.6	0.0399
660.13	0.015	192.8	0.0435
660.15	0.017	193.1	0.047
660.17	0.02	193.3	0.047

Prova triassiale ciclica SN04-C1			
pressione di confinamento (kPa)		80	
deviatore ciclico (kPa)		95	
frequenza (hz)		0.00625	
tempo	cella di carico	$\Delta u$	LVDT
(min)	kN	(kPa)	$\delta$ (mm)
660.18	0.02	193.3	0.0506
660.20	0.02	193.6	0.0533
660.22	0.022	193.8	0.0559
660.23	0.024	194	0.0586
660.25	0.025	194.2	0.0612
660.27	0.026	194.4	0.063
660.28	0.027	194.7	0.063
660.30	0.027	194.7	0.0648
660.32	0.027	194.8	0.0657
660.33	0.028	195	0.0666
660.35	0.029	195.2	0.0683
660.38	0.029	195.3	0.0683
660.40	0.029	195.5	0.0683
660.42	0.029	195.6	0.0683
660.42	0.028	195.6	0.0683
660.43	0.028	195.7	0.0683
660.45	0.028	195.7	0.0683
660.47	0.027	195.8	0.0666
660.48	0.026	195.8	0.0657
660.50	0.025	195.8	0.0639
660.52	0.023	195.7	0.0639
660.53	0.022	195.7	0.0621
660.55	0.022	195.7	0.0604
660.57	0.021	195.6	0.0577
660.58	0.018	195.4	0.055
660.60	0.017	195.3	0.0524
660.62	0.016	195.1	0.0497
660.63	0.012	195	0.0497
660.65	0.011	195	0.0453
660.67	0.011	194.8	0.0435
660.68	0.01	194.6	0.0391
660.70	0.006	194.4	0.0346
660.72	0.005	194.2	0.0328
660.73	0.005	194.1	0.0302
660.75	0.001	193.8	0.0249
660.77	0	193.6	0.0222
660.78	-0.002	193.4	0.0178
660.80	-0.005	193	0.0178
660.82	-0.006	192.8	0.0133
660.83	-0.006	192.8	0.0107
660.85	-0.007	192.6	0.0071
660.87	-0.01	192.2	0.0036
660.88	-0.011	192	0.0009
660.90	-0.012	191.8	-0.0018
660.92	-0.014	191.5	-0.0036
660.93	-0.015	191.3	-0.0036
660.95	-0.015	191.3	-0.0053
660.97	-0.015	191.2	-0.0071
660.98	-0.016	190.9	-0.0089
661.00	-0.017	190.8	-0.0089
661.02	-0.017	190.6	-0.0098
661.03	-0.017	190.5	-0.0098
661.05	-0.017	190.4	-0.0098
661.07	-0.017	190.4	-0.0107
661.08	-0.017	190.3	-0.0107
661.10	-0.017	190.2	-0.0107
661.12	-0.016	190.2	-0.0098
661.13	-0.015	190.2	-0.008



Prova triassiale ciclica SN04-C1			
pressione di confinamento (kPa)		80	
deviatore ciclico (kPa)		95	
frequenza (hz)		0.00625	
tempo	cella di carico	$\Delta u$	LVDT
(min)	kN	(kPa)	$\delta$ (mm)
661.15	-0.015	190.2	-0.0071
661.17	-0.013	190.2	-0.0071
661.18	-0.012	190.2	-0.0053
661.20	-0.012	190.2	-0.0036
661.22	-0.011	190.3	-0.0027
661.23	-0.008	190.4	0
661.25	-0.007	190.5	0.0027
661.27	-0.006	190.7	0.0053
661.28	-0.002	190.8	0.0053
661.30	-0.002	190.8	0.0089
661.32	-0.002	191	0.0115
661.33	0	191.2	0.0151
661.35	0.004	191.4	0.0195
661.37	0.005	191.6	0.0231
661.38	0.006	191.8	0.0275
661.40	0.01	192.1	0.0275
661.42	0.011	192.1	0.032
661.43	0.011	192.3	0.0346
661.45	0.014	192.7	0.0391
661.47	0.016	192.7	0.0408
661.48	0.016	193	0.0435
661.50	0.017	193.2	0.0479
661.52	0.021	193.5	0.0515
661.53	0.021	193.7	0.0541
661.55	0.022	193.9	0.0568
661.57	0.024	194.1	0.0568
661.58	0.025	194.3	0.0595
661.60	0.025	194.3	0.0612
661.62	0.026	194.6	0.0639
661.63	0.027	194.8	0.0657
661.65	0.028	195	0.0666
661.67	0.028	195.1	0.0675
661.68	0.029	195.2	0.0675
661.70	0.029	195.4	0.0683
661.72	0.029	195.4	0.0683
661.73	0.029	195.6	0.0683
661.75	0.029	195.7	0.0683
661.77	0.028	195.8	0.0683
661.78	0.028	195.8	0.0666
661.82	0.026	195.8	0.0666
661.83	0.025	195.8	0.0657
661.85	0.025	195.8	0.0648
661.87	0.025	195.8	0.063
661.88	0.023	195.7	0.0612
661.88	0.021	195.7	0.0595
661.90	0.02	195.6	0.0559
661.92	0.018	195.4	0.0541
661.93	0.016	195.3	0.0541
661.95	0.016	195.3	0.0515
661.97	0.015	195.2	0.0479
661.98	0.013	194.9	0.0444
662.00	0.01	194.8	0.0408
662.02	0.009	194.6	0.0382
662.03	0.007	194.4	0.0346
662.05	0.004	194.1	0.0346
662.07	0.003	194.1	0.0302
662.08	0.003	193.9	0.0275
662.10	0	193.6	0.0222

Prova triassiale ciclica SN04-C1			
pressione di confinamento (kPa)		80	
deviatore ciclico (kPa)		95	
frequenza (hz)		0.00625	
tempo	cella di carico	$\Delta u$	LVDT
(min)	kN	(kPa)	$\delta$ (mm)
662.12	-0.003	193.4	0.0178
662.13	-0.004	193.2	0.0151
662.15	-0.005	192.9	0.0115
662.17	-0.008	192.6	0.0115
662.18	-0.008	192.4	0.0053
662.20	-0.01	192.2	0.0027
662.22	-0.012	191.9	0.0027
662.23	-0.013	191.9	0
662.25	-0.013	191.7	-0.0018
662.27	-0.014	191.5	-0.0044
662.28	-0.015	191.3	-0.0062
662.30	-0.016	191.1	-0.008
662.32	-0.016	190.9	-0.0089
662.33	-0.017	190.7	-0.0089
662.35	-0.017	190.7	-0.0098
662.37	-0.017	190.6	-0.0107
662.38	-0.017	190.5	-0.0107
662.40	-0.017	190.4	-0.0115
662.42	-0.017	190.3	-0.0107
662.43	-0.016	190.2	-0.0098
662.45	-0.015	190.2	-0.0098
662.47	-0.015	190.2	-0.0089
662.48	-0.015	190.2	-0.0089
662.50	-0.014	190.2	-0.0071
662.52	-0.012	190.2	-0.0053
662.53	-0.011	190.3	-0.0036
662.55	-0.01	190.4	-0.0009
662.57	-0.007	190.5	-0.0009
662.58	-0.007	190.5	0.0009
662.60	-0.007	190.6	0.0036
662.62	-0.005	190.7	0.0071
662.63	-0.001	190.9	0.0107
662.65	-0.001	191	0.0124
662.67	0.001	191.3	0.0169
662.68	0.005	191.5	0.0169
662.70	0.005	191.5	0.0213
662.72	0.005	191.7	0.024
662.73	0.007	191.9	0.0293
662.75	0.011	192.2	0.0337
662.77	0.012	192.4	0.0364
662.78	0.013	192.7	0.0399
662.80	0.017	192.9	0.0399
662.82	0.018	192.9	0.0444
662.83	0.018	193.1	0.047
662.85	0.019	193.4	0.0506
662.87	0.022	193.7	0.0541
662.88	0.022	193.9	0.0559
662.90	0.024	194.1	0.0595
662.92	0.025	194.3	0.0604
662.93	0.026	194.5	0.0621
662.95	0.026	194.7	0.0639
662.97	0.027	194.9	0.0639
662.98	0.028	195.1	0.0657
663.00	0.028	195.1	0.0666
663.02	0.028	195.2	0.0675
663.03	0.029	195.4	0.0683
663.05	0.029	195.5	0.0683
663.07	0.029	195.6	0.0683

Prova triassiale ciclica SN04-C1			
pressione di confinamento (kPa)		80	
deviatore ciclico (kPa)		95	
frequenza (hz)		0.00625	
tempo	cella di carico	$\Delta u$	LVDT
(min)	kN	(kPa)	$\delta$ (mm)
663.08	0.029	195.7	0.0683
663.10	0.028	195.8	0.0683
663.12	0.028	195.8	0.0683
663.13	0.027	195.8	0.0666
663.15	0.026	195.8	0.0648
663.17	0.025	195.8	0.0639
663.18	0.024	195.8	0.063
663.20	0.023	195.7	0.0604
663.22	0.021	195.7	0.0604
663.23	0.02	195.7	0.0586
663.25	0.02	195.6	0.0559
663.28	0.018	195.4	0.0533
663.30	0.015	195.2	0.0497
663.32	0.014	195.1	0.0479
663.33	0.012	194.9	0.0435
663.33	0.008	194.7	0.0435
663.35	0.007	194.7	0.0391
663.37	0.007	194.6	0.0373
663.38	0.006	194.3	0.0337
663.40	0.002	194.1	0.0284
663.42	0.002	193.9	0.0249
663.43	0	193.6	0.0204
663.45	-0.004	193.3	0.0204
663.47	-0.005	193.3	0.016
663.48	-0.005	193.1	0.0133
663.50	-0.006	192.8	0.0098
663.52	-0.009	192.5	0.0062
663.53	-0.01	192.3	0.0036
663.55	-0.011	192	0.0009
663.57	-0.013	191.8	0.0009
663.58	-0.014	191.8	-0.0018
663.60	-0.014	191.6	-0.0044
663.62	-0.015	191.4	-0.0062
663.63	-0.016	191.2	-0.008
663.65	-0.016	191	-0.008
663.67	-0.016	190.8	-0.0098
663.68	-0.017	190.7	-0.0107
663.70	-0.017	190.5	-0.0107
663.72	-0.017	190.4	-0.0107
663.73	-0.017	190.3	-0.0107
663.75	-0.017	190.3	-0.0107
663.77	-0.017	190.3	-0.0107
663.78	-0.016	190.2	-0.0098
663.80	-0.015	190.2	-0.0089
663.82	-0.014	190.2	-0.008
663.83	-0.014	190.2	-0.0062
663.85	-0.012	190.3	-0.0062
663.87	-0.011	190.3	-0.0044
663.88	-0.011	190.3	-0.0027
663.90	-0.01	190.4	0
663.92	-0.007	190.5	0.0027
663.93	-0.006	190.6	0.0044
663.95	-0.004	190.8	0.0089
663.97	-0.001	191	0.0089
663.98	0	191.2	0.0115
664.00	0	191.2	0.0142
664.02	0.002	191.3	0.0186
664.03	0.005	191.6	0.0222

Prova triassiale ciclica SN04-C1			
pressione di confinamento (kPa)		80	
deviatore ciclico (kPa)		95	
frequenza (hz)		0.00625	
tempo	cella di carico	$\Delta u$	LVDT
(min)	kN	(kPa)	$\delta$ (mm)
664.05	0.007	191.8	0.0257
664.07	0.008	192	0.0302
664.08	0.011	192.3	0.0302
664.10	0.013	192.5	0.0346
664.12	0.013	192.5	0.0382
664.13	0.014	192.7	0.0417
664.15	0.016	193.1	0.0453
664.17	0.019	193.3	0.0488
664.18	0.02	193.5	0.0524
664.20	0.022	193.8	0.055
664.22	0.023	194	0.055
664.23	0.023	194	0.0568
664.25	0.024	194.2	0.0595
664.27	0.025	194.5	0.0621
664.28	0.027	194.7	0.0639
664.30	0.027	194.8	0.0648
664.32	0.028	195	0.0657
664.33	0.028	195.2	0.0657
664.35	0.029	195.3	0.0683
664.37	0.029	195.5	0.0683
664.38	0.029	195.6	0.0683
664.40	0.029	195.6	0.0683
664.42	0.029	195.7	0.0683
664.43	0.028	195.8	0.0683
664.45	0.028	195.9	0.0675
664.47	0.027	195.9	0.0666
664.48	0.026	195.9	0.0648
664.50	0.024	195.9	0.0648
664.52	0.023	195.9	0.0639
664.53	0.023	195.8	0.0621
664.55	0.022	195.8	0.0595
664.57	0.02	195.7	0.0577
664.58	0.019	195.6	0.055
664.60	0.017	195.4	0.0515
664.62	0.014	195.2	0.0515
664.63	0.013	195.2	0.0488
664.65	0.013	195.1	0.0462
664.67	0.011	194.9	0.0417
664.68	0.008	194.7	0.0382
664.72	0.007	194.5	0.0355
664.73	0.005	194.2	0.032
664.75	0.001	194	0.032
664.77	0.001	194	0.0257
664.78	0.001	193.8	0.0231
664.78	-0.001	193.5	0.0186
664.80	-0.005	193.2	0.0151
664.82	-0.005	193	0.0115
664.83	-0.007	192.7	0.008
664.85	-0.01	192.4	0.008
664.87	-0.01	192.4	0.0044
664.88	-0.01	192.2	0.0018
664.90	-0.011	192	-0.0009
664.92	-0.014	191.7	-0.0036
664.93	-0.014	191.5	-0.0053
664.95	-0.015	191.3	-0.0071
664.97	-0.016	191.1	-0.0071
664.98	-0.017	191.1	-0.008
665.00	-0.017	190.9	-0.0098

Prova triassiale ciclica SN04-C1			
pressione di confinamento (kPa)		80	
deviatore ciclico (kPa)		95	
frequenza (hz)		0.00625	
tempo	cella di carico	$\Delta u$	LVDT
(min)	kN	(kPa)	$\delta$ (mm)
665.02	-0.017	190.8	-0.0107
665.03	-0.017	190.7	-0.0107
665.05	-0.017	190.5	-0.0107
665.07	-0.017	190.4	-0.0107
665.08	-0.017	190.3	-0.0107
665.10	-0.017	190.3	-0.0107
665.12	-0.016	190.2	-0.0098
665.13	-0.015	190.2	-0.0098
665.15	-0.014	190.2	-0.0089
665.17	-0.014	190.2	-0.0071
665.18	-0.013	190.2	-0.0053
665.20	-0.011	190.3	-0.0044
665.22	-0.01	190.4	-0.0018
665.23	-0.009	190.4	0.0009
665.25	-0.006	190.6	0.0009
665.27	-0.005	190.7	0.0036
665.28	-0.005	190.7	0.0062
665.30	-0.003	190.9	0.0098
665.32	-0.001	191.1	0.0124
665.33	0.001	191.3	0.016
665.35	0.002	191.4	0.0195
665.37	0.005	191.7	0.0195
665.38	0.008	192	0.024
665.40	0.008	192	0.0284
665.42	0.009	192.1	0.032
665.43	0.012	192.4	0.0364
665.45	0.014	192.6	0.0391
665.47	0.015	192.9	0.0426
665.48	0.017	193.2	0.047
665.50	0.02	193.4	0.047
665.52	0.02	193.4	0.0497
665.53	0.02	193.6	0.0524
665.55	0.022	193.9	0.0559
665.57	0.024	194.1	0.0586
665.58	0.025	194.3	0.0604
665.60	0.026	194.6	0.0621
665.62	0.027	194.8	0.0621
665.63	0.027	194.8	0.0648
665.65	0.027	194.9	0.0657
665.67	0.028	195.1	0.0666
665.68	0.029	195.3	0.0675
665.70	0.029	195.4	0.0675
665.72	0.029	195.6	0.0675
665.73	0.029	195.7	0.0675
665.75	0.029	195.7	0.0683
665.77	0.029	195.8	0.0683
665.78	0.028	195.8	0.0675
665.80	0.026	195.9	0.0666
665.82	0.026	195.9	0.0657
665.83	0.026	195.9	0.0639
665.85	0.024	195.8	0.0621
665.87	0.023	195.8	0.0612
665.88	0.022	195.7	0.0577
665.90	0.019	195.6	0.0577
665.92	0.017	195.6	0.055
665.93	0.017	195.5	0.0533
665.95	0.017	195.4	0.0506
665.97	0.013	195.2	0.047

Prova triassiale ciclica SN04-C1			
pressione di confinamento (kPa)		80	
deviatore ciclico (kPa)		95	
frequenza (hz)		0.00625	
tempo	cella di carico	$\Delta u$	LVDT
(min)	kN	(kPa)	$\delta$ (mm)
665.98	0.012	195	0.0435
666.00	0.01	194.8	0.0399
666.02	0.007	194.6	0.0399
666.03	0.006	194.6	0.0364
666.05	0.006	194.4	0.0337
666.07	0.005	194.2	0.0293
666.08	0	193.9	0.024
666.10	0	193.7	0.0213
666.12	-0.002	193.5	0.0169
666.13	-0.005	193.1	0.0169
666.15	-0.006	192.9	0.0133
666.18	-0.006	192.9	0.0098
666.20	-0.008	192.7	0.0062
666.22	-0.01	192.4	0.0027
666.23	-0.011	192.1	0.0009
666.23	-0.012	191.9	-0.0018
666.25	-0.014	191.6	-0.0018
666.27	-0.015	191.4	-0.0044
666.28	-0.015	191.4	-0.0062
666.30	-0.016	191.2	-0.0071
666.32	-0.016	191.1	-0.0089
666.33	-0.017	190.9	-0.0098
666.35	-0.017	190.7	-0.0107
666.37	-0.017	190.6	-0.0107
666.38	-0.017	190.5	-0.0107
666.40	-0.017	190.5	-0.0115
666.42	-0.017	190.4	-0.0107
666.43	-0.017	190.3	-0.0107
666.45	-0.016	190.3	-0.0098
666.47	-0.015	190.2	-0.0089
666.48	-0.014	190.3	-0.008
666.50	-0.012	190.3	-0.008
666.52	-0.012	190.3	-0.0062
666.53	-0.011	190.4	-0.0036
666.55	-0.009	190.4	-0.0036
666.57	-0.008	190.4	-0.0018
666.58	-0.008	190.5	0.0009
666.60	-0.007	190.7	0.0036
666.62	-0.003	190.8	0.0071
666.63	-0.003	190.9	0.0098
666.65	-0.001	191.2	0.0133
666.67	0.003	191.4	0.0133
666.68	0.004	191.4	0.0178
666.70	0.004	191.5	0.0204
666.72	0.005	191.8	0.0249
666.73	0.009	192.1	0.0302
666.75	0.01	192.3	0.0328
666.77	0.011	192.5	0.0364
666.78	0.015	192.8	0.0364
666.80	0.016	192.8	0.0408
666.82	0.016	193	0.0444
666.83	0.017	193.2	0.0479
666.85	0.021	193.5	0.0515
666.87	0.021	193.7	0.0533
666.88	0.022	194	0.0568
666.90	0.024	194.2	0.0568
666.92	0.025	194.2	0.0595
666.93	0.025	194.4	0.0612

Prova triassiale ciclica SN04-C1			
pressione di confinamento (kPa)		80	
deviatore ciclico (kPa)		95	
frequenza (hz)		0.00625	
tempo	cella di carico	$\Delta u$	LVDT
(min)	kN	(kPa)	$\delta$ (mm)
666.95	0.026	194.6	0.063
666.97	0.028	194.8	0.0648
666.98	0.028	195	0.0657
667.00	0.028	195.1	0.0666
667.02	0.029	195.3	0.0666
667.03	0.029	195.3	0.0675
667.05	0.029	195.5	0.0675
667.07	0.029	195.6	0.0675
667.08	0.029	195.7	0.0683
667.10	0.028	195.8	0.0675
667.12	0.028	195.9	0.0666
667.13	0.026	195.9	0.0666
667.15	0.025	195.9	0.0657
667.17	0.025	195.9	0.0648
667.18	0.025	195.9	0.063
667.20	0.023	195.8	0.0612
667.22	0.021	195.7	0.0586
667.23	0.02	195.7	0.0559
667.25	0.018	195.5	0.0559
667.27	0.016	195.4	0.0515
667.28	0.016	195.3	0.0488
667.30	0.013	195.1	0.0488
667.32	0.011	194.9	0.0462
667.33	0.011	194.9	0.0426
667.35	0.01	194.8	0.0391
667.37	0.006	194.5	0.0346
667.38	0.005	194.3	0.032
667.40	0.003	194.1	0.0284
667.42	0.001	193.8	0.0284
667.43	-0.002	193.6	0.0231
667.45	-0.002	193.6	0.0195
667.47	-0.003	193.4	0.016
667.48	-0.005	193	0.0115
667.50	-0.007	192.8	0.008
667.52	-0.008	192.5	0.0053
667.53	-0.01	192.2	0.0018
667.55	-0.012	192	0.0018
667.57	-0.013	192	-0.0009
667.58	-0.013	191.8	-0.0027
667.62	-0.014	191.6	-0.0044
667.63	-0.016	191.3	-0.0071
667.65	-0.016	191.2	-0.008
667.67	-0.016	191	-0.0089
667.68	-0.017	190.8	-0.0089
667.68	-0.017	190.8	-0.0107
667.70	-0.017	190.7	-0.0107
667.72	-0.017	190.5	-0.0115
667.73	-0.017	190.4	-0.0115
667.75	-0.017	190.4	-0.0115
667.77	-0.016	190.3	-0.0107
667.78	-0.016	190.3	-0.0107
667.80	-0.015	190.3	-0.0098
667.82	-0.015	190.3	-0.0089
667.83	-0.014	190.3	-0.0071
667.85	-0.012	190.3	-0.0053
667.87	-0.011	190.3	-0.0044
667.88	-0.01	190.4	-0.0018
667.90	-0.008	190.6	-0.0018

Prova triassiale ciclica SN04-C1			
pressione di confinamento (kPa)		80	
deviatore ciclico (kPa)		95	
frequenza (hz)		0.00625	
tempo	cella di carico	$\Delta u$	LVDT
(min)	kN	(kPa)	$\delta$ (mm)
667.92	-0.006	190.6	0.0009
667.93	-0.006	190.6	0.0027
667.95	-0.005	190.8	0.0062
667.97	-0.002	191	0.0098
667.98	-0.001	191.2	0.0133
668.00	0	191.2	0.0151
668.02	0.003	191.5	0.0186
668.03	0.004	191.7	0.0222
668.05	0.006	191.9	0.0275
668.07	0.01	192.2	0.0275
668.08	0.011	192.4	0.032
668.10	0.011	192.4	0.0346
668.12	0.012	192.6	0.0382
668.13	0.015	192.9	0.0426
668.15	0.017	193.1	0.0453
668.17	0.018	193.3	0.0488
668.18	0.02	193.6	0.0488
668.20	0.022	193.9	0.0524
668.22	0.022	193.9	0.055
668.23	0.023	194.1	0.0577
668.25	0.024	194.3	0.0604
668.27	0.026	194.5	0.0621
668.28	0.026	194.7	0.0639
668.30	0.027	194.9	0.0639
668.32	0.028	195.1	0.0657
668.33	0.028	195.1	0.0666
668.35	0.028	195.2	0.0675
668.37	0.029	195.4	0.0675
668.38	0.029	195.6	0.0675
668.40	0.029	195.7	0.0683
668.42	0.029	195.8	0.0683
668.43	0.028	195.9	0.0683
668.45	0.028	195.9	0.0683
668.47	0.027	195.9	0.0657
668.48	0.026	195.9	0.0648
668.50	0.025	195.9	0.0639
668.52	0.024	195.9	0.0612
668.53	0.023	195.8	0.0604
668.55	0.02	195.7	0.0604
668.57	0.019	195.7	0.0577
668.58	0.019	195.6	0.0559
668.60	0.018	195.5	0.0533
668.62	0.015	195.3	0.0497
668.63	0.014	195.2	0.0462
668.65	0.012	195	0.0435
668.67	0.009	194.8	0.0435
668.68	0.008	194.8	0.0391
668.70	0.008	194.6	0.0364
668.72	0.004	194.2	0.0328
668.73	0.002	194.2	0.0311
668.75	0.002	194	0.0275
668.77	0.001	193.7	0.0222
668.78	-0.003	193.4	0.0178
668.80	-0.004	193.2	0.0151
668.82	-0.005	192.9	0.0107
668.83	-0.008	192.7	0.0107
668.85	-0.009	192.7	0.0071
668.87	-0.009	192.4	0.0044



Prova triassiale ciclica SN04-C1			
pressione di confinamento (kPa)		80	
deviatore ciclico (kPa)		95	
frequenza (hz)		0.00625	
tempo	cella di carico	$\Delta u$	LVDT
(min)	kN	(kPa)	$\delta$ (mm)
668.88	-0.01	192.2	0.0018
668.90	-0.013	191.9	-0.0018
668.92	-0.013	191.7	-0.0036
668.93	-0.014	191.5	-0.0053
668.95	-0.016	191.3	-0.0053
668.97	-0.016	191.3	-0.008
668.98	-0.016	191.1	-0.0089
669.00	-0.016	190.9	-0.0098
669.02	-0.017	190.8	-0.0107
669.03	-0.017	190.6	-0.0115
669.05	-0.017	190.5	-0.0115
669.08	-0.017	190.4	-0.0115
669.10	-0.017	190.4	-0.0115
669.12	-0.017	190.4	-0.0107
669.13	-0.016	190.3	-0.0098
669.13	-0.015	190.3	-0.0089
669.15	-0.015	190.3	-0.008
669.17	-0.014	190.3	-0.0062
669.18	-0.012	190.4	-0.0062
669.20	-0.011	190.4	-0.0044
669.22	-0.011	190.4	-0.0027
669.23	-0.01	190.5	-0.0009
669.25	-0.007	190.6	0.0018
669.27	-0.006	190.7	0.0044
669.28	-0.004	190.9	0.008
669.30	0	191.1	0.008
669.32	0	191.1	0.0115
669.33	0	191.2	0.0142
669.35	0.002	191.4	0.0186
669.37	0.005	191.7	0.0222
669.38	0.006	191.9	0.0257
669.40	0.008	192.1	0.0302
669.42	0.012	192.4	0.0302
669.43	0.013	192.6	0.0373
669.45	0.013	192.8	0.0391
669.47	0.016	193	0.0391
669.48	0.018	193	0.0435
669.50	0.018	193.2	0.047
669.52	0.019	193.5	0.0506
669.53	0.022	193.8	0.0533
669.55	0.023	194	0.0559
669.57	0.023	194.2	0.0586
669.58	0.025	194.5	0.0586
669.60	0.026	194.7	0.0612
669.62	0.026	194.7	0.063
669.63	0.027	194.8	0.0639
669.65	0.028	195	0.0657
669.67	0.028	195.2	0.0666
669.68	0.029	195.4	0.0675
669.70	0.029	195.5	0.0675
669.72	0.029	195.7	0.0683
669.73	0.029	195.7	0.0683
669.75	0.029	195.8	0.0683
669.77	0.029	195.9	0.0683
669.78	0.027	195.9	0.0666
669.80	0.027	195.9	0.0657
669.82	0.026	195.9	0.0639
669.83	0.024	195.9	0.0639

Prova triassiale ciclica SN04-C1			
pressione di confinamento (kPa)		80	
deviatore ciclico (kPa)		95	
frequenza (hz)		0.00625	
tempo	cella di carico	$\Delta u$	LVDT
(min)	kN	(kPa)	$\delta$ (mm)
669.85	0.024	195.9	0.063
669.87	0.024	195.9	0.0612
669.88	0.022	195.8	0.0595
669.90	0.02	195.7	0.0568
669.92	0.019	195.6	0.0541
669.93	0.017	195.4	0.0515
669.95	0.014	195.2	0.0515
669.97	0.013	195.2	0.0479
669.98	0.013	195.1	0.0453
670.00	0.011	194.9	0.0417
670.02	0.008	194.7	0.0382
670.03	0.007	194.5	0.0346
670.05	0.005	194.3	0.0311
670.07	0.002	194	0.0311
670.08	0.001	194	0.0257
670.10	0.001	193.8	0.0222
670.12	-0.001	193.5	0.0186
670.13	-0.005	193.3	0.0142
670.15	-0.005	193	0.0115
670.17	-0.006	192.8	0.008
670.18	-0.009	192.6	0.0062
670.20	-0.009	192.4	0.0027
670.22	-0.011	192.1	0
670.23	-0.013	191.8	0
670.25	-0.014	191.8	-0.0027
670.27	-0.014	191.6	-0.0044
670.28	-0.014	191.4	-0.0062
670.30	-0.016	191.2	-0.008
670.32	-0.017	191	-0.0089
670.33	-0.017	190.9	-0.0098
670.35	-0.017	190.7	-0.0098
670.37	-0.017	190.7	-0.0107
670.38	-0.017	190.6	-0.0107
670.40	-0.017	190.5	-0.0115
670.42	-0.017	190.4	-0.0115
670.43	-0.016	190.3	-0.0107
670.45	-0.016	190.3	-0.0098
670.47	-0.015	190.3	-0.0098
670.48	-0.014	190.3	-0.0089
670.50	-0.014	190.3	-0.008
670.52	-0.013	190.3	0.0062
670.55	-0.011	190.4	
670.57	-0.01	190.4	
670.58	-0.009	190.6	
670.60	-0.006	190.7	
670.60	-0.005	190.7	
670.62	-0.005	190.8	
670.63	-0.003	191	
670.65	0	191.2	
670.67	0.001	191.3	
670.68	0.002	191.5	
670.70	0.006	191.8	
670.72	0.007	192	
670.73	0.007	192	
670.75	0.009	192.2	
670.77	0.012	192.5	0.0355
670.78	0.014	192.7	0.0391
670.80	0.015	192.9	0.0426

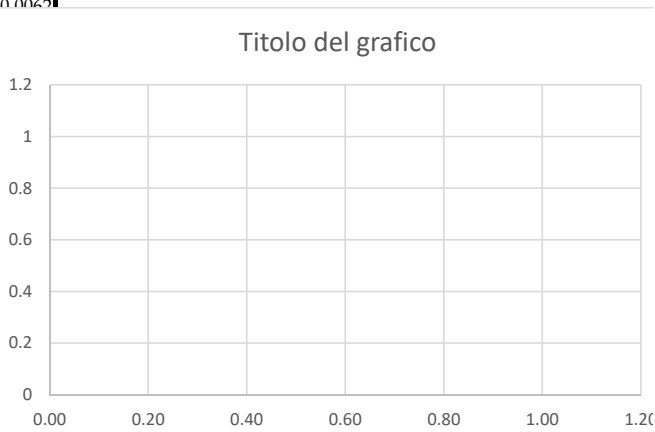

Prova triassiale ciclica SN04-C1			
pressione di confinamento (kPa)		80	
deviatore ciclico (kPa)		95	
frequenza (hz)		0.00625	
tempo	cella di carico	$\Delta u$	LVDT
(min)	kN	(kPa)	$\delta$ (mm)
670.82	0.018	193.3	0.0426
670.83	0.02	193.5	0.047
670.85	0.02	193.5	0.0497
670.87	0.02	193.7	0.0524
670.88	0.023	194.2	0.0559
670.90	0.023	194.2	0.0568
670.92	0.024	194.4	0.0595
670.93	0.025	194.6	0.0612
670.95	0.027	194.8	0.063
670.97	0.027	195	0.0648
670.98	0.028	195.2	0.0666
671.00	0.029	195.4	0.0666
671.02	0.029	195.4	0.0666
671.03	0.029	195.5	0.0675
671.05	0.029	195.6	0.0675
671.07	0.029	195.7	0.0675
671.08	0.029	195.8	0.0675
671.10	0.028	195.9	0.0675
671.12	0.027	196	0.0675
671.13	0.027	196	0.0666
671.15	0.027	196	0.0657
671.17	0.025	196	0.0639
671.18	0.023	195.9	0.0621
671.20	0.023	195.9	0.0604
671.22	0.022	195.8	0.0577
671.23	0.019	195.7	0.0577
671.25	0.018	195.7	0.0559
671.27	0.018	195.6	0.0533
671.28	0.016	195.4	0.0497
671.30	0.013	195.2	0.0462
671.32	0.012	195.1	0.0435
671.33	0.011	194.9	0.0399
671.35	0.007	194.7	0.0399
671.37	0.006	194.7	0.0364
671.38	0.006	194.5	0.0328
671.40	0.004	194.2	0.0293
671.42	0.001	194	0.024
671.43	0	193.8	0.0204
671.45	-0.002	193.5	0.016
671.47	-0.006	193.2	0.016
671.48	-0.006	193.2	0.0124
671.50	-0.006	193	0.0098
671.52	-0.007	192.7	0.0062
671.53	-0.01	192.4	0.0027
671.55	-0.011	192.2	0.0009
671.57	-0.012	191.9	-0.0018
671.58	-0.014	191.7	-0.0018
671.60	-0.015	191.7	-0.0053
671.62	-0.015	191.3	-0.0071
671.63	-0.016	191.2	-0.0071
671.65	-0.016	191.2	-0.0089
671.67	-0.016	191	-0.0107
671.68	-0.017	190.8	-0.0107
671.70	-0.017	190.7	-0.0115
671.72	-0.017	190.6	-0.0115
671.73	-0.017	190.5	-0.0115
671.75	-0.017	190.4	-0.0115
671.77	-0.016	190.4	-0.0115

Prova triassiale ciclica SN04-C1			
pressione di confinamento (kPa)		80	
deviatore ciclico (kPa)		95	
frequenza (hz)		0.00625	
tempo	cella di carico	$\Delta u$	LVDT
(min)	kN	(kPa)	$\delta$ (mm)
671.78	-0.016	190.3	-0.0107
671.80	-0.016	190.3	-0.0098
671.82	-0.014	190.3	-0.0089
671.83	-0.014	190.3	-0.008
671.85	-0.012	190.4	-0.0062
671.87	-0.01	190.5	-0.0062
671.88	-0.009	190.5	-0.0036
671.90	-0.009	190.5	-0.0018
671.92	-0.008	190.6	0
671.93	-0.006	190.8	0.0036
671.95	-0.004	190.9	0.0053
671.98	-0.002	191.1	0.0098
672.00	0.001	191.3	0.0098
672.02	0.002	191.4	0.0133
672.03	0.002	191.4	0.016
672.05	0.003	191.6	0.0204
672.05	0.007	191.9	0.024
672.07	0.009	192.1	0.0284
672.08	0.01	192.3	0.032
672.10	0.013	192.6	0.032
672.12	0.014	192.8	0.0364
672.13	0.014	192.8	0.0391
672.15	0.016	193.1	0.0435
672.17	0.019	193.4	0.047
672.18	0.02	193.6	0.0497
672.20	0.021	193.8	0.0524
672.22	0.023	194.1	0.0524
672.23	0.025	194.3	0.055
672.25	0.025	194.3	0.0577
672.27	0.025	194.5	0.0604
672.28	0.026	194.7	0.0621
672.30	0.027	194.9	0.063
672.32	0.027	195.1	0.0639
672.33	0.028	195.3	0.0657
672.35	0.029	195.5	0.0666
672.37	0.029	195.6	0.0666
672.38	0.029	195.7	0.0666
672.40	0.029	195.8	0.0666
672.42	0.029	195.8	0.0666
672.43	0.029	195.9	0.0666
672.45	0.028	196	0.0657
672.47	0.026	195.9	0.0648
672.48	0.026	196	0.0639
672.50	0.025	196	0.0621
672.52	0.023	195.9	0.0621
672.53	0.022	195.9	0.0595
672.55	0.022	195.9	0.0586
672.57	0.021	195.8	0.0559
672.58	0.018	195.7	0.0533
672.60	0.017	195.6	0.0515
672.62	0.016	195.4	0.0479
672.63	0.012	195.2	0.0479
672.65	0.011	195.2	0.0435
672.67	0.011	195	0.0417
672.68	0.01	194.8	0.0382
672.70	0.006	194.6	0.0337
672.72	0.005	194.4	0.0311
672.73	0.004	194.2	0.0257

Prova triassiale ciclica SN04-C1			
pressione di confinamento (kPa)		80	
deviatore ciclico (kPa)		95	
frequenza (hz)		0.00625	
tempo	cella di carico	$\Delta u$	LVDT
(min)	kN	(kPa)	$\delta$ (mm)
672.75	-0.001	193.9	0.0257
672.77	-0.001	193.9	0.0213
672.78	-0.001	193.7	0.0186
672.80	-0.003	193.4	0.0142
672.82	-0.006	193.1	0.0107
672.83	-0.007	192.9	0.0071
672.85	-0.008	192.6	0.0044
672.87	-0.011	192.3	0.0044
672.88	-0.011	192.3	0.0009
672.90	-0.011	192.1	-0.0009
672.92	-0.013	191.9	-0.0044
672.93	-0.014	191.6	-0.0062
672.95	-0.015	191.4	-0.008
672.97	-0.016	191.2	-0.0098
672.98	-0.017	191	-0.0098
673.00	-0.017	190.9	-0.0107
673.02	-0.017	190.9	-0.0115
673.03	-0.017	190.8	-0.0115
673.05	-0.017	190.6	-0.0124
673.07	-0.017	190.5	-0.0124
673.08	-0.017	190.4	-0.0115
673.10	-0.017	190.4	-0.0115
673.12	-0.016	190.3	-0.0107
673.13	-0.015	190.3	-0.0098
673.15	-0.014	190.3	-0.0098
673.17	-0.013	190.3	-0.008
673.18	-0.013	190.3	-0.0071
673.20	-0.012	190.4	-0.0053
673.22	-0.01	190.5	-0.0036
673.23	-0.008	190.6	-0.0009
673.25	-0.007	190.6	0.0018
673.27	-0.005	190.8	0.0044
673.28	-0.003	191	0.0044
673.30	-0.003	191	0.008
673.32	-0.002	191.2	0.0115
673.33	0.001	191.4	0.0151
673.35	0.003	191.6	0.0186
673.37	0.004	191.7	0.0222
673.38	0.007	192	0.0275
673.40	0.01	192.2	0.0275
673.42	0.011	192.2	0.0311
673.45	0.011	192.4	0.0337
673.47	0.012	192.7	0.0382
673.48	0.016	193	0.0417
673.50	0.017	193.2	0.0453
673.50	0.018	193.5	0.0479
673.52	0.021	193.7	0.0479
673.53	0.022	193.7	0.0524
673.55	0.022	193.9	0.0541
673.57	0.023	194.2	0.0568
673.58	0.025	194.4	0.0595
673.60	0.026	194.6	0.0612
673.62	0.026	194.8	0.063
673.63	0.028	195	0.063
673.65	0.028	195	0.0648
673.67	0.028	195.2	0.0666
673.68	0.029	195.4	0.0675
673.70	0.029	195.5	0.0675

Prova triassiale ciclica SN04-C1			
pressione di confinamento (kPa)		80	
deviatore ciclico (kPa)		95	
frequenza (hz)		0.00625	
tempo	cella di carico	$\Delta u$	LVDT
(min)	kN	(kPa)	$\delta$ (mm)
673.72	0.029	195.7	0.0675
673.73	0.029	195.7	0.0675
673.75	0.028	195.8	0.0675
673.77	0.028	195.8	0.0675
673.78	0.028	195.9	0.0675
673.80	0.026	196	0.0657
673.82	0.026	196	0.0657
673.83	0.026	196	0.0648
673.85	0.024	196	0.0621
673.87	0.023	195.9	0.0604
673.88	0.021	195.9	0.0586
673.90	0.02	195.8	0.0559
673.92	0.018	195.6	0.0559
673.93	0.016	195.5	0.0533
673.95	0.016	195.5	0.0506
673.97	0.015	195.4	0.047
673.98	0.012	195.1	0.0435
674.00	0.01	194.9	0.0408
674.02	0.009	194.8	0.0373
674.03	0.006	194.5	0.0373
674.05	0.004	194.3	0.0337
674.07	0.004	194.3	0.0302
674.08	0.002	194.1	0.0249
674.10	0	193.8	0.0213
674.12	-0.003	193.5	0.0178
674.13	-0.003	193.3	0.0142
674.15	-0.006	193	0.0098
674.17	-0.008	192.8	0.0098
674.18	-0.008	192.8	0.0071
674.20	-0.009	192.5	0.0044
674.22	-0.011	192.2	0.0009
674.23	-0.013	192	-0.0018
674.25	-0.013	191.8	-0.0036
674.27	-0.014	191.6	-0.0053
674.28	-0.016	191.4	-0.0053
674.30	-0.016	191.4	-0.0071
674.32	-0.016	191.2	-0.008
674.33	-0.017	191	-0.0098
674.35	-0.017	190.9	-0.0107
674.37	-0.017	190.7	-0.0107
674.38	-0.017	190.6	-0.0107
674.40	-0.017	190.5	-0.0107
674.42	-0.017	190.5	-0.0107
674.43	-0.017	190.4	-0.0107
674.45	-0.016	190.4	-0.0098
674.47	-0.015	190.4	-0.0089
674.48	-0.015	190.3	-0.008
674.50	-0.014	190.4	-0.0062
674.52	-0.012	190.4	-0.0044
674.53	-0.011	190.4	-0.0027
674.55	-0.01	190.5	-0.0009
674.57	-0.008	190.7	-0.0009
674.58	-0.006	190.7	0.0018
674.60	-0.006	190.7	0.0036
674.62	-0.005	190.9	0.0071
674.63	-0.002	191.1	0.0107
674.65	0	191.2	0.0133
674.67	0.001	191.4	0.0169

Prova triassiale ciclica SN04-C1			
pressione di confinamento (kPa)		80	
deviatore ciclico (kPa)		95	
frequenza (hz)		0.00625	
tempo	cella di carico	$\Delta u$	LVDT
(min)	kN	(kPa)	$\delta$ (mm)
674.68	0.004	191.7	0.0169
674.70	0.006	191.9	0.0204
674.72	0.006	191.9	0.024
674.73	0.007	192.1	0.0284
674.75	0.01	192.4	0.0328
674.77	0.012	192.6	0.0364
674.78	0.013	192.8	0.0408
674.80	0.016	193.1	0.0408
674.82	0.018	193.3	0.0444
674.83	0.018	193.3	0.047
674.85	0.019	193.5	0.0506
674.88	0.021	193.8	0.0541
674.90	0.023	194.1	0.0568
674.92	0.024	194.3	0.0595
674.93	0.025	194.5	0.0595
674.95	0.026	194.7	0.0612
674.95	0.026	194.7	0.063
674.97	0.027	194.9	0.0648
674.98	0.028	195.1	0.0666
675.00	0.029	195.3	0.0675
675.02	0.028	195.4	0.0675
675.03	0.029	195.6	0.0683
675.05	0.029	195.7	0.0683
675.07	0.029	195.7	0.0683
675.08	0.029	195.8	0.0683
675.10	0.029	195.9	0.0683
675.12	0.028	196	0.0675
675.13	0.027	196	0.0666
675.15	0.026	196	0.0648
675.17	0.024	196	0.0648
675.18	0.023	196	0.0639
675.20	0.023	196	0.0621
675.22	0.022	195.9	0.0595
675.23	0.02	195.8	0.0568
675.25	0.019	195.7	0.055
675.27	0.018	195.6	0.0533
675.28	0.015	195.4	0.0497
675.30	0.014	195.3	0.0479
675.32	0.012	195.1	0.0444
675.33	0.009	194.9	0.0444
675.35	0.008	194.9	0.0399
675.37	0.008	194.7	0.0373
675.38	0.006	194.5	0.0337
675.40	0.002	194.2	0.0293
675.42	0.002	194.1	0.0249
675.43	0	193.8	0.0204
675.45	-0.004	193.5	0.0204
675.47	-0.005	193.5	0.0169
675.48	-0.005	193.3	0.0142
675.50	-0.006	193	0.0098
675.52	-0.009	192.7	0.0062
675.53	-0.01	192.5	0.0044
675.55	-0.011	192.2	0.0009
675.57	-0.013	192	0.0009
675.58	-0.014	192	-0.0018
675.60	-0.014	191.8	-0.0036
675.62	-0.015	191.5	-0.0053
675.63	-0.016	191.3	-0.0071

Prova triassiale ciclica SN04-C1			
pressione di confinamento (kPa)		80	
deviatore ciclico (kPa)		95	
frequenza (hz)		0.00625	
tempo	cella di carico	$\Delta u$	LVDT
(min)	kN	(kPa)	$\delta$ (mm)
675.65	-0.017	191.2	-0.0089
675.67	-0.017	191	-0.0089
675.68	-0.017	190.8	-0.0089
675.70	-0.017	190.8	-0.0098
675.72	-0.017	190.7	-0.0107
675.73	-0.017	190.6	-0.0107
675.75	-0.017	190.5	-0.0107
675.77	-0.017	190.5	-0.0098
675.78	-0.016	190.4	-0.0089
675.80	-0.015	190.4	-0.0089
675.82	-0.014	190.4	-0.008
675.83	-0.014	190.4	-0.0071
675.85	-0.013	190.4	-0.0044
675.87	-0.011	190.5	-0.0027
675.88	-0.01	190.6	-0.0018
675.90	-0.009	190.6	0.0009
675.92	-0.006	190.8	0.0009
675.93	-0.004	190.9	0.0044
675.95	-0.004	190.9	0.0062
675.97	-0.003	191	0.0098
675.98	0.001	191.4	0.0133
676.00	0.001	191.4	0.0151
676.02	0.002	191.5	0.0186
676.03	0.005	191.8	0.0231
676.05	0.007	192	0.0275
676.07	0.008	192.2	0.0311
676.08	0.011	192.5	0.0355
676.10	0.013	192.8	0.0355
676.12	0.013	192.8	0.0391
676.13	0.014	192.9	0.0426
676.15	0.016	193.3	0.0462
676.17	0.019	193.5	0.0497
676.18	0.02	193.7	0.0524
676.20	0.021	194	0.055
676.22	0.024	194.2	0.055
676.23	0.024	194.2	0.0586
676.25	0.024	194.4	0.0604
676.27	0.025	194.7	0.0621
676.28	0.027	194.9	0.0648
676.30	0.027	195	0.0657
676.32	0.028	195.2	0.0675
676.35	0.029	195.4	0.0675
676.37	0.029	195.4	0.0675
676.38	0.029	195.6	0.0683
676.40	0.029	195.7	0.0683
676.40	0.029	195.8	0.0692
676.42	0.029	195.9	0.0692
676.43	0.028	196	0.0683
676.45	0.027	196	0.0683
676.47	0.026	196	0.0675
676.48	0.026	196.1	0.0666
676.50	0.026	196	0.0648
676.52	0.023	196	0.063
676.53	0.023	196	0.0621
676.55	0.022	195.9	0.0595
676.57	0.019	195.8	0.0595
676.58	0.018	195.8	0.0559
676.60	0.018	195.7	0.0541



Prova triassiale ciclica SN04-C1			
pressione di confinamento (kPa)		80	
deviatore ciclico (kPa)		95	
frequenza (hz)		0.00625	
tempo	cella di carico	$\Delta u$	LVDT
(min)	kN	(kPa)	$\delta$ (mm)
676.62	0.017	195.5	0.0515
676.63	0.013	195.3	0.0479
676.65	0.012	195.2	0.0444
676.67	0.011	195	0.0417
676.68	0.007	194.7	0.0417
676.70	0.006	194.6	0.0346
676.72	0.005	194.4	0.0328
676.73	0.002	194.2	0.0328
676.75	0.001	194.2	0.0284
676.77	0.001	194	0.024
676.78	-0.001	193.7	0.0186
676.80	-0.005	193.4	0.0151
676.82	-0.005	193.2	0.0124
676.83	-0.006	192.9	0.0089
676.85	-0.01	192.6	0.0089
676.87	-0.01	192.6	0.0053
676.88	-0.01	192.4	0.0027
676.90	-0.011	192.1	0
676.92	-0.014	191.9	-0.0036
676.93	-0.014	191.7	-0.0044
676.95	-0.015	191.5	-0.0062
676.97	-0.016	191.3	-0.0062
676.98	-0.016	191.3	-0.0071
677.00	-0.016	191.1	-0.0089
677.02	-0.017	191	-0.0098
677.03	-0.017	190.8	-0.0098
677.05	-0.017	190.7	-0.0107
677.07	-0.017	190.6	-0.0107
677.08	-0.017	190.5	-0.0107
677.10	-0.016	190.5	-0.0107
677.12	-0.016	190.5	-0.0098
677.13	-0.016	190.4	-0.008
677.15	-0.014	190.4	-0.0071
677.17	-0.013	190.4	-0.0062
677.18	-0.013	190.5	-0.0044
677.20	-0.011	190.6	-0.0044
677.22	-0.009	190.6	-0.0018
677.23	-0.009	190.6	0
677.25	-0.008	190.7	0.0027
677.27	-0.006	190.9	0.0053
677.28	-0.004	191	0.008
677.30	-0.002	191.2	0.0115
677.32	0	191.4	0.0151
677.33	0.002	191.6	0.0151
677.35	0.002	191.6	0.0186
677.37	0.004	191.7	0.0222
677.38	0.006	192	0.0257
677.40	0.009	192.3	0.0311
677.42	0.01	192.5	0.0346
677.43	0.012	192.8	0.0382
677.45	0.014	192.9	0.0408
677.47	0.015	193.1	0.0435
677.48	0.017	193.4	0.047
677.50	0.02	193.7	0.047
677.52	0.02	193.7	0.0506
677.53	0.02	193.9	0.0533
677.55	0.022	194.1	0.0568
677.57	0.024	194.4	0.0595

Prova triassiale ciclica SN04-C1			
pressione di confinamento (kPa)		80	
deviatore ciclico (kPa)		95	
frequenza (hz)		0.00625	
tempo	cella di carico	$\Delta u$	LVDT
(min)	kN	(kPa)	$\delta$ (mm)
677.58	0.024	194.5	0.0612
677.60	0.026	194.8	0.0639
677.62	0.027	195	0.0639
677.63	0.027	195	0.0657
677.65	0.027	195.1	0.0666
677.67	0.028	195.4	0.0675
677.68	0.029	195.5	0.0692
677.70	0.029	195.7	0.0692
677.72	0.029	195.8	0.0692
677.73	0.029	195.9	0.0692
677.75	0.029	195.9	0.0692
677.77	0.029	196	0.0692
677.80	0.028	196.1	0.0683
677.82	0.027	196.1	0.0675
677.83	0.026	196.1	0.0666
677.85	0.025	196	0.0639
677.85	0.023	196	0.0639
677.87	0.022	196	0.063
677.88	0.022	196	0.0612
677.90	0.021	195.9	0.0586
677.92	0.018	195.7	0.055
677.93	0.017	195.7	0.0533
677.95	0.016	195.5	0.0497
677.97	0.012	195.3	0.0497
677.98	0.012	195.3	0.047
678.00	0.012	195.1	0.0435
678.02	0.01	194.9	0.0399
678.03	0.005	194.7	0.0355
678.05	0.005	194.5	0.0328
678.07	0.004	194.3	0.0284
678.08	0	194	0.0284
678.10	-0.001	194	0.024
678.12	-0.001	193.8	0.0204
678.13	-0.003	193.5	0.0169
678.15	-0.006	193.2	0.0124
678.17	-0.006	193	0.0107
678.18	-0.008	192.8	0.0071
678.20	-0.01	192.5	0.0044
678.22	-0.011	192.3	0.0018
678.23	-0.012	192	-0.0009
678.25	-0.014	191.8	-0.0009
678.27	-0.015	191.6	-0.0027
678.28	-0.015	191.6	-0.0044
678.30	-0.016	191.4	-0.0062
678.32	-0.016	191.2	-0.008
678.33	-0.017	191	-0.0089
678.35	-0.017	190.9	-0.0089
678.37	-0.017	190.7	-0.0089
678.38	-0.017	190.6	-0.0098
678.40	-0.017	190.6	-0.0098
678.42	-0.017	190.5	-0.0098
678.43	-0.017	190.5	-0.0089
678.45	-0.016	190.5	-0.0089
678.47	-0.015	190.4	-0.008
678.48	-0.014	190.4	-0.008
678.50	-0.012	190.5	-0.0062
678.52	-0.012	190.5	-0.0044
678.53	-0.012	190.5	-0.0036

Prova triassiale ciclica SN04-C1			
pressione di confinamento (kPa)		80	
deviatore ciclico (kPa)		95	
frequenza (hz)		0.00625	
tempo	cella di carico	$\Delta u$	LVDT
(min)	kN	(kPa)	$\delta$ (mm)
678.55	-0.01	190.6	-0.0009
678.57	-0.009	190.7	0.0009
678.58	-0.007	190.8	0.0044
678.60	-0.005	191	0.0071
678.62	-0.003	191.1	0.0071
678.63	-0.003	191.1	0.0098
678.65	-0.002	191.2	0.0133
678.67	0.001	191.5	0.0169
678.68	0.004	191.7	0.0204
678.70	0.004	191.8	0.024
678.72	0.007	192.1	0.0284
678.73	0.01	192.4	0.0284
678.75	0.01	192.4	0.0328
678.77	0.011	192.6	0.0364
678.78	0.013	192.8	0.0399
678.80	0.016	193.1	0.0435
678.82	0.016	193.3	0.047
678.83	0.019	193.6	0.0506
678.85	0.021	193.9	0.0506
678.87	0.021	193.9	0.0541
678.88	0.023	194.3	0.0577
678.90	0.024	194.5	0.0577
678.92	0.025	194.5	0.0595
678.93	0.025	194.7	0.0612
678.95	0.026	194.9	0.0639
678.97	0.028	195.1	0.0657
678.98	0.028	195.3	0.0666
679.00	0.028	195.4	0.0666
679.02	0.028	195.6	0.0666
679.03	0.029	195.6	0.0683
679.05	0.029	195.8	0.0683
679.07	0.029	195.9	0.0692
679.08	0.029	196	0.0692
679.10	0.028	196	0.0692
679.12	0.028	196.1	0.0683
679.13	0.026	196.1	0.0683
679.15	0.025	196.1	0.0666
679.17	0.025	196.1	0.0648
679.18	0.025	196.1	0.0639
679.20	0.022	196	0.0621
679.22	0.022	196	0.0595
679.25	0.02	195.9	0.0568
679.27	0.018	195.7	0.0568
679.28	0.016	195.7	0.0541
679.30	0.016	195.6	0.0515
679.30	0.015	195.5	0.0488
679.32	0.012	195.2	0.0453
679.33	0.01	195.1	0.0426
679.35	0.009	194.9	0.0373
679.37	0.005	194.6	0.0373
679.38	0.004	194.6	0.0346
679.40	0.004	194.4	0.0311
679.42	0.003	194.2	0.0275
679.43	-0.001	193.9	0.0222
679.45	-0.002	193.7	0.0195
679.47	-0.003	193.4	0.0142
679.48	-0.007	193.1	0.0142
679.50	-0.008	192.9	0.0107

Prova triassiale ciclica SN04-C1			
pressione di confinamento (kPa)		80	
deviatore ciclico (kPa)		95	
frequenza (hz)		0.00625	
tempo	cella di carico	$\Delta u$	LVDT
(min)	kN	(kPa)	$\delta$ (mm)
679.52	-0.008	192.9	0.008
679.53	-0.009	192.7	0.0044
679.55	-0.012	192.3	0.0009
679.57	-0.012	192.2	0
679.58	-0.013	191.9	-0.0027
679.60	-0.015	191.7	-0.0053
679.62	-0.015	191.5	-0.0062
679.63	-0.016	191.3	-0.008
679.65	-0.016	191.2	-0.008
679.67	-0.017	191	-0.0089
679.68	-0.017	191	-0.0098
679.70	-0.017	190.8	-0.0107
679.72	-0.017	190.7	-0.0107
679.73	-0.017	190.6	-0.0107
679.75	-0.017	190.5	-0.0107
679.77	-0.016	190.5	-0.0098
679.78	-0.016	190.5	-0.0098
679.80	-0.015	190.5	-0.0089
679.82	-0.015	190.4	-0.008
679.83	-0.014	190.5	-0.0071
679.85	-0.012	190.5	-0.0053
679.87	-0.011	190.5	-0.0027
679.88	-0.01	190.6	-0.0009
679.90	-0.007	190.8	-0.0009
679.92	-0.007	190.8	0.0018
679.93	-0.007	190.8	0.0036
679.95	-0.005	191	0.0071
679.97	-0.002	191.2	0.0107
679.98	-0.001	191.3	0.0133
680.00	0.001	191.6	0.0169
680.02	0.005	191.8	0.0169
680.03	0.005	191.8	0.0213
680.05	0.005	191.9	0.024
680.07	0.007	192.2	0.0293
680.08	0.012	192.5	0.0337
680.10	0.012	192.7	0.0364
680.12	0.013	192.9	0.0399
680.13	0.017	193.2	0.0399
680.15	0.018	193.2	0.0444
680.17	0.018	193.4	0.047
680.18	0.019	193.6	0.0506
680.20	0.021	193.9	0.0541
680.22	0.023	194.1	0.0568
680.23	0.023	194.4	0.0595
680.25	0.025	194.6	0.0595
680.27	0.026	194.6	0.0612
680.28	0.026	194.8	0.063
680.30	0.027	195	0.0648
680.32	0.028	195.2	0.0666
680.33	0.028	195.4	0.0666
680.35	0.028	195.6	0.0675
680.37	0.029	195.7	0.0683
680.38	0.029	195.8	0.0683
680.40	0.029	195.9	0.0683
680.42	0.029	196	0.0683
680.43	0.028	196.1	0.0683
680.45	0.028	196.1	0.0683
680.47	0.028	196.1	0.0675

Prova triassiale ciclica SN04-C1			
pressione di confinamento (kPa)		80	
deviatore ciclico (kPa)		95	
frequenza (hz)		0.00625	
tempo	cella di carico	$\Delta u$	LVDT
(min)	kN	(kPa)	$\delta$ (mm)
680.48	0.026	196.1	0.0657
680.50	0.025	196.1	0.0639
680.52	0.024	196.1	0.063
680.53	0.022	196	0.063
680.55	0.021	195.9	0.0604
680.57	0.021	195.9	0.0586
680.58	0.019	195.9	0.055
680.60	0.017	195.7	0.0524
680.62	0.015	195.6	0.0497
680.63	0.014	195.4	0.047
680.65	0.011	195.2	0.047
680.67	0.009	195	0.0426
680.68	0.009	195	0.0399
680.72	0.008	194.8	0.0364
680.73	0.005	194.5	0.032
680.75	0.003	194.3	0.0293
680.77	0.002	194.1	0.024
680.77	-0.001	193.8	0.0204
680.78	-0.004	193.6	0.0204
680.80	-0.005	193.6	0.016
680.82	-0.005	193.3	0.0133
680.83	-0.006	193	0.0098
680.85	-0.009	192.8	0.0062
680.87	-0.01	192.6	0.0036
680.88	-0.011	192.3	0.0009
680.90	-0.013	192	0.0009
680.92	-0.014	192	-0.0027
680.93	-0.014	191.9	-0.0036
680.95	-0.015	191.6	-0.0062
680.97	-0.016	191.4	-0.008
680.98	-0.016	191.2	-0.0089
681.00	-0.017	191.1	-0.0098
681.02	-0.017	190.9	-0.0098
681.03	-0.017	190.9	-0.0107
681.05	-0.017	190.8	-0.0107
681.07	-0.017	190.6	-0.0115
681.08	-0.017	190.6	-0.0115
681.10	-0.017	190.5	-0.0107
681.12	-0.016	190.5	-0.0098
681.13	-0.015	190.5	-0.0089
681.15	-0.014	190.4	-0.008
681.17	-0.014	190.5	-0.0062
681.18	-0.011	190.5	-0.0062
681.20	-0.011	190.5	-0.0044
681.22	-0.011	190.5	-0.0036
681.23	-0.01	190.7	-0.0009
681.25	-0.007	190.8	0.0018
681.27	-0.006	190.9	0.0044
681.28	-0.005	191.1	0.008
681.30	-0.001	191.3	0.008
681.32	0	191.3	0.0115
681.33	0	191.4	0.0142
681.35	0.002	191.6	0.0186
681.37	0.005	191.9	0.0231
681.38	0.006	192.1	0.0257
681.40	0.008	192.3	0.0302
681.42	0.011	192.6	0.0302
681.43	0.013	192.6	0.0346

Prova triassiale ciclica SN04-C1			
pressione di confinamento (kPa)		80	
deviatore ciclico (kPa)		95	
frequenza (hz)		0.00625	
tempo	cella di carico	$\Delta u$	LVDT
(min)	kN	(kPa)	$\delta$ (mm)
681.45	0.013	192.8	0.0382
681.47	0.014	193	0.0417
681.48	0.017	193.3	0.0453
681.50	0.018	193.5	0.0479
681.52	0.019	193.8	0.0515
681.53	0.022	194.1	0.0515
681.55	0.023	194.3	0.055
681.57	0.023	194.3	0.0568
681.58	0.024	194.5	0.0595
681.60	0.026	194.7	0.0621
681.62	0.027	194.9	0.0639
681.63	0.027	195.1	0.0648
681.65	0.028	195.3	0.0648
681.67	0.029	195.5	0.0666
681.68	0.029	195.5	0.0675
681.70	0.029	195.7	0.0675
681.72	0.029	195.8	0.0675
681.73	0.028	195.9	0.0675
681.75	0.028	196	0.0675
681.77	0.028	196.1	0.0675
681.78	0.027	196.1	0.0675
681.80	0.027	196.1	0.0666
681.82	0.026	196.1	0.0666
681.83	0.024	196.1	0.0648
681.85	0.024	196.1	0.063
681.87	0.023	196.1	0.0612
681.88	0.021	196	0.0586
681.90	0.02	196	0.0568
681.92	0.019	195.9	0.0541
681.93	0.017	195.6	0.0541
681.95	0.014	195.5	0.0515
681.97	0.014	195.5	0.0479
681.98	0.013	195.4	0.0444
682.00	0.011	195.1	0.0408
682.02	0.008	194.9	0.0382
682.03	0.007	194.8	0.0346
682.05	0.005	194.5	0.0311
682.07	0.002	194.2	0.0311
682.08	0.002	194.2	0.0275
682.10	0.001	194	0.0222
682.12	-0.002	193.7	0.0178
682.15	-0.004	193.5	0.0142
682.17	-0.005	193.3	0.0107
682.18	-0.007	192.9	0.0071
682.20	-0.01	192.7	0.0071
682.22	-0.01	192.7	0.0044
682.22	-0.01	192.5	0.0018
682.23	-0.011	192.2	0
682.25	-0.014	192	-0.0027
682.27	-0.014	191.8	-0.0053
682.28	-0.015	191.5	-0.0071
682.30	-0.016	191.3	-0.0071
682.32	-0.017	191.3	-0.0089
682.33	-0.017	191.2	-0.0098
682.35	-0.017	191	-0.0107
682.37	-0.017	190.9	-0.0107
682.38	-0.017	190.8	-0.0115
682.40	-0.017	190.7	-0.0115

Prova triassiale ciclica SN04-C1			
pressione di confinamento (kPa)		80	
deviatore ciclico (kPa)		95	
frequenza (hz)		0.00625	
tempo	cella di carico	$\Delta u$	LVDT
(min)	kN	(kPa)	$\delta$ (mm)
682.42	-0.017	190.6	-0.0115
682.43	-0.016	190.6	-0.0107
682.45	-0.016	190.5	-0.0107
682.47	-0.016	190.5	-0.0098
682.48	-0.014	190.5	-0.008
682.50	-0.014	190.5	-0.0071
682.52	-0.013	190.6	-0.0053
682.53	-0.011	190.6	-0.0044
682.55	-0.01	190.6	-0.0027
682.57	-0.009	190.7	0
682.58	-0.006	190.9	0
682.60	-0.005	190.9	0.0036
682.62	-0.005	191	0.0062
682.63	-0.003	191.2	0.0098
682.65	0	191.4	0.0124
682.67	0.001	191.5	0.0151
682.68	0.002	191.7	0.0195
682.70	0.006	192	0.0195
682.72	0.007	192	0.024
682.73	0.007	192.2	0.0275
682.75	0.009	192.4	0.032
682.77	0.012	192.7	0.0364
682.78	0.014	192.9	0.0391
682.80	0.015	193.2	0.0426
682.82	0.018	193.5	0.0426
682.83	0.019	193.7	0.047
682.85	0.019	193.7	0.0497
682.87	0.02	193.9	0.0524
682.88	0.023	194.2	0.0559
682.90	0.024	194.4	0.0586
682.92	0.025	194.6	0.0604
682.93	0.026	194.8	0.0604
682.95	0.027	195	0.0621
682.97	0.027	195	0.0639
682.98	0.027	195.2	0.0657
683.00	0.029	195.4	0.0675
683.02	0.029	195.6	0.0675
683.03	0.029	195.7	0.0675
683.05	0.029	195.9	0.0675
683.07	0.028	196	0.0675
683.08	0.028	196	0.0675
683.10	0.028	196	0.0675
683.12	0.028	196.1	0.0675
683.13	0.027	196.1	0.0666
683.15	0.026	196.2	0.0648
683.17	0.025	196.1	0.063
683.18	0.023	196.1	0.063
683.20	0.023	196.1	0.0612
683.22	0.022	196	0.0595
683.23	0.019	195.9	0.0568
683.25	0.019	195.9	0.055
683.27	0.017	195.8	0.0524
683.28	0.016	195.6	0.0497
683.30	0.013	195.4	0.047
683.32	0.012	195.3	0.0435
683.33	0.01	195	0.0399
683.35	0.007	194.8	0.0399
683.37	0.006	194.8	0.0364

Prova triassiale ciclica SN04-C1			
pressione di confinamento (kPa)		80	
deviatore ciclico (kPa)		95	
frequenza (hz)		0.00625	
tempo	cella di carico	$\Delta u$	LVDT
(min)	kN	(kPa)	$\delta$ (mm)
683.38	0.006	194.7	0.0328
683.40	0.004	194.4	0.0293
683.42	0.001	194.1	0.024
683.43	0	193.9	0.0213
683.45	-0.002	193.6	0.0169
683.47	-0.006	193.4	0.0169
683.48	-0.006	193.4	0.0124
683.50	-0.006	193.2	0.0098
683.52	-0.008	192.9	0.0062
683.53	-0.01	192.6	0.0036
683.55	-0.011	192.4	0.0009
683.57	-0.012	192.1	-0.0018
683.58	-0.014	191.9	-0.0018
683.62	-0.015	191.9	-0.0044
683.63	-0.015	191.7	-0.0053
683.65	-0.015	191.5	-0.008
683.67	-0.017	191.3	-0.0098
683.67	-0.017	191.2	-0.0098
683.68	-0.017	191	-0.0107
683.70	-0.017	190.8	-0.0107
683.72	-0.017	190.8	-0.0115
683.73	-0.017	190.7	-0.0115
683.75	-0.017	190.6	-0.0115
683.77	-0.016	190.6	-0.0107
683.78	-0.016	190.5	-0.0098
683.80	-0.015	190.5	-0.0089
683.82	-0.014	190.5	-0.0089
683.83	-0.013	190.5	-0.0071
683.85	-0.013	190.5	-0.0062
683.87	-0.012	190.6	-0.0044
683.88	-0.01	190.7	-0.0027
683.90	-0.009	190.8	-0.0009
683.92	-0.007	190.9	0.0027
683.93	-0.004	191	0.0027
683.95	-0.003	191.2	0.0062
683.97	-0.002	191.3	0.0098
683.98	0	191.5	0.0098
684.00	0.002	191.7	0.0133
684.02	0.002	191.7	0.0169
684.03	0.004	191.8	0.0213
684.05	0.007	192.1	0.0257
684.07	0.009	192.3	0.0293
684.08	0.01	192.5	0.0337
684.10	0.013	192.8	0.0337
684.12	0.014	193	0.0373
684.13	0.014	193	0.0399
684.15	0.016	193.3	0.0444
684.17	0.019	193.6	0.0479
684.18	0.02	193.8	0.0506
684.20	0.021	194	0.0541
684.22	0.023	194.3	0.0541
684.23	0.024	194.5	0.0568
684.25	0.024	194.5	0.0586
684.27	0.025	194.7	0.0612
684.28	0.026	194.9	0.0639
684.30	0.028	195.1	0.0648
684.32	0.028	195.3	0.0657
684.33	0.028	195.5	0.0657



Prova triassiale ciclica SN04-C1			
pressione di confinamento (kPa)		80	
deviatore ciclico (kPa)		95	
frequenza (hz)		0.00625	
tempo	cella di carico	$\Delta u$	LVDT
(min)	kN	(kPa)	$\delta$ (mm)
684.35	0.029	195.7	0.0666
684.37	0.029	195.7	0.0675
684.38	0.029	195.8	0.0675
684.40	0.029	195.9	0.0675
684.42	0.029	196	0.0675
684.43	0.028	196.1	0.0675
684.45	0.028	196.2	0.0666
684.47	0.026	196.2	0.0666
684.48	0.025	196.2	0.0657
684.50	0.025	196.2	0.0639
684.52	0.025	196.2	0.0621
684.53	0.022	196.1	0.0604
684.55	0.022	196	0.0586
684.57	0.02	195.9	0.0559
684.58	0.017	195.8	0.0559
684.60	0.016	195.8	0.0533
684.62	0.016	195.7	0.0506
684.63	0.015	195.5	0.047
684.65	0.011	195.3	0.0435
684.67	0.01	195.1	0.0408
684.68	0.009	194.9	0.0373
684.70	0.007	194.8	0.0346
684.72	0.005	194.6	0.0311
684.73	0.004	194.3	0.0275
684.75	0	194	0.0275
684.77	-0.001	194	0.0222
684.78	-0.001	193.8	0.0186
684.80	-0.003	193.6	0.0151
684.82	-0.006	193.3	0.0107
684.83	-0.007	193.1	0.008
684.85	-0.008	192.8	0.0044
684.87	-0.011	192.5	0.0044
684.88	-0.011	192.5	0.0018
684.90	-0.011	192.3	-0.0009
684.92	-0.013	192	-0.0036
684.93	-0.015	191.8	-0.0062
684.95	-0.015	191.6	-0.0071
684.97	-0.016	191.4	-0.008
684.98	-0.016	191.2	-0.008
685.00	-0.017	191.1	-0.0098
685.02	-0.017	191.1	-0.0107
685.05	-0.017	190.9	-0.0107
685.07	-0.017	190.8	-0.0115
685.08	-0.017	190.7	-0.0115
685.10	-0.017	190.6	-0.0115
685.12	-0.016	190.6	-0.0115
685.12	-0.015	190.6	-0.0107
685.13	-0.015	190.6	-0.0098
685.15	-0.015	190.5	-0.008
685.17	-0.014	190.6	-0.0071
685.18	-0.012	190.6	-0.0062
685.20	-0.012	190.6	-0.0036
685.22	-0.01	190.8	-0.0036
685.23	-0.007	190.9	-0.0009
685.25	-0.007	190.9	0.0009
685.27	-0.006	190.9	0.0036
685.28	-0.004	191.2	0.0062
685.30	-0.002	191.3	0.0089

Prova triassiale ciclica SN04-C1			
pressione di confinamento (kPa)		80	
deviatore ciclico (kPa)		95	
frequenza (hz)		0.00625	
tempo	cella di carico	$\Delta u$	LVDT
(min)	kN	(kPa)	$\delta$ (mm)
685.32	-0.001	191.4	0.0124
685.33	0.002	191.7	0.0169
685.35	0.004	191.9	0.0169
685.37	0.004	191.9	0.0204
685.38	0.005	192.1	0.024
685.40	0.008	192.4	0.0284
685.42	0.011	192.6	0.0328
685.43	0.011	192.7	0.0346
685.45	0.013	193	0.0382
685.47	0.016	193.2	0.0417
685.48	0.017	193.4	0.0453
685.50	0.019	193.7	0.0497
685.52	0.021	194	0.0497
685.53	0.021	194	0.0524
685.55	0.022	194.2	0.055
685.57	0.023	194.5	0.0577
685.58	0.025	194.7	0.0604
685.60	0.026	194.9	0.0621
685.62	0.026	195.1	0.0639
685.63	0.028	195.3	0.0639
685.65	0.028	195.3	0.0657
685.67	0.028	195.5	0.0657
685.68	0.028	195.6	0.0666
685.70	0.029	195.8	0.0675
685.72	0.029	195.9	0.0675
685.73	0.029	196	0.0675
685.75	0.028	196.1	0.0675
685.77	0.028	196.1	0.0675
685.78	0.028	196.2	0.0675
685.80	0.027	196.2	0.0657
685.82	0.026	196.2	0.0648
685.83	0.025	196.2	0.0639
685.85	0.024	196.2	0.0621
685.87	0.022	196.1	0.0621
685.88	0.021	196.1	0.0595
685.90	0.021	196.1	0.0577
685.92	0.02	195.9	0.055
685.93	0.016	195.8	0.0515
685.95	0.016	195.7	0.0488
685.97	0.014	195.5	0.0453
685.98	0.01	195.2	0.0453
686.00	0.01	195.2	0.0417
686.02	0.01	195.1	0.0391
686.03	0.008	194.8	0.0355
686.05	0.004	194.6	0.032
686.07	0.003	194.4	0.0284
686.08	0.001	194.2	0.0231
686.10	-0.002	193.9	0.0231
686.12	-0.003	193.9	0.0186
686.13	-0.003	193.7	0.016
686.15	-0.006	193.2	0.0124
686.17	-0.007	193.2	0.0098
686.18	-0.007	192.9	0.0071
686.20	-0.009	192.7	0.0036
686.22	-0.012	192.4	0
686.23	-0.012	192.2	-0.0018
686.25	-0.013	192	-0.0044
686.27	-0.015	191.7	-0.0044

Prova triassiale ciclica SN04-C1			
pressione di confinamento (kPa)		80	
deviatore ciclico (kPa)		95	
frequenza (hz)		0.00625	
tempo	cella di carico	$\Delta u$	LVDT
(min)	kN	(kPa)	$\delta$ (mm)
686.28	-0.015	191.7	-0.0062
686.30	-0.015	191.5	-0.0071
686.32	-0.016	191.4	-0.0089
686.33	-0.017	191.2	-0.0107
686.35	-0.017	191	-0.0115
686.37	-0.017	190.9	-0.0115
686.38	-0.017	190.8	-0.0115
686.40	-0.017	190.8	-0.0115
686.42	-0.017	190.7	-0.0115
686.43	-0.017	190.6	-0.0115
686.45	-0.016	190.6	-0.0107
686.47	-0.015	190.6	-0.0098
686.48	-0.014	190.5	-0.008
686.52	-0.013	190.6	-0.008
686.53	-0.012	190.6	-0.0062
686.55	-0.012	190.6	-0.0053
686.57	-0.011	190.7	-0.0027
686.57	-0.008	190.8	-0.0009
686.58	-0.007	190.9	0.0018
686.60	-0.006	191	0.0053
686.62	-0.003	191.2	0.0053
686.63	-0.001	191.2	0.008
686.65	-0.001	191.4	0.0107
686.67	0	191.5	0.0151
686.68	0.004	191.8	0.0186
686.70	0.004	191.9	0.0213
686.72	0.006	192.2	0.0257
686.73	0.01	192.5	0.0257
686.75	0.011	192.5	0.0311
686.77	0.011	192.7	0.0337
686.78	0.012	192.9	0.0373
686.80	0.016	193.2	0.0417
686.82	0.017	193.4	0.0444
686.83	0.018	193.6	0.0479
686.85	0.02	193.9	0.0479
686.87	0.022	194.2	0.0541
686.88	0.022	194.3	0.0559
686.90	0.024	194.6	0.0559
686.92	0.026	194.8	0.0586
686.93	0.026	194.8	0.0612
686.95	0.026	195	0.0621
686.97	0.027	195.2	0.0639
686.98	0.028	195.4	0.0657
687.00	0.028	195.6	0.0666
687.02	0.029	195.7	0.0675
687.03	0.029	195.9	0.0675
687.05	0.029	195.9	0.0675
687.07	0.029	196	0.0675
687.08	0.029	196.1	0.0675
687.10	0.028	196.2	0.0675
687.12	0.028	196.2	0.0666
687.13	0.027	196.2	0.0657
687.15	0.025	196.2	0.0657
687.17	0.025	196.2	0.0639
687.18	0.025	196.2	0.0621
687.20	0.023	196.2	0.0604
687.22	0.021	196.1	0.0577
687.23	0.02	196	0.0568

Prova triassiale ciclica SN04-C1			
pressione di confinamento (kPa)		80	
deviatore ciclico (kPa)		95	
frequenza (hz)		0.00625	
tempo	cella di carico	$\Delta u$	LVDT
(min)	kN	(kPa)	$\delta$ (mm)
687.25	0.019	195.9	0.0533
687.27	0.015	195.8	0.0533
687.28	0.015	195.8	0.0506
687.30	0.015	195.7	0.0479
687.32	0.013	195.4	0.0435
687.33	0.01	195.2	0.0399
687.35	0.009	195	0.0373
687.37	0.007	194.8	0.0328
687.38	0.003	194.5	0.0328
687.40	0.003	194.5	0.0293
687.42	0.003	194.4	0.0257
687.43	0.001	194.1	0.0213
687.45	-0.003	193.8	0.0169
687.47	-0.004	193.6	0.0142
687.48	-0.005	193.3	0.0107
687.50	-0.008	193	0.0107
687.52	-0.009	193	0.0062
687.53	-0.009	192.8	0.0044
687.55	-0.01	192.5	0.0009
687.57	-0.013	192.3	-0.0018
687.58	-0.013	192.1	-0.0036
687.60	-0.014	191.8	-0.0053
687.62	-0.015	191.6	-0.0071
687.63	-0.016	191.5	-0.008
687.65	-0.016	191.3	-0.0098
687.67	-0.017	191.2	-0.0098
687.68	-0.017	191	-0.0107
687.70	-0.017	191	-0.0115
687.72	-0.017	190.9	-0.0115
687.73	-0.017	190.8	-0.0115
687.75	-0.017	190.7	-0.0115
687.77	-0.016	190.6	-0.0115
687.78	-0.016	190.6	-0.0107
687.80	-0.014	190.6	-0.0107
687.82	-0.014	190.6	-0.0089
687.83	-0.014	190.5	-0.008
687.85	-0.013	190.6	-0.0062
687.87	-0.011	190.7	-0.0044
687.88	-0.01	190.7	-0.0027
687.90	-0.009	190.9	0
687.92	-0.006	191	0
687.93	-0.005	191	0.0027
687.95	-0.005	191.1	0.0062
687.98	-0.004	191.3	0.008
688.00	0	191.5	0.0115
688.02	0.001	191.6	0.0151
688.02	0.003	191.9	0.0204
688.03	0.007	192.1	0.0204
688.05	0.007	192.1	0.024
688.07	0.007	192.3	0.0275
688.08	0.009	192.6	0.032
688.10	0.012	192.8	0.0355
688.12	0.014	193	0.0391
688.13	0.015	193.3	0.0426
688.15	0.018	193.6	0.0426
688.17	0.019	193.6	0.0462
688.18	0.019	193.8	0.0497
688.20	0.021	194	0.0524

Prova triassiale ciclica SN04-C1			
pressione di confinamento (kPa)		80	
deviatore ciclico (kPa)		95	
frequenza (hz)		0.00625	
tempo	cella di carico	$\Delta u$	LVDT
(min)	kN	(kPa)	$\delta$ (mm)
688.22	0.023	194.3	0.0559
688.23	0.023	194.5	0.0568
688.25	0.024	194.7	0.0604
688.27	0.026	195	0.0604
688.28	0.027	195	0.0621
688.30	0.027	195.1	0.0639
688.32	0.028	195.6	0.0657
688.33	0.028	195.6	0.0666
688.35	0.028	195.7	0.0666
688.37	0.028	195.8	0.0666
688.38	0.029	196	0.0675
688.40	0.029	196.1	0.0683
688.42	0.029	196.2	0.0683
688.43	0.028	196.2	0.0683
688.45	0.027	196.2	0.0675
688.47	0.027	196.3	0.0666
688.48	0.027	196.3	0.0648
688.50	0.024	196.2	0.063
688.52	0.024	196.3	0.0621
688.53	0.023	196.2	0.0595
688.55	0.02	196.1	0.0595
688.57	0.019	196.1	0.0568
688.58	0.019	196	0.0559
688.60	0.018	195.9	0.0524
688.62	0.015	195.7	0.0497
688.63	0.014	195.6	0.0462
688.65	0.012	195.4	0.0426
688.67	0.009	195.1	0.0426
688.68	0.008	195.1	0.0391
688.70	0.008	195	0.0364
688.72	0.006	194.8	0.0328
688.73	0.002	194.5	0.0275
688.75	0.001	194.3	0.024
688.77	0	194	0.0204
688.78	-0.004	193.7	0.0204
688.80	-0.004	193.7	0.016
688.82	-0.004	193.5	0.0133
688.83	-0.006	193.3	0.0089
688.85	-0.009	192.9	0.0053
688.87	-0.01	192.7	0.0027
688.88	-0.011	192.5	0
688.90	-0.013	192.2	0
688.92	-0.014	192.2	-0.0036
688.93	-0.014	192	-0.0044
688.95	-0.014	191.8	-0.0062
688.97	-0.016	191.6	-0.0089
688.98	-0.016	191.4	-0.0098
689.00	-0.017	191.2	-0.0107
689.02	-0.017	191.1	-0.0107
689.03	-0.017	191	-0.0115
689.05	-0.017	190.8	-0.0115
689.07	-0.017	190.8	-0.0115
689.08	-0.017	190.7	-0.0115
689.10	-0.017	190.7	-0.0115
689.12	-0.016	190.6	-0.0107
689.13	-0.015	190.6	-0.0098
689.15	-0.014	190.6	-0.0089
689.17	-0.014	190.6	-0.0071

Prova triassiale ciclica SN04-C1			
pressione di confinamento (kPa)		80	
deviatore ciclico (kPa)		95	
frequenza (hz)		0.00625	
tempo	cella di carico	$\Delta u$	LVDT
(min)	kN	(kPa)	$\delta$ (mm)
689.18	-0.012	190.7	-0.0053
689.20	-0.01	190.8	-0.0053
689.22	-0.009	190.8	-0.0036
689.23	-0.009	190.8	-0.0018
689.25	-0.008	190.9	0.0009
689.27	-0.005	191.1	0.0036
689.28	-0.004	191.2	0.0062
689.30	-0.002	191.4	0.0107
689.32	0.001	191.6	0.0107
689.33	0.002	191.6	0.0133
689.35	0.002	191.7	0.0169
689.37	0.004	192	0.0213
689.38	0.007	192.2	0.0249
689.42	0.008	192.4	0.0284
689.43	0.01	192.7	0.0328
689.45	0.013	193	0.0328
689.47	0.015	193	0.0373
689.48	0.015	193.2	0.0408
689.48	0.016	193.4	0.0444
689.50	0.019	193.7	0.0479
689.52	0.02	193.9	0.0497
689.53	0.021	194.2	0.0533
689.55	0.024	194.4	0.0533
689.57	0.024	194.4	0.0568
689.58	0.024	194.6	0.0586
689.60	0.025	194.9	0.0612
689.62	0.027	195.1	0.063
689.63	0.027	195.3	0.0639
689.65	0.028	195.5	0.0657
689.67	0.029	195.7	0.0657
689.68	0.029	195.7	0.0666
689.70	0.029	195.8	0.0675
689.72	0.029	195.9	0.0675
689.73	0.029	196	0.0675
689.75	0.029	196.1	0.0675
689.77	0.028	196.2	0.0675
689.78	0.027	196.2	0.0657
689.80	0.027	196.3	0.0657
689.82	0.026	196.3	0.0639
689.83	0.025	196.3	0.0639
689.85	0.023	196.3	0.063
689.87	0.023	196.2	0.0612
689.88	0.022	196.2	0.0577
689.90	0.02	196.1	0.0559
689.92	0.018	196	0.0533
689.93	0.017	195.9	0.0515
689.95	0.014	195.7	0.0515
689.97	0.013	195.7	0.0479
689.98	0.013	195.6	0.0453
690.00	0.011	195.4	0.0408
690.02	0.008	195.1	0.0373
690.03	0.007	194.9	0.0346
690.05	0.006	194.7	0.0311
690.07	0.002	194.4	0.0311
690.08	0	194.4	0.0257
690.10	0	194.2	0.0222
690.12	-0.001	194	0.0178
690.13	-0.005	193.7	0.0133

Prova triassiale ciclica SN04-C1			
pressione di confinamento (kPa)		80	
deviatore ciclico (kPa)		95	
frequenza (hz)		0.00625	
tempo	cella di carico	$\Delta u$	LVDT
(min)	kN	(kPa)	$\delta$ (mm)
690.15	-0.005	193.5	0.0107
690.17	-0.007	193.2	0.0071
690.18	-0.009	192.9	0.0071
690.20	-0.01	192.9	0.0044
690.22	-0.01	192.6	0.0009
690.23	-0.012	192.4	-0.0018
690.25	-0.013	192.1	-0.0044
690.27	-0.014	191.9	-0.0062
690.28	-0.015	191.7	-0.0071
690.30	-0.016	191.5	-0.0071
690.32	-0.017	191.5	-0.0098
690.33	-0.017	191.3	-0.0107
690.35	-0.017	191.2	-0.0107
690.37	-0.017	191.1	-0.0115
690.38	-0.017	190.9	-0.0115
690.40	-0.017	190.8	-0.0124
690.42	-0.017	190.7	-0.0124
690.43	-0.016	190.7	-0.0124
690.45	-0.016	190.7	-0.0107
690.47	-0.016	190.6	-0.0107
690.48	-0.015	190.7	-0.0098
690.50	-0.013	190.7	-0.008
690.52	-0.013	190.6	-0.0071
690.53	-0.012	190.7	-0.0053
690.55	-0.01	190.8	-0.0036
690.57	-0.009	190.8	0
690.58	-0.006	191	0
690.60	-0.005	191.2	0.0027
690.62	-0.005	191.2	0.0053
690.63	-0.004	191.3	0.008
690.65	-0.001	191.5	0.0124
690.67	0.002	191.7	0.0151
690.68	0.003	191.9	0.0186
690.70	0.005	192.2	0.0222
690.72	0.007	192.4	0.0222
690.73	0.007	192.4	0.0257
690.75	0.009	192.6	0.0311
690.77	0.012	192.9	0.0355
690.78	0.015	193.1	0.0391
690.80	0.015	193.3	0.0417
690.82	0.017	193.6	0.0453
690.83	0.02	193.8	0.0453
690.85	0.02	193.8	0.0488
690.88	0.02	194	0.0524
690.90	0.022	194.3	0.055
690.92	0.024	194.6	0.0577
690.93	0.025	194.8	0.0595
690.93	0.025	195	0.0612
690.95	0.027	195.2	0.0612
690.97	0.027	195.2	0.063
690.98	0.027	195.4	0.0639
691.00	0.028	195.6	0.0657
691.02	0.029	195.7	0.0666
691.03	0.029	195.9	0.0666
691.05	0.029	196	0.0675
691.07	0.029	196.1	0.0675
691.08	0.029	196.1	0.0675
691.10	0.029	196.2	0.0675

Prova triassiale ciclica SN04-C1			
pressione di confinamento (kPa)		80	
deviatore ciclico (kPa)		95	
frequenza (hz)		0.00625	
tempo	cella di carico	$\Delta u$	LVDT
(min)	kN	(kPa)	$\delta$ (mm)
691.12	0.028	196.2	0.0666
691.13	0.027	196.3	0.0657
691.15	0.026	196.3	0.0639
691.17	0.025	196.3	0.0621
691.18	0.023	196.2	0.0621
691.20	0.022	196.2	0.0604
691.22	0.022	196.2	0.0595
691.23	0.019	196	0.0559
691.25	0.018	196	0.055
691.27	0.018	196	0.0524
691.28	0.016	195.8	0.0488
691.30	0.013	195.6	0.0453
691.32	0.012	195.5	0.0435
691.33	0.011	195.3	0.0399
691.35	0.007	195	0.0399
691.37	0.006	195	0.0355
691.38	0.006	194.9	0.0328
691.40	0.004	194.6	0.0284
691.42	0.001	194.3	0.0231
691.43	-0.001	194.1	0.0204
691.45	-0.002	193.9	0.016
691.47	-0.005	193.6	0.016
691.48	-0.006	193.3	0.0124
691.50	-0.006	193.3	0.0089
691.52	-0.007	193.1	0.0053
691.53	-0.01	192.7	0.0018
691.55	-0.011	192.5	-0.0009
691.57	-0.012	192.3	-0.0027
691.58	-0.014	192.1	-0.0027
691.60	-0.015	191.8	-0.0053
691.62	-0.015	191.8	-0.0071
691.63	-0.016	191.7	-0.0089
691.65	-0.016	191.5	-0.0098
691.67	-0.017	191.3	-0.0115
691.68	-0.017	191.2	-0.0115
691.70	-0.017	191	-0.0115
691.72	-0.017	190.9	-0.0115
691.73	-0.017	190.9	-0.0124
691.75	-0.017	190.8	-0.0115
691.77	-0.016	190.7	-0.0115
691.78	-0.016	190.7	-0.0115
691.80	-0.016	190.7	-0.0098
691.82	-0.014	190.7	-0.0089
691.83	-0.012	190.7	-0.0089
691.85	-0.012	190.7	-0.0071
691.87	-0.012	190.7	-0.0053
691.88	-0.011	190.8	-0.0036
691.90	-0.008	190.9	-0.0009
691.92	-0.007	191	0.0009
691.93	-0.006	191.2	0.0044
691.95	-0.003	191.3	0.0071
691.97	-0.002	191.4	0.0098
691.98	-0.001	191.6	0.0133
692.00	0.002	191.8	0.0133
692.02	0.004	191.8	0.0169
692.03	0.004	192	0.0204
692.05	0.005	192.3	0.024
692.07	0.009	192.5	0.0284



Prova triassiale ciclica SN04-C1			
pressione di confinamento (kPa)		80	
deviatore ciclico (kPa)		95	
frequenza (hz)		0.00625	
tempo	cella di carico	$\Delta u$	LVDT
(min)	kN	(kPa)	$\delta$ (mm)
692.08	0.01	192.7	0.032
692.10	0.012	193	0.0364
692.12	0.015	193.2	0.0364
692.13	0.016	193.2	0.0399
692.15	0.016	193.4	0.0426
692.17	0.017	193.7	0.0462
692.18	0.021	194	0.0506
692.20	0.021	194.2	0.0524
692.22	0.022	194.4	0.0559
692.23	0.025	194.7	0.0559
692.25	0.025	194.7	0.0586
692.27	0.025	194.9	0.0595
692.28	0.026	195.1	0.0621
692.32	0.027	195.3	0.0639
692.33	0.028	195.5	0.0648
692.35	0.028	195.7	0.0657
692.37	0.028	195.8	0.0657
692.38	0.029	195.8	0.0666
692.38	0.029	196	0.0675
692.40	0.029	196.1	0.0675
692.42	0.029	196.2	0.0675
692.43	0.028	196.3	0.0666
692.45	0.028	196.3	0.0657
692.47	0.027	196.3	0.0657
692.48	0.025	196.3	0.0648
692.50	0.025	196.3	0.063
692.52	0.025	196.3	0.0621
692.53	0.023	196.2	0.0595
692.55	0.021	196.2	0.0577
692.57	0.02	196.1	0.055
692.58	0.018	196	0.055
692.60	0.016	195.8	0.0524
692.62	0.016	195.8	0.0497
692.63	0.015	195.7	0.047
692.65	0.012	195.5	0.0435
692.67	0.01	195.3	0.0399
692.68	0.009	195.1	0.0364
692.70	0.007	194.9	0.0337
692.72	0.005	194.7	0.0311
692.73	0.003	194.5	0.0257
692.75	0	194.2	0.0257
692.77	-0.002	194	0.0213
692.78	-0.002	194	0.0178
692.80	-0.003	193.8	0.0142
692.82	-0.005	193.4	0.0107
692.83	-0.007	193.2	0.0071
692.85	-0.008	193	0.0044
692.87	-0.01	192.6	0.0044
692.88	-0.012	192.4	0.0009
692.90	-0.012	192.4	-0.0018
692.92	-0.012	192.2	-0.0036
692.93	-0.014	192	-0.0062
692.95	-0.015	191.7	-0.008
692.97	-0.016	191.6	-0.0098
692.98	-0.017	191.4	-0.0107
693.00	-0.017	191.2	-0.0107
693.02	-0.017	191.2	-0.0124
693.03	-0.017	191.1	-0.0124

Prova triassiale ciclica SN04-C1			
pressione di confinamento (kPa)		80	
deviatore ciclico (kPa)		95	
frequenza (hz)		0.00625	
tempo	cella di carico	$\Delta u$	LVDT
(min)	kN	(kPa)	$\delta$ (mm)
693.05	-0.017	191	-0.0124
693.07	-0.017	190.9	-0.0124
693.08	-0.017	190.8	-0.0115
693.10	-0.016	190.7	-0.0115
693.12	-0.016	190.7	-0.0115
693.13	-0.016	190.7	-0.0115
693.15	-0.015	190.7	-0.0098
693.17	-0.014	190.7	-0.008
693.18	-0.012	190.7	-0.0071
693.20	-0.011	190.8	-0.0044
693.22	-0.01	190.9	-0.0027
693.23	-0.007	191	-0.0027
693.25	-0.006	191	0
693.27	-0.006	191.1	0.0018
693.28	-0.005	191.2	0.0053
693.30	-0.002	191.4	0.0089
693.32	-0.001	191.5	0.0115
693.33	0.001	191.8	0.0151
693.35	0.004	192	0.0151
693.37	0.005	192	0.0186
693.38	0.005	192.2	0.0222
693.40	0.01	192.6	0.0284
693.42	0.011	192.6	0.0302
693.43	0.011	192.8	0.0328
693.45	0.012	193.1	0.0373
693.47	0.016	193.3	0.0408
693.48	0.017	193.6	0.0444
693.50	0.018	193.8	0.0479
693.52	0.021	194.1	0.0479
693.53	0.022	194.1	0.0515
693.55	0.022	194.3	0.0533
693.57	0.023	194.5	0.0559
693.58	0.025	194.8	0.0595
693.60	0.026	195	0.0612
693.62	0.026	195.2	0.0621
693.63	0.028	195.4	0.0621
693.65	0.028	195.4	0.0639
693.67	0.028	195.6	0.0657
693.68	0.028	195.7	0.0657
693.70	0.029	195.9	0.0666
693.72	0.029	196	0.0666
693.73	0.028	196.1	0.0666
693.75	0.028	196.2	0.0666
693.78	0.028	196.2	0.0666
693.80	0.028	196.3	0.0666
693.82	0.028	196.3	0.0657
693.83	0.026	196.3	0.0639
693.83	0.025	196.3	0.0621
693.85	0.024	196.3	0.0604
693.87	0.022	196.2	0.0604
693.88	0.021	196.2	0.0586
693.90	0.021	196.2	0.0568
693.92	0.02	196.1	0.0533
693.93	0.017	195.9	0.0506
693.95	0.015	195.8	0.0479
693.97	0.014	195.7	0.0444
693.98	0.011	195.4	0.0444
694.00	0.009	195.2	0.0408

Prova triassiale ciclica SN04-C1			
pressione di confinamento (kPa)		80	
deviatore ciclico (kPa)		95	
frequenza (hz)		0.00625	
tempo	cella di carico	$\Delta u$	LVDT
(min)	kN	(kPa)	$\delta$ (mm)
694.02	0.009	195.2	0.0382
694.03	0.008	195	0.0337
694.05	0.005	194.7	0.0302
694.07	0.003	194.5	0.0257
694.08	0.001	194.3	0.0222
694.10	-0.002	194	0.0222
694.12	-0.003	193.8	0.0178
694.13	-0.004	193.6	0.0124
694.15	-0.006	193.3	0.0124
694.17	-0.007	193.1	0.0098
694.18	-0.007	193.1	0.0062
694.20	-0.009	192.8	0.0027
694.22	-0.011	192.5	-0.0009
694.23	-0.013	192.3	-0.0036
694.25	-0.013	192.1	-0.0053
694.27	-0.015	191.8	-0.008
694.28	-0.016	191.6	-0.008
694.30	-0.016	191.6	-0.0089
694.32	-0.016	191.5	-0.0098
694.33	-0.017	191.3	-0.0115
694.35	-0.018	191.2	-0.0124
694.37	-0.017	191	-0.0124
694.38	-0.017	190.9	-0.0124
694.40	-0.017	190.8	-0.0124
694.42	-0.017	190.8	-0.0124
694.43	-0.017	190.8	-0.0124
694.45	-0.016	190.8	-0.0115
694.47	-0.015	190.7	-0.0107
694.48	-0.015	190.7	-0.0089
694.50	-0.013	190.7	-0.0071
694.52	-0.011	190.8	-0.0071
694.53	-0.011	190.8	-0.0062
694.55	-0.011	190.8	-0.0036
694.57	-0.01	190.9	-0.0018
694.58	-0.007	191	0.0009
694.60	-0.006	191.2	0.0036
694.62	-0.004	191.3	0.0071
694.63	-0.001	191.5	0.0071
694.65	0	191.5	0.0107
694.67	0	191.6	0.0133
694.68	0.002	191.9	0.0169
694.70	0.005	192.1	0.0213
694.72	0.006	192.3	0.0249
694.73	0.008	192.6	0.0293
694.75	0.012	192.9	0.0293
694.77	0.012	192.9	0.0337
694.78	0.012	193	0.0364
694.80	0.014	193.3	0.0408
694.82	0.017	193.6	0.0444
694.83	0.019	193.8	0.0479
694.85	0.02	194.1	0.0506
694.87	0.023	194.3	0.0541
694.88	0.023	194.5	0.055
694.90	0.023	194.7	0.0577
694.92	0.026	194.9	0.0577
694.93	0.026	194.9	0.0604
694.95	0.026	195.1	0.0612
694.97	0.027	195.4	0.063

Prova triassiale ciclica SN04-C1			
pressione di confinamento (kPa)		80	
deviatore ciclico (kPa)		95	
frequenza (hz)		0.00625	
tempo	cella di carico	$\Delta u$	LVDT
(min)	kN	(kPa)	$\delta$ (mm)
694.98	0.028	195.6	0.0648
695.00	0.028	195.7	0.0657
695.02	0.029	195.9	0.0666
695.03	0.029	196	0.0666
695.05	0.029	196	0.0675
695.07	0.029	196.1	0.0675
695.08	0.029	196.2	0.0675
695.10	0.028	196.3	0.0666
695.12	0.027	196.4	0.0657
695.13	0.027	196.4	0.0648
695.15	0.026	196.4	0.0648
695.17	0.025	196.4	0.063
695.18	0.025	196.4	0.0621
695.20	0.023	196.3	0.0595
695.23	0.021	196.2	0.0577
695.25	0.02	196.2	0.055
695.27	0.019	196.1	0.0533
695.28	0.016	195.9	0.0533
695.28	0.015	195.9	0.0497
695.30	0.015	195.8	0.047
695.32	0.013	195.6	0.0426
695.33	0.01	195.4	0.0391
695.35	0.008	195.2	0.0364
695.37	0.007	195	0.0328
695.38	0.004	194.7	0.0328
695.40	0.002	194.5	0.0284
695.42	0.002	194.5	0.0249
695.43	0.001	194.3	0.0204
695.45	-0.002	194	0.0169
695.47	-0.004	193.7	0.0142
695.48	-0.005	193.5	0.0098
695.50	-0.008	193.2	0.0098
695.52	-0.009	192.9	0.0062
695.53	-0.009	192.9	0.0036
695.55	-0.01	192.7	0
695.57	-0.012	192.4	-0.0036
695.58	-0.014	192.2	-0.0053
695.60	-0.014	192	-0.0062
695.62	-0.015	191.8	-0.008
695.63	-0.016	191.6	-0.0098
695.65	-0.016	191.5	-0.0107
695.67	-0.017	191.3	-0.0107
695.68	-0.017	191.2	-0.0115
695.70	-0.017	191.2	-0.0115
695.72	-0.017	191	-0.0124
695.73	-0.017	190.9	-0.0133
695.75	-0.017	190.8	-0.0124
695.77	-0.017	190.8	-0.0115
695.78	-0.016	190.8	-0.0115
695.80	-0.014	190.7	-0.0107
695.82	-0.014	190.7	-0.0098
695.83	-0.014	190.7	-0.0089
695.85	-0.013	190.8	-0.0071
695.87	-0.011	190.8	-0.0053
695.88	-0.01	190.9	-0.0027
695.90	-0.008	191	0
695.92	-0.006	191.2	0
695.93	-0.006	191.2	0.0018

Prova triassiale ciclica SN04-C1			
pressione di confinamento (kPa)		80	
deviatore ciclico (kPa)		95	
frequenza (hz)		0.00625	
tempo	cella di carico	$\Delta u$	LVDT
(min)	kN	(kPa)	$\delta$ (mm)
695.95	-0.005	191.2	0.0044
695.97	-0.003	191.5	0.008
695.98	-0.001	191.6	0.0107
696.00	0.001	191.8	0.0151
696.02	0.004	192.1	0.0195
696.03	0.006	192.2	0.0195
696.05	0.006	192.2	0.0222
696.07	0.007	192.4	0.0257
696.08	0.01	192.7	0.0302
696.10	0.012	193	0.0346
696.12	0.014	193.2	0.0382
696.13	0.016	193.5	0.0426
696.15	0.018	193.7	0.0426
696.17	0.018	193.7	0.0453
696.18	0.019	194	0.0479
696.20	0.021	194.2	0.0506
696.22	0.023	194.5	0.0533
696.23	0.024	194.7	0.0559
696.25	0.025	194.9	0.0586
696.27	0.026	195.1	0.0586
696.28	0.027	195.1	0.0604
696.30	0.027	195.3	0.0621
696.32	0.028	195.7	0.0639
696.33	0.028	195.7	0.0639
696.35	0.028	195.8	0.0648
696.37	0.029	196	0.0657
696.38	0.029	196.1	0.0657
696.40	0.029	196.2	0.0657
696.42	0.029	196.3	0.0657
696.43	0.028	196.4	0.0657
696.45	0.027	196.4	0.0657
696.47	0.027	196.4	0.0648
696.48	0.027	196.4	0.063
696.50	0.024	196.4	0.0612
696.52	0.024	196.4	0.0604
696.53	0.023	196.4	0.0586
696.55	0.021	196.2	0.0586
696.57	0.019	196.2	0.0559
696.58	0.019	196.2	0.0533
696.60	0.018	196.1	0.0506
696.62	0.015	195.9	0.0479
696.63	0.014	195.8	0.0453
696.65	0.012	195.6	0.0408
696.68	0.008	195.3	0.0408
696.70	0.008	195.3	0.0373
696.72	0.008	195.1	0.0346
696.73	0.006	194.9	0.0311
696.73	0.002	194.6	0.0257
696.75	0.001	194.4	0.0222
696.77	0	194.2	0.0186
696.78	-0.003	193.9	0.0186
696.80	-0.005	193.7	0.0142
696.82	-0.005	193.7	0.0115
696.83	-0.006	193.4	0.0071
696.85	-0.009	193.1	0.0036
696.87	-0.01	192.9	0.0009
696.88	-0.011	192.6	-0.0018
696.90	-0.013	192.3	-0.0018

Prova triassiale ciclica SN04-C1			
pressione di confinamento (kPa)		80	
deviatore ciclico (kPa)		95	
frequenza (hz)		0.00625	
tempo	cella di carico	$\Delta u$	LVDT
(min)	kN	(kPa)	$\delta$ (mm)
696.92	-0.014	192.1	-0.0044
696.93	-0.014	192.1	-0.0062
696.95	-0.014	191.9	-0.008
696.97	-0.016	191.7	-0.0107
696.98	-0.016	191.5	-0.0107
697.00	-0.017	191.4	-0.0124
697.02	-0.017	191.2	-0.0124
697.03	-0.017	191.1	-0.0133
697.05	-0.017	191	-0.0133
697.07	-0.017	190.9	-0.0133
697.08	-0.017	190.8	-0.0133
697.10	-0.016	190.8	-0.0133
697.12	-0.016	190.7	-0.0124
697.13	-0.016	190.8	-0.0115
697.15	-0.014	190.7	-0.0098
697.17	-0.014	190.7	-0.0089
697.18	-0.013	190.8	-0.0071
697.20	-0.01	190.9	-0.0071
697.22	-0.009	190.9	-0.0053
697.23	-0.009	190.9	-0.0027
697.25	-0.008	191.1	0
697.27	-0.005	191.2	0.0027
697.28	-0.004	191.3	0.0053
697.30	-0.002	191.6	0.008
697.32	0.001	191.7	0.008
697.33	0.002	191.7	0.0124
697.35	0.002	191.9	0.016
697.37	0.004	192.1	0.0195
697.38	0.007	192.4	0.0231
697.40	0.008	192.5	0.0275
697.42	0.01	192.9	0.032
697.43	0.014	193.1	0.032
697.45	0.014	193.1	0.0355
697.47	0.014	193.3	0.0391
697.48	0.016	193.6	0.0426
697.50	0.019	193.9	0.0462
697.52	0.02	194.1	0.0488
697.53	0.021	194.3	0.0524
697.55	0.024	194.6	0.0524
697.57	0.024	194.6	0.0559
697.58	0.024	194.8	0.0577
697.60	0.025	195	0.0595
697.62	0.027	195.2	0.0621
697.63	0.027	195.4	0.063
697.65	0.028	195.6	0.0639
697.67	0.028	195.8	0.0639
697.68	0.029	195.8	0.0648
697.70	0.029	196	0.0657
697.72	0.029	196.1	0.0657
697.73	0.029	196.2	0.0657
697.75	0.029	196.3	0.0657
697.77	0.028	196.4	0.0657
697.78	0.028	196.4	0.0648
697.80	0.027	196.4	0.0639
697.82	0.026	196.5	0.063
697.83	0.025	196.4	0.063
697.85	0.023	196.4	0.0612
697.87	0.023	196.4	0.0595

Prova triassiale ciclica SN04-C1			
pressione di confinamento (kPa)		80	
deviatore ciclico (kPa)		95	
frequenza (hz)		0.00625	
tempo	cella di carico	$\Delta u$	LVDT
(min)	kN	(kPa)	$\delta$ (mm)
697.88	0.022	196.3	0.0577
697.90	0.02	196.2	0.055
697.92	0.019	196.2	0.0524
697.93	0.017	196	0.0497
697.95	0.014	195.8	0.0497
697.97	0.013	195.8	0.0462
697.98	0.013	195.7	0.0435
698.00	0.011	195.6	0.0399
698.02	0.008	195.2	0.0355
698.03	0.007	195.1	0.0328
698.05	0.005	194.9	0.0293
698.07	0.002	194.6	0.0293
698.08	0	194.3	0.024
698.10	0	194.3	0.0213
698.12	-0.001	194.1	0.0169
698.15	-0.004	193.8	0.0124
698.17	-0.006	193.6	0.0098
698.18	-0.006	193.3	0.0062
698.20	-0.009	193	0.0062
698.20	-0.011	192.8	0.0018
698.22	-0.011	192.8	0
698.23	-0.012	192.5	-0.0027
698.25	-0.013	192.3	-0.0053
698.27	-0.014	192.1	-0.0071
698.28	-0.015	191.9	-0.0089
698.30	-0.016	191.6	-0.0089
698.32	-0.017	191.5	-0.0107
698.33	-0.017	191.5	-0.0124
698.35	-0.017	191.3	-0.0124
698.37	-0.017	191.2	-0.0124
698.38	-0.017	191.1	-0.0133
698.40	-0.017	191	-0.0133
698.42	-0.017	190.9	-0.0133
698.43	-0.016	190.8	-0.0133
698.45	-0.015	190.8	-0.0124
698.47	-0.015	190.8	-0.0115
698.48	-0.015	190.8	-0.0107
698.50	-0.013	190.8	-0.0089
698.52	-0.013	190.8	-0.008
698.53	-0.012	190.9	-0.0062
698.55	-0.01	190.9	-0.0044
698.57	-0.009	191	-0.0018
698.58	-0.007	191.2	0.0009
698.60	-0.004	191.3	0.0009
698.62	-0.003	191.3	0.0044
698.63	-0.003	191.4	0.0062
698.65	-0.002	191.6	0.0107
698.67	0.002	191.8	0.0142
698.68	0.003	192	0.0169
698.70	0.004	192.2	0.0213
698.72	0.008	192.5	0.0213
698.73	0.009	192.5	0.0249
698.75	0.009	192.7	0.0293
698.77	0.011	193	0.0337
698.78	0.015	193.2	0.0382
698.80	0.015	193.4	0.0399
698.82	0.017	193.7	0.0444
698.83	0.02	194	0.0444

Prova triassiale ciclica SN04-C1			
pressione di confinamento (kPa)		80	
deviatore ciclico (kPa)		95	
frequenza (hz)		0.00625	
tempo	cella di carico	$\Delta u$	LVDT
(min)	kN	(kPa)	$\delta$ (mm)
698.85	0.021	194	0.0479
698.87	0.021	194.2	0.0497
698.88	0.022	194.4	0.0533
698.90	0.024	194.7	0.0559
698.92	0.025	194.9	0.0586
698.93	0.026	195.1	0.0612
698.95	0.027	195.4	0.0612
698.97	0.028	195.6	0.063
698.98	0.028	195.6	0.0639
699.00	0.028	195.7	0.0648
699.02	0.029	195.9	0.0657
699.03	0.029	196	0.0657
699.05	0.029	196.1	0.0666
699.07	0.029	196.3	0.0666
699.08	0.029	196.4	0.0666
699.10	0.029	196.4	0.0666
699.12	0.028	196.4	0.0657
699.13	0.027	196.5	0.0639
699.15	0.025	196.4	0.063
699.17	0.025	196.5	0.0621
699.18	0.024	196.4	0.0604
699.20	0.022	196.3	0.0604
699.22	0.021	196.3	0.0568
699.23	0.02	196.2	0.055
699.25	0.018	196.1	0.055
699.27	0.016	196.1	0.0524
699.28	0.016	196	0.0488
699.30	0.014	195.8	0.0453
699.32	0.011	195.6	0.0426
699.33	0.011	195.5	0.0391
699.35	0.009	195.2	0.0355
699.37	0.005	194.9	0.0355
699.38	0.004	194.9	0.0311
699.40	0.004	194.8	0.0284
699.42	0.002	194.5	0.0231
699.43	-0.001	194.2	0.0186
699.45	-0.002	194	0.016
699.47	-0.003	193.7	0.0124
699.48	-0.007	193.4	0.0124
699.50	-0.008	193.4	0.008
699.52	-0.008	193.2	0.0044
699.53	-0.009	192.9	0.0018
699.55	-0.011	192.7	-0.0009
699.58	-0.012	192.5	-0.0027
699.60	-0.013	192.2	-0.0053
699.62	-0.015	192	-0.0053
699.63	-0.015	192	-0.008
699.65	-0.015	191.8	-0.0098
699.65	-0.016	191.6	-0.0107
699.67	-0.017	191.5	-0.0115
699.68	-0.017	191.3	-0.0124
699.70	-0.017	191.2	-0.0124
699.72	-0.017	191.1	-0.0124
699.73	-0.017	191.1	-0.0124
699.75	-0.017	191	-0.0133
699.77	-0.017	190.9	-0.0124
699.78	-0.016	190.9	-0.0115
699.80	-0.015	190.8	-0.0107



Prova triassiale ciclica SN04-C1			
pressione di confinamento (kPa)		80	
deviatore ciclico (kPa)		95	
frequenza (hz)		0.00625	
tempo	cella di carico	$\Delta u$	LVDT
(min)	kN	(kPa)	$\delta$ (mm)
699.82	-0.015	190.8	-0.0098
699.83	-0.013	190.9	-0.0098
699.85	-0.012	190.9	-0.008
699.87	-0.012	190.9	-0.0062
699.88	-0.011	190.9	-0.0044
699.90	-0.008	191.1	-0.0018
699.92	-0.007	191.2	0
699.93	-0.006	191.3	0.0036
699.95	-0.002	191.5	0.0071
699.97	-0.002	191.5	0.008
699.98	-0.001	191.7	0.0115
700.00	0.002	191.9	0.0115
700.02	0.004	192.1	0.0151
700.03	0.004	192.1	0.0186
700.05	0.005	192.3	0.0222
700.07	0.008	192.6	0.0275
700.08	0.01	192.8	0.0311
700.10	0.012	193	0.0346
700.12	0.015	193.3	0.0346
700.13	0.016	193.6	0.0391
700.15	0.016	193.6	0.0417
700.17	0.017	193.8	0.0453
700.18	0.02	194.1	0.0488
700.20	0.021	194.3	0.0515
700.22	0.022	194.5	0.055
700.23	0.024	194.8	0.055
700.25	0.026	195	0.0568
700.27	0.026	195	0.0595
700.28	0.026	195.2	0.0612
700.30	0.027	195.4	0.063
700.32	0.028	195.7	0.0639
700.33	0.028	195.8	0.0648
700.35	0.029	196	0.0657
700.37	0.029	196.1	0.0657
700.38	0.029	196.1	0.0666
700.40	0.029	196.2	0.0666
700.42	0.029	196.3	0.0666
700.43	0.029	196.4	0.0666
700.45	0.027	196.4	0.0648
700.47	0.027	196.5	0.0639
700.48	0.026	196.5	0.0639
700.50	0.024	196.5	0.063
700.52	0.024	196.4	0.0612
700.53	0.024	196.4	0.0595
700.55	0.022	196.3	0.0577
700.57	0.02	196.3	0.055
700.58	0.018	196.1	0.0515
700.60	0.016	196	0.0515
700.62	0.015	196	0.0488
700.63	0.015	195.9	0.047
700.65	0.013	195.7	0.0426
700.67	0.009	195.4	0.0382
700.68	0.009	195.3	0.0373
700.70	0.008	195	0.0337
700.72	0.004	194.8	0.0302
700.73	0.003	194.6	0.0249
700.75	0.002	194.4	0.0213
700.77	-0.002	194.1	0.0213

Prova triassiale ciclica SN04-C1			
pressione di confinamento (kPa)		80	
deviatore ciclico (kPa)		95	
frequenza (hz)		0.00625	
tempo	cella di carico	$\Delta u$	LVDT
(min)	kN	(kPa)	$\delta$ (mm)
700.78	-0.003	194.1	0.0169
700.80	-0.003	193.9	0.0142
700.82	-0.004	193.6	0.0107
700.83	-0.008	193.3	0.0062
700.85	-0.008	193.1	0.0036
700.87	-0.01	192.8	0.0009
700.88	-0.012	192.5	0.0009
700.90	-0.013	192.5	-0.0027
700.92	-0.013	192.3	-0.0044
700.93	-0.013	192.1	-0.0071
700.95	-0.015	191.9	-0.0089
700.97	-0.016	191.7	-0.0098
700.98	-0.016	191.5	-0.0115
701.00	-0.017	191.4	-0.0115
701.02	-0.017	191.4	-0.0124
701.05	-0.017	191.2	-0.0133
701.07	-0.017	191.1	-0.0133
701.08	-0.017	191	-0.0133
701.10	-0.017	190.9	-0.0133
701.10	-0.017	190.8	-0.0124
701.12	-0.016	190.8	-0.0124
701.13	-0.015	190.8	-0.0115
701.15	-0.015	190.8	-0.0107
701.17	-0.014	190.8	-0.0089
701.18	-0.012	190.9	-0.0071
701.20	-0.011	190.9	-0.0062
701.22	-0.01	191	-0.0036
701.23	-0.007	191.1	-0.0036
701.25	-0.007	191.1	-0.0009
701.27	-0.007	191.2	0.0009
701.28	-0.005	191.3	0.0044
701.30	-0.001	191.6	0.008
701.32	-0.001	191.7	0.0107
701.33	0.001	191.9	0.0142
701.35	0.005	192.1	0.0142
701.37	0.006	192.1	0.0186
701.38	0.006	192.3	0.0213
701.40	0.009	192.7	0.0257
701.42	0.011	192.7	0.0284
701.43	0.011	192.9	0.032
701.45	0.012	193.2	0.0364
701.47	0.016	193.5	0.0408
701.48	0.017	193.7	0.0435
701.50	0.018	193.9	0.047
701.52	0.021	194.2	0.047
701.53	0.022	194.2	0.0497
701.55	0.022	194.4	0.0524
701.57	0.023	194.6	0.0559
701.58	0.025	194.9	0.0586
701.60	0.026	195.1	0.0604
701.62	0.027	195.3	0.0621
701.63	0.027	195.6	0.0621
701.65	0.028	195.7	0.063
701.67	0.028	195.7	0.0639
701.68	0.028	195.9	0.0657
701.70	0.029	196.1	0.0657
701.72	0.029	196.2	0.0666
701.73	0.029	196.3	0.0666

Prova triassiale ciclica SN04-C1			
pressione di confinamento (kPa)		80	
deviatore ciclico (kPa)		95	
frequenza (hz)		0.00625	
tempo	cella di carico	$\Delta u$	LVDT
(min)	kN	(kPa)	$\delta$ (mm)
701.75	0.029	196.4	0.0666
701.77	0.028	196.4	0.0666
701.78	0.028	196.4	0.0657
701.80	0.027	196.4	0.0648
701.82	0.026	196.5	0.063
701.83	0.025	196.4	0.0612
701.85	0.024	196.4	0.0595
701.87	0.022	196.3	0.0577
701.88	0.021	196.3	0.0577
701.90	0.02	196.3	0.0559
701.92	0.02	196.2	0.0541
701.93	0.018	196.1	0.0506
701.95	0.015	195.9	0.047
701.97	0.013	195.8	0.0453
701.98	0.012	195.6	0.0417
702.00	0.009	195.4	0.0417
702.02	0.009	195.4	0.0382
702.03	0.008	195.2	0.0346
702.05	0.006	194.9	0.0302
702.07	0.002	194.7	0.0257
702.08	0.001	194.5	0.0222
702.10	0	194.2	0.0186
702.12	-0.004	193.9	0.0142
702.13	-0.004	193.8	0.0124
702.15	-0.005	193.5	0.0089
702.17	-0.008	193.2	0.0089
702.18	-0.009	193.2	0.0053
702.20	-0.009	193	0.0027
702.22	-0.01	192.7	0
702.23	-0.013	192.4	-0.0036
702.25	-0.013	192.2	-0.0053
702.27	-0.014	192	-0.0071
702.28	-0.016	191.8	-0.0071
702.30	-0.016	191.8	-0.0089
702.32	-0.016	191.6	-0.0107
702.33	-0.017	191.5	-0.0115
702.35	-0.017	191.3	-0.0124
702.37	-0.017	191.2	-0.0124
702.38	-0.017	191	-0.0124
702.40	-0.017	191	-0.0124
702.42	-0.017	191	-0.0133
702.43	-0.017	190.9	-0.0124
702.45	-0.016	190.8	-0.0115
702.48	-0.015	190.8	-0.0107
702.50	-0.014	190.8	-0.0098
702.52	-0.014	190.8	-0.008
702.53	-0.012	190.9	-0.008
702.55	-0.011	190.9	-0.0062
702.55	-0.011	190.9	-0.0044
702.57	-0.009	191	-0.0018
702.58	-0.007	191.2	0
702.60	-0.006	191.3	0.0036
702.62	-0.004	191.4	0.0071
702.63	0	191.6	0.0071
702.65	0	191.6	0.0107
702.67	0	191.8	0.0124
702.68	0.001	192	0.016
702.70	0.005	192.2	0.0204

Prova triassiale ciclica SN04-C1			
pressione di confinamento (kPa)		80	
deviatore ciclico (kPa)		95	
frequenza (hz)		0.00625	
tempo	cella di carico	$\Delta u$	LVDT
(min)	kN	(kPa)	$\delta$ (mm)
702.72	0.006	192.4	0.024
702.73	0.008	192.6	0.0293
702.75	0.012	192.9	0.0293
702.77	0.013	192.9	0.0337
702.78	0.013	193.1	0.0364
702.80	0.014	193.4	0.0399
702.82	0.017	193.7	0.0444
702.83	0.018	193.9	0.0462
702.85	0.02	194.1	0.0506
702.87	0.021	194.4	0.0524
702.88	0.023	194.6	0.055
702.90	0.024	194.8	0.0577
702.92	0.025	195	0.0577
702.93	0.027	195.2	0.0604
702.95	0.027	195.2	0.0621
702.97	0.027	195.5	0.063
702.98	0.027	195.7	0.0639
703.00	0.028	195.8	0.0657
703.02	0.028	196	0.0657
703.03	0.029	196.1	0.0657
703.05	0.029	196.2	0.0666
703.07	0.029	196.2	0.0666
703.08	0.029	196.3	0.0666
703.10	0.028	196.4	0.0666
703.12	0.028	196.5	0.0657
703.13	0.027	196.5	0.0648
703.15	0.026	196.5	0.063
703.17	0.024	196.5	0.063
703.18	0.024	196.5	0.0612
703.20	0.023	196.5	0.0595
703.22	0.022	196.4	0.0577
703.23	0.02	196.3	0.055
703.25	0.019	196.2	0.0533
703.27	0.017	196	0.0497
703.28	0.014	195.9	0.0497
703.30	0.013	195.9	0.047
703.32	0.013	195.8	0.0435
703.33	0.011	195.5	0.0399
703.35	0.008	195.3	0.0364
703.37	0.007	195.1	0.0337
703.38	0.005	194.8	0.0302
703.40	0.002	194.6	0.0302
703.42	0.001	194.6	0.0249
703.43	0.001	194.4	0.0213
703.45	-0.001	194.1	0.0169
703.47	-0.004	193.8	0.0124
703.48	-0.006	193.6	0.0098
703.50	-0.007	193.3	0.0071
703.52	-0.009	193	0.0071
703.53	-0.01	193	0.0036
703.55	-0.01	192.8	0
703.57	-0.011	192.5	-0.0027
703.58	-0.014	192.3	-0.0053
703.60	-0.014	192.1	-0.0062
703.62	-0.015	191.9	-0.008
703.63	-0.016	191.7	-0.0098
703.65	-0.016	191.6	-0.0107
703.67	-0.017	191.4	-0.0115

Prova triassiale ciclica SN04-C1			
pressione di confinamento (kPa)		80	
deviatore ciclico (kPa)		95	
frequenza (hz)		0.00625	
tempo	cella di carico	$\Delta u$	LVDT
(min)	kN	(kPa)	$\delta$ (mm)
703.68	-0.017	191.2	-0.0115
703.70	-0.017	191.2	-0.0124
703.72	-0.017	191.2	-0.0124
703.73	-0.017	191	-0.0124
703.75	-0.017	190.9	-0.0124
703.77	-0.017	190.9	-0.0124
703.78	-0.016	190.8	-0.0107
703.80	-0.015	190.8	-0.0107
703.82	-0.014	190.8	-0.0098
703.83	-0.014	190.8	-0.0089
703.85	-0.013	190.9	-0.0071
703.87	-0.011	190.9	-0.0053
703.88	-0.01	191	-0.0036
703.90	-0.009	191.2	-0.0009
703.92	-0.006	191.3	-0.0009
703.95	-0.005	191.3	0.0018
703.97	-0.005	191.4	0.0044
703.98	-0.003	191.6	0.0089
704.00	0	191.7	0.0115
704.00	0.001	191.9	0.0142
704.02	0.002	192.1	0.0178
704.03	0.006	192.4	0.0178
704.05	0.007	192.4	0.0222
704.07	0.007	192.5	0.0257
704.08	0.009	192.8	0.0311
704.10	0.013	193.1	0.0355
704.12	0.014	193.3	0.0382
704.13	0.015	193.6	0.0417
704.15	0.018	193.8	0.0417
704.17	0.019	193.8	0.0462
704.18	0.019	194.1	0.0488
704.20	0.02	194.3	0.0524
704.22	0.023	194.5	0.0559
704.23	0.023	194.8	0.0568
704.25	0.024	195	0.0595
704.27	0.026	195.2	0.0595
704.28	0.027	195.2	0.0621
704.30	0.027	195.6	0.0639
704.32	0.028	195.8	0.0639
704.33	0.027	195.8	0.0648
704.35	0.027	195.9	0.0648
704.37	0.028	196.1	0.0666
704.38	0.029	196.2	0.0666
704.40	0.029	196.3	0.0675
704.42	0.028	196.4	0.0675
704.43	0.028	196.5	0.0675
704.45	0.027	196.5	0.0675
704.47	0.027	196.6	0.0666
704.48	0.027	196.6	0.0639
704.50	0.025	196.5	0.063
704.52	0.024	196.5	0.0621
704.53	0.023	196.5	0.0595
704.55	0.02	196.4	0.0595
704.57	0.019	196.3	0.0568
704.58	0.019	196.3	0.055
704.60	0.018	196.2	0.0524
704.62	0.015	196	0.0488
704.63	0.014	195.9	0.0462

Prova triassiale ciclica SN04-C1			
pressione di confinamento (kPa)		80	
deviatore ciclico (kPa)		95	
frequenza (hz)		0.00625	
tempo	cella di carico	$\Delta u$	LVDT
(min)	kN	(kPa)	$\delta$ (mm)
704.65	0.012	195.8	0.0426
704.67	0.009	195.5	0.0426
704.68	0.008	195.3	0.0391
704.70	0.008	195.3	0.0355
704.72	0.006	195.1	0.032
704.73	0.003	194.8	0.0275
704.75	0.001	194.5	0.0231
704.77	0	194.3	0.0195
704.78	-0.003	194	0.0195
704.80	-0.005	193.8	0.0151
704.82	-0.005	193.8	0.0115
704.83	-0.006	193.5	0.008
704.85	-0.008	193.2	0.0044
704.87	-0.011	193	0.0018
704.88	-0.011	192.8	-0.0009
704.90	-0.012	192.5	-0.0009
704.92	-0.014	192.3	-0.0027
704.93	-0.014	192.3	-0.0062
704.95	-0.014	192.1	-0.0071
704.97	-0.016	191.8	-0.0089
704.98	-0.016	191.7	-0.0107
705.00	-0.017	191.5	-0.0115
705.02	-0.017	191.4	-0.0124
705.03	-0.017	191.2	-0.0115
705.05	-0.017	191.2	-0.0124
705.07	-0.017	191	-0.0124
705.08	-0.017	191	-0.0124
705.10	-0.016	191	-0.0124
705.12	-0.016	190.9	-0.0115
705.13	-0.016	190.9	-0.0107
705.15	-0.014	190.9	-0.0098
705.17	-0.013	190.9	-0.008
705.18	-0.012	190.9	-0.0062
705.20	-0.01	191	-0.0062
705.22	-0.01	191	-0.0044
705.23	-0.01	191.1	-0.0027
705.25	-0.008	191.3	0
705.27	-0.005	191.4	0.0036
705.28	-0.004	191.5	0.0062
705.30	-0.003	191.7	0.0098
705.32	0.001	191.9	0.0098
705.33	0.002	191.9	0.0142
705.35	0.002	192	0.0169
705.37	0.004	192.2	0.0195
705.38	0.007	192.5	0.0231
705.42	0.008	192.7	0.0275
705.43	0.01	193	0.0328
705.45	0.014	193.2	0.0328
705.45	0.014	193.2	0.0373
705.47	0.014	193.5	0.0399
705.48	0.016	193.7	0.0435
705.50	0.019	194	0.0479
705.52	0.02	194.2	0.0497
705.53	0.021	194.5	0.0524
705.55	0.024	194.7	0.0524
705.57	0.024	194.7	0.0559
705.58	0.024	194.9	0.0577
705.60	0.025	195.1	0.0604

Prova triassiale ciclica SN04-C1			
pressione di confinamento (kPa)		80	
deviatore ciclico (kPa)		95	
frequenza (hz)		0.00625	
tempo	cella di carico	$\Delta u$	LVDT
(min)	kN	(kPa)	$\delta$ (mm)
705.62	0.027	195.4	0.063
705.63	0.027	195.6	0.0639
705.65	0.028	195.8	0.0648
705.67	0.029	196	0.0648
705.68	0.029	196	0.0657
705.70	0.029	196.1	0.0666
705.72	0.029	196.2	0.0666
705.73	0.029	196.3	0.0666
705.75	0.028	196.4	0.0666
705.77	0.028	196.5	0.0666
705.78	0.028	196.6	0.0666
705.80	0.027	196.6	0.0648
705.82	0.026	196.6	0.0639
705.83	0.025	196.6	0.0639
705.85	0.023	196.6	0.0612
705.87	0.023	196.6	0.0604
705.88	0.022	196.5	0.0586
705.90	0.02	196.4	0.0559
705.92	0.019	196.3	0.0533
705.93	0.017	196.2	0.0506
705.95	0.014	196	0.0506
705.97	0.013	195.9	0.047
705.98	0.013	195.9	0.0444
706.00	0.011	195.7	0.0408
706.02	0.008	195.4	0.0364
706.03	0.007	195.2	0.0337
706.05	0.005	195	0.0293
706.07	0.002	194.7	0.0293
706.08	0	194.5	0.0249
706.10	0	194.5	0.0213
706.12	-0.001	194.3	0.0178
706.13	-0.004	194	0.0124
706.15	-0.006	193.7	0.0098
706.17	-0.007	193.5	0.0071
706.18	-0.008	193.2	0.0071
706.20	-0.011	192.9	0.0036
706.22	-0.011	192.9	0.0009
706.23	-0.011	192.7	-0.0027
706.25	-0.013	192.4	-0.0053
706.27	-0.015	192.2	-0.0071
706.28	-0.015	192	-0.008
706.30	-0.016	191.8	-0.008
706.32	-0.016	191.7	-0.0098
706.33	-0.016	191.7	-0.0107
706.35	-0.017	191.5	-0.0124
706.37	-0.017	191.3	-0.0124
706.38	-0.017	191.2	-0.0124
706.40	-0.017	191.1	-0.0124
706.42	-0.017	191	-0.0124
706.43	-0.016	191	-0.0124
706.45	-0.016	191	-0.0115
706.47	-0.016	191	-0.0107
706.48	-0.014	190.9	-0.0098
706.50	-0.013	190.9	-0.0089
706.52	-0.013	190.9	-0.008
706.53	-0.012	191	-0.0053
706.55	-0.009	191.1	-0.0027
706.57	-0.009	191.2	-0.0018

Prova triassiale ciclica SN04-C1			
pressione di confinamento (kPa)		80	
deviatore ciclico (kPa)		95	
frequenza (hz)		0.00625	
tempo	cella di carico	$\Delta u$	LVDT
(min)	kN	(kPa)	$\delta$ (mm)
706.58	-0.007	191.3	0.0018
706.60	-0.004	191.5	0.0018
706.62	-0.004	191.5	0.0044
706.63	-0.004	191.6	0.0071
706.65	-0.002	191.8	0.0115
706.67	0.001	192	0.0151
706.68	0.003	192.2	0.0186
706.70	0.005	192.4	0.0222
706.72	0.009	192.7	0.0222
706.73	0.009	192.7	0.0275
706.75	0.009	192.9	0.0302
706.77	0.011	193.2	0.0337
706.78	0.015	193.4	0.0382
706.80	0.015	193.6	0.0417
706.82	0.017	193.9	0.0444
706.85	0.02	194.2	0.0444
706.87	0.021	194.2	0.0488
706.88	0.021	194.4	0.0506
706.90	0.022	194.6	0.0541
706.92	0.024	194.8	0.0568
706.92	0.025	195.1	0.0586
706.93	0.025	195.3	0.0604
706.95	0.027	195.6	0.0604
706.97	0.028	195.6	0.0621
706.98	0.028	195.8	0.0639
707.00	0.028	195.9	0.0648
707.02	0.029	196.1	0.0657
707.03	0.029	196.2	0.0666
707.05	0.029	196.3	0.0666
707.07	0.029	196.4	0.0666
707.08	0.029	196.4	0.0666
707.10	0.029	196.5	0.0666
707.12	0.028	196.6	0.0666
707.13	0.027	196.6	0.0648
707.15	0.026	196.6	0.0639
707.17	0.025	196.6	0.0612
707.18	0.023	196.5	0.0612
707.20	0.021	196.5	0.0586
707.22	0.023	196.5	0.0577
707.23	0.02	196.4	0.0577
707.25	0.018	196.4	0.055
707.27	0.018	196.3	0.0506
707.28	0.017	196.2	0.0479
707.30	0.012	195.9	0.0435
707.32	0.013	195.8	0.0426
707.33	0.011	195.7	0.0382
707.35	0.007	195.3	0.0382
707.37	0.004	195.1	0.0337
707.38	0.004	195.1	0.0302
707.40	0.005	195	0.0293
707.42	0.002	194.7	0.024
707.43	0	194.4	0.0204
707.45	-0.003	194.1	0.0133
707.47	-0.004	193.9	0.0133
707.48	-0.006	193.7	0.0124
707.50	-0.006	193.7	0.0089
707.52	-0.007	193.4	0.0053
707.53	-0.01	193.1	0



Prova triassiale ciclica SN04-C1			
pressione di confinamento (kPa)		80	
deviatore ciclico (kPa)		95	
frequenza (hz)		0.00625	
tempo	cella di carico	$\Delta u$	LVDT
(min)	kN	(kPa)	$\delta$ (mm)
707.55	-0.011	192.8	-0.0027
707.57	-0.014	192.6	-0.0036
707.58	-0.013	192.4	-0.0036
707.60	-0.016	192.1	-0.0044
707.62	-0.016	192.1	-0.0089
707.63	-0.014	192	-0.008
707.65	-0.015	191.8	-0.0098
707.67	-0.017	191.6	-0.0115
707.68	-0.017	191.5	-0.0115
707.70	-0.017	191.4	-0.0115
707.72	-0.017	191.2	-0.0133
707.73	-0.017	191.2	-0.0133
707.75	-0.018	191.1	-0.0124
707.77	-0.016	191.1	-0.0115
707.78	-0.015	191	-0.0115
707.80	-0.015	191	-0.0124
707.82	-0.014	191	-0.0124
707.83	-0.013	191	-0.0107
707.85	-0.013	191	-0.008
707.87	-0.012	191	-0.0062
707.88	-0.01	191.2	-0.0036
707.90	-0.009	191.2	-0.0018
707.92	-0.007	191.3	0
707.93	-0.005	191.5	0.0044
707.95	-0.005	191.6	0.0053
707.97	-0.002	191.8	0.0107
707.98	0.001	192	0.0107
708.00	0.003	192.2	0.0142
708.02	0.003	192.2	0.016
708.03	0.004	192.3	0.0195
708.05	0.006	192.6	0.0231
708.07	0.009	192.8	0.0284
708.08	0.01	193	0.032
708.10	0.012	193.3	0.0346
708.12	0.015	193.5	0.0346
708.13	0.016	193.5	0.0391
708.15	0.016	193.8	0.0426
708.17	0.018	194.1	0.0462
708.18	0.021	194.3	0.0497
708.20	0.021	194.5	0.0524
708.22	0.023	194.8	0.055
708.23	0.025	195	0.055
708.25	0.025	195	0.0577
708.27	0.025	195.2	0.0595
708.28	0.026	195.5	0.0621
708.32	0.027	195.7	0.063
708.33	0.028	195.9	0.0639
708.35	0.028	196	0.0648
708.37	0.029	196.2	0.0648
708.37	0.029	196.2	0.0666
708.38	0.029	196.3	0.0666
708.40	0.029	196.4	0.0666
708.42	0.029	196.5	0.0666
708.43	0.028	196.6	0.0657
708.45	0.027	196.6	0.0648
708.47	0.026	196.6	0.0648
708.48	0.025	196.6	0.0639
708.50	0.025	196.7	0.063

Prova triassiale ciclica SN04-C1			
pressione di confinamento (kPa)		80	
deviatore ciclico (kPa)		95	
frequenza (hz)		0.00625	
tempo	cella di carico	$\Delta u$	LVDT
(min)	kN	(kPa)	$\delta$ (mm)
708.52	0.024	196.7	0.0612
708.53	0.023	196.6	0.0595
708.55	0.022	196.5	0.0568
708.57	0.02	196.4	0.0541
708.58	0.017	196.3	0.0541
708.60	0.016	196.3	0.0515
708.62	0.016	196.2	0.0488
708.63	0.015	196	0.0453
708.65	0.011	195.8	0.0426
708.67	0.011	195.7	0.0391
708.68	0.01	195.6	0.0373
708.70	0.006	195.3	0.0337
708.72	0.006	195.1	0.0302
708.73	0.004	194.8	0.0249
708.75	0	194.5	0.0249
708.77	-0.001	194.5	0.0213
708.78	-0.001	194.3	0.0178
708.80	-0.003	194.1	0.0133
708.82	-0.006	193.8	0.0089
708.83	-0.007	193.6	0.0071
708.85	-0.008	193.3	0.0036
708.87	-0.011	193	0.0036
708.88	-0.012	193	0
708.90	-0.012	192.8	-0.0018
708.92	-0.012	192.5	-0.0044
708.93	-0.015	192.2	-0.008
708.95	-0.016	192	-0.0098
708.97	-0.016	191.9	-0.0107
708.98	-0.016	191.7	-0.0107
709.00	-0.017	191.7	-0.0115
709.02	-0.017	191.6	-0.0124
709.03	-0.017	191.4	-0.0133
709.05	-0.017	191.3	-0.0133
709.07	-0.017	191.2	-0.0133
709.08	-0.017	191.1	-0.0133
709.10	-0.016	191	-0.0133
709.12	-0.015	191	-0.0124
709.13	-0.015	191	-0.0115
709.15	-0.015	191	-0.0115
709.17	-0.014	191	-0.0098
709.18	-0.012	191	-0.008
709.20	-0.011	191.1	-0.0053
709.22	-0.009	191.2	-0.0053
709.23	-0.008	191.3	-0.0036
709.25	-0.008	191.3	-0.0009
709.27	-0.007	191.4	0.0009
709.28	-0.004	191.6	0.0044
709.30	-0.002	191.7	0.008
709.32	-0.001	191.9	0.0115
709.33	0.002	192.1	0.0115
709.35	0.004	192.3	0.0151
709.37	0.004	192.3	0.0186
709.38	0.008	192.7	0.0231
709.40	0.01	192.9	0.0249
709.42	0.01	192.9	0.0293
709.43	0.011	193.1	0.0328
709.45	0.013	193.5	0.0364
709.47	0.016	193.7	0.0408

Prova triassiale ciclica SN04-C1			
pressione di confinamento (kPa)		80	
deviatore ciclico (kPa)		95	
frequenza (hz)		0.00625	
tempo	cella di carico	$\Delta u$	LVDT
(min)	kN	(kPa)	$\delta$ (mm)
709.48	0.017	193.9	0.0435
709.50	0.019	194.2	0.0435
709.52	0.021	194.5	0.0479
709.53	0.021	194.5	0.0506
709.55	0.022	194.6	0.0533
709.57	0.023	194.9	0.0559
709.58	0.025	195.1	0.0586
709.60	0.026	195.4	0.0604
709.62	0.027	195.6	0.0621
709.63	0.028	195.8	0.0621
709.65	0.028	195.8	0.0639
709.67	0.028	196	0.0639
709.68	0.029	196.1	0.0648
709.70	0.029	196.3	0.0657
709.72	0.029	196.4	0.0657
709.75	0.029	196.5	0.0657
709.77	0.028	196.6	0.0657
709.78	0.028	196.6	0.0657
709.80	0.028	196.6	0.0657
709.82	0.028	196.7	0.0639
709.82	0.026	196.7	0.063
709.83	0.025	196.7	0.0621
709.85	0.024	196.7	0.0595
709.87	0.022	196.6	0.0595
709.88	0.021	196.6	0.0577
709.90	0.021	196.5	0.0559
709.92	0.02	196.4	0.0533
709.93	0.017	196.2	0.0497
709.95	0.015	196.2	0.0479
709.97	0.014	196	0.0444
709.98	0.01	195.8	0.0444
710.00	0.01	195.8	0.0408
710.02	0.01	195.7	0.0382
710.03	0.008	195.4	0.0337
710.05	0.005	195.1	0.0302
710.07	0.003	194.9	0.0257
710.08	0.001	194.7	0.0213
710.10	-0.002	194.4	0.0213
710.12	-0.003	194.2	0.0151
710.13	-0.004	194	0.0124
710.15	-0.006	193.7	0.0124
710.17	-0.007	193.7	0.0089
710.18	-0.007	193.5	0.0053
710.20	-0.009	193.2	0.0018
710.22	-0.011	192.9	-0.0018
710.23	-0.012	192.7	-0.0036
710.25	-0.013	192.5	-0.0062
710.27	-0.015	192.2	-0.0062
710.28	-0.015	192.2	-0.008
710.30	-0.015	192	-0.0089
710.32	-0.016	191.9	-0.0107
710.33	-0.017	191.7	-0.0115
710.35	-0.017	191.5	-0.0124
710.37	-0.017	191.4	-0.0133
710.38	-0.017	191.3	-0.0133
710.40	-0.017	191.2	-0.0133
710.42	-0.017	191.2	-0.0133
710.43	-0.017	191.2	-0.0133

Prova triassiale ciclica SN04-C1			
pressione di confinamento (kPa)		80	
deviatore ciclico (kPa)		95	
frequenza (hz)		0.00625	
tempo	cella di carico	$\Delta u$	LVDT
(min)	kN	(kPa)	$\delta$ (mm)
710.45	-0.016	191.1	-0.0124
710.47	-0.015	191.1	-0.0107
710.48	-0.014	191	-0.0098
710.50	-0.013	191.1	-0.008
710.52	-0.012	191.2	-0.008
710.53	-0.011	191.2	-0.0071
710.55	-0.011	191.2	-0.0053
710.57	-0.009	191.3	-0.0027
710.58	-0.007	191.4	0
710.60	-0.006	191.5	0.0027
710.62	-0.004	191.7	0.0062
710.63	-0.001	191.9	0.0062
710.65	0	191.9	0.0098
710.67	0	192	0.0124
710.68	0.002	192.3	0.016
710.70	0.005	192.5	0.0204
710.72	0.006	192.7	0.0231
710.73	0.008	192.9	0.0284
710.75	0.012	193.2	0.0284
710.77	0.013	193.2	0.0328
710.78	0.013	193.4	0.0355
710.80	0.014	193.7	0.0399
710.82	0.018	193.9	0.0444
710.83	0.018	194.2	0.0462
710.85	0.019	194.3	0.0479
710.87	0.021	194.6	0.0515
710.88	0.022	194.8	0.0533
710.90	0.024	195.1	0.0568
710.92	0.026	195.3	0.0568
710.93	0.026	195.3	0.0595
710.95	0.026	195.5	0.0604
710.97	0.027	195.7	0.0621
710.98	0.028	195.9	0.0639
711.00	0.028	196.1	0.0648
711.02	0.028	196.2	0.0648
711.03	0.029	196.4	0.0648
711.05	0.029	196.4	0.0657
711.07	0.029	196.5	0.0657
711.08	0.029	196.6	0.0657
711.10	0.028	196.7	0.0657
711.12	0.028	196.7	0.0648
711.13	0.027	196.7	0.0639
711.15	0.025	196.7	0.0639
711.17	0.024	196.7	0.0621
711.18	0.024	196.7	0.0612
711.22	0.023	196.7	0.0586
711.23	0.022	196.6	0.0577
711.25	0.02	196.5	0.055
711.27	0.019	196.4	0.0515
711.27	0.016	196.3	0.0515
711.28	0.014	196.3	0.0488
711.30	0.014	196.1	0.0462
711.32	0.013	196	0.0426
711.33	0.01	195.8	0.0391
711.35	0.009	195.6	0.0355
711.37	0.007	195.4	0.0311
711.38	0.004	195	0.0311
711.40	0.002	195	0.0275

Prova triassiale ciclica SN04-C1			
pressione di confinamento (kPa)		80	
deviatore ciclico (kPa)		95	
frequenza (hz)		0.00625	
tempo	cella di carico	$\Delta u$	LVDT
(min)	kN	(kPa)	$\delta$ (mm)
711.42	0.002	194.8	0.024
711.43	0.001	194.6	0.0195
711.45	-0.002	194.3	0.016
711.47	-0.004	194.1	0.0115
711.48	-0.005	193.8	0.0089
711.50	-0.008	193.5	0.0089
711.52	-0.009	193.3	0.0044
711.53	-0.009	193.3	0.0027
711.55	-0.01	193	-0.0009
711.57	-0.013	192.6	-0.0036
711.58	-0.013	192.6	-0.0053
711.60	-0.014	192.4	-0.0071
711.62	-0.015	192.2	-0.0089
711.63	-0.016	192	-0.0098
711.65	-0.016	191.8	-0.0107
711.67	-0.017	191.6	-0.0107
711.68	-0.017	191.5	-0.0124
711.70	-0.017	191.5	-0.0133
711.72	-0.017	191.3	-0.0142
711.73	-0.017	191.2	-0.0133
711.75	-0.017	191.2	-0.0133
711.77	-0.016	191.1	-0.0124
711.78	-0.016	191.1	-0.0124
711.80	-0.015	191.1	-0.0124
711.82	-0.015	191.1	-0.0107
711.83	-0.014	191	-0.0098
711.85	-0.013	191.2	-0.008
711.87	-0.011	191.2	-0.0062
711.88	-0.01	191.2	-0.0044
711.90	-0.008	191.4	-0.0018
711.92	-0.006	191.5	-0.0018
711.93	-0.005	191.5	0.0009
711.95	-0.005	191.6	0.0036
711.97	-0.003	191.8	0.0071
711.98	0	192	0.0107
712.00	0.001	192.1	0.0133
712.02	0.003	192.4	0.0178
712.03	0.006	192.6	0.0178
712.05	0.007	192.6	0.0213
712.07	0.007	192.8	0.0249
712.08	0.009	193.1	0.0302
712.10	0.013	193.3	0.0346
712.12	0.014	193.5	0.0373
712.13	0.015	193.8	0.0408
712.15	0.018	194.1	0.0408
712.17	0.019	194.1	0.0444
712.18	0.019	194.3	0.0479
712.20	0.02	194.5	0.0506
712.22	0.022	194.8	0.0533
712.23	0.024	195	0.0568
712.25	0.024	195.2	0.0577
712.27	0.027	195.5	0.0577
712.28	0.027	195.5	0.0604
712.30	0.027	195.9	0.063
712.32	0.028	196	0.063
712.33	0.028	196	0.0639
712.35	0.028	196.2	0.0648
712.37	0.028	196.3	0.0648

Prova triassiale ciclica SN04-C1			
pressione di confinamento (kPa)		80	
deviatore ciclico (kPa)		95	
frequenza (hz)		0.00625	
tempo	cella di carico	$\Delta u$	LVDT
(min)	kN	(kPa)	$\delta$ (mm)
712.38	0.029	196.4	0.0657
712.40	0.029	196.6	0.0657
712.42	0.029	196.7	0.0657
712.43	0.028	196.7	0.0657
712.45	0.027	196.7	0.0657
712.47	0.027	196.8	0.0639
712.48	0.026	196.8	0.063
712.50	0.025	196.7	0.0612
712.52	0.024	196.7	0.0595
712.53	0.023	196.7	0.0577
712.55	0.021	196.6	0.0577
712.57	0.019	196.5	0.0559
712.58	0.019	196.5	0.0533
712.60	0.018	196.4	0.0506
712.62	0.015	196.2	0.047
712.65	0.014	196.1	0.0444
712.67	0.012	196	0.0408
712.68	0.01	195.7	0.0408
712.70	0.007	195.5	0.0373
712.72	0.007	195.5	0.0337
712.72	0.006	195.3	0.0302
712.73	0.003	195	0.0257
712.75	0.001	194.8	0.0222
712.77	0	194.6	0.0178
712.78	-0.003	194.2	0.0178
712.80	-0.005	194	0.0133
712.82	-0.005	194	0.0107
712.83	-0.006	193.8	0.0071
712.85	-0.008	193.4	0.0036
712.87	-0.01	193.2	0
712.88	-0.011	193	-0.0027
712.90	-0.012	192.7	-0.0027
712.92	-0.014	192.5	-0.0044
712.93	-0.014	192.5	-0.0071
712.95	-0.015	192.3	-0.0089
712.97	-0.016	192.1	-0.0107
712.98	-0.016	191.9	-0.0115
713.00	-0.017	191.7	-0.0124
713.02	-0.017	191.6	-0.0133
713.03	-0.017	191.4	-0.0142
713.05	-0.017	191.3	-0.0142
713.07	-0.017	191.2	-0.0142
713.08	-0.017	191.2	-0.0142
713.10	-0.016	191.2	-0.0133
713.12	-0.016	191.1	-0.0133
713.13	-0.016	191.1	-0.0124
713.15	-0.015	191.1	-0.0107
713.17	-0.014	191.1	-0.0098
713.18	-0.012	191.2	-0.0071
713.20	-0.01	191.2	-0.0071
713.22	-0.009	191.2	-0.0053
713.23	-0.009	191.3	-0.0036
713.25	-0.008	191.4	-0.0009
713.27	-0.005	191.5	0.0018
713.28	-0.004	191.6	0.0044
713.30	-0.003	191.9	0.008
713.32	0.001	192.1	0.008
713.33	0.002	192.1	0.0115

Prova triassiale ciclica SN04-C1			
pressione di confinamento (kPa)		80	
deviatore ciclico (kPa)		95	
frequenza (hz)		0.00625	
tempo	cella di carico	$\Delta u$	LVDT
(min)	kN	(kPa)	$\delta$ (mm)
713.35	0.002	192.2	0.0142
713.37	0.003	192.5	0.0186
713.38	0.007	192.7	0.0231
713.40	0.009	192.9	0.0257
713.42	0.01	193.2	0.0302
713.43	0.013	193.4	0.0302
713.45	0.014	193.4	0.0346
713.47	0.014	193.6	0.0382
713.48	0.016	193.9	0.0426
713.50	0.019	194.2	0.0462
713.52	0.019	194.4	0.0479
713.53	0.021	194.7	0.0515
713.55	0.024	194.9	0.0515
713.57	0.024	194.9	0.055
713.58	0.024	195.1	0.0559
713.60	0.025	195.4	0.0586
713.62	0.027	195.6	0.0612
713.63	0.027	195.8	0.0621
713.65	0.028	196	0.0639
713.67	0.028	196.1	0.0639
713.68	0.029	196.1	0.0639
713.70	0.029	196.3	0.0648
713.72	0.029	196.4	0.0648
713.73	0.029	196.5	0.0657
713.75	0.029	196.6	0.0657
713.77	0.028	196.7	0.0657
713.78	0.028	196.8	0.0648
713.80	0.027	196.8	0.063
713.82	0.026	196.8	0.0621
713.83	0.024	196.8	0.0621
713.85	0.023	196.7	0.0604
713.87	0.023	196.7	0.0586
713.88	0.022	196.7	0.0568
713.90	0.02	196.6	0.0541
713.92	0.019	196.5	0.0524
713.93	0.017	196.4	0.0488
713.95	0.015	196.2	0.0488
713.97	0.012	196	0.0453
713.98	0.012	196	0.0426
714.00	0.011	195.9	0.0391
714.02	0.009	195.7	0.0355
714.03	0.006	195.4	0.032
714.05	0.005	195.2	0.0284
714.07	0.002	194.9	0.0284
714.08	0	194.7	0.0231
714.12	0	194.7	0.0195
714.13	-0.001	194.5	0.016
714.15	-0.003	194.1	0.0115
714.17	-0.006	193.9	0.008
714.17	-0.007	193.6	0.0053
714.18	-0.009	193.3	0.0018
714.20	-0.011	193.1	0.0018
714.22	-0.012	193.1	-0.0018
714.23	-0.012	192.9	-0.0027
714.25	-0.013	192.6	-0.0053
714.27	-0.015	192.4	-0.008
714.28	-0.015	192.2	-0.0098
714.30	-0.016	192	-0.0107

Prova triassiale ciclica SN04-C1			
pressione di confinamento (kPa)		80	
deviatore ciclico (kPa)		95	
frequenza (hz)		0.00625	
tempo	cella di carico	$\Delta u$	LVDT
(min)	kN	(kPa)	$\delta$ (mm)
714.32	-0.017	191.8	-0.0107
714.33	-0.017	191.8	-0.0124
714.35	-0.017	191.7	-0.0133
714.37	-0.017	191.5	-0.0142
714.38	-0.017	191.4	-0.0142
714.40	-0.017	191.3	-0.0142
714.42	-0.017	191.2	-0.0142
714.43	-0.016	191.2	-0.0142
714.45	-0.015	191.2	-0.0133
714.47	-0.015	191.1	-0.0115
714.48	-0.014	191.1	-0.0115
714.50	-0.013	191.1	-0.0107
714.52	-0.013	191.1	-0.0089
714.53	-0.012	191.2	-0.0071
714.55	-0.01	191.3	-0.0044
714.57	-0.009	191.3	-0.0027
714.58	-0.007	191.4	0
714.60	-0.004	191.6	0
714.62	-0.004	191.6	0.0036
714.63	-0.004	191.7	0.0053
714.65	-0.002	191.9	0.0098
714.67	0.002	192.1	0.0133
714.68	0.003	192.3	0.016
714.70	0.005	192.5	0.0204
714.72	0.007	192.8	0.0204
714.73	0.01	193	0.0249
714.75	0.01	193	0.0284
714.77	0.011	193.2	0.0328
714.78	0.014	193.5	0.0364
714.80	0.015	193.8	0.0391
714.82	0.017	194	0.0435
714.83	0.019	194.3	0.0435
714.85	0.021	194.5	0.047
714.87	0.021	194.5	0.0497
714.88	0.022	194.7	0.0524
714.90	0.023	195	0.055
714.92	0.025	195.2	0.0577
714.93	0.026	195.4	0.0595
714.95	0.026	195.7	0.0612
714.97	0.028	195.9	0.0612
714.98	0.028	195.9	0.0621
715.00	0.028	196	0.0639
715.02	0.029	196.2	0.0648
715.03	0.029	196.4	0.0648
715.05	0.029	196.5	0.0648
715.07	0.029	196.6	0.0648
715.08	0.029	196.7	0.0648
715.10	0.028	196.7	0.0648
715.12	0.028	196.8	0.0639
715.13	0.027	196.7	0.063
715.15	0.026	196.8	0.0612
715.17	0.025	196.8	0.0604
715.18	0.024	196.7	0.0577
715.20	0.022	196.7	0.0559
715.22	0.022	196.7	0.0559
715.23	0.02	196.5	0.0533
715.25	0.017	196.4	0.0533
715.27	0.016	196.4	0.0497



Prova triassiale ciclica SN04-C1			
pressione di confinamento (kPa)		80	
deviatore ciclico (kPa)		95	
frequenza (hz)		0.00625	
tempo	cella di carico	$\Delta u$	LVDT
(min)	kN	(kPa)	$\delta$ (mm)
715.28	0.016	196.3	0.0479
715.30	0.015	196.2	0.0435
715.32	0.011	196	0.0399
715.33	0.011	195.8	0.0391
715.35	0.009	195.6	0.0337
715.37	0.005	195.3	0.0337
715.38	0.004	195.3	0.0293
715.40	0.004	195.1	0.0275
715.42	0.002	194.8	0.0222
715.43	-0.001	194.6	0.0178
715.45	-0.002	194.4	0.0151
715.47	-0.004	194.1	0.0107
715.48	-0.007	193.8	0.0107
715.50	-0.008	193.8	0.0062
715.52	-0.008	193.6	0.0044
715.53	-0.009	193.3	0.0009
715.55	-0.011	193	-0.0027
715.58	-0.012	192.8	-0.0044
715.60	-0.013	192.6	-0.0071
715.62	-0.015	192.3	-0.0071
715.63	-0.015	192.3	-0.0089
715.63	-0.015	192.1	-0.0107
715.65	-0.016	192	-0.0115
715.67	-0.017	191.8	-0.0124
715.68	-0.017	191.6	-0.0133
715.70	-0.017	191.5	-0.0142
715.72	-0.017	191.4	-0.0142
715.73	-0.017	191.3	-0.0142
715.75	-0.017	191.3	-0.0142
715.77	-0.017	191.2	-0.0133
715.78	-0.016	191.2	-0.0133
715.80	-0.015	191.2	-0.0124
715.82	-0.015	191.1	-0.0107
715.83	-0.013	191.2	-0.0107
715.85	-0.012	191.2	-0.0089
715.87	-0.012	191.2	-0.008
715.88	-0.011	191.2	-0.0053
715.90	-0.009	191.4	-0.0036
715.92	-0.007	191.5	-0.0009
715.93	-0.006	191.5	0.0009
715.95	-0.004	191.7	0.0036
715.97	-0.002	191.9	0.0062
715.98	-0.001	192	0.0107
716.00	0.001	192.3	0.0107
716.02	0.004	192.5	0.0133
716.03	0.004	192.5	0.0178
716.05	0.005	192.6	0.0213
716.07	0.008	192.9	0.0257
716.08	0.011	193.2	0.0302
716.10	0.012	193.4	0.0328
716.12	0.014	193.7	0.0373
716.13	0.017	193.9	0.0373
716.15	0.017	193.9	0.0408
716.17	0.017	194.1	0.0435
716.18	0.019	194.4	0.0479
716.20	0.022	194.7	0.0506
716.22	0.022	194.9	0.0533
716.23	0.023	195.1	0.055

Prova triassiale ciclica SN04-C1			
pressione di confinamento (kPa)		80	
deviatore ciclico (kPa)		95	
frequenza (hz)		0.00625	
tempo	cella di carico	$\Delta u$	LVDT
(min)	kN	(kPa)	$\delta$ (mm)
716.25	0.025	195.4	0.055
716.27	0.026	195.4	0.0577
716.28	0.026	195.6	0.0595
716.30	0.027	195.8	0.0612
716.32	0.028	196	0.0621
716.33	0.028	196.1	0.063
716.35	0.029	196.3	0.0639
716.37	0.029	196.4	0.0639
716.38	0.029	196.4	0.0648
716.40	0.029	196.5	0.0648
716.42	0.029	196.6	0.0648
716.43	0.028	196.7	0.0648
716.45	0.028	196.8	0.0639
716.47	0.027	196.8	0.063
716.48	0.025	196.8	0.063
716.50	0.024	196.8	0.0612
716.52	0.024	196.8	0.0595
716.53	0.024	196.8	0.0577
716.55	0.021	196.7	0.0559
716.57	0.02	196.6	0.0533
716.58	0.019	196.5	0.0506
716.60	0.016	196.3	0.0506
716.62	0.014	196.2	0.0479
716.63	0.014	196.2	0.0453
716.65	0.011	195.9	0.0417
716.67	0.009	195.8	0.0399
716.68	0.009	195.8	0.0364
716.70	0.008	195.6	0.032
716.72	0.005	195.2	0.0284
716.73	0.003	195	0.024
716.75	0.002	194.8	0.0204
716.77	-0.001	194.5	0.0204
716.78	-0.003	194.2	0.016
716.80	-0.003	194.2	0.0124
716.82	-0.005	194	0.0089
716.83	-0.007	193.7	0.0053
716.85	-0.009	193.4	0.0018
716.87	-0.01	193.2	-0.0009
716.88	-0.011	192.9	-0.0036
716.90	-0.013	192.7	-0.0036
716.92	-0.013	192.7	-0.0062
716.93	-0.014	192.5	-0.008
716.95	-0.015	192.3	-0.0098
716.97	-0.016	192.1	-0.0115
716.98	-0.016	191.9	-0.0124
717.02	-0.017	191.7	-0.0133
717.03	-0.017	191.6	-0.0133
717.05	-0.017	191.6	-0.0142
717.07	-0.017	191.5	-0.0142
717.08	-0.017	191.4	-0.0142
717.08	-0.017	191.3	-0.0142
717.10	-0.017	191.2	-0.0142
717.12	-0.016	191.2	-0.0133
717.13	-0.015	191.2	-0.0133
717.15	-0.014	191.2	-0.0115
717.17	-0.014	191.2	-0.0107
717.18	-0.013	191.2	-0.0089
717.20	-0.011	191.3	-0.0071

Prova triassiale ciclica SN04-C1			
pressione di confinamento (kPa)		80	
deviatore ciclico (kPa)		95	
frequenza (hz)		0.00625	
tempo	cella di carico	$\Delta u$	LVDT
(min)	kN	(kPa)	$\delta$ (mm)
717.22	-0.01	191.3	-0.0053
717.23	-0.009	191.4	-0.0027
717.25	-0.006	191.6	-0.0027
717.27	-0.005	191.6	0
717.28	-0.005	191.7	0.0027
717.30	-0.004	191.8	0.0062
717.32	0	192	0.0098
717.33	0.001	192.2	0.0115
717.35	0.002	192.4	0.016
717.37	0.006	192.7	0.016
717.38	0.008	192.9	0.024
717.40	0.008	193	0.0275
717.42	0.011	193.3	0.0275
717.43	0.013	193.5	0.0311
717.45	0.013	193.5	0.0337
717.47	0.014	193.7	0.0382
717.48	0.017	194.1	0.0417
717.50	0.019	194.3	0.0453
717.52	0.02	194.5	0.0488
717.53	0.022	194.8	0.0488
717.55	0.023	195	0.0515
717.57	0.023	195	0.0541
717.58	0.024	195.2	0.0568
717.60	0.026	195.5	0.0595
717.62	0.027	195.7	0.0604
717.63	0.027	195.9	0.0612
717.65	0.028	196.1	0.063
717.67	0.028	196.2	0.063
717.68	0.028	196.2	0.0639
717.70	0.029	196.4	0.0648
717.72	0.029	196.5	0.0648
717.73	0.029	196.6	0.0648
717.75	0.029	196.7	0.0648
717.77	0.028	196.8	0.0648
717.78	0.027	196.8	0.0648
717.80	0.026	196.8	0.063
717.82	0.026	196.8	0.0621
717.83	0.026	196.8	0.0612
717.85	0.024	196.8	0.0595
717.87	0.023	196.8	0.0577
717.88	0.021	196.7	0.055
717.90	0.019	196.6	0.055
717.92	0.018	196.6	0.0524
717.93	0.018	196.5	0.0506
717.95	0.017	196.3	0.047
717.97	0.013	196.1	0.0435
717.98	0.012	196	0.0408
718.00	0.011	195.8	0.0373
718.02	0.007	195.6	0.0373
718.03	0.006	195.6	0.0328
718.05	0.006	195.4	0.0302
718.07	0.004	195.1	0.0257
718.08	0.001	194.8	0.0213
718.10	0	194.6	0.0178
718.12	-0.001	194.4	0.016
718.13	-0.004	194.1	0.0115
718.15	-0.005	193.9	0.0089
718.17	-0.007	193.6	0.0044

Prova triassiale ciclica SN04-C1			
pressione di confinamento (kPa)		80	
deviatore ciclico (kPa)		95	
frequenza (hz)		0.00625	
tempo	cella di carico	$\Delta u$	LVDT
(min)	kN	(kPa)	$\delta$ (mm)
718.18	-0.01	193.3	0.0044
718.20	-0.01	193.3	0.0009
718.22	-0.01	193.1	-0.0018
718.23	-0.011	192.9	-0.0044
718.25	-0.014	192.6	-0.0071
718.27	-0.014	192.4	-0.008
718.28	-0.015	192.2	-0.0098
718.30	-0.016	192	-0.0098
718.32	-0.017	192	-0.0115
718.33	-0.017	191.8	-0.0124
718.35	-0.017	191.7	-0.0133
718.37	-0.017	191.5	-0.0142
718.38	-0.017	191.4	-0.0142
718.40	-0.017	191.3	-0.0142
718.42	-0.017	191.3	-0.0142
718.43	-0.016	191.3	-0.0133
718.45	-0.016	191.2	-0.0133
718.48	-0.016	191.2	-0.0124
718.50	-0.015	191.2	-0.0115
718.52	-0.013	191.2	-0.0098
718.53	-0.013	191.2	-0.008
718.53	-0.011	191.3	-0.008
718.55	-0.009	191.4	-0.0062
718.57	-0.009	191.4	-0.0036
718.58	-0.008	191.5	-0.0009
718.60	-0.006	191.6	0.0018
718.62	-0.004	191.8	0.0036
718.63	-0.003	191.9	0.008
718.65	0	192.1	0.008
718.67	0.002	192.3	0.0115
718.68	0.002	192.3	0.0142
718.70	0.004	192.5	0.0186
718.72	0.006	192.8	0.0222
718.73	0.009	193	0.0257
718.75	0.01	193.2	0.0311
718.77	0.012	193.5	0.0346
718.78	0.015	193.7	0.0346
718.80	0.015	193.7	0.0382
718.82	0.016	194	0.0408
718.83	0.019	194.4	0.0444
718.85	0.021	194.4	0.047
718.87	0.021	194.7	0.0497
718.88	0.022	194.9	0.0524
718.90	0.024	195.1	0.055
718.92	0.024	195.4	0.0568
718.93	0.026	195.6	0.0595
718.95	0.027	195.8	0.0595
718.97	0.028	195.8	0.0612
718.98	0.028	196	0.063
719.00	0.028	196.2	0.0639
719.02	0.029	196.3	0.0648
719.03	0.029	196.5	0.0648
719.05	0.029	196.6	0.0648
719.07	0.029	196.7	0.0648
719.08	0.029	196.7	0.0648
719.10	0.029	196.8	0.0648
719.12	0.028	196.8	0.0648
719.13	0.027	196.9	0.063

Prova triassiale ciclica SN04-C1			
pressione di confinamento (kPa)		80	
deviatore ciclico (kPa)		95	
frequenza (hz)		0.00625	
tempo	cella di carico	$\Delta u$	LVDT
(min)	kN	(kPa)	$\delta$ (mm)
719.15	0.026	196.9	0.0621
719.17	0.025	196.9	0.0604
719.18	0.023	196.8	0.0604
719.20	0.022	196.8	0.0586
719.22	0.022	196.8	0.0568
719.23	0.021	196.7	0.0541
719.25	0.018	196.5	0.0515
719.27	0.017	196.5	0.0497
719.28	0.016	196.3	0.0453
719.30	0.012	196.1	0.0453
719.32	0.011	196.1	0.0426
719.33	0.011	196	0.0399
719.35	0.01	195.8	0.0355
719.37	0.006	195.5	0.032
719.38	0.005	195.3	0.0293
719.40	0.004	195.1	0.024
719.42	0	194.8	0.024
719.43	-0.001	194.5	0.0195
719.45	-0.001	194.5	0.0169
719.47	-0.003	194.3	0.0124
719.48	-0.006	194	0.0089
719.50	-0.007	193.8	0.0062
719.52	-0.008	193.5	0.0027
719.53	-0.01	193.2	0.0027
719.55	-0.012	193	-0.0036
719.57	-0.012	192.8	-0.0053
719.58	-0.014	192.5	-0.0071
719.60	-0.015	192.3	-0.0071
719.62	-0.015	192.3	-0.0089
719.63	-0.016	192.1	-0.0107
719.65	-0.016	191.9	-0.0124
719.67	-0.017	191.8	-0.0124
719.68	-0.017	191.7	-0.0133
719.70	-0.017	191.5	-0.0142
719.72	-0.017	191.4	-0.0142
719.73	-0.017	191.4	-0.0151
719.75	-0.017	191.3	-0.0142
719.77	-0.017	191.2	-0.0142
719.78	-0.015	191.2	-0.0124
719.80	-0.016	191.2	-0.0124
719.82	-0.014	191.2	-0.0107
719.83	-0.013	191.2	-0.0107
719.85	-0.012	191.2	-0.0098
719.87	-0.012	191.2	-0.0071
719.88	-0.011	191.4	-0.0053
719.92	-0.008	191.4	-0.0027
719.93	-0.007	191.5	0
719.95	-0.006	191.7	0.0018
719.97	-0.003	191.9	0.0018
719.98	-0.001	191.9	0.0053
719.98	-0.001	192	0.0089
720.00	0	192.2	0.0124
720.02	0.004	192.4	0.016
720.03	0.005	192.6	0.0195
720.05	0.006	192.9	0.0231
720.07	0.01	193.1	0.0231
720.08	0.011	193.1	0.0284
720.10	0.011	193.3	0.032

Prova triassiale ciclica SN04-C1			
pressione di confinamento (kPa)		80	
deviatore ciclico (kPa)		95	
frequenza (hz)		0.00625	
tempo	cella di carico	$\Delta u$	LVDT
(min)	kN	(kPa)	$\delta$ (mm)
720.12	0.013	193.6	0.0355
720.13	0.016	193.9	0.0399
720.15	0.017	194.1	0.0426
720.17	0.018	194.4	0.0462
720.18	0.021	194.6	0.0462
720.20	0.022	194.6	0.0497
720.22	0.022	194.8	0.0515
720.23	0.023	195.1	0.055
720.25	0.025	195.4	0.0577
720.27	0.026	195.6	0.0595
720.28	0.026	195.8	0.0612
720.30	0.027	196	0.0621
720.32	0.028	196.1	0.063
720.33	0.028	196.3	0.0639
720.35	0.029	196.4	0.0639
720.37	0.029	196.4	0.0648
720.38	0.029	196.5	0.0648
720.40	0.029	196.7	0.0657
720.42	0.029	196.8	0.0648
720.43	0.028	196.8	0.0648
720.45	0.028	196.9	0.0639
720.47	0.027	196.9	0.0639
720.48	0.025	196.9	0.063
720.50	0.025	196.9	0.0612
720.52	0.024	196.9	0.0595
720.53	0.023	196.8	0.0577
720.55	0.021	196.8	0.0559
720.57	0.02	196.7	0.0533
720.58	0.018	196.5	0.0533
720.60	0.016	196.4	0.0506
720.62	0.016	196.4	0.0479
720.63	0.015	196.3	0.0444
720.65	0.012	196.1	0.0417
720.67	0.01	195.9	0.0382
720.68	0.009	195.7	0.0337
720.70	0.006	195.4	0.0302
720.72	0.004	195.2	0.0302
720.73	0.004	195.2	0.0275
720.75	0.002	195	0.0222
720.77	0	194.7	0.0178
720.78	-0.003	194.4	0.0151
720.80	-0.004	194.2	0.0115
720.82	-0.006	193.9	0.008
720.83	-0.008	193.6	0.008
720.85	-0.008	193.6	0.0036
720.87	-0.009	193.4	0.0018
720.88	-0.011	193.1	-0.0018
720.90	-0.012	192.9	-0.0044
720.92	-0.013	192.7	-0.0062
720.93	-0.015	192.4	-0.0089
720.95	-0.016	192.2	-0.0089
720.97	-0.016	192.2	-0.0107
720.98	-0.016	192	-0.0115
721.00	-0.017	191.8	-0.0133
721.02	-0.018	191.7	-0.0142
721.03	-0.018	191.6	-0.0142
721.05	-0.017	191.5	-0.0142
721.07	-0.017	191.4	-0.0142

Prova triassiale ciclica SN04-C1			
pressione di confinamento (kPa)		80	
deviatore ciclico (kPa)		95	
frequenza (hz)		0.00625	
tempo	cella di carico	$\Delta u$	LVDT
(min)	kN	(kPa)	$\delta$ (mm)
721.08	-0.017	191.3	-0.0133
721.10	-0.016	191.2	-0.0133
721.12	-0.016	191.2	-0.0133
721.13	-0.015	191.2	-0.0124
721.15	-0.015	191.2	-0.0115
721.17	-0.014	191.2	-0.0098
721.18	-0.012	191.2	-0.008
721.20	-0.011	191.3	-0.0071
721.22	-0.01	191.4	-0.0044
721.23	-0.008	191.5	-0.0044
721.25	-0.007	191.5	-0.0018
721.27	-0.007	191.6	0.0009
721.28	-0.005	191.8	0.0036
721.30	-0.002	192	0.0071
721.32	-0.001	192.1	0.0107
721.33	0.001	192.3	0.0142
721.35	0.004	192.5	0.0142
721.38	0.006	192.5	0.0178
721.40	0.006	192.7	0.0213
721.42	0.007	193	0.0257
721.43	0.011	193.2	0.0302
721.43	0.012	193.4	0.0328
721.45	0.013	193.7	0.0373
721.47	0.017	194	0.0373
721.48	0.017	194	0.0417
721.50	0.017	194.2	0.0444
721.52	0.019	194.5	0.0479
721.53	0.022	194.7	0.0515
721.55	0.022	194.9	0.0533
721.57	0.024	195.2	0.0568
721.58	0.026	195.5	0.0568
721.60	0.026	195.7	0.0586
721.62	0.026	195.7	0.0604
721.63	0.027	195.8	0.0621
721.65	0.028	196.1	0.063
721.67	0.028	196.2	0.0639
721.68	0.028	196.4	0.0648
721.70	0.029	196.5	0.0648
721.72	0.029	196.6	0.0657
721.73	0.029	196.7	0.0657
721.75	0.029	196.8	0.0657
721.77	0.028	196.9	0.0657
721.78	0.028	196.9	0.0657
721.80	0.027	196.9	0.0639
721.82	0.026	196.9	0.0621
721.83	0.025	196.9	0.0612
721.85	0.024	196.9	0.0595
721.87	0.023	196.8	0.0577
721.88	0.021	196.8	0.0577
721.90	0.019	196.8	0.0559
721.92	0.019	196.7	0.0533
721.93	0.018	196.5	0.0497
721.95	0.015	196.4	0.047
721.97	0.014	196.3	0.0444
721.98	0.012	196	0.0408
722.00	0.009	195.8	0.0408
722.02	0.008	195.8	0.0364
722.03	0.008	195.7	0.0337

Prova triassiale ciclica SN04-C1			
pressione di confinamento (kPa)		80	
deviatore ciclico (kPa)		95	
frequenza (hz)		0.00625	
tempo	cella di carico	$\Delta u$	LVDT
(min)	kN	(kPa)	$\delta$ (mm)
722.05	0.006	195.4	0.0302
722.07	0.003	195.1	0.0249
722.08	0.002	194.9	0.0213
722.10	0	194.6	0.0178
722.12	-0.004	194.3	0.0178
722.13	-0.005	194.3	0.0124
722.15	-0.005	194.1	0.0107
722.17	-0.006	193.8	0.0062
722.18	-0.009	193.5	0.0027
722.20	-0.01	193.3	0
722.22	-0.011	193.1	-0.0027
722.23	-0.014	192.8	-0.0027
722.25	-0.014	192.8	-0.0062
722.27	-0.014	192.6	-0.0071
722.28	-0.014	192.4	-0.0089
722.30	-0.016	192.2	-0.0107
722.32	-0.016	192	-0.0115
722.33	-0.017	191.8	-0.0124
722.35	-0.017	191.7	-0.0124
722.37	-0.017	191.7	-0.0133
722.38	-0.017	191.5	-0.0142
722.40	-0.017	191.4	-0.0142
722.42	-0.017	191.4	-0.0142
722.43	-0.017	191.3	-0.0133
722.45	-0.016	191.3	-0.0124
722.47	-0.015	191.2	-0.0115
722.48	-0.014	191.2	-0.0107
722.50	-0.014	191.2	-0.0089
722.52	-0.011	191.3	-0.0089
722.53	-0.011	191.3	-0.008
722.55	-0.011	191.3	-0.0062
722.57	-0.01	191.4	-0.0036
722.58	-0.007	191.6	-0.0009
722.60	-0.006	191.7	0.0018
722.62	-0.004	191.8	0.0053
722.63	-0.001	192.1	0.0053
722.65	0	192.2	0.0089
722.67	0	192.2	0.0115
722.68	0.002	192.4	0.0151
722.70	0.005	192.6	0.0195
722.72	0.006	192.8	0.0222
722.73	0.008	193	0.0275
722.75	0.011	193.4	0.0275
722.77	0.013	193.6	0.032
722.78	0.013	193.6	0.0346
722.80	0.014	193.8	0.0382
722.83	0.017	194.1	0.0426
722.85	0.019	194.3	0.0462
722.87	0.02	194.5	0.0488
722.88	0.021	194.8	0.0524
722.88	0.023	195.1	0.0524
722.90	0.024	195.1	0.0541
722.92	0.024	195.3	0.0568
722.93	0.025	195.6	0.0586
722.95	0.027	195.8	0.0612
722.97	0.027	196	0.0621
722.98	0.028	196.1	0.0639
723.00	0.028	196.3	0.0639



Prova triassiale ciclica SN04-C1			
pressione di confinamento (kPa)		80	
deviatore ciclico (kPa)		95	
frequenza (hz)		0.00625	
tempo	cella di carico	$\Delta u$	LVDT
(min)	kN	(kPa)	$\delta$ (mm)
723.02	0.029	196.3	0.0648
723.03	0.029	196.5	0.0648
723.05	0.029	196.6	0.0648
723.07	0.029	196.7	0.0657
723.08	0.029	196.8	0.0657
723.10	0.028	196.9	0.0648
723.12	0.028	196.9	0.0648
723.13	0.027	196.9	0.0648
723.15	0.027	196.9	0.063
723.17	0.025	196.9	0.0612
723.18	0.023	196.9	0.0595
723.20	0.023	196.9	0.0586
723.22	0.023	196.8	0.0568
723.23	0.019	196.7	0.0541
723.25	0.019	196.7	0.0515
723.27	0.017	196.5	0.0488
723.28	0.014	196.3	0.0488
723.30	0.013	196.3	0.0453
723.32	0.013	196.2	0.0435
723.33	0.011	196	0.0391
723.35	0.008	195.8	0.0355
723.37	0.007	195.6	0.0328
723.38	0.005	195.4	0.0284
723.40	0.002	195	0.0284
723.42	0	195	0.0231
723.43	0	194.8	0.0204
723.45	-0.001	194.6	0.016
723.47	-0.004	194.3	0.0124
723.48	-0.006	194	0.0089
723.50	-0.007	193.8	0.0053
723.52	-0.009	193.5	0.0053
723.53	-0.011	193.2	0.0018
723.55	-0.011	193.2	-0.0009
723.57	-0.012	193	-0.0036
723.58	-0.013	192.7	-0.0062
723.60	-0.015	192.5	-0.008
723.62	-0.015	192.4	-0.0098
723.63	-0.016	192.1	-0.0098
723.65	-0.017	192	-0.0115
723.67	-0.017	192	-0.0124
723.68	-0.017	191.8	-0.0133
723.70	-0.017	191.7	-0.0133
723.72	-0.017	191.5	-0.0142
723.73	-0.017	191.4	-0.0142
723.75	-0.017	191.4	-0.0133
723.77	-0.016	191.3	-0.0133
723.78	-0.016	191.3	-0.0133
723.80	-0.016	191.3	-0.0124
723.82	-0.015	191.3	-0.0115
723.83	-0.013	191.3	-0.0098
723.85	-0.012	191.3	-0.0089
723.87	-0.012	191.4	-0.0062
723.88	-0.009	191.5	-0.0062
723.90	-0.008	191.5	-0.0036
723.92	-0.007	191.6	-0.0009
723.93	-0.005	191.7	-0.0009
723.95	-0.004	191.7	0.0018
723.97	-0.004	191.9	0.0053

Prova triassiale ciclica SN04-C1			
pressione di confinamento (kPa)		80	
deviatore ciclico (kPa)		95	
frequenza (hz)		0.00625	
tempo	cella di carico	$\Delta u$	LVDT
(min)	kN	(kPa)	$\delta$ (mm)
723.98	-0.002	192	0.0089
724.00	0.002	192.3	0.0133
724.02	0.003	192.5	0.0151
724.03	0.004	192.7	0.0195
724.05	0.008	193	0.0195
724.07	0.01	193.2	0.024
724.08	0.01	193.2	0.0284
724.10	0.011	193.4	0.032
724.12	0.013	193.7	0.0364
724.13	0.016	193.9	0.0399
724.15	0.017	194.1	0.0426
724.17	0.019	194.4	0.0426
724.18	0.021	194.7	0.0462
724.20	0.021	194.7	0.0497
724.22	0.022	194.9	0.0524
724.23	0.024	195.2	0.055
724.25	0.025	195.4	0.0577
724.28	0.026	195.6	0.0595
724.30	0.027	195.9	0.0595
724.32	0.028	196.1	0.0621
724.33	0.028	196.1	0.063
724.33	0.028	196.2	0.0639
724.35	0.029	196.4	0.0648
724.37	0.029	196.5	0.0648
724.38	0.029	196.7	0.0648
724.40	0.029	196.7	0.0648
724.42	0.029	196.8	0.0657
724.43	0.029	196.8	0.0648
724.45	0.028	196.9	0.0648
724.47	0.027	197	0.063
724.48	0.026	196.9	0.0621
724.50	0.025	197	0.0612
724.52	0.024	196.9	0.0586
724.53	0.022	196.8	0.0586
724.55	0.022	196.8	0.0568
724.57	0.021	196.8	0.0541
724.58	0.019	196.6	0.0515
724.60	0.016	196.5	0.0488
724.62	0.016	196.4	0.047
724.63	0.014	196.2	0.0426
724.65	0.012	196.1	0.0408
724.67	0.011	196	0.0382
724.68	0.009	195.7	0.0337
724.70	0.005	195.5	0.0337
724.72	0.004	195.5	0.0302
724.73	0.004	195.3	0.0257
724.75	0.003	195	0.0222
724.77	-0.001	194.7	0.0178
724.78	-0.002	194.5	0.0142
724.80	-0.004	194.2	0.0107
724.82	-0.007	193.9	0.0107
724.83	-0.008	193.9	0.0071
724.85	-0.008	193.7	0.0036
724.87	-0.009	193.4	0.0009
724.88	-0.011	193.1	-0.0027
724.90	-0.012	192.9	-0.0044
724.92	-0.013	192.7	-0.0071
724.93	-0.015	192.5	-0.0071

Prova triassiale ciclica SN04-C1			
pressione di confinamento (kPa)		80	
deviatore ciclico (kPa)		95	
frequenza (hz)		0.00625	
tempo	cella di carico	$\Delta u$	LVDT
(min)	kN	(kPa)	$\delta$ (mm)
724.95	-0.015	192.5	-0.0098
724.97	-0.015	192.3	-0.0107
724.98	-0.016	192.1	-0.0115
725.00	-0.017	191.9	-0.0133
725.02	-0.017	191.8	-0.0142
725.03	-0.017	191.6	-0.0142
725.05	-0.017	191.5	-0.0142
725.07	-0.017	191.5	-0.0142
725.08	-0.017	191.4	-0.0142
725.10	-0.016	191.4	-0.0142
725.12	-0.016	191.3	-0.0133
725.13	-0.015	191.3	-0.0124
725.15	-0.015	191.3	-0.0115
725.17	-0.013	191.3	-0.0115
725.18	-0.012	191.3	-0.0098
725.20	-0.012	191.3	-0.008
725.22	-0.011	191.4	-0.0053
725.23	-0.008	191.6	-0.0036
725.25	-0.007	191.6	-0.0009
725.27	-0.006	191.8	0.0018
725.28	-0.003	192	0.0018
725.30	-0.002	192.1	0.0053
725.32	-0.002	192.1	0.008
725.33	0	192.3	0.0115
725.35	0.003	192.5	0.016
725.37	0.005	192.7	0.0186
725.38	0.005	192.8	0.0213
725.40	0.008	193.1	0.0249
725.42	0.011	193.3	0.0293
725.43	0.011	193.5	0.0328
725.45	0.015	193.9	0.0328
725.47	0.016	194.1	0.0373
725.48	0.016	194.1	0.0399
725.50	0.017	194.3	0.0444
725.52	0.02	194.6	0.0479
725.53	0.021	194.8	0.0506
725.55	0.022	195.1	0.0533
725.57	0.024	195.3	0.0533
725.58	0.026	195.6	0.0559
725.60	0.026	195.6	0.0577
725.62	0.026	195.8	0.0595
725.63	0.027	196	0.0612
725.65	0.028	196.2	0.063
725.67	0.028	196.3	0.0639
725.68	0.029	196.5	0.0639
725.70	0.029	196.6	0.0639
725.72	0.029	196.6	0.0648
725.75	0.029	196.7	0.0648
725.77	0.029	196.8	0.0648
725.78	0.029	196.9	0.0648
725.80	0.028	197	0.0639
725.80	0.027	197	0.0621
725.82	0.025	197	0.0621
725.83	0.024	197	0.0612
725.85	0.024	197	0.0595
725.87	0.024	196.9	0.0577
725.88	0.021	196.8	0.055
725.90	0.02	196.8	0.0533

Prova triassiale ciclica SN04-C1			
pressione di confinamento (kPa)		80	
deviatore ciclico (kPa)		95	
frequenza (hz)		0.00625	
tempo	cella di carico	$\Delta u$	LVDT
(min)	kN	(kPa)	$\delta$ (mm)
725.92	0.019	196.7	0.0506
725.93	0.016	196.5	0.0506
725.95	0.015	196.5	0.047
725.97	0.015	196.4	0.0453
725.98	0.013	196.2	0.0408
726.00	0.009	196	0.0373
726.02	0.009	195.8	0.0346
726.03	0.007	195.6	0.0302
726.05	0.003	195.3	0.0302
726.07	0.002	195.3	0.0257
726.08	0.002	195.1	0.0222
726.10	-0.001	194.6	0.0186
726.12	-0.003	194.4	0.016
726.13	-0.003	194.4	0.0133
726.15	-0.004	194.2	0.0089
726.17	-0.007	193.8	0.0044
726.18	-0.009	193.6	0.0018
726.20	-0.009	193.4	-0.0009
726.22	-0.012	193	-0.0009
726.23	-0.013	192.8	-0.0044
726.25	-0.013	192.8	-0.0062
726.27	-0.014	192.7	-0.008
726.28	-0.015	192.4	-0.0098
726.30	-0.016	192.2	-0.0115
726.32	-0.016	192	-0.0124
726.33	-0.017	191.9	-0.0133
726.35	-0.017	191.7	-0.0133
726.37	-0.017	191.7	-0.0142
726.38	-0.017	191.6	-0.0151
726.40	-0.017	191.5	-0.0142
726.42	-0.017	191.4	-0.0151
726.43	-0.017	191.4	-0.0142
726.45	-0.016	191.3	-0.0133
726.47	-0.015	191.3	-0.0133
726.48	-0.014	191.3	-0.0124
726.50	-0.014	191.3	-0.0115
726.52	-0.013	191.4	-0.0089
726.53	-0.011	191.4	-0.0071
726.55	-0.01	191.5	-0.0062
726.57	-0.009	191.6	-0.0027
726.58	-0.006	191.7	-0.0027
726.60	-0.005	191.7	0
726.62	-0.005	191.8	0.0018
726.63	-0.003	192	0.0062
726.65	0	192.2	0.0098
726.67	0.001	192.3	0.0124
726.68	0.003	192.6	0.016
726.70	0.006	192.8	0.016
726.72	0.007	192.8	0.0204
726.73	0.007	193	0.024
726.75	0.009	193.3	0.0284
726.77	0.013	193.6	0.0328
726.78	0.013	193.8	0.0355
726.80	0.015	194.1	0.0399
726.82	0.019	194.3	0.0435
726.83	0.019	194.5	0.0453
726.85	0.02	194.7	0.0488
726.87	0.022	195	0.0488

Prova triassiale ciclica SN04-C1			
pressione di confinamento (kPa)		80	
deviatore ciclico (kPa)		95	
frequenza (hz)		0.00625	
tempo	cella di carico	$\Delta u$	LVDT
(min)	kN	(kPa)	$\delta$ (mm)
726.88	0.023	195	0.0515
726.90	0.023	195.2	0.0533
726.92	0.024	195.4	0.0559
726.93	0.026	195.7	0.0586
726.95	0.026	195.9	0.0595
726.97	0.027	196.1	0.0621
726.98	0.029	196.3	0.0621
727.00	0.028	196.3	0.063
727.02	0.028	196.4	0.0639
727.03	0.029	196.6	0.0639
727.05	0.029	196.7	0.0639
727.07	0.029	196.8	0.0648
727.08	0.028	196.9	0.0648
727.10	0.028	197	0.0648
727.12	0.027	197	0.0648
727.13	0.027	197	0.063
727.15	0.027	197	0.0621
727.18	0.025	197	0.0604
727.20	0.024	197	0.0595
727.22	0.023	196.9	0.0568
727.23	0.021	196.8	0.0568
727.25	0.019	196.7	0.055
727.25	0.019	196.7	0.0524
727.27	0.018	196.7	0.0497
727.28	0.016	196.5	0.0462
727.30	0.014	196.3	0.0435
727.32	0.012	196.2	0.0399
727.33	0.01	195.9	0.0399
727.35	0.007	195.8	0.0355
727.37	0.007	195.8	0.0328
727.38	0.006	195.6	0.0293
727.40	0.003	195.2	0.024
727.42	0.001	195	0.0204
727.43	0	194.8	0.0169
727.45	-0.003	194.5	0.0124
727.47	-0.005	194.2	0.0124
727.48	-0.005	194.2	0.0089
727.50	-0.006	194	0.0062
727.52	-0.008	193.7	0.0027
727.53	-0.01	193.4	-0.0009
727.55	-0.011	193.2	-0.0036
727.57	-0.012	193	-0.0044
727.58	-0.013	192.7	-0.0071
727.60	-0.014	192.5	-0.0089
727.62	-0.015	192.3	-0.0115
727.63	-0.017	192.1	-0.0115
727.65	-0.017	192.1	-0.0124
727.67	-0.017	192	-0.0133
727.68	-0.017	191.8	-0.0133
727.70	-0.017	191.7	-0.0142
727.72	-0.017	191.5	-0.0142
727.73	-0.017	191.4	-0.0151
727.75	-0.017	191.4	-0.0151
727.77	-0.016	191.4	-0.0151
727.78	-0.016	191.4	-0.0142
727.80	-0.016	191.3	-0.0133
727.82	-0.014	191.3	-0.0115
727.83	-0.014	191.3	-0.0107

Prova triassiale ciclica SN04-C1			
pressione di confinamento (kPa)		80	
deviatore ciclico (kPa)		95	
frequenza (hz)		0.00625	
tempo	cella di carico	$\Delta u$	LVDT
(min)	kN	(kPa)	$\delta$ (mm)
727.85	-0.012	191.4	-0.0089
727.87	-0.01	191.4	-0.0089
727.88	-0.009	191.4	-0.0071
727.90	-0.009	191.5	-0.0044
727.92	-0.008	191.7	-0.0018
727.93	-0.005	191.8	0.0009
727.95	-0.004	191.9	0.0036
727.97	-0.002	192.1	0.0071
727.98	0.001	192.3	0.0071
728.00	0.002	192.3	0.0107
728.02	0.002	192.5	0.0142
728.03	0.003	192.7	0.0178
728.05	0.007	193	0.0222
728.07	0.008	193.1	0.0249
728.08	0.01	193.4	0.0302
728.10	0.014	193.7	0.0302
728.12	0.014	193.7	0.0346
728.13	0.014	193.9	0.0373
728.15	0.016	194.2	0.0408
728.17	0.019	194.4	0.0453
728.18	0.02	194.6	0.047
728.20	0.021	194.9	0.0506
728.22	0.023	195.2	0.0506
728.23	0.024	195.2	0.0533
728.25	0.024	195.4	0.055
728.27	0.026	195.8	0.0586
728.28	0.027	195.8	0.0595
728.30	0.027	196	0.0612
728.32	0.027	196.2	0.0612
728.33	0.028	196.4	0.063
728.35	0.028	196.5	0.063
728.37	0.029	196.7	0.0639
728.38	0.029	196.8	0.0639
728.40	0.029	196.8	0.0648
728.42	0.029	196.9	0.0648
728.43	0.029	197	0.0648
728.45	0.028	197	0.0639
728.47	0.027	197	0.063
728.48	0.026	197.1	0.0612
728.50	0.024	197	0.0612
728.52	0.023	197	0.0586
728.53	0.023	197	0.0577
728.55	0.022	196.9	0.055
728.57	0.02	196.8	0.0533
728.58	0.019	196.7	0.0515
728.60	0.017	196.6	0.0479
728.62	0.014	196.4	0.0479
728.65	0.013	196.4	0.0444
728.67	0.013	196.3	0.0426
728.68	0.012	196.1	0.0382
728.70	0.008	195.9	0.0337
728.70	0.007	195.7	0.032
728.72	0.005	195.5	0.0275
728.73	0.002	195.1	0.0275
728.75	0	194.9	0.0222
728.77	0	194.9	0.0195
728.78	-0.001	194.7	0.0151
728.80	-0.004	194.4	0.0107

Prova triassiale ciclica SN04-C1			
pressione di confinamento (kPa)		80	
deviatore ciclico (kPa)		95	
frequenza (hz)		0.00625	
tempo	cella di carico	$\Delta u$	LVDT
(min)	kN	(kPa)	$\delta$ (mm)
728.82	-0.005	194.1	0.008
728.83	-0.006	193.9	0.0044
728.85	-0.01	193.6	0.0044
728.87	-0.011	193.3	0.0009
728.88	-0.011	193.3	-0.0018
728.90	-0.011	193.1	-0.0044
728.92	-0.014	192.8	-0.0071
728.93	-0.014	192.6	-0.0089
728.95	-0.015	192.4	-0.0107
728.97	-0.016	192.2	-0.0107
728.98	-0.017	192.1	-0.0124
729.00	-0.017	191.9	-0.0142
729.02	-0.017	191.8	-0.0142
729.03	-0.017	191.7	-0.0142
729.05	-0.017	191.7	-0.0151
729.07	-0.017	191.5	-0.0151
729.08	-0.017	191.4	-0.0151
729.10	-0.016	191.4	-0.0142
729.12	-0.016	191.3	-0.0142
729.13	-0.015	191.4	-0.0142
729.15	-0.014	191.3	-0.0124
729.17	-0.014	191.3	-0.0115
729.18	-0.013	191.4	-0.0098
729.20	-0.012	191.4	-0.008
729.22	-0.01	191.5	-0.0062
729.23	-0.009	191.6	-0.0036
729.25	-0.007	191.7	-0.0009
729.27	-0.004	191.9	-0.0009
729.28	-0.003	191.9	0.0018
729.30	-0.003	192	0.0044
729.32	-0.002	192.2	0.0089
729.33	0.002	192.4	0.0124
729.35	0.002	192.6	0.0142
729.37	0.004	192.9	0.0186
729.38	0.008	193.1	0.0186
729.40	0.009	193.1	0.0231
729.42	0.009	193.3	0.0275
729.43	0.011	193.5	0.032
729.45	0.014	193.8	0.0355
729.47	0.015	194	0.0382
729.48	0.017	194.3	0.0426
729.50	0.02	194.6	0.0426
729.52	0.021	194.6	0.0462
729.53	0.021	194.8	0.0488
729.55	0.022	195	0.0515
729.57	0.024	195.3	0.0541
729.58	0.024	195.5	0.0559
729.60	0.026	195.8	0.0586
729.62	0.027	196	0.0586
729.63	0.027	196	0.0604
729.65	0.027	196.2	0.0612
729.67	0.028	196.3	0.063
729.68	0.029	196.5	0.063
729.70	0.029	196.6	0.0639
729.72	0.029	196.7	0.0639
729.73	0.029	196.8	0.0639
729.75	0.029	196.9	0.0639
729.77	0.028	197	0.0639

Prova triassiale ciclica SN04-C1			
pressione di confinamento (kPa)		80	
deviatore ciclico (kPa)		95	
frequenza (hz)		0.00625	
tempo	cella di carico	$\Delta u$	LVDT
(min)	kN	(kPa)	$\delta$ (mm)
729.78	0.028	197.1	0.0639
729.80	0.026	197.1	0.063
729.82	0.026	197.1	0.0612
729.83	0.025	197.1	0.0604
729.85	0.024	197	0.0577
729.87	0.023	197	0.0568
729.88	0.021	196.9	0.0541
729.90	0.02	196.8	0.0541
729.92	0.017	196.7	0.0524
729.93	0.017	196.7	0.0497
729.95	0.016	196.6	0.0462
729.97	0.014	196.4	0.0426
729.98	0.012	196.2	0.0399
730.00	0.011	196.1	0.0364
730.02	0.008	195.8	0.032
730.03	0.005	195.6	0.032
730.05	0.005	195.6	0.0293
730.08	0.004	195.4	0.0249
730.10	0.002	195.1	0.0204
730.12	-0.001	194.8	0.0169
730.13	-0.002	194.6	0.0133
730.15	-0.004	194.3	0.0089
730.15	-0.007	194	0.0089
730.17	-0.007	194	0.0053
730.18	-0.008	193.8	0.0027
730.20	-0.009	193.5	-0.0009
730.22	-0.012	193.2	-0.0036
730.23	-0.012	193	-0.0053
730.25	-0.013	192.8	-0.008
730.27	-0.015	192.5	-0.008
730.28	-0.015	192.5	-0.0098
730.30	-0.015	192.4	-0.0115
730.32	-0.016	192.2	-0.0133
730.33	-0.017	192	-0.0142
730.35	-0.017	191.9	-0.0151
730.37	-0.017	191.7	-0.0151
730.38	-0.017	191.6	-0.0151
730.40	-0.017	191.6	-0.0151
730.42	-0.017	191.5	-0.0151
730.43	-0.017	191.4	-0.0151
730.45	-0.016	191.4	-0.0142
730.47	-0.016	191.4	-0.0142
730.48	-0.015	191.4	-0.0124
730.50	-0.013	191.4	-0.0107
730.52	-0.012	191.4	-0.0098
730.53	-0.012	191.5	-0.0071
730.55	-0.009	191.6	-0.0071
730.57	-0.008	191.6	-0.0053
730.58	-0.008	191.6	-0.0036
730.60	-0.007	191.8	0
730.62	-0.003	192	0.0036
730.63	-0.002	192.1	0.0053
730.65	-0.001	192.3	0.0098
730.67	0.003	192.5	0.0098
730.68	0.003	192.5	0.0133
730.70	0.003	192.7	0.016
730.72	0.005	192.9	0.0213
730.73	0.009	193.2	0.0249



Prova triassiale ciclica SN04-C1			
pressione di confinamento (kPa)		80	
deviatore ciclico (kPa)		95	
frequenza (hz)		0.00625	
tempo	cella di carico	$\Delta u$	LVDT
(min)	kN	(kPa)	$\delta$ (mm)
730.75	0.01	193.4	0.0284
730.77	0.012	193.6	0.032
730.78	0.015	193.9	0.032
730.80	0.016	194.1	0.0364
730.82	0.016	194.1	0.0391
730.83	0.017	194.4	0.0435
730.85	0.02	194.7	0.047
730.87	0.021	194.9	0.0497
730.88	0.022	195.1	0.0524
730.90	0.024	195.4	0.0524
730.92	0.025	195.7	0.055
730.93	0.025	195.7	0.0568
730.95	0.026	195.8	0.0595
730.97	0.027	196.1	0.0612
730.98	0.028	196.3	0.0621
731.00	0.029	196.4	0.063
731.02	0.029	196.6	0.063
731.03	0.029	196.7	0.063
731.05	0.029	196.7	0.0639
731.07	0.029	196.8	0.0639
731.08	0.029	196.9	0.0639
731.10	0.028	197	0.0639
731.12	0.028	197	0.063
731.13	0.027	197.1	0.0612
731.15	0.025	197	0.0612
731.17	0.025	197	0.0604
731.18	0.023	197	0.0577
731.20	0.022	197	0.0577
731.22	0.021	197	0.0559
731.23	0.021	196.9	0.0541
731.25	0.019	196.8	0.0506
731.27	0.016	196.6	0.0479
731.28	0.016	196.6	0.0453
731.30	0.014	196.3	0.0417
731.32	0.01	196.2	0.0417
731.33	0.01	196.2	0.0382
731.35	0.01	196	0.0355
731.37	0.008	195.8	0.0311
731.38	0.004	195.5	0.0275
731.40	0.003	195.3	0.024
731.42	0.002	195	0.0195
731.43	-0.002	194.7	0.0195
731.45	-0.003	194.7	0.0151
731.47	-0.003	194.5	0.0115
731.48	-0.004	194.2	0.008
731.50	-0.008	193.9	0.0044
731.52	-0.008	193.7	0.0018
731.55	-0.009	193.5	-0.0018
731.57	-0.012	193.2	-0.0018
731.58	-0.013	193.2	-0.0044
731.60	-0.013	193	-0.0062
731.60	-0.013	192.7	-0.0089
731.62	-0.016	192.5	-0.0115
731.63	-0.016	192.3	-0.0124
731.65	-0.016	192.2	-0.0133
731.67	-0.017	192	-0.0133
731.68	-0.017	192	-0.0142
731.70	-0.017	191.8	-0.0151

Prova triassiale ciclica SN04-C1			
pressione di confinamento (kPa)		80	
deviatore ciclico (kPa)		95	
frequenza (hz)		0.00625	
tempo	cella di carico	$\Delta u$	LVDT
(min)	kN	(kPa)	$\delta$ (mm)
731.72	-0.017	191.7	-0.016
731.73	-0.017	191.6	-0.016
731.75	-0.017	191.5	-0.016
731.77	-0.016	191.4	-0.0142
731.78	-0.015	191.4	-0.0142
731.80	-0.015	191.4	-0.0133
731.82	-0.015	191.4	-0.0133
731.83	-0.014	191.4	-0.0115
731.85	-0.012	191.5	-0.0098
731.87	-0.011	191.5	-0.008
731.88	-0.01	191.6	-0.0053
731.90	-0.007	191.7	-0.0027
731.92	-0.007	191.7	-0.0018
731.93	-0.006	191.9	0.0018
731.95	-0.003	192.1	0.0018
731.97	-0.001	192.1	0.0044
731.98	-0.001	192.2	0.0071
732.00	0	192.4	0.0107
732.02	0.004	192.6	0.0142
732.03	0.005	192.8	0.0178
732.05	0.006	193	0.0222
732.07	0.01	193.3	0.0222
732.08	0.011	193.3	0.0275
732.10	0.011	193.5	0.0302
732.12	0.012	193.8	0.0346
732.13	0.016	194.1	0.0382
732.15	0.017	194.3	0.0408
732.17	0.018	194.5	0.0453
732.18	0.021	194.8	0.0453
732.20	0.022	195	0.0488
732.22	0.022	195	0.0506
732.23	0.023	195.2	0.0533
732.25	0.025	195.6	0.0559
732.27	0.026	195.8	0.0577
732.28	0.026	196	0.0595
732.30	0.027	196.2	0.0595
732.32	0.028	196.4	0.0612
732.33	0.028	196.4	0.0621
732.35	0.029	196.5	0.063
732.37	0.029	196.6	0.0639
732.38	0.029	196.8	0.0639
732.40	0.029	196.9	0.0639
732.42	0.029	197	0.0639
732.43	0.028	197.1	0.0639
732.45	0.028	197.1	0.063
732.47	0.027	197.1	0.0621
732.48	0.026	197.1	0.0604
732.50	0.025	197.1	0.0595
732.52	0.024	197.1	0.0577
732.53	0.022	197	0.0577
732.55	0.021	196.9	0.0559
732.57	0.021	196.9	0.0541
732.58	0.019	196.9	0.0506
732.60	0.017	196.7	0.0479
732.62	0.015	196.5	0.0453
732.63	0.014	196.4	0.0426
732.65	0.013	196.3	0.0408
732.67	0.01	196.1	0.0373

Prova triassiale ciclica SN04-C1			
pressione di confinamento (kPa)		80	
deviatore ciclico (kPa)		95	
frequenza (hz)		0.00625	
tempo	cella di carico	$\Delta u$	LVDT
(min)	kN	(kPa)	$\delta$ (mm)
732.68	0.009	196	0.0337
732.70	0.007	195.6	0.0293
732.72	0.003	195.4	0.0293
732.73	0.002	195.4	0.0249
732.75	0.002	195.2	0.0222
732.77	0.001	194.9	0.0178
732.78	-0.003	194.6	0.0133
732.80	-0.004	194.4	0.0107
732.82	-0.005	194.1	0.0062
732.83	-0.008	193.8	0.0062
732.85	-0.009	193.8	0.0027
732.87	-0.009	193.6	0
732.88	-0.01	193.3	-0.0027
732.90	-0.013	193.1	-0.0062
732.92	-0.014	192.9	-0.008
732.93	-0.014	192.7	-0.0098
732.95	-0.015	192.4	-0.0098
732.97	-0.016	192.4	-0.0115
732.98	-0.016	192.3	-0.0124
733.02	-0.016	192.1	-0.0142
733.03	-0.017	191.9	-0.0151
733.05	-0.017	191.8	-0.0151
733.05	-0.017	191.7	-0.0151
733.07	-0.017	191.6	-0.0151
733.08	-0.017	191.6	-0.0151
733.10	-0.017	191.5	-0.0151
733.12	-0.016	191.4	-0.0142
733.13	-0.015	191.4	-0.0133
733.15	-0.015	191.4	-0.0124
733.17	-0.014	191.4	-0.0107
733.18	-0.012	191.5	-0.0107
733.20	-0.011	191.5	-0.0089
733.22	-0.011	191.6	-0.0071
733.23	-0.01	191.6	-0.0044
733.25	-0.006	191.8	-0.0018
733.27	-0.006	191.9	0.0009
733.28	-0.004	192.1	0.0036
733.30	-0.001	192.3	0.0036
733.32	0	192.3	0.0071
733.33	0	192.4	0.0107
733.35	0.004	192.8	0.0142
733.37	0.005	192.8	0.016
733.38	0.005	193	0.0195
733.40	0.007	193.2	0.024
733.42	0.011	193.5	0.0293
733.43	0.012	193.7	0.032
733.45	0.013	193.9	0.0355
733.47	0.016	194.2	0.0355
733.48	0.018	194.4	0.0399
733.50	0.018	194.4	0.0426
733.52	0.019	194.7	0.0462
733.53	0.021	195	0.0497
733.55	0.023	195.2	0.0524
733.57	0.024	195.4	0.0541
733.58	0.025	195.7	0.0541
733.60	0.026	195.9	0.0568
733.62	0.026	195.9	0.0586
733.63	0.027	196.1	0.0604

Prova triassiale ciclica SN04-C1			
pressione di confinamento (kPa)		80	
deviatore ciclico (kPa)		95	
frequenza (hz)		0.00625	
tempo	cella di carico	$\Delta u$	LVDT
(min)	kN	(kPa)	$\delta$ (mm)
733.65	0.028	196.3	0.0621
733.67	0.029	196.5	0.063
733.68	0.029	196.6	0.063
733.70	0.029	196.7	0.063
733.72	0.029	196.9	0.0639
733.73	0.029	196.9	0.0639
733.75	0.029	197	0.0639
733.77	0.028	197.1	0.0639
733.78	0.028	197.1	0.0639
733.80	0.027	197.1	0.0612
733.82	0.026	197.1	0.0604
733.83	0.024	197.1	0.0604
733.85	0.023	197.1	0.0586
733.87	0.023	197.1	0.0568
733.88	0.022	197	0.055
733.90	0.02	196.9	0.0524
733.92	0.019	196.8	0.0506
733.93	0.017	196.7	0.047
733.95	0.014	196.5	0.047
733.97	0.013	196.5	0.0444
733.98	0.013	196.4	0.0408
734.00	0.012	196.1	0.0382
734.02	0.008	196	0.0337
734.03	0.007	195.8	0.0311
734.05	0.005	195.5	0.0257
734.07	0.002	195.2	0.0257
734.08	0.001	195	0.0186
734.10	0	194.8	0.016
734.12	-0.004	194.5	0.016
734.13	-0.004	194.5	0.0124
734.15	-0.004	194.3	0.0089
734.17	-0.006	194	0.0044
734.18	-0.009	193.7	0.0009
734.20	-0.009	193.5	-0.0018
734.22	-0.011	193.2	-0.0044
734.23	-0.013	193	-0.0044
734.25	-0.014	193	-0.0071
734.27	-0.014	192.8	-0.0089
734.28	-0.014	192.6	-0.0107
734.30	-0.016	192.4	-0.0124
734.32	-0.016	192.2	-0.0133
734.33	-0.017	192	-0.0151
734.35	-0.017	191.9	-0.0151
734.37	-0.017	191.9	-0.0151
734.38	-0.017	191.7	-0.016
734.40	-0.017	191.6	-0.016
734.42	-0.017	191.6	-0.0151
734.45	-0.016	191.5	-0.0151
734.47	-0.016	191.5	-0.0142
734.48	-0.015	191.4	-0.0142
734.50	-0.014	191.5	-0.0133
734.52	-0.014	191.5	-0.0124
734.52	-0.013	191.4	-0.0107
734.53	-0.011	191.6	-0.0089
734.55	-0.01	191.6	-0.0062
734.57	-0.009	191.7	-0.0036
734.58	-0.006	191.9	-0.0036
734.60	-0.005	192	-0.0009

Prova triassiale ciclica SN04-C1			
pressione di confinamento (kPa)		80	
deviatore ciclico (kPa)		95	
frequenza (hz)		0.00625	
tempo	cella di carico	$\Delta u$	LVDT
(min)	kN	(kPa)	$\delta$ (mm)
734.62	-0.005	192	0.0018
734.63	-0.003	192.1	0.0053
734.65	-0.001	192.3	0.008
734.67	0.002	192.5	0.0115
734.68	0.003	192.7	0.0151
734.70	0.005	193	0.0151
734.72	0.008	193.2	0.0186
734.73	0.008	193.2	0.0222
734.75	0.009	193.4	0.0275
734.77	0.012	193.7	0.032
734.78	0.014	193.9	0.0346
734.80	0.015	194.1	0.0391
734.82	0.017	194.4	0.0426
734.83	0.019	194.6	0.0444
734.85	0.02	194.8	0.047
734.87	0.021	195.1	0.0497
734.88	0.023	195.4	0.0497
734.90	0.023	195.4	0.0524
734.92	0.024	195.6	0.055
734.93	0.025	195.9	0.0577
734.95	0.027	196.1	0.0595
734.97	0.027	196.2	0.0604
734.98	0.027	196.4	0.0612
735.00	0.029	196.6	0.0612
735.02	0.029	196.6	0.063
735.03	0.029	196.7	0.063
735.05	0.029	196.8	0.063
735.07	0.028	196.9	0.063
735.08	0.028	197	0.063
735.10	0.028	197.1	0.063
735.12	0.028	197.2	0.063
735.13	0.026	197.2	0.063
735.15	0.026	197.2	0.0612
735.17	0.026	197.2	0.0595
735.18	0.024	197.1	0.0577
735.20	0.023	197.1	0.0559
735.22	0.022	197	0.0541
735.23	0.019	196.9	0.0541
735.25	0.018	196.9	0.0515
735.27	0.018	196.8	0.0488
735.28	0.017	196.7	0.0462
735.30	0.013	196.5	0.0417
735.32	0.012	196.4	0.0391
735.33	0.011	196.1	0.0355
735.35	0.007	195.9	0.0355
735.37	0.006	195.9	0.0311
735.38	0.006	195.8	0.0284
735.40	0.004	195.4	0.0231
735.42	0.001	195.1	0.0195
735.43	0	194.9	0.016
735.45	-0.002	194.7	0.0124
735.47	-0.005	194.4	0.0124
735.48	-0.006	194.4	0.008
735.50	-0.006	194.1	0.0053
735.52	-0.007	193.9	0.0018
735.53	-0.011	193.6	-0.0018
735.55	-0.011	193.4	-0.0036
735.57	-0.012	193.2	-0.0062

Prova triassiale ciclica SN04-C1			
pressione di confinamento (kPa)		80	
deviatore ciclico (kPa)		95	
frequenza (hz)		0.00625	
tempo	cella di carico	$\Delta u$	LVDT
(min)	kN	(kPa)	$\delta$ (mm)
735.58	-0.014	192.9	-0.008
735.60	-0.014	192.7	-0.0098
735.62	-0.015	192.5	-0.0124
735.63	-0.016	192.3	-0.0124
735.65	-0.016	192.1	-0.0133
735.67	-0.016	192.1	-0.0142
735.68	-0.017	192	-0.0151
735.70	-0.017	191.8	-0.016
735.72	-0.017	191.7	-0.016
735.73	-0.017	191.6	-0.016
735.75	-0.017	191.5	-0.016
735.77	-0.016	191.5	-0.016
735.78	-0.015	191.5	-0.0151
735.80	-0.015	191.4	-0.0142
735.82	-0.015	191.4	-0.0133
735.83	-0.013	191.5	-0.0115
735.85	-0.012	191.5	-0.0107
735.87	-0.011	191.6	-0.0089
735.88	-0.009	191.6	-0.0089
735.92	-0.008	191.6	-0.0062
735.93	-0.008	191.7	-0.0036
735.95	-0.007	191.9	-0.0009
735.97	-0.003	192.1	0.0027
735.97	-0.003	192.2	0.0053
735.98	-0.001	192.4	0.0089
736.00	0.003	192.6	0.0089
736.02	0.004	192.6	0.0124
736.03	0.004	192.8	0.016
736.05	0.005	193	0.0204
736.07	0.009	193.3	0.024
736.08	0.01	193.5	0.0284
736.10	0.011	193.8	0.032
736.12	0.015	194	0.032
736.13	0.016	194	0.0364
736.15	0.016	194.2	0.0391
736.17	0.017	194.5	0.0426
736.18	0.021	194.8	0.0462
736.20	0.021	195	0.0488
736.22	0.022	195.2	0.0515
736.23	0.024	195.6	0.0515
736.25	0.025	195.6	0.0541
736.27	0.026	195.9	0.0577
736.28	0.027	196.1	0.0577
736.30	0.027	196.1	0.0595
736.32	0.027	196.3	0.0604
736.33	0.028	196.5	0.0612
736.35	0.028	196.6	0.0621
736.37	0.029	196.8	0.063
736.38	0.029	196.9	0.0639
736.40	0.029	197	0.0639
736.42	0.029	197	0.0639
736.43	0.029	197.1	0.063
736.45	0.028	197.2	0.063
736.47	0.027	197.2	0.0612
736.48	0.026	197.2	0.0604
736.50	0.025	197.2	0.0586
736.52	0.023	197.1	0.0586
736.53	0.022	197.1	0.0568

Prova triassiale ciclica SN04-C1			
pressione di confinamento (kPa)		80	
deviatore ciclico (kPa)		95	
frequenza (hz)		0.00625	
tempo	cella di carico	$\Delta u$	LVDT
(min)	kN	(kPa)	$\delta$ (mm)
736.55	0.022	197.1	0.055
736.57	0.021	197	0.0524
736.58	0.019	196.9	0.0497
736.60	0.017	196.8	0.047
736.62	0.015	196.6	0.0435
736.63	0.013	196.4	0.0435
736.65	0.011	196.2	0.0408
736.67	0.011	196.2	0.0373
736.68	0.01	196.1	0.0337
736.70	0.006	195.8	0.0302
736.72	0.005	195.6	0.0275
736.73	0.004	195.4	0.0222
736.75	0	195.1	0.0222
736.77	-0.002	194.8	0.0178
736.78	-0.002	194.8	0.0151
736.80	-0.003	194.6	0.0107
736.82	-0.005	194.3	0.0071
736.83	-0.007	194	0.0036
736.85	-0.009	193.8	0
736.87	-0.01	193.5	0
736.88	-0.012	193.2	-0.0027
736.90	-0.012	193.2	-0.0053
736.92	-0.013	193	-0.008
736.93	-0.014	192.8	-0.0098
736.95	-0.016	192.6	-0.0115
736.97	-0.016	192.4	-0.0124
736.98	-0.016	192.2	-0.0142
737.00	-0.016	192.1	-0.0142
737.02	-0.017	191.9	-0.0151
737.03	-0.017	191.8	-0.016
737.05	-0.017	191.7	-0.016
737.07	-0.017	191.7	-0.0169
737.08	-0.017	191.6	-0.016
737.10	-0.017	191.5	-0.016
737.12	-0.015	191.5	-0.0151
737.13	-0.015	191.4	-0.0142
737.15	-0.014	191.5	-0.0124
737.17	-0.013	191.5	-0.0124
737.18	-0.013	191.5	-0.0115
737.20	-0.012	191.5	-0.0098
737.22	-0.011	191.6	-0.0071
737.23	-0.008	191.7	-0.0044
737.25	-0.007	191.8	-0.0018
737.27	-0.005	192	0.0009
737.28	-0.003	192.1	0.0009
737.30	-0.003	192.1	0.0036
737.32	-0.002	192.3	0.0071
737.35	0.001	192.5	0.0107
737.37	0.003	192.7	0.0142
737.38	0.004	192.9	0.0178
737.40	0.007	193.2	0.0222
737.42	0.01	193.4	0.0222
737.42	0.01	193.4	0.0257
737.43	0.011	193.6	0.0302
737.45	0.013	193.9	0.0346
737.47	0.016	194.2	0.0382
737.48	0.017	194.4	0.0408
737.50	0.019	194.7	0.0444

Prova triassiale ciclica SN04-C1			
pressione di confinamento (kPa)		80	
deviatore ciclico (kPa)		95	
frequenza (hz)		0.00625	
tempo	cella di carico	$\Delta u$	LVDT
(min)	kN	(kPa)	$\delta$ (mm)
737.52	0.021	194.9	0.0444
737.53	0.021	194.9	0.0479
737.55	0.022	195.1	0.0497
737.57	0.023	195.4	0.0533
737.58	0.025	195.7	0.0559
737.60	0.026	195.9	0.0568
737.62	0.026	196.1	0.0595
737.63	0.028	196.3	0.0595
737.65	0.028	196.3	0.0612
737.67	0.028	196.4	0.0612
737.68	0.028	196.6	0.0621
737.70	0.029	196.7	0.063
737.72	0.029	196.9	0.063
737.73	0.029	197	0.063
737.75	0.029	197.1	0.063
737.77	0.028	197.2	0.063
737.78	0.028	197.2	0.0621
737.80	0.026	197.2	0.0621
737.82	0.025	197.2	0.0604
737.83	0.025	197.2	0.0595
737.85	0.025	197.2	0.0577
737.87	0.023	197.1	0.0559
737.88	0.021	197.1	0.0541
737.90	0.02	197	0.0515
737.92	0.017	196.8	0.0515
737.93	0.016	196.8	0.0488
737.95	0.016	196.7	0.0462
737.97	0.015	196.6	0.0426
737.98	0.011	196.4	0.0391
738.00	0.011	196.3	0.0364
738.02	0.009	196	0.032
738.03	0.005	195.8	0.032
738.05	0.004	195.8	0.0284
738.07	0.004	195.6	0.024
738.08	0.003	195.3	0.0195
738.10	-0.001	195	0.016
738.12	-0.002	194.7	0.0133
738.13	-0.003	194.5	0.0089
738.15	-0.007	194.2	0.0089
738.17	-0.008	194.2	0.0044
738.18	-0.008	193.9	0.0027
738.20	-0.009	193.7	-0.0009
738.22	-0.011	193.4	-0.0044
738.23	-0.012	193.2	-0.0062
738.25	-0.013	193	-0.0089
738.27	-0.014	192.7	-0.0089
738.28	-0.016	192.5	-0.0107
738.30	-0.016	192.5	-0.0124
738.32	-0.016	192.3	-0.0133
738.33	-0.017	192.1	-0.0151
738.35	-0.017	192	-0.016
738.37	-0.017	191.9	-0.016
738.38	-0.017	191.8	-0.016
738.40	-0.017	191.7	-0.016
738.42	-0.017	191.7	-0.016
738.43	-0.017	191.6	-0.016
738.45	-0.015	191.5	-0.0151
738.47	-0.015	191.5	-0.0151



Prova triassiale ciclica SN04-C1			
pressione di confinamento (kPa)		80	
deviatore ciclico (kPa)		95	
frequenza (hz)		0.00625	
tempo	cella di carico	$\Delta u$	LVDT
(min)	kN	(kPa)	$\delta$ (mm)
738.48	-0.015	191.5	-0.0142
738.50	-0.014	191.5	-0.0124
738.52	-0.012	191.5	-0.0107
738.53	-0.011	191.6	-0.0089
738.55	-0.01	191.7	-0.0062
738.57	-0.007	191.8	-0.0062
738.58	-0.007	191.8	-0.0044
738.60	-0.007	191.9	-0.0018
738.62	-0.005	192.1	0.0018
738.63	-0.002	192.2	0.0053
738.65	-0.001	192.4	0.008
738.67	0.001	192.6	0.0115
738.68	0.004	192.8	0.0115
738.70	0.006	192.8	0.0151
738.72	0.006	193	0.0195
738.73	0.007	193.2	0.0231
738.75	0.011	193.5	0.0284
738.77	0.012	193.7	0.0311
738.78	0.013	194	0.0346
738.82	0.017	194.3	0.0346
738.83	0.017	194.3	0.0382
738.85	0.017	194.5	0.0408
738.87	0.019	194.7	0.0453
738.87	0.022	195	0.0488
738.88	0.022	195.2	0.0506
738.90	0.024	195.5	0.0533
738.92	0.025	195.8	0.0533
738.93	0.027	196	0.0559
738.95	0.027	196	0.0577
738.97	0.027	196.1	0.0595
738.98	0.028	196.3	0.0604
739.00	0.028	196.5	0.0621
739.02	0.028	196.7	0.0621
739.03	0.029	196.8	0.0621
739.05	0.029	196.9	0.063
739.07	0.029	196.9	0.063
739.08	0.029	197	0.063
739.10	0.029	197.1	0.063
739.12	0.028	197.2	0.063
739.13	0.027	197.2	0.0612
739.15	0.026	197.2	0.0595
739.17	0.024	197.2	0.0586
739.18	0.024	197.2	0.0577
739.20	0.023	197.1	0.055
739.22	0.02	197	0.055
739.23	0.02	197	0.0533
739.25	0.02	197	0.0506
739.27	0.018	196.8	0.0479
739.28	0.015	196.7	0.0444
739.30	0.014	196.5	0.0417
739.32	0.012	196.3	0.0382
739.33	0.009	196.1	0.0382
739.35	0.008	196.1	0.0346
739.37	0.008	196	0.032
739.38	0.006	195.7	0.0275
739.40	0.002	195.4	0.0231
739.42	0.002	195.2	0.0195
739.43	0	194.9	0.0151

Prova triassiale ciclica SN04-C1			
pressione di confinamento (kPa)		80	
deviatore ciclico (kPa)		95	
frequenza (hz)		0.00625	
tempo	cella di carico	$\Delta u$	LVDT
(min)	kN	(kPa)	$\delta$ (mm)
739.45	-0.003	194.6	0.0151
739.47	-0.004	194.6	0.0115
739.48	-0.004	194.4	0.008
739.50	-0.006	194.1	0.0036
739.52	-0.009	193.8	0.0009
739.53	-0.01	193.6	-0.0018
739.55	-0.011	193.3	-0.0053
739.57	-0.013	193.1	-0.0053
739.58	-0.014	193.1	-0.0071
739.60	-0.014	192.9	-0.0089
739.62	-0.015	192.6	-0.0115
739.63	-0.016	192.4	-0.0133
739.65	-0.016	192.3	-0.0142
739.67	-0.017	192.1	-0.0151
739.68	-0.017	192	-0.0151
739.70	-0.017	192	-0.0151
739.72	-0.017	191.8	-0.016
739.73	-0.017	191.7	-0.016
739.75	-0.017	191.6	-0.016
739.77	-0.017	191.6	-0.0151
739.78	-0.016	191.5	-0.0151
739.80	-0.014	191.5	-0.0151
739.82	-0.014	191.5	-0.0133
739.83	-0.014	191.5	-0.0124
739.85	-0.013	191.5	-0.0107
739.87	-0.011	191.6	-0.0089
739.88	-0.01	191.7	-0.0071
739.90	-0.009	191.7	-0.0044
739.92	-0.007	191.8	-0.0036
739.93	-0.006	191.9	-0.0009
739.95	-0.004	192.1	0.0027
739.97	-0.001	192.3	0.0027
739.98	0	192.5	0.0062
740.00	0	192.5	0.0089
740.02	0.002	192.6	0.0133
740.03	0.005	192.9	0.0178
740.05	0.006	193.1	0.0204
740.07	0.008	193.3	0.0249
740.08	0.011	193.6	0.0249
740.10	0.013	193.9	0.0293
740.12	0.013	193.9	0.0328
740.13	0.014	194.1	0.0364
740.15	0.017	194.4	0.0399
740.17	0.019	194.6	0.0435
740.18	0.02	194.8	0.047
740.20	0.022	195.1	0.047
740.22	0.024	195.4	0.0497
740.23	0.024	195.4	0.0524
740.27	0.024	195.6	0.0541
740.28	0.025	195.9	0.0568
740.30	0.027	196.1	0.0586
740.32	0.027	196.2	0.0595
740.32	0.028	196.4	0.0595
740.33	0.029	196.6	0.0612
740.35	0.029	196.6	0.0621
740.37	0.029	196.7	0.063
740.38	0.029	196.8	0.063
740.40	0.029	197	0.063

Prova triassiale ciclica SN04-C1			
pressione di confinamento (kPa)		80	
deviatore ciclico (kPa)		95	
frequenza (hz)		0.00625	
tempo	cella di carico	$\Delta u$	LVDT
(min)	kN	(kPa)	$\delta$ (mm)
740.42	0.029	197.1	0.063
740.43	0.028	197.1	0.063
740.45	0.027	197.2	0.063
740.47	0.027	197.2	0.0621
740.48	0.027	197.2	0.0612
740.50	0.026	197.2	0.0586
740.52	0.023	197.1	0.0568
740.53	0.023	197.1	0.0568
740.55	0.022	197	0.0533
740.57	0.019	196.9	0.0533
740.58	0.018	196.9	0.0506
740.60	0.018	196.8	0.0488
740.62	0.015	196.6	0.0453
740.63	0.013	196.6	0.0444
740.65	0.013	196.5	0.0408
740.67	0.012	196.3	0.0373
740.68	0.008	196	0.0328
740.70	0.007	195.9	0.0311
740.72	0.005	195.7	0.0257
740.73	0.002	195.3	0.0257
740.75	0	195.1	0.0213
740.77	0	195.1	0.0186
740.78	-0.001	194.9	0.0142
740.80	-0.004	194.5	0.0098
740.82	-0.006	194.3	0.0071
740.83	-0.006	194.1	0.0036
740.85	-0.009	193.7	0.0036
740.87	-0.011	193.5	-0.0009
740.88	-0.011	193.5	-0.0027
740.90	-0.011	193.3	-0.0053
740.92	-0.013	193	-0.008
740.93	-0.015	192.8	-0.0098
740.95	-0.015	192.6	-0.0115
740.97	-0.016	192.4	-0.0133
740.98	-0.017	192.2	-0.0133
741.00	-0.017	192.2	-0.0142
741.02	-0.017	192.1	-0.0151
741.03	-0.017	191.9	-0.016
741.05	-0.017	191.8	-0.016
741.07	-0.017	191.7	-0.016
741.08	-0.017	191.6	-0.0151
741.10	-0.016	191.6	-0.0151
741.12	-0.016	191.6	-0.0151
741.13	-0.016	191.5	-0.0142
741.15	-0.015	191.5	-0.0133
741.17	-0.013	191.6	-0.0115
741.18	-0.012	191.6	-0.0107
741.20	-0.012	191.6	-0.008
741.22	-0.009	191.7	-0.008
741.23	-0.008	191.7	-0.0062
741.25	-0.008	191.8	-0.0036
741.27	-0.007	192	-0.0009
741.28	-0.004	192.1	0.0027
741.30	-0.003	192.3	0.0053
741.32	-0.001	192.5	0.0089
741.33	0.003	192.7	0.0089
741.35	0.004	192.9	0.0151
741.37	0.004	193	0.0178

Prova triassiale ciclica SN04-C1			
pressione di confinamento (kPa)		80	
deviatore ciclico (kPa)		95	
frequenza (hz)		0.00625	
tempo	cella di carico	$\Delta u$	LVDT
(min)	kN	(kPa)	$\delta$ (mm)
741.38	0.008	193.3	0.0178
741.40	0.009	193.3	0.0222
741.42	0.009	193.5	0.0257
741.43	0.011	193.8	0.0302
741.45	0.014	194	0.0346
741.47	0.015	194.2	0.0382
741.48	0.017	194.5	0.0417
741.50	0.02	194.8	0.0417
741.52	0.02	194.8	0.0453
741.53	0.02	195	0.0479
741.55	0.022	195.2	0.0506
741.57	0.024	195.6	0.0541
741.58	0.025	195.8	0.0559
741.60	0.025	196	0.0577
741.62	0.027	196.2	0.0577
741.63	0.027	196.2	0.0595
741.65	0.027	196.4	0.0604
741.67	0.028	196.5	0.0621
741.68	0.028	196.7	0.0621
741.72	0.029	196.8	0.063
741.73	0.029	196.9	0.063
741.75	0.029	197	0.063
741.77	0.029	197	0.063
741.77	0.029	197.1	0.063
741.78	0.028	197.2	0.063
741.80	0.027	197.2	0.0621
741.82	0.026	197.2	0.0604
741.83	0.025	197.2	0.0586
741.85	0.024	197.2	0.0586
741.87	0.022	197.1	0.0568
741.88	0.022	197.1	0.055
741.90	0.021	197.1	0.0524
741.92	0.018	196.9	0.0497
741.93	0.017	196.8	0.047
741.95	0.016	196.7	0.0444
741.97	0.013	196.5	0.0444
741.98	0.011	196.4	0.0408
742.00	0.011	196.4	0.0382
742.02	0.01	196.2	0.0346
742.03	0.006	195.9	0.0302
742.05	0.004	195.7	0.0257
742.07	0.004	195.5	0.0222
742.08	0.002	195.2	0.0204
742.10	0	195	0.0169
742.12	-0.002	194.8	0.0124
742.13	-0.005	194.4	0.0124
742.15	-0.007	194.2	0.008
742.17	-0.007	194.2	0.0053
742.18	-0.007	194	0.0018
742.20	-0.01	193.7	-0.0018
742.22	-0.011	193.4	-0.0044
742.23	-0.012	193.2	-0.0071
742.25	-0.013	192.9	-0.0071
742.27	-0.015	192.7	-0.0089
742.28	-0.015	192.7	-0.0115
742.30	-0.015	192.5	-0.0124
742.32	-0.016	192.4	-0.0133
742.33	-0.017	192.2	-0.0142

Prova triassiale ciclica SN04-C1			
pressione di confinamento (kPa)		80	
deviatore ciclico (kPa)		95	
frequenza (hz)		0.00625	
tempo	cella di carico	$\Delta u$	LVDT
(min)	kN	(kPa)	$\delta$ (mm)
742.35	-0.017	192	-0.0151
742.37	-0.017	191.9	-0.016
742.38	-0.017	191.8	-0.016
742.40	-0.017	191.8	-0.016
742.42	-0.017	191.7	-0.016
742.43	-0.017	191.6	-0.016
742.45	-0.016	191.6	-0.0151
742.47	-0.015	191.5	-0.0142
742.48	-0.014	191.6	-0.0124
742.50	-0.012	191.6	-0.0124
742.52	-0.012	191.6	-0.0107
742.53	-0.012	191.6	-0.0089
742.55	-0.011	191.7	-0.0071
742.57	-0.008	191.8	-0.0044
742.58	-0.007	191.9	-0.0027
742.60	-0.006	192.1	0.0009
742.62	-0.002	192.2	0.0009
742.63	-0.002	192.2	0.0044
742.65	-0.002	192.4	0.0062
742.67	0	192.5	0.0098
742.68	0.004	192.8	0.0142
742.70	0.004	193	0.0169
742.72	0.006	193.2	0.0213
742.73	0.01	193.5	0.0213
742.75	0.011	193.5	0.0257
742.77	0.011	193.7	0.0293
742.78	0.013	193.9	0.0337
742.80	0.016	194.4	0.0382
742.82	0.016	194.4	0.0391
742.83	0.018	194.6	0.0435
742.85	0.02	194.9	0.047
742.87	0.022	195.2	0.0488
742.88	0.022	195.4	0.0515
742.90	0.024	195.7	0.0515
742.92	0.025	195.9	0.0541
742.93	0.025	195.9	0.0559
742.95	0.026	196.1	0.0577
742.97	0.027	196.3	0.0595
742.98	0.028	196.5	0.0612
743.00	0.028	196.6	0.0621
743.02	0.028	196.8	0.0621
743.03	0.029	196.9	0.0621
743.05	0.029	196.9	0.063
743.07	0.029	197	0.063
743.08	0.029	197.1	0.063
743.10	0.028	197.2	0.063
743.12	0.028	197.3	0.0621
743.13	0.027	197.3	0.0612
743.15	0.025	197.2	0.0612
743.18	0.024	197.2	0.0595
743.20	0.024	197.3	0.0586
743.22	0.024	197.2	0.0568
743.23	0.021	197.2	0.0541
743.23	0.02	197.1	0.0524
743.25	0.019	197	0.0488
743.27	0.016	196.8	0.0488
743.28	0.015	196.8	0.0462
743.30	0.015	196.7	0.0435

Prova triassiale ciclica SN04-C1			
pressione di confinamento (kPa)		80	
deviatore ciclico (kPa)		95	
frequenza (hz)		0.00625	
tempo	cella di carico	$\Delta u$	LVDT
(min)	kN	(kPa)	$\delta$ (mm)
743.32	0.013	196.5	0.0399
743.33	0.01	196.3	0.0355
743.35	0.008	196.1	0.0328
743.37	0.007	195.9	0.0293
743.38	0.004	195.7	0.0293
743.40	0.002	195.4	0.0249
743.42	0.002	195.4	0.0213
743.43	0.001	195.2	0.0169
743.45	-0.003	194.8	0.0124
743.47	-0.004	194.6	0.0098
743.48	-0.005	194.4	0.0062
743.50	-0.008	194	0.0062
743.52	-0.009	193.8	0.0027
743.53	-0.01	193.6	-0.0027
743.55	-0.011	193.4	-0.0027
743.57	-0.013	193.1	-0.0044
743.58	-0.013	193.1	-0.008
743.60	-0.014	192.9	-0.0098
743.62	-0.015	192.7	-0.0115
743.63	-0.016	192.5	-0.0133
743.65	-0.016	192.3	-0.0142
743.67	-0.017	192.1	-0.0151
743.68	-0.017	192	-0.0151
743.70	-0.017	192	-0.016
743.72	-0.017	191.9	-0.016
743.73	-0.017	191.8	-0.016
743.75	-0.017	191.7	-0.016
743.77	-0.016	191.6	-0.016
743.78	-0.016	191.6	-0.0151
743.80	-0.015	191.6	-0.0151
743.82	-0.014	191.6	-0.0142
743.83	-0.014	191.5	-0.0124
743.85	-0.013	191.6	-0.0107
743.87	-0.011	191.7	-0.0089
743.88	-0.01	191.7	-0.0071
743.90	-0.009	191.8	-0.0044
743.92	-0.006	192	-0.0044
743.93	-0.005	192	-0.0018
743.95	-0.005	192.1	0.0009
743.97	-0.003	192.3	0.0044
743.98	0	192.5	0.008
744.00	0.001	192.6	0.0107
744.02	0.002	192.8	0.0151
744.03	0.006	193.1	0.0151
744.05	0.007	193.1	0.0195
744.07	0.007	193.3	0.0222
744.08	0.009	193.5	0.0257
744.10	0.013	193.8	0.032
744.12	0.014	194	0.0337
744.13	0.015	194.3	0.0382
744.15	0.018	194.6	0.0382
744.17	0.019	194.8	0.0426
744.18	0.019	194.8	0.0444
744.20	0.02	195	0.0479
744.22	0.023	195.3	0.0515
744.23	0.024	195.6	0.0533
744.25	0.025	195.8	0.0559
744.27	0.025	196	0.0568

Prova triassiale ciclica SN04-C1			
pressione di confinamento (kPa)		80	
deviatore ciclico (kPa)		95	
frequenza (hz)		0.00625	
tempo	cella di carico	$\Delta u$	LVDT
(min)	kN	(kPa)	$\delta$ (mm)
744.28	0.026	196.2	0.0586
744.30	0.027	196.4	0.0604
744.32	0.028	196.6	0.0604
744.33	0.029	196.7	0.0621
744.35	0.029	196.7	0.0621
744.37	0.029	196.9	0.063
744.38	0.029	197	0.063
744.40	0.029	197.1	0.063
744.42	0.029	197.2	0.063
744.43	0.028	197.3	0.063
744.45	0.027	197.3	0.063
744.47	0.026	197.3	0.0621
744.48	0.026	197.3	0.0604
744.50	0.025	197.3	0.0595
744.52	0.024	197.3	0.0577
744.53	0.023	197.2	0.0559
744.55	0.022	197.2	0.0533
744.57	0.019	197.1	0.0533
744.58	0.018	197.1	0.0506
744.62	0.018	197	0.0488
744.63	0.017	196.8	0.0453
744.65	0.013	196.6	0.0417
744.67	0.012	196.5	0.0391
744.68	0.011	196.3	0.0355
744.68	0.007	196	0.0355
744.70	0.006	196	0.0311
744.72	0.006	195.9	0.0284
744.73	0.004	195.6	0.0231
744.75	0	195.3	0.0186
744.77	0	195.1	0.016
744.78	-0.002	194.8	0.0124
744.80	-0.005	194.5	0.0124
744.82	-0.006	194.5	0.008
744.83	-0.006	194.3	0.0053
744.85	-0.007	194	0.0018
744.87	-0.01	193.7	-0.0018
744.88	-0.011	193.5	-0.0044
744.90	-0.012	193.2	-0.0071
744.92	-0.014	193	-0.0071
744.93	-0.015	193	-0.0098
744.95	-0.015	192.8	-0.0115
744.97	-0.015	192.6	-0.0124
744.98	-0.017	192.4	-0.0142
745.00	-0.017	192.2	-0.0151
745.02	-0.017	192.1	-0.0151
745.03	-0.017	192	-0.016
745.05	-0.017	191.8	-0.016
745.07	-0.017	191.7	-0.016
745.08	-0.017	191.7	-0.016
745.10	-0.016	191.7	-0.016
745.12	-0.016	191.6	-0.0151
745.13	-0.016	191.6	-0.0142
745.15	-0.014	191.6	-0.0133
745.17	-0.013	191.6	-0.0115
745.18	-0.012	191.6	-0.0098
745.20	-0.011	191.7	-0.0098
745.22	-0.009	191.7	-0.008
745.23	-0.009	191.8	-0.0062

Prova triassiale ciclica SN04-C1			
pressione di confinamento (kPa)		80	
deviatore ciclico (kPa)		95	
frequenza (hz)		0.00625	
tempo	cella di carico	$\Delta u$	LVDT
(min)	kN	(kPa)	$\delta$ (mm)
745.25	-0.008	191.9	-0.0036
745.27	-0.005	192.1	0
745.28	-0.004	192.2	0.0018
745.30	-0.003	192.3	0.0053
745.32	0	192.6	0.0053
745.33	0.002	192.8	0.0098
745.35	0.002	192.8	0.0124
745.37	0.003	192.9	0.016
745.38	0.006	193.2	0.0204
745.40	0.009	193.4	0.024
745.42	0.01	193.6	0.0284
745.43	0.012	193.9	0.0284
745.45	0.015	194.2	0.032
745.47	0.015	194.2	0.0355
745.48	0.016	194.4	0.0399
745.50	0.018	194.7	0.0435
745.52	0.02	195	0.047
745.53	0.021	195.2	0.0497
745.55	0.023	195.5	0.0524
745.57	0.025	195.7	0.0524
745.58	0.025	195.7	0.0541
745.60	0.025	195.9	0.0559
745.62	0.026	196.1	0.0586
745.63	0.027	196.3	0.0604
745.65	0.028	196.5	0.0612
745.67	0.028	196.7	0.0621
745.68	0.029	196.8	0.0621
745.70	0.029	196.9	0.063
745.72	0.029	197	0.063
745.73	0.029	197.2	0.063
745.75	0.029	197.2	0.063
745.77	0.029	197.3	0.063
745.78	0.028	197.3	0.0621
745.80	0.027	197.3	0.0612
745.82	0.026	197.3	0.0604
745.83	0.025	197.3	0.0586
745.85	0.023	197.3	0.0586
745.87	0.022	197.3	0.0568
745.88	0.022	197.2	0.055
745.90	0.021	197.2	0.0524
745.92	0.018	197	0.0497
745.93	0.017	196.9	0.0479
745.95	0.016	196.8	0.0444
745.97	0.013	196.6	0.0444
745.98	0.011	196.4	0.0408
746.00	0.011	196.4	0.0382
746.02	0.01	196.3	0.0337
746.03	0.006	196	0.0302
746.05	0.005	195.8	0.0275
746.08	0.003	195.6	0.0222
746.10	0	195.2	0.0222
746.12	-0.001	195	0.0178
746.13	-0.001	195	0.0151
746.13	-0.002	194.8	0.0107
746.15	-0.005	194.4	0.0062
746.17	-0.007	194.2	0.0036
746.18	-0.008	194	0
746.20	-0.01	193.6	0



Prova triassiale ciclica SN04-C1			
pressione di confinamento (kPa)		80	
deviatore ciclico (kPa)		95	
frequenza (hz)		0.00625	
tempo	cella di carico	$\Delta u$	LVDT
(min)	kN	(kPa)	$\delta$ (mm)
746.22	-0.012	193.4	-0.0027
746.23	-0.012	193.4	-0.0053
746.25	-0.013	193.2	-0.008
746.27	-0.014	192.9	-0.0107
746.28	-0.015	192.7	-0.0115
746.30	-0.016	192.6	-0.0133
746.32	-0.016	192.3	-0.0142
746.33	-0.017	192.2	-0.0142
746.35	-0.017	192.2	-0.0151
746.37	-0.017	192	-0.016
746.38	-0.017	191.9	-0.016
746.40	-0.017	191.8	-0.016
746.42	-0.017	191.7	-0.016
746.43	-0.017	191.7	-0.016
746.45	-0.016	191.6	-0.0151
746.47	-0.015	191.6	-0.0142
746.48	-0.015	191.6	-0.0133
746.50	-0.013	191.6	-0.0133
746.52	-0.012	191.6	-0.0115
746.53	-0.012	191.7	-0.0098
746.55	-0.011	191.8	-0.0071
746.57	-0.008	191.9	-0.0044
746.58	-0.007	191.9	-0.0036
746.60	-0.006	192.1	0
746.62	-0.002	192.3	0
746.63	-0.002	192.3	0.0036
746.65	-0.002	192.4	0.0062
746.67	0	192.6	0.0098
746.68	0.004	192.9	0.0142
746.70	0.004	193	0.0169
746.72	0.006	193.3	0.0213
746.73	0.01	193.6	0.0213
746.75	0.011	193.6	0.0257
746.77	0.011	193.7	0.0302
746.78	0.012	194	0.0328
746.80	0.016	194.3	0.0373
746.82	0.016	194.5	0.0399
746.83	0.018	194.8	0.0444
746.85	0.021	195.1	0.0444
746.87	0.022	195.1	0.0479
746.88	0.022	195.3	0.0497
746.90	0.023	195.6	0.0524
746.92	0.025	195.8	0.055
746.93	0.026	196	0.0568
746.95	0.026	196.2	0.0595
746.97	0.028	196.4	0.0595
746.98	0.028	196.4	0.0604
747.00	0.028	196.6	0.0612
747.02	0.028	196.7	0.0621
747.03	0.029	196.9	0.063
747.05	0.029	197	0.063
747.07	0.029	197.1	0.063
747.08	0.029	197.2	0.063
747.10	0.028	197.2	0.063
747.12	0.028	197.3	0.063
747.13	0.027	197.3	0.0612
747.15	0.025	197.3	0.0595
747.17	0.025	197.3	0.0595

Prova triassiale ciclica SN04-C1			
pressione di confinamento (kPa)		80	
deviatore ciclico (kPa)		95	
frequenza (hz)		0.00625	
tempo	cella di carico	$\Delta u$	LVDT
(min)	kN	(kPa)	$\delta$ (mm)
747.18	0.025	197.4	0.0577
747.20	0.023	197.3	0.0559
747.22	0.021	197.2	0.0541
747.23	0.02	197.1	0.0515
747.25	0.018	197	0.0515
747.27	0.016	196.9	0.0488
747.28	0.016	196.9	0.0462
747.30	0.015	196.7	0.0426
747.32	0.012	196.5	0.0391
747.33	0.01	196.4	0.0364
747.35	0.009	196.2	0.0328
747.37	0.006	195.9	0.0328
747.38	0.004	195.7	0.0284
747.40	0.004	195.7	0.024
747.42	0.002	195.5	0.0204
747.43	-0.001	195.1	0.016
747.45	-0.002	194.9	0.0133
747.47	-0.004	194.7	0.0089
747.48	-0.006	194.3	0.0089
747.52	-0.008	194.1	0.0053
747.53	-0.008	194.1	0.0018
747.55	-0.009	193.9	-0.0009
747.57	-0.011	193.6	-0.0044
747.58	-0.012	193.3	-0.0071
747.58	-0.013	193.1	-0.0089
747.60	-0.014	192.9	-0.0107
747.62	-0.016	192.6	-0.0107
747.63	-0.016	192.6	-0.0124
747.65	-0.016	192.5	-0.0142
747.67	-0.016	192.3	-0.0151
747.68	-0.017	192.1	-0.016
747.70	-0.017	192	-0.016
747.72	-0.017	191.9	-0.0169
747.73	-0.017	191.8	-0.0169
747.75	-0.017	191.8	-0.0169
747.77	-0.017	191.7	-0.016
747.78	-0.016	191.7	-0.0151
747.80	-0.015	191.7	-0.0142
747.82	-0.014	191.6	-0.0133
747.83	-0.014	191.7	-0.0115
747.85	-0.012	191.7	-0.0115
747.87	-0.011	191.7	-0.0098
747.88	-0.01	191.9	-0.0071
747.90	-0.008	191.9	-0.0071
747.92	-0.007	191.9	-0.0053
747.93	-0.007	192	-0.0018
747.95	-0.005	192.2	0.0018
747.97	-0.001	192.4	0.0053
747.98	-0.001	192.5	0.008
748.00	0.001	192.8	0.0115
748.02	0.005	193	0.0115
748.03	0.006	193	0.016
748.05	0.006	193.2	0.0195
748.07	0.007	193.4	0.0231
748.08	0.011	193.7	0.0284
748.10	0.012	193.9	0.0311
748.12	0.013	194.2	0.0346
748.13	0.017	194.5	0.0346

Prova triassiale ciclica SN04-C1			
pressione di confinamento (kPa)		80	
deviatore ciclico (kPa)		95	
frequenza (hz)		0.00625	
tempo	cella di carico	$\Delta u$	LVDT
(min)	kN	(kPa)	$\delta$ (mm)
748.15	0.017	194.5	0.0391
748.17	0.017	194.7	0.0417
748.18	0.019	194.9	0.0453
748.20	0.022	195.2	0.0488
748.22	0.023	195.4	0.0506
748.23	0.023	195.7	0.0533
748.25	0.026	195.9	0.0533
748.27	0.026	195.9	0.0559
748.28	0.026	196.1	0.0577
748.30	0.027	196.3	0.0595
748.32	0.028	196.5	0.0604
748.33	0.028	196.7	0.0612
748.35	0.029	196.8	0.0621
748.37	0.029	197	0.0621
748.38	0.029	197	0.063
748.40	0.029	197.1	0.063
748.42	0.029	197.2	0.063
748.43	0.029	197.3	0.063
748.45	0.027	197.3	0.0621
748.47	0.027	197.4	0.0612
748.48	0.026	197.3	0.0612
748.50	0.024	197.3	0.0595
748.52	0.024	197.3	0.0577
748.53	0.023	197.3	0.0559
748.55	0.021	197.2	0.0533
748.57	0.02	197.1	0.0515
748.58	0.019	197.1	0.0488
748.60	0.016	196.9	0.0488
748.62	0.014	196.8	0.0435
748.63	0.014	196.7	0.0408
748.65	0.012	196.4	0.0408
748.67	0.009	196.3	0.0373
748.68	0.009	196.3	0.0346
748.70	0.008	196.1	0.0311
748.72	0.005	195.8	0.0257
748.73	0.003	195.6	0.0222
748.75	0.001	195.4	0.0186
748.77	-0.001	195	0.0142
748.78	-0.003	194.8	0.0142
748.80	-0.003	194.8	0.0107
748.82	-0.005	194.5	0.0071
748.83	-0.006	194.2	0.0036
748.85	-0.009	193.9	0
748.87	-0.01	193.8	-0.0027
748.88	-0.011	193.4	-0.0053
748.90	-0.013	193.2	-0.0053
748.92	-0.014	193.2	-0.008
748.93	-0.014	193	-0.0098
748.95	-0.015	192.8	-0.0115
748.98	-0.016	192.6	-0.0133
749.00	-0.016	192.4	-0.0142
749.02	-0.017	192.2	-0.0151
749.03	-0.017	192.1	-0.0151
749.03	-0.017	192.1	-0.016
749.05	-0.017	192	-0.0169
749.07	-0.017	191.9	-0.0169
749.08	-0.017	191.8	-0.0169
749.10	-0.017	191.7	-0.016

Prova triassiale ciclica SN04-C1			
pressione di confinamento (kPa)		80	
deviatore ciclico (kPa)		95	
frequenza (hz)		0.00625	
tempo	cella di carico	$\Delta u$	LVDT
(min)	kN	(kPa)	$\delta$ (mm)
749.12	-0.016	191.7	-0.0151
749.13	-0.015	191.7	-0.0151
749.15	-0.014	191.7	-0.0142
749.17	-0.014	191.7	-0.0124
749.18	-0.013	191.7	-0.0107
749.20	-0.011	191.8	-0.0089
749.22	-0.01	191.8	-0.0071
749.23	-0.009	191.9	-0.0044
749.25	-0.006	192.1	-0.0044
749.27	-0.004	192.2	-0.0018
749.28	-0.004	192.2	0.0009
749.30	-0.003	192.3	0.0044
749.32	-0.001	192.6	0.0071
749.33	0.001	192.7	0.0098
749.35	0.002	192.8	0.0124
749.37	0.005	193.1	0.0169
749.38	0.007	193.3	0.0204
749.40	0.008	193.5	0.024
749.42	0.011	193.8	0.024
749.43	0.013	194	0.0293
749.45	0.013	194	0.0328
749.47	0.014	194.3	0.0355
749.48	0.017	194.5	0.0399
749.50	0.019	194.8	0.0435
749.52	0.02	195	0.0462
749.53	0.022	195.4	0.0497
749.55	0.024	195.6	0.0497
749.57	0.024	195.6	0.0524
749.58	0.024	195.8	0.0541
749.60	0.025	196.1	0.0568
749.62	0.027	196.3	0.0586
749.63	0.027	196.4	0.0595
749.65	0.028	196.6	0.0612
749.67	0.029	196.8	0.0612
749.68	0.028	196.8	0.0621
749.70	0.028	196.9	0.0621
749.72	0.029	197	0.063
749.73	0.029	197.2	0.063
749.75	0.029	197.3	0.063
749.77	0.029	197.3	0.0621
749.78	0.027	197.4	0.0621
749.80	0.027	197.4	0.0612
749.82	0.027	197.4	0.0604
749.83	0.025	197.4	0.0586
749.85	0.024	197.3	0.0568
749.87	0.023	197.3	0.055
749.88	0.022	197.2	0.0524
749.90	0.019	197.1	0.0524
749.92	0.018	197.1	0.0497
749.93	0.018	197	0.0488
749.95	0.017	196.9	0.0444
749.97	0.013	196.7	0.0408
749.98	0.012	196.6	0.0382
750.00	0.011	196.4	0.0346
750.02	0.007	196.1	0.0346
750.03	0.006	196.1	0.0311
750.05	0.006	195.9	0.0284
750.07	0.002	195.5	0.0231

Prova triassiale ciclica SN04-C1			
pressione di confinamento (kPa)		80	
deviatore ciclico (kPa)		95	
frequenza (hz)		0.00625	
tempo	cella di carico	$\Delta u$	LVDT
(min)	kN	(kPa)	$\delta$ (mm)
750.08	0.001	195.2	0.0204
750.10	0.001	195.2	0.0178
750.12	-0.001	195	0.0133
750.13	-0.004	194.7	0.0089
750.15	-0.006	194.4	0.0053
750.17	-0.006	194.2	0.0027
750.18	-0.009	193.9	0.0027
750.20	-0.011	193.7	-0.0009
750.22	-0.011	193.7	-0.0044
750.23	-0.011	193.4	-0.0062
750.25	-0.013	193.2	-0.0089
750.27	-0.015	192.9	-0.0115
750.28	-0.015	192.8	-0.0124
750.30	-0.016	192.5	-0.0124
750.32	-0.017	192.4	-0.0142
750.33	-0.017	192.4	-0.0151
750.35	-0.017	192.2	-0.016
750.37	-0.017	192.1	-0.0169
750.38	-0.017	191.9	-0.0169
750.40	-0.017	191.8	-0.0169
750.42	-0.017	191.8	-0.0169
750.45	-0.016	191.7	-0.0169
750.47	-0.016	191.7	-0.016
750.48	-0.016	191.7	-0.016
750.48	-0.015	191.7	-0.0142
750.50	-0.014	191.7	-0.0133
750.52	-0.013	191.7	-0.0115
750.53	-0.011	191.8	-0.0089
750.55	-0.009	191.9	-0.0089
750.57	-0.008	191.9	-0.0071
750.58	-0.008	191.9	-0.0044
750.60	-0.007	192.1	-0.0018
750.62	-0.003	192.3	0.0018
750.63	-0.003	192.4	0.0044
750.65	-0.001	192.7	0.008
750.67	0.003	192.9	0.008
750.68	0.004	192.9	0.0115
750.70	0.004	193	0.0151
750.72	0.006	193.3	0.0195
750.73	0.009	193.5	0.0231
750.75	0.01	193.7	0.0275
750.77	0.012	194	0.0311
750.78	0.015	194.3	0.0355
750.80	0.015	194.4	0.0373
750.82	0.017	194.7	0.0408
750.83	0.02	194.9	0.0408
750.85	0.02	194.9	0.0444
750.87	0.02	195.1	0.047
750.88	0.022	195.5	0.0497
750.90	0.024	195.7	0.0533
750.92	0.025	195.9	0.055
750.93	0.026	196.1	0.0568
750.95	0.027	196.4	0.0568
750.97	0.028	196.4	0.0586
750.98	0.028	196.5	0.0595
751.00	0.028	196.7	0.0604
751.02	0.028	196.9	0.0612
751.03	0.029	197	0.0621

Prova triassiale ciclica SN04-C1			
pressione di confinamento (kPa)		80	
deviatore ciclico (kPa)		95	
frequenza (hz)		0.00625	
tempo	cella di carico	$\Delta u$	LVDT
(min)	kN	(kPa)	$\delta$ (mm)
751.05	0.029	197.1	0.0621
751.07	0.029	197.2	0.0621
751.08	0.028	197.2	0.0621
751.10	0.028	197.3	0.0621
751.12	0.028	197.4	0.0612
751.13	0.027	197.4	0.0604
751.15	0.026	197.4	0.0595
751.17	0.025	197.4	0.0577
751.18	0.023	197.3	0.0577
751.20	0.022	197.3	0.0559
751.22	0.022	197.3	0.0541
751.23	0.021	197.2	0.0515
751.25	0.018	197.1	0.0488
751.27	0.017	197	0.047
751.28	0.016	196.9	0.0435
751.30	0.013	196.6	0.0435
751.32	0.011	196.5	0.0399
751.33	0.011	196.5	0.0373
751.35	0.01	196.3	0.0337
751.37	0.007	196	0.0293
751.38	0.004	195.8	0.0257
751.40	0.003	195.7	0.0213
751.42	0.001	195.3	0.0213
751.43	-0.002	195	0.0178
751.45	-0.002	195	0.0142
751.47	-0.003	194.8	0.0098
751.48	-0.005	194.5	0.0062
751.50	-0.007	194.2	0.0036
751.52	-0.008	194	0
751.53	-0.009	193.8	-0.0018
751.55	-0.011	193.5	-0.0053
751.57	-0.012	193.3	-0.0071
751.58	-0.013	193.1	-0.0098
751.60	-0.015	192.8	-0.0098
751.62	-0.015	192.8	-0.0115
751.63	-0.015	192.7	-0.0124
751.65	-0.016	192.5	-0.0142
751.67	-0.017	192.3	-0.0151
751.68	-0.017	192.2	-0.016
751.70	-0.017	192	-0.0169
751.72	-0.017	191.9	-0.0169
751.73	-0.017	191.9	-0.0169
751.75	-0.017	191.8	-0.0169
751.77	-0.017	191.8	-0.016
751.78	-0.016	191.7	-0.0151
751.80	-0.015	191.7	-0.0142
751.82	-0.015	191.7	-0.0133
751.83	-0.012	191.7	-0.0133
751.85	-0.012	191.7	-0.0115
751.88	-0.012	191.7	-0.0098
751.90	-0.011	191.9	-0.008
751.92	-0.008	191.9	-0.0053
751.93	-0.007	192	-0.0027
751.95	-0.006	192.2	0
751.95	-0.002	192.4	0
751.97	-0.002	192.4	0.0036
751.98	-0.002	192.5	0.0062
752.00	0	192.7	0.0098

Prova triassiale ciclica SN04-C1			
pressione di confinamento (kPa)		80	
deviatore ciclico (kPa)		95	
frequenza (hz)		0.00625	
tempo	cella di carico	$\Delta u$	LVDT
(min)	kN	(kPa)	$\delta$ (mm)
752.02	0.004	193	0.0142
752.03	0.005	193.1	0.0169
752.05	0.006	193.4	0.0213
752.07	0.01	193.7	0.0213
752.08	0.011	193.7	0.0257
752.10	0.011	193.9	0.0293
752.12	0.013	194.1	0.0337
752.13	0.016	194.4	0.0373
752.15	0.017	194.6	0.0399
752.17	0.018	194.9	0.0444
752.18	0.021	195.2	0.0444
752.20	0.022	195.2	0.047
752.22	0.022	195.4	0.0497
752.23	0.023	195.7	0.0524
752.25	0.025	195.9	0.055
752.27	0.025	196.1	0.0559
752.28	0.026	196.3	0.0577
752.30	0.028	196.5	0.0595
752.32	0.028	196.6	0.0604
752.33	0.028	196.8	0.0612
752.35	0.029	197	0.0612
752.37	0.029	197	0.0621
752.38	0.029	197.1	0.063
752.40	0.029	197.2	0.063
752.42	0.029	197.3	0.063
752.43	0.028	197.4	0.063
752.45	0.028	197.4	0.0612
752.47	0.027	197.4	0.0612
752.48	0.025	197.4	0.0604
752.50	0.025	197.4	0.0586
752.52	0.024	197.4	0.0568
752.53	0.023	197.4	0.055
752.55	0.021	197.3	0.0533
752.57	0.02	197.2	0.0506
752.58	0.018	197.1	0.0479
752.60	0.016	196.9	0.0479
752.62	0.016	196.9	0.0453
752.63	0.015	196.8	0.0417
752.65	0.012	196.6	0.0382
752.67	0.01	196.4	0.0355
752.68	0.009	196.3	0.032
752.70	0.006	196	0.0284
752.72	0.003	195.8	0.0284
752.73	0.003	195.8	0.024
752.75	0.002	195.6	0.0204
752.77	0	195.2	0.016
752.78	-0.003	195	0.0115
752.80	-0.004	194.7	0.0089
752.82	-0.006	194.4	0.0053
752.83	-0.008	194.1	0.0053
752.85	-0.009	194.1	0.0018
752.87	-0.009	193.9	-0.0018
752.88	-0.011	193.6	-0.0044
752.90	-0.013	193.4	-0.0071
752.92	-0.013	193.2	-0.0089
752.93	-0.014	192.9	-0.0107
752.95	-0.016	192.7	-0.0107
752.97	-0.016	192.6	-0.0133

Prova triassiale ciclica SN04-C1			
pressione di confinamento (kPa)		80	
deviatore ciclico (kPa)		95	
frequenza (hz)		0.00625	
tempo	cella di carico	$\Delta u$	LVDT
(min)	kN	(kPa)	$\delta$ (mm)
752.98	-0.016	192.4	-0.0142
753.00	-0.017	192.2	-0.0142
753.02	-0.017	192.2	-0.016
753.03	-0.017	192.1	-0.016
753.05	-0.017	192	-0.016
753.07	-0.017	191.9	-0.0169
753.08	-0.017	191.8	-0.016
753.10	-0.017	191.8	-0.016
753.12	-0.015	191.7	-0.016
753.13	-0.015	191.7	-0.0151
753.15	-0.015	191.7	-0.0142
753.17	-0.014	191.7	-0.0124
753.18	-0.012	191.8	-0.0107
753.20	-0.011	191.8	-0.0089
753.22	-0.01	191.9	-0.0071
753.23	-0.007	192	-0.0071
753.25	-0.007	192	-0.0044
753.27	-0.007	192.1	-0.0018
753.28	-0.005	192.3	0.0009
753.30	-0.001	192.5	0.0053
753.32	-0.001	192.6	0.0071
753.35	0.001	192.8	0.0115
753.37	0.005	193	0.0115
753.38	0.005	193	0.0151
753.40	0.005	193.2	0.0186
753.40	0.007	193.5	0.0231
753.42	0.011	193.8	0.0284
753.43	0.012	194	0.0311
753.45	0.014	194.2	0.0355
753.47	0.017	194.5	0.0355
753.48	0.018	194.5	0.0391
753.50	0.018	194.7	0.0417
753.52	0.019	194.9	0.0453
753.53	0.021	195.2	0.0479
753.55	0.022	195.5	0.0506
753.57	0.024	195.7	0.0541
753.58	0.025	196	0.0541
753.60	0.026	196.2	0.0559
753.62	0.026	196.2	0.0577
753.63	0.027	196.4	0.0595
753.65	0.028	196.6	0.0604
753.67	0.028	196.8	0.0612
753.68	0.029	196.9	0.0621
753.70	0.029	197	0.063
753.72	0.029	197.2	0.063
753.73	0.029	197.3	0.063
753.75	0.029	197.4	0.063
753.77	0.028	197.4	0.063
753.78	0.028	197.4	0.063
753.80	0.027	197.5	0.0604
753.82	0.026	197.4	0.0595
753.83	0.025	197.4	0.0577
753.85	0.024	197.4	0.0568
753.87	0.023	197.4	0.055
753.88	0.02	197.3	0.055
753.90	0.02	197.3	0.0524
753.92	0.02	197.2	0.0506
753.93	0.018	197.1	0.047



Prova triassiale ciclica SN04-C1			
pressione di confinamento (kPa)		80	
deviatore ciclico (kPa)		95	
frequenza (hz)		0.00625	
tempo	cella di carico	$\Delta u$	LVDT
(min)	kN	(kPa)	$\delta$ (mm)
753.95	0.015	196.9	0.0444
753.97	0.014	196.8	0.0417
753.98	0.012	196.6	0.0373
754.00	0.009	196.4	0.0373
754.02	0.008	196.4	0.0337
754.03	0.008	196.2	0.0311
754.05	0.006	195.9	0.0275
754.07	0.003	195.7	0.0222
754.08	0.001	195.5	0.0186
754.10	0	195.1	0.0151
754.12	-0.004	194.9	0.0151
754.13	-0.004	194.9	0.0107
754.15	-0.004	194.7	0.008
754.17	-0.006	194.4	0.0036
754.18	-0.009	194.1	0
754.20	-0.01	193.9	-0.0027
754.22	-0.011	193.6	-0.0053
754.23	-0.014	193.3	-0.0053
754.25	-0.014	193.3	-0.008
754.27	-0.014	193.1	-0.0098
754.28	-0.014	192.9	-0.0115
754.30	-0.016	192.7	-0.0133
754.32	-0.017	192.5	-0.0142
754.33	-0.017	192.4	-0.0151
754.35	-0.017	192.2	-0.0151
754.37	-0.017	192.2	-0.016
754.38	-0.017	192.1	-0.0169
754.40	-0.017	192	-0.0169
754.42	-0.017	191.9	-0.0169
754.43	-0.017	191.8	-0.0169
754.45	-0.016	191.7	-0.0151
754.47	-0.015	191.7	-0.0142
754.48	-0.015	191.7	-0.0142
754.50	-0.014	191.7	-0.0124
754.52	-0.012	191.8	-0.0124
754.53	-0.011	191.8	-0.0107
754.55	-0.011	191.8	-0.0089
754.57	-0.009	191.9	-0.0062
754.58	-0.007	192.1	-0.0036
754.60	-0.006	192.2	-0.0009
754.62	-0.004	192.3	0.0027
754.63	-0.001	192.5	0.0027
754.65	0	192.5	0.0062
754.67	0	192.7	0.0089
754.68	0.002	192.9	0.0124
754.70	0.006	193.2	0.0169
754.72	0.006	193.3	0.0195
754.73	0.008	193.6	0.024
754.75	0.012	193.9	0.024
754.78	0.013	194.1	0.0293
754.80	0.013	194.1	0.032
754.82	0.014	194.3	0.0364
754.83	0.017	194.6	0.0408
754.85	0.019	194.8	0.0426
754.85	0.02	195.1	0.0462
754.87	0.022	195.4	0.0462
754.88	0.023	195.7	0.0488
754.90	0.023	195.7	0.0515

Prova triassiale ciclica SN04-C1			
pressione di confinamento (kPa)		80	
deviatore ciclico (kPa)		95	
frequenza (hz)		0.00625	
tempo	cella di carico	$\Delta u$	LVDT
(min)	kN	(kPa)	$\delta$ (mm)
754.92	0.024	195.9	0.0541
754.93	0.026	196.1	0.0568
754.95	0.027	196.3	0.0577
754.97	0.027	196.5	0.0595
754.98	0.028	196.7	0.0595
755.00	0.029	196.8	0.0604
755.02	0.029	196.8	0.0612
755.03	0.029	197	0.0621
755.05	0.029	197.1	0.0621
755.07	0.029	197.2	0.0621
755.08	0.028	197.3	0.0621
755.10	0.028	197.4	0.0621
755.12	0.027	197.4	0.0621
755.13	0.027	197.4	0.0612
755.15	0.026	197.5	0.0595
755.17	0.024	197.5	0.0595
755.18	0.024	197.5	0.0577
755.20	0.024	197.4	0.0568
755.22	0.022	197.3	0.0541
755.23	0.02	197.2	0.0515
755.25	0.019	197.2	0.0488
755.27	0.017	197	0.0462
755.28	0.014	196.9	0.0462
755.30	0.013	196.9	0.0426
755.32	0.013	196.7	0.0399
755.33	0.011	196.5	0.0355
755.35	0.007	196.3	0.032
755.37	0.007	196.1	0.0293
755.38	0.006	195.9	0.0249
755.40	0.001	195.6	0.0249
755.42	0.001	195.6	0.0204
755.43	0.001	195.4	0.0169
755.45	-0.001	195.1	0.0133
755.47	-0.005	194.8	0.0089
755.48	-0.005	194.5	0.0062
755.50	-0.006	194.3	0.0027
755.52	-0.009	194	0.0027
755.53	-0.011	193.7	-0.0009
755.55	-0.011	193.7	-0.0036
755.57	-0.012	193.5	-0.0062
755.58	-0.013	193.2	-0.0089
755.60	-0.014	193	-0.0107
755.62	-0.015	192.9	-0.0124
755.63	-0.016	192.6	-0.0142
755.65	-0.017	192.4	-0.0142
755.67	-0.017	192.4	-0.0151
755.68	-0.017	192.3	-0.016
755.70	-0.017	192.2	-0.016
755.72	-0.017	192	-0.0169
755.73	-0.017	191.9	-0.0169
755.75	-0.017	191.9	-0.0169
755.77	-0.016	191.8	-0.0169
755.78	-0.015	191.8	-0.016
755.80	-0.015	191.8	-0.0151
755.82	-0.015	191.8	-0.0142
755.83	-0.013	191.8	-0.0133
755.85	-0.013	191.8	-0.0115
755.87	-0.011	191.9	-0.0089

Prova triassiale ciclica SN04-C1			
pressione di confinamento (kPa)		80	
deviatore ciclico (kPa)		95	
frequenza (hz)		0.00625	
tempo	cella di carico	$\Delta u$	LVDT
(min)	kN	(kPa)	$\delta$ (mm)
755.88	-0.01	191.9	-0.008
755.90	-0.009	192	-0.0053
755.92	-0.007	192.1	-0.0027
755.93	-0.004	192.3	-0.0027
755.95	-0.003	192.3	0
755.97	-0.003	192.4	0.0027
755.98	-0.002	192.6	0.0062
756.00	0.002	192.8	0.0098
756.02	0.003	193	0.0133
756.03	0.004	193.3	0.0169
756.05	0.009	193.5	0.0169
756.07	0.009	193.5	0.0222
756.08	0.009	193.7	0.0249
756.10	0.011	194	0.0293
756.12	0.014	194.2	0.0337
756.13	0.015	194.4	0.0364
756.15	0.017	194.7	0.0408
756.17	0.02	195	0.0408
756.18	0.021	195	0.0444
756.20	0.021	195.2	0.047
756.22	0.022	195.5	0.0497
756.25	0.024	195.8	0.0524
756.27	0.025	196	0.0541
756.28	0.026	196.2	0.0568
756.30	0.027	196.4	0.0568
756.30	0.027	196.4	0.0586
756.32	0.027	196.6	0.0595
756.33	0.028	196.7	0.0604
756.35	0.028	196.9	0.0612
756.37	0.029	197	0.0621
756.38	0.029	197.2	0.0621
756.40	0.029	197.3	0.0621
756.42	0.029	197.3	0.0621
756.43	0.029	197.3	0.0621
756.45	0.028	197.4	0.0612
756.47	0.027	197.4	0.0604
756.48	0.026	197.4	0.0595
756.50	0.025	197.5	0.0577
756.52	0.024	197.4	0.0577
756.53	0.022	197.3	0.0559
756.55	0.022	197.3	0.0541
756.57	0.021	197.3	0.0515
756.58	0.019	197.1	0.0488
756.60	0.016	197	0.0462
756.62	0.016	197	0.0444
756.63	0.015	196.8	0.0417
756.65	0.011	196.6	0.0382
756.67	0.01	196.5	0.0355
756.68	0.009	196.2	0.032
756.70	0.005	196	0.032
756.72	0.004	196	0.0275
756.73	0.004	195.8	0.024
756.75	0.003	195.5	0.0195
756.77	-0.001	195.2	0.0142
756.78	-0.002	195	0.0115
756.80	-0.003	194.7	0.008
756.82	-0.007	194.4	0.008
756.83	-0.008	194.4	0.0044

Prova triassiale ciclica SN04-C1			
pressione di confinamento (kPa)		80	
deviatore ciclico (kPa)		95	
frequenza (hz)		0.00625	
tempo	cella di carico	$\Delta u$	LVDT
(min)	kN	(kPa)	$\delta$ (mm)
756.85	-0.008	194.2	0.0018
756.87	-0.009	193.9	-0.0018
756.88	-0.012	193.6	-0.0053
756.90	-0.012	193.4	-0.0071
756.92	-0.013	193.2	-0.0098
756.93	-0.015	192.9	-0.0098
756.95	-0.015	192.9	-0.0115
756.97	-0.015	192.8	-0.0133
756.98	-0.016	192.6	-0.0151
757.00	-0.017	192.4	-0.016
757.02	-0.017	192.2	-0.0169
757.03	-0.017	192.1	-0.0169
757.05	-0.017	192	-0.0169
757.07	-0.017	192	-0.0169
757.08	-0.017	191.9	-0.0169
757.10	-0.017	191.8	-0.0169
757.12	-0.016	191.8	-0.016
757.13	-0.015	191.8	-0.0151
757.15	-0.015	191.8	-0.0133
757.17	-0.013	191.8	-0.0133
757.18	-0.012	191.8	-0.0124
757.20	-0.012	191.8	-0.0107
757.22	-0.011	191.9	-0.008
757.23	-0.008	192	-0.0053
757.25	-0.007	192.1	-0.0036
757.27	-0.006	192.2	-0.0009
757.28	-0.002	192.4	-0.0009
757.30	-0.002	192.4	0.0027
757.32	-0.002	192.6	0.0053
757.33	0.002	192.9	0.0089
757.35	0.004	193.1	0.0115
757.37	0.004	193.1	0.0142
757.38	0.005	193.3	0.0186
757.40	0.009	193.6	0.0231
757.42	0.01	193.8	0.0257
757.43	0.012	194	0.0311
757.45	0.015	194.3	0.0311
757.47	0.016	194.6	0.0355
757.48	0.016	194.6	0.0382
757.50	0.017	194.8	0.0417
757.52	0.02	195.1	0.0453
757.53	0.022	195.4	0.0479
757.55	0.022	195.6	0.0506
757.57	0.024	195.9	0.0506
757.58	0.026	196.1	0.0533
757.60	0.026	196.1	0.055
757.62	0.026	196.3	0.0568
757.63	0.027	196.5	0.0586
757.65	0.028	196.7	0.0604
757.68	0.028	196.8	0.0612
757.70	0.028	197	0.0612
757.72	0.029	197.1	0.0612
757.73	0.029	197.1	0.0621
757.75	0.029	197.2	0.0621
757.75	0.029	197.3	0.0621
757.77	0.028	197.4	0.0621
757.78	0.028	197.5	0.0612
757.80	0.027	197.5	0.0604

Prova triassiale ciclica SN04-C1			
pressione di confinamento (kPa)		80	
deviatore ciclico (kPa)		95	
frequenza (hz)		0.00625	
tempo	cella di carico	$\Delta u$	LVDT
(min)	kN	(kPa)	$\delta$ (mm)
757.82	0.025	197.5	0.0604
757.83	0.024	197.5	0.0586
757.85	0.024	197.5	0.0568
757.87	0.023	197.4	0.055
757.88	0.021	197.3	0.0533
757.90	0.02	197.3	0.0515
757.92	0.019	197.1	0.0479
757.93	0.016	197	0.0479
757.95	0.015	197	0.0453
757.97	0.015	196.9	0.0426
757.98	0.013	196.7	0.0391
758.00	0.01	196.5	0.0355
758.02	0.008	196.3	0.032
758.03	0.007	196.1	0.0284
758.05	0.003	195.9	0.024
758.07	0.003	195.7	0.0222
758.08	0.002	195.5	0.0178
758.10	-0.002	195.1	0.0178
758.12	-0.003	194.9	0.0133
758.13	-0.003	194.9	0.0107
758.15	-0.005	194.6	0.0062
758.17	-0.007	194.3	0.0027
758.18	-0.009	194.1	0
758.20	-0.01	193.8	-0.0036
758.22	-0.012	193.5	-0.0036
758.23	-0.013	193.3	-0.0062
758.25	-0.013	193.3	-0.008
758.27	-0.014	193.1	-0.0107
758.28	-0.015	192.9	-0.0133
758.30	-0.016	192.7	-0.0142
758.32	-0.016	192.5	-0.0151
758.33	-0.017	192.3	-0.0151
758.35	-0.017	192.2	-0.016
758.37	-0.017	192.2	-0.016
758.38	-0.017	192.1	-0.0169
758.40	-0.018	191.9	-0.0178
758.42	-0.017	191.9	-0.0169
758.43	-0.016	191.8	-0.016
758.45	-0.016	191.8	-0.016
758.47	-0.015	191.8	-0.016
758.48	-0.015	191.8	-0.0142
758.50	-0.014	191.8	-0.0124
758.52	-0.013	191.8	-0.0115
758.53	-0.011	191.9	-0.0098
758.55	-0.01	191.9	-0.008
758.57	-0.009	192.1	-0.0053
758.58	-0.006	192.2	-0.0053
758.60	-0.005	192.2	-0.0027
758.62	-0.005	192.3	0.0009
758.63	-0.003	192.5	0.0036
758.65	0	192.7	0.0062
758.67	0.001	192.8	0.0098
758.68	0.003	193.1	0.0142
758.70	0.006	193.3	0.0142
758.72	0.007	193.3	0.0178
758.73	0.007	193.5	0.0213
758.75	0.009	193.8	0.0257
758.77	0.013	194.1	0.0311

Prova triassiale ciclica SN04-C1			
pressione di confinamento (kPa)		80	
deviatore ciclico (kPa)		95	
frequenza (hz)		0.00625	
tempo	cella di carico	$\Delta u$	LVDT
(min)	kN	(kPa)	$\delta$ (mm)
758.78	0.013	194.3	0.0337
758.80	0.014	194.5	0.0355
758.82	0.017	194.7	0.0391
758.83	0.018	194.9	0.0426
758.85	0.02	195.2	0.0462
758.87	0.023	195.5	0.0462
758.88	0.023	195.5	0.0497
758.90	0.023	195.7	0.0515
758.92	0.024	196	0.0541
758.93	0.026	196.2	0.0559
758.95	0.026	196.4	0.0577
758.97	0.027	196.6	0.0595
758.98	0.028	196.8	0.0595
759.00	0.029	196.8	0.0604
759.02	0.029	196.9	0.0612
759.03	0.029	197.1	0.0612
759.05	0.029	197.2	0.0621
759.07	0.029	197.3	0.0621
759.08	0.029	197.4	0.0621
759.10	0.028	197.5	0.0621
759.12	0.027	197.5	0.0621
759.15	0.027	197.5	0.0604
759.17	0.026	197.5	0.0595
759.18	0.025	197.5	0.0577
759.20	0.024	197.5	0.0559
759.20	0.023	197.4	0.0541
759.22	0.021	197.3	0.0541
759.23	0.019	197.2	0.0515
759.25	0.019	197.2	0.0497
759.27	0.018	197.2	0.047
759.28	0.015	197	0.0435
759.30	0.014	196.9	0.0417
759.32	0.012	196.7	0.0373
759.33	0.009	196.4	0.0373
759.35	0.007	196.3	0.0328
759.37	0.007	196.3	0.0302
759.38	0.006	196.1	0.0257
759.40	0.003	195.8	0.0222
759.42	0.001	195.6	0.0186
759.43	0	195.3	0.0142
759.45	-0.003	195	0.0142
759.47	-0.005	194.7	0.0098
759.48	-0.005	194.7	0.0062
759.50	-0.008	194.2	0.0036
759.52	-0.009	194	0.0018
759.53	-0.009	194	-0.0009
759.55	-0.01	193.8	-0.0053
759.57	-0.012	193.4	-0.008
759.58	-0.014	193.2	-0.0107
759.60	-0.014	193	-0.0115
759.62	-0.015	192.8	-0.0115
759.63	-0.016	192.6	-0.0133
759.65	-0.016	192.6	-0.0151
759.67	-0.016	192.5	-0.016
759.68	-0.017	192.3	-0.0169
759.70	-0.017	192.1	-0.0178
759.72	-0.017	192	-0.0178
759.73	-0.017	191.9	-0.0178

Prova triassiale ciclica SN04-C1			
pressione di confinamento (kPa)		80	
deviatore ciclico (kPa)		95	
frequenza (hz)		0.00625	
tempo	cella di carico	$\Delta u$	LVDT
(min)	kN	(kPa)	$\delta$ (mm)
759.75	-0.017	191.9	-0.0178
759.77	-0.017	191.9	-0.0169
759.78	-0.016	191.8	-0.0169
759.80	-0.015	191.8	-0.016
759.82	-0.015	191.8	-0.0151
759.83	-0.014	191.8	-0.0133
759.85	-0.012	191.9	-0.0115
759.87	-0.01	191.9	-0.0115
759.88	-0.01	191.9	-0.0098
759.90	-0.01	192	-0.0071
759.92	-0.008	192.1	-0.0044
759.93	-0.005	192.3	-0.0018
759.95	-0.004	192.4	0.0009
759.97	-0.003	192.6	0.0044
759.98	0.001	192.8	0.0044
760.00	0.002	192.8	0.008
760.02	0.002	192.9	0.0115
760.03	0.004	193.2	0.0151
760.05	0.007	193.4	0.0195
760.07	0.008	193.6	0.0231
760.08	0.01	193.9	0.0275
760.10	0.014	194.2	0.0275
760.12	0.015	194.2	0.032
760.13	0.015	194.4	0.0346
760.15	0.016	194.7	0.0382
760.17	0.019	194.9	0.0417
760.18	0.019	195.1	0.0444
760.20	0.021	195.5	0.0479
760.22	0.024	195.7	0.0479
760.23	0.024	195.9	0.0533
760.25	0.025	196.1	0.0541
760.27	0.026	196.3	0.0541
760.28	0.027	196.3	0.0559
760.30	0.027	196.5	0.0577
760.32	0.027	196.7	0.0595
760.33	0.028	196.9	0.0604
760.35	0.029	197	0.0612
760.37	0.029	197.1	0.0612
760.38	0.029	197.3	0.0612
760.40	0.029	197.3	0.0612
760.42	0.029	197.4	0.0621
760.43	0.029	197.4	0.0612
760.45	0.028	197.5	0.0612
760.47	0.027	197.5	0.0604
760.48	0.026	197.5	0.0586
760.50	0.025	197.5	0.0586
760.52	0.023	197.5	0.0568
760.53	0.023	197.5	0.055
760.55	0.022	197.5	0.0533
760.57	0.02	197.3	0.0506
760.58	0.019	197.2	0.0488
760.62	0.017	197.1	0.0453
760.63	0.014	196.9	0.0453
760.65	0.012	196.8	0.0417
760.67	0.012	196.8	0.0391
760.67	0.011	196.6	0.0355
760.68	0.008	196.4	0.032
760.70	0.007	196.2	0.0293

Prova triassiale ciclica SN04-C1			
ensione di confinamento (kPa)		80	
deviatore ciclico (kPa)		95	
frequenza (hz)		0.00625	
tempo	cella di carico	$\Delta u$	LVDT
(min)	kN	(kPa)	$\delta$ (mm)
760.72	0.005	196	0.024
760.73	0.002	195.7	0.024
760.75	0	195.4	0.0195
760.77	0	195.4	0.0169
760.78	-0.001	195.2	0.0124
760.80	-0.003	194.9	0.0089
760.82	-0.006	194.6	0.0044
760.83	-0.007	194.4	0.0018
760.85	-0.009	194.1	0.0018
760.87	-0.011	193.8	-0.0018
760.88	-0.011	193.8	-0.0044
760.90	-0.011	193.6	-0.0071
760.92	-0.013	193.3	-0.0098
760.93	-0.015	193.1	-0.0115
760.95	-0.015	192.9	-0.0133
760.97	-0.016	192.7	-0.0142
760.98	-0.016	192.5	-0.0151
761.00	-0.017	192.4	-0.016
761.02	-0.017	192.2	-0.0169
761.03	-0.017	192.1	-0.0169
761.05	-0.017	192.1	-0.0178
761.07	-0.017	192	-0.0178
761.08	-0.017	191.9	-0.0178
761.10	-0.016	191.9	-0.0169
761.12	-0.016	191.8	-0.016
761.13	-0.015	191.8	-0.0151
761.15	-0.014	191.8	-0.0151
761.17	-0.013	191.8	-0.0142
761.18	-0.013	191.8	-0.0124
761.20	-0.012	191.9	-0.0107
761.22	-0.01	192	-0.008
761.23	-0.009	192	-0.0062
761.25	-0.007	192.2	-0.0036
761.27	-0.004	192.3	-0.0036
761.28	-0.003	192.3	0
761.30	-0.003	192.4	0.0027
761.32	-0.002	192.7	0.0062
761.33	0.002	192.9	0.0098
761.35	0.003	193	0.0133
761.37	0.004	193.3	0.0169
761.38	0.009	193.5	0.0169
761.40	0.009	193.5	0.0213
761.42	0.009	193.7	0.024
761.43	0.011	194	0.0284
761.45	0.014	194.2	0.0328
761.47	0.015	194.5	0.0364
761.48	0.016	194.7	0.0399
761.50	0.02	195	0.0399
761.52	0.021	195	0.0444
761.53	0.021	195.2	0.0462
761.55	0.021	195.5	0.0488
761.57	0.024	195.8	0.0524
761.58	0.025	196	0.0541
761.60	0.025	196.2	0.0559
761.62	0.027	196.4	0.0559
761.63	0.027	196.6	0.0577
761.65	0.027	196.6	0.0586
761.67	0.028	196.8	0.0604



Prova triassiale ciclica SN04-C1			
pressione di confinamento (kPa)		80	
deviatore ciclico (kPa)		95	
frequenza (hz)		0.00625	
tempo	cella di carico	$\Delta u$	LVDT
(min)	kN	(kPa)	$\delta$ (mm)
761.68	0.029	197.1	0.0612
761.70	0.029	197.1	0.0612
761.72	0.029	197.2	0.0612
761.73	0.029	197.3	0.0621
761.75	0.029	197.4	0.0621
761.77	0.028	197.5	0.0621
761.78	0.028	197.5	0.0604
761.80	0.026	197.5	0.0604
761.82	0.025	197.5	0.0595
761.83	0.025	197.5	0.0586
761.85	0.024	197.5	0.0568
761.87	0.023	197.5	0.055
761.88	0.022	197.4	0.0533
761.90	0.02	197.3	0.0506
761.92	0.017	197.2	0.0506
761.93	0.017	197.2	0.047
761.95	0.017	197.1	0.0453
761.97	0.015	196.9	0.0408
761.98	0.011	196.7	0.0373
762.00	0.01	196.6	0.0346
762.02	0.009	196.3	0.0311
762.05	0.005	196.1	0.0311
762.07	0.004	196.1	0.0257
762.08	0.004	195.9	0.0231
762.10	0.003	195.6	0.0186
762.12	-0.001	195.3	0.0142
762.12	-0.002	195.1	0.0115
762.13	-0.003	194.8	0.008
762.15	-0.007	194.5	0.008
762.17	-0.007	194.5	0.0036
762.18	-0.007	194.3	0.0009
762.20	-0.009	194	-0.0027
762.22	-0.012	193.7	-0.0053
762.23	-0.012	193.5	-0.008
762.25	-0.013	193.3	-0.0098
762.27	-0.015	193	-0.0098
762.28	-0.016	193	-0.0124
762.30	-0.016	192.8	-0.0142
762.32	-0.016	192.6	-0.0151
762.33	-0.017	192.5	-0.016
762.35	-0.017	192.3	-0.0169
762.37	-0.017	192.2	-0.0178
762.38	-0.017	192.1	-0.0178
762.40	-0.017	192.1	-0.0178
762.42	-0.017	191.9	-0.0169
762.43	-0.016	191.8	-0.0169
762.45	-0.016	191.8	-0.0169
762.47	-0.016	191.8	-0.016
762.48	-0.015	191.8	-0.0151
762.50	-0.013	191.8	-0.0133
762.52	-0.013	191.8	-0.0124
762.53	-0.012	191.9	-0.0098
762.55	-0.009	192	-0.0098
762.57	-0.008	192	-0.0071
762.58	-0.008	192.1	-0.0053
762.60	-0.007	192.2	-0.0027
762.62	-0.004	192.4	0.0009
762.63	-0.003	192.5	0.0027

Prova triassiale ciclica SN04-C1			
pressione di confinamento (kPa)		80	
deviatore ciclico (kPa)		95	
frequenza (hz)		0.00625	
tempo	cella di carico	$\Delta u$	LVDT
(min)	kN	(kPa)	$\delta$ (mm)
762.65	-0.001	192.7	0.008
762.67	0.002	193	0.008
762.68	0.004	193.1	0.0115
762.70	0.004	193.1	0.0142
762.72	0.005	193.3	0.0186
762.73	0.009	193.6	0.0222
762.75	0.011	193.9	0.0257
762.77	0.012	194	0.0302
762.78	0.014	194.4	0.0346
762.80	0.016	194.6	0.0346
762.82	0.016	194.6	0.0373
762.83	0.017	194.8	0.0408
762.85	0.019	195.2	0.0444
762.87	0.022	195.4	0.0479
762.88	0.023	195.6	0.0497
762.90	0.023	195.9	0.0524
762.92	0.026	196.1	0.0524
762.93	0.026	196.1	0.055
762.95	0.026	196.3	0.0559
762.97	0.027	196.5	0.0577
762.98	0.028	196.7	0.0595
763.00	0.028	196.9	0.0604
763.02	0.028	197	0.0604
763.03	0.029	197.1	0.0604
763.05	0.029	197.1	0.0612
763.07	0.029	197.3	0.0612
763.08	0.029	197.4	0.0612
763.10	0.028	197.5	0.0612
763.12	0.028	197.5	0.0612
763.13	0.027	197.5	0.0595
763.15	0.026	197.6	0.0586
763.17	0.025	197.5	0.0568
763.18	0.024	197.5	0.055
763.20	0.022	197.4	0.055
763.22	0.021	197.4	0.0533
763.23	0.021	197.4	0.0515
763.25	0.02	197.3	0.0479
763.27	0.016	197.1	0.0453
763.28	0.015	197	0.0435
763.30	0.014	196.9	0.0391
763.32	0.01	196.6	0.0391
763.33	0.009	196.6	0.0355
763.35	0.009	196.5	0.0328
763.37	0.008	196.3	0.0293
763.38	0.005	196	0.0249
763.40	0.003	195.8	0.0213
763.42	0.002	195.6	0.0169
763.43	-0.002	195.2	0.0169
763.45	-0.003	195	0.0124
763.47	-0.003	195	0.0098
763.48	-0.004	194.7	0.0062
763.52	-0.007	194.4	0.0027
763.53	-0.009	194.2	-0.0009
763.55	-0.01	193.9	-0.0044
763.57	-0.012	193.6	-0.0044
763.57	-0.013	193.4	-0.0071
763.58	-0.013	193.4	-0.0098
763.60	-0.013	193.2	-0.0115

Prova triassiale ciclica SN04-C1			
pressione di confinamento (kPa)		80	
deviatore ciclico (kPa)		95	
frequenza (hz)		0.00625	
tempo	cella di carico	$\Delta u$	LVDT
(min)	kN	(kPa)	$\delta$ (mm)
763.62	-0.015	192.9	-0.0133
763.63	-0.016	192.7	-0.0151
763.65	-0.016	192.6	-0.016
763.67	-0.017	192.4	-0.016
763.68	-0.017	192.3	-0.0169
763.70	-0.017	192.3	-0.0178
763.72	-0.017	192.1	-0.0178
763.73	-0.017	192	-0.0178
763.75	-0.017	192	-0.0178
763.77	-0.016	191.9	-0.0178
763.78	-0.016	191.8	-0.0169
763.80	-0.015	191.9	-0.0169
763.82	-0.014	191.9	-0.016
763.83	-0.014	191.8	-0.0151
763.85	-0.013	191.9	-0.0133
763.87	-0.011	191.9	-0.0115
763.88	-0.011	191.9	-0.0098
763.90	-0.01	192.1	-0.008
763.92	-0.007	192.2	-0.0044
763.93	-0.006	192.3	-0.0027
763.95	-0.004	192.5	0.0009
763.97	-0.001	192.7	0.0009
763.98	0	192.7	0.0044
764.00	0	192.8	0.008
764.02	0.002	193	0.0115
764.03	0.005	193.3	0.0151
764.05	0.006	193.4	0.0186
764.07	0.008	193.7	0.0231
764.08	0.012	194	0.0231
764.10	0.013	194	0.0284
764.12	0.013	194.2	0.0311
764.13	0.014	194.4	0.0346
764.15	0.018	194.7	0.0391
764.17	0.018	194.9	0.0417
764.18	0.02	195.2	0.0453
764.20	0.023	195.5	0.0453
764.22	0.023	195.5	0.0479
764.23	0.023	195.7	0.0497
764.25	0.024	196	0.0533
764.27	0.026	196.2	0.055
764.28	0.027	196.4	0.0568
764.30	0.027	196.6	0.0577
764.32	0.028	196.8	0.0577
764.33	0.029	196.9	0.0595
764.35	0.029	196.9	0.0604
764.37	0.029	197.1	0.0612
764.38	0.029	197.2	0.0612
764.40	0.029	197.3	0.0612
764.42	0.029	197.4	0.0612
764.43	0.028	197.5	0.0612
764.45	0.027	197.5	0.0612
764.47	0.027	197.5	0.0595
764.48	0.027	197.6	0.0586
764.50	0.026	197.5	0.0577
764.52	0.024	197.5	0.0559
764.53	0.023	197.5	0.0541
764.55	0.022	197.4	0.0515
764.57	0.019	197.3	0.0515

Prova triassiale ciclica SN04-C1			
pressione di confinamento (kPa)		80	
deviatore ciclico (kPa)		95	
frequenza (hz)		0.00625	
tempo	cella di carico	$\Delta u$	LVDT
(min)	kN	(kPa)	$\delta$ (mm)
764.58	0.018	197.2	0.0479
764.60	0.017	197.1	0.0453
764.62	0.014	196.9	0.0453
764.63	0.013	196.9	0.0417
764.65	0.013	196.8	0.0391
764.67	0.011	196.6	0.0355
764.68	0.008	196.4	0.0311
764.70	0.007	196.2	0.0284
764.72	0.005	195.9	0.0231
764.73	0.001	195.7	0.0231
764.75	0.001	195.7	0.0186
764.77	0.001	195.5	0.016
764.78	-0.001	195.1	0.0115
764.80	-0.005	194.8	0.008
764.82	-0.005	194.6	0.0044
764.83	-0.007	194.3	0.0009
764.85	-0.01	194	0.0009
764.87	-0.01	194	-0.0027
764.88	-0.01	193.9	-0.0053
764.90	-0.012	193.5	-0.008
764.92	-0.014	193.3	-0.0107
764.95	-0.014	193.1	-0.0124
764.97	-0.015	192.9	-0.0142
764.98	-0.016	192.7	-0.0142
765.00	-0.016	192.7	-0.0151
765.02	-0.016	192.5	-0.016
765.02	-0.017	192.4	-0.0169
765.03	-0.017	192.2	-0.0178
765.05	-0.017	192.1	-0.0178
765.07	-0.017	192	-0.0178
765.08	-0.017	191.9	-0.0178
765.10	-0.017	191.9	-0.0178
765.12	-0.017	191.9	-0.0178
765.13	-0.016	191.8	-0.016
765.15	-0.014	191.9	-0.0142
765.17	-0.013	191.9	-0.0133
765.18	-0.013	191.9	-0.0124
765.20	-0.011	192	-0.0098
765.22	-0.009	192.1	-0.0098
765.23	-0.009	192.1	-0.008
765.25	-0.008	192.2	-0.0053
765.27	-0.006	192.3	-0.0018
765.28	-0.004	192.5	0.0009
765.30	-0.002	192.6	0.0036
765.32	0	192.8	0.0071
765.33	0.001	192.9	0.0089
765.35	0.002	193.1	0.0124
765.37	0.005	193.4	0.0169
765.38	0.008	193.6	0.0169
765.40	0.009	193.6	0.0204
765.42	0.009	193.8	0.024
765.43	0.011	194.1	0.0284
765.45	0.014	194.4	0.0328
765.47	0.015	194.6	0.0364
765.48	0.017	194.9	0.0399
765.50	0.02	195.1	0.0399
765.52	0.02	195.1	0.0435
765.53	0.02	195.3	0.0462

Prova triassiale ciclica SN04-C1			
pressione di confinamento (kPa)		80	
deviatore ciclico (kPa)		95	
frequenza (hz)		0.00625	
tempo	cella di carico	$\Delta u$	LVDT
(min)	kN	(kPa)	$\delta$ (mm)
765.55	0.022	195.7	0.0488
765.57	0.024	195.9	0.0515
765.58	0.025	196.1	0.0533
765.60	0.026	196.3	0.0559
765.62	0.027	196.5	0.0559
765.63	0.028	196.5	0.0577
765.65	0.028	196.7	0.0586
765.67	0.028	196.8	0.0595
765.68	0.028	197	0.0604
765.70	0.029	197.2	0.0612
765.72	0.029	197.3	0.0612
765.73	0.029	197.4	0.0612
765.75	0.029	197.4	0.0612
765.77	0.029	197.5	0.0612
765.78	0.028	197.5	0.0604
765.80	0.027	197.5	0.0595
765.82	0.026	197.6	0.0586
765.83	0.025	197.6	0.0568
765.85	0.023	197.5	0.0568
765.87	0.022	197.4	0.0541
765.88	0.022	197.4	0.0533
765.90	0.021	197.4	0.0506
765.92	0.019	197.2	0.0479
765.93	0.017	197.1	0.0453
765.95	0.016	197	0.0417
765.97	0.013	196.8	0.0417
765.98	0.011	196.6	0.0382
766.00	0.011	196.6	0.0355
766.02	0.01	196.5	0.032
766.03	0.007	196.2	0.0284
766.05	0.005	196	0.024
766.07	0.004	195.9	0.0213
766.08	0.002	195.6	0.0178
766.10	-0.001	195.3	0.0142
766.12	-0.002	195.1	0.0098
766.13	-0.004	194.7	0.0062
766.15	-0.007	194.5	0.0062
766.17	-0.008	194.5	0.0027
766.18	-0.008	194.3	0.0009
766.20	-0.009	194	-0.0027
766.22	-0.012	193.7	-0.0062
766.23	-0.012	193.5	-0.008
766.25	-0.013	193.3	-0.0115
766.27	-0.015	193	-0.0115
766.28	-0.015	193	-0.0133
766.30	-0.015	192.9	-0.0142
766.32	-0.016	192.7	-0.016
766.33	-0.017	192.5	-0.0169
766.35	-0.017	192.3	-0.0169
766.37	-0.017	192.2	-0.0178
766.38	-0.017	192.1	-0.0178
766.42	-0.017	192.1	-0.0186
766.43	-0.017	192	-0.0186
766.45	-0.017	191.9	-0.0178
766.47	-0.016	191.9	-0.0169
766.47	-0.015	191.9	-0.016
766.48	-0.015	191.9	-0.0151
766.50	-0.013	191.9	-0.0151

Prova triassiale ciclica SN04-C1			
pressione di confinamento (kPa)		80	
deviatore ciclico (kPa)		95	
frequenza (hz)		0.00625	
tempo	cella di carico	$\Delta u$	LVDT
(min)	kN	(kPa)	$\delta$ (mm)
766.52	-0.012	191.9	-0.0133
766.53	-0.012	191.9	-0.0115
766.55	-0.011	192	-0.0089
766.57	-0.008	192.1	-0.0071
766.58	-0.007	192.2	-0.0053
766.60	-0.006	192.3	-0.0018
766.62	-0.002	192.5	-0.0018
766.63	-0.002	192.5	0.0018
766.65	-0.002	192.6	0.0044
766.67	0	192.8	0.008
766.68	0.003	193.1	0.0124
766.70	0.005	193.3	0.0151
766.72	0.006	193.5	0.0195
766.73	0.01	193.8	0.0195
766.75	0.011	194	0.024
766.77	0.013	194.2	0.0302
766.78	0.014	194.4	0.0302
766.80	0.016	194.7	0.0328
766.82	0.016	194.7	0.0364
766.83	0.017	194.9	0.0408
766.85	0.02	195.2	0.0444
766.87	0.022	195.5	0.047
766.88	0.022	195.7	0.0497
766.90	0.024	196	0.0497
766.92	0.025	196.2	0.0524
766.93	0.025	196.2	0.0541
766.95	0.026	196.4	0.0568
766.97	0.027	196.6	0.0586
766.98	0.028	196.8	0.0595
767.00	0.028	196.9	0.0604
767.02	0.029	197.1	0.0604
767.03	0.029	197.2	0.0612
767.05	0.029	197.2	0.0612
767.07	0.029	197.3	0.0612
767.08	0.029	197.4	0.0612
767.10	0.028	197.5	0.0612
767.12	0.028	197.6	0.0604
767.13	0.027	197.6	0.0604
767.15	0.025	197.6	0.0586
767.17	0.025	197.6	0.0577
767.18	0.025	197.6	0.0559
767.20	0.023	197.5	0.0541
767.22	0.021	197.4	0.0524
767.23	0.02	197.4	0.0488
767.25	0.018	197.2	0.0462
767.27	0.016	197.1	0.0462
767.28	0.016	197.1	0.0435
767.30	0.015	197	0.0408
767.32	0.013	196.7	0.0373
767.33	0.01	196.6	0.0346
767.35	0.009	196.4	0.0311
767.37	0.006	196.1	0.0257
767.38	0.004	195.9	0.0257
767.40	0.004	195.9	0.0222
767.42	0.002	195.7	0.0186
767.43	0	195.4	0.0142
767.45	-0.003	195.1	0.0107
767.47	-0.004	194.9	0.008

Prova triassiale ciclica SN04-C1			
pressione di confinamento (kPa)		80	
deviatore ciclico (kPa)		95	
frequenza (hz)		0.00625	
tempo	cella di carico	$\Delta u$	LVDT
(min)	kN	(kPa)	$\delta$ (mm)
767.48	-0.005	194.6	0.0036
767.50	-0.008	194.3	0.0009
767.52	-0.008	194.1	-0.0009
767.53	-0.01	193.9	-0.0044
767.55	-0.012	193.6	-0.0044
767.57	-0.013	193.6	-0.0071
767.58	-0.013	193.4	-0.0098
767.60	-0.014	193.1	-0.0115
767.62	-0.015	192.9	-0.0133
767.63	-0.015	192.8	-0.0151
767.65	-0.016	192.5	-0.016
767.67	-0.017	192.4	-0.016
767.68	-0.017	192.4	-0.0178
767.70	-0.017	192.2	-0.0178
767.72	-0.017	192.2	-0.0178
767.73	-0.017	192.1	-0.0178
767.75	-0.017	192	-0.0178
767.77	-0.017	191.9	-0.0169
767.78	-0.015	191.9	-0.0169
767.80	-0.015	191.9	-0.016
767.82	-0.015	191.9	-0.016
767.83	-0.014	191.9	-0.0142
767.85	-0.012	191.9	-0.0124
767.88	-0.011	192	-0.0107
767.90	-0.01	192.1	-0.008
767.92	-0.007	192.2	-0.008
767.92	-0.006	192.2	-0.0053
767.93	-0.006	192.3	-0.0036
767.95	-0.005	192.4	0
767.97	-0.002	192.6	0.0036
767.98	-0.001	192.7	0.0062
768.00	0.001	193	0.0098
768.02	0.005	193.2	0.0098
768.03	0.006	193.2	0.0142
768.05	0.006	193.4	0.0169
768.07	0.007	193.6	0.0213
768.08	0.011	193.9	0.0257
768.10	0.012	194.1	0.0293
768.12	0.013	194.3	0.0328
768.13	0.016	194.6	0.0328
768.15	0.018	194.9	0.0373
768.17	0.018	194.9	0.0399
768.18	0.019	195.1	0.0444
768.20	0.021	195.5	0.047
768.22	0.023	195.7	0.0497
768.23	0.023	195.9	0.0515
768.25	0.025	196.1	0.0533
768.27	0.026	196.3	0.055
768.28	0.026	196.5	0.0577
768.30	0.027	196.7	0.0577
768.32	0.028	196.9	0.0586
768.33	0.028	196.9	0.0595
768.35	0.028	197.1	0.0612
768.37	0.029	197.2	0.0612
768.38	0.029	197.3	0.0612
768.40	0.029	197.4	0.0612
768.42	0.029	197.5	0.0612
768.43	0.028	197.6	0.0612

Prova triassiale ciclica SN04-C1			
pressione di confinamento (kPa)		80	
deviatore ciclico (kPa)		95	
frequenza (hz)		0.00625	
tempo	cella di carico	$\Delta u$	LVDT
(min)	kN	(kPa)	$\delta$ (mm)
768.45	0.028	197.6	0.0604
768.47	0.027	197.6	0.0595
768.48	0.026	197.6	0.0577
768.50	0.025	197.6	0.0568
768.52	0.024	197.6	0.055
768.53	0.023	197.5	0.0533
768.55	0.021	197.4	0.0533
768.57	0.019	197.4	0.0506
768.58	0.019	197.4	0.0488
768.60	0.018	197.2	0.0453
768.62	0.015	197	0.0426
768.63	0.014	196.9	0.0399
768.65	0.012	196.7	0.0364
768.67	0.009	196.5	0.0364
768.68	0.008	196.5	0.0328
768.70	0.008	196.3	0.0302
768.72	0.006	196.1	0.0249
768.73	0.002	195.8	0.0204
768.75	0.002	195.6	0.0178
768.77	0	195.3	0.0124
768.78	-0.004	195	0.0124
768.80	-0.004	195	0.0089
768.82	-0.004	194.8	0.0062
768.83	-0.006	194.5	0.0027
768.85	-0.009	194.2	-0.0018
768.87	-0.009	194	-0.0036
768.88	-0.011	193.7	-0.0071
768.90	-0.014	193.4	-0.0071
768.92	-0.014	193.4	-0.0098
768.93	-0.014	193.3	-0.0115
768.95	-0.015	192.8	-0.0133
768.97	-0.016	192.8	-0.0142
768.98	-0.016	192.7	-0.0151
769.00	-0.016	192.5	-0.0169
769.02	-0.017	192.3	-0.0178
769.03	-0.017	192.2	-0.0178
769.05	-0.017	192.1	-0.0178
769.07	-0.017	192	-0.0178
769.08	-0.017	191.9	-0.0178
769.10	-0.017	191.9	-0.0178
769.12	-0.016	191.9	-0.0169
769.13	-0.015	191.9	-0.016
769.15	-0.014	191.9	-0.0151
769.17	-0.014	191.8	-0.0133
769.18	-0.012	191.9	-0.0133
769.20	-0.01	192	-0.0115
769.22	-0.01	192	-0.0098
769.23	-0.01	192	-0.0071
769.25	-0.007	192.2	-0.0053
769.27	-0.005	192.3	-0.0018
769.28	-0.004	192.4	0.0009
769.32	-0.002	192.7	0.0009
769.33	0.001	192.8	0.0044
769.35	0.001	192.8	0.0071
769.37	0.002	193	0.0107
769.38	0.004	193.3	0.0151
769.38	0.007	193.5	0.0186
769.40	0.008	193.7	0.0222



Prova triassiale ciclica SN04-C1			
pressione di confinamento (kPa)		80	
deviatore ciclico (kPa)		95	
frequenza (hz)		0.00625	
tempo	cella di carico	$\Delta u$	LVDT
(min)	kN	(kPa)	$\delta$ (mm)
769.42	0.01	194	0.0257
769.43	0.013	194.2	0.0257
769.45	0.014	194.2	0.0311
769.47	0.014	194.4	0.0346
769.48	0.016	194.7	0.0382
769.50	0.019	195	0.0417
769.52	0.02	195.2	0.0435
769.53	0.021	195.6	0.0479
769.55	0.024	195.8	0.0479
769.57	0.024	195.8	0.0506
769.58	0.024	196	0.0524
769.60	0.025	196.2	0.0541
769.62	0.027	196.5	0.0568
769.63	0.027	196.6	0.0577
769.65	0.028	196.8	0.0595
769.67	0.028	197	0.0604
769.68	0.028	197.1	0.0604
769.70	0.029	197.2	0.0612
769.72	0.029	197.3	0.0612
769.73	0.029	197.3	0.0612
769.75	0.029	197.4	0.0612
769.77	0.029	197.5	0.0612
769.78	0.028	197.6	0.0604
769.80	0.027	197.6	0.0595
769.82	0.026	197.6	0.0577
769.83	0.025	197.6	0.0577
769.85	0.023	197.6	0.0559
769.87	0.023	197.5	0.055
769.88	0.023	197.5	0.0524
769.90	0.02	197.4	0.0497
769.92	0.018	197.3	0.0479
769.93	0.017	197.2	0.0453
769.95	0.015	197	0.0453
769.97	0.012	196.8	0.0417
769.98	0.012	196.8	0.0382
770.00	0.011	196.7	0.0355
770.02	0.009	196.4	0.0311
770.03	0.006	196.2	0.0284
770.05	0.005	196.1	0.0231
770.07	0.002	195.7	0.0231
770.08	0	195.5	0.0186
770.10	0	195.5	0.016
770.12	-0.001	195.3	0.0115
770.13	-0.004	194.9	0.008
770.15	-0.006	194.7	0.0053
770.17	-0.006	194.4	0.0018
770.18	-0.009	194.1	0.0018
770.20	-0.011	193.9	-0.0027
770.22	-0.011	193.9	-0.0053
770.23	-0.012	193.7	-0.008
770.25	-0.013	193.4	-0.0107
770.27	-0.014	193.2	-0.0124
770.28	-0.015	193	-0.0142
770.30	-0.016	192.7	-0.016
770.32	-0.017	192.6	-0.016
770.33	-0.017	192.6	-0.0169
770.35	-0.017	192.4	-0.0169
770.37	-0.017	192.3	-0.0178

Prova triassiale ciclica SN04-C1			
pressione di confinamento (kPa)		80	
deviatore ciclico (kPa)		95	
frequenza (hz)		0.00625	
tempo	cella di carico	$\Delta u$	LVDT
(min)	kN	(kPa)	$\delta$ (mm)
770.38	-0.017	192.2	-0.0178
770.40	-0.017	192.1	-0.0178
770.42	-0.017	192	-0.0178
770.43	-0.017	191.9	-0.0178
770.45	-0.016	191.9	-0.0169
770.47	-0.015	191.8	-0.016
770.48	-0.014	191.9	-0.016
770.50	-0.013	191.9	-0.0151
770.52	-0.013	191.9	-0.0133
770.53	-0.012	192	-0.0115
770.55	-0.009	192	-0.0089
770.57	-0.009	192.1	-0.0071
770.58	-0.007	192.3	-0.0036
770.60	-0.004	192.4	-0.0036
770.62	-0.003	192.4	-0.0009
770.63	-0.003	192.5	0.0018
770.65	-0.002	192.7	0.0053
770.67	0.002	192.9	0.0089
770.68	0.003	193.1	0.0124
770.70	0.004	193.4	0.016
770.72	0.008	193.6	0.016
770.73	0.009	193.6	0.0204
770.75	0.009	193.8	0.024
770.78	0.011	194.1	0.0284
770.80	0.014	194.3	0.0328
770.82	0.015	194.5	0.0355
770.83	0.016	194.8	0.0391
770.83	0.02	195.1	0.0391
770.85	0.02	195.1	0.0435
770.87	0.02	195.3	0.0453
770.88	0.022	195.6	0.0488
770.90	0.024	195.9	0.0515
770.92	0.025	196.1	0.0533
770.93	0.025	196.3	0.055
770.95	0.027	196.5	0.055
770.97	0.028	196.5	0.0577
770.98	0.028	196.7	0.0586
771.00	0.029	196.9	0.0604
771.02	0.028	197	0.0604
771.03	0.028	197.1	0.0604
771.05	0.029	197.3	0.0612
771.07	0.029	197.4	0.0612
771.08	0.029	197.5	0.0612
771.10	0.029	197.5	0.0612
771.12	0.028	197.5	0.0604
771.13	0.026	197.6	0.0595
771.15	0.026	197.6	0.0586
771.17	0.025	197.6	0.0577
771.18	0.024	197.6	0.055
771.20	0.023	197.5	0.0541
771.22	0.021	197.5	0.0515
771.23	0.02	197.3	0.0488
771.25	0.017	197.2	0.0488
771.27	0.017	197.2	0.0462
771.28	0.016	197.1	0.0435
771.30	0.014	196.9	0.0399
771.32	0.011	196.7	0.0373
771.33	0.01	196.6	0.0337

Prova triassiale ciclica SN04-C1			
pressione di confinamento (kPa)		80	
deviatore ciclico (kPa)		95	
frequenza (hz)		0.00625	
tempo	cella di carico	$\Delta u$	LVDT
(min)	kN	(kPa)	$\delta$ (mm)
771.35	0.009	196.3	0.0302
771.37	0.005	196.1	0.0302
771.38	0.004	196.1	0.0257
771.40	0.004	196	0.0222
771.42	0.002	195.7	0.0186
771.43	-0.001	195.4	0.0142
771.45	-0.002	195.1	0.0107
771.47	-0.004	194.8	0.0071
771.48	-0.007	194.5	0.0071
771.50	-0.007	194.5	0.0027
771.52	-0.007	194.3	0
771.53	-0.009	194	-0.0036
771.55	-0.012	193.7	-0.0062
771.57	-0.012	193.6	-0.008
771.58	-0.013	193.3	-0.0107
771.60	-0.015	193.1	-0.0107
771.62	-0.015	193.1	-0.0133
771.63	-0.015	192.9	-0.0142
771.65	-0.016	192.7	-0.016
771.67	-0.017	192.5	-0.0169
771.68	-0.017	192.4	-0.0169
771.70	-0.017	192.2	-0.0178
771.72	-0.017	192.1	-0.0178
771.73	-0.017	192.1	-0.0178
771.75	-0.017	192	-0.0178
771.77	-0.017	192	-0.0178
771.78	-0.016	191.9	-0.0169
771.80	-0.015	191.9	-0.016
771.82	-0.015	191.9	-0.0142
771.83	-0.012	191.9	-0.0142
771.85	-0.012	191.9	-0.0124
771.87	-0.012	191.9	-0.0107
771.88	-0.009	192.1	-0.0107
771.90	-0.008	192.1	-0.008
771.92	-0.008	192.1	-0.0053
771.93	-0.007	192.3	-0.0027
771.95	-0.003	192.5	0.0009
771.97	-0.002	192.6	0.0036
771.98	-0.001	192.8	0.0071
772.00	0.003	193	0.0071
772.02	0.004	193	0.0107
772.03	0.004	193.2	0.0142
772.05	0.005	193.4	0.0178
772.07	0.009	193.7	0.0222
772.08	0.01	193.9	0.0249
772.10	0.011	194.1	0.0302
772.12	0.015	194.4	0.0302
772.13	0.016	194.4	0.0346
772.15	0.016	194.7	0.0373
772.17	0.017	194.9	0.0408
772.18	0.02	195.2	0.0453
772.22	0.021	195.5	0.047
772.23	0.022	195.7	0.0497
772.25	0.024	196	0.0497
772.27	0.026	196.2	0.0524
772.28	0.026	196.2	0.055
772.28	0.026	196.4	0.0568
772.30	0.027	196.6	0.0586

Prova triassiale ciclica SN04-C1			
pressione di confinamento (kPa)		80	
deviatore ciclico (kPa)		95	
frequenza (hz)		0.00625	
tempo	cella di carico	$\Delta u$	LVDT
(min)	kN	(kPa)	$\delta$ (mm)
772.32	0.028	196.8	0.0595
772.33	0.028	196.9	0.0604
772.35	0.029	197.1	0.0604
772.37	0.029	197.2	0.0612
772.38	0.029	197.2	0.0612
772.40	0.029	197.4	0.0621
772.42	0.029	197.5	0.0621
772.43	0.028	197.5	0.0612
772.45	0.027	197.6	0.0604
772.47	0.027	197.6	0.0595
772.48	0.025	197.6	0.0595
772.50	0.024	197.6	0.0577
772.52	0.024	197.6	0.0568
772.53	0.023	197.5	0.0541
772.55	0.021	197.5	0.0524
772.57	0.02	197.4	0.0497
772.58	0.019	197.3	0.047
772.60	0.017	197.2	0.0453
772.62	0.016	197.1	0.0435
772.63	0.014	196.9	0.0399
772.65	0.01	196.7	0.0399
772.67	0.01	196.7	0.0355
772.68	0.01	196.6	0.0328
772.70	0.008	196.3	0.0284
772.72	0.004	196.1	0.024
772.73	0.003	195.9	0.0204
772.75	0.002	195.6	0.0169
772.77	-0.002	195.2	0.0169
772.78	-0.003	195.2	0.0124
772.80	-0.003	195	0.0098
772.82	-0.005	194.7	0.0053
772.83	-0.007	194.5	0.0018
772.85	-0.009	194.2	-0.0009
772.87	-0.009	194	-0.0036
772.88	-0.012	193.7	-0.0036
772.90	-0.013	193.7	-0.0071
772.92	-0.013	193.5	-0.0089
772.93	-0.014	193.2	-0.0115
772.95	-0.015	193	-0.0133
772.97	-0.016	192.8	-0.0142
772.98	-0.016	192.6	-0.016
773.00	-0.017	192.5	-0.016
773.02	-0.017	192.5	-0.0169
773.03	-0.017	192.3	-0.0178
773.05	-0.017	192.2	-0.0178
773.07	-0.017	192.1	-0.0178
773.08	-0.017	192	-0.0178
773.10	-0.016	191.9	-0.0169
773.12	-0.016	191.9	-0.0169
773.13	-0.015	191.9	-0.016
773.15	-0.015	191.9	-0.0151
773.17	-0.014	191.9	-0.0142
773.18	-0.012	192	-0.0124
773.20	-0.011	192	-0.0107
773.22	-0.01	192	-0.008
773.23	-0.008	192.2	-0.0062
773.25	-0.006	192.3	-0.0062
773.27	-0.005	192.3	-0.0036

Prova triassiale ciclica SN04-C1			
pressione di confinamento (kPa)		80	
deviatore ciclico (kPa)		95	
frequenza (hz)		0.00625	
tempo	cella di carico	$\Delta u$	LVDT
(min)	kN	(kPa)	$\delta$ (mm)
773.28	-0.005	192.4	-0.0009
773.30	-0.001	192.7	0.0027
773.32	0	192.7	0.0044
773.33	0	192.9	0.008
773.35	0.002	193.1	0.0115
773.37	0.005	193.4	0.016
773.38	0.006	193.5	0.0186
773.40	0.008	193.8	0.0231
773.42	0.012	194.1	0.0231
773.43	0.013	194.1	0.0284
773.45	0.013	194.2	0.0311
773.47	0.014	194.5	0.0346
773.48	0.018	194.8	0.0391
773.50	0.018	195	0.0417
773.52	0.019	195.3	0.0444
773.53	0.022	195.6	0.0444
773.55	0.023	195.6	0.0479
773.57	0.023	195.8	0.0506
773.58	0.024	196.1	0.0533
773.60	0.026	196.3	0.0559
773.62	0.026	196.5	0.0568
773.63	0.027	196.7	0.0586
773.65	0.028	196.9	0.0586
773.68	0.029	196.9	0.0595
773.70	0.029	197	0.0604
773.72	0.029	197.2	0.0612
773.73	0.029	197.3	0.0612
773.73	0.029	197.4	0.0612
773.75	0.029	197.5	0.0612
773.77	0.028	197.6	0.0612
773.78	0.027	197.6	0.0612
773.80	0.027	197.6	0.0595
773.82	0.026	197.6	0.0586
773.83	0.025	197.6	0.0568
773.85	0.024	197.6	0.0559
773.87	0.023	197.5	0.0533
773.88	0.021	197.4	0.0533
773.90	0.019	197.3	0.0515
773.92	0.019	197.3	0.0488
773.93	0.018	197.3	0.0462
773.95	0.016	197.1	0.0426
773.97	0.013	196.9	0.0399
773.98	0.012	196.8	0.0373
774.00	0.01	196.5	0.0328
774.02	0.007	196.3	0.0328
774.03	0.006	196.2	0.0275
774.05	0.005	196	0.024
774.07	0.002	195.7	0.024
774.08	0.001	195.7	0.0195
774.10	0.001	195.5	0.016
774.12	-0.001	195.1	0.0115
774.13	-0.004	194.9	0.008
774.15	-0.005	194.7	0.0044
774.17	-0.007	194.4	0.0009
774.18	-0.01	194.1	0.0009
774.20	-0.01	194.1	-0.0027
774.22	-0.01	193.9	-0.0053
774.23	-0.011	193.6	-0.008

Prova triassiale ciclica SN04-C1			
pressione di confinamento (kPa)		80	
deviatore ciclico (kPa)		95	
frequenza (hz)		0.00625	
tempo	cella di carico	$\Delta u$	LVDT
(min)	kN	(kPa)	$\delta$ (mm)
774.25	-0.014	193.3	-0.0107
774.27	-0.014	193.1	-0.0124
774.28	-0.015	192.9	-0.0142
774.30	-0.016	192.7	-0.0142
774.32	-0.017	192.7	-0.016
774.33	-0.017	192.6	-0.016
774.35	-0.017	192.4	-0.0169
774.37	-0.017	192.3	-0.0178
774.38	-0.017	192.2	-0.0178
774.40	-0.017	192.1	-0.0178
774.42	-0.017	192	-0.0178
774.43	-0.016	192	-0.0178
774.45	-0.016	191.9	-0.0169
774.47	-0.016	191.9	-0.016
774.48	-0.014	191.9	-0.0151
774.50	-0.014	191.9	-0.0133
774.52	-0.013	192	-0.0115
774.53	-0.01	192.1	-0.0115
774.55	-0.01	192.1	-0.0098
774.57	-0.01	192.1	-0.008
774.58	-0.008	192.2	-0.0044
774.60	-0.005	192.4	-0.0018
774.62	-0.004	192.5	0.0009
774.63	-0.002	192.7	0.0044
774.65	0.001	192.9	0.0044
774.67	0.002	192.9	0.008
774.68	0.002	193	0.0107
774.70	0.003	193.3	0.0151
774.72	0.007	193.6	0.0195
774.73	0.009	193.7	0.0222
774.75	0.01	193.9	0.0257
774.77	0.012	194.2	0.0293
774.78	0.014	194.4	0.032
774.80	0.015	194.6	0.0364
774.82	0.018	194.9	0.0364
774.83	0.019	195.2	0.0399
774.85	0.019	195.2	0.0426
774.87	0.02	195.4	0.0462
774.88	0.023	195.8	0.0488
774.90	0.024	196	0.0515
774.92	0.024	196.2	0.0533
774.93	0.026	196.4	0.0533
774.95	0.028	196.6	0.0559
774.97	0.028	196.6	0.0577
774.98	0.027	196.8	0.0586
775.00	0.028	196.9	0.0595
775.02	0.028	197.1	0.0604
775.03	0.029	197.2	0.0604
775.05	0.029	197.4	0.0612
775.07	0.029	197.4	0.0612
775.08	0.029	197.4	0.0612
775.12	0.029	197.5	0.0612
775.13	0.028	197.6	0.0604
775.15	0.027	197.6	0.0595
775.17	0.026	197.7	0.0577
775.18	0.025	197.6	0.0559
775.18	0.023	197.6	0.0559
775.20	0.022	197.6	0.0541

Prova triassiale ciclica SN04-C1			
pressione di confinamento (kPa)		80	
deviatore ciclico (kPa)		95	
frequenza (hz)		0.00625	
tempo	cella di carico	$\Delta u$	LVDT
(min)	kN	(kPa)	$\delta$ (mm)
775.22	0.022	197.5	0.0533
775.23	0.021	197.4	0.0506
775.25	0.018	197.3	0.047
775.27	0.017	197.2	0.0453
775.28	0.016	197	0.0417
775.30	0.012	196.9	0.0417
775.32	0.011	196.9	0.0382
775.33	0.011	196.7	0.0355
775.35	0.01	196.5	0.0311
775.37	0.006	196.3	0.0275
775.38	0.005	196.1	0.0231
775.40	0.004	195.8	0.0195
775.42	0	195.5	0.0195
775.43	-0.001	195.5	0.0151
775.45	-0.001	195.3	0.0124
775.47	-0.002	195	0.008
775.48	-0.006	194.7	0.0044
775.50	-0.006	194.5	0.0018
775.52	-0.008	194.2	-0.0018
775.53	-0.011	194	-0.0044
775.55	-0.011	193.8	-0.0062
775.57	-0.012	193.5	-0.0089
775.58	-0.014	193.3	-0.0089
775.60	-0.015	193.3	-0.0115
775.62	-0.015	193.1	-0.0133
775.63	-0.015	192.9	-0.0151
775.65	-0.017	192.6	-0.0169
775.67	-0.017	192.5	-0.0178
775.68	-0.017	192.4	-0.0186
775.70	-0.017	192.2	-0.0186
775.72	-0.017	192.2	-0.0186
775.73	-0.017	192.1	-0.0186
775.75	-0.017	192	-0.0186
775.77	-0.016	192	-0.0178
775.78	-0.016	191.9	-0.0178
775.80	-0.015	191.9	-0.016
775.82	-0.014	191.9	-0.016
775.83	-0.013	191.9	-0.0151
775.85	-0.013	191.9	-0.0133
775.87	-0.012	192	-0.0115
775.88	-0.01	192.1	-0.0089
775.90	-0.009	192.2	-0.0071
775.92	-0.007	192.3	-0.0044
775.93	-0.004	192.5	-0.0044
775.95	-0.003	192.6	-0.0009
775.97	-0.003	192.6	0.0018
775.98	-0.002	192.7	0.0053
776.00	0.001	193	0.0089
776.02	0.003	193.1	0.0115
776.03	0.004	193.3	0.0151
776.05	0.008	193.6	0.0151
776.07	0.01	193.8	0.0195
776.08	0.01	193.8	0.0231
776.10	0.011	194.1	0.0275
776.12	0.013	194.4	0.0311
776.13	0.016	194.6	0.0346
776.15	0.017	194.8	0.0391
776.17	0.019	195.1	0.0391

Prova triassiale ciclica SN04-C1			
pressione di confinamento (kPa)		80	
deviatore ciclico (kPa)		95	
frequenza (hz)		0.00625	
tempo	cella di carico	$\Delta u$	LVDT
(min)	kN	(kPa)	$\delta$ (mm)
776.18	0.021	195.4	0.0426
776.20	0.021	195.4	0.0453
776.22	0.023	195.9	0.0497
776.23	0.024	196.1	0.0497
776.25	0.025	196.1	0.0515
776.27	0.025	196.3	0.0533
776.28	0.026	196.5	0.0559
776.30	0.028	196.7	0.0577
776.32	0.028	196.9	0.0586
776.33	0.028	197	0.0595
776.35	0.029	197.2	0.0595
776.37	0.029	197.2	0.0604
776.38	0.029	197.3	0.0604
776.40	0.029	197.4	0.0604
776.42	0.029	197.5	0.0604
776.43	0.028	197.6	0.0604
776.45	0.028	197.6	0.0595
776.47	0.026	197.6	0.0595
776.48	0.026	197.6	0.0577
776.50	0.026	197.7	0.0568
776.52	0.025	197.6	0.055
776.53	0.023	197.5	0.0533
776.55	0.021	197.5	0.0515
776.58	0.02	197.4	0.0488
776.60	0.017	197.3	0.0488
776.62	0.016	197.3	0.0453
776.63	0.016	197.2	0.0435
776.63	0.015	197	0.0399
776.65	0.012	196.8	0.0364
776.67	0.01	196.7	0.0337
776.68	0.009	196.5	0.0293
776.70	0.005	196.2	0.0293
776.72	0.004	196	0.0249
776.73	0.004	196	0.0213
776.75	0.002	195.8	0.0178
776.77	0	195.5	0.0133
776.78	-0.002	195.2	0.0107
776.80	-0.004	194.9	0.0062
776.82	-0.006	194.6	0.0062
776.83	-0.008	194.4	0.0018
776.85	-0.008	194.4	-0.0009
776.87	-0.009	194.1	-0.0036
776.88	-0.011	193.8	-0.0071
776.90	-0.013	193.6	-0.0089
776.92	-0.013	193.4	-0.0115
776.93	-0.014	193.1	-0.0133
776.95	-0.015	193	-0.0142
776.97	-0.016	192.8	-0.016
776.98	-0.016	192.6	-0.0178
777.00	-0.017	192.4	-0.0178
777.02	-0.017	192.4	-0.0178
777.03	-0.017	192.3	-0.0186
777.05	-0.017	192.2	-0.0186
777.07	-0.017	192.1	-0.0186
777.08	-0.017	192	-0.0186
777.10	-0.016	191.9	-0.0178
777.12	-0.015	191.9	-0.0178
777.13	-0.015	191.9	-0.0169



Prova triassiale ciclica SN04-C1			
pressione di confinamento (kPa)		80	
deviatore ciclico (kPa)		95	
frequenza (hz)		0.00625	
tempo	cella di carico	$\Delta u$	LVDT
(min)	kN	(kPa)	$\delta$ (mm)
777.15	-0.015	191.9	-0.016
777.17	-0.014	191.9	-0.0142
777.18	-0.012	192	-0.0133
777.20	-0.011	192	-0.0115
777.22	-0.01	192.1	-0.0089
777.23	-0.007	192.2	-0.0089
777.25	-0.006	192.2	-0.0062
777.27	-0.006	192.3	-0.0044
777.28	-0.005	192.5	-0.0009
777.30	-0.002	192.6	0.0027
777.32	-0.001	192.8	0.0053
777.33	0.001	193	0.0098
777.35	0.005	193.3	0.0098
777.37	0.006	193.3	0.0142
777.38	0.006	193.4	0.0169
777.40	0.007	193.7	0.0204
777.42	0.011	194	0.0249
777.43	0.012	194.2	0.0293
777.45	0.013	194.4	0.0328
777.47	0.017	194.7	0.0328
777.48	0.017	194.7	0.0373
777.50	0.017	194.9	0.0399
777.52	0.019	195.2	0.0435
777.53	0.022	195.5	0.047
777.55	0.023	195.7	0.0488
777.57	0.024	196	0.0515
777.58	0.025	196.2	0.0515
777.60	0.026	196.2	0.0541
777.62	0.026	196.4	0.0559
777.63	0.027	196.6	0.0568
777.65	0.028	196.8	0.0586
777.67	0.028	197	0.0595
777.68	0.028	197.1	0.0604
777.70	0.029	197.2	0.0604
777.72	0.029	197.4	0.0612
777.73	0.029	197.5	0.0612
777.75	0.029	197.6	0.0612
777.77	0.028	197.6	0.0612
777.78	0.028	197.6	0.0604
777.80	0.027	197.7	0.0595
777.82	0.026	197.7	0.0577
777.83	0.025	197.7	0.0568
777.85	0.024	197.6	0.0541
777.87	0.022	197.5	0.0541
777.88	0.021	197.5	0.0524
777.90	0.021	197.5	0.0506
777.92	0.02	197.4	0.0479
777.93	0.017	197.2	0.0444
777.95	0.015	197.1	0.0417
777.97	0.014	197	0.0391
777.98	0.012	196.8	0.0391
778.00	0.009	196.6	0.0355
778.02	0.009	196.6	0.0328
778.05	0.008	196.4	0.0293
778.07	0.005	196.1	0.024
778.08	0.003	195.9	0.0204
778.08	0.001	195.7	0.016
778.10	-0.001	195.3	0.0124

Prova triassiale ciclica SN04-C1			
pressione di confinamento (kPa)		80	
deviatore ciclico (kPa)		95	
frequenza (hz)		0.00625	
tempo	cella di carico	$\Delta u$	LVDT
(min)	kN	(kPa)	$\delta$ (mm)
778.12	-0.004	195.1	0.0124
778.13	-0.004	195.1	0.0089
778.15	-0.004	194.9	0.0053
778.17	-0.006	194.5	0.0018
778.18	-0.009	194.3	-0.0018
778.20	-0.01	194	-0.0053
778.22	-0.011	193.7	-0.008
778.23	-0.014	193.5	-0.008
778.25	-0.013	193.5	-0.0107
778.27	-0.013	193.3	-0.0115
778.28	-0.015	193	-0.0142
778.30	-0.016	192.8	-0.016
778.32	-0.016	192.7	-0.016
778.33	-0.017	192.5	-0.0178
778.35	-0.018	192.3	-0.0178
778.37	-0.017	192.3	-0.0186
778.38	-0.017	192.1	-0.0186
778.40	-0.017	192	-0.0186
778.42	-0.017	192	-0.0186
778.43	-0.017	192	-0.0186
778.45	-0.016	191.9	-0.0178
778.47	-0.015	191.9	-0.0169
778.48	-0.015	191.9	-0.016
778.50	-0.014	191.9	-0.0142
778.52	-0.012	192	-0.0142
778.53	-0.01	192	-0.0124
778.55	-0.01	192	-0.0107
778.57	-0.009	192.1	-0.0089
778.58	-0.007	192.3	-0.0062
778.60	-0.005	192.4	-0.0036
778.62	-0.004	192.5	0
778.63	-0.001	192.7	0
778.65	0	192.9	0.0036
778.67	0	192.9	0.0062
778.68	0.002	193.1	0.0107
778.70	0.005	193.4	0.0142
778.72	0.007	193.6	0.0178
778.73	0.008	193.7	0.0213
778.75	0.011	194.1	0.0257
778.77	0.013	194.3	0.0257
778.78	0.013	194.3	0.0302
778.80	0.014	194.5	0.0337
778.82	0.016	194.8	0.0373
778.83	0.019	195.1	0.0408
778.85	0.02	195.3	0.0435
778.87	0.021	195.6	0.047
778.88	0.023	195.9	0.047
778.90	0.024	195.9	0.0497
778.92	0.024	196.1	0.0515
778.93	0.025	196.3	0.0541
778.95	0.027	196.5	0.0559
778.97	0.027	196.7	0.0568
778.98	0.028	196.9	0.0586
779.00	0.028	197	0.0586
779.02	0.029	197	0.0595
779.03	0.029	197.2	0.0604
779.05	0.029	197.3	0.0604
779.07	0.029	197.4	0.0604

Prova triassiale ciclica SN04-C1			
pressione di confinamento (kPa)		80	
deviatore ciclico (kPa)		95	
frequenza (hz)		0.00625	
tempo	cella di carico	$\Delta u$	LVDT
(min)	kN	(kPa)	$\delta$ (mm)
779.08	0.029	197.5	0.0604
779.10	0.028	197.6	0.0604
779.12	0.027	197.6	0.0586
779.13	0.027	197.7	0.0586
779.15	0.026	197.7	0.0568
779.17	0.025	197.7	0.0568
779.18	0.023	197.7	0.0559
779.20	0.023	197.6	0.0533
779.22	0.022	197.6	0.0524
779.23	0.02	197.5	0.0497
779.25	0.019	197.4	0.047
779.27	0.017	197.3	0.0435
779.28	0.014	197.1	0.0435
779.30	0.013	197.1	0.0408
779.32	0.013	196.9	0.0373
779.33	0.012	196.8	0.0337
779.35	0.008	196.5	0.0302
779.37	0.007	196.4	0.0275
779.38	0.005	196.1	0.0222
779.40	0.002	195.8	0.0222
779.42	0	195.6	0.0186
779.43	0	195.6	0.0151
779.45	-0.001	195.3	0.0115
779.48	-0.004	195	0.0071
779.50	-0.006	194.8	0.0044
779.52	-0.006	194.5	0.0009
779.53	-0.009	194.2	0.0009
779.55	-0.011	194	-0.0036
779.55	-0.011	194	-0.0062
779.57	-0.011	193.7	-0.0089
779.58	-0.013	193.4	-0.0107
779.60	-0.015	193.2	-0.0133
779.62	-0.015	193	-0.0142
779.63	-0.016	192.8	-0.0142
779.65	-0.017	192.6	-0.0169
779.67	-0.017	192.6	-0.0169
779.68	-0.017	192.5	-0.0178
779.70	-0.017	192.4	-0.0186
779.72	-0.017	192.2	-0.0186
779.73	-0.017	192.1	-0.0186
779.75	-0.017	192.1	-0.0186
779.77	-0.016	192	-0.0186
779.78	-0.016	192	-0.0178
779.80	-0.016	191.9	-0.0169
779.82	-0.015	192	-0.016
779.83	-0.013	192	-0.0151
779.85	-0.013	192	-0.0133
779.87	-0.012	192	-0.0124
779.88	-0.01	192.1	-0.0098
779.90	-0.009	192.2	-0.0071
779.92	-0.007	192.3	-0.0053
779.93	-0.004	192.5	-0.0053
779.95	-0.003	192.5	-0.0018
779.97	-0.003	192.6	0.0009
779.98	-0.002	192.8	0.0044
780.00	0.002	193	0.008
780.02	0.003	193.2	0.0115
780.03	0.004	193.5	0.0151

Prova triassiale ciclica SN04-C1			
pressione di confinamento (kPa)		80	
deviatore ciclico (kPa)		95	
frequenza (hz)		0.00625	
tempo	cella di carico	$\Delta u$	LVDT
(min)	kN	(kPa)	$\delta$ (mm)
780.05	0.008	193.7	0.0151
780.07	0.009	193.7	0.0195
780.08	0.009	193.9	0.0231
780.10	0.011	194.2	0.0275
780.12	0.014	194.4	0.032
780.13	0.015	194.6	0.0355
780.15	0.017	194.9	0.0391
780.17	0.02	195.2	0.0391
780.18	0.021	195.2	0.0426
780.20	0.021	195.4	0.0444
780.22	0.022	195.7	0.0479
780.23	0.024	196	0.0506
780.25	0.025	196.2	0.0524
780.27	0.025	196.4	0.055
780.28	0.027	196.6	0.055
780.30	0.028	196.6	0.0568
780.32	0.028	196.8	0.0577
780.33	0.028	197	0.0586
780.35	0.029	197.1	0.0595
780.37	0.029	197.2	0.0604
780.38	0.029	197.4	0.0604
780.40	0.029	197.5	0.0604
780.42	0.029	197.6	0.0604
780.43	0.029	197.6	0.0604
780.45	0.028	197.6	0.0595
780.47	0.027	197.6	0.0586
780.48	0.026	197.7	0.0568
780.50	0.025	197.7	0.0559
780.52	0.024	197.6	0.0559
780.53	0.022	197.5	0.0541
780.55	0.022	197.5	0.0524
780.57	0.019	197.4	0.0497
780.58	0.018	197.3	0.0479
780.60	0.018	197.3	0.0462
780.62	0.016	197.2	0.0426
780.63	0.015	197	0.0391
780.65	0.012	196.8	0.0364
780.67	0.011	196.7	0.0337
780.68	0.009	196.4	0.0293
780.70	0.005	196.2	0.0293
780.72	0.004	196.2	0.0249
780.73	0.004	196	0.0213
780.75	0.002	195.7	0.0178
780.77	-0.001	195.4	0.0133
780.78	-0.002	195.2	0.0107
780.80	-0.004	194.9	0.0062
780.82	-0.007	194.6	0.0062
780.83	-0.008	194.6	0.0018
780.85	-0.008	194.4	-0.0009
780.87	-0.009	194.1	-0.0036
780.88	-0.012	193.9	-0.0062
780.90	-0.012	193.7	-0.0089
780.92	-0.013	193.4	-0.0115
780.95	-0.015	193.2	-0.0115
780.97	-0.015	193.2	-0.0133
780.98	-0.015	193	-0.0151
781.00	-0.016	192.8	-0.016
781.00	-0.017	192.6	-0.0178

Prova triassiale ciclica SN04-C1			
pressione di confinamento (kPa)		80	
deviatore ciclico (kPa)		95	
frequenza (hz)		0.00625	
tempo	cella di carico	$\Delta u$	LVDT
(min)	kN	(kPa)	$\delta$ (mm)
781.02	-0.017	192.4	-0.0178
781.03	-0.017	192.3	-0.0186
781.05	-0.017	192.2	-0.0186
781.07	-0.017	192.2	-0.0186
781.08	-0.017	192.1	-0.0186
781.10	-0.017	192	-0.0186
781.12	-0.016	192	-0.0178
781.13	-0.015	192	-0.0169
781.15	-0.015	192	-0.0151
781.17	-0.013	192	-0.0151
781.18	-0.012	192	-0.0133
781.20	-0.012	192	-0.0124
781.22	-0.011	192.1	-0.0098
781.23	-0.008	192.2	-0.0071
781.25	-0.007	192.3	-0.0053
781.27	-0.006	192.4	-0.0018
781.28	-0.003	192.6	-0.0018
781.30	-0.001	192.8	0.0036
781.32	-0.001	192.9	0.0062
781.33	0.002	193.1	0.0062
781.35	0.004	193.3	0.0098
781.37	0.004	193.3	0.0133
781.38	0.005	193.5	0.0169
781.40	0.008	193.8	0.0213
781.42	0.011	194	0.0249
781.43	0.012	194.2	0.0293
781.45	0.014	194.5	0.0328
781.47	0.016	194.8	0.0328
781.48	0.016	194.8	0.0364
781.50	0.018	195	0.0399
781.52	0.02	195.3	0.0435
781.53	0.021	195.6	0.0462
781.55	0.022	195.8	0.0488
781.57	0.024	196.1	0.0515
781.58	0.026	196.3	0.0515
781.60	0.026	196.3	0.0541
781.62	0.026	196.5	0.0559
781.63	0.027	196.7	0.0568
781.65	0.028	196.9	0.0586
781.67	0.028	197	0.0595
781.68	0.028	197.2	0.0595
781.70	0.029	197.3	0.0595
781.72	0.029	197.3	0.0604
781.73	0.029	197.4	0.0604
781.75	0.029	197.5	0.0604
781.77	0.028	197.6	0.0604
781.78	0.028	197.7	0.0595
781.80	0.027	197.7	0.0586
781.82	0.026	197.7	0.0586
781.83	0.024	197.7	0.0568
781.85	0.024	197.7	0.055
781.87	0.023	197.6	0.0533
781.88	0.021	197.6	0.0515
781.90	0.02	197.5	0.0497
781.92	0.019	197.4	0.047
781.93	0.016	197.2	0.047
781.95	0.015	197.2	0.0435
781.97	0.015	197.1	0.0417

Prova triassiale ciclica SN04-C1			
pressione di confinamento (kPa)		80	
deviatore ciclico (kPa)		95	
frequenza (hz)		0.00625	
tempo	cella di carico	$\Delta u$	LVDT
(min)	kN	(kPa)	$\delta$ (mm)
781.98	0.013	196.9	0.0373
782.00	0.009	196.7	0.0328
782.02	0.009	196.5	0.0302
782.03	0.008	196.4	0.0284
782.05	0.005	196.1	0.024
782.07	0.003	195.9	0.0204
782.08	0.002	195.7	0.016
782.10	-0.001	195.3	0.016
782.12	-0.004	195.1	0.0115
782.13	-0.004	195.1	0.0089
782.15	-0.004	194.9	0.0044
782.17	-0.007	194.5	0.0009
782.18	-0.009	194.3	-0.0018
782.20	-0.01	194	-0.0053
782.22	-0.012	193.8	-0.0053
782.23	-0.013	193.5	-0.008
782.25	-0.013	193.5	-0.0107
782.27	-0.014	193.3	-0.0124
782.28	-0.015	193.1	-0.0142
782.30	-0.016	192.9	-0.016
782.32	-0.016	192.7	-0.016
782.33	-0.016	192.6	-0.0178
782.35	-0.017	192.4	-0.0178
782.38	-0.017	192.4	-0.0186
782.40	-0.017	192.3	-0.0186
782.42	-0.017	192.2	-0.0186
782.43	-0.017	192.1	-0.0186
782.45	-0.016	192	-0.0186
782.45	-0.016	192	-0.0169
782.47	-0.015	192	-0.0169
782.48	-0.014	192	-0.0169
782.50	-0.014	192	-0.0151
782.52	-0.013	192	-0.0133
782.53	-0.011	192.1	-0.0115
782.55	-0.01	192.1	-0.0098
782.57	-0.009	192.2	-0.0071
782.58	-0.006	192.4	-0.0071
782.60	-0.005	192.4	-0.0044
782.62	-0.005	192.5	-0.0018
782.63	-0.004	192.7	0.0018
782.65	0	192.9	0.0053
782.67	0.001	193	0.008
782.68	0.002	193.3	0.0115
782.70	0.006	193.5	0.0115
782.72	0.007	193.5	0.016
782.73	0.007	193.7	0.0195
782.75	0.012	194.2	0.024
782.77	0.013	194.2	0.0275
782.78	0.013	194.4	0.0302
782.80	0.014	194.6	0.0337
782.82	0.018	194.9	0.0382
782.83	0.018	195.1	0.0408
782.85	0.02	195.4	0.0435
782.87	0.023	195.7	0.0435
782.88	0.023	195.7	0.047
782.90	0.023	195.9	0.0497
782.92	0.024	196.1	0.0515
782.93	0.026	196.4	0.0541

Prova triassiale ciclica SN04-C1			
pressione di confinamento (kPa)		80	
deviatore ciclico (kPa)		95	
frequenza (hz)		0.00625	
tempo	cella di carico	$\Delta u$	LVDT
(min)	kN	(kPa)	$\delta$ (mm)
782.95	0.027	196.6	0.0559
782.97	0.027	196.8	0.0568
782.98	0.028	196.9	0.0568
783.00	0.029	197.1	0.0586
783.02	0.029	197.1	0.0595
783.03	0.029	197.2	0.0595
783.05	0.029	197.3	0.0595
783.07	0.029	197.4	0.0604
783.08	0.029	197.5	0.0604
783.10	0.028	197.6	0.0604
783.12	0.027	197.7	0.0595
783.13	0.027	197.7	0.0586
783.15	0.027	197.7	0.0577
783.17	0.025	197.6	0.0559
783.18	0.023	197.6	0.0541
783.20	0.023	197.6	0.0524
783.22	0.022	197.5	0.0506
783.23	0.019	197.4	0.0506
783.25	0.018	197.4	0.0479
783.27	0.018	197.3	0.0453
783.28	0.016	197.1	0.0417
783.30	0.013	197	0.0382
783.32	0.012	196.8	0.0355
783.33	0.011	196.6	0.032
783.35	0.007	196.4	0.032
783.37	0.006	196.4	0.0284
783.38	0.006	196.2	0.024
783.40	0.004	195.9	0.0204
783.42	0.001	195.7	0.016
783.43	0	195.4	0.0124
783.45	-0.002	195.1	0.0089
783.47	-0.005	194.8	0.0089
783.48	-0.006	194.6	0.0027
783.50	-0.007	194.4	-0.0009
783.52	-0.01	194.1	-0.0009
783.53	-0.01	194.1	-0.0036
783.55	-0.01	193.9	-0.0062
783.57	-0.011	193.6	-0.0089
783.58	-0.014	193.4	-0.0115
783.60	-0.014	193.2	-0.0133
783.62	-0.015	193	-0.0151
783.63	-0.016	192.8	-0.0151
783.65	-0.017	192.8	-0.0169
783.67	-0.017	192.6	-0.0178
783.68	-0.017	192.5	-0.0178
783.70	-0.017	192.3	-0.0186
783.72	-0.017	192.2	-0.0186
783.73	-0.017	192.1	-0.0195
783.75	-0.017	192	-0.0195
783.77	-0.016	192	-0.0186
783.78	-0.016	192	-0.0186
783.80	-0.016	191.9	-0.0178
783.82	-0.014	191.9	-0.0169
783.85	-0.014	191.9	-0.0151
783.87	-0.013	192	-0.0133
783.88	-0.011	192.1	-0.0133
783.90	-0.009	192.2	-0.0115
783.90	-0.009	192.2	-0.0089

Prova triassiale ciclica SN04-C1			
pressione di confinamento (kPa)		80	
deviatore ciclico (kPa)		95	
frequenza (hz)		0.00625	
tempo	cella di carico	$\Delta u$	LVDT
(min)	kN	(kPa)	$\delta$ (mm)
783.92	-0.008	192.2	-0.0062
783.93	-0.005	192.4	-0.0027
783.95	-0.004	192.5	-0.0009
783.97	-0.003	192.7	0.0027
783.98	0	192.9	0.0027
784.00	0.002	193.1	0.0062
784.02	0.002	193.1	0.0098
784.03	0.004	193.3	0.0142
784.05	0.007	193.6	0.0178
784.07	0.009	193.8	0.0213
784.08	0.01	194	0.0249
784.10	0.013	194.3	0.0249
784.12	0.015	194.6	0.0302
784.13	0.015	194.6	0.0337
784.15	0.016	194.8	0.0373
784.17	0.018	195.1	0.0408
784.18	0.02	195.3	0.0435
784.20	0.021	195.6	0.0462
784.22	0.022	195.8	0.0479
784.23	0.024	196.1	0.0506
784.25	0.025	196.3	0.0533
784.27	0.026	196.5	0.055
784.28	0.027	196.7	0.055
784.30	0.027	196.7	0.0568
784.32	0.027	196.9	0.0577
784.33	0.028	197	0.0595
784.35	0.029	197.2	0.0604
784.37	0.028	197.3	0.0604
784.38	0.029	197.4	0.0604
784.40	0.029	197.5	0.0604
784.42	0.029	197.5	0.0612
784.43	0.029	197.6	0.0604
784.45	0.028	197.7	0.0595
784.47	0.026	197.7	0.0586
784.48	0.026	197.7	0.0577
784.50	0.025	197.7	0.0559
784.52	0.023	197.6	0.0559
784.53	0.022	197.6	0.0541
784.55	0.022	197.6	0.0524
784.57	0.021	197.5	0.0497
784.58	0.018	197.4	0.0462
784.60	0.017	197.3	0.0453
784.62	0.016	197.1	0.0417
784.63	0.012	196.9	0.0417
784.65	0.011	196.9	0.0382
784.67	0.011	196.8	0.0355
784.68	0.01	196.6	0.0311
784.70	0.006	196.4	0.0275
784.72	0.005	196.2	0.0231
784.73	0.004	195.9	0.0195
784.75	0	195.6	0.0195
784.77	-0.001	195.4	0.0151
784.78	-0.001	195.4	0.0124
784.80	-0.003	195.1	0.008
784.82	-0.006	194.8	0.0044
784.83	-0.007	194.6	0.0018
784.85	-0.008	194.3	-0.0018
784.87	-0.01	194	-0.0018



Prova triassiale ciclica SN04-C1			
pressione di confinamento (kPa)		80	
deviatore ciclico (kPa)		95	
frequenza (hz)		0.00625	
tempo	cella di carico	$\Delta u$	LVDT
(min)	kN	(kPa)	$\delta$ (mm)
784.88	-0.012	193.7	-0.0053
784.90	-0.012	193.7	-0.008
784.92	-0.013	193.5	-0.0107
784.93	-0.015	193.1	-0.0124
784.95	-0.015	193.1	-0.0133
784.97	-0.015	192.9	-0.0151
784.98	-0.016	192.7	-0.0169
785.00	-0.017	192.6	-0.0178
785.02	-0.017	192.4	-0.0178
785.03	-0.017	192.3	-0.0186
785.05	-0.017	192.2	-0.0186
785.07	-0.017	192.2	-0.0186
785.08	-0.017	192.1	-0.0186
785.10	-0.017	192	-0.0178
785.12	-0.016	192	-0.0169
785.13	-0.015	191.9	-0.016
785.15	-0.014	192	-0.0151
785.17	-0.013	192	-0.0151
785.18	-0.012	192	-0.0142
785.20	-0.012	192	-0.0124
785.22	-0.011	192.1	-0.0107
785.23	-0.008	192.2	-0.0071
785.25	-0.007	192.3	-0.0053
785.27	-0.006	192.5	-0.0018
785.30	-0.003	192.7	-0.0018
785.32	-0.002	192.7	0.0018
785.33	-0.002	192.8	0.0036
785.35	0	193	0.008
785.35	0.004	193.2	0.0115
785.37	0.005	193.4	0.0151
785.38	0.006	193.7	0.0195
785.40	0.01	193.9	0.0195
785.42	0.011	193.9	0.024
785.43	0.011	194.1	0.0275
785.45	0.012	194.4	0.0311
785.47	0.016	194.7	0.0355
785.48	0.017	194.9	0.0382
785.50	0.018	195.2	0.0417
785.52	0.021	195.5	0.0417
785.53	0.022	195.5	0.0453
785.55	0.022	195.7	0.0479
785.57	0.023	196	0.0506
785.58	0.025	196.2	0.0533
785.60	0.026	196.4	0.055
785.62	0.026	196.6	0.0568
785.63	0.028	196.8	0.0568
785.65	0.028	197	0.0586
785.67	0.028	197.1	0.0595
785.68	0.028	197.2	0.0595
785.70	0.029	197.4	0.0604
785.72	0.029	197.4	0.0604
785.73	0.029	197.5	0.0612
785.75	0.029	197.6	0.0612
785.77	0.028	197.7	0.0604
785.78	0.028	197.7	0.0595
785.80	0.027	197.7	0.0595
785.82	0.025	197.7	0.0577
785.83	0.025	197.7	0.0568

Prova triassiale ciclica SN04-C1			
pressione di confinamento (kPa)		80	
deviatore ciclico (kPa)		95	
frequenza (hz)		0.00625	
tempo	cella di carico	$\Delta u$	LVDT
(min)	kN	(kPa)	$\delta$ (mm)
785.85	0.024	197.7	0.055
785.87	0.023	197.6	0.0533
785.88	0.021	197.6	0.0515
785.90	0.02	197.5	0.0497
785.92	0.019	197.4	0.047
785.93	0.016	197.2	0.047
785.95	0.016	197.2	0.0435
785.97	0.015	197.1	0.0399
785.98	0.012	196.9	0.0364
786.00	0.009	196.7	0.0337
786.02	0.009	196.6	0.0302
786.03	0.007	196.3	0.0257
786.05	0.004	196	0.0257
786.07	0.004	196	0.0222
786.08	0.002	195.9	0.0178
786.10	0	195.5	0.0133
786.12	-0.003	195.2	0.0098
786.13	-0.004	195	0.0071
786.15	-0.005	194.7	0.0036
786.17	-0.008	194.4	0.0036
786.18	-0.009	194.4	0
786.20	-0.009	194.2	-0.0027
786.22	-0.01	193.9	-0.0062
786.23	-0.013	193.7	-0.0089
786.25	-0.013	193.5	-0.0107
786.27	-0.014	193.2	-0.0124
786.28	-0.016	193	-0.0124
786.30	-0.016	193	-0.0151
786.32	-0.016	192.8	-0.016
786.33	-0.017	192.7	-0.0169
786.35	-0.017	192.5	-0.0178
786.37	-0.017	192.4	-0.0186
786.38	-0.017	192.3	-0.0186
786.40	-0.017	192.2	-0.0186
786.42	-0.017	192.1	-0.0186
786.43	-0.016	192	-0.0178
786.45	-0.016	192	-0.0178
786.47	-0.015	192	-0.0169
786.48	-0.015	192	-0.016
786.50	-0.014	192	-0.0142
786.52	-0.012	192	-0.0133
786.53	-0.012	192	-0.0115
786.55	-0.01	192.1	-0.0089
786.57	-0.007	192.3	-0.0089
786.58	-0.006	192.4	-0.0062
786.60	-0.006	192.4	-0.0044
786.62	-0.005	192.5	-0.0009
786.63	-0.002	192.7	0.0027
786.65	-0.001	192.9	0.0053
786.67	0.001	193	0.0098
786.68	0.004	193.3	0.0098
786.70	0.006	193.5	0.0133
786.72	0.006	193.5	0.0169
786.75	0.007	193.7	0.0204
786.77	0.011	194	0.0249
786.78	0.012	194.2	0.0293
786.80	0.013	194.4	0.0328
786.80	0.016	194.8	0.0328

Prova triassiale ciclica SN04-C1			
pressione di confinamento (kPa)		80	
deviatore ciclico (kPa)		95	
frequenza (hz)		0.00625	
tempo	cella di carico	$\Delta u$	LVDT
(min)	kN	(kPa)	$\delta$ (mm)
786.82	0.018	195	0.0364
786.83	0.018	195	0.0399
786.85	0.019	195.2	0.0435
786.87	0.021	195.6	0.0462
786.88	0.023	195.8	0.0488
786.90	0.023	196	0.0515
786.92	0.025	196.3	0.0541
786.93	0.026	196.5	0.0541
786.95	0.027	196.5	0.0559
786.97	0.027	196.7	0.0577
786.98	0.028	196.9	0.0595
787.00	0.029	197	0.0604
787.02	0.028	197.2	0.0604
787.03	0.029	197.3	0.0604
787.05	0.029	197.4	0.0604
787.07	0.029	197.4	0.0612
787.08	0.029	197.5	0.0612
787.10	0.028	197.7	0.0612
787.12	0.027	197.7	0.0604
787.13	0.027	197.7	0.0595
787.15	0.026	197.7	0.0577
787.17	0.025	197.7	0.0568
787.18	0.024	197.7	0.055
787.20	0.023	197.7	0.0533
787.22	0.02	197.6	0.0533
787.23	0.02	197.6	0.0506
787.25	0.02	197.5	0.0488
787.27	0.018	197.3	0.0453
787.28	0.015	197.2	0.0417
787.30	0.014	197.1	0.0399
787.32	0.012	196.9	0.0364
787.33	0.009	196.6	0.0364
787.35	0.008	196.6	0.032
787.37	0.008	196.5	0.0293
787.38	0.006	196.2	0.0249
787.40	0.003	196	0.0204
787.42	0.001	195.8	0.0169
787.43	0	195.5	0.0133
787.45	-0.004	195.1	0.0133
787.47	-0.005	195.1	0.0089
787.48	-0.005	194.9	0.0062
787.50	-0.006	194.7	0.0018
787.52	-0.009	194.4	-0.0018
787.53	-0.01	194.1	-0.0036
787.55	-0.011	193.9	-0.0071
787.57	-0.013	193.6	-0.0071
787.58	-0.014	193.6	-0.0098
787.60	-0.014	193.4	-0.0115
787.62	-0.015	193.2	-0.0133
787.63	-0.016	193	-0.0151
787.65	-0.016	192.8	-0.016
787.67	-0.017	192.6	-0.0178
787.68	-0.017	192.5	-0.0178
787.70	-0.017	192.3	-0.0178
787.72	-0.017	192.3	-0.0186
787.73	-0.017	192.2	-0.0186
787.75	-0.017	192.1	-0.0178
787.77	-0.017	192.1	-0.0178

Prova triassiale ciclica SN04-C1			
pressione di confinamento (kPa)		80	
deviatore ciclico (kPa)		95	
frequenza (hz)		0.00625	
tempo	cella di carico	$\Delta u$	LVDT
(min)	kN	(kPa)	$\delta$ (mm)
787.78	-0.016	192	-0.0169
787.80	-0.015	192	-0.0169
787.82	-0.014	192	-0.016
787.83	-0.013	192	-0.0142
787.85	-0.012	192	-0.0142
787.87	-0.011	192.1	-0.0124
787.88	-0.011	192.1	-0.0107
787.90	-0.01	192.2	-0.0071
787.92	-0.007	192.4	-0.0044
787.93	-0.005	192.5	-0.0027
787.95	-0.004	192.6	0.0009
787.97	-0.002	192.8	0.0009
787.98	0.001	193	0.0044
788.00	0.001	193	0.0071
788.02	0.002	193.1	0.0107
788.03	0.004	193.4	0.0151
788.05	0.007	193.7	0.0186
788.07	0.008	193.8	0.0222
788.08	0.01	194.2	0.0275
788.10	0.013	194.4	0.0275
788.12	0.014	194.4	0.0311
788.13	0.014	194.6	0.0346
788.15	0.016	194.9	0.0373
788.17	0.019	195.1	0.0408
788.18	0.02	195.4	0.0444
788.22	0.021	195.7	0.047
788.23	0.023	195.9	0.047
788.25	0.024	195.9	0.0506
788.27	0.024	196.1	0.0524
788.27	0.025	196.4	0.055
788.28	0.027	196.6	0.0568
788.30	0.027	196.8	0.0577
788.32	0.028	197	0.0586
788.33	0.029	197.1	0.0586
788.35	0.029	197.1	0.0604
788.37	0.029	197.3	0.0604
788.38	0.029	197.4	0.0604
788.40	0.029	197.5	0.0612
788.42	0.029	197.6	0.0612
788.43	0.028	197.7	0.0604
788.45	0.027	197.7	0.0604
788.47	0.027	197.7	0.0595
788.48	0.027	197.7	0.0586
788.50	0.026	197.7	0.0568
788.52	0.023	197.7	0.055
788.53	0.023	197.6	0.0533
788.55	0.022	197.6	0.0506
788.57	0.019	197.5	0.0488
788.58	0.019	197.4	0.047
788.60	0.017	197.3	0.0444
788.62	0.014	197.1	0.0444
788.63	0.013	197.1	0.0408
788.65	0.013	197	0.0382
788.67	0.012	196.8	0.0346
788.68	0.008	196.5	0.0311
788.70	0.007	196.4	0.0275
788.72	0.005	196.2	0.0231
788.73	0.001	195.9	0.0231

Prova triassiale ciclica SN04-C1			
pressione di confinamento (kPa)		80	
deviatore ciclico (kPa)		95	
frequenza (hz)		0.00625	
tempo	cella di carico	$\Delta u$	LVDT
(min)	kN	(kPa)	$\delta$ (mm)
788.75	0.001	195.9	0.0186
788.77	0.001	195.7	0.016
788.78	-0.001	195.4	0.0115
788.80	-0.004	195	0.0071
788.82	-0.006	194.8	0.0044
788.83	-0.007	194.6	0.0009
788.85	-0.009	194.2	0.0009
788.87	-0.01	194	-0.0027
788.88	-0.01	194	-0.0053
788.90	-0.012	193.8	-0.008
788.92	-0.013	193.5	-0.0107
788.93	-0.014	193.3	-0.0124
788.95	-0.015	193.1	-0.0142
788.97	-0.016	192.8	-0.0142
788.98	-0.017	192.7	-0.016
789.00	-0.017	192.7	-0.0169
789.02	-0.017	192.5	-0.0169
789.03	-0.017	192.4	-0.0178
789.05	-0.017	192.3	-0.0186
789.07	-0.017	192.2	-0.0186
789.08	-0.017	192.1	-0.0186
789.10	-0.016	192	-0.0178
789.12	-0.016	192	-0.0169
789.13	-0.016	192	-0.016
789.15	-0.015	192	-0.0151
789.17	-0.014	192	-0.0142
789.18	-0.013	192.1	-0.0115
789.20	-0.011	192.2	-0.0098
789.22	-0.009	192.2	-0.0098
789.23	-0.009	192.2	-0.008
789.25	-0.008	192.3	-0.0053
789.27	-0.006	192.5	-0.0027
789.28	-0.004	192.6	0
789.30	-0.003	192.7	0.0027
789.32	-0.001	192.9	0.0053
789.33	0.001	193.1	0.0089
789.35	0.003	193.3	0.0124
789.37	0.005	193.5	0.0169
789.38	0.008	193.8	0.0169
789.40	0.009	193.8	0.0204
789.42	0.009	193.9	0.024
789.43	0.011	194.2	0.0284
789.45	0.014	194.5	0.032
789.47	0.015	194.7	0.0355
789.48	0.017	195	0.0391
789.50	0.02	195.3	0.0391
789.52	0.021	195.3	0.0435
789.53	0.021	195.5	0.0462
789.55	0.022	195.8	0.0488
789.57	0.024	196	0.0515
789.58	0.025	196.2	0.0533
789.60	0.025	196.5	0.055
789.62	0.027	196.7	0.055
789.65	0.028	196.7	0.0577
789.67	0.028	196.9	0.0586
789.68	0.028	197	0.0595
789.70	0.029	197.2	0.0604
789.72	0.029	197.3	0.0612

Prova triassiale ciclica SN04-C1			
pressione di confinamento (kPa)		80	
deviatore ciclico (kPa)		95	
frequenza (hz)		0.00625	
tempo	cella di carico	$\Delta u$	LVDT
(min)	kN	(kPa)	$\delta$ (mm)
789.72	0.029	197.4	0.0612
789.73	0.029	197.5	0.0612
789.75	0.028	197.5	0.0612
789.77	0.028	197.6	0.0612
789.78	0.028	197.7	0.0604
789.80	0.027	197.7	0.0586
789.82	0.026	197.7	0.0577
789.83	0.025	197.7	0.0559
789.85	0.023	197.7	0.0559
789.87	0.022	197.7	0.0541
789.88	0.022	197.6	0.0533
789.90	0.021	197.6	0.0506
789.92	0.018	197.4	0.047
789.93	0.017	197.3	0.0453
789.95	0.016	197.2	0.0417
789.97	0.013	197	0.0417
789.98	0.011	196.8	0.0391
790.00	0.011	196.8	0.0355
790.02	0.007	196.4	0.032
790.03	0.006	196.3	0.0302
790.05	0.006	196.3	0.0257
790.07	0.005	196.1	0.0222
790.08	0.001	195.7	0.0169
790.10	-0.001	195.5	0.0142
790.12	-0.002	195.3	0.0107
790.13	-0.005	194.9	0.0107
790.15	-0.007	194.7	0.0062
790.17	-0.007	194.7	0.0036
790.18	-0.007	194.5	0
790.20	-0.01	194.1	-0.0036
790.22	-0.011	193.9	-0.0062
790.23	-0.012	193.7	-0.008
790.25	-0.013	193.4	-0.008
790.27	-0.015	193.2	-0.0107
790.28	-0.015	193.2	-0.0133
790.30	-0.016	193	-0.0142
790.32	-0.016	192.8	-0.016
790.33	-0.017	192.6	-0.0169
790.35	-0.017	192.5	-0.0169
790.37	-0.017	192.3	-0.0178
790.38	-0.017	192.2	-0.0178
790.40	-0.017	192.2	-0.0178
790.42	-0.017	192.1	-0.0178
790.43	-0.017	192.1	-0.0178
790.45	-0.016	192	-0.0169
790.47	-0.015	192	-0.016
790.48	-0.015	192	-0.0142
790.50	-0.012	192	-0.0142
790.52	-0.012	192	-0.0124
790.53	-0.012	192.1	-0.0115
790.55	-0.011	192.2	-0.0098
790.57	-0.008	192.3	-0.0071
790.58	-0.007	192.4	-0.0044
790.60	-0.006	192.5	-0.0009
790.62	-0.002	192.7	-0.0009
790.63	-0.001	192.7	0.0027
790.65	-0.001	192.8	0.0053
790.67	0	193	0.008

Prova triassiale ciclica SN04-C1			
pressione di confinamento (kPa)		80	
deviatore ciclico (kPa)		95	
frequenza (hz)		0.00625	
tempo	cella di carico	$\Delta u$	LVDT
(min)	kN	(kPa)	$\delta$ (mm)
790.68	0.004	193.3	0.0124
790.70	0.004	193.4	0.0151
790.72	0.006	193.7	0.0195
790.73	0.01	194	0.024
790.75	0.01	194.1	0.0257
790.77	0.012	194.3	0.0302
790.78	0.015	194.6	0.0302
790.80	0.016	194.6	0.0346
790.82	0.016	194.8	0.0373
790.83	0.017	195.1	0.0408
790.85	0.02	195.4	0.0444
790.87	0.021	195.7	0.047
790.88	0.022	195.9	0.0497
790.90	0.024	196.2	0.0497
790.92	0.026	196.2	0.0524
790.93	0.026	196.4	0.055
790.95	0.026	196.6	0.0568
790.97	0.027	196.8	0.0586
790.98	0.028	197	0.0595
791.00	0.028	197.1	0.0604
791.02	0.029	197.3	0.0604
791.03	0.029	197.4	0.0612
791.05	0.029	197.4	0.0612
791.07	0.029	197.5	0.0621
791.08	0.029	197.6	0.0621
791.12	0.028	197.7	0.0612
791.13	0.028	197.7	0.0604
791.15	0.027	197.7	0.0586
791.17	0.025	197.7	0.0586
791.17	0.025	197.7	0.0577
791.18	0.025	197.7	0.0568
791.20	0.023	197.7	0.0541
791.22	0.021	197.6	0.0524
791.23	0.02	197.5	0.0506
791.25	0.019	197.4	0.047
791.27	0.016	197.2	0.047
791.28	0.016	197.2	0.0435
791.30	0.015	197.1	0.0408
791.32	0.013	196.9	0.0373
791.33	0.01	196.7	0.0337
791.35	0.009	196.5	0.0311
791.37	0.007	196.3	0.0275
791.38	0.004	196.1	0.0275
791.40	0.002	196.1	0.0222
791.42	0.002	195.9	0.0186
791.43	0.001	195.6	0.0151
791.45	-0.003	195.2	0.0107
791.47	-0.004	195	0.008
791.48	-0.004	194.8	0.0062
791.50	-0.007	194.5	0.0027
791.52	-0.008	194.3	-0.0009
791.53	-0.01	194	-0.0044
791.55	-0.013	193.7	-0.0044
791.57	-0.013	193.7	-0.008
791.58	-0.013	193.5	-0.0089
791.60	-0.014	193.3	-0.0115
791.62	-0.015	193.1	-0.0142
791.63	-0.016	192.9	-0.0151

Prova triassiale ciclica SN04-C1			
pressione di confinamento (kPa)		80	
deviatore ciclico (kPa)		95	
frequenza (hz)		0.00625	
tempo	cella di carico	$\Delta u$	LVDT
(min)	kN	(kPa)	$\delta$ (mm)
791.65	-0.016	192.7	-0.016
791.67	-0.017	192.5	-0.016
791.68	-0.017	192.5	-0.0178
791.70	-0.017	192.4	-0.0178
791.72	-0.017	192.3	-0.0178
791.73	-0.017	192.2	-0.0178
791.75	-0.017	192.1	-0.0178
791.77	-0.017	192	-0.0169
791.78	-0.015	192	-0.0169
791.80	-0.015	192	-0.016
791.82	-0.015	192	-0.0151
791.83	-0.014	192	-0.0142
791.85	-0.012	192.1	-0.0124
791.87	-0.011	192.1	-0.0107
791.88	-0.01	192.1	-0.0089
791.90	-0.007	192.3	-0.0089
791.92	-0.007	192.3	-0.0062
791.93	-0.007	192.4	-0.0036
791.95	-0.005	192.5	0
791.97	-0.002	192.7	0.0036
791.98	-0.001	192.9	0.0062
792.00	0.001	193.1	0.0098
792.02	0.004	193.4	0.0098
792.03	0.006	193.5	0.0142
792.05	0.006	193.5	0.0169
792.07	0.007	193.7	0.0213
792.08	0.01	194.1	0.0249
792.10	0.012	194.3	0.0293
792.12	0.013	194.5	0.0337
792.13	0.016	194.8	0.0337
792.15	0.018	195	0.0382
792.17	0.018	195	0.0399
792.18	0.021	195.6	0.0453
792.20	0.022	195.8	0.0453
792.22	0.022	195.8	0.0479
792.23	0.023	196	0.0506
792.25	0.025	196.2	0.0533
792.27	0.026	196.5	0.0559
792.28	0.027	196.6	0.0568
792.30	0.027	196.8	0.0586
792.32	0.028	197	0.0586
792.33	0.028	197	0.0595
792.35	0.028	197.2	0.0604
792.37	0.029	197.3	0.0612
792.38	0.029	197.4	0.0612
792.40	0.029	197.6	0.0612
792.42	0.028	197.6	0.0612
792.43	0.028	197.7	0.0612
792.45	0.028	197.7	0.0604
792.47	0.027	197.7	0.0595
792.48	0.026	197.7	0.0586
792.50	0.025	197.7	0.0568
792.52	0.024	197.7	0.055
792.55	0.023	197.6	0.0533
792.57	0.02	197.6	0.0533
792.58	0.02	197.6	0.0506
792.60	0.02	197.5	0.0479
792.62	0.017	197.3	0.0453



Prova triassiale ciclica SN04-C1			
pressione di confinamento (kPa)		80	
deviatore ciclico (kPa)		95	
frequenza (hz)		0.00625	
tempo	cella di carico	$\Delta u$	LVDT
(min)	kN	(kPa)	$\delta$ (mm)
792.62	0.015	197.2	0.0426
792.63	0.014	197.1	0.0391
792.65	0.011	196.8	0.0355
792.67	0.009	196.6	0.0355
792.68	0.009	196.6	0.032
792.70	0.007	196.5	0.0284
792.72	0.006	196.2	0.0249
792.73	0.002	196	0.0204
792.75	0.001	195.8	0.0178
792.77	0	195.5	0.0133
792.78	-0.003	195.1	0.0133
792.80	-0.005	195.1	0.0089
792.82	-0.005	194.9	0.0053
792.83	-0.006	194.6	0.0027
792.85	-0.009	194.3	-0.0009
792.87	-0.01	194.1	-0.0036
792.88	-0.011	193.8	-0.0071
792.90	-0.013	193.6	-0.0071
792.92	-0.014	193.4	-0.0107
792.93	-0.014	193.2	-0.0124
792.95	-0.016	193	-0.0124
792.97	-0.016	193	-0.0142
792.98	-0.016	192.8	-0.016
793.00	-0.016	192.7	-0.0169
793.02	-0.017	192.5	-0.0178
793.03	-0.017	192.4	-0.0178
793.05	-0.017	192.2	-0.0186
793.07	-0.017	192.1	-0.0186
793.08	-0.017	192.1	-0.0186
793.10	-0.017	192.1	-0.0178
793.12	-0.016	192	-0.0169
793.13	-0.015	192	-0.016
793.15	-0.014	192	-0.0151
793.17	-0.014	192	-0.0133
793.18	-0.012	192.1	-0.0133
793.20	-0.01	192.1	-0.0115
793.22	-0.01	192.1	-0.0107
793.23	-0.01	192.2	-0.008
793.25	-0.007	192.4	-0.0044
793.27	-0.005	192.5	-0.0027
793.28	-0.004	192.6	0.0009
793.30	-0.001	192.8	0.0009
793.32	0	192.8	0.0036
793.33	0	193	0.0071
793.35	0.002	193.2	0.0107
793.37	0.005	193.4	0.0151
793.38	0.007	193.6	0.0178
793.40	0.008	193.8	0.0222
793.42	0.011	194.2	0.0222
793.43	0.013	194.4	0.0275
793.45	0.013	194.4	0.0311
793.47	0.014	194.6	0.0346
793.48	0.017	194.9	0.0382
793.50	0.019	195.2	0.0417
793.52	0.02	195.4	0.0444
793.53	0.022	195.7	0.0444
793.55	0.023	196	0.047
793.57	0.023	196	0.0497

Prova triassiale ciclica SN04-C1			
pressione di confinamento (kPa)		80	
deviatore ciclico (kPa)		95	
frequenza (hz)		0.00625	
tempo	cella di carico	$\Delta u$	LVDT
(min)	kN	(kPa)	$\delta$ (mm)
793.58	0.024	196.2	0.0524
793.60	0.025	196.4	0.055
793.62	0.027	196.6	0.0568
793.63	0.027	196.8	0.0577
793.65	0.028	197	0.0595
793.67	0.028	197.1	0.0595
793.68	0.029	197.3	0.0604
793.70	0.029	197.4	0.0604
793.72	0.029	197.5	0.0604
793.73	0.029	197.5	0.0612
793.75	0.029	197.6	0.0612
793.77	0.029	197.7	0.0604
793.78	0.028	197.7	0.0595
793.80	0.027	197.8	0.0586
793.82	0.026	197.8	0.0577
793.83	0.024	197.8	0.0577
793.85	0.024	197.8	0.0559
793.87	0.024	197.8	0.0541
793.88	0.022	197.6	0.0524
793.90	0.02	197.6	0.0497
793.92	0.019	197.5	0.047
793.93	0.017	197.3	0.0444
793.95	0.014	197.1	0.0444
793.97	0.013	197.1	0.0408
793.98	0.013	197	0.0382
794.02	0.011	196.8	0.0346
794.03	0.008	196.6	0.0302
794.05	0.007	196.4	0.0275
794.07	0.005	196.2	0.0231
794.07	0.002	195.9	0.0231
794.08	0.001	195.9	0.0186
794.10	0.001	195.7	0.0151
794.12	-0.001	195.4	0.0107
794.13	-0.005	195.1	0.0071
794.15	-0.005	194.8	0.0044
794.17	-0.006	194.5	0.0009
794.18	-0.01	194.2	0.0009
794.20	-0.01	194.2	-0.0036
794.22	-0.01	194	-0.0062
794.23	-0.012	193.7	-0.0089
794.25	-0.014	193.5	-0.0107
794.27	-0.014	193.3	-0.0133
794.28	-0.015	193.1	-0.0142
794.30	-0.016	192.9	-0.0142
794.32	-0.017	192.9	-0.016
794.33	-0.017	192.7	-0.0169
794.35	-0.017	192.6	-0.0178
794.37	-0.017	192.3	-0.0178
794.38	-0.017	192.3	-0.0186
794.40	-0.017	192.2	-0.0186
794.42	-0.017	192.1	-0.0186
794.43	-0.016	192.1	-0.0178
794.45	-0.016	192	-0.0169
794.47	-0.015	192	-0.0169
794.48	-0.014	192	-0.016
794.50	-0.014	192	-0.0151
794.52	-0.013	192	-0.0133
794.53	-0.012	192.1	-0.0115

Prova triassiale ciclica SN04-C1			
pressione di confinamento (kPa)		80	
deviatore ciclico (kPa)		95	
frequenza (hz)		0.00625	
tempo	cella di carico	$\Delta u$	LVDT
(min)	kN	(kPa)	$\delta$ (mm)
794.55	-0.01	192.2	-0.0098
794.57	-0.009	192.2	-0.0071
794.58	-0.006	192.4	-0.0044
794.60	-0.004	192.5	-0.0044
794.62	-0.004	192.5	-0.0018
794.63	-0.004	192.6	0.0018
794.65	-0.001	192.9	0.0053
794.67	0.001	193.1	0.008
794.68	0.003	193.2	0.0115
794.70	0.005	193.5	0.016
794.72	0.008	193.7	0.016
794.73	0.008	193.7	0.0195
794.75	0.009	193.9	0.024
794.77	0.011	194.3	0.0284
794.78	0.014	194.5	0.0328
794.80	0.015	194.7	0.0355
794.82	0.017	195	0.0391
794.83	0.02	195.3	0.0391
794.85	0.02	195.3	0.0426
794.87	0.02	195.5	0.0453
794.88	0.022	195.8	0.0479
794.90	0.024	196.1	0.0506
794.92	0.025	196.3	0.0524
794.93	0.025	196.5	0.055
794.95	0.027	196.7	0.055
794.97	0.027	196.7	0.0568
794.98	0.027	196.9	0.0577
795.00	0.028	197	0.0595
795.02	0.029	197.2	0.0604
795.03	0.029	197.3	0.0604
795.05	0.029	197.5	0.0604
795.07	0.029	197.5	0.0604
795.08	0.028	197.5	0.0604
795.10	0.028	197.7	0.0604
795.12	0.027	197.8	0.0604
795.13	0.026	197.8	0.0595
795.15	0.026	197.8	0.0577
795.17	0.026	197.8	0.0568
795.18	0.024	197.7	0.055
795.20	0.023	197.7	0.0533
795.22	0.022	197.6	0.0506
795.23	0.019	197.5	0.0506
795.25	0.017	197.5	0.0479
795.27	0.017	197.4	0.0462
795.28	0.016	197.3	0.0426
795.30	0.013	197.1	0.0399
795.32	0.012	197	0.0364
795.33	0.011	196.8	0.0328
795.35	0.007	196.5	0.0328
795.37	0.006	196.3	0.0284
795.38	0.006	196.3	0.0249
795.40	0.004	196.1	0.0204
795.42	0.001	195.8	0.0169
795.43	0	195.6	0.0133
795.45	-0.002	195.3	0.0089
795.48	-0.005	194.9	0.0089
795.50	-0.006	194.7	0.0053
795.52	-0.006	194.7	0.0027

Prova triassiale ciclica SN04-C1			
pressione di confinamento (kPa)		80	
deviatore ciclico (kPa)		95	
frequenza (hz)		0.00625	
tempo	cella di carico	$\Delta u$	LVDT
(min)	kN	(kPa)	$\delta$ (mm)
795.52	-0.007	194.5	-0.0009
795.53	-0.01	194.2	-0.0044
795.55	-0.011	193.9	-0.0071
795.57	-0.012	193.7	-0.0098
795.58	-0.014	193.4	-0.0098
795.60	-0.015	193.2	-0.0124
795.62	-0.015	193.2	-0.0142
795.63	-0.015	193	-0.016
795.65	-0.016	192.8	-0.0169
795.67	-0.017	192.6	-0.0178
795.68	-0.017	192.5	-0.0186
795.70	-0.017	192.4	-0.0195
795.72	-0.017	192.3	-0.0195
795.73	-0.017	192.3	-0.0195
795.75	-0.017	192.2	-0.0186
795.77	-0.017	192.1	-0.0186
795.78	-0.016	192.1	-0.0178
795.80	-0.015	192	-0.0169
795.82	-0.015	192.1	-0.016
795.83	-0.013	192	-0.0151
795.85	-0.013	192	-0.0133
795.87	-0.011	192.1	-0.0115
795.88	-0.009	192.2	-0.0115
795.90	-0.008	192.2	-0.0089
795.92	-0.008	192.3	-0.0071
795.93	-0.007	192.4	-0.0036
795.95	-0.003	192.6	-0.0009
795.97	-0.002	192.7	0.0018
795.98	-0.001	193	0.0053
796.00	0.003	193.2	0.0053
796.02	0.004	193.2	0.0098
796.03	0.004	193.3	0.0124
796.05	0.005	193.6	0.0169
796.07	0.01	193.9	0.0213
796.08	0.01	194.1	0.024
796.10	0.011	194.3	0.0284
796.12	0.015	194.6	0.0284
796.13	0.016	194.6	0.0328
796.15	0.016	194.8	0.0355
796.17	0.017	195.1	0.0399
796.18	0.021	195.4	0.0435
796.20	0.021	195.6	0.0453
796.22	0.022	195.9	0.0488
796.23	0.025	196.1	0.0488
796.25	0.025	196.1	0.0515
796.27	0.025	196.4	0.0533
796.28	0.026	196.6	0.055
796.30	0.027	196.8	0.0568
796.32	0.028	196.9	0.0577
796.33	0.028	197.1	0.0595
796.35	0.029	197.3	0.0595
796.37	0.029	197.4	0.0595
796.38	0.029	197.4	0.0595
796.40	0.029	197.5	0.0595
796.42	0.029	197.6	0.0595
796.43	0.028	197.7	0.0595
796.45	0.028	197.7	0.0586
796.47	0.027	197.7	0.0586

Prova triassiale ciclica SN04-C1			
pressione di confinamento (kPa)		80	
deviatore ciclico (kPa)		95	
frequenza (hz)		0.00625	
tempo	cella di carico	$\Delta u$	LVDT
(min)	kN	(kPa)	$\delta$ (mm)
796.48	0.025	197.7	0.0568
796.50	0.025	197.7	0.0559
796.52	0.024	197.7	0.0541
796.53	0.023	197.7	0.0524
796.55	0.021	197.6	0.0506
796.57	0.021	197.6	0.0497
796.58	0.019	197.4	0.0462
796.60	0.017	197.3	0.0435
796.62	0.016	197.2	0.0408
796.63	0.014	197	0.0373
796.65	0.01	196.8	0.0373
796.67	0.01	196.8	0.0337
796.68	0.01	196.7	0.0311
796.70	0.008	196.4	0.0257
796.72	0.004	196.2	0.0231
796.73	0.003	196	0.0195
796.75	0.001	195.7	0.0151
796.77	-0.002	195.4	0.0151
796.78	-0.003	195.4	0.0115
796.80	-0.003	195.2	0.008
796.82	-0.004	194.9	0.0036
796.83	-0.007	194.6	0
796.85	-0.008	194.4	-0.0027
796.87	-0.01	194.1	-0.0053
796.88	-0.012	193.8	-0.0053
796.92	-0.012	193.8	-0.0089
796.93	-0.012	193.6	-0.0107
796.95	-0.014	193.3	-0.0133
796.97	-0.015	193.1	-0.0151
796.98	-0.016	192.9	-0.016
796.98	-0.016	192.8	-0.0169
797.00	-0.017	192.6	-0.0169
797.02	-0.017	192.6	-0.0186
797.03	-0.017	192.5	-0.0195
797.05	-0.017	192.3	-0.0195
797.07	-0.017	192.2	-0.0195
797.08	-0.017	192.1	-0.0195
797.10	-0.016	192.1	-0.0186
797.12	-0.015	192	-0.0186
797.13	-0.015	192	-0.0178
797.15	-0.015	192	-0.0169
797.17	-0.014	192	-0.0151
797.18	-0.012	192.1	-0.0142
797.20	-0.011	192.1	-0.0124
797.22	-0.01	192.2	-0.0098
797.23	-0.008	192.3	-0.0098
797.25	-0.006	192.4	-0.0071
797.27	-0.006	192.4	-0.0053
797.28	-0.003	192.7	-0.0018
797.30	-0.002	192.8	0
797.32	-0.002	192.8	0.0027
797.33	0	193	0.0071
797.35	0.003	193.3	0.0107
797.37	0.005	193.5	0.0142
797.38	0.006	193.7	0.0178
797.40	0.01	194	0.0178
797.42	0.011	194.2	0.0222
797.43	0.011	194.2	0.0249

Prova triassiale ciclica SN04-C1			
pressione di confinamento (kPa)		80	
deviatore ciclico (kPa)		95	
frequenza (hz)		0.00625	
tempo	cella di carico	$\Delta u$	LVDT
(min)	kN	(kPa)	$\delta$ (mm)
797.45	0.012	194.4	0.0302
797.47	0.016	194.7	0.0337
797.48	0.017	194.9	0.0364
797.50	0.018	195.2	0.0408
797.52	0.02	195.5	0.0408
797.53	0.022	195.8	0.0435
797.55	0.022	195.8	0.047
797.57	0.023	196	0.0488
797.58	0.025	196.2	0.0515
797.60	0.026	196.5	0.0541
797.62	0.026	196.6	0.0559
797.63	0.027	196.9	0.0559
797.65	0.028	197	0.0568
797.67	0.028	197	0.0577
797.68	0.028	197.2	0.0586
797.70	0.029	197.3	0.0586
797.72	0.029	197.4	0.0595
797.73	0.029	197.5	0.0595
797.75	0.029	197.6	0.0595
797.77	0.028	197.7	0.0595
797.78	0.028	197.7	0.0595
797.80	0.027	197.7	0.0568
797.82	0.026	197.8	0.0568
797.83	0.025	197.7	0.055
797.85	0.024	197.7	0.0533
797.87	0.023	197.6	0.0515
797.88	0.02	197.6	0.0515
797.90	0.019	197.6	0.0497
797.92	0.019	197.5	0.047
797.93	0.018	197.4	0.0444
797.95	0.015	197.2	0.0408
797.97	0.014	197.1	0.0382
797.98	0.012	196.9	0.0346
798.00	0.009	196.7	0.0311
798.02	0.009	196.6	0.0293
798.03	0.007	196.3	0.0249
798.05	0.004	196.1	0.0249
798.07	0.002	196.1	0.0204
798.08	0.002	195.9	0.0169
798.10	0.001	195.6	0.0133
798.12	-0.003	195.2	0.0089
798.13	-0.004	195	0.0062
798.15	-0.005	194.7	0.0018
798.17	-0.008	194.5	0.0018
798.18	-0.009	194.5	-0.0018
798.20	-0.009	194.3	-0.0044
798.22	-0.01	194	-0.0071
798.23	-0.013	193.7	-0.0107
798.25	-0.013	193.5	-0.0124
798.27	-0.014	193.3	-0.0142
798.28	-0.016	193	-0.0142
798.30	-0.016	193	-0.016
798.32	-0.016	192.9	-0.0169
798.33	-0.016	192.7	-0.0186
798.35	-0.017	192.5	-0.0195
798.38	-0.017	192.4	-0.0195
798.40	-0.017	192.3	-0.0195
798.42	-0.017	192.2	-0.0195

Prova triassiale ciclica SN04-C1			
pressione di confinamento (kPa)		80	
deviatore ciclico (kPa)		95	
frequenza (hz)		0.00625	
tempo	cella di carico	$\Delta u$	LVDT
(min)	kN	(kPa)	$\delta$ (mm)
798.43	-0.017	192.2	-0.0195
798.43	-0.017	192.1	-0.0195
798.45	-0.016	192.1	-0.0186
798.47	-0.015	192	-0.0178
798.48	-0.014	192	-0.0169
798.52	-0.014	192	-0.0151
798.52	-0.012	192.1	-0.0151
798.53	-0.011	192.1	-0.0133
798.55	-0.011	192.2	-0.0115
798.57	-0.01	192.2	-0.0089
798.58	-0.007	192.4	-0.0062
798.60	-0.006	192.5	-0.0036
798.62	-0.004	192.6	-0.0009
798.63	-0.001	192.9	-0.0009
798.65	0	192.9	0.0027
798.67	0	193	0.0053
798.68	0.001	193.2	0.0098
798.70	0.005	193.5	0.0142
798.72	0.006	193.7	0.0169
798.73	0.008	193.9	0.0213
798.75	0.01	194.1	0.024
798.77	0.012	194.3	0.0275
798.78	0.013	194.5	0.0311
798.80	0.016	194.9	0.0311
798.82	0.018	195.1	0.0355
798.83	0.018	195.1	0.0382
798.85	0.019	195.3	0.0417
798.87	0.021	195.7	0.0453
798.88	0.023	195.9	0.0479
798.90	0.024	196.1	0.0497
798.92	0.025	196.4	0.0524
798.93	0.027	196.6	0.0524
798.95	0.027	196.6	0.0541
798.97	0.027	196.7	0.0559
798.98	0.027	196.9	0.0577
799.00	0.028	197.1	0.0586
799.02	0.029	197.2	0.0586
799.03	0.029	197.4	0.0595
799.05	0.029	197.5	0.0595
799.07	0.029	197.5	0.0595
799.08	0.029	197.6	0.0595
799.10	0.028	197.7	0.0595
799.12	0.028	197.7	0.0586
799.13	0.027	197.8	0.0577
799.15	0.026	197.8	0.0559
799.17	0.024	197.7	0.0559
799.18	0.024	197.7	0.0541
799.20	0.024	197.7	0.0533
799.22	0.022	197.6	0.0506
799.23	0.02	197.5	0.0479
799.25	0.019	197.4	0.0462
799.27	0.017	197.3	0.0426
799.28	0.014	197.1	0.0426
799.30	0.013	197.1	0.0399
799.32	0.013	197	0.0373
799.33	0.012	196.8	0.0328
799.35	0.008	196.6	0.0293
799.37	0.007	196.4	0.0257

Prova triassiale ciclica SN04-C1			
pressione di confinamento (kPa)		80	
deviatore ciclico (kPa)		95	
frequenza (hz)		0.00625	
tempo	cella di carico	$\Delta u$	LVDT
(min)	kN	(kPa)	$\delta$ (mm)
799.38	0.005	196.2	0.0213
799.40	0.001	195.9	0.0213
799.42	0.001	195.9	0.0178
799.43	0.001	195.7	0.0142
799.45	-0.003	195.1	0.0098
799.47	-0.005	195.1	0.008
799.48	-0.005	194.9	0.0044
799.50	-0.006	194.6	0.0009
799.52	-0.009	194.3	-0.0036
799.53	-0.009	194.1	-0.0053
799.55	-0.011	193.8	-0.008
799.57	-0.013	193.6	-0.008
799.58	-0.014	193.6	-0.0115
799.60	-0.014	193.4	-0.0124
799.62	-0.015	193.2	-0.0151
799.63	-0.015	192.9	-0.0169
799.65	-0.017	192.8	-0.0178
799.67	-0.017	192.6	-0.0186
799.68	-0.017	192.5	-0.0186
799.70	-0.017	192.3	-0.0195
799.72	-0.017	192.3	-0.0195
799.73	-0.017	192.2	-0.0195
799.75	-0.017	192.1	-0.0195
799.77	-0.017	192.1	-0.0195
799.78	-0.016	192	-0.0186
799.82	-0.015	192	-0.0186
799.83	-0.014	192	-0.0169
799.85	-0.014	192	-0.016
799.87	-0.013	192	-0.0142
799.88	-0.011	192.1	-0.0124
799.88	-0.01	192.2	-0.0107
799.90	-0.008	192.3	-0.008
799.92	-0.007	192.4	-0.008
799.93	-0.004	192.5	-0.0053
799.95	-0.004	192.5	-0.0027
799.97	-0.004	192.7	0
799.98	-0.001	192.9	0.0044
800.00	0.001	193.1	0.0071
800.02	0.003	193.2	0.0107
800.03	0.005	193.5	0.0151
800.05	0.006	193.7	0.0151
800.07	0.006	193.7	0.016
800.08	0.007	193.8	0.0195
800.10	0.01	194.1	0.0231
800.12	0.013	194.3	0.0275
800.13	0.013	194.5	0.0311
800.15	0.016	194.8	0.0346
800.17	0.018	195.1	0.0346
800.18	0.019	195.3	0.0408
800.20	0.02	195.6	0.0426
800.22	0.022	195.8	0.0426
800.23	0.023	195.8	0.0462
800.25	0.023	196	0.0479
800.27	0.024	196.3	0.0506
800.28	0.026	196.5	0.0541
800.30	0.027	196.7	0.055
800.32	0.027	196.9	0.0568
800.33	0.028	197.1	0.0568



Prova triassiale ciclica SN04-C1			
pressione di confinamento (kPa)		80	
deviatore ciclico (kPa)		95	
frequenza (hz)		0.00625	
tempo	cella di carico	$\Delta u$	LVDT
(min)	kN	(kPa)	$\delta$ (mm)
800.35	0.028	197.1	0.0577
800.37	0.028	197.2	0.0586
800.38	0.029	197.3	0.0586
800.40	0.029	197.5	0.0595
800.42	0.029	197.6	0.0595
800.43	0.029	197.7	0.0595
800.45	0.028	197.7	0.0595
800.47	0.027	197.7	0.0586
800.48	0.027	197.8	0.0577
800.50	0.026	197.8	0.0559
800.52	0.025	197.7	0.0541
800.53	0.024	197.7	0.0533
800.55	0.023	197.7	0.0515
800.57	0.02	197.6	0.0515
800.58	0.019	197.6	0.0488
800.60	0.019	197.5	0.047
800.62	0.018	197.4	0.0435
800.63	0.015	197.2	0.0408
800.65	0.014	197.1	0.0382
800.67	0.012	196.9	0.0337
800.68	0.009	196.7	0.0337
800.70	0.007	196.7	0.0302
800.72	0.007	196.5	0.0275
800.73	0.006	196.3	0.0231
800.75	0.003	196	0.0186
800.77	0.001	195.8	0.016
800.78	0	195.6	0.0115
800.80	-0.003	195.2	0.0115
800.82	-0.005	195.2	0.0071
800.83	-0.005	194.9	0.0044
800.85	-0.006	194.7	0.0009
800.87	-0.009	194.4	-0.0027
800.88	-0.01	194.2	-0.0053
800.90	-0.011	193.9	-0.0089
800.92	-0.012	193.7	-0.0098
800.93	-0.013	193.5	-0.0115
800.95	-0.014	193.3	-0.0142
800.97	-0.016	193	-0.0142
800.98	-0.016	192.8	-0.016
801.00	-0.016	192.8	-0.0169
801.02	-0.016	192.7	-0.0186
801.03	-0.017	192.5	-0.0195
801.05	-0.017	192.4	-0.0195
801.07	-0.017	192.2	-0.0195
801.08	-0.017	192.2	-0.0195
801.10	-0.017	192.1	-0.0195
801.12	-0.017	192.1	-0.0195
801.13	-0.016	192	-0.0186
801.15	-0.015	192	-0.0178
801.17	-0.014	192	-0.0169
801.18	-0.014	192	-0.0151
801.20	-0.013	192.1	-0.0142
801.22	-0.01	192.2	-0.0142
801.23	-0.009	192.2	-0.0115
801.25	-0.009	192.2	-0.0098
801.28	-0.008	192.3	-0.0071
801.30	-0.005	192.5	-0.0036
801.32	-0.004	192.6	-0.0009

Prova triassiale ciclica SN04-C1			
pressione di confinamento (kPa)		80	
deviatore ciclico (kPa)		95	
frequenza (hz)		0.00625	
tempo	cella di carico	$\Delta u$	LVDT
(min)	kN	(kPa)	$\delta$ (mm)
801.33	-0.003	192.8	0.0018
801.33	0.001	193	0.0018
801.35	0.002	193	0.0062
801.37	0.002	193.1	0.0089
801.38	0.003	193.4	0.0124
801.40	0.007	193.6	0.0169
801.42	0.009	193.8	0.0204
801.43	0.01	194.1	0.0249
801.45	0.013	194.4	0.0249
801.47	0.014	194.4	0.0293
801.48	0.014	194.6	0.032
801.50	0.016	194.9	0.0364
801.52	0.019	195.2	0.0408
801.53	0.02	195.4	0.0426
801.55	0.021	195.7	0.0462
801.57	0.024	196	0.0462
801.58	0.024	196	0.0497
801.60	0.024	196.2	0.0515
801.62	0.025	196.4	0.0533
801.63	0.027	196.6	0.055
801.65	0.027	196.8	0.0559
801.67	0.028	196.9	0.0568
801.68	0.028	197.1	0.0586
801.70	0.029	197.3	0.0595
801.72	0.029	197.4	0.0595
801.73	0.029	197.5	0.0595
801.75	0.029	197.6	0.0595
801.77	0.029	197.6	0.0595
801.78	0.029	197.7	0.0595
801.80	0.028	197.7	0.0586
801.82	0.027	197.8	0.0577
801.83	0.026	197.8	0.0568
801.85	0.025	197.8	0.055
801.87	0.023	197.7	0.055
801.88	0.023	197.7	0.0533
801.90	0.023	197.7	0.0515
801.92	0.021	197.5	0.0488
801.93	0.018	197.4	0.0462
801.95	0.017	197.3	0.0435
801.97	0.016	197.2	0.0408
801.98	0.012	197	0.0408
802.00	0.011	197	0.0373
802.02	0.011	196.9	0.0337
802.03	0.01	196.6	0.0302
802.05	0.006	196.4	0.0257
802.07	0.005	196.2	0.0231
802.08	0.003	195.9	0.0178
802.10	-0.001	195.7	0.0178
802.12	-0.001	195.7	0.0133
802.13	-0.001	195.4	0.0107
802.15	-0.002	195.1	0.008
802.17	-0.006	194.8	0.0027
802.18	-0.007	194.6	0
802.20	-0.008	194.3	-0.0036
802.22	-0.011	194	-0.0036
802.23	-0.011	194	-0.0062
802.25	-0.011	193.8	-0.0089
802.27	-0.012	193.5	-0.0115

Prova triassiale ciclica SN04-C1			
pressione di confinamento (kPa)		80	
deviatore ciclico (kPa)		95	
frequenza (hz)		0.00625	
tempo	cella di carico	$\Delta u$	LVDT
(min)	kN	(kPa)	$\delta$ (mm)
802.28	-0.015	193.3	-0.0142
802.30	-0.015	193.1	-0.0151
802.32	-0.016	192.9	-0.0169
802.33	-0.016	192.7	-0.0169
802.35	-0.017	192.7	-0.0178
802.37	-0.017	192.4	-0.0186
802.38	-0.017	192.3	-0.0186
802.40	-0.017	192.3	-0.0195
802.42	-0.017	192.2	-0.0195
802.43	-0.017	192.1	-0.0195
802.45	-0.017	192.1	-0.0186
802.47	-0.016	192	-0.0186
802.48	-0.015	192	-0.0169
802.50	-0.014	192	-0.0169
802.52	-0.013	192	-0.016
802.53	-0.013	192	-0.0151
802.55	-0.012	192	-0.0124
802.57	-0.01	192.2	-0.0107
802.58	-0.009	192.2	-0.0089
802.60	-0.007	192.3	-0.0053
802.62	-0.005	192.5	-0.0053
802.63	-0.003	192.7	-0.0027
802.65	-0.003	192.7	0
802.67	-0.002	192.8	0.0036
802.68	0.001	193.1	0.008
802.70	0.004	193.3	0.0107
802.73	0.004	193.4	0.0142
802.75	0.007	193.7	0.0142
802.77	0.01	193.9	0.0186
802.78	0.01	193.9	0.0222
802.78	0.01	194.1	0.0257
802.80	0.014	194.5	0.0311
802.82	0.016	194.7	0.0346
802.83	0.017	194.9	0.0382
802.85	0.019	195.2	0.0382
802.87	0.021	195.5	0.0417
802.88	0.021	195.5	0.0444
802.90	0.022	195.8	0.047
802.92	0.023	196	0.0497
802.93	0.025	196.3	0.0524
802.95	0.025	196.4	0.0541
802.97	0.027	196.7	0.0568
802.98	0.028	196.9	0.0568
803.00	0.028	196.9	0.0577
803.02	0.028	197	0.0577
803.03	0.028	197.2	0.0586
803.05	0.029	197.3	0.0595
803.07	0.029	197.5	0.0604
803.08	0.029	197.6	0.0604
803.10	0.029	197.7	0.0604
803.12	0.029	197.7	0.0595
803.13	0.028	197.7	0.0586
803.15	0.026	197.8	0.0586
803.17	0.025	197.8	0.0568
803.18	0.025	197.8	0.0559
803.20	0.025	197.8	0.0541
803.22	0.022	197.7	0.0524
803.23	0.022	197.6	0.0506

Prova triassiale ciclica SN04-C1			
pressione di confinamento (kPa)		80	
deviatore ciclico (kPa)		95	
frequenza (hz)		0.00625	
tempo	cella di carico	$\Delta u$	LVDT
(min)	kN	(kPa)	$\delta$ (mm)
803.25	0.02	197.5	0.0479
803.27	0.017	197.4	0.0479
803.28	0.016	197.4	0.0453
803.30	0.016	197.3	0.0426
803.32	0.015	197.1	0.0391
803.33	0.011	196.9	0.0355
803.35	0.011	196.8	0.0328
803.37	0.009	196.5	0.0284
803.38	0.005	196.3	0.0284
803.40	0.004	196.3	0.024
803.42	0.004	196.1	0.0213
803.43	0.003	195.9	0.0178
803.45	-0.001	195.6	0.0124
803.47	-0.002	195.3	0.0089
803.48	-0.004	195	0.0053
803.50	-0.007	194.7	0.0053
803.52	-0.008	194.7	0.0018
803.53	-0.008	194.5	-0.0009
803.55	-0.009	194.2	-0.0044
803.57	-0.011	193.9	-0.0071
803.58	-0.012	193.7	-0.0098
803.60	-0.013	193.5	-0.0115
803.62	-0.015	193.2	-0.0115
803.63	-0.015	193.1	-0.0142
803.65	-0.015	193.1	-0.0151
803.67	-0.016	192.9	-0.0169
803.68	-0.017	192.7	-0.0178
803.70	-0.017	192.5	-0.0186
803.72	-0.017	192.4	-0.0195
803.73	-0.017	192.3	-0.0195
803.75	-0.017	192.2	-0.0195
803.77	-0.017	192.2	-0.0195
803.78	-0.017	192.1	-0.0186
803.80	-0.016	192.1	-0.0178
803.82	-0.015	192	-0.0169
803.83	-0.015	192	-0.0169
803.85	-0.014	192	-0.0151
803.87	-0.012	192.1	-0.0142
803.88	-0.012	192.1	-0.0115
803.90	-0.01	192.3	-0.0089
803.92	-0.007	192.3	-0.0089
803.93	-0.007	192.3	-0.0062
803.95	-0.007	192.4	-0.0044
803.97	-0.005	192.6	-0.0009
803.98	-0.002	192.8	0.0018
804.00	-0.001	192.9	0.0053
804.02	0.002	193.2	0.0089
804.03	0.004	193.4	0.0089
804.05	0.004	193.4	0.0124
804.07	0.005	193.5	0.016
804.08	0.008	193.9	0.0204
804.10	0.011	194.1	0.024
804.12	0.012	194.3	0.0284
804.13	0.014	194.6	0.0328
804.15	0.017	194.9	0.0328
804.18	0.017	194.9	0.0364
804.20	0.017	195.1	0.0391
804.22	0.019	195.4	0.0426

Prova triassiale ciclica SN04-C1			
pressione di confinamento (kPa)		80	
deviatore ciclico (kPa)		95	
frequenza (hz)		0.00625	
tempo	cella di carico	$\Delta u$	LVDT
(min)	kN	(kPa)	$\delta$ (mm)
804.23	0.022	195.7	0.0462
804.23	0.022	195.9	0.0479
804.25	0.024	196.2	0.0515
804.27	0.026	196.4	0.0515
804.28	0.026	196.4	0.0533
804.30	0.026	196.6	0.055
804.32	0.027	196.8	0.0568
804.33	0.028	197	0.0577
804.35	0.028	197.1	0.0586
804.37	0.029	197.2	0.0595
804.38	0.029	197.4	0.0595
804.40	0.029	197.4	0.0604
804.42	0.029	197.5	0.0604
804.43	0.029	197.6	0.0604
804.45	0.028	197.7	0.0595
804.47	0.028	197.7	0.0586
804.48	0.027	197.7	0.0577
804.50	0.025	197.7	0.0577
804.52	0.025	197.7	0.0568
804.53	0.023	197.7	0.0541
804.55	0.022	197.7	0.0541
804.57	0.021	197.7	0.0524
804.58	0.021	197.6	0.0497
804.60	0.02	197.5	0.047
804.62	0.016	197.4	0.0444
804.63	0.016	197.3	0.0417
804.65	0.014	197.1	0.0382
804.67	0.011	196.9	0.0382
804.68	0.01	196.9	0.0346
804.70	0.01	196.7	0.0311
804.72	0.008	196.5	0.0275
804.73	0.004	196.2	0.0222
804.75	0.003	196	0.0195
804.77	0.002	195.8	0.0151
804.78	-0.002	195.4	0.0151
804.80	-0.003	195.4	0.0115
804.82	-0.003	195.2	0.008
804.83	-0.004	194.9	0.0044
804.85	-0.007	194.6	0.0009
804.87	-0.009	194.4	-0.0027
804.88	-0.01	194.1	-0.0053
804.90	-0.012	193.8	-0.0053
804.92	-0.013	193.6	-0.008
804.93	-0.013	193.6	-0.0098
804.95	-0.014	193.4	-0.0124
804.97	-0.015	193.1	-0.0151
804.98	-0.016	193	-0.016
805.00	-0.016	192.8	-0.0178
805.02	-0.017	192.6	-0.0178
805.03	-0.017	192.4	-0.0186
805.05	-0.017	192.4	-0.0186
805.07	-0.017	192.3	-0.0195
805.08	-0.017	192.2	-0.0195
805.10	-0.017	192.1	-0.0195
805.12	-0.017	192.1	-0.0186
805.13	-0.016	192.1	-0.0178
805.15	-0.014	192	-0.0178
805.17	-0.014	192	-0.0169

Prova triassiale ciclica SN04-C1			
pressione di confinamento (kPa)		80	
deviatore ciclico (kPa)		95	
frequenza (hz)		0.00625	
tempo	cella di carico	$\Delta u$	LVDT
(min)	kN	(kPa)	$\delta$ (mm)
805.18	-0.014	192	-0.016
805.20	-0.013	192.1	-0.0142
805.22	-0.011	192.1	-0.0124
805.23	-0.01	192.2	-0.0098
805.25	-0.008	192.3	-0.0071
805.27	-0.006	192.4	-0.0044
805.28	-0.005	192.5	-0.0027
805.30	-0.004	192.7	0
805.32	-0.001	192.9	0
805.33	0	192.9	0.0036
805.35	0	193	0.0062
805.37	0.002	193.3	0.0098
805.38	0.005	193.5	0.0142
805.40	0.006	193.7	0.0178
805.42	0.008	194	0.0222
805.43	0.012	194.2	0.0222
805.45	0.013	194.2	0.0257
805.47	0.013	194.4	0.0302
805.48	0.014	194.7	0.0337
805.50	0.017	195	0.0382
805.52	0.018	195.2	0.0399
805.53	0.019	195.5	0.0435
805.55	0.023	195.8	0.0435
805.57	0.023	195.8	0.047
805.58	0.023	196	0.0488
805.60	0.024	196.2	0.0515
805.62	0.026	196.4	0.0541
805.65	0.026	196.6	0.0559
805.67	0.027	196.9	0.0577
805.68	0.028	197	0.0577
805.70	0.028	197	0.0586
805.70	0.028	197.2	0.0595
805.72	0.029	197.3	0.0595
805.73	0.029	197.5	0.0604
805.75	0.029	197.6	0.0604
805.77	0.029	197.6	0.0604
805.78	0.028	197.7	0.0604
805.80	0.027	197.7	0.0595
805.82	0.027	197.7	0.0586
805.83	0.027	197.8	0.0577
805.85	0.024	197.7	0.055
805.87	0.024	197.7	0.055
805.88	0.023	197.7	0.0524
805.90	0.021	197.6	0.0524
805.92	0.02	197.6	0.0497
805.93	0.02	197.5	0.047
805.95	0.018	197.4	0.0444
805.97	0.015	197.2	0.0408
805.98	0.014	197.1	0.0391
806.00	0.012	197	0.0364
806.02	0.011	196.8	0.0337
806.03	0.009	196.6	0.0302
806.05	0.007	196.4	0.0249
806.07	0.003	196.1	0.0249
806.08	0.002	195.9	0.0213
806.10	0.002	195.9	0.0178
806.12	0.001	195.7	0.0133
806.13	-0.003	195.3	0.0089

Prova triassiale ciclica SN04-C1			
pressione di confinamento (kPa)		80	
deviatore ciclico (kPa)		95	
frequenza (hz)		0.00625	
tempo	cella di carico	$\Delta u$	LVDT
(min)	kN	(kPa)	$\delta$ (mm)
806.15	-0.004	195.1	0.0071
806.17	-0.005	194.8	0.0027
806.18	-0.008	194.5	0.0027
806.20	-0.009	194.2	-0.0009
806.22	-0.009	194.2	-0.0036
806.23	-0.01	194	-0.0071
806.25	-0.012	193.7	-0.0098
806.27	-0.014	193.5	-0.0124
806.28	-0.014	193.3	-0.0142
806.30	-0.015	193	-0.0142
806.32	-0.016	192.9	-0.016
806.33	-0.016	192.9	-0.0169
806.35	-0.016	192.7	-0.0186
806.37	-0.017	192.5	-0.0195
806.38	-0.017	192.4	-0.0195
806.40	-0.017	192.3	-0.0195
806.42	-0.017	192.2	-0.0195
806.43	-0.017	192.1	-0.0195
806.45	-0.017	192.1	-0.0186
806.47	-0.016	192.1	-0.0186
806.48	-0.015	192	-0.0178
806.50	-0.014	192	-0.016
806.52	-0.014	192	-0.0142
806.53	-0.012	192.1	-0.0124
806.55	-0.01	192.2	-0.0124
806.57	-0.009	192.2	-0.0107
806.58	-0.009	192.2	-0.0098
806.60	-0.008	192.4	-0.0071
806.62	-0.006	192.5	-0.0036
806.63	-0.004	192.6	-0.0009
806.65	-0.002	192.8	0.0027
806.67	0.001	193	0.0027
806.68	0.002	193	0.0062
806.70	0.002	193.2	0.0089
806.72	0.006	193.6	0.0133
806.73	0.007	193.6	0.016
806.75	0.007	193.8	0.0195
806.77	0.009	194.1	0.0231
806.78	0.012	194.3	0.0275
806.80	0.013	194.5	0.0311
806.82	0.015	194.8	0.0355
806.83	0.018	195.1	0.0355
806.85	0.019	195.1	0.0391
806.87	0.019	195.3	0.0417
806.88	0.02	195.6	0.0453
806.90	0.023	195.9	0.0479
806.92	0.024	196.1	0.0506
806.93	0.025	196.3	0.0524
806.95	0.026	196.5	0.0524
806.97	0.027	196.5	0.055
806.98	0.027	196.7	0.0559
807.00	0.027	196.9	0.0577
807.02	0.028	197.1	0.0586
807.03	0.029	197.2	0.0595
807.05	0.029	197.4	0.0595
807.08	0.029	197.5	0.0595
807.10	0.029	197.6	0.0595
807.12	0.029	197.6	0.0595

Prova triassiale ciclica SN04-C1			
pressione di confinamento (kPa)		80	
deviatore ciclico (kPa)		95	
frequenza (hz)		0.00625	
tempo	cella di carico	$\Delta u$	LVDT
(min)	kN	(kPa)	$\delta$ (mm)
807.13	0.028	197.7	0.0595
807.15	0.028	197.7	0.0586
807.15	0.026	197.7	0.0577
807.17	0.026	197.8	0.0568
807.18	0.025	197.7	0.0568
807.20	0.023	197.7	0.055
807.22	0.023	197.7	0.0533
807.23	0.022	197.6	0.0506
807.25	0.02	197.5	0.0479
807.27	0.018	197.4	0.0462
807.28	0.017	197.3	0.0435
807.30	0.014	197.1	0.0435
807.32	0.012	197	0.0399
807.33	0.012	197	0.0364
807.35	0.011	196.8	0.0337
807.37	0.009	196.6	0.0302
807.38	0.006	196.4	0.0257
807.40	0.005	196.2	0.0222
807.42	0.002	195.9	0.0222
807.43	0	195.7	0.0169
807.45	-0.001	195.4	0.0115
807.47	-0.002	195.2	0.0115
807.48	-0.004	194.9	0.0089
807.50	-0.004	194.9	0.0053
807.52	-0.006	194.7	0.0009
807.53	-0.008	194.3	-0.0027
807.55	-0.01	194.1	-0.0053
807.57	-0.011	193.9	-0.008
807.58	-0.012	193.6	-0.008
807.60	-0.014	193.3	-0.0107
807.62	-0.014	193.3	-0.0133
807.63	-0.014	193.1	-0.0151
807.65	-0.016	192.9	-0.0169
807.67	-0.017	192.7	-0.0178
807.68	-0.017	192.6	-0.0186
807.70	-0.017	192.4	-0.0195
807.72	-0.017	192.3	-0.0195
807.73	-0.017	192.3	-0.0204
807.75	-0.017	192.2	-0.0204
807.77	-0.017	192.1	-0.0195
807.78	-0.016	192	-0.0186
807.80	-0.016	192	-0.0186
807.82	-0.015	192	-0.0178
807.83	-0.014	192	-0.0178
807.85	-0.013	192	-0.016
807.87	-0.013	192	-0.0151
807.88	-0.012	192.1	-0.0124
807.90	-0.01	192.2	-0.0107
807.92	-0.009	192.2	-0.0089
807.93	-0.007	192.3	-0.0062
807.95	-0.005	192.5	-0.0062
807.97	-0.003	192.5	-0.0027
807.98	-0.003	192.6	0.0009
808.00	-0.002	192.8	0.0036
808.02	0.002	193	0.0071
808.03	0.003	193.2	0.0098
808.05	0.004	193.5	0.0142
808.07	0.008	193.7	0.0142



Prova triassiale ciclica SN04-C1			
pressione di confinamento (kPa)		80	
deviatore ciclico (kPa)		95	
frequenza (hz)		0.00625	
tempo	cella di carico	$\Delta u$	LVDT
(min)	kN	(kPa)	$\delta$ (mm)
808.08	0.009	193.7	0.0186
808.10	0.009	193.9	0.0222
808.12	0.01	194.2	0.0257
808.13	0.015	194.5	0.0311
808.15	0.015	194.6	0.0337
808.17	0.016	194.9	0.0373
808.18	0.019	195.1	0.0399
808.20	0.02	195.4	0.0426
808.22	0.021	195.7	0.0462
808.23	0.024	195.9	0.0462
808.25	0.024	195.9	0.0488
808.27	0.024	196.1	0.0506
808.28	0.025	196.4	0.0533
808.30	0.027	196.6	0.0559
808.32	0.027	196.8	0.0559
808.33	0.028	196.9	0.0577
808.35	0.028	197.1	0.0577
808.37	0.029	197.2	0.0586
808.38	0.029	197.2	0.0595
808.40	0.029	197.4	0.0595
808.42	0.028	197.5	0.0595
808.43	0.028	197.6	0.0595
808.45	0.028	197.6	0.0595
808.47	0.028	197.7	0.0586
808.48	0.026	197.7	0.0586
808.50	0.026	197.7	0.0568
808.52	0.026	197.7	0.0559
808.55	0.025	197.7	0.0541
808.57	0.022	197.6	0.0524
808.58	0.022	197.6	0.0506
808.60	0.02	197.5	0.0479
808.60	0.017	197.3	0.0479
808.62	0.016	197.3	0.0444
808.63	0.016	197.3	0.0426
808.65	0.015	197.1	0.0391
808.67	0.012	196.9	0.0355
808.68	0.01	196.7	0.0328
808.70	0.009	196.5	0.0293
808.72	0.005	196.2	0.0293
808.73	0.004	196.2	0.024
808.75	0.004	196.1	0.0204
808.77	0.002	195.8	0.0169
808.78	-0.001	195.5	0.0124
808.80	-0.002	195.2	0.0098
808.82	-0.004	194.9	0.0053
808.83	-0.007	194.6	0.0053
808.85	-0.008	194.6	0.0018
808.87	-0.008	194.4	-0.0018
808.88	-0.009	194.1	-0.0044
808.90	-0.012	193.9	-0.0071
808.92	-0.012	193.7	-0.0089
808.93	-0.012	193.4	-0.0115
808.95	-0.015	193.2	-0.0133
808.97	-0.015	193	-0.0151
808.98	-0.016	192.8	-0.016
809.00	-0.017	192.6	-0.016
809.02	-0.017	192.6	-0.0178
809.03	-0.017	192.5	-0.0186

Prova triassiale ciclica SN04-C1			
pressione di confinamento (kPa)		80	
deviatore ciclico (kPa)		95	
frequenza (hz)		0.00625	
tempo	cella di carico	$\Delta u$	LVDT
(min)	kN	(kPa)	$\delta$ (mm)
809.05	-0.017	192.4	-0.0186
809.07	-0.017	192.2	-0.0195
809.08	-0.017	192.1	-0.0195
809.10	-0.017	192.1	-0.0186
809.12	-0.016	192	-0.0186
809.13	-0.016	192	-0.0186
809.15	-0.016	192	-0.0178
809.17	-0.015	191.9	-0.0169
809.18	-0.014	192	-0.0151
809.20	-0.012	192	-0.0133
809.22	-0.011	192.1	-0.0115
809.23	-0.009	192.2	-0.0115
809.25	-0.008	192.2	-0.0098
809.27	-0.008	192.2	-0.0071
809.28	-0.007	192.4	-0.0044
809.30	-0.004	192.6	-0.0009
809.32	-0.002	192.7	0.0018
809.33	-0.001	192.9	0.0053
809.35	0.002	193.1	0.0053
809.37	0.004	193.3	0.0089
809.38	0.004	193.3	0.0124
809.40	0.005	193.5	0.0169
809.42	0.009	193.8	0.0204
809.43	0.01	194	0.024
809.45	0.012	194.2	0.0284
809.47	0.015	194.5	0.0284
809.48	0.016	194.8	0.0328
809.50	0.016	194.8	0.0355
809.52	0.017	195	0.0391
809.53	0.02	195.3	0.0426
809.55	0.022	195.6	0.0462
809.57	0.022	195.8	0.0479
809.58	0.024	196.1	0.0479
809.60	0.026	196.3	0.0506
809.62	0.026	196.5	0.0541
809.63	0.027	196.7	0.0559
809.65	0.027	196.9	0.0559
809.67	0.027	196.9	0.0568
809.68	0.028	197	0.0586
809.70	0.028	197.2	0.0595
809.72	0.029	197.3	0.0595
809.73	0.029	197.4	0.0604
809.75	0.029	197.5	0.0604
809.77	0.029	197.7	0.0604
809.78	0.028	197.7	0.0604
809.80	0.028	197.7	0.0595
809.82	0.027	197.7	0.0577
809.83	0.026	197.7	0.0568
809.85	0.025	197.7	0.0559
809.87	0.024	197.7	0.0533
809.88	0.022	197.6	0.0533
809.90	0.021	197.6	0.0515
809.92	0.021	197.6	0.0497
809.93	0.02	197.4	0.047
809.95	0.016	197.3	0.0435
809.98	0.015	197.2	0.0417
810.00	0.014	197	0.0382
810.02	0.01	196.8	0.0382

Prova triassiale ciclica SN04-C1			
pressione di confinamento (kPa)		80	
deviatore ciclico (kPa)		95	
frequenza (hz)		0.00625	
tempo	cella di carico	$\Delta u$	LVDT
(min)	kN	(kPa)	$\delta$ (mm)
810.03	0.01	196.8	0.0337
810.05	0.01	196.7	0.032
810.05	0.008	196.4	0.0275
810.07	0.004	196.2	0.0222
810.08	0.004	196	0.0195
810.10	0.002	195.7	0.0151
810.12	-0.002	195.4	0.0151
810.13	-0.003	195.4	0.0107
810.15	-0.003	195.1	0.008
810.17	-0.004	194.8	0.0036
810.18	-0.008	194.6	0
810.20	-0.008	194.3	-0.0027
810.22	-0.01	194.1	-0.0062
810.23	-0.012	193.8	-0.0062
810.25	-0.013	193.8	-0.0089
810.27	-0.013	193.6	-0.0107
810.28	-0.014	193.3	-0.0124
810.30	-0.015	193.1	-0.0151
810.32	-0.016	192.9	-0.016
810.33	-0.016	192.7	-0.0178
810.35	-0.017	192.6	-0.0186
810.37	-0.017	192.4	-0.0186
810.38	-0.017	192.3	-0.0195
810.40	-0.017	192.2	-0.0195
810.42	-0.017	192.2	-0.0195
810.43	-0.017	192.1	-0.0195
810.45	-0.017	192	-0.0186
810.47	-0.016	192	-0.0178
810.48	-0.015	192	-0.0169
810.50	-0.014	191.9	-0.016
810.52	-0.013	192	-0.016
810.53	-0.012	192	-0.0142
810.55	-0.012	192	-0.0124
810.57	-0.011	192.1	-0.0107
810.58	-0.009	192.2	-0.0089
810.60	-0.007	192.3	-0.0062
810.62	-0.006	192.4	-0.0027
810.63	-0.003	192.6	-0.0027
810.65	-0.001	192.8	0.0009
810.67	-0.001	192.8	0.0036
810.68	0	193	0.0062
810.70	0.003	193.3	0.0107
810.72	0.005	193.4	0.0142
810.73	0.006	193.6	0.0178
810.75	0.009	193.9	0.0178
810.77	0.011	194.1	0.0222
810.78	0.011	194.1	0.0257
810.80	0.013	194.4	0.0311
810.82	0.015	194.7	0.0346
810.83	0.017	194.9	0.0373
810.85	0.018	195.1	0.0408
810.87	0.02	195.5	0.0444
810.88	0.022	195.7	0.0444
810.90	0.022	195.7	0.047
810.92	0.023	195.9	0.0497
810.93	0.024	196.2	0.0524
810.95	0.026	196.4	0.0541
810.97	0.027	196.6	0.0559

Prova triassiale ciclica SN04-C1			
pressione di confinamento (kPa)		80	
deviatore ciclico (kPa)		95	
frequenza (hz)		0.00625	
tempo	cella di carico	$\Delta u$	LVDT
(min)	kN	(kPa)	$\delta$ (mm)
810.98	0.027	196.8	0.0568
811.00	0.028	197	0.0568
811.02	0.028	197	0.0586
811.03	0.028	197.1	0.0586
811.05	0.029	197.3	0.0595
811.07	0.029	197.4	0.0604
811.08	0.029	197.5	0.0604
811.10	0.029	197.6	0.0604
811.12	0.028	197.7	0.0595
811.13	0.027	197.7	0.0586
811.15	0.027	197.7	0.0577
811.17	0.025	197.7	0.0577
811.18	0.025	197.7	0.0559
811.20	0.025	197.7	0.055
811.22	0.024	197.7	0.0533
811.23	0.021	197.6	0.0506
811.25	0.02	197.5	0.0488
811.27	0.019	197.4	0.0462
811.28	0.015	197.2	0.0462
811.30	0.015	197.2	0.0426
811.32	0.015	197.2	0.0399
811.33	0.013	197	0.0364
811.35	0.01	196.7	0.0328
811.37	0.009	196.6	0.0302
811.38	0.007	196.3	0.0249
811.40	0.003	196.1	0.0249
811.42	0.002	196.1	0.0204
811.45	0.002	195.9	0.0178
811.47	0.001	195.6	0.0133
811.48	-0.003	195.2	0.0089
811.50	-0.004	195	0.0062
811.50	-0.005	194.7	0.0027
811.52	-0.008	194.4	0.0027
811.53	-0.009	194.4	-0.0009
811.55	-0.009	194.2	-0.0036
811.57	-0.01	193.9	-0.0071
811.58	-0.013	193.7	-0.0098
811.60	-0.013	193.5	-0.0115
811.62	-0.014	193.3	-0.0133
811.63	-0.016	193	-0.0133
811.65	-0.016	193	-0.0151
811.67	-0.016	192.8	-0.0169
811.68	-0.016	192.7	-0.0178
811.70	-0.017	192.5	-0.0186
811.72	-0.017	192.4	-0.0195
811.73	-0.017	192.2	-0.0195
811.75	-0.017	192.1	-0.0195
811.77	-0.017	192.1	-0.0195
811.78	-0.017	192.1	-0.0186
811.80	-0.016	192	-0.0178
811.82	-0.015	191.9	-0.0178
811.83	-0.015	191.9	-0.0169
811.85	-0.014	191.9	-0.016
811.87	-0.013	192	-0.0142
811.88	-0.011	192.1	-0.0115
811.90	-0.01	192.1	-0.0098
811.92	-0.008	192.3	-0.0071
811.93	-0.006	192.4	-0.0071

Prova triassiale ciclica SN04-C1			
pressione di confinamento (kPa)		80	
deviatore ciclico (kPa)		95	
frequenza (hz)		0.00625	
tempo	cella di carico	$\Delta u$	LVDT
(min)	kN	(kPa)	$\delta$ (mm)
811.95	-0.005	192.4	-0.0044
811.97	-0.005	192.5	-0.0027
811.98	-0.003	192.7	0.0009
812.00	0	192.9	0.0044
812.02	0.001	193	0.008
812.03	0.003	193.3	0.0115
812.05	0.006	193.5	0.0115
812.07	0.007	193.5	0.016
812.08	0.007	193.7	0.0195
812.10	0.009	194	0.0231
812.12	0.012	194.2	0.0284
812.13	0.014	194.4	0.0311
812.15	0.015	194.7	0.0346
812.17	0.018	195	0.0346
812.18	0.019	195	0.0391
812.20	0.019	195.2	0.0417
812.22	0.02	195.6	0.0444
812.23	0.023	195.8	0.0479
812.25	0.023	196	0.0497
812.27	0.025	196.3	0.0524
812.28	0.027	196.5	0.0524
812.30	0.027	196.5	0.055
812.32	0.027	196.7	0.0559
812.33	0.027	196.8	0.0568
812.35	0.028	197	0.0586
812.37	0.029	197.2	0.0595
812.38	0.029	197.3	0.0595
812.40	0.029	197.4	0.0595
812.42	0.029	197.4	0.0604
812.43	0.029	197.5	0.0604
812.45	0.029	197.6	0.0595
812.47	0.027	197.7	0.0586
812.48	0.027	197.7	0.0577
812.50	0.026	197.7	0.0559
812.52	0.024	197.7	0.0559
812.53	0.023	197.6	0.0533
812.55	0.023	197.6	0.0524
812.57	0.021	197.5	0.0524
812.58	0.019	197.5	0.0497
812.60	0.019	197.5	0.0479
812.62	0.018	197.4	0.0444
812.63	0.015	197.2	0.0417
812.65	0.014	197	0.0382
812.67	0.013	196.9	0.0355
812.68	0.009	196.6	0.0355
812.70	0.007	196.5	0.0311
812.72	0.007	196.5	0.0284
812.73	0.006	196.3	0.0231
812.75	0.003	196	0.0195
812.77	0.001	195.7	0.016
812.78	0	195.5	0.0124
812.80	-0.003	195.1	0.0124
812.82	-0.005	194.9	0.008
812.83	-0.005	194.9	0.0053
812.85	-0.006	194.7	0.0009
812.87	-0.008	194.3	-0.0018
812.88	-0.01	194.1	-0.0053
812.92	-0.011	193.9	-0.0071

Prova triassiale ciclica SN04-C1			
pressione di confinamento (kPa)		80	
deviatore ciclico (kPa)		95	
frequenza (hz)		0.00625	
tempo	cella di carico	$\Delta u$	LVDT
(min)	kN	(kPa)	$\delta$ (mm)
812.93	-0.012	193.6	-0.0071
812.95	-0.014	193.3	-0.0098
812.95	-0.014	193.3	-0.0124
812.97	-0.015	193.2	-0.0142
812.98	-0.016	192.9	-0.016
813.00	-0.017	192.7	-0.0169
813.02	-0.017	192.6	-0.0178
813.03	-0.017	192.4	-0.0186
813.05	-0.017	192.3	-0.0186
813.07	-0.017	192.3	-0.0186
813.08	-0.017	192.2	-0.0195
813.10	-0.017	192.1	-0.0195
813.12	-0.017	192.1	-0.0186
813.13	-0.016	192	-0.0178
813.15	-0.015	192	-0.0169
813.17	-0.014	192	-0.0169
813.18	-0.013	192	-0.016
813.20	-0.013	192	-0.0142
813.22	-0.012	192.1	-0.0124
813.23	-0.009	192.2	-0.0098
813.25	-0.009	192.2	-0.008
813.27	-0.008	192.3	-0.0071
813.28	-0.005	192.4	-0.0036
813.30	-0.005	192.5	-0.0009
813.32	-0.002	192.7	0.0036
813.33	0.001	193	0.0036
813.35	0.002	193	0.0062
813.37	0.002	193.1	0.0098
813.38	0.004	193.4	0.0142
813.40	0.007	193.6	0.0178
813.42	0.008	193.8	0.0204
813.43	0.01	194.1	0.0249
813.45	0.014	194.3	0.0249
813.47	0.014	194.3	0.0302
813.48	0.014	194.5	0.0328
813.50	0.016	194.8	0.0364
813.52	0.019	195.1	0.0408
813.53	0.02	195.3	0.0426
813.55	0.021	195.6	0.0462
813.57	0.024	195.9	0.0462
813.58	0.024	195.9	0.0488
813.60	0.024	196.1	0.0506
813.62	0.025	196.3	0.0533
813.63	0.027	196.5	0.055
813.65	0.027	196.7	0.0568
813.67	0.028	196.9	0.0586
813.68	0.028	197.1	0.0586
813.70	0.029	197.2	0.0595
813.72	0.029	197.2	0.0595
813.73	0.029	197.3	0.0595
813.75	0.029	197.5	0.0595
813.77	0.029	197.5	0.0595
813.78	0.028	197.6	0.0595
813.80	0.027	197.6	0.0595
813.82	0.026	197.7	0.0586
813.83	0.026	197.7	0.0577
813.85	0.026	197.7	0.0559
813.87	0.024	197.6	0.0541

Prova triassiale ciclica SN04-C1			
pressione di confinamento (kPa)		80	
deviatore ciclico (kPa)		95	
frequenza (hz)		0.00625	
tempo	cella di carico	$\Delta u$	LVDT
(min)	kN	(kPa)	$\delta$ (mm)
813.88	0.022	197.6	0.0524
813.90	0.022	197.6	0.0506
813.92	0.02	197.4	0.0479
813.93	0.017	197.3	0.0479
813.95	0.017	197.3	0.0453
813.97	0.016	197.2	0.0417
813.98	0.013	196.9	0.0391
814.00	0.011	196.9	0.0373
814.02	0.011	196.8	0.0337
814.03	0.01	196.5	0.0302
814.05	0.006	196.3	0.0257
814.07	0.005	196.1	0.0231
814.08	0.003	195.8	0.0186
814.10	0	195.6	0.0186
814.12	-0.001	195.6	0.0142
814.13	-0.001	195.3	0.0115
814.15	-0.003	195	0.0071
814.17	-0.006	194.7	0.0036
814.18	-0.007	194.5	0
814.20	-0.008	194.2	-0.0027
814.22	-0.011	193.9	-0.0027
814.23	-0.011	193.9	-0.0062
814.25	-0.011	193.7	-0.0089
814.27	-0.013	193.5	-0.0107
814.28	-0.015	193.2	-0.0133
814.30	-0.015	193	-0.0151
814.32	-0.015	192.8	-0.0169
814.35	-0.017	192.6	-0.0169
814.37	-0.017	192.6	-0.0178
814.38	-0.017	192.5	-0.0186
814.40	-0.017	192.4	-0.0186
814.42	-0.017	192.2	-0.0195
814.42	-0.017	192.1	-0.0195
814.43	-0.017	192	-0.0186
814.45	-0.016	192	-0.0186
814.47	-0.015	192	-0.0186
814.48	-0.015	192	-0.0178
814.50	-0.015	191.9	-0.0169
814.52	-0.014	192	-0.0151
814.53	-0.012	192	-0.0142
814.55	-0.011	192	-0.0115
814.57	-0.009	192.2	-0.0115
814.58	-0.008	192.2	-0.0089
814.60	-0.008	192.2	-0.0071
814.62	-0.007	192.3	-0.0044
814.63	-0.004	192.6	-0.0009
814.65	-0.002	192.7	0.0018
814.67	-0.001	192.9	0.0053
814.68	0.002	193.1	0.0053
814.70	0.004	193.3	0.0089
814.72	0.005	193.4	0.0142
814.73	0.007	193.7	0.0142
814.75	0.01	193.9	0.0186
814.77	0.01	193.9	0.0222
814.78	0.011	194.1	0.0257
814.80	0.013	194.4	0.0311
814.82	0.016	194.7	0.0346
814.83	0.017	194.9	0.0382

Prova triassiale ciclica SN04-C1			
pressione di confinamento (kPa)		80	
deviatore ciclico (kPa)		95	
frequenza (hz)		0.00625	
tempo	cella di carico	$\Delta u$	LVDT
(min)	kN	(kPa)	$\delta$ (mm)
814.85	0.019	195.2	0.0417
814.87	0.021	195.5	0.0417
814.88	0.021	195.5	0.0444
814.90	0.022	195.7	0.047
814.92	0.023	196	0.0497
814.93	0.025	196.2	0.0524
814.95	0.026	196.4	0.0541
814.97	0.027	196.6	0.0559
814.98	0.028	196.8	0.0559
815.00	0.028	196.8	0.0568
815.02	0.028	196.9	0.0577
815.03	0.028	197.1	0.0586
815.05	0.029	197.3	0.0595
815.07	0.029	197.4	0.0595
815.08	0.029	197.5	0.0604
815.10	0.029	197.6	0.0604
815.12	0.028	197.6	0.0595
815.13	0.028	197.6	0.0586
815.15	0.027	197.7	0.0577
815.17	0.026	197.7	0.0568
815.18	0.025	197.7	0.0559
815.20	0.024	197.6	0.0533
815.22	0.022	197.6	0.0533
815.23	0.021	197.6	0.0515
815.25	0.021	197.5	0.0497
815.27	0.019	197.4	0.0462
815.28	0.017	197.3	0.0435
815.30	0.015	197.1	0.0417
815.32	0.014	197	0.0382
815.33	0.01	196.8	0.0382
815.35	0.01	196.8	0.0346
815.37	0.01	196.6	0.032
815.38	0.008	196.4	0.0257
815.40	0.004	196.1	0.0222
815.42	0.003	195.9	0.0195
815.43	0.001	195.7	0.0151
815.45	0	195.5	0.0133
815.47	-0.002	195.2	0.0098
815.48	-0.003	195	0.0062
815.50	-0.006	194.6	0.0062
815.52	-0.008	194.4	0.0018
815.53	-0.008	194.4	-0.0009
815.55	-0.009	194.1	-0.0044
815.57	-0.011	193.8	-0.008
815.58	-0.013	193.6	-0.0098
815.60	-0.013	193.4	-0.0124
815.62	-0.014	193.1	-0.0124
815.63	-0.016	192.9	-0.0142
815.65	-0.016	192.9	-0.016
815.67	-0.016	192.8	-0.0169
815.68	-0.016	192.6	-0.0178
815.70	-0.017	192.4	-0.0186
815.72	-0.017	192.3	-0.0195
815.73	-0.017	192.2	-0.0195
815.75	-0.017	192.1	-0.0195
815.77	-0.016	192.1	-0.0195
815.78	-0.016	192	-0.0186
815.82	-0.016	191.9	-0.0186



Prova triassiale ciclica SN04-C1			
pressione di confinamento (kPa)		80	
deviatore ciclico (kPa)		95	
frequenza (hz)		0.00625	
tempo	cella di carico	$\Delta u$	LVDT
(min)	kN	(kPa)	$\delta$ (mm)
815.83	-0.015	191.9	-0.0178
815.85	-0.015	191.9	-0.016
815.87	-0.013	192	-0.0142
815.87	-0.012	192	-0.0142
815.88	-0.011	192	-0.0124
815.90	-0.011	192.1	-0.0107
815.92	-0.01	192.2	-0.008
815.93	-0.006	192.3	-0.0053
815.95	-0.006	192.4	-0.0036
815.97	-0.004	192.6	0
815.98	-0.001	192.8	0
816.00	0	192.8	0.0036
816.02	0	192.9	0.0062
816.03	0.002	193.1	0.0098
816.05	0.005	193.4	0.0142
816.07	0.006	193.6	0.0169
816.08	0.008	193.9	0.0222
816.10	0.012	194.1	0.0222
816.12	0.013	194.1	0.0275
816.13	0.013	194.3	0.0293
816.15	0.014	194.6	0.0337
816.17	0.018	194.9	0.0373
816.18	0.018	195.1	0.0391
816.20	0.019	195.3	0.0426
816.22	0.021	195.6	0.0453
816.23	0.023	195.8	0.0479
816.25	0.024	196	0.0506
816.27	0.025	196.3	0.0506
816.28	0.026	196.3	0.0533
816.30	0.026	196.5	0.0541
816.32	0.027	196.7	0.0568
816.33	0.028	196.9	0.0577
816.35	0.028	197	0.0586
816.37	0.029	197.2	0.0595
816.38	0.029	197.3	0.0595
816.40	0.029	197.4	0.0595
816.42	0.029	197.4	0.0604
816.43	0.029	197.6	0.0604
816.45	0.028	197.6	0.0595
816.47	0.027	197.7	0.0586
816.48	0.027	197.7	0.0577
816.50	0.026	197.7	0.0577
816.52	0.024	197.7	0.0559
816.53	0.024	197.7	0.055
816.55	0.024	197.6	0.0524
816.57	0.021	197.5	0.0506
816.58	0.02	197.5	0.0488
816.60	0.019	197.4	0.0462
816.62	0.016	197.2	0.0462
816.63	0.014	197.1	0.0426
816.65	0.014	197.1	0.0399
816.67	0.013	197	0.0364
816.68	0.011	196.7	0.0328
816.70	0.008	196.5	0.0293
816.72	0.007	196.3	0.0257
816.73	0.005	196	0.0213
816.75	0.002	195.8	0.0213
816.77	0.002	195.8	0.0178

Prova triassiale ciclica SN04-C1			
pressione di confinamento (kPa)		80	
deviatore ciclico (kPa)		95	
frequenza (hz)		0.00625	
tempo	cella di carico	$\Delta u$	LVDT
(min)	kN	(kPa)	$\delta$ (mm)
816.78	0	195.6	0.0133
816.80	-0.001	195.2	0.0098
816.82	-0.005	195	0.0062
816.83	-0.005	194.7	0.0027
816.85	-0.007	194.4	-0.0009
816.87	-0.01	194.1	-0.0009
816.88	-0.01	193.9	-0.0062
816.90	-0.011	193.7	-0.008
816.92	-0.013	193.5	-0.008
816.93	-0.013	193.5	-0.0107
816.95	-0.013	193.3	-0.0124
816.97	-0.015	193	-0.0151
816.98	-0.016	192.8	-0.0169
817.00	-0.016	192.7	-0.0169
817.02	-0.017	192.5	-0.0178
817.03	-0.017	192.4	-0.0178
817.05	-0.017	192.4	-0.0186
817.07	-0.017	192.2	-0.0195
817.08	-0.017	192.1	-0.0195
817.10	-0.017	192	-0.0195
817.12	-0.016	192	-0.0186
817.13	-0.016	191.9	-0.0178
817.15	-0.015	191.9	-0.0178
817.17	-0.014	191.9	-0.0169
817.18	-0.014	191.9	-0.016
817.20	-0.013	192	-0.0142
817.22	-0.011	192	-0.0124
817.25	-0.01	192.1	-0.0098
817.27	-0.009	192.2	-0.008
817.28	-0.006	192.3	-0.008
817.30	-0.005	192.3	-0.0044
817.32	-0.005	192.5	-0.0018
817.32	-0.003	192.6	0.0009
817.33	-0.001	192.8	0.0044
817.35	0.001	193	0.008
817.37	0.002	193.2	0.0107
817.38	0.006	193.5	0.0107
817.40	0.007	193.5	0.016
817.42	0.007	193.7	0.0195
817.43	0.009	193.9	0.0231
817.45	0.012	194.2	0.0284
817.47	0.014	194.4	0.0311
817.48	0.015	194.7	0.0355
817.50	0.018	195	0.0355
817.52	0.019	195.2	0.0391
817.53	0.019	195.2	0.0417
817.55	0.021	195.5	0.0444
817.57	0.022	195.8	0.0479
817.58	0.024	196	0.0497
817.60	0.024	196.2	0.0524
817.62	0.026	196.4	0.0541
817.63	0.027	196.6	0.0559
817.65	0.027	196.8	0.0568
817.67	0.028	196.9	0.0577
817.68	0.029	197.1	0.0577
817.70	0.029	197.1	0.0586
817.72	0.029	197.3	0.0595
817.73	0.029	197.4	0.0595

Prova triassiale ciclica SN04-C1			
pressione di confinamento (kPa)		80	
deviatore ciclico (kPa)		95	
frequenza (hz)		0.00625	
tempo	cella di carico	$\Delta u$	LVDT
(min)	kN	(kPa)	$\delta$ (mm)
817.75	0.029	197.5	0.0595
817.77	0.029	197.6	0.0595
817.78	0.028	197.7	0.0595
817.80	0.027	197.7	0.0595
817.82	0.026	197.7	0.0586
817.83	0.026	197.7	0.0568
817.85	0.026	197.7	0.0559
817.87	0.024	197.6	0.0541
817.88	0.023	197.6	0.0524
817.90	0.022	197.6	0.0497
817.92	0.019	197.4	0.0497
817.93	0.018	197.4	0.047
817.95	0.018	197.3	0.0453
817.97	0.017	197.2	0.0417
817.98	0.014	197	0.0391
818.00	0.012	196.9	0.0355
818.02	0.011	196.7	0.032
818.03	0.007	196.4	0.032
818.05	0.006	196.4	0.0275
818.07	0.006	196.3	0.024
818.08	0.004	196	0.0195
818.10	0.001	195.7	0.016
818.12	-0.001	195.5	0.0124
818.13	-0.002	195.2	0.0089
818.15	-0.005	194.9	0.0089
818.17	-0.006	194.7	0.0044
818.18	-0.006	194.7	0.0018
818.20	-0.007	194.4	-0.0018
818.22	-0.01	194.1	-0.0053
818.23	-0.011	193.8	-0.0071
818.25	-0.012	193.6	-0.0098
818.27	-0.014	193.3	-0.0098
818.28	-0.015	193.1	-0.0124
818.30	-0.015	193.1	-0.0142
818.32	-0.015	192.9	-0.016
818.33	-0.017	192.6	-0.0169
818.35	-0.017	192.6	-0.0178
818.37	-0.017	192.4	-0.0186
818.38	-0.017	192.3	-0.0195
818.40	-0.017	192.2	-0.0195
818.42	-0.017	192.1	-0.0195
818.43	-0.017	192	-0.0186
818.45	-0.016	192	-0.0186
818.47	-0.015	192	-0.0186
818.48	-0.015	191.9	-0.0178
818.50	-0.015	191.9	-0.0169
818.52	-0.013	191.9	-0.0151
818.53	-0.013	192	-0.0133
818.55	-0.011	192.1	-0.0115
818.57	-0.009	192.1	-0.0115
818.58	-0.008	192.1	-0.0089
818.60	-0.008	192.2	-0.0071
818.62	-0.006	192.4	-0.0044
818.63	-0.004	192.5	-0.0009
818.65	-0.003	192.7	0.0018
818.67	-0.001	192.9	0.0053
818.68	0.003	193.1	0.0053
818.72	0.004	193.1	0.0089

Prova triassiale ciclica SN04-C1			
pressione di confinamento (kPa)		80	
deviatore ciclico (kPa)		95	
frequenza (hz)		0.00625	
tempo	cella di carico	$\Delta u$	LVDT
(min)	kN	(kPa)	$\delta$ (mm)
818.73	0.004	193.3	0.0124
818.75	0.006	193.6	0.0169
818.77	0.009	193.8	0.0204
818.77	0.01	194	0.024
818.78	0.012	194.3	0.0293
818.80	0.015	194.5	0.0293
818.82	0.016	194.5	0.0328
818.83	0.016	194.7	0.0355
818.85	0.017	195	0.0399
818.87	0.02	195.3	0.0435
818.88	0.021	195.6	0.0453
818.90	0.022	195.8	0.0488
818.92	0.025	196.1	0.0488
818.93	0.025	196.1	0.0506
818.95	0.025	196.3	0.0533
818.97	0.026	196.5	0.055
818.98	0.028	196.7	0.0568
819.00	0.028	196.9	0.0577
819.02	0.028	197	0.0586
819.03	0.029	197.2	0.0586
819.05	0.029	197.2	0.0595
819.07	0.029	197.4	0.0604
819.08	0.029	197.5	0.0604
819.10	0.028	197.5	0.0604
819.12	0.028	197.6	0.0595
819.13	0.028	197.7	0.0586
819.15	0.027	197.7	0.0577
819.17	0.026	197.7	0.0568
819.18	0.025	197.7	0.055
819.20	0.023	197.6	0.055
819.22	0.022	197.6	0.0533
819.23	0.022	197.6	0.0515
819.25	0.021	197.5	0.0488
819.27	0.018	197.4	0.0462
819.28	0.017	197.3	0.0444
819.30	0.016	197.2	0.0408
819.32	0.013	196.9	0.0408
819.33	0.011	196.8	0.0373
819.35	0.011	196.8	0.0346
819.37	0.01	196.6	0.0311
819.38	0.006	196.3	0.0257
819.40	0.005	196.1	0.0231
819.42	0.003	195.9	0.0186
819.43	0	195.6	0.0186
819.45	-0.001	195.4	0.0142
819.47	-0.001	195.4	0.0115
819.48	-0.002	195.1	0.0071
819.50	-0.006	194.7	0.0027
819.52	-0.007	194.5	0
819.53	-0.008	194.3	-0.0036
819.55	-0.01	194	-0.0036
819.57	-0.012	193.7	-0.0062
819.58	-0.012	193.7	-0.0089
819.60	-0.012	193.5	-0.0107
819.62	-0.014	193.2	-0.0133
819.63	-0.015	193	-0.0151
819.65	-0.016	192.8	-0.0169
819.67	-0.016	192.7	-0.0178

Prova triassiale ciclica SN04-C1			
pressione di confinamento (kPa)		80	
deviatore ciclico (kPa)		95	
frequenza (hz)		0.00625	
tempo	cella di carico	$\Delta u$	LVDT
(min)	kN	(kPa)	$\delta$ (mm)
819.68	-0.017	192.5	-0.0178
819.70	-0.017	192.5	-0.0186
819.72	-0.017	192.4	-0.0186
819.73	-0.017	192.2	-0.0195
819.75	-0.017	192.1	-0.0195
819.77	-0.017	192	-0.0186
819.78	-0.017	192	-0.0186
819.80	-0.016	192	-0.0178
819.82	-0.015	191.9	-0.0178
819.83	-0.015	191.9	-0.016
819.85	-0.013	191.9	-0.016
819.87	-0.012	191.9	-0.0142
819.88	-0.012	192	-0.0133
819.90	-0.011	192	-0.0107
819.92	-0.008	192.2	-0.008
819.93	-0.007	192.2	-0.0062
819.95	-0.006	192.4	-0.0027
819.97	-0.002	192.6	-0.0027
819.98	-0.002	192.6	0
820.00	-0.002	192.7	0.0027
820.02	0	192.9	0.0071
820.03	0.003	193.2	0.0107
820.05	0.005	193.4	0.0142
820.07	0.006	193.6	0.0186
820.08	0.01	193.9	0.0186
820.10	0.011	193.9	0.0222
820.12	0.011	194.1	0.0257
820.15	0.012	194.3	0.0302
820.17	0.016	194.6	0.0346
820.18	0.017	194.8	0.0373
820.20	0.018	195.1	0.0408
820.22	0.021	195.4	0.0408
820.22	0.022	195.7	0.0444
820.23	0.022	195.7	0.0462
820.25	0.023	195.9	0.0497
820.27	0.025	196.1	0.0524
820.28	0.026	196.3	0.0541
820.30	0.026	196.5	0.0559
820.32	0.027	196.7	0.0559
820.33	0.028	196.9	0.0568
820.35	0.028	196.9	0.0586
820.37	0.028	197.1	0.0586
820.38	0.029	197.2	0.0595
820.40	0.029	197.3	0.0595
820.42	0.029	197.4	0.0595
820.43	0.029	197.5	0.0595
820.45	0.028	197.6	0.0595
820.47	0.027	197.6	0.0595
820.48	0.027	197.6	0.0586
820.50	0.027	197.7	0.0577
820.52	0.025	197.6	0.0559
820.53	0.025	197.7	0.055
820.55	0.024	197.6	0.0524
820.57	0.021	197.5	0.0506
820.58	0.02	197.4	0.0488
820.60	0.019	197.3	0.0453
820.62	0.015	197.2	0.0453
820.63	0.015	197.2	0.0426

Prova triassiale ciclica SN04-C1			
pressione di confinamento (kPa)		80	
deviatore ciclico (kPa)		95	
frequenza (hz)		0.00625	
tempo	cella di carico	$\Delta u$	LVDT
(min)	kN	(kPa)	$\delta$ (mm)
820.65	0.015	197.1	0.0399
820.67	0.013	196.9	0.0364
820.68	0.01	196.7	0.0328
820.70	0.009	196.5	0.0302
820.72	0.007	196.3	0.0257
820.73	0.003	196	0.0257
820.75	0.002	196	0.0213
820.77	0.002	195.8	0.0178
820.78	0.001	195.6	0.0133
820.80	-0.003	195.2	0.0098
820.82	-0.004	195	0.0071
820.83	-0.005	194.7	0.0027
820.85	-0.008	194.4	0.0027
820.87	-0.009	194.1	-0.0009
820.88	-0.009	194.1	-0.0036
820.90	-0.01	193.9	-0.0071
820.92	-0.012	193.6	-0.0089
820.93	-0.013	193.4	-0.0115
820.95	-0.014	193.2	-0.0133
820.97	-0.015	192.9	-0.0133
820.98	-0.016	192.8	-0.0151
821.00	-0.016	192.8	-0.0169
821.02	-0.017	192.6	-0.0178
821.03	-0.017	192.4	-0.0186
821.05	-0.017	192.3	-0.0195
821.07	-0.017	192.2	-0.0195
821.08	-0.017	192.1	-0.0195
821.10	-0.017	192	-0.0195
821.12	-0.016	192	-0.0186
821.13	-0.016	192	-0.0186
821.15	-0.016	191.9	-0.0178
821.17	-0.014	191.9	-0.016
821.18	-0.014	191.9	-0.0151
821.20	-0.013	192	-0.0133
821.22	-0.01	192.1	-0.0133
821.23	-0.01	192.1	-0.0107
821.25	-0.008	192.2	-0.008
821.27	-0.007	192.3	-0.008
821.28	-0.005	192.3	-0.0062
821.30	-0.005	192.4	-0.0027
821.32	-0.004	192.6	0.0009
821.33	0	192.8	0.0044
821.35	0.001	192.9	0.008
821.37	0.003	193.2	0.0124
821.38	0.007	193.4	0.0124
821.40	0.007	193.4	0.016
821.42	0.007	193.6	0.0186
821.43	0.009	193.8	0.0231
821.45	0.012	194.1	0.0284
821.47	0.014	194.4	0.0311
821.48	0.015	194.6	0.0346
821.50	0.018	194.9	0.0346
821.52	0.02	195.2	0.0391
821.53	0.02	195.2	0.0417
821.55	0.02	195.4	0.0453
821.57	0.022	195.7	0.0479
821.58	0.024	196	0.0497
821.62	0.025	196.1	0.0524

Prova triassiale ciclica SN04-C1			
pressione di confinamento (kPa)		80	
deviatore ciclico (kPa)		95	
frequenza (hz)		0.00625	
tempo	cella di carico	$\Delta u$	LVDT
(min)	kN	(kPa)	$\delta$ (mm)
821.63	0.026	196.4	0.0524
821.65	0.027	196.6	0.055
821.67	0.027	196.6	0.0568
821.67	0.028	196.8	0.0577
821.68	0.028	196.9	0.0586
821.70	0.029	197.1	0.0595
821.72	0.029	197.2	0.0595
821.73	0.029	197.3	0.0604
821.75	0.029	197.5	0.0604
821.77	0.029	197.5	0.0604
821.78	0.029	197.6	0.0595
821.80	0.028	197.6	0.0586
821.82	0.027	197.6	0.0577
821.83	0.026	197.6	0.0568
821.85	0.025	197.6	0.055
821.87	0.023	197.6	0.055
821.88	0.022	197.6	0.0533
821.90	0.022	197.5	0.0515
821.92	0.021	197.4	0.0488
821.93	0.018	197.3	0.0462
821.95	0.017	197.2	0.0444
821.97	0.016	197.1	0.0408
821.98	0.013	197	0.0391
822.00	0.012	196.8	0.0364
822.02	0.011	196.6	0.0328
822.03	0.007	196.4	0.0328
822.05	0.006	196.4	0.0284
822.07	0.006	196.2	0.024
822.08	0.004	196	0.0204
822.10	0	195.7	0.016
822.12	0	195.4	0.0133
822.13	-0.002	195.1	0.0089
822.15	-0.006	194.8	0.0089
822.17	-0.006	194.8	0.0044
822.18	-0.006	194.6	0.0018
822.20	-0.007	194.3	-0.0018
822.22	-0.011	194	-0.0053
822.23	-0.011	193.8	-0.0071
822.25	-0.012	193.5	-0.0098
822.27	-0.014	193.3	-0.0098
822.28	-0.015	193.3	-0.0124
822.30	-0.015	193.1	-0.0133
822.32	-0.016	192.9	-0.016
822.33	-0.016	192.7	-0.0169
822.35	-0.017	192.5	-0.0178
822.37	-0.017	192.4	-0.0178
822.38	-0.017	192.3	-0.0178
822.40	-0.017	192.2	-0.0186
822.42	-0.017	192.2	-0.0195
822.43	-0.017	192.1	-0.0195
822.45	-0.017	192	-0.0186
822.47	-0.016	191.9	-0.0178
822.48	-0.015	191.9	-0.0169
822.50	-0.014	191.9	-0.0169
822.52	-0.013	192	-0.016
822.53	-0.013	192	-0.0142
822.55	-0.012	192	-0.0124
822.57	-0.01	192.1	-0.0098

Prova triassiale ciclica SN04-C1			
pressione di confinamento (kPa)		80	
deviatore ciclico (kPa)		95	
frequenza (hz)		0.00625	
tempo	cella di carico	$\Delta u$	LVDT
(min)	kN	(kPa)	$\delta$ (mm)
822.58	-0.009	192.2	-0.008
822.60	-0.008	192.2	-0.0053
822.62	-0.005	192.5	-0.0053
822.63	-0.003	192.6	-0.0018
822.65	-0.003	192.6	0.0009
822.67	-0.002	192.7	0.0044
822.68	0.001	193	0.008
822.70	0.003	193.1	0.0107
822.72	0.003	193.3	0.0133
822.73	0.006	193.6	0.0169
822.75	0.009	193.8	0.0204
822.77	0.01	194	0.024
822.78	0.012	194.3	0.0293
822.80	0.015	194.5	0.0293
822.82	0.015	194.5	0.0328
822.83	0.016	194.7	0.0373
822.85	0.018	195	0.0408
822.87	0.02	195.3	0.0435
822.88	0.021	195.6	0.0462
822.90	0.022	195.8	0.0479
822.92	0.025	196.1	0.0479
822.93	0.025	196.1	0.0515
822.95	0.025	196.3	0.0533
822.97	0.026	196.5	0.055
822.98	0.027	196.7	0.0568
823.00	0.028	196.9	0.0577
823.02	0.028	197	0.0586
823.03	0.029	197.2	0.0586
823.05	0.029	197.2	0.0595
823.08	0.029	197.3	0.0604
823.10	0.029	197.4	0.0604
823.12	0.029	197.5	0.0604
823.12	0.028	197.6	0.0595
823.13	0.028	197.6	0.0586
823.15	0.026	197.6	0.0586
823.17	0.026	197.6	0.0577
823.18	0.026	197.6	0.0568
823.20	0.025	197.6	0.0541
823.22	0.022	197.5	0.0524
823.23	0.021	197.5	0.0506
823.25	0.02	197.4	0.0479
823.27	0.017	197.3	0.0479
823.28	0.017	197.3	0.0453
823.30	0.017	197.2	0.0426
823.32	0.015	197	0.0399
823.33	0.011	196.8	0.0355
823.35	0.01	196.7	0.0328
823.37	0.009	196.4	0.0293
823.38	0.005	196.2	0.0293
823.40	0.004	196.2	0.024
823.42	0.003	195.8	0.0195
823.43	0.001	195.6	0.0195
823.45	-0.001	195.6	0.0169
823.47	-0.001	195.3	0.0124
823.48	-0.002	195	0.008
823.50	-0.006	194.7	0.0036
823.52	-0.007	194.4	0.0009
823.53	-0.008	194.2	-0.0027



Prova triassiale ciclica SN04-C1			
pressione di confinamento (kPa)		80	
deviatore ciclico (kPa)		95	
frequenza (hz)		0.00625	
tempo	cella di carico	$\Delta u$	LVDT
(min)	kN	(kPa)	$\delta$ (mm)
823.55	-0.011	193.9	-0.0027
823.57	-0.011	193.9	-0.0053
823.58	-0.011	193.7	-0.0071
823.60	-0.013	193.4	-0.0098
823.62	-0.014	193.2	-0.0124
823.63	-0.015	193	-0.0142
823.65	-0.015	192.8	-0.0151
823.67	-0.016	192.6	-0.0151
823.68	-0.017	192.4	-0.0169
823.70	-0.017	192.4	-0.0178
823.72	-0.017	192.3	-0.0186
823.73	-0.017	192.2	-0.0186
823.75	-0.017	192.1	-0.0186
823.77	-0.017	192	-0.0186
823.78	-0.016	191.9	-0.0186
823.80	-0.016	191.9	-0.0178
823.82	-0.016	191.9	-0.0169
823.83	-0.015	191.9	-0.016
823.85	-0.014	191.9	-0.0142
823.87	-0.012	191.9	-0.0133
823.88	-0.012	192	-0.0115
823.90	-0.01	192.1	-0.0089
823.92	-0.007	192.2	-0.0089
823.93	-0.006	192.2	-0.0062
823.95	-0.006	192.3	-0.0044
823.97	-0.005	192.5	-0.0009
823.98	-0.001	192.6	0.0027
824.00	-0.001	192.8	0.0053
824.02	0.001	193	0.0098
824.03	0.005	193.2	0.0098
824.05	0.005	193.2	0.0133
824.07	0.005	193.4	0.016
824.08	0.007	193.7	0.0204
824.10	0.011	194	0.0249
824.12	0.012	194.1	0.0284
824.13	0.013	194.4	0.032
824.15	0.017	194.7	0.0364
824.17	0.017	194.9	0.0373
824.18	0.018	195.1	0.0408
824.20	0.021	195.4	0.0408
824.22	0.022	195.4	0.0444
824.23	0.022	195.7	0.047
824.25	0.023	195.9	0.0497
824.27	0.025	196.1	0.0524
824.28	0.026	196.3	0.0541
824.30	0.027	196.5	0.0559
824.32	0.027	196.7	0.0559
824.33	0.028	196.7	0.0577
824.35	0.028	196.9	0.0586
824.37	0.028	197	0.0595
824.38	0.029	197.2	0.0595
824.40	0.029	197.3	0.0604
824.42	0.029	197.4	0.0604
824.43	0.029	197.5	0.0604
824.45	0.028	197.6	0.0604
824.47	0.028	197.6	0.0595
824.48	0.027	197.6	0.0586
824.52	0.026	197.6	0.0568

Prova triassiale ciclica SN04-C1			
pressione di confinamento (kPa)		80	
deviatore ciclico (kPa)		95	
frequenza (hz)		0.00625	
tempo	cella di carico	$\Delta u$	LVDT
(min)	kN	(kPa)	$\delta$ (mm)
824.53	0.025	197.6	0.0559
824.55	0.024	197.6	0.0541
824.57	0.022	197.5	0.0515
824.58	0.021	197.4	0.0515
824.58	0.021	197.4	0.0506
824.60	0.019	197.4	0.047
824.62	0.017	197.2	0.0435
824.63	0.015	197.1	0.0417
824.65	0.014	196.9	0.0382
824.67	0.011	196.7	0.0346
824.68	0.009	196.5	0.0346
824.70	0.009	196.5	0.032
824.72	0.008	196.4	0.0275
824.73	0.005	196.1	0.0231
824.75	0.003	195.8	0.0195
824.77	0.002	195.6	0.016
824.78	-0.001	195.2	0.0115
824.80	-0.004	195	0.0115
824.82	-0.004	195	0.008
824.83	-0.004	194.8	0.0044
824.85	-0.006	194.4	0.0009
824.87	-0.009	194.2	-0.0027
824.88	-0.01	194	-0.0053
824.90	-0.01	193.7	-0.0071
824.92	-0.012	193.5	-0.0098
824.93	-0.013	193.3	-0.0115
824.95	-0.014	193	-0.0142
824.97	-0.016	192.8	-0.0142
824.98	-0.016	192.8	-0.016
825.00	-0.016	192.6	-0.0169
825.02	-0.016	192.5	-0.0178
825.03	-0.017	192.3	-0.0186
825.05	-0.017	192.2	-0.0186
825.07	-0.017	192.1	-0.0195
825.08	-0.017	192	-0.0195
825.10	-0.017	192	-0.0195
825.12	-0.017	191.9	-0.0186
825.13	-0.016	191.9	-0.0186
825.15	-0.015	191.8	-0.0178
825.17	-0.015	191.8	-0.0169
825.18	-0.014	191.9	-0.0151
825.20	-0.011	191.9	-0.0151
825.22	-0.011	191.9	-0.0133
825.23	-0.011	192	-0.0115
825.25	-0.009	192.1	-0.0089
825.27	-0.007	192.2	-0.0062
825.28	-0.006	192.3	-0.0036
825.30	-0.004	192.5	-0.0009
825.32	-0.001	192.7	-0.0009
825.33	0	192.7	0.0027
825.35	0	192.8	0.0062
825.37	0.002	193.1	0.0098
825.38	0.005	193.3	0.0133
825.40	0.006	193.5	0.0169
825.42	0.008	193.8	0.0213
825.43	0.012	194.1	0.0213
825.45	0.013	194.1	0.0257
825.47	0.013	194.2	0.0293

Prova triassiale ciclica SN04-C1			
pressione di confinamento (kPa)		80	
deviatore ciclico (kPa)		95	
frequenza (hz)		0.00625	
tempo	cella di carico	$\Delta u$	LVDT
(min)	kN	(kPa)	$\delta$ (mm)
825.48	0.014	194.5	0.0328
825.50	0.017	194.8	0.0364
825.52	0.018	195	0.0399
825.53	0.02	195.3	0.0435
825.55	0.022	195.6	0.0435
825.57	0.023	195.6	0.0462
825.58	0.023	195.8	0.0479
825.60	0.025	196.2	0.0506
825.62	0.026	196.2	0.0524
825.63	0.026	196.4	0.0533
825.65	0.027	196.6	0.0559
825.67	0.028	196.8	0.0577
825.68	0.028	197	0.0577
825.70	0.029	197.1	0.0586
825.72	0.029	197.2	0.0586
825.73	0.029	197.4	0.0586
825.75	0.029	197.4	0.0586
825.77	0.029	197.4	0.0586
825.78	0.028	197.5	0.0586
825.80	0.028	197.6	0.0586
825.82	0.027	197.6	0.0568
825.83	0.026	197.6	0.0568
825.85	0.024	197.6	0.055
825.87	0.024	197.6	0.0541
825.88	0.024	197.6	0.0515
825.90	0.022	197.4	0.0497
825.92	0.02	197.4	0.0479
825.93	0.019	197.3	0.0453
825.95	0.016	197.1	0.0453
825.98	0.014	197	0.0417
826.00	0.014	197	0.0391
826.02	0.013	196.9	0.0355
826.03	0.011	196.6	0.032
826.03	0.008	196.4	0.0284
826.05	0.007	196.3	0.024
826.07	0.005	196	0.0204
826.08	0.002	195.7	0.0204
826.10	0.002	195.7	0.0169
826.12	0.001	195.5	0.0124
826.13	-0.002	195.1	0.0089
826.15	-0.005	194.9	0.0044
826.17	-0.005	194.6	0.0018
826.18	-0.007	194.3	-0.0018
826.20	-0.01	194.1	-0.0018
826.22	-0.01	194.1	-0.0053
826.23	-0.01	193.8	-0.008
826.25	-0.012	193.5	-0.0107
826.27	-0.014	193.3	-0.0133
826.28	-0.014	193.1	-0.0142
826.30	-0.015	192.9	-0.016
826.32	-0.016	192.7	-0.016
826.33	-0.016	192.6	-0.0186
826.35	-0.017	192.4	-0.0195
826.37	-0.017	192.3	-0.0195
826.38	-0.017	192.3	-0.0204
826.40	-0.017	192.1	-0.0204
826.42	-0.017	192	-0.0204
826.43	-0.017	191.9	-0.0204

Prova triassiale ciclica SN04-C1			
pressione di confinamento (kPa)		80	
deviatore ciclico (kPa)		95	
frequenza (hz)		0.00625	
tempo	cella di carico	$\Delta u$	LVDT
(min)	kN	(kPa)	$\delta$ (mm)
826.45	-0.016	191.9	-0.0195
826.47	-0.016	191.8	-0.0195
826.48	-0.014	191.8	-0.0195
826.50	-0.014	191.8	-0.0178
826.52	-0.014	191.8	-0.0169
826.53	-0.013	191.9	-0.0151
826.55	-0.011	191.9	-0.0133
826.57	-0.01	192	-0.0115
826.58	-0.009	192.1	-0.0089
826.60	-0.006	192.3	-0.0089
826.62	-0.005	192.3	-0.0062
826.63	-0.005	192.4	-0.0036
826.65	-0.003	192.5	0
826.67	0	192.7	0.0036
826.68	0.001	192.9	0.0062
826.70	0.002	193.1	0.0098
826.72	0.006	193.4	0.0098
826.73	0.008	193.6	0.0142
826.75	0.008	193.6	0.0178
826.77	0.009	193.8	0.0213
826.78	0.012	194.1	0.0257
826.80	0.014	194.3	0.0302
826.82	0.015	194.5	0.0328
826.83	0.017	194.8	0.0328
826.85	0.02	195.1	0.0364
826.87	0.02	195.1	0.0399
826.88	0.02	195.3	0.0435
826.90	0.023	195.7	0.0462
826.92	0.024	195.9	0.0488
826.93	0.025	196.1	0.0506
826.95	0.026	196.3	0.0533
826.97	0.027	196.6	0.0533
826.98	0.027	196.6	0.055
827.00	0.027	196.7	0.0559
827.02	0.028	196.9	0.0568
827.03	0.029	197.1	0.0577
827.05	0.029	197.2	0.0577
827.07	0.029	197.3	0.0577
827.08	0.029	197.4	0.0586
827.10	0.029	197.5	0.0577
827.12	0.028	197.6	0.0577
827.13	0.027	197.6	0.0577
827.15	0.026	197.6	0.0568
827.17	0.026	197.6	0.0559
827.18	0.026	197.6	0.0541
827.20	0.023	197.6	0.0524
827.22	0.023	197.6	0.0506
827.23	0.022	197.5	0.0488
827.25	0.019	197.3	0.0488
827.27	0.018	197.3	0.0453
827.28	0.018	197.3	0.0435
827.30	0.016	197.1	0.0399
827.32	0.013	196.9	0.0364
827.33	0.012	196.8	0.0337
827.35	0.011	196.6	0.0302
827.37	0.007	196.3	0.0302
827.38	0.006	196.3	0.0257
827.42	0.006	196.2	0.0222

Prova triassiale ciclica SN04-C1			
pressione di confinamento (kPa)		80	
deviatore ciclico (kPa)		95	
frequenza (hz)		0.00625	
tempo	cella di carico	$\Delta u$	LVDT
(min)	kN	(kPa)	$\delta$ (mm)
827.43	0.004	195.9	0.0186
827.45	0.001	195.6	0.0142
827.47	0	195.4	0.0115
827.48	-0.002	195.1	0.0071
827.48	-0.005	194.8	0.0071
827.50	-0.006	194.5	0.0027
827.52	-0.006	194.5	0
827.53	-0.007	194.3	-0.0036
827.55	-0.01	194	-0.0071
827.57	-0.011	193.8	-0.0089
827.58	-0.012	193.5	-0.0115
827.60	-0.014	193.2	-0.0115
827.62	-0.015	193.1	-0.0142
827.63	-0.015	193.1	-0.016
827.65	-0.015	192.9	-0.0169
827.67	-0.016	192.7	-0.0178
827.68	-0.017	192.5	-0.0195
827.70	-0.017	192.3	-0.0204
827.72	-0.017	192.2	-0.0204
827.73	-0.017	192.1	-0.0204
827.75	-0.017	192.1	-0.0204
827.77	-0.017	192	-0.0204
827.78	-0.016	191.9	-0.0195
827.80	-0.015	191.9	-0.0195
827.82	-0.015	191.8	-0.0186
827.83	-0.015	191.8	-0.0178
827.85	-0.013	191.8	-0.016
827.87	-0.013	191.9	-0.0151
827.88	-0.011	192	-0.0124
827.90	-0.009	192.1	-0.0124
827.92	-0.008	192.1	-0.0107
827.93	-0.008	192.1	-0.008
827.95	-0.006	192.3	-0.0044
827.97	-0.003	192.5	-0.0018
827.98	-0.002	192.6	0.0009
828.00	-0.001	192.8	0.0044
828.02	0.003	193	0.0044
828.03	0.004	193	0.008
828.05	0.004	193.2	0.0115
828.07	0.006	193.5	0.016
828.08	0.009	193.7	0.0195
828.10	0.01	193.9	0.0222
828.12	0.011	194.2	0.0275
828.13	0.015	194.4	0.0275
828.15	0.016	194.4	0.032
828.17	0.016	194.6	0.0346
828.18	0.017	194.9	0.0382
828.20	0.02	195.2	0.0417
828.22	0.021	195.4	0.0444
828.23	0.022	195.7	0.0479
828.25	0.025	196	0.0479
828.27	0.025	196	0.0506
828.28	0.025	196.2	0.0515
828.30	0.026	196.4	0.0541
828.32	0.027	196.6	0.0559
828.33	0.028	196.8	0.0568
828.35	0.028	196.9	0.0577
828.37	0.028	197.1	0.0577

Prova triassiale ciclica SN04-C1			
pressione di confinamento (kPa)		80	
deviatore ciclico (kPa)		95	
frequenza (hz)		0.00625	
tempo	cella di carico	$\Delta u$	LVDT
(min)	kN	(kPa)	$\delta$ (mm)
828.38	0.029	197.1	0.0586
828.40	0.029	197.2	0.0586
828.42	0.029	197.3	0.0586
828.43	0.029	197.4	0.0586
828.45	0.028	197.5	0.0586
828.47	0.028	197.5	0.0577
828.48	0.026	197.5	0.0577
828.50	0.025	197.5	0.0559
828.52	0.025	197.6	0.0541
828.53	0.024	197.5	0.0541
828.55	0.022	197.5	0.0524
828.57	0.022	197.5	0.0506
828.58	0.021	197.4	0.0479
828.60	0.018	197.3	0.0453
828.62	0.017	197.2	0.0426
828.63	0.016	197.1	0.0399
828.65	0.013	196.8	0.0399
828.67	0.011	196.7	0.0364
828.68	0.011	196.7	0.0337
828.70	0.01	196.5	0.0302
828.72	0.007	196.2	0.0249
828.73	0.005	196	0.0222
828.75	0.003	195.8	0.0178
828.77	0	195.5	0.0178
828.78	-0.002	195.2	0.0133
828.80	-0.002	195.2	0.0098
828.82	-0.003	195	0.0071
828.83	-0.005	194.7	0.0027
828.85	-0.007	194.4	0
828.88	-0.008	194.2	-0.0036
828.90	-0.01	193.9	-0.0036
828.92	-0.012	193.6	-0.0071
828.93	-0.012	193.6	-0.0098
828.93	-0.013	193.4	-0.0124
828.95	-0.014	193.1	-0.0142
828.97	-0.016	192.9	-0.016
828.98	-0.016	192.7	-0.0169
829.00	-0.016	192.6	-0.0186
829.02	-0.017	192.4	-0.0186
829.03	-0.017	192.4	-0.0195
829.05	-0.017	192.2	-0.0195
829.07	-0.017	192.1	-0.0204
829.08	-0.017	192	-0.0204
829.10	-0.017	191.9	-0.0204
829.12	-0.017	191.9	-0.0195
829.13	-0.016	191.8	-0.0195
829.15	-0.015	191.8	-0.0186
829.17	-0.015	191.8	-0.0178
829.18	-0.014	191.9	-0.016
829.20	-0.012	191.9	-0.0142
829.22	-0.011	191.9	-0.0133
829.23	-0.01	192	-0.0107
829.25	-0.008	192.1	-0.0089
829.27	-0.008	192.1	-0.0071
829.28	-0.006	192.3	-0.0036
829.30	-0.002	192.5	-0.0036
829.32	-0.002	192.5	0
829.33	-0.002	192.6	0.0027

Prova triassiale ciclica SN04-C1			
pressione di confinamento (kPa)		80	
deviatore ciclico (kPa)		95	
frequenza (hz)		0.00625	
tempo	cella di carico	$\Delta u$	LVDT
(min)	kN	(kPa)	$\delta$ (mm)
829.35	0	192.8	0.0062
829.37	0.004	193.1	0.0098
829.38	0.005	193.2	0.0124
829.40	0.006	193.5	0.0169
829.42	0.01	193.8	0.0169
829.43	0.011	193.8	0.0222
829.45	0.011	194	0.0249
829.47	0.012	194.2	0.0293
829.48	0.016	194.5	0.0337
829.50	0.017	194.7	0.0355
829.52	0.018	195	0.0399
829.53	0.021	195.3	0.0399
829.55	0.022	195.6	0.0435
829.57	0.022	195.6	0.0462
829.58	0.023	195.8	0.0488
829.60	0.025	196.1	0.0515
829.62	0.026	196.2	0.0533
829.63	0.026	196.4	0.055
829.65	0.027	196.6	0.055
829.67	0.028	196.8	0.0568
829.68	0.028	196.8	0.0577
829.70	0.028	197	0.0586
829.72	0.029	197.1	0.0586
829.73	0.029	197.2	0.0595
829.75	0.029	197.4	0.0595
829.77	0.029	197.5	0.0595
829.78	0.028	197.5	0.0595
829.80	0.028	197.5	0.0586
829.82	0.027	197.5	0.0577
829.83	0.026	197.5	0.0559
829.85	0.025	197.5	0.0541
829.87	0.024	197.5	0.0533
829.88	0.023	197.5	0.0506
829.90	0.021	197.4	0.0506
829.92	0.021	197.4	0.0488
829.93	0.019	197.3	0.0453
829.95	0.017	197.1	0.0435
829.97	0.015	197	0.0408
829.98	0.015	196.9	0.0391
830.00	0.013	196.7	0.0355
830.02	0.01	196.5	0.032
830.03	0.009	196.4	0.0293
830.05	0.007	196.1	0.0249
830.07	0.004	195.9	0.0249
830.08	0.002	195.9	0.0204
830.10	0.002	195.7	0.0169
830.12	0.001	195.4	0.0133
830.13	-0.003	195.1	0.0089
830.15	-0.004	194.8	0.0062
830.17	-0.005	194.5	0.0018
830.18	-0.008	194.3	0.0018
830.20	-0.009	194.3	-0.0018
830.22	-0.009	194	-0.0044
830.23	-0.01	193.7	-0.008
830.25	-0.013	193.5	-0.0107
830.27	-0.013	193.3	-0.0115
830.28	-0.014	193	-0.0142
830.30	-0.016	192.8	-0.0142

Prova triassiale ciclica SN04-C1			
pressione di confinamento (kPa)		80	
deviatore ciclico (kPa)		95	
frequenza (hz)		0.00625	
tempo	cella di carico	$\Delta u$	LVDT
(min)	kN	(kPa)	$\delta$ (mm)
830.33	-0.016	192.8	-0.016
830.35	-0.016	192.7	-0.0178
830.37	-0.017	192.5	-0.0186
830.38	-0.017	192.3	-0.0195
830.38	-0.017	192.2	-0.0195
830.40	-0.017	192.1	-0.0195
830.42	-0.017	192	-0.0195
830.43	-0.017	192	-0.0195
830.45	-0.017	191.9	-0.0195
830.47	-0.016	191.8	-0.0186
830.48	-0.015	191.8	-0.0178
830.50	-0.015	191.8	-0.0169
830.52	-0.014	191.8	-0.0151
830.53	-0.011	191.9	-0.0151
830.55	-0.011	191.9	-0.0133
830.57	-0.011	191.9	-0.0124
830.58	-0.01	192	-0.0089
830.60	-0.007	192.2	-0.0062
830.62	-0.006	192.3	-0.0044
830.63	-0.004	192.4	-0.0009
830.65	-0.001	192.6	-0.0009
830.67	0	192.6	0.0027
830.68	0.002	193	0.008
830.70	0.003	193.1	0.008
830.72	0.005	193.3	0.0107
830.73	0.005	193.3	0.0142
830.75	0.007	193.6	0.0195
830.77	0.01	193.9	0.024
830.78	0.012	194.1	0.0275
830.80	0.014	194.3	0.0311
830.82	0.016	194.6	0.0311
830.83	0.018	194.9	0.0346
830.85	0.018	194.9	0.0382
830.87	0.019	195.1	0.0417
830.88	0.021	195.4	0.0453
830.90	0.023	195.7	0.0479
830.92	0.023	195.9	0.0497
830.93	0.025	196.2	0.0515
830.95	0.027	196.4	0.0515
830.97	0.027	196.4	0.0541
830.98	0.027	196.5	0.0559
831.00	0.028	196.7	0.0568
831.02	0.029	196.9	0.0577
831.03	0.028	197	0.0586
831.05	0.029	197.2	0.0586
831.07	0.029	197.3	0.0586
831.08	0.029	197.3	0.0595
831.10	0.029	197.4	0.0595
831.12	0.028	197.5	0.0595
831.13	0.028	197.5	0.0586
831.15	0.027	197.5	0.0577
831.17	0.026	197.5	0.0559
831.18	0.024	197.5	0.0559
831.20	0.023	197.5	0.0541
831.22	0.023	197.5	0.0524
831.23	0.022	197.4	0.0497
831.25	0.02	197.3	0.0479
831.27	0.019	197.3	0.0462



Prova triassiale ciclica SN04-C1			
pressione di confinamento (kPa)		80	
deviatore ciclico (kPa)		95	
frequenza (hz)		0.00625	
tempo	cella di carico	$\Delta u$	LVDT
(min)	kN	(kPa)	$\delta$ (mm)
831.28	0.017	197.1	0.0426
831.30	0.014	196.9	0.0426
831.32	0.013	196.9	0.0382
831.33	0.013	196.8	0.0373
831.35	0.012	196.6	0.0328
831.37	0.008	196.4	0.0293
831.38	0.007	196.2	0.0257
831.40	0.005	196	0.0213
831.42	0.001	195.7	0.0169
831.43	0.001	195.5	0.0151
831.45	0	195.3	0.0115
831.47	-0.003	194.9	0.0115
831.48	-0.005	194.7	0.0071
831.50	-0.005	194.7	0.0044
831.52	-0.006	194.5	0.0009
831.53	-0.009	194.1	-0.0027
831.55	-0.01	193.9	-0.0053
831.57	-0.011	193.7	-0.0089
831.58	-0.013	193.4	-0.0089
831.60	-0.014	193.2	-0.0115
831.62	-0.014	193.2	-0.0124
831.63	-0.014	193	-0.0142
831.65	-0.015	192.7	-0.0169
831.67	-0.017	192.5	-0.0186
831.68	-0.017	192.4	-0.0186
831.70	-0.017	192.3	-0.0186
831.72	-0.017	192.1	-0.0195
831.73	-0.017	192.1	-0.0195
831.75	-0.017	192	-0.0195
831.78	-0.017	191.9	-0.0195
831.80	-0.017	191.9	-0.0195
831.82	-0.016	191.8	-0.0186
831.83	-0.015	191.8	-0.0186
831.83	-0.014	191.8	-0.0178
831.85	-0.014	191.8	-0.0169
831.87	-0.013	191.8	-0.0142
831.88	-0.011	191.9	-0.0124
831.90	-0.01	192	-0.0107
831.92	-0.009	192	-0.008
831.93	-0.006	192.2	-0.008
831.95	-0.005	192.3	-0.0053
831.97	-0.005	192.3	-0.0027
831.98	-0.003	192.5	0.0009
832.00	-0.001	192.7	0.0044
832.02	0.002	192.9	0.0071
832.03	0.003	193	0.0107
832.05	0.005	193.3	0.0142
832.07	0.008	193.6	0.0142
832.08	0.008	193.6	0.0186
832.10	0.009	193.7	0.0222
832.12	0.012	194	0.0275
832.13	0.014	194.3	0.0302
832.15	0.014	194.5	0.0328
832.17	0.016	194.8	0.0364
832.18	0.019	195	0.0399
832.20	0.02	195.2	0.0426
832.22	0.021	195.6	0.0453
832.23	0.023	195.8	0.0453

Prova triassiale ciclica SN04-C1			
pressione di confinamento (kPa)		80	
deviatore ciclico (kPa)		95	
frequenza (hz)		0.00625	
tempo	cella di carico	$\Delta u$	LVDT
(min)	kN	(kPa)	$\delta$ (mm)
832.25	0.024	195.8	0.0479
832.27	0.024	196	0.0506
832.28	0.025	196.2	0.0533
832.30	0.027	196.4	0.055
832.32	0.027	196.6	0.0559
832.33	0.027	196.8	0.0568
832.35	0.029	197	0.0568
832.37	0.029	197	0.0586
832.38	0.029	197.1	0.0586
832.40	0.029	197.2	0.0595
832.42	0.029	197.3	0.0595
832.43	0.029	197.4	0.0595
832.45	0.028	197.5	0.0586
832.47	0.027	197.5	0.0586
832.48	0.026	197.5	0.0577
832.50	0.026	197.6	0.0568
832.52	0.026	197.5	0.055
832.53	0.024	197.5	0.0533
832.55	0.023	197.5	0.0524
832.57	0.022	197.4	0.0497
832.58	0.019	197.3	0.0497
832.60	0.018	197.3	0.0462
832.62	0.018	197.2	0.0444
832.63	0.016	197	0.0408
832.65	0.013	196.8	0.0382
832.67	0.012	196.7	0.0355
832.68	0.011	196.5	0.032
832.70	0.006	196.3	0.032
832.72	0.006	196.3	0.0275
832.73	0.006	196.1	0.024
832.75	0.004	195.9	0.0204
832.77	0.001	195.6	0.016
832.78	0	195.3	0.0124
832.80	-0.002	195	0.0089
832.82	-0.005	194.7	0.0089
832.83	-0.006	194.7	0.0044
832.85	-0.006	194.5	0.0009
832.87	-0.009	194	-0.0027
832.88	-0.01	193.8	-0.0044
832.90	-0.01	193.8	-0.0071
832.92	-0.011	193.5	-0.0098
832.93	-0.013	193.2	-0.0124
832.95	-0.014	193	-0.0133
832.97	-0.015	192.8	-0.0151
832.98	-0.016	192.6	-0.0151
833.00	-0.017	192.4	-0.0169
833.02	-0.017	192.4	-0.0186
833.03	-0.017	192.3	-0.0186
833.05	-0.017	192.2	-0.0195
833.07	-0.017	192.1	-0.0204
833.08	-0.017	192	-0.0195
833.10	-0.017	191.9	-0.0195
833.12	-0.016	191.8	-0.0195
833.13	-0.016	191.8	-0.0186
833.15	-0.016	191.8	-0.0178
833.17	-0.015	191.8	-0.0169
833.18	-0.013	191.8	-0.016
833.20	-0.013	191.8	-0.0142

Prova triassiale ciclica SN04-C1			
pressione di confinamento (kPa)		80	
deviatore ciclico (kPa)		95	
frequenza (hz)		0.00625	
tempo	cella di carico	$\Delta u$	LVDT
(min)	kN	(kPa)	$\delta$ (mm)
833.22	-0.011	191.9	-0.0115
833.25	-0.009	192	-0.0115
833.27	-0.008	192	-0.0098
833.28	-0.008	192.1	-0.0071
833.30	-0.006	192.3	-0.0044
833.30	-0.004	192.4	-0.0009
833.32	-0.002	192.5	0.0018
833.33	-0.001	192.8	0.0053
833.35	0.003	193	0.0053
833.37	0.003	193	0.0089
833.38	0.003	193.1	0.0124
833.40	0.005	193.4	0.016
833.42	0.009	193.7	0.0204
833.43	0.01	193.8	0.0231
833.45	0.012	194.1	0.0284
833.47	0.015	194.4	0.0284
833.48	0.016	194.4	0.0328
833.50	0.016	194.6	0.0355
833.52	0.018	194.9	0.0391
833.53	0.02	195.1	0.0417
833.55	0.021	195.4	0.0453
833.57	0.022	195.7	0.0479
833.58	0.025	196	0.0479
833.60	0.025	196.1	0.0524
833.62	0.026	196.3	0.0541
833.63	0.027	196.5	0.0541
833.65	0.027	196.5	0.055
833.67	0.027	196.7	0.0568
833.68	0.028	196.9	0.0577
833.70	0.029	197	0.0586
833.72	0.029	197.1	0.0595
833.73	0.029	197.3	0.0595
833.75	0.029	197.4	0.0595
833.77	0.029	197.4	0.0595
833.78	0.029	197.5	0.0595
833.80	0.028	197.5	0.0577
833.82	0.027	197.5	0.0577
833.83	0.026	197.6	0.0559
833.85	0.025	197.5	0.0541
833.87	0.023	197.5	0.0541
833.88	0.022	197.5	0.0524
833.90	0.022	197.4	0.0515
833.92	0.021	197.4	0.0488
833.93	0.018	197.2	0.0453
833.95	0.017	197.1	0.0435
833.97	0.016	197	0.0399
833.98	0.013	196.8	0.0399
834.00	0.011	196.6	0.0373
834.02	0.011	196.6	0.0337
834.03	0.01	196.5	0.0302
834.05	0.006	196.2	0.0257
834.07	0.005	196	0.0222
834.08	0.004	195.8	0.0186
834.10	0	195.4	0.0186
834.12	-0.002	195.2	0.0142
834.13	-0.002	195.2	0.0107
834.15	-0.003	195	0.0071
834.17	-0.005	194.6	0.0036

Prova triassiale ciclica SN04-C1			
pressione di confinamento (kPa)		80	
deviatore ciclico (kPa)		95	
frequenza (hz)		0.00625	
tempo	cella di carico	$\Delta u$	LVDT
(min)	kN	(kPa)	$\delta$ (mm)
834.18	-0.007	194.4	0
834.20	-0.008	194.1	-0.0036
834.22	-0.01	193.8	-0.0036
834.23	-0.012	193.6	-0.0062
834.25	-0.012	193.6	-0.0089
834.27	-0.013	193.4	-0.0115
834.28	-0.014	193.1	-0.0142
834.30	-0.015	192.9	-0.0151
834.32	-0.016	192.7	-0.016
834.33	-0.016	192.5	-0.0169
834.35	-0.017	192.4	-0.0186
834.37	-0.017	192.2	-0.0195
834.38	-0.017	192.1	-0.0204
834.40	-0.017	192	-0.0204
834.42	-0.017	192	-0.0204
834.43	-0.017	191.9	-0.0195
834.45	-0.016	191.8	-0.0195
834.47	-0.016	191.8	-0.0186
834.48	-0.015	191.7	-0.0178
834.50	-0.015	191.8	-0.0169
834.52	-0.012	191.8	-0.0169
834.53	-0.012	191.8	-0.0151
834.55	-0.012	191.8	-0.0133
834.57	-0.011	191.9	-0.0115
834.58	-0.008	192	-0.008
834.60	-0.007	192.1	-0.0062
834.62	-0.006	192.3	-0.0036
834.63	-0.003	192.5	-0.0036
834.65	-0.001	192.5	0
834.68	-0.001	192.6	0.0027
834.70	0	192.8	0.0062
834.72	0.004	193	0.0107
834.73	0.005	193.2	0.0142
834.75	0.006	193.5	0.0178
834.75	0.01	193.7	0.0178
834.77	0.011	193.7	0.0222
834.78	0.011	193.9	0.0249
834.80	0.012	194.2	0.0302
834.82	0.016	194.5	0.0337
834.83	0.017	194.7	0.0373
834.85	0.018	194.9	0.0399
834.87	0.021	195.2	0.0399
834.88	0.022	195.2	0.0435
834.90	0.022	195.5	0.0462
834.92	0.023	195.7	0.0488
834.93	0.025	196	0.0515
834.95	0.026	196.2	0.0533
834.97	0.026	196.4	0.055
834.98	0.027	196.6	0.055
835.00	0.028	196.6	0.0568
835.02	0.028	196.8	0.0577
835.03	0.029	196.9	0.0586
835.05	0.029	197.2	0.0595
835.07	0.029	197.2	0.0595
835.08	0.029	197.3	0.0595
835.10	0.029	197.4	0.0595
835.12	0.028	197.5	0.0595
835.13	0.027	197.5	0.0577

Prova triassiale ciclica SN04-C1			
pressione di confinamento (kPa)		80	
deviatore ciclico (kPa)		95	
frequenza (hz)		0.00625	
tempo	cella di carico	$\Delta u$	LVDT
(min)	kN	(kPa)	$\delta$ (mm)
835.15	0.026	197.5	0.0577
835.17	0.026	197.5	0.0568
835.18	0.026	197.5	0.0559
835.20	0.025	197.5	0.0541
835.22	0.023	197.4	0.0515
835.23	0.021	197.4	0.0497
835.25	0.02	197.3	0.047
835.27	0.018	197.1	0.047
835.28	0.016	197	0.0444
835.30	0.016	197	0.0417
835.32	0.015	196.9	0.0391
835.33	0.012	196.7	0.0355
835.35	0.01	196.6	0.0328
835.37	0.009	196.4	0.0284
835.38	0.006	196.1	0.0284
835.40	0.004	195.9	0.024
835.42	0.004	195.9	0.0204
835.43	0.003	195.7	0.0169
835.45	0	195.2	0.0124
835.47	-0.003	195	0.008
835.48	-0.004	194.8	0.0044
835.50	-0.006	194.5	0.0018
835.52	-0.008	194.2	0.0018
835.53	-0.008	194.2	-0.0018
835.55	-0.009	194	-0.0044
835.57	-0.01	193.7	-0.0071
835.58	-0.013	193.4	-0.0107
835.60	-0.013	193.2	-0.0124
835.62	-0.015	193	-0.0151
835.63	-0.016	192.8	-0.0151
835.65	-0.016	192.8	-0.0169
835.67	-0.016	192.6	-0.0169
835.68	-0.016	192.4	-0.0186
835.70	-0.017	192.3	-0.0186
835.72	-0.017	192.1	-0.0195
835.73	-0.017	192	-0.0204
835.75	-0.017	191.9	-0.0204
835.77	-0.017	191.8	-0.0195
835.78	-0.016	191.8	-0.0195
835.80	-0.016	191.7	-0.0195
835.82	-0.015	191.7	-0.0186
835.83	-0.015	191.7	-0.0178
835.85	-0.014	191.8	-0.016
835.87	-0.012	191.8	-0.0142
835.88	-0.011	191.8	-0.0133
835.90	-0.01	191.9	-0.0098
835.92	-0.007	192	-0.0098
835.93	-0.007	192	-0.008
835.95	-0.007	192.1	-0.0053
835.97	-0.005	192.3	-0.0018
835.98	-0.002	192.5	0.0018
836.00	-0.001	192.7	0.0044
836.02	0.001	192.9	0.008
836.03	0.005	193.1	0.008
836.05	0.006	193.1	0.0124
836.07	0.006	193.3	0.0151
836.08	0.007	193.6	0.0195
836.10	0.011	193.8	0.024

Prova triassiale ciclica SN04-C1			
pressione di confinamento (kPa)		80	
deviatore ciclico (kPa)		95	
frequenza (hz)		0.00625	
tempo	cella di carico	$\Delta u$	LVDT
(min)	kN	(kPa)	$\delta$ (mm)
836.12	0.012	194	0.0275
836.15	0.013	194.3	0.032
836.17	0.017	194.6	0.032
836.18	0.017	194.6	0.0355
836.20	0.017	194.8	0.0382
836.20	0.019	195.1	0.0417
836.22	0.022	195.3	0.0453
836.23	0.023	195.6	0.047
836.25	0.023	195.8	0.0497
836.27	0.026	196.1	0.0497
836.28	0.026	196.1	0.0524
836.30	0.026	196.3	0.0541
836.32	0.027	196.5	0.0559
836.33	0.028	196.6	0.0568
836.35	0.028	196.8	0.0577
836.37	0.029	197	0.0586
836.38	0.029	197.1	0.0586
836.40	0.029	197.1	0.0586
836.42	0.029	197.2	0.0595
836.43	0.029	197.3	0.0595
836.45	0.028	197.4	0.0586
836.47	0.028	197.4	0.0586
836.48	0.027	197.5	0.0568
836.50	0.025	197.5	0.055
836.52	0.025	197.5	0.055
836.53	0.024	197.5	0.0524
836.55	0.022	197.4	0.0524
836.57	0.021	197.3	0.0506
836.58	0.021	197.3	0.0488
836.60	0.02	197.3	0.0462
836.62	0.017	197.1	0.0435
836.63	0.015	197	0.0408
836.65	0.014	196.8	0.0373
836.67	0.011	196.6	0.0373
836.68	0.009	196.4	0.0337
836.70	0.009	196.4	0.0311
836.72	0.008	196.2	0.0275
836.73	0.005	195.9	0.0222
836.75	0.003	195.7	0.0186
836.77	0.002	195.5	0.0151
836.78	-0.001	195.1	0.0151
836.80	-0.004	194.9	0.0107
836.82	-0.004	194.9	0.0071
836.83	-0.005	194.7	0.0036
836.85	-0.006	194.3	0
836.87	-0.009	194.1	-0.0027
836.88	-0.01	193.9	-0.0062
836.90	-0.012	193.5	-0.0062
836.92	-0.013	193.3	-0.0089
836.93	-0.013	193.3	-0.0115
836.95	-0.014	193.1	-0.0133
836.97	-0.015	192.9	-0.016
836.98	-0.016	192.7	-0.0169
837.00	-0.016	192.5	-0.0178
837.02	-0.017	192.3	-0.0178
837.03	-0.017	192.2	-0.0186
837.05	-0.017	192.2	-0.0195
837.07	-0.017	192	-0.0195

Prova triassiale ciclica SN04-C1			
pressione di confinamento (kPa)		80	
deviatore ciclico (kPa)		95	
frequenza (hz)		0.00625	
tempo	cella di carico	$\Delta u$	LVDT
(min)	kN	(kPa)	$\delta$ (mm)
837.08	-0.017	191.9	-0.0195
837.10	-0.017	191.9	-0.0195
837.12	-0.016	191.8	-0.0195
837.13	-0.016	191.8	-0.0195
837.15	-0.015	191.7	-0.0186
837.17	-0.015	191.7	-0.0178
837.18	-0.014	191.7	-0.016
837.20	-0.013	191.8	-0.0142
837.22	-0.011	191.9	-0.0124
837.23	-0.01	191.9	-0.0115
837.25	-0.009	192	-0.0089
837.27	-0.007	192.1	-0.0071
837.28	-0.006	192.2	-0.0036
837.30	-0.004	192.4	0
837.32	-0.001	192.6	0
837.33	0	192.6	0.0027
837.35	0	192.7	0.0053
837.37	0.002	192.9	0.0089
837.38	0.005	193.2	0.0133
837.40	0.006	193.4	0.0169
837.42	0.008	193.7	0.0204
837.43	0.012	193.9	0.0204
837.45	0.012	193.9	0.0249
837.47	0.012	194.1	0.0293
837.48	0.014	194.4	0.0328
837.50	0.017	194.7	0.0373
837.52	0.019	194.9	0.0399
837.53	0.02	195.2	0.0435
837.55	0.022	195.4	0.0435
837.58	0.023	195.4	0.0462
837.60	0.023	195.7	0.0488
837.62	0.024	196	0.0506
837.63	0.026	196.2	0.0533
837.65	0.027	196.4	0.055
837.65	0.027	196.5	0.0568
837.67	0.028	196.7	0.0568
837.68	0.028	196.7	0.0577
837.70	0.028	196.9	0.0586
837.72	0.029	197	0.0586
837.73	0.029	197.1	0.0586
837.75	0.029	197.3	0.0595
837.77	0.029	197.3	0.0595
837.78	0.028	197.4	0.0595
837.80	0.027	197.4	0.0586
837.82	0.027	197.4	0.0577
837.83	0.026	197.4	0.0559
837.85	0.025	197.4	0.055
837.87	0.024	197.4	0.0533
837.88	0.023	197.4	0.0515
837.90	0.02	197.3	0.0515
837.92	0.019	197.3	0.0488
837.93	0.019	197.2	0.0462
837.95	0.016	197	0.0444
837.97	0.015	197	0.0417
837.98	0.015	196.9	0.0399
838.00	0.013	196.7	0.0364
838.02	0.01	196.5	0.032
838.03	0.009	196.3	0.0293

Prova triassiale ciclica SN04-C1			
pressione di confinamento (kPa)		80	
deviatore ciclico (kPa)		95	
frequenza (hz)		0.00625	
tempo	cella di carico	$\Delta u$	LVDT
(min)	kN	(kPa)	$\delta$ (mm)
838.05	0.007	196.1	0.024
838.07	0.003	195.8	0.024
838.08	0.002	195.8	0.0204
838.10	0.002	195.6	0.0169
838.12	0.001	195.3	0.0133
838.13	-0.003	195	0.0089
838.15	-0.004	194.8	0.0062
838.17	-0.005	194.5	0.0018
838.18	-0.008	194.2	0.0018
838.20	-0.009	194.2	-0.0018
838.22	-0.009	194	-0.0044
838.23	-0.01	193.7	-0.0071
838.25	-0.012	193.4	-0.0098
838.27	-0.014	193.2	-0.0124
838.28	-0.014	193	-0.0142
838.30	-0.015	192.8	-0.0142
838.32	-0.016	192.6	-0.016
838.33	-0.016	192.6	-0.0169
838.35	-0.016	192.4	-0.0178
838.37	-0.017	192.3	-0.0186
838.38	-0.017	192.1	-0.0195
838.40	-0.017	192	-0.0195
838.42	-0.017	191.9	-0.0195
838.43	-0.017	191.8	-0.0195
838.45	-0.017	191.8	-0.0195
838.47	-0.016	191.8	-0.0186
838.48	-0.015	191.7	-0.0178
838.50	-0.014	191.7	-0.0169
838.52	-0.014	191.7	-0.0151
838.53	-0.012	191.8	-0.0151
838.55	-0.01	191.9	-0.0133
838.57	-0.01	191.9	-0.0124
838.58	-0.01	191.9	-0.0098
838.60	-0.007	192.1	-0.0071
838.62	-0.005	192.2	-0.0044
838.63	-0.004	192.3	-0.0009
838.65	-0.002	192.6	-0.0009
838.67	0.001	192.7	0.0027
838.68	0.002	192.9	0.008
838.70	0.003	193.1	0.0098
838.72	0.006	193.3	0.0098
838.73	0.007	193.3	0.0142
838.75	0.007	193.5	0.0186
838.77	0.009	193.7	0.0222
838.78	0.013	194	0.0275
838.80	0.013	194.2	0.0302
838.82	0.015	194.5	0.0346
838.83	0.018	194.8	0.0346
838.85	0.019	194.8	0.0382
838.87	0.019	195	0.0408
838.88	0.02	195.3	0.0444
838.90	0.023	195.6	0.047
838.92	0.024	195.8	0.0497
838.93	0.025	196	0.0515
838.95	0.026	196.2	0.0515
838.97	0.027	196.2	0.0541
838.98	0.027	196.4	0.055
839.00	0.028	196.6	0.0568



Prova triassiale ciclica SN04-C1			
pressione di confinamento (kPa)		80	
deviatore ciclico (kPa)		95	
frequenza (hz)		0.00625	
tempo	cella di carico	$\Delta u$	LVDT
(min)	kN	(kPa)	$\delta$ (mm)
839.02	0.028	196.8	0.0577
839.05	0.029	196.9	0.0586
839.07	0.029	197.1	0.0586
839.08	0.029	197.2	0.0586
839.10	0.028	197.2	0.0586
839.10	0.028	197.3	0.0586
839.12	0.028	197.4	0.0586
839.13	0.028	197.4	0.0586
839.15	0.027	197.4	0.0568
839.17	0.026	197.5	0.0559
839.18	0.025	197.4	0.0559
839.20	0.023	197.4	0.0541
839.22	0.023	197.4	0.0524
839.23	0.022	197.4	0.0506
839.25	0.02	197.3	0.0479
839.27	0.019	197.2	0.0462
839.28	0.017	197.1	0.0426
839.30	0.014	196.8	0.0426
839.32	0.013	196.7	0.0391
839.33	0.013	196.7	0.0364
839.35	0.011	196.5	0.0328
839.37	0.008	196.3	0.0293
839.38	0.006	196.1	0.0249
839.40	0.005	195.9	0.0213
839.42	0.004	195.7	0.0195
839.43	0.001	195.4	0.016
839.45	0	195.2	0.0115
839.47	-0.003	194.9	0.0115
839.48	-0.005	194.6	0.0071
839.50	-0.005	194.6	0.0044
839.52	-0.006	194.4	0.0009
839.53	-0.008	194.1	-0.0027
839.55	-0.01	193.8	-0.0062
839.57	-0.011	193.6	-0.008
839.58	-0.012	193.3	-0.008
839.60	-0.014	193.1	-0.0107
839.62	-0.014	193.1	-0.0133
839.63	-0.015	192.9	-0.0151
839.65	-0.015	192.7	-0.0169
839.67	-0.017	192.5	-0.0178
839.68	-0.016	192.3	-0.0186
839.70	-0.017	192.1	-0.0195
839.72	-0.017	192	-0.0195
839.73	-0.017	192	-0.0204
839.75	-0.017	191.9	-0.0204
839.77	-0.017	191.8	-0.0195
839.78	-0.017	191.8	-0.0195
839.80	-0.016	191.7	-0.0186
839.82	-0.015	191.7	-0.0178
839.83	-0.014	191.7	-0.0178
839.85	-0.013	191.7	-0.0169
839.87	-0.013	191.7	-0.0151
839.88	-0.012	191.8	-0.0133
839.90	-0.01	191.9	-0.0107
839.92	-0.009	191.9	-0.0089
839.93	-0.007	192.1	-0.0062
839.95	-0.004	192.3	-0.0062
839.97	-0.003	192.3	-0.0027

Prova triassiale ciclica SN04-C1			
pressione di confinamento (kPa)		80	
deviatore ciclico (kPa)		95	
frequenza (hz)		0.00625	
tempo	cella di carico	$\Delta u$	LVDT
(min)	kN	(kPa)	$\delta$ (mm)
839.98	-0.003	192.4	0
840.00	-0.002	192.6	0.0036
840.02	0.002	192.8	0.0071
840.03	0.003	192.9	0.0098
840.05	0.004	193.2	0.0133
840.07	0.008	193.4	0.0133
840.08	0.009	193.4	0.0186
840.10	0.009	193.6	0.0213
840.12	0.011	193.9	0.0257
840.13	0.014	194.2	0.0302
840.15	0.014	194.4	0.032
840.17	0.016	194.6	0.0355
840.18	0.019	194.9	0.0399
840.20	0.02	195.1	0.0426
840.22	0.021	195.4	0.0453
840.23	0.023	195.7	0.0453
840.25	0.025	195.7	0.0479
840.27	0.025	195.9	0.0506
840.28	0.025	196.1	0.0524
840.30	0.026	196.3	0.055
840.32	0.027	196.5	0.0559
840.33	0.028	196.7	0.0577
840.35	0.029	196.8	0.0577
840.37	0.029	197	0.0586
840.38	0.029	197	0.0586
840.40	0.029	197.1	0.0586
840.42	0.029	197.2	0.0586
840.43	0.029	197.3	0.0595
840.45	0.028	197.4	0.0586
840.47	0.027	197.4	0.0586
840.48	0.026	197.4	0.0577
840.52	0.026	197.4	0.0568
840.53	0.026	197.5	0.055
840.55	0.024	197.4	0.0533
840.55	0.023	197.4	0.0515
840.57	0.022	197.3	0.0488
840.58	0.02	197.2	0.0488
840.60	0.017	197.1	0.047
840.62	0.017	197.1	0.0444
840.63	0.016	197	0.0417
840.65	0.014	196.8	0.0382
840.67	0.012	196.6	0.0355
840.68	0.01	196.5	0.0311
840.70	0.008	196.2	0.0275
840.72	0.005	196	0.0275
840.73	0.004	196	0.024
840.75	0.004	195.8	0.0213
840.77	0.002	195.5	0.0169
840.78	-0.001	195.2	0.0124
840.80	-0.002	195	0.0089
840.82	-0.004	194.6	0.0044
840.83	-0.007	194.4	0.0044
840.85	-0.007	194.2	-0.0009
840.87	-0.008	193.9	-0.0036
840.88	-0.01	193.7	-0.0036
840.90	-0.012	193.7	-0.0062
840.92	-0.012	193.4	-0.0098
840.93	-0.012	193.2	-0.0115

Prova triassiale ciclica SN04-C1			
pressione di confinamento (kPa)		80	
deviatore ciclico (kPa)		95	
frequenza (hz)		0.00625	
tempo	cella di carico	$\Delta u$	LVDT
(min)	kN	(kPa)	$\delta$ (mm)
840.95	-0.014	193	-0.0142
840.97	-0.015	192.8	-0.016
840.98	-0.016	192.6	-0.0178
841.00	-0.017	192.4	-0.0178
841.02	-0.017	192.4	-0.0186
841.03	-0.017	192.2	-0.0186
841.05	-0.017	192.1	-0.0195
841.07	-0.017	192	-0.0195
841.08	-0.017	191.9	-0.0204
841.10	-0.017	191.8	-0.0195
841.12	-0.016	191.7	-0.0195
841.13	-0.015	191.7	-0.0186
841.15	-0.015	191.7	-0.0186
841.17	-0.015	191.7	-0.0169
841.18	-0.013	191.7	-0.016
841.20	-0.012	191.7	-0.0142
841.22	-0.011	191.7	-0.0124
841.23	-0.009	191.9	-0.0124
841.25	-0.008	191.9	-0.0107
841.27	-0.008	191.9	-0.008
841.28	-0.007	192.1	-0.0053
841.30	-0.003	192.3	-0.0009
841.32	-0.003	192.4	0.0009
841.33	-0.001	192.6	0.0044
841.35	0.003	192.9	0.0044
841.37	0.004	192.9	0.0089
841.38	0.004	193	0.0115
841.40	0.005	193.2	0.016
841.42	0.009	193.5	0.0204
841.43	0.01	193.7	0.0231
841.45	0.012	194	0.0284
841.47	0.015	194.3	0.0284
841.48	0.016	194.5	0.032
841.50	0.016	194.5	0.0355
841.52	0.018	194.7	0.0391
841.53	0.02	195	0.0426
841.55	0.021	195.2	0.0444
841.57	0.022	195.5	0.0479
841.58	0.024	195.8	0.0506
841.60	0.025	196	0.0515
841.62	0.025	196.2	0.0533
841.63	0.027	196.4	0.0533
841.65	0.028	196.6	0.055
841.67	0.028	196.6	0.0568
841.68	0.028	196.7	0.0577
841.70	0.029	196.9	0.0586
841.72	0.029	197	0.0586
841.73	0.029	197.2	0.0595
841.75	0.029	197.2	0.0595
841.77	0.028	197.4	0.0595
841.78	0.028	197.4	0.0595
841.80	0.028	197.4	0.0586
841.82	0.027	197.4	0.0577
841.83	0.026	197.4	0.0559
841.85	0.025	197.4	0.055
841.87	0.024	197.4	0.0533
841.88	0.022	197.3	0.0533
841.90	0.021	197.3	0.0506

Prova triassiale ciclica SN04-C1			
pressione di confinamento (kPa)		80	
deviatore ciclico (kPa)		95	
frequenza (hz)		0.00625	
tempo	cella di carico	$\Delta u$	LVDT
(min)	kN	(kPa)	$\delta$ (mm)
841.92	0.021	197.3	0.0488
841.95	0.02	197.1	0.0462
841.97	0.016	197	0.0426
841.98	0.016	196.9	0.0408
842.00	0.014	196.7	0.0373
842.02	0.01	196.5	0.0373
842.02	0.01	196.5	0.0337
842.03	0.01	196.4	0.0302
842.05	0.008	196.1	0.0257
842.07	0.004	195.9	0.0222
842.08	0.003	195.7	0.0186
842.10	0.002	195.3	0.0151
842.12	-0.002	195.1	0.0151
842.13	-0.003	195.1	0.0107
842.15	-0.003	194.8	0.0071
842.17	-0.004	194.5	0.0036
842.18	-0.007	194.2	-0.0009
842.20	-0.008	194	-0.0036
842.22	-0.01	193.7	-0.0062
842.23	-0.012	193.4	-0.0062
842.25	-0.013	193.4	-0.0098
842.27	-0.013	193.3	-0.0115
842.28	-0.014	193	-0.0133
842.30	-0.015	192.8	-0.0151
842.32	-0.016	192.6	-0.0169
842.33	-0.016	192.5	-0.0178
842.35	-0.017	192.3	-0.0186
842.37	-0.017	192.1	-0.0195
842.38	-0.017	192	-0.0195
842.40	-0.017	191.9	-0.0195
842.42	-0.017	191.9	-0.0204
842.43	-0.017	191.8	-0.0195
842.45	-0.017	191.7	-0.0195
842.47	-0.016	191.7	-0.0186
842.48	-0.015	191.6	-0.0178
842.50	-0.015	191.7	-0.0169
842.52	-0.013	191.7	-0.0169
842.53	-0.012	191.7	-0.0151
842.55	-0.012	191.7	-0.0133
842.57	-0.011	191.8	-0.0115
842.58	-0.008	191.9	-0.0089
842.60	-0.007	192	-0.0071
842.62	-0.006	192.1	-0.0036
842.63	-0.003	192.3	-0.0036
842.65	-0.002	192.5	0
842.67	-0.002	192.5	0.0027
842.68	0	192.7	0.0062
842.70	0.003	192.9	0.0107
842.72	0.005	193.1	0.0133
842.73	0.006	193.3	0.0178
842.75	0.01	193.6	0.0178
842.77	0.011	193.8	0.0213
842.78	0.011	193.8	0.0249
842.80	0.012	194	0.0293
842.82	0.015	194.4	0.0337
842.83	0.017	194.6	0.0364
842.85	0.018	194.8	0.0399
842.87	0.021	195.1	0.0399

Prova triassiale ciclica SN04-C1			
pressione di confinamento (kPa)		80	
deviatore ciclico (kPa)		95	
frequenza (hz)		0.00625	
tempo	cella di carico	$\Delta u$	LVDT
(min)	kN	(kPa)	$\delta$ (mm)
842.88	0.022	195.4	0.0435
842.90	0.022	195.4	0.0462
842.92	0.023	195.6	0.0488
842.93	0.024	195.9	0.0515
842.95	0.026	196.1	0.0533
842.97	0.027	196.3	0.055
842.98	0.027	196.5	0.0568
843.00	0.028	196.7	0.0568
843.02	0.029	196.7	0.0577
843.03	0.029	197	0.0586
843.05	0.029	197.1	0.0586
843.07	0.029	197.1	0.0595
843.08	0.029	197.2	0.0595
843.10	0.029	197.3	0.0595
843.12	0.028	197.4	0.0586
843.13	0.027	197.4	0.0577
843.15	0.027	197.4	0.0568
843.17	0.025	197.4	0.0568
843.18	0.024	197.4	0.0559
843.20	0.024	197.4	0.0541
843.22	0.024	197.4	0.0524
843.23	0.022	197.3	0.0506
843.25	0.02	197.2	0.0479
843.27	0.019	197.1	0.0453
843.28	0.016	197	0.0453
843.30	0.015	197	0.0417
843.32	0.015	196.8	0.0399
843.33	0.013	196.6	0.0364
843.35	0.01	196.4	0.0328
843.37	0.009	196.3	0.0293
843.38	0.007	196	0.024
843.42	0.003	195.8	0.024
843.43	0.002	195.8	0.0204
843.45	0.002	195.6	0.0178
843.47	0.001	195.2	0.0124
843.47	-0.003	194.9	0.0089
843.48	-0.004	194.7	0.0062
843.50	-0.005	194.5	0.0018
843.52	-0.008	194.1	0.0018
843.53	-0.009	194.1	-0.0018
843.55	-0.009	193.9	-0.0044
843.57	-0.01	193.6	-0.0071
843.58	-0.013	193.4	-0.0107
843.60	-0.013	193.2	-0.0124
843.62	-0.014	193	-0.0142
843.63	-0.015	192.7	-0.0142
843.65	-0.016	192.7	-0.016
843.67	-0.016	192.5	-0.0178
843.68	-0.017	192.4	-0.0178
843.70	-0.017	192.2	-0.0186
843.72	-0.017	192.1	-0.0195
843.73	-0.017	191.9	-0.0204
843.75	-0.017	191.8	-0.0204
843.77	-0.016	191.8	-0.0195
843.78	-0.016	191.7	-0.0195
843.80	-0.016	191.6	-0.0195
843.82	-0.015	191.7	-0.0186
843.83	-0.015	191.7	-0.0178

Prova triassiale ciclica SN04-C1			
pressione di confinamento (kPa)		80	
deviatore ciclico (kPa)		95	
frequenza (hz)		0.00625	
tempo	cella di carico	$\Delta u$	LVDT
(min)	kN	(kPa)	$\delta$ (mm)
843.85	-0.014	191.6	-0.016
843.87	-0.013	191.7	-0.0151
843.88	-0.011	191.7	-0.0124
843.90	-0.01	191.8	-0.0107
843.92	-0.008	191.9	-0.008
843.93	-0.006	192.1	-0.008
843.95	-0.006	192.1	-0.0053
843.97	-0.005	192.2	-0.0018
843.98	-0.003	192.4	0.0009
844.00	0	192.6	0.0044
844.02	0.001	192.7	0.0071
844.03	0.003	193	0.0115
844.05	0.006	193.2	0.0115
844.07	0.007	193.2	0.0151
844.08	0.007	193.4	0.0186
844.10	0.009	193.7	0.0222
844.12	0.012	193.9	0.0275
844.13	0.014	194.1	0.0311
844.15	0.015	194.4	0.0346
844.17	0.018	194.7	0.0346
844.18	0.019	194.7	0.0382
844.20	0.019	194.9	0.0408
844.22	0.02	195.2	0.0444
844.23	0.023	195.5	0.047
844.25	0.023	195.7	0.0497
844.27	0.025	196	0.0524
844.28	0.026	196.2	0.0524
844.30	0.027	196.2	0.0541
844.32	0.027	196.4	0.055
844.33	0.027	196.6	0.0568
844.35	0.028	196.7	0.0577
844.37	0.029	196.9	0.0586
844.38	0.029	197	0.0595
844.40	0.029	197.1	0.0595
844.42	0.029	197.1	0.0595
844.43	0.029	197.2	0.0595
844.45	0.028	197.3	0.0586
844.47	0.028	197.4	0.0586
844.48	0.027	197.4	0.0568
844.50	0.026	197.4	0.0568
844.52	0.025	197.4	0.055
844.53	0.024	197.4	0.0541
844.55	0.023	197.3	0.0515
844.57	0.021	197.2	0.0488
844.58	0.019	197.1	0.0488
844.60	0.019	197.1	0.0462
844.62	0.018	197.1	0.0435
844.63	0.016	196.9	0.0408
844.65	0.013	196.7	0.0382
844.67	0.012	196.6	0.0346
844.68	0.01	196.3	0.0311
844.70	0.007	196.1	0.0311
844.72	0.007	196.1	0.0275
844.73	0.006	196	0.024
844.75	0.004	195.7	0.0195
844.77	0.001	195.4	0.0151
844.78	0	195.1	0.0115
844.80	-0.002	194.8	0.0071

Prova triassiale ciclica SN04-C1			
pressione di confinamento (kPa)		80	
deviatore ciclico (kPa)		95	
frequenza (hz)		0.00625	
tempo	cella di carico	$\Delta u$	LVDT
(min)	kN	(kPa)	$\delta$ (mm)
844.82	-0.005	194.6	0.0071
844.85	-0.006	194.6	0.0044
844.87	-0.006	194.3	0.0009
844.88	-0.007	194	-0.0027
844.90	-0.011	193.8	-0.0062
844.92	-0.011	193.6	-0.008
844.92	-0.012	193.3	-0.0107
844.93	-0.014	193	-0.0107
844.95	-0.014	193	-0.0133
844.97	-0.014	192.9	-0.0151
844.98	-0.015	192.6	-0.0169
845.00	-0.016	192.4	-0.0178
845.02	-0.017	192.3	-0.0186
845.03	-0.017	192.1	-0.0195
845.05	-0.017	192	-0.0195
845.07	-0.017	192	-0.0195
845.08	-0.017	191.9	-0.0204
845.10	-0.017	191.8	-0.0195
845.12	-0.017	191.7	-0.0195
845.13	-0.016	191.7	-0.0186
845.15	-0.015	191.7	-0.0178
845.17	-0.014	191.7	-0.0178
845.18	-0.013	191.7	-0.0169
845.20	-0.013	191.7	-0.0151
845.22	-0.011	191.8	-0.0133
845.23	-0.009	191.8	-0.0124
845.25	-0.009	191.8	-0.0098
845.27	-0.008	191.9	-0.0071
845.28	-0.005	192.1	-0.0044
845.30	-0.004	192.2	-0.0018
845.32	-0.002	192.4	0.0018
845.33	0	192.6	0.0018
845.35	0.002	192.8	0.0053
845.37	0.002	192.8	0.0089
845.38	0.004	193	0.0124
845.40	0.006	193.3	0.0169
845.42	0.009	193.5	0.0204
845.43	0.01	193.7	0.024
845.45	0.012	194	0.024
845.47	0.015	194.3	0.0284
845.48	0.015	194.3	0.032
845.50	0.016	194.5	0.0364
845.52	0.018	194.8	0.0399
845.53	0.02	195	0.0426
845.55	0.021	195.2	0.0453
845.57	0.023	195.6	0.0479
845.58	0.025	195.8	0.0479
845.60	0.025	195.8	0.0506
845.62	0.025	196	0.0524
845.63	0.026	196.2	0.0541
845.65	0.028	196.4	0.0559
845.67	0.028	196.6	0.0568
845.68	0.028	196.7	0.0577
845.70	0.029	196.9	0.0577
845.72	0.029	196.9	0.0586
845.73	0.029	197	0.0586
845.75	0.029	197.1	0.0586
845.77	0.029	197.2	0.0586

Prova triassiale ciclica SN04-C1			
pressione di confinamento (kPa)		80	
deviatore ciclico (kPa)		95	
frequenza (hz)		0.00625	
tempo	cella di carico	$\Delta u$	LVDT
(min)	kN	(kPa)	$\delta$ (mm)
845.78	0.028	197.3	0.0586
845.80	0.028	197.3	0.0577
845.82	0.026	197.4	0.0577
845.83	0.025	197.4	0.0559
845.85	0.025	197.4	0.055
845.87	0.025	197.4	0.0541
845.88	0.023	197.3	0.0524
845.90	0.022	197.3	0.0506
845.92	0.02	197.1	0.047
845.93	0.017	197	0.0444
845.95	0.017	197	0.0426
845.97	0.015	196.8	0.0391
845.98	0.012	196.6	0.0391
846.00	0.011	196.6	0.0364
846.02	0.011	196.5	0.0337
846.03	0.01	196.3	0.0302
846.05	0.006	196	0.0249
846.07	0.005	195.8	0.0222
846.08	0.004	195.6	0.0178
846.10	-0.001	195.2	0.0178
846.12	-0.001	195.2	0.0124
846.13	-0.001	195	0.0107
846.15	-0.003	194.7	0.0062
846.17	-0.006	194.4	0.0027
846.18	-0.007	194.2	0
846.20	-0.008	193.9	-0.0036
846.22	-0.011	193.7	-0.0036
846.23	-0.012	193.7	-0.0071
846.25	-0.012	193.4	-0.0089
846.27	-0.013	193.2	-0.0115
846.28	-0.014	192.9	-0.0142
846.32	-0.015	192.7	-0.0151
846.33	-0.016	192.6	-0.0169
846.35	-0.016	192.4	-0.0169
846.37	-0.017	192.2	-0.0186
846.37	-0.017	192.2	-0.0195
846.38	-0.017	192.1	-0.0195
846.40	-0.017	191.9	-0.0195
846.42	-0.017	191.8	-0.0204
846.43	-0.017	191.7	-0.0195
846.45	-0.016	191.7	-0.0195
846.47	-0.016	191.6	-0.0195
846.48	-0.016	191.6	-0.0186
846.50	-0.015	191.6	-0.0169
846.52	-0.014	191.7	-0.016
846.53	-0.012	191.7	-0.0142
846.55	-0.011	191.7	-0.0124
846.57	-0.009	191.9	-0.0124
846.58	-0.007	191.9	-0.0098
846.60	-0.007	191.9	-0.0071
846.62	-0.007	192	-0.0044
846.63	-0.004	192.3	-0.0018
846.65	-0.002	192.4	0.0009
846.67	-0.001	192.5	0.0044
846.68	0.001	192.7	0.0071
846.70	0.003	192.9	0.0098
846.72	0.004	193.1	0.0142
846.73	0.007	193.4	0.0178



Prova triassiale ciclica SN04-C1			
pressione di confinamento (kPa)		80	
deviatore ciclico (kPa)		95	
frequenza (hz)		0.00625	
tempo	cella di carico	$\Delta u$	LVDT
(min)	kN	(kPa)	$\delta$ (mm)
846.75	0.01	193.6	0.0178
846.77	0.011	193.6	0.0222
846.78	0.011	193.8	0.0249
846.80	0.013	194.1	0.0293
846.82	0.016	194.4	0.0337
846.83	0.017	194.6	0.0364
846.85	0.018	194.8	0.0399
846.87	0.021	195.1	0.0399
846.88	0.022	195.1	0.0435
846.90	0.022	195.4	0.0462
846.92	0.023	195.7	0.0488
846.93	0.025	195.9	0.0515
846.95	0.026	196.1	0.0533
846.97	0.026	196.3	0.055
846.98	0.028	196.5	0.055
847.00	0.028	196.5	0.0568
847.02	0.028	196.7	0.0577
847.03	0.029	196.8	0.0586
847.05	0.029	197	0.0595
847.07	0.029	197.1	0.0595
847.08	0.029	197.2	0.0586
847.10	0.028	197.3	0.0586
847.12	0.028	197.3	0.0586
847.13	0.028	197.3	0.0586
847.15	0.027	197.4	0.0577
847.17	0.026	197.4	0.0559
847.18	0.025	197.4	0.055
847.20	0.024	197.3	0.0524
847.22	0.022	197.3	0.0524
847.23	0.021	197.3	0.0506
847.25	0.021	197.2	0.0488
847.27	0.02	197.1	0.0462
847.28	0.017	197	0.0435
847.30	0.016	196.8	0.0399
847.32	0.014	196.6	0.0373
847.33	0.01	196.4	0.0373
847.35	0.01	196.4	0.0328
847.37	0.01	196.3	0.0311
847.38	0.008	196.1	0.0257
847.40	0.004	195.8	0.0222
847.42	0.004	195.7	0.0195
847.43	0.003	195.4	0.016
847.45	-0.001	195.1	0.0124
847.47	-0.002	194.9	0.0089
847.48	-0.003	194.7	0.0053
847.50	-0.006	194.3	0.0053
847.52	-0.008	194.1	0.0018
847.53	-0.008	194.1	-0.0018
847.55	-0.009	193.8	-0.0044
847.57	-0.011	193.5	-0.008
847.58	-0.012	193.3	-0.0107
847.60	-0.013	193.1	-0.0124
847.62	-0.015	192.8	-0.0124
847.63	-0.016	192.6	-0.0151
847.65	-0.016	192.6	-0.016
847.67	-0.016	192.4	-0.0178
847.68	-0.016	192.3	-0.0186
847.70	-0.017	192.1	-0.0195

Prova triassiale ciclica SN04-C1			
pressione di confinamento (kPa)		80	
deviatore ciclico (kPa)		95	
frequenza (hz)		0.00625	
tempo	cella di carico	$\Delta u$	LVDT
(min)	kN	(kPa)	$\delta$ (mm)
847.72	-0.017	192	-0.0195
847.73	-0.017	191.9	-0.0195
847.77	-0.017	191.8	-0.0195
847.78	-0.017	191.8	-0.0204
847.80	-0.017	191.7	-0.0195
847.82	-0.016	191.7	-0.0186
847.82	-0.015	191.6	-0.0178
847.83	-0.014	191.6	-0.0169
847.85	-0.014	191.7	-0.0151
847.87	-0.012	191.7	-0.0151
847.88	-0.011	191.7	-0.0133
847.90	-0.011	191.7	-0.0115
847.92	-0.009	191.9	-0.0089
847.93	-0.006	192	-0.0062
847.95	-0.006	192.1	-0.0044
847.97	-0.004	192.3	-0.0009
847.98	-0.001	192.5	-0.0009
848.00	0	192.5	0.0027
848.02	0	192.6	0.0062
848.03	0.002	192.9	0.0089
848.05	0.005	193.1	0.0133
848.07	0.006	193.3	0.0169
848.08	0.008	193.5	0.0204
848.10	0.012	193.8	0.0204
848.12	0.013	194	0.0284
848.13	0.013	194.2	0.0311
848.15	0.016	194.5	0.0311
848.17	0.017	194.5	0.0346
848.18	0.017	194.7	0.0382
848.20	0.019	194.9	0.0417
848.22	0.022	195.2	0.0444
848.23	0.022	195.4	0.047
848.25	0.023	195.7	0.0497
848.27	0.025	196	0.0497
848.28	0.026	196	0.0524
848.30	0.026	196.2	0.0541
848.32	0.027	196.3	0.0559
848.33	0.028	196.5	0.0568
848.35	0.028	196.7	0.0577
848.37	0.029	196.8	0.0586
848.38	0.029	197	0.0586
848.40	0.029	197.1	0.0586
848.42	0.029	197.1	0.0595
848.43	0.029	197.2	0.0595
848.45	0.029	197.3	0.0586
848.47	0.028	197.3	0.0577
848.48	0.027	197.4	0.0559
848.50	0.026	197.3	0.055
848.52	0.024	197.3	0.055
848.53	0.024	197.3	0.0541
848.55	0.024	197.3	0.0524
848.57	0.022	197.2	0.0497
848.58	0.02	197.1	0.0479
848.60	0.019	197	0.0453
848.62	0.017	196.9	0.0426
848.63	0.014	196.7	0.0426
848.65	0.013	196.7	0.0391
848.67	0.013	196.6	0.0364

Prova triassiale ciclica SN04-C1			
pressione di confinamento (kPa)		80	
deviatore ciclico (kPa)		95	
frequenza (hz)		0.00625	
tempo	cella di carico	$\Delta u$	LVDT
(min)	kN	(kPa)	$\delta$ (mm)
848.68	0.011	196.4	0.032
848.70	0.008	196.1	0.0284
848.72	0.007	196	0.0249
848.73	0.005	195.7	0.0204
848.75	0.001	195.4	0.0204
848.77	0	195.4	0.0169
848.78	0	195.2	0.0133
848.80	-0.001	194.9	0.0098
848.82	-0.004	194.6	0.0053
848.83	-0.005	194.4	0.0027
848.85	-0.006	194.1	-0.0009
848.87	-0.009	193.9	-0.0036
848.88	-0.01	193.7	-0.0053
848.90	-0.011	193.4	-0.0089
848.92	-0.013	193.2	-0.0089
848.93	-0.014	193.2	-0.0115
848.95	-0.014	192.9	-0.0133
848.97	-0.014	192.7	-0.0151
848.98	-0.016	192.5	-0.0169
849.00	-0.016	192.4	-0.0178
849.02	-0.017	192.2	-0.0186
849.03	-0.017	192	-0.0186
849.05	-0.017	192	-0.0195
849.07	-0.017	191.9	-0.0204
849.08	-0.017	191.8	-0.0204
849.10	-0.017	191.7	-0.0195
849.12	-0.016	191.7	-0.0195
849.13	-0.016	191.6	-0.0186
849.15	-0.015	191.6	-0.0186
849.17	-0.014	191.6	-0.0178
849.18	-0.014	191.6	-0.0169
849.22	-0.013	191.6	-0.0151
849.23	-0.011	191.7	-0.0124
849.25	-0.01	191.7	-0.0107
849.27	-0.009	191.8	-0.008
849.27	-0.006	192	-0.008
849.28	-0.005	192.1	-0.0053
849.30	-0.005	192.1	-0.0027
849.32	-0.003	192.3	0
849.33	0	192.5	0.0036
849.35	0.001	192.7	0.0071
849.37	0.002	192.8	0.0107
849.38	0.005	193.1	0.0151
849.40	0.009	193.4	0.0151
849.42	0.009	193.4	0.0186
849.43	0.009	193.5	0.0222
849.45	0.011	193.8	0.0257
849.47	0.014	194.1	0.0302
849.48	0.015	194.3	0.0346
849.50	0.017	194.6	0.0382
849.52	0.02	194.9	0.0382
849.53	0.021	194.9	0.0417
849.55	0.021	195.1	0.0444
849.57	0.023	195.6	0.0462
849.58	0.024	195.6	0.0479
849.60	0.024	195.8	0.0506
849.62	0.025	196	0.0524
849.63	0.027	196.2	0.0541

Prova triassiale ciclica SN04-C1			
pressione di confinamento (kPa)		80	
deviatore ciclico (kPa)		95	
frequenza (hz)		0.00625	
tempo	cella di carico	$\Delta u$	LVDT
(min)	kN	(kPa)	$\delta$ (mm)
849.65	0.027	196.4	0.0559
849.67	0.028	196.6	0.0568
849.68	0.029	196.7	0.0568
849.70	0.029	196.7	0.0586
849.72	0.029	196.9	0.0586
849.73	0.029	197	0.0595
849.75	0.029	197.1	0.0595
849.77	0.028	197.2	0.0595
849.78	0.028	197.3	0.0586
849.80	0.027	197.3	0.0586
849.82	0.026	197.3	0.0577
849.83	0.026	197.3	0.0568
849.85	0.026	197.3	0.055
849.87	0.024	197.3	0.0533
849.88	0.023	197.3	0.0515
849.90	0.022	197.2	0.0488
849.92	0.019	197	0.0488
849.93	0.018	197	0.0462
849.95	0.018	197	0.0444
849.97	0.017	196.8	0.0408
849.98	0.014	196.6	0.0373
850.00	0.012	196.5	0.0355
850.02	0.01	196.3	0.0311
850.03	0.007	196	0.0311
850.05	0.006	195.9	0.0257
850.07	0.006	195.9	0.024
850.08	0.005	195.7	0.0195
850.10	0.001	195.3	0.0151
850.12	-0.001	195	0.0124
850.13	-0.002	194.8	0.008
850.15	-0.004	194.5	0.008
850.17	-0.007	194.2	0.0036
850.18	-0.007	194.2	0
850.20	-0.007	194	-0.0027
850.22	-0.009	193.7	-0.0062
850.23	-0.012	193.4	-0.0089
850.25	-0.012	193.2	-0.0107
850.27	-0.014	192.9	-0.0133
850.28	-0.015	192.7	-0.0133
850.30	-0.015	192.5	-0.016
850.32	-0.016	192.4	-0.0178
850.33	-0.017	192.2	-0.0178
850.35	-0.017	192.2	-0.0186
850.37	-0.017	192	-0.0195
850.38	-0.017	191.9	-0.0195
850.40	-0.017	191.8	-0.0204
850.42	-0.017	191.7	-0.0204
850.43	-0.017	191.6	-0.0204
850.45	-0.016	191.6	-0.0204
850.47	-0.016	191.6	-0.0195
850.48	-0.016	191.5	-0.0186
850.50	-0.015	191.5	-0.0169
850.52	-0.013	191.6	-0.016
850.53	-0.012	191.6	-0.0142
850.55	-0.012	191.6	-0.0124
850.57	-0.009	191.7	-0.0124
850.58	-0.008	191.7	-0.0098
850.60	-0.008	191.8	-0.008

Prova triassiale ciclica SN04-C1			
pressione di confinamento (kPa)		80	
deviatore ciclico (kPa)		95	
frequenza (hz)		0.00625	
tempo	cella di carico	$\Delta u$	LVDT
(min)	kN	(kPa)	$\delta$ (mm)
850.62	-0.006	192	-0.0053
850.63	-0.003	192.1	-0.0018
850.65	-0.003	192.2	0.0009
850.68	-0.001	192.4	0.0044
850.70	0.002	192.7	0.0044
850.72	0.004	192.7	0.008
850.73	0.004	192.9	0.0115
850.73	0.005	193.2	0.016
850.75	0.009	193.4	0.0204
850.77	0.01	193.6	0.0231
850.78	0.012	193.9	0.0284
850.80	0.015	194.1	0.0284
850.82	0.016	194.1	0.032
850.83	0.016	194.3	0.0355
850.85	0.017	194.6	0.0382
850.87	0.02	194.9	0.0426
850.88	0.022	195.1	0.0453
850.90	0.022	195.4	0.047
850.92	0.024	195.7	0.047
850.93	0.025	195.7	0.0506
850.95	0.025	195.9	0.0524
850.97	0.026	196.1	0.0541
850.98	0.027	196.3	0.0559
851.00	0.028	196.5	0.0568
851.02	0.028	196.6	0.0577
851.03	0.029	196.8	0.0586
851.05	0.029	196.9	0.0586
851.07	0.029	197	0.0595
851.08	0.029	197.1	0.0595
851.10	0.029	197.2	0.0595
851.12	0.029	197.2	0.0595
851.13	0.028	197.3	0.0586
851.15	0.027	197.3	0.0568
851.17	0.026	197.3	0.0559
851.18	0.025	197.3	0.0541
851.20	0.024	197.2	0.0541
851.22	0.022	197.2	0.0524
851.23	0.022	197.2	0.0515
851.25	0.021	197.2	0.0479
851.27	0.019	197	0.0453
851.28	0.017	196.9	0.0435
851.30	0.015	196.8	0.0399
851.32	0.013	196.6	0.0373
851.33	0.01	196.4	0.0373
851.35	0.01	196.4	0.0337
851.37	0.01	196.2	0.0302
851.38	0.007	196	0.0257
851.40	0.004	195.7	0.0222
851.42	0.003	195.5	0.0186
851.43	0.001	195.2	0.0142
851.45	-0.002	194.9	0.0142
851.47	-0.003	194.9	0.0107
851.48	-0.003	194.7	0.0071
851.50	-0.004	194.4	0.0036
851.52	-0.007	194.1	0
851.53	-0.008	193.9	-0.0027
851.55	-0.01	193.6	-0.0062
851.57	-0.012	193.3	-0.0062

Prova triassiale ciclica SN04-C1			
pressione di confinamento (kPa)		80	
deviatore ciclico (kPa)		95	
frequenza (hz)		0.00625	
tempo	cella di carico	$\Delta u$	LVDT
(min)	kN	(kPa)	$\delta$ (mm)
851.58	-0.012	193.3	-0.0089
851.60	-0.012	193.1	-0.0115
851.62	-0.014	192.9	-0.0133
851.63	-0.015	192.7	-0.0151
851.65	-0.016	192.5	-0.0169
851.67	-0.016	192.3	-0.0178
851.68	-0.017	192.1	-0.0178
851.70	-0.017	192.1	-0.0186
851.72	-0.017	192	-0.0195
851.73	-0.017	191.9	-0.0195
851.75	-0.017	191.8	-0.0195
851.77	-0.017	191.7	-0.0195
851.78	-0.017	191.6	-0.0195
851.80	-0.016	191.6	-0.0186
851.82	-0.015	191.5	-0.0178
851.83	-0.015	191.5	-0.0169
851.85	-0.013	191.6	-0.0169
851.87	-0.012	191.6	-0.0151
851.88	-0.012	191.6	-0.0133
851.90	-0.011	191.6	-0.0107
851.92	-0.008	191.8	-0.008
851.93	-0.007	191.9	-0.0071
851.95	-0.006	192	-0.0036
851.97	-0.003	192.2	-0.0036
851.98	-0.001	192.4	0
852.00	-0.001	192.4	0.0027
852.02	0	192.5	0.0062
852.03	0.003	192.8	0.0107
852.05	0.005	193	0.0133
852.07	0.006	193.2	0.0169
852.08	0.009	193.5	0.0169
852.12	0.011	193.7	0.0213
852.13	0.011	193.7	0.0249
852.15	0.013	193.9	0.0302
852.17	0.015	194.2	0.0337
852.18	0.018	194.5	0.0373
852.18	0.018	194.7	0.0399
852.20	0.02	195	0.0435
852.22	0.022	195.2	0.0435
852.23	0.023	195.2	0.0462
852.25	0.023	195.4	0.0479
852.27	0.024	195.7	0.0506
852.28	0.026	195.9	0.0533
852.30	0.026	196.1	0.055
852.32	0.027	196.3	0.0559
852.33	0.028	196.5	0.0559
852.35	0.028	196.5	0.0577
852.37	0.028	196.7	0.0586
852.38	0.029	196.8	0.0595
852.40	0.029	197	0.0595
852.42	0.029	197.1	0.0595
852.43	0.029	197.1	0.0595
852.45	0.028	197.2	0.0595
852.47	0.027	197.2	0.0586
852.48	0.026	197.3	0.0568
852.50	0.026	197.3	0.0568
852.52	0.025	197.3	0.0559
852.53	0.025	197.3	0.0541

Prova triassiale ciclica SN04-C1			
pressione di confinamento (kPa)		80	
deviatore ciclico (kPa)		95	
frequenza (hz)		0.00625	
tempo	cella di carico	$\Delta u$	LVDT
(min)	kN	(kPa)	$\delta$ (mm)
852.55	0.023	197.2	0.0524
852.57	0.021	197.2	0.0506
852.58	0.02	197.1	0.0479
852.60	0.019	196.9	0.0453
852.62	0.016	196.8	0.0453
852.63	0.015	196.8	0.0426
852.65	0.015	196.7	0.0391
852.67	0.013	196.5	0.0355
852.68	0.01	196.3	0.032
852.70	0.009	196.1	0.0293
852.72	0.007	195.9	0.024
852.73	0.003	195.6	0.024
852.75	0.002	195.6	0.0204
852.77	0.002	195.4	0.0169
852.78	0.001	195.1	0.0133
852.80	-0.003	194.8	0.0089
852.82	-0.004	194.6	0.0053
852.83	-0.005	194.3	0.0018
852.85	-0.008	194	0.0018
852.87	-0.009	194	-0.0018
852.88	-0.009	193.8	-0.0044
852.90	-0.01	193.5	-0.0071
852.92	-0.013	193.2	-0.0107
852.93	-0.013	193	-0.0115
852.95	-0.014	192.8	-0.0142
852.97	-0.015	192.6	-0.0142
852.98	-0.016	192.6	-0.016
853.00	-0.016	192.4	-0.0169
853.02	-0.017	192.2	-0.0186
853.03	-0.017	192.1	-0.0186
853.05	-0.017	191.9	-0.0195
853.07	-0.017	191.8	-0.0195
853.08	-0.017	191.7	-0.0195
853.10	-0.017	191.6	-0.0195
853.12	-0.017	191.6	-0.0195
853.13	-0.016	191.6	-0.0186
853.15	-0.015	191.6	-0.0178
853.17	-0.014	191.5	-0.0169
853.18	-0.014	191.5	-0.0151
853.20	-0.012	191.6	-0.0133
853.22	-0.011	191.6	-0.0124
853.23	-0.01	191.7	-0.0098
853.25	-0.008	191.8	-0.0098
853.27	-0.006	191.9	-0.0071
853.28	-0.006	191.9	-0.0053
853.30	-0.005	192	-0.0027
853.32	-0.002	192.3	0.0009
853.33	0	192.4	0.0036
853.35	0.001	192.6	0.008
853.37	0.004	192.9	0.0124
853.38	0.006	193.1	0.0124
853.40	0.006	193.1	0.0151
853.42	0.007	193.2	0.0195
853.43	0.01	193.6	0.0231
853.45	0.012	193.8	0.0275
853.47	0.013	194	0.0311
853.48	0.016	194.3	0.0355
853.50	0.018	194.6	0.0355

Prova triassiale ciclica SN04-C1			
pressione di confinamento (kPa)		80	
deviatore ciclico (kPa)		95	
frequenza (hz)		0.00625	
tempo	cella di carico	$\Delta u$	LVDT
(min)	kN	(kPa)	$\delta$ (mm)
853.52	0.019	194.6	0.0391
853.53	0.019	194.8	0.0408
853.55	0.021	195.1	0.0444
853.58	0.023	195.3	0.047
853.60	0.024	195.6	0.0488
853.62	0.025	195.8	0.0515
853.63	0.026	196	0.0515
853.63	0.027	196	0.0541
853.65	0.027	196.2	0.055
853.67	0.027	196.4	0.0568
853.68	0.028	196.6	0.0577
853.70	0.028	196.7	0.0586
853.72	0.029	196.8	0.0595
853.73	0.029	197	0.0595
853.75	0.029	197	0.0595
853.77	0.029	197.1	0.0595
853.78	0.028	197.2	0.0595
853.80	0.028	197.2	0.0586
853.82	0.027	197.2	0.0577
853.83	0.026	197.3	0.0559
853.85	0.024	197.2	0.0559
853.87	0.023	197.2	0.0541
853.88	0.023	197.2	0.0524
853.90	0.023	197.2	0.0506
853.92	0.02	197	0.0479
853.93	0.018	196.9	0.0462
853.95	0.018	196.9	0.0444
853.97	0.016	196.7	0.0417
853.98	0.014	196.6	0.0382
854.00	0.012	196.4	0.0346
854.02	0.009	196.2	0.0346
854.03	0.007	196	0.0302
854.05	0.007	196	0.0275
854.07	0.006	195.8	0.0231
854.08	0.004	195.5	0.0186
854.10	0.001	195.2	0.016
854.12	0	195	0.0115
854.13	-0.003	194.7	0.0115
854.15	-0.005	194.4	0.0071
854.17	-0.005	194.4	0.0044
854.18	-0.006	194.2	0.0009
854.20	-0.008	193.8	-0.0027
854.22	-0.01	193.6	-0.0053
854.23	-0.011	193.4	-0.008
854.25	-0.012	193.1	-0.008
854.27	-0.014	192.9	-0.0107
854.28	-0.014	192.9	-0.0133
854.30	-0.015	192.7	-0.0142
854.32	-0.015	192.5	-0.0169
854.33	-0.017	192.3	-0.0178
854.35	-0.016	192.1	-0.0178
854.37	-0.017	192	-0.0195
854.38	-0.017	191.8	-0.0195
854.40	-0.017	191.8	-0.0195
854.42	-0.017	191.7	-0.0195
854.43	-0.017	191.6	-0.0195
854.45	-0.016	191.6	-0.0195
854.47	-0.016	191.5	-0.0186



Prova triassiale ciclica SN04-C1			
pressione di confinamento (kPa)		80	
deviatore ciclico (kPa)		95	
frequenza (hz)		0.00625	
tempo	cella di carico	$\Delta u$	LVDT
(min)	kN	(kPa)	$\delta$ (mm)
854.48	-0.015	191.5	-0.0169
854.50	-0.014	191.5	-0.0169
854.52	-0.013	191.5	-0.016
854.53	-0.013	191.5	-0.0142
854.55	-0.012	191.6	-0.0124
854.57	-0.01	191.7	-0.0107
854.58	-0.009	191.7	-0.0089
854.60	-0.007	191.9	-0.0062
854.62	-0.005	192	-0.0062
854.63	-0.003	192	-0.0027
854.65	-0.002	192.3	0.0018
854.67	0	192.5	0.0018
854.68	0.001	192.5	0.0044
854.70	0.001	192.6	0.0089
854.72	0.004	192.9	0.0124
854.73	0.007	193.2	0.0169
854.75	0.008	193.4	0.0204
854.77	0.01	193.6	0.024
854.78	0.014	193.9	0.024
854.80	0.014	193.9	0.0293
854.82	0.014	194.1	0.032
854.83	0.016	194.4	0.0355
854.85	0.019	194.7	0.0399
854.87	0.02	194.9	0.0426
854.88	0.021	195.1	0.0462
854.90	0.024	195.4	0.0462
854.92	0.024	195.4	0.0488
854.93	0.024	195.6	0.0506
854.95	0.025	195.9	0.0533
854.97	0.027	196.1	0.055
854.98	0.027	196.3	0.0559
855.02	0.028	196.4	0.0577
855.03	0.029	196.6	0.0577
855.05	0.029	196.8	0.0586
855.07	0.029	196.8	0.0586
855.08	0.029	196.9	0.0595
855.08	0.029	197	0.0595
855.10	0.029	197.1	0.0595
855.12	0.028	197.2	0.0586
855.13	0.027	197.2	0.0586
855.15	0.026	197.2	0.0577
855.17	0.026	197.2	0.0568
855.18	0.026	197.3	0.055
855.20	0.024	197.2	0.0533
855.22	0.023	197.2	0.0524
855.23	0.022	197.1	0.0497
855.25	0.02	197	0.047
855.27	0.017	196.9	0.047
855.28	0.017	196.9	0.0444
855.30	0.017	196.8	0.0417
855.32	0.014	196.5	0.0382
855.33	0.012	196.4	0.0355
855.35	0.011	196.2	0.032
855.37	0.008	196	0.0275
855.38	0.005	195.7	0.0231
855.40	0.005	195.6	0.0213
855.42	0.003	195.3	0.0178
855.43	0	195.1	0.0178

Prova triassiale ciclica SN04-C1			
pressione di confinamento (kPa)		80	
deviatore ciclico (kPa)		95	
frequenza (hz)		0.00625	
tempo	cella di carico	$\Delta u$	LVDT
(min)	kN	(kPa)	$\delta$ (mm)
855.45	-0.001	195.1	0.0142
855.47	-0.001	194.8	0.0107
855.48	-0.003	194.5	0.0071
855.50	-0.006	194.3	0.0027
855.52	-0.007	194.1	0
855.53	-0.008	193.7	-0.0036
855.55	-0.011	193.5	-0.0036
855.57	-0.012	193.5	-0.0071
855.58	-0.012	193.2	-0.0089
855.60	-0.012	193	-0.0115
855.62	-0.015	192.8	-0.0142
855.63	-0.015	192.6	-0.0151
855.65	-0.016	192.4	-0.0169
855.67	-0.016	192.2	-0.0169
855.68	-0.017	192.2	-0.0178
855.70	-0.017	192	-0.0195
855.72	-0.017	191.9	-0.0195
855.73	-0.017	191.8	-0.0195
855.75	-0.017	191.7	-0.0204
855.77	-0.017	191.6	-0.0195
855.78	-0.016	191.5	-0.0195
855.80	-0.016	191.5	-0.0186
855.82	-0.016	191.5	-0.0186
855.83	-0.015	191.5	-0.0169
855.85	-0.013	191.5	-0.0151
855.87	-0.012	191.5	-0.0142
855.88	-0.011	191.6	-0.0124
855.90	-0.009	191.7	-0.0124
855.92	-0.008	191.7	-0.0098
855.93	-0.008	191.8	-0.008
855.95	-0.007	191.9	-0.0044
855.97	-0.003	192.1	-0.0018
855.98	-0.003	192.2	0.0009
856.00	-0.001	192.4	0.0053
856.02	0.003	192.7	0.0053
856.03	0.004	192.7	0.0089
856.05	0.004	192.8	0.0124
856.07	0.005	193.1	0.0169
856.08	0.009	193.3	0.0204
856.10	0.01	193.5	0.0231
856.12	0.011	193.7	0.0275
856.13	0.013	194	0.0302
856.15	0.015	194.2	0.0337
856.17	0.016	194.4	0.0373
856.18	0.02	194.8	0.0373
856.20	0.021	195	0.0417
856.22	0.021	195	0.0435
856.23	0.022	195.2	0.047
856.25	0.024	195.5	0.0488
856.27	0.025	195.8	0.0515
856.28	0.026	196	0.0533
856.30	0.027	196.2	0.0533
856.32	0.028	196.3	0.055
856.33	0.028	196.3	0.0568
856.35	0.028	196.5	0.0586
856.37	0.029	196.7	0.0586
856.38	0.029	196.8	0.0586
856.40	0.029	196.9	0.0586

Prova triassiale ciclica SN04-C1			
pressione di confinamento (kPa)		80	
deviatore ciclico (kPa)		95	
frequenza (hz)		0.00625	
tempo	cella di carico	$\Delta u$	LVDT
(min)	kN	(kPa)	$\delta$ (mm)
856.42	0.028	197	0.0586
856.43	0.028	197.1	0.0586
856.45	0.028	197.1	0.0586
856.48	0.028	197.2	0.0586
856.50	0.027	197.2	0.0577
856.52	0.026	197.2	0.0559
856.53	0.025	197.2	0.055
856.53	0.024	197.2	0.0533
856.55	0.022	197.1	0.0533
856.57	0.022	197.1	0.0515
856.58	0.021	197.1	0.0479
856.60	0.019	196.9	0.0453
856.62	0.016	196.8	0.0435
856.63	0.015	196.7	0.0408
856.65	0.013	196.5	0.0364
856.67	0.011	196.3	0.0364
856.68	0.011	196.3	0.0337
856.70	0.01	196.1	0.0302
856.72	0.007	195.8	0.0257
856.73	0.004	195.6	0.0222
856.75	0.003	195.4	0.0178
856.77	0.001	195.1	0.0142
856.78	-0.002	194.8	0.0142
856.80	-0.002	194.8	0.0107
856.82	-0.002	194.6	0.008
856.83	-0.006	194.1	0.0036
856.85	-0.008	194.1	0.0009
856.87	-0.008	193.9	-0.0027
856.88	-0.009	193.6	-0.0053
856.90	-0.011	193.3	-0.008
856.92	-0.012	193.1	-0.0107
856.93	-0.013	192.8	-0.0133
856.95	-0.015	192.6	-0.0133
856.97	-0.015	192.6	-0.0151
856.98	-0.015	192.4	-0.016
857.00	-0.016	192.2	-0.0178
857.02	-0.017	192	-0.0186
857.03	-0.017	191.9	-0.0195
857.05	-0.017	191.8	-0.0195
857.07	-0.017	191.7	-0.0195
857.08	-0.017	191.7	-0.0195
857.10	-0.017	191.6	-0.0195
857.12	-0.017	191.5	-0.0195
857.13	-0.016	191.5	-0.0186
857.15	-0.015	191.4	-0.0178
857.17	-0.015	191.5	-0.016
857.18	-0.012	191.5	-0.016
857.20	-0.012	191.5	-0.0151
857.22	-0.012	191.5	-0.0133
857.23	-0.011	191.6	-0.0107
857.25	-0.008	191.7	-0.008
857.27	-0.007	191.8	-0.0062
857.28	-0.006	191.9	-0.0036
857.30	-0.002	192.1	-0.0036
857.32	-0.002	192.1	0
857.33	-0.002	192.2	0.0027
857.35	0	192.5	0.0062
857.37	0.004	192.7	0.0107

Prova triassiale ciclica SN04-C1			
pressione di confinamento (kPa)		80	
deviatore ciclico (kPa)		95	
frequenza (hz)		0.00625	
tempo	cella di carico	$\Delta u$	LVDT
(min)	kN	(kPa)	$\delta$ (mm)
857.38	0.004	192.9	0.0133
857.40	0.006	193.1	0.0178
857.42	0.01	193.4	0.0178
857.43	0.011	193.4	0.0222
857.45	0.011	193.6	0.0249
857.47	0.012	193.8	0.0302
857.48	0.016	194.1	0.0337
857.50	0.017	194.4	0.0364
857.52	0.018	194.6	0.0399
857.53	0.021	194.9	0.0399
857.55	0.022	195.1	0.0444
857.57	0.023	195.4	0.0479
857.58	0.024	195.6	0.0479
857.60	0.025	195.8	0.0497
857.62	0.025	195.8	0.0524
857.63	0.026	196	0.0541
857.65	0.027	196.3	0.0559
857.67	0.028	196.4	0.0568
857.68	0.028	196.6	0.0577
857.70	0.029	196.7	0.0586
857.72	0.029	196.9	0.0586
857.73	0.029	196.9	0.0595
857.75	0.029	197	0.0595
857.77	0.029	197.1	0.0595
857.78	0.028	197.2	0.0595
857.80	0.027	197.2	0.0586
857.82	0.027	197.2	0.0568
857.83	0.025	197.2	0.0568
857.85	0.025	197.2	0.0559
857.87	0.025	197.2	0.0541
857.88	0.023	197.1	0.0524
857.90	0.021	197.1	0.0497
857.92	0.02	197	0.0479
857.95	0.019	196.9	0.0453
857.97	0.016	196.7	0.0453
857.98	0.015	196.7	0.0417
857.98	0.015	196.6	0.0391
858.00	0.013	196.4	0.0364
858.02	0.01	196.2	0.0328
858.03	0.008	196	0.0293
858.05	0.007	195.8	0.0249
858.07	0.004	195.6	0.0249
858.08	0.003	195.6	0.0213
858.10	0.003	195.3	0.0178
858.12	0.001	195	0.0133
858.13	-0.003	194.7	0.0089
858.15	-0.004	194.5	0.0053
858.17	-0.005	194.2	0.0018
858.18	-0.008	193.9	0.0018
858.20	-0.009	193.9	-0.0018
858.22	-0.009	193.7	-0.0044
858.23	-0.01	193.4	-0.0071
858.25	-0.013	193.2	-0.0098
858.27	-0.013	192.9	-0.0115
858.28	-0.014	192.7	-0.0133
858.30	-0.015	192.5	-0.0151
858.32	-0.015	192.4	-0.0169
858.33	-0.016	192.2	-0.0178

Prova triassiale ciclica SN04-C1			
pressione di confinamento (kPa)		80	
deviatore ciclico (kPa)		95	
frequenza (hz)		0.00625	
tempo	cella di carico	$\Delta u$	LVDT
(min)	kN	(kPa)	$\delta$ (mm)
858.35	-0.017	192	-0.0178
858.37	-0.017	192	-0.0195
858.38	-0.017	191.8	-0.0195
858.40	-0.017	191.7	-0.0195
858.42	-0.017	191.6	-0.0195
858.43	-0.017	191.5	-0.0195
858.45	-0.016	191.5	-0.0186
858.47	-0.016	191.5	-0.0186
858.48	-0.015	191.5	-0.0178
858.50	-0.015	191.4	-0.0169
858.52	-0.014	191.4	-0.016
858.53	-0.012	191.5	-0.0142
858.55	-0.011	191.5	-0.0124
858.57	-0.01	191.6	-0.0098
858.58	-0.008	191.7	-0.0098
858.60	-0.006	191.8	-0.008
858.62	-0.006	191.8	-0.0053
858.63	-0.005	192	-0.0027
858.65	-0.002	192.2	0.0018
858.67	-0.001	192.3	0.0044
858.68	0.001	192.5	0.008
858.70	0.004	192.8	0.008
858.72	0.006	193	0.0124
858.73	0.006	193	0.0151
858.75	0.007	193.2	0.0195
858.77	0.01	193.5	0.024
858.78	0.012	193.7	0.0275
858.80	0.013	193.9	0.0311
858.82	0.016	194.2	0.0311
858.83	0.018	194.5	0.0355
858.85	0.018	194.5	0.0382
858.87	0.019	194.7	0.0417
858.88	0.021	195	0.0453
858.90	0.023	195.3	0.047
858.92	0.024	195.5	0.0506
858.93	0.025	195.8	0.0506
858.95	0.027	196	0.0524
858.97	0.027	196	0.055
858.98	0.027	196.1	0.0559
859.00	0.027	196.3	0.0568
859.02	0.029	196.5	0.0586
859.03	0.028	196.6	0.0586
859.05	0.028	196.8	0.0586
859.07	0.029	196.9	0.0595
859.08	0.029	197	0.0595
859.10	0.029	197.1	0.0595
859.12	0.028	197.2	0.0595
859.13	0.027	197.2	0.0595
859.15	0.027	197.2	0.0577
859.17	0.026	197.2	0.0568
859.18	0.025	197.2	0.055
859.20	0.024	197.2	0.0541
859.22	0.023	197.1	0.0524
859.23	0.02	197	0.0524
859.25	0.02	197	0.0488
859.27	0.02	197	0.047
859.28	0.018	196.8	0.0444
859.30	0.015	196.7	0.0408

Prova triassiale ciclica SN04-C1			
pressione di confinamento (kPa)		80	
deviatore ciclico (kPa)		95	
frequenza (hz)		0.00625	
tempo	cella di carico	$\Delta u$	LVDT
(min)	kN	(kPa)	$\delta$ (mm)
859.32	0.014	196.6	0.0382
859.33	0.012	196.4	0.0346
859.35	0.009	196.1	0.0346
859.38	0.008	196.1	0.0311
859.40	0.008	196	0.0275
859.42	0.006	195.7	0.0231
859.43	0.002	195.4	0.0186
859.45	0.002	195.2	0.016
859.45	0	194.9	0.0115
859.47	-0.004	194.6	0.0115
859.48	-0.004	194.6	0.0071
859.50	-0.004	194.4	0.0044
859.52	-0.006	194.1	0.0009
859.53	-0.009	193.8	-0.0027
859.55	-0.009	193.6	-0.0053
859.57	-0.011	193.3	-0.008
859.58	-0.013	193.1	-0.008
859.60	-0.014	193.1	-0.0107
859.62	-0.014	192.9	-0.0124
859.63	-0.014	192.6	-0.0151
859.65	-0.016	192.4	-0.0169
859.67	-0.016	192.2	-0.0178
859.68	-0.017	192.1	-0.0186
859.70	-0.017	191.9	-0.0186
859.72	-0.017	191.9	-0.0195
859.73	-0.017	191.8	-0.0195
859.75	-0.017	191.6	-0.0195
859.77	-0.017	191.5	-0.0195
859.78	-0.017	191.5	-0.0195
859.80	-0.016	191.4	-0.0186
859.82	-0.015	191.4	-0.0178
859.83	-0.014	191.4	-0.0169
859.85	-0.014	191.4	-0.0151
859.87	-0.012	191.5	-0.0151
859.88	-0.01	191.6	-0.0133
859.90	-0.01	191.6	-0.0115
859.92	-0.009	191.6	-0.0089
859.93	-0.007	191.8	-0.0062
859.95	-0.006	191.9	-0.0044
859.97	-0.004	192	-0.0009
859.98	-0.001	192.3	-0.0009
860.00	0	192.4	0.0027
860.02	0	192.4	0.0062
860.03	0.002	192.6	0.0098
860.05	0.005	192.9	0.0142
860.07	0.007	193.1	0.0169
860.08	0.008	193.3	0.0213
860.10	0.011	193.6	0.0213
860.12	0.013	193.8	0.0249
860.13	0.013	193.8	0.0293
860.15	0.014	194	0.0328
860.17	0.017	194.4	0.0364
860.18	0.019	194.6	0.0399
860.20	0.02	194.8	0.0435
860.22	0.022	195.1	0.0462
860.23	0.024	195.4	0.0462
860.25	0.024	195.4	0.0488
860.27	0.024	195.6	0.0506

Prova triassiale ciclica SN04-C1			
pressione di confinamento (kPa)		80	
deviatore ciclico (kPa)		95	
frequenza (hz)		0.00625	
tempo	cella di carico	$\Delta u$	LVDT
(min)	kN	(kPa)	$\delta$ (mm)
860.28	0.025	195.8	0.0533
860.30	0.027	196.1	0.055
860.32	0.027	196.2	0.0568
860.33	0.028	196.4	0.0586
860.35	0.029	196.6	0.0586
860.37	0.028	196.6	0.0586
860.38	0.028	196.7	0.0586
860.40	0.029	196.8	0.0595
860.42	0.029	197	0.0595
860.43	0.029	197	0.0595
860.45	0.028	197.1	0.0595
860.47	0.027	197.2	0.0586
860.48	0.027	197.2	0.0568
860.50	0.026	197.2	0.0559
860.52	0.024	197.2	0.0559
860.53	0.023	197.2	0.055
860.55	0.023	197.2	0.0524
860.57	0.022	197.1	0.0506
860.58	0.02	197	0.0479
860.60	0.019	196.9	0.0462
860.62	0.017	196.7	0.0435
860.63	0.014	196.6	0.0435
860.65	0.013	196.6	0.0399
860.67	0.013	196.5	0.0373
860.68	0.011	196.3	0.0328
860.70	0.008	196	0.0293
860.72	0.007	195.9	0.0249
860.73	0.005	195.6	0.0213
860.75	0.001	195.3	0.0213
860.77	0.001	195.3	0.0178
860.78	0.001	195.1	0.0142
860.80	-0.001	194.8	0.0098
860.82	-0.005	194.5	0.0053
860.85	-0.005	194.3	0.0036
860.87	-0.007	194	-0.0009
860.88	-0.01	193.7	-0.0009
860.90	-0.01	193.7	-0.0044
860.90	-0.01	193.5	-0.0062
860.92	-0.011	193.2	-0.0089
860.93	-0.013	192.9	-0.0115
860.95	-0.014	192.7	-0.0133
860.97	-0.015	192.5	-0.0151
860.98	-0.016	192.3	-0.0151
861.00	-0.017	192.1	-0.0169
861.02	-0.017	192.1	-0.0178
861.03	-0.017	192	-0.0186
861.05	-0.017	191.9	-0.0186
861.07	-0.017	191.7	-0.0195
861.08	-0.017	191.6	-0.0195
861.10	-0.017	191.5	-0.0195
861.12	-0.016	191.5	-0.0195
861.13	-0.016	191.5	-0.0186
861.15	-0.016	191.4	-0.0178
861.17	-0.015	191.5	-0.0169
861.18	-0.013	191.5	-0.0151
861.20	-0.012	191.5	-0.0133
861.22	-0.012	191.5	-0.0124
861.23	-0.01	191.6	-0.0107

Prova triassiale ciclica SN04-C1			
pressione di confinamento (kPa)		80	
deviatore ciclico (kPa)		95	
frequenza (hz)		0.00625	
tempo	cella di carico	$\Delta u$	LVDT
(min)	kN	(kPa)	$\delta$ (mm)
861.25	-0.009	191.6	-0.008
861.27	-0.007	191.8	-0.0053
861.28	-0.004	192	-0.0053
861.30	-0.004	192	-0.0027
861.32	-0.004	192.1	0.0009
861.33	-0.002	192.3	0.0036
861.35	0.002	192.5	0.008
861.37	0.003	192.7	0.0107
861.38	0.004	192.9	0.0151
861.40	0.008	193.2	0.0151
861.42	0.009	193.2	0.0195
861.43	0.009	193.4	0.0222
861.45	0.011	193.7	0.0275
861.47	0.014	193.9	0.0311
861.48	0.015	194.1	0.0346
861.50	0.017	194.4	0.0382
861.52	0.02	194.7	0.0382
861.53	0.021	194.7	0.0417
861.55	0.021	194.9	0.0444
861.57	0.022	195.1	0.047
861.58	0.024	195.4	0.0497
861.60	0.024	195.7	0.0515
861.62	0.026	195.9	0.0541
861.63	0.027	196.1	0.0541
861.65	0.028	196.1	0.0559
861.67	0.028	196.3	0.0568
861.68	0.028	196.5	0.0577
861.70	0.029	196.6	0.0586
861.72	0.029	196.7	0.0595
861.73	0.029	196.9	0.0595
861.75	0.029	197	0.0595
861.77	0.029	197.1	0.0595
861.78	0.029	197.1	0.0595
861.80	0.028	197.1	0.0586
861.82	0.027	197.1	0.0577
861.83	0.026	197.2	0.0568
861.85	0.025	197.2	0.055
861.87	0.023	197.1	0.055
861.88	0.022	197	0.0533
861.90	0.022	197	0.0515
861.92	0.019	196.9	0.0488
861.93	0.018	196.8	0.0479
861.95	0.018	196.8	0.0453
861.97	0.017	196.7	0.0417
861.98	0.014	196.5	0.0382
862.00	0.011	196.3	0.0355
862.02	0.011	196.2	0.032
862.03	0.008	195.9	0.032
862.05	0.005	195.7	0.0284
862.07	0.005	195.7	0.024
862.08	0.004	195.5	0.0204
862.10	0.001	195.1	0.016
862.12	-0.001	194.9	0.0133
862.13	-0.002	194.7	0.0089
862.15	-0.005	194.3	0.0053
862.17	-0.007	194.1	0.0053
862.18	-0.007	194.1	0.0018
862.20	-0.007	193.9	-0.0018



Prova triassiale ciclica SN04-C1			
pressione di confinamento (kPa)		80	
deviatore ciclico (kPa)		95	
frequenza (hz)		0.00625	
tempo	cella di carico	$\Delta u$	LVDT
(min)	kN	(kPa)	$\delta$ (mm)
862.22	-0.01	193.5	-0.0053
862.23	-0.011	193.3	-0.008
862.25	-0.012	193.1	-0.0098
862.28	-0.013	192.8	-0.0124
862.30	-0.015	192.6	-0.0124
862.32	-0.015	192.6	-0.0142
862.33	-0.015	192.4	-0.016
862.35	-0.016	192.2	-0.0169
862.35	-0.017	192	-0.0178
862.37	-0.017	191.9	-0.0186
862.38	-0.017	191.8	-0.0195
862.40	-0.017	191.7	-0.0195
862.42	-0.017	191.7	-0.0195
862.43	-0.017	191.6	-0.0195
862.45	-0.017	191.5	-0.0186
862.47	-0.016	191.5	-0.0178
862.48	-0.015	191.4	-0.0178
862.50	-0.015	191.4	-0.016
862.52	-0.013	191.4	-0.016
862.53	-0.012	191.4	-0.0142
862.55	-0.012	191.5	-0.0124
862.57	-0.011	191.5	-0.0107
862.58	-0.008	191.7	-0.008
862.60	-0.007	191.7	-0.0062
862.62	-0.006	191.9	-0.0027
862.63	-0.002	192.1	-0.0027
862.65	-0.002	192.2	0.0027
862.67	-0.001	192.3	0.0053
862.68	0.002	192.6	0.0053
862.70	0.004	192.6	0.0089
862.72	0.004	192.7	0.0115
862.73	0.005	193	0.0169
862.75	0.009	193.3	0.0204
862.77	0.01	193.5	0.024
862.78	0.012	193.7	0.0284
862.80	0.015	194	0.0284
862.82	0.016	194.2	0.0328
862.83	0.016	194.2	0.0355
862.85	0.017	194.4	0.0391
862.87	0.02	194.8	0.0426
862.88	0.021	195	0.0453
862.90	0.022	195.2	0.0479
862.92	0.024	195.5	0.0479
862.93	0.026	195.8	0.0506
862.95	0.026	195.8	0.0533
862.97	0.026	195.9	0.055
862.98	0.027	196.2	0.0568
863.00	0.028	196.4	0.0577
863.02	0.028	196.5	0.0586
863.03	0.028	196.6	0.0586
863.05	0.029	196.8	0.0586
863.07	0.029	196.8	0.0595
863.08	0.029	196.9	0.0595
863.10	0.029	197	0.0595
863.12	0.028	197.1	0.0595
863.13	0.028	197.1	0.0586
863.15	0.027	197.1	0.0577
863.17	0.025	197.1	0.0577

Prova triassiale ciclica SN04-C1			
pressione di confinamento (kPa)		80	
deviatore ciclico (kPa)		95	
frequenza (hz)		0.00625	
tempo	cella di carico	$\Delta u$	LVDT
(min)	kN	(kPa)	$\delta$ (mm)
863.18	0.024	197.1	0.0559
863.20	0.024	197.1	0.0541
863.22	0.024	197.1	0.0524
863.23	0.021	197	0.0506
863.25	0.02	196.9	0.0488
863.27	0.019	196.8	0.0453
863.28	0.016	196.7	0.0453
863.30	0.015	196.7	0.0426
863.32	0.015	196.5	0.0399
863.33	0.013	196.3	0.0364
863.35	0.01	196.1	0.0328
863.37	0.009	196	0.0293
863.38	0.008	195.8	0.0275
863.40	0.005	195.6	0.0231
863.42	0.003	195.4	0.0195
863.43	0.002	195.1	0.016
863.45	-0.002	194.8	0.016
863.47	-0.003	194.8	0.0115
863.48	-0.003	194.5	0.008
863.50	-0.004	194.3	0.0044
863.52	-0.007	194	0
863.53	-0.008	193.7	-0.0027
863.55	-0.009	193.5	-0.0053
863.57	-0.012	193.2	-0.0053
863.58	-0.013	193.2	-0.0089
863.60	-0.013	193	-0.0107
863.62	-0.013	192.8	-0.0124
863.63	-0.015	192.5	-0.0151
863.65	-0.016	192.3	-0.016
863.67	-0.016	192.2	-0.0169
863.68	-0.017	192	-0.0169
863.70	-0.017	191.8	-0.0186
863.72	-0.017	191.8	-0.0186
863.75	-0.017	191.7	-0.0186
863.77	-0.017	191.6	-0.0186
863.78	-0.017	191.5	-0.0195
863.80	-0.017	191.4	-0.0186
863.80	-0.016	191.4	-0.0186
863.82	-0.015	191.4	-0.0178
863.83	-0.015	191.4	-0.0169
863.85	-0.014	191.4	-0.0151
863.87	-0.013	191.4	-0.0142
863.88	-0.011	191.5	-0.0124
863.90	-0.01	191.5	-0.0098
863.92	-0.008	191.7	-0.0098
863.93	-0.006	191.8	-0.0071
863.95	-0.006	191.8	-0.0044
863.97	-0.005	191.9	-0.0018
863.98	-0.003	192.1	0.0018
864.00	0	192.3	0.0053
864.02	0.001	192.4	0.008
864.03	0.003	192.7	0.0115
864.05	0.006	193	0.0115
864.07	0.007	193	0.016
864.08	0.007	193.1	0.0195
864.10	0.011	193.6	0.0231
864.12	0.012	193.6	0.0257
864.13	0.012	193.8	0.0302

Prova triassiale ciclica SN04-C1			
pressione di confinamento (kPa)		80	
deviatore ciclico (kPa)		95	
frequenza (hz)		0.00625	
tempo	cella di carico	$\Delta u$	LVDT
(min)	kN	(kPa)	$\delta$ (mm)
864.15	0.014	194.1	0.0337
864.17	0.018	194.4	0.0373
864.18	0.018	194.6	0.0399
864.20	0.019	194.8	0.0435
864.22	0.022	195.1	0.0435
864.23	0.023	195.1	0.047
864.25	0.023	195.3	0.0488
864.27	0.024	195.6	0.0515
864.28	0.026	195.8	0.0541
864.30	0.026	196	0.055
864.32	0.027	196.2	0.0568
864.33	0.028	196.4	0.0568
864.35	0.028	196.4	0.0586
864.37	0.028	196.5	0.0586
864.38	0.029	196.7	0.0595
864.40	0.029	196.8	0.0595
864.42	0.029	196.9	0.0604
864.43	0.029	197	0.0595
864.45	0.028	197.1	0.0595
864.47	0.027	197.1	0.0595
864.48	0.027	197.1	0.0577
864.50	0.026	197.1	0.0568
864.52	0.025	197.1	0.0559
864.53	0.024	197.1	0.0541
864.55	0.023	197.1	0.0515
864.57	0.021	196.9	0.0515
864.58	0.019	196.9	0.0497
864.60	0.019	196.9	0.0479
864.62	0.018	196.8	0.0444
864.63	0.015	196.6	0.0408
864.65	0.014	196.4	0.0382
864.67	0.012	196.3	0.0346
864.68	0.009	196.1	0.0346
864.70	0.007	195.9	0.0311
864.72	0.007	195.9	0.0284
864.73	0.006	195.7	0.024
864.75	0.003	195.3	0.0195
864.77	0.001	195.1	0.016
864.78	0	194.8	0.0115
864.80	-0.004	194.5	0.0115
864.82	-0.005	194.3	0.0071
864.83	-0.006	194.1	0.0027
864.85	-0.007	193.8	0.0027
864.87	-0.009	193.6	0
864.88	-0.009	193.6	-0.0027
864.90	-0.01	193.4	-0.0062
864.92	-0.012	193	-0.0098
864.93	-0.014	192.8	-0.0115
864.95	-0.014	192.6	-0.0133
864.97	-0.015	192.4	-0.0151
864.98	-0.016	192.2	-0.0151
865.00	-0.017	192.2	-0.0169
865.02	-0.017	192	-0.0178
865.03	-0.017	191.9	-0.0186
865.05	-0.017	191.7	-0.0195
865.07	-0.017	191.6	-0.0195
865.08	-0.017	191.5	-0.0195
865.10	-0.017	191.4	-0.0195

Prova triassiale ciclica SN04-C1			
pressione di confinamento (kPa)		80	
deviatore ciclico (kPa)		95	
frequenza (hz)		0.00625	
tempo	cella di carico	$\Delta u$	LVDT
(min)	kN	(kPa)	$\delta$ (mm)
865.12	-0.016	191.4	-0.0195
865.13	-0.016	191.4	-0.0186
865.15	-0.016	191.3	-0.0178
865.18	-0.014	191.4	-0.016
865.20	-0.014	191.3	-0.0151
865.22	-0.013	191.4	-0.0133
865.23	-0.01	191.5	-0.0133
865.25	-0.009	191.5	-0.0107
865.25	-0.009	191.5	-0.0089
865.27	-0.008	191.7	-0.0062
865.28	-0.006	191.8	-0.0036
865.30	-0.004	192	0
865.32	-0.002	192.1	0.0036
865.33	0.001	192.4	0.0036
865.35	0.002	192.4	0.0062
865.37	0.002	192.5	0.0089
865.38	0.003	192.7	0.0133
865.40	0.007	193	0.0178
865.42	0.008	193.2	0.0204
865.43	0.01	193.4	0.0249
865.45	0.013	193.7	0.0249
865.47	0.015	194	0.0302
865.48	0.015	194	0.0328
865.50	0.016	194.2	0.0364
865.52	0.019	194.5	0.0399
865.53	0.02	194.7	0.0426
865.55	0.021	194.9	0.0462
865.57	0.022	195.2	0.047
865.58	0.024	195.4	0.0497
865.60	0.025	195.6	0.0524
865.62	0.026	195.9	0.055
865.63	0.027	196.1	0.055
865.65	0.028	196.1	0.0559
865.67	0.028	196.3	0.0568
865.68	0.028	196.4	0.0586
865.70	0.028	196.6	0.0586
865.72	0.029	196.7	0.0595
865.73	0.029	196.8	0.0604
865.75	0.029	196.9	0.0604
865.77	0.029	196.9	0.0604
865.78	0.029	197	0.0604
865.80	0.028	197.1	0.0586
865.82	0.027	197.1	0.0577
865.83	0.026	197.1	0.0568
865.85	0.025	197.1	0.055
865.87	0.023	197.1	0.055
865.88	0.022	197.1	0.0533
865.90	0.022	197	0.0515
865.92	0.021	197	0.0488
865.93	0.018	196.8	0.0462
865.95	0.017	196.7	0.0444
865.97	0.015	196.6	0.0399
865.98	0.012	196.3	0.0399
866.00	0.011	196.3	0.0373
866.02	0.011	196.2	0.0346
866.03	0.01	196	0.0311
866.05	0.006	195.8	0.0257
866.07	0.005	195.6	0.0231

Prova triassiale ciclica SN04-C1			
pressione di confinamento (kPa)		80	
deviatore ciclico (kPa)		95	
frequenza (hz)		0.00625	
tempo	cella di carico	$\Delta u$	LVDT
(min)	kN	(kPa)	$\delta$ (mm)
866.08	0.003	195.3	0.0186
866.10	0	195	0.0186
866.12	-0.001	195	0.0142
866.13	-0.001	194.8	0.0115
866.15	-0.003	194.5	0.0071
866.17	-0.006	194.2	0.0036
866.18	-0.007	193.9	0.0009
866.20	-0.008	193.7	-0.0027
866.22	-0.011	193.4	-0.0027
866.23	-0.012	193.2	-0.0062
866.25	-0.012	193.2	-0.008
866.27	-0.013	192.9	-0.0107
866.28	-0.015	192.5	-0.0133
866.30	-0.015	192.5	-0.0142
866.32	-0.015	192.3	-0.016
866.33	-0.016	192.1	-0.0169
866.35	-0.017	191.9	-0.0178
866.37	-0.017	191.8	-0.0186
866.38	-0.017	191.7	-0.0186
866.40	-0.017	191.6	-0.0195
866.42	-0.017	191.6	-0.0195
866.43	-0.017	191.5	-0.0186
866.45	-0.017	191.4	-0.0186
866.47	-0.016	191.3	-0.0178
866.48	-0.015	191.3	-0.0169
866.50	-0.014	191.3	-0.016
866.52	-0.013	191.4	-0.016
866.53	-0.013	191.4	-0.0142
866.55	-0.012	191.4	-0.0124
866.57	-0.01	191.5	-0.0098
866.58	-0.008	191.6	-0.008
866.60	-0.007	191.7	-0.0053
866.62	-0.005	191.9	-0.0027
866.65	-0.003	192	-0.0027
866.67	-0.003	192	0.0009
866.68	-0.002	192.2	0.0036
866.70	0.001	192.4	0.008
866.70	0.003	192.6	0.0107
866.72	0.005	192.8	0.0151
866.73	0.007	193.1	0.0186
866.75	0.01	193.3	0.0186
866.77	0.01	193.3	0.0222
866.78	0.011	193.5	0.0257
866.80	0.013	193.8	0.0311
866.82	0.016	194.1	0.0346
866.83	0.017	194.3	0.0373
866.85	0.018	194.6	0.0408
866.87	0.021	194.8	0.0408
866.88	0.021	194.8	0.0444
866.90	0.022	195	0.047
866.92	0.023	195.3	0.0497
866.93	0.025	195.6	0.0524
866.95	0.026	195.8	0.0533
866.97	0.026	196	0.0559
866.98	0.028	196.2	0.0559
867.00	0.028	196.3	0.0577
867.02	0.028	196.4	0.0577
867.03	0.028	196.6	0.0577

Prova triassiale ciclica SN04-C1			
pressione di confinamento (kPa)		80	
deviatore ciclico (kPa)		95	
frequenza (hz)		0.00625	
tempo	cella di carico	$\Delta u$	LVDT
(min)	kN	(kPa)	$\delta$ (mm)
867.05	0.028	196.6	0.0586
867.07	0.028	196.7	0.0595
867.08	0.029	196.9	0.0595
867.10	0.029	197	0.0595
867.12	0.028	197	0.0595
867.13	0.028	197.1	0.0586
867.15	0.026	197.1	0.0586
867.17	0.026	197.1	0.0577
867.18	0.026	197.1	0.0559
867.20	0.024	197.1	0.0541
867.22	0.022	197	0.0524
867.23	0.022	197	0.0506
867.25	0.02	196.9	0.0479
867.27	0.017	196.7	0.0479
867.28	0.016	196.7	0.0453
867.30	0.016	196.6	0.0426
867.32	0.015	196.5	0.0391
867.33	0.012	196.3	0.0355
867.35	0.01	196.1	0.0328
867.37	0.009	195.9	0.0293
867.38	0.005	195.6	0.0293
867.40	0.004	195.4	0.024
867.42	0.004	195.4	0.0213
867.43	0.002	195.2	0.0169
867.45	0	194.9	0.0133
867.47	-0.002	194.6	0.0098
867.48	-0.004	194.4	0.0053
867.50	-0.006	194.1	0.0053
867.52	-0.008	193.8	0.0018
867.53	-0.008	193.8	-0.0009
867.55	-0.009	193.6	-0.0036
867.57	-0.011	193.3	-0.0071
867.58	-0.013	193	-0.0098
867.60	-0.013	192.8	-0.0115
867.62	-0.014	192.6	-0.0115
867.63	-0.016	192.4	-0.0142
867.65	-0.016	192.4	-0.0151
867.67	-0.016	192.2	-0.0169
867.68	-0.017	192	-0.0178
867.70	-0.017	191.8	-0.0186
867.72	-0.017	191.7	-0.0186
867.73	-0.017	191.6	-0.0195
867.75	-0.017	191.5	-0.0195
867.77	-0.017	191.4	-0.0186
867.78	-0.016	191.4	-0.0186
867.80	-0.015	191.3	-0.0186
867.82	-0.015	191.3	-0.0178
867.83	-0.015	191.3	-0.0169
867.85	-0.014	191.3	-0.016
867.87	-0.012	191.4	-0.0133
867.88	-0.011	191.4	-0.0115
867.90	-0.01	191.5	-0.0098
867.92	-0.007	191.6	-0.0098
867.93	-0.006	191.6	-0.0071
867.95	-0.006	191.7	-0.0044
867.97	-0.005	191.9	-0.0018
867.98	-0.002	192.1	0.0018
868.00	-0.001	192.2	0.0044

Prova triassiale ciclica SN04-C1			
pressione di confinamento (kPa)		80	
deviatore ciclico (kPa)		95	
frequenza (hz)		0.00625	
tempo	cella di carico	$\Delta u$	LVDT
(min)	kN	(kPa)	$\delta$ (mm)
868.02	0.001	192.5	0.0089
868.03	0.004	192.7	0.0089
868.05	0.006	192.7	0.0124
868.07	0.006	192.8	0.016
868.08	0.007	193.1	0.0195
868.12	0.011	193.4	0.024
868.13	0.012	193.6	0.0275
868.15	0.013	193.9	0.032
868.17	0.017	194.1	0.032
868.17	0.018	194.1	0.0364
868.18	0.018	194.4	0.0391
868.20	0.019	194.6	0.0417
868.22	0.021	194.9	0.0453
868.23	0.023	195.1	0.0479
868.25	0.023	195.4	0.0497
868.27	0.026	195.6	0.0497
868.28	0.026	195.6	0.0524
868.30	0.026	195.8	0.055
868.32	0.027	196.1	0.0568
868.33	0.028	196.2	0.0577
868.35	0.028	196.4	0.0586
868.37	0.029	196.5	0.0595
868.38	0.029	196.7	0.0595
868.40	0.029	196.7	0.0595
868.42	0.029	196.8	0.0595
868.43	0.029	196.9	0.0595
868.45	0.028	196.9	0.0586
868.47	0.028	197	0.0586
868.48	0.027	197.1	0.0577
868.50	0.026	197	0.0559
868.52	0.025	197	0.055
868.53	0.024	197.1	0.0533
868.55	0.022	197	0.0533
868.57	0.021	196.9	0.0515
868.58	0.021	196.9	0.0497
868.60	0.02	196.8	0.047
868.62	0.017	196.6	0.0435
868.63	0.015	196.5	0.0408
868.65	0.014	196.4	0.0373
868.67	0.011	196.1	0.0373
868.68	0.009	196	0.0346
868.70	0.009	196	0.0311
868.72	0.008	195.8	0.0275
868.73	0.005	195.5	0.0222
868.75	0.003	195.2	0.0195
868.77	0.002	195	0.016
868.78	-0.002	194.7	0.016
868.80	-0.003	194.4	0.0107
868.82	-0.003	194.4	0.008
868.83	-0.004	194.2	0.0036
868.85	-0.007	193.9	0
868.87	-0.008	193.7	-0.0018
868.88	-0.01	193.4	-0.0053
868.90	-0.012	193.1	-0.0053
868.92	-0.013	192.9	-0.008
868.93	-0.013	192.9	-0.0115
868.95	-0.014	192.6	-0.0133
868.97	-0.015	192.4	-0.0151

Prova triassiale ciclica SN04-C1			
pressione di confinamento (kPa)		80	
deviatore ciclico (kPa)		95	
frequenza (hz)		0.00625	
tempo	cella di carico	$\Delta u$	LVDT
(min)	kN	(kPa)	$\delta$ (mm)
868.98	-0.016	192.2	-0.0169
869.00	-0.016	192	-0.0169
869.02	-0.017	191.8	-0.0186
869.03	-0.017	191.7	-0.0186
869.05	-0.017	191.7	-0.0195
869.07	-0.017	191.6	-0.0195
869.08	-0.017	191.5	-0.0195
869.10	-0.017	191.4	-0.0195
869.12	-0.017	191.3	-0.0186
869.13	-0.016	191.3	-0.0178
869.15	-0.015	191.3	-0.0178
869.17	-0.014	191.3	-0.0169
869.18	-0.013	191.3	-0.0151
869.20	-0.012	191.3	-0.0151
869.22	-0.011	191.3	-0.0133
869.23	-0.011	191.4	-0.0115
869.25	-0.01	191.5	-0.0089
869.27	-0.006	191.6	-0.0062
869.28	-0.006	191.7	-0.0036
869.30	-0.004	191.9	0
869.32	-0.001	192.1	0
869.33	0	192.1	0.0036
869.35	0	192.2	0.0062
869.37	0.002	192.4	0.0098
869.38	0.005	192.7	0.0133
869.40	0.006	192.9	0.0169
869.42	0.008	193.1	0.0213
869.43	0.012	193.4	0.0213
869.45	0.013	193.4	0.0257
869.47	0.013	193.6	0.0293
869.48	0.014	193.9	0.0328
869.50	0.018	194.2	0.0373
869.52	0.019	194.4	0.0399
869.55	0.02	194.6	0.0426
869.57	0.022	194.9	0.0426
869.58	0.023	195.1	0.0462
869.60	0.023	195.1	0.0488
869.62	0.024	195.4	0.0506
869.62	0.026	195.7	0.0533
869.63	0.027	195.9	0.055
869.65	0.027	196.1	0.0568
869.67	0.028	196.2	0.0568
869.68	0.029	196.4	0.0577
869.70	0.029	196.4	0.0586
869.72	0.029	196.5	0.0595
869.73	0.029	196.6	0.0595
869.75	0.029	196.8	0.0595
869.77	0.028	196.9	0.0595
869.78	0.028	196.9	0.0586
869.80	0.027	197	0.0586
869.82	0.027	197	0.0577
869.83	0.026	197	0.0559
869.85	0.025	197	0.055
869.87	0.024	197	0.0541
869.88	0.023	196.9	0.0515
869.90	0.022	196.8	0.0497
869.92	0.019	196.7	0.047
869.93	0.019	196.7	0.0453



Prova triassiale ciclica SN04-C1			
pressione di confinamento (kPa)		80	
deviatore ciclico (kPa)		95	
frequenza (hz)		0.00625	
tempo	cella di carico	$\Delta u$	LVDT
(min)	kN	(kPa)	$\delta$ (mm)
869.95	0.017	196.5	0.0426
869.97	0.014	196.4	0.0426
869.98	0.013	196.4	0.0391
870.00	0.013	196.3	0.0373
870.02	0.011	196	0.0337
870.03	0.008	195.8	0.0293
870.05	0.007	195.6	0.0257
870.07	0.005	195.3	0.0213
870.08	0.002	195.1	0.0213
870.10	0.001	195.1	0.0178
870.12	0.001	194.9	0.0142
870.13	-0.001	194.6	0.0098
870.15	-0.005	194.3	0.0062
870.17	-0.005	194.1	0.0036
870.18	-0.007	193.8	0
870.20	-0.01	193.5	0
870.22	-0.011	193.5	-0.0044
870.23	-0.011	193.2	-0.0062
870.25	-0.011	193	-0.008
870.27	-0.014	192.7	-0.0115
870.28	-0.014	192.5	-0.0133
870.30	-0.015	192.3	-0.0151
870.32	-0.016	192.1	-0.0151
870.33	-0.017	192.1	-0.0169
870.35	-0.017	191.9	-0.0178
870.37	-0.017	191.8	-0.0186
870.38	-0.017	191.6	-0.0186
870.40	-0.017	191.5	-0.0195
870.42	-0.017	191.4	-0.0195
870.43	-0.016	191.4	-0.0195
870.45	-0.016	191.4	-0.0186
870.47	-0.016	191.3	-0.0178
870.48	-0.016	191.3	-0.0178
870.50	-0.014	191.3	-0.0169
870.52	-0.014	191.3	-0.0151
870.53	-0.013	191.3	-0.0133
870.55	-0.011	191.4	-0.0133
870.57	-0.009	191.5	-0.0115
870.58	-0.009	191.5	-0.0098
870.60	-0.008	191.5	-0.0071
870.62	-0.006	191.7	-0.0036
870.63	-0.004	191.9	-0.0009
870.65	-0.003	192	0.0009
870.67	-0.001	192.2	0.0044
870.68	0.001	192.3	0.0071
870.70	0.003	192.5	0.0124
870.72	0.005	192.8	0.016
870.73	0.008	193	0.016
870.75	0.009	193	0.0186
870.77	0.009	193.2	0.0222
870.78	0.011	193.5	0.0257
870.80	0.014	193.7	0.0311
870.82	0.015	193.9	0.0337
870.83	0.017	194.3	0.0382
870.85	0.02	194.5	0.0382
870.87	0.02	194.5	0.0408
870.88	0.02	194.7	0.0435
870.90	0.022	195	0.047

Prova triassiale ciclica SN04-C1			
pressione di confinamento (kPa)		80	
deviatore ciclico (kPa)		95	
frequenza (hz)		0.00625	
tempo	cella di carico	$\Delta u$	LVDT
(min)	kN	(kPa)	$\delta$ (mm)
870.92	0.024	195.2	0.0497
870.93	0.025	195.5	0.0515
870.95	0.025	195.7	0.0533
870.97	0.027	195.9	0.0533
870.98	0.027	195.9	0.0559
871.02	0.027	196.1	0.0568
871.03	0.028	196.3	0.0577
871.05	0.029	196.4	0.0586
871.07	0.029	196.6	0.0595
871.07	0.029	196.7	0.0595
871.08	0.029	196.8	0.0595
871.10	0.029	196.8	0.0595
871.12	0.029	196.9	0.0595
871.13	0.028	196.9	0.0586
871.15	0.027	197	0.0577
871.17	0.026	197	0.0559
871.18	0.025	197	0.055
871.20	0.023	196.9	0.055
871.22	0.022	196.9	0.0524
871.23	0.022	196.9	0.0515
871.25	0.021	196.8	0.0488
871.27	0.019	196.7	0.0453
871.28	0.017	196.5	0.0435
871.30	0.015	196.4	0.0408
871.32	0.013	196.2	0.0408
871.33	0.011	196.1	0.0373
871.35	0.011	196.1	0.0337
871.37	0.007	195.7	0.0302
871.38	0.006	195.5	0.0284
871.40	0.006	195.5	0.0249
871.42	0.005	195.3	0.0204
871.43	0.001	194.9	0.016
871.45	-0.002	194.6	0.0115
871.47	-0.001	194.5	0.0098
871.48	-0.003	194.2	0.0053
871.50	-0.007	193.9	0.0053
871.52	-0.007	193.9	0.0009
871.53	-0.007	193.7	-0.0018
871.55	-0.01	193.3	-0.0062
871.57	-0.011	193.1	-0.008
871.58	-0.012	192.9	-0.0107
871.60	-0.013	192.6	-0.0133
871.62	-0.016	192.4	-0.0133
871.63	-0.016	192.4	-0.0151
871.65	-0.015	192.2	-0.016
871.67	-0.016	192	-0.0169
871.68	-0.017	191.8	-0.0186
871.70	-0.017	191.7	-0.0195
871.72	-0.018	191.5	-0.0204
871.73	-0.017	191.4	-0.0204
871.75	-0.017	191.4	-0.0204
871.77	-0.017	191.4	-0.0195
871.78	-0.017	191.3	-0.0186
871.80	-0.016	191.2	-0.0195
871.82	-0.016	191.2	-0.0169
871.83	-0.015	191.3	-0.016
871.85	-0.012	191.3	-0.016
871.87	-0.012	191.3	-0.0133

Prova triassiale ciclica SN04-C1			
pressione di confinamento (kPa)		80	
deviatore ciclico (kPa)		95	
frequenza (hz)		0.00625	
tempo	cella di carico	$\Delta u$	LVDT
(min)	kN	(kPa)	$\delta$ (mm)
871.88	-0.012	191.3	-0.0124
871.90	-0.012	191.3	-0.0107
871.92	-0.007	191.5	-0.0071
871.93	-0.007	191.6	-0.0053
871.95	-0.007	191.7	-0.0027
871.97	-0.002	191.9	-0.0027
871.98	-0.002	191.9	0
872.00	-0.002	192.1	0.0036
872.02	0	192.3	0.0071
872.03	0.003	192.4	0.0115
872.05	0.006	192.7	0.0151
872.07	0.007	192.9	0.0178
872.08	0.008	193.1	0.0222
872.10	0.01	193.3	0.024
872.12	0.012	193.6	0.0284
872.13	0.015	193.9	0.0284
872.15	0.016	193.9	0.0311
872.17	0.016	194.1	0.0337
872.18	0.017	194.3	0.0391
872.20	0.02	194.6	0.0426
872.22	0.021	194.8	0.0453
872.23	0.022	195	0.0479
872.25	0.024	195.3	0.0479
872.27	0.025	195.3	0.0497
872.28	0.025	195.6	0.0524
872.30	0.026	195.8	0.0541
872.32	0.028	196	0.0559
872.33	0.028	196.1	0.0568
872.35	0.028	196.3	0.0586
872.37	0.029	196.5	0.0586
872.38	0.029	196.6	0.0595
872.40	0.029	196.6	0.0595
872.42	0.029	196.7	0.0595
872.45	0.028	196.7	0.0586
872.47	0.029	196.9	0.0586
872.48	0.028	197	0.0586
872.50	0.026	196.9	0.0586
872.52	0.025	196.9	0.0568
872.52	0.025	196.9	0.0559
872.53	0.025	196.9	0.0541
872.55	0.023	196.9	0.0524
872.57	0.021	196.8	0.0506
872.58	0.02	196.7	0.0479
872.60	0.018	196.6	0.0453
872.62	0.015	196.4	0.0453
872.63	0.015	196.4	0.0426
872.65	0.015	196.3	0.0399
872.67	0.013	196.1	0.0364
872.68	0.01	195.9	0.0328
872.70	0.009	195.8	0.0284
872.72	0.006	195.5	0.024
872.73	0.004	195.3	0.024
872.75	0.004	195.3	0.0213
872.77	0.003	195	0.0169
872.78	0	194.7	0.0124
872.80	-0.003	194.4	0.0089
872.82	-0.004	194.2	0.0062
872.83	-0.004	194	0.0044

Prova triassiale ciclica SN04-C1			
pressione di confinamento (kPa)		80	
deviatore ciclico (kPa)		95	
frequenza (hz)		0.00625	
tempo	cella di carico	$\Delta u$	LVDT
(min)	kN	(kPa)	$\delta$ (mm)
872.85	-0.007	193.8	0.0009
872.87	-0.008	193.5	-0.0027
872.88	-0.01	193.2	-0.0062
872.90	-0.012	193	-0.0062
872.92	-0.013	193	-0.0089
872.93	-0.013	192.7	-0.0107
872.95	-0.013	192.5	-0.0124
872.97	-0.015	192.3	-0.0151
872.98	-0.016	192.1	-0.016
873.00	-0.016	191.9	-0.0178
873.02	-0.017	191.7	-0.0178
873.03	-0.017	191.7	-0.0186
873.05	-0.017	191.6	-0.0195
873.07	-0.017	191.5	-0.0195
873.08	-0.017	191.4	-0.0195
873.10	-0.017	191.3	-0.0195
873.12	-0.016	191.2	-0.0186
873.13	-0.015	191.2	-0.0186
873.15	-0.015	191.2	-0.0178
873.17	-0.015	191.2	-0.0169
873.18	-0.014	191.2	-0.016
873.20	-0.012	191.2	-0.0142
873.22	-0.011	191.3	-0.0124
873.23	-0.01	191.3	-0.0098
873.25	-0.007	191.5	-0.0098
873.27	-0.006	191.5	-0.0071
873.28	-0.006	191.6	-0.0053
873.30	-0.005	191.7	-0.0018
873.32	-0.002	191.9	0.0018
873.33	-0.001	192.1	0.0036
873.35	0.001	192.2	0.008
873.37	0.004	192.5	0.008
873.38	0.005	192.7	0.0124
873.40	0.005	192.7	0.0151
873.42	0.007	192.9	0.0195
873.43	0.011	193.3	0.024
873.45	0.012	193.5	0.0275
873.47	0.013	193.7	0.0311
873.48	0.016	194	0.0311
873.50	0.018	194.2	0.0355
873.52	0.018	194.2	0.0382
873.53	0.019	194.4	0.0417
873.55	0.022	194.9	0.0444
873.57	0.022	194.9	0.0462
873.58	0.023	195.1	0.0488
873.60	0.024	195.4	0.0515
873.62	0.026	195.7	0.0541
873.63	0.026	195.8	0.0541
873.65	0.027	196	0.0559
873.67	0.028	196.2	0.0559
873.68	0.028	196.2	0.0568
873.70	0.028	196.4	0.0586
873.72	0.029	196.5	0.0595
873.73	0.029	196.6	0.0595
873.75	0.029	196.7	0.0595
873.77	0.029	196.8	0.0595
873.78	0.027	196.9	0.0595
873.80	0.027	196.9	0.0577

Prova triassiale ciclica SN04-C1			
pressione di confinamento (kPa)		80	
deviatore ciclico (kPa)		95	
frequenza (hz)		0.00625	
tempo	cella di carico	$\Delta u$	LVDT
(min)	kN	(kPa)	$\delta$ (mm)
873.82	0.027	197	0.0577
873.83	0.027	197	0.0568
873.85	0.025	196.9	0.055
873.87	0.024	196.9	0.0541
873.88	0.023	196.8	0.0515
873.92	0.02	196.8	0.0515
873.93	0.019	196.8	0.0488
873.95	0.019	196.7	0.047
873.97	0.018	196.6	0.0444
873.97	0.015	196.4	0.0408
873.98	0.014	196.3	0.0382
874.00	0.012	196.1	0.0346
874.02	0.009	195.9	0.0346
874.03	0.008	195.9	0.0311
874.05	0.008	195.7	0.0275
874.07	0.006	195.4	0.0231
874.08	0.003	195.1	0.0195
874.10	0.002	194.9	0.016
874.12	0	194.6	0.0115
874.13	-0.004	194.3	0.0115
874.15	-0.004	194.3	0.0071
874.17	-0.004	194.1	0.0044
874.18	-0.006	193.8	0
874.20	-0.009	193.5	-0.0036
874.22	-0.01	193.3	-0.0053
874.23	-0.011	193.1	-0.008
874.25	-0.013	192.8	-0.008
874.27	-0.014	192.6	-0.0124
874.28	-0.014	192.4	-0.0133
874.30	-0.016	192.2	-0.0133
874.32	-0.016	192	-0.016
874.33	-0.016	192	-0.0169
874.35	-0.016	191.8	-0.0178
874.37	-0.017	191.7	-0.0186
874.38	-0.017	191.5	-0.0195
874.40	-0.017	191.4	-0.0195
874.42	-0.017	191.3	-0.0195
874.43	-0.017	191.2	-0.0195
874.45	-0.017	191.2	-0.0195
874.47	-0.016	191.2	-0.0178
874.48	-0.015	191.2	-0.0178
874.50	-0.015	191.2	-0.0169
874.52	-0.014	191.2	-0.0151
874.53	-0.012	191.3	-0.0133
874.55	-0.01	191.3	-0.0133
874.57	-0.01	191.3	-0.0115
874.58	-0.009	191.4	-0.0089
874.60	-0.008	191.6	-0.0062
874.62	-0.005	191.7	-0.0036
874.63	-0.004	191.8	-0.0009
874.65	-0.002	192	0.0027
874.67	0.001	192.2	0.0027
874.68	0.002	192.2	0.0062
874.70	0.002	192.3	0.0089
874.72	0.004	192.6	0.0133
874.73	0.007	192.8	0.0178
874.75	0.008	193	0.0213
874.77	0.01	193.3	0.0249

Prova triassiale ciclica SN04-C1			
pressione di confinamento (kPa)		80	
deviatore ciclico (kPa)		95	
frequenza (hz)		0.00625	
tempo	cella di carico	$\Delta u$	LVDT
(min)	kN	(kPa)	$\delta$ (mm)
874.78	0.014	193.6	0.0249
874.80	0.015	193.6	0.0302
874.82	0.015	193.8	0.0328
874.83	0.016	194.1	0.0364
874.85	0.019	194.3	0.0399
874.87	0.02	194.5	0.0426
874.88	0.021	194.8	0.0462
874.90	0.023	195.1	0.0462
874.92	0.024	195.1	0.0488
874.93	0.024	195.3	0.0506
874.95	0.025	195.6	0.0533
874.97	0.027	195.8	0.055
874.98	0.027	196	0.0568
875.00	0.028	196.1	0.0577
875.02	0.028	196.3	0.0586
875.03	0.028	196.4	0.0586
875.05	0.029	196.6	0.0595
875.07	0.029	196.7	0.0595
875.08	0.029	196.7	0.0595
875.10	0.029	196.8	0.0595
875.12	0.029	196.9	0.0595
875.13	0.028	196.9	0.0586
875.15	0.027	196.9	0.0577
875.17	0.026	197	0.0559
875.18	0.025	196.9	0.0559
875.20	0.023	196.9	0.0541
875.22	0.023	196.9	0.0533
875.23	0.022	196.8	0.0506
875.25	0.02	196.7	0.0488
875.27	0.018	196.6	0.0462
875.28	0.017	196.5	0.0435
875.30	0.015	196.3	0.0435
875.32	0.012	196.2	0.0399
875.33	0.012	196.2	0.0373
875.37	0.011	196	0.0337
875.38	0.009	195.8	0.0302
875.40	0.006	195.6	0.0257
875.42	0.005	195.4	0.0222
875.42	0.002	195	0.0222
875.43	0	194.8	0.0178
875.45	0	194.8	0.0142
875.47	-0.001	194.6	0.0107
875.48	-0.004	194.2	0.0062
875.50	-0.006	194	0.0027
875.52	-0.007	193.8	0
875.53	-0.009	193.4	0
875.55	-0.011	193.2	-0.0036
875.57	-0.011	193.2	-0.0062
875.58	-0.012	192.9	-0.0089
875.60	-0.013	192.7	-0.0115
875.62	-0.015	192.4	-0.0133
875.63	-0.015	192.3	-0.0151
875.65	-0.016	192.1	-0.0169
875.67	-0.017	191.9	-0.0169
875.68	-0.017	191.9	-0.0178
875.70	-0.017	191.7	-0.0186
875.72	-0.017	191.5	-0.0186
875.73	-0.017	191.5	-0.0195

Prova triassiale ciclica SN04-C1			
pressione di confinamento (kPa)		80	
deviatore ciclico (kPa)		95	
frequenza (hz)		0.00625	
tempo	cella di carico	$\Delta u$	LVDT
(min)	kN	(kPa)	$\delta$ (mm)
875.75	-0.017	191.4	-0.0195
875.77	-0.017	191.3	-0.0195
875.78	-0.016	191.2	-0.0186
875.80	-0.016	191.2	-0.0186
875.82	-0.015	191.1	-0.0178
875.83	-0.014	191.2	-0.0178
875.85	-0.013	191.2	-0.016
875.87	-0.013	191.2	-0.0142
875.88	-0.012	191.2	-0.0124
875.90	-0.01	191.3	-0.0107
875.92	-0.009	191.4	-0.008
875.93	-0.007	191.6	-0.0053
875.95	-0.004	191.7	-0.0053
875.97	-0.003	191.7	-0.0027
875.98	-0.003	191.8	0
876.00	-0.002	192	0.0044
876.02	0.002	192.2	0.008
876.03	0.003	192.4	0.0107
876.05	0.005	192.7	0.0151
876.07	0.008	192.9	0.0151
876.08	0.009	192.9	0.0195
876.10	0.009	193.1	0.0222
876.12	0.011	193.4	0.0257
876.13	0.015	193.7	0.0311
876.15	0.015	193.9	0.0346
876.17	0.017	194.1	0.0382
876.18	0.02	194.4	0.0382
876.20	0.02	194.4	0.0417
876.22	0.02	194.6	0.0435
876.23	0.022	194.9	0.047
876.25	0.024	195.1	0.0497
876.27	0.025	195.4	0.0515
876.28	0.026	195.6	0.0541
876.30	0.027	195.8	0.0541
876.32	0.027	195.8	0.055
876.33	0.027	196	0.0568
876.35	0.028	196.2	0.0577
876.37	0.029	196.3	0.0586
876.38	0.029	196.5	0.0595
876.40	0.029	196.6	0.0595
876.42	0.029	196.7	0.0595
876.43	0.028	196.7	0.0595
876.45	0.027	196.9	0.0586
876.47	0.028	196.9	0.0586
876.48	0.026	196.9	0.0586
876.50	0.026	196.9	0.0568
876.52	0.026	196.9	0.0559
876.53	0.024	196.9	0.0541
876.55	0.023	196.8	0.0524
876.57	0.022	196.8	0.0488
876.58	0.02	196.7	0.0488
876.60	0.017	196.5	0.047
876.62	0.017	196.5	0.0444
876.63	0.017	196.4	0.0417
876.65	0.014	196.2	0.0382
876.67	0.012	196.1	0.0355
876.68	0.011	195.9	0.032
876.70	0.008	195.6	0.032

Prova triassiale ciclica SN04-C1			
pressione di confinamento (kPa)		80	
deviatore ciclico (kPa)		95	
frequenza (hz)		0.00625	
tempo	cella di carico	$\Delta u$	LVDT
(min)	kN	(kPa)	$\delta$ (mm)
876.72	0.006	195.4	0.0284
876.73	0.006	195.4	0.024
876.75	0.004	195.2	0.0204
876.77	0.002	194.9	0.016
876.78	-0.001	194.6	0.0124
876.82	-0.002	194.4	0.0089
876.83	-0.005	194.1	0.0053
876.85	-0.006	193.9	0.0053
876.87	-0.006	193.9	0.0018
876.87	-0.007	193.6	-0.0018
876.88	-0.01	193.3	-0.0053
876.90	-0.011	193	-0.008
876.92	-0.012	192.8	-0.0107
876.93	-0.014	192.6	-0.0124
876.95	-0.015	192.3	-0.0124
876.97	-0.015	192.3	-0.0142
876.98	-0.015	192.2	-0.016
877.00	-0.016	191.9	-0.0178
877.02	-0.017	191.8	-0.0186
877.03	-0.017	191.7	-0.0186
877.05	-0.017	191.5	-0.0195
877.07	-0.017	191.4	-0.0195
877.08	-0.017	191.4	-0.0195
877.10	-0.017	191.3	-0.0195
877.12	-0.017	191.2	-0.0186
877.13	-0.016	191.2	-0.0186
877.15	-0.015	191.2	-0.0178
877.17	-0.015	191.2	-0.016
877.18	-0.014	191.2	-0.016
877.20	-0.013	191.2	-0.0142
877.22	-0.011	191.3	-0.0115
877.23	-0.009	191.4	-0.0115
877.25	-0.008	191.4	-0.0089
877.27	-0.008	191.4	-0.0071
877.28	-0.007	191.6	-0.0044
877.30	-0.004	191.7	-0.0018
877.32	-0.002	191.9	0.0018
877.33	-0.001	192.1	0.0053
877.35	0.003	192.3	0.0053
877.37	0.004	192.5	0.0089
877.38	0.004	192.5	0.0115
877.40	0.005	192.7	0.016
877.42	0.009	193	0.0204
877.43	0.011	193.2	0.0231
877.45	0.012	193.4	0.0284
877.47	0.014	193.7	0.0284
877.48	0.017	194	0.032
877.50	0.017	194	0.0355
877.52	0.017	194.2	0.0391
877.53	0.02	194.5	0.0417
877.55	0.022	194.7	0.0453
877.57	0.022	194.9	0.0479
877.58	0.024	195.2	0.0479
877.60	0.026	195.4	0.0506
877.62	0.026	195.4	0.0524
877.63	0.026	195.7	0.055
877.65	0.027	195.9	0.0559
877.67	0.028	196.1	0.0577



Prova triassiale ciclica SN04-C1			
pressione di confinamento (kPa)		80	
deviatore ciclico (kPa)		95	
frequenza (hz)		0.00625	
tempo	cella di carico	$\Delta u$	LVDT
(min)	kN	(kPa)	$\delta$ (mm)
877.68	0.028	196.2	0.0586
877.70	0.029	196.4	0.0595
877.72	0.029	196.5	0.0595
877.73	0.029	196.5	0.0595
877.75	0.029	196.6	0.0595
877.77	0.029	196.7	0.0595
877.78	0.028	196.8	0.0595
877.80	0.027	196.8	0.0586
877.82	0.027	196.9	0.0568
877.83	0.025	196.9	0.0568
877.85	0.025	196.9	0.0559
877.87	0.025	196.9	0.055
877.88	0.023	196.8	0.0533
877.90	0.021	196.7	0.0506
877.92	0.021	196.7	0.0488
877.93	0.02	196.6	0.047
877.95	0.016	196.4	0.0435
877.97	0.016	196.3	0.0417
877.98	0.014	196.2	0.0382
878.00	0.011	196	0.0382
878.02	0.009	196	0.0346
878.03	0.009	195.8	0.0311
878.05	0.008	195.6	0.0275
878.07	0.005	195.3	0.0231
878.08	0.003	195.1	0.0195
878.10	0.002	194.9	0.0151
878.12	-0.001	194.5	0.0151
878.13	-0.003	194.3	0.0115
878.15	-0.003	194.3	0.008
878.17	-0.005	194	0.0036
878.18	-0.007	193.7	0.0009
878.20	-0.009	193.5	-0.0027
878.22	-0.01	193.2	-0.0053
878.23	-0.012	192.9	-0.0053
878.25	-0.013	192.7	-0.0089
878.28	-0.013	192.7	-0.0107
878.30	-0.014	192.5	-0.0133
878.32	-0.015	192.2	-0.0151
878.33	-0.016	192	-0.016
878.33	-0.016	191.9	-0.0169
878.35	-0.017	191.7	-0.0178
878.37	-0.017	191.6	-0.0178
878.38	-0.017	191.6	-0.0186
878.40	-0.017	191.4	-0.0195
878.42	-0.017	191.3	-0.0195
878.43	-0.017	191.3	-0.0195
878.45	-0.017	191.2	-0.0186
878.47	-0.016	191.2	-0.0178
878.48	-0.014	191.2	-0.0178
878.50	-0.014	191.2	-0.0169
878.52	-0.014	191.2	-0.016
878.53	-0.013	191.2	-0.0142
878.55	-0.011	191.2	-0.0124
878.57	-0.01	191.3	-0.0107
878.58	-0.009	191.4	-0.008
878.60	-0.006	191.6	-0.008
878.62	-0.005	191.6	-0.0044
878.63	-0.004	191.8	-0.0009

Prova triassiale ciclica SN04-C1			
pressione di confinamento (kPa)		80	
deviatore ciclico (kPa)		95	
frequenza (hz)		0.00625	
tempo	cella di carico	$\Delta u$	LVDT
(min)	kN	(kPa)	$\delta$ (mm)
878.65	-0.002	191.9	-0.0009
878.67	0	191.9	0.0027
878.68	0	192.1	0.0053
878.70	0.002	192.3	0.0098
878.72	0.005	192.6	0.0142
878.73	0.006	192.7	0.0169
878.75	0.008	193	0.0213
878.77	0.012	193.3	0.0213
878.78	0.013	193.3	0.0257
878.80	0.013	193.5	0.0293
878.82	0.014	193.7	0.0328
878.83	0.017	194	0.0373
878.85	0.019	194.3	0.0399
878.87	0.02	194.5	0.0435
878.88	0.022	194.8	0.0435
878.90	0.023	195	0.0462
878.92	0.023	195	0.0488
878.93	0.024	195.2	0.0515
878.95	0.026	195.5	0.0533
878.97	0.027	195.7	0.055
878.98	0.027	195.9	0.0559
879.00	0.028	196.1	0.0559
879.02	0.029	196.2	0.0577
879.03	0.029	196.2	0.0586
879.05	0.029	196.4	0.0586
879.07	0.029	196.5	0.0595
879.08	0.029	196.6	0.0595
879.10	0.028	196.7	0.0595
879.12	0.028	196.8	0.0595
879.13	0.028	196.8	0.0595
879.15	0.026	196.8	0.0586
879.17	0.026	196.9	0.0568
879.18	0.025	196.8	0.0559
879.20	0.024	196.8	0.0541
879.22	0.023	196.8	0.0515
879.23	0.022	196.7	0.0497
879.25	0.019	196.6	0.0497
879.27	0.018	196.6	0.047
879.28	0.018	196.5	0.0444
879.30	0.016	196.3	0.0417
879.32	0.013	196.1	0.0382
879.33	0.012	196	0.0355
879.35	0.01	195.8	0.032
879.37	0.008	195.7	0.0302
879.38	0.007	195.5	0.0257
879.40	0.005	195.1	0.0213
879.42	0.002	194.9	0.0213
879.43	0.001	194.9	0.0169
879.45	0.001	194.7	0.0142
879.47	-0.001	194.4	0.0098
879.48	-0.004	194.1	0.0062
879.50	-0.005	193.9	0.0036
879.52	-0.007	193.6	0
879.53	-0.01	193.3	0
879.55	-0.01	193.3	-0.0044
879.57	-0.01	193.1	-0.0062
879.58	-0.011	192.8	-0.0089
879.60	-0.014	192.6	-0.0115

Prova triassiale ciclica SN04-C1			
pressione di confinamento (kPa)		80	
deviatore ciclico (kPa)		95	
frequenza (hz)		0.00625	
tempo	cella di carico	$\Delta u$	LVDT
(min)	kN	(kPa)	$\delta$ (mm)
879.62	-0.014	192.4	-0.0133
879.63	-0.015	192.1	-0.016
879.65	-0.016	191.9	-0.016
879.67	-0.017	191.9	-0.0169
879.68	-0.017	191.8	-0.0178
879.72	-0.017	191.6	-0.0186
879.73	-0.017	191.5	-0.0186
879.75	-0.017	191.4	-0.0195
879.77	-0.017	191.3	-0.0195
879.78	-0.016	191.2	-0.0195
879.78	-0.016	191.2	-0.0186
879.80	-0.016	191.2	-0.0186
879.82	-0.016	191.1	-0.0178
879.83	-0.014	191.1	-0.016
879.85	-0.014	191.1	-0.0151
879.87	-0.013	191.2	-0.0133
879.88	-0.01	191.2	-0.0133
879.90	-0.009	191.2	-0.0115
879.92	-0.009	191.3	-0.0098
879.93	-0.008	191.4	-0.0071
879.95	-0.005	191.6	-0.0036
879.97	-0.004	191.7	-0.0009
879.98	-0.003	191.9	0.0027
880.00	0.001	192.1	0.0027
880.02	0.002	192.1	0.0062
880.03	0.002	192.2	0.0089
880.05	0.004	192.5	0.0133
880.07	0.007	192.8	0.0178
880.08	0.008	192.9	0.0204
880.10	0.009	193.1	0.0231
880.12	0.012	193.4	0.0275
880.13	0.014	193.6	0.0311
880.15	0.015	193.8	0.0355
880.17	0.018	194.1	0.0355
880.18	0.019	194.4	0.0391
880.20	0.019	194.4	0.0417
880.22	0.02	194.6	0.0444
880.23	0.022	194.9	0.0479
880.25	0.024	195.1	0.0506
880.27	0.025	195.3	0.0533
880.28	0.026	195.6	0.0533
880.30	0.027	195.8	0.055
880.32	0.027	195.8	0.0559
880.33	0.027	196	0.0577
880.35	0.028	196.2	0.0586
880.37	0.029	196.3	0.0595
880.38	0.029	196.5	0.0595
880.40	0.029	196.6	0.0595
880.42	0.029	196.7	0.0595
880.43	0.028	196.7	0.0595
880.45	0.028	196.7	0.0595
880.47	0.028	196.8	0.0586
880.48	0.027	196.8	0.0577
880.50	0.026	196.8	0.0568
880.52	0.025	196.8	0.055
880.53	0.023	196.8	0.055
880.55	0.022	196.8	0.0533
880.57	0.022	196.8	0.0515

Prova triassiale ciclica SN04-C1			
pressione di confinamento (kPa)		80	
deviatore ciclico (kPa)		95	
frequenza (hz)		0.00625	
tempo	cella di carico	$\Delta u$	LVDT
(min)	kN	(kPa)	$\delta$ (mm)
880.58	0.021	196.7	0.0488
880.60	0.018	196.5	0.0462
880.62	0.017	196.4	0.0435
880.63	0.016	196.3	0.0408
880.65	0.012	196.1	0.0408
880.67	0.011	196.1	0.0373
880.68	0.011	196	0.0346
880.70	0.01	195.7	0.0302
880.72	0.006	195.4	0.0257
880.73	0.005	195.2	0.0231
880.75	0.003	194.9	0.0186
880.77	0	194.7	0.0186
880.78	-0.001	194.7	0.0142
880.80	-0.002	194.3	0.0098
880.82	-0.005	194	0.0098
880.83	-0.006	194	0.0062
880.85	-0.006	193.8	0.0027
880.87	-0.007	193.5	-0.0009
880.88	-0.01	193.2	-0.0053
880.90	-0.011	193	-0.0071
880.92	-0.012	192.7	-0.0098
880.93	-0.014	192.5	-0.0098
880.95	-0.015	192.3	-0.0115
880.97	-0.015	192.3	-0.0142
880.98	-0.015	192.1	-0.016
881.00	-0.016	191.9	-0.0169
881.02	-0.017	191.7	-0.0178
881.03	-0.017	191.6	-0.0186
881.05	-0.017	191.4	-0.0186
881.07	-0.017	191.3	-0.0186
881.08	-0.017	191.3	-0.0186
881.10	-0.017	191.2	-0.0186
881.12	-0.017	191.2	-0.0186
881.13	-0.016	191.2	-0.0178
881.15	-0.015	191.1	-0.0169
881.18	-0.014	191.1	-0.0151
881.20	-0.013	191.2	-0.0151
881.22	-0.012	191.2	-0.0142
881.23	-0.012	191.2	-0.0124
881.23	-0.011	191.3	-0.0107
881.25	-0.008	191.4	-0.008
881.27	-0.007	191.4	-0.0062
881.28	-0.006	191.6	-0.0027
881.30	-0.003	191.8	-0.0027
881.32	-0.002	191.8	0
881.33	-0.002	191.9	0.0036
881.35	0	192.1	0.0071
881.37	0.004	192.4	0.0115
881.38	0.004	192.5	0.0133
881.40	0.006	192.8	0.0178
881.42	0.01	193	0.0178
881.43	0.011	193	0.0222
881.45	0.011	193.2	0.0257
881.47	0.012	193.5	0.0302
881.48	0.016	193.8	0.0346
881.50	0.017	194	0.0373
881.52	0.018	194.3	0.0408
881.53	0.021	194.6	0.0444

Prova triassiale ciclica SN04-C1			
pressione di confinamento (kPa)		80	
deviatore ciclico (kPa)		95	
frequenza (hz)		0.00625	
tempo	cella di carico	$\Delta u$	LVDT
(min)	kN	(kPa)	$\delta$ (mm)
881.55	0.021	194.7	0.0462
881.57	0.022	195	0.0488
881.58	0.025	195.2	0.0488
881.60	0.025	195.2	0.0515
881.62	0.025	195.4	0.0533
881.63	0.026	195.7	0.055
881.65	0.027	195.9	0.0568
881.67	0.028	196.1	0.0577
881.68	0.028	196.2	0.0586
881.70	0.029	196.4	0.0586
881.72	0.029	196.4	0.0595
881.73	0.029	196.5	0.0595
881.75	0.029	196.6	0.0595
881.77	0.029	196.7	0.0595
881.78	0.028	196.8	0.0595
881.80	0.028	196.8	0.0586
881.82	0.027	196.8	0.0586
881.83	0.025	196.8	0.0568
881.85	0.025	196.8	0.0559
881.87	0.025	196.8	0.055
881.88	0.023	196.8	0.0524
881.90	0.022	196.7	0.0515
881.92	0.021	196.6	0.0479
881.93	0.018	196.5	0.0479
881.95	0.016	196.3	0.0453
881.97	0.016	196.3	0.0426
881.98	0.015	196.2	0.0391
882.00	0.012	196	0.0355
882.02	0.01	195.8	0.0328
882.03	0.009	195.7	0.0293
882.05	0.006	195.3	0.0293
882.07	0.004	195.1	0.024
882.08	0.004	195.1	0.0213
882.10	0.003	194.9	0.0169
882.12	-0.001	194.6	0.0124
882.13	-0.003	194.3	0.0098
882.15	-0.003	194.1	0.0062
882.17	-0.006	193.8	0.0062
882.18	-0.008	193.5	0.0018
882.20	-0.008	193.5	-0.0009
882.22	-0.009	193.3	-0.0044
882.23	-0.011	193	-0.0071
882.25	-0.013	192.8	-0.0098
882.27	-0.013	192.6	-0.0107
882.28	-0.014	192.4	-0.0124
882.30	-0.015	192.1	-0.0142
882.32	-0.016	192	-0.016
882.33	-0.016	191.8	-0.0178
882.35	-0.017	191.6	-0.0178
882.37	-0.017	191.6	-0.0186
882.38	-0.017	191.5	-0.0186
882.40	-0.017	191.3	-0.0186
882.42	-0.017	191.2	-0.0195
882.43	-0.017	191.2	-0.0195
882.45	-0.017	191.1	-0.0186
882.47	-0.015	191.1	-0.0186
882.48	-0.015	191.1	-0.0178
882.50	-0.015	191	-0.0169

Prova triassiale ciclica SN04-C1			
pressione di confinamento (kPa)		80	
deviatore ciclico (kPa)		95	
frequenza (hz)		0.00625	
tempo	cella di carico	$\Delta u$	LVDT
(min)	kN	(kPa)	$\delta$ (mm)
882.52	-0.014	191.1	-0.0151
882.53	-0.012	191.1	-0.0133
882.55	-0.011	191.2	-0.0124
882.57	-0.01	191.3	-0.0089
882.58	-0.007	191.4	-0.0089
882.62	-0.007	191.4	-0.0062
882.63	-0.007	191.4	-0.0044
882.65	-0.005	191.6	-0.0018
882.67	-0.002	191.8	0.0018
882.68	-0.001	191.9	0.0053
882.68	0.001	192.2	0.0089
882.70	0.005	192.4	0.0089
882.72	0.006	192.4	0.0133
882.73	0.006	192.6	0.016
882.75	0.007	192.8	0.0195
882.77	0.011	193.1	0.024
882.78	0.012	193.3	0.0284
882.80	0.013	193.6	0.032
882.82	0.017	193.8	0.032
882.83	0.017	193.8	0.0355
882.85	0.017	194.1	0.0382
882.87	0.019	194.3	0.0426
882.88	0.022	194.6	0.0462
882.90	0.022	194.8	0.047
882.92	0.023	195	0.0506
882.93	0.025	195.3	0.0506
882.95	0.027	195.6	0.0533
882.97	0.027	195.6	0.055
882.98	0.027	195.9	0.0559
883.00	0.028	196.1	0.0568
883.02	0.028	196.1	0.0577
883.03	0.029	196.3	0.0586
883.05	0.029	196.4	0.0595
883.07	0.029	196.5	0.0595
883.08	0.029	196.6	0.0595
883.10	0.029	196.7	0.0595
883.12	0.028	196.8	0.0604
883.13	0.028	196.8	0.0595
883.15	0.027	196.8	0.0577
883.17	0.026	196.8	0.0568
883.18	0.024	196.8	0.055
883.20	0.024	196.8	0.0541
883.22	0.023	196.7	0.0515
883.23	0.02	196.6	0.0515
883.25	0.02	196.6	0.0497
883.27	0.02	196.6	0.0479
883.28	0.018	196.4	0.0444
883.30	0.015	196.2	0.0408
883.32	0.014	196.1	0.0382
883.33	0.012	195.9	0.0346
883.35	0.009	195.7	0.0346
883.37	0.008	195.7	0.0311
883.38	0.008	195.5	0.0275
883.40	0.006	195.2	0.0231
883.42	0.002	195	0.0195
883.43	0.002	194.8	0.016
883.45	0	194.5	0.0124
883.47	-0.004	194.2	0.0124

Prova triassiale ciclica SN04-C1			
pressione di confinamento (kPa)		80	
deviatore ciclico (kPa)		95	
frequenza (hz)		0.00625	
tempo	cella di carico	$\Delta u$	LVDT
(min)	kN	(kPa)	$\delta$ (mm)
883.48	-0.004	194.2	0.008
883.50	-0.004	194	0.0044
883.52	-0.006	193.7	0.0009
883.53	-0.009	193.4	-0.0027
883.55	-0.01	193.2	-0.0053
883.57	-0.011	192.9	-0.008
883.58	-0.013	192.6	-0.008
883.60	-0.014	192.6	-0.0107
883.62	-0.014	192.4	-0.0124
883.63	-0.015	192.2	-0.0151
883.65	-0.016	192	-0.016
883.67	-0.016	191.8	-0.0169
883.68	-0.017	191.7	-0.0178
883.70	-0.017	191.5	-0.0178
883.72	-0.017	191.4	-0.0195
883.73	-0.017	191.3	-0.0195
883.75	-0.017	191.2	-0.0195
883.77	-0.017	191.1	-0.0195
883.78	-0.017	191.1	-0.0195
883.80	-0.016	191	-0.0186
883.82	-0.015	191	-0.0178
883.83	-0.014	191	-0.0169
883.85	-0.014	191	-0.0151
883.87	-0.012	191.1	-0.0133
883.88	-0.01	191.2	-0.0133
883.90	-0.01	191.2	-0.0115
883.92	-0.009	191.2	-0.0089
883.93	-0.008	191.4	-0.0062
883.95	-0.005	191.5	-0.0036
883.97	-0.004	191.6	0
883.98	-0.002	191.9	0.0036
884.00	0	192	0.0036
884.02	0	192	0.0062
884.03	0.002	192.2	0.0098
884.05	0.004	192.5	0.0142
884.08	0.007	192.7	0.0178
884.10	0.008	192.9	0.0204
884.12	0.01	193.2	0.0249
884.13	0.014	193.4	0.0249
884.13	0.014	193.4	0.0293
884.15	0.014	193.6	0.0328
884.17	0.016	193.9	0.0364
884.18	0.019	194.2	0.0399
884.20	0.02	194.4	0.0426
884.22	0.021	194.7	0.0462
884.23	0.024	194.9	0.0462
884.25	0.024	194.9	0.0488
884.27	0.024	195.1	0.0506
884.28	0.025	195.4	0.0533
884.30	0.027	195.6	0.055
884.32	0.027	195.8	0.0559
884.33	0.027	196	0.0577
884.35	0.028	196.2	0.0577
884.37	0.029	196.2	0.0586
884.38	0.029	196.3	0.0586
884.40	0.029	196.4	0.0595
884.42	0.029	196.5	0.0595
884.43	0.029	196.6	0.0595

Prova triassiale ciclica SN04-C1			
pressione di confinamento (kPa)		80	
deviatore ciclico (kPa)		95	
frequenza (hz)		0.00625	
tempo	cella di carico	$\Delta u$	LVDT
(min)	kN	(kPa)	$\delta$ (mm)
884.45	0.028	196.7	0.0595
884.47	0.028	196.8	0.0586
884.48	0.027	196.8	0.0577
884.50	0.026	196.8	0.0568
884.52	0.024	196.8	0.0568
884.53	0.023	196.8	0.055
884.55	0.023	196.8	0.0533
884.57	0.022	196.7	0.0515
884.58	0.02	196.6	0.0488
884.60	0.019	196.5	0.047
884.62	0.017	196.4	0.0435
884.63	0.014	196.2	0.0435
884.65	0.013	196.2	0.0399
884.67	0.013	196.1	0.0373
884.68	0.011	195.9	0.0337
884.70	0.008	195.6	0.0293
884.72	0.006	195.4	0.0257
884.73	0.005	195.2	0.0222
884.75	0.002	194.9	0.0222
884.77	0.001	194.7	0.0178
884.78	0.001	194.7	0.0151
884.80	-0.001	194.4	0.0098
884.82	-0.004	194.1	0.0062
884.83	-0.005	193.8	0.0036
884.85	-0.007	193.6	0
884.87	-0.009	193.3	0
884.88	-0.011	193	-0.0036
884.90	-0.011	193	-0.0062
884.92	-0.011	192.8	-0.0089
884.93	-0.013	192.5	-0.0115
884.95	-0.015	192.3	-0.0133
884.97	-0.015	192.1	-0.0142
884.98	-0.016	191.9	-0.016
885.00	-0.016	191.7	-0.016
885.02	-0.016	191.7	-0.0169
885.03	-0.017	191.6	-0.0178
885.05	-0.017	191.4	-0.0186
885.07	-0.017	191.3	-0.0186
885.08	-0.017	191.2	-0.0195
885.10	-0.017	191.2	-0.0186
885.12	-0.016	191.1	-0.0186
885.13	-0.016	191.1	-0.0178
885.15	-0.016	191	-0.0178
885.17	-0.014	191	-0.016
885.18	-0.013	191	-0.0151
885.20	-0.013	191	-0.0142
885.22	-0.012	191.1	-0.0124
885.23	-0.009	191.2	-0.0098
885.25	-0.009	191.3	-0.008
885.27	-0.007	191.4	-0.0053
885.28	-0.004	191.5	-0.0053
885.30	-0.003	191.5	-0.0018
885.32	-0.003	191.7	0.0009
885.33	-0.002	191.9	0.0044
885.35	0.002	192.1	0.008
885.37	0.003	192.2	0.0115
885.38	0.004	192.5	0.0151
885.40	0.009	192.8	0.0151



Prova triassiale ciclica SN04-C1			
pressione di confinamento (kPa)		80	
deviatore ciclico (kPa)		95	
frequenza (hz)		0.00625	
tempo	cella di carico	$\Delta u$	LVDT
(min)	kN	(kPa)	$\delta$ (mm)
885.42	0.009	192.8	0.0195
885.43	0.009	192.9	0.0222
885.45	0.011	193.2	0.0275
885.47	0.014	193.5	0.0311
885.48	0.015	193.7	0.0346
885.50	0.017	194	0.0382
885.52	0.02	194.3	0.0382
885.55	0.021	194.3	0.0417
885.57	0.021	194.5	0.0444
885.58	0.022	194.7	0.047
885.58	0.024	195	0.0497
885.60	0.025	195.2	0.0515
885.62	0.026	195.4	0.0541
885.63	0.027	195.7	0.0541
885.65	0.027	195.9	0.0559
885.67	0.027	195.9	0.0568
885.68	0.028	196	0.0586
885.70	0.028	196.2	0.0595
885.72	0.029	196.3	0.0595
885.73	0.029	196.4	0.0595
885.75	0.029	196.6	0.0595
885.77	0.029	196.6	0.0595
885.78	0.029	196.6	0.0595
885.80	0.028	196.7	0.0595
885.82	0.027	196.7	0.0577
885.83	0.026	196.7	0.0559
885.85	0.025	196.7	0.0559
885.87	0.024	196.7	0.0541
885.88	0.022	196.6	0.0515
885.90	0.022	196.6	0.0506
885.92	0.021	196.5	0.0479
885.93	0.017	196.4	0.0479
885.95	0.016	196.4	0.0453
885.97	0.016	196.3	0.0426
885.98	0.015	196.1	0.0391
886.00	0.011	195.9	0.0355
886.02	0.01	195.8	0.0328
886.03	0.009	195.5	0.0284
886.05	0.005	195.2	0.0284
886.07	0.004	195.2	0.024
886.08	0.004	195	0.0213
886.10	0.002	194.7	0.0169
886.12	-0.001	194.5	0.0124
886.13	-0.002	194.3	0.0098
886.15	-0.004	194	0.0053
886.17	-0.007	193.7	0.0053
886.18	-0.007	193.7	0.0018
886.20	-0.007	193.5	-0.0009
886.22	-0.009	193.2	-0.0044
886.23	-0.012	192.9	-0.0071
886.25	-0.012	192.7	-0.0089
886.27	-0.013	192.5	-0.0115
886.28	-0.015	192.2	-0.0115
886.30	-0.016	192.2	-0.0142
886.32	-0.016	192	-0.0151
886.33	-0.016	191.8	-0.016
886.35	-0.017	191.7	-0.0178
886.37	-0.017	191.5	-0.0186

Prova triassiale ciclica SN04-C1			
pressione di confinamento (kPa)		80	
deviatore ciclico (kPa)		95	
frequenza (hz)		0.00625	
tempo	cella di carico	$\Delta u$	LVDT
(min)	kN	(kPa)	$\delta$ (mm)
886.38	-0.017	191.4	-0.0186
886.40	-0.017	191.3	-0.0186
886.42	-0.017	191.3	-0.0186
886.43	-0.017	191.2	-0.0186
886.45	-0.017	191.1	-0.0186
886.47	-0.016	191	-0.0178
886.48	-0.015	191	-0.0169
886.50	-0.015	191	-0.016
886.52	-0.013	191	-0.016
886.53	-0.011	191.1	-0.0142
886.55	-0.011	191.1	-0.0124
886.57	-0.011	191.1	-0.0107
886.58	-0.008	191.3	-0.008
886.60	-0.007	191.3	-0.0062
886.62	-0.006	191.4	-0.0027
886.63	-0.004	191.6	-0.0009
886.65	-0.002	191.7	0.0018
886.67	-0.001	191.9	0.0053
886.68	0.002	192.2	0.0053
886.70	0.004	192.3	0.0089
886.72	0.004	192.3	0.0124
886.73	0.006	192.5	0.0169
886.75	0.008	192.8	0.0204
886.77	0.011	193.1	0.024
886.78	0.012	193.3	0.0284
886.80	0.014	193.6	0.0284
886.82	0.016	193.8	0.0328
886.83	0.016	193.8	0.0355
886.85	0.017	194	0.0391
886.87	0.019	194.3	0.0426
886.88	0.022	194.6	0.0453
886.90	0.022	194.8	0.0479
886.92	0.024	195	0.0506
886.93	0.026	195.3	0.0506
886.95	0.026	195.3	0.0533
886.98	0.026	195.5	0.0541
887.00	0.027	195.7	0.0559
887.02	0.028	195.9	0.0577
887.03	0.028	196.1	0.0586
887.05	0.029	196.2	0.0595
887.05	0.029	196.4	0.0595
887.07	0.029	196.4	0.0595
887.08	0.029	196.5	0.0595
887.10	0.029	196.6	0.0595
887.12	0.028	196.7	0.0595
887.13	0.028	196.7	0.0586
887.15	0.027	196.7	0.0577
887.17	0.025	196.7	0.0577
887.18	0.025	196.7	0.0559
887.20	0.025	196.7	0.055
887.22	0.024	196.6	0.0524
887.23	0.021	196.6	0.0506
887.25	0.02	196.5	0.0488
887.27	0.019	196.4	0.0453
887.28	0.016	196.2	0.0453
887.30	0.015	196.2	0.0426
887.32	0.015	196.1	0.0408
887.33	0.013	196	0.0364

Prova triassiale ciclica SN04-C1			
pressione di confinamento (kPa)		80	
deviatore ciclico (kPa)		95	
frequenza (hz)		0.00625	
tempo	cella di carico	$\Delta u$	LVDT
(min)	kN	(kPa)	$\delta$ (mm)
887.35	0.01	195.7	0.0328
887.37	0.01	195.6	0.0311
887.38	0.008	195.4	0.0275
887.40	0.004	195.1	0.0222
887.42	0.003	194.9	0.0195
887.43	0.002	194.7	0.0151
887.45	-0.002	194.3	0.0151
887.47	-0.003	194.1	0.0115
887.48	-0.003	194.1	0.008
887.50	-0.004	193.9	0.0044
887.52	-0.007	193.6	0.0009
887.53	-0.008	193.3	-0.0018
887.55	-0.01	193.1	-0.0053
887.57	-0.012	192.8	-0.0053
887.58	-0.013	192.5	-0.0089
887.60	-0.013	192.5	-0.0107
887.62	-0.014	192.3	-0.0124
887.63	-0.015	192.1	-0.0151
887.65	-0.016	191.9	-0.016
887.67	-0.016	191.7	-0.0169
887.68	-0.017	191.5	-0.0169
887.70	-0.017	191.4	-0.0186
887.72	-0.017	191.4	-0.0186
887.73	-0.017	191.3	-0.0186
887.75	-0.017	191.2	-0.0186
887.77	-0.017	191.1	-0.0186
887.78	-0.017	191	-0.0178
887.80	-0.016	191	-0.0178
887.82	-0.015	191	-0.0178
887.83	-0.014	191	-0.0169
887.85	-0.014	191	-0.0151
887.87	-0.013	191	-0.0133
887.88	-0.011	191.1	-0.0115
887.90	-0.01	191.1	-0.0098
887.92	-0.009	191.3	-0.0071
887.93	-0.006	191.4	-0.0071
887.95	-0.005	191.4	-0.0044
887.97	-0.005	191.5	-0.0018
887.98	-0.003	191.7	0.0018
888.00	0	191.9	0.0053
888.02	0.001	192	0.008
888.03	0.003	192.3	0.0115
888.05	0.006	192.5	0.0115
888.07	0.007	192.7	0.0186
888.08	0.008	192.9	0.0213
888.10	0.011	193.2	0.0213
888.12	0.013	193.2	0.0249
888.13	0.013	193.4	0.0293
888.15	0.014	193.7	0.0337
888.17	0.017	193.9	0.0373
888.18	0.018	194.1	0.0399
888.20	0.02	194.4	0.0435
888.22	0.022	194.7	0.0435
888.23	0.023	194.7	0.047
888.25	0.023	194.9	0.0497
888.27	0.024	195.1	0.0515
888.28	0.026	195.4	0.0541
888.30	0.027	195.6	0.0559

Prova triassiale ciclica SN04-C1			
pressione di confinamento (kPa)		80	
deviatore ciclico (kPa)		95	
frequenza (hz)		0.00625	
tempo	cella di carico	$\Delta u$	LVDT
(min)	kN	(kPa)	$\delta$ (mm)
888.32	0.027	195.8	0.0568
888.33	0.028	196	0.0568
888.35	0.029	196	0.0586
888.37	0.029	196.1	0.0586
888.38	0.029	196.3	0.0595
888.40	0.029	196.4	0.0595
888.42	0.029	196.5	0.0595
888.45	0.029	196.6	0.0595
888.47	0.028	196.7	0.0595
888.48	0.027	196.7	0.0595
888.50	0.027	196.7	0.0586
888.50	0.027	196.7	0.0568
888.52	0.025	196.7	0.0559
888.53	0.024	196.7	0.0541
888.55	0.023	196.6	0.0524
888.57	0.021	196.5	0.0524
888.58	0.019	196.5	0.0497
888.60	0.019	196.5	0.0479
888.62	0.018	196.4	0.0444
888.63	0.015	196.1	0.0408
888.65	0.014	196	0.0391
888.67	0.012	195.9	0.0355
888.68	0.009	195.6	0.0355
888.70	0.007	195.4	0.0311
888.72	0.007	195.4	0.0284
888.73	0.006	195.2	0.024
888.75	0.003	194.9	0.0195
888.77	0.001	194.7	0.0169
888.78	0	194.4	0.0124
888.80	-0.003	194.1	0.008
888.82	-0.004	193.9	0.0062
888.83	-0.005	193.7	0.0027
888.85	-0.007	193.4	0.0027
888.87	-0.01	193.1	-0.0009
888.88	-0.01	193.1	-0.0036
888.90	-0.01	192.9	-0.0062
888.92	-0.012	192.6	-0.0098
888.93	-0.014	192.4	-0.0115
888.95	-0.014	192.2	-0.0133
888.97	-0.015	192	-0.0151
888.98	-0.016	191.8	-0.0151
889.00	-0.017	191.8	-0.016
889.02	-0.017	191.6	-0.0169
889.03	-0.017	191.5	-0.0178
889.05	-0.017	191.3	-0.0186
889.07	-0.017	191.2	-0.0186
889.08	-0.017	191.1	-0.0186
889.10	-0.017	191	-0.0186
889.12	-0.016	191	-0.0186
889.13	-0.016	191	-0.0186
889.15	-0.016	191	-0.0169
889.17	-0.014	191	-0.016
889.18	-0.014	190.9	-0.0151
889.20	-0.012	191	-0.0124
889.22	-0.01	191.1	-0.0124
889.23	-0.009	191.1	-0.0107
889.25	-0.009	191.2	-0.0089
889.27	-0.008	191.3	-0.0062

Prova triassiale ciclica SN04-C1			
pressione di confinamento (kPa)		80	
deviatore ciclico (kPa)		95	
frequenza (hz)		0.00625	
tempo	cella di carico	$\Delta u$	LVDT
(min)	kN	(kPa)	$\delta$ (mm)
889.28	-0.005	191.4	-0.0036
889.30	-0.004	191.5	0
889.32	-0.002	191.7	0.0036
889.33	0.001	192	0.0036
889.35	0.002	192	0.0071
889.37	0.002	192.1	0.0098
889.38	0.003	192.3	0.0133
889.40	0.007	192.6	0.0186
889.42	0.008	192.8	0.0213
889.43	0.01	193	0.0257
889.45	0.013	193.3	0.0257
889.47	0.014	193.3	0.0302
889.48	0.014	193.6	0.0328
889.50	0.016	193.8	0.0373
889.52	0.019	194.3	0.0408
889.53	0.019	194.3	0.0426
889.55	0.02	194.5	0.0453
889.57	0.023	194.8	0.0488
889.58	0.024	195	0.0506
889.60	0.024	195.2	0.0524
889.62	0.026	195.5	0.0524
889.63	0.027	195.7	0.055
889.65	0.027	195.7	0.0568
889.67	0.028	195.9	0.0577
889.68	0.028	196	0.0586
889.70	0.029	196.2	0.0595
889.72	0.029	196.3	0.0595
889.73	0.029	196.4	0.0604
889.75	0.029	196.5	0.0604
889.77	0.028	196.5	0.0604
889.78	0.028	196.6	0.0604
889.80	0.028	196.7	0.0595
889.82	0.027	196.7	0.0586
889.83	0.026	196.7	0.0577
889.85	0.025	196.7	0.055
889.88	0.023	196.6	0.055
889.90	0.022	196.6	0.0533
889.92	0.022	196.6	0.0515
889.93	0.021	196.5	0.0497
889.95	0.018	196.4	0.047
889.95	0.017	196.3	0.0444
889.97	0.016	196.1	0.0408
889.98	0.012	195.9	0.0408
890.00	0.011	195.9	0.0373
890.02	0.011	195.8	0.0346
890.03	0.01	195.6	0.0311
890.05	0.006	195.3	0.0257
890.07	0.005	195.1	0.0231
890.08	0.003	194.8	0.0186
890.10	0	194.6	0.0186
890.12	-0.001	194.6	0.0142
890.13	-0.001	194.4	0.0115
890.15	-0.003	194	0.008
890.17	-0.006	193.8	0.0036
890.18	-0.007	193.5	0.0009
890.20	-0.008	193.2	-0.0027
890.22	-0.011	193	-0.0027
890.23	-0.012	193	-0.0062

Prova triassiale ciclica SN04-C1			
pressione di confinamento (kPa)		80	
deviatore ciclico (kPa)		95	
frequenza (hz)		0.00625	
tempo	cella di carico	$\Delta u$	LVDT
(min)	kN	(kPa)	$\delta$ (mm)
890.25	-0.012	192.6	-0.0089
890.27	-0.013	192.4	-0.0089
890.28	-0.015	192.4	-0.0115
890.30	-0.015	192.1	-0.0133
890.32	-0.015	191.9	-0.0151
890.33	-0.016	191.7	-0.016
890.35	-0.017	191.6	-0.0169
890.37	-0.017	191.4	-0.0178
890.38	-0.017	191.3	-0.0178
890.40	-0.017	191.3	-0.0186
890.42	-0.017	191.2	-0.0186
890.43	-0.017	191.1	-0.0186
890.45	-0.017	191	-0.0178
890.47	-0.016	191	-0.0178
890.48	-0.015	191	-0.016
890.50	-0.014	191	-0.016
890.52	-0.013	191	-0.0151
890.53	-0.013	191	-0.0142
890.55	-0.012	191	-0.0115
890.57	-0.01	191.1	-0.0098
890.58	-0.008	191.2	-0.0071
890.60	-0.007	191.3	-0.0044
890.62	-0.005	191.5	-0.0044
890.63	-0.003	191.6	-0.0018
890.65	-0.003	191.6	0.0009
890.67	-0.002	191.8	0.0044
890.68	0.001	192	0.008
890.70	0.003	192.2	0.0115
890.72	0.004	192.4	0.016
890.73	0.007	192.7	0.016
890.75	0.01	192.9	0.0204
890.77	0.01	192.9	0.0231
890.78	0.011	193.1	0.0284
890.80	0.013	193.5	0.0311
890.82	0.016	193.7	0.0346
890.83	0.017	193.9	0.0382
890.85	0.019	194.2	0.0382
890.87	0.021	194.4	0.0426
890.88	0.021	194.4	0.0453
890.90	0.022	194.6	0.0479
890.92	0.023	194.9	0.0497
890.93	0.025	195.1	0.0524
890.95	0.026	195.4	0.0541
890.97	0.027	195.6	0.0568
890.98	0.027	195.8	0.0577
891.00	0.028	196	0.0577
891.02	0.028	196.1	0.0586
891.03	0.029	196.3	0.0586
891.05	0.029	196.3	0.0595
891.07	0.029	196.4	0.0604
891.08	0.029	196.5	0.0604
891.10	0.029	196.6	0.0604
891.12	0.028	196.7	0.0604
891.13	0.028	196.7	0.0595
891.15	0.027	196.7	0.0595
891.17	0.025	196.7	0.0577
891.18	0.025	196.7	0.0568
891.20	0.025	196.7	0.055

Prova triassiale ciclica SN04-C1			
pressione di confinamento (kPa)		80	
deviatore ciclico (kPa)		95	
frequenza (hz)		0.00625	
tempo	cella di carico	$\Delta u$	LVDT
(min)	kN	(kPa)	$\delta$ (mm)
891.22	0.022	196.6	0.0524
891.23	0.022	196.6	0.0515
891.25	0.02	196.5	0.0479
891.27	0.017	196.3	0.0479
891.28	0.016	196.3	0.0453
891.30	0.016	196.3	0.0426
891.32	0.015	196.1	0.0399
891.35	0.011	195.9	0.0355
891.37	0.01	195.7	0.0337
891.38	0.009	195.5	0.0293
891.40	0.005	195.2	0.0293
891.40	0.004	195.2	0.0249
891.42	0.004	195	0.0222
891.43	0.003	194.8	0.0178
891.45	-0.001	194.5	0.0133
891.47	-0.002	194.2	0.0107
891.48	-0.004	194	0.0062
891.50	-0.007	193.7	0.0062
891.52	-0.008	193.4	0.0018
891.53	-0.008	193.4	0
891.55	-0.009	193.2	-0.0036
891.57	-0.011	192.9	-0.0071
891.58	-0.012	192.7	-0.0089
891.60	-0.013	192.4	-0.0115
891.62	-0.014	192.2	-0.0115
891.63	-0.016	192	-0.0133
891.65	-0.016	192	-0.0151
891.67	-0.016	191.8	-0.016
891.68	-0.016	191.6	-0.0169
891.70	-0.017	191.5	-0.0178
891.72	-0.017	191.3	-0.0186
891.73	-0.017	191.2	-0.0186
891.75	-0.017	191.2	-0.0186
891.77	-0.017	191	-0.0186
891.78	-0.016	191	-0.0186
891.80	-0.016	190.9	-0.0178
891.82	-0.016	190.9	-0.0169
891.83	-0.015	190.9	-0.016
891.85	-0.014	191	-0.0142
891.87	-0.012	191	-0.0133
891.88	-0.011	191	-0.0107
891.90	-0.01	191.2	-0.0089
891.92	-0.007	191.2	-0.0089
891.93	-0.007	191.2	-0.0062
891.95	-0.006	191.3	-0.0036
891.97	-0.005	191.5	-0.0009
891.98	-0.002	191.7	0.0027
892.00	-0.001	191.8	0.0053
892.02	0.001	192.1	0.0089
892.03	0.005	192.3	0.0089
892.05	0.005	192.3	0.0133
892.07	0.005	192.5	0.016
892.08	0.007	192.8	0.0204
892.10	0.011	193	0.0249
892.12	0.012	193.2	0.0284
892.13	0.013	193.5	0.032
892.15	0.017	193.8	0.032
892.17	0.018	193.8	0.0364

Prova triassiale ciclica SN04-C1			
pressione di confinamento (kPa)		80	
deviatore ciclico (kPa)		95	
frequenza (hz)		0.00625	
tempo	cella di carico	$\Delta u$	LVDT
(min)	kN	(kPa)	$\delta$ (mm)
892.18	0.018	194	0.0391
892.20	0.019	194.2	0.0426
892.22	0.022	194.5	0.0462
892.23	0.022	194.7	0.0479
892.25	0.024	195	0.0506
892.27	0.026	195.2	0.0506
892.28	0.026	195.2	0.0533
892.30	0.026	195.4	0.055
892.32	0.027	195.7	0.0568
892.33	0.028	195.9	0.0586
892.35	0.028	196	0.0586
892.37	0.028	196.2	0.0595
892.38	0.029	196.3	0.0595
892.40	0.029	196.3	0.0604
892.42	0.029	196.4	0.0604
892.43	0.028	196.6	0.0604
892.45	0.028	196.6	0.0604
892.47	0.028	196.7	0.0604
892.48	0.027	196.7	0.0586
892.50	0.026	196.7	0.0577
892.52	0.025	196.7	0.0559
892.53	0.024	196.7	0.0541
892.55	0.022	196.6	0.0541
892.57	0.021	196.6	0.0524
892.58	0.021	196.5	0.0506
892.60	0.02	196.4	0.0479
892.62	0.016	196.3	0.0444
892.63	0.015	196.2	0.0426
892.65	0.014	196	0.0391
892.67	0.011	195.8	0.0391
892.68	0.009	195.6	0.0346
892.70	0.009	195.6	0.032
892.72	0.008	195.4	0.0275
892.73	0.005	195.1	0.0231
892.75	0.003	194.9	0.0204
892.77	0.001	194.7	0.016
892.80	-0.001	194.3	0.016
892.82	-0.004	194.1	0.0115
892.83	-0.004	194.1	0.0089
892.85	-0.004	193.9	0.0053
892.85	-0.007	193.5	0.0018
892.87	-0.009	193.3	-0.0018
892.88	-0.01	193.1	-0.0044
892.90	-0.011	192.7	-0.0044
892.92	-0.013	192.5	-0.008
892.93	-0.013	192.5	-0.0098
892.95	-0.014	192.3	-0.0124
892.97	-0.015	192.1	-0.0142
892.98	-0.016	191.9	-0.0151
893.00	-0.016	191.7	-0.0169
893.02	-0.017	191.5	-0.0178
893.03	-0.017	191.4	-0.0178
893.05	-0.017	191.4	-0.0178
893.07	-0.017	191.3	-0.0186
893.08	-0.017	191.2	-0.0186
893.10	-0.017	191.1	-0.0186
893.12	-0.016	191	-0.0178
893.13	-0.016	191	-0.0178



Prova triassiale ciclica SN04-C1			
pressione di confinamento (kPa)		80	
deviatore ciclico (kPa)		95	
frequenza (hz)		0.00625	
tempo	cella di carico	$\Delta u$	LVDT
(min)	kN	(kPa)	$\delta$ (mm)
893.15	-0.015	191	-0.016
893.17	-0.015	190.9	-0.016
893.18	-0.014	190.9	-0.0142
893.20	-0.012	191	-0.0142
893.22	-0.011	191	-0.0124
893.23	-0.011	191	-0.0107
893.25	-0.01	191.2	-0.008
893.27	-0.007	191.3	-0.0053
893.28	-0.006	191.4	-0.0027
893.30	-0.004	191.6	0.0009
893.32	0	191.8	0.0009
893.33	0	191.8	0.0044
893.35	0	191.9	0.0071
893.37	0.002	192.1	0.0107
893.38	0.005	192.4	0.0142
893.40	0.006	192.5	0.0178
893.42	0.008	192.8	0.0222
893.43	0.012	193.1	0.0222
893.45	0.013	193.1	0.0275
893.47	0.013	193.3	0.0302
893.48	0.014	193.6	0.0337
893.50	0.017	193.8	0.0382
893.52	0.018	194.1	0.0408
893.53	0.02	194.3	0.0435
893.55	0.022	194.6	0.0435
893.57	0.023	194.6	0.047
893.58	0.023	194.8	0.0497
893.60	0.024	195	0.0524
893.62	0.026	195.3	0.0541
893.63	0.027	195.5	0.0559
893.65	0.027	195.7	0.0577
893.67	0.028	195.9	0.0577
893.68	0.029	195.9	0.0586
893.70	0.029	196.1	0.0595
893.72	0.029	196.2	0.0595
893.73	0.029	196.3	0.0595
893.75	0.029	196.4	0.0604
893.77	0.029	196.5	0.0604
893.78	0.028	196.6	0.0604
893.80	0.027	196.6	0.0595
893.82	0.027	196.6	0.0586
893.83	0.026	196.7	0.0568
893.85	0.025	196.6	0.0559
893.87	0.024	196.6	0.0541
893.88	0.023	196.6	0.0524
893.90	0.022	196.5	0.0515
893.92	0.02	196.4	0.0488
893.93	0.019	196.4	0.047
893.95	0.017	196.2	0.0435
893.97	0.014	196	0.0435
893.98	0.013	196	0.0399
894.00	0.013	195.9	0.0382
894.02	0.011	195.7	0.0346
894.03	0.008	195.4	0.0302
894.05	0.007	195.3	0.0275
894.07	0.005	195	0.0222
894.08	0.001	194.7	0.0222
894.10	0.001	194.7	0.0178

Prova triassiale ciclica SN04-C1			
pressione di confinamento (kPa)		80	
deviatore ciclico (kPa)		95	
frequenza (hz)		0.00625	
tempo	cella di carico	$\Delta u$	LVDT
(min)	kN	(kPa)	$\delta$ (mm)
894.12	0.001	194.5	0.0151
894.13	-0.001	194.2	0.0107
894.15	-0.005	193.9	0.0071
894.17	-0.005	193.7	0.0036
894.18	-0.007	193.4	0
894.20	-0.01	193.1	0
894.22	-0.011	193.1	-0.0036
894.25	-0.011	192.9	-0.0062
894.27	-0.011	192.7	-0.008
894.28	-0.014	192.4	-0.0107
894.30	-0.014	192.2	-0.0124
894.30	-0.015	192	-0.0142
894.32	-0.016	191.8	-0.0142
894.33	-0.017	191.8	-0.016
894.35	-0.017	191.6	-0.0169
894.37	-0.017	191.5	-0.0178
894.38	-0.017	191.3	-0.0186
894.40	-0.017	191.2	-0.0186
894.42	-0.017	191.1	-0.0186
894.43	-0.017	191	-0.0186
894.45	-0.016	191	-0.0186
894.47	-0.016	191	-0.0178
894.48	-0.016	190.9	-0.0169
894.50	-0.015	190.9	-0.016
894.52	-0.013	190.9	-0.0142
894.53	-0.012	191	-0.0124
894.55	-0.011	191	-0.0124
894.57	-0.009	191.2	-0.0107
894.58	-0.009	191.2	-0.008
894.60	-0.006	191.3	-0.0053
894.62	-0.005	191.4	-0.0044
894.63	-0.005	191.4	-0.0018
894.65	-0.004	191.6	0.0018
894.67	-0.001	191.8	0.0053
894.68	0.002	192	0.0089
894.70	0.003	192.2	0.0124
894.72	0.005	192.4	0.016
894.73	0.008	192.7	0.016
894.75	0.008	192.7	0.0195
894.77	0.009	192.9	0.024
894.78	0.012	193.2	0.0284
894.80	0.014	193.4	0.032
894.82	0.015	193.6	0.0355
894.83	0.017	193.9	0.0391
894.85	0.019	194.2	0.0391
894.87	0.019	194.2	0.0417
894.88	0.021	194.4	0.0453
894.90	0.022	194.7	0.0488
894.92	0.024	194.9	0.0506
894.93	0.025	195.1	0.0533
894.95	0.026	195.4	0.0559
894.97	0.027	195.6	0.0559
894.98	0.027	195.6	0.0568
895.00	0.027	195.8	0.0577
895.02	0.028	196	0.0586
895.03	0.028	196.1	0.0595
895.05	0.029	196.2	0.0604
895.07	0.029	196.4	0.0604

Prova triassiale ciclica SN04-C1			
pressione di confinamento (kPa)		80	
deviatore ciclico (kPa)		95	
frequenza (hz)		0.00625	
tempo	cella di carico	$\Delta u$	LVDT
(min)	kN	(kPa)	$\delta$ (mm)
895.08	0.029	196.5	0.0604
895.10	0.029	196.5	0.0604
895.12	0.029	196.6	0.0604
895.13	0.028	196.6	0.0595
895.15	0.027	196.6	0.0586
895.17	0.026	196.6	0.0577
895.18	0.025	196.7	0.0559
895.20	0.023	196.6	0.0559
895.22	0.022	196.6	0.0541
895.23	0.022	196.6	0.0524
895.25	0.021	196.5	0.0497
895.27	0.018	196.3	0.047
895.28	0.017	196.2	0.0444
895.30	0.016	196.1	0.0417
895.32	0.012	195.9	0.0417
895.33	0.011	195.7	0.0355
895.35	0.011	195.7	0.0328
895.37	0.007	195.4	0.0328
895.38	0.006	195.1	0.0293
895.40	0.006	195.1	0.0249
895.42	0.004	194.9	0.0213
895.43	0.001	194.6	0.0169
895.45	-0.001	194.4	0.0133
895.47	-0.002	194.2	0.0098
895.48	-0.005	193.8	0.0098
895.50	-0.006	193.6	0.0053
895.52	-0.006	193.6	0.0036
895.53	-0.007	193.4	-0.0009
895.55	-0.01	193	-0.0044
895.57	-0.011	192.8	-0.0071
895.58	-0.012	192.6	-0.0098
895.60	-0.014	192.3	-0.0098
895.62	-0.015	192.1	-0.0124
895.63	-0.015	192.1	-0.0133
895.65	-0.015	191.9	-0.0151
895.67	-0.016	191.7	-0.0169
895.68	-0.017	191.5	-0.0178
895.72	-0.017	191.4	-0.0186
895.73	-0.017	191.2	-0.0186
895.75	-0.017	191.2	-0.0186
895.77	-0.017	191.2	-0.0186
895.77	-0.017	191	-0.0186
895.78	-0.017	191	-0.0186
895.80	-0.016	190.9	-0.0178
895.82	-0.016	190.9	-0.0169
895.83	-0.015	190.9	-0.0151
895.85	-0.013	190.9	-0.0151
895.87	-0.013	190.9	-0.0133
895.88	-0.012	191	-0.0115
895.90	-0.01	191.1	-0.0098
895.92	-0.008	191.2	-0.0071
895.93	-0.007	191.2	-0.0053
895.95	-0.006	191.4	-0.0018
895.97	-0.002	191.6	-0.0018
895.98	-0.002	191.6	0.0009
896.00	-0.002	191.7	0.0044
896.02	0	192	0.008
896.03	0.004	192.2	0.0124

Prova triassiale ciclica SN04-C1			
pressione di confinamento (kPa)		80	
deviatore ciclico (kPa)		95	
frequenza (hz)		0.00625	
tempo	cella di carico	$\Delta u$	LVDT
(min)	kN	(kPa)	$\delta$ (mm)
896.05	0.005	192.3	0.0151
896.07	0.006	192.6	0.0186
896.08	0.009	192.8	0.0213
896.10	0.01	193	0.0249
896.12	0.012	193.3	0.0293
896.13	0.015	193.5	0.0293
896.15	0.016	193.5	0.0337
896.17	0.016	193.8	0.0364
896.18	0.017	194	0.0399
896.20	0.02	194.3	0.0435
896.22	0.021	194.5	0.0462
896.23	0.022	194.7	0.0488
896.25	0.024	195	0.0488
896.27	0.025	195	0.0515
896.28	0.025	195.2	0.0533
896.30	0.026	195.4	0.0559
896.32	0.027	195.7	0.0568
896.33	0.028	195.8	0.0577
896.35	0.028	196	0.0595
896.37	0.029	196.2	0.0595
896.38	0.029	196.3	0.0604
896.40	0.029	196.3	0.0604
896.42	0.029	196.4	0.0604
896.43	0.029	196.5	0.0604
896.45	0.028	196.6	0.0604
896.47	0.028	196.6	0.0595
896.48	0.027	196.6	0.0595
896.50	0.025	196.6	0.0577
896.52	0.025	196.6	0.0568
896.53	0.025	196.6	0.055
896.55	0.023	196.5	0.0533
896.57	0.021	196.5	0.0515
896.58	0.02	196.4	0.0479
896.60	0.018	196.2	0.0453
896.62	0.016	196.1	0.0453
896.63	0.014	196.1	0.0426
896.65	0.014	196	0.0399
896.67	0.013	195.8	0.0373
896.68	0.01	195.6	0.0337
896.70	0.009	195.4	0.0302
896.72	0.007	195.1	0.0249
896.73	0.003	194.9	0.0249
896.75	0.002	194.9	0.0213
896.77	0.002	194.7	0.0186
896.78	-0.002	194.2	0.0142
896.80	-0.002	194.2	0.0115
896.82	-0.002	194	0.008
896.83	-0.005	193.7	0.0044
896.85	-0.007	193.4	0.0009
896.87	-0.008	193.2	-0.0018
896.88	-0.01	192.9	-0.0044
896.90	-0.012	192.6	-0.0044
896.92	-0.013	192.6	-0.008
896.93	-0.013	192.5	-0.0098
896.95	-0.014	192.2	-0.0124
896.97	-0.016	192	-0.0142
896.98	-0.015	191.8	-0.0151
897.00	-0.016	191.6	-0.0169

Prova triassiale ciclica SN04-C1			
pressione di confinamento (kPa)		80	
deviatore ciclico (kPa)		95	
frequenza (hz)		0.00625	
tempo	cella di carico	$\Delta u$	LVDT
(min)	kN	(kPa)	$\delta$ (mm)
897.02	-0.017	191.4	-0.0169
897.03	-0.017	191.4	-0.0178
897.05	-0.017	191.3	-0.0186
897.07	-0.017	191.2	-0.0186
897.08	-0.017	191.1	-0.0186
897.10	-0.017	191	-0.0186
897.12	-0.016	190.9	-0.0178
897.15	-0.016	190.9	-0.0178
897.17	-0.015	190.9	-0.0169
897.18	-0.015	190.9	-0.016
897.20	-0.014	190.9	-0.0151
897.22	-0.012	191	-0.0133
897.22	-0.011	191	-0.0115
897.23	-0.01	191	-0.0089
897.25	-0.008	191.2	-0.0089
897.27	-0.006	191.3	-0.0062
897.28	-0.006	191.3	-0.0044
897.30	-0.005	191.4	-0.0009
897.32	-0.002	191.6	0.0027
897.33	0	191.8	0.0053
897.35	0.001	191.9	0.0089
897.37	0.004	192.2	0.0089
897.38	0.006	192.4	0.0133
897.40	0.006	192.4	0.016
897.42	0.007	192.6	0.0204
897.43	0.01	192.9	0.0249
897.45	0.012	193.2	0.0284
897.47	0.013	193.4	0.032
897.48	0.015	193.7	0.0355
897.50	0.018	193.9	0.0355
897.52	0.019	194.1	0.0417
897.53	0.02	194.4	0.0435
897.55	0.022	194.6	0.0435
897.57	0.023	194.6	0.047
897.58	0.023	194.8	0.0497
897.60	0.024	195	0.0524
897.62	0.026	195.3	0.0541
897.63	0.027	195.5	0.0559
897.65	0.027	195.7	0.0568
897.67	0.028	195.9	0.0568
897.68	0.028	195.9	0.0586
897.70	0.028	196	0.0595
897.72	0.029	196.2	0.0595
897.73	0.029	196.3	0.0604
897.75	0.029	196.4	0.0604
897.77	0.028	196.5	0.0604
897.78	0.028	196.6	0.0604
897.80	0.027	196.6	0.0604
897.82	0.027	196.6	0.0586
897.83	0.026	196.6	0.0577
897.85	0.025	196.6	0.0559
897.87	0.024	196.6	0.0541
897.88	0.023	196.5	0.0524
897.90	0.02	196.4	0.0524
897.92	0.02	196.4	0.0497
897.93	0.02	196.4	0.0479
897.95	0.018	196.2	0.0453
897.97	0.015	196.1	0.0417

Prova triassiale ciclica SN04-C1			
pressione di confinamento (kPa)		80	
deviatore ciclico (kPa)		95	
frequenza (hz)		0.00625	
tempo	cella di carico	$\Delta u$	LVDT
(min)	kN	(kPa)	$\delta$ (mm)
897.98	0.014	195.9	0.0391
898.00	0.012	195.8	0.0346
898.02	0.009	195.5	0.0346
898.03	0.007	195.3	0.0311
898.05	0.007	195.3	0.0284
898.07	0.006	195.1	0.024
898.08	0.003	194.8	0.0204
898.10	0.001	194.6	0.0169
898.12	0	194.4	0.0124
898.13	-0.003	194	0.0124
898.15	-0.005	193.8	0.0089
898.17	-0.005	193.8	0.0053
898.18	-0.006	193.6	0.0018
898.20	-0.008	193.2	-0.0018
898.22	-0.01	193	-0.0044
898.23	-0.011	192.8	-0.008
898.25	-0.012	192.5	-0.0089
898.27	-0.014	192.3	-0.0107
898.28	-0.014	192.1	-0.0124
898.30	-0.015	191.8	-0.0151
898.32	-0.016	191.7	-0.0151
898.33	-0.016	191.7	-0.016
898.35	-0.016	191.5	-0.0169
898.37	-0.017	191.4	-0.0178
898.38	-0.017	191.2	-0.0186
898.40	-0.017	191.1	-0.0186
898.42	-0.017	191	-0.0186
898.43	-0.017	190.9	-0.0186
898.45	-0.016	190.9	-0.0178
898.47	-0.016	190.9	-0.0178
898.48	-0.016	190.8	-0.0169
898.50	-0.014	190.9	-0.016
898.52	-0.013	190.9	-0.0142
898.53	-0.013	190.9	-0.0124
898.55	-0.01	191	-0.0124
898.57	-0.01	191	-0.0107
898.58	-0.01	191	-0.008
898.62	-0.008	191.2	-0.0053
898.63	-0.005	191.4	-0.0027
898.65	-0.004	191.5	0
898.67	-0.002	191.7	0.0036
898.67	0.001	191.9	0.0036
898.68	0.002	191.9	0.0071
898.70	0.002	192	0.0098
898.72	0.004	192.3	0.0142
898.73	0.007	192.5	0.0178
898.75	0.008	192.7	0.0213
898.77	0.01	193	0.0257
898.78	0.013	193.2	0.0257
898.80	0.014	193.2	0.0302
898.82	0.014	193.5	0.0337
898.83	0.016	193.7	0.0373
898.85	0.019	194	0.0417
898.87	0.02	194.2	0.0435
898.88	0.021	194.5	0.0462
898.90	0.023	194.7	0.0462
898.92	0.024	194.7	0.0488
898.93	0.024	194.9	0.0515

Prova triassiale ciclica SN04-C1			
pressione di confinamento (kPa)		80	
deviatore ciclico (kPa)		95	
frequenza (hz)		0.00625	
tempo	cella di carico	$\Delta u$	LVDT
(min)	kN	(kPa)	$\delta$ (mm)
898.95	0.025	195.2	0.0541
898.97	0.027	195.4	0.0559
898.98	0.027	195.6	0.0568
899.00	0.027	195.8	0.0577
899.02	0.028	196	0.0595
899.03	0.029	196.1	0.0595
899.05	0.029	196.2	0.0604
899.07	0.029	196.4	0.0604
899.08	0.029	196.4	0.0604
899.10	0.029	196.4	0.0604
899.12	0.029	196.5	0.0604
899.13	0.028	196.6	0.0595
899.15	0.027	196.6	0.0586
899.17	0.026	196.6	0.0568
899.18	0.025	196.6	0.0568
899.20	0.023	196.6	0.055
899.22	0.023	196.6	0.0541
899.23	0.022	196.5	0.0515
899.25	0.02	196.4	0.0488
899.27	0.018	196.3	0.047
899.28	0.017	196.2	0.0444
899.30	0.015	196	0.0408
899.32	0.012	195.8	0.0408
899.33	0.012	195.8	0.0373
899.35	0.011	195.7	0.0346
899.37	0.009	195.4	0.0302
899.38	0.006	195.2	0.0275
899.40	0.005	195	0.0231
899.42	0.003	194.7	0.0186
899.43	0	194.4	0.0186
899.45	0	194.4	0.0151
899.47	-0.001	194.2	0.0115
899.48	-0.003	193.9	0.0071
899.50	-0.006	193.6	0.0036
899.52	-0.007	193.4	0.0009
899.53	-0.009	193.1	-0.0027
899.55	-0.011	192.8	-0.0027
899.57	-0.012	192.8	-0.0062
899.58	-0.012	192.6	-0.008
899.60	-0.013	192.4	-0.0107
899.62	-0.015	192.1	-0.0124
899.63	-0.015	192	-0.0142
899.65	-0.016	191.8	-0.0151
899.67	-0.017	191.6	-0.0151
899.68	-0.017	191.4	-0.0178
899.70	-0.017	191.3	-0.0178
899.72	-0.017	191.2	-0.0178
899.73	-0.017	191.2	-0.0186
899.75	-0.017	191	-0.0186
899.77	-0.017	190.9	-0.0186
899.78	-0.016	190.9	-0.0178
899.80	-0.016	190.8	-0.0178
899.82	-0.015	190.8	-0.016
899.83	-0.014	190.9	-0.016
899.85	-0.013	190.9	-0.0151
899.87	-0.013	190.8	-0.0133
899.88	-0.012	190.9	-0.0115
899.90	-0.009	191	-0.0098

Prova triassiale ciclica SN04-C1			
pressione di confinamento (kPa)		80	
deviatore ciclico (kPa)		95	
frequenza (hz)		0.00625	
tempo	cella di carico	$\Delta u$	LVDT
(min)	kN	(kPa)	$\delta$ (mm)
899.92	-0.009	191.1	-0.008
899.93	-0.007	191.2	-0.0044
899.95	-0.004	191.4	-0.0044
899.97	-0.003	191.4	-0.0018
899.98	-0.003	191.5	0.0009
900.00	-0.002	191.7	0.0053
900.02	0.002	191.9	0.0089
900.05	0.003	192.1	0.0107
900.07	0.004	192.3	0.016
900.08	0.008	192.6	0.016
900.10	0.01	192.8	0.0195
900.12	0.01	192.8	0.0231
900.12	0.011	193	0.0275
900.13	0.014	193.3	0.032
900.15	0.015	193.5	0.0346
900.17	0.017	193.8	0.0382
900.18	0.019	194.1	0.0382
900.20	0.021	194.3	0.0426
900.22	0.021	194.3	0.0453
900.23	0.022	194.5	0.0479
900.25	0.023	194.8	0.0506
900.27	0.025	195	0.0524
900.28	0.026	195.2	0.0541
900.30	0.027	195.5	0.0541
900.32	0.028	195.7	0.0568
900.33	0.028	195.7	0.0577
900.35	0.028	195.9	0.0586
900.37	0.028	196	0.0595
900.38	0.029	196.1	0.0604
900.40	0.029	196.3	0.0604
900.42	0.029	196.4	0.0604
900.43	0.029	196.5	0.0604
900.45	0.028	196.6	0.0604
900.47	0.028	196.6	0.0586
900.48	0.026	196.6	0.0586
900.50	0.025	196.6	0.0577
900.52	0.025	196.6	0.0568
900.53	0.025	196.6	0.055
900.55	0.023	196.5	0.0533
900.57	0.021	196.5	0.0515
900.58	0.02	196.4	0.0488
900.60	0.017	196.2	0.0488
900.62	0.016	196.2	0.0453
900.63	0.016	196.1	0.0435
900.65	0.015	196	0.0399
900.67	0.011	195.7	0.0364
900.68	0.01	195.6	0.0337
900.70	0.009	195.4	0.0293
900.72	0.005	195.1	0.0293
900.73	0.004	195.1	0.0249
900.75	0.004	194.9	0.0222
900.77	0.003	194.6	0.0178
900.78	-0.001	194.3	0.0133
900.80	-0.002	194.1	0.0107
900.82	-0.003	193.9	0.0071
900.83	-0.007	193.5	0.0071
900.85	-0.008	193.3	0.0027
900.87	-0.008	193.3	0



Prova triassiale ciclica SN04-C1			
pressione di confinamento (kPa)		80	
deviatore ciclico (kPa)		95	
frequenza (hz)		0.00625	
tempo	cella di carico	$\Delta u$	LVDT
(min)	kN	(kPa)	$\delta$ (mm)
900.88	-0.009	193.1	-0.0036
900.90	-0.011	192.8	-0.0071
900.92	-0.012	192.5	-0.0089
900.93	-0.013	192.3	-0.0115
900.95	-0.015	192	-0.0115
900.97	-0.016	191.8	-0.0133
900.98	-0.016	191.8	-0.0151
901.00	-0.016	191.7	-0.0169
901.02	-0.017	191.5	-0.0169
901.03	-0.017	191.3	-0.0178
901.05	-0.017	191.2	-0.0186
901.07	-0.017	191.1	-0.0186
901.08	-0.017	191	-0.0186
901.10	-0.017	191	-0.0186
901.12	-0.017	190.9	-0.0186
901.13	-0.016	190.9	-0.0178
901.15	-0.015	190.9	-0.016
901.17	-0.015	190.8	-0.016
901.18	-0.014	190.9	-0.0142
901.20	-0.012	190.9	-0.0124
901.22	-0.012	190.9	-0.0115
901.23	-0.01	191.1	-0.0089
901.25	-0.007	191.2	-0.0089
901.27	-0.007	191.2	-0.0062
901.28	-0.007	191.2	-0.0044
901.30	-0.005	191.4	-0.0009
901.32	-0.001	191.6	0.0027
901.33	-0.001	191.7	0.0053
901.35	0.001	192	0.0089
901.37	0.004	192.2	0.0089
901.38	0.005	192.2	0.0133
901.40	0.005	192.4	0.016
901.42	0.007	192.6	0.0204
901.43	0.011	192.9	0.0249
901.45	0.012	193.1	0.0284
901.47	0.013	193.4	0.0328
901.48	0.017	193.7	0.0328
901.52	0.017	193.7	0.0364
901.53	0.017	193.9	0.0391
901.55	0.019	194.2	0.0435
901.57	0.022	194.4	0.0462
901.57	0.022	194.6	0.0488
901.58	0.023	194.9	0.0515
901.60	0.026	195.1	0.0515
901.62	0.026	195.1	0.0533
901.63	0.026	195.3	0.055
901.65	0.027	195.5	0.0568
901.67	0.028	195.7	0.0586
901.68	0.028	195.9	0.0586
901.70	0.028	196	0.0595
901.72	0.029	196.2	0.0595
901.73	0.029	196.2	0.0604
901.75	0.029	196.3	0.0604
901.77	0.029	196.4	0.0604
901.78	0.029	196.5	0.0604
901.80	0.027	196.5	0.0595
901.82	0.027	196.6	0.0577
901.83	0.026	196.5	0.0577

Prova triassiale ciclica SN04-C1			
pressione di confinamento (kPa)		80	
deviatore ciclico (kPa)		95	
frequenza (hz)		0.00625	
tempo	cella di carico	$\Delta u$	LVDT
(min)	kN	(kPa)	$\delta$ (mm)
901.85	0.024	196.5	0.0568
901.87	0.023	196.5	0.0541
901.88	0.023	196.5	0.0541
901.90	0.021	196.4	0.0533
901.92	0.021	196.4	0.0506
901.93	0.02	196.3	0.047
901.95	0.017	196.2	0.0444
901.97	0.015	196	0.0417
901.98	0.014	195.9	0.0382
902.00	0.011	195.7	0.0382
902.02	0.009	195.5	0.0355
902.03	0.009	195.5	0.032
902.05	0.008	195.2	0.0284
902.07	0.005	195	0.024
902.08	0.003	194.8	0.0204
902.10	0.001	194.6	0.016
902.12	-0.001	194.2	0.016
902.13	-0.003	194	0.0124
902.15	-0.003	194	0.0089
902.17	-0.004	193.8	0.0053
902.18	-0.007	193.4	0.0018
902.20	-0.009	193.2	-0.0018
902.22	-0.01	192.9	-0.0044
902.23	-0.012	192.6	-0.0044
902.25	-0.013	192.4	-0.0071
902.27	-0.013	192.4	-0.0098
902.28	-0.014	192.2	-0.0115
902.30	-0.015	192	-0.0142
902.32	-0.016	191.8	-0.0151
902.33	-0.016	191.6	-0.016
902.35	-0.017	191.4	-0.0169
902.37	-0.017	191.3	-0.0169
902.38	-0.017	191.3	-0.0178
902.40	-0.017	191.2	-0.0186
902.42	-0.017	191	-0.0186
902.43	-0.017	191	-0.0186
902.45	-0.017	190.9	-0.0178
902.47	-0.016	190.9	-0.0169
902.48	-0.015	190.9	-0.0169
902.50	-0.014	190.9	-0.016
902.52	-0.014	190.8	-0.0151
902.53	-0.013	190.9	-0.0133
902.55	-0.011	190.9	-0.0107
902.57	-0.01	191	-0.0089
902.58	-0.009	191.2	-0.0062
902.60	-0.006	191.3	-0.0036
902.62	-0.006	191.3	-0.0018
902.63	-0.004	191.5	0.0009
902.65	-0.001	191.7	0.0009
902.67	0	191.7	0.0044
902.68	0	191.8	0.0071
902.70	0.002	192.1	0.0107
902.72	0.006	192.3	0.0151
902.73	0.006	192.5	0.0186
902.75	0.008	192.8	0.0222
902.77	0.012	193	0.0222
902.78	0.012	193	0.0275
902.80	0.012	193.2	0.0302

Prova triassiale ciclica SN04-C1			
pressione di confinamento (kPa)		80	
deviatore ciclico (kPa)		95	
frequenza (hz)		0.00625	
tempo	cella di carico	$\Delta u$	LVDT
(min)	kN	(kPa)	$\delta$ (mm)
902.82	0.014	193.5	0.0346
902.83	0.018	193.7	0.0382
902.85	0.018	194	0.0408
902.87	0.02	194.2	0.0444
902.88	0.022	194.5	0.0444
902.90	0.023	194.5	0.047
902.92	0.023	194.7	0.0488
902.93	0.024	194.9	0.0524
902.95	0.026	195.2	0.0541
902.98	0.027	195.4	0.0559
903.00	0.027	195.6	0.0577
903.02	0.028	195.8	0.0577
903.02	0.028	195.8	0.0586
903.03	0.028	195.9	0.0595
903.05	0.029	196.1	0.0604
903.07	0.029	196.2	0.0604
903.08	0.029	196.3	0.0604
903.10	0.028	196.4	0.0604
903.12	0.028	196.5	0.0604
903.13	0.028	196.5	0.0604
903.15	0.028	196.5	0.0595
903.17	0.026	196.6	0.0577
903.18	0.025	196.5	0.0559
903.20	0.024	196.5	0.055
903.22	0.023	196.5	0.0524
903.23	0.021	196.4	0.0524
903.25	0.019	196.3	0.0506
903.27	0.019	196.3	0.0479
903.28	0.018	196.2	0.0453
903.30	0.016	196	0.0417
903.32	0.013	195.9	0.0391
903.33	0.013	195.8	0.0373
903.35	0.011	195.5	0.0337
903.37	0.008	195.3	0.0311
903.38	0.007	195.1	0.0275
903.40	0.005	194.8	0.0222
903.42	0.002	194.6	0.0222
903.43	0.002	194.6	0.0186
903.45	0.001	194.4	0.0142
903.47	-0.002	194.1	0.0107
903.48	-0.004	193.8	0.0071
903.50	-0.005	193.6	0.0036
903.52	-0.007	193.3	0
903.53	-0.01	193	0
903.55	-0.01	193	-0.0036
903.57	-0.01	192.8	-0.0053
903.58	-0.012	192.5	-0.008
903.60	-0.014	192.3	-0.0107
903.62	-0.014	192.1	-0.0124
903.63	-0.015	191.8	-0.0142
903.65	-0.016	191.7	-0.0142
903.67	-0.017	191.7	-0.016
903.68	-0.017	191.5	-0.0169
903.70	-0.017	191.3	-0.0178
903.72	-0.017	191.2	-0.0178
903.73	-0.017	191.1	-0.0186
903.75	-0.017	191	-0.0186
903.77	-0.017	190.9	-0.0186

Prova triassiale ciclica SN04-C1			
pressione di confinamento (kPa)		80	
deviatore ciclico (kPa)		95	
frequenza (hz)		0.00625	
tempo	cella di carico	$\Delta u$	LVDT
(min)	kN	(kPa)	$\delta$ (mm)
903.78	-0.016	190.9	-0.0178
903.80	-0.016	190.8	-0.0178
903.82	-0.016	190.8	-0.0169
903.83	-0.015	190.8	-0.0151
903.85	-0.013	190.8	-0.0142
903.87	-0.013	190.8	-0.0124
903.88	-0.01	190.9	-0.0124
903.90	-0.009	191	-0.0098
903.92	-0.009	191	-0.0089
903.93	-0.008	191.1	-0.0062
903.95	-0.006	191.3	-0.0027
903.97	-0.004	191.4	0
903.98	-0.002	191.5	0.0044
904.00	0	191.8	0.0044
904.02	0.002	192	0.0071
904.03	0.002	192	0.0107
904.05	0.006	192.4	0.016
904.07	0.007	192.6	0.016
904.08	0.007	192.6	0.0195
904.10	0.009	192.8	0.024
904.12	0.012	193.1	0.0284
904.13	0.014	193.3	0.032
904.15	0.015	193.5	0.0355
904.17	0.017	193.8	0.0391
904.18	0.02	194.1	0.0391
904.20	0.021	194.1	0.0426
904.22	0.021	194.3	0.0453
904.23	0.022	194.5	0.0479
904.25	0.024	194.8	0.0506
904.27	0.025	195	0.0524
904.28	0.026	195.2	0.055
904.30	0.027	195.5	0.055
904.32	0.027	195.5	0.0568
904.33	0.027	195.7	0.0577
904.35	0.028	195.9	0.0595
904.37	0.029	196	0.0595
904.38	0.029	196.1	0.0604
904.42	0.029	196.3	0.0604
904.43	0.029	196.4	0.0604
904.45	0.029	196.4	0.0604
904.47	0.029	196.4	0.0604
904.48	0.028	196.5	0.0595
904.48	0.027	196.5	0.0586
904.50	0.026	196.5	0.0577
904.52	0.025	196.6	0.0559
904.53	0.024	196.5	0.0559
904.55	0.022	196.4	0.0541
904.57	0.022	196.4	0.0524
904.58	0.021	196.4	0.0497
904.60	0.018	196.2	0.047
904.62	0.017	196.1	0.0453
904.63	0.016	196	0.0417
904.65	0.013	195.8	0.0417
904.67	0.011	195.6	0.0382
904.68	0.011	195.6	0.0355
904.70	0.01	195.4	0.0311
904.72	0.006	195.1	0.0275
904.73	0.005	194.9	0.024

Prova triassiale ciclica SN04-C1			
pressione di confinamento (kPa)		80	
deviatore ciclico (kPa)		95	
frequenza (hz)		0.00625	
tempo	cella di carico	$\Delta u$	LVDT
(min)	kN	(kPa)	$\delta$ (mm)
904.75	0.004	194.7	0.0195
904.77	0.001	194.4	0.0195
904.78	-0.001	194.2	0.0133
904.80	-0.002	194	0.0098
904.82	-0.005	193.7	0.0098
904.83	-0.006	193.4	0.0062
904.85	-0.006	193.4	0.0027
904.87	-0.008	193.2	-0.0009
904.88	-0.01	192.9	-0.0036
904.90	-0.011	192.7	-0.0062
904.92	-0.012	192.5	-0.0089
904.93	-0.014	192.2	-0.0089
904.95	-0.015	192	-0.0107
904.97	-0.015	192	-0.0133
904.98	-0.015	191.8	-0.0151
905.00	-0.016	191.6	-0.016
905.02	-0.017	191.4	-0.0169
905.03	-0.017	191.3	-0.0178
905.05	-0.017	191.2	-0.0178
905.07	-0.017	191	-0.0178
905.08	-0.017	191	-0.0178
905.10	-0.017	190.9	-0.0178
905.12	-0.017	190.8	-0.0178
905.13	-0.016	190.8	-0.0169
905.15	-0.015	190.8	-0.016
905.17	-0.015	190.8	-0.0151
905.18	-0.013	190.8	-0.0151
905.20	-0.012	190.8	-0.0133
905.22	-0.012	190.8	-0.0115
905.23	-0.011	191	-0.0098
905.25	-0.008	191.1	-0.0071
905.27	-0.007	191.2	-0.0044
905.28	-0.006	191.3	-0.0018
905.30	-0.002	191.5	-0.0018
905.32	-0.002	191.5	0.0018
905.33	-0.002	191.6	0.0044
905.35	0	191.8	0.008
905.37	0.004	192.1	0.0124
905.38	0.005	192.2	0.0151
905.40	0.006	192.5	0.0186
905.42	0.01	192.7	0.0186
905.43	0.011	192.7	0.0231
905.45	0.011	192.9	0.0275
905.47	0.012	193.2	0.0311
905.48	0.016	193.5	0.0355
905.50	0.017	193.7	0.0382
905.52	0.017	193.9	0.0399
905.53	0.02	194.2	0.0435
905.55	0.021	194.4	0.0462
905.57	0.022	194.6	0.0497
905.58	0.025	194.9	0.0497
905.60	0.025	194.9	0.0524
905.62	0.025	195.1	0.0541
905.63	0.026	195.3	0.0559
905.65	0.028	195.6	0.0577
905.67	0.028	195.7	0.0586
905.68	0.028	195.9	0.0595
905.70	0.029	196.1	0.0595

Prova triassiale ciclica SN04-C1			
pressione di confinamento (kPa)		80	
deviatore ciclico (kPa)		95	
frequenza (hz)		0.00625	
tempo	cella di carico	$\Delta u$	LVDT
(min)	kN	(kPa)	$\delta$ (mm)
905.72	0.029	196.1	0.0604
905.73	0.029	196.2	0.0604
905.75	0.029	196.3	0.0604
905.77	0.029	196.4	0.0604
905.78	0.028	196.5	0.0604
905.80	0.028	196.5	0.0595
905.82	0.026	196.5	0.0595
905.83	0.026	196.5	0.0577
905.85	0.026	196.5	0.0568
905.88	0.025	196.5	0.055
905.90	0.022	196.4	0.0533
905.92	0.022	196.4	0.0515
905.93	0.02	196.3	0.0488
905.93	0.018	196.2	0.0488
905.95	0.016	196.2	0.0462
905.97	0.016	196	0.0435
905.98	0.015	195.9	0.0408
906.00	0.012	195.7	0.0364
906.02	0.01	195.5	0.0337
906.03	0.009	195.3	0.0302
906.05	0.006	195	0.0302
906.07	0.004	194.8	0.0257
906.08	0.004	194.8	0.0222
906.10	0.002	194.6	0.0178
906.12	-0.001	194.3	0.0142
906.13	-0.002	194.1	0.0107
906.15	-0.004	193.8	0.0071
906.17	-0.006	193.5	0.0071
906.18	-0.008	193.2	0.0027
906.20	-0.008	193.2	0
906.22	-0.009	193	-0.0036
906.23	-0.012	192.5	-0.0062
906.25	-0.012	192.5	-0.008
906.27	-0.013	192.3	-0.0107
906.28	-0.014	192	-0.0124
906.30	-0.016	191.8	-0.0142
906.32	-0.016	191.7	-0.0151
906.33	-0.016	191.5	-0.016
906.35	-0.017	191.3	-0.016
906.37	-0.017	191.3	-0.0169
906.38	-0.017	191.2	-0.0178
906.40	-0.017	191	-0.0186
906.42	-0.017	190.9	-0.0178
906.43	-0.017	190.9	-0.0178
906.45	-0.016	190.8	-0.0169
906.47	-0.016	190.8	-0.0169
906.48	-0.015	190.8	-0.0169
906.50	-0.015	190.8	-0.016
906.52	-0.014	190.8	-0.0142
906.53	-0.012	190.8	-0.0124
906.55	-0.011	190.8	-0.0115
906.57	-0.01	191	-0.008
906.58	-0.007	191.1	-0.008
906.60	-0.007	191.1	-0.0053
906.62	-0.007	191.2	-0.0036
906.63	-0.005	191.3	0
906.65	-0.001	191.5	0.0036
906.67	-0.001	191.7	0.0062

Prova triassiale ciclica SN04-C1			
pressione di confinamento (kPa)		80	
deviatore ciclico (kPa)		95	
frequenza (hz)		0.00625	
tempo	cella di carico	$\Delta u$	LVDT
(min)	kN	(kPa)	$\delta$ (mm)
906.68	0.001	191.9	0.0098
906.70	0.005	192.1	0.0098
906.72	0.005	192.1	0.0133
906.73	0.005	192.3	0.0169
906.75	0.007	192.5	0.0213
906.77	0.011	192.8	0.0249
906.78	0.012	193	0.0293
906.80	0.013	193.3	0.0328
906.82	0.017	193.6	0.0328
906.83	0.018	193.6	0.0373
906.85	0.018	193.8	0.0391
906.87	0.019	194	0.0435
906.88	0.021	194.3	0.0462
906.90	0.023	194.5	0.0488
906.92	0.024	194.8	0.0515
906.93	0.025	195	0.0515
906.95	0.026	195.2	0.055
906.97	0.026	195.4	0.0559
906.98	0.027	195.6	0.0559
907.00	0.028	195.8	0.0577
907.02	0.028	195.8	0.0586
907.03	0.028	196	0.0595
907.05	0.029	196.1	0.0604
907.07	0.029	196.2	0.0604
907.08	0.029	196.3	0.0604
907.10	0.028	196.4	0.0604
907.12	0.028	196.5	0.0604
907.13	0.028	196.5	0.0604
907.15	0.027	196.5	0.0595
907.17	0.026	196.5	0.0568
907.18	0.025	196.5	0.0559
907.20	0.024	196.5	0.0541
907.22	0.023	196.4	0.0524
907.23	0.02	196.3	0.0524
907.25	0.02	196.3	0.0506
907.27	0.02	196.3	0.0479
907.28	0.018	196.1	0.0444
907.32	0.014	195.9	0.0417
907.33	0.014	195.8	0.0391
907.35	0.012	195.6	0.0355
907.37	0.009	195.4	0.0355
907.38	0.008	195.4	0.032
907.38	0.008	195.2	0.0293
907.40	0.006	194.9	0.0249
907.42	0.003	194.7	0.0204
907.43	0.001	194.5	0.0178
907.45	0	194.2	0.0133
907.47	-0.004	193.9	0.0133
907.48	-0.004	193.9	0.0089
907.50	-0.004	193.7	0.0062
907.52	-0.006	193.4	0.0027
907.53	-0.009	193.1	-0.0018
907.55	-0.01	192.9	-0.0044
907.57	-0.011	192.6	-0.0071
907.58	-0.013	192.3	-0.0071
907.60	-0.014	192.3	-0.0098
907.62	-0.014	192.1	-0.0115
907.63	-0.014	191.9	-0.0133

Prova triassiale ciclica SN04-C1			
pressione di confinamento (kPa)		80	
deviatore ciclico (kPa)		95	
frequenza (hz)		0.00625	
tempo	cella di carico	$\Delta u$	LVDT
(min)	kN	(kPa)	$\delta$ (mm)
907.65	-0.016	191.7	-0.0151
907.67	-0.017	191.5	-0.016
907.68	-0.017	191.4	-0.0169
907.70	-0.017	191.2	-0.0169
907.72	-0.017	191.1	-0.0178
907.73	-0.017	191	-0.0178
907.75	-0.017	190.9	-0.0178
907.77	-0.017	190.9	-0.0178
907.78	-0.017	190.8	-0.0178
907.80	-0.016	190.8	-0.0169
907.82	-0.015	190.7	-0.016
907.83	-0.014	190.7	-0.0151
907.85	-0.014	190.8	-0.0133
907.87	-0.012	190.8	-0.0133
907.88	-0.011	190.8	-0.0115
907.90	-0.011	190.9	-0.0098
907.92	-0.009	191	-0.0071
907.93	-0.006	191.1	-0.0044
907.95	-0.006	191.2	-0.0027
907.97	-0.004	191.4	0.0009
907.98	-0.001	191.6	0.0009
908.00	0	191.6	0.0053
908.02	0	191.7	0.0071
908.03	0.002	192	0.0115
908.05	0.006	192.2	0.0151
908.07	0.006	192.4	0.0186
908.08	0.008	192.6	0.0222
908.10	0.012	192.9	0.0222
908.12	0.013	192.9	0.0275
908.13	0.013	193.1	0.0302
908.15	0.014	193.4	0.0337
908.17	0.017	193.7	0.0382
908.18	0.018	193.9	0.0408
908.20	0.02	194.1	0.0444
908.22	0.022	194.4	0.0444
908.23	0.023	194.6	0.0479
908.25	0.023	194.6	0.0497
908.27	0.024	194.8	0.0524
908.28	0.026	195.1	0.055
908.30	0.027	195.3	0.0559
908.32	0.027	195.5	0.0568
908.33	0.028	195.7	0.0568
908.35	0.029	195.9	0.0586
908.37	0.029	195.9	0.0595
908.38	0.029	196	0.0604
908.40	0.029	196.2	0.0604
908.42	0.029	196.2	0.0604
908.43	0.029	196.3	0.0604
908.45	0.029	196.5	0.0604
908.47	0.028	196.5	0.0595
908.48	0.027	196.5	0.0577
908.50	0.026	196.5	0.0577
908.52	0.024	196.5	0.0568
908.53	0.024	196.5	0.055
908.55	0.024	196.5	0.0533
908.57	0.022	196.4	0.0515
908.58	0.02	196.3	0.0497
908.60	0.019	196.2	0.047



Prova triassiale ciclica SN04-C1			
pressione di confinamento (kPa)		80	
deviatore ciclico (kPa)		95	
frequenza (hz)		0.00625	
tempo	cella di carico	$\Delta u$	LVDT
(min)	kN	(kPa)	$\delta$ (mm)
908.62	0.017	196	0.0444
908.63	0.014	195.9	0.0444
908.65	0.013	195.9	0.0408
908.67	0.013	195.8	0.0382
908.68	0.011	195.5	0.0346
908.70	0.008	195.2	0.0302
908.72	0.007	195.1	0.0275
908.73	0.005	194.8	0.0231
908.75	0.002	194.6	0.0231
908.78	0.001	194.6	0.0186
908.80	0.001	194.4	0.0151
908.82	-0.001	194.1	0.0115
908.83	-0.004	193.8	0.0071
908.83	-0.005	193.6	0.0044
908.85	-0.007	193.3	0.0009
908.87	-0.01	193	0.0009
908.88	-0.01	193	-0.0027
908.90	-0.01	192.8	-0.0053
908.92	-0.012	192.5	-0.008
908.93	-0.014	192.2	-0.0107
908.95	-0.015	192	-0.0124
908.97	-0.015	191.8	-0.0133
908.98	-0.016	191.6	-0.0133
909.00	-0.017	191.6	-0.0151
909.02	-0.017	191.4	-0.0169
909.03	-0.017	191.3	-0.0169
909.05	-0.017	191.2	-0.0178
909.07	-0.017	191	-0.0178
909.08	-0.017	190.9	-0.0178
909.10	-0.017	190.9	-0.0178
909.12	-0.016	190.8	-0.0178
909.13	-0.016	190.8	-0.0169
909.15	-0.015	190.7	-0.0169
909.17	-0.014	190.7	-0.016
909.18	-0.014	190.7	-0.0142
909.20	-0.013	190.7	-0.0133
909.22	-0.012	190.8	-0.0107
909.23	-0.01	190.9	-0.0089
909.25	-0.009	191	-0.0062
909.27	-0.007	191.2	-0.0062
909.28	-0.004	191.3	-0.0036
909.30	-0.004	191.3	-0.0009
909.32	-0.003	191.4	0.0027
909.33	-0.001	191.6	0.0053
909.35	0.001	191.8	0.0089
909.37	0.002	192	0.0124
909.38	0.005	192.3	0.0169
909.40	0.009	192.5	0.0169
909.42	0.009	192.5	0.0204
909.43	0.009	192.7	0.024
909.45	0.011	193	0.0284
909.47	0.014	193.2	0.032
909.48	0.015	193.4	0.0355
909.50	0.017	193.7	0.0391
909.52	0.02	194	0.0391
909.53	0.02	194	0.0426
909.55	0.02	194.2	0.0453
909.57	0.022	194.5	0.0488

Prova triassiale ciclica SN04-C1			
pressione di confinamento (kPa)		80	
deviatore ciclico (kPa)		95	
frequenza (hz)		0.00625	
tempo	cella di carico	$\Delta u$	LVDT
(min)	kN	(kPa)	$\delta$ (mm)
909.58	0.024	194.7	0.0515
909.60	0.025	194.9	0.0533
909.62	0.026	195.2	0.055
909.63	0.027	195.4	0.055
909.65	0.028	195.4	0.0568
909.67	0.028	195.6	0.0577
909.68	0.028	195.8	0.0595
909.70	0.029	195.9	0.0604
909.72	0.029	196	0.0604
909.73	0.029	196.2	0.0604
909.75	0.029	196.3	0.0604
909.77	0.028	196.3	0.0604
909.78	0.028	196.4	0.0604
909.80	0.028	196.4	0.0604
909.82	0.027	196.4	0.0586
909.83	0.026	196.5	0.0577
909.85	0.025	196.5	0.0559
909.87	0.023	196.4	0.0541
909.88	0.023	196.4	0.0533
909.90	0.022	196.3	0.0506
909.92	0.02	196.2	0.0506
909.93	0.017	196.2	0.0488
909.95	0.017	196.1	0.0462
909.97	0.017	196	0.0435
909.98	0.013	195.8	0.0399
910.00	0.012	195.7	0.0373
910.02	0.011	195.4	0.0328
910.03	0.007	195.1	0.0328
910.05	0.006	195	0.0293
910.07	0.006	195	0.0257
910.08	0.004	194.8	0.0213
910.10	0.001	194.5	0.0169
910.12	0	194.2	0.0142
910.13	-0.002	194	0.0098
910.15	-0.005	193.7	0.0098
910.17	-0.007	193.4	0.0062
910.18	-0.007	193.4	0.0027
910.22	-0.007	193.2	0
910.23	-0.01	192.9	-0.0036
910.25	-0.011	192.6	-0.0062
910.27	-0.012	192.4	-0.0089
910.28	-0.014	192.1	-0.0089
910.28	-0.015	191.9	-0.0115
910.30	-0.015	191.9	-0.0133
910.32	-0.016	191.7	-0.0151
910.33	-0.016	191.5	-0.016
910.35	-0.017	191.4	-0.0169
910.37	-0.017	191.2	-0.0178
910.38	-0.017	191.1	-0.0178
910.40	-0.017	191	-0.0178
910.42	-0.017	191	-0.0178
910.43	-0.017	190.9	-0.0178
910.45	-0.017	190.8	-0.0178
910.47	-0.016	190.8	-0.0169
910.48	-0.015	190.7	-0.0151
910.50	-0.014	190.7	-0.0142
910.52	-0.013	190.8	-0.0142
910.53	-0.012	190.8	-0.0133

Prova triassiale ciclica SN04-C1			
pressione di confinamento (kPa)		80	
deviatore ciclico (kPa)		95	
frequenza (hz)		0.00625	
tempo	cella di carico	$\Delta u$	LVDT
(min)	kN	(kPa)	$\delta$ (mm)
910.55	-0.012	190.8	-0.0115
910.57	-0.011	190.9	-0.0098
910.58	-0.008	191	-0.0071
910.60	-0.008	191	-0.0053
910.62	-0.007	191.2	-0.0027
910.63	-0.003	191.3	0.0009
910.65	-0.002	191.5	0.0036
910.67	-0.001	191.7	0.0062
910.68	0.002	191.9	0.0062
910.70	0.004	191.9	0.0107
910.72	0.004	192.1	0.0142
910.73	0.005	192.3	0.0178
910.75	0.009	192.6	0.0213
910.77	0.01	192.8	0.0249
910.78	0.012	193.1	0.0302
910.80	0.015	193.3	0.0302
910.82	0.016	193.3	0.0346
910.83	0.016	193.5	0.0364
910.85	0.017	193.8	0.0399
910.87	0.02	194.1	0.0444
910.88	0.021	194.3	0.0462
910.90	0.022	194.5	0.0497
910.92	0.025	194.8	0.0497
910.93	0.025	194.8	0.0515
910.95	0.025	195	0.0541
910.97	0.026	195.2	0.0559
910.98	0.027	195.4	0.0577
911.00	0.028	195.6	0.0586
911.02	0.028	195.8	0.0595
911.03	0.029	196	0.0595
911.05	0.029	196.1	0.0604
911.07	0.029	196.1	0.0604
911.08	0.029	196.2	0.0604
911.10	0.029	196.3	0.0604
911.12	0.028	196.4	0.0604
911.13	0.028	196.4	0.0595
911.15	0.027	196.4	0.0595
911.17	0.025	196.4	0.0577
911.18	0.025	196.4	0.0568
911.20	0.024	196.4	0.055
911.22	0.023	196.4	0.0533
911.23	0.021	196.3	0.0515
911.25	0.02	196.2	0.0488
911.27	0.018	196	0.0488
911.28	0.016	195.9	0.0462
911.30	0.016	195.9	0.0435
911.32	0.013	195.7	0.0382
911.33	0.011	195.5	0.0382
911.35	0.011	195.5	0.0364
911.37	0.01	195.3	0.032
911.38	0.007	195	0.0275
911.40	0.004	194.8	0.024
911.42	0.003	194.6	0.0195
911.43	0.001	194.3	0.016
911.45	-0.002	194	0.016
911.47	-0.003	194	0.0124
911.48	-0.003	193.8	0.0089
911.50	-0.004	193.5	0.0053

Prova triassiale ciclica SN04-C1			
pressione di confinamento (kPa)		80	
deviatore ciclico (kPa)		95	
frequenza (hz)		0.00625	
tempo	cella di carico	$\Delta u$	LVDT
(min)	kN	(kPa)	$\delta$ (mm)
911.52	-0.007	193.2	0.0009
911.53	-0.008	193	-0.0018
911.55	-0.01	192.7	-0.0044
911.57	-0.012	192.5	-0.0044
911.58	-0.013	192.5	-0.0071
911.60	-0.013	192.3	-0.0089
911.62	-0.014	192	-0.0115
911.63	-0.015	191.8	-0.0133
911.65	-0.015	191.6	-0.0151
911.68	-0.016	191.4	-0.016
911.70	-0.017	191.2	-0.016
911.72	-0.017	191.2	-0.0178
911.73	-0.017	191.1	-0.0178
911.73	-0.017	191	-0.0178
911.75	-0.017	190.9	-0.0186
911.77	-0.017	190.8	-0.0178
911.78	-0.017	190.7	-0.0169
911.80	-0.016	190.7	-0.0169
911.82	-0.015	190.7	-0.0169
911.83	-0.015	190.7	-0.016
911.85	-0.014	190.7	-0.0142
911.87	-0.012	190.8	-0.0124
911.88	-0.011	190.8	-0.0107
911.90	-0.01	190.8	-0.008
911.92	-0.008	191	-0.008
911.93	-0.006	191.1	-0.0062
911.95	-0.006	191.1	-0.0036
911.97	-0.005	191.2	0
911.98	-0.002	191.4	0.0027
912.00	0	191.6	0.0053
912.02	0.001	191.8	0.0098
912.03	0.004	192	0.0133
912.05	0.005	192.2	0.0151
912.07	0.006	192.3	0.0195
912.08	0.009	192.7	0.0231
912.10	0.011	192.9	0.0231
912.12	0.011	192.9	0.0275
912.13	0.013	193.1	0.032
912.15	0.015	193.4	0.0355
912.17	0.017	193.6	0.0382
912.18	0.018	193.9	0.0408
912.20	0.02	194.1	0.0444
912.22	0.022	194.4	0.0444
912.23	0.023	194.4	0.0479
912.25	0.023	194.6	0.0497
912.27	0.024	194.8	0.0524
912.28	0.026	195.1	0.055
912.30	0.026	195.3	0.0559
912.32	0.027	195.5	0.0577
912.33	0.028	195.7	0.0577
912.35	0.028	195.7	0.0595
912.37	0.028	195.8	0.0595
912.38	0.029	196	0.0604
912.40	0.029	196.1	0.0604
912.42	0.029	196.2	0.0604
912.43	0.028	196.3	0.0604
912.45	0.028	196.4	0.0604
912.47	0.027	196.4	0.0604

Prova triassiale ciclica SN04-C1			
pressione di confinamento (kPa)		80	
deviatore ciclico (kPa)		95	
frequenza (hz)		0.00625	
tempo	cella di carico	$\Delta u$	LVDT
(min)	kN	(kPa)	$\delta$ (mm)
912.48	0.027	196.4	0.0595
912.50	0.027	196.4	0.0577
912.52	0.025	196.4	0.0559
912.53	0.024	196.4	0.055
912.55	0.023	196.4	0.0533
912.57	0.021	196.2	0.0533
912.58	0.019	196.2	0.0506
912.60	0.019	196.2	0.0488
912.62	0.018	196.1	0.0453
912.63	0.015	195.9	0.0426
912.65	0.013	195.7	0.0399
912.67	0.012	195.6	0.0364
912.68	0.009	195.3	0.0364
912.70	0.007	195.1	0.0328
912.72	0.007	195.1	0.0293
912.73	0.006	194.9	0.0249
912.75	0.003	194.6	0.0204
912.77	0.001	194.4	0.0169
912.78	0.001	194.2	0.0151
912.80	-0.002	193.9	0.0115
912.82	-0.004	193.7	0.008
912.83	-0.005	193.5	0.0036
912.85	-0.007	193.1	0.0009
912.87	-0.01	192.9	0.0009
912.88	-0.01	192.9	-0.0027
912.90	-0.01	192.7	-0.0053
912.92	-0.012	192.4	-0.008
912.93	-0.014	192.1	-0.0107
912.95	-0.014	191.9	-0.0124
912.97	-0.015	191.7	-0.0142
912.98	-0.016	191.5	-0.0142
913.00	-0.017	191.5	-0.016
913.02	-0.017	191.4	-0.016
913.03	-0.017	191.2	-0.0169
913.05	-0.017	191.1	-0.0178
913.07	-0.017	190.9	-0.0178
913.08	-0.017	190.8	-0.0178
913.10	-0.016	190.8	-0.0178
913.12	-0.016	190.8	-0.0178
913.15	-0.016	190.7	-0.0169
913.17	-0.016	190.7	-0.016
913.18	-0.014	190.7	-0.0151
913.20	-0.014	190.7	-0.0142
913.20	-0.012	190.7	-0.0115
913.22	-0.01	190.8	-0.0115
913.23	-0.009	190.8	-0.0098
913.25	-0.009	190.8	-0.008
913.27	-0.008	191	-0.0053
913.28	-0.005	191.2	-0.0027
913.30	-0.004	191.2	0
913.32	-0.003	191.4	0.0036
913.33	0.001	191.7	0.0036
913.35	0.002	191.7	0.0071
913.37	0.002	191.8	0.0107
913.38	0.003	192	0.0142
913.40	0.007	192.3	0.0186
913.42	0.008	192.5	0.0222
913.43	0.01	192.7	0.0257

Prova triassiale ciclica SN04-C1			
pressione di confinamento (kPa)		80	
deviatore ciclico (kPa)		95	
frequenza (hz)		0.00625	
tempo	cella di carico	$\Delta u$	LVDT
(min)	kN	(kPa)	$\delta$ (mm)
913.45	0.013	193	0.0257
913.47	0.015	193.3	0.0311
913.48	0.015	193.3	0.0337
913.50	0.017	193.7	0.0373
913.52	0.019	194	0.0399
913.53	0.019	194	0.0426
913.55	0.021	194.2	0.0462
913.57	0.022	194.5	0.0488
913.58	0.024	194.7	0.0515
913.60	0.025	194.9	0.0533
913.62	0.026	195.1	0.0533
913.63	0.027	195.3	0.055
913.65	0.027	195.3	0.0568
913.67	0.027	195.5	0.0586
913.68	0.028	195.7	0.0595
913.70	0.029	195.9	0.0604
913.72	0.029	196	0.0604
913.73	0.029	196.1	0.0612
913.75	0.029	196.2	0.0612
913.77	0.028	196.2	0.0612
913.78	0.028	196.3	0.0604
913.80	0.028	196.4	0.0604
913.82	0.027	196.4	0.0595
913.83	0.026	196.4	0.0577
913.85	0.025	196.4	0.0559
913.87	0.023	196.3	0.0559
913.88	0.022	196.3	0.0541
913.90	0.022	196.3	0.0524
913.92	0.021	196.2	0.0497
913.93	0.018	196.1	0.047
913.95	0.017	196	0.0453
913.97	0.016	195.8	0.0417
913.98	0.012	195.6	0.0417
914.00	0.011	195.6	0.0382
914.02	0.011	195.5	0.0355
914.03	0.01	195.2	0.0311
914.05	0.006	195	0.0275
914.07	0.005	194.8	0.024
914.08	0.004	194.6	0.0195
914.10	0	194.3	0.0195
914.12	-0.001	194.3	0.016
914.13	-0.001	194	0.0124
914.15	-0.002	193.8	0.0089
914.17	-0.006	193.5	0.0044
914.18	-0.007	193.3	0.0018
914.20	-0.008	193	-0.0018
914.22	-0.01	192.7	-0.0044
914.23	-0.011	192.5	-0.0062
914.25	-0.012	192.3	-0.0089
914.27	-0.014	192	-0.0089
914.28	-0.015	191.8	-0.0115
914.30	-0.015	191.8	-0.0133
914.32	-0.015	191.6	-0.0142
914.33	-0.016	191.4	-0.0151
914.35	-0.017	191.2	-0.0169
914.37	-0.017	191.1	-0.0169
914.38	-0.017	191	-0.0178
914.40	-0.017	190.9	-0.0178

Prova triassiale ciclica SN04-C1			
pressione di confinamento (kPa)		80	
deviatore ciclico (kPa)		95	
frequenza (hz)		0.00625	
tempo	cella di carico	$\Delta u$	LVDT
(min)	kN	(kPa)	$\delta$ (mm)
914.42	-0.017	190.9	-0.0178
914.43	-0.017	190.8	-0.0178
914.45	-0.017	190.7	-0.0178
914.47	-0.016	190.7	-0.0169
914.48	-0.015	190.6	-0.016
914.50	-0.015	190.6	-0.0142
914.52	-0.013	190.7	-0.0142
914.53	-0.012	190.7	-0.0133
914.55	-0.012	190.7	-0.0115
914.58	-0.011	190.8	-0.0089
914.60	-0.008	190.9	-0.0062
914.62	-0.007	191	-0.0053
914.63	-0.006	191.2	-0.0018
914.65	-0.002	191.3	-0.0018
914.65	-0.002	191.3	0.0018
914.67	-0.002	191.4	0.0053
914.68	0	191.7	0.008
914.70	0.004	191.9	0.0124
914.72	0.004	192.1	0.0151
914.73	0.006	192.3	0.0195
914.75	0.01	192.6	0.0195
914.77	0.011	192.6	0.0231
914.78	0.011	192.8	0.0275
914.80	0.012	193	0.032
914.82	0.016	193.3	0.0355
914.83	0.017	193.6	0.0382
914.85	0.018	193.8	0.0417
914.87	0.021	194.1	0.0417
914.88	0.022	194.1	0.0453
914.90	0.022	194.3	0.0479
914.92	0.023	194.5	0.0506
914.93	0.025	194.8	0.0533
914.95	0.026	195	0.055
914.97	0.026	195.2	0.0559
914.98	0.027	195.4	0.0577
915.00	0.028	195.6	0.0586
915.02	0.028	195.8	0.0595
915.03	0.029	195.9	0.0595
915.05	0.029	196.1	0.0604
915.07	0.029	196.1	0.0612
915.08	0.029	196.1	0.0612
915.10	0.029	196.3	0.0612
915.12	0.028	196.3	0.0604
915.13	0.027	196.4	0.0595
915.15	0.026	196.4	0.0595
915.17	0.025	196.4	0.0577
915.18	0.025	196.4	0.0568
915.20	0.025	196.4	0.0559
915.22	0.023	196.3	0.0541
915.23	0.021	196.3	0.0515
915.25	0.02	196.2	0.0488
915.27	0.018	196	0.0462
915.28	0.015	195.9	0.0462
915.30	0.015	195.9	0.0435
915.32	0.015	195.8	0.0408
915.33	0.013	195.5	0.0373
915.35	0.009	195.3	0.0337
915.37	0.009	195.2	0.0311

Prova triassiale ciclica SN04-C1			
pressione di confinamento (kPa)		80	
deviatore ciclico (kPa)		95	
frequenza (hz)		0.00625	
tempo	cella di carico	$\Delta u$	LVDT
(min)	kN	(kPa)	$\delta$ (mm)
915.38	0.007	194.9	0.0257
915.40	0.004	194.7	0.0257
915.42	0.002	194.7	0.0222
915.43	0.002	194.5	0.0186
915.45	0.001	194.2	0.0151
915.47	-0.003	193.9	0.0107
915.48	-0.004	193.7	0.0071
915.50	-0.005	193.4	0.0036
915.52	-0.008	193.1	0.0036
915.53	-0.009	193.1	0
915.55	-0.009	192.9	-0.0027
915.57	-0.01	192.6	-0.0053
915.58	-0.013	192.3	-0.0089
915.60	-0.013	192.1	-0.0107
915.62	-0.014	191.9	-0.0124
915.63	-0.016	191.7	-0.0124
915.65	-0.016	191.7	-0.0142
915.67	-0.016	191.3	-0.016
915.68	-0.017	191.2	-0.016
915.70	-0.017	191.2	-0.0169
915.72	-0.017	191	-0.0178
915.73	-0.017	190.9	-0.0178
915.75	-0.017	190.8	-0.0178
915.77	-0.017	190.7	-0.0178
915.78	-0.017	190.7	-0.0169
915.80	-0.016	190.6	-0.0169
915.82	-0.015	190.6	-0.016
915.83	-0.015	190.6	-0.0151
915.85	-0.014	190.6	-0.0142
915.87	-0.012	190.7	-0.0124
915.88	-0.011	190.7	-0.0107
915.90	-0.01	190.8	-0.0089
915.92	-0.008	190.9	-0.0089
915.93	-0.006	191	-0.0053
915.95	-0.006	191	-0.0036
915.97	-0.005	191.2	0
915.98	-0.002	191.4	0.0036
916.00	0	191.5	0.0062
916.02	0.001	191.7	0.0098
916.05	0.004	192	0.0098
916.07	0.006	192.2	0.0133
916.08	0.006	192.2	0.0169
916.10	0.007	192.4	0.0204
916.10	0.01	192.7	0.0249
916.12	0.012	192.9	0.0293
916.13	0.013	193.1	0.0328
916.15	0.016	193.4	0.0328
916.17	0.018	193.7	0.0364
916.18	0.018	193.7	0.0399
916.20	0.019	193.9	0.0426
916.22	0.021	194.2	0.0462
916.23	0.023	194.4	0.0488
916.25	0.024	194.6	0.0515
916.27	0.025	194.9	0.0541
916.28	0.027	195.1	0.0541
916.30	0.027	195.1	0.0559
916.32	0.027	195.3	0.0568
916.33	0.027	195.5	0.0586



Prova triassiale ciclica SN04-C1			
pressione di confinamento (kPa)		80	
deviatore ciclico (kPa)		95	
frequenza (hz)		0.00625	
tempo	cella di carico	$\Delta u$	LVDT
(min)	kN	(kPa)	$\delta$ (mm)
916.35	0.029	195.7	0.0595
916.37	0.029	195.8	0.0604
916.38	0.029	196	0.0604
916.40	0.029	196.1	0.0604
916.42	0.028	196.2	0.0604
916.43	0.028	196.3	0.0604
916.45	0.028	196.3	0.0604
916.47	0.028	196.3	0.0604
916.48	0.028	196.4	0.0595
916.50	0.027	196.4	0.0577
916.52	0.025	196.4	0.0559
916.53	0.024	196.3	0.055
916.55	0.023	196.3	0.0524
916.57	0.021	196.2	0.0524
916.58	0.02	196.2	0.0506
916.60	0.02	196.1	0.0488
916.62	0.018	196	0.0453
916.63	0.015	195.8	0.0417
916.65	0.014	195.7	0.0399
916.67	0.012	195.5	0.0364
916.68	0.009	195.2	0.0364
916.70	0.008	195.2	0.032
916.72	0.008	195	0.0293
916.73	0.006	194.8	0.0249
916.75	0.002	194.6	0.0204
916.77	0.001	194.4	0.0178
916.78	0	194.1	0.0133
916.80	-0.004	193.8	0.0133
916.82	-0.004	193.8	0.0089
916.83	-0.004	193.6	0.0062
916.85	-0.006	193.3	0.0027
916.87	-0.009	193	-0.0009
916.88	-0.01	192.7	-0.0036
916.90	-0.011	192.5	-0.0062
916.92	-0.013	192.2	-0.0062
916.93	-0.014	192	-0.0089
916.95	-0.014	192	-0.0107
916.97	-0.014	191.8	-0.0133
916.98	-0.016	191.6	-0.0151
917.00	-0.017	191.4	-0.016
917.02	-0.017	191.2	-0.0169
917.03	-0.017	191.1	-0.0169
917.05	-0.017	190.9	-0.0178
917.07	-0.017	190.9	-0.0178
917.08	-0.017	190.8	-0.0178
917.10	-0.017	190.8	-0.0178
917.12	-0.016	190.7	-0.0169
917.13	-0.016	190.6	-0.0169
917.15	-0.015	190.6	-0.016
917.17	-0.014	190.6	-0.0151
917.18	-0.014	190.6	-0.0142
917.20	-0.012	190.7	-0.0115
917.22	-0.01	190.7	-0.0115
917.23	-0.009	190.7	-0.0098
917.25	-0.009	190.8	-0.008
917.27	-0.008	190.9	-0.0053
917.28	-0.005	191.1	-0.0027
917.30	-0.004	191.2	0.0009

Prova triassiale ciclica SN04-C1			
pressione di confinamento (kPa)		80	
deviatore ciclico (kPa)		95	
frequenza (hz)		0.00625	
tempo	cella di carico	$\Delta u$	LVDT
(min)	kN	(kPa)	$\delta$ (mm)
917.32	-0.003	191.4	0.0044
917.33	0.001	191.6	0.0044
917.35	0.002	191.6	0.008
917.37	0.002	191.7	0.0107
917.38	0.003	192	0.0142
917.40	0.007	192.2	0.0186
917.42	0.008	192.4	0.0222
917.43	0.01	192.7	0.0257
917.45	0.013	193	0.0257
917.48	0.014	193	0.0311
917.50	0.014	193.2	0.0337
917.52	0.016	193.5	0.0373
917.53	0.019	193.8	0.0417
917.55	0.02	194	0.0444
917.55	0.021	194.2	0.047
917.57	0.023	194.5	0.047
917.58	0.024	194.5	0.0497
917.60	0.024	194.7	0.0515
917.62	0.025	194.9	0.0541
917.63	0.027	195.1	0.0559
917.65	0.027	195.3	0.0577
917.67	0.028	195.5	0.0595
917.68	0.028	195.7	0.0595
917.70	0.029	195.9	0.0595
917.72	0.029	195.9	0.0604
917.73	0.029	196	0.0604
917.75	0.029	196.1	0.0604
917.77	0.029	196.2	0.0604
917.78	0.028	196.3	0.0604
917.80	0.027	196.3	0.0604
917.82	0.026	196.3	0.0595
917.83	0.026	196.3	0.0586
917.85	0.025	196.3	0.0559
917.87	0.023	196.3	0.0559
917.88	0.022	196.3	0.055
917.90	0.022	196.3	0.0533
917.92	0.021	196.2	0.0506
917.93	0.018	196	0.0479
917.95	0.017	195.9	0.0453
917.97	0.016	195.8	0.0417
917.98	0.012	195.6	0.0417
918.00	0.011	195.6	0.0382
918.02	0.011	195.4	0.0355
918.03	0.01	195.1	0.032
918.05	0.006	194.9	0.0275
918.07	0.005	194.7	0.024
918.08	0.003	194.5	0.0195
918.10	0	194.2	0.0195
918.12	-0.001	194.2	0.016
918.13	-0.001	194	0.0124
918.15	-0.003	193.7	0.0089
918.17	-0.006	193.4	0.0053
918.18	-0.007	193.2	0.0018
918.20	-0.008	192.9	-0.0018
918.22	-0.011	192.6	-0.0018
918.23	-0.011	192.6	-0.0053
918.25	-0.011	192.4	-0.0071
918.27	-0.013	192.1	-0.0098

Prova triassiale ciclica SN04-C1			
pressione di confinamento (kPa)		80	
deviatore ciclico (kPa)		95	
frequenza (hz)		0.00625	
tempo	cella di carico	$\Delta u$	LVDT
(min)	kN	(kPa)	$\delta$ (mm)
918.28	-0.015	191.9	-0.0124
918.30	-0.015	191.7	-0.0133
918.32	-0.016	191.5	-0.0151
918.33	-0.017	191.3	-0.0151
918.35	-0.017	191.3	-0.016
918.37	-0.017	191.2	-0.0169
918.38	-0.017	191	-0.0178
918.40	-0.017	190.9	-0.0178
918.42	-0.017	190.8	-0.0178
918.43	-0.017	190.7	-0.0178
918.45	-0.016	190.6	-0.0178
918.47	-0.016	190.6	-0.0169
918.48	-0.016	190.6	-0.016
918.50	-0.015	190.6	-0.0151
918.52	-0.013	190.6	-0.0133
918.53	-0.013	190.7	-0.0124
918.55	-0.012	190.7	-0.0107
918.57	-0.009	190.8	-0.0107
918.58	-0.008	190.9	-0.0062
918.60	-0.007	190.9	-0.0044
918.62	-0.005	191.2	-0.0044
918.63	-0.003	191.2	-0.0009
918.65	-0.003	191.3	0.0018
918.67	-0.002	191.4	0.0053
918.68	0.001	191.7	0.0089
918.70	0.003	191.8	0.0124
918.72	0.004	192	0.016
918.73	0.008	192.3	0.016
918.75	0.01	192.5	0.0204
918.77	0.01	192.5	0.024
918.78	0.011	192.7	0.0284
918.80	0.014	193.1	0.032
918.82	0.016	193.3	0.0355
918.83	0.017	193.5	0.0391
918.85	0.019	193.8	0.0391
918.87	0.021	194.1	0.0426
918.88	0.021	194.1	0.0453
918.90	0.022	194.3	0.0488
918.92	0.023	194.6	0.0506
918.95	0.025	194.8	0.0533
918.97	0.026	195	0.055
918.98	0.026	195.2	0.0568
919.00	0.028	195.4	0.0568
919.00	0.028	195.4	0.0577
919.02	0.028	195.6	0.0595
919.03	0.028	195.7	0.0595
919.05	0.029	195.9	0.0604
919.07	0.029	196	0.0612
919.08	0.029	196.1	0.0612
919.10	0.029	196.2	0.0612
919.12	0.028	196.2	0.0612
919.13	0.028	196.3	0.0604
919.15	0.027	196.3	0.0595
919.17	0.026	196.3	0.0577
919.18	0.025	196.3	0.0568
919.20	0.024	196.2	0.0541
919.22	0.022	196.2	0.0541
919.23	0.021	196.2	0.0524

Prova triassiale ciclica SN04-C1			
pressione di confinamento (kPa)		80	
deviatore ciclico (kPa)		95	
frequenza (hz)		0.00625	
tempo	cella di carico	$\Delta u$	LVDT
(min)	kN	(kPa)	$\delta$ (mm)
919.25	0.021	196.2	0.0506
919.27	0.02	196	0.0479
919.28	0.016	195.9	0.0453
919.30	0.016	195.8	0.0426
919.32	0.015	195.7	0.0408
919.33	0.011	195.5	0.0373
919.35	0.01	195.3	0.0337
919.37	0.009	195	0.0302
919.38	0.005	194.8	0.0302
919.40	0.004	194.8	0.0257
919.42	0.004	194.6	0.0222
919.43	0.003	194.3	0.0186
919.45	-0.001	194	0.0142
919.47	-0.002	193.9	0.0115
919.48	-0.004	193.6	0.0071
919.50	-0.006	193.3	0.0071
919.52	-0.008	193.3	0.0036
919.53	-0.008	193	0.0009
919.55	-0.009	192.8	-0.0027
919.57	-0.011	192.5	-0.0062
919.58	-0.012	192.3	-0.008
919.60	-0.013	192.1	-0.0107
919.62	-0.015	191.8	-0.0107
919.63	-0.016	191.6	-0.0124
919.65	-0.016	191.6	-0.0142
919.67	-0.016	191.4	-0.0151
919.68	-0.017	191.2	-0.0169
919.70	-0.017	191.1	-0.0169
919.72	-0.017	190.9	-0.0178
919.73	-0.017	190.8	-0.0178
919.75	-0.017	190.7	-0.0178
919.77	-0.017	190.7	-0.0178
919.78	-0.017	190.7	-0.0178
919.80	-0.016	190.6	-0.016
919.82	-0.015	190.6	-0.016
919.83	-0.014	190.6	-0.0142
919.85	-0.013	190.6	-0.0124
919.87	-0.012	190.7	-0.0124
919.88	-0.011	190.7	-0.0107
919.90	-0.011	190.7	-0.0089
919.92	-0.009	190.9	-0.0071
919.93	-0.006	191	-0.0044
919.95	-0.006	191	-0.0018
919.97	-0.004	191.2	0.0009
919.98	-0.001	191.4	0.0009
920.00	0	191.4	0.0044
920.02	0	191.6	0.008
920.03	0.004	192	0.0115
920.05	0.005	192	0.0142
920.07	0.005	192.1	0.0178
920.08	0.007	192.4	0.0213
920.10	0.011	192.7	0.0257
920.12	0.012	192.9	0.0293
920.13	0.013	193.2	0.0337
920.15	0.017	193.4	0.0337
920.17	0.018	193.4	0.0373
920.18	0.018	193.6	0.0399
920.20	0.019	193.9	0.0435

Prova triassiale ciclica SN04-C1			
pressione di confinamento (kPa)		80	
deviatore ciclico (kPa)		95	
frequenza (hz)		0.00625	
tempo	cella di carico	$\Delta u$	LVDT
(min)	kN	(kPa)	$\delta$ (mm)
920.22	0.022	194.2	0.047
920.23	0.022	194.4	0.0488
920.25	0.024	194.6	0.0524
920.27	0.026	194.9	0.0524
920.28	0.026	194.9	0.055
920.30	0.026	195	0.0559
920.32	0.027	195.2	0.0577
920.33	0.028	195.5	0.0586
920.35	0.028	195.7	0.0595
920.37	0.028	195.8	0.0604
920.40	0.029	196	0.0604
920.42	0.029	196	0.0612
920.43	0.029	196.1	0.0612
920.45	0.029	196.2	0.0612
920.45	0.028	196.3	0.0612
920.47	0.028	196.3	0.0604
920.48	0.027	196.3	0.0586
920.50	0.025	196.3	0.0586
920.52	0.024	196.3	0.0577
920.53	0.024	196.3	0.0559
920.55	0.023	196.3	0.0541
920.57	0.022	196.2	0.0524
920.58	0.02	196.1	0.0497
920.60	0.019	196	0.047
920.62	0.016	195.8	0.047
920.63	0.015	195.8	0.0435
920.65	0.015	195.7	0.0417
920.67	0.013	195.6	0.0382
920.68	0.01	195.2	0.0337
920.70	0.008	195.1	0.0311
920.72	0.007	194.9	0.0275
920.73	0.004	194.6	0.0275
920.75	0.002	194.4	0.0195
920.77	0.002	194.3	0.0169
920.78	-0.001	193.9	0.0169
920.80	-0.003	193.7	0.0133
920.82	-0.003	193.7	0.0098
920.83	-0.004	193.5	0.0062
920.85	-0.007	193.1	0.0018
920.87	-0.009	192.9	-0.0009
920.88	-0.01	192.7	-0.0036
920.90	-0.011	192.4	-0.0036
920.92	-0.013	192.1	-0.0062
920.93	-0.013	192.1	-0.0089
920.95	-0.013	191.9	-0.0107
920.97	-0.015	191.7	-0.0133
920.98	-0.016	191.5	-0.0142
921.00	-0.016	191.3	-0.0151
921.02	-0.016	191.2	-0.0151
921.03	-0.017	191	-0.016
921.05	-0.017	191	-0.0178
921.07	-0.017	190.9	-0.0178
921.08	-0.017	190.8	-0.0178
921.10	-0.017	190.7	-0.0178
921.12	-0.017	190.6	-0.0169
921.13	-0.016	190.6	-0.016
921.15	-0.015	190.6	-0.016
921.17	-0.014	190.6	-0.0151

Prova triassiale ciclica SN04-C1			
pressione di confinamento (kPa)		80	
deviatore ciclico (kPa)		95	
frequenza (hz)		0.00625	
tempo	cella di carico	$\Delta u$	LVDT
(min)	kN	(kPa)	$\delta$ (mm)
921.18	-0.014	190.6	-0.0133
921.20	-0.013	190.6	-0.0124
921.22	-0.011	190.7	-0.0107
921.23	-0.01	190.7	-0.0089
921.25	-0.009	190.9	-0.0062
921.27	-0.006	191	-0.0062
921.28	-0.005	191	-0.0027
921.30	-0.005	191.1	-0.0009
921.32	-0.003	191.3	0.0027
921.33	0	191.5	0.0062
921.35	0.001	191.6	0.0098
921.37	0.003	191.9	0.0133
921.38	0.006	192.1	0.0133
921.40	0.007	192.1	0.0178
921.42	0.007	192.3	0.0204
921.43	0.009	192.6	0.0249
921.45	0.012	192.9	0.0302
921.47	0.014	193.1	0.0328
921.48	0.015	193.4	0.0364
921.50	0.017	193.5	0.0391
921.52	0.018	193.7	0.0417
921.53	0.02	194	0.0453
921.55	0.022	194.3	0.0453
921.57	0.023	194.3	0.0479
921.58	0.023	194.5	0.0497
921.60	0.024	194.7	0.0524
921.62	0.026	194.9	0.055
921.63	0.026	195.1	0.0559
921.65	0.027	195.4	0.0586
921.67	0.028	195.6	0.0586
921.68	0.029	195.6	0.0595
921.70	0.029	195.7	0.0604
921.72	0.029	195.9	0.0604
921.73	0.029	196	0.0612
921.75	0.029	196.1	0.0612
921.77	0.029	196.2	0.0612
921.78	0.028	196.3	0.0612
921.80	0.027	196.3	0.0612
921.82	0.027	196.3	0.0595
921.85	0.027	196.3	0.0586
921.87	0.025	196.3	0.0568
921.88	0.024	196.3	0.055
921.90	0.023	196.2	0.0533
921.90	0.021	196.1	0.0533
921.92	0.019	196	0.0506
921.93	0.019	196	0.0488
921.95	0.018	195.9	0.0462
921.97	0.015	195.7	0.0426
921.98	0.014	195.6	0.0399
922.00	0.012	195.5	0.0364
922.02	0.009	195.2	0.0364
922.03	0.007	195	0.0328
922.05	0.007	195	0.0302
922.07	0.006	194.8	0.0257
922.08	0.003	194.5	0.0213
922.10	0.001	194.3	0.0178
922.12	0	194	0.0142
922.13	-0.003	193.7	0.0142

Prova triassiale ciclica SN04-C1			
pressione di confinamento (kPa)		80	
deviatore ciclico (kPa)		95	
frequenza (hz)		0.00625	
tempo	cella di carico	$\Delta u$	LVDT
(min)	kN	(kPa)	$\delta$ (mm)
922.15	-0.005	193.5	0.0098
922.17	-0.005	193.5	0.0062
922.18	-0.006	193.2	0.0027
922.20	-0.009	192.7	0
922.22	-0.009	192.7	-0.0018
922.23	-0.01	192.5	-0.0053
922.25	-0.012	192.2	-0.008
922.27	-0.014	192	-0.0098
922.28	-0.014	191.8	-0.0115
922.30	-0.015	191.6	-0.0133
922.32	-0.016	191.4	-0.0133
922.33	-0.016	191.4	-0.0151
922.35	-0.016	191.2	-0.016
922.37	-0.017	191	-0.0169
922.38	-0.017	190.9	-0.0178
922.40	-0.017	190.8	-0.0178
922.42	-0.017	190.7	-0.0178
922.43	-0.017	190.6	-0.0178
922.45	-0.016	190.6	-0.0178
922.47	-0.016	190.6	-0.0169
922.48	-0.016	190.5	-0.016
922.50	-0.014	190.5	-0.0151
922.52	-0.014	190.5	-0.0133
922.53	-0.012	190.6	-0.0115
922.55	-0.01	190.7	-0.0115
922.57	-0.01	190.7	-0.0098
922.58	-0.01	190.7	-0.0071
922.60	-0.008	190.8	-0.0044
922.62	-0.005	191	-0.0018
922.63	-0.004	191.1	0.0009
922.65	-0.003	191.3	0.0036
922.67	0.001	191.5	0.0036
922.68	0.002	191.5	0.008
922.70	0.002	191.7	0.0107
922.72	0.004	191.9	0.0151
922.73	0.007	192.2	0.0186
922.75	0.008	192.3	0.0222
922.77	0.01	192.6	0.0257
922.78	0.014	192.9	0.0257
922.80	0.014	192.9	0.0311
922.82	0.014	193.1	0.0337
922.83	0.016	193.4	0.0373
922.85	0.019	193.7	0.0417
922.87	0.02	193.9	0.0444
922.88	0.021	194.1	0.047
922.90	0.023	194.4	0.047
922.92	0.025	194.6	0.0497
922.93	0.025	194.8	0.0533
922.95	0.026	195	0.0533
922.97	0.027	195.2	0.055
922.98	0.027	195.2	0.0568
923.00	0.027	195.4	0.0586
923.02	0.028	195.6	0.0595
923.03	0.029	195.8	0.0604
923.05	0.029	195.9	0.0604
923.07	0.029	196	0.0612
923.08	0.029	196.1	0.0612
923.10	0.029	196.1	0.0612

Prova triassiale ciclica SN04-C1			
pressione di confinamento (kPa)		80	
deviatore ciclico (kPa)		95	
frequenza (hz)		0.00625	
tempo	cella di carico	$\Delta u$	LVDT
(min)	kN	(kPa)	$\delta$ (mm)
923.12	0.029	196.2	0.0604
923.13	0.028	196.3	0.0595
923.15	0.027	196.3	0.0586
923.17	0.026	196.3	0.0577
923.18	0.025	196.3	0.0559
923.20	0.023	196.2	0.0559
923.22	0.022	196.2	0.0541
923.23	0.022	196.2	0.0524
923.25	0.021	196.1	0.0506
923.27	0.018	196	0.0479
923.28	0.017	195.9	0.0453
923.32	0.016	195.7	0.0417
923.33	0.012	195.5	0.0417
923.35	0.011	195.5	0.0382
923.37	0.011	195.4	0.0355
923.37	0.01	195.1	0.032
923.38	0.006	194.8	0.0275
923.40	0.005	194.7	0.024
923.42	0.003	194.4	0.0204
923.43	0	194.1	0.0204
923.45	-0.001	194.1	0.016
923.47	-0.001	193.9	0.0124
923.48	-0.003	193.6	0.0089
923.50	-0.006	193.3	0.0044
923.52	-0.007	193.1	0.0018
923.53	-0.008	192.9	-0.0018
923.55	-0.011	192.6	-0.0018
923.57	-0.011	192.6	-0.0044
923.58	-0.011	192.3	-0.0071
923.60	-0.012	192.1	-0.0098
923.62	-0.015	191.8	-0.0124
923.63	-0.015	191.6	-0.0133
923.65	-0.016	191.4	-0.0151
923.67	-0.017	191.2	-0.016
923.68	-0.017	191.1	-0.0169
923.70	-0.017	190.9	-0.0169
923.72	-0.017	190.8	-0.0169
923.73	-0.017	190.7	-0.0178
923.75	-0.017	190.7	-0.0178
923.77	-0.017	190.6	-0.0178
923.78	-0.017	190.6	-0.0169
923.80	-0.016	190.5	-0.016
923.82	-0.015	190.5	-0.0151
923.83	-0.014	190.5	-0.0151
923.85	-0.013	190.5	-0.0142
923.87	-0.013	190.5	-0.0124
923.88	-0.012	190.6	-0.0107
923.90	-0.01	190.7	-0.0089
923.92	-0.009	190.8	-0.0062
923.93	-0.007	190.8	-0.0036
923.95	-0.005	191	-0.0036
923.97	-0.003	191.2	0
923.98	-0.003	191.2	0.0027
924.00	-0.002	191.3	0.0062
924.02	0.001	191.6	0.0098
924.03	0.003	191.8	0.0124
924.05	0.005	191.9	0.016
924.07	0.007	192.2	0.0204



Prova triassiale ciclica SN04-C1			
pressione di confinamento (kPa)		80	
deviatore ciclico (kPa)		95	
frequenza (hz)		0.00625	
tempo	cella di carico	$\Delta u$	LVDT
(min)	kN	(kPa)	$\delta$ (mm)
924.08	0.01	192.5	0.0204
924.10	0.01	192.5	0.024
924.12	0.01	192.7	0.0284
924.13	0.013	193	0.0328
924.15	0.016	193.2	0.0364
924.17	0.017	193.4	0.0391
924.18	0.019	193.8	0.0426
924.20	0.021	194	0.0426
924.22	0.022	194	0.0462
924.23	0.022	194.2	0.0479
924.25	0.023	194.5	0.0506
924.27	0.025	194.7	0.0533
924.28	0.026	194.9	0.055
924.30	0.026	195.1	0.0568
924.32	0.028	195.3	0.0568
924.33	0.028	195.3	0.0586
924.35	0.028	195.5	0.0595
924.37	0.029	195.7	0.0604
924.38	0.029	195.8	0.0612
924.40	0.029	195.9	0.0612
924.42	0.029	196	0.0612
924.43	0.029	196.1	0.0612
924.45	0.028	196.2	0.0612
924.47	0.028	196.3	0.0595
924.48	0.026	196.3	0.0595
924.50	0.025	196.3	0.0586
924.52	0.025	196.3	0.0577
924.53	0.025	196.3	0.0559
924.55	0.023	196.2	0.0541
924.57	0.021	196.1	0.0524
924.58	0.02	196.1	0.0497
924.60	0.018	195.9	0.0497
924.62	0.016	195.8	0.0462
924.63	0.016	195.8	0.0435
924.65	0.015	195.7	0.0408
924.67	0.013	195.4	0.0373
924.68	0.01	195.2	0.0346
924.70	0.009	195	0.0302
924.72	0.006	194.8	0.0257
924.75	0.003	194.5	0.0257
924.77	0.003	194.5	0.0222
924.78	0.003	194.4	0.0195
924.80	0	194	0.0142
924.82	-0.003	193.8	0.0115
924.82	-0.004	193.6	0.008
924.83	-0.006	193.2	0.0036
924.85	-0.008	193	0.0036
924.87	-0.008	193	0
924.88	-0.009	192.8	-0.0027
924.90	-0.011	192.5	-0.0053
924.92	-0.013	192.2	-0.008
924.93	-0.013	192	-0.0098
924.95	-0.014	191.8	-0.0124
924.97	-0.016	191.5	-0.0124
924.98	-0.016	191.5	-0.0142
925.00	-0.016	191.4	-0.0151
925.02	-0.016	191.2	-0.016
925.03	-0.017	191	-0.0169

Prova triassiale ciclica SN04-C1			
pressione di confinamento (kPa)		80	
deviatore ciclico (kPa)		95	
frequenza (hz)		0.00625	
tempo	cella di carico	$\Delta u$	LVDT
(min)	kN	(kPa)	$\delta$ (mm)
925.05	-0.017	190.9	-0.0169
925.07	-0.017	190.8	-0.0169
925.08	-0.017	190.7	-0.0169
925.10	-0.017	190.7	-0.0169
925.12	-0.016	190.6	-0.016
925.13	-0.016	190.5	-0.016
925.15	-0.015	190.5	-0.016
925.17	-0.015	190.5	-0.0151
925.18	-0.014	190.5	-0.0133
925.20	-0.012	190.6	-0.0115
925.22	-0.011	190.6	-0.0107
925.23	-0.01	190.7	-0.008
925.25	-0.008	190.8	-0.008
925.27	-0.006	190.8	-0.0053
925.28	-0.006	190.9	-0.0036
925.30	-0.005	191	0
925.32	-0.002	191.2	0.0036
925.33	-0.001	191.4	0.0062
925.35	0.001	191.6	0.0098
925.37	0.004	191.9	0.0098
925.38	0.006	192	0.0142
925.40	0.006	192	0.0178
925.42	0.007	192.2	0.0213
925.43	0.011	192.6	0.0257
925.45	0.012	192.8	0.0293
925.47	0.013	193	0.0328
925.48	0.016	193.3	0.0328
925.50	0.018	193.5	0.0373
925.52	0.018	193.5	0.0408
925.53	0.019	193.7	0.0435
925.55	0.021	194.1	0.047
925.57	0.023	194.3	0.0497
925.58	0.024	194.5	0.0515
925.60	0.025	194.7	0.0541
925.62	0.027	195	0.0541
925.63	0.027	195	0.0559
925.65	0.027	195.1	0.0577
925.67	0.027	195.3	0.0586
925.68	0.028	195.6	0.0595
925.70	0.029	195.7	0.0604
925.72	0.029	195.8	0.0604
925.73	0.029	196	0.0604
925.75	0.029	196	0.0612
925.77	0.029	196.1	0.0612
925.78	0.029	196.2	0.0612
925.80	0.028	196.2	0.0604
925.82	0.027	196.2	0.0595
925.83	0.026	196.2	0.0577
925.85	0.025	196.2	0.0568
925.87	0.024	196.2	0.0559
925.88	0.023	196.2	0.0533
925.90	0.021	196.1	0.0533
925.92	0.019	196.1	0.0506
925.93	0.019	196	0.0488
925.95	0.018	195.9	0.0462
925.97	0.015	195.7	0.0426
925.98	0.014	195.6	0.0399
926.00	0.012	195.4	0.0364

Prova triassiale ciclica SN04-C1			
pressione di confinamento (kPa)		80	
deviatore ciclico (kPa)		95	
frequenza (hz)		0.00625	
tempo	cella di carico	$\Delta u$	LVDT
(min)	kN	(kPa)	$\delta$ (mm)
926.02	0.009	195.1	0.0364
926.03	0.007	195.1	0.0328
926.05	0.007	194.9	0.0302
926.07	0.006	194.8	0.0249
926.08	0.003	194.5	0.0213
926.10	0.002	194.2	0.0178
926.12	0	194	0.0133
926.13	-0.004	193.7	0.0133
926.15	-0.005	193.4	0.0098
926.17	-0.005	193.4	0.0071
926.18	-0.006	193.2	0.0036
926.22	-0.009	192.9	0
926.23	-0.01	192.7	-0.0027
926.25	-0.011	192.4	-0.0062
926.27	-0.012	192.1	-0.0062
926.27	-0.014	191.9	-0.0089
926.28	-0.014	191.9	-0.0107
926.30	-0.015	191.7	-0.0124
926.32	-0.016	191.5	-0.0142
926.33	-0.016	191.3	-0.0151
926.35	-0.017	191.2	-0.016
926.37	-0.017	191	-0.0169
926.38	-0.017	190.8	-0.0169
926.40	-0.017	190.8	-0.0178
926.42	-0.017	190.7	-0.0178
926.43	-0.017	190.6	-0.0178
926.45	-0.016	190.6	-0.0169
926.47	-0.016	190.5	-0.016
926.48	-0.015	190.5	-0.0151
926.50	-0.014	190.5	-0.0151
926.52	-0.013	190.5	-0.0142
926.53	-0.013	190.5	-0.0124
926.55	-0.012	190.6	-0.0107
926.57	-0.01	190.7	-0.0089
926.58	-0.01	190.7	-0.0071
926.60	-0.008	190.9	-0.0044
926.62	-0.005	191	-0.0018
926.63	-0.004	191.1	0.0009
926.65	-0.003	191.3	0.0044
926.67	0.001	191.5	0.0044
926.68	0.002	191.5	0.008
926.70	0.002	191.6	0.0115
926.72	0.003	191.9	0.0151
926.73	0.007	192.1	0.0186
926.75	0.009	192.3	0.0222
926.77	0.01	192.6	0.0257
926.78	0.014	192.9	0.0257
926.80	0.014	192.9	0.0311
926.82	0.014	193.1	0.0346
926.83	0.016	193.4	0.0382
926.85	0.019	193.6	0.0426
926.87	0.02	193.8	0.0444
926.88	0.021	194.1	0.0479
926.90	0.024	194.4	0.0479
926.92	0.024	194.4	0.0506
926.93	0.024	194.6	0.0524
926.95	0.025	194.8	0.055
926.97	0.027	195	0.0568

Prova triassiale ciclica SN04-C1			
pressione di confinamento (kPa)		80	
deviatore ciclico (kPa)		95	
frequenza (hz)		0.00625	
tempo	cella di carico	$\Delta u$	LVDT
(min)	kN	(kPa)	$\delta$ (mm)
926.98	0.027	195.2	0.0586
927.00	0.028	195.4	0.0595
927.02	0.029	195.6	0.0595
927.03	0.029	195.7	0.0604
927.05	0.029	195.7	0.0612
927.07	0.029	195.9	0.0612
927.08	0.029	196	0.0612
927.10	0.029	196.1	0.0612
927.12	0.028	196.2	0.0612
927.13	0.028	196.2	0.0612
927.15	0.026	196.2	0.0604
927.17	0.026	196.2	0.0586
927.18	0.026	196.2	0.0568
927.20	0.024	196.1	0.055
927.22	0.022	196.1	0.0541
927.23	0.022	196.1	0.0515
927.25	0.02	195.9	0.0515
927.27	0.017	195.8	0.0488
927.28	0.017	195.8	0.0462
927.30	0.015	195.6	0.0417
927.32	0.012	195.4	0.0417
927.33	0.011	195.4	0.0391
927.35	0.011	195.2	0.0355
927.37	0.01	195	0.032
927.38	0.006	194.8	0.0284
927.40	0.005	194.6	0.024
927.42	0.003	194.3	0.0204
927.43	0	194	0.0204
927.45	-0.001	194	0.016
927.47	-0.001	193.8	0.0133
927.48	-0.003	193.5	0.0089
927.50	-0.006	193.2	0.0053
927.52	-0.007	193	0.0027
927.53	-0.008	192.7	-0.0018
927.55	-0.011	192.5	-0.0018
927.57	-0.011	192.5	-0.0044
927.58	-0.011	192.3	-0.0071
927.60	-0.013	192	-0.0089
927.62	-0.015	191.8	-0.0115
927.65	-0.015	191.6	-0.0124
927.67	-0.016	191.4	-0.0151
927.68	-0.017	191.2	-0.0151
927.70	-0.017	191.2	-0.016
927.72	-0.017	191	-0.016
927.72	-0.017	190.9	-0.0169
927.73	-0.017	190.8	-0.0169
927.75	-0.017	190.7	-0.0169
927.77	-0.017	190.6	-0.0169
927.78	-0.016	190.5	-0.0169
927.80	-0.016	190.5	-0.016
927.82	-0.016	190.5	-0.0151
927.83	-0.015	190.5	-0.0142
927.85	-0.014	190.5	-0.0124
927.87	-0.012	190.5	-0.0115
927.88	-0.012	190.6	-0.0098
927.90	-0.009	190.7	-0.0098
927.92	-0.007	190.8	-0.0071
927.93	-0.007	190.8	-0.0053

Prova triassiale ciclica SN04-C1			
pressione di confinamento (kPa)		80	
deviatore ciclico (kPa)		95	
frequenza (hz)		0.00625	
tempo	cella di carico	$\Delta u$	LVDT
(min)	kN	(kPa)	$\delta$ (mm)
927.95	-0.007	190.9	-0.0027
927.97	-0.004	191.1	0.0009
927.98	-0.002	191.2	0.0036
928.00	-0.001	191.4	0.0071
928.02	0.002	191.6	0.0107
928.03	0.003	191.8	0.0124
928.05	0.004	191.9	0.0169
928.07	0.007	192.2	0.0169
928.08	0.01	192.4	0.0204
928.10	0.01	192.4	0.024
928.12	0.011	192.7	0.0293
928.13	0.013	193	0.0328
928.15	0.016	193.2	0.0355
928.17	0.017	193.4	0.0391
928.18	0.018	193.7	0.0426
928.20	0.021	194	0.0426
928.22	0.022	194	0.0462
928.23	0.022	194.2	0.0479
928.25	0.023	194.4	0.0506
928.27	0.025	194.7	0.0533
928.28	0.026	194.8	0.055
928.30	0.026	195	0.0568
928.32	0.028	195.2	0.0568
928.33	0.028	195.2	0.0586
928.35	0.028	195.4	0.0595
928.37	0.028	195.6	0.0604
928.38	0.029	195.8	0.0612
928.40	0.029	195.9	0.0612
928.42	0.029	196	0.0612
928.43	0.029	196.1	0.0612
928.45	0.028	196.1	0.0612
928.47	0.028	196.1	0.0604
928.48	0.027	196.2	0.0595
928.50	0.026	196.2	0.0586
928.52	0.025	196.2	0.0568
928.53	0.024	196.2	0.055
928.55	0.022	196.1	0.055
928.57	0.021	196.1	0.0533
928.58	0.021	196	0.0515
928.60	0.02	195.9	0.0488
928.62	0.016	195.8	0.0453
928.63	0.016	195.7	0.0426
928.65	0.014	195.5	0.0391
928.67	0.01	195.2	0.0391
928.68	0.01	195.2	0.0355
928.70	0.01	195.1	0.0328
928.72	0.008	194.8	0.0293
928.73	0.004	194.6	0.024
928.75	0.003	194.4	0.0204
928.77	0.003	194.2	0.0195
928.78	-0.001	193.9	0.0151
928.80	-0.002	193.7	0.0115
928.82	-0.004	193.5	0.0071
928.83	-0.007	193.1	0.0071
928.85	-0.008	193.1	0.0036
928.87	-0.008	192.9	0.0009
928.88	-0.009	192.7	-0.0027
928.90	-0.011	192.4	-0.0053

Prova triassiale ciclica SN04-C1			
pressione di confinamento (kPa)		80	
deviatore ciclico (kPa)		95	
frequenza (hz)		0.00625	
tempo	cella di carico	$\Delta u$	LVDT
(min)	kN	(kPa)	$\delta$ (mm)
928.92	-0.012	192.1	-0.008
928.93	-0.013	191.9	-0.0098
928.95	-0.014	191.6	-0.0098
928.97	-0.016	191.5	-0.0124
928.98	-0.016	191.5	-0.0133
929.00	-0.016	191.3	-0.0151
929.02	-0.017	191.1	-0.016
929.03	-0.017	190.9	-0.0169
929.05	-0.017	190.8	-0.0169
929.07	-0.017	190.7	-0.0169
929.08	-0.017	190.6	-0.0178
929.12	-0.017	190.6	-0.0178
929.13	-0.017	190.5	-0.0169
929.15	-0.016	190.5	-0.0169
929.17	-0.015	190.5	-0.016
929.17	-0.015	190.4	-0.0142
929.18	-0.014	190.5	-0.0124
929.20	-0.011	190.5	-0.0124
929.22	-0.011	190.5	-0.0115
929.23	-0.011	190.6	-0.0098
929.25	-0.009	190.7	-0.0071
929.27	-0.006	190.8	-0.0044
929.28	-0.006	190.9	-0.0018
929.30	-0.004	191.1	0.0018
929.32	-0.001	191.3	0.0018
929.33	0	191.3	0.0053
929.35	0	191.4	0.008
929.37	0.002	191.7	0.0115
929.38	0.005	191.9	0.0151
929.40	0.006	192.1	0.0186
929.42	0.008	192.4	0.0231
929.43	0.012	192.6	0.0231
929.45	0.013	192.6	0.0284
929.47	0.014	193	0.0328
929.48	0.016	193.2	0.0328
929.50	0.017	193.2	0.0364
929.52	0.017	193.5	0.0399
929.53	0.019	193.8	0.0435
929.55	0.022	194	0.047
929.57	0.022	194.2	0.0488
929.58	0.023	194.5	0.0515
929.60	0.026	194.7	0.0515
929.62	0.026	194.7	0.0541
929.63	0.026	194.9	0.0559
929.65	0.027	195.1	0.0577
929.67	0.028	195.3	0.0586
929.68	0.028	195.5	0.0595
929.70	0.028	195.6	0.0604
929.72	0.029	195.8	0.0604
929.73	0.029	195.8	0.0612
929.75	0.029	195.9	0.0612
929.77	0.029	196	0.0612
929.78	0.028	196.1	0.0612
929.80	0.027	196.1	0.0604
929.82	0.027	196.2	0.0586
929.83	0.026	196.2	0.0586
929.85	0.024	196.2	0.0577
929.87	0.024	196.2	0.0559

Prova triassiale ciclica SN04-C1			
pressione di confinamento (kPa)		80	
deviatore ciclico (kPa)		95	
frequenza (hz)		0.00625	
tempo	cella di carico	$\Delta u$	LVDT
(min)	kN	(kPa)	$\delta$ (mm)
929.88	0.023	196.1	0.0541
929.90	0.022	196	0.0524
929.92	0.02	196	0.0497
929.93	0.019	195.9	0.047
929.95	0.016	195.7	0.047
929.97	0.014	195.5	0.0435
929.98	0.014	195.5	0.0417
930.00	0.013	195.4	0.0382
930.02	0.011	195.1	0.0346
930.03	0.008	194.9	0.0311
930.05	0.007	194.8	0.0275
930.07	0.005	194.4	0.0231
930.08	0.002	194.2	0.0231
930.10	0.002	194.2	0.0186
930.12	0.001	194	0.0151
930.13	-0.002	193.7	0.0115
930.15	-0.005	193.4	0.008
930.17	-0.005	193.2	0.0053
930.18	-0.007	192.9	0.0009
930.20	-0.01	192.6	-0.0018
930.22	-0.01	192.4	-0.0036
930.23	-0.011	192.2	-0.0062
930.25	-0.013	191.9	-0.0062
930.27	-0.014	191.9	-0.0089
930.28	-0.014	191.8	-0.0107
930.30	-0.015	191.5	-0.0124
930.32	-0.016	191.3	-0.0142
930.33	-0.016	191.2	-0.0151
930.35	-0.017	191	-0.016
930.37	-0.017	190.8	-0.016
930.38	-0.017	190.8	-0.0178
930.40	-0.017	190.7	-0.0178
930.42	-0.017	190.6	-0.0178
930.43	-0.017	190.5	-0.0178
930.45	-0.016	190.5	-0.0169
930.47	-0.016	190.4	-0.016
930.48	-0.015	190.4	-0.016
930.50	-0.014	190.4	-0.0151
930.52	-0.014	190.4	-0.0142
930.53	-0.013	190.4	-0.0115
930.55	-0.011	190.5	-0.0098
930.58	-0.01	190.6	-0.008
930.60	-0.009	190.6	-0.0062
930.62	-0.006	190.8	-0.0062
930.62	-0.005	190.8	-0.0027
930.63	-0.005	190.9	0
930.65	-0.004	191.1	0.0027
930.67	0	191.3	0.0062
930.68	0.001	191.4	0.0089
930.70	0.003	191.6	0.0133
930.72	0.006	191.9	0.0133
930.73	0.008	192.1	0.0178
930.75	0.008	192.1	0.0204
930.77	0.009	192.4	0.0249
930.78	0.012	192.7	0.0293
930.80	0.014	192.9	0.0328
930.82	0.015	193.1	0.0364
930.83	0.017	193.4	0.0364

Prova triassiale ciclica SN04-C1			
pressione di confinamento (kPa)		80	
deviatore ciclico (kPa)		95	
frequenza (hz)		0.00625	
tempo	cella di carico	$\Delta u$	LVDT
(min)	kN	(kPa)	$\delta$ (mm)
930.85	0.019	193.7	0.0399
930.87	0.019	193.7	0.0435
930.88	0.02	193.9	0.047
930.90	0.022	194.2	0.0497
930.92	0.024	194.4	0.0515
930.93	0.024	194.6	0.0533
930.95	0.025	194.8	0.055
930.97	0.027	195	0.0577
930.98	0.027	195.2	0.0586
931.00	0.028	195.4	0.0595
931.02	0.028	195.6	0.0595
931.03	0.029	195.6	0.0604
931.05	0.029	195.7	0.0612
931.07	0.029	195.9	0.0612
931.08	0.029	196	0.0612
931.10	0.029	196	0.0612
931.12	0.028	196.1	0.0612
931.13	0.027	196.2	0.0612
931.15	0.026	196.2	0.0595
931.17	0.026	196.2	0.0595
931.18	0.026	196.2	0.0577
931.20	0.024	196.1	0.0559
931.22	0.023	196.1	0.0541
931.23	0.022	196	0.0515
931.25	0.019	195.9	0.0515
931.27	0.018	195.9	0.0488
931.28	0.018	195.8	0.047
931.30	0.017	195.7	0.0444
931.32	0.013	195.4	0.0408
931.33	0.013	195.3	0.0382
931.35	0.01	195	0.0337
931.37	0.007	194.8	0.0337
931.38	0.006	194.8	0.0302
931.40	0.006	194.7	0.0257
931.42	0.004	194.4	0.0222
931.43	0.001	194.1	0.0186
931.45	0	193.9	0.0151
931.47	-0.002	193.6	0.0107
931.48	-0.005	193.3	0.0107
931.50	-0.006	193.3	0.0062
931.52	-0.006	193.1	0.0036
931.53	-0.008	192.8	0
931.55	-0.011	192.5	-0.0036
931.57	-0.011	192.3	-0.0053
931.58	-0.012	192.1	-0.008
931.60	-0.014	191.8	-0.008
931.62	-0.015	191.8	-0.0107
931.63	-0.015	191.6	-0.0115
931.65	-0.016	191.2	-0.0133
931.67	-0.016	191.2	-0.0142
931.68	-0.016	191.1	-0.0151
931.70	-0.017	190.9	-0.016
931.72	-0.017	190.8	-0.0169
931.73	-0.017	190.7	-0.0178
931.75	-0.017	190.5	-0.0178
931.77	-0.017	190.5	-0.0178
931.78	-0.016	190.4	-0.0169
931.80	-0.016	190.4	-0.0169



Prova triassiale ciclica SN04-C1			
pressione di confinamento (kPa)		80	
deviatore ciclico (kPa)		95	
frequenza (hz)		0.00625	
tempo	cella di carico	$\Delta u$	LVDT
(min)	kN	(kPa)	$\delta$ (mm)
931.82	-0.016	190.4	-0.016
931.83	-0.015	190.4	-0.0142
931.85	-0.013	190.4	-0.0133
931.87	-0.012	190.4	-0.0115
931.88	-0.011	190.5	-0.0115
931.90	-0.009	190.6	-0.0098
931.92	-0.009	190.6	-0.0071
931.93	-0.008	190.7	-0.0044
931.95	-0.006	190.9	-0.0018
931.97	-0.004	191	0.0018
931.98	-0.002	191.2	0.0044
932.02	0	191.4	0.0044
932.03	0.002	191.6	0.0071
932.05	0.002	191.6	0.0107
932.07	0.004	191.8	0.0151
932.08	0.006	192.1	0.0195
932.08	0.009	192.3	0.0222
932.10	0.01	192.5	0.0275
932.12	0.013	192.8	0.0275
932.13	0.015	193	0.0311
932.15	0.015	193	0.0346
932.17	0.016	193.2	0.0382
932.18	0.018	193.5	0.0417
932.20	0.02	193.8	0.0444
932.22	0.021	194	0.0479
932.23	0.023	194.3	0.0479
932.25	0.025	194.5	0.0506
932.27	0.025	194.5	0.0533
932.28	0.025	194.7	0.055
932.30	0.026	194.9	0.0568
932.32	0.028	195.1	0.0586
932.33	0.028	195.3	0.0595
932.35	0.028	195.5	0.0604
932.37	0.029	195.7	0.0604
932.38	0.029	195.8	0.0612
932.40	0.029	195.9	0.0612
932.42	0.029	196	0.0612
932.43	0.028	196	0.0612
932.45	0.028	196.1	0.0612
932.47	0.028	196.1	0.0604
932.48	0.027	196.2	0.0595
932.50	0.026	196.2	0.0586
932.52	0.025	196.2	0.0568
932.53	0.023	196.1	0.0568
932.55	0.022	196.1	0.055
932.57	0.022	196.1	0.0533
932.58	0.021	196	0.0506
932.60	0.018	195.9	0.0479
932.62	0.017	195.8	0.0453
932.63	0.016	195.6	0.0426
932.65	0.012	195.4	0.0426
932.67	0.012	195.4	0.0391
932.68	0.012	195.2	0.0364
932.70	0.01	195	0.0328
932.72	0.006	194.7	0.0284
932.73	0.005	194.6	0.0249
932.75	0.003	194.3	0.0204
932.77	0	194	0.0204

Prova triassiale ciclica SN04-C1			
pressione di confinamento (kPa)		80	
deviatore ciclico (kPa)		95	
frequenza (hz)		0.00625	
tempo	cella di carico	$\Delta u$	LVDT
(min)	kN	(kPa)	$\delta$ (mm)
932.78	-0.001	194	0.0169
932.80	-0.001	193.8	0.0133
932.82	-0.003	193.5	0.0089
932.83	-0.006	193.2	0.0053
932.85	-0.007	193	0.0027
932.87	-0.008	192.7	-0.0009
932.88	-0.011	192.4	-0.0009
932.90	-0.012	192.4	-0.0044
932.92	-0.012	192.2	-0.0062
932.93	-0.013	192	-0.0089
932.95	-0.015	191.7	-0.0115
932.97	-0.015	191.5	-0.0124
932.98	-0.016	191.3	-0.0142
933.00	-0.016	191.2	-0.0142
933.02	-0.017	191.2	-0.016
933.03	-0.017	191	-0.0169
933.05	-0.017	190.8	-0.0169
933.07	-0.017	190.7	-0.0169
933.08	-0.017	190.6	-0.0169
933.10	-0.017	190.5	-0.0169
933.12	-0.017	190.4	-0.0169
933.13	-0.016	190.4	-0.016
933.15	-0.015	190.4	-0.0151
933.17	-0.014	190.4	-0.0151
933.18	-0.013	190.4	-0.0133
933.20	-0.013	190.4	-0.0124
933.22	-0.012	190.4	-0.0107
933.23	-0.01	190.5	-0.008
933.25	-0.008	190.6	-0.0062
933.27	-0.007	190.7	-0.0027
933.28	-0.005	190.9	-0.0009
933.30	-0.003	191.1	-0.0009
933.32	-0.003	191.1	0.0027
933.33	-0.002	191.2	0.0062
933.35	0.001	191.5	0.0098
933.37	0.003	191.6	0.0133
933.38	0.005	191.8	0.0169
933.40	0.007	192.1	0.0204
933.42	0.01	192.4	0.0204
933.43	0.011	192.4	0.0249
933.45	0.011	192.6	0.0284
933.48	0.013	192.8	0.032
933.50	0.016	193.1	0.0364
933.52	0.017	193.3	0.0391
933.53	0.018	193.6	0.0426
933.53	0.021	193.9	0.0426
933.55	0.022	193.9	0.0462
933.57	0.022	194.1	0.0479
933.58	0.023	194.3	0.0506
933.60	0.025	194.5	0.0533
933.62	0.026	194.7	0.055
933.63	0.026	195	0.0568
933.65	0.028	195.2	0.0568
933.67	0.028	195.2	0.0586
933.68	0.028	195.4	0.0595
933.70	0.029	195.6	0.0604
933.72	0.029	195.7	0.0612
933.73	0.029	195.8	0.0612

Prova triassiale ciclica SN04-C1			
pressione di confinamento (kPa)		80	
deviatore ciclico (kPa)		95	
frequenza (hz)		0.00625	
tempo	cella di carico	$\Delta u$	LVDT
(min)	kN	(kPa)	$\delta$ (mm)
933.75	0.029	195.9	0.0612
933.77	0.029	196	0.0612
933.78	0.028	196	0.0612
933.80	0.028	196.1	0.0604
933.82	0.027	196.1	0.0595
933.83	0.025	196.1	0.0586
933.85	0.025	196.1	0.0577
933.87	0.025	196.1	0.0559
933.88	0.022	196	0.0533
933.90	0.022	196	0.0524
933.92	0.02	195.9	0.0497
933.93	0.017	195.8	0.0497
933.95	0.016	195.8	0.047
933.97	0.016	195.7	0.0444
933.98	0.015	195.5	0.0408
934.00	0.011	195.2	0.0373
934.02	0.01	195.1	0.0346
934.03	0.009	194.9	0.0302
934.05	0.005	194.6	0.0302
934.07	0.004	194.4	0.0257
934.08	0.004	194.4	0.0231
934.10	0.003	194.2	0.0195
934.12	-0.001	193.9	0.0142
934.13	-0.003	193.7	0.0115
934.15	-0.004	193.4	0.008
934.17	-0.006	193.1	0.008
934.18	-0.008	192.9	0.0044
934.20	-0.008	192.9	0.0009
934.22	-0.009	192.6	-0.0027
934.23	-0.011	192.3	-0.0053
934.25	-0.013	192	-0.008
934.27	-0.013	191.9	-0.0098
934.28	-0.014	191.6	-0.0115
934.30	-0.016	191.4	-0.0115
934.32	-0.016	191.4	-0.0133
934.33	-0.016	191.2	-0.0151
934.35	-0.017	191	-0.016
934.37	-0.017	190.9	-0.0169
934.38	-0.017	190.8	-0.0169
934.40	-0.017	190.6	-0.0178
934.42	-0.017	190.5	-0.0178
934.43	-0.017	190.5	-0.0169
934.45	-0.017	190.5	-0.0169
934.47	-0.016	190.4	-0.016
934.48	-0.015	190.4	-0.0151
934.50	-0.015	190.4	-0.0142
934.52	-0.014	190.4	-0.0124
934.53	-0.011	190.5	-0.0124
934.55	-0.011	190.5	-0.0098
934.57	-0.01	190.5	-0.008
934.58	-0.008	190.7	-0.008
934.60	-0.007	190.7	-0.0053
934.62	-0.007	190.7	-0.0036
934.63	-0.005	190.9	0
934.65	-0.001	191.2	0.0044
934.67	-0.001	191.2	0.0071
934.68	0.001	191.5	0.0107
934.70	0.005	191.7	0.0107

Prova triassiale ciclica SN04-C1			
pressione di confinamento (kPa)		80	
deviatore ciclico (kPa)		95	
frequenza (hz)		0.00625	
tempo	cella di carico	$\Delta u$	LVDT
(min)	kN	(kPa)	$\delta$ (mm)
934.72	0.005	191.7	0.0142
934.73	0.005	191.9	0.0178
934.75	0.007	192.1	0.0213
934.77	0.011	192.4	0.0257
934.78	0.012	192.6	0.0302
934.80	0.014	192.9	0.0337
934.82	0.016	193.2	0.0337
934.83	0.018	193.4	0.0373
934.85	0.018	193.4	0.0399
934.87	0.019	193.6	0.0444
934.88	0.022	193.9	0.047
934.92	0.022	194.1	0.0497
934.93	0.024	194.3	0.0524
934.95	0.025	194.6	0.0524
934.97	0.026	194.8	0.0541
934.98	0.026	194.8	0.0559
934.98	0.027	195	0.0577
935.00	0.027	195.2	0.0595
935.02	0.029	195.4	0.0604
935.03	0.029	195.6	0.0604
935.05	0.029	195.7	0.0612
935.07	0.029	195.8	0.0612
935.08	0.029	195.8	0.0612
935.10	0.029	195.9	0.0612
935.12	0.029	196	0.0612
935.13	0.028	196	0.0604
935.15	0.027	196.1	0.0586
935.17	0.026	196.1	0.0577
935.18	0.024	196.1	0.0577
935.20	0.023	196.1	0.0559
935.22	0.023	196	0.055
935.23	0.023	196	0.0524
935.25	0.02	195.9	0.0497
935.27	0.019	195.8	0.0479
935.28	0.017	195.7	0.0444
935.30	0.015	195.5	0.0435
935.32	0.014	195.4	0.0399
935.33	0.013	195.2	0.0364
935.35	0.009	194.9	0.0364
935.37	0.007	194.9	0.0328
935.38	0.007	194.8	0.0293
935.40	0.006	194.6	0.0249
935.42	0.002	194.3	0.0213
935.43	0.002	194.1	0.0178
935.45	0	193.8	0.0142
935.47	-0.004	193.5	0.0142
935.48	-0.004	193.5	0.0098
935.50	-0.004	193.3	0.0062
935.52	-0.006	193	0.0027
935.53	-0.009	192.7	-0.0009
935.55	-0.01	192.5	-0.0036
935.57	-0.011	192.3	-0.0062
935.58	-0.013	192	-0.0062
935.60	-0.014	191.7	-0.0089
935.62	-0.014	191.7	-0.0107
935.63	-0.014	191.6	-0.0124
935.65	-0.016	191.3	-0.0142
935.67	-0.016	191.2	-0.0151

Prova triassiale ciclica SN04-C1			
pressione di confinamento (kPa)		80	
deviatore ciclico (kPa)		95	
frequenza (hz)		0.00625	
tempo	cella di carico	$\Delta u$	LVDT
(min)	kN	(kPa)	$\delta$ (mm)
935.68	-0.017	191	-0.016
935.70	-0.017	190.8	-0.016
935.72	-0.017	190.7	-0.0169
935.73	-0.017	190.7	-0.0178
935.75	-0.017	190.6	-0.0178
935.77	-0.017	190.5	-0.0169
935.78	-0.016	190.4	-0.0169
935.80	-0.016	190.4	-0.016
935.82	-0.015	190.4	-0.016
935.83	-0.014	190.4	-0.0151
935.85	-0.014	190.4	-0.0142
935.87	-0.013	190.4	-0.0115
935.88	-0.012	190.5	-0.0098
935.90	-0.01	190.5	-0.008
935.92	-0.009	190.6	-0.0062
935.93	-0.007	190.8	-0.0027
935.95	-0.004	190.9	-0.0027
935.97	-0.004	190.9	0
935.98	-0.004	191	0.0027
936.00	-0.002	191.3	0.0062
936.02	0.002	191.5	0.0098
936.03	0.002	191.6	0.0124
936.05	0.004	191.8	0.0151
936.07	0.007	192	0.0195
936.08	0.008	192.2	0.0222
936.10	0.01	192.5	0.0275
936.12	0.014	192.8	0.0275
936.13	0.014	192.8	0.0311
936.15	0.014	193	0.0346
936.17	0.016	193.3	0.0382
936.18	0.019	193.5	0.0426
936.20	0.02	193.7	0.0444
936.22	0.021	194	0.0479
936.23	0.024	194.2	0.0479
936.25	0.024	194.2	0.0506
936.27	0.024	194.4	0.0533
936.28	0.025	194.6	0.055
936.30	0.027	194.9	0.0568
936.32	0.027	195	0.0577
936.33	0.028	195.2	0.0595
936.35	0.029	195.4	0.0595
936.38	0.029	195.4	0.0604
936.40	0.029	195.6	0.0612
936.42	0.029	195.7	0.0612
936.43	0.029	195.8	0.0612
936.43	0.028	195.9	0.0612
936.45	0.028	196	0.0612
936.47	0.027	196	0.0612
936.48	0.026	196	0.0604
936.50	0.026	196.1	0.0595
936.52	0.026	196.1	0.0577
936.53	0.024	196.1	0.0559
936.55	0.023	196	0.0541
936.57	0.022	196	0.0524
936.58	0.02	195.8	0.0524
936.60	0.017	195.7	0.0488
936.62	0.017	195.7	0.047
936.63	0.016	195.6	0.0444

Prova triassiale ciclica SN04-C1			
pressione di confinamento (kPa)		80	
deviatore ciclico (kPa)		95	
frequenza (hz)		0.00625	
tempo	cella di carico	$\Delta u$	LVDT
(min)	kN	(kPa)	$\delta$ (mm)
936.65	0.014	195.4	0.0408
936.67	0.012	195.2	0.0382
936.68	0.01	195	0.0337
936.70	0.008	194.7	0.0337
936.72	0.005	194.6	0.0302
936.73	0.004	194.4	0.024
936.75	0.003	194.2	0.0213
936.77	0	193.9	0.0213
936.78	0	193.9	0.0169
936.80	-0.001	193.7	0.0124
936.82	-0.004	193.4	0.0089
936.83	-0.006	193.1	0.0053
936.85	-0.007	192.9	0.0018
936.87	-0.009	192.6	-0.0018
936.88	-0.011	192.3	-0.0018
936.90	-0.011	192.3	-0.0044
936.92	-0.011	192.1	-0.0062
936.93	-0.013	191.8	-0.0089
936.95	-0.015	191.6	-0.0115
936.97	-0.015	191.4	-0.0124
936.98	-0.016	191.2	-0.0142
937.00	-0.017	191.1	-0.0142
937.02	-0.017	191.1	-0.016
937.03	-0.017	190.9	-0.016
937.05	-0.017	190.8	-0.016
937.07	-0.017	190.6	-0.0169
937.08	-0.017	190.5	-0.0169
937.10	-0.017	190.4	-0.0169
937.12	-0.016	190.4	-0.0169
937.13	-0.016	190.4	-0.016
937.15	-0.016	190.4	-0.0151
937.17	-0.015	190.4	-0.0142
937.18	-0.013	190.4	-0.0124
937.20	-0.013	190.4	-0.0115
937.22	-0.011	190.5	-0.0089
937.23	-0.009	190.6	-0.0089
937.25	-0.008	190.6	-0.0071
937.27	-0.008	190.6	-0.0053
937.28	-0.006	190.8	-0.0018
937.30	-0.004	191	0.0009
937.32	-0.002	191.1	0.0036
937.33	-0.001	191.3	0.008
937.35	0.003	191.5	0.008
937.37	0.004	191.5	0.0115
937.38	0.004	191.7	0.0151
937.40	0.005	191.9	0.0186
937.42	0.009	192.2	0.0231
937.43	0.01	192.4	0.0257
937.45	0.012	192.7	0.0311
937.47	0.015	193	0.0346
937.48	0.015	193.1	0.0364
937.50	0.017	193.4	0.0399
937.52	0.02	193.6	0.0399
937.53	0.02	193.6	0.0435
937.55	0.02	193.8	0.0462
937.57	0.022	194.1	0.0488
937.58	0.024	194.3	0.0524
937.60	0.025	194.5	0.0541

Prova triassiale ciclica SN04-C1			
pressione di confinamento (kPa)		80	
deviatore ciclico (kPa)		95	
frequenza (hz)		0.00625	
tempo	cella di carico	$\Delta u$	LVDT
(min)	kN	(kPa)	$\delta$ (mm)
937.62	0.026	194.8	0.0568
937.63	0.027	195	0.0568
937.65	0.028	195.1	0.0577
937.67	0.028	195.1	0.0586
937.68	0.028	195.3	0.0595
937.70	0.028	195.5	0.0604
937.72	0.029	195.7	0.0612
937.73	0.029	195.8	0.0612
937.75	0.029	195.9	0.0612
937.77	0.028	196	0.0612
937.78	0.028	196	0.0612
937.80	0.028	196.1	0.0604
937.83	0.027	196.1	0.0595
937.85	0.026	196.1	0.0586
937.87	0.025	196.1	0.0568
937.88	0.024	196	0.055
937.88	0.022	196	0.055
937.90	0.022	196	0.0533
937.92	0.021	195.9	0.0506
937.93	0.019	195.8	0.0479
937.95	0.016	195.6	0.0453
937.97	0.016	195.6	0.0426
937.98	0.013	195.3	0.0391
938.00	0.011	195.1	0.0391
938.02	0.011	195.1	0.0364
938.03	0.01	194.9	0.0328
938.05	0.007	194.7	0.0293
938.07	0.004	194.4	0.0249
938.08	0.003	194.3	0.0204
938.10	0.001	193.9	0.0169
938.12	-0.002	193.7	0.0169
938.13	-0.002	193.7	0.0133
938.15	-0.003	193.5	0.0089
938.17	-0.005	193.1	0.0053
938.18	-0.008	192.9	0.0018
938.20	-0.008	192.7	0
938.22	-0.009	192.4	-0.0027
938.23	-0.012	192.2	-0.0053
938.25	-0.012	192	-0.0071
938.27	-0.013	191.7	-0.0098
938.28	-0.015	191.5	-0.0098
938.30	-0.015	191.5	-0.0115
938.32	-0.015	191.3	-0.0133
938.33	-0.016	191.2	-0.0142
938.35	-0.017	191	-0.016
938.37	-0.017	190.8	-0.016
938.38	-0.017	190.7	-0.0169
938.40	-0.017	190.6	-0.0169
938.42	-0.017	190.6	-0.0169
938.43	-0.017	190.5	-0.0169
938.45	-0.017	190.4	-0.0169
938.47	-0.016	190.4	-0.016
938.48	-0.015	190.3	-0.0151
938.50	-0.015	190.3	-0.0133
938.52	-0.012	190.4	-0.0133
938.53	-0.012	190.4	-0.0115
938.55	-0.012	190.4	-0.0107
938.57	-0.011	190.4	-0.0089

Prova triassiale ciclica SN04-C1			
pressione di confinamento (kPa)		80	
deviatore ciclico (kPa)		95	
frequenza (hz)		0.00625	
tempo	cella di carico	$\Delta u$	LVDT
(min)	kN	(kPa)	$\delta$ (mm)
938.58	-0.008	190.6	-0.0062
938.60	-0.007	190.6	-0.0036
938.62	-0.006	190.8	-0.0009
938.63	-0.003	191	-0.0009
938.65	-0.002	191.2	0.0027
938.67	-0.002	191.2	0.0053
938.68	0	191.3	0.0089
938.70	0.003	191.6	0.0133
938.72	0.005	191.8	0.016
938.73	0.006	192	0.0204
938.75	0.009	192.3	0.0204
938.77	0.011	192.5	0.0249
938.78	0.011	192.5	0.0284
938.80	0.012	192.7	0.0328
938.82	0.016	193	0.0364
938.83	0.017	193.2	0.0391
938.85	0.018	193.5	0.0435
938.87	0.021	193.8	0.0435
938.88	0.022	194	0.0462
938.90	0.022	194	0.0488
938.92	0.024	194.4	0.0515
938.93	0.025	194.6	0.0524
938.95	0.025	194.6	0.0541
938.97	0.026	194.8	0.0568
938.98	0.027	195	0.0586
939.00	0.028	195.2	0.0595
939.02	0.028	195.4	0.0604
939.03	0.029	195.6	0.0612
939.05	0.029	195.7	0.0612
939.07	0.029	195.7	0.0612
939.08	0.029	195.8	0.0621
939.10	0.029	195.9	0.0621
939.12	0.028	196	0.0612
939.13	0.027	196	0.0604
939.15	0.027	196.1	0.0595
939.17	0.025	196.1	0.0595
939.18	0.025	196.1	0.0586
939.20	0.025	196.1	0.0568
939.22	0.024	196	0.055
939.23	0.021	195.9	0.0524
939.25	0.02	195.9	0.0506
939.28	0.019	195.7	0.0479
939.30	0.015	195.6	0.0479
939.32	0.015	195.6	0.0444
939.33	0.015	195.5	0.0417
939.33	0.013	195.2	0.0382
939.35	0.009	195	0.0337
939.37	0.009	194.8	0.032
939.38	0.007	194.6	0.0284
939.40	0.004	194.3	0.0284
939.42	0.002	194.3	0.0231
939.43	0.002	194.1	0.0195
939.45	0.001	193.9	0.016
939.47	-0.003	193.6	0.0115
939.48	-0.004	193.4	0.0089
939.50	-0.005	193.1	0.0053
939.52	-0.008	192.8	0.0053
939.53	-0.009	192.8	0.0009



Prova triassiale ciclica SN04-C1			
pressione di confinamento (kPa)		80	
deviatore ciclico (kPa)		95	
frequenza (hz)		0.00625	
tempo	cella di carico	$\Delta u$	LVDT
(min)	kN	(kPa)	$\delta$ (mm)
939.55	-0.009	192.6	-0.0018
939.57	-0.01	192.3	-0.0044
939.58	-0.013	192	-0.008
939.60	-0.013	191.8	-0.0089
939.62	-0.014	191.6	-0.0115
939.63	-0.016	191.3	-0.0133
939.65	-0.016	191.2	-0.0142
939.67	-0.016	191	-0.0142
939.68	-0.017	190.9	-0.0142
939.70	-0.017	190.9	-0.016
939.72	-0.017	190.7	-0.016
939.73	-0.017	190.6	-0.0169
939.75	-0.017	190.5	-0.0169
939.77	-0.017	190.4	-0.0169
939.78	-0.016	190.4	-0.016
939.80	-0.016	190.3	-0.016
939.82	-0.015	190.3	-0.0151
939.83	-0.015	190.3	-0.0142
939.85	-0.014	190.3	-0.0124
939.87	-0.012	190.4	-0.0115
939.88	-0.011	190.4	-0.0098
939.90	-0.01	190.5	-0.0071
939.92	-0.008	190.6	-0.0071
939.93	-0.006	190.7	-0.0044
939.95	-0.006	190.7	-0.0027
939.97	-0.005	190.8	0.0009
939.98	-0.002	191.1	0.0044
940.00	0	191.2	0.0071
940.02	0.001	191.4	0.0107
940.03	0.003	191.7	0.0107
940.05	0.006	191.9	0.0151
940.07	0.006	191.9	0.0178
940.08	0.007	192.1	0.0222
940.10	0.01	192.4	0.0257
940.12	0.013	192.6	0.0302
940.13	0.013	192.8	0.0337
940.15	0.016	193.1	0.0373
940.17	0.018	193.4	0.0373
940.18	0.018	193.4	0.0408
940.20	0.019	193.6	0.0435
940.22	0.021	193.9	0.047
940.23	0.023	194.1	0.0506
940.25	0.024	194.3	0.0524
940.27	0.025	194.6	0.055
940.28	0.026	194.8	0.055
940.30	0.027	194.8	0.0568
940.32	0.027	194.9	0.0577
940.33	0.027	195.1	0.0595
940.35	0.029	195.4	0.0604
940.37	0.028	195.5	0.0612
940.38	0.029	195.7	0.0612
940.40	0.029	195.8	0.0621
940.42	0.029	195.9	0.0621
940.43	0.029	196	0.0621
940.45	0.028	196	0.0621
940.47	0.027	196	0.0612
940.48	0.027	196.1	0.0604
940.50	0.027	196.1	0.0595

Prova triassiale ciclica SN04-C1			
pressione di confinamento (kPa)		80	
deviatore ciclico (kPa)		95	
frequenza (hz)		0.00625	
tempo	cella di carico	$\Delta u$	LVDT
(min)	kN	(kPa)	$\delta$ (mm)
940.52	0.025	196.1	0.0577
940.53	0.024	196	0.0559
940.55	0.023	196	0.0541
940.57	0.021	195.9	0.0541
940.58	0.019	195.8	0.0515
940.60	0.019	195.8	0.0497
940.62	0.018	195.7	0.047
940.63	0.015	195.5	0.0435
940.65	0.014	195.4	0.0408
940.67	0.012	195.2	0.0373
940.68	0.009	194.9	0.0373
940.70	0.007	194.7	0.0337
940.72	0.007	194.7	0.0311
940.75	0.006	194.6	0.0257
940.77	0.003	194.3	0.0213
940.78	0.001	194	0.0178
940.80	0	193.8	0.0142
940.80	-0.003	193.5	0.0142
940.82	-0.005	193.2	0.0107
940.83	-0.005	193.2	0.0071
940.85	-0.006	193	0.0044
940.87	-0.008	192.7	0
940.88	-0.01	192.4	-0.0027
940.90	-0.011	192.2	-0.0053
940.92	-0.012	191.9	-0.008
940.93	-0.014	191.7	-0.008
940.95	-0.015	191.7	-0.0098
940.97	-0.015	191.5	-0.0115
940.98	-0.015	191.3	-0.0133
941.00	-0.016	191.1	-0.0151
941.02	-0.017	190.9	-0.016
941.03	-0.017	190.8	-0.016
941.05	-0.017	190.7	-0.016
941.07	-0.017	190.7	-0.0169
941.08	-0.017	190.5	-0.0169
941.10	-0.017	190.4	-0.0169
941.12	-0.016	190.4	-0.016
941.13	-0.016	190.3	-0.016
941.15	-0.016	190.3	-0.0151
941.17	-0.014	190.3	-0.0142
941.18	-0.014	190.3	-0.0124
941.20	-0.013	190.4	-0.0107
941.22	-0.01	190.4	-0.0107
941.23	-0.009	190.4	-0.0089
941.25	-0.009	190.5	-0.0071
941.27	-0.008	190.6	-0.0044
941.28	-0.005	190.8	-0.0009
941.30	-0.004	190.9	0.0009
941.32	-0.003	191.1	0.0053
941.33	0.001	191.3	0.0053
941.35	0.002	191.3	0.008
941.37	0.002	191.5	0.0115
941.38	0.004	191.7	0.016
941.40	0.007	191.9	0.0195
941.42	0.008	192.1	0.0231
941.43	0.01	192.4	0.0275
941.45	0.013	192.7	0.0275
941.47	0.015	192.9	0.032

Prova triassiale ciclica SN04-C1			
pressione di confinamento (kPa)		80	
deviatore ciclico (kPa)		95	
frequenza (hz)		0.00625	
tempo	cella di carico	$\Delta u$	LVDT
(min)	kN	(kPa)	$\delta$ (mm)
941.48	0.015	192.9	0.0355
941.50	0.016	193.1	0.0391
941.52	0.019	193.4	0.0426
941.53	0.02	193.6	0.0444
941.55	0.021	193.9	0.0479
941.57	0.023	194.2	0.0479
941.58	0.024	194.4	0.0506
941.60	0.024	194.4	0.0533
941.62	0.025	194.6	0.0559
941.63	0.026	194.8	0.0577
941.65	0.027	195	0.0586
941.67	0.028	195.2	0.0604
941.68	0.028	195.4	0.0604
941.70	0.029	195.6	0.0604
941.72	0.029	195.6	0.0612
941.73	0.029	195.7	0.0612
941.75	0.029	195.8	0.0612
941.77	0.029	195.9	0.0612
941.78	0.028	196	0.0612
941.80	0.028	196	0.0604
941.82	0.026	196	0.0595
941.83	0.026	196.1	0.0595
941.85	0.025	196	0.0568
941.87	0.023	196	0.0568
941.88	0.022	196	0.055
941.90	0.022	195.9	0.0533
941.92	0.021	195.9	0.0515
941.93	0.018	195.7	0.0488
941.95	0.017	195.6	0.0462
941.97	0.016	195.5	0.0435
941.98	0.012	195.2	0.0435
942.00	0.011	195.2	0.0399
942.02	0.011	195.1	0.0364
942.03	0.01	194.9	0.0328
942.05	0.006	194.6	0.0293
942.07	0.005	194.5	0.0257
942.08	0.004	194.2	0.0213
942.10	0	193.9	0.0213
942.12	-0.001	193.9	0.0169
942.13	-0.001	193.7	0.0133
942.15	-0.003	193.4	0.0098
942.18	-0.006	193.1	0.0053
942.20	-0.007	192.9	0.0027
942.22	-0.008	192.6	0
942.23	-0.011	192.3	0
942.25	-0.012	192.3	-0.0036
942.25	-0.012	192.1	-0.0062
942.27	-0.013	191.9	-0.0089
942.28	-0.015	191.6	-0.0107
942.30	-0.015	191.4	-0.0124
942.32	-0.016	191.2	-0.0133
942.33	-0.017	191	-0.0133
942.35	-0.017	191	-0.0151
942.37	-0.017	190.9	-0.0151
942.38	-0.017	190.7	-0.016
942.40	-0.017	190.6	-0.0169
942.42	-0.017	190.5	-0.016
942.43	-0.017	190.4	-0.016

Prova triassiale ciclica SN04-C1			
pressione di confinamento (kPa)		80	
deviatore ciclico (kPa)		95	
frequenza (hz)		0.00625	
tempo	cella di carico	$\Delta u$	LVDT
(min)	kN	(kPa)	$\delta$ (mm)
942.45	-0.016	190.4	-0.016
942.47	-0.016	190.4	-0.016
942.48	-0.016	190.3	-0.0151
942.50	-0.015	190.3	-0.0133
942.52	-0.013	190.3	-0.0124
942.53	-0.012	190.3	-0.0107
942.55	-0.012	190.4	-0.0089
942.57	-0.01	190.4	-0.008
942.58	-0.009	190.5	-0.0062
942.60	-0.007	190.6	-0.0036
942.62	-0.005	190.8	-0.0036
942.63	-0.003	190.9	0
942.65	-0.003	190.9	0.0027
942.67	-0.002	191.1	0.0062
942.68	0.001	191.3	0.0098
942.70	0.003	191.5	0.0133
942.72	0.004	191.7	0.0169
942.73	0.007	192	0.0169
942.75	0.01	192.2	0.0204
942.77	0.01	192.2	0.024
942.78	0.011	192.4	0.0293
942.80	0.013	192.7	0.0328
942.82	0.016	193	0.0364
942.83	0.017	193.2	0.0399
942.85	0.019	193.5	0.0435
942.87	0.021	193.7	0.0435
942.88	0.021	193.7	0.0462
942.90	0.022	193.9	0.0488
942.92	0.023	194.2	0.0515
942.93	0.025	194.4	0.0541
942.95	0.026	194.6	0.0559
942.97	0.026	194.8	0.0577
942.98	0.028	195	0.0577
943.00	0.028	195	0.0586
943.02	0.028	195.2	0.0604
943.03	0.028	195.4	0.0612
943.05	0.029	195.6	0.0621
943.07	0.029	195.7	0.0621
943.08	0.029	195.8	0.0612
943.10	0.028	195.9	0.0612
943.12	0.028	195.9	0.0612
943.13	0.028	196	0.0612
943.15	0.027	196	0.0595
943.17	0.026	196	0.0586
943.18	0.025	196	0.0577
943.20	0.024	196	0.0559
943.22	0.022	195.9	0.0559
943.23	0.021	195.9	0.0533
943.25	0.021	195.8	0.0515
943.27	0.018	195.6	0.0488
943.28	0.016	195.5	0.047
943.30	0.016	195.5	0.0453
943.32	0.015	195.4	0.0417
943.33	0.012	195.1	0.0382
943.35	0.01	194.9	0.0355
943.37	0.009	194.7	0.0311
943.38	0.006	194.5	0.0311
943.40	0.004	194.3	0.0275

Prova triassiale ciclica SN04-C1			
pressione di confinamento (kPa)		80	
deviatore ciclico (kPa)		95	
frequenza (hz)		0.00625	
tempo	cella di carico	$\Delta u$	LVDT
(min)	kN	(kPa)	$\delta$ (mm)
943.42	0.004	194.3	0.0231
943.43	0.002	194.1	0.0195
943.45	0	193.8	0.016
943.47	-0.002	193.5	0.0124
943.48	-0.004	193.3	0.0089
943.50	-0.006	193	0.0089
943.52	-0.007	192.7	0.0044
943.53	-0.007	192.7	0.0018
943.55	-0.009	192.5	-0.0018
943.57	-0.011	192.2	-0.0053
943.58	-0.013	191.9	-0.0071
943.60	-0.013	191.7	-0.0098
943.62	-0.014	191.5	-0.0115
943.65	-0.015	191.3	-0.0115
943.67	-0.015	191.3	-0.0133
943.68	-0.016	191.1	-0.0142
943.70	-0.017	190.9	-0.0151
943.70	-0.017	190.8	-0.016
943.72	-0.017	190.6	-0.0169
943.73	-0.017	190.5	-0.0169
943.75	-0.017	190.4	-0.0169
943.77	-0.017	190.4	-0.0169
943.78	-0.017	190.3	-0.016
943.80	-0.016	190.3	-0.0151
943.82	-0.015	190.3	-0.0151
943.83	-0.014	190.3	-0.0133
943.85	-0.013	190.3	-0.0115
943.87	-0.011	190.3	-0.0115
943.88	-0.011	190.3	-0.0098
943.90	-0.011	190.4	-0.008
943.92	-0.009	190.5	-0.0053
943.93	-0.007	190.6	-0.0036
943.95	-0.006	190.7	-0.0009
943.97	-0.004	190.9	0.0027
943.98	-0.001	191.1	0.0027
944.00	0	191.3	0.008
944.02	0.001	191.4	0.0107
944.03	0.004	191.6	0.0107
944.05	0.005	191.6	0.0142
944.07	0.005	191.8	0.0186
944.08	0.007	192.1	0.0231
944.10	0.011	192.3	0.0275
944.12	0.012	192.5	0.0311
944.13	0.013	192.8	0.0346
944.15	0.017	193.1	0.0346
944.17	0.017	193.1	0.0382
944.18	0.017	193.3	0.0408
944.20	0.019	193.6	0.0435
944.22	0.022	193.8	0.0479
944.23	0.023	194	0.0497
944.25	0.024	194.3	0.0524
944.27	0.026	194.5	0.0524
944.28	0.026	194.5	0.055
944.30	0.026	194.7	0.0568
944.32	0.027	194.9	0.0586
944.33	0.028	195.1	0.0595
944.35	0.028	195.3	0.0604
944.37	0.028	195.4	0.0612

Prova triassiale ciclica SN04-C1			
pressione di confinamento (kPa)		80	
deviatore ciclico (kPa)		95	
frequenza (hz)		0.00625	
tempo	cella di carico	$\Delta u$	LVDT
(min)	kN	(kPa)	$\delta$ (mm)
944.38	0.029	195.6	0.0612
944.40	0.029	195.6	0.0612
944.42	0.029	195.7	0.0621
944.43	0.029	195.8	0.0621
944.45	0.028	195.9	0.0621
944.47	0.027	195.9	0.0604
944.48	0.027	196	0.0595
944.50	0.025	196	0.0595
944.52	0.025	196	0.0586
944.53	0.025	196	0.0568
944.55	0.024	195.9	0.055
944.57	0.021	195.8	0.0524
944.58	0.02	195.8	0.0506
944.60	0.019	195.7	0.0479
944.62	0.016	195.5	0.0479
944.63	0.014	195.5	0.0444
944.65	0.014	195.3	0.0426
944.67	0.014	195.2	0.0391
944.68	0.01	194.9	0.0355
944.70	0.008	194.8	0.032
944.72	0.007	194.6	0.0284
944.73	0.005	194.4	0.0257
944.75	0.003	194.2	0.0222
944.77	0.001	193.9	0.0178
944.78	-0.001	193.6	0.0178
944.80	-0.003	193.4	0.0133
944.82	-0.003	193.4	0.0107
944.83	-0.004	193.1	0.0071
944.85	-0.007	192.8	0.0036
944.87	-0.009	192.6	0
944.88	-0.01	192.3	-0.0036
944.90	-0.011	192	-0.0036
944.92	-0.013	191.8	-0.0062
944.93	-0.013	191.8	-0.008
944.95	-0.014	191.6	-0.0098
944.97	-0.015	191.3	-0.0124
944.98	-0.016	191.2	-0.0133
945.00	-0.016	191	-0.0142
945.02	-0.017	190.8	-0.016
945.03	-0.017	190.7	-0.016
945.05	-0.017	190.7	-0.0169
945.08	-0.017	190.5	-0.0169
945.10	-0.017	190.4	-0.0169
945.12	-0.017	190.3	-0.0169
945.13	-0.017	190.3	-0.016
945.15	-0.016	190.3	-0.0151
945.15	-0.015	190.3	-0.0151
945.17	-0.014	190.3	-0.0142
945.18	-0.014	190.2	-0.0133
945.20	-0.013	190.3	-0.0115
945.22	-0.011	190.4	-0.0089
945.23	-0.01	190.4	-0.008
945.25	-0.009	190.5	-0.0044
945.27	-0.006	190.6	-0.0044
945.28	-0.005	190.6	-0.0018
945.30	-0.005	190.8	0
945.32	-0.003	191	0.0036
945.33	0	191.2	0.0071

Prova triassiale ciclica SN04-C1			
pressione di confinamento (kPa)		80	
deviatore ciclico (kPa)		95	
frequenza (hz)		0.00625	
tempo	cella di carico	$\Delta u$	LVDT
(min)	kN	(kPa)	$\delta$ (mm)
945.35	0.001	191.3	0.0107
945.37	0.003	191.5	0.0142
945.38	0.006	191.8	0.0142
945.40	0.008	191.8	0.0186
945.42	0.008	192	0.0222
945.43	0.009	192.2	0.0257
945.45	0.013	192.7	0.0302
945.47	0.013	192.7	0.032
945.48	0.014	192.9	0.0364
945.50	0.017	193.2	0.0399
945.52	0.019	193.4	0.0426
945.53	0.02	193.6	0.0462
945.55	0.022	193.9	0.0462
945.57	0.023	194.1	0.0488
945.58	0.023	194.1	0.0515
945.60	0.024	194.4	0.0541
945.62	0.026	194.6	0.0559
945.63	0.027	194.8	0.0577
945.65	0.027	195	0.0586
945.67	0.028	195.1	0.0595
945.68	0.029	195.3	0.0595
945.70	0.029	195.3	0.0612
945.72	0.029	195.5	0.0612
945.73	0.029	195.6	0.0612
945.75	0.029	195.8	0.0621
945.77	0.029	195.9	0.0621
945.78	0.028	195.9	0.0612
945.80	0.027	196	0.0612
945.82	0.026	196	0.0604
945.83	0.026	196	0.0595
945.85	0.026	195.9	0.0577
945.87	0.024	195.9	0.0559
945.88	0.023	195.9	0.0541
945.90	0.022	195.8	0.0524
945.92	0.019	195.7	0.0524
945.93	0.018	195.7	0.0488
945.95	0.018	195.6	0.047
945.97	0.017	195.4	0.0444
945.98	0.013	195.2	0.0408
946.00	0.012	195.1	0.0382
946.02	0.011	194.9	0.0346
946.03	0.007	194.6	0.0346
946.05	0.006	194.6	0.0302
946.07	0.006	194.5	0.0275
946.08	0.004	194.2	0.0222
946.10	0	193.9	0.0178
946.12	0	193.7	0.0151
946.13	-0.002	193.4	0.0107
946.15	-0.005	193.1	0.0107
946.17	-0.006	193.1	0.0071
946.18	-0.007	192.7	0.0018
946.20	-0.009	192.5	0.0018
946.22	-0.01	192.5	-0.0009
946.23	-0.01	192.2	-0.0036
946.25	-0.012	192	-0.0071
946.27	-0.014	191.7	-0.0089
946.28	-0.014	191.5	-0.0107
946.30	-0.015	191.3	-0.0124

Prova triassiale ciclica SN04-C1			
pressione di confinamento (kPa)		80	
deviatore ciclico (kPa)		95	
frequenza (hz)		0.00625	
tempo	cella di carico	$\Delta u$	LVDT
(min)	kN	(kPa)	$\delta$ (mm)
946.32	-0.016	191.1	-0.0124
946.33	-0.016	191.1	-0.0142
946.35	-0.016	190.9	-0.0151
946.37	-0.017	190.7	-0.016
946.38	-0.017	190.6	-0.0169
946.40	-0.017	190.5	-0.0169
946.42	-0.017	190.4	-0.0169
946.43	-0.017	190.3	-0.0169
946.45	-0.016	190.3	-0.016
946.47	-0.016	190.3	-0.016
946.48	-0.016	190.2	-0.0142
946.50	-0.015	190.3	-0.0133
946.52	-0.013	190.2	-0.0124
946.55	-0.012	190.3	-0.0107
946.57	-0.011	190.4	-0.008
946.58	-0.009	190.5	-0.008
946.60	-0.009	190.5	-0.0062
946.60	-0.008	190.5	-0.0036
946.62	-0.006	190.7	-0.0009
946.63	-0.004	190.8	0.0018
946.65	-0.003	191	0.0044
946.67	0	191.2	0.008
946.68	0.002	191.4	0.008
946.70	0.004	191.4	0.0115
946.72	0.004	191.6	0.0151
946.73	0.006	191.8	0.0186
946.75	0.009	192.1	0.0231
946.77	0.01	192.2	0.0257
946.78	0.012	192.6	0.0311
946.80	0.015	192.8	0.0311
946.82	0.016	192.8	0.0355
946.83	0.016	193	0.0382
946.85	0.017	193.3	0.0417
946.87	0.021	193.6	0.0453
946.88	0.021	193.8	0.047
946.90	0.022	194.1	0.0506
946.92	0.024	194.2	0.0515
946.93	0.025	194.4	0.055
946.95	0.025	194.7	0.0568
946.97	0.027	194.9	0.0568
946.98	0.028	194.9	0.0586
947.00	0.028	195	0.0595
947.02	0.028	195.2	0.0604
947.03	0.029	195.4	0.0612
947.05	0.029	195.6	0.0612
947.07	0.029	195.7	0.0621
947.08	0.029	195.8	0.0621
947.10	0.029	195.8	0.0621
947.12	0.029	195.9	0.0621
947.13	0.028	195.9	0.0612
947.15	0.027	196	0.0604
947.17	0.026	196	0.0595
947.18	0.026	196	0.0577
947.20	0.023	195.9	0.0577
947.22	0.022	195.9	0.055
947.23	0.022	195.9	0.0541
947.25	0.021	195.8	0.0515
947.27	0.018	195.6	0.0488



Prova triassiale ciclica SN04-C1			
pressione di confinamento (kPa)		80	
deviatore ciclico (kPa)		95	
frequenza (hz)		0.00625	
tempo	cella di carico	$\Delta u$	LVDT
(min)	kN	(kPa)	$\delta$ (mm)
947.28	0.017	195.6	0.0462
947.30	0.016	195.3	0.0426
947.32	0.012	195.1	0.0426
947.33	0.011	195.1	0.0399
947.35	0.011	195	0.0364
947.37	0.01	194.8	0.0328
947.38	0.006	194.5	0.0284
947.40	0.005	194.3	0.0249
947.42	0.003	194.1	0.0213
947.43	0	193.8	0.0213
947.45	-0.001	193.6	0.0169
947.47	-0.001	193.6	0.0142
947.48	-0.003	193.4	0.0098
947.50	-0.006	193	0.0062
947.52	-0.007	192.8	0.0036
947.53	-0.008	192.5	-0.0009
947.55	-0.01	192.2	-0.0009
947.57	-0.012	192	-0.0036
947.58	-0.012	192	-0.0053
947.60	-0.013	191.8	-0.0089
947.62	-0.014	191.5	-0.0107
947.63	-0.015	191.3	-0.0124
947.65	-0.015	191.2	-0.0133
947.67	-0.016	191	-0.0142
947.68	-0.017	190.8	-0.0151
947.70	-0.017	190.6	-0.016
947.72	-0.017	190.5	-0.016
947.73	-0.017	190.4	-0.016
947.75	-0.017	190.4	-0.016
947.77	-0.017	190.3	-0.016
947.78	-0.016	190.3	-0.016
947.80	-0.016	190.2	-0.0151
947.82	-0.015	190.2	-0.0151
947.83	-0.015	190.2	-0.0133
947.85	-0.013	190.2	-0.0133
947.87	-0.012	190.2	-0.0115
947.88	-0.012	190.2	-0.0107
947.90	-0.011	190.3	-0.008
947.92	-0.008	190.4	-0.0053
947.93	-0.007	190.5	-0.0036
947.95	-0.006	190.7	-0.0009
947.97	-0.003	190.9	-0.0009
947.98	-0.001	190.9	0.0027
948.02	-0.001	191	0.0062
948.03	0	191.2	0.0098
948.05	0.004	191.4	0.0133
948.05	0.005	191.6	0.016
948.07	0.006	191.8	0.0204
948.08	0.01	192.1	0.0204
948.10	0.011	192.1	0.0249
948.12	0.011	192.3	0.0284
948.13	0.012	192.6	0.0328
948.15	0.016	192.9	0.0364
948.17	0.017	193.1	0.0391
948.18	0.018	193.3	0.0426
948.20	0.021	193.6	0.0426
948.22	0.022	193.8	0.0462
948.23	0.022	193.8	0.0488

Prova triassiale ciclica SN04-C1			
pressione di confinamento (kPa)		80	
deviatore ciclico (kPa)		95	
frequenza (hz)		0.00625	
tempo	cella di carico	$\Delta u$	LVDT
(min)	kN	(kPa)	$\delta$ (mm)
948.25	0.023	194.1	0.0515
948.27	0.024	194.4	0.0541
948.28	0.026	194.6	0.0568
948.30	0.026	194.7	0.0577
948.32	0.027	194.9	0.0577
948.33	0.028	195.1	0.0595
948.35	0.028	195.2	0.0612
948.37	0.029	195.4	0.0612
948.38	0.029	195.6	0.0612
948.40	0.029	195.6	0.0621
948.42	0.029	195.7	0.0621
948.43	0.029	195.8	0.0621
948.45	0.028	195.9	0.0621
948.47	0.027	195.9	0.0604
948.48	0.026	195.9	0.0595
948.50	0.025	195.9	0.0595
948.52	0.025	195.9	0.0586
948.53	0.025	195.9	0.0577
948.55	0.023	195.8	0.055
948.57	0.021	195.8	0.0533
948.58	0.02	195.7	0.0506
948.60	0.019	195.6	0.0479
948.62	0.016	195.4	0.0479
948.63	0.015	195.4	0.0453
948.65	0.015	195.3	0.0426
948.67	0.013	195.1	0.0391
948.68	0.01	194.9	0.0346
948.70	0.009	194.7	0.032
948.72	0.007	194.4	0.0284
948.73	0.004	194.2	0.0284
948.75	0.002	194.2	0.024
948.77	0.002	194	0.0204
948.78	0.001	193.7	0.016
948.80	-0.003	193.4	0.0124
948.82	-0.004	193.2	0.0089
948.83	-0.005	192.9	0.0053
948.85	-0.008	192.6	0.0053
948.87	-0.009	192.6	0.0018
948.88	-0.009	192.4	-0.0009
948.90	-0.01	192.1	-0.0044
948.92	-0.013	191.9	-0.0071
948.93	-0.013	191.7	-0.0089
948.95	-0.014	191.5	-0.0107
948.97	-0.016	191.2	-0.0107
948.98	-0.016	191.2	-0.0133
949.00	-0.016	191	-0.0133
949.02	-0.016	190.9	-0.0142
949.03	-0.017	190.7	-0.016
949.05	-0.017	190.6	-0.016
949.07	-0.017	190.5	-0.016
949.08	-0.017	190.4	-0.0169
949.10	-0.017	190.3	-0.0169
949.12	-0.017	190.2	-0.016
949.13	-0.015	190.2	-0.016
949.15	-0.015	190.2	-0.0142
949.17	-0.015	190.1	-0.0133
949.18	-0.014	190.2	-0.0124
949.20	-0.012	190.2	-0.0107

Prova triassiale ciclica SN04-C1			
pressione di confinamento (kPa)		80	
deviatore ciclico (kPa)		95	
frequenza (hz)		0.00625	
tempo	cella di carico	$\Delta u$	LVDT
(min)	kN	(kPa)	$\delta$ (mm)
949.22	-0.012	190.2	-0.0098
949.23	-0.01	190.3	-0.0062
949.25	-0.007	190.5	-0.0062
949.27	-0.007	190.5	-0.0036
949.28	-0.007	190.6	-0.0018
949.30	-0.005	190.7	0.0009
949.32	-0.001	190.9	0.0053
949.33	-0.001	191	0.008
949.35	0.001	191.3	0.0115
949.37	0.005	191.5	0.0115
949.38	0.005	191.5	0.0151
949.40	0.005	191.7	0.0186
949.42	0.007	191.9	0.0222
949.45	0.011	192.2	0.0275
949.47	0.012	192.4	0.0311
949.48	0.013	192.7	0.0346
949.50	0.017	193	0.0346
949.52	0.018	193	0.0391
949.52	0.018	193.2	0.0408
949.53	0.019	193.4	0.0444
949.55	0.021	193.7	0.0479
949.57	0.023	193.9	0.0506
949.58	0.023	194.1	0.0524
949.60	0.025	194.4	0.0524
949.62	0.026	194.6	0.055
949.63	0.026	194.6	0.0568
949.65	0.027	194.8	0.0586
949.67	0.028	195	0.0595
949.68	0.028	195.2	0.0604
949.70	0.028	195.3	0.0612
949.72	0.029	195.5	0.0612
949.73	0.029	195.6	0.0621
949.75	0.029	195.6	0.0621
949.77	0.029	195.7	0.0621
949.78	0.028	195.8	0.0621
949.80	0.028	195.9	0.0612
949.82	0.027	195.9	0.0604
949.83	0.027	195.9	0.0595
949.85	0.025	195.9	0.0577
949.87	0.024	195.9	0.0559
949.88	0.023	195.8	0.0541
949.90	0.021	195.7	0.0541
949.92	0.019	195.7	0.0524
949.93	0.019	195.7	0.0497
949.95	0.018	195.5	0.047
949.97	0.015	195.3	0.0435
949.98	0.014	195.2	0.0408
950.00	0.012	195	0.0373
950.02	0.008	194.7	0.0373
950.03	0.008	194.7	0.0337
950.05	0.008	194.6	0.0311
950.07	0.006	194.3	0.0257
950.08	0.002	194.1	0.0222
950.10	0.002	193.9	0.0186
950.12	0	193.6	0.0151
950.13	-0.004	193.3	0.0151
950.15	-0.004	193.3	0.0107
950.17	-0.004	193.1	0.0071

Prova triassiale ciclica SN04-C1			
pressione di confinamento (kPa)		80	
deviatore ciclico (kPa)		95	
frequenza (hz)		0.00625	
tempo	cella di carico	$\Delta u$	LVDT
(min)	kN	(kPa)	$\delta$ (mm)
950.18	-0.006	192.7	0.0036
950.20	-0.009	192.5	0
950.22	-0.009	192.3	-0.0027
950.23	-0.011	192	-0.0053
950.25	-0.014	191.7	-0.0053
950.27	-0.014	191.7	-0.0089
950.28	-0.014	191.5	-0.0098
950.30	-0.015	191.3	-0.0115
950.32	-0.016	191.1	-0.0133
950.33	-0.017	190.9	-0.0142
950.35	-0.017	190.8	-0.0151
950.37	-0.017	190.6	-0.0151
950.38	-0.017	190.6	-0.016
950.40	-0.017	190.5	-0.016
950.42	-0.017	190.4	-0.0169
950.43	-0.017	190.3	-0.0169
950.45	-0.016	190.2	-0.016
950.47	-0.016	190.2	-0.0151
950.48	-0.015	190.2	-0.0151
950.50	-0.014	190.2	-0.0142
950.52	-0.014	190.2	-0.0124
950.53	-0.012	190.2	-0.0107
950.55	-0.011	190.2	-0.0107
950.57	-0.011	190.3	-0.008
950.58	-0.01	190.4	-0.0062
950.60	-0.007	190.5	-0.0027
950.62	-0.006	190.6	-0.0009
950.63	-0.004	190.7	0.0027
950.65	-0.001	191	0.0027
950.67	0.001	191.2	0.0062
950.68	0.001	191.2	0.0089
950.70	0.002	191.3	0.0124
950.72	0.005	191.6	0.016
950.73	0.007	191.8	0.0195
950.75	0.008	192	0.024
950.77	0.011	192.3	0.024
950.78	0.013	192.5	0.0284
950.80	0.013	192.5	0.032
950.82	0.014	192.7	0.0355
950.83	0.017	193	0.0399
950.85	0.019	193.3	0.0426
950.87	0.02	193.5	0.0453
950.88	0.022	193.8	0.0453
950.92	0.024	194	0.0488
950.93	0.024	194	0.0515
950.95	0.024	194.2	0.0533
950.97	0.025	194.5	0.0559
950.97	0.027	194.7	0.0577
950.98	0.027	194.9	0.0586
951.00	0.028	195	0.0595
951.02	0.028	195.2	0.0595
951.03	0.029	195.2	0.0612
951.05	0.029	195.4	0.0612
951.07	0.029	195.5	0.0621
951.08	0.029	195.6	0.0621
951.10	0.029	195.7	0.0621
951.12	0.028	195.8	0.0621
951.13	0.027	195.9	0.0621

Prova triassiale ciclica SN04-C1			
pressione di confinamento (kPa)		80	
deviatore ciclico (kPa)		95	
frequenza (hz)		0.00625	
tempo	cella di carico	$\Delta u$	LVDT
(min)	kN	(kPa)	$\delta$ (mm)
951.15	0.027	195.9	0.0604
951.17	0.027	195.9	0.0595
951.18	0.025	195.9	0.0577
951.20	0.024	195.8	0.0559
951.22	0.023	195.8	0.055
951.23	0.021	195.7	0.0524
951.25	0.019	195.6	0.0524
951.27	0.018	195.5	0.0479
951.28	0.017	195.4	0.0462
951.30	0.014	195.2	0.0462
951.32	0.013	195.2	0.0426
951.33	0.013	195.1	0.0399
951.35	0.012	194.9	0.0364
951.37	0.007	194.6	0.032
951.38	0.007	194.5	0.0293
951.40	0.005	194.2	0.0249
951.42	0.001	194	0.0249
951.43	0.001	194	0.0204
951.45	0.001	193.8	0.0169
951.47	-0.001	193.5	0.0133
951.48	-0.005	193.2	0.0089
951.50	-0.005	193	0.0053
951.52	-0.007	192.7	0.0027
951.53	-0.01	192.4	0.0027
951.55	-0.011	192.4	-0.0009
951.57	-0.011	192.2	-0.0036
951.58	-0.011	191.9	-0.0062
951.60	-0.014	191.6	-0.0089
951.62	-0.014	191.5	-0.0107
951.63	-0.015	191.2	-0.0124
951.65	-0.016	191	-0.0124
951.67	-0.017	191	-0.0142
951.68	-0.017	190.8	-0.0151
951.70	-0.017	190.7	-0.016
951.72	-0.018	190.5	-0.0169
951.73	-0.017	190.4	-0.0169
951.75	-0.017	190.3	-0.016
951.77	-0.017	190.3	-0.016
951.78	-0.016	190.2	-0.016
951.80	-0.016	190.2	-0.016
951.82	-0.016	190.1	-0.0151
951.83	-0.015	190.1	-0.0142
951.85	-0.013	190.2	-0.0124
951.87	-0.012	190.2	-0.0107
951.88	-0.011	190.3	-0.0107
951.90	-0.009	190.3	-0.0089
951.92	-0.009	190.3	-0.0062
951.93	-0.008	190.4	-0.0036
951.95	-0.006	190.6	-0.0009
951.97	-0.004	190.8	0.0018
951.98	-0.003	190.9	0.0053
952.00	-0.001	191.1	0.0071
952.02	0.001	191.2	0.0107
952.03	0.003	191.4	0.0133
952.05	0.005	191.7	0.0178
952.07	0.008	191.9	0.0178
952.08	0.009	191.9	0.0213
952.10	0.009	192.1	0.0249

Prova triassiale ciclica SN04-C1			
pressione di confinamento (kPa)		80	
deviatore ciclico (kPa)		95	
frequenza (hz)		0.00625	
tempo	cella di carico	$\Delta u$	LVDT
(min)	kN	(kPa)	$\delta$ (mm)
952.12	0.011	192.4	0.0302
952.13	0.014	192.7	0.0337
952.15	0.015	192.9	0.0373
952.17	0.017	193.2	0.0408
952.18	0.02	193.4	0.0408
952.20	0.021	193.4	0.0444
952.22	0.021	193.6	0.047
952.23	0.022	193.9	0.0497
952.25	0.024	194.1	0.0524
952.27	0.025	194.3	0.0541
952.28	0.025	194.5	0.0559
952.30	0.027	194.8	0.0559
952.32	0.027	194.8	0.0586
952.35	0.027	194.9	0.0595
952.37	0.028	195.1	0.0604
952.38	0.029	195.3	0.0612
952.40	0.029	195.4	0.0612
952.42	0.029	195.6	0.0621
952.42	0.029	195.7	0.0621
952.43	0.028	195.7	0.0621
952.45	0.028	195.8	0.0621
952.47	0.028	195.8	0.0612
952.48	0.026	195.8	0.0595
952.50	0.026	195.9	0.0586
952.52	0.025	195.9	0.0577
952.53	0.023	195.8	0.0577
952.55	0.022	195.8	0.055
952.57	0.022	195.8	0.0541
952.58	0.021	195.7	0.0506
952.60	0.018	195.5	0.0479
952.62	0.017	195.4	0.0462
952.63	0.016	195.3	0.0435
952.65	0.013	195	0.0435
952.67	0.011	194.9	0.0399
952.68	0.011	194.9	0.0364
952.70	0.01	194.7	0.0328
952.72	0.005	194.3	0.0293
952.73	0.005	194.3	0.0275
952.75	0.004	194.1	0.0231
952.77	0.001	193.8	0.0186
952.78	-0.001	193.6	0.0151
952.80	-0.001	193.4	0.0124
952.82	-0.004	193	0.0124
952.83	-0.007	192.8	0.008
952.85	-0.007	192.8	0.0044
952.87	-0.008	192.6	0.0009
952.88	-0.01	192.3	-0.0018
952.90	-0.011	192	-0.0044
952.92	-0.012	191.8	-0.0071
952.93	-0.014	191.5	-0.0071
952.95	-0.015	191.3	-0.0098
952.97	-0.015	191.3	-0.0115
952.98	-0.015	191.2	-0.0124
953.00	-0.016	190.9	-0.0142
953.02	-0.017	190.8	-0.0151
953.03	-0.017	190.6	-0.016
953.05	-0.017	190.5	-0.0169
953.07	-0.017	190.4	-0.0169

Prova triassiale ciclica SN04-C1			
pressione di confinamento (kPa)		80	
deviatore ciclico (kPa)		95	
frequenza (hz)		0.00625	
tempo	cella di carico	$\Delta u$	LVDT
(min)	kN	(kPa)	$\delta$ (mm)
953.08	-0.017	190.4	-0.016
953.10	-0.017	190.3	-0.016
953.12	-0.017	190.2	-0.016
953.13	-0.016	190.2	-0.0151
953.15	-0.015	190.1	-0.0142
953.17	-0.014	190.1	-0.0133
953.18	-0.013	190.2	-0.0133
953.20	-0.013	190.2	-0.0115
953.22	-0.012	190.2	-0.0098
953.23	-0.01	190.3	-0.0071
953.25	-0.008	190.4	-0.0053
953.27	-0.007	190.5	-0.0027
953.28	-0.006	190.7	0
953.30	-0.003	190.8	0
953.32	-0.001	190.8	0.0036
953.33	-0.001	191	0.0062
953.35	0	191.2	0.0098
953.37	0.003	191.4	0.0133
953.38	0.005	191.6	0.016
953.40	0.006	191.8	0.0204
953.42	0.01	192.1	0.0204
953.43	0.011	192.3	0.0284
953.45	0.012	192.5	0.0311
953.47	0.015	192.7	0.0311
953.48	0.016	192.7	0.0346
953.50	0.016	193	0.0382
953.52	0.017	193.2	0.0417
953.53	0.02	193.5	0.0453
953.55	0.021	193.7	0.0479
953.57	0.022	194	0.0506
953.58	0.025	194.2	0.0506
953.60	0.025	194.2	0.0533
953.62	0.025	194.4	0.055
953.63	0.026	194.6	0.0577
953.65	0.027	194.8	0.0586
953.67	0.028	195	0.0604
953.68	0.028	195.2	0.0612
953.70	0.029	195.4	0.0612
953.72	0.029	195.4	0.0621
953.73	0.029	195.5	0.0621
953.75	0.029	195.6	0.0621
953.77	0.029	195.7	0.0621
953.78	0.028	195.8	0.0621
953.82	0.028	195.8	0.0604
953.83	0.026	195.8	0.0604
953.85	0.026	195.8	0.0595
953.87	0.026	195.9	0.0586
953.87	0.025	195.8	0.0568
953.88	0.023	195.8	0.055
953.90	0.021	195.7	0.0524
953.92	0.02	195.6	0.0497
953.93	0.018	195.4	0.0497
953.95	0.016	195.3	0.047
953.97	0.016	195.3	0.0444
953.98	0.015	195.2	0.0417
954.00	0.012	194.9	0.0382
954.02	0.01	194.8	0.0355
954.03	0.009	194.6	0.0311

Prova triassiale ciclica SN04-C1			
pressione di confinamento (kPa)		80	
deviatore ciclico (kPa)		95	
frequenza (hz)		0.00625	
tempo	cella di carico	$\Delta u$	LVDT
(min)	kN	(kPa)	$\delta$ (mm)
954.05	0.006	194.3	0.0311
954.07	0.004	194.1	0.0275
954.08	0.004	194.1	0.024
954.10	0.002	193.9	0.0195
954.12	0	193.6	0.0151
954.13	-0.003	193.4	0.0115
954.15	-0.004	193.1	0.0089
954.17	-0.006	192.8	0.0044
954.18	-0.007	192.6	0.0027
954.20	-0.008	192.4	0
954.22	-0.01	192.1	-0.0036
954.23	-0.012	191.8	-0.0036
954.25	-0.012	191.8	-0.0062
954.27	-0.013	191.6	-0.008
954.28	-0.014	191.4	-0.0098
954.30	-0.015	191.2	-0.0115
954.32	-0.016	191	-0.0133
954.33	-0.017	190.8	-0.0151
954.35	-0.017	190.6	-0.0151
954.37	-0.017	190.6	-0.0151
954.38	-0.017	190.5	-0.016
954.40	-0.017	190.4	-0.0169
954.42	-0.017	190.3	-0.0169
954.43	-0.017	190.2	-0.016
954.45	-0.016	190.1	-0.016
954.47	-0.015	190.1	-0.016
954.48	-0.015	190.1	-0.0151
954.50	-0.015	190.1	-0.0142
954.52	-0.014	190.1	-0.0124
954.53	-0.012	190.2	-0.0107
954.55	-0.012	190.2	-0.0089
954.57	-0.01	190.3	-0.0062
954.58	-0.007	190.4	-0.0062
954.60	-0.006	190.4	-0.0044
954.62	-0.006	190.5	-0.0018
954.63	-0.005	190.7	0.0018
954.65	-0.002	190.8	0.0044
954.67	-0.001	191	0.008
954.68	0.001	191.2	0.0115
954.70	0.004	191.5	0.0115
954.72	0.006	191.5	0.0151
954.73	0.006	191.7	0.0186
954.75	0.007	191.9	0.0222
954.77	0.011	192.2	0.0275
954.78	0.012	192.3	0.0302
954.80	0.013	192.6	0.0346
954.82	0.017	192.9	0.0346
954.83	0.017	192.9	0.0391
954.85	0.017	193.1	0.0408
954.87	0.019	193.4	0.0444
954.88	0.022	193.7	0.0479
954.90	0.022	193.9	0.0506
954.92	0.023	194.1	0.0515
954.93	0.025	194.3	0.0541
954.95	0.026	194.5	0.0559
954.97	0.026	194.7	0.0577
954.98	0.027	194.9	0.0577
955.00	0.028	195	0.0595



Prova triassiale ciclica SN04-C1			
pressione di confinamento (kPa)		80	
deviatore ciclico (kPa)		95	
frequenza (hz)		0.00625	
tempo	cella di carico	$\Delta u$	LVDT
(min)	kN	(kPa)	$\delta$ (mm)
955.02	0.028	195	0.0604
955.03	0.028	195.2	0.0612
955.05	0.029	195.4	0.0621
955.07	0.029	195.5	0.0621
955.08	0.029	195.6	0.0621
955.10	0.029	195.7	0.0621
955.12	0.028	195.8	0.0621
955.13	0.028	195.8	0.0621
955.15	0.027	195.8	0.0604
955.17	0.026	195.8	0.0586
955.18	0.025	195.8	0.0577
955.20	0.024	195.8	0.0559
955.22	0.022	195.7	0.0541
955.25	0.02	195.6	0.0541
955.27	0.02	195.6	0.0515
955.28	0.02	195.6	0.0488
955.30	0.018	195.4	0.0462
955.32	0.015	195.2	0.0435
955.32	0.014	195.1	0.0408
955.33	0.012	194.9	0.0373
955.35	0.009	194.7	0.0373
955.37	0.008	194.7	0.0337
955.38	0.008	194.5	0.0311
955.40	0.006	194.3	0.0275
955.42	0.002	194	0.0222
955.43	0.002	193.8	0.0186
955.45	0	193.5	0.0142
955.47	-0.004	193.2	0.0142
955.48	-0.004	193.2	0.0107
955.50	-0.004	193	0.0071
955.52	-0.006	192.7	0.0036
955.53	-0.009	192.4	0
955.55	-0.01	192.2	-0.0027
955.57	-0.011	191.9	-0.0053
955.58	-0.013	191.6	-0.0053
955.60	-0.014	191.6	-0.008
955.62	-0.014	191.3	-0.0107
955.63	-0.015	191.1	-0.0107
955.65	-0.016	191.1	-0.0124
955.67	-0.016	190.9	-0.0133
955.68	-0.017	190.7	-0.0151
955.70	-0.017	190.6	-0.016
955.72	-0.017	190.4	-0.016
955.73	-0.017	190.3	-0.016
955.75	-0.017	190.2	-0.016
955.77	-0.017	190.2	-0.016
955.78	-0.017	190.1	-0.016
955.80	-0.016	190.1	-0.0151
955.82	-0.015	190.1	-0.0142
955.83	-0.015	190.1	-0.0133
955.85	-0.014	190.1	-0.0115
955.87	-0.012	190.2	-0.0115
955.88	-0.011	190.2	-0.0098
955.90	-0.011	190.2	-0.008
955.92	-0.01	190.3	-0.0053
955.93	-0.006	190.4	-0.0027
955.95	-0.006	190.5	-0.0009
955.97	-0.004	190.7	0.0027

Prova triassiale ciclica SN04-C1			
pressione di confinamento (kPa)		80	
deviatore ciclico (kPa)		95	
frequenza (hz)		0.00625	
tempo	cella di carico	$\Delta u$	LVDT
(min)	kN	(kPa)	$\delta$ (mm)
955.98	-0.001	190.9	0.0027
956.00	0	191.1	0.0062
956.02	0	191.1	0.0089
956.03	0.002	191.2	0.0124
956.05	0.005	191.5	0.0169
956.07	0.007	191.7	0.0204
956.08	0.008	191.9	0.024
956.10	0.011	192.2	0.024
956.12	0.013	192.5	0.0293
956.13	0.013	192.5	0.0328
956.15	0.015	192.7	0.0364
956.17	0.017	193	0.0399
956.18	0.019	193.2	0.0426
956.20	0.02	193.4	0.0462
956.22	0.022	193.7	0.0497
956.23	0.024	194	0.0497
956.25	0.024	194	0.0515
956.27	0.024	194.2	0.0541
956.28	0.025	194.4	0.0559
956.30	0.027	194.6	0.0577
956.32	0.027	194.8	0.0595
956.33	0.028	195	0.0604
956.35	0.028	195.1	0.0612
956.37	0.029	195.3	0.0612
956.38	0.029	195.4	0.0621
956.40	0.029	195.6	0.0621
956.42	0.029	195.6	0.0621
956.43	0.029	195.7	0.0621
956.45	0.028	195.8	0.0621
956.47	0.028	195.8	0.0612
956.48	0.027	195.8	0.0604
956.50	0.026	195.8	0.0586
956.52	0.025	195.8	0.0586
956.53	0.023	195.8	0.0577
956.55	0.023	195.8	0.0559
956.57	0.022	195.7	0.0533
956.58	0.02	195.6	0.0506
956.60	0.019	195.5	0.0488
956.62	0.017	195.4	0.0462
956.63	0.014	195.1	0.0462
956.65	0.013	195	0.0426
956.67	0.013	195	0.0399
956.68	0.012	194.8	0.0364
956.72	0.008	194.6	0.0328
956.73	0.007	194.4	0.0302
956.75	0.005	194.2	0.0249
956.77	0.002	193.9	0.0249
956.77	0	193.7	0.0204
956.78	0	193.7	0.0169
956.80	-0.001	193.4	0.0133
956.82	-0.004	193.1	0.0098
956.83	-0.005	192.9	0.0071
956.85	-0.007	192.7	0.0027
956.87	-0.009	192.3	0.0027
956.88	-0.011	192.1	-0.0009
956.90	-0.011	192.1	-0.0036
956.92	-0.012	191.9	-0.0062
956.93	-0.013	191.6	-0.0089

Prova triassiale ciclica SN04-C1			
pressione di confinamento (kPa)		80	
deviatore ciclico (kPa)		95	
frequenza (hz)		0.00625	
tempo	cella di carico	$\Delta u$	LVDT
(min)	kN	(kPa)	$\delta$ (mm)
956.95	-0.015	191.4	-0.0107
956.97	-0.015	191.2	-0.0115
956.98	-0.016	191	-0.0133
957.00	-0.017	190.8	-0.0133
957.02	-0.017	190.8	-0.0142
957.03	-0.017	190.6	-0.0151
957.05	-0.017	190.5	-0.016
957.07	-0.017	190.4	-0.016
957.08	-0.017	190.3	-0.016
957.10	-0.017	190.2	-0.016
957.12	-0.016	190.1	-0.016
957.13	-0.016	190.1	-0.0151
957.15	-0.015	190	-0.0142
957.17	-0.014	190.1	-0.0142
957.18	-0.013	190.1	-0.0133
957.20	-0.013	190.1	-0.0115
957.22	-0.012	190.1	-0.0098
957.23	-0.01	190.2	-0.0071
957.25	-0.009	190.3	-0.0053
957.27	-0.007	190.4	-0.0027
957.28	-0.005	190.6	-0.0027
957.30	-0.003	190.7	0.0009
957.32	-0.003	190.7	0.0036
957.33	-0.002	190.9	0.0062
957.35	0.001	191.2	0.0107
957.37	0.003	191.3	0.0133
957.38	0.004	191.5	0.0178
957.40	0.007	191.8	0.0178
957.42	0.01	192	0.0213
957.43	0.01	192	0.0249
957.45	0.011	192.2	0.0293
957.47	0.013	192.5	0.0328
957.48	0.015	192.8	0.0364
957.50	0.017	193	0.0408
957.52	0.019	193.3	0.0408
957.53	0.021	193.5	0.0444
957.55	0.021	193.5	0.047
957.57	0.022	193.7	0.0497
957.58	0.023	194	0.0524
957.60	0.025	194.2	0.0541
957.62	0.026	194.4	0.0559
957.63	0.027	194.7	0.0559
957.65	0.028	194.8	0.0586
957.67	0.028	194.8	0.0595
957.68	0.028	195	0.0604
957.70	0.028	195.2	0.0612
957.72	0.029	195.3	0.0621
957.73	0.029	195.4	0.0621
957.75	0.029	195.6	0.0621
957.77	0.029	195.7	0.0621
957.78	0.028	195.7	0.0621
957.80	0.027	195.8	0.0612
957.82	0.027	195.8	0.0612
957.83	0.026	195.8	0.0604
957.85	0.026	195.8	0.0586
957.87	0.025	195.8	0.0568
957.88	0.023	195.7	0.055
957.90	0.021	195.7	0.0533

Prova triassiale ciclica SN04-C1			
pressione di confinamento (kPa)		80	
deviatore ciclico (kPa)		95	
frequenza (hz)		0.00625	
tempo	cella di carico	$\Delta u$	LVDT
(min)	kN	(kPa)	$\delta$ (mm)
957.92	0.02	195.6	0.0506
957.93	0.017	195.4	0.0506
957.95	0.016	195.4	0.0479
957.97	0.016	195.3	0.0453
957.98	0.015	195.1	0.0417
958.00	0.012	194.9	0.0382
958.02	0.01	194.8	0.0355
958.03	0.009	194.6	0.0311
958.05	0.005	194.3	0.0311
958.07	0.004	194.3	0.0275
958.08	0.004	194.1	0.024
958.10	0.003	193.9	0.0204
958.12	-0.001	193.5	0.016
958.13	-0.002	193.3	0.0124
958.15	-0.004	193.1	0.008
958.18	-0.007	192.8	0.008
958.20	-0.008	192.5	0.0044
958.22	-0.008	192.5	0.0018
958.23	-0.009	192.3	-0.0018
958.23	-0.011	192	-0.0044
958.25	-0.012	191.8	-0.0062
958.27	-0.013	191.5	-0.0089
958.28	-0.015	191.3	-0.0089
958.30	-0.015	191.1	-0.0115
958.32	-0.015	191.1	-0.0124
958.33	-0.016	190.9	-0.0142
958.35	-0.017	190.7	-0.0151
958.37	-0.017	190.6	-0.016
958.38	-0.017	190.4	-0.016
958.40	-0.017	190.3	-0.016
958.42	-0.017	190.2	-0.016
958.43	-0.017	190.2	-0.016
958.45	-0.017	190.1	-0.016
958.47	-0.016	190.1	-0.0151
958.48	-0.015	190.1	-0.0142
958.50	-0.015	190.1	-0.0133
958.52	-0.014	190.1	-0.0133
958.53	-0.013	190.1	-0.0107
958.55	-0.011	190.1	-0.008
958.57	-0.009	190.3	-0.0062
958.58	-0.007	190.4	-0.0062
958.60	-0.007	190.4	-0.0036
958.62	-0.007	190.4	-0.0018
958.63	-0.005	190.7	0.0018
958.65	-0.002	190.8	0.0053
958.67	-0.001	191	0.0089
958.68	0.002	191.2	0.0124
958.70	0.004	191.4	0.0124
958.72	0.005	191.4	0.0151
958.73	0.005	191.6	0.0186
958.75	0.007	191.9	0.0231
958.77	0.011	192.2	0.0275
958.78	0.012	192.3	0.0311
958.80	0.014	192.6	0.0355
958.82	0.017	192.9	0.0355
958.83	0.017	192.9	0.0382
958.85	0.017	193.1	0.0417
958.87	0.019	193.4	0.0444

Prova triassiale ciclica SN04-C1			
pressione di confinamento (kPa)		80	
deviatore ciclico (kPa)		95	
frequenza (hz)		0.00625	
tempo	cella di carico	$\Delta u$	LVDT
(min)	kN	(kPa)	$\delta$ (mm)
958.88	0.022	193.6	0.0479
958.90	0.022	193.8	0.0506
958.92	0.023	194.1	0.0524
958.93	0.026	194.3	0.0524
958.95	0.026	194.3	0.0559
958.97	0.026	194.5	0.0568
958.98	0.027	194.7	0.0586
959.00	0.028	194.9	0.0604
959.02	0.028	195.1	0.0612
959.03	0.028	195.2	0.0621
959.05	0.029	195.4	0.0621
959.07	0.029	195.4	0.0621
959.08	0.029	195.5	0.0621
959.10	0.029	195.6	0.0621
959.12	0.028	195.7	0.0621
959.13	0.028	195.8	0.0612
959.15	0.027	195.8	0.0604
959.17	0.026	195.8	0.0604
959.18	0.024	195.8	0.0586
959.20	0.024	195.8	0.0568
959.22	0.024	195.7	0.055
959.23	0.021	195.6	0.0533
959.25	0.02	195.5	0.0515
959.27	0.02	195.5	0.0497
959.28	0.017	195.3	0.0462
959.30	0.015	195.2	0.0444
959.32	0.014	195.1	0.0408
959.33	0.011	194.8	0.0408
959.35	0.009	194.6	0.0373
959.37	0.009	194.6	0.0346
959.38	0.008	194.5	0.0302
959.40	0.005	194.2	0.0257
959.42	0.003	194	0.0222
959.43	0.002	193.8	0.0186
959.45	-0.001	193.4	0.0186
959.47	-0.003	193.2	0.0142
959.48	-0.003	193.2	0.0107
959.50	-0.005	193	0.0071
959.52	-0.007	192.7	0.0036
959.53	-0.009	192.4	0
959.55	-0.01	192.2	-0.0018
959.57	-0.011	191.9	-0.0053
959.58	-0.013	191.6	-0.0053
959.62	-0.013	191.6	-0.008
959.63	-0.014	191.4	-0.0098
959.65	-0.015	191.2	-0.0115
959.67	-0.016	191	-0.0133
959.68	-0.016	190.8	-0.0142
959.68	-0.017	190.6	-0.0151
959.70	-0.017	190.5	-0.0151
959.72	-0.017	190.5	-0.016
959.73	-0.017	190.4	-0.016
959.75	-0.017	190.3	-0.016
959.77	-0.017	190.2	-0.016
959.78	-0.016	190.1	-0.0151
959.80	-0.016	190.1	-0.0151
959.82	-0.015	190.1	-0.0151
959.83	-0.014	190.1	-0.0142

Prova triassiale ciclica SN04-C1			
pressione di confinamento (kPa)		80	
deviatore ciclico (kPa)		95	
frequenza (hz)		0.00625	
tempo	cella di carico	$\Delta u$	LVDT
(min)	kN	(kPa)	$\delta$ (mm)
959.85	-0.014	190	-0.0124
959.87	-0.013	190.1	-0.0107
959.88	-0.011	190.2	-0.0089
959.90	-0.01	190.2	-0.0071
959.92	-0.009	190.3	-0.0044
959.93	-0.006	190.4	-0.0044
959.95	-0.005	190.4	-0.0018
959.97	-0.005	190.6	0.0009
959.98	-0.001	190.9	0.0044
960.00	0	190.9	0.0062
960.02	0	191	0.0098
960.03	0.002	191.2	0.0133
960.05	0.006	191.5	0.0169
960.07	0.007	191.7	0.0204
960.08	0.008	191.9	0.024
960.10	0.012	192.2	0.024
960.12	0.013	192.2	0.0293
960.13	0.013	192.4	0.032
960.15	0.014	192.7	0.0364
960.17	0.017	192.9	0.0399
960.18	0.019	193.2	0.0426
960.20	0.02	193.4	0.0462
960.22	0.022	193.7	0.0462
960.23	0.023	193.7	0.0497
960.25	0.023	193.9	0.0515
960.27	0.024	194.1	0.0541
960.28	0.026	194.4	0.0568
960.30	0.027	194.6	0.0577
960.32	0.027	194.8	0.0604
960.33	0.028	194.9	0.0604
960.35	0.029	195.1	0.0604
960.37	0.029	195.1	0.0612
960.38	0.029	195.2	0.0621
960.40	0.029	195.4	0.0621
960.42	0.029	195.5	0.0621
960.43	0.028	195.6	0.0621
960.45	0.028	195.7	0.0621
960.47	0.027	195.7	0.0621
960.48	0.027	195.7	0.0612
960.50	0.026	195.8	0.0595
960.52	0.025	195.8	0.0586
960.53	0.024	195.7	0.0568
960.55	0.023	195.7	0.055
960.57	0.021	195.6	0.055
960.58	0.019	195.5	0.0524
960.60	0.019	195.5	0.0506
960.62	0.018	195.4	0.047
960.63	0.016	195.1	0.0435
960.65	0.013	195	0.0417
960.67	0.012	194.9	0.0382
960.68	0.01	194.6	0.0337
960.70	0.007	194.4	0.0311
960.72	0.007	194.3	0.0293
960.73	0.005	194	0.0249
960.75	0.002	193.8	0.0249
960.77	0.001	193.8	0.0213
960.78	0.001	193.6	0.0178
960.80	-0.001	193.3	0.0133

Prova triassiale ciclica SN04-C1			
pressione di confinamento (kPa)		80	
deviatore ciclico (kPa)		95	
frequenza (hz)		0.00625	
tempo	cella di carico	$\Delta u$	LVDT
(min)	kN	(kPa)	$\delta$ (mm)
960.82	-0.004	193	0.0098
960.83	-0.005	192.8	0.0062
960.85	-0.007	192.5	0.0027
960.87	-0.01	192.2	0.0027
960.88	-0.01	192.2	-0.0009
960.90	-0.01	192	-0.0027
960.92	-0.012	191.7	-0.0062
960.93	-0.014	191.5	-0.008
960.95	-0.014	191.3	-0.0098
960.97	-0.015	191.1	-0.0124
960.98	-0.017	190.9	-0.0124
961.00	-0.016	190.9	-0.0133
961.02	-0.016	190.7	-0.0142
961.03	-0.017	190.6	-0.0151
961.05	-0.017	190.4	-0.016
961.08	-0.017	190.3	-0.016
961.10	-0.017	190.2	-0.016
961.12	-0.017	190.1	-0.016
961.13	-0.016	190.1	-0.016
961.13	-0.016	190.1	-0.0151
961.15	-0.016	190.1	-0.0133
961.17	-0.014	190.1	-0.0124
961.18	-0.013	190.1	-0.0115
961.20	-0.012	190.1	-0.0098
961.22	-0.011	190.2	-0.0098
961.23	-0.009	190.2	-0.008
961.25	-0.009	190.2	-0.0062
961.27	-0.008	190.3	-0.0027
961.28	-0.005	190.5	0
961.30	-0.004	190.6	0.0027
961.32	-0.003	190.8	0.0053
961.33	0.001	191	0.0053
961.35	0.002	191.2	0.0098
961.37	0.002	191.2	0.0124
961.38	0.003	191.4	0.016
961.40	0.007	191.7	0.0204
961.42	0.009	191.9	0.024
961.43	0.01	192.1	0.0284
961.45	0.011	192.3	0.0302
961.47	0.014	192.5	0.0337
961.48	0.015	192.7	0.0382
961.50	0.017	193	0.0417
961.52	0.02	193.3	0.0417
961.53	0.02	193.3	0.0453
961.55	0.021	193.5	0.0479
961.57	0.022	193.8	0.0506
961.58	0.024	194	0.0533
961.60	0.024	194.2	0.055
961.62	0.026	194.5	0.0568
961.63	0.027	194.7	0.0568
961.65	0.027	194.7	0.0586
961.67	0.027	194.8	0.0595
961.68	0.028	195	0.0612
961.70	0.029	195.2	0.0621
961.72	0.029	195.3	0.0621
961.73	0.029	195.4	0.063
961.75	0.029	195.6	0.063
961.77	0.028	195.6	0.063

Prova triassiale ciclica SN04-C1			
pressione di confinamento (kPa)		80	
deviatore ciclico (kPa)		95	
frequenza (hz)		0.00625	
tempo	cella di carico	$\Delta u$	LVDT
(min)	kN	(kPa)	$\delta$ (mm)
961.78	0.028	195.7	0.0621
961.80	0.028	195.7	0.0621
961.82	0.027	195.8	0.0612
961.83	0.026	195.8	0.0595
961.85	0.025	195.7	0.0577
961.87	0.023	195.7	0.0577
961.88	0.022	195.7	0.055
961.90	0.022	195.7	0.0541
961.92	0.021	195.5	0.0515
961.93	0.018	195.4	0.0488
961.95	0.017	195.3	0.047
961.97	0.016	195.1	0.0435
961.98	0.012	194.9	0.0435
962.00	0.011	194.9	0.0399
962.02	0.011	194.8	0.0373
962.03	0.01	194.5	0.0337
962.05	0.006	194.3	0.0293
962.07	0.005	194.2	0.0257
962.08	0.003	193.9	0.0222
962.10	0	193.6	0.0222
962.12	-0.001	193.6	0.0178
962.13	-0.001	193.4	0.0142
962.15	-0.005	192.9	0.0107
962.17	-0.006	192.9	0.0089
962.18	-0.006	192.7	0.0053
962.20	-0.007	192.4	0.0018
962.22	-0.011	192.1	-0.0018
962.23	-0.011	191.9	-0.0036
962.25	-0.012	191.7	-0.0062
962.27	-0.014	191.4	-0.0062
962.28	-0.015	191.2	-0.0089
962.30	-0.015	191.2	-0.0107
962.32	-0.015	191	-0.0124
962.33	-0.016	190.8	-0.0133
962.35	-0.017	190.6	-0.0142
962.37	-0.017	190.5	-0.0151
962.38	-0.017	190.4	-0.0151
962.40	-0.017	190.2	-0.016
962.42	-0.017	190.2	-0.016
962.43	-0.017	190.1	-0.016
962.45	-0.017	190.1	-0.0151
962.47	-0.016	190	-0.0151
962.48	-0.015	190	-0.0133
962.52	-0.014	190	-0.0124
962.53	-0.013	190.1	-0.0124
962.55	-0.012	190.1	-0.0107
962.57	-0.012	190.1	-0.0089
962.58	-0.011	190.2	-0.0071
962.58	-0.008	190.3	-0.0044
962.60	-0.007	190.3	-0.0027
962.62	-0.006	190.5	0.0009
962.63	-0.003	190.7	0.0009
962.65	-0.002	190.7	0.0036
962.67	-0.002	190.8	0.0071
962.68	0	191.1	0.0107
962.70	0.004	191.3	0.0142
962.72	0.005	191.5	0.0178
962.73	0.006	191.7	0.0213



Prova triassiale ciclica SN04-C1			
pressione di confinamento (kPa)		80	
deviatore ciclico (kPa)		95	
frequenza (hz)		0.00625	
tempo	cella di carico	$\Delta u$	LVDT
(min)	kN	(kPa)	$\delta$ (mm)
962.75	0.01	192	0.0213
962.77	0.011	192	0.0257
962.78	0.011	192.1	0.0293
962.80	0.013	192.5	0.0337
962.82	0.016	192.7	0.0373
962.83	0.017	192.9	0.0399
962.85	0.018	193.2	0.0435
962.87	0.021	193.5	0.0435
962.88	0.022	193.7	0.0488
962.90	0.022	193.9	0.0515
962.92	0.024	194.1	0.0515
962.93	0.025	194.1	0.0533
962.95	0.025	194.3	0.055
962.97	0.026	194.6	0.0577
962.98	0.028	194.8	0.0595
963.00	0.028	194.9	0.0604
963.02	0.028	195.1	0.0612
963.03	0.029	195.2	0.0612
963.05	0.029	195.2	0.0621
963.07	0.029	195.4	0.0621
963.08	0.029	195.5	0.063
963.10	0.029	195.6	0.0621
963.12	0.028	195.7	0.0621
963.13	0.027	195.7	0.0612
963.15	0.027	195.7	0.0612
963.17	0.025	195.7	0.0604
963.18	0.025	195.8	0.0586
963.20	0.024	195.8	0.0568
963.22	0.023	195.7	0.055
963.23	0.022	195.6	0.0533
963.25	0.02	195.5	0.0506
963.27	0.018	195.4	0.0506
963.28	0.016	195.2	0.0479
963.30	0.016	195.2	0.0453
963.32	0.015	195.1	0.0417
963.33	0.012	194.9	0.0391
963.35	0.01	194.7	0.0355
963.37	0.009	194.5	0.0328
963.38	0.006	194.3	0.0328
963.40	0.004	194.1	0.0284
963.42	0.004	194.1	0.0249
963.43	0.002	193.8	0.0204
963.45	0	193.5	0.016
963.47	-0.003	193.3	0.0124
963.48	-0.003	193	0.0089
963.50	-0.006	192.7	0.0089
963.52	-0.008	192.5	0.0053
963.53	-0.008	192.5	0.0018
963.55	-0.009	192.3	-0.0009
963.57	-0.011	191.9	-0.0036
963.58	-0.012	191.7	-0.0062
963.60	-0.013	191.5	-0.0089
963.62	-0.015	191.2	-0.0115
963.63	-0.015	191	-0.0124
963.65	-0.016	190.9	-0.0133
963.67	-0.016	190.7	-0.0142
963.68	-0.017	190.5	-0.0142
963.70	-0.017	190.5	-0.0151

Prova triassiale ciclica SN04-C1			
pressione di confinamento (kPa)		80	
deviatore ciclico (kPa)		95	
frequenza (hz)		0.00625	
tempo	cella di carico	$\Delta u$	LVDT
(min)	kN	(kPa)	$\delta$ (mm)
963.72	-0.017	190.4	-0.0151
963.73	-0.017	190.3	-0.016
963.75	-0.017	190.2	-0.016
963.77	-0.017	190.1	-0.016
963.78	-0.016	190	-0.0151
963.80	-0.016	190	-0.0151
963.82	-0.015	190	-0.0142
963.83	-0.015	190	-0.0133
963.85	-0.014	190	-0.0124
963.87	-0.012	190	-0.0107
963.88	-0.011	190.1	-0.0089
963.90	-0.01	190.2	-0.0062
963.92	-0.007	190.3	-0.0062
963.93	-0.006	190.3	-0.0036
963.95	-0.006	190.4	-0.0018
963.98	-0.005	190.5	0.0018
964.00	-0.002	190.7	0.0053
964.02	-0.001	190.9	0.008
964.03	0.001	191.1	0.0115
964.03	0.005	191.3	0.0115
964.05	0.005	191.3	0.016
964.07	0.005	191.5	0.0186
964.08	0.007	191.7	0.0231
964.10	0.011	192.1	0.0284
964.12	0.012	192.2	0.0302
964.13	0.013	192.5	0.0346
964.15	0.017	192.8	0.0346
964.17	0.018	193	0.0391
964.18	0.018	193	0.0417
964.20	0.019	193.2	0.0453
964.22	0.021	193.6	0.0479
964.23	0.023	193.8	0.0506
964.25	0.023	194	0.0533
964.27	0.025	194.2	0.0533
964.28	0.027	194.4	0.055
964.30	0.027	194.4	0.0577
964.32	0.027	194.6	0.0586
964.33	0.028	195	0.0604
964.35	0.028	195	0.0604
964.37	0.028	195.1	0.0612
964.38	0.028	195.2	0.0621
964.40	0.029	195.4	0.063
964.42	0.029	195.5	0.063
964.43	0.029	195.6	0.063
964.45	0.028	195.7	0.063
964.47	0.028	195.7	0.0621
964.48	0.027	195.7	0.0604
964.50	0.026	195.7	0.0595
964.52	0.025	195.7	0.0577
964.53	0.024	195.7	0.0568
964.55	0.023	195.6	0.0541
964.57	0.02	195.5	0.0541
964.58	0.02	195.5	0.0524
964.60	0.02	195.5	0.0506
964.62	0.018	195.3	0.047
964.63	0.015	195.1	0.0435
964.65	0.014	195	0.0417
964.67	0.012	194.8	0.0373

Prova triassiale ciclica SN04-C1			
pressione di confinamento (kPa)		80	
deviatore ciclico (kPa)		95	
frequenza (hz)		0.00625	
tempo	cella di carico	$\Delta u$	LVDT
(min)	kN	(kPa)	$\delta$ (mm)
964.68	0.009	194.5	0.0373
964.70	0.008	194.5	0.0337
964.72	0.008	194.4	0.0311
964.73	0.006	194.1	0.0275
964.75	0.002	193.9	0.0222
964.77	0.002	193.7	0.0195
964.78	0	193.4	0.0151
964.80	-0.004	193.1	0.0151
964.82	-0.005	193.1	0.0107
964.83	-0.005	192.9	0.008
964.85	-0.006	192.6	0.0044
964.87	-0.009	192.3	0.0009
964.88	-0.01	192.1	-0.0018
964.90	-0.011	191.8	-0.0044
964.92	-0.013	191.6	-0.0044
964.93	-0.014	191.6	-0.008
964.95	-0.014	191.4	-0.0089
964.97	-0.015	191.2	-0.0115
964.98	-0.016	190.9	-0.0133
965.00	-0.016	190.8	-0.0133
965.02	-0.017	190.6	-0.0151
965.03	-0.017	190.4	-0.0151
965.05	-0.017	190.4	-0.016
965.07	-0.017	190.2	-0.016
965.08	-0.017	190.1	-0.016
965.10	-0.017	190.1	-0.016
965.12	-0.017	190	-0.0151
965.13	-0.016	190	-0.0151
965.15	-0.015	190	-0.0142
965.17	-0.014	190	-0.0124
965.18	-0.014	190	-0.0115
965.20	-0.011	190	-0.0115
965.22	-0.011	190	-0.0098
965.23	-0.011	190.1	-0.008
965.25	-0.01	190.2	-0.0053
965.27	-0.007	190.3	-0.0027
965.28	-0.006	190.4	-0.0009
965.30	-0.004	190.6	0.0027
965.32	-0.001	190.8	0.0027
965.33	0.001	191	0.0062
965.35	0.001	191	0.0098
965.37	0.002	191.1	0.0133
965.38	0.005	191.4	0.0169
965.40	0.007	191.6	0.0204
965.42	0.008	191.8	0.024
965.45	0.011	192.2	0.024
965.47	0.013	192.4	0.0293
965.48	0.013	192.4	0.0328
965.48	0.014	192.6	0.0364
965.50	0.016	192.9	0.0399
965.52	0.019	193.1	0.0435
965.53	0.02	193.3	0.0462
965.55	0.022	193.6	0.0497
965.57	0.024	193.9	0.0497
965.58	0.024	193.9	0.0515
965.60	0.024	194	0.0533
965.62	0.025	194.3	0.0559
965.63	0.027	194.5	0.0586

Prova triassiale ciclica SN04-C1			
pressione di confinamento (kPa)		80	
deviatore ciclico (kPa)		95	
frequenza (hz)		0.00625	
tempo	cella di carico	$\Delta u$	LVDT
(min)	kN	(kPa)	$\delta$ (mm)
965.65	0.027	194.7	0.0595
965.67	0.028	194.9	0.0604
965.68	0.028	195	0.0604
965.70	0.029	195	0.0612
965.72	0.029	195.2	0.0621
965.73	0.029	195.3	0.0621
965.75	0.029	195.4	0.0621
965.77	0.029	195.6	0.0621
965.78	0.028	195.7	0.0621
965.80	0.028	195.7	0.0612
965.82	0.027	195.7	0.0604
965.83	0.026	195.8	0.0595
965.85	0.024	195.7	0.0595
965.87	0.023	195.7	0.0577
965.88	0.023	195.7	0.0559
965.90	0.023	195.6	0.0541
965.92	0.02	195.5	0.0515
965.93	0.019	195.4	0.0488
965.95	0.017	195.2	0.0462
965.97	0.014	195	0.0462
965.98	0.013	194.9	0.0426
966.00	0.013	194.9	0.0408
966.02	0.012	194.8	0.0364
966.03	0.008	194.5	0.0328
966.05	0.006	194.3	0.0302
966.07	0.006	194.1	0.0257
966.08	0.002	193.8	0.0257
966.10	0	193.6	0.0213
966.12	0	193.6	0.0178
966.13	-0.001	193.4	0.0133
966.15	-0.004	193	0.0098
966.17	-0.005	192.8	0.0062
966.18	-0.007	192.6	0.0027
966.20	-0.009	192.2	0.0027
966.22	-0.011	192	-0.0009
966.23	-0.011	192	-0.0036
966.25	-0.011	191.8	-0.0053
966.27	-0.013	191.5	-0.008
966.28	-0.015	191.3	-0.0098
966.30	-0.015	191.1	-0.0115
966.32	-0.016	190.9	-0.0133
966.33	-0.017	190.7	-0.0133
966.35	-0.017	190.7	-0.0142
966.37	-0.017	190.5	-0.0151
966.38	-0.017	190.4	-0.0151
966.40	-0.017	190.3	-0.016
966.42	-0.017	190.2	-0.016
966.43	-0.017	190.1	-0.016
966.45	-0.016	190	-0.016
966.47	-0.016	190	-0.0151
966.48	-0.016	190	-0.0142
966.50	-0.014	190	-0.0124
966.52	-0.013	190	-0.0115
966.53	-0.013	190	-0.0107
966.55	-0.012	190.1	-0.0089
966.57	-0.01	190.2	-0.0071
966.58	-0.009	190.2	-0.0044
966.60	-0.007	190.4	-0.0027

Prova triassiale ciclica SN04-C1			
pressione di confinamento (kPa)		80	
deviatore ciclico (kPa)		95	
frequenza (hz)		0.00625	
tempo	cella di carico	$\Delta u$	LVDT
(min)	kN	(kPa)	$\delta$ (mm)
966.62	-0.004	190.5	-0.0027
966.63	-0.004	190.5	0.0009
966.65	-0.004	190.6	0.0036
966.67	-0.002	190.9	0.0071
966.68	0.002	191.1	0.0115
966.70	0.003	191.2	0.0142
966.72	0.004	191.5	0.0178
966.73	0.008	191.7	0.0178
966.75	0.009	191.7	0.0222
966.77	0.009	191.9	0.0249
966.78	0.011	192.2	0.0302
966.80	0.014	192.5	0.0346
966.82	0.015	192.7	0.0373
966.83	0.017	193	0.0408
966.85	0.02	193.2	0.0408
966.88	0.021	193.2	0.0444
966.90	0.021	193.4	0.047
966.92	0.022	193.7	0.0497
966.93	0.024	193.9	0.0533
966.95	0.025	194.1	0.055
966.95	0.026	194.4	0.0568
966.97	0.027	194.6	0.0568
966.98	0.027	194.6	0.0586
967.00	0.027	194.7	0.0595
967.02	0.028	194.9	0.0604
967.03	0.029	195.1	0.0621
967.05	0.029	195.2	0.0621
967.07	0.029	195.3	0.0621
967.08	0.029	195.4	0.0621
967.10	0.028	195.6	0.0621
967.12	0.028	195.6	0.0621
967.13	0.028	195.7	0.0612
967.15	0.027	195.7	0.0604
967.17	0.026	195.7	0.0595
967.18	0.025	195.7	0.0577
967.20	0.024	195.6	0.0577
967.22	0.022	195.6	0.0559
967.23	0.021	195.5	0.0533
967.25	0.02	195.4	0.0506
967.27	0.017	195.3	0.0506
967.28	0.016	195.3	0.0479
967.30	0.016	195.2	0.0453
967.32	0.015	195	0.0417
967.33	0.011	194.8	0.0382
967.35	0.011	194.6	0.0355
967.37	0.008	194.4	0.032
967.38	0.005	194.2	0.032
967.40	0.004	194.2	0.0275
967.42	0.004	194	0.024
967.43	0.002	193.7	0.0195
967.45	-0.001	193.4	0.016
967.47	-0.002	193.2	0.0124
967.48	-0.004	192.9	0.008
967.50	-0.007	192.6	0.008
967.52	-0.007	192.6	0.0053
967.53	-0.007	192.4	0.0018
967.55	-0.009	192.1	-0.0018
967.57	-0.012	191.8	-0.0044

Prova triassiale ciclica SN04-C1			
pressione di confinamento (kPa)		80	
deviatore ciclico (kPa)		95	
frequenza (hz)		0.00625	
tempo	cella di carico	$\Delta u$	LVDT
(min)	kN	(kPa)	$\delta$ (mm)
967.58	-0.012	191.6	-0.0062
967.60	-0.013	191.4	-0.008
967.62	-0.015	191.2	-0.008
967.63	-0.015	191.2	-0.0107
967.65	-0.015	191	-0.0115
967.67	-0.016	190.8	-0.0133
967.68	-0.017	190.6	-0.0151
967.70	-0.017	190.5	-0.0151
967.72	-0.017	190.3	-0.016
967.73	-0.017	190.2	-0.016
967.75	-0.017	190.2	-0.016
967.77	-0.017	190.1	-0.016
967.78	-0.017	190	-0.0151
967.80	-0.016	190	-0.0142
967.82	-0.015	190	-0.0133
967.83	-0.015	190	-0.0124
967.85	-0.013	190	-0.0124
967.87	-0.012	190	-0.0107
967.88	-0.012	190	-0.0089
967.90	-0.011	190.1	-0.0071
967.92	-0.008	190.2	-0.0044
967.93	-0.007	190.3	-0.0027
967.95	-0.006	190.5	0.0009
967.97	-0.003	190.7	0.0036
967.98	-0.002	190.7	0.0053
968.00	-0.001	190.9	0.0089
968.02	0.003	191.2	0.0089
968.03	0.004	191.2	0.0124
968.05	0.004	191.3	0.0151
968.07	0.005	191.5	0.0195
968.08	0.009	191.8	0.024
968.10	0.01	192	0.0275
968.12	0.012	192.2	0.032
968.13	0.015	192.6	0.032
968.15	0.016	192.7	0.0355
968.17	0.016	192.7	0.0382
968.18	0.017	193	0.0426
968.20	0.02	193.3	0.0462
968.22	0.021	193.5	0.0479
968.23	0.022	193.7	0.0515
968.25	0.024	194	0.0515
968.27	0.025	194.2	0.0541
968.28	0.025	194.2	0.0559
968.30	0.026	194.4	0.0577
968.32	0.027	194.6	0.0595
968.35	0.028	194.8	0.0604
968.37	0.028	195	0.0612
968.38	0.028	195.1	0.0612
968.40	0.029	195.2	0.0621
968.40	0.029	195.2	0.0621
968.42	0.029	195.4	0.063
968.43	0.029	195.5	0.063
968.45	0.028	195.6	0.0621
968.47	0.028	195.7	0.0612
968.48	0.027	195.7	0.0604
968.50	0.025	195.7	0.0604
968.52	0.025	195.7	0.0586
968.53	0.025	195.7	0.0577

Prova triassiale ciclica SN04-C1			
pressione di confinamento (kPa)		80	
deviatore ciclico (kPa)		95	
frequenza (hz)		0.00625	
tempo	cella di carico	$\Delta u$	LVDT
(min)	kN	(kPa)	$\delta$ (mm)
968.55	0.024	195.6	0.0559
968.57	0.021	195.5	0.0533
968.58	0.02	195.4	0.0515
968.60	0.019	195.2	0.0479
968.62	0.015	195.1	0.0479
968.63	0.015	195.1	0.0453
968.65	0.015	195	0.0435
968.67	0.013	194.8	0.0391
968.68	0.01	194.6	0.0355
968.70	0.009	194.4	0.032
968.72	0.008	194.3	0.0302
968.73	0.005	194	0.0257
968.75	0.003	193.9	0.0222
968.77	0.002	193.6	0.0186
968.78	-0.002	193.3	0.0186
968.80	-0.003	193.3	0.0142
968.82	-0.003	193.1	0.0115
968.83	-0.004	192.8	0.008
968.85	-0.007	192.5	0.0036
968.87	-0.009	192.3	0.0009
968.88	-0.01	192	-0.0018
968.90	-0.012	191.8	-0.0018
968.92	-0.013	191.6	-0.0053
968.93	-0.013	191.6	-0.0071
968.95	-0.014	191.3	-0.0089
968.97	-0.015	191.1	-0.0115
968.98	-0.016	190.9	-0.0124
969.00	-0.016	190.7	-0.0133
969.02	-0.017	190.5	-0.0133
969.03	-0.017	190.4	-0.0142
969.05	-0.017	190.4	-0.0151
969.07	-0.017	190.3	-0.016
969.08	-0.018	190.2	-0.016
969.10	-0.017	190.1	-0.0151
969.12	-0.016	190	-0.0151
969.13	-0.016	190	-0.0151
969.15	-0.015	190	-0.0142
969.17	-0.015	190	-0.0133
969.18	-0.014	190	-0.0115
969.20	-0.013	190	-0.0107
969.22	-0.011	190.1	-0.0089
969.23	-0.01	190.1	-0.0062
969.25	-0.008	190.3	-0.0062
969.27	-0.006	190.4	-0.0036
969.28	-0.006	190.4	-0.0018
969.30	-0.005	190.5	0.0018
969.32	-0.002	190.7	0.0053
969.33	0	190.9	0.008
969.35	0.001	191	0.0115
969.37	0.004	191.3	0.016
969.38	0.006	191.5	0.016
969.40	0.006	191.5	0.0186
969.42	0.009	191.9	0.0249
969.43	0.011	192.1	0.0249
969.45	0.011	192.1	0.0284
969.47	0.012	192.3	0.0337
969.48	0.015	192.7	0.0382
969.50	0.018	192.9	0.0408

Prova triassiale ciclica SN04-C1			
pressione di confinamento (kPa)		80	
deviatore ciclico (kPa)		95	
frequenza (hz)		0.00625	
tempo	cella di carico	$\Delta u$	LVDT
(min)	kN	(kPa)	$\delta$ (mm)
969.52	0.018	193.1	0.0435
969.53	0.02	193.4	0.0462
969.55	0.022	193.6	0.0462
969.57	0.023	193.6	0.0497
969.58	0.023	193.8	0.0524
969.60	0.024	194.1	0.055
969.62	0.026	194.3	0.0568
969.63	0.026	194.5	0.0586
969.65	0.027	194.7	0.0595
969.67	0.028	194.9	0.0595
969.68	0.028	194.9	0.0612
969.70	0.028	195	0.0612
969.72	0.029	195.2	0.0621
969.73	0.029	195.3	0.0621
969.75	0.029	195.4	0.063
969.78	0.029	195.5	0.063
969.80	0.028	195.6	0.063
969.82	0.027	195.6	0.0621
969.83	0.027	195.7	0.0612
969.85	0.026	195.7	0.0595
969.85	0.025	195.6	0.0586
969.87	0.024	195.6	0.0568
969.88	0.023	195.6	0.055
969.90	0.02	195.4	0.055
969.92	0.019	195.4	0.0524
969.93	0.019	195.4	0.0506
969.95	0.018	195.2	0.0479
969.97	0.015	195.1	0.0444
969.98	0.014	194.9	0.0417
970.00	0.012	194.8	0.0382
970.02	0.009	194.5	0.0382
970.03	0.007	194.3	0.0346
970.05	0.007	194.3	0.032
970.07	0.006	194.2	0.0275
970.08	0.003	193.9	0.0231
970.10	0.001	193.7	0.0195
970.12	0	193.4	0.0151
970.13	-0.003	193.1	0.0151
970.15	-0.005	192.8	0.008
970.17	-0.005	192.7	0.0062
970.18	-0.007	192.4	0.0062
970.20	-0.009	192.1	0.0027
970.22	-0.009	192.1	-0.0009
970.23	-0.01	191.9	-0.0036
970.25	-0.012	191.6	-0.0062
970.27	-0.014	191.4	-0.008
970.28	-0.014	191.2	-0.0098
970.30	-0.015	190.9	-0.0115
970.32	-0.016	190.7	-0.0115
970.33	-0.016	190.7	-0.0133
970.35	-0.016	190.6	-0.0142
970.37	-0.017	190.4	-0.0151
970.38	-0.017	190.3	-0.016
970.40	-0.017	190.2	-0.016
970.42	-0.017	190.1	-0.016
970.43	-0.017	190	-0.016
970.45	-0.016	190	-0.016
970.47	-0.016	189.9	-0.0151



Prova triassiale ciclica SN04-C1			
pressione di confinamento (kPa)		80	
deviatore ciclico (kPa)		95	
frequenza (hz)		0.00625	
tempo	cella di carico	$\Delta u$	LVDT
(min)	kN	(kPa)	$\delta$ (mm)
970.48	-0.016	189.9	-0.0133
970.50	-0.014	189.9	-0.0124
970.52	-0.013	189.9	-0.0115
970.53	-0.013	190	-0.0098
970.55	-0.011	190	-0.0098
970.57	-0.009	190	-0.008
970.58	-0.009	190.1	-0.0053
970.60	-0.008	190.2	-0.0036
970.62	-0.005	190.4	0
970.63	-0.004	190.5	0.0027
970.65	-0.003	190.7	0.0062
970.67	0.001	190.9	0.0062
970.68	0.002	190.9	0.0098
970.70	0.002	191	0.0133
970.72	0.004	191.3	0.0169
970.73	0.008	191.6	0.0213
970.75	0.008	191.7	0.024
970.77	0.01	192	0.0293
970.78	0.013	192.3	0.0293
970.80	0.014	192.3	0.0328
970.82	0.014	192.5	0.0355
970.83	0.016	192.7	0.0399
970.85	0.019	193	0.0435
970.87	0.02	193.3	0.0462
970.88	0.02	193.4	0.0479
970.90	0.023	193.7	0.0506
970.92	0.023	193.9	0.0524
970.93	0.025	194.1	0.055
970.95	0.026	194.4	0.055
970.97	0.027	194.6	0.0577
970.98	0.027	194.6	0.0586
971.00	0.027	194.7	0.0604
971.02	0.028	194.9	0.0612
971.03	0.029	195.1	0.0621
971.05	0.029	195.2	0.0621
971.07	0.029	195.3	0.0621
971.08	0.029	195.4	0.0621
971.10	0.029	195.4	0.0621
971.12	0.028	195.6	0.0621
971.13	0.028	195.6	0.0612
971.15	0.027	195.6	0.0604
971.17	0.026	195.7	0.0586
971.18	0.025	195.6	0.0586
971.20	0.023	195.6	0.0568
971.22	0.023	195.6	0.0559
971.25	0.023	195.5	0.0541
971.27	0.02	195.4	0.0515
971.28	0.018	195.3	0.0488
971.30	0.017	195.2	0.0453
971.30	0.014	195	0.0453
971.32	0.013	194.8	0.0426
971.33	0.013	194.8	0.0399
971.35	0.011	194.7	0.0373
971.37	0.009	194.4	0.0328
971.38	0.006	194.2	0.0293
971.40	0.005	194	0.0249
971.42	0.003	193.7	0.0213
971.43	0	193.5	0.0213

Prova triassiale ciclica SN04-C1			
pressione di confinamento (kPa)		80	
deviatore ciclico (kPa)		95	
frequenza (hz)		0.00625	
tempo	cella di carico	$\Delta u$	LVDT
(min)	kN	(kPa)	$\delta$ (mm)
971.45	0	193.5	0.0178
971.47	-0.001	193.3	0.0142
971.48	-0.003	192.9	0.0098
971.50	-0.006	192.7	0.0062
971.52	-0.007	192.5	0.0027
971.53	-0.009	192.1	0
971.55	-0.011	191.9	0
971.57	-0.011	191.9	-0.0027
971.58	-0.011	191.7	-0.0053
971.60	-0.014	191.2	-0.008
971.62	-0.015	191.2	-0.0098
971.63	-0.015	191	-0.0107
971.65	-0.015	190.8	-0.0124
971.67	-0.017	190.6	-0.0142
971.68	-0.017	190.5	-0.0142
971.70	-0.017	190.3	-0.0151
971.72	-0.017	190.2	-0.0151
971.73	-0.017	190.2	-0.016
971.75	-0.017	190.1	-0.016
971.77	-0.017	190	-0.0151
971.78	-0.016	189.9	-0.0151
971.80	-0.016	189.9	-0.0142
971.82	-0.015	189.9	-0.0133
971.83	-0.014	189.9	-0.0133
971.85	-0.013	189.9	-0.0124
971.87	-0.013	189.9	-0.0107
971.88	-0.012	190	-0.0089
971.90	-0.01	190.1	-0.0062
971.92	-0.009	190.1	-0.0044
971.93	-0.007	190.3	-0.0018
971.95	-0.004	190.4	-0.0018
971.97	-0.003	190.4	0.0018
971.98	-0.003	190.5	0.0036
972.00	-0.002	190.8	0.0071
972.02	0.002	190.9	0.0115
972.03	0.003	191.1	0.0142
972.05	0.004	191.4	0.0186
972.07	0.008	191.6	0.0186
972.08	0.009	191.6	0.0231
972.10	0.009	191.8	0.0257
972.12	0.011	192.1	0.0302
972.13	0.014	192.4	0.0346
972.15	0.015	192.6	0.0373
972.17	0.017	192.8	0.0417
972.18	0.02	193.1	0.0417
972.20	0.02	193.1	0.0444
972.22	0.02	193.3	0.047
972.23	0.022	193.6	0.0506
972.25	0.024	193.8	0.0533
972.27	0.025	194.1	0.0559
972.28	0.026	194.2	0.0568
972.30	0.027	194.5	0.0568
972.32	0.028	194.6	0.0586
972.33	0.028	194.8	0.0612
972.35	0.028	194.9	0.0612
972.37	0.028	195.1	0.0621
972.38	0.028	195.1	0.0621
972.40	0.029	195.2	0.063

Prova triassiale ciclica SN04-C1			
pressione di confinamento (kPa)		80	
deviatore ciclico (kPa)		95	
frequenza (hz)		0.00625	
tempo	cella di carico	$\Delta u$	LVDT
(min)	kN	(kPa)	$\delta$ (mm)
972.42	0.029	195.4	0.063
972.43	0.029	195.5	0.063
972.45	0.029	195.6	0.063
972.47	0.028	195.6	0.0612
972.48	0.026	195.6	0.0612
972.50	0.026	195.6	0.0604
972.52	0.026	195.7	0.0595
972.53	0.025	195.6	0.0577
972.55	0.022	195.6	0.055
972.57	0.022	195.5	0.0533
972.58	0.02	195.3	0.0506
972.60	0.017	195.2	0.0506
972.62	0.016	195.2	0.0479
972.63	0.016	195.1	0.0453
972.65	0.015	194.9	0.0426
972.68	0.011	194.7	0.0382
972.70	0.01	194.6	0.0355
972.72	0.009	194.3	0.032
972.73	0.005	194.1	0.032
972.75	0.004	194.1	0.0284
972.75	0.004	193.9	0.0249
972.77	0.003	193.6	0.0204
972.78	-0.001	193.4	0.016
972.80	-0.002	193.2	0.0124
972.82	-0.004	192.8	0.0089
972.83	-0.007	192.6	0.0089
972.85	-0.008	192.6	0.0053
972.87	-0.008	192.3	0.0027
972.88	-0.009	192.1	-0.0009
972.90	-0.012	191.8	-0.0044
972.92	-0.012	191.6	-0.0053
972.93	-0.013	191.3	-0.008
972.95	-0.015	191.1	-0.008
972.97	-0.016	191.1	-0.0107
972.98	-0.016	190.9	-0.0115
973.00	-0.016	190.7	-0.0133
973.02	-0.017	190.6	-0.0142
973.03	-0.017	190.4	-0.0151
973.05	-0.017	190.3	-0.0151
973.07	-0.017	190.1	-0.0151
973.08	-0.017	190.1	-0.0151
973.10	-0.017	190	-0.0151
973.12	-0.016	189.9	-0.0151
973.13	-0.016	189.9	-0.0151
973.15	-0.016	189.9	-0.0142
973.17	-0.015	189.9	-0.0124
973.18	-0.013	189.9	-0.0107
973.20	-0.012	189.9	-0.0107
973.22	-0.011	190	-0.008
973.23	-0.009	190.1	-0.008
973.25	-0.008	190.2	-0.0053
973.27	-0.008	190.2	-0.0036
973.28	-0.006	190.3	0
973.30	-0.004	190.5	0.0027
973.32	-0.002	190.6	0.0053
973.33	-0.001	190.8	0.0089
973.35	0.002	191	0.0089
973.37	0.004	191.2	0.0124

Prova triassiale ciclica SN04-C1			
pressione di confinamento (kPa)		80	
deviatore ciclico (kPa)		95	
frequenza (hz)		0.00625	
tempo	cella di carico	$\Delta u$	LVDT
(min)	kN	(kPa)	$\delta$ (mm)
973.38	0.004	191.2	0.016
973.40	0.005	191.4	0.0204
973.42	0.009	191.7	0.024
973.43	0.011	191.9	0.0284
973.45	0.012	192.1	0.032
973.47	0.014	192.4	0.032
973.48	0.016	192.7	0.0364
973.50	0.016	192.7	0.0391
973.52	0.017	192.9	0.0426
973.53	0.019	193.2	0.0453
973.55	0.021	193.4	0.0488
973.57	0.022	193.7	0.0515
973.58	0.024	193.9	0.0541
973.60	0.026	194.1	0.0541
973.62	0.026	194.1	0.0559
973.63	0.026	194.3	0.0577
973.65	0.027	194.5	0.0595
973.67	0.028	194.7	0.0604
973.68	0.028	194.9	0.0612
973.70	0.029	195	0.0621
973.72	0.029	195.2	0.0621
973.73	0.029	195.2	0.0621
973.75	0.029	195.3	0.0621
973.77	0.029	195.4	0.063
973.78	0.028	195.5	0.063
973.80	0.028	195.6	0.0621
973.82	0.027	195.6	0.0612
973.83	0.026	195.6	0.0604
973.85	0.025	195.6	0.0586
973.87	0.024	195.6	0.0568
973.88	0.022	195.5	0.0568
973.90	0.021	195.5	0.055
973.92	0.021	195.4	0.0533
973.93	0.02	195.3	0.0506
973.95	0.017	195.1	0.047
973.97	0.015	195	0.0444
973.98	0.014	194.9	0.0417
974.00	0.011	194.7	0.0417
974.02	0.01	194.7	0.0373
974.03	0.01	194.5	0.0346
974.05	0.008	194.3	0.0311
974.07	0.004	194	0.0257
974.08	0.003	193.8	0.0231
974.10	0.002	193.6	0.0186
974.12	-0.002	193.3	0.0186
974.15	-0.003	193	0.0142
974.17	-0.003	193	0.0115
974.18	-0.005	192.8	0.008
974.20	-0.007	192.5	0.0044
974.20	-0.008	192.2	0.0018
974.22	-0.01	192	-0.0018
974.23	-0.012	191.7	-0.0018
974.25	-0.013	191.5	-0.0053
974.27	-0.013	191.5	-0.0071
974.28	-0.014	191.3	-0.0089
974.30	-0.015	191	-0.0115
974.32	-0.016	190.8	-0.0124
974.33	-0.016	190.6	-0.0133

Prova triassiale ciclica SN04-C1			
pressione di confinamento (kPa)		80	
deviatore ciclico (kPa)		95	
frequenza (hz)		0.00625	
tempo	cella di carico	$\Delta u$	LVDT
(min)	kN	(kPa)	$\delta$ (mm)
974.35	-0.016	190.5	-0.0133
974.37	-0.017	190.3	-0.0142
974.38	-0.017	190.3	-0.0151
974.40	-0.017	190.2	-0.0151
974.42	-0.017	190.1	-0.016
974.43	-0.017	190	-0.0151
974.45	-0.016	189.9	-0.0151
974.47	-0.016	189.9	-0.0151
974.48	-0.015	189.9	-0.0142
974.50	-0.014	189.9	-0.0124
974.52	-0.014	189.9	-0.0107
974.53	-0.012	189.9	-0.0107
974.55	-0.011	189.9	-0.0089
974.57	-0.011	190	-0.0071
974.58	-0.009	190.1	-0.0044
974.60	-0.007	190.2	-0.0027
974.62	-0.006	190.3	0
974.63	-0.004	190.5	0.0036
974.65	-0.001	190.7	0.0036
974.67	0	190.7	0.0071
974.68	0	190.8	0.0098
974.70	0.002	191.1	0.0133
974.72	0.005	191.3	0.0178
974.73	0.006	191.5	0.0213
974.75	0.009	191.8	0.0249
974.77	0.012	192	0.0249
974.78	0.013	192	0.0302
974.80	0.013	192.2	0.0328
974.82	0.014	192.5	0.0364
974.83	0.017	192.8	0.0408
974.85	0.018	193	0.0435
974.87	0.02	193.3	0.047
974.88	0.023	193.5	0.047
974.90	0.023	193.5	0.0506
974.92	0.023	193.7	0.0524
974.93	0.024	194	0.055
974.95	0.026	194.2	0.0568
974.97	0.027	194.4	0.0586
974.98	0.027	194.6	0.0595
975.00	0.028	194.8	0.0595
975.02	0.028	194.8	0.0612
975.03	0.028	194.9	0.0621
975.05	0.029	195.1	0.0621
975.07	0.029	195.2	0.063
975.08	0.029	195.3	0.063
975.10	0.028	195.4	0.063
975.12	0.028	195.5	0.063
975.13	0.027	195.5	0.0621
975.15	0.027	195.6	0.0612
975.17	0.027	195.6	0.0604
975.18	0.025	195.6	0.0586
975.20	0.024	195.6	0.0577
975.22	0.023	195.5	0.055
975.23	0.021	195.4	0.0533
975.25	0.02	195.3	0.0524
975.27	0.019	195.2	0.0488
975.28	0.016	195	0.0488
975.30	0.015	195	0.0462

Prova triassiale ciclica SN04-C1			
pressione di confinamento (kPa)		80	
deviatore ciclico (kPa)		95	
frequenza (hz)		0.00625	
tempo	cella di carico	$\Delta u$	LVDT
(min)	kN	(kPa)	$\delta$ (mm)
975.32	0.015	194.9	0.0435
975.33	0.013	194.7	0.0399
975.35	0.01	194.5	0.0364
975.37	0.009	194.4	0.0337
975.38	0.007	194.2	0.0293
975.40	0.003	193.9	0.0293
975.42	0.002	193.9	0.024
975.43	0.002	193.7	0.0213
975.45	0.001	193.5	0.0178
975.47	-0.002	193.1	0.0133
975.48	-0.004	192.9	0.0107
975.50	-0.005	192.7	0.0062
975.52	-0.008	192.3	0.0062
975.53	-0.009	192.1	0.0027
975.55	-0.009	192.1	0
975.57	-0.01	191.8	-0.0027
975.58	-0.012	191.5	-0.0062
975.62	-0.014	191.3	-0.008
975.63	-0.014	191.2	-0.0098
975.65	-0.015	190.9	-0.0098
975.65	-0.016	190.7	-0.0115
975.67	-0.016	190.7	-0.0124
975.68	-0.017	190.5	-0.0142
975.70	-0.017	190.4	-0.0151
975.72	-0.017	190.3	-0.0151
975.73	-0.017	190.1	-0.0151
975.75	-0.017	190	-0.0151
975.77	-0.017	189.9	-0.0151
975.78	-0.017	189.9	-0.0151
975.80	-0.016	189.9	-0.0142
975.82	-0.016	189.9	-0.0133
975.83	-0.014	189.9	-0.0124
975.85	-0.014	189.9	-0.0107
975.87	-0.012	189.9	-0.0107
975.88	-0.01	190	-0.0089
975.90	-0.01	190	-0.0071
975.92	-0.009	190.1	-0.0044
975.93	-0.007	190.2	-0.0027
975.95	-0.005	190.3	0
975.97	-0.005	190.4	0.0018
975.98	-0.003	190.6	0.0053
976.00	0	190.8	0.0089
976.02	0.001	190.9	0.0115
976.03	0.003	191.2	0.0151
976.05	0.006	191.4	0.0151
976.07	0.007	191.4	0.0195
976.08	0.007	191.6	0.0231
976.10	0.009	191.9	0.0275
976.12	0.013	192.1	0.032
976.13	0.014	192.3	0.0346
976.15	0.015	192.6	0.0382
976.17	0.018	192.9	0.0382
976.18	0.019	192.9	0.0426
976.20	0.019	193.1	0.0453
976.22	0.02	193.4	0.0479
976.23	0.023	193.6	0.0515
976.25	0.024	193.8	0.0533
976.27	0.024	194.1	0.0559

Prova triassiale ciclica SN04-C1			
pressione di confinamento (kPa)		80	
deviatore ciclico (kPa)		95	
frequenza (hz)		0.00625	
tempo	cella di carico	$\Delta u$	LVDT
(min)	kN	(kPa)	$\delta$ (mm)
976.28	0.026	194.3	0.0559
976.30	0.027	194.3	0.0577
976.32	0.027	194.5	0.0595
976.33	0.027	194.7	0.0604
976.35	0.028	194.8	0.0612
976.37	0.029	195	0.0621
976.38	0.029	195.1	0.063
976.40	0.029	195.2	0.063
976.42	0.029	195.2	0.063
976.43	0.029	195.3	0.063
976.45	0.028	195.5	0.063
976.47	0.028	195.5	0.0621
976.48	0.027	195.6	0.0612
976.50	0.026	195.6	0.0595
976.52	0.024	195.5	0.0595
976.53	0.024	195.5	0.0577
976.55	0.024	195.5	0.0568
976.57	0.022	195.4	0.0541
976.58	0.02	195.3	0.0515
976.60	0.019	195.2	0.0497
976.62	0.017	195.1	0.0462
976.63	0.014	194.9	0.0462
976.65	0.013	194.8	0.0435
976.67	0.013	194.8	0.0408
976.68	0.009	194.4	0.0364
976.70	0.008	194.2	0.0346
976.72	0.008	194.2	0.032
976.73	0.006	194.1	0.0284
976.75	0.004	193.7	0.0231
976.77	0.001	193.5	0.0195
976.78	0	193.3	0.016
976.80	-0.003	193	0.0115
976.82	-0.005	192.7	0.0115
976.83	-0.005	192.7	0.008
976.85	-0.006	192.5	0.0044
976.87	-0.008	192.2	0.0018
976.88	-0.011	191.9	-0.0018
976.90	-0.011	191.7	-0.0036
976.92	-0.012	191.4	-0.0062
976.93	-0.014	191.2	-0.0062
976.95	-0.015	191.2	-0.0089
976.97	-0.015	191	-0.0107
976.98	-0.015	190.8	-0.0115
977.00	-0.016	190.6	-0.0133
977.02	-0.017	190.5	-0.0142
977.05	-0.017	190.3	-0.0142
977.07	-0.017	190.2	-0.0142
977.08	-0.017	190.2	-0.0151
977.10	-0.017	190.1	-0.0151
977.12	-0.017	190	-0.0151
977.12	-0.017	189.9	-0.0151
977.13	-0.016	189.9	-0.0142
977.15	-0.015	189.8	-0.0133
977.17	-0.014	189.8	-0.0133
977.18	-0.013	189.8	-0.0115
977.20	-0.013	189.9	-0.0098
977.22	-0.012	189.9	-0.0089
977.23	-0.009	190	-0.0062

Prova triassiale ciclica SN04-C1			
pressione di confinamento (kPa)		80	
deviatore ciclico (kPa)		95	
frequenza (hz)		0.00625	
tempo	cella di carico	$\Delta u$	LVDT
(min)	kN	(kPa)	$\delta$ (mm)
977.25	-0.009	190.1	-0.0044
977.27	-0.007	190.2	-0.0018
977.28	-0.004	190.4	-0.0018
977.30	-0.003	190.4	0.0018
977.32	-0.003	190.5	0.0044
977.33	-0.002	190.7	0.008
977.35	0.002	190.9	0.0115
977.37	0.003	191.1	0.0151
977.38	0.004	191.3	0.0186
977.40	0.008	191.6	0.0186
977.42	0.009	191.8	0.0257
977.43	0.01	191.9	0.0293
977.45	0.013	192.2	0.0293
977.47	0.015	192.4	0.0328
977.48	0.015	192.4	0.0364
977.50	0.016	192.7	0.0399
977.52	0.019	193	0.0435
977.53	0.02	193.2	0.0462
977.55	0.021	193.4	0.0488
977.57	0.023	193.7	0.0488
977.58	0.024	193.9	0.0524
977.60	0.024	193.9	0.0541
977.62	0.025	194.1	0.0568
977.63	0.026	194.4	0.0586
977.65	0.027	194.5	0.0595
977.67	0.028	194.7	0.0612
977.68	0.029	194.9	0.0612
977.70	0.029	195	0.0621
977.72	0.029	195	0.063
977.73	0.029	195.1	0.063
977.75	0.029	195.2	0.063
977.77	0.029	195.4	0.063
977.78	0.028	195.5	0.063
977.80	0.027	195.6	0.0621
977.82	0.027	195.6	0.0621
977.83	0.025	195.6	0.0612
977.85	0.025	195.6	0.0595
977.87	0.024	195.5	0.0577
977.88	0.023	195.5	0.0559
977.90	0.022	195.4	0.0541
977.92	0.02	195.2	0.0515
977.93	0.017	195.1	0.0515
977.95	0.017	195.1	0.0479
977.97	0.017	195.1	0.0462
977.98	0.015	194.8	0.0426
978.00	0.011	194.6	0.0391
978.02	0.011	194.5	0.0364
978.03	0.009	194.2	0.032
978.05	0.005	194	0.032
978.07	0.004	194	0.0284
978.08	0.004	193.8	0.0249
978.10	0.002	193.5	0.0204
978.12	-0.001	193.3	0.016
978.13	-0.002	193.1	0.0133
978.15	-0.002	192.8	0.0107
978.17	-0.006	192.6	0.0071
978.18	-0.007	192.4	0.0044
978.20	-0.008	192.1	0.0009



Prova triassiale ciclica SN04-C1			
pressione di confinamento (kPa)		80	
deviatore ciclico (kPa)		95	
frequenza (hz)		0.00625	
tempo	cella di carico	$\Delta u$	LVDT
(min)	kN	(kPa)	$\delta$ (mm)
978.22	-0.011	191.8	0.0009
978.23	-0.011	191.8	-0.0027
978.25	-0.011	191.6	-0.0044
978.27	-0.012	191.3	-0.0071
978.28	-0.015	191.1	-0.0098
978.30	-0.015	190.9	-0.0107
978.32	-0.015	190.7	-0.0124
978.33	-0.017	190.5	-0.0124
978.35	-0.017	190.5	-0.0133
978.37	-0.017	190.4	-0.0142
978.38	-0.017	190.2	-0.0151
978.40	-0.017	190.1	-0.0151
978.42	-0.017	190	-0.0151
978.43	-0.017	189.9	-0.0151
978.45	-0.016	189.9	-0.0151
978.47	-0.016	189.8	-0.0142
978.48	-0.016	189.8	-0.0142
978.52	-0.015	189.8	-0.0124
978.53	-0.014	189.9	-0.0107
978.55	-0.012	189.9	-0.0098
978.57	-0.012	189.9	-0.008
978.57	-0.01	190	-0.0053
978.58	-0.007	190.2	-0.0053
978.60	-0.007	190.2	-0.0027
978.62	-0.006	190.2	0
978.63	-0.005	190.4	0.0027
978.65	-0.002	190.6	0.0053
978.67	-0.001	190.7	0.0089
978.68	0.001	191	0.0124
978.70	0.004	191.2	0.0124
978.72	0.005	191.2	0.016
978.73	0.005	191.3	0.0195
978.75	0.007	191.6	0.024
978.77	0.011	191.9	0.0284
978.78	0.012	192.1	0.032
978.80	0.014	192.4	0.0355
978.82	0.017	192.6	0.0355
978.83	0.017	192.6	0.0391
978.85	0.017	192.8	0.0426
978.87	0.021	193.3	0.0462
978.88	0.022	193.3	0.0479
978.90	0.022	193.5	0.0497
978.92	0.023	193.8	0.0524
978.93	0.025	194	0.0559
978.95	0.026	194.2	0.0568
978.97	0.026	194.4	0.0586
978.98	0.028	194.6	0.0586
979.00	0.028	194.6	0.0604
979.02	0.028	194.8	0.0612
979.03	0.028	194.9	0.0621
979.05	0.029	195.1	0.063
979.07	0.029	195.2	0.063
979.08	0.029	195.3	0.0639
979.10	0.029	195.4	0.0639
979.12	0.028	195.4	0.063
979.13	0.028	195.5	0.063
979.15	0.027	195.6	0.0612
979.17	0.026	195.5	0.0604

Prova triassiale ciclica SN04-C1			
pressione di confinamento (kPa)		80	
deviatore ciclico (kPa)		95	
frequenza (hz)		0.00625	
tempo	cella di carico	$\Delta u$	LVDT
(min)	kN	(kPa)	$\delta$ (mm)
979.18	0.025	195.5	0.0595
979.20	0.024	195.5	0.0568
979.22	0.022	195.4	0.0568
979.23	0.021	195.4	0.055
979.25	0.021	195.4	0.0533
979.27	0.02	195.2	0.0506
979.28	0.017	195	0.047
979.30	0.015	194.9	0.0453
979.32	0.014	194.8	0.0417
979.33	0.011	194.6	0.0417
979.35	0.009	194.4	0.0373
979.37	0.009	194.4	0.0346
979.38	0.008	194.2	0.032
979.40	0.006	193.9	0.0284
979.42	0.003	193.7	0.0231
979.43	0.001	193.5	0.0195
979.45	-0.001	193.2	0.0151
979.47	-0.003	193	0.0151
979.48	-0.004	193	0.0115
979.50	-0.004	192.7	0.008
979.52	-0.006	192.4	0.0053
979.53	-0.009	192.2	0.0009
979.55	-0.01	192	-0.0009
979.57	-0.011	191.7	-0.0036
979.58	-0.013	191.4	-0.0071
979.60	-0.013	191.2	-0.0071
979.62	-0.014	191	-0.0098
979.63	-0.016	190.8	-0.0098
979.65	-0.016	190.8	-0.0115
979.67	-0.016	190.6	-0.0124
979.68	-0.016	190.5	-0.0142
979.70	-0.017	190.3	-0.0142
979.72	-0.017	190.2	-0.0151
979.73	-0.017	190	-0.0151
979.75	-0.017	189.9	-0.0151
979.77	-0.017	189.9	-0.0151
979.78	-0.017	189.9	-0.0151
979.80	-0.016	189.8	-0.0133
979.82	-0.015	189.8	-0.0133
979.83	-0.014	189.8	-0.0115
979.85	-0.014	189.8	-0.0107
979.87	-0.011	189.9	-0.0107
979.88	-0.011	189.9	-0.0089
979.90	-0.011	189.9	-0.0071
979.92	-0.01	190	-0.0044
979.95	-0.007	190.2	-0.0018
979.97	-0.006	190.3	0
979.98	-0.004	190.4	0.0044
980.00	-0.001	190.6	0.0044
980.02	0	190.8	0.008
980.02	0	190.8	0.0098
980.03	0.002	191	0.0142
980.05	0.005	191.2	0.0178
980.07	0.007	191.4	0.0213
980.08	0.008	191.6	0.0257
980.10	0.011	192	0.0257
980.12	0.013	192.2	0.0311
980.13	0.013	192.2	0.0337

Prova triassiale ciclica SN04-C1			
pressione di confinamento (kPa)		80	
deviatore ciclico (kPa)		95	
frequenza (hz)		0.00625	
tempo	cella di carico	$\Delta u$	LVDT
(min)	kN	(kPa)	$\delta$ (mm)
980.15	0.014	192.4	0.0373
980.17	0.017	192.7	0.0408
980.18	0.019	193	0.0435
980.20	0.02	193.2	0.047
980.22	0.022	193.5	0.0506
980.23	0.023	193.7	0.0506
980.25	0.023	193.7	0.0524
980.27	0.024	193.9	0.055
980.28	0.026	194.2	0.0577
980.30	0.027	194.4	0.0586
980.32	0.027	194.5	0.0604
980.33	0.027	194.7	0.0612
980.35	0.028	194.8	0.0621
980.37	0.029	195	0.063
980.38	0.029	195.1	0.063
980.40	0.029	195.2	0.063
980.42	0.029	195.2	0.063
980.43	0.029	195.4	0.063
980.45	0.028	195.4	0.063
980.47	0.028	195.5	0.063
980.48	0.027	195.6	0.0612
980.50	0.026	195.6	0.0604
980.52	0.024	195.5	0.0604
980.53	0.023	195.5	0.0577
980.55	0.023	195.5	0.0568
980.57	0.022	195.4	0.055
980.58	0.02	195.3	0.0524
980.60	0.019	195.2	0.0506
980.62	0.017	195	0.0462
980.63	0.014	194.9	0.0462
980.65	0.013	194.9	0.0435
980.67	0.013	194.7	0.0408
980.68	0.011	194.5	0.0373
980.70	0.008	194.3	0.0337
980.72	0.007	194.1	0.0302
980.73	0.005	193.9	0.0257
980.75	0.001	193.6	0.0257
980.77	0.001	193.6	0.0213
980.78	0.001	193.4	0.0186
980.80	-0.001	193.2	0.0142
980.82	-0.004	192.9	0.0107
980.83	-0.006	192.6	0.0071
980.85	-0.007	192.4	0.0044
980.87	-0.009	192.1	0.0044
980.88	-0.011	191.8	0.0009
980.90	-0.011	191.8	-0.0018
980.92	-0.011	191.6	-0.0044
980.93	-0.014	191.3	-0.0071
980.95	-0.014	191.1	-0.0089
980.97	-0.015	190.9	-0.0107
980.98	-0.016	190.7	-0.0107
981.00	-0.017	190.5	-0.0124
981.02	-0.017	190.5	-0.0142
981.03	-0.017	190.4	-0.0142
981.05	-0.017	190.1	-0.0151
981.07	-0.017	190.1	-0.0151
981.08	-0.017	190	-0.0151
981.10	-0.017	189.9	-0.0151

Prova triassiale ciclica SN04-C1			
pressione di confinamento (kPa)		80	
deviatore ciclico (kPa)		95	
frequenza (hz)		0.00625	
tempo	cella di carico	$\Delta u$	LVDT
(min)	kN	(kPa)	$\delta$ (mm)
981.12	-0.016	189.8	-0.0142
981.13	-0.016	189.8	-0.0142
981.15	-0.015	189.8	-0.0124
981.17	-0.014	189.8	-0.0124
981.18	-0.013	189.8	-0.0115
981.20	-0.013	189.8	-0.0107
981.22	-0.012	189.9	-0.008
981.23	-0.01	190	-0.0062
981.25	-0.009	190	-0.0044
981.27	-0.007	190.2	-0.0018
981.28	-0.004	190.3	-0.0018
981.30	-0.003	190.3	0.0018
981.32	-0.003	190.4	0.0044
981.33	-0.002	190.7	0.008
981.35	0.002	190.9	0.0115
981.37	0.002	191	0.0142
981.38	0.004	191.3	0.0186
981.42	0.009	191.5	0.0186
981.43	0.009	191.5	0.0231
981.45	0.009	191.7	0.0275
981.47	0.01	192	0.0302
981.47	0.014	192.3	0.0346
981.48	0.015	192.5	0.0373
981.50	0.016	192.8	0.0417
981.52	0.02	193	0.0417
981.53	0.021	193	0.0453
981.55	0.021	193.3	0.0479
981.57	0.022	193.5	0.0506
981.58	0.024	193.7	0.0541
981.60	0.025	193.9	0.0559
981.62	0.026	194.2	0.0577
981.63	0.027	194.4	0.0577
981.65	0.027	194.4	0.0595
981.67	0.027	194.6	0.0604
981.68	0.028	194.7	0.0612
981.70	0.029	194.9	0.0621
981.72	0.029	195	0.063
981.73	0.029	195.1	0.063
981.75	0.029	195.2	0.063
981.77	0.029	195.4	0.063
981.78	0.028	195.5	0.063
981.80	0.028	195.5	0.063
981.82	0.026	195.5	0.0621
981.83	0.026	195.5	0.0604
981.85	0.026	195.6	0.0595
981.87	0.024	195.4	0.0568
981.88	0.023	195.4	0.0559
981.90	0.022	195.4	0.0533
981.92	0.02	195.2	0.0533
981.93	0.017	195.1	0.0515
981.95	0.017	195.1	0.0488
981.97	0.016	195	0.0453
981.98	0.014	194.8	0.0426
982.00	0.012	194.6	0.0391
982.02	0.01	194.5	0.0355
982.03	0.008	194.2	0.032
982.05	0.005	194	0.032
982.07	0.004	194	0.0284

Prova triassiale ciclica SN04-C1			
pressione di confinamento (kPa)		80	
deviatore ciclico (kPa)		95	
frequenza (hz)		0.00625	
tempo	cella di carico	$\Delta u$	LVDT
(min)	kN	(kPa)	$\delta$ (mm)
982.08	0.004	193.8	0.0249
982.10	0.002	193.5	0.0213
982.12	-0.001	193.3	0.0169
982.13	-0.002	193	0.0133
982.15	-0.004	192.7	0.0098
982.17	-0.007	192.5	0.0098
982.18	-0.007	192.5	0.0053
982.20	-0.007	192.3	0.0036
982.22	-0.009	191.9	0
982.23	-0.012	191.7	-0.0027
982.25	-0.012	191.5	-0.0053
982.27	-0.013	191.2	-0.008
982.28	-0.015	191	-0.008
982.30	-0.015	191	-0.0107
982.32	-0.015	190.8	-0.0115
982.33	-0.016	190.6	-0.0124
982.35	-0.017	190.4	-0.0142
982.37	-0.017	190.3	-0.0142
982.38	-0.017	190.2	-0.0142
982.40	-0.017	190	-0.0142
982.42	-0.017	190	-0.0151
982.43	-0.017	189.9	-0.0151
982.45	-0.017	189.9	-0.0142
982.47	-0.016	189.8	-0.0133
982.48	-0.015	189.8	-0.0133
982.50	-0.014	189.8	-0.0115
982.52	-0.013	189.8	-0.0107
982.53	-0.013	189.8	-0.0098
982.55	-0.011	189.9	-0.0071
982.57	-0.009	190	-0.0071
982.58	-0.008	190	-0.0053
982.60	-0.008	190	-0.0036
982.62	-0.007	190.2	0
982.63	-0.003	190.4	0.0036
982.65	-0.002	190.5	0.0062
982.67	-0.001	190.7	0.0098
982.68	0.003	191	0.0098
982.70	0.004	191.1	0.0133
982.72	0.004	191.1	0.0169
982.73	0.005	191.3	0.0213
982.75	0.009	191.6	0.0249
982.77	0.011	191.8	0.0284
982.78	0.012	192	0.032
982.80	0.014	192.3	0.032
982.82	0.016	192.6	0.0364
982.83	0.016	192.6	0.0391
982.87	0.017	192.8	0.0426
982.88	0.02	193.1	0.0462
982.90	0.022	193.3	0.0488
982.92	0.022	193.6	0.0515
982.92	0.024	193.8	0.0515
982.93	0.026	194	0.0541
982.95	0.026	194	0.0568
982.97	0.026	194.2	0.0586
982.98	0.027	194.5	0.0604
983.00	0.028	194.6	0.0612
983.02	0.028	194.8	0.0621
983.03	0.029	194.9	0.063

Prova triassiale ciclica SN04-C1			
pressione di confinamento (kPa)		80	
deviatore ciclico (kPa)		95	
frequenza (hz)		0.00625	
tempo	cella di carico	$\Delta u$	LVDT
(min)	kN	(kPa)	$\delta$ (mm)
983.05	0.029	195.1	0.063
983.07	0.029	195.1	0.063
983.08	0.029	195.2	0.063
983.10	0.029	195.3	0.063
983.12	0.028	195.4	0.063
983.13	0.028	195.4	0.0621
983.15	0.027	195.5	0.0612
983.17	0.025	195.4	0.0612
983.18	0.025	195.4	0.0595
983.20	0.025	195.5	0.0586
983.22	0.022	195.4	0.0559
983.23	0.021	195.4	0.0559
983.25	0.021	195.3	0.0533
983.27	0.02	195.2	0.0506
983.28	0.016	195	0.0479
983.30	0.015	194.9	0.0453
983.32	0.014	194.8	0.0417
983.33	0.011	194.5	0.0417
983.35	0.01	194.5	0.0382
983.37	0.01	194.4	0.0355
983.38	0.008	194.2	0.0311
983.40	0.005	193.9	0.0275
983.42	0.003	193.7	0.0231
983.43	0.002	193.5	0.0195
983.45	-0.001	193.2	0.0195
983.47	-0.003	192.9	0.0151
983.48	-0.003	192.9	0.0124
983.50	-0.004	192.7	0.008
983.52	-0.007	192.4	0.0044
983.53	-0.008	192.2	0.0018
983.55	-0.01	191.9	-0.0009
983.57	-0.012	191.6	-0.0009
983.58	-0.013	191.4	-0.0044
983.60	-0.013	191.4	-0.0062
983.62	-0.014	191.2	-0.0089
983.63	-0.015	190.9	-0.0107
983.65	-0.016	190.7	-0.0115
983.67	-0.016	190.5	-0.0133
983.68	-0.017	190.4	-0.0133
983.70	-0.017	190.2	-0.0142
983.72	-0.017	190.2	-0.0142
983.73	-0.017	190.1	-0.0142
983.75	-0.017	190	-0.0151
983.77	-0.017	189.9	-0.0151
983.78	-0.016	189.8	-0.0142
983.80	-0.016	189.8	-0.0133
983.82	-0.015	189.8	-0.0133
983.83	-0.014	189.8	-0.0124
983.85	-0.014	189.8	-0.0115
983.87	-0.013	189.8	-0.0098
983.88	-0.011	189.9	-0.008
983.90	-0.01	189.9	-0.0053
983.92	-0.009	190.1	-0.0027
983.93	-0.006	190.2	-0.0027
983.95	-0.005	190.3	0.0018
983.97	-0.004	190.5	0.0036
983.98	-0.001	190.6	0.0036
984.00	0	190.6	0.0071

Prova triassiale ciclica SN04-C1			
pressione di confinamento (kPa)		80	
deviatore ciclico (kPa)		95	
frequenza (hz)		0.00625	
tempo	cella di carico	$\Delta u$	LVDT
(min)	kN	(kPa)	$\delta$ (mm)
984.02	0	190.8	0.0107
984.03	0.002	191	0.0142
984.05	0.006	191.3	0.0186
984.07	0.006	191.4	0.0213
984.08	0.008	191.7	0.0257
984.10	0.012	192	0.0257
984.12	0.013	192	0.0311
984.13	0.013	192.2	0.0337
984.15	0.014	192.4	0.0373
984.17	0.017	192.7	0.0408
984.18	0.018	192.9	0.0435
984.20	0.02	193.2	0.047
984.22	0.022	193.4	0.047
984.23	0.023	193.4	0.0506
984.25	0.023	193.6	0.0524
984.27	0.024	193.9	0.055
984.28	0.026	194.1	0.0577
984.32	0.027	194.3	0.0586
984.33	0.027	194.5	0.0604
984.35	0.028	194.7	0.0604
984.37	0.028	194.7	0.0612
984.37	0.028	194.8	0.0621
984.38	0.029	195	0.063
984.40	0.029	195.1	0.063
984.42	0.029	195.2	0.063
984.43	0.028	195.3	0.063
984.45	0.028	195.4	0.063
984.47	0.027	195.4	0.0621
984.48	0.027	195.4	0.0612
984.50	0.027	195.5	0.0604
984.52	0.025	195.4	0.0595
984.53	0.024	195.4	0.0577
984.55	0.023	195.4	0.055
984.57	0.021	195.2	0.055
984.58	0.019	195.1	0.0533
984.60	0.019	195.1	0.0515
984.62	0.018	195.1	0.0479
984.63	0.016	194.9	0.0444
984.65	0.013	194.7	0.0417
984.67	0.012	194.6	0.0382
984.68	0.011	194.4	0.0373
984.70	0.008	194.2	0.0337
984.72	0.007	194.1	0.0302
984.73	0.004	193.8	0.0302
984.75	0.002	193.6	0.0249
984.77	0.002	193.6	0.0222
984.78	0.001	193.3	0.0178
984.80	-0.002	193	0.0133
984.82	-0.004	192.8	0.0107
984.83	-0.005	192.6	0.0071
984.85	-0.007	192.2	0.0036
984.87	-0.009	192	0.0036
984.88	-0.009	192	0
984.90	-0.01	191.7	-0.0027
984.92	-0.012	191.4	-0.0053
984.93	-0.014	191.2	-0.008
984.95	-0.014	191	-0.0098
984.97	-0.015	190.8	-0.0115

Prova triassiale ciclica SN04-C1			
pressione di confinamento (kPa)		80	
deviatore ciclico (kPa)		95	
frequenza (hz)		0.00625	
tempo	cella di carico	$\Delta u$	LVDT
(min)	kN	(kPa)	$\delta$ (mm)
984.98	-0.016	190.6	-0.0115
985.00	-0.017	190.6	-0.0124
985.02	-0.017	190.4	-0.0133
985.03	-0.017	190.3	-0.0142
985.05	-0.017	190.1	-0.0142
985.07	-0.017	190	-0.0151
985.08	-0.017	189.9	-0.0151
985.10	-0.016	189.8	-0.0151
985.12	-0.016	189.8	-0.0142
985.13	-0.016	189.8	-0.0142
985.15	-0.016	189.8	-0.0133
985.17	-0.014	189.8	-0.0124
985.18	-0.013	189.8	-0.0107
985.20	-0.012	189.8	-0.0089
985.22	-0.01	189.9	-0.0089
985.23	-0.01	189.9	-0.0071
985.25	-0.01	190	-0.0044
985.27	-0.008	190.1	-0.0018
985.28	-0.005	190.3	0.0009
985.30	-0.004	190.4	0.0036
985.32	-0.002	190.6	0.0071
985.33	0.001	190.8	0.0071
985.35	0.002	190.8	0.0107
985.37	0.002	190.9	0.0142
985.38	0.004	191.2	0.0178
985.40	0.008	191.4	0.0222
985.42	0.008	191.6	0.024
985.43	0.009	191.8	0.0284
985.45	0.012	192	0.032
985.47	0.014	192.3	0.0355
985.48	0.015	192.5	0.0391
985.50	0.018	192.8	0.0391
985.52	0.019	192.8	0.0426
985.53	0.019	193	0.0453
985.55	0.02	193.3	0.0488
985.57	0.023	193.5	0.0515
985.58	0.024	193.7	0.0541
985.60	0.024	194	0.0559
985.62	0.026	194.2	0.0559
985.63	0.027	194.4	0.0586
985.65	0.027	194.4	0.0604
985.67	0.027	194.6	0.0604
985.68	0.028	194.8	0.0621
985.70	0.029	194.9	0.063
985.72	0.029	195	0.0639
985.73	0.029	195.2	0.0639
985.75	0.029	195.3	0.0639
985.78	0.029	195.3	0.0639
985.80	0.028	195.4	0.063
985.82	0.027	195.4	0.063
985.83	0.027	195.5	0.0621
985.83	0.026	195.5	0.0604
985.85	0.025	195.4	0.0586
985.87	0.023	195.4	0.0586
985.88	0.023	195.4	0.0568
985.90	0.022	195.4	0.055
985.92	0.021	195.2	0.0533
985.93	0.018	195.1	0.0506



Prova triassiale ciclica SN04-C1			
pressione di confinamento (kPa)		80	
deviatore ciclico (kPa)		95	
frequenza (hz)		0.00625	
tempo	cella di carico	$\Delta u$	LVDT
(min)	kN	(kPa)	$\delta$ (mm)
985.95	0.017	195	0.0479
985.97	0.016	194.9	0.0444
985.98	0.012	194.7	0.0444
986.00	0.011	194.7	0.0417
986.02	0.011	194.5	0.0391
986.03	0.01	194.3	0.0346
986.05	0.006	194.1	0.0302
986.07	0.005	193.9	0.0275
986.08	0.003	193.6	0.0231
986.10	0	193.4	0.0231
986.12	-0.001	193.4	0.0186
986.13	-0.002	192.9	0.0133
986.15	-0.005	192.7	0.0133
986.17	-0.006	192.7	0.0107
986.18	-0.006	192.4	0.0062
986.20	-0.007	192.1	0.0027
986.22	-0.011	191.8	-0.0009
986.23	-0.011	191.6	-0.0027
986.25	-0.012	191.4	-0.0053
986.27	-0.014	191.2	-0.0053
986.28	-0.015	191.2	-0.008
986.30	-0.015	191	-0.0089
986.32	-0.015	190.7	-0.0115
986.33	-0.016	190.5	-0.0124
986.35	-0.017	190.4	-0.0133
986.37	-0.017	190.2	-0.0142
986.38	-0.017	190.1	-0.0142
986.40	-0.017	190.1	-0.0142
986.42	-0.017	190	-0.0151
986.43	-0.017	189.9	-0.0151
986.45	-0.016	189.8	-0.0142
986.47	-0.016	189.8	-0.0133
986.48	-0.015	189.8	-0.0124
986.50	-0.014	189.8	-0.0124
986.52	-0.013	189.8	-0.0115
986.53	-0.013	189.8	-0.0098
986.55	-0.012	189.9	-0.008
986.57	-0.009	189.9	-0.0053
986.58	-0.009	190	-0.0044
986.60	-0.007	190.1	-0.0009
986.62	-0.004	190.3	-0.0009
986.63	-0.003	190.4	0.0027
986.65	-0.003	190.4	0.0053
986.67	-0.002	190.6	0.008
986.68	0.001	190.8	0.0124
986.70	0.003	191	0.0151
986.72	0.004	191.2	0.0186
986.73	0.007	191.5	0.0186
986.75	0.01	191.7	0.0231
986.77	0.01	191.7	0.0275
986.78	0.011	191.9	0.0311
986.80	0.014	192.2	0.0355
986.82	0.016	192.5	0.0382
986.83	0.017	192.7	0.0417
986.85	0.019	193	0.0453
986.87	0.02	193.2	0.047
986.88	0.021	193.4	0.0497
986.90	0.023	193.6	0.0533

Prova triassiale ciclica SN04-C1			
pressione di confinamento (kPa)		80	
deviatore ciclico (kPa)		95	
frequenza (hz)		0.00625	
tempo	cella di carico	$\Delta u$	LVDT
(min)	kN	(kPa)	$\delta$ (mm)
986.92	0.025	193.9	0.0533
986.93	0.025	193.9	0.055
986.95	0.025	194.1	0.0568
986.97	0.026	194.2	0.0586
986.98	0.027	194.5	0.0604
987.00	0.028	194.6	0.0612
987.02	0.028	194.8	0.0621
987.03	0.029	194.9	0.0621
987.05	0.029	194.9	0.063
987.07	0.029	195.1	0.063
987.08	0.029	195.2	0.0639
987.10	0.029	195.3	0.0639
987.12	0.028	195.4	0.063
987.13	0.027	195.4	0.0621
987.15	0.026	195.5	0.0621
987.17	0.025	195.5	0.0612
987.18	0.025	195.5	0.0604
987.22	0.025	195.5	0.0586
987.23	0.023	195.4	0.0568
987.25	0.021	195.3	0.055
987.27	0.02	195.2	0.0515
987.28	0.017	195.1	0.0515
987.28	0.017	195.1	0.0488
987.30	0.017	195	0.047
987.32	0.015	194.8	0.0435
987.33	0.011	194.6	0.0399
987.35	0.011	194.5	0.0364
987.37	0.009	194.2	0.032
987.38	0.005	194	0.032
987.40	0.004	194	0.0284
987.42	0.004	193.8	0.0257
987.43	0.002	193.6	0.0213
987.45	-0.001	193.3	0.0178
987.47	-0.002	193	0.0142
987.48	-0.004	192.8	0.0098
987.50	-0.006	192.4	0.0098
987.52	-0.008	192.2	0.0062
987.53	-0.008	192.2	0.0036
987.55	-0.009	192	0
987.57	-0.011	191.7	-0.0027
987.58	-0.012	191.5	-0.0044
987.60	-0.013	191.3	-0.0062
987.62	-0.014	191	-0.0089
987.63	-0.015	190.8	-0.0107
987.65	-0.015	190.6	-0.0115
987.67	-0.016	190.4	-0.0115
987.68	-0.017	190.3	-0.0124
987.70	-0.017	190.3	-0.0142
987.72	-0.017	190.1	-0.0142
987.73	-0.017	190	-0.0151
987.75	-0.017	189.9	-0.0142
987.77	-0.017	189.8	-0.0142
987.78	-0.016	189.8	-0.0142
987.80	-0.015	189.8	-0.0142
987.82	-0.015	189.8	-0.0133
987.83	-0.015	189.7	-0.0124
987.85	-0.014	189.7	-0.0107
987.87	-0.012	189.8	-0.0089

Prova triassiale ciclica SN04-C1			
pressione di confinamento (kPa)		80	
deviatore ciclico (kPa)		95	
frequenza (hz)		0.00625	
tempo	cella di carico	$\Delta u$	LVDT
(min)	kN	(kPa)	$\delta$ (mm)
987.88	-0.011	189.8	-0.0071
987.90	-0.01	189.9	-0.0044
987.92	-0.007	190.1	-0.0044
987.93	-0.007	190.1	-0.0018
987.95	-0.007	190.1	0
987.97	-0.005	190.3	0.0036
987.98	-0.002	190.5	0.0062
988.00	-0.001	190.6	0.0089
988.02	0.001	190.9	0.0133
988.03	0.004	191.1	0.0133
988.05	0.005	191.1	0.0169
988.07	0.005	191.3	0.0195
988.08	0.007	191.5	0.024
988.10	0.011	191.8	0.0293
988.12	0.012	192	0.0328
988.13	0.013	192.3	0.0355
988.15	0.016	192.5	0.0355
988.17	0.017	192.5	0.0399
988.18	0.017	192.8	0.0435
988.20	0.019	193	0.0462
988.22	0.022	193.3	0.0497
988.23	0.022	193.5	0.0515
988.25	0.023	193.7	0.0541
988.27	0.025	194	0.0541
988.28	0.026	194	0.0568
988.30	0.027	194.4	0.0595
988.32	0.027	194.5	0.0595
988.33	0.028	194.7	0.0604
988.35	0.028	194.7	0.0621
988.37	0.028	194.9	0.063
988.38	0.029	195	0.063
988.40	0.029	195.1	0.063
988.42	0.029	195.2	0.0639
988.43	0.029	195.3	0.063
988.45	0.028	195.4	0.063
988.47	0.028	195.4	0.063
988.48	0.027	195.5	0.0621
988.50	0.026	195.4	0.0604
988.52	0.024	195.4	0.0586
988.53	0.024	195.4	0.0577
988.55	0.023	195.3	0.0559
988.57	0.021	195.3	0.0559
988.58	0.019	195.3	0.0541
988.60	0.019	195.2	0.0506
988.62	0.018	195	0.0479
988.63	0.015	194.9	0.0453
988.65	0.014	194.7	0.0426
988.68	0.012	194.5	0.0391
988.70	0.009	194.3	0.0391
988.72	0.008	194.3	0.0355
988.73	0.008	194.1	0.032
988.73	0.006	193.9	0.0284
988.75	0.002	193.7	0.024
988.77	0.001	193.5	0.0204
988.78	0	193.2	0.016
988.80	-0.004	192.9	0.016
988.82	-0.004	192.9	0.0124
988.83	-0.004	192.7	0.0089

Prova triassiale ciclica SN04-C1			
pressione di confinamento (kPa)		80	
deviatore ciclico (kPa)		95	
frequenza (hz)		0.00625	
tempo	cella di carico	$\Delta u$	LVDT
(min)	kN	(kPa)	$\delta$ (mm)
988.85	-0.006	192.3	0.0053
988.87	-0.009	192.1	0.0018
988.88	-0.01	191.9	-0.0009
988.90	-0.011	191.6	-0.0036
988.92	-0.013	191.3	-0.0036
988.93	-0.014	191.3	-0.0062
988.95	-0.014	191.2	-0.008
988.97	-0.015	190.9	-0.0098
988.98	-0.016	190.7	-0.0115
989.00	-0.016	190.5	-0.0124
989.02	-0.017	190.3	-0.0133
989.03	-0.017	190.2	-0.0142
989.05	-0.017	190	-0.0142
989.07	-0.017	190	-0.0151
989.08	-0.017	189.9	-0.0151
989.10	-0.017	189.9	-0.0151
989.12	-0.017	189.8	-0.0142
989.13	-0.016	189.7	-0.0133
989.15	-0.015	189.7	-0.0133
989.17	-0.015	189.7	-0.0115
989.18	-0.014	189.7	-0.0098
989.20	-0.012	189.8	-0.0098
989.22	-0.011	189.8	-0.008
989.23	-0.011	189.8	-0.0062
989.25	-0.009	189.9	-0.0044
989.27	-0.007	190.1	-0.0018
989.28	-0.006	190.2	0.0009
989.30	-0.004	190.3	0.0044
989.32	-0.001	190.5	0.0044
989.33	0	190.7	0.008
989.35	0	190.7	0.0107
989.37	0.002	190.9	0.0142
989.38	0.005	191.2	0.0186
989.40	0.007	191.3	0.0213
989.42	0.008	191.5	0.0257
989.43	0.011	191.9	0.0257
989.45	0.013	192.1	0.0311
989.47	0.013	192.1	0.0337
989.48	0.014	192.3	0.0373
989.50	0.017	192.6	0.0417
989.52	0.019	192.9	0.0444
989.53	0.02	193.1	0.047
989.55	0.021	193.4	0.047
989.57	0.023	193.6	0.0497
989.58	0.023	193.6	0.0533
989.60	0.024	193.8	0.055
989.62	0.025	194	0.0577
989.63	0.027	194.2	0.0595
989.65	0.027	194.4	0.0604
989.67	0.028	194.6	0.0621
989.68	0.028	194.8	0.0621
989.70	0.029	194.8	0.063
989.72	0.029	194.9	0.0639
989.73	0.029	195	0.063
989.75	0.029	195.1	0.0639
989.77	0.028	195.2	0.0639
989.78	0.028	195.4	0.0639
989.80	0.027	195.4	0.063

Prova triassiale ciclica SN04-C1			
pressione di confinamento (kPa)		80	
deviatore ciclico (kPa)		95	
frequenza (hz)		0.00625	
tempo	cella di carico	$\Delta u$	LVDT
(min)	kN	(kPa)	$\delta$ (mm)
989.82	0.027	195.4	0.0621
989.83	0.026	195.4	0.0604
989.85	0.024	195.4	0.0604
989.87	0.024	195.4	0.0586
989.88	0.024	195.4	0.0568
989.90	0.022	195.3	0.055
989.92	0.02	195.2	0.0524
989.93	0.019	195.1	0.0497
989.95	0.017	195	0.047
989.97	0.014	194.8	0.047
989.98	0.013	194.8	0.0435
990.00	0.013	194.6	0.0408
990.02	0.012	194.5	0.0373
990.03	0.008	194.2	0.0337
990.05	0.007	194	0.0311
990.07	0.005	193.8	0.0257
990.08	0.001	193.5	0.0257
990.12	0.001	193.5	0.0222
990.13	0.001	193.3	0.0186
990.15	-0.001	193.1	0.0151
990.17	-0.004	192.8	0.0115
990.18	-0.006	192.6	0.008
990.18	-0.006	192.3	0.0044
990.20	-0.009	192	0.0044
990.22	-0.011	191.7	0.0009
990.23	-0.011	191.7	-0.0018
990.25	-0.012	191.5	-0.0044
990.27	-0.013	191.2	-0.0071
990.28	-0.014	191	-0.0089
990.30	-0.015	190.8	-0.0107
990.32	-0.016	190.6	-0.0107
990.33	-0.017	190.4	-0.0115
990.35	-0.017	190.4	-0.0133
990.37	-0.017	190.3	-0.0133
990.38	-0.017	190.1	-0.0142
990.40	-0.017	190	-0.0142
990.42	-0.017	189.9	-0.0142
990.43	-0.017	189.8	-0.0142
990.45	-0.016	189.8	-0.0142
990.47	-0.016	189.8	-0.0133
990.48	-0.015	189.7	-0.0124
990.50	-0.014	189.7	-0.0124
990.52	-0.013	189.7	-0.0115
990.53	-0.013	189.7	-0.0098
990.55	-0.012	189.8	-0.008
990.57	-0.01	189.9	-0.0053
990.58	-0.008	190	-0.0036
990.60	-0.007	190.1	-0.0009
990.62	-0.004	190.3	-0.0009
990.63	-0.003	190.3	0.0018
990.65	-0.003	190.4	0.0053
990.67	-0.002	190.6	0.0089
990.68	0.002	190.8	0.0124
990.70	0.003	191	0.0151
990.72	0.004	191.2	0.0195
990.73	0.008	191.5	0.0195
990.75	0.01	191.5	0.0231
990.77	0.01	191.7	0.0275

Prova triassiale ciclica SN04-C1			
pressione di confinamento (kPa)		80	
deviatore ciclico (kPa)		95	
frequenza (hz)		0.00625	
tempo	cella di carico	$\Delta u$	LVDT
(min)	kN	(kPa)	$\delta$ (mm)
990.78	0.011	191.9	0.0311
990.80	0.014	192.2	0.0346
990.82	0.015	192.4	0.0373
990.83	0.016	192.6	0.0417
990.85	0.02	193	0.0417
990.87	0.02	193	0.0462
990.88	0.02	193.1	0.0479
990.90	0.022	193.4	0.0515
990.92	0.024	193.7	0.0541
990.93	0.025	193.9	0.0559
990.95	0.026	194.1	0.0586
990.97	0.027	194.3	0.0586
990.98	0.027	194.3	0.0604
991.00	0.027	194.5	0.0604
991.02	0.028	194.6	0.0621
991.03	0.028	194.8	0.063
991.05	0.029	194.9	0.063
991.07	0.029	195.1	0.063
991.08	0.029	195.2	0.063
991.10	0.028	195.3	0.0639
991.12	0.028	195.3	0.063
991.13	0.028	195.4	0.063
991.15	0.027	195.4	0.0612
991.17	0.026	195.4	0.0604
991.18	0.025	195.4	0.0586
991.20	0.023	195.3	0.0568
991.22	0.022	195.3	0.0559
991.23	0.022	195.3	0.0541
991.25	0.02	195.1	0.0515
991.27	0.018	195	0.0515
991.28	0.018	195	0.0488
991.30	0.016	194.9	0.0453
991.32	0.014	194.7	0.0426
991.33	0.011	194.5	0.0391
991.35	0.01	194.4	0.0364
991.37	0.008	194.1	0.0328
991.38	0.005	193.9	0.0328
991.40	0.004	193.9	0.0293
991.42	0.004	193.7	0.0249
991.43	0.002	193.4	0.0213
991.45	-0.001	193.2	0.0178
991.47	-0.002	193	0.0142
991.48	-0.004	192.7	0.0107
991.50	-0.006	192.4	0.0107
991.52	-0.007	192.4	0.0062
991.53	-0.007	192.2	0.0036
991.55	-0.009	191.9	0
991.58	-0.012	191.6	-0.0027
991.60	-0.012	191.4	-0.0053
991.62	-0.013	191.2	-0.0071
991.63	-0.015	190.9	-0.0071
991.63	-0.015	190.9	-0.0098
991.65	-0.015	190.7	-0.0107
991.67	-0.016	190.5	-0.0124
991.68	-0.017	190.4	-0.0133
991.70	-0.017	190.2	-0.0142
991.72	-0.017	190.1	-0.0142
991.73	-0.017	190	-0.0142

Prova triassiale ciclica SN04-C1			
pressione di confinamento (kPa)		80	
deviatore ciclico (kPa)		95	
frequenza (hz)		0.00625	
tempo	cella di carico	$\Delta u$	LVDT
(min)	kN	(kPa)	$\delta$ (mm)
991.75	-0.017	190	-0.0142
991.77	-0.017	189.9	-0.0142
991.78	-0.017	189.8	-0.0142
991.80	-0.016	189.8	-0.0133
991.82	-0.015	189.7	-0.0124
991.83	-0.014	189.7	-0.0115
991.85	-0.013	189.8	-0.0115
991.87	-0.012	189.8	-0.0098
991.88	-0.012	189.8	-0.008
991.90	-0.011	189.9	-0.0062
991.92	-0.008	190	-0.0036
991.93	-0.007	190	-0.0018
991.95	-0.007	190.1	0
991.97	-0.003	190.3	0.0036
991.98	-0.003	190.4	0.0062
992.00	-0.001	190.6	0.0107
992.02	0.003	190.9	0.0107
992.03	0.004	191	0.0142
992.05	0.004	191	0.0169
992.07	0.005	191.3	0.0204
992.08	0.009	191.6	0.0249
992.10	0.01	191.7	0.0293
992.12	0.012	192	0.0328
992.13	0.015	192.3	0.0328
992.15	0.016	192.5	0.0373
992.17	0.016	192.5	0.0399
992.18	0.018	192.7	0.0435
992.20	0.02	193	0.047
992.22	0.021	193.2	0.0488
992.23	0.022	193.5	0.0524
992.25	0.024	193.8	0.0524
992.27	0.026	194	0.055
992.28	0.026	194	0.0577
992.30	0.026	194.1	0.0586
992.32	0.027	194.4	0.0604
992.33	0.028	194.5	0.0612
992.35	0.028	194.7	0.0621
992.37	0.029	194.9	0.0621
992.38	0.029	195	0.063
992.40	0.029	195	0.063
992.42	0.029	195.1	0.0639
992.43	0.029	195.2	0.0639
992.45	0.028	195.3	0.0639
992.47	0.028	195.4	0.0621
992.48	0.027	195.4	0.0612
992.50	0.025	195.4	0.0612
992.52	0.025	195.4	0.0595
992.53	0.025	195.4	0.0586
992.55	0.023	195.3	0.0559
992.57	0.021	195.2	0.0541
992.58	0.02	195.1	0.0524
992.60	0.019	195	0.0497
992.62	0.016	194.9	0.0497
992.63	0.015	194.9	0.0462
992.65	0.015	194.7	0.0444
992.67	0.011	194.4	0.0408
992.68	0.01	194.4	0.0391
992.70	0.01	194.3	0.0355

Prova triassiale ciclica SN04-C1			
pressione di confinamento (kPa)		80	
deviatore ciclico (kPa)		95	
frequenza (hz)		0.00625	
tempo	cella di carico	$\Delta u$	LVDT
(min)	kN	(kPa)	$\delta$ (mm)
992.72	0.008	194	0.0311
992.73	0.005	193.8	0.0275
992.75	0.003	193.6	0.024
992.77	0.001	193.3	0.0195
992.78	-0.002	193.1	0.0195
992.80	-0.003	193.1	0.016
992.82	-0.003	192.8	0.0115
992.83	-0.005	192.5	0.008
992.85	-0.007	192.3	0.0044
992.87	-0.009	192	0.0018
992.88	-0.009	191.8	0
992.90	-0.012	191.5	0
992.92	-0.013	191.5	-0.0036
992.93	-0.013	191.3	-0.0062
992.95	-0.013	191.1	-0.008
992.97	-0.015	190.8	-0.0107
992.98	-0.016	190.6	-0.0115
993.00	-0.016	190.5	-0.0124
993.02	-0.017	190.3	-0.0124
993.05	-0.018	190.1	-0.0142
993.07	-0.018	190.1	-0.0151
993.08	-0.017	190	-0.0142
993.08	-0.017	189.9	-0.0142
993.10	-0.017	189.8	-0.0142
993.12	-0.017	189.7	-0.0142
993.13	-0.016	189.7	-0.0142
993.15	-0.015	189.7	-0.0133
993.17	-0.015	189.7	-0.0124
993.18	-0.014	189.7	-0.0107
993.20	-0.012	189.8	-0.0089
993.22	-0.011	189.8	-0.0071
993.23	-0.01	189.9	-0.0044
993.25	-0.008	190	-0.0027
993.27	-0.006	190.1	-0.0027
993.28	-0.006	190.1	0
993.30	-0.005	190.2	0.0036
993.32	-0.002	190.5	0.0071
993.33	0	190.6	0.0098
993.35	0.001	190.8	0.0133
993.37	0.004	191.1	0.0178
993.38	0.006	191.3	0.0204
993.40	0.007	191.4	0.0222
993.42	0.008	191.6	0.0257
993.43	0.011	191.9	0.0257
993.45	0.013	191.9	0.0311
993.47	0.013	192.1	0.0346
993.48	0.015	192.4	0.0382
993.50	0.017	192.7	0.0417
993.52	0.018	192.9	0.0444
993.53	0.02	193.1	0.0479
993.55	0.022	193.4	0.0479
993.57	0.023	193.4	0.0506
993.58	0.023	193.6	0.0533
993.60	0.024	193.9	0.0559
993.62	0.026	194.1	0.0577
993.63	0.027	194.3	0.0595
993.65	0.027	194.4	0.0604
993.67	0.028	194.6	0.0604



Prova triassiale ciclica SN04-C1			
pressione di confinamento (kPa)		80	
deviatore ciclico (kPa)		95	
frequenza (hz)		0.00625	
tempo	cella di carico	$\Delta u$	LVDT
(min)	kN	(kPa)	$\delta$ (mm)
993.68	0.028	194.6	0.0621
993.70	0.028	194.8	0.063
993.72	0.029	194.9	0.063
993.73	0.029	195	0.0639
993.75	0.029	195.1	0.0639
993.77	0.029	195.2	0.0639
993.78	0.028	195.3	0.0639
993.80	0.027	195.4	0.063
993.82	0.027	195.4	0.0621
993.83	0.026	195.4	0.0612
993.85	0.025	195.4	0.0595
993.87	0.024	195.3	0.0577
993.88	0.023	195.3	0.055
993.90	0.021	195.1	0.055
993.92	0.019	195.1	0.0533
993.93	0.019	195.1	0.0515
993.95	0.018	195	0.0488
993.97	0.016	194.8	0.0453
993.98	0.013	194.7	0.0426
994.00	0.012	194.5	0.0391
994.02	0.01	194.3	0.0355
994.03	0.007	194.1	0.0355
994.05	0.007	194.1	0.032
994.07	0.006	193.9	0.0293
994.08	0.004	193.6	0.024
994.10	0.001	193.4	0.0204
994.12	-0.001	193.2	0.0151
994.13	-0.002	192.9	0.0142
994.15	-0.004	192.7	0.0107
994.17	-0.006	192.4	0.0071
994.18	-0.007	192.1	0.0044
994.20	-0.009	191.9	0.0044
994.22	-0.01	191.9	0.0009
994.23	-0.01	191.6	-0.0018
994.25	-0.012	191.4	-0.0044
994.27	-0.014	191.2	-0.0071
994.28	-0.014	190.9	-0.0089
994.30	-0.015	190.7	-0.0098
994.32	-0.016	190.5	-0.0098
994.33	-0.016	190.5	-0.0115
994.35	-0.016	190.4	-0.0133
994.37	-0.017	190.2	-0.0142
994.38	-0.017	190	-0.0142
994.40	-0.017	189.9	-0.0142
994.42	-0.017	189.8	-0.0142
994.43	-0.016	189.8	-0.0142
994.45	-0.016	189.8	-0.0142
994.48	-0.016	189.7	-0.0133
994.50	-0.016	189.7	-0.0115
994.52	-0.014	189.7	-0.0115
994.53	-0.014	189.7	-0.0107
994.55	-0.013	189.7	-0.0089
994.55	-0.011	189.8	-0.0089
994.57	-0.009	189.8	-0.0062
994.58	-0.009	189.9	-0.0036
994.60	-0.008	190	-0.0018
994.62	-0.005	190.1	0.0009
994.63	-0.004	190.3	0.0036

Prova triassiale ciclica SN04-C1			
pressione di confinamento (kPa)		80	
deviatore ciclico (kPa)		95	
frequenza (hz)		0.00625	
tempo	cella di carico	$\Delta u$	LVDT
(min)	kN	(kPa)	$\delta$ (mm)
994.65	-0.003	190.4	0.0071
994.67	0.001	190.6	0.0071
994.68	0.002	190.6	0.0107
994.70	0.002	190.8	0.0142
994.72	0.003	191	0.0178
994.73	0.007	191.3	0.0222
994.75	0.009	191.5	0.0257
994.77	0.01	191.7	0.0302
994.78	0.013	192	0.0302
994.80	0.015	192.3	0.0337
994.82	0.015	192.3	0.0373
994.83	0.016	192.5	0.0408
994.85	0.019	193	0.0444
994.87	0.019	193	0.0462
994.88	0.02	193.2	0.0488
994.90	0.023	193.5	0.0524
994.92	0.024	193.7	0.0541
994.93	0.024	193.9	0.0559
994.95	0.026	194.1	0.0559
994.97	0.027	194.3	0.0586
994.98	0.027	194.3	0.0604
995.00	0.027	194.5	0.0612
995.02	0.028	194.7	0.063
995.03	0.029	194.8	0.063
995.05	0.029	194.9	0.0639
995.07	0.029	195.1	0.0639
995.08	0.029	195.2	0.0639
995.10	0.029	195.2	0.0639
995.12	0.028	195.2	0.0639
995.13	0.028	195.3	0.063
995.15	0.027	195.4	0.0621
995.17	0.026	195.4	0.0604
995.18	0.025	195.3	0.0586
995.20	0.023	195.3	0.0586
995.22	0.022	195.3	0.0577
995.23	0.022	195.2	0.0559
995.25	0.021	195.1	0.0533
995.27	0.018	195	0.0506
995.28	0.017	194.9	0.0479
995.30	0.015	194.7	0.0444
995.32	0.013	194.6	0.0444
995.33	0.011	194.6	0.0417
995.35	0.011	194.4	0.0382
995.37	0.01	194.1	0.0346
995.38	0.006	194	0.0311
995.40	0.005	193.8	0.0284
995.42	0.003	193.5	0.0231
995.43	0	193.2	0.0231
995.45	-0.001	193.2	0.0186
995.47	-0.001	193	0.0151
995.48	-0.003	192.7	0.0115
995.50	-0.006	192.4	0.008
995.52	-0.007	192.2	0.0044
995.53	-0.008	191.9	0.0009
995.55	-0.011	191.7	0.0009
995.57	-0.011	191.4	-0.0036
995.58	-0.012	191.2	-0.0053
995.60	-0.014	191	-0.0053

Prova triassiale ciclica SN04-C1			
pressione di confinamento (kPa)		80	
deviatore ciclico (kPa)		95	
frequenza (hz)		0.00625	
tempo	cella di carico	$\Delta u$	LVDT
(min)	kN	(kPa)	$\delta$ (mm)
995.62	-0.015	191	-0.008
995.63	-0.015	190.8	-0.0098
995.65	-0.015	190.6	-0.0107
995.67	-0.016	190.4	-0.0124
995.68	-0.017	190.3	-0.0133
995.70	-0.017	190.1	-0.0133
995.72	-0.017	190	-0.0133
995.73	-0.017	190	-0.0142
995.75	-0.017	189.9	-0.0142
995.77	-0.017	189.8	-0.0142
995.78	-0.016	189.7	-0.0142
995.80	-0.016	189.7	-0.0133
995.82	-0.015	189.6	-0.0124
995.83	-0.014	189.7	-0.0124
995.85	-0.013	189.7	-0.0107
995.87	-0.013	189.7	-0.0098
995.88	-0.012	189.7	-0.008
995.90	-0.01	189.8	-0.0053
995.92	-0.008	189.9	-0.0036
995.95	-0.008	190	-0.0009
995.97	-0.005	190.2	-0.0009
995.98	-0.003	190.3	0.0018
996.00	-0.003	190.3	0.0053
996.00	-0.002	190.5	0.0089
996.02	0.002	190.7	0.0124
996.03	0.003	190.9	0.0151
996.05	0.005	191.1	0.0195
996.07	0.008	191.4	0.0195
996.08	0.01	191.6	0.0231
996.10	0.01	191.6	0.0275
996.12	0.011	191.8	0.0311
996.13	0.014	192.1	0.0355
996.15	0.016	192.4	0.0391
996.17	0.017	192.6	0.0417
996.18	0.019	192.9	0.0462
996.20	0.021	193.1	0.0462
996.22	0.021	193.1	0.0488
996.23	0.022	193.4	0.0515
996.25	0.023	193.6	0.0541
996.27	0.025	193.8	0.0568
996.28	0.026	194	0.0586
996.30	0.027	194.3	0.0604
996.32	0.027	194.4	0.0604
996.33	0.028	194.6	0.0621
996.35	0.028	194.7	0.063
996.37	0.029	194.9	0.063
996.38	0.029	194.9	0.0639
996.40	0.029	195	0.0639
996.42	0.029	195.1	0.0639
996.43	0.029	195.2	0.0639
996.45	0.028	195.3	0.063
996.47	0.028	195.4	0.0621
996.48	0.027	195.4	0.0621
996.50	0.025	195.4	0.0612
996.52	0.025	195.4	0.0604
996.53	0.025	195.4	0.0586
996.55	0.022	195.2	0.0568
996.57	0.021	195.2	0.055

Prova triassiale ciclica SN04-C1			
pressione di confinamento (kPa)		80	
deviatore ciclico (kPa)		95	
frequenza (hz)		0.00625	
tempo	cella di carico	$\Delta u$	LVDT
(min)	kN	(kPa)	$\delta$ (mm)
996.58	0.02	195.1	0.0524
996.60	0.018	195	0.0524
996.62	0.016	195	0.0497
996.63	0.016	194.9	0.047
996.65	0.015	194.7	0.0435
996.67	0.012	194.5	0.0399
996.68	0.01	194.3	0.0373
996.70	0.009	194.2	0.0337
996.72	0.005	193.9	0.0337
996.73	0.004	193.7	0.0302
996.75	0.004	193.7	0.0257
996.77	0.002	193.5	0.0222
996.78	0	193.2	0.0178
996.80	-0.003	192.9	0.0142
996.82	-0.003	192.7	0.0115
996.83	-0.006	192.4	0.0115
996.85	-0.008	192.1	0.0071
996.87	-0.008	192.1	0.0036
996.88	-0.009	191.9	0
996.90	-0.011	191.6	-0.0027
996.92	-0.012	191.4	-0.0044
996.93	-0.013	191.2	-0.0071
996.95	-0.015	190.9	-0.0071
996.97	-0.016	190.6	-0.0098
996.98	-0.016	190.6	-0.0107
997.00	-0.016	190.5	-0.0115
997.02	-0.017	190.2	-0.0124
997.03	-0.017	190.2	-0.0133
997.05	-0.017	190	-0.0133
997.07	-0.017	189.9	-0.0142
997.08	-0.017	189.8	-0.0142
997.10	-0.017	189.7	-0.0142
997.12	-0.016	189.7	-0.0133
997.13	-0.016	189.6	-0.0133
997.15	-0.015	189.6	-0.0124
997.17	-0.015	189.6	-0.0115
997.18	-0.014	189.7	-0.0107
997.20	-0.012	189.7	-0.0089
997.22	-0.011	189.7	-0.0071
997.23	-0.01	189.8	-0.0044
997.25	-0.008	190	-0.0044
997.27	-0.006	190	-0.0027
997.28	-0.006	190.1	0
997.30	-0.005	190.2	0.0036
997.32	-0.002	190.4	0.0062
997.33	0	190.6	0.0098
997.35	0.001	190.7	0.0133
997.38	0.004	191	0.0133
997.40	0.006	191	0.0169
997.42	0.006	191.2	0.0204
997.43	0.007	191.4	0.0249
997.45	0.011	191.7	0.0293
997.45	0.012	191.9	0.0328
997.47	0.013	192.1	0.0364
997.48	0.016	192.4	0.0364
997.50	0.018	192.7	0.0399
997.52	0.018	192.7	0.0435
997.53	0.019	192.9	0.0462

Prova triassiale ciclica SN04-C1			
pressione di confinamento (kPa)		80	
deviatore ciclico (kPa)		95	
frequenza (hz)		0.00625	
tempo	cella di carico	$\Delta u$	LVDT
(min)	kN	(kPa)	$\delta$ (mm)
997.55	0.021	193.2	0.0497
997.57	0.023	193.4	0.0524
997.58	0.024	193.6	0.055
997.60	0.025	193.9	0.055
997.62	0.026	194.1	0.0568
997.63	0.026	194.1	0.0586
997.65	0.027	194.3	0.0604
997.67	0.028	194.5	0.0621
997.68	0.029	194.6	0.063
997.70	0.028	194.8	0.063
997.72	0.028	194.9	0.0639
997.73	0.029	195	0.0639
997.75	0.029	195.1	0.0639
997.77	0.029	195.2	0.0639
997.78	0.028	195.3	0.0639
997.80	0.028	195.3	0.0639
997.82	0.028	195.4	0.0621
997.83	0.026	195.3	0.0612
997.85	0.025	195.4	0.0595
997.87	0.024	195.3	0.0577
997.88	0.023	195.3	0.0568
997.90	0.021	195.2	0.0568
997.92	0.02	195.2	0.0541
997.93	0.02	195.1	0.0524
997.95	0.018	194.9	0.0488
997.97	0.015	194.8	0.0453
997.98	0.014	194.7	0.0426
998.00	0.012	194.4	0.0399
998.02	0.009	194.3	0.0399
998.03	0.008	194.3	0.0355
998.05	0.008	194.1	0.0328
998.07	0.006	193.8	0.0293
998.08	0.003	193.6	0.024
998.10	0.002	193.4	0.0213
998.12	0	193.1	0.016
998.13	-0.004	192.8	0.016
998.15	-0.005	192.8	0.0124
998.17	-0.005	192.6	0.0089
998.18	-0.006	192.3	0.0053
998.20	-0.009	192	0.0027
998.22	-0.01	191.8	0
998.23	-0.011	191.5	-0.0027
998.25	-0.013	191.3	-0.0027
998.27	-0.014	191.3	-0.0053
998.28	-0.014	191	-0.0071
998.30	-0.014	190.8	-0.0098
998.32	-0.016	190.6	-0.0107
998.33	-0.016	190.4	-0.0124
998.35	-0.017	190.2	-0.0133
998.37	-0.018	190.1	-0.0133
998.38	-0.017	190.1	-0.0142
998.40	-0.017	190	-0.0142
998.42	-0.017	189.9	-0.0142
998.43	-0.017	189.8	-0.0142
998.45	-0.016	189.7	-0.0133
998.47	-0.016	189.7	-0.0124
998.48	-0.015	189.6	-0.0124
998.50	-0.015	189.6	-0.0107

Prova triassiale ciclica SN04-C1			
pressione di confinamento (kPa)		80	
deviatore ciclico (kPa)		95	
frequenza (hz)		0.00625	
tempo	cella di carico	$\Delta u$	LVDT
(min)	kN	(kPa)	$\delta$ (mm)
998.52	-0.014	189.6	-0.0098
998.53	-0.011	189.7	-0.0098
998.55	-0.011	189.7	-0.008
998.57	-0.011	189.7	-0.0071
998.58	-0.01	189.8	-0.0036
998.60	-0.007	190	-0.0009
998.62	-0.006	190.1	0.0018
998.63	-0.004	190.2	0.0044
998.65	-0.001	190.4	0.0044
998.67	0	190.6	0.008
998.68	0	190.6	0.0107
998.70	0.002	190.8	0.0151
998.72	0.005	191.1	0.0195
998.73	0.007	191.3	0.0222
998.75	0.008	191.5	0.0275
998.77	0.011	191.8	0.0275
998.78	0.013	192	0.032
998.80	0.013	192	0.0346
998.82	0.014	192.3	0.0382
998.85	0.017	192.6	0.0426
998.87	0.019	192.8	0.0453
998.88	0.02	193	0.0479
998.90	0.022	193.3	0.0479
998.90	0.024	193.5	0.0506
998.92	0.024	193.5	0.0533
998.93	0.024	193.7	0.0559
998.95	0.025	194	0.0586
998.97	0.027	194.2	0.0604
998.98	0.027	194.4	0.0612
999.00	0.028	194.5	0.0612
999.02	0.029	194.7	0.0621
999.03	0.029	194.7	0.0639
999.05	0.029	194.8	0.0639
999.07	0.029	195	0.0648
999.08	0.029	195.1	0.0648
999.10	0.029	195.2	0.0648
999.12	0.028	195.2	0.0639
999.13	0.027	195.3	0.0639
999.15	0.026	195.3	0.063
999.17	0.026	195.3	0.0612
999.18	0.026	195.3	0.0604
999.20	0.023	195.2	0.0586
999.22	0.023	195.3	0.0577
999.23	0.022	195.2	0.055
999.25	0.019	195.1	0.0524
999.27	0.019	195	0.0506
999.28	0.017	194.8	0.0479
999.30	0.014	194.7	0.0479
999.32	0.013	194.7	0.0444
999.33	0.013	194.5	0.0417
999.35	0.011	194.3	0.0391
999.37	0.008	194.1	0.0346
999.38	0.007	194	0.032
999.40	0.005	193.7	0.0275
999.42	0.001	193.4	0.0275
999.43	0.001	193.4	0.0222
999.45	0.001	193.3	0.0195
999.47	-0.001	193	0.0151

Prova triassiale ciclica SN04-C1			
pressione di confinamento (kPa)		80	
deviatore ciclico (kPa)		95	
frequenza (hz)		0.00625	
tempo	cella di carico	$\Delta u$	LVDT
(min)	kN	(kPa)	$\delta$ (mm)
999.48	-0.005	192.7	0.0107
999.50	-0.005	192.4	0.008
999.52	-0.007	192.2	0.0053
999.53	-0.01	191.9	0.0053
999.55	-0.01	191.7	0.0009
999.57	-0.01	191.7	-0.0009
999.58	-0.011	191.4	-0.0036
999.60	-0.014	191.2	-0.0071
999.62	-0.014	190.9	-0.008
999.63	-0.015	190.7	-0.0098
999.65	-0.016	190.5	-0.0098
999.67	-0.017	190.3	-0.0115
999.68	-0.017	190.3	-0.0124
999.70	-0.017	190.2	-0.0133
999.72	-0.017	190	-0.0133
999.73	-0.017	189.9	-0.0142
999.75	-0.017	189.8	-0.0142
999.77	-0.017	189.7	-0.0142
999.78	-0.016	189.7	-0.0133
999.80	-0.016	189.7	-0.0133
999.82	-0.016	189.6	-0.0124
999.83	-0.015	189.7	-0.0107
999.85	-0.013	189.7	-0.0098
999.87	-0.013	189.7	-0.0089
999.88	-0.011	189.8	-0.0053
999.90	-0.009	189.9	-0.0053
999.92	-0.009	189.9	-0.0036
999.93	-0.006	190	0
999.95	-0.005	190.2	0
999.97	-0.004	190.2	0.0027
999.98	-0.004	190.3	0.0053
1000.00	-0.002	190.5	0.0089
1000.02	0.002	190.7	0.0133
1000.03	0.003	190.9	0.016
1000.05	0.004	191.2	0.0195
1000.07	0.008	191.4	0.0195
1000.08	0.009	191.4	0.024
1000.10	0.009	191.6	0.0284
1000.12	0.011	191.9	0.0328
1000.13	0.014	192.1	0.0364
1000.15	0.015	192.3	0.0391
1000.17	0.017	192.6	0.0426
1000.18	0.02	192.9	0.0426
1000.20	0.02	192.9	0.0462
1000.22	0.02	193.1	0.0488
1000.23	0.022	193.4	0.0515
1000.25	0.024	193.6	0.0541
1000.27	0.025	193.8	0.0568
1000.30	0.026	194	0.0586
1000.32	0.027	194.2	0.0586
1000.33	0.027	194.2	0.0604
1000.35	0.027	194.4	0.0621
1000.35	0.028	194.6	0.0621
1000.37	0.029	194.7	0.0639
1000.38	0.029	194.9	0.0639
1000.40	0.029	195	0.0639
1000.42	0.029	195.1	0.0639
1000.43	0.029	195.1	0.0639

Prova triassiale ciclica SN04-C1			
pressione di confinamento (kPa)		80	
deviatore ciclico (kPa)		95	
frequenza (hz)		0.00625	
tempo	cella di carico	$\Delta u$	LVDT
(min)	kN	(kPa)	$\delta$ (mm)
1000.45	0.029	195.2	0.0639
1000.47	0.028	195.2	0.063
1000.48	0.027	195.3	0.0621
1000.50	0.026	195.3	0.0604
1000.52	0.025	195.3	0.0595
1000.53	0.023	195.2	0.0595
1000.55	0.022	195.2	0.0577
1000.57	0.022	195.2	0.0559
1000.58	0.021	195.1	0.0533
1000.60	0.018	194.9	0.0506
1000.62	0.017	194.8	0.0488
1000.63	0.016	194.7	0.0453
1000.65	0.012	194.5	0.0417
1000.67	0.012	194.4	0.0408
1000.68	0.011	194.3	0.0373
1000.70	0.007	194	0.0373
1000.72	0.006	193.8	0.0328
1000.73	0.006	193.8	0.0302
1000.75	0.005	193.7	0.0249
1000.77	0.002	193.3	0.0213
1000.78	-0.001	193.1	0.0178
1000.80	-0.002	192.9	0.0142
1000.82	-0.005	192.5	0.0142
1000.83	-0.006	192.3	0.0098
1000.85	-0.006	192.3	0.0071
1000.87	-0.007	192.1	0.0036
1000.88	-0.01	191.8	0
1000.90	-0.012	191.5	-0.0027
1000.92	-0.012	191.3	-0.0044
1000.93	-0.014	191	-0.0044
1000.95	-0.015	190.8	-0.0071
1000.97	-0.015	190.8	-0.0089
1000.98	-0.015	190.6	-0.0107
1001.00	-0.016	190.4	-0.0115
1001.02	-0.017	190.3	-0.0133
1001.03	-0.017	190.1	-0.0133
1001.05	-0.017	190	-0.0133
1001.07	-0.017	189.9	-0.0133
1001.08	-0.017	189.9	-0.0133
1001.10	-0.017	189.8	-0.0133
1001.12	-0.017	189.7	-0.0133
1001.13	-0.016	189.7	-0.0133
1001.15	-0.015	189.6	-0.0124
1001.17	-0.014	189.6	-0.0107
1001.18	-0.013	189.7	-0.0107
1001.20	-0.012	189.7	-0.0089
1001.22	-0.012	189.7	-0.008
1001.23	-0.011	189.8	-0.0053
1001.25	-0.009	189.9	-0.0036
1001.27	-0.007	190	-0.0009
1001.28	-0.006	190.2	0.0027
1001.30	-0.002	190.3	0.0027
1001.32	-0.001	190.3	0.0062
1001.33	-0.001	190.4	0.0089
1001.35	0	190.7	0.0115
1001.37	0.003	190.9	0.016
1001.38	0.005	191.1	0.0195
1001.40	0.005	191.2	0.0213



Prova triassiale ciclica SN04-C1			
pressione di confinamento (kPa)		80	
deviatore ciclico (kPa)		95	
frequenza (hz)		0.00625	
tempo	cella di carico	$\Delta u$	LVDT
(min)	kN	(kPa)	$\delta$ (mm)
1001.42	0.009	191.5	0.0249
1001.43	0.01	191.7	0.0302
1001.45	0.012	192	0.0337
1001.47	0.015	192.2	0.0337
1001.48	0.016	192.2	0.0373
1001.50	0.016	192.4	0.0399
1001.52	0.017	192.7	0.0435
1001.53	0.02	193	0.0479
1001.55	0.021	193.2	0.0497
1001.57	0.022	193.4	0.0533
1001.58	0.025	193.7	0.0533
1001.60	0.025	193.7	0.0559
1001.62	0.025	193.9	0.0568
1001.63	0.026	194.1	0.0595
1001.65	0.027	194.3	0.0612
1001.67	0.028	194.5	0.0621
1001.68	0.028	194.6	0.063
1001.70	0.029	194.8	0.063
1001.72	0.029	194.8	0.0639
1001.75	0.029	194.9	0.0639
1001.77	0.029	195	0.0639
1001.78	0.029	195.1	0.0639
1001.80	0.028	195.2	0.0639
1001.80	0.028	195.3	0.063
1001.82	0.026	195.2	0.063
1001.83	0.025	195.2	0.0612
1001.85	0.025	195.2	0.0604
1001.87	0.025	195.2	0.0595
1001.88	0.023	195.2	0.0568
1001.90	0.021	195.1	0.055
1001.92	0.02	195	0.0524
1001.93	0.018	194.9	0.0524
1001.95	0.016	194.8	0.0497
1001.97	0.016	194.8	0.047
1001.98	0.015	194.7	0.0444
1002.00	0.012	194.4	0.0408
1002.02	0.01	194.3	0.0382
1002.03	0.009	194.1	0.0337
1002.05	0.005	193.8	0.0337
1002.07	0.004	193.6	0.0293
1002.08	0.004	193.6	0.0257
1002.10	0.001	193.2	0.0222
1002.12	-0.001	193	0.0204
1002.13	-0.001	193	0.0169
1002.15	-0.003	192.7	0.0115
1002.17	-0.005	192.4	0.008
1002.18	-0.007	192.1	0.0053
1002.20	-0.008	191.9	0.0027
1002.22	-0.01	191.6	-0.0009
1002.23	-0.012	191.4	-0.0009
1002.25	-0.013	191.4	-0.0036
1002.27	-0.013	191.2	-0.0053
1002.28	-0.014	190.9	-0.0071
1002.30	-0.015	190.7	-0.0098
1002.32	-0.016	190.5	-0.0107
1002.33	-0.016	190.3	-0.0124
1002.35	-0.017	190.2	-0.0124
1002.37	-0.017	190.2	-0.0133

Prova triassiale ciclica SN04-C1			
pressione di confinamento (kPa)		80	
deviatore ciclico (kPa)		95	
frequenza (hz)		0.00625	
tempo	cella di carico	$\Delta u$	LVDT
(min)	kN	(kPa)	$\delta$ (mm)
1002.38	-0.017	190	-0.0133
1002.40	-0.017	189.9	-0.0133
1002.42	-0.017	189.8	-0.0142
1002.43	-0.017	189.7	-0.0142
1002.45	-0.016	189.7	-0.0133
1002.47	-0.015	189.6	-0.0133
1002.48	-0.015	189.6	-0.0124
1002.50	-0.015	189.6	-0.0115
1002.52	-0.014	189.6	-0.0098
1002.53	-0.012	189.7	-0.008
1002.55	-0.011	189.7	-0.0071
1002.57	-0.01	189.8	-0.0044
1002.58	-0.007	189.9	-0.0044
1002.60	-0.007	189.9	-0.0018
1002.62	-0.007	190	0.0009
1002.63	-0.005	190.2	0.0036
1002.65	-0.002	190.4	0.0071
1002.67	-0.001	190.5	0.0098
1002.68	0.001	190.7	0.0133
1002.70	0.005	191	0.0133
1002.72	0.005	191	0.0178
1002.73	0.005	191.2	0.0204
1002.75	0.007	191.4	0.0249
1002.77	0.011	191.6	0.0293
1002.78	0.012	191.9	0.0328
1002.80	0.013	192.1	0.0364
1002.82	0.017	192.4	0.0364
1002.83	0.018	192.6	0.0426
1002.85	0.018	192.8	0.0444
1002.87	0.021	193.1	0.0444
1002.88	0.022	193.3	0.0479
1002.90	0.022	193.3	0.0506
1002.92	0.023	193.5	0.0533
1002.93	0.024	193.8	0.0559
1002.95	0.026	194	0.0586
1002.97	0.026	194.1	0.0595
1002.98	0.027	194.4	0.0595
1003.00	0.028	194.5	0.0612
1003.02	0.028	194.5	0.063
1003.03	0.028	194.7	0.063
1003.05	0.028	194.8	0.0639
1003.07	0.029	195	0.0639
1003.08	0.029	195.1	0.0648
1003.10	0.029	195.2	0.0639
1003.12	0.028	195.2	0.0639
1003.13	0.027	195.2	0.0639
1003.15	0.027	195.3	0.063
1003.17	0.027	195.3	0.0612
1003.18	0.025	195.2	0.0595
1003.22	0.024	195.2	0.0586
1003.23	0.023	195.2	0.0559
1003.25	0.02	195.1	0.0559
1003.27	0.02	195.1	0.0541
1003.27	0.02	195	0.0515
1003.28	0.018	194.9	0.0488
1003.30	0.015	194.7	0.0453
1003.32	0.014	194.6	0.0435
1003.33	0.012	194.4	0.0391

Prova triassiale ciclica SN04-C1			
pressione di confinamento (kPa)		80	
deviatore ciclico (kPa)		95	
frequenza (hz)		0.00625	
tempo	cella di carico	$\Delta u$	LVDT
(min)	kN	(kPa)	$\delta$ (mm)
1003.35	0.009	194.2	0.0391
1003.37	0.008	194.2	0.0355
1003.38	0.008	194	0.0328
1003.40	0.006	193.7	0.0293
1003.42	0.002	193.5	0.024
1003.43	0.002	193.3	0.0213
1003.45	0	193	0.0169
1003.47	-0.004	192.7	0.0169
1003.48	-0.005	192.7	0.0124
1003.50	-0.005	192.5	0.0098
1003.52	-0.006	192.3	0.0062
1003.53	-0.009	192	0.0027
1003.55	-0.01	191.7	0
1003.57	-0.011	191.5	-0.0018
1003.58	-0.012	191.3	-0.0036
1003.60	-0.013	191.1	-0.0062
1003.62	-0.014	190.8	-0.008
1003.63	-0.016	190.6	-0.008
1003.65	-0.016	190.6	-0.0107
1003.67	-0.016	190.4	-0.0115
1003.68	-0.017	190.2	-0.0124
1003.70	-0.017	190.1	-0.0133
1003.72	-0.017	189.9	-0.0142
1003.73	-0.017	189.8	-0.0142
1003.75	-0.017	189.7	-0.0142
1003.77	-0.017	189.7	-0.0142
1003.78	-0.017	189.7	-0.0142
1003.80	-0.016	189.6	-0.0133
1003.82	-0.015	189.6	-0.0124
1003.83	-0.014	189.6	-0.0115
1003.85	-0.014	189.6	-0.0089
1003.87	-0.012	189.7	-0.0089
1003.88	-0.011	189.7	-0.008
1003.90	-0.011	189.7	-0.0062
1003.92	-0.01	189.8	-0.0036
1003.93	-0.007	189.9	-0.0009
1003.95	-0.005	190	0.0018
1003.97	-0.004	190.2	0.0053
1003.98	-0.001	190.4	0.0053
1004.00	0	190.6	0.008
1004.02	0	190.6	0.0107
1004.03	0.002	190.7	0.0151
1004.05	0.005	191	0.0186
1004.07	0.007	191.2	0.0222
1004.08	0.008	191.4	0.0257
1004.10	0.011	191.7	0.0257
1004.12	0.013	192	0.0311
1004.13	0.013	192	0.0346
1004.15	0.014	192.2	0.0373
1004.17	0.016	192.5	0.0417
1004.18	0.019	192.7	0.0444
1004.20	0.02	192.9	0.0479
1004.22	0.022	193.2	0.0479
1004.23	0.023	193.4	0.0506
1004.25	0.023	193.4	0.0533
1004.27	0.024	193.6	0.0559
1004.28	0.026	194.1	0.0577
1004.30	0.026	194.1	0.0595

Prova triassiale ciclica SN04-C1			
pressione di confinamento (kPa)		80	
deviatore ciclico (kPa)		95	
frequenza (hz)		0.00625	
tempo	cella di carico	$\Delta u$	LVDT
(min)	kN	(kPa)	$\delta$ (mm)
1004.32	0.027	194.3	0.0604
1004.33	0.028	194.5	0.0621
1004.35	0.028	194.6	0.063
1004.37	0.028	194.8	0.063
1004.38	0.029	194.9	0.0639
1004.40	0.029	195	0.0639
1004.42	0.029	195	0.0639
1004.43	0.029	195.1	0.0639
1004.45	0.029	195.2	0.0639
1004.47	0.027	195.2	0.063
1004.48	0.027	195.3	0.0621
1004.50	0.026	195.2	0.0604
1004.52	0.024	195.2	0.0604
1004.53	0.023	195.2	0.0586
1004.55	0.023	195.2	0.0577
1004.57	0.022	195.1	0.055
1004.58	0.02	195	0.0533
1004.60	0.019	195	0.0506
1004.62	0.017	194.8	0.047
1004.65	0.014	194.6	0.047
1004.67	0.013	194.6	0.0444
1004.68	0.013	194.5	0.0426
1004.70	0.012	194.3	0.0382
1004.72	0.008	194.1	0.0346
1004.72	0.007	193.9	0.032
1004.73	0.005	193.7	0.0275
1004.75	0.002	193.4	0.0275
1004.77	0	193.4	0.0231
1004.78	0	193.2	0.0195
1004.80	-0.001	193	0.016
1004.82	-0.004	192.6	0.0115
1004.83	-0.005	192.4	0.008
1004.85	-0.007	192.2	0.0044
1004.87	-0.01	191.8	0.0044
1004.88	-0.01	191.6	0.0018
1004.90	-0.01	191.6	-0.0009
1004.92	-0.011	191.4	-0.0036
1004.93	-0.013	191.1	-0.0062
1004.95	-0.015	190.9	-0.008
1004.97	-0.015	190.7	-0.0098
1004.98	-0.016	190.5	-0.0098
1005.00	-0.017	190.3	-0.0115
1005.02	-0.017	190.2	-0.0124
1005.03	-0.017	190	-0.0133
1005.05	-0.017	189.9	-0.0133
1005.07	-0.017	189.9	-0.0142
1005.08	-0.017	189.8	-0.0142
1005.10	-0.017	189.7	-0.0142
1005.12	-0.017	189.6	-0.0133
1005.13	-0.016	189.6	-0.0124
1005.15	-0.015	189.6	-0.0115
1005.17	-0.014	189.6	-0.0115
1005.18	-0.013	189.6	-0.0107
1005.20	-0.013	189.6	-0.0089
1005.22	-0.012	189.6	-0.0071
1005.23	-0.009	189.8	-0.0053
1005.25	-0.009	189.8	-0.0027
1005.27	-0.007	190	0

Prova triassiale ciclica SN04-C1			
pressione di confinamento (kPa)		80	
deviatore ciclico (kPa)		95	
frequenza (hz)		0.00625	
tempo	cella di carico	$\Delta u$	LVDT
(min)	kN	(kPa)	$\delta$ (mm)
1005.28	-0.004	190.1	0
1005.30	-0.003	190.1	0.0036
1005.32	-0.003	190.2	0.0062
1005.33	-0.002	190.4	0.0089
1005.35	0.002	190.6	0.0133
1005.37	0.002	190.8	0.016
1005.38	0.004	191.1	0.0204
1005.40	0.008	191.3	0.0204
1005.42	0.009	191.3	0.024
1005.43	0.009	191.5	0.0284
1005.45	0.011	191.7	0.032
1005.47	0.014	192	0.0364
1005.48	0.015	192.2	0.0391
1005.50	0.017	192.5	0.0426
1005.52	0.02	192.8	0.0426
1005.53	0.02	192.8	0.0462
1005.55	0.02	193	0.0488
1005.57	0.022	193.3	0.0515
1005.58	0.024	193.5	0.0541
1005.60	0.025	193.7	0.0568
1005.62	0.026	193.9	0.0586
1005.63	0.027	194.2	0.0586
1005.65	0.028	194.2	0.0612
1005.67	0.028	194.3	0.0612
1005.68	0.028	194.5	0.063
1005.70	0.029	194.7	0.0639
1005.72	0.029	194.8	0.0639
1005.73	0.029	194.9	0.0639
1005.75	0.029	195	0.0639
1005.77	0.029	195.1	0.0639
1005.78	0.028	195.2	0.0639
1005.80	0.028	195.2	0.0639
1005.82	0.026	195.2	0.063
1005.83	0.026	195.2	0.0612
1005.85	0.026	195.2	0.0604
1005.87	0.024	195.2	0.0586
1005.88	0.022	195.1	0.0568
1005.90	0.022	195.1	0.0541
1005.92	0.02	195	0.0541
1005.93	0.017	194.9	0.0524
1005.95	0.017	194.9	0.0497
1005.97	0.017	194.8	0.047
1005.98	0.014	194.6	0.0435
1006.00	0.011	194.4	0.0399
1006.02	0.011	194.2	0.0373
1006.03	0.008	194	0.0373
1006.05	0.005	193.8	0.0337
1006.07	0.005	193.8	0.0302
1006.08	0.004	193.6	0.0249
1006.12	0.001	193.3	0.0213
1006.13	-0.001	193	0.0178
1006.15	-0.002	192.8	0.0142
1006.17	-0.005	192.5	0.0142
1006.17	-0.006	192.2	0.0098
1006.18	-0.006	192.2	0.0071
1006.20	-0.007	192	0.0036
1006.22	-0.01	191.7	0
1006.23	-0.011	191.4	-0.0027

Prova triassiale ciclica SN04-C1			
pressione di confinamento (kPa)		80	
deviatore ciclico (kPa)		95	
frequenza (hz)		0.00625	
tempo	cella di carico	$\Delta u$	LVDT
(min)	kN	(kPa)	$\delta$ (mm)
1006.25	-0.012	191.2	-0.0053
1006.27	-0.014	190.9	-0.0071
1006.28	-0.015	190.7	-0.0071
1006.30	-0.015	190.7	-0.0089
1006.32	-0.015	190.6	-0.0107
1006.33	-0.016	190.4	-0.0115
1006.35	-0.017	190.2	-0.0124
1006.37	-0.017	190	-0.0133
1006.38	-0.017	189.9	-0.0142
1006.40	-0.017	189.8	-0.0142
1006.42	-0.017	189.8	-0.0142
1006.43	-0.017	189.7	-0.0142
1006.45	-0.017	189.6	-0.0133
1006.47	-0.016	189.6	-0.0124
1006.48	-0.016	189.5	-0.0124
1006.50	-0.015	189.5	-0.0107
1006.52	-0.014	189.5	-0.0098
1006.53	-0.012	189.6	-0.008
1006.55	-0.011	189.7	-0.0062
1006.57	-0.009	189.7	-0.0062
1006.58	-0.008	189.7	-0.0036
1006.60	-0.008	189.8	-0.0018
1006.62	-0.007	190	0.0009
1006.63	-0.004	190.1	0.0044
1006.65	-0.002	190.3	0.0071
1006.67	-0.001	190.4	0.0107
1006.68	0.003	190.7	0.0107
1006.70	0.004	190.7	0.0142
1006.72	0.004	190.8	0.0178
1006.73	0.005	191.1	0.0222
1006.75	0.009	191.4	0.0257
1006.77	0.01	191.6	0.0293
1006.78	0.011	191.8	0.0337
1006.80	0.015	192.1	0.0337
1006.82	0.016	192.3	0.0382
1006.83	0.016	192.3	0.0408
1006.85	0.017	192.6	0.0444
1006.87	0.02	192.9	0.0479
1006.88	0.021	193.1	0.0497
1006.90	0.022	193.3	0.0533
1006.92	0.024	193.6	0.0533
1006.93	0.025	193.8	0.055
1006.95	0.025	193.8	0.0577
1006.97	0.026	194	0.0595
1006.98	0.027	194.2	0.0612
1007.00	0.028	194.4	0.0621
1007.02	0.028	194.5	0.063
1007.03	0.029	194.7	0.063
1007.05	0.029	194.8	0.0639
1007.07	0.029	194.8	0.0639
1007.08	0.029	195	0.0648
1007.10	0.029	195	0.0648
1007.12	0.028	195.1	0.0639
1007.13	0.028	195.2	0.063
1007.15	0.027	195.2	0.0621
1007.17	0.025	195.2	0.0621
1007.18	0.025	195.2	0.0604
1007.20	0.024	195.2	0.0586

Prova triassiale ciclica SN04-C1			
pressione di confinamento (kPa)		80	
deviatore ciclico (kPa)		95	
frequenza (hz)		0.00625	
tempo	cella di carico	$\Delta u$	LVDT
(min)	kN	(kPa)	$\delta$ (mm)
1007.22	0.022	195.1	0.0586
1007.23	0.021	195.1	0.0559
1007.25	0.021	195	0.0541
1007.27	0.02	194.9	0.0515
1007.28	0.016	194.8	0.0488
1007.30	0.015	194.7	0.0462
1007.32	0.014	194.5	0.0426
1007.33	0.011	194.3	0.0426
1007.35	0.01	194.3	0.0391
1007.37	0.01	194.1	0.0355
1007.38	0.008	193.9	0.032
1007.40	0.004	193.6	0.0284
1007.42	0.003	193.5	0.0249
1007.43	0.002	193.1	0.0204
1007.45	-0.002	192.9	0.0204
1007.47	-0.003	192.9	0.016
1007.48	-0.003	192.7	0.0133
1007.50	-0.005	192.4	0.0089
1007.52	-0.007	192.1	0.0062
1007.55	-0.008	191.9	0.0027
1007.57	-0.009	191.6	0
1007.58	-0.012	191.3	0
1007.60	-0.013	191.3	-0.0036
1007.62	-0.013	191.1	-0.0053
1007.62	-0.014	190.8	-0.008
1007.63	-0.016	190.6	-0.0098
1007.65	-0.016	190.5	-0.0107
1007.67	-0.016	190.3	-0.0115
1007.68	-0.017	190.1	-0.0115
1007.70	-0.017	190.1	-0.0133
1007.72	-0.017	190	-0.0133
1007.73	-0.017	189.8	-0.0133
1007.75	-0.017	189.7	-0.0133
1007.77	-0.017	189.7	-0.0133
1007.78	-0.016	189.6	-0.0124
1007.80	-0.016	189.6	-0.0124
1007.82	-0.015	189.6	-0.0115
1007.83	-0.015	189.5	-0.0107
1007.85	-0.014	189.5	-0.0098
1007.87	-0.012	189.6	-0.008
1007.88	-0.011	189.6	-0.0071
1007.90	-0.01	189.7	-0.0044
1007.92	-0.007	189.9	-0.0018
1007.93	-0.007	189.9	0
1007.95	-0.006	190.1	0.0027
1007.97	-0.002	190.2	0.0027
1007.98	-0.002	190.2	0.0062
1008.00	-0.002	190.3	0.008
1008.02	0	190.5	0.0124
1008.03	0.004	190.8	0.016
1008.05	0.005	190.9	0.0186
1008.07	0.006	191.2	0.0231
1008.08	0.01	191.5	0.0231
1008.10	0.011	191.5	0.0284
1008.12	0.011	191.7	0.0311
1008.13	0.012	191.9	0.0346
1008.15	0.016	192.2	0.0391
1008.17	0.017	192.4	0.0426

Prova triassiale ciclica SN04-C1			
pressione di confinamento (kPa)		80	
deviatore ciclico (kPa)		95	
frequenza (hz)		0.00625	
tempo	cella di carico	$\Delta u$	LVDT
(min)	kN	(kPa)	$\delta$ (mm)
1008.18	0.018	192.7	0.0462
1008.20	0.021	193	0.0462
1008.22	0.022	193.2	0.0488
1008.23	0.022	193.2	0.0515
1008.25	0.023	193.4	0.0541
1008.27	0.025	193.7	0.0568
1008.28	0.026	193.9	0.0586
1008.30	0.026	194.1	0.0604
1008.32	0.027	194.3	0.0604
1008.33	0.028	194.4	0.0621
1008.35	0.028	194.4	0.063
1008.37	0.028	194.6	0.063
1008.38	0.029	194.7	0.0639
1008.40	0.029	194.9	0.0648
1008.42	0.029	195	0.0648
1008.43	0.029	195.1	0.0648
1008.45	0.028	195.1	0.0648
1008.47	0.028	195.1	0.0639
1008.48	0.027	195.2	0.0621
1008.50	0.026	195.2	0.0612
1008.52	0.025	195.2	0.0604
1008.53	0.024	195.1	0.0586
1008.55	0.023	195.1	0.0568
1008.57	0.021	195	0.0568
1008.58	0.019	195	0.0541
1008.60	0.019	194.9	0.0524
1008.62	0.018	194.8	0.0497
1008.63	0.015	194.6	0.0462
1008.65	0.014	194.5	0.0435
1008.67	0.013	194.4	0.0417
1008.68	0.01	194.2	0.0382
1008.70	0.009	194	0.0346
1008.72	0.007	193.7	0.0311
1008.73	0.003	193.5	0.0311
1008.75	0.002	193.5	0.0257
1008.77	0.002	193.3	0.0231
1008.78	0.001	193	0.0186
1008.80	-0.003	192.8	0.0142
1008.82	-0.004	192.5	0.0115
1008.83	-0.005	192.2	0.008
1008.85	-0.008	191.9	0.008
1008.87	-0.009	191.9	0.0036
1008.88	-0.009	191.7	0.0009
1008.90	-0.01	191.5	-0.0009
1008.92	-0.013	191.2	-0.0044
1008.93	-0.013	191	-0.0062
1008.95	-0.014	190.8	-0.008
1008.97	-0.015	190.6	-0.008
1008.98	-0.016	190.6	-0.0098
1009.02	-0.016	190.4	-0.0107
1009.03	-0.016	190.2	-0.0124
1009.05	-0.017	190	-0.0133
1009.07	-0.017	189.9	-0.0133
1009.07	-0.017	189.8	-0.0133
1009.08	-0.017	189.7	-0.0133
1009.10	-0.017	189.7	-0.0142
1009.12	-0.017	189.6	-0.0133
1009.13	-0.016	189.6	-0.0124



Prova triassiale ciclica SN04-C1			
pressione di confinamento (kPa)		80	
deviatore ciclico (kPa)		95	
frequenza (hz)		0.00625	
tempo	cella di carico	$\Delta u$	LVDT
(min)	kN	(kPa)	$\delta$ (mm)
1009.15	-0.015	189.5	-0.0115
1009.17	-0.015	189.5	-0.0107
1009.18	-0.014	189.5	-0.0089
1009.20	-0.012	189.6	-0.0089
1009.22	-0.011	189.6	-0.0071
1009.23	-0.011	189.7	-0.0053
1009.25	-0.009	189.7	-0.0027
1009.27	-0.007	189.9	-0.0009
1009.28	-0.006	190	0.0018
1009.30	-0.004	190.1	0.0053
1009.32	-0.001	190.3	0.0053
1009.33	0	190.5	0.0089
1009.35	0	190.5	0.0115
1009.37	0.004	190.9	0.0151
1009.38	0.005	191.1	0.0178
1009.40	0.005	191.1	0.0204
1009.42	0.007	191.3	0.0249
1009.43	0.01	191.6	0.0302
1009.45	0.012	191.8	0.0337
1009.47	0.013	192	0.0364
1009.48	0.016	192.3	0.0364
1009.50	0.018	192.6	0.0408
1009.52	0.018	192.6	0.0444
1009.53	0.019	192.8	0.047
1009.55	0.021	193.1	0.0506
1009.57	0.023	193.3	0.0533
1009.58	0.024	193.5	0.055
1009.60	0.025	193.8	0.0577
1009.62	0.026	194	0.0577
1009.63	0.027	194	0.0595
1009.65	0.027	194.1	0.0604
1009.67	0.027	194.3	0.0621
1009.68	0.028	194.5	0.063
1009.70	0.029	194.6	0.0639
1009.72	0.029	194.8	0.0639
1009.73	0.029	194.9	0.0639
1009.75	0.029	194.9	0.0639
1009.77	0.029	195	0.0648
1009.78	0.028	195.1	0.0648
1009.80	0.028	195.2	0.0639
1009.82	0.027	195.2	0.0621
1009.83	0.026	195.2	0.0612
1009.85	0.024	195.1	0.0612
1009.87	0.024	195.1	0.0595
1009.88	0.024	195.1	0.0586
1009.90	0.022	195.1	0.0559
1009.92	0.02	195	0.0533
1009.93	0.019	194.9	0.0515
1009.95	0.017	194.7	0.0479
1009.97	0.014	194.5	0.0479
1009.98	0.013	194.5	0.0444
1010.00	0.013	194.4	0.0417
1010.02	0.012	194.2	0.0391
1010.03	0.008	194	0.0346
1010.05	0.007	193.8	0.032
1010.07	0.005	193.6	0.0275
1010.08	0.002	193.3	0.0275
1010.10	0	193.1	0.0204

Prova triassiale ciclica SN04-C1			
pressione di confinamento (kPa)		80	
deviatore ciclico (kPa)		95	
frequenza (hz)		0.00625	
tempo	cella di carico	$\Delta u$	LVDT
(min)	kN	(kPa)	$\delta$ (mm)
1010.12	0	192.9	0.0178
1010.13	-0.003	192.6	0.0178
1010.15	-0.004	192.6	0.0133
1010.17	-0.004	192.4	0.0107
1010.18	-0.006	192.2	0.0071
1010.20	-0.009	191.8	0.0027
1010.22	-0.01	191.6	0.0009
1010.23	-0.011	191.4	-0.0027
1010.25	-0.013	191.1	-0.0027
1010.27	-0.014	190.9	-0.0053
1010.28	-0.014	190.9	-0.0071
1010.30	-0.015	190.7	-0.0098
1010.32	-0.016	190.4	-0.0107
1010.33	-0.016	190.3	-0.0115
1010.35	-0.016	190.1	-0.0124
1010.37	-0.017	190	-0.0124
1010.38	-0.017	189.8	-0.0133
1010.40	-0.017	189.8	-0.0133
1010.42	-0.017	189.7	-0.0142
1010.43	-0.017	189.6	-0.0142
1010.45	-0.016	189.6	-0.0133
1010.48	-0.016	189.5	-0.0124
1010.50	-0.015	189.5	-0.0124
1010.52	-0.014	189.5	-0.0115
1010.52	-0.014	189.5	-0.0098
1010.53	-0.013	189.5	-0.008
1010.55	-0.012	189.6	-0.0071
1010.57	-0.01	189.7	-0.0044
1010.58	-0.009	189.7	-0.0027
1010.60	-0.007	189.9	0.0009
1010.62	-0.005	190.1	0.0009
1010.63	-0.005	190.1	0.0036
1010.65	-0.003	190.2	0.0071
1010.67	-0.001	190.4	0.0098
1010.68	0.002	190.6	0.0133
1010.70	0.003	190.7	0.0169
1010.72	0.005	191	0.0204
1010.73	0.008	191.3	0.0204
1010.75	0.009	191.3	0.024
1010.77	0.009	191.5	0.0284
1010.78	0.011	191.7	0.032
1010.80	0.014	192	0.0364
1010.82	0.015	192.2	0.0391
1010.83	0.016	192.4	0.0408
1010.85	0.019	192.7	0.0453
1010.87	0.02	192.9	0.0479
1010.88	0.021	193.2	0.0506
1010.90	0.024	193.4	0.0506
1010.92	0.024	193.4	0.0541
1010.93	0.024	193.6	0.0559
1010.95	0.025	193.8	0.0577
1010.97	0.027	194.1	0.0604
1010.98	0.027	194.2	0.0612
1011.00	0.028	194.4	0.063
1011.02	0.029	194.6	0.063
1011.03	0.029	194.6	0.0639
1011.05	0.029	194.7	0.0639
1011.07	0.029	194.8	0.0639

Prova triassiale ciclica SN04-C1			
pressione di confinamento (kPa)		80	
deviatore ciclico (kPa)		95	
frequenza (hz)		0.00625	
tempo	cella di carico	$\Delta u$	LVDT
(min)	kN	(kPa)	$\delta$ (mm)
1011.08	0.029	194.9	0.0648
1011.10	0.029	195	0.0648
1011.12	0.028	195.1	0.0639
1011.13	0.028	195.2	0.0639
1011.15	0.026	195.2	0.063
1011.17	0.026	195.2	0.0621
1011.18	0.026	195.2	0.0604
1011.20	0.024	195.1	0.0586
1011.22	0.023	195.1	0.0568
1011.23	0.022	195	0.055
1011.25	0.019	194.9	0.055
1011.27	0.018	194.9	0.0524
1011.28	0.018	194.8	0.0497
1011.30	0.016	194.7	0.047
1011.32	0.013	194.5	0.0435
1011.33	0.012	194.4	0.0408
1011.35	0.01	194.2	0.0373
1011.37	0.007	193.9	0.0373
1011.38	0.006	193.9	0.0328
1011.40	0.006	193.7	0.0302
1011.42	0.004	193.5	0.0249
1011.43	0.001	193.2	0.0213
1011.45	0	193	0.0186
1011.47	-0.002	192.8	0.0142
1011.48	-0.005	192.4	0.0142
1011.50	-0.006	192.2	0.0098
1011.52	-0.006	192.2	0.0071
1011.53	-0.007	191.9	0.0036
1011.55	-0.011	191.4	0
1011.57	-0.011	191.4	-0.0009
1011.58	-0.011	191.2	-0.0036
1011.60	-0.013	190.9	-0.0062
1011.62	-0.015	190.7	-0.008
1011.63	-0.015	190.6	-0.0098
1011.65	-0.016	190.3	-0.0098
1011.67	-0.017	190.1	-0.0115
1011.68	-0.017	190.1	-0.0124
1011.70	-0.017	190	-0.0124
1011.72	-0.017	189.9	-0.0133
1011.73	-0.017	189.8	-0.0133
1011.75	-0.017	189.6	-0.0133
1011.77	-0.017	189.6	-0.0133
1011.78	-0.016	189.5	-0.0133
1011.80	-0.016	189.5	-0.0133
1011.82	-0.016	189.5	-0.0124
1011.83	-0.015	189.5	-0.0107
1011.85	-0.013	189.5	-0.0098
1011.87	-0.013	189.5	-0.008
1011.88	-0.011	189.6	-0.0053
1011.92	-0.009	189.7	-0.0053
1011.93	-0.008	189.7	-0.0036
1011.95	-0.008	189.8	-0.0009
1011.97	-0.007	189.9	0.0018
1011.98	-0.003	190.1	0.0044
1011.98	-0.003	190.2	0.0071
1012.00	-0.001	190.5	0.0107
1012.02	0.003	190.7	0.0107
1012.03	0.004	190.7	0.0151

Prova triassiale ciclica SN04-C1			
pressione di confinamento (kPa)		80	
deviatore ciclico (kPa)		95	
frequenza (hz)		0.00625	
tempo	cella di carico	$\Delta u$	LVDT
(min)	kN	(kPa)	$\delta$ (mm)
1012.05	0.004	190.8	0.0178
1012.07	0.005	191.1	0.0222
1012.08	0.009	191.3	0.0257
1012.10	0.01	191.6	0.0302
1012.12	0.012	191.8	0.0337
1012.13	0.015	192.1	0.0337
1012.15	0.016	192.1	0.0373
1012.17	0.016	192.3	0.0408
1012.18	0.017	192.6	0.0444
1012.20	0.02	192.8	0.0479
1012.22	0.021	193	0.0506
1012.23	0.022	193.3	0.0524
1012.25	0.025	193.5	0.0524
1012.27	0.025	193.5	0.0559
1012.28	0.025	193.9	0.0586
1012.30	0.027	194.1	0.0586
1012.32	0.027	194.1	0.0604
1012.33	0.027	194.3	0.0612
1012.35	0.028	194.5	0.063
1012.37	0.029	194.6	0.0639
1012.38	0.029	194.7	0.0639
1012.40	0.029	194.9	0.0648
1012.42	0.029	195	0.0648
1012.43	0.029	195.1	0.0648
1012.45	0.029	195.1	0.0648
1012.47	0.028	195.1	0.063
1012.48	0.027	195.1	0.0621
1012.50	0.026	195.1	0.0612
1012.52	0.025	195.2	0.0595
1012.53	0.024	195.1	0.0595
1012.55	0.022	195.1	0.0577
1012.57	0.022	195.1	0.0568
1012.58	0.021	195	0.0533
1012.60	0.019	194.8	0.0515
1012.62	0.017	194.7	0.0488
1012.63	0.016	194.6	0.0453
1012.65	0.013	194.4	0.0453
1012.67	0.011	194.2	0.0417
1012.68	0.011	194.2	0.0391
1012.70	0.01	194.1	0.0355
1012.72	0.007	193.8	0.032
1012.73	0.004	193.6	0.0284
1012.75	0.003	193.4	0.024
1012.77	0.001	193.1	0.0195
1012.78	-0.002	192.8	0.0195
1012.80	-0.002	192.8	0.016
1012.82	-0.003	192.6	0.0124
1012.83	-0.005	192.3	0.0089
1012.85	-0.007	192	0.0053
1012.87	-0.008	191.8	0.0027
1012.88	-0.01	191.5	-0.0009
1012.90	-0.012	191.3	-0.0009
1012.92	-0.012	191.3	-0.0036
1012.93	-0.013	191.1	-0.0053
1012.95	-0.014	190.8	-0.0071
1012.97	-0.015	190.6	-0.0089
1012.98	-0.016	190.4	-0.0107
1013.00	-0.017	190.2	-0.0124

Prova triassiale ciclica SN04-C1			
pressione di confinamento (kPa)		80	
deviatore ciclico (kPa)		95	
frequenza (hz)		0.00625	
tempo	cella di carico	$\Delta u$	LVDT
(min)	kN	(kPa)	$\delta$ (mm)
1013.02	-0.017	190	-0.0133
1013.03	-0.017	189.9	-0.0133
1013.05	-0.017	189.8	-0.0133
1013.07	-0.017	189.7	-0.0133
1013.08	-0.017	189.7	-0.0133
1013.10	-0.017	189.6	-0.0142
1013.12	-0.017	189.5	-0.0133
1013.13	-0.016	189.5	-0.0124
1013.15	-0.015	189.5	-0.0115
1013.17	-0.015	189.5	-0.0098
1013.18	-0.013	189.5	-0.0098
1013.20	-0.012	189.5	-0.0089
1013.22	-0.012	189.5	-0.0071
1013.23	-0.011	189.6	-0.0053
1013.25	-0.008	189.7	-0.0027
1013.27	-0.007	189.8	-0.0009
1013.28	-0.006	189.9	0.0027
1013.30	-0.002	190.1	0.0027
1013.32	-0.002	190.1	0.0053
1013.33	-0.002	190.2	0.0089
1013.35	0	190.5	0.0124
1013.38	0.004	190.7	0.016
1013.40	0.005	190.9	0.0195
1013.42	0.006	191.2	0.0231
1013.43	0.01	191.4	0.0231
1013.43	0.011	191.4	0.0284
1013.45	0.011	191.6	0.0311
1013.47	0.013	191.9	0.0355
1013.48	0.016	192.1	0.0399
1013.50	0.017	192.4	0.0417
1013.52	0.018	192.6	0.0453
1013.53	0.021	192.9	0.0453
1013.55	0.022	192.9	0.0488
1013.57	0.022	193.1	0.0515
1013.58	0.023	193.3	0.0541
1013.60	0.025	193.6	0.0568
1013.62	0.026	193.8	0.0586
1013.63	0.026	194	0.0604
1013.65	0.027	194.2	0.0604
1013.67	0.028	194.4	0.0612
1013.68	0.028	194.4	0.063
1013.70	0.028	194.5	0.063
1013.72	0.029	194.7	0.0639
1013.73	0.029	194.8	0.0648
1013.75	0.029	194.9	0.0648
1013.77	0.029	195	0.0639
1013.78	0.028	195.1	0.0648
1013.80	0.028	195.1	0.063
1013.82	0.027	195.1	0.063
1013.83	0.025	195.1	0.0621
1013.85	0.025	195.1	0.0604
1013.87	0.025	195.1	0.0595
1013.88	0.023	195	0.0568
1013.90	0.021	195	0.0559
1013.92	0.02	194.9	0.0533
1013.93	0.019	194.7	0.0497
1013.95	0.015	194.6	0.0497
1013.97	0.015	194.6	0.047

Prova triassiale ciclica SN04-C1			
pressione di confinamento (kPa)		80	
deviatore ciclico (kPa)		95	
frequenza (hz)		0.00625	
tempo	cella di carico	$\Delta u$	LVDT
(min)	kN	(kPa)	$\delta$ (mm)
1013.98	0.015	194.5	0.0444
1014.00	0.013	194.3	0.0408
1014.02	0.01	194.1	0.0373
1014.03	0.009	194	0.0346
1014.05	0.007	193.7	0.0302
1014.07	0.003	193.4	0.0302
1014.08	0.002	193.4	0.0257
1014.10	0.002	193.3	0.0231
1014.12	0.001	192.9	0.0186
1014.13	-0.003	192.7	0.0142
1014.15	-0.004	192.5	0.0115
1014.17	-0.005	192.1	0.008
1014.18	-0.009	191.9	0.008
1014.20	-0.009	191.9	0.0036
1014.22	-0.009	191.7	0.0018
1014.23	-0.01	191.4	-0.0018
1014.25	-0.013	191.2	-0.0044
1014.27	-0.013	190.9	-0.0062
1014.28	-0.014	190.7	-0.0089
1014.30	-0.016	190.4	-0.0089
1014.32	-0.016	190.4	-0.0107
1014.33	-0.016	190.3	-0.0115
1014.35	-0.017	190.1	-0.0124
1014.37	-0.017	190	-0.0133
1014.38	-0.017	189.8	-0.0133
1014.40	-0.017	189.7	-0.0142
1014.42	-0.017	189.6	-0.0142
1014.43	-0.017	189.6	-0.0133
1014.45	-0.016	189.5	-0.0124
1014.47	-0.016	189.4	-0.0124
1014.48	-0.015	189.4	-0.0124
1014.50	-0.015	189.4	-0.0115
1014.52	-0.014	189.4	-0.0098
1014.53	-0.012	189.5	-0.008
1014.55	-0.011	189.5	-0.0071
1014.57	-0.01	189.6	-0.0044
1014.58	-0.007	189.7	-0.0044
1014.60	-0.006	189.8	-0.0018
1014.62	-0.006	189.8	0
1014.63	-0.005	189.9	0.0036
1014.65	-0.002	190.2	0.0071
1014.67	0	190.3	0.0098
1014.68	0.001	190.5	0.0133
1014.70	0.004	190.7	0.0133
1014.72	0.006	190.9	0.0178
1014.73	0.006	190.9	0.0213
1014.75	0.007	191.2	0.0249
1014.77	0.01	191.5	0.0302
1014.78	0.012	191.7	0.0328
1014.82	0.013	191.9	0.0364
1014.83	0.016	192.2	0.0364
1014.85	0.018	192.5	0.0399
1014.87	0.018	192.5	0.0435
1014.88	0.019	192.7	0.047
1014.88	0.021	193	0.0506
1014.90	0.023	193.2	0.0524
1014.92	0.023	193.4	0.055
1014.93	0.025	193.7	0.0568

Prova triassiale ciclica SN04-C1			
pressione di confinamento (kPa)		80	
deviatore ciclico (kPa)		95	
frequenza (hz)		0.00625	
tempo	cella di carico	$\Delta u$	LVDT
(min)	kN	(kPa)	$\delta$ (mm)
1014.95	0.027	193.9	0.0568
1014.97	0.027	193.9	0.0595
1014.98	0.027	194.1	0.0604
1015.00	0.027	194.2	0.0621
1015.02	0.028	194.4	0.063
1015.03	0.029	194.6	0.0639
1015.05	0.029	194.7	0.0639
1015.07	0.029	194.8	0.0639
1015.08	0.028	194.8	0.0639
1015.10	0.028	194.9	0.0639
1015.12	0.028	195	0.0639
1015.13	0.028	195	0.0639
1015.15	0.027	195.1	0.0621
1015.17	0.026	195.1	0.0612
1015.18	0.024	195	0.0595
1015.20	0.024	195.1	0.0586
1015.22	0.023	195	0.0559
1015.23	0.02	194.9	0.0559
1015.25	0.019	194.9	0.0541
1015.27	0.019	194.8	0.0524
1015.28	0.018	194.7	0.0488
1015.30	0.015	194.5	0.0462
1015.32	0.014	194.4	0.0435
1015.33	0.012	194.3	0.0399
1015.35	0.009	194	0.0399
1015.37	0.007	193.8	0.0355
1015.38	0.007	193.8	0.0328
1015.40	0.006	193.6	0.0293
1015.42	0.003	193.3	0.0249
1015.43	0.001	193.1	0.0213
1015.45	0	192.9	0.0178
1015.47	-0.003	192.6	0.0178
1015.48	-0.005	192.3	0.0133
1015.50	-0.005	192.3	0.0098
1015.52	-0.006	192.1	0.0062
1015.53	-0.008	191.8	0.0027
1015.55	-0.01	191.5	0
1015.57	-0.011	191.3	-0.0027
1015.58	-0.013	191	-0.0027
1015.60	-0.014	190.8	-0.0053
1015.62	-0.014	190.8	-0.0071
1015.63	-0.015	190.6	-0.0089
1015.65	-0.015	190.4	-0.0107
1015.67	-0.017	190.2	-0.0124
1015.68	-0.017	190	-0.0124
1015.70	-0.017	189.9	-0.0133
1015.72	-0.017	189.7	-0.0133
1015.73	-0.017	189.7	-0.0142
1015.75	-0.017	189.6	-0.0133
1015.77	-0.017	189.6	-0.0133
1015.78	-0.017	189.5	-0.0133
1015.80	-0.016	189.5	-0.0124
1015.82	-0.015	189.4	-0.0115
1015.83	-0.014	189.4	-0.0115
1015.85	-0.013	189.4	-0.0107
1015.87	-0.013	189.4	-0.0089
1015.88	-0.012	189.5	-0.0071
1015.90	-0.009	189.6	-0.0044

Prova triassiale ciclica SN04-C1			
pressione di confinamento (kPa)		80	
deviatore ciclico (kPa)		95	
frequenza (hz)		0.00625	
tempo	cella di carico	$\Delta u$	LVDT
(min)	kN	(kPa)	$\delta$ (mm)
1015.92	-0.009	189.6	-0.0036
1015.93	-0.008	189.8	-0.0009
1015.95	-0.005	189.9	0.0018
1015.97	-0.004	190	0.0044
1015.98	-0.003	190.2	0.008
1016.00	0.001	190.4	0.008
1016.02	0.002	190.4	0.0115
1016.03	0.002	190.6	0.0142
1016.05	0.004	190.8	0.0186
1016.07	0.007	191.1	0.0222
1016.08	0.008	191.3	0.0257
1016.10	0.01	191.5	0.0311
1016.12	0.014	191.8	0.0311
1016.13	0.014	191.8	0.0346
1016.15	0.014	192	0.0382
1016.17	0.016	192.3	0.0417
1016.18	0.019	192.6	0.0453
1016.20	0.02	192.8	0.047
1016.22	0.021	193	0.0506
1016.23	0.024	193.3	0.0506
1016.25	0.024	193.3	0.0541
1016.28	0.024	193.5	0.0559
1016.30	0.025	193.7	0.0577
1016.32	0.027	193.9	0.0604
1016.33	0.027	194.1	0.0612
1016.33	0.028	194.3	0.0621
1016.35	0.029	194.4	0.0621
1016.37	0.028	194.4	0.0639
1016.38	0.028	194.6	0.0639
1016.40	0.029	194.7	0.0639
1016.42	0.028	194.8	0.0639
1016.43	0.029	194.9	0.0648
1016.45	0.029	195	0.0639
1016.47	0.027	195	0.0639
1016.48	0.027	195	0.063
1016.50	0.027	195.1	0.0621
1016.52	0.025	195.1	0.0604
1016.53	0.024	195	0.0586
1016.55	0.023	195	0.0568
1016.57	0.022	194.9	0.0541
1016.58	0.019	194.8	0.0541
1016.60	0.018	194.8	0.0515
1016.62	0.018	194.7	0.0497
1016.63	0.014	194.4	0.0462
1016.65	0.013	194.4	0.0453
1016.67	0.013	194.3	0.0426
1016.68	0.011	194.1	0.0382
1016.70	0.008	193.9	0.0346
1016.72	0.007	193.7	0.032
1016.73	0.005	193.5	0.0284
1016.75	0.002	193.2	0.0284
1016.77	0	193	0.0231
1016.78	0	193	0.0195
1016.80	-0.001	192.8	0.016
1016.82	-0.004	192.4	0.0115
1016.83	-0.005	192.2	0.0089
1016.85	-0.007	192	0.0053
1016.87	-0.01	191.6	0.0053



Prova triassiale ciclica SN04-C1			
pressione di confinamento (kPa)		80	
deviatore ciclico (kPa)		95	
frequenza (hz)		0.00625	
tempo	cella di carico	$\Delta u$	LVDT
(min)	kN	(kPa)	$\delta$ (mm)
1016.88	-0.011	191.4	0.0018
1016.90	-0.011	191.4	-0.0009
1016.92	-0.011	191.2	-0.0027
1016.93	-0.013	190.9	-0.0053
1016.95	-0.015	190.7	-0.008
1016.97	-0.015	190.5	-0.0089
1016.98	-0.016	190.3	-0.0089
1017.00	-0.017	190.1	-0.0107
1017.02	-0.017	190.1	-0.0124
1017.03	-0.017	189.9	-0.0133
1017.05	-0.017	189.8	-0.0133
1017.07	-0.017	189.7	-0.0133
1017.08	-0.017	189.6	-0.0142
1017.10	-0.017	189.5	-0.0133
1017.12	-0.016	189.5	-0.0133
1017.13	-0.016	189.5	-0.0133
1017.15	-0.016	189.4	-0.0124
1017.17	-0.015	189.4	-0.0107
1017.18	-0.013	189.4	-0.0098
1017.20	-0.013	189.4	-0.008
1017.22	-0.011	189.5	-0.0053
1017.23	-0.009	189.6	-0.0053
1017.25	-0.008	189.6	-0.0036
1017.27	-0.008	189.7	-0.0018
1017.28	-0.007	189.9	0.0009
1017.30	-0.004	190	0.0044
1017.32	-0.003	190.1	0.0071
1017.33	-0.001	190.4	0.0107
1017.35	0.003	190.6	0.0107
1017.37	0.003	190.7	0.0169
1017.38	0.004	190.9	0.0195
1017.40	0.008	191.2	0.0195
1017.42	0.009	191.2	0.024
1017.43	0.009	191.4	0.0284
1017.45	0.011	191.7	0.0328
1017.47	0.014	191.9	0.0373
1017.48	0.015	192.1	0.0399
1017.50	0.016	192.4	0.0426
1017.52	0.02	192.7	0.0426
1017.53	0.02	192.7	0.0462
1017.55	0.02	192.9	0.0488
1017.57	0.022	193.1	0.0524
1017.58	0.024	193.4	0.055
1017.60	0.025	193.6	0.0559
1017.62	0.025	193.8	0.0586
1017.63	0.027	194	0.0586
1017.65	0.028	194	0.0604
1017.67	0.028	194.2	0.0621
1017.68	0.028	194.3	0.063
1017.72	0.028	194.5	0.0639
1017.73	0.029	194.6	0.0639
1017.75	0.029	194.8	0.0648
1017.77	0.029	194.9	0.0648
1017.78	0.029	195	0.0648
1017.78	0.029	195	0.0648
1017.80	0.028	195	0.0639
1017.82	0.027	195	0.0621
1017.83	0.026	195	0.0612

Prova triassiale ciclica SN04-C1			
pressione di confinamento (kPa)		80	
deviatore ciclico (kPa)		95	
frequenza (hz)		0.00625	
tempo	cella di carico	$\Delta u$	LVDT
(min)	kN	(kPa)	$\delta$ (mm)
1017.85	0.025	195	0.0595
1017.87	0.024	195	0.0595
1017.88	0.022	194.9	0.0577
1017.90	0.022	194.9	0.0559
1017.92	0.021	194.9	0.0541
1017.93	0.019	194.7	0.0515
1017.95	0.017	194.6	0.0488
1017.97	0.016	194.5	0.0453
1017.98	0.013	194.3	0.0417
1018.00	0.011	194.1	0.0417
1018.02	0.011	194.1	0.0391
1018.03	0.01	194	0.0355
1018.05	0.007	193.7	0.032
1018.07	0.004	193.5	0.0284
1018.08	0.003	193.3	0.024
1018.10	0.002	193.1	0.0222
1018.12	-0.001	192.8	0.0178
1018.13	-0.002	192.6	0.0151
1018.15	-0.004	192.3	0.0115
1018.17	-0.007	192	0.0115
1018.18	-0.008	192	0.0071
1018.20	-0.008	191.8	0.0036
1018.22	-0.009	191.6	0.0009
1018.23	-0.011	191.3	-0.0018
1018.25	-0.012	191.1	-0.0036
1018.27	-0.013	190.8	-0.0062
1018.28	-0.015	190.6	-0.0062
1018.30	-0.015	190.6	-0.008
1018.32	-0.015	190.4	-0.0098
1018.33	-0.016	190.2	-0.0115
1018.35	-0.017	190	-0.0124
1018.37	-0.017	189.9	-0.0133
1018.38	-0.017	189.8	-0.0133
1018.40	-0.017	189.6	-0.0133
1018.42	-0.017	189.6	-0.0133
1018.43	-0.017	189.5	-0.0133
1018.45	-0.017	189.5	-0.0133
1018.47	-0.016	189.4	-0.0124
1018.48	-0.015	189.4	-0.0115
1018.50	-0.015	189.4	-0.0098
1018.52	-0.012	189.4	-0.0098
1018.53	-0.012	189.4	-0.0089
1018.55	-0.012	189.4	-0.0071
1018.57	-0.011	189.6	-0.0053
1018.58	-0.008	189.7	-0.0027
1018.60	-0.007	189.7	0
1018.62	-0.006	189.9	0.0027
1018.63	-0.002	190.1	0.0027
1018.65	-0.002	190.1	0.0062
1018.67	-0.002	190.2	0.0089
1018.68	0	190.4	0.0124
1018.70	0.004	190.6	0.016
1018.72	0.005	190.8	0.0195
1018.73	0.006	191.1	0.024
1018.75	0.01	191.3	0.024
1018.77	0.011	191.3	0.0284
1018.78	0.011	191.5	0.0311
1018.80	0.012	191.8	0.0355

Prova triassiale ciclica SN04-C1			
pressione di confinamento (kPa)		80	
deviatore ciclico (kPa)		95	
frequenza (hz)		0.00625	
tempo	cella di carico	$\Delta u$	LVDT
(min)	kN	(kPa)	$\delta$ (mm)
1018.82	0.016	192.3	0.0391
1018.83	0.016	192.3	0.0408
1018.85	0.017	192.5	0.0444
1018.87	0.02	192.8	0.0479
1018.88	0.022	193	0.0506
1018.90	0.022	193.2	0.0533
1018.92	0.024	193.5	0.0533
1018.93	0.026	193.7	0.0559
1018.95	0.026	193.7	0.0577
1018.97	0.026	193.9	0.0595
1018.98	0.027	194.1	0.0612
1019.00	0.028	194.3	0.0621
1019.02	0.028	194.4	0.063
1019.03	0.028	194.5	0.063
1019.05	0.029	194.7	0.0639
1019.07	0.029	194.7	0.0648
1019.08	0.029	194.8	0.0648
1019.10	0.029	194.9	0.0648
1019.12	0.028	195	0.0648
1019.13	0.028	195.1	0.0639
1019.15	0.027	195.1	0.0621
1019.18	0.025	195.1	0.0621
1019.20	0.025	195.1	0.0612
1019.22	0.025	195	0.0595
1019.23	0.023	195	0.0577
1019.23	0.021	194.9	0.055
1019.25	0.02	194.9	0.0533
1019.27	0.019	194.7	0.0506
1019.28	0.016	194.6	0.0506
1019.30	0.015	194.6	0.0479
1019.32	0.015	194.4	0.0453
1019.33	0.013	194.2	0.0417
1019.35	0.009	194	0.0373
1019.37	0.009	193.9	0.0346
1019.38	0.007	193.6	0.0311
1019.40	0.003	193.4	0.0311
1019.42	0.003	193.4	0.0257
1019.43	0.003	193.2	0.0231
1019.45	0.001	192.9	0.0186
1019.47	-0.003	192.6	0.0142
1019.48	-0.004	192.4	0.0124
1019.50	-0.005	192.1	0.008
1019.52	-0.009	191.8	0.008
1019.53	-0.009	191.6	0.0027
1019.55	-0.01	191.4	0
1019.57	-0.012	191.2	0
1019.58	-0.012	191.2	-0.0027
1019.60	-0.012	190.9	-0.0044
1019.62	-0.014	190.7	-0.0071
1019.63	-0.016	190.4	-0.0098
1019.65	-0.016	190.3	-0.0107
1019.67	-0.016	190.1	-0.0115
1019.68	-0.017	189.9	-0.0115
1019.70	-0.017	189.9	-0.0124
1019.72	-0.017	189.8	-0.0133
1019.73	-0.017	189.7	-0.0133
1019.75	-0.017	189.6	-0.0133
1019.77	-0.017	189.5	-0.0133

Prova triassiale ciclica SN04-C1			
pressione di confinamento (kPa)		80	
deviatore ciclico (kPa)		95	
frequenza (hz)		0.00625	
tempo	cella di carico	$\Delta u$	LVDT
(min)	kN	(kPa)	$\delta$ (mm)
1019.78	-0.017	189.4	-0.0133
1019.80	-0.016	189.4	-0.0133
1019.82	-0.015	189.4	-0.0115
1019.83	-0.015	189.4	-0.0107
1019.85	-0.014	189.4	-0.0098
1019.87	-0.012	189.4	-0.008
1019.88	-0.011	189.5	-0.0071
1019.90	-0.01	189.5	-0.0036
1019.92	-0.007	189.7	-0.0036
1019.93	-0.006	189.8	-0.0009
1019.95	-0.006	189.8	0.0009
1019.97	-0.005	189.9	0.0044
1019.98	-0.002	190.1	0.0071
1020.00	-0.001	190.3	0.0098
1020.02	0.001	190.4	0.0142
1020.03	0.004	190.7	0.0142
1020.05	0.006	190.9	0.0178
1020.07	0.006	190.9	0.0213
1020.08	0.007	191.1	0.0257
1020.10	0.01	191.4	0.0302
1020.12	0.012	191.6	0.0337
1020.13	0.013	191.8	0.0373
1020.15	0.016	192.2	0.0408
1020.17	0.018	192.4	0.0408
1020.18	0.018	192.4	0.0444
1020.20	0.019	192.6	0.047
1020.22	0.021	192.9	0.0497
1020.23	0.023	193.1	0.0524
1020.25	0.023	193.3	0.055
1020.27	0.025	193.6	0.0577
1020.28	0.026	193.8	0.0595
1020.30	0.027	194	0.0604
1020.32	0.027	194.2	0.0621
1020.33	0.028	194.3	0.0621
1020.35	0.029	194.3	0.063
1020.37	0.029	194.5	0.0639
1020.38	0.029	194.6	0.0639
1020.40	0.029	194.7	0.0639
1020.42	0.028	194.8	0.0648
1020.43	0.029	194.9	0.0648
1020.45	0.028	195	0.0648
1020.47	0.027	195	0.0648
1020.48	0.027	195	0.063
1020.50	0.027	195	0.0621
1020.52	0.025	195	0.0604
1020.53	0.024	195	0.0595
1020.55	0.023	195	0.0568
1020.57	0.02	194.9	0.0568
1020.58	0.02	194.9	0.0541
1020.60	0.02	194.8	0.0524
1020.62	0.018	194.6	0.0497
1020.65	0.015	194.5	0.0462
1020.67	0.014	194.4	0.0444
1020.68	0.012	194.2	0.0399
1020.70	0.009	193.9	0.0399
1020.70	0.007	193.9	0.0364
1020.72	0.007	193.8	0.0337
1020.73	0.006	193.6	0.0293

Prova triassiale ciclica SN04-C1			
pressione di confinamento (kPa)		80	
deviatore ciclico (kPa)		95	
frequenza (hz)		0.00625	
tempo	cella di carico	$\Delta u$	LVDT
(min)	kN	(kPa)	$\delta$ (mm)
1020.75	0.003	193.3	0.0249
1020.77	0.002	193.1	0.0222
1020.78	0	192.8	0.0169
1020.80	-0.004	192.5	0.0169
1020.82	-0.005	192.5	0.0133
1020.83	-0.005	192.3	0.0107
1020.85	-0.006	192	0.0071
1020.87	-0.009	191.7	0.0036
1020.88	-0.01	191.5	0.0009
1020.90	-0.011	191.2	-0.0027
1020.92	-0.013	191	-0.0027
1020.93	-0.014	190.8	-0.0053
1020.95	-0.014	190.8	-0.0062
1020.97	-0.015	190.6	-0.0089
1020.98	-0.016	190.2	-0.0098
1021.00	-0.016	190.2	-0.0115
1021.02	-0.017	190	-0.0115
1021.03	-0.017	189.8	-0.0124
1021.05	-0.017	189.7	-0.0133
1021.07	-0.017	189.6	-0.0133
1021.08	-0.017	189.5	-0.0133
1021.10	-0.017	189.4	-0.0133
1021.12	-0.017	189.4	-0.0133
1021.13	-0.016	189.4	-0.0124
1021.15	-0.015	189.4	-0.0115
1021.17	-0.014	189.4	-0.0107
1021.18	-0.014	189.4	-0.0089
1021.20	-0.012	189.4	-0.0089
1021.22	-0.01	189.5	-0.0071
1021.23	-0.01	189.5	-0.0053
1021.25	-0.01	189.5	-0.0036
1021.27	-0.007	189.7	0
1021.28	-0.005	189.8	0.0018
1021.30	-0.004	189.9	0.0053
1021.32	-0.002	190.2	0.0089
1021.33	0.001	190.4	0.0089
1021.35	0.001	190.4	0.0115
1021.37	0.002	190.5	0.0151
1021.38	0.004	190.8	0.0195
1021.40	0.007	191	0.0231
1021.42	0.008	191.2	0.0275
1021.43	0.011	191.5	0.032
1021.45	0.013	191.8	0.032
1021.47	0.013	191.8	0.0355
1021.48	0.014	191.9	0.0391
1021.50	0.017	192.3	0.0426
1021.52	0.019	192.5	0.0453
1021.53	0.02	192.7	0.0488
1021.55	0.021	193	0.0515
1021.57	0.024	193.2	0.0515
1021.58	0.024	193.2	0.0541
1021.60	0.024	193.4	0.0568
1021.62	0.025	193.7	0.0586
1021.63	0.027	193.9	0.0604
1021.65	0.027	194	0.0612
1021.67	0.028	194.2	0.063
1021.68	0.028	194.4	0.063
1021.70	0.029	194.4	0.0639

Prova triassiale ciclica SN04-C1			
pressione di confinamento (kPa)		80	
deviatore ciclico (kPa)		95	
frequenza (hz)		0.00625	
tempo	cella di carico	$\Delta u$	LVDT
(min)	kN	(kPa)	$\delta$ (mm)
1021.72	0.029	194.7	0.0639
1021.73	0.029	194.8	0.0639
1021.75	0.029	194.8	0.0648
1021.77	0.029	194.9	0.0648
1021.78	0.029	194.9	0.0648
1021.80	0.028	195	0.0639
1021.82	0.027	195	0.063
1021.83	0.026	195	0.0612
1021.85	0.024	195	0.0612
1021.87	0.023	195	0.0595
1021.88	0.023	195	0.0577
1021.90	0.022	194.9	0.0559
1021.92	0.02	194.8	0.0533
1021.93	0.019	194.7	0.0515
1021.95	0.017	194.6	0.0479
1021.97	0.014	194.4	0.0479
1021.98	0.013	194.4	0.0453
1022.00	0.013	194.3	0.0426
1022.02	0.012	194.1	0.0391
1022.03	0.008	193.9	0.0346
1022.05	0.007	193.7	0.032
1022.08	0.005	193.5	0.0284
1022.10	0.002	193.2	0.0284
1022.12	0	193	0.0231
1022.13	0	193	0.0195
1022.15	-0.001	192.7	0.016
1022.15	-0.004	192.4	0.0124
1022.17	-0.006	192.2	0.0089
1022.18	-0.006	191.9	0.0053
1022.20	-0.009	191.6	0.0053
1022.22	-0.011	191.4	0.0018
1022.23	-0.011	191.4	-0.0009
1022.25	-0.012	191.2	-0.0036
1022.27	-0.014	190.9	-0.0062
1022.28	-0.014	190.7	-0.0071
1022.30	-0.015	190.5	-0.0089
1022.32	-0.016	190.2	-0.0089
1022.33	-0.017	190.1	-0.0107
1022.35	-0.017	190.1	-0.0115
1022.37	-0.017	189.9	-0.0124
1022.38	-0.017	189.8	-0.0133
1022.40	-0.017	189.7	-0.0133
1022.42	-0.017	189.5	-0.0133
1022.43	-0.017	189.5	-0.0133
1022.45	-0.016	189.4	-0.0124
1022.47	-0.016	189.4	-0.0124
1022.48	-0.015	189.3	-0.0115
1022.50	-0.014	189.3	-0.0115
1022.52	-0.013	189.3	-0.0098
1022.53	-0.013	189.3	-0.0089
1022.55	-0.012	189.4	-0.0071
1022.57	-0.009	189.5	-0.0044
1022.58	-0.009	189.6	-0.0027
1022.60	-0.007	189.7	0
1022.62	-0.004	189.9	0
1022.63	-0.004	189.9	0.0036
1022.65	-0.004	190	0.0062
1022.67	-0.002	190.2	0.0098

Prova triassiale ciclica SN04-C1			
pressione di confinamento (kPa)		80	
deviatore ciclico (kPa)		95	
frequenza (hz)		0.00625	
tempo	cella di carico	$\Delta u$	LVDT
(min)	kN	(kPa)	$\delta$ (mm)
1022.68	0.002	190.4	0.0133
1022.70	0.003	190.6	0.016
1022.72	0.004	190.8	0.0204
1022.73	0.008	191.1	0.0204
1022.75	0.009	191.1	0.0249
1022.77	0.009	191.3	0.0284
1022.78	0.011	191.5	0.0328
1022.80	0.014	191.8	0.0364
1022.82	0.015	192	0.0399
1022.83	0.016	192.3	0.0426
1022.85	0.02	192.6	0.0426
1022.87	0.02	192.6	0.047
1022.88	0.02	192.8	0.0488
1022.90	0.022	193	0.0524
1022.92	0.024	193.3	0.055
1022.93	0.025	193.5	0.0568
1022.95	0.026	193.7	0.0586
1022.97	0.027	193.9	0.0586
1022.98	0.028	193.9	0.0604
1023.00	0.028	194.1	0.0621
1023.02	0.028	194.3	0.063
1023.03	0.028	194.4	0.0639
1023.05	0.029	194.6	0.0648
1023.07	0.029	194.7	0.0648
1023.08	0.029	194.8	0.0648
1023.10	0.029	194.9	0.0648
1023.12	0.029	194.9	0.0648
1023.13	0.028	195	0.0639
1023.15	0.027	194.9	0.0621
1023.17	0.026	195	0.0612
1023.18	0.025	195	0.0612
1023.20	0.024	195	0.0595
1023.22	0.022	194.9	0.0577
1023.23	0.022	194.9	0.055
1023.25	0.02	194.7	0.0524
1023.27	0.017	194.6	0.0524
1023.28	0.017	194.6	0.0497
1023.30	0.017	194.5	0.047
1023.32	0.014	194.3	0.0435
1023.33	0.012	194.2	0.0408
1023.35	0.011	194	0.0382
1023.37	0.009	193.8	0.0337
1023.38	0.005	193.5	0.0337
1023.40	0.004	193.5	0.0302
1023.42	0.004	193.4	0.0275
1023.43	0.002	193	0.0222
1023.45	-0.001	192.8	0.0186
1023.47	-0.002	192.6	0.0151
1023.48	-0.004	192.3	0.0115
1023.50	-0.007	192	0.0115
1023.52	-0.008	192	0.0071
1023.55	-0.008	191.8	0.0044
1023.57	-0.009	191.5	0.0018
1023.58	-0.011	191.2	-0.0018
1023.60	-0.012	191	-0.0036
1023.60	-0.013	190.8	-0.0062
1023.62	-0.015	190.5	-0.0062
1023.63	-0.015	190.5	-0.0089

Prova triassiale ciclica SN04-C1			
pressione di confinamento (kPa)		80	
deviatore ciclico (kPa)		95	
frequenza (hz)		0.00625	
tempo	cella di carico	$\Delta u$	LVDT
(min)	kN	(kPa)	$\delta$ (mm)
1023.65	-0.015	190.3	-0.0098
1023.67	-0.016	190.2	-0.0107
1023.68	-0.017	190	-0.0124
1023.70	-0.017	189.8	-0.0124
1023.72	-0.017	189.7	-0.0124
1023.73	-0.017	189.6	-0.0124
1023.75	-0.017	189.6	-0.0133
1023.77	-0.017	189.5	-0.0133
1023.78	-0.017	189.4	-0.0133
1023.80	-0.016	189.4	-0.0124
1023.82	-0.015	189.3	-0.0107
1023.83	-0.014	189.4	-0.0098
1023.85	-0.013	189.4	-0.0098
1023.87	-0.012	189.4	-0.0089
1023.88	-0.012	189.4	-0.0071
1023.90	-0.009	189.5	-0.0044
1023.92	-0.008	189.5	-0.0036
1023.93	-0.008	189.6	-0.0009
1023.95	-0.007	189.8	0.0018
1023.97	-0.004	190	0.0044
1023.98	-0.002	190.1	0.008
1024.00	-0.001	190.3	0.0115
1024.02	0.003	190.5	0.0115
1024.03	0.004	190.5	0.0151
1024.05	0.004	190.7	0.0186
1024.07	0.005	190.9	0.0222
1024.08	0.009	191.2	0.0257
1024.10	0.01	191.4	0.0311
1024.12	0.012	191.7	0.0346
1024.13	0.015	191.9	0.0346
1024.15	0.016	191.9	0.0382
1024.17	0.016	192.1	0.0408
1024.18	0.017	192.4	0.0453
1024.20	0.02	192.7	0.0479
1024.22	0.021	192.9	0.0506
1024.23	0.023	193.1	0.0533
1024.25	0.024	193.4	0.0533
1024.27	0.026	193.6	0.0559
1024.28	0.026	193.6	0.0577
1024.30	0.026	193.8	0.0595
1024.32	0.027	194	0.0612
1024.33	0.028	194.2	0.063
1024.35	0.028	194.3	0.0639
1024.37	0.029	194.5	0.0639
1024.38	0.029	194.6	0.0648
1024.40	0.029	194.6	0.0648
1024.42	0.029	194.7	0.0648
1024.43	0.029	194.8	0.0648
1024.45	0.028	194.9	0.0648
1024.47	0.028	195	0.0639
1024.48	0.027	194.9	0.0621
1024.50	0.025	195	0.0621
1024.52	0.025	195	0.0612
1024.53	0.025	195	0.0595
1024.55	0.023	194.9	0.0577
1024.57	0.021	194.9	0.0559
1024.58	0.021	194.8	0.0541
1024.60	0.019	194.6	0.0506



Prova triassiale ciclica SN04-C1			
pressione di confinamento (kPa)		80	
deviatore ciclico (kPa)		95	
frequenza (hz)		0.00625	
tempo	cella di carico	$\Delta u$	LVDT
(min)	kN	(kPa)	$\delta$ (mm)
1024.62	0.016	194.5	0.0506
1024.63	0.015	194.5	0.0479
1024.65	0.015	194.4	0.0453
1024.67	0.013	194.2	0.0417
1024.68	0.009	194	0.0382
1024.70	0.009	193.8	0.0355
1024.72	0.007	193.6	0.0311
1024.73	0.003	193.3	0.0275
1024.75	0.003	193.2	0.024
1024.77	0.002	192.9	0.0204
1024.78	-0.002	192.7	0.0204
1024.80	-0.003	192.7	0.0169
1024.82	-0.003	192.5	0.0142
1024.83	-0.004	192.2	0.0098
1024.85	-0.007	191.9	0.0062
1024.87	-0.009	191.6	0.0036
1024.88	-0.01	191.4	0
1024.90	-0.012	191.1	0
1024.92	-0.013	190.9	-0.0027
1024.93	-0.013	190.9	-0.0053
1024.95	-0.014	190.7	-0.0071
1024.98	-0.015	190.4	-0.0089
1025.00	-0.016	190.2	-0.0107
1025.02	-0.016	190.1	-0.0115
1025.03	-0.017	189.9	-0.0115
1025.05	-0.017	189.7	-0.0124
1025.05	-0.017	189.7	-0.0133
1025.07	-0.017	189.6	-0.0133
1025.08	-0.017	189.5	-0.0133
1025.10	-0.017	189.4	-0.0133
1025.12	-0.016	189.4	-0.0124
1025.13	-0.016	189.3	-0.0115
1025.15	-0.015	189.3	-0.0115
1025.17	-0.014	189.3	-0.0107
1025.18	-0.014	189.3	-0.0098
1025.20	-0.013	189.4	-0.008
1025.22	-0.011	189.4	-0.0062
1025.23	-0.01	189.5	-0.0036
1025.25	-0.009	189.6	-0.0018
1025.27	-0.006	189.7	-0.0018
1025.28	-0.005	189.7	0.0009
1025.30	-0.005	189.8	0.0036
1025.32	-0.004	190.1	0.0071
1025.33	0	190.3	0.0107
1025.35	0.001	190.4	0.0142
1025.37	0.003	190.6	0.0178
1025.38	0.006	190.9	0.0178
1025.40	0.007	190.9	0.0213
1025.42	0.007	191	0.0249
1025.43	0.009	191.3	0.0302
1025.45	0.013	191.6	0.0337
1025.47	0.013	191.8	0.0355
1025.48	0.014	192	0.0399
1025.50	0.018	192.3	0.0426
1025.52	0.018	192.5	0.0453
1025.53	0.019	192.8	0.0488
1025.55	0.023	193	0.0488
1025.57	0.023	193	0.0524

Prova triassiale ciclica SN04-C1			
pressione di confinamento (kPa)		80	
deviatore ciclico (kPa)		95	
frequenza (hz)		0.00625	
tempo	cella di carico	$\Delta u$	LVDT
(min)	kN	(kPa)	$\delta$ (mm)
1025.58	0.023	193.2	0.0541
1025.60	0.024	193.4	0.0568
1025.62	0.026	193.7	0.0595
1025.63	0.027	193.9	0.0604
1025.65	0.027	194	0.0621
1025.67	0.028	194.2	0.0621
1025.68	0.029	194.2	0.063
1025.70	0.029	194.4	0.0639
1025.72	0.029	194.5	0.0648
1025.73	0.029	194.7	0.0648
1025.75	0.029	194.8	0.0648
1025.77	0.029	194.8	0.0648
1025.78	0.028	194.9	0.0648
1025.80	0.027	195	0.0648
1025.82	0.027	195	0.0639
1025.83	0.026	195	0.0621
1025.85	0.025	195	0.0604
1025.87	0.024	194.9	0.0595
1025.88	0.023	194.9	0.0568
1025.90	0.021	194.8	0.055
1025.92	0.019	194.7	0.055
1025.93	0.019	194.7	0.0524
1025.95	0.018	194.6	0.0497
1025.97	0.016	194.4	0.047
1025.98	0.013	194.3	0.0435
1026.00	0.012	194.2	0.0408
1026.02	0.01	193.9	0.0364
1026.03	0.007	193.7	0.0364
1026.05	0.006	193.7	0.0328
1026.07	0.006	193.5	0.0311
1026.08	0.004	193.2	0.0257
1026.10	0.001	193	0.0222
1026.12	0	192.8	0.0186
1026.13	-0.002	192.5	0.0142
1026.15	-0.006	192.2	0.0142
1026.17	-0.006	192.2	0.0098
1026.18	-0.007	191.8	0.0062
1026.20	-0.009	191.6	0.0062
1026.22	-0.01	191.6	0.0036
1026.23	-0.01	191.3	0
1026.25	-0.012	191	-0.0027
1026.27	-0.014	190.8	-0.0053
1026.28	-0.014	190.6	-0.0071
1026.30	-0.015	190.4	-0.0089
1026.32	-0.016	190.2	-0.0089
1026.33	-0.016	190.2	-0.0107
1026.35	-0.016	190	-0.0115
1026.37	-0.017	189.8	-0.0124
1026.38	-0.017	189.7	-0.0133
1026.40	-0.017	189.6	-0.0133
1026.42	-0.017	189.5	-0.0133
1026.45	-0.017	189.4	-0.0133
1026.47	-0.016	189.4	-0.0124
1026.48	-0.016	189.3	-0.0124
1026.50	-0.016	189.3	-0.0115
1026.50	-0.015	189.3	-0.0107
1026.52	-0.013	189.3	-0.0089
1026.53	-0.013	189.3	-0.0071

Prova triassiale ciclica SN04-C1			
pressione di confinamento (kPa)		80	
deviatore ciclico (kPa)		95	
frequenza (hz)		0.00625	
tempo	cella di carico	$\Delta u$	LVDT
(min)	kN	(kPa)	$\delta$ (mm)
1026.55	-0.01	189.4	-0.0071
1026.57	-0.01	189.4	-0.0053
1026.58	-0.01	189.5	-0.0027
1026.60	-0.008	189.6	0
1026.62	-0.005	189.8	0.0027
1026.63	-0.004	189.9	0.0053
1026.65	-0.003	190.1	0.0089
1026.67	0.001	190.3	0.0089
1026.68	0.002	190.3	0.0124
1026.70	0.002	190.4	0.0151
1026.72	0.004	190.7	0.0195
1026.73	0.007	190.9	0.0231
1026.75	0.008	191.2	0.0275
1026.77	0.01	191.4	0.032
1026.78	0.014	191.7	0.032
1026.80	0.014	191.7	0.0355
1026.82	0.014	191.9	0.0382
1026.83	0.016	192.1	0.0417
1026.85	0.019	192.4	0.0453
1026.87	0.02	192.6	0.0479
1026.88	0.021	192.9	0.0515
1026.90	0.023	193.2	0.0515
1026.92	0.024	193.4	0.0559
1026.93	0.025	193.5	0.0586
1026.95	0.026	193.8	0.0586
1026.97	0.027	194	0.0595
1026.98	0.027	194	0.0612
1027.00	0.027	194.1	0.063
1027.02	0.028	194.3	0.0639
1027.03	0.029	194.5	0.0639
1027.05	0.029	194.6	0.0648
1027.07	0.029	194.7	0.0648
1027.08	0.029	194.8	0.0648
1027.10	0.029	194.8	0.0648
1027.12	0.029	194.9	0.0648
1027.13	0.028	194.9	0.0639
1027.15	0.027	195	0.063
1027.17	0.026	195	0.0612
1027.18	0.025	194.9	0.0604
1027.20	0.023	194.9	0.0604
1027.22	0.022	194.9	0.0586
1027.23	0.022	194.9	0.0568
1027.25	0.021	194.8	0.0541
1027.27	0.018	194.7	0.0515
1027.28	0.017	194.6	0.0488
1027.30	0.015	194.4	0.0462
1027.32	0.012	194.2	0.0462
1027.33	0.011	194.2	0.0426
1027.35	0.011	194.1	0.0391
1027.37	0.009	193.8	0.0355
1027.38	0.006	193.6	0.032
1027.40	0.005	193.4	0.0293
1027.42	0.003	193.1	0.024
1027.43	0	192.9	0.024
1027.45	-0.001	192.9	0.0204
1027.47	-0.001	192.7	0.0169
1027.48	-0.003	192.4	0.0133
1027.50	-0.006	192.1	0.0089

Prova triassiale ciclica SN04-C1			
pressione di confinamento (kPa)		80	
deviatore ciclico (kPa)		95	
frequenza (hz)		0.00625	
tempo	cella di carico	$\Delta u$	LVDT
(min)	kN	(kPa)	$\delta$ (mm)
1027.52	-0.007	191.9	0.0062
1027.53	-0.008	191.6	0.0027
1027.55	-0.011	191.3	0.0027
1027.57	-0.011	191.3	0
1027.58	-0.011	191.1	-0.0027
1027.60	-0.013	190.8	-0.0044
1027.62	-0.014	190.6	-0.0071
1027.63	-0.015	190.4	-0.0089
1027.65	-0.015	190.2	-0.0098
1027.67	-0.016	190	-0.0107
1027.68	-0.017	189.9	-0.0115
1027.70	-0.017	189.7	-0.0124
1027.72	-0.017	189.6	-0.0124
1027.73	-0.017	189.6	-0.0133
1027.75	-0.017	189.5	-0.0133
1027.77	-0.017	189.4	-0.0133
1027.78	-0.017	189.3	-0.0124
1027.80	-0.016	189.3	-0.0115
1027.82	-0.015	189.3	-0.0107
1027.83	-0.014	189.3	-0.0107
1027.85	-0.013	189.3	-0.0098
1027.87	-0.013	189.3	-0.008
1027.90	-0.012	189.3	-0.0062
1027.92	-0.01	189.5	-0.0036
1027.93	-0.009	189.5	-0.0018
1027.95	-0.007	189.6	0.0009
1027.95	-0.005	189.8	0.0009
1027.97	-0.003	190	0.0036
1027.98	-0.003	190	0.0062
1028.00	-0.001	190.1	0.0098
1028.02	0.001	190.4	0.0133
1028.03	0.003	190.5	0.0169
1028.05	0.004	190.7	0.0204
1028.07	0.008	191	0.0204
1028.08	0.01	191.2	0.0249
1028.10	0.01	191.2	0.0293
1028.12	0.011	191.4	0.0328
1028.13	0.013	191.8	0.0364
1028.15	0.016	192	0.0399
1028.17	0.017	192.2	0.0435
1028.18	0.019	192.5	0.0435
1028.20	0.021	192.8	0.047
1028.22	0.021	192.8	0.0497
1028.23	0.022	193	0.0524
1028.25	0.023	193.2	0.055
1028.27	0.025	193.5	0.0577
1028.28	0.026	193.6	0.0595
1028.30	0.027	193.9	0.0612
1028.32	0.028	194	0.0612
1028.33	0.028	194	0.063
1028.35	0.028	194.2	0.0639
1028.37	0.029	194.5	0.0639
1028.38	0.029	194.5	0.0648
1028.40	0.029	194.6	0.0648
1028.42	0.029	194.7	0.0648
1028.43	0.029	194.8	0.0648
1028.45	0.028	194.9	0.0648
1028.47	0.028	195	0.0639

Prova triassiale ciclica SN04-C1			
pressione di confinamento (kPa)		80	
deviatore ciclico (kPa)		95	
frequenza (hz)		0.00625	
tempo	cella di carico	$\Delta u$	LVDT
(min)	kN	(kPa)	$\delta$ (mm)
1028.48	0.026	194.9	0.0639
1028.50	0.026	194.9	0.0621
1028.52	0.026	195	0.0621
1028.53	0.025	194.9	0.0595
1028.55	0.022	194.9	0.0577
1028.57	0.022	194.8	0.0559
1028.58	0.02	194.7	0.0533
1028.60	0.017	194.6	0.0533
1028.62	0.017	194.6	0.0506
1028.63	0.017	194.5	0.0479
1028.65	0.015	194.3	0.0444
1028.67	0.011	194.1	0.0408
1028.68	0.01	194	0.0382
1028.70	0.009	193.8	0.0346
1028.72	0.005	193.5	0.0346
1028.73	0.004	193.5	0.0311
1028.75	0.004	193.3	0.0284
1028.77	0.003	193.1	0.0231
1028.78	-0.001	192.8	0.0186
1028.80	-0.002	192.6	0.016
1028.82	-0.004	192.3	0.0115
1028.83	-0.007	192	0.0115
1028.85	-0.007	192	0.008
1028.87	-0.007	191.8	0.0053
1028.88	-0.009	191.5	0.0018
1028.90	-0.012	191.2	-0.0018
1028.92	-0.012	191	-0.0036
1028.93	-0.013	190.8	-0.0053
1028.95	-0.015	190.5	-0.0053
1028.97	-0.016	190.3	-0.008
1028.98	-0.016	190.3	-0.0098
1029.00	-0.016	190.1	-0.0107
1029.02	-0.017	189.9	-0.0124
1029.03	-0.017	189.8	-0.0124
1029.05	-0.017	189.6	-0.0124
1029.07	-0.017	189.5	-0.0124
1029.08	-0.017	189.5	-0.0133
1029.10	-0.017	189.4	-0.0133
1029.12	-0.016	189.3	-0.0133
1029.13	-0.015	189.3	-0.0124
1029.15	-0.015	189.3	-0.0115
1029.17	-0.015	189.2	-0.0098
1029.18	-0.014	189.3	-0.0089
1029.20	-0.012	189.3	-0.0071
1029.22	-0.011	189.4	-0.0053
1029.23	-0.01	189.5	-0.0027
1029.25	-0.007	189.6	-0.0027
1029.27	-0.007	189.6	-0.0009
1029.28	-0.007	189.6	0.0018
1029.30	-0.005	189.9	0.0044
1029.32	-0.002	190	0.008
1029.35	-0.001	190.2	0.0115
1029.37	0.001	190.4	0.0142
1029.38	0.004	190.6	0.0142
1029.40	0.005	190.6	0.0178
1029.40	0.005	190.8	0.0213
1029.42	0.007	191.1	0.0257
1029.43	0.011	191.3	0.0311

Prova triassiale ciclica SN04-C1			
pressione di confinamento (kPa)		80	
deviatore ciclico (kPa)		95	
frequenza (hz)		0.00625	
tempo	cella di carico	$\Delta u$	LVDT
(min)	kN	(kPa)	$\delta$ (mm)
1029.45	0.012	191.5	0.0337
1029.47	0.013	191.8	0.0373
1029.48	0.017	192.1	0.0373
1029.50	0.017	192.1	0.0417
1029.52	0.017	192.3	0.0444
1029.53	0.019	192.6	0.0479
1029.55	0.022	192.8	0.0506
1029.57	0.022	193	0.0533
1029.58	0.024	193.3	0.0559
1029.60	0.026	193.5	0.0559
1029.62	0.026	193.5	0.0586
1029.63	0.026	193.7	0.0604
1029.65	0.027	193.9	0.0612
1029.67	0.027	194.1	0.0621
1029.68	0.028	194.3	0.0639
1029.70	0.029	194.4	0.0648
1029.72	0.029	194.5	0.0648
1029.73	0.029	194.5	0.0648
1029.75	0.029	194.7	0.0648
1029.77	0.029	194.7	0.0648
1029.78	0.028	194.8	0.0648
1029.80	0.028	194.9	0.0639
1029.82	0.027	194.9	0.063
1029.83	0.026	194.9	0.0621
1029.85	0.025	194.9	0.0604
1029.87	0.024	194.9	0.0586
1029.88	0.022	194.8	0.0586
1029.90	0.021	194.8	0.0568
1029.92	0.021	194.8	0.055
1029.93	0.019	194.7	0.0515
1029.95	0.017	194.5	0.0488
1029.97	0.015	194.4	0.047
1029.98	0.014	194.3	0.0435
1030.00	0.011	194	0.0435
1030.02	0.009	193.9	0.0399
1030.03	0.009	193.9	0.0373
1030.05	0.008	193.7	0.0328
1030.07	0.005	193.4	0.0293
1030.08	0.003	193.2	0.0249
1030.10	0.002	193	0.0213
1030.12	-0.002	192.6	0.0213
1030.13	-0.003	192.4	0.0169
1030.15	-0.003	192.4	0.0142
1030.17	-0.004	192.2	0.0107
1030.18	-0.007	191.8	0.0062
1030.20	-0.009	191.6	0.0036
1030.22	-0.01	191.4	0.0009
1030.23	-0.012	191.1	0.0009
1030.25	-0.013	190.9	-0.0027
1030.27	-0.013	190.9	-0.0044
1030.28	-0.014	190.7	-0.0071
1030.30	-0.015	190.4	-0.0089
1030.32	-0.016	190.2	-0.0098
1030.33	-0.016	190	-0.0115
1030.35	-0.017	189.9	-0.0124
1030.37	-0.017	189.7	-0.0124
1030.38	-0.017	189.7	-0.0124
1030.40	-0.017	189.6	-0.0124

Prova triassiale ciclica SN04-C1			
pressione di confinamento (kPa)		80	
deviatore ciclico (kPa)		95	
frequenza (hz)		0.00625	
tempo	cella di carico	$\Delta u$	LVDT
(min)	kN	(kPa)	$\delta$ (mm)
1030.42	-0.017	189.5	-0.0133
1030.43	-0.017	189.4	-0.0124
1030.45	-0.017	189.3	-0.0124
1030.47	-0.016	189.3	-0.0115
1030.48	-0.015	189.3	-0.0115
1030.50	-0.014	189.3	-0.0107
1030.52	-0.014	189.3	-0.0089
1030.53	-0.013	189.3	-0.0071
1030.55	-0.011	189.4	-0.0053
1030.57	-0.011	189.4	-0.0044
1030.58	-0.01	189.5	-0.0027
1030.60	-0.006	189.6	0.0009
1030.62	-0.006	189.7	0.0027
1030.63	-0.004	189.9	0.0062
1030.65	-0.001	190.1	0.0062
1030.67	0	190.1	0.0098
1030.68	0	190.2	0.0124
1030.70	0.002	190.5	0.016
1030.72	0.005	190.7	0.0204
1030.73	0.006	190.9	0.0231
1030.75	0.008	191.2	0.0284
1030.77	0.012	191.4	0.0284
1030.78	0.013	191.4	0.0328
1030.82	0.013	191.6	0.0355
1030.83	0.014	191.9	0.0391
1030.85	0.018	192.2	0.0426
1030.87	0.018	192.4	0.0453
1030.87	0.019	192.7	0.0488
1030.88	0.022	192.9	0.0488
1030.90	0.023	192.9	0.0515
1030.92	0.023	193.1	0.0541
1030.93	0.024	193.4	0.0568
1030.95	0.026	193.6	0.0595
1030.97	0.026	193.8	0.0604
1030.98	0.027	194	0.0621
1031.00	0.028	194.2	0.0621
1031.02	0.029	194.2	0.0639
1031.03	0.029	194.3	0.0639
1031.05	0.028	194.5	0.0648
1031.07	0.029	194.6	0.0648
1031.08	0.029	194.7	0.0648
1031.10	0.029	194.8	0.0648
1031.12	0.028	194.9	0.0648
1031.13	0.028	194.9	0.0648
1031.15	0.028	194.9	0.0639
1031.17	0.027	194.9	0.0621
1031.18	0.025	194.9	0.0604
1031.20	0.024	194.9	0.0595
1031.22	0.023	194.8	0.0568
1031.23	0.021	194.7	0.0568
1031.25	0.019	194.6	0.055
1031.27	0.018	194.5	0.0506
1031.28	0.017	194.5	0.0506
1031.30	0.015	194.3	0.0488
1031.32	0.015	194.3	0.0462
1031.33	0.013	194.2	0.0417
1031.35	0.01	193.9	0.0382
1031.37	0.008	193.7	0.0346

Prova triassiale ciclica SN04-C1			
pressione di confinamento (kPa)		80	
deviatore ciclico (kPa)		95	
frequenza (hz)		0.00625	
tempo	cella di carico	$\Delta u$	LVDT
(min)	kN	(kPa)	$\delta$ (mm)
1031.38	0.007	193.6	0.032
1031.40	0.005	193.3	0.032
1031.42	0.002	193	0.0284
1031.43	0.002	193	0.0231
1031.45	0.001	192.9	0.0195
1031.47	-0.002	192.5	0.0151
1031.48	-0.005	192.2	0.0115
1031.50	-0.005	192	0.0089
1031.52	-0.007	191.7	0.0053
1031.53	-0.009	191.5	0.0053
1031.55	-0.009	191.5	0.0018
1031.57	-0.01	191.2	-0.0009
1031.58	-0.012	190.9	-0.0036
1031.60	-0.014	190.7	-0.0062
1031.62	-0.014	190.5	-0.0071
1031.63	-0.015	190.3	-0.0089
1031.65	-0.016	190.1	-0.0089
1031.67	-0.016	190.1	-0.0107
1031.68	-0.016	189.9	-0.0115
1031.70	-0.017	189.8	-0.0124
1031.72	-0.017	189.6	-0.0133
1031.73	-0.017	189.5	-0.0133
1031.75	-0.017	189.4	-0.0133
1031.77	-0.017	189.4	-0.0133
1031.78	-0.016	189.4	-0.0124
1031.80	-0.016	189.3	-0.0115
1031.82	-0.016	189.3	-0.0115
1031.83	-0.014	189.3	-0.0098
1031.85	-0.014	189.3	-0.0089
1031.87	-0.013	189.3	-0.0071
1031.88	-0.01	189.4	-0.0071
1031.90	-0.01	189.4	-0.0053
1031.92	-0.01	189.5	-0.0027
1031.93	-0.008	189.6	0
1031.95	-0.005	189.7	0.0027
1031.97	-0.004	189.8	0.0053
1031.98	-0.002	190	0.0089
1032.00	0.001	190.2	0.0124
1032.02	0.001	190.3	0.0142
1032.03	0.003	190.6	0.0178
1032.05	0.006	190.8	0.0178
1032.07	0.007	190.8	0.0213
1032.08	0.007	191	0.0249
1032.10	0.009	191.3	0.0293
1032.12	0.013	191.5	0.0337
1032.13	0.014	191.7	0.0373
1032.15	0.015	192	0.0408
1032.17	0.018	192.3	0.0408
1032.18	0.019	192.3	0.0444
1032.20	0.019	192.5	0.047
1032.22	0.02	192.7	0.0506
1032.25	0.023	193	0.0533
1032.27	0.024	193.2	0.055
1032.28	0.025	193.4	0.0577
1032.30	0.026	193.7	0.0577
1032.32	0.027	193.9	0.0595
1032.32	0.027	193.9	0.0612
1032.33	0.027	194	0.0621



Prova triassiale ciclica SN04-C1			
pressione di confinamento (kPa)		80	
deviatore ciclico (kPa)		95	
frequenza (hz)		0.00625	
tempo	cella di carico	$\Delta u$	LVDT
(min)	kN	(kPa)	$\delta$ (mm)
1032.35	0.028	194.2	0.0639
1032.37	0.029	194.4	0.0639
1032.38	0.029	194.5	0.0648
1032.40	0.029	194.6	0.0648
1032.42	0.029	194.7	0.0648
1032.43	0.029	194.7	0.0648
1032.45	0.029	194.8	0.0648
1032.47	0.028	194.9	0.0648
1032.48	0.027	194.9	0.063
1032.50	0.026	194.9	0.0612
1032.52	0.024	194.9	0.0612
1032.53	0.023	194.8	0.0595
1032.55	0.023	194.8	0.0577
1032.57	0.022	194.8	0.0559
1032.58	0.02	194.7	0.0541
1032.60	0.018	194.6	0.0515
1032.62	0.017	194.5	0.0488
1032.63	0.015	194.2	0.0453
1032.65	0.012	194.1	0.0453
1032.67	0.012	194.1	0.0426
1032.68	0.011	194	0.0391
1032.70	0.009	193.7	0.0355
1032.72	0.006	193.5	0.032
1032.73	0.006	193.4	0.0302
1032.75	0.004	193.1	0.0257
1032.77	0.001	192.9	0.0222
1032.78	0	192.7	0.0178
1032.80	-0.002	192.4	0.0142
1032.82	-0.005	192.1	0.0142
1032.83	-0.006	192.1	0.0107
1032.85	-0.006	191.9	0.008
1032.87	-0.008	191.6	0.0044
1032.88	-0.01	191.3	0.0018
1032.90	-0.011	191.2	-0.0009
1032.92	-0.012	190.8	-0.0036
1032.93	-0.014	190.6	-0.0036
1032.95	-0.015	190.6	-0.0062
1032.97	-0.015	190.4	-0.008
1032.98	-0.015	190.2	-0.0098
1033.00	-0.017	190	-0.0107
1033.02	-0.017	189.8	-0.0115
1033.03	-0.017	189.7	-0.0124
1033.05	-0.017	189.6	-0.0124
1033.07	-0.017	189.6	-0.0124
1033.08	-0.017	189.5	-0.0133
1033.10	-0.017	189.4	-0.0124
1033.12	-0.017	189.3	-0.0124
1033.13	-0.016	189.3	-0.0115
1033.15	-0.015	189.2	-0.0107
1033.17	-0.014	189.2	-0.0107
1033.18	-0.013	189.2	-0.0098
1033.20	-0.013	189.3	-0.008
1033.22	-0.012	189.3	-0.0062
1033.23	-0.01	189.4	-0.0036
1033.25	-0.009	189.5	-0.0018
1033.27	-0.007	189.6	0.0009
1033.28	-0.004	189.8	0.0009
1033.30	-0.003	189.8	0.0036

Prova triassiale ciclica SN04-C1			
pressione di confinamento (kPa)		80	
deviatore ciclico (kPa)		95	
frequenza (hz)		0.00625	
tempo	cella di carico	$\Delta u$	LVDT
(min)	kN	(kPa)	$\delta$ (mm)
1033.32	-0.003	189.9	0.0071
1033.33	-0.002	190.1	0.0107
1033.35	0.002	190.3	0.0142
1033.37	0.003	190.5	0.0169
1033.38	0.004	190.7	0.0204
1033.40	0.008	191	0.0204
1033.42	0.009	191	0.0249
1033.43	0.009	191.2	0.0284
1033.45	0.013	191.6	0.0328
1033.47	0.014	191.8	0.0346
1033.48	0.014	191.8	0.0382
1033.50	0.016	192.1	0.0426
1033.52	0.018	192.4	0.0453
1033.53	0.02	192.6	0.0488
1033.55	0.021	192.8	0.0515
1033.57	0.023	193.1	0.0515
1033.58	0.025	193.3	0.055
1033.60	0.025	193.3	0.0568
1033.62	0.025	193.5	0.0586
1033.63	0.026	193.7	0.0612
1033.65	0.028	193.9	0.0621
1033.67	0.027	194.1	0.063
1033.68	0.028	194.3	0.063
1033.72	0.029	194.4	0.0639
1033.73	0.029	194.4	0.0648
1033.75	0.029	194.5	0.0648
1033.77	0.029	194.7	0.0648
1033.77	0.029	194.7	0.0657
1033.78	0.029	194.8	0.0648
1033.80	0.028	194.9	0.0639
1033.82	0.026	194.9	0.0639
1033.83	0.026	194.9	0.063
1033.85	0.026	194.9	0.0612
1033.87	0.024	194.8	0.0595
1033.88	0.022	194.8	0.0577
1033.90	0.022	194.7	0.0568
1033.92	0.021	194.7	0.0541
1033.93	0.017	194.5	0.0541
1033.95	0.016	194.5	0.0506
1033.97	0.016	194.4	0.0488
1033.98	0.015	194.2	0.0453
1034.00	0.011	194	0.0417
1034.02	0.011	193.9	0.0382
1034.03	0.009	193.7	0.0346
1034.05	0.005	193.4	0.0346
1034.07	0.004	193.4	0.0302
1034.08	0.004	193.2	0.0284
1034.10	0.002	193	0.0231
1034.12	-0.001	192.7	0.0186
1034.13	-0.002	192.5	0.016
1034.15	-0.004	192.2	0.0124
1034.17	-0.007	191.9	0.008
1034.18	-0.007	191.7	0.0062
1034.20	-0.008	191.4	0.0027
1034.22	-0.011	191.2	0.0027
1034.23	-0.011	191.2	0
1034.25	-0.011	191	-0.0018
1034.27	-0.012	190.7	-0.0044

Prova triassiale ciclica SN04-C1			
pressione di confinamento (kPa)		80	
deviatore ciclico (kPa)		95	
frequenza (hz)		0.00625	
tempo	cella di carico	$\Delta u$	LVDT
(min)	kN	(kPa)	$\delta$ (mm)
1034.28	-0.015	190.5	-0.0071
1034.30	-0.015	190.3	-0.008
1034.32	-0.016	190.1	-0.0098
1034.33	-0.017	189.9	-0.0098
1034.35	-0.017	189.9	-0.0107
1034.37	-0.017	189.8	-0.0115
1034.38	-0.017	189.6	-0.0124
1034.40	-0.017	189.5	-0.0124
1034.42	-0.017	189.4	-0.0124
1034.43	-0.017	189.3	-0.0124
1034.45	-0.016	189.3	-0.0124
1034.47	-0.015	189.3	-0.0115
1034.48	-0.015	189.3	-0.0107
1034.50	-0.015	189.2	-0.0098
1034.52	-0.014	189.3	-0.0089
1034.53	-0.012	189.3	-0.0071
1034.55	-0.012	189.3	-0.0053
1034.57	-0.01	189.4	-0.0027
1034.58	-0.008	189.5	-0.0027
1034.60	-0.006	189.5	0
1034.62	-0.006	189.6	0.0027
1034.63	-0.005	189.8	0.0053
1034.65	-0.002	190	0.008
1034.67	-0.001	190.1	0.0115
1034.68	0.001	190.4	0.0151
1034.70	0.005	190.6	0.0151
1034.72	0.005	190.6	0.0195
1034.73	0.005	190.8	0.0222
1034.75	0.007	191	0.0275
1034.77	0.011	191.3	0.0311
1034.78	0.012	191.5	0.0346
1034.80	0.013	191.8	0.0382
1034.82	0.017	192	0.0382
1034.83	0.018	192	0.0417
1034.85	0.018	192.3	0.0453
1034.87	0.019	192.5	0.0479
1034.88	0.022	192.8	0.0515
1034.90	0.022	193	0.0533
1034.92	0.023	193.2	0.055
1034.93	0.025	193.4	0.0577
1034.95	0.025	193.6	0.0595
1034.97	0.026	193.8	0.0612
1034.98	0.028	194	0.0612
1035.00	0.028	194	0.063
1035.02	0.028	194.2	0.0639
1035.03	0.028	194.3	0.0648
1035.05	0.029	194.5	0.0657
1035.07	0.029	194.6	0.0657
1035.08	0.029	194.7	0.0657
1035.10	0.028	194.8	0.0657
1035.12	0.028	194.8	0.0657
1035.15	0.028	194.9	0.0648
1035.17	0.027	194.9	0.0639
1035.18	0.026	194.9	0.063
1035.20	0.025	194.9	0.0612
1035.22	0.024	194.9	0.0595
1035.22	0.022	194.8	0.0595
1035.23	0.021	194.8	0.0568

Prova triassiale ciclica SN04-C1			
pressione di confinamento (kPa)		80	
deviatore ciclico (kPa)		95	
frequenza (hz)		0.00625	
tempo	cella di carico	$\Delta u$	LVDT
(min)	kN	(kPa)	$\delta$ (mm)
1035.25	0.021	194.7	0.055
1035.27	0.02	194.6	0.0524
1035.28	0.016	194.5	0.0497
1035.30	0.015	194.4	0.047
1035.32	0.014	194.2	0.0435
1035.33	0.01	194	0.0435
1035.35	0.009	194	0.0399
1035.37	0.009	193.8	0.0373
1035.38	0.008	193.6	0.0337
1035.40	0.004	193.4	0.0293
1035.42	0.003	193.2	0.0257
1035.43	0.002	192.9	0.0213
1035.45	-0.002	192.6	0.0213
1035.47	-0.003	192.6	0.0169
1035.48	-0.003	192.4	0.0142
1035.50	-0.004	192.1	0.0107
1035.52	-0.007	191.8	0.0071
1035.53	-0.009	191.6	0.0036
1035.55	-0.01	191.3	0.0009
1035.57	-0.012	191	0.0009
1035.58	-0.013	190.8	-0.0018
1035.60	-0.013	190.8	-0.0036
1035.62	-0.014	190.6	-0.0062
1035.63	-0.016	190.2	-0.008
1035.65	-0.016	190.2	-0.0089
1035.67	-0.016	190	-0.0098
1035.68	-0.016	189.8	-0.0107
1035.70	-0.017	189.7	-0.0115
1035.72	-0.017	189.6	-0.0124
1035.73	-0.017	189.4	-0.0124
1035.75	-0.017	189.4	-0.0124
1035.77	-0.017	189.4	-0.0124
1035.78	-0.017	189.3	-0.0124
1035.80	-0.016	189.2	-0.0115
1035.82	-0.015	189.2	-0.0107
1035.83	-0.015	189.2	-0.0098
1035.85	-0.014	189.2	-0.008
1035.87	-0.012	189.3	-0.008
1035.88	-0.011	189.3	-0.0062
1035.90	-0.011	189.3	-0.0044
1035.92	-0.009	189.5	-0.0018
1035.93	-0.007	189.6	0.0009
1035.95	-0.006	189.7	0.0036
1035.97	-0.004	189.9	0.0062
1035.98	-0.001	190	0.0062
1036.00	0	190	0.0098
1036.02	0	190.2	0.0124
1036.03	0.002	190.4	0.016
1036.05	0.005	190.6	0.0204
1036.07	0.006	190.8	0.024
1036.08	0.008	191.2	0.0284
1036.10	0.012	191.4	0.0284
1036.12	0.013	191.4	0.0328
1036.13	0.013	191.6	0.0355
1036.15	0.014	191.9	0.0391
1036.17	0.017	192.1	0.0435
1036.18	0.018	192.3	0.0462
1036.20	0.02	192.6	0.0497

Prova triassiale ciclica SN04-C1			
pressione di confinamento (kPa)		80	
deviatore ciclico (kPa)		95	
frequenza (hz)		0.00625	
tempo	cella di carico	$\Delta u$	LVDT
(min)	kN	(kPa)	$\delta$ (mm)
1036.22	0.023	192.9	0.0497
1036.23	0.023	192.9	0.0524
1036.25	0.023	193.1	0.055
1036.27	0.024	193.3	0.0568
1036.28	0.026	193.5	0.0595
1036.30	0.026	193.7	0.0612
1036.32	0.027	193.9	0.0621
1036.33	0.028	194.1	0.0621
1036.35	0.028	194.2	0.0648
1036.37	0.029	194.4	0.0648
1036.38	0.029	194.5	0.0648
1036.40	0.029	194.5	0.0648
1036.42	0.029	194.6	0.0657
1036.43	0.029	194.7	0.0657
1036.45	0.028	194.8	0.0657
1036.47	0.028	194.9	0.0648
1036.48	0.027	194.9	0.063
1036.50	0.026	194.9	0.063
1036.52	0.025	194.9	0.0621
1036.53	0.025	194.9	0.0604
1036.55	0.024	194.8	0.0577
1036.57	0.021	194.7	0.0559
1036.58	0.02	194.7	0.0541
1036.62	0.019	194.5	0.0515
1036.63	0.016	194.4	0.0515
1036.65	0.015	194.4	0.0488
1036.67	0.015	194.3	0.0462
1036.67	0.013	194.1	0.0417
1036.68	0.009	193.9	0.0382
1036.70	0.009	193.7	0.0355
1036.72	0.007	193.5	0.032
1036.73	0.003	193.2	0.032
1036.75	0.002	193.2	0.0275
1036.77	0.002	193	0.024
1036.78	0.001	192.8	0.0195
1036.80	-0.003	192.5	0.016
1036.82	-0.004	192.3	0.0133
1036.83	-0.005	192	0.0089
1036.85	-0.009	191.7	0.0089
1036.87	-0.009	191.7	0.0053
1036.88	-0.009	191.4	0.0027
1036.90	-0.01	191.2	0
1036.92	-0.012	190.9	-0.0027
1036.93	-0.013	190.7	-0.0044
1036.95	-0.014	190.5	-0.0071
1036.97	-0.016	190.2	-0.0071
1036.98	-0.016	190.2	-0.0089
1037.00	-0.016	190.1	-0.0098
1037.02	-0.016	189.9	-0.0115
1037.03	-0.017	189.7	-0.0115
1037.05	-0.017	189.6	-0.0124
1037.07	-0.017	189.5	-0.0124
1037.08	-0.017	189.4	-0.0133
1037.10	-0.017	189.3	-0.0124
1037.12	-0.016	189.2	-0.0124
1037.13	-0.016	189.2	-0.0124
1037.15	-0.015	189.2	-0.0115
1037.17	-0.015	189.2	-0.0107

Prova triassiale ciclica SN04-C1			
pressione di confinamento (kPa)		80	
deviatore ciclico (kPa)		95	
frequenza (hz)		0.00625	
tempo	cella di carico	$\Delta u$	LVDT
(min)	kN	(kPa)	$\delta$ (mm)
1037.18	-0.014	189.2	-0.0089
1037.20	-0.013	189.2	-0.0071
1037.22	-0.011	189.3	-0.0053
1037.23	-0.01	189.4	-0.0036
1037.25	-0.008	189.5	-0.0036
1037.27	-0.006	189.6	-0.0009
1037.28	-0.006	189.6	0.0018
1037.30	-0.005	189.7	0.0044
1037.32	-0.003	189.9	0.008
1037.33	0	190.1	0.0115
1037.35	0.001	190.2	0.0142
1037.37	0.003	190.5	0.0186
1037.38	0.006	190.7	0.0186
1037.40	0.006	190.7	0.0222
1037.42	0.007	190.9	0.0257
1037.43	0.01	191.2	0.0311
1037.45	0.013	191.5	0.0346
1037.47	0.013	191.7	0.0373
1037.48	0.015	192	0.0408
1037.50	0.018	192.2	0.0408
1037.52	0.019	192.2	0.0444
1037.53	0.019	192.4	0.0479
1037.55	0.02	192.7	0.0506
1037.57	0.023	193	0.0533
1037.58	0.024	193.2	0.0559
1037.60	0.025	193.4	0.0586
1037.62	0.027	193.6	0.0586
1037.63	0.027	193.6	0.0604
1037.65	0.027	193.8	0.0612
1037.67	0.027	194	0.063
1037.68	0.028	194.2	0.0639
1037.70	0.029	194.3	0.0648
1037.72	0.029	194.4	0.0648
1037.73	0.029	194.6	0.0648
1037.75	0.029	194.6	0.0657
1037.77	0.029	194.7	0.0648
1037.78	0.029	194.7	0.0657
1037.80	0.027	194.8	0.0648
1037.82	0.027	194.9	0.0639
1037.83	0.027	194.9	0.063
1037.85	0.025	194.8	0.0612
1037.87	0.024	194.8	0.0595
1037.88	0.023	194.8	0.0577
1037.90	0.021	194.7	0.0577
1037.92	0.019	194.6	0.055
1037.93	0.019	194.6	0.0533
1037.95	0.018	194.5	0.0506
1037.97	0.015	194.3	0.047
1037.98	0.014	194.2	0.0444
1038.00	0.012	194	0.0408
1038.02	0.009	193.8	0.0408
1038.03	0.007	193.6	0.0373
1038.05	0.007	193.6	0.0346
1038.08	0.006	193.4	0.0311
1038.10	0.004	193.1	0.0275
1038.12	0.001	192.9	0.0222
1038.12	0	192.7	0.0186
1038.13	-0.003	192.4	0.0186

Prova triassiale ciclica SN04-C1			
pressione di confinamento (kPa)		80	
deviatore ciclico (kPa)		95	
frequenza (hz)		0.00625	
tempo	cella di carico	$\Delta u$	LVDT
(min)	kN	(kPa)	$\delta$ (mm)
1038.15	-0.005	192.1	0.0142
1038.17	-0.005	192.1	0.0115
1038.18	-0.006	191.9	0.008
1038.20	-0.008	191.5	0.0044
1038.22	-0.01	191.3	0.0009
1038.23	-0.011	191.1	-0.0018
1038.25	-0.012	190.8	-0.0036
1038.27	-0.014	190.6	-0.0036
1038.28	-0.014	190.6	-0.0062
1038.30	-0.015	190.4	-0.008
1038.32	-0.016	190.2	-0.0089
1038.33	-0.016	190	-0.0107
1038.35	-0.017	189.8	-0.0115
1038.37	-0.017	189.7	-0.0124
1038.38	-0.017	189.5	-0.0124
1038.40	-0.017	189.5	-0.0124
1038.42	-0.017	189.4	-0.0124
1038.43	-0.017	189.3	-0.0124
1038.45	-0.016	189.3	-0.0124
1038.47	-0.016	189.2	-0.0115
1038.48	-0.015	189.2	-0.0098
1038.50	-0.014	189.2	-0.0098
1038.52	-0.013	189.2	-0.0089
1038.53	-0.012	189.2	-0.0071
1038.55	-0.011	189.3	-0.0071
1038.57	-0.01	189.3	-0.0053
1038.58	-0.01	189.3	-0.0027
1038.60	-0.008	189.5	0
1038.62	-0.005	189.7	0.0027
1038.63	-0.004	189.8	0.0053
1038.65	-0.003	190	0.0089
1038.67	0.001	190.2	0.0089
1038.68	0.002	190.2	0.0124
1038.70	0.002	190.3	0.016
1038.72	0.004	190.6	0.0204
1038.73	0.007	190.8	0.024
1038.75	0.009	191	0.0284
1038.77	0.01	191.3	0.032
1038.78	0.013	191.6	0.032
1038.80	0.014	191.6	0.0355
1038.82	0.014	191.8	0.0391
1038.83	0.016	192.1	0.0426
1038.85	0.019	192.3	0.0462
1038.87	0.02	192.5	0.0488
1038.88	0.021	192.8	0.0524
1038.90	0.023	193.1	0.0524
1038.92	0.024	193.1	0.055
1038.93	0.024	193.3	0.0568
1038.95	0.025	193.5	0.0586
1038.97	0.027	193.7	0.0612
1038.98	0.027	193.9	0.0621
1039.00	0.028	194.1	0.0639
1039.02	0.028	194.2	0.0639
1039.03	0.029	194.2	0.0639
1039.05	0.029	194.4	0.0648
1039.07	0.029	194.5	0.0648
1039.08	0.029	194.6	0.0657
1039.10	0.029	194.7	0.0657

Prova triassiale ciclica SN04-C1			
pressione di confinamento (kPa)		80	
deviatore ciclico (kPa)		95	
frequenza (hz)		0.00625	
tempo	cella di carico	$\Delta u$	LVDT
(min)	kN	(kPa)	$\delta$ (mm)
1039.12	0.028	194.8	0.0648
1039.13	0.027	194.8	0.0648
1039.15	0.026	194.8	0.0639
1039.17	0.026	194.8	0.063
1039.18	0.026	194.8	0.0612
1039.20	0.024	194.8	0.0595
1039.22	0.023	194.8	0.0586
1039.23	0.022	194.7	0.0559
1039.25	0.019	194.6	0.0533
1039.27	0.019	194.5	0.0524
1039.28	0.017	194.4	0.0488
1039.30	0.014	194.2	0.0488
1039.32	0.013	194.1	0.0453
1039.33	0.013	194.1	0.0435
1039.35	0.012	193.9	0.0399
1039.37	0.008	193.7	0.0355
1039.38	0.007	193.5	0.0337
1039.40	0.005	193.3	0.0293
1039.42	0.002	193	0.0293
1039.43	0	192.8	0.024
1039.45	0	192.8	0.0213
1039.47	-0.001	192.5	0.0169
1039.48	-0.004	192.2	0.0124
1039.52	-0.006	192	0.0089
1039.53	-0.007	191.7	0.0062
1039.55	-0.009	191.4	0.0062
1039.57	-0.011	191.2	0.0036
1039.58	-0.011	191.2	0
1039.58	-0.012	191	-0.0027
1039.60	-0.013	190.7	-0.0053
1039.62	-0.015	190.5	-0.0071
1039.63	-0.015	190.3	-0.008
1039.65	-0.016	190.1	-0.0098
1039.67	-0.017	189.9	-0.0098
1039.68	-0.017	189.9	-0.0107
1039.70	-0.017	189.7	-0.0115
1039.72	-0.017	189.6	-0.0115
1039.73	-0.017	189.5	-0.0124
1039.75	-0.017	189.4	-0.0124
1039.77	-0.017	189.3	-0.0124
1039.78	-0.016	189.2	-0.0124
1039.80	-0.016	189.2	-0.0115
1039.82	-0.016	189.2	-0.0107
1039.83	-0.015	189.2	-0.0098
1039.85	-0.013	189.2	-0.008
1039.87	-0.012	189.2	-0.0062
1039.88	-0.011	189.3	-0.0044
1039.90	-0.009	189.4	-0.0044
1039.92	-0.009	189.4	-0.0027
1039.93	-0.009	189.5	-0.0009
1039.95	-0.006	189.7	0.0027
1039.97	-0.003	189.8	0.0053
1039.98	-0.002	189.9	0.008
1040.00	-0.002	190.1	0.0107
1040.02	0.001	190.3	0.0142
1040.03	0.003	190.4	0.0178
1040.05	0.005	190.7	0.0213
1040.07	0.008	190.9	0.0213



Prova triassiale ciclica SN04-C1			
pressione di confinamento (kPa)		80	
deviatore ciclico (kPa)		95	
frequenza (hz)		0.00625	
tempo	cella di carico	$\Delta u$	LVDT
(min)	kN	(kPa)	$\delta$ (mm)
1040.08	0.009	190.9	0.0249
1040.10	0.009	191.2	0.0293
1040.12	0.011	191.4	0.0328
1040.13	0.014	191.7	0.0373
1040.15	0.015	191.9	0.0399
1040.17	0.016	192.1	0.0435
1040.18	0.02	192.4	0.0435
1040.20	0.021	192.4	0.0479
1040.22	0.021	192.6	0.0506
1040.23	0.022	192.9	0.0533
1040.25	0.024	193.1	0.0559
1040.27	0.024	193.3	0.0568
1040.28	0.026	193.5	0.0595
1040.30	0.027	193.8	0.0595
1040.32	0.028	193.8	0.0621
1040.33	0.028	193.9	0.063
1040.35	0.028	194.1	0.0639
1040.37	0.028	194.3	0.0648
1040.38	0.029	194.4	0.0648
1040.40	0.029	194.5	0.0657
1040.42	0.029	194.6	0.0657
1040.43	0.029	194.6	0.0657
1040.45	0.029	194.7	0.0657
1040.47	0.028	194.8	0.0648
1040.48	0.027	194.8	0.063
1040.50	0.026	194.8	0.0621
1040.52	0.025	194.8	0.0612
1040.53	0.024	194.8	0.0612
1040.55	0.022	194.7	0.0586
1040.57	0.022	194.7	0.0577
1040.58	0.021	194.7	0.055
1040.60	0.019	194.5	0.0524
1040.62	0.017	194.4	0.0497
1040.63	0.016	194.3	0.047
1040.65	0.013	194.1	0.047
1040.67	0.011	193.9	0.0435
1040.68	0.011	193.9	0.0408
1040.70	0.01	193.7	0.0364
1040.72	0.006	193.3	0.0328
1040.73	0.006	193.3	0.0311
1040.75	0.004	193.2	0.0275
1040.77	0.001	192.8	0.0231
1040.78	0	192.6	0.0195
1040.80	-0.002	192.4	0.0151
1040.82	-0.005	192.1	0.0151
1040.83	-0.007	191.8	0.0107
1040.85	-0.007	191.8	0.008
1040.87	-0.008	191.6	0.0044
1040.88	-0.01	191.3	0.0018
1040.90	-0.011	191	-0.0009
1040.92	-0.012	190.8	-0.0036
1040.93	-0.014	190.6	-0.0036
1040.95	-0.015	190.3	-0.0053
1040.98	-0.015	190.3	-0.0071
1041.00	-0.015	190.2	-0.0098
1041.02	-0.017	190	-0.0115
1041.03	-0.017	189.8	-0.0115
1041.03	-0.017	189.7	-0.0115

Prova triassiale ciclica SN04-C1			
pressione di confinamento (kPa)		80	
deviatore ciclico (kPa)		95	
frequenza (hz)		0.00625	
tempo	cella di carico	$\Delta u$	LVDT
(min)	kN	(kPa)	$\delta$ (mm)
1041.05	-0.017	189.5	-0.0124
1041.07	-0.017	189.4	-0.0124
1041.08	-0.017	189.4	-0.0124
1041.10	-0.017	189.3	-0.0124
1041.12	-0.017	189.2	-0.0124
1041.13	-0.016	189.2	-0.0115
1041.15	-0.015	189.2	-0.0107
1041.17	-0.014	189.2	-0.0089
1041.18	-0.013	189.2	-0.0089
1041.20	-0.012	189.2	-0.008
1041.22	-0.012	189.2	-0.0062
1041.23	-0.011	189.3	-0.0044
1041.25	-0.008	189.4	-0.0018
1041.27	-0.007	189.5	0.0009
1041.28	-0.006	189.7	0.0036
1041.30	-0.002	189.9	0.0036
1041.32	-0.001	189.9	0.0071
1041.33	-0.001	190	0.0098
1041.35	0	190.2	0.0133
1041.37	0.004	190.4	0.0178
1041.38	0.004	190.6	0.0204
1041.40	0.006	190.9	0.024
1041.42	0.01	191.2	0.024
1041.43	0.011	191.3	0.032
1041.45	0.011	191.5	0.0346
1041.47	0.015	191.8	0.0346
1041.48	0.016	191.8	0.0382
1041.50	0.016	192	0.0426
1041.52	0.017	192.3	0.0462
1041.53	0.02	192.5	0.0488
1041.55	0.021	192.7	0.0515
1041.57	0.022	193	0.0541
1041.58	0.024	193.2	0.0541
1041.60	0.025	193.2	0.0568
1041.62	0.025	193.4	0.0586
1041.63	0.026	193.6	0.0612
1041.65	0.027	193.8	0.0621
1041.67	0.028	194	0.063
1041.68	0.028	194.2	0.0639
1041.70	0.028	194.3	0.0639
1041.72	0.029	194.3	0.0648
1041.73	0.029	194.5	0.0657
1041.75	0.029	194.6	0.0657
1041.77	0.029	194.7	0.0657
1041.78	0.029	194.8	0.0657
1041.80	0.027	194.8	0.0639
1041.82	0.027	194.8	0.0639
1041.83	0.025	194.8	0.063
1041.85	0.025	194.8	0.0621
1041.87	0.025	194.8	0.0604
1041.88	0.023	194.7	0.0586
1041.90	0.021	194.7	0.0568
1041.92	0.02	194.6	0.0533
1041.93	0.018	194.4	0.0533
1041.95	0.016	194.3	0.0515
1041.97	0.016	194.3	0.0479
1041.98	0.015	194.2	0.0453
1042.00	0.012	194	0.0417

Prova triassiale ciclica SN04-C1			
pressione di confinamento (kPa)		80	
deviatore ciclico (kPa)		95	
frequenza (hz)		0.00625	
tempo	cella di carico	$\Delta u$	LVDT
(min)	kN	(kPa)	$\delta$ (mm)
1042.02	0.01	193.8	0.0391
1042.03	0.009	193.7	0.0355
1042.05	0.006	193.4	0.0355
1042.07	0.004	193.1	0.032
1042.08	0.004	193.1	0.0284
1042.10	0.003	193	0.024
1042.12	0	192.6	0.0195
1042.13	-0.003	192.4	0.016
1042.15	-0.004	192.2	0.0124
1042.17	-0.006	191.8	0.0089
1042.18	-0.007	191.7	0.0071
1042.20	-0.008	191.4	0.0036
1042.22	-0.01	191.1	0
1042.23	-0.013	190.9	0
1042.25	-0.013	190.9	-0.0027
1042.27	-0.013	190.7	-0.0044
1042.28	-0.014	190.4	-0.0062
1042.30	-0.015	190.2	-0.008
1042.32	-0.016	190.1	-0.0098
1042.33	-0.016	189.8	-0.0115
1042.35	-0.017	189.7	-0.0115
1042.37	-0.017	189.7	-0.0115
1042.38	-0.017	189.5	-0.0124
1042.42	-0.017	189.4	-0.0124
1042.43	-0.017	189.3	-0.0124
1042.45	-0.017	189.3	-0.0124
1042.47	-0.016	189.2	-0.0115
1042.48	-0.016	189.1	-0.0115
1042.48	-0.015	189.1	-0.0107
1042.50	-0.015	189.1	-0.0098
1042.52	-0.014	189.2	-0.0089
1042.53	-0.012	189.2	-0.0071
1042.55	-0.011	189.2	-0.0053
1042.57	-0.01	189.3	-0.0027
1042.58	-0.007	189.4	-0.0027
1042.60	-0.007	189.4	0
1042.62	-0.007	189.5	0.0018
1042.63	-0.005	189.7	0.0053
1042.65	-0.001	189.9	0.0089
1042.67	-0.001	190	0.0115
1042.68	0.001	190.3	0.0151
1042.70	0.005	190.5	0.0151
1042.72	0.005	190.5	0.0186
1042.73	0.005	190.7	0.0222
1042.75	0.007	190.9	0.0275
1042.77	0.011	191.2	0.0311
1042.78	0.012	191.4	0.0346
1042.80	0.013	191.7	0.0382
1042.82	0.017	191.9	0.0382
1042.83	0.017	191.9	0.0417
1042.85	0.017	192.1	0.0453
1042.87	0.019	192.4	0.0488
1042.88	0.022	192.7	0.0515
1042.90	0.022	192.9	0.0533
1042.92	0.023	193.1	0.0559
1042.93	0.025	193.3	0.0577
1042.95	0.026	193.5	0.0595
1042.97	0.026	193.7	0.0621

Prova triassiale ciclica SN04-C1			
pressione di confinamento (kPa)		80	
deviatore ciclico (kPa)		95	
frequenza (hz)		0.00625	
tempo	cella di carico	$\Delta u$	LVDT
(min)	kN	(kPa)	$\delta$ (mm)
1042.98	0.028	193.9	0.0621
1043.00	0.028	193.9	0.063
1043.02	0.028	194.1	0.0639
1043.03	0.028	194.2	0.0648
1043.05	0.029	194.4	0.0657
1043.07	0.029	194.5	0.0657
1043.08	0.029	194.6	0.0657
1043.10	0.029	194.7	0.0657
1043.12	0.028	194.7	0.0657
1043.13	0.028	194.8	0.0648
1043.15	0.027	194.8	0.0639
1043.17	0.026	194.8	0.0621
1043.18	0.025	194.8	0.0612
1043.20	0.024	194.8	0.0595
1043.22	0.022	194.7	0.0595
1043.23	0.021	194.7	0.0577
1043.25	0.021	194.7	0.0559
1043.27	0.02	194.5	0.0533
1043.28	0.016	194.4	0.0488
1043.30	0.015	194.3	0.047
1043.32	0.014	194.1	0.0444
1043.33	0.011	193.9	0.0444
1043.35	0.01	193.7	0.0408
1043.37	0.01	193.7	0.0373
1043.38	0.008	193.5	0.0328
1043.40	0.004	193.3	0.0293
1043.42	0.003	193.1	0.0257
1043.43	0.002	192.8	0.0213
1043.45	-0.002	192.5	0.0213
1043.47	-0.003	192.3	0.0178
1043.48	-0.003	192.3	0.0151
1043.50	-0.004	192.1	0.0107
1043.52	-0.007	191.7	0.0071
1043.53	-0.008	191.5	0.0044
1043.55	-0.01	191.3	0.0009
1043.57	-0.012	190.9	0.0009
1043.58	-0.013	190.7	-0.0018
1043.60	-0.013	190.7	-0.0036
1043.62	-0.015	190.3	-0.0071
1043.63	-0.015	190.1	-0.0071
1043.65	-0.015	190.1	-0.008
1043.67	-0.016	190	-0.0098
1043.68	-0.017	189.7	-0.0107
1043.70	-0.017	189.6	-0.0115
1043.72	-0.017	189.5	-0.0124
1043.73	-0.017	189.4	-0.0124
1043.75	-0.017	189.3	-0.0124
1043.77	-0.017	189.3	-0.0124
1043.78	-0.017	189.2	-0.0124
1043.80	-0.016	189.2	-0.0115
1043.82	-0.015	189.1	-0.0107
1043.83	-0.014	189.1	-0.0089
1043.85	-0.014	189.1	-0.008
1043.88	-0.012	189.2	-0.008
1043.90	-0.011	189.2	-0.0062
1043.92	-0.011	189.2	-0.0036
1043.93	-0.01	189.4	-0.0018
1043.93	-0.007	189.5	0.0009

Prova triassiale ciclica SN04-C1			
pressione di confinamento (kPa)		80	
deviatore ciclico (kPa)		95	
frequenza (hz)		0.00625	
tempo	cella di carico	$\Delta u$	LVDT
(min)	kN	(kPa)	$\delta$ (mm)
1043.95	-0.006	189.6	0.0036
1043.97	-0.004	189.8	0.0071
1043.98	-0.001	190	0.0071
1044.00	0	190	0.0098
1044.02	0	190.1	0.0133
1044.03	0.002	190.3	0.0178
1044.05	0.006	190.6	0.0213
1044.07	0.006	190.7	0.024
1044.08	0.008	191	0.0284
1044.10	0.012	191.3	0.0284
1044.12	0.013	191.3	0.0328
1044.13	0.013	191.5	0.0355
1044.15	0.014	191.8	0.0399
1044.17	0.017	192	0.0435
1044.18	0.018	192.3	0.0462
1044.20	0.019	192.5	0.0488
1044.22	0.023	192.8	0.0488
1044.23	0.023	192.8	0.0533
1044.25	0.023	193	0.055
1044.27	0.024	193.2	0.0577
1044.28	0.026	193.5	0.0595
1044.30	0.027	193.6	0.0612
1044.32	0.027	193.8	0.063
1044.33	0.028	194	0.063
1044.35	0.028	194.2	0.0648
1044.37	0.029	194.3	0.0648
1044.38	0.029	194.4	0.0648
1044.40	0.029	194.5	0.0657
1044.42	0.029	194.5	0.0657
1044.43	0.029	194.6	0.0657
1044.45	0.029	194.7	0.0657
1044.47	0.027	194.8	0.0648
1044.48	0.027	194.8	0.0639
1044.50	0.026	194.8	0.0621
1044.52	0.024	194.8	0.0621
1044.53	0.024	194.8	0.0612
1044.55	0.024	194.7	0.0595
1044.57	0.022	194.6	0.0568
1044.58	0.02	194.6	0.0541
1044.60	0.019	194.5	0.0524
1044.62	0.017	194.3	0.0497
1044.63	0.014	194.2	0.0497
1044.65	0.013	194.2	0.0462
1044.67	0.013	194.1	0.0435
1044.68	0.011	193.8	0.0399
1044.70	0.008	193.6	0.0364
1044.72	0.007	193.5	0.0337
1044.73	0.005	193.2	0.0284
1044.75	0.001	192.9	0.0284
1044.77	0	192.9	0.024
1044.78	0	192.7	0.0213
1044.80	-0.001	192.4	0.0169
1044.82	-0.005	192.2	0.0133
1044.83	-0.005	191.9	0.0107
1044.85	-0.007	191.6	0.0062
1044.87	-0.01	191.4	0.0062
1044.88	-0.01	191.4	0.0036
1044.90	-0.01	191.2	0.0009

Prova triassiale ciclica SN04-C1			
pressione di confinamento (kPa)		80	
deviatore ciclico (kPa)		95	
frequenza (hz)		0.00625	
tempo	cella di carico	$\Delta u$	LVDT
(min)	kN	(kPa)	$\delta$ (mm)
1044.92	-0.011	190.8	-0.0018
1044.93	-0.014	190.6	-0.0053
1044.95	-0.014	190.4	-0.0062
1044.97	-0.015	190.2	-0.008
1044.98	-0.016	190	-0.008
1045.00	-0.017	190	-0.0098
1045.02	-0.017	189.9	-0.0107
1045.03	-0.017	189.7	-0.0115
1045.05	-0.017	189.5	-0.0115
1045.07	-0.017	189.4	-0.0115
1045.08	-0.017	189.3	-0.0115
1045.10	-0.017	189.2	-0.0115
1045.12	-0.017	189.2	-0.0115
1045.13	-0.016	189.2	-0.0107
1045.15	-0.015	189.1	-0.0107
1045.17	-0.014	189.1	-0.0098
1045.18	-0.014	189.1	-0.008
1045.20	-0.013	189.2	-0.0062
1045.22	-0.011	189.2	-0.0053
1045.23	-0.01	189.3	-0.0036
1045.25	-0.009	189.4	-0.0009
1045.27	-0.006	189.5	-0.0009
1045.28	-0.005	189.5	0.0027
1045.30	-0.005	189.6	0.0053
1045.33	-0.003	189.8	0.008
1045.35	0	190	0.0115
1045.37	0.001	190.2	0.0142
1045.38	0.002	190.4	0.0178
1045.38	0.006	190.7	0.0178
1045.40	0.007	190.7	0.0231
1045.42	0.007	190.9	0.0257
1045.43	0.009	191.2	0.0311
1045.45	0.013	191.4	0.0346
1045.47	0.013	191.6	0.0373
1045.48	0.015	191.9	0.0417
1045.50	0.018	192.2	0.0417
1045.52	0.019	192.2	0.0453
1045.53	0.019	192.4	0.0479
1045.55	0.02	192.6	0.0515
1045.57	0.023	192.9	0.0541
1045.58	0.024	193.1	0.0559
1045.60	0.025	193.3	0.0595
1045.62	0.027	193.5	0.0595
1045.63	0.027	193.5	0.0612
1045.65	0.027	193.7	0.0621
1045.67	0.027	193.9	0.063
1045.68	0.028	194.1	0.0648
1045.70	0.028	194.3	0.0648
1045.72	0.029	194.4	0.0657
1045.73	0.029	194.5	0.0657
1045.75	0.029	194.5	0.0666
1045.77	0.029	194.6	0.0666
1045.78	0.029	194.7	0.0657
1045.80	0.027	194.7	0.0648
1045.82	0.027	194.8	0.0648
1045.83	0.027	194.8	0.063
1045.85	0.025	194.8	0.0612
1045.87	0.024	194.8	0.0604

Prova triassiale ciclica SN04-C1			
pressione di confinamento (kPa)		80	
deviatore ciclico (kPa)		95	
frequenza (hz)		0.00625	
tempo	cella di carico	$\Delta u$	LVDT
(min)	kN	(kPa)	$\delta$ (mm)
1045.88	0.023	194.7	0.0577
1045.90	0.021	194.6	0.0577
1045.92	0.019	194.6	0.0559
1045.93	0.019	194.6	0.0541
1045.95	0.018	194.5	0.0497
1045.97	0.015	194.2	0.0479
1045.98	0.014	194.1	0.0453
1046.00	0.012	194	0.0417
1046.02	0.009	193.7	0.0417
1046.03	0.007	193.5	0.0373
1046.05	0.007	193.5	0.0346
1046.07	0.006	193.3	0.0311
1046.08	0.003	193	0.0275
1046.10	0.001	192.8	0.0231
1046.12	0	192.6	0.0186
1046.13	-0.003	192.3	0.0186
1046.15	-0.005	192	0.0151
1046.17	-0.005	192	0.0115
1046.18	-0.006	191.8	0.008
1046.20	-0.008	191.5	0.0044
1046.22	-0.011	191.2	0.0009
1046.23	-0.011	191	-0.0009
1046.25	-0.012	190.7	-0.0036
1046.27	-0.014	190.5	-0.0036
1046.28	-0.014	190.5	-0.0053
1046.30	-0.014	190.3	-0.0071
1046.32	-0.015	190.1	-0.0089
1046.33	-0.017	189.9	-0.0107
1046.35	-0.017	189.7	-0.0115
1046.37	-0.017	189.6	-0.0115
1046.38	-0.017	189.5	-0.0115
1046.40	-0.017	189.5	-0.0115
1046.42	-0.017	189.3	-0.0115
1046.43	-0.017	189.3	-0.0115
1046.45	-0.017	189.2	-0.0115
1046.47	-0.016	189.1	-0.0107
1046.48	-0.016	189.2	-0.0098
1046.50	-0.014	189.2	-0.0098
1046.52	-0.013	189.2	-0.0071
1046.53	-0.013	189.2	-0.0062
1046.55	-0.01	189.3	-0.0062
1046.57	-0.009	189.3	-0.0044
1046.58	-0.009	189.3	-0.0018
1046.60	-0.008	189.4	0
1046.62	-0.005	189.6	0.0036
1046.63	-0.004	189.7	0.0062
1046.65	-0.003	189.9	0.0098
1046.67	0.001	190.1	0.0098
1046.68	0.002	190.1	0.0133
1046.70	0.002	190.3	0.0169
1046.72	0.004	190.5	0.0195
1046.73	0.007	190.8	0.024
1046.75	0.008	191	0.0284
1046.78	0.01	191.2	0.032
1046.80	0.014	191.5	0.032
1046.82	0.015	191.5	0.0364
1046.83	0.015	191.7	0.0391
1046.83	0.016	192	0.0426

Prova triassiale ciclica SN04-C1			
pressione di confinamento (kPa)		80	
deviatore ciclico (kPa)		95	
frequenza (hz)		0.00625	
tempo	cella di carico	$\Delta u$	LVDT
(min)	kN	(kPa)	$\delta$ (mm)
1046.85	0.019	192.2	0.0462
1046.87	0.02	192.5	0.0488
1046.88	0.021	192.7	0.0524
1046.90	0.024	193	0.0524
1046.92	0.024	193	0.0559
1046.93	0.024	193.1	0.0568
1046.95	0.025	193.4	0.0595
1046.97	0.027	193.6	0.0612
1046.98	0.027	193.8	0.0621
1047.00	0.028	193.9	0.0639
1047.02	0.028	194.1	0.0639
1047.03	0.028	194.1	0.0648
1047.05	0.028	194.3	0.0648
1047.07	0.029	194.4	0.0657
1047.08	0.029	194.5	0.0657
1047.10	0.029	194.6	0.0666
1047.12	0.029	194.7	0.0657
1047.13	0.027	194.7	0.0657
1047.15	0.027	194.7	0.0639
1047.17	0.027	194.8	0.063
1047.18	0.026	194.7	0.0621
1047.20	0.023	194.7	0.0595
1047.22	0.023	194.7	0.0586
1047.23	0.022	194.6	0.0568
1047.25	0.019	194.5	0.0541
1047.27	0.019	194.4	0.0524
1047.28	0.017	194.3	0.0497
1047.30	0.014	194.1	0.0497
1047.32	0.013	194.1	0.0462
1047.33	0.013	194	0.0435
1047.35	0.012	193.8	0.0399
1047.37	0.007	193.6	0.0364
1047.38	0.007	193.4	0.0337
1047.40	0.005	193.2	0.0293
1047.42	0.001	192.9	0.0293
1047.43	0.001	192.9	0.024
1047.45	0.001	192.7	0.0213
1047.47	-0.001	192.4	0.0178
1047.48	-0.005	192.1	0.0133
1047.50	-0.005	191.9	0.0107
1047.52	-0.007	191.6	0.0071
1047.53	-0.01	191.3	0.0071
1047.55	-0.011	191.1	0.0036
1047.57	-0.011	191.1	0.0009
1047.58	-0.012	190.9	-0.0018
1047.60	-0.013	190.6	-0.0044
1047.62	-0.014	190.4	-0.0062
1047.63	-0.015	190.2	-0.0071
1047.65	-0.016	190	-0.0071
1047.67	-0.017	189.8	-0.0098
1047.68	-0.017	189.8	-0.0107
1047.70	-0.017	189.7	-0.0107
1047.72	-0.017	189.5	-0.0115
1047.73	-0.017	189.4	-0.0124
1047.75	-0.017	189.3	-0.0115
1047.77	-0.017	189.2	-0.0115
1047.78	-0.016	189.2	-0.0115
1047.80	-0.016	189.2	-0.0115



Prova triassiale ciclica SN04-C1			
pressione di confinamento (kPa)		80	
deviatore ciclico (kPa)		95	
frequenza (hz)		0.00625	
tempo	cella di carico	$\Delta u$	LVDT
(min)	kN	(kPa)	$\delta$ (mm)
1047.82	-0.015	189.1	-0.0098
1047.83	-0.015	189.1	-0.0089
1047.85	-0.013	189.1	-0.008
1047.87	-0.013	189.1	-0.0062
1047.88	-0.011	189.2	-0.0044
1047.90	-0.009	189.3	-0.0044
1047.92	-0.008	189.3	-0.0027
1047.93	-0.008	189.4	0
1047.95	-0.006	189.6	0.0036
1047.97	-0.003	189.7	0.0062
1047.98	-0.003	189.8	0.008
1048.00	-0.002	190	0.0107
1048.02	0.001	190.2	0.0142
1048.03	0.003	190.4	0.0178
1048.05	0.004	190.6	0.0222
1048.07	0.008	190.8	0.0222
1048.08	0.009	190.8	0.0257
1048.10	0.009	191	0.0302
1048.12	0.011	191.3	0.0337
1048.13	0.014	191.6	0.0382
1048.15	0.015	191.8	0.0408
1048.17	0.016	192	0.0444
1048.18	0.02	192.3	0.0444
1048.20	0.02	192.3	0.0479
1048.22	0.02	192.5	0.0506
1048.25	0.022	192.8	0.0541
1048.27	0.024	193	0.0568
1048.28	0.025	193.2	0.0586
1048.30	0.026	193.5	0.0604
1048.30	0.027	193.7	0.0604
1048.32	0.028	193.7	0.0621
1048.33	0.028	193.8	0.0639
1048.35	0.028	194	0.0639
1048.37	0.029	194.2	0.0657
1048.38	0.029	194.3	0.0657
1048.40	0.029	194.4	0.0657
1048.42	0.029	194.5	0.0657
1048.43	0.029	194.5	0.0657
1048.45	0.029	194.6	0.0657
1048.47	0.028	194.7	0.0657
1048.48	0.027	194.7	0.0639
1048.50	0.026	194.7	0.063
1048.52	0.025	194.7	0.0612
1048.53	0.024	194.7	0.0612
1048.55	0.022	194.6	0.0604
1048.57	0.022	194.6	0.0577
1048.58	0.021	194.6	0.0559
1048.60	0.019	194.4	0.0533
1048.62	0.017	194.3	0.0506
1048.63	0.016	194.2	0.047
1048.65	0.013	194	0.047
1048.67	0.011	193.8	0.0444
1048.68	0.011	193.8	0.0408
1048.70	0.007	193.5	0.0355
1048.72	0.006	193.3	0.0355
1048.73	0.004	193.3	0.0328
1048.75	0.004	193.1	0.0293
1048.77	0.002	192.8	0.024

Prova triassiale ciclica SN04-C1			
pressione di confinamento (kPa)		80	
deviatore ciclico (kPa)		95	
frequenza (hz)		0.00625	
tempo	cella di carico	$\Delta u$	LVDT
(min)	kN	(kPa)	$\delta$ (mm)
1048.78	-0.001	192.5	0.0204
1048.80	-0.002	192.3	0.0169
1048.82	-0.004	192	0.0124
1048.83	-0.007	191.7	0.0124
1048.85	-0.008	191.7	0.0089
1048.87	-0.008	191.5	0.0062
1048.88	-0.009	191.2	0.0027
1048.90	-0.011	191	0
1048.92	-0.012	190.8	-0.0018
1048.93	-0.013	190.5	-0.0044
1048.95	-0.015	190.3	-0.0044
1048.97	-0.015	190.3	-0.0071
1048.98	-0.015	190.1	-0.008
1049.00	-0.016	189.9	-0.0089
1049.02	-0.017	189.7	-0.0107
1049.03	-0.017	189.6	-0.0107
1049.05	-0.017	189.4	-0.0115
1049.07	-0.017	189.3	-0.0115
1049.08	-0.017	189.3	-0.0115
1049.10	-0.017	189.2	-0.0115
1049.12	-0.017	189.2	-0.0115
1049.13	-0.016	189.1	-0.0107
1049.15	-0.015	189.1	-0.0098
1049.17	-0.014	189.1	-0.008
1049.18	-0.013	189.1	-0.008
1049.20	-0.012	189.1	-0.0071
1049.22	-0.012	189.1	-0.0053
1049.23	-0.011	189.3	-0.0027
1049.25	-0.008	189.4	-0.0009
1049.27	-0.007	189.4	0.0009
1049.28	-0.006	189.6	0.0044
1049.30	-0.002	189.8	0.0044
1049.32	-0.002	189.8	0.008
1049.33	-0.002	189.9	0.0107
1049.35	0	190.1	0.0142
1049.37	0.004	190.4	0.0186
1049.38	0.004	190.5	0.0213
1049.40	0.006	190.8	0.0257
1049.42	0.01	191.1	0.0257
1049.43	0.011	191.2	0.0328
1049.45	0.012	191.4	0.0355
1049.47	0.015	191.7	0.0355
1049.48	0.016	191.7	0.0391
1049.50	0.016	191.9	0.0426
1049.52	0.017	192.2	0.0462
1049.53	0.02	192.4	0.0497
1049.55	0.021	192.7	0.0515
1049.57	0.022	192.9	0.055
1049.58	0.025	193.2	0.055
1049.60	0.025	193.2	0.0577
1049.62	0.025	193.4	0.0595
1049.63	0.026	193.6	0.0612
1049.65	0.027	193.8	0.063
1049.68	0.028	193.9	0.0639
1049.70	0.028	194.1	0.0648
1049.72	0.029	194.2	0.0648
1049.73	0.029	194.4	0.0657
1049.75	0.029	194.4	0.0657

Prova triassiale ciclica SN04-C1			
pressione di confinamento (kPa)		80	
deviatore ciclico (kPa)		95	
frequenza (hz)		0.00625	
tempo	cella di carico	$\Delta u$	LVDT
(min)	kN	(kPa)	$\delta$ (mm)
1049.75	0.029	194.5	0.0666
1049.77	0.029	194.6	0.0666
1049.78	0.028	194.7	0.0666
1049.80	0.028	194.7	0.0657
1049.82	0.026	194.7	0.0657
1049.83	0.025	194.7	0.0639
1049.85	0.025	194.7	0.0621
1049.87	0.025	194.7	0.0612
1049.88	0.023	194.7	0.0595
1049.90	0.021	194.6	0.0577
1049.92	0.02	194.5	0.0541
1049.93	0.018	194.4	0.0541
1049.95	0.016	194.2	0.0515
1049.97	0.016	194.2	0.0488
1049.98	0.015	194.1	0.0462
1050.00	0.012	193.9	0.0426
1050.02	0.01	193.8	0.0399
1050.03	0.009	193.6	0.0355
1050.05	0.005	193.3	0.0355
1050.07	0.004	193.1	0.032
1050.08	0.004	193.1	0.0284
1050.10	0.003	192.9	0.024
1050.12	0	192.6	0.0204
1050.13	-0.002	192.3	0.0169
1050.15	-0.004	192.1	0.0124
1050.17	-0.005	191.8	0.0107
1050.18	-0.007	191.6	0.008
1050.20	-0.008	191.4	0.0044
1050.22	-0.01	191	0.0009
1050.23	-0.012	190.8	0.0009
1050.25	-0.012	190.8	-0.0018
1050.27	-0.013	190.6	-0.0036
1050.28	-0.014	190.4	-0.0053
1050.30	-0.015	190.2	-0.008
1050.32	-0.016	190	-0.0089
1050.33	-0.016	189.8	-0.0107
1050.35	-0.017	189.6	-0.0107
1050.37	-0.017	189.6	-0.0115
1050.38	-0.017	189.5	-0.0115
1050.40	-0.017	189.4	-0.0115
1050.42	-0.017	189.3	-0.0115
1050.43	-0.017	189.2	-0.0115
1050.45	-0.016	189.1	-0.0107
1050.47	-0.015	189.1	-0.0107
1050.48	-0.015	189.1	-0.0107
1050.50	-0.015	189.1	-0.0098
1050.52	-0.014	189.1	-0.008
1050.53	-0.012	189.2	-0.0062
1050.55	-0.011	189.2	-0.0044
1050.57	-0.01	189.3	-0.0027
1050.58	-0.007	189.4	-0.0027
1050.60	-0.006	189.4	0
1050.62	-0.006	189.5	0.0027
1050.63	-0.005	189.6	0.0062
1050.65	-0.002	189.8	0.0089
1050.67	-0.001	190	0.0124
1050.68	0.001	190.2	0.016
1050.70	0.004	190.4	0.016

Prova triassiale ciclica SN04-C1			
pressione di confinamento (kPa)		80	
deviatore ciclico (kPa)		95	
frequenza (hz)		0.00625	
tempo	cella di carico	$\Delta u$	LVDT
(min)	kN	(kPa)	$\delta$ (mm)
1050.72	0.006	190.4	0.0195
1050.73	0.006	190.6	0.0231
1050.75	0.007	190.8	0.0275
1050.77	0.011	191.2	0.032
1050.78	0.012	191.3	0.0346
1050.80	0.013	191.5	0.0382
1050.82	0.016	191.9	0.0382
1050.83	0.018	192.1	0.0426
1050.85	0.018	192.1	0.0453
1050.87	0.019	192.3	0.0488
1050.88	0.022	192.8	0.0524
1050.90	0.022	192.8	0.0533
1050.92	0.023	193	0.0559
1050.93	0.025	193.3	0.0586
1050.95	0.026	193.5	0.0604
1050.97	0.026	193.7	0.0621
1050.98	0.028	193.9	0.0621
1051.00	0.028	194	0.0639
1051.02	0.028	194	0.0648
1051.03	0.028	194.2	0.0657
1051.05	0.029	194.3	0.0657
1051.07	0.029	194.4	0.0666
1051.08	0.029	194.5	0.0666
1051.10	0.029	194.6	0.0666
1051.12	0.028	194.7	0.0666
1051.15	0.027	194.7	0.0657
1051.17	0.027	194.7	0.0648
1051.18	0.026	194.7	0.063
1051.20	0.025	194.7	0.0621
1051.20	0.024	194.7	0.0604
1051.22	0.023	194.7	0.0586
1051.23	0.021	194.6	0.0586
1051.25	0.02	194.6	0.0559
1051.27	0.02	194.5	0.0541
1051.28	0.018	194.3	0.0506
1051.30	0.015	194.2	0.0479
1051.32	0.014	194.1	0.0453
1051.33	0.012	193.9	0.0417
1051.35	0.009	193.7	0.0417
1051.37	0.008	193.7	0.0382
1051.38	0.008	193.5	0.0346
1051.40	0.006	193.2	0.0311
1051.42	0.002	193	0.0275
1051.43	0.001	192.8	0.0231
1051.45	0	192.5	0.0195
1051.47	-0.004	192.2	0.0195
1051.48	-0.005	192.2	0.0151
1051.50	-0.005	192	0.0124
1051.52	-0.006	191.8	0.0089
1051.53	-0.009	191.4	0.0053
1051.55	-0.01	191.2	0.0027
1051.57	-0.011	191	0
1051.58	-0.013	190.7	0
1051.60	-0.014	190.5	-0.0044
1051.62	-0.014	190.3	-0.0053
1051.63	-0.015	190.1	-0.0053
1051.65	-0.016	189.9	-0.008
1051.67	-0.016	189.9	-0.0089

Prova triassiale ciclica SN04-C1			
pressione di confinamento (kPa)		80	
deviatore ciclico (kPa)		95	
frequenza (hz)		0.00625	
tempo	cella di carico	$\Delta u$	LVDT
(min)	kN	(kPa)	$\delta$ (mm)
1051.68	-0.016	189.7	-0.0098
1051.70	-0.017	189.6	-0.0107
1051.72	-0.017	189.4	-0.0115
1051.73	-0.017	189.3	-0.0115
1051.75	-0.017	189.2	-0.0115
1051.77	-0.017	189.2	-0.0115
1051.78	-0.017	189.2	-0.0115
1051.80	-0.016	189.1	-0.0107
1051.82	-0.016	189.1	-0.0098
1051.83	-0.014	189.1	-0.008
1051.85	-0.014	189.1	-0.0071
1051.87	-0.012	189.2	-0.0053
1051.88	-0.01	189.2	-0.0053
1051.90	-0.009	189.2	-0.0036
1051.92	-0.009	189.3	-0.0009
1051.93	-0.008	189.4	0.0009
1051.95	-0.005	189.6	0.0044
1051.97	-0.004	189.7	0.0062
1051.98	-0.003	189.9	0.0098
1052.00	0.001	190.1	0.0098
1052.02	0.002	190.1	0.0142
1052.03	0.002	190.2	0.0169
1052.05	0.003	190.5	0.0204
1052.07	0.007	190.7	0.0249
1052.08	0.009	190.9	0.0293
1052.10	0.01	191.2	0.0328
1052.12	0.013	191.4	0.0328
1052.13	0.014	191.4	0.0364
1052.15	0.014	191.6	0.0399
1052.17	0.016	192	0.0435
1052.18	0.019	192.2	0.0479
1052.20	0.02	192.4	0.0497
1052.22	0.021	192.7	0.0533
1052.23	0.024	192.9	0.0533
1052.25	0.024	192.9	0.0559
1052.27	0.024	193.1	0.0577
1052.28	0.025	193.4	0.0604
1052.30	0.027	193.6	0.0621
1052.32	0.027	193.8	0.063
1052.33	0.028	193.9	0.0648
1052.35	0.028	194.1	0.0657
1052.37	0.028	194.2	0.0657
1052.38	0.029	194.4	0.0666
1052.40	0.029	194.5	0.0666
1052.42	0.029	194.6	0.0666
1052.43	0.029	194.6	0.0666
1052.45	0.028	194.7	0.0666
1052.47	0.028	194.7	0.0657
1052.48	0.027	194.7	0.0648
1052.50	0.026	194.8	0.063
1052.52	0.024	194.7	0.063
1052.53	0.023	194.7	0.0612
1052.55	0.023	194.7	0.0604
1052.58	0.022	194.6	0.0577
1052.60	0.02	194.5	0.055
1052.62	0.018	194.4	0.0533
1052.63	0.017	194.3	0.0497
1052.65	0.015	194.1	0.0497

Prova triassiale ciclica SN04-C1			
pressione di confinamento (kPa)		80	
deviatore ciclico (kPa)		95	
frequenza (hz)		0.00625	
tempo	cella di carico	$\Delta u$	LVDT
(min)	kN	(kPa)	$\delta$ (mm)
1052.65	0.012	194	0.047
1052.67	0.012	194	0.0444
1052.68	0.011	193.8	0.0408
1052.70	0.008	193.6	0.0364
1052.72	0.006	193.4	0.0337
1052.73	0.005	193.2	0.0302
1052.75	0.002	192.9	0.0302
1052.77	0	192.7	0.0249
1052.78	0	192.7	0.0222
1052.80	-0.001	192.5	0.0186
1052.82	-0.004	192.1	0.0133
1052.83	-0.006	191.9	0.0107
1052.85	-0.007	191.7	0.0071
1052.87	-0.009	191.3	0.0036
1052.88	-0.011	191.1	0.0036
1052.90	-0.011	191.1	0.0009
1052.92	-0.012	190.9	-0.0009
1052.93	-0.013	190.6	-0.0036
1052.95	-0.015	190.4	-0.0062
1052.97	-0.015	190.2	-0.0071
1052.98	-0.016	190	-0.0089
1053.00	-0.017	189.8	-0.0089
1053.02	-0.017	189.8	-0.0098
1053.03	-0.017	189.6	-0.0107
1053.05	-0.017	189.5	-0.0115
1053.07	-0.017	189.4	-0.0115
1053.08	-0.017	189.2	-0.0115
1053.10	-0.017	189.2	-0.0115
1053.12	-0.016	189.1	-0.0115
1053.13	-0.016	189.1	-0.0107
1053.15	-0.015	189.1	-0.0089
1053.17	-0.014	189.1	-0.0089
1053.18	-0.013	189.1	-0.008
1053.20	-0.013	189.1	-0.0071
1053.22	-0.012	189.2	-0.0044
1053.23	-0.01	189.2	-0.0027
1053.25	-0.009	189.3	0
1053.27	-0.007	189.5	0.0018
1053.28	-0.004	189.6	0.0018
1053.30	-0.003	189.6	0.0053
1053.32	-0.003	189.7	0.008
1053.33	-0.001	189.9	0.0115
1053.35	0.002	190.1	0.0151
1053.37	0.003	190.3	0.0178
1053.38	0.004	190.6	0.0213
1053.40	0.008	190.8	0.0213
1053.42	0.009	190.8	0.0275
1053.43	0.009	191	0.0302
1053.45	0.011	191.3	0.0337
1053.47	0.014	191.5	0.0382
1053.48	0.015	191.7	0.0408
1053.50	0.016	192	0.0444
1053.52	0.02	192.3	0.0444
1053.53	0.02	192.3	0.0479
1053.55	0.02	192.5	0.0506
1053.57	0.022	192.8	0.0541
1053.58	0.024	193	0.0568
1053.60	0.025	193.2	0.0586

Prova triassiale ciclica SN04-C1			
pressione di confinamento (kPa)		80	
deviatore ciclico (kPa)		95	
frequenza (hz)		0.00625	
tempo	cella di carico	$\Delta u$	LVDT
(min)	kN	(kPa)	$\delta$ (mm)
1053.62	0.026	193.4	0.0612
1053.63	0.027	193.6	0.0612
1053.65	0.027	193.6	0.0621
1053.67	0.027	193.8	0.063
1053.68	0.028	194	0.0648
1053.70	0.029	194.1	0.0657
1053.72	0.029	194.3	0.0657
1053.73	0.029	194.4	0.0666
1053.75	0.029	194.5	0.0666
1053.77	0.029	194.5	0.0666
1053.78	0.028	194.7	0.0657
1053.80	0.028	194.7	0.0657
1053.82	0.026	194.7	0.0648
1053.83	0.026	194.7	0.0639
1053.85	0.026	194.7	0.0621
1053.87	0.024	194.7	0.0604
1053.88	0.023	194.7	0.0595
1053.90	0.022	194.6	0.0568
1053.92	0.02	194.4	0.0568
1053.93	0.017	194.4	0.0541
1053.95	0.017	194.4	0.0524
1053.97	0.017	194.3	0.0488
1053.98	0.014	194	0.0462
1054.00	0.011	193.9	0.0426
1054.02	0.011	193.8	0.0391
1054.05	0.008	193.5	0.0391
1054.07	0.005	193.3	0.0355
1054.08	0.005	193.3	0.032
1054.10	0.004	193.1	0.0284
1054.10	0.002	192.8	0.024
1054.12	-0.001	192.5	0.0195
1054.13	-0.002	192.3	0.0169
1054.15	-0.004	192	0.0124
1054.17	-0.006	191.7	0.0124
1054.18	-0.006	191.7	0.0089
1054.20	-0.007	191.5	0.0062
1054.22	-0.009	191.2	0.0027
1054.23	-0.012	190.9	0
1054.25	-0.012	190.7	-0.0027
1054.27	-0.013	190.4	-0.0044
1054.28	-0.015	190.2	-0.0044
1054.30	-0.016	190.2	-0.0071
1054.32	-0.016	190	-0.008
1054.33	-0.016	189.9	-0.0089
1054.35	-0.017	189.7	-0.0098
1054.37	-0.017	189.5	-0.0107
1054.38	-0.017	189.4	-0.0115
1054.40	-0.017	189.3	-0.0115
1054.42	-0.017	189.3	-0.0115
1054.43	-0.017	189.2	-0.0115
1054.45	-0.017	189.1	-0.0107
1054.47	-0.016	189.1	-0.0098
1054.48	-0.015	189.1	-0.0098
1054.50	-0.015	189.1	-0.008
1054.52	-0.013	189.1	-0.0062
1054.53	-0.012	189.1	-0.0062
1054.55	-0.011	189.1	-0.0036
1054.57	-0.009	189.3	-0.0036

Prova triassiale ciclica SN04-C1			
pressione di confinamento (kPa)		80	
deviatore ciclico (kPa)		95	
frequenza (hz)		0.00625	
tempo	cella di carico	$\Delta u$	LVDT
(min)	kN	(kPa)	$\delta$ (mm)
1054.58	-0.008	189.3	-0.0018
1054.60	-0.008	189.3	0.0009
1054.62	-0.007	189.5	0.0036
1054.63	-0.003	189.7	0.0071
1054.65	-0.002	189.8	0.0089
1054.67	-0.001	189.9	0.0124
1054.68	0.002	190.2	0.0124
1054.70	0.004	190.4	0.0169
1054.72	0.004	190.4	0.0195
1054.73	0.005	190.6	0.024
1054.75	0.009	190.9	0.0284
1054.77	0.01	191.1	0.032
1054.78	0.012	191.3	0.0355
1054.80	0.015	191.6	0.0355
1054.82	0.016	191.8	0.0399
1054.83	0.016	191.8	0.0426
1054.85	0.017	192.1	0.0462
1054.87	0.02	192.4	0.0497
1054.88	0.022	192.6	0.0524
1054.90	0.022	192.8	0.055
1054.92	0.024	193.1	0.055
1054.93	0.026	193.3	0.0577
1054.95	0.026	193.3	0.0595
1054.97	0.026	193.5	0.0612
1054.98	0.027	193.7	0.063
1055.00	0.028	193.9	0.0639
1055.02	0.028	194	0.0648
1055.03	0.028	194.2	0.0657
1055.05	0.029	194.3	0.0657
1055.07	0.029	194.3	0.0666
1055.08	0.029	194.4	0.0666
1055.10	0.029	194.5	0.0666
1055.12	0.028	194.6	0.0666
1055.13	0.028	194.6	0.0648
1055.15	0.026	194.6	0.0639
1055.17	0.025	194.7	0.0639
1055.18	0.025	194.7	0.063
1055.20	0.025	194.7	0.0612
1055.22	0.023	194.6	0.0586
1055.23	0.021	194.5	0.0577
1055.25	0.021	194.5	0.0559
1055.27	0.02	194.4	0.0533
1055.28	0.016	194.2	0.0506
1055.30	0.015	194.2	0.0479
1055.32	0.014	194	0.0444
1055.33	0.011	193.8	0.0444
1055.35	0.01	193.8	0.0408
1055.37	0.01	193.6	0.0391
1055.38	0.008	193.3	0.0346
1055.40	0.004	193.1	0.0302
1055.42	0.003	193	0.0257
1055.43	0.001	192.7	0.0222
1055.45	-0.002	192.4	0.0222
1055.47	-0.002	192.4	0.0186
1055.48	-0.002	192.2	0.0151
1055.52	-0.004	191.8	0.0115
1055.53	-0.007	191.5	0.0071
1055.55	-0.009	191.4	0.0044



Prova triassiale ciclica SN04-C1			
pressione di confinamento (kPa)		80	
deviatore ciclico (kPa)		95	
frequenza (hz)		0.00625	
tempo	cella di carico	$\Delta u$	LVDT
(min)	kN	(kPa)	$\delta$ (mm)
1055.55	-0.01	191.1	0.0018
1055.57	-0.012	190.8	0.0018
1055.58	-0.013	190.8	-0.0009
1055.60	-0.013	190.6	-0.0027
1055.62	-0.014	190.3	-0.0053
1055.63	-0.015	190.1	-0.0071
1055.65	-0.016	189.9	-0.0089
1055.67	-0.016	189.8	-0.0098
1055.68	-0.017	189.6	-0.0098
1055.70	-0.017	189.6	-0.0107
1055.72	-0.017	189.5	-0.0115
1055.73	-0.017	189.4	-0.0115
1055.75	-0.017	189.3	-0.0115
1055.77	-0.017	189.2	-0.0115
1055.78	-0.016	189.1	-0.0107
1055.80	-0.016	189.1	-0.0107
1055.82	-0.015	189.1	-0.0098
1055.83	-0.015	189.1	-0.0089
1055.85	-0.014	189	-0.008
1055.87	-0.012	189.1	-0.0062
1055.88	-0.012	189.1	-0.0044
1055.90	-0.01	189.2	-0.0018
1055.92	-0.008	189.4	-0.0018
1055.93	-0.006	189.5	0.0009
1055.95	-0.006	189.5	0.0036
1055.97	-0.003	189.7	0.0062
1055.98	-0.002	189.9	0.008
1056.00	-0.002	189.9	0.0107
1056.02	0	190	0.0142
1056.03	0.003	190.3	0.0186
1056.05	0.005	190.5	0.0213
1056.07	0.006	190.7	0.0257
1056.08	0.009	191	0.0257
1056.10	0.011	191.2	0.0302
1056.12	0.011	191.2	0.0337
1056.13	0.012	191.4	0.0373
1056.15	0.015	191.7	0.0417
1056.17	0.017	192	0.0444
1056.18	0.018	192.2	0.0479
1056.20	0.02	192.5	0.0479
1056.22	0.022	192.7	0.0515
1056.23	0.022	192.7	0.0533
1056.25	0.023	192.9	0.0559
1056.27	0.024	193.2	0.0595
1056.28	0.026	193.4	0.0612
1056.30	0.026	193.6	0.063
1056.32	0.027	193.8	0.0639
1056.33	0.028	194	0.0639
1056.35	0.028	194	0.0648
1056.37	0.028	194.1	0.0657
1056.38	0.028	194.2	0.0666
1056.40	0.029	194.4	0.0666
1056.42	0.029	194.5	0.0666
1056.43	0.029	194.6	0.0666
1056.45	0.028	194.6	0.0666
1056.47	0.027	194.6	0.0666
1056.48	0.027	194.7	0.0648
1056.50	0.026	194.7	0.0639

Prova triassiale ciclica SN04-C1			
pressione di confinamento (kPa)		80	
deviatore ciclico (kPa)		95	
frequenza (hz)		0.00625	
tempo	cella di carico	$\Delta u$	LVDT
(min)	kN	(kPa)	$\delta$ (mm)
1056.52	0.025	194.7	0.0621
1056.53	0.024	194.6	0.0612
1056.55	0.023	194.6	0.0595
1056.57	0.02	194.5	0.0595
1056.58	0.02	194.5	0.0568
1056.60	0.02	194.5	0.0541
1056.62	0.018	194.3	0.0515
1056.63	0.015	194.1	0.0479
1056.65	0.014	194	0.0462
1056.67	0.012	193.8	0.0426
1056.68	0.009	193.6	0.0382
1056.70	0.009	193.5	0.0364
1056.72	0.007	193.3	0.0328
1056.73	0.003	193	0.0328
1056.75	0.002	193	0.0284
1056.77	0.002	192.8	0.0257
1056.78	0.001	192.5	0.0213
1056.80	-0.003	192.2	0.0169
1056.82	-0.004	192.1	0.0142
1056.83	-0.005	191.8	0.0098
1056.85	-0.008	191.5	0.0098
1056.87	-0.009	191.5	0.0062
1056.88	-0.009	191.2	0.0044
1056.90	-0.01	191	0.0018
1056.92	-0.013	190.7	-0.0018
1056.95	-0.013	190.5	-0.0036
1056.97	-0.014	190.3	-0.0062
1056.98	-0.016	190	-0.0062
1057.00	-0.016	189.9	-0.008
1057.02	-0.016	189.9	-0.0089
1057.02	-0.016	189.7	-0.0098
1057.03	-0.017	189.5	-0.0107
1057.05	-0.017	189.4	-0.0115
1057.07	-0.017	189.3	-0.0115
1057.08	-0.017	189.2	-0.0115
1057.10	-0.017	189.1	-0.0115
1057.12	-0.017	189.1	-0.0115
1057.13	-0.016	189	-0.0107
1057.15	-0.015	189.1	-0.0089
1057.17	-0.014	189	-0.008
1057.18	-0.014	189	-0.0071
1057.20	-0.012	189.1	-0.0044
1057.22	-0.01	189.2	-0.0044
1057.23	-0.01	189.2	-0.0036
1057.25	-0.01	189.2	-0.0018
1057.27	-0.008	189.4	0.0018
1057.28	-0.005	189.5	0.0044
1057.30	-0.004	189.6	0.0071
1057.32	-0.002	189.8	0.0107
1057.33	0.001	190	0.0107
1057.35	0.002	190	0.0142
1057.37	0.002	190.2	0.0169
1057.38	0.004	190.4	0.0213
1057.40	0.007	190.7	0.0249
1057.42	0.008	190.9	0.0293
1057.43	0.009	191	0.0311
1057.45	0.012	191.3	0.0346
1057.47	0.013	191.5	0.0382

Prova triassiale ciclica SN04-C1			
pressione di confinamento (kPa)		80	
deviatore ciclico (kPa)		95	
frequenza (hz)		0.00625	
tempo	cella di carico	$\Delta u$	LVDT
(min)	kN	(kPa)	$\delta$ (mm)
1057.48	0.015	191.8	0.0426
1057.50	0.018	192.1	0.0426
1057.52	0.019	192.1	0.0462
1057.53	0.019	192.3	0.0488
1057.55	0.02	192.5	0.0515
1057.57	0.023	192.8	0.055
1057.58	0.024	193	0.0568
1057.60	0.024	193.2	0.0595
1057.62	0.027	193.5	0.0595
1057.63	0.027	193.5	0.0612
1057.65	0.027	193.6	0.063
1057.67	0.027	193.8	0.0639
1057.68	0.028	194	0.0657
1057.70	0.029	194.1	0.0657
1057.72	0.029	194.3	0.0666
1057.73	0.029	194.4	0.0666
1057.75	0.028	194.5	0.0666
1057.77	0.028	194.5	0.0666
1057.78	0.028	194.6	0.0666
1057.80	0.028	194.6	0.0657
1057.82	0.027	194.7	0.0648
1057.83	0.026	194.7	0.063
1057.85	0.025	194.7	0.063
1057.87	0.023	194.6	0.0621
1057.88	0.023	194.6	0.0604
1057.90	0.022	194.6	0.0586
1057.92	0.021	194.5	0.0559
1057.93	0.018	194.4	0.0533
1057.95	0.017	194.3	0.0497
1057.97	0.015	194	0.0497
1057.98	0.012	193.9	0.047
1058.00	0.012	193.9	0.0444
1058.02	0.011	193.8	0.0408
1058.03	0.009	193.5	0.0373
1058.05	0.006	193.3	0.0337
1058.07	0.005	193.1	0.0302
1058.08	0.002	192.8	0.0302
1058.10	0	192.6	0.0257
1058.12	0	192.6	0.0213
1058.13	-0.001	192.4	0.0178
1058.15	-0.005	191.9	0.0142
1058.17	-0.005	191.9	0.0124
1058.18	-0.006	191.7	0.0089
1058.20	-0.008	191.3	0.0053
1058.22	-0.01	191.1	0.0027
1058.23	-0.011	190.9	0
1058.25	-0.012	190.6	-0.0027
1058.27	-0.014	190.4	-0.0027
1058.28	-0.014	190.4	-0.0053
1058.30	-0.015	190.2	-0.0062
1058.32	-0.015	189.9	-0.008
1058.33	-0.017	189.7	-0.0098
1058.35	-0.017	189.6	-0.0107
1058.37	-0.017	189.5	-0.0107
1058.38	-0.017	189.3	-0.0107
1058.42	-0.017	189.3	-0.0115
1058.43	-0.017	189.2	-0.0115
1058.45	-0.017	189.1	-0.0115

Prova triassiale ciclica SN04-C1			
pressione di confinamento (kPa)		80	
deviatore ciclico (kPa)		95	
frequenza (hz)		0.00625	
tempo	cella di carico	$\Delta u$	LVDT
(min)	kN	(kPa)	$\delta$ (mm)
1058.47	-0.017	189	-0.0107
1058.47	-0.016	189	-0.0098
1058.48	-0.015	189	-0.0089
1058.50	-0.014	189	-0.0089
1058.52	-0.013	189	-0.008
1058.53	-0.013	189	-0.0062
1058.55	-0.012	189.1	-0.0044
1058.57	-0.01	189.2	-0.0027
1058.58	-0.009	189.2	0
1058.60	-0.007	189.4	0.0027
1058.62	-0.004	189.5	0.0027
1058.63	-0.003	189.5	0.0053
1058.65	-0.003	189.6	0.008
1058.67	-0.002	189.9	0.0115
1058.68	0.002	190.1	0.016
1058.70	0.003	190.2	0.0186
1058.72	0.005	190.5	0.0222
1058.73	0.008	190.7	0.0222
1058.75	0.009	190.7	0.0275
1058.77	0.009	190.9	0.0311
1058.78	0.011	191.2	0.0346
1058.80	0.014	191.5	0.0382
1058.82	0.015	191.7	0.0417
1058.83	0.017	192	0.0453
1058.85	0.02	192.2	0.0453
1058.87	0.021	192.4	0.0506
1058.88	0.021	192.6	0.0533
1058.90	0.023	192.9	0.0533
1058.92	0.024	192.9	0.0559
1058.93	0.024	193.1	0.0577
1058.95	0.025	193.3	0.0604
1058.97	0.027	193.5	0.063
1058.98	0.027	193.7	0.0639
1059.00	0.028	193.9	0.0657
1059.02	0.028	194	0.0657
1059.03	0.029	194.2	0.0657
1059.05	0.029	194.2	0.0666
1059.07	0.029	194.3	0.0666
1059.08	0.029	194.4	0.0666
1059.10	0.029	194.5	0.0666
1059.12	0.028	194.6	0.0666
1059.13	0.028	194.6	0.0666
1059.15	0.026	194.6	0.0657
1059.17	0.026	194.6	0.0648
1059.18	0.025	194.7	0.063
1059.20	0.024	194.6	0.0612
1059.22	0.023	194.6	0.0595
1059.23	0.022	194.5	0.0568
1059.25	0.02	194.4	0.055
1059.27	0.017	194.3	0.055
1059.28	0.017	194.3	0.0524
1059.30	0.016	194.2	0.0497
1059.32	0.014	194	0.0462
1059.33	0.011	193.8	0.0435
1059.35	0.01	193.7	0.0399
1059.37	0.008	193.4	0.0364
1059.38	0.005	193.2	0.0364
1059.40	0.005	193.2	0.0328

Prova triassiale ciclica SN04-C1			
pressione di confinamento (kPa)		80	
deviatore ciclico (kPa)		95	
frequenza (hz)		0.00625	
tempo	cella di carico	$\Delta u$	LVDT
(min)	kN	(kPa)	$\delta$ (mm)
1059.42	0.004	193	0.0293
1059.43	0.002	192.7	0.024
1059.45	-0.001	192.5	0.0204
1059.47	-0.002	192.3	0.0169
1059.48	-0.004	191.9	0.0133
1059.50	-0.007	191.6	0.0133
1059.52	-0.008	191.6	0.0098
1059.53	-0.008	191.4	0.0071
1059.55	-0.009	191.2	0.0036
1059.57	-0.011	190.9	0.0009
1059.58	-0.012	190.7	-0.0018
1059.60	-0.013	190.4	-0.0044
1059.62	-0.015	190.2	-0.0053
1059.63	-0.015	190	-0.0062
1059.65	-0.016	189.8	-0.008
1059.67	-0.017	189.7	-0.008
1059.68	-0.017	189.7	-0.0089
1059.70	-0.017	189.5	-0.0098
1059.72	-0.017	189.4	-0.0107
1059.73	-0.017	189.2	-0.0107
1059.75	-0.017	189.1	-0.0107
1059.77	-0.017	189.1	-0.0107
1059.78	-0.016	189	-0.0107
1059.80	-0.016	189	-0.0098
1059.82	-0.016	189	-0.0089
1059.85	-0.015	189	-0.008
1059.87	-0.013	189	-0.0071
1059.88	-0.012	189	-0.0053
1059.90	-0.012	189	-0.0036
1059.92	-0.009	189.2	-0.0036
1059.92	-0.008	189.2	-0.0009
1059.93	-0.008	189.3	0.0009
1059.95	-0.007	189.4	0.0036
1059.97	-0.004	189.6	0.0071
1059.98	-0.002	189.7	0.0098
1060.00	-0.001	189.9	0.0133
1060.02	0.003	190.1	0.0133
1060.03	0.004	190.1	0.0178
1060.05	0.004	190.3	0.0204
1060.07	0.005	190.5	0.024
1060.08	0.009	190.8	0.0293
1060.10	0.01	191	0.0328
1060.12	0.012	191.2	0.0373
1060.13	0.015	191.5	0.0373
1060.15	0.016	191.8	0.0408
1060.17	0.016	191.8	0.0435
1060.18	0.017	192	0.047
1060.20	0.02	192.3	0.0506
1060.22	0.021	192.5	0.0533
1060.23	0.022	192.7	0.0559
1060.25	0.024	193	0.0559
1060.27	0.025	193.2	0.0586
1060.28	0.025	193.2	0.0604
1060.30	0.026	193.4	0.0621
1060.32	0.028	193.8	0.0639
1060.33	0.028	193.8	0.0648
1060.35	0.028	194	0.0657
1060.37	0.029	194.1	0.0666

Prova triassiale ciclica SN04-C1			
pressione di confinamento (kPa)		80	
deviatore ciclico (kPa)		95	
frequenza (hz)		0.00625	
tempo	cella di carico	$\Delta u$	LVDT
(min)	kN	(kPa)	$\delta$ (mm)
1060.38	0.029	194.2	0.0675
1060.40	0.029	194.3	0.0675
1060.42	0.029	194.5	0.0675
1060.43	0.029	194.6	0.0675
1060.45	0.029	194.6	0.0675
1060.47	0.028	194.6	0.0666
1060.48	0.027	194.6	0.0657
1060.50	0.026	194.7	0.0648
1060.52	0.025	194.7	0.063
1060.53	0.024	194.6	0.0612
1060.55	0.022	194.5	0.0612
1060.57	0.021	194.5	0.0586
1060.58	0.021	194.5	0.0568
1060.60	0.02	194.3	0.0541
1060.62	0.016	194.2	0.0515
1060.63	0.015	194.1	0.0488
1060.65	0.014	193.9	0.0462
1060.67	0.01	193.7	0.0462
1060.68	0.01	193.7	0.0417
1060.70	0.01	193.6	0.0399
1060.72	0.008	193.3	0.0355
1060.73	0.004	193.1	0.032
1060.75	0.003	192.9	0.0284
1060.77	0.002	192.6	0.024
1060.78	-0.002	192.3	0.024
1060.80	-0.003	192.3	0.0195
1060.82	-0.003	192.1	0.0169
1060.83	-0.004	191.8	0.0133
1060.85	-0.007	191.6	0.0098
1060.87	-0.008	191.3	0.0062
1060.88	-0.01	191	0.0036
1060.90	-0.012	190.8	0.0036
1060.92	-0.012	190.8	0.0009
1060.93	-0.012	190.6	-0.0009
1060.95	-0.014	190.3	-0.0036
1060.97	-0.015	190.1	-0.0053
1060.98	-0.016	189.9	-0.0071
1061.00	-0.016	189.7	-0.008
1061.02	-0.017	189.5	-0.008
1061.03	-0.017	189.5	-0.0098
1061.05	-0.017	189.3	-0.0107
1061.07	-0.017	189.2	-0.0107
1061.08	-0.017	189.2	-0.0098
1061.10	-0.017	189.1	-0.0098
1061.12	-0.017	189	-0.0098
1061.13	-0.016	189	-0.0089
1061.15	-0.015	188.9	-0.008
1061.17	-0.014	188.9	-0.0062
1061.18	-0.013	189	-0.0062
1061.20	-0.012	189	-0.0053
1061.22	-0.012	189	-0.0036
1061.23	-0.011	189.1	-0.0018
1061.25	-0.008	189.2	0.0009
1061.27	-0.007	189.3	0.0036
1061.28	-0.006	189.5	0.0071
1061.32	-0.002	189.6	0.0071
1061.33	-0.002	189.6	0.0098
1061.35	-0.002	189.8	0.0124

Prova triassiale ciclica SN04-C1			
pressione di confinamento (kPa)		80	
deviatore ciclico (kPa)		95	
frequenza (hz)		0.00625	
tempo	cella di carico	$\Delta u$	LVDT
(min)	kN	(kPa)	$\delta$ (mm)
1061.37	0	190	0.016
1061.37	0.004	190.2	0.0204
1061.38	0.004	190.4	0.0231
1061.40	0.006	190.7	0.0275
1061.42	0.01	190.9	0.0275
1061.43	0.011	190.9	0.0328
1061.45	0.011	191.2	0.0355
1061.47	0.012	191.4	0.0391
1061.48	0.016	191.7	0.0426
1061.50	0.017	191.9	0.0462
1061.52	0.018	192.1	0.0497
1061.53	0.021	192.4	0.0497
1061.55	0.022	192.4	0.0524
1061.57	0.022	192.6	0.055
1061.58	0.023	192.9	0.0577
1061.60	0.025	193.1	0.0612
1061.62	0.026	193.3	0.0621
1061.63	0.026	193.5	0.0639
1061.65	0.028	193.7	0.0639
1061.67	0.028	193.7	0.0657
1061.68	0.028	193.9	0.0666
1061.70	0.028	194	0.0675
1061.72	0.029	194.2	0.0675
1061.73	0.029	194.3	0.0683
1061.75	0.029	194.4	0.0683
1061.77	0.029	194.5	0.0683
1061.78	0.028	194.5	0.0683
1061.80	0.028	194.6	0.0666
1061.82	0.026	194.6	0.0666
1061.83	0.026	194.6	0.0657
1061.85	0.026	194.6	0.0648
1061.87	0.025	194.6	0.063
1061.88	0.023	194.5	0.0612
1061.90	0.021	194.5	0.0595
1061.92	0.02	194.4	0.0559
1061.93	0.018	194.3	0.0559
1061.95	0.016	194.2	0.0533
1061.97	0.016	194.2	0.0506
1061.98	0.015	194	0.0479
1062.00	0.012	193.8	0.0444
1062.02	0.01	193.6	0.0408
1062.03	0.009	193.5	0.0373
1062.05	0.006	193.2	0.0373
1062.07	0.003	192.9	0.0337
1062.08	0.003	192.9	0.0302
1062.10	0.002	192.8	0.0257
1062.12	0	192.5	0.0213
1062.13	-0.003	192.2	0.0178
1062.15	-0.003	192	0.0151
1062.17	-0.006	191.7	0.0151
1062.18	-0.008	191.4	0.0107
1062.20	-0.008	191.4	0.0071
1062.22	-0.009	191.2	0.0044
1062.23	-0.011	190.9	0.0018
1062.25	-0.012	190.6	-0.0009
1062.27	-0.013	190.4	-0.0036
1062.28	-0.015	190.2	-0.0062
1062.30	-0.016	190	-0.0062

Prova triassiale ciclica SN04-C1			
pressione di confinamento (kPa)		80	
deviatore ciclico (kPa)		95	
frequenza (hz)		0.00625	
tempo	cella di carico	$\Delta u$	LVDT
(min)	kN	(kPa)	$\delta$ (mm)
1062.32	-0.016	190	-0.0071
1062.33	-0.016	189.8	-0.0089
1062.35	-0.016	189.6	-0.0098
1062.37	-0.017	189.5	-0.0098
1062.38	-0.017	189.3	-0.0107
1062.40	-0.017	189.2	-0.0107
1062.42	-0.017	189.1	-0.0107
1062.43	-0.017	189.1	-0.0107
1062.45	-0.017	189.1	-0.0098
1062.47	-0.016	189	-0.0098
1062.48	-0.015	189	-0.0089
1062.50	-0.015	189	-0.0071
1062.52	-0.014	189	-0.0062
1062.53	-0.012	189	-0.0053
1062.55	-0.012	189	-0.0036
1062.57	-0.01	189.2	-0.0009
1062.58	-0.007	189.3	-0.0009
1062.60	-0.006	189.3	0.0018
1062.62	-0.006	189.4	0.0044
1062.63	-0.005	189.5	0.0071
1062.65	-0.002	189.7	0.0098
1062.67	-0.001	189.9	0.0133
1062.68	0.001	190.1	0.0169
1062.70	0.005	190.3	0.0169
1062.72	0.005	190.3	0.0204
1062.75	0.005	190.5	0.024
1062.77	0.008	190.7	0.0293
1062.78	0.01	191	0.0328
1062.80	0.012	191.2	0.0355
1062.82	0.013	191.5	0.0399
1062.82	0.017	191.8	0.0399
1062.83	0.018	191.8	0.0435
1062.85	0.018	192	0.0462
1062.87	0.019	192.2	0.0497
1062.88	0.022	192.5	0.0533
1062.90	0.022	192.7	0.055
1062.92	0.023	192.9	0.0577
1062.93	0.026	193.2	0.0577
1062.95	0.026	193.2	0.0604
1062.97	0.026	193.4	0.0621
1062.98	0.027	193.6	0.0639
1063.00	0.028	193.8	0.0648
1063.02	0.028	193.9	0.0657
1063.03	0.029	194.1	0.0666
1063.05	0.029	194.2	0.0666
1063.07	0.029	194.2	0.0666
1063.08	0.029	194.3	0.0666
1063.10	0.029	194.4	0.0666
1063.12	0.028	194.5	0.0666
1063.13	0.028	194.6	0.0666
1063.15	0.027	194.6	0.0648
1063.17	0.026	194.6	0.0648
1063.18	0.024	194.6	0.063
1063.20	0.024	194.6	0.0621
1063.22	0.023	194.6	0.0604
1063.23	0.021	194.4	0.0577
1063.25	0.021	194.4	0.0568
1063.27	0.02	194.4	0.0541



Prova triassiale ciclica SN04-C1			
pressione di confinamento (kPa)		80	
deviatore ciclico (kPa)		95	
frequenza (hz)		0.00625	
tempo	cella di carico	$\Delta u$	LVDT
(min)	kN	(kPa)	$\delta$ (mm)
1063.28	0.017	194.2	0.0515
1063.30	0.015	194.1	0.0488
1063.32	0.014	193.9	0.0453
1063.33	0.012	193.7	0.0417
1063.35	0.009	193.5	0.0417
1063.37	0.009	193.5	0.0391
1063.38	0.008	193.4	0.0355
1063.40	0.006	193.1	0.032
1063.42	0.002	192.8	0.0275
1063.43	0.001	192.7	0.0231
1063.45	-0.001	192.3	0.0195
1063.47	-0.004	192.1	0.0195
1063.48	-0.004	192.1	0.016
1063.50	-0.004	191.9	0.0124
1063.52	-0.006	191.5	0.0089
1063.53	-0.009	191.3	0.0053
1063.55	-0.01	191	0.0027
1063.57	-0.011	190.8	0
1063.58	-0.013	190.5	0
1063.60	-0.014	190.5	-0.0027
1063.62	-0.014	190.3	-0.0044
1063.63	-0.015	190.1	-0.0062
1063.65	-0.016	189.9	-0.008
1063.67	-0.016	189.7	-0.0089
1063.68	-0.016	189.6	-0.0089
1063.70	-0.017	189.4	-0.0089
1063.72	-0.017	189.4	-0.0107
1063.73	-0.017	189.3	-0.0107
1063.75	-0.017	189.2	-0.0107
1063.77	-0.017	189.1	-0.0107
1063.78	-0.017	189	-0.0107
1063.80	-0.016	189	-0.0098
1063.82	-0.015	189	-0.0098
1063.83	-0.014	189	-0.008
1063.85	-0.014	189	-0.0071
1063.87	-0.013	189	-0.0053
1063.88	-0.011	189.1	-0.0036
1063.90	-0.01	189.1	-0.0018
1063.92	-0.009	189.3	0.0009
1063.93	-0.006	189.4	0.0009
1063.95	-0.005	189.5	0.0053
1063.97	-0.004	189.6	0.008
1063.98	-0.001	189.8	0.008
1064.00	0	189.8	0.0115
1064.02	0	189.9	0.0142
1064.03	0.002	190.2	0.0186
1064.05	0.006	190.4	0.0222
1064.07	0.006	190.6	0.0257
1064.08	0.008	190.9	0.0302
1064.10	0.012	191.2	0.0302
1064.12	0.013	191.2	0.0346
1064.13	0.013	191.3	0.0373
1064.15	0.014	191.6	0.0417
1064.17	0.018	191.9	0.0453
1064.18	0.018	192.1	0.0479
1064.22	0.02	192.3	0.0515
1064.23	0.023	192.6	0.0515
1064.25	0.023	192.6	0.055

Prova triassiale ciclica SN04-C1			
pressione di confinamento (kPa)		80	
deviatore ciclico (kPa)		95	
frequenza (hz)		0.00625	
tempo	cella di carico	$\Delta u$	LVDT
(min)	kN	(kPa)	$\delta$ (mm)
1064.27	0.023	192.8	0.0559
1064.27	0.024	193	0.0595
1064.28	0.026	193.3	0.0612
1064.30	0.027	193.5	0.063
1064.32	0.027	193.6	0.0648
1064.33	0.028	193.9	0.0648
1064.35	0.029	194	0.0657
1064.37	0.029	194	0.0666
1064.38	0.029	194.1	0.0666
1064.40	0.029	194.3	0.0675
1064.42	0.029	194.4	0.0675
1064.43	0.028	194.5	0.0675
1064.45	0.028	194.5	0.0675
1064.47	0.027	194.6	0.0675
1064.48	0.027	194.6	0.0666
1064.50	0.027	194.6	0.0648
1064.52	0.025	194.6	0.063
1064.53	0.024	194.5	0.0621
1064.55	0.023	194.5	0.0595
1064.57	0.021	194.4	0.0577
1064.58	0.019	194.3	0.0577
1064.60	0.019	194.3	0.055
1064.62	0.018	194.3	0.0524
1064.63	0.016	194	0.0497
1064.65	0.013	193.9	0.0462
1064.67	0.012	193.8	0.0435
1064.68	0.01	193.5	0.0399
1064.70	0.008	193.4	0.0382
1064.72	0.007	193.2	0.0355
1064.73	0.005	193	0.032
1064.75	0.002	192.7	0.032
1064.77	0.001	192.7	0.0275
1064.78	0.001	192.5	0.0231
1064.80	-0.001	192.2	0.0195
1064.82	-0.005	191.9	0.0151
1064.83	-0.005	191.7	0.0124
1064.85	-0.007	191.4	0.0089
1064.87	-0.01	191.2	0.0089
1064.88	-0.01	191.2	0.0053
1064.90	-0.01	190.9	0.0027
1064.92	-0.011	190.6	0
1064.93	-0.014	190.4	-0.0018
1064.95	-0.014	190.2	-0.0036
1064.97	-0.015	190	-0.0053
1064.98	-0.016	189.8	-0.0053
1065.00	-0.016	189.8	-0.0071
1065.02	-0.016	189.6	-0.008
1065.03	-0.017	189.5	-0.0089
1065.05	-0.017	189.3	-0.0098
1065.07	-0.017	189.2	-0.0098
1065.08	-0.017	189.1	-0.0098
1065.10	-0.017	189	-0.0098
1065.12	-0.016	189	-0.0098
1065.13	-0.016	189	-0.0089
1065.15	-0.016	188.9	-0.008
1065.17	-0.014	189	-0.0071
1065.18	-0.014	189	-0.0053
1065.20	-0.013	189	-0.0036

Prova triassiale ciclica SN04-C1			
pressione di confinamento (kPa)		80	
deviatore ciclico (kPa)		95	
frequenza (hz)		0.00625	
tempo	cella di carico	$\Delta u$	LVDT
(min)	kN	(kPa)	$\delta$ (mm)
1065.22	-0.01	189.1	-0.0036
1065.23	-0.01	189.1	-0.0018
1065.25	-0.01	189.1	0
1065.27	-0.008	189.3	0.0036
1065.28	-0.006	189.4	0.0062
1065.30	-0.004	189.6	0.0089
1065.32	-0.002	189.7	0.0124
1065.33	0.001	189.9	0.0124
1065.35	0.002	189.9	0.0151
1065.37	0.002	190.1	0.0186
1065.38	0.004	190.3	0.0231
1065.40	0.007	190.7	0.0275
1065.42	0.007	190.7	0.0284
1065.43	0.008	191	0.0328
1065.45	0.013	191.3	0.0382
1065.47	0.014	191.5	0.0399
1065.48	0.015	191.7	0.0435
1065.50	0.018	192	0.0435
1065.52	0.019	192.2	0.0479
1065.53	0.019	192.2	0.0506
1065.55	0.02	192.4	0.0533
1065.57	0.023	192.7	0.0568
1065.58	0.024	192.9	0.0586
1065.60	0.025	193.1	0.0604
1065.62	0.026	193.4	0.0604
1065.63	0.027	193.6	0.063
1065.65	0.027	193.6	0.0648
1065.68	0.028	193.8	0.0657
1065.70	0.028	193.9	0.0666
1065.72	0.029	194.1	0.0675
1065.73	0.029	194.2	0.0683
1065.73	0.029	194.3	0.0683
1065.75	0.029	194.4	0.0683
1065.77	0.029	194.4	0.0683
1065.78	0.028	194.5	0.0683
1065.80	0.028	194.6	0.0675
1065.82	0.027	194.6	0.0666
1065.83	0.026	194.6	0.0648
1065.85	0.025	194.6	0.0639
1065.87	0.023	194.5	0.0639
1065.88	0.022	194.5	0.0612
1065.90	0.022	194.5	0.0604
1065.92	0.021	194.4	0.0577
1065.93	0.018	194.3	0.055
1065.95	0.017	194.2	0.0524
1065.97	0.015	194	0.0488
1065.98	0.012	193.8	0.0488
1066.00	0.011	193.8	0.0462
1066.02	0.011	193.7	0.0435
1066.03	0.01	193.4	0.0399
1066.05	0.006	193.2	0.0355
1066.07	0.005	193	0.032
1066.08	0.003	192.8	0.0284
1066.10	0	192.5	0.0284
1066.12	-0.001	192.5	0.0231
1066.13	-0.003	192.1	0.0178
1066.15	-0.005	191.8	0.0178
1066.17	-0.006	191.8	0.0151

Prova triassiale ciclica SN04-C1			
pressione di confinamento (kPa)		80	
deviatore ciclico (kPa)		95	
frequenza (hz)		0.00625	
tempo	cella di carico	$\Delta u$	LVDT
(min)	kN	(kPa)	$\delta$ (mm)
1066.18	-0.006	191.6	0.0115
1066.20	-0.007	191.3	0.0071
1066.22	-0.011	191	0.0036
1066.23	-0.011	190.8	0.0018
1066.25	-0.012	190.5	-0.0018
1066.27	-0.014	190.3	-0.0018
1066.28	-0.015	190.3	-0.0036
1066.30	-0.015	190.1	-0.0053
1066.32	-0.015	189.9	-0.0071
1066.33	-0.016	189.7	-0.0089
1066.35	-0.017	189.5	-0.0089
1066.37	-0.017	189.4	-0.0098
1066.38	-0.017	189.3	-0.0098
1066.40	-0.017	189.3	-0.0107
1066.42	-0.017	189.1	-0.0107
1066.43	-0.017	189.1	-0.0098
1066.45	-0.017	189	-0.0098
1066.47	-0.016	188.9	-0.0089
1066.48	-0.015	188.9	-0.008
1066.50	-0.014	188.9	-0.008
1066.52	-0.013	188.9	-0.0071
1066.53	-0.013	189	-0.0053
1066.55	-0.012	189	-0.0036
1066.57	-0.01	189.1	-0.0018
1066.58	-0.009	189.2	0.0009
1066.60	-0.007	189.3	0.0036
1066.62	-0.005	189.5	0.0036
1066.63	-0.003	189.6	0.0062
1066.65	-0.003	189.6	0.0098
1066.67	-0.002	189.7	0.0124

# SN04-C1 PROVA TXC

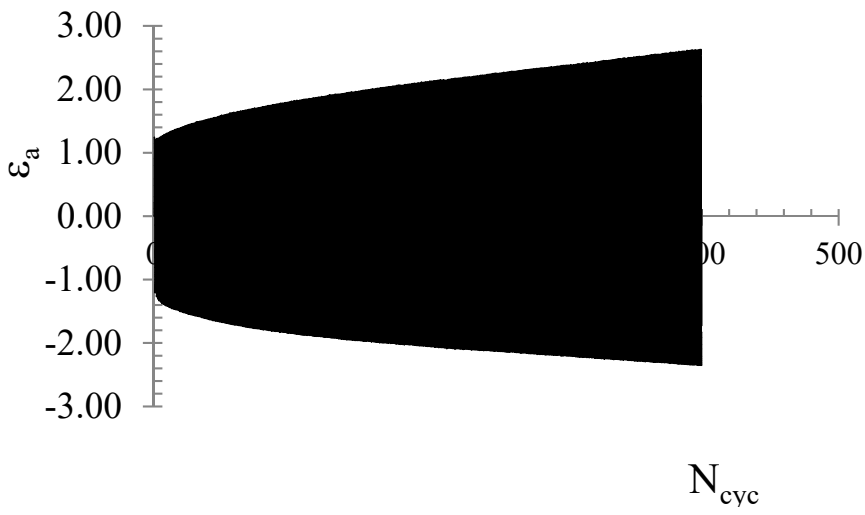
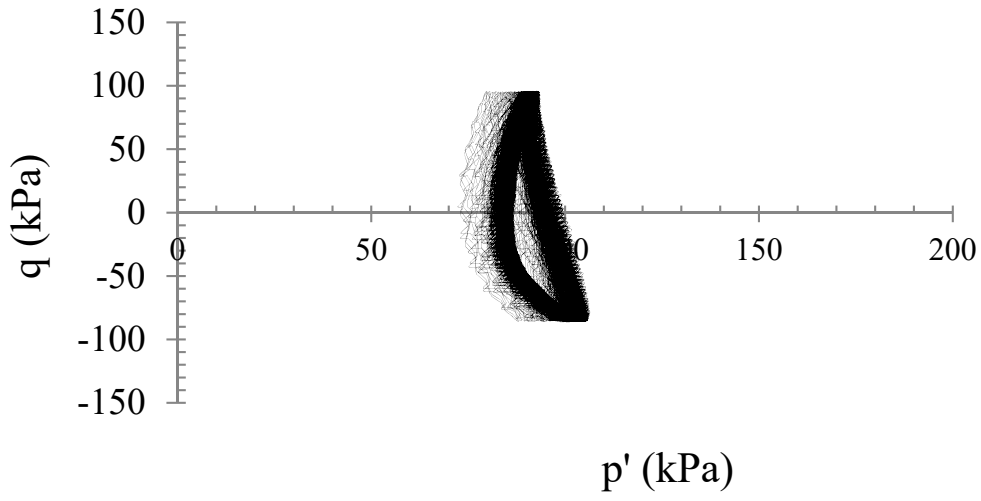
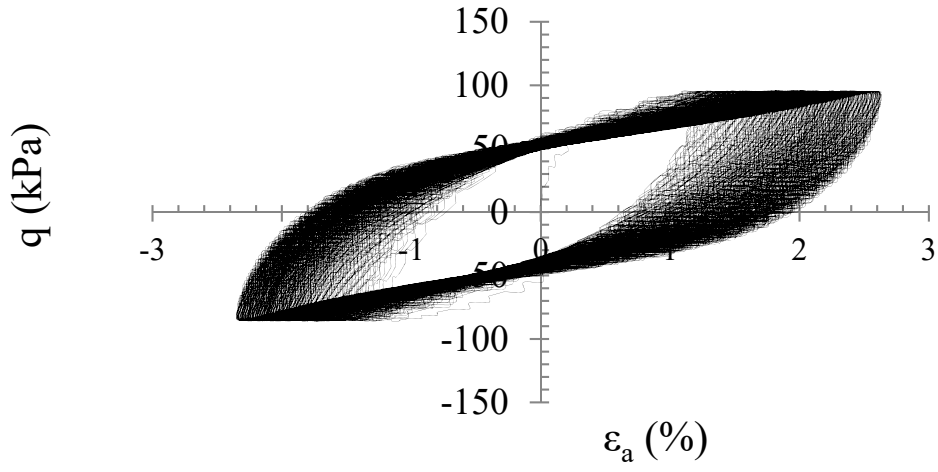

# SN04-C1 PROVA TXC

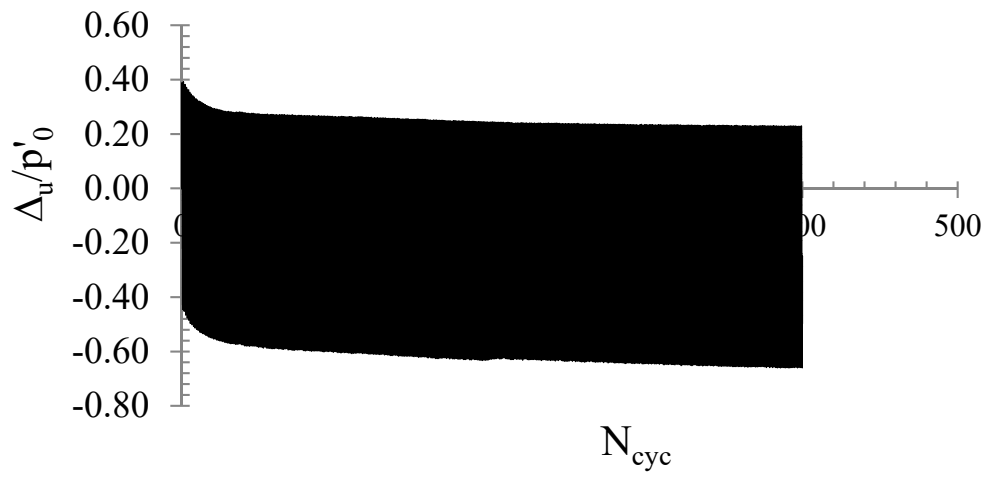



Università degli Studi di Napoli Federico II  
Dipartimento di Ingegneria Idraulica,  
Geotecnica ed Ambientale

Prova Compressione Triassiale n.		Celle n.
Prova tipo	CU (consolidata non drenata)	
Committente	Consorzio Hirpinia AV	
Indagine	I lotto funzionale Apice-Hirpinia	
Sondaggio	SN04	
Campione	1	
Profondità	5.50 ÷ 6.00 m	

Provino 1			Provino 2			Provino 3		
Condizioni inizio prova			Condizioni inizio prova			Condizioni inizio prova		
altezza ho	mm	71.97	altezza ho	mm	71.96	altezza ho	mm	71.95
diametro d	mm	35.85	diametro d	mm	35.83	diametro d	mm	35.84
peso umido iniziale	g	155.29	peso umido iniziale	g	154.87	peso umido iniziale	g	156.83
Peso specifico $\gamma_s$	kN/m <sup>3</sup>	27.05	Peso specifico $\gamma_s$	kN/m <sup>3</sup>	27.05	Peso specifico $\gamma_s$	kN/m <sup>3</sup>	27.05
Peso secco dell'udv $\gamma_d$	kN/m <sup>3</sup>	18.06	Peso secco dell'udv $\gamma_d$	kN/m <sup>3</sup>	18.30	Peso secco dell'udv $\gamma_d$	kN/m <sup>3</sup>	17.95
Contenuto d'acqua w		0.161	Contenuto d'acqua w		0.143	Contenuto d'acqua w		0.180
Peso umido dell'udv $\gamma$	kN/m <sup>3</sup>	20.97	Peso umido dell'udv $\gamma$	kN/m <sup>3</sup>	20.91	Peso umido dell'udv $\gamma$	kN/m <sup>3</sup>	21.18
Indice dei vuoti e		0.498	Indice dei vuoti e		0.478	Indice dei vuoti e		0.507
Grado di saturazione Sr		0.9	Grado di saturazione Sr		0.8	Grado di saturazione Sr		1.0
Condizioni fine prova			Condizioni fine prova			Condizioni fine prova		
Pesafiltro n° 40	g	14.41	Pesafiltro n° 20	g	15.54	Pesafiltro n° 23	g	14.30
Pf + prov. umido	g	172.81	Pf + prov. umido	g	173.79	Pf + prov. umido	g	171.35
Pf + prov.secco	g	148.12	Pf + prov.secco	g	151.09	Pf + prov.secco	g	147.20
Peso secco dell'udv $\gamma_d$	kN/m <sup>3</sup>	18.10	Peso secco dell'udv $\gamma_d$	kN/m <sup>3</sup>	18.49	Peso secco dell'udv $\gamma_d$	kN/m <sup>3</sup>	18.04
Contenuto d'acqua w		0.185	Contenuto d'acqua w		0.167	Contenuto d'acqua w		0.182
Peso umido dell'udv $\gamma$	kN/m <sup>3</sup>	21.44	Peso umido dell'udv $\gamma$	kN/m <sup>3</sup>	21.58	Peso umido dell'udv $\gamma$	kN/m <sup>3</sup>	21.32
Indice dei vuoti e		0.494	Indice dei vuoti e		0.463	Indice dei vuoti e		0.499
Grado di saturazione Sr		1.0	Grado di saturazione Sr		1.0	Grado di saturazione Sr		1.0





**Laboratorio di Geotecnica**

Prova Compressione Triassiale n.		Prova Compressione Triassiale n.		Prova Compressione Triassiale n.				
CIU (consolidata non drenata)		CIU (consolidata non drenata)		CIU (consolidata non drenata)				
Provino 1		Provino 2		Provino 3				
Velocità di prova (mm/min)	0.01	Velocità di prova (mm/min)	0.01	Velocità di prova (mm/min)	0.01			
tensione di confinamento (kPa)	80	tensione di confinamento (kPa)	160	tensione di confinamento (kPa)	320			
	cella di carico	$\Delta u$	LVDT	cella di carico	$\Delta u$	LVDT	cella di carico	$\Delta u$
$\delta$ (mm)	kg	(kPa)	$\delta$ (mm)	kg	(kPa)	$\delta$ (mm)	kg	(kPa)
0	0	0	0	0	0	0	0	0
0.001	0.103	0.000	0.002	0.106	0.900	0.001	0.1515	0.1
0.003	0.203	0.000	0.004	0.281	1.400	0.002	0.499344	0.1
0.004	0.661	0.200	0.006	0.987	1.800	0.003	1.106556	0.4
0.008	0.848	0.600	0.008	1.693	2.400	0.007	1.570752	0.8
0.012	1.017	0.900	0.010	2.069	3.000	0.013	1.785276	1.1
0.018	1.187	1.200	0.012	2.444	3.600	0.017	1.820424	1.3
0.022	1.288	1.600	0.014	2.727	4.200	0.024	1.856784	1.5
0.028	1.407	2.000	0.016	2.962	4.700	0.029	1.928292	1.6
0.033	1.475	2.300	0.018	3.197	5.300	0.034	1.96344	1.9
0.038	1.594	2.700	0.020	3.432	6.200	0.039	1.9998	2.1
0.043	1.678	3.100	0.022	3.667	6.900	0.044	2.106456	2.2
0.049	1.797	3.300	0.024	3.760	7.200	0.05	2.071308	2.4
0.054	1.848	3.600	0.026	4.043	7.600	0.054	2.142816	2.6
0.058	1.899	3.900	0.028	4.090	7.800	0.06	2.142816	2.7
0.064	1.967	4.100	0.030	4.325	8.100	0.066	2.28462	2.8
0.069	2.034	4.300	0.032	4.419	8.400	0.072	2.32098	3
0.075	2.119	4.500	0.034	4.560	8.600	0.076	2.392488	3.3
0.080	2.153	4.700	0.036	4.749	8.900	0.082	2.499144	3.4
0.084	2.221	4.900	0.038	4.842	9.100	0.086	2.67852	3.6
0.091	2.306	5.100	0.040	5.030	9.400	0.092	2.820324	3.8
0.095	2.374	5.400	0.042	5.219	10.100	0.096	3.034848	4.2
0.100	2.390	5.600	0.044	5.312	10.500	0.102	3.213012	4.5
0.106	2.441	5.800	0.046	5.500	10.800	0.107	3.427536	4.8
0.111	2.509	5.900	0.048	5.548	10.900	0.113	3.606912	5.1
0.115	2.560	6.100	0.050	5.736	11.100	0.117	3.891732	5.5
0.122	2.611	6.200	0.052	5.782	11.300	0.122	4.034748	5.9
0.126	2.662	6.300	0.054	6.018	11.500	0.127	4.249272	6.3
0.132	2.679	6.500	0.056	6.018	11.500	0.133	4.427436	6.6
0.137	2.730	6.600	0.058	6.206	11.700	0.137	4.677108	7
0.142	2.747	6.700	0.060	6.252	11.900	0.143	4.891632	7.5
0.148	2.865	6.900	0.062	6.440	12.300	0.147	5.106156	8
0.152	2.848	7.100	0.064	6.535	12.900	0.153	5.355828	8.5
0.157	2.933	7.200	0.066	6.629	13.100	0.159	5.570352	9
0.163	2.933	7.300	0.068	6.769	13.200	0.163	5.784876	9.5
0.168	2.984	7.400	0.070	6.863	13.400	0.168	5.998188	10
0.174	3.018	7.600	0.072	6.958	13.500	0.173	6.177564	10.5
0.179	3.069	7.700	0.074	7.099	13.600	0.179	6.462384	11
0.183	3.103	7.800	0.076	7.099	13.800	0.183	6.6054	11.5
0.189	3.153	7.800	0.078	7.286	13.800	0.189	6.92658	12
0.195	3.187	7.900	0.080	7.286	13.900	0.195	7.034448	12.5
0.199	3.187	8.000	0.082	7.475	14.100	0.199	7.355628	13
0.205	3.238	8.200	0.084	7.522	14.700	0.205	7.498644	13.7
0.210	3.272	8.300	0.086	7.711	15.000	0.209	7.713168	14.2
0.214	3.306	8.400	0.088	7.711	15.100	0.215	7.96284	14.8
0.221	3.340	8.500	0.090	7.803	15.200	0.219	8.105856	15.4
0.227	3.374	8.600	0.092	7.945	15.300	0.225	8.319168	16
0.231	3.408	8.700	0.094	7.992	15.400	0.229	8.498544	16.6
0.236	3.459	8.700	0.096	8.086	15.400	0.235	8.711856	17.1
0.241	3.476	8.800	0.098	8.134	15.400	0.239	8.891232	17.7
0.247	3.543	8.900	0.100	8.181	15.500	0.243	9.034248	18.2
0.252	3.476	8.900	0.102	8.321	15.600	0.249	9.24756	18.8
0.258	3.594	9.000	0.104	8.368	15.800	0.255	9.390576	19.3
0.262	3.577	9.100	0.106	8.556	16.400	0.261	9.640248	19.9
0.267	3.645	9.200	0.108	8.556	16.500	0.265	9.748116	20.4

Laboratorio di Geotecnica								
Prova Compressione Triassiale n.			Prova Compressione Triassiale n.			Prova Compressione Triassiale n.		
CIU (consolidata non drenata)			CIU (consolidata non drenata)			CIU (consolidata non drenata)		
Provino 1			Provino 2			Provino 3		
Velocità di prova (mm/min)		0.01	Velocità di prova (mm/min)		0.01	Velocità di prova (mm/min)		0.01
tensione di confinamento (kPa)		80	tensione di confinamento (kPa)		160	tensione di confinamento (kPa)		320
	cella di carico	Δu	LVDT	cella di carico	Δu	LVDT	cella di carico	Δu
δ (mm)	kg	(kPa)	δ (mm)	kg	(kPa)	δ (mm)	kg	(kPa)
0.273	3.645	9.300	0.110	8.651	16.600	0.271	9.92628	21
0.277	3.730	9.300	0.112	8.651	16.700	0.276	10.069296	21.5
0.283	3.679	9.400	0.114	8.745	16.700	0.282	10.212312	22.1
0.288	3.747	9.500	0.116	8.838	16.700	0.288	10.390476	22.6
0.294	3.747	9.600	0.118	8.838	16.700	0.291	10.497132	23.1
0.298	3.815	9.600	0.120	8.979	16.800	0.296	10.711656	23.7
0.304	3.848	9.700	0.122	8.979	16.700	0.302	10.783164	24.2
0.309	3.899	9.700	0.124	9.121	16.800	0.308	10.997688	24.7
0.315	3.848	9.800	0.126	9.168	17.200	0.312	11.104344	25.3
0.319	3.967	9.900	0.128	9.168	17.500	0.318	11.24736	25.8
0.324	3.916	10.000	0.130	9.308	17.600	0.322	11.390376	26.3
0.330	4.052	10.100	0.132	9.308	17.600	0.328	11.533392	26.8
0.334	3.967	10.100	0.134	9.402	17.700	0.332	11.676408	27.3
0.339	4.103	10.100	0.135	9.402	17.500	0.338	11.783064	27.8
0.346	4.086	10.200	0.134	9.591	17.600	0.342	11.88972	28.2
0.350	4.103	10.200	0.136	9.591	17.500	0.349	12.032736	28.7
0.370	4.221	10.500	0.136	9.872	18.200	0.369	12.56844	30.6
0.392	4.357	10.600	0.136	9.966	18.200	0.389	12.961128	32.4
0.412	4.510	10.700	0.136	10.014	18.000	0.411	13.390176	34
0.433	4.578	11.000	0.155	10.202	18.800	0.431	13.854372	35.9
0.453	4.730	11.200	0.177	10.295	18.500	0.451	14.24706	37.3
0.475	4.849	11.200	0.196	10.295	18.400	0.472	14.533092	38.8
0.494	4.917	11.400	0.216	10.389	18.800	0.493	14.854272	40.2
0.515	5.052	11.500	0.237	10.531	18.600	0.514	15.24696	41.6
0.534	5.171	11.700	0.257	10.625	19.000	0.535	15.461484	42.9
0.556	5.256	11.800	0.276	10.672	18.900	0.556	15.711156	44.1
0.576	5.340	11.800	0.296	10.812	18.700	0.577	15.960828	45.2
0.598	5.459	12.000	0.317	10.907	19.200	0.597	16.2105	46.3
0.620	5.510	12.000	0.336	10.907	18.900	0.619	16.425024	47.3
0.639	5.561	12.100	0.354	11.001	18.800	0.639	16.711056	48.3
0.661	5.629	12.200	0.376	11.142	19.300	0.659	16.960728	49.5
0.681	5.680	12.200	0.395	11.189	19.000	0.68	17.103744	50.3
0.701	5.781	12.400	0.415	11.282	19.400	0.702	17.353416	51.4
0.722	5.781	12.400	0.434	11.424	19.300	0.722	17.56794	52.3
0.743	5.849	12.400	0.454	11.424	19.000	0.742	17.639448	53
0.762	5.934	12.500	0.473	11.518	19.600	0.763	17.817612	53.9
0.783	5.951	12.500	0.493	11.660	19.300	0.785	17.995776	54.7
0.804	6.069	12.500	0.514	11.752	19.300	0.805	18.138792	55.4
0.825	6.137	12.600	0.534	11.847	19.700	0.826	18.138792	56.3
0.845	6.171	12.600	0.552	11.894	19.400	0.848	18.245448	56.8
0.865	6.273	12.700	0.573	12.035	19.900	0.868	18.316956	57.4
0.886	6.375	12.800	0.593	12.035	19.600	0.889	18.281808	57.9
0.906	6.442	12.700	0.612	12.035	19.400	0.909	18.316956	58.3
0.926	6.527	12.800	0.632	12.177	20.000	0.931	18.496332	58.9
0.947	6.663	12.700	0.653	12.224	19.700	0.951	18.639348	59.3
0.967	6.748	12.700	0.672	12.269	19.600	0.972	18.709644	59.7
0.987	6.798	12.800	0.692	12.317	20.000	0.994	18.924168	60.3
1.008	6.934	12.700	0.712	12.411	19.700	1.014	19.067184	60.7
1.029	7.002	12.800	0.733	12.458	20.000	1.034	19.2102	61.1
1.048	7.070	12.800	0.751	12.458	19.800	1.055	19.353216	61.6
1.069	7.104	12.700	0.770	12.552	19.600	1.077	19.496232	62
1.090	7.154	12.800	0.792	12.647	20.000	1.097	19.602888	62.5
1.111	7.222	12.700	0.810	12.647	19.800	1.118	19.745904	62.9
1.130	7.239	12.700	0.831	12.741	19.700	1.138	19.88892	63.2
1.150	7.290	12.800	0.850	12.834	20.100	1.16	20.030724	63.8
1.170	7.358	12.700	0.870	12.834	19.700	1.18	20.067084	64.1
1.191	7.392	12.800	0.889	12.928	20.100	1.2	20.2101	64.6
1.213	7.409	12.700	0.909	12.975	19.800	1.22	20.353116	65
1.232	7.477	12.600	0.929	13.022	19.600	1.241	20.424624	65.2
1.252	7.544	12.700	0.948	13.070	20.000	1.263	20.53128	65.8
1.272	7.578	12.600	0.968	13.164	19.700	1.284	20.674296	66.1
1.293	7.595	12.600	0.987	13.304	20.200	1.304	20.817312	66.5
1.313	7.663	12.600	1.007	13.257	20.000	1.324	20.85246	67

**Laboratorio di Geotecnica**

Prova Compressione Triassiale n.		Prova Compressione Triassiale n.		Prova Compressione Triassiale n.				
CIU (consolidata non drenata)		CIU (consolidata non drenata)		CIU (consolidata non drenata)				
Provino 1		Provino 2		Provino 3				
Velocità di prova (mm/min)	0.01	Velocità di prova (mm/min)	0.01	Velocità di prova (mm/min)	0.01			
tensione di confinamento (kPa)	80	tensione di confinamento (kPa)	160	tensione di confinamento (kPa)	320			
	cella di carico	Δu	LVDT	cella di carico	Δu	LVDT	cella di carico	Δu
δ (mm)	kg	(kPa)	δ (mm)	kg	(kPa)	δ (mm)	kg	(kPa)
1.332	7.68	12.5	1.028	13.25662155	19.6	1.346	20.959116	67.2
1.354	7.799	12.6	1.046	13.39811659	20.1	1.366	21.138492	67.6
1.374	7.85	12.5	1.067	13.35095158	19.7	1.386	21.17364	67.9
1.394	7.917	12.5	1.087	13.39811659	19.7	1.407	21.281508	68.2
1.415	7.951	12.5	1.106	13.49244662	20	1.427	21.423312	68.6
1.435	8.053	12.4	1.126	13.49244662	19.7	1.448	21.49482	68.8
1.455	8.121	12.5	1.146	13.53961164	20.2	1.469	21.602688	69.2
1.474	8.155	12.4	1.165	13.58677665	19.9	1.489	21.709344	69.5
1.495	8.223	12.2	1.185	13.63394166	19.5	1.509	21.780852	69.5
1.515	8.307	12.3	1.204	13.63394166	20	1.531	21.85236	70
1.535	8.358	12.2	1.224	13.63394166	19.8	1.551	21.923868	70.2
1.556	8.358	12.1	1.243	13.72827169	19.5	1.571	22.066884	70.3
1.577	8.409	12.2	1.265	13.77381032	20	1.591	22.102032	70.7
1.598	8.46	12.1	1.284	13.77381032	19.7	1.611	22.17354	70.8
1.617	8.443	12	1.304	13.86814035	19.4	1.632	22.281408	71
1.637	8.494	12	1.323	13.96247038	19.9	1.652	22.388064	71.4
1.659	8.528	12	1.343	13.91530536	19.6	1.672	22.351704	71.6
1.678	8.494	11.8	1.362	13.91530536	19.2	1.694	22.423212	71.9
1.698	8.545	11.9	1.384	14.00963539	19.9	1.714	22.53108	72.2
1.8	8.731	11.6	1.403	14.15113043	19.2	1.817	22.85226	73
1.9	9.036	11.3	1.501	14.38532912	19.4	1.92	23.244948	74
2.002	9.342	11.1	1.599	14.47965915	19.5	2.022	23.602488	74.9
2.102	9.443	10.6	1.697	14.71548421	18.9	2.123	23.887308	75.7
2.204	9.596	10.4	1.796	14.9496829	19	2.225	24.101832	76.1
2.304	9.765	9.9	1.894	15.13834296	18.5	2.328	24.351504	76.6
2.405	10.02	9.6	1.992	15.27821162	18.9	2.428	24.672684	77.2
2.505	10.172	9.2	2.09	15.37254164	18.7	2.53	24.8157	77.5
2.605	10.24	8.8	2.188	15.5612017	17.9	2.633	24.995076	77.7
2.706	10.325	8.4	2.286	15.74823537	18.1	2.735	25.065372	78.1
2.806	10.562	8	2.384	15.88973041	17.4	2.836	25.244748	78.2
2.907	10.8	8	2.481	15.93689543	17.6	2.937	25.422912	78.4
3.007	10.918	8.2	2.581	16.17272049	17.7	3.038	25.601076	78.5
3.107	11.02	8.2	2.677	16.31258915	17	3.14	25.565928	78.5
3.208	11.122	7.7	2.775	16.50124921	17.1	3.242	25.708944	78.6
3.308	11.291	7	2.875	16.59557923	16.6	3.343	25.8156	78.5
3.408	11.478	6.4	2.972	16.68990926	16.5	3.446	25.85196	78.5
3.509	11.512	6	3.07	16.78261291	16.5	3.548	25.923468	78.4
3.608	11.512	5.5	3.167	16.92410795	15.7	3.65	25.887108	78.1
3.708	11.647	5.5	3.266	17.112768	15.7	3.754	25.958616	78
3.807	11.935	4.3	3.362	17.112768	15.7	3.854	26.030124	77.8
3.906	12.088	3.8	3.46	17.112768	14.9	3.957	26.101632	77.5
4.006	12.156	4	3.558	17.20709803	14.9	4.059	26.065272	77.2
4.105	12.156	2.8	3.656	17.3941317	14.9	4.162	26.101632	77
4.205	12.291	2.2	3.752	17.34696669	13.9	4.264	26.065272	76.5
4.304	12.444	1.5	3.85	17.34696669	13.7	4.365	26.13678	76.2
4.403	12.512	1	3.946	17.3941317	13.5	4.467	26.101632	75.9
4.5	12.512	0.5	4.042	17.48846173	13.5	4.57	26.101632	75.7
4.598	12.614	-0.1	4.139	17.53562674	12.6	4.672	25.993764	75.2
4.695	12.8	-0.6	4.235	17.53562674	12.7	4.775	25.993764	75
4.792	13.004	-1.1	4.333	17.58279176	12.7	4.877	26.065272	74.6
4.888	13.037	-1.8	4.429	17.58279176	11.9	4.978	25.993764	74.1
4.986	13.088	-2.3	4.525	17.76982543	11.9	5.078	25.993764	73.8
5.082	13.224	-2.8	4.622	17.81699045	11.8	5.182	25.958616	73.5
5.178	13.343	-3.4	4.718	17.81699045	11.1	5.285	25.993764	73
5.273	13.461	-3.9	4.814	17.76982543	10.9	5.386	25.958616	72.5
5.37	13.427	-4.5	4.91	17.91132047	10.7	5.489	25.958616	72.3
5.465	13.461	-5	5.006	18.0056505	10.6	5.591	25.887108	72
5.561	13.563	-5.5	5.103	18.05281551	10.5	5.693	25.887108	71.6
5.656	13.8	-6	5.199	17.95848549	10.3	5.793	25.887108	71.4
5.752	13.817	-6.6	5.295	18.0056505	9.5	5.895	25.887108	70.8
5.847	13.817	-7.1	5.391	18.14714554	9.3	5.996	25.8156	70.6
5.942	13.953	-7.6	5.488	18.24147557	9.2	6.098	25.8156	70.3
6.037	14.072	-8	5.584	18.24147557	9.2	6.2	25.8156	70.1

Laboratorio di Geotecnica								
Prova Compressione Triassiale n.			Prova Compressione Triassiale n.			Prova Compressione Triassiale n.		
CIU (consolidata non drenata)			CIU (consolidata non drenata)			CIU (consolidata non drenata)		
Provino 1			Provino 2			Provino 3		
Velocità di prova (mm/min)		0.01	Velocità di prova (mm/min)		0.01	Velocità di prova (mm/min)		0.01
tensione di confinamento (kPa)		80	tensione di confinamento (kPa)		160	tensione di confinamento (kPa)		320
	cella di carico	$\Delta u$	LVDT	cella di carico	$\Delta u$	LVDT	cella di carico	$\Delta u$
$\delta$ (mm)	kg	(kPa)	$\delta$ (mm)	kg	(kPa)	$\delta$ (mm)	kg	(kPa)
6.132	14.19	-8.5	5.682	18.33417921	9.1	6.301	25.8156	69.7
6.227	14.207	-9.2	5.78	18.33417921	8.2	6.403	25.780452	69.3
6.322	14.173	-9.7	5.874	18.38134423	8.1	6.504	25.672584	69.2
6.418	14.241	-10.2	5.971	18.47567426	8.1	6.608	25.744092	68.9
6.512	14.462	-10.6	6.068	18.42850924	7.9	6.708	25.708944	68.7
6.607	14.529	-11.1	6.166	18.47567426	7.8	6.809	25.780452	68.5
6.703	14.597	-11.6	6.264	18.6171693	7.7	6.91	25.708944	68.4
6.798	14.614	-12.2	6.362	18.71149932	6.8	7.011	25.672584	67.9
6.893	14.716	-12.6	6.458	18.71149932	6.7	7.112	25.565928	67.8
6.988	14.801	-13.1	6.556	18.71149932	6.6	7.212	25.601076	67.7
7.084	14.885	-13.6	6.656	18.75703796	6.6	7.312	25.49442	67.3
7.179	14.835	-14	6.753	18.80420297	6.5	7.414	25.422912	67
7.274	14.902	-14.5	6.851	18.94569801	5.6	7.514	25.244748	66.6
7.369	15.038	-15.1	6.949	18.898533	5.4	7.616	25.13688	66.4
7.464	15.208	-15.5	7.049	18.94569801	5.5	7.716	25.17324	66.1
7.559	15.258	-16	7.147	18.94569801	5.3	7.816	25.030224	66
7.655	15.258	-16.5	7.244	19.18152308	5.2	7.916	24.958716	66
7.75	15.36	-16.9	7.344	19.22868809	5.2	8.018	24.85206	65.7
7.845	15.411	-17.4	7.442	19.32139174	4.3	8.118	24.780552	65.4
7.938	15.53	-18	7.541	19.36855675	4.1	8.218	24.672684	65.2
8.033	15.496	-18.4	7.641	19.46288678	4	8.319	24.566028	65.1
8.128	15.564	-18.8	7.739	19.60438182	3.9	8.417	24.423012	65
8.222	15.631	-19.2	7.837	19.65154683	3.8	8.518	24.279996	64.9
8.315	15.818	-19.7	7.936	19.65154683	3.7	8.618	24.244848	64.6
8.408	15.869	-20.2	8.036	19.65154683	2.8	8.717	24.17334	64.2
8.501	15.92	-20.7	8.133	19.83858051	2.8	8.817	24.066684	64.1
8.596	15.97	-21.1	8.233	19.88574552	2.7	8.916	23.958816	64
8.69	16.038	-21.5	8.331	19.93291053	2.7	9.014	23.887308	63.9
8.782	16.174	-21.8	8.43	19.98007555	2.6	9.113	23.780652	63.8
8.874	16.157	-22.3	8.528	20.02724056	2.5	9.212	23.709144	63.6
8.966	16.157	-22.9	8.626	20.07440558	1.6	9.309	23.53098	63.2
9.059	16.225	-23.3	8.726	20.12157059	1.6	9.408	23.49462	63.1
9.152	16.377	-23.7	8.825	20.1687356	1.4	9.505	23.423112	63.1
9.243	16.428	-24	8.923	20.1687356	1.4	9.604	23.423112	63.1
9.337	16.496	-24.5	9.022	20.26143925	1.4	9.703	23.351604	63.1
9.429	16.513	-24.8	9.122	20.40293429	1.2	9.802	23.387964	62.9
9.521	16.615	-25	9.221	20.49726432	0.5	9.899	23.351604	62.7
9.613	16.733	-25.8	9.321	20.4500993	0.2	9.997	23.316456	62.8
9.706	16.784	-25.7	9.419	20.59159434	0.1	10.094	23.316456	62.6
9.799	16.75	-26	9.52	20.4500993	0.1	10.193	23.208588	62.6
9.891	16.784	-27.2	9.618	20.4500993	0	10.29	23.17344	62.5
9.985	16.937	-27.7	9.719	20.49726432	-0.1	10.387	23.101932	62.5
10.077	17.022	-28.2	9.818	20.4500993	-0.8	10.485	23.138292	62
10.169	17.089	-28.6	9.92	20.54442933	-1	10.582	23.030424	61.9
10.263	17.072	-29	10.019	20.63875936	-1.2	10.681	23.030424	62.1
10.355	17.174	-29.2	10.119	20.68592437	-1.2	10.778	22.958916	61.8
10.449	17.259	-29.7	10.218	20.68592437	-1.4	10.877	22.958916	61.7
10.542	17.378	-30	10.321	20.87295805	-1.4	10.974	22.923768	61.8
10.636	17.327	-30.4	10.42	20.92012306	-1.6	11.073	22.85226	61.5
10.73	17.344	-30.9	10.521	21.10878311	-2.5	11.171	22.8159	61.4
10.825	17.462	-31.2	10.621	21.0616181	-2.6	11.269	22.745604	61.1
10.918	17.581	-31.6	10.722	21.10878311	-2.7	11.367	22.8159	61
11.012	17.666	-31.9	10.823	21.0616181	-2.8	11.466	22.745604	60.9
11.105	17.666	-32.3	10.924	21.29581679	-2.9	11.564	22.745604	60.9
11.2	17.751	-32.7	11.027	21.39014681	-3.1	11.665	22.745604	61
11.294	17.801	-33	11.127	21.39014681	-4	11.762	22.780752	60.6
11.389	17.886	-33.5	11.226	21.29581679	-4.3	11.862	22.709244	60.4
11.482	17.886	-33.9	11.327	21.43731183	-4.4	11.961	22.745604	60.4
11.577	17.903	-34.2	11.428	21.48447684	-4.4	12.061	22.709244	60.4
11.671	17.92	-34.5	11.53	21.57880687	-4.4	12.16	22.745604	60.4
11.766	18.124	-34.9	11.631	21.57880687	-4.6	12.26	22.85226	60.3
11.859	18.191	-35.2	11.732	21.43731183	-5	12.359	22.8159	60
11.953	18.208	-35.6	11.831	21.67313689	-5.5	12.459	22.8159	59.9



# Prova Triassiale CIU

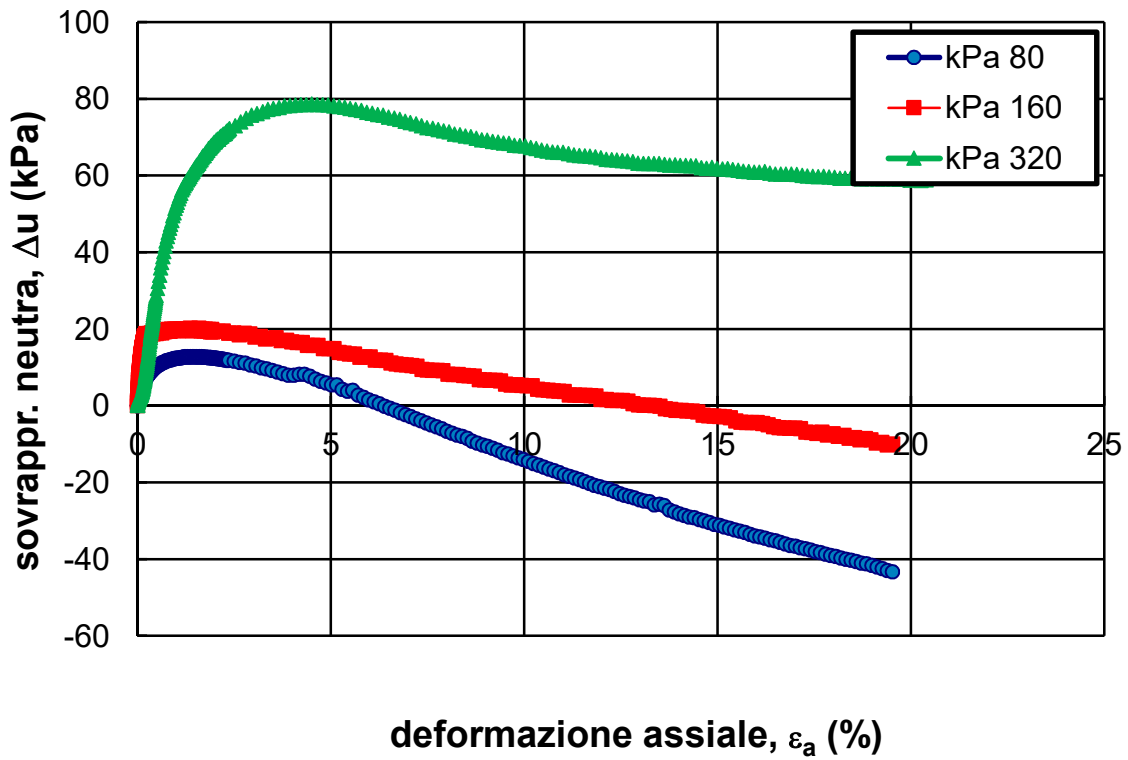
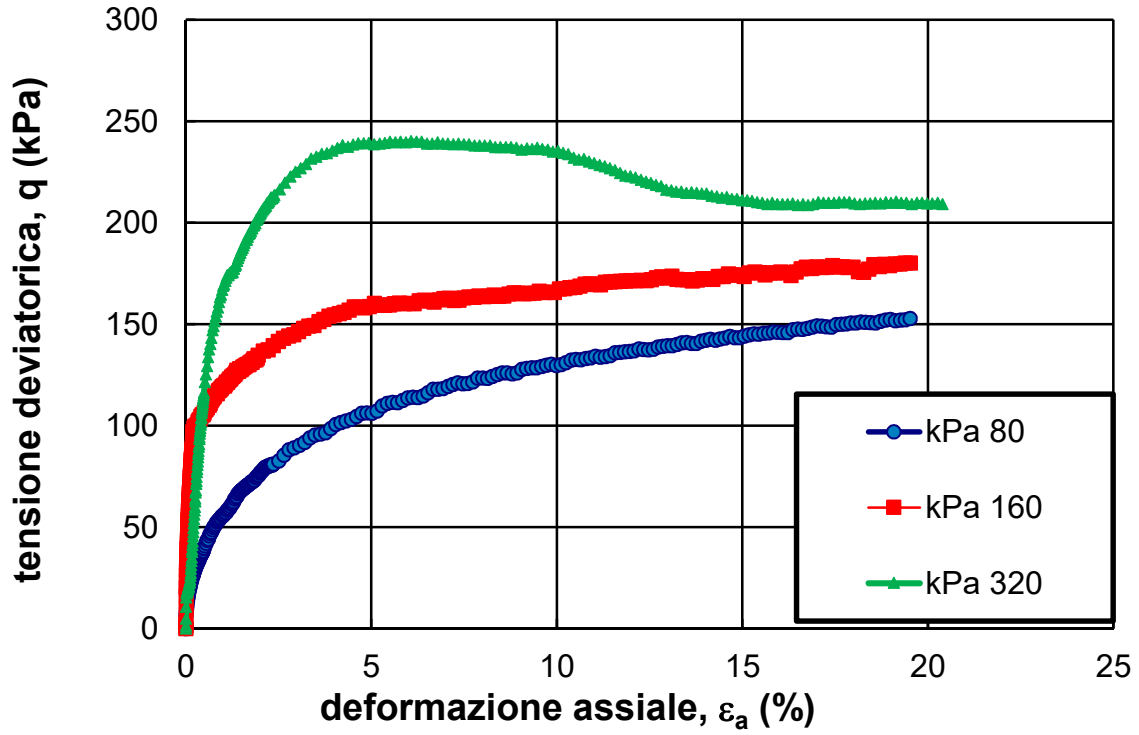

# Prova Triassiale CIU

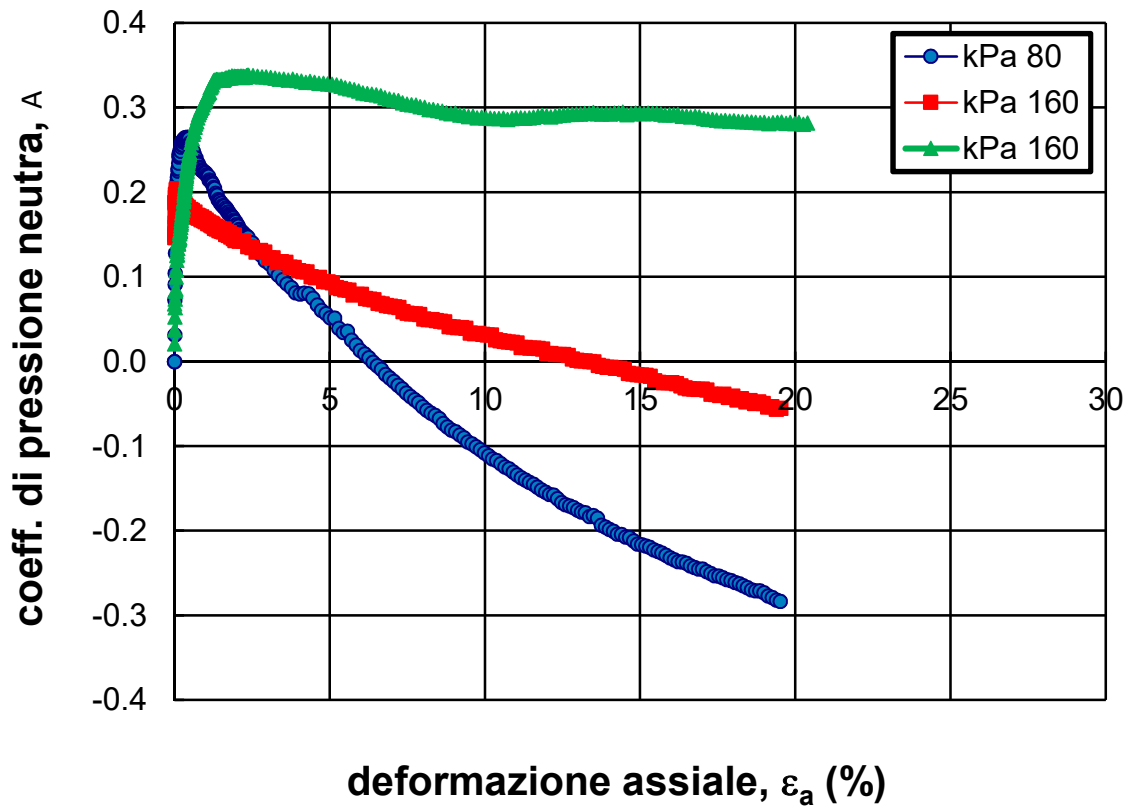
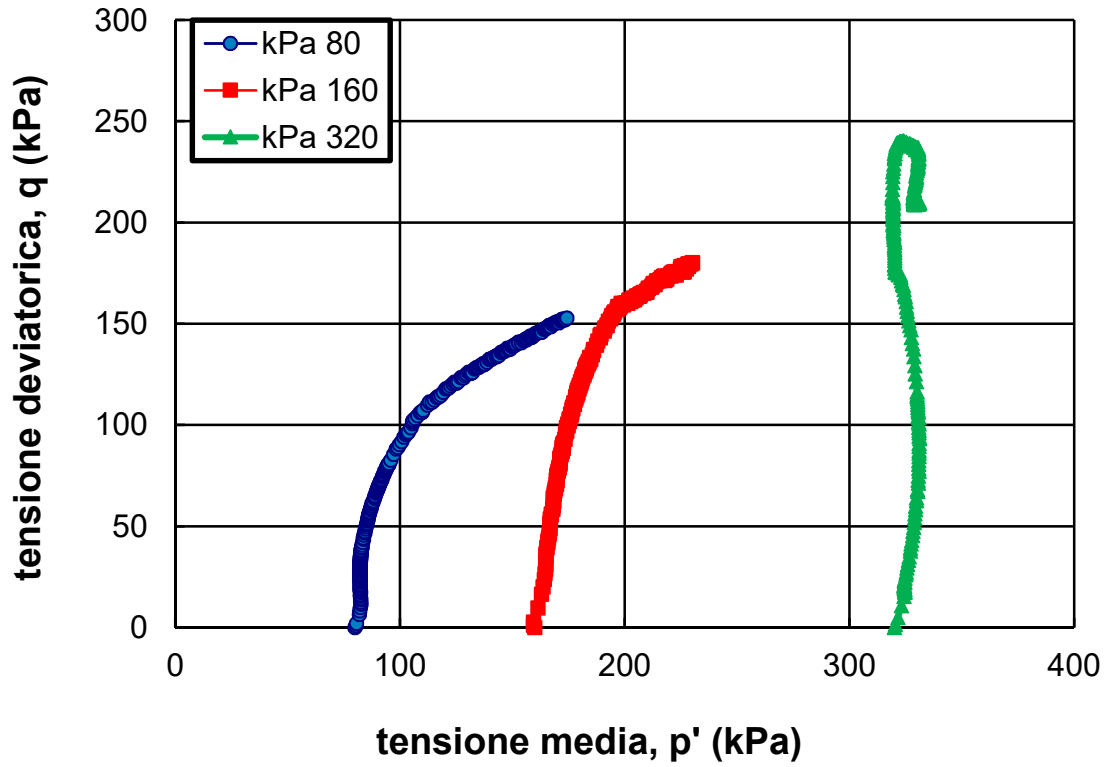

# Prova Triassiale CIU

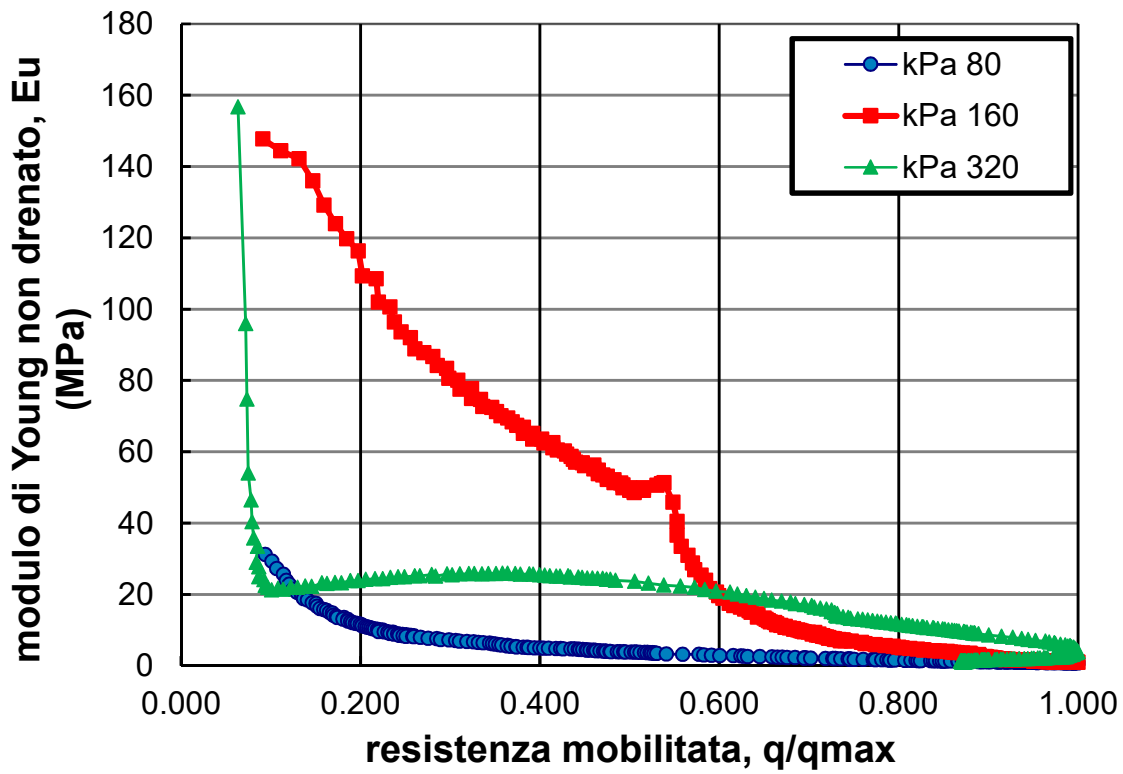
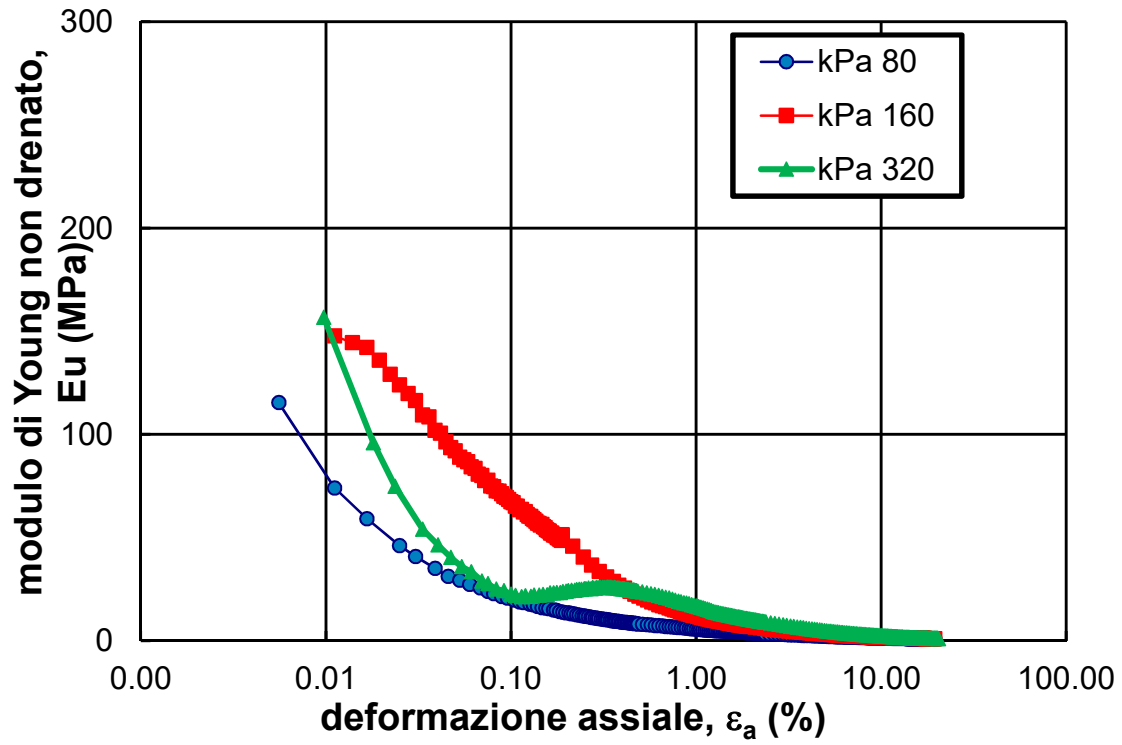



# Prova Triassiale CIU

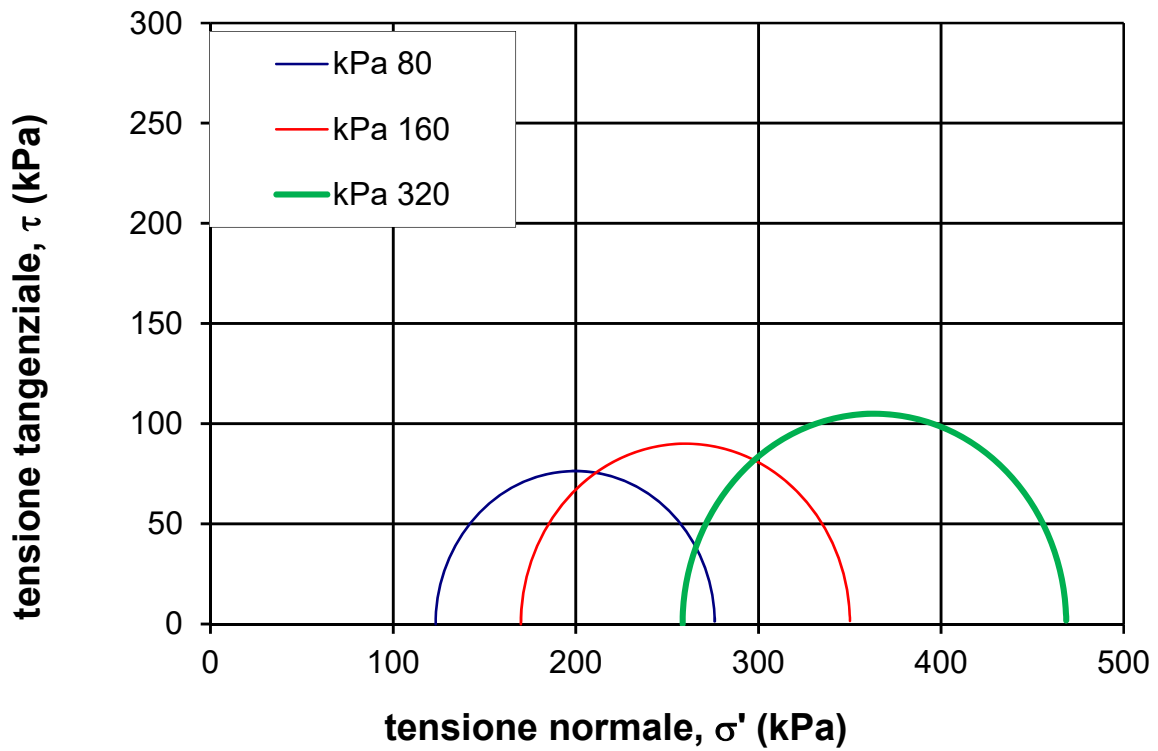
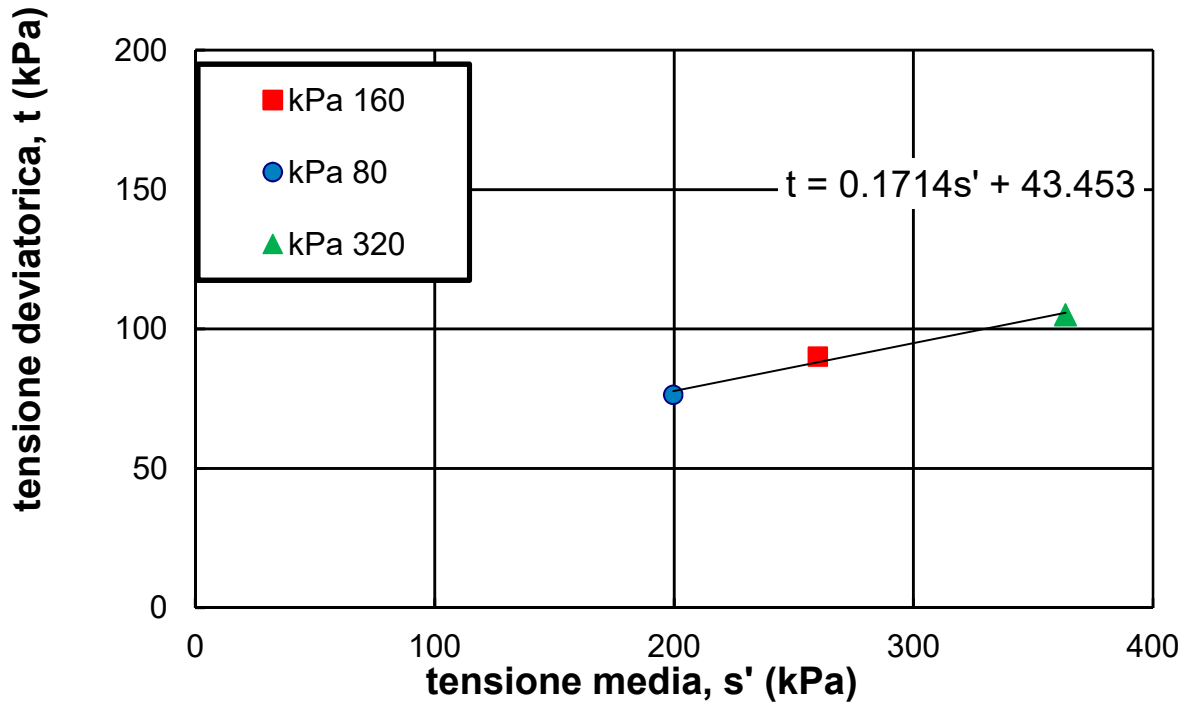

# Prova Triassiale CIU

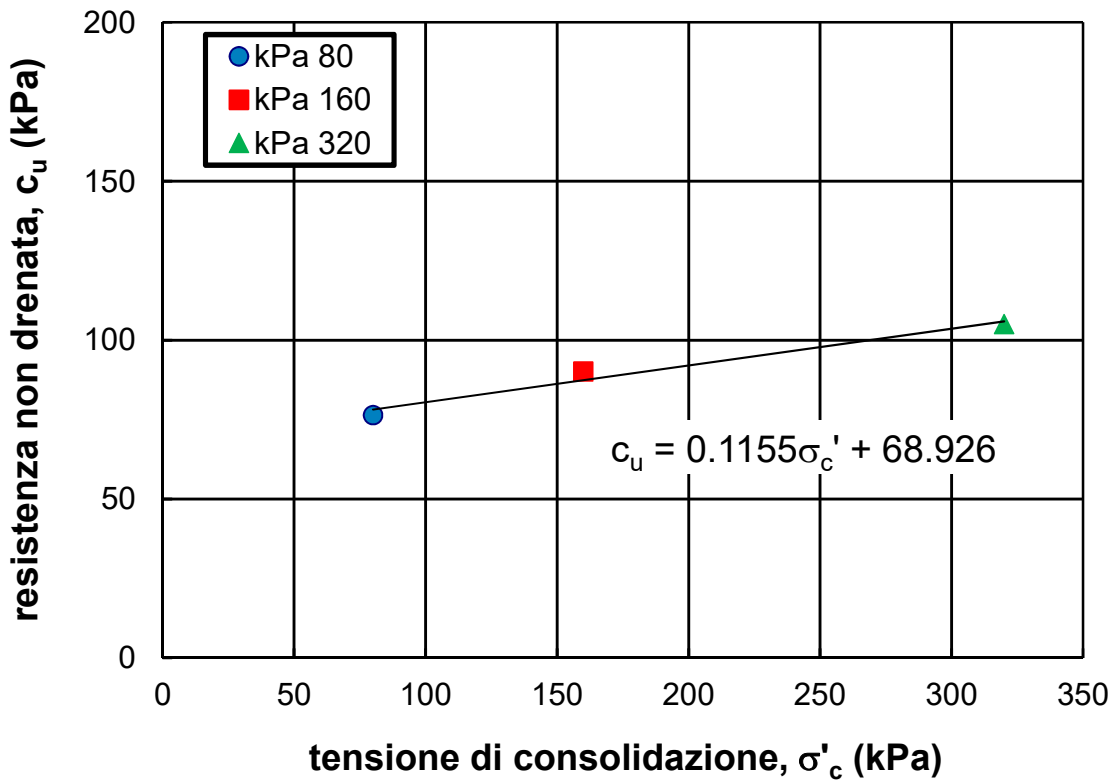
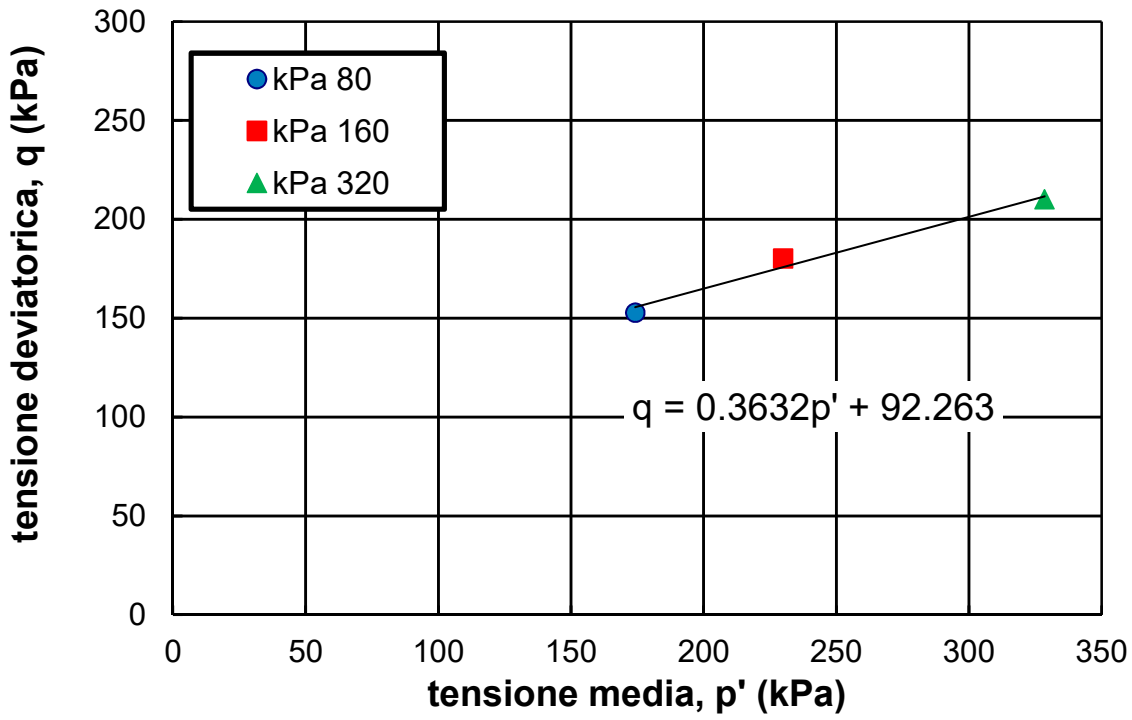



Università degli Studi di Napoli Federico II  
Dipartimento di Ingegneria Civile, Edile ed Ambientale  
Laboratorio di Geotecnica

<u>Committente</u>	Consorzio HirpiniaAV
<u>Indagine</u>	I lotto funzionale Apice-Hirpinia
<u>Sondaggio</u>	SN04
<u>Campione</u>	C1
<u>Profondità</u>	5.50 ÷ 6.00 m
<u>Data apertura</u>	17/10/19
<u>Operatore</u>	

### Prova di TAGLIO TORSIONALE

Dati iniziali								
D (mm)	H (mm)	V (cm <sup>3</sup> )	$\gamma$ (kN/m <sup>3</sup> )	w (%)	$\gamma_s$ (kN/m <sup>3</sup> )	e (/)	S <sub>r</sub> (%)	p' (kPa)
35.60	71.91	71.54	21.39	16.53	27.04	0.473	0.96	120

Dati fine consolidazione								
D (mm)	H (mm)	V (cm <sup>3</sup> )	$\gamma$ (kN/m <sup>3</sup> )	w (%)	$\gamma_d$ (kN/m <sup>3</sup> )	e (/)	S <sub>r</sub> (%)	p' (kPa)
36.31	72.29	74.81	20.88	18.98	17.6	0.540	0.97	120

TAGLIO TORSIONALE					
$\gamma$ (%)	G (MPa)	D (%)	f <sub>r</sub> (Hz)	G/G <sub>0</sub> (/)	Du/p'
5.01E-04	51.91	4.96	0.5	1.00	0.00
7.57E-04	51.91	3.19	0.5	1.00	0.00
1.18E-03	51.32	2.7	0.5	0.99	0.00
1.58E-03	51.11	3.19	0.5	0.98	0.00
2.51E-03	51.49	2.68	0.5	0.99	0.00
3.79E-03	51.08	3.29	0.5	0.98	0.00
5.83E-03	50.54	2.99	0.5	0.97	0.00
7.65E-03	49.84	3.34	0.5	0.96	0.00
7.64E-03	49.97	3.2	0.5	0.96	0.00
1.01E-02	48.63	3.42	0.5	0.94	0.00
1.40E-02	47.60	3.96	0.5	0.92	0.00
1.42E-02	47.80	3.81	0.5	0.92	0.00
1.92E-02	45.94	4.36	0.5	0.89	0.00
2.59E-02	43.52	5.14	0.5	0.84	0.00
3.62E-02	40.16	6.16	0.5	0.77	0.00
5.05E-02	37.16	7.25	0.5	0.72	0.00
5.05E-02	37.65	8.41	0.5	0.73	0.00
7.99E-02	33.51	10.09	0.5	0.65	0.00
1.22E-01	29.79	11.23	0.5	0.57	0.00
1.88E-01	26.04	12.52	0.5	0.50	0.00
2.65E-01	23.18	13.62	0.5	0.45	0.00
2.90E-01	21.54	13.46	0.5	0.41	0.00
4.29E-01	16.96	21.6	0.5	0.33	0.00



<u>Committente</u>	Consorzio HirpiniaAV
<u>Indagine</u>	I lotto funzionale Apice-Hirpinia
<u>Sondaggio</u>	SN04
<u>Campione</u>	C1
<u>Profondità</u>	5.50 ÷ 6.00 m
<u>Data apertura</u>	17/10/19
<u>Operatore</u>	

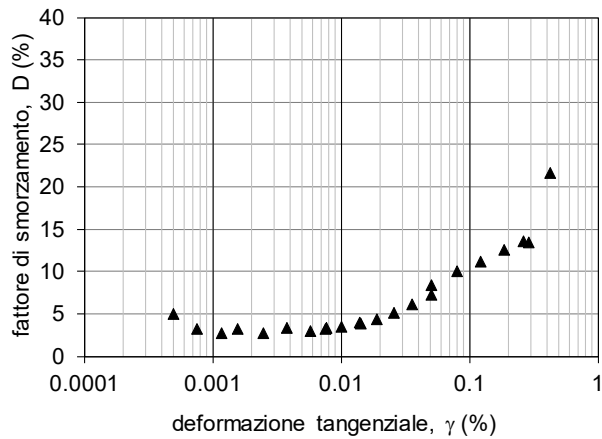
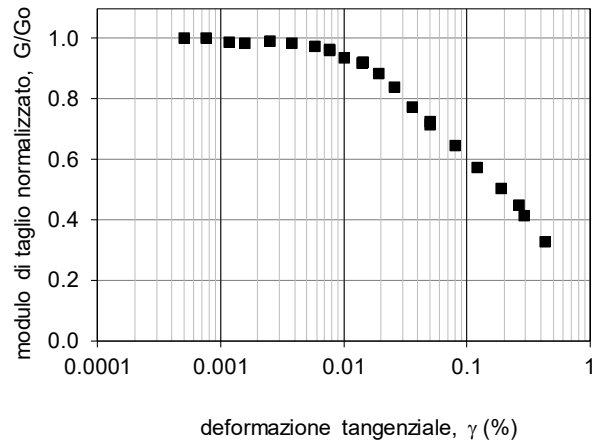
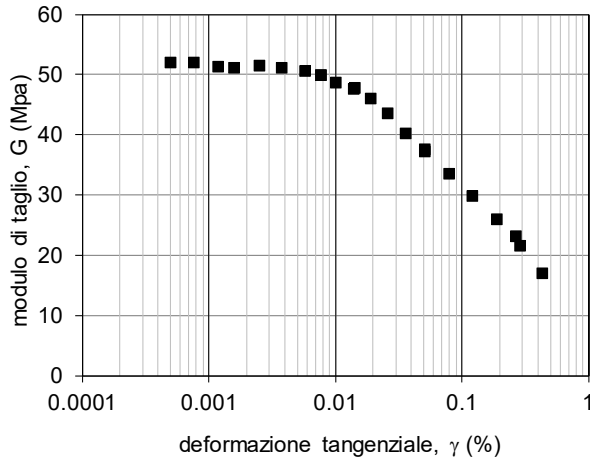



<u>Committente</u>	Consorzio HirpiniaAV
<u>Indagine</u>	I lotto funzionale Apice-Hirpinia
<u>Sondaggio</u>	SN04
<u>Campione</u>	C1
<u>Profondità</u>	5.50 ÷ 6.00 m
<u>Data apertura</u>	17/10/19
<u>Operatore</u>	

## APPENDICE

### 1. L'attrezzatura sperimentale per prove di taglio torsionale

L'apparecchiatura utilizzata è la cella di taglio torsionale THOR (Figura A.1), progettata e realizzata presso l'Università di Napoli Federico II (d'Onofrio, 1996) sulla base del prototipo originario di colonna risonante 'fixed-free' messo a punto presso l'Università del Texas di Austin (Isenhower, 1979; Ni, 1987). Le caratteristiche tecniche dell'apparecchiatura sono dettagliate da d'Onofrio et al. (1999). In Tabella A.1 sono sintetizzate le principali caratteristiche del sistema, ed in Figura A.2 uno schema della catena strumentale per il controllo e l'acquisizione.

Tipo di prova		Colonna risonante / Taglio torsionale
Nome dell'apparecchiatura		THOR
Provino	Diametro esterno	36mm
	Altezza	72mm
	Accuratezza nella misura delle dimensioni e del peso del provino	0.1 mm, 0.1gr
	Metodo di preparazione del provino	Fustellamento
	Saturazione	In cella via back-pressure
	Test di B	B > 0.95 mediando i valori ottenuti incrementando e decrementando la pressione di cella
	Contatto tra provino e apparecchiatura	Piastra rugosa avvitata nella testa di carico e pietra porosa di carburo di silicio avvitata al piedistallo
Sistema di applicazione dei carichi torcenti	Tipo	Motore elettromagnetico
Accuratezza del sistema di controllo	Pressione di cella	40 Pa attraverso convertitore E/P
	Contropressione	Senza controllo
	Sistema di applicazione dei carichi torcenti	Controllo in corrente risoluzione $1.6 \cdot 10^{-5}$ Nm (2 Pa per il provino $\varnothing$ 36 mm) Fondo scala 5 Nm Non c'è effetto della forza elettromotrice indotta
Tipo di trasduttori utilizzati	Pressione di cella	Sensore di pressione di elevate prestazioni con membrana al silicone
	Contropressione	Trasduttore miniaturizzato con diaframma al silicone
	Pressione neutra	Trasduttore miniaturizzato con diaframma al silicone
	Coppia torcente	Cella torsionale a strain-gage
	Spostamenti assiali	LVDT in corrente continua
	Variazioni di volume	Trasduttore differenziale di pressione/ volumometro
	Accelerazioni	Accelerometro piezoelettrico
	Rotazioni	Laser /Proximitor
Accuratezza delle misure	Pressione di cella	1.5 Pa
	Contropressione	0.7 Pa
	Pressione interstiziale	0.7 Pa
	Coppia torcente	$6 \cdot 10^{-3}$ Nm
	Spostamenti assiali	1 $\mu$ m
	Variazioni di volume	0.0014 cm <sup>3</sup>
	Rotazioni	$2.5 \cdot 10^{-7}$ rad (prox)

Tabella A.1. Principali caratteristiche della cella di taglio torsionale THOR.



Università degli Studi di Napoli Federico II  
Dipartimento di Ingegneria Civile, Edile ed Ambientale  
Laboratorio di Geotecnica

<u>Committente</u>	Consorzio HirpiniaAV
<u>Indagine</u>	I lotto funzionale Apice-Hirpinia
<u>Sondaggio</u>	SN04
<u>Campione</u>	C1
<u>Profondità</u>	5,50 ÷ 6,00 m
<u>Data apertura</u>	17/10/19
<u>Operatore</u>	



Figura A.1. L'apparecchiatura di taglio torsionale THOR.



Figura A.2. Diagramma schematico del sistema di controllo e acquisizione di THOR



<u>Committente</u>	Consorzio HirpiniaAV
<u>Indagine</u>	I lotto funzionale Apice-Hirpinia
<u>Sondaggio</u>	SN04
<u>Campione</u>	C1
<u>Profondità</u>	5.50 ÷ 6.00 m
<u>Data apertura</u>	17/10/19
<u>Operatore</u>	

## 2. Procedure sperimentali per le prove RC e CTS

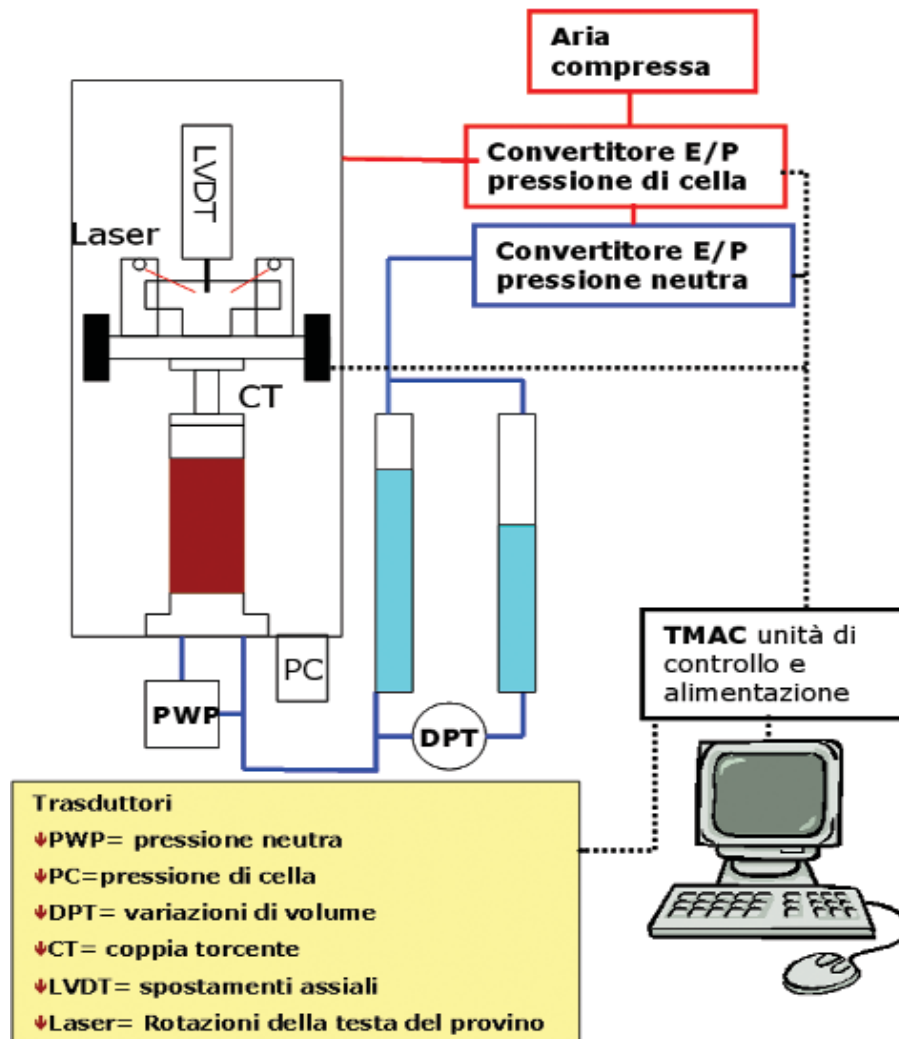
Ciascun provino è stato sottoposto ad una prima fase di applicazione della sollecitazione sferica per ricondurre il provino alla tensione efficace stimata agente in sito.

Al termine di questa fase è stato poi applicato il carico torsionale  $M(t)$ , avente caratteristiche diverse in funzione del tipo di prova. In particolare, in relazione alla frequenza con la quale vengono fatte variare le sollecitazioni nel tempo, è possibile distinguere due tipi di prova: prove «cicliche» (torsione ciclica, CTS) e prove «dinamiche» propriamente dette (colonna risonante, RC).

I criteri di interpretazione delle prove in termini di rigidità e smorzamento sono variabili a seconda delle caratteristiche della sollecitazione torsionale applicata. Infatti, nelle prove TS l'effetto delle forze di inerzia è trascurabile e quindi l'interpretazione è di tipo «quasi statico», mentre per le prove RC è necessario fare riferimento a modelli d'analisi dinamici. I criteri descritti in seguito sono quelli pressoché universalmente adottati per l'interpretazione delle prove RC e CTS, conformi alle norme ASTM (ASTM D4015/92). Presso il DIGA sono state messe a punto, e vengono normalmente utilizzate, procedure di interpretazione più complesse, che si avvalgono della completa automazione e digitalizzazione delle prove. Queste procedure, ampiamente descritte altrove (Papa et al., 1988; Silvestri, 1991, d'Onofrio, 1996), tra l'altro consentono di aumentare l'affidabilità dei risultati anche quando il livello di deformazioni indagato è basso e quindi si è in presenza di un rapporto segnale/rumore non elevato. Per approfondimenti si rimanda a Silvestri (1991).

### 2.1 Prove di colonna risonante (RC)

Durante una prova di colonna risonante (Figura A.3) il provino è sottoposto ad una sollecitazione torsionale di ampiezza  $M$  costante e frequenza  $f$  variabile nel tempo:

$$M(t) = M \sin[2\pi ft]$$

Nell'attrezzatura utilizzata, l'estremità superiore del provino è libera, mentre la base è rigidamente vincolata al piedistallo fisso; in tal modo lo schema dinamico di riferimento è del tipo «a base fissa» o «fixed-free» (Woods, 1978).

Durante la prova, viene registrata la vibrazione della testa del provino in termini di rotazione,  $\theta$ , rilevata a seconda dei casi da una coppia di sensori laser oppure da due coppie di trasduttori di prossimità. Tale misura viene convertita in deformazioni tangenziali,  $\gamma$ , mediante le opportune costanti di taratura (d'Onofrio, 1996). La risposta del provino risulta in ogni istante isofrequenziale con la sollecitazione, mentre l'ampiezza ( $\theta$  o  $\gamma$ ) varia in relazione alla frequenza, ed attinge il valore massimo quando vengono raggiunte le cosiddette "condizioni di risonanza" ( $f = f_R$ ).

Il modulo tangenziale  $G$  viene dedotto dalla misura della velocità delle onde di taglio,  $V_s$ , ottenuta analizzando la risposta del sistema composto da provino e dispositivo di carico torsionale, sulla base di classici modelli teorici di vibrazione torsionale di solidi cilindrici (Richart et al, 1970). Dalla conoscenza delle caratteristiche fisico-geometriche del sistema,  $V_s$  e  $G$  si ricavano applicando le espressioni:

$$V_s = \frac{2\pi f L}{\beta}$$

$$G = \rho V_s^2$$

dove  $L$  indica l'altezza del provino e  $\rho$  la densità del terreno. La costante adimensionale  $\beta$  è funzione dell'inerzia polare di massa del provino,  $I$ , e di quella del sistema di eccitazione,  $I_0$ , secondo l'equazione:

$$\frac{I}{I_0} = \beta \tan \beta$$

Dalla curva di risposta è possibile anche ricavare il fattore di smorzamento  $D$ , individuando i valori di frequenza ( $f_1, f_2$ ) corrispondenti ad un'ampiezza di vibrazione pari a  $\gamma_{\max}/\sqrt{2}$  (metodo della "semibanda di potenza"):

$$D_{hp} = \frac{f_2 - f_1}{2 f_R}$$

A causa della non linearità e della degradazione ciclica, questo criterio non sempre fornisce una valutazione attendibile del fattore di smorzamento  $D$ . In casi del genere si può, in alternativa, ricorrere al metodo basato sull'espressione analitica del



<u>Committente</u>	Consorzio HirpiniaAV
<u>Indagine</u>	I lotto funzionale Apice-Hirpinia
<u>Sondaggio</u>	SN04
<u>Campione</u>	C1
<u>Profondità</u>	5.50 ÷ 6.00 m
<u>Data apertura</u>	17/10/19
<u>Operatore</u>	

fattore di risonanza (metodo del fattore di risonanza), cioè il rapporto tra il valore di picco,  $\gamma_{\max}$ , della curva di risposta  $\gamma(f)$  e la rotazione statica corrispondente ad una coppia di eguale ampiezza M. Da esso si ricava D, una volta noti le ampiezze M e  $\gamma_{\max}$ , ed il valore di G già calcolato, con l'espressione seguente:

$$D_{rf} = \frac{M_0 \bar{R}}{2G\gamma_{\max}}$$

Questo metodo appare in genere più attendibile di quello precedente, perché meno sensibile agli effetti della non linearità e della degradazione ciclica del terreno.



Figura A.3: Interpretazione delle prove di colonna risonante.



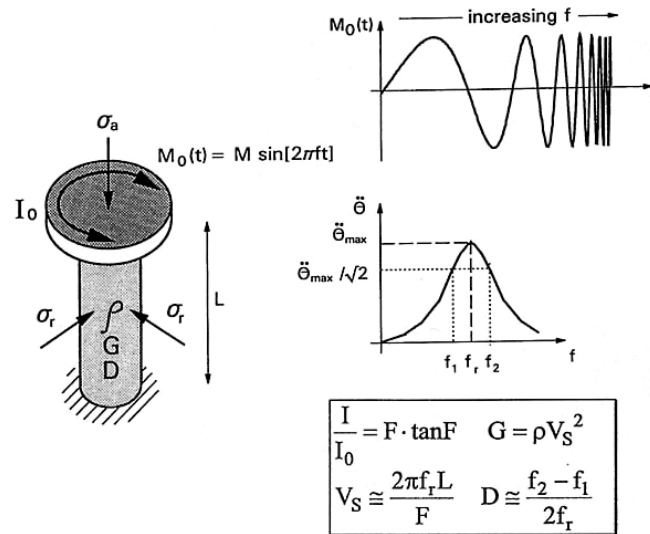

<u>Committente</u>	Consorzio HirpiniaAV
<u>Indagine</u>	I lotto funzionale Apice-Hirpinia
<u>Sondaggio</u>	SN04
<u>Campione</u>	C1
<u>Profondità</u>	5.50 ÷ 6.00 m
<u>Data apertura</u>	17/10/19
<u>Operatore</u>	

## 2.2 Prova di torsione ciclica (CTS)

Durante una prova di torsione ciclica (Figura A.4), il provino viene sottoposto ad un momento torcente  $M(t)$  variabile nel tempo con legge sinusoidale (di ampiezza e frequenza costanti) e si misura la rotazione della testa  $\theta(t)$ .

Le tracce temporali rappresentative di momenti e rotazioni vengono tradotte in termini di andamenti  $\tau(t)$  e  $\gamma(t)$ , mediante le opportune costanti di taratura ed assumendo alcune ipotesi semplificative sulla distribuzione dello stato tensio-deformativo all'interno del provino.

Per ciascun ciclo di carico si individuano quindi i valori di picco della tensione e della deformazione tangenziali ( $\tau_{max}$  e  $\gamma_{max}$ ), e l'andamento del ciclo di isteresi risultante dall'accoppiamento di  $\tau(t)$  e  $\gamma(t)$ .

I valori di  $G$  e  $D$  vengono calcolati utilizzando le relazioni:

$$G = \frac{\tau_{pp}}{\gamma_{pp}} \qquad D = \frac{W_d}{4\pi W_s}$$

Per l'interpretazione dei risultati relativi alle prove di torsione ciclica si è attribuita maggiore affidabilità a tecniche di regressione statistica ai bassi livelli di deformazione (adoperando una regressione sinusoidale, cfr. Papa et al., 1988); non appena i disturbi elettrici sono apparsi senz'altro trascurabili, si è ricorsi ai criteri ordinari (ampiezze picco-picco, area del ciclo di isteresi).



Figura A.4: Interpretazione delle prove di torsione ciclica.



Università degli Studi di Napoli Federico II  
Dipartimento di Ingegneria Civile, Edile ed Ambientale  
**Laboratorio di Geotecnica**

<u>Committente</u>	Consorzio HirpiniaAV
<u>Indagine</u>	I lotto funzionale Apice-Hirpinia
<u>Sondaggio</u>	SN04
<u>Campione</u>	C1
<u>Profondità</u>	5.50 ÷ 6.00 m
<u>Data apertura</u>	17/10/19
<u>Operatore</u>	

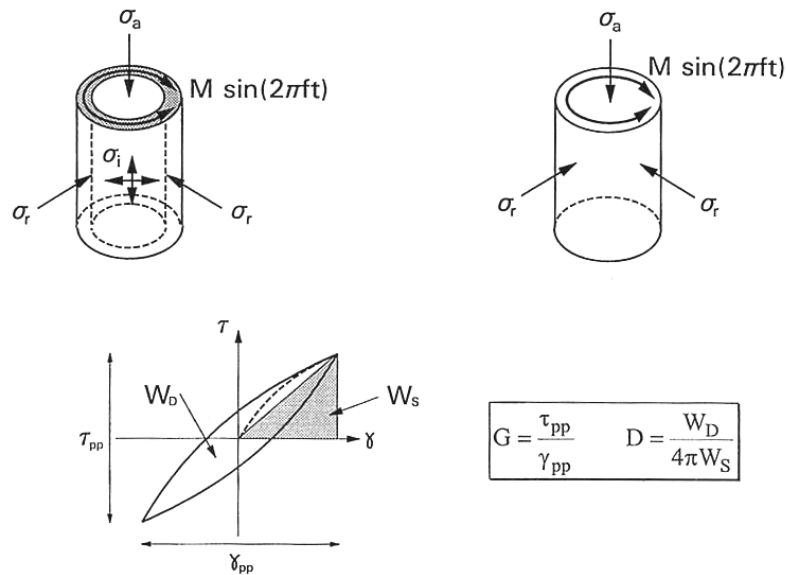
## Riferimenti

AGI (1994) - *Raccomandazioni sulle prove geotecniche di laboratorio*

ASTM D422/90 - *Standard Test Method for particle-size analysis of soils.*

ASTM D4318 - *Standard Test Methods for liquid limit, plastic limit, and plasticity index of Soils.*

ASTM D2435/96 - *Standard Test Methods for one-dimensional consolidation properties of soils using incremental loading.*

ASTM D4015/92 - *Standard Test Methods for modulus and damping of soils by Resonant-Column method.*

d'Onofrio A. (1996) – *Comportamento meccanico dell'argilla di Vallericca in condizioni lontane dalla rottura* – Tesi di dottorato in Ingegneria Geotecnica, Università degli Studi di Napoli.

d'Onofrio A., Silvestri F., Vinale F. (1999) - *A new torsional shear device* - ASTM Geotechnical Testing Journal, Vol 22-2 pp.107-117.

Isenhower W.M. (1979) - *Torsional Simple Shear/Resonant Column properties of San Francisco Bay Mud* - M.S. Thesis, The University of Texas at Austin.

Ni S. H. (1987) *Dynamic properties of sand under true triaxial stress states from Resonant Column/Torsional Shear tests* - Ph. D. dissertation, The University of Texas at Austin.

Papa V., Silvestri F., Vinale F. (1988) - *Recenti sviluppi e prospettive nelle tecniche di interpretazione di prove dinamiche di taglio semplice* - Atti del Convegno del Gruppo Nazionale di Coordinamento per gli Studi di Ingegneria Geotecnica, Monselice.

Richart F.E., Hall J.R., Woods R.D. (1970) - *Vibrations of soils and foundations* - Prentice-Hall Inc., Englewood Cliffs, New Jersey.

Silvestri F. (1991) - *Analisi del comportamento dei terreni naturali in prove cicliche e dinamiche di taglio torsionale* - Tesi di Dottorato in Ingegneria Geotecnica, Università degli Studi di Napoli.

Woods R.D. (1978) - *Measurement of dynamic soil properties* - Proc. "Geotechnical Engineering Division Specialty Conference on Earthquake Engineering and Soil Dynamics", ASCE, Pasadena (California).

Il responsabile della sperimentazione  
Prof. Ing. Anna d'Onofrio



Università degli Studi di Napoli Federico II  
 Dipartimento di Ingegneria Civile, Edile ed Ambientale  
**Laboratorio di Geotecnica**

<u>Committente</u>	Consorzio HirpiniaAV
<u>Indagine</u>	I lotto funzionale Apice-Hirpinia
<u>Sondaggio</u>	SN04
<u>Campione</u>	C2
<u>Profondità</u>	11,50 ÷ 12,00 m
<u>Data apertura</u>	21/10/19
<u>Operatore</u>	Alfredo Pozzo

Diametro (mm):	85
Lunghezza (mm):	430
Data di apertura:	21/10/2019

<b>Stato del Campione</b>	Indisturbato	x
	Parzialmente Rimaneggiato	
	Rimaneggiato	

<b>Descrizione:</b> Argilla grigio piombo con presenza di diffusi noduli marnosi e calcarei.						
<b>Colore</b>	Grigio piombo					
<b>Plasticità</b>	<input type="checkbox"/> Non Plastico	<input type="checkbox"/> Bassa	<input type="checkbox"/> Media alta	<input checked="" type="checkbox"/> Elevata		
<b>Addensamento</b> (Terreni granulari)	<input type="checkbox"/> Molto sciolto ( $D_r=0.0\div 0.2$ )	<input type="checkbox"/> Sciolto ( $D_r=0.2\div 0.4$ )	<input type="checkbox"/> Medio ( $D_r=0.4\div 0.6$ )	<input type="checkbox"/> Denso ( $D_r=0.6\div 0.8$ )	<input type="checkbox"/> Molto denso ( $D_r=0.8\div 1.0$ )	
<b>Consistenza</b> (Terreni coesivi)	<input type="checkbox"/> Molto molle ( $I_c < 0.0$ )	<input type="checkbox"/> Molle ( $I_c=0.0\div 0.5$ )	<input type="checkbox"/> Media ( $I_c=0.5\div 1.0$ )	<input checked="" type="checkbox"/> Consistente ( $I_c > 1.0$ )	<input type="checkbox"/> Molto consist. ( $I_c \gg 1.0$ )	
<b>Grado di umidità</b>	<input type="checkbox"/> Asciutto	<input type="checkbox"/> Poco Umido	<input checked="" type="checkbox"/> Umido	<input type="checkbox"/> Molto Umido		
<b>Alterazione</b>	<input checked="" type="checkbox"/> Assente	<input type="checkbox"/> Debole	<input type="checkbox"/> Media	<input type="checkbox"/> Elevata		
<b>Struttura</b>	<input type="checkbox"/> Omogenea	<input type="checkbox"/> Stratificata	<input type="checkbox"/> Scagliosa	<input type="checkbox"/> Laminata	<input type="checkbox"/> Caotica	
<b>Fratturazione</b>	<input checked="" type="checkbox"/> Assente	<input type="checkbox"/> Moderata	<input type="checkbox"/> Elevata			
<b>Cementazione</b>	<input checked="" type="checkbox"/> Assente	<input type="checkbox"/> Debole	<input type="checkbox"/> Media	<input type="checkbox"/> Elevata		

Proprietà fisiche			Proprietà meccaniche			
n,γ,w	X		Compressione uniassiale			
Analisi granulometrica	X			TX-UU		
Limiti	X			TX-CIU	x	
CaCO <sub>3</sub>				TX-CID		
Sostanze organiche				TX-Ciclica		
Peso specifico del solido				Taglio anulare		
Proctor				Taglio diretto		
CBR				RC TS		
Altro _____				Altro _____		



Università degli Studi di Napoli Federico II

Dipartimento di Ingegneria Civile, Edile ed Ambientale

Laboratorio di Geotecnica

<u>Committente</u>	Consorzio HirpiniaAV
<u>Indagine</u>	I lotto funzionale Apice-Hirpinia
<u>Sondaggio</u>	SN04
<u>Campione</u>	C2
<u>Profondità</u>	11,50 ÷ 12,00 m
<u>Data apertura</u>	21/10/19
<u>Operatore</u>	Alfredo Ponzio

FOTO CAMPIONE

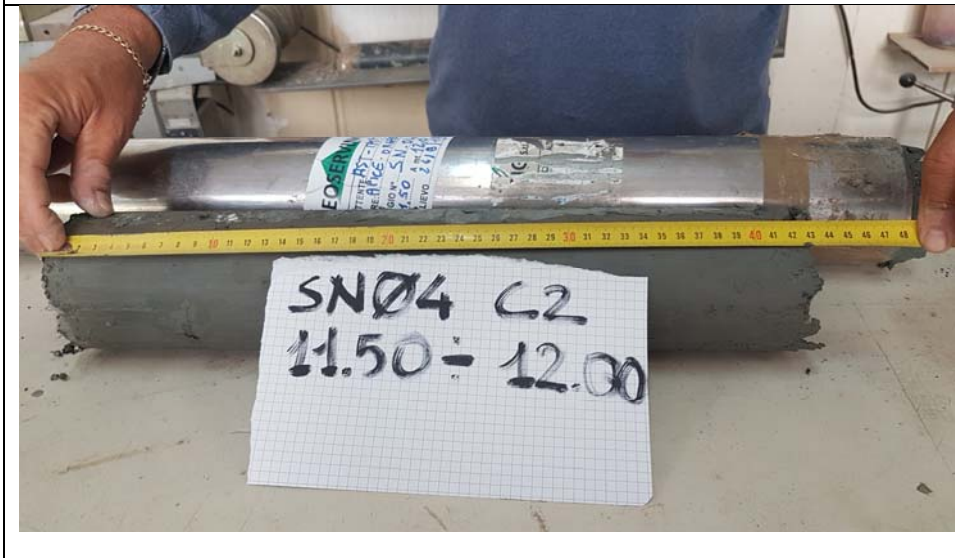



Committente	Consorzio HirpiniaAV
Indagine	I lotto funzionale Apice-Hirpinia
Sondaggio	SN04
Campione	C2
Profondità	11.50-12.00
Data	21/10/2019
Operatore	Alfredo Ponzo

LIMITE DI PLASTICITA'				
pesafiltro n°	Tara	Peso lordo umido (P <sub>u</sub> )	Peso lordo secco (P <sub>s</sub> )	Contenuto d'acqua (w)
[-]	[gr]	[gr]	[gr]	[-]
37	14.94	56.5	50.63	0.164
<b>w<sub>P</sub></b>				0.164

LIMITE DI LIQUIDITA' (Metodo di Casagrande ASTM)					
Pesafiltro n°	N° colpi (N)	Tara (P <sub>c</sub> )	Peso lordo umido (P <sub>u</sub> )	Peso lordo secco (P <sub>s</sub> )	Contenuto d'acqua (w)
[-]	[-]	[g]	[g]	[g]	[g]
49	11	10.51	45.01	33.42	0.506
178	20	12.55	40.58	31.51	0.478
131	25	10.96	38.41	29.74	0.462
<b>Limite di liquidità ASTM (w<sub>L</sub>)</b>					0.465

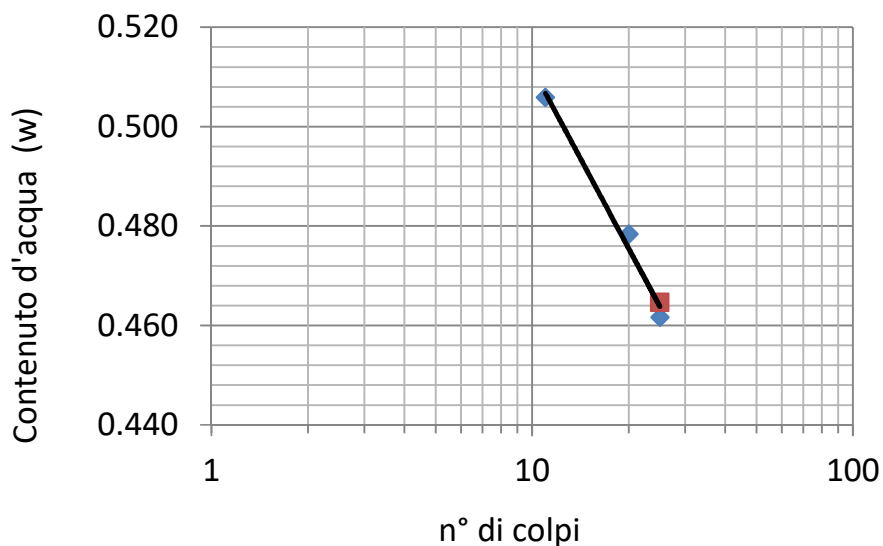

Indice di plasticità (I <sub>p</sub> )	Frazione argillosa CF (d < 2 μm)	Indice di attività (I <sub>A</sub> )
[%]	[%]	[-]
30.01	30.000	1.00

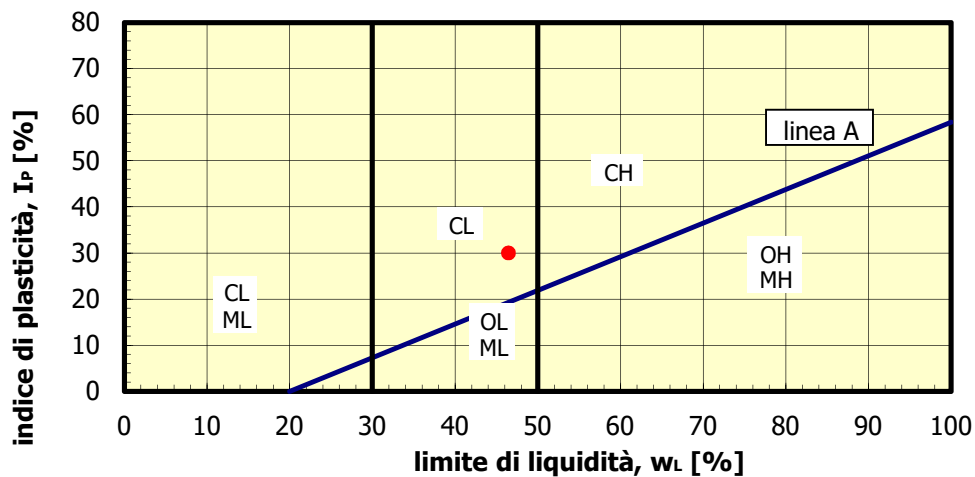

ML	Limi inorganici da bassa a media plasticità	M = limi
CL	Argille inorganiche da bassa a media plasticità	C = argille
OL	Limi e argille organiche di bassa plasticità	O = sostanze organiche
MH	Limi inorganici di alta plasticità	L = bassa plasticità
CH	Argille inorganiche di alta plasticità	H = alta plasticità
OH	Argille organiche da media ad alta plasticità	

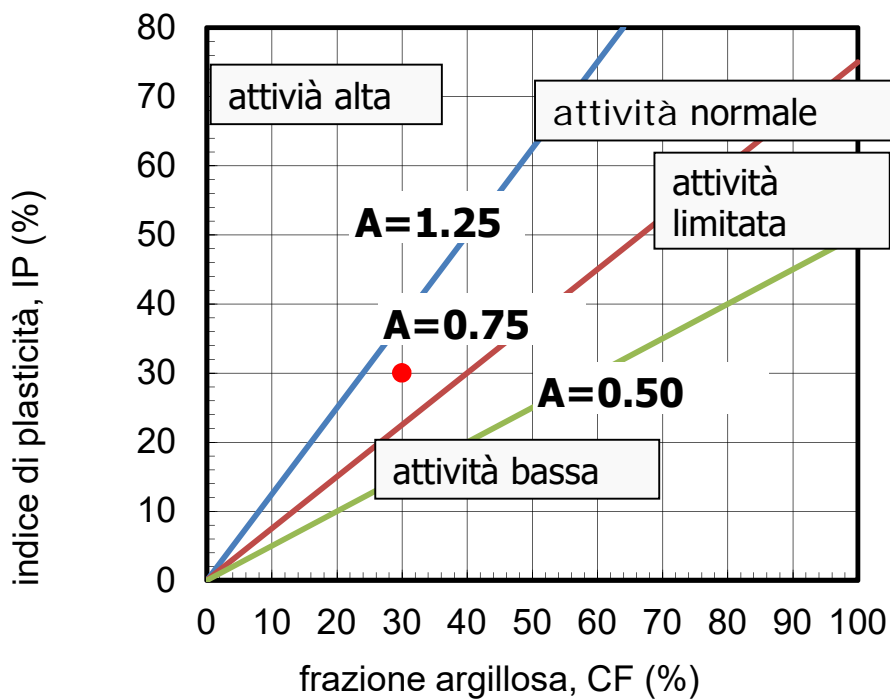

CONSISTENZA TERRENO A GRANA FINE		
$w_L$	$I_p$	$I_c$
[ - ]	[ - ]	[ - ]
46.462	30.01	1.54
COMPATTEZZA TERRENO A GRANA GROSSA		
$e_{max}$	$e_{min}$	$D_r$
[ - ]	[ - ]	[ - ]



Università degli Studi di Napoli  
Dipartimento di Ingegneria Civile, Edile e Ambientale  
Laboratorio di Geotecnica

Committente	Consorzio HirpiniaAV
Indagine	Apice-Hirpinia
Sondaggio	SN04
Campione	C2
Profondità	11.50-12.00
Data	21/10/2019
Operatore	Alfredo Ponzo

Peso specifico del solido	
Peso specifico dell'acqua ( $\gamma_w$ ) (g/cm <sup>3</sup> )	1.000
picnometro n°	18.000
Peso picnometro ( $P_p$ ) (g)	42.54
Peso picnometro + acqua ( $P_{pw}$ ) (g)	140.190
Volume picnometro ( $V_p$ ) (cm <sup>3</sup> )	97.65
Peso picnometro + terreno ( $P_{ps}$ ) (g)	63.68
Peso terreno ( $P_s$ )	21.14
Peso picnometro + terreno + acqua ( $P_{psw}$ ) (g)	153.740
Volume acqua aggiunta ( $V_w$ ) (cm <sup>3</sup> )	90.06
Volume terreno ( $V_s$ ) (cm <sup>3</sup> )	7.590
Peso specifico del terreno ( $\gamma_s$ ) (kN/m <sup>3</sup> )	27.312

Caratteristiche Fisiche Generali			
pesafiltro n°	A	94	140
Peso contenitore ( $P_c$ ) (g)	29.39	11.56	11.89
Diametro (D) (mm)	35.31		
Altezza (H) (mm)	72.10		
Volume (V) (cm <sup>3</sup> )	70.57		
Peso lordo umido ( $P_u$ ) (g)	189.12	53.44	58.07
Peso lordo secco ( $P_s$ ) (g)	171.94	47.99	53.27
Contenuto d'acqua (w)	0.12	0.15	0.12
Peso umido unità di volume ( $\gamma$ ) (kN/m <sup>3</sup> )	22.19		
Peso secco unità di volume ( $\gamma_d$ ) (kN/m <sup>3</sup> )	19.81		
Peso specifico del solido ( $\gamma_s$ ) (kN/m <sup>3</sup> )	27.31		
Porosità (n)	0.27		
Indice dei vuoti (e)	0.38		
Grado di Saturazione ( $S_r$ )	0.89		

il responsabile della sperimentazione

prof. Ing. Anna d'Onofri



Università degli Studi di Napoli  
 Dipartimento di Ingegneria Civile, Edile e Ambientale  
 Laboratorio di Geotecnica

Committente	Consorzio HirpiniaAV
Indagine	I lotto funzionale Apice-Hirpinia
Sondaggio	SN04
Campione	C2
Profondità	11.50 + 12.00 m
Data	24/10/2019
Operatore	Alfredo Ponzo

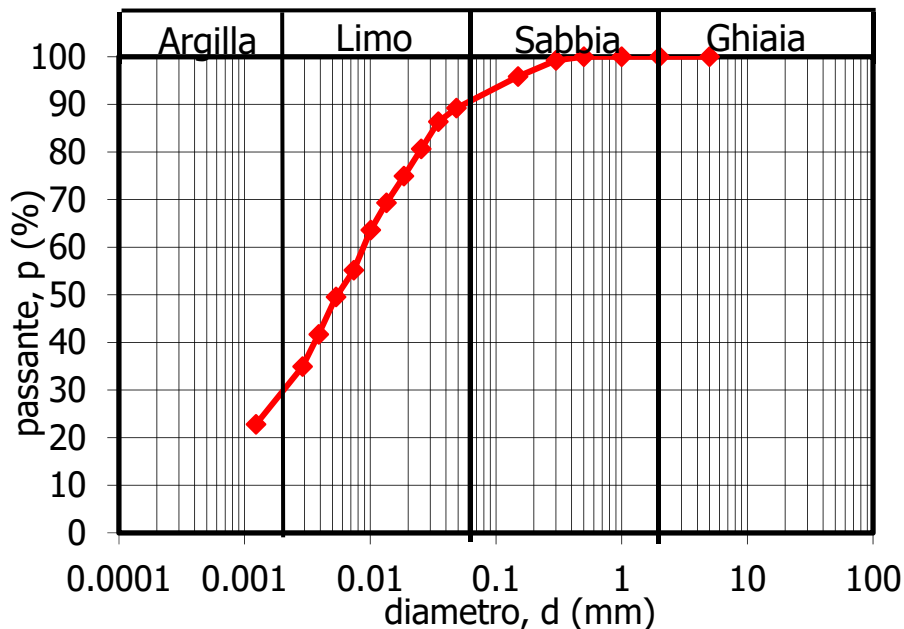

Curva granulometrica	
diametro (mm)	passante (%)
0.500	100.00
0.300	99.23
0.150	95.86
0.048	89.22
0.035	86.36
0.025	80.65
0.019	74.94
0.013	69.33
0.010	63.62
0.007	55.16
0.005	49.56
0.004	41.70
0.003	34.93
0.001	22.79

Limo con argilla sabbioso

peso secco totale (g)	peso secco sediment. (g)
54.57	54.57

STACCIATURA			SEDIMENTAZIONE		
d (mm)	peso trattenuto (g)	peso passante (g)	tempo (min)	temperatura (°C)	lettura areometro (g/cm <sup>3</sup> )
0.50	0.00	54.57		25.25	
0.30	0.42	54.15	0.5	25.25	1.032
0.15	2.26	52.31	1	25.25	1.031
			2	25.25	1.029
			4	25.25	1.027
			8	25.5	1.025
			15	25.5	1.023
			30	25.75	1.02
			60	26	1.018
			120	26	1.01525
			240	23.5	1.01325
			1440	23.5	1.009

G<sub>s</sub>= 2.790

%<0.075mm	%ghiaia	%sabbia	%limo	%argilla	D <sub>max</sub> (mm)	D <sub>60</sub> (mm)	D <sub>10</sub> (mm)
92	0	9	61	30	0.50	0.0090	

Normativa di riferimento : ASTM 422/90

il responsabile della sperimentazione

*Alfredo Ponzo*  
 Ing. Alfredo Ponzo



31

U



Università degli Studi di Napoli Federico II  
Dipartimento di Ingegneria Idraulica,  
Geotecnica ed Ambientale

Prova Compressione Triassiale n.		Celle n.
Prova tipo	TXC	
Committente	Consorzio Hirpinia AV	
Indagine	I lotto funzionale Apice-Hirpinia	
Sondaggio	SN04	
Campione	2	
Profondità	11.50 ± 12.00 m	

Condizioni inizio prova		Consolidazione		Condizioni fine prova	
		Pressione di cella $\sigma_c$ kPa	450		
altezza $h_0$ mm	76.30	Contropressione $u_0$ kPa	200	altezza $h$ mm	76.02
diametro $d$ mm	37.60	Tensione effettiva $\sigma'_c$ kPa	250	diametro $d$ mm	37.04
peso umido iniziale g	194.55			Pesafiltro n° 37 g	14.98
Peso specifico $\gamma_s$ kN/m <sup>3</sup>	27.04			Pf + prov. umido g	210.90
<b>Peso secco dell'udv <math>\gamma_d</math></b> kN/m <sup>3</sup>	20.09			Pf + prov.secco g	188.44
Contenuto d'acqua $w$	0.122			Peso specifico $\gamma_s$ kN/m <sup>3</sup>	27.31
<b>Peso umido dell'udv <math>\gamma</math></b> kN/m <sup>3</sup>	27.31			<b>Peso secco dell'udv <math>\gamma_d</math></b> kN/m <sup>3</sup>	20.77
Indice dei vuoti $e$	0.346			Contenuto d'acqua $w$	0.129
Grado di saturazione $S_r$	1.0			<b>Peso umido dell'udv <math>\gamma</math></b> kN/m <sup>3</sup>	23.46
				Indice dei vuoti $e$	0.315
				Grado di saturazione $S_r$	1.0

Prova triassiale ciclica SN04-C2			
pressione di confinamento (kPa)		250	
deviatore ciclico (kPa)		230	
frequenza (hz)		0.00625	
tempo	cella di carico	u	LVDT
(min)	kN	(kPa)	$\delta$ (mm)
0.00	0.006	201	0.0009
0.15	0.02	203	0.0044
0.18	0.02	204	0.0071
0.22	0.024	205.1	0.008
0.25	0.03	206.1	0.0107
0.28	0.107	228.9	0.1198
0.32	0.148	249.4	0.2397
0.35	0.195	262.8	0.2397
0.38	0.195	262.8	0.3409
0.42	0.195	266.2	0.3737
0.45	0.206	272.7	0.427
0.48	0.227	279	0.4997
0.53	0.229	282.6	0.5548
0.57	0.233	286.7	0.6009
0.58	0.25	291.4	0.664
0.62	0.255	294.3	0.7172
0.65	0.257	296.7	0.7598
0.68	0.26	298.4	0.7598
0.72	0.262	298.4	0.7918
0.75	0.262	299.6	0.8184
0.78	0.256	299.3	0.8299
0.82	0.256	299.8	0.8397
0.85	0.249	298.6	0.8397
0.88	0.24	296	0.8379
0.92	0.226	294.2	0.8379
0.95	0.219	294.2	0.8335
0.98	0.219	292.3	0.8282
1.02	0.208	287.4	0.8193
1.05	0.179	283	0.806
1.08	0.171	280.4	0.7953
1.12	0.157	273.8	0.7776
1.15	0.123	267.6	0.7776
1.18	0.113	267.6	0.7518
1.22	0.113	264	0.7305
1.25	0.095	254.9	0.6924
1.28	0.055	246.4	0.6462
1.32	0.045	242.1	0.6142
1.35	0.028	232.4	0.5583
1.38	-0.011	222.6	0.5583
1.42	-0.026	222.6	0.4838
1.45	-0.026	216.7	0.4261
1.48	-0.044	206.5	0.34
1.52	-0.083	194.1	0.2299
1.55	-0.093	188.9	0.1678
1.58	-0.109	179.1	0.0657
1.62	-0.141	168.2	0.0657
1.65	-0.153	168.2	-0.063
1.68	-0.153	162.6	-0.166
1.72	-0.165	154.9	-0.2903
1.75	-0.189	146.5	-0.4518
1.78	-0.198	142.2	-0.577
1.82	-0.208	135.9	-0.7163
1.85	-0.224	129.4	-0.7163
1.88	-0.231	129.4	-0.8814
1.92	-0.231	126.3	-1.0066
1.95	-0.235	123.1	-1.1131

Prova triassiale ciclica SN04-C2			
pressione di confinamento (kPa)		250	
deviatore ciclico (kPa)		230	
frequenza (hz)		0.00625	
tempo	cella di carico	u	LVDT
(min)	kN	(kPa)	$\delta$ (mm)
2.00	-0.242	120.7	-1.209
2.03	-0.242	120.1	-1.2711
2.05	-0.243	119.7	-1.3173
2.08	-0.242	119.9	-1.3492
2.12	-0.24	120.6	-1.3679
2.15	-0.237	122.8	-1.3741
2.18	-0.227	125.5	-1.3741
2.22	-0.221	125.5	-1.3723
2.25	-0.221	127.9	-1.367
2.28	-0.213	133.2	-1.3563
2.30	-0.192	138.8	-1.3563
2.32	-0.192	138.8	-1.3412
2.33	-0.185	138.8	-1.3412
2.35	-0.185	142.6	-1.3244
2.37	-0.185	142.6	-1.3244
2.38	-0.171	151.2	-1.296
2.40	-0.171	151.2	-1.296
2.42	-0.142	160	-1.296
2.43	-0.142	160	-1.2613
2.45	-0.133	160	-1.2613
2.47	-0.133	165.4	-1.2329
2.48	-0.133	165.4	-1.2329
2.50	-0.118	175.7	-1.1841
2.52	-0.118	175.7	-1.1841
2.53	-0.084	187.9	-1.1841
2.55	-0.084	187.9	-1.1211
2.57	-0.071	187.9	-1.1211
2.58	-0.071	194.9	-1.0696
2.60	-0.071	194.9	-1.0696
2.62	-0.054	207.1	-0.9862
2.63	-0.054	207.1	-0.9862
2.65	-0.016	221.7	-0.9862
2.67	-0.016	221.7	-0.8885
2.68	0.001	221.7	-0.8885
2.70	0.001	230.8	-0.8078
2.72	0.001	230.8	-0.8078
2.73	0.017	242.3	-0.7074
2.75	0.017	242.3	-0.7074
2.77	0.051	254.8	-0.7074
2.78	0.051	254.8	-0.5947
2.80	0.065	254.8	-0.5947
2.82	0.065	262.4	-0.5113
2.83	0.065	262.4	-0.5113
2.85	0.081	273.4	-0.3897
2.87	0.081	273.4	-0.3897
2.88	0.116	285.1	-0.3897
2.90	0.116	285.1	-0.2503
2.92	0.13	285.1	-0.2503
2.93	0.13	291.9	-0.1518
2.95	0.13	291.9	-0.1518
2.97	0.145	301.1	-0.0266
2.98	0.145	301.1	-0.0266
3.00	0.175	310.6	-0.0266
3.02	0.175	310.6	0.1163
3.03	0.184	310.6	0.1163
3.05	0.184	315	0.1988
3.07	0.184	315	0.1988
3.08	0.196	322.2	0.3071

Prova triassiale ciclica SN04-C2			
pressione di confinamento (kPa)		250	
deviatore ciclico (kPa)		230	
frequenza (hz)		0.00625	
tempo	cella di carico	u	LVDT
(min)	kN	(kPa)	$\delta$ (mm)
3.10	0.196	322.2	0.3071
3.12	0.221	328.8	0.3071
3.13	0.221	328.8	0.4349
3.15	0.228	328.8	0.4349
3.17	0.228	332.3	0.521
3.18	0.228	332.3	0.521
3.20	0.237	336.4	0.6018
3.22	0.237	336.4	0.6018
3.23	0.252	340	0.6018
3.25	0.252	340	0.6879
3.27	0.253	340	0.6879
3.28	0.253	341.4	0.7447
3.30	0.253	341.4	0.7447
3.32	0.257	343.5	0.7936
3.33	0.257	343.5	0.7936
3.35	0.261	344.7	0.7936
3.37	0.261	344.7	0.8353
3.38	0.261	345.1	0.8353
3.40	0.261	345.1	0.8628
3.43	0.258	344.8	0.8761
3.45	0.258	344.8	0.8761
3.47	0.256	344.5	0.8859
3.48	0.256	344.5	0.8859
3.50	0.251	343.5	0.8859
3.52	0.251	343.5	0.8894
3.53	0.251	343.5	0.8894
3.55	0.246	342.4	0.8876
3.57	0.246	342.4	0.8876
3.57	0.231	338.9	0.8876
3.58	0.231	338.9	0.8832
3.60	0.224	337.3	0.8832
3.62	0.224	337.3	0.8797
3.63	0.214	337.3	0.8797
3.65	0.214	334.7	0.8708
3.67	0.214	334.7	0.8708
3.68	0.196	328.9	0.8592
3.70	0.196	328.9	0.8592
3.72	0.176	325.1	0.8592
3.73	0.176	325.1	0.8477
3.75	0.166	325.1	0.8477
3.77	0.166	321.6	0.8317
3.78	0.166	321.6	0.8317
3.80	0.149	314.8	0.8042
3.82	0.149	314.8	0.8042
3.83	0.113	306.3	0.8042
3.85	0.113	306.3	0.7696
3.87	0.104	306.3	0.7696
3.88	0.104	302.5	0.7447
3.90	0.104	302.5	0.7447
3.92	0.086	293.1	0.6924
3.93	0.086	293.1	0.6924
3.95	0.047	283.1	0.6924
3.97	0.047	283.1	0.6276
3.98	0.037	283.1	0.6276
4.00	0.037	278.7	0.5832
4.02	0.037	278.7	0.5832
4.03	0.018	267.6	0.4989
4.05	0.018	267.6	0.4989

Prova triassiale ciclica SN04-C2			
pressione di confinamento (kPa)		250	
deviatore ciclico (kPa)		230	
frequenza (hz)		0.00625	
tempo	cella di carico	u	LVDT
(min)	kN	(kPa)	$\delta$ (mm)
4.07	-0.02	256.5	0.4989
4.08	-0.02	256.5	0.3932
4.10	-0.034	256.5	0.3932
4.12	-0.034	250.2	0.3071
4.13	-0.034	250.2	0.3071
4.15	-0.056	237.6	0.1669
4.17	-0.056	237.6	0.1669
4.18	-0.089	225.5	0.1669
4.20	-0.089	225.5	0.0071
4.22	-0.089	225.5	0.0071
4.23	-0.102	218.4	-0.1331
4.25	-0.102	218.4	-0.1331
4.27	-0.126	205.1	-0.1331
4.28	-0.126	205.1	-0.3116
4.30	-0.148	195.7	-0.3116
4.32	-0.148	195.7	-0.4651
4.33	-0.148	195.7	-0.4651
4.35	-0.157	188.3	-0.6009
4.37	-0.157	188.3	-0.6009
4.38	-0.18	175.3	-0.6009
4.40	-0.18	175.3	-0.7767
4.42	-0.195	175.3	-0.7767
4.43	-0.195	167	-0.9214
4.45	-0.195	167	-0.9214
4.47	-0.203	159.8	-1.043
4.48	-0.203	159.8	-1.043
4.50	-0.219	151.2	-1.043
4.52	-0.219	151.2	-1.1752
4.53	-0.225	151.2	-1.1752
4.55	-0.225	146.9	-1.2729
4.57	-0.225	146.9	-1.2729
4.58	-0.23	142.4	-1.3581
4.60	-0.23	142.4	-1.3581
4.62	-0.239	138.1	-1.3581
4.63	-0.239	138.1	-1.4433
4.65	-0.241	138.1	-1.4433
4.67	-0.241	136.1	-1.5125
4.68	-0.241	136.1	-1.5125
4.70	-0.243	134.4	-1.5658
4.72	-0.243	134.4	-1.5658
4.73	-0.242	134.1	-1.5658
4.75	-0.242	134.1	-1.6022
4.77	-0.24	134.1	-1.6022
4.78	-0.24	134.9	-1.6199
4.80	-0.24	134.9	-1.6199
4.82	-0.235	137.6	-1.6253
4.83	-0.235	137.6	-1.6253
4.85	-0.226	140.3	-1.6253
4.87	-0.226	140.3	-1.6226
4.90	-0.221	142.9	-1.6191
4.92	-0.221	142.9	-1.6191
4.93	-0.215	146.5	-1.6128
4.95	-0.215	146.5	-1.6128
4.95	-0.2	151.6	-1.6128
4.97	-0.2	151.6	-1.5995
4.98	-0.19	151.6	-1.5995
5.02	-0.19	156.5	-1.5818
5.02	-0.19	156.5	-1.5818

Prova triassiale ciclica SN04-C2			
pressione di confinamento (kPa)		250	
deviatore ciclico (kPa)		230	
frequenza (hz)		0.00625	
tempo	cella di carico	u	LVDT
(min)	kN	(kPa)	$\delta$ (mm)
5.03	-0.173	165.9	-1.5551
5.05	-0.173	165.9	-1.5551
5.07	-0.151	173.8	-1.5551
5.08	-0.151	173.8	-1.5241
5.10	-0.141	173.8	-1.5241
5.12	-0.141	179.6	-1.493
5.13	-0.141	179.6	-1.493
5.15	-0.122	191.7	-1.4424
5.17	-0.122	191.7	-1.4424
5.18	-0.094	202.3	-1.4424
5.20	-0.094	202.3	-1.3856
5.22	-0.083	202.3	-1.3856
5.23	-0.083	209.7	-1.3332
5.28	-0.061	223.9	-1.2445
5.32	-0.028	236.6	-1.1459
5.35	-0.013	245.4	-1.0545
5.38	0.011	260.1	-0.9143
5.42	0.043	272.1	-0.9143
5.45	0.055	272.1	-0.7793
5.48	0.055	278.9	-0.6853
5.52	0.075	290.9	-0.5388
5.55	0.105	301.5	-0.3835
5.58	0.116	307	-0.2752
5.62	0.137	317.8	-0.1003
5.65	0.167	326.6	-0.1003
5.68	0.178	326.6	0.0799
5.72	0.178	331.3	0.1917
5.75	0.192	338.5	0.3231
5.78	0.214	344.1	0.4571
5.82	0.223	347.3	0.553
5.85	0.231	351.5	0.6489
5.88	0.249	355.5	0.6489
5.92	0.253	355.5	0.758
5.95	0.253	356.9	0.8264
5.98	0.255	358.2	0.8779
6.02	0.261	360.3	0.9302
6.05	0.263	360.7	0.972
6.08	0.261	360.5	0.9933
6.12	0.257	359.4	1.0013
6.15	0.25	358.1	1.0013
6.18	0.246	358.1	1.0039
6.22	0.246	357.1	1.0039
6.25	0.238	354	1.0004
6.28	0.221	351.3	0.9942
6.33	0.214	349.2	0.9844
6.37	0.203	345.2	0.9791
6.40	0.184	341.5	0.9658
6.43	0.173	337.8	0.9453
6.47	0.144	329.1	0.9453
6.48	0.128	324.9	0.9178
6.52	0.128	324.9	0.8947
6.55	0.115	319.2	0.8575
6.58	0.079	308.1	0.8033
6.62	0.064	302.8	0.7589
6.65	0.047	293.7	0.6826
6.68	0.011	282.2	0.6826
6.72	-0.004	282.2	0.5903
6.75	-0.004	276	0.5113

Prova triassiale ciclica SN04-C2			
pressione di confinamento (kPa)		250	
deviatore ciclico (kPa)		230	
frequenza (hz)		0.00625	
tempo	cella di carico	u	LVDT
(min)	kN	(kPa)	$\delta$ (mm)
6.78	-0.021	264.6	0.3808
6.82	-0.059	250.7	0.2006
6.85	-0.076	242.6	0.0639
6.88	-0.092	231.2	-0.1207
6.92	-0.122	218.4	-0.1207
6.95	-0.136	218.4	-0.34
6.98	-0.136	210.8	-0.5006
7.02	-0.151	199	-0.7048
7.05	-0.177	186.3	-0.9285
7.08	-0.187	180	-1.0669
7.12	-0.199	171	-1.2107
7.15	-0.213	163.5	-1.2107
7.18	-0.213	163.5	-1.3466
7.22	-0.219	158.4	-1.4548
7.25	-0.231	150.6	-1.5729
7.28	-0.238	146.4	-1.6688
7.32	-0.24	144.3	-1.7345
7.35	-0.242	142.3	-1.7345
7.38	-0.242	141.8	-1.7895
7.42	-0.242	141.8	-1.8277
7.45	-0.24	142.6	-1.8481
7.48	-0.234	144.7	-1.8552
7.52	-0.23	146.6	-1.8561
7.55	-0.224	150.3	-1.8507
7.58	-0.208	155.7	-1.8507
7.62	-0.202	155.7	-1.841
7.65	-0.202	159.3	-1.8277
7.68	-0.189	167.6	-1.8046
7.72	-0.163	177	-1.7753
7.75	-0.155	181.9	-1.7495
7.80	-0.141	193	-1.7052
7.83	-0.12	199.2	-1.6785
7.87	-0.109	206.2	-1.6333
7.90	-0.091	219.9	-1.5578
7.93	-0.054	234	-1.5578
7.95	-0.043	234	-1.4628
7.98	-0.043	241.2	-1.3945
8.02	-0.023	254.7	-1.2764
8.05	0.015	269.8	-1.1175
8.08	0.027	277	-1.0163
8.12	0.045	288.5	-0.8672
8.15	0.078	300.7	-0.8672
8.18	0.093	300.7	-0.679
8.22	0.093	307.7	-0.5459
8.25	0.11	317.6	-0.379
8.28	0.139	326.3	-0.1846
8.32	0.154	332.4	-0.024
8.35	0.169	340.5	0.1544
8.38	0.195	347.2	0.1544
8.42	0.205	347.2	0.3453
8.45	0.205	350.8	0.4696
8.48	0.217	356.5	0.6018
8.52	0.236	360.5	0.7394
8.55	0.242	362.8	0.8335
8.58	0.25	365.9	0.9205
8.62	0.259	367.5	0.9205
8.65	0.26	367.5	1.0004
8.68	0.26	368.2	1.0527



Prova triassiale ciclica SN04-C2			
pressione di confinamento (kPa)		250	
deviatore ciclico (kPa)		230	
frequenza (hz)		0.00625	
tempo	cella di carico	u	LVDT
(min)	kN	(kPa)	$\delta$ (mm)
8.72	0.262	368.9	1.0927
8.75	0.261	368.8	1.1202
8.78	0.258	368.2	1.1326
8.82	0.254	366.8	1.138
8.85	0.245	365.2	1.138
8.88	0.239	365.2	1.1371
8.92	0.239	363.8	1.1344
8.95	0.229	359.8	1.1282
8.98	0.21	356.7	1.1193
9.02	0.202	354.3	1.1087
9.05	0.186	347.7	1.0927
9.08	0.159	342.8	1.0927
9.12	0.149	342.8	1.0714
9.15	0.149	339.3	1.051
9.18	0.13	330.2	1.0155
9.23	0.094	323.1	0.9711
9.27	0.094	320.7	0.948
9.30	0.075	310.6	0.8859
9.32	0.038	300.8	0.8051
9.35	0.028	295.9	0.7438
9.38	0.007	283.9	0.624
9.42	-0.03	271.7	0.624
9.45	-0.045	271.7	0.4704
9.48	-0.045	264.8	0.3506
9.52	-0.063	252	0.1447
9.55	-0.097	237.7	-0.1198
9.58	-0.113	230.2	-0.3009
9.62	-0.125	219.7	-0.506
9.65	-0.152	207	-0.506
9.68	-0.168	207	-0.774
9.72	-0.168	198	-0.9871
9.75	-0.179	188.3	-1.1779
9.78	-0.198	178.6	-1.3661
9.82	-0.207	172.7	-1.5001
9.85	-0.216	164.7	-1.6324
9.88	-0.229	157.7	-1.6324
9.92	-0.232	157.7	-1.7629
9.95	-0.232	154.6	-1.8534
9.98	-0.237	150.7	-1.9324
10.02	-0.242	148	-2.007
10.05	-0.241	147.3	-2.0576
10.08	-0.241	147.7	-2.0877
10.12	-0.236	148.8	-2.0877
10.15	-0.233	148.8	-2.1028
10.18	-0.233	150.6	-2.1055
10.22	-0.227	155.1	-2.1028
10.25	-0.212	159.4	-2.0939
10.28	-0.206	163	-2.0824
10.32	-0.194	171.7	-2.0629
10.35	-0.17	180.1	-2.0629
10.38	-0.162	180.1	-2.0354
10.42	-0.162	184.8	-2.0123
10.45	-0.148	195.9	-1.9697
10.48	-0.117	207.5	-1.9164
10.52	-0.107	213.7	-1.8729
10.55	-0.091	226.9	-1.7957
10.58	-0.055	241.3	-1.7957
10.62	-0.042	241.3	-1.6989

Prova triassiale ciclica SN04-C2			
pressione di confinamento (kPa)		250	
deviatore ciclico (kPa)		230	
frequenza (hz)		0.00625	
tempo	cella di carico	u	LVDT
(min)	kN	(kPa)	$\delta$ (mm)
10.65	-0.042	248.7	-1.6253
10.70	0.002	272.3	-1.4983
10.73	0.017	272.3	-1.398
10.75	0.017	279.6	-1.2986
10.78	0.032	291.1	-1.1424
10.82	0.068	304.2	-0.9205
10.85	0.086	311.9	-0.7563
10.88	0.1	321.2	-0.5716
10.92	0.131	330.9	-0.5716
10.95	0.145	330.9	-0.3409
10.98	0.145	336.3	-0.1687
11.02	0.159	344.4	0.0435
11.05	0.188	351.7	0.2965
11.08	0.2	355.6	0.4589
11.12	0.211	361	0.6213
11.15	0.231	365.4	0.6213
11.18	0.238	365.4	0.7927
11.22	0.238	367.7	0.9081
11.25	0.246	370.6	1.0128
11.28	0.257	372.8	1.1122
11.32	0.259	373.4	1.1814
11.35	0.26	374.2	1.2347
11.38	0.263	374.6	1.2347
11.42	0.26	374.6	1.2738
11.45	0.26	374.2	1.2968
11.48	0.258	373	1.3057
11.52	0.248	371.6	1.3075
11.55	0.244	370.5	1.3057
11.58	0.236	366.8	1.3013
11.62	0.215	363.5	1.3013
11.65	0.208	363.5	1.2924
11.68	0.208	361.6	1.2844
11.72	0.196	355.5	1.2702
11.75	0.166	350.3	1.248
11.78	0.158	347.4	1.2303
11.82	0.141	339.1	1.1974
11.85	0.106	331.2	1.1974
11.88	0.096	331.2	1.1522
11.92	0.096	327.2	1.1167
11.95	0.077	316.9	1.0456
11.98	0.037	305.9	0.9533
12.02	0.025	300.9	0.8912
12.05	0.009	290.3	0.7722
12.08	-0.028	277.3	0.7722
12.12	-0.046	277.3	0.6018
12.17	-0.062	261	0.3178
12.20	-0.077	252.2	0.3178
12.22	-0.1	252.2	0.1518
12.25	-0.1	241.2	-0.111
12.28	-0.116	230	-0.4021
12.32	-0.143	216.2	-0.7509
12.35	-0.163	205.4	-1.0448
12.38	-0.173	196.8	-1.2658
12.42	-0.191	187.3	-1.2658
12.45	-0.203	187.3	-1.4682
12.48	-0.203	179.8	-1.6475
12.52	-0.21	172.8	-1.7966
12.55	-0.225	164.8	-1.9493

Prova triassiale ciclica SN04-C2			
pressione di confinamento (kPa)		250	
deviatore ciclico (kPa)		230	
frequenza (hz)		0.00625	
tempo	cella di carico	u	LVDT
(min)	kN	(kPa)	$\delta$ (mm)
12.58	-0.23	160.8	-2.0638
12.62	-0.234	156.8	-2.1579
12.65	-0.24	153.2	-2.1579
12.68	-0.241	153.2	-2.2493
12.72	-0.241	152.1	-2.315
12.75	-0.241	151.8	-2.3576
12.78	-0.237	152.7	-2.3815
12.82	-0.234	154.2	-2.3913
12.85	-0.229	157.4	-2.3913
12.88	-0.216	162	-2.3913
12.92	-0.21	162	-2.3842
12.95	-0.21	165.1	-2.3744
12.98	-0.2	172.1	-2.3576
13.02	-0.176	181.7	-2.3318
13.05	-0.168	186.2	-2.3123
13.08	-0.155	195.1	-2.2732
13.12	-0.125	208.5	-2.2732
13.15	-0.114	208.5	-2.2227
13.18	-0.114	215.3	-2.1809
13.22	-0.099	225.6	-2.1117
13.25	-0.067	241.4	-2.0194
13.28	-0.05	250	-1.943
13.32	-0.035	260.7	-1.8312
13.35	0	277.7	-1.8312
13.38	0.024	277.7	-1.651
13.42	0.024	288.4	-1.5081
13.45	0.035	296.1	-1.3785
13.48	0.062	307.9	-1.1814
13.52	0.084	316.7	-0.9871
13.55	0.099	325.1	-0.7625
13.60	0.129	336.3	-0.4589
13.63	0.141	339.9	-0.316
13.67	0.151	345.1	-0.1278
13.68	0.175	353.5	-0.1278
13.72	0.194	358.6	0.1669
13.75	0.194	358.6	0.4172
13.78	0.204	362.7	0.6205
13.82	0.224	368.1	0.8424
13.85	0.236	371.1	1.0101
13.88	0.242	373.4	1.1344
13.92	0.254	376.4	1.1344
13.95	0.259	377.4	1.2622
13.98	0.259	377.4	1.3572
14.02	0.26	378	1.4282
14.05	0.264	379	1.4877
14.08	0.263	378.8	1.5276
14.12	0.259	377.9	1.5427
14.15	0.252	376.3	1.5427
14.18	0.247	375.3	1.5472
14.22	0.247	375.3	1.548
14.25	0.241	373.2	1.5445
14.28	0.222	369.5	1.5374
14.32	0.215	367.5	1.5303
14.35	0.203	363.4	1.5161
14.38	0.175	356.9	1.5161
14.42	0.165	353.8	1.4975
14.45	0.165	353.8	1.4824
14.48	0.151	348.6	1.4495

Prova triassiale ciclica SN04-C2			
pressione di confinamento (kPa)		250	
deviatore ciclico (kPa)		230	
frequenza (hz)		0.00625	
tempo	cella di carico	u	LVDT
(min)	kN	(kPa)	$\delta$ (mm)
14.52	0.117	338.6	1.4078
14.55	0.103	334.2	1.375
14.58	0.088	327.5	1.3155
14.62	0.053	314.4	1.3155
14.65	0.032	307.6	1.2276
14.68	0.032	307.6	1.1566
14.72	0.02	300.9	1.0607
14.75	-0.012	286.4	0.8921
14.78	-0.039	276.2	0.7252
14.82	-0.053	268.4	0.5388
14.85	-0.081	252.7	0.5388
14.88	-0.107	240.9	0.2139
14.92	-0.107	240.9	-0.1278
14.95	-0.119	233.8	-0.403
14.98	-0.139	221.7	-0.758
15.02	-0.161	209.6	-1.1628
15.07	-0.173	202	-1.438
15.10	-0.185	193.7	-1.6341
15.12	-0.197	186.7	-1.8152
15.15	-0.205	180.8	-1.9839
15.18	-0.218	171.7	-1.9839
15.22	-0.228	165.9	-2.1641
15.25	-0.228	165.9	-2.3203
15.28	-0.232	162.3	-2.4366
15.32	-0.237	157.8	-2.5466
15.35	-0.24	155.7	-2.6381
15.38	-0.24	154.9	-2.6993
15.42	-0.239	155.6	-2.7375
15.45	-0.234	157	-2.7375
15.48	-0.23	157	-2.7543
15.52	-0.23	158.6	-2.7597
15.55	-0.225	162.9	-2.7561
15.58	-0.21	167.5	-2.7472
15.62	-0.204	171.4	-2.7357
15.65	-0.193	180.6	-2.7144
15.68	-0.168	189.3	-2.7144
15.72	-0.161	189.3	-2.6851
15.75	-0.161	194.1	-2.6603
15.78	-0.146	206.3	-2.6159
15.82	-0.116	218	-2.56
15.85	-0.105	224.5	-2.5191
15.88	-0.091	235.2	-2.4366
15.92	-0.067	250.8	-2.3345
15.95	-0.034	263.9	-2.3345
15.98	-0.022	263.9	-2.2244
16.02	-0.022	270.8	-2.1374
16.05	-0.001	285	-1.9688
16.08	0.033	298.2	-1.7682
16.12	0.046	304.7	-1.6155
16.15	0.071	317.9	-1.6155
16.18	0.094	326.1	-1.3723
16.22	0.094	326.1	-1.1459
16.25	0.107	332.7	-0.9045
16.28	0.135	343.7	-0.5255
16.32	0.156	349.8	-0.1917
16.35	0.169	355.5	0.1154
16.38	0.191	362.5	0.1154
16.42	0.206	362.5	0.4687

Prova triassiale ciclica SN04-C2			
pressione di confinamento (kPa)		250	
deviatore ciclico (kPa)		230	
frequenza (hz)		0.00625	
tempo	cella di carico	u	LVDT
(min)	kN	(kPa)	$\delta$ (mm)
16.45	0.206	366.4	0.7412
16.50	0.231	373.7	0.9773
16.53	0.239	373.7	1.177
16.57	0.239	375.8	1.3075
16.60	0.245	378.6	1.4442
16.63	0.258	380.7	1.588
16.65	0.261	381.5	1.6989
16.68	0.264	382.2	1.7842
16.72	0.265	382.5	1.7842
16.75	0.263	382.5	1.8445
16.78	0.263	381.9	1.8756
16.82	0.258	380.6	1.8871
16.85	0.25	379.1	1.8898
16.88	0.246	378	1.888
16.92	0.234	374.6	1.8827
16.95	0.219	371.9	1.8827
16.98	0.219	371.9	1.8747
17.02	0.21	369.2	1.8623
17.05	0.185	362.6	1.8454
17.08	0.173	359.4	1.8303
17.12	0.161	354.5	1.8019
17.15	0.127	344.9	1.8019
17.18	0.112	340.4	1.7629
17.22	0.112	340.4	1.7318
17.25	0.097	332.8	1.6741
17.28	0.06	320.8	1.5933
17.32	0.044	314.8	1.5285
17.35	0.029	304.9	1.4264
17.38	-0.007	292.5	1.4264
17.42	-0.026	292.5	1.2755
17.45	-0.026	284.6	1.1291
17.48	-0.042	272.9	0.9152
17.52	-0.076	258.3	0.5645
17.55	-0.096	248.9	0.2299
17.58	-0.111	238.7	-0.1465
17.62	-0.133	228	-0.1465
17.65	-0.133	228	-0.6418
17.68	-0.151	217.8	-1.1823
17.72	-0.173	203.5	-1.7007
17.75	-0.192	193.4	-2.0354
17.78	-0.196	189.5	-2.1863
17.82	-0.207	181.3	-2.1863
17.85	-0.218	174.8	-2.3531
17.88	-0.218	174.8	-2.5378
17.92	-0.225	168.9	-2.7144
17.97	-0.237	162.9	-2.8839
18.00	-0.237	159.8	-3.018
18.03	-0.238	157.9	-3.1121
18.07	-0.238	157.1	-3.1822
18.10	-0.237	157	-3.2319
18.12	-0.235	158.4	-3.2576
18.15	-0.228	161.2	-3.2576
18.18	-0.223	161.2	-3.2656
18.22	-0.223	163.6	-3.2639
18.25	-0.217	169.1	-3.2568
18.28	-0.199	175.3	-3.2417
18.32	-0.192	179.8	-3.2266
18.35	-0.177	190.1	-3.1991

Prova triassiale ciclica SN04-C2			
pressione di confinamento (kPa)		250	
deviatore ciclico (kPa)		230	
frequenza (hz)		0.00625	
tempo	cella di carico	u	LVDT
(min)	kN	(kPa)	$\delta$ (mm)
18.38	-0.155	198.6	-3.1991
18.42	-0.155	198.6	-3.1671
18.45	-0.146	204.8	-3.1272
18.48	-0.121	220	-3.0695
18.52	-0.101	229.2	-3.0153
18.55	-0.09	238.1	-2.9443
18.58	-0.058	255	-2.9443
18.62	-0.038	255	-2.8351
18.65	-0.038	264.7	-2.7437
18.68	-0.025	274.5	-2.6194
18.72	0.01	291.9	-2.4002
18.75	0.034	301.8	-2.2351
18.78	0.045	310.1	-2.0842
18.82	0.071	320.7	-2.0842
18.85	0.091	320.7	-1.8445
18.88	0.091	328.8	-1.5729
18.92	0.107	338.4	-1.2365
18.95	0.134	346.9	-0.7776
18.98	0.153	353.6	-0.3133
19.02	0.168	360.5	0.126
19.05	0.192	366.5	0.126
19.08	0.192	366.5	0.6258
19.12	0.206	370.3	0.9906
19.15	0.224	376.3	1.3545
19.18	0.24	378.9	1.612
19.22	0.246	380.6	1.7762
19.25	0.252	382.6	1.7762
19.28	0.26	384	1.9013
19.32	0.26	384	2.0336
19.35	0.264	385	2.1534
19.40	0.267	385.6	2.2493
19.43	0.267	385.2	2.3123
19.47	0.265	384.4	2.3451
19.50	0.258	383.3	2.3567
19.52	0.254	382.2	2.3602
19.55	0.248	379.7	2.3576
19.58	0.23	377	2.3576
19.62	0.224	377	2.3522
19.65	0.224	374.7	2.3443
19.68	0.211	369	2.3309
19.72	0.185	364.6	2.3132
19.75	0.176	361.6	2.2963
19.78	0.157	353.5	2.267
19.82	0.127	347.1	2.267
19.85	0.127	347.1	2.2306
19.88	0.118	343	2.1942
19.92	0.095	332.2	2.1286
19.95	0.057	321.5	2.0487
19.98	0.045	316.5	1.9901
20.02	0.029	305.4	1.8862
20.05	-0.007	293.6	1.8862
20.08	-0.024	293.6	1.7353
20.12	-0.024	286.2	1.596
20.15	-0.044	273	1.3439
20.18	-0.078	258.6	0.8956
20.22	-0.097	250.6	0.4997
20.25	-0.11	241.6	0.0435
20.28	-0.131	231.2	0.0435

Prova triassiale ciclica SN04-C2			
pressione di confinamento (kPa)		250	
deviatore ciclico (kPa)		230	
frequenza (hz)		0.00625	
tempo	cella di carico	u	LVDT
(min)	kN	(kPa)	$\delta$ (mm)
20.32	-0.131	231.2	-0.6489
20.35	-0.15	219.4	-1.4406
20.38	-0.176	202.8	-2.1552
20.42	-0.193	193	-2.5253
20.45	-0.194	189.4	-2.6718
20.48	-0.205	182.5	-2.6718
20.52	-0.217	182.5	-2.8325
20.55	-0.217	175	-3.0721
20.58	-0.224	168	-3.3109
20.62	-0.233	160.9	-3.5577
20.65	-0.235	157	-3.7512
20.68	-0.236	154.9	-3.8914
20.72	-0.236	153.7	-3.8914
20.75	-0.235	153.7	-3.9988
20.78	-0.235	153.9	-4.0689
20.82	-0.231	156.3	-4.1018
20.87	-0.22	159.6	-4.1071
20.90	-0.22	161.4	-4.1089
20.93	-0.214	166.9	-4.1018
20.97	-0.197	173.3	-4.0867
21.00	-0.19	178.4	-4.0698
21.02	-0.174	189	-4.0423
21.05	-0.154	197.5	-4.0423
21.08	-0.145	197.5	-4.0086
21.12	-0.145	204.1	-3.9749
21.15	-0.125	218.2	-3.918
21.18	-0.1	229.8	-3.855
21.22	-0.088	237.6	-3.7929
21.25	-0.067	253.1	-3.6926
21.28	-0.036	266.7	-3.6926
21.32	-0.024	266.7	-3.5728
21.35	-0.024	274.7	-3.4716
21.38	-0.002	289.2	-3.2976
21.42	0.032	303.4	-3.0721
21.45	0.047	310.7	-2.907
21.48	0.063	321	-2.654
21.52	0.09	331.5	-2.654
21.55	0.107	331.5	-2.2599
21.58	0.107	338.4	-1.8623
21.62	0.124	347.8	-1.3332
21.65	0.15	356.7	-0.5468
21.68	0.168	362.8	0.1172
21.72	0.185	369.7	0.703
21.75	0.207	374.5	0.703
21.78	0.22	374.5	1.2347
21.82	0.22	377.6	1.5986
21.85	0.232	381.6	1.9067
21.88	0.247	383.7	2.1925
21.92	0.253	384.7	2.3815
21.95	0.26	386.4	2.56
21.98	0.267	386.9	2.56
22.02	0.267	386.9	2.7206
22.05	0.267	386.8	2.828
22.08	0.267	386.3	2.8937
22.12	0.264	385.9	2.9301
22.15	0.261	385	2.947
22.18	0.255	382.9	2.9523
22.22	0.244	380.8	2.9523

Prova triassiale ciclica SN04-C2			
pressione di confinamento (kPa)		250	
deviatore ciclico (kPa)		230	
frequenza (hz)		0.00625	
tempo	cella di carico	u	LVDT
(min)	kN	(kPa)	$\delta$ (mm)
22.25	0.236	380.8	2.9496
22.28	0.236	378.8	2.9443
22.33	0.211	372.2	2.9345
22.37	0.2	372.2	2.9283
22.38	0.2	369	2.915
22.42	0.184	361.6	2.8937
22.45	0.155	356.2	2.868
22.48	0.145	352.3	2.8431
22.52	0.125	342.2	2.7978
22.55	0.089	334	2.7978
22.58	0.078	334	2.7384
22.62	0.078	328.9	2.6904
22.65	0.057	316.7	2.5955
22.68	0.018	305.7	2.4765
22.72	0.007	300.4	2.3922
22.75	-0.012	287.1	2.2191
22.78	-0.048	272.9	2.2191
22.82	-0.066	272.9	1.9546
22.85	-0.066	265.5	1.643
22.88	-0.084	254.6	1.1282
22.92	-0.109	244.8	0.3506
22.95	-0.126	236.1	-0.561
22.98	-0.142	223.3	-1.5534
23.02	-0.167	205.8	-1.5534
23.05	-0.186	205.8	-2.5617
23.08	-0.186	192.2	-3.1707
23.12	-0.188	187	-3.3899
23.15	-0.199	180.2	-3.6198
23.18	-0.209	171.2	-3.966
23.22	-0.217	159.8	-4.3903
23.25	-0.226	148.3	-4.3903
23.28	-0.23	148.3	-4.8572
23.32	-0.23	140	-5.2717
23.35	-0.232	134.5	-5.6072
23.38	-0.232	131	-5.8735
23.42	-0.231	130.1	-6.0493
23.45	-0.228	132.6	-6.1345
23.48	-0.22	136.6	-6.1345
23.52	-0.215	136.6	-6.1602
23.55	-0.215	140.2	-6.1647
23.58	-0.21	146.7	-6.1576
23.62	-0.192	154.4	-6.1398
23.65	-0.185	160	-6.1221
23.68	-0.173	171.1	-6.0928
23.72	-0.149	182.3	-6.0928
23.77	-0.141	188.9	-6.0253
23.80	-0.135	197.2	-5.9907
23.83	-0.107	210.9	-5.9907
23.85	-0.094	210.9	-5.925
23.88	-0.094	219.6	-5.8629
23.92	-0.078	235.4	-5.7617
23.95	-0.043	252.4	-5.6356
23.98	-0.03	261	-5.5371
24.02	-0.011	277	-5.3551
24.05	0.023	293	-5.3551
24.08	0.036	293	-5.1297
24.12	0.036	300.7	-4.9539
24.15	0.049	311.4	-4.6779



Prova triassiale ciclica SN04-C2			
pressione di confinamento (kPa)		250	
deviatore ciclico (kPa)		230	
frequenza (hz)		0.00625	
tempo	cella di carico	u	LVDT
(min)	kN	(kPa)	$\delta$ (mm)
24.18	0.077	324.7	-4.1675
24.22	0.097	335.2	-3.563
24.25	0.113	346.3	-2.8218
24.28	0.138	357.8	-2.8218
24.32	0.158	357.8	-1.762
24.35	0.158	365.9	-0.7021
24.38	0.176	373	0.2246
24.42	0.199	378.4	1.0749
24.45	0.215	381.2	1.6643
24.48	0.226	384.2	2.0931
24.52	0.243	385.9	2.0931
24.55	0.253	385.9	2.52
24.58	0.253	385.9	2.8564
24.62	0.257	386.3	3.089
24.65	0.267	386.5	3.3216
24.68	0.27	385.6	3.5035
24.72	0.27	384.8	3.6242
24.75	0.269	383.8	3.6242
24.78	0.264	383.8	3.6917
24.82	0.264	383	3.7228
24.85	0.262	381.7	3.7379
24.88	0.25	379.6	3.7379
24.92	0.244	377.9	3.7334
24.95	0.233	373.3	3.7254
24.98	0.209	369	3.7254
25.02	0.202	369	3.7121
25.05	0.202	366.7	3.7006
25.08	0.188	360.1	3.6793
25.12	0.155	353.2	3.6509
25.15	0.146	350	3.6278
25.18	0.13	341.4	3.5834
25.23	0.09	331	3.523
25.27	0.086	328.8	3.4973
25.28	0.07	319.9	3.4236
25.32	0.031	306.7	3.4236
25.35	0.015	306.7	3.3127
25.38	0.015	300.7	3.2319
25.42	-0.001	290.5	3.097
25.45	-0.037	273.7	2.8609
25.48	-0.059	266.3	2.5076
25.52	-0.075	259.2	2.0114
25.55	-0.099	249.5	2.0114
25.58	-0.119	249.5	1.1468
25.62	-0.119	241.8	-0.0586
25.65	-0.132	231.2	-1.4167
25.68	-0.153	210.9	-3.0189
25.72	-0.176	183.4	-4.4666
25.75	-0.189	165.5	-5.2983
25.78	-0.196	156.5	-5.2983
25.82	-0.2	156.5	-5.7244
25.85	-0.2	150.3	-6.0475
25.88	-0.205	141.6	-6.4416
25.92	-0.213	127.3	-7.0532
25.95	-0.218	113.6	-7.797
25.98	-0.222	100.8	-8.6243
26.02	-0.223	90.2	-8.6243
26.05	-0.222	90.2	-9.4294
26.08	-0.222	83	-10.1049

Prova triassiale ciclica SN04-C2			
pressione di confinamento (kPa)		250	
deviatore ciclico (kPa)		230	
frequenza (hz)		0.00625	
tempo	cella di carico	u	LVDT
(min)	kN	(kPa)	$\delta$ (mm)
26.12	-0.22	79.9	-10.602
26.15	-0.21	84.9	-10.7902
26.18	-0.201	92.8	-10.7973
26.22	-0.198	97.8	-10.7973
26.25	-0.19	102.8	-10.7973
26.28	-0.185	102.8	-10.7928
26.32	-0.185	107.7	-10.7795
26.35	-0.176	116.2	-10.7538
26.38	-0.149	130.8	-10.7103
26.42	-0.139	139	-10.6748
26.45	-0.127	151.1	-10.6162
26.48	-0.1	168.4	-10.6162
26.52	-0.087	168.4	-10.5443
26.55	-0.087	179	-10.4839
26.58	-0.075	192.2	-10.3881
26.62	-0.045	214	-10.2514
26.67	-0.026	227.8	-10.1333
26.70	-0.021	235.6	-10.049
26.73	0.001	253.5	-9.8359
26.75	0.024	273.7	-9.4658
26.78	0.04	290.6	-9.0158
26.82	0.063	312.7	-9.0158
26.85	0.082	331.6	-8.2524
26.88	0.082	331.6	-7.2795
26.92	0.098	345.8	-6.1966
26.95	0.12	361.6	-4.6131
26.98	0.145	373.5	-2.8174
27.02	0.167	380.6	-1.1921
27.05	0.191	385.3	-1.1921
27.08	0.209	385.2	0.261
27.12	0.209	385.2	1.2303
27.15	0.217	383.8	1.8161
27.18	0.234	382	2.5014
27.22	0.25	376	3.1289
27.25	0.258	372	3.5603
27.28	0.267	370.1	3.5603
27.32	0.27	368.2	3.8994
27.35	0.27	368.2	4.1258
27.38	0.271	367.4	4.2775
27.42	0.271	366.6	4.3823
27.45	0.274	366.3	4.4844
27.48	0.27	364.8	4.519
27.52	0.254	362.7	4.519
27.55	0.247	361.6	4.5199
27.58	0.247	361.6	4.5172
27.62	0.24	359.7	4.511
27.65	0.22	355.2	4.5021
27.68	0.211	353.2	4.4915
27.72	0.198	348.7	4.4737
27.75	0.167	340.9	4.4737
27.78	0.155	337.8	4.4471
27.82	0.155	337.8	4.4267
27.85	0.14	331.9	4.3867
27.88	0.103	320.5	4.329
27.92	0.086	315.5	4.2846
27.95	0.071	308.8	4.2145
27.98	0.034	294	4.2145
28.02	0.012	287.2	4.1036

Prova triassiale ciclica SN04-C2			
pressione di confinamento (kPa)		250	
deviatore ciclico (kPa)		230	
frequenza (hz)		0.00625	
tempo	cella di carico	u	LVDT
(min)	kN	(kPa)	$\delta$ (mm)
28.05	0.012	287.2	4.0139
28.08	-0.001	279.5	3.8923
28.13	-0.049	259.9	3.6757
28.17	-0.049	259.9	3.4511
28.18	-0.063	257.7	3.0331
28.22	-0.089	250.5	2.149
28.25	-0.111	247.7	0.837
28.28	-0.123	241.9	-0.7137
28.32	-0.139	224.6	-0.7137
28.35	-0.159	191.2	-2.9337
28.38	-0.159	191.2	-5.5939
28.42	-0.176	149.3	-8.1246
28.45	-0.191	112.1	-10.1972
28.48	-0.178	115.6	-10.8292
28.52	-0.174	123.3	-10.8461
28.55	-0.175	126.6	-10.8461
28.58	-0.172	129.6	-10.8621
28.62	-0.172	129.6	-10.8772
28.65	-0.172	131.4	-10.8958
28.68	-0.173	132.1	-10.9127
28.72	-0.173	133.8	-10.9286
28.75	-0.171	135.3	-10.9428
28.78	-0.171	136.7	-10.9428
28.82	-0.17	138.2	-10.9535
28.85	-0.17	138.2	-10.9615
28.88	-0.169	139.7	-10.9677
28.92	-0.168	141.2	-10.9704
28.95	-0.167	142.6	-10.9739
28.98	-0.166	144.1	-10.9748
29.02	-0.164	145.6	-10.9757
29.05	-0.163	147.1	-10.9757
29.08	-0.161	147.1	-10.9757
29.12	-0.161	148.9	-10.9721
29.15	-0.154	153.1	-10.9677
29.18	-0.147	157	-10.957
29.22	-0.14	161.7	-10.934
29.25	-0.125	171.5	-10.9073
29.28	-0.112	179	-10.9073
29.32	-0.1	179	-10.8727
29.35	-0.1	189.5	-10.7937
29.38	-0.05	238.7	-10.4227
29.42	0.02	287.1	-9.6424
29.45	0.044	310.3	-8.9084
29.48	0.062	331.8	-7.8467
29.52	0.083	349.8	-7.8467
29.55	0.103	349.8	-6.3795
29.60	0.119	371.2	-3.3189
29.63	0.139	378.2	-3.3189
29.65	0.157	378.2	-1.8312
29.68	0.157	382	-0.4589
29.72	0.175	383.9	0.8033
29.75	0.198	378.3	2.1019
29.78	0.218	368.4	3.0899
29.82	0.23	363.3	3.7121
29.85	0.248	357.3	3.7121
29.88	0.259	357.3	4.2811
29.92	0.259	352.4	4.7222
29.95	0.265	349.9	5.0436

Prova triassiale ciclica SN04-C2			
pressione di confinamento (kPa)		250	
deviatore ciclico (kPa)		230	
frequenza (hz)		0.00625	
tempo	cella di carico	u	LVDT
(min)	kN	(kPa)	$\delta$ (mm)
29.98	0.274	346.5	5.3223
30.02	0.276	344.9	5.5176
30.05	0.279	343.7	5.6729
30.08	0.279	342.6	5.6729
30.12	0.276	342.6	5.7856
30.15	0.276	342.5	5.8407
30.18	0.271	341.5	5.8558
30.22	0.257	341	5.854
30.25	0.251	340.4	5.8504
30.28	0.24	336.4	5.8433
30.32	0.218	333.3	5.8433
30.35	0.208	333.3	5.8318
30.38	0.208	331.5	5.8194
30.42	0.191	324	5.7972
30.45	0.161	319	5.7688
30.48	0.15	316.3	5.7439
30.52	0.13	306.4	5.6995
30.55	0.093	299	5.6995
30.58	0.082	299	5.641
30.62	0.082	295.3	5.5948
30.65	0.059	282.4	5.5016
30.68	0.019	271.9	5.3933
30.72	0.007	267.4	5.3072
30.75	-0.014	253.1	5.1394
30.78	-0.047	247.5	5.1394
30.82	-0.069	247.5	4.7329
30.85	-0.069	251.4	4.0902
30.88	-0.086	251.4	3.2639
30.92	-0.107	253.3	1.833
30.95	-0.122	248.4	-0.2121
30.98	-0.134	229.1	-2.7535
31.03	-0.151	191.2	-5.8771
31.07	-0.167	143.7	-8.9066
31.08	-0.18	109.1	-10.8399
31.12	-0.154	133.5	-10.8399
31.15	-0.156	133.5	-10.839
31.18	-0.156	136.5	-10.8612
31.22	-0.156	139.3	-10.8807
31.25	-0.158	142.7	-10.902
31.28	-0.157	144.8	-10.9251
31.32	-0.156	146	-10.9428
31.35	-0.156	147.5	-10.9428
31.38	-0.155	147.5	-10.9562
31.42	-0.155	149.1	-10.9659
31.45	-0.154	150.6	-10.9739
31.48	-0.154	151.9	-10.9819
31.52	-0.154	152.9	-10.9961
31.55	-0.153	153.4	-11.0059
31.58	-0.153	154.7	-11.0059
31.62	-0.152	154.7	-11.0138
31.65	-0.152	156	-11.0201
31.68	-0.151	157.2	-11.0227
31.72	-0.15	158.7	-11.0227
31.75	-0.148	160.2	-11.0218
31.78	-0.146	162.2	-11.0192
31.82	-0.143	164.3	-11.0192
31.85	-0.14	164.3	-11.0165
31.88	-0.14	166.5	-11.013

Prova triassiale ciclica SN04-C2			
pressione di confinamento (kPa)		250	
deviatore ciclico (kPa)		230	
frequenza (hz)		0.00625	
tempo	cella di carico	u	LVDT
(min)	kN	(kPa)	$\delta$ (mm)
31.92	-0.136	169.1	-11.0085
31.95	-0.125	174.6	-10.9934
31.98	-0.117	180.3	-10.9615
32.02	-0.108	190.4	-10.9313
32.05	-0.088	198.9	-10.9313
32.08	-0.076	198.9	-10.8896
32.12	-0.076	209.1	-10.7928
32.15	-0.019	259.5	-10.2283
32.18	0.048	332.3	-8.058
32.22	0.09	366.2	-4.7569
32.25	0.127	380.8	-1.5241
32.28	0.162	382.4	-1.5241
32.32	0.18	382.4	1.1096
32.35	0.18	375.3	2.3238
32.38	0.182	374.3	2.7259
32.42	0.196	371.8	3.2825
32.45	0.217	360.9	4.1524
32.50	0.235	350.9	4.9743
32.53	0.252	342.6	5.5389
32.55	0.259	339	5.854
32.58	0.262	339.3	6.0688
32.62	0.274	336.7	6.0688
32.65	0.281	332.3	6.3493
32.68	0.281	332.3	6.6174
32.72	0.284	329.6	6.8073
32.75	0.285	328.6	6.9325
32.78	0.282	328.8	6.9928
32.82	0.277	329.2	7.0133
32.85	0.267	329.2	7.0133
32.88	0.26	329	7.0159
32.92	0.26	329	7.0141
32.95	0.252	327.4	7.007
32.98	0.228	322.9	6.9964
33.02	0.219	321.4	6.9866
33.05	0.205	317.6	6.9689
33.08	0.173	309.9	6.9689
33.12	0.161	307.8	6.9431
33.15	0.161	307.8	6.9218
33.18	0.145	302.5	6.8828
33.22	0.107	291.5	6.8277
33.25	0.089	287.7	6.7842
33.28	0.074	281.1	6.7123
33.32	0.036	266.6	6.7123
33.35	0.013	260.5	6.6049
33.38	0.013	260.5	6.5162
33.42	-0.002	253.2	6.3892
33.45	-0.036	236.9	6.1336
33.48	-0.06	247.2	5.5114
33.52	-0.078	250.6	4.8039
33.55	-0.098	253.1	4.8039
33.58	-0.116	256	3.5941
33.62	-0.116	256	1.659
33.65	-0.128	242.9	-0.9959
33.68	-0.142	208.9	-4.2988
33.72	-0.156	161.5	-7.7464
33.75	-0.17	112.3	-10.8603
33.78	-0.153	138.1	-10.8603
33.82	-0.149	143	-10.8878

Prova triassiale ciclica SN04-C2			
pressione di confinamento (kPa)		250	
deviatore ciclico (kPa)		230	
frequenza (hz)		0.00625	
tempo	cella di carico	u	LVDT
(min)	kN	(kPa)	$\delta$ (mm)
33.85	-0.149	143	-10.9011
33.88	-0.148	144.3	-10.9206
33.93	-0.148	149.7	-10.9428
33.97	-0.148	149.7	-10.9526
34.00	-0.149	150.9	-10.9677
34.02	-0.148	152.8	-10.9801
34.05	-0.148	154.7	-10.9899
34.08	-0.147	156	-11.0032
34.12	-0.149	156.4	-11.0032
34.15	-0.147	157.5	-11.0174
34.18	-0.147	157.5	-11.0325
34.22	-0.147	158.5	-11.0449
34.25	-0.147	159.2	-11.0538
34.28	-0.146	160.5	-11.0618
34.32	-0.145	161.8	-11.0671
34.35	-0.145	163	-11.0671
34.38	-0.143	164.4	-11.0689
34.42	-0.143	164.4	-11.0698
34.45	-0.142	165.9	-11.0689
34.48	-0.139	168	-11.0671
34.52	-0.135	170	-11.0636
34.55	-0.131	172.9	-11.0565
34.58	-0.125	177.2	-11.0485
34.62	-0.12	180.7	-11.0485
34.65	-0.12	180.7	-11.0387
34.68	-0.113	184.6	-11.0165
34.72	-0.097	193.7	-10.9881
34.75	-0.089	199.6	-10.9508
34.78	-0.08	207.5	-10.8914
34.82	-0.053	229.4	-10.791
34.85	0.014	291.7	-10.791
34.88	0.059	291.7	-9.7561
34.92	0.059	352.3	-7.0878
34.95	0.1	385.1	-3.3198
34.98	0.151	394.8	1.2054
35.02	0.209	356.6	4.7817
35.05	0.231	342.1	5.6649
35.08	0.218	347.7	5.6649
35.12	0.225	347.7	5.7191
35.15	0.225	352.6	5.8247
35.18	0.24	350.6	6.1478
35.22	0.261	338.5	6.7212
35.25	0.271	330.4	7.1473
35.28	0.283	325.7	7.5485
35.32	0.289	321.8	7.5485
35.35	0.289	321.8	7.8112
35.40	0.288	321.6	8.0314
35.43	0.287	321.8	8.0314
35.45	0.284	321.8	8.0944
35.48	0.284	322.6	8.1228
35.52	0.278	322.2	8.1326
35.55	0.267	322.1	8.1308
35.58	0.26	321.8	8.1264
35.62	0.247	317.6	8.1193
35.65	0.225	315	8.1193
35.68	0.217	315	8.1068
35.72	0.217	313.3	8.0944
35.75	0.196	305.8	8.0731

Prova triassiale ciclica SN04-C2			
pressione di confinamento (kPa)		250	
deviatore ciclico (kPa)		230	
frequenza (hz)		0.00625	
tempo	cella di carico	u	LVDT
(min)	kN	(kPa)	$\delta$ (mm)
35.78	0.168	301.8	8.0465
35.82	0.156	299	8.0207
35.85	0.134	289	7.9746
35.88	0.096	282.6	7.9746
35.92	0.085	282.6	7.916
35.95	0.085	278.9	7.8689
35.98	0.059	265.6	7.7766
36.02	0.022	256.8	7.6728
36.05	0.008	252	7.5822
36.08	-0.015	237.5	7.41
36.12	-0.048	236.5	7.41
36.15	-0.07	236.5	6.9307
36.18	-0.07	244.7	6.2943
36.22	-0.088	248.8	5.4137
36.25	-0.108	257.4	3.8115
36.28	-0.123	256.5	1.454
36.32	-0.134	231.9	-1.6537
36.35	-0.146	192.4	-1.6537
36.38	-0.158	192.4	-5.1039
36.42	-0.158	144.9	-8.5737
36.45	-0.167	124	-10.8878
36.48	-0.148	138.4	-10.8967
36.52	-0.147	142.4	-10.9171
36.55	-0.147	143.5	-10.9366
36.58	-0.147	146.1	-10.9366
36.62	-0.146	146.1	-10.9553
36.65	-0.146	149	-10.9712
36.68	-0.145	151.4	-10.9828
36.72	-0.145	153.2	-10.9934
36.75	-0.145	154.6	-11.0112
36.78	-0.146	155	-11.0263
36.83	-0.145	156.5	-11.0387
36.87	-0.144	158.1	-11.0494
36.90	-0.144	158.4	-11.06
36.92	-0.144	159.8	-11.06
36.95	-0.143	159.8	-11.068
36.98	-0.143	161	-11.076
37.02	-0.142	162.2	-11.0795
37.05	-0.141	163.6	-11.0822
37.08	-0.14	164.9	-11.0822
37.12	-0.138	166.7	-11.0804
37.15	-0.135	168.4	-11.0804
37.18	-0.132	168.4	-11.0778
37.22	-0.132	170.6	-11.0724
37.25	-0.127	174.3	-11.0653
37.28	-0.119	179.1	-11.0547
37.32	-0.113	182.8	-11.0423
37.35	-0.108	188.6	-11.0236
37.38	-0.093	194.5	-11.0236
37.42	-0.087	194.5	-10.9952
37.45	-0.087	200.6	-10.9464
37.48	-0.076	215.8	-10.8931
37.52	-0.044	231.4	-10.7884
37.55	0.017	300	-9.4773
37.58	0.064	368.9	-6.1815
37.62	0.116	398.9	-6.1815
37.65	0.174	398.9	-1.3723
37.68	0.174	386.7	3.5399

Prova triassiale ciclica SN04-C2			
pressione di confinamento (kPa)		250	
deviatore ciclico (kPa)		230	
frequenza (hz)		0.00625	
tempo	cella di carico	u	LVDT
(min)	kN	(kPa)	$\delta$ (mm)
37.72	0.237	333.6	6.7949
37.75	0.248	325.4	7.4455
37.78	0.232	332.9	7.458
37.82	0.238	342.3	7.5068
37.85	0.261	338.6	7.5068
37.88	0.27	338.6	7.7225
37.92	0.27	331.1	8.0083
37.95	0.276	326.7	8.279
37.98	0.288	320.6	8.5924
38.02	0.292	316.8	8.8169
38.05	0.292	315.2	8.943
38.08	0.291	315.1	8.943
38.12	0.288	315.1	9.0255
38.15	0.288	315.8	9.0664
38.18	0.284	316.2	9.0788
38.22	0.27	315.9	9.0779
38.25	0.263	315.9	9.0744
38.30	0.253	311.8	9.0655
38.33	0.236	311.5	9.0601
38.35	0.227	310.1	9.0486
38.38	0.211	303.2	9.03
38.42	0.176	298.3	9.03
38.45	0.167	298.3	9.0051
38.48	0.167	297	8.9847
38.52	0.149	288.2	8.9448
38.55	0.107	280.6	8.8906
38.58	0.095	277.9	8.8498
38.62	0.076	267.7	8.7726
38.65	0.032	255.6	8.7726
38.68	0.016	255.6	8.6625
38.72	0.016	251.5	8.5817
38.75	-0.001	240.9	8.4441
38.78	-0.04	229.5	8.1468
38.82	-0.061	241.1	7.5556
38.85	-0.079	245.9	6.8002
38.88	-0.1	254.3	6.8002
38.92	-0.117	254.3	5.5824
38.95	-0.117	261.6	3.5053
38.98	-0.129	247.1	0.5672
39.02	-0.14	213.1	-2.9399
39.05	-0.151	168	-6.6174
39.08	-0.162	119.3	-10.0836
39.12	-0.15	130.9	-10.0836
39.15	-0.146	130.9	-10.8949
39.18	-0.146	138.9	-10.9127
39.22	-0.145	140.7	-10.9322
39.25	-0.146	144.3	-10.9526
39.28	-0.145	147.4	-10.9677
39.32	-0.144	149.8	-10.9801
39.35	-0.143	151.7	-10.9801
39.38	-0.143	153.2	-10.9899
39.42	-0.143	153.2	-11.0067
39.45	-0.143	154.7	-11.0245
39.48	-0.144	155.2	-11.0387
39.52	-0.143	156.8	-11.052
39.55	-0.142	158	-11.0653
39.58	-0.142	158.8	-11.0742
39.62	-0.141	160.3	-11.0742



Prova triassiale ciclica SN04-C2			
pressione di confinamento (kPa)		250	
deviatore ciclico (kPa)		230	
frequenza (hz)		0.00625	
tempo	cella di carico	u	LVDT
(min)	kN	(kPa)	$\delta$ (mm)
39.65	-0.14	160.3	-11.0804
39.68	-0.14	161.7	-11.0866
39.72	-0.14	163	-11.0884
39.77	-0.138	165.6	-11.0893
39.80	-0.136	165.6	-11.0893
39.83	-0.136	167.1	-11.0875
39.87	-0.134	169.2	-11.0849
39.88	-0.129	171.6	-11.0795
39.92	-0.123	174.8	-11.0715
39.95	-0.117	179.8	-11.0591
39.98	-0.109	184.2	-11.0591
40.02	-0.104	184.2	-11.0449
40.05	-0.104	187.8	-11.0254
40.08	-0.091	196.3	-10.9952
40.12	-0.081	202.4	-10.9553
40.15	-0.073	210.2	-10.8905
40.18	-0.043	234	-10.8905
40.22	0.02	308.4	-10.768
40.25	0.02	308.4	-9.3069
40.28	0.068	374.5	-5.6392
40.32	0.121	409.2	-0.5281
40.35	0.181	387.6	4.6637
40.38	0.262	310.4	8.5569
40.42	0.281	296.5	8.5569
40.45	0.236	296.5	9.3939
40.48	0.236	304.7	9.3859
40.52	0.249	320	9.401
40.55	0.277	324.7	9.4844
40.58	0.286	320.7	9.6176
40.62	0.29	317.8	9.7525
40.65	0.295	315.2	9.7525
40.68	0.296	315.2	9.8901
40.72	0.296	313.5	9.9957
40.75	0.297	312.8	10.0756
40.78	0.294	312.7	10.1244
40.82	0.291	313.5	10.144
40.85	0.283	312.8	10.1475
40.88	0.271	312.5	10.1475
40.92	0.271	312.5	10.1448
40.95	0.263	311.8	10.1377
40.98	0.239	306.5	10.1271
41.02	0.228	305.3	10.1164
41.05	0.215	301.2	10.0978
41.08	0.179	293.6	10.0978
41.12	0.169	293.6	10.0712
41.15	0.169	292.1	10.0499
41.20	0.125	280.8	10.0099
41.23	0.109	280.8	9.9815
41.27	0.109	276.5	9.9451
41.30	0.088	268.3	9.8706
41.33	0.045	254.2	9.7694
41.35	0.024	249.6	9.6922
41.38	0.009	240.7	9.5768
41.42	-0.03	225.9	9.5768
41.45	-0.051	225.9	9.3655
41.48	-0.051	232	8.9545
41.52	-0.068	236.6	8.3447
41.55	-0.096	247.3	7.1641

Prova triassiale ciclica SN04-C2			
pressione di confinamento (kPa)		250	
deviatore ciclico (kPa)		230	
frequenza (hz)		0.00625	
tempo	cella di carico	u	LVDT
(min)	kN	(kPa)	$\delta$ (mm)
41.58	-0.115	259.8	5.3525
41.62	-0.127	256.7	2.8848
41.65	-0.137	228.6	2.8848
41.68	-0.146	228.6	-0.5237
41.72	-0.146	190.5	-4.1222
41.75	-0.157	144.7	-7.766
41.78	-0.166	101.7	-10.8914
41.82	-0.147	132.5	-10.9153
41.85	-0.146	137.2	-10.9313
41.88	-0.145	140	-10.9313
41.92	-0.145	140	-10.9499
41.95	-0.144	142.9	-10.9677
41.98	-0.144	145.6	-10.981
42.02	-0.143	148.2	-10.9917
42.05	-0.142	149.8	-11.0067
42.08	-0.144	151.2	-11.0067
42.12	-0.142	151.2	-11.0227
42.15	-0.142	152.8	-11.0414
42.18	-0.142	153.6	-11.0556
42.22	-0.143	155.1	-11.0671
42.25	-0.141	156.6	-11.0778
42.28	-0.14	157.7	-11.0857
42.32	-0.14	159.2	-11.0857
42.35	-0.139	160.6	-11.0902
42.38	-0.139	160.6	-11.0937
42.42	-0.138	162.1	-11.0946
42.45	-0.136	163.6	-11.0937
42.48	-0.134	165.1	-11.092
42.52	-0.132	167.1	-11.0884
42.55	-0.127	170.3	-11.0884
42.58	-0.12	174.3	-11.0831
42.62	-0.12	174.3	-11.0733
42.67	-0.107	182.9	-11.0582
42.70	-0.103	185.7	-11.0449
42.72	-0.103	185.7	-11.0343
42.75	-0.097	190.4	-11.0014
42.78	-0.078	200.4	-10.965
42.82	-0.071	207.6	-10.9109
42.85	-0.061	218.2	-10.8053
42.88	0.005	289.5	-9.733
42.92	0.064	371.6	-9.733
42.95	0.064	371.6	-6.1114
42.98	0.111	403.3	-1.1903
43.02	0.169	402.3	4.1835
43.05	0.249	327.9	8.8631
43.08	0.288	291	10.1093
43.12	0.255	302.1	10.1147
43.15	0.246	311.1	10.1147
43.18	0.246	311.1	10.1218
43.22	0.262	320.4	10.1741
43.25	0.284	321.6	10.3348
43.28	0.295	313.7	10.5603
43.32	0.297	309.9	10.7263
43.35	0.301	307.5	10.8745
43.38	0.302	305.8	10.8745
43.42	0.302	305.8	10.9925
43.45	0.3	306	11.0529
43.48	0.295	306.4	11.0769

Prova triassiale ciclica SN04-C2			
pressione di confinamento (kPa)		250	
deviatore ciclico (kPa)		230	
frequenza (hz)		0.00625	
tempo	cella di carico	u	LVDT
(min)	kN	(kPa)	$\delta$ (mm)
43.52	0.288	307.5	11.084
43.55	0.281	308.2	11.0813
43.58	0.264	304.8	11.0751
43.62	0.252	303.9	11.0751
43.65	0.252	303.9	11.0698
43.68	0.241	302.3	11.0565
43.72	0.216	295.7	11.0396
43.75	0.196	293.2	11.0227
43.78	0.182	290.2	10.9961
43.82	0.153	279.8	10.9562
43.85	0.124	276	10.9562
43.88	0.111	276	10.918
43.92	0.111	272.5	10.8763
43.95	0.083	259.8	10.8026
43.98	0.045	252.2	10.7156
44.02	0.032	248.1	10.6393
44.05	0.006	233.6	10.5008
44.10	-0.033	222.6	10.3037
44.13	-0.038	228.6	10.0987
44.17	-0.06	229.4	9.5572
44.18	-0.091	241.4	9.5572
44.22	-0.109	241.4	8.5098
44.25	-0.109	256.3	7.0417
44.28	-0.123	261.6	4.9637
44.32	-0.135	242.8	1.762
44.35	-0.143	208.3	-1.7762
44.38	-0.151	166.6	-5.4688
44.42	-0.16	121.8	-5.4688
44.45	-0.151	121.8	-9.2119
44.48	-0.151	120.6	-10.9189
44.52	-0.146	132.5	-10.934
44.55	-0.144	136.4	-10.9499
44.58	-0.143	139.6	-10.9677
44.62	-0.143	142.3	-10.9819
44.65	-0.142	145.1	-10.9819
44.68	-0.141	145.1	-10.9943
44.72	-0.141	147.5	-11.0076
44.75	-0.142	148.6	-11.0254
44.78	-0.142	150.4	-11.0423
44.82	-0.141	151.9	-11.0618
44.85	-0.141	152.8	-11.0742
44.88	-0.141	154.5	-11.0742
44.92	-0.14	154.5	-11.0857
44.95	-0.14	156	-11.0955
44.98	-0.139	157.1	-11.1008
45.02	-0.138	158.6	-11.1044
45.05	-0.138	160	-11.107
45.08	-0.136	161.5	-11.107
45.12	-0.134	163.1	-11.107
45.15	-0.132	163.1	-11.1062
45.18	-0.132	164.7	-11.1035
45.22	-0.129	167.4	-11.0999
45.25	-0.123	170.6	-11.0928
45.28	-0.116	174.7	-11.0804
45.32	-0.109	179.9	-11.0636
45.35	-0.102	183.9	-11.0636
45.38	-0.096	183.9	-11.0485
45.42	-0.096	188.3	-11.0201

Prova triassiale ciclica SN04-C2			
pressione di confinamento (kPa)		250	
deviatore ciclico (kPa)		230	
frequenza (hz)		0.00625	
tempo	cella di carico	u	LVDT
(min)	kN	(kPa)	$\delta$ (mm)
45.45	-0.083	197.8	-10.9837
45.48	-0.071	204.6	-10.9419
45.52	-0.063	214.2	-10.8532
45.57	-0.025	265.6	-10.2682
45.60	0.032	329.3	-8.6075
45.62	0.076	386.5	-4.7489
45.65	0.124	414.5	0.2725
45.68	0.181	394.9	0.2725
45.72	0.26	394.9	5.6232
45.75	0.26	316	9.8359
45.78	0.283	295.3	10.7458
45.82	0.247	305.8	10.7502
45.85	0.258	317.6	10.7795
45.88	0.272	323.3	10.8887
45.92	0.291	312.9	10.8887
45.95	0.301	312.9	11.1541
45.98	0.301	303.6	11.4674
46.02	0.305	298.9	11.7098
46.05	0.306	297.1	11.8669
46.08	0.305	297.4	11.9574
46.12	0.303	298	12.0027
46.15	0.295	299.6	12.0027
46.18	0.289	299.6	12.0178
46.22	0.289	300.9	12.0204
46.25	0.28	299	12.016
46.28	0.258	297.3	12.0089
46.32	0.25	296.6	12
46.35	0.236	291.4	11.9867
46.38	0.206	287.9	11.9867
46.42	0.195	287.9	11.9681
46.45	0.195	286.1	11.9485
46.48	0.174	277.3	11.9148
46.52	0.135	272	11.8722
46.55	0.123	269.4	11.8349
46.58	0.1	258.2	11.7701
46.62	0.056	250	11.7701
46.65	0.043	250	11.6858
46.68	0.043	246.5	11.6183
46.72	0.02	233.4	11.4958
46.75	-0.025	221.8	11.3041
46.78	-0.039	223.4	11.0502
46.82	-0.06	226.2	10.4946
46.85	-0.091	239.6	10.4946
46.88	-0.111	239.6	9.4321
46.92	-0.111	256.3	7.892
46.95	-0.124	262.3	5.7697
46.98	-0.136	241.9	2.5804
47.03	-0.144	208.2	-0.9569
47.07	-0.151	170.2	-4.5332
47.08	-0.159	128.8	-8.216
47.12	-0.165	107.6	-10.8967
47.15	-0.145	127.2	-10.9162
47.18	-0.144	132.6	-10.9162
47.22	-0.143	132.6	-10.934
47.25	-0.143	135.7	-10.9544
47.28	-0.142	138	-10.9712
47.32	-0.141	141.3	-10.9863
47.35	-0.141	144.2	-10.9988

Prova triassiale ciclica SN04-C2			
pressione di confinamento (kPa)		250	
deviatore ciclico (kPa)		230	
frequenza (hz)		0.00625	
tempo	cella di carico	u	LVDT
(min)	kN	(kPa)	$\delta$ (mm)
47.38	-0.14	145.4	-11.0147
47.42	-0.141	147	-11.0147
47.45	-0.14	147	-11.0316
47.48	-0.14	148.5	-11.0529
47.52	-0.14	149.4	-11.0671
47.55	-0.14	151.3	-11.0786
47.58	-0.139	152.8	-11.092
47.62	-0.138	154	-11.0982
47.65	-0.138	155.6	-11.0982
47.68	-0.137	155.6	-11.1026
47.72	-0.137	157	-11.1062
47.75	-0.136	158.4	-11.107
47.78	-0.134	159.9	-11.107
47.82	-0.133	161.5	-11.1044
47.85	-0.131	163.8	-11.1017
47.88	-0.125	166.4	-11.1017
47.92	-0.119	166.4	-11.0973
47.95	-0.119	170	-11.0884
47.98	-0.112	174.9	-11.0715
48.02	-0.104	179.6	-11.0556
48.05	-0.099	183.3	-11.0352
48.08	-0.092	192.6	-11.0023
48.12	-0.076	198.5	-11.0023
48.15	-0.068	198.5	-10.965
48.18	-0.068	206.6	-10.8914
48.22	-0.054	228.7	-10.7236
48.25	0.023	318.7	-8.9048
48.28	0.077	390.5	-4.4568
48.32	0.128	415.3	1.0234
48.35	0.188	392.9	1.0234
48.38	0.27	392.9	6.5295
48.42	0.27	308.2	10.9544
48.47	0.264	295.4	11.913
48.50	0.257	305.1	11.921
48.52	0.257	305.1	11.9317
48.55	0.271	315.7	11.9823
48.58	0.295	311.5	12.1713
48.62	0.304	302	12.4119
48.65	0.307	298.4	12.5796
48.68	0.31	296.3	12.5796
48.72	0.311	295.4	12.735
48.75	0.311	295.4	12.8424
48.78	0.309	295.6	12.9027
48.82	0.303	296.5	12.9276
48.85	0.297	298	12.9338
48.88	0.29	298	12.9312
48.92	0.268	295.4	12.9312
48.95	0.26	294.9	12.9249
48.98	0.26	294.9	12.9187
49.02	0.249	292.5	12.9063
49.05	0.217	286.5	12.8894
49.08	0.205	285.2	12.8735
49.12	0.188	281	12.8451
49.15	0.149	271.6	12.8451
49.18	0.131	269	12.8042
49.22	0.131	269	12.7714
49.25	0.115	264.1	12.719
49.28	0.075	250.5	12.6391

Prova triassiale ciclica SN04-C2			
pressione di confinamento (kPa)		250	
deviatore ciclico (kPa)		230	
frequenza (hz)		0.00625	
tempo	cella di carico	u	LVDT
(min)	kN	(kPa)	$\delta$ (mm)
49.32	0.048	245.9	12.5717
49.35	0.033	240.1	12.4758
49.38	-0.004	224.4	12.4758
49.42	-0.036	217.5	12.3178
49.45	-0.036	217.5	12.1261
49.48	-0.049	223.7	11.7497
49.52	-0.077	228.2	10.9739
49.55	-0.103	246	9.6646
49.58	-0.119	260.5	7.8654
49.62	-0.133	252.8	7.8654
49.65	-0.143	222.8	5.0285
49.68	-0.143	222.8	1.4797
49.72	-0.149	186.4	-2.2395
49.75	-0.156	144.9	-6.0963
49.78	-0.163	101.7	-10.0943
49.82	-0.15	118.7	-10.934
49.85	-0.144	126.5	-10.934
49.88	-0.143	131.1	-10.9464
49.93	-0.142	134.1	-10.9775
49.97	-0.141	137.4	-10.9775
49.98	-0.14	139.9	-10.9872
50.02	-0.14	139.9	-10.9988
50.05	-0.14	142.1	-11.013
50.08	-0.142	143.3	-11.0307
50.12	-0.14	145.2	-11.0502
50.15	-0.14	146.7	-11.0671
50.18	-0.141	147.8	-11.0671
50.22	-0.139	149.5	-11.0795
50.25	-0.139	149.5	-11.092
50.28	-0.139	151	-11.1008
50.32	-0.139	152.3	-11.1062
50.35	-0.138	153.7	-11.1115
50.38	-0.137	155.2	-11.1142
50.42	-0.135	156.7	-11.1142
50.45	-0.134	158.2	-11.1142
50.48	-0.131	158.2	-11.1124
50.52	-0.131	159.9	-11.1097
50.55	-0.128	162.7	-11.1062
50.58	-0.122	165.5	-11.0999
50.62	-0.116	169.5	-11.0875
50.65	-0.108	175	-11.0698
50.68	-0.101	179.3	-11.0698
50.72	-0.096	179.3	-11.0529
50.75	-0.096	183.2	-11.028
50.78	-0.085	192.3	-10.9925
50.82	-0.072	198.8	-10.9535
50.85	-0.065	208.3	-10.8718
50.88	-0.037	250.3	-10.4404
50.92	0.043	353.6	-10.4404
50.95	0.091	353.6	-7.5911
50.98	0.091	404.8	-2.7579
51.02	0.143	420.6	2.7606
51.05	0.204	379.7	8.2675
51.08	0.289	287.4	12.3586
51.12	0.3	273.7	13.0758
51.15	0.255	284.9	13.0758
51.18	0.269	284.9	13.0687
51.22	0.269	299	13.0918

Prova triassiale ciclica SN04-C2			
pressione di confinamento (kPa)		250	
deviatore ciclico (kPa)		230	
frequenza (hz)		0.00625	
tempo	cella di carico	u	LVDT
(min)	kN	(kPa)	$\delta$ (mm)
51.25	0.289	308.3	13.1753
51.28	0.311	300	13.4007
51.32	0.314	294.3	13.5747
51.37	0.314	293.4	13.6839
51.40	0.315	293.6	13.7655
51.43	0.314	293.8	13.825
51.45	0.313	294.8	13.8623
51.48	0.304	295.4	13.8623
51.52	0.298	295.4	13.8738
51.55	0.298	296.3	13.8738
51.58	0.29	294.3	13.8703
51.62	0.264	292	13.8614
51.65	0.26	292.3	13.8552
51.68	0.244	285.4	13.8383
51.72	0.207	281.4	13.8383
51.75	0.198	281.4	13.8161
51.78	0.198	280.2	13.801
51.82	0.179	271.8	13.77
51.85	0.139	266.5	13.7283
51.88	0.127	264.3	13.6945
51.92	0.104	252.7	13.6271
51.95	0.055	243.7	13.6271
51.98	0.044	243.7	13.5383
52.02	0.044	241.3	13.4779
52.05	0.022	228.2	13.3563
52.08	-0.024	215.4	13.1682
52.12	-0.041	216.8	12.9187
52.15	-0.065	220.3	12.3267
52.18	-0.094	233.7	12.3267
52.22	-0.114	233.7	11.3414
52.25	-0.114	250.9	9.8901
52.28	-0.128	259.7	7.8104
52.32	-0.14	240.8	4.6557
52.35	-0.148	209.5	1.0652
52.38	-0.153	172.8	-2.6745
52.42	-0.159	132.1	-2.6745
52.45	-0.165	132.1	-6.66
52.48	-0.165	91.1	-10.6615
52.52	-0.148	116	-10.9411
52.55	-0.144	122.2	-10.9544
52.58	-0.143	125.5	-10.9686
52.62	-0.142	129.1	-10.9846
52.65	-0.141	132.7	-10.9846
52.68	-0.141	132.7	-10.9961
52.72	-0.141	135.8	-11.0103
52.75	-0.141	137.1	-11.0289
52.78	-0.142	139	-11.044
52.83	-0.14	140.6	-11.0644
52.87	-0.139	142.1	-11.0715
52.88	-0.14	143.9	-11.084
52.92	-0.139	145.6	-11.0955
52.95	-0.139	146.9	-11.1017
52.98	-0.139	148.4	-11.1017
53.02	-0.138	148.4	-11.1079
53.05	-0.138	149.9	-11.1115
53.08	-0.136	151.4	-11.1124
53.12	-0.135	153	-11.1115
53.15	-0.133	154.8	-11.1088

Prova triassiale ciclica SN04-C2			
pressione di confinamento (kPa)		250	
deviatore ciclico (kPa)		230	
frequenza (hz)		0.00625	
tempo	cella di carico	u	LVDT
(min)	kN	(kPa)	$\delta$ (mm)
53.18	-0.13	157.1	-11.1062
53.22	-0.125	159.8	-11.1062
53.25	-0.119	159.8	-11.1017
53.28	-0.119	163.4	-11.092
53.32	-0.112	168.3	-11.0751
53.35	-0.104	173.2	-11.0573
53.38	-0.099	176.9	-11.0387
53.42	-0.092	186	-11.0067
53.45	-0.076	191.7	-11.0067
53.48	-0.069	191.7	-10.9686
53.52	-0.069	199.4	-10.8976
53.55	-0.056	223.5	-10.7626
53.58	0.02	309.1	-9.1063
53.62	0.071	387	-4.8439
53.65	0.12	416.7	0.6506
53.68	0.178	405	0.6506
53.72	0.249	405	6.3289
53.75	0.249	331.9	11.3192
53.78	0.315	264.1	13.8002
53.82	0.277	276	13.9537
53.85	0.271	289.8	13.9644
53.88	0.285	302.5	14.0034
53.92	0.313	299.4	14.0034
53.95	0.316	299.4	14.1818
53.98	0.316	293.8	14.3514
54.02	0.314	293.9	14.4437
54.05	0.317	294.6	14.5254
54.08	0.318	293.9	14.6017
54.12	0.316	293.7	14.6434
54.15	0.309	294.4	14.6434
54.18	0.301	294.4	14.6585
54.22	0.301	295.5	14.6603
54.27	0.28	294.1	14.6567
54.30	0.269	294.1	14.6532
54.33	0.269	292.9	14.6461
54.35	0.255	287.9	14.6336
54.38	0.22	283.4	14.6159
54.42	0.211	282.4	14.6017
54.45	0.194	275.4	14.5724
54.48	0.15	268.2	14.5724
54.52	0.139	268.2	14.5333
54.55	0.139	266.4	14.5032
54.58	0.117	257.2	14.4446
54.62	0.071	246.2	14.3647
54.65	0.055	243.2	14.3061
54.68	0.034	233.3	14.2005
54.72	-0.009	219	14.2005
54.75	-0.035	219	14.0398
54.78	-0.035	213.5	13.8596
54.82	-0.051	216.8	13.4557
54.85	-0.083	223.2	12.6693
54.88	-0.107	240.8	11.4541
54.92	-0.122	254.4	9.7667
54.95	-0.137	251.7	9.7667
54.98	-0.149	251.7	7.0425
55.02	-0.149	223.6	3.5532
55.05	-0.154	190	-0.1491
55.08	-0.159	152.9	-3.9837



Prova triassiale ciclica SN04-C2			
pressione di confinamento (kPa)		250	
deviatore ciclico (kPa)		230	
frequenza (hz)		0.00625	
tempo	cella di carico	u	LVDT
(min)	kN	(kPa)	$\delta$ (mm)
55.12	-0.166	112.5	-8.0678
55.15	-0.169	102.2	-10.9118
55.18	-0.151	116.3	-10.9118
55.22	-0.148	116.3	-10.9437
55.25	-0.148	121.3	-10.9588
55.28	-0.147	124.6	-10.973
55.32	-0.146	128	-10.9863
55.35	-0.145	131.4	-10.9979
55.38	-0.144	133.8	-11.0103
55.42	-0.146	135.8	-11.0103
55.45	-0.144	135.8	-11.0263
55.48	-0.144	137.7	-11.0458
55.52	-0.144	138.7	-11.0591
55.55	-0.145	140.7	-11.0707
55.58	-0.143	142.4	-11.0831
55.62	-0.143	143.8	-11.0902
55.65	-0.142	145.6	-11.0902
55.68	-0.141	145.6	-11.0937
55.73	-0.14	148.7	-11.0973
55.77	-0.138	150.3	-11.0973
55.78	-0.137	151.9	-11.0973
55.82	-0.137	151.9	-11.0955
55.85	-0.135	153.9	-11.0928
55.88	-0.13	156.8	-11.0884
55.92	-0.124	160.6	-11.0795
55.95	-0.117	165.1	-11.0644
55.98	-0.11	169.4	-11.0644
56.02	-0.105	173.4	-11.0502
56.05	-0.105	173.4	-11.0298
56.08	-0.097	180.3	-10.9952
56.12	-0.078	189.5	-10.9597
56.15	-0.072	197.8	-10.8931
56.18	-0.059	213.8	-10.7112
56.22	0.021	312	-10.7112
56.25	0.074	388.4	-8.959
56.28	0.074	388.4	-4.6805
56.32	0.122	414.3	0.6959
56.35	0.178	408.4	6.1975
56.38	0.242	347.2	11.1053
56.42	0.29	292.9	13.351
56.45	0.278	302.1	13.351
56.48	0.263	312.6	13.5632
56.52	0.263	312.6	13.5738
56.52	0.263	312.6	13.5738

# SN04-C2 PROVA TXC

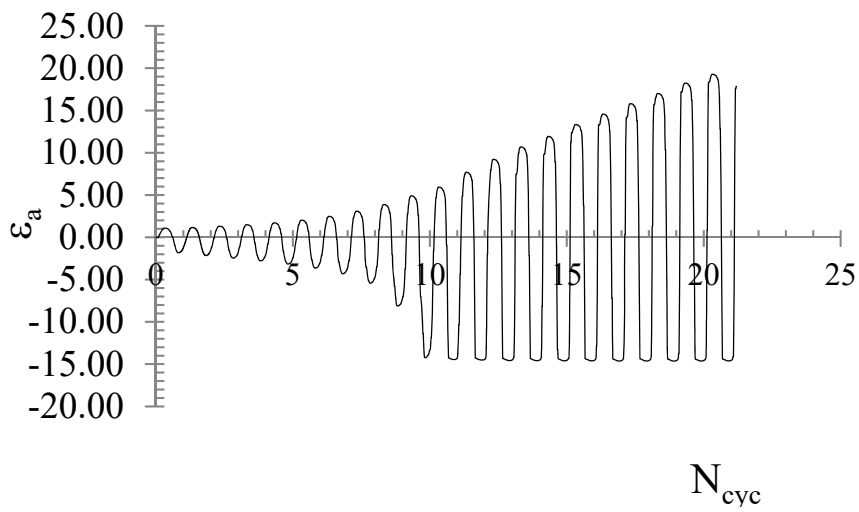
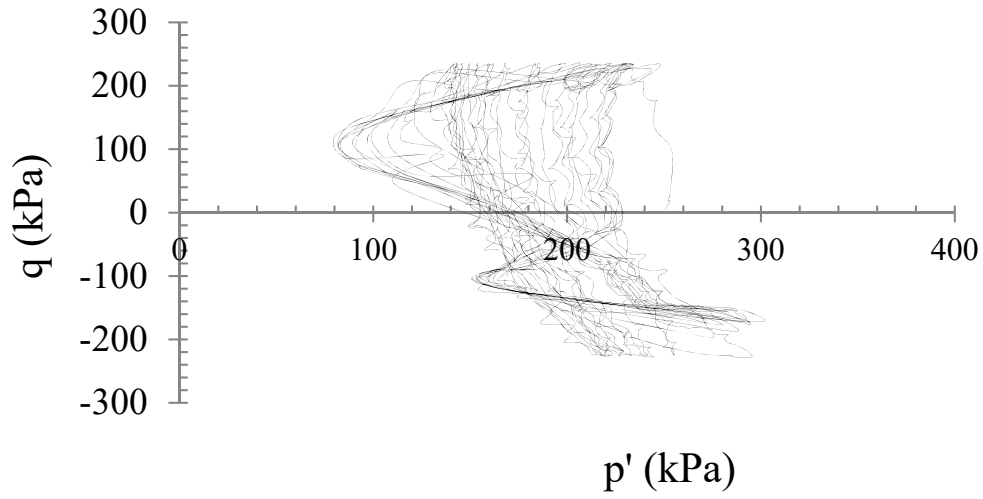
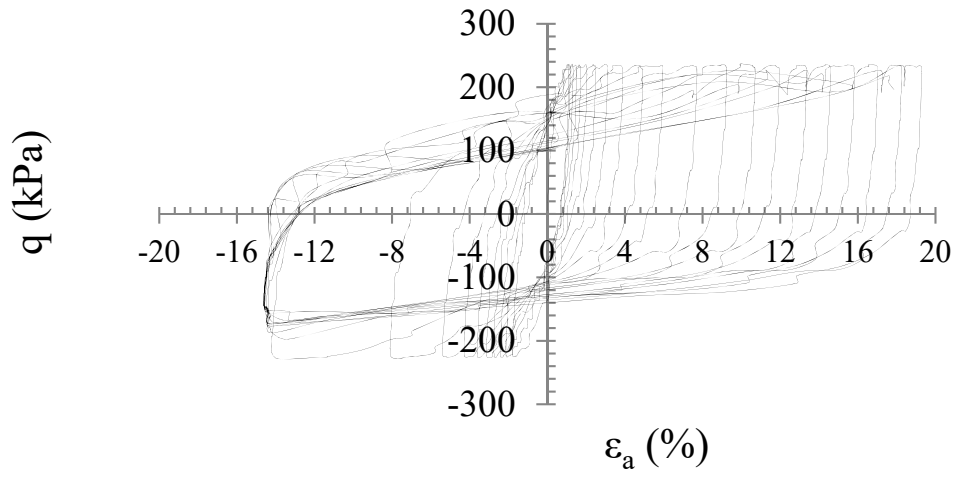

# SN04-C2 PROVA TXC

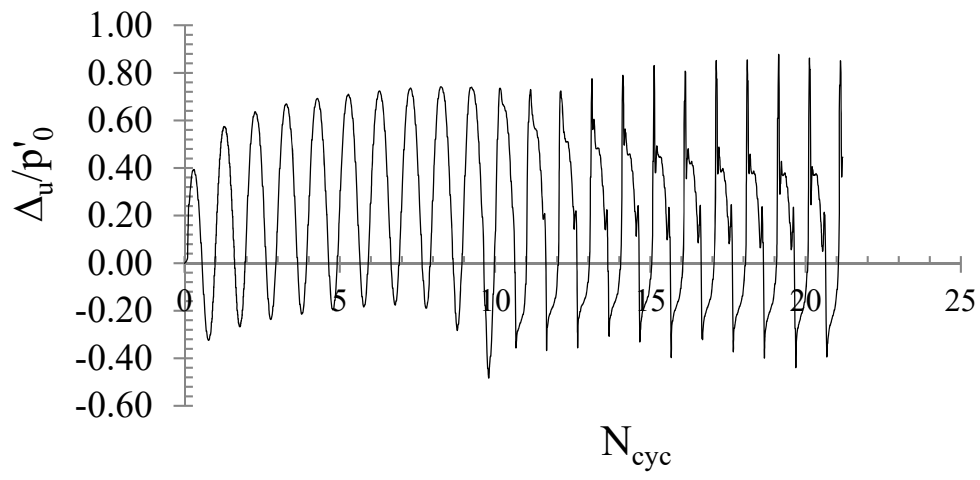



Università degli Studi di Napoli Federico II  
Dipartimento di Ingegneria Idraulica,  
Geotecnica ed Ambientale

Prova Compressione Triassiale n.		Celle n.
Prova tipo	CU (consolidata non drenata)	
Committente	Consorzio Hirpinia AV	
Indagine	I lotto funzionale Apice-Hirpinia	
Sondaggio	SN04	
Campione	2	
Profondità	11.50 ÷ 12.00 m	

Provino 1			Provino 2			Provino 3		
Condizioni inizio prova			Condizioni inizio prova			Condizioni inizio prova		
altezza ho	mm	72.10	altezza ho	mm	72.10	altezza ho	mm	72.10
diametro d	mm	35.51	diametro d	mm	35.31	diametro d	mm	35.51
peso umido iniziale	g	159.05	peso umido iniziale	g	157.25	peso umido iniziale	g	159.05
Peso specifico $\gamma_s$	kN/m <sup>3</sup>	27.31	Peso specifico $\gamma_s$	kN/m <sup>3</sup>	27.31	Peso specifico $\gamma_s$	kN/m <sup>3</sup>	27.31
Peso secco dell'udv $\gamma_d$	kN/m <sup>3</sup>	19.45	Peso secco dell'udv $\gamma_d$	kN/m <sup>3</sup>	19.21	Peso secco dell'udv $\gamma_d$	kN/m <sup>3</sup>	19.45
Contenuto d'acqua w		0.124	Contenuto d'acqua w		0.125	Contenuto d'acqua w		0.124
Peso umido dell'udv $\gamma$	kN/m <sup>3</sup>	21.85	Peso umido dell'udv $\gamma$	kN/m <sup>3</sup>	21.60	Peso umido dell'udv $\gamma$	kN/m <sup>3</sup>	21.85
Indice dei vuoti e		0.404	Indice dei vuoti e		0.422	Indice dei vuoti e		0.404
Grado di saturazione Sr		0.9	Grado di saturazione Sr		0.8	Grado di saturazione Sr		0.9
Condizioni fine prova			Condizioni fine prova			Condizioni fine prova		
Pesafiltro n° 40	g	14.18	Pesafiltro n° 20	g	20.89	Pesafiltro n° 23	g	14.18
Pf + prov. umido	g	174.45	Pf + prov. umido	g	179.74	Pf + prov. umido	g	174.45
Pf + prov.secco	g	155.73	Pf + prov.secco	g	160.71	Pf + prov.secco	g	155.73
Peso secco dell'udv $\gamma_d$	kN/m <sup>3</sup>	19.89	Peso secco dell'udv $\gamma_d$	kN/m <sup>3</sup>	19.81	Peso secco dell'udv $\gamma_d$	kN/m <sup>3</sup>	19.46
Contenuto d'acqua w		0.132	Contenuto d'acqua w		0.136	Contenuto d'acqua w		0.132
Peso umido dell'udv $\gamma$	kN/m <sup>3</sup>	22.52	Peso umido dell'udv $\gamma$	kN/m <sup>3</sup>	22.50	Peso umido dell'udv $\gamma$	kN/m <sup>3</sup>	22.03
Indice dei vuoti e		0.373	Indice dei vuoti e		0.379	Indice dei vuoti e		0.404
Grado di saturazione Sr		1.0	Grado di saturazione Sr		1.0	Grado di saturazione Sr		0.9

Consolidazione			Consolidazione			Consolidazione		
Pressione di cella $\sigma_c$	kPa	800	Pressione di cella $\sigma_c$	kPa	600	Pressione di cella $\sigma_c$	kPa	450
Contropressione $u_0$	kPa	200	Contropressione $u_0$	kPa	200	Contropressione $u_0$	kPa	200
Tensione effettiva $\sigma'_c$	kPa	600	Tensione effettiva $\sigma'_c$	kPa	400	Tensione effettiva $\sigma'_c$	kPa	250
Data & ora	t	$\Delta V$	Data & ora	t	$\Delta V$	Data & ora	t	$\Delta V$
(gg-hh-min)	(min)	(cmc)	(gg-hh-min)	(min)	(cmc)	(gg-hh-min)	(min)	(cmc)
	0	0		0	0		0	0
	0.13	0.369		0.13	0.285		0.133	0.222
	0.27	0.372		0.27	0.292		0.267	0.224
	0.52	0.377		0.52	0.299		0.517	0.224
	1	0.382		1	0.312		1	0.222
	2	0.387		2	0.325		2	0.222
	4	0.389		4	0.332		4	0.217
	8	0.396		8	0.341		8	0.208
	15	0.408		15	0.352		15	0.216
	30	0.421		30	0.369		30	0.242
	60	0.463		60	0.465		60	0.365
	120	0.620		120	0.886		120	0.541
	240	0.914		240	1.205		240	0.721
	480	1.439		480	1.319		480	0.784
	960	1.554		960	1.319		960	0.799
	1254	1.550		1254	1.322		1287	0.808
<b>Volume finale Vc</b>	(cmc)	69.82	<b>Volume finale Vc</b>	(cmc)	69.24	<b>Volume finale Vc</b>	(cmc)	71.37
<b>Altezza finale hc</b>	(mm)	71.58	<b>Altezza finale hc</b>	(mm)	71.65	<b>Altezza finale hc</b>	(mm)	72.10
<b>Area finale Ac</b>	(cmq)	9.98	<b>Area finale Ac</b>	(cmq)	9.85	<b>Area finale Ac</b>	(cmq)	9.90
<b>t100</b>	(min)		<b>t100</b>	(min)		<b>t100</b>	(min)	

<b>Laboratorio di Geotecnica</b>									
Prova Compressione Triassiale n.			Prova Compressione Triassiale n.			Prova Compressione Triassiale n.			
CIU (consolidata non drenata)			CIU (consolidata non drenata)			CIU (consolidata non drenata)			
<b>Provino 1</b>			<b>Provino 2</b>			<b>Provino 3</b>			
Velocità di prova (mm/min)		0.01	Velocità di prova (mm/min)		0.01	Velocità di prova (mm/min)		0.01	
tensione di confinamento (kPa)		600	tensione di confinamento (kPa)		400	tensione di confinamento (kPa)		250	
	cella di carico	$\Delta u$	LVDT	cella di carico	$\Delta u$		LVDT	cella di carico	$\Delta u$
$\delta$ (mm)	kg	(kPa)	$\delta$ (mm)	kg	(kPa)		$\delta$ (mm)	kg	(kPa)
0	0	0	0	0	0		0.000	0.000	0.000
0.003	0.615	0.150	0.000	0.112	0.101	0.123	0.056	0.034	0.107
0.003	1.328	0.300	0.002	1.905	1.925	2.095	0.060	0.126	0.161
0.006	2.245	0.749	0.003	3.547	4.863	3.902	0.086	1.209	0.856
0.013	3.083	1.049	0.005	4.817	8.106	5.299	0.110	3.501	2.889
0.016	3.626	1.498	0.011	5.769	11.449	6.346	0.139	5.265	5.243
0.021	3.653	1.948	0.021	6.498	14.692	7.148	0.165	6.625	7.544
0.027	3.546	2.098	0.034	7.058	17.630	7.763	0.193	7.834	9.898
0.031	3.541	2.397	0.045	7.542	20.366	8.297	0.220	8.891	12.252
0.038	3.666	2.547	0.057	7.954	22.798	8.749	0.248	9.798	14.660
0.043	3.873	2.847	0.067	8.327	25.027	9.159	0.275	10.705	16.907
0.047	4.275	3.296	0.079	8.682	27.154	9.550	0.303	11.511	19.261
0.052	4.574	3.596	0.091	9.018	29.079	9.920	0.331	12.291	21.455
0.058	4.976	4.046	0.102	9.353	30.903	10.289	0.361	13.073	23.649
0.062	5.238	4.495	0.115	9.653	33.031	10.618	0.390	13.702	25.682
0.067	5.570	4.945	0.127	9.876	34.247	10.864	0.416	14.408	27.769
0.074	5.771	5.544	0.138	10.176	35.665	11.193	0.445	14.987	29.962
0.079	5.962	5.994	0.150	10.474	37.084	11.521	0.474	15.591	31.835
0.083	6.187	6.593	0.164	10.717	38.401	11.788	0.503	16.145	33.815
0.089	6.401	7.042	0.175	10.960	39.617	12.056	0.530	16.775	35.687
0.094	6.695	7.642	0.187	11.183	40.833	12.302	0.559	17.355	37.506
0.098	6.864	8.091	0.199	11.408	41.846	12.549	0.585	17.934	39.379
0.104	7.111	8.691	0.213	11.632	42.961	12.795	0.614	18.438	41.091
0.110	7.313	9.290	0.224	11.856	43.873	13.042	0.643	18.916	42.857
0.114	7.466	9.889	0.237	12.062	44.886	13.268	0.671	19.370	44.462
0.120	7.705	10.339	0.249	12.285	45.798	13.514	0.700	19.848	45.960
0.126	7.882	10.938	0.261	12.510	46.608	13.761	0.729	20.326	47.672
0.131	8.130	11.538	0.275	12.696	47.318	13.966	0.756	20.831	49.170
0.136	8.283	12.137	0.286	12.902	48.128	14.192	0.785	21.309	50.668
0.141	8.438	12.736	0.299	13.069	48.837	14.376	0.814	21.712	52.059
0.147	8.662	13.336	0.311	13.256	49.547	14.582	0.845	22.115	53.397
0.152	8.699	13.935	0.324	13.443	50.256	14.787	0.873	22.543	54.788
0.157	8.971	14.534	0.335	13.592	50.864	14.951	0.901	22.946	56.126
0.162	9.091	14.984	0.350	13.760	51.370	15.136	0.930	23.299	57.303
0.167	9.326	15.733	0.361	13.910	51.978	15.300	0.959	23.778	58.640
0.172	9.408	16.333	0.374	14.078	52.485	15.486	0.989	24.155	59.764
0.179	9.540	16.932	0.389	14.227	52.992	15.650	1.018	24.608	60.995
0.184	9.694	17.531	0.400	14.377	53.397	15.814	1.046	24.936	62.065
0.188	9.885	17.981	0.413	14.600	53.903	16.060	1.075	25.289	63.081
0.194	10.002	18.730	0.426	14.694	54.410	16.163	1.105	25.667	64.205
0.201	10.146	19.180	0.439	14.861	54.815	16.348	1.134	26.069	65.168
0.206	10.324	19.779	0.451	14.992	55.221	16.491	1.163	26.422	66.131
0.210	10.477	20.378	0.465	15.198	55.626	16.717	1.191	26.850	67.094
0.216	10.515	20.978	0.477	15.328	55.930	16.861	1.221	27.203	67.950
0.221	10.763	21.577	0.491	15.497	56.234	17.047	1.250	27.555	68.913
0.228	10.777	22.176	0.503	15.665	56.639	17.231	1.279	27.858	69.662
0.232	11.001	22.776	0.517	15.814	57.044	17.396	1.308	28.210	70.465
0.237	11.038	23.375	0.529	15.963	57.247	17.559	1.338	28.563	71.374
0.243	11.261	23.974	0.541	16.076	57.551	17.683	1.366	28.866	72.123
0.247	11.322	24.574	0.556	16.224	57.855	17.847	1.398	29.268	72.872
0.252	11.430	25.173	0.568	16.374	58.159	18.012	1.425	29.621	73.622
0.259	11.560	25.772	0.580	16.505	58.362	18.155	1.454	29.924	74.264
0.264	11.705	26.222	0.594	16.655	58.666	18.320	1.485	30.250	75.066
0.269	11.799	26.971	0.606	16.766	58.868	18.443	1.514	30.553	75.655
0.276	11.928	27.571	0.619	16.916	59.071	18.608	1.544	30.855	76.243

Laboratorio di Geotecnica									
Prova Compressione Triassiale n.		Prova Compressione Triassiale n.				Prova Compressione Triassiale n.			
CIU (consolidata non drenata)		CIU (consolidata non drenata)				CIU (consolidata non drenata)			
Provino 1		Provino 2				Provino 3			
Velocità di prova (mm/min)	0.01	Velocità di prova (mm/min)	0.01			Velocità di prova (mm/min)	0.01		
tensione di confinamento (kPa)	600	tensione di confinamento (kPa)	400			tensione di confinamento (kPa)	250		
	cella di carico	$\Delta u$	LVDT	cella di carico	$\Delta u$		LVDT	cella di carico	$\Delta u$
$\delta$ (mm)	kg	(kPa)	$\delta$ (mm)	kg	(kPa)		$\delta$ (mm)	kg	(kPa)
0.281	12.121	28.020	0.633	17.009	59.274	18.710	1.573	31.208	76.992
0.286	12.205	28.619	0.645	17.158	59.476	18.874	1.601	31.485	77.527
0.290	12.170	29.219	0.659	17.308	59.679	19.039	1.631	31.938	78.223
0.298	12.419	29.818	0.672	17.457	59.780	19.202	1.663	32.215	78.758
0.303	12.433	30.418	0.687	17.625	59.983	19.388	1.690	32.492	79.186
0.307	12.656	31.017	0.697	17.756	60.287	19.532	1.721	32.820	79.881
0.313	12.661	31.466	0.712	17.887	60.388	19.676	1.750	33.097	80.310
0.318	12.886	32.066	0.727	17.999	60.489	19.798	1.780	33.399	80.898
0.325	12.875	32.665	0.738	18.166	60.591	19.983	1.809	33.676	81.326
0.329	13.006	33.264	0.753	18.279	60.793	20.107	1.840	34.003	81.701
0.335	13.114	33.864	0.765	18.410	60.793	20.251	1.870	34.306	82.289
0.340	13.196	34.463	0.778	18.521	60.996	20.374	1.899	34.557	82.664
0.347	13.342	34.913	0.791	18.671	61.097	20.538	1.929	34.835	83.092
0.351	13.426	35.512	0.803	18.802	61.199	20.682	1.958	35.061	83.520
0.357	13.510	36.111	0.818	18.895	61.199	20.784	1.989	35.288	83.787
0.362	13.663	36.711	0.830	19.006	61.401	20.907	2.016	35.615	84.215
0.368	13.668	37.160	0.846	19.250	61.503	21.175	2.048	35.843	84.483
0.373	13.846	37.760	0.861	19.324	61.503	21.256	2.078	36.195	84.750
0.379	13.873	38.209	0.874	19.454	61.503	21.400	2.109	36.421	85.232
0.386	14.051	38.809	0.888	19.585	61.604	21.544	2.138	36.673	85.446
0.390	14.088	39.408	0.900	19.698	61.705	21.668	2.168	36.926	85.874
0.395	14.209	39.857	0.914	19.810	61.705	21.791	2.199	37.202	86.088
0.401	14.269	40.457	0.928	19.959	61.807	21.955	2.226	37.379	86.248
0.405	14.377	41.056	0.942	20.052	61.807	22.057	2.258	37.707	86.676
0.412	14.499	41.506	0.954	20.202	61.807	22.222	2.286	38.008	86.837
0.417	14.596	41.955	0.968	20.314	61.807	22.345	2.316	38.285	87.158
0.423	14.727	42.555	0.979	20.444	61.908	22.489	2.348	38.487	87.319
0.427	14.755	43.004	0.994	20.594	61.908	22.653	2.378	38.714	87.586
0.484	15.593	48.248	1.008	20.706	61.908	22.776	2.409	38.915	87.693
0.539	16.400	53.343	1.022	20.874	61.908	22.962	2.439	39.142	87.961
0.595	17.015	57.988	1.035	20.967	61.908	23.064	2.468	39.368	88.121
0.650	17.550	62.483	1.048	21.098	61.908	23.208	2.498	39.620	88.175
0.707	18.161	66.679	1.062	21.210	61.908	23.330	2.529	39.922	88.549
0.761	18.856	70.724	1.074	21.322	61.908	23.455	2.559	40.125	88.603
0.818	19.438	74.470	1.087	21.434	61.908	23.577	2.590	40.376	88.763
0.872	19.959	78.366	1.102	21.527	61.807	23.680	2.620	40.552	88.977
0.929	20.640	81.813	1.115	21.696	61.705	23.865	2.651	40.754	88.977
0.984	21.265	85.109	1.128	21.788	61.807	23.967	2.680	40.955	89.245
1.041	21.708	88.106	1.143	21.882	61.807	24.070	2.710	41.208	89.298
1.095	22.164	90.953	1.155	22.013	61.908	24.214	2.741	41.459	89.298
1.153	22.669	93.800	1.170	22.125	61.604	24.337	2.771	41.711	89.566
1.208	23.092	96.497	1.183	22.274	61.604	24.502	2.801	41.862	89.512
1.265	23.568	98.894	1.196	22.367	61.503	24.604	2.835	42.114	89.780
1.319	24.090	101.292	1.210	22.498	61.401	24.747	2.863	42.290	89.726
1.377	24.604	103.539	1.224	22.647	61.401	24.912	2.894	42.517	89.833
1.432	25.029	105.487	1.238	22.778	61.401	25.056	2.924	42.693	89.940
1.486	25.383	107.435	1.251	22.890	61.604	25.179	2.955	42.920	89.833
1.543	25.896	109.683	1.264	22.984	61.199	25.282	2.985	43.172	90.101
1.600	26.358	111.481	1.278	23.095	61.199	25.405	3.016	43.323	90.101
1.656	26.680	113.279	1.292	23.189	61.097	25.508	3.046	43.499	89.994
1.711	27.063	114.927	1.304	23.320	60.996	25.652	3.078	43.726	90.208
1.767	27.600	116.426	1.320	23.432	60.895	25.775	3.106	43.878	90.101
1.824	28.021	117.924	1.333	23.526	60.895	25.878	3.136	44.054	90.261
1.880	28.454	119.273	1.347	23.637	60.692	26.001	3.169	44.255	90.208
1.935	28.865	120.621	1.361	23.712	60.591	26.083	3.200	44.456	90.101
1.992	29.407	121.820	1.374	23.843	60.591	26.227	3.230	44.708	90.261
2.048	29.795	123.168	1.388	23.955	60.489	26.350	3.260	44.809	90.154
2.104	30.093	124.217	1.403	24.066	60.287	26.473	3.291	45.036	90.208
2.159	30.617	125.116	1.416	24.160	60.185	26.576	3.321	45.162	90.208
2.216	31.056	126.165	1.429	24.309	60.185	26.740	3.350	45.313	89.994
2.272	31.369	127.064	1.443	24.458	59.983	26.904	3.381	45.464	90.101
2.327	31.790	127.814	1.457	24.570	59.881	27.027	3.411	45.691	89.994
2.384	32.384	128.713	1.472	24.683	59.780	27.151	3.443	45.867	89.887
2.441	32.772	129.312	1.486	24.776	59.679	27.253	3.473	46.043	90.047

Laboratorio di Geotecnica									
Prova Compressione Triassiale n.			Prova Compressione Triassiale n.			Prova Compressione Triassiale n.			
CIU (consolidata non drenata)			CIU (consolidata non drenata)			CIU (consolidata non drenata)			
Provino 1			Provino 2			Provino 3			
Velocità di prova (mm/min)		0.01	Velocità di prova (mm/min)		0.01	Velocità di prova (mm/min)		0.01	
tensione di confinamento (kPa)		600	tensione di confinamento (kPa)		400	tensione di confinamento (kPa)		250	
	cella di carico	$\Delta u$	LVDT	cella di carico	$\Delta u$		LVDT	cella di carico	$\Delta u$
$\delta$ (mm)	kg	(kPa)	$\delta$ (mm)	kg	(kPa)		$\delta$ (mm)	kg	(kPa)
2.496	33.122	130.061	1.499	24.906	59.578	27.397	3.504	46.169	89.833
2.550	33.496	130.810	1.512	25.000	59.476	27.500	3.536	46.345	89.833
2.608	34.048	131.410	1.526	25.131	59.375	27.644	3.566	46.497	89.780
2.665	34.365	132.009	1.541	25.243	59.172	27.767	3.598	46.622	89.566
2.720	34.712	132.309	1.554	25.337	59.071	27.870	3.628	46.824	89.619
2.774	35.020	132.758	1.570	25.448	58.868	27.993	3.659	47.026	89.512
2.831	35.525	133.358	1.582	25.560	58.767	28.116	3.689	47.202	89.512
2.888	35.918	133.657	1.597	25.691	58.666	28.260	3.720	47.278	89.405
2.942	36.240	133.957	1.652	26.195	58.058	28.814	3.753	47.428	89.191
2.998	36.797	134.257	1.723	26.754	57.247	29.430	3.783	47.555	89.245
3.055	37.274	134.406	1.793	27.315	56.538	30.047	3.814	47.705	89.084
3.109	37.620	134.706	1.865	27.931	55.525	30.724	3.844	47.807	88.977
3.165	37.934	134.856	1.934	28.529	54.613	31.381	3.873	48.033	88.924
3.221	38.435	135.006	2.006	29.107	53.599	32.018	3.905	48.134	88.763
3.276	38.832	135.006	2.079	29.667	52.586	32.634	3.935	48.310	88.763
3.330	39.216	135.156	2.151	30.321	51.573	33.353	3.966	48.386	88.549
3.386	39.591	135.156	2.223	30.881	50.357	33.970	3.996	48.511	88.335
3.442	40.104	135.156	2.295	31.441	49.243	34.585	4.028	48.638	88.335
3.496	40.447	135.006	2.368	32.095	48.128	35.304	4.058	48.738	88.121
3.553	40.821	135.006	2.442	32.729	46.811	36.002	4.089	48.915	88.121
3.606	41.312	135.006	2.515	33.289	45.494	36.618	4.121	49.066	87.961
3.663	41.700	134.856	2.590	33.943	44.278	37.337	4.151	49.167	87.693
3.717	41.949	134.706	2.663	34.578	42.859	38.036	4.183	49.267	87.693
3.772	42.267	134.556	2.737	35.157	41.542	38.673	4.213	49.343	87.479
3.829	42.749	134.406	2.811	35.773	40.124	39.350	4.244	49.444	87.319
3.883	43.129	134.107	2.885	36.407	38.604	40.048	4.274	49.544	87.265
3.939	43.508	133.807	2.960	37.005	37.185	40.705	4.306	49.620	86.998
3.992	43.872	133.657	3.036	37.547	35.665	41.301	4.338	49.821	86.944
4.048	44.368	133.358	3.108	38.200	34.247	42.020	4.368	49.872	86.783
4.103	44.655	133.058	3.183	38.797	32.930	42.677	4.399	49.973	86.462
4.156	44.963	132.758	3.256	39.320	31.815	43.252	4.429	50.023	86.462
4.211	45.343	132.459	3.331	39.956	30.802	43.951	4.460	50.123	86.195
4.265	45.745	132.159	3.405	40.534	29.789	44.588	4.490	50.199	86.088
4.321	46.007	131.859	3.480	41.075	28.066	45.183	4.521	50.300	85.927
4.375	46.260	131.410	3.554	41.636	26.141	45.799	4.551	50.401	85.660
4.431	46.747	130.960	3.628	42.215	24.419	46.436	4.584	50.552	85.606
4.485	47.071	130.511	3.703	42.699	22.798	46.969	4.615	50.602	85.392
4.540	47.394	130.061	3.777	43.222	21.075	47.545	4.645	50.703	85.285
4.593	47.647	129.612	3.852	43.764	19.960	48.141	4.676	50.753	85.071
4.648	48.073	129.312	3.926	44.287	17.529	48.716	4.706	50.804	84.804
4.704	48.325	128.862	4.001	44.753	16.516	49.228	4.736	50.854	84.750
4.757	48.499	128.263	4.077	45.332	14.692	49.865	4.768	50.955	84.536
4.813	48.729	127.814	4.151	45.781	12.463	50.359	4.800	51.106	84.376
4.868	49.122	127.364	4.225	46.191	10.538	50.810	4.830	51.131	84.269
4.921	49.422	126.914	4.299	46.714	9.626	51.385	4.861	51.181	84.001
4.977	49.759	126.315	4.376	47.162	7.093	51.878	4.891	51.232	83.894
5.031	50.199	125.866	4.451	47.535	5.471	52.288	4.923	51.282	83.680
5.087	50.537	125.266	4.525	47.983	4.661	52.781	4.955	51.308	83.359
5.141	50.780	124.667	4.602	48.413	2.533	53.254	4.985	51.383	83.306
5.194	51.104	124.217	4.677	48.749	0.608	53.624	5.016	51.484	83.092
5.251	51.449	123.768	4.753	49.084	-0.811	53.993	5.046	51.635	82.931
5.306	51.717	123.168	4.828	49.477	-2.330	54.424	5.078	51.635	82.771
5.360	51.922	122.719	4.905	49.813	-4.458	54.794	5.108	51.660	82.450
5.413	52.190	122.120	4.980	50.074	-5.775	55.082	5.140	51.685	82.450
5.469	52.667	121.520	5.057	50.392	-7.295	55.431	5.171	51.735	82.182
5.523	52.902	120.771	5.133	50.691	-9.322	55.760	5.201	51.786	81.968
5.579	53.145	120.172	5.207	51.008	-10.335	56.109	5.234	51.912	81.861
5.632	53.530	119.572	5.281	51.418	-12.057	56.560	5.265	51.962	81.540
5.688	53.751	118.973	5.357	51.774	-13.577	56.951	5.295	52.013	81.540
5.742	53.923	118.374	5.431	52.035	-14.996	57.239	5.326	52.013	81.273
5.796	54.182	117.624	5.508	52.278	-16.414	57.505	5.356	52.013	81.005
5.851	54.518	117.025	5.582	52.651	-17.326	57.916	5.388	52.088	80.952
5.906	54.716	116.426	5.656	52.875	-19.049	58.163	5.420	52.088	80.631
5.959	54.866	115.826	5.730	53.137	-20.264	58.450	5.450	52.189	80.577



Laboratorio di Geotecnica									
Prova Compressione Triassiale n.			Prova Compressione Triassiale n.			Prova Compressione Triassiale n.			
CIU (consolidata non drenata)			CIU (consolidata non drenata)			CIU (consolidata non drenata)			
Provino 1			Provino 2			Provino 3			
Velocità di prova (mm/min)		0.01	Velocità di prova (mm/min)		0.01	Velocità di prova (mm/min)		0.01	
tensione di confinamento (kPa)		600	tensione di confinamento (kPa)		400	tensione di confinamento (kPa)		250	
	cella di carico	$\Delta u$	LVDT	cella di carico	$\Delta u$		LVDT	cella di carico	$\Delta u$
$\delta$ (mm)	kg	(kPa)	$\delta$ (mm)	kg	(kPa)		$\delta$ (mm)	kg	(kPa)
6.014	55.170	115.077	5.805	53.529	-21.582	58.882	5.481	52.239	80.417
6.067	55.545	114.328	5.880	53.808	-22.696	59.189	5.511	52.290	80.095
6.124	55.663	113.579	5.954	54.070	-23.709	59.477	5.544	52.290	79.988
6.177	55.790	112.979	6.028	54.388	-25.432	59.827	5.575	52.315	79.721
6.231	56.117	112.230	6.101	54.705	-26.242	60.176	5.605	52.340	79.560
6.287	56.455	111.631	6.175	54.910	-27.661	60.401	5.636	52.391	79.400
6.341	56.571	110.882	6.249	55.153	-28.776	60.669	5.666	52.365	79.132
6.394	56.666	110.132	6.323	55.471	-29.687	61.018	5.699	52.516	79.079
6.450	57.004	109.533	6.397	55.732	-30.397	61.305	5.730	52.541	78.811
6.504	57.253	108.634	6.469	55.955	-32.018	61.551	5.763	52.516	78.544
6.559	57.345	107.885	6.543	56.236	-32.322	61.859	5.793	52.516	78.437
6.612	57.519	107.285	6.618	56.441	-33.943	62.086	5.821	52.541	78.169
6.667	57.824	106.536	6.691	56.534	-35.361	62.188	5.854	52.592	78.062
6.723	57.872	105.787	6.764	56.759	-35.767	62.435	5.885	52.592	77.848
6.776	57.895	105.038	6.837	56.926	-37.388	62.619	5.915	52.617	77.581
6.832	58.036	104.289	6.910	57.039	-38.300	62.743	5.948	52.693	77.527
6.886	58.293	103.539	6.984	57.244	-39.212	62.968	5.980	52.693	77.260
6.942	58.318	102.790	7.056	57.449	-40.225	63.194	6.011	52.693	77.099
6.995	58.496	101.891	7.129	57.562	-41.036	63.318	6.041	52.668	76.885
7.049	58.731	101.142	7.202	57.692	-41.947	63.461	6.073	52.617	76.618
7.104	58.928	100.543	7.275	57.935	-42.758	63.729	6.105	52.668	76.511
7.158	59.107	99.644	7.349	57.972	-43.670	63.769	6.135	52.668	76.243
7.212	59.199	98.894	7.421	58.047	-44.480	63.852	6.166	52.768	76.083
7.265	59.448	97.995	7.494	58.289	-45.291	64.118	6.199	52.743	75.922
7.320	59.636	97.246	7.567	58.345	-46.102	64.180	6.229	52.743	75.548
7.374	59.707	96.497	7.639	58.476	-46.811	64.324	6.263	52.718	75.441
7.429	59.895	95.748	7.712	58.607	-47.621	64.467	6.290	52.668	75.173
7.482	60.152	94.999	7.784	58.700	-48.331	64.570	6.323	52.643	74.906
7.536	60.293	94.249	7.857	58.793	-49.040	64.673	6.356	52.643	74.799
7.590	60.317	93.500	7.928	58.868	-49.749	64.755	6.386	52.643	74.531
7.643	60.458	92.751	8.001	59.074	-50.459	64.981	6.418	52.693	74.317
7.698	60.669	92.002	8.072	59.148	-51.066	65.063	6.448	52.643	74.103
7.751	60.716	91.253	8.144	59.148	-51.776	65.063	6.480	52.541	73.729
7.804	60.740	90.503	8.214	59.354	-52.384	65.289	6.511	52.516	73.568
7.857	60.928	89.754	8.286	59.429	-52.992	65.372	6.544	52.416	73.247
7.913	61.045	89.005	8.357	59.410	-53.701	65.351	6.576	52.416	73.086
7.966	61.046	88.256	8.429	59.596	-54.309	65.556	6.606	52.391	72.819
8.019	61.187	87.507	8.501	59.578	-54.917	65.535	6.638	52.365	72.498
8.073	61.420	86.757	8.571	59.596	-55.525	65.556	6.668	52.315	72.337
8.127	61.547	86.158	8.643	59.708	-56.133	65.679	6.700	52.264	71.963
8.181	61.515	85.259	8.714	59.839	-56.842	65.823	6.731	52.189	71.802
8.235	61.549	84.660	8.785	59.764	-57.450	65.741	6.764	52.139	71.481
8.288	61.722	84.060	8.856	59.783	-57.956	65.761	6.794	52.013	71.053
8.344	61.736	83.161	8.928	59.821	-58.564	65.803	6.826	52.038	70.946
8.397	61.853	82.412	9.000	59.877	-59.172	65.865	6.858	51.987	70.625
8.450	61.924	81.663	9.071	59.783	-59.679	65.761	6.888	51.987	70.358
8.503	62.136	80.914	9.141	59.783	-60.185	65.761	6.920	51.887	70.197
8.556	62.098	80.314	9.214	59.708	-60.692	65.679	6.954	51.786	69.769
8.609	62.169	79.565	9.285	59.671	-61.199	65.638	6.984	51.710	69.555
8.663	62.286	78.816	9.357	59.652	-61.705	65.618	7.016	51.610	69.234
8.718	62.343	78.216	9.430	59.690	-62.212	65.659	7.048	51.559	68.860
8.771	62.320	77.467	9.501	59.671	-62.617	65.638	7.080	51.585	68.753
8.824	62.320	76.718	9.574	59.578	-63.124	65.535	7.110	51.509	68.432
8.877	62.494	76.119	9.646	59.633	-63.529	65.597	7.143	51.433	68.218
8.933	62.447	75.370	9.719	59.541	-64.036	65.495	7.174	51.383	67.897
8.986	62.449	74.620	9.792	59.560	-64.340	65.516	7.204	51.232	67.576
9.039	62.659	73.871	9.862	59.952	-64.846	65.947	7.236	51.207	67.308
9.092	62.739	73.272	9.934	60.082	-65.252	66.091	7.268	51.081	67.041
9.145	62.763	72.523	10.008	59.764	-65.657	65.741	7.300	51.081	66.719
9.198	62.786	71.773	10.080	59.633	-65.961	65.597	7.333	51.031	66.452
9.252	62.890	71.174	10.152	59.447	-66.265	65.391	7.363	50.980	66.131
9.307	62.923	70.575	10.225	59.316	-66.670	65.248	7.395	50.854	65.863
9.360	62.807	69.825	10.296	59.223	-66.974	65.146	7.429	50.728	65.542
9.413	62.737	69.076	10.368	59.148	-67.278	65.063	7.459	50.602	65.168

Laboratorio di Geotecnica									
Prova Compressione Triassiale n.			Prova Compressione Triassiale n.			Prova Compressione Triassiale n.			
CIU (consolidata non drenata)			CIU (consolidata non drenata)			CIU (consolidata non drenata)			
Provino 1			Provino 2			Provino 3			
Velocità di prova (mm/min)		0.01	Velocità di prova (mm/min)		0.01	Velocità di prova (mm/min)		0.01	
tensione di confinamento (kPa)		600	tensione di confinamento (kPa)		400	tensione di confinamento (kPa)		250	
	cella di carico	$\Delta u$	LVDT	cella di carico	$\Delta u$		LVDT	cella di carico	$\Delta u$
$\delta$ (mm)	kg	(kPa)	$\delta$ (mm)	kg	(kPa)		$\delta$ (mm)	kg	(kPa)
9.468	62.888	68.477	10.441	58.981	-67.582	64.879	7.491	50.527	65.007
9.522	62.935	67.728	10.511	58.681	-67.886	64.550	7.523	50.401	64.633
9.575	62.907	67.278	10.583	58.570	-68.291	64.427	7.555	50.451	64.472
9.628	62.954	66.529	10.654	58.402	-68.494	64.242	7.588	50.325	64.098
9.682	63.043	66.079	10.725	58.233	-68.798	64.057	7.618	50.174	63.723
9.735	63.006	65.480	10.795	58.066	-69.102	63.872	7.650	50.123	63.509
9.791	62.922	64.881	10.866	57.935	-69.304	63.729	7.683	49.947	63.188
9.844	63.096	64.281	10.937	57.785	-69.406	63.564	7.714	49.897	62.974
9.897	63.003	63.532	11.008	57.766	-69.608	63.543	7.746	49.771	62.707
9.953	62.896	62.933	11.078	57.655	-69.811	63.420	7.778	49.670	62.279
10.006	62.797	62.483	11.147	57.468	-70.014	63.215	7.808	49.645	62.172
10.060	62.948	61.884	11.218	57.282	-70.115	63.010	7.840	49.569	61.797
10.113	62.863	61.285	11.288	57.282	-70.318	63.010	7.873	49.419	61.530
10.169	62.757	60.685	11.359	57.001	-70.419	62.701	7.905	49.343	61.262
10.222	62.720	60.086	11.428	56.684	-70.622	62.352	7.936	49.192	60.888
10.276	62.692	59.636	11.499	56.703	-70.723	62.373	7.969	49.167	60.727
10.331	62.514	59.037	11.568	56.553	-70.824	62.208	7.999	49.015	60.406
10.386	62.361	58.438	11.638	56.403	-70.926	62.044	8.031	49.066	60.085
10.439	62.403	57.988	11.708	56.330	-70.723	61.963	8.065	48.965	59.978
10.494	62.413	57.389	11.779	56.217	-71.027	61.839	8.098	48.839	59.657
10.547	62.281	56.789	11.848	56.030	-71.027	61.633	8.128	48.713	59.443
10.602	62.184	56.340	11.917	55.919	-71.128	61.510	8.159	48.562	59.229
10.657	62.241	55.740	11.988	55.919	-71.230	61.510	8.191	48.411	58.801
10.711	62.072	55.291	12.058	55.807	-71.230	61.387	8.224	48.361	58.694
10.767	61.819	54.991	12.127	55.694	-71.331	61.263	8.256	48.260	58.373
10.821	61.689	54.392	12.198	55.694	-71.432	61.263	8.286	48.260	58.159
10.877	61.732	53.942	12.267	55.545	-71.432	61.100	8.319	48.134	57.945
10.931	61.586	53.493	12.336	55.359	-71.534	60.895	8.353	47.957	57.570
10.986	61.503	52.894	12.406	55.340	-71.534	60.874	8.385	47.882	57.463
11.041	61.662	52.444	12.476	55.190	-71.635	60.709	8.413	47.731	57.142
11.097	61.704	51.994	12.546	54.985	-71.736	60.483	8.448	47.680	56.982
11.152	61.631	51.545	12.615	54.948	-71.736	60.442	8.479	47.555	56.714
11.207	61.603	51.095	12.684	54.873	-71.838	60.360	8.511	47.555	56.393
11.261	61.808	50.646	12.756	54.667	-71.838	60.134	8.544	47.403	56.233
11.318	61.780	50.196	12.825	54.611	-71.939	60.073	8.576	47.328	56.019
11.373	61.659	49.747	12.893	54.630	-71.939	60.093	8.606	47.227	55.751
11.430	61.772	49.297	12.962	54.519	-72.040	59.970	8.638	47.227	55.644
11.484	61.861	48.848	13.032	54.462	-72.141	59.908	8.670	47.177	55.323
11.541	61.819	48.548	13.100	54.537	-72.243	59.990	8.703	47.202	55.216
11.597	61.744	48.099	13.169	54.519	-72.243	59.970	8.734	47.177	54.949
11.652	61.810	47.649	13.238	54.462	-72.344	59.908	8.764	47.151	54.628
11.707	61.923	47.200	13.307	54.537	-72.445	59.990	8.796	47.151	54.574
11.763	61.857	46.900	13.376	54.444	-72.547	59.888	8.829	47.051	54.307
11.818	61.736	46.450	13.445	54.350	-72.547	59.785	8.861	46.975	54.200
11.872	61.740	46.151	13.515	54.294	-72.648	59.724	8.893	46.849	53.986
11.929	61.535	45.851	13.585	54.313	-72.749	59.744	8.923	46.774	53.665
11.985	61.461	45.402	13.654	54.200	-72.851	59.620	8.955	46.774	53.665
12.040	61.480	44.952	13.724	54.089	-72.952	59.497	8.988	46.723	53.450
12.095	61.681	44.802	13.793	54.089	-73.155	59.497	9.019	46.597	53.290
12.149	61.630	44.353	13.864	54.014	-73.256	59.415	9.051	46.547	53.129
12.206	61.555	43.903	13.934	53.939	-73.357	59.333	9.081	46.396	52.915
12.261	61.593	43.753	14.005	54.033	-73.459	59.436	9.113	46.396	52.808
12.318	61.658	43.304	14.075	53.958	-73.560	59.354	9.148	46.245	52.648
12.372	61.602	43.154	14.145	53.902	-73.661	59.292	9.180	46.194	52.380
12.429	61.551	42.704	14.216	53.977	-73.763	59.374	9.210	46.169	52.380
12.486	61.649	42.405	14.288	53.958	-73.965	59.354	9.241	46.169	52.166
12.539	61.621	41.955	14.359	53.883	-74.067	59.271	9.274	46.119	52.113
12.595	61.743	41.656	14.429	53.865	-74.168	59.252	9.306	46.043	51.952
12.650	61.842	41.356	14.500	53.958	-74.269	59.354	9.336	45.943	51.685
12.706	61.917	41.056	14.572	53.865	-74.472	59.252	9.369	45.867	51.685
12.760	61.946	40.756	14.643	53.808	-74.573	59.189	9.400	45.791	51.471

Laboratorio di Geotecnica									
Prova Compressione Triassiale n.			Prova Compressione Triassiale n.			Prova Compressione Triassiale n.			
CIU (consolidata non drenata)			CIU (consolidata non drenata)			CIU (consolidata non drenata)			
Provino 1			Provino 2			Provino 3			
Velocità di prova (mm/min)		0.01	Velocità di prova (mm/min)		0.01	Velocità di prova (mm/min)		0.01	
tensione di confinamento (kPa)		600	tensione di confinamento (kPa)		400	tensione di confinamento (kPa)		250	
	cella di carico	$\Delta u$	LVDT	cella di carico	$\Delta u$	LVDT	cella di carico	$\Delta u$	
$\delta$ (mm)	kg	(kPa)	$\delta$ (mm)	kg	(kPa)	$\delta$ (mm)	kg	(kPa)	
12.817	61.903	40.457				9.433	45.816	51.417	
12.874	61.955	40.157				9.465	45.766	51.310	
12.928	61.983	39.857				9.496	45.666	51.043	
12.985	61.871	39.558				9.526	45.640	51.043	
13.041	61.769	39.408				9.559	45.564	50.829	
13.097	61.979	39.408				9.591	45.564	50.722	
13.152	62.049	39.408				9.623	45.539	50.668	
13.209	62.049	39.408				9.655	45.464	50.454	
13.265	61.923	39.258				9.685	45.464	50.454	
13.322	62.068	38.958				9.716	45.464	50.294	
13.376	61.989	38.809				9.749	45.388	50.240	
13.435	61.946	38.509				9.781	45.338	50.133	
13.490	62.031	38.359				9.811	45.212	49.973	
13.547	62.153	38.059				9.843	45.212	50.026	
13.604	62.120	37.910				9.873	45.111	49.866	
13.661	62.167	37.910				9.905	45.212	49.705	
13.718	62.210	37.460				9.939	45.212	49.759	
13.773	62.036	37.310				9.966	45.162	49.598	
13.831	62.064	37.010				9.999	45.137	49.598	
13.889	62.069	36.711				10.033	45.010	49.491	
13.945	62.177	36.561				10.065	44.910	49.331	
14.002	62.158	36.261				10.095	44.885	49.438	
14.060	62.047	35.962				10.126	44.860	49.331	
14.116	62.122	35.662				10.156	44.910	49.331	
14.174	62.299	35.512				10.189	44.885	49.277	
14.231	62.281	35.212				10.220	44.758	49.117	
14.286	62.309	34.913				10.254	44.758	49.224	
14.345	62.478	34.613				10.285	44.658	49.117	
14.403	62.539	34.463				10.315	44.684	49.170	
						10.348	44.608	49.170	
						10.381	44.708	49.063	
						10.411	44.608	49.170	
						10.441	44.532	49.170	
						10.475	44.456	49.063	
						10.508	44.431	49.277	
						10.538	44.356	49.224	
						10.570	44.356	49.331	
						10.601	44.331	49.384	
						10.634	44.280	49.331	
						10.666	44.255	49.491	
						10.696	44.129	49.438	
						10.729	44.079	49.598	
						10.760	43.978	49.652	
						10.793	43.902	49.545	
						10.823	43.852	49.759	
						10.856	43.827	49.759	
						10.889	43.776	49.866	
						10.919	43.726	49.919	
						10.951	43.650	49.866	
						10.984	43.701	50.080	
						11.015	43.650	50.026	
						11.045	43.650	50.080	
						11.078	43.625	50.240	
						11.110	43.625	50.187	
						11.144	43.600	50.294	
						11.174	43.499	50.294	
						11.206	43.474	50.347	
						11.235	43.398	50.454	
						11.270	43.298	50.401	
						11.300	43.349	50.615	
						11.335	43.349	50.615	



# Prova Triassiale CIU

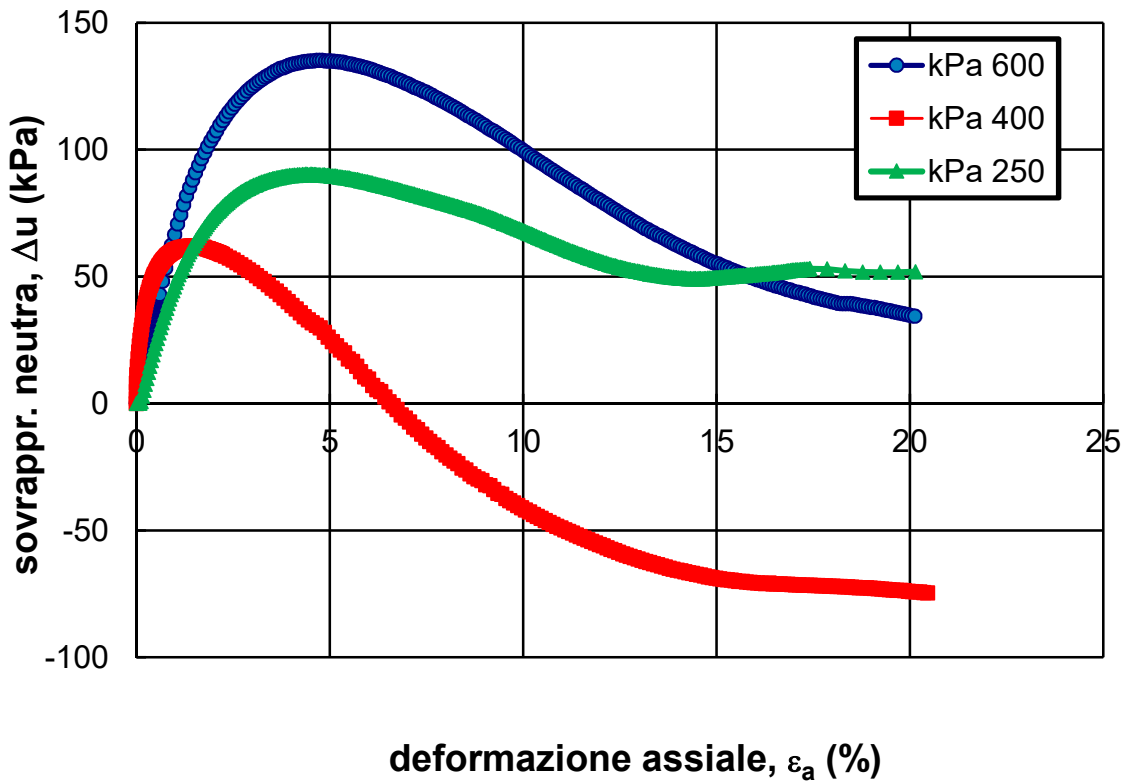
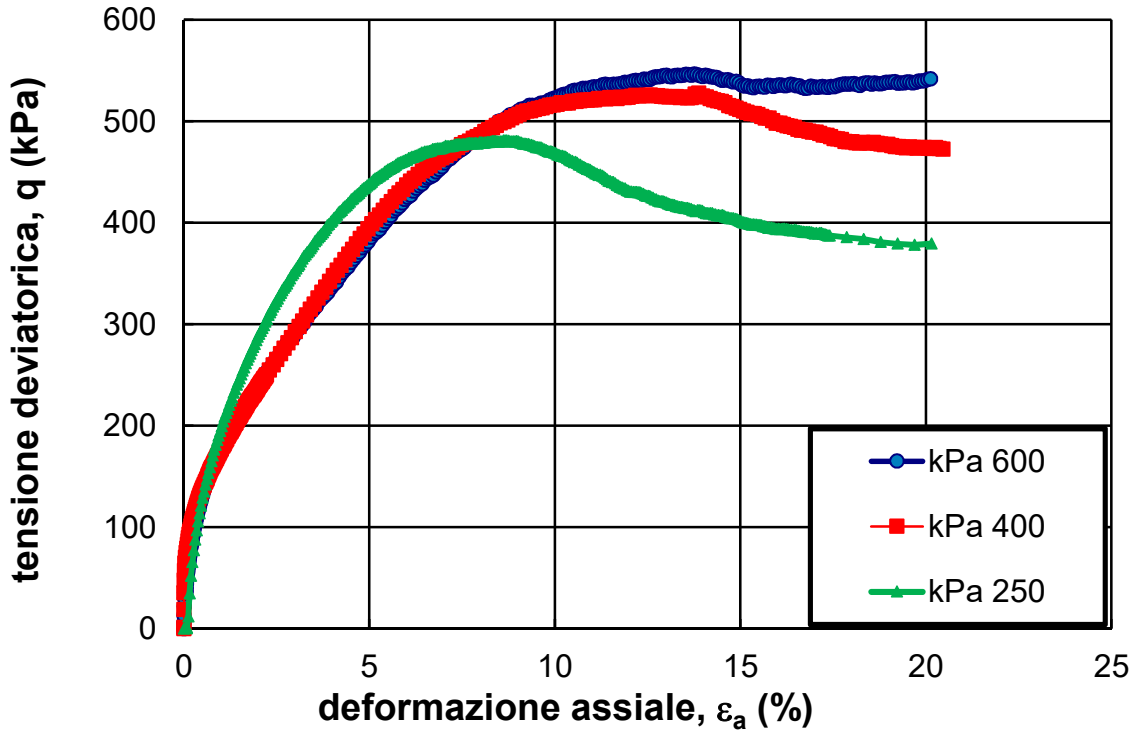

# Prova Triassiale CIU

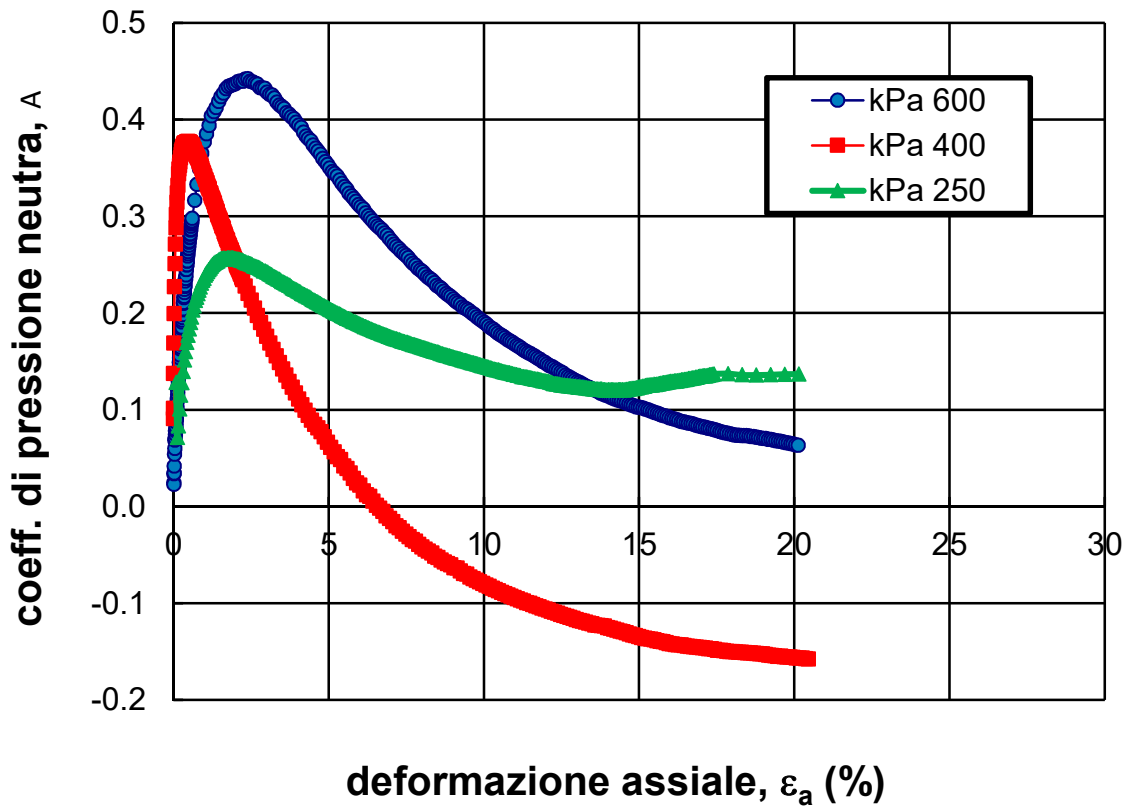
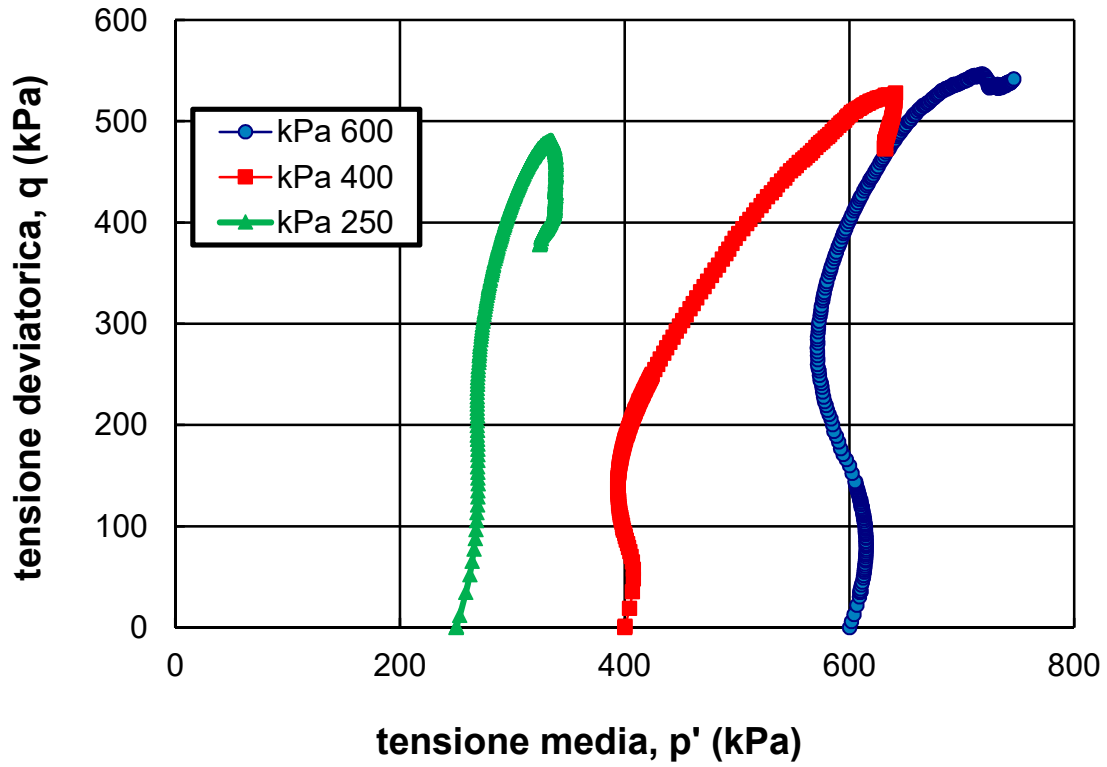

# Prova Triassiale CIU

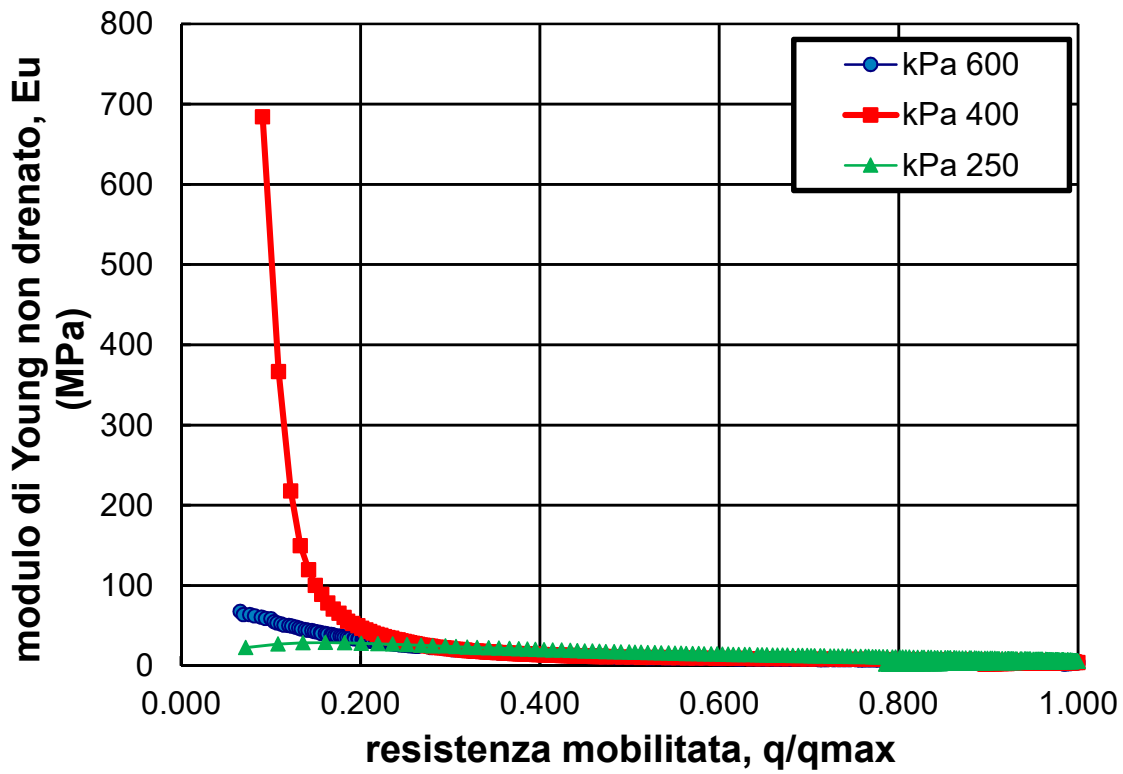
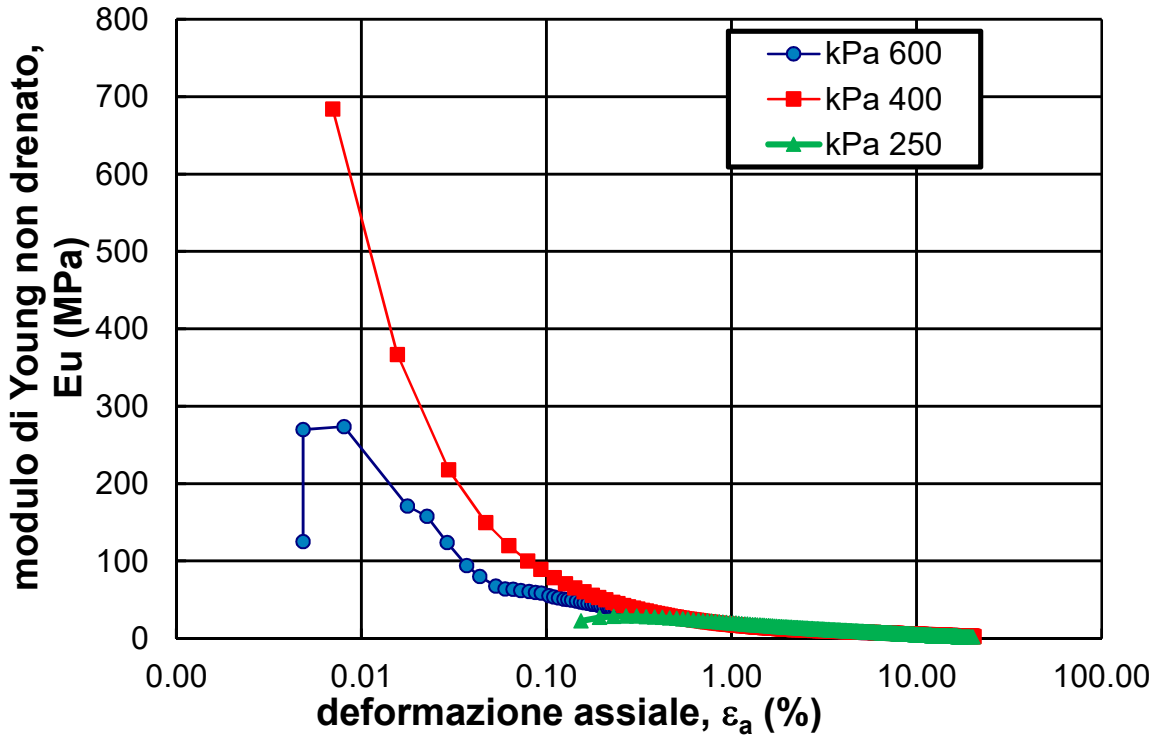

# Prova Triassiale CIU

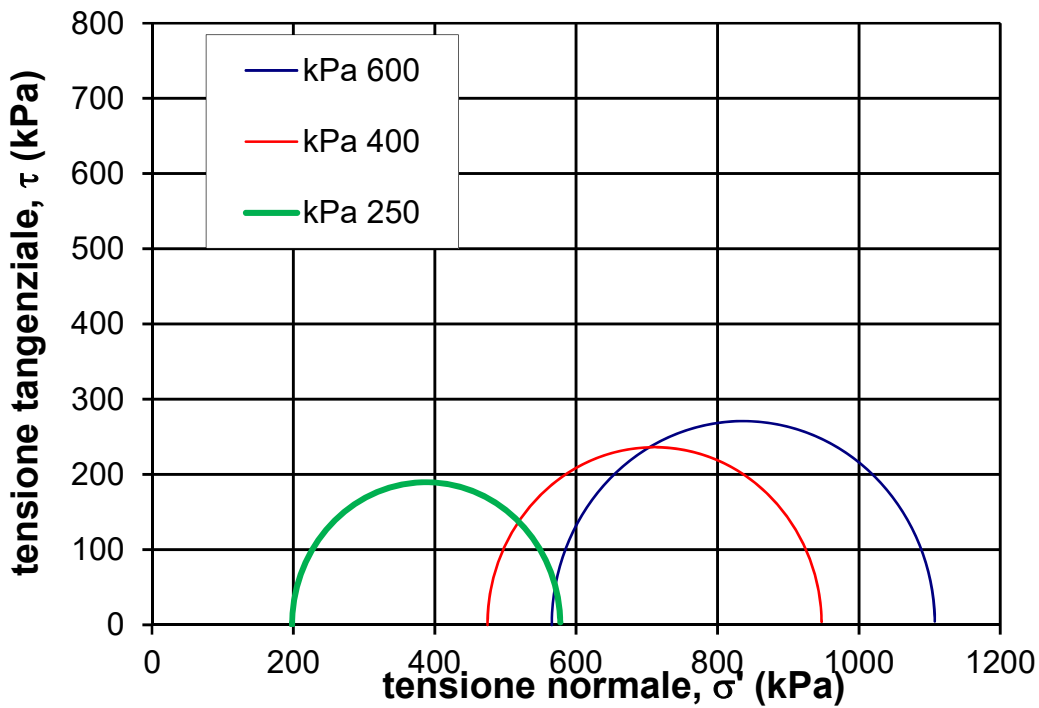
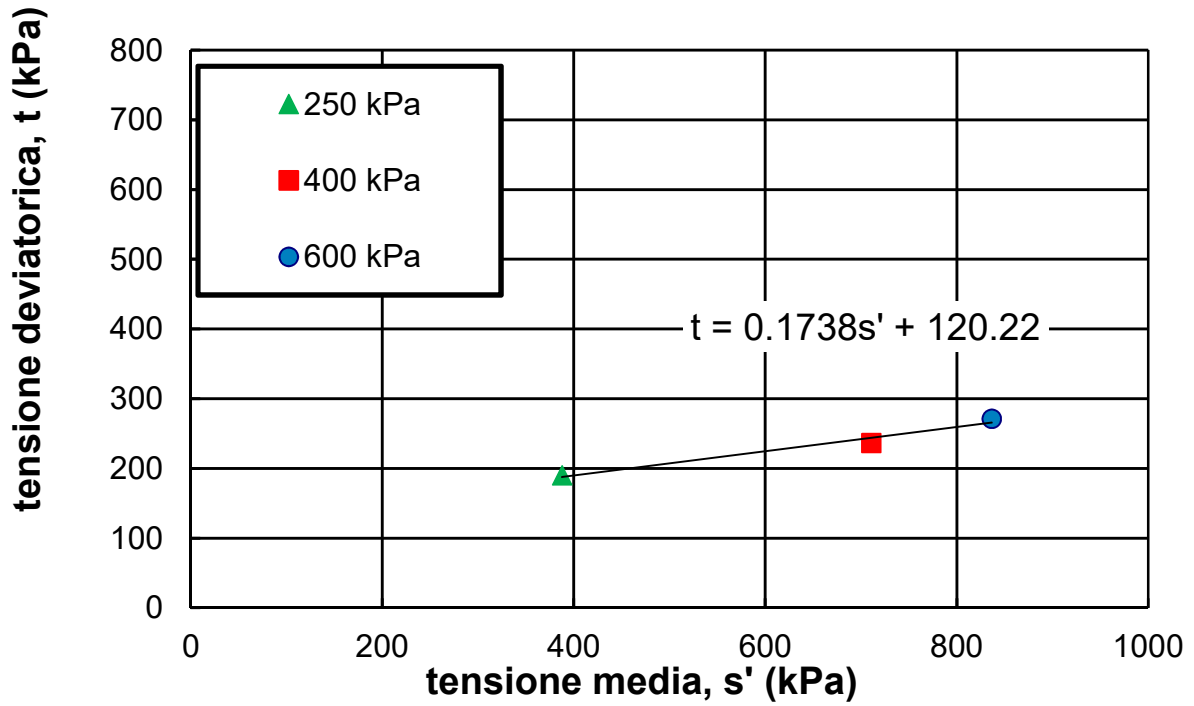



# Prova Triassiale CIU

