



<u>Committente</u>	Consorzio HirpiniaAV
<u>Indagine</u>	I lotto funzionale Apice-Hirpinia
<u>Sondaggio</u>	SNGR03
<u>Campione</u>	C2
<u>Profondità</u>	15,45 ÷ 16,00 m
<u>Data apertura</u>	25/11/19
<u>Operatore</u>	Alfredo Ponzo

Diametro (mm):	80
Lunghezza (mm):	550
Data di apertura:	25/11/2019

Stato del Campione	Indisturbato	
	Parzialmente Rimaneggiato	
	Rimaneggiato	X

Descrizione: Argilla grigia marnosa con struttura laminare caratterizzata da una giacitura a basso angolo (<10°) e inframmezzata da livelletti millimetrici di sabbia fine

Colore	Grigio scuro con striature				
Plasticità	<input type="checkbox"/> Non Plastico	<input type="checkbox"/> Bassa	<input checked="" type="checkbox"/> Media	<input type="checkbox"/> Elevata	
Addensamento (Terreni granulari)	<input type="checkbox"/> Molto sciolto (D _r =0.0÷0.2)	<input type="checkbox"/> Sciolto (D _r =0.2÷0.4)	<input type="checkbox"/> Medio (D _r =0.4÷0.6)	<input type="checkbox"/> Denso (D _r =0.6÷0.8)	<input type="checkbox"/> Molto denso (D _r =0.8÷1.0)
Consistenza (Terreni coesivi)	<input type="checkbox"/> Molto molle (I _c < 0.0)	<input type="checkbox"/> Molle (I _c =0.0÷0.5)	<input type="checkbox"/> Media (I _c =0.5÷1.0)	<input checked="" type="checkbox"/> Consistente (I _c >1.0)	<input type="checkbox"/> Molto consist. (I _c >>1.0)
Grado di umidità	<input type="checkbox"/> Asciutto	<input type="checkbox"/> Poco Umido	<input checked="" type="checkbox"/> Umido	<input type="checkbox"/> Molto Umido	
Alterazione	Assente	<input type="checkbox"/> Debole	<input type="checkbox"/> Media	<input type="checkbox"/> Elevata	
Struttura	Omogenea	<input type="checkbox"/> Stratificata	<input type="checkbox"/> Scagliosa	<input checked="" type="checkbox"/> Laminata	Caotica
Fratturazione	Assente	<input type="checkbox"/> Moderata	<input type="checkbox"/> Elevata		
Cementazione	Assente	<input type="checkbox"/> Debole	<input type="checkbox"/> Media	<input type="checkbox"/> Elevata	

Proprietà fisiche			Proprietà meccaniche	
n,γ,w	X		Compressione uniassiale	
Analisi granulometrica	X		TX-UU	
Limiti	X		TX-CIU	
CaCO ₃			TX-CID	
Sostanze organiche			TX-Ciclica	
Peso specifico del solido			Taglio anulare	
Proctor			Taglio diretto	
CBR			RC TS	
Altro _____			Altro _____	

Nota: non è stato possibile confezionare i provini dal momento che il campione risulta fratturato in più parti



Università degli Studi di Napoli
 Dipartimento di Ingegneria Civile, Edile e Ambientale
 Laboratorio di Geotecnica

Committente	Consorzio HirpiniaAV
Indagine	I lotto funzionale Apice-Hirpinia
Sondaggio	SNGR03
Campione	C2
Profondità	15.45-16.00
Data	28/11/2019
Operatore	Alfredo Ponzo

LIMITE DI PLASTICITA'				
pesafiltro n°	Tara	Peso lordo umido (P _u)	Peso lordo secco (P _s)	Contenuto d'acqua (w)
[-]	[gr]	[gr]	[gr]	[-]
40	14.88	50.97	43.42	0.265
w_p				0.265

LIMITE DI LIQUIDITA' (Metodo di Casagrande ASTM)					
Pesafiltro n°	N° colpi (N)	Tara (P _c)	Peso lordo umido (P _u)	Peso lordo secco (P _s)	Contenuto d'acqua (w)
[-]	[-]	[g]	[g]	[g]	[g]
177	10	12.13	45.46	32.42	0.643
23	16	11.95	37.42	27.69	0.618
58	30	11.69	44.75	32.59	0.582
Limite di liquidità ASTM (w_L)					0.591

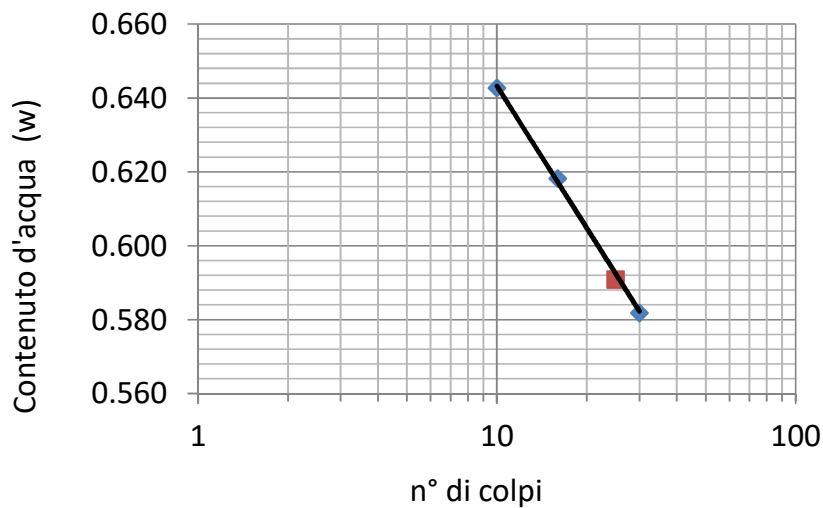

Indice di plasticità (I _p)	Frazione argillosa CF (d < 2 μm)	Indice di attività (I _A)
[%]	[%]	[-]
32.63	50.000	0.65

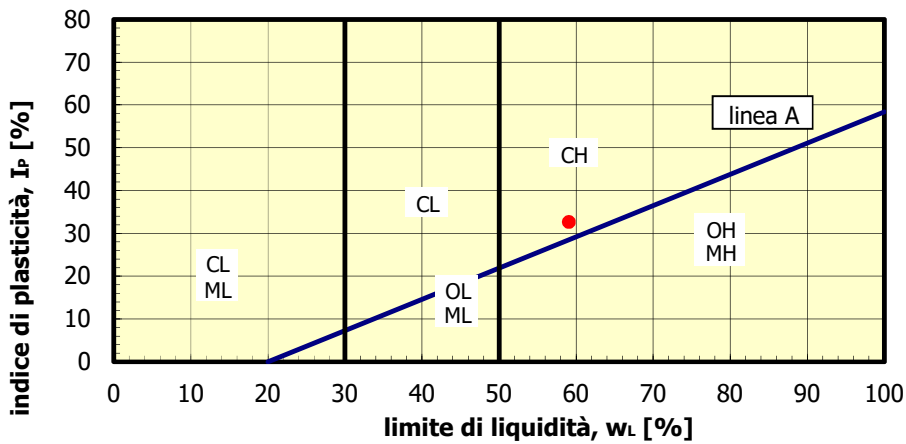

ML	Limi inorganici da bassa a media plasticità	M = limi
CL	Argille inorganiche da bassa a media plasticità	C = argille
OL	Limi e argille organiche di bassa plasticità	O = sostanze organiche
MH	Limi inorganici di alta plasticità	L = bassa plasticità
CH	Argille inorganiche di alta plasticità	H = alta plasticità
OH	Argille organiche da media ad alta plasticità	

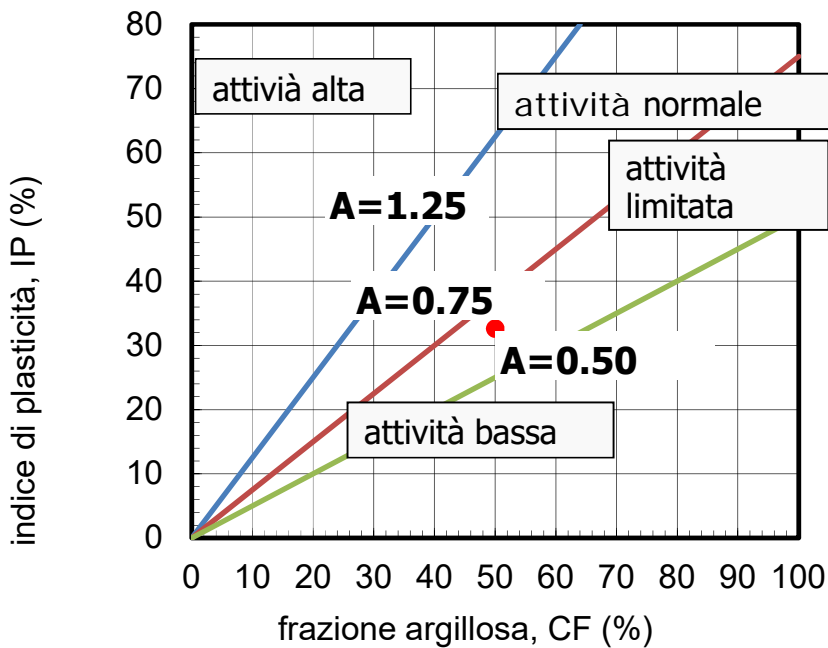

CONSISTENZA TERRENO A GRANA FINE		
w_L	I_p	I_c
[-]	[-]	[-]
59.084	32.63	1.80
COMPATTEZZA TERRENO A GRANA GROSSA		
e_{max}	e_{min}	D_r
[-]	[-]	[-]



Università degli Studi di Napoli
Dipartimento di Ingegneria Civile, Edile e Ambientale
Laboratorio di Geotecnica

Committente	Consorzio HirpiniaAV
Indagine	Apice-Hirpinia
Sondaggio	SNGR03
Campione	C2
Profondità	15.45-16.00
Data	28/11/2019
Operatore	Alfredo Ponzo

Peso specifico del solido	
Peso specifico dell'acqua (γ_w) (g/cm ³)	1.000
picnometro n°	18.000
Peso picnometro (P_p) (g)	59.76
Peso picnometro + acqua (P_{pw}) (g)	158.130
Volume picnometro (V_p) (cm ³)	98.37
Peso picnometro + terreno (P_{ps}) (g)	79.32
Peso terreno (P_s)	19.56
Peso picnometro + terreno + acqua (P_{psw}) (g)	170.460
Volume acqua aggiunta (V_w) (cm ³)	91.14
Volume terreno (V_s) (cm ³)	7.230
Peso specifico del terreno (γ_s) (kN/m ³)	26.529

Caratteristiche Fisiche Generali			
pesafiltro n°	19	81.000	19.000
Peso contenitore (P_c) (g)	14.18	11.420	9.400
Diametro (D) (mm)	56.00		
Altezza (H) (mm)	40.00		
Volume (V) (cm ³)	98.47		
Peso lordo umido (P_u) (g)	213.50	57.4	44.1
Peso lordo secco (P_s) (g)	175.59	51.39	37.61
Contenuto d'acqua (w)	0.23	0.150	0.230
Peso umido unità di volume (γ) (kN/m ³)	19.85		
Peso secco unità di volume (γ_d) (kN/m ³)	16.07		
Peso specifico del solido (γ_s) (kN/m ³)	26.53		
Porosità (n)	0.39		
Indice dei vuoti (e)	0.65		
Grado di Saturazione (S_r)	0.98		

il responsabile della sperimentazione

prof. Ing. Anna D'Onofrio



Università degli Studi di Napoli
 Dipartimento di Ingegneria Civile, Edile e Ambientale
 Laboratorio di Geotecnica

Committente	Consorzio HirpiniaAV
Indagine	I lotto funzionale Apice-Hirpinia
Sondaggio	SNGR03
Campione	C2
Profondità	15.45 ÷ 16.00 m
Data	28/11/2019
Operatore	Alfredo Ponzio

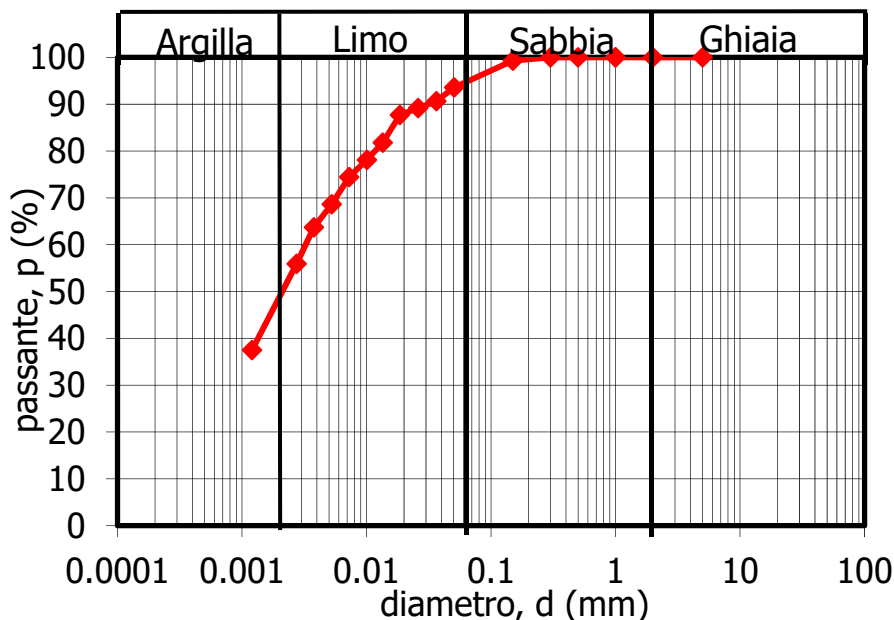

Curva granulometrica	
diametro (mm)	passante (%)
1.000	100.00
0.500	100.00
0.300	100.00
0.150	99.29
0.051	93.58
0.036	90.64
0.026	89.16
0.019	87.69
0.014	81.80
0.010	78.12
0.007	74.43
0.005	68.64
0.004	63.70
0.003	55.91
0.001	37.50

Argilla con limo debolmente sabbiosa

peso secco totale (g)	peso secco sediment. (g)
53.86	53.86

STACCIATURA			SEDIMENTAZIONE		
d (mm)	peso trattenuto (g)	peso passante (g)	tempo (min)	temperatura (°C)	lettura areometro (g/cm ³)
1.00	0.00	53.86		22	
0.50	0.00	53.86	0.5	22	1.033
0.30	0.00	53.86	1	22	1.032
0.15	0.38	53.48	2	22	1.0315
			4	22	1.031
			8	22	1.029
			15	22	1.02775
			30	22	1.0265
			60	22.25	1.0245
			120	22.75	1.02275
			240	23.5	1.02
			1440	23.5	1.01375

Gs= 2.705

%<0.075mm	%ghiaia	%sabbia	%limo	%argilla	D _{max} (mm)	D ₆₀ (mm)	D ₁₀ (mm)
96	0	5	45	50	0.30	0.0030	

Normativa di riferimento : ASTM 422/90

il responsabile della sperimentazione
 prof. Ing. Anna d'Onofrio



Università degli Studi di Napoli Federico II
 Dipartimento di Ingegneria Civile, Edile ed Ambientale
 Laboratorio di Geotecnica

<u>Committente</u>	Consorzio HirpiniaAV
<u>Indagine</u>	I lotto funzionale Apice-Hirpinia
<u>Sondaggio</u>	SNGR03
<u>Campione</u>	C4
<u>Profondità</u>	37.40 ÷ 37.90 m
<u>Data apertura</u>	26/11/19
<u>Operatore</u>	Alfredo Pozzo

Diametro (mm):	85
Lunghezza (mm):	400
Data di apertura:	26/11/2019

Stato del Campione	Indisturbato	x
	Parzialmente Rimaneggiato	
	Rimaneggiato	

Descrizione: Argilla marnosa strutturata grigio azzurra. Tracce di ossidazione nella parte inferiore (circa 10 cm)					
Colore	Grigio-azzurra				
Plasticità	Non Plastico	<input type="checkbox"/> Bassa	Media alta	x Elevata	
Addensamento (Terreni granulari)	<input type="checkbox"/> Molto sciolto ($D_r=0.0\div 0.2$)	<input type="checkbox"/> Sciolto ($D_r=0.2\div 0.4$)	<input type="checkbox"/> Medio ($D_r=0.4\div 0.6$)	Denso ($D_r=0.6\div 0.8$)	<input type="checkbox"/> Molto denso ($D_r=0.8\div 1.0$)
Consistenza (Terreni coesivi)	<input type="checkbox"/> Molto molle ($I_c < 0.0$)	<input type="checkbox"/> Molle ($I_c=0.0\div 0.5$)	<input type="checkbox"/> Media ($I_c=0.5\div 1.0$)	Consistente ($I_c > 1.0$)	x <input type="checkbox"/> Molto consist. ($I_c >> 1.0$)
Grado di umidità	<input type="checkbox"/> Asciutto	<input type="checkbox"/> Poco Umido	x Umido	<input type="checkbox"/> Molto Umido	
Alterazione	x Assente	<input type="checkbox"/> Debole	<input type="checkbox"/> Media	<input type="checkbox"/> Elevata	
Struttura	Omogenea	<input type="checkbox"/> Stratificata	<input checked="" type="checkbox"/> Scagliosa	<input type="checkbox"/> Laminata	Caotica
Fratturazione	x Assente	Moderata	<input type="checkbox"/> Elevata		
Cementazione	x Assente	<input type="checkbox"/> Debole	<input checked="" type="checkbox"/> Media	<input type="checkbox"/> Elevata	

Proprietà fisiche			Proprietà meccaniche	
n,γ,w	X		Compressione uniaassiale	
Analisi granulometrica	X		TX -UU	
Limiti	x		TX-CIU	
CaCO ₃			TX-CID	
Sostanze organiche			TX-Ciclica	x
Peso specifico del solido	x		Taglio anulare	
Proctor			Taglio diretto	
CBR			RC TS	x
Altro _____			Altro _____	



Committente	Consorzio HirpiniaAV
Indagine	I lotto funzionale Apice-Hirpinia
Sondaggio	SNGR03
Campione	C4
Profondità	37.40-37.90
Data	28/11/2019
Operatore	Alfredo Ponzo

LIMITE DI PLASTICITA'				
pesafiltro n°	Tara	Peso lordo umido (P _u)	Peso lordo secco (P _s)	Contenuto d'acqua (w)
[-]	[gr]	[gr]	[gr]	[-]
20	20.92	51.94	45.23	0.276
w_P				0.276

LIMITE DI LIQUIDITA' (Metodo di Casagrande ASTM)					
Pesafiltro n°	N° colpi (N)	Tara (P _c)	Peso lordo umido (P _u)	Peso lordo secco (P _s)	Contenuto d'acqua (w)
[-]	[-]	[g]	[g]	[g]	[g]
23	18	11.97	47.01	32.39	0.716
177	25	12.19	41.95	29.83	0.687
176	31	12.07	46.97	32.98	0.669
25	Limite di liquidità ASTM (w_L)				0.689

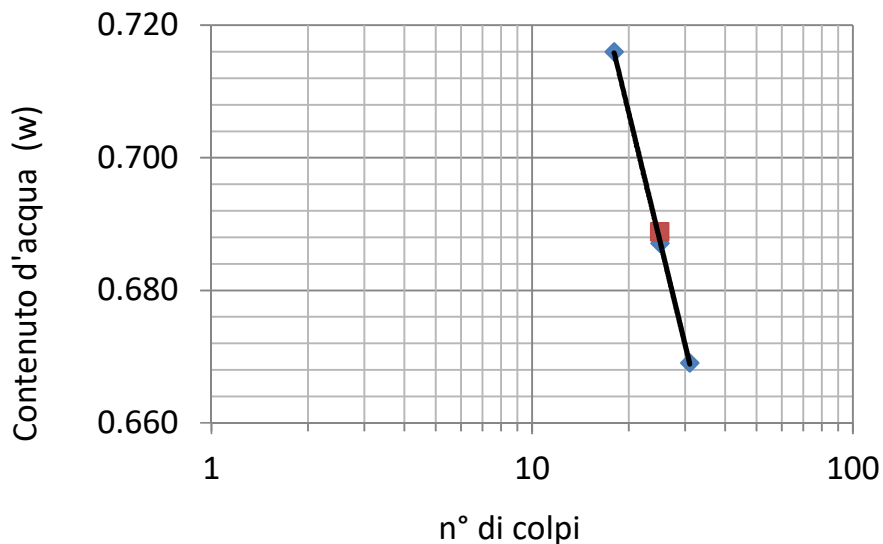

Indice di plasticità (I _p)	Frazione argillosa CF (d < 2 μm)	Indice di attività (I _A)
[%]	[%]	[-]
41.28	48.000	0.86

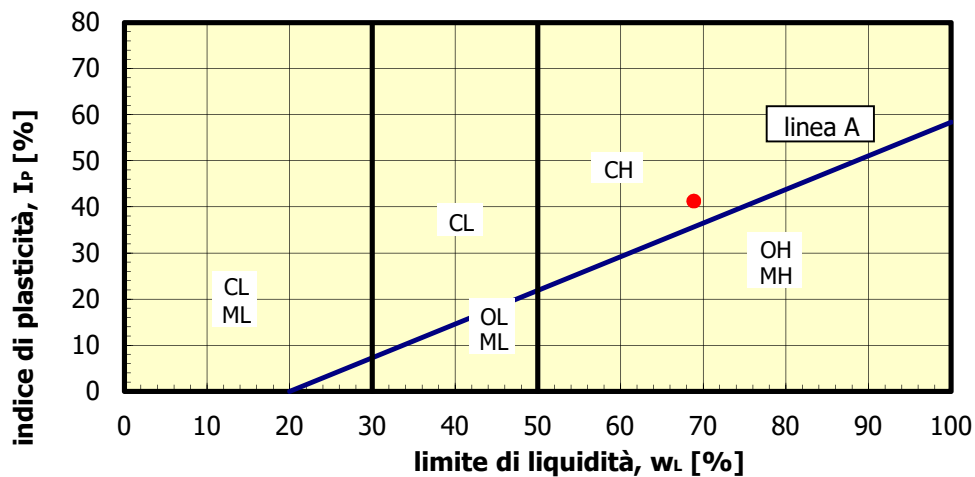

ML	Limi inorganici da bassa a media plasticità	M = limi
CL	Argille inorganiche da bassa a media plasticità	C = argille
OL	Limi e argille organiche di bassa plasticità	O = sostanze organiche
MH	Limi inorganici di alta plasticità	L = bassa plasticità
CH	Argille inorganiche di alta plasticità	H = alta plasticità
OH	Argille organiche da media ad alta plasticità	

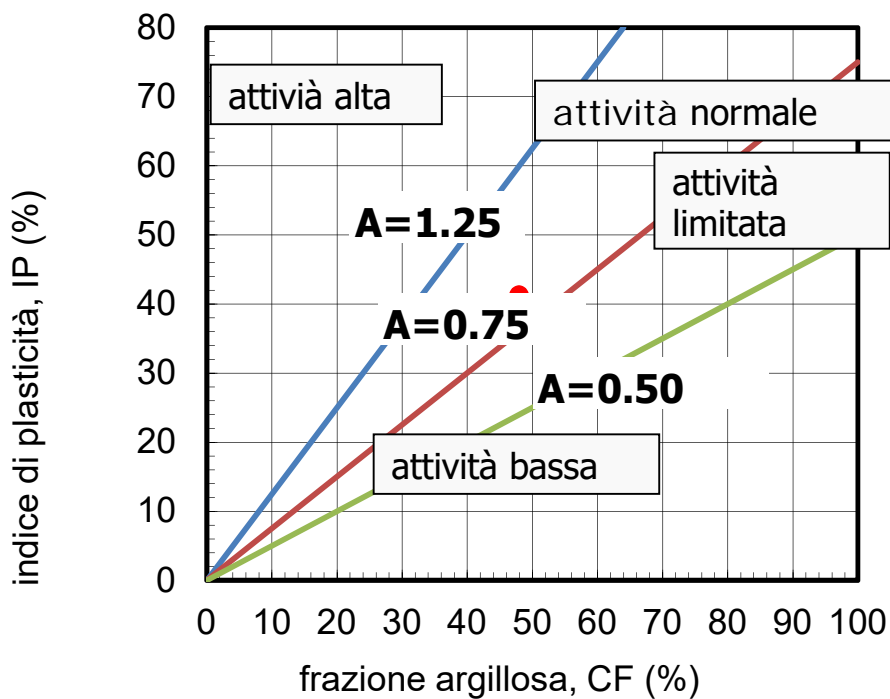

CONSISTENZA TERRENO A GRANA FINE		
w_L	I_p	I_c
[-]	[-]	[-]
68.878	41.28	1.66
COMPATTEZZA TERRENO A GRANA GROSSA		
e_{max}	e_{min}	D_r
[-]	[-]	[-]



Università degli Studi di Napoli
Dipartimento di Ingegneria Civile, Edile e Ambientale
Laboratorio di Geotecnica

Committente	Consorzio HirpiniaAV
Indagine	Apice-Hirpinia
Sondaggio	SNGR03
Campione	C4
Profondità	37.40-37.90
Data	28/11/2019
Operatore	Alfredo Ponzo

Peso specifico del solido	
Peso specifico dell'acqua (γ_w) (g/cm ³)	1.000
picnometro n°	XX
Peso picnometro (P_p) (g)	42.55
Peso picnometro + acqua (P_{pw}) (g)	140.260
Volume picnometro (V_p) (cm ³)	97.71
Peso picnometro + terreno (P_{ps}) (g)	63.68
Peso terreno (P_s)	21.13
Peso picnometro + terreno + acqua (P_{psw}) (g)	153.770
Volume acqua aggiunta (V_w) (cm ³)	90.09
Volume terreno (V_s) (cm ³)	7.620
Peso specifico del terreno (γ_s) (kN/m ³)	27.192

Caratteristiche Fisiche Generali	
pesafiltro n°	177.000
Peso contenitore (P_c) (g)	11.850
Diametro (D) (mm)	
Altezza (H) (mm)	
Volume (V) (cm ³)	
Peso lordo umido (P_u) (g)	41.69
Peso lordo secco (P_s) (g)	34.91
Contenuto d'acqua (w)	0.294
Peso umido unità di volume (γ) (kN/m ³)	
Peso secco unità di volume (γ_d) (kN/m ³)	
Peso specifico del solido (γ_s) (kN/m ³)	
Porosità (n)	
Indice dei vuoti (e)	
Grado di Saturazione (S_r)	

il responsabile della sperimentazione

Alfredo Ponzo
prof. Ing. Alfredo Ponzo



Università degli Studi di Napoli
 Dipartimento di Ingegneria Civile, Edile e Ambientale
 Laboratorio di Geotecnica

Committente	Consorzio HirpiniaAV
Indagine	I lotto funzionale Apice-Hirpinia
Sondaggio	SNGR03
Campione	C4
Profondità	37.40 ÷ 37.90 m
Data	29/11/2019
Operatore	Alfredo Ponzio

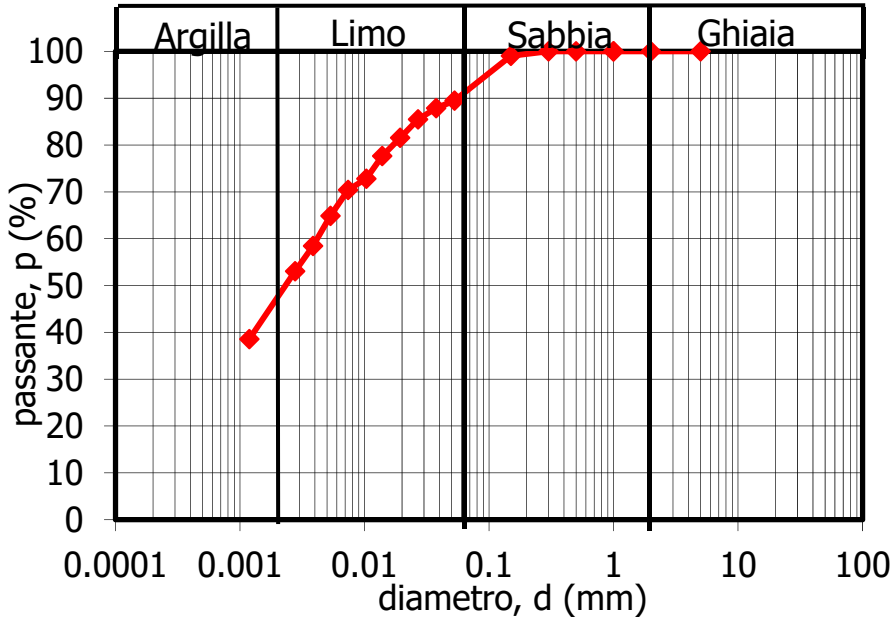

Curva granulometrica	
diametro (mm)	passante (%)
1.000	100.00
0.500	100.00
0.300	100.00
0.150	99.05
0.053	89.49
0.038	87.88
0.027	85.47
0.019	81.55
0.014	77.64
0.010	72.82
0.007	70.40
0.005	64.88
0.004	58.45
0.003	53.04
0.001	38.56

Argilla con limo debolmente sabbiosa

peso secco totale (g)	peso secco sediment. (g)
48.54	48.54

STACCIATURA			SEDIMENTAZIONE		
d (mm)	peso trattenuto (g)	peso passante (g)	tempo (min)	temperatura (°C)	lettura areometro (g/cm ³)
1.00	0.00	48.54		22.25	
0.50	0.00	48.54	0.5	22.25	1.029
0.30	0.00	48.54	1	22.25	1.0285
0.15	0.46	48.08	2	22.25	1.02775
			4	22.5	1.0265
			8	22.75	1.02525
			15	22.75	1.02375
			30	22.75	1.023
			60	23	1.02125
			120	23	1.01925
			240	23.5	1.0175
			1440	23.5	1.013

Gs= 2.778

%<0.075mm	%ghiaia	%sabbia	%limo	%argilla	D _{max} (mm)	D ₆₀ (mm)	D ₁₀ (mm)
92	0	9	43	48	0.30	0.0045	

Normativa di riferimento : ASTM 422/90

il responsabile della sperimentazione
 prof. Ing. Anna d'Onofrio



Università degli Studi di Napoli Federico II
Dipartimento di Ingegneria Idraulica,
Geotecnica ed Ambientale

Prova Compressione Triassiale n.		Celle n.
Prova tipo	TXC	
Committente	Consorzio Hirpinia AV	
Indagine	I lotto funzionale Apice-Hirpinia	
Sondaggio	SNGR03	
Campione	C4	
Profondità	37.30 ÷ 37.90 m	

Condizioni inizio prova			Consolidazione		Condizioni fine prova			
altezza ho	mm	76.70	Pressione di cella σ_c	kPa	650	altezza h	mm	72.50
diámetro d	mm	37.90	Contropressione u_0	kPa	200	diámetro d	mm	38.60
peso umido iniziale	g	176.98	Tensione effettiva σ'_c	kPa	450	Pesafiltro n° 37	g	15.55
Peso specifico γ_s	kN/m ³	27.19				Pf + prov. umido	g	195.23
Peso secco dell'udv γ_d	kN/m ³	17.13				Pf + prov.secco	g	166.66
Contenuto d'acqua w		0.171				Peso specifico γ_s	kN/m ³	27.19
Peso umido dell'udv γ	kN/m ³	20.06				Peso secco dell'udv γ_d	kN/m ³	17.47
Indice dei vuoti e		0.587				Contenuto d'acqua w		0.189
Grado di saturazione Sr		0.8				Peso umido dell'udv γ	kN/m ³	20.78
						Indice dei vuoti e		0.556
						Grado di saturazione Sr		0.9

Prova triassiale ciclica SNGR03-C4							
tensione di confinamento (kPa)		450		tensione di confinamento (kPa)		450	
deviatore ciclico (kPa)		80		deviatore ciclico (kPa)		120	
frequenza (hz)		0.00071429		frequenza (hz)		0.0007143	
tempo	cella di carico	u	LVDT	tempo	cella di carico	u	LVDT
(min)	kN	(kPa)	δ (mm)	(min)	kN	(kPa)	δ (mm)
0.00	0.023	213.4	0	0.00	666.68	244.1	0.0027
0.03	0.023	213.4	0.0905	0.08	666	244.3	-0.0009
0.07	0.026	213.9	0.1207	0.18	669.17	245.1	0.0053
0.10	0.025	214	0.1367	0.25	671.53	245.8	0.0124
0.13	0.027	214.4	0.1571	0.33	673.96	246.4	0.0213
0.17	0.027	214.8	0.1802	0.42	678.16	247.3	0.0355
0.20	0.03	215.4	0.1802	0.50	680.35	248.4	0.0533
0.23	0.031	215.7	0.205	0.58	681.18	249.1	0.0905
0.27	0.031	215.7	0.2263	0.67	684.82	250.1	0.1243
0.30	0.032	216.1	0.2494	0.75	688.74	251.5	0.1571
0.33	0.037	216.9	0.2734	0.83	690.16	252.2	0.1651
0.37	0.035	217.1	0.2929	0.92	692.9	253	0.1704
0.40	0.036	217.5	0.3018	1.00	696.93	253.9	0.1766
0.43	0.037	217.7	0.3018	1.08	699.48	255.2	0.1811
0.47	0.036	217.9	0.3035	1.17	700.9	256.1	0.1891
0.50	0.036	217.9	0.3062	1.25	703.57	256.8	0.1926
0.53	0.039	218.4	0.3098	1.33	706.6	257.7	0.1971
0.57	0.041	218.8	0.3124	1.42	708.63	258.5	0.2015
0.60	0.044	219.3	0.316	1.50	710.89	259.3	0.205
0.63	0.043	219.5	0.3169	1.60	713.75	260.5	0.2113
0.67	0.044	219.7	0.3169	1.67	716.1	261.3	0.2148
0.70	0.045	220	0.3186	1.75	718.33	262.2	0.2184
0.73	0.045	220	0.3204	1.83	720.39	263	0.2228
0.77	0.046	220.3	0.3222	1.92	723.45	263.9	0.2272
0.80	0.048	220.7	0.324	2.00	726.67	265.2	0.2308
0.83	0.048	220.9	0.3249	2.08	730.5	266.3	0.2379
0.87	0.05	221.4	0.3275	2.17	729.53	266.7	0.2397
0.90	0.051	221.7	0.3275	2.25	732.55	267.6	0.2441
0.93	0.052	222	0.3293	2.33	734.16	268.4	0.2477
0.97	0.052	222	0.3302	2.42	736.03	269.2	0.2503
1.00	0.053	222.3	0.332	2.50	739.7	270.1	0.2548
1.03	0.052	222.4	0.332	2.58	741.66	271.3	0.2574
1.08	0.054	222.8	0.3346	2.67	744.56	272.3	0.2636
1.12	0.055	223.1	0.3355	2.75	743.85	272.7	0.2654
1.15	0.056	223.5	0.3382	2.83	747.7	273.7	0.2698
1.17	0.058	223.8	0.3408	2.92	749.44	274.6	0.2734
1.20	0.061	224.3	0.3435	3.00	749.38	275	0.2752
1.23	0.061	224.6	0.3435	3.08	752.65	276.1	0.2796
1.27	0.061	224.8	0.3453	3.17	755.13	277	0.284
1.30	0.061	224.8	0.3462	3.25	755.97	277.7	0.2867
1.33	0.062	225.1	0.347	3.33	757.93	278.4	0.2885
1.37	0.062	225.3	0.3479	3.42	760.69	279.1	0.2911
1.40	0.062	225.5	0.3497	3.50	761.95	280.2	0.2938
1.43	0.067	226.2	0.3541	3.58	763.3	280.9	0.2982
1.47	0.068	226.5	0.3541	3.67	763.91	281.4	0.3
1.50	0.067	226.6	0.355	3.75	765.38	282.1	0.3027
1.53	0.067	226.6	0.3559	3.83	768.72	283.1	0.3071
1.57	0.068	226.9	0.3568	3.92	767.57	283.3	0.308
1.60	0.069	227.2	0.3577	4.00	772.75	284	0.3107
1.63	0.069	227.3	0.3586	4.08	770.97	284.8	0.3133
1.67	0.07	227.7	0.3604	4.17	771.96	285.4	0.316
1.70	0.073	228.1	0.3604	4.25	773.76	286.1	0.3187

Prova triassiale ciclica SNGR03-C4

tensione di confinamento (kPa)		450		tensione di confinamento (kPa)		450	
deviatore ciclico (kPa)		80		deviatore ciclico (kPa)		120	
frequenza (hz)		0.00071429		frequenza (hz)		0.0007143	
1.73	0.073	228.4	0.3621	4.33	777.56	287	0.3222
1.77	0.073	228.4	0.3648	4.42	775.59	287.2	0.3231
1.80	0.076	228.9	0.3666	4.52	775.49	287.8	0.3249
1.83	0.076	229.2	0.3675	4.58	778	288.5	0.3275
1.87	0.076	229.4	0.3683	4.67	778.65	289	0.3293
1.90	0.077	229.6	0.3701	4.75	778.77	289.3	0.3302
1.93	0.077	229.9	0.3701	4.83	782.43	290.2	0.3338
1.97	0.078	230.2	0.3701	4.92	780.76	290.3	0.3338
2.00	0.078	230.2	0.3719	5.00	780.53	290.8	0.3355
2.03	0.079	230.5	0.3737	5.08	784.35	291.7	0.3391
2.07	0.083	231.2	0.3763	5.17	782.23	291.7	0.3382
2.10	0.083	231.4	0.3772	5.25	786.09	292.5	0.3409
2.13	0.082	231.5	0.3781	5.33	783.97	292.5	0.3409
2.17	0.083	231.8	0.3781	5.42	782.36	292.5	0.3409
2.20	0.084	232.1	0.379	5.50	784.22	293.1	0.3426
2.23	0.084	232.1	0.3799	5.58	786.8	293.9	0.3435
2.27	0.083	232.2	0.3808	5.67	785.32	294	0.3453
2.30	0.086	232.6	0.3825	5.75	783.42	293.9	0.3444
2.33	0.087	232.9	0.3843	5.83	785.05	294.3	0.3462
2.37	0.088	233.2	0.3852	5.93	785.34	294.7	0.348
2.40	0.092	233.8	0.3852	6.00	783.95	294.7	0.3471
2.43	0.09	234	0.3888	6.08	784.82	295	0.348
2.47	0.09	234	0.3888	6.17	784.34	295.1	0.348
2.50	0.089	234.2	0.3896	6.25	784.4	295.3	0.348
2.55	0.092	234.7	0.3914	6.33	785.72	295.7	0.3497
2.58	0.092	234.7	0.3923	6.42	782.47	295.3	0.348
2.60	0.091	234.9	0.3923	6.50	784.85	296	0.3497
2.63	0.092	235.2	0.395	6.58	782.12	295.7	0.348
2.67	0.097	235.7	0.3967	6.67	783.92	296	0.3488
2.70	0.095	235.8	0.3967	6.75	780	295.6	0.3471
2.73	0.094	236	0.3967	6.83	780.12	295.7	0.3471
2.77	0.097	236.4	0.3976	6.92	782.02	296.1	0.3488
2.80	0.097	236.4	0.3985	7.00	778.01	295.6	0.3462
2.83	0.095	236.4	0.3985	7.08	778.26	295.6	0.3462
2.87	0.096	236.7	0.4003	7.17	778.03	295.7	0.3462
2.90	0.099	237.1	0.403	7.25	777.84	295.7	0.3462
2.93	0.101	237.6	0.4047	7.33	775.75	295.4	0.3444
2.97	0.1	237.7	0.4047	7.43	773.85	295.1	0.3435
3.00	0.099	237.8	0.4047	7.50	773.85	295.2	0.3435
3.03	0.099	237.8	0.4047	7.58	774.14	295.3	0.3435
3.07	0.1	238.1	0.4065	7.67	770.45	294.7	0.3409
3.10	0.104	238.8	0.4092	7.75	770.09	294.6	0.3409
3.13	0.104	238.9	0.4101	7.83	768.68	294.4	0.3391
3.17	0.103	239.1	0.4101	7.92	766.65	294	0.3373
3.20	0.103	239.3	0.4101	8.00	765.07	293.7	0.3373
3.23	0.105	239.6	0.411	8.08	764.34	293.5	0.3355
3.27	0.105	239.6	0.4127	8.17	763.79	293.4	0.3355
3.30	0.105	239.8	0.4136	8.25	760.99	292.9	0.3329
3.33	0.107	240.1	0.4145	8.33	759.71	292.6	0.332
3.37	0.106	240.3	0.4154	8.42	758.23	292.3	0.3302
3.40	0.107	240.6	0.4163	8.50	753.72	291.9	0.3275
3.43	0.108	240.8	0.4163	8.58	754.37	291.3	0.3267
3.47	0.108	241.1	0.4172	8.67	754.37	291.2	0.3258
3.50	0.108	241.1	0.4181	8.75	750.28	290.4	0.3231
3.53	0.109	241.3	0.4198	8.85	748.32	290	0.3213
3.57	0.109	241.6	0.4198	8.92	746.49	289.4	0.3196
3.60	0.109	241.7	0.4207	9.00	745.78	289.1	0.3178
3.63	0.108	241.9	0.4207	9.08	740.96	288.2	0.3142
3.67	0.11	242.2	0.4207	9.17	742.21	288.2	0.3142
3.70	0.115	242.8	0.4234	9.25	739.25	287.5	0.3116

Prova triassiale ciclica SNGR03-C4								
tensione di confinamento (kPa)		450			tensione di confinamento (kPa)		450	
deviatore ciclico (kPa)		80			deviatore ciclico (kPa)		120	
frequenza (hz)		0.00071429			frequenza (hz)		0.0007143	
3.73	0.115	242.8	0.4252	9.33	736.55	286.9	0.3089	
3.77	0.113	242.8	0.4243	9.42	734.94	286.3	0.3071	
3.80	0.11	242.8	0.4243	9.50	730.72	285.4	0.3045	
3.83	0.111	243	0.4252	9.58	729.44	284.9	0.3009	
3.87	0.114	243.4	0.4278	9.67	725	283.8	0.2965	
3.90	0.115	243.7	0.4278	9.75	726.38	283.8	0.2965	
3.93	0.115	243.9	0.4287	9.83	721.2	282.6	0.2911	
3.97	0.115	243.9	0.4296	9.92	722.29	282.5	0.2911	
4.02	0.115	244.3	0.4296	10.00	716.5	281.2	0.2867	
4.05	0.114	244.3	0.4305	10.08	714.73	280.6	0.2849	
4.07	0.114	244.3	0.4305	10.17	713.28	280	0.2814	
4.10	0.115	244.6	0.4314	10.25	710.7	279.3	0.2787	
4.13	0.115	244.8	0.4323	10.35	707.55	278.5	0.2752	
4.17	0.117	245.1	0.4331	10.42	704.94	277.4	0.2725	
4.20	0.116	245.2	0.434	10.50	703.24	276.7	0.2672	
4.23	0.118	245.6	0.434	10.58	700.08	275.8	0.2645	
4.27	0.117	245.7	0.4358	10.67	697.63	275.1	0.261	
4.30	0.117	245.7	0.4349	10.75	696.22	274.4	0.2565	
4.33	0.117	245.8	0.4349	10.83	693.12	273.5	0.253	
4.37	0.117	245.9	0.4358	10.92	689.74	272.6	0.2494	
4.40	0.12	246.4	0.4385	11.00	686.26	271.3	0.2459	
4.43	0.119	246.5	0.4376	11.08	684.85	270.6	0.2397	
4.47	0.118	246.5	0.4376	11.17	681.3	269.7	0.2352	
4.50	0.117	246.6	0.4376	11.25	679.5	268.8	0.2317	
4.53	0.117	246.6	0.4376	11.33	679.26	268.3	0.229	
4.57	0.121	247.1	0.4402	11.42	673.6	267	0.2228	
4.60	0.12	247.3	0.4402	11.50	669.6	265.5	0.2157	
4.63	0.119	247.3	0.4411	11.58	668.41	264.8	0.2104	
4.67	0.121	247.6	0.4411	11.67	665.83	263.9	0.2059	
4.70	0.121	247.7	0.4411	11.77	663.76	262.9	0.2024	
4.73	0.119	247.8	0.442	11.85	660.22	261.9	0.1944	
4.77	0.119	247.8	0.4411	11.92	657.12	260.9	0.1864	
4.80	0.119	247.9	0.442	12.00	655.73	260.2	0.1749	
4.83	0.122	248.3	0.4429	12.08	652.73	259.2	0.1607	
4.87	0.121	248.3	0.4429	12.17	648.6	257.7	0.1465	
4.90	0.12	248.4	0.4429	12.25	647.04	256.8	0.1331	
4.93	0.12	248.5	0.4429	12.33	644.74	255.8	0.111	
4.97	0.12	248.6	0.4429	12.42	641.93	254.8	0.0985	
5.00	0.12	248.6	0.4438	12.50	639.51	253.7	0.0852	
5.03	0.123	249	0.4447	12.58	637.4	252.6	0.0737	
5.07	0.122	249.1	0.4447	12.67	634.39	251.5	0.063	
5.10	0.121	249.1	0.4447	12.75	630.71	250.4	0.0541	
5.13	0.121	249.2	0.4447	12.83	630.45	249.1	0.0462	
5.17	0.122	249.4	0.4447	12.92	626.33	247.8	0.0337	
5.20	0.121	249.5	0.4456	13.00	623.88	246.7	0.0257	
5.23	0.121	249.5	0.4456	13.08	620.73	245.5	0.0186	
5.27	0.124	249.8	0.4473	13.17	619.24	244.4	0.0124	
5.30	0.122	249.8	0.4473	13.27	616.33	242.9	0.0071	
5.33	0.122	249.9	0.4465	13.33	613.83	241.9	-0.0009	
5.37	0.121	250	0.4465	13.42	611.02	240.7	-0.0062	
5.40	0.121	250.1	0.4465	13.50	609.01	239.7	-0.0107	
5.45	0.121	250.1	0.4473	13.58	607.03	238.7	-0.0151	
5.48	0.123	250.4	0.4482	13.67	604.96	237.7	-0.0186	
5.50	0.122	250.5	0.4482	13.75	601.88	236.5	-0.0222	
5.53	0.121	250.5	0.4482	13.83	598.48	234.9	-0.0257	
5.57	0.121	250.5	0.4482	13.92	597.28	234.1	-0.0311	
5.60	0.122	250.7	0.4482	14.00	594.95	233.2	-0.0337	
5.63	0.122	250.8	0.4482	14.08	593.42	232.2	-0.0364	
5.67	0.121	250.7	0.4482	14.17	591.54	231.3	-0.0399	
5.70	0.119	250.8	0.4473	14.25	588.2	230.1	-0.0435	

Prova triassiale ciclica SNGR03-C4

tensione di confinamento (kPa)		450			tensione di confinamento (kPa)	450		
deviatore ciclico (kPa)		80			deviatore ciclico (kPa)	120		
frequenza (hz)		0.00071429			frequenza (hz)	0.0007143		
5.73	0.121	251	0.4482	14.33	586.49	229.4	-0.0453	
5.77	0.121	251.1	0.4482	14.42	585.87	228.3	-0.0479	
5.80	0.121	251.1	0.4482	14.50	582.66	227.3	-0.0515	
5.83	0.12	251.1	0.4482	14.58	580.72	226.3	-0.0533	
5.87	0.121	251.2	0.4491	14.68	578.19	225.5	-0.0568	
5.90	0.12	251.3	0.4491	14.75	576.44	224.2	-0.0586	
5.93	0.12	251.3	0.4482	14.83	574.72	223.4	-0.0621	
5.97	0.119	251.3	0.4482	14.92	574	222.7	-0.0639	
6.00	0.12	251.4	0.4482	15.00	571.22	221.7	-0.0666	
6.03	0.12	251.4	0.4491	15.08	570.63	221.1	-0.0683	
6.07	0.12	251.5	0.4491	15.17	568.01	220.3	-0.0701	
6.10	0.119	251.5	0.4491	15.25	566.39	219.7	-0.0719	
6.13	0.119	251.6	0.4491	15.33	564.64	218.3	-0.0737	
6.17	0.119	251.6	0.4482	15.42	563.79	217.8	-0.0763	
6.20	0.118	251.7	0.4482	15.50	562.36	217.1	-0.0781	
6.23	0.116	251.5	0.4482	15.58	561.23	216.4	-0.0799	
6.27	0.116	251.5	0.4473	15.67	560.13	215.8	-0.0817	
6.30	0.116	251.6	0.4473	15.75	558.76	215.1	-0.0834	
6.33	0.119	251.8	0.4482	15.83	556.4	214.5	-0.0843	
6.37	0.116	251.8	0.4482	15.92	556.07	213.6	-0.0861	
6.40	0.116	251.8	0.4482	16.00	555.1	213	-0.0879	
6.43	0.118	252	0.4482	16.10	553.8	212.4	-0.0888	
6.47	0.115	251.9	0.4482	16.17	553.12	212	-0.0897	
6.50	0.115	251.9	0.4473	16.25	551.6	211.1	-0.0914	
6.53	0.115	251.9	0.4473	16.33	551.27	210.7	-0.0932	
6.57	0.116	252	0.4482	16.42	550.49	210.1	-0.0941	
6.60	0.115	251.9	0.4473	16.50	549.55	209.7	-0.095	
6.63	0.114	251.9	0.4473	16.58	548.64	209.2	-0.0968	
6.67	0.115	252.1	0.4473	16.67	548.19	208.8	-0.0976	
6.70	0.115	252.1	0.4473	16.75	547.99	208.4	-0.0985	
6.73	0.115	252.1	0.4473	16.83	546.98	207.8	-0.0994	
6.77	0.114	252.1	0.4465	16.92	546.2	207.4	-0.1003	
6.80	0.112	252	0.4456	17.00	546.04	207.1	-0.1012	
6.83	0.11	251.7	0.4447	17.08	546.01	206.8	-0.1012	
6.87	0.112	251.9	0.4456	17.17	545.55	206.5	-0.1021	
6.92	0.112	252	0.4456	17.25	545.52	206.2	-0.103	
6.95	0.11	251.9	0.4447	17.33	544.87	205.9	-0.1039	
6.97	0.11	251.9	0.4447	17.42	545.52	205.7	-0.1039	
7.00	0.111	252	0.4447	17.50	544.74	205.4	-0.1047	
7.03	0.109	251.8	0.4447	17.60	544.55	205.2	-0.1047	
7.07	0.108	251.8	0.4438	17.67	545.55	205.1	-0.1047	
7.10	0.108	251.8	0.4438	17.75	545.26	204.8	-0.1056	
7.13	0.109	251.9	0.4438	17.83	545.03	204.6	-0.1056	
7.17	0.107	251.7	0.4429	17.92	545.52	204.6	-0.1056	
7.20	0.107	251.7	0.4429	18.00	546	204.5	-0.1056	
7.23	0.107	251.8	0.4429	18.08	546.26	204.4	-0.1056	
7.27	0.105	251.6	0.4429	18.17	546.81	204.4	-0.1056	
7.30	0.105	251.6	0.4411	18.25	546.97	204.3	-0.1056	
7.33	0.105	251.6	0.4411	18.33	547.65	204.2	-0.1056	
7.37	0.106	251.6	0.4411	18.42	548.53	204.3	-0.1056	
7.40	0.102	251.4	0.4402	18.50	548.98	204.3	-0.1056	
7.43	0.103	251.4	0.4402	18.58	549.83	204.4	-0.1056	
7.47	0.103	251.4	0.4402	18.67	550.38	204.4	-0.1047	
7.50	0.102	251.3	0.4402	18.75	551.15	204.5	-0.1047	
7.53	0.101	251.3	0.4394	18.83	552.58	204.7	-0.1039	
7.57	0.101	251.3	0.4385	18.92	553.41	204.9	-0.1039	
7.60	0.101	251.3	0.4385	19.02	553.62	204.8	-0.1039	
7.63	0.099	251.1	0.4376	19.08	555.33	205.1	-0.103	
7.67	0.1	251.1	0.4376	19.17	556.34	205.3	-0.1021	
7.70	0.1	251.1	0.4376	19.25	557.93	205.6	-0.1021	

Prova triassiale ciclica SNGR03-C4

tensione di confinamento (kPa)		450			tensione di confinamento (kPa)	450		
deviatore ciclico (kPa)		80			deviatore ciclico (kPa)	120		
frequenza (hz)		0.00071429			frequenza (hz)	0.0007143		
7.73	0.095	250.8	0.4376	19.33	558.8	205.8	-0.1021	
7.77	0.096	250.8	0.4349	19.42	560.88	206.1	-0.1012	
7.80	0.096	250.8	0.4349	19.50	560.97	206.2	-0.1012	
7.83	0.095	250.7	0.434	19.58	562.69	206.5	-0.0994	
7.87	0.095	250.7	0.4349	19.67	564.57	206.9	-0.0994	
7.90	0.095	250.6	0.434	19.75	566.32	207.1	-0.0985	
7.93	0.094	250.5	0.4331	19.83	567.94	207.8	-0.0976	
7.97	0.093	250.3	0.4331	19.92	569.47	208.1	-0.0959	
8.00	0.094	250.3	0.4323	20.00	570.89	208.5	-0.095	
8.03	0.094	250.4	0.4323	20.08	571.86	208.8	-0.0941	
8.07	0.093	250.2	0.4314	20.17	572.58	209.1	-0.0932	
8.10	0.09	250	0.4305	20.25	575.52	209.7	-0.0914	
8.13	0.09	250	0.4305	20.33	577.92	210.2	-0.0905	
8.17	0.087	249.6	0.4278	20.42	579.94	210.9	-0.0897	
8.20	0.089	249.7	0.4278	20.52	581	211.3	-0.0879	
8.23	0.088	249.7	0.4287	20.58	582.69	211.8	-0.087	
8.27	0.088	249.6	0.4278	20.67	586.06	212.7	-0.0843	
8.30	0.085	249.2	0.426	20.75	585.96	213	-0.0843	
8.35	0.086	249.2	0.426	20.83	588.85	213.6	-0.0817	
8.38	0.086	249.2	0.426	20.92	591.41	214.3	-0.0799	
8.42	0.084	249	0.4243	21.00	593.68	215	-0.0781	
8.43	0.083	248.8	0.4243	21.08	595.75	215.6	-0.0763	
8.47	0.083	248.8	0.4243	21.17	597.5	216.2	-0.0754	
8.50	0.083	248.8	0.4234	21.25	600.93	217	-0.0728	
8.53	0.081	248.5	0.4234	21.33	602.68	217.9	-0.0719	
8.57	0.08	248.5	0.4225	21.42	605.11	218.6	-0.0683	
8.60	0.08	248.4	0.4198	21.50	607.58	219.4	-0.0666	
8.63	0.077	248	0.4189	21.58	609.74	220.2	-0.0639	
8.67	0.076	247.9	0.4189	21.67	611.37	220.8	-0.0621	
8.70	0.078	247.8	0.4181	21.75	613.8	221.6	-0.0604	
8.73	0.075	247.6	0.4163	21.83	618	222.5	-0.0577	
8.77	0.074	247.5	0.4163	21.93	620.53	223.8	-0.0533	
8.80	0.076	247.5	0.4163	22.00	621.67	224.4	-0.0506	
8.83	0.076	247.5	0.4163	22.08	623.03	225	-0.0497	
8.87	0.072	247	0.4145	22.17	627.53	226	-0.0462	
8.90	0.072	247	0.4145	22.25	629.95	227.2	-0.0435	
8.93	0.072	247	0.4136	22.33	631.81	228	-0.0391	
8.97	0.071	246.7	0.4127	22.42	635.59	229.1	-0.0364	
9.00	0.068	246.4	0.4127	22.50	636.98	229.9	-0.0328	
9.03	0.068	246.4	0.411	22.58	639.57	230.8	-0.0293	
9.07	0.068	246.3	0.4101	22.67	642.74	231.7	-0.0257	
9.10	0.067	246.1	0.4083	22.75	645.92	232.7	-0.0222	
9.13	0.065	245.8	0.4074	22.83	648.44	234	-0.0186	
9.17	0.065	245.8	0.4074	22.92	650.64	234.9	-0.0115	
9.20	0.062	245.4	0.4056	23.00	655.85	236.3	-0.0053	
9.23	0.061	245.2	0.4056	23.08	655.99	237	-0.0027	
9.27	0.061	245.2	0.4047	23.17	656.31	237.6	0.0018	
9.30	0.061	245.1	0.4039	23.25	660.57	238.8	0.008	
9.33	0.062	245	0.4039	23.33	665.13	239.9	0.0151	
9.37	0.058	244.6	0.4012	23.43	667.36	241.3	0.0249	
9.40	0.059	244.6	0.4003	23.50	668.95	242.2	0.0328	
9.43	0.057	244.3	0.4003	23.58	671.53	243.2	0.0435	
9.47	0.058	244.3	0.4003	23.67	675.76	244.9	0.0559	
9.50	0.054	244.3	0.4003	23.75	677.57	245.9	0.0683	
9.53	0.054	243.8	0.3967	23.83	680.02	247	0.0968	
9.57	0.054	243.7	0.3967	23.92	682.92	248	0.1181	
9.60	0.055	243.7	0.3959	24.00	685.1	249.2	0.142	
9.63	0.051	243.2	0.3941	24.08	687.2	250.1	0.1536	
9.67	0.051	243	0.3932	24.17	690.43	251.2	0.1598	
9.70	0.05	242.8	0.3932	24.25	694.23	252.6	0.166	

Prova triassiale ciclica SNGR03-C4								
tensione di confinamento (kPa)		450			tensione di confinamento (kPa)		450	
deviatore ciclico (kPa)		80			deviatore ciclico (kPa)		120	
frequenza (hz)		0.00071429			frequenza (hz)		0.0007143	
9.73	0.048	242.8	0.3914	24.33	694.29	253.2	0.1704	
9.77	0.048	242.7	0.3905	24.42	697.87	254.3	0.1775	
9.82	0.047	242.3	0.3896	24.50	701.19	255.3	0.1829	
9.85	0.048	242.3	0.3888	24.58	704.09	256.3	0.1873	
9.87	0.048	242.2	0.3879	24.67	705.8	257.1	0.1908	
9.90	0.046	241.8	0.3852	24.75	710.73	258.4	0.1979	
9.93	0.04	241.1	0.3817	24.85	710.02	259.2	0.2006	
9.97	0.041	241.1	0.3817	24.92	713.62	260.2	0.2059	
10.00	0.043	241.1	0.3825	25.00	717.49	261.4	0.2121	
10.03	0.039	240.7	0.3825	25.08	718.11	262.1	0.2148	
10.07	0.039	240.7	0.3799	25.17	720.23	263.2	0.2184	
10.10	0.039	240.5	0.3781	25.25	724.16	264.3	0.221	
10.13	0.038	240.3	0.3772	25.33	725.51	265.1	0.2272	
10.17	0.038	240.2	0.3772	25.42	728.12	266	0.2308	
10.20	0.036	239.9	0.3754	25.50	732.11	267.2	0.2361	
10.23	0.035	239.5	0.3737	25.58	732.17	267.8	0.2388	
10.27	0.032	239.2	0.3737	25.67	734.49	268.6	0.2414	
10.30	0.03	239.2	0.3719	25.75	736.84	269.7	0.245	
10.33	0.03	238.9	0.3692	25.83	739.48	270.8	0.2485	
10.37	0.031	238.7	0.3683	25.92	741.12	271.5	0.2539	
10.40	0.029	238.4	0.3666	26.00	745.47	272.7	0.2583	
10.43	0.029	238.2	0.3657	26.08	743.6	273	0.2592	
10.47	0.03	238.2	0.3657	26.17	746.78	273.9	0.2627	
10.50	0.024	237.5	0.3657	26.27	749.03	275	0.2672	
10.53	0.024	237.5	0.3612	26.33	753.28	276.2	0.2725	
10.57	0.024	237.3	0.3604	26.42	752.31	276.6	0.2743	
10.60	0.024	237.1	0.3595	26.50	754.27	277.3	0.2769	
10.63	0.023	236.8	0.3568	26.58	755.01	277.9	0.2787	
10.67	0.024	236.8	0.3568	26.67	759.83	279.5	0.284	
10.70	0.021	236.3	0.3541	26.75	758.55	279.8	0.2849	
10.73	0.018	235.9	0.3541	26.83	761.24	280.6	0.2885	
10.77	0.018	235.9	0.3515	26.92	763.37	281.3	0.292	
10.80	0.018	235.7	0.3506	27.00	764.59	282.1	0.2947	
10.83	0.017	235.4	0.3488	27.08	766.52	282.8	0.2974	
10.87	0.015	235.1	0.3462	27.17	766.55	283.2	0.2991	
10.90	0.013	234.6	0.3426	27.25	767.86	284.1	0.3018	
10.93	0.011	234.3	0.3408	27.33	772.5	285.3	0.3027	
10.97	0.011	234.1	0.3408	27.42	771.82	285.6	0.308	
11.00	0.012	234.1	0.3399	27.50	772.91	286.1	0.3098	
11.03	0.012	234.1	0.3382	27.58	773.61	286.6	0.3107	
11.07	0.011	233.4	0.3355	27.67	774.03	287.1	0.3124	
11.10	0.005	233	0.332	27.77	775.96	288.1	0.316	
11.13	0.008	233.1	0.332	27.83	777.76	288.7	0.3187	
11.17	0.005	232.6	0.3293	27.92	777.85	289.1	0.3196	
11.20	0.003	232.3	0.3293	28.00	778.49	289.5	0.3213	
11.25	0.005	232.3	0.3266	28.08	777.98	289.8	0.3222	
11.28	0.005	232	0.324	28.17	781.44	290.9	0.3258	
11.32	0.002	231.6	0.324	28.25	780.68	291.1	0.3258	
11.33	0	231.6	0.3213	28.33	781.19	291.5	0.3275	
11.37	0	231.3	0.316	28.42	781.57	291.9	0.3284	
11.40	-0.003	230.7	0.3098	28.50	784.4	292.6	0.332	
11.43	-0.003	230.6	0.3053	28.58	782.95	292.8	0.332	
11.47	-0.003	230.4	0.3018	28.67	783.62	293.1	0.3329	
11.50	-0.002	230.3	0.2973	28.75	783.37	293.5	0.3329	
11.53	-0.006	229.7	0.2973	28.83	784.2	293.9	0.3338	
11.57	-0.006	229.7	0.2893	28.92	786.93	294.6	0.3373	
11.60	-0.006	229.6	0.2831	29.00	785.52	294.7	0.3373	
11.63	-0.007	229.2	0.2743	29.08	782.91	294.5	0.3364	
11.67	-0.009	228.8	0.2654	29.18	784.71	295.1	0.3373	
11.70	-0.01	228.5	0.2565	29.25	784.84	295.3	0.3382	

Prova triassiale ciclica SNGR03-C4

tensione di confinamento (kPa)		450			tensione di confinamento (kPa)	450		
deviatore ciclico (kPa)		80			deviatore ciclico (kPa)	120		
frequenza (hz)		0.00071429			frequenza (hz)	0.0007143		
11.73	-0.011	228.2	0.2476	29.33	783.84	295.4	0.34	
11.77	-0.012	227.9	0.2476	29.42	786.19	296	0.34	
11.80	-0.014	227.9	0.2387	29.50	785.03	296	0.34	
11.83	-0.014	227.3	0.2272	29.58	782.94	295.9	0.3391	
11.87	-0.017	226.8	0.2183	29.67	785.38	296.6	0.3409	
11.90	-0.017	226.6	0.2103	29.75	782.23	296.2	0.3391	
11.93	-0.018	226.3	0.2032	29.83	782.74	296.4	0.3409	
11.97	-0.015	226.3	0.1988	29.92	784.54	296.9	0.3409	
12.00	-0.02	225.8	0.1988	30.00	782.04	296.6	0.34	
12.03	-0.02	225.8	0.1908	30.08	781.52	296.6	0.34	
12.07	-0.02	225.5	0.1837	30.17	781.39	296.7	0.34	
12.10	-0.022	225.1	0.1775	30.25	779.3	296.5	0.3382	
12.13	-0.024	224.6	0.1704	30.33	779.33	296.6	0.3382	
12.17	-0.024	224.4	0.166	30.42	778.98	296.6	0.3382	
12.20	-0.026	223.9	0.1597	30.50	778.18	296.6	0.3382	
12.23	-0.027	223.6	0.1597	30.58	778.15	296.6	0.3373	
12.27	-0.027	223.6	0.1553	30.68	775.7	296.3	0.3373	
12.30	-0.027	223.3	0.1509	30.75	774.64	296.2	0.3355	
12.33	-0.031	222.6	0.1438	30.83	772.45	295.8	0.3338	
12.37	-0.032	222.3	0.1393	30.92	772.71	295.9	0.3338	
12.40	-0.029	222.3	0.1384	31.00	770.65	295.6	0.332	
12.43	-0.03	221.9	0.1349	31.08	769.69	295.4	0.332	
12.47	-0.034	221.4	0.1349	31.17	768.52	295.2	0.332	
12.50	-0.035	221.4	0.1296	31.25	766.86	294.8	0.3293	
12.53	-0.035	221.1	0.126	31.33	765.57	294.7	0.3284	
12.57	-0.035	220.8	0.1234	31.42	762.13	294.1	0.3258	
12.60	-0.037	220.4	0.1198	31.50	762.77	294.1	0.3258	
12.63	-0.037	220.1	0.1171	31.58	761.71	293.9	0.3249	
12.67	-0.039	219.7	0.1136	31.67	759.56	293.5	0.3231	
12.72	-0.041	219.3	0.11	31.75	757.72	292.9	0.3231	
12.75	-0.041	219.1	0.1083	31.83	756.11	292.6	0.3204	
12.77	-0.041	218.8	0.1056	31.92	754.51	292.3	0.3187	
12.80	-0.043	218.4	0.1056	32.00	752.45	291.8	0.3169	
12.83	-0.044	218.4	0.1021	32.10	749.94	291.2	0.3151	
12.87	-0.044	218	0.0994	32.17	748.78	290.8	0.3124	
12.90	-0.045	217.7	0.0976	32.25	745.63	290.1	0.3098	
12.93	-0.046	217.3	0.095	32.33	744.11	289.7	0.308	
12.97	-0.047	217.1	0.0932	32.42	743.28	289.4	0.3071	
13.00	-0.047	216.8	0.0905	32.50	741.16	288.9	0.3045	
13.03	-0.049	216.4	0.0905	32.58	738.26	288.2	0.3027	
13.07	-0.05	216.4	0.0879	32.67	735.88	287.5	0.3	
13.10	-0.05	216	0.0861	32.75	734.11	286.9	0.2974	
13.13	-0.051	215.7	0.0843	32.83	732.86	286.6	0.2956	
13.17	-0.052	215.4	0.0816	32.92	729.22	285.8	0.2929	
13.20	-0.055	214.8	0.0781	33.00	728	285.2	0.2903	
13.23	-0.055	214.7	0.0772	33.08	725.91	284.6	0.2876	
13.27	-0.055	214.4	0.0772	33.17	721.72	283.6	0.284	
13.30	-0.054	214.4	0.0754	33.25	719.6	282.9	0.2823	
13.33	-0.054	214.3	0.0754	33.33	718.02	282.2	0.2787	
13.37	-0.055	213.9	0.0728	33.42	716.21	281.8	0.2769	
13.40	-0.06	213.4	0.0701	33.50	712.45	280.9	0.2734	
13.43	-0.059	213.2	0.0692	33.60	709.33	279.9	0.2707	
13.47	-0.059	212.9	0.0674	33.67	707.88	279.1	0.2654	
13.50	-0.061	212.5	0.0674	33.75	703.5	278	0.261	
13.53	-0.062	212.5	0.0648	33.83	702.92	277.6	0.2592	
13.57	-0.062	212.1	0.0639	33.92	701.12	276.8	0.2556	
13.60	-0.063	211.9	0.0621	34.00	698.6	276.3	0.253	
13.63	-0.064	211.5	0.0603	34.08	694.26	275.4	0.2494	
13.67	-0.065	211.2	0.0586	34.17	692.36	274.1	0.2459	
13.70	-0.065	210.9	0.0577	34.25	689.71	273.2	0.2397	

Prova triassiale ciclica SNGR03-C4							
tensione di confinamento (kPa)		450	tensione di confinamento (kPa)		450		
deviatore ciclico (kPa)		80	deviatore ciclico (kPa)		120		
frequenza (hz)		0.00071429	frequenza (hz)		0.0007143		
13.73	-0.068	210.4	0.0577	34.33	688.1	272.6	0.2361
13.77	-0.066	210.4	0.055	34.42	684.04	271.6	0.2317
13.80	-0.066	210.4	0.0541	34.50	682.75	270.8	0.2281
13.83	-0.068	210	0.0523	34.58	679.47	269.8	0.2228
13.87	-0.069	209.6	0.0506	34.67	674.47	268.9	0.2192
13.90	-0.071	209.3	0.0488	34.75	673.15	267.4	0.2139
13.93	-0.071	209.1	0.0479	34.83	673.5	267.1	0.2095
13.97	-0.072	208.7	0.0479	34.92	669.22	266	0.2042
14.00	-0.073	208.7	0.047	35.02	665.06	264.8	0.1979
14.03	-0.073	208.5	0.0452	35.08	662.67	263.6	0.1944
14.07	-0.074	208.2	0.0435	35.17	659.05	262.5	0.1855
14.10	-0.075	207.8	0.0426	35.25	657.25	261.9	0.1802
14.13	-0.076	207.5	0.0408	35.33	654.8	261	0.1713
14.18	-0.075	207.3	0.0399	35.42	653.09	260.1	0.1624
14.22	-0.076	207	0.039	35.50	650.92	259.4	0.1536
14.23	-0.077	206.7	0.0373	35.58	644.56	258.2	0.1411
14.27	-0.078	206.5	0.0364	35.67	644.3	256.7	0.1287
14.30	-0.079	206.2	0.0364	35.75	641.81	255.7	0.1127
14.33	-0.08	206.2	0.0355	35.83	641.16	255.1	0.1039
14.37	-0.08	205.9	0.0337	35.92	635.99	253.6	0.0941
14.40	-0.08	205.6	0.0328	36.00	634.79	252.7	0.0861
14.43	-0.081	205.4	0.0319	36.08	631.36	251.4	0.0763
14.47	-0.082	205.1	0.031	36.17	629.32	250.9	0.0719
14.50	-0.082	204.9	0.0302	36.25	624.64	248.7	0.063
14.53	-0.083	204.6	0.0302	36.33	623.82	247.8	0.0541
14.57	-0.084	204.6	0.0293	36.43	621.14	246.7	0.0488
14.60	-0.084	204.3	0.0284	36.50	618.39	245.7	0.0435
14.63	-0.085	203.9	0.0266	36.58	615.02	244	0.0382
14.67	-0.086	203.7	0.0257	36.67	613.33	243	0.0311
14.70	-0.086	203.5	0.0248	36.75	611.26	242.1	0.0275
14.73	-0.087	203.2	0.0239	36.83	608.61	240.9	0.0231
14.77	-0.088	203	0.0239	36.92	609.45	240.5	0.0204
14.80	-0.088	203	0.0231	37.00	605.34	239.2	0.016
14.83	-0.088	202.7	0.0213	37.08	602.01	238	0.0124
14.87	-0.089	202.3	0.0195	37.17	598.7	236.4	0.008
14.90	-0.092	201.9	0.0186	37.25	597.73	235.5	0.0036
14.93	-0.091	201.8	0.0186	37.33	594.75	234.5	0.0009
14.97	-0.089	201.8	0.0186	37.42	592.55	233.5	-0.0018
15.00	-0.09	201.6	0.0186	37.50	591.22	232.6	-0.0053
15.03	-0.091	201.6	0.0177	37.58	588.76	231.6	-0.0089
15.07	-0.091	201.3	0.0168	37.67	586.13	230.4	-0.0115
15.10	-0.092	201	0.0151	37.75	583.67	229.2	-0.0124
15.13	-0.093	200.8	0.0142	37.83	582.47	228.4	-0.0169
15.17	-0.094	200.6	0.0133	37.93	582.18	227.8	-0.0178
15.20	-0.095	200.3	0.0124	38.00	578.17	226.8	-0.0204
15.23	-0.094	200.2	0.0124	38.08	576.84	225.6	-0.0222
15.27	-0.095	200.2	0.0124	38.17	575.64	224.6	-0.0266
15.30	-0.095	199.9	0.0115	38.25	573.63	224	-0.0275
15.33	-0.095	199.8	0.0106	38.33	571.68	223.1	-0.0302
15.37	-0.096	199.5	0.0097	38.42	570.52	222.5	-0.032
15.40	-0.098	199.2	0.0089	38.50	568.83	221.7	-0.0346
15.43	-0.097	199.1	0.0089	38.58	566.69	220.6	-0.0364
15.47	-0.097	198.9	0.0089	38.67	565.04	219.7	-0.0373
15.50	-0.098	198.9	0.008	38.75	563.87	219	-0.0399
15.53	-0.098	198.6	0.0071	38.83	562.45	218.3	-0.0408
15.57	-0.098	198.5	0.0062	38.92	560.89	217.6	-0.0426
15.62	-0.099	198.3	0.0053	39.00	560.43	217.1	-0.0444
15.65	-0.099	198.1	0.0044	39.08	558.36	216.3	-0.0462
15.68	-0.099	197.9	0.0044	39.17	557.03	216.1	-0.0462
15.70	-0.1	197.7	0.0035	39.25	553.28	214.5	-0.0479

Prova triassiale ciclica SNGR03-C4							
tensione di confinamento (kPa)		450	tensione di confinamento (kPa)		450		
deviatore ciclico (kPa)		80	deviatore ciclico (kPa)		120		
frequenza (hz)		0.00071429	frequenza (hz)		0.0007143		
15.73	-0.1	197.5	0.0026	39.35	555.28	214.3	-0.0506
15.77	-0.1	197.4	0.0017	39.42	555.37	214	-0.0515
15.80	-0.101	197.2	0.0017	39.50	552.49	213.3	-0.0533
15.83	-0.102	197.2	0.0017	39.58	549.8	212.1	-0.055
15.87	-0.102	197	0.0009	39.67	551.23	211.9	-0.0568
15.90	-0.102	196.9	0.0009	39.75	550.25	211.4	-0.0577
15.93	-0.102	196.7	0	39.83	549.57	211	-0.0595
15.97	-0.102	196.5	-0.0009	39.92	548.63	210.4	-0.0604
16.00	-0.102	196.4	-0.0009	40.00	548.04	210.1	-0.0612
16.03	-0.106	195.9	-0.0009	40.08	547.23	209.7	-0.0612
16.07	-0.105	195.9	-0.0027	40.17	547.14	209	-0.0621
16.10	-0.105	195.9	-0.0018	40.25	546.78	208.7	-0.0639
16.13	-0.104	195.8	-0.0018	40.33	547.46	208.6	-0.0639
16.17	-0.103	195.8	-0.0027	40.42	545.8	208.1	-0.0648
16.20	-0.104	195.6	-0.0027	40.50	545.61	207.8	-0.0657
16.23	-0.104	195.4	-0.0036	40.58	545.42	207.5	-0.0657
16.27	-0.104	195.3	-0.0036	40.67	545.25	207.2	-0.0666
16.30	-0.103	195.3	-0.0036	40.75	545.19	206.8	-0.0666
16.33	-0.103	195.2	-0.0036	40.85	544.93	206.6	-0.0675
16.37	-0.104	195.1	-0.0054	40.93	544.89	206.4	-0.0683
16.40	-0.105	194.8	-0.0054	41.00	545.09	206.2	-0.0683
16.43	-0.106	194.6	-0.0062	41.08	545.09	206	-0.0683
16.47	-0.105	194.6	-0.0062	41.17	545.48	205.9	-0.0683
16.50	-0.105	194.6	-0.0062	41.25	545.77	205.8	-0.0692
16.53	-0.106	194.6	-0.0062	41.33	545.7	205.6	-0.0692
16.57	-0.106	194.4	-0.0071	41.42	545.9	205.5	-0.0692
16.60	-0.106	194.3	-0.0071	41.50	547.32	205.6	-0.0683
16.63	-0.106	194.1	-0.008	41.58	547.52	205.5	-0.0692
16.67	-0.107	193.9	-0.008	41.67	547.39	205.4	-0.0692
16.70	-0.106	193.9	-0.008	41.75	548.14	205.4	-0.0692
16.73	-0.106	193.9	-0.008	41.83	549.2	205.5	-0.0683
16.77	-0.106	193.9	-0.0089	41.92	548.49	205.3	-0.0692
16.80	-0.106	193.7	-0.0089	42.00	550.14	205.5	-0.0683
16.83	-0.106	193.6	-0.0089	42.08	551.18	205.7	-0.0675
16.87	-0.106	193.5	-0.0098	42.17	552.99	205.8	-0.0675
16.90	-0.107	193.4	-0.0098	42.27	553.15	205.9	-0.0675
16.93	-0.107	193.3	-0.0098	42.35	555.9	206.3	-0.0657
16.97	-0.106	193.2	-0.0098	42.42	555.97	206.4	-0.0657
17.00	-0.106	193.2	-0.0107	42.50	555.97	206.4	-0.0657
17.03	-0.106	193.2	-0.0107	42.58	558.89	206.8	-0.0648
17.08	-0.108	192.8	-0.0116	42.67	558.69	206.9	-0.0639
17.12	-0.107	192.8	-0.0116	42.75	560.41	207.2	-0.063
17.13	-0.107	192.8	-0.0116	42.83	561.8	207.5	-0.063
17.17	-0.106	192.8	-0.0116	42.92	562.16	207.7	-0.0621
17.20	-0.104	193	-0.0107	43.00	564.26	208	-0.0612
17.23	-0.104	192.9	-0.0116	43.08	564.95	208.2	-0.0612
17.27	-0.105	192.6	-0.0125	43.17	568.09	208.9	-0.0595
17.30	-0.107	192.5	-0.0125	43.25	568.99	209.2	-0.0586
17.33	-0.107	192.5	-0.0125	43.33	570.9	209.6	-0.0577
17.37	-0.107	192.4	-0.0125	43.42	572.01	209.9	-0.0559
17.40	-0.106	192.4	-0.0125	43.50	573.6	210.4	-0.055
17.43	-0.105	192.5	-0.0125	43.58	577.9	211.3	-0.0524
17.47	-0.105	192.4	-0.0133	43.67	577.52	211.5	-0.0515
17.50	-0.107	192.2	-0.0133	43.77	579.88	211.9	-0.0506
17.53	-0.107	192.1	-0.0133	43.85	581.3	212.6	-0.0497
17.57	-0.105	192.1	-0.0142	43.92	583.64	213.3	-0.0479
17.60	-0.105	192.2	-0.0133	44.00	585.13	213.7	-0.0462
17.63	-0.105	192.2	-0.0133	44.08	587.56	214.3	-0.0453
17.67	-0.105	192.2	-0.0133	44.17	588.95	214.8	-0.0435
17.70	-0.102	192.4	-0.0125	44.25	590.47	215.3	-0.0417

Prova triassiale ciclica SNGR03-C4

tensione di confinamento (kPa)		450	tensione di confinamento (kPa)		450		
deviatore ciclico (kPa)		80	deviatore ciclico (kPa)		120		
frequenza (hz)		0.00071429	frequenza (hz)		0.0007143		
17.73	-0.102	192.4	-0.0125	44.33	593.29	216	-0.0408
17.77	-0.104	192.2	-0.0125	44.42	596.14	216.8	-0.0382
17.80	-0.104	192.2	-0.0133	44.50	598.6	217.6	-0.0373
17.83	-0.104	192.1	-0.0133	44.58	600.38	218.4	-0.0346
17.87	-0.103	192.1	-0.0133	44.67	602.65	219	-0.0328
17.90	-0.103	192.1	-0.0133	44.75	605.59	219.9	-0.0302
17.93	-0.103	192.1	-0.0133	44.83	609.32	220.9	-0.0275
17.97	-0.105	191.8	-0.0142	44.92	609	221.3	-0.0266
18.00	-0.103	191.9	-0.0142	45.00	611.62	222	-0.024
18.03	-0.102	191.9	-0.0142	45.08	614.98	222.7	-0.0231
18.07	-0.102	192	-0.0133	45.18	617.32	223.9	-0.0195
18.10	-0.101	192	-0.0133	45.27	618.71	224.7	-0.0169
18.13	-0.1	192.1	-0.0133	45.33	621.36	225.4	-0.0151
18.17	-0.1	192.1	-0.0133	45.42	624.82	226.4	-0.0115
18.20	-0.1	192.1	-0.0133	45.50	628.06	227.6	-0.0098
18.23	-0.098	192.2	-0.0133	45.58	629.42	228.4	-0.0053
18.27	-0.098	192.2	-0.0125	45.67	632.04	229.3	-0.0027
18.30	-0.098	192.2	-0.0125	45.75	635.44	230.3	0.0009
18.33	-0.098	192.2	-0.0125	45.83	636.74	231.1	0.0036
18.37	-0.098	192.2	-0.0125	45.92	639.55	232	0.0071
18.40	-0.098	192.2	-0.0125	46.00	641.85	232.7	0.0098
18.43	-0.098	192.2	-0.0125	46.08	645.99	233.8	0.0142
18.47	-0.098	192.2	-0.0125	46.17	648.74	235.3	0.0178
18.52	-0.097	192.2	-0.0125	46.25	651	236.3	0.0249
18.55	-0.096	192.3	-0.0116	46.33	652.42	236.9	0.0275
18.58	-0.096	192.3	-0.0116	46.42	656.56	238.2	0.0328
18.60	-0.096	192.3	-0.0116	46.50	657.86	239.1	0.0382
18.63	-0.096	192.4	-0.0116	46.60	663.29	240.9	0.0453
18.67	-0.095	192.4	-0.0116	46.68	662.83	241.5	0.0515
18.70	-0.094	192.5	-0.0107	46.75	668.16	242.7	0.0604
18.73	-0.094	192.6	-0.0107	46.83	668.68	243.4	0.0666
18.77	-0.093	192.6	-0.0107	46.92	671.39	244.4	0.0754
18.80	-0.093	192.6	-0.0107	47.00	675.24	245.7	0.087
18.83	-0.092	192.6	-0.0107	47.08	677.69	246.6	0.0985
18.87	-0.092	192.8	-0.0098	47.17	679.98	248.1	0.1145
18.90	-0.092	192.8	-0.0098	47.25	682.56	249.4	0.1296
18.93	-0.091	192.8	-0.0098	47.33	685.07	250.2	0.1473
18.97	-0.09	192.9	-0.0089	47.42	688.07	251.2	0.1536
19.00	-0.09	193	-0.0089	47.50	690.88	252.2	0.1598
19.03	-0.089	193	-0.0089	47.58	692.36	253	0.1642
19.07	-0.088	193	-0.0089	47.67	697.71	254.4	0.1704
19.10	-0.088	193.2	-0.0089	47.75	699.1	255	0.174
19.13	-0.088	193.2	-0.008	47.83	701.42	256.4	0.1784
19.17	-0.087	193.3	-0.008	47.92	703.67	257.4	0.1855
19.20	-0.086	193.4	-0.0071	48.00	706.03	258.2	0.1891
19.23	-0.086	193.5	-0.0071	48.10	708.05	259.1	0.1935
19.27	-0.085	193.6	-0.0071	48.18	710.5	260.3	0.1979
19.30	-0.084	193.6	-0.0071	48.25	714.34	261.4	0.2015
19.33	-0.084	193.7	-0.0071	48.33	716.14	262.3	0.2068
19.37	-0.084	193.8	-0.0062	48.42	718.37	263.2	0.2113
19.40	-0.083	193.9	-0.0062	48.50	722.1	264.3	0.2166
19.43	-0.082	194	-0.0054	48.58	722.1	264.9	0.2192
19.47	-0.081	194.1	-0.0045	48.67	725.16	265.8	0.2228
19.50	-0.081	194.2	-0.0045	48.75	727.32	266.7	0.2263
19.53	-0.08	194.2	-0.0045	48.83	730.54	268.1	0.2308
19.57	-0.08	194.3	-0.0045	48.92	732.96	269	0.2334
19.60	-0.079	194.4	-0.0036	49.00	736.3	270.1	0.2406
19.63	-0.078	194.6	-0.0036	49.08	736.23	270.7	0.2423
19.67	-0.078	194.7	-0.0027	49.17	739.03	271.6	0.2468
19.70	-0.077	194.8	-0.0027	49.25	740.99	272.5	0.2503

Prova triassiale ciclica SNGR03-C4							
tensione di confinamento (kPa)		450		tensione di confinamento (kPa)		450	
deviatore ciclico (kPa)		80		deviatore ciclico (kPa)		120	
frequenza (hz)		0.00071429		frequenza (hz)		0.0007143	
19.73	-0.076	195	-0.0027	49.33	742.82	273.2	0.253
19.77	-0.075	195	-0.0018	49.42	744.69	274	0.2565
19.80	-0.075	195.1	-0.0018	49.50	747.62	275.3	0.2601
19.83	-0.075	195.2	-0.0018	49.60	748.87	276	0.2645
19.87	-0.073	195.4	-0.0018	49.67	750.64	276.7	0.2672
19.90	-0.073	195.6	-0.0009	49.75	752.73	277.5	0.2707
19.93	-0.072	195.6	-0.0009	49.83	755.27	278.2	0.2734
19.98	-0.071	195.8	0	49.92	756.56	279.5	0.2769
20.02	-0.071	195.9	0	50.00	757.91	280.1	0.2805
20.03	-0.07	196	0	50.08	759.9	280.9	0.2832
20.07	-0.069	196.3	0	50.17	761.48	281.6	0.2858
20.10	-0.068	196.3	0.0009	50.25	764.08	282.5	0.2894
20.13	-0.068	196.4	0.0017	50.33	764.4	283.1	0.2911
20.17	-0.067	196.5	0.0017	50.42	765.52	283.7	0.2929
20.20	-0.066	196.7	0.0026	50.50	767.61	284.3	0.2956
20.23	-0.065	196.9	0.0035	50.58	769.67	285.3	0.2982
20.27	-0.065	197	0.0035	50.67	769.12	285.7	0.3009
20.30	-0.063	197.3	0.0035	50.75	771.37	286.4	0.3036
20.33	-0.063	197.3	0.0044	50.83	772.56	287.1	0.3053
20.37	-0.063	197.3	0.0044	50.92	773.59	287.7	0.3071
20.40	-0.063	197.4	0.0053	51.02	775.38	288.5	0.3098
20.43	-0.06	197.7	0.0062	51.10	775.99	289	0.3124
20.47	-0.06	197.9	0.0071	51.17	777.73	289.7	0.3151
20.50	-0.059	198.1	0.008	51.25	776.7	289.9	0.3151
20.53	-0.058	198.3	0.008	51.33	777.95	290.4	0.3169
20.57	-0.057	198.3	0.008	51.42	779.36	291	0.3187
20.60	-0.057	198.5	0.0089	51.50	780.13	291.5	0.3204
20.63	-0.056	198.7	0.0097	51.58	781.23	292.2	0.3222
20.67	-0.055	198.9	0.0106	51.67	784.32	292.9	0.324
20.70	-0.054	199.1	0.0115	51.75	781.58	292.9	0.3249
20.73	-0.052	199.3	0.0124	51.83	782.09	293.2	0.3267
20.77	-0.052	199.5	0.0124	51.92	783.47	293.7	0.3275
20.80	-0.051	199.5	0.0124	52.00	783.57	294.1	0.3284
20.83	-0.051	199.7	0.0133	52.08	783.92	294.4	0.3293
20.87	-0.05	199.9	0.0142	52.17	784.31	294.7	0.3302
20.90	-0.049	200.2	0.0151	52.25	785.72	295.4	0.3329
20.93	-0.048	200.3	0.016	52.33	784.85	295.5	0.3329
20.97	-0.047	200.5	0.0168	52.43	783.53	295.5	0.3329
21.00	-0.045	200.8	0.0168	52.52	784.71	295.9	0.3338
21.03	-0.044	200.8	0.0177	52.58	784.69	296.2	0.3338
21.07	-0.044	201	0.0186	52.67	785.01	296.6	0.3346
21.10	-0.043	201.3	0.0195	52.75	786.01	296.9	0.3355
21.13	-0.042	201.5	0.0204	52.83	784.33	296.9	0.3355
21.17	-0.041	201.7	0.0213	52.92	783.91	297	0.3355
21.20	-0.037	202.2	0.0231	53.00	783.72	297.1	0.3355
21.23	-0.037	202.4	0.0231	53.08	783.81	297.2	0.3355
21.27	-0.038	202.4	0.0239	53.17	783.17	297.3	0.3355
21.30	-0.038	202.5	0.0239	53.25	782.65	297.4	0.3355
21.33	-0.038	202.6	0.0239	53.33	782.27	297.6	0.3355
21.37	-0.038	202.7	0.0248	53.42	781.69	297.6	0.3355
21.42	-0.035	203.1	0.0257	53.50	781.01	297.6	0.3355
21.45	-0.035	203.3	0.0275	53.58	780.08	297.5	0.3346
21.48	-0.032	203.7	0.0284	53.67	779.69	297.5	0.3346
21.50	-0.032	203.8	0.0293	53.75	778.5	297.5	0.3338
21.53	-0.031	204.2	0.0302	53.83	778.99	297.6	0.3346
21.57	-0.029	204.5	0.0302	53.93	776.45	297.3	0.3329
21.60	-0.029	204.5	0.0319	54.02	775.8	297.2	0.332
21.63	-0.029	204.7	0.0328	54.08	775.32	297.2	0.332
21.67	-0.027	204.9	0.0337	54.17	773.39	296.9	0.3311
21.70	-0.026	205.2	0.0355	54.25	772.07	296.9	0.3302

Prova triassiale ciclica SNGR03-C4

tensione di confinamento (kPa)		450			tensione di confinamento (kPa)	450		
deviatore ciclico (kPa)		80			deviatore ciclico (kPa)	120		
frequenza (hz)		0.00071429			frequenza (hz)	0.0007143		
21.73	-0.025	205.5	0.0364	54.33	771.11	296.6	0.3293	
21.77	-0.024	205.8	0.0381	54.42	769.72	296.4	0.3275	
21.80	-0.023	206.1	0.0381	54.50	769.63	296.3	0.3267	
21.83	-0.021	206.1	0.039	54.58	766.42	295.7	0.324	
21.87	-0.021	206.3	0.0399	54.67	765.86	295.6	0.324	
21.90	-0.021	206.6	0.0417	54.75	764.32	295.3	0.3222	
21.93	-0.018	206.9	0.0426	54.83	763.07	295.1	0.3213	
21.97	-0.018	207.1	0.0435	54.92	760.5	294.7	0.3196	
22.00	-0.017	207.4	0.0452	55.00	760.43	294.4	0.3196	
22.03	-0.015	207.7	0.0452	55.08	756.48	293.8	0.316	
22.07	-0.015	207.7	0.047	55.17	755.96	293.6	0.3151	
22.10	-0.015	208	0.0479	55.25	754.38	293.2	0.3133	
22.13	-0.013	208.3	0.0497	55.35	751.81	292.6	0.3116	
22.17	-0.012	208.6	0.0506	55.43	750.27	292.2	0.3098	
22.20	-0.011	208.9	0.0523	55.50	748.88	291.8	0.3071	
22.23	-0.008	209.4	0.0559	55.58	746.02	291.2	0.3053	
22.27	-0.008	209.6	0.0559	55.67	745.06	290.9	0.3036	
22.30	-0.01	209.6	0.0568	55.75	743.16	290.3	0.3009	
22.33	-0.01	209.6	0.0568	55.83	741.65	290	0.2991	
22.37	-0.008	209.9	0.0586	55.92	738.2	289.2	0.2965	
22.40	-0.005	210.4	0.0612	56.00	735.69	288.4	0.2947	
22.43	-0.004	210.7	0.063	56.08	733.67	287.8	0.2929	
22.47	-0.003	211	0.0648	56.17	731.99	287.3	0.2894	
22.50	-0.001	211.3	0.0648	56.25	729.52	286.7	0.2867	
22.53	0	211.3	0.0674	56.33	727.71	286.1	0.2858	
22.57	0	211.6	0.0692	56.42	726.43	285.5	0.2832	
22.60	0	211.9	0.071	56.50	722.85	284.7	0.2796	
22.63	0.002	212.3	0.0736	56.58	720.34	284	0.2769	
22.67	0.003	212.6	0.0763	56.67	716.99	283.1	0.2743	
22.70	0.005	213.1	0.0799	56.75	715.03	282.4	0.2716	
22.73	0.004	213.3	0.0799	56.85	713.9	281.9	0.2681	
22.77	0.006	213.3	0.0807	56.92	711.07	281.1	0.2645	
22.80	0.006	213.5	0.0834	57.00	707.59	280.3	0.261	
22.83	0.007	213.9	0.087	57.08	705.01	279.2	0.2583	
22.88	0.01	214.6	0.0914	57.17	703.47	278.5	0.2539	
22.92	0.01	214.6	0.095	57.25	700.51	277.7	0.2503	
22.93	0.011	214.8	0.0976	57.33	697.93	276.8	0.2468	
22.97	0.013	215.3	0.1021	57.42	695.13	276	0.2423	
23.00	0.013	215.5	0.1056	57.50	693.1	275.2	0.2388	
23.03	0.014	215.8	0.1109	57.58	690.27	274.4	0.2352	
23.07	0.015	216.2	0.1109	57.67	686.75	273.5	0.2317	
23.10	0.02	216.2	0.1171	57.75	683.79	272.2	0.2272	
23.13	0.02	216.9	0.1278	57.83	682.53	271.5	0.2219	
23.17	0.017	216.9	0.1305	57.92	679.63	270.6	0.2175	
23.20	0.017	217.1	0.1358	58.00	676.37	269.6	0.213	
23.23	0.02	217.5	0.1438	58.08	674.02	268.6	0.2077	
23.27	0.021	217.9	0.1544	58.17	671.86	267.8	0.2042	
23.30	0.023	218.4	0.1544	58.27	668.57	266.5	0.1971	
23.33	0.024	218.8	0.1651	58.35	665.96	265.6	0.1926	
23.37	0.024	218.8	0.1766	58.42	663.09	264.6	0.1882	
23.40	0.027	219.4	0.1926	58.50	660.67	263.9	0.1846	
23.43	0.027	219.7	0.2059	58.58	658.83	263.3	0.1811	
23.47	0.028	220.1	0.2192	58.67	655.02	262.1	0.174	
23.50	0.028	220.3	0.2325	58.75	652.15	260.7	0.1651	
23.53	0.027	220.8	0.2325	58.83	649.37	259.7	0.1553	
23.57	0.031	220.8	0.2459	58.92	647.69	258.9	0.1402	
23.60	0.031	221.2	0.2601	59.00	644.88	257.9	0.1305	
23.63	0.035	222.1	0.2769	59.08	641.58	256.8	0.1207	
23.67	0.034	222.3	0.2902	59.17	638.99	255.7	0.111	
23.70	0.035	222.6	0.2982	59.25	636.96	254.8	0.103	

Prova triassiale ciclica SNGR03-C4								
tensione di confinamento (kPa)		450			tensione di confinamento (kPa)		450	
deviatore ciclico (kPa)		80			deviatore ciclico (kPa)		120	
frequenza (hz)		0.00071429			frequenza (hz)		0.0007143	
23.73	0.034	222.8	0.3018	59.33	633.41	253.7	0.095	
23.77	0.036	223.2	0.3018	59.42	630.72	252.1	0.0879	
23.80	0.038	223.5	0.3044	59.50	628.36	251	0.0808	
23.83	0.038	223.5	0.308	59.58	626.64	250.1	0.071	
23.87	0.039	223.9	0.3106	59.67	623.51	248.9	0.0648	
23.90	0.041	224.3	0.3124	59.77	620.66	247.5	0.0604	
23.93	0.044	224.8	0.316	59.83	617.91	246.3	0.0559	
23.97	0.043	225	0.3169	59.92	615.51	245.4	0.0488	
24.00	0.042	225.1	0.3169	60.00	613.96	244.3	0.0444	
24.03	0.044	225.1	0.3177	60.08	611.24	243.2	0.0399	
24.07	0.044	225.4	0.3195	60.17	609.36	242.2	0.0364	
24.10	0.045	225.7	0.3213	60.25	608.65	241.5	0.0337	
24.13	0.048	226.1	0.324	60.33	603.93	240.2	0.0293	
24.17	0.051	226.7	0.3275	60.42	601.14	239.3	0.0257	
24.20	0.05	226.8	0.3275	60.50	599.43	237.6	0.0222	
24.23	0.048	226.9	0.3275	60.58	597.51	236.7	0.0169	
24.27	0.05	227.2	0.3275	60.67	594.18	235.3	0.0133	
24.30	0.05	227.2	0.3293	60.75	592.85	234.6	0.0107	
24.35	0.054	227.9	0.332	60.83	591.23	233.7	0.008	
24.38	0.055	228.2	0.3328	60.92	589	232.7	0.0053	
24.40	0.055	228.2	0.3346	61.00	586.86	231.7	0.0036	
24.43	0.058	228.7	0.3382	61.08	584.01	230.9	0.0009	
24.47	0.057	229	0.3399	61.18	581.23	229.6	-0.0027	
24.50	0.056	229.1	0.3399	61.27	580.9	228.9	-0.0044	
24.53	0.058	229.5	0.3426	61.33	579.09	228	-0.0062	
24.57	0.06	229.9	0.3426	61.42	577.46	227	-0.0089	
24.60	0.062	230.2	0.3444	61.50	575.16	225.9	-0.0107	
24.63	0.062	230.2	0.3453	61.58	573.71	225.1	-0.0142	
24.67	0.061	230.4	0.3462	61.67	571.7	224.2	-0.016	
24.70	0.063	230.8	0.3479	61.75	569.5	223.4	-0.0178	
24.73	0.064	231.1	0.3497	61.83	567.82	222.3	-0.0204	
24.77	0.065	231.4	0.3515	61.92	566.74	221.8	-0.0213	
24.80	0.066	231.7	0.3515	62.00	565.64	221.2	-0.0231	
24.83	0.067	232	0.3533	62.08	563.79	220.4	-0.0249	
24.87	0.067	232	0.3541	62.17	561.98	219.3	-0.0266	
24.90	0.068	232.3	0.3559	62.25	561.07	218.7	-0.0293	
24.93	0.071	232.9	0.3595	62.33	559.71	218	-0.0302	
24.97	0.07	232.9	0.3586	62.42	560.58	217.8	-0.0311	
25.00	0.07	233.2	0.3595	62.50	555.47	216.4	-0.0346	
25.03	0.072	233.5	0.3595	62.60	556.37	215.9	-0.0346	
25.07	0.073	233.8	0.3612	62.68	554.98	215.3	-0.0364	
25.10	0.073	233.8	0.363	62.75	553.52	214.6	-0.0382	
25.13	0.074	234.1	0.3648	62.83	553.13	214.2	-0.0391	
25.17	0.075	234.4	0.3657	62.92	552.12	213.7	-0.0399	
25.20	0.076	234.7	0.3675	63.00	551.15	213.1	-0.0408	
25.23	0.077	235	0.3683	63.08	551.05	212.7	-0.0417	
25.27	0.081	235.5	0.3683	63.17	550.24	212.2	-0.0426	
25.30	0.079	235.7	0.3719	63.25	548.79	211.5	-0.0444	
25.33	0.079	235.7	0.3719	63.33	548.23	211.1	-0.0453	
25.37	0.08	235.9	0.3728	63.42	547.97	210.7	-0.0462	
25.40	0.079	236.1	0.3737	63.50	546.93	210.2	-0.047	
25.43	0.081	236.4	0.3754	63.58	546.87	209.9	-0.0479	
25.47	0.082	236.7	0.3772	63.67	546.03	209.5	-0.0497	
25.50	0.083	237.1	0.3772	63.75	544.44	208.8	-0.0506	
25.53	0.084	237.4	0.3781	63.83	546.06	208.8	-0.0497	
25.57	0.084	237.4	0.3799	63.92	545.25	208.4	-0.0506	
25.60	0.087	237.9	0.3825	64.00	545.12	208.2	-0.0515	
25.63	0.088	238.2	0.3834	64.10	544.89	207.9	-0.0515	
25.67	0.087	238.4	0.3843	64.18	544.95	207.7	-0.0524	
25.70	0.087	238.6	0.3843	64.25	546.15	207.6	-0.0515	

Prova triassiale ciclica SNGR03-C4

pressione di confinamento (kPa)		450			pressione di confinamento (kPa)		450	
deviatore ciclico (kPa)		80			deviatore ciclico (kPa)		120	
frequenza (hz)		0.00071429			frequenza (hz)		0.0007143	
25.73	0.086	238.8	0.3843	64.33	544.27	207.1	-0.0533	
25.78	0.089	239.2	0.387	64.42	545.31	207.1	-0.0533	
25.82	0.089	239.4	0.3879	64.50	545.66	207	-0.0533	
25.85	0.09	239.7	0.3879	64.58	545.89	206.9	-0.0533	
25.87	0.092	240	0.3888	64.67	546.89	206.9	-0.0533	
25.90	0.092	240	0.3905	64.75	546.08	206.6	-0.0533	
25.93	0.092	240.2	0.3914	64.83	544.76	206.3	-0.055	
25.97	0.095	240.7	0.3941	64.92	547.22	206.5	-0.0533	
26.00	0.093	240.8	0.3941	65.00	548.03	206.5	-0.0533	
26.03	0.094	241	0.395	65.08	548.25	206.5	-0.0533	
26.07	0.096	241.3	0.395	65.17	549.06	206.5	-0.0524	
26.10	0.097	241.7	0.3967	65.25	549.74	206.6	-0.0524	
26.13	0.097	241.7	0.3976	65.33	552.04	207	-0.0515	
26.17	0.099	242.1	0.4003	65.42	551	206.7	-0.0533	
26.20	0.098	242.2	0.4003	65.52	551.43	206.7	-0.0515	
26.23	0.097	242.3	0.4003	65.60	553.37	207	-0.0515	
26.27	0.099	242.6	0.4021	65.67	554.05	207.1	-0.0506	
26.30	0.1	242.9	0.4021	65.75	555.31	207.3	-0.0497	
26.33	0.101	243.2	0.403	65.83	556.9	207.4	-0.0497	
26.37	0.101	243.2	0.4047	65.92	558.06	207.8	-0.0488	
26.40	0.101	243.4	0.4056	66.00	558.84	208.1	-0.0488	
26.43	0.102	243.7	0.4065	66.08	561.76	208.6	-0.047	
26.47	0.103	244	0.4074	66.17	560.82	208.5	-0.047	
26.50	0.103	244.2	0.4083	66.25	562.89	208.9	-0.0462	
26.53	0.104	244.5	0.4083	66.33	564.03	209.2	-0.0453	
26.57	0.107	244.9	0.4092	66.42	564.71	209.3	-0.0453	
26.60	0.107	244.9	0.4118	66.50	567.27	209.9	-0.0435	
26.63	0.106	245	0.4118	66.58	569.18	210.4	-0.0435	
26.67	0.104	245.2	0.4118	66.67	570.7	210.8	-0.0417	
26.70	0.104	245.4	0.4127	66.75	572.64	211.2	-0.0399	
26.73	0.108	245.8	0.4154	66.83	575.46	211.9	-0.0382	
26.77	0.11	246.1	0.4154	66.92	575.14	212	-0.0382	
26.80	0.108	246.2	0.4163	67.02	578.4	212.7	-0.0382	
26.83	0.108	246.2	0.4172	67.08	579.38	213.1	-0.0355	
26.87	0.108	246.3	0.4163	67.17	581.35	213.6	-0.0346	
26.90	0.108	246.5	0.4181	67.25	583.88	214.3	-0.0328	
26.93	0.109	246.8	0.4189	67.33	584.78	214.7	-0.0311	
26.97	0.11	247	0.4198	67.42	587.34	215.3	-0.0302	
27.00	0.114	247.5	0.4198	67.50	589.48	215.9	-0.0284	
27.03	0.113	247.7	0.4216	67.58	591.75	216.5	-0.0275	
27.07	0.113	247.7	0.4225	67.67	594.86	217.5	-0.0257	
27.10	0.111	247.8	0.4225	67.75	595.25	217.9	-0.0231	
27.13	0.111	247.9	0.4225	67.83	598.06	218.6	-0.0213	
27.17	0.112	248.2	0.4234	67.92	600.46	219.4	-0.0195	
27.20	0.113	248.4	0.4243	68.00	602.85	220.1	-0.0178	
27.25	0.114	248.6	0.426	68.08	604.25	220.7	-0.016	
27.28	0.116	249	0.4269	68.17	607.1	221.6	-0.0142	
27.30	0.115	249.1	0.4269	68.25	610.1	222.3	-0.0124	
27.33	0.114	249.2	0.4269	68.33	615.15	223.8	-0.0098	
27.37	0.114	249.3	0.4269	68.43	614.38	224.2	-0.0071	
27.40	0.114	249.3	0.4287	68.52	616.77	224.9	-0.0044	
27.43	0.117	249.8	0.4296	68.58	617.29	225.4	-0.0036	
27.47	0.118	250	0.4305	68.67	622.99	226.9	0	
27.50	0.117	250.1	0.4305	68.75	624.94	227.8	0.0027	
27.53	0.117	250.3	0.4314	68.83	627.2	228.6	0.0062	
27.57	0.117	250.5	0.4314	68.92	629.78	229.5	0.0089	
27.60	0.118	250.6	0.4323	69.00	632.08	230.4	0.0115	
27.63	0.118	250.6	0.4323	69.08	634.18	231.2	0.0151	
27.67	0.117	250.7	0.4323	69.17	637.23	232.2	0.0178	
27.70	0.117	250.9	0.4323	69.25	640.59	233.1	0.0213	

Prova triassiale ciclica SNGR03-C4								
tensione di confinamento (kPa)		450		tensione di confinamento (kPa)		450		
deviatore ciclico (kPa)		80		deviatore ciclico (kPa)		120		
frequenza (hz)		0.00071429		frequenza (hz)		0.0007143		
27.73	0.118	251.1	0.434	69.33	643.63	234.4	0.0249	
27.77	0.121	251.5	0.4358	69.42	645.28	235.4	0.0284	
27.80	0.119	251.6	0.4358	69.50	647.87	236.3	0.0337	
27.83	0.118	251.6	0.4349	69.58	650.62	237.3	0.0382	
27.87	0.118	251.6	0.4358	69.67	653.17	238.3	0.0426	
27.90	0.118	251.7	0.4358	69.75	655.01	239.2	0.047	
27.93	0.119	251.9	0.4358	69.83	657.92	240.2	0.0515	
27.97	0.122	252.3	0.4376	69.93	661.57	241.6	0.0586	
28.00	0.12	252.3	0.4376	70.00	663.83	242.5	0.0639	
28.03	0.119	252.4	0.4376	70.08	666.71	243.6	0.071	
28.07	0.12	252.6	0.4376	70.17	668.55	244.5	0.0781	
28.10	0.12	252.6	0.4385	70.25	672.43	245.8	0.0888	
28.13	0.12	252.7	0.4385	70.33	675.17	246.4	0.095	
28.17	0.119	252.8	0.4385	70.42	678.2	248.3	0.1074	
28.20	0.122	253.2	0.4402	70.50	679.24	249.2	0.1287	
28.23	0.121	253.2	0.4402	70.58	682.53	250.3	0.1394	
28.27	0.121	253.3	0.4402	70.67	686.04	251.4	0.1473	
28.30	0.121	253.4	0.4402	70.75	687.59	252.2	0.1527	
28.33	0.121	253.4	0.4402	70.83	690.52	253.2	0.158	
28.37	0.121	253.6	0.4411	70.92	693.43	254.3	0.1624	
28.40	0.121	253.7	0.4411	71.00	696.97	255.6	0.1678	
28.43	0.121	253.8	0.442	71.08	698.87	256.5	0.1713	
28.47	0.122	254	0.442	71.17	703.45	257.8	0.1811	
28.50	0.121	254	0.442	71.25	704.13	258.5	0.1837	
28.53	0.121	254.1	0.442	71.35	706.32	259.2	0.1873	
28.57	0.121	254.1	0.442	71.43	709.31	260.6	0.1908	
28.60	0.122	254.4	0.4429	71.50	710.99	261.4	0.1971	
28.63	0.122	254.5	0.4429	71.58	713.69	262.5	0.2015	
28.68	0.121	254.6	0.4438	71.67	714.85	263.2	0.2042	
28.72	0.122	254.7	0.4438	71.75	718.62	264.3	0.2095	
28.75	0.122	254.8	0.4438	71.83	720.4	265.1	0.213	
28.77	0.122	254.9	0.4438	71.92	722.97	266	0.2166	
28.80	0.122	255	0.4438	72.00	725.68	267	0.2201	
28.83	0.122	255.1	0.4438	72.08	729.32	268.5	0.2263	
28.87	0.121	255.2	0.4447	72.17	730.31	269.2	0.2308	
28.90	0.121	255.2	0.4456	72.25	732.6	270	0.2334	
28.93	0.122	255.3	0.4456	72.33	734.75	271	0.237	
28.97	0.121	255.3	0.4447	72.42	736.65	271.9	0.2406	
29.00	0.122	255.5	0.4447	72.50	736.81	272.4	0.2432	
29.03	0.122	255.5	0.4456	72.58	741.06	273.5	0.2477	
29.07	0.121	255.6	0.4456	72.67	743.7	274.3	0.2503	
29.10	0.12	255.6	0.4456	72.77	745.5	275.5	0.2556	
29.13	0.12	255.6	0.4447	72.85	749.27	276.6	0.261	
29.17	0.12	255.7	0.4447	72.92	748.81	277.1	0.2627	
29.20	0.12	255.8	0.4447	73.00	750.84	277.9	0.2654	
29.23	0.12	255.8	0.4456	73.08	751.67	278.7	0.2672	
29.27	0.121	256	0.4456	73.17	754.99	279.8	0.2707	
29.30	0.12	256	0.4456	73.25	756.33	280.5	0.2752	
29.33	0.119	256	0.4447	73.33	759.01	281.4	0.2787	
29.37	0.119	256	0.4447	73.42	761.67	282.3	0.2823	
29.40	0.119	256	0.4447	73.50	761.22	282.7	0.284	
29.43	0.119	256.1	0.4447	73.58	762.83	283.4	0.2858	
29.47	0.119	256.1	0.4447	73.67	764.12	284	0.2876	
29.50	0.12	256.3	0.4456	73.75	768.91	285.5	0.292	
29.53	0.118	256.2	0.4456	73.83	765.98	285.6	0.2929	
29.57	0.117	256.2	0.4447	73.92	768.1	286.2	0.2965	
29.60	0.117	256.2	0.4447	74.00	770.22	287	0.2991	
29.63	0.118	256.3	0.4447	74.08	773.63	288	0.3027	
29.67	0.118	256.3	0.4447	74.17	772.6	288.3	0.3036	
29.70	0.117	256.3	0.4438	74.27	772.01	288.9	0.3062	

Prova triassiale ciclica SNGR03-C4							
tensione di confinamento (kPa)		450			tensione di confinamento (kPa)		450
deviatore ciclico (kPa)		80			deviatore ciclico (kPa)		120
frequenza (hz)		0.00071429			frequenza (hz)		0.0007143
29.73	0.116	256.3	0.4438	74.35	776.11	290	0.308
29.77	0.117	256.4	0.4438	74.42	776.44	290.2	0.3107
29.80	0.115	256.3	0.4447	74.50	776.61	290.7	0.3116
29.83	0.115	256.3	0.4438	74.58	776.9	291	0.3133
29.87	0.115	256.4	0.4438	74.67	781.23	292	0.316
29.90	0.116	256.5	0.4438	74.75	778.37	292.1	0.316
29.93	0.115	256.4	0.4438	74.83	780.49	292.8	0.3178
29.97	0.114	256.4	0.4429	74.92	780.85	293.3	0.3196
30.00	0.114	256.5	0.4429	75.00	781.9	293.9	0.3222
30.03	0.113	256.4	0.4429	75.08	783.16	294.3	0.3231
30.07	0.113	256.4	0.4429	75.17	782.38	294.5	0.324
30.10	0.113	256.4	0.442	75.25	783.09	294.9	0.3249
30.15	0.112	256.4	0.442	75.33	782.45	295	0.3249
30.18	0.112	256.4	0.442	75.42	784.39	295.6	0.3267
30.20	0.112	256.4	0.442	75.50	784.6	296.1	0.3284
30.23	0.112	256.4	0.442	75.58	784.3	296.3	0.3293
30.27	0.11	256.3	0.4411	75.68	784.66	296.6	0.3293
30.30	0.11	256.3	0.4411	75.77	785.3	297.1	0.3311
30.33	0.11	256.3	0.4411	75.83	784.66	297.3	0.3311
30.37	0.11	256.3	0.4411	75.92	784.46	297.4	0.3311
30.40	0.11	256.3	0.4411	76.00	784.85	297.7	0.332
30.43	0.107	256.1	0.4394	76.08	784.98	297.9	0.332
30.47	0.107	256.1	0.4394	76.17	786.04	298.2	0.3329
30.50	0.107	256.1	0.4385	76.25	784.66	298	0.332
30.53	0.107	256.1	0.4385	76.33	782.17	298.1	0.3329
30.57	0.106	256	0.4385	76.42	784.33	298.6	0.3338
30.60	0.107	256.1	0.4385	76.50	781.47	298.3	0.3329
30.63	0.107	256.1	0.4385	76.58	781.95	298.4	0.332
30.67	0.106	256	0.4385	76.67	784.14	298.9	0.3338
30.70	0.102	255.6	0.4358	76.75	780.7	298.5	0.332
30.73	0.103	255.7	0.4358	76.83	780.44	298.6	0.332
30.77	0.103	255.7	0.4358	76.92	780.34	298.7	0.332
30.80	0.102	255.6	0.4358	77.00	779.99	298.7	0.3311
30.83	0.102	255.5	0.4358	77.08	778.73	298.8	0.332
30.87	0.102	255.5	0.4349	77.18	776.97	298.4	0.3293
30.90	0.102	255.6	0.4349	77.25	777.06	298.4	0.3293
30.93	0.1	255.4	0.434	77.33	776.23	298.4	0.3293
30.97	0.099	255.3	0.4331	77.42	774.94	298.2	0.3284
31.00	0.1	255.3	0.434	77.50	772.91	297.9	0.3275
31.03	0.1	255.3	0.4331	77.58	772.14	297.8	0.3267
31.07	0.099	255.2	0.4331	77.67	771.5	297.7	0.3258
31.10	0.099	255.2	0.4331	77.75	770.05	297.5	0.3249
31.13	0.097	255	0.4305	77.83	769.63	297.4	0.324
31.17	0.093	254.7	0.4296	77.92	767.64	297	0.3222
31.20	0.094	254.6	0.4296	78.00	765.81	296.7	0.3213
31.23	0.094	254.6	0.4296	78.08	764.68	296.5	0.3204
31.27	0.094	254.7	0.4296	78.17	760.27	295.6	0.3187
31.30	0.093	254.5	0.4296	78.25	761.21	295.6	0.3169
31.33	0.093	254.5	0.4287	78.33	759.44	295.3	0.3151
31.37	0.094	254.5	0.4287	78.42	758.15	295	0.3142
31.40	0.091	254.2	0.4269	78.50	756.29	294.6	0.3124
31.43	0.091	254.2	0.4269	78.60	752.49	293.8	0.3107
31.47	0.089	253.9	0.4252	78.68	752.36	293.6	0.3089
31.50	0.088	253.8	0.4252	78.75	750.4	293.2	0.3062
31.53	0.089	253.7	0.4252	78.83	747.99	292.7	0.3045
31.57	0.089	253.7	0.4243	78.92	746.86	292.3	0.3036
31.62	0.086	253.5	0.4234	79.00	746.96	292.2	0.3027
31.65	0.085	253.3	0.4234	79.08	742.9	291.3	0.2991
31.67	0.085	253.3	0.4225	79.17	739.75	290.8	0.2974
31.70	0.085	253.3	0.4225	79.25	740.04	290.3	0.2956

Prova triassiale ciclica SNGR03-C4								
pressione di confinamento (kPa)		450			pressione di confinamento (kPa)		450	
deviatore ciclico (kPa)		80			deviatore ciclico (kPa)		120	
frequenza (hz)		0.00071429			frequenza (hz)		0.0007143	
31.73	0.086	253.3	0.4216	79.33	736.28	289.5	0.292	
31.77	0.083	253	0.4207	79.42	733.8	288.9	0.2894	
31.80	0.083	252.9	0.4198	79.50	731.35	288.3	0.2867	
31.83	0.082	252.7	0.4189	79.58	731.61	288	0.2867	
31.87	0.08	252.5	0.4189	79.67	728.46	287.2	0.284	
31.90	0.08	252.5	0.4181	79.75	725.69	286.5	0.2805	
31.93	0.08	252.4	0.4172	79.83	722.28	285.6	0.2769	
31.97	0.078	252.2	0.4163	79.92	719.15	284.6	0.2752	
32.00	0.076	251.8	0.4136	80.00	718.41	284.1	0.2707	
32.03	0.075	251.7	0.4136	80.10	715.42	283.4	0.2681	
32.07	0.077	251.8	0.4136	80.17	713.1	282.7	0.2654	
32.10	0.076	251.6	0.4136	80.25	709.85	281.7	0.2627	
32.13	0.076	251.6	0.4136	80.33	708.59	281.1	0.261	
32.17	0.073	251.4	0.411	80.42	705.66	280.4	0.2556	
32.20	0.072	251.2	0.4101	80.50	702.89	279.5	0.2521	
32.23	0.072	251.1	0.4101	80.58	700.83	278.7	0.2485	
32.27	0.073	251.1	0.4101	80.67	698.58	277.9	0.245	
32.30	0.071	250.7	0.4083	80.75	693.78	276.7	0.2397	
32.33	0.065	250.3	0.4083	80.83	693.16	276.2	0.237	
32.37	0.065	250.3	0.4056	80.92	688.85	274.9	0.2343	
32.40	0.067	250.3	0.4065	81.00	686.17	273.9	0.229	
32.43	0.069	250.4	0.4065	81.08	684.85	273.3	0.2237	
32.47	0.068	250.2	0.4056	81.17	681.6	272.3	0.2192	
32.50	0.065	249.8	0.4039	81.25	679.69	271.5	0.2157	
32.53	0.064	249.6	0.403	81.33	677.31	270.6	0.2113	
32.57	0.063	249.4	0.403	81.42	675.86	269.9	0.2068	
32.60	0.063	249.4	0.4012	81.52	670.63	268.3	0.1997	
32.63	0.062	249.2	0.4003	81.60	667.77	267.4	0.1962	
32.67	0.061	249	0.3994	81.67	668.51	266.9	0.1935	
32.70	0.059	248.7	0.3976	81.75	664.38	265.9	0.1882	
32.73	0.056	248.3	0.395	81.83	661.28	264.8	0.1829	
32.77	0.056	248.1	0.395	81.92	657.47	264.1	0.1793	
32.80	0.057	248.1	0.395	82.00	653.37	262.3	0.1704	
32.83	0.057	248.1	0.395	82.08	654.53	262	0.1624	
32.87	0.057	248	0.3941	82.17	650.18	260.9	0.1536	
32.90	0.055	247.6	0.3923	82.25	646.92	259.7	0.1438	
32.93	0.052	247.3	0.3896	82.33	644.85	258.8	0.1349	
32.97	0.05	246.9	0.3879	82.42	641.88	257.7	0.1252	
33.00	0.051	246.8	0.3879	82.50	639.84	256.8	0.1172	
33.05	0.052	246.8	0.3879	82.58	635.45	255.3	0.1065	
33.08	0.051	246.7	0.387	82.67	633.31	254.1	0.1003	
33.12	0.046	246.1	0.3834	82.75	631.82	253.1	0.0905	
33.13	0.045	245.9	0.3834	82.83	631.04	252.5	0.0852	
33.17	0.047	245.9	0.3825	82.93	624.84	250.7	0.0763	
33.20	0.047	245.8	0.3825	83.02	622.73	249.4	0.0728	
33.23	0.044	245.4	0.3799	83.08	621.05	248.5	0.0666	
33.27	0.043	245.1	0.379	83.17	619.2	247.5	0.0595	
33.30	0.043	245	0.379	83.25	615.78	246.3	0.0559	
33.33	0.043	244.8	0.3772	83.33	613.93	245.3	0.0515	
33.37	0.04	244.5	0.3772	83.42	611.44	244.2	0.047	
33.40	0.039	244.5	0.3763	83.50	608.78	243.1	0.0426	
33.43	0.039	244.3	0.3746	83.58	606.49	242.1	0.0391	
33.47	0.038	244	0.3728	83.67	603.06	240.5	0.0364	
33.50	0.036	243.7	0.371	83.75	601.6	239.6	0.0328	
33.53	0.033	243.3	0.3692	83.83	598.72	238.6	0.0275	
33.57	0.034	243.2	0.3683	83.92	597.55	237.7	0.0249	
33.60	0.033	243	0.3683	84.00	594.61	236.5	0.0213	
33.63	0.034	243	0.3675	84.08	593.08	235.6	0.0186	
33.67	0.034	242.9	0.3666	84.17	590.95	234.6	0.016	
33.70	0.032	242.5	0.3648	84.25	588.29	233.8	0.0133	

Prova triassiale ciclica SNGR03-C4

tensione di confinamento (kPa)		450			tensione di confinamento (kPa)		450	
deviatore ciclico (kPa)		80			deviatore ciclico (kPa)		120	
frequenza (hz)		0.00071429			frequenza (hz)		0.0007143	
33.73	0.029	242.2	0.363	84.33	586.38	232.4	0.0107	
33.77	0.029	242	0.3604	84.43	585.47	231.6	0.0071	
33.80	0.025	241.4	0.3577	84.52	583.24	230.8	0.0053	
33.83	0.025	241.2	0.3577	84.58	580.91	229.8	0.0027	
33.87	0.027	241.2	0.3577	84.67	577.61	229	0.0009	
33.90	0.027	241.2	0.3568	84.75	576.92	227.7	-0.0018	
33.93	0.025	240.7	0.3541	84.83	574.27	226.6	-0.0053	
33.97	0.022	240.4	0.3515	84.92	575.24	226.3	-0.0062	
34.00	0.019	240	0.3497	85.00	568.02	224.5	-0.0107	
34.03	0.02	239.9	0.3488	85.08	572.64	224.7	-0.0098	
34.07	0.022	239.9	0.3488	85.17	569.24	223.7	-0.0133	
34.10	0.019	239.9	0.3488	85.25	567.11	222.8	-0.0151	
34.13	0.019	239.5	0.3462	85.33	564.78	222.2	-0.016	
34.17	0.015	238.8	0.3417	85.42	563.25	221	-0.0178	
34.20	0.014	238.6	0.3408	85.50	562.64	220.4	-0.0204	
34.23	0.015	238.5	0.3408	85.58	560.92	219.6	-0.0222	
34.27	0.015	238.3	0.3382	85.67	559.91	219	-0.0231	
34.30	0.011	237.8	0.3382	85.75	558.68	218.2	-0.0249	
34.33	0.011	237.8	0.3355	85.85	557.03	217.4	-0.0266	
34.37	0.011	237.6	0.3346	85.93	556.32	216.8	-0.0275	
34.40	0.01	237.2	0.332	86.00	554.95	216.2	-0.0293	
34.43	0.007	236.8	0.3302	86.08	554.02	215.6	-0.0302	
34.47	0.007	236.7	0.3284	86.17	553.49	215.1	-0.032	
34.52	0.006	236.3	0.3266	86.25	552.07	214.5	-0.0328	
34.55	0.006	236.1	0.3257	86.33	551.03	214	-0.0337	
34.57	0.004	235.8	0.3231	86.42	550.03	213.3	-0.0355	
34.60	0.003	235.4	0.3213	86.50	549.8	212.9	-0.0364	
34.63	0.002	235.1	0.3213	86.58	549.02	212.4	-0.0373	
34.67	-0.002	235.1	0.3186	86.67	548.08	211.9	-0.0382	
34.70	-0.002	234.5	0.3142	86.75	547.76	211.6	-0.0391	
34.73	-0.001	234.4	0.3124	86.83	546.88	211.1	-0.0399	
34.77	-0.001	234.2	0.3098	86.92	546.62	210.8	-0.0408	
34.80	-0.001	234.2	0.3071	87.00	546.2	210.4	-0.0417	
34.83	-0.004	233.4	0.3018	87.08	545.94	209.9	-0.0417	
34.87	-0.006	233.2	0.3018	87.17	545.52	209.6	-0.0435	
34.90	-0.006	233.2	0.2964	87.25	545.74	209.4	-0.0435	
34.93	-0.006	232.9	0.2893	87.35	545.13	209	-0.0444	
34.97	-0.01	232.2	0.2822	87.42	545.06	208.6	-0.0453	
35.00	-0.011	232	0.276	87.50	545.51	208.5	-0.0444	
35.03	-0.01	231.9	0.2716	87.58	545.93	208.4	-0.0444	
35.07	-0.009	231.8	0.2663	87.67	545.32	208.2	-0.0453	
35.10	-0.013	231.2	0.2663	87.75	544.93	207.9	-0.0462	
35.13	-0.016	231.2	0.2583	87.83	545.32	207.8	-0.0462	
35.17	-0.016	230.8	0.2503	87.92	545.71	207.7	-0.0462	
35.20	-0.015	230.6	0.2441	88.00	546.09	207.6	-0.0462	
35.23	-0.016	230.2	0.2387	88.08	546.45	207.5	-0.0462	
35.27	-0.015	230.2	0.2343	88.17	546.74	207.4	-0.0462	
35.30	-0.02	229.3	0.2254	88.25	546.58	207.2	-0.0462	
35.33	-0.021	229.1	0.2254	88.33	547.42	207.3	-0.0462	
35.37	-0.019	229.1	0.221	88.42	548.81	207.4	-0.0453	
35.40	-0.019	229.1	0.2183	88.50	548.97	207.4	-0.0453	
35.43	-0.021	228.6	0.213	88.58	549.53	207.4	-0.0453	
35.47	-0.027	227.8	0.2059	88.67	550.79	207.5	-0.0453	
35.50	-0.024	227.7	0.2024	88.77	551.5	207.6	-0.0444	
35.53	-0.023	227.7	0.1997	88.85	552.12	207.7	-0.0444	
35.57	-0.027	227.2	0.1997	88.92	553.38	207.9	-0.0435	
35.60	-0.027	227.2	0.1953	89.00	554.09	208	-0.0435	
35.63	-0.027	226.9	0.1917	89.08	555.48	208.2	-0.0426	
35.67	-0.029	226.4	0.1873	89.17	556.49	208.4	-0.0426	
35.70	-0.031	226	0.1837	89.25	557.56	208.7	-0.0417	

Prova triassiale ciclica SNGR03-C4

tensione di confinamento (kPa)		450	tensione di confinamento (kPa)		450		
deviatore ciclico (kPa)		80	deviatore ciclico (kPa)		120		
frequenza (hz)		0.00071429	frequenza (hz)		0.0007143		
35.73	-0.031	225.8	0.1811	89.33	559.11	208.9	-0.0408
35.77	-0.032	225.4	0.1775	89.42	560.28	209.2	-0.0399
35.80	-0.034	225	0.1775	89.50	561.44	209.4	-0.0399
35.83	-0.035	225	0.174	89.58	563.29	209.8	-0.0382
35.87	-0.035	224.7	0.1713	89.67	564.3	210.1	-0.0382
35.90	-0.036	224.3	0.1686	89.75	566.85	210.6	-0.0364
35.95	-0.037	224	0.166	89.83	567.14	210.8	-0.0364
35.98	-0.037	223.7	0.1633	89.92	568.99	211.3	-0.0355
36.02	-0.038	223.3	0.1606	90.00	570.58	211.6	-0.0346
36.03	-0.04	222.9	0.1589	90.08	572.42	212.1	-0.0328
36.07	-0.041	222.6	0.1562	90.17	574.14	212.6	-0.032
36.10	-0.042	222.2	0.1535	90.27	575.66	213	-0.0311
36.13	-0.042	221.9	0.1535	90.33	577.38	213.5	-0.0302
36.17	-0.047	221.9	0.1509	90.42	579.78	214.1	-0.0284
36.20	-0.047	221.2	0.1482	90.50	581.07	214.5	-0.0275
36.23	-0.045	221.2	0.1473	90.58	583.01	215	-0.0257
36.27	-0.043	221.1	0.1473	90.67	585.54	215.7	-0.024
36.30	-0.046	220.7	0.1447	90.75	587.74	216.2	-0.0231
36.33	-0.048	220.2	0.142	90.83	590.2	217.1	-0.0213
36.37	-0.05	219.8	0.142	90.92	591.85	217.7	-0.0204
36.40	-0.05	219.8	0.1393	91.00	593.7	218.2	-0.0178
36.43	-0.05	219.6	0.1384	91.08	594.73	218.6	-0.0169
36.47	-0.051	219.1	0.1358	91.17	598.3	219.6	-0.0142
36.50	-0.053	218.8	0.134	91.25	600.75	220.6	-0.0115
36.53	-0.053	218.5	0.1331	91.33	601.96	221	-0.0115
36.57	-0.054	218.1	0.1305	91.42	605.51	221.7	-0.0098
36.60	-0.056	217.8	0.1305	91.50	608.52	222.9	-0.0071
36.63	-0.056	217.8	0.1296	91.58	609.4	223.6	-0.0053
36.67	-0.056	217.6	0.1278	91.68	611.5	224.2	-0.0027
36.70	-0.057	217.2	0.126	91.77	614.8	225.1	0
36.73	-0.058	216.9	0.1251	91.83	618.27	225.8	0.0018
36.77	-0.06	216.5	0.1225	91.92	619.72	227	0.0044
36.80	-0.059	216.2	0.1216	92.00	621.8	227.7	0.008
36.83	-0.061	215.8	0.1216	92.08	624.29	228.7	0.0107
36.87	-0.062	215.8	0.1207	92.17	627.29	229.6	0.0133
36.90	-0.062	215.6	0.1189	92.25	631.05	230.8	0.0178
36.93	-0.063	215.2	0.1171	92.33	631.63	231.3	0.0186
36.97	-0.064	214.9	0.1163	92.42	633.67	232	0.0213
37.00	-0.064	214.6	0.1154	92.50	636.84	233.5	0.0257
37.03	-0.068	214	0.1127	92.58	639.72	234.5	0.0266
37.07	-0.068	213.8	0.1127	92.67	642.5	235.3	0.0328
37.10	-0.068	213.8	0.1109	92.75	646.77	236.7	0.0382
37.13	-0.068	213.5	0.11	92.83	646	237	0.0391
37.17	-0.066	213.5	0.11	92.92	649.48	238.1	0.0435
37.20	-0.069	213.1	0.1083	93.00	652.88	239.1	0.0479
37.23	-0.07	212.8	0.1065	93.10	656.79	240.6	0.055
37.27	-0.071	212.4	0.1056	93.18	659.18	241.5	0.0595
37.30	-0.073	212	0.1056	93.25	660.77	242.4	0.0639
37.33	-0.073	212	0.1038	93.33	663.35	243.4	0.0692
37.37	-0.073	211.8	0.1029	93.42	666.42	244.4	0.0754
37.42	-0.074	211.2	0.1021	93.50	668.29	245.7	0.0852
37.45	-0.075	211.2	0.1012	93.58	673.3	247.1	0.0914
37.47	-0.075	210.9	0.1003	93.67	674.49	248.1	0.1065
37.50	-0.075	210.7	0.0985	93.75	679.59	249.5	0.1216
37.53	-0.077	210.3	0.0976	93.83	680.68	250.4	0.1331
37.57	-0.077	210.1	0.0967	93.92	682.78	251.3	0.1402
37.60	-0.078	209.8	0.0958	94.00	684.62	252.1	0.1456
37.63	-0.08	209.4	0.0958	94.08	687.69	253.1	0.1509
37.67	-0.079	209.4	0.0941	94.17	691.1	254.2	0.1571
37.70	-0.079	209.2	0.0941	94.25	696.17	256	0.1624

Prova triassiale ciclica SNGR03-C4							
tensione di confinamento (kPa)		450	tensione di confinamento (kPa)		450		
deviatore ciclico (kPa)		80	deviatore ciclico (kPa)		120		
frequenza (hz)		0.00071429	frequenza (hz)		0.0007143		
37.73	-0.08	208.9	0.0923	94.33	695.91	256.5	0.1678
37.77	-0.082	208.6	0.0914	94.42	698.55	257.4	0.1722
37.80	-0.082	208.4	0.0914	94.50	700.74	258.2	0.1766
37.83	-0.083	208.1	0.0896	94.60	703.07	259.5	0.1829
37.87	-0.084	207.8	0.0896	94.68	706.86	260.7	0.1855
37.90	-0.084	207.8	0.0887	94.75	708.99	261.5	0.1917
37.93	-0.084	207.6	0.0879	94.83	714.34	262.9	0.1979
37.97	-0.085	207.3	0.087	94.92	712.02	263.2	0.1979
38.00	-0.085	207.1	0.0861	95.00	715.17	264.2	0.2033
38.03	-0.086	206.8	0.0852	95.08	717.82	265.1	0.2068
38.07	-0.087	206.5	0.0843	95.17	721.04	266.1	0.2113
38.10	-0.088	206.2	0.0843	95.25	724.3	267.5	0.2148
38.13	-0.088	206.2	0.0834	95.33	725.94	268.3	0.2184
38.17	-0.088	206.1	0.0834	95.42	728.22	269.2	0.2246
38.20	-0.089	205.8	0.0816	95.50	730.06	270	0.2281
38.23	-0.09	205.5	0.0816	95.58	732.41	271	0.2317
38.27	-0.09	205.3	0.0807	95.67	733.88	271.8	0.2352
38.30	-0.091	205	0.0799	95.75	736.75	272.7	0.2388
38.33	-0.092	204.8	0.0799	95.83	738.81	273.7	0.2423
38.37	-0.092	204.8	0.079	95.92	742.32	274.9	0.2459
38.40	-0.092	204.6	0.0781	96.02	743.35	275.6	0.2503
38.43	-0.092	204.3	0.0772	96.10	744.63	276.4	0.2539
38.47	-0.093	204	0.0763	96.17	746.98	277.2	0.2565
38.50	-0.094	203.8	0.0763	96.25	749.36	278	0.2601
38.53	-0.094	203.6	0.0754	96.33	751.55	279.3	0.2627
38.57	-0.094	203.4	0.0754	96.42	752.99	280	0.2672
38.60	-0.096	203.4	0.0745	96.50	754.47	280.7	0.2707
38.63	-0.096	203.1	0.0736	96.58	758.59	281.9	0.2752
38.67	-0.096	202.9	0.0736	96.67	756.18	282	0.2752
38.70	-0.099	202.4	0.071	96.75	759.48	282.9	0.2787
38.73	-0.097	202.3	0.071	96.83	761.16	283.7	0.2823
38.77	-0.096	202.3	0.071	96.92	763.41	284.4	0.2849
38.80	-0.096	202.2	0.071	97.00	764.86	285.4	0.2867
38.85	-0.097	202	0.0701	97.08	765.85	286.1	0.2903
38.88	-0.098	201.7	0.0692	97.17	767.65	286.7	0.292
38.92	-0.099	201.5	0.0692	97.25	768.58	287.3	0.2947
38.93	-0.099	201.5	0.0692	97.33	770.23	288.1	0.2965
38.97	-0.099	201.3	0.0683	97.42	771.41	288.6	0.2991
39.00	-0.1	201	0.0674	97.52	772.57	289.4	0.3018
39.03	-0.1	200.9	0.0674	97.60	773.72	290	0.3036
39.07	-0.1	200.7	0.0665	97.67	774.69	290.6	0.3053
39.10	-0.101	200.5	0.0665	97.75	775.78	291.1	0.308
39.13	-0.101	200.4	0.0665	97.83	776.81	291.7	0.3098
39.17	-0.102	200.4	0.0657	97.92	778.06	292.2	0.3116
39.20	-0.102	200.2	0.0648	98.00	779.31	293	0.3124
39.23	-0.102	200	0.0648	98.08	781.5	293.7	0.316
39.27	-0.102	199.8	0.0639	98.17	779.76	293.8	0.3169
39.30	-0.103	199.7	0.063	98.25	780.88	294.3	0.3178
39.33	-0.103	199.5	0.063	98.33	782.07	294.8	0.3196
39.37	-0.103	199.3	0.063	98.42	782.39	295.2	0.3204
39.40	-0.103	199.3	0.0621	98.50	782.81	295.5	0.3222
39.43	-0.103	199.2	0.0621	98.58	783.64	295.9	0.3231
39.47	-0.104	199	0.0612	98.67	783.74	296.5	0.324
39.50	-0.104	198.9	0.0612	98.75	784.7	296.9	0.3249
39.53	-0.105	198.6	0.0603	98.83	784.48	297.1	0.3258
39.57	-0.104	198.6	0.0603	98.93	784.31	297.4	0.3267
39.60	-0.104	198.5	0.0603	99.02	784.7	297.7	0.3275
39.63	-0.105	198.5	0.0603	99.08	784.89	298.1	0.3284
39.67	-0.105	198.3	0.0594	99.17	785.57	298.4	0.3293
39.70	-0.105	198.1	0.0594	99.25	784.6	298.5	0.3293

Prova triassiale ciclica SNGR03-C4							
tensione di confinamento (kPa)		450		tensione di confinamento (kPa)		450	
deviatore ciclico (kPa)		80		deviatore ciclico (kPa)		120	
frequenza (hz)		0.00071429		frequenza (hz)		0.0007143	
39.73	-0.105	198	0.0586	99.33	784.27	298.6	0.3293
39.77	-0.105	197.9	0.0586	99.42	785.02	298.9	0.3302
39.80	-0.106	197.7	0.0577	99.50	784.6	299.1	0.3302
39.83	-0.106	197.6	0.0577	99.58	784.44	299.2	0.3302
39.87	-0.106	197.6	0.0577	99.67	784.11	299.3	0.3311
39.90	-0.106	197.5	0.0577	99.75	783.63	299.5	0.3311
39.93	-0.106	197.4	0.0568	99.83	783.24	299.6	0.3311
39.97	-0.106	197.3	0.0568	99.92	782.99	299.7	0.3311
40.00	-0.107	197.1	0.055	100.00	782.54	299.8	0.3311
40.03	-0.109	196.7	0.055	100.08	781.8	299.7	0.3302
40.07	-0.107	196.8	0.055	100.17	780.83	299.7	0.3302
40.10	-0.105	196.8	0.0559	100.25	780.39	299.7	0.3293
40.13	-0.105	196.9	0.0559	100.33	779.42	299.7	0.3293
40.17	-0.105	196.8	0.0559	100.43	778.87	299.7	0.3293
40.20	-0.105	196.7	0.055	100.50	779.03	299.7	0.3284
40.23	-0.107	196.5	0.055	100.58	775.4	299.2	0.3267
40.27	-0.107	196.4	0.055	100.67	775.72	299.3	0.3267
40.32	-0.106	196.4	0.055	100.75	774.68	299.2	0.3267
40.35	-0.106	196.3	0.055	100.83	773.43	299	0.3258
40.37	-0.107	196.2	0.0541	100.92	773.4	299	0.3249
40.40	-0.107	196.1	0.0541	101.00	769.61	298.5	0.3231
40.43	-0.107	196.1	0.0541	101.08	770.28	298.5	0.3231
40.47	-0.107	196	0.0541	101.17	769.12	298.3	0.3222
40.50	-0.107	195.9	0.0532	101.25	767.19	298	0.3204
40.53	-0.107	195.9	0.0532	101.33	765.1	297.7	0.3196
40.57	-0.106	195.8	0.0532	101.42	764.56	297.5	0.3187
40.60	-0.106	195.8	0.0532	101.50	762.95	297.2	0.3178
40.63	-0.106	195.7	0.0532	101.58	760.31	296.6	0.3142
40.67	-0.106	195.7	0.0532	101.67	759.86	296.5	0.3142
40.70	-0.106	195.6	0.0532	101.75	758.54	296.2	0.3124
40.73	-0.106	195.6	0.0532	101.85	755.83	295.4	0.3107
40.77	-0.106	195.5	0.0523	101.93	755.2	295.3	0.3089
40.80	-0.106	195.4	0.0523	102.00	752.15	294.8	0.3071
40.83	-0.106	195.4	0.0523	102.08	750.88	294.3	0.3053
40.87	-0.105	195.4	0.0523	102.17	748.91	293.7	0.3036
40.90	-0.105	195.4	0.0523	102.25	746.77	293.3	0.3018
40.93	-0.105	195.3	0.0523	102.33	743.65	292.7	0.2991
40.97	-0.105	195.2	0.0523	102.42	742.26	292.1	0.2982
41.00	-0.104	195.2	0.0523	102.50	739.75	291.5	0.2956
41.03	-0.105	195.1	0.0523	102.58	739.62	291.3	0.2929
41.07	-0.105	195.1	0.0523	102.67	736.63	290.6	0.2903
41.10	-0.104	195.1	0.0523	102.75	733.16	289.6	0.2867
41.13	-0.104	195.1	0.0523	102.83	732.13	289.4	0.2867
41.17	-0.104	195.1	0.0523	102.92	731.9	289.1	0.2849
41.20	-0.103	195.1	0.0523	103.00	725.47	287.8	0.2796
41.23	-0.103	195.1	0.0523	103.08	724.43	287.1	0.2796
41.27	-0.103	195	0.0523	103.17	723.27	286.6	0.2778
41.30	-0.104	194.9	0.0523	103.27	719.71	285.8	0.2716
41.33	-0.103	194.9	0.0523	103.35	720.51	285.6	0.2707
41.37	-0.102	194.9	0.0523	103.42	715.19	284.4	0.2663
41.40	-0.102	195	0.0523	103.50	712.14	283.4	0.2645
41.43	-0.102	195	0.0523	103.58	710.3	282.7	0.2592
41.47	-0.101	195.1	0.0532	103.67	707.79	282.1	0.2565
41.50	-0.1	195.1	0.0532	103.75	707.37	281.6	0.2548
41.53	-0.1	195.1	0.0532	103.83	702.86	280.4	0.2485
41.57	-0.1	195.1	0.0532	103.92	700.61	279.6	0.2459
41.60	-0.097	195.1	0.0532	104.00	700.22	279.2	0.2441
41.63	-0.097	195.4	0.055	104.08	695.52	277.9	0.2388
41.67	-0.097	195.4	0.0541	104.17	689.94	276.3	0.2343
41.70	-0.098	195.3	0.0541	104.25	689.82	275.9	0.2299

Prova triassiale ciclica SNGR03-C4							
tensione di confinamento (kPa)		450		tensione di confinamento (kPa)		450	
deviatore ciclico (kPa)		80		deviatore ciclico (kPa)		120	
frequenza (hz)		0.00071429		frequenza (hz)		0.0007143	
41.73	-0.099	195.2	0.0541	104.33	687.5	275.2	0.2255
41.78	-0.098	195.2	0.0541	104.42	686.4	274.6	0.2237
41.82	-0.098	195.2	0.0541	104.50	680.44	272.9	0.2166
41.83	-0.098	195.2	0.0541	104.58	679.85	272.4	0.2139
41.87	-0.097	195.2	0.0541	104.67	676.86	271.5	0.2095
41.90	-0.096	195.4	0.0541	104.77	674.7	270.5	0.205
41.93	-0.095	195.4	0.055	104.85	671.08	269.3	0.1997
41.97	-0.095	195.4	0.055	104.92	666.86	268.1	0.1935
42.00	-0.095	195.4	0.055	105.00	666.18	267.5	0.19
42.03	-0.095	195.5	0.055	105.08	665.89	267	0.1873
42.07	-0.094	195.6	0.0559	105.17	658.45	265.1	0.1793
42.10	-0.094	195.6	0.0559	105.25	657.8	264.4	0.1775
42.13	-0.093	195.7	0.0559	105.33	656.12	263.8	0.1687
42.17	-0.093	195.7	0.0559	105.42	651.66	262.4	0.1598
42.20	-0.093	195.7	0.0559	105.50	650.05	261.7	0.1536
42.23	-0.093	195.7	0.0559	105.58	647.76	260.6	0.1447
42.27	-0.092	195.8	0.0559	105.67	644.78	259.6	0.1349
42.30	-0.091	195.9	0.0568	105.75	642.33	258.7	0.1269
42.33	-0.09	196	0.0568	105.83	638.58	257.2	0.1181
42.37	-0.09	196.1	0.0568	105.92	637.38	256.5	0.111
42.40	-0.088	196.1	0.0577	106.00	634.89	255.4	0.0994
42.43	-0.088	196.2	0.0586	106.08	630.17	253.9	0.0914
42.47	-0.088	196.3	0.0586	106.18	628.49	253	0.0861
42.50	-0.088	196.3	0.0586	106.27	624.97	251.4	0.0808
42.53	-0.084	196.7	0.0603	106.33	624.09	250.6	0.0737
42.57	-0.084	196.7	0.0603	106.42	621.37	249.7	0.0683
42.60	-0.085	196.7	0.0603	106.50	618.33	248.4	0.063
42.63	-0.085	196.7	0.0603	106.58	616.68	247.5	0.0595
42.67	-0.085	196.7	0.0594	106.67	614.26	246.4	0.055
42.70	-0.085	196.8	0.0603	106.75	611.73	245.3	0.0506
42.73	-0.084	196.8	0.0603	106.83	608.79	244.2	0.0462
42.77	-0.082	197	0.0612	106.92	604.71	242.3	0.0408
42.80	-0.081	197.2	0.0612	107.00	604.13	241.6	0.0364
42.83	-0.081	197.3	0.0612	107.08	601.02	240.4	0.0337
42.87	-0.081	197.3	0.0621	107.17	601.79	240	0.032
42.90	-0.081	197.3	0.0621	107.25	598.04	238.6	0.0275
42.93	-0.08	197.5	0.063	107.33	595.03	237.6	0.024
42.97	-0.078	197.7	0.063	107.42	593.18	236.6	0.0213
43.00	-0.077	197.8	0.063	107.50	590.24	235.1	0.0186
43.03	-0.078	197.8	0.063	107.58	587.65	234.1	0.016
43.07	-0.077	197.9	0.063	107.68	587.35	233.5	0.0133
43.10	-0.076	197.9	0.0639	107.77	582.02	232	0.0089
43.13	-0.076	198	0.0639	107.83	582.63	231.7	0.0089
43.17	-0.076	198.2	0.0648	107.92	580.56	230.4	0.0062
43.22	-0.073	198.4	0.0657	108.00	578.81	229.5	0.0027
43.25	-0.073	198.5	0.0657	108.08	577.22	228.7	0
43.28	-0.073	198.6	0.0665	108.17	575.18	227.8	-0.0009
43.30	-0.071	198.8	0.0674	108.25	574.47	227.1	-0.0036
43.33	-0.068	199.2	0.0692	108.33	572.26	226.3	-0.0053
43.37	-0.068	199.2	0.0683	108.42	569.96	225.3	-0.0071
43.40	-0.069	199.3	0.0683	108.50	567.5	224.6	-0.0098
43.43	-0.069	199.3	0.0683	108.58	566.47	223.4	-0.0115
43.47	-0.069	199.3	0.0683	108.67	565.94	222.8	-0.0133
43.50	-0.069	199.3	0.0683	108.75	564.23	222.1	-0.0151
43.53	-0.067	199.6	0.0701	108.83	561.77	221.2	-0.0169
43.57	-0.065	199.8	0.071	108.92	558.98	220.1	-0.0195
43.60	-0.062	200.2	0.0728	109.00	559.85	219.8	-0.0204
43.63	-0.062	200.4	0.0728	109.10	558.4	219	-0.0222
43.67	-0.063	200.4	0.0728	109.18	557.39	218.3	-0.024
43.70	-0.063	200.4	0.0728	109.25	556.32	217.7	-0.0249

Prova triassiale ciclica SNGR03-C4							
pressione di confinamento (kPa)		450			pressione di confinamento (kPa)		450
deviatore ciclico (kPa)		80			deviatore ciclico (kPa)		120
frequenza (hz)		0.00071429			frequenza (hz)		0.0007143
43.73	-0.062	200.6	0.0736	109.33	555.38	217.1	-0.0266
43.77	-0.06	200.8	0.0745	109.42	554.28	216.6	-0.0275
43.80	-0.06	201	0.0745	109.50	552.88	216	-0.0284
43.83	-0.059	201.1	0.0754	109.58	552.56	215.3	-0.0302
43.87	-0.057	201.4	0.0754	109.67	552.04	214.8	-0.0302
43.90	-0.058	201.4	0.0763	109.75	550.55	214.3	-0.0328
43.93	-0.058	201.4	0.0763	109.83	549.45	213.8	-0.0337
43.97	-0.058	201.5	0.0772	109.92	549.18	213.4	-0.0346
44.00	-0.055	201.9	0.0781	110.00	548.5	212.9	-0.0355
44.03	-0.05	202.4	0.0799	110.08	547.4	212.3	-0.0364
44.07	-0.052	202.5	0.0799	110.17	546.89	212.1	-0.0364
44.10	-0.052	202.5	0.0799	110.25	545.04	211.1	-0.0391
44.13	-0.052	202.5	0.0799	110.33	546.31	211.1	-0.0391
44.17	-0.052	202.6	0.0807	110.42	546.65	210.9	-0.0391
44.20	-0.05	202.9	0.0816	110.50	545.55	210.5	-0.0399
44.23	-0.048	203.3	0.0834	110.60	545.03	210	-0.0408
44.27	-0.048	203.4	0.0834	110.67	544.58	209.7	-0.0408
44.30	-0.048	203.5	0.0834	110.75	547.1	209.9	-0.0408
44.33	-0.047	203.8	0.0834	110.83	545.1	209.4	-0.0417
44.37	-0.044	203.8	0.0843	110.92	544.55	209.1	-0.0426
44.40	-0.044	204	0.0861	111.00	545.22	209	-0.0426
44.43	-0.044	204.2	0.087	111.08	545.48	208.9	-0.0426
44.47	-0.042	204.5	0.0879	111.17	544.81	208.6	-0.0426
44.50	-0.041	204.8	0.0887	111.25	545.81	208.5	-0.0426
44.53	-0.04	205	0.0896	111.33	545.97	208.4	-0.0426
44.57	-0.039	205.3	0.0896	111.42	546.29	208.3	-0.0426
44.60	-0.038	205.3	0.0905	111.50	546.72	208.3	-0.0426
44.63	-0.038	205.5	0.0914	111.58	547.1	208.2	-0.0426
44.68	-0.036	206	0.0923	111.67	547.43	208.2	-0.0426
44.72	-0.035	206	0.0932	111.75	548.4	208.3	-0.0426
44.73	-0.035	206.2	0.0941	111.83	549.21	208.3	-0.0426
44.77	-0.034	206.4	0.095	111.92	549.62	208.3	-0.0426
44.80	-0.03	207	0.0976	112.02	551	208.5	-0.0417
44.83	-0.031	207.1	0.0976	112.10	550.99	208.5	-0.0417
44.87	-0.031	207.2	0.0985	112.17	552.48	208.6	-0.0408
44.90	-0.03	207.4	0.0985	112.25	553.77	208.7	-0.0408
44.93	-0.029	207.4	0.0985	112.33	553.97	208.8	-0.0408
44.97	-0.029	207.7	0.1003	112.42	554.16	208.9	-0.0399
45.00	-0.028	207.9	0.1012	112.50	556.49	209.3	-0.0391
45.03	-0.027	208.2	0.1021	112.58	557.47	209.5	-0.0382
45.07	-0.025	208.5	0.1038	112.67	558.86	209.7	-0.0382
45.10	-0.024	208.8	0.1047	112.75	559.96	210	-0.0373
45.13	-0.023	209.1	0.1047	112.83	563.94	210.8	-0.0355
45.17	-0.022	209.1	0.1065	112.92	562.49	210.7	-0.0355
45.20	-0.022	209.3	0.1074	113.00	564.2	211.1	-0.0355
45.23	-0.021	209.6	0.1092	113.08	566.11	211.5	-0.0337
45.27	-0.016	210.2	0.1127	113.17	567.28	211.7	-0.0328
45.30	-0.018	210.2	0.1127	113.25	568.93	212.1	-0.032
45.33	-0.019	210.3	0.1127	113.33	569.39	212.4	-0.0311
45.37	-0.015	210.8	0.1127	113.43	572.3	213	-0.0302
45.40	-0.015	210.8	0.1145	113.52	574.11	213.4	-0.0284
45.43	-0.015	211	0.1163	113.58	576.96	214.2	-0.0266
45.47	-0.014	211.3	0.118	113.67	576.6	214.3	-0.0266
45.50	-0.011	211.7	0.1198	113.75	579.13	214.8	-0.0249
45.53	-0.011	211.9	0.1207	113.83	580.98	215.3	-0.024
45.57	-0.01	212.3	0.1242	113.92	583.99	216.1	-0.0222
45.60	-0.007	212.8	0.1242	114.00	586.25	216.8	-0.0213
45.63	-0.007	212.8	0.1251	114.08	587.42	217.4	-0.0195
45.67	-0.007	213	0.126	114.17	588.82	217.8	-0.0178
45.70	-0.007	213.2	0.1278	114.25	592.15	218.6	-0.016

Prova triassiale ciclica SNGR03-C4							
tensione di confinamento (kPa)		450	tensione di confinamento (kPa)		450		
deviatore ciclico (kPa)		80	deviatore ciclico (kPa)		120		
frequenza (hz)		0.00071429	frequenza (hz)		0.0007143		
45.73	-0.005	213.6	0.1296	114.33	593.83	219.2	-0.0151
45.77	-0.003	213.9	0.1313	114.42	595.35	219.7	-0.0133
45.80	-0.004	214.1	0.1331	114.50	597.94	220.5	-0.0115
45.83	-0.002	214.5	0.1331	114.58	598.46	221.1	-0.0107
45.87	0	214.5	0.1349	114.67	604.19	222.4	-0.008
45.90	0	214.8	0.1367	114.75	604.67	222.8	-0.0053
45.93	0	215	0.1393	114.83	607.01	223.5	-0.0027
45.97	0.002	215.4	0.1411	114.93	609.24	224.2	-0.0018
46.00	0.002	215.7	0.1429	115.02	612.8	225.1	0.0009
46.03	0.002	215.8	0.1447	115.08	615.03	226.2	0.0027
46.07	0.006	216.4	0.1447	115.17	617.01	227	0.0062
46.12	0.006	216.7	0.1509	115.25	619.43	227.8	0.008
46.15	0.007	216.9	0.1535	115.33	622.64	228.7	0.0107
46.18	0.009	217.3	0.1535	115.42	626.45	230	0.0151
46.20	0.01	217.7	0.1562	115.50	627.07	230.5	0.0169
46.23	0.01	217.7	0.1597	115.58	629.47	231.3	0.0195
46.27	0.01	217.9	0.1633	115.67	632.7	232.4	0.0204
46.30	0.012	218.3	0.1677	115.75	634.87	233.4	0.024
46.33	0.016	218.9	0.1731	115.83	637.49	234.3	0.0284
46.37	0.013	218.9	0.1748	115.92	639.46	235.2	0.032
46.40	0.014	219.2	0.1748	116.00	643.79	236.4	0.0364
46.43	0.017	219.6	0.1793	116.08	646.64	237.5	0.0408
46.47	0.017	219.6	0.1846	116.17	647.42	238.1	0.0435
46.50	0.018	220	0.1908	116.25	650.33	239.2	0.047
46.53	0.019	220.4	0.1979	116.35	651.46	240.1	0.0515
46.57	0.021	220.8	0.205	116.43	656.53	241.5	0.0577
46.60	0.021	221.1	0.2121	116.50	658.15	242.3	0.0612
46.63	0.022	221.5	0.2121	116.58	661.09	243.3	0.0657
46.67	0.025	222	0.2201	116.67	664.64	244.3	0.0719
46.70	0.025	222	0.2281	116.75	667.45	246	0.0781
46.73	0.024	222.3	0.2379	116.83	669.2	246.9	0.0888
46.77	0.028	223	0.2503	116.92	671.75	247.8	0.0968
46.80	0.028	223.3	0.2609	117.00	675.36	249	0.1074
46.83	0.028	223.4	0.2689	117.08	676.59	249.9	0.1198
46.87	0.028	223.8	0.2689	117.17	677.98	250.8	0.1287
46.90	0.031	224.3	0.2769	117.25	682.52	252	0.1376
46.93	0.031	224.3	0.2858	117.33	685.91	253	0.1438
46.97	0.031	224.6	0.292	117.42	688.36	254.5	0.15
47.00	0.034	225.1	0.2964	117.50	690.46	255.4	0.1571
47.03	0.038	225.6	0.3009	117.58	693.72	256.4	0.1616
47.07	0.036	225.8	0.3027	117.67	696.43	257.4	0.1669
47.10	0.036	226	0.3027	117.75	701.58	258.8	0.174
47.13	0.039	226.4	0.3035	117.85	701.26	259.6	0.1758
47.17	0.039	226.4	0.3062	117.93	702.13	260.2	0.1802
47.20	0.037	226.5	0.3062	118.00	706.16	261.4	0.1855
47.23	0.039	226.8	0.3089	118.08	709.22	262.5	0.19
47.27	0.042	227.3	0.3133	118.17	712.38	263.6	0.1962
47.30	0.044	227.7	0.3142	118.25	713.09	264.3	0.1979
47.33	0.043	227.9	0.3142	118.33	716.56	265.2	0.2015
47.37	0.045	228.2	0.3151	118.42	719.3	266.6	0.2059
47.40	0.045	228.2	0.3169	118.50	721.33	267.5	0.2095
47.43	0.045	228.5	0.3186	118.58	723.2	268.3	0.2148
47.47	0.049	229.1	0.3213	118.67	725.82	269.2	0.2184
47.50	0.048	229.2	0.3222	118.75	727.87	270.2	0.2228
47.53	0.048	229.4	0.3231	118.83	729.77	271.1	0.2263
47.58	0.051	229.9	0.3257	118.92	732.15	271.9	0.2299
47.62	0.054	230.3	0.3275	119.00	735.69	273.3	0.2361
47.63	0.051	230.4	0.3275	119.08	736.98	274.1	0.2379
47.67	0.052	230.6	0.3275	119.17	738.07	274.9	0.2414
47.70	0.054	231	0.3293	119.27	740.48	275.7	0.2459

Prova triassiale ciclica SNGR03-C4								
tensione di confinamento (kPa)		450			tensione di confinamento (kPa)		450	
deviatore ciclico (kPa)		80			deviatore ciclico (kPa)		120	
frequenza (hz)		0.00071429			frequenza (hz)		0.0007143	
47.73	0.054	231	0.3311	119.35	742.67	276.5	0.2485	
47.77	0.055	231.3	0.3337	119.42	745.73	277.3	0.2521	
47.80	0.059	232	0.3364	119.50	747.85	278.6	0.2556	
47.83	0.058	232.1	0.3364	119.58	749.46	279.4	0.2601	
47.87	0.057	232.2	0.3373	119.67	751.07	280.2	0.2627	
47.90	0.059	232.6	0.3373	119.75	753	280.9	0.2663	
47.93	0.061	233	0.3399	119.83	754.12	281.7	0.269	
47.97	0.061	233	0.3408	119.92	755.92	282.6	0.2734	
48.00	0.065	233.6	0.3444	120.00	758.79	283.4	0.2761	
48.03	0.062	233.6	0.3444	120.08	759	284.1	0.2778	
48.07	0.062	233.8	0.3444	120.17	761.74	285	0.2796	
48.10	0.064	234.1	0.347	120.25	763.18	285.7	0.2849	
48.13	0.067	234.5	0.347	120.33	764.57	286.3	0.2867	
48.17	0.07	235	0.3488	120.42	765.86	287	0.2885	
48.20	0.07	235	0.3515	120.50	767.33	287.7	0.2911	
48.23	0.067	235.1	0.3515	120.58	768.58	288.3	0.2929	
48.27	0.066	235.2	0.3515	120.67	770.19	289	0.2956	
48.30	0.07	235.6	0.3533	120.77	771.61	289.8	0.2982	
48.33	0.071	235.9	0.355	120.83	772.76	290.4	0.3009	
48.37	0.074	236.5	0.355	120.92	773.43	291	0.3027	
48.40	0.073	236.6	0.3586	121.00	775.4	291.7	0.3053	
48.43	0.073	236.6	0.3586	121.08	776.1	292.1	0.3062	
48.47	0.072	236.8	0.3586	121.17	776.39	292.8	0.3089	
48.50	0.077	237.4	0.3621	121.25	777.96	293.4	0.3107	
48.53	0.077	237.6	0.363	121.33	778.83	293.9	0.3124	
48.57	0.076	237.8	0.3639	121.42	779.21	294.3	0.3142	
48.60	0.076	237.9	0.3639	121.50	780.5	294.9	0.316	
48.63	0.081	238.6	0.3639	121.58	780.86	295.3	0.3169	
48.67	0.081	238.6	0.3675	121.67	781.69	295.7	0.3187	
48.70	0.08	238.8	0.3683	121.75	782.59	296.1	0.3196	
48.73	0.081	239.1	0.3692	121.83	782.78	296.7	0.3204	
48.77	0.081	239.3	0.371	121.92	783.36	297.1	0.3222	
48.80	0.082	239.6	0.3719	122.00	783.68	297.4	0.3231	
48.83	0.082	239.8	0.3719	122.08	784.19	297.8	0.324	
48.87	0.085	240.2	0.3728	122.18	784.54	298.2	0.3249	
48.90	0.085	240.2	0.3737	122.27	785.48	298.7	0.3275	
48.93	0.087	240.6	0.3763	122.33	784.35	298.8	0.3267	
48.97	0.084	240.7	0.3763	122.42	784.28	298.9	0.3275	
49.00	0.086	240.9	0.3772	122.50	785.24	299.3	0.3284	
49.05	0.089	241.4	0.3799	122.58	784.99	299.5	0.3284	
49.08	0.088	241.6	0.3799	122.67	784.99	299.7	0.3284	
49.10	0.088	241.8	0.3808	122.75	785.02	299.9	0.3293	
49.13	0.089	242.1	0.3825	122.83	784.34	300.1	0.3293	
49.17	0.091	242.5	0.3825	122.92	784.47	300.3	0.3293	
49.20	0.091	242.8	0.3843	123.00	784.05	300.4	0.3293	
49.23	0.091	242.8	0.3852	123.08	783.67	300.5	0.3293	
49.27	0.092	243	0.387	123.17	783.34	300.5	0.3293	
49.30	0.093	243.4	0.3879	123.25	782.89	300.6	0.3293	
49.33	0.096	243.8	0.3905	123.33	783.92	300.9	0.3302	
49.37	0.094	243.8	0.3896	123.42	781.32	300.7	0.3293	
49.40	0.094	244	0.3896	123.50	780.77	300.7	0.3293	
49.43	0.096	244.3	0.3905	123.60	780.35	300.7	0.3284	
49.47	0.096	244.3	0.3923	123.68	779.67	300.7	0.3284	
49.50	0.097	244.6	0.3932	123.75	778.65	300.6	0.3275	
49.53	0.098	244.9	0.395	123.83	778.23	300.6	0.3275	
49.57	0.099	245.2	0.3959	123.92	776.17	300.4	0.3267	
49.60	0.099	245.4	0.3967	124.00	775.62	300.3	0.3258	
49.63	0.099	245.6	0.3967	124.08	774.72	300.2	0.3249	
49.67	0.1	246	0.3976	124.17	773.15	300	0.324	
49.70	0.1	246	0.3985	124.25	772.79	299.9	0.324	

Prova triassiale ciclica SNGR03-C4							
tensione di confinamento (kPa)		450		tensione di confinamento (kPa)		450	
deviatore ciclico (kPa)		80		deviatore ciclico (kPa)		120	
frequenza (hz)		0.00071429		frequenza (hz)		0.0007143	
49.73	0.101	246.2	0.4003	124.33	771.37	299.7	0.3231
49.77	0.105	246.7	0.4021	124.42	771.25	299.7	0.3222
49.80	0.103	246.8	0.403	124.50	767.33	299	0.3196
49.83	0.102	247	0.403	124.58	767.42	299	0.3196
49.87	0.102	247.2	0.403	124.67	765.23	298.6	0.3178
49.90	0.105	247.5	0.4039	124.75	764.33	298.4	0.3169
49.93	0.105	247.5	0.4047	124.83	762.37	298	0.3151
49.97	0.105	247.7	0.4056	124.92	761.31	297.7	0.3142
50.00	0.105	248	0.4065	125.00	760.09	297.5	0.3124
50.03	0.106	248.2	0.4074	125.10	758.93	297.2	0.3116
50.07	0.107	248.5	0.4083	125.18	755.52	296.5	0.3089
50.10	0.108	248.7	0.4083	125.25	754.36	296.1	0.308
50.13	0.108	249	0.4092	125.33	753.08	295.7	0.3062
50.17	0.108	249	0.411	125.42	750.86	295.3	0.3045
50.20	0.111	249.4	0.4127	125.50	748.09	294.8	0.3027
50.23	0.11	249.5	0.4127	125.58	746.22	294.2	0.3009
50.27	0.109	249.6	0.4127	125.67	744.29	293.7	0.2991
50.30	0.109	249.7	0.4136	125.75	741.78	293.1	0.2947
50.33	0.112	250.3	0.4136	125.83	740.07	292.6	0.2938
50.37	0.111	250.4	0.4163	125.92	738.6	292.1	0.2911
50.40	0.111	250.4	0.4163	126.00	736.93	291.7	0.2894
50.43	0.111	250.5	0.4163	126.08	734.32	291	0.2876
50.48	0.112	251	0.4172	126.17	732.52	290.4	0.2858
50.52	0.112	251	0.4181	126.25	728.62	289.4	0.284
50.53	0.114	251.3	0.4198	126.33	726.72	288.8	0.2796
50.57	0.113	251.4	0.4198	126.42	725.08	288.3	0.2769
50.60	0.114	251.6	0.4198	126.52	724.63	287.9	0.2761
50.63	0.114	251.8	0.4207	126.60	717.83	286.9	0.2716
50.67	0.115	252	0.4207	126.67	717.9	285.9	0.269
50.70	0.118	252.5	0.4216	126.75	715.59	285.3	0.2654
50.73	0.118	252.5	0.4243	126.83	713.1	284.6	0.2619
50.77	0.116	252.5	0.4234	126.92	710.46	284	0.2601
50.80	0.114	252.5	0.4234	127.00	708.76	283.1	0.2565
50.83	0.114	252.6	0.4234	127.08	705.96	282.4	0.253
50.87	0.118	253	0.426	127.17	703.83	281.6	0.2494
50.90	0.118	253.3	0.426	127.25	699.13	280.4	0.2441
50.93	0.118	253.4	0.4269	127.33	697.61	279.4	0.2423
50.97	0.118	253.4	0.4269	127.42	695	278.7	0.237
51.00	0.117	253.5	0.4269	127.50	694.58	278.2	0.2352
51.03	0.116	253.6	0.4269	127.58	688.81	276.8	0.2299
51.07	0.118	253.8	0.4278	127.67	688.33	276.2	0.2263
51.10	0.121	254.3	0.4296	127.75	685.85	275.4	0.2228
51.13	0.119	254.3	0.4296	127.83	680.18	274	0.2166
51.17	0.118	254.4	0.4296	127.92	678.57	273	0.2139
51.20	0.118	254.4	0.4296	128.02	677.08	272.3	0.2077
51.23	0.118	254.5	0.4296	128.10	674.5	271.4	0.2033
51.27	0.12	254.9	0.4305	128.17	674.27	270.9	0.2006
51.30	0.12	254.9	0.4314	128.25	667.73	269.3	0.1944
51.33	0.119	255	0.4314	128.33	665.38	268.1	0.19
51.37	0.122	255.3	0.4314	128.42	663.7	267.3	0.1837
51.40	0.121	255.4	0.4331	128.50	660.86	266.4	0.1793
51.43	0.121	255.4	0.4331	128.58	656.05	265.3	0.1722
51.47	0.121	255.6	0.4331	128.67	655.73	264.6	0.1678
51.50	0.121	255.7	0.4331	128.75	653.34	263.8	0.1624
51.53	0.12	255.8	0.4331	128.83	649.34	262.7	0.1544
51.57	0.12	255.9	0.4331	128.92	647.56	262.1	0.1482
51.60	0.12	256	0.4331	129.00	643.36	260.2	0.1385
51.63	0.123	256.4	0.434	129.08	641.16	259.1	0.1252
51.67	0.123	256.4	0.4358	129.17	639.71	258.4	0.1181
51.70	0.123	256.5	0.4358	129.25	635.77	257.2	0.1101

Prova triassiale ciclica SNGR03-C4

pressione di confinamento (kPa)		450			pressione di confinamento (kPa)		450	
deviatore ciclico (kPa)		80			deviatore ciclico (kPa)		120	
frequenza (hz)		0.00071429			frequenza (hz)		0.0007143	
51.73	0.121	256.5	0.4358	129.33	636.89	256.6	0.1056	
51.77	0.121	256.6	0.4358	129.43	630.79	254.8	0.0976	
51.80	0.12	256.7	0.4358	129.52	629.46	253.9	0.0888	
51.83	0.12	256.7	0.4358	129.58	626.13	252.7	0.0826	
51.87	0.122	257	0.4358	129.67	623.75	251.6	0.0763	
51.90	0.122	257	0.4367	129.75	622.38	250.7	0.0719	
51.95	0.121	257.1	0.4367	129.83	619.52	249.6	0.0675	
51.98	0.122	257.3	0.4367	129.92	616.29	248.3	0.0612	
52.00	0.122	257.3	0.4367	130.00	612.84	246.8	0.0577	
52.03	0.124	257.6	0.4385	130.08	610.79	245.7	0.0541	
52.07	0.123	257.6	0.4376	130.17	608.4	244.7	0.0479	
52.10	0.121	257.7	0.4376	130.25	606.39	243.6	0.0444	
52.13	0.121	257.7	0.4376	130.33	604.16	242.6	0.0408	
52.17	0.121	257.8	0.4376	130.42	602.41	241.6	0.0373	
52.20	0.121	257.9	0.4376	130.50	599.5	240.4	0.0337	
52.23	0.121	257.9	0.4376	130.58	597.53	239.5	0.0311	
52.27	0.121	257.9	0.4385	130.67	594.87	238.2	0.0284	
52.30	0.121	258	0.4385	130.75	592.86	237.1	0.024	
52.33	0.123	258.2	0.4394	130.83	590.92	236.2	0.0213	
52.37	0.122	258.3	0.4385	130.93	588.66	235.2	0.0186	
52.40	0.121	258.3	0.4385	131.00	586.68	234.3	0.0169	
52.43	0.121	258.4	0.4385	131.08	583.67	232.9	0.0142	
52.47	0.121	258.4	0.4385	131.17	582.95	232.2	0.0107	
52.50	0.121	258.4	0.4385	131.25	580.82	231.3	0.0089	
52.53	0.12	258.5	0.4385	131.33	578.52	230.4	0.0062	
52.57	0.12	258.6	0.4385	131.42	577.45	229.6	0.0044	
52.60	0.12	258.6	0.4385	131.50	575.57	228.7	0.0027	
52.63	0.12	258.7	0.4385	131.58	573.27	227.8	0	
52.67	0.118	258.6	0.4385	131.67	571.1	227.1	-0.0018	
52.70	0.118	258.6	0.4385	131.75	569.48	225.8	-0.0036	
52.73	0.119	258.6	0.4385	131.83	568.38	225.1	-0.0062	
52.77	0.12	258.8	0.4385	131.92	566.47	224.2	-0.0089	
52.80	0.119	258.8	0.4385	132.00	565.82	223.7	-0.0098	
52.83	0.119	258.9	0.4385	132.08	563.81	222.8	-0.0115	
52.87	0.118	258.9	0.4385	132.17	562.77	222.2	-0.0133	
52.90	0.117	258.9	0.4385	132.25	561.64	221.5	-0.0142	
52.93	0.117	258.9	0.4376	132.35	559.82	220.5	-0.0169	
52.97	0.118	258.9	0.4385	132.43	558.21	219.8	-0.0186	
53.00	0.117	259	0.4376	132.50	556.52	219.1	-0.0195	
53.03	0.117	259	0.4376	132.58	556.65	218.6	-0.0204	
53.07	0.117	259	0.4376	132.67	554.77	218	-0.0222	
53.10	0.117	259	0.4376	132.75	553.89	217.2	-0.0231	
53.13	0.116	259	0.4376	132.83	553.15	216.6	-0.0249	
53.17	0.116	259	0.4376	132.92	551.27	215.9	-0.0266	
53.20	0.116	259.1	0.4376	133.00	551.36	215.5	-0.0275	
53.23	0.116	259.1	0.4376	133.08	549.32	214.9	-0.0293	
53.27	0.114	259	0.4367	133.17	550	214.6	-0.0293	
53.30	0.114	259	0.4367	133.25	548.19	214	-0.0302	
53.33	0.114	259	0.4358	133.33	547.9	213.8	-0.0311	
53.38	0.113	259	0.4358	133.42	547.8	213.1	-0.032	
53.42	0.113	259.1	0.4358	133.50	546.99	212.7	-0.0328	
53.45	0.113	259.1	0.4358	133.58	546.76	212.3	-0.0337	
53.47	0.113	259.1	0.4358	133.67	546.24	212	-0.0346	
53.50	0.113	259.1	0.4358	133.77	545.4	211.5	-0.0355	
53.53	0.112	259	0.4349	133.85	545.69	211.2	-0.0355	
53.57	0.11	258.9	0.434	133.92	545.65	211	-0.0364	
53.60	0.11	258.9	0.434	134.00	544.39	210.5	-0.0373	
53.63	0.11	258.9	0.434	134.08	545.2	210.4	-0.0373	
53.67	0.11	258.9	0.434	134.17	545.1	210.2	-0.0373	
53.70	0.109	258.8	0.434	134.25	545.1	210	-0.0382	

Prova triassiale ciclica SNGR03-C4

pressione di confinamento (kPa)		450			pressione di confinamento (kPa)		450	
deviatore ciclico (kPa)		80			deviatore ciclico (kPa)		120	
frequenza (hz)		0.00071429			frequenza (hz)		0.0007143	
53.73	0.109	258.8	0.434	134.33	543.9	209.5	-0.0391	
53.77	0.109	258.9	0.4331	134.42	545.52	209.5	-0.0382	
53.80	0.108	258.8	0.4331	134.50	545.97	209.5	-0.0382	
53.83	0.107	258.7	0.4323	134.58	546.53	209.4	-0.0382	
53.87	0.107	258.7	0.4323	134.67	545.53	209.2	-0.0391	
53.90	0.106	258.6	0.4314	134.75	545.42	209	-0.0391	
53.93	0.107	258.7	0.4314	134.83	547.14	209.2	-0.0382	
53.97	0.107	258.7	0.4314	134.92	547.3	209.1	-0.0391	
54.00	0.104	258.5	0.4305	135.00	547.37	209	-0.0391	
54.03	0.104	258.4	0.4296	135.08	548.5	209	-0.0382	
54.07	0.103	258.3	0.4296	135.17	549.5	209.1	-0.0382	
54.10	0.103	258.3	0.4296	135.27	549.66	209.1	-0.0382	
54.13	0.104	258.4	0.4296	135.35	550.38	209.1	-0.0382	
54.17	0.101	258.1	0.4296	135.42	551.93	209.2	-0.0373	
54.20	0.101	258.1	0.4278	135.50	552.32	209.4	-0.0373	
54.23	0.101	258.1	0.4278	135.58	553.42	209.6	-0.0364	
54.27	0.101	258	0.4278	135.67	554.3	209.7	-0.0364	
54.30	0.101	258	0.4278	135.75	555.3	209.9	-0.0355	
54.33	0.1	257.9	0.426	135.83	556.3	210.1	-0.0346	
54.37	0.095	257.6	0.4243	135.92	557.63	210.3	-0.0346	
54.40	0.095	257.4	0.4243	136.00	558.93	210.6	-0.0337	
54.43	0.095	257.4	0.4234	136.08	560.58	210.7	-0.0337	
54.47	0.099	257.5	0.426	136.17	561.58	211.2	-0.0328	
54.50	0.099	257.5	0.4252	136.25	563.13	211.5	-0.032	
54.53	0.096	257.4	0.4243	136.33	564.47	211.8	-0.0302	
54.57	0.096	257.4	0.4234	136.42	565.38	212.1	-0.0302	
54.60	0.092	257	0.4207	136.50	567.78	212.7	-0.0284	
54.63	0.092	257	0.4207	136.58	568.99	212.9	-0.0275	
54.67	0.092	257	0.4207	136.68	570.29	213.3	-0.0266	
54.70	0.092	256.9	0.4207	136.77	572.43	213.8	-0.0257	
54.73	0.092	256.8	0.4207	136.83	573.76	214.2	-0.0249	
54.77	0.092	256.7	0.4198	136.92	574.99	214.6	-0.024	
54.80	0.089	256.6	0.4189	137.00	577.39	215.1	-0.0222	
54.85	0.089	256.5	0.4189	137.08	580.17	215.8	-0.0213	
54.88	0.089	256.5	0.4181	137.17	582.17	216.5	-0.0204	
54.90	0.086	256.1	0.4163	137.25	583.41	216.9	-0.0186	
54.93	0.087	256.1	0.4163	137.33	585.45	217.5	-0.0169	
54.97	0.087	256.1	0.4163	137.42	587.72	218.1	-0.0151	
55.00	0.084	256.1	0.4163	137.50	589.4	218.7	-0.0142	
55.03	0.084	255.8	0.4154	137.58	590.69	219.3	-0.0124	
55.07	0.085	255.8	0.4145	137.67	594.19	220	-0.0107	
55.10	0.083	255.5	0.4136	137.75	596.29	220.6	-0.0098	
55.13	0.083	255.5	0.4136	137.83	598.08	221.6	-0.008	
55.17	0.083	255.4	0.4127	137.92	601.31	222.4	-0.0053	
55.20	0.08	255.1	0.4127	138.00	602.73	223	-0.0036	
55.23	0.08	255.1	0.4118	138.08	604.74	223.6	-0.0018	
55.27	0.08	255	0.411	138.18	608.43	224.3	0.0009	
55.30	0.077	254.6	0.4083	138.27	609.82	225.4	0.0018	
55.33	0.076	254.4	0.4083	138.33	611.99	226.1	0.0053	
55.37	0.078	254.5	0.4074	138.42	614.84	227	0.008	
55.40	0.075	254.2	0.4065	138.50	616.85	227.8	0.0098	
55.43	0.074	254	0.4065	138.58	619.53	228.7	0.0124	
55.47	0.074	254	0.4056	138.67	622.31	229.7	0.0151	
55.50	0.074	253.9	0.4056	138.75	626	230.6	0.0186	
55.53	0.075	253.8	0.4039	138.83	625.91	231.2	0.0195	
55.57	0.07	253.3	0.4021	138.92	629.88	232.5	0.0222	
55.60	0.07	253.3	0.4021	139.00	631.83	233.4	0.0266	
55.63	0.071	253.2	0.4012	139.08	634.58	234.2	0.0293	
55.67	0.068	252.9	0.4012	139.17	637.94	235.3	0.0328	
55.70	0.068	252.9	0.4003	139.25	639.69	236.2	0.0364	

Prova triassiale ciclica SNGR03-C4

pressione di confinamento (kPa)		450		pressione di confinamento (kPa)		450	
deviatore ciclico (kPa)		80		deviatore ciclico (kPa)		120	
frequenza (hz)		0.00071429		frequenza (hz)		0.0007143	
55.73	0.068	252.8	0.3994	139.33	642.11	237.1	0.0391
55.77	0.068	252.7	0.3985	139.42	644.54	238	0.0426
55.80	0.067	252.6	0.3985	139.50	647.9	239.1	0.047
55.83	0.063	252	0.3959	139.60	651.71	240.5	0.0533
55.87	0.063	252	0.395	139.68	652.72	241.3	0.0568
55.90	0.064	251.9	0.395	139.75	656.02	242.4	0.0612
55.93	0.063	251.9	0.395	139.83	657.57	243.1	0.0639
55.97	0.063	251.8	0.3941	139.92	662.15	244.7	0.0701
56.00	0.059	251.2	0.3905	140.00	664.26	245.7	0.0754
56.03	0.058	251	0.3896	140.08	666.84	246.7	0.0852
56.07	0.059	251	0.3905	140.17	669.52	247.7	0.0923
56.10	0.06	251	0.3896	140.25	672.26	248.8	0.1003
56.13	0.054	250.3	0.3896	140.33	674.04	249.8	0.1101
56.17	0.055	250.3	0.3861	140.42	676.85	250.9	0.1207
56.20	0.055	250.3	0.3861	140.50	680.17	252	0.1314
56.23	0.056	250.3	0.3861	140.58	684.27	253.5	0.1376
56.28	0.051	249.7	0.3834	140.67	685.63	254.4	0.142
56.32	0.051	249.6	0.3825	140.75	689.65	255.5	0.1509
56.35	0.051	249.4	0.3817	140.83	691.04	256.4	0.1553
56.37	0.052	249.4	0.3817	140.92	693.55	257.3	0.1598
56.40	0.05	249.1	0.3799	141.00	695.58	258.2	0.1642
56.43	0.048	248.7	0.3781	141.10	698.71	259.5	0.1704
56.47	0.043	248.2	0.3781	141.17	700.87	260.3	0.1749
56.50	0.045	248.2	0.3746	141.25	704.29	261.4	0.1802
56.53	0.045	248.1	0.3746	141.33	706.03	262.4	0.1837
56.57	0.045	248	0.3746	141.42	707.71	263.2	0.1873
56.60	0.046	248	0.3737	141.50	710.99	264.2	0.1917
56.63	0.041	247.4	0.371	141.58	714.31	265.1	0.1962
56.67	0.041	247.2	0.3701	141.67	716.95	266.6	0.1997
56.70	0.041	246.9	0.3701	141.75	718.35	267.4	0.2059
56.73	0.038	246.9	0.3683	141.83	721.53	268.4	0.2095
56.77	0.038	246.6	0.3675	141.92	723.46	269.2	0.213
56.80	0.038	246.5	0.3666	142.00	725.68	270.2	0.2175
56.83	0.038	246.4	0.3657	142.08	730.32	271.5	0.2228
56.87	0.036	246	0.3639	142.17	728	271.7	0.2237
56.90	0.036	245.8	0.3621	142.25	733.21	272.9	0.229
56.93	0.032	245.3	0.3621	142.33	735.5	274.2	0.2326
56.97	0.03	245.3	0.3604	142.42	736.6	275	0.237
57.00	0.03	245	0.3586	142.52	738.4	275.8	0.2406
57.03	0.031	244.8	0.3577	142.60	741.77	276.7	0.2441
57.07	0.029	244.5	0.3559	142.67	743.54	277.8	0.2468
57.10	0.031	244.5	0.355	142.75	745.57	278.8	0.2503
57.13	0.026	243.8	0.3515	142.83	747.02	279.5	0.2548
57.17	0.025	243.5	0.3515	142.92	749.53	280.4	0.2583
57.20	0.024	243.5	0.3497	143.00	751.17	281.1	0.261
57.23	0.024	243.4	0.3488	143.08	752.48	281.9	0.2645
57.27	0.026	243.3	0.3488	143.17	754.13	282.6	0.2672
57.30	0.021	242.8	0.3453	143.25	758.66	283.9	0.2725
57.33	0.021	242.6	0.3444	143.33	756.69	284.3	0.2734
57.37	0.02	242.2	0.3417	143.42	760.65	285.3	0.2761
57.40	0.021	242.2	0.3417	143.50	761.39	285.9	0.2796
57.43	0.017	242.2	0.3408	143.58	762.8	286.6	0.2823
57.47	0.017	241.6	0.3373	143.67	764.38	287.3	0.2849
57.50	0.017	241.4	0.3364	143.75	765.96	288.1	0.2867
57.53	0.015	241	0.3346	143.83	767.46	288.7	0.2894
57.57	0.014	240.8	0.3328	143.93	769.23	289.7	0.292
57.60	0.015	240.7	0.3328	144.02	770.13	290.2	0.2947
57.63	0.009	240.1	0.3328	144.08	771.81	291	0.2974
57.67	0.011	240.1	0.3284	144.17	771.51	291.3	0.2982
57.70	0.011	239.9	0.3275	144.25	773.66	292	0.3009

Prova triassiale ciclica SNGR03-C4								
tensione di confinamento (kPa)		450			tensione di confinamento (kPa)		450	
deviatore ciclico (kPa)		80			deviatore ciclico (kPa)		120	
frequenza (hz)		0.00071429			frequenza (hz)		0.0007143	
57.75	0.008	239.3	0.3266	144.33	775.04	292.5	0.3027	
57.78	0.008	239.3	0.324	144.42	778.52	293.7	0.3045	
57.80	0.008	239.1	0.3222	144.50	776.1	293.8	0.3071	
57.83	0.007	238.9	0.3213	144.58	777.74	294.3	0.3089	
57.87	0.006	238.6	0.3195	144.67	778.8	294.9	0.3107	
57.90	0.004	238.2	0.3177	144.75	779.67	295.3	0.3124	
57.93	0.001	237.6	0.3133	144.83	782.47	296.2	0.3151	
57.97	0	237.3	0.3133	144.92	780.47	296.3	0.3151	
58.00	0.001	237.3	0.3115	145.00	781.88	296.9	0.316	
58.03	0.001	237.2	0.3098	145.08	782.36	297.3	0.3178	
58.07	0.002	237.1	0.3098	145.17	782.91	297.7	0.3187	
58.10	-0.002	236.6	0.3053	145.25	783.43	298.1	0.3204	
58.13	-0.005	236	0.3	145.33	783.53	298.5	0.3204	
58.17	-0.005	235.8	0.2964	145.43	783.78	298.9	0.3222	
58.20	-0.006	235.5	0.2964	145.52	784.42	299.2	0.3231	
58.23	-0.004	235.5	0.2929	145.58	784.86	299.5	0.324	
58.27	-0.004	235.6	0.2902	145.67	784.6	299.7	0.3249	
58.30	-0.006	235	0.2849	145.75	784.64	300	0.3249	
58.33	-0.011	234.5	0.2787	145.83	787.21	300.5	0.3267	
58.37	-0.01	234.4	0.2734	145.92	784.44	300.4	0.3258	
58.40	-0.012	234	0.2663	146.00	784.57	300.5	0.3267	
58.43	-0.016	233.3	0.2663	146.08	784.76	300.9	0.3267	
58.47	-0.015	233.3	0.2592	146.17	786.89	301.4	0.3284	
58.50	-0.015	233.2	0.2538	146.25	784.02	301.2	0.3275	
58.53	-0.014	233	0.2494	146.33	783.7	301.3	0.3284	
58.57	-0.018	232.5	0.2441	146.42	784.06	301.5	0.3275	
58.60	-0.014	232.6	0.2405	146.50	782.96	301.5	0.3275	
58.63	-0.017	231.9	0.2352	146.58	782.73	301.5	0.3275	
58.67	-0.022	231.5	0.2352	146.67	782.38	301.6	0.3275	
58.70	-0.021	231.5	0.229	146.75	782.28	301.8	0.3284	
58.73	-0.021	231.2	0.2254	146.85	781.06	301.7	0.3267	
58.77	-0.021	231	0.2219	146.93	778.88	301.4	0.3258	
58.80	-0.027	230.2	0.2148	147.00	780.87	301.8	0.3267	
58.83	-0.025	230.1	0.213	147.08	777.82	301.4	0.3249	
58.87	-0.023	230	0.2112	147.17	777.81	301.5	0.3249	
58.90	-0.029	229.3	0.2112	147.25	778.04	301.6	0.3249	
58.93	-0.029	229.3	0.205	147.33	775.53	301.3	0.324	
58.97	-0.029	229	0.2024	147.42	774.76	301.1	0.3231	
59.00	-0.031	228.5	0.1988	147.50	771.96	300.8	0.3213	
59.03	-0.029	228.5	0.1979	147.58	772.79	300.8	0.3213	
59.07	-0.029	228.3	0.1953	147.67	771.16	300.6	0.3204	
59.10	-0.035	227.3	0.189	147.75	769.58	300.3	0.3196	
59.13	-0.035	227.1	0.189	147.83	769.42	300.3	0.3187	
59.17	-0.033	227.1	0.1873	147.92	767.13	299.9	0.3169	
59.22	-0.035	226.6	0.1837	148.00	763.24	299.2	0.3142	
59.25	-0.036	226.3	0.1837	148.08	766.17	299.5	0.3151	
59.27	-0.037	226.3	0.1811	148.17	762.89	299	0.3133	
59.30	-0.037	226	0.1793	148.25	762.5	298.9	0.3124	
59.33	-0.038	225.6	0.1766	148.35	759.93	298.4	0.3107	
59.37	-0.04	225.3	0.174	148.43	755.27	297.5	0.3071	
59.40	-0.041	225	0.1722	148.50	757.51	297.7	0.308	
59.43	-0.041	224.6	0.1704	148.58	754.43	297.2	0.3053	
59.47	-0.044	224.1	0.1704	148.67	750.79	296.4	0.3027	
59.50	-0.044	224.1	0.1677	148.75	749.18	296.5	0.3027	
59.53	-0.044	223.8	0.166	148.83	748.58	295.6	0.3009	
59.57	-0.045	223.5	0.1642	148.92	746.64	295.2	0.2982	
59.60	-0.047	223.1	0.1624	149.00	743.3	294.5	0.2956	
59.63	-0.05	222.5	0.1589	149.08	744.62	294.4	0.2956	
59.67	-0.048	222.5	0.1589	149.17	741.59	293.7	0.292	
59.70	-0.049	222.2	0.1589	149.25	736.41	292.7	0.2885	

Prova triassiale ciclica SNGR03-C4

tensione di confinamento (kPa)		450			tensione di confinamento (kPa)	450		
deviatore ciclico (kPa)		80			deviatore ciclico (kPa)	120		
frequenza (hz)		0.00071429			frequenza (hz)	0.0007143		
59.73	-0.05	222.2	0.1571	149.33	736.54	292.4	0.2867	
59.77	-0.05	221.8	0.1553	149.42	733.96	291.8	0.2867	
59.80	-0.05	221.6	0.1544	149.50	729.97	290.7	0.284	
59.83	-0.05	221.4	0.1535	149.58	731.29	290.7	0.2814	
59.87	-0.053	220.9	0.1509	149.67	725.82	289.7	0.2769	
59.90	-0.053	220.6	0.15	149.77	726.53	289.2	0.2752	
59.93	-0.055	220.2	0.15	149.85	721.64	288.2	0.2734	
59.97	-0.056	220.2	0.1482	149.92	719.89	287.5	0.269	
60.00	-0.056	219.8	0.1464	150.00	720.54	287.3	0.2681	
60.03	-0.057	219.5	0.1455	150.08	714.14	286	0.2619	
60.07	-0.058	219.2	0.1438	150.17	713.87	285.5	0.261	
60.10	-0.059	218.8	0.142	150.25	713.32	285.1	0.2592	
60.13	-0.06	218.5	0.1402	150.33	708.63	284.1	0.2548	
60.17	-0.064	217.8	0.1402	150.42	705.12	283.2	0.2503	
60.20	-0.063	217.8	0.1376	150.50	702.93	282.1	0.2477	
60.23	-0.063	217.7	0.1376	150.58	700.32	281.2	0.2423	
60.27	-0.063	217.4	0.1367	150.67	697.52	280.4	0.2388	
60.30	-0.063	217.3	0.1358	150.75	695.29	279.6	0.2352	
60.33	-0.063	217.1	0.1349	150.83	694.87	279.1	0.2334	
60.37	-0.065	216.5	0.1331	150.92	690.88	278.1	0.229	
60.40	-0.068	216.1	0.1331	151.00	686.89	276.9	0.2228	
60.43	-0.07	216.1	0.1313	151.08	683.95	275.7	0.2201	
60.47	-0.07	215.6	0.1296	151.17	682.5	274.9	0.2184	
60.50	-0.068	215.5	0.1287	151.27	679.99	273.9	0.2104	
60.53	-0.068	215.4	0.1287	151.33	676.51	273	0.2059	
60.57	-0.068	215.2	0.1278	151.42	674.89	272.1	0.2024	
60.60	-0.07	214.7	0.126	151.50	670.74	270.8	0.1988	
60.65	-0.073	214.3	0.1242	151.58	668.31	270	0.1908	
60.68	-0.073	214.1	0.1242	151.67	665.57	268.9	0.1864	
60.72	-0.074	213.8	0.1225	151.75	663.28	268.1	0.1829	
60.73	-0.073	213.6	0.1225	151.83	661.7	267.4	0.1784	
60.77	-0.074	213.6	0.1225	151.92	657.93	266.4	0.174	
60.80	-0.074	213.3	0.1216	152.00	654.18	265.1	0.1687	
60.83	-0.076	212.8	0.1198	152.08	650.44	263.7	0.1633	
60.87	-0.076	212.6	0.1189	152.17	649.41	263.1	0.15	
60.90	-0.078	212.3	0.118	152.25	647.21	262.2	0.1438	
60.93	-0.078	212	0.1171	152.33	644.43	261.1	0.1358	
60.97	-0.08	211.6	0.1171	152.42	644.59	260.7	0.1305	
61.00	-0.08	211.6	0.1154	152.50	639.1	259.2	0.1216	
61.03	-0.08	211.4	0.1154	152.58	635.51	257.7	0.1145	
61.07	-0.082	211.1	0.1136	152.68	633.67	256.8	0.1047	
61.10	-0.081	210.9	0.1136	152.75	632.27	256	0.0985	
61.13	-0.081	210.6	0.1127	152.83	628.59	254.7	0.0923	
61.17	-0.081	210.4	0.1109	152.92	626.39	253.3	0.087	
61.20	-0.084	210	0.1109	153.00	622.8	251.9	0.0808	
61.23	-0.084	210	0.1092	153.08	621.09	251.1	0.0737	
61.27	-0.084	209.8	0.1092	153.17	618.17	249.9	0.0683	
61.30	-0.085	209.5	0.1083	153.25	613.2	248.3	0.0612	
61.33	-0.086	209.2	0.1074	153.33	613.84	247.8	0.0595	
61.37	-0.086	209	0.1065	153.42	610.57	246.8	0.0559	
61.40	-0.087	208.7	0.1056	153.50	607.86	245.1	0.0533	
61.43	-0.088	208.4	0.1056	153.58	608.85	244.8	0.0488	
61.47	-0.088	208.4	0.1047	153.67	603.71	243.2	0.0444	
61.50	-0.088	208.3	0.1038	153.75	602.77	242.4	0.0408	
61.53	-0.088	208	0.1029	153.83	599.44	240.8	0.0373	
61.57	-0.09	207.6	0.1021	153.92	597.04	239.7	0.0346	
61.60	-0.09	207.4	0.1021	154.00	595.01	238.8	0.0302	
61.63	-0.091	207.2	0.1012	154.10	592.84	237.8	0.0275	
61.67	-0.091	207	0.1012	154.18	589.98	236.4	0.0249	
61.70	-0.092	207	0.1003	154.25	588.37	235.5	0.0231	

Prova triassiale ciclica SNGR03-C4

tensione di confinamento (kPa)		450	tensione di confinamento (kPa)		450		
deviatore ciclico (kPa)		80	deviatore ciclico (kPa)		120		
frequenza (hz)		0.00071429	frequenza (hz)		0.0007143		
61.73	-0.092	206.7	0.0994	154.33	586.71	234.7	0.0195
61.77	-0.093	206.5	0.0985	154.42	586.61	234.2	0.0186
61.80	-0.093	206.3	0.0976	154.50	581.89	232.7	0.0142
61.83	-0.094	206	0.0976	154.58	580.86	232	0.0124
61.87	-0.094	205.8	0.0967	154.67	579.2	231.2	0.0107
61.90	-0.095	205.5	0.0967	154.75	575.7	229.9	0.0071
61.93	-0.095	205.5	0.0958	154.83	574.5	228.9	0.0062
61.97	-0.095	205.3	0.095	154.92	574.44	228.3	0.0036
62.00	-0.096	205.1	0.0941	155.00	571.4	227.4	0.0018
62.03	-0.097	204.9	0.0941	155.08	570	226.5	0
62.07	-0.096	204.7	0.0932	155.17	566.09	225.3	-0.0036
62.12	-0.097	204.4	0.0923	155.25	567.28	225	-0.0044
62.15	-0.098	204.2	0.0923	155.33	565.95	224.2	-0.0053
62.17	-0.098	204	0.0914	155.42	565.21	223.6	-0.0071
62.20	-0.099	203.8	0.0914	155.50	561.91	222.5	-0.0089
62.23	-0.1	203.5	0.0914	155.60	560.9	221.8	-0.0115
62.27	-0.099	203.5	0.0905	155.68	559.89	221.2	-0.0124
62.30	-0.099	203.5	0.0905	155.75	555.81	220.6	-0.0151
62.33	-0.099	203.3	0.0896	155.83	557.76	219.7	-0.016
62.37	-0.1	203	0.0887	155.92	556.69	219.1	-0.0169
62.40	-0.101	202.8	0.0887	156.00	554.94	218.3	-0.0186
62.43	-0.101	202.7	0.0879	156.08	554.68	217.9	-0.0195
62.47	-0.102	202.5	0.0879	156.17	551.57	217	-0.0222
62.50	-0.102	202.5	0.087	156.25	551.89	216.6	-0.0222
62.53	-0.102	202.3	0.087	156.33	551.05	216.5	-0.0222
62.57	-0.102	202.2	0.087	156.42	549.98	215.4	-0.0249
62.60	-0.102	201.9	0.0861	156.50	549.91	215.1	-0.0257
62.63	-0.102	201.8	0.0852	156.58	547.38	214.2	-0.0275
62.67	-0.103	201.6	0.0852	156.67	550.39	214.5	-0.0266
62.70	-0.103	201.4	0.0852	156.75	548.46	213.9	-0.0284
62.73	-0.104	201.4	0.0843	156.83	546.77	213.3	-0.0293
62.77	-0.104	201.3	0.0843	156.92	546.83	212.9	-0.0293
62.80	-0.103	201.2	0.0843	157.00	545.86	212.4	-0.0302
62.83	-0.104	201	0.0834	157.08	545.6	212.2	-0.0311
62.87	-0.104	200.8	0.0834	157.17	545.83	211.9	-0.0311
62.90	-0.104	200.7	0.0825	157.25	545.32	211.5	-0.032
62.93	-0.105	200.4	0.0825	157.33	544.04	210.9	-0.0337
62.97	-0.105	200.4	0.0816	157.42	545.33	210.9	-0.0328
63.00	-0.105	200.4	0.0816	157.50	545.4	210.8	-0.0337
63.03	-0.104	200.3	0.0816	157.58	545.37	210.6	-0.0337
63.07	-0.105	200.2	0.0816	157.67	545.76	210.5	-0.0337
63.10	-0.105	200	0.0816	157.75	544.36	210	-0.0346
63.13	-0.106	199.8	0.0807	157.83	545.66	210	-0.0346
63.17	-0.109	199.4	0.0807	157.92	545.98	209.9	-0.0346
63.20	-0.108	199.4	0.079	158.00	546.27	209.8	-0.0346
63.23	-0.108	199.3	0.079	158.08	545.98	209.6	-0.0346
63.27	-0.107	199.3	0.079	158.17	545.05	209.3	-0.0355
63.30	-0.106	199.3	0.079	158.25	547.18	209.6	-0.0346
63.33	-0.105	199.3	0.079	158.33	548.12	209.6	-0.0337
63.37	-0.109	198.9	0.0781	158.42	548.31	209.6	-0.0346
63.40	-0.108	198.8	0.0781	158.52	548.6	209.5	-0.0337
63.43	-0.105	198.8	0.0781	158.58	551.13	209.9	-0.0337
63.47	-0.105	199	0.079	158.67	550	209.7	-0.0337
63.50	-0.105	198.9	0.079	158.75	551.03	209.7	-0.0346
63.55	-0.106	198.8	0.0781	158.83	552.26	209.9	-0.0328
63.58	-0.106	198.7	0.0781	158.92	554.47	210.3	-0.032
63.62	-0.106	198.5	0.0772	159.00	554.27	210.3	-0.032
63.63	-0.107	198.4	0.0772	159.08	554.5	210.3	-0.0311
63.67	-0.107	198.3	0.0772	159.17	556.08	210.6	-0.0311
63.70	-0.107	198.3	0.0772	159.25	557.35	210.9	-0.0302

Prova triassiale ciclica SNGR03-C4

tensione di confinamento (kPa)		450	tensione di confinamento (kPa)		450		
deviatore ciclico (kPa)		80	deviatore ciclico (kPa)		120		
frequenza (hz)		0.00071429	frequenza (hz)		0.0007143		
63.73	-0.107	198.2	0.0772	159.33	558.25	211.1	-0.0293
63.77	-0.106	198.2	0.0772	159.42	559.77	211.4	-0.0293
63.80	-0.106	198.1	0.0772	159.50	561.2	211.7	-0.0275
63.83	-0.107	198	0.0763	159.58	565.24	212.5	-0.0257
63.87	-0.107	198	0.0763	159.67	564.09	212.4	-0.0266
63.90	-0.107	197.8	0.0763	159.75	564.96	212.6	-0.0257
63.93	-0.106	197.8	0.0763	159.83	567.28	213.1	-0.0249
63.97	-0.106	197.8	0.0763	159.93	569.23	213.6	-0.0231
64.00	-0.106	197.8	0.0763	160.00	569.23	213.7	-0.0231
64.03	-0.106	197.7	0.0763	160.08	571.27	214.1	-0.0222
64.07	-0.106	197.7	0.0763	160.17	573.7	214.7	-0.0204
64.10	-0.105	197.7	0.0763	160.25	578.1	215.8	-0.0186
64.13	-0.105	197.6	0.0763	160.33	577.72	215.9	-0.0178
64.17	-0.106	197.5	0.0754	160.42	579.23	216.3	-0.0169
64.20	-0.105	197.5	0.0754	160.50	581.28	217	-0.0151
64.23	-0.105	197.5	0.0754	160.58	583.61	217.6	-0.0142
64.27	-0.105	197.4	0.0754	160.67	584.87	218	-0.0124
64.30	-0.105	197.4	0.0754	160.75	587.07	218.6	-0.0107
64.33	-0.105	197.4	0.0754	160.83	589.98	219.6	-0.0098
64.37	-0.104	197.3	0.0754	160.92	591.52	220.1	-0.008
64.40	-0.105	197.3	0.0754	161.00	594.26	220.8	-0.0053
64.43	-0.104	197.2	0.0754	161.08	596.23	221.5	-0.0044
64.47	-0.104	197.2	0.0754	161.17	597.69	222	-0.0027
64.50	-0.104	197.2	0.0754	161.25	600.32	222.8	-0.0009
64.53	-0.104	197.2	0.0754	161.33	602.54	223.5	0.0009
64.57	-0.104	197.1	0.0754	161.43	604.81	224.3	0.0027
64.60	-0.104	197.1	0.0754	161.50	607.23	225.1	0.0053
64.63	-0.103	197.1	0.0754	161.58	609.21	225.8	0.0071
64.67	-0.101	197.2	0.0754	161.67	612.32	226.7	0.0098
64.70	-0.102	197.2	0.0763	161.75	614.39	227.7	0.0115
64.73	-0.102	197.2	0.0763	161.83	618.04	228.7	0.0151
64.77	-0.102	197.2	0.0763	161.92	619.37	229.4	0.0169
64.80	-0.101	197.2	0.0763	162.00	622.75	230.5	0.0204
64.83	-0.099	197.4	0.0772	162.08	623.61	231.1	0.0222
64.87	-0.099	197.4	0.0772	162.17	626.52	231.8	0.024
64.90	-0.099	197.4	0.0772	162.25	628.88	232.6	0.0266
64.93	-0.099	197.4	0.0772	162.33	633.19	234.2	0.0302
64.97	-0.099	197.3	0.0772	162.42	634.46	235	0.0346
65.02	-0.099	197.3	0.0772	162.50	636.91	235.8	0.0373
65.05	-0.099	197.3	0.0772	162.58	641.31	237.2	0.0417
65.07	-0.099	197.3	0.0772	162.67	642.08	237.9	0.0444
65.10	-0.099	197.3	0.0772	162.75	644.58	238.7	0.0479
65.13	-0.098	197.3	0.0772	162.85	648.19	240.1	0.0533
65.17	-0.097	197.4	0.0781	162.92	651.07	241.1	0.0568
65.20	-0.097	197.4	0.0781	163.00	652.62	242	0.0604
65.23	-0.096	197.5	0.0781	163.08	655.21	242.9	0.0639
65.27	-0.095	197.5	0.0781	163.17	657.53	243.7	0.0675
65.30	-0.095	197.6	0.079	163.25	662.73	245.5	0.0737
65.33	-0.095	197.6	0.079	163.33	663.77	246.4	0.0817
65.37	-0.094	197.7	0.079	163.42	666.23	247.3	0.0879
65.40	-0.094	197.7	0.079	163.50	670.19	248.6	0.0959
65.43	-0.094	197.7	0.079	163.58	671.68	249.5	0.1039
65.47	-0.093	197.8	0.079	163.67	674.23	250.5	0.1127
65.50	-0.092	197.8	0.0799	163.75	677.43	251.7	0.1234
65.53	-0.092	197.9	0.0799	163.83	681.82	253.3	0.1323
65.57	-0.091	198	0.0807	163.92	683.52	254.2	0.1402
65.60	-0.091	198	0.0807	164.00	685.16	255.1	0.1438
65.63	-0.091	198.1	0.0807	164.08	686.82	255.8	0.1473
65.67	-0.09	198.1	0.0807	164.17	691.35	257.1	0.1544
65.70	-0.089	198.2	0.0807	164.27	694.4	258.3	0.1598

Prova triassiale ciclica SNGR03-C4

tensione di confinamento (kPa)		450	tensione di confinamento (kPa)		450		
deviatore ciclico (kPa)		80	deviatore ciclico (kPa)		120		
frequenza (hz)		0.00071429	frequenza (hz)		0.0007143		
65.73	-0.089	198.2	0.0816	164.33	695.56	259.1	0.1633
65.77	-0.089	198.3	0.0816	164.42	699.45	260.2	0.1687
65.80	-0.088	198.4	0.0816	164.50	701.19	261.1	0.174
65.83	-0.087	198.5	0.0825	164.58	703.26	261.9	0.1775
65.87	-0.087	198.6	0.0825	164.67	706.42	262.8	0.1802
65.90	-0.088	198.5	0.0825	164.75	709.77	264.3	0.1855
65.93	-0.087	198.6	0.0825	164.83	710.61	265.1	0.1908
65.97	-0.085	198.6	0.0825	164.92	713.83	266.1	0.1953
66.00	-0.085	198.8	0.0843	165.00	716.41	267.2	0.2006
66.03	-0.081	199.2	0.0852	165.08	718.57	268.1	0.2042
66.07	-0.082	199.2	0.0852	165.17	720.43	268.9	0.2077
66.10	-0.082	199.3	0.0852	165.25	723.43	269.9	0.2121
66.13	-0.082	199.3	0.0852	165.33	726.62	271.3	0.2157
66.17	-0.082	199.3	0.0852	165.42	727.84	272	0.2201
66.20	-0.08	199.3	0.0852	165.50	728.96	272.7	0.2237
66.23	-0.08	199.5	0.0861	165.58	732.54	273.8	0.2281
66.27	-0.08	199.6	0.0861	165.67	734.22	274.7	0.2317
66.30	-0.078	199.8	0.087	165.77	737.37	275.9	0.2361
66.33	-0.078	199.9	0.087	165.83	739.24	276.7	0.2397
66.37	-0.078	200	0.0879	165.92	741.16	277.6	0.2432
66.40	-0.076	200.2	0.0879	166.00	742.77	278.3	0.2459
66.43	-0.075	200.2	0.0887	166.08	744.38	279.2	0.2494
66.48	-0.075	200.3	0.0896	166.17	748.08	280.1	0.253
66.52	-0.074	200.5	0.0896	166.25	749.24	281.3	0.2556
66.53	-0.073	200.5	0.0896	166.33	751.3	282.1	0.261
66.57	-0.073	200.7	0.0905	166.42	752.74	282.7	0.2636
66.60	-0.072	200.8	0.0905	166.50	754.74	283.6	0.2663
66.63	-0.072	200.9	0.0914	166.58	754.45	284	0.2681
66.67	-0.071	201.1	0.0914	166.67	757.89	285	0.2725
66.70	-0.07	201.2	0.0923	166.75	759.79	285.7	0.2743
66.73	-0.069	201.4	0.0923	166.83	761.78	286.8	0.2778
66.77	-0.068	201.4	0.0932	166.92	763.45	287.6	0.2814
66.80	-0.068	201.5	0.0932	167.00	766.66	288.6	0.2858
66.83	-0.067	201.7	0.0941	167.08	764.19	288.7	0.2858
66.87	-0.066	201.9	0.0941	167.17	767.11	289.5	0.2885
66.90	-0.066	202	0.095	167.25	768.81	290.4	0.2911
66.93	-0.064	202.2	0.0958	167.33	769.95	291	0.2929
66.97	-0.063	202.4	0.0958	167.42	771.49	291.7	0.2956
67.00	-0.064	202.4	0.0958	167.50	772.29	292.2	0.2974
67.03	-0.064	202.4	0.0958	167.58	773.35	292.7	0.2991
67.07	-0.063	202.6	0.0967	167.67	775.18	293.3	0.3009
67.10	-0.06	202.9	0.0985	167.75	777.34	294.4	0.3036
67.13	-0.06	203.1	0.0985	167.83	776.72	294.7	0.3062
67.17	-0.059	203.3	0.0994	167.92	777.62	295.1	0.3071
67.20	-0.058	203.5	0.0994	168.00	780.47	296	0.3107
67.23	-0.054	203.5	0.1003	168.08	778.84	296.1	0.3107
67.27	-0.054	204	0.1021	168.17	779.48	296.5	0.3116
67.30	-0.055	204.1	0.1021	168.25	781.37	297.1	0.3142
67.33	-0.055	204.1	0.1021	168.33	782.5	297.9	0.3151
67.37	-0.055	204.3	0.1029	168.42	782.15	298.1	0.3169
67.40	-0.053	204.6	0.1038	168.50	782.82	298.4	0.3178
67.43	-0.051	204.8	0.1038	168.58	782.95	298.8	0.3187
67.47	-0.052	204.8	0.1047	168.68	785.13	299.6	0.3213
67.50	-0.052	204.8	0.1047	168.75	784	299.7	0.3213
67.53	-0.051	205.1	0.1065	168.83	783.04	299.8	0.3213
67.57	-0.048	205.4	0.1074	168.92	784.87	300.3	0.3231
67.60	-0.044	206	0.1092	169.00	784.81	300.5	0.3231
67.63	-0.047	205.9	0.1083	169.08	785.03	300.8	0.324
67.67	-0.047	206	0.1083	169.17	784.58	301	0.3249
67.70	-0.043	206	0.1092	169.25	787.87	301.7	0.3249

Prova triassiale ciclica SNGR03-C4							
tensione di confinamento (kPa)		450	tensione di confinamento (kPa)		450		
deviatore ciclico (kPa)		80	deviatore ciclico (kPa)		120		
frequenza (hz)		0.00071429	frequenza (hz)		0.0007143		
67.73	-0.043	206.4	0.1109	169.33	784.29	301.4	0.3258
67.77	-0.043	206.5	0.1109	169.42	784.51	301.6	0.3258
67.80	-0.043	206.8	0.1127	169.50	784.44	301.8	0.3267
67.83	-0.041	207	0.1136	169.58	784.57	302	0.3267
67.87	-0.041	207.2	0.1145	169.67	784.19	302.1	0.3267
67.92	-0.04	207.4	0.1145	169.75	785.96	302.2	0.3267
67.95	-0.04	207.5	0.1154	169.83	782.62	302.3	0.3267
67.97	-0.038	207.9	0.1171	169.92	782.32	302.3	0.3258
68.00	-0.035	208.4	0.1171	170.00	782.16	302.4	0.3258
68.03	-0.032	208.4	0.1189	170.10	781.68	302.5	0.3258
68.07	-0.032	208.8	0.1207	170.17	782.13	302.7	0.3258
68.10	-0.033	208.8	0.1207	170.25	779.97	302.4	0.3249
68.13	-0.034	208.9	0.1216	170.33	779.55	302.4	0.3249
68.17	-0.032	209.2	0.1225	170.42	779.65	302.6	0.3249
68.20	-0.031	209.4	0.1234	170.50	777.43	302.2	0.324
68.23	-0.032	209.5	0.1234	170.58	777.23	302.2	0.324
68.27	-0.028	209.5	0.1234	170.67	775.5	302.1	0.3231
68.30	-0.028	210	0.1251	170.75	775.79	302.1	0.3222
68.33	-0.028	210.2	0.1269	170.83	773.15	301.7	0.3204
68.37	-0.026	210.5	0.1278	170.92	772.41	301.6	0.3204
68.40	-0.024	210.8	0.1296	171.00	770.93	301.3	0.3196
68.43	-0.024	211	0.1305	171.08	770	301.2	0.3187
68.47	-0.023	211.3	0.1305	171.17	769.13	301	0.3178
68.50	-0.021	211.3	0.1322	171.25	766.96	300.7	0.316
68.53	-0.021	211.7	0.1331	171.33	766.45	300.5	0.316
68.57	-0.021	211.9	0.134	171.42	763.35	300	0.3133
68.60	-0.02	212.2	0.1349	171.50	762.63	299.8	0.3124
68.63	-0.015	212.9	0.1384	171.60	760.67	299.5	0.3116
68.67	-0.017	212.9	0.1384	171.67	759.45	299.1	0.3098
68.70	-0.018	213	0.1384	171.75	757.84	298.7	0.308
68.73	-0.016	213	0.1384	171.83	756.07	298.3	0.3062
68.77	-0.016	213.2	0.1393	171.92	754.85	298	0.3053
68.80	-0.014	213.6	0.142	172.00	753.3	297.6	0.3036
68.83	-0.012	214.1	0.1438	172.08	750.73	297	0.3009
68.87	-0.01	214.4	0.1455	172.17	748.25	296.8	0.3
68.90	-0.01	214.6	0.1473	172.25	745.97	295.6	0.2982
68.93	-0.009	214.9	0.1473	172.33	744.43	295.3	0.2947
68.97	-0.007	214.9	0.1482	172.42	742.91	294.9	0.2929
69.00	-0.007	215.2	0.15	172.50	740.3	294.3	0.2911
69.03	-0.007	215.5	0.1518	172.58	738.67	293.8	0.2885
69.07	-0.005	215.9	0.1535	172.67	736.67	293.3	0.2867
69.10	0	216.6	0.158	172.75	735.73	292.7	0.2858
69.13	-0.001	216.8	0.1597	172.83	731.23	291.8	0.2832
69.17	-0.002	216.9	0.1597	172.92	727.85	290.9	0.2778
69.20	-0.001	216.9	0.1597	173.02	727.33	290.6	0.2769
69.23	-0.001	217.2	0.1615	173.08	724.7	290	0.2743
69.27	-0.001	217.3	0.1624	173.17	720.31	288.8	0.2734
69.30	-0.002	217.3	0.1624	173.25	720.58	288.5	0.2681
69.33	0.002	217.8	0.1651	173.33	717.87	287.7	0.2654
69.38	0.003	218.3	0.1686	173.42	715.29	286.9	0.2619
69.42	0.005	218.7	0.1713	173.50	715.77	286.6	0.261
69.43	0.007	219	0.174	173.58	711.05	285.7	0.2574
69.47	0.007	219.3	0.1766	173.67	707.67	284.9	0.2539
69.50	0.008	219.6	0.1766	173.75	704.12	283.4	0.2494
69.53	0.01	219.6	0.1793	173.83	703.12	282.9	0.245
69.57	0.01	220	0.1828	173.92	699.9	282	0.2414
69.60	0.01	220.3	0.1855	174.00	697.68	281.4	0.2379
69.63	0.015	221	0.1917	174.08	695.78	280.5	0.2352
69.67	0.014	221.2	0.1953	174.17	693.52	279.7	0.2317
69.70	0.014	221.5	0.1988	174.25	689.68	278.6	0.2272

Prova triassiale ciclica SNGR03-C4								
tensione di confinamento (kPa)		450			tensione di confinamento (kPa)		450	
deviatore ciclico (kPa)		80			deviatore ciclico (kPa)		120	
frequenza (hz)		0.00071429			frequenza (hz)		0.0007143	
69.73	0.013	221.5	0.1988	174.33	686.69	277.4	0.2246	
69.77	0.017	221.5	0.2006	174.42	684.18	276.6	0.2184	
69.80	0.017	222	0.2059	174.50	683.98	276.2	0.2166	
69.83	0.017	222.4	0.2121	174.58	678.21	274.5	0.2095	
69.87	0.02	222.9	0.2183	174.67	676.25	273.6	0.2059	
69.90	0.021	223.2	0.2254	174.75	674.06	272.8	0.2006	
69.93	0.022	223.6	0.2316	174.83	671.54	271.9	0.1962	
69.97	0.023	224	0.2316	174.92	668.96	271	0.1926	
70.00	0.024	224	0.2387	175.00	666.22	270	0.1873	
70.03	0.024	224.3	0.2467	175.08	664.03	269.1	0.1829	
70.07	0.025	224.7	0.2556	175.17	660.28	268	0.1775	
70.10	0.027	225.2	0.2645	175.25	656.96	266.8	0.1722	
70.13	0.028	225.6	0.2725	175.33	655.44	266	0.166	
70.17	0.029	225.9	0.2805	175.42	653.11	265.1	0.1616	
70.20	0.03	226.3	0.2805	175.50	648.72	263.7	0.1518	
70.23	0.031	226.3	0.2867	175.58	647.85	263.1	0.1456	
70.27	0.031	226.6	0.2902	175.67	645.17	262.1	0.1385	
70.30	0.032	226.9	0.2929	175.75	641.72	261	0.1305	
70.33	0.033	227.3	0.2956	175.83	638.26	259.5	0.1234	
70.37	0.035	227.6	0.2982	175.93	637.29	258.8	0.1145	
70.40	0.038	228.1	0.3018	176.00	635.35	257.9	0.1092	
70.43	0.04	228.5	0.3018	176.08	630.18	256.3	0.1003	
70.47	0.038	228.5	0.3044	176.17	628.43	255.1	0.0959	
70.50	0.038	228.6	0.3044	176.25	626.68	254.2	0.0879	
70.53	0.038	228.8	0.3062	176.33	623.64	253	0.0826	
70.57	0.041	229.3	0.308	176.42	621.47	252	0.0772	
70.60	0.042	229.6	0.3098	176.50	619.18	251	0.0728	
70.63	0.043	229.9	0.3115	176.58	616.36	249.9	0.0683	
70.67	0.045	230.3	0.3115	176.67	614.74	249	0.0657	
70.70	0.046	230.3	0.3133	176.75	610.1	247.2	0.0604	
70.73	0.046	230.6	0.316	176.83	609.12	246.3	0.055	
70.77	0.047	231	0.3169	176.92	606.82	245.3	0.0524	
70.82	0.047	231.4	0.3177	177.00	604.1	244.1	0.0479	
70.85	0.047	231.4	0.3186	177.08	602.16	243.1	0.0444	
70.88	0.049	231.7	0.3213	177.17	600.06	242.1	0.0417	
70.90	0.051	232.1	0.3231	177.25	596.44	241.1	0.0391	
70.93	0.052	232.5	0.3249	177.33	595.13	239.7	0.0364	
70.97	0.052	232.7	0.3266	177.42	593.71	238.9	0.0328	
71.00	0.055	233.2	0.3266	177.50	591.16	237.9	0.0302	
71.03	0.053	233.3	0.3284	177.58	588.82	236.8	0.0275	
71.07	0.053	233.3	0.3284	177.67	586.4	235.6	0.0249	
71.10	0.055	233.6	0.3311	177.75	584.48	234.6	0.0213	
71.13	0.057	234.1	0.3328	177.83	582.45	233.7	0.0186	
71.17	0.059	234.3	0.3346	177.92	580.47	232.8	0.0169	
71.20	0.058	234.5	0.3355	178.00	579.72	232	0.0142	
71.23	0.06	234.9	0.3355	178.08	577.43	231.1	0.0124	
71.27	0.061	235.2	0.3373	178.17	574.78	230.2	0.0107	
71.30	0.061	235.2	0.3382	178.25	573.06	229	0.0089	
71.33	0.064	235.7	0.3426	178.33	571.95	228.3	0.0062	
71.37	0.064	236	0.3435	178.42	569.59	227.3	0.0036	
71.40	0.062	236.1	0.3435	178.50	568.03	226.4	0.0018	
71.43	0.064	236.4	0.3453	178.58	566.87	225.8	0	
71.47	0.066	236.8	0.3453	178.67	565.51	225.1	-0.0018	
71.50	0.068	237.2	0.347	178.75	563.53	224.3	-0.0036	
71.53	0.068	237.2	0.3488	178.85	562.63	223.4	-0.0053	
71.57	0.068	237.4	0.3497	178.92	561	222.7	-0.0071	
71.60	0.068	237.7	0.3515	179.00	559.61	222	-0.008	
71.63	0.07	238.1	0.3524	179.08	557.89	221.4	-0.0098	
71.67	0.071	238.3	0.3541	179.17	557.28	220.5	-0.0107	
71.70	0.072	238.7	0.3541	179.25	557.08	220	-0.0124	

Prova triassiale ciclica SNGR03-C4								
tensione di confinamento (kPa)		450			tensione di confinamento (kPa)		450	
deviatore ciclico (kPa)		80			deviatore ciclico (kPa)		120	
frequenza (hz)		0.00071429			frequenza (hz)		0.0007143	
71.73	0.073	239	0.3559	179.33	554.88	219.3	-0.0142	
71.77	0.073	239	0.3568	179.42	554.55	218.7	-0.0151	
71.80	0.074	239.3	0.3586	179.50	553.39	218.1	-0.016	
71.83	0.075	239.6	0.3595	179.58	552.16	217.6	-0.0178	
71.87	0.078	240.1	0.363	179.67	551.15	217	-0.0186	
71.90	0.077	240.2	0.3621	179.75	550.21	216.1	-0.0204	
71.93	0.076	240.3	0.3621	179.83	548.95	215.7	-0.0213	
71.97	0.079	240.7	0.363	179.92	549.59	215.5	-0.0222	
72.00	0.079	240.7	0.3648	180.00	547.72	214.8	-0.0231	
72.03	0.079	241	0.3666	180.08	547.42	214.5	-0.024	
72.07	0.081	241.4	0.3683	180.17	547.17	214.2	-0.0249	
72.10	0.082	241.7	0.3692	180.27	546.61	213.6	-0.0257	
72.13	0.082	242	0.371	180.33	547.58	213.5	-0.0257	
72.17	0.084	242.4	0.371	180.42	546.29	213.1	-0.0266	
72.20	0.085	242.6	0.3728	180.50	545.41	212.6	-0.0275	
72.23	0.085	242.6	0.3737	180.58	544.08	212	-0.0284	
72.28	0.086	243.1	0.3746	180.67	544.96	211.9	-0.0284	
72.32	0.086	243.4	0.3763	180.75	545.44	211.8	-0.0284	
72.33	0.086	243.4	0.3772	180.83	545.18	211.5	-0.0293	
72.37	0.09	243.9	0.3799	180.92	544.99	211.3	-0.0293	
72.40	0.089	244.1	0.3808	181.00	544.73	211.1	-0.0293	
72.43	0.088	244.2	0.3808	181.08	545.44	211.1	-0.0293	
72.47	0.089	244.5	0.3825	181.17	546.28	211	-0.0293	
72.50	0.091	244.8	0.3825	181.25	545.63	210.7	-0.0302	
72.53	0.092	245.1	0.3834	181.33	545.73	210.6	-0.0302	
72.57	0.092	245.1	0.3843	181.42	546.25	210.5	-0.0302	
72.60	0.093	245.3	0.3852	181.50	546.67	210.5	-0.0302	
72.63	0.093	245.6	0.3861	181.58	547.06	210.4	-0.0302	
72.67	0.094	246	0.3879	181.67	547.64	210.4	-0.0302	
72.70	0.095	246.2	0.3888	181.77	548.23	210.4	-0.0302	
72.73	0.095	246.5	0.3888	181.83	548.94	210.4	-0.0293	
72.77	0.096	246.7	0.3905	181.92	549.68	210.5	-0.0293	
72.80	0.096	246.7	0.3914	182.00	550.62	210.6	-0.0293	
72.83	0.097	247	0.3923	182.08	551.59	210.7	-0.0284	
72.87	0.098	247.3	0.3932	182.17	552.14	210.8	-0.0284	
72.90	0.098	247.5	0.3941	182.25	552.83	210.9	-0.0275	
72.93	0.099	247.8	0.3959	182.33	554.47	211.2	-0.0275	
72.97	0.102	248.3	0.3959	182.42	555.28	211.3	-0.0266	
73.00	0.1	248.4	0.3976	182.50	556.22	211.5	-0.0257	
73.03	0.1	248.4	0.3976	182.58	557.58	211.7	-0.0257	
73.07	0.1	248.5	0.3985	182.67	559.2	212.1	-0.0249	
73.10	0.102	248.8	0.3994	182.75	560.52	212.4	-0.0249	
73.13	0.103	249.1	0.4003	182.83	561.83	212.7	-0.0231	
73.17	0.103	249.3	0.4021	182.92	561.37	212.7	-0.0231	
73.20	0.106	249.8	0.4021	183.00	564.47	213.3	-0.0213	
73.23	0.105	249.9	0.4039	183.08	565.22	213.5	-0.0213	
73.27	0.105	249.9	0.4039	183.18	567.13	213.9	-0.0204	
73.30	0.104	250.1	0.4039	183.25	569.11	214.4	-0.0186	
73.33	0.104	250.3	0.4047	183.33	570.4	214.7	-0.0178	
73.37	0.107	250.6	0.4065	183.42	571.83	215.1	-0.0178	
73.40	0.107	250.8	0.4074	183.50	573.48	215.5	-0.0169	
73.43	0.11	251.3	0.4074	183.58	576.29	216.3	-0.0151	
73.47	0.108	251.4	0.4092	183.67	577.62	216.7	-0.0142	
73.50	0.108	251.4	0.4092	183.75	580.57	217.5	-0.0115	
73.53	0.108	251.4	0.4092	183.83	580.18	217.6	-0.0115	
73.57	0.108	251.6	0.4101	183.92	583.51	218.4	-0.0089	
73.60	0.11	251.9	0.4118	184.00	584.62	218.8	-0.0089	
73.63	0.11	252.1	0.4118	184.08	587.12	219.5	-0.0071	
73.67	0.11	252.4	0.4118	184.17	590.34	220.4	-0.0053	
73.72	0.114	252.9	0.4154	184.25	589.86	220.7	-0.0044	

Prova triassiale ciclica SNGR03-C4								
tensione di confinamento (kPa)		450			tensione di confinamento (kPa)		450	
deviatore ciclico (kPa)		80			deviatore ciclico (kPa)		120	
frequenza (hz)		0.00071429			frequenza (hz)		0.0007143	
73.75	0.113	253	0.4163	184.33	593.39	221.4	-0.0018	
73.78	0.112	253.1	0.4163	184.42	595.92	222.2	0	
73.80	0.111	253.2	0.4163	184.50	597.85	222.9	0.0018	
73.83	0.111	253.2	0.4163	184.58	599.8	223.5	0.0036	
73.87	0.112	253.3	0.4163	184.67	602.62	224.5	0.0062	
73.90	0.115	253.8	0.4189	184.75	604.88	225.2	0.0071	
73.93	0.114	253.9	0.4189	184.83	607.82	226.1	0.0098	
73.97	0.114	254.1	0.4198	184.92	608.34	226.6	0.0107	
74.00	0.114	254.3	0.4198	185.00	612.66	227.6	0.0142	
74.03	0.115	254.5	0.4198	185.08	614.58	228.6	0.016	
74.07	0.115	254.5	0.4207	185.17	617.31	229.5	0.0178	
74.10	0.116	254.7	0.4216	185.25	621.8	230.6	0.0231	
74.13	0.118	255.1	0.4234	185.33	621.87	231.1	0.0231	
74.17	0.117	255.2	0.4234	185.42	624.55	232	0.0266	
74.20	0.116	255.3	0.4234	185.50	626.33	232.7	0.0284	
74.23	0.116	255.4	0.4234	185.58	629.18	233.7	0.0311	
74.27	0.117	255.5	0.4234	185.67	632.28	235	0.0346	
74.30	0.117	255.5	0.4243	185.75	634.78	235.9	0.0364	
74.33	0.117	255.8	0.4252	185.83	637.88	236.9	0.0417	
74.37	0.118	256	0.426	185.92	639.98	237.8	0.0453	
74.40	0.119	256.2	0.4269	186.00	642.92	238.8	0.0488	
74.43	0.12	256.5	0.4278	186.10	644.96	239.9	0.0515	
74.47	0.12	256.7	0.4278	186.17	646.81	240.6	0.0559	
74.50	0.119	256.8	0.4287	186.25	650.78	241.9	0.0595	
74.53	0.119	256.8	0.4278	186.33	653.39	243	0.0639	
74.57	0.118	256.8	0.4287	186.42	653.89	243.6	0.0666	
74.60	0.12	257.1	0.4296	186.50	658.02	244.7	0.0719	
74.63	0.12	257.2	0.4296	186.58	662.02	246.3	0.0781	
74.67	0.119	257.3	0.4305	186.67	664.25	247.3	0.0826	
74.70	0.12	257.6	0.4305	186.75	666.68	248.3	0.0932	
74.73	0.12	257.6	0.4305	186.83	669.2	249.3	0.0994	
74.77	0.12	257.6	0.4305	186.92	672.16	250.4	0.1074	
74.80	0.119	257.7	0.4305	187.00	674.23	251.3	0.1163	
74.83	0.12	257.9	0.4314	187.08	676.85	252.4	0.1243	
74.87	0.123	258.3	0.4331	187.17	681.75	254.2	0.1331	
74.90	0.122	258.3	0.4331	187.25	682.1	254.8	0.1358	
74.93	0.121	258.4	0.4331	187.33	684.91	255.8	0.1438	
74.97	0.12	258.5	0.4331	187.42	688.36	256.9	0.1482	
75.00	0.12	258.5	0.4331	187.50	691	257.8	0.1536	
75.03	0.12	258.5	0.4331	187.58	693.82	259.2	0.1571	
75.07	0.12	258.7	0.434	187.67	696.07	260	0.1633	
75.10	0.124	259.1	0.4349	187.75	698.33	260.9	0.1669	
75.13	0.122	259.1	0.4349	187.83	701.2	261.9	0.1722	
75.18	0.121	259.1	0.434	187.92	703.26	262.8	0.1766	
75.22	0.12	259.1	0.434	188.00	705.93	263.8	0.1811	
75.23	0.121	259.3	0.4349	188.08	708.93	265.3	0.1855	
75.27	0.121	259.3	0.4349	188.17	711.45	266.2	0.1882	
75.30	0.121	259.4	0.4349	188.25	714.02	267.1	0.1953	
75.33	0.121	259.4	0.4349	188.33	716.28	268	0.1988	
75.37	0.121	259.6	0.4358	188.42	718.28	268.9	0.2033	
75.40	0.124	260	0.4367	188.50	720.82	269.8	0.2068	
75.43	0.122	259.9	0.4367	188.58	724.01	270.9	0.2113	
75.47	0.122	260	0.4367	188.67	726.07	272.1	0.2139	
75.50	0.121	260	0.4367	188.75	728.42	273.1	0.2184	
75.53	0.121	260	0.4367	188.83	729.93	273.8	0.2237	
75.57	0.121	260	0.4367	188.92	732.64	274.7	0.2272	
75.60	0.122	260.2	0.4367	189.02	733.96	275.8	0.2308	
75.63	0.121	260.2	0.4367	189.08	737.18	276.9	0.2334	
75.67	0.121	260.3	0.4367	189.17	739.26	277.6	0.2397	
75.70	0.122	260.4	0.4376	189.25	741.48	278.5	0.2432	

Prova triassiale ciclica SNGR03-C4							
tensione di confinamento (kPa)		450	tensione di confinamento (kPa)		450		
deviatore ciclico (kPa)		80	deviatore ciclico (kPa)		120		
frequenza (hz)		0.00071429	frequenza (hz)		0.0007143		
75.73	0.121	260.5	0.4376	189.33	742.87	279.4	0.2459
75.77	0.12	260.5	0.4367	189.42	744.67	280.1	0.2494
75.80	0.12	260.5	0.4367	189.50	747.11	281	0.2521
75.83	0.12	260.5	0.4367	189.58	749.91	282.2	0.2556
75.87	0.12	260.6	0.4376	189.67	751.17	283	0.2583
75.90	0.121	260.8	0.4376	189.75	752.93	283.7	0.2627
75.93	0.12	260.8	0.4376	189.83	754.67	284.5	0.2663
75.97	0.12	260.9	0.4376	189.92	755.79	285.2	0.269
76.00	0.12	260.9	0.4376	190.00	757.79	285.9	0.2716
76.03	0.12	260.9	0.4367	190.08	759.53	286.7	0.2743
76.07	0.119	260.8	0.4367	190.17	761.68	287.8	0.2769
76.10	0.119	260.9	0.4367	190.25	763.45	288.5	0.2796
76.13	0.118	261	0.4367	190.33	764.23	289.2	0.2832
76.17	0.119	261	0.4367	190.43	766.86	290	0.2867
76.20	0.118	261.1	0.4367	190.50	767.82	290.7	0.2867
76.23	0.118	261.1	0.4367	190.58	768.91	291.3	0.2903
76.27	0.118	261.1	0.4367	190.67	770.39	292	0.2929
76.30	0.118	261.1	0.4367	190.75	771.61	292.6	0.2947
76.33	0.117	261.1	0.4367	190.83	772.51	293.1	0.2965
76.37	0.117	261.2	0.4367	190.92	773.89	293.7	0.2991
76.40	0.116	261.1	0.4358	191.00	774.82	294.3	0.3009
76.43	0.115	261.1	0.4358	191.08	776.34	295.1	0.3018
76.47	0.115	261.1	0.4358	191.17	777.17	295.5	0.3045
76.50	0.115	261.1	0.4358	191.25	777.94	296.1	0.3062
76.53	0.115	261.2	0.4358	191.33	778.58	296.6	0.308
76.57	0.115	261.2	0.4358	191.42	779.32	297.1	0.3098
76.60	0.116	261.3	0.4358	191.50	780.83	297.7	0.3124
76.65	0.115	261.3	0.4358	191.58	781.86	298.2	0.3133
76.68	0.114	261.2	0.4349	191.67	781.21	298.5	0.3133
76.70	0.114	261.2	0.4349	191.75	782.52	299	0.316
76.73	0.113	261.2	0.434	191.83	783.04	299.4	0.3169
76.77	0.113	261.2	0.434	191.93	782.78	299.6	0.3178
76.80	0.112	261.1	0.434	192.00	784.26	300.3	0.3187
76.83	0.112	261.1	0.4331	192.08	784.1	300.5	0.3204
76.87	0.111	261.1	0.4331	192.17	786.35	301.2	0.3222
76.90	0.112	261.2	0.4331	192.25	785.48	301.3	0.3222
76.93	0.112	261.2	0.4331	192.33	783.29	301.2	0.3222
76.97	0.11	261	0.4323	192.42	784.16	301.5	0.3231
77.00	0.109	260.9	0.4314	192.50	785.38	301.9	0.324
77.03	0.109	261	0.4314	192.58	784.87	302.2	0.324
77.07	0.109	261	0.4314	192.67	785.31	302.4	0.3249
77.10	0.109	260.9	0.4314	192.75	784.9	302.6	0.3249
77.13	0.108	260.9	0.4314	192.83	783.58	302.5	0.3249
77.17	0.107	260.8	0.4305	192.92	786.4	303.1	0.3267
77.20	0.106	260.8	0.4305	193.00	784.99	303.1	0.3258
77.23	0.106	260.8	0.4296	193.08	783.77	303.1	0.3258
77.27	0.105	260.7	0.4296	193.17	782.32	303	0.324
77.30	0.105	260.7	0.4296	193.25	782.77	303.2	0.3249
77.33	0.105	260.7	0.4296	193.35	782.51	303.3	0.3258
77.37	0.106	260.7	0.4296	193.42	781.42	303.3	0.3249
77.40	0.103	260.4	0.4278	193.50	781.71	303.4	0.3249
77.43	0.103	260.4	0.4278	193.58	779.97	303.3	0.3249
77.47	0.103	260.4	0.4269	193.67	779.49	303.3	0.324
77.50	0.103	260.3	0.4269	193.75	779.68	303.4	0.324
77.53	0.103	260.3	0.4269	193.83	777.27	303	0.3231
77.57	0.101	260.2	0.426	193.92	778.2	303.2	0.3231
77.60	0.1	260.1	0.4252	194.00	775.85	302.9	0.3222
77.63	0.099	260	0.4252	194.08	774.6	302.8	0.3213
77.67	0.099	260	0.4252	194.17	773.95	302.6	0.3204
77.70	0.099	259.9	0.4243	194.25	772.32	302.4	0.3196

Prova triassiale ciclica SNGR03-C4								
tensione di confinamento (kPa)		450			tensione di confinamento (kPa)		450	
deviatore ciclico (kPa)		80			deviatore ciclico (kPa)		120	
frequenza (hz)		0.00071429			frequenza (hz)		0.0007143	
77.73	0.097	259.8	0.4243	194.33	771.13	302.1	0.3178	
77.77	0.097	259.8	0.4234	194.42	769.06	301.8	0.3169	
77.80	0.097	259.7	0.4234	194.50	769.35	301.8	0.3169	
77.83	0.096	259.6	0.4225	194.58	767.55	301.7	0.316	
77.87	0.095	259.5	0.4216	194.67	765.04	301.1	0.3142	
77.90	0.095	259.4	0.4216	194.75	761.87	300.5	0.3107	
77.93	0.094	259.3	0.4207	194.85	763.21	300.6	0.3116	
77.97	0.093	259.2	0.4207	194.92	760.93	300.3	0.3098	
78.00	0.093	259.2	0.4198	195.00	759.77	299.9	0.3098	
78.03	0.092	259.1	0.4189	195.08	758.23	299.6	0.3071	
78.08	0.09	258.8	0.4189	195.17	756.11	298.9	0.3045	
78.12	0.09	258.8	0.4181	195.25	753.14	298.4	0.3027	
78.15	0.09	258.8	0.4181	195.33	753.76	298.4	0.3027	
78.17	0.09	258.7	0.4172	195.42	750.31	297.7	0.3	
78.20	0.089	258.6	0.4163	195.50	749.76	297.4	0.2991	
78.23	0.089	258.6	0.4163	195.58	746.32	296.7	0.2974	
78.27	0.086	258.1	0.4136	195.67	744.59	296.2	0.2938	
78.30	0.085	258	0.4136	195.75	743.2	295.8	0.2929	
78.33	0.085	258	0.4136	195.83	739.53	294.9	0.2894	
78.37	0.086	257.9	0.4136	195.92	740.59	294.8	0.2894	
78.40	0.086	257.9	0.4127	196.00	736.93	294.1	0.2867	
78.43	0.082	257.6	0.411	196.08	733.67	293.5	0.2849	
78.47	0.082	257.4	0.4101	196.17	730.65	292.4	0.2805	
78.50	0.081	257.3	0.4092	196.27	730.07	291.9	0.2787	
78.53	0.081	257.3	0.4092	196.33	727.95	291.4	0.2761	
78.57	0.081	257.3	0.4092	196.42	725.11	290.9	0.2743	
78.60	0.079	257	0.4074	196.50	721.22	289.6	0.2698	
78.63	0.078	256.8	0.4074	196.58	720.5	289.3	0.2681	
78.67	0.078	256.6	0.4065	196.67	717.58	288.4	0.2645	
78.70	0.078	256.6	0.4065	196.75	716.65	288	0.2627	
78.73	0.078	256.6	0.4056	196.83	714.39	287	0.2592	
78.77	0.074	256	0.4056	196.92	711.2	286.3	0.2556	
78.80	0.073	256	0.403	197.00	707.34	285.6	0.253	
78.83	0.073	255.9	0.403	197.08	703.25	284.1	0.2494	
78.87	0.072	255.8	0.4021	197.17	703.18	283.6	0.245	
78.90	0.073	255.6	0.4012	197.25	699.9	282.7	0.2414	
78.93	0.071	255.4	0.4003	197.33	698.19	282.1	0.2388	
78.97	0.07	255.2	0.3994	197.42	696.3	281.2	0.2343	
79.00	0.069	255	0.3994	197.50	693.3	280.4	0.2308	
79.03	0.067	255	0.3985	197.58	689.49	279.5	0.2272	
79.07	0.067	254.8	0.3976	197.67	686.59	278.1	0.2237	
79.10	0.067	254.7	0.3967	197.75	685.53	277.5	0.2184	
79.13	0.068	254.7	0.3967	197.83	680.05	276.2	0.213	
79.17	0.063	254.1	0.3941	197.92	680.01	275.7	0.2104	
79.20	0.064	254	0.3932	198.00	675.85	274.2	0.2059	
79.23	0.065	254	0.3932	198.08	675.64	273.8	0.2006	
79.27	0.06	254	0.3923	198.17	671.44	272.7	0.1962	
79.30	0.06	253.5	0.3905	198.25	668.09	271.6	0.1908	
79.33	0.062	253.5	0.3905	198.33	666.83	270.8	0.1873	
79.37	0.061	253.4	0.3896	198.42	663.8	269.7	0.182	
79.40	0.057	252.8	0.387	198.50	659.89	268.5	0.1766	
79.43	0.058	252.9	0.387	198.58	656.5	267.4	0.1713	
79.47	0.059	252.8	0.387	198.67	657.54	267	0.1678	
79.50	0.056	252.8	0.387	198.75	650.31	265.3	0.1598	
79.55	0.052	251.9	0.3825	198.83	650.6	264.8	0.1544	
79.58	0.053	251.8	0.3825	198.92	647.99	263.8	0.1473	
79.60	0.053	251.8	0.3817	199.00	645.72	262.9	0.142	
79.63	0.053	251.7	0.3817	199.08	641.07	261.8	0.134	
79.67	0.053	251.6	0.3808	199.18	639.26	260.4	0.1234	
79.70	0.05	251.2	0.379	199.25	637.39	259.5	0.1172	

Prova triassiale ciclica SNGR03-C4

pressione di confinamento (kPa)		450		pressione di confinamento (kPa)		450	
deviatore ciclico (kPa)		80		deviatore ciclico (kPa)		120	
frequenza (hz)		0.00071429		frequenza (hz)		0.0007143	
79.73	0.05	251.1	0.3781	199.33	634.96	258.5	0.111
79.77	0.048	250.8	0.3763	199.42	630.73	257.3	0.1047
79.80	0.044	250.2	0.3763	199.50	627.5	255.7	0.0994
79.83	0.045	250.2	0.3728	199.58	626.1	254.8	0.0905
79.87	0.045	250.1	0.3728	199.67	623.87	253.8	0.0861
79.90	0.046	250.1	0.3728	199.75	620.16	252.5	0.0799
79.93	0.043	249.6	0.3701	199.83	619.73	251.6	0.0763
79.97	0.042	249.4	0.3692	199.92	616.72	250.6	0.0719
80.00	0.042	249.3	0.3692	200.00	612.97	248.9	0.0657
80.03	0.039	248.9	0.3692	200.08	610.58	247.8	0.063
80.07	0.04	248.9	0.3666	200.17	609.05	247	0.0586
80.10	0.04	248.8	0.3657	200.25	607.12	246	0.055
80.13	0.038	248.4	0.3639	200.33	603.72	244.8	0.0515
80.17	0.039	248.4	0.3639	200.42	602.58	243.8	0.0479
80.20	0.033	247.7	0.3604	200.50	600.03	242.8	0.0453
80.23	0.035	247.7	0.3604	200.60	597.08	241.3	0.0408
80.27	0.034	247.5	0.3604	200.67	595.47	240.4	0.0382
80.30	0.035	247.5	0.3595	200.75	593.97	239.6	0.0355
80.33	0.035	247.4	0.3586	200.83	591.68	238.6	0.0328
80.37	0.03	246.5	0.3541	200.92	588.44	237.6	0.0302
80.40	0.027	246.2	0.3524	201.00	585.59	235.9	0.0266
80.43	0.028	246.2	0.3515	201.08	584.62	235.2	0.024
80.47	0.028	246	0.3506	201.17	582.48	234.3	0.0222
80.50	0.025	245.6	0.3506	201.25	580.54	233.4	0.0195
80.53	0.027	245.6	0.3488	201.33	579.28	232.6	0.0178
80.57	0.027	245.6	0.3488	201.42	578.49	231.9	0.0169
80.60	0.025	245.2	0.3462	201.50	574.94	230.9	0.0142
80.63	0.021	244.7	0.3435	201.58	572.45	229.6	0.0115
80.67	0.019	244.2	0.3408	201.67	572.05	228.9	0.0089
80.70	0.02	244.2	0.3399	201.75	570.34	228.1	0.0071
80.73	0.022	244.1	0.3399	201.83	568.36	227.2	0.0053
80.77	0.018	244.1	0.3399	201.92	567.26	226.5	0.0036
80.80	0.018	243.5	0.3355	202.00	565.57	225.7	0.0018
80.83	0.016	243.2	0.3337	202.10	563.44	224.6	-0.0009
80.87	0.014	242.9	0.332	202.17	562.95	224.1	-0.0018
80.90	0.016	242.8	0.332	202.25	561.59	223.4	-0.0036
80.93	0.013	242.2	0.3284	202.33	560	222.7	-0.0053
80.98	0.01	242	0.3257	202.42	558.29	222	-0.0062
81.02	0.011	241.9	0.3257	202.50	556.9	221.1	-0.008
81.05	0.009	241.5	0.3231	202.58	556.47	220.6	-0.0098
81.07	0.009	241.3	0.3231	202.67	554.72	219.8	-0.0107
81.10	0.009	241.3	0.3222	202.75	554.4	219.3	-0.0115
81.13	0.009	241.1	0.3213	202.83	553.33	218.7	-0.0133
81.17	0.004	240.3	0.316	202.92	552.42	218.2	-0.0142
81.20	0.003	240.1	0.3151	203.00	551.22	217.5	-0.0151
81.23	0.005	240.1	0.3151	203.08	550.18	216.9	-0.016
81.27	0.002	239.6	0.3115	203.17	549.76	216.5	-0.0178
81.30	0	239.2	0.3098	203.25	548.99	216.1	-0.0186
81.33	0.001	239.1	0.3098	203.33	548.27	215.5	-0.0195
81.37	0.002	239.1	0.308	203.42	547.13	215	-0.0204
81.40	0.002	239	0.3053	203.52	547.2	214.6	-0.0213
81.43	-0.003	238	0.3009	203.58	546.75	214.3	-0.0222
81.47	-0.005	237.8	0.2973	203.67	546.39	213.9	-0.0222
81.50	-0.003	237.9	0.2956	203.75	543.28	213.1	-0.0249
81.53	-0.004	237.4	0.2902	203.83	545.06	213.1	-0.024
81.57	-0.01	236.7	0.2902	203.92	546.03	213	-0.024
81.60	-0.006	236.7	0.2849	204.00	545.06	212.6	-0.0249
81.63	-0.008	237	0.2822	204.08	546	212.5	-0.0249
81.67	-0.008	236.6	0.2778	204.17	544.93	212.2	-0.0257
81.70	-0.012	235.8	0.2698	204.25	544.73	211.9	-0.0257

Prova triassiale ciclica SNGR03-C4

tensione di confinamento (kPa)		450			tensione di confinamento (kPa)	450		
deviatore ciclico (kPa)		80			deviatore ciclico (kPa)	120		
frequenza (hz)		0.00071429			frequenza (hz)	0.0007143		
81.73	-0.013	235.6	0.2654	204.33	545.18	211.8	-0.0257	
81.77	-0.012	235.5	0.2627	204.42	545.51	211.6	-0.0266	
81.80	-0.011	235.3	0.2583	204.50	545.12	211.4	-0.0266	
81.83	-0.015	234.8	0.2583	204.58	545.31	211.2	-0.0266	
81.87	-0.015	234.8	0.253	204.67	544.12	210.8	-0.0275	
81.90	-0.016	234.6	0.2485	204.75	546.09	211	-0.0266	
81.93	-0.02	233.9	0.2414	204.83	546.39	211	-0.0266	
81.97	-0.019	233.7	0.237	204.92	549.33	211.4	-0.0257	
82.00	-0.017	233.8	0.2361	205.02	548	211.1	-0.0266	
82.03	-0.02	233.3	0.2361	205.08	546.77	210.7	-0.0266	
82.07	-0.022	232.8	0.2316	205.17	548.91	211	-0.0257	
82.10	-0.022	232.8	0.2263	205.25	549.72	211.1	-0.0257	
82.13	-0.022	232.5	0.2245	205.33	552.31	211.5	-0.0249	
82.17	-0.027	231.7	0.2183	205.42	550.85	211.2	-0.0257	
82.20	-0.026	231.6	0.2157	205.50	552.5	211.4	-0.0249	
82.23	-0.026	231.4	0.213	205.58	551.6	211.2	-0.0249	
82.27	-0.024	231.3	0.213	205.67	553.86	211.5	-0.024	
82.30	-0.028	231.3	0.2121	205.75	555.12	211.8	-0.0231	
82.33	-0.028	230.8	0.2077	205.83	556.1	212.1	-0.0231	
82.37	-0.03	230.4	0.2041	205.92	558.49	212.5	-0.0222	
82.40	-0.032	229.9	0.2015	206.00	559.07	212.5	-0.0222	
82.45	-0.033	229.5	0.1988	206.08	559.56	212.8	-0.0213	
82.48	-0.033	229.3	0.1961	206.17	560.86	213	-0.0204	
82.52	-0.034	228.9	0.1944	206.25	563.25	213.5	-0.0195	
82.55	-0.035	228.5	0.1917	206.33	565.52	214.1	-0.0178	
82.58	-0.036	228.1	0.189	206.43	565.33	214.2	-0.0178	
82.60	-0.037	227.8	0.189	206.50	566.78	214.5	-0.0169	
82.63	-0.038	227.8	0.1873	206.58	568.98	214.9	-0.016	
82.67	-0.038	227.5	0.1855	206.67	570.66	215.3	-0.0151	
82.70	-0.039	227.1	0.1828	206.75	571.67	215.7	-0.0142	
82.73	-0.042	226.7	0.1811	206.83	573.65	216.2	-0.0124	
82.77	-0.044	226.2	0.1784	206.92	576.46	216.6	-0.0115	
82.80	-0.043	226	0.1766	207.00	577.86	217.3	-0.0107	
82.83	-0.044	225.7	0.1766	207.08	579.06	217.8	-0.0089	
82.87	-0.044	225.7	0.1757	207.17	579.99	218.1	-0.0089	
82.90	-0.044	225.5	0.1731	207.25	583.39	219	-0.0062	
82.93	-0.044	225.2	0.1731	207.33	584.59	219.4	-0.0053	
82.97	-0.047	224.8	0.1704	207.42	589.5	220.5	-0.0027	
83.00	-0.048	224.4	0.1686	207.50	589.28	220.6	-0.0027	
83.03	-0.049	224.1	0.1686	207.58	592.03	221.6	-0.0009	
83.07	-0.051	224.1	0.1669	207.67	593.59	222.2	0.0018	
83.10	-0.051	223.6	0.1651	207.75	596.24	222.9	0.0036	
83.13	-0.053	223.2	0.1633	207.83	597.56	223.3	0.0044	
83.17	-0.054	222.8	0.1606	207.92	601.06	224.6	0.0053	
83.20	-0.057	222.2	0.158	208.00	603.04	225.2	0.0089	
83.23	-0.055	222.2	0.158	208.08	605.14	225.9	0.0107	
83.27	-0.054	222	0.158	208.17	609.5	227	0.0142	
83.30	-0.055	222	0.1571	208.25	609.35	227.4	0.0151	
83.33	-0.055	221.8	0.1562	208.33	611.88	228.3	0.0169	
83.37	-0.055	221.4	0.1544	208.42	615.33	229	0.0186	
83.40	-0.059	220.9	0.1526	208.50	617.34	230.2	0.0213	
83.43	-0.059	220.7	0.1518	208.58	617.08	230.6	0.0231	
83.47	-0.06	220.2	0.15	208.67	622	231.7	0.0266	
83.50	-0.062	219.9	0.15	208.75	627.33	233.1	0.0311	
83.53	-0.062	219.9	0.1482	208.83	626.21	233.5	0.032	
83.57	-0.065	219.3	0.1455	208.92	628.92	234.4	0.0346	
83.60	-0.064	219.1	0.1455	209.00	632.77	235.4	0.0382	
83.63	-0.062	219.1	0.1455	209.08	635.23	236.8	0.0399	
83.67	-0.063	218.8	0.1438	209.17	637.33	237.6	0.0453	
83.70	-0.066	218.3	0.142	209.25	640.49	238.6	0.0479	

Prova triassiale ciclica SNGR03-C4

pressione di confinamento (kPa)		450			pressione di confinamento (kPa)		450	
deviatore ciclico (kPa)		80			deviatore ciclico (kPa)		120	
frequenza (hz)		0.00071429			frequenza (hz)		0.0007143	
83.73	-0.067	217.9	0.142	209.35	642.73	239	0.0497	
83.77	-0.067	217.9	0.1402	209.42	645.64	240.6	0.0541	
83.80	-0.067	217.7	0.1393	209.50	647.93	241.6	0.0595	
83.83	-0.068	217.3	0.1384	209.58	651.52	242.7	0.063	
83.88	-0.07	217	0.1376	209.67	652.62	243.5	0.0675	
83.92	-0.07	216.7	0.1367	209.75	655.63	244.7	0.0719	
83.95	-0.071	216.5	0.1358	209.83	657.92	245.6	0.0763	
83.98	-0.072	216.1	0.1349	209.92	661.44	246.7	0.0817	
84.02	-0.072	215.9	0.1331	210.00	664.81	248.3	0.087	
84.03	-0.073	215.5	0.1331	210.08	665.52	248.9	0.095	
84.07	-0.074	215.3	0.1322	210.17	670.32	250.2	0.103	
84.10	-0.074	215.3	0.1313	210.25	671.61	251.1	0.1101	
84.13	-0.075	214.9	0.1305	210.33	674.26	252.1	0.1189	
84.17	-0.076	214.6	0.1296	210.42	676.72	253.1	0.1252	
84.20	-0.08	214	0.1269	210.50	680.88	254.7	0.1314	
84.23	-0.078	213.9	0.1269	210.58	685.37	256	0.1376	
84.27	-0.076	213.9	0.1269	210.67	685.11	256.5	0.1438	
84.30	-0.077	213.9	0.1269	210.77	688.5	257.6	0.1482	
84.33	-0.077	213.7	0.126	210.83	691.69	258.9	0.1509	
84.37	-0.079	213.3	0.1242	210.92	694.23	259.9	0.1562	
84.40	-0.082	212.8	0.1234	211.00	695.46	260.6	0.1616	
84.43	-0.082	212.5	0.1225	211.08	698.59	261.6	0.166	
84.47	-0.082	212.3	0.1216	211.17	704.2	263.2	0.1722	
84.50	-0.083	212	0.1216	211.25	703.45	263.6	0.1758	
84.53	-0.083	212	0.1207	211.33	705.45	264.5	0.1802	
84.57	-0.083	211.7	0.1198	211.42	709.75	265.9	0.1829	
84.60	-0.084	211.4	0.1189	211.50	711.67	266.9	0.1873	
84.63	-0.085	211.2	0.118	211.58	713.38	267.7	0.1935	
84.67	-0.086	210.9	0.1171	211.67	716.31	268.7	0.1979	
84.70	-0.087	210.6	0.1163	211.75	718	269.6	0.2015	
84.73	-0.087	210.3	0.1163	211.83	720.5	270.6	0.205	
84.77	-0.087	210.3	0.1154	211.92	723.11	271.5	0.2095	
84.80	-0.09	209.8	0.1136	212.00	726.14	272.9	0.213	
84.83	-0.089	209.7	0.1136	212.08	728.45	274.1	0.2166	
84.87	-0.088	209.6	0.1136	212.17	729.36	274.6	0.2219	
84.90	-0.088	209.5	0.1136	212.27	731.19	275.3	0.2255	
84.93	-0.09	209.1	0.1109	212.33	735.21	276.8	0.2299	
84.97	-0.091	208.8	0.1109	212.42	737.05	277.6	0.2334	
85.00	-0.091	208.8	0.1109	212.50	738.61	278.5	0.2379	
85.03	-0.091	208.6	0.11	212.58	741.76	279.3	0.2423	
85.07	-0.092	208.4	0.1092	212.67	742.68	280.2	0.245	
85.10	-0.093	208.1	0.1074	212.75	745.29	281	0.2477	
85.13	-0.095	207.6	0.1065	212.83	746.57	281.7	0.2512	
85.17	-0.095	207.5	0.1065	212.92	749.53	283	0.2539	
85.20	-0.094	207.4	0.1065	213.00	753.78	284.1	0.2574	
85.23	-0.094	207.4	0.1065	213.08	753	284.5	0.2627	
85.27	-0.093	207.3	0.1065	213.17	752.97	285	0.2636	
85.30	-0.095	207	0.1056	213.25	756.29	286.1	0.2681	
85.35	-0.097	206.6	0.1047	213.33	757.73	286.8	0.2707	
85.38	-0.097	206.5	0.1038	213.42	759.66	287.5	0.2734	
85.40	-0.096	206.4	0.1038	213.50	761.55	288.6	0.2761	
85.43	-0.097	206.2	0.1029	213.58	765.13	289.6	0.2796	
85.47	-0.098	205.9	0.1021	213.68	763.45	289.8	0.2823	
85.50	-0.098	205.7	0.1012	213.75	765.57	290.6	0.2849	
85.53	-0.099	205.5	0.1012	213.83	767.79	291.5	0.2867	
85.57	-0.099	205.5	0.1012	213.92	769.82	292.6	0.2885	
85.60	-0.099	205.3	0.1003	214.00	770.14	292.8	0.2911	
85.63	-0.099	205.1	0.1003	214.08	771.52	293.4	0.2938	
85.67	-0.1	204.9	0.0994	214.17	772.48	293.9	0.2956	
85.70	-0.101	204.7	0.0985	214.25	773.42	294.5	0.2974	

Prova triassiale ciclica SNGR03-C4							
tensione di confinamento (kPa)		450		tensione di confinamento (kPa)		450	
deviatore ciclico (kPa)		80		deviatore ciclico (kPa)		120	
frequenza (hz)		0.00071429		frequenza (hz)		0.0007143	
85.73	-0.1	204.5	0.0985	214.33	775.03	295.1	0.2991
85.77	-0.101	204.3	0.0985	214.42	778.18	296.2	0.3009
85.80	-0.101	204.3	0.0976	214.50	775.72	296.2	0.3027
85.83	-0.102	204	0.0976	214.58	777.75	296.9	0.3053
85.87	-0.101	203.9	0.0976	214.67	778.42	297.3	0.3071
85.90	-0.102	203.7	0.0967	214.75	780.03	297.9	0.3089
85.93	-0.103	203.5	0.0958	214.83	780.93	298.4	0.3107
85.97	-0.103	203.3	0.0958	214.92	780.87	298.8	0.3116
86.00	-0.103	203.2	0.0958	215.00	784.21	299.7	0.3124
86.03	-0.103	203.2	0.095	215.08	781.63	299.7	0.3142
86.07	-0.103	203	0.095	215.18	781.76	300	0.3151
86.10	-0.103	202.9	0.095	215.25	783.59	300.6	0.3169
86.13	-0.104	202.7	0.0941	215.33	783.62	301	0.3178
86.17	-0.104	202.6	0.0941	215.42	785.07	301.4	0.3204
86.20	-0.104	202.4	0.0932	215.50	783.53	301.5	0.3196
86.23	-0.105	202.3	0.0932	215.58	784.39	301.9	0.3204
86.27	-0.105	202.3	0.0932	215.67	785.32	302.2	0.3213
86.30	-0.105	202.1	0.0932	215.75	786.23	302.7	0.3231
86.33	-0.105	202	0.0923	215.83	783.18	302.5	0.3213
86.37	-0.105	201.8	0.0923	215.92	787.2	303.3	0.3231
86.40	-0.105	201.7	0.0914	216.00	784.03	303.1	0.324
86.43	-0.106	201.5	0.0914	216.08	783.94	303.2	0.3231
86.47	-0.106	201.5	0.0914	216.17	784.1	303.4	0.324
86.50	-0.105	201.5	0.0914	216.25	784.58	303.6	0.324
86.53	-0.105	201.4	0.0905	216.33	786.18	304.1	0.3258
86.57	-0.106	201.2	0.0905	216.42	784.48	304	0.3249
86.60	-0.107	201	0.0905	216.50	782	303.8	0.3231
86.63	-0.11	200.7	0.0887	216.60	782.64	304	0.324
86.67	-0.108	200.7	0.0896	216.67	783.84	304.1	0.324
86.70	-0.106	200.7	0.0896	216.75	780.55	303.9	0.3231
86.73	-0.106	200.7	0.0896	216.83	780.52	304.1	0.3231
86.77	-0.106	200.7	0.0896	216.92	780.88	304.2	0.324
86.82	-0.105	200.6	0.0896	217.00	779.43	304.1	0.3231
86.85	-0.105	200.6	0.0896	217.08	778.59	304	0.3222
86.87	-0.105	200.6	0.0896	217.17	777.5	303.8	0.3213
86.90	-0.106	200.3	0.0887	217.25	776.86	303.8	0.3213
86.93	-0.107	200.1	0.0887	217.33	775.92	303.7	0.3204
86.97	-0.107	200.1	0.0887	217.42	773.21	303.4	0.3204
87.00	-0.107	200	0.0879	217.50	773.32	303.3	0.3187
87.03	-0.106	199.9	0.0879	217.58	772.35	303.2	0.3178
87.07	-0.107	199.9	0.0879	217.67	772.54	303.2	0.3178
87.10	-0.107	199.8	0.0879	217.75	768.33	302.5	0.3151
87.13	-0.107	199.7	0.0879	217.83	768.85	302.6	0.316
87.17	-0.106	199.7	0.0879	217.92	767.66	302.3	0.3142
87.20	-0.106	199.6	0.0879	218.00	765.11	301.8	0.3124
87.23	-0.106	199.6	0.0879	218.08	765.18	301.7	0.3116
87.27	-0.106	199.5	0.0879	218.17	762.74	301.4	0.3098
87.30	-0.106	199.5	0.087	218.25	760.9	301	0.3089
87.33	-0.106	199.4	0.087	218.33	757.45	300.3	0.3071
87.37	-0.106	199.3	0.087	218.42	757.56	300.2	0.3062
87.40	-0.106	199.3	0.087	218.50	756.17	299.9	0.3045
87.43	-0.106	199.2	0.087	218.58	753.82	299.4	0.3027
87.47	-0.106	199.2	0.087	218.67	752.79	298.9	0.3009
87.50	-0.106	199.2	0.087	218.75	750.64	298.6	0.2991
87.53	-0.105	199.2	0.087	218.83	749.06	298.1	0.2974
87.57	-0.105	199.1	0.087	218.92	746.62	297.4	0.2956
87.60	-0.105	199	0.087	219.00	743.72	296.8	0.2947
87.63	-0.105	199	0.087	219.08	742.43	296.4	0.2903
87.67	-0.105	199	0.087	219.17	740.08	295.7	0.2885
87.70	-0.105	199	0.087	219.25	738.99	295.3	0.2867

Prova triassiale ciclica SNGR03-C4							
tensione di confinamento (kPa)		450		tensione di confinamento (kPa)		450	
deviatore ciclico (kPa)		80		deviatore ciclico (kPa)		120	
frequenza (hz)		0.00071429		frequenza (hz)		0.0007143	
87.73	-0.104	198.9	0.087	219.33	735.87	294.7	0.2849
87.77	-0.104	198.9	0.087	219.42	734.96	294.2	0.2832
87.80	-0.104	198.9	0.087	219.52	731.9	293.5	0.2805
87.83	-0.104	198.9	0.087	219.58	730.91	292.9	0.2778
87.87	-0.104	198.9	0.087	219.67	726.02	291.9	0.2743
87.90	-0.103	198.8	0.087	219.75	725.73	291.5	0.2725
87.93	-0.103	198.9	0.087	219.83	721.93	290.4	0.2698
87.97	-0.102	198.8	0.087	219.92	719.84	289.8	0.2672
88.00	-0.102	198.8	0.0879	220.00	717.88	289.1	0.2627
88.03	-0.102	198.9	0.0879	220.08	715.33	288.5	0.261
88.07	-0.102	198.9	0.0879	220.17	712.85	287.6	0.2565
88.10	-0.102	198.8	0.0879	220.25	711.17	286.9	0.2539
88.13	-0.102	198.8	0.0879	220.33	708.12	286.1	0.2503
88.17	-0.101	198.8	0.0879	220.42	704.38	284.9	0.2477
88.20	-0.101	198.8	0.0879	220.50	703.19	284.3	0.245
88.25	-0.1	198.9	0.0879	220.58	700.64	283.5	0.2397
88.28	-0.1	198.9	0.0879	220.67	697.61	282.6	0.237
88.32	-0.098	199	0.0879	220.75	695.91	281.9	0.2326
88.33	-0.097	199	0.0887	220.83	692.36	280.8	0.2281
88.37	-0.097	199.1	0.0887	220.93	689.3	279.7	0.2237
88.40	-0.097	199.1	0.0896	221.00	689.3	279.4	0.221
88.43	-0.098	199.1	0.0887	221.08	683.54	277.8	0.2148
88.47	-0.098	199.1	0.0887	221.17	682.44	277.1	0.2121
88.50	-0.097	199.1	0.0887	221.25	681.56	276.6	0.2104
88.53	-0.097	199	0.0887	221.33	675.83	274.9	0.2042
88.57	-0.097	199	0.0896	221.42	673.9	274	0.1979
88.60	-0.097	199.1	0.0896	221.50	671.65	273.1	0.1944
88.63	-0.096	199.2	0.0896	221.58	668.67	272.1	0.19
88.67	-0.096	199.2	0.0896	221.67	665.84	271.2	0.1846
88.70	-0.096	199.2	0.0896	221.75	663.54	270.3	0.1802
88.73	-0.094	199.3	0.0905	221.83	660.31	269.1	0.1749
88.77	-0.094	199.4	0.0905	221.92	656.64	268	0.1704
88.80	-0.092	199.4	0.0905	222.00	655.6	267.1	0.1651
88.83	-0.092	199.5	0.0914	222.08	654.79	266.6	0.1616
88.87	-0.09	199.8	0.0923	222.17	649.15	265.2	0.1544
88.90	-0.09	199.8	0.0923	222.25	647.98	264.3	0.1473
88.93	-0.091	199.8	0.0923	222.33	645.04	263.4	0.1411
88.97	-0.091	199.8	0.0923	222.43	641.42	261.8	0.1296
89.00	-0.09	199.8	0.0923	222.50	639.16	260.9	0.1243
89.03	-0.09	199.8	0.0923	222.58	637.61	260	0.1189
89.07	-0.09	199.9	0.0923	222.67	634.48	259	0.1118
89.10	-0.089	200	0.0932	222.75	631.54	257.9	0.1065
89.13	-0.087	200.2	0.0941	222.83	627.1	256.2	0.0994
89.17	-0.087	200.2	0.0941	222.92	625.98	255.3	0.0923
89.20	-0.087	200.3	0.0941	223.00	623.68	254.3	0.087
89.23	-0.086	200.4	0.0941	223.08	621.09	253.2	0.0826
89.27	-0.085	200.4	0.095	223.17	618.69	252.1	0.0772
89.30	-0.085	200.5	0.095	223.25	617.37	251.4	0.0737
89.33	-0.085	200.6	0.095	223.33	611.74	249.5	0.0675
89.37	-0.083	200.7	0.0958	223.42	609.9	248.4	0.0657
89.40	-0.083	200.7	0.0958	223.50	609.25	247.6	0.0604
89.43	-0.083	200.9	0.0967	223.58	606.53	246.5	0.0568
89.47	-0.081	201.1	0.0967	223.67	604.49	245.4	0.0533
89.50	-0.08	201.1	0.0967	223.75	601.81	244.2	0.0506
89.53	-0.08	201.2	0.0976	223.85	599.61	243	0.047
89.57	-0.08	201.3	0.0976	223.92	597.83	242.2	0.0444
89.60	-0.08	201.3	0.0976	224.00	595.2	241	0.0408
89.63	-0.079	201.5	0.0985	224.08	593.46	240.1	0.0382
89.67	-0.078	201.6	0.0994	224.17	589.22	238.6	0.0337
89.72	-0.077	201.8	0.0994	224.25	588.6	238.2	0.0328

Prova triassiale ciclica SNGR03-C4

pressione di confinamento (kPa)		450			pressione di confinamento (kPa)		450	
deviatore ciclico (kPa)		80			deviatore ciclico (kPa)		120	
frequenza (hz)		0.00071429			frequenza (hz)		0.0007143	
89.75	-0.077	201.8	0.0994	224.33	587.92	237.1	0.0311	
89.77	-0.077	201.9	0.0994	224.42	584.91	235.9	0.0275	
89.80	-0.076	202	0.0994	224.50	582.65	235	0.0249	
89.83	-0.074	202	0.1003	224.58	580.86	234.1	0.0222	
89.87	-0.074	202.3	0.1012	224.67	579.5	233.3	0.0204	
89.90	-0.073	202.5	0.1021	224.75	577.4	232.3	0.0186	
89.93	-0.069	202.9	0.1038	224.83	575.03	231.5	0.0169	
89.97	-0.07	202.9	0.1038	224.92	572.9	230.2	0.0142	
90.00	-0.07	203	0.1029	225.00	571.86	229.4	0.0115	
90.03	-0.072	202.9	0.1029	225.08	570.43	228.7	0.0098	
90.07	-0.071	202.9	0.1029	225.17	568.36	227.8	0.008	
90.10	-0.071	203	0.1038	225.25	567.13	227	0.0062	
90.13	-0.069	203.4	0.1056	225.35	565.06	225.9	0.0036	
90.17	-0.066	203.6	0.1065	225.42	563.6	225.2	0.0027	
90.20	-0.066	203.8	0.1065	225.50	562.21	224.6	0.0009	
90.23	-0.063	204.2	0.1083	225.58	561.07	223.9	-0.0009	
90.27	-0.063	204.3	0.1083	225.67	560.04	223.2	-0.0027	
90.30	-0.063	204.3	0.1083	225.75	558.32	222.5	-0.0036	
90.33	-0.063	204.3	0.1083	225.83	557.22	221.7	-0.0053	
90.37	-0.063	204.5	0.1092	225.92	557.31	221.3	-0.0062	
90.40	-0.061	204.7	0.11	226.00	555.14	220.5	-0.008	
90.43	-0.06	204.9	0.11	226.08	553.91	219.9	-0.0098	
90.47	-0.059	205.1	0.1109	226.17	553.17	219.3	-0.0107	
90.50	-0.059	205.2	0.1109	226.25	551.87	218.7	-0.0115	
90.53	-0.058	205.2	0.1109	226.33	551.09	218.1	-0.0124	
90.57	-0.058	205.4	0.1127	226.42	550.25	217.5	-0.0133	
90.60	-0.057	205.7	0.1136	226.50	548.82	216.6	-0.016	
90.63	-0.055	205.9	0.1145	226.58	548.01	216.3	-0.0169	
90.67	-0.055	206	0.1154	226.67	548.37	216.1	-0.0169	
90.70	-0.055	206.2	0.1154	226.77	548.08	215.6	-0.0169	
90.73	-0.054	206.3	0.1154	226.83	547.26	215.2	-0.0186	
90.77	-0.052	206.3	0.1163	226.92	546.2	214.7	-0.0195	
90.80	-0.052	206.6	0.1171	227.00	546.74	214.5	-0.0195	
90.83	-0.051	206.8	0.118	227.08	545.68	214.1	-0.0204	
90.87	-0.049	207.1	0.1198	227.17	543.45	213.5	-0.0213	
90.90	-0.049	207.3	0.1198	227.25	545.64	213.5	-0.0213	
90.93	-0.048	207.5	0.1207	227.33	545.25	213.2	-0.0222	
90.97	-0.047	207.8	0.1207	227.42	544.87	212.9	-0.0222	
91.00	-0.045	207.8	0.1216	227.50	544.83	212.7	-0.0231	
91.03	-0.045	208.1	0.1225	227.58	545.03	212.5	-0.0231	
91.07	-0.044	208.4	0.1251	227.67	544.89	212.3	-0.0231	
91.10	-0.041	208.8	0.126	227.75	546.39	212.4	-0.0231	
91.15	-0.041	208.9	0.126	227.83	545.45	212.1	-0.024	
91.18	-0.041	209	0.126	227.92	545.74	211.9	-0.024	
91.22	-0.041	209.1	0.1269	228.00	545.77	211.7	-0.024	
91.23	-0.04	209.3	0.1278	228.08	546.15	211.7	-0.024	
91.27	-0.04	209.5	0.1287	228.17	546.48	211.6	-0.024	
91.30	-0.037	209.9	0.1287	228.25	547.2	211.6	-0.024	
91.33	-0.037	209.9	0.1296	228.33	547.61	211.5	-0.0231	
91.37	-0.037	210	0.1305	228.42	547.78	211.5	-0.024	
91.40	-0.035	210.3	0.1322	228.50	548.23	211.5	-0.024	
91.43	-0.034	210.6	0.1331	228.58	549.78	211.6	-0.0231	
91.47	-0.033	210.9	0.134	228.67	550.33	211.7	-0.0231	
91.50	-0.032	211.2	0.1349	228.75	551.4	211.8	-0.0222	
91.53	-0.027	211.8	0.1349	228.83	552.28	212.1	-0.0222	
91.57	-0.028	211.8	0.1376	228.92	554.84	212.4	-0.0204	
91.60	-0.028	211.9	0.1384	229.00	552.7	212	-0.0213	
91.63	-0.029	212	0.1384	229.08	555.74	212.6	-0.0204	
91.67	-0.027	212.3	0.1402	229.17	555.97	212.7	-0.0195	
91.70	-0.026	212.6	0.1411	229.25	557.36	212.9	-0.0195	

Prova triassiale ciclica SNGR03-C4

tensione di confinamento (kPa)		450			tensione di confinamento (kPa)	450		
deviatore ciclico (kPa)		80			deviatore ciclico (kPa)	120		
frequenza (hz)		0.00071429			frequenza (hz)	0.0007143		
91.73	-0.027	212.8	0.1411	229.33	559.6	213.5	-0.0178	
91.77	-0.025	213	0.1411	229.42	559.76	213.4	-0.0178	
91.80	-0.023	213	0.142	229.50	561.63	213.8	-0.0169	
91.83	-0.023	213.4	0.1438	229.58	562.84	214.1	-0.016	
91.87	-0.022	213.7	0.1455	229.68	564.52	214.4	-0.0151	
91.90	-0.02	214	0.1473	229.75	565.07	214.7	-0.0151	
91.93	-0.019	214.3	0.1482	229.83	567.14	215.1	-0.0142	
91.97	-0.018	214.6	0.15	229.92	569.21	215.5	-0.0124	
92.00	-0.016	214.9	0.15	230.00	570.67	216	-0.0115	
92.03	-0.013	214.9	0.1509	230.08	571.74	216.4	-0.0107	
92.07	-0.013	215.4	0.1535	230.17	576.43	217.3	-0.008	
92.10	-0.015	215.5	0.1544	230.25	575.26	217.3	-0.0089	
92.13	-0.015	215.6	0.1544	230.33	577.47	217.8	-0.0089	
92.17	-0.014	215.8	0.1553	230.42	579.8	218.5	-0.0053	
92.20	-0.012	216.3	0.158	230.50	581.19	219	-0.0044	
92.23	-0.009	216.7	0.158	230.58	583.68	219.7	-0.0027	
92.27	-0.006	216.7	0.1606	230.67	584.53	220.1	-0.0018	
92.30	-0.006	217.2	0.1633	230.75	587.24	220.8	0	
92.33	-0.007	217.3	0.1633	230.83	588.5	221.8	0.0027	
92.37	-0.008	217.4	0.1642	230.92	592.13	222.3	0.0027	
92.40	-0.006	217.7	0.166	231.00	593.49	222.9	0.0044	
92.43	-0.005	218.1	0.1686	231.10	597.05	223.7	0.0071	
92.47	-0.002	218.6	0.1686	231.17	598.54	224.1	0.008	
92.50	0.002	218.6	0.1704	231.25	601.68	225.2	0.0098	
92.53	0.002	219.2	0.1748	231.33	602.68	225.8	0.0124	
92.57	-0.001	219.1	0.1748	231.42	605.11	226.6	0.0142	
92.62	0	219.3	0.1757	231.50	607.25	227.2	0.0151	
92.65	0	219.6	0.1775	231.58	608.63	228	0.0178	
92.67	0.002	220	0.1802	231.67	611.68	228.8	0.0195	
92.70	0.005	220.5	0.1837	231.75	614.82	229.7	0.0222	
92.73	0.005	220.8	0.1855	231.83	618.53	231	0.024	
92.77	0.006	221.1	0.1882	231.92	619.28	231.7	0.0275	
92.80	0.008	221.6	0.1882	232.00	623.16	232.8	0.0311	
92.83	0.009	221.6	0.1917	232.08	624.84	233.5	0.0328	
92.87	0.009	221.8	0.1944	232.17	626.2	234.2	0.0355	
92.90	0.01	222.1	0.197	232.25	629.11	235.1	0.0382	
92.93	0.012	222.7	0.2024	232.33	631.44	236.1	0.0408	
92.97	0.014	223	0.2059	232.42	635.71	237.5	0.0426	
93.00	0.012	223	0.2068	232.50	637.46	238.3	0.0479	
93.03	0.014	223.5	0.2068	232.60	639.24	239.1	0.0506	
93.07	0.016	223.5	0.2112	232.67	643.34	240.1	0.0541	
93.10	0.016	223.8	0.2157	232.75	645.7	241.4	0.0577	
93.13	0.019	224.5	0.2237	232.83	647.55	242.3	0.0621	
93.17	0.019	224.8	0.2281	232.92	650.24	243.3	0.0657	
93.20	0.02	225	0.2334	233.00	656.6	245	0.0728	
93.23	0.021	225.4	0.2387	233.08	655.56	245.5	0.0754	
93.27	0.02	225.5	0.2387	233.17	658.05	246.4	0.0799	
93.30	0.023	225.5	0.2432	233.25	661.54	247.1	0.0834	
93.33	0.023	226	0.2503	233.33	664.71	248.9	0.0897	
93.37	0.023	226.3	0.2574	233.42	666.58	249.8	0.0985	
93.40	0.025	226.8	0.2645	233.50	669.29	250.8	0.1056	
93.43	0.027	227.3	0.2725	233.58	672.52	252	0.1136	
93.47	0.027	227.6	0.2796	233.67	673.7	252.8	0.1189	
93.50	0.028	228	0.2796	233.75	677.68	253.9	0.1252	
93.53	0.031	228	0.2849	233.83	680.07	255.2	0.1323	
93.57	0.031	228.4	0.2893	233.92	682.43	256.1	0.1358	
93.60	0.034	228.9	0.2938	234.02	684.85	257	0.1411	
93.63	0.033	229.1	0.2947	234.08	686.98	257.9	0.1456	
93.67	0.034	229.4	0.2964	234.17	691.1	259.1	0.1509	
93.70	0.033	229.6	0.2973	234.25	696.94	260.8	0.1544	

Prova triassiale ciclica SNGR03-C4								
pressione di confinamento (kPa)		450			pressione di confinamento (kPa)		450	
deviatore ciclico (kPa)		80			deviatore ciclico (kPa)		120	
frequenza (hz)		0.00071429			frequenza (hz)		0.0007143	
93.73	0.035	229.9	0.2973	234.33	694.98	261.2	0.1607	
93.77	0.037	229.9	0.2991	234.42	698.97	262.4	0.1651	
93.80	0.037	230.3	0.3018	234.50	701.42	263.4	0.1695	
93.83	0.038	230.6	0.3035	234.58	704.68	264.5	0.1766	
93.87	0.04	231	0.3053	234.67	704.01	265	0.1784	
93.90	0.041	231.3	0.3071	234.75	708.77	266.4	0.1837	
93.93	0.041	231.6	0.3089	234.83	714.41	268	0.1873	
93.97	0.043	231.9	0.3089	234.92	712.26	268.3	0.1926	
94.00	0.047	231.9	0.3106	235.00	715.41	269.3	0.1971	
94.03	0.047	232.5	0.3142	235.08	718.86	270.4	0.2015	
94.08	0.045	232.7	0.3142	235.17	722.18	271.6	0.2059	
94.12	0.047	232.7	0.3151	235.25	721.56	272.1	0.2077	
94.13	0.047	233.2	0.3169	235.33	726.14	273.2	0.213	
94.17	0.047	233.4	0.3186	235.42	728.78	274.5	0.2166	
94.20	0.049	233.8	0.3204	235.52	729.56	275.3	0.221	
94.23	0.054	234.3	0.324	235.58	731.67	276	0.2237	
94.27	0.051	234.4	0.324	235.67	735.34	277	0.2281	
94.30	0.052	234.7	0.324	235.75	740.24	278.6	0.2317	
94.33	0.054	234.7	0.3249	235.83	738.95	279.2	0.237	
94.37	0.054	235.1	0.3266	235.92	740.78	280	0.2406	
94.40	0.055	235.3	0.3284	236.00	743.42	280.9	0.2441	
94.43	0.053	235.4	0.3284	236.08	744.77	281.6	0.2477	
94.47	0.057	235.9	0.3311	236.17	746.96	282.5	0.2503	
94.50	0.057	236.2	0.3328	236.25	749.98	283.3	0.2539	
94.53	0.059	236.6	0.3328	236.33	751.79	284.6	0.2583	
94.57	0.06	236.6	0.3346	236.42	750.98	284.9	0.2601	
94.60	0.06	236.9	0.3364	236.50	754.32	285.9	0.2636	
94.63	0.061	237.2	0.3382	236.58	756.76	286.8	0.2672	
94.67	0.065	237.8	0.3417	236.67	757.79	287.5	0.2707	
94.70	0.062	237.8	0.3417	236.75	759.35	288.3	0.2734	
94.73	0.062	238.1	0.3426	236.83	762.95	289.1	0.2761	
94.77	0.067	238.6	0.3426	236.93	762.77	289.9	0.2796	
94.80	0.068	238.6	0.3453	237.00	764.23	290.6	0.2823	
94.83	0.068	239	0.3479	237.08	768.63	291.8	0.2858	
94.87	0.068	239.2	0.3479	237.17	766.73	291.9	0.2867	
94.90	0.066	239.3	0.3479	237.25	769.11	292.9	0.2876	
94.93	0.069	239.7	0.3497	237.33	769.94	293.4	0.2911	
94.97	0.069	240	0.3524	237.42	772.33	294.2	0.2938	
95.00	0.074	240.7	0.3524	237.50	771.81	294.6	0.2956	
95.03	0.072	240.7	0.3559	237.58	773.58	295.2	0.2974	
95.07	0.072	240.7	0.355	237.67	774.92	295.8	0.3	
95.10	0.072	240.9	0.3559	237.75	775.92	296.3	0.3009	
95.13	0.074	241.3	0.3577	237.83	776.99	297.1	0.3027	
95.17	0.074	241.6	0.3586	237.92	777.88	297.7	0.3053	
95.20	0.076	241.9	0.3612	238.00	781.61	298.5	0.3089	
95.23	0.078	242.4	0.3612	238.08	777.65	298.3	0.308	
95.27	0.079	242.4	0.3639	238.17	780.71	299.1	0.3107	
95.30	0.079	242.7	0.3648	238.25	780.74	299.5	0.3116	
95.33	0.078	242.8	0.3648	238.33	781.89	300	0.3133	
95.37	0.08	243.2	0.3666	238.42	782.25	300.6	0.3151	
95.40	0.08	243.4	0.3675	238.50	781.83	300.7	0.3151	
95.43	0.081	243.7	0.3692	238.58	783.46	301.2	0.3169	
95.47	0.083	244.1	0.3692	238.67	784.01	301.5	0.3178	
95.52	0.084	244.4	0.3719	238.75	784.07	302	0.3187	
95.55	0.084	244.6	0.3728	238.83	784.56	302.4	0.3196	
95.57	0.088	245.1	0.3728	238.92	784.87	302.7	0.3204	
95.60	0.085	245.1	0.3754	239.00	784.39	302.8	0.3204	
95.63	0.085	245.1	0.3754	239.08	786.84	303.5	0.3231	
95.67	0.085	245.3	0.3763	239.17	783.72	303.3	0.3213	
95.70	0.088	245.8	0.3781	239.25	785.03	303.5	0.3222	

Prova triassiale ciclica SNGR03-C4								
pressione di confinamento (kPa)		450			pressione di confinamento (kPa)		450	
deviatore ciclico (kPa)		80			deviatore ciclico (kPa)		120	
frequenza (hz)		0.00071429			frequenza (hz)		0.0007143	
95.73	0.088	246	0.379	239.33	786.77	304.1	0.3249	
95.77	0.089	246.3	0.3808	239.42	783.62	303.9	0.3231	
95.80	0.091	246.7	0.3808	239.50	784.8	304.2	0.324	
95.83	0.092	246.7	0.3817	239.58	784.23	304.3	0.324	
95.87	0.092	247.1	0.3834	239.67	785.61	304.7	0.3249	
95.90	0.091	247.2	0.3834	239.75	782.72	304.5	0.324	
95.93	0.091	247.4	0.3843	239.85	784.48	304.9	0.3249	
95.97	0.093	247.8	0.3861	239.92	782.2	304.7	0.324	
96.00	0.094	248.1	0.387	240.00	782	304.7	0.324	
96.03	0.096	248.4	0.387	240.08	781.72	305	0.3249	
96.07	0.095	248.4	0.3888	240.17	778.33	305	0.324	
96.10	0.095	248.6	0.3896	240.25	780.05	304.8	0.3222	
96.13	0.097	248.9	0.3914	240.33	779.81	304.8	0.3231	
96.17	0.097	249.2	0.3923	240.42	778.72	304.7	0.3222	
96.20	0.098	249.4	0.3932	240.50	777.34	304.6	0.3213	
96.23	0.098	249.7	0.3941	240.58	777.02	304.5	0.3204	
96.27	0.1	250	0.3941	240.67	775.63	304.4	0.3204	
96.30	0.1	250	0.395	240.75	773.93	304.2	0.3196	
96.33	0.1	250.2	0.3967	240.83	773.29	304	0.3187	
96.37	0.1	250.5	0.3967	240.92	772.45	303.9	0.3178	
96.40	0.101	250.7	0.3976	241.00	771.16	303.7	0.3178	
96.43	0.102	251	0.3994	241.08	768.88	303.2	0.3151	
96.47	0.103	251.3	0.4003	241.17	768.49	303.2	0.3151	
96.50	0.103	251.4	0.4003	241.27	767.3	303	0.3133	
96.53	0.104	251.4	0.4012	241.33	764.89	302.5	0.3124	
96.57	0.104	251.7	0.4021	241.42	764.7	302.4	0.3116	
96.60	0.104	252	0.403	241.50	764.28	302.3	0.3107	
96.63	0.105	252.2	0.4039	241.58	760.96	301.6	0.3089	
96.67	0.107	252.6	0.4056	241.67	758.9	301.4	0.308	
96.70	0.106	252.7	0.4056	241.75	757.75	300.9	0.3062	
96.73	0.107	252.9	0.4056	241.83	755.27	300.5	0.3036	
96.77	0.107	252.9	0.4065	241.92	755.54	300.4	0.3027	
96.80	0.107	253.1	0.4074	242.00	752.98	299.7	0.3009	
96.83	0.108	253.4	0.4083	242.08	751.34	299.3	0.2991	
96.87	0.109	253.6	0.4092	242.17	747.2	298.5	0.2965	
96.90	0.11	253.9	0.4101	242.25	746.49	298.3	0.2956	
96.93	0.113	254.3	0.4127	242.33	743.75	297.5	0.2938	
96.98	0.11	254.4	0.4127	242.42	744.65	297.4	0.292	
97.02	0.11	254.5	0.4127	242.50	738.41	296.2	0.2876	
97.03	0.11	254.6	0.4127	242.58	739.34	296	0.2867	
97.07	0.114	255.2	0.4127	242.67	736.83	295.4	0.2849	
97.10	0.113	255.2	0.4154	242.77	733.87	294.6	0.2823	
97.13	0.113	255.2	0.4154	242.83	733.74	294.3	0.2814	
97.17	0.112	255.3	0.4154	242.92	729.43	293.4	0.2769	
97.20	0.112	255.5	0.4163	243.00	725.86	292.5	0.2734	
97.23	0.113	255.8	0.4172	243.08	725.6	292.1	0.2725	
97.27	0.114	256	0.4181	243.17	722.28	291.1	0.2698	
97.30	0.114	256.2	0.4181	243.25	720.84	290.6	0.2681	
97.33	0.115	256.2	0.4189	243.33	718.36	289.8	0.2636	
97.37	0.115	256.5	0.4198	243.42	715.33	289.1	0.2601	
97.40	0.115	256.6	0.4198	243.50	710.89	288	0.2556	
97.43	0.116	256.8	0.4207	243.58	711.24	287.6	0.2539	
97.47	0.116	257	0.4216	243.67	708.79	286.8	0.2512	
97.50	0.117	257.2	0.4225	243.75	706.51	285.9	0.2485	
97.53	0.12	257.6	0.4225	243.83	702.25	284.8	0.245	
97.57	0.118	257.6	0.4243	243.92	698.74	283.8	0.2379	
97.60	0.118	257.7	0.4243	244.00	697.78	283.2	0.2361	
97.63	0.117	257.8	0.4243	244.08	695.1	282.3	0.2326	
97.67	0.116	257.8	0.4243	244.18	692.4	281.2	0.229	
97.70	0.116	257.9	0.4243	244.25	689.21	280.3	0.2237	

Prova triassiale ciclica SNGR03-C4								
pressione di confinamento (kPa)		450			pressione di confinamento (kPa)		450	
deviatore ciclico (kPa)		80			deviatore ciclico (kPa)		120	
frequenza (hz)		0.00071429			frequenza (hz)		0.0007143	
97.73	0.118	258.2	0.4252	244.33	687.17	279.5	0.2201	
97.77	0.122	258.7	0.4252	244.42	684.92	278.6	0.2166	
97.80	0.12	258.7	0.4278	244.50	682.82	277.8	0.213	
97.83	0.12	258.8	0.4278	244.58	679.4	276.8	0.2086	
97.87	0.119	258.9	0.4278	244.67	676.09	275.6	0.205	
97.90	0.119	258.9	0.4278	244.75	673.47	274.5	0.2006	
97.93	0.118	259	0.4278	244.83	671.25	273.7	0.1944	
97.97	0.119	259.3	0.4296	244.92	666.54	272.4	0.1882	
98.00	0.122	259.7	0.4296	245.00	666.79	271.9	0.1855	
98.03	0.121	259.7	0.4305	245.08	663.76	271	0.182	
98.07	0.121	259.7	0.4305	245.17	661.16	269.9	0.1766	
98.10	0.12	259.8	0.4305	245.25	657.25	268.4	0.1713	
98.13	0.12	259.9	0.4305	245.33	655.02	267.8	0.1669	
98.17	0.12	260	0.4305	245.42	652.8	266.9	0.1607	
98.20	0.12	260	0.4305	245.50	650.05	265.9	0.1553	
98.23	0.12	260.2	0.4305	245.58	647.21	264.8	0.1491	
98.27	0.121	260.2	0.4314	245.68	643.75	263.4	0.1447	
98.30	0.121	260.4	0.4314	245.75	641.52	262.6	0.1331	
98.33	0.121	260.5	0.4323	245.83	639	261.5	0.1278	
98.37	0.124	260.9	0.434	245.92	635.06	260.1	0.1198	
98.42	0.122	260.9	0.4331	246.00	633.86	259.4	0.1145	
98.45	0.122	261	0.4331	246.08	631.6	258.6	0.1092	
98.48	0.121	261.1	0.4331	246.17	630.34	257.4	0.1039	
98.50	0.121	261.1	0.4331	246.25	624.78	255.8	0.0985	
98.53	0.121	261.2	0.4331	246.33	623.71	254.9	0.0914	
98.57	0.121	261.3	0.4331	246.42	620.57	253.6	0.0852	
98.60	0.121	261.4	0.4331	246.50	618.82	252.5	0.0808	
98.63	0.121	261.4	0.434	246.58	616.82	251.7	0.0772	
98.67	0.121	261.5	0.434	246.67	613.56	250.5	0.0728	
98.70	0.122	261.7	0.434	246.75	611.19	249.2	0.071	
98.73	0.122	261.8	0.4349	246.83	608.51	248.1	0.0657	
98.77	0.122	261.9	0.4349	246.92	606.63	247.1	0.0604	
98.80	0.124	262.2	0.4349	247.00	604.08	246	0.0577	
98.83	0.123	262.2	0.4358	247.10	601.23	244.5	0.0541	
98.87	0.123	262.2	0.4358	247.17	598.93	243.5	0.0515	
98.90	0.122	262.2	0.4349	247.25	597.05	242.5	0.047	
98.93	0.12	262.1	0.4349	247.33	595.08	241.5	0.0444	
98.97	0.121	262.3	0.4349	247.42	592.85	240.4	0.0417	
99.00	0.12	262.3	0.4349	247.50	591.58	239.7	0.0391	
99.03	0.12	262.4	0.4349	247.58	589.19	238.7	0.0364	
99.07	0.12	262.4	0.4349	247.67	586.15	237.3	0.0337	
99.10	0.12	262.4	0.4349	247.75	584.85	236.4	0.032	
99.13	0.12	262.5	0.4349	247.83	582.19	235.4	0.0284	
99.17	0.121	262.8	0.4367	247.92	580.45	234.5	0.0257	
99.20	0.122	262.8	0.4367	248.00	579.41	233.7	0.024	
99.23	0.121	262.9	0.4358	248.08	577.69	232.9	0.0213	
99.27	0.119	262.8	0.4358	248.17	574.88	231.8	0.0195	
99.30	0.119	262.8	0.4349	248.25	573.13	230.7	0.0178	
99.33	0.119	262.8	0.4349	248.33	571.54	229.9	0.016	
99.37	0.119	262.9	0.4349	248.42	569.92	229.1	0.0133	
99.40	0.12	263	0.4358	248.50	568.63	228.3	0.0115	
99.43	0.119	263	0.4349	248.60	566.13	227.2	0.0098	
99.47	0.119	263	0.4349	248.67	565.32	226.5	0.008	
99.50	0.118	263.1	0.4349	248.75	563.57	225.7	0.0053	
99.53	0.118	263.1	0.4349	248.83	561.27	225	0.0044	
99.57	0.118	263.1	0.4349	248.92	562.24	224.6	0.0036	
99.60	0.118	263.1	0.4349	249.00	559.56	223.7	0.0009	
99.63	0.117	263.2	0.4349	249.08	559.17	223.1	0	
99.67	0.117	263.2	0.4349	249.17	556.41	222.1	-0.0018	
99.70	0.117	263.2	0.4349	249.25	556.15	221.6	-0.0027	

Prova triassiale ciclica SNGR03-C4								
tensione di confinamento (kPa)		450			tensione di confinamento (kPa)		450	
deviatore ciclico (kPa)		80			deviatore ciclico (kPa)		120	
frequenza (hz)		0.00071429			frequenza (hz)		0.0007143	
99.73	0.118	263.3	0.4349	249.33	554.79	220.8	-0.0053	
99.77	0.115	263.2	0.4349	249.42	553.6	220.3	-0.0062	
99.80	0.115	263.2	0.434	249.50	553.27	219.8	-0.0071	
99.83	0.116	263.2	0.434	249.58	552.52	219.3	-0.008	
99.88	0.115	263.3	0.434	249.67	551.36	218.6	-0.0089	
99.92	0.115	263.3	0.434	249.75	550.22	218	-0.0107	
99.93	0.115	263.3	0.434	249.83	549.67	217.5	-0.0107	
99.97	0.115	263.3	0.4331	249.92	548.99	217.1	-0.0124	
100.00	0.114	263.2	0.4331	250.02	548.44	216.6	-0.0133	
100.03	0.112	263.1	0.4323	250.08	547.14	215.9	-0.0142	
100.07	0.112	263.1	0.4323	250.17	547.4	215.6	-0.0151	
100.10	0.112	263.2	0.4323	250.25	546.88	215.3	-0.016	
100.13	0.112	263.2	0.4323	250.33	546.01	214.9	-0.0169	
100.17	0.113	263.2	0.4323	250.42	546.04	214.6	-0.0169	
100.20	0.112	263.1	0.4323	250.50	545.91	214.4	-0.0178	
100.23	0.11	263.1	0.4314	250.58	545.32	214	-0.0178	
100.27	0.111	263.1	0.4314	250.67	545.1	213.6	-0.0186	
100.30	0.11	263	0.4314	250.75	545.16	213.4	-0.0186	
100.33	0.11	263	0.4305	250.83	545.04	213.2	-0.0195	
100.37	0.11	263	0.4305	250.92	545.03	213	-0.0195	
100.40	0.109	262.9	0.4305	251.00	545.22	212.8	-0.0195	
100.43	0.109	262.9	0.4305	251.08	545	212.7	-0.0204	
100.47	0.109	263	0.4305	251.17	545.35	212.5	-0.0204	
100.50	0.106	262.8	0.4287	251.25	545.54	212.4	-0.0204	
100.53	0.107	262.8	0.4287	251.33	545.87	212.3	-0.0204	
100.57	0.106	262.7	0.4287	251.43	546.22	212.2	-0.0204	
100.60	0.106	262.7	0.4278	251.50	546.62	212.1	-0.0204	
100.63	0.106	262.7	0.4278	251.58	547.1	212	-0.0204	
100.67	0.106	262.7	0.4278	251.67	547.59	212.1	-0.0204	
100.70	0.106	262.7	0.4278	251.75	548.43	212.1	-0.0195	
100.73	0.103	262.4	0.426	251.83	549.11	212.1	-0.0195	
100.77	0.102	262.3	0.426	251.92	549.5	212.2	-0.0195	
100.80	0.101	262.2	0.4252	252.00	550.37	212.3	-0.0195	
100.83	0.101	262.2	0.4252	252.08	551.37	212.4	-0.0186	
100.87	0.102	262.2	0.4252	252.17	552.54	212.6	-0.0186	
100.90	0.102	262.2	0.4243	252.25	553.28	212.7	-0.0178	
100.93	0.1	262	0.4243	252.33	554.52	212.9	-0.0178	
100.97	0.099	261.9	0.4234	252.42	554.55	212.9	-0.0178	
101.00	0.099	261.9	0.4234	252.50	556.59	213.3	-0.016	
101.03	0.099	261.8	0.4225	252.58	557.37	213.4	-0.016	
101.07	0.099	261.8	0.4225	252.67	558.53	213.7	-0.0151	
101.10	0.097	261.7	0.4216	252.75	560.14	214	-0.0151	
101.13	0.096	261.5	0.4207	252.83	561.77	214.4	-0.0133	
101.17	0.095	261.5	0.4207	252.93	562.87	214.6	-0.0133	
101.20	0.095	261.4	0.4198	253.00	564.06	214.9	-0.0124	
101.23	0.095	261.3	0.4198	253.08	565.91	215.4	-0.0115	
101.27	0.094	261.3	0.4198	253.17	567.73	215.8	-0.0098	
101.32	0.092	261	0.4181	253.25	568.92	216.1	-0.0089	
101.35	0.092	261	0.4181	253.33	570.77	216.6	-0.0089	
101.38	0.092	260.9	0.4181	253.42	572.32	217	-0.0071	
101.40	0.092	260.9	0.4172	253.50	573.42	217.3	-0.0062	
101.43	0.091	260.7	0.4163	253.58	576.06	218	-0.0053	
101.47	0.09	260.6	0.4154	253.67	578.08	218.6	-0.0044	
101.50	0.089	260.5	0.4154	253.75	579.25	219.1	-0.0027	
101.53	0.089	260.4	0.4145	253.83	581.29	219.6	-0.0009	
101.57	0.087	260.2	0.4145	253.92	583.23	220.2	0	
101.60	0.087	260.2	0.4136	254.00	585.21	220.8	0.0018	
101.63	0.087	260.2	0.4127	254.08	587.5	221.4	0.0027	
101.67	0.085	260	0.4118	254.17	588.48	221.9	0.0044	
101.70	0.084	259.8	0.411	254.25	592.62	223	0.0062	

Prova triassiale ciclica SNGR03-C4								
tensione di confinamento (kPa)		450			tensione di confinamento (kPa)		450	
deviatore ciclico (kPa)		80			deviatore ciclico (kPa)		120	
frequenza (hz)		0.00071429			frequenza (hz)		0.0007143	
101.73	0.084	259.7	0.411	254.35	594.33	223.5	0.008	
101.77	0.083	259.6	0.4101	254.42	595.14	223.9	0.0089	
101.80	0.082	259.4	0.4101	254.50	597.9	224.4	0.0098	
101.83	0.081	259.2	0.4092	254.58	601.74	225.8	0.0124	
101.87	0.081	259.2	0.4083	254.67	602.68	226.4	0.0151	
101.90	0.08	259.1	0.4074	254.75	604.92	227.1	0.0169	
101.93	0.079	258.9	0.4065	254.83	607.41	227.9	0.0186	
101.97	0.079	258.8	0.4056	254.92	609.54	228.7	0.0213	
102.00	0.077	258.6	0.4047	255.00	611.71	229.4	0.0231	
102.03	0.076	258.4	0.4047	255.08	615.3	230.3	0.0249	
102.07	0.076	258.2	0.4039	255.17	617.37	231.5	0.0275	
102.10	0.076	258.2	0.403	255.25	618.9	232.1	0.0302	
102.13	0.075	258	0.4021	255.33	622.03	233.1	0.0328	
102.17	0.073	257.8	0.4012	255.42	624.75	234	0.0355	
102.20	0.072	257.6	0.4003	255.50	626.6	234.9	0.0382	
102.23	0.072	257.5	0.3994	255.58	628.86	235.6	0.0408	
102.27	0.071	257.3	0.3994	255.67	631.73	236.7	0.0435	
102.30	0.069	257.1	0.3985	255.75	635.55	238.1	0.047	
102.33	0.069	257.1	0.3976	255.85	636.78	238.8	0.0506	
102.37	0.069	257	0.3967	255.92	639.04	239.6	0.0541	
102.40	0.07	256.9	0.3967	256.00	643.87	240.7	0.0568	
102.43	0.065	256.4	0.3932	256.08	646.61	242.1	0.0595	
102.47	0.065	256.3	0.3932	256.17	647.94	243.1	0.0648	
102.50	0.065	256.2	0.3932	256.25	650.55	243.9	0.0692	
102.53	0.063	255.9	0.3923	256.33	653.85	245.1	0.0737	
102.57	0.063	255.9	0.3914	256.42	655.02	245.9	0.0772	
102.60	0.063	255.7	0.3905	256.50	657.86	246.9	0.0817	
102.63	0.061	255.4	0.3888	256.58	661.31	248.1	0.0879	
102.67	0.062	255.4	0.3888	256.67	668.1	250.1	0.0923	
102.70	0.058	255	0.3861	256.75	666.84	250.6	0.1021	
102.73	0.058	254.8	0.3861	256.83	669.42	251.4	0.1074	
102.78	0.057	254.6	0.3843	256.92	671.74	252.4	0.1145	
102.82	0.057	254.4	0.3843	257.00	674.07	253.5	0.1207	
102.83	0.055	254.2	0.3843	257.08	677.17	254.5	0.126	
102.87	0.055	254	0.3825	257.17	680.65	255.5	0.1314	
102.90	0.055	254	0.3825	257.27	683.63	257	0.1385	
102.93	0.055	253.9	0.3808	257.33	685.3	257.8	0.142	
102.97	0.05	253.3	0.3781	257.42	688.1	258.7	0.1465	
103.00	0.05	253.1	0.3772	257.50	691.24	259.6	0.15	
103.03	0.05	253	0.3763	257.58	694.23	261.2	0.1553	
103.07	0.051	252.9	0.3763	257.67	696.36	262.2	0.1616	
103.10	0.046	252.4	0.3763	257.75	698.08	263	0.1642	
103.13	0.046	252.4	0.3728	257.83	701.72	264.1	0.1695	
103.17	0.047	252.3	0.3728	257.92	703.19	264.9	0.174	
103.20	0.046	252	0.371	258.00	705.68	265.9	0.1784	
103.23	0.044	251.7	0.3701	258.08	709.61	266.9	0.1829	
103.27	0.045	251.7	0.3701	258.17	712.09	268.3	0.1873	
103.30	0.044	251.4	0.3701	258.25	713.9	269.2	0.1926	
103.33	0.038	250.8	0.3683	258.33	716.09	270.1	0.1971	
103.37	0.038	250.8	0.3648	258.42	719.25	271.3	0.2006	
103.40	0.039	250.7	0.3639	258.50	720.34	272	0.2042	
103.43	0.039	250.5	0.3639	258.58	726.17	273.3	0.2095	
103.47	0.04	250.5	0.363	258.67	724.95	273.5	0.2104	
103.50	0.037	250.1	0.3595	258.77	727.91	275.1	0.2166	
103.53	0.032	249.3	0.3595	258.83	729.42	275.8	0.2201	
103.57	0.033	249.2	0.3568	258.92	734.09	277.1	0.2255	
103.60	0.033	249.2	0.3568	259.00	734.71	277.6	0.2272	
103.63	0.034	249.2	0.3559	259.08	737.73	279.1	0.2317	
103.67	0.031	248.7	0.3541	259.17	738.69	279.8	0.2361	
103.70	0.03	248.5	0.3524	259.25	741.36	280.8	0.2397	

Prova triassiale ciclica SNGR03-C4

tensione di confinamento (kPa)		450			tensione di confinamento (kPa)	450		
deviatore ciclico (kPa)		80			deviatore ciclico (kPa)	120		
frequenza (hz)		0.00071429			frequenza (hz)	0.0007143		
103.73	0.031	248.4	0.3524	259.33	743	281.6	0.2432	
103.77	0.027	247.9	0.3524	259.42	744.74	282.3	0.2459	
103.80	0.026	247.6	0.3497	259.50	746.99	283.2	0.2494	
103.83	0.026	247.6	0.3479	259.58	749.6	284	0.253	
103.87	0.026	247.4	0.3462	259.67	751.62	285.2	0.2556	
103.90	0.027	247.3	0.3453	259.75	752.28	285.9	0.2601	
103.93	0.022	246.7	0.3426	259.83	754.68	286.7	0.2627	
103.97	0.024	246.6	0.3426	259.92	757.06	287.6	0.2663	
104.00	0.024	246.4	0.3426	260.00	757.57	288.3	0.269	
104.03	0.019	245.9	0.3417	260.08	759.92	289	0.2716	
104.07	0.019	245.9	0.3373	260.18	761.3	289.9	0.2752	
104.10	0.02	245.7	0.3364	260.25	763.13	290.7	0.2778	
104.13	0.018	245.3	0.3337	260.33	764.41	291.3	0.2805	
104.17	0.015	244.9	0.332	260.42	766.47	292	0.2832	
104.20	0.013	244.5	0.3284	260.50	766.73	292.6	0.2849	
104.25	0.013	244.2	0.3275	260.58	769.3	293.5	0.2867	
104.28	0.014	244.1	0.3266	260.67	769.72	294.1	0.2894	
104.30	0.014	244	0.3266	260.75	773.26	295	0.2929	
104.33	0.012	243.6	0.3266	260.83	771.32	295.1	0.2938	
104.37	0.006	242.9	0.3222	260.92	773.38	295.9	0.2956	
104.40	0.006	242.9	0.3195	261.00	774.54	296.5	0.2974	
104.43	0.008	242.8	0.3195	261.08	776.11	297.1	0.3	
104.47	0.008	242.7	0.3186	261.17	777.46	297.9	0.3009	
104.50	0.008	242.6	0.3177	261.25	777.82	298.3	0.3036	
104.53	0.004	242	0.3133	261.33	778.86	298.9	0.3053	
104.57	0.002	241.6	0.3133	261.42	779.81	299.3	0.3071	
104.60	0.003	241.5	0.3106	261.50	780.13	299.7	0.308	
104.63	0.003	241.5	0.3106	261.60	782.19	300.6	0.3107	
104.67	0	241.1	0.308	261.67	780.51	300.6	0.3107	
104.70	-0.001	240.7	0.3053	261.75	782.34	301.2	0.3124	
104.73	-0.001	240.4	0.3027	261.83	782.95	301.5	0.3142	
104.77	0	240.4	0.3	261.92	783.08	301.9	0.3142	
104.80	-0.005	239.5	0.2956	262.00	784.01	302.3	0.316	
104.83	-0.004	239.6	0.2956	262.08	783.88	302.7	0.3169	
104.87	-0.004	239.6	0.2938	262.17	784.36	303	0.3178	
104.90	-0.004	239.2	0.2885	262.25	784.65	303.3	0.3187	
104.93	-0.009	238.6	0.2831	262.33	784.87	303.5	0.3196	
104.97	-0.009	238.4	0.2805	262.42	784.84	303.8	0.3196	
105.00	-0.006	238.4	0.2778	262.50	785.04	304.1	0.3204	
105.03	-0.01	237.9	0.2725	262.58	785	304.2	0.3204	
105.07	-0.013	237.5	0.2725	262.67	786.54	304.9	0.3222	
105.10	-0.013	237.5	0.2672	262.75	783.43	304.5	0.3213	
105.13	-0.012	237.4	0.2627	262.83	784.84	304.9	0.3222	
105.17	-0.014	236.8	0.2565	262.92	784.36	305	0.3222	
105.20	-0.018	236.2	0.2503	263.00	783.94	305.1	0.3222	
105.23	-0.017	236.1	0.2467	263.10	783.9	305.3	0.3222	
105.27	-0.014	236.1	0.245	263.17	783.42	305.4	0.3222	
105.30	-0.022	235.2	0.245	263.25	783	305.5	0.3222	
105.33	-0.022	235.2	0.2379	263.33	782.65	305.5	0.3222	
105.37	-0.02	235.1	0.2352	263.42	781.62	305.5	0.3213	
105.40	-0.019	235	0.2325	263.50	780.85	305.5	0.3213	
105.43	-0.021	234.6	0.229	263.58	780.07	305.5	0.3213	
105.47	-0.022	234.3	0.2254	263.67	778.98	305.3	0.3204	
105.50	-0.025	233.7	0.221	263.75	778.72	305.4	0.3204	
105.53	-0.03	233	0.221	263.83	777.92	305.3	0.3196	
105.57	-0.03	233	0.2157	263.92	776.79	305.2	0.3187	
105.60	-0.027	233	0.2139	264.00	775.92	305.1	0.3187	
105.63	-0.025	233	0.213	264.08	774.54	304.9	0.3178	
105.68	-0.028	232.5	0.2103	264.17	773.57	304.6	0.3169	
105.72	-0.028	232.2	0.2077	264.25	772.03	304.4	0.316	

Prova triassiale ciclica SNGR03-C4							
tensione di confinamento (kPa)		450	tensione di confinamento (kPa)		450		
deviatore ciclico (kPa)		80	deviatore ciclico (kPa)		120		
frequenza (hz)		0.00071429	frequenza (hz)		0.0007143		
105.75	-0.03	231.7	0.2041	264.33	771.45	304.3	0.3151
105.77	-0.033	231.3	0.1988	264.42	769.49	304	0.3142
105.80	-0.037	230.5	0.1961	264.50	768.56	303.8	0.3133
105.83	-0.034	230.6	0.1961	264.58	767.21	303.5	0.3116
105.87	-0.035	230.3	0.1961	264.67	765.54	303.2	0.3107
105.90	-0.035	230.3	0.1935	264.75	764.15	303	0.3098
105.93	-0.036	229.9	0.1908	264.83	761.67	302.5	0.308
105.97	-0.041	229.1	0.1864	264.92	761.03	302.3	0.3071
106.00	-0.04	228.8	0.1855	265.00	760.48	302.1	0.3062
106.03	-0.04	228.7	0.1837	265.08	756.11	301.2	0.3027
106.07	-0.041	228.3	0.1828	265.17	756.08	301.1	0.3018
106.10	-0.04	228.3	0.1828	265.25	754.11	300.7	0.3009
106.13	-0.04	228.3	0.1819	265.33	752.76	300.3	0.2991
106.17	-0.045	227.5	0.1766	265.42	751.22	299.9	0.2974
106.20	-0.047	227	0.1748	265.50	748.61	299.4	0.2965
106.23	-0.044	227	0.1757	265.58	746.59	299	0.2938
106.27	-0.044	226.8	0.174	265.67	744.23	298.1	0.292
106.30	-0.047	226.3	0.1713	265.75	742.6	297.7	0.2885
106.33	-0.05	225.8	0.1713	265.83	740.12	297.1	0.2867
106.37	-0.05	225.8	0.1695	265.92	738.47	296.6	0.2858
106.40	-0.048	225.7	0.1686	266.02	737	296	0.2849
106.43	-0.05	225.2	0.1669	266.08	732.29	294.9	0.2796
106.47	-0.052	224.9	0.1651	266.17	731.91	294.6	0.2778
106.50	-0.056	224.3	0.1624	266.25	729.4	293.9	0.2752
106.53	-0.054	224.2	0.1624	266.33	728.11	293.4	0.2734
106.57	-0.052	224.2	0.1624	266.42	724.96	292.7	0.2707
106.60	-0.052	224.2	0.1624	266.50	722.41	292	0.2681
106.63	-0.054	223.8	0.1597	266.58	721.51	291.3	0.2654
106.67	-0.057	223	0.1571	266.67	718.62	290.5	0.2601
106.70	-0.058	222.8	0.1562	266.75	715.04	289.6	0.2574
106.73	-0.061	222.2	0.1535	266.83	713.2	288.8	0.2556
106.77	-0.061	222	0.1526	266.92	710.66	288.4	0.253
106.80	-0.06	221.8	0.1526	267.00	708.51	287.5	0.2503
106.83	-0.06	221.8	0.1526	267.08	704.99	286.6	0.2468
106.87	-0.061	221.6	0.1509	267.17	702.16	285.4	0.2432
106.90	-0.06	221.4	0.1509	267.25	700.58	284.7	0.2388
106.93	-0.063	220.9	0.1491	267.33	698.07	283.6	0.2334
106.97	-0.066	220.3	0.1464	267.43	694.36	282.8	0.2299
107.00	-0.065	220.2	0.1464	267.50	691.75	281.7	0.2272
107.03	-0.066	219.9	0.1464	267.58	690.17	281	0.2228
107.07	-0.064	219.9	0.1455	267.67	686.95	280.1	0.2192
107.10	-0.064	219.9	0.1447	267.75	685.62	279.3	0.2166
107.15	-0.068	219	0.1429	267.83	682.63	278.4	0.2113
107.18	-0.069	219	0.142	267.92	679.54	277.5	0.2077
107.20	-0.069	218.7	0.1402	268.00	676.54	276.5	0.2033
107.23	-0.07	218.3	0.1393	268.08	672.99	275	0.1988
107.27	-0.071	218.1	0.1384	268.17	671.54	274.3	0.1926
107.30	-0.072	217.7	0.1376	268.25	668.96	273.4	0.1882
107.33	-0.072	217.5	0.1367	268.33	663.25	271.9	0.182
107.37	-0.074	217.1	0.1367	268.42	663.38	271.4	0.1793
107.40	-0.074	217.1	0.1358	268.50	661.47	270.5	0.1758
107.43	-0.074	216.9	0.1349	268.58	657.15	269.3	0.1695
107.47	-0.075	216.5	0.1331	268.67	654.66	268.2	0.166
107.50	-0.076	216.2	0.1322	268.75	652.27	267.3	0.1598
107.53	-0.077	215.9	0.1313	268.83	649.66	266.2	0.1544
107.57	-0.077	215.7	0.1313	268.93	647.01	265.5	0.15
107.60	-0.078	215.4	0.1313	269.00	645.2	264.3	0.1429
107.63	-0.079	215.4	0.1296	269.08	641.59	263.2	0.1349
107.67	-0.079	215.1	0.1287	269.17	639.58	262.2	0.1287
107.70	-0.08	214.8	0.1278	269.25	636.55	261.1	0.1225

Prova triassiale ciclica SNGR03-C4							
tensione di confinamento (kPa)		450	tensione di confinamento (kPa)		450		
deviatore ciclico (kPa)		80	deviatore ciclico (kPa)		120		
frequenza (hz)		0.00071429	frequenza (hz)		0.0007143		
107.73	-0.081	214.5	0.1269	269.33	634.61	260.1	0.1163
107.77	-0.081	214.3	0.126	269.42	631.7	259	0.1101
107.80	-0.084	213.7	0.1242	269.50	627.92	257.9	0.1047
107.83	-0.085	213.4	0.1242	269.58	625.37	256.1	0.1003
107.87	-0.083	213.4	0.1234	269.67	623.48	255.3	0.0914
107.90	-0.083	213.4	0.1234	269.75	621.15	254.4	0.087
107.93	-0.083	213.2	0.1234	269.83	618.96	253.2	0.0826
107.97	-0.083	213.1	0.1225	269.92	616.37	252.2	0.0781
108.00	-0.085	212.6	0.1216	270.00	614.82	251.3	0.0746
108.03	-0.086	212.3	0.1207	270.08	610.65	250.2	0.0701
108.07	-0.088	211.9	0.1207	270.17	608.61	248.6	0.0666
108.10	-0.089	211.9	0.1189	270.25	606.41	247.5	0.0612
108.13	-0.089	211.7	0.1189	270.35	605.27	246.8	0.0595
108.17	-0.088	211.6	0.1189	270.42	601.68	245.7	0.0568
108.20	-0.088	211.3	0.118	270.50	597.48	243.6	0.0533
108.23	-0.089	211	0.1171	270.58	597.37	243	0.0488
108.27	-0.09	210.7	0.1163	270.67	594.85	242	0.0453
108.30	-0.092	210.4	0.1163	270.75	593.4	241.1	0.0426
108.33	-0.091	210.4	0.1154	270.83	591.13	240.2	0.0399
108.37	-0.091	210.3	0.1154	270.92	589.54	239.4	0.0382
108.40	-0.092	210	0.1136	271.00	586.21	238.4	0.0355
108.43	-0.095	209.4	0.1109	271.08	584.44	236.9	0.0337
108.47	-0.094	209.3	0.1109	271.17	582.49	236	0.0302
108.50	-0.094	209.2	0.1109	271.25	580.9	235.1	0.0275
108.53	-0.093	209.1	0.1109	271.33	578.93	234.2	0.0249
108.58	-0.096	208.7	0.1092	271.42	577.69	233.4	0.0231
108.62	-0.095	208.7	0.1092	271.50	575.85	232.5	0.0213
108.65	-0.094	208.6	0.1092	271.58	573.46	231.4	0.0186
108.67	-0.095	208.6	0.1092	271.67	571.19	230.4	0.0169
108.70	-0.095	208.4	0.1083	271.77	569.66	229.6	0.0142
108.73	-0.096	208	0.1074	271.83	568.98	229	0.0133
108.77	-0.098	207.7	0.1065	271.92	566.62	228.2	0.0115
108.80	-0.098	207.6	0.1065	272.00	565.1	227	0.0098
108.83	-0.098	207.3	0.1056	272.08	563.55	226.3	0.0071
108.87	-0.099	207.1	0.1056	272.17	562.96	225.7	0.0062
108.90	-0.099	207.1	0.1056	272.25	561.24	224.9	0.0044
108.93	-0.099	207	0.1047	272.33	560.08	224.2	0.0027
108.97	-0.099	206.7	0.1038	272.42	558.88	223.6	0.0009
109.00	-0.1	206.5	0.1038	272.50	555.26	223	0
109.03	-0.101	206.3	0.1029	272.58	556.41	222.1	-0.0018
109.07	-0.1	206.2	0.1029	272.67	554.83	221.4	-0.0036
109.10	-0.101	206	0.1029	272.75	554.21	220.9	-0.0044
109.13	-0.101	206	0.1021	272.83	554.25	220.6	-0.0053
109.17	-0.101	205.8	0.1021	272.92	552.3	219.8	-0.0062
109.20	-0.101	205.6	0.1012	273.00	551.46	219.3	-0.008
109.23	-0.102	205.5	0.1012	273.08	548.32	218.7	-0.0089
109.27	-0.103	205.2	0.1003	273.17	550.64	218.2	-0.0098
109.30	-0.103	205.1	0.0994	273.27	549.58	217.7	-0.0107
109.33	-0.106	204.6	0.0994	273.33	548.67	217.2	-0.0115
109.37	-0.105	204.6	0.0985	273.42	547.57	216.7	-0.0124
109.40	-0.105	204.5	0.0985	273.50	546.7	216.1	-0.0133
109.43	-0.103	204.6	0.0994	273.58	546.82	215.8	-0.0142
109.47	-0.102	204.6	0.0994	273.67	544.91	215.1	-0.016
109.50	-0.102	204.5	0.0985	273.75	546.98	215.3	-0.0151
109.53	-0.104	204.1	0.0976	273.83	546.72	215	-0.016
109.57	-0.105	203.9	0.0976	273.92	545.3	214.5	-0.0169
109.60	-0.105	203.9	0.0967	274.00	545.36	214.3	-0.0169
109.63	-0.105	203.7	0.0967	274.08	544.13	213.7	-0.0178
109.67	-0.104	203.6	0.0967	274.17	544.9	213.6	-0.0178
109.70	-0.105	203.4	0.0958	274.25	545.26	213.5	-0.0178

Prova triassiale ciclica SNGR03-C4							
pressione di confinamento (kPa)		450		pressione di confinamento (kPa)		450	
deviatore ciclico (kPa)		80		deviatore ciclico (kPa)		120	
frequenza (hz)		0.00071429		frequenza (hz)		0.0007143	
109.73	-0.105	203.3	0.0958	274.33	545.2	213.4	-0.0186
109.77	-0.106	203.2	0.0958	274.42	546.01	213.2	-0.0178
109.80	-0.106	203.1	0.0958	274.50	546.36	213.2	-0.0186
109.83	-0.107	203.1	0.0958	274.58	545.78	212.9	-0.0186
109.87	-0.107	202.9	0.095	274.67	545.84	212.7	-0.0195
109.90	-0.106	202.8	0.095	274.75	546.13	212.6	-0.0195
109.93	-0.106	202.8	0.095	274.83	546.49	212.6	-0.0195
109.97	-0.106	202.6	0.095	274.92	546.94	212.5	-0.0195
110.00	-0.106	202.5	0.0941	275.00	548.01	212.6	-0.0195
110.05	-0.106	202.3	0.0941	275.08	548.37	212.6	-0.0186
110.08	-0.107	202.2	0.0941	275.17	549.17	212.6	-0.0186
110.10	-0.106	202.1	0.0932	275.25	549.63	212.7	-0.0186
110.13	-0.107	202.1	0.0932	275.33	550.44	212.7	-0.0178
110.17	-0.107	202.1	0.0932	275.42	551.54	212.9	-0.0178
110.20	-0.107	202	0.0932	275.50	552.64	212.9	-0.0178
110.23	-0.111	201.5	0.0914	275.58	553.58	213.2	-0.0169
110.27	-0.109	201.5	0.0914	275.67	554.16	213.3	-0.0169
110.30	-0.107	201.6	0.0923	275.75	554.55	213.3	-0.016
110.33	-0.107	201.5	0.0923	275.83	557.3	213.9	-0.0142
110.37	-0.106	201.5	0.0923	275.92	558.31	214.1	-0.0142
110.40	-0.105	201.5	0.0923	276.00	558.11	214.1	-0.0142
110.43	-0.105	201.6	0.0932	276.08	560.47	214.4	-0.0133
110.47	-0.105	201.5	0.0923	276.18	560.42	214.5	-0.0133
110.50	-0.106	201.4	0.0923	276.25	562.22	214.9	-0.0115
110.53	-0.106	201.3	0.0923	276.33	564.23	215.4	-0.0115
110.57	-0.107	201	0.0914	276.42	566.56	215.7	-0.0107
110.60	-0.107	201	0.0914	276.50	569.54	216.6	-0.0098
110.63	-0.107	201	0.0914	276.58	569.32	216.7	-0.008
110.67	-0.107	201	0.0914	276.67	570.45	217	-0.0071
110.70	-0.106	200.9	0.0914	276.75	572.52	217.5	-0.0062
110.73	-0.106	200.9	0.0914	276.83	573.65	217.8	-0.0053
110.77	-0.106	200.9	0.0914	276.92	575.63	218.4	-0.0044
110.80	-0.105	200.8	0.0914	277.00	578.12	218.8	-0.0027
110.83	-0.105	200.8	0.0914	277.08	579.86	219.6	-0.0018
110.87	-0.105	200.8	0.0914	277.17	581.2	220.1	0
110.90	-0.105	200.7	0.0914	277.25	583.5	220.8	0.0009
110.93	-0.105	200.7	0.0914	277.33	585.66	221.4	0.0027
110.97	-0.105	200.7	0.0914	277.42	586.55	221.8	0.0036
111.00	-0.105	200.6	0.0914	277.50	589.26	222.5	0.0053
111.03	-0.104	200.6	0.0914	277.60	591.81	223.3	0.0071
111.07	-0.104	200.5	0.0914	277.67	593.88	223.9	0.0089
111.10	-0.104	200.5	0.0914	277.75	595.57	224.5	0.0107
111.13	-0.104	200.5	0.0914	277.83	597.51	225.2	0.0124
111.17	-0.104	200.5	0.0914	277.92	601.03	226.3	0.0142
111.20	-0.105	200.3	0.0905	278.00	603.17	227	0.0151
111.23	-0.104	200.4	0.0914	278.08	604.95	227.7	0.0178
111.27	-0.102	200.6	0.0923	278.17	607.54	228.5	0.0204
111.30	-0.102	200.5	0.0923	278.25	609.58	229.3	0.0222
111.33	-0.102	200.5	0.0914	278.33	610.84	229.9	0.024
111.37	-0.102	200.5	0.0914	278.42	614.27	230.9	0.0266
111.40	-0.102	200.5	0.0923	278.50	617.63	232	0.0284
111.43	-0.101	200.5	0.0923	278.58	620.09	232.9	0.0311
111.47	-0.101	200.5	0.0923	278.67	622.04	233.7	0.0346
111.52	-0.1	200.5	0.0923	278.75	624.62	234.6	0.0373
111.55	-0.1	200.5	0.0923	278.83	626.63	235.4	0.0391
111.57	-0.1	200.5	0.0923	278.92	629.47	236.6	0.0435
111.60	-0.1	200.5	0.0923	279.00	632.16	237.5	0.0453
111.63	-0.099	200.6	0.0923	279.10	635.29	238.7	0.0497
111.67	-0.099	200.6	0.0932	279.17	637.23	239.6	0.0524
111.70	-0.099	200.6	0.0932	279.25	638.96	240.3	0.055

Prova triassiale ciclica SNGR03-C4							
pressione di confinamento (kPa)		450		tensione di confinamento (kPa)		450	
deviatore ciclico (kPa)		80		deviatore ciclico (kPa)		120	
frequenza (hz)		0.00071429		frequenza (hz)		0.0007143	
111.73	-0.099	200.6	0.0932	279.33	641.76	241.1	0.0577
111.77	-0.098	200.6	0.0932	279.42	646.25	242.8	0.0612
111.80	-0.098	200.6	0.0932	279.50	648.55	243.7	0.0648
111.83	-0.098	200.6	0.0932	279.58	650.46	244.6	0.0701
111.87	-0.097	200.7	0.0932	279.67	653.63	245.7	0.0746
111.90	-0.095	200.7	0.0941	279.75	655.82	246.7	0.079
111.93	-0.095	200.9	0.095	279.83	658.18	247.6	0.0834
111.97	-0.095	200.9	0.095	279.92	660.9	248.7	0.0888
112.00	-0.095	200.9	0.095	280.00	665.19	250.2	0.0941
112.03	-0.095	200.9	0.095	280.08	666.77	251.1	0.0985
112.07	-0.095	200.9	0.095	280.17	670.03	252.2	0.1092
112.10	-0.094	201	0.095	280.25	671.91	253.2	0.1154
112.13	-0.093	201	0.095	280.33	673.42	254.1	0.1198
112.17	-0.093	201.1	0.0958	280.42	676.52	255	0.1243
112.20	-0.093	201.2	0.0958	280.52	680.65	256.6	0.1323
112.23	-0.092	201.3	0.0958	280.58	682.72	257.4	0.1358
112.27	-0.091	201.3	0.0967	280.67	687.15	258.8	0.142
112.30	-0.09	201.4	0.0967	280.75	686.75	259.2	0.1447
112.33	-0.089	201.5	0.0967	280.83	690.65	260.4	0.1491
112.37	-0.089	201.5	0.0967	280.92	694.1	261.7	0.1536
112.40	-0.089	201.6	0.0976	281.00	696.11	262.8	0.1571
112.43	-0.089	201.6	0.0976	281.08	698.62	263.7	0.1642
112.47	-0.087	201.8	0.0985	281.17	701.39	264.7	0.1678
112.50	-0.087	201.8	0.0985	281.25	703.58	265.7	0.1722
112.53	-0.087	201.9	0.0985	281.33	705.59	266.6	0.1766
112.57	-0.086	202	0.0985	281.42	708.77	267.6	0.1811
112.60	-0.085	202	0.0985	281.50	710.13	268.8	0.1864
112.63	-0.085	202.1	0.0994	281.58	714.48	270	0.1891
112.67	-0.085	202.2	0.0994	281.67	716.09	270.9	0.1953
112.70	-0.084	202.3	0.1003	281.75	719.08	271.9	0.1997
112.73	-0.083	202.4	0.1003	281.83	720.5	272.7	0.2024
112.77	-0.082	202.6	0.1012	281.92	722.69	273.5	0.2068
112.80	-0.082	202.7	0.1012	282.00	725.56	274.8	0.2121
112.83	-0.081	202.7	0.1012	282.08	728.29	275.8	0.2157
112.87	-0.081	202.8	0.1012	282.17	729.74	276.7	0.2192
112.90	-0.08	202.9	0.1021	282.25	732.09	277.5	0.2228
112.95	-0.079	203	0.1029	282.33	734.19	278.4	0.2263
112.98	-0.079	203.1	0.1029	282.42	737.6	279.8	0.2299
113.00	-0.078	203.2	0.1029	282.50	739.27	280.6	0.2334
113.03	-0.078	203.2	0.1029	282.58	741.27	281.4	0.2379
113.07	-0.078	203.3	0.1038	282.67	743.16	282.3	0.2414
113.10	-0.077	203.5	0.1047	282.75	747.51	283.4	0.2459
113.13	-0.073	203.9	0.1047	282.83	747.02	283.9	0.2485
113.17	-0.074	203.9	0.1056	282.92	749.12	284.7	0.2512
113.20	-0.074	203.9	0.1056	283.00	750.89	285.7	0.253
113.23	-0.074	204	0.1065	283.08	753.56	286.6	0.2565
113.27	-0.069	204.5	0.1083	283.17	754.45	287.3	0.261
113.30	-0.07	204.6	0.1083	283.25	756.51	288.2	0.2645
113.33	-0.071	204.6	0.1083	283.33	758.05	288.9	0.2672
113.37	-0.07	204.7	0.1083	283.43	759.92	290	0.2698
113.40	-0.069	204.7	0.1083	283.50	763.33	290.9	0.2752
113.43	-0.069	204.8	0.1092	283.58	762.59	291.3	0.2761
113.47	-0.068	205.1	0.11	283.67	764.48	292	0.2787
113.50	-0.067	205.2	0.11	283.75	765.9	292.7	0.2814
113.53	-0.066	205.4	0.1109	283.83	767.29	293.3	0.2832
113.57	-0.065	205.6	0.1127	283.92	769.02	294.2	0.2858
113.60	-0.065	205.7	0.1127	284.00	772.34	295.2	0.2867
113.63	-0.063	205.7	0.1127	284.08	770.85	295.4	0.2894
113.67	-0.063	206	0.1136	284.17	773	296.1	0.292
113.70	-0.063	206.1	0.1145	284.25	773.42	296.6	0.2938

Prova triassiale ciclica SNGR03-C4							
tensione di confinamento (kPa)		450	tensione di confinamento (kPa)		450		
deviatore ciclico (kPa)		80	deviatore ciclico (kPa)		120		
frequenza (hz)		0.00071429	frequenza (hz)		0.0007143		
113.73	-0.061	206.4	0.1154	284.33	774.87	297.2	0.2956
113.77	-0.061	206.5	0.1154	284.42	775.99	297.8	0.2974
113.80	-0.059	206.8	0.1171	284.50	776.47	298.4	0.2991
113.83	-0.058	207	0.1171	284.58	777.89	299	0.3009
113.87	-0.058	207	0.1171	284.67	780.58	299.8	0.3045
113.90	-0.058	207.1	0.118	284.75	779.24	300	0.3053
113.93	-0.058	207.2	0.118	284.83	779.55	300.4	0.3062
113.97	-0.056	207.4	0.1189	284.92	781.13	301	0.308
114.00	-0.055	207.6	0.1198	285.00	781.96	301.5	0.3098
114.03	-0.054	207.9	0.1207	285.08	782.51	301.9	0.3107
114.07	-0.052	208.2	0.1207	285.17	784.5	302.5	0.3133
114.10	-0.052	208.2	0.1216	285.25	783.05	302.6	0.3133
114.13	-0.052	208.4	0.1225	285.33	783.11	302.9	0.3142
114.17	-0.048	208.9	0.1251	285.42	784.17	303.4	0.3142
114.20	-0.048	209	0.1251	285.50	785.14	303.8	0.316
114.23	-0.05	209	0.1242	285.58	784.25	304	0.316
114.27	-0.05	209.1	0.1251	285.67	784.51	304.3	0.3169
114.30	-0.047	209.4	0.1251	285.75	785.01	304.5	0.3178
114.33	-0.046	209.4	0.126	285.83	785.3	304.8	0.3187
114.37	-0.046	209.7	0.1269	285.92	784.94	305	0.3187
114.42	-0.043	210.1	0.1278	286.00	784.32	305.2	0.3196
114.45	-0.042	210.1	0.1296	286.08	783.91	305.4	0.3196
114.47	-0.042	210.6	0.1313	286.17	783.97	305.5	0.3196
114.50	-0.04	210.8	0.1322	286.25	784.36	305.7	0.3196
114.53	-0.04	211	0.1322	286.35	783.94	305.9	0.3204
114.57	-0.041	211	0.1322	286.42	783.78	306	0.3204
114.60	-0.041	211.1	0.1331	286.50	783.68	306.2	0.3204
114.63	-0.037	211.6	0.1331	286.58	783.78	306.3	0.3204
114.67	-0.036	211.6	0.1349	286.67	781.63	306	0.3196
114.70	-0.036	211.8	0.1358	286.75	780.98	306	0.3196
114.73	-0.035	212.1	0.1367	286.83	780.88	306.1	0.3196
114.77	-0.033	212.5	0.1384	286.92	780.56	306.2	0.3196
114.80	-0.033	212.6	0.1384	287.00	779.24	306.1	0.3187
114.83	-0.032	213	0.1402	287.08	778.79	306.1	0.3187
114.87	-0.03	213.3	0.1402	287.17	777.79	305.9	0.3178
114.90	-0.029	213.3	0.142	287.25	776.89	305.8	0.3169
114.93	-0.029	213.5	0.1429	287.33	775.96	305.7	0.316
114.97	-0.026	214	0.1447	287.42	775.12	305.6	0.316
115.00	-0.026	214.2	0.1455	287.50	773.87	305.4	0.3151
115.03	-0.026	214.4	0.1464	287.58	773.29	305.3	0.3151
115.07	-0.027	214.4	0.1464	287.67	771.04	305	0.3133
115.10	-0.025	214.8	0.1464	287.77	769.3	304.6	0.3116
115.13	-0.022	214.8	0.1482	287.83	766.92	304.2	0.3107
115.17	-0.022	215.2	0.15	287.92	766.83	304.1	0.3098
115.20	-0.022	215.4	0.15	288.00	765.54	303.8	0.3089
115.23	-0.02	215.9	0.1535	288.08	763.86	303.5	0.3071
115.27	-0.017	216.4	0.1553	288.17	763.03	303.3	0.3062
115.30	-0.017	216.5	0.1553	288.25	761.42	303	0.3053
115.33	-0.017	216.7	0.1553	288.33	760	302.6	0.3036
115.37	-0.016	216.7	0.1562	288.42	757.37	302	0.3018
115.40	-0.016	216.9	0.158	288.50	756.91	301.8	0.3018
115.43	-0.015	217.2	0.1597	288.58	753.67	301.2	0.2982
115.47	-0.012	217.6	0.1606	288.67	752.67	300.8	0.2965
115.50	-0.013	217.8	0.1615	288.75	750.49	300.4	0.2947
115.53	-0.011	218.1	0.1642	288.83	748.87	299.9	0.2929
115.57	-0.009	218.5	0.1642	288.92	746.88	299.4	0.2911
115.60	-0.01	218.5	0.166	289.00	744.05	298.6	0.2894
115.63	-0.01	218.6	0.166	289.08	742.66	298.2	0.2876
115.67	-0.009	218.9	0.1686	289.17	740.41	297.7	0.2849
115.70	-0.005	219.4	0.1704	289.27	739.09	297.2	0.284

Prova triassiale ciclica SNGR03-C4

pressione di confinamento (kPa)		450			pressione di confinamento (kPa)		450	
deviatore ciclico (kPa)		80			deviatore ciclico (kPa)		120	
frequenza (hz)		0.00071429			frequenza (hz)		0.0007143	
115.73	-0.005	219.7	0.1722	289.33	735.29	296.3	0.2814	
115.77	-0.004	220	0.1748	289.42	735.9	296.1	0.2796	
115.80	0.002	220.8	0.1748	289.50	730.56	295	0.2752	
115.85	-0.001	220.8	0.1784	289.58	730.04	294.6	0.2734	
115.88	-0.003	220.8	0.1793	289.67	727.34	293.8	0.2707	
115.92	-0.001	221.2	0.1793	289.75	725.48	293.2	0.2681	
115.93	0.002	221.2	0.1811	289.83	723.32	292.5	0.2654	
115.97	0.002	221.6	0.1837	289.92	719.36	291.4	0.2627	
116.00	0.005	222.2	0.1882	290.00	719.87	291.1	0.261	
116.03	0.005	222.4	0.1899	290.08	715.91	290.2	0.2565	
116.07	0.003	222.5	0.1908	290.17	712.15	289.2	0.2521	
116.10	0.005	222.8	0.1935	290.25	711.02	288.7	0.2503	
116.13	0.01	223.7	0.1935	290.33	708.89	288	0.2468	
116.17	0.01	223.7	0.1997	290.42	707.41	287.4	0.245	
116.20	0.01	223.8	0.2024	290.50	702.32	285.9	0.2406	
116.23	0.01	224.1	0.2041	290.58	698.36	284.7	0.2343	
116.27	0.011	224.4	0.2068	290.68	698.13	284.3	0.2326	
116.30	0.013	224.7	0.2103	290.75	695.75	283.5	0.229	
116.33	0.011	224.7	0.2112	290.83	691.85	282.3	0.2255	
116.37	0.014	225.3	0.2112	290.92	689.71	281.4	0.221	
116.40	0.015	225.3	0.2157	291.00	687.4	280.6	0.2166	
116.43	0.015	225.6	0.221	291.08	684.56	279.8	0.2139	
116.47	0.016	225.9	0.2254	291.17	682.66	278.8	0.2095	
116.50	0.019	226.5	0.2299	291.25	678.19	277.7	0.2042	
116.53	0.019	226.8	0.237	291.33	677.18	276.9	0.2006	
116.57	0.024	227.5	0.2459	291.42	672.99	275.6	0.1971	
116.60	0.021	227.5	0.2459	291.50	673.31	275	0.1917	
116.63	0.022	227.5	0.2494	291.58	668.51	273.8	0.1873	
116.67	0.022	227.9	0.2565	291.67	663.67	272.4	0.1802	
116.70	0.024	228.2	0.2627	291.75	663.83	271.9	0.1775	
116.73	0.026	228.7	0.2707	291.83	661.16	271	0.1722	
116.77	0.027	229.1	0.2778	291.92	658.18	269.9	0.1687	
116.80	0.027	229.4	0.2822	292.00	655.96	268.9	0.1642	
116.83	0.029	229.9	0.2822	292.08	650.34	267.4	0.1562	
116.87	0.033	229.9	0.2867	292.17	650.27	266.9	0.1536	
116.90	0.033	230.5	0.2911	292.25	647.59	265.9	0.1482	
116.93	0.031	230.6	0.292	292.33	643.5	264.4	0.142	
116.97	0.032	230.8	0.2938	292.42	643.78	263.8	0.1349	
117.00	0.033	231.1	0.2947	292.50	639.42	262.7	0.1287	
117.03	0.033	231.3	0.2964	292.58	636.52	261.5	0.1225	
117.07	0.036	231.8	0.2964	292.67	634.31	260.5	0.1163	
117.10	0.039	232.2	0.3	292.75	631.63	259.5	0.111	
117.13	0.039	232.2	0.3018	292.83	629.18	258.5	0.1056	
117.17	0.037	232.4	0.3027	292.92	625.56	256.9	0.1003	
117.20	0.039	232.7	0.3044	293.00	623.71	255.8	0.0923	
117.23	0.04	233.1	0.308	293.08	620.8	254.8	0.0879	
117.27	0.044	233.6	0.3106	293.17	618.19	253.6	0.0834	
117.32	0.043	233.9	0.3115	293.25	615.56	252.5	0.0781	
117.35	0.042	234	0.3115	293.33	614.14	251.6	0.0746	
117.37	0.044	234.2	0.3133	293.42	611.43	250.5	0.071	
117.40	0.046	234.7	0.3133	293.50	607.86	248.9	0.0675	
117.43	0.047	235	0.316	293.60	607.34	248.1	0.063	
117.47	0.047	235	0.3169	293.67	605.18	247.2	0.0595	
117.50	0.048	235.3	0.3186	293.75	601.29	246	0.0568	
117.53	0.048	235.6	0.3204	293.83	598.58	244.3	0.0533	
117.57	0.051	236	0.3222	293.92	597.83	243.5	0.0497	
117.60	0.051	236.3	0.324	294.00	594.92	242.5	0.047	
117.63	0.055	236.9	0.324	294.08	593.37	241.8	0.0444	
117.67	0.054	237	0.3275	294.17	591.88	240.7	0.0417	
117.70	0.054	237	0.3275	294.25	588.96	239.7	0.0391	

Prova triassiale ciclica SNGR03-C4								
tensione di confinamento (kPa)		450			tensione di confinamento (kPa)		450	
deviatore ciclico (kPa)		80			deviatore ciclico (kPa)		120	
frequenza (hz)		0.00071429			frequenza (hz)		0.0007143	
117.73	0.054	237.1	0.3284	294.33	586.41	238.7	0.0364	
117.77	0.055	237.5	0.3293	294.42	584.31	237.4	0.0337	
117.80	0.058	238	0.332	294.50	582.72	236.5	0.0311	
117.83	0.058	238.2	0.3328	294.58	580.74	235.5	0.0284	
117.87	0.059	238.6	0.3328	294.67	578.86	234.6	0.0257	
117.90	0.06	238.9	0.3346	294.75	577.24	233.7	0.024	
117.93	0.06	238.9	0.3364	294.83	575.46	232.9	0.0222	
117.97	0.062	239.2	0.3382	294.92	573.26	231.9	0.0195	
118.00	0.064	239.7	0.3408	295.00	571.32	230.8	0.0178	
118.03	0.065	240.1	0.3426	295.08	567.6	229.7	0.0151	
118.07	0.063	240.1	0.3426	295.17	569.37	229.5	0.0142	
118.10	0.064	240.4	0.3426	295.25	568.47	228.4	0.0115	
118.13	0.066	240.7	0.3444	295.33	562.74	226.9	0.0098	
118.17	0.066	240.7	0.3462	295.42	563.96	226.7	0.008	
118.20	0.068	241.1	0.3479	295.50	562.54	226	0.0062	
118.23	0.069	241.6	0.3506	295.58	562.09	225.6	0.0053	
118.27	0.072	241.9	0.3524	295.67	560.63	224.8	0.0036	
118.30	0.07	242.1	0.3524	295.75	558.66	224	0.0018	
118.33	0.069	242.2	0.3524	295.83	556.9	223.3	0.0009	
118.37	0.072	242.6	0.3524	295.92	555.71	222.4	-0.0009	
118.40	0.072	242.6	0.3541	296.00	555.25	221.9	-0.0027	
118.43	0.073	242.9	0.3559	296.08	553.96	221.3	-0.0044	
118.47	0.074	243.2	0.3577	296.17	553.05	220.7	-0.0044	
118.50	0.075	243.5	0.3586	296.25	552.17	220.2	-0.0062	
118.53	0.076	243.7	0.3595	296.33	551.27	219.6	-0.0071	
118.57	0.077	244.1	0.3595	296.42	549.55	219.1	-0.008	
118.60	0.078	244.4	0.3612	296.52	550.07	218.5	-0.0089	
118.63	0.078	244.4	0.363	296.58	548.87	218	-0.0098	
118.67	0.081	244.9	0.3657	296.67	548.35	217.6	-0.0107	
118.70	0.081	245.2	0.3666	296.75	547.57	217.1	-0.0115	
118.75	0.08	245.3	0.3666	296.83	547.02	216.5	-0.0124	
118.78	0.079	245.4	0.3675	296.92	546.47	216.2	-0.0133	
118.82	0.082	245.9	0.3692	297.00	546.43	215.8	-0.0142	
118.83	0.084	246.2	0.371	297.08	545.56	215.4	-0.0142	
118.87	0.084	246.5	0.3719	297.17	545.27	215.1	-0.0151	
118.90	0.084	246.7	0.3719	297.25	545.36	214.9	-0.0151	
118.93	0.086	247.1	0.3728	297.33	545.4	214.6	-0.016	
118.97	0.086	247.1	0.3746	297.42	545.07	214.3	-0.0169	
119.00	0.087	247.4	0.3754	297.50	543.88	214	-0.0169	
119.03	0.089	247.9	0.3781	297.58	544.84	213.8	-0.0169	
119.07	0.09	248.1	0.379	297.67	544.49	213.6	-0.0178	
119.10	0.088	248.2	0.379	297.75	545.07	213.5	-0.0178	
119.13	0.088	248.4	0.379	297.83	545.65	213.5	-0.0178	
119.17	0.091	248.8	0.3799	297.93	545.91	213.3	-0.0178	
119.20	0.091	248.8	0.3817	298.00	546.04	213.2	-0.0178	
119.23	0.094	249.3	0.3843	298.08	546.17	213.1	-0.0178	
119.27	0.093	249.5	0.3852	298.17	546.5	213	-0.0178	
119.30	0.092	249.6	0.3852	298.25	547.01	213	-0.0178	
119.33	0.093	249.9	0.3861	298.33	547.98	213.1	-0.0178	
119.37	0.095	250.3	0.3861	298.42	548.34	213	-0.0178	
119.40	0.096	250.5	0.3879	298.50	550.41	213.4	-0.0169	
119.43	0.096	250.5	0.3888	298.58	549.67	213.1	-0.0169	
119.47	0.096	250.8	0.3896	298.67	549.95	213.1	-0.0169	
119.50	0.097	251	0.3914	298.75	551.09	213.3	-0.0169	
119.53	0.1	251.5	0.3932	298.83	551.35	213.4	-0.016	
119.57	0.099	251.7	0.3932	298.92	553.65	213.6	-0.016	
119.60	0.098	251.7	0.3932	299.00	554.39	213.7	-0.0151	
119.63	0.099	252	0.3932	299.08	554.94	213.9	-0.0142	
119.67	0.099	252	0.3941	299.17	556.5	214.2	-0.0142	
119.70	0.1	252.3	0.3959	299.25	557.34	214.4	-0.0133	

Prova triassiale ciclica SNGR03-C4							
pressione di confinamento (kPa)		450			pressione di confinamento (kPa)		450
deviatore ciclico (kPa)		80			deviatore ciclico (kPa)		120
frequenza (hz)		0.00071429			frequenza (hz)		0.0007143
119.73	0.102	252.6	0.3976	299.33	558.38	214.5	-0.0133
119.77	0.102	252.8	0.3976	299.43	560.15	214.9	-0.0124
119.80	0.103	253.1	0.3994	299.50	561.38	215.2	-0.0115
119.83	0.106	253.6	0.3994	299.58	562.29	215.4	-0.0107
119.87	0.104	253.6	0.4012	299.67	564.07	215.8	-0.0098
119.90	0.104	253.6	0.4012	299.75	565.98	216.2	-0.0089
119.93	0.103	253.7	0.4012	299.83	567.37	216.7	-0.008
119.97	0.104	254	0.4021	299.92	568.74	217.1	-0.0071
120.00	0.106	254.3	0.4039	300.00	570.58	217.5	-0.0062
120.03	0.106	254.7	0.4056	300.08	572.46	217.9	-0.0044
120.07	0.108	254.9	0.4056	300.17	575.5	218.7	-0.0036
120.10	0.107	255	0.4065	300.25	575.47	218.9	-0.0027
120.13	0.107	255	0.4065	300.33	576.57	219.4	-0.0018
120.17	0.108	255.2	0.4074	300.42	580.68	220.2	-0.0009
120.22	0.11	255.8	0.4101	300.50	580.84	220.5	0.0018
120.25	0.11	255.8	0.4101	300.58	583.4	221.2	0.0027
120.27	0.109	256	0.4101	300.67	585.79	221.8	0.0044
120.30	0.109	256.2	0.411	300.75	586.66	222.3	0.0053
120.33	0.112	256.7	0.4127	300.85	589.39	223.1	0.0071
120.37	0.112	256.8	0.4127	300.92	591.46	223.7	0.0089
120.40	0.111	256.8	0.4127	301.00	593.72	224.4	0.0107
120.43	0.111	257	0.4127	301.08	595.15	225	0.0124
120.47	0.111	257	0.4136	301.17	597.7	225.7	0.0133
120.50	0.112	257.2	0.4145	301.25	600.78	226.4	0.0151
120.53	0.113	257.6	0.4163	301.33	603.14	227.6	0.0169
120.57	0.114	257.8	0.4181	301.42	605.08	228.3	0.0204
120.60	0.116	258.1	0.4181	301.50	607.15	229	0.0222
120.63	0.114	258.2	0.4181	301.58	610.26	229.8	0.024
120.67	0.114	258.3	0.4181	301.67	611.49	230.5	0.0257
120.70	0.114	258.3	0.4181	301.75	616.71	231.8	0.0293
120.73	0.115	258.5	0.4189	301.83	617.31	232.1	0.0302
120.77	0.115	258.7	0.4198	301.92	617.99	233.1	0.032
120.80	0.117	259.1	0.4216	302.00	621.29	234	0.0355
120.83	0.117	259.2	0.4216	302.08	624.14	235	0.0382
120.87	0.116	259.3	0.4216	302.17	627.89	236.2	0.0417
120.90	0.116	259.4	0.4216	302.25	629.02	236.8	0.0435
120.93	0.116	259.4	0.4216	302.35	632.16	238.1	0.047
120.97	0.118	259.7	0.4225	302.42	634.97	239.1	0.0506
121.00	0.118	259.8	0.4234	302.50	637.78	240	0.0533
121.03	0.121	260.2	0.4252	302.58	639.88	240.9	0.0568
121.07	0.119	260.3	0.4252	302.67	642.05	241.8	0.0595
121.10	0.118	260.3	0.4252	302.75	645.77	242.8	0.0621
121.13	0.117	260.4	0.4243	302.83	648.61	244.2	0.0666
121.17	0.117	260.4	0.4252	302.92	650.52	245.2	0.0719
121.20	0.119	260.7	0.426	303.00	652.95	246.1	0.0754
121.23	0.121	260.9	0.4278	303.08	655.79	247.2	0.0808
121.27	0.12	261.1	0.4278	303.17	658.41	248.2	0.0852
121.30	0.12	261.2	0.4278	303.25	660.18	249	0.0897
121.33	0.119	261.3	0.4278	303.33	664.8	250.3	0.095
121.37	0.119	261.3	0.4278	303.42	666.78	251.7	0.1003
121.40	0.119	261.3	0.4278	303.50	669.3	252.7	0.1092
121.43	0.122	261.7	0.4296	303.58	671.88	253.7	0.1145
121.47	0.121	261.8	0.4287	303.67	674.98	254.8	0.1198
121.50	0.12	261.8	0.4296	303.77	677.33	256	0.1234
121.53	0.12	261.9	0.4296	303.83	679.65	256.9	0.1296
121.57	0.123	262.3	0.4296	303.92	683.43	257.9	0.1349
121.60	0.121	262.3	0.4305	304.00	685.62	258.9	0.1394
121.63	0.121	262.3	0.4305	304.08	687.56	259.9	0.1438
121.68	0.121	262.5	0.4305	304.17	689.56	260.7	0.1473
121.72	0.122	262.8	0.4305	304.25	693.52	261.7	0.1518

Prova triassiale ciclica SNGR03-C4							
tensione di confinamento (kPa)		450			tensione di confinamento (kPa)		450
deviatore ciclico (kPa)		80			deviatore ciclico (kPa)		120
frequenza (hz)		0.00071429			frequenza (hz)		0.0007143
121.73	0.122	262.8	0.4323	304.33	696.46	263.3	0.1562
121.77	0.122	262.8	0.4314	304.42	698.65	264.2	0.1624
121.80	0.121	262.9	0.4314	304.50	700.88	265.1	0.166
121.83	0.121	263	0.4314	304.58	703.92	266.2	0.1704
121.87	0.121	263	0.4314	304.67	705.84	267.1	0.1758
121.90	0.12	263.1	0.4314	304.75	708.55	268.1	0.1802
121.93	0.121	263.3	0.4323	304.83	711.55	269.1	0.1837
121.97	0.121	263.3	0.4331	304.92	716.93	270.9	0.1882
122.00	0.124	263.7	0.434	305.00	715.54	271.3	0.1935
122.03	0.123	263.7	0.434	305.08	718.31	272.3	0.1979
122.07	0.122	263.7	0.4331	305.17	721.24	273.3	0.2015
122.10	0.121	263.8	0.4331	305.25	723.59	274.5	0.205
122.13	0.121	263.8	0.4331	305.33	725.28	275.4	0.2104
122.17	0.121	263.9	0.4331	305.42	728.3	276.3	0.2139
122.20	0.121	263.9	0.434	305.50	730.87	277.3	0.2184
122.23	0.121	264	0.434	305.58	734.19	278.5	0.2237
122.27	0.121	264.1	0.434	305.67	732.77	278.8	0.2246
122.30	0.121	264.1	0.434	305.75	737.83	279.9	0.229
122.33	0.121	264.2	0.434	305.83	739.27	281.2	0.2326
122.37	0.121	264.3	0.434	305.92	741.63	282.1	0.237
122.40	0.122	264.5	0.434	306.00	743.07	282.8	0.2406
122.43	0.122	264.5	0.4349	306.08	745.64	283.7	0.2441
122.47	0.121	264.5	0.434	306.17	746.51	284.4	0.2468
122.50	0.12	264.5	0.434	306.25	748.92	285.3	0.2503
122.53	0.12	264.5	0.434	306.33	751.47	286.1	0.253
122.57	0.12	264.6	0.434	306.42	753.36	287.2	0.2565
122.60	0.119	264.7	0.4349	306.50	754.71	288	0.261
122.63	0.121	264.8	0.4349	306.58	756.29	288.8	0.2636
122.67	0.121	264.8	0.4349	306.68	758.16	289.5	0.2663
122.70	0.12	264.8	0.4349	306.75	760.57	290.6	0.269
122.73	0.119	264.8	0.434	306.83	764.23	291.7	0.2743
122.77	0.119	264.8	0.434	306.92	762.88	292	0.2752
122.80	0.119	264.9	0.434	307.00	763.33	292.4	0.2769
122.83	0.118	264.9	0.434	307.08	765.77	293.2	0.2796
122.87	0.119	265	0.434	307.17	767.45	293.9	0.2823
122.90	0.118	265	0.434	307.25	769.08	294.5	0.284
122.93	0.118	265	0.434	307.33	770.4	295.5	0.2867
122.97	0.118	265	0.434	307.42	771.46	296.1	0.2894
123.00	0.117	265	0.4331	307.50	772.84	296.7	0.2911
123.03	0.117	265	0.4331	307.58	774.1	297.3	0.2929
123.07	0.117	265	0.4331	307.67	776.22	298.1	0.2965
123.12	0.116	265	0.4331	307.75	774.96	298.3	0.2965
123.15	0.116	265	0.4331	307.83	777.5	298.9	0.2982
123.18	0.116	265.1	0.4323	307.92	777.82	299.6	0.3
123.20	0.115	265.1	0.4323	308.00	778.81	300.1	0.3027
123.23	0.114	265.1	0.4323	308.10	779.62	300.6	0.3045
123.27	0.114	265.1	0.4323	308.17	780.75	301.2	0.3062
123.30	0.115	265.2	0.4323	308.25	779.91	301.4	0.3062
123.33	0.114	265.1	0.4314	308.33	781.74	302	0.3089
123.37	0.114	265.1	0.4314	308.42	782.38	302.4	0.3098
123.40	0.113	265.1	0.4314	308.50	783.38	302.9	0.3116
123.43	0.113	265.1	0.4314	308.58	783.02	303.1	0.3116
123.47	0.111	265.1	0.4314	308.67	785.01	303.8	0.3142
123.50	0.111	265	0.4305	308.75	783.05	303.7	0.3133
123.53	0.112	265	0.4305	308.83	784.34	304.3	0.3142
123.57	0.111	265	0.4305	308.92	784.43	304.5	0.316
123.60	0.111	264.9	0.4305	309.00	787.1	305.2	0.3178
123.63	0.111	265	0.4305	309.08	784.66	305.1	0.3169
123.67	0.111	264.9	0.4305	309.17	784.14	305.2	0.3169
123.70	0.108	264.9	0.4296	309.25	784.75	305.5	0.3178

Prova triassiale ciclica SNGR03-C4							
tensione di confinamento (kPa)		450			tensione di confinamento (kPa)		450
deviatore ciclico (kPa)		80			deviatore ciclico (kPa)		120
frequenza (hz)		0.00071429			frequenza (hz)		0.0007143
123.73	0.108	264.7	0.4287	309.33	785.07	305.8	0.3187
123.77	0.108	264.7	0.4287	309.42	786.49	306.3	0.3204
123.80	0.108	264.7	0.4287	309.50	783.33	306	0.3187
123.83	0.109	264.8	0.4287	309.60	782.98	306.1	0.3187
123.87	0.108	264.7	0.4278	309.67	784.13	306.4	0.3196
123.90	0.105	264.4	0.4278	309.75	784.91	306.7	0.3204
123.93	0.104	264.4	0.426	309.83	782.95	306.6	0.3196
123.97	0.104	264.4	0.426	309.92	782.75	306.6	0.3196
124.00	0.105	264.4	0.426	310.00	782.11	306.7	0.3196
124.03	0.105	264.4	0.426	310.08	782.72	306.9	0.3196
124.07	0.103	264.2	0.4252	310.17	779.15	306.4	0.3178
124.10	0.103	264.2	0.4252	310.25	782.01	306.6	0.3178
124.13	0.103	264.1	0.4252	310.33	778.02	306.4	0.3178
124.17	0.103	264.1	0.4243	310.42	778.02	306.4	0.3169
124.20	0.103	264.1	0.4243	310.50	779.44	306.7	0.3178
124.23	0.102	264.1	0.4243	310.58	776.51	306.3	0.316
124.27	0.099	263.7	0.4216	310.67	775.93	306.3	0.316
124.30	0.099	263.7	0.4216	310.75	774.74	306.1	0.3151
124.33	0.099	263.7	0.4216	310.83	773.19	305.9	0.3142
124.37	0.099	263.7	0.4216	310.92	772.04	305.7	0.3133
124.40	0.099	263.7	0.4216	311.02	771.11	305.5	0.3124
124.43	0.099	263.6	0.4216	311.08	770.3	305.4	0.3116
124.47	0.095	263.2	0.4189	311.17	767.57	305	0.3098
124.50	0.095	263.2	0.4189	311.25	767.11	304.7	0.3089
124.53	0.096	263.2	0.4189	311.33	767.31	304.7	0.3089
124.58	0.094	263.1	0.4181	311.42	762.42	303.8	0.3053
124.62	0.094	263	0.4181	311.50	763.19	303.9	0.3053
124.63	0.094	263	0.4181	311.58	761.55	303.5	0.3036
124.67	0.091	262.7	0.4154	311.67	759.53	303.1	0.3027
124.70	0.091	262.6	0.4154	311.75	757.46	302.7	0.3018
124.73	0.091	262.6	0.4154	311.83	755.79	302.2	0.3
124.77	0.091	262.5	0.4154	311.92	755.28	302	0.2982
124.80	0.09	262.4	0.4145	312.00	751.8	301.2	0.2956
124.83	0.089	262.2	0.4136	312.08	750.39	300.8	0.2938
124.87	0.088	262.1	0.4127	312.17	749.07	300.5	0.2929
124.90	0.088	262	0.4127	312.25	747	299.9	0.2911
124.93	0.087	261.9	0.4127	312.33	744.89	299.5	0.2885
124.97	0.085	261.9	0.4118	312.42	741.85	298.6	0.2867
125.00	0.085	261.7	0.411	312.52	740.54	298.2	0.2849
125.03	0.085	261.6	0.4101	312.58	740.73	298.1	0.2832
125.07	0.084	261.5	0.4101	312.67	735.32	296.9	0.2796
125.10	0.082	261.2	0.4083	312.75	734	296.3	0.2787
125.13	0.083	261.2	0.4083	312.83	732.68	295.8	0.2761
125.17	0.081	261	0.4083	312.92	729.66	295	0.2734
125.20	0.081	261	0.4074	313.00	725.21	293.9	0.269
125.23	0.081	260.9	0.4065	313.08	725.54	293.7	0.2681
125.27	0.081	260.8	0.4065	313.17	723.19	293.2	0.2663
125.30	0.08	260.6	0.4056	313.25	719.75	292.1	0.2619
125.33	0.078	260.4	0.4039	313.33	717.33	291.3	0.2601
125.37	0.077	260.2	0.403	313.42	715.11	290.6	0.2556
125.40	0.075	260	0.403	313.50	713.37	290	0.253
125.43	0.073	260	0.4021	313.58	708.38	288.8	0.2485
125.47	0.073	259.7	0.4003	313.67	708.38	288.3	0.2459
125.50	0.073	259.6	0.3994	313.75	706.18	287.7	0.2432
125.53	0.074	259.5	0.3994	313.83	702.19	286.8	0.2406
125.57	0.074	259.5	0.3994	313.93	700.97	285.7	0.2352
125.60	0.069	258.9	0.3959	314.00	700.48	285.3	0.2334
125.63	0.068	258.7	0.3959	314.08	695.39	284	0.2281
125.67	0.069	258.7	0.395	314.17	691.27	283.3	0.2255
125.70	0.069	258.6	0.395	314.25	689.63	282	0.2219

Prova triassiale ciclica SNGR03-C4								
pressione di confinamento (kPa)		450		pressione di confinamento (kPa)		450		
deviatore ciclico (kPa)		80		deviatore ciclico (kPa)		120		
frequenza (hz)		0.00071429		frequenza (hz)		0.0007143		
125.73	0.069	258.6	0.395	314.33	689.24	281.5	0.2175	
125.77	0.066	258.2	0.3923	314.42	685.43	280.3	0.213	
125.80	0.066	258.1	0.3923	314.50	681.34	279.2	0.2086	
125.83	0.065	257.8	0.3914	314.58	679.64	278.4	0.2042	
125.87	0.064	257.6	0.3914	314.67	677.28	277.5	0.2006	
125.90	0.062	257.6	0.3896	314.75	670.57	276.8	0.1979	
125.93	0.062	257.4	0.3888	314.83	671.77	275.3	0.1926	
125.97	0.063	257.4	0.3879	314.92	668.77	274.3	0.1864	
126.02	0.059	256.9	0.3861	315.00	666.08	273.3	0.182	
126.05	0.059	256.7	0.3861	315.08	663.29	272.2	0.1766	
126.08	0.06	256.8	0.3861	315.17	662.18	271.5	0.1722	
126.10	0.059	256.6	0.3843	315.25	658.02	270.1	0.1669	
126.13	0.054	256	0.3817	315.33	656.57	269.5	0.1642	
126.17	0.056	256	0.3817	315.42	649.95	267.9	0.1562	
126.20	0.057	255.9	0.3817	315.50	650.69	267.4	0.1536	
126.23	0.051	255.9	0.3817	315.58	647.7	266.3	0.1482	
126.27	0.051	255.3	0.3781	315.67	644.2	265.3	0.1429	
126.30	0.052	255.3	0.3781	315.75	641.39	263.9	0.1367	
126.33	0.053	255.2	0.3781	315.83	641.52	263.4	0.1296	
126.37	0.052	254.9	0.3754	315.92	636.74	262	0.1225	
126.40	0.047	254.3	0.3728	316.00	633.54	260.8	0.1163	
126.43	0.046	254	0.3728	316.08	634.54	260.5	0.1136	
126.47	0.046	254	0.3719	316.17	630.05	259.1	0.1065	
126.50	0.046	253.9	0.371	316.25	625.2	257.4	0.0994	
126.53	0.046	253.7	0.3701	316.33	622.91	256.2	0.0959	
126.57	0.047	253.7	0.3701	316.42	621.22	255.3	0.0888	
126.60	0.044	253.3	0.3683	316.50	618.76	254.2	0.0843	
126.63	0.043	253	0.3666	316.58	617.31	253.3	0.0808	
126.67	0.041	252.7	0.3666	316.67	614.4	252.2	0.0772	
126.70	0.039	252.7	0.3648	316.75	611.65	251.1	0.0728	
126.73	0.039	252.3	0.3621	316.85	608.67	249.4	0.0666	
126.77	0.036	251.9	0.3604	316.92	606.76	248.5	0.0639	
126.80	0.037	251.7	0.3595	317.00	604.43	247.5	0.0604	
126.83	0.037	251.7	0.3595	317.08	602.4	246.5	0.0586	
126.87	0.037	251.5	0.3586	317.17	598.71	245.5	0.055	
126.90	0.034	251.1	0.3586	317.25	597.8	244.1	0.0533	
126.93	0.031	251.1	0.3568	317.33	595.24	243	0.0479	
126.97	0.031	250.6	0.3541	317.42	592.3	241.9	0.0453	
127.00	0.031	250.5	0.3524	317.50	591.36	241	0.0426	
127.03	0.031	250.3	0.3524	317.58	589.45	240.2	0.0399	
127.07	0.032	250.3	0.3515	317.67	586.99	239.1	0.0382	
127.10	0.03	249.8	0.3488	317.75	584.24	238.1	0.0346	
127.13	0.025	249.2	0.3488	317.83	582.01	236.8	0.0328	
127.17	0.026	249.2	0.347	317.92	580.94	236	0.0293	
127.20	0.026	249.1	0.3453	318.00	578.35	234.9	0.0275	
127.23	0.023	248.5	0.3417	318.08	576.83	234.1	0.0257	
127.27	0.021	248.2	0.3408	318.17	577.46	233.7	0.0249	
127.30	0.024	248.3	0.3408	318.27	573.43	232	0.0204	
127.33	0.021	247.7	0.3364	318.33	571.77	231.3	0.0186	
127.37	0.019	247.5	0.3364	318.42	569.54	230.4	0.0169	
127.40	0.019	247.5	0.3346	318.50	568.7	229.8	0.0151	
127.43	0.019	247.3	0.3346	318.58	566.85	229	0.0133	
127.48	0.018	246.9	0.3337	318.67	565.68	228	0.0115	
127.52	0.013	246.9	0.332	318.75	564.23	227.2	0.0107	
127.53	0.013	246.2	0.3284	318.83	562.61	226.5	0.008	
127.57	0.015	246.1	0.3275	318.92	558.33	225.3	0.0053	
127.60	0.015	246	0.3275	319.00	560.63	225.1	0.0053	
127.63	0.014	245.8	0.3257	319.08	558.75	224.4	0.0036	
127.67	0.012	245.2	0.3222	319.17	557.78	223.7	0.0027	
127.70	0.006	244.5	0.3222	319.25	555.29	223.1	0.0009	

Prova triassiale ciclica SNGR03-C4							
pressione di confinamento (kPa)		450			pressione di confinamento (kPa)		450
deviatore ciclico (kPa)		80			deviatore ciclico (kPa)		120
frequenza (hz)		0.00071429			frequenza (hz)		0.0007143
127.73	0.007	244.5	0.3177	319.33	555.83	222.4	0
127.77	0.007	244.3	0.3169	319.42	554.41	221.8	-0.0018
127.80	0.009	244.3	0.3169	319.50	552.69	221.1	-0.0027
127.83	0.01	244.2	0.3169	319.58	551.76	220.6	-0.0036
127.87	0.006	243.8	0.3142	319.67	551.75	220.1	-0.0053
127.90	0.004	243.4	0.3115	319.77	550.2	219.3	-0.0062
127.93	0.002	243	0.3115	319.83	549.29	218.8	-0.0071
127.97	-0.001	243	0.3098	319.92	549.35	218.4	-0.008
128.00	-0.001	242.5	0.3062	320.00	548.28	217.9	-0.0089
128.03	0.001	242.5	0.3053	320.08	547.76	217.5	-0.0098
128.07	0.001	242.4	0.3044	320.17	547.09	217.2	-0.0098
128.10	-0.001	241.9	0.3009	320.25	546.79	216.6	-0.0107
128.13	-0.003	241.5	0.2973	320.33	544.95	215.9	-0.0124
128.17	-0.005	241.1	0.2973	320.42	546.11	215.9	-0.0124
128.20	-0.006	241.1	0.2929	320.50	546.34	215.6	-0.0133
128.23	-0.006	240.8	0.2893	320.58	545.57	215.3	-0.0133
128.27	-0.009	240.2	0.2822	320.67	545.99	215.2	-0.0133
128.30	-0.01	240	0.2787	320.75	545.62	215	-0.0133
128.33	-0.008	240	0.276	320.83	544.68	214.4	-0.0151
128.37	-0.012	239.3	0.2698	320.92	545.17	214.3	-0.0151
128.40	-0.012	239.1	0.2698	321.00	545.25	214.1	-0.0151
128.43	-0.01	239.1	0.2654	321.08	544.55	213.9	-0.0151
128.47	-0.01	239.2	0.2627	321.18	545.1	213.7	-0.016
128.50	-0.013	238.4	0.2574	321.25	545.72	213.7	-0.0151
128.53	-0.018	237.9	0.2521	321.33	546.17	213.6	-0.0151
128.57	-0.017	237.7	0.2476	321.42	544.94	213.3	-0.016
128.60	-0.017	237.5	0.245	321.50	545.94	213.3	-0.016
128.63	-0.022	236.7	0.245	321.58	547.5	213.5	-0.0151
128.67	-0.02	236.7	0.2387	321.67	547.82	213.4	-0.0151
128.70	-0.02	236.6	0.2361	321.75	548.53	213.5	-0.0151
128.73	-0.02	236.3	0.2316	321.83	548.79	213.4	-0.0151
128.77	-0.022	236.1	0.2299	321.92	549.58	213.6	-0.0151
128.80	-0.023	235.7	0.2263	322.00	550.89	213.7	-0.0142
128.83	-0.026	235.1	0.2219	322.08	551.51	213.7	-0.0142
128.87	-0.027	234.8	0.2219	322.17	552.58	213.9	-0.0133
128.92	-0.027	234.6	0.2166	322.25	553.26	214	-0.0133
128.95	-0.027	234.3	0.2139	322.33	555.88	214.5	-0.0115
128.98	-0.029	233.9	0.2139	322.42	555.4	214.4	-0.0124
129.00	-0.028	233.9	0.2112	322.50	555.88	214.5	-0.0115
129.03	-0.028	233.8	0.2103	322.58	557.66	214.8	-0.0107
129.07	-0.029	233.3	0.2068	322.68	558.73	215.1	-0.0107
129.10	-0.033	232.8	0.2032	322.75	560.35	215.4	-0.0098
129.13	-0.034	232.4	0.2006	322.83	561.05	215.7	-0.0089
129.17	-0.036	231.8	0.197	322.92	563.71	216.1	-0.0071
129.20	-0.036	231.7	0.197	323.00	563.06	216.1	-0.008
129.23	-0.035	231.7	0.1961	323.08	564.63	216.4	-0.0071
129.27	-0.035	231.6	0.1935	323.17	567.67	217.1	-0.0053
129.30	-0.038	230.9	0.1908	323.25	569.19	217.6	-0.0044
129.33	-0.04	230.4	0.1882	323.33	570.87	218	-0.0036
129.37	-0.041	230.2	0.1873	323.42	572.29	218.4	-0.0027
129.40	-0.038	230.3	0.1873	323.50	573.92	218.9	-0.0009
129.43	-0.04	229.9	0.1873	323.58	577.57	219.7	0.0009
129.47	-0.042	229.9	0.1855	323.67	577.38	219.9	0.0009
129.50	-0.042	229.4	0.1828	323.75	580.2	220.6	0.0018
129.53	-0.046	228.7	0.1793	323.83	582.04	221.2	0.0036
129.57	-0.046	228.4	0.1775	323.92	583.17	221.6	0.0053
129.60	-0.046	228.2	0.1766	324.00	584.15	222	0.0062
129.63	-0.047	227.8	0.1748	324.10	587.51	223	0.008
129.67	-0.048	227.5	0.1748	324.17	589.51	223.6	0.0089
129.70	-0.049	227.5	0.1731	324.25	591.52	224.2	0.0115

Prova triassiale ciclica SNGR03-C4

pressione di confinamento (kPa)		450	tensione di confinamento (kPa)		450		
deviatore ciclico (kPa)		80	deviatore ciclico (kPa)		120		
frequenza (hz)		0.00071429	frequenza (hz)		0.0007143		
129.73	-0.049	227.2	0.1722	324.33	593.66	224.9	0.0133
129.77	-0.05	226.8	0.1695	324.42	597.09	225.8	0.0151
129.80	-0.052	226.4	0.1686	324.50	597.48	226.2	0.016
129.83	-0.053	226	0.1669	324.58	599.97	226.9	0.0178
129.87	-0.053	225.8	0.166	324.67	603.3	228	0.0204
129.90	-0.054	225.5	0.166	324.75	605.47	228.9	0.0213
129.93	-0.055	225.5	0.1642	324.83	607.64	229.6	0.0249
129.97	-0.055	225.2	0.1633	324.92	609.61	230.3	0.0266
130.00	-0.056	224.9	0.1615	325.00	611.66	231.1	0.0284
130.03	-0.058	224.4	0.1597	325.08	614.05	231.8	0.0302
130.07	-0.058	224.1	0.1589	325.17	616.57	232.7	0.0328
130.10	-0.06	223.7	0.1571	325.25	620.06	233.9	0.0355
130.13	-0.06	223.4	0.1571	325.33	622.71	234.9	0.0373
130.17	-0.061	223.4	0.1562	325.42	624.85	235.7	0.0408
130.20	-0.061	223.1	0.1544	325.50	626.92	236.4	0.0426
130.23	-0.062	222.7	0.1535	325.58	629.99	237.7	0.0453
130.27	-0.063	222.4	0.1518	325.67	633.16	238.8	0.0488
130.30	-0.065	222	0.1509	325.75	634.78	239.8	0.0541
130.33	-0.065	221.8	0.15	325.83	638.11	240.7	0.0568
130.38	-0.066	221.5	0.1482	325.92	638.98	241.4	0.0586
130.42	-0.066	221.2	0.1473	326.00	641.28	242.2	0.0612
130.43	-0.067	220.8	0.1464	326.08	644.61	243.3	0.0648
130.47	-0.068	220.4	0.1464	326.17	648.74	244.8	0.0692
130.50	-0.069	220.4	0.1447	326.25	650.97	245.8	0.0719
130.53	-0.069	220.2	0.1438	326.33	654.04	246.8	0.079
130.57	-0.07	219.8	0.1429	326.42	656.92	248	0.0843
130.60	-0.073	219.3	0.1411	326.50	659.08	248.9	0.0888
130.63	-0.073	219	0.1402	326.58	661.48	249.9	0.0941
130.67	-0.073	218.8	0.1393	326.67	663.93	250.9	0.0985
130.70	-0.074	218.5	0.1393	326.75	666.22	252	0.1039
130.73	-0.075	218.5	0.1384	326.83	670.85	253.5	0.1101
130.77	-0.075	218.2	0.1376	326.92	672.29	254.3	0.1163
130.80	-0.075	217.9	0.1367	327.02	675.87	255.3	0.1216
130.83	-0.076	217.6	0.1358	327.08	677.75	256.5	0.1234
130.87	-0.077	217.4	0.1349	327.17	680.62	257.5	0.1278
130.90	-0.078	217.1	0.134	327.25	683.1	258.7	0.1367
130.93	-0.078	216.8	0.134	327.33	685.34	259.5	0.1394
130.97	-0.079	216.8	0.1331	327.42	687.78	260.5	0.1447
131.00	-0.079	216.5	0.1322	327.50	690.72	261.5	0.1482
131.03	-0.079	216.2	0.1313	327.58	692.63	262.5	0.1527
131.07	-0.081	215.9	0.1305	327.67	696.56	263.9	0.1571
131.10	-0.082	215.6	0.1296	327.75	698.69	264.8	0.1607
131.13	-0.082	215.4	0.1287	327.83	701.16	265.7	0.1678
131.17	-0.086	214.7	0.1287	327.92	703.3	266.7	0.1704
131.20	-0.084	214.7	0.126	328.00	706.43	267.8	0.1758
131.23	-0.084	214.7	0.126	328.08	708.22	268.6	0.1802
131.27	-0.083	214.6	0.126	328.17	710.83	269.6	0.1846
131.30	-0.085	214.2	0.1251	328.25	714.38	271.1	0.1882
131.33	-0.085	214	0.1242	328.33	716.99	272.1	0.1926
131.37	-0.086	213.7	0.1234	328.43	718.39	273	0.1979
131.40	-0.087	213.5	0.1234	328.50	721.05	273.8	0.2015
131.43	-0.088	213.5	0.1225	328.58	724.47	275.2	0.205
131.47	-0.088	213.2	0.1225	328.67	725.98	276.1	0.2095
131.50	-0.088	212.9	0.1216	328.75	728.46	276.9	0.2148
131.53	-0.089	212.6	0.1207	328.83	730.35	277.8	0.2184
131.57	-0.09	212.4	0.1198	328.92	732.38	278.7	0.2219
131.60	-0.09	212.2	0.1198	329.00	734.51	279.7	0.2255
131.63	-0.091	211.9	0.1198	329.08	736.44	280.5	0.229
131.67	-0.092	211.9	0.118	329.17	739.34	281.8	0.2326
131.70	-0.092	211.6	0.118	329.25	741.88	282.7	0.2361

Prova triassiale ciclica SNGR03-C4							
tensione di confinamento (kPa)		450	tensione di confinamento (kPa)		450		
deviatore ciclico (kPa)		80	deviatore ciclico (kPa)		120		
frequenza (hz)		0.00071429	frequenza (hz)		0.0007143		
131.73	-0.092	211.4	0.1171	329.33	742.88	283.3	0.2406
131.77	-0.093	211.1	0.1163	329.42	745.32	284.3	0.2441
131.80	-0.093	210.9	0.1154	329.50	747.61	285.2	0.2477
131.85	-0.093	210.7	0.1154	329.58	748.47	285.8	0.2503
131.88	-0.094	210.5	0.1145	329.67	751.11	286.7	0.253
131.90	-0.095	210.2	0.1136	329.75	753.36	287.9	0.2565
131.93	-0.095	210	0.1136	329.83	755.17	288.7	0.2592
131.97	-0.095	209.8	0.1136	329.93	756.32	289.3	0.2636
132.00	-0.096	209.8	0.1127	330.00	758.25	290.1	0.2663
132.03	-0.096	209.6	0.1109	330.08	760.67	291.2	0.269
132.07	-0.097	209.4	0.1109	330.17	761.67	291.9	0.2716
132.10	-0.097	209.1	0.11	330.25	762.98	292.5	0.2752
132.13	-0.098	208.9	0.1092	330.33	764.68	293.2	0.2778
132.17	-0.098	208.7	0.1092	330.42	765.87	293.8	0.2796
132.20	-0.098	208.6	0.1092	330.50	767.15	294.4	0.2823
132.23	-0.1	208.6	0.1083	330.58	771.21	295.4	0.2858
132.27	-0.1	208.3	0.1074	330.67	770.34	296	0.2858
132.30	-0.099	208.2	0.1074	330.75	771.56	296.7	0.2876
132.33	-0.1	208	0.1074	330.83	772.81	297.3	0.2911
132.37	-0.1	207.7	0.1065	330.92	774.25	297.8	0.2929
132.40	-0.101	207.5	0.1056	331.00	774.64	298.3	0.2947
132.43	-0.101	207.3	0.1056	331.08	775.7	298.8	0.2965
132.47	-0.101	207.3	0.1056	331.17	776.34	299.3	0.2982
132.50	-0.101	207.2	0.1047	331.25	777.31	300.1	0.3009
132.53	-0.102	207	0.1047	331.35	779.04	300.7	0.3027
132.57	-0.103	206.7	0.1038	331.42	779.23	301	0.3036
132.60	-0.103	206.6	0.1038	331.50	780.39	301.5	0.3053
132.63	-0.103	206.4	0.1029	331.58	781.42	302.2	0.3071
132.67	-0.103	206.3	0.1029	331.67	782.96	302.7	0.3089
132.70	-0.103	206.3	0.1029	331.75	781.09	302.8	0.3098
132.73	-0.103	206.1	0.1021	331.83	782.95	303.3	0.3107
132.77	-0.103	205.9	0.1021	331.92	785.27	304	0.3133
132.80	-0.104	205.8	0.1021	332.00	783.34	304	0.3133
132.83	-0.104	205.6	0.1012	332.08	782.66	304.1	0.3124
132.87	-0.104	205.5	0.1003	332.17	784.98	304.9	0.3142
132.90	-0.105	205.3	0.1003	332.25	784.17	305	0.3151
132.93	-0.105	205.3	0.1003	332.33	784.66	305.3	0.316
132.97	-0.105	205.2	0.1003	332.42	785.75	305.7	0.3169
133.00	-0.105	205.1	0.1003	332.50	784.68	305.8	0.3169
133.03	-0.105	204.9	0.0994	332.58	784.52	305.9	0.3169
133.07	-0.105	204.8	0.0994	332.67	785.04	306.2	0.3178
133.10	-0.106	204.6	0.0994	332.75	784.84	306.4	0.3187
133.13	-0.106	204.5	0.0994	332.85	786.04	306.8	0.3196
133.17	-0.106	204.5	0.0985	332.92	784.52	306.8	0.3187
133.20	-0.106	204.4	0.0985	333.00	783.68	306.8	0.3187
133.23	-0.106	204.2	0.0985	333.08	783.78	307	0.3187
133.28	-0.106	204	0.0976	333.17	782.82	307	0.3187
133.32	-0.106	204	0.0976	333.25	782.66	307.1	0.3187
133.35	-0.106	203.9	0.0976	333.33	783.07	307.3	0.3187
133.37	-0.107	203.8	0.0976	333.42	781.08	307.1	0.3178
133.40	-0.107	203.6	0.0967	333.50	779.6	306.9	0.3169
133.43	-0.107	203.5	0.0967	333.58	782.52	307.1	0.3178
133.47	-0.107	203.4	0.0967	333.67	778.79	307	0.3169
133.50	-0.107	203.3	0.0967	333.75	778.44	307	0.3169
133.53	-0.107	203.3	0.0967	333.83	777.76	306.9	0.316
133.57	-0.107	203.2	0.0967	333.92	776.67	306.8	0.3151
133.60	-0.106	203.1	0.0967	334.00	777.27	306.9	0.316
133.63	-0.106	203.1	0.0958	334.08	774.26	306.5	0.3133
133.67	-0.107	203	0.0958	334.17	773.55	306.5	0.3133
133.70	-0.107	202.9	0.0958	334.27	772.61	306.3	0.3124

Prova triassiale ciclica SNGR03-C4							
pressione di confinamento (kPa)		450		pressione di confinamento (kPa)		450	
deviatore ciclico (kPa)		80		deviatore ciclico (kPa)		120	
frequenza (hz)		0.00071429		frequenza (hz)		0.0007143	
133.73	-0.107	202.8	0.0958	334.33	770.21	305.8	0.3107
133.77	-0.107	202.8	0.0958	334.42	769.94	305.7	0.3107
133.80	-0.107	202.7	0.0958	334.50	768.08	305.5	0.3089
133.83	-0.106	202.7	0.0958	334.58	767.15	305.3	0.308
133.87	-0.106	202.6	0.095	334.67	766.09	305	0.3071
133.90	-0.106	202.5	0.095	334.75	761.71	304.2	0.3045
133.93	-0.107	202.4	0.095	334.83	762.87	304.3	0.3045
133.97	-0.106	202.4	0.095	334.92	761.65	304	0.3036
134.00	-0.106	202.4	0.095	335.00	759.17	303.5	0.3018
134.03	-0.106	202.3	0.095	335.08	757.63	303.2	0.3009
134.07	-0.106	202.3	0.095	335.17	757.08	302.8	0.2991
134.10	-0.106	202.3	0.095	335.25	754.47	302.3	0.2974
134.13	-0.106	202.2	0.095	335.33	750.71	301.6	0.2947
134.17	-0.106	202.1	0.095	335.42	750.93	301.4	0.2938
134.20	-0.105	202.1	0.095	335.50	750.93	301.2	0.2929
134.23	-0.105	202.1	0.095	335.58	746.97	300.4	0.2894
134.27	-0.105	202	0.095	335.67	744.3	299.9	0.2876
134.30	-0.105	202	0.095	335.75	742.31	299.2	0.2858
134.33	-0.105	202	0.095	335.83	742.89	299.1	0.2858
134.37	-0.105	202	0.095	335.92	739.57	298.4	0.2832
134.40	-0.104	201.9	0.095	336.00	735.42	297.6	0.2805
134.43	-0.104	201.9	0.095	336.08	733.4	296.7	0.2769
134.47	-0.104	201.9	0.095	336.17	731.98	296.1	0.2743
134.50	-0.104	201.9	0.095	336.25	729.08	295.4	0.2716
134.53	-0.103	201.9	0.095	336.33	726.12	294.6	0.269
134.57	-0.103	201.9	0.095	336.42	725.51	294.1	0.2663
134.60	-0.103	201.8	0.095	336.50	723.25	293.5	0.2645
134.63	-0.103	201.8	0.095	336.58	720	292.8	0.261
134.67	-0.102	201.8	0.095	336.67	717.84	291.8	0.2592
134.70	-0.102	201.8	0.0958	336.75	717.14	291.4	0.2556
134.75	-0.101	201.9	0.0958	336.83	713.37	290.5	0.2521
134.78	-0.1	202	0.0958	336.92	709.63	289.4	0.2477
134.80	-0.1	202	0.0958	337.00	707.96	288.8	0.2459
134.83	-0.1	202	0.0958	337.08	708.15	288.5	0.2441
134.87	-0.1	202	0.0958	337.18	702.61	286.9	0.2379
134.90	-0.1	202	0.0967	337.25	700.49	286.1	0.2343
134.93	-0.1	201.9	0.0958	337.33	696.56	285.1	0.2299
134.97	-0.099	201.9	0.0958	337.42	695.87	284.4	0.2281
135.00	-0.099	201.9	0.0958	337.50	691.72	283.6	0.2246
135.03	-0.099	201.9	0.0967	337.58	689.31	282.3	0.221
135.07	-0.099	201.9	0.0967	337.67	687.08	281.5	0.2148
135.10	-0.097	202.1	0.0967	337.75	684.6	280.6	0.2113
135.13	-0.098	202.1	0.0967	337.83	682.15	279.7	0.2077
135.17	-0.097	202.1	0.0976	337.92	680.18	278.9	0.2042
135.20	-0.097	202.2	0.0976	338.00	678.6	278.2	0.2006
135.23	-0.096	202.2	0.0976	338.08	672.99	276.7	0.1944
135.27	-0.096	202.2	0.0976	338.17	670.48	275.4	0.1917
135.30	-0.095	202.2	0.0976	338.25	668.83	274.6	0.1855
135.33	-0.095	202.2	0.0976	338.33	666.31	273.8	0.182
135.37	-0.094	202.3	0.0985	338.42	663.18	272.7	0.1766
135.40	-0.094	202.4	0.0985	338.50	661.22	271.7	0.1713
135.43	-0.093	202.5	0.0985	338.60	655.63	270	0.1642
135.47	-0.093	202.5	0.0994	338.67	655.27	269.4	0.1616
135.50	-0.093	202.5	0.0994	338.75	652.63	268.6	0.1571
135.53	-0.093	202.5	0.0994	338.83	650.57	267.7	0.1527
135.57	-0.091	202.7	0.1003	338.92	647.21	266.7	0.1473
135.60	-0.091	202.8	0.1003	339.00	644.27	265.6	0.1429
135.63	-0.091	202.8	0.1003	339.08	640.69	264.2	0.1367
135.67	-0.09	203	0.1003	339.17	641.87	263.8	0.1305
135.70	-0.089	203	0.1012	339.25	636.38	262.3	0.1225

Prova triassiale ciclica SNGR03-C4							
tensione di confinamento (kPa)		450	tensione di confinamento (kPa)		450		
deviatore ciclico (kPa)		80	deviatore ciclico (kPa)		120		
frequenza (hz)		0.00071429	frequenza (hz)		0.0007143		
135.73	-0.089	203	0.1012	339.33	633.51	261.2	0.1172
135.77	-0.088	203.1	0.1012	339.42	631.96	260.3	0.1118
135.80	-0.087	203.2	0.1021	339.50	631.56	259.7	0.1083
135.83	-0.087	203.2	0.1021	339.58	625.3	258	0.1012
135.87	-0.088	203.2	0.1021	339.67	623.75	256.7	0.0976
135.90	-0.088	203.3	0.1021	339.75	621.22	255.6	0.0905
135.93	-0.085	203.5	0.1021	339.83	618.41	254.6	0.0861
135.97	-0.085	203.5	0.1029	339.92	613.92	253	0.0808
136.00	-0.085	203.5	0.1029	340.00	614.27	252.4	0.0772
136.03	-0.084	203.7	0.1038	340.10	611.61	251	0.0719
136.07	-0.083	203.9	0.1047	340.17	608.12	249.8	0.0692
136.10	-0.083	204	0.1047	340.25	605.86	248.9	0.0657
136.13	-0.082	204.1	0.1047	340.33	605.18	248.1	0.063
136.18	-0.081	204.3	0.1056	340.42	602.88	247.1	0.0595
136.22	-0.079	204.5	0.1074	340.50	599.19	245.8	0.0568
136.25	-0.077	204.7	0.1074	340.58	597.03	244.3	0.0541
136.27	-0.078	204.8	0.1074	340.67	595.47	243.4	0.0497
136.30	-0.078	204.8	0.1074	340.75	593.01	242.4	0.047
136.33	-0.078	204.8	0.1074	340.83	591.04	241.4	0.0444
136.37	-0.078	204.8	0.1074	340.92	588.96	240.4	0.0417
136.40	-0.077	204.9	0.1083	341.00	586.99	239.5	0.0391
136.43	-0.077	205	0.1083	341.08	584.44	238.6	0.0373
136.47	-0.074	205.4	0.11	341.17	580.16	236.6	0.0337
136.50	-0.073	205.6	0.11	341.25	580.52	236.1	0.0311
136.53	-0.073	205.6	0.1109	341.33	578.7	235.3	0.0284
136.57	-0.073	205.6	0.1109	341.42	576.76	234.4	0.0266
136.60	-0.073	205.7	0.1109	341.52	574.76	233.2	0.0249
136.63	-0.071	205.9	0.1127	341.58	573.88	232.4	0.0222
136.67	-0.071	206	0.1127	341.67	571.9	231.7	0.0204
136.70	-0.07	206.2	0.1136	341.75	569.19	230.7	0.0178
136.73	-0.069	206.4	0.1136	341.83	571.02	230.5	0.0178
136.77	-0.069	206.4	0.1145	341.92	567.63	229.5	0.0151
136.80	-0.068	206.5	0.1145	342.00	565.11	228.5	0.0133
136.83	-0.068	206.7	0.1154	342.08	563.23	227.3	0.0124
136.87	-0.066	206.9	0.1163	342.17	562.67	226.8	0.0098
136.90	-0.065	207.1	0.1163	342.25	560.8	226.1	0.008
136.93	-0.064	207.2	0.1171	342.33	559.98	225.4	0.0071
136.97	-0.063	207.4	0.1171	342.42	558.98	224.8	0.0053
137.00	-0.063	207.4	0.118	342.50	557.81	224.1	0.0036
137.03	-0.062	207.6	0.1189	342.58	556.29	223.4	0.0027
137.07	-0.061	207.8	0.1189	342.67	555	222.6	0.0009
137.10	-0.062	207.9	0.1189	342.75	553.05	221.8	-0.0009
137.13	-0.061	208.1	0.1198	342.83	553.6	221.5	-0.0018
137.17	-0.059	208.4	0.1216	342.92	551.69	220.8	-0.0027
137.20	-0.057	208.6	0.1216	343.02	551.4	220.1	-0.0044
137.23	-0.057	208.6	0.1225	343.08	550.72	219.7	-0.0053
137.27	-0.057	208.8	0.1225	343.17	549.71	219.2	-0.0062
137.30	-0.056	209	0.1234	343.25	548.78	218.7	-0.0071
137.33	-0.055	209.2	0.1242	343.33	549.58	218.5	-0.0071
137.37	-0.054	209.4	0.1251	343.42	547.67	217.8	-0.0089
137.40	-0.05	210	0.1278	343.50	547.19	217.4	-0.0089
137.43	-0.05	210.1	0.1278	343.58	546.6	216.9	-0.0098
137.47	-0.05	210.1	0.1278	343.67	544.89	216.3	-0.0115
137.50	-0.05	210.1	0.1278	343.75	546.18	216.3	-0.0115
137.53	-0.051	210.3	0.1278	343.83	546.63	215.8	-0.0115
137.57	-0.051	210.4	0.1278	343.92	546.44	215.8	-0.0124
137.60	-0.049	210.7	0.1305	344.00	545.05	215.4	-0.0124
137.65	-0.046	211.1	0.1322	344.08	545.11	215.1	-0.0133
137.68	-0.044	211.3	0.1322	344.17	545.18	214.8	-0.0133
137.70	-0.045	211.4	0.1322	344.25	545.1	214.6	-0.0142

Prova triassiale ciclica SNGR03-C4

pressione di confinamento (kPa)		450			pressione di confinamento (kPa)		450		
deviatore ciclico (kPa)		80			deviatore ciclico (kPa)		120		
frequenza (hz)		0.00071429			frequenza (hz)		0.0007143		
137.73	-0.044	211.6	0.134	344.33	545.27	214.5	-0.0142		
137.77	-0.043	211.9	0.134	344.43	545.14	214.3	-0.0142		
137.80	-0.043	211.9	0.1349	344.50	545.33	214.1	-0.0142		
137.83	-0.042	212.1	0.1349	344.58	545.82	214	-0.0142		
137.87	-0.041	212.4	0.1367	344.67	546.01	213.9	-0.0142		
137.90	-0.036	213.1	0.1393	344.75	546.3	213.8	-0.0142		
137.93	-0.037	213.1	0.1393	344.83	546.37	213.8	-0.0151		
137.97	-0.039	213.1	0.1384	344.92	545.56	213.5	-0.0151		
138.00	-0.038	213.2	0.1384	345.00	548.5	213.7	-0.0142		
138.03	-0.038	213.2	0.1393	345.08	548.53	213.8	-0.0142		
138.07	-0.036	213.6	0.1411	345.17	548.8	213.7	-0.0142		
138.10	-0.031	214.4	0.1447	345.25	549.7	213.8	-0.0133		
138.13	-0.031	214.5	0.1447	345.33	550.67	214	-0.0133		
138.17	-0.032	214.6	0.1455	345.42	551.58	214.4	-0.0124		
138.20	-0.031	214.8	0.1464	345.50	553.26	214.4	-0.0124		
138.23	-0.031	214.9	0.1464	345.58	553.23	214.4	-0.0124		
138.27	-0.03	214.9	0.1464	345.67	553.94	214.5	-0.0124		
138.30	-0.03	215.2	0.1473	345.75	555.3	214.7	-0.0115		
138.33	-0.028	215.6	0.15	345.83	556.21	214.9	-0.0107		
138.37	-0.025	216	0.1518	345.92	558.02	215.1	-0.0107		
138.40	-0.025	216.2	0.1518	346.00	558.76	215.5	-0.0098		
138.43	-0.024	216.5	0.1535	346.08	560.29	215.7	-0.0089		
138.47	-0.022	216.8	0.1535	346.17	561.46	216	-0.008		
138.50	-0.022	216.8	0.1544	346.25	563.3	216.4	-0.0071		
138.53	-0.022	217	0.1562	346.33	563.91	216.6	-0.0062		
138.57	-0.02	217.3	0.1571	346.42	564.04	216.7	-0.0062		
138.60	-0.016	218	0.1606	346.50	568.05	217.4	-0.0044		
138.63	-0.017	218.1	0.1606	346.58	569.06	217.9	-0.0036		
138.67	-0.018	218.2	0.1615	346.67	570.71	218.3	-0.0027		
138.70	-0.015	218.7	0.1615	346.75	572.2	218.7	-0.0018		
138.73	-0.015	218.7	0.1633	346.83	574.37	219.3	0		
138.77	-0.015	218.8	0.1642	346.92	575.02	219.6	0		
138.80	-0.013	219.2	0.166	347.00	577.29	220.3	0.0018		
138.83	-0.013	219.4	0.1669	347.08	581.94	220.8	0.0036		
138.87	-0.013	219.5	0.1677	347.17	581.33	221.5	0.0044		
138.90	-0.01	220.1	0.1704	347.25	581.49	221.7	0.0053		
138.93	-0.007	220.4	0.1704	347.35	585.83	222.8	0.0071		
138.97	-0.008	220.4	0.1731	347.42	588.06	223.1	0.0089		
139.00	-0.008	220.7	0.174	347.50	589.52	224	0.0098		
139.03	-0.007	221.1	0.1757	347.58	591.88	224.7	0.0124		
139.07	-0.005	221.5	0.1784	347.67	593.63	225.3	0.0133		
139.12	-0.004	221.7	0.1793	347.75	595.7	226	0.0151		
139.15	-0.004	222	0.1811	347.83	596.7	226.4	0.016		
139.17	0.001	222.6	0.1855	347.92	599.88	227.3	0.0178		
139.20	0	222.7	0.1864	348.00	603.47	228.2	0.0204		
139.23	0.001	223.1	0.1882	348.08	605.08	229.1	0.0222		
139.27	0.001	223.3	0.1882	348.17	606.64	229.9	0.0249		
139.30	0.001	223.3	0.1899	348.25	609.9	230.7	0.0266		
139.33	0.001	223.4	0.1908	348.33	611.94	231.5	0.0293		
139.37	0.003	224	0.1935	348.42	614.95	232.5	0.0328		
139.40	0.005	224.3	0.1961	348.50	615.76	233.1	0.0337		
139.43	0.006	224.6	0.1988	348.58	620.22	234	0.0364		
139.47	0.008	225.1	0.2024	348.67	622.39	235.2	0.0382		
139.50	0.009	225.4	0.2024	348.77	624.3	236.1	0.0417		
139.53	0.01	225.4	0.205	348.83	626.46	236.9	0.0444		
139.57	0.01	225.6	0.2077	348.92	630.02	237.8	0.047		
139.60	0.013	226.3	0.213	349.00	633.32	239.3	0.0515		
139.63	0.014	226.5	0.2174	349.08	633.39	239.8	0.0533		
139.67	0.013	226.6	0.2192	349.17	637.27	240.9	0.0568		
139.70	0.012	226.8	0.221	349.25	639.92	242	0.0595		

Prova triassiale ciclica SNGR03-C4								
tensione di confinamento (kPa)		450			tensione di confinamento (kPa)		450	
deviatore ciclico (kPa)		80			deviatore ciclico (kPa)		120	
frequenza (hz)		0.00071429			frequenza (hz)		0.0007143	
139.73	0.016	227.4	0.221	349.33	641.83	242.8	0.0621	
139.77	0.017	227.4	0.2254	349.42	644.39	243.8	0.0657	
139.80	0.017	227.7	0.2299	349.50	648.74	244.9	0.0701	
139.83	0.017	228	0.2343	349.58	651.07	246.3	0.0728	
139.87	0.022	228.7	0.2423	349.67	655.3	247.7	0.0817	
139.90	0.02	228.8	0.2476	349.75	655.89	248.4	0.0843	
139.93	0.02	229	0.2512	349.83	657.76	249.1	0.0879	
139.97	0.023	229.5	0.2512	349.92	663.7	250.7	0.095	
140.00	0.024	229.5	0.2574	350.00	663.28	251.3	0.0985	
140.03	0.024	229.9	0.2645	350.08	666.71	252.1	0.103	
140.07	0.024	230.5	0.2734	350.17	670.61	253.9	0.1083	
140.10	0.03	231.1	0.2814	350.27	671.01	254.6	0.1145	
140.13	0.026	231	0.2831	350.33	674.29	255.6	0.1198	
140.17	0.028	231.5	0.2867	350.42	675.89	256.9	0.1234	
140.20	0.031	231.9	0.2867	350.50	681.99	258.2	0.1287	
140.23	0.034	231.9	0.2893	350.58	685.18	259.3	0.1358	
140.27	0.034	232.4	0.2929	350.67	685.15	260	0.1385	
140.30	0.032	232.5	0.2938	350.75	688.85	261.1	0.1438	
140.33	0.032	232.7	0.2956	350.83	690.49	262	0.1473	
140.37	0.035	233.3	0.2982	350.92	692.11	262.8	0.15	
140.40	0.036	233.5	0.3	351.00	696.33	264.4	0.1553	
140.43	0.037	233.9	0.3	351.08	700.01	265.6	0.1616	
140.47	0.036	233.9	0.3018	351.17	700.66	266.3	0.166	
140.50	0.036	234	0.3018	351.25	703.81	267.3	0.1704	
140.55	0.042	235	0.3044	351.33	706.75	268.4	0.1758	
140.58	0.042	235	0.308	351.42	708.13	269.2	0.1784	
140.60	0.042	235.1	0.3089	351.50	710.52	270	0.182	
140.63	0.042	235.3	0.3098	351.58	714.23	271.6	0.1864	
140.67	0.041	235.5	0.3098	351.68	716.83	272.5	0.1926	
140.70	0.043	235.9	0.3124	351.75	720.51	273.7	0.1979	
140.73	0.048	236.5	0.3169	351.83	720.44	274.4	0.2006	
140.77	0.049	236.8	0.3169	351.92	724.04	275.7	0.2042	
140.80	0.047	236.8	0.3177	352.00	724.76	276.4	0.2077	
140.83	0.047	236.9	0.3186	352.08	727.59	277.3	0.213	
140.87	0.047	237.1	0.3186	352.17	730.2	278.3	0.2166	
140.90	0.051	237.6	0.3213	352.25	732.45	279.3	0.2201	
140.93	0.051	237.9	0.3231	352.33	734.06	280.1	0.2237	
140.97	0.052	238.2	0.324	352.42	736.31	281	0.2272	
141.00	0.053	238.6	0.324	352.50	739.7	282.4	0.2326	
141.03	0.056	238.6	0.3257	352.58	741.01	283.1	0.2334	
141.07	0.056	239.2	0.3293	352.67	743.2	283.9	0.2397	
141.10	0.056	239.3	0.3302	352.75	744.52	284.7	0.2423	
141.13	0.055	239.4	0.3302	352.83	746.99	285.6	0.2459	
141.17	0.057	239.8	0.332	352.92	750.54	286.6	0.2503	
141.20	0.058	240.2	0.3346	353.00	750.5	287.2	0.2521	
141.23	0.061	240.6	0.3346	353.08	753.04	288.4	0.2556	
141.27	0.061	240.6	0.3364	353.18	753.46	289	0.2583	
141.30	0.061	240.8	0.3373	353.25	755.77	289.8	0.2619	
141.33	0.062	241.1	0.3382	353.33	757.77	290.6	0.2645	
141.37	0.064	241.6	0.3417	353.42	762.41	292.1	0.269	
141.40	0.064	241.8	0.3417	353.50	760.21	292.2	0.2707	
141.43	0.067	242.4	0.3453	353.58	762.3	292.9	0.2734	
141.47	0.067	242.6	0.3453	353.67	764.62	293.7	0.2761	
141.50	0.066	242.6	0.3462	353.75	768.55	294.9	0.2805	
141.53	0.066	242.7	0.3462	353.83	765.74	294.9	0.2805	
141.57	0.069	243.3	0.3497	353.92	768.8	295.7	0.2832	
141.60	0.07	243.5	0.3506	354.00	770.27	296.6	0.2858	
141.63	0.07	243.7	0.3515	354.08	771.79	297.3	0.2867	
141.67	0.07	243.9	0.3524	354.17	773.59	298	0.2903	
141.70	0.072	244.2	0.3524	354.25	772.2	298.1	0.2911	

Prova triassiale ciclica SNGR03-C4								
tensione di confinamento (kPa)		450			tensione di confinamento (kPa)		450	
deviatore ciclico (kPa)		80			deviatore ciclico (kPa)		120	
frequenza (hz)		0.00071429			frequenza (hz)		0.0007143	
141.73	0.073	244.2	0.3533	354.33	774.83	298.9	0.2938	
141.77	0.073	244.6	0.355	354.42	775.39	299.5	0.2956	
141.80	0.073	244.8	0.3568	354.50	776.25	299.9	0.2965	
141.83	0.078	245.5	0.3604	354.60	777.98	300.7	0.3	
141.87	0.077	245.6	0.3604	354.67	777.95	301.1	0.3009	
141.90	0.075	245.7	0.3604	354.75	779.14	301.6	0.3027	
141.93	0.077	246.1	0.3604	354.83	781.55	302.3	0.3053	
141.97	0.079	246.1	0.3621	354.92	779.75	302.5	0.3053	
142.02	0.08	246.7	0.3648	355.00	782.29	303.3	0.3071	
142.05	0.081	247	0.3648	355.08	783.29	303.6	0.3089	
142.07	0.081	247	0.3666	355.17	781.03	303.6	0.3089	
142.10	0.081	247.4	0.3683	355.25	786.04	304.7	0.3124	
142.13	0.083	247.8	0.371	355.33	783.12	304.6	0.3116	
142.17	0.088	248.4	0.3737	355.42	783.63	304.9	0.3124	
142.20	0.085	248.5	0.3737	355.50	784.08	305.4	0.3142	
142.23	0.084	248.6	0.3737	355.58	783.56	305.6	0.3142	
142.27	0.084	248.8	0.3737	355.67	784.95	306	0.3151	
142.30	0.086	248.8	0.3737	355.75	783.82	306.1	0.3151	
142.33	0.086	249.1	0.3754	355.83	784.49	306.4	0.316	
142.37	0.087	249.4	0.3772	355.92	785.14	306.7	0.3169	
142.40	0.089	249.7	0.3781	356.00	787.36	307.2	0.3187	
142.43	0.089	250	0.379	356.10	783.63	306.9	0.3169	
142.47	0.09	250.3	0.3808	356.17	784.1	307.1	0.3178	
142.50	0.091	250.6	0.3808	356.25	786.65	307.7	0.3196	
142.53	0.092	250.6	0.3817	356.33	784.08	307.5	0.3178	
142.57	0.092	250.9	0.3843	356.42	783.33	307.6	0.3187	
142.60	0.094	251.4	0.3861	356.50	783.04	307.6	0.3178	
142.63	0.094	251.5	0.3861	356.58	782.28	307.7	0.3178	
142.67	0.093	251.6	0.3861	356.67	781.25	307.6	0.3169	
142.70	0.094	251.9	0.387	356.75	781.66	307.8	0.3178	
142.73	0.095	252.2	0.387	356.83	781.05	307.8	0.3169	
142.77	0.096	252.2	0.3888	356.92	779.66	307.6	0.3169	
142.80	0.096	252.5	0.3896	357.00	780.3	307.9	0.3169	
142.83	0.097	252.8	0.3905	357.08	777.8	307.5	0.316	
142.87	0.098	253.2	0.3932	357.17	777.44	307.4	0.3151	
142.90	0.099	253.4	0.3932	357.25	776.09	307.3	0.3142	
142.93	0.099	253.6	0.3941	357.33	776.13	307.3	0.3142	
142.97	0.1	253.8	0.3941	357.42	774.19	307	0.3133	
143.00	0.101	253.8	0.395	357.52	773.42	306.9	0.3124	
143.03	0.101	254.1	0.3959	357.58	773.52	306.9	0.3124	
143.07	0.101	254.3	0.3967	357.67	770.14	306.4	0.3107	
143.10	0.103	254.7	0.3976	357.75	770.24	306.3	0.3098	
143.13	0.102	254.8	0.3985	357.83	768.44	306	0.3089	
143.17	0.103	255.1	0.3994	357.92	766.57	305.7	0.308	
143.20	0.104	255.4	0.3994	358.00	765.51	305.5	0.3071	
143.23	0.105	255.4	0.4012	358.08	764.16	305.1	0.3053	
143.27	0.105	255.6	0.4021	358.17	762.74	304.9	0.3053	
143.30	0.105	255.9	0.4021	358.25	762.26	304.6	0.3036	
143.33	0.106	256.1	0.4039	358.33	757.66	303.8	0.3	
143.37	0.107	256.4	0.4047	358.42	757.85	303.7	0.3	
143.40	0.109	256.9	0.4065	358.50	756.72	303.3	0.3	
143.45	0.108	257	0.4065	358.58	751.58	302.4	0.2974	
143.48	0.107	257.1	0.4065	358.67	752.29	302.3	0.2947	
143.52	0.11	257.4	0.4083	358.75	750.36	301.8	0.2929	
143.53	0.108	257.5	0.4083	358.83	750	301.5	0.292	
143.57	0.108	257.5	0.4083	358.93	744.92	300.5	0.2876	
143.60	0.108	257.6	0.4092	359.00	745.07	300.3	0.2867	
143.63	0.109	257.9	0.4101	359.08	741.89	299.6	0.2849	
143.67	0.113	258.4	0.4127	359.17	739.84	299.1	0.2832	
143.70	0.112	258.5	0.4127	359.25	739.03	298.7	0.2814	

Prova triassiale ciclica SNGR03-C4								
tensione di confinamento (kPa)		450			tensione di confinamento (kPa)		450	
deviatore ciclico (kPa)		80			deviatore ciclico (kPa)		120	
frequenza (hz)		0.00071429			frequenza (hz)		0.0007143	
143.73	0.111	258.6	0.4127	359.33	738.45	298.4	0.2805	
143.77	0.111	258.8	0.4127	359.42	731.05	296.8	0.2761	
143.80	0.113	258.8	0.4127	359.50	732.56	296.7	0.2743	
143.83	0.113	259	0.4136	359.58	729.69	296	0.2716	
143.87	0.115	259.5	0.4163	359.67	725.28	295.1	0.2681	
143.90	0.114	259.6	0.4163	359.75	726.25	294.8	0.2672	
143.93	0.113	259.7	0.4163	359.83	723.42	294.1	0.2636	
143.97	0.113	259.8	0.4163	359.92	720.55	293.2	0.261	
144.00	0.115	260.1	0.4163	360.00	717.75	292.4	0.2583	
144.03	0.115	260.1	0.4172	360.08	714.92	291.5	0.2556	
144.07	0.115	260.2	0.4181	360.17	713.18	290.8	0.2512	
144.10	0.116	260.5	0.4189	360.25	711.34	290.2	0.2485	
144.13	0.116	260.6	0.4198	360.33	706.83	289	0.2441	
144.17	0.119	261	0.4216	360.43	706.86	288.4	0.2414	
144.20	0.117	261.1	0.4207	360.50	703.19	287.4	0.237	
144.23	0.116	261.1	0.4207	360.58	699.81	286.4	0.2334	
144.27	0.116	261.1	0.4207	360.67	698.26	285.8	0.2317	
144.30	0.116	261.2	0.4216	360.75	696.49	285.1	0.2281	
144.33	0.117	261.4	0.4225	360.83	692.37	284	0.2237	
144.37	0.121	262	0.4243	360.92	691.11	283.1	0.2201	
144.40	0.119	262	0.4243	361.00	687.47	282	0.2148	
144.43	0.118	262.1	0.4243	361.08	682.03	280.8	0.2095	
144.47	0.12	262.3	0.4243	361.17	682.47	280.2	0.2068	
144.50	0.119	262.3	0.4252	361.25	679.54	279.2	0.2033	
144.53	0.119	262.4	0.4252	361.33	679.02	278.6	0.2006	
144.57	0.118	262.5	0.4252	361.42	673.44	277.1	0.1944	
144.60	0.119	262.8	0.4269	361.50	670.6	275.9	0.1908	
144.63	0.12	262.9	0.4269	361.58	668.38	275	0.1846	
144.67	0.119	263	0.4269	361.67	667.25	274.4	0.182	
144.70	0.119	263.1	0.4269	361.75	663.02	273.1	0.1766	
144.73	0.122	263.1	0.4269	361.85	660.44	271.9	0.1713	
144.77	0.122	263.6	0.4296	361.92	655.34	270.3	0.1633	
144.80	0.122	263.6	0.4287	362.00	654.92	269.7	0.1598	
144.83	0.121	263.7	0.4287	362.08	653.92	269.4	0.158	
144.87	0.12	263.8	0.4287	362.17	650.05	268.1	0.1527	
144.92	0.12	263.8	0.4305	362.25	645.59	266.7	0.1465	
144.95	0.121	264	0.4296	362.33	645.91	266.3	0.1429	
144.97	0.121	264.1	0.4296	362.42	640.4	264.6	0.1376	
145.00	0.12	264.2	0.4305	362.50	638.97	263.7	0.1287	
145.03	0.121	264.4	0.4305	362.58	636.45	262.8	0.1234	
145.07	0.121	264.4	0.4305	362.67	633.32	261.6	0.1181	
145.10	0.121	264.5	0.4305	362.75	632.11	260.5	0.1127	
145.13	0.121	264.6	0.4314	362.83	629.34	259.7	0.1074	
145.17	0.122	264.8	0.4314	362.92	625.92	258.6	0.1021	
145.20	0.122	265	0.4323	363.00	623.26	257	0.0976	
145.23	0.122	265	0.4323	363.08	622.96	256.3	0.0923	
145.27	0.121	265.1	0.4323	363.17	619.29	255.1	0.087	
145.30	0.123	265.1	0.4323	363.25	614.95	253.7	0.0826	
145.33	0.123	265.4	0.4331	363.35	612.85	252.3	0.079	
145.37	0.123	265.4	0.4331	363.42	611.75	251.4	0.0737	
145.40	0.122	265.5	0.4323	363.50	608.96	250.4	0.0701	
145.43	0.12	265.4	0.4323	363.58	606.35	249.3	0.0666	
145.47	0.12	265.5	0.4323	363.67	602.33	247.8	0.0612	
145.50	0.12	265.5	0.4323	363.75	602.52	247.2	0.0595	
145.53	0.121	265.5	0.4323	363.83	600.72	245.9	0.0568	
145.57	0.121	265.7	0.4331	363.92	596.67	244.7	0.055	
145.60	0.124	266	0.434	364.00	595.21	243.7	0.0506	
145.63	0.123	266.1	0.4349	364.08	592.24	242.5	0.047	
145.67	0.122	266.1	0.434	364.17	591.13	241.7	0.0453	
145.70	0.12	266	0.4331	364.25	589.1	240.7	0.0426	

Prova triassiale ciclica SNGR03-C4

tensione di confinamento (kPa)		450	tensione di confinamento (kPa)		450		
deviatore ciclico (kPa)		80	deviatore ciclico (kPa)		120		
frequenza (hz)		0.00071429	frequenza (hz)		0.0007143		
145.73	0.119	266	0.4331	364.33	587.15	239.9	0.0399
145.77	0.119	266	0.4331	364.42	584.31	238.9	0.0373
145.80	0.119	266	0.4331	364.50	582.36	237.5	0.0355
145.83	0.119	266.1	0.4331	364.58	580.62	236.6	0.032
145.87	0.12	266.2	0.4331	364.67	579.16	235.7	0.0302
145.90	0.12	266.3	0.434	364.77	576.57	234.8	0.0275
145.93	0.12	266.4	0.434	364.83	574.76	233.6	0.0257
145.97	0.123	266.8	0.434	364.92	573.39	232.7	0.0231
146.00	0.121	266.8	0.4349	365.00	571.42	231.9	0.0213
146.03	0.121	266.6	0.434	365.08	569.9	231.2	0.0195
146.07	0.118	266.5	0.4331	365.17	568.53	230.4	0.0178
146.10	0.118	266.5	0.4331	365.25	567.05	229.7	0.016
146.13	0.118	266.5	0.4331	365.33	565.01	228.9	0.0142
146.17	0.118	266.6	0.4331	365.42	563.61	227.8	0.0124
146.20	0.118	266.6	0.4331	365.50	562.58	227.1	0.0107
146.23	0.118	266.6	0.4331	365.58	561.79	226.5	0.0089
146.27	0.118	266.8	0.434	365.67	559.4	225.7	0.0071
146.30	0.119	266.9	0.434	365.75	558.79	225.1	0.0062
146.35	0.117	266.9	0.434	365.83	558.27	224.6	0.0053
146.38	0.117	266.8	0.4331	365.92	555.71	223.8	0.0036
146.42	0.117	266.9	0.4331	366.00	555.09	222.9	0.0027
146.43	0.116	266.9	0.4323	366.08	553.86	222.3	0
146.47	0.117	266.9	0.4323	366.17	553.02	221.8	-0.0009
146.50	0.115	266.8	0.4323	366.27	551.66	221.3	-0.0018
146.53	0.115	266.8	0.4323	366.33	551.02	220.5	-0.0027
146.57	0.114	266.8	0.4323	366.42	550.3	220	-0.0044
146.60	0.114	266.8	0.4314	366.50	548.32	219.2	-0.0053
146.63	0.114	266.8	0.4323	366.58	549.26	219.1	-0.0062
146.67	0.115	266.9	0.4323	366.67	548.45	218.6	-0.0071
146.70	0.113	266.8	0.4305	366.75	547.54	218.1	-0.0071
146.73	0.113	266.8	0.4305	366.83	546.93	217.8	-0.008
146.77	0.113	266.8	0.4305	366.92	546.73	217.3	-0.0089
146.80	0.112	266.8	0.4305	367.00	546.41	216.9	-0.0098
146.83	0.112	266.7	0.4305	367.08	546.02	216.6	-0.0107
146.87	0.112	266.8	0.4305	367.17	545.18	216.2	-0.0107
146.90	0.112	266.7	0.4296	367.25	545.53	216	-0.0115
146.93	0.11	266.6	0.4296	367.33	545.34	215.7	-0.0115
146.97	0.109	266.6	0.4287	367.42	544.85	215.4	-0.0124
147.00	0.111	266.6	0.4287	367.50	545.14	215.2	-0.0124
147.03	0.109	266.6	0.4287	367.58	544.98	214.9	-0.0124
147.07	0.109	266.5	0.4287	367.68	544.95	214.8	-0.0133
147.10	0.11	266.5	0.4278	367.75	545.24	214.6	-0.0133
147.13	0.109	266.5	0.4278	367.83	545.5	214.5	-0.0133
147.17	0.109	266.5	0.4278	367.92	545.5	214.3	-0.0133
147.20	0.107	266.3	0.4252	368.00	545.91	214.3	-0.0133
147.23	0.104	266	0.4252	368.08	546.27	214.2	-0.0133
147.27	0.105	266	0.4252	368.17	546.14	214.1	-0.0133
147.30	0.105	266	0.4252	368.25	547.11	214.1	-0.0133
147.33	0.104	266	0.4252	368.33	548.02	214.1	-0.0133
147.37	0.105	266.1	0.4252	368.42	548.41	214.1	-0.0133
147.40	0.104	266	0.4243	368.50	548.86	214.1	-0.0133
147.43	0.104	265.9	0.4234	368.58	549.83	214.2	-0.0124
147.47	0.102	265.8	0.4234	368.67	550.67	214.3	-0.0124
147.50	0.102	265.8	0.4234	368.75	551.45	214.4	-0.0124
147.53	0.102	265.7	0.4225	368.83	551.97	214.5	-0.0115
147.57	0.1	265.6	0.4225	368.92	553.49	214.7	-0.0115
147.60	0.101	265.6	0.4225	369.00	554.59	214.9	-0.0107
147.63	0.1	265.4	0.4207	369.10	555.17	215.1	-0.0098
147.67	0.098	265.3	0.4207	369.17	556.69	215.3	-0.0098
147.70	0.097	265.2	0.4207	369.25	558.48	215.4	-0.0098

Prova triassiale ciclica SNGR03-C4								
tensione di confinamento (kPa)		450			tensione di confinamento (kPa)		450	
deviatore ciclico (kPa)		80			deviatore ciclico (kPa)		120	
frequenza (hz)		0.00071429			frequenza (hz)		0.0007143	
147.73	0.099	265.2	0.4198	369.33	558.83	215.7	-0.0089	
147.77	0.099	265.2	0.4198	369.42	560.45	216.1	-0.008	
147.82	0.094	264.8	0.4189	369.50	561.81	216.4	-0.0071	
147.85	0.095	264.8	0.4181	369.58	562.75	216.7	-0.0062	
147.87	0.095	264.8	0.4181	369.67	564.21	217	-0.0053	
147.90	0.095	264.8	0.4181	369.75	565.66	217.4	-0.0044	
147.93	0.095	264.8	0.4172	369.83	567.28	217.8	-0.0036	
147.97	0.092	264.5	0.4163	369.92	569.39	218.3	-0.0027	
148.00	0.093	264.5	0.4163	370.00	571	218.7	-0.0018	
148.03	0.092	264.4	0.4163	370.08	572.75	219.2	0	
148.07	0.093	264.4	0.4154	370.17	573.79	219.6	0.0009	
148.10	0.093	264.4	0.4145	370.25	575.47	220	0.0018	
148.13	0.089	264	0.4127	370.33	577.35	220.6	0.0027	
148.17	0.088	263.8	0.4127	370.42	579.52	221.1	0.0044	
148.20	0.088	263.8	0.4118	370.50	581.52	222	0.0053	
148.23	0.088	263.7	0.4118	370.60	583.14	222.4	0.0071	
148.27	0.087	263.5	0.4118	370.67	585.54	223	0.008	
148.30	0.085	263.5	0.411	370.75	587.35	223.6	0.0098	
148.33	0.085	263.4	0.4101	370.83	589.97	224.4	0.0107	
148.37	0.085	263.3	0.4092	370.92	591.3	225	0.0133	
148.40	0.084	263.1	0.4083	371.00	594.27	225.8	0.0151	
148.43	0.083	263	0.4083	371.08	595.35	226.3	0.016	
148.47	0.082	262.8	0.4074	371.17	597.77	227	0.0178	
148.50	0.082	262.6	0.4074	371.25	599.97	227.7	0.0195	
148.53	0.08	262.6	0.4065	371.33	603.79	228.4	0.0213	
148.57	0.08	262.4	0.4056	371.42	604.86	229.5	0.0231	
148.60	0.08	262.3	0.4047	371.50	607.41	230.4	0.0257	
148.63	0.078	262.1	0.4039	371.58	609.9	231.2	0.0284	
148.67	0.077	261.9	0.403	371.67	612.27	232	0.0302	
148.70	0.077	261.8	0.4021	371.75	613.79	232.8	0.0328	
148.73	0.076	261.5	0.4021	371.83	617.41	233.7	0.0346	
148.77	0.075	261.5	0.4012	371.92	619.16	234.4	0.0364	
148.80	0.075	261.4	0.4003	372.00	623.07	235.8	0.0391	
148.83	0.074	261.2	0.3994	372.08	623.98	236.5	0.0426	
148.87	0.073	261	0.3985	372.17	625.92	237.2	0.0444	
148.90	0.072	260.9	0.3976	372.25	629.83	238.4	0.0479	
148.93	0.07	260.7	0.3959	372.33	632.93	239.6	0.0506	
148.97	0.07	260.5	0.3959	372.42	634.84	240.4	0.0541	
149.00	0.069	260.5	0.395	372.50	638.92	241.7	0.0586	
149.03	0.069	260.3	0.3941	372.58	638.14	242.1	0.0595	
149.07	0.068	260.1	0.3932	372.67	641.5	243.1	0.063	
149.10	0.067	259.9	0.3923	372.75	644.71	244.2	0.0666	
149.13	0.065	259.7	0.3914	372.83	648.88	245.3	0.0701	
149.17	0.065	259.5	0.3905	372.92	651.39	246.8	0.0737	
149.20	0.063	259.2	0.3905	373.00	653.82	247.8	0.0799	
149.23	0.062	259.2	0.3888	373.08	656.02	248.7	0.0843	
149.28	0.063	259	0.3879	373.17	658.34	249.7	0.0897	
149.32	0.063	258.9	0.3879	373.25	663.09	251.2	0.0959	
149.33	0.057	258.2	0.3879	373.33	662.61	251.6	0.0985	
149.37	0.057	258.2	0.3843	373.42	667.42	252.9	0.1039	
149.40	0.059	258.2	0.3843	373.52	668.97	254.1	0.1101	
149.43	0.058	258.1	0.3834	373.58	671.49	255.1	0.1145	
149.47	0.058	257.9	0.3825	373.67	674.13	256	0.1189	
149.50	0.057	257.8	0.3808	373.75	677.91	257.1	0.1234	
149.53	0.052	257.1	0.3808	373.83	680.15	258.5	0.1269	
149.57	0.052	257	0.3781	373.92	682.65	259.5	0.134	
149.60	0.052	257	0.3781	374.00	685.56	260.5	0.1385	
149.63	0.052	256.8	0.3772	374.08	688.43	261.6	0.1429	
149.67	0.052	256.6	0.3763	374.17	690.01	262.5	0.1465	
149.70	0.051	256.5	0.3754	374.25	692.78	263.4	0.1509	

Prova triassiale ciclica SNGR03-C4								
tensione di confinamento (kPa)		450			tensione di confinamento (kPa)		450	
deviatore ciclico (kPa)		80			deviatore ciclico (kPa)		120	
frequenza (hz)		0.00071429			frequenza (hz)		0.0007143	
149.73	0.048	256	0.3728	374.33	699.05	264.5	0.1562	
149.77	0.048	255.8	0.3728	374.42	697.52	265.6	0.1589	
149.80	0.048	255.8	0.3719	374.50	700.55	266.7	0.1651	
149.83	0.048	255.8	0.3719	374.58	703.69	267.7	0.1695	
149.87	0.046	255.4	0.3692	374.67	706	268.7	0.174	
149.90	0.044	255	0.3666	374.75	708.07	269.6	0.1784	
149.93	0.041	254.5	0.3648	374.83	710.87	270.7	0.182	
149.97	0.041	254.4	0.3648	374.93	714.16	272.1	0.1882	
150.00	0.042	254.3	0.3648	375.00	716.04	273	0.1917	
150.03	0.042	254.3	0.3648	375.08	717.96	273.8	0.1953	
150.07	0.042	254.3	0.3639	375.17	721.25	274.8	0.1988	
150.10	0.037	253.5	0.3595	375.25	727.02	275.8	0.2033	
150.13	0.036	253.2	0.3586	375.33	723.6	276.6	0.2068	
150.17	0.036	253.1	0.3586	375.42	727.46	277.8	0.2121	
150.20	0.037	253.1	0.3586	375.50	730.26	278.8	0.2157	
150.23	0.035	252.7	0.3586	375.58	732.55	279.8	0.2201	
150.27	0.032	252.4	0.3559	375.67	734.06	280.7	0.2237	
150.30	0.032	252.4	0.3541	375.75	736.8	281.6	0.2272	
150.33	0.03	251.9	0.3515	375.83	739.21	282.5	0.2308	
150.37	0.029	251.7	0.3506	375.92	741.88	283.7	0.2343	
150.40	0.031	251.7	0.3506	376.00	745.14	284.9	0.2406	
150.43	0.03	251.4	0.3479	376.08	744.33	285.2	0.2414	
150.47	0.027	250.9	0.3479	376.17	747.41	286.2	0.2459	
150.50	0.023	250.4	0.3462	376.25	748.67	286.9	0.2485	
150.53	0.023	250.4	0.3426	376.33	750.89	287.8	0.2521	
150.57	0.024	250.2	0.3426	376.43	752.95	288.9	0.2574	
150.60	0.025	250	0.3417	376.50	755.84	289.9	0.2601	
150.63	0.025	250	0.3408	376.58	755.42	290.3	0.2619	
150.67	0.023	249.6	0.3373	376.67	758.32	291.2	0.2645	
150.72	0.019	249.1	0.3355	376.75	759.96	291.9	0.2672	
150.75	0.019	248.8	0.3328	376.83	761.83	292.9	0.2698	
150.78	0.016	248.3	0.3302	376.92	762.72	293.6	0.2734	
150.80	0.016	248.1	0.3302	377.00	764.01	294.2	0.2761	
150.83	0.015	247.9	0.3293	377.08	766.35	295	0.2787	
150.87	0.015	247.9	0.3284	377.17	767.48	295.6	0.2814	
150.90	0.015	247.7	0.3266	377.25	768.73	296.3	0.2832	
150.93	0.014	247.4	0.3257	377.33	770.58	297	0.2849	
150.97	0.012	247	0.3231	377.42	772.11	297.9	0.2867	
151.00	0.011	246.8	0.3222	377.50	772.62	298.3	0.2894	
151.03	0.012	246.7	0.3222	377.58	776.26	299.2	0.292	
151.07	0.009	246.2	0.3222	377.67	772.82	299.2	0.292	
151.10	0.009	246.2	0.3195	377.75	775.54	299.9	0.2947	
151.13	0.008	245.9	0.3177	377.85	776.93	300.7	0.2974	
151.17	0.004	245.2	0.3133	377.92	777.95	301.2	0.2991	
151.20	0.004	245	0.3115	378.00	778.66	301.7	0.3009	
151.23	0.004	244.8	0.3106	378.08	778.96	302.2	0.3018	
151.27	0.003	244.5	0.3106	378.17	780.51	302.6	0.3036	
151.30	0.001	244.2	0.3089	378.25	781.04	303	0.3045	
151.33	0.001	244.2	0.3071	378.33	781.9	303.7	0.3062	
151.37	0.001	244.1	0.3062	378.42	782.54	304.1	0.308	
151.40	0.001	243.6	0.3027	378.50	782.74	304.5	0.3089	
151.43	-0.005	243	0.2982	378.58	782.7	304.8	0.3098	
151.47	-0.003	242.9	0.2964	378.67	783.6	305.2	0.3107	
151.50	-0.004	242.7	0.2964	378.75	784.25	305.5	0.3116	
151.53	-0.006	242.4	0.2929	378.83	784.27	305.9	0.3124	
151.57	-0.006	242.4	0.2902	378.92	785.05	306.3	0.3133	
151.60	-0.004	242.4	0.2885	379.00	784.59	306.5	0.3142	
151.63	-0.01	241.5	0.2805	379.08	784.89	306.8	0.3151	
151.67	-0.01	241.2	0.276	379.17	785.05	307	0.316	
151.70	-0.01	241	0.2725	379.27	787.2	307.6	0.316	

Prova triassiale ciclica SNGR03-C4

tensione di confinamento (kPa)		450	tensione di confinamento (kPa)		450		
deviatore ciclico (kPa)		80	deviatore ciclico (kPa)		120		
frequenza (hz)		0.00071429	frequenza (hz)		0.0007143		
151.73	-0.011	240.7	0.2725	379.33	784.63	307.5	0.3169
151.77	-0.013	240.4	0.268	379.42	784.3	307.5	0.3169
151.80	-0.013	240.4	0.2636	379.50	784.79	307.8	0.3169
151.83	-0.014	240.1	0.2583	379.58	784.46	308	0.3178
151.87	-0.016	239.6	0.2547	379.67	784.69	308.1	0.3169
151.90	-0.014	239.6	0.2512	379.75	782.6	307.9	0.3169
151.93	-0.019	238.8	0.2441	379.83	783.17	308.1	0.3169
151.97	-0.021	238.3	0.2441	379.92	782.72	308.5	0.3178
152.00	-0.02	238.1	0.2405	380.00	783.05	308.5	0.3178
152.03	-0.02	238.1	0.237	380.08	781.69	308.3	0.3169
152.07	-0.021	237.9	0.2343	380.17	782.43	308.5	0.3178
152.10	-0.022	237.4	0.2308	380.25	779.77	308.2	0.316
152.13	-0.024	237.1	0.2272	380.33	779.66	308.2	0.316
152.18	-0.024	236.8	0.2254	380.42	779.41	308.3	0.316
152.22	-0.022	236.8	0.2245	380.50	777.41	308	0.3151
152.23	-0.027	236.1	0.2201	380.58	777.22	308	0.3142
152.27	-0.029	235.6	0.2166	380.67	776.26	307.9	0.3142
152.30	-0.029	235.4	0.2166	380.77	775.77	307.8	0.3133
152.33	-0.03	235	0.2139	380.83	772.94	307.4	0.3116
152.37	-0.03	235	0.2112	380.92	773.88	307.5	0.3107
152.40	-0.031	234.8	0.2086	381.00	769.86	306.9	0.3098
152.43	-0.029	234.7	0.2086	381.08	771.88	307.1	0.3098
152.47	-0.033	234.1	0.2041	381.17	768.41	306.6	0.308
152.50	-0.035	233.6	0.2006	381.25	767.67	306.3	0.3071
152.53	-0.036	233.2	0.2006	381.33	764.48	305.8	0.3053
152.57	-0.037	232.9	0.1988	381.42	765.96	306	0.3053
152.60	-0.037	232.9	0.197	381.50	761.04	305.1	0.3027
152.63	-0.035	232.9	0.197	381.58	761.23	305	0.3018
152.67	-0.037	232.4	0.1935	381.67	760.88	304.9	0.3018
152.70	-0.04	231.9	0.1908	381.75	756.95	304	0.2991
152.73	-0.04	231.6	0.189	381.83	757.34	303.9	0.2982
152.77	-0.042	231.2	0.189	381.92	753.73	303.2	0.2974
152.80	-0.044	230.7	0.1873	382.00	750.58	302.5	0.2929
152.83	-0.044	230.7	0.1846	382.08	750.39	302.3	0.292
152.87	-0.043	230.6	0.1837	382.17	749.74	302	0.2911
152.90	-0.044	230.2	0.1819	382.25	746.46	301.3	0.2894
152.93	-0.047	229.7	0.1793	382.33	743.89	300.6	0.2867
152.97	-0.047	229.4	0.1784	382.42	743.6	300.4	0.2858
153.00	-0.048	229	0.1784	382.50	740.32	299.7	0.2832
153.03	-0.052	228.2	0.1748	382.58	738.87	299.2	0.2814
153.07	-0.052	228.2	0.1731	382.67	734.65	298.2	0.2778
153.10	-0.051	228.1	0.1722	382.75	735.58	298	0.2769
153.13	-0.051	227.9	0.1713	382.83	731.53	297.1	0.2752
153.17	-0.051	227.7	0.1704	382.92	729.86	296.5	0.2707
153.20	-0.051	227.4	0.1695	383.00	726.92	295.7	0.2681
153.23	-0.054	226.9	0.1677	383.08	725.25	295.1	0.2654
153.27	-0.056	226.5	0.1677	383.17	722.74	294.4	0.2627
153.30	-0.056	226.5	0.166	383.25	722.54	293.9	0.261
153.33	-0.056	226.2	0.1642	383.33	717.04	292.6	0.2565
153.37	-0.058	225.8	0.1624	383.42	716.17	292.1	0.2556
153.40	-0.058	225.5	0.1615	383.50	713.34	291.4	0.2512
153.43	-0.059	225.2	0.1606	383.58	710.38	290.5	0.2477
153.47	-0.06	224.9	0.1589	383.68	707.54	289.5	0.245
153.50	-0.061	224.5	0.158	383.75	704.26	288.5	0.2406
153.53	-0.062	224.1	0.158	383.83	703.22	287.9	0.237
153.57	-0.062	224.1	0.1562	383.92	700.74	287.1	0.2343
153.62	-0.066	223.2	0.1526	384.00	695.85	285.8	0.229
153.65	-0.065	223.1	0.1526	384.08	697.52	285.6	0.2272
153.68	-0.065	223.1	0.1526	384.17	692.76	284.5	0.2237
153.72	-0.065	222.9	0.1518	384.25	687.95	282.9	0.2184

Prova triassiale ciclica SNGR03-C4							
pressione di confinamento (kPa)		450		pressione di confinamento (kPa)		450	
deviatore ciclico (kPa)		80		deviatore ciclico (kPa)		120	
frequenza (hz)		0.00071429		frequenza (hz)		0.0007143	
153.75	-0.065	222.6	0.1509	384.33	688.17	282.6	0.2157
153.77	-0.067	222.2	0.15	384.42	683.15	281.3	0.2095
153.80	-0.066	222.1	0.15	384.50	682.28	280.6	0.2059
153.83	-0.068	221.7	0.1473	384.58	680.73	279.9	0.2033
153.87	-0.07	221.2	0.1473	384.67	677.57	278.9	0.1988
153.90	-0.071	220.9	0.1464	384.75	674.8	277.9	0.1944
153.93	-0.071	220.9	0.1447	384.83	670.64	276.3	0.19
153.97	-0.071	220.6	0.1447	384.92	668.05	275.3	0.1864
154.00	-0.072	220.2	0.1429	385.00	665.54	274.5	0.1802
154.03	-0.073	220	0.142	385.10	662.8	273.5	0.1758
154.07	-0.074	219.7	0.1411	385.17	660.28	272.2	0.1713
154.10	-0.075	219.3	0.1411	385.25	654.83	270.7	0.1651
154.13	-0.076	219.3	0.1402	385.33	654.89	270.1	0.1598
154.17	-0.076	219.1	0.1393	385.42	652.37	269.4	0.1562
154.20	-0.077	218.7	0.1384	385.50	648.66	268.2	0.1518
154.23	-0.077	218.5	0.1376	385.58	647.98	267.5	0.1473
154.27	-0.078	218.2	0.1367	385.67	646.27	266.8	0.1438
154.30	-0.079	217.9	0.1358	385.75	640.82	265	0.1376
154.33	-0.08	217.6	0.1358	385.83	638.97	264.1	0.1323
154.37	-0.081	217.6	0.1349	385.92	636.48	263.2	0.1243
154.40	-0.081	217.3	0.1331	386.00	634.16	262.1	0.1189
154.43	-0.081	217	0.1331	386.08	631.21	261	0.1127
154.47	-0.082	216.8	0.1322	386.17	629.02	259.9	0.1074
154.50	-0.082	216.5	0.1313	386.25	626.82	259	0.103
154.53	-0.083	216.2	0.1305	386.33	622.55	257.3	0.0976
154.57	-0.085	215.8	0.1305	386.42	622.26	256.6	0.095
154.60	-0.085	215.8	0.1296	386.50	619.12	255.5	0.0879
154.63	-0.085	215.6	0.1278	386.60	616.15	254.4	0.0834
154.67	-0.087	215.1	0.1269	386.67	612.56	252.8	0.0799
154.70	-0.087	214.9	0.1269	386.75	611.59	251.9	0.0763
154.73	-0.086	214.8	0.1269	386.83	609.06	250.8	0.0701
154.77	-0.088	214.5	0.1251	386.92	606.31	249.7	0.0675
154.80	-0.088	214.3	0.1251	387.00	604.31	248.6	0.0639
154.83	-0.089	214.3	0.1251	387.08	602.59	247.7	0.0604
154.87	-0.089	214	0.1242	387.17	599.68	246.6	0.0577
154.90	-0.089	213.8	0.1234	387.25	596.93	245.1	0.055
154.93	-0.09	213.5	0.1225	387.33	595.02	244.1	0.0524
154.97	-0.091	213.3	0.1225	387.42	592.23	242.9	0.0479
155.00	-0.091	213.1	0.1216	387.50	590.46	242.1	0.0462
155.03	-0.092	212.7	0.1216	387.58	589.16	241.1	0.0435
155.08	-0.093	212.5	0.1198	387.67	587.51	240.3	0.0408
155.12	-0.092	212.4	0.1207	387.75	584.28	239.2	0.0382
155.13	-0.092	212.3	0.1207	387.83	581.62	237.9	0.0364
155.17	-0.093	212.3	0.1198	387.92	582.81	237.5	0.0346
155.20	-0.093	211.9	0.1189	388.02	579.03	236.2	0.0311
155.23	-0.094	211.7	0.118	388.08	577.22	235.3	0.0293
155.27	-0.095	211.4	0.1171	388.17	574.59	234	0.0275
155.30	-0.098	210.9	0.1154	388.25	573.49	233.3	0.0249
155.33	-0.097	210.8	0.1154	388.33	571.97	232.5	0.0222
155.37	-0.096	210.7	0.1154	388.42	569.64	231.5	0.0204
155.40	-0.096	210.7	0.1154	388.50	568.64	230.8	0.0186
155.43	-0.096	210.6	0.1154	388.58	567.01	230	0.0169
155.47	-0.098	210.3	0.1145	388.67	565.4	229.3	0.0151
155.50	-0.098	210	0.1136	388.75	563.2	228.1	0.0133
155.53	-0.098	209.9	0.1136	388.83	562.32	227.5	0.0124
155.57	-0.097	209.8	0.1136	388.92	561.31	226.8	0.0098
155.60	-0.097	209.6	0.1136	389.00	558.98	226	0.008
155.63	-0.1	209.6	0.1127	389.08	559.15	225.5	0.0071
155.67	-0.1	209.3	0.1109	389.17	557.68	224.8	0.0062
155.70	-0.1	209.1	0.1109	389.25	555.94	224	0.0044

Prova triassiale ciclica SNGR03-C4							
tensione di confinamento (kPa)		450	tensione di confinamento (kPa)		450		
deviatore ciclico (kPa)		80	deviatore ciclico (kPa)		120		
frequenza (hz)		0.00071429	frequenza (hz)		0.0007143		
155.73	-0.1	208.9	0.11	389.33	554.1	223.1	0.0036
155.77	-0.101	208.7	0.1092	389.42	554.28	222.7	0.0018
155.80	-0.101	208.5	0.1092	389.50	552.63	222.1	0
155.83	-0.102	208.3	0.1092	389.58	552.73	221.7	-0.0009
155.87	-0.102	208.3	0.1083	389.67	550.75	220.8	-0.0018
155.90	-0.102	208.2	0.1083	389.75	548.03	219.9	-0.0036
155.93	-0.102	208	0.1074	389.83	549.23	219.7	-0.0044
155.97	-0.106	207.4	0.1056	389.92	549.26	219.4	-0.0053
156.00	-0.104	207.4	0.1056	390.00	548.09	218.9	-0.0062
156.03	-0.104	207.3	0.1056	390.08	549.42	218.9	-0.0062
156.07	-0.103	207.3	0.1056	390.17	546.7	218.1	-0.0071
156.10	-0.103	207.3	0.1056	390.25	546.21	217.6	-0.008
156.13	-0.103	207.2	0.1056	390.33	546.48	217.3	-0.008
156.17	-0.102	207.1	0.1056	390.42	545.53	216.9	-0.0098
156.20	-0.102	207	0.1056	390.50	545.6	216.7	-0.0098
156.23	-0.104	206.8	0.1047	390.58	545.34	216.4	-0.0107
156.27	-0.105	206.6	0.1047	390.67	544.95	216	-0.0107
156.30	-0.105	206.4	0.1047	390.75	544.92	215.8	-0.0115
156.33	-0.106	206.4	0.1038	390.83	544.53	215.3	-0.0115
156.37	-0.106	206.2	0.1038	390.93	544.72	214.8	-0.0133
156.40	-0.105	206.1	0.1038	391.00	543.91	214.8	-0.0124
156.43	-0.105	206	0.1029	391.08	545.33	215	-0.0124
156.47	-0.105	205.9	0.1021	391.17	545.76	214.8	-0.0124
156.50	-0.108	205.4	0.1012	391.25	545.72	214.7	-0.0124
156.55	-0.108	205.3	0.1012	391.33	546.89	214.8	-0.0124
156.58	-0.107	205.2	0.1012	391.42	546.15	214.5	-0.0124
156.60	-0.107	205.2	0.1012	391.50	546.21	214.4	-0.0124
156.63	-0.106	205.1	0.1012	391.58	545.49	214.1	-0.0133
156.67	-0.106	205.1	0.1012	391.67	547.41	214.4	-0.0124
156.70	-0.106	205.1	0.1012	391.75	548.67	214.5	-0.0124
156.73	-0.106	205	0.1012	391.83	549.12	214.5	-0.0124
156.77	-0.105	205	0.1012	391.92	551.61	214.9	-0.0115
156.80	-0.105	205	0.1012	392.00	549.74	214.6	-0.0115
156.83	-0.105	204.9	0.1012	392.08	550.83	214.7	-0.0115
156.87	-0.106	204.6	0.1012	392.17	550.58	214.6	-0.0115
156.90	-0.107	204.5	0.1003	392.25	552.78	214.9	-0.0107
156.93	-0.107	204.5	0.1003	392.33	556.08	215.7	-0.0089
156.97	-0.107	204.4	0.1003	392.42	555.44	215.5	-0.0089
157.00	-0.107	204.3	0.1003	392.50	555.33	215.5	-0.0098
157.03	-0.106	204.3	0.1003	392.58	557.54	215.9	-0.008
157.07	-0.107	204.2	0.0994	392.67	559.22	216.3	-0.0071
157.10	-0.107	204.1	0.0994	392.75	560.65	216.6	-0.0071
157.13	-0.106	204	0.0994	392.83	561.1	216.7	-0.0062
157.17	-0.106	204	0.0994	392.92	563.46	217.2	-0.0053
157.20	-0.106	204	0.0994	393.00	563.75	217.4	-0.0044
157.23	-0.106	203.9	0.0994	393.08	565.5	217.8	-0.0036
157.27	-0.107	203.7	0.0985	393.17	567.67	218.3	-0.0027
157.30	-0.107	203.7	0.0985	393.25	569.13	218.7	-0.0018
157.33	-0.109	203.3	0.0985	393.33	569.55	219	-0.0018
157.37	-0.108	203.3	0.0976	393.42	571.91	219.4	0
157.40	-0.108	203.3	0.0976	393.50	574.21	220	0.0018
157.43	-0.107	203.4	0.0985	393.58	575.25	220.5	0.0027
157.47	-0.105	203.5	0.0994	393.67	577.09	221	0.0036
157.50	-0.105	203.5	0.0994	393.75	581.72	222	0.0062
157.53	-0.104	203.6	0.0994	393.85	580.49	222.1	0.0062
157.57	-0.104	203.5	0.0994	393.92	583.24	222.8	0.008
157.60	-0.104	203.5	0.0994	394.00	584.27	223.2	0.0089
157.63	-0.104	203.5	0.0994	394.08	587.19	224	0.0107
157.67	-0.104	203.4	0.0994	394.17	590.59	225	0.0115
157.70	-0.104	203.3	0.0994	394.25	591.4	225.6	0.0151

Prova triassiale ciclica SNGR03-C4

pressione di confinamento (kPa)		450			pressione di confinamento (kPa)		450	
deviatore ciclico (kPa)		80			deviatore ciclico (kPa)		120	
frequenza (hz)		0.00071429			frequenza (hz)		0.0007143	
157.73	-0.104	203.3	0.0985	394.33	595.02	226.4	0.016	
157.77	-0.104	203.2	0.0985	394.42	595.57	226.8	0.0169	
157.80	-0.104	203.2	0.0985	394.50	597.71	227.5	0.0186	
157.83	-0.104	203.1	0.0985	394.58	599.81	228.2	0.0204	
157.87	-0.104	203.1	0.0985	394.67	602.66	229.1	0.0222	
157.90	-0.104	203.1	0.0985	394.75	605.28	230.1	0.024	
157.93	-0.103	203.1	0.0994	394.83	607.22	230.8	0.0257	
157.98	-0.103	203.1	0.0994	394.92	608.32	231.4	0.0284	
158.02	-0.103	203.1	0.0985	395.00	612.59	232.4	0.0311	
158.03	-0.103	203.1	0.0994	395.08	614.08	233.2	0.0337	
158.07	-0.102	203.1	0.0994	395.17	616.35	234	0.0355	
158.10	-0.102	203	0.0994	395.27	620.36	235.3	0.0391	
158.13	-0.101	203.2	0.0994	395.33	621.36	236	0.0408	
158.17	-0.1	203.2	0.0994	395.42	623.88	237	0.0435	
158.20	-0.1	203.2	0.1003	395.50	625.05	237.7	0.0453	
158.23	-0.1	203.2	0.1003	395.58	629.09	238.6	0.0479	
158.27	-0.1	203.2	0.1003	395.67	632.64	240.1	0.0515	
158.30	-0.097	203.5	0.1012	395.75	636.36	241.3	0.0568	
158.33	-0.098	203.4	0.1012	395.83	635.62	241.6	0.0577	
158.37	-0.098	203.4	0.1012	395.92	641.34	243	0.0612	
158.40	-0.098	203.4	0.1012	396.00	641.44	243.7	0.0639	
158.43	-0.098	203.4	0.1012	396.08	644.87	244.7	0.0675	
158.47	-0.098	203.4	0.1012	396.17	651.13	246.3	0.0728	
158.50	-0.098	203.4	0.1012	396.25	651.24	247.3	0.0746	
158.53	-0.098	203.4	0.1012	396.33	654.2	248.3	0.0817	
158.57	-0.097	203.4	0.1012	396.42	656.05	249.2	0.0852	
158.60	-0.096	203.5	0.1012	396.50	658.89	250.3	0.0905	
158.63	-0.095	203.6	0.1021	396.58	659.89	251.2	0.0941	
158.67	-0.095	203.6	0.1021	396.67	663.32	252.2	0.0994	
158.70	-0.095	203.6	0.1021	396.77	666.61	253.6	0.1065	
158.73	-0.094	203.7	0.1029	396.83	669.55	254.7	0.111	
158.77	-0.094	203.8	0.1029	396.92	674.07	256.1	0.1172	
158.80	-0.093	203.8	0.1029	397.00	674.23	256.7	0.1198	
158.83	-0.094	203.8	0.1029	397.08	677.01	257.6	0.1243	
158.87	-0.093	203.9	0.1029	397.17	681.14	259.1	0.1269	
158.90	-0.093	203.9	0.1029	397.25	683.91	260.2	0.1349	
158.93	-0.092	204	0.1038	397.33	684.85	260.9	0.1385	
158.97	-0.091	204.2	0.1047	397.42	687.3	261.9	0.142	
159.00	-0.089	204.4	0.1056	397.50	689.59	262.9	0.1456	
159.03	-0.088	204.6	0.1056	397.58	692.69	263.9	0.15	
159.07	-0.087	204.6	0.1056	397.67	696.2	265	0.1553	
159.10	-0.089	204.5	0.1056	397.75	698.14	266.3	0.1607	
159.13	-0.089	204.5	0.1056	397.83	700.3	267.3	0.1642	
159.17	-0.089	204.5	0.1056	397.92	706	268.6	0.1704	
159.20	-0.088	204.6	0.1056	398.00	706.07	269.3	0.174	
159.23	-0.086	204.8	0.1065	398.08	708.07	270.2	0.1775	
159.27	-0.086	204.9	0.1074	398.18	711.07	271.7	0.1837	
159.30	-0.085	205	0.1074	398.25	713.64	272.5	0.1873	
159.33	-0.081	205.4	0.1083	398.33	716.32	273.5	0.1917	
159.37	-0.081	205.4	0.1092	398.42	717.67	274.3	0.1944	
159.40	-0.083	205.3	0.1083	398.50	720.73	275.3	0.1988	
159.45	-0.084	205.3	0.1083	398.58	723.6	276.1	0.2015	
159.48	-0.084	205.3	0.1083	398.67	726.43	277.6	0.2059	
159.50	-0.083	205.4	0.1092	398.75	727.91	278.5	0.2121	
159.53	-0.081	205.7	0.11	398.83	730.14	279.4	0.2157	
159.57	-0.077	206.1	0.1127	398.92	732.42	280.4	0.2192	
159.60	-0.077	206.2	0.1127	399.00	734.8	281.3	0.2228	
159.63	-0.078	206.2	0.1127	399.08	736.35	282.1	0.2263	
159.67	-0.078	206.2	0.1127	399.17	739.02	282.9	0.2299	
159.70	-0.078	206.2	0.1109	399.25	741.5	284.2	0.2334	

Prova triassiale ciclica SNGR03-C4							
pressione di confinamento (kPa)		450			pressione di confinamento (kPa)		450
deviatore ciclico (kPa)		80			deviatore ciclico (kPa)		120
frequenza (hz)		0.00071429			frequenza (hz)		0.0007143
159.73	-0.079	206.1	0.1109	399.33	746.13	285.5	0.2397
159.77	-0.078	206.3	0.1127	399.42	743.43	285.6	0.2406
159.80	-0.076	206.5	0.1136	399.50	747.74	286.8	0.245
159.83	-0.074	206.7	0.1145	399.58	748.96	287.5	0.2477
159.87	-0.073	206.9	0.1145	399.67	750.57	288.6	0.2521
159.90	-0.069	207.4	0.1145	399.75	752.53	289.4	0.2548
159.93	-0.069	207.4	0.1171	399.83	754.91	290.3	0.2583
159.97	-0.071	207.4	0.1171	399.92	755.87	290.9	0.261
160.00	-0.071	207.4	0.1171	400.00	757.07	291.7	0.2636
160.03	-0.071	207.5	0.1171	400.08	760.41	292.5	0.2672
160.07	-0.07	207.6	0.118	400.17	761.66	293.5	0.269
160.10	-0.068	207.9	0.118	400.25	763.02	294.2	0.2725
160.13	-0.067	208.1	0.118	400.33	764.6	294.9	0.2752
160.17	-0.067	208.1	0.1189	400.42	766.68	295.7	0.2778
160.20	-0.066	208.3	0.1198	400.50	767.19	296.1	0.2805
160.23	-0.066	208.4	0.1198	400.58	768.51	296.8	0.2823
160.27	-0.065	208.6	0.1207	400.67	770.5	297.5	0.2849
160.30	-0.065	208.6	0.1207	400.75	772.01	298.4	0.2867
160.33	-0.063	208.9	0.1207	400.83	772.65	298.9	0.2885
160.37	-0.062	209.1	0.1216	400.92	772.78	299.3	0.2903
160.40	-0.062	209.1	0.1234	401.00	776.61	300.4	0.2938
160.43	-0.061	209.3	0.1234	401.10	775.22	300.7	0.2947
160.47	-0.059	209.6	0.1251	401.17	776.89	301.3	0.2974
160.50	-0.059	209.8	0.1251	401.25	778.01	301.8	0.2991
160.53	-0.058	210	0.126	401.33	779.66	302.5	0.3009
160.57	-0.057	210.2	0.126	401.42	778.08	302.6	0.3009
160.60	-0.056	210.4	0.1269	401.50	780.11	303.1	0.3027
160.63	-0.056	210.4	0.1269	401.58	780.88	303.9	0.3053
160.67	-0.055	210.6	0.1278	401.67	782.23	304.3	0.3053
160.70	-0.054	210.9	0.1287	401.75	782.19	304.6	0.3089
160.73	-0.053	211.1	0.1296	401.83	783.09	305.1	0.3089
160.77	-0.052	211.3	0.1305	401.92	782.57	305.3	0.3098
160.80	-0.051	211.6	0.1305	402.00	783.41	305.7	0.3107
160.83	-0.05	211.7	0.1313	402.08	783.99	306	0.3116
160.88	-0.049	211.9	0.1331	402.17	787.43	306.4	0.3124
160.92	-0.049	212.1	0.1331	402.25	784.57	306.8	0.3142
160.95	-0.048	212.3	0.1331	402.33	784.15	307	0.3133
160.97	-0.048	212.3	0.134	402.42	783.66	307.1	0.3142
161.00	-0.046	212.6	0.1358	402.50	785.3	307.6	0.3151
161.03	-0.045	212.9	0.1367	402.58	784.59	307.7	0.3151
161.07	-0.043	213.2	0.1376	402.67	785.63	308.1	0.316
161.10	-0.043	213.3	0.1376	402.75	784.82	308.1	0.316
161.13	-0.042	213.6	0.1376	402.83	786.42	308.6	0.3178
161.17	-0.041	213.8	0.1393	402.92	783.24	308.3	0.316
161.20	-0.041	213.8	0.1393	403.00	783.21	308.4	0.316
161.23	-0.04	214.1	0.1411	403.08	783.69	308.6	0.3169
161.27	-0.038	214.5	0.142	403.17	784.53	308.9	0.3169
161.30	-0.038	214.6	0.1429	403.25	782.53	308.8	0.3169
161.33	-0.037	214.9	0.1438	403.33	782.3	308.8	0.3169
161.37	-0.035	215.2	0.1438	403.42	782.02	308.9	0.3169
161.40	-0.033	215.5	0.1455	403.50	781.15	308.8	0.316
161.43	-0.033	215.5	0.1464	403.58	780.25	308.8	0.316
161.47	-0.033	215.7	0.1473	403.67	779.25	308.8	0.316
161.50	-0.032	215.9	0.1482	403.75	778.15	308.6	0.3151
161.53	-0.031	216.3	0.15	403.83	777.83	308.6	0.3142
161.57	-0.03	216.5	0.1509	403.92	775.74	308.3	0.3133
161.60	-0.028	216.9	0.1509	404.02	775.77	308.4	0.3133
161.63	-0.027	217.1	0.1526	404.08	774.39	308.1	0.3124
161.67	-0.027	217.1	0.1535	404.17	773.71	308	0.3116
161.70	-0.026	217.4	0.1544	404.25	772.14	307.7	0.3107

Prova triassiale ciclica SNGR03-C4							
tensione di confinamento (kPa)		450	tensione di confinamento (kPa)		450		
deviatore ciclico (kPa)		80	deviatore ciclico (kPa)		120		
frequenza (hz)		0.00071429	frequenza (hz)		0.0007143		
161.73	-0.025	217.7	0.1553	404.33	770.6	307.5	0.3098
161.77	-0.024	217.9	0.1562	404.42	770.34	307.4	0.3089
161.80	-0.023	218.2	0.158	404.50	768.89	307.1	0.308
161.83	-0.022	218.5	0.158	404.58	766.76	306.9	0.3071
161.87	-0.021	218.8	0.1597	404.67	765.16	306.4	0.3062
161.90	-0.021	218.8	0.1606	404.75	763.84	306.1	0.3045
161.93	-0.02	219.1	0.1624	404.83	762.61	305.9	0.3036
161.97	-0.018	219.4	0.1633	404.92	760.75	305.5	0.3018
162.00	-0.015	219.9	0.166	405.00	760.08	305.2	0.3009
162.03	-0.017	219.9	0.166	405.08	758.14	304.8	0.2991
162.07	-0.017	220.1	0.166	405.17	755.02	304.4	0.2974
162.10	-0.014	220.5	0.1669	405.25	754.41	303.8	0.2965
162.13	-0.014	220.5	0.1686	405.33	752.42	303.3	0.2938
162.17	-0.013	220.9	0.1704	405.43	750.84	302.9	0.292
162.20	-0.011	221.3	0.1722	405.50	748.91	302.8	0.292
162.23	-0.01	221.6	0.174	405.58	745.66	301.6	0.2876
162.27	-0.009	221.9	0.1757	405.67	744.63	301.2	0.2867
162.30	-0.008	222.2	0.1757	405.75	743.16	300.7	0.2858
162.35	-0.006	222.6	0.1793	405.83	739.95	300	0.2823
162.38	-0.006	222.8	0.1802	405.92	738.64	299.7	0.2805
162.40	-0.005	223.1	0.1802	406.00	736.78	299.1	0.2787
162.43	-0.003	223.5	0.1819	406.08	733.78	298.5	0.2761
162.47	-0.003	223.5	0.1846	406.17	731.53	297.6	0.2743
162.50	-0.003	223.7	0.1855	406.25	729.11	296.8	0.2698
162.53	-0.001	224.1	0.1882	406.33	727.18	296.3	0.2681
162.57	0.001	224.4	0.1908	406.42	724.74	295.5	0.2654
162.60	0.001	224.7	0.1926	406.50	723.55	294.9	0.2627
162.63	0.005	225.4	0.1926	406.58	720.94	294.3	0.2601
162.67	0.002	225.3	0.1961	406.67	715.55	293.8	0.2583
162.70	0.002	225.3	0.197	406.75	715.65	292.6	0.2548
162.73	0.004	225.6	0.1997	406.83	713.31	291.9	0.2503
162.77	0.006	226.1	0.2024	406.93	711.6	291.2	0.2477
162.80	0.008	226.5	0.2059	407.00	707.51	290.2	0.2441
162.83	0.007	226.7	0.2068	407.08	703.8	288.9	0.2423
162.87	0.009	227.1	0.2068	407.17	702.9	288.4	0.2361
162.90	0.012	227.5	0.2103	407.25	700.68	287.6	0.2334
162.93	0.012	227.5	0.2148	407.33	697.78	286.6	0.2299
162.97	0.012	227.8	0.2174	407.42	696.13	285.9	0.2263
163.00	0.012	228.1	0.221	407.50	693.36	285	0.2228
163.03	0.015	228.5	0.2245	407.58	689.53	284.1	0.2192
163.07	0.015	228.8	0.2281	407.67	686.6	282.7	0.2157
163.10	0.016	229.2	0.2281	407.75	684.92	282	0.2104
163.13	0.018	229.6	0.2325	407.83	682.47	281.1	0.2059
163.17	0.018	229.6	0.2379	407.92	679.7	280.1	0.2024
163.20	0.019	230	0.2432	408.00	677.44	279.2	0.1988
163.23	0.02	230.4	0.2485	408.08	674.64	278.2	0.1944
163.27	0.021	230.7	0.2547	408.17	670.67	277.3	0.19
163.30	0.022	231.1	0.2609	408.25	668.44	275.9	0.1873
163.33	0.023	231.4	0.2609	408.35	665.89	275	0.1802
163.37	0.025	231.9	0.2672	408.42	663.77	274.1	0.1766
163.40	0.025	231.9	0.2734	408.50	658.15	273.1	0.1704
163.43	0.026	232.2	0.2778	408.58	657.86	271.7	0.166
163.47	0.028	232.6	0.2822	408.67	655.54	270.8	0.1607
163.50	0.029	232.9	0.284	408.75	652.47	269.7	0.1562
163.53	0.029	233.3	0.2867	408.83	649.82	268.8	0.1527
163.57	0.031	233.7	0.2867	408.92	647.56	267.9	0.1482
163.60	0.033	234	0.2893	409.00	644.91	266.9	0.1429
163.63	0.033	234	0.2911	409.08	641.23	265.9	0.1376
163.67	0.033	234.2	0.2929	409.17	638.58	264.4	0.1323
163.70	0.034	234.6	0.2956	409.25	636.58	263.6	0.1243

Prova triassiale ciclica SNGR03-C4								
tensione di confinamento (kPa)		450			tensione di confinamento (kPa)		450	
deviatore ciclico (kPa)		80			deviatore ciclico (kPa)		120	
frequenza (hz)		0.00071429			frequenza (hz)		0.0007143	
163.73	0.036	234.9	0.2964	409.33	633.96	262.5	0.1189	
163.78	0.037	235.3	0.2991	409.42	631.15	261.4	0.1136	
163.82	0.038	235.6	0.3009	409.50	630.37	260.7	0.1101	
163.85	0.038	235.8	0.3018	409.58	627.11	259.5	0.1047	
163.87	0.039	236.1	0.3035	409.67	622.97	258.3	0.0994	
163.90	0.041	236.5	0.3035	409.75	618.71	256.4	0.095	
163.93	0.042	236.8	0.3053	409.85	618.99	255.8	0.0888	
163.97	0.042	236.8	0.3071	409.92	616.76	254.8	0.0843	
164.00	0.043	237.1	0.3089	410.00	612.66	253.8	0.0808	
164.03	0.044	237.5	0.3106	410.08	611.04	252.1	0.0772	
164.07	0.046	237.8	0.3124	410.17	609.16	251.2	0.0719	
164.10	0.047	238.1	0.3142	410.25	606.67	250.1	0.0683	
164.13	0.047	238.5	0.3142	410.33	604.21	249	0.0648	
164.17	0.049	238.9	0.316	410.42	602.11	248	0.0612	
164.20	0.049	238.9	0.3169	410.50	600.1	247	0.0595	
164.23	0.049	239.1	0.3177	410.58	596.84	245.9	0.0559	
164.27	0.05	239.4	0.3195	410.67	594.79	244.4	0.0533	
164.30	0.052	239.8	0.3222	410.75	592.85	243.4	0.0488	
164.33	0.053	240.1	0.3231	410.83	590.85	242.5	0.047	
164.37	0.054	240.4	0.3231	410.92	588.55	241.5	0.0444	
164.40	0.056	240.8	0.3257	411.00	586.77	240.5	0.0417	
164.43	0.056	240.8	0.3266	411.08	585.05	239.6	0.0391	
164.47	0.056	241	0.3284	411.17	583.18	239	0.0382	
164.50	0.058	241.4	0.3302	411.27	580.52	237.4	0.0346	
164.53	0.059	241.8	0.332	411.33	579.39	236.7	0.032	
164.57	0.06	242	0.3328	411.42	577.15	235.6	0.0302	
164.60	0.061	242.4	0.3328	411.50	574.98	234.5	0.0275	
164.63	0.062	242.7	0.3346	411.58	572.98	233.5	0.0257	
164.67	0.062	242.7	0.3364	411.67	571.78	232.7	0.0231	
164.70	0.063	243	0.3373	411.75	569.8	231.9	0.0213	
164.73	0.064	243.4	0.3399	411.83	568.41	231.1	0.0195	
164.77	0.065	243.6	0.3417	411.92	567.08	230.4	0.0178	
164.80	0.066	243.9	0.3435	412.00	565.66	229.7	0.016	
164.83	0.067	244.3	0.3435	412.08	563.1	228.9	0.0142	
164.87	0.068	244.6	0.3444	412.17	562.35	227.9	0.0124	
164.90	0.068	244.6	0.3462	412.25	560.32	227	0.0107	
164.93	0.068	244.8	0.347	412.33	559.86	226.5	0.0098	
164.97	0.07	245.2	0.3488	412.42	558.53	225.8	0.008	
165.00	0.071	245.5	0.3506	412.50	558.69	225.4	0.0071	
165.03	0.072	245.8	0.3515	412.58	556.04	224.6	0.0053	
165.07	0.073	246.1	0.3515	412.67	554.71	224	0.0044	
165.10	0.074	246.5	0.3533	412.75	554.45	223.2	0.0027	
165.13	0.074	246.5	0.3541	412.83	552.96	222.5	0.0009	
165.17	0.075	246.8	0.3559	412.92	552.47	222	0.0009	
165.20	0.076	247.2	0.3568	413.00	551.02	221.2	-0.0009	
165.25	0.074	247.4	0.3577	413.08	549.69	220.6	-0.0018	
165.28	0.076	247.7	0.3595	413.17	549.95	220.3	-0.0027	
165.30	0.079	248.1	0.3612	413.25	547.52	219.5	-0.0044	
165.33	0.081	248.4	0.363	413.33	548.55	219.3	-0.0044	
165.37	0.08	248.5	0.363	413.42	547.74	218.9	-0.0053	
165.40	0.081	248.9	0.3648	413.50	547.09	218.5	-0.0062	
165.43	0.082	249.2	0.3648	413.58	547.67	218.2	-0.0062	
165.47	0.082	249.2	0.3666	413.67	546.09	217.6	-0.0071	
165.50	0.082	249.4	0.3675	413.75	545.41	217.2	-0.0089	
165.53	0.086	250.1	0.371	413.83	545.92	217	-0.0089	
165.57	0.085	250.1	0.3701	413.92	545.25	216.7	-0.0098	
165.60	0.084	250.3	0.371	414.00	545.63	216.5	-0.0098	
165.63	0.086	250.7	0.3728	414.08	544.92	216.2	-0.0098	
165.67	0.088	251	0.3728	414.18	545.18	215.9	-0.0107	
165.70	0.088	251	0.3746	414.25	544.95	215.7	-0.0107	

Prova triassiale ciclica SNGR03-C4

pressione di confinamento (kPa)		450		pressione di confinamento (kPa)		450	
deviatore ciclico (kPa)		80		deviatore ciclico (kPa)		120	
frequenza (hz)		0.00071429		frequenza (hz)		0.0007143	
165.73	0.088	251.2	0.3746	414.33	545.05	215.5	-0.0107
165.77	0.089	251.5	0.3763	414.42	545.34	215.4	-0.0115
165.80	0.09	251.8	0.3772	414.50	545.27	215.1	-0.0115
165.83	0.091	252.1	0.379	414.58	545.17	215	-0.0115
165.87	0.092	252.4	0.3799	414.67	545.76	214.9	-0.0115
165.90	0.093	252.7	0.3799	414.75	545.6	214.8	-0.0115
165.93	0.093	252.7	0.3817	414.83	546.5	214.8	-0.0115
165.97	0.093	252.9	0.3825	414.92	547.21	214.8	-0.0115
166.00	0.094	253.2	0.3834	415.00	547.67	214.8	-0.0115
166.03	0.095	253.5	0.3843	415.08	548.57	214.9	-0.0115
166.07	0.095	253.7	0.3852	415.17	548.7	214.9	-0.0115
166.10	0.096	254	0.387	415.25	549.19	214.9	-0.0115
166.13	0.097	254.3	0.387	415.33	549.12	214.9	-0.0107
166.17	0.097	254.3	0.3879	415.42	553.2	215.6	-0.0089
166.20	0.098	254.6	0.3888	415.50	552.91	215.5	-0.0089
166.23	0.098	254.9	0.3905	415.60	552.88	215.4	-0.0098
166.27	0.102	255.4	0.3923	415.67	554.66	215.7	-0.0089
166.30	0.099	255.4	0.3923	415.75	555.11	215.8	-0.008
166.33	0.099	255.5	0.3923	415.83	556.02	216	-0.008
166.37	0.099	255.8	0.3923	415.92	557.35	216.3	-0.0071
166.40	0.099	255.8	0.3932	416.00	557.73	216.3	-0.0071
166.43	0.101	256.1	0.395	416.08	560.45	217	-0.0062
166.47	0.103	256.5	0.3967	416.17	561.71	217.2	-0.0044
166.50	0.104	256.7	0.3976	416.25	563.08	217.5	-0.0044
166.53	0.104	256.9	0.3976	416.33	566.02	218.2	-0.0027
166.57	0.104	257.2	0.3994	416.42	565.73	218.3	-0.0027
166.60	0.105	257.5	0.3994	416.50	566.6	218.6	-0.0018
166.63	0.105	257.5	0.4003	416.58	569.22	219.2	-0.0009
166.67	0.105	257.7	0.4012	416.67	570.68	219.6	0
166.72	0.107	258.3	0.403	416.75	572.63	220.1	0.0018
166.75	0.107	258.3	0.403	416.83	574.4	220.6	0.0027
166.77	0.107	258.4	0.403	416.92	575.47	221	0.0036
166.80	0.107	258.5	0.4039	417.00	576.87	221.4	0.0044
166.83	0.111	259	0.4056	417.10	579.81	222.2	0.0062
166.87	0.109	259.1	0.4056	417.17	581.65	222.8	0.008
166.90	0.108	259.2	0.4056	417.25	582.76	223.2	0.0089
166.93	0.108	259.4	0.4056	417.33	583.99	223.6	0.0098
166.97	0.108	259.4	0.4065	417.42	587.38	224.5	0.0115
167.00	0.11	259.7	0.4083	417.50	590.2	225.4	0.0124
167.03	0.111	260	0.4092	417.58	591.66	226	0.0151
167.07	0.112	260.2	0.4101	417.67	593.99	226.6	0.0169
167.10	0.112	260.4	0.411	417.75	595.81	227.3	0.0178
167.13	0.112	260.6	0.4118	417.83	598.1	228.1	0.0204
167.17	0.113	260.8	0.4118	417.92	600	228.7	0.0213
167.20	0.113	260.8	0.4127	418.00	601.95	229.4	0.0231
167.23	0.113	261	0.4127	418.08	606.8	230.9	0.0266
167.27	0.113	261.2	0.4136	418.17	605.15	231	0.0275
167.30	0.116	261.6	0.4154	418.25	608.93	231.9	0.0302
167.33	0.115	261.6	0.4154	418.33	612.27	233	0.0328
167.37	0.114	261.7	0.4154	418.42	614.69	233.9	0.0346
167.40	0.115	261.9	0.4154	418.52	616.6	234.9	0.0373
167.43	0.115	261.9	0.4154	418.58	619.22	235.6	0.0399
167.47	0.116	262.1	0.4172	418.67	622.07	236.6	0.0417
167.50	0.117	262.4	0.4181	418.75	626.63	237.9	0.0462
167.53	0.117	262.6	0.4181	418.83	626.34	238.4	0.047
167.57	0.117	262.7	0.4189	418.92	629.51	239.4	0.0497
167.60	0.12	263.2	0.4207	419.00	632.84	240.5	0.0515
167.63	0.118	263.2	0.4207	419.08	634.61	241.6	0.0568
167.67	0.118	263.2	0.4198	419.17	637.88	242.4	0.0595
167.70	0.117	263.3	0.4207	419.25	640.18	243.4	0.0621

Prova triassiale ciclica SNGR03-C4								
pressione di confinamento (kPa)		450		pressione di confinamento (kPa)		450		
deviatore ciclico (kPa)		80		deviatore ciclico (kPa)		120		
frequenza (hz)		0.00071429		frequenza (hz)		0.0007143		
167.73	0.117	263.4	0.4207	419.33	642.41	244.3	0.0657	
167.77	0.121	263.8	0.4225	419.42	644.03	245.2	0.0683	
167.80	0.118	263.8	0.4216	419.50	647.9	246.4	0.0728	
167.83	0.118	263.8	0.4216	419.58	651.04	247.8	0.0763	
167.87	0.118	263.9	0.4216	419.67	653.95	248.9	0.0826	
167.90	0.118	263.9	0.4216	419.75	655.86	249.8	0.0861	
167.93	0.119	264.4	0.4243	419.83	661.64	251.3	0.0932	
167.97	0.12	264.5	0.4243	419.92	660.28	251.8	0.0959	
168.00	0.12	264.6	0.4243	420.02	663.7	253.1	0.1021	
168.03	0.12	264.7	0.4243	420.08	666.2	254.1	0.1065	
168.07	0.12	264.9	0.4252	420.17	668.68	255.1	0.111	
168.10	0.12	265	0.4252	420.25	671.16	256.1	0.1145	
168.15	0.121	265.2	0.426	420.33	674.45	257.1	0.1189	
168.18	0.123	265.5	0.4278	420.42	678.24	258.1	0.1234	
168.22	0.121	265.5	0.4278	420.50	680.24	259.5	0.1269	
168.23	0.121	265.5	0.4269	420.58	682.98	260.6	0.134	
168.27	0.121	265.6	0.4269	420.67	684.88	261.3	0.1376	
168.30	0.122	265.8	0.4278	420.75	689.46	262.7	0.1429	
168.33	0.121	265.8	0.4269	420.83	689.88	263.5	0.1465	
168.37	0.12	265.9	0.4269	420.92	692.67	264.5	0.15	
168.40	0.12	266	0.4269	421.00	696.53	265.5	0.1544	
168.43	0.123	266.4	0.4269	421.08	699.72	267	0.158	
168.47	0.123	266.4	0.4287	421.17	701.27	267.9	0.1651	
168.50	0.121	266.3	0.4287	421.25	703.81	268.8	0.1687	
168.53	0.121	266.4	0.4278	421.33	706.1	269.8	0.174	
168.57	0.12	266.4	0.4287	421.43	708.88	271.2	0.1775	
168.60	0.121	266.5	0.4287	421.50	710.97	272.1	0.1829	
168.63	0.123	266.9	0.4305	421.58	713.45	273.1	0.1864	
168.67	0.123	267	0.4305	421.67	717.29	274.2	0.1908	
168.70	0.123	267	0.4305	421.75	717.96	275	0.1944	
168.73	0.121	266.9	0.4296	421.83	722.41	276.3	0.1997	
168.77	0.121	267	0.4296	421.92	723.86	276.6	0.2015	
168.80	0.121	267	0.4305	422.00	726.05	278.2	0.2059	
168.83	0.122	267.2	0.4305	422.08	727.98	279.1	0.2113	
168.87	0.121	267.2	0.4305	422.17	730.46	280	0.2148	
168.90	0.123	267.5	0.4305	422.25	732.62	281	0.2192	
168.93	0.121	267.5	0.4314	422.33	734.51	281.9	0.2228	
168.97	0.121	267.5	0.4305	422.42	736.54	282.7	0.2263	
169.00	0.121	267.5	0.4305	422.50	739.41	283.6	0.2299	
169.03	0.121	267.6	0.4305	422.58	741.76	285	0.2334	
169.07	0.121	267.6	0.4305	422.67	742.66	285.6	0.2379	
169.10	0.121	267.7	0.4305	422.75	745.45	286.5	0.2414	
169.13	0.12	267.8	0.4305	422.83	747.03	287.2	0.2441	
169.17	0.12	267.8	0.4305	422.92	750.12	288.5	0.2468	
169.20	0.12	267.8	0.4314	423.00	751.15	289.2	0.2512	
169.23	0.121	267.9	0.4314	423.08	753.72	290.1	0.2548	
169.27	0.12	267.9	0.4305	423.17	754.75	290.8	0.2574	
169.30	0.121	268.1	0.4314	423.25	756	291.5	0.2601	
169.33	0.12	268.1	0.4314	423.33	758.32	292.3	0.2636	
169.37	0.119	268	0.4314	423.42	760.64	292.8	0.2654	
169.40	0.119	268	0.4305	423.50	762.86	294.2	0.269	
169.43	0.119	268.1	0.4305	423.58	762.56	294.6	0.2725	
169.47	0.119	268.2	0.4305	423.67	764.81	295.4	0.2752	
169.50	0.118	268.2	0.4305	423.75	765.84	296.1	0.2769	
169.53	0.118	268.2	0.4305	423.83	767.12	296.7	0.2796	
169.57	0.118	268.3	0.4305	423.92	768.71	297.4	0.2814	
169.62	0.118	268.3	0.4296	424.00	770.12	298	0.284	
169.65	0.118	268.3	0.4296	424.08	771.85	298.9	0.2858	
169.67	0.117	268.3	0.4296	424.17	772.94	299.5	0.2885	
169.70	0.117	268.3	0.4296	424.25	773.88	300.1	0.2903	

Prova triassiale ciclica SNGR03-C4								
tensione di confinamento (kPa)		450			tensione di confinamento (kPa)		450	
deviatore ciclico (kPa)		80			deviatore ciclico (kPa)		120	
frequenza (hz)		0.00071429			frequenza (hz)		0.0007143	
169.73	0.116	268.3	0.4296	424.35	775.35	300.6	0.292	
169.77	0.116	268.3	0.4296	424.42	776.32	301.4	0.2938	
169.80	0.116	268.3	0.4296	424.50	777.22	301.9	0.2965	
169.83	0.117	268.4	0.4296	424.58	777.66	302.3	0.2982	
169.87	0.115	268.3	0.4287	424.67	779.09	303	0.3	
169.90	0.114	268.2	0.4287	424.75	778.98	303.3	0.3009	
169.93	0.115	268.3	0.4287	424.83	780.11	303.7	0.3027	
169.97	0.113	268.3	0.4287	424.92	781.39	304.2	0.3036	
170.00	0.113	268.2	0.4278	425.00	781.84	304.9	0.3045	
170.03	0.114	268.4	0.4287	425.08	782.58	305.3	0.3071	
170.07	0.114	268.4	0.4287	425.17	785.86	306.1	0.3089	
170.10	0.114	268.4	0.4278	425.25	781.65	305.8	0.308	
170.13	0.113	268.3	0.4278	425.33	783.25	306.2	0.3098	
170.17	0.109	268	0.4278	425.42	784.05	306.6	0.3107	
170.20	0.11	268	0.426	425.50	784.31	306.9	0.3116	
170.23	0.11	268.1	0.426	425.58	784.95	307.4	0.3124	
170.27	0.111	268.2	0.426	425.67	784.86	307.6	0.3133	
170.30	0.111	268.2	0.426	425.77	784.82	307.8	0.3142	
170.33	0.11	268.2	0.426	425.83	785.15	308.1	0.3142	
170.37	0.111	268.1	0.4252	425.92	784.98	308.4	0.3151	
170.40	0.107	267.8	0.4252	426.00	784.79	308.6	0.3151	
170.43	0.109	267.8	0.4243	426.08	786.98	309.1	0.3169	
170.47	0.109	267.9	0.4243	426.17	783.82	308.8	0.3151	
170.50	0.108	267.8	0.4234	426.25	783.98	308.9	0.316	
170.53	0.107	267.8	0.4234	426.33	783.95	309.1	0.316	
170.57	0.107	267.8	0.4234	426.42	783.56	309.2	0.316	
170.60	0.105	267.6	0.4225	426.50	785.24	309.7	0.3169	
170.63	0.105	267.6	0.4225	426.58	782.32	309.3	0.316	
170.67	0.104	267.6	0.4216	426.67	782.11	309.3	0.316	
170.70	0.104	267.5	0.4216	426.75	781.79	309.4	0.316	
170.73	0.105	267.6	0.4216	426.83	781.47	309.4	0.316	
170.77	0.103	267.3	0.4207	426.92	780.18	309.3	0.3151	
170.80	0.104	267.4	0.4207	427.00	779.28	309.3	0.3151	
170.83	0.103	267.2	0.4198	427.08	778.67	309.2	0.3142	
170.87	0.099	267	0.4198	427.17	778.89	309.3	0.3142	
170.90	0.1	267	0.4181	427.27	776.13	308.9	0.3124	
170.93	0.1	267	0.4189	427.33	775.65	309	0.3124	
170.97	0.101	267.1	0.4189	427.42	774.39	308.7	0.3116	
171.00	0.099	266.9	0.4181	427.50	773.72	308.6	0.3107	
171.05	0.098	266.8	0.4172	427.58	771.91	308.3	0.3098	
171.08	0.098	266.8	0.4172	427.67	771.21	308.1	0.3089	
171.12	0.097	266.6	0.4163	427.75	770.34	307.9	0.308	
171.13	0.097	266.6	0.4163	427.83	769.4	307.8	0.308	
171.17	0.097	266.5	0.4154	427.92	765.77	307.1	0.3053	
171.20	0.094	266.2	0.4154	428.00	765.8	307	0.3053	
171.23	0.094	266.2	0.4145	428.08	764.29	306.7	0.3036	
171.27	0.094	266.2	0.4145	428.17	762.81	306.4	0.3027	
171.30	0.094	266.2	0.4136	428.25	762.23	306.3	0.3009	
171.33	0.093	266	0.4127	428.33	759.05	305.6	0.2991	
171.37	0.09	265.7	0.4118	428.42	758.14	305.3	0.2982	
171.40	0.091	265.8	0.4118	428.50	755.8	304.9	0.2965	
171.43	0.092	265.8	0.4118	428.58	753.67	304.2	0.2947	
171.47	0.089	265.8	0.4118	428.68	752.32	303.8	0.2929	
171.50	0.089	265.5	0.4101	428.75	751.23	303.5	0.2911	
171.53	0.089	265.4	0.4101	428.83	748.01	303	0.2894	
171.57	0.088	265.3	0.4092	428.92	746.53	302.3	0.2876	
171.60	0.087	265.1	0.4083	429.00	744.4	301.7	0.2858	
171.63	0.087	265	0.4074	429.08	742.67	301.3	0.284	
171.67	0.084	264.7	0.4074	429.17	740.7	300.7	0.2823	
171.70	0.084	264.7	0.4065	429.25	740.8	300.5	0.2814	

Prova triassiale ciclica SNGR03-C4

pressione di confinamento (kPa)		450		pressione di confinamento (kPa)		450	
deviatore ciclico (kPa)		80		deviatore ciclico (kPa)		120	
frequenza (hz)		0.00071429		frequenza (hz)		0.0007143	
171.73	0.084	264.6	0.4056	429.33	736.87	299.6	0.2778
171.77	0.085	264.6	0.4056	429.42	733.2	299	0.2752
171.80	0.082	264.2	0.4039	429.50	731.82	298.1	0.2734
171.83	0.081	264.1	0.403	429.58	728.57	297.2	0.2681
171.87	0.08	263.9	0.4021	429.67	727.06	296.7	0.2663
171.90	0.081	263.9	0.4021	429.75	725.09	296.1	0.2645
171.93	0.078	263.9	0.4021	429.83	723.71	295.5	0.2619
171.97	0.078	263.6	0.4003	429.92	722.26	295	0.2601
172.00	0.078	263.4	0.3994	430.00	717.43	293.9	0.2556
172.03	0.077	263.3	0.3994	430.08	713.85	292.8	0.2539
172.07	0.076	263.1	0.3976	430.18	716.27	292.8	0.2512
172.10	0.076	263	0.3976	430.25	709.48	291.4	0.2459
172.13	0.076	262.9	0.3976	430.33	707.54	290.9	0.2441
172.17	0.074	262.9	0.3976	430.42	704.67	289.5	0.2406
172.20	0.074	262.7	0.3959	430.50	702.78	288.8	0.2352
172.23	0.072	262.4	0.395	430.58	700.84	288.1	0.2326
172.27	0.068	261.9	0.3914	430.67	696.94	286.9	0.2281
172.30	0.069	261.8	0.3914	430.75	695.65	286.3	0.2255
172.33	0.069	261.7	0.3914	430.83	692.69	285.4	0.2219
172.37	0.068	261.6	0.3914	430.92	689.95	284.5	0.2184
172.40	0.069	261.6	0.3905	431.00	687.37	283.3	0.2157
172.43	0.069	261.5	0.3896	431.08	684.31	282.4	0.2095
172.47	0.064	261	0.387	431.17	682.63	281.6	0.2059
172.52	0.064	260.8	0.3861	431.25	679.31	280.5	0.2015
172.55	0.064	260.7	0.3861	431.33	675.89	279.3	0.1962
172.57	0.064	260.7	0.3861	431.42	674.47	278.6	0.1926
172.60	0.065	260.6	0.3861	431.50	670.93	277.8	0.19
172.63	0.06	260.1	0.3834	431.60	667.09	276.1	0.182
172.67	0.06	260	0.3834	431.67	666.41	275.4	0.1793
172.70	0.061	260	0.3834	431.75	665.28	274.8	0.1766
172.73	0.059	260	0.3825	431.83	659.9	273.2	0.1687
172.77	0.059	259.7	0.3808	431.92	657.38	272	0.166
172.80	0.055	259	0.3772	432.00	655.54	271	0.1598
172.83	0.056	259	0.3772	432.08	652.5	270.1	0.1553
172.87	0.055	258.8	0.3763	432.17	650.37	269.5	0.1527
172.90	0.055	258.5	0.3746	432.25	648.47	268.4	0.1473
172.93	0.052	258.2	0.3746	432.33	644.88	267.4	0.1429
172.97	0.052	258.2	0.3737	432.42	641.13	265.9	0.1358
173.00	0.052	258.1	0.3719	432.50	638.39	264.8	0.1323
173.03	0.049	257.7	0.371	432.58	636.9	264	0.1243
173.07	0.05	257.6	0.3701	432.67	633.87	262.9	0.1189
173.10	0.046	257.1	0.3675	432.75	630.96	261.7	0.1136
173.13	0.048	257.1	0.3675	432.83	629.02	260.7	0.1083
173.17	0.046	256.7	0.3675	432.92	627.08	259.9	0.1039
173.20	0.047	256.7	0.3657	433.00	622.84	258.7	0.0994
173.23	0.047	256.7	0.3657	433.08	621.81	257.5	0.0941
173.27	0.043	256.1	0.3621	433.17	619.51	256.4	0.0897
173.30	0.041	255.8	0.3612	433.25	616.37	255.2	0.0852
173.33	0.042	255.8	0.3612	433.33	613.31	254.1	0.0808
173.37	0.04	255.3	0.3586	433.42	610.19	252.4	0.0772
173.40	0.038	255	0.3586	433.50	608.96	251.6	0.0719
173.43	0.037	255	0.3577	433.58	606.25	250.5	0.0683
173.47	0.037	254.8	0.3568	433.67	604.53	249.5	0.0648
173.50	0.038	254.8	0.3568	433.75	602.56	248.5	0.0612
173.53	0.035	254.2	0.3533	433.83	599.81	247.4	0.0595
173.57	0.034	254.1	0.3524	433.92	597.26	246.7	0.0577
173.60	0.033	253.8	0.3515	434.00	594.18	244.7	0.0541
173.63	0.034	253.8	0.3515	434.08	592.98	243.9	0.0497
173.67	0.029	253.8	0.3497	434.17	590.69	242.9	0.047
173.70	0.029	253	0.347	434.25	588.26	241.4	0.0435

Prova triassiale ciclica SNGR03-C4

pressione di confinamento (kPa)		450			pressione di confinamento (kPa)		450		
deviatore ciclico (kPa)		80			deviatore ciclico (kPa)		120		
frequenza (hz)		0.00071429			frequenza (hz)		0.0007143		
173.73	0.03	252.9	0.347	434.33	586.93	240.9	0.0417		
173.77	0.029	252.7	0.3453	434.42	585.51	240.1	0.0399		
173.80	0.029	252.5	0.3444	434.52	582.47	238.7	0.0364		
173.83	0.026	252	0.3417	434.58	580.75	237.8	0.0346		
173.87	0.024	251.6	0.3417	434.67	579	236.8	0.032		
173.90	0.023	251.6	0.3382	434.75	577.15	236.1	0.0302		
173.95	0.024	251.2	0.3364	434.83	577.08	235.2	0.0284		
173.98	0.023	251	0.3364	434.92	570.33	233.3	0.0249		
174.02	0.02	251	0.3346	435.00	571.94	233.1	0.0231		
174.03	0.02	250.6	0.3328	435.08	570.13	232.3	0.0222		
174.07	0.02	250.4	0.332	435.17	568.8	231.6	0.0204		
174.10	0.018	250.1	0.3302	435.25	567.5	230.9	0.0186		
174.13	0.018	249.8	0.3284	435.33	565.63	230	0.0169		
174.17	0.016	249.4	0.3266	435.42	563.33	229.2	0.0151		
174.20	0.015	249.1	0.3266	435.50	562.45	228.2	0.0133		
174.23	0.014	249.1	0.324	435.58	561.35	227.5	0.0115		
174.27	0.014	248.8	0.3222	435.67	559.63	226.8	0.0098		
174.30	0.012	248.5	0.3204	435.75	558.3	226.1	0.008		
174.33	0.011	248.2	0.3195	435.83	557.78	225.6	0.0071		
174.37	0.011	247.9	0.3177	435.93	556.62	224.7	0.0053		
174.40	0.009	247.5	0.3151	436.00	555.29	224.1	0.0036		
174.43	0.007	247.2	0.3151	436.08	554.09	223.4	0.0027		
174.47	0.007	247.2	0.3133	436.17	553.22	222.9	0.0018		
174.50	0.007	246.9	0.3115	436.25	552.08	222.3	0.0009		
174.53	0.005	246.6	0.3098	436.33	551.21	221.9	0		
174.57	0.004	246.2	0.308	436.42	549.65	221	-0.0018		
174.60	0.002	245.9	0.3062	436.50	549.69	220.6	-0.0027		
174.63	0.002	245.7	0.3044	436.58	548.94	220.1	-0.0036		
174.67	0.001	245.3	0.3044	436.67	548.23	219.7	-0.0044		
174.70	0.001	245.3	0.3027	436.75	547.55	219.1	-0.0053		
174.73	0.001	245.3	0.3018	436.83	546.57	218.6	-0.0062		
174.77	-0.001	244.8	0.2973	436.92	547.25	218.4	-0.0071		
174.80	-0.003	244.3	0.2929	437.00	547.32	218.1	-0.0062		
174.83	-0.007	243.7	0.2893	437.08	546.18	217.7	-0.008		
174.87	-0.006	243.6	0.2867	437.17	545.41	217.3	-0.0089		
174.90	-0.006	243.4	0.2867	437.25	545.44	217.1	-0.0089		
174.93	-0.008	243.4	0.2831	437.33	545.25	216.8	-0.0089		
174.97	-0.008	243.1	0.2787	437.43	545.18	216.4	-0.0098		
175.00	-0.009	242.8	0.2743	437.50	545.14	216.2	-0.0098		
175.03	-0.008	242.6	0.2716	437.58	544.79	216	-0.0107		
175.07	-0.01	242.2	0.2672	437.67	545.08	215.8	-0.0107		
175.10	-0.012	241.7	0.2601	437.75	545.21	215.7	-0.0107		
175.13	-0.016	241	0.2601	437.83	545.34	215.5	-0.0107		
175.17	-0.015	241	0.2556	437.92	545.79	215.4	-0.0107		
175.20	-0.015	240.9	0.2521	438.00	546.05	215.3	-0.0115		
175.23	-0.017	240.6	0.2476	438.08	546.44	215.3	-0.0115		
175.27	-0.017	240.3	0.2441	438.17	546.67	215.2	-0.0107		
175.30	-0.019	239.9	0.2405	438.25	546.95	215.1	-0.0115		
175.33	-0.017	239.9	0.2387	438.33	547.05	215	-0.0115		
175.37	-0.02	239.4	0.2387	438.42	548.12	215	-0.0115		
175.42	-0.022	239	0.2308	438.50	549.19	215.2	-0.0107		
175.45	-0.022	238.7	0.2281	438.58	549.7	215.3	-0.0107		
175.47	-0.027	238	0.2281	438.67	550.68	215.4	-0.0098		
175.50	-0.025	238	0.2237	438.75	553.11	215.8	-0.0089		
175.53	-0.025	237.9	0.221	438.85	552.78	215.7	-0.0089		
175.57	-0.026	237.5	0.2183	438.92	552.97	215.7	-0.0089		
175.60	-0.027	237.1	0.2157	439.00	553.98	215.9	-0.0089		
175.63	-0.029	236.8	0.2139	439.08	554.4	216	-0.008		
175.67	-0.026	236.8	0.213	439.17	555.79	216.4	-0.0071		
175.70	-0.03	236.2	0.213	439.25	557.77	216.7	-0.0062		

Prova triassiale ciclica SNGR03-C4							
tensione di confinamento (kPa)		450	tensione di confinamento (kPa)		450		
deviatore ciclico (kPa)		80	deviatore ciclico (kPa)		120		
frequenza (hz)		0.00071429	frequenza (hz)		0.0007143		
175.73	-0.031	236.2	0.2095	439.33	559.32	217.1	-0.0053
175.77	-0.031	235.9	0.2068	439.42	559.64	217.2	-0.0053
175.80	-0.032	235.4	0.2032	439.50	561.33	217.5	-0.0044
175.83	-0.035	234.9	0.1997	439.58	563.04	217.9	-0.0036
175.87	-0.037	234.4	0.197	439.67	564.27	218.2	-0.0027
175.90	-0.036	234.2	0.1961	439.75	565.44	218.5	-0.0027
175.93	-0.037	234	0.1961	439.83	566.99	218.9	-0.0009
175.97	-0.038	234	0.1944	439.92	569.22	219.3	0
176.00	-0.038	233.6	0.1917	440.00	569.68	219.7	0
176.03	-0.039	233.2	0.1899	440.08	571.78	220.3	0.0018
176.07	-0.038	233.2	0.1899	440.17	573.47	220.7	0.0027
176.10	-0.042	232.6	0.1873	440.25	575.99	221.4	0.0044
176.13	-0.042	232.3	0.1855	440.35	577.87	222	0.0044
176.17	-0.043	231.9	0.1855	440.42	580.33	222.7	0.0071
176.20	-0.045	231.9	0.1828	440.50	578.94	222.6	0.0071
176.23	-0.045	231.5	0.1811	440.58	583.98	223.7	0.0098
176.27	-0.045	231.1	0.1793	440.67	585.73	224.3	0.0115
176.30	-0.048	230.7	0.1775	440.75	586.9	224.8	0.0115
176.33	-0.048	230.4	0.1757	440.83	590	225.5	0.0133
176.37	-0.049	230	0.174	440.92	589.91	226	0.0142
176.40	-0.05	229.7	0.174	441.00	593.21	226.8	0.0169
176.43	-0.051	229.7	0.1731	441.08	596.25	227.7	0.0186
176.47	-0.051	229.3	0.1713	441.17	598	228.4	0.0204
176.50	-0.052	229	0.1695	441.25	599.59	229	0.0222
176.53	-0.054	228.5	0.1677	441.33	602.66	229.9	0.024
176.57	-0.053	228.3	0.1669	441.42	605.02	230.7	0.0257
176.60	-0.058	227.6	0.1633	441.50	607.87	231.8	0.0275
176.63	-0.058	227.3	0.1633	441.58	609.36	232.4	0.0302
176.67	-0.057	227.3	0.1624	441.67	612.2	233.3	0.0328
176.70	-0.057	227.1	0.1624	441.77	614.79	234.1	0.0346
176.73	-0.058	226.8	0.1606	441.83	617.8	235.3	0.0364
176.77	-0.059	226.5	0.1597	441.92	619.61	236.1	0.0399
176.80	-0.059	226.2	0.1589	442.00	621.91	236.9	0.0426
176.83	-0.059	226.1	0.158	442.08	624.5	237.9	0.0453
176.88	-0.062	225.5	0.1562	442.17	626.63	238.7	0.047
176.92	-0.063	225.3	0.1544	442.25	629.44	239.6	0.0497
176.93	-0.063	224.9	0.1535	442.33	630.96	240.7	0.0533
176.97	-0.064	224.6	0.1535	442.42	635.33	242	0.055
177.00	-0.065	224.6	0.1526	442.50	637.3	242.9	0.0595
177.03	-0.065	224.2	0.1518	442.58	640.18	243.8	0.0621
177.07	-0.066	223.9	0.15	442.67	642.51	244.8	0.0657
177.10	-0.067	223.5	0.1491	442.75	644.8	245.8	0.0692
177.13	-0.068	223.3	0.1482	442.83	647.29	246.7	0.0728
177.17	-0.069	222.9	0.1464	442.92	651.69	247.8	0.0763
177.20	-0.07	222.5	0.1464	443.00	653.95	249.3	0.0808
177.23	-0.071	222.5	0.1455	443.08	655.86	250.2	0.087
177.27	-0.071	222.3	0.1447	443.17	658.79	251.3	0.0914
177.30	-0.071	222	0.1438	443.25	662.32	252.1	0.095
177.33	-0.072	221.6	0.1429	443.33	663.96	253.6	0.0994
177.37	-0.073	221.4	0.142	443.42	666.42	254.6	0.1056
177.40	-0.075	221	0.1402	443.50	669.42	255.6	0.1101
177.43	-0.074	220.7	0.1402	443.58	674.07	257	0.1163
177.47	-0.075	220.7	0.1402	443.67	673.01	257.4	0.1181
177.50	-0.075	220.3	0.1393	443.75	677.26	258.5	0.1225
177.53	-0.076	220.1	0.1384	443.83	680.72	259.4	0.1269
177.57	-0.078	219.7	0.1367	443.92	683.41	261.1	0.1305
177.60	-0.082	219.1	0.1349	444.00	685.53	262	0.1376
177.63	-0.079	219	0.1349	444.08	688.24	263	0.1411
177.67	-0.079	219	0.1349	444.17	691.14	264.1	0.1456
177.70	-0.08	219	0.1349	444.25	692.98	265	0.15

Prova triassiale ciclica SNGR03-C4							
pressione di confinamento (kPa)		450		tensione di confinamento (kPa)		450	
deviatore ciclico (kPa)		80		deviatore ciclico (kPa)		120	
frequenza (hz)		0.00071429		frequenza (hz)		0.0007143	
177.73	-0.08	218.7	0.134	444.33	695.24	265.9	0.1536
177.77	-0.081	218.4	0.1331	444.42	698.88	267.2	0.1589
177.80	-0.082	218	0.1313	444.50	700.1	268.1	0.1616
177.83	-0.083	217.7	0.1313	444.58	703.39	269.2	0.1678
177.87	-0.082	217.7	0.1313	444.68	706.36	270.3	0.1722
177.90	-0.082	217.4	0.1313	444.75	709.62	271.7	0.1766
177.93	-0.086	217.4	0.1305	444.83	713.74	273	0.1802
177.97	-0.086	217	0.1287	444.92	713.35	273.6	0.1864
178.00	-0.084	216.8	0.1278	445.00	716.15	274.5	0.19
178.03	-0.087	216.4	0.1269	445.08	718.51	275.5	0.1944
178.07	-0.086	216.2	0.1269	445.17	720.18	276.3	0.1979
178.10	-0.087	215.9	0.1251	445.25	722.87	277.4	0.2015
178.13	-0.088	215.6	0.1251	445.33	726.59	278.7	0.2059
178.17	-0.089	215.6	0.1251	445.42	728.56	279.7	0.2086
178.20	-0.089	215.3	0.1242	445.50	730.59	280.6	0.2148
178.23	-0.089	215.1	0.1234	445.58	731.94	281.4	0.2184
178.27	-0.09	214.8	0.1225	445.67	734.48	282.4	0.2219
178.32	-0.091	214.6	0.1216	445.75	736.48	283.2	0.2255
178.35	-0.091	214.4	0.1216	445.83	738.66	284.1	0.2308
178.38	-0.092	214.1	0.1207	445.92	740.47	285.2	0.2326
178.40	-0.092	213.9	0.1198	446.00	743.49	286.2	0.2361
178.43	-0.093	213.6	0.1189	446.10	745.74	287.1	0.2406
178.47	-0.093	213.4	0.1189	446.17	746.86	288.1	0.245
178.50	-0.095	213.4	0.1189	446.25	749.86	289.1	0.2477
178.53	-0.095	213	0.118	446.33	749.57	289.5	0.2494
178.57	-0.096	212.6	0.1163	446.42	752.66	290.5	0.2539
178.60	-0.096	212.5	0.1163	446.50	756.36	291.7	0.2583
178.63	-0.096	212.4	0.1163	446.58	755.49	292	0.2592
178.67	-0.096	212.2	0.1154	446.67	757.64	292.7	0.2627
178.70	-0.096	211.9	0.1154	446.75	760.28	293.6	0.2654
178.73	-0.097	211.9	0.1154	446.83	762.5	294.7	0.2672
178.77	-0.097	211.7	0.1145	446.92	763.14	295.3	0.2725
178.80	-0.097	211.5	0.1145	447.00	764.36	296	0.2743
178.83	-0.096	211.5	0.1145	447.08	769.09	297.2	0.2787
178.87	-0.097	211.3	0.1136	447.17	765.29	297.1	0.2778
178.90	-0.099	210.9	0.1127	447.25	768.02	297.8	0.2814
178.93	-0.1	210.7	0.1127	447.33	769.82	298.5	0.284
178.97	-0.1	210.7	0.1109	447.42	770.03	299.2	0.2858
179.00	-0.1	210.5	0.1109	447.50	773.24	300.1	0.2867
179.03	-0.1	210.3	0.11	447.60	773.91	300.6	0.2894
179.07	-0.1	210.2	0.11	447.67	774.87	301.1	0.2911
179.10	-0.101	209.9	0.1083	447.75	778.48	302.3	0.2938
179.13	-0.103	209.5	0.1074	447.83	775.77	302.2	0.2947
179.17	-0.103	209.3	0.1074	447.92	777.4	302.8	0.2974
179.20	-0.103	209.3	0.1074	448.00	778.72	303.4	0.2991
179.23	-0.103	209.2	0.1074	448.08	779.6	303.9	0.3
179.27	-0.102	209.1	0.1074	448.17	779.98	304.3	0.3018
179.30	-0.101	209.2	0.1074	448.25	781.2	304.8	0.3036
179.33	-0.101	209.1	0.1074	448.33	781.97	305.4	0.3045
179.37	-0.102	208.8	0.1065	448.42	782.81	305.9	0.3053
179.40	-0.104	208.5	0.1065	448.50	783.22	306.2	0.3071
179.43	-0.104	208.5	0.1056	448.58	783.57	306.6	0.3089
179.47	-0.104	208.4	0.1056	448.67	783.51	306.8	0.3089
179.50	-0.104	208.2	0.1056	448.75	785.41	307.4	0.3107
179.53	-0.104	208.1	0.1047	448.83	783.32	307.3	0.3098
179.57	-0.105	207.9	0.1047	448.92	785.37	308	0.3116
179.60	-0.105	207.7	0.1038	449.02	784.82	308.1	0.3124
179.63	-0.105	207.6	0.1038	449.08	784.82	308.4	0.3133
179.67	-0.105	207.6	0.1038	449.17	784.79	308.6	0.3133
179.70	-0.105	207.5	0.1038	449.25	785.08	309	0.3142

Prova triassiale ciclica SNGR03-C4							
tensione di confinamento (kPa)		450		tensione di confinamento (kPa)		450	
deviatore ciclico (kPa)		80		deviatore ciclico (kPa)		120	
frequenza (hz)		0.00071429		frequenza (hz)		0.0007143	
179.73	-0.105	207.4	0.1038	449.33	785.21	309.1	0.3151
179.78	-0.105	207.2	0.1029	449.42	786.33	309.5	0.316
179.82	-0.105	207.1	0.1029	449.50	785.43	309.6	0.316
179.83	-0.106	206.9	0.1021	449.58	782.53	309.2	0.3142
179.87	-0.106	206.8	0.1021	449.67	783.79	309.5	0.3151
179.90	-0.106	206.7	0.1021	449.75	783.66	309.7	0.3151
179.93	-0.106	206.6	0.1021	449.83	783.18	309.8	0.3151
179.97	-0.106	206.5	0.1021	449.92	783.4	310	0.3169
180.00	-0.106	206.5	0.1021	450.00	782.47	309.9	0.3151
180.03	-0.106	206.3	0.1012	450.08	781.12	309.8	0.3151
180.07	-0.106	206.2	0.1012	450.17	780.95	309.8	0.3151
180.10	-0.107	205.9	0.1003	450.25	780.44	309.9	0.3142
180.13	-0.107	205.9	0.1003	450.33	779.67	309.8	0.3142
180.17	-0.107	205.9	0.1003	450.42	777.74	309.5	0.3133
180.20	-0.107	205.8	0.1003	450.52	777.77	309.6	0.3133
180.23	-0.106	205.8	0.1003	450.58	777.45	309.6	0.3124
180.27	-0.106	205.8	0.1003	450.67	775.42	309.3	0.3116
180.30	-0.106	205.7	0.1003	450.75	774.01	309.1	0.3107
180.33	-0.106	205.6	0.1003	450.83	773.49	309	0.3107
180.37	-0.106	205.5	0.1003	450.92	772.3	308.8	0.3089
180.40	-0.107	205.4	0.0994	451.00	770.72	308.6	0.308
180.43	-0.107	205.3	0.0994	451.08	770.37	308.5	0.308
180.47	-0.107	205.3	0.0994	451.17	770.28	308.4	0.3071
180.50	-0.107	205.2	0.0994	451.25	767.44	307.9	0.3053
180.53	-0.107	205.1	0.0994	451.33	767.28	307.7	0.3036
180.57	-0.107	205.1	0.0994	451.42	762.33	306.8	0.3036
180.60	-0.106	205	0.0994	451.50	762.33	306.8	0.3009
180.63	-0.106	205	0.0994	451.58	760.72	306.5	0.3
180.67	-0.106	204.9	0.0994	451.67	759.43	306.2	0.2991
180.70	-0.106	204.9	0.0994	451.75	756.89	305.7	0.2965
180.73	-0.106	204.9	0.0994	451.83	756.22	305.4	0.2956
180.77	-0.106	204.8	0.0994	451.93	753.8	304.7	0.2938
180.80	-0.106	204.8	0.0994	452.00	752.94	304.4	0.292
180.83	-0.105	204.7	0.0994	452.08	750.9	303.9	0.2903
180.87	-0.105	204.7	0.0994	452.17	749.27	303.5	0.2894
180.90	-0.105	204.7	0.0994	452.25	744.56	302.5	0.2876
180.93	-0.105	204.7	0.0994	452.33	744.92	302.3	0.2858
180.97	-0.105	204.6	0.0994	452.42	742.86	301.7	0.2832
181.00	-0.105	204.6	0.0994	452.50	739.9	301	0.2805
181.03	-0.105	204.5	0.0994	452.58	739.42	300.6	0.2787
181.07	-0.104	204.5	0.0994	452.67	736.58	300.1	0.2769
181.10	-0.104	204.5	0.0994	452.75	734.74	299.4	0.2752
181.13	-0.105	204.3	0.0994	452.83	731.34	298.4	0.2725
181.17	-0.105	204.3	0.0985	452.92	731.59	298.1	0.2707
181.22	-0.105	204.3	0.0985	453.00	727.22	297.3	0.2663
181.25	-0.104	204.3	0.0985	453.08	725.35	296.6	0.2636
181.28	-0.103	204.3	0.0985	453.17	722.81	295.8	0.261
181.30	-0.103	204.3	0.0994	453.25	720.75	295.1	0.2583
181.33	-0.103	204.4	0.0994	453.33	718.75	294.5	0.2556
181.37	-0.102	204.4	0.0994	453.42	714.76	293.3	0.2512
181.40	-0.101	204.4	0.0994	453.50	712.95	292.6	0.2485
181.43	-0.101	204.4	0.0994	453.58	711.96	292.2	0.2468
181.47	-0.101	204.4	0.0994	453.67	708.19	291.1	0.2414
181.50	-0.099	204.4	0.1003	453.75	705.74	290.2	0.2388
181.53	-0.099	204.6	0.1003	453.83	701.45	288.9	0.2379
181.57	-0.1	204.5	0.1003	453.92	700.17	288.4	0.2308
181.60	-0.1	204.5	0.1003	454.00	697.75	287.5	0.2281
181.63	-0.098	204.6	0.1012	454.08	695.43	286.6	0.2246
181.67	-0.098	204.6	0.1012	454.17	692.98	285.8	0.221
181.70	-0.098	204.6	0.1012	454.25	692.88	285.4	0.2192

Prova triassiale ciclica SNGR03-C4							
tensione di confinamento (kPa)		450		tensione di confinamento (kPa)		450	
deviatore ciclico (kPa)		80		deviatore ciclico (kPa)		120	
frequenza (hz)		0.00071429		frequenza (hz)		0.0007143	
181.73	-0.098	204.6	0.1012	454.33	686.21	283.5	0.213
181.77	-0.098	204.6	0.1012	454.42	685.57	282.9	0.2113
181.80	-0.099	204.5	0.1012	454.50	681.47	281.8	0.2042
181.83	-0.098	204.5	0.1012	454.58	681.57	281.3	0.2024
181.87	-0.098	204.5	0.1012	454.67	675.41	279.7	0.1953
181.90	-0.096	204.7	0.1021	454.75	674.41	279.1	0.1926
181.93	-0.095	204.8	0.1021	454.85	670.76	277.6	0.1864
181.97	-0.095	204.8	0.1021	454.92	668.63	276.7	0.1829
182.00	-0.095	204.8	0.1021	455.00	666.06	275.8	0.1784
182.03	-0.094	204.9	0.1021	455.08	665.34	275.2	0.1758
182.07	-0.094	204.9	0.1029	455.17	658.22	273.5	0.1687
182.10	-0.094	205	0.1029	455.25	656.89	272.4	0.166
182.13	-0.093	205.1	0.1038	455.33	656.89	271.8	0.1607
182.17	-0.091	205.3	0.1038	455.42	652.5	270.7	0.1553
182.20	-0.089	205.3	0.1047	455.50	649.37	269.6	0.15
182.23	-0.089	205.5	0.1047	455.58	647.76	268.6	0.1465
182.27	-0.09	205.5	0.1047	455.67	647.46	268.2	0.1438
182.30	-0.092	205.3	0.1038	455.75	641.2	266.7	0.1376
182.33	-0.092	205.3	0.1047	455.83	638.43	265.3	0.1323
182.37	-0.091	205.4	0.1047	455.92	636.06	264.2	0.1243
182.40	-0.088	205.7	0.1047	456.00	630.73	262.8	0.1181
182.43	-0.088	205.7	0.1056	456.08	631.96	262.4	0.1145
182.47	-0.088	205.7	0.1056	456.17	628.98	261.1	0.1083
182.50	-0.088	205.8	0.1065	456.27	627.3	260	0.1039
182.53	-0.087	205.9	0.1065	456.33	623.42	258.7	0.0985
182.57	-0.086	206	0.1074	456.42	620.64	257.5	0.0932
182.60	-0.085	206.3	0.1083	456.50	616.77	256	0.0879
182.63	-0.083	206.5	0.1083	456.58	616.73	255.5	0.0852
182.68	-0.083	206.6	0.1092	456.67	613.46	254.9	0.0826
182.72	-0.083	206.6	0.1092	456.75	611.04	252.9	0.0781
182.73	-0.083	206.6	0.1092	456.83	609.13	251.9	0.0728
182.77	-0.083	206.6	0.1092	456.92	606.7	250.9	0.0683
182.80	-0.083	206.6	0.1092	457.00	602.5	249.6	0.0648
182.83	-0.082	206.8	0.11	457.08	602.85	248.8	0.0621
182.87	-0.08	207	0.11	457.17	599.81	247.7	0.0595
182.90	-0.079	207.1	0.1109	457.25	596.93	246.7	0.0577
182.93	-0.079	207.2	0.1109	457.33	593.05	244.8	0.0533
182.97	-0.078	207.4	0.1109	457.42	592.46	244	0.0497
183.00	-0.077	207.4	0.1127	457.50	590.56	243.2	0.047
183.03	-0.077	207.5	0.1127	457.58	590.68	242.6	0.0462
183.07	-0.077	207.5	0.1127	457.67	585.09	240.8	0.0408
183.10	-0.076	207.7	0.1136	457.77	586.15	240.2	0.0399
183.13	-0.075	207.9	0.1145	457.83	582.5	239.1	0.0373
183.17	-0.074	208	0.1154	457.92	580.94	238.2	0.0346
183.20	-0.073	208.2	0.1154	458.00	579.16	237.3	0.0328
183.23	-0.072	208.2	0.1154	458.08	577.45	236.4	0.0311
183.27	-0.072	208.4	0.1163	458.17	575.5	235.4	0.0284
183.30	-0.072	208.4	0.1163	458.25	572.98	234.3	0.0266
183.33	-0.072	208.5	0.1163	458.33	571.49	233.5	0.024
183.37	-0.07	208.7	0.1171	458.42	570.29	232.6	0.0222
183.40	-0.07	208.8	0.118	458.50	568.18	231.7	0.0204
183.43	-0.068	209.1	0.118	458.58	567.41	231.2	0.0186
183.47	-0.067	209.1	0.1189	458.67	565.37	230.3	0.0169
183.50	-0.067	209.3	0.1189	458.75	563.52	229.6	0.0151
183.53	-0.066	209.5	0.1198	458.83	562	228.5	0.0142
183.57	-0.066	209.7	0.1207	458.92	560.9	227.8	0.0115
183.60	-0.065	209.9	0.1207	459.00	559.92	227.2	0.0098
183.63	-0.064	210	0.1216	459.08	558.01	226.4	0.0089
183.67	-0.062	210.2	0.1216	459.18	554	225.1	0.0071
183.70	-0.062	210.2	0.1225	459.25	556.62	225	0.0062

Prova triassiale ciclica SNGR03-C4

pressione di confinamento (kPa)		450	tensione di confinamento (kPa)		450		
deviatore ciclico (kPa)		80	deviatore ciclico (kPa)		120		
frequenza (hz)		0.00071429	frequenza (hz)		0.0007143		
183.73	-0.062	210.4	0.1234	459.33	554.61	224.3	0.0044
183.77	-0.061	210.6	0.1234	459.42	554.1	223.8	0.0036
183.80	-0.06	210.9	0.1251	459.50	553.12	223.2	0.0027
183.83	-0.059	211	0.1251	459.58	552.86	222.8	0.0009
183.87	-0.058	211.2	0.126	459.67	550.89	222.1	0
183.90	-0.057	211.5	0.126	459.75	551.56	221.7	0
183.93	-0.055	211.5	0.1269	459.83	549.78	221	-0.0027
183.97	-0.055	211.7	0.1278	459.92	548.29	220.4	-0.0036
184.00	-0.056	211.8	0.1287	460.00	548.52	220.1	-0.0036
184.03	-0.051	212.4	0.1305	460.08	547.87	219.7	-0.0044
184.07	-0.053	212.4	0.1305	460.17	547.19	219.2	-0.0053
184.10	-0.053	212.5	0.1305	460.25	546.09	218.8	-0.0062
184.15	-0.052	212.6	0.1313	460.33	545.44	218.1	-0.0071
184.18	-0.051	212.9	0.1313	460.42	546.15	218	-0.0071
184.20	-0.05	213.1	0.1322	460.50	545.99	217.7	-0.008
184.23	-0.047	213.5	0.1322	460.58	544.79	217.3	-0.0089
184.27	-0.048	213.5	0.134	460.68	545.31	217	-0.0089
184.30	-0.048	213.6	0.1349	460.75	545.28	216.8	-0.0089
184.33	-0.046	213.9	0.1358	460.83	545.83	216.8	-0.0089
184.37	-0.044	214.2	0.1367	460.92	545.08	216.4	-0.0098
184.40	-0.044	214.3	0.1376	461.00	544.67	216.2	-0.0107
184.43	-0.043	214.6	0.1384	461.08	545.2	216	-0.0098
184.47	-0.041	214.9	0.1384	461.17	545.33	215.9	-0.0107
184.50	-0.041	214.9	0.1393	461.25	545.53	215.7	-0.0107
184.53	-0.041	215.1	0.1402	461.33	545.92	215.6	-0.0107
184.57	-0.04	215.4	0.1411	461.42	546.31	215.6	-0.0107
184.60	-0.038	215.7	0.142	461.50	546.54	215.5	-0.0107
184.63	-0.037	215.9	0.1438	461.58	546.95	215.4	-0.0107
184.67	-0.037	216.1	0.1447	461.67	546.37	215.3	-0.0107
184.70	-0.035	216.5	0.1447	461.75	548.45	215.5	-0.0107
184.73	-0.034	216.5	0.1455	461.83	549.39	215.6	-0.0098
184.77	-0.034	216.7	0.1464	461.92	550.06	215.7	-0.0098
184.80	-0.033	217	0.1482	462.00	550.51	215.7	-0.0089
184.83	-0.032	217.3	0.1491	462.10	551.52	215.9	-0.0089
184.87	-0.028	217.8	0.1509	462.17	552.52	216.1	-0.0089
184.90	-0.03	217.9	0.1509	462.25	553.08	216.1	-0.008
184.93	-0.031	217.9	0.1509	462.33	554.53	216.4	-0.008
184.97	-0.029	217.9	0.1509	462.42	556.66	216.8	-0.0062
185.00	-0.029	218.2	0.1526	462.50	555.27	216.6	-0.0071
185.03	-0.027	218.5	0.1544	462.58	557.28	216.9	-0.0062
185.07	-0.025	218.9	0.1562	462.67	559.06	217.2	-0.0053
185.10	-0.023	219.2	0.1571	462.75	561.75	217.8	-0.0053
185.13	-0.023	219.5	0.158	462.83	561.78	218	-0.0036
185.17	-0.022	219.8	0.158	462.92	562.66	218.2	-0.0036
185.20	-0.021	219.8	0.1597	463.00	563.82	218.5	-0.0027
185.23	-0.021	220.1	0.1606	463.08	565.28	218.9	-0.0018
185.27	-0.019	220.4	0.1624	463.17	566.96	219.3	-0.0009
185.30	-0.018	220.7	0.1642	463.25	569.35	219.7	0
185.33	-0.017	221	0.1651	463.33	570.69	220.3	0.0009
185.37	-0.016	221.3	0.1669	463.42	572.43	220.8	0.0027
185.40	-0.014	221.9	0.1669	463.50	574.44	221.3	0.0036
185.43	-0.012	221.9	0.1695	463.60	576.51	221.3	0.0036
185.47	-0.012	222.3	0.1713	463.67	577.42	222.3	0.0053
185.50	-0.013	222.3	0.1713	463.75	579.32	222.8	0.0071
185.53	-0.013	222.5	0.1722	463.83	581.5	223.4	0.0089
185.58	-0.01	222.9	0.174	463.92	583.47	224	0.0098
185.62	-0.01	223	0.1757	464.00	584.96	224.6	0.0115
185.65	-0.008	223.4	0.1775	464.08	586.81	225.1	0.0124
185.67	-0.007	223.8	0.1793	464.17	590.94	226.3	0.0151
185.70	-0.006	224.1	0.1811	464.25	591.04	226.5	0.0142

Prova triassiale ciclica SNGR03-C4

tensione di confinamento (kPa)		450	tensione di confinamento (kPa)		450		
deviatore ciclico (kPa)		80	deviatore ciclico (kPa)		120		
frequenza (hz)		0.00071429	frequenza (hz)		0.0007143		
185.73	-0.005	224.5	0.1811	464.33	593.53	227.3	0.0178
185.77	-0.003	224.5	0.1828	464.42	595.9	228	0.0195
185.80	-0.003	224.8	0.1846	464.50	598.49	228.9	0.0213
185.83	-0.003	225.1	0.1864	464.58	602.11	229.9	0.024
185.87	-0.001	225.5	0.189	464.67	601.86	230.3	0.024
185.90	0.001	225.8	0.1917	464.75	605.54	231	0.0266
185.93	0.001	226	0.1935	464.83	607.8	232.2	0.0284
185.97	0.002	226.3	0.1935	464.92	609.94	233	0.0311
186.00	0.004	226.3	0.1953	465.02	612.11	233.8	0.0328
186.03	0.004	226.7	0.1979	465.08	614.37	234.3	0.0346
186.07	0.005	227.1	0.2006	465.17	617.7	235.7	0.0364
186.10	0.007	227.5	0.2041	465.25	618.93	236.4	0.0399
186.13	0.007	227.8	0.2068	465.33	622.01	237.4	0.0426
186.17	0.008	228.1	0.2095	465.42	624.69	238.3	0.0453
186.20	0.01	228.5	0.2095	465.50	626.28	239.1	0.0488
186.23	0.012	228.5	0.2121	465.58	629.61	240.2	0.0515
186.27	0.012	229	0.2166	465.67	630.7	241	0.0533
186.30	0.01	229.1	0.2183	465.75	636.24	242.5	0.0559
186.33	0.012	229.5	0.2219	465.83	636.98	243.2	0.0595
186.37	0.014	229.9	0.2254	465.92	639.66	244.2	0.063
186.40	0.015	230.2	0.2299	466.00	642.99	245.4	0.0666
186.43	0.017	230.7	0.2299	466.08	644.31	246.1	0.0692
186.47	0.018	230.7	0.2343	466.17	646.87	247.1	0.0728
186.50	0.018	231	0.2387	466.25	651.07	248.3	0.0772
186.53	0.019	231.3	0.2441	466.33	654.14	249.8	0.0817
186.57	0.02	231.7	0.2494	466.43	656.08	250.7	0.087
186.60	0.021	232.1	0.2547	466.50	658.57	251.8	0.0923
186.63	0.022	232.5	0.2601	466.58	659.63	252.7	0.0959
186.67	0.024	232.9	0.2601	466.67	665.35	254.3	0.0994
186.70	0.025	232.9	0.2672	466.75	664.77	254.7	0.1047
186.73	0.025	233.3	0.2725	466.83	666.06	255.4	0.1074
186.77	0.026	233.6	0.2769	466.92	664.42	255.5	0.1074
186.80	0.028	234	0.2805	467.00	663.96	255.7	0.1083
186.83	0.029	234.3	0.2831	467.08	665.38	256.1	0.1092
186.87	0.029	234.6	0.2849	467.17	664.83	256.3	0.1092
186.90	0.031	235	0.2849	467.25	666.32	257	0.1118
186.93	0.035	235.5	0.2876	467.33	663.45	256.7	0.1101
186.97	0.035	235.5	0.2911	467.42	664.51	257	0.111
187.00	0.033	235.6	0.2911	467.50	664.9	257.3	0.111
187.05	0.033	236	0.292	467.58	665.26	257.5	0.1118
187.08	0.033	236	0.2938	467.67	664.8	257.7	0.1118
187.10	0.036	236.4	0.2964	467.75	666.52	258.3	0.1136
187.13	0.039	236.9	0.2991	467.83	663.16	257.8	0.111
187.17	0.038	237.1	0.3	467.93	664.51	258.2	0.1118
187.20	0.039	237.5	0.3018	468.00	665.28	258.5	0.1127
187.23	0.041	237.9	0.3018	468.08	664.87	258.6	0.1127
187.27	0.042	238.2	0.3035	468.17	664.99	258.8	0.1127
187.30	0.042	238.2	0.3053	468.25	667.52	259.4	0.1145
187.33	0.043	238.5	0.3071	468.33	664.61	258.9	0.1127
187.37	0.044	238.9	0.3089	468.42	663.77	259	0.1127
187.40	0.046	239.2	0.3106	468.50	664.77	259.3	0.1136
187.43	0.047	239.5	0.3115	468.58	665.09	259.5	0.1136
187.47	0.048	239.8	0.3115	468.67	667.22	259.6	0.1136
187.50	0.049	240.2	0.3133	468.75	663.48	259.5	0.1145
187.53	0.049	240.2	0.3151	468.83	664.22	259.7	0.1136
187.57	0.053	240.7	0.3177	468.92	665.12	260	0.1145
187.60	0.052	240.9	0.3186	469.00	665.03	260.1	0.1145
187.63	0.052	241.2	0.3204	469.08	665.03	260.2	0.1145
187.67	0.053	241.5	0.3222	469.17	664.9	260.3	0.1145
187.70	0.055	241.9	0.3222	469.25	664.96	260.4	0.1145

Prova triassiale ciclica SNGR03-C4								
pressione di confinamento (kPa)		450		pressione di confinamento (kPa)		450		
deviatore ciclico (kPa)		80		deviatore ciclico (kPa)		120		
frequenza (hz)		0.00071429		frequenza (hz)		0.0007143		
187.73	0.054	242.1	0.324	469.35	665.32	260.5	0.1145	
187.77	0.054	242.1	0.324	469.42	665.06	260.6	0.1145	
187.80	0.055	242.3	0.3257	469.50	665.71	260.8	0.1154	
187.83	0.057	242.8	0.3284	469.58	663.77	260.5	0.1136	
187.87	0.059	243.1	0.3293	469.67	664.77	260.9	0.1145	
187.90	0.06	243.4	0.3311	469.75	665.32	261	0.1154	
187.93	0.06	243.8	0.3311	469.83	665.09	261	0.1154	
187.97	0.062	244.1	0.3328	469.92	664.92	261.1	0.1154	
188.00	0.062	244.1	0.3337	470.00	665.22	261.2	0.1154	
188.03	0.065	244.6	0.3373	470.08	666.35	261.5	0.1163	
188.07	0.065	244.9	0.3382	470.17	664.19	261.2	0.1136	
188.10	0.063	245	0.3382	470.25	665.22	261.4	0.1154	
188.13	0.064	245.2	0.3408	470.33	665.26	261.6	0.1154	
188.17	0.067	245.7	0.3408	470.42	665.16	261.6	0.1154	
188.20	0.069	246.1	0.3426	470.50	664.9	261.6	0.1154	
188.23	0.069	246.1	0.3444	470.58	664.93	261.7	0.1154	
188.27	0.069	246.3	0.3453	470.67	665.09	261.7	0.1154	
188.30	0.07	246.7	0.347	470.75	665.39	261.8	0.1163	
188.33	0.071	246.9	0.3479	470.85	663.97	261.8	0.1145	
188.37	0.071	247.3	0.3497	470.92	664.64	261.9	0.1154	
188.40	0.073	247.6	0.3497	471.00	665.18	262	0.1154	
188.43	0.074	248	0.3515	471.08	665.03	262.1	0.1154	
188.48	0.075	248.2	0.3541	471.17	664.96	262.2	0.1154	
188.52	0.075	248.5	0.3541	471.25	664.96	262.3	0.1154	
188.55	0.076	248.8	0.355	471.33	664.9	262.3	0.1154	
188.57	0.076	248.8	0.3568	471.42	664.99	262.3	0.1154	
188.60	0.079	249.3	0.3595	471.50	664.93	262.4	0.1154	
188.63	0.079	249.5	0.3595	471.58	664.93	262.4	0.1163	
188.67	0.078	249.6	0.3604	471.67	664.16	262.4	0.1154	
188.70	0.08	250	0.3621	471.75	664.41	262.5	0.1154	
188.73	0.082	250.4	0.3621	471.83	665.15	262.6	0.1163	
188.77	0.085	250.9	0.3639	471.92	664.96	262.7	0.1154	
188.80	0.085	250.9	0.3657	472.00	664.9	262.7	0.1154	
188.83	0.082	250.9	0.3657	472.08	665	262.8	0.1163	
188.87	0.082	251.1	0.3657	472.17	665.03	262.8	0.1154	
188.90	0.084	251.4	0.3675	472.27	665.03	262.9	0.1163	
188.93	0.087	251.9	0.3701	472.33	667.29	263.2	0.1172	
188.97	0.086	252.1	0.3701	472.42	665.51	263.1	0.1163	
189.00	0.086	252.3	0.371	472.50	664.26	262.8	0.1154	
189.03	0.086	252.3	0.3719	472.58	665.6	263.1	0.1163	
189.07	0.087	252.6	0.3728	472.67	665.42	263.2	0.1163	
189.10	0.089	253	0.3746	472.75	664.77	263.1	0.1163	
189.13	0.09	253.3	0.3754	472.83	664.77	263.1	0.1163	
189.17	0.093	253.8	0.3781	472.92	664.93	263.2	0.1163	
189.20	0.093	254	0.3781	473.00	665.06	263.2	0.1163	
189.23	0.092	254.2	0.379	473.08	665.25	263.5	0.1172	
189.27	0.092	254.2	0.3799	473.17	665.28	263.4	0.1163	
189.30	0.092	254.3	0.3799	473.25	664.61	263.3	0.1163	
189.33	0.092	254.6	0.3808	473.33	663.06	263	0.1154	
189.37	0.095	255	0.3834	473.42	664.77	263.3	0.1163	
189.40	0.097	255.4	0.3852	473.50	667.35	263.8	0.1172	
189.43	0.096	255.5	0.3852	473.58	665.16	263.6	0.1163	
189.47	0.095	255.7	0.3852	473.67	663.61	263.2	0.1154	
189.50	0.095	255.7	0.3852	473.77	665.12	263.5	0.1163	
189.53	0.097	256	0.387	473.83	665.06	263.5	0.1163	
189.57	0.099	256.4	0.3879	473.92	667.42	264	0.1172	
189.60	0.102	256.9	0.3905	474.00	662.42	263.6	0.1163	
189.63	0.1	256.9	0.3905	474.08	665.28	263.7	0.1154	
189.67	0.099	257	0.3905	474.17	665.35	263.7	0.1163	
189.70	0.1	257.2	0.3905	474.25	665.15	263.7	0.1163	

Prova triassiale ciclica SNGR03-C4							
tensione di confinamento (kPa)		450	tensione di confinamento (kPa)		450		
deviatore ciclico (kPa)		80	deviatore ciclico (kPa)		120		
frequenza (hz)		0.00071429	frequenza (hz)		0.0007143		
189.73	0.1	257.2	0.3914	474.33	664.96	263.7	0.1163
189.77	0.101	257.5	0.3932	474.42	665	263.7	0.1163
189.80	0.103	257.9	0.3941	474.50	664.96	263.7	0.1163
189.83	0.104	258.2	0.3959	474.58	664.93	263.8	0.1163
189.87	0.104	258.4	0.3959	474.67	664.93	263.8	0.1163
189.90	0.104	258.7	0.3959	474.75	664.9	263.8	0.1163
189.95	0.108	259.2	0.3985	474.83	665.03	263.9	0.1163
189.98	0.106	259.2	0.3985	474.92	664.99	263.9	0.1163
190.00	0.105	259.3	0.3985	475.00	664.96	263.9	0.1163
190.03	0.105	259.5	0.3985	475.08	664.99	263.9	0.1163
190.07	0.105	259.5	0.3994	475.18	665.03	264	0.1163
190.10	0.107	259.8	0.4012	475.25	664.9	264	0.1163
190.13	0.108	260.1	0.4021	475.33	664.03	263.9	0.1154
190.17	0.109	260.3	0.403	475.42	664.45	263.9	0.1163
190.20	0.111	260.7	0.4047	475.50	665.16	264.1	0.1163
190.23	0.11	260.8	0.4047	475.58	665.09	264.1	0.1163
190.27	0.109	260.9	0.4047	475.67	665.03	264.1	0.1163
190.30	0.109	260.9	0.4047	475.75	665.16	264.2	0.1163
190.33	0.109	261	0.4056	475.83	664.99	264.2	0.1163
190.37	0.111	261.4	0.4074	475.92	664.96	264.2	0.1163
190.40	0.112	261.6	0.4083	476.00	664.96	264.2	0.1163
190.43	0.112	261.8	0.4083	476.08	664.99	264.2	0.1163
190.47	0.112	262.1	0.4083	476.17	665.03	264.3	0.1163
190.50	0.113	262.3	0.4092	476.25	665.03	264.3	0.1163
190.53	0.113	262.3	0.411	476.33	665.03	264.3	0.1163
190.57	0.115	262.7	0.4127	476.42	665.06	264.3	0.1163
190.60	0.115	262.9	0.4127	476.50	666.22	264.5	0.1172
190.63	0.114	262.9	0.4127	476.60	664.61	264.3	0.1163
190.67	0.114	263	0.4127	476.67	664.7	264.3	0.1163
190.70	0.114	263.2	0.4127	476.75	664.9	264.3	0.1163
190.73	0.116	263.5	0.4127	476.83	665.19	264.4	0.1163
190.77	0.116	263.5	0.4145	476.92	665.09	264.4	0.1163
190.80	0.115	263.7	0.4145	477.00	664.99	264.5	0.1163
190.83	0.116	263.8	0.4154	477.08	665.06	264.5	0.1163
190.87	0.116	264	0.4163	477.17	664.99	264.5	0.1163
190.90	0.117	264.3	0.4181	477.25	665.03	264.5	0.1163
190.93	0.119	264.6	0.4181	477.33	665.09	264.5	0.1163
190.97	0.118	264.7	0.4181	477.42	665	264.5	0.1163
191.00	0.118	264.7	0.4181	477.50	664.9	264.5	0.1163
191.03	0.117	264.8	0.4181	477.58	664.8	264.5	0.1163
191.07	0.118	265	0.4189	477.67	664.83	264.5	0.1163
191.10	0.118	265.1	0.4189	477.75	664.93	264.6	0.1163
191.13	0.118	265.3	0.4198	477.83	665.06	264.6	0.1163
191.17	0.119	265.5	0.4198	477.92	664.99	264.6	0.1163
191.20	0.122	265.9	0.4207	478.00	665.03	264.6	0.1163
191.23	0.122	265.9	0.4225	478.10	667	265	0.1172
191.27	0.121	266	0.4225	478.17	665	264.7	0.1163
191.30	0.12	266.1	0.4225	478.25	663.6	264.4	0.1154
191.33	0.118	266	0.4216	478.33	665.16	264.7	0.1163
191.38	0.118	266.1	0.4216	478.42	665.12	264.7	0.1163
191.42	0.121	266.5	0.4234	478.50	664.99	264.7	0.1163
191.45	0.121	266.6	0.4243	478.58	665.06	264.7	0.1163
191.47	0.12	266.7	0.4234	478.67	665.12	264.7	0.1163
191.50	0.12	266.8	0.4234	478.75	664.96	264.7	0.1163
191.53	0.12	266.9	0.4234	478.83	665.09	264.7	0.1163
191.57	0.12	266.9	0.4243	478.92	665.03	264.8	0.1163
191.60	0.12	267	0.4252	479.00	665.06	264.8	0.1163
191.63	0.121	267.2	0.4252	479.08	665.06	264.8	0.1163
191.67	0.122	267.5	0.426	479.17	664.9	264.8	0.1163
191.70	0.122	267.6	0.426	479.25	664.93	264.8	0.1163

Prova triassiale ciclica SNGR03-C4							
tensione di confinamento (kPa)		450	tensione di confinamento (kPa)		450		
deviatore ciclico (kPa)		80	deviatore ciclico (kPa)		120		
frequenza (hz)		0.00071429	frequenza (hz)		0.0007143		
191.73	0.122	267.8	0.426	479.33	664.96	264.8	0.1163
191.77	0.122	267.8	0.4269	479.42	664.99	264.8	0.1163
191.80	0.122	267.8	0.4269	479.52	665.03	264.9	0.1163
191.83	0.121	267.9	0.4269	479.58	665.1	264.9	0.1163
191.87	0.122	268	0.4269	479.67	664.81	264.9	0.1154
191.90	0.122	268.1	0.4269	479.75	664.84	264.9	0.1154
191.93	0.121	268.2	0.4269	479.83	664.9	264.8	0.1163
191.97	0.121	268.2	0.4269	479.92	665.09	264.9	0.1163
192.00	0.12	268.2	0.4269	480.00	665.12	264.9	0.1163
192.03	0.12	268.2	0.4269	480.08	665.55	265	0.1163
192.07	0.123	268.5	0.4278	480.17	664.83	264.9	0.1163
192.10	0.122	268.6	0.4278	480.25	664.9	264.9	0.1163
192.13	0.123	268.7	0.4278	480.33	664.9	264.9	0.1163
192.17	0.12	268.6	0.4278	480.42	664.8	264.9	0.1163
192.20	0.12	268.7	0.4278	480.50	664.77	264.9	0.1163
192.23	0.122	268.8	0.4278	480.58	664.86	264.9	0.1163
192.27	0.122	268.8	0.4287	480.67	664.99	264.9	0.1163
192.30	0.121	268.9	0.4287	480.75	664.96	265	0.1163
192.33	0.121	268.9	0.4287	480.83	664.99	265	0.1163
192.37	0.121	269	0.4287	480.92	664.96	265	0.1163
192.40	0.121	269.2	0.4287	481.02	664.9	265	0.1163
192.43	0.121	269.3	0.4287	481.08	665.06	265	0.1163
192.47	0.121	269.3	0.4296	481.17	664.99	265	0.1163
192.50	0.121	269.3	0.4287	481.25	664.96	265	0.1163
192.53	0.12	269.3	0.4287	481.33	664.99	265	0.1163
192.57	0.119	269.3	0.4287	481.42	664.96	265.1	0.1163
192.60	0.119	269.4	0.4287	481.50	664.99	265.1	0.1163
192.63	0.121	269.5	0.4287	481.58	666.83	265.3	0.1172
192.67	0.119	269.5	0.4287	481.67	663.06	264.8	0.1145
192.70	0.119	269.6	0.4287	481.75	664.48	265	0.1154
192.73	0.119	269.6	0.4287	481.83	665.28	265.1	0.1163
192.77	0.119	269.6	0.4287	481.92	665.12	265.1	0.1163
192.80	0.119	269.6	0.4287	482.00	665.09	265.1	0.1163
192.85	0.118	269.6	0.4278	482.08	665.16	265.1	0.1163
192.88	0.117	269.8	0.4269	482.17	665.03	265.1	0.1154
192.90	0.117	269.5	0.4278	482.25	664.8	265.1	0.1154
192.93	0.119	269.6	0.4287	482.33	664.8	265.1	0.1154
192.97	0.118	269.7	0.4287	482.43	664.93	265.1	0.1154
193.00	0.117	269.8	0.4287	482.50	664.96	265.1	0.1154
193.03	0.116	269.8	0.4278	482.58	664.93	265.1	0.1154
193.07	0.116	269.8	0.4278	482.67	665	265.2	0.1154
193.10	0.116	269.8	0.4269	482.75	664.99	265.1	0.1154
193.13	0.116	269.8	0.4269	482.83	666.9	265.2	0.1154
193.17	0.116	269.8	0.4269	482.92	664.83	265.2	0.1163
193.20	0.116	269.8	0.4269	483.00	664.83	265.1	0.1154
193.23	0.115	269.8	0.4269	483.08	664.9	265.2	0.1163
193.27	0.114	269.8	0.4269	483.17	663.48	264.9	0.1154
193.30	0.114	269.8	0.4269	483.25	664.35	265.1	0.1154
193.33	0.114	269.8	0.426	483.33	665.16	265.2	0.1163
193.37	0.114	269.8	0.426	483.42	665.15	265.2	0.1154
193.40	0.113	269.8	0.426	483.50	665.12	265.2	0.1163
193.43	0.113	269.7	0.4252	483.58	664.99	265.2	0.1154
193.47	0.112	269.7	0.4252	483.67	665.06	265.2	0.1154
193.50	0.112	269.7	0.4252	483.75	665.12	265.2	0.1154
193.53	0.112	269.7	0.4252	483.83	665.03	265.2	0.1163
193.57	0.111	269.6	0.4243	483.93	665.74	265.4	0.1163
193.60	0.111	269.6	0.4243	484.00	663.16	265	0.1145
193.63	0.11	269.5	0.4234	484.08	664.83	265.2	0.1154
193.67	0.109	269.5	0.4234	484.17	665.15	265.2	0.1154
193.70	0.109	269.5	0.4234	484.25	665.09	265.3	0.1154

Prova triassiale ciclica SNGR03-C4							
pressione di confinamento (kPa)		450			pressione di confinamento (kPa)		450
deviatore ciclico (kPa)		80			deviatore ciclico (kPa)		120
frequenza (hz)		0.00071429			frequenza (hz)		0.0007143
193.73	0.109	269.4	0.4234	484.33	664.99	265.3	0.1154
193.77	0.109	269.4	0.4234	484.42	665.03	265.3	0.1154
193.80	0.109	269.5	0.4234	484.50	664.93	265.3	0.1154
193.83	0.107	269.2	0.4216	484.58	664.96	265.3	0.1154
193.87	0.106	269.2	0.4216	484.67	664.87	265.3	0.1154
193.90	0.106	269.2	0.4207	484.75	664.9	265.3	0.1154
193.93	0.106	269.1	0.4207	484.83	664.96	265.3	0.1154
193.97	0.106	269.1	0.4207	484.92	664.99	265.3	0.1154
194.00	0.106	269.1	0.4207	485.00	665	265.3	0.1154
194.03	0.104	268.9	0.4198	485.08	664.9	265.3	0.1154
194.07	0.103	268.8	0.4189	485.17	665.03	265.3	0.1154
194.10	0.103	268.8	0.4189	485.25	665.07	265.4	0.1154
194.13	0.103	268.8	0.4189	485.35	664.93	265.3	0.1154
194.17	0.103	268.8	0.4189	485.42	664.96	265.3	0.1154
194.20	0.1	268.6	0.4189	485.50	665	265.3	0.1154
194.23	0.1	268.6	0.4172	485.58	665.12	265.4	0.1163
194.27	0.1	268.5	0.4172	485.67	666.58	265.7	0.1154
194.32	0.099	268.4	0.4163	485.75	663.38	265.1	0.1145
194.35	0.099	268.4	0.4163	485.83	665.31	265.4	0.1163
194.37	0.1	268.4	0.4163	485.92	665.16	265.4	0.1163
194.40	0.1	268.4	0.4154	486.00	665.06	265.4	0.1163
194.43	0.095	267.9	0.4136	486.08	665.03	265.4	0.1163
194.47	0.095	267.9	0.4136	486.17	665.03	265.4	0.1163
194.50	0.096	267.9	0.4136	486.25	664.86	265.4	0.1163
194.53	0.096	267.9	0.4136	486.33	664.93	265.4	0.1163
194.57	0.096	267.9	0.4127	486.42	664.93	265.4	0.1163
194.60	0.094	267.8	0.4127	486.50	664.9	265.4	0.1163
194.63	0.095	267.6	0.411	486.58	664.83	265.4	0.1163
194.67	0.091	267.3	0.4101	486.67	666.51	265.7	0.1172
194.70	0.092	267.3	0.4101	486.77	663.77	265.2	0.1154
194.73	0.091	267.2	0.4101	486.83	665.06	265.4	0.1154
194.77	0.091	267.2	0.4101	486.92	665.25	265.5	0.1163
194.80	0.091	267.2	0.4092	487.00	665.09	265.4	0.1163
194.83	0.089	266.9	0.4083	487.08	665.06	265.4	0.1163
194.87	0.088	266.8	0.4074	487.17	665	265.5	0.1163
194.90	0.087	266.6	0.4065	487.25	664.96	265.4	0.1163
194.93	0.086	266.6	0.4056	487.33	664.96	265.5	0.1163
194.97	0.087	266.5	0.4056	487.42	664.93	265.4	0.1163
195.00	0.084	266.2	0.4056	487.50	664.96	265.5	0.1163
195.03	0.084	266.2	0.4039	487.58	664.93	265.4	0.1163
195.07	0.084	266.1	0.4039	487.67	665	265.5	0.1163
195.10	0.084	265.9	0.403	487.75	665.09	265.5	0.1163
195.13	0.082	265.7	0.4021	487.83	665.09	265.5	0.1163
195.17	0.082	265.6	0.4012	487.92	664.8	265.5	0.1163
195.20	0.082	265.6	0.4012	488.00	665.04	265.6	0.1172
195.23	0.078	265.1	0.4012	488.08	665.99	265.7	0.1172
195.27	0.078	265.1	0.3994	488.17	664.09	265.3	0.1154
195.30	0.079	265	0.3985	488.27	664.58	265.4	0.1154
195.33	0.078	264.9	0.3985	488.33	664.96	265.5	0.1163
195.37	0.078	264.9	0.3967	488.42	664.96	265.5	0.1163
195.40	0.074	264.4	0.395	488.50	665.15	265.5	0.1163
195.43	0.074	264.2	0.3941	488.58	665.52	265.6	0.1163
195.47	0.075	264.2	0.3941	488.67	664.93	265.5	0.1163
195.50	0.075	264.2	0.395	488.75	665.05	265.5	0.1163
195.53	0.075	264.1	0.3932	488.83	664.99	265.5	0.1163
195.57	0.07	263.5	0.3905	488.92	666.19	265.6	0.1163
195.60	0.069	263.3	0.3905	489.00	664.77	265.5	0.1163
195.63	0.07	263.3	0.3896	489.08	663.64	265.3	0.1154
195.67	0.07	263.1	0.3888	489.17	664.74	265.4	0.1163
195.70	0.068	262.9	0.3888	489.25	665.06	265.5	0.1163

Prova triassiale ciclica SNGR03-C4								
tensione di confinamento (kPa)		450			tensione di confinamento (kPa)		450	
deviatore ciclico (kPa)		80			deviatore ciclico (kPa)		120	
frequenza (hz)		0.00071429			frequenza (hz)		0.0007143	
195.75	0.067	262.8	0.3879	489.33	665.06	265.5	0.1163	
195.78	0.067	262.6	0.387	489.42	664.99	265.5	0.1163	
195.82	0.065	262.4	0.387	489.50	664.96	265.5	0.1163	
195.83	0.065	262.4	0.3861	489.58	664.93	265.5	0.1163	
195.87	0.066	262.3	0.3861	489.67	665.03	265.6	0.1163	
195.90	0.063	261.7	0.3825	489.75	664.99	265.5	0.1163	
195.93	0.061	261.6	0.3817	489.83	665	265.6	0.1163	
195.97	0.061	261.5	0.3817	489.92	664.93	265.5	0.1163	
196.00	0.06	261.3	0.3808	490.00	664.96	265.5	0.1163	
196.03	0.059	261.1	0.3808	490.08	665.03	265.8	0.1172	
196.07	0.058	261.1	0.379	490.17	666.26	265.8	0.1172	
196.10	0.058	260.9	0.3781	490.25	664.19	265.3	0.1154	
196.13	0.057	260.5	0.3763	490.33	665.19	265.6	0.1163	
196.17	0.054	260.2	0.3746	490.42	665.12	265.6	0.1163	
196.20	0.055	260.1	0.3746	490.50	664.99	265.6	0.1163	
196.23	0.056	260	0.3746	490.58	665	265.6	0.1163	
196.27	0.054	259.9	0.3746	490.67	665.03	265.6	0.1163	
196.30	0.05	259.9	0.3737	490.75	665.03	265.6	0.1163	
196.33	0.05	259.3	0.3701	490.83	665.03	265.6	0.1163	
196.37	0.05	259.2	0.3701	490.92	664.96	265.6	0.1163	
196.40	0.05	259	0.3683	491.00	664.99	265.6	0.1163	
196.43	0.05	258.9	0.3683	491.08	666.55	265.9	0.1172	
196.47	0.049	258.6	0.3666	491.18	663.81	265.4	0.1163	
196.50	0.046	258.1	0.3666	491.25	664.12	265.4	0.1154	
196.53	0.042	258.1	0.3639	491.33	665.19	265.6	0.1163	
196.57	0.042	257.6	0.3621	491.42	665.06	265.6	0.1163	
196.60	0.043	257.6	0.3612	491.50	664.99	265.6	0.1163	
196.63	0.043	257.4	0.3612	491.58	664.93	265.6	0.1163	
196.67	0.042	257.1	0.3595	491.67	665.03	265.6	0.1163	
196.70	0.043	257.1	0.3595	491.75	664.9	265.6	0.1163	
196.73	0.037	256.4	0.3595	491.83	664.96	265.6	0.1163	
196.77	0.038	256.4	0.3559	491.92	664.93	265.6	0.1163	
196.80	0.038	256.3	0.355	492.00	664.96	265.6	0.1172	
196.83	0.037	256	0.3533	492.08	665.68	265.7	0.1172	
196.87	0.036	255.7	0.3524	492.17	664.96	265.6	0.1163	
196.90	0.034	255.4	0.3506	492.25	664.9	265.6	0.1163	
196.93	0.035	255.1	0.3497	492.33	665	265.6	0.1163	
196.97	0.031	254.8	0.3497	492.42	664.93	265.6	0.1163	
197.00	0.03	254.8	0.347	492.50	664.86	265.6	0.1163	
197.03	0.03	254.5	0.3462	492.60	664.96	265.6	0.1163	
197.07	0.03	254.3	0.3453	492.67	665.06	265.6	0.1163	
197.10	0.028	253.9	0.3435	492.75	664.9	265.6	0.1163	
197.13	0.027	253.7	0.3417	492.83	664.9	265.6	0.1163	
197.17	0.027	253.5	0.3408	492.92	664.99	265.6	0.1163	
197.22	0.024	253.1	0.3373	493.00	666.58	265.9	0.1172	
197.25	0.025	252.9	0.3364	493.08	664.87	265.6	0.1163	
197.27	0.025	252.7	0.3355	493.17	664.96	265.6	0.1163	
197.30	0.023	252.4	0.3355	493.25	664.86	265.6	0.1163	
197.33	0.021	252.4	0.3337	493.33	664.87	265.6	0.1163	
197.37	0.021	252.1	0.332	493.42	664.9	265.6	0.1163	
197.40	0.017	251.5	0.3284	493.50	665	265.7	0.1163	
197.43	0.018	251.3	0.3275	493.58	664.96	265.7	0.1163	
197.47	0.018	251.1	0.3257	493.67	664.96	265.7	0.1163	
197.50	0.016	250.7	0.324	493.75	664.9	265.6	0.1163	
197.53	0.016	250.6	0.324	493.83	666.48	266	0.1181	
197.57	0.015	250.6	0.324	493.92	663.93	265.5	0.1163	
197.60	0.015	250.3	0.3222	494.00	665.09	265.7	0.1172	
197.63	0.013	249.9	0.3195	494.10	665.06	265.7	0.1163	
197.67	0.011	249.5	0.3177	494.17	664.96	265.7	0.1172	
197.70	0.008	249	0.3142	494.25	667	266	0.1172	

Prova triassiale ciclica SNGR03-C4

pressione di confinamento (kPa)		450			pressione di confinamento (kPa)		450	
deviatore ciclico (kPa)		80			deviatore ciclico (kPa)		120	
frequenza (hz)		0.00071429			frequenza (hz)		0.0007143	
197.73	0.009	248.8	0.3133	494.33	663.17	265.5	0.1154	
197.77	0.007	248.5	0.3133	494.42	665.09	265.7	0.1172	
197.80	0.007	248.5	0.3115	494.50	665.54	265.7	0.1172	
197.83	0.007	248.3	0.3106	494.58	665.15	265.7	0.1172	
197.87	0.009	248.2	0.3098	494.67	664.77	265.7	0.1163	
197.90	0.004	247.6	0.3071	494.75	666.19	265.9	0.1181	
197.93	0.003	247.4	0.3053	494.83	663.45	265.5	0.1163	
197.97	0.002	247	0.3027	494.92	664.28	265.6	0.1163	
198.00	0	246.6	0.3027	495.00	664.99	265.7	0.1172	
198.03	-0.003	246.6	0.3009	495.08	665.09	265.7	0.1172	
198.07	-0.003	246.1	0.2973	495.17	665.25	265.8	0.1172	
198.10	-0.002	245.9	0.2956	495.25	665.16	265.7	0.1172	
198.13	-0.003	245.6	0.292	495.33	666.19	265.9	0.1172	
198.17	-0.004	245.3	0.2893	495.42	664.67	265.7	0.1172	
198.20	-0.005	245	0.2858	495.52	664.83	265.7	0.1172	
198.23	-0.005	244.9	0.2858	495.58	664.83	265.7	0.1172	
198.27	-0.006	244.9	0.284	495.67	665.03	265.7	0.1172	
198.30	-0.006	244.5	0.2796	495.75	664.96	265.7	0.1172	
198.33	-0.009	244	0.2751	495.83	664.86	265.7	0.1172	
198.37	-0.011	243.6	0.2698	495.92	665.06	265.7	0.1172	
198.40	-0.011	243.4	0.2663	496.00	666.39	266	0.1172	
198.43	-0.012	243	0.2618	496.08	665.03	265.7	0.1172	
198.47	-0.014	242.7	0.2618	496.17	664.93	265.7	0.1172	
198.50	-0.015	242.7	0.2574	496.25	663.48	265.4	0.1163	
198.53	-0.015	242.4	0.253	496.33	664.38	265.6	0.1163	
198.57	-0.015	242.1	0.2494	496.42	665.25	265.7	0.1172	
198.60	-0.018	241.6	0.245	496.50	665.35	265.8	0.1172	
198.65	-0.018	241.3	0.2414	496.58	665.22	265.7	0.1172	
198.68	-0.019	241	0.2379	496.67	664.93	265.7	0.1172	
198.72	-0.021	240.5	0.2343	496.75	664.87	265.7	0.1172	
198.73	-0.021	240.4	0.2308	496.83	665.04	265.8	0.1172	
198.77	-0.022	240	0.2263	496.92	666.16	266	0.1181	
198.80	-0.027	239.2	0.2263	497.00	664	265.6	0.1172	
198.83	-0.025	239.2	0.2228	497.08	664.96	265.6	0.1172	
198.87	-0.025	239.1	0.221	497.17	664.9	265.7	0.1172	
198.90	-0.026	238.8	0.2183	497.25	664.9	265.7	0.1172	
198.93	-0.027	238.4	0.2166	497.33	666.58	266	0.1181	
198.97	-0.026	238.4	0.2148	497.42	664.9	265.8	0.1172	
199.00	-0.031	237.5	0.2095	497.50	664.77	265.7	0.1172	
199.03	-0.032	237.2	0.2095	497.58	663.28	265.5	0.1163	
199.07	-0.032	237.2	0.2068	497.67	665.22	265.6	0.1172	
199.10	-0.032	237	0.205	497.75	664.99	265.7	0.1172	
199.13	-0.033	236.6	0.2024	497.83	665.12	265.8	0.1172	
199.17	-0.034	236.2	0.2006	497.92	665.09	265.7	0.1172	
199.20	-0.035	235.9	0.1979	498.00	665.06	265.7	0.1172	
199.23	-0.033	235.8	0.1979	498.08	665	265.8	0.1172	
199.27	-0.038	234.9	0.1979	498.17	665.03	265.7	0.1172	
199.30	-0.039	234.9	0.1935	498.25	664.9	265.7	0.1172	
199.33	-0.039	234.7	0.1917	498.33	665	265.7	0.1172	
199.37	-0.039	234.4	0.1899	498.43	664.86	265.7	0.1172	
199.40	-0.041	234.1	0.1873	498.50	667.03	266	0.1181	
199.43	-0.04	234	0.1873	498.58	663.71	265.5	0.1163	
199.47	-0.042	233.5	0.1846	498.67	664.96	265.7	0.1172	
199.50	-0.045	232.7	0.1846	498.75	664.96	265.7	0.1172	
199.53	-0.047	232.7	0.1811	498.83	664.93	265.7	0.1172	
199.57	-0.047	232.4	0.1793	498.92	665.03	265.7	0.1181	
199.60	-0.046	232.2	0.1784	499.00	666.45	266	0.1181	
199.63	-0.046	232	0.1775	499.08	664.87	265.6	0.1163	
199.67	-0.046	231.8	0.1766	499.17	664.32	265.6	0.1163	
199.70	-0.051	231	0.1731					

Prova triassiale ciclica SNGR03-C4

tensione di confinamento (kPa)		450	tensione di confinamento (kPa)		450
deviatore ciclico (kPa)		80	deviatore ciclico (kPa)		120
frequenza (hz)		0.00071429	frequenza (hz)		0.0007143
199.73	-0.051	230.7	0.1731		
199.77	-0.052	230.7	0.1713		
199.80	-0.052	230.4	0.1704		
199.83	-0.05	230.4	0.1704		
199.87	-0.052	229.9	0.1686		
199.90	-0.054	229.5	0.1669		
199.93	-0.055	229.2	0.166		
199.97	-0.056	228.8	0.166		
200.00	-0.06	228.8	0.1624		
200.03	-0.06	228.1	0.1615		
200.07	-0.059	227.9	0.1606		
200.12	-0.057	227.7	0.1597		
200.15	-0.057	227.7	0.1597		
200.17	-0.059	227.2	0.158		
200.20	-0.062	226.7	0.1562		
200.23	-0.062	226.5	0.1553		
200.27	-0.063	226.1	0.1544		
200.30	-0.067	225.4	0.1544		
200.33	-0.066	225.4	0.1509		
200.37	-0.066	225.3	0.1509		
200.40	-0.066	225.1	0.15		
200.43	-0.067	224.8	0.1491		
200.47	-0.066	224.7	0.1491		
200.50	-0.068	224.2	0.1473		
200.53	-0.07	223.7	0.1473		
200.57	-0.071	223.7	0.1464		
200.60	-0.071	223.5	0.1447		
200.63	-0.072	223.2	0.1438		
200.67	-0.072	222.9	0.1429		
200.70	-0.076	222.2	0.1402		
200.73	-0.074	222.2	0.1402		
200.77	-0.074	222	0.1402		
200.80	-0.075	222	0.1402		
200.83	-0.075	221.7	0.1384		
200.87	-0.076	221.4	0.1384		
200.90	-0.077	221	0.1367		
200.93	-0.079	220.6	0.1358		
200.97	-0.077	220.6	0.1358		
201.00	-0.078	220.3	0.1358		
201.03	-0.079	220.3	0.1349		
201.07	-0.079	220	0.134		
201.10	-0.081	219.5	0.1322		
201.13	-0.082	219.2	0.1313		
201.17	-0.083	219	0.1313		
201.20	-0.083	218.7	0.1305		
201.23	-0.084	218.4	0.1305		
201.27	-0.084	218.4	0.1296		
201.30	-0.084	218.2	0.1287		
201.33	-0.085	217.8	0.1278		
201.37	-0.087	217.5	0.1269		
201.40	-0.087	217.2	0.126		
201.43	-0.087	217	0.1251		
201.47	-0.088	216.8	0.1251		
201.50	-0.089	216.8	0.1242		
201.53	-0.089	216.5	0.1242		
201.58	-0.089	216.1	0.1234		
201.62	-0.091	216.1	0.1225		
201.63	-0.091	215.8	0.1216		
201.67	-0.091	215.5	0.1207		
201.70	-0.092	215.3	0.1207		

Prova triassiale ciclica SNGR03-C4

tensione di confinamento (kPa)		450	tensione di confinamento (kPa)		450
deviatore ciclico (kPa)		80	deviatore ciclico (kPa)		120
frequenza (hz)		0.00071429	frequenza (hz)		0.0007143
201.73	-0.092	215.1	0.1198		
201.77	-0.092	214.8	0.1189		
201.80	-0.094	214.5	0.1189		
201.83	-0.095	214.5	0.118		
201.87	-0.095	214.3	0.118		
201.90	-0.094	214.1	0.1171		
201.93	-0.097	213.6	0.1154		
201.97	-0.097	213.5	0.1154		
202.00	-0.096	213.3	0.1154		
202.03	-0.096	213.2	0.1154		
202.07	-0.097	213.2	0.1154		
202.10	-0.097	212.9	0.1145		
202.13	-0.096	212.9	0.1145		
202.17	-0.096	212.8	0.1145		
202.20	-0.098	212.4	0.1136		
202.23	-0.099	212.1	0.1127		
202.27	-0.099	211.9	0.1127		
202.30	-0.1	211.9	0.1109		
202.33	-0.1	211.7	0.1109		
202.37	-0.102	211.2	0.1092		
202.40	-0.102	211	0.1083		
202.43	-0.101	210.9	0.1083		
202.47	-0.101	210.8	0.1083		
202.50	-0.101	210.7	0.1083		
202.53	-0.102	210.7	0.1083		
202.57	-0.102	210.5	0.1074		
202.60	-0.102	210.4	0.1074		
202.63	-0.102	210.2	0.1065		
202.67	-0.102	210	0.1065		
202.70	-0.102	209.9	0.1065		
202.73	-0.103	209.8	0.1065		
202.77	-0.104	209.8	0.1065		
202.80	-0.104	209.5	0.1056		
202.83	-0.104	209.4	0.1056		
202.87	-0.105	209.2	0.1047		
202.90	-0.104	209.1	0.1047		
202.93	-0.105	208.9	0.1038		
202.97	-0.105	208.7	0.1038		
203.02	-0.105	208.6	0.1038		
203.05	-0.105	208.4	0.1029		
203.07	-0.105	208.4	0.1029		
203.10	-0.106	208.4	0.1029		
203.13	-0.106	208.2	0.1021		
203.17	-0.106	208.1	0.1021		
203.20	-0.106	208	0.1021		
203.23	-0.105	207.9	0.1021		
203.27	-0.106	207.7	0.1012		
203.30	-0.107	207.5	0.1012		
203.33	-0.107	207.5	0.1012		
203.37	-0.107	207.4	0.1012		
203.40	-0.106	207.4	0.1012		
203.43	-0.106	207.2	0.1012		
203.47	-0.107	207.1	0.1003		
203.50	-0.107	207	0.1003		
203.53	-0.107	207	0.1003		
203.57	-0.109	207	0.1003		
203.60	-0.109	206.5	0.0985		
203.63	-0.109	206.5	0.0994		
203.67	-0.107	206.6	0.0994		
203.70	-0.107	206.5	0.0994		

Prova triassiale ciclica SNGR03-C4

tensione di confinamento (kPa)		450	tensione di confinamento (kPa)		450
deviatore ciclico (kPa)		80	deviatore ciclico (kPa)		120
frequenza (hz)		0.00071429	frequenza (hz)		0.0007143
203.73	-0.107	206.5	0.0994		
203.77	-0.106	206.4	0.0994		
203.80	-0.106	206.4	0.0994		
203.83	-0.106	206.4	0.0994		
203.87	-0.106	206.3	0.0994		
203.90	-0.106	206.3	0.0994		
203.93	-0.106	206.2	0.0994		
203.97	-0.105	206.2	0.0994		
204.00	-0.105	206.2	0.0994		
204.03	-0.106	206.2	0.0994		
204.07	-0.106	206.1	0.0994		
204.10	-0.106	206	0.0994		
204.13	-0.105	205.9	0.0994		
204.17	-0.105	205.9	0.0994		
204.20	-0.105	205.9	0.0994		
204.23	-0.105	205.8	0.0994		
204.27	-0.105	205.8	0.0985		
204.30	-0.105	205.7	0.0985		
204.33	-0.105	205.7	0.0985		
204.37	-0.104	205.7	0.0985		
204.40	-0.104	205.6	0.0985		
204.43	-0.104	205.6	0.0985		
204.48	-0.104	205.6	0.0985		
204.52	-0.104	205.5	0.0985		
204.55	-0.104	205.5	0.0985		
204.58	-0.103	205.5	0.0985		
204.60	-0.103	205.5	0.0985		
204.63	-0.103	205.5	0.0994		
204.67	-0.103	205.5	0.0994		
204.70	-0.102	205.4	0.0994		
204.73	-0.102	205.5	0.0994		
204.77	-0.101	205.5	0.0994		
204.80	-0.101	205.5	0.0994		
204.83	-0.101	205.5	0.0994		
204.87	-0.101	205.5	0.0994		
204.90	-0.1	205.6	0.1003		
204.93	-0.1	205.6	0.1003		
204.97	-0.099	205.6	0.1003		
205.00	-0.099	205.6	0.1003		
205.03	-0.098	205.6	0.1003		
205.07	-0.098	205.7	0.1012		
205.10	-0.098	205.7	0.1012		
205.13	-0.098	205.7	0.1012		
205.17	-0.097	205.8	0.1012		
205.20	-0.097	205.8	0.1012		
205.23	-0.096	205.9	0.1012		
205.27	-0.096	205.9	0.1021		
205.30	-0.096	205.9	0.1021		
205.33	-0.095	205.9	0.1021		
205.37	-0.095	206	0.1021		
205.40	-0.094	206.1	0.1029		
205.43	-0.093	206.2	0.1029		
205.47	-0.093	206.3	0.1029		
205.50	-0.093	206.3	0.1038		
205.53	-0.092	206.3	0.1038		
205.57	-0.093	206.3	0.1038		
205.60	-0.092	206.4	0.1038		
205.63	-0.091	206.4	0.1038		
205.67	-0.09	206.6	0.1038		
205.70	-0.089	206.6	0.1047		

Prova triassiale ciclica SNGR03-C4

pressione di confinamento (kPa)		450		pressione di confinamento (kPa)		450	
deviatore ciclico (kPa)		80		deviatore ciclico (kPa)		120	
frequenza (hz)		0.00071429		frequenza (hz)		0.0007143	
205.73	-0.089	206.7	0.1056				
205.77	-0.088	206.8	0.1056				
205.80	-0.088	206.9	0.1056				
205.83	-0.087	207	0.1065				
205.87	-0.084	207.4	0.1083				
205.92	-0.084	207.4	0.1083				
205.95	-0.084	207.5	0.1083				
205.98	-0.086	207.3	0.1074				
206.02	-0.086	207.3	0.1074				
206.05	-0.085	207.3	0.1074				
206.07	-0.085	207.3	0.1074				
206.10	-0.083	207.6	0.1092				
206.13	-0.078	208.2	0.1109				
206.17	-0.079	208.3	0.1109				
206.20	-0.08	208.3	0.1109				
206.23	-0.08	208.3	0.1109				
206.27	-0.08	208.3	0.11				
206.30	-0.08	208.3	0.1109				
206.33	-0.08	208.3	0.1109				
206.37	-0.077	208.6	0.1127				
206.40	-0.076	208.7	0.1136				
206.43	-0.076	208.8	0.1136				
206.47	-0.075	209	0.1136				
206.50	-0.074	209	0.1145				
206.53	-0.074	209.2	0.1145				
206.57	-0.073	209.3	0.1154				
206.60	-0.073	209.4	0.1154				
206.63	-0.073	209.4	0.1154				
206.67	-0.072	209.6	0.1163				
206.70	-0.07	209.9	0.1171				
206.73	-0.069	210	0.118				
206.77	-0.068	210.2	0.118				
206.80	-0.067	210.2	0.118				
206.83	-0.067	210.4	0.1189				
206.87	-0.067	210.6	0.1198				
206.90	-0.065	210.8	0.1207				
206.93	-0.062	211.3	0.1225				
206.97	-0.062	211.4	0.1225				
207.00	-0.062	211.5	0.1225				
207.03	-0.063	211.5	0.1225				
207.07	-0.062	211.6	0.1225				
207.10	-0.06	211.9	0.1234				
207.13	-0.06	211.9	0.1242				
207.17	-0.06	212.1	0.1242				
207.20	-0.059	212.4	0.1251				
207.23	-0.057	212.7	0.1269				
207.27	-0.056	212.8	0.1269				
207.30	-0.055	213.1	0.1269				
207.33	-0.054	213.1	0.1278				
207.38	-0.054	213.4	0.1287				
207.42	-0.052	213.7	0.1287				
207.45	-0.052	213.7	0.1305				
207.48	-0.052	213.9	0.1305				
207.52	-0.051	214	0.1313				
207.53	-0.049	214.4	0.1322				
207.57	-0.048	214.5	0.1331				
207.60	-0.048	214.7	0.134				
207.63	-0.046	215	0.134				
207.67	-0.047	215	0.1349				
207.70	-0.047	215.1	0.1349				

Prova triassiale ciclica SNGR03-C4

tensione di confinamento (kPa)		450	tensione di confinamento (kPa)		450
deviatore ciclico (kPa)		80	deviatore ciclico (kPa)		120
frequenza (hz)		0.00071429	frequenza (hz)		0.0007143
207.73	-0.046	215.3	0.1358		
207.77	-0.043	215.7	0.1376		
207.80	-0.043	215.9	0.1384		
207.83	-0.041	216.3	0.1393		
207.87	-0.04	216.5	0.1393		
207.90	-0.04	216.5	0.1411		
207.93	-0.036	217.1	0.1438		
207.97	-0.036	217.3	0.1438		
208.00	-0.037	217.3	0.1438		
208.03	-0.036	217.5	0.1447		
208.07	-0.036	217.6	0.1447		
208.10	-0.034	218	0.1455		
208.13	-0.034	218	0.1464		
208.17	-0.032	218.3	0.1482		
208.20	-0.031	218.7	0.1491		
208.23	-0.028	219.2	0.1518		
208.27	-0.027	219.4	0.1526		
208.30	-0.028	219.5	0.1526		
208.33	-0.027	219.5	0.1526		
208.37	-0.027	219.8	0.1544		
208.40	-0.026	220	0.1562		
208.43	-0.023	220.6	0.158		
208.47	-0.022	220.8	0.1589		
208.50	-0.022	221	0.1597		
208.53	-0.021	221.3	0.1597		
208.57	-0.022	221.3	0.1606		
208.60	-0.022	221.4	0.1615		
208.63	-0.019	221.9	0.1633		
208.67	-0.016	222.3	0.166		
208.70	-0.015	222.8	0.1677		
208.73	-0.014	223	0.1695		
208.77	-0.013	223.3	0.1695		
208.82	-0.015	223.3	0.1704		
208.85	-0.014	223.6	0.1713		
208.88	-0.01	224.1	0.1713		
208.92	-0.01	224.1	0.1748		
208.95	-0.01	224.3	0.1757		
208.97	-0.009	224.6	0.1775		
209.00	-0.004	225.3	0.1811		
209.03	-0.007	225.2	0.1802		
209.07	-0.008	225.4	0.1802		
209.10	-0.003	225.9	0.1811		
209.13	-0.003	225.9	0.1837		
209.17	-0.003	226.2	0.1864		
209.20	-0.001	226.6	0.189		
209.23	0.001	226.9	0.1917		
209.27	0.003	227.4	0.1953		
209.30	0.003	227.7	0.1953		
209.33	0.004	227.7	0.197		
209.37	0.004	228	0.1988		
209.40	0.005	228.3	0.2015		
209.43	0.005	228.6	0.2032		
209.47	0.006	228.8	0.2059		
209.50	0.007	229.3	0.2086		
209.53	0.011	229.8	0.2086		
209.57	0.01	229.8	0.213		
209.60	0.01	230	0.2148		
209.63	0.011	230.4	0.2192		
209.67	0.014	230.8	0.2228		
209.70	0.014	231.1	0.2263		

Prova triassiale ciclica SNGR03-C4

tensione di confinamento (kPa)		450	tensione di confinamento (kPa)		450
deviatore ciclico (kPa)		80	deviatore ciclico (kPa)		120
frequenza (hz)		0.00071429	frequenza (hz)		0.0007143
209.73	0.015	231.5	0.2308		
209.77	0.017	231.9	0.2308		
209.80	0.018	231.9	0.2352		
209.83	0.018	232.2	0.2396		
209.87	0.022	232.9	0.2467		
209.90	0.019	232.9	0.2503		
209.93	0.021	233.3	0.2556		
209.97	0.024	234	0.2645		
210.00	0.024	234.2	0.2645		
210.03	0.024	234.2	0.2689		
210.07	0.024	234.4	0.2725		
210.10	0.025	234.8	0.276		
210.13	0.031	235.5	0.2814		
210.17	0.028	235.5	0.2822		
210.20	0.028	235.8	0.284		
210.23	0.034	236.5	0.284		
210.28	0.031	236.5	0.2885		
210.32	0.031	236.6	0.2893		
210.35	0.034	237.1	0.2893		
210.38	0.037	237.1	0.292		
210.42	0.037	237.7	0.2947		
210.43	0.036	237.9	0.2956		
210.47	0.035	238	0.2964		
210.50	0.038	238.4	0.2982		
210.53	0.04	238.8	0.3018		
210.57	0.044	239.5	0.3018		
210.60	0.044	239.5	0.3044		
210.63	0.042	239.5	0.3044		
210.67	0.041	239.7	0.3044		
210.70	0.044	240.1	0.3071		
210.73	0.045	240.4	0.3089		
210.77	0.046	240.8	0.3089		
210.80	0.048	241.2	0.3106		
210.83	0.048	241.2	0.3124		
210.87	0.049	241.4	0.3142		
210.90	0.05	241.9	0.316		
210.93	0.051	242.2	0.3177		
210.97	0.054	242.7	0.3204		
211.00	0.053	242.8	0.3204		
211.03	0.054	243	0.3204		
211.07	0.054	243	0.3222		
211.10	0.055	243.4	0.324		
211.13	0.058	243.9	0.3257		
211.17	0.058	244.1	0.3275		
211.20	0.058	244.4	0.3284		
211.23	0.06	244.8	0.3284		
211.27	0.061	244.8	0.3302		
211.30	0.061	245.1	0.332		
211.33	0.062	245.4	0.3337		
211.37	0.063	245.8	0.3346		
211.40	0.064	246.1	0.3373		
211.43	0.067	246.7	0.3408		
211.47	0.067	246.8	0.3408		
211.50	0.066	246.8	0.3408		
211.53	0.066	247	0.3417		
211.57	0.068	247.4	0.3435		
211.60	0.07	247.8	0.3444		
211.63	0.07	248	0.3462		
211.67	0.071	248.4	0.3479		
211.70	0.072	248.7	0.3479		

Prova triassiale ciclica SNGR03-C4

pressione di confinamento (kPa)		450		pressione di confinamento (kPa)		450	
deviatore ciclico (kPa)		80		deviatore ciclico (kPa)		120	
frequenza (hz)		0.00071429		frequenza (hz)		0.0007143	
211.75	0.073	249	0.3506				
211.78	0.074	249.2	0.3515				
211.82	0.075	249.5	0.3515				
211.85	0.076	249.5	0.3524				
211.87	0.076	249.8	0.3541				
211.90	0.076	250.1	0.355				
211.93	0.078	250.5	0.3568				
211.97	0.08	251	0.3595				
212.00	0.08	251.2	0.3595				
212.03	0.079	251.3	0.3595				
212.07	0.079	251.3	0.3604				
212.10	0.08	251.6	0.3621				
212.13	0.082	252	0.3639				
212.17	0.084	252.3	0.3648				
212.20	0.084	252.6	0.3666				
212.23	0.085	252.9	0.3666				
212.27	0.086	252.9	0.3675				
212.30	0.086	253.2	0.3683				
212.33	0.087	253.5	0.3701				
212.37	0.087	253.8	0.371				
212.40	0.089	254.1	0.3728				
212.43	0.089	254.4	0.3737				
212.47	0.09	254.7	0.3737				
212.50	0.093	254.7	0.3746				
212.53	0.093	255.2	0.3772				
212.57	0.092	255.3	0.3772				
212.60	0.091	255.4	0.3772				
212.63	0.092	255.7	0.379				
212.67	0.094	256	0.3808				
212.70	0.095	256.4	0.3808				
212.73	0.097	256.4	0.3817				
212.77	0.097	256.9	0.3843				
212.80	0.097	257	0.3843				
212.83	0.096	257.1	0.3843				
212.87	0.097	257.4	0.3861				
212.90	0.101	257.9	0.3888				
212.93	0.1	258.1	0.3888				
212.97	0.099	258.1	0.3888				
213.00	0.099	258.2	0.3888				
213.03	0.102	258.7	0.3914				
213.07	0.102	258.9	0.3914				
213.10	0.1	259	0.3914				
213.13	0.103	259.5	0.3941				
213.18	0.104	259.7	0.3941				
213.22	0.103	259.8	0.3941				
213.25	0.106	260.2	0.3941				
213.28	0.105	260.3	0.3967				
213.32	0.105	260.3	0.3967				
213.33	0.104	260.4	0.3967				
213.37	0.105	260.6	0.3994				
213.40	0.107	260.9	0.4021				
213.43	0.108	261.3	0.4021				
213.47	0.108	261.4	0.4021				
213.50	0.111	261.4	0.4021				
213.53	0.111	261.9	0.4047				
213.57	0.109	261.9	0.4039				
213.60	0.108	262.1	0.4047				
213.63	0.11	262.3	0.4056				
213.67	0.109	262.4	0.4056				
213.70	0.114	263	0.4056				

Prova triassiale ciclica SNGR03-C4

tensione di confinamento (kPa)		450	tensione di confinamento (kPa)		450
deviatore ciclico (kPa)		80	deviatore ciclico (kPa)		120
frequenza (hz)		0.00071429	frequenza (hz)		0.0007143
213.73	0.112	263	0.4083		
213.77	0.112	263.1	0.4083		
213.80	0.111	263.1	0.4083		
213.83	0.111	263.3	0.4101		
213.87	0.114	263.7	0.411		
213.90	0.113	263.8	0.411		
213.93	0.113	264	0.411		
213.97	0.117	264	0.4118		
214.00	0.117	264.5	0.4136		
214.03	0.115	264.6	0.4136		
214.07	0.116	264.8	0.4145		
214.10	0.115	264.8	0.4145		
214.13	0.114	264.9	0.4145		
214.17	0.115	265.2	0.4145		
214.20	0.115	265.2	0.4163		
214.23	0.118	265.6	0.4172		
214.27	0.117	265.7	0.4172		
214.30	0.119	266	0.4181		
214.33	0.118	266	0.4181		
214.37	0.117	266.1	0.4181		
214.40	0.117	266.1	0.4181		
214.43	0.117	266.2	0.4198		
214.47	0.119	266.5	0.4198		
214.50	0.118	266.6	0.4198		
214.53	0.121	267.1	0.4216		
214.57	0.12	267.1	0.4216		
214.60	0.119	267.2	0.4216		
214.65	0.12	267.4	0.4225		
214.68	0.119	267.5	0.4225		
214.72	0.121	267.7	0.4225		
214.75	0.12	267.7	0.4234		
214.78	0.12	267.8	0.4234		
214.80	0.12	267.8	0.4243		
214.83	0.121	268.1	0.4243		
214.87	0.123	268.3	0.4252		
214.90	0.121	268.4	0.4252		
214.93	0.12	268.4	0.4243		
214.97	0.12	268.4	0.4252		
215.00	0.121	268.6	0.4252		
215.03	0.12	268.6	0.4252		
215.07	0.12	268.7	0.4269		
215.10	0.123	269.1	0.4269		
215.13	0.122	269.1	0.4269		
215.17	0.122	269.1	0.4269		
215.20	0.122	269.2	0.4269		
215.23	0.121	269.3	0.4269		
215.27	0.121	269.3	0.4269		
215.30	0.121	269.4	0.4269		
215.33	0.121	269.5	0.4269		
215.37	0.122	269.7	0.4269		
215.40	0.123	269.7	0.4287		
215.43	0.123	269.9	0.4287		
215.47	0.122	270	0.4287		
215.50	0.121	270	0.4278		
215.53	0.121	270	0.4278		
215.57	0.121	270	0.4278		
215.60	0.121	270.1	0.4278		
215.63	0.121	270.1	0.4278		
215.67	0.121	270.2	0.4278		
215.70	0.123	270.4	0.4296		

Prova triassiale ciclica SNGR03-C4

pressione di confinamento (kPa)		450		pressione di confinamento (kPa)		450	
deviatore ciclico (kPa)		80		deviatore ciclico (kPa)		120	
frequenza (hz)		0.00071429		frequenza (hz)		0.0007143	
215.73	0.122	270.5	0.4287				
215.77	0.12	270.4	0.4278				
215.80	0.119	270.4	0.4278				
215.83	0.119	270.4	0.4278				
215.87	0.119	270.4	0.4278				
215.90	0.12	270.6	0.4287				
215.93	0.12	270.6	0.4287				
215.97	0.12	270.7	0.4287				
216.00	0.12	270.7	0.4287				
216.03	0.12	270.8	0.4287				
216.08	0.119	270.8	0.4287				
216.12	0.12	270.9	0.4287				
216.15	0.118	270.8	0.4287				
216.18	0.118	270.8	0.4278				
216.22	0.118	270.9	0.4278				
216.23	0.119	271	0.4287				
216.27	0.117	270.9	0.4278				
216.30	0.117	271	0.4278				
216.33	0.117	271	0.4278				
216.37	0.118	271.1	0.4278				
216.40	0.117	271.1	0.4278				
216.43	0.117	271.1	0.4278				
216.47	0.116	270.9	0.426				
216.50	0.114	270.9	0.426				
216.53	0.115	270.9	0.4269				
216.57	0.115	271.1	0.4269				
216.60	0.114	271	0.4269				
216.63	0.114	271	0.426				
216.67	0.114	271	0.426				
216.70	0.114	271	0.426				
216.73	0.114	271	0.426				
216.77	0.113	271	0.4252				
216.80	0.111	270.8	0.4252				
216.83	0.112	270.8	0.4243				
216.87	0.112	270.9	0.4243				
216.90	0.111	270.8	0.4243				
216.93	0.111	270.8	0.4243				
216.97	0.11	270.7	0.4234				
217.00	0.11	270.7	0.4234				
217.03	0.109	270.6	0.4234				
217.07	0.108	270.6	0.4234				
217.10	0.108	270.6	0.4225				
217.13	0.108	270.6	0.4225				
217.17	0.107	270.5	0.4216				
217.20	0.107	270.5	0.4216				
217.23	0.107	270.4	0.4216				
217.27	0.105	270.3	0.4216				
217.30	0.105	270.3	0.4207				
217.33	0.105	270.2	0.4198				
217.37	0.105	270.2	0.4198				
217.40	0.104	270.1	0.4189				
217.43	0.103	270	0.4189				
217.47	0.102	269.9	0.4189				
217.50	0.102	269.8	0.4181				
217.55	0.101	269.8	0.4172				
217.58	0.101	269.8	0.4172				
217.62	0.101	269.8	0.4172				
217.65	0.101	269.8	0.4163				
217.68	0.098	269.5	0.4154				
217.70	0.097	269.3	0.4145				

Prova triassiale ciclica SNGR03-C4

pressione di confinamento (kPa)		450		pressione di confinamento (kPa)		450	
deviatore ciclico (kPa)		80		deviatore ciclico (kPa)		120	
frequenza (hz)		0.00071429		frequenza (hz)		0.0007143	
217.73	0.097	269.3	0.4145				
217.77	0.098	269.2	0.4145				
217.80	0.098	269.2	0.4145				
217.83	0.097	269.2	0.4145				
217.87	0.097	269.2	0.4136				
217.90	0.093	268.7	0.4118				
217.93	0.094	268.7	0.4118				
217.97	0.092	268.6	0.411				
218.00	0.093	268.6	0.411				
218.03	0.093	268.5	0.411				
218.07	0.09	268.5	0.4101				
218.10	0.09	268.2	0.4092				
218.13	0.091	268.3	0.4092				
218.17	0.091	268.2	0.4074				
218.20	0.087	267.8	0.4065				
218.23	0.088	267.9	0.4074				
218.27	0.086	267.6	0.4074				
218.30	0.086	267.6	0.4056				
218.33	0.086	267.6	0.4056				
218.37	0.086	267.3	0.4047				
218.40	0.083	267.1	0.403				
218.43	0.084	267.2	0.4039				
218.47	0.084	267.1	0.403				
218.50	0.081	266.7	0.403				
218.53	0.081	266.7	0.4012				
218.57	0.081	266.6	0.4003				
218.60	0.077	266.1	0.3976				
218.63	0.077	266.1	0.3976				
218.67	0.078	265.9	0.3976				
218.70	0.077	265.8	0.3967				
218.73	0.076	265.6	0.3967				
218.77	0.076	265.6	0.3959				
218.80	0.074	265.4	0.395				
218.83	0.074	265.4	0.395				
218.87	0.072	265	0.3923				
218.90	0.072	264.9	0.3923				
218.93	0.073	264.9	0.3923				
218.97	0.067	264.9	0.3914				
219.02	0.069	264.3	0.3896				
219.05	0.068	264.1	0.3896				
219.08	0.068	264.1	0.3879				
219.12	0.068	264	0.3879				
219.13	0.068	263.7	0.3861				
219.17	0.063	263.2	0.3843				
219.20	0.064	263.2	0.3843				
219.23	0.063	262.9	0.3834				
219.27	0.061	262.7	0.3834				
219.30	0.061	262.7	0.3817				
219.33	0.061	262.6	0.3817				
219.37	0.061	262.4	0.3808				
219.40	0.058	262	0.379				
219.43	0.057	261.8	0.3781				
219.47	0.058	261.8	0.3781				
219.50	0.055	261.4	0.3781				
219.53	0.055	261.4	0.3754				
219.57	0.055	261.2	0.3746				
219.60	0.055	261.2	0.3746				
219.63	0.053	260.8	0.371				
219.67	0.048	260.1	0.3692				
219.70	0.049	260	0.3683				

Prova triassiale ciclica SNGR03-C4

pressione di confinamento (kPa)		450		pressione di confinamento (kPa)		450	
deviatore ciclico (kPa)		80		deviatore ciclico (kPa)		120	
frequenza (hz)		0.00071429		frequenza (hz)		0.0007143	
219.73	0.048	259.9	0.3683				
219.77	0.048	259.9	0.3675				
219.80	0.049	259.7	0.3675				
219.83	0.046	259.3	0.3648				
219.87	0.045	259	0.3639				
219.90	0.045	259	0.363				
219.93	0.045	258.9	0.363				
219.97	0.041	258.4	0.363				
220.00	0.041	258.4	0.3604				
220.03	0.042	258.2	0.3595				
220.07	0.037	257.5	0.3559				
220.10	0.037	257.4	0.355				
220.13	0.037	257.2	0.3541				
220.17	0.038	257.1	0.3541				
220.20	0.034	257.1	0.3541				
220.23	0.034	256.6	0.3515				
220.27	0.033	256.3	0.3497				
220.30	0.033	256.2	0.3497				
220.33	0.031	255.8	0.347				
220.37	0.03	255.5	0.3453				
220.40	0.031	255.4	0.3453				
220.45	0.029	255	0.3435				
220.48	0.029	254.9	0.3417				
220.52	0.026	254.4	0.3417				
220.55	0.026	254.4	0.3399				
220.58	0.026	254.1	0.3382				
220.60	0.022	253.5	0.3346				
220.63	0.021	253.2	0.3328				
220.67	0.021	253	0.332				
220.70	0.021	252.8	0.3302				
220.73	0.021	252.7	0.3302				
220.77	0.018	252.7	0.3302				
220.80	0.018	252.3	0.3275				
220.83	0.017	252	0.3257				
220.87	0.015	251.6	0.324				
220.90	0.014	251.3	0.3222				
220.93	0.013	251	0.3204				
220.97	0.011	250.6	0.3204				
221.00	0.011	250.6	0.3186				
221.03	0.011	250.4	0.3169				
221.07	0.009	250	0.3151				
221.10	0.005	249.3	0.3106				
221.13	0.007	249.3	0.3106				
221.17	0.006	249.1	0.3106				
221.20	0.007	249	0.3098				
221.23	0.007	249	0.3089				
221.27	0.004	248.6	0.3062				
221.30	0.002	248	0.3035				
221.33	-0.002	247.4	0.3				
221.37	0	247.3	0.2991				
221.40	-0.001	247.2	0.2991				
221.43	-0.001	247.2	0.2973				
221.47	-0.001	247	0.2947				
221.50	-0.002	246.6	0.292				
221.53	-0.005	246.1	0.2876				
221.57	-0.007	245.7	0.284				
221.60	-0.007	245.5	0.2805				
221.63	-0.008	245.2	0.2805				
221.67	-0.01	245.2	0.276				
221.70	-0.01	244.7	0.2716				

Prova triassiale ciclica SNGR03-C4

tensione di confinamento (kPa)		450	tensione di confinamento (kPa)		450
deviatore ciclico (kPa)		80	deviatore ciclico (kPa)		120
frequenza (hz)		0.00071429	frequenza (hz)		0.0007143
221.73	-0.011	244.4	0.268		
221.77	-0.012	244.1	0.2636		
221.80	-0.016	243.5	0.2574		
221.83	-0.015	243.3	0.2538		
221.87	-0.015	243.1	0.2538		
221.92	-0.014	242.8	0.2476		
221.95	-0.019	242.2	0.2476		
221.98	-0.02	241.9	0.2423		
222.02	-0.02	241.9	0.2387		
222.03	-0.018	242	0.237		
222.07	-0.02	241.4	0.2325		
222.10	-0.025	240.7	0.2272		
222.13	-0.024	240.6	0.2254		
222.17	-0.024	240.4	0.2254		
222.20	-0.026	240.4	0.2237		
222.23	-0.026	240	0.221		
222.27	-0.026	239.6	0.2183		
222.30	-0.027	239.4	0.2166		
222.33	-0.029	239	0.213		
222.37	-0.029	238.6	0.2103		
222.40	-0.034	237.7	0.2103		
222.43	-0.033	237.7	0.2059		
222.47	-0.033	237.6	0.2041		
222.50	-0.033	237.3	0.2015		
222.53	-0.035	236.9	0.1997		
222.57	-0.035	236.6	0.1979		
222.60	-0.037	236.1	0.1953		
222.63	-0.036	236.1	0.1953		
222.67	-0.036	236.1	0.1944		
222.70	-0.04	235.5	0.1908		
222.73	-0.041	235.1	0.189		
222.77	-0.042	234.7	0.1873		
222.80	-0.042	234.4	0.1855		
222.83	-0.043	234.1	0.1855		
222.87	-0.045	233.6	0.1837		
222.90	-0.045	233.6	0.1819		
222.93	-0.046	233.3	0.1802		
222.97	-0.047	232.9	0.1784		
223.00	-0.048	232.6	0.1766		
223.03	-0.048	232.3	0.1748		
223.07	-0.051	231.8	0.1748		
223.10	-0.051	231.8	0.1731		
223.13	-0.051	231.5	0.1722		
223.17	-0.052	231.2	0.1704		
223.20	-0.053	230.8	0.1686		
223.23	-0.054	230.5	0.1677		
223.27	-0.055	230.1	0.166		
223.30	-0.059	229.3	0.166		
223.35	-0.058	229.2	0.1624		
223.38	-0.058	229	0.1615		
223.42	-0.059	228.6	0.1615		
223.45	-0.06	228.6	0.1606		
223.48	-0.06	228.4	0.1589		
223.50	-0.059	228.2	0.1589		
223.53	-0.06	227.8	0.158		
223.57	-0.063	227.4	0.1562		
223.60	-0.066	226.7	0.1562		
223.63	-0.065	226.5	0.1535		
223.67	-0.065	226.5	0.1526		
223.70	-0.065	226.4	0.1526		

Prova triassiale ciclica SNGR03-C4

tensione di confinamento (kPa)		450	tensione di confinamento (kPa)		450
deviatore ciclico (kPa)		80	deviatore ciclico (kPa)		120
frequenza (hz)		0.00071429	frequenza (hz)		0.0007143
223.73	-0.064	226.3	0.1518		
223.77	-0.067	225.8	0.1509		
223.80	-0.068	225.5	0.1491		
223.83	-0.069	225.1	0.1491		
223.87	-0.07	225.1	0.1482		
223.90	-0.07	224.7	0.1464		
223.93	-0.071	224.4	0.1455		
223.97	-0.071	224.1	0.1447		
224.00	-0.073	223.7	0.1438		
224.03	-0.073	223.5	0.1429		
224.07	-0.074	223.2	0.1429		
224.10	-0.075	223.2	0.142		
224.13	-0.075	222.9	0.1411		
224.17	-0.076	222.6	0.1402		
224.20	-0.077	222.2	0.1384		
224.23	-0.078	221.9	0.1376		
224.27	-0.078	221.6	0.1367		
224.30	-0.079	221.3	0.1367		
224.33	-0.079	221.3	0.1358		
224.37	-0.08	221	0.1349		
224.40	-0.081	220.7	0.134		
224.43	-0.081	220.4	0.1331		
224.47	-0.082	220.1	0.1322		
224.50	-0.083	219.8	0.1322		
224.53	-0.084	219.4	0.1322		
224.57	-0.084	219.4	0.1305		
224.60	-0.083	219.3	0.1305		
224.63	-0.084	219	0.1296		
224.67	-0.086	218.7	0.1287		
224.70	-0.086	218.4	0.1278		
224.73	-0.088	218.1	0.1278		
224.77	-0.088	218.1	0.1269		
224.82	-0.088	217.6	0.1242		
224.85	-0.091	217.1	0.1242		
224.87	-0.09	217.1	0.1242		
224.90	-0.09	217	0.1234		
224.93	-0.09	216.8	0.1234		
224.97	-0.09	216.6	0.1234		
225.00	-0.091	216.4	0.1225		
225.03	-0.092	216.1	0.1216		
225.07	-0.092	215.8	0.1216		
225.10	-0.093	215.8	0.1207		
225.13	-0.093	215.6	0.1207		
225.17	-0.092	215.6	0.1207		
225.20	-0.092	215.4	0.1198		
225.23	-0.094	215	0.1189		
225.27	-0.095	214.7	0.118		
225.30	-0.098	214.2	0.118		
225.33	-0.097	214.2	0.1163		
225.37	-0.097	214.1	0.1163		
225.40	-0.097	214	0.1163		
225.43	-0.097	213.8	0.1154		
225.47	-0.098	213.6	0.1154		
225.50	-0.098	213.4	0.1145		
225.53	-0.099	213.1	0.1145		
225.57	-0.099	213.1	0.1136		
225.60	-0.099	212.9	0.1136		
225.63	-0.1	212.7	0.1127		
225.67	-0.1	212.5	0.1127		
225.70	-0.099	212.4	0.1127		

Prova triassiale ciclica SNGR03-C4

pressione di confinamento (kPa)		450	pressione di confinamento (kPa)		450
deviatore ciclico (kPa)		80	deviatore ciclico (kPa)		120
frequenza (hz)		0.00071429	frequenza (hz)		0.0007143
225.73	-0.099	212.3	0.1109		
225.77	-0.1	212	0.1109		
225.80	-0.101	212	0.11		
225.83	-0.101	211.7	0.1083		
225.87	-0.104	211.2	0.1083		
225.90	-0.104	211.1	0.1083		
225.93	-0.103	211	0.1083		
225.97	-0.103	210.9	0.1083		
226.00	-0.102	210.9	0.1083		
226.03	-0.103	210.9	0.1083		
226.07	-0.103	210.7	0.1074		
226.10	-0.104	210.5	0.1065		
226.13	-0.103	210.4	0.1065		
226.17	-0.103	210.3	0.1065		
226.20	-0.103	210.2	0.1056		
226.25	-0.105	209.8	0.1056		
226.28	-0.107	209.4	0.1038		
226.32	-0.107	209.3	0.1038		
226.33	-0.106	209.3	0.1038		
226.37	-0.105	209.3	0.1038		
226.40	-0.105	209.2	0.1038		
226.43	-0.105	209.2	0.1038		
226.47	-0.105	209.1	0.1038		
226.50	-0.105	209	0.1038		
226.53	-0.105	208.8	0.1038		
226.57	-0.107	208.6	0.1038		
226.60	-0.106	208.6	0.1029		
226.63	-0.106	208.5	0.1029		
226.67	-0.106	208.4	0.1029		
226.70	-0.106	208.4	0.1029		
226.73	-0.107	208.2	0.1021		
226.77	-0.107	208.1	0.1021		
226.80	-0.107	208	0.1021		
226.83	-0.106	208	0.1021		
226.87	-0.106	208	0.1021		
226.90	-0.106	208	0.1021		
226.93	-0.106	207.9	0.1012		
226.97	-0.109	207.4	0.1003		
227.00	-0.108	207.3	0.1003		
227.03	-0.108	207.3	0.1003		
227.07	-0.107	207.3	0.1003		
227.10	-0.107	207.3	0.1003		
227.13	-0.107	207.3	0.1003		
227.17	-0.106	207.2	0.1003		
227.20	-0.104	207.4	0.1012		
227.23	-0.106	207.1	0.1003		
227.27	-0.107	207	0.1003		
227.30	-0.107	207	0.1003		
227.33	-0.107	206.9	0.1003		
227.37	-0.106	206.8	0.1003		
227.40	-0.106	206.8	0.1003		
227.43	-0.105	206.9	0.1003		
227.47	-0.105	206.9	0.1003		
227.50	-0.105	206.8	0.1003		
227.53	-0.105	206.8	0.1003		
227.57	-0.105	206.8	0.1003		
227.60	-0.105	206.7	0.1003		
227.63	-0.105	206.6	0.1003		
227.67	-0.105	206.6	0.1003		
227.72	-0.107	206.3	0.0994		

Prova triassiale ciclica SNGR03-C4

tensione di confinamento (kPa)		450	tensione di confinamento (kPa)		450
deviatore ciclico (kPa)		80	deviatore ciclico (kPa)		120
frequenza (hz)		0.00071429	frequenza (hz)		0.0007143
227.75	-0.106	206.3	0.0994		
227.77	-0.106	206.2	0.0994		
227.80	-0.105	206.3	0.1003		
227.83	-0.103	206.5	0.1003		
227.87	-0.103	206.5	0.1003		
227.90	-0.103	206.5	0.1003		
227.93	-0.103	206.4	0.1003		
227.97	-0.101	206.6	0.1012		
228.00	-0.101	206.6	0.1012		
228.03	-0.101	206.6	0.1012		
228.07	-0.101	206.5	0.1012		
228.10	-0.101	206.5	0.1012		
228.13	-0.101	206.5	0.1003		
228.17	-0.103	206.2	0.1003		
228.20	-0.103	206.2	0.1003		
228.23	-0.101	206.3	0.1012		
228.27	-0.101	206.4	0.1012		
228.30	-0.099	206.6	0.1012		
228.33	-0.099	206.6	0.1021		
228.37	-0.099	206.6	0.1021		
228.40	-0.099	206.6	0.1021		
228.43	-0.096	206.9	0.1029		
228.47	-0.096	206.9	0.1029		
228.50	-0.096	206.8	0.1029		
228.53	-0.096	206.8	0.1029		
228.57	-0.096	206.8	0.1029		
228.60	-0.096	206.8	0.1029		
228.63	-0.098	206.6	0.1021		
228.67	-0.097	206.6	0.1029		
228.70	-0.095	206.8	0.1029		
228.73	-0.094	206.9	0.1038		
228.77	-0.093	207.1	0.1038		
228.80	-0.093	207.1	0.1038		
228.83	-0.093	207.1	0.1047		
228.87	-0.092	207.2	0.1047		
228.90	-0.092	207.3	0.1056		
228.93	-0.088	207.7	0.1065		
228.97	-0.089	207.7	0.1065		
229.00	-0.089	207.7	0.1065		
229.03	-0.092	207.7	0.1065		
229.07	-0.092	207.4	0.1056		
229.10	-0.091	207.5	0.1056		
229.13	-0.088	207.8	0.1065		
229.18	-0.087	208	0.1074		
229.22	-0.087	208	0.1074		
229.23	-0.087	208	0.1074		
229.27	-0.086	208.2	0.1083		
229.30	-0.084	208.3	0.1092		
229.33	-0.084	208.4	0.1092		
229.37	-0.081	208.8	0.1092		
229.40	-0.081	208.8	0.1109		
229.43	-0.081	208.9	0.1109		
229.47	-0.082	208.9	0.1109		
229.50	-0.082	208.9	0.1109		
229.53	-0.081	208.9	0.1109		
229.57	-0.08	209.1	0.1109		
229.60	-0.08	209.1	0.1127		
229.63	-0.08	209.1	0.1127		
229.67	-0.079	209.2	0.1127		
229.70	-0.077	209.5	0.1136		

Prova triassiale ciclica SNGR03-C4

pressione di confinamento (kPa)		450	tensione di confinamento (kPa)		450
deviatore ciclico (kPa)		80	deviatore ciclico (kPa)		120
frequenza (hz)		0.00071429	frequenza (hz)		0.0007143
229.73	-0.076	209.7	0.1145		
229.77	-0.076	209.8	0.1154		
229.80	-0.075	210	0.1154		
229.83	-0.074	210.1	0.1154		
229.87	-0.074	210.1	0.1163		
229.90	-0.073	210.3	0.1163		
229.93	-0.072	210.4	0.1171		
229.97	-0.072	210.6	0.1171		
230.00	-0.071	210.8	0.118		
230.03	-0.07	211	0.118		
230.07	-0.069	211.1	0.1189		
230.10	-0.069	211.1	0.1198		
230.13	-0.065	211.6	0.1216		
230.17	-0.065	211.7	0.1216		
230.20	-0.067	211.6	0.1216		
230.23	-0.067	211.7	0.1216		
230.27	-0.066	211.9	0.1216		
230.30	-0.064	212.2	0.1216		
230.33	-0.064	212.2	0.1234		
230.37	-0.063	212.4	0.1242		
230.40	-0.062	212.6	0.1242		
230.43	-0.06	213	0.1251		
230.47	-0.06	213	0.126		
230.50	-0.059	213.3	0.126		
230.53	-0.058	213.5	0.1269		
230.57	-0.058	213.5	0.1269		
230.62	-0.056	213.9	0.1278		
230.65	-0.054	214.2	0.1296		
230.68	-0.054	214.2	0.1296		
230.70	-0.055	214.3	0.1305		
230.73	-0.054	214.4	0.1305		
230.77	-0.052	214.7	0.1313		
230.80	-0.051	215	0.1331		
230.83	-0.05	215.2	0.1331		
230.87	-0.048	215.5	0.1331		
230.90	-0.048	215.5	0.134		
230.93	-0.049	215.6	0.1349		
230.97	-0.048	215.8	0.1358		
231.00	-0.046	216.1	0.1367		
231.03	-0.045	216.4	0.1384		
231.07	-0.041	217	0.1384		
231.10	-0.041	217.1	0.1402		
231.13	-0.041	217.1	0.1402		
231.17	-0.042	217.2	0.1411		
231.20	-0.042	217.3	0.1411		
231.23	-0.04	217.5	0.142		
231.27	-0.039	217.8	0.1429		
231.30	-0.037	218.2	0.1429		
231.33	-0.037	218.4	0.1447		
231.37	-0.037	218.4	0.1455		
231.40	-0.035	218.7	0.1464		
231.43	-0.034	219	0.1473		
231.47	-0.032	219.3	0.1491		
231.50	-0.032	219.5	0.15		
231.53	-0.031	219.8	0.15		
231.57	-0.029	220.1	0.1509		
231.60	-0.029	220.1	0.1526		
231.63	-0.029	220.3	0.1535		
231.67	-0.027	220.8	0.1562		
231.70	-0.024	221.3	0.158		

Prova triassiale ciclica SNGR03-C4

pressione di confinamento (kPa)		450	tensione di confinamento (kPa)		450
deviatore ciclico (kPa)		80	deviatore ciclico (kPa)		120
frequenza (hz)		0.00071429	frequenza (hz)		0.0007143
231.73	-0.025	221.5	0.158		
231.77	-0.024	221.7	0.158		
231.80	-0.023	221.9	0.1589		
231.83	-0.023	221.9	0.1597		
231.87	-0.022	222.1	0.1606		
231.90	-0.022	222.4	0.1624		
231.93	-0.018	222.9	0.1642		
231.97	-0.019	223	0.1651		
232.00	-0.017	223.4	0.1651		
232.03	-0.016	223.7	0.1669		
232.08	-0.014	224.1	0.1695		
232.12	-0.014	224.3	0.1695		
232.13	-0.013	224.5	0.1713		
232.17	-0.013	224.5	0.1722		
232.20	-0.012	224.9	0.1748		
232.23	-0.01	225.3	0.1757		
232.27	-0.009	225.6	0.1775		
232.30	-0.008	225.8	0.1793		
232.33	-0.004	226.5	0.1793		
232.37	-0.005	226.6	0.1828		
232.40	-0.005	226.6	0.1837		
232.43	-0.005	226.8	0.1855		
232.47	-0.003	227.2	0.1873		
232.50	-0.002	227.5	0.189		
232.53	0	227.9	0.1917		
232.57	0	228.2	0.1917		
232.60	0.001	228.4	0.1935		
232.63	0.001	228.4	0.1953		
232.67	0.001	228.6	0.197		
232.70	0.003	229.2	0.1997		
232.73	0.006	229.6	0.2032		
232.77	0.006	229.9	0.2059		
232.80	0.007	230.3	0.2059		
232.83	0.009	230.7	0.2086		
232.87	0.009	230.7	0.213		
232.90	0.01	231	0.2157		
232.93	0.011	231.3	0.2183		
232.97	0.013	231.7	0.2219		
233.00	0.013	231.9	0.2254		
233.03	0.015	232.6	0.2254		
233.07	0.018	233	0.2299		
233.10	0.018	233	0.2352		
233.13	0.017	233.2	0.2387		
233.17	0.015	233.3	0.2414		
233.20	0.019	233.8	0.2467		
233.23	0.02	234.1	0.2512		
233.27	0.024	234.9	0.2512		
233.30	0.024	235.1	0.2609		
233.33	0.024	235.1	0.2663		
233.37	0.024	235.4	0.2716		
233.40	0.023	235.6	0.2734		
233.43	0.027	236.1	0.2778		
233.47	0.027	236.4	0.2805		
233.52	0.029	236.7	0.2822		
233.55	0.03	237	0.2849		
233.58	0.032	237.5	0.2876		
233.60	0.03	237.6	0.2876		
233.63	0.032	238	0.2876		
233.67	0.032	238	0.2902		
233.70	0.034	238.3	0.2929		

Prova triassiale ciclica SNGR03-C4

tensione di confinamento (kPa)		450	tensione di confinamento (kPa)		450
deviatore ciclico (kPa)		80	deviatore ciclico (kPa)		120
frequenza (hz)		0.00071429	frequenza (hz)		0.0007143
233.73	0.036	238.8	0.2956		
233.77	0.039	239.3	0.2982		
233.80	0.038	239.5	0.2982		
233.83	0.038	239.7	0.2982		
233.87	0.04	240.1	0.3		
233.90	0.04	240.1	0.3018		
233.93	0.04	240.2	0.3018		
233.97	0.041	240.6	0.3044		
234.00	0.044	241.1	0.3062		
234.03	0.044	241.3	0.308		
234.07	0.045	241.7	0.308		
234.10	0.049	242.3	0.3098		
234.13	0.049	242.3	0.3133		
234.17	0.048	242.5	0.3133		
234.20	0.047	242.6	0.3133		
234.23	0.05	242.9	0.316		
234.27	0.051	243.3	0.3177		
234.30	0.053	243.7	0.3177		
234.33	0.057	244.2	0.3195		
234.37	0.057	244.2	0.3222		
234.40	0.054	244.3	0.3222		
234.43	0.053	244.4	0.3231		
234.47	0.056	244.9	0.3249		
234.50	0.058	245.4	0.3284		
234.53	0.062	246	0.3284		
234.57	0.061	246.2	0.3311		
234.60	0.061	246.2	0.332		
234.63	0.06	246.3	0.332		
234.67	0.06	246.5	0.3328		
234.70	0.063	247	0.3355		
234.73	0.064	247.3	0.3364		
234.77	0.065	247.6	0.3364		
234.80	0.066	248	0.3382		
234.83	0.066	248	0.3408		
234.87	0.067	248.2	0.3426		
234.90	0.071	248.9	0.3453		
234.93	0.069	249	0.3453		
234.98	0.069	249.2	0.3462		
235.02	0.07	249.5	0.347		
235.03	0.071	249.8	0.3488		
235.07	0.073	250.1	0.3506		
235.10	0.074	250.5	0.3506		
235.13	0.075	250.8	0.3515		
235.17	0.075	250.8	0.3533		
235.20	0.076	251	0.3541		
235.23	0.077	251.4	0.3559		
235.27	0.078	251.7	0.3568		
235.30	0.079	252	0.3586		
235.33	0.08	252.3	0.3586		
235.37	0.081	252.7	0.3612		
235.40	0.081	252.7	0.3612		
235.43	0.08	252.8	0.3621		
235.47	0.082	253.2	0.363		
235.50	0.084	253.5	0.3648		
235.53	0.083	253.7	0.3657		
235.57	0.085	254.1	0.3657		
235.60	0.089	254.6	0.3675		
235.63	0.089	254.6	0.3701		
235.67	0.086	254.7	0.3701		
235.70	0.085	254.8	0.3701		

Prova triassiale ciclica SNGR03-C4

pressione di confinamento (kPa)		450		pressione di confinamento (kPa)		450	
deviatore ciclico (kPa)		80		deviatore ciclico (kPa)		120	
frequenza (hz)		0.00071429		frequenza (hz)		0.0007143	
235.73	0.091	255.4	0.3728				
235.77	0.089	255.5	0.3728				
235.80	0.087	255.5	0.3728				
235.83	0.09	256	0.3728				
235.87	0.09	256	0.3746				
235.90	0.091	256.3	0.3763				
235.93	0.095	256.9	0.3799				
235.97	0.094	257.1	0.3808				
236.00	0.094	257.3	0.3808				
236.03	0.093	257.4	0.3808				
236.07	0.094	257.7	0.3808				
236.10	0.094	257.7	0.3817				
236.13	0.096	258	0.3834				
236.17	0.099	258.6	0.3861				
236.20	0.097	258.6	0.3861				
236.23	0.097	258.9	0.387				
236.27	0.101	259.4	0.387				
236.30	0.1	259.4	0.3888				
236.33	0.1	259.4	0.3888				
236.37	0.099	259.6	0.3896				
236.42	0.103	260.3	0.3923				
236.45	0.103	260.3	0.3932				
236.48	0.102	260.4	0.3932				
236.50	0.102	260.5	0.3932				
236.53	0.104	260.9	0.395				
236.57	0.104	261.1	0.3967				
236.60	0.108	261.6	0.3976				
236.63	0.106	261.7	0.3976				
236.67	0.106	261.7	0.3976				
236.70	0.105	261.8	0.3976				
236.73	0.108	262.3	0.4003				
236.77	0.107	262.4	0.4003				
236.80	0.107	262.6	0.4021				
236.83	0.11	263.1	0.403				
236.87	0.11	263.2	0.403				
236.90	0.11	263.2	0.403				
236.93	0.109	263.4	0.4039				
236.97	0.11	263.6	0.4047				
237.00	0.11	263.7	0.4047				
237.03	0.11	263.9	0.4056				
237.07	0.113	264.4	0.4074				
237.10	0.112	264.5	0.4074				
237.13	0.112	264.5	0.4074				
237.17	0.112	264.6	0.4074				
237.20	0.114	265	0.4092				
237.23	0.113	265	0.4092				
237.27	0.113	265.2	0.4101				
237.30	0.114	265.4	0.411				
237.33	0.118	266	0.411				
237.37	0.118	266	0.4127				
237.40	0.115	266	0.4127				
237.43	0.114	266	0.4127				
237.47	0.114	266.1	0.4127				
237.50	0.118	266.6	0.4154				
237.53	0.117	266.7	0.4154				
237.57	0.117	266.8	0.4154				
237.60	0.117	266.8	0.4154				
237.63	0.116	266.9	0.4154				
237.67	0.119	267.3	0.4172				
237.70	0.118	267.4	0.4172				

Prova triassiale ciclica SNGR03-C4

pressione di confinamento (kPa)		450		pressione di confinamento (kPa)		450	
deviatore ciclico (kPa)		80		deviatore ciclico (kPa)		120	
frequenza (hz)		0.00071429		frequenza (hz)		0.0007143	
237.73	0.117	267.5	0.4172				
237.77	0.118	267.6	0.4172				
237.80	0.121	268.1	0.4172				
237.83	0.121	268.1	0.4198				
237.88	0.118	268.1	0.4189				
237.92	0.118	268.2	0.4189				
237.93	0.121	268.2	0.4189				
237.97	0.121	268.6	0.4207				
238.00	0.12	268.6	0.4207				
238.03	0.118	268.6	0.4198				
238.07	0.12	268.9	0.4216				
238.10	0.12	269	0.4216				
238.13	0.12	269.1	0.4216				
238.17	0.123	269.1	0.4216				
238.20	0.123	269.5	0.4234				
238.23	0.121	269.5	0.4234				
238.27	0.12	269.5	0.4234				
238.30	0.121	269.7	0.4234				
238.33	0.121	269.7	0.4234				
238.37	0.12	269.8	0.4234				
238.40	0.123	269.8	0.4234				
238.43	0.123	270.2	0.4252				
238.47	0.121	270.1	0.4243				
238.50	0.12	270.2	0.4243				
238.53	0.121	270.4	0.4252				
238.57	0.121	270.4	0.4252				
238.60	0.121	270.5	0.4252				
238.63	0.121	270.5	0.4252				
238.67	0.121	270.6	0.4252				
238.70	0.121	270.7	0.426				
238.73	0.123	271.1	0.4269				
238.77	0.122	271.1	0.4269				
238.80	0.122	271.1	0.4269				
238.83	0.121	271.2	0.4269				
238.87	0.121	271.2	0.4269				
238.90	0.121	271.2	0.4269				
238.93	0.121	271.3	0.4269				
238.97	0.121	271.3	0.4269				
239.00	0.121	271.4	0.4269				
239.03	0.121	271.6	0.4269				
239.07	0.121	271.6	0.4269				
239.10	0.121	271.6	0.4269				
239.13	0.121	271.7	0.4269				
239.17	0.122	271.8	0.4278				
239.20	0.121	271.9	0.4278				
239.23	0.119	271.8	0.4269				
239.27	0.119	271.8	0.4269				
239.30	0.119	271.9	0.4269				
239.35	0.12	272	0.4269				
239.38	0.12	272	0.4269				
239.40	0.119	272.1	0.4269				
239.43	0.118	272.1	0.4269				
239.47	0.118	272.1	0.4269				
239.50	0.119	272.2	0.4269				
239.53	0.118	272.1	0.4269				
239.57	0.118	272.2	0.4269				
239.60	0.118	272.2	0.426				
239.63	0.118	272.3	0.426				
239.67	0.116	272.3	0.4269				
239.70	0.116	272.2	0.426				

Prova triassiale ciclica SNGR03-C4

pressione di confinamento (kPa)		450		pressione di confinamento (kPa)		450	
deviatore ciclico (kPa)		80		deviatore ciclico (kPa)		120	
frequenza (hz)		0.00071429		frequenza (hz)		0.0007143	
239.73	0.117	272.2	0.426				
239.77	0.116	272.2	0.426				
239.80	0.116	272.2	0.426				
239.83	0.116	272.3	0.426				
239.87	0.115	272.2	0.426				
239.90	0.115	272.2	0.4252				
239.93	0.115	272.2	0.4252				
239.97	0.114	272.2	0.4252				
240.00	0.114	272.2	0.4243				
240.03	0.114	272.2	0.4243				
240.07	0.113	272.1	0.4234				
240.10	0.112	272.1	0.4234				
240.13	0.112	272.1	0.4234				
240.17	0.112	272.1	0.4234				
240.20	0.112	272.2	0.4234				
240.23	0.11	272	0.4225				
240.27	0.11	272	0.4225				
240.30	0.111	272	0.4225				
240.33	0.109	271.9	0.4225				
240.37	0.109	271.9	0.4216				
240.40	0.109	271.9	0.4216				
240.43	0.109	271.8	0.4207				
240.47	0.109	271.8	0.4207				
240.50	0.107	271.6	0.4198				
240.53	0.107	271.6	0.4198				
240.57	0.106	271.5	0.4198				
240.60	0.105	271.5	0.4189				
240.63	0.105	271.5	0.4189				
240.67	0.105	271.4	0.4189				
240.70	0.104	271.3	0.4181				
240.73	0.105	271.4	0.4181				
240.78	0.103	271.1	0.4172				
240.82	0.102	271.1	0.4172				
240.85	0.102	271	0.4163				
240.87	0.103	271.1	0.4172				
240.90	0.099	270.7	0.4172				
240.93	0.1	270.7	0.4154				
240.97	0.1	270.8	0.4154				
241.00	0.1	270.8	0.4154				
241.03	0.097	270.4	0.4136				
241.07	0.098	270.5	0.4136				
241.10	0.098	270.5	0.4136				
241.13	0.095	270.2	0.4136				
241.17	0.097	270.2	0.4118				
241.20	0.097	270.3	0.4118				
241.23	0.094	269.9	0.4101				
241.27	0.094	269.9	0.4101				
241.30	0.093	269.8	0.4101				
241.33	0.093	269.7	0.4092				
241.37	0.091	269.6	0.4092				
241.40	0.09	269.6	0.4083				
241.43	0.09	269.4	0.4074				
241.47	0.091	269.4	0.4074				
241.50	0.09	269.3	0.4074				
241.53	0.088	269	0.4056				
241.57	0.088	268.9	0.4056				
241.60	0.087	268.7	0.4056				
241.63	0.086	268.7	0.4039				
241.67	0.086	268.6	0.4039				
241.70	0.085	268.5	0.403				

Prova triassiale ciclica SNGR03-C4

tensione di confinamento (kPa)		450		tensione di confinamento (kPa)		450	
deviatore ciclico (kPa)		80		deviatore ciclico (kPa)		120	
frequenza (hz)		0.00071429		frequenza (hz)		0.0007143	
241.73	0.083	268.3	0.4021				
241.77	0.083	268.2	0.4012				
241.80	0.083	268.1	0.4012				
241.83	0.081	267.9	0.4012				
241.87	0.08	267.9	0.3994				
241.90	0.08	267.6	0.3985				
241.93	0.08	267.5	0.3976				
241.97	0.078	267.3	0.3967				
242.00	0.077	267.1	0.3959				
242.03	0.076	266.9	0.395				
242.07	0.076	266.8	0.395				
242.10	0.074	266.8	0.395				
242.13	0.074	266.5	0.3932				
242.17	0.074	266.4	0.3923				
242.20	0.072	266.1	0.3914				
242.25	0.072	266	0.3905				
242.28	0.071	265.8	0.3905				
242.30	0.07	265.6	0.3888				
242.33	0.069	265.4	0.3879				
242.37	0.068	265.2	0.387				
242.40	0.067	265	0.387				
242.43	0.066	265	0.3861				
242.47	0.066	264.7	0.3852				
242.50	0.066	264.6	0.3843				
242.53	0.066	264.5	0.3843				
242.57	0.061	264	0.3817				
242.60	0.063	264	0.3817				
242.63	0.061	263.8	0.3817				
242.67	0.06	263.8	0.3799				
242.70	0.06	263.5	0.379				
242.73	0.059	263.2	0.3781				
242.77	0.058	263	0.3763				
242.80	0.057	262.8	0.3754				
242.83	0.056	262.5	0.3746				
242.87	0.054	262.2	0.3746				
242.90	0.053	262.2	0.3728				
242.93	0.053	262	0.3719				
242.97	0.053	261.8	0.371				
243.00	0.051	261.5	0.3692				
243.03	0.05	261.3	0.3683				
243.07	0.049	261	0.3666				
243.10	0.047	260.7	0.3666				
243.13	0.047	260.7	0.3648				
243.17	0.047	260.5	0.3639				
243.20	0.047	260.3	0.3639				
243.23	0.043	259.8	0.3612				
243.27	0.044	259.7	0.3604				
243.30	0.043	259.4	0.3586				
243.33	0.041	259.1	0.3586				
243.37	0.04	259.1	0.3577				
243.40	0.04	258.9	0.3559				
243.43	0.039	258.6	0.355				
243.47	0.038	258.4	0.3541				
243.50	0.037	258.2	0.3524				
243.53	0.034	257.6	0.3497				
243.57	0.033	257.4	0.3497				
243.60	0.033	257.4	0.3488				
243.63	0.033	257.2	0.3479				
243.68	0.03	256.6	0.3462				
243.72	0.03	256.6	0.3444				

Prova triassiale ciclica SNGR03-C4

tensione di confinamento (kPa)		450		tensione di confinamento (kPa)		450	
deviatore ciclico (kPa)		80		deviatore ciclico (kPa)		120	
frequenza (hz)		0.00071429		frequenza (hz)		0.0007143	
243.75	0.03	256.4	0.3444				
243.77	0.031	256.4	0.3435				
243.80	0.026	255.6	0.3399				
243.83	0.026	255.5	0.3382				
243.87	0.025	255.1	0.3355				
243.90	0.023	254.8	0.3355				
243.93	0.023	254.8	0.3346				
243.97	0.023	254.6	0.3328				
244.00	0.024	254.5	0.332				
244.03	0.019	253.8	0.3293				
244.07	0.019	253.6	0.3275				
244.10	0.018	253.3	0.3257				
244.13	0.017	252.9	0.3257				
244.17	0.015	252.9	0.324				
244.20	0.015	252.6	0.3222				
244.23	0.015	252.3	0.3204				
244.27	0.015	252.2	0.3204				
244.30	0.013	251.9	0.3186				
244.33	0.012	251.5	0.316				
244.37	0.006	250.8	0.316				
244.40	0.009	250.8	0.3124				
244.43	0.009	250.8	0.3115				
244.47	0.008	250.5	0.3098				
244.50	0.005	250.1	0.308				
244.53	0.005	249.8	0.3071				
244.57	0.004	249.5	0.3044				
244.60	0.004	249.3	0.3044				
244.63	0	249.3	0.3035				
244.67	0	248.7	0.3				
244.70	0	248.5	0.2991				
244.73	0	248.3	0.2973				
244.77	0	248.2	0.2947				
244.80	-0.004	247.4	0.2902				
244.83	-0.006	247	0.2902				
244.87	-0.006	247	0.2867				
244.90	-0.006	246.8	0.2831				
244.93	-0.007	246.5	0.2796				
244.97	-0.009	246.1	0.276				
245.00	-0.009	245.9	0.2716				
245.03	-0.01	245.5	0.268				
245.07	-0.011	245.1	0.268				
245.10	-0.011	245.1	0.2636				
245.15	-0.015	244.3	0.2547				
245.18	-0.015	244.2	0.2547				
245.20	-0.016	244.2	0.2521				
245.23	-0.016	243.8	0.2476				
245.27	-0.017	243.5	0.2441				
245.30	-0.019	243.1	0.2405				
245.33	-0.017	243.1	0.2379				
245.37	-0.019	242.5	0.2343				
245.40	-0.023	242	0.2343				
245.43	-0.023	242	0.2299				
245.47	-0.023	241.8	0.2272				
245.50	-0.024	241.4	0.2245				
245.53	-0.025	241	0.221				
245.57	-0.026	240.7	0.2183				
245.60	-0.028	240.2	0.2148				
245.63	-0.029	239.8	0.2148				
245.67	-0.03	239.8	0.2121				
245.70	-0.03	239.2	0.2086				

Prova triassiale ciclica SNGR03-C4

tensione di confinamento (kPa)		450	tensione di confinamento (kPa)		450
deviatore ciclico (kPa)		80	deviatore ciclico (kPa)		120
frequenza (hz)		0.00071429	frequenza (hz)		0.0007143
245.73	-0.033	238.9	0.2059		
245.77	-0.033	238.7	0.2041		
245.80	-0.033	238.4	0.2024		
245.83	-0.034	238	0.1997		
245.87	-0.033	237.9	0.1997		
245.90	-0.039	237.9	0.1979		
245.93	-0.039	237.1	0.1944		
245.97	-0.037	236.9	0.1935		
246.00	-0.038	236.6	0.1917		
246.03	-0.039	236.2	0.1899		
246.07	-0.041	235.8	0.1873		
246.10	-0.04	235.7	0.1873		
246.13	-0.042	235.7	0.1864		
246.17	-0.042	235.2	0.1846		
246.20	-0.043	234.8	0.1819		
246.23	-0.046	234.3	0.1802		
246.27	-0.046	234.1	0.1784		
246.30	-0.047	233.7	0.1766		
246.33	-0.048	233.3	0.1766		
246.37	-0.049	233.3	0.1748		
246.40	-0.049	233	0.174		
246.43	-0.05	232.6	0.1713		
246.47	-0.052	232.2	0.1704		
246.50	-0.052	231.9	0.1686		
246.53	-0.053	231.5	0.1669		
246.57	-0.054	231.2	0.1669		
246.62	-0.056	230.8	0.1642		
246.65	-0.056	230.5	0.1633		
246.67	-0.057	230.2	0.1633		
246.70	-0.058	230.2	0.1624		
246.73	-0.058	229.8	0.1606		
246.77	-0.058	229.5	0.1597		
246.80	-0.06	229.1	0.158		
246.83	-0.062	228.7	0.1562		
246.87	-0.063	228.2	0.1544		
246.90	-0.063	227.9	0.1544		
246.93	-0.064	227.9	0.1535		
246.97	-0.064	227.7	0.1526		
247.00	-0.064	227.4	0.1518		
247.03	-0.066	227	0.1509		
247.07	-0.067	226.7	0.1491		
247.10	-0.067	226.4	0.1482		
247.13	-0.068	226	0.1482		
247.17	-0.069	226	0.1473		
247.20	-0.069	225.7	0.1464		
247.23	-0.07	225.5	0.1447		
247.27	-0.071	225.1	0.1438		
247.30	-0.072	224.8	0.1429		
247.33	-0.073	224.4	0.142		
247.37	-0.072	224.3	0.142		
247.40	-0.072	224.3	0.142		
247.43	-0.072	224.1	0.1411		
247.47	-0.075	223.6	0.1393		
247.50	-0.076	223.2	0.1376		
247.53	-0.077	222.9	0.1367		
247.57	-0.078	222.5	0.1358		
247.60	-0.078	222.3	0.1358		
247.63	-0.079	222.3	0.1358		
247.67	-0.079	222	0.1349		
247.70	-0.079	221.8	0.134		

Prova triassiale ciclica SNGR03-C4

tensione di confinamento (kPa)		450	tensione di confinamento (kPa)		450
deviatore ciclico (kPa)		80	deviatore ciclico (kPa)		120
frequenza (hz)		0.00071429	frequenza (hz)		0.0007143
247.73	-0.081	221.4	0.1322		
247.77	-0.081	221.2	0.1322		
247.80	-0.082	220.8	0.1313		
247.83	-0.083	220.6	0.1313		
247.87	-0.083	220.6	0.1305		
247.90	-0.083	220.2	0.1296		
247.93	-0.084	219.9	0.1278		
247.97	-0.086	219.6	0.1278		
248.00	-0.086	219.4	0.1269		
248.05	-0.086	219.2	0.126		
248.08	-0.086	218.9	0.126		
248.10	-0.087	218.7	0.1251		
248.13	-0.088	218.4	0.1242		
248.17	-0.09	218	0.1242		
248.20	-0.09	218	0.1234		
248.23	-0.09	217.5	0.1216		
248.27	-0.091	217.4	0.1216		
248.30	-0.09	217.2	0.1216		
248.33	-0.091	217	0.1207		
248.37	-0.092	216.9	0.1198		
248.40	-0.092	216.6	0.1198		
248.43	-0.093	216.6	0.1198		
248.47	-0.093	216.4	0.1189		
248.50	-0.094	216.1	0.118		
248.53	-0.095	215.8	0.1171		
248.57	-0.095	215.6	0.1171		
248.60	-0.095	215.4	0.1163		
248.63	-0.094	215.3	0.1163		
248.67	-0.094	215.3	0.1163		
248.70	-0.094	215.2	0.1163		
248.73	-0.096	214.8	0.1145		
248.77	-0.098	214.4	0.1136		
248.80	-0.098	214.3	0.1136		
248.83	-0.098	214.1	0.1136		
248.87	-0.098	213.9	0.1136		
248.90	-0.1	213.9	0.1127		
248.93	-0.1	213.6	0.1109		
248.97	-0.099	213.5	0.1109		
249.00	-0.1	213.3	0.1109		
249.03	-0.1	213.1	0.11		
249.07	-0.1	212.9	0.1092		
249.10	-0.101	212.6	0.1092		
249.13	-0.101	212.6	0.1092		
249.17	-0.101	212.4	0.1083		
249.20	-0.104	211.9	0.1074		
249.23	-0.104	211.8	0.1065		
249.27	-0.103	211.8	0.1065		
249.30	-0.103	211.7	0.1065		
249.33	-0.103	211.6	0.1065		
249.37	-0.103	211.6	0.1065		
249.40	-0.103	211.4	0.1056		
249.43	-0.103	211.2	0.1056		
249.47	-0.104	211	0.1056		
249.52	-0.104	210.8	0.1047		
249.55	-0.104	210.7	0.1047		
249.57	-0.104	210.6	0.1038		
249.60	-0.104	210.4	0.1038		
249.63	-0.105	210.2	0.1038		
249.67	-0.105	210.1	0.1038		
249.70	-0.106	210.1	0.1029		

Prova triassiale ciclica SNGR03-C4

tensione di confinamento (kPa)		450	tensione di confinamento (kPa)		450
deviatore ciclico (kPa)		80	deviatore ciclico (kPa)		120
frequenza (hz)		0.00071429	frequenza (hz)		0.0007143
249.73	-0.106	209.9	0.1029		
249.77	-0.104	210	0.1029		
249.80	-0.104	209.9	0.1029		
249.83	-0.104	209.8	0.1029		
249.87	-0.105	209.6	0.1021		
249.90	-0.106	209.3	0.1021		
249.93	-0.107	209.3	0.1021		
249.97	-0.107	209.2	0.1021		
250.00	-0.106	209.1	0.1012		
250.03	-0.107	208.9	0.1012		
250.07	-0.107	208.9	0.1012		
250.10	-0.106	208.8	0.1012		
250.13	-0.106	208.7	0.1012		
250.17	-0.107	208.7	0.1012		
250.20	-0.107	208.6	0.1003		
250.23	-0.107	208.5	0.1003		
250.27	-0.107	208.4	0.1003		
250.30	-0.106	208.4	0.1003		
250.33	-0.107	208.3	0.1003		
250.37	-0.107	208.1	0.1003		
250.40	-0.11	208.1	0.0985		
250.43	-0.11	207.7	0.0985		
250.47	-0.108	207.7	0.0994		
250.50	-0.107	207.8	0.0994		
250.53	-0.106	207.8	0.0994		
250.57	-0.106	207.8	0.0994		
250.60	-0.106	207.7	0.0994		
250.63	-0.106	207.7	0.0994		
250.67	-0.106	207.7	0.0994		
250.70	-0.106	207.6	0.0994		
250.73	-0.106	207.6	0.0994		
250.77	-0.105	207.5	0.0994		
250.80	-0.105	207.5	0.0994		
250.83	-0.105	207.4	0.0994		
250.87	-0.104	207.4	0.0994		
250.90	-0.104	207.4	0.0994		
250.95	-0.104	207.4	0.0994		
250.98	-0.104	207.4	0.0994		
251.02	-0.104	207.3	0.0994		
251.03	-0.104	207.3	0.0994		
251.07	-0.104	207.2	0.0994		
251.10	-0.104	207.2	0.0994		
251.13	-0.104	207.2	0.0994		
251.17	-0.104	207.1	0.0994		
251.20	-0.104	207.1	0.0994		
251.23	-0.104	207.1	0.0994		
251.27	-0.103	207.1	0.0994		
251.30	-0.103	207.1	0.0994		
251.33	-0.102	207.1	0.0994		
251.37	-0.102	207.1	0.0994		
251.40	-0.102	207.1	0.0994		
251.43	-0.102	207.1	0.0994		
251.47	-0.102	207.1	0.1003		
251.50	-0.101	207.2	0.1003		
251.53	-0.1	207.2	0.1003		
251.57	-0.1	207.2	0.1003		
251.60	-0.1	207.2	0.1003		
251.63	-0.1	207.2	0.1003		
251.67	-0.099	207.2	0.1003		
251.70	-0.099	207.2	0.1003		

Prova triassiale ciclica SNGR03-C4

tensione di confinamento (kPa)		450	tensione di confinamento (kPa)		450
deviatore ciclico (kPa)		80	deviatore ciclico (kPa)		120
frequenza (hz)		0.00071429	frequenza (hz)		0.0007143
251.73	-0.098	207.3	0.1012		
251.77	-0.097	207.4	0.1012		
251.80	-0.097	207.4	0.1012		
251.83	-0.097	207.4	0.1012		
251.87	-0.096	207.5	0.1012		
251.90	-0.096	207.5	0.1021		
251.93	-0.096	207.5	0.1021		
251.97	-0.096	207.6	0.1021		
252.00	-0.095	207.6	0.1029		
252.03	-0.095	207.6	0.1029		
252.07	-0.094	207.7	0.1029		
252.10	-0.093	207.8	0.1029		
252.13	-0.093	207.8	0.1029		
252.17	-0.093	207.9	0.1038		
252.20	-0.093	207.9	0.1038		
252.23	-0.093	207.9	0.1038		
252.27	-0.091	208.1	0.1038		
252.30	-0.091	208.2	0.1047		
252.33	-0.09	208.3	0.1047		
252.37	-0.089	208.3	0.1047		
252.42	-0.088	208.5	0.1056		
252.45	-0.088	208.5	0.1056		
252.47	-0.088	208.5	0.1056		
252.50	-0.088	208.6	0.1065		
252.53	-0.087	208.7	0.1065		
252.57	-0.087	208.8	0.1074		
252.60	-0.083	209.2	0.1083		
252.63	-0.083	209.3	0.1083		
252.67	-0.084	209.3	0.1083		
252.70	-0.084	209.3	0.1083		
252.73	-0.084	209.3	0.1083		
252.77	-0.084	209.3	0.1083		
252.80	-0.083	209.4	0.1092		
252.83	-0.082	209.6	0.1092		
252.87	-0.082	209.6	0.1092		
252.90	-0.08	209.8	0.1092		
252.93	-0.079	209.8	0.11		
252.97	-0.079	209.9	0.1109		
253.00	-0.078	210.1	0.1127		
253.03	-0.077	210.3	0.1127		
253.07	-0.076	210.4	0.1136		
253.10	-0.074	210.8	0.1145		
253.13	-0.075	210.9	0.1145		
253.17	-0.075	210.9	0.1145		
253.20	-0.075	210.9	0.1145		
253.23	-0.074	211	0.1154		
253.27	-0.074	211	0.1154		
253.30	-0.072	211.3	0.1163		
253.33	-0.071	211.5	0.1171		
253.37	-0.07	211.7	0.1171		
253.40	-0.069	211.7	0.118		
253.43	-0.069	211.9	0.118		
253.47	-0.068	212	0.1189		
253.50	-0.067	212.3	0.1198		
253.53	-0.066	212.4	0.1198		
253.57	-0.063	212.9	0.1216		
253.60	-0.064	213	0.1216		
253.63	-0.064	213	0.1216		
253.67	-0.064	213	0.1216		
253.70	-0.064	213.2	0.1225		

Prova triassiale ciclica SNGR03-C4

tensione di confinamento (kPa)		450	tensione di confinamento (kPa)		450
deviatore ciclico (kPa)		80	deviatore ciclico (kPa)		120
frequenza (hz)		0.00071429	frequenza (hz)		0.0007143
253.73	-0.061	213.5	0.1242		
253.77	-0.06	213.7	0.1242		
253.80	-0.06	213.8	0.1242		
253.85	-0.06	214	0.1251		
253.88	-0.058	214.2	0.126		
253.92	-0.057	214.4	0.1269		
253.93	-0.056	214.7	0.1269		
253.97	-0.055	214.7	0.1278		
254.00	-0.055	214.9	0.1287		
254.03	-0.054	215.1	0.1287		
254.07	-0.053	215.3	0.1305		
254.10	-0.048	215.9	0.1322		
254.13	-0.052	215.8	0.1313		
254.17	-0.052	215.8	0.1313		
254.20	-0.05	215.8	0.1313		
254.23	-0.05	216	0.1322		
254.27	-0.048	216.4	0.134		
254.30	-0.046	216.7	0.1349		
254.33	-0.046	217	0.1358		
254.37	-0.045	217.2	0.1367		
254.40	-0.043	217.5	0.1367		
254.43	-0.04	217.5	0.1384		
254.47	-0.04	218	0.1393		
254.50	-0.041	218	0.1402		
254.53	-0.041	218.1	0.1402		
254.57	-0.041	218.3	0.1402		
254.60	-0.04	218.6	0.142		
254.63	-0.037	219	0.142		
254.67	-0.035	219	0.1438		
254.70	-0.035	219.3	0.1447		
254.73	-0.035	219.5	0.1455		
254.77	-0.034	219.8	0.1464		
254.80	-0.032	220.1	0.1482		
254.83	-0.032	220.3	0.1491		
254.87	-0.031	220.6	0.1491		
254.90	-0.027	220.6	0.15		
254.93	-0.027	221.2	0.1526		
254.97	-0.028	221.3	0.1526		
255.00	-0.029	221.4	0.1526		
255.03	-0.027	221.7	0.1544		
255.07	-0.026	222	0.1562		
255.10	-0.023	222.5	0.1562		
255.13	-0.022	222.5	0.158		
255.17	-0.022	222.8	0.1589		
255.20	-0.022	223	0.1597		
255.23	-0.02	223.3	0.1615		
255.27	-0.019	223.6	0.1633		
255.32	-0.018	223.9	0.1642		
255.35	-0.017	224.2	0.166		
255.37	-0.016	224.5	0.1669		
255.40	-0.015	224.9	0.1704		
255.43	-0.012	225.4	0.1704		
255.47	-0.012	225.4	0.1713		
255.50	-0.012	225.6	0.1722		
255.53	-0.012	225.8	0.1731		
255.57	-0.01	226.1	0.1748		
255.60	-0.01	226.2	0.1757		
255.63	-0.009	226.6	0.1775		
255.67	-0.006	227	0.1775		
255.70	-0.006	227	0.1802		

Prova triassiale ciclica SNGR03-C4

tensione di confinamento (kPa)		450	tensione di confinamento (kPa)		450
deviatore ciclico (kPa)		80	deviatore ciclico (kPa)		120
frequenza (hz)		0.00071429	frequenza (hz)		0.0007143
255.73	-0.006	227.3	0.1819		
255.77	-0.005	227.7	0.1837		
255.80	-0.003	228.1	0.1864		
255.83	-0.002	228.3	0.1882		
255.87	-0.001	228.7	0.1899		
255.90	0.002	229.3	0.1899		
255.93	0.002	229.3	0.1935		
255.97	0.002	229.5	0.1953		
256.00	0.002	229.8	0.197		
256.03	0.004	230.1	0.1997		
256.07	0.006	230.5	0.2024		
256.10	0.006	230.7	0.2041		
256.13	0.005	230.9	0.2041		
256.17	0.009	230.9	0.205		
256.20	0.009	231.4	0.2095		
256.23	0.009	231.7	0.2121		
256.27	0.011	232.2	0.2157		
256.30	0.012	232.4	0.2192		
256.33	0.014	232.9	0.2237		
256.37	0.015	233.2	0.2237		
256.40	0.016	233.2	0.2263		
256.43	0.016	233.6	0.2308		
256.47	0.016	233.9	0.2352		
256.50	0.02	234.5	0.2414		
256.53	0.018	234.6	0.245		
256.57	0.02	235	0.2512		
256.60	0.022	235.4	0.2512		
256.63	0.023	235.4	0.2565		
256.67	0.023	235.8	0.2627		
256.70	0.024	236.1	0.2689		
256.73	0.026	236.6	0.2725		
256.78	0.027	237	0.276		
256.82	0.026	237.1	0.2778		
256.83	0.029	237.6	0.2805		
256.87	0.03	237.9	0.2831		
256.90	0.031	238.2	0.2849		
256.93	0.032	238.6	0.2849		
256.97	0.033	238.6	0.2867		
257.00	0.033	238.9	0.2885		
257.03	0.034	239.2	0.292		
257.07	0.038	239.8	0.2947		
257.10	0.037	240	0.2956		
257.13	0.037	240.2	0.2964		
257.17	0.037	240.4	0.2964		
257.20	0.04	240.4	0.2973		
257.23	0.04	240.9	0.2991		
257.27	0.041	241.1	0.3009		
257.30	0.042	241.5	0.3027		
257.33	0.047	242.1	0.3062		
257.37	0.044	242.2	0.3062		
257.40	0.045	242.5	0.3062		
257.43	0.046	242.5	0.308		
257.47	0.046	242.8	0.3098		
257.50	0.048	243.1	0.3115		
257.53	0.048	243.4	0.3124		
257.57	0.05	243.8	0.3142		
257.60	0.051	244.1	0.316		
257.63	0.052	244.5	0.316		
257.67	0.053	244.5	0.3177		
257.70	0.053	244.8	0.3195		

Prova triassiale ciclica SNGR03-C4

pressione di confinamento (kPa)		450		pressione di confinamento (kPa)		450	
deviatore ciclico (kPa)		80		deviatore ciclico (kPa)		120	
frequenza (hz)		0.00071429		frequenza (hz)		0.0007143	
257.73	0.054	245.1	0.3213				
257.77	0.056	245.5	0.3231				
257.80	0.057	245.9	0.3249				
257.83	0.057	246.1	0.3257				
257.87	0.059	246.5	0.3257				
257.90	0.06	246.5	0.3275				
257.93	0.06	246.8	0.3293				
257.97	0.064	247.5	0.3328				
258.00	0.062	247.6	0.3328				
258.03	0.062	247.7	0.3328				
258.07	0.063	248.1	0.3355				
258.10	0.066	248.5	0.3355				
258.13	0.067	248.5	0.3373				
258.17	0.067	248.9	0.3382				
258.22	0.068	249.4	0.3408				
258.25	0.071	249.4	0.3417				
258.28	0.071	249.9	0.3444				
258.30	0.069	250.1	0.3444				
258.33	0.069	250.3	0.3453				
258.37	0.07	250.5	0.3462				
258.40	0.072	250.9	0.3479				
258.43	0.074	251.4	0.3479				
258.47	0.075	251.4	0.3506				
258.50	0.075	251.6	0.3515				
258.53	0.078	252.1	0.3541				
258.57	0.078	252.3	0.355				
258.60	0.078	252.5	0.3559				
258.63	0.078	252.7	0.3559				
258.67	0.078	253	0.3559				
258.70	0.08	253	0.3577				
258.73	0.08	253.3	0.3586				
258.77	0.081	253.7	0.3612				
258.80	0.083	254	0.3621				
258.83	0.083	254.3	0.363				
258.87	0.084	254.6	0.3648				
258.90	0.085	254.9	0.3648				
258.93	0.089	254.9	0.3657				
258.97	0.089	255.5	0.3692				
259.00	0.087	255.6	0.3692				
259.03	0.087	255.8	0.3692				
259.07	0.088	256.1	0.371				
259.10	0.088	256.3	0.3719				
259.13	0.089	256.7	0.3719				
259.17	0.091	256.7	0.3728				
259.20	0.091	257	0.3746				
259.23	0.092	257.2	0.3754				
259.27	0.092	257.5	0.3772				
259.30	0.097	258.1	0.379				
259.33	0.094	258.2	0.379				
259.37	0.093	258.2	0.379				
259.40	0.094	258.2	0.379				
259.43	0.094	258.5	0.3799				
259.47	0.096	258.9	0.3817				
259.50	0.097	259.2	0.3834				
259.53	0.099	259.5	0.3843				
259.57	0.101	260	0.387				
259.60	0.099	260	0.387				
259.63	0.098	260	0.387				
259.68	0.099	260.4	0.3879				
259.72	0.1	260.7	0.3879				

Prova triassiale ciclica SNGR03-C4

pressione di confinamento (kPa)		450	pressione di confinamento (kPa)		450
deviatore ciclico (kPa)		80	deviatore ciclico (kPa)		120
frequenza (hz)		0.00071429	frequenza (hz)		0.0007143
259.73	0.102	261	0.3888		
259.77	0.102	261	0.3905		
259.80	0.102	261.2	0.3914		
259.83	0.103	261.4	0.3923		
259.87	0.104	261.7	0.3932		
259.90	0.106	262.1	0.395		
259.93	0.104	262.2	0.395		
259.97	0.104	262.4	0.395		
260.00	0.104	262.4	0.3959		
260.03	0.106	262.7	0.3967		
260.07	0.107	263	0.3994		
260.10	0.109	263.4	0.3994		
260.13	0.108	263.4	0.3994		
260.17	0.107	263.6	0.3994		
260.20	0.111	263.6	0.4003		
260.23	0.111	264.1	0.4021		
260.27	0.11	264.1	0.4021		
260.30	0.109	264.3	0.4021		
260.33	0.109	264.5	0.403		
260.37	0.114	265	0.4056		
260.40	0.113	265.2	0.4056		
260.43	0.112	265.2	0.4056		
260.47	0.112	265.2	0.4056		
260.50	0.111	265.4	0.4065		
260.53	0.112	265.6	0.4074		
260.57	0.116	266.2	0.4092		
260.60	0.115	266.2	0.4092		
260.63	0.113	266.2	0.4092		
260.67	0.113	266.2	0.4092		
260.70	0.113	266.3	0.4092		
260.73	0.114	266.6	0.411		
260.77	0.116	267	0.4118		
260.80	0.116	267.1	0.4118		
260.83	0.116	267.3	0.4127		
260.87	0.118	267.6	0.4127		
260.90	0.117	267.6	0.4136		
260.93	0.117	267.7	0.4136		
260.97	0.117	267.8	0.4145		
261.00	0.12	268.2	0.4163		
261.03	0.119	268.3	0.4163		
261.07	0.118	268.3	0.4163		
261.12	0.117	268.4	0.4154		
261.15	0.117	268.5	0.4163		
261.18	0.118	268.7	0.4172		
261.20	0.119	268.9	0.4172		
261.23	0.119	269.1	0.4181		
261.27	0.119	269.1	0.4181		
261.30	0.12	269.3	0.4189		
261.33	0.12	269.5	0.4207		
261.37	0.122	269.8	0.4207		
261.40	0.121	269.8	0.4207		
261.43	0.12	269.9	0.4207		
261.47	0.12	269.9	0.4207		
261.50	0.12	269.9	0.4207		
261.53	0.119	270	0.4207		
261.57	0.12	270.1	0.4207		
261.60	0.121	270.3	0.4216		
261.63	0.124	270.7	0.4234		
261.67	0.123	270.8	0.4234		
261.70	0.121	270.7	0.4234		

Prova triassiale ciclica SNGR03-C4

pressione di confinamento (kPa)		450		pressione di confinamento (kPa)		450	
deviatore ciclico (kPa)		80		deviatore ciclico (kPa)		120	
frequenza (hz)		0.00071429		frequenza (hz)		0.0007143	
261.73	0.121	270.7	0.4225				
261.77	0.12	270.8	0.4225				
261.80	0.12	270.9	0.4225				
261.83	0.12	271	0.4234				
261.87	0.121	271.2	0.4234				
261.90	0.124	271.5	0.4234				
261.93	0.122	271.5	0.4252				
261.97	0.122	271.5	0.4252				
262.00	0.122	271.6	0.4243				
262.03	0.122	271.6	0.4243				
262.07	0.121	271.7	0.4243				
262.10	0.121	271.7	0.4243				
262.13	0.122	271.9	0.4243				
262.17	0.121	271.9	0.4252				
262.20	0.121	271.9	0.4252				
262.23	0.121	272	0.4252				
262.27	0.121	272	0.4252				
262.30	0.121	272.1	0.4252				
262.33	0.121	272.2	0.4252				
262.37	0.12	272.2	0.4252				
262.40	0.121	272.3	0.4252				
262.43	0.121	272.3	0.4252				
262.47	0.121	272.4	0.4252				
262.50	0.123	272.7	0.4269				
262.53	0.12	272.6	0.4252				
262.58	0.12	272.6	0.426				
262.62	0.12	272.7	0.426				
262.63	0.119	272.7	0.4252				
262.67	0.119	272.7	0.426				
262.70	0.119	272.8	0.426				
262.73	0.119	272.8	0.4252				
262.77	0.119	272.8	0.4252				
262.80	0.119	272.8	0.4252				
262.83	0.118	272.8	0.4252				
262.87	0.118	272.9	0.4252				
262.90	0.119	273	0.426				
262.93	0.119	273.1	0.426				
262.97	0.116	272.9	0.426				
263.00	0.116	272.9	0.4243				
263.03	0.117	273	0.4243				
263.07	0.117	273	0.4243				
263.10	0.117	273	0.4243				
263.13	0.116	273.1	0.4243				
263.17	0.115	273	0.4243				
263.20	0.115	273	0.4234				
263.23	0.115	273	0.4234				
263.27	0.115	273	0.4234				
263.30	0.115	273	0.4234				
263.33	0.114	272.9	0.4225				
263.37	0.113	272.9	0.4225				
263.40	0.113	272.9	0.4225				
263.43	0.112	272.8	0.4225				
263.47	0.112	272.8	0.4225				
263.50	0.112	272.8	0.4216				
263.53	0.112	272.8	0.4216				
263.57	0.111	272.8	0.4216				
263.60	0.11	272.7	0.4207				
263.63	0.11	272.7	0.4207				
263.67	0.11	272.6	0.4207				
263.70	0.11	272.6	0.4207				

Prova triassiale ciclica SNGR03-C4

pressione di confinamento (kPa)		450		pressione di confinamento (kPa)		450	
deviatore ciclico (kPa)		80		deviatore ciclico (kPa)		120	
frequenza (hz)		0.00071429		frequenza (hz)		0.0007143	
263.73	0.109	272.6	0.4198				
263.77	0.11	272.6	0.4198				
263.80	0.107	272.4	0.4189				
263.83	0.106	272.3	0.4181				
263.87	0.107	272.3	0.4181				
263.90	0.106	272.3	0.4181				
263.93	0.106	272.3	0.4181				
263.97	0.107	272.3	0.4181				
264.00	0.104	272.1	0.4163				
264.05	0.103	272	0.4163				
264.08	0.104	272.1	0.4163				
264.10	0.104	272.1	0.4163				
264.13	0.102	271.8	0.4154				
264.17	0.101	271.8	0.4145				
264.20	0.101	271.7	0.4145				
264.23	0.102	271.7	0.4145				
264.27	0.102	271.7	0.4145				
264.30	0.1	271.5	0.4136				
264.33	0.098	271.3	0.4127				
264.37	0.098	271.3	0.4127				
264.40	0.097	271.2	0.4118				
264.43	0.097	271.1	0.4118				
264.47	0.095	271	0.4118				
264.50	0.095	271	0.411				
264.53	0.096	271	0.4101				
264.57	0.095	270.8	0.4101				
264.60	0.095	270.8	0.4101				
264.63	0.094	270.7	0.4092				
264.67	0.092	270.4	0.4092				
264.70	0.091	270.2	0.4074				
264.73	0.091	270.2	0.4065				
264.77	0.089	269.9	0.4047				
264.80	0.089	269.8	0.4047				
264.83	0.089	269.8	0.4047				
264.87	0.09	269.8	0.4047				
264.90	0.088	269.6	0.4047				
264.93	0.087	269.5	0.403				
264.97	0.087	269.5	0.403				
265.00	0.087	269.5	0.403				
265.03	0.082	268.8	0.3994				
265.07	0.083	268.8	0.4003				
265.10	0.084	268.8	0.3994				
265.13	0.082	268.6	0.3994				
265.17	0.081	268.5	0.3985				
265.20	0.081	268.5	0.3985				
265.23	0.08	268.4	0.3976				
265.27	0.08	268.2	0.3959				
265.30	0.078	268	0.3959				
265.33	0.077	267.8	0.395				
265.37	0.076	267.6	0.395				
265.40	0.077	267.6	0.3932				
265.43	0.077	267.6	0.3932				
265.48	0.073	267	0.3914				
265.52	0.073	266.9	0.3905				
265.53	0.073	266.9	0.3905				
265.57	0.073	266.8	0.3896				
265.60	0.071	266.5	0.3888				
265.63	0.07	266.3	0.3879				
265.67	0.07	266.2	0.387				
265.70	0.068	265.9	0.387				

Prova triassiale ciclica SNGR03-C4

tensione di confinamento (kPa)		450		tensione di confinamento (kPa)		450	
deviatore ciclico (kPa)		80		deviatore ciclico (kPa)		120	
frequenza (hz)		0.00071429		frequenza (hz)		0.0007143	
265.73	0.067	265.6	0.3852				
265.77	0.067	265.6	0.3843				
265.80	0.066	265.5	0.3834				
265.83	0.065	265.3	0.3825				
265.87	0.064	265	0.3817				
265.90	0.063	264.8	0.3808				
265.93	0.062	264.5	0.3808				
265.97	0.06	264.3	0.379				
266.00	0.06	264.3	0.3781				
266.03	0.06	264.2	0.3772				
266.07	0.059	263.9	0.3763				
266.10	0.057	263.7	0.3754				
266.13	0.056	263.4	0.3737				
266.17	0.055	263.2	0.3737				
266.20	0.054	262.9	0.3728				
266.23	0.054	262.9	0.371				
266.27	0.055	262.9	0.371				
266.30	0.053	262.3	0.3683				
266.33	0.05	262	0.3675				
266.37	0.05	261.8	0.3666				
266.40	0.049	261.6	0.3666				
266.43	0.047	261.3	0.3648				
266.47	0.047	261.3	0.3639				
266.50	0.048	261.2	0.363				
266.53	0.045	260.8	0.3612				
266.57	0.044	260.6	0.3604				
266.60	0.043	260.3	0.3586				
266.63	0.042	260	0.3586				
266.67	0.041	259.8	0.3568				
266.70	0.041	259.8	0.3559				
266.73	0.042	259.7	0.3559				
266.77	0.037	259	0.3524				
266.80	0.037	258.9	0.3515				
266.83	0.037	258.7	0.3506				
266.87	0.036	258.5	0.3506				
266.90	0.034	258.1	0.3488				
266.95	0.033	257.8	0.3462				
266.98	0.033	257.6	0.3462				
267.00	0.031	257.3	0.3453				
267.03	0.031	257.3	0.3435				
267.07	0.031	257.2	0.3435				
267.10	0.031	256.9	0.3417				
267.13	0.027	256.5	0.3399				
267.17	0.027	256.3	0.3373				
267.20	0.025	255.6	0.3337				
267.23	0.022	255.2	0.3337				
267.27	0.022	255.2	0.332				
267.30	0.024	255.3	0.332				
267.33	0.023	254.9	0.3293				
267.37	0.019	254.5	0.3275				
267.40	0.017	254.1	0.3257				
267.43	0.018	253.9	0.3257				
267.47	0.017	253.6	0.3249				
267.50	0.017	253.6	0.3231				
267.53	0.016	253.3	0.3204				
267.57	0.016	253.2	0.3204				
267.60	0.011	252.4	0.3169				
267.63	0.012	252.3	0.316				
267.67	0.014	252.3	0.316				
267.70	0.011	251.8	0.316				

Prova triassiale ciclica SNGR03-C4

pressione di confinamento (kPa)		450		pressione di confinamento (kPa)		450	
deviatore ciclico (kPa)		80		deviatore ciclico (kPa)		120	
frequenza (hz)		0.00071429		frequenza (hz)		0.0007143	
267.73	0.011	251.8	0.3133				
267.77	0.009	251.5	0.3115				
267.80	0.005	250.8	0.3071				
267.83	0.005	250.6	0.3062				
267.87	0.005	250.4	0.3053				
267.90	0.004	250.1	0.3027				
267.93	0.002	249.7	0.3027				
267.97	0.002	249.7	0.3009				
268.00	0.003	249.6	0.3009				
268.03	0.001	249.3	0.2982				
268.07	-0.003	248.6	0.2938				
268.10	-0.002	248.5	0.292				
268.13	-0.003	248.2	0.2893				
268.17	-0.005	247.8	0.2893				
268.20	-0.005	247.8	0.2858				
268.23	-0.006	247.5	0.2822				
268.27	-0.007	247.1	0.2787				
268.30	-0.008	246.8	0.2743				
268.33	-0.007	246.7	0.2716				
268.38	-0.01	246.1	0.2663				
268.42	-0.013	245.5	0.2609				
268.45	-0.013	245.3	0.2583				
268.47	-0.013	245.1	0.2547				
268.50	-0.015	244.8	0.2547				
268.53	-0.015	244.8	0.2503				
268.57	-0.016	244.4	0.2467				
268.60	-0.017	244.1	0.2432				
268.63	-0.019	243.6	0.2387				
268.67	-0.018	243.6	0.237				
268.70	-0.018	243.2	0.2343				
268.73	-0.024	242.5	0.2343				
268.77	-0.024	242.5	0.2281				
268.80	-0.023	242.3	0.2254				
268.83	-0.024	242	0.2237				
268.87	-0.025	241.6	0.2201				
268.90	-0.026	241.3	0.2174				
268.93	-0.025	241.1	0.2157				
268.97	-0.031	240.3	0.2157				
269.00	-0.031	240.3	0.2112				
269.03	-0.03	240.1	0.2095				
269.07	-0.031	239.8	0.2068				
269.10	-0.032	239.4	0.2041				
269.13	-0.033	239	0.2015				
269.17	-0.035	238.6	0.1988				
269.20	-0.036	238.2	0.1988				
269.23	-0.036	238.2	0.197				
269.27	-0.036	237.9	0.1953				
269.30	-0.035	237.8	0.1944				
269.33	-0.039	237.1	0.1908				
269.37	-0.041	236.6	0.1882				
269.40	-0.042	236.3	0.1864				
269.43	-0.042	236	0.1864				
269.47	-0.042	236	0.1846				
269.50	-0.043	235.6	0.1828				
269.53	-0.044	235.3	0.1811				
269.57	-0.045	234.9	0.1793				
269.60	-0.046	234.5	0.1775				
269.63	-0.047	234.1	0.1757				
269.67	-0.048	233.8	0.1757				
269.70	-0.048	233.8	0.174				

Prova triassiale ciclica SNGR03-C4

tensione di confinamento (kPa)		450	tensione di confinamento (kPa)		450
deviatore ciclico (kPa)		80	deviatore ciclico (kPa)		120
frequenza (hz)		0.00071429	frequenza (hz)		0.0007143
269.73	-0.049	233.5	0.1722		
269.77	-0.049	233.3	0.1713		
269.80	-0.051	232.8	0.1695		
269.85	-0.055	232.1	0.1669		
269.88	-0.056	231.7	0.1651		
269.90	-0.054	231.7	0.1651		
269.93	-0.054	231.4	0.1642		
269.97	-0.056	231	0.1624		
270.00	-0.057	230.6	0.1624		
270.03	-0.057	230.6	0.1606		
270.07	-0.058	230.3	0.1597		
270.10	-0.059	230	0.158		
270.13	-0.058	229.8	0.158		
270.17	-0.06	229.4	0.1571		
270.20	-0.061	229	0.1553		
270.23	-0.063	228.6	0.1553		
270.27	-0.063	228.6	0.1535		
270.30	-0.064	228.2	0.1518		
270.33	-0.064	227.9	0.1509		
270.37	-0.065	227.6	0.15		
270.40	-0.066	227.3	0.1482		
270.43	-0.068	226.8	0.1473		
270.47	-0.069	226.5	0.1473		
270.50	-0.069	226.5	0.1464		
270.53	-0.069	226.1	0.1447		
270.57	-0.073	225.6	0.1429		
270.60	-0.072	225.4	0.1429		
270.63	-0.071	225.3	0.1429		
270.67	-0.072	225	0.1411		
270.70	-0.074	224.6	0.1411		
270.73	-0.074	224.6	0.1402		
270.77	-0.074	224.4	0.1393		
270.80	-0.074	224.1	0.1384		
270.83	-0.074	223.9	0.1384		
270.87	-0.076	223.6	0.1367		
270.90	-0.077	223.1	0.1358		
270.93	-0.079	222.7	0.1358		
270.97	-0.079	222.7	0.134		
271.00	-0.079	222.5	0.134		
271.03	-0.08	222.3	0.1331		
271.07	-0.081	221.9	0.1322		
271.10	-0.081	221.7	0.1313		
271.13	-0.082	221.3	0.1305		
271.17	-0.083	221	0.1305		
271.20	-0.083	221	0.1296		
271.23	-0.083	220.7	0.1287		
271.28	-0.085	220.2	0.1278		
271.32	-0.086	220.2	0.1278		
271.35	-0.086	219.9	0.1269		
271.37	-0.086	219.7	0.126		
271.40	-0.086	219.4	0.1251		
271.43	-0.088	219.1	0.1251		
271.47	-0.088	218.9	0.1242		
271.50	-0.089	218.6	0.1242		
271.53	-0.089	218.6	0.1234		
271.57	-0.089	218.4	0.1225		
271.60	-0.09	218.1	0.1216		
271.63	-0.091	217.8	0.1216		
271.67	-0.091	217.7	0.1207		
271.70	-0.092	217.3	0.1198		

Prova triassiale ciclica SNGR03-C4

tensione di confinamento (kPa)		450	tensione di confinamento (kPa)		450
deviatore ciclico (kPa)		80	deviatore ciclico (kPa)		120
frequenza (hz)		0.00071429	frequenza (hz)		0.0007143
271.73	-0.093	217	0.1198		
271.77	-0.093	217	0.1189		
271.80	-0.093	216.9	0.1189		
271.83	-0.094	216.6	0.118		
271.87	-0.094	216.4	0.1171		
271.90	-0.094	216.2	0.1171		
271.93	-0.095	216	0.1163		
271.97	-0.096	215.7	0.1163		
272.00	-0.096	215.7	0.1154		
272.03	-0.096	215.5	0.1154		
272.07	-0.097	215.1	0.1136		
272.10	-0.1	214.6	0.1127		
272.13	-0.099	214.6	0.1127		
272.17	-0.098	214.5	0.1127		
272.20	-0.098	214.4	0.1127		
272.23	-0.098	214.4	0.1127		
272.27	-0.098	214.2	0.1109		
272.30	-0.099	213.9	0.11		
272.33	-0.1	213.7	0.11		
272.37	-0.1	213.5	0.1092		
272.40	-0.1	213.4	0.1092		
272.43	-0.101	213.2	0.1092		
272.47	-0.1	213.2	0.1092		
272.50	-0.1	213.1	0.1092		
272.53	-0.103	212.5	0.1065		
272.57	-0.104	212.4	0.1065		
272.60	-0.103	212.3	0.1065		
272.63	-0.102	212.2	0.1065		
272.67	-0.103	212	0.1065		
272.70	-0.103	212	0.1056		
272.75	-0.103	211.7	0.1056		
272.78	-0.104	211.5	0.1056		
272.80	-0.103	211.5	0.1047		
272.83	-0.103	211.4	0.1047		
272.87	-0.103	211.4	0.1047		
272.90	-0.103	211.2	0.1047		
272.93	-0.104	211	0.1038		
272.97	-0.105	210.8	0.1029		
273.00	-0.105	210.5	0.1029		
273.03	-0.106	210.5	0.1029		
273.07	-0.106	210.4	0.1029		
273.10	-0.105	210.4	0.1029		
273.13	-0.105	210.3	0.1029		
273.17	-0.107	210	0.1021		
273.20	-0.106	210	0.1021		
273.23	-0.108	209.6	0.1021		
273.27	-0.107	209.6	0.1012		
273.30	-0.107	209.6	0.1012		
273.33	-0.107	209.5	0.1012		
273.37	-0.106	209.5	0.1012		
273.40	-0.106	209.4	0.1012		
273.43	-0.106	209.3	0.1012		
273.47	-0.106	209.2	0.1012		
273.50	-0.107	209.2	0.1003		
273.53	-0.107	209.1	0.1003		
273.57	-0.107	209	0.1003		
273.60	-0.107	208.9	0.0994		
273.63	-0.107	208.7	0.0994		
273.67	-0.107	208.6	0.0994		
273.70	-0.107	208.6	0.0994		

Prova triassiale ciclica SNGR03-C4

tensione di confinamento (kPa)		450	tensione di confinamento (kPa)		450
deviatore ciclico (kPa)		80	deviatore ciclico (kPa)		120
frequenza (hz)		0.00071429	frequenza (hz)		0.0007143
273.73	-0.107	208.6	0.0994		
273.77	-0.107	208.5	0.0994		
273.80	-0.105	208.6	0.1003		
273.83	-0.105	208.6	0.0994		
273.87	-0.105	208.5	0.0994		
273.90	-0.106	208.4	0.0994		
273.93	-0.106	208.3	0.0994		
273.97	-0.106	208.3	0.0994		
274.00	-0.106	208.2	0.0994		
274.03	-0.106	208.1	0.0985		
274.07	-0.106	208.1	0.0985		
274.10	-0.106	208	0.0985		
274.13	-0.106	207.9	0.0985		
274.17	-0.106	207.8	0.0985		
274.22	-0.106	207.8	0.0985		
274.25	-0.105	207.8	0.0985		
274.27	-0.105	207.8	0.0985		
274.30	-0.105	207.8	0.0985		
274.33	-0.105	207.8	0.0985		
274.37	-0.105	207.7	0.0985		
274.40	-0.104	207.7	0.0985		
274.43	-0.104	207.6	0.0985		
274.47	-0.104	207.6	0.0985		
274.50	-0.104	207.6	0.0985		
274.53	-0.103	207.6	0.0994		
274.57	-0.103	207.7	0.0994		
274.60	-0.103	207.7	0.0994		
274.63	-0.103	207.6	0.0994		
274.67	-0.103	207.6	0.0994		
274.70	-0.102	207.6	0.0994		
274.73	-0.101	207.6	0.0994		
274.77	-0.102	207.6	0.0994		
274.80	-0.102	207.6	0.0994		
274.83	-0.102	207.5	0.0994		
274.87	-0.101	207.5	0.0994		
274.90	-0.1	207.6	0.0994		
274.93	-0.1	207.6	0.1003		
274.97	-0.099	207.7	0.1003		
275.00	-0.099	207.7	0.1003		
275.03	-0.099	207.8	0.1003		
275.07	-0.099	207.8	0.1003		
275.10	-0.098	207.8	0.1012		
275.13	-0.097	207.9	0.1012		
275.17	-0.097	207.9	0.1012		
275.20	-0.097	208	0.1012		
275.23	-0.096	208	0.1021		
275.27	-0.096	208.1	0.1021		
275.30	-0.093	208.3	0.1029		
275.33	-0.093	208.4	0.1029		
275.37	-0.094	208.3	0.1029		
275.40	-0.094	208.3	0.1029		
275.43	-0.094	208.3	0.1029		
275.47	-0.093	208.3	0.1029		
275.50	-0.093	208.3	0.1029		
275.53	-0.093	208.4	0.1029		
275.57	-0.092	208.5	0.1038		
275.60	-0.091	208.6	0.1038		
275.65	-0.09	208.7	0.1047		
275.68	-0.09	208.8	0.1047		
275.72	-0.09	208.8	0.1047		

Prova triassiale ciclica SNGR03-C4

pressione di confinamento (kPa)		450	tensione di confinamento (kPa)		450
deviatore ciclico (kPa)		80	deviatore ciclico (kPa)		120
frequenza (hz)		0.00071429	frequenza (hz)		0.0007143
275.73	-0.09	208.8	0.1047		
275.77	-0.089	208.9	0.1047		
275.80	-0.088	208.9	0.1047		
275.83	-0.088	209.1	0.1056		
275.87	-0.088	209.2	0.1056		
275.90	-0.087	209.2	0.1065		
275.93	-0.085	209.4	0.1074		
275.97	-0.084	209.5	0.1074		
276.00	-0.085	209.6	0.1074		
276.03	-0.083	209.6	0.1074		
276.07	-0.083	209.8	0.1083		
276.10	-0.083	209.8	0.1083		
276.13	-0.082	210	0.1092		
276.17	-0.081	210.1	0.11		
276.20	-0.081	210.2	0.11		
276.23	-0.077	210.8	0.11		
276.27	-0.077	210.8	0.1127		
276.30	-0.077	210.8	0.1127		
276.33	-0.077	210.8	0.1127		
276.37	-0.078	210.8	0.1127		
276.40	-0.077	210.9	0.1127		
276.43	-0.078	210.8	0.1127		
276.47	-0.075	211.1	0.1127		
276.50	-0.074	211.1	0.1145		
276.53	-0.074	211.3	0.1145		
276.57	-0.073	211.6	0.1154		
276.60	-0.072	211.7	0.1163		
276.63	-0.071	211.9	0.1163		
276.67	-0.071	212	0.1171		
276.70	-0.069	212.3	0.1171		
276.73	-0.069	212.3	0.118		
276.77	-0.069	212.4	0.118		
276.80	-0.065	212.9	0.1198		
276.83	-0.066	213	0.1198		
276.87	-0.066	213	0.1198		
276.90	-0.066	213.2	0.1207		
276.93	-0.064	213.4	0.1207		
276.97	-0.063	213.4	0.1216		
277.00	-0.063	213.6	0.1225		
277.03	-0.063	213.7	0.1225		
277.07	-0.063	213.8	0.1225		
277.12	-0.061	214.1	0.1234		
277.15	-0.061	214.2	0.1242		
277.17	-0.059	214.5	0.1251		
277.20	-0.058	214.7	0.126		
277.23	-0.057	214.9	0.1269		
277.27	-0.055	215.2	0.1269		
277.30	-0.053	215.2	0.1278		
277.33	-0.053	215.6	0.1287		
277.37	-0.054	215.7	0.1287		
277.40	-0.054	215.8	0.1296		
277.43	-0.054	215.8	0.1296		
277.47	-0.052	216.2	0.1313		
277.50	-0.048	216.7	0.1313		
277.53	-0.049	216.7	0.1331		
277.57	-0.049	216.8	0.1331		
277.60	-0.048	217	0.134		
277.63	-0.047	217.2	0.1349		
277.67	-0.043	217.8	0.1367		
277.70	-0.045	217.7	0.1367		

Prova triassiale ciclica SNGR03-C4

tensione di confinamento (kPa)		450	tensione di confinamento (kPa)		450
deviatore ciclico (kPa)		80	deviatore ciclico (kPa)		120
frequenza (hz)		0.00071429	frequenza (hz)		0.0007143
277.73	-0.045	217.8	0.1367		
277.77	-0.043	217.8	0.1367		
277.80	-0.043	218.1	0.1376		
277.83	-0.042	218.4	0.1393		
277.87	-0.04	218.8	0.1402		
277.90	-0.039	219	0.1411		
277.93	-0.039	219.2	0.142		
277.97	-0.037	219.6	0.142		
278.00	-0.036	219.6	0.1438		
278.03	-0.036	219.9	0.1447		
278.07	-0.035	220	0.1455		
278.10	-0.033	220.4	0.1473		
278.13	-0.033	220.6	0.1473		
278.17	-0.032	221	0.1491		
278.20	-0.027	221.7	0.1491		
278.23	-0.029	221.7	0.1518		
278.27	-0.029	221.7	0.1518		
278.30	-0.03	221.8	0.1518		
278.33	-0.029	222	0.1526		
278.37	-0.026	222.4	0.1544		
278.40	-0.025	222.6	0.1562		
278.43	-0.023	223.1	0.1562		
278.47	-0.023	223.1	0.1571		
278.50	-0.023	223.3	0.1589		
278.55	-0.02	223.9	0.1597		
278.58	-0.02	223.9	0.1615		
278.62	-0.02	224.1	0.1624		
278.63	-0.016	224.8	0.1651		
278.67	-0.017	224.8	0.1651		
278.70	-0.017	225	0.166		
278.73	-0.016	225.4	0.1686		
278.77	-0.012	225.9	0.1686		
278.80	-0.013	225.9	0.1704		
278.83	-0.013	226	0.1713		
278.87	-0.011	226.3	0.1731		
278.90	-0.01	226.6	0.1748		
278.93	-0.01	226.9	0.1766		
278.97	-0.008	227.4	0.1784		
279.00	-0.006	227.7	0.1784		
279.03	-0.002	227.7	0.1802		
279.07	-0.002	228.3	0.1837		
279.10	-0.004	228.4	0.1846		
279.13	-0.004	228.6	0.1855		
279.17	-0.003	228.8	0.1873		
279.20	-0.003	229.1	0.189		
279.23	0.001	229.7	0.189		
279.27	0.002	229.7	0.1917		
279.30	0.002	230	0.1944		
279.33	0.002	230.3	0.1961		
279.37	0.007	231.1	0.2006		
279.40	0.005	231.1	0.2015		
279.43	0.006	231.5	0.205		
279.47	0.006	231.6	0.205		
279.50	0.009	231.6	0.2059		
279.53	0.009	232	0.2095		
279.57	0.009	232.4	0.2121		
279.60	0.011	232.8	0.2157		
279.63	0.012	233.1	0.2192		
279.67	0.016	233.8	0.2254		
279.70	0.015	233.9	0.2254		

Prova triassiale ciclica SNGR03-C4

tensione di confinamento (kPa)		450		tensione di confinamento (kPa)		450	
deviatore ciclico (kPa)		80		deviatore ciclico (kPa)		120	
frequenza (hz)		0.00071429		frequenza (hz)		0.0007143	
279.73	0.017	233.9	0.2272				
279.77	0.017	234.3	0.2316				
279.80	0.016	234.5	0.2352				
279.83	0.019	235	0.2396				
279.87	0.019	235.2	0.2441				
279.90	0.018	235.4	0.2476				
279.93	0.022	236	0.2476				
279.97	0.022	236	0.253				
280.02	0.023	236.6	0.2627				
280.05	0.025	237	0.2627				
280.07	0.025	237	0.2672				
280.10	0.025	237.3	0.2716				
280.13	0.027	237.7	0.2743				
280.17	0.029	238.1	0.2778				
280.20	0.03	238.4	0.2814				
280.23	0.033	239.1	0.284				
280.27	0.033	239.3	0.284				
280.30	0.032	239.3	0.2858				
280.33	0.032	239.4	0.2858				
280.37	0.033	239.8	0.2885				
280.40	0.036	240.2	0.2902				
280.43	0.037	240.5	0.292				
280.47	0.037	240.8	0.2938				
280.50	0.039	241.1	0.2938				
280.53	0.041	241.1	0.2956				
280.57	0.041	241.8	0.2991				
280.60	0.042	242.1	0.3				
280.63	0.043	242.3	0.3018				
280.67	0.042	242.4	0.3018				
280.70	0.043	242.8	0.3035				
280.73	0.049	243.5	0.3035				
280.77	0.048	243.5	0.308				
280.80	0.048	243.6	0.3089				
280.83	0.046	243.7	0.3089				
280.87	0.048	244.1	0.3106				
280.90	0.05	244.4	0.3124				
280.93	0.051	245	0.3151				
280.97	0.052	245.2	0.3151				
281.00	0.053	245.2	0.316				
281.03	0.053	245.5	0.3169				
281.07	0.057	246.2	0.3213				
281.10	0.057	246.4	0.3222				
281.13	0.057	246.6	0.3231				
281.17	0.058	246.9	0.324				
281.20	0.059	247.2	0.324				
281.23	0.059	247.2	0.3257				
281.27	0.059	247.4	0.3266				
281.30	0.06	247.7	0.3284				
281.33	0.062	248.2	0.3302				
281.37	0.066	248.8	0.3328				
281.40	0.064	248.9	0.3328				
281.45	0.064	249.1	0.3337				
281.48	0.063	249.2	0.3346				
281.52	0.066	249.7	0.3364				
281.53	0.069	250.2	0.3364				
281.57	0.072	250.2	0.3399				
281.60	0.072	250.6	0.3417				
281.63	0.069	250.6	0.3417				
281.67	0.068	250.8	0.3426				
281.70	0.072	251.2	0.3444				

Prova triassiale ciclica SNGR03-C4

tensione di confinamento (kPa)		450	tensione di confinamento (kPa)		450
deviatore ciclico (kPa)		80	deviatore ciclico (kPa)		120
frequenza (hz)		0.00071429	frequenza (hz)		0.0007143
281.73	0.073	251.6	0.3462		
281.77	0.077	252.1	0.3462		
281.80	0.075	252.1	0.3488		
281.83	0.075	252.2	0.3497		
281.87	0.075	252.4	0.3497		
281.90	0.075	252.7	0.3506		
281.93	0.08	253.2	0.3533		
281.97	0.079	253.4	0.3541		
282.00	0.08	253.7	0.3541		
282.03	0.079	253.7	0.3559		
282.07	0.079	253.9	0.3559		
282.10	0.079	254.1	0.3568		
282.13	0.085	254.8	0.3604		
282.17	0.083	254.9	0.3612		
282.20	0.082	255.1	0.3612		
282.23	0.085	255.5	0.3612		
282.27	0.088	255.5	0.363		
282.30	0.088	256	0.3657		
282.33	0.086	256.1	0.3657		
282.37	0.086	256.3	0.3666		
282.40	0.088	256.7	0.3683		
282.43	0.092	257.3	0.3719		
282.47	0.09	257.4	0.3719		
282.50	0.089	257.4	0.3719		
282.53	0.089	257.5	0.3719		
282.57	0.094	258.1	0.3746		
282.60	0.093	258.3	0.3754		
282.63	0.092	258.4	0.3754		
282.67	0.094	258.8	0.3781		
282.70	0.098	259.4	0.3781		
282.73	0.096	259.4	0.3799		
282.77	0.096	259.4	0.3799		
282.80	0.098	259.8	0.3817		
282.83	0.097	259.9	0.3817		
282.87	0.097	260.1	0.3825		
282.92	0.099	260.4	0.3834		
282.95	0.099	260.6	0.3843		
282.97	0.098	260.7	0.3843		
283.00	0.099	261	0.3861		
283.03	0.102	261.5	0.3861		
283.07	0.102	261.5	0.3888		
283.10	0.102	261.7	0.3888		
283.13	0.105	262.2	0.3905		
283.17	0.103	262.2	0.3905		
283.20	0.102	262.3	0.3905		
283.23	0.104	262.7	0.3923		
283.27	0.105	262.9	0.3923		
283.30	0.105	262.9	0.3923		
283.33	0.105	263.2	0.395		
283.37	0.109	263.7	0.3967		
283.40	0.107	263.7	0.3959		
283.43	0.107	263.8	0.3967		
283.47	0.108	264.2	0.3976		
283.50	0.108	264.3	0.3976		
283.53	0.111	264.3	0.3976		
283.57	0.111	264.8	0.3994		
283.60	0.109	264.8	0.4003		
283.63	0.109	264.9	0.4003		
283.67	0.11	265.3	0.4012		
283.70	0.11	265.4	0.4021		

Prova triassiale ciclica SNGR03-C4

pressione di confinamento (kPa)		450		pressione di confinamento (kPa)		450	
deviatore ciclico (kPa)		80		deviatore ciclico (kPa)		120	
frequenza (hz)		0.00071429		frequenza (hz)		0.0007143	
283.73	0.111	265.7	0.4021				
283.77	0.113	265.7	0.403				
283.80	0.113	266.1	0.4047				
283.83	0.112	266.1	0.4047				
283.87	0.112	266.3	0.4056				
283.90	0.116	266.8	0.4074				
283.93	0.115	266.9	0.4065				
283.97	0.113	266.9	0.4065				
284.00	0.115	266.9	0.4065				
284.03	0.115	267.3	0.4083				
284.07	0.115	267.4	0.4083				
284.10	0.114	267.4	0.4083				
284.13	0.117	267.8	0.4101				
284.17	0.116	267.8	0.4101				
284.20	0.116	268.2	0.4101				
284.23	0.116	268.2	0.411				
284.27	0.116	268.2	0.411				
284.30	0.116	268.3	0.411				
284.33	0.119	268.8	0.4136				
284.38	0.118	268.9	0.4136				
284.42	0.118	269	0.4145				
284.43	0.119	269.2	0.4145				
284.47	0.121	269.5	0.4154				
284.50	0.12	269.5	0.4154				
284.53	0.119	269.6	0.4154				
284.57	0.118	269.6	0.4154				
284.60	0.118	269.6	0.4154				
284.63	0.118	269.7	0.4154				
284.67	0.121	270.2	0.4172				
284.70	0.12	270.2	0.4172				
284.73	0.12	270.3	0.4172				
284.77	0.122	270.6	0.4172				
284.80	0.122	270.6	0.4189				
284.83	0.122	270.8	0.4189				
284.87	0.12	270.8	0.4189				
284.90	0.12	270.8	0.4198				
284.93	0.121	271.1	0.4198				
284.97	0.121	271.1	0.4198				
285.00	0.12	271.2	0.4198				
285.03	0.12	271.2	0.4198				
285.07	0.12	271.4	0.4198				
285.10	0.123	271.8	0.4216				
285.13	0.123	271.8	0.4216				
285.17	0.121	271.8	0.4216				
285.20	0.121	271.9	0.4216				
285.23	0.122	272.1	0.4216				
285.27	0.121	272.1	0.4216				
285.30	0.121	272.1	0.4216				
285.33	0.121	272.1	0.4216				
285.37	0.121	272.2	0.4216				
285.40	0.123	272.5	0.4225				
285.43	0.121	272.4	0.4225				
285.47	0.121	272.5	0.4225				
285.50	0.121	272.5	0.4225				
285.53	0.121	272.5	0.4225				
285.57	0.123	272.8	0.4234				
285.60	0.122	272.8	0.4234				
285.63	0.121	272.8	0.4234				
285.67	0.122	273	0.4234				
285.70	0.121	273	0.4234				

Prova triassiale ciclica SNGR03-C4

pressione di confinamento (kPa)		450		pressione di confinamento (kPa)		450	
deviatore ciclico (kPa)		80		deviatore ciclico (kPa)		120	
frequenza (hz)		0.00071429		frequenza (hz)		0.0007143	
285.73	0.12	273	0.4234				
285.77	0.12	273	0.4234				
285.82	0.12	273.1	0.4234				
285.85	0.121	273.1	0.4234				
285.88	0.121	273.3	0.4234				
285.90	0.121	273.3	0.4234				
285.93	0.12	273.3	0.4234				
285.97	0.119	273.3	0.4234				
286.00	0.119	273.3	0.4234				
286.03	0.119	273.4	0.4234				
286.07	0.12	273.4	0.4234				
286.10	0.12	273.5	0.4234				
286.13	0.119	273.5	0.4234				
286.17	0.118	273.5	0.4225				
286.20	0.118	273.5	0.4225				
286.23	0.118	273.5	0.4225				
286.27	0.118	273.6	0.4225				
286.30	0.118	273.6	0.4225				
286.33	0.118	273.6	0.4225				
286.37	0.118	273.6	0.4225				
286.40	0.117	273.6	0.4225				
286.43	0.116	273.6	0.4216				
286.47	0.116	273.6	0.4216				
286.50	0.116	273.6	0.4216				
286.53	0.115	273.6	0.4216				
286.57	0.115	273.6	0.4216				
286.60	0.115	273.6	0.4216				
286.63	0.114	273.6	0.4216				
286.67	0.114	273.6	0.4207				
286.70	0.113	273.5	0.4207				
286.73	0.113	273.5	0.4207				
286.77	0.112	273.5	0.4198				
286.80	0.112	273.5	0.4198				
286.83	0.112	273.5	0.4198				
286.87	0.112	273.4	0.4198				
286.90	0.111	273.4	0.4189				
286.93	0.11	273.3	0.4189				
286.97	0.11	273.3	0.4189				
287.00	0.11	273.3	0.4189				
287.03	0.11	273.3	0.4181				
287.07	0.109	273.1	0.4172				
287.10	0.108	273.1	0.4172				
287.13	0.109	273.2	0.4181				
287.17	0.109	273.2	0.4172				
287.20	0.107	273.1	0.4172				
287.23	0.104	273.1	0.4163				
287.28	0.105	272.7	0.4154				
287.32	0.105	272.7	0.4154				
287.33	0.104	272.7	0.4154				
287.37	0.104	272.6	0.4145				
287.40	0.105	272.7	0.4145				
287.43	0.105	272.6	0.4136				
287.47	0.101	272.3	0.4127				
287.50	0.101	272.3	0.4127				
287.53	0.101	272.3	0.4127				
287.57	0.101	272.3	0.4127				
287.60	0.101	272.2	0.4118				
287.63	0.1	272.1	0.4118				
287.67	0.1	272.1	0.4118				
287.70	0.098	271.9	0.411				

Prova triassiale ciclica SNGR03-C4

pressione di confinamento (kPa)		450		pressione di confinamento (kPa)		450	
deviatore ciclico (kPa)		80		deviatore ciclico (kPa)		120	
frequenza (hz)		0.00071429		frequenza (hz)		0.0007143	
287.73	0.099	271.9	0.4101				
287.77	0.098	271.8	0.4101				
287.80	0.096	271.8	0.4101				
287.83	0.096	271.6	0.4092				
287.87	0.096	271.5	0.4083				
287.90	0.095	271.3	0.4074				
287.93	0.091	270.9	0.4056				
287.97	0.092	271	0.4056				
288.00	0.093	271.1	0.4056				
288.03	0.093	271.1	0.4065				
288.07	0.093	271	0.4056				
288.10	0.09	270.6	0.4047				
288.13	0.091	270.7	0.4047				
288.17	0.09	270.5	0.403				
288.20	0.087	270.1	0.4012				
288.23	0.086	270	0.4012				
288.27	0.086	270	0.4012				
288.30	0.086	269.9	0.4003				
288.33	0.086	269.8	0.4003				
288.37	0.084	269.6	0.3994				
288.40	0.084	269.5	0.3985				
288.43	0.083	269.3	0.3976				
288.47	0.082	269.1	0.3976				
288.50	0.082	269.1	0.3967				
288.53	0.082	269.1	0.3967				
288.57	0.082	269	0.3959				
288.60	0.078	268.5	0.3932				
288.63	0.077	268.4	0.3932				
287.67	0.1	272.1	0.4118				
287.70	0.098	271.9	0.411				
287.73	0.099	271.9	0.4101				
287.77	0.098	271.8	0.4101				
287.80	0.096	271.8	0.4101				
287.83	0.096	271.6	0.4092				
287.87	0.096	271.5	0.4083				
287.90	0.095	271.3	0.4074				
287.93	0.091	270.9	0.4056				
287.97	0.092	271	0.4056				
288.00	0.093	271.1	0.4056				
288.03	0.093	271.1	0.4065				
288.07	0.093	271	0.4056				
288.10	0.09	270.6	0.4047				
288.13	0.091	270.7	0.4047				
288.17	0.09	270.5	0.403				
288.20	0.087	270.1	0.4012				
288.23	0.086	270	0.4012				
288.27	0.086	270	0.4012				
288.30	0.086	269.9	0.4003				
288.33	0.086	269.8	0.4003				
288.37	0.084	269.6	0.3994				
288.40	0.084	269.5	0.3985				
288.43	0.083	269.3	0.3976				
288.47	0.082	269.1	0.3976				
288.50	0.082	269.1	0.3967				
288.53	0.082	269.1	0.3967				
288.57	0.082	269	0.3959				
288.60	0.078	268.5	0.3932				
288.63	0.077	268.4	0.3932				
288.67	0.078	268.3	0.3923				
288.72	0.077	268.1	0.3923				

Prova triassiale ciclica SNGR03-C4

pressione di confinamento (kPa)		450		pressione di confinamento (kPa)		450	
deviatore ciclico (kPa)		80		deviatore ciclico (kPa)		120	
frequenza (hz)		0.00071429		frequenza (hz)		0.0007143	
288.75	0.075	267.9	0.3914				
288.78	0.077	268	0.3914				
288.82	0.076	267.9	0.3905				
288.85	0.074	267.5	0.3896				
288.87	0.072	267.3	0.3896				
288.90	0.069	267.3	0.3879				
288.93	0.069	266.8	0.3861				
288.97	0.069	266.8	0.3852				
289.00	0.07	266.7	0.3852				
289.03	0.069	266.5	0.3843				
289.07	0.068	266.2	0.3834				
289.10	0.066	266	0.3834				
289.13	0.067	266	0.3825				
289.17	0.067	265.9	0.3825				
289.20	0.064	265.5	0.3799				
289.23	0.062	265.3	0.379				
289.27	0.062	265.1	0.3781				
289.30	0.061	264.9	0.3763				
289.33	0.06	264.6	0.3763				
289.37	0.058	264.6	0.3754				
289.40	0.058	264.4	0.3746				
289.43	0.058	264.2	0.3737				
289.47	0.056	263.9	0.3728				
289.50	0.056	263.8	0.3719				
289.53	0.056	263.6	0.3719				
289.57	0.051	263	0.371				
289.60	0.051	263	0.3683				
289.63	0.052	262.9	0.3683				
289.67	0.052	262.7	0.3666				
289.70	0.05	262.4	0.3648				
289.73	0.049	262.2	0.3639				
289.77	0.05	262	0.3639				
289.80	0.048	262	0.3639				
289.83	0.048	261.7	0.3621				
289.87	0.046	261.4	0.3604				
289.90	0.042	260.8	0.3577				
289.93	0.042	260.6	0.3568				
289.97	0.042	260.5	0.3559				
290.00	0.042	260.3	0.3559				
290.03	0.04	260	0.355				
290.07	0.039	259.7	0.3533				
290.10	0.039	259.7	0.3524				
290.13	0.037	259.5	0.3506				
290.18	0.036	259	0.3497				
290.22	0.036	259	0.3488				
290.25	0.037	258.9	0.347				
290.28	0.032	258.2	0.3453				
290.32	0.032	258	0.3435				
290.33	0.032	257.8	0.3426				
290.37	0.03	257.5	0.3426				
290.40	0.029	257.2	0.3417				
290.43	0.029	257.2	0.3399				
290.47	0.028	257	0.3373				
290.50	0.026	256.5	0.3355				
290.53	0.027	256.5	0.3346				
290.57	0.025	256.2	0.3328				
290.60	0.023	255.6	0.3328				
290.63	0.021	255.3	0.3311				
290.67	0.021	255.3	0.3293				
290.70	0.021	255.1	0.3266				

Prova triassiale ciclica SNGR03-C4

tensione di confinamento (kPa)		450	tensione di confinamento (kPa)		450
deviatore ciclico (kPa)		80	deviatore ciclico (kPa)		120
frequenza (hz)		0.00071429	frequenza (hz)		0.0007143
290.73	0.018	254.5	0.324		
290.77	0.017	254.3	0.3231		
290.80	0.017	254.1	0.3222		
290.83	0.016	253.7	0.3222		
290.87	0.015	253.7	0.3204		
290.90	0.015	253.5	0.3186		
290.93	0.014	253.1	0.3169		
290.97	0.012	252.8	0.3151		
291.00	0.012	252.6	0.3142		
291.03	0.011	252.3	0.3124		
291.07	0.005	251.6	0.3124		
291.10	0.007	251.6	0.3089		
291.13	0.007	251.5	0.308		
291.17	0.007	251.2	0.3062		
291.20	0.005	250.8	0.3044		
291.23	0.004	250.5	0.3027		
291.27	0.003	250.2	0.3009		
291.30	0.001	249.9	0.3009		
291.33	0.001	249.9	0.2991		
291.37	0.001	249.7	0.2973		
291.40	0.001	249.5	0.2964		
291.43	-0.002	249	0.2929		
291.47	-0.004	248.6	0.2902		
291.50	-0.004	248.4	0.2876		
291.53	-0.005	248.1	0.2876		
291.57	-0.006	248.1	0.284		
291.60	-0.006	247.7	0.2805		
291.65	-0.011	246.6	0.2743		
291.68	-0.01	246.5	0.2707		
291.72	-0.01	246.5	0.2672		
291.75	-0.011	246.3	0.2636		
291.77	-0.012	246	0.2601		
291.80	-0.012	245.8	0.2574		
291.83	-0.014	245.4	0.253		
291.87	-0.016	244.9	0.253		
291.90	-0.017	244.9	0.2485		
291.93	-0.017	244.6	0.245		
291.97	-0.018	244.3	0.2405		
292.00	-0.02	243.8	0.237		
292.03	-0.02	243.5	0.2334		
292.07	-0.024	242.9	0.229		
292.10	-0.023	242.8	0.229		
292.13	-0.023	242.8	0.2263		
292.17	-0.023	242.5	0.2245		
292.20	-0.025	242.1	0.221		
292.23	-0.027	241.6	0.2183		
292.27	-0.027	241.3	0.2157		
292.30	-0.028	240.9	0.2121		
292.33	-0.03	240.5	0.2121		
292.37	-0.03	240.5	0.2095		
292.40	-0.031	240.2	0.2077		
292.43	-0.031	239.8	0.205		
292.47	-0.031	239.7	0.2032		
292.50	-0.034	239.2	0.2006		
292.53	-0.035	238.7	0.2006		
292.57	-0.037	238.2	0.1979		
292.60	-0.037	238.2	0.1953		
292.63	-0.037	238	0.1935		
292.67	-0.038	237.6	0.1908		
292.70	-0.04	237.2	0.189		

Prova triassiale ciclica SNGR03-C4

tensione di confinamento (kPa)		450	tensione di confinamento (kPa)		450
deviatore ciclico (kPa)		80	deviatore ciclico (kPa)		120
frequenza (hz)		0.00071429	frequenza (hz)		0.0007143
292.73	-0.041	236.8	0.1873		
292.77	-0.043	236.3	0.1873		
292.80	-0.045	236.3	0.1846		
292.83	-0.045	235.7	0.1819		
292.87	-0.044	235.6	0.1811		
292.90	-0.044	235.3	0.1793		
292.93	-0.046	234.9	0.1775		
292.97	-0.047	234.6	0.1757		
293.00	-0.049	234.1	0.1757		
293.03	-0.049	234.1	0.174		
293.08	-0.048	233.8	0.1731		
293.12	-0.052	233.1	0.1731		
293.15	-0.052	233.1	0.1695		
293.18	-0.052	232.9	0.1686		
293.22	-0.053	232.5	0.1669		
293.23	-0.054	232.1	0.166		
293.27	-0.055	231.8	0.1642		
293.30	-0.056	231.5	0.1633		
293.33	-0.057	231.1	0.1633		
293.37	-0.058	231.1	0.1615		
293.40	-0.058	230.8	0.1606		
293.43	-0.059	230.4	0.1589		
293.47	-0.059	230.1	0.158		
293.50	-0.059	230	0.1571		
293.53	-0.062	229.1	0.1571		
293.57	-0.066	228.6	0.1544		
293.60	-0.066	228.6	0.1526		
293.63	-0.064	228.5	0.1526		
293.67	-0.064	228.3	0.1518		
293.70	-0.066	227.9	0.1509		
293.73	-0.064	227.9	0.1509		
293.77	-0.067	227.4	0.1509		
293.80	-0.067	227.4	0.1491		
293.83	-0.067	227.1	0.1473		
293.87	-0.069	226.7	0.1464		
293.90	-0.071	226.3	0.1447		
293.93	-0.071	226	0.1438		
293.97	-0.072	225.7	0.1429		
294.00	-0.072	225.4	0.1429		
294.03	-0.074	225.4	0.142		
294.07	-0.074	225	0.1411		
294.10	-0.077	224.5	0.1393		
294.13	-0.076	224.3	0.1384		
294.17	-0.076	224.1	0.1376		
294.20	-0.077	223.7	0.1367		
294.23	-0.078	223.5	0.1367		
294.27	-0.078	223.5	0.1358		
294.30	-0.078	223.2	0.1349		
294.33	-0.079	222.8	0.134		
294.37	-0.081	222.5	0.1331		
294.40	-0.081	222.3	0.1322		
294.43	-0.081	222	0.1313		
294.47	-0.083	221.6	0.1313		
294.50	-0.083	221.6	0.1305		
294.55	-0.084	221	0.1296		
294.58	-0.083	221	0.1296		
294.62	-0.083	221	0.1296		
294.65	-0.083	220.8	0.1287		
294.67	-0.085	220.3	0.1269		
294.70	-0.087	220	0.126		

Prova triassiale ciclica SNGR03-C4

tensione di confinamento (kPa)		450	tensione di confinamento (kPa)		450
deviatore ciclico (kPa)		80	deviatore ciclico (kPa)		120
frequenza (hz)		0.00071429	frequenza (hz)		0.0007143
294.73	-0.087	219.7	0.126		
294.77	-0.088	219.4	0.126		
294.80	-0.088	219.2	0.1251		
294.83	-0.089	219.2	0.1242		
294.87	-0.089	218.9	0.1234		
294.90	-0.09	218.7	0.1234		
294.93	-0.09	218.5	0.1225		
294.97	-0.091	218.2	0.1216		
295.00	-0.091	218	0.1216		
295.03	-0.092	217.7	0.1216		
295.07	-0.093	217.7	0.1207		
295.10	-0.093	217.4	0.1198		
295.13	-0.093	217.2	0.1198		
295.17	-0.093	217	0.1189		
295.20	-0.094	216.7	0.118		
295.23	-0.095	216.5	0.1171		
295.27	-0.095	216.3	0.1171		
295.30	-0.096	216.3	0.1171		
295.33	-0.096	216	0.1163		
295.37	-0.097	215.8	0.1154		
295.40	-0.097	215.5	0.1154		
295.43	-0.098	215.3	0.1145		
295.47	-0.098	215.1	0.1145		
295.50	-0.098	214.9	0.1136		
295.53	-0.098	214.9	0.1136		
295.57	-0.101	214.3	0.1109		
295.60	-0.101	214.2	0.1109		
295.63	-0.1	214.1	0.1109		
295.67	-0.1	214.1	0.11		
295.70	-0.1	213.9	0.11		
295.73	-0.1	213.7	0.11		
295.77	-0.101	213.7	0.11		
295.80	-0.101	213.4	0.1092		
295.83	-0.101	213.3	0.1083		
295.87	-0.102	213	0.1083		
295.90	-0.102	212.9	0.1074		
295.93	-0.102	212.8	0.1074		
295.98	-0.103	212.5	0.1074		
296.02	-0.102	212.5	0.1074		
296.05	-0.102	212.4	0.1074		
296.07	-0.103	212.1	0.1074		
296.10	-0.105	212.1	0.1065		
296.13	-0.105	211.8	0.1056		
296.17	-0.104	211.7	0.1056		
296.20	-0.104	211.6	0.1056		
296.23	-0.107	211.2	0.1038		
296.27	-0.106	211.1	0.1038		
296.30	-0.105	211	0.1038		
296.33	-0.105	211	0.1038		
296.37	-0.105	211	0.1038		
296.40	-0.105	210.9	0.1038		
296.43	-0.105	210.7	0.1038		
296.47	-0.105	210.6	0.1029		
296.50	-0.107	210.3	0.1029		
296.53	-0.106	210.3	0.1029		
296.57	-0.105	210.3	0.1029		
296.60	-0.105	210.3	0.1029		
296.63	-0.105	210.2	0.1029		
296.67	-0.105	210.1	0.1021		
296.70	-0.109	209.6	0.1012		

Prova triassiale ciclica SNGR03-C4

tensione di confinamento (kPa)		450	tensione di confinamento (kPa)		450
deviatore ciclico (kPa)		80	deviatore ciclico (kPa)		120
frequenza (hz)		0.00071429	frequenza (hz)		0.0007143
296.73	-0.108	209.5	0.1012		
296.77	-0.107	209.5	0.1012		
296.80	-0.106	209.5	0.1012		
296.83	-0.106	209.5	0.1012		
296.87	-0.106	209.4	0.1012		
296.90	-0.106	209.4	0.1012		
296.93	-0.106	209.3	0.1012		
296.97	-0.106	209.2	0.1012		
297.00	-0.106	209.2	0.1012		
297.03	-0.106	209.2	0.1012		
297.07	-0.106	209.1	0.1012		
297.10	-0.106	209	0.1003		
297.13	-0.106	208.9	0.1003		
297.17	-0.107	208.8	0.1003		
297.20	-0.106	208.7	0.1003		
297.23	-0.106	208.7	0.1003		
297.27	-0.107	208.7	0.1003		
297.30	-0.107	208.5	0.0994		
297.33	-0.106	208.5	0.0994		
297.37	-0.106	208.5	0.0994		
297.40	-0.106	208.4	0.0994		
297.45	-0.106	208.4	0.0994		
297.48	-0.105	208.4	0.0994		
297.50	-0.106	208.3	0.0994		
297.53	-0.105	208.2	0.0994		
297.57	-0.105	208.2	0.0994		
297.60	-0.105	208.2	0.0994		
297.63	-0.105	208.1	0.0994		
297.67	-0.105	208.1	0.0994		
297.70	-0.105	208.1	0.0994		
297.73	-0.104	208.1	0.0994		
297.77	-0.104	208	0.0994		
297.80	-0.104	208	0.0994		
297.83	-0.104	208	0.0994		
297.87	-0.104	208	0.0994		
297.90	-0.104	207.9	0.0994		
297.93	-0.104	207.9	0.0994		
297.97	-0.103	208	0.1003		
298.00	-0.103	208	0.1003		
298.03	-0.102	208.1	0.1003		
298.07	-0.102	208.1	0.1003		
298.10	-0.102	208	0.1003		
298.13	-0.102	208	0.1003		
298.17	-0.101	208.1	0.1012		
298.20	-0.1	208.1	0.1012		
298.23	-0.1	208.1	0.1012		
298.27	-0.099	208.1	0.1012		
298.30	-0.099	208.1	0.1012		
298.33	-0.099	208.2	0.1012		
298.37	-0.096	208.4	0.1029		
298.40	-0.097	208.4	0.1029		
298.43	-0.097	208.4	0.1021		
298.47	-0.097	208.4	0.1021		
298.50	-0.097	208.4	0.1021		
298.53	-0.097	208.4	0.1021		
298.57	-0.097	208.4	0.1029		
298.60	-0.097	208.4	0.1021		
298.63	-0.097	208.4	0.1029		
298.67	-0.095	208.5	0.1029		
298.70	-0.095	208.5	0.1029		

Prova triassiale ciclica SNGR03-C4

tensione di confinamento (kPa)		450	tensione di confinamento (kPa)		450
deviatore ciclico (kPa)		80	deviatore ciclico (kPa)		120
frequenza (hz)		0.00071429	frequenza (hz)		0.0007143
298.73	-0.094	208.6	0.1029		
298.77	-0.093	208.6	0.1038		
298.80	-0.093	208.7	0.1038		
298.83	-0.093	208.7	0.1038		
298.88	-0.091	208.8	0.1047		
298.92	-0.091	208.9	0.1047		
298.95	-0.092	208.9	0.1047		
298.97	-0.092	208.9	0.1047		
299.00	-0.091	208.9	0.1056		
299.03	-0.09	209.1	0.1056		
299.07	-0.088	209.3	0.1056		
299.10	-0.088	209.3	0.1065		
299.13	-0.088	209.4	0.1065		
299.17	-0.088	209.4	0.1065		
299.20	-0.087	209.6	0.1074		
299.23	-0.086	209.7	0.1074		
299.27	-0.086	209.8	0.1083		
299.30	-0.084	210	0.1083		
299.33	-0.084	210	0.1092		
299.37	-0.084	210.1	0.1092		
299.40	-0.084	210.2	0.11		
299.43	-0.08	210.6	0.1109		
299.47	-0.08	210.7	0.1109		
299.50	-0.08	210.7	0.1109		
299.53	-0.081	210.7	0.1109		
299.57	-0.081	210.7	0.1109		
299.60	-0.081	210.7	0.1109		
299.63	-0.08	210.8	0.1127		
299.67	-0.077	211.1	0.1136		
299.70	-0.077	211.2	0.1136		
299.73	-0.077	211.2	0.1136		
299.77	-0.077	211.3	0.1136		
299.80	-0.075	211.3	0.1145		
299.83	-0.075	211.6	0.1154		
299.87	-0.074	211.8	0.1163		
299.90	-0.072	212	0.1163		
299.93	-0.072	212.1	0.1171		
299.97	-0.072	212.3	0.1171		
300.00	-0.07	212.5	0.1171		
300.03	-0.07	212.5	0.118		
300.07	-0.07	212.6	0.1189		
300.10	-0.069	212.9	0.1198		
300.13	-0.067	213.1	0.1198		
300.17	-0.064	213.5	0.1216		
300.20	-0.065	213.6	0.1216		
300.23	-0.065	213.6	0.1216		
300.27	-0.065	213.6	0.1216		
300.30	-0.065	213.7	0.1225		
300.35	-0.062	214.3	0.1234		
300.38	-0.062	214.3	0.1242		
300.40	-0.062	214.3	0.1242		
300.43	-0.061	214.6	0.1251		
300.47	-0.061	214.7	0.126		
300.50	-0.058	215	0.1269		
300.53	-0.059	215.1	0.1269		
300.57	-0.059	215.2	0.1269		
300.60	-0.056	215.2	0.1269		
300.63	-0.056	215.6	0.1287		
300.67	-0.056	215.8	0.1296		
300.70	-0.054	216.1	0.1305		

Prova triassiale ciclica SNGR03-C4

tensione di confinamento (kPa)		450	tensione di confinamento (kPa)		450
deviatore ciclico (kPa)		80	deviatore ciclico (kPa)		120
frequenza (hz)		0.00071429	frequenza (hz)		0.0007143
300.73	-0.053	216.3	0.1313		
300.77	-0.052	216.5	0.1322		
300.80	-0.051	216.8	0.1322		
300.83	-0.05	216.8	0.1331		
300.87	-0.05	217	0.1331		
300.90	-0.046	217.5	0.1358		
300.93	-0.046	217.7	0.1367		
300.97	-0.047	217.7	0.1367		
301.00	-0.046	218	0.1376		
301.03	-0.045	218.2	0.1376		
301.07	-0.044	218.2	0.1376		
301.10	-0.044	218.4	0.1384		
301.13	-0.044	218.5	0.1393		
301.17	-0.042	218.9	0.1402		
301.20	-0.04	219.1	0.1411		
301.23	-0.04	219.4	0.1429		
301.27	-0.038	219.7	0.1429		
301.30	-0.037	219.7	0.1438		
301.33	-0.037	220	0.1447		
301.37	-0.036	220.3	0.1464		
301.40	-0.035	220.5	0.1473		
301.43	-0.033	220.9	0.1482		
301.47	-0.031	221.4	0.1509		
301.50	-0.03	221.6	0.1509		
301.53	-0.03	221.6	0.1518		
301.57	-0.03	221.8	0.1518		
301.60	-0.031	221.9	0.1526		
301.63	-0.029	222.2	0.1535		
301.67	-0.027	222.6	0.1553		
301.70	-0.027	222.8	0.1562		
301.73	-0.025	223.2	0.1562		
301.77	-0.023	223.2	0.158		
301.82	-0.02	224	0.1615		
301.85	-0.021	224.2	0.1615		
301.87	-0.021	224.2	0.1624		
301.90	-0.021	224.3	0.1624		
301.93	-0.02	224.7	0.1642		
301.97	-0.018	225.1	0.166		
302.00	-0.017	225.3	0.1677		
302.03	-0.016	225.6	0.1686		
302.07	-0.016	225.7	0.1686		
302.10	-0.014	225.7	0.1695		
302.13	-0.014	226.1	0.1713		
302.17	-0.013	226.4	0.1722		
302.20	-0.011	226.8	0.1748		
302.23	-0.01	227.1	0.1766		
302.27	-0.009	227.5	0.1784		
302.30	-0.007	227.8	0.1784		
302.33	-0.006	227.8	0.1802		
302.37	-0.006	228.2	0.1819		
302.40	-0.006	228.4	0.1828		
302.43	-0.004	228.8	0.1855		
302.47	-0.003	229.2	0.1873		
302.50	-0.002	229.4	0.189		
302.53	0	229.9	0.189		
302.57	0	229.9	0.1917		
302.60	0	230.1	0.1935		
302.63	0.001	230.5	0.1961		
302.67	0.003	230.9	0.1988		
302.70	0.004	231.2	0.2015		

Prova triassiale ciclica SNGR03-C4

pressione di confinamento (kPa)		450		pressione di confinamento (kPa)		450	
deviatore ciclico (kPa)		80		deviatore ciclico (kPa)		120	
frequenza (hz)		0.00071429		frequenza (hz)		0.0007143	
302.73	0.005	231.6	0.2041				
302.77	0.007	232.1	0.2041				
302.80	0.011	232.1	0.2068				
302.83	0.011	232.6	0.2112				
302.87	0.008	232.6	0.2121				
302.90	0.01	232.9	0.2157				
302.93	0.011	233.3	0.2192				
302.97	0.012	233.7	0.2228				
303.00	0.014	234.1	0.2228				
303.03	0.014	234.1	0.2254				
303.07	0.014	234.2	0.229				
303.10	0.015	234.6	0.2325				
303.13	0.017	235	0.237				
303.17	0.021	235.7	0.245				
303.20	0.018	235.7	0.2476				
303.25	0.02	236.1	0.253				
303.28	0.021	236.4	0.2574				
303.32	0.022	236.8	0.2645				
303.33	0.027	237.6	0.2645				
303.37	0.024	237.6	0.2716				
303.40	0.024	237.5	0.2734				
303.43	0.027	238	0.2769				
303.47	0.026	238.3	0.2778				
303.50	0.031	239	0.2822				
303.53	0.029	239.1	0.2831				
303.57	0.029	239.2	0.2831				
303.60	0.032	239.2	0.284				
303.63	0.032	239.6	0.2867				
303.67	0.033	240	0.2893				
303.70	0.035	240.4	0.2911				
303.73	0.036	240.7	0.2929				
303.77	0.037	241	0.2947				
303.80	0.039	241.4	0.2947				
303.83	0.039	241.4	0.2964				
303.87	0.039	241.8	0.2982				
303.90	0.04	242	0.2991				
303.93	0.044	242.7	0.3035				
303.97	0.043	242.8	0.3035				
304.00	0.043	243	0.3053				
304.03	0.045	243.3	0.3053				
304.07	0.045	243.3	0.3062				
304.10	0.045	243.5	0.308				
304.13	0.046	244	0.3098				
304.17	0.049	244.4	0.3115				
304.20	0.05	244.7	0.3133				
304.23	0.05	245	0.3142				
304.27	0.052	245.4	0.3142				
304.30	0.052	245.4	0.3169				
304.33	0.052	245.7	0.3177				
304.37	0.053	246.1	0.3195				
304.40	0.058	246.7	0.3231				
304.43	0.056	246.8	0.3231				
304.47	0.056	247.1	0.324				
304.50	0.058	247.4	0.324				
304.53	0.058	247.4	0.3257				
304.57	0.058	247.6	0.3266				
304.60	0.059	248	0.3293				
304.63	0.063	248.5	0.3311				
304.67	0.062	248.7	0.332				
304.72	0.063	249	0.3328				

Prova triassiale ciclica SNGR03-C4

pressione di confinamento (kPa)		450		pressione di confinamento (kPa)		450	
deviatore ciclico (kPa)		80		deviatore ciclico (kPa)		120	
frequenza (hz)		0.00071429		frequenza (hz)		0.0007143	
304.75	0.064	249.3	0.3346				
304.77	0.065	249.6	0.3355				
304.80	0.066	250	0.3373				
304.83	0.067	250.3	0.3373				
304.87	0.068	250.3	0.3399				
304.90	0.068	250.6	0.3408				
304.93	0.069	251	0.3426				
304.97	0.071	251.3	0.3444				
305.00	0.071	251.5	0.3453				
305.03	0.072	251.8	0.347				
305.07	0.076	252.5	0.347				
305.10	0.075	252.5	0.3497				
305.13	0.075	252.6	0.3497				
305.17	0.073	252.7	0.3506				
305.20	0.075	253	0.3515				
305.23	0.077	253.4	0.3533				
305.27	0.078	253.7	0.355				
305.30	0.079	254	0.355				
305.33	0.08	254	0.3559				
305.37	0.08	254.4	0.3577				
305.40	0.08	254.6	0.3586				
305.43	0.082	255	0.3604				
305.47	0.082	255.3	0.3612				
305.50	0.083	255.6	0.3621				
305.53	0.084	255.9	0.3621				
305.57	0.085	255.9	0.3639				
305.60	0.085	256.2	0.3648				
305.63	0.086	256.5	0.3666				
305.67	0.087	256.9	0.3683				
305.70	0.088	257.1	0.3692				
305.73	0.088	257.4	0.3701				
305.77	0.089	257.7	0.3701				
305.80	0.09	257.7	0.371				
305.83	0.09	258	0.3728				
305.87	0.091	258.3	0.3737				
305.90	0.092	258.6	0.3746				
305.93	0.095	259.1	0.3772				
305.97	0.094	259.3	0.3772				
306.00	0.093	259.4	0.3772				
306.03	0.093	259.4	0.3781				
306.07	0.093	259.5	0.3781				
306.10	0.095	259.9	0.3799				
306.15	0.097	260.3	0.3817				
306.18	0.097	260.5	0.3825				
306.22	0.097	260.7	0.3834				
306.23	0.098	261	0.3843				
306.27	0.099	261.2	0.3852				
306.30	0.1	261.5	0.387				
306.33	0.101	261.8	0.387				
306.37	0.101	261.8	0.3879				
306.40	0.101	262	0.3879				
306.43	0.102	262.3	0.3896				
306.47	0.103	262.6	0.3905				
306.50	0.103	262.8	0.3914				
306.53	0.106	263.4	0.3941				
306.57	0.105	263.4	0.3941				
306.60	0.104	263.4	0.3932				
306.63	0.104	263.5	0.3941				
306.67	0.105	263.7	0.395				
306.70	0.107	264.1	0.3959				

Prova triassiale ciclica SNGR03-C4

tensione di confinamento (kPa)		450	tensione di confinamento (kPa)		450
deviatore ciclico (kPa)		80	deviatore ciclico (kPa)		120
frequenza (hz)		0.00071429	frequenza (hz)		0.0007143
306.73	0.107	264.3	0.3967		
306.77	0.108	264.5	0.3976		
306.80	0.108	264.8	0.3976		
306.83	0.109	264.8	0.3985		
306.87	0.109	265	0.3994		
306.90	0.111	265.5	0.4021		
306.93	0.11	265.6	0.4021		
306.97	0.11	265.7	0.4021		
307.00	0.109	265.8	0.4021		
307.03	0.111	266.1	0.4021		
307.07	0.112	266.1	0.4039		
307.10	0.112	266.4	0.4047		
307.13	0.112	266.6	0.4047		
307.17	0.113	266.8	0.4056		
307.20	0.113	267	0.4065		
307.23	0.113	267.2	0.4074		
307.27	0.114	267.5	0.4074		
307.30	0.115	267.5	0.4092		
307.33	0.115	267.8	0.4092		
307.37	0.115	267.8	0.4092		
307.40	0.114	268	0.4092		
307.43	0.116	268.2	0.4101		
307.47	0.116	268.3	0.411		
307.50	0.119	268.8	0.411		
307.53	0.117	268.8	0.4127		
307.57	0.117	268.8	0.4118		
307.62	0.116	268.9	0.4127		
307.65	0.117	268.9	0.4127		
307.67	0.117	269.2	0.4136		
307.70	0.117	269.4	0.4136		
307.73	0.118	269.5	0.4145		
307.77	0.119	269.8	0.4154		
307.80	0.119	269.9	0.4154		
307.83	0.119	270.1	0.4154		
307.87	0.122	270.1	0.4163		
307.90	0.122	270.5	0.4181		
307.93	0.12	270.5	0.4172		
307.97	0.119	270.5	0.4172		
308.00	0.119	270.6	0.4172		
308.03	0.119	270.7	0.4181		
308.07	0.12	271	0.4181		
308.10	0.121	271	0.4189		
308.13	0.121	271.2	0.4189		
308.17	0.121	271.3	0.4189		
308.20	0.12	271.4	0.4198		
308.23	0.121	271.5	0.4198		
308.27	0.121	271.7	0.4207		
308.30	0.121	271.8	0.4207		
308.33	0.121	271.8	0.4207		
308.37	0.121	271.9	0.4207		
308.40	0.121	272	0.4216		
308.43	0.121	272.2	0.4216		
308.47	0.122	272.3	0.4216		
308.50	0.124	272.7	0.4234		
308.53	0.122	272.6	0.4234		
308.57	0.121	272.6	0.4225		
308.60	0.121	272.6	0.4225		
308.63	0.121	272.7	0.4225		
308.67	0.121	272.7	0.4225		
308.70	0.121	272.8	0.4225		

Prova triassiale ciclica SNGR03-C4

pressione di confinamento (kPa)		450		pressione di confinamento (kPa)		450	
deviatore ciclico (kPa)		80		deviatore ciclico (kPa)		120	
frequenza (hz)		0.00071429		frequenza (hz)		0.0007143	
308.73	0.121	272.9	0.4234				
308.77	0.121	273	0.4234				
308.80	0.121	273	0.4234				
308.83	0.121	273.1	0.4234				
308.87	0.122	273.3	0.4234				
308.90	0.122	273.4	0.4234				
308.93	0.121	273.4	0.4243				
308.97	0.121	273.5	0.4243				
309.00	0.123	273.8	0.4243				
309.03	0.122	273.8	0.4252				
309.08	0.121	273.7	0.4243				
309.12	0.12	273.7	0.4243				
309.13	0.12	273.7	0.4243				
309.17	0.12	273.8	0.4243				
309.20	0.12	273.8	0.4243				
309.23	0.12	273.9	0.4243				
309.27	0.12	273.9	0.4243				
309.30	0.12	274	0.4243				
309.33	0.12	274	0.4243				
309.37	0.12	274	0.4243				
309.40	0.12	274.1	0.4243				
309.43	0.119	274.1	0.4243				
309.47	0.119	274.1	0.4243				
309.50	0.118	274.1	0.4234				
309.53	0.117	274.1	0.4234				
309.57	0.118	274.2	0.4234				
309.60	0.118	274.2	0.4243				
309.63	0.118	274.2	0.4243				
309.67	0.118	274.2	0.4234				
309.70	0.117	274.2	0.4234				
309.73	0.116	274.2	0.4234				
309.77	0.116	274.2	0.4234				
309.80	0.116	274.2	0.4234				
309.83	0.115	274.2	0.4225				
309.87	0.115	274.2	0.4225				
309.90	0.116	274.3	0.4225				
309.93	0.116	274.3	0.4225				
309.97	0.115	274.3	0.4225				
310.00	0.114	274.3	0.4216				
310.03	0.113	274.2	0.4216				
310.07	0.11	273.9	0.4216				
310.10	0.11	273.9	0.4198				
310.13	0.112	274.1	0.4207				
310.17	0.112	274.1	0.4207				
310.20	0.112	274.1	0.4207				
310.23	0.112	274.2	0.4207				
310.27	0.111	274.1	0.4207				
310.30	0.108	273.8	0.4198				
310.33	0.108	273.8	0.4181				
310.37	0.108	273.8	0.4181				
310.40	0.109	273.8	0.4181				
310.43	0.109	273.9	0.4189				
310.47	0.109	273.9	0.4189				
310.52	0.106	273.5	0.4172				
310.55	0.105	273.5	0.4163				
310.57	0.106	273.6	0.4172				
310.60	0.107	273.6	0.4172				
310.63	0.107	273.6	0.4172				
310.67	0.107	273.6	0.4172				
310.70	0.103	273.3	0.4145				

Prova triassiale ciclica SNGR03-C4

pressione di confinamento (kPa)		450		pressione di confinamento (kPa)		450	
deviatore ciclico (kPa)		80		deviatore ciclico (kPa)		120	
frequenza (hz)		0.00071429		frequenza (hz)		0.0007143	
310.73	0.102	273.1	0.4145				
310.77	0.104	273.2	0.4145				
310.80	0.103	273.2	0.4145				
310.83	0.1	272.8	0.4145				
310.87	0.1	272.8	0.4127				
310.90	0.1	272.8	0.4127				
310.93	0.102	272.9	0.4136				
310.97	0.102	272.9	0.4127				
311.00	0.098	272.5	0.411				
311.03	0.098	272.5	0.411				
311.07	0.098	272.4	0.411				
311.10	0.098	272.4	0.411				
311.13	0.098	272.4	0.411				
311.17	0.098	272.3	0.4101				
311.20	0.095	272.1	0.4083				
311.23	0.092	271.7	0.4074				
311.27	0.093	271.7	0.4074				
311.30	0.095	271.9	0.4074				
311.33	0.092	271.5	0.4074				
311.37	0.092	271.5	0.4065				
311.40	0.091	271.4	0.4056				
311.43	0.092	271.4	0.4056				
311.47	0.092	271.3	0.4056				
311.50	0.089	271.1	0.4039				
311.53	0.086	270.6	0.4039				
311.57	0.085	270.5	0.4012				
311.60	0.085	270.5	0.4012				
311.63	0.087	270.6	0.4021				
311.67	0.087	270.6	0.4012				
311.70	0.082	270.1	0.3994				
311.73	0.083	270.1	0.3994				
311.77	0.085	270.2	0.3994				
311.80	0.084	270	0.3994				
311.83	0.084	270	0.3985				
311.87	0.081	269.7	0.3959				
311.90	0.078	269.1	0.395				
311.93	0.078	269.1	0.3941				
311.98	0.078	269	0.3941				
312.02	0.078	268.8	0.3932				
312.03	0.077	268.7	0.3932				
312.07	0.076	268.6	0.3923				
312.10	0.077	268.6	0.3923				
312.13	0.074	268.2	0.3923				
312.17	0.074	268.2	0.3905				
312.20	0.072	267.9	0.3888				
312.23	0.071	267.7	0.3879				
312.27	0.07	267.5	0.387				
312.30	0.071	267.5	0.387				
312.33	0.069	267.1	0.387				
312.37	0.067	266.9	0.3852				
312.40	0.067	266.9	0.3843				
312.43	0.066	266.7	0.3834				
312.47	0.068	266.7	0.3834				
312.50	0.066	266.5	0.3817				
312.53	0.062	265.9	0.379				
312.57	0.061	265.7	0.379				
312.60	0.061	265.6	0.3781				
312.63	0.061	265.6	0.3781				
312.67	0.063	265.6	0.3781				
312.70	0.062	265.3	0.3772				

Prova triassiale ciclica SNGR03-C4

pressione di confinamento (kPa)		450		pressione di confinamento (kPa)		450	
deviatore ciclico (kPa)		80		deviatore ciclico (kPa)		120	
frequenza (hz)		0.00071429		frequenza (hz)		0.0007143	
312.73	0.055	264.7	0.3737				
312.77	0.057	264.7	0.3737				
312.80	0.058	264.6	0.3737				
312.83	0.055	264.2	0.3737				
312.87	0.055	264.2	0.3719				
312.90	0.055	264	0.3701				
312.93	0.054	263.8	0.3701				
312.97	0.054	263.7	0.3692				
313.00	0.051	263.3	0.3666				
313.03	0.048	262.5	0.3666				
313.07	0.047	262.4	0.3639				
313.10	0.047	262.4	0.363				
313.13	0.047	262.3	0.363				
313.17	0.047	262.1	0.3621				
313.20	0.045	261.8	0.3604				
313.23	0.044	261.6	0.3595				
313.27	0.044	261.4	0.3595				
313.30	0.042	261	0.3586				
313.33	0.042	261	0.3568				
313.37	0.04	260.7	0.355				
313.42	0.041	260.5	0.355				
313.45	0.041	260.5	0.3541				
313.48	0.036	259.9	0.3506				
313.50	0.035	259.6	0.3488				
313.53	0.035	259.4	0.3479				
313.57	0.034	259.1	0.347				
313.60	0.035	259	0.347				
313.63	0.034	258.8	0.347				
313.67	0.034	258.8	0.3453				
313.70	0.031	258.4	0.3435				
313.73	0.029	257.9	0.3408				
313.77	0.025	257.4	0.3373				
313.80	0.027	257.3	0.3373				
313.83	0.027	257.1	0.3373				
313.87	0.025	256.8	0.3364				
313.90	0.025	256.8	0.3346				
313.93	0.024	256.4	0.332				
313.97	0.023	256.1	0.3311				
314.00	0.021	255.8	0.3293				
314.03	0.022	255.7	0.3284				
314.07	0.018	255	0.3284				
314.10	0.017	254.8	0.3249				
314.13	0.017	254.8	0.324				
314.17	0.017	254.5	0.3222				
314.20	0.015	254.2	0.3204				
314.23	0.014	253.9	0.3186				
314.27	0.014	253.7	0.3177				
314.30	0.014	253.3	0.3177				
314.33	0.008	252.6	0.3151				
314.37	0.008	252.6	0.3124				
314.40	0.009	252.5	0.3115				
314.43	0.009	252.3	0.3106				
314.47	0.009	252.1	0.308				
314.50	0.004	251.5	0.3053				
314.53	0.004	251.2	0.3053				
314.57	0.002	250.8	0.3035				
314.60	0.002	250.8	0.3018				
314.63	0.003	250.7	0.3018				
314.67	0.004	250.6	0.3009				
314.70	0	250.1	0.2982				

Prova triassiale ciclica SNGR03-C4

tensione di confinamento (kPa)		450	tensione di confinamento (kPa)		450
deviatore ciclico (kPa)		80	deviatore ciclico (kPa)		120
frequenza (hz)		0.00071429	frequenza (hz)		0.0007143
314.73	0.001	250	0.2964		
314.77	-0.002	249.3	0.2964		
314.80	-0.004	249	0.2929		
314.83	-0.004	249	0.2893		
314.88	-0.006	248.3	0.2867		
314.92	-0.007	248.1	0.2831		
314.93	-0.007	248.1	0.2805		
314.97	-0.007	247.9	0.2769		
315.00	-0.009	247.4	0.2725		
315.03	-0.01	247.1	0.2689		
315.07	-0.011	246.8	0.2654		
315.10	-0.013	246.3	0.2654		
315.13	-0.014	246	0.2601		
315.17	-0.014	246	0.2565		
315.20	-0.017	245.4	0.2521		
315.23	-0.015	245.4	0.2494		
315.27	-0.017	245	0.245		
315.30	-0.018	244.6	0.2414		
315.33	-0.02	244.2	0.2414		
315.37	-0.021	243.8	0.237		
315.40	-0.021	243.8	0.2334		
315.43	-0.025	243.1	0.2281		
315.47	-0.022	243.2	0.2263		
315.50	-0.026	242.6	0.2237		
315.53	-0.023	242.7	0.2228		
315.57	-0.025	242.2	0.2228		
315.60	-0.028	241.7	0.2192		
315.63	-0.028	241.7	0.2157		
315.67	-0.029	241.4	0.213		
315.70	-0.033	240.6	0.2086		
315.73	-0.032	240.4	0.2068		
315.77	-0.029	240.5	0.2068		
315.80	-0.031	239.9	0.2068		
315.83	-0.035	239.4	0.2041		
315.87	-0.035	239.4	0.2006		
315.90	-0.037	238.8	0.197		
315.93	-0.038	238.5	0.1953		
315.97	-0.037	238.3	0.1935		
316.00	-0.037	238.2	0.1926		
316.03	-0.041	237.3	0.1926		
316.07	-0.043	236.9	0.189		
316.10	-0.043	236.9	0.1864		
316.13	-0.042	236.7	0.1855		
316.17	-0.043	236.4	0.1837		
316.20	-0.045	236	0.1819		
316.23	-0.045	235.7	0.1802		
316.27	-0.046	235.3	0.1802		
316.32	-0.047	234.9	0.1766		
316.35	-0.047	234.7	0.1766		
316.38	-0.05	234.2	0.174		
316.40	-0.05	234	0.174		
316.43	-0.05	234	0.1731		
316.47	-0.051	233.7	0.1713		
316.50	-0.052	233.2	0.1695		
316.53	-0.053	232.9	0.1686		
316.57	-0.054	232.5	0.1669		
316.60	-0.055	232.2	0.1651		
316.63	-0.057	231.8	0.1651		
316.67	-0.057	231.8	0.1642		
316.70	-0.057	231.5	0.1624		

Prova triassiale ciclica SNGR03-C4

tensione di confinamento (kPa)		450	tensione di confinamento (kPa)		450
deviatore ciclico (kPa)		80	deviatore ciclico (kPa)		120
frequenza (hz)		0.00071429	frequenza (hz)		0.0007143
316.73	-0.058	231.1	0.1615		
316.77	-0.059	230.8	0.1597		
316.80	-0.06	230.4	0.1589		
316.83	-0.061	230.1	0.158		
316.87	-0.062	229.7	0.158		
316.90	-0.062	229.7	0.1562		
316.93	-0.063	229.4	0.1553		
316.97	-0.064	229	0.1535		
317.00	-0.065	228.7	0.1526		
317.03	-0.066	228.3	0.1509		
317.07	-0.067	228	0.15		
317.10	-0.067	227.6	0.15		
317.13	-0.067	227.6	0.1491		
317.17	-0.069	227.3	0.1482		
317.20	-0.069	227	0.1473		
317.23	-0.07	226.7	0.1464		
317.27	-0.071	226.4	0.1447		
317.30	-0.072	226	0.1438		
317.33	-0.073	225.7	0.1438		
317.37	-0.073	225.7	0.1429		
317.40	-0.074	225.4	0.142		
317.43	-0.074	225.1	0.1411		
317.47	-0.075	224.8	0.1402		
317.50	-0.076	224.4	0.1393		
317.53	-0.077	224.1	0.1384		
317.57	-0.078	223.9	0.1384		
317.60	-0.078	223.9	0.1376		
317.63	-0.078	223.5	0.1367		
317.67	-0.079	223.2	0.1358		
317.70	-0.08	222.9	0.134		
317.73	-0.081	222.6	0.1331		
317.78	-0.082	222.2	0.1331		
317.82	-0.083	222	0.1322		
317.83	-0.082	221.8	0.1322		
317.87	-0.083	221.6	0.1313		
317.90	-0.084	221.2	0.1313		
317.93	-0.084	221.2	0.1296		
317.97	-0.085	220.9	0.1296		
318.00	-0.086	220.7	0.1287		
318.03	-0.087	220.3	0.1278		
318.07	-0.087	220.1	0.1269		
318.10	-0.087	219.9	0.1269		
318.13	-0.088	219.6	0.1269		
318.17	-0.09	219.6	0.126		
318.20	-0.09	219.2	0.1251		
318.23	-0.089	219.1	0.1242		
318.27	-0.089	219	0.1242		
318.30	-0.088	218.9	0.1234		
318.33	-0.091	218.4	0.1225		
318.37	-0.093	218	0.1225		
318.40	-0.093	218	0.1216		
318.43	-0.093	217.8	0.1207		
318.47	-0.093	217.6	0.1207		
318.50	-0.094	217.3	0.1198		
318.53	-0.094	217.2	0.1198		
318.57	-0.095	216.9	0.1189		
318.60	-0.095	216.7	0.1189		
318.63	-0.097	216.7	0.118		
318.67	-0.097	216.4	0.1171		
318.70	-0.096	216.2	0.1171		

Prova triassiale ciclica SNGR03-C4

tensione di confinamento (kPa)		450	tensione di confinamento (kPa)		450
deviatore ciclico (kPa)		80	deviatore ciclico (kPa)		120
frequenza (hz)		0.00071429	frequenza (hz)		0.0007143
318.73	-0.096	216	0.1163		
318.77	-0.098	215.7	0.1154		
318.80	-0.097	215.5	0.1154		
318.83	-0.098	215.3	0.1154		
318.87	-0.098	215.3	0.1154		
318.90	-0.098	215.1	0.1145		
318.93	-0.099	214.8	0.1136		
318.97	-0.1	214.6	0.1127		
319.00	-0.1	214.4	0.1127		
319.03	-0.1	214.3	0.1127		
319.07	-0.1	214.1	0.1127		
319.10	-0.101	214.1	0.1127		
319.13	-0.101	213.9	0.1109		
319.17	-0.102	213.7	0.11		
319.20	-0.102	213.5	0.1092		
319.25	-0.102	213.3	0.1092		
319.28	-0.102	213.2	0.1092		
319.30	-0.103	213	0.1083		
319.33	-0.103	212.8	0.1083		
319.37	-0.103	212.6	0.1083		
319.40	-0.104	212.4	0.1083		
319.43	-0.106	212.4	0.1074		
319.47	-0.106	212	0.1065		
319.50	-0.105	211.9	0.1065		
319.53	-0.105	211.8	0.1065		
319.57	-0.104	211.8	0.1065		
319.60	-0.104	211.7	0.1065		
319.63	-0.104	211.6	0.1065		
319.67	-0.105	211.6	0.1056		
319.70	-0.105	211.4	0.1056		
319.73	-0.105	211.2	0.1047		
319.77	-0.106	211	0.1047		
319.80	-0.106	210.9	0.1047		
319.83	-0.106	210.8	0.1047		
319.87	-0.106	210.7	0.1047		
319.90	-0.106	210.7	0.1038		
319.93	-0.106	210.5	0.1038		
319.97	-0.106	210.4	0.1038		
320.00	-0.107	210.2	0.1029		
320.03	-0.108	210	0.1029		
320.07	-0.108	209.9	0.1029		
320.10	-0.107	209.9	0.1029		
320.13	-0.107	209.9	0.1021		
320.17	-0.107	209.8	0.1021		
320.20	-0.107	209.8	0.1021		
320.23	-0.106	209.7	0.1021		
320.27	-0.106	209.6	0.1021		
320.30	-0.107	209.5	0.1021		
320.33	-0.108	209.3	0.1021		
320.37	-0.107	209.3	0.1012		
320.40	-0.107	209.2	0.1021		
320.43	-0.107	209.2	0.1021		
320.47	-0.107	209.1	0.1012		
320.50	-0.107	209.1	0.1012		
320.53	-0.106	209.1	0.1012		
320.57	-0.106	209	0.1012		
320.60	-0.106	209	0.1012		
320.63	-0.106	208.9	0.1012		
320.68	-0.106	208.8	0.1012		
320.72	-0.105	208.8	0.1012		

Prova triassiale ciclica SNGR03-C4

tensione di confinamento (kPa)		450	tensione di confinamento (kPa)		450
deviatore ciclico (kPa)		80	deviatore ciclico (kPa)		120
frequenza (hz)		0.00071429	frequenza (hz)		0.0007143
320.75	-0.105	208.8	0.1012		
320.77	-0.105	208.8	0.1012		
320.80	-0.105	208.7	0.1012		
320.83	-0.105	208.7	0.1012		
320.87	-0.105	208.6	0.1012		
320.90	-0.105	208.5	0.1012		
320.93	-0.106	208.5	0.1012		
320.97	-0.106	208.2	0.1003		
321.00	-0.107	208.2	0.1003		
321.03	-0.106	208.3	0.1003		
321.07	-0.105	208.3	0.1012		
321.10	-0.104	208.4	0.1012		
321.13	-0.104	208.3	0.1012		
321.17	-0.104	208.3	0.1012		
321.20	-0.104	208.3	0.1012		
321.23	-0.103	208.4	0.1012		
321.27	-0.103	208.4	0.1021		
321.30	-0.102	208.4	0.1021		
321.33	-0.102	208.4	0.1021		
321.37	-0.102	208.4	0.1021		
321.40	-0.102	208.4	0.1021		
321.43	-0.102	208.4	0.1021		
321.47	-0.101	208.4	0.1021		
321.50	-0.101	208.4	0.1021		
321.53	-0.1	208.4	0.1021		
321.57	-0.1	208.4	0.1021		
321.60	-0.1	208.4	0.1021		
321.63	-0.099	208.4	0.1021		
321.67	-0.099	208.5	0.1029		
321.70	-0.099	208.5	0.1029		
321.73	-0.098	208.5	0.1029		
321.77	-0.098	208.5	0.1029		
321.80	-0.098	208.6	0.1038		
321.83	-0.097	208.6	0.1038		
321.87	-0.096	208.6	0.1038		
321.90	-0.096	208.7	0.1038		
321.93	-0.096	208.7	0.1038		
321.97	-0.095	208.8	0.1047		
322.00	-0.094	209	0.1056		
322.03	-0.092	209.2	0.1056		
322.07	-0.093	209.2	0.1056		
322.10	-0.093	209.2	0.1056		
322.15	-0.095	208.9	0.1047		
322.18	-0.095	208.9	0.1047		
322.20	-0.092	208.9	0.1047		
322.23	-0.092	209.1	0.1056		
322.27	-0.091	209.3	0.1065		
322.30	-0.09	209.4	0.1074		
322.33	-0.09	209.4	0.1065		
322.37	-0.09	209.5	0.1074		
322.40	-0.089	209.6	0.1074		
322.43	-0.088	209.6	0.1083		
322.47	-0.088	209.8	0.1083		
322.50	-0.088	209.8	0.1083		
322.53	-0.087	210	0.1092		
322.57	-0.086	210.1	0.1092		
322.60	-0.086	210.1	0.11		
322.63	-0.082	210.6	0.11		
322.67	-0.083	210.6	0.1109		
322.70	-0.083	210.6	0.1109		

Prova triassiale ciclica SNGR03-C4

pressione di confinamento (kPa)		450	tensione di confinamento (kPa)		450
deviatore ciclico (kPa)		80	deviatore ciclico (kPa)		120
frequenza (hz)		0.00071429	frequenza (hz)		0.0007143
322.73	-0.083	210.6	0.1109		
322.77	-0.083	210.6	0.1109		
322.80	-0.084	210.5	0.1109		
322.83	-0.083	210.7	0.1127		
322.87	-0.078	211.1	0.1127		
322.90	-0.08	211.1	0.1136		
322.93	-0.08	211.1	0.1136		
322.97	-0.079	211.2	0.1136		
323.00	-0.078	211.4	0.1145		
323.03	-0.077	211.6	0.1154		
323.07	-0.077	211.6	0.1154		
323.10	-0.075	211.8	0.1154		
323.13	-0.075	211.8	0.1163		
323.17	-0.075	212	0.1171		
323.20	-0.074	212.2	0.1171		
323.23	-0.072	212.4	0.118		
323.27	-0.073	212.5	0.118		
323.30	-0.072	212.7	0.1189		
323.33	-0.07	212.9	0.1189		
323.37	-0.069	212.9	0.1198		
323.40	-0.069	213.1	0.1198		
323.43	-0.069	213.2	0.1207		
323.47	-0.068	213.4	0.1216		
323.50	-0.067	213.6	0.1216		
323.53	-0.067	213.8	0.1225		
323.58	-0.065	214	0.1234		
323.62	-0.064	214.1	0.1234		
323.65	-0.064	214.4	0.1251		
323.67	-0.06	214.9	0.1251		
323.70	-0.06	214.9	0.1269		
323.73	-0.06	214.9	0.126		
323.77	-0.063	214.8	0.126		
323.80	-0.062	214.9	0.126		
323.83	-0.059	215.2	0.1278		
323.87	-0.059	215.4	0.1287		
323.90	-0.057	215.7	0.1287		
323.93	-0.056	215.7	0.1296		
323.97	-0.056	216	0.1305		
324.00	-0.055	216.2	0.1305		
324.03	-0.054	216.4	0.1313		
324.07	-0.053	216.7	0.1322		
324.10	-0.052	216.9	0.1331		
324.13	-0.051	217.1	0.1331		
324.17	-0.05	217.1	0.134		
324.20	-0.05	217.4	0.1349		
324.23	-0.048	217.6	0.1358		
324.27	-0.048	217.8	0.1367		
324.30	-0.047	218	0.1376		
324.33	-0.046	218.3	0.1384		
324.37	-0.044	218.6	0.1384		
324.40	-0.044	218.6	0.1393		
324.43	-0.044	218.8	0.1402		
324.47	-0.042	219.1	0.1411		
324.50	-0.041	219.4	0.142		
324.53	-0.04	219.6	0.1429		
324.57	-0.037	220.2	0.1455		
324.60	-0.038	220.2	0.1455		
324.63	-0.039	220.2	0.1455		
324.67	-0.039	220.2	0.1455		
324.70	-0.037	220.6	0.1473		

Prova triassiale ciclica SNGR03-C4

tensione di confinamento (kPa)		450	tensione di confinamento (kPa)		450
deviatore ciclico (kPa)		80	deviatore ciclico (kPa)		120
frequenza (hz)		0.00071429	frequenza (hz)		0.0007143
324.73	-0.035	221	0.1491		
324.77	-0.033	221.4	0.15		
324.80	-0.032	221.5	0.1509		
324.83	-0.032	221.9	0.1509		
324.87	-0.03	221.9	0.1518		
324.90	-0.03	222.1	0.1526		
324.93	-0.031	222.4	0.1535		
324.97	-0.028	222.8	0.1553		
325.00	-0.027	223	0.1562		
325.05	-0.026	223.4	0.1589		
325.08	-0.024	223.7	0.1597		
325.10	-0.025	223.8	0.1597		
325.13	-0.023	224.1	0.1615		
325.17	-0.021	224.5	0.1615		
325.20	-0.021	224.5	0.1633		
325.23	-0.021	224.7	0.1642		
325.27	-0.02	225	0.1651		
325.30	-0.019	225.3	0.1669		
325.33	-0.017	225.6	0.1686		
325.37	-0.016	225.9	0.1695		
325.40	-0.014	226.3	0.1695		
325.43	-0.014	226.3	0.1713		
325.47	-0.014	226.5	0.1722		
325.50	-0.012	226.9	0.1748		
325.53	-0.011	227.2	0.1766		
325.57	-0.01	227.5	0.1775		
325.60	-0.009	227.8	0.1793		
325.63	-0.008	228.2	0.1793		
325.67	-0.006	228.2	0.1811		
325.70	-0.006	228.5	0.1828		
325.73	-0.006	228.8	0.1846		
325.77	-0.004	229.3	0.1873		
325.80	-0.003	229.6	0.189		
325.83	-0.002	229.9	0.1908		
325.87	0	230.3	0.1908		
325.90	0.003	230.3	0.1944		
325.93	0.003	230.9	0.1979		
325.97	0.001	230.9	0.1979		
326.00	0.001	231.1	0.1988		
326.03	0.004	231.6	0.2024		
326.07	0.005	231.9	0.205		
326.10	0.007	232.3	0.205		
326.13	0.007	232.3	0.2077		
326.17	0.007	232.6	0.2112		
326.20	0.009	233	0.2139		
326.23	0.013	233.7	0.2192		
326.27	0.011	233.8	0.2219		
326.30	0.013	234.1	0.2254		
326.33	0.012	234.2	0.2254		
326.37	0.015	234.2	0.2263		
326.40	0.015	234.7	0.2308		
326.43	0.015	235	0.2343		
326.48	0.018	235.5	0.2396		
326.52	0.018	235.8	0.2432		
326.55	0.019	236.1	0.2485		
326.57	0.021	236.6	0.2538		
326.60	0.021	236.9	0.2583		
326.63	0.022	237.3	0.2645		
326.67	0.024	237.7	0.2645		
326.70	0.026	237.7	0.2689		

Prova triassiale ciclica SNGR03-C4

pressione di confinamento (kPa)		450		pressione di confinamento (kPa)		450	
deviatore ciclico (kPa)		80		deviatore ciclico (kPa)		120	
frequenza (hz)		0.00071429		frequenza (hz)		0.0007143	
326.73	0.026	238.1	0.2734				
326.77	0.026	238.4	0.276				
326.80	0.028	238.8	0.2787				
326.83	0.028	239	0.2805				
326.87	0.032	239.7	0.2849				
326.90	0.032	239.9	0.2849				
326.93	0.032	239.9	0.2858				
326.97	0.032	240.1	0.2876				
327.00	0.034	240.5	0.2893				
327.03	0.035	240.9	0.2911				
327.07	0.034	240.9	0.292				
327.10	0.036	241.4	0.2938				
327.13	0.039	241.9	0.2938				
327.17	0.04	241.9	0.2964				
327.20	0.04	242.2	0.2973				
327.23	0.04	242.4	0.2991				
327.27	0.041	242.8	0.3009				
327.30	0.043	243.1	0.3027				
327.33	0.044	243.4	0.3044				
327.37	0.045	243.7	0.3044				
327.40	0.046	243.7	0.3062				
327.43	0.046	244.1	0.308				
327.47	0.047	244.4	0.3089				
327.50	0.051	245	0.3124				
327.53	0.05	245.3	0.3133				
327.57	0.049	245.3	0.3133				
327.60	0.05	245.6	0.3133				
327.63	0.052	245.6	0.3151				
327.67	0.052	246.1	0.3169				
327.70	0.053	246.4	0.3186				
327.73	0.055	246.8	0.3204				
327.77	0.058	247.4	0.324				
327.80	0.056	247.5	0.324				
327.83	0.056	247.6	0.324				
327.87	0.059	247.6	0.324				
327.90	0.059	248.1	0.3266				
327.95	0.063	249	0.3293				
327.98	0.061	249	0.3311				
328.00	0.061	249	0.3311				
328.03	0.063	249.4	0.3328				
328.07	0.065	249.9	0.3346				
328.10	0.066	250.2	0.3364				
328.13	0.068	250.7	0.3399				
328.17	0.068	251	0.3399				
328.20	0.068	251	0.3408				
328.23	0.068	251.1	0.3417				
328.27	0.067	251.2	0.3417				
328.30	0.069	251.6	0.3435				
328.33	0.071	252	0.3453				
328.37	0.072	252.2	0.347				
328.40	0.073	252.6	0.347				
328.43	0.074	252.6	0.3479				
328.47	0.074	252.9	0.3488				
328.50	0.075	253.2	0.3506				
328.53	0.076	253.5	0.3524				
328.57	0.077	253.8	0.3533				
328.60	0.078	254.2	0.355				
328.63	0.078	254.5	0.355				
328.67	0.081	254.5	0.3559				
328.70	0.081	255	0.3586				

Prova triassiale ciclica SNGR03-C4

pressione di confinamento (kPa)		450		pressione di confinamento (kPa)		450	
deviatore ciclico (kPa)		80		deviatore ciclico (kPa)		120	
frequenza (hz)		0.00071429		frequenza (hz)		0.0007143	
328.73	0.081	255.2	0.3586				
328.77	0.08	255.3	0.3595				
328.80	0.082	255.6	0.3604				
328.83	0.083	256	0.3621				
328.87	0.085	256.4	0.3621				
328.90	0.085	256.4	0.3639				
328.93	0.085	256.6	0.3648				
328.97	0.088	257.2	0.3675				
329.00	0.088	257.4	0.3683				
329.03	0.087	257.5	0.3683				
329.07	0.087	257.7	0.3692				
329.10	0.089	258.1	0.3692				
329.13	0.091	258.1	0.371				
329.17	0.091	258.5	0.3728				
329.20	0.091	258.7	0.3737				
329.23	0.092	259	0.3746				
329.27	0.092	259.2	0.3754				
329.30	0.097	259.8	0.3781				
329.33	0.094	259.8	0.3781				
329.37	0.093	259.8	0.3781				
329.42	0.095	260.2	0.379				
329.45	0.095	260.5	0.379				
329.47	0.097	260.5	0.3808				
329.50	0.097	260.8	0.3817				
329.53	0.097	261.1	0.3825				
329.57	0.099	261.4	0.3843				
329.60	0.099	261.6	0.3843				
329.63	0.1	261.9	0.3861				
329.67	0.1	262.3	0.3861				
329.70	0.104	262.3	0.3879				
329.73	0.104	262.7	0.3896				
329.77	0.102	262.8	0.3888				
329.80	0.101	262.9	0.3896				
329.83	0.102	263.1	0.3905				
329.87	0.103	263.4	0.3914				
329.90	0.105	263.7	0.3914				
329.93	0.106	263.7	0.3923				
329.97	0.106	264	0.3941				
330.00	0.105	264.2	0.3941				
330.03	0.106	264.5	0.395				
330.07	0.106	264.7	0.3959				
330.10	0.107	264.9	0.3967				
330.13	0.108	265.2	0.3967				
330.17	0.109	265.2	0.3976				
330.20	0.109	265.4	0.3985				
330.23	0.112	265.9	0.4003				
330.27	0.11	265.9	0.4012				
330.30	0.109	266	0.4012				
330.33	0.109	266.2	0.4012				
330.37	0.111	266.5	0.4012				
330.40	0.112	266.5	0.403				
330.43	0.112	266.8	0.4039				
330.47	0.112	267	0.4039				
330.50	0.113	267.2	0.4056				
330.53	0.115	267.6	0.4074				
330.57	0.115	267.7	0.4074				
330.60	0.114	267.9	0.4074				
330.63	0.113	267.9	0.4074				
330.67	0.113	267.9	0.4074				
330.70	0.114	268.1	0.4083				

Prova triassiale ciclica SNGR03-C4

pressione di confinamento (kPa)		450	pressione di confinamento (kPa)		450
deviatore ciclico (kPa)		80	deviatore ciclico (kPa)		120
frequenza (hz)		0.00071429	frequenza (hz)		0.0007143
330.73	0.115	268.4	0.4092		
330.77	0.115	268.6	0.4092		
330.80	0.116	268.8	0.4101		
330.85	0.117	269	0.411		
330.88	0.117	269.1	0.411		
330.92	0.12	269.5	0.4136		
330.93	0.119	269.6	0.4136		
330.97	0.117	269.6	0.4136		
331.00	0.117	269.6	0.4127		
331.03	0.116	269.7	0.4127		
331.07	0.117	269.8	0.4136		
331.10	0.118	270.2	0.4145		
331.13	0.117	270.3	0.4145		
331.17	0.118	270.5	0.4145		
331.20	0.12	270.5	0.4154		
331.23	0.12	270.7	0.4163		
331.27	0.12	270.8	0.4163		
331.30	0.12	271	0.4172		
331.33	0.122	271.3	0.4189		
331.37	0.121	271.3	0.4181		
331.40	0.12	271.4	0.4181		
331.43	0.12	271.4	0.4181		
331.47	0.12	271.5	0.4181		
331.50	0.119	271.5	0.4181		
331.53	0.12	271.7	0.4189		
331.57	0.124	272.2	0.4207		
331.60	0.121	272.1	0.4198		
331.63	0.12	272.1	0.4198		
331.67	0.12	272.1	0.4198		
331.70	0.12	272.2	0.4198		
331.73	0.123	272.5	0.4216		
331.77	0.123	272.7	0.4216		
331.80	0.122	272.7	0.4216		
331.83	0.122	272.8	0.4216		
331.87	0.121	272.9	0.4216		
331.90	0.121	272.9	0.4216		
331.93	0.121	273	0.4216		
331.97	0.121	273	0.4216		
332.00	0.12	273.1	0.4216		
332.03	0.121	273.2	0.4216		
332.07	0.122	273.4	0.4234		
332.10	0.124	273.7	0.4234		
332.13	0.123	273.7	0.4234		
332.17	0.123	273.7	0.4234		
332.20	0.122	273.7	0.4234		
332.23	0.12	273.7	0.4225		
332.27	0.12	273.7	0.4225		
332.32	0.122	273.9	0.4234		
332.35	0.121	274	0.4243		
332.37	0.122	274.1	0.4234		
332.40	0.121	274.1	0.4234		
332.43	0.121	274.2	0.4234		
332.47	0.121	274.2	0.4234		
332.50	0.121	274.2	0.4234		
332.53	0.119	274.1	0.4234		
332.57	0.119	274.2	0.4234		
332.60	0.119	274.2	0.4234		
332.63	0.119	274.3	0.4234		
332.67	0.119	274.5	0.4234		
332.70	0.121	274.6	0.4243		

Prova triassiale ciclica SNGR03-C4

tensione di confinamento (kPa)		450		tensione di confinamento (kPa)		450	
deviatore ciclico (kPa)		80		deviatore ciclico (kPa)		120	
frequenza (hz)		0.00071429		frequenza (hz)		0.0007143	
332.73	0.121	274.6	0.4243				
332.77	0.119	274.5	0.4234				
332.80	0.118	274.5	0.4234				
332.83	0.118	274.5	0.4225				
332.87	0.118	274.5	0.4225				
332.90	0.118	274.5	0.4225				
332.93	0.118	274.6	0.4234				
332.97	0.118	274.6	0.4225				
333.00	0.118	274.6	0.4225				
333.03	0.117	274.6	0.4225				
333.07	0.116	274.6	0.4225				
333.10	0.116	274.6	0.4225				
333.13	0.115	274.6	0.4225				
333.17	0.116	274.6	0.4216				
333.20	0.116	274.6	0.4225				
333.23	0.116	274.7	0.4216				
333.27	0.115	274.6	0.4216				
333.30	0.114	274.5	0.4207				
333.33	0.114	274.5	0.4207				
333.37	0.114	274.5	0.4207				
333.40	0.114	274.6	0.4207				
333.43	0.114	274.6	0.4207				
333.47	0.114	274.6	0.4207				
333.50	0.11	274.3	0.4189				
333.53	0.11	274.3	0.4189				
333.57	0.111	274.3	0.4189				
333.60	0.111	274.4	0.4189				
333.63	0.111	274.3	0.4189				
333.67	0.111	274.3	0.4189				
333.70	0.11	274.3	0.4181				
333.75	0.108	274.1	0.4181				
333.78	0.108	274.1	0.4172				
333.82	0.108	274.1	0.4172				
333.83	0.108	274	0.4172				
333.87	0.107	274	0.4163				
333.90	0.106	273.9	0.4163				
333.93	0.107	273.9	0.4163				
333.97	0.106	273.9	0.4163				
334.00	0.106	273.9	0.4163				
334.03	0.104	273.6	0.4145				
334.07	0.102	273.5	0.4136				
334.10	0.102	273.4	0.4136				
334.13	0.102	273.4	0.4136				
334.17	0.102	273.4	0.4136				
334.20	0.101	273.3	0.4136				
334.23	0.101	273.3	0.4127				
334.27	0.101	273.2	0.4118				
334.30	0.099	273	0.411				
334.33	0.1	273.1	0.4118				
334.37	0.1	273	0.411				
334.40	0.098	272.8	0.411				
334.43	0.094	272.3	0.4101				
334.47	0.094	272.3	0.4083				
334.50	0.095	272.4	0.4083				
334.53	0.095	272.4	0.4083				
334.57	0.096	272.4	0.4083				
334.60	0.095	272.3	0.4074				
334.63	0.093	272	0.4074				
334.67	0.093	272	0.4065				
334.70	0.093	272	0.4065				

Prova triassiale ciclica SNGR03-C4

tensione di confinamento (kPa)		450		tensione di confinamento (kPa)		450	
deviatore ciclico (kPa)		80		deviatore ciclico (kPa)		120	
frequenza (hz)		0.00071429		frequenza (hz)		0.0007143	
334.73	0.091	271.7	0.4039				
334.77	0.09	271.6	0.4039				
334.80	0.089	271.5	0.403				
334.83	0.089	271.4	0.403				
334.87	0.088	271.2	0.403				
334.90	0.087	271.1	0.4021				
334.93	0.087	271.1	0.4021				
334.97	0.087	270.9	0.4012				
335.00	0.086	270.7	0.4003				
335.03	0.085	270.6	0.3994				
335.07	0.084	270.4	0.3985				
335.10	0.084	270.3	0.3985				
335.13	0.082	270	0.3985				
335.17	0.082	270	0.3967				
335.22	0.08	269.7	0.3959				
335.25	0.08	269.6	0.395				
335.27	0.08	269.6	0.395				
335.30	0.079	269.5	0.3941				
335.33	0.077	269.2	0.3923				
335.37	0.077	269.1	0.3923				
335.40	0.076	268.9	0.3914				
335.43	0.075	268.7	0.3914				
335.47	0.074	268.6	0.3905				
335.50	0.074	268.6	0.3896				
335.53	0.073	268.4	0.3888				
335.57	0.072	268.1	0.3879				
335.60	0.07	267.9	0.387				
335.63	0.07	267.8	0.3861				
335.67	0.069	267.6	0.3861				
335.70	0.068	267.3	0.3852				
335.73	0.068	267.3	0.3843				
335.77	0.067	267.1	0.3825				
335.80	0.066	266.9	0.3817				
335.83	0.065	266.6	0.3808				
335.87	0.064	266.4	0.3799				
335.90	0.063	266.2	0.3799				
335.93	0.062	266	0.379				
335.97	0.062	266	0.3781				
336.00	0.062	266	0.3781				
336.03	0.061	265.7	0.3763				
336.07	0.058	265.3	0.3746				
336.10	0.058	265.2	0.3737				
336.13	0.054	264.5	0.3737				
336.17	0.055	264.5	0.371				
336.20	0.055	264.5	0.371				
336.23	0.055	264.3	0.3701				
336.27	0.053	263.9	0.3683				
336.30	0.052	263.8	0.3675				
336.33	0.052	263.6	0.3666				
336.37	0.05	263.3	0.3666				
336.40	0.048	263	0.3648				
336.43	0.048	263	0.3639				
336.47	0.047	262.8	0.3621				
336.50	0.046	262.4	0.3612				
336.53	0.047	262.4	0.3612				
336.57	0.045	262.1	0.3595				
336.60	0.042	261.4	0.3595				
336.63	0.04	261.1	0.3559				
336.68	0.04	261	0.3541				
336.72	0.04	260.8	0.3541				

Prova triassiale ciclica SNGR03-C4

tensione di confinamento (kPa)		450	tensione di confinamento (kPa)		450
deviatore ciclico (kPa)		80	deviatore ciclico (kPa)		120
frequenza (hz)		0.00071429	frequenza (hz)		0.0007143
336.73	0.039	260.6	0.3533		
336.77	0.039	260.6	0.3524		
336.80	0.038	260.3	0.3506		
336.83	0.037	260.1	0.3497		
336.87	0.035	259.7	0.3479		
336.90	0.035	259.6	0.347		
336.93	0.036	259.5	0.347		
336.97	0.032	259	0.347		
337.00	0.032	259	0.3444		
337.03	0.03	258.5	0.3417		
337.07	0.029	258.2	0.3399		
337.10	0.028	258	0.3382		
337.13	0.028	257.7	0.3373		
337.17	0.026	257.4	0.3373		
337.20	0.025	257	0.3346		
337.23	0.025	257	0.3328		
337.27	0.024	256.8	0.332		
337.30	0.023	256.6	0.3311		
337.33	0.023	256.4	0.3302		
337.37	0.019	255.8	0.3257		
337.40	0.017	255.2	0.3257		
337.43	0.017	255.1	0.324		
337.47	0.017	255.1	0.3231		
337.50	0.017	254.8	0.3213		
337.53	0.015	254.5	0.3195		
337.57	0.014	254.2	0.3186		
337.60	0.015	254.2	0.3177		
337.63	0.013	253.7	0.3177		
337.67	0.007	252.9	0.3151		
337.70	0.007	252.9	0.3115		
337.73	0.009	252.8	0.3106		
337.77	0.009	252.6	0.3098		
337.80	0.007	252.2	0.308		
337.83	0.006	252	0.3062		
337.87	0.004	251.5	0.3062		
337.90	0.003	251.3	0.3035		
337.93	0.003	251.3	0.3018		
337.97	0.002	251	0.3		
338.00	0.002	250.7	0.2991		
338.03	0.002	250.6	0.2982		
338.07	-0.001	250.1	0.2947		
338.12	-0.003	249.6	0.292		
338.15	-0.006	249.1	0.2876		
338.17	-0.004	249.1	0.2867		
338.20	-0.005	248.8	0.2867		
338.23	-0.007	248.4	0.284		
338.27	-0.007	248.4	0.2805		
338.30	-0.008	248.1	0.276		
338.33	-0.009	247.7	0.2725		
338.37	-0.011	247.4	0.2689		
338.40	-0.009	247.3	0.2663		
338.43	-0.011	246.9	0.2663		
338.47	-0.017	246.1	0.2627		
338.50	-0.017	246.1	0.2556		
338.53	-0.015	246	0.253		
338.57	-0.015	245.7	0.2494		
338.60	-0.017	245.3	0.2459		
338.63	-0.015	245.3	0.2432		
338.67	-0.021	244.3	0.2432		
338.70	-0.022	244	0.237		

Prova triassiale ciclica SNGR03-C4

pressione di confinamento (kPa)		450	pressione di confinamento (kPa)		450
deviatore ciclico (kPa)		80	deviatore ciclico (kPa)		120
frequenza (hz)		0.00071429	frequenza (hz)		0.0007143
338.73	-0.022	244	0.2334		
338.77	-0.022	243.8	0.2308		
338.80	-0.023	243.5	0.2281		
338.83	-0.024	243.1	0.2254		
338.87	-0.025	242.8	0.2228		
338.90	-0.027	242.3	0.2228		
338.93	-0.029	241.9	0.2192		
338.97	-0.029	241.9	0.2166		
339.00	-0.028	241.7	0.2148		
339.03	-0.03	241.3	0.2112		
339.07	-0.032	240.8	0.2086		
339.10	-0.031	240.6	0.2068		
339.13	-0.033	240.2	0.2068		
339.17	-0.035	239.8	0.2041		
339.20	-0.035	239.8	0.2015		
339.23	-0.035	239.5	0.1988		
339.27	-0.037	238.8	0.1961		
339.30	-0.035	238.9	0.1961		
339.33	-0.038	238.4	0.1926		
339.37	-0.042	237.5	0.1926		
339.40	-0.043	237.2	0.189		
339.43	-0.043	237.2	0.1873		
339.47	-0.042	237	0.1864		
339.50	-0.043	236.7	0.1846		
339.53	-0.044	236.3	0.1828		
339.58	-0.045	236	0.1811		
339.62	-0.043	236	0.1811		
339.63	-0.047	235.4	0.1784		
339.67	-0.047	235.1	0.1775		
339.70	-0.049	234.7	0.1748		
339.73	-0.051	234.3	0.1748		
339.77	-0.051	234.3	0.1731		
339.80	-0.051	234	0.1722		
339.83	-0.052	233.6	0.1704		
339.87	-0.053	233.2	0.1686		
339.90	-0.054	232.9	0.1677		
339.93	-0.055	232.4	0.1651		
339.97	-0.057	232.1	0.1651		
340.00	-0.057	232.1	0.1642		
340.03	-0.057	231.8	0.1633		
340.07	-0.058	231.3	0.1606		
340.10	-0.062	230.7	0.1589		
340.13	-0.061	230.6	0.1589		
340.17	-0.06	230.4	0.158		
340.20	-0.063	229.9	0.158		
340.23	-0.063	229.9	0.1562		
340.27	-0.062	229.7	0.1553		
340.30	-0.063	229.3	0.1544		
340.33	-0.065	228.9	0.1526		
340.37	-0.064	228.8	0.1535		
340.40	-0.067	228.1	0.1509		
340.43	-0.068	227.9	0.1509		
340.47	-0.068	227.9	0.15		
340.50	-0.068	227.6	0.1491		
340.53	-0.069	227.3	0.1482		
340.57	-0.068	227.2	0.1482		
340.60	-0.07	226.8	0.1464		
340.63	-0.075	225.9	0.1429		
340.67	-0.074	225.8	0.1429		
340.70	-0.074	225.8	0.1429		

Prova triassiale ciclica SNGR03-C4

tensione di confinamento (kPa)		450	tensione di confinamento (kPa)		450
deviatore ciclico (kPa)		80	deviatore ciclico (kPa)		120
frequenza (hz)		0.00071429	frequenza (hz)		0.0007143
340.73	-0.073	225.6	0.142		
340.77	-0.074	225.4	0.142		
340.80	-0.074	225.2	0.1411		
340.83	-0.075	225	0.1402		
340.87	-0.077	224.5	0.1393		
340.90	-0.081	223.8	0.1393		
340.93	-0.081	223.8	0.1367		
340.97	-0.079	223.6	0.1367		
341.02	-0.078	223.4	0.1367		
341.05	-0.078	223.4	0.1358		
341.08	-0.08	223	0.1349		
341.10	-0.079	222.9	0.1349		
341.13	-0.081	222.5	0.134		
341.17	-0.083	222.2	0.1322		
341.20	-0.084	221.8	0.1313		
341.23	-0.085	221.5	0.1313		
341.27	-0.085	221.5	0.1305		
341.30	-0.085	221.3	0.1305		
341.33	-0.086	221	0.1296		
341.37	-0.086	220.7	0.1287		
341.40	-0.086	220.5	0.1278		
341.43	-0.088	220.1	0.1269		
341.47	-0.088	219.9	0.1269		
341.50	-0.088	219.9	0.126		
341.53	-0.089	219.6	0.126		
341.57	-0.089	219.3	0.1251		
341.60	-0.092	218.9	0.1234		
341.63	-0.091	218.8	0.1234		
341.67	-0.09	218.7	0.1234		
341.70	-0.091	218.5	0.1234		
341.73	-0.091	218.5	0.1234		
341.77	-0.092	218.2	0.1216		
341.80	-0.093	217.8	0.1207		
341.83	-0.095	217.5	0.1198		
341.87	-0.094	217.4	0.1198		
341.90	-0.094	217.2	0.1198		
341.93	-0.096	216.8	0.1198		
341.97	-0.096	216.8	0.118		
342.00	-0.096	216.7	0.118		
342.03	-0.096	216.5	0.118		
342.07	-0.097	216.2	0.1171		
342.10	-0.097	216	0.1171		
342.13	-0.098	215.8	0.1163		
342.17	-0.098	215.6	0.1163		
342.20	-0.098	215.6	0.1154		
342.23	-0.099	215.3	0.1154		
342.27	-0.099	215.1	0.1145		
342.30	-0.1	214.9	0.1136		
342.33	-0.1	214.7	0.1136		
342.37	-0.1	214.5	0.1136		
342.40	-0.1	214.3	0.1136		
342.43	-0.101	214.3	0.1127		
342.48	-0.101	214	0.1109		
342.52	-0.101	213.8	0.1109		
342.53	-0.102	213.8	0.1109		
342.57	-0.102	213.7	0.11		
342.60	-0.102	213.4	0.11		
342.63	-0.103	213.2	0.1092		
342.67	-0.103	213.1	0.1083		
342.70	-0.107	212.4	0.1074		

Prova triassiale ciclica SNGR03-C4

tensione di confinamento (kPa)		450	tensione di confinamento (kPa)		450
deviatore ciclico (kPa)		80	deviatore ciclico (kPa)		120
frequenza (hz)		0.00071429	frequenza (hz)		0.0007143
342.73	-0.105	212.4	0.1074		
342.77	-0.103	212.4	0.1074		
342.80	-0.103	212.6	0.1083		
342.83	-0.102	212.6	0.1083		
342.87	-0.103	212.4	0.1074		
342.90	-0.106	211.9	0.1065		
342.93	-0.105	211.8	0.1065		
342.97	-0.105	211.7	0.1065		
343.00	-0.105	211.7	0.1065		
343.03	-0.105	211.6	0.1065		
343.07	-0.105	211.5	0.1056		
343.10	-0.106	211.3	0.1047		
343.13	-0.106	211.1	0.1047		
343.17	-0.106	211	0.1047		
343.20	-0.106	210.9	0.1047		
343.23	-0.106	210.9	0.1047		
343.27	-0.106	210.8	0.1047		
343.30	-0.106	210.7	0.1047		
343.33	-0.106	210.6	0.1038		
343.37	-0.106	210.5	0.1038		
343.40	-0.106	210.4	0.1038		
343.43	-0.107	210.2	0.1038		
343.47	-0.107	210.2	0.1038		
343.50	-0.107	210.1	0.1038		
343.53	-0.107	210	0.1029		
343.57	-0.106	210	0.1029		
343.60	-0.107	209.9	0.1029		
343.63	-0.107	209.8	0.1029		
343.67	-0.107	209.7	0.1029		
343.70	-0.107	209.7	0.1029		
343.73	-0.107	209.6	0.1029		
343.77	-0.106	209.6	0.1029		
343.80	-0.108	209.3	0.1021		
343.83	-0.107	209.2	0.1021		
343.87	-0.107	209.2	0.1021		
343.92	-0.106	209.2	0.1021		
343.95	-0.106	209.2	0.1021		
343.98	-0.106	209.1	0.1021		
344.00	-0.106	209.1	0.1021		
344.03	-0.106	209.1	0.1021		
344.07	-0.106	209	0.1021		
344.10	-0.105	209	0.1021		
344.13	-0.105	208.9	0.1021		
344.17	-0.105	208.9	0.1021		
344.20	-0.105	208.9	0.1021		
344.23	-0.104	208.9	0.1021		
344.27	-0.105	208.9	0.1021		
344.30	-0.105	208.8	0.1021		
344.33	-0.104	208.8	0.1021		
344.37	-0.104	208.7	0.1021		
344.40	-0.104	208.7	0.1021		
344.43	-0.104	208.6	0.1021		
344.47	-0.104	208.6	0.1021		
344.50	-0.104	208.6	0.1021		
344.53	-0.104	208.6	0.1021		
344.57	-0.104	208.6	0.1021		
344.60	-0.103	208.6	0.1021		
344.63	-0.103	208.6	0.1021		
344.67	-0.103	208.6	0.1021		
344.70	-0.102	208.7	0.1021		

Prova triassiale ciclica SNGR03-C4

tensione di confinamento (kPa)		450	tensione di confinamento (kPa)		450
deviatore ciclico (kPa)		80	deviatore ciclico (kPa)		120
frequenza (hz)		0.00071429	frequenza (hz)		0.0007143
344.73	-0.101	208.7	0.1029		
344.77	-0.101	208.6	0.1029		
344.80	-0.101	208.7	0.1029		
344.83	-0.101	208.6	0.1029		
344.87	-0.101	208.7	0.1029		
344.90	-0.1	208.7	0.1029		
344.93	-0.1	208.6	0.1029		
344.97	-0.1	208.6	0.1029		
345.00	-0.1	208.6	0.1029		
345.03	-0.1	208.7	0.1038		
345.07	-0.098	208.8	0.1038		
345.10	-0.098	208.8	0.1038		
345.13	-0.098	208.9	0.1047		
345.17	-0.097	208.9	0.1047		
345.20	-0.096	208.9	0.1047		
345.23	-0.096	209	0.1047		
345.27	-0.094	209.3	0.1056		
345.30	-0.095	209.1	0.1056		
345.33	-0.095	209.1	0.1056		
345.38	-0.095	209.1	0.1056		
345.42	-0.095	209.1	0.1056		
345.43	-0.094	209.2	0.1056		
345.47	-0.093	209.3	0.1065		
345.50	-0.093	209.4	0.1065		
345.53	-0.091	209.4	0.1065		
345.57	-0.091	209.5	0.1074		
345.60	-0.091	209.6	0.1074		
345.63	-0.091	209.6	0.1074		
345.67	-0.09	209.8	0.1083		
345.70	-0.09	209.8	0.1083		
345.73	-0.089	209.9	0.1083		
345.77	-0.088	209.9	0.1083		
345.80	-0.088	210	0.1092		
345.83	-0.087	210.1	0.1092		
345.87	-0.086	210.2	0.11		
345.90	-0.086	210.4	0.11		
345.93	-0.085	210.5	0.1109		
345.97	-0.082	210.8	0.1109		
346.00	-0.083	210.8	0.1127		
346.03	-0.083	210.9	0.1127		
346.07	-0.083	210.9	0.1127		
346.10	-0.083	210.9	0.1127		
346.13	-0.082	211	0.1127		
346.17	-0.083	211	0.1127		
346.20	-0.081	211.2	0.1127		
346.23	-0.08	211.2	0.1136		
346.27	-0.08	211.3	0.1145		
346.30	-0.079	211.6	0.1154		
346.33	-0.078	211.7	0.1154		
346.37	-0.077	211.8	0.1163		
346.40	-0.076	212	0.1163		
346.43	-0.075	212.2	0.1163		
346.47	-0.075	212.2	0.1171		
346.50	-0.075	212.3	0.1171		
346.53	-0.074	212.4	0.118		
346.57	-0.073	212.6	0.1189		
346.60	-0.072	212.9	0.1198		
346.63	-0.071	213	0.1198		
346.67	-0.071	213.2	0.1198		
346.70	-0.069	213.2	0.1207		

Prova triassiale ciclica SNGR03-C4

tensione di confinamento (kPa)		450	tensione di confinamento (kPa)		450
deviatore ciclico (kPa)		80	deviatore ciclico (kPa)		120
frequenza (hz)		0.00071429	frequenza (hz)		0.0007143
346.73	-0.069	213.4	0.1216		
346.77	-0.069	213.5	0.1216		
346.80	-0.068	213.7	0.1225		
346.85	-0.067	213.9	0.1225		
346.88	-0.067	214	0.1234		
346.90	-0.064	214.3	0.1242		
346.93	-0.065	214.4	0.1242		
346.97	-0.064	214.6	0.1251		
347.00	-0.062	214.9	0.1251		
347.03	-0.062	214.9	0.126		
347.07	-0.062	215	0.1269		
347.10	-0.061	215.2	0.1269		
347.13	-0.059	215.5	0.1287		
347.17	-0.059	215.6	0.1287		
347.20	-0.058	215.9	0.1296		
347.23	-0.056	216.1	0.1296		
347.27	-0.056	216.1	0.1305		
347.30	-0.056	216.3	0.1313		
347.33	-0.055	216.6	0.1322		
347.37	-0.054	216.8	0.1331		
347.40	-0.051	217.3	0.1349		
347.43	-0.051	217.4	0.1349		
347.47	-0.052	217.4	0.1349		
347.50	-0.052	217.4	0.1349		
347.53	-0.052	217.5	0.1349		
347.57	-0.049	217.9	0.1367		
347.60	-0.047	218.3	0.1384		
347.63	-0.046	218.4	0.1384		
347.67	-0.046	218.6	0.1393		
347.70	-0.045	218.9	0.1393		
347.73	-0.043	218.9	0.1402		
347.77	-0.043	219.2	0.1411		
347.80	-0.043	219.4	0.142		
347.83	-0.041	219.7	0.1429		
347.87	-0.041	219.9	0.1447		
347.90	-0.039	220.2	0.1455		
347.93	-0.037	220.8	0.1455		
347.97	-0.035	220.8	0.1473		
348.00	-0.035	221.1	0.1482		
348.03	-0.037	221	0.1482		
348.07	-0.037	221.2	0.1482		
348.10	-0.035	221.5	0.15		
348.13	-0.034	222	0.1518		
348.17	-0.031	222.3	0.1518		
348.20	-0.031	222.3	0.1535		
348.23	-0.031	222.5	0.1535		
348.28	-0.028	223.1	0.1553		
348.32	-0.027	223.1	0.1562		
348.35	-0.027	223.3	0.1571		
348.37	-0.027	223.5	0.158		
348.40	-0.025	223.8	0.1597		
348.43	-0.021	224.4	0.1624		
348.47	-0.023	224.4	0.1615		
348.50	-0.025	224.4	0.1615		
348.53	-0.021	224.4	0.1624		
348.57	-0.021	224.9	0.1642		
348.60	-0.02	225.3	0.166		
348.63	-0.017	225.7	0.1677		
348.67	-0.017	226	0.1695		
348.70	-0.016	226.2	0.1704		

Prova triassiale ciclica SNGR03-C4

pressione di confinamento (kPa)		450	pressione di confinamento (kPa)		450
deviatore ciclico (kPa)		80	deviatore ciclico (kPa)		120
frequenza (hz)		0.00071429	frequenza (hz)		0.0007143
348.73	-0.014	226.6	0.1704		
348.77	-0.014	226.6	0.1722		
348.80	-0.014	226.9	0.174		
348.83	-0.012	227.2	0.1757		
348.87	-0.011	227.6	0.1775		
348.90	-0.01	227.9	0.1793		
348.93	-0.008	228.2	0.1811		
348.97	-0.007	228.5	0.1811		
349.00	-0.004	228.5	0.1828		
349.03	-0.004	229.2	0.1855		
349.07	-0.005	229.3	0.1864		
349.10	-0.007	229.3	0.1864		
349.13	-0.004	229.7	0.189		
349.17	-0.002	230.2	0.1917		
349.20	0	230.6	0.1917		
349.23	0	230.6	0.1944		
349.27	0	230.9	0.1961		
349.30	0.002	231.3	0.1988		
349.33	0.003	231.7	0.2015		
349.37	0.004	232	0.2041		
349.40	0.005	232.2	0.2059		
349.43	0.006	232.7	0.2059		
349.47	0.008	232.7	0.2086		
349.50	0.008	233	0.2112		
349.53	0.009	233.4	0.2148		
349.57	0.014	234.2	0.2201		
349.60	0.011	234.2	0.2228		
349.63	0.01	234.3	0.2245		
349.67	0.014	234.8	0.2245		
349.70	0.014	234.8	0.2272		
349.75	0.016	235.5	0.2352		
349.78	0.016	235.7	0.2352		
349.80	0.018	235.7	0.2387		
349.83	0.018	236.1	0.2441		
349.87	0.019	236.5	0.2485		
349.90	0.021	236.9	0.2538		
349.93	0.021	237.2	0.2583		
349.97	0.022	237.7	0.2645		
350.00	0.024	238.1	0.2645		
350.03	0.025	238.1	0.2689		
350.07	0.025	238.4	0.2725		
350.10	0.026	238.8	0.276		
350.13	0.028	239.1	0.2787		
350.17	0.029	239.5	0.2805		
350.20	0.028	239.7	0.2814		
350.23	0.032	240.2	0.2814		
350.27	0.034	240.2	0.2849		
350.30	0.034	240.8	0.2885		
350.33	0.033	240.8	0.2885		
350.37	0.033	241	0.2893		
350.40	0.036	241.5	0.292		
350.43	0.036	241.8	0.2938		
350.47	0.039	242.2	0.2938		
350.50	0.039	242.2	0.2964		
350.53	0.039	242.5	0.2973		
350.57	0.04	242.8	0.2991		
350.60	0.042	243.2	0.3009		
350.63	0.042	243.5	0.3027		
350.67	0.043	243.8	0.3044		
350.70	0.045	244.1	0.3044		

Prova triassiale ciclica SNGR03-C4

pressione di confinamento (kPa)		450		pressione di confinamento (kPa)		450	
deviatore ciclico (kPa)		80		deviatore ciclico (kPa)		120	
frequenza (hz)		0.00071429		frequenza (hz)		0.0007143	
350.73	0.046	244.1	0.3062				
350.77	0.046	244.5	0.308				
350.80	0.046	244.8	0.3089				
350.83	0.051	245.5	0.3133				
350.87	0.048	245.5	0.3124				
350.90	0.049	245.7	0.3133				
350.93	0.052	246.2	0.3133				
350.97	0.053	246.2	0.316				
351.00	0.053	246.5	0.3177				
351.03	0.054	246.9	0.3195				
351.07	0.055	247.3	0.3213				
351.10	0.056	247.5	0.3222				
351.13	0.056	247.8	0.324				
351.18	0.058	248.3	0.3257				
351.22	0.058	248.5	0.3266				
351.25	0.06	248.8	0.3284				
351.27	0.061	249.2	0.3284				
351.30	0.062	249.2	0.3302				
351.33	0.062	249.5	0.3311				
351.37	0.063	249.8	0.3328				
351.40	0.065	250.2	0.3346				
351.43	0.064	250.4	0.3355				
351.47	0.068	251.1	0.3399				
351.50	0.069	251.3	0.3399				
351.53	0.067	251.3	0.3408				
351.57	0.067	251.4	0.3408				
351.60	0.067	251.6	0.3417				
351.63	0.07	252	0.3435				
351.67	0.071	252.4	0.3453				
351.70	0.072	252.6	0.3462				
351.73	0.073	253	0.3462				
351.77	0.074	253	0.3479				
351.80	0.074	253.3	0.3488				
351.83	0.074	253.6	0.3506				
351.87	0.076	253.9	0.3515				
351.90	0.077	254.3	0.3533				
351.93	0.081	254.8	0.3559				
351.97	0.079	254.9	0.3559				
352.00	0.078	254.9	0.3559				
352.03	0.078	255	0.3568				
352.07	0.08	255.4	0.3586				
352.10	0.082	255.9	0.3604				
352.13	0.082	256.1	0.3612				
352.17	0.083	256.4	0.3621				
352.20	0.084	256.8	0.3621				
352.23	0.086	256.8	0.3639				
352.27	0.086	257.1	0.3648				
352.30	0.086	257.3	0.3657				
352.33	0.087	257.6	0.3675				
352.37	0.088	257.9	0.3683				
352.40	0.089	258.4	0.371				
352.43	0.092	258.8	0.371				
352.47	0.09	258.8	0.3728				
352.50	0.09	258.9	0.3728				
352.53	0.09	259.1	0.3728				
352.57	0.092	259.4	0.3746				
352.60	0.093	259.7	0.3754				
352.65	0.093	260	0.3763				
352.68	0.094	260.2	0.3781				
352.70	0.094	260.4	0.379				

Prova triassiale ciclica SNGR03-C4

pressione di confinamento (kPa)		450		pressione di confinamento (kPa)		450	
deviatore ciclico (kPa)		80		deviatore ciclico (kPa)		120	
frequenza (hz)		0.00071429		frequenza (hz)		0.0007143	
352.73	0.096	260.8	0.3799				
352.77	0.096	261	0.3799				
352.80	0.097	261	0.3808				
352.83	0.097	261.2	0.3817				
352.87	0.098	261.5	0.3825				
352.90	0.099	261.8	0.3843				
352.93	0.099	262	0.3852				
352.97	0.1	262.3	0.3861				
353.00	0.101	262.7	0.3861				
353.03	0.101	262.7	0.387				
353.07	0.101	262.9	0.3879				
353.10	0.102	263.2	0.3888				
353.13	0.102	263.4	0.3896				
353.17	0.106	263.9	0.3923				
353.20	0.104	263.9	0.3923				
353.23	0.103	264	0.3923				
353.27	0.103	264	0.3923				
353.30	0.103	264.2	0.3932				
353.33	0.105	264.6	0.3941				
353.37	0.107	264.9	0.3959				
353.40	0.107	265.2	0.3967				
353.43	0.11	265.6	0.3985				
353.47	0.108	265.6	0.3985				
353.50	0.107	265.6	0.3985				
353.53	0.107	265.7	0.3985				
353.57	0.109	266	0.3994				
353.60	0.11	266.3	0.4012				
353.63	0.11	266.5	0.4012				
353.67	0.111	266.8	0.4021				
353.70	0.111	267	0.4021				
353.73	0.112	267	0.403				
353.77	0.112	267.2	0.4039				
353.80	0.112	267.4	0.4039				
353.83	0.113	267.7	0.4047				
353.87	0.113	267.9	0.4056				
353.90	0.113	268	0.4065				
353.93	0.117	268.5	0.4065				
353.97	0.115	268.5	0.4083				
354.00	0.115	268.6	0.4083				
354.03	0.115	268.7	0.4083				
354.07	0.114	268.7	0.4083				
354.12	0.114	268.8	0.4092				
354.15	0.115	269.1	0.4101				
354.17	0.117	269.3	0.411				
354.20	0.117	269.5	0.411				
354.23	0.117	269.7	0.4118				
354.27	0.117	269.9	0.4118				
354.30	0.118	269.9	0.4118				
354.33	0.118	270.1	0.4127				
354.37	0.118	270.2	0.4136				
354.40	0.118	270.4	0.4145				
354.43	0.118	270.6	0.4145				
354.47	0.121	271	0.4163				
354.50	0.12	271.1	0.4163				
354.53	0.119	271.1	0.4163				
354.57	0.119	271.1	0.4163				
354.60	0.119	271.2	0.4163				
354.63	0.118	271.3	0.4163				
354.67	0.119	271.4	0.4172				
354.70	0.12	271.7	0.4181				

Prova triassiale ciclica SNGR03-C4

pressione di confinamento (kPa)		450		pressione di confinamento (kPa)		450	
deviatore ciclico (kPa)		80		deviatore ciclico (kPa)		120	
frequenza (hz)		0.00071429		frequenza (hz)		0.0007143	
354.73	0.121	271.8	0.4181				
354.77	0.12	271.8	0.4181				
354.80	0.12	272	0.4181				
354.83	0.121	272.1	0.4189				
354.87	0.121	272.2	0.4189				
354.90	0.121	272.4	0.4198				
354.93	0.121	272.5	0.4198				
354.97	0.121	272.6	0.4198				
355.00	0.121	272.6	0.4198				
355.03	0.121	272.7	0.4207				
355.07	0.122	272.9	0.4207				
355.10	0.121	273	0.4207				
355.13	0.121	273.1	0.4207				
355.17	0.124	273.5	0.4225				
355.20	0.122	273.4	0.4225				
355.23	0.122	273.4	0.4225				
355.27	0.122	273.5	0.4225				
355.30	0.122	273.6	0.4225				
355.33	0.121	273.6	0.4225				
355.37	0.121	273.7	0.4225				
355.40	0.121	273.7	0.4225				
355.43	0.121	273.8	0.4225				
355.47	0.121	273.8	0.4225				
355.50	0.121	273.9	0.4225				
355.55	0.122	274.2	0.4225				
355.58	0.121	274.2	0.4234				
355.60	0.121	274.2	0.4234				
355.63	0.121	274.3	0.4234				
355.67	0.121	274.4	0.4234				
355.70	0.121	274.4	0.4234				
355.73	0.121	274.5	0.4234				
355.77	0.12	274.5	0.4234				
355.80	0.12	274.5	0.4234				
355.83	0.12	274.5	0.4234				
355.87	0.12	274.6	0.4234				
355.90	0.123	274.9	0.4243				
355.93	0.12	274.8	0.4243				
355.97	0.12	274.8	0.4234				
356.00	0.119	274.8	0.4234				
356.03	0.119	274.8	0.4234				
356.07	0.119	274.8	0.4234				
356.10	0.119	274.9	0.4234				
356.13	0.119	274.9	0.4234				
356.17	0.118	274.9	0.4234				
356.20	0.118	274.9	0.4225				
356.23	0.118	274.9	0.4225				
356.27	0.117	274.9	0.4225				
356.30	0.117	275	0.4225				
356.33	0.117	275	0.4225				
356.37	0.117	275	0.4225				
356.40	0.117	275	0.4225				
356.43	0.116	275	0.4225				
356.47	0.115	275	0.4225				
356.50	0.115	275	0.4216				
356.53	0.115	275.1	0.4216				
356.57	0.115	275.1	0.4216				
356.60	0.114	275	0.4216				
356.63	0.114	275	0.4207				
356.67	0.114	275	0.4207				
356.70	0.113	274.9	0.4207				

Prova triassiale ciclica SNGR03-C4

pressione di confinamento (kPa)		450		pressione di confinamento (kPa)		450	
deviatore ciclico (kPa)		80		deviatore ciclico (kPa)		120	
frequenza (hz)		0.00071429		frequenza (hz)		0.0007143	
356.73	0.113	274.9	0.4207				
356.77	0.113	274.9	0.4207				
356.80	0.113	274.9	0.4207				
356.83	0.113	274.8	0.4198				
356.87	0.112	274.8	0.4198				
356.90	0.111	274.8	0.4198				
356.93	0.111	274.9	0.4198				
356.97	0.109	274.9	0.4198				
357.02	0.109	274.6	0.4181				
357.05	0.109	274.6	0.4181				
357.07	0.108	274.6	0.4181				
357.10	0.108	274.5	0.4172				
357.13	0.108	274.5	0.4172				
357.17	0.108	274.5	0.4172				
357.20	0.107	274.4	0.4172				
357.23	0.106	274.3	0.4163				
357.27	0.106	274.3	0.4163				
357.30	0.105	274.3	0.4163				
357.33	0.105	274.2	0.4154				
357.37	0.104	274.1	0.4145				
357.40	0.103	274	0.4145				
357.43	0.103	273.9	0.4136				
357.47	0.103	273.8	0.4136				
357.50	0.102	273.8	0.4136				
357.53	0.102	273.8	0.4127				
357.57	0.102	273.7	0.4127				
357.60	0.102	273.7	0.4127				
357.63	0.098	273.3	0.411				
357.67	0.098	273.3	0.4101				
357.70	0.098	273.2	0.4101				
357.73	0.098	273.2	0.4101				
357.77	0.097	273.1	0.4101				
357.80	0.097	273.1	0.4092				
357.83	0.096	273	0.4083				
357.87	0.095	272.7	0.4074				
357.90	0.095	272.7	0.4074				
357.93	0.094	272.6	0.4065				
357.97	0.093	272.4	0.4065				
358.00	0.093	272.4	0.4065				
358.03	0.093	272.4	0.4065				
358.07	0.092	272.2	0.4047				
358.10	0.09	272	0.4039				
358.13	0.091	272	0.4039				
358.17	0.09	271.9	0.4039				
358.20	0.085	271.3	0.4039				
358.23	0.086	271.5	0.4012				
358.27	0.086	271.5	0.4021				
358.30	0.088	271.5	0.4021				
358.33	0.088	271.2	0.4003				
358.37	0.082	270.8	0.3985				
358.40	0.084	270.8	0.3985				
358.45	0.085	270.9	0.3994				
358.48	0.085	270.6	0.3976				
358.52	0.08	270.3	0.3959				
358.53	0.081	270.2	0.3959				
358.57	0.081	270.1	0.3959				
358.60	0.081	270.1	0.395				
358.63	0.076	269.6	0.3923				
358.67	0.077	269.5	0.3923				
358.70	0.077	269.4	0.3914				

Prova triassiale ciclica SNGR03-C4

pressione di confinamento (kPa)		450	pressione di confinamento (kPa)		450
deviatore ciclico (kPa)		80	deviatore ciclico (kPa)		120
frequenza (hz)		0.00071429	frequenza (hz)		0.0007143
358.73	0.076	269.2	0.3914		
358.77	0.074	269	0.3914		
358.80	0.074	269	0.3896		
358.83	0.074	269	0.3896		
358.87	0.072	268.6	0.3879		
358.90	0.072	268.4	0.387		
358.93	0.071	268.3	0.3861		
358.97	0.07	268.1	0.3861		
359.00	0.069	267.9	0.3861		
359.03	0.068	267.7	0.3852		
359.07	0.068	267.7	0.3834		
359.10	0.067	267.5	0.3825		
359.13	0.066	267.2	0.3817		
359.17	0.065	267	0.3808		
359.20	0.064	266.8	0.3799		
359.23	0.065	266.8	0.3799		
359.27	0.061	266.2	0.3799		
359.30	0.061	266.2	0.3772		
359.33	0.06	266.1	0.3763		
359.37	0.06	265.9	0.3754		
359.40	0.058	265.7	0.3746		
359.43	0.057	265.4	0.3737		
359.47	0.056	265.2	0.3737		
359.50	0.055	264.9	0.3719		
359.53	0.055	264.9	0.371		
359.57	0.055	264.7	0.3701		
359.60	0.053	264.4	0.3683		
359.63	0.052	264.2	0.3675		
359.67	0.051	263.9	0.3666		
359.70	0.05	263.6	0.3666		
359.73	0.048	263.3	0.3648		
359.77	0.048	263.3	0.3639		
359.80	0.048	263.1	0.363		
359.83	0.047	262.9	0.3621		
359.87	0.047	262.7	0.3612		
359.92	0.045	262.4	0.3595		
359.95	0.044	262.1	0.3577		
359.97	0.043	261.8	0.3568		
360.00	0.039	261.3	0.3533		
360.03	0.039	261	0.3533		
360.07	0.039	260.9	0.3524		
360.10	0.039	260.9	0.3524		
360.13	0.038	260.7	0.3506		
360.17	0.036	260.3	0.3488		
360.20	0.035	260	0.3479		
360.23	0.034	259.8	0.347		
360.27	0.033	259.5	0.347		
360.30	0.032	259.3	0.3453		
360.33	0.032	259.3	0.3444		
360.37	0.031	259	0.3426		
360.40	0.029	258.6	0.3408		
360.43	0.028	258.4	0.3382		
360.47	0.027	258.1	0.3364		
360.50	0.026	257.7	0.3364		
360.53	0.025	257.4	0.3346		
360.57	0.025	257.4	0.3337		
360.60	0.024	257.1	0.332		
360.63	0.023	256.8	0.3302		
360.67	0.021	256.4	0.3284		
360.70	0.02	256.1	0.3257		

Prova triassiale ciclica SNGR03-C4

tensione di confinamento (kPa)		450	tensione di confinamento (kPa)		450
deviatore ciclico (kPa)		80	deviatore ciclico (kPa)		120
frequenza (hz)		0.00071429	frequenza (hz)		0.0007143
360.73	0.019	255.8	0.3257		
360.77	0.018	255.5	0.3249		
360.80	0.018	255.5	0.3231		
360.83	0.017	255.2	0.3213		
360.87	0.015	254.8	0.3195		
360.90	0.014	254.5	0.3177		
360.93	0.014	254.4	0.3177		
360.97	0.012	253.8	0.3177		
361.00	0.011	253.5	0.3142		
361.03	0.011	253.5	0.3124		
361.07	0.009	253.2	0.3115		
361.10	0.008	252.8	0.3089		
361.13	0.008	252.6	0.3089		
361.17	0.007	252.4	0.3071		
361.20	0.002	251.6	0.3071		
361.23	0.003	251.5	0.3027		
361.27	0.003	251.5	0.3018		
361.30	0.002	251.3	0.3		
361.35	0	250.7	0.2982		
361.38	0	250.7	0.2973		
361.42	0	250.5	0.2956		
361.43	-0.002	250	0.2929		
361.47	-0.004	249.7	0.2902		
361.50	-0.003	249.5	0.2885		
361.53	-0.005	249.1	0.2885		
361.57	-0.007	248.6	0.2849		
361.60	-0.007	248.6	0.2814		
361.63	-0.008	248.4	0.2778		
361.67	-0.009	248.1	0.2743		
361.70	-0.009	247.9	0.2716		
361.73	-0.01	247.6	0.2672		
361.77	-0.013	246.9	0.2672		
361.80	-0.015	246.6	0.2618		
361.83	-0.015	246.6	0.2583		
361.87	-0.015	246.4	0.2547		
361.90	-0.016	245.9	0.2503		
361.93	-0.02	245.2	0.245		
361.97	-0.019	245.1	0.2423		
362.00	-0.02	244.8	0.2423		
362.03	-0.021	244.4	0.2387		
362.07	-0.021	244.4	0.2352		
362.10	-0.022	244.2	0.2325		
362.13	-0.023	243.7	0.229		
362.17	-0.025	243.3	0.2254		
362.20	-0.026	243	0.2237		
362.23	-0.027	242.7	0.2237		
362.27	-0.028	242.3	0.221		
362.30	-0.028	242.3	0.2174		
362.33	-0.028	242	0.2157		
362.37	-0.03	241.6	0.213		
362.40	-0.032	241.1	0.2095		
362.43	-0.032	240.8	0.2077		
362.47	-0.034	240.4	0.2077		
362.50	-0.035	240	0.205		
362.53	-0.035	240	0.2024		
362.57	-0.035	239.7	0.2006		
362.60	-0.036	239.3	0.1979		
362.63	-0.036	239.1	0.197		
362.67	-0.038	238.7	0.1944		
362.70	-0.041	238	0.1944		

Prova triassiale ciclica SNGR03-C4

pressione di confinamento (kPa)		450	tensione di confinamento (kPa)		450
deviatore ciclico (kPa)		80	deviatore ciclico (kPa)		120
frequenza (hz)		0.00071429	frequenza (hz)		0.0007143
362.73	-0.041	237.8	0.1917		
362.77	-0.041	237.8	0.1899		
362.82	-0.043	237.1	0.1882		
362.85	-0.047	236.3	0.1864		
362.87	-0.047	236.3	0.1828		
362.90	-0.045	236.3	0.1828		
362.93	-0.045	236	0.1811		
362.97	-0.047	235.6	0.1793		
363.00	-0.047	235.3	0.1784		
363.03	-0.049	234.9	0.1784		
363.07	-0.051	234.4	0.1766		
363.10	-0.051	234.4	0.174		
363.13	-0.051	234.2	0.1731		
363.17	-0.052	233.8	0.1713		
363.20	-0.054	233.4	0.1704		
363.23	-0.054	233.2	0.1695		
363.27	-0.055	232.7	0.1695		
363.30	-0.057	232.4	0.1677		
363.33	-0.057	232.4	0.166		
363.37	-0.057	232.1	0.1651		
363.40	-0.058	231.7	0.1633		
363.43	-0.059	231.3	0.1624		
363.47	-0.06	231	0.1606		
363.50	-0.061	230.6	0.1606		
363.53	-0.063	230.2	0.1597		
363.57	-0.063	230.2	0.158		
363.60	-0.063	230	0.1571		
363.63	-0.064	229.6	0.1562		
363.67	-0.064	229.3	0.1553		
363.70	-0.064	229.1	0.1544		
363.73	-0.065	228.8	0.1544		
363.77	-0.071	227.8	0.1535		
363.80	-0.071	227.8	0.15		
363.83	-0.069	227.8	0.15		
363.87	-0.068	227.7	0.15		
363.90	-0.07	227.2	0.1482		
363.93	-0.071	227	0.1473		
363.97	-0.073	226.5	0.1473		
364.00	-0.071	226.5	0.1464		
364.03	-0.071	226.5	0.1464		
364.07	-0.072	226.2	0.1447		
364.10	-0.075	225.6	0.1429		
364.13	-0.076	225.3	0.142		
364.17	-0.076	225	0.1411		
364.20	-0.077	224.6	0.1411		
364.23	-0.078	224.4	0.1402		
364.28	-0.078	224.1	0.1393		
364.32	-0.078	223.9	0.1384		
364.33	-0.082	223.3	0.1384		
364.37	-0.082	223.3	0.1358		
364.40	-0.082	223	0.1358		
364.43	-0.082	222.9	0.1358		
364.47	-0.082	222.6	0.1349		
364.50	-0.082	222.4	0.134		
364.53	-0.084	222	0.1331		
364.57	-0.084	221.8	0.1331		
364.60	-0.084	221.8	0.1322		
364.63	-0.085	221.6	0.1313		
364.67	-0.086	221.2	0.1305		
364.70	-0.087	220.9	0.1305		

Prova triassiale ciclica SNGR03-C4

tensione di confinamento (kPa)		450	tensione di confinamento (kPa)		450
deviatore ciclico (kPa)		80	deviatore ciclico (kPa)		120
frequenza (hz)		0.00071429	frequenza (hz)		0.0007143
364.73	-0.087	220.7	0.1296		
364.77	-0.088	220.4	0.1287		
364.80	-0.087	220.3	0.1287		
364.83	-0.087	220.3	0.1287		
364.87	-0.088	220.1	0.1278		
364.90	-0.089	219.6	0.1269		
364.93	-0.091	219.3	0.126		
364.97	-0.091	219.1	0.1251		
365.00	-0.091	218.9	0.1251		
365.03	-0.092	218.6	0.1251		
365.07	-0.092	218.6	0.1242		
365.10	-0.093	218.3	0.1234		
365.13	-0.093	218.1	0.1234		
365.17	-0.093	217.9	0.1225		
365.20	-0.094	217.6	0.1216		
365.23	-0.095	217.3	0.1207		
365.27	-0.095	217.1	0.1207		
365.30	-0.095	217.1	0.1207		
365.33	-0.095	217	0.1198		
365.37	-0.097	216.6	0.1189		
365.40	-0.097	216.4	0.1189		
365.43	-0.097	216.2	0.118		
365.47	-0.098	216	0.118		
365.50	-0.098	215.8	0.118		
365.53	-0.098	215.8	0.1171		
365.57	-0.099	215.5	0.1163		
365.60	-0.1	215.3	0.1163		
365.63	-0.1	215.1	0.1154		
365.67	-0.099	215	0.1154		
365.72	-0.099	214.8	0.1154		
365.75	-0.1	214.6	0.1145		
365.78	-0.101	214.4	0.1145		
365.80	-0.105	213.7	0.1109		
365.83	-0.103	213.7	0.1109		
365.87	-0.103	213.7	0.1127		
365.90	-0.103	213.6	0.1127		
365.93	-0.103	213.6	0.1109		
365.97	-0.103	213.4	0.1109		
366.00	-0.103	213.2	0.11		
366.03	-0.103	213	0.11		
366.07	-0.104	212.9	0.11		
366.10	-0.104	212.9	0.11		
366.13	-0.105	212.6	0.1092		
366.17	-0.104	212.5	0.1092		
366.20	-0.104	212.4	0.1092		
366.23	-0.104	212.4	0.1092		
366.27	-0.103	212.3	0.1092		
366.30	-0.105	212	0.1092		
366.33	-0.105	212	0.1083		
366.37	-0.104	211.9	0.1083		
366.40	-0.105	211.7	0.1074		
366.43	-0.106	211.5	0.1074		
366.47	-0.106	211.4	0.1065		
366.50	-0.106	211.2	0.1065		
366.53	-0.106	211.1	0.1065		
366.57	-0.106	211.1	0.1065		
366.60	-0.106	211	0.1065		
366.63	-0.106	210.9	0.1065		
366.67	-0.107	210.8	0.1056		
366.70	-0.107	210.6	0.1056		

Prova triassiale ciclica SNGR03-C4

tensione di confinamento (kPa)		450	tensione di confinamento (kPa)		450
deviatore ciclico (kPa)		80	deviatore ciclico (kPa)		120
frequenza (hz)		0.00071429	frequenza (hz)		0.0007143
366.73	-0.107	210.5	0.1056		
366.77	-0.106	210.5	0.1056		
366.80	-0.106	210.5	0.1056		
366.83	-0.106	210.4	0.1056		
366.87	-0.106	210.3	0.1056		
366.90	-0.107	210.1	0.1047		
366.93	-0.107	210.1	0.1047		
366.97	-0.107	209.9	0.1047		
367.00	-0.107	209.8	0.1047		
367.03	-0.107	209.8	0.1047		
367.07	-0.107	209.8	0.1047		
367.10	-0.107	209.7	0.1038		
367.13	-0.107	209.7	0.1038		
367.18	-0.106	209.6	0.1038		
367.22	-0.106	209.6	0.1038		
367.23	-0.106	209.5	0.1038		
367.27	-0.106	209.4	0.1038		
367.30	-0.106	209.4	0.1038		
367.33	-0.106	209.3	0.1038		
367.37	-0.106	209.3	0.1038		
367.40	-0.106	209.2	0.1038		
367.43	-0.106	209.1	0.1038		
367.47	-0.106	209.1	0.1038		
367.50	-0.106	209	0.1038		
367.53	-0.106	209	0.1038		
367.57	-0.106	208.9	0.1038		
367.60	-0.105	208.9	0.1038		
367.63	-0.105	208.9	0.1038		
367.67	-0.105	209	0.1038		
367.70	-0.104	208.9	0.1038		
367.73	-0.104	208.9	0.1038		
367.77	-0.104	208.9	0.1038		
367.80	-0.104	208.9	0.1038		
367.83	-0.104	208.9	0.1038		
367.87	-0.104	208.8	0.1038		
367.90	-0.103	208.8	0.1038		
367.93	-0.103	208.8	0.1038		
367.97	-0.102	208.8	0.1047		
368.00	-0.102	208.8	0.1047		
368.03	-0.102	208.9	0.1047		
368.07	-0.103	208.9	0.1047		
368.10	-0.103	208.7	0.1038		
368.13	-0.103	208.7	0.1038		
368.17	-0.102	208.7	0.1047		
368.20	-0.1	208.9	0.1047		
368.23	-0.1	208.9	0.1056		
368.27	-0.098	209.1	0.1056		
368.30	-0.097	209.1	0.1065		
368.33	-0.097	209.2	0.1065		
368.37	-0.098	209.1	0.1065		
368.40	-0.098	209.1	0.1065		
368.43	-0.101	208.7	0.1047		
368.47	-0.1	208.8	0.1056		
368.50	-0.096	209.2	0.1056		
368.53	-0.097	209.2	0.1065		
368.57	-0.097	209.2	0.1065		
368.62	-0.096	209.2	0.1065		
368.65	-0.096	209.2	0.1065		
368.68	-0.096	209.2	0.1074		
368.70	-0.095	209.4	0.1083		

Prova triassiale ciclica SNGR03-C4

tensione di confinamento (kPa)		450	tensione di confinamento (kPa)		450
deviatore ciclico (kPa)		80	deviatore ciclico (kPa)		120
frequenza (hz)		0.00071429	frequenza (hz)		0.0007143
368.73	-0.091	209.8	0.1092		
368.77	-0.092	209.8	0.1092		
368.80	-0.092	209.7	0.1092		
368.83	-0.093	209.7	0.1092		
368.87	-0.093	209.7	0.1092		
368.90	-0.093	209.6	0.1083		
368.93	-0.093	209.6	0.1092		
368.97	-0.091	209.9	0.11		
369.00	-0.09	210	0.11		
369.03	-0.089	210.1	0.11		
369.07	-0.089	210.2	0.11		
369.10	-0.088	210.2	0.1109		
369.13	-0.088	210.2	0.1109		
369.17	-0.087	210.4	0.1127		
369.20	-0.086	210.5	0.1127		
369.23	-0.086	210.6	0.1127		
369.27	-0.086	210.6	0.1127		
369.30	-0.085	210.8	0.1127		
369.33	-0.084	210.8	0.1136		
369.37	-0.084	210.9	0.1145		
369.40	-0.083	211	0.1145		
369.43	-0.082	211.2	0.1154		
369.47	-0.081	211.3	0.1154		
369.50	-0.081	211.5	0.1163		
369.53	-0.081	211.5	0.1163		
369.57	-0.08	211.5	0.1163		
369.60	-0.08	211.7	0.1171		
369.63	-0.079	211.9	0.1171		
369.67	-0.077	212.1	0.118		
369.70	-0.077	212.2	0.118		
369.73	-0.077	212.2	0.1189		
369.77	-0.076	212.5	0.1189		
369.80	-0.074	212.5	0.1189		
369.83	-0.074	212.6	0.1198		
369.87	-0.074	212.8	0.1198		
369.90	-0.073	212.9	0.1207		
369.93	-0.073	213	0.1207		
369.97	-0.071	213.3	0.1216		
370.00	-0.071	213.4	0.1216		
370.03	-0.071	213.4	0.1225		
370.08	-0.07	213.7	0.1225		
370.12	-0.068	213.9	0.1225		
370.13	-0.067	213.9	0.1242		
370.17	-0.067	214	0.1242		
370.20	-0.067	214.2	0.1251		
370.23	-0.065	214.5	0.126		
370.27	-0.065	214.6	0.1269		
370.30	-0.061	215.2	0.1287		
370.33	-0.061	215.4	0.1287		
370.37	-0.061	215.4	0.1287		
370.40	-0.061	215.4	0.1287		
370.43	-0.062	215.4	0.1287		
370.47	-0.06	215.7	0.1305		
370.50	-0.059	215.8	0.1305		
370.53	-0.057	216.2	0.1313		
370.57	-0.057	216.4	0.1313		
370.60	-0.058	216.4	0.1322		
370.63	-0.058	216.4	0.1322		
370.67	-0.056	216.7	0.1331		
370.70	-0.054	217	0.134		

Prova triassiale ciclica SNGR03-C4

tensione di confinamento (kPa)		450	tensione di confinamento (kPa)		450
deviatore ciclico (kPa)		80	deviatore ciclico (kPa)		120
frequenza (hz)		0.00071429	frequenza (hz)		0.0007143
370.73	-0.052	217.2	0.1349		
370.77	-0.053	217.4	0.1358		
370.80	-0.051	217.7	0.1358		
370.83	-0.05	217.7	0.1367		
370.87	-0.05	217.9	0.1376		
370.90	-0.05	218.1	0.1384		
370.93	-0.048	218.4	0.1393		
370.97	-0.046	218.7	0.1402		
371.00	-0.046	218.9	0.1411		
371.03	-0.045	219.1	0.1411		
371.07	-0.044	219.1	0.142		
371.10	-0.044	219.4	0.1429		
371.13	-0.042	219.8	0.1447		
371.17	-0.041	220	0.1455		
371.20	-0.04	220.2	0.1464		
371.23	-0.04	220.5	0.1473		
371.27	-0.037	221	0.1473		
371.30	-0.035	221	0.15		
371.33	-0.035	221.4	0.1509		
371.37	-0.035	221.5	0.1509		
371.40	-0.035	221.6	0.1518		
371.43	-0.034	221.9	0.1526		
371.47	-0.033	222.2	0.1535		
371.52	-0.033	222.3	0.1535		
371.55	-0.032	222.5	0.1553		
371.58	-0.03	222.9	0.1562		
371.60	-0.028	223.4	0.1562		
371.63	-0.028	223.4	0.158		
371.67	-0.028	223.5	0.1589		
371.70	-0.027	223.8	0.1597		
371.73	-0.025	224.1	0.1615		
371.77	-0.024	224.5	0.1633		
371.80	-0.023	224.7	0.1642		
371.83	-0.022	225.1	0.1642		
371.87	-0.021	225.1	0.1651		
371.90	-0.021	225.4	0.1669		
371.93	-0.02	225.6	0.1686		
371.97	-0.018	226	0.1704		
372.00	-0.017	226.3	0.1713		
372.03	-0.017	226.6	0.1731		
372.07	-0.015	226.9	0.1731		
372.10	-0.011	226.9	0.1748		
372.13	-0.011	227.6	0.1775		
372.17	-0.013	227.6	0.1775		
372.20	-0.013	227.7	0.1784		
372.23	-0.011	228	0.1802		
372.27	-0.01	228.4	0.1819		
372.30	-0.007	229	0.1819		
372.33	-0.007	229	0.1846		
372.37	-0.007	229.2	0.1864		
372.40	-0.006	229.5	0.1882		
372.43	-0.004	230	0.1899		
372.47	-0.004	230.2	0.1917		
372.50	-0.002	230.6	0.1944		
372.53	0.003	231.4	0.1944		
372.57	0.001	231.4	0.1988		
372.60	0.001	231.4	0.1997		
372.63	0.002	231.7	0.2015		
372.67	0.004	232.1	0.2041		
372.70	0.004	232.3	0.2059		

Prova triassiale ciclica SNGR03-C4

pressione di confinamento (kPa)		450		pressione di confinamento (kPa)		450	
deviatore ciclico (kPa)		80		deviatore ciclico (kPa)		120	
frequenza (hz)		0.00071429		frequenza (hz)		0.0007143	
372.73	0.003	232.4	0.2068				
372.77	0.007	233	0.2068				
372.80	0.007	233	0.2103				
372.83	0.007	233.3	0.213				
372.87	0.009	233.7	0.2166				
372.90	0.011	234.1	0.2201				
372.93	0.012	234.4	0.2228				
372.98	0.012	234.7	0.2254				
373.02	0.013	235.1	0.229				
373.03	0.014	235.4	0.2325				
373.07	0.015	235.7	0.2361				
373.10	0.017	236.2	0.2361				
373.13	0.018	236.2	0.2405				
373.17	0.018	236.5	0.245				
373.20	0.019	236.8	0.2494				
373.23	0.02	237.3	0.2538				
373.27	0.022	237.7	0.2592				
373.30	0.022	237.9	0.2636				
373.33	0.026	238.8	0.2636				
373.37	0.026	238.8	0.2707				
373.40	0.026	238.9	0.2734				
373.43	0.026	239.2	0.2751				
373.47	0.026	239.4	0.2769				
373.50	0.028	239.7	0.2787				
373.53	0.029	240.1	0.2822				
373.57	0.031	240.5	0.2822				
373.60	0.033	240.5	0.2849				
373.63	0.033	240.8	0.2867				
373.67	0.033	241.1	0.2885				
373.70	0.034	241.5	0.2902				
373.73	0.035	241.8	0.292				
373.77	0.037	242.2	0.2947				
373.80	0.039	242.7	0.2947				
373.83	0.039	242.7	0.2964				
373.87	0.039	242.8	0.2973				
373.90	0.04	243.2	0.2991				
373.93	0.042	243.5	0.3018				
373.97	0.046	244.2	0.3053				
374.00	0.043	244.3	0.3044				
374.03	0.042	244.3	0.3044				
374.07	0.046	244.3	0.3053				
374.10	0.046	244.8	0.3071				
374.13	0.046	245.1	0.3089				
374.17	0.048	245.5	0.3106				
374.20	0.049	245.9	0.3133				
374.23	0.05	246.2	0.3142				
374.27	0.052	246.6	0.3142				
374.30	0.052	246.6	0.316				
374.33	0.052	246.8	0.3177				
374.37	0.053	247.2	0.3195				
374.40	0.055	247.7	0.3213				
374.45	0.056	248	0.3231				
374.48	0.056	248.2	0.324				
374.50	0.06	248.8	0.3266				
374.53	0.058	248.9	0.3266				
374.57	0.058	249.1	0.3284				
374.60	0.062	249.8	0.3284				
374.63	0.063	249.8	0.3311				
374.67	0.063	250.1	0.332				
374.70	0.063	250.3	0.3337				

Prova triassiale ciclica SNGR03-C4

pressione di confinamento (kPa)		450		pressione di confinamento (kPa)		450	
deviatore ciclico (kPa)		80		deviatore ciclico (kPa)		120	
frequenza (hz)		0.00071429		frequenza (hz)		0.0007143	
374.73	0.064	250.6	0.3346				
374.77	0.065	250.9	0.3364				
374.80	0.066	251.2	0.3373				
374.83	0.068	251.5	0.3373				
374.87	0.068	251.5	0.3399				
374.90	0.068	251.7	0.3408				
374.93	0.069	252.1	0.3426				
374.97	0.07	252.4	0.3444				
375.00	0.071	252.8	0.3453				
375.03	0.072	253.1	0.347				
375.07	0.075	253.5	0.347				
375.10	0.073	253.5	0.3488				
375.13	0.073	253.6	0.3497				
375.17	0.075	254	0.3515				
375.20	0.076	254.3	0.3524				
375.23	0.077	254.7	0.3541				
375.27	0.077	254.9	0.355				
375.30	0.079	255.3	0.355				
375.33	0.079	255.3	0.3559				
375.37	0.079	255.5	0.3577				
375.40	0.081	255.9	0.3586				
375.43	0.082	256.3	0.3604				
375.47	0.082	256.5	0.3612				
375.50	0.083	256.8	0.363				
375.53	0.084	257.1	0.363				
375.57	0.085	257.1	0.3639				
375.60	0.085	257.5	0.3657				
375.63	0.086	257.7	0.3666				
375.67	0.088	258.1	0.3683				
375.70	0.087	258.3	0.3692				
375.73	0.088	258.6	0.3701				
375.77	0.09	259	0.3701				
375.80	0.093	259	0.3728				
375.83	0.093	259.5	0.3746				
375.88	0.09	259.6	0.3737				
375.92	0.091	259.6	0.3746				
375.95	0.091	259.9	0.3754				
375.97	0.093	260.2	0.3772				
376.00	0.094	260.6	0.3781				
376.03	0.095	260.8	0.379				
376.07	0.095	261.1	0.3799				
376.10	0.096	261.4	0.3799				
376.13	0.097	261.4	0.3808				
376.17	0.097	261.6	0.3817				
376.20	0.097	261.9	0.3834				
376.23	0.099	262.2	0.3843				
376.27	0.099	262.5	0.3852				
376.30	0.1	262.7	0.3861				
376.33	0.1	263	0.3861				
376.37	0.103	263	0.387				
376.40	0.103	263.6	0.3896				
376.43	0.102	263.6	0.3896				
376.47	0.102	263.8	0.3905				
376.50	0.102	263.9	0.3905				
376.53	0.102	264.1	0.3914				
376.57	0.105	264.6	0.3914				
376.60	0.105	264.6	0.3932				
376.63	0.105	264.8	0.3941				
376.67	0.105	265	0.395				
376.70	0.106	265.3	0.3959				

Prova triassiale ciclica SNGR03-C4

pressione di confinamento (kPa)		450	pressione di confinamento (kPa)		450
deviatore ciclico (kPa)		80	deviatore ciclico (kPa)		120
frequenza (hz)		0.00071429	frequenza (hz)		0.0007143
376.73	0.107	265.5	0.3967		
376.77	0.108	265.8	0.3976		
376.80	0.108	266	0.3976		
376.83	0.108	266	0.3985		
376.87	0.108	266.2	0.3985		
376.90	0.109	266.4	0.3994		
376.93	0.11	266.7	0.4012		
376.97	0.11	266.9	0.4012		
377.00	0.111	267.1	0.4021		
377.03	0.111	267.4	0.4021		
377.07	0.112	267.4	0.403		
377.10	0.112	267.6	0.4039		
377.13	0.112	267.8	0.4047		
377.17	0.113	268	0.4056		
377.20	0.113	268.2	0.4074		
377.23	0.115	268.5	0.4074		
377.27	0.114	268.6	0.4074		
377.30	0.114	268.6	0.4074		
377.35	0.114	269	0.4083		
377.38	0.115	269.2	0.4083		
377.40	0.115	269.2	0.4092		
377.43	0.115	269.4	0.4101		
377.47	0.116	269.5	0.4101		
377.50	0.116	269.7	0.411		
377.53	0.117	269.9	0.4118		
377.57	0.117	270.1	0.4118		
377.60	0.117	270.3	0.4118		
377.63	0.118	270.3	0.4127		
377.67	0.118	270.5	0.4145		
377.70	0.12	270.9	0.4154		
377.73	0.12	271	0.4154		
377.77	0.119	271.1	0.4154		
377.80	0.118	271.1	0.4154		
377.83	0.117	271.2	0.4154		
377.87	0.118	271.2	0.4154		
377.90	0.118	271.3	0.4154		
377.93	0.119	271.6	0.4172		
377.97	0.12	271.8	0.4172		
378.00	0.12	271.9	0.4172		
378.03	0.122	272.3	0.4189		
378.07	0.122	272.4	0.4189		
378.10	0.12	272.4	0.4189		
378.13	0.12	272.4	0.4189		
378.17	0.12	272.5	0.4189		
378.20	0.12	272.5	0.4189		
378.23	0.12	272.6	0.4189		
378.27	0.12	272.8	0.4198		
378.30	0.121	273	0.4198		
378.33	0.122	273	0.4198		
378.37	0.122	273.2	0.4207		
378.40	0.121	273.3	0.4207		
378.43	0.121	273.4	0.4207		
378.47	0.121	273.5	0.4216		
378.50	0.122	273.6	0.4216		
378.53	0.122	273.7	0.4216		
378.57	0.122	273.7	0.4216		
378.60	0.122	273.8	0.4216		
378.63	0.121	273.9	0.4225		
378.67	0.124	274.2	0.4234		
378.70	0.122	274.2	0.4234		

Prova triassiale ciclica SNGR03-C4

pressione di confinamento (kPa)		450	pressione di confinamento (kPa)		450
deviatore ciclico (kPa)		80	deviatore ciclico (kPa)		120
frequenza (hz)		0.00071429	frequenza (hz)		0.0007143
378.73	0.122	274.2	0.4225		
378.78	0.121	274.2	0.4234		
378.82	0.122	274.4	0.4234		
378.85	0.121	274.4	0.4234		
378.87	0.121	274.4	0.4234		
378.90	0.12	274.4	0.4234		
378.93	0.12	274.5	0.4225		
378.97	0.12	274.6	0.4234		
379.00	0.12	274.6	0.4234		
379.03	0.12	274.7	0.4234		
379.07	0.121	274.9	0.4243		
379.10	0.122	275.2	0.4243		
379.13	0.122	275.2	0.4243		
379.17	0.122	275.2	0.4243		
379.20	0.121	275.2	0.4243		
379.23	0.12	275.1	0.4234		
379.27	0.12	275.1	0.4234		
379.30	0.12	275.2	0.4234		
379.33	0.119	275.2	0.4234		
379.37	0.119	275.2	0.4234		
379.40	0.119	275.3	0.4234		
379.43	0.119	275.3	0.4234		
379.47	0.118	275.3	0.4234		
379.50	0.118	275.3	0.4234		
379.53	0.118	275.3	0.4234		
379.57	0.118	275.4	0.4234		
379.60	0.118	275.4	0.4234		
379.63	0.118	275.4	0.4234		
379.67	0.119	275.5	0.4234		
379.70	0.118	275.6	0.4234		
379.73	0.115	275.3	0.4216		
379.77	0.115	275.3	0.4216		
379.80	0.115	275.4	0.4216		
379.83	0.115	275.4	0.4216		
379.87	0.115	275.4	0.4216		
379.90	0.115	275.4	0.4216		
379.93	0.115	275.4	0.4216		
379.97	0.115	275.4	0.4216		
380.00	0.115	275.5	0.4207		
380.03	0.113	275.3	0.4207		
380.07	0.112	275.3	0.4207		
380.10	0.112	275.3	0.4207		
380.13	0.112	275.3	0.4198		
380.17	0.112	275.3	0.4198		
380.20	0.112	275.3	0.4198		
380.25	0.111	275.2	0.4198		
380.28	0.111	275.2	0.4198		
380.30	0.111	275.2	0.4189		
380.33	0.109	275	0.4181		
380.37	0.108	274.9	0.4181		
380.40	0.108	274.9	0.4181		
380.43	0.108	274.9	0.4181		
380.47	0.108	274.9	0.4172		
380.50	0.108	274.8	0.4172		
380.53	0.107	274.7	0.4172		
380.57	0.106	274.7	0.4163		
380.60	0.105	274.6	0.4163		
380.63	0.105	274.6	0.4154		
380.67	0.105	274.6	0.4154		
380.70	0.104	274.4	0.4145		

Prova triassiale ciclica SNGR03-C4

tensione di confinamento (kPa)		450	tensione di confinamento (kPa)		450
deviatore ciclico (kPa)		80	deviatore ciclico (kPa)		120
frequenza (hz)		0.00071429	frequenza (hz)		0.0007143
380.73	0.104	274.4	0.4145		
380.77	0.103	274.3	0.4136		
380.80	0.102	274.2	0.4136		
380.83	0.102	274.1	0.4136		
380.87	0.101	274.1	0.4136		
380.90	0.101	274.1	0.4127		
380.93	0.102	274.1	0.4127		
380.97	0.099	273.8	0.411		
381.00	0.098	273.7	0.411		
381.03	0.098	273.6	0.411		
381.07	0.098	273.6	0.411		
381.10	0.096	273.6	0.4101		
381.13	0.096	273.4	0.4092		
381.17	0.096	273.3	0.4092		
381.20	0.095	273.2	0.4083		
381.23	0.096	273.2	0.4083		
381.27	0.095	273.1	0.4083		
381.30	0.093	272.8	0.4083		
381.33	0.092	272.8	0.4065		
381.37	0.092	272.7	0.4056		
381.40	0.091	272.5	0.4056		
381.43	0.091	272.4	0.4047		
381.47	0.088	272.1	0.403		
381.50	0.088	272	0.403		
381.53	0.089	272	0.403		
381.57	0.088	272	0.403		
381.60	0.088	271.8	0.4021		
381.63	0.087	271.7	0.4012		
381.67	0.086	271.5	0.4003		
381.72	0.084	271.4	0.3994		
381.75	0.083	271.2	0.3985		
381.77	0.083	271.1	0.3985		
381.80	0.082	270.8	0.3976		
381.83	0.082	270.8	0.3967		
381.87	0.082	270.7	0.3967		
381.90	0.08	270.5	0.3967		
381.93	0.08	270.5	0.3959		
381.97	0.078	270	0.3932		
382.00	0.075	269.8	0.3923		
382.03	0.076	269.8	0.3923		
382.07	0.078	269.8	0.3923		
382.10	0.076	269.6	0.3923		
382.13	0.071	269.1	0.3914		
382.17	0.071	269.1	0.3888		
382.20	0.073	269.1	0.3888		
382.23	0.073	269	0.3888		
382.27	0.071	268.7	0.387		
382.30	0.07	268.5	0.3861		
382.33	0.07	268.4	0.3861		
382.37	0.069	268.2	0.3861		
382.40	0.069	268.2	0.3852		
382.43	0.067	267.9	0.3834		
382.47	0.063	267.3	0.3808		
382.50	0.063	267.3	0.3799		
382.53	0.064	267.2	0.3799		
382.57	0.063	267	0.3799		
382.60	0.062	266.7	0.379		
382.63	0.062	266.7	0.3781		
382.67	0.061	266.4	0.3772		
382.70	0.06	266.2	0.3754		

Prova triassiale ciclica SNGR03-C4

pressione di confinamento (kPa)		450		pressione di confinamento (kPa)		450	
deviatore ciclico (kPa)		80		deviatore ciclico (kPa)		120	
frequenza (hz)		0.00071429		frequenza (hz)		0.0007143	
382.73	0.058	265.9	0.3746				
382.77	0.058	265.8	0.3746				
382.80	0.059	265.8	0.3746				
382.83	0.053	265.1	0.3737				
382.87	0.053	265.1	0.371				
382.90	0.054	265	0.3701				
382.93	0.053	264.8	0.3692				
382.97	0.052	264.6	0.3675				
383.00	0.052	264.4	0.3675				
383.03	0.049	263.8	0.3675				
383.07	0.048	263.6	0.3648				
383.10	0.048	263.6	0.3639				
383.15	0.049	263.5	0.3639				
383.18	0.046	263.1	0.363				
383.22	0.046	263.1	0.3612				
383.23	0.045	262.8	0.3595				
383.27	0.044	262.5	0.3586				
383.30	0.042	262.2	0.3568				
383.33	0.042	261.9	0.3559				
383.37	0.04	261.4	0.3559				
383.40	0.036	261	0.3524				
383.43	0.036	261	0.3506				
383.47	0.037	260.9	0.3506				
383.50	0.037	260.7	0.3497				
383.53	0.034	260.4	0.3479				
383.57	0.035	260.2	0.3479				
383.60	0.034	259.9	0.3479				
383.63	0.032	259.6	0.3462				
383.67	0.032	259.6	0.3444				
383.70	0.032	259.5	0.3435				
383.73	0.028	258.8	0.3399				
383.77	0.028	258.6	0.3382				
383.80	0.028	258.4	0.3373				
383.83	0.026	258	0.3373				
383.87	0.026	257.9	0.3355				
383.90	0.026	257.9	0.3346				
383.93	0.025	257.6	0.3328				
383.97	0.02	256.8	0.3293				
384.00	0.021	256.7	0.3284				
384.03	0.021	256.5	0.3266				
384.07	0.018	256	0.3266				
384.10	0.018	255.8	0.3249				
384.13	0.018	255.8	0.3231				
384.17	0.017	255.5	0.3222				
384.20	0.015	255.1	0.3195				
384.23	0.016	255	0.3195				
384.27	0.014	254.7	0.3177				
384.30	0.012	254.2	0.3177				
384.33	0.01	253.5	0.3151				
384.37	0.01	253.5	0.3115				
384.40	0.007	253.2	0.3089				
384.43	0.007	253	0.3089				
384.47	0.008	252.8	0.308				
384.50	0.006	252.5	0.3062				
384.53	0.007	252.5	0.3062				
384.57	0.001	251.6	0.3062				
384.62	0.002	251.5	0.3				
384.65	0.002	251.3	0.3				
384.67	0.003	251.3	0.2991				
384.70	0.003	251.3	0.2991				

Prova triassiale ciclica SNGR03-C4

tensione di confinamento (kPa)		450	tensione di confinamento (kPa)		450
deviatore ciclico (kPa)		80	deviatore ciclico (kPa)		120
frequenza (hz)		0.00071429	frequenza (hz)		0.0007143
384.73	0	250.9	0.2964		
384.77	-0.002	250.4	0.2938		
384.80	-0.004	250	0.2911		
384.83	-0.004	249.7	0.2885		
384.87	-0.006	249.3	0.2885		
384.90	-0.006	249	0.2858		
384.93	-0.006	249	0.2822		
384.97	-0.008	248.6	0.2787		
385.00	-0.009	248.3	0.2751		
385.03	-0.011	248	0.2707		
385.07	-0.012	247.3	0.2654		
385.10	-0.012	247.1	0.2654		
385.13	-0.012	246.9	0.2627		
385.17	-0.012	246.9	0.2601		
385.20	-0.015	246.6	0.2556		
385.23	-0.017	246.1	0.2512		
385.27	-0.021	245.4	0.245		
385.30	-0.019	245.4	0.2432		
385.33	-0.016	245.5	0.2432		
385.37	-0.02	244.9	0.2423		
385.40	-0.02	244.9	0.2387		
385.43	-0.021	244.5	0.2343		
385.47	-0.023	244.1	0.2308		
385.50	-0.025	243.6	0.2281		
385.53	-0.025	243.4	0.2254		
385.57	-0.027	242.9	0.2254		
385.60	-0.028	242.6	0.2228		
385.63	-0.028	242.6	0.2201		
385.67	-0.029	242.3	0.2174		
385.70	-0.03	241.8	0.2139		
385.73	-0.032	241.4	0.2112		
385.77	-0.033	241.1	0.2095		
385.80	-0.033	240.7	0.2095		
385.83	-0.037	240	0.2068		
385.87	-0.037	240	0.2032		
385.90	-0.035	240	0.2024		
385.93	-0.034	239.8	0.2015		
385.97	-0.038	239.3	0.1979		
386.00	-0.039	238.9	0.1961		
386.05	-0.04	238.4	0.1935		
386.08	-0.041	238.1	0.1926		
386.12	-0.041	237.8	0.1899		
386.13	-0.043	237.3	0.1899		
386.17	-0.044	237	0.1882		
386.20	-0.044	237	0.1864		
386.23	-0.045	236.6	0.1846		
386.27	-0.046	236.2	0.1828		
386.30	-0.047	235.9	0.1811		
386.33	-0.048	235.5	0.1793		
386.37	-0.049	235.2	0.1793		
386.40	-0.051	234.8	0.1784		
386.43	-0.051	234.8	0.1766		
386.47	-0.051	234.4	0.1748		
386.50	-0.052	234.2	0.174		
386.53	-0.054	233.7	0.1722		
386.57	-0.054	233.4	0.1713		
386.60	-0.055	233	0.1713		
386.63	-0.056	232.6	0.1695		
386.67	-0.056	232.6	0.1677		
386.70	-0.057	232.3	0.1669		

Prova triassiale ciclica SNGR03-C4

tensione di confinamento (kPa)		450	tensione di confinamento (kPa)		450
deviatore ciclico (kPa)		80	deviatore ciclico (kPa)		120
frequenza (hz)		0.00071429	frequenza (hz)		0.0007143
386.73	-0.059	231.9	0.1651		
386.77	-0.059	231.6	0.1642		
386.80	-0.06	231.3	0.1633		
386.83	-0.061	230.9	0.1633		
386.87	-0.062	230.5	0.1615		
386.90	-0.062	230.5	0.1606		
386.93	-0.063	230.2	0.1589		
386.97	-0.064	229.9	0.158		
387.00	-0.064	229.5	0.1571		
387.03	-0.066	229.1	0.1553		
387.07	-0.066	228.6	0.1553		
387.10	-0.07	228.1	0.1535		
387.13	-0.07	228.1	0.1518		
387.17	-0.069	227.9	0.1518		
387.20	-0.069	227.8	0.1518		
387.23	-0.069	227.5	0.15		
387.27	-0.071	227.1	0.1491		
387.30	-0.073	226.7	0.1491		
387.33	-0.072	226.6	0.1482		
387.37	-0.072	226.6	0.1473		
387.40	-0.072	226.4	0.1473		
387.43	-0.074	225.9	0.1455		
387.47	-0.079	225.1	0.1429		
387.52	-0.078	225	0.1429		
387.55	-0.076	224.9	0.1429		
387.57	-0.077	224.7	0.142		
387.60	-0.077	224.5	0.1411		
387.63	-0.079	224	0.1393		
387.67	-0.081	223.6	0.1393		
387.70	-0.081	223.6	0.1393		
387.73	-0.08	223.5	0.1384		
387.77	-0.081	223.2	0.1376		
387.80	-0.082	222.9	0.1367		
387.83	-0.083	222.6	0.1367		
387.87	-0.084	222.3	0.1349		
387.90	-0.084	222	0.1349		
387.93	-0.084	222	0.1349		
387.97	-0.085	221.7	0.1331		
388.00	-0.087	221.3	0.1322		
388.03	-0.087	221.1	0.1322		
388.07	-0.087	220.8	0.1313		
388.10	-0.088	220.5	0.1305		
388.13	-0.089	220.2	0.1305		
388.17	-0.089	220.2	0.1296		
388.20	-0.089	220	0.1296		
388.23	-0.09	219.7	0.1287		
388.27	-0.09	219.5	0.1278		
388.30	-0.09	219.4	0.1278		
388.33	-0.089	219.2	0.1278		
388.37	-0.092	218.8	0.1278		
388.40	-0.092	218.8	0.126		
388.43	-0.092	218.6	0.126		
388.47	-0.093	218.3	0.1251		
388.50	-0.094	218	0.1242		
388.53	-0.095	217.7	0.1234		
388.57	-0.095	217.5	0.1234		
388.60	-0.095	217.3	0.1234		
388.63	-0.095	217.3	0.1225		
388.67	-0.096	217	0.1216		
388.70	-0.097	216.5	0.1198		

Prova triassiale ciclica SNGR03-C4

tensione di confinamento (kPa)		450	tensione di confinamento (kPa)		450
deviatore ciclico (kPa)		80	deviatore ciclico (kPa)		120
frequenza (hz)		0.00071429	frequenza (hz)		0.0007143
388.73	-0.099	216.3	0.1198		
388.77	-0.098	216.2	0.1198		
388.80	-0.098	216.1	0.1198		
388.83	-0.097	216	0.1198		
388.87	-0.097	216	0.1198		
388.90	-0.098	215.8	0.1189		
388.95	-0.098	215.5	0.1189		
388.98	-0.098	215.5	0.1189		
389.02	-0.099	215.3	0.118		
389.03	-0.1	215	0.1171		
389.07	-0.101	214.8	0.1171		
389.10	-0.101	214.6	0.1163		
389.13	-0.102	214.4	0.1163		
389.17	-0.101	214.3	0.1163		
389.20	-0.101	214.3	0.1154		
389.23	-0.102	214	0.1154		
389.27	-0.103	213.8	0.1145		
389.30	-0.103	213.7	0.1145		
389.33	-0.103	213.5	0.1136		
389.37	-0.103	213.3	0.1136		
389.40	-0.103	213.2	0.1136		
389.43	-0.103	213.2	0.1136		
389.47	-0.103	213	0.1127		
389.50	-0.104	212.8	0.1127		
389.53	-0.104	212.6	0.1109		
389.57	-0.105	212.5	0.1109		
389.60	-0.105	212.4	0.1109		
389.63	-0.105	212.2	0.1109		
389.67	-0.105	212.2	0.1109		
389.70	-0.105	212	0.11		
389.73	-0.105	211.9	0.11		
389.77	-0.106	211.8	0.11		
389.80	-0.106	211.6	0.1092		
389.83	-0.106	211.5	0.1092		
389.87	-0.106	211.4	0.1092		
389.90	-0.106	211.4	0.1092		
389.93	-0.106	211.3	0.1092		
389.97	-0.106	211.1	0.1083		
390.00	-0.107	211	0.1083		
390.03	-0.107	210.9	0.1083		
390.07	-0.106	210.8	0.1083		
390.10	-0.106	210.7	0.1083		
390.13	-0.107	210.7	0.1074		
390.17	-0.107	210.6	0.1074		
390.20	-0.107	210.5	0.1074		
390.23	-0.107	210.4	0.1074		
390.27	-0.107	210.3	0.1074		
390.30	-0.107	210.2	0.1074		
390.33	-0.106	210.2	0.1074		
390.37	-0.107	210.2	0.1074		
390.42	-0.107	210	0.1065		
390.45	-0.107	209.8	0.1065		
390.47	-0.107	209.8	0.1065		
390.50	-0.107	209.8	0.1065		
390.53	-0.107	209.7	0.1065		
390.57	-0.106	209.7	0.1065		
390.60	-0.106	209.6	0.1065		
390.63	-0.107	209.5	0.1065		
390.67	-0.107	209.5	0.1065		
390.70	-0.106	209.5	0.1065		

Prova triassiale ciclica SNGR03-C4

tensione di confinamento (kPa)		450	tensione di confinamento (kPa)		450
deviatore ciclico (kPa)		80	deviatore ciclico (kPa)		120
frequenza (hz)		0.00071429	frequenza (hz)		0.0007143
390.73	-0.106	209.4	0.1065		
390.77	-0.108	209.2	0.1056		
390.80	-0.107	209.2	0.1056		
390.83	-0.106	209.2	0.1056		
390.87	-0.106	209.2	0.1056		
390.90	-0.105	209.2	0.1056		
390.93	-0.103	209.2	0.1065		
390.97	-0.103	209.4	0.1074		
391.00	-0.103	209.4	0.1074		
391.03	-0.103	209.3	0.1065		
391.07	-0.104	209.2	0.1065		
391.10	-0.104	209.1	0.1065		
391.13	-0.104	209	0.1065		
391.17	-0.104	209	0.1065		
391.20	-0.104	209	0.1065		
391.23	-0.104	209	0.1065		
391.27	-0.104	209	0.1065		
391.30	-0.103	209	0.1065		
391.33	-0.103	209	0.1065		
391.37	-0.102	209.1	0.1065		
391.40	-0.101	209.1	0.1074		
391.43	-0.101	209.1	0.1074		
391.47	-0.101	209.1	0.1074		
391.50	-0.1	209.1	0.1074		
391.53	-0.1	209.1	0.1074		
391.57	-0.1	209.1	0.1074		
391.60	-0.1	209.1	0.1074		
391.63	-0.099	209.1	0.1083		
391.67	-0.099	209.2	0.1083		
391.70	-0.099	209.2	0.1083		
391.73	-0.098	209.3	0.1083		
391.77	-0.098	209.3	0.1083		
391.80	-0.097	209.4	0.1092		
391.83	-0.097	209.4	0.1092		
391.88	-0.097	209.4	0.1092		
391.92	-0.096	209.4	0.1092		
391.93	-0.096	209.5	0.1092		
391.97	-0.095	209.5	0.1092		
392.00	-0.095	209.6	0.11		
392.03	-0.095	209.6	0.11		
392.07	-0.094	209.7	0.11		
392.10	-0.093	209.7	0.1109		
392.13	-0.093	209.8	0.1109		
392.17	-0.092	209.9	0.1109		
392.20	-0.092	209.9	0.1109		
392.23	-0.092	210	0.1127		
392.27	-0.092	210	0.1127		
392.30	-0.09	210.2	0.1136		
392.33	-0.09	210.2	0.1136		
392.37	-0.09	210.3	0.1136		
392.40	-0.089	210.4	0.1136		
392.43	-0.088	210.4	0.1145		
392.47	-0.088	210.5	0.1145		
392.50	-0.088	210.6	0.1145		
392.53	-0.086	210.8	0.1154		
392.57	-0.086	210.9	0.1154		
392.60	-0.086	210.9	0.1154		
392.63	-0.087	210.8	0.1154		
392.67	-0.086	210.8	0.1154		
392.70	-0.086	211	0.1154		

Prova triassiale ciclica SNGR03-C4

tensione di confinamento (kPa)		450	tensione di confinamento (kPa)		450
deviatore ciclico (kPa)		80	deviatore ciclico (kPa)		120
frequenza (hz)		0.00071429	frequenza (hz)		0.0007143
392.73	-0.084	211.2	0.1163		
392.77	-0.082	211.5	0.1171		
392.80	-0.082	211.5	0.118		
392.83	-0.081	211.6	0.118		
392.87	-0.079	211.9	0.118		
392.90	-0.08	211.9	0.1189		
392.93	-0.08	211.9	0.1189		
392.97	-0.08	212	0.1198		
393.00	-0.077	212.3	0.1198		
393.03	-0.077	212.3	0.1207		
393.07	-0.076	212.5	0.1216		
393.10	-0.075	212.7	0.1216		
393.13	-0.074	212.7	0.1216		
393.17	-0.074	212.9	0.1225		
393.20	-0.071	213.3	0.1242		
393.23	-0.071	213.5	0.1242		
393.27	-0.072	213.5	0.1242		
393.32	-0.072	213.5	0.1242		
393.35	-0.072	213.6	0.1242		
393.38	-0.071	213.7	0.1251		
393.40	-0.069	214	0.126		
393.43	-0.068	214.2	0.126		
393.47	-0.067	214.2	0.1269		
393.50	-0.067	214.4	0.1269		
393.53	-0.066	214.6	0.1278		
393.57	-0.066	214.6	0.1278		
393.60	-0.066	214.8	0.1287		
393.63	-0.064	215.1	0.1296		
393.67	-0.062	215.4	0.1296		
393.70	-0.062	215.4	0.1305		
393.73	-0.062	215.5	0.1313		
393.77	-0.061	215.7	0.1322		
393.80	-0.06	216	0.1322		
393.83	-0.059	216.2	0.1331		
393.87	-0.058	216.4	0.134		
393.90	-0.057	216.7	0.134		
393.93	-0.056	216.7	0.1349		
393.97	-0.056	216.9	0.1358		
394.00	-0.055	217	0.1367		
394.03	-0.053	217.4	0.1376		
394.07	-0.053	217.5	0.1376		
394.10	-0.053	217.7	0.1384		
394.13	-0.051	218	0.1384		
394.17	-0.05	218	0.1393		
394.20	-0.05	218.2	0.1402		
394.23	-0.049	218.4	0.1411		
394.27	-0.047	218.8	0.142		
394.30	-0.047	218.9	0.1429		
394.33	-0.046	219.2	0.1438		
394.37	-0.045	219.4	0.1438		
394.40	-0.043	219.4	0.1447		
394.43	-0.043	219.7	0.1455		
394.47	-0.043	219.9	0.1464		
394.50	-0.042	220.2	0.1473		
394.53	-0.041	220.4	0.1482		
394.57	-0.036	221.1	0.1509		
394.60	-0.036	221.3	0.1509		
394.63	-0.037	221.3	0.1518		
394.67	-0.037	221.4	0.1518		
394.70	-0.037	221.5	0.1526		

Prova triassiale ciclica SNGR03-C4

pressione di confinamento (kPa)		450	tensione di confinamento (kPa)		450
deviatore ciclico (kPa)		80	deviatore ciclico (kPa)		120
frequenza (hz)		0.00071429	frequenza (hz)		0.0007143
394.73	-0.036	221.8	0.1526		
394.78	-0.034	222.1	0.1544		
394.82	-0.033	222.3	0.1553		
394.83	-0.032	222.7	0.1562		
394.87	-0.031	222.9	0.158		
394.90	-0.03	223.2	0.1589		
394.93	-0.027	223.7	0.1589		
394.97	-0.028	223.7	0.1606		
395.00	-0.028	223.8	0.1615		
395.03	-0.026	224.2	0.1633		
395.07	-0.024	224.7	0.166		
395.10	-0.022	225	0.1669		
395.13	-0.023	225.2	0.1669		
395.17	-0.022	225.4	0.1669		
395.20	-0.02	225.4	0.1677		
395.23	-0.02	225.7	0.1695		
395.27	-0.02	226	0.1713		
395.30	-0.019	226.1	0.1713		
395.33	-0.017	226.5	0.1731		
395.37	-0.016	226.9	0.1748		
395.40	-0.014	227.3	0.1748		
395.43	-0.014	227.3	0.1766		
395.47	-0.014	227.5	0.1784		
395.50	-0.013	227.8	0.1802		
395.53	-0.011	228.2	0.1819		
395.57	-0.007	228.8	0.1846		
395.60	-0.008	228.9	0.1855		
395.63	-0.008	229.1	0.1855		
395.67	-0.006	229.1	0.1864		
395.70	-0.006	229.5	0.189		
395.73	-0.007	229.6	0.189		
395.77	-0.005	230.1	0.1917		
395.80	-0.003	230.5	0.1935		
395.83	-0.002	230.9	0.1961		
395.87	0	231.2	0.1961		
395.90	0.001	231.2	0.1988		
395.93	0.001	231.5	0.2006		
395.97	0.002	231.9	0.2024		
396.00	0.003	232.3	0.205		
396.03	0.004	232.6	0.2077		
396.07	0.006	233.3	0.2121		
396.10	0.009	233.7	0.2121		
396.13	0.008	233.7	0.2157		
396.17	0.008	233.9	0.2174		
396.22	0.01	234.4	0.221		
396.25	0.009	234.4	0.2237		
396.28	0.009	234.5	0.2254		
396.30	0.011	235	0.2281		
396.33	0.014	235.5	0.2325		
396.37	0.015	235.8	0.237		
396.40	0.019	236.6	0.2441		
396.43	0.019	236.8	0.2441		
396.47	0.016	236.8	0.2485		
396.50	0.016	236.8	0.2503		
396.53	0.018	237.3	0.2547		
396.57	0.021	237.7	0.2601		
396.60	0.022	238	0.2645		
396.63	0.023	238.4	0.268		
396.67	0.026	239	0.268		
396.70	0.025	239	0.2725		

Prova triassiale ciclica SNGR03-C4

pressione di confinamento (kPa)		450		pressione di confinamento (kPa)		450	
deviatore ciclico (kPa)		80		deviatore ciclico (kPa)		120	
frequenza (hz)		0.00071429		frequenza (hz)		0.0007143	
396.73	0.025	239.2	0.2743				
396.77	0.026	239.5	0.2769				
396.80	0.028	239.8	0.2787				
396.83	0.029	240.1	0.2805				
396.87	0.028	240.3	0.2814				
396.90	0.031	240.8	0.2814				
396.93	0.032	240.8	0.284				
396.97	0.032	241	0.2858				
397.00	0.033	241.5	0.2876				
397.03	0.036	242.1	0.2911				
397.07	0.036	242.3	0.292				
397.10	0.035	242.4	0.2929				
397.13	0.037	242.8	0.2929				
397.17	0.039	242.8	0.2947				
397.20	0.039	243.1	0.2964				
397.23	0.043	243.8	0.3				
397.27	0.04	243.7	0.3				
397.30	0.044	244.2	0.3027				
397.33	0.043	244.4	0.3035				
397.37	0.043	244.6	0.3035				
397.40	0.045	244.6	0.3035				
397.43	0.045	245	0.3062				
397.47	0.046	245.3	0.308				
397.50	0.048	245.8	0.3106				
397.53	0.05	246.3	0.3133				
397.57	0.052	246.7	0.3151				
397.60	0.052	246.9	0.3151				
397.63	0.051	246.9	0.3151				
397.68	0.053	247.4	0.3177				
397.72	0.054	247.7	0.3177				
397.73	0.058	247.7	0.3195				
397.77	0.058	248.4	0.3231				
397.80	0.056	248.5	0.3231				
397.83	0.057	248.8	0.324				
397.87	0.059	249.1	0.3257				
397.90	0.058	249.3	0.3257				
397.93	0.06	249.7	0.3257				
397.97	0.061	249.7	0.3284				
398.00	0.061	250.1	0.3302				
398.03	0.062	250.4	0.332				
398.07	0.067	251.1	0.3355				
398.10	0.066	251.2	0.3355				
398.13	0.066	251.4	0.3364				
398.17	0.066	251.6	0.3364				
398.20	0.067	251.6	0.3373				
398.23	0.067	251.9	0.3382				
398.27	0.069	252.4	0.3417				
398.30	0.071	252.7	0.3435				
398.33	0.072	253.1	0.3462				
398.37	0.072	253.4	0.3462				
398.40	0.073	253.7	0.3462				
398.43	0.073	253.7	0.347				
398.47	0.073	253.9	0.3488				
398.50	0.075	254.4	0.3515				
398.53	0.079	255	0.3533				
398.57	0.077	255	0.3533				
398.60	0.076	255.2	0.3541				
398.63	0.078	255.6	0.3541				
398.67	0.08	255.6	0.3559				
398.70	0.08	256	0.3586				

Prova triassiale ciclica SNGR03-C4

pressione di confinamento (kPa)		450		pressione di confinamento (kPa)		450	
deviatore ciclico (kPa)		80		deviatore ciclico (kPa)		120	
frequenza (hz)		0.00071429		frequenza (hz)		0.0007143	
398.73	0.083	256.5	0.3604				
398.77	0.083	256.7	0.3604				
398.80	0.081	256.8	0.3604				
398.83	0.082	257.1	0.3621				
398.87	0.084	257.5	0.3621				
398.90	0.087	257.5	0.3639				
398.93	0.087	258	0.3666				
398.97	0.086	258.1	0.3657				
399.00	0.085	258.2	0.3666				
399.03	0.087	258.6	0.3683				
399.07	0.088	258.9	0.3692				
399.10	0.092	259.5	0.3692				
399.15	0.092	259.7	0.3728				
399.18	0.09	259.8	0.3728				
399.20	0.09	259.9	0.3728				
399.23	0.092	259.9	0.3728				
399.27	0.092	260.3	0.3746				
399.30	0.093	260.6	0.3754				
399.33	0.094	260.9	0.3772				
399.37	0.096	261.4	0.3799				
399.40	0.097	261.6	0.3799				
399.43	0.097	261.8	0.3799				
399.47	0.095	261.8	0.3808				
399.50	0.095	261.9	0.3808				
399.53	0.097	262.2	0.3825				
399.57	0.099	262.6	0.3834				
399.60	0.099	262.8	0.3843				
399.63	0.099	263	0.3852				
399.67	0.104	263.6	0.3852				
399.70	0.102	263.6	0.3879				
399.73	0.102	263.7	0.3879				
399.77	0.102	263.8	0.3888				
399.80	0.102	264	0.3888				
399.83	0.102	264.2	0.3896				
399.87	0.103	264.5	0.3914				
399.90	0.105	264.9	0.3914				
399.93	0.105	264.9	0.3923				
399.97	0.105	265.1	0.3932				
400.00	0.108	265.6	0.3959				
400.03	0.108	265.8	0.3959				
400.07	0.106	265.8	0.3959				
400.10	0.106	265.9	0.3959				
400.13	0.108	266.3	0.3959				
400.17	0.109	266.3	0.3976				
400.20	0.109	266.5	0.3985				
400.23	0.109	266.8	0.4003				
400.27	0.112	267.3	0.4012				
400.30	0.11	267.3	0.4012				
400.33	0.109	267.4	0.4012				
400.37	0.11	267.6	0.4012				
400.40	0.112	267.6	0.4021				
400.43	0.112	267.9	0.403				
400.47	0.114	268.4	0.4047				
400.50	0.113	268.4	0.4047				
400.53	0.113	268.5	0.4047				
400.58	0.112	268.6	0.4056				
400.62	0.113	268.8	0.4065				
400.63	0.117	269.4	0.4083				
400.67	0.114	269.3	0.4074				
400.70	0.114	269.4	0.4074				

Prova triassiale ciclica SNGR03-C4

pressione di confinamento (kPa)		450	pressione di confinamento (kPa)		450
deviatore ciclico (kPa)		80	deviatore ciclico (kPa)		120
frequenza (hz)		0.00071429	frequenza (hz)		0.0007143
400.73	0.114	269.4	0.4074		
400.77	0.114	269.5	0.4083		
400.80	0.115	269.8	0.411		
400.83	0.119	270.3	0.4118		
400.87	0.118	270.4	0.4118		
400.90	0.116	270.4	0.411		
400.93	0.116	270.5	0.411		
400.97	0.116	270.5	0.411		
401.00	0.116	270.6	0.4118		
401.03	0.118	270.9	0.4127		
401.07	0.119	271.4	0.4154		
401.10	0.12	271.5	0.4154		
401.13	0.119	271.6	0.4154		
401.17	0.118	271.6	0.4154		
401.20	0.118	271.6	0.4154		
401.23	0.118	271.7	0.4154		
401.27	0.118	271.9	0.4154		
401.30	0.12	272.1	0.4163		
401.33	0.123	272.6	0.4181		
401.37	0.12	272.4	0.4163		
401.40	0.118	272.4	0.4163		
401.43	0.119	272.4	0.4163		
401.47	0.119	272.5	0.4172		
401.50	0.12	272.7	0.4181		
401.53	0.124	273.3	0.4198		
401.57	0.123	273.3	0.4198		
401.60	0.121	273.3	0.4189		
401.63	0.12	273.3	0.4189		
401.67	0.12	273.3	0.4189		
401.70	0.12	273.3	0.4189		
401.73	0.12	273.5	0.4198		
401.77	0.121	273.7	0.4198		
401.80	0.121	273.8	0.4198		
401.83	0.121	273.9	0.4207		
401.87	0.121	274	0.4207		
401.90	0.122	274	0.4207		
401.93	0.122	274.2	0.4207		
401.97	0.122	274.3	0.4216		
402.00	0.121	274.3	0.4216		
402.05	0.122	274.4	0.4216		
402.08	0.122	274.5	0.4216		
402.10	0.122	274.7	0.4234		
402.13	0.124	275	0.4234		
402.17	0.123	274.9	0.4225		
402.20	0.12	274.8	0.4225		
402.23	0.12	274.8	0.4225		
402.27	0.12	274.8	0.4225		
402.30	0.12	274.9	0.4225		
402.33	0.12	274.9	0.4225		
402.37	0.12	275	0.4225		
402.40	0.122	275.3	0.4234		
402.43	0.122	275.4	0.4234		
402.47	0.121	275.4	0.4234		
402.50	0.121	275.4	0.4234		
402.53	0.121	275.4	0.4234		
402.57	0.12	275.5	0.4234		
402.60	0.121	275.5	0.4234		
402.63	0.12	275.6	0.4234		
402.67	0.118	275.5	0.4234		
402.70	0.118	275.5	0.4225		

Prova triassiale ciclica SNGR03-C4

tensione di confinamento (kPa)		450	tensione di confinamento (kPa)		450
deviatore ciclico (kPa)		80	deviatore ciclico (kPa)		120
frequenza (hz)		0.00071429	frequenza (hz)		0.0007143
402.73	0.118	275.5	0.4225		
402.77	0.118	275.5	0.4225		
402.80	0.118	275.6	0.4225		
402.83	0.118	275.6	0.4225		
402.87	0.118	275.6	0.4225		
402.90	0.118	275.7	0.4225		
402.93	0.118	275.7	0.4225		
402.97	0.118	275.7	0.4225		
403.00	0.119	275.9	0.4234		
403.03	0.117	275.8	0.4216		
403.07	0.117	275.8	0.4216		
403.10	0.116	275.7	0.4216		
403.13	0.116	275.7	0.4216		
403.17	0.115	275.7	0.4216		
403.20	0.115	275.7	0.4216		
403.23	0.115	275.7	0.4207		
403.27	0.114	275.7	0.4207		
403.30	0.115	275.8	0.4207		
403.33	0.114	275.7	0.4198		
403.37	0.113	275.6	0.4198		
403.40	0.113	275.6	0.4198		
403.43	0.113	275.6	0.4198		
403.48	0.112	275.5	0.4198		
403.52	0.111	275.5	0.4189		
403.55	0.111	275.5	0.4189		
403.57	0.112	275.6	0.4189		
403.60	0.111	275.5	0.4189		
403.63	0.11	275.5	0.4181		
403.67	0.11	275.4	0.4181		
403.70	0.109	275.3	0.4181		
403.73	0.109	275.3	0.4172		
403.77	0.109	275.3	0.4172		
403.80	0.108	275.2	0.4163		
403.83	0.107	275.1	0.4163		
403.87	0.108	275.2	0.4163		
403.90	0.106	274.9	0.4154		
403.93	0.105	274.9	0.4154		
403.97	0.105	274.9	0.4145		
404.00	0.105	274.8	0.4145		
404.03	0.105	274.8	0.4145		
404.07	0.104	274.7	0.4136		
404.10	0.103	274.6	0.4136		
404.13	0.103	274.6	0.4127		
404.17	0.101	274.4	0.4127		
404.20	0.101	274.4	0.4118		
404.23	0.101	274.3	0.4118		
404.27	0.101	274.3	0.4118		
404.30	0.1	274.2	0.411		
404.33	0.101	274.2	0.411		
404.37	0.097	273.8	0.4092		
404.40	0.096	273.7	0.4092		
404.43	0.096	273.7	0.4083		
404.47	0.096	273.7	0.4083		
404.50	0.097	273.6	0.4083		
404.53	0.095	273.5	0.4074		
404.57	0.095	273.4	0.4074		
404.60	0.094	273.2	0.4065		
404.63	0.093	273.1	0.4065		
404.67	0.092	273.1	0.4056		
404.70	0.092	273	0.4047		

Prova triassiale ciclica SNGR03-C4

pressione di confinamento (kPa)		450		pressione di confinamento (kPa)		450	
deviatore ciclico (kPa)		80		deviatore ciclico (kPa)		120	
frequenza (hz)		0.00071429		frequenza (hz)		0.0007143	
404.73	0.091	272.8	0.4047				
404.77	0.09	272.7	0.4039				
404.80	0.09	272.6	0.403				
404.83	0.09	272.6	0.403				
404.87	0.089	272.4	0.403				
404.90	0.085	272.4	0.4021				
404.95	0.086	271.9	0.4003				
404.98	0.086	271.8	0.4003				
405.00	0.085	271.8	0.3994				
405.03	0.085	271.7	0.3994				
405.07	0.085	271.6	0.3985				
405.10	0.083	271.4	0.3976				
405.13	0.082	271.2	0.3967				
405.17	0.082	271.1	0.3959				
405.20	0.08	270.8	0.3959				
405.23	0.079	270.8	0.395				
405.27	0.079	270.6	0.3941				
405.30	0.079	270.5	0.3932				
405.33	0.078	270.3	0.3923				
405.37	0.077	270.1	0.3914				
405.40	0.077	270	0.3914				
405.43	0.074	269.6	0.3914				
405.47	0.074	269.6	0.3896				
405.50	0.074	269.5	0.3888				
405.53	0.072	269.3	0.3879				
405.57	0.072	269.1	0.387				
405.60	0.071	268.9	0.3861				
405.63	0.07	268.7	0.3852				
405.67	0.068	268.5	0.3852				
405.70	0.068	268.5	0.3843				
405.73	0.068	268.4	0.3834				
405.77	0.066	268.1	0.3817				
405.80	0.066	267.9	0.3817				
405.83	0.065	267.7	0.3808				
405.87	0.065	267.6	0.3799				
405.90	0.062	267.1	0.3799				
405.93	0.062	267.1	0.3781				
405.97	0.062	267	0.3772				
406.00	0.06	266.8	0.3763				
406.03	0.059	266.5	0.3746				
406.07	0.058	266.2	0.3737				
406.10	0.058	266.1	0.3728				
406.13	0.057	265.8	0.3728				
406.17	0.055	265.8	0.3719				
406.20	0.055	265.5	0.3701				
406.23	0.054	265.3	0.3692				
406.27	0.055	265.2	0.3692				
406.30	0.051	264.7	0.3666				
406.33	0.051	264.5	0.3657				
406.38	0.05	264.3	0.3648				
406.42	0.051	264.2	0.3648				
406.45	0.049	263.9	0.3621				
406.47	0.045	263.2	0.3621				
406.50	0.045	263.2	0.3595				
406.53	0.045	263.1	0.3586				
406.57	0.045	263	0.3577				
406.60	0.044	262.6	0.3568				
406.63	0.042	262.3	0.355				
406.67	0.042	262.2	0.355				
406.70	0.041	261.9	0.355				

Prova triassiale ciclica SNGR03-C4

pressione di confinamento (kPa)		450		pressione di confinamento (kPa)		450	
deviatore ciclico (kPa)		80		deviatore ciclico (kPa)		120	
frequenza (hz)		0.00071429		frequenza (hz)		0.0007143	
406.73	0.038	261.9	0.3533				
406.77	0.038	261.5	0.3515				
406.80	0.038	261.3	0.3506				
406.83	0.038	261.2	0.3497				
406.87	0.034	260.5	0.347				
406.90	0.035	260.4	0.347				
406.93	0.033	260	0.347				
406.97	0.032	260	0.3444				
407.00	0.032	259.9	0.3435				
407.03	0.031	259.6	0.3417				
407.07	0.029	259.2	0.3399				
407.10	0.028	258.9	0.3373				
407.13	0.028	258.7	0.3364				
407.17	0.026	258.2	0.3364				
407.20	0.027	258.2	0.3346				
407.23	0.027	258.2	0.3337				
407.27	0.025	257.8	0.332				
407.30	0.02	257	0.3284				
407.33	0.021	256.9	0.3275				
407.37	0.02	256.7	0.3257				
407.40	0.019	256.3	0.3257				
407.43	0.018	256.3	0.324				
407.47	0.018	256.1	0.3231				
407.50	0.017	255.8	0.3213				
407.53	0.015	255.4	0.3195				
407.57	0.014	255.1	0.3177				
407.60	0.013	254.8	0.316				
407.63	0.011	254.3	0.316				
407.67	0.01	254.3	0.3142				
407.70	0.01	254	0.3124				
407.73	0.01	253.8	0.3106				
407.77	0.008	253.4	0.3089				
407.80	0.009	253.2	0.308				
407.85	0.007	253	0.3062				
407.88	0.003	252.3	0.3035				
407.90	0.004	252.1	0.3018				
407.93	0.003	251.8	0.3				
407.97	0.001	251.5	0.3				
408.00	0	251.5	0.2982				
408.03	0	251.3	0.2964				
408.07	0	251.1	0.2947				
408.10	-0.002	250.5	0.292				
408.13	-0.004	250.2	0.2893				
408.17	-0.004	249.9	0.2876				
408.20	-0.004	249.8	0.2876				
408.23	-0.008	249.8	0.2858				
408.27	-0.008	249.1	0.2805				
408.30	-0.008	248.9	0.2778				
408.33	-0.01	248.5	0.2734				
408.37	-0.01	248.3	0.2707				
408.40	-0.009	248.2	0.268				
408.43	-0.011	247.7	0.268				
408.47	-0.015	247.7	0.2645				
408.50	-0.015	247.2	0.2601				
408.53	-0.015	246.9	0.2565				
408.57	-0.016	246.5	0.2521				
408.60	-0.017	246.1	0.2485				
408.63	-0.018	245.8	0.245				
408.67	-0.022	245	0.245				
408.70	-0.022	245	0.2396				

Prova triassiale ciclica SNGR03-C4

pressione di confinamento (kPa)		450	pressione di confinamento (kPa)		450
deviatore ciclico (kPa)		80	deviatore ciclico (kPa)		120
frequenza (hz)		0.00071429	frequenza (hz)		0.0007143
408.73	-0.022	244.9	0.237		
408.77	-0.022	244.6	0.2334		
408.80	-0.023	244.3	0.2308		
408.83	-0.025	243.9	0.2272		
408.87	-0.025	243.5	0.2254		
408.90	-0.027	243.1	0.2254		
408.93	-0.028	242.8	0.2228		
408.97	-0.028	242.8	0.2201		
409.00	-0.028	242.5	0.2166		
409.03	-0.03	242	0.2139		
409.07	-0.032	241.6	0.2112		
409.10	-0.032	241.4	0.2095		
409.13	-0.033	240.9	0.2095		
409.17	-0.032	240.9	0.2068		
409.20	-0.032	240.9	0.2059		
409.23	-0.037	240	0.2006		
409.27	-0.039	239.5	0.1979		
409.32	-0.038	239.3	0.197		
409.35	-0.038	239.1	0.1953		
409.37	-0.04	238.6	0.1935		
409.40	-0.04	238.3	0.1917		
409.43	-0.041	238	0.1899		
409.47	-0.043	237.6	0.1899		
409.50	-0.044	237.2	0.1873		
409.53	-0.044	237.2	0.1855		
409.57	-0.045	236.8	0.1837		
409.60	-0.046	236.4	0.1819		
409.63	-0.047	236.1	0.1811		
409.67	-0.045	236.1	0.1802		
409.70	-0.048	235.4	0.1802		
409.73	-0.053	234.7	0.1775		
409.77	-0.053	234.7	0.1748		
409.80	-0.051	234.6	0.174		
409.83	-0.052	234.3	0.1731		
409.87	-0.053	233.9	0.1713		
409.90	-0.054	233.6	0.1704		
409.93	-0.056	233.2	0.1704		
409.97	-0.056	232.9	0.1686		
410.00	-0.056	232.9	0.1669		
410.03	-0.057	232.5	0.166		
410.07	-0.058	232.2	0.1651		
410.10	-0.06	231.8	0.1633		
410.13	-0.06	231.5	0.1624		
410.17	-0.061	231.1	0.1624		
410.20	-0.062	230.7	0.1606		
410.23	-0.062	230.7	0.1597		
410.27	-0.063	230.5	0.1589		
410.30	-0.064	230.1	0.1571		
410.33	-0.065	229.7	0.1562		
410.37	-0.064	229.6	0.1562		
410.40	-0.065	229.2	0.1562		
410.43	-0.067	228.8	0.1544		
410.47	-0.067	228.8	0.1535		
410.50	-0.068	228.4	0.1518		
410.53	-0.07	228	0.1509		
410.57	-0.07	227.7	0.15		
410.60	-0.071	227.4	0.1482		
410.63	-0.072	227	0.1482		
410.67	-0.076	226.4	0.1473		
410.70	-0.076	226.4	0.1455		

Prova triassiale ciclica SNGR03-C4

tensione di confinamento (kPa)		450	tensione di confinamento (kPa)		450
deviatore ciclico (kPa)		80	deviatore ciclico (kPa)		120
frequenza (hz)		0.00071429	frequenza (hz)		0.0007143
410.75	-0.073	226.2	0.1455		
410.78	-0.075	225.9	0.1447		
410.82	-0.075	225.9	0.1438		
410.83	-0.076	225.6	0.1429		
410.87	-0.076	225.2	0.142		
410.90	-0.077	224.9	0.1411		
410.93	-0.078	224.6	0.1402		
410.97	-0.079	224.3	0.1402		
411.00	-0.08	223.9	0.1393		
411.03	-0.08	223.9	0.1384		
411.07	-0.081	223.7	0.1376		
411.10	-0.081	223.4	0.1367		
411.13	-0.082	223.1	0.1367		
411.17	-0.083	222.8	0.1358		
411.20	-0.084	222.5	0.1358		
411.23	-0.084	222.2	0.1349		
411.27	-0.084	222.2	0.134		
411.30	-0.084	222.1	0.1331		
411.33	-0.086	221.7	0.1322		
411.37	-0.086	221.4	0.1313		
411.40	-0.087	221.2	0.1313		
411.43	-0.088	220.9	0.1313		
411.47	-0.088	220.6	0.1305		
411.50	-0.088	220.6	0.1296		
411.53	-0.089	220.3	0.1287		
411.57	-0.09	220	0.1278		
411.60	-0.091	219.7	0.1269		
411.63	-0.089	219.7	0.1278		
411.67	-0.092	219.1	0.1278		
411.70	-0.093	218.9	0.126		
411.73	-0.093	218.9	0.1251		
411.77	-0.093	218.7	0.1251		
411.80	-0.093	218.5	0.1242		
411.83	-0.094	218.3	0.1234		
411.87	-0.094	218	0.1234		
411.90	-0.095	217.8	0.1234		
411.93	-0.095	217.5	0.1225		
411.97	-0.095	217.5	0.1225		
412.00	-0.096	217.3	0.1216		
412.03	-0.097	217.1	0.1207		
412.07	-0.097	216.9	0.1207		
412.10	-0.097	216.7	0.1198		
412.13	-0.098	216.5	0.1198		
412.17	-0.098	216.2	0.1198		
412.22	-0.097	216.2	0.1189		
412.25	-0.097	216.1	0.1189		
412.27	-0.099	215.7	0.1189		
412.30	-0.099	215.7	0.1171		
412.33	-0.102	215.2	0.1163		
412.37	-0.102	215	0.1163		
412.40	-0.101	214.9	0.1163		
412.43	-0.1	214.8	0.1163		
412.47	-0.101	214.6	0.1163		
412.50	-0.102	214.4	0.1154		
412.53	-0.102	214.4	0.1145		
412.57	-0.102	214.3	0.1145		
412.60	-0.102	214.1	0.1145		
412.63	-0.103	213.9	0.1136		
412.67	-0.103	213.7	0.1136		
412.70	-0.103	213.6	0.1136		

Prova triassiale ciclica SNGR03-C4

tensione di confinamento (kPa)		450	tensione di confinamento (kPa)		450
deviatore ciclico (kPa)		80	deviatore ciclico (kPa)		120
frequenza (hz)		0.00071429	frequenza (hz)		0.0007143
412.73	-0.103	213.4	0.1127		
412.77	-0.103	213.4	0.1127		
412.80	-0.103	213.3	0.1127		
412.83	-0.104	213.1	0.1109		
412.87	-0.104	212.9	0.1109		
412.90	-0.105	212.7	0.11		
412.93	-0.105	212.5	0.11		
412.97	-0.105	212.4	0.11		
413.00	-0.105	212.4	0.11		
413.03	-0.104	212.4	0.11		
413.07	-0.104	212.3	0.11		
413.10	-0.104	212.2	0.11		
413.13	-0.105	211.9	0.1092		
413.17	-0.107	211.6	0.1092		
413.20	-0.107	211.5	0.1083		
413.23	-0.107	211.5	0.1083		
413.27	-0.107	211.4	0.1083		
413.30	-0.106	211.3	0.1083		
413.33	-0.107	211.1	0.1074		
413.37	-0.107	211	0.1074		
413.40	-0.107	211	0.1074		
413.43	-0.106	210.9	0.1074		
413.47	-0.106	210.9	0.1074		
413.50	-0.106	210.8	0.1074		
413.53	-0.106	210.7	0.1074		
413.57	-0.106	210.6	0.1065		
413.60	-0.107	210.5	0.1065		
413.65	-0.107	210.4	0.1065		
413.68	-0.107	210.3	0.1065		
413.72	-0.107	210.2	0.1065		
413.73	-0.107	210.2	0.1065		
413.77	-0.106	210.1	0.1065		
413.80	-0.106	210.1	0.1065		
413.83	-0.106	210.1	0.1065		
413.87	-0.106	210	0.1056		
413.90	-0.106	209.9	0.1056		
413.93	-0.107	209.8	0.1056		
413.97	-0.106	209.8	0.1056		
414.00	-0.106	209.7	0.1056		
414.03	-0.106	209.7	0.1056		
414.07	-0.106	209.7	0.1056		
414.10	-0.107	209.6	0.1056		
414.13	-0.106	209.5	0.1056		
414.17	-0.106	209.5	0.1056		
414.20	-0.106	209.4	0.1056		
414.23	-0.105	209.4	0.1056		
414.27	-0.105	209.4	0.1056		
414.30	-0.104	209.4	0.1056		
414.33	-0.104	209.4	0.1056		
414.37	-0.104	209.4	0.1056		
414.40	-0.104	209.4	0.1056		
414.43	-0.104	209.3	0.1056		
414.47	-0.104	209.3	0.1056		
414.50	-0.104	209.3	0.1056		
414.53	-0.104	209.3	0.1056		
414.57	-0.103	209.3	0.1065		
414.60	-0.102	209.3	0.1065		
414.63	-0.102	209.3	0.1065		
414.67	-0.102	209.3	0.1065		
414.70	-0.102	209.3	0.1065		

Prova triassiale ciclica SNGR03-C4

tensione di confinamento (kPa)		450	tensione di confinamento (kPa)		450
deviatore ciclico (kPa)		80	deviatore ciclico (kPa)		120
frequenza (hz)		0.00071429	frequenza (hz)		0.0007143
414.73	-0.102	209.3	0.1065		
414.77	-0.102	209.3	0.1065		
414.80	-0.102	209.3	0.1065		
414.83	-0.101	209.3	0.1065		
414.87	-0.101	209.3	0.1065		
414.90	-0.1	209.4	0.1065		
414.93	-0.099	209.4	0.1074		
414.97	-0.099	209.4	0.1074		
415.00	-0.099	209.4	0.1074		
415.03	-0.098	209.5	0.1083		
415.07	-0.098	209.5	0.1083		
415.12	-0.098	209.5	0.1083		
415.15	-0.098	209.5	0.1083		
415.17	-0.097	209.5	0.1083		
415.20	-0.097	209.6	0.1083		
415.23	-0.096	209.7	0.1083		
415.27	-0.095	209.8	0.1092		
415.30	-0.095	209.8	0.1092		
415.33	-0.095	209.8	0.1092		
415.37	-0.095	209.9	0.1092		
415.40	-0.094	209.9	0.11		
415.43	-0.093	210	0.11		
415.47	-0.093	210.1	0.11		
415.50	-0.093	210.1	0.1109		
415.53	-0.093	210.1	0.1109		
415.57	-0.092	210.2	0.1109		
415.60	-0.091	210.3	0.1127		
415.63	-0.09	210.4	0.1127		
415.67	-0.09	210.4	0.1127		
415.70	-0.089	210.6	0.1127		
415.73	-0.089	210.7	0.1127		
415.77	-0.089	210.7	0.1136		
415.80	-0.088	210.8	0.1136		
415.83	-0.087	210.9	0.1145		
415.87	-0.086	211	0.1145		
415.90	-0.086	211.1	0.1145		
415.93	-0.086	211.1	0.1145		
415.97	-0.085	211.3	0.1154		
416.00	-0.085	211.3	0.1154		
416.03	-0.083	211.5	0.1163		
416.07	-0.083	211.5	0.1163		
416.10	-0.083	211.6	0.1171		
416.13	-0.082	211.8	0.1171		
416.17	-0.08	212	0.1171		
416.20	-0.08	212.1	0.118		
416.23	-0.08	212.1	0.118		
416.27	-0.08	212.2	0.1189		
416.30	-0.079	212.4	0.1189		
416.33	-0.078	212.5	0.1198		
416.37	-0.077	212.7	0.1207		
416.40	-0.076	212.8	0.1207		
416.43	-0.076	213	0.1207		
416.47	-0.076	213	0.1207		
416.50	-0.074	213.2	0.1216		
416.53	-0.074	213.3	0.1225		
416.58	-0.073	213.5	0.1234		
416.62	-0.072	213.6	0.1234		
416.63	-0.07	213.9	0.1242		
416.67	-0.071	214	0.1242		
416.70	-0.07	214.1	0.1251		

Prova triassiale ciclica SNGR03-C4

tensione di confinamento (kPa)		450	tensione di confinamento (kPa)		450
deviatore ciclico (kPa)		80	deviatore ciclico (kPa)		120
frequenza (hz)		0.00071429	frequenza (hz)		0.0007143
416.73	-0.07	214.2	0.1251		
416.77	-0.069	214.3	0.1251		
416.80	-0.069	214.3	0.1251		
416.83	-0.067	214.6	0.1269		
416.87	-0.066	214.9	0.1278		
416.90	-0.066	215	0.1278		
416.93	-0.064	215.2	0.1287		
416.97	-0.063	215.5	0.1287		
417.00	-0.063	215.6	0.1296		
417.03	-0.063	215.6	0.1296		
417.07	-0.062	215.8	0.1305		
417.10	-0.061	216.1	0.1313		
417.13	-0.059	216.3	0.1322		
417.17	-0.059	216.5	0.1322		
417.20	-0.058	216.7	0.1331		
417.23	-0.057	216.9	0.1331		
417.27	-0.057	216.9	0.134		
417.30	-0.055	217.2	0.1358		
417.33	-0.055	217.4	0.1358		
417.37	-0.054	217.6	0.1367		
417.40	-0.053	217.8	0.1376		
417.43	-0.049	218.3	0.1393		
417.47	-0.051	218.3	0.1393		
417.50	-0.051	218.3	0.1393		
417.53	-0.051	218.4	0.1393		
417.57	-0.05	218.6	0.1402		
417.60	-0.047	219	0.142		
417.63	-0.047	219.2	0.142		
417.67	-0.046	219.5	0.1438		
417.70	-0.044	219.7	0.1438		
417.73	-0.044	219.7	0.1447		
417.77	-0.043	220	0.1455		
417.80	-0.043	220.2	0.1464		
417.83	-0.041	220.6	0.1473		
417.87	-0.041	220.8	0.1482		
417.90	-0.039	221.1	0.1491		
417.93	-0.038	221.4	0.1491		
417.97	-0.038	221.4	0.1509		
418.02	-0.036	221.9	0.1518		
418.05	-0.035	222.1	0.1518		
418.07	-0.035	222.1	0.1535		
418.10	-0.035	222.4	0.1544		
418.13	-0.033	222.7	0.1553		
418.17	-0.032	223	0.1562		
418.20	-0.031	223.3	0.158		
418.23	-0.03	223.6	0.1589		
418.27	-0.028	223.9	0.1589		
418.30	-0.028	223.9	0.1606		
418.33	-0.027	224.2	0.1615		
418.37	-0.026	224.5	0.1633		
418.40	-0.023	225.1	0.166		
418.43	-0.025	225.1	0.1651		
418.47	-0.025	225.2	0.166		
418.50	-0.022	225.6	0.166		
418.53	-0.022	225.6	0.1677		
418.57	-0.021	225.9	0.1686		
418.60	-0.019	226.3	0.1713		
418.63	-0.018	226.6	0.1722		
418.67	-0.017	226.9	0.174		
418.70	-0.016	227.2	0.1757		

Prova triassiale ciclica SNGR03-C4

pressione di confinamento (kPa)		450	pressione di confinamento (kPa)		450
deviatore ciclico (kPa)		80	deviatore ciclico (kPa)		120
frequenza (hz)		0.00071429	frequenza (hz)		0.0007143
418.73	-0.014	227.6	0.1757		
418.77	-0.014	227.6	0.1766		
418.80	-0.013	227.8	0.1784		
418.83	-0.012	228.2	0.1802		
418.87	-0.011	228.5	0.1819		
418.90	-0.01	228.8	0.1837		
418.93	-0.009	229.2	0.1855		
418.97	-0.007	229.6	0.1855		
419.00	-0.007	229.6	0.1873		
419.03	-0.007	229.8	0.189		
419.07	-0.006	230.2	0.1908		
419.10	-0.004	230.6	0.1926		
419.13	-0.003	230.9	0.1953		
419.17	-0.002	231.2	0.197		
419.20	0	231.7	0.197		
419.23	0	231.7	0.1997		
419.27	0	231.9	0.2006		
419.30	0.002	232.3	0.2032		
419.33	0.003	232.6	0.2059		
419.37	0.004	232.9	0.2086		
419.40	0.005	233.4	0.2112		
419.43	0.007	233.8	0.2112		
419.48	0.008	234	0.2174		
419.52	0.008	234.3	0.2201		
419.53	0.012	235	0.2201		
419.57	0.01	235	0.2245		
419.60	0.01	234.9	0.2254		
419.63	0.01	235.3	0.2281		
419.67	0.014	235.7	0.2325		
419.70	0.014	236	0.2352		
419.73	0.015	236.4	0.2396		
419.77	0.017	236.8	0.2396		
419.80	0.018	236.8	0.2441		
419.83	0.018	237.1	0.2485		
419.87	0.019	237.6	0.253		
419.90	0.02	237.9	0.2574		
419.93	0.02	238.2	0.2618		
419.97	0.023	238.8	0.2663		
420.00	0.024	239.1	0.2663		
420.03	0.025	239.1	0.2707		
420.07	0.025	239.4	0.2734		
420.10	0.026	239.8	0.276		
420.13	0.028	240.2	0.2787		
420.17	0.029	240.4	0.2805		
420.20	0.029	240.8	0.2822		
420.23	0.031	241.2	0.2822		
420.27	0.031	241.2	0.284		
420.30	0.032	241.4	0.2858		
420.33	0.036	242.2	0.2902		
420.37	0.035	242.4	0.2911		
420.40	0.035	242.5	0.292		
420.43	0.035	242.7	0.2938		
420.47	0.039	243.2	0.2938		
420.50	0.039	243.2	0.2956		
420.53	0.039	243.5	0.2973		
420.57	0.04	243.8	0.2991		
420.60	0.042	244.2	0.3009		
420.63	0.042	244.5	0.3027		
420.67	0.044	244.8	0.3044		
420.70	0.045	245.2	0.3044		

Prova triassiale ciclica SNGR03-C4

pressione di confinamento (kPa)		450		pressione di confinamento (kPa)		450	
deviatore ciclico (kPa)		80		deviatore ciclico (kPa)		120	
frequenza (hz)		0.00071429		frequenza (hz)		0.0007143	
420.73	0.046	245.2	0.3062				
420.77	0.046	245.5	0.3071				
420.80	0.047	245.9	0.3089				
420.83	0.048	246.2	0.3106				
420.87	0.05	246.5	0.3124				
420.92	0.05	246.9	0.3142				
420.95	0.051	247.2	0.3151				
420.98	0.052	247.5	0.3169				
421.00	0.053	247.9	0.3186				
421.03	0.055	248.3	0.3186				
421.07	0.055	248.3	0.3204				
421.10	0.055	248.5	0.3213				
421.13	0.056	248.9	0.3231				
421.17	0.058	249.2	0.3249				
421.20	0.059	249.5	0.3257				
421.23	0.06	249.8	0.3275				
421.27	0.061	250.2	0.3275				
421.30	0.064	250.2	0.3293				
421.33	0.064	250.8	0.332				
421.37	0.062	250.8	0.332				
421.40	0.062	251	0.3328				
421.43	0.064	251.4	0.3346				
421.47	0.066	251.8	0.3364				
421.50	0.068	252.2	0.3364				
421.53	0.068	252.2	0.3382				
421.57	0.068	252.4	0.3399				
421.60	0.069	252.8	0.3417				
421.63	0.07	253.1	0.3435				
421.67	0.07	253.4	0.3444				
421.70	0.072	253.8	0.3462				
421.73	0.074	254.3	0.3462				
421.77	0.074	254.3	0.3479				
421.80	0.074	254.4	0.3488				
421.83	0.075	254.7	0.3506				
421.87	0.076	255	0.3515				
421.90	0.077	255.3	0.3524				
421.93	0.078	255.6	0.3541				
421.97	0.079	256	0.3541				
422.00	0.079	256	0.3559				
422.03	0.079	256.2	0.3568				
422.07	0.08	256.6	0.3586				
422.10	0.082	256.9	0.3595				
422.13	0.082	257.2	0.3612				
422.17	0.086	257.8	0.3639				
422.20	0.085	258	0.3639				
422.23	0.086	258	0.3648				
422.27	0.086	258.2	0.3657				
422.30	0.084	258.3	0.3657				
422.33	0.087	258.7	0.3666				
422.38	0.087	258.9	0.3683				
422.42	0.087	259.2	0.3692				
422.43	0.09	259.6	0.371				
422.47	0.09	259.8	0.371				
422.50	0.09	260	0.3719				
422.53	0.092	260.4	0.3719				
422.57	0.092	260.4	0.3737				
422.60	0.092	260.7	0.3746				
422.63	0.093	260.9	0.3754				
422.67	0.094	261.3	0.3772				
422.70	0.094	261.5	0.3781				

Prova triassiale ciclica SNGR03-C4

tensione di confinamento (kPa)		450		tensione di confinamento (kPa)		450	
deviatore ciclico (kPa)		80		deviatore ciclico (kPa)		120	
frequenza (hz)		0.00071429		frequenza (hz)		0.0007143	
422.73	0.098	262.1	0.3808				
422.77	0.097	262.2	0.3808				
422.80	0.096	262.2	0.3817				
422.83	0.096	262.3	0.3817				
422.87	0.096	262.6	0.3825				
422.90	0.098	262.9	0.3834				
422.93	0.099	263.2	0.3843				
422.97	0.1	263.4	0.3852				
423.00	0.101	263.7	0.3852				
423.03	0.101	263.7	0.3861				
423.07	0.101	263.9	0.3879				
423.10	0.101	264.2	0.3879				
423.13	0.103	264.5	0.3896				
423.17	0.103	264.8	0.3905				
423.20	0.104	265	0.3914				
423.23	0.105	265.3	0.3914				
423.27	0.105	265.3	0.3923				
423.30	0.105	265.5	0.3932				
423.33	0.105	265.7	0.3941				
423.37	0.107	266	0.395				
423.40	0.107	266.2	0.3959				
423.43	0.11	266.8	0.3985				
423.47	0.108	266.8	0.3985				
423.50	0.108	266.8	0.3985				
423.53	0.108	266.9	0.3976				
423.57	0.108	267.1	0.3985				
423.60	0.11	267.4	0.4003				
423.63	0.11	267.6	0.4003				
423.67	0.11	267.8	0.4012				
423.70	0.111	268.1	0.4012				
423.73	0.112	268.1	0.4021				
423.77	0.112	268.3	0.403				
423.82	0.112	268.7	0.4039				
423.85	0.115	268.7	0.4047				
423.88	0.115	269.2	0.4065				
423.90	0.114	269.2	0.4065				
423.93	0.113	269.2	0.4056				
423.97	0.112	269.3	0.4065				
424.00	0.114	269.7	0.4074				
424.03	0.116	269.9	0.4074				
424.07	0.116	269.9	0.4092				
424.10	0.116	270.1	0.4092				
424.13	0.116	270.3	0.4101				
424.17	0.117	270.5	0.4101				
424.20	0.117	270.6	0.411				
424.23	0.117	270.8	0.411				
424.27	0.117	271	0.411				
424.30	0.118	271	0.4118				
424.33	0.118	271.2	0.4127				
424.37	0.118	271.3	0.4127				
424.40	0.117	271.5	0.4127				
424.43	0.119	271.7	0.4145				
424.47	0.121	272.1	0.4154				
424.50	0.119	272.1	0.4154				
424.53	0.119	272.1	0.4154				
424.57	0.119	272.2	0.4154				
424.60	0.119	272.3	0.4154				
424.63	0.119	272.4	0.4163				
424.67	0.12	272.6	0.4163				
424.70	0.122	273.1	0.4189				

Prova triassiale ciclica SNGR03-C4

pressione di confinamento (kPa)		450		pressione di confinamento (kPa)		450	
deviatore ciclico (kPa)		80		deviatore ciclico (kPa)		120	
frequenza (hz)		0.00071429		frequenza (hz)		0.0007143	
424.73	0.122	273.2	0.4189				
424.77	0.12	273.2	0.4181				
424.80	0.12	273.2	0.4181				
424.83	0.12	273.2	0.4181				
424.87	0.12	273.3	0.4181				
424.90	0.12	273.4	0.4189				
424.93	0.121	273.6	0.4189				
424.97	0.122	274	0.4189				
425.00	0.123	274	0.4207				
425.03	0.123	274.1	0.4207				
425.07	0.122	274.2	0.4207				
425.10	0.12	274.1	0.4198				
425.13	0.12	274.1	0.4198				
425.17	0.12	274.2	0.4207				
425.20	0.121	274.3	0.4207				
425.23	0.121	274.3	0.4207				
425.28	0.125	274.9	0.4225				
425.32	0.123	274.9	0.4225				
425.33	0.123	274.9	0.4225				
425.37	0.123	275	0.4225				
425.40	0.12	274.8	0.4216				
425.43	0.12	274.8	0.4216				
425.47	0.12	274.9	0.4216				
425.50	0.121	275	0.4216				
425.53	0.122	275.2	0.4216				
425.57	0.121	275.2	0.4225				
425.60	0.121	275.3	0.4225				
425.63	0.121	275.4	0.4225				
425.67	0.123	275.7	0.4234				
425.70	0.122	275.7	0.4234				
425.73	0.121	275.7	0.4234				
425.77	0.12	275.6	0.4234				
425.80	0.12	275.6	0.4225				
425.83	0.12	275.7	0.4225				
425.87	0.12	275.7	0.4225				
425.90	0.12	275.8	0.4225				
425.93	0.12	275.8	0.4225				
425.97	0.12	275.9	0.4225				
426.00	0.119	275.9	0.4225				
426.03	0.121	275.9	0.4225				
426.07	0.121	276.1	0.4234				
426.10	0.12	276.1	0.4225				
426.13	0.118	275.9	0.4216				
426.17	0.118	276	0.4225				
426.20	0.118	276	0.4225				
426.23	0.118	276	0.4225				
426.27	0.117	276	0.4225				
426.30	0.117	276.1	0.4225				
426.33	0.117	276.1	0.4225				
426.37	0.117	276.1	0.4225				
426.40	0.117	276.2	0.4225				
426.43	0.118	276.3	0.4225				
426.47	0.115	276	0.4225				
426.50	0.115	276	0.4207				
426.53	0.115	276.1	0.4207				
426.57	0.115	276.1	0.4207				
426.60	0.115	276.1	0.4207				
426.63	0.115	276.1	0.4207				
426.67	0.114	276.1	0.4207				
426.70	0.113	276	0.4207				

Prova triassiale ciclica SNGR03-C4

pressione di confinamento (kPa)		450	pressione di confinamento (kPa)		450
deviatore ciclico (kPa)		80	deviatore ciclico (kPa)		120
frequenza (hz)		0.00071429	frequenza (hz)		0.0007143
426.75	0.113	276	0.4198		
426.78	0.113	276	0.4198		
426.80	0.112	276	0.4198		
426.83	0.112	276	0.4198		
426.87	0.112	276	0.4189		
426.90	0.112	275.9	0.4189		
426.93	0.111	275.9	0.4189		
426.97	0.11	275.8	0.4181		
427.00	0.11	275.8	0.4181		
427.03	0.109	275.7	0.4181		
427.07	0.109	275.7	0.4172		
427.10	0.109	275.6	0.4172		
427.13	0.108	275.6	0.4172		
427.17	0.108	275.6	0.4172		
427.20	0.106	275.4	0.4154		
427.23	0.106	275.4	0.4154		
427.27	0.106	275.4	0.4154		
427.30	0.107	275.4	0.4154		
427.33	0.107	275.4	0.4154		
427.37	0.104	275.1	0.4136		
427.40	0.103	275	0.4136		
427.43	0.103	275	0.4127		
427.47	0.102	274.9	0.4127		
427.50	0.102	274.8	0.4127		
427.53	0.103	274.8	0.4127		
427.57	0.103	274.9	0.4127		
427.60	0.102	274.8	0.4118		
427.63	0.097	274.3	0.4092		
427.67	0.098	274.3	0.4092		
427.70	0.098	274.3	0.4092		
427.73	0.098	274.2	0.4092		
427.77	0.098	274.2	0.4092		
427.80	0.098	274.2	0.4092		
427.83	0.095	274	0.4083		
427.87	0.095	273.9	0.4074		
427.90	0.095	273.7	0.4065		
427.93	0.094	273.6	0.4065		
427.97	0.093	273.4	0.4065		
428.00	0.092	273.4	0.4056		
428.03	0.092	273.4	0.4047		
428.07	0.093	273.4	0.4056		
428.10	0.09	273	0.4039		
428.13	0.09	273	0.403		
428.18	0.089	272.8	0.4021		
428.22	0.088	272.6	0.4021		
428.25	0.087	272.5	0.4012		
428.27	0.088	272.5	0.4012		
428.30	0.087	272.4	0.4012		
428.33	0.083	272.4	0.4003		
428.37	0.083	271.9	0.3985		
428.40	0.084	271.9	0.3985		
428.43	0.083	271.8	0.3976		
428.47	0.082	271.6	0.3967		
428.50	0.082	271.4	0.3959		
428.53	0.081	271.2	0.3959		
428.57	0.079	271.2	0.395		
428.60	0.079	271	0.3941		
428.63	0.079	270.9	0.3941		
428.67	0.079	270.8	0.3932		
428.70	0.077	270.6	0.3923		

Prova triassiale ciclica SNGR03-C4

pressione di confinamento (kPa)		450		pressione di confinamento (kPa)		450	
deviatore ciclico (kPa)		80		deviatore ciclico (kPa)		120	
frequenza (hz)		0.00071429		frequenza (hz)		0.0007143	
428.73	0.073	270.1	0.3896				
428.77	0.073	270	0.3896				
428.80	0.074	270	0.3888				
428.83	0.074	269.9	0.3888				
428.87	0.075	269.9	0.3888				
428.90	0.07	269.3	0.387				
428.93	0.071	269.3	0.3861				
428.97	0.07	269.1	0.3852				
429.00	0.068	268.8	0.3852				
429.03	0.069	268.8	0.3843				
429.07	0.069	268.8	0.3843				
429.10	0.066	268.4	0.3817				
429.13	0.065	268.1	0.3808				
429.17	0.065	268	0.3799				
429.20	0.064	267.8	0.379				
429.23	0.064	267.7	0.379				
429.27	0.063	267.7	0.379				
429.30	0.063	267.6	0.3781				
429.33	0.06	267.1	0.3763				
429.37	0.059	266.9	0.3754				
429.40	0.056	266.3	0.3728				
429.43	0.057	266.3	0.3728				
429.47	0.057	266.2	0.3728				
429.50	0.057	266.2	0.3719				
429.53	0.057	266.1	0.3719				
429.57	0.054	265.5	0.3683				
429.60	0.051	265.2	0.3666				
429.65	0.051	265	0.3666				
429.68	0.051	264.8	0.3657				
429.70	0.052	264.8	0.3657				
429.73	0.05	264.5	0.3639				
429.77	0.049	264.2	0.363				
429.80	0.044	263.6	0.363				
429.83	0.045	263.6	0.3595				
429.87	0.045	263.4	0.3586				
429.90	0.045	263.3	0.3586				
429.93	0.046	263.3	0.3586				
429.97	0.043	262.9	0.3568				
430.00	0.041	262.5	0.355				
430.03	0.04	262.1	0.355				
430.07	0.037	262.1	0.3524				
430.10	0.037	261.6	0.3506				
430.13	0.037	261.5	0.3497				
430.17	0.037	261.3	0.3488				
430.20	0.035	261	0.3479				
430.23	0.035	260.8	0.3462				
430.27	0.033	260.4	0.3462				
430.30	0.032	260.4	0.3444				
430.33	0.032	260.1	0.3435				
430.37	0.033	260.1	0.3435				
430.40	0.03	259.7	0.3408				
430.43	0.029	259.4	0.3382				
430.47	0.026	258.8	0.3355				
430.50	0.025	258.5	0.3355				
430.53	0.025	258.5	0.3337				
430.57	0.025	258.3	0.3328				
430.60	0.024	258	0.3311				
430.63	0.022	257.6	0.3293				
430.67	0.021	257.3	0.3275				
430.70	0.023	257.3	0.3284				

Prova triassiale ciclica SNGR03-C4

tensione di confinamento (kPa)		450	tensione di confinamento (kPa)		450
deviatore ciclico (kPa)		80	deviatore ciclico (kPa)		120
frequenza (hz)		0.00071429	frequenza (hz)		0.0007143
430.73	0.02	256.8	0.3284		
430.77	0.018	256.8	0.3257		
430.80	0.018	256.5	0.324		
430.83	0.014	255.9	0.3195		
430.87	0.014	255.5	0.3186		
430.90	0.015	255.4	0.3177		
430.93	0.013	255	0.316		
430.97	0.011	254.6	0.316		
431.00	0.012	254.6	0.3142		
431.03	0.012	254.6	0.3133		
431.08	0.009	253.8	0.3115		
431.12	0.007	253.8	0.3098		
431.15	0.007	253.5	0.308		
431.17	0.007	253.2	0.3062		
431.20	0.005	252.8	0.3044		
431.23	0.004	252.5	0.3009		
431.27	0.001	251.8	0.2982		
431.30	0	251.6	0.2982		
431.33	0.001	251.6	0.2973		
431.37	0.001	251.6	0.2973		
431.40	0.001	251.4	0.2964		
431.43	-0.002	251	0.2938		
431.47	-0.003	250.6	0.2911		
431.50	-0.004	250.3	0.2876		
431.53	-0.006	249.8	0.2876		
431.57	-0.009	249.8	0.2849		
431.60	-0.009	249.3	0.2805		
431.63	-0.008	249.2	0.2778		
431.67	-0.009	248.8	0.2743		
431.70	-0.011	248.5	0.2707		
431.73	-0.011	248.2	0.2672		
431.77	-0.013	247.8	0.2672		
431.80	-0.014	247.8	0.2636		
431.83	-0.014	247.5	0.2592		
431.87	-0.015	247.2	0.2565		
431.90	-0.014	247	0.2547		
431.93	-0.02	246.2	0.2485		
431.97	-0.018	246.1	0.2459		
432.00	-0.019	245.8	0.2459		
432.03	-0.021	245.8	0.2423		
432.07	-0.021	245.3	0.2387		
432.10	-0.022	245	0.2352		
432.13	-0.023	244.6	0.2316		
432.17	-0.025	244.2	0.229		
432.20	-0.022	244.3	0.2281		
432.23	-0.026	243.6	0.2281		
432.27	-0.03	243.6	0.2245		
432.30	-0.03	242.8	0.2201		
432.33	-0.029	242.8	0.2183		
432.37	-0.029	242.5	0.2157		
432.40	-0.032	242	0.213		
432.43	-0.031	241.8	0.2112		
432.47	-0.033	241.3	0.2112		
432.50	-0.034	241.3	0.2086		
432.55	-0.035	240.6	0.2032		
432.58	-0.034	240.5	0.2032		
432.60	-0.036	240.5	0.2024		
432.63	-0.036	239.9	0.1988		
432.67	-0.04	239.2	0.1953		
432.70	-0.041	238.8	0.1935		

Prova triassiale ciclica SNGR03-C4

tensione di confinamento (kPa)		450	tensione di confinamento (kPa)		450
deviatore ciclico (kPa)		80	deviatore ciclico (kPa)		120
frequenza (hz)		0.00071429	frequenza (hz)		0.0007143
432.73	-0.041	238.7	0.1926		
432.77	-0.041	238.3	0.1908		
432.80	-0.043	237.9	0.1908		
432.83	-0.042	237.9	0.189		
432.87	-0.042	237.7	0.1882		
432.90	-0.043	237.3	0.1855		
432.93	-0.048	236.5	0.1819		
432.97	-0.048	236.2	0.1811		
433.00	-0.048	236	0.1802		
433.03	-0.049	235.6	0.1802		
433.07	-0.05	235.6	0.1784		
433.10	-0.05	235.3	0.1766		
433.13	-0.051	235	0.1757		
433.17	-0.052	234.6	0.174		
433.20	-0.053	234.2	0.1731		
433.23	-0.054	233.9	0.1713		
433.27	-0.056	233.5	0.1713		
433.30	-0.056	233.5	0.1695		
433.33	-0.056	233.2	0.1686		
433.37	-0.057	232.9	0.1677		
433.40	-0.056	232.7	0.1669		
433.43	-0.058	232.3	0.1651		
433.47	-0.06	231.8	0.1633		
433.50	-0.062	231.4	0.1633		
433.53	-0.062	231.4	0.1615		
433.57	-0.062	231	0.1597		
433.60	-0.065	230.4	0.158		
433.63	-0.066	230.1	0.1571		
433.67	-0.065	229.9	0.1562		
433.70	-0.065	229.6	0.1562		
433.73	-0.067	229.2	0.1562		
433.77	-0.067	229.2	0.1544		
433.80	-0.067	229	0.1535		
433.83	-0.068	228.6	0.1526		
433.87	-0.07	228.2	0.1518		
433.90	-0.069	228.1	0.1518		
433.93	-0.07	227.8	0.15		
433.98	-0.072	227.1	0.1482		
434.02	-0.072	227	0.1482		
434.05	-0.073	226.8	0.1473		
434.07	-0.074	226.4	0.1473		
434.10	-0.075	226.4	0.1455		
434.13	-0.075	226	0.1455		
434.17	-0.076	225.8	0.1438		
434.20	-0.077	225.4	0.1429		
434.23	-0.077	225.2	0.142		
434.27	-0.078	224.9	0.1411		
434.30	-0.079	224.5	0.1411		
434.33	-0.08	224.5	0.1402		
434.37	-0.08	224.3	0.1402		
434.40	-0.08	224	0.1393		
434.43	-0.081	223.7	0.1384		
434.47	-0.082	223.4	0.1376		
434.50	-0.083	223.1	0.1367		
434.53	-0.084	222.8	0.1367		
434.57	-0.084	222.8	0.1358		
434.60	-0.084	222.6	0.1349		
434.63	-0.085	222.2	0.134		
434.67	-0.087	221.8	0.1331		
434.70	-0.086	221.7	0.1331		

Prova triassiale ciclica SNGR03-C4

tensione di confinamento (kPa)		450	tensione di confinamento (kPa)		450
deviatore ciclico (kPa)		80	deviatore ciclico (kPa)		120
frequenza (hz)		0.00071429	frequenza (hz)		0.0007143
434.73	-0.086	221.5	0.1322		
434.77	-0.088	221.1	0.1322		
434.80	-0.089	221.1	0.1313		
434.83	-0.089	220.8	0.1305		
434.87	-0.089	220.6	0.1305		
434.90	-0.09	220.3	0.1296		
434.93	-0.09	220	0.1287		
434.97	-0.091	219.8	0.1278		
435.00	-0.091	219.5	0.1278		
435.03	-0.092	219.5	0.1278		
435.07	-0.092	219.3	0.1269		
435.10	-0.092	219	0.126		
435.13	-0.093	218.7	0.1251		
435.17	-0.094	218.5	0.1242		
435.20	-0.094	218.2	0.1242		
435.23	-0.095	218	0.1242		
435.27	-0.095	218	0.1234		
435.30	-0.095	217.8	0.1234		
435.33	-0.096	217.6	0.1225		
435.37	-0.097	217.3	0.1216		
435.40	-0.097	217.1	0.1216		
435.45	-0.097	216.9	0.1207		
435.48	-0.098	216.7	0.1207		
435.50	-0.098	216.5	0.1198		
435.53	-0.099	216.2	0.1198		
435.57	-0.099	216	0.1198		
435.60	-0.099	216	0.1189		
435.63	-0.099	215.8	0.1189		
435.67	-0.1	215.6	0.118		
435.70	-0.1	215.4	0.118		
435.73	-0.1	215.2	0.1171		
435.77	-0.102	214.9	0.1163		
435.80	-0.102	214.8	0.1163		
435.83	-0.101	214.8	0.1163		
435.87	-0.101	214.7	0.1163		
435.90	-0.102	214.5	0.1154		
435.93	-0.104	214.1	0.1145		
435.97	-0.103	214	0.1145		
436.00	-0.103	214	0.1145		
436.03	-0.102	213.9	0.1145		
436.07	-0.104	213.9	0.1145		
436.10	-0.104	213.6	0.1136		
436.13	-0.104	213.5	0.1136		
436.17	-0.104	213.3	0.1136		
436.20	-0.104	213.1	0.1127		
436.23	-0.104	213	0.1127		
436.27	-0.105	212.8	0.1127		
436.30	-0.105	212.8	0.1127		
436.33	-0.105	212.6	0.1109		
436.37	-0.106	212.4	0.11		
436.40	-0.105	212.3	0.11		
436.43	-0.105	212.3	0.11		
436.47	-0.105	212.2	0.11		
436.50	-0.106	211.9	0.11		
436.53	-0.106	211.9	0.11		
436.57	-0.106	211.8	0.11		
436.60	-0.106	211.7	0.11		
436.63	-0.106	211.6	0.1092		
436.67	-0.106	211.4	0.1092		
436.70	-0.107	211.3	0.1083		

Prova triassiale ciclica SNGR03-C4

tensione di confinamento (kPa)		450	tensione di confinamento (kPa)		450
deviatore ciclico (kPa)		80	deviatore ciclico (kPa)		120
frequenza (hz)		0.00071429	frequenza (hz)		0.0007143
436.73	-0.107	211.2	0.1083		
436.77	-0.107	211.2	0.1083		
436.80	-0.107	211.1	0.1083		
436.83	-0.107	211	0.1083		
436.87	-0.106	210.9	0.1083		
436.92	-0.106	210.9	0.1083		
436.95	-0.107	210.7	0.1083		
436.97	-0.107	210.6	0.1074		
437.00	-0.107	210.6	0.1074		
437.03	-0.108	210.3	0.1074		
437.07	-0.107	210.3	0.1074		
437.10	-0.107	210.3	0.1074		
437.13	-0.107	210.3	0.1074		
437.17	-0.107	210.2	0.1074		
437.20	-0.106	210.2	0.1074		
437.23	-0.106	210.1	0.1074		
437.27	-0.106	210.1	0.1074		
437.30	-0.106	210	0.1074		
437.33	-0.106	210	0.1074		
437.37	-0.106	209.9	0.1065		
437.40	-0.107	209.8	0.1065		
437.43	-0.106	209.8	0.1065		
437.47	-0.106	209.7	0.1065		
437.50	-0.106	209.7	0.1065		
437.53	-0.105	209.7	0.1065		
437.57	-0.105	209.7	0.1074		
437.60	-0.105	209.7	0.1074		
437.63	-0.105	209.7	0.1074		
437.67	-0.105	209.5	0.1065		
437.70	-0.105	209.5	0.1065		
437.73	-0.105	209.5	0.1065		
437.77	-0.104	209.5	0.1065		
437.80	-0.104	209.5	0.1065		
437.83	-0.104	209.5	0.1065		
437.87	-0.104	209.5	0.1074		
437.90	-0.103	209.5	0.1074		
437.93	-0.103	209.5	0.1074		
437.97	-0.103	209.5	0.1074		
438.00	-0.102	209.5	0.1074		
438.03	-0.102	209.5	0.1074		
438.07	-0.102	209.5	0.1074		
438.10	-0.102	209.5	0.1074		
438.13	-0.101	209.5	0.1083		
438.17	-0.1	209.6	0.1083		
438.20	-0.1	209.6	0.1083		
438.23	-0.1	209.6	0.1083		
438.27	-0.1	209.6	0.1083		
438.30	-0.1	209.6	0.1083		
438.35	-0.098	209.7	0.1083		
438.38	-0.098	209.7	0.1092		
438.42	-0.098	209.7	0.1092		
438.43	-0.096	210	0.11		
438.47	-0.096	210	0.11		
438.50	-0.099	209.7	0.1092		
438.53	-0.098	209.7	0.1092		
438.57	-0.097	209.9	0.1092		
438.60	-0.095	210	0.11		
438.63	-0.095	210	0.1109		
438.67	-0.095	210	0.11		
438.70	-0.095	210	0.11		

Prova triassiale ciclica SNGR03-C4

tensione di confinamento (kPa)		450	tensione di confinamento (kPa)		450
deviatore ciclico (kPa)		80	deviatore ciclico (kPa)		120
frequenza (hz)		0.00071429	frequenza (hz)		0.0007143
438.73	-0.094	210.1	0.1109		
438.77	-0.094	210.2	0.1127		
438.80	-0.093	210.3	0.1127		
438.83	-0.092	210.4	0.1127		
438.87	-0.092	210.4	0.1127		
438.90	-0.092	210.5	0.1136		
438.93	-0.091	210.5	0.1136		
438.97	-0.091	210.6	0.1136		
439.00	-0.09	210.7	0.1136		
439.03	-0.089	210.8	0.1136		
439.07	-0.088	210.9	0.1145		
439.10	-0.088	210.9	0.1145		
439.13	-0.088	210.9	0.1154		
439.17	-0.087	211.1	0.1154		
439.20	-0.086	211.2	0.1163		
439.23	-0.086	211.3	0.1163		
439.27	-0.085	211.4	0.1163		
439.30	-0.084	211.6	0.1163		
439.33	-0.084	211.6	0.1171		
439.37	-0.084	211.6	0.1171		
439.40	-0.084	211.7	0.118		
439.43	-0.083	211.9	0.118		
439.47	-0.082	212.1	0.1189		
439.50	-0.081	212.2	0.1189		
439.53	-0.08	212.3	0.1189		
439.57	-0.08	212.3	0.1198		
439.60	-0.079	212.5	0.1198		
439.63	-0.078	212.7	0.1207		
439.67	-0.078	212.8	0.1207		
439.70	-0.077	212.9	0.1216		
439.73	-0.076	213.1	0.1216		
439.77	-0.075	213.3	0.1225		
439.82	-0.075	213.4	0.1225		
439.85	-0.074	213.5	0.1225		
439.87	-0.073	213.6	0.1234		
439.90	-0.073	213.6	0.1234		
439.93	-0.073	213.8	0.1242		
439.97	-0.072	214	0.1251		
440.00	-0.067	214.5	0.1269		
440.03	-0.069	214.5	0.1269		
440.07	-0.069	214.5	0.1269		
440.10	-0.069	214.6	0.1269		
440.13	-0.069	214.6	0.126		
440.17	-0.07	214.5	0.1269		
440.20	-0.067	215	0.1278		
440.23	-0.065	215.2	0.1287		
440.27	-0.064	215.4	0.1296		
440.30	-0.064	215.6	0.1296		
440.33	-0.062	215.9	0.1305		
440.37	-0.062	215.9	0.1313		
440.40	-0.062	216	0.1313		
440.43	-0.061	216.2	0.1331		
440.47	-0.06	216.5	0.1331		
440.50	-0.059	216.7	0.134		
440.53	-0.058	217	0.134		
440.57	-0.057	217.2	0.1349		
440.60	-0.057	217.2	0.1358		
440.63	-0.056	217.3	0.1358		
440.67	-0.055	217.6	0.1376		
440.70	-0.054	217.8	0.1384		

Prova triassiale ciclica SNGR03-C4

pressione di confinamento (kPa)		450	pressione di confinamento (kPa)		450
deviatore ciclico (kPa)		80	deviatore ciclico (kPa)		120
frequenza (hz)		0.00071429	frequenza (hz)		0.0007143
440.73	-0.053	218.1	0.1384		
440.77	-0.052	218.3	0.1384		
440.80	-0.05	218.6	0.1393		
440.83	-0.05	218.6	0.1402		
440.87	-0.05	218.7	0.1411		
440.90	-0.048	219.1	0.1429		
440.93	-0.045	219.5	0.1438		
440.97	-0.046	219.6	0.1438		
441.00	-0.046	219.7	0.1438		
441.03	-0.044	220	0.1447		
441.07	-0.044	220	0.1455		
441.10	-0.043	220.3	0.1464		
441.13	-0.044	220.3	0.1464		
441.17	-0.043	220.6	0.1473		
441.20	-0.04	221	0.15		
441.25	-0.038	221.5	0.1509		
441.28	-0.038	221.6	0.1518		
441.32	-0.037	221.9	0.1526		
441.33	-0.037	222.1	0.1526		
441.37	-0.035	222.5	0.1526		
441.40	-0.035	222.5	0.1544		
441.43	-0.035	222.7	0.1553		
441.47	-0.033	223	0.1571		
441.50	-0.032	223.3	0.158		
441.53	-0.031	223.5	0.1589		
441.57	-0.03	223.9	0.1589		
441.60	-0.028	224.1	0.1606		
441.63	-0.028	224.1	0.1624		
441.67	-0.026	224.8	0.1633		
441.70	-0.027	225	0.1642		
441.73	-0.025	225.2	0.166		
441.77	-0.023	225.4	0.1669		
441.80	-0.021	225.8	0.1669		
441.83	-0.021	226	0.1686		
441.87	-0.021	226	0.1695		
441.90	-0.023	226	0.1695		
441.93	-0.021	226.5	0.1713		
441.97	-0.018	226.8	0.1731		
442.00	-0.017	227.1	0.1748		
442.03	-0.015	227.6	0.1748		
442.07	-0.014	227.9	0.1766		
442.10	-0.014	227.9	0.1784		
442.13	-0.014	228.1	0.1793		
442.17	-0.013	228.4	0.1811		
442.20	-0.011	228.8	0.1828		
442.23	-0.01	229.1	0.1846		
442.27	-0.009	229.5	0.1846		
442.30	-0.007	229.8	0.1864		
442.33	-0.007	229.8	0.1882		
442.37	-0.007	230.1	0.1899		
442.40	-0.005	230.5	0.1917		
442.43	-0.004	230.9	0.1944		
442.47	-0.003	231.4	0.1979		
442.50	0	231.9	0.1979		
442.53	0	232.1	0.2006		
442.57	0	232.1	0.2015		
442.60	0.001	232.3	0.2032		
442.63	0.002	232.7	0.2059		
442.67	0.003	233	0.2077		
442.72	0.005	233.4	0.2103		

Prova triassiale ciclica SNGR03-C4

tensione di confinamento (kPa)		450		tensione di confinamento (kPa)		450	
deviatore ciclico (kPa)		80		deviatore ciclico (kPa)		120	
frequenza (hz)		0.00071429		frequenza (hz)		0.0007143	
442.75	0.003	233.5	0.2112				
442.77	0.005	233.8	0.2139				
442.80	0.007	234.2	0.2166				
442.83	0.008	234.4	0.2166				
442.87	0.007	234.6	0.2192				
442.90	0.007	234.6	0.2201				
442.93	0.007	234.7	0.2219				
442.97	0.007	234.9	0.2228				
443.00	0.006	235	0.2237				
443.03	0.008	235.2	0.2254				
443.07	0.008	235.4	0.2254				
443.10	0.007	235.5	0.2263				
443.13	0.007	235.5	0.2263				
443.17	0.007	235.6	0.2272				
443.20	0.007	235.7	0.2281				
443.23	0.007	235.8	0.229				
443.27	0.007	235.9	0.229				
443.30	0.007	236	0.2299				
443.33	0.009	236.4	0.2299				
443.37	0.009	236.4	0.2325				
443.40	0.007	236.3	0.2316				
443.43	0.006	236.3	0.2316				
443.47	0.006	236.4	0.2316				
443.50	0.007	236.5	0.2325				
443.53	0.007	236.6	0.2325				
443.57	0.007	236.8	0.2325				
443.60	0.007	236.8	0.2334				
443.63	0.007	236.8	0.2343				
443.67	0.007	236.9	0.2343				
443.70	0.007	237	0.2343				
443.73	0.007	237.1	0.2352				
443.77	0.007	237.2	0.2352				
443.80	0.007	237.2	0.2352				
443.83	0.007	237.2	0.2361				
443.87	0.007	237.4	0.2361				
443.90	0.009	237.7	0.2379				
443.93	0.009	237.7	0.2387				
443.97	0.006	237.5	0.237				
444.00	0.006	237.6	0.237				
444.03	0.007	237.7	0.237				
444.07	0.007	237.7	0.2379				
444.10	0.007	237.8	0.2379				
444.13	0.007	237.9	0.2379				
444.18	0.007	237.9	0.2387				
444.22	0.007	238	0.2387				
444.23	0.007	238.1	0.2387				
444.27	0.007	238.2	0.2387				
444.30	0.007	238.3	0.2396				
444.33	0.007	238.3	0.2396				
444.37	0.007	238.3	0.2396				
444.40	0.007	238.3	0.2396				
444.43	0.007	238.4	0.2387				
444.47	0.007	238.5	0.2396				
444.50	0.01	238.8	0.2414				
444.53	0.008	238.8	0.2414				
444.57	0.008	238.8	0.2414				
444.60	0.005	238.6	0.2414				
444.63	0.006	238.6	0.2396				
444.67	0.006	238.7	0.2396				
444.70	0.006	238.7	0.2396				

Prova triassiale ciclica SNGR03-C4

tensione di confinamento (kPa)		450		tensione di confinamento (kPa)		450	
deviatore ciclico (kPa)		80		deviatore ciclico (kPa)		120	
frequenza (hz)		0.00071429		frequenza (hz)		0.0007143	
444.73	0.007	238.9	0.2405				
444.77	0.007	238.9	0.2405				
444.80	0.007	239	0.2414				
444.83	0.007	239.1	0.2414				
444.87	0.007	239.1	0.2414				
444.90	0.007	239.1	0.2414				
444.93	0.007	239.1	0.2414				
444.97	0.007	239.2	0.2414				
445.00	0.007	239.2	0.2414				
445.03	0.007	239.3	0.2414				
445.07	0.007	239.3	0.2414				
445.10	0.01	239.3	0.2414				
445.13	0.01	239.7	0.2432				
445.17	0.009	239.6	0.2432				
445.20	0.007	239.5	0.2423				
445.23	0.007	239.5	0.2423				
445.27	0.007	239.5	0.2423				
445.30	0.007	239.6	0.2423				
445.33	0.007	239.6	0.2423				
445.37	0.007	239.6	0.2423				
445.40	0.007	239.7	0.2423				
445.43	0.007	239.7	0.2423				
445.47	0.007	239.8	0.2423				
445.50	0.007	239.8	0.2423				
445.53	0.007	239.8	0.2423				
445.57	0.007	239.8	0.2423				
445.62	0.007	239.9	0.2423				
445.65	0.007	239.9	0.2423				
445.67	0.007	239.9	0.2423				
445.70	0.007	240	0.2423				
445.73	0.007	240	0.2423				
445.77	0.007	240	0.2423				
445.80	0.007	240.1	0.2423				
445.83	0.007	240.1	0.2423				
445.87	0.009	240.4	0.2423				
445.90	0.008	240.4	0.2432				
445.93	0.008	240.4	0.2441				
445.97	0.008	240.2	0.2423				
446.00	0.006	240.2	0.2423				
446.03	0.006	240.2	0.2423				
446.07	0.006	240.3	0.2423				
446.10	0.007	240.3	0.2423				
446.13	0.007	240.3	0.2423				
446.17	0.007	240.4	0.2423				
446.20	0.007	240.4	0.2423				
446.23	0.007	240.5	0.2423				
446.27	0.007	240.5	0.2423				
446.30	0.007	240.6	0.2423				
446.33	0.008	240.8	0.2423				
446.37	0.008	240.8	0.2432				
446.40	0.008	240.8	0.2432				
446.43	0.008	240.8	0.2432				
446.47	0.007	240.8	0.2432				
446.50	0.007	240.8	0.2432				
446.53	0.007	240.8	0.2432				
446.57	0.007	240.8	0.2432				
446.60	0.005	240.8	0.2432				
446.63	0.005	240.6	0.2414				
446.67	0.006	240.7	0.2414				
446.70	0.006	240.8	0.2423				

Prova triassiale ciclica SNGR03-C4

pressione di confinamento (kPa)		450		pressione di confinamento (kPa)		450	
deviatore ciclico (kPa)		80		deviatore ciclico (kPa)		120	
frequenza (hz)		0.00071429		frequenza (hz)		0.0007143	
446.73	0.007	240.9	0.2423				
446.77	0.007	240.9	0.2423				
446.80	0.007	240.9	0.2423				
446.83	0.007	240.9	0.2423				
446.87	0.007	240.9	0.2423				
446.90	0.007	241	0.2423				
446.93	0.007	241	0.2423				
446.97	0.007	241	0.2423				
447.00	0.007	241.1	0.2423				
447.03	0.009	241.3	0.2423				
447.08	0.009	241.3	0.2441				
447.12	0.007	241.2	0.2432				
447.13	0.007	241.1	0.2432				
447.17	0.007	241.1	0.2432				
447.20	0.007	241.2	0.2432				
447.23	0.007	241.2	0.2432				
447.27	0.007	241.2	0.2432				
447.30	0.007	241.3	0.2432				
447.33	0.007	241.3	0.2432				
447.37	0.007	241.3	0.2432				
447.40	0.007	241.3	0.2432				
447.43	0.007	241.4	0.2432				
447.47	0.007	241.4	0.2432				
447.50	0.007	241.4	0.2432				
447.53	0.007	241.4	0.2441				
447.57	0.009	241.6	0.2441				
447.60	0.007	241.5	0.2441				
447.63	0.007	241.5	0.2432				
447.67	0.007	241.5	0.2432				
447.70	0.007	241.6	0.2432				
447.73	0.007	241.6	0.2432				
447.77	0.007	241.6	0.2432				
447.80	0.007	241.6	0.2432				
447.83	0.007	241.6	0.2432				
447.87	0.007	241.6	0.2432				
447.90	0.007	241.7	0.2432				
447.93	0.007	241.7	0.2423				
447.97	0.007	241.7	0.2423				
448.00	0.007	241.7	0.2432				
448.03	0.008	241.8	0.2432				
448.07	0.008	241.9	0.2432				
448.10	0.008	241.9	0.2432				
448.13	0.008	241.9	0.2432				
448.17	0.008	241.9	0.2432				
448.20	0.008	241.9	0.2432				
448.23	0.005	241.6	0.2414				
448.27	0.006	241.7	0.2414				
448.30	0.007	241.8	0.2414				
448.33	0.007	241.8	0.2414				
448.37	0.007	241.8	0.2414				
448.40	0.007	241.9	0.2423				
448.43	0.007	241.9	0.2423				
448.47	0.007	242	0.2423				
448.52	0.007	242	0.2423				
448.55	0.007	242	0.2423				
448.58	0.007	242	0.2423				
448.60	0.007	242	0.2423				
448.63	0.007	242	0.2423				
448.67	0.007	242	0.2423				
448.70	0.007	242.1	0.2423				

Prova triassiale ciclica SNGR03-C4

pressione di confinamento (kPa)		450		pressione di confinamento (kPa)		450	
deviatore ciclico (kPa)		80		deviatore ciclico (kPa)		120	
frequenza (hz)		0.00071429		frequenza (hz)		0.0007143	
448.73	0.007	242.1	0.2423				
448.77	0.007	242.1	0.2423				
448.80	0.007	242.1	0.2423				
448.83	0.007	242.1	0.2423				
448.87	0.007	242.1	0.2423				
448.90	0.008	242.1	0.2423				
448.93	0.008	242.3	0.2423				
448.97	0.008	242.3	0.2423				
449.00	0.008	242.3	0.2423				
449.03	0.005	242	0.2405				
449.07	0.006	242.1	0.2414				
449.10	0.006	242.1	0.2414				
449.13	0.007	242.1	0.2414				
449.17	0.007	242.2	0.2414				
449.20	0.007	242.2	0.2414				
449.23	0.007	242.3	0.2414				
449.27	0.007	242.3	0.2414				
449.30	0.007	242.3	0.2414				
449.33	0.007	242.3	0.2414				
449.37	0.007	242.3	0.2414				
449.40	0.007	242.3	0.2414				
449.43	0.007	242.4	0.2414				
449.47	0.007	242.4	0.2414				
449.50	0.007	242.4	0.2414				
449.53	0.007	242.4	0.2414				
449.57	0.007	242.4	0.2414				
449.60	0.007	242.4	0.2414				
449.63	0.007	242.4	0.2414				
449.67	0.007	242.5	0.2414				
449.70	0.007	242.5	0.2414				
449.73	0.007	242.5	0.2414				
449.77	0.007	242.5	0.2414				
449.80	0.007	242.4	0.2414				
449.83	0.008	242.4	0.2414				
449.87	0.008	242.6	0.2414				
449.90	0.008	242.6	0.2414				
449.93	0.008	242.6	0.2414				
449.98	0.008	242.6	0.2414				
450.02	0.005	242.4	0.2396				
450.03	0.006	242.4	0.2396				
450.07	0.006	242.5	0.2396				
450.10	0.007	242.5	0.2396				
450.13	0.007	242.6	0.2396				
450.17	0.007	242.6	0.2405				
450.20	0.007	242.6	0.2405				
450.23	0.007	242.6	0.2405				
450.27	0.007	242.6	0.2405				
450.30	0.007	242.7	0.2405				
450.33	0.007	242.7	0.2405				
450.37	0.007	242.7	0.2405				
450.40	0.007	242.7	0.2405				
450.43	0.007	242.7	0.2405				
450.47	0.007	242.7	0.2405				
450.50	0.007	242.7	0.2405				
450.53	0.007	242.7	0.2405				
450.57	0.007	242.7	0.2396				
450.60	0.007	242.8	0.2396				
450.63	0.007	242.8	0.2396				
450.67	0.007	242.8	0.2396				
450.70	0.007	242.7	0.2396				

Prova triassiale ciclica SNGR03-C4

tensione di confinamento (kPa)		450		tensione di confinamento (kPa)		450	
deviatore ciclico (kPa)		80		deviatore ciclico (kPa)		120	
frequenza (hz)		0.00071429		frequenza (hz)		0.0007143	
450.73	0.007	242.8	0.2396				
450.77	0.007	242.8	0.2396				
450.80	0.007	242.8	0.2396				
450.83	0.007	242.8	0.2396				
450.87	0.007	242.8	0.2396				
450.90	0.007	242.8	0.2396				
450.93	0.007	242.8	0.2396				
450.97	0.007	242.8	0.2396				
451.00	0.008	242.9	0.2396				
451.03	0.006	242.8	0.2387				
451.07	0.006	242.8	0.2387				
451.10	0.007	242.8	0.2387				
451.13	0.007	242.8	0.2387				
451.17	0.007	242.8	0.2387				
451.20	0.007	242.8	0.2387				
451.23	0.007	242.8	0.2387				
451.27	0.007	242.9	0.2387				
451.30	0.007	242.9	0.2387				
451.33	0.007	242.9	0.2387				
451.37	0.007	242.9	0.2387				
451.42	0.007	243	0.2387				
451.45	0.007	243	0.2387				
451.48	0.007	243	0.2387				
451.50	0.007	243	0.2387				
451.53	0.007	243	0.2387				
451.57	0.007	243	0.2387				
451.60	0.007	243	0.2387				
451.63	0.007	243	0.2387				
451.67	0.007	243	0.2387				
451.70	0.007	243	0.2387				
451.73	0.007	243	0.2387				
451.77	0.006	242.9	0.2379				
451.80	0.007	243	0.2379				
451.83	0.007	243	0.2379				
451.87	0.009	243.2	0.2379				
451.90	0.007	243.1	0.2396				
451.93	0.007	243.1	0.2387				
451.97	0.007	243.1	0.2387				
452.00	0.007	243.1	0.2387				
452.03	0.007	243.1	0.2379				
452.07	0.007	243.1	0.2379				
452.10	0.007	243.1	0.2379				
452.13	0.007	243.1	0.2379				
452.17	0.007	243.1	0.2379				
452.20	0.007	243.1	0.2379				
452.23	0.007	243.1	0.2379				
452.27	0.007	243.1	0.2379				
452.30	0.007	243.1	0.2379				
452.33	0.007	243.1	0.2379				
452.37	0.007	243.2	0.2379				
452.40	0.007	243.2	0.2379				
452.43	0.007	243.2	0.2379				
452.47	0.007	243.2	0.2379				
452.50	0.007	243.2	0.2379				
452.53	0.006	243.1	0.237				
452.57	0.007	243.2	0.237				
452.60	0.007	243.2	0.237				
452.63	0.007	243.2	0.237				
452.67	0.007	243.2	0.237				
452.70	0.007	243.2	0.237				

Prova triassiale ciclica SNGR03-C4

tensione di confinamento (kPa)		450		tensione di confinamento (kPa)		450	
deviatore ciclico (kPa)		80		deviatore ciclico (kPa)		120	
frequenza (hz)		0.00071429		frequenza (hz)		0.0007143	
452.73	0.007	243.2	0.237				
452.77	0.007	243.2	0.237				
452.80	0.009	243.4	0.2379				
452.83	0.008	243.4	0.2379				
452.88	0.008	243.4	0.2379				
452.92	0.008	243.4	0.2379				
452.93	0.007	243.3	0.2379				
452.97	0.007	243.3	0.237				
453.00	0.007	243.3	0.237				
453.03	0.007	243.3	0.237				
453.07	0.007	243.3	0.237				
453.10	0.007	243.1	0.2361				
453.13	0.005	243.1	0.2352				
453.17	0.006	243.1	0.2352				
453.20	0.006	243.1	0.2352				
453.23	0.006	243.2	0.2352				
453.27	0.007	243.3	0.2361				
453.30	0.007	243.3	0.2361				
453.33	0.007	243.3	0.2361				

Prova triassiale ciclica SNGR03-C4							
tensione di confinamento (kPa)		450		tensione di confinamento (kPa)		450	
deviatore ciclico (kPa)		150		deviatore ciclico (kPa)		180	
frequenza (hz)		0.0007143		frequenza (hz)		0.0007143	
tempo	cella di carico	u	LVDT	tempo	cella di carico	u	LVDT
(min)	kN	(kPa)	δ (mm)	(min)	kN	(kPa)	δ (mm)
0.00	666.2	262.8	0	0.00	0.006	273.4	0
0.08	666.1	262.9	0	0.08	0.009	274	0.0009
0.17	669.63	263.6	0.0018	0.17	0.014	275.6	0.0044
0.25	673.54	264.5	0.0044	0.25	0.016	276.1	0.0053
0.35	677.71	265.7	0.0062	0.33	0.023	277.6	0.008
0.43	680.61	266.6	0.0107	0.42	0.028	279.5	0.0107
0.52	684.42	267.9	0.0142	0.50	0.032	280.5	0.0142
0.60	688.61	268.8	0.0195	0.58	0.037	282	0.0186
0.68	689.42	269.7	0.0222	0.68	0.042	284	0.0213
0.77	693.22	270.8	0.0257	0.75	0.045	284.9	0.0266
0.85	697.55	272	0.0302	0.83	0.05	286.7	0.0311
0.93	701.79	273.6	0.0346	0.92	0.053	287.9	0.0346
1.02	703.42	274.6	0.0408	1.00	0.06	290	0.0399
1.10	706.85	275.7	0.0453	1.08	0.065	291.7	0.0417
1.18	710.32	276.9	0.0497	1.17	0.067	293.1	0.0488
1.28	714.48	278.5	0.0541	1.25	0.071	294.4	0.0533
1.35	716.51	279.6	0.0604	1.33	0.077	296.2	0.0586
1.43	719.95	280.7	0.0648	1.42	0.077	297.1	0.0612
1.52	722.88	281.9	0.0701	1.50	0.083	298.8	0.0666
1.60	725.21	283	0.0754	1.58	0.089	300.7	0.0719
1.68	728.57	284	0.079	1.67	0.093	302.7	0.079
1.77	732.43	285.2	0.0834	1.75	0.099	304.6	0.0843
1.85	735.7	286.8	0.0879	1.83	0.102	305.3	0.087
1.93	738.16	288	0.095	1.92	0.106	307.7	0.0923
2.02	741.42	289.1	0.0994	2.00	0.109	309	0.0994
2.10	744.08	290.3	0.1047	2.10	0.112	310.2	0.103
2.18	745.97	291.2	0.1083	2.17	0.118	311.8	0.1083
2.27	749.93	292.5	0.1136	2.25	0.122	313.9	0.1118
2.35	752.39	293.3	0.1172	2.33	0.125	315.1	0.1198
2.43	756.12	295	0.1216	2.42	0.129	316.5	0.1243
2.52	757.45	295.9	0.1278	2.50	0.135	318.3	0.1296
2.60	759.94	297	0.1314	2.58	0.133	318.7	0.1314
2.68	763.37	298.2	0.1367	2.67	0.138	320.2	0.1358
2.78	765.16	299.4	0.1394	2.75	0.143	321.8	0.1411
2.85	767.48	300.3	0.1447	2.83	0.147	323.7	0.1456
2.93	770.68	301.4	0.1491	2.92	0.147	324.6	0.1509
3.02	772.5	302.3	0.1527	3.00	0.153	326.1	0.1553
3.10	773.66	303.1	0.1553	3.08	0.155	327.2	0.1598
3.18	776.02	304	0.1589	3.17	0.16	328.8	0.1651
3.27	779.65	305.2	0.1633	3.25	0.159	329.3	0.1678
3.35	781.77	306.4	0.1669	3.33	0.164	330.8	0.1722
3.43	786.16	307.7	0.1731	3.42	0.166	332.3	0.1766
3.52	785.29	308.1	0.1749	3.52	0.171	333.8	0.1829
3.60	786.98	308.9	0.1775	3.58	0.172	334.5	0.1855
3.68	788.84	309.7	0.1802	3.67	0.175	335.3	0.1882
3.77	790.87	310.5	0.1829	3.75	0.177	337.1	0.1926
3.85	792.79	311.4	0.1864	3.83	0.182	338.3	0.1988
3.93	795.42	312.5	0.1882	3.92	0.183	338.9	0.2006
4.02	796.41	313.2	0.1926	4.00	0.185	339.8	0.2042
4.10	798.24	314	0.1953	4.08	0.187	340.9	0.2068
4.20	800.43	315	0.1997	4.17	0.189	341.6	0.2095
4.27	800.83	315.6	0.1997	4.25	0.193	342.2	0.2121

Prova triassiale ciclica SNGR03-C4							
tensione di confinamento (kPa)	450			tensione di confinamento (kPa)	450		
deviatore ciclico (kPa)	150			deviatore ciclico (kPa)	180		
frequenza (hz)	0.0007143			frequenza (hz)	0.0007143		
4.35	802.62	316.2	0.2033	4.33	0.194	343.8	0.2157
4.43	804.24	317	0.2059	4.42	0.195	344.2	0.2192
4.52	805.2	317.6	0.2086	4.50	0.195	344.7	0.221
4.60	805.93	318.1	0.2104	4.58	0.197	345.6	0.2255
4.68	806.99	318.6	0.2121	4.67	0.2	346.6	0.2281
4.77	808.39	319.2	0.2139	4.75	0.202	347.2	0.2299
4.85	809.85	320.1	0.2157	4.83	0.201	347.6	0.2317
4.93	810.31	320.6	0.2184	4.92	0.206	349	0.2352
5.02	813.5	321.4	0.221	5.02	0.204	348.9	0.237
5.10	810.01	321.2	0.221	5.08	0.206	349.6	0.2397
5.18	812.73	322.1	0.2237	5.17	0.207	350	0.2414
5.27	812.83	322.3	0.2246	5.25	0.206	350.4	0.2441
5.35	813.52	322.6	0.2255	5.33	0.207	350.9	0.2459
5.43	813.92	323.3	0.2272	5.42	0.21	351.5	0.2485
5.52	816.01	323.9	0.2299	5.50	0.21	351.8	0.2494
5.60	814.58	324	0.2299	5.58	0.21	352	0.2503
5.68	813.78	324.1	0.2299	5.67	0.21	352.2	0.2521
5.77	815.05	324.7	0.2308	5.75	0.21	352.7	0.2539
5.85	815.24	324.9	0.2326	5.83	0.211	352.9	0.2548
5.93	814.91	325	0.2326	5.92	0.21	352.9	0.2556
6.02	814.7	325.2	0.2334	6.00	0.21	353	0.2556
6.10	814.77	325.4	0.2334	6.08	0.211	353.2	0.2565
6.18	814.54	325.6	0.2343	6.17	0.21	353.2	0.2574
6.27	814.4	325.7	0.2343	6.25	0.209	353.1	0.2574
6.35	813.6	325.8	0.2343	6.33	0.208	353.4	0.2583
6.43	813.37	325.9	0.2343	6.43	0.208	353.3	0.2583
6.52	812.77	325.9	0.2343	6.50	0.207	353.2	0.2583
6.60	812.31	326	0.2343	6.58	0.207	353.1	0.2583
6.68	811.81	326	0.2343	6.67	0.206	353	0.2583
6.77	811.31	326	0.2343	6.75	0.205	352.8	0.2583
6.85	809.85	325.9	0.2343	6.83	0.204	352.7	0.2583
6.93	808.92	325.7	0.2334	6.92	0.201	352.1	0.2565
7.02	807.98	325.6	0.2334	7.00	0.202	352.2	0.2565
7.12	806.72	325.5	0.2326	7.08	0.201	352.1	0.2565
7.18	805.66	325.5	0.2326	7.17	0.199	351.7	0.2556
7.27	804.46	325.1	0.2317	7.25	0.196	351.4	0.2548
7.35	803.43	324.9	0.2308	7.33	0.194	350.5	0.253
7.43	801.8	324.7	0.2299	7.42	0.194	350.4	0.253
7.52	800.57	324.4	0.229	7.50	0.191	349.8	0.2512
7.60	799.44	324.2	0.2281	7.58	0.187	348.9	0.2494
7.68	798.11	323.9	0.2272	7.67	0.187	348.8	0.2494
7.77	795.49	323.5	0.2263	7.75	0.186	348.4	0.2477
7.85	794.22	323	0.2255	7.83	0.181	347.7	0.2468
7.93	792.96	322.7	0.2237	7.92	0.181	347.1	0.245
8.02	791.07	322.3	0.2228	8.00	0.179	346.5	0.2432
8.10	790	322	0.2219	8.08	0.175	345.6	0.2406
8.18	786.38	321.3	0.2192	8.17	0.173	344.8	0.2388
8.27	785.58	320.9	0.2184	8.25	0.167	343.4	0.237
8.35	782.69	320.3	0.2166	8.33	0.168	343.4	0.2334
8.43	780.43	319.6	0.2148	8.42	0.164	342.4	0.2317
8.52	778.74	319.1	0.2121	8.50	0.162	341.7	0.2299
8.60	777.01	318.6	0.2113	8.58	0.159	340.8	0.2281
8.68	774.05	318	0.2086	8.67	0.154	339.5	0.2246
8.77	771.39	317.2	0.2068	8.75	0.152	338.7	0.2237
8.85	769.23	316.5	0.2042	8.83	0.148	337.6	0.221
8.93	767.2	315.9	0.2024	8.92	0.143	336.2	0.2157
9.02	764.44	315.2	0.1997	9.00	0.142	335.6	0.2139
9.10	762.78	314.6	0.1979	9.08	0.138	334.5	0.2104
9.18	760.19	313.9	0.1953	9.17	0.135	333.4	0.2068
9.27	756.66	312.9	0.1926	9.25	0.131	332.4	0.205

Prova triassiale ciclica SNGR03-C4								
tensione di confinamento (kPa)	450				tensione di confinamento (kPa)	450		
deviatore ciclico (kPa)	150				deviatore ciclico (kPa)	180		
frequenza (hz)	0.0007143				frequenza (hz)	0.0007143		
9.35	755.8	312.2	0.19	9.35	0.126	330.8	0.1997	
9.43	751.61	311.3	0.1864	9.42	0.123	329.8	0.1971	
9.52	748.75	310.4	0.1837	9.50	0.123	329.2	0.1953	
9.60	746.02	309.5	0.1811	9.58	0.116	327.3	0.19	
9.68	742.13	308.3	0.1775	9.67	0.112	325.8	0.1873	
9.77	740.37	307.7	0.1749	9.75	0.107	324.3	0.1837	
9.85	736.11	306.9	0.1722	9.83	0.104	323.1	0.1766	
9.93	733.85	305.6	0.1695	9.92	0.1	321.9	0.174	
10.03	731.86	304.7	0.1651	10.00	0.095	320.2	0.1687	
10.10	728.46	303.7	0.1616	10.08	0.094	319.5	0.166	
10.18	726.63	302.7	0.1589	10.17	0.088	317.7	0.1616	
10.27	720.77	301.2	0.1544	10.25	0.082	315.6	0.1571	
10.35	718.28	300.3	0.1491	10.33	0.078	314	0.1527	
10.43	715.39	299.3	0.1456	10.42	0.075	312.9	0.1456	
10.52	712.82	298.3	0.142	10.50	0.071	311.3	0.142	
10.60	710.23	297.3	0.1385	10.58	0.064	309.1	0.1358	
10.68	706.86	296.2	0.134	10.67	0.063	308.3	0.1314	
10.77	702.27	295.4	0.1314	10.75	0.06	307	0.1287	
10.85	698.97	293.3	0.126	10.83	0.052	304.4	0.1207	
10.93	696.74	292.4	0.1198	10.92	0.048	302.7	0.1163	
11.02	692.18	291	0.1145	11.00	0.043	301	0.1101	
11.10	689.48	289.9	0.1101	11.08	0.04	299.5	0.1065	
11.18	687.28	288.9	0.1056	11.17	0.037	297.8	0.1012	
11.27	683.15	287.5	0.1012	11.25	0.028	295.1	0.0959	
11.35	679.55	286.8	0.0985	11.33	0.026	293.9	0.0888	
11.45	674.99	284.4	0.0897	11.42	0.021	292.1	0.0843	
11.52	673.79	283.6	0.0861	11.50	0.017	290.3	0.079	
11.60	670.39	282.3	0.0817	11.58	0.013	288.9	0.0746	
11.68	665.69	281	0.0763	11.67	0.006	286.5	0.0683	
11.77	661.99	279.1	0.0719	11.75	0.001	284.2	0.0639	
11.85	659.19	277.9	0.0639	11.83	-0.003	282.3	0.0595	
11.93	655.69	276.6	0.0595	11.92	-0.004	281.3	0.0533	
12.02	653.25	275.4	0.055	12.00	-0.011	279	0.047	
12.10	650.28	274.2	0.0497	12.08	-0.015	277	0.0408	
12.18	646.48	272.8	0.0453	12.17	-0.02	275.1	0.0364	
12.27	642.38	271.5	0.0408	12.27	-0.027	272.4	0.0293	
12.35	638.61	269.5	0.0355	12.33	-0.03	270.8	0.0249	
12.43	637.57	269.1	0.0302	12.42	-0.031	269.6	0.0213	
12.52	633.27	267.6	0.0257	12.50	-0.037	267.4	0.016	
12.60	629.73	265.7	0.0195	12.58	-0.043	265.2	0.0089	
12.68	626.52	264.8	0.016	12.67	-0.048	262.9	0.0053	
12.77	623.48	263.5	0.0107	12.75	-0.053	260.8	0.0027	
12.85	619.21	262.1	0.0062	12.83	-0.056	259.4	-0.0053	
12.95	616.97	260.5	0	12.92	-0.06	257.4	-0.0098	
13.02	614.2	259.3	-0.0036	13.00	-0.064	255.5	-0.0133	
13.10	610.16	257.8	-0.0089	13.08	-0.068	253.8	-0.0178	
13.18	606.22	256.9	-0.0115	13.17	-0.072	252	-0.0231	
13.27	603.41	254.6	-0.016	13.25	-0.079	249	-0.0266	
13.35	601.67	253.5	-0.0222	13.33	-0.082	247.3	-0.0302	
13.43	597.69	252	-0.0266	13.42	-0.086	245.7	-0.0355	
13.52	594.68	250.6	-0.0311	13.50	-0.088	244.3	-0.0382	
13.60	592.64	249.2	-0.0346	13.58	-0.094	241.6	-0.0426	
13.68	589.37	248	-0.0382	13.68	-0.1	238.9	-0.0479	
13.77	586.09	247	-0.0408	13.75	-0.102	237.8	-0.0515	
13.85	582.28	244.6	-0.0453	13.83	-0.105	235.9	-0.0541	
13.93	580.37	243.4	-0.0488	13.92	-0.109	233.9	-0.0577	
14.02	577.66	242.1	-0.0524	14.00	-0.111	232.8	-0.0612	
14.10	574.96	240.7	-0.0559	14.08	-0.117	230.3	-0.0648	
14.18	573.05	239.6	-0.0586	14.17	-0.12	228.3	-0.0675	
14.27	569.94	238.1	-0.0621	14.25	-0.125	226	-0.071	

Prova triassiale ciclica SNGR03-C4								
tensione di confinamento (kPa)		450		tensione di confinamento (kPa)		450		
deviatore ciclico (kPa)		150		deviatore ciclico (kPa)		180		
frequenza (hz)		0.0007143		frequenza (hz)		0.0007143		
14.37	566.76	236.4	-0.0648	14.33	-0.128	224.9	-0.0746	
14.45	564.59	235.2	-0.0675	14.42	-0.134	222.6	-0.079	
14.52	562.61	234.2	-0.0692	14.50	-0.133	221.7	-0.0808	
14.60	562.34	233.4	-0.0719	14.58	-0.134	220.9	-0.0826	
14.68	556.73	231.5	-0.0754	14.67	-0.14	218.6	-0.0861	
14.77	554.72	230.1	-0.0772	14.75	-0.145	216.2	-0.0888	
14.85	553.08	229.1	-0.0808	14.83	-0.147	214.6	-0.0914	
14.93	550.37	227.9	-0.0834	14.92	-0.15	213.3	-0.0959	
15.02	548.56	226.7	-0.0852	15.00	-0.153	211.7	-0.0976	
15.10	546.99	225.8	-0.0879	15.08	-0.156	210.1	-0.0994	
15.18	543.84	224.4	-0.0905	15.18	-0.159	208.4	-0.1012	
15.27	542.57	223.4	-0.0914	15.25	-0.164	206.3	-0.1065	
15.35	539.76	222.2	-0.0941	15.33	-0.164	205.7	-0.1074	
15.43	538.82	221.4	-0.0968	15.42	-0.167	204.4	-0.1092	
15.52	536.78	220.4	-0.0985	15.50	-0.166	203.9	-0.111	
15.60	535.17	219.4	-0.1003	15.58	-0.17	202.2	-0.1136	
15.68	533.26	218.5	-0.1021	15.67	-0.174	200.4	-0.1154	
15.77	531.69	217.7	-0.1039	15.75	-0.176	199.1	-0.1172	
15.87	530.68	216.6	-0.1065	15.83	-0.178	198	-0.1207	
15.93	529.11	215.8	-0.1074	15.92	-0.182	196.3	-0.1234	
16.02	527.3	215	-0.1092	16.00	-0.18	196.3	-0.1243	
16.10	526.03	214.3	-0.111	16.08	-0.181	195.3	-0.1252	
16.18	524.42	213.1	-0.1118	16.17	-0.187	193.3	-0.1287	
16.27	524.22	212.7	-0.1145	16.25	-0.186	193	-0.1287	
16.35	522.91	212	-0.1154	16.33	-0.186	192.5	-0.1305	
16.43	521.64	211.2	-0.1172	16.42	-0.189	191.3	-0.1331	
16.52	520.77	210.6	-0.1181	16.50	-0.19	190.5	-0.1358	
16.60	520.33	210.1	-0.1189	16.60	-0.191	189.4	-0.1367	
16.68	518.66	209.5	-0.1198	16.67	-0.193	188.6	-0.1376	
16.77	518.22	208.8	-0.1216	16.75	-0.193	188.3	-0.1402	
16.85	517.59	208.3	-0.1225	16.83	-0.195	187.3	-0.142	
16.93	516.55	207.7	-0.1234	16.92	-0.195	187	-0.1429	
17.02	516.88	207.4	-0.1243	17.00	-0.196	186.3	-0.1438	
17.10	515.98	206.9	-0.1252	17.08	-0.198	185.5	-0.1456	
17.18	515.64	206.6	-0.126	17.17	-0.197	185.3	-0.1465	
17.28	515.17	206.1	-0.1269	17.25	-0.198	184.8	-0.1473	
17.35	515.37	205.9	-0.1269	17.33	-0.196	185.2	-0.1482	
17.43	512.63	205	-0.1287	17.42	-0.197	184.6	-0.15	
17.52	511.79	205.2	-0.1287	17.50	-0.2	183.5	-0.1509	
17.60	517.04	205.4	-0.1278	17.58	-0.197	184.1	-0.1509	
17.68	516.1	205	-0.1287	17.67	-0.197	184.1	-0.1509	
17.77	516.4	204.8	-0.1287	17.75	-0.198	183.6	-0.1518	
17.85	516	204.6	-0.1296	17.83	-0.197	183.7	-0.1527	
17.93	515.87	204.5	-0.1296	17.92	-0.197	183.7	-0.1527	
18.02	516.17	204.3	-0.1296	18.00	-0.197	183.6	-0.1536	
18.10	516.77	204.2	-0.1296	18.08	-0.196	183.6	-0.1536	
18.18	517.07	204.2	-0.1296	18.17	-0.195	184	-0.1536	
18.27	517.5	204.2	-0.1296	18.25	-0.195	183.9	-0.1536	
18.35	518.41	204.2	-0.1296	18.33	-0.193	184.3	-0.1536	
18.43	519.08	204.3	-0.1296	18.42	-0.192	184.5	-0.1536	
18.52	519.98	204.4	-0.1296	18.50	-0.191	184.8	-0.1536	
18.60	520.95	204.5	-0.1287	18.58	-0.19	185.1	-0.1527	
18.68	523.06	204.8	-0.1287	18.67	-0.188	185.7	-0.1527	
18.77	522.89	204.8	-0.1287	18.75	-0.186	186.1	-0.1518	
18.85	523.23	204.9	-0.1278	18.83	-0.186	186.4	-0.1518	
18.93	525.3	205.3	-0.1278	18.92	-0.184	187	-0.1509	
19.02	527.41	205.7	-0.1269	19.00	-0.185	187.6	-0.1509	
19.10	528.11	205.9	-0.126	19.08	-0.181	187.9	-0.1509	
19.18	528.91	206.1	-0.126	19.17	-0.18	188.5	-0.15	
19.27	531.05	206.6	-0.1252	19.25	-0.176	189.6	-0.1491	

Prova triassiale ciclica SNGR03-C4							
tensione di confinamento (kPa)	450			tensione di confinamento (kPa)	450		
deviatore ciclico (kPa)	150			deviatore ciclico (kPa)	180		
frequenza (hz)	0.0007143			frequenza (hz)	0.0007143		
19.35	530.35	206.5	-0.1252	19.33	-0.174	190.3	-0.1473
19.43	533.73	207.2	-0.1234	19.42	-0.169	191.7	-0.1456
19.52	536	207.9	-0.1225	19.52	-0.171	191.6	-0.1465
19.60	537.64	208.4	-0.1225	19.58	-0.167	192.9	-0.1456
19.68	538.95	208.8	-0.1207	19.67	-0.163	194.2	-0.1438
19.77	540.96	209.3	-0.1198	19.75	-0.163	194.3	-0.1429
19.85	542.93	209.9	-0.1189	19.83	-0.159	195.6	-0.142
19.93	545.77	210.7	-0.1172	19.92	-0.158	196.5	-0.1411
20.02	545.57	210.8	-0.1172	20.00	-0.155	197.3	-0.1394
20.10	549.45	211.8	-0.1163	20.08	-0.153	198	-0.1394
20.20	550.66	212.3	-0.1145	20.17	-0.148	200	-0.1367
20.27	554	213.3	-0.1127	20.25	-0.146	201.1	-0.1349
20.35	554.91	213.7	-0.1118	20.33	-0.143	202	-0.134
20.43	558.89	214.9	-0.1101	20.42	-0.139	203.4	-0.1323
20.52	560.83	215.5	-0.1083	20.50	-0.137	204.4	-0.1305
20.60	563.1	216.3	-0.1065	20.58	-0.133	205.9	-0.1287
20.68	565.84	217.1	-0.1047	20.67	-0.132	206.3	-0.1287
20.77	565.38	217.4	-0.1047	20.75	-0.125	208.9	-0.1252
20.85	569.59	218.5	-0.1021	20.83	-0.123	210.1	-0.1234
20.93	573.84	219.5	-0.1003	20.92	-0.119	211.3	-0.1216
21.02	576.48	220.9	-0.0985	21.00	-0.115	212.8	-0.1198
21.10	578.52	221.7	-0.0959	21.08	-0.113	214.3	-0.1181
21.18	580.99	222.6	-0.0941	21.17	-0.108	215.9	-0.1154
21.27	584.31	223.7	-0.0914	21.25	-0.104	217.4	-0.1136
21.35	586.61	224.8	-0.0888	21.33	-0.097	219.8	-0.1092
21.43	589.99	225.8	-0.0879	21.42	-0.098	220.4	-0.1083
21.52	592.76	226.7	-0.0861	21.50	-0.095	221.6	-0.1074
21.62	595.21	228	-0.0834	21.58	-0.088	223.6	-0.1039
21.68	597.55	228.9	-0.0808	21.67	-0.082	226.2	-0.1021
21.77	600.99	230.1	-0.0781	21.75	-0.081	227.4	-0.0985
21.85	605.57	231.9	-0.0754	21.83	-0.076	229.1	-0.0968
21.93	608.64	233	-0.0728	21.92	-0.071	230.8	-0.0932
22.02	610.42	233.8	-0.0692	22.00	-0.068	232.5	-0.0914
22.10	614.29	235.1	-0.0666	22.08	-0.062	234.7	-0.087
22.18	617.73	236.5	-0.0639	22.17	-0.059	235.9	-0.0852
22.27	619.64	237.4	-0.0612	22.25	-0.053	238.5	-0.0826
22.35	623.58	238.7	-0.0586	22.33	-0.05	240.1	-0.0781
22.43	628.7	240.7	-0.0533	22.43	-0.047	241.5	-0.0754
22.52	630.07	241.7	-0.0506	22.50	-0.04	243.5	-0.0719
22.60	633.94	242.9	-0.0479	22.58	-0.035	246.2	-0.0692
22.68	637.25	244	-0.0453	22.67	-0.032	247.8	-0.0648
22.77	639.29	245.1	-0.0426	22.75	-0.026	249.9	-0.0604
22.85	642.33	246.4	-0.0391	22.83	-0.024	251.2	-0.0577
22.93	647.57	247.9	-0.0346	22.92	-0.02	252.9	-0.0541
23.02	651.64	249.7	-0.032	23.00	-0.016	254.6	-0.0506
23.12	652.68	250.6	-0.0275	23.08	-0.009	256.9	-0.047
23.18	656.12	251.9	-0.024	23.17	-0.003	259.7	-0.0435
23.27	661.79	253.9	-0.0178	23.25	-0.001	261.2	-0.0373
23.35	663.73	255	-0.016	23.33	0.003	262.6	-0.0337
23.43	666.63	256.2	-0.0107	23.42	0.01	264.9	-0.0293
23.52	670.6	257.6	-0.0062	23.50	0.013	266.7	-0.0257
23.60	674.11	258.9	-0.0027	23.58	0.017	268.3	-0.0222
23.68	676.28	259.9	0.0018	23.67	0.023	270.2	-0.0178
23.77	680.11	261.4	0.0053	23.75	0.031	273.6	-0.0133
23.85	687.52	263.8	0.0098	23.85	0.032	274.7	-0.0071
23.93	686.65	264.5	0.0133	23.92	0.033	275.7	-0.0044
24.02	690.32	265.7	0.0195	24.00	0.041	278.2	0.0009
24.10	694.72	267.3	0.0249	24.08	0.048	280.9	0.0044
24.18	694.65	268	0.0275	24.17	0.05	282.2	0.0115
24.27	699.32	269.4	0.032	24.25	0.054	283.7	0.0169

Prova triassiale ciclica SNGR03-C4							
tensione di confinamento (kPa)	450			tensione di confinamento (kPa)	450		
deviatore ciclico (kPa)	150			deviatore ciclico (kPa)	180		
frequenza (hz)	0.0007143			frequenza (hz)	0.0007143		
24.35	704.19	271	0.0373	24.33	0.059	285.7	0.0213
24.43	707.82	272.9	0.0417	24.42	0.062	287.4	0.0257
24.53	709.85	274	0.0479	24.50	0.069	289.5	0.032
24.60	712.42	275.1	0.0524	24.58	0.072	290.5	0.0346
24.68	716.95	276.5	0.0568	24.67	0.078	293.3	0.0399
24.77	720.92	278.3	0.0612	24.75	0.083	295.4	0.0497
24.85	724.85	280	0.0701	24.83	0.084	296.5	0.0533
24.93	725.77	280.7	0.0737	24.92	0.089	298.2	0.0568
25.02	728.7	281.9	0.0781	25.00	0.092	299.8	0.0621
25.10	731.13	283	0.0826	25.08	0.096	301.4	0.0666
25.18	733.93	284.2	0.087	25.17	0.102	303.1	0.0719
25.27	738.63	286.1	0.0914	25.25	0.108	305.8	0.0772
25.35	740.82	287.2	0.0959	25.35	0.108	306.7	0.0834
25.43	746.44	288.9	0.1047	25.42	0.111	308.1	0.0888
25.52	746.21	289.6	0.1065	25.50	0.118	310.1	0.0941
25.60	748.5	290.7	0.111	25.58	0.122	312.1	0.0985
25.68	752.26	292.1	0.1163	25.67	0.125	313.6	0.1056
25.77	754.32	292.9	0.1198	25.75	0.131	315.5	0.1118
25.85	760.55	295	0.1234	25.83	0.13	316.1	0.1145
25.93	758.78	295.5	0.1296	25.92	0.134	317.6	0.1198
26.03	761.9	296.6	0.1331	26.00	0.138	319.2	0.1252
26.10	765.7	297.7	0.1376	26.08	0.143	320.5	0.1287
26.18	768.59	299.3	0.1411	26.17	0.146	322.5	0.1331
26.27	769.61	300.2	0.1465	26.25	0.148	323.8	0.1402
26.35	772.84	301.3	0.1509	26.33	0.151	324.8	0.1447
26.43	774.7	302.2	0.1544	26.42	0.156	326.5	0.15
26.52	776.33	303.1	0.1571	26.50	0.158	327.6	0.1536
26.60	778.65	304	0.1607	26.58	0.161	328.9	0.158
26.68	782.04	305.1	0.1651	26.67	0.165	330	0.1616
26.77	786.13	306.8	0.1687	26.77	0.167	331.6	0.1678
26.85	785.66	307.3	0.1731	26.83	0.169	332.6	0.1713
26.93	787.65	308.2	0.1758	26.92	0.173	333.8	0.1758
27.02	789.51	309.1	0.1793	27.00	0.175	335.3	0.1802
27.10	790.24	309.7	0.1811	27.08	0.179	336.3	0.1829
27.18	793.03	310.7	0.1846	27.17	0.18	337.2	0.1882
27.27	795.09	311.8	0.1864	27.25	0.182	338.1	0.1908
27.35	797.22	312.7	0.1891	27.33	0.185	339.2	0.1944
27.45	797.44	313.2	0.1935	27.42	0.186	339.9	0.1971
27.52	799.7	314.1	0.1962	27.50	0.191	341.2	0.2015
27.60	802.36	315.3	0.1988	27.58	0.191	341.5	0.2033
27.68	801.59	315.6	0.2015	27.67	0.194	342.9	0.2068
27.77	803.95	316.4	0.2042	27.75	0.194	343.5	0.2104
27.85	804.68	317	0.2059	27.83	0.197	344.4	0.2139
27.93	806.6	318	0.2095	27.92	0.199	345.4	0.2175
28.02	807.73	318.4	0.2104	28.00	0.2	345.8	0.2192
28.10	808.63	318.6	0.2113	28.08	0.201	346.4	0.221
28.18	809.05	319.5	0.213	28.17	0.203	347.1	0.2237
28.27	810.29	320.4	0.2157	28.27	0.203	347.9	0.2272
28.35	814.13	321	0.2192	28.33	0.205	348.4	0.229
28.43	810.91	321.1	0.2192	28.42	0.208	349.2	0.2317
28.52	810.84	321.3	0.2201	28.50	0.206	349.3	0.2326
28.60	812.83	321.9	0.2219	28.58	0.21	350.6	0.2352
28.68	812.69	322.5	0.2246	28.67	0.207	350.4	0.237
28.77	812.76	322.8	0.2246	28.75	0.209	350.9	0.2388
28.85	814.29	323.3	0.2263	28.83	0.21	351.3	0.2406
28.93	816.15	324	0.2281	28.92	0.21	351.7	0.2432
29.02	814.38	324	0.2281	29.00	0.209	351.6	0.2432
29.10	814.88	324.4	0.229	29.08	0.211	352.1	0.245
29.18	814.25	324.5	0.2299	29.17	0.21	352.4	0.2459
29.27	815.34	324.9	0.2308	29.25	0.212	352.8	0.2477

Prova triassiale ciclica SNGR03-C4							
tensione di confinamento (kPa)	450			tensione di confinamento (kPa)	450		
deviatore ciclico (kPa)	150			deviatore ciclico (kPa)	180		
frequenza (hz)	0.0007143			frequenza (hz)	0.0007143		
29.35	813.91	324.9	0.2308	29.33	0.21	352.7	0.2477
29.43	814.44	325.2	0.2308	29.42	0.209	352.7	0.2477
29.52	815.17	325.6	0.2326	29.50	0.21	353.1	0.2485
29.60	814.21	325.6	0.2326	29.58	0.209	353	0.2485
29.68	813.61	325.7	0.2326	29.68	0.208	352.9	0.2485
29.77	813.25	325.8	0.2326	29.75	0.208	353	0.2494
29.85	812.15	325.7	0.2317	29.83	0.208	353	0.2494
29.93	813.94	326.1	0.2334	29.92	0.207	353	0.2494
30.02	810.15	325.6	0.2317	30.00	0.206	352.9	0.2494
30.10	812.18	326	0.2326	30.08	0.206	352.8	0.2494
30.18	808.29	325.5	0.2308	30.17	0.203	352.5	0.2485
30.27	808.68	325.8	0.2317	30.25	0.202	352.3	0.2477
30.37	809.72	325.8	0.2308	30.33	0.201	352.1	0.2477
30.43	806.29	325.4	0.2299	30.42	0.199	351.7	0.2468
30.52	806.13	325.4	0.2299	30.50	0.198	351.5	0.2459
30.60	804.96	325.3	0.229	30.58	0.196	351.3	0.2459
30.68	803.37	325	0.2281	30.67	0.194	350.6	0.245
30.77	801.94	324.7	0.2272	30.75	0.192	350.1	0.2432
30.85	800.94	324.5	0.2272	30.83	0.191	349.7	0.2414
30.93	799.05	324.2	0.2263	30.92	0.189	349.4	0.2397
31.02	797.15	323.8	0.2246	31.00	0.187	348.8	0.2388
31.10	796.52	323.6	0.2237	31.08	0.184	348.2	0.237
31.18	792.87	323	0.2219	31.17	0.182	347.6	0.2352
31.27	793.26	322.9	0.2219	31.25	0.181	347.2	0.2343
31.35	791.34	322.5	0.2201	31.33	0.178	346.5	0.2326
31.43	788.55	321.9	0.2184	31.42	0.176	345.9	0.2308
31.52	786.52	321.6	0.2175	31.50	0.171	345	0.229
31.60	786.02	321.1	0.2166	31.58	0.169	344	0.2272
31.68	782.56	320.3	0.213	31.67	0.167	343.3	0.2237
31.78	782.4	320.2	0.2121	31.75	0.164	342.5	0.2219
31.85	778.14	319.2	0.2104	31.83	0.161	341.7	0.2201
31.93	774.02	318.2	0.2086	31.92	0.158	340.9	0.2175
32.02	773.82	318	0.205	32.00	0.156	340.1	0.2157
32.10	770.46	317.4	0.2033	32.08	0.151	338.9	0.2121
32.18	770.17	316.9	0.2015	32.17	0.148	337.7	0.2104
32.27	769.73	316.7	0.2006	32.25	0.145	336.8	0.2068
32.35	764.28	315.4	0.1971	32.33	0.141	335.8	0.2042
32.43	762.38	314.7	0.1962	32.42	0.138	334.7	0.2006
32.52	757.93	313.6	0.1908	32.50	0.136	333.8	0.1979
32.60	756.87	313	0.1891	32.60	0.131	332.4	0.1935
32.68	755.11	312.4	0.1873	32.67	0.128	331.3	0.1908
32.77	750.18	311.2	0.1829	32.75	0.122	329.8	0.1873
32.85	749.12	310.7	0.1811	32.83	0.121	329	0.1846
32.93	744.69	309.9	0.1793	32.92	0.117	327.9	0.1811
33.02	742.57	308.7	0.1775	33.00	0.114	326.5	0.1766
33.10	740.74	307.9	0.1722	33.08	0.105	324.2	0.1722
33.18	736.18	306.7	0.1678	33.17	0.104	323.4	0.1678
33.28	733.65	306.5	0.1669	33.25	0.101	322.3	0.1642
33.35	730.16	304.6	0.1616	33.33	0.095	320.5	0.1598
33.43	730.26	304.2	0.1589	33.42	0.093	319.5	0.1562
33.52	725.54	302.9	0.1536	33.50	0.088	318.1	0.1518
33.60	721.08	301.6	0.1491	33.58	0.082	316.6	0.1473
33.68	719.35	300.8	0.1465	33.67	0.077	314.3	0.1429
33.77	716.02	299.9	0.1438	33.75	0.075	313.1	0.1367
33.85	710.86	298	0.1385	33.83	0.071	311.6	0.1323
33.93	709.1	297.2	0.1331	33.92	0.066	309.9	0.1278
34.02	708.17	296.6	0.1305	34.02	0.06	307.9	0.1234
34.10	701.94	294.9	0.1243	34.08	0.058	306.6	0.1172
34.18	699.71	293.8	0.1207	34.17	0.053	305	0.1127
34.27	697.98	293	0.1181	34.25	0.048	303.2	0.1074

Prova triassiale ciclica SNGR03-C4							
tensione di confinamento (kPa)	450			tensione di confinamento (kPa)	450		
deviatore ciclico (kPa)	150			deviatore ciclico (kPa)	180		
frequenza (hz)	0.0007143			frequenza (hz)	0.0007143		
34.35	692.28	291.6	0.1127	34.33	0.046	301.7	0.103
34.43	688.12	289.7	0.1065	34.42	0.04	300.2	0.0985
34.52	686.32	288.8	0.1012	34.50	0.034	298.1	0.0932
34.60	681.96	287.4	0.0968	34.58	0.029	295.7	0.0888
34.70	678.96	286.3	0.0923	34.67	0.025	294.2	0.0808
34.77	677.69	285.1	0.0888	34.75	0.021	292.4	0.0754
34.85	673.32	283.7	0.0826	34.83	0.016	290.6	0.071
34.93	669.72	282.4	0.0772	34.92	0.013	289.1	0.0657
35.02	664.89	280.7	0.0719	35.00	0.008	287.2	0.0612
35.10	663.72	279.9	0.0675	35.08	0.002	285.4	0.0559
35.18	659.66	278.6	0.063	35.17	-0.003	282.6	0.0515
35.27	654.85	276.7	0.0577	35.25	-0.007	281.1	0.0435
35.35	652.89	275.4	0.0506	35.33	-0.011	279.3	0.0391
35.43	649.98	274.3	0.0462	35.42	-0.015	277.3	0.0337
35.52	645.21	272.5	0.0408	35.52	-0.022	274.8	0.0293
35.60	643.71	271.5	0.0364	35.58	-0.025	273.3	0.0231
35.68	639.54	270.1	0.032	35.67	-0.029	271.2	0.0178
35.77	636.5	269.7	0.0293	35.75	-0.035	269.2	0.0115
35.85	629.26	266.9	0.0249	35.83	-0.037	267.7	0.008
35.93	629.79	266.2	0.0169	35.92	-0.042	265.9	0.0027
36.02	628.29	265.4	0.0133	36.00	-0.048	263.8	-0.0018
36.10	621.71	263.3	0.0071	36.08	-0.053	261	-0.0062
36.20	619.34	261.8	0.0036	36.17	-0.056	259.4	-0.0124
36.27	614.83	260	-0.0036	36.25	-0.06	257.9	-0.0169
36.35	613.33	259.2	-0.0071	36.33	-0.068	254.8	-0.0222
36.43	609.89	257.8	-0.0115	36.42	-0.068	253.8	-0.0257
36.52	607.75	256.8	-0.0151	36.50	-0.072	252.1	-0.0293
36.60	604.17	255.4	-0.0186	36.58	-0.078	250.1	-0.0328
36.68	600.03	253.5	-0.0222	36.67	-0.083	247.4	-0.0364
36.77	597.92	252.1	-0.0284	36.75	-0.085	245.8	-0.0426
36.85	594.95	250.8	-0.032	36.83	-0.089	244	-0.0462
36.93	592.31	249.4	-0.0364	36.93	-0.095	241.9	-0.0497
37.02	588.8	248	-0.0399	37.00	-0.099	239.6	-0.0524
37.10	584.42	246.3	-0.0444	37.08	-0.102	238	-0.0577
37.18	582.65	245.5	-0.0462	37.17	-0.105	236.3	-0.0612
37.27	581.51	243.9	-0.0488	37.25	-0.11	234.3	-0.0648
37.35	578.37	242.5	-0.0524	37.33	-0.112	232.9	-0.0675
37.43	575.16	241.1	-0.0559	37.42	-0.118	230.4	-0.0719
37.52	571.51	239.5	-0.0595	37.50	-0.121	229.5	-0.0737
37.62	570.01	238.2	-0.0621	37.58	-0.125	226.6	-0.0772
37.68	564.96	236.3	-0.0675	37.67	-0.127	225.6	-0.0817
37.77	564.52	235.5	-0.0692	37.75	-0.131	223.8	-0.0852
37.85	562.08	234.3	-0.071	37.83	-0.135	221.9	-0.0879
37.93	560.57	233.3	-0.0737	37.92	-0.137	220.5	-0.0905
38.02	557.53	232.1	-0.0763	38.00	-0.14	218.9	-0.0932
38.10	556.62	230.9	-0.079	38.08	-0.144	217.5	-0.0959
38.18	551.98	229.3	-0.0808	38.17	-0.148	215.1	-0.0985
38.27	551	228.3	-0.0843	38.25	-0.15	213.8	-0.103
38.35	547.99	227	-0.087	38.33	-0.153	212.3	-0.1047
38.43	546.65	226.1	-0.0888	38.43	-0.156	211	-0.1065
38.52	542.24	224.4	-0.0923	38.50	-0.158	209.1	-0.1092
38.60	541.9	224	-0.0932	38.58	-0.161	207.7	-0.1127
38.68	539.83	222.5	-0.095	38.67	-0.164	206.4	-0.1145
38.77	536.98	221.6	-0.0985	38.75	-0.166	205.3	-0.1172
38.85	539.32	221.4	-0.0985	38.83	-0.168	204.1	-0.1189
38.93	534.1	219.7	-0.1021	38.92	-0.171	202.7	-0.1216
39.02	533.96	219.1	-0.103	39.00	-0.174	201.5	-0.1234
39.10	532.06	217.9	-0.1056	39.08	-0.175	199.8	-0.126
39.18	530.01	217	-0.1074	39.17	-0.177	198.7	-0.1287
39.27	529.21	216.3	-0.1083	39.25	-0.179	197.7	-0.1305

Prova triassiale ciclica SNGR03-C4							
tensione di confinamento (kPa)	450			tensione di confinamento (kPa)	450		
deviatore ciclico (kPa)	150			deviatore ciclico (kPa)	180		
frequenza (hz)	0.0007143			frequenza (hz)	0.0007143		
39.35	527.94	215.5	-0.1101	39.33	-0.182	196.6	-0.1323
39.43	526.53	214.8	-0.1118	39.42	-0.182	195.8	-0.134
39.52	525.09	213.7	-0.1136	39.50	-0.184	194.8	-0.1358
39.60	523.42	212.9	-0.1145	39.58	-0.186	193.8	-0.1376
39.68	523.01	212.4	-0.1163	39.67	-0.189	192.3	-0.1394
39.77	521.54	211.7	-0.1172	39.75	-0.187	192.2	-0.1411
39.85	520.97	211.1	-0.1189	39.85	-0.19	191.3	-0.1429
39.93	520.13	210.6	-0.1198	39.92	-0.192	190.3	-0.1447
40.02	518.96	210	-0.1207	40.00	-0.193	189.3	-0.1456
40.10	518.19	209.2	-0.1216	40.08	-0.194	188.7	-0.1482
40.18	517.79	208.7	-0.1234	40.17	-0.195	188.2	-0.1491
40.27	515.84	208	-0.1243	40.25	-0.195	187.8	-0.15
40.35	516.51	207.8	-0.1252	40.33	-0.196	187.2	-0.1518
40.43	516.48	207.4	-0.1252	40.42	-0.197	186.6	-0.1527
40.53	515.84	206.9	-0.126	40.50	-0.197	186.2	-0.1536
40.60	515.51	206.6	-0.1269	40.58	-0.2	185	-0.1553
40.68	515.41	206.3	-0.1269	40.67	-0.198	185.3	-0.1562
40.77	515.1	206	-0.1278	40.75	-0.198	185.1	-0.1562
40.85	514.94	205.8	-0.1278	40.83	-0.198	184.9	-0.1571
40.93	515.14	205.5	-0.1287	40.92	-0.198	184.7	-0.158
41.02	515.37	205.3	-0.1287	41.00	-0.198	184.7	-0.158
41.10	515.2	205.1	-0.1296	41.08	-0.198	184.7	-0.158
41.18	516.17	205.1	-0.1296	41.17	-0.197	184.6	-0.1589
41.27	515.97	204.9	-0.1296	41.25	-0.197	184.5	-0.1598
41.35	514.93	204.5	-0.1305	41.33	-0.196	184.6	-0.1598
41.43	517.24	204.8	-0.1296	41.42	-0.196	184.5	-0.1598
41.52	517.41	204.7	-0.1296	41.50	-0.195	184.7	-0.1598
41.60	517.64	204.7	-0.1296	41.58	-0.194	184.9	-0.1598
41.68	518.28	204.7	-0.1296	41.67	-0.192	185.5	-0.1589
41.77	520.59	205.1	-0.1287	41.75	-0.192	185.6	-0.1589
41.85	519.88	204.9	-0.1287	41.83	-0.191	185.6	-0.1598
41.95	520.99	205	-0.1287	41.92	-0.19	185.9	-0.1589
42.02	521.75	205.2	-0.1287	42.00	-0.188	186.3	-0.1589
42.10	522.76	205.4	-0.1278	42.08	-0.186	187.1	-0.158
42.18	524.03	205.6	-0.1287	42.17	-0.186	187.4	-0.158
42.27	524.9	205.7	-0.1278	42.25	-0.183	188	-0.1571
42.35	526.87	206.1	-0.1278	42.33	-0.183	188.3	-0.1571
42.43	528.08	206.4	-0.1269	42.42	-0.181	189	-0.1562
42.52	529.25	206.7	-0.126	42.50	-0.179	189.6	-0.1553
42.60	531.12	207.1	-0.1252	42.58	-0.176	190.2	-0.1544
42.68	532.29	207.5	-0.1252	42.67	-0.174	191.2	-0.1536
42.77	533.43	207.8	-0.1243	42.77	-0.173	191.8	-0.1527
42.85	536	208.3	-0.1234	42.83	-0.17	192.6	-0.1518
42.93	538.01	209	-0.1225	42.92	-0.167	193.5	-0.1509
43.02	539.38	209.4	-0.1216	43.00	-0.164	194.7	-0.15
43.10	540.69	209.8	-0.1207	43.08	-0.162	195.5	-0.1482
43.18	542.96	210.5	-0.1198	43.17	-0.161	196.2	-0.1482
43.27	544.47	210.9	-0.1189	43.25	-0.157	197.4	-0.1465
43.35	547.15	211.7	-0.1172	43.33	-0.156	198.1	-0.1456
43.45	549.22	212.4	-0.1163	43.42	-0.152	199.3	-0.1447
43.52	551.29	213	-0.1145	43.50	-0.148	200.4	-0.1429
43.60	552.83	213.6	-0.1136	43.58	-0.145	201.9	-0.1411
43.68	555.47	214.4	-0.1118	43.67	-0.143	203	-0.1394
43.77	558.65	215.4	-0.111	43.75	-0.14	204.2	-0.1376
43.85	561.13	216.2	-0.1101	43.83	-0.136	205.7	-0.1358
43.93	562.87	216.9	-0.1074	43.92	-0.134	206.4	-0.1349
44.02	565.41	217.6	-0.1065	44.00	-0.13	207.8	-0.1331
44.10	567.11	218.4	-0.1047	44.08	-0.126	209.3	-0.1314
44.18	569.79	219.2	-0.103	44.18	-0.122	211.3	-0.1287
44.27	573.23	220.3	-0.1012	44.25	-0.12	212.3	-0.1269

Prova triassiale ciclica SNGR03-C4							
tensione di confinamento (kPa)	450			tensione di confinamento (kPa)	450		
deviatore ciclico (kPa)	150			deviatore ciclico (kPa)	180		
frequenza (hz)	0.0007143			frequenza (hz)	0.0007143		
44.35	576.68	221.5	-0.0994	44.33	-0.116	213.7	-0.1252
44.43	578.25	222.4	-0.0968	44.42	-0.112	215.2	-0.1234
44.52	581.8	223.4	-0.095	44.50	-0.107	217.4	-0.1207
44.60	584.24	224.3	-0.0932	44.58	-0.104	218.5	-0.1181
44.68	586.05	225.3	-0.0905	44.67	-0.098	220.8	-0.1154
44.77	589.32	226.3	-0.0888	44.75	-0.097	221.8	-0.1136
44.87	594.84	228.2	-0.0843	44.83	-0.094	223.1	-0.1118
44.93	595.14	228.7	-0.0834	44.92	-0.089	224.7	-0.1092
45.02	597.91	229.7	-0.0817	45.00	-0.085	226.5	-0.1065
45.10	601.12	230.8	-0.079	45.08	-0.078	229.1	-0.1047
45.18	605.03	232	-0.0763	45.17	-0.076	230.3	-0.1003
45.27	608.84	233.5	-0.0746	45.25	-0.072	232	-0.0985
45.35	611.32	234.6	-0.0701	45.33	-0.067	233.9	-0.0959
45.43	614.9	235.9	-0.0675	45.42	-0.065	235.3	-0.0932
45.52	617.6	237.1	-0.0648	45.50	-0.059	237.2	-0.0905
45.60	619.61	238	-0.0621	45.58	-0.054	239.1	-0.087
45.68	626.46	239.8	-0.0577	45.68	-0.05	241.4	-0.0826
45.77	627.96	241	-0.0568	45.75	-0.046	242.9	-0.0799
45.85	630.83	242.3	-0.0533	45.83	-0.042	244.7	-0.0772
45.93	634.07	243.4	-0.0488	45.92	-0.036	246.7	-0.0737
46.02	637.28	244.7	-0.0462	46.00	-0.032	249.2	-0.0701
46.10	639.79	245.7	-0.0435	46.08	-0.029	250.8	-0.0657
46.18	642.22	246.8	-0.0408	46.17	-0.023	252.8	-0.0621
46.27	647.67	248.3	-0.0364	46.25	-0.018	254.8	-0.0577
46.37	649.67	250	-0.032	46.33	-0.015	256.2	-0.0541
46.43	652.88	251.2	-0.0284	46.42	-0.008	258.7	-0.0497
46.52	655.98	252.4	-0.0249	46.50	-0.004	260.6	-0.0479
46.60	660.99	253.9	-0.0204	46.58	0	262.9	-0.0435
46.68	664.8	255.8	-0.0178	46.67	0.004	264.4	-0.0373
46.77	667.3	256.9	-0.0115	46.75	0.009	266.3	-0.0328
46.85	670.34	258.2	-0.008	46.83	0.014	268.3	-0.0293
46.93	674.41	259.6	-0.0036	46.92	0.017	270	-0.0257
47.02	676.34	260.6	-0.0009	47.00	0.022	271.9	-0.0213
47.10	679.68	261.9	0.0036	47.10	0.027	274.2	-0.0151
47.18	684.52	264	0.008	47.17	0.032	276.3	-0.0107
47.27	688.15	265.4	0.0124	47.25	0.035	277.7	-0.0062
47.35	690.55	266.5	0.0186	47.33	0.04	279.5	-0.0027
47.43	692.99	267.7	0.0222	47.42	0.046	282.2	0.0018
47.52	697.45	269.3	0.0275	47.50	0.051	284	0.0062
47.60	699.59	270.3	0.032	47.58	0.053	285.4	0.0133
47.68	705.92	271.7	0.0364	47.67	0.058	287.3	0.0186
47.78	706.25	273.4	0.0417	47.75	0.063	289.2	0.024
47.85	709.39	274.7	0.0462	47.83	0.066	290.6	0.0284
47.93	712.35	275.8	0.0506	47.92	0.072	292.6	0.0328
48.02	717.59	277.3	0.055	48.00	0.077	295	0.0373
48.10	721.12	279.2	0.0595	48.08	0.081	296.9	0.0426
48.18	722.51	280.2	0.0666	48.17	0.084	298.4	0.0506
48.27	725.68	281.4	0.071	48.25	0.09	300.4	0.0559
48.35	728.87	282.7	0.0763	48.33	0.092	301.7	0.0604
48.43	731.2	283.8	0.0799	48.42	0.096	303.2	0.0657
48.52	736.73	285.4	0.0861	48.50	0.1	305	0.0701
48.60	737.83	286.7	0.0897	48.60	0.105	307	0.0772
48.68	741.66	288.2	0.0932	48.67	0.109	308.8	0.0826
48.77	743.08	289.1	0.1003	48.75	0.112	310.1	0.087
48.85	747.01	290.5	0.1047	48.83	0.117	311.8	0.0923
48.93	749.64	291.7	0.1092	48.92	0.122	314.1	0.0968
49.02	751.07	292.5	0.1136	49.00	0.125	315.5	0.1021
49.10	754.53	293.8	0.1181	49.08	0.128	316.7	0.1092
49.18	758.18	295.5	0.1234	49.17	0.132	318.2	0.1145
49.27	759.48	296.5	0.1278	49.25	0.135	319.7	0.1189

Prova triassiale ciclica SNGR03-C4							
tensione di confinamento (kPa)	450			tensione di confinamento (kPa)	450		
deviatore ciclico (kPa)	150			deviatore ciclico (kPa)	180		
frequenza (hz)	0.0007143			frequenza (hz)	0.0007143		
49.35	762.04	297.4	0.1314	49.33	0.138	320.9	0.1234
49.43	765.37	298.3	0.1349	49.42	0.142	322.5	0.1287
49.52	768.52	300.1	0.1394	49.50	0.146	324.4	0.1323
49.60	770.08	301	0.1456	49.58	0.15	325.9	0.1376
49.68	771.28	301.8	0.1482	49.67	0.152	327	0.1438
49.77	775.03	303	0.1527	49.75	0.154	328	0.1482
49.85	776.73	303.9	0.1562	49.83	0.159	329.6	0.1527
49.93	780.65	305.2	0.1607	49.92	0.161	330.5	0.1571
50.02	781.58	305.7	0.1633	50.02	0.164	332.1	0.1633
50.10	784.2	307.3	0.1669	50.08	0.168	333.4	0.1669
50.18	785.49	308.1	0.1722	50.17	0.17	334.4	0.1713
50.27	788.08	309.1	0.1758	50.25	0.172	335.4	0.1749
50.35	790.24	310	0.1793	50.33	0.175	336.6	0.1793
50.43	791.11	310.7	0.1811	50.42	0.179	338.1	0.1829
50.52	791.4	311.3	0.1829	50.50	0.181	339.1	0.1864
50.60	795.59	312.8	0.1864	50.58	0.183	340	0.1917
50.70	795.95	313.3	0.19	50.67	0.185	341	0.1962
50.77	799.54	314.4	0.1935	50.75	0.186	341.8	0.1979
50.85	799.67	314.6	0.1944	50.83	0.188	342.5	0.2015
50.93	801.03	315.8	0.1971	50.92	0.191	343.5	0.2042
51.02	804.98	316.9	0.2024	51.00	0.195	344.8	0.2068
51.10	802.92	317.1	0.2033	51.08	0.197	345.8	0.2104
51.18	804.21	317.7	0.205	51.17	0.197	346.1	0.2157
51.27	805.8	318.3	0.2077	51.25	0.198	346.9	0.2184
51.35	807.8	319.1	0.2104	51.33	0.2	347.5	0.221
51.43	808.46	319.3	0.2113	51.42	0.201	348.2	0.2237
51.52	809.39	320.3	0.213	51.50	0.203	349	0.2263
51.60	809.45	320.8	0.2157	51.58	0.204	349.6	0.229
51.68	810.71	321.3	0.2166	51.67	0.205	350.2	0.2308
51.77	811.47	321.8	0.2192	51.75	0.206	350.7	0.2326
51.85	812.14	322.3	0.2201	51.83	0.207	351.1	0.2343
51.93	814.93	323.1	0.2228	51.92	0.208	351.7	0.237
52.02	812.1	323.2	0.2228	52.00	0.208	352.1	0.2379
52.12	813.72	323.7	0.2246	52.08	0.21	352.6	0.2406
52.18	814.98	324.2	0.2263	52.17	0.21	352.9	0.2414
52.27	813.89	324.3	0.2263	52.25	0.21	353.1	0.2432
52.35	814.65	324.8	0.2272	52.33	0.211	353.5	0.245
52.43	817.27	325.6	0.2299	52.42	0.21	353.6	0.2459
52.52	814.45	325.3	0.229	52.50	0.211	354	0.2468
52.60	814.18	325.5	0.229	52.58	0.21	354.1	0.2477
52.68	814.68	325.8	0.2308	52.67	0.21	354.2	0.2485
52.77	815.07	326	0.2308	52.75	0.211	354.4	0.2485
52.85	814.34	326.1	0.2308	52.83	0.21	354.4	0.2485
52.93	814.81	326.6	0.2317	52.93	0.21	354.5	0.2485
53.02	813.25	326.4	0.2308	53.00	0.21	354.7	0.2503
53.10	812.41	326.4	0.2317	53.08	0.208	354.5	0.2494
53.18	813.31	326.5	0.2317	53.17	0.208	354.5	0.2503
53.27	812.54	326.6	0.2317	53.25	0.207	354.4	0.2494
53.35	813.21	326.8	0.2326	53.33	0.206	354.3	0.2494
53.43	809.95	326.4	0.2308	53.42	0.205	354.1	0.2494
53.52	809.98	326.5	0.2317	53.50	0.202	353.6	0.2494
53.62	808.82	326.4	0.2308	53.58	0.203	353.6	0.2485
53.68	808.69	326.4	0.2308	53.67	0.202	353.5	0.2477
53.77	806.13	326	0.229	53.75	0.2	353.1	0.2477
53.85	805.79	326	0.229	53.83	0.198	352.8	0.2468
53.93	804.83	325.9	0.2281	53.92	0.195	352.2	0.245
54.02	803.27	325.6	0.2272	54.00	0.195	352	0.2441
54.10	802.2	325.4	0.2272	54.08	0.193	351.5	0.2441
54.18	800.84	325.2	0.2263	54.17	0.191	351.1	0.2414
54.27	799.15	324.9	0.2255	54.25	0.19	350.8	0.2406

Prova triassiale ciclica SNGR03-C4							
tensione di confinamento (kPa)	450			tensione di confinamento (kPa)	450		
deviatore ciclico (kPa)	150			deviatore ciclico (kPa)	180		
frequenza (hz)	0.0007143			frequenza (hz)	0.0007143		
54.35	797.28	324.4	0.2246	54.35	0.185	349.6	0.2379
54.43	796.39	324.2	0.2228	54.42	0.185	349.6	0.2379
54.52	794.39	323.8	0.2219	54.50	0.18	348.6	0.2352
54.60	792.37	323.4	0.2201	54.58	0.18	348.4	0.2343
54.68	791.1	323.1	0.2192	54.67	0.178	347.6	0.2326
54.77	789.81	322.7	0.2175	54.75	0.177	347.4	0.2326
54.85	786.72	322	0.2166	54.83	0.172	346.3	0.229
54.93	784.19	321.4	0.2148	54.92	0.168	345.1	0.2272
55.03	783.29	321.1	0.213	55.00	0.168	344.7	0.2246
55.10	781.53	320.6	0.2113	55.08	0.163	343.6	0.2219
55.18	778.44	319.8	0.2095	55.17	0.161	343.1	0.2201
55.27	776.41	319.3	0.2068	55.25	0.158	342.2	0.2175
55.35	774.46	318.7	0.2042	55.33	0.155	341.2	0.2148
55.43	772	318.1	0.2024	55.42	0.152	340.3	0.2121
55.52	770.57	317.6	0.2006	55.50	0.148	339.1	0.2113
55.60	767.37	316.9	0.1988	55.58	0.143	337.6	0.205
55.68	763.52	316.2	0.1962	55.67	0.142	337.1	0.2033
55.77	761.85	315.2	0.1944	55.75	0.139	336.2	0.1997
55.85	759.53	314.5	0.19	55.85	0.135	334.8	0.1962
55.93	756.57	313.7	0.1873	55.92	0.129	333.1	0.1917
56.02	754.94	313	0.1855	56.00	0.128	332.4	0.19
56.10	751.85	312.1	0.182	56.08	0.125	331.5	0.1873
56.18	748.75	311.2	0.1793	56.17	0.121	330.2	0.1846
56.27	745.26	310.5	0.1775	56.25	0.117	329.1	0.1811
56.35	742.53	309.2	0.1749	56.33	0.111	327.2	0.1758
56.43	740.24	308.5	0.1704	56.42	0.107	325.9	0.1749
56.53	737.81	307.6	0.1678	56.50	0.104	324.6	0.1678
56.60	733.42	306.2	0.1642	56.58	0.102	323.6	0.1642
56.68	730.69	305.2	0.1607	56.67	0.096	321.9	0.1598
56.77	728.3	304.4	0.1562	56.75	0.09	320.3	0.1544
56.85	724.97	303.3	0.1527	56.83	0.088	319.2	0.1518
56.93	722.45	302.3	0.1482	56.92	0.082	317.5	0.1473
57.02	719.55	301.5	0.1456	57.00	0.077	315.5	0.1429
57.10	715.32	300.3	0.1411	57.08	0.076	314.6	0.1376
57.18	712.16	298.9	0.1376	57.17	0.07	312.6	0.1314
57.27	709.36	297.8	0.1314	57.27	0.064	311.2	0.1287
57.35	704.64	296.5	0.1269	57.33	0.063	309.6	0.1243
57.43	702.91	295.5	0.1234	57.42	0.058	307.8	0.1181
57.52	700.54	294.5	0.1189	57.50	0.052	306.1	0.1127
57.60	697.28	293.4	0.1154	57.58	0.048	304.4	0.1083
57.68	692.18	291.6	0.1101	57.67	0.044	302.3	0.1021
57.77	688.48	290.3	0.1065	57.75	0.04	301	0.0976
57.85	686.95	289.5	0.0994	57.83	0.034	299.5	0.0932
57.95	683.82	288.3	0.0959	57.92	0.028	296.9	0.0888
58.02	678.72	286.4	0.0914	58.00	0.025	295.3	0.0808
58.10	675.76	285.1	0.0843	58.08	0.021	293.6	0.0754
58.18	672.86	284.1	0.0799	58.17	0.016	291.8	0.071
58.27	669.23	282.7	0.0754	58.25	0.011	289.5	0.0648
58.35	666.53	281.5	0.0701	58.33	0.008	288.3	0.0604
58.43	663.36	280.4	0.0666	58.42	0.004	286.3	0.0559
58.52	659.22	279.1	0.0604	58.50	-0.004	283.7	0.0515
58.60	654.42	276.9	0.0559	58.58	-0.006	282.2	0.0435
58.68	655.75	276.5	0.0506	58.67	-0.011	280.4	0.0391
58.77	649.92	274.8	0.0453	58.77	-0.016	278.6	0.0337
58.85	645.35	273.2	0.0399	58.83	-0.025	275.2	0.0293
58.93	643.01	272	0.0346	58.92	-0.025	274.1	0.0222
59.02	640.24	270.9	0.0311	59.00	-0.028	272.7	0.0178
59.10	635.13	269.4	0.0257	59.08	-0.035	270.3	0.0115
59.18	632.3	267.9	0.0213	59.17	-0.037	268.5	0.0071
59.27	629.56	266.7	0.0151	59.25	-0.042	266.6	0.0018

Prova triassiale ciclica SNGR03-C4							
tensione di confinamento (kPa)	450			tensione di confinamento (kPa)	450		
deviatore ciclico (kPa)	150			deviatore ciclico (kPa)	180		
frequenza (hz)	0.0007143			frequenza (hz)	0.0007143		
59.35	625.79	265.3	0.0107	59.33	-0.048	265.5	-0.0018
59.43	621.68	263.5	0.0071	59.42	-0.053	262.2	-0.0071
59.52	619.58	262.4	0.0027	59.50	-0.058	259.7	-0.0151
59.60	616.53	261	-0.0044	59.58	-0.061	258.3	-0.0186
59.68	613.26	259.7	-0.008	59.67	-0.065	256.6	-0.0222
59.77	610.25	258.3	-0.0124	59.75	-0.068	254.7	-0.0266
59.85	607.58	257.2	-0.0169	59.83	-0.071	253.4	-0.0293
59.93	603.91	255.7	-0.0204	59.92	-0.078	250.4	-0.0355
60.02	599.93	253.7	-0.0249	60.00	-0.082	248.3	-0.0391
60.10	598.29	252.4	-0.0302	60.08	-0.083	247.2	-0.0426
60.18	594.75	251.2	-0.0337	60.18	-0.088	245.2	-0.047
60.27	593.91	250.3	-0.0364	60.25	-0.094	243.1	-0.0506
60.35	589.3	248.6	-0.0408	60.33	-0.099	240.4	-0.0541
60.43	586.63	247.4	-0.0435	60.42	-0.102	238.7	-0.0595
60.52	582.68	246	-0.047	60.50	-0.106	236.9	-0.063
60.60	579.64	243.9	-0.0497	60.58	-0.11	234.8	-0.0675
60.68	578.2	242.9	-0.0541	60.67	-0.112	233.6	-0.0701
60.77	574.92	241.5	-0.0577	60.75	-0.114	232.3	-0.0719
60.87	571.68	240.2	-0.0604	60.83	-0.123	230.2	-0.0772
60.93	568.8	238.4	-0.063	60.92	-0.125	227.6	-0.0799
61.02	568.03	237.5	-0.0666	61.00	-0.128	225.9	-0.0843
61.10	564.29	236.1	-0.0692	61.08	-0.13	224.8	-0.087
61.18	562.98	235.1	-0.0719	61.17	-0.134	223	-0.0897
61.27	560.2	233.8	-0.0746	61.25	-0.136	221.5	-0.0923
61.35	556.89	232.6	-0.0772	61.33	-0.14	219.8	-0.0959
61.43	556.56	231.4	-0.079	61.42	-0.144	218	-0.0985
61.52	553.01	230.1	-0.0826	61.50	-0.148	215.7	-0.1012
61.60	549.87	228.7	-0.0852	61.58	-0.149	214.5	-0.1047
61.68	548.56	227.7	-0.0879	61.67	-0.153	213.1	-0.1074
61.77	547.05	226.7	-0.0897	61.75	-0.156	211.6	-0.1092
61.85	544.31	225.4	-0.0923	61.83	-0.16	209.4	-0.1118
61.93	542	224.6	-0.0941	61.92	-0.161	208.2	-0.1154
62.02	539.76	223	-0.0968	62.00	-0.163	207.2	-0.1181
62.10	539.02	222.3	-0.0994	62.08	-0.166	205.7	-0.1207
62.18	536.34	221.2	-0.1012	62.17	-0.171	203.8	-0.1243
62.28	534.17	220	-0.103	62.25	-0.17	203.2	-0.1252
62.35	534.03	219.3	-0.1047	62.33	-0.173	202.1	-0.1278
62.43	531.89	218.4	-0.1065	62.42	-0.174	200.8	-0.1296
62.52	530.01	217.5	-0.1083	62.50	-0.177	199.4	-0.1323
62.60	529.24	216.7	-0.1101	62.58	-0.178	198.6	-0.134
62.68	527.63	215.9	-0.1118	62.67	-0.184	196.5	-0.1376
62.77	526.36	215.1	-0.1136	62.75	-0.182	196.5	-0.1376
62.85	526.02	214.4	-0.1145	62.83	-0.184	195.4	-0.1402
62.93	521.21	213.1	-0.1172	62.92	-0.185	194.4	-0.1411
63.02	523.01	212.9	-0.1172	63.00	-0.189	193	-0.1429
63.10	521.67	212.2	-0.1189	63.10	-0.189	192.4	-0.1456
63.18	520.87	211.6	-0.1198	63.17	-0.19	191.8	-0.1465
63.27	520.23	211.1	-0.1207	63.25	-0.19	191.3	-0.1473
63.35	519.06	210.3	-0.1225	63.33	-0.194	189.2	-0.1491
63.43	517.92	209.6	-0.1234	63.42	-0.194	189.2	-0.1518
63.52	518.08	209.3	-0.1243	63.50	-0.192	189.5	-0.1518
63.60	517.05	208.7	-0.1252	63.58	-0.196	188.2	-0.1544
63.68	517.88	208.6	-0.126	63.67	-0.196	187.9	-0.1544
63.78	516.07	207.7	-0.1269	63.75	-0.196	187.7	-0.1553
63.85	515.7	207.4	-0.1278	63.83	-0.197	187.1	-0.1562
63.93	515.37	207.1	-0.1287	63.92	-0.198	186.4	-0.1571
64.02	515.27	206.8	-0.1287	64.00	-0.197	186.3	-0.158
64.10	512.52	205.9	-0.1305	64.08	-0.198	186	-0.1589
64.18	514.6	206	-0.1305	64.17	-0.198	185.8	-0.1598
64.27	515.67	206	-0.1305	64.25	-0.199	185.5	-0.1607

Prova triassiale ciclica SNGR03-C4								
tensione di confinamento (kPa)	450				tensione di confinamento (kPa)	450		
deviatore ciclico (kPa)	150				deviatore ciclico (kPa)	180		
frequenza (hz)	0.0007143				frequenza (hz)	0.0007143		
64.35	515.4	205.8	-0.1305	64.33	-0.198	185.5	-0.1607	
64.43	515	205.5	-0.1314	64.42	-0.199	184.8	-0.1616	
64.52	515.63	205.4	-0.1314	64.52	-0.197	185.3	-0.1616	
64.60	515.8	205.3	-0.1314	64.58	-0.195	185.8	-0.1616	
64.68	516	205.2	-0.1314	64.67	-0.196	185.5	-0.1616	
64.77	516.67	205.2	-0.1314	64.75	-0.196	185.2	-0.1624	
64.85	517	205.1	-0.1314	64.83	-0.194	185.7	-0.1624	
64.93	517.5	205.2	-0.1314	64.92	-0.196	185.4	-0.1624	
65.02	518.61	205.3	-0.1314	65.00	-0.193	186	-0.1624	
65.10	520.28	205.5	-0.1305	65.08	-0.191	186.8	-0.1607	
65.20	520.35	205.4	-0.1305	65.17	-0.192	186.3	-0.1616	
65.27	520.71	205.4	-0.1305	65.25	-0.19	186.8	-0.1616	
65.35	521.85	205.6	-0.1305	65.33	-0.188	187.2	-0.1616	
65.43	523.22	205.9	-0.1296	65.42	-0.186	188	-0.1607	
65.52	523.89	205.8	-0.1296	65.50	-0.186	188.2	-0.1607	
65.60	524.49	206	-0.1296	65.58	-0.184	188.7	-0.1598	
65.68	527.14	206.6	-0.1287	65.67	-0.183	189	-0.1598	
65.77	527.54	206.8	-0.1278	65.75	-0.179	190.3	-0.1571	
65.85	530.35	207.4	-0.1269	65.83	-0.178	190.6	-0.1571	
65.93	530.62	207.5	-0.1269	65.92	-0.178	191	-0.1571	
66.02	531.19	207.8	-0.126	66.02	-0.174	192.3	-0.1553	
66.10	533.29	208.2	-0.1252	66.08	-0.173	192.6	-0.1553	
66.18	537.11	209.1	-0.1234	66.17	-0.172	193.1	-0.1553	
66.27	536.91	209.3	-0.1234	66.25	-0.167	194.2	-0.1536	
66.35	539.72	210	-0.1216	66.33	-0.165	195.4	-0.1527	
66.43	540.92	210.3	-0.1207	66.42	-0.16	197	-0.15	
66.52	543.26	211	-0.1198	66.50	-0.16	197.3	-0.15	
66.60	544.53	211.4	-0.1189	66.58	-0.157	198.2	-0.1491	
66.70	546.91	212.2	-0.1181	66.67	-0.157	198.8	-0.1482	
66.77	549.22	212.8	-0.1163	66.75	-0.152	200.1	-0.1465	
66.85	551.89	213.6	-0.1154	66.83	-0.149	201.1	-0.1456	
66.93	553.13	214.1	-0.1145	66.92	-0.147	202.6	-0.1429	
67.02	555.04	214.8	-0.1127	67.00	-0.143	203.9	-0.142	
67.10	558.48	215.6	-0.111	67.08	-0.139	205.1	-0.1402	
67.18	561.89	216.8	-0.1101	67.17	-0.135	206.5	-0.1385	
67.27	562.33	217.3	-0.1083	67.25	-0.132	208	-0.1367	
67.35	565.31	218.2	-0.1065	67.33	-0.131	208.5	-0.1358	
67.43	567.95	219.1	-0.1047	67.43	-0.126	210.5	-0.1331	
67.52	570.39	219.8	-0.103	67.50	-0.123	212.1	-0.1314	
67.60	571.96	220.5	-0.1021	67.58	-0.121	213.3	-0.1296	
67.68	576.38	222	-0.0994	67.67	-0.116	214.5	-0.1278	
67.77	578.99	223	-0.0976	67.75	-0.11	216.9	-0.1243	
67.85	581.5	223.8	-0.095	67.83	-0.107	218.2	-0.1234	
67.93	584.21	224.9	-0.0932	67.92	-0.105	219.4	-0.1207	
68.02	587.01	225.9	-0.0905	68.00	-0.1	221	-0.1181	
68.12	590.52	227.2	-0.0879	68.08	-0.098	222.2	-0.1172	
68.18	593.1	228.2	-0.0861	68.17	-0.093	224	-0.1136	
68.27	596.01	229.3	-0.0834	68.25	-0.089	225.7	-0.111	
68.35	598.15	230.2	-0.0817	68.33	-0.081	227.6	-0.1083	
68.43	600.39	231.2	-0.0799	68.42	-0.078	230	-0.1056	
68.52	605.94	232.5	-0.0763	68.50	-0.076	231.5	-0.1021	
68.60	609.08	234.1	-0.0746	68.58	-0.072	233	-0.0994	
68.68	610.82	235.2	-0.0701	68.67	-0.068	234.5	-0.0985	
68.77	616.9	236.9	-0.0666	68.75	-0.064	236.4	-0.095	
68.85	615.9	237.3	-0.0657	68.83	-0.06	238.2	-0.0923	
68.93	619.44	238.5	-0.0621	68.93	-0.054	240.6	-0.0879	
69.02	623.12	239.8	-0.0595	69.00	-0.049	242.4	-0.0843	
69.10	627.99	241.6	-0.0559	69.08	-0.047	244	-0.0817	
69.18	630.33	242.7	-0.0541	69.17	-0.042	245.8	-0.0781	
69.27	633.77	244	-0.0488	69.25	-0.036	247.7	-0.0754	

Prova triassiale ciclica SNGR03-C4								
tensione di confinamento (kPa)	450				tensione di confinamento (kPa)	450		
deviatore ciclico (kPa)	150				deviatore ciclico (kPa)	180		
frequenza (hz)	0.0007143				frequenza (hz)	0.0007143		
69.35	637.11	245.3	-0.0462	69.33	-0.031	250.4	-0.0719	
69.43	640.02	246.6	-0.0426	69.42	-0.028	251.9	-0.0666	
69.52	642.96	247.7	-0.0399	69.50	-0.023	253.7	-0.063	
69.62	646.67	249.2	-0.0355	69.58	-0.02	255.5	-0.0604	
69.68	650.61	250.6	-0.032	69.67	-0.015	257.4	-0.0559	
69.77	652.84	251.9	-0.0284	69.75	-0.011	259.2	-0.0524	
69.85	656.72	253.1	-0.0249	69.83	-0.004	261.3	-0.0488	
69.93	660.66	254.6	-0.0213	69.92	0.001	264.1	-0.0444	
70.02	665.4	256.6	-0.016	70.00	0.004	265.7	-0.0382	
70.10	666.67	257.5	-0.0124	70.08	0.009	267.7	-0.0346	
70.18	668.63	258.5	-0.0089	70.17	0.015	269.8	-0.0293	
70.27	674.54	260.4	-0.0036	70.25	0.016	271.1	-0.0257	
70.35	676.24	261.3	-0.0009	70.35	0.022	273.7	-0.0204	
70.43	679.98	262.7	0.0036	70.42	0.027	275.5	-0.016	
70.52	684.18	264.1	0.008	70.50	0.032	277.4	-0.0124	
70.60	688.25	266.1	0.0115	70.58	0.034	278.9	-0.008	
70.68	690.49	267.2	0.0186	70.67	0.039	280.6	-0.0036	
70.77	694.29	268.6	0.0222	70.75	0.048	282.8	0.0018	
70.85	696.99	269.8	0.0266	70.83	0.048	284.8	0.0053	
70.93	699.42	271	0.0311	70.92	0.054	286.7	0.0124	
71.03	703.59	272.8	0.0373	71.00	0.06	289.1	0.0195	
71.10	707.46	274.2	0.0417	71.08	0.062	290.4	0.0231	
71.18	709.19	275.4	0.0453	71.17	0.066	292.1	0.0284	
71.27	712.95	276.6	0.0506	71.25	0.07	293.7	0.0328	
71.35	717.18	278.3	0.0559	71.33	0.076	295.7	0.0382	
71.43	720.88	279.9	0.0595	71.42	0.081	298.3	0.0426	
71.52	722.01	280.9	0.0666	71.50	0.084	299.6	0.0506	
71.60	725.91	282.2	0.071	71.58	0.088	301.2	0.055	
71.68	728.94	283.5	0.0754	71.67	0.093	303.1	0.0612	
71.77	731.54	284.6	0.0799	71.75	0.095	304.9	0.0666	
71.85	734.76	285.9	0.0852	71.83	0.104	307.5	0.0737	
71.93	738.59	287	0.0897	71.92	0.105	308.5	0.0781	
72.02	741.42	288.9	0.0932	72.00	0.109	310	0.0826	
72.10	743.42	289.9	0.1003	72.08	0.112	311.5	0.0879	
72.18	747.08	291.2	0.1047	72.17	0.116	313.1	0.0923	
72.27	749.07	292.3	0.1083	72.25	0.121	314.7	0.0985	
72.35	751.4	293.3	0.1127	72.33	0.125	316.9	0.1021	
72.45	754.29	294.8	0.1189	72.42	0.128	318.6	0.111	
72.52	757.48	296	0.1234	72.50	0.133	319.9	0.1163	
72.60	759.71	297.1	0.1269	72.58	0.135	321.1	0.1207	
72.68	761.7	298.1	0.1314	72.67	0.137	322.2	0.1243	
72.77	765.93	299.3	0.1349	72.75	0.142	323.8	0.1287	
72.85	767.89	300.7	0.1394	72.83	0.148	326.1	0.1349	
72.93	770.22	301.8	0.1447	72.92	0.149	326.9	0.1411	
73.02	774.8	303.1	0.15	73.00	0.153	328.3	0.1456	
73.10	774.1	303.6	0.1518	73.08	0.155	329.4	0.15	
73.18	777.02	304.7	0.1562	73.17	0.16	331.2	0.1553	
73.27	778.85	305.7	0.1589	73.27	0.161	332.2	0.1598	
73.35	781.18	306.6	0.1624	73.35	0.167	334	0.166	
73.43	783.94	308	0.166	73.42	0.166	334.4	0.1687	
73.52	785.66	308.8	0.1713	73.50	0.17	336	0.174	
73.60	787.95	309.8	0.1749	73.58	0.173	337.2	0.1766	
73.68	789.05	310.6	0.1775	73.67	0.174	337.9	0.182	
73.77	791.14	311.4	0.1802	73.75	0.18	339.5	0.1873	
73.85	792.83	312.2	0.1829	73.83	0.178	339.7	0.1891	
73.95	794.92	313.3	0.1864	73.92	0.182	341	0.1935	
74.02	795.85	314	0.1891	74.00	0.187	342.4	0.1979	
74.10	798.01	314.8	0.1917	74.08	0.187	342.8	0.1997	
74.18	799.94	315.6	0.1944	74.17	0.19	344.4	0.205	
74.27	801.4	316.5	0.1971	74.25	0.191	345	0.2086	

Prova triassiale ciclica SNGR03-C4							
tensione di confinamento (kPa)	450			tensione di confinamento (kPa)	450		
deviatore ciclico (kPa)	150			deviatore ciclico (kPa)	180		
frequenza (hz)	0.0007143			frequenza (hz)	0.0007143		
74.35	802.19	317.2	0.1997	74.33	0.193	345.9	0.2121
74.43	804.01	317.8	0.2024	74.42	0.195	346.7	0.2148
74.52	804.94	318.5	0.205	74.50	0.198	347.7	0.2184
74.60	805.74	319	0.2068	74.58	0.197	348	0.2192
74.68	806.93	319.6	0.2086	74.68	0.201	349.3	0.2246
74.77	809.35	320.7	0.2121	74.75	0.2	349.4	0.2255
74.85	808.02	320.9	0.2121	74.83	0.202	350.1	0.2281
74.93	809.75	321.5	0.2148	74.92	0.206	351.2	0.2317
75.02	810.88	322.1	0.2166	75.00	0.205	351.3	0.2317
75.10	813.6	322.9	0.2192	75.08	0.208	352.2	0.2343
75.18	811.57	322.9	0.2192	75.17	0.205	352.3	0.2361
75.27	813	323.5	0.221	75.25	0.208	353	0.2388
75.37	813.53	324	0.2228	75.33	0.208	353.3	0.2397
75.43	813.92	324.4	0.2237	75.42	0.208	353.5	0.2414
75.52	814.39	324.7	0.2255	75.50	0.212	354.4	0.245
75.60	814.42	325	0.2255	75.58	0.208	354.2	0.245
75.68	814.95	325.5	0.2263	75.67	0.21	354.7	0.245
75.77	815.05	325.9	0.2281	75.75	0.211	355	0.2477
75.85	814.15	325.9	0.2281	75.83	0.211	355.4	0.2485
75.93	815.08	326.2	0.229	75.92	0.21	355.2	0.2485
76.02	814.91	326.4	0.229	76.00	0.209	355.2	0.2494
76.10	814.78	326.6	0.2299	76.08	0.212	355.9	0.2503
76.18	814.41	326.7	0.2299	76.18	0.209	355.6	0.2503
76.27	815.67	327.2	0.2317	76.25	0.209	355.7	0.2512
76.35	813.84	327.1	0.2308	76.33	0.208	355.6	0.2503
76.43	811.78	326.8	0.2299	76.42	0.208	355.6	0.2512
76.52	812.68	327.1	0.2308	76.50	0.209	355.9	0.2512
76.60	812.55	327.2	0.2308	76.58	0.207	355.6	0.2512
76.68	813.14	327.2	0.2308	76.67	0.206	355.4	0.2512
76.77	808.82	326.9	0.2308	76.75	0.204	355.1	0.2503
76.87	810.39	327.3	0.2299	76.83	0.204	355.1	0.2503
76.93	809.95	327.3	0.2299	76.92	0.203	354.9	0.2503
77.02	808.32	326.8	0.229	77.00	0.201	354.5	0.2494
77.10	807.66	326.9	0.2299	77.08	0.199	354.2	0.2494
77.18	803.93	326.3	0.2272	77.17	0.198	353.7	0.2485
77.27	805.1	326.6	0.2281	77.25	0.196	353.4	0.2468
77.35	804.47	326.4	0.2272	77.33	0.195	353.1	0.2468
77.43	801.31	325.9	0.2255	77.42	0.193	352.7	0.2459
77.52	802.5	326.1	0.2263	77.50	0.191	352.2	0.2441
77.60	798.75	325.3	0.2228	77.60	0.19	351.8	0.2432
77.68	798.28	325.2	0.2237	77.67	0.186	351.1	0.2414
77.77	794.26	324.5	0.221	77.75	0.185	350.7	0.2397
77.85	795.46	324.6	0.221	77.83	0.183	350.1	0.2388
77.93	792.74	324.1	0.2192	77.92	0.181	349.5	0.237
78.02	790.31	323.5	0.2184	78.00	0.175	348.3	0.2361
78.10	791.07	323.6	0.2175	78.08	0.175	348	0.2343
78.18	786.79	322.6	0.2148	78.17	0.172	347.2	0.2308
78.28	785.19	322.2	0.213	78.25	0.168	346.3	0.229
78.35	782.37	321.6	0.2113	78.33	0.168	345.8	0.2272
78.43	779	321.5	0.2113	78.42	0.165	345	0.2246
78.52	778.74	320.5	0.2086	78.50	0.161	344.1	0.2228
78.60	777.48	320	0.2059	78.58	0.157	343	0.2201
78.68	772.49	319	0.2033	78.67	0.155	342	0.2175
78.77	773.1	318.6	0.2015	78.75	0.151	341.2	0.2139
78.85	771.17	318.3	0.2006	78.83	0.148	340.3	0.2113
78.93	767.51	317.5	0.1979	78.92	0.145	339.1	0.2086
79.02	761.69	316.8	0.1944	79.00	0.143	338.4	0.2059
79.10	764.09	316.2	0.1926	79.10	0.138	336.9	0.2015
79.18	757.27	314.8	0.1882	79.17	0.135	335.8	0.1988
79.27	757.07	314.3	0.1873	79.25	0.13	334.5	0.1944

Prova triassiale ciclica SNGR03-C4							
tensione di confinamento (kPa)	450			tensione di confinamento (kPa)	450		
deviatore ciclico (kPa)	150			deviatore ciclico (kPa)	180		
frequenza (hz)	0.0007143			frequenza (hz)	0.0007143		
79.35	754.84	313.6	0.1846	79.33	0.128	333.7	0.1926
79.43	752.35	312.8	0.182	79.42	0.124	332.5	0.1891
79.52	746.86	311.5	0.1784	79.50	0.119	330.9	0.1855
79.60	747.59	311	0.1775	79.58	0.115	329.5	0.182
79.68	741.8	309.7	0.174	79.67	0.112	328.5	0.1766
79.78	740.91	309.1	0.1695	79.75	0.108	327.1	0.1731
79.85	735.98	307.8	0.1651	79.83	0.106	326.2	0.1704
79.93	732.82	306.7	0.1633	79.92	0.1	324.6	0.1651
80.02	730.93	305.9	0.1589	80.00	0.097	323.2	0.1616
80.10	726.87	304.9	0.1536	80.08	0.091	321.2	0.1571
80.18	724.74	303.8	0.1509	80.17	0.087	319.7	0.1536
80.27	722.38	303	0.1482	80.25	0.084	318.6	0.1473
80.35	719.55	302.2	0.1456	80.33	0.078	316.8	0.1429
80.43	715.59	301	0.1411	80.42	0.076	315.6	0.1385
80.52	710.13	299.1	0.1358	80.52	0.069	313.2	0.1314
80.60	709.56	298.5	0.1314	80.58	0.066	312.1	0.1287
80.68	706.4	297.5	0.1278	80.67	0.063	310.7	0.1252
80.77	700.81	295.6	0.1216	80.75	0.057	308.8	0.1189
80.85	701.61	295.4	0.1198	80.83	0.054	307.4	0.1145
80.93	697.05	294	0.1145	80.92	0.048	305.5	0.1092
81.02	692.02	292.2	0.1101	81.00	0.042	303.1	0.1047
81.10	688.85	290.9	0.1065	81.08	0.038	301.4	0.0968
81.20	686.15	289.8	0.0985	81.17	0.035	300.2	0.0923
81.27	683.79	288.8	0.095	81.25	0.03	298.3	0.0879
81.35	678.76	287	0.0923	81.33	0.025	296.3	0.0817
81.43	675.99	285.9	0.0843	81.42	0.024	295.3	0.0781
81.52	672.36	284.5	0.0799	81.50	0.017	293	0.0719
81.60	667.42	282.9	0.0737	81.58	0.011	290.4	0.0666
81.68	666.96	282	0.0701	81.67	0.006	288.6	0.0595
81.77	666.49	281.5	0.0666	81.75	0.002	286.9	0.0541
81.85	658.36	279.4	0.0595	81.83	-0.002	285	0.0497
81.93	653.15	277.1	0.0541	81.92	-0.009	282.6	0.0435
82.02	652.75	276.3	0.0479	82.02	-0.011	280.7	0.0373
82.10	647.32	274.9	0.0435	82.08	-0.015	279.2	0.032
82.18	646.71	273.9	0.0391	82.17	-0.021	277.1	0.0266
82.27	644.38	272.7	0.0346	82.25	-0.024	275.5	0.0231
82.35	640.37	271.3	0.0302	82.33	-0.027	273.6	0.016
82.43	635.1	269.7	0.0249	82.42	-0.034	271.3	0.0107
82.52	632.4	268.4	0.0204	82.50	-0.04	268.7	0.0071
82.62	629.46	267.2	0.0142	82.58	-0.043	267	0
82.68	626.29	265.8	0.0098	82.67	-0.047	265.5	-0.0044
82.77	622.08	263.9	0.0053	82.75	-0.053	263.2	-0.0098
82.85	620.81	262.9	0.0027	82.83	-0.053	261.5	-0.0124
82.93	617.27	261.7	-0.0044	82.92	-0.059	259.8	-0.0178
83.02	613.09	260.1	-0.0089	83.00	-0.065	257.7	-0.0222
83.10	611.59	259	-0.0124	83.08	-0.068	255.6	-0.0257
83.18	608.11	257.7	-0.0169	83.17	-0.075	252.6	-0.0337
83.27	603.51	256.2	-0.0213	83.25	-0.077	251.4	-0.0373
83.35	599.83	254.2	-0.0249	83.33	-0.082	249.5	-0.0408
83.43	597.92	252.8	-0.0311	83.43	-0.087	247.1	-0.0444
83.52	595.08	251.7	-0.0346	83.50	-0.09	245.2	-0.0497
83.60	590.87	250	-0.0391	83.58	-0.094	243.6	-0.0533
83.68	589.83	248.9	-0.0417	83.67	-0.099	241.6	-0.0568
83.77	587.26	247.8	-0.0444	83.75	-0.1	240	-0.0604
83.85	582.75	246.7	-0.0479	83.83	-0.104	238.5	-0.0639
83.93	579.61	244.3	-0.0506	83.92	-0.11	235.3	-0.0692
84.02	577.9	243.2	-0.055	84.00	-0.114	233.9	-0.071
84.12	575.52	242	-0.0577	84.08	-0.116	232.2	-0.0754
84.18	571.44	240.1	-0.0612	84.17	-0.12	230.8	-0.079
84.27	569.04	238.8	-0.0639	84.25	-0.124	228.7	-0.0826

Prova triassiale ciclica SNGR03-C4							
tensione di confinamento (kPa)	450			tensione di confinamento (kPa)	450		
deviatore ciclico (kPa)	150			deviatore ciclico (kPa)	180		
frequenza (hz)	0.0007143			frequenza (hz)	0.0007143		
84.35	566.99	237.8	-0.0675	84.33	-0.126	227.1	-0.0861
84.43	562.01	235.9	-0.0719	84.42	-0.133	224.9	-0.0897
84.52	562.91	235.3	-0.0728	84.50	-0.134	223.7	-0.0923
84.60	560.7	234.4	-0.0763	84.58	-0.139	221.3	-0.095
84.68	557.39	232.9	-0.0781	84.67	-0.14	220	-0.0985
84.77	553.81	231.2	-0.0808	84.75	-0.144	218.5	-0.1012
84.85	552.97	230.4	-0.0843	84.85	-0.148	216.8	-0.1039
84.93	548.53	228.7	-0.0879	84.92	-0.151	214.8	-0.1065
85.02	550.66	228.5	-0.0879	85.00	-0.153	213.6	-0.1101
85.10	547.19	227	-0.0905	85.08	-0.155	212.3	-0.1127
85.18	544.61	226	-0.0932	85.17	-0.159	210.4	-0.1163
85.27	541.69	224.3	-0.0968	85.25	-0.16	209.5	-0.1181
85.35	539.99	223.4	-0.0976	85.33	-0.163	208	-0.1207
85.43	540.29	223	-0.0994	85.42	-0.167	206.6	-0.1234
85.52	537.54	221.9	-0.1021	85.50	-0.169	204.8	-0.1252
85.60	534.53	221	-0.103	85.58	-0.17	203.8	-0.1287
85.68	533.36	219.6	-0.1047	85.67	-0.173	202.7	-0.1305
85.77	531.72	218.7	-0.1074	85.75	-0.175	201.3	-0.1331
85.85	530.35	217.9	-0.1092	85.83	-0.177	200.4	-0.1349
85.93	529.04	217.1	-0.111	85.92	-0.179	199.3	-0.1367
86.02	527.93	216.4	-0.1127	86.00	-0.182	198.1	-0.1385
86.10	526.33	215.6	-0.1136	86.08	-0.183	196.8	-0.1402
86.18	524.25	214.4	-0.1154	86.17	-0.185	195.8	-0.1429
86.27	520.57	213.3	-0.1172	86.25	-0.186	194.8	-0.1447
86.35	523.41	213.4	-0.1181	86.35	-0.188	194.2	-0.1465
86.43	522.17	212.8	-0.1198	86.42	-0.189	192.9	-0.1482
86.52	521	212	-0.1207	86.50	-0.19	192.3	-0.15
86.60	519.89	211.4	-0.1225	86.58	-0.192	191.5	-0.1518
86.68	518.96	210.9	-0.1234	86.67	-0.192	190.8	-0.1527
86.77	517.58	209.7	-0.1243	86.75	-0.193	190.1	-0.1544
86.85	517.68	209.6	-0.1252	86.83	-0.194	189.6	-0.1553
86.93	516.14	208.9	-0.1269	86.92	-0.195	188.9	-0.1562
87.03	518.11	208.8	-0.1269	87.00	-0.197	188.2	-0.1571
87.10	515.87	208.2	-0.1269	87.08	-0.196	188	-0.1589
87.18	515.27	207.7	-0.1287	87.17	-0.197	187.4	-0.1598
87.27	515.4	207.4	-0.1296	87.25	-0.196	187.6	-0.1598
87.35	515.27	207.2	-0.1296	87.33	-0.198	186.8	-0.1616
87.43	514.8	206.8	-0.1305	87.42	-0.198	186.6	-0.1624
87.52	514.97	206.6	-0.1305	87.50	-0.198	186.4	-0.1624
87.60	515	206.3	-0.1314	87.58	-0.198	185.9	-0.1633
87.68	515.57	206.2	-0.1314	87.67	-0.2	185.4	-0.1651
87.77	514.29	205.8	-0.1323	87.77	-0.198	185.8	-0.1642
87.85	515.36	205.8	-0.1323	87.83	-0.197	185.9	-0.1651
87.93	515.83	205.8	-0.1323	87.92	-0.197	185.8	-0.1651
88.02	516.37	205.7	-0.1323	88.00	-0.197	185.9	-0.1651
88.10	515.8	205.4	-0.1331	88.08	-0.196	186	-0.1651
88.18	517.8	205.7	-0.1323	88.17	-0.195	186.1	-0.1651
88.27	519.91	206	-0.1314	88.25	-0.194	186.3	-0.1651
88.35	519.11	205.8	-0.1323	88.33	-0.194	186.4	-0.1651
88.45	519.14	205.7	-0.1323	88.42	-0.192	186.6	-0.1651
88.52	519.84	205.8	-0.1323	88.50	-0.191	187.2	-0.1651
88.60	521.05	205.9	-0.1314	88.58	-0.188	188	-0.1642
88.68	521.92	206.1	-0.1314	88.67	-0.191	187.1	-0.1651
88.77	523.16	206.2	-0.1305	88.75	-0.187	188.3	-0.1642
88.85	523.69	206.4	-0.1305	88.83	-0.186	188.6	-0.1633
88.93	525.93	206.8	-0.1296	88.92	-0.182	189.8	-0.1616
89.02	526.57	206.8	-0.1296	89.00	-0.182	189.8	-0.1624
89.10	528.21	207.4	-0.1287	89.08	-0.18	190.6	-0.1616
89.18	529.48	207.7	-0.1278	89.17	-0.178	191.3	-0.1607
89.27	529.75	207.8	-0.1278	89.27	-0.177	191.8	-0.1598

Prova triassiale ciclica SNGR03-C4							
tensione di confinamento (kPa)	450			tensione di confinamento (kPa)	450		
deviatore ciclico (kPa)	150			deviatore ciclico (kPa)	180		
frequenza (hz)	0.0007143			frequenza (hz)	0.0007143		
89.35	532.42	208.4	-0.126	89.33	-0.174	192.6	-0.1589
89.43	533.59	208.7	-0.126	89.42	-0.171	193.6	-0.1589
89.52	535.47	209.2	-0.1252	89.50	-0.17	194.2	-0.1571
89.60	538.18	210	-0.1234	89.58	-0.168	194.8	-0.1571
89.68	538.78	210.3	-0.1225	89.67	-0.164	196	-0.1553
89.77	541.15	210.8	-0.1225	89.75	-0.163	196.8	-0.1544
89.85	543.4	211.4	-0.1207	89.83	-0.16	197.6	-0.1536
89.95	545.94	212.3	-0.1198	89.92	-0.157	198.6	-0.1518
90.02	545.47	212.4	-0.1189	90.00	-0.154	200.2	-0.1509
90.10	548.85	213.3	-0.1172	90.08	-0.151	201.1	-0.1491
90.18	553	214.4	-0.1154	90.17	-0.147	202.6	-0.1473
90.27	552.46	214.5	-0.1154	90.25	-0.147	203.1	-0.1465
90.35	555.14	215.2	-0.1136	90.33	-0.143	204.5	-0.1447
90.43	559.02	216.1	-0.1118	90.42	-0.142	205.2	-0.1438
90.52	558.82	216.7	-0.111	90.50	-0.136	207.1	-0.142
90.60	562.4	217.7	-0.1083	90.58	-0.132	208.8	-0.1402
90.68	568.18	219.2	-0.1056	90.68	-0.13	209.8	-0.1376
90.77	567.08	219.4	-0.1056	90.75	-0.127	210.8	-0.1367
90.85	570.39	220.3	-0.1039	90.83	-0.122	212.5	-0.134
90.93	572.53	221.2	-0.1021	90.92	-0.117	214.5	-0.1331
91.02	576.81	222.6	-0.1003	91.00	-0.116	215.6	-0.1296
91.10	578.89	223.5	-0.0985	91.08	-0.112	217	-0.1278
91.18	581.63	224.4	-0.0959	91.17	-0.107	218.9	-0.126
91.27	583.94	225.3	-0.0941	91.25	-0.105	220	-0.1234
91.37	588.18	226.8	-0.0914	91.33	-0.102	221.3	-0.1216
91.43	590.02	227.7	-0.0888	91.42	-0.095	223.2	-0.1189
91.52	593.2	228.7	-0.087	91.50	-0.089	226.1	-0.1154
91.60	596.51	229.8	-0.0843	91.58	-0.089	227	-0.1136
91.68	597.78	230.7	-0.0826	91.67	-0.085	228.4	-0.111
91.77	601.89	232	-0.0799	91.75	-0.08	230.4	-0.1083
91.85	606.2	233	-0.0772	91.83	-0.077	231.9	-0.1056
91.93	608.91	234.7	-0.0754	91.92	-0.073	233.5	-0.103
92.02	610.88	235.7	-0.071	92.00	-0.067	235.5	-0.1003
92.10	614.39	236.9	-0.0683	92.08	-0.062	238.1	-0.0985
92.18	615.86	237.9	-0.0666	92.18	-0.059	239.4	-0.0941
92.27	619.81	239	-0.063	92.25	-0.056	240.9	-0.0914
92.35	622.71	240.2	-0.0604	92.33	-0.049	243	-0.0879
92.43	628.46	242.2	-0.0568	92.42	-0.044	245.6	-0.0852
92.52	631.8	243.6	-0.0524	92.50	-0.041	247.2	-0.0808
92.60	633.04	244.4	-0.0497	92.58	-0.037	248.9	-0.0772
92.68	636.98	245.8	-0.047	92.67	-0.032	251	-0.0737
92.78	641.09	247.6	-0.0435	92.75	-0.029	252.4	-0.0701
92.85	643.73	248.9	-0.0382	92.83	-0.025	254.3	-0.0666
92.93	647.14	250	-0.0364	92.92	-0.017	256.5	-0.0621
93.02	651.11	251.4	-0.032	93.00	-0.012	259.3	-0.0586
93.10	652.78	252.4	-0.0293	93.08	-0.011	260.8	-0.0533
93.18	654.55	253.3	-0.0266	93.17	-0.005	262.6	-0.0497
93.27	661.09	255.1	-0.0222	93.25	0	264.6	-0.0453
93.35	664.36	257	-0.0186	93.33	0.003	266.4	-0.0417
93.43	667.07	258.1	-0.0115	93.42	0.008	268.1	-0.0382
93.52	670.94	259.5	-0.008	93.50	0.014	270.3	-0.0328
93.60	672.01	260.4	-0.0053	93.60	0.018	272.7	-0.0275
93.68	675.94	261.7	-0.0018	93.67	0.021	274.2	-0.024
93.77	680.15	263.4	0.0036	93.75	0.025	275.9	-0.0195
93.85	684.72	265.2	0.0071	93.83	0.032	278.2	-0.0142
93.93	687.55	266.6	0.0115	93.92	0.038	280.9	-0.0107
94.02	689.02	267.6	0.0169	94.00	0.041	282.5	-0.0036
94.10	694.72	269.1	0.0222	94.08	0.045	284.2	0.0009
94.18	696.75	270.3	0.0266	94.17	0.051	286.2	0.0062
94.28	701.79	272.5	0.0337	94.25	0.053	287.8	0.0107

Prova triassiale ciclica SNGR03-C4							
tensione di confinamento (kPa)	450			tensione di confinamento (kPa)	450		
deviatore ciclico (kPa)	150			deviatore ciclico (kPa)	180		
frequenza (hz)	0.0007143			frequenza (hz)	0.0007143		
94.35	702.55	273.2	0.0364	94.33	0.061	290.1	0.0178
94.43	707.32	274.8	0.0417	94.42	0.064	291	0.0204
94.52	710.79	276.5	0.047	94.50	0.068	293.9	0.0257
94.60	713.29	277.4	0.0506	94.58	0.072	295.5	0.0328
94.68	717.15	278.3	0.0541	94.67	0.076	297.3	0.0382
94.77	720.48	280.4	0.0586	94.75	0.081	299.1	0.0435
94.85	722.61	281.6	0.0666	94.83	0.083	300.5	0.0488
94.93	726.04	282.8	0.071	94.92	0.087	302.1	0.0533
95.02	729.34	284.2	0.0763	95.02	0.094	305	0.0621
95.10	731.14	285.2	0.0799	95.08	0.096	306	0.0657
95.18	734.7	286.6	0.0852	95.17	0.1	307.7	0.0701
95.27	739.03	288.4	0.0897	95.25	0.104	309.3	0.0754
95.35	740.69	289.5	0.0932	95.33	0.11	311	0.0808
95.43	743.61	290.7	0.1021	95.42	0.114	313.3	0.0861
95.52	745.78	291.8	0.1047	95.50	0.117	314.7	0.0941
95.60	749.5	293	0.1092	95.58	0.12	316.1	0.0985
95.68	751.93	294.2	0.1145	95.67	0.125	317.9	0.1039
95.77	754.96	295.4	0.1189	95.75	0.127	319	0.1092
95.85	757.12	296.8	0.1243	95.83	0.131	320.5	0.1136
95.93	760.04	297.9	0.1278	95.92	0.137	322	0.1189
96.02	760.94	298.6	0.1305	96.00	0.139	324	0.1243
96.10	765.36	300.1	0.1358	96.08	0.142	325.3	0.1296
96.18	771.02	302	0.1394	96.17	0.146	326.7	0.1349
96.27	769.65	302.3	0.1447	96.25	0.149	328.1	0.1402
96.35	772.91	303.5	0.1491	96.33	0.152	329.2	0.1447
96.43	774.66	304.4	0.1527	96.42	0.155	330.5	0.1491
96.52	776.79	305.4	0.1562	96.52	0.159	332.2	0.1562
96.60	780.95	306.8	0.1607	96.58	0.161	333.4	0.1598
96.68	781.98	307.1	0.1624	96.67	0.164	334.5	0.1642
96.77	783.84	308.6	0.166	96.75	0.167	335.6	0.1687
96.85	787.59	309.9	0.1731	96.83	0.171	336.8	0.1731
96.93	787.12	310.3	0.1749	96.92	0.173	338.3	0.1766
97.02	789.87	311.4	0.1784	97.00	0.174	339.1	0.182
97.10	790.97	312	0.1802	97.08	0.178	340.4	0.1864
97.20	792.63	313.2	0.1846	97.17	0.18	341.3	0.19
97.27	795.32	314.4	0.1882	97.25	0.182	342.3	0.1935
97.35	796.11	314.8	0.19	97.33	0.185	343.2	0.1971
97.43	798.94	315.8	0.1935	97.42	0.188	344	0.2006
97.52	799.3	316	0.1944	97.50	0.19	345.3	0.2042
97.60	801.16	317.2	0.1971	97.58	0.191	346.1	0.2086
97.68	802.82	318	0.2015	97.67	0.195	347.4	0.213
97.77	802.72	318.4	0.2024	97.75	0.194	347.5	0.2139
97.85	805.11	319.2	0.205	97.83	0.196	348.4	0.2175
97.93	808.16	320.1	0.2086	97.92	0.198	349.1	0.2201
98.02	806.1	320.2	0.2086	98.00	0.2	350.1	0.2237
98.10	810.62	320.9	0.2113	98.08	0.201	350.8	0.2263
98.18	808.02	321.5	0.213	98.17	0.202	351.4	0.2281
98.27	809.84	322.2	0.2157	98.25	0.205	352.1	0.2308
98.35	810.67	322.8	0.2175	98.33	0.206	352.3	0.2326
98.43	810.87	323.1	0.2184	98.42	0.206	353.1	0.2343
98.52	812.37	323.7	0.2201	98.50	0.207	353.5	0.237
98.62	813.06	324.3	0.2219	98.58	0.208	353.9	0.2388
98.68	814.95	324.9	0.2246	98.67	0.208	354.4	0.2397
98.77	813.09	325	0.2237	98.75	0.208	354.7	0.2414
98.85	813.79	325.3	0.2255	98.83	0.21	355.2	0.2441
98.93	814.78	325.7	0.2263	98.92	0.21	355.1	0.2441
99.02	815.68	326.3	0.2281	99.00	0.213	356.1	0.2459
99.10	813.68	326.3	0.2281	99.08	0.21	355.9	0.2468
99.18	814.91	326.6	0.229	99.17	0.21	356.1	0.2485
99.27	815.21	326.9	0.229	99.25	0.212	356.6	0.2494

Prova triassiale ciclica SNGR03-C4							
tensione di confinamento (kPa)	450			tensione di confinamento (kPa)	450		
deviatore ciclico (kPa)	150			deviatore ciclico (kPa)	180		
frequenza (hz)	0.0007143			frequenza (hz)	0.0007143		
99.35	814.94	327	0.2299	99.33	0.21	356.5	0.2494
99.43	814.87	327.2	0.2299	99.43	0.209	356.5	0.2503
99.52	814.37	327.3	0.2308	99.50	0.21	356.7	0.2503
99.60	815.94	327.9	0.2317	99.58	0.211	357.1	0.2521
99.68	813.05	327.5	0.2308	99.67	0.209	356.9	0.2512
99.77	812.41	327.5	0.2308	99.75	0.208	356.7	0.2512
99.85	814.54	328	0.2317	99.83	0.207	356.6	0.2512
99.93	812.48	327.8	0.2308	99.92	0.207	356.6	0.2512
100.02	811.61	327.8	0.2308	100.00	0.206	356.5	0.2512
100.12	810.29	327.8	0.2308	100.08	0.204	356.1	0.2512
100.18	810.28	327.9	0.2308	100.17	0.204	356.1	0.2512
100.27	809.59	327.7	0.2299	100.25	0.203	356	0.2503
100.35	808.12	327.5	0.2299	100.33	0.201	355.5	0.2494
100.43	807.19	327.3	0.229	100.42	0.199	355.1	0.2485
100.52	805.33	327.1	0.2281	100.50	0.198	354.9	0.2485
100.60	804.4	327	0.2272	100.58	0.197	354.7	0.2485
100.68	803.57	326.8	0.2272	100.67	0.193	353.9	0.2459
100.77	802.34	326.6	0.2272	100.75	0.194	353.7	0.2459
100.85	801.11	326.4	0.2255	100.85	0.189	352.7	0.2441
100.93	798.75	326.1	0.2246	100.92	0.19	352.8	0.2441
101.02	797.12	325.6	0.2237	101.00	0.185	351.8	0.2406
101.10	796.19	325.4	0.2219	101.08	0.186	351.8	0.2406
101.18	793.73	324.9	0.2201	101.17	0.183	351.2	0.2388
101.27	793.2	324.7	0.2201	101.25	0.18	350.5	0.237
101.35	791.54	324.4	0.2184	101.33	0.177	349.4	0.2352
101.43	789.68	323.9	0.2175	101.42	0.176	349.1	0.2343
101.53	788.28	323.4	0.2148	101.50	0.17	347.8	0.2308
101.60	784.13	322.6	0.213	101.58	0.169	347.3	0.229
101.68	783.63	322.4	0.2121	101.67	0.169	347	0.2281
101.77	781.6	321.8	0.2104	101.75	0.165	346.1	0.2255
101.85	777.48	320.8	0.2077	101.83	0.159	344.6	0.2219
101.93	776.38	320.4	0.205	101.92	0.158	344.6	0.2219
102.02	776.25	320.2	0.2042	102.00	0.154	343	0.2184
102.10	770.9	319	0.2015	102.08	0.151	342.2	0.2139
102.18	769.14	318.5	0.1997	102.17	0.147	341	0.2113
102.27	767.67	318	0.1979	102.25	0.147	340.7	0.2095
102.35	763.88	317	0.1944	102.35	0.142	339.1	0.2068
102.43	764.05	316.7	0.1926	102.42	0.139	338.2	0.2024
102.52	759.56	315.6	0.1891	102.50	0.134	336.8	0.1988
102.60	759.06	315.2	0.1882	102.58	0.13	335.5	0.1953
102.68	753.61	314	0.1837	102.67	0.13	335.1	0.1935
102.77	752.08	313.3	0.1811	102.75	0.122	333.2	0.1882
102.85	749.49	312.5	0.1793	102.83	0.121	332.3	0.1855
102.93	745.89	311.9	0.1775	102.92	0.115	330.5	0.182
103.02	742.17	310.2	0.1722	103.00	0.112	329.3	0.1766
103.10	740.68	309.6	0.1687	103.08	0.109	328.4	0.174
103.18	738.01	308.7	0.1669	103.17	0.104	326.7	0.1687
103.27	733.52	307.4	0.1624	103.25	0.101	325.6	0.1651
103.35	730.73	306.4	0.158	103.33	0.096	324.1	0.1616
103.43	726.8	305.3	0.1536	103.42	0.091	322.1	0.1571
103.52	724.57	304.3	0.1509	103.50	0.087	320.7	0.1536
103.60	722.78	303.5	0.1473	103.58	0.084	319.7	0.1473
103.68	717.65	302.2	0.1429	103.67	0.079	318	0.1429
103.77	714.95	301.5	0.1402	103.77	0.072	315.6	0.1367
103.85	713.26	300.2	0.1367	103.83	0.068	314.1	0.1349
103.93	709.53	298.9	0.1305	103.92	0.069	313.6	0.1287
104.02	705.87	297.8	0.126	104.00	0.06	311.1	0.1234
104.10	702.57	296.6	0.1225	104.08	0.058	309.9	0.1189
104.18	702.41	296	0.1198	104.17	0.057	309	0.1154
104.27	696.68	294.3	0.1136	104.25	0.05	306.8	0.1101

Prova triassiale ciclica SNGR03-C4							
tensione di confinamento (kPa)	450			tensione di confinamento (kPa)	450		
deviatore ciclico (kPa)	150			deviatore ciclico (kPa)	180		
frequenza (hz)	0.0007143			frequenza (hz)	0.0007143		
104.35	691.98	293	0.1092	104.33	0.045	304.6	0.1039
104.45	689.95	291.6	0.1039	104.42	0.038	302.3	0.0994
104.52	686.82	290.5	0.0985	104.50	0.035	301.1	0.0923
104.60	683.12	289.2	0.0941	104.58	0.029	299.1	0.087
104.68	678.86	287.4	0.0897	104.67	0.026	297.6	0.0817
104.77	676.32	286.1	0.0834	104.75	0.022	296	0.0772
104.85	674.86	285.4	0.0799	104.83	0.018	294.1	0.0719
104.93	668.26	283.5	0.0728	104.92	0.011	291.3	0.0657
105.02	667.13	282.5	0.0692	105.00	0.006	289.4	0.0612
105.10	663.72	281.4	0.0639	105.08	0.003	288.1	0.0533
105.18	658.96	280	0.0586	105.18	-0.004	285.4	0.047
105.27	654.92	277.9	0.0541	105.25	-0.007	283.8	0.0435
105.35	653.05	276.7	0.047	105.33	-0.015	281.1	0.0399
105.43	649.05	275.4	0.0426	105.42	-0.013	280.7	0.032
105.52	645.65	274	0.0382	105.50	-0.019	278.5	0.0266
105.60	643.28	272.8	0.0337	105.58	-0.025	276.1	0.0213
105.68	640.47	271.8	0.0293	105.67	-0.028	274.6	0.016
105.77	634.83	269.7	0.0231	105.75	-0.033	272.7	0.0107
105.85	632.4	268.7	0.0195	105.83	-0.04	269.3	0.0053
105.93	630.12	267.7	0.0133	105.92	-0.042	268.1	0
106.02	626.65	266.3	0.0098	106.00	-0.047	266.3	-0.0062
106.10	624.08	264.9	0.0062	106.08	-0.055	263.6	-0.0115
106.18	618.91	262.9	0.0018	106.17	-0.052	263.1	-0.0142
106.27	614.2	261.3	-0.0071	106.25	-0.059	260.7	-0.0195
106.35	613.79	260.5	-0.0107	106.33	-0.064	258.6	-0.024
106.43	609.99	259	-0.0151	106.42	-0.07	256	-0.0275
106.52	607.25	257.9	-0.0186	106.50	-0.071	254.7	-0.032
106.60	606.14	256.5	-0.0222	106.58	-0.077	252.5	-0.0382
106.68	598.83	254.3	-0.0257	106.68	-0.081	250.6	-0.0426
106.77	597.69	253.1	-0.032	106.75	-0.087	247.9	-0.0462
106.85	594.71	251.9	-0.0355	106.83	-0.09	246.2	-0.0497
106.93	591.4	250.3	-0.0399	106.92	-0.094	244.4	-0.0559
107.02	589.73	249.2	-0.0426	107.00	-0.098	242.3	-0.0595
107.10	587.16	248	-0.0462	107.08	-0.102	240.4	-0.063
107.18	582.61	246.5	-0.0488	107.17	-0.104	239.1	-0.0666
107.27	581.41	245	-0.0515	107.25	-0.108	237.3	-0.0701
107.37	578.97	243.8	-0.0559	107.33	-0.114	234.4	-0.0737
107.43	575.22	242.3	-0.0595	107.42	-0.118	232.7	-0.0772
107.52	571.91	240.4	-0.0621	107.50	-0.12	231.5	-0.0817
107.60	569.2	239.1	-0.0648	107.58	-0.124	229.5	-0.0852
107.68	567.49	238.1	-0.0683	107.67	-0.127	227.2	-0.0888
107.77	563.98	236.7	-0.0719	107.75	-0.13	226.2	-0.0914
107.85	562.51	235.5	-0.0746	107.83	-0.133	224.7	-0.095
107.93	560.67	234.6	-0.0763	107.92	-0.138	222	-0.0985
108.02	557.49	233.2	-0.0799	108.00	-0.141	220.6	-0.1003
108.10	553.85	231.5	-0.0817	108.08	-0.144	219.1	-0.1039
108.18	553.21	230.5	-0.0852	108.17	-0.145	217.9	-0.1065
108.27	550.76	229.4	-0.0879	108.25	-0.155	214.5	-0.1101
108.35	548.49	228.3	-0.0897	108.33	-0.149	214.9	-0.1127
108.43	546.55	227.2	-0.0923	108.42	-0.155	213	-0.1163
108.52	544.47	226.2	-0.0941	108.50	-0.161	210.4	-0.1198
108.60	541.7	225.3	-0.0959	108.58	-0.159	210.4	-0.1207
108.68	540.02	223.7	-0.0985	108.67	-0.162	209	-0.1243
108.78	538.18	222.8	-0.1012	108.75	-0.17	206.3	-0.1278
108.85	537.07	222.1	-0.103	108.83	-0.169	205.7	-0.1278
108.93	534.8	221.2	-0.1047	108.92	-0.174	203.6	-0.1314
109.02	532.83	219.8	-0.1065	109.00	-0.173	203.1	-0.134
109.10	532.19	219.1	-0.1083	109.08	-0.173	202.5	-0.1358
109.18	530.01	218.1	-0.111	109.17	-0.178	200.5	-0.1385
109.27	529.24	217.4	-0.1118	109.25	-0.179	199.9	-0.1402

Prova triassiale ciclica SNGR03-C4							
tensione di confinamento (kPa)	450			tensione di confinamento (kPa)	450		
deviatore ciclico (kPa)	150			deviatore ciclico (kPa)	180		
frequenza (hz)	0.0007143			frequenza (hz)	0.0007143		
109.35	527.53	216.6	-0.1136	109.33	-0.181	198.7	-0.1429
109.43	526.73	215.9	-0.1145	109.42	-0.183	197.2	-0.1438
109.52	524.95	214.8	-0.1163	109.50	-0.185	196.4	-0.1465
109.60	524.08	214.2	-0.1181	109.60	-0.186	195.6	-0.1482
109.68	522.81	213.5	-0.1198	109.67	-0.187	194.8	-0.15
109.77	521.7	212.9	-0.1207	109.75	-0.189	193.5	-0.1518
109.85	521	212.3	-0.1216	109.83	-0.191	192.6	-0.1544
109.93	517.79	211.2	-0.1243	109.92	-0.191	192.1	-0.1553
110.02	519.42	211.2	-0.1243	110.00	-0.193	191.2	-0.1571
110.10	517.65	210.3	-0.1252	110.08	-0.194	190.6	-0.158
110.18	517.51	209.8	-0.1269	110.17	-0.194	190.2	-0.1589
110.28	517.25	209.4	-0.1269	110.25	-0.195	189.2	-0.1607
110.35	516.48	209	-0.1278	110.33	-0.196	189	-0.1616
110.43	516.24	208.4	-0.1287	110.42	-0.196	188.6	-0.1624
110.52	515.67	208.1	-0.1296	110.50	-0.198	187.9	-0.1642
110.60	516.41	208	-0.1296	110.58	-0.197	187.9	-0.1642
110.68	514.33	207.3	-0.1314	110.67	-0.198	187.5	-0.1651
110.77	515.37	207.2	-0.1314	110.75	-0.199	186.9	-0.166
110.85	515.33	207	-0.1314	110.83	-0.198	187	-0.166
110.93	514.8	206.6	-0.1323	110.92	-0.198	186.7	-0.1669
111.02	514.96	206.4	-0.1323	111.02	-0.197	186.7	-0.1678
111.10	514.16	206	-0.1331	111.08	-0.197	186.8	-0.1678
111.18	515.63	206.2	-0.1331	111.17	-0.198	186.1	-0.1687
111.27	515.79	206	-0.1331	111.25	-0.197	186.5	-0.1687
111.35	516	206.1	-0.1331	111.33	-0.196	186.6	-0.1687
111.43	517.17	205.9	-0.1331	111.42	-0.195	186.9	-0.1687
111.52	517.23	205.9	-0.1331	111.50	-0.195	186.9	-0.1687
111.60	517.63	205.9	-0.1331	111.58	-0.195	186.9	-0.1687
111.70	518.54	205.9	-0.1331	111.67	-0.194	186.9	-0.1687
111.77	521.55	205.9	-0.1323	111.75	-0.192	187.4	-0.1687
111.85	520.48	206.2	-0.1323	111.83	-0.19	187.9	-0.1687
111.93	520.08	206	-0.1323	111.92	-0.19	188.1	-0.1678
112.02	519.91	205.9	-0.1323	112.00	-0.188	188.6	-0.1678
112.10	523.46	206.7	-0.1305	112.08	-0.187	188.9	-0.1669
112.18	524.09	206.7	-0.1314	112.17	-0.186	189.4	-0.1669
112.27	526.83	207.3	-0.1296	112.25	-0.185	189.8	-0.166
112.35	526.4	207.3	-0.1296	112.33	-0.182	190.4	-0.166
112.43	527.44	207.6	-0.1296	112.42	-0.18	191.3	-0.1651
112.52	529.21	207.9	-0.1287	112.52	-0.179	191.7	-0.1642
112.60	530.58	208.3	-0.1278	112.58	-0.177	192.4	-0.1633
112.68	531.85	208.7	-0.1269	112.67	-0.174	193.2	-0.1624
112.77	533.73	209.1	-0.126	112.75	-0.171	194.3	-0.1616
112.85	535.4	209.6	-0.1252	112.83	-0.171	194.7	-0.1607
112.93	538.11	210.3	-0.1243	112.92	-0.168	195.7	-0.1598
113.02	538.98	210.7	-0.1234	113.00	-0.165	196.6	-0.1589
113.10	539.48	210.8	-0.1234	113.08	-0.163	197.4	-0.158
113.18	544.37	212.1	-0.1207	113.17	-0.161	198.1	-0.1571
113.27	544.6	212.3	-0.1207	113.25	-0.157	199.5	-0.1553
113.35	547.48	213.1	-0.1189	113.33	-0.154	200.7	-0.1544
113.43	549.15	213.6	-0.1181	113.42	-0.152	202	-0.1527
113.52	549.19	214	-0.1172	113.50	-0.149	202.9	-0.1509
113.60	552.8	214.8	-0.1154	113.58	-0.145	204.3	-0.1491
113.68	555.64	215.6	-0.1145	113.67	-0.144	205.1	-0.1482
113.77	558.82	216.3	-0.1127	113.75	-0.139	206.4	-0.1465
113.85	560.46	217.3	-0.1118	113.83	-0.136	207.7	-0.1447
113.93	564.91	218.5	-0.1083	113.93	-0.131	209.5	-0.1429
114.02	565.64	219.1	-0.1074	114.00	-0.13	210.5	-0.1411
114.10	567.58	219.8	-0.1056	114.08	-0.126	211.5	-0.1402
114.18	569.96	220.6	-0.1047	114.17	-0.123	212.7	-0.1385
114.27	573.07	221.2	-0.1039	114.25	-0.118	215.2	-0.1358

Prova triassiale ciclica SNGR03-C4							
tensione di confinamento (kPa)	450			tensione di confinamento (kPa)	450		
deviatore ciclico (kPa)	150			deviatore ciclico (kPa)	180		
frequenza (hz)	0.0007143			frequenza (hz)	0.0007143		
114.35	576.71	222.9	-0.1012	114.33	-0.115	216.5	-0.1331
114.43	580.66	224.1	-0.0968	114.42	-0.111	217.9	-0.1314
114.52	581.16	224.7	-0.0968	114.50	-0.108	219.5	-0.1287
114.62	584.4	225.6	-0.0941	114.58	-0.105	221.1	-0.1269
114.68	588.35	227.1	-0.0923	114.67	-0.102	222.2	-0.1252
114.77	589.69	227.9	-0.0897	114.75	-0.095	224.1	-0.1225
114.85	592.93	229	-0.087	114.83	-0.092	226.1	-0.1207
114.93	595.81	230.1	-0.0852	114.92	-0.089	227.7	-0.1172
115.02	597.75	231	-0.0834	115.00	-0.085	229.2	-0.1145
115.10	601.46	232.2	-0.0808	115.08	-0.079	231.3	-0.111
115.18	605.73	233.9	-0.0781	115.17	-0.075	233	-0.1083
115.27	608.28	234.9	-0.0754	115.25	-0.073	234.1	-0.1065
115.35	611.25	236.1	-0.0719	115.33	-0.067	236.2	-0.103
115.43	614.76	237.3	-0.0692	115.42	-0.062	238.6	-0.0994
115.52	617.2	238.4	-0.0666	115.50	-0.06	240.2	-0.0976
115.60	620.11	239.5	-0.063	115.58	-0.055	241.8	-0.095
115.68	623.72	240.7	-0.0604	115.67	-0.049	243.9	-0.0914
115.77	627.99	242.5	-0.0577	115.75	-0.043	246.6	-0.0888
115.85	630.27	243.6	-0.0533	115.83	-0.041	248.2	-0.0826
115.93	633.84	244.9	-0.0497	115.92	-0.037	249.8	-0.0799
116.02	637.65	246.3	-0.0479	116.00	-0.031	252	-0.0763
116.10	639.49	247.6	-0.0453	116.08	-0.029	253.6	-0.0728
116.18	643.23	248.9	-0.0399	116.17	-0.024	255.3	-0.0701
116.27	647.27	250.3	-0.0364	116.25	-0.018	257.2	-0.0666
116.35	650.87	251.6	-0.0328	116.33	-0.012	260.1	-0.0621
116.43	652.84	252.7	-0.0293	116.42	-0.01	261.8	-0.0568
116.52	655.82	254	-0.0266	116.50	-0.005	263.6	-0.0533
116.60	660.82	255.5	-0.0222	116.58	0.001	265.6	-0.0488
116.68	664.36	257.4	-0.0186	116.67	0.002	267.1	-0.0453
116.77	666.83	258.5	-0.0133	116.75	0.008	269	-0.0408
116.85	670.74	259.9	-0.0089	116.85	0.014	271.9	-0.0337
116.93	674.27	261.3	-0.0053	116.92	0.018	273.5	-0.0302
117.02	676.44	262.4	-0.0009	117.00	0.021	275.2	-0.0266
117.10	679.81	263.7	0.0027	117.08	0.026	276.9	-0.0222
117.18	684.38	265.7	0.0071	117.17	0.032	279.7	-0.016
117.27	688.75	267.3	0.0133	117.25	0.037	281.8	-0.0133
117.35	690.99	268.3	0.0178	117.33	0.041	283.3	-0.0062
117.43	694.29	269.6	0.0213	117.42	0.045	285.1	-0.0018
117.53	697.99	271.4	0.0257	117.50	0.05	287.1	0.0036
117.60	700.12	272.7	0.032	117.58	0.052	288.7	0.008
117.68	704.29	274	0.0364	117.67	0.059	291	0.0142
117.77	708.76	275.6	0.0426	117.75	0.064	292.5	0.0195
117.85	708.75	276.4	0.0453	117.83	0.068	294.8	0.0231
117.93	712.99	277.7	0.0497	117.92	0.07	296.6	0.0311
118.02	716.92	279.2	0.055	118.00	0.076	298.3	0.0355
118.10	720.75	281	0.0586	118.08	0.08	300.2	0.0417
118.18	723.18	282.1	0.0666	118.17	0.084	301.8	0.047
118.27	725.94	283.3	0.071	118.25	0.087	303.1	0.0506
118.35	731.6	285.1	0.0772	118.33	0.092	305.3	0.0577
118.43	730.93	285.8	0.0808	118.42	0.097	307.5	0.0639
118.52	734.7	287.1	0.0852	118.50	0.103	309.3	0.0701
118.60	738.56	288.9	0.0897	118.58	0.104	310.2	0.0737
118.68	739.52	289.8	0.0941	118.67	0.109	311.9	0.079
118.77	743.68	291.1	0.1003	118.75	0.114	314.3	0.0843
118.85	746.71	292.3	0.1047	118.83	0.117	315.9	0.0923
118.95	749.3	293.8	0.1083	118.92	0.12	317.3	0.0976
119.02	752.19	294.9	0.1154	119.00	0.125	318.8	0.1021
119.10	753.19	295.8	0.1181	119.08	0.127	320.1	0.1074
119.18	757.78	297.3	0.1234	119.17	0.131	321.5	0.1118
119.27	759.54	298.3	0.1278	119.25	0.138	323.1	0.1181

Prova triassiale ciclica SNGR03-C4							
tensione di confinamento (kPa)	450			tensione di confinamento (kPa)	450		
deviatore ciclico (kPa)	150			deviatore ciclico (kPa)	180		
frequenza (hz)	0.0007143			frequenza (hz)	0.0007143		
119.35	762.14	299.3	0.1314	119.33	0.139	325	0.1216
119.43	765.86	300.5	0.1358	119.42	0.142	326.3	0.1287
119.52	767.82	301.9	0.1394	119.50	0.145	327.7	0.134
119.60	770.08	303	0.1456	119.58	0.149	329.1	0.1394
119.68	771.04	303.7	0.1482	119.67	0.152	330.4	0.1438
119.77	775.33	305.1	0.1527	119.77	0.154	331.9	0.15
119.85	776.52	305.9	0.1562	119.83	0.159	333.2	0.1544
119.93	780.55	307.2	0.1616	119.92	0.161	334.4	0.1589
120.02	782.54	308.3	0.1633	120.00	0.162	335.2	0.1624
120.10	783.3	309.1	0.1687	120.08	0.166	336.5	0.1669
120.18	785.56	310	0.1722	120.17	0.171	338.1	0.1731
120.27	787.68	311	0.1758	120.25	0.173	339.4	0.1758
120.35	790.57	312	0.1793	120.33	0.175	340.5	0.182
120.45	790.33	312.9	0.182	120.42	0.18	341.9	0.1864
120.52	793.16	313.8	0.1846	120.50	0.179	342.2	0.1882
120.60	797.38	314.9	0.1891	120.58	0.182	343.3	0.1926
120.68	796.11	315.3	0.19	120.67	0.184	344.1	0.1962
120.77	797.14	315.9	0.1926	120.75	0.188	345.3	0.2006
120.85	800.69	317.1	0.1971	120.83	0.19	346.3	0.2033
120.93	801.13	317.8	0.1979	120.92	0.193	347.5	0.2086
121.02	800.92	318.2	0.2006	121.00	0.192	347.7	0.2104
121.10	803.84	319	0.2033	121.08	0.197	349.2	0.2157
121.18	804.84	319.6	0.2059	121.18	0.197	349.7	0.2175
121.27	805.7	320.3	0.2077	121.25	0.198	350.3	0.2201
121.35	807.43	321	0.2095	121.33	0.201	351.3	0.2228
121.43	809.19	321.8	0.2121	121.42	0.202	351.9	0.2255
121.52	808.69	322.3	0.213	121.50	0.203	352.4	0.2281
121.60	812.04	323.2	0.2175	121.58	0.205	353.1	0.2299
121.68	810.07	323.1	0.2175	121.67	0.205	353.5	0.2326
121.77	811.34	323.7	0.2192	121.75	0.206	354	0.2334
121.87	812.4	324.4	0.221	121.83	0.208	355	0.237
121.93	812.49	324.7	0.2228	121.92	0.209	355.2	0.2388
122.02	812.86	325	0.2237	122.00	0.208	355.4	0.2397
122.10	813.52	325.5	0.2255	122.08	0.209	355.9	0.2414
122.18	815.45	326.1	0.2263	122.17	0.209	355.9	0.2432
122.27	813.48	326	0.2263	122.25	0.209	356.5	0.245
122.35	814.98	326.6	0.2281	122.33	0.209	356.6	0.2459
122.43	814.81	326.8	0.229	122.42	0.21	356.9	0.2468
122.52	816.73	327.5	0.2308	122.50	0.212	357.4	0.2485
122.60	814.11	327.2	0.2299	122.58	0.21	357.3	0.2485
122.68	813.81	327.3	0.2299	122.68	0.21	357.5	0.2494
122.77	816.7	328	0.2317	122.75	0.211	357.8	0.2503
122.85	813.81	327.8	0.2308	122.83	0.21	357.8	0.2503
122.93	813.6	327.9	0.2317	122.92	0.209	357.7	0.2503
123.02	813.84	328.1	0.2317	123.00	0.209	357.8	0.2512
123.10	813.37	328.2	0.2317	123.08	0.209	357.8	0.2512
123.18	812.94	328.3	0.2317	123.17	0.207	357.6	0.2512
123.27	812.38	328.3	0.2317	123.25	0.207	357.5	0.2512
123.37	811.71	328.4	0.2317	123.33	0.206	357.4	0.2503
123.43	812.04	328.4	0.2317	123.42	0.205	357.3	0.2503
123.52	810.01	328.2	0.2317	123.50	0.203	357	0.2503
123.60	809.28	328.2	0.2308	123.58	0.203	356.9	0.2494
123.68	807.92	328	0.2308	123.67	0.202	356.6	0.2494
123.77	806.86	327.8	0.2299	123.75	0.199	356.2	0.2485
123.85	805.99	327.7	0.229	123.83	0.198	355.7	0.2485
123.93	804.6	327.5	0.2281	123.92	0.196	355.3	0.2468
124.02	802.87	327.2	0.2272	124.00	0.195	355	0.2459
124.10	802.34	327.1	0.2272	124.10	0.192	354.7	0.245
124.18	801.27	326.9	0.2263	124.17	0.191	354	0.2441
124.27	798.75	326.4	0.2255	124.25	0.189	353.5	0.2432

Prova triassiale ciclica SNGR03-C4							
tensione di confinamento (kPa)	450			tensione di confinamento (kPa)	450		
deviatore ciclico (kPa)	150			deviatore ciclico (kPa)	180		
frequenza (hz)	0.0007143			frequenza (hz)	0.0007143		
124.35	797.48	326.2	0.2246	124.33	0.187	353.1	0.2406
124.43	794.63	325.7	0.2219	124.42	0.185	352.4	0.2397
124.52	794.46	325.5	0.221	124.50	0.183	352	0.2379
124.60	792.6	325.1	0.2201	124.58	0.181	351.3	0.237
124.68	791.17	324.8	0.2192	124.67	0.177	350.7	0.2352
124.78	788.88	324.2	0.2175	124.75	0.176	350	0.2343
124.85	787.12	323.8	0.2157	124.83	0.172	349	0.2308
124.93	786.88	323.5	0.2148	124.92	0.169	348.3	0.229
125.02	781.96	322.6	0.2121	125.00	0.167	347.7	0.2272
125.10	782.2	322.4	0.2113	125.08	0.164	346.9	0.2255
125.18	777.94	321.5	0.2095	125.17	0.162	346.3	0.2237
125.27	775.09	320.7	0.205	125.25	0.156	344.8	0.2192
125.35	774.22	320.3	0.2042	125.33	0.154	343.8	0.2175
125.43	773.52	319.9	0.2033	125.42	0.152	343.2	0.2139
125.52	770.17	319.2	0.2006	125.50	0.146	341.7	0.2104
125.60	766.17	318.2	0.1979	125.58	0.145	341.8	0.2104
125.68	763.91	317.8	0.1962	125.67	0.141	339.9	0.2059
125.77	761.79	316.8	0.1935	125.75	0.138	338.7	0.2015
125.85	760.63	316.2	0.19	125.83	0.136	338.1	0.1988
125.93	756.6	315.2	0.1873	125.92	0.131	336.6	0.1944
126.02	754.21	314.5	0.1846	126.00	0.126	335.2	0.19
126.10	752.31	313.9	0.182	126.08	0.126	334.8	0.1891
126.18	748.52	312.8	0.1793	126.17	0.118	332.9	0.1837
126.27	746.13	311.8	0.1766	126.25	0.115	331.5	0.1811
126.35	744.43	311.1	0.174	126.33	0.112	330.2	0.1758
126.43	740.81	310.2	0.1704	126.42	0.109	329.3	0.1731
126.52	736.55	309.1	0.166	126.50	0.102	327.2	0.1669
126.60	733.28	307.8	0.1642	126.58	0.101	326.5	0.1642
126.68	733.03	307.4	0.1598	126.67	0.097	325.3	0.1607
126.77	728.8	306.2	0.1562	126.75	0.093	323.6	0.1562
126.85	724.97	305	0.1518	126.83	0.086	321.4	0.1518
126.93	722.44	304	0.1482	126.92	0.084	320.4	0.1465
127.02	717.25	302.6	0.1438	127.02	0.08	319	0.142
127.10	714.92	301.9	0.1411	127.08	0.074	317.5	0.1376
127.18	711.73	300.4	0.1367	127.17	0.069	315.2	0.1331
127.27	709.93	299.6	0.1314	127.25	0.066	313.9	0.1278
127.35	705.27	298.2	0.1269	127.33	0.064	312.7	0.1234
127.43	701.41	296.8	0.1216	127.42	0.056	310.3	0.1172
127.52	700.24	296	0.1181	127.50	0.053	309.1	0.1127
127.60	696.78	294.8	0.1145	127.58	0.051	308	0.1092
127.70	693.22	293.3	0.1083	127.67	0.043	305.1	0.1021
127.77	692.18	292.5	0.1056	127.75	0.037	303	0.0976
127.85	686.89	291	0.0994	127.83	0.036	301.8	0.0905
127.93	682.12	289.7	0.095	127.92	0.03	299.9	0.0852
128.02	678.82	288	0.0905	128.00	0.026	298.2	0.0808
128.10	677.32	287.1	0.0852	128.08	0.022	296.7	0.0754
128.18	673.06	285.6	0.079	128.17	0.019	295.3	0.071
128.27	669.26	284.1	0.0746	128.25	0.01	292.7	0.0639
128.35	667.93	283.3	0.071	128.33	0.006	290.3	0.0595
128.43	662.39	281.6	0.0639	128.42	0.001	288.4	0.0515
128.52	658.69	280.4	0.0595	128.50	-0.001	287	0.047
128.60	654.72	278.4	0.055	128.58	-0.007	285	0.0426
128.68	652.82	277.3	0.0479	128.67	-0.012	282.6	0.0373
128.77	648.88	275.9	0.0435	128.75	-0.015	281	0.0293
128.85	645.91	274.6	0.0391	128.83	-0.021	278.7	0.024
128.93	643.71	273.5	0.0337	128.92	-0.025	276.9	0.0195
129.02	639.81	272.2	0.0302	129.00	-0.028	275.4	0.0142
129.12	634.67	270	0.0222	129.08	-0.032	273.6	0.0089
129.18	633.5	269.5	0.0186	129.17	-0.039	271.4	0.0036
129.27	630.16	268.2	0.0142	129.25	-0.044	268.6	-0.0009

Prova triassiale ciclica SNGR03-C4							
tensione di confinamento (kPa)	450			tensione di confinamento (kPa)	450		
deviatore ciclico (kPa)	150			deviatore ciclico (kPa)	180		
frequenza (hz)	0.0007143			frequenza (hz)	0.0007143		
129.35	626.55	267.3	0.0115	129.33	-0.047	267	-0.0071
129.43	620.25	264.5	0.0062	129.42	-0.051	264.8	-0.0124
129.52	619.87	263.7	-0.0009	129.50	-0.057	262.9	-0.0178
129.60	616.93	262.4	-0.0053	129.58	-0.06	261.3	-0.0213
129.68	614.06	261.2	-0.0089	129.67	-0.063	259.8	-0.0249
129.77	610.85	259.8	-0.0133	129.75	-0.069	257.3	-0.0302
129.85	606.85	258.6	-0.0169	129.83	-0.074	254.6	-0.0346
129.93	603.07	256.4	-0.0213	129.93	-0.076	253.3	-0.0399
130.02	600.8	255.2	-0.0275	130.00	-0.08	251.4	-0.0435
130.10	597.86	253.8	-0.0311	130.08	-0.087	248.6	-0.0488
130.18	594.81	252.4	-0.0346	130.17	-0.09	246.8	-0.0524
130.27	592.54	251.1	-0.0391	130.25	-0.094	245.1	-0.0577
130.35	589.77	249.9	-0.0417	130.33	-0.097	243.3	-0.0612
130.43	585.05	247.9	-0.0462	130.42	-0.102	241	-0.0657
130.52	581.68	246.3	-0.0479	130.50	-0.105	239.6	-0.0683
130.62	581.57	245.5	-0.0524	130.58	-0.109	237.7	-0.0719
130.70	578.8	244.2	-0.055	130.67	-0.114	236	-0.0754
130.77	574.89	242.5	-0.0586	130.75	-0.117	233.9	-0.0772
130.85	571.44	240.6	-0.0612	130.83	-0.122	231.3	-0.0852
130.93	570.04	239.6	-0.0657	130.92	-0.125	229.8	-0.0879
131.02	564.55	238.2	-0.0683	131.00	-0.127	228.4	-0.0905
131.10	565.22	237.4	-0.0701	131.08	-0.13	226.8	-0.0941
131.18	563.35	236.3	-0.0728	131.17	-0.134	225.2	-0.0968
131.27	560.7	235	-0.0754	131.25	-0.138	222.9	-0.0994
131.35	557.43	233.6	-0.079	131.35	-0.141	221.2	-0.1039
131.43	554.55	232	-0.0817	131.42	-0.143	220.1	-0.1065
131.52	551.04	230.6	-0.0826	131.50	-0.147	218.4	-0.1092
131.60	550.4	229.7	-0.087	131.58	-0.151	216.1	-0.1118
131.68	547.65	228.6	-0.0897	131.67	-0.152	215.1	-0.1136
131.77	546.42	227.6	-0.0914	131.75	-0.156	213.4	-0.1189
131.85	547.15	227.2	-0.0923	131.83	-0.158	212	-0.1216
131.93	543.3	225.8	-0.0959	131.92	-0.161	210.5	-0.1243
132.03	540.16	224.1	-0.0985	132.00	-0.164	209	-0.1269
132.12	538.65	223.3	-0.1003	132.08	-0.166	207.9	-0.1287
132.18	537.31	222.4	-0.1021	132.17	-0.169	206	-0.1314
132.27	535.13	221.5	-0.1039	132.25	-0.171	204.9	-0.134
132.35	533.96	220.7	-0.1056	132.33	-0.172	204.1	-0.1367
132.43	531.19	219.2	-0.1074	132.42	-0.175	202.7	-0.1385
132.52	530.28	218.5	-0.1092	132.50	-0.177	201.5	-0.1411
132.60	529.37	217.8	-0.1118	132.58	-0.179	200.5	-0.1429
132.68	527.37	216.9	-0.1127	132.67	-0.181	199.3	-0.1456
132.77	526.49	216.2	-0.1145	132.75	-0.183	198.1	-0.1473
132.85	523.01	215	-0.1172	132.85	-0.188	196.3	-0.1509
132.93	524.22	214.7	-0.1172	132.92	-0.186	196.2	-0.1509
133.02	522.41	214	-0.1189	133.00	-0.187	195.3	-0.1527
133.10	521.7	213.2	-0.1198	133.08	-0.19	194	-0.1553
133.18	520.46	212.5	-0.1216	133.17	-0.189	193.8	-0.1562
133.27	519.9	212	-0.1225	133.25	-0.192	192.8	-0.158
133.35	518.99	211.4	-0.1234	133.33	-0.193	191.9	-0.1598
133.43	519.36	211.1	-0.1243	133.42	-0.193	191.4	-0.1607
133.53	517.52	210.2	-0.1252	133.50	-0.195	190.6	-0.1624
133.62	517.08	209.8	-0.1269	133.58	-0.195	190.3	-0.1633
133.68	516.58	209.4	-0.1269	133.67	-0.196	189.5	-0.1642
133.77	515.47	208.9	-0.1278	133.75	-0.197	189.1	-0.1651
133.85	516.61	208.7	-0.1278	133.83	-0.197	188.8	-0.166
133.93	516.01	208.4	-0.1287	133.92	-0.198	188.3	-0.1669
134.02	514.97	208	-0.1296	134.00	-0.197	188.2	-0.1678
134.10	514.9	207.5	-0.1305	134.08	-0.198	187.9	-0.1687
134.18	514.93	207.3	-0.1314	134.17	-0.198	187.6	-0.1695
134.27	515.06	207.1	-0.1314	134.27	-0.198	187.5	-0.1695

Prova triassiale ciclica SNGR03-C4							
tensione di confinamento (kPa)	450			tensione di confinamento (kPa)	450		
deviatore ciclico (kPa)	150			deviatore ciclico (kPa)	180		
frequenza (hz)	0.0007143			frequenza (hz)	0.0007143		
134.35	515.23	206.9	-0.1314	134.33	-0.198	187.3	-0.1704
134.43	515.47	206.8	-0.1314	134.42	-0.198	187.2	-0.1704
134.52	515.2	206.5	-0.1323	134.50	-0.198	187	-0.1713
134.60	516.07	206.5	-0.1323	134.58	-0.196	187.2	-0.1713
134.68	515.06	206.1	-0.1323	134.67	-0.196	187.4	-0.1713
134.77	516.53	206.3	-0.1323	134.75	-0.196	187.3	-0.1713
134.85	517.07	206.3	-0.1323	134.83	-0.195	187.4	-0.1713
134.95	517.64	206.3	-0.1323	134.92	-0.196	187.3	-0.1722
135.03	518.51	206.4	-0.1323	135.00	-0.193	187.8	-0.1713
135.10	519.44	206.5	-0.1323	135.08	-0.193	188	-0.1713
135.18	520.11	206.5	-0.1314	135.17	-0.191	188.5	-0.1713
135.27	521.15	206.7	-0.1314	135.25	-0.19	188.8	-0.1704
135.35	521.65	206.8	-0.1314	135.33	-0.188	189.3	-0.1704
135.43	522.99	207	-0.1305	135.42	-0.188	189.5	-0.1695
135.52	523.83	207.2	-0.1305	135.50	-0.186	190.1	-0.1695
135.60	525.97	207.4	-0.1296	135.58	-0.184	190.6	-0.1687
135.68	526.57	207.8	-0.1296	135.67	-0.183	191.1	-0.1687
135.77	528.11	208.1	-0.1287	135.77	-0.182	191.5	-0.1678
135.85	529.45	208.5	-0.1278	135.83	-0.179	192.5	-0.1669
135.93	530.55	208.8	-0.1269	135.92	-0.177	193.1	-0.166
136.02	532.69	209.3	-0.126	136.00	-0.175	193.8	-0.1651
136.10	533.73	209.6	-0.126	136.08	-0.171	195.1	-0.1642
136.18	534.77	209.9	-0.1252	136.17	-0.17	195.7	-0.1633
136.27	537.78	210.5	-0.1243	136.25	-0.167	196.5	-0.1624
136.35	539.95	211.3	-0.1234	136.33	-0.166	197.3	-0.1616
136.45	540.55	211.6	-0.1216	136.42	-0.163	198.3	-0.1598
136.52	542.26	212.1	-0.1207	136.50	-0.161	199.1	-0.1589
136.60	545.17	212.8	-0.1198	136.58	-0.157	200.2	-0.158
136.68	547.31	213.5	-0.1198	136.67	-0.153	201.8	-0.1571
136.77	549.15	214.1	-0.1172	136.75	-0.151	202.7	-0.1553
136.85	550.79	214.6	-0.1163	136.83	-0.149	203.6	-0.1536
136.93	552.97	215.4	-0.1145	136.92	-0.144	205.4	-0.1518
137.02	556.41	216.4	-0.1127	137.00	-0.144	206.1	-0.1509
137.10	557.48	216.9	-0.1118	137.08	-0.141	206.9	-0.1491
137.18	560.32	217.7	-0.111	137.18	-0.136	208.8	-0.1473
137.27	563.83	218.4	-0.1092	137.25	-0.135	209.3	-0.1465
137.35	568.15	220.2	-0.1065	137.33	-0.13	211.3	-0.1438
137.43	567.58	220.6	-0.1047	137.42	-0.127	212.5	-0.142
137.52	570.26	221.3	-0.1039	137.50	-0.123	213.9	-0.1402
137.60	574.17	222.4	-0.1012	137.58	-0.118	216.2	-0.1385
137.68	575.17	223.1	-0.1003	137.67	-0.116	217.3	-0.1358
137.77	578.22	224	-0.0976	137.75	-0.113	218.5	-0.134
137.87	581.43	225.4	-0.0959	137.83	-0.107	220.5	-0.1314
137.95	583.67	226.1	-0.0941	137.92	-0.104	221.8	-0.1296
138.02	586.85	227.4	-0.0914	138.00	-0.101	223.1	-0.1269
138.10	589.39	228.3	-0.0897	138.08	-0.096	225.1	-0.1243
138.18	592.46	229.4	-0.0879	138.17	-0.091	227.2	-0.1225
138.27	596.38	230.9	-0.0852	138.25	-0.089	228.8	-0.1189
138.35	599.88	232.1	-0.0826	138.33	-0.084	230.3	-0.1163
138.43	601.79	233	-0.079	138.42	-0.08	231.9	-0.1136
138.52	605	234.2	-0.0772	138.50	-0.076	233.8	-0.111
138.60	608.31	235.4	-0.0746	138.58	-0.073	235.1	-0.1092
138.68	612.92	236.9	-0.0701	138.67	-0.068	237.4	-0.1047
138.77	614.09	237.8	-0.0683	138.75	-0.062	239.5	-0.1012
138.85	618.17	238.9	-0.0666	138.83	-0.059	241.1	-0.0985
138.93	622.21	240.6	-0.0639	138.92	-0.056	242.6	-0.0968
139.02	622.55	241.6	-0.0595	139.00	-0.05	244.8	-0.0932
139.10	627.02	242.7	-0.0559	139.08	-0.046	246.9	-0.0905
139.18	630.93	244.2	-0.0533	139.17	-0.04	249.2	-0.0852
139.28	634.04	245.7	-0.0506	139.25	-0.037	250.8	-0.0817

Prova triassiale ciclica SNGR03-C4							
tensione di confinamento (kPa)	450			tensione di confinamento (kPa)	450		
deviatore ciclico (kPa)	150			deviatore ciclico (kPa)	180		
frequenza (hz)	0.0007143			frequenza (hz)	0.0007143		
139.37	637.58	247.2	-0.0479	139.33	-0.031	252.8	-0.079
139.43	640.49	248.2	-0.0435	139.42	-0.028	254.5	-0.0754
139.52	643.66	249.4	-0.0399	139.50	-0.025	256.1	-0.0719
139.60	647.27	250.9	-0.0364	139.58	-0.019	258.2	-0.0683
139.68	649.47	252	-0.0337	139.67	-0.01	261.6	-0.0639
139.77	653.25	253.3	-0.0293	139.75	-0.011	262.4	-0.0595
139.85	658.05	254.8	-0.0257	139.83	-0.005	264.4	-0.055
139.93	661.12	256.6	-0.0231	139.92	-0.001	266.4	-0.0515
140.02	663.93	257.8	-0.0169	140.00	0.004	268.6	-0.0462
140.10	667.23	259.1	-0.0133	140.10	0.009	270.8	-0.0408
140.18	673.14	261	-0.008	140.17	0.012	272.4	-0.0373
140.27	672.34	261.8	-0.0053	140.25	0.019	274.7	-0.032
140.35	676.48	263.1	-0.0009	140.33	0.021	276.1	-0.0284
140.43	680.28	264.4	0.0027	140.42	0.025	277.9	-0.024
140.52	684.88	266.4	0.0071	140.50	0.032	280.1	-0.0186
140.60	687.69	267.7	0.0115	140.58	0.035	282.3	-0.0142
140.68	690.29	269	0.0178	140.67	0.04	284.3	-0.008
140.78	693.82	270.2	0.0222	140.75	0.045	285.9	-0.0036
140.87	698.06	271.4	0.0257	140.83	0.052	288.6	0.0027
140.93	700.92	273.4	0.0302	140.92	0.052	289.5	0.0062
141.02	706.26	275	0.0382	141.00	0.057	291.3	0.0107
141.10	705.45	275.6	0.0408	141.08	0.063	293.5	0.0178
141.18	710.52	277.3	0.0462	141.17	0.069	296.1	0.0222
141.27	712.65	278.5	0.0506	141.25	0.071	297.7	0.0302
141.35	716.15	279.8	0.055	141.33	0.078	299.8	0.0355
141.43	722.12	281.1	0.0595	141.42	0.08	300.8	0.0391
141.52	723.01	282.9	0.0639	141.52	0.085	303.3	0.0444
141.60	725.81	284.1	0.071	141.58	0.088	305	0.0524
141.68	727.3	285	0.0754	141.67	0.093	306.5	0.0568
141.77	731.9	286.5	0.0808	141.75	0.098	308.4	0.063
141.85	734.8	288	0.0861	141.83	0.1	309.8	0.0675
141.93	737.43	289	0.0897	141.92	0.104	311.3	0.0728
142.02	740.26	290.3	0.0941	142.00	0.11	313.5	0.079
142.10	744.38	291.4	0.0985	142.08	0.113	315.2	0.0826
142.20	746.54	293.1	0.1047	142.17	0.116	316.8	0.0905
142.28	748.67	294.1	0.1092	142.25	0.12	318.3	0.0959
142.35	751.36	295.2	0.1136	142.33	0.125	320	0.1021
142.43	754.92	296.7	0.1189	142.42	0.127	321.1	0.1056
142.52	757.78	298.1	0.1216	142.50	0.131	322.7	0.1118
142.60	759.84	299.1	0.1287	142.58	0.136	324.2	0.1163
142.68	762.57	300.3	0.1323	142.67	0.14	326.2	0.1216
142.77	765.23	301.3	0.1367	142.75	0.143	327.5	0.1287
142.85	767.22	302.3	0.1411	142.83	0.144	328.5	0.1331
142.93	769.98	303.3	0.1447	142.92	0.15	330.3	0.1385
143.02	773.77	304.7	0.15	143.02	0.153	331.8	0.1429
143.10	774.93	305.8	0.1518	143.08	0.155	332.9	0.1491
143.18	776.79	306.7	0.1571	143.17	0.158	334.2	0.1536
143.27	779.42	307.8	0.1607	143.25	0.161	335.4	0.158
143.35	781.51	308.7	0.1642	143.33	0.164	336.4	0.1624
143.43	783.07	309.6	0.1678	143.42	0.167	337.6	0.1669
143.52	786.82	310.9	0.1722	143.50	0.171	338.9	0.1713
143.60	788.12	311.2	0.174	143.58	0.173	340.5	0.1749
143.70	789.11	312.5	0.1793	143.67	0.175	341.3	0.1811
143.77	790.7	313.3	0.1811	143.75	0.178	342.4	0.1846
143.85	792.86	314.2	0.1837	143.83	0.18	343.5	0.1891
143.93	794.45	315.3	0.1882	143.92	0.182	344.4	0.1926
144.02	796.61	316.1	0.19	144.00	0.184	345.1	0.1962
144.10	798.01	316.8	0.1935	144.08	0.19	346.3	0.1997
144.18	799.5	317.6	0.1962	144.17	0.189	347.3	0.2033
144.27	801.16	318.3	0.1988	144.25	0.19	348.1	0.2077

Prova triassiale ciclica SNGR03-C4							
tensione di confinamento (kPa)	450			tensione di confinamento (kPa)	450		
deviatore ciclico (kPa)	150			deviatore ciclico (kPa)	180		
frequenza (hz)	0.0007143			frequenza (hz)	0.0007143		
144.35	801.95	318.8	0.2015	144.33	0.195	349.4	0.2121
144.43	803.71	319.5	0.2033	144.43	0.194	349.6	0.213
144.52	805.17	320.2	0.2059	144.50	0.197	350.9	0.2157
144.60	807.23	321.3	0.2086	144.58	0.198	351.4	0.2201
144.68	807.09	321.7	0.2113	144.67	0.199	352	0.2228
144.77	808.49	322.3	0.213	144.75	0.201	353	0.2263
144.85	809.25	322.9	0.2148	144.83	0.202	353.3	0.2272
144.93	808.75	323.2	0.2148	144.92	0.206	354.2	0.2308
145.02	811.21	323.9	0.2175	145.00	0.204	354.4	0.2317
145.12	811.53	324.4	0.2192	145.08	0.209	355.6	0.2334
145.18	812.3	324.9	0.221	145.17	0.205	355.3	0.2361
145.27	813.66	325.6	0.2237	145.25	0.208	356.1	0.2388
145.35	813.92	325.9	0.2237	145.33	0.209	356.6	0.2397
145.43	814.05	325.9	0.2246	145.42	0.208	356.5	0.2406
145.52	814.02	326.5	0.2255	145.50	0.208	356.8	0.2414
145.60	815.01	326.9	0.2272	145.58	0.211	357.6	0.245
145.68	814.78	327.1	0.2281	145.67	0.21	357.8	0.245
145.77	816.57	327.7	0.2299	145.75	0.211	358	0.2468
145.85	814.54	327.6	0.229	145.83	0.21	358.2	0.2477
145.93	814.01	327.7	0.2299	145.93	0.21	358.3	0.2485
146.02	814.84	328.1	0.2308	146.00	0.211	358.6	0.2485
146.10	814.54	328.3	0.2308	146.08	0.21	358.6	0.2494
146.18	814.44	328.5	0.2308	146.17	0.21	358.6	0.2503
146.27	816.17	328.9	0.2326	146.25	0.209	358.7	0.2503
146.35	813.28	328.6	0.2317	146.33	0.208	358.6	0.2503
146.43	812.91	328.6	0.2317	146.42	0.208	358.6	0.2503
146.52	812.68	328.8	0.2317	146.50	0.208	358.6	0.2512
146.60	812.31	328.9	0.2317	146.58	0.207	358.5	0.2503
146.68	811.84	328.9	0.2317	146.67	0.206	358.4	0.2503
146.77	812.08	329.1	0.2317	146.75	0.205	358.3	0.2503
146.85	808.65	328.6	0.2299	146.83	0.204	358	0.2503
146.93	808.88	328.6	0.2308	146.92	0.203	357.6	0.2485
147.02	808.55	328.7	0.2308	147.00	0.201	357.4	0.2494
147.10	807.36	328.5	0.2299	147.08	0.2	357.2	0.2485
147.18	805.83	328.2	0.229	147.17	0.198	356.7	0.2477
147.27	804.26	328	0.2281	147.25	0.196	356.4	0.2468
147.35	803.27	327.9	0.2272	147.35	0.195	356	0.2459
147.43	802.24	327.6	0.2263	147.42	0.193	355.8	0.2459
147.52	800.67	327.4	0.2263	147.50	0.19	354.8	0.2432
147.60	798.38	326.9	0.2246	147.58	0.19	354.7	0.2432
147.68	797.92	326.7	0.2237	147.67	0.187	354	0.2406
147.77	795.99	326.3	0.2228	147.75	0.184	353.3	0.2397
147.85	794.3	326.1	0.221	147.83	0.181	352.5	0.2379
147.93	792.97	325.8	0.2201	147.92	0.181	352.4	0.237
148.03	791.7	325.2	0.2184	148.00	0.176	351.3	0.2343
148.10	788.45	324.7	0.2166	148.08	0.176	351	0.2343
148.18	787.35	324.3	0.2157	148.17	0.171	349.7	0.2299
148.27	785.62	323.9	0.2139	148.25	0.17	349.4	0.2299
148.35	783.53	323.4	0.213	148.33	0.167	348.5	0.2272
148.43	780.5	322.8	0.2113	148.42	0.165	347.8	0.2255
148.52	778.28	322	0.2086	148.50	0.161	346.8	0.2228
148.60	776.71	321.5	0.2059	148.58	0.157	345.8	0.2201
148.68	774.22	321	0.205	148.67	0.155	345	0.2184
148.77	772.56	320.4	0.2024	148.75	0.151	343.9	0.2139
148.85	769.44	319.6	0.1997	148.83	0.15	343.3	0.2121
148.93	767.84	319	0.1979	148.92	0.145	342	0.2077
149.02	763.95	318.3	0.1953	149.00	0.141	340.5	0.2059
149.10	761.69	317.3	0.1935	149.08	0.14	340.1	0.2024
149.18	759.76	316.6	0.1891	149.17	0.134	338.6	0.1988
149.27	756.97	315.8	0.1873	149.25	0.131	337.4	0.1944

Prova triassiale ciclica SNGR03-C4							
tensione di confinamento (kPa)	450			tensione di confinamento (kPa)	450		
deviatore ciclico (kPa)	150			deviatore ciclico (kPa)	180		
frequenza (hz)	0.0007143			frequenza (hz)	0.0007143		
149.35	754.31	315	0.1837	149.33	0.128	336.5	0.1917
149.45	750.58	313.9	0.1811	149.42	0.124	335.3	0.1882
149.52	748.92	313	0.1775	149.50	0.118	334.2	0.1846
149.60	745.2	312.1	0.1749	149.58	0.116	332.4	0.1811
149.68	742.74	311.3	0.1722	149.67	0.112	331.3	0.1766
149.77	741.01	310.6	0.1695	149.75	0.108	330.1	0.1722
149.85	737.25	309.6	0.166	149.83	0.104	328.6	0.1678
149.93	733.89	308.7	0.1624	149.92	0.102	327.5	0.1651
150.02	731.09	307.4	0.1598	150.00	0.097	326	0.1607
150.10	730.16	306.8	0.1553	150.08	0.091	324.5	0.1562
150.18	725.01	305.5	0.1509	150.17	0.087	322.5	0.1527
150.27	721.58	304.2	0.1473	150.27	0.084	321.3	0.1465
150.35	719.85	303.4	0.1438	150.33	0.079	319.7	0.142
150.43	716.12	302.3	0.1394	150.42	0.074	318.9	0.1394
150.52	711.99	301.3	0.1358	150.50	0.067	315.6	0.134
150.60	708.33	299.6	0.1323	150.58	0.065	314.4	0.1269
150.68	705.84	298.6	0.126	150.67	0.06	313	0.1225
150.77	702.11	297.4	0.1216	150.75	0.06	312	0.1189
150.85	699.44	296.3	0.1172	150.83	0.054	310.1	0.1136
150.95	696.08	294.8	0.1136	150.92	0.047	308.1	0.1083
151.02	692.58	293.7	0.1074	151.00	0.042	306.5	0.103
151.10	689.95	292.7	0.1039	151.08	0.039	304.4	0.0994
151.18	686.69	291.3	0.0994	151.17	0.035	302.9	0.0914
151.27	683.76	290.2	0.0941	151.25	0.03	301.1	0.0861
151.35	680.06	288.9	0.0897	151.33	0.026	299.2	0.0808
151.43	675.39	287.6	0.0852	151.42	0.022	297.5	0.0754
151.52	672.46	285.8	0.0808	151.50	0.019	296.1	0.071
151.60	669.76	284.6	0.0737	151.58	0.01	293.3	0.0639
151.68	666.06	283.3	0.0683	151.68	0.005	291.1	0.0568
151.77	662.99	282	0.063	151.75	0.004	290	0.0533
151.85	660.05	280.8	0.0586	151.83	-0.003	287.9	0.0479
151.93	656.59	279.5	0.0541	151.92	-0.007	286.2	0.0426
152.02	651.79	277.4	0.0488	152.00	-0.01	283.9	0.0382
152.10	648.75	276.1	0.0444	152.08	-0.015	281.9	0.0302
152.18	646.51	275	0.0373	152.17	-0.02	280	0.0249
152.27	642.78	273.6	0.0328	152.25	-0.025	277.8	0.0195
152.37	639.71	272.1	0.0275	152.33	-0.028	276.2	0.0133
152.43	635.7	270.5	0.0249	152.42	-0.033	274.2	0.008
152.52	631.59	269.5	0.016	152.50	-0.04	272.2	0.0027
152.60	629.39	268.3	0.0124	152.58	-0.044	269.2	-0.0027
152.68	626.45	267	0.008	152.67	-0.047	267.8	-0.0089
152.77	624.01	265.8	0.0044	152.75	-0.051	266.2	-0.0124
152.85	620.91	264.5	0	152.83	-0.056	263.7	-0.0178
152.93	615.7	262.4	-0.0044	152.92	-0.059	262.4	-0.0222
153.02	612.69	261	-0.0089	153.00	-0.066	259.6	-0.0275
153.10	609.85	259.8	-0.0151	153.08	-0.07	258.3	-0.0311
153.18	606.48	258.4	-0.0186	153.18	-0.07	256.5	-0.0355
153.27	604.34	257.1	-0.0231	153.25	-0.078	253.6	-0.0417
153.35	601.6	255.9	-0.0266	153.33	-0.081	252.1	-0.0453
153.43	598.29	254.4	-0.0311	153.42	-0.087	250.1	-0.0497
153.52	594.21	252.4	-0.0346	153.50	-0.088	248.1	-0.0533
153.60	591.21	251	-0.0382	153.58	-0.092	246.4	-0.0577
153.68	588.63	249.8	-0.0435	153.67	-0.098	243.9	-0.0621
153.77	585.86	248.5	-0.0462	153.75	-0.102	242	-0.0666
153.87	582.75	246.7	-0.0488	153.83	-0.104	240.5	-0.0701
153.93	579.77	245.3	-0.0515	153.92	-0.109	238.6	-0.0737
154.02	577.93	244.2	-0.0559	154.00	-0.114	236.8	-0.0772
154.10	574.29	242.8	-0.0595	154.08	-0.119	233.8	-0.0817
154.18	572.88	241.6	-0.0621	154.17	-0.12	232.6	-0.0861
154.27	570.27	240.4	-0.0648	154.25	-0.124	230.8	-0.0897

Prova triassiale ciclica SNGR03-C4							
tensione di confinamento (kPa)	450			tensione di confinamento (kPa)	450		
deviatore ciclico (kPa)	150			deviatore ciclico (kPa)	180		
frequenza (hz)	0.0007143			frequenza (hz)	0.0007143		
154.35	567.43	239.1	-0.0675	154.33	-0.127	229	-0.0923
154.43	563.95	237.3	-0.071	154.42	-0.127	228.3	-0.0941
154.52	562.78	236.4	-0.0737	154.50	-0.134	225.9	-0.0985
154.60	559.7	235.1	-0.0772	154.60	-0.139	223.1	-0.103
154.68	557.16	233.8	-0.0799	154.67	-0.141	221.9	-0.1056
154.77	555.08	232.5	-0.0826	154.75	-0.143	220.7	-0.1083
154.85	552.97	231.5	-0.0852	154.83	-0.147	218.9	-0.111
154.93	551.3	230.5	-0.087	154.92	-0.151	217.1	-0.1127
155.02	546.25	228.3	-0.0905	155.00	-0.154	215.2	-0.1154
155.10	546.31	227.7	-0.0923	155.08	-0.154	214.6	-0.1198
155.18	544.91	226.8	-0.095	155.17	-0.158	212.8	-0.1225
155.28	542.67	225.7	-0.0968	155.25	-0.161	211.1	-0.126
155.35	540.09	224.3	-0.0985	155.33	-0.162	210.2	-0.1278
155.43	537.98	223.3	-0.1012	155.42	-0.166	208.5	-0.1305
155.52	536.47	222.5	-0.1039	155.50	-0.17	206.5	-0.1331
155.60	535.13	221.6	-0.1056	155.58	-0.171	205.6	-0.1349
155.68	533.66	220.7	-0.1074	155.67	-0.173	204.5	-0.1394
155.77	531.89	219.8	-0.1083	155.75	-0.176	202.9	-0.142
155.85	530.08	218.9	-0.1101	155.83	-0.177	202.1	-0.1438
155.93	528.6	217.8	-0.1118	155.92	-0.178	201.2	-0.1447
156.02	527.03	217	-0.1127	156.00	-0.181	200	-0.1473
156.10	526.36	216.4	-0.1154	156.10	-0.182	198.8	-0.1491
156.18	525.02	215.6	-0.1172	156.17	-0.184	197.6	-0.1518
156.27	523.51	214.8	-0.1181	156.25	-0.186	196.8	-0.1536
156.35	522.88	214.3	-0.1189	156.33	-0.187	196.1	-0.1553
156.43	521.87	213.7	-0.1207	156.42	-0.189	194.8	-0.1571
156.52	520.33	212.7	-0.1216	156.50	-0.191	194	-0.158
156.60	521.17	212.5	-0.1225	156.58	-0.191	193.4	-0.1598
156.68	519.49	211.8	-0.1243	156.67	-0.192	192.7	-0.1616
156.77	518.52	211.2	-0.1252	156.75	-0.194	191.9	-0.1633
156.85	517.11	210.4	-0.126	156.83	-0.194	191.5	-0.1642
156.93	516.74	210	-0.1269	156.92	-0.195	190.9	-0.166
157.02	516.71	209.6	-0.1278	157.00	-0.198	189.8	-0.166
157.10	515.4	209	-0.1287	157.08	-0.196	190	-0.1669
157.18	514.87	208.7	-0.1296	157.17	-0.197	189.2	-0.1687
157.27	516.04	208.6	-0.1296	157.25	-0.198	188.9	-0.1695
157.35	514.13	207.9	-0.1314	157.33	-0.199	188.6	-0.1704
157.43	515.57	207.9	-0.1314	157.42	-0.197	188.7	-0.1704
157.52	515.03	207.5	-0.1314	157.52	-0.198	188.2	-0.1713
157.60	515.03	207.3	-0.1323	157.58	-0.198	188.1	-0.1722
157.68	515.03	207.1	-0.1323	157.67	-0.198	187.9	-0.1722
157.77	515.33	206.9	-0.1323	157.75	-0.198	187.8	-0.1731
157.85	515.46	206.8	-0.1331	157.83	-0.198	187.7	-0.1731
157.93	515.6	206.7	-0.1331	157.92	-0.197	187.9	-0.1731
158.02	516.37	206.6	-0.1331	158.00	-0.196	188	-0.1731
158.10	516.73	206.6	-0.1331	158.08	-0.195	188.1	-0.1731
158.20	517.13	206.5	-0.1331	158.17	-0.196	187.7	-0.174
158.27	517.57	206.5	-0.1331	158.25	-0.196	187.8	-0.174
158.35	518.04	206.5	-0.1331	158.33	-0.194	188.3	-0.174
158.43	519.37	206.7	-0.1331	158.42	-0.192	188.7	-0.1731
158.52	521.98	207.2	-0.1314	158.50	-0.188	189.9	-0.1731
158.60	520.85	206.9	-0.1323	158.58	-0.192	189	-0.1722
158.68	521.31	207	-0.1323	158.67	-0.189	189.6	-0.1722
158.77	522.79	207.2	-0.1314	158.75	-0.185	190.9	-0.1722
158.85	524.29	207.5	-0.1305	158.83	-0.188	190.3	-0.1722
158.93	525.2	207.7	-0.1305	158.92	-0.185	191.1	-0.1713
159.02	527.2	208.2	-0.1296	159.00	-0.182	192.3	-0.1695
159.10	527.87	208.3	-0.1287	159.08	-0.179	192.8	-0.1695
159.18	529.31	208.7	-0.1287	159.17	-0.179	193.2	-0.1687
159.27	530.72	209.1	-0.1278	159.25	-0.177	193.7	-0.1687

Prova triassiale ciclica SNGR03-C4							
tensione di confinamento (kPa)	450			tensione di confinamento (kPa)	450		
deviatore ciclico (kPa)	150			deviatore ciclico (kPa)	180		
frequenza (hz)	0.0007143			frequenza (hz)	0.0007143		
159.35	531.89	209.4	-0.1269	159.33	-0.175	194.5	-0.1669
159.43	533.53	209.8	-0.126	159.42	-0.171	195.8	-0.166
159.52	536.27	210.5	-0.1252	159.50	-0.169	196.5	-0.1651
159.62	537.51	210.9	-0.1243	159.58	-0.167	197.3	-0.1642
159.68	539.65	211.4	-0.1234	159.67	-0.165	198	-0.1633
159.77	540.69	211.8	-0.1225	159.75	-0.163	199	-0.1624
159.85	543.6	212.7	-0.1216	159.83	-0.161	199.8	-0.1607
159.93	544.8	213.2	-0.1198	159.92	-0.157	200.9	-0.1598
160.02	547.21	213.8	-0.1189	160.00	-0.154	202.5	-0.1589
160.10	548.72	214.3	-0.1181	160.08	-0.151	203.5	-0.158
160.18	551.16	215	-0.1163	160.17	-0.149	204.4	-0.1553
160.27	553.03	215.6	-0.1154	160.25	-0.148	204.9	-0.1553
160.35	555.77	216.4	-0.1136	160.33	-0.142	206.8	-0.1527
160.43	558.85	217.5	-0.1127	160.43	-0.139	208.2	-0.1518
160.52	560.93	218.3	-0.1101	160.50	-0.137	209.2	-0.1491
160.60	562.37	218.9	-0.1092	160.58	-0.132	210.8	-0.1473
160.68	566.38	220	-0.1074	160.67	-0.129	212.4	-0.1456
160.77	567.42	220.6	-0.1056	160.75	-0.129	212.8	-0.1447
160.85	570.19	221.5	-0.1039	160.83	-0.123	214.7	-0.142
160.93	572.63	222.4	-0.103	160.92	-0.115	217.4	-0.1402
161.02	577.28	224	-0.1003	161.00	-0.116	217.8	-0.1385
161.12	579.46	224.8	-0.0976	161.08	-0.112	219.1	-0.1358
161.18	580.86	225.4	-0.0959	161.17	-0.107	221.2	-0.1331
161.27	582.6	226.5	-0.095	161.25	-0.105	222.6	-0.1314
161.35	588.65	228	-0.0923	161.33	-0.1	224.2	-0.1287
161.43	590.06	228.9	-0.0888	161.42	-0.098	225.2	-0.1278
161.52	592.93	229.9	-0.087	161.50	-0.091	227.9	-0.1252
161.60	596.14	231	-0.0852	161.58	-0.088	229.7	-0.1207
161.68	598.41	232	-0.0826	161.67	-0.085	230.9	-0.1189
161.77	600.92	233	-0.0808	161.75	-0.077	233.5	-0.1145
161.85	605.67	234.3	-0.0781	161.85	-0.075	235	-0.1127
161.93	608.88	235.9	-0.0754	161.92	-0.073	236.4	-0.1101
162.02	611.22	237.2	-0.0719	162.00	-0.068	238	-0.1065
162.10	614.36	238.2	-0.0692	162.08	-0.062	240.3	-0.1039
162.18	618.17	239.4	-0.0657	162.17	-0.06	241.8	-0.1012
162.27	619.77	240.3	-0.063	162.25	-0.056	243.4	-0.0985
162.35	623.08	241.5	-0.0604	162.33	-0.05	245.6	-0.095
162.43	627.33	242.9	-0.0577	162.42	-0.042	248.8	-0.0923
162.53	630.47	244.5	-0.0533	162.50	-0.043	249.4	-0.0879
162.60	633.01	245.9	-0.0497	162.58	-0.037	251.2	-0.0843
162.68	636.55	247	-0.0479	162.67	-0.032	253.5	-0.0808
162.77	640.62	248.3	-0.0444	162.75	-0.028	255.4	-0.0772
162.85	644.13	250.1	-0.0417	162.83	-0.021	257.7	-0.0719
162.93	646.97	251.3	-0.0364	162.92	-0.02	259.1	-0.0692
163.02	650.07	252.4	-0.0328	163.00	-0.014	261.6	-0.0657
163.10	654.51	254	-0.0293	163.08	-0.009	263.7	-0.0604
163.18	658.89	255.6	-0.0249	163.17	-0.005	265.3	-0.0559
163.27	659.82	256.5	-0.0222	163.25	0	267.4	-0.0524
163.35	662.76	257.7	-0.0186	163.35	0.008	270.4	-0.0488
163.43	668.47	259.8	-0.0151	163.42	0.007	271.4	-0.0435
163.52	670.24	260.8	-0.0089	163.50	0.013	273.2	-0.0391
163.60	674.01	262.3	-0.0053	163.58	0.018	275.3	-0.0346
163.68	678.18	263.8	-0.0009	163.67	0.021	277.1	-0.0302
163.77	679.75	264.9	0.0036	163.75	0.025	278.5	-0.0257
163.85	683.28	266.2	0.0071	163.83	0.032	280.9	-0.0213
163.93	687.69	267.6	0.0115	163.92	0.037	283.5	-0.016
164.03	689.72	269.2	0.0169	164.00	0.04	285.2	-0.0098
164.10	692.92	270.5	0.0213	164.08	0.045	286.9	-0.0053
164.18	696.29	271.8	0.0257	164.17	0.052	289.5	0.0018
164.27	701.02	273.3	0.0302	164.25	0.053	290.7	0.0053

Prova triassiale ciclica SNGR03-C4							
tensione di confinamento (kPa)	450			tensione di confinamento (kPa)	450		
deviatore ciclico (kPa)	150			deviatore ciclico (kPa)	180		
frequenza (hz)	0.0007143			frequenza (hz)	0.0007143		
164.35	704.92	275.2	0.0346	164.33	0.057	292.1	0.0098
164.43	709.29	276.9	0.0435	164.42	0.063	294.2	0.0142
164.52	709.35	277.6	0.0453	164.50	0.069	296.9	0.0204
164.60	714.22	279.3	0.0515	164.58	0.072	298.5	0.0284
164.68	716.22	280.4	0.0559	164.67	0.078	300.6	0.0346
164.77	718.92	281.6	0.0595	164.77	0.08	301.8	0.0382
164.85	722.31	282.7	0.063	164.83	0.086	304.3	0.0435
164.93	726.78	284.7	0.0692	164.92	0.088	306	0.0506
165.02	727.64	285.6	0.0754	165.00	0.093	307.9	0.0577
165.10	731.2	286.9	0.0808	165.08	0.096	309.1	0.0612
165.18	735.06	288.3	0.0852	165.17	0.1	310.7	0.0666
165.27	736.83	289.4	0.0897	165.25	0.104	312.1	0.0719
165.35	742.39	291.1	0.0959	165.33	0.11	314.1	0.0772
165.45	742.85	292.1	0.1003	165.42	0.116	316.8	0.0817
165.52	747.47	293.6	0.1056	165.50	0.116	317.7	0.0897
165.60	748.47	294.5	0.1092	165.58	0.123	319.7	0.0968
165.68	751.3	295.6	0.1136	165.67	0.124	320.8	0.1003
165.77	755.22	297	0.1181	165.75	0.128	322.3	0.1056
165.85	758.25	298.6	0.1216	165.83	0.131	323.5	0.1101
165.93	760.21	299.6	0.1287	165.92	0.137	325	0.1154
166.02	762.6	300.6	0.1323	166.00	0.138	326.9	0.1216
166.10	765.73	301.8	0.1367	166.08	0.142	328.4	0.1278
166.18	767.62	302.8	0.1411	166.17	0.145	329.7	0.1323
166.27	769.45	303.7	0.1447	166.27	0.15	331.2	0.1376
166.35	773.21	305	0.1482	166.33	0.153	333	0.142
166.43	776.26	306.5	0.1527	166.42	0.158	334.5	0.15
166.52	777.29	307.3	0.158	166.50	0.158	335.1	0.1527
166.60	779.18	308.2	0.1616	166.58	0.161	336.3	0.158
166.68	782.81	309.4	0.1651	166.67	0.163	337.4	0.1616
166.77	783.63	310.2	0.1687	166.75	0.166	338.5	0.166
166.85	785.49	311	0.1722	166.83	0.173	339.9	0.1704
166.93	787.71	312.1	0.1766	166.92	0.172	341.2	0.174
167.02	789.21	313	0.1793	167.00	0.176	342.5	0.1811
167.10	791.4	313.9	0.1811	167.08	0.177	343.2	0.1837
167.18	792.89	314.7	0.1846	167.17	0.18	344.2	0.1891
167.27	795.45	315.4	0.1873	167.25	0.183	345.5	0.1926
167.35	796.98	316.6	0.1891	167.33	0.184	346	0.1953
167.43	800	317.7	0.1944	167.42	0.187	347.1	0.1988
167.52	799.06	317.9	0.1962	167.50	0.19	348.5	0.2024
167.60	800.82	318.6	0.1988	167.58	0.193	349.7	0.2077
167.68	801.92	319.3	0.2006	167.68	0.193	349.9	0.2104
167.77	803.78	320.1	0.2033	167.75	0.198	350.5	0.2121
167.85	805.08	320.7	0.205	167.83	0.195	351.4	0.2157
167.93	806.63	321.6	0.2077	167.92	0.2	352.6	0.2201
168.02	807.02	322.1	0.2104	168.00	0.2	353	0.2219
168.10	808.55	322.7	0.213	168.08	0.2	353.5	0.2237
168.18	808.82	323.2	0.2139	168.17	0.202	354.1	0.2263
168.27	810.04	323.8	0.2157	168.25	0.205	355.1	0.2299
168.37	811.04	324.5	0.2184	168.33	0.204	355	0.2299
168.43	811.83	324.9	0.2201	168.42	0.206	356.1	0.2343
168.52	812.83	325.4	0.221	168.50	0.206	356.4	0.2352
168.60	812.72	325.8	0.2228	168.58	0.207	356.9	0.2379
168.68	813.06	326.2	0.2237	168.67	0.21	357.7	0.2406
168.77	814.29	326.6	0.2246	168.75	0.208	357.5	0.2406
168.85	814.35	327	0.2255	168.83	0.209	357.9	0.2432
168.93	814.58	327.3	0.2272	168.92	0.21	358.5	0.245
169.02	814.55	327.6	0.2281	169.00	0.209	358.5	0.245
169.10	814.94	327.9	0.229	169.08	0.211	358.9	0.2468
169.18	815.11	328.1	0.2299	169.17	0.212	359.4	0.2485
169.27	814.81	328.3	0.2308	169.25	0.21	359.2	0.2485

Prova triassiale ciclica SNGR03-C4							
tensione di confinamento (kPa)	450			tensione di confinamento (kPa)	450		
deviatore ciclico (kPa)	150			deviatore ciclico (kPa)	180		
frequenza (hz)	0.0007143			frequenza (hz)	0.0007143		
169.35	815.07	328.7	0.2308	169.33	0.211	359.5	0.2494
169.43	814.41	328.7	0.2308	169.42	0.209	359.4	0.2494
169.52	813.87	328.8	0.2308	169.50	0.211	359.8	0.2503
169.60	814.04	329	0.2317	169.58	0.21	359.6	0.2503
169.68	813.91	329.2	0.2317	169.67	0.209	359.5	0.2503
169.78	813.31	329.3	0.2317	169.75	0.209	359.6	0.2503
169.85	812.88	329.3	0.2317	169.83	0.207	359.4	0.2503
169.93	812.37	329.3	0.2317	169.92	0.207	359.4	0.2503
170.02	811.61	329.3	0.2317	170.00	0.206	359.2	0.2503
170.10	811.18	329.3	0.2317	170.08	0.205	359	0.2503
170.18	810.18	329.2	0.2317	170.17	0.204	358.9	0.2494
170.27	809.38	329.2	0.2317	170.25	0.203	358.6	0.2494
170.35	807.79	329	0.2308	170.33	0.202	358.5	0.2494
170.43	806.79	328.8	0.2299	170.42	0.199	357.9	0.2477
170.52	805.99	328.7	0.229	170.50	0.197	357.4	0.2477
170.60	804.86	328.5	0.2281	170.60	0.196	357.1	0.2468
170.68	803.63	328.3	0.2281	170.67	0.195	356.8	0.2459
170.77	802.37	328.1	0.2272	170.75	0.192	356.6	0.245
170.85	799.28	328.1	0.2263	170.83	0.19	355.7	0.2441
170.93	799.28	327.5	0.2246	170.92	0.189	355.3	0.2414
171.02	796.79	327	0.2228	171.00	0.186	354.7	0.2406
171.10	795.76	326.8	0.2228	171.08	0.185	354.3	0.2397
171.18	793.43	326.3	0.221	171.17	0.183	353.7	0.2379
171.28	792.6	326.1	0.2201	171.25	0.181	353.1	0.237
171.35	792.5	326	0.2192	171.33	0.176	352.6	0.2352
171.43	788.98	325.3	0.2175	171.42	0.175	351.6	0.2334
171.52	786.35	324.6	0.2157	171.50	0.173	351.1	0.2317
171.60	785.79	324.3	0.2148	171.58	0.169	350.1	0.229
171.68	783.66	324	0.213	171.67	0.167	349.3	0.2272
171.77	780.1	323.2	0.2104	171.75	0.165	348.7	0.2255
171.85	778.37	322.5	0.2086	171.83	0.163	348	0.2237
171.93	777.85	322.1	0.2059	171.92	0.157	346.6	0.2201
172.02	773.52	321.2	0.2042	172.02	0.156	345.5	0.2175
172.10	772.19	320.7	0.2024	172.08	0.153	344.8	0.2157
172.18	769.8	320.1	0.1997	172.17	0.149	343.9	0.213
172.27	767.9	319.5	0.1988	172.25	0.144	342.8	0.2095
172.35	763.52	318.3	0.1944	172.33	0.143	341.8	0.2077
172.43	762.32	317.8	0.1944	172.42	0.137	340.1	0.2024
172.52	757.67	316.7	0.1882	172.50	0.135	339.5	0.1997
172.60	756.94	316.3	0.1873	172.58	0.131	338.3	0.1953
172.70	754.31	315.8	0.1855	172.67	0.13	337.6	0.1935
172.77	747.98	314	0.1829	172.75	0.124	336	0.1891
172.85	748.42	313.6	0.1784	172.83	0.121	335	0.1855
172.93	744.06	312.5	0.1758	172.92	0.112	332.6	0.182
173.02	743.47	311.9	0.1731	173.00	0.112	332	0.1758
173.10	741.11	311.1	0.1695	173.08	0.11	331.1	0.1731
173.18	736.81	309.9	0.166	173.17	0.103	329	0.1678
173.27	731.76	309.2	0.1624	173.25	0.101	328.1	0.1642
173.35	731.76	308.1	0.1598	173.33	0.097	326.7	0.1607
173.43	729.13	307	0.1544	173.42	0.091	325.1	0.1562
173.52	723.97	305.6	0.15	173.52	0.088	323.5	0.1509
173.60	722.84	304.9	0.1482	173.58	0.086	322.6	0.1482
173.68	718.78	303.7	0.1429	173.67	0.081	320.7	0.1429
173.77	718.89	303.3	0.1411	173.75	0.073	318.9	0.1376
173.85	713.79	301.4	0.1349	173.83	0.07	317	0.1349
173.93	705.73	299.5	0.1314	173.92	0.066	315.5	0.1287
174.02	706.04	299	0.1252	174.00	0.062	313.9	0.1234
174.10	705.54	298.5	0.1225	174.08	0.059	312.7	0.1198
174.20	698.38	296.4	0.1163	174.17	0.054	310.9	0.1136
174.27	695.45	295.1	0.1136	174.25	0.049	309	0.1083

Prova triassiale ciclica SNGR03-C4							
tensione di confinamento (kPa)	450			tensione di confinamento (kPa)	450		
deviatore ciclico (kPa)	150			deviatore ciclico (kPa)	180		
frequenza (hz)	0.0007143			frequenza (hz)	0.0007143		
174.35	693.25	294.2	0.1074	174.33	0.043	307.4	0.1039
174.43	689.69	293	0.103	174.42	0.039	305.2	0.0985
174.52	684.39	291.2	0.0968	174.50	0.036	303.4	0.0914
174.60	684.22	290.6	0.0941	174.58	0.029	301.3	0.0852
174.68	679.56	289.1	0.0888	174.67	0.026	299.9	0.0808
174.77	677.86	288	0.0843	174.75	0.023	298.4	0.0763
174.85	671.39	286	0.0808	174.83	0.017	296.6	0.0701
174.93	669.49	284.9	0.0728	174.93	0.014	294.5	0.0639
175.02	665.49	283.5	0.0683	175.00	0.005	291.6	0.0568
175.10	665.36	282.9	0.0648	175.08	0.003	290.5	0.0524
175.18	660.99	281.4	0.0586	175.17	-0.001	288.7	0.047
175.27	656.62	279.7	0.0533	175.25	-0.007	286.8	0.0417
175.35	651.85	278.3	0.0479	175.33	-0.013	283.9	0.0364
175.43	648.92	276.6	0.0453	175.42	-0.015	282.4	0.0293
175.52	646.45	275.4	0.0373	175.50	-0.02	280.7	0.0249
175.62	642.11	273.8	0.032	175.58	-0.025	278.5	0.0195
175.68	638.67	272.7	0.0284	175.67	-0.027	277.1	0.0133
175.77	635.13	270.9	0.0257	175.75	-0.033	274.9	0.008
175.85	632.13	270	0.0169	175.83	-0.039	272.9	0.0027
175.93	629.22	268.7	0.0124	175.92	-0.043	270.1	-0.0018
176.02	626.22	267.3	0.008	176.00	-0.047	268.5	-0.0089
176.10	623.81	266.1	0.0036	176.08	-0.051	266.6	-0.0133
176.18	620.21	264.7	0	176.17	-0.056	264.7	-0.0169
176.27	616.84	263.6	-0.0036	176.25	-0.058	263.1	-0.0213
176.35	612.39	261.3	-0.0089	176.33	-0.064	260.9	-0.0266
176.43	608.48	259.8	-0.016	176.43	-0.07	258.1	-0.0337
176.52	607.61	258.9	-0.0186	176.50	-0.073	256.4	-0.0373
176.60	603.74	257.4	-0.0231	176.58	-0.077	254.8	-0.0408
176.68	601.93	256.3	-0.0266	176.67	-0.081	252.9	-0.0453
176.77	598.49	254.9	-0.0311	176.75	-0.087	250.9	-0.0497
176.85	595.12	254	-0.0328	176.83	-0.089	248.8	-0.0533
176.93	590.61	251.3	-0.0373	176.92	-0.095	246.1	-0.0604
177.02	589.5	250.2	-0.0435	177.00	-0.098	244.5	-0.063
177.12	587.02	249.1	-0.0453	177.08	-0.102	242.6	-0.0675
177.18	580.54	247.6	-0.0479	177.17	-0.104	241.1	-0.0701
177.27	579.74	245.7	-0.0515	177.25	-0.109	239.3	-0.0737
177.35	578.5	244.7	-0.0559	177.33	-0.114	237.5	-0.0772
177.43	575.05	243.2	-0.0586	177.42	-0.117	234.8	-0.0808
177.52	574.35	242.3	-0.0612	177.50	-0.12	233.4	-0.0861
177.60	571.04	240.9	-0.0648	177.58	-0.124	231.7	-0.0897
177.68	567.23	239.4	-0.0675	177.67	-0.127	229.8	-0.0932
177.77	563.88	238.3	-0.0701	177.75	-0.129	228.3	-0.0959
177.85	562.08	236.5	-0.0728	177.85	-0.136	225.4	-0.1003
177.93	559.8	235.3	-0.0772	177.92	-0.137	224.3	-0.103
178.02	556.96	234	-0.0799	178.00	-0.142	222.4	-0.1065
178.10	552.88	232.4	-0.0834	178.08	-0.142	221.3	-0.1092
178.18	552.94	231.8	-0.0843	178.17	-0.146	219.8	-0.1118
178.27	551.2	230.8	-0.087	178.25	-0.151	218.1	-0.1145
178.35	549.53	229.7	-0.0888	178.33	-0.153	216	-0.1172
178.43	545.18	227.9	-0.0905	178.42	-0.155	214.8	-0.1216
178.53	544.67	227.2	-0.0941	178.50	-0.159	213.1	-0.1243
178.60	542.83	226.1	-0.0968	178.58	-0.161	211.7	-0.1269
178.68	539.92	225.1	-0.0985	178.67	-0.163	210.3	-0.1296
178.77	538.42	223.4	-0.1003	178.75	-0.166	209.2	-0.1323
178.85	536.84	222.9	-0.103	178.83	-0.17	207.9	-0.1349
178.93	535.07	221.9	-0.1047	178.92	-0.17	206.5	-0.1367
179.02	533.26	221.1	-0.1065	179.00	-0.172	205.1	-0.1402
179.10	532.62	220.4	-0.1083	179.08	-0.178	203.2	-0.1429
179.18	530.38	219.4	-0.1101	179.17	-0.175	203.2	-0.1438
179.27	528.67	218.6	-0.1118	179.25	-0.179	201.6	-0.1465

Prova triassiale ciclica SNGR03-C4							
tensione di confinamento (kPa)	450			tensione di confinamento (kPa)	450		
deviatore ciclico (kPa)	150			deviatore ciclico (kPa)	180		
frequenza (hz)	0.0007143			frequenza (hz)	0.0007143		
179.35	527.33	217.4	-0.1127	179.33	-0.181	200.1	-0.1491
179.43	526.32	216.8	-0.1154	179.42	-0.183	199.2	-0.1509
179.52	525.12	216	-0.1163	179.50	-0.184	198.3	-0.1527
179.60	523.81	215.3	-0.1181	179.58	-0.186	197.3	-0.1553
179.68	523.01	214.7	-0.1189	179.67	-0.187	196.6	-0.1562
179.77	521.8	214	-0.1207	179.75	-0.19	195.7	-0.158
179.85	520.46	213	-0.1225	179.83	-0.191	194.5	-0.1598
179.95	521.57	212.9	-0.1225	179.92	-0.191	194	-0.1616
180.02	519.26	212.1	-0.1243	180.00	-0.193	193.2	-0.1633
180.10	518.32	211.5	-0.1252	180.08	-0.194	192.6	-0.1642
180.18	517.38	210.8	-0.126	180.17	-0.194	192	-0.166
180.27	516.88	210.3	-0.1269	180.25	-0.195	191.5	-0.1669
180.35	516.68	210	-0.1278	180.33	-0.196	190.6	-0.1678
180.43	516.11	209.5	-0.1287	180.42	-0.199	189.4	-0.1687
180.52	515.67	209.2	-0.1296	180.50	-0.197	189.7	-0.1704
180.60	514.73	208.7	-0.1305	180.58	-0.197	189.8	-0.1704
180.68	515.13	208.5	-0.1305	180.67	-0.197	189.6	-0.1713
180.77	514.93	208.1	-0.1305	180.77	-0.199	188.8	-0.1722
180.85	515.1	207.9	-0.1314	180.83	-0.2	188.3	-0.1731
180.93	514.29	207.5	-0.1323	180.92	-0.198	188.6	-0.1731
181.02	515.1	207.4	-0.1323	181.00	-0.197	188.7	-0.174
181.10	515.6	207.4	-0.1323	181.08	-0.198	188.3	-0.174
181.18	514.59	207	-0.1331	181.17	-0.197	188.4	-0.174
181.27	515.73	207	-0.1331	181.25	-0.198	188.3	-0.1749
181.35	516.33	207	-0.1331	181.33	-0.196	188.6	-0.1749
181.45	516.7	206.9	-0.1331	181.42	-0.195	188.7	-0.1749
181.52	517.2	206.9	-0.1331	181.50	-0.195	188.7	-0.1749
181.60	517.54	206.9	-0.1331	181.58	-0.195	188.7	-0.1749
181.68	518.94	207	-0.1323	181.67	-0.194	188.8	-0.1749
181.77	519.24	207	-0.1323	181.75	-0.192	189.3	-0.1749
181.85	520.04	207.1	-0.1323	181.83	-0.191	189.7	-0.174
181.93	521.01	207.3	-0.1323	181.92	-0.19	190	-0.174
182.02	521.72	207.4	-0.1314	182.00	-0.188	190.5	-0.1731
182.10	522.65	207.6	-0.1314	182.08	-0.187	190.9	-0.1731
182.18	524.19	207.9	-0.1305	182.18	-0.185	191.5	-0.1722
182.27	526.13	208.3	-0.1305	182.25	-0.184	192.1	-0.1722
182.35	526.3	208.4	-0.1296	182.33	-0.183	192.4	-0.1722
182.43	528.11	208.8	-0.1287	182.42	-0.181	193	-0.1713
182.52	529.41	209.1	-0.1287	182.50	-0.179	193.8	-0.1704
182.60	530.95	209.5	-0.1278	182.58	-0.177	194.4	-0.1695
182.68	532.02	209.8	-0.1269	182.67	-0.175	195.2	-0.1687
182.77	534.1	210.3	-0.126	182.75	-0.172	196.4	-0.1678
182.87	535.8	210.8	-0.1252	182.83	-0.17	197.1	-0.1669
182.93	537.11	211.2	-0.1243	182.92	-0.168	197.8	-0.166
183.02	538.88	211.7	-0.1234	183.00	-0.162	199.5	-0.1633
183.10	540.39	212.2	-0.1225	183.08	-0.163	199.6	-0.1633
183.18	542.29	212.8	-0.1216	183.17	-0.16	200.5	-0.1624
183.27	545.27	213.6	-0.1207	183.25	-0.16	201	-0.1616
183.35	547.44	214.2	-0.1189	183.33	-0.153	203.1	-0.1598
183.43	548.92	214.7	-0.1181	183.42	-0.151	204.3	-0.1589
183.52	550.82	215.4	-0.1163	183.50	-0.149	205	-0.1571
183.60	552.73	216	-0.1154	183.58	-0.145	206.3	-0.1553
183.68	555.64	216.9	-0.1136	183.68	-0.14	208.4	-0.1544
183.77	561.56	218.4	-0.1127	183.75	-0.14	208.9	-0.1527
183.85	559.92	218.5	-0.111	183.83	-0.138	209.6	-0.1518
183.93	562.13	219.2	-0.1092	183.92	-0.133	211.2	-0.1491
184.02	565.91	220.3	-0.1074	184.00	-0.13	212.7	-0.1473
184.10	567.55	221.1	-0.1056	184.08	-0.127	213.9	-0.1456
184.18	569.89	221.9	-0.1047	184.17	-0.122	215.4	-0.1438
184.27	571.13	222.4	-0.103	184.25	-0.117	217.5	-0.142

Prova triassiale ciclica SNGR03-C4							
tensione di confinamento (kPa)	450			tensione di confinamento (kPa)	450		
deviatore ciclico (kPa)	150			deviatore ciclico (kPa)	180		
frequenza (hz)	0.0007143			frequenza (hz)	0.0007143		
184.37	575.31	223.8	-0.1003	184.33	-0.115	218.7	-0.1402
184.43	578.49	224.9	-0.0985	184.42	-0.112	220.1	-0.1367
184.52	580.83	225.8	-0.0968	184.50	-0.108	221.8	-0.1349
184.60	583.67	226.8	-0.095	184.58	-0.104	223.3	-0.1323
184.68	588.22	228.4	-0.0923	184.67	-0.101	224.5	-0.1305
184.77	590.19	229.3	-0.0905	184.75	-0.097	226.2	-0.1278
184.85	593	230.3	-0.087	184.83	-0.091	228.9	-0.1252
184.93	598.82	231.9	-0.0834	184.92	-0.088	230.5	-0.1234
185.02	597.75	232.3	-0.0834	185.00	-0.084	231.9	-0.1198
185.10	598.95	232.9	-0.0817	185.10	-0.082	233	-0.1181
185.18	604.47	234.5	-0.0781	185.17	-0.075	235.8	-0.1145
185.27	609.08	236.4	-0.0746	185.25	-0.071	237.5	-0.1118
185.35	611.72	237.6	-0.0728	185.33	-0.067	239.1	-0.1074
185.43	613.83	238.5	-0.0692	185.42	-0.062	241	-0.1047
185.52	617.47	239.7	-0.0666	185.50	-0.06	242.7	-0.1021
185.60	620.58	240.9	-0.063	185.58	-0.055	244.3	-0.0985
185.68	623.42	242.1	-0.0604	185.67	-0.05	246.3	-0.0968
185.78	627.76	243.8	-0.0559	185.75	-0.044	248.9	-0.0932
185.85	630.9	245	-0.0533	185.83	-0.04	250.9	-0.0905
185.93	633.17	246.2	-0.0506	185.92	-0.037	252.4	-0.0852
186.02	635.88	247.2	-0.0479	186.00	-0.033	254.1	-0.0817
186.10	639.72	248.7	-0.0453	186.08	-0.028	256.3	-0.0772
186.18	645	250.6	-0.0417	186.17	-0.024	257.9	-0.0737
186.27	646.93	251.7	-0.0391	186.25	-0.019	259.9	-0.0701
186.35	649.91	252.8	-0.0337	186.33	-0.013	262.7	-0.0666
186.43	654.08	254.4	-0.0293	186.42	-0.009	264.7	-0.063
186.52	658.65	256	-0.0249	186.50	-0.005	266.2	-0.0568
186.60	659.02	256.8	-0.0222	186.60	-0.002	267.9	-0.0533
186.68	663.23	258.2	-0.0186	186.67	0.005	270.8	-0.0488
186.77	668.67	260.5	-0.0133	186.75	0.01	272.9	-0.0444
186.85	669.43	261.3	-0.0098	186.83	0.012	274	-0.0399
186.93	673.24	262.6	-0.0053	186.92	0.019	276.3	-0.0346
187.02	678.05	264.3	0	187.00	0.019	278	-0.032
187.10	680.28	265.5	0.0036	187.08	0.028	279.8	-0.0249
187.18	682.91	266.7	0.008	187.17	0.03	281.6	-0.0222
187.28	687.69	268.6	0.0133	187.25	0.038	284.6	-0.0169
187.35	690.35	269.8	0.0169	187.33	0.041	286.4	-0.0115
187.43	693.72	271.2	0.0222	187.42	0.045	288.1	-0.0044
187.52	696.25	272.4	0.0275	187.50	0.05	290	0
187.60	700.76	274	0.0311	187.58	0.053	291.6	0.0044
187.68	703.82	275.6	0.0346	187.67	0.057	293.2	0.0098
187.77	707.15	277	0.0417	187.75	0.063	295.3	0.016
187.85	712.12	278.6	0.047	187.83	0.068	297.9	0.0213
187.93	713.15	279.6	0.0506	187.92	0.074	300.3	0.0266
188.02	716.85	281	0.0559	188.02	0.074	301	0.0337
188.10	718.98	282.1	0.0595	188.08	0.081	302.8	0.0382
188.18	722.11	283.3	0.0639	188.17	0.085	305.2	0.0426
188.27	727.11	285.3	0.0692	188.25	0.089	307	0.0506
188.35	730.2	286.6	0.0772	188.33	0.094	308.6	0.0559
188.43	730.33	287.3	0.0799	188.42	0.097	310.2	0.0612
188.52	735.86	289	0.0852	188.50	0.1	311.7	0.0666
188.60	737.56	290.1	0.0897	188.58	0.104	313.3	0.0719
188.70	741.18	291.8	0.0968	188.67	0.108	314.9	0.0772
188.77	744.35	292.9	0.1003	188.75	0.114	317.4	0.0826
188.85	746.57	294	0.1047	188.83	0.117	318.9	0.0905
188.93	749.87	295.3	0.1101	188.92	0.12	320.4	0.0959
189.02	751.76	296.4	0.1136	189.00	0.124	321.7	0.1003
189.10	752.76	297.2	0.1172	189.08	0.128	323.3	0.1056
189.18	758.05	299.1	0.1225	189.17	0.131	324.5	0.111
189.27	760.64	300.3	0.1287	189.25	0.135	326.2	0.1163

Prova triassiale ciclica SNGR03-C4							
tensione di confinamento (kPa)	450			tensione di confinamento (kPa)	450		
deviatore ciclico (kPa)	150			deviatore ciclico (kPa)	180		
frequenza (hz)	0.0007143			frequenza (hz)	0.0007143		
189.35	762.44	301.1	0.1323	189.33	0.14	328.1	0.1216
189.43	765.73	302.3	0.1367	189.42	0.143	329.6	0.1287
189.52	768.29	303.5	0.1411	189.52	0.145	330.7	0.1323
189.60	770.21	304.4	0.1447	189.58	0.149	332.1	0.1376
189.68	771.21	305.2	0.1473	189.67	0.156	334.4	0.1411
189.77	775.16	306.9	0.1527	189.75	0.154	334.9	0.1482
189.85	780.35	308.3	0.1589	189.83	0.158	336.1	0.1536
189.93	777.98	308.6	0.1607	189.92	0.162	337.4	0.158
190.02	782.84	310	0.166	190.00	0.164	338.6	0.1624
190.12	782.23	310.7	0.1678	190.08	0.166	339.6	0.1669
190.18	785.62	311.8	0.1722	190.17	0.17	340.8	0.1713
190.27	787.61	312.7	0.1758	190.25	0.174	342.5	0.1758
190.35	789.54	313.6	0.1793	190.33	0.175	343.5	0.182
190.43	790.14	314.4	0.1811	190.42	0.178	344.3	0.1855
190.52	792.3	315.1	0.1837	190.50	0.181	345.4	0.1891
190.60	793.62	316.1	0.1882	190.58	0.185	346.8	0.1944
190.68	796.78	317.1	0.19	190.67	0.183	347	0.1962
190.77	798.74	317.9	0.1944	190.75	0.187	348.2	0.1997
190.85	798.2	318.3	0.1962	190.83	0.19	349.4	0.2033
190.93	800.89	319.2	0.1988	190.93	0.191	350.1	0.2077
191.02	804.78	320.3	0.2024	191.00	0.193	350.8	0.2104
191.10	802.41	320.3	0.2033	191.08	0.195	351.8	0.2139
191.18	805.2	321.3	0.2068	191.17	0.197	352.6	0.2166
191.27	805.87	322	0.2077	191.25	0.198	353.3	0.2201
191.35	807.09	322.6	0.2113	191.33	0.2	353.9	0.2228
191.43	807.92	323.2	0.213	191.42	0.203	354.9	0.2263
191.52	809.21	323.8	0.2148	191.50	0.202	355.1	0.2272
191.62	810.08	324.4	0.2166	191.58	0.204	355.7	0.2299
191.68	811.04	325	0.2184	191.67	0.206	356.6	0.2334
191.77	810.17	325.2	0.2192	191.75	0.205	356.8	0.2343
191.85	814.89	326.3	0.2228	191.83	0.207	357.4	0.237
191.93	812.56	326.2	0.2228	191.92	0.207	357.8	0.2388
192.02	812.29	326.4	0.2237	192.00	0.209	358.5	0.2406
192.10	813.98	327	0.2255	192.08	0.208	358.4	0.2414
192.18	813.98	327.5	0.2263	192.17	0.209	358.9	0.2441
192.27	814.68	327.8	0.2272	192.25	0.21	359.5	0.2459
192.35	815.18	328.2	0.2281	192.35	0.209	359.5	0.2468
192.43	814.41	328.3	0.229	192.42	0.211	359.9	0.2477
192.52	815.04	328.6	0.2299	192.50	0.21	360	0.2485
192.60	814.08	328.6	0.2299	192.58	0.21	360.3	0.2494
192.68	814.7	328.9	0.2308	192.67	0.212	360.6	0.2494
192.77	815.77	329.5	0.2326	192.75	0.21	360.4	0.2503
192.85	813.31	329.3	0.2317	192.83	0.209	360.3	0.2503
192.93	814.2	329.6	0.2326	192.92	0.212	360.8	0.2521
193.03	813.6	329.6	0.2326	193.00	0.209	360.6	0.2521
193.10	813.11	329.7	0.2326	193.08	0.209	360.5	0.2512
193.18	814	330	0.2326	193.17	0.207	360.3	0.2512
193.27	812.57	329.9	0.2326	193.25	0.207	360.3	0.2521
193.35	810.15	329.6	0.2317	193.33	0.206	360.1	0.2512
193.43	810.34	329.6	0.2317	193.42	0.205	359.9	0.2512
193.52	810.21	329.7	0.2317	193.50	0.204	359.8	0.2512
193.60	809.21	329.9	0.2317	193.58	0.202	359.4	0.2503
193.68	806.89	329.3	0.2299	193.67	0.202	359.3	0.2503
193.77	806.92	329.3	0.2299	193.75	0.198	358.7	0.2485
193.85	806.26	329.2	0.2299	193.85	0.199	358.5	0.2485
193.93	804.4	328.9	0.2281	193.92	0.197	358.3	0.2485
194.02	803.8	328.8	0.2281	194.00	0.195	357.8	0.2468
194.10	802.47	328.6	0.2272	194.08	0.193	357.3	0.2459
194.18	801.47	328.3	0.2263	194.17	0.19	356.5	0.245
194.27	798.51	327.8	0.2255	194.25	0.189	356.1	0.2432

Prova triassiale ciclica SNGR03-C4							
tensione di confinamento (kPa)	450			tensione di confinamento (kPa)	450		
deviatore ciclico (kPa)	150			deviatore ciclico (kPa)	180		
frequenza (hz)	0.0007143			frequenza (hz)	0.0007143		
194.35	797.62	327.6	0.2237	194.33	0.187	355.5	0.2414
194.43	795.89	327.2	0.2228	194.42	0.185	355	0.2397
194.53	792.77	327.4	0.2228	194.50	0.183	354.5	0.2388
194.60	793.33	326.6	0.221	194.58	0.18	353.9	0.2379
194.68	792.06	326.3	0.2201	194.67	0.177	353.3	0.2361
194.77	788.78	325.7	0.2175	194.75	0.175	352.4	0.2343
194.85	788.77	325.5	0.2175	194.83	0.172	351.7	0.2317
194.93	785.72	324.8	0.2148	194.92	0.169	350.9	0.2299
195.02	783.76	324.4	0.213	195.00	0.167	350.2	0.2281
195.10	781.93	323.7	0.2113	195.08	0.165	349.4	0.2263
195.18	776.44	322.6	0.2095	195.17	0.161	348.5	0.2237
195.27	776.51	322.4	0.2068	195.27	0.158	347.4	0.221
195.35	772.46	321.4	0.2042	195.33	0.157	346.9	0.2192
195.43	774.39	321.6	0.2042	195.42	0.152	345.7	0.2157
195.52	769.57	320.5	0.2006	195.50	0.15	344.8	0.2139
195.60	767.17	319.8	0.1979	195.58	0.144	343.7	0.2104
195.68	763.78	319.1	0.1962	195.67	0.141	342.3	0.2086
195.77	763.55	318.5	0.1944	195.75	0.138	341.2	0.2024
195.85	759.63	317.5	0.19	195.83	0.134	340.1	0.1997
195.95	757.33	316.8	0.1882	195.92	0.131	339	0.1962
196.02	753.48	316	0.1846	196.00	0.128	337.9	0.1926
196.10	750.55	314.7	0.182	196.08	0.125	336.9	0.19
196.18	748.79	314.1	0.1793	196.17	0.119	335.6	0.1855
196.27	743.93	312.9	0.1758	196.25	0.116	333.9	0.1829
196.35	743.17	312.3	0.174	196.33	0.112	332.8	0.1766
196.43	740.77	311.6	0.1704	196.42	0.108	331.5	0.1731
196.52	737.81	310.6	0.1669	196.50	0.103	330	0.1687
196.60	734.02	309.8	0.1642	196.58	0.101	328.9	0.1651
196.68	728.53	307.7	0.1598	196.67	0.096	327.5	0.1616
196.77	727.97	307.2	0.1544	196.77	0.093	325.9	0.1562
196.85	727.6	306.8	0.1509	196.83	0.087	324.2	0.1518
196.93	720.28	304.9	0.1465	196.92	0.084	322.9	0.1482
197.02	719.62	304.3	0.1438	197.00	0.08	321.5	0.1438
197.10	714.36	302.8	0.1394	197.08	0.072	320.3	0.1402
197.18	711.79	302.1	0.1358	197.17	0.07	317.7	0.1349
197.27	708.43	300.4	0.1323	197.25	0.066	316.2	0.1287
197.35	706.27	299.5	0.126	197.33	0.062	314.7	0.1243
197.45	705.74	298.9	0.1225	197.42	0.057	313	0.1189
197.52	698.84	296.9	0.1163	197.50	0.054	311.6	0.1145
197.60	696.58	295.7	0.1145	197.58	0.05	310.1	0.1092
197.68	690.65	294	0.1056	197.67	0.044	308	0.1039
197.77	689.92	293.3	0.103	197.75	0.038	305.6	0.0994
197.85	686.32	292	0.0985	197.83	0.035	304.1	0.0914
197.93	683.86	290.8	0.0941	197.92	0.03	302.4	0.0861
198.02	680.52	289.8	0.0897	198.00	0.025	300.6	0.0808
198.10	673.96	288.1	0.0843	198.08	0.022	298.9	0.0763
198.18	672.42	286.5	0.0799	198.18	0.016	296.6	0.0683
198.27	669.16	285.2	0.0728	198.25	0.012	294.9	0.0639
198.35	664.46	283.8	0.0683	198.33	0.006	293	0.0586
198.43	663.12	282.8	0.063	198.42	0.004	291.3	0.0533
198.52	660.32	281.5	0.0577	198.50	0	289.7	0.0479
198.60	656.72	280.2	0.0541	198.58	-0.009	288.2	0.0435
198.68	652.15	278.7	0.0488	198.67	-0.012	285	0.0382
198.77	649.68	277.1	0.0444	198.75	-0.016	282.9	0.0293
198.87	646.65	275.9	0.0382	198.83	-0.02	281.3	0.0249
198.93	640.24	274	0.0328	198.92	-0.025	279.3	0.0195
199.02	639.41	273.8	0.0302	199.00	-0.028	277.5	0.0133
199.10	634.74	271.1	0.024	199.08	-0.032	275.8	0.0089
199.18	632.53	270.4	0.0169	199.17	-0.039	273.7	0.0036
199.27	629.42	269.2	0.0133	199.25	-0.044	270.7	-0.0018

Prova triassiale ciclica SNGR03-C4							
tensione di confinamento (kPa)	450			tensione di confinamento (kPa)	450		
deviatore ciclico (kPa)	150			deviatore ciclico (kPa)	180		
frequenza (hz)	0.0007143			frequenza (hz)	0.0007143		
199.35	625.99	267.6	0.0089	199.33	-0.047	269	-0.0089
199.43	623.55	266.4	0.0044	199.42	-0.051	267.4	-0.0133
199.52	619.88	265	0	199.50	-0.059	264.8	-0.0186
199.60	615.8	263.9	-0.0036	199.58	-0.059	263.6	-0.0222
199.68	612.09	261.7	-0.008	199.68	-0.064	260.9	-0.0293
199.77	610.99	260.7	-0.0142	199.75	-0.069	259	-0.0328
199.85	604.98	258.8	-0.0195	199.83	-0.074	257	-0.0373
199.93	604.37	257.8	-0.0222	199.92	-0.076	255.3	-0.0417
200.02	602.1	256.7	-0.0266	200.00	-0.08	253.7	-0.0453
200.10	598.02	255.1	-0.0302	200.08	-0.084	251.4	-0.0497
200.18	594.62	253.7	-0.0337	200.17	-0.094	247.9	-0.0533
200.28	591.17	251.7	-0.0399	200.25	-0.093	247.1	-0.0604
200.35	590	250.8	-0.0426	200.33	-0.099	245.1	-0.0639
200.43	586.96	249.4	-0.0453	200.42	-0.102	243.3	-0.0675
200.52	582.31	248	-0.0479	200.50	-0.104	241.5	-0.071
200.60	580.11	246.1	-0.0506	200.58	-0.109	239.7	-0.0746
200.68	579.07	245.2	-0.055	200.67	-0.114	238	-0.0781
200.77	576.33	243.9	-0.0577	200.75	-0.118	235.3	-0.0817
200.85	571.85	242.2	-0.0621	200.83	-0.118	234.4	-0.0861
200.93	570	240.9	-0.0648	200.92	-0.123	232.3	-0.0897
201.02	567.76	239.8	-0.0675	201.00	-0.13	229.4	-0.095
201.10	563.75	238.5	-0.0701	201.10	-0.131	228	-0.0968
201.18	561.91	236.7	-0.0728	201.17	-0.134	226.4	-0.1003
201.27	559.87	235.6	-0.0763	201.25	-0.138	224.8	-0.1039
201.35	556.99	234.4	-0.079	201.33	-0.141	223.2	-0.1065
201.43	554.58	233.1	-0.0817	201.42	-0.143	221.6	-0.1101
201.52	552.94	232	-0.0843	201.50	-0.146	220.4	-0.1127
201.60	551.33	231.1	-0.087	201.58	-0.149	218.7	-0.1154
201.68	545.95	229.3	-0.0905	201.67	-0.154	216.3	-0.1181
201.78	547.08	228.5	-0.0923	201.75	-0.155	215	-0.1225
201.85	544.84	227.5	-0.0941	201.83	-0.158	213.8	-0.1252
201.93	542.57	226.5	-0.0959	201.92	-0.164	211.5	-0.1287
202.02	542.1	225.7	-0.0976	202.00	-0.163	210.9	-0.1305
202.10	537.51	223.8	-0.1003	202.08	-0.166	209.5	-0.1331
202.18	536.44	223.1	-0.103	202.17	-0.169	208.2	-0.1358
202.27	535.3	222.4	-0.1047	202.25	-0.171	206.6	-0.1385
202.35	533.66	221.4	-0.1065	202.33	-0.173	205.5	-0.1411
202.43	530.75	220.2	-0.1083	202.42	-0.175	204.3	-0.1438
202.52	530.55	219.6	-0.1101	202.52	-0.175	203.3	-0.1456
202.60	528.84	218.9	-0.111	202.58	-0.181	201.3	-0.1473
202.68	527.7	217.9	-0.1118	202.67	-0.183	199.9	-0.1518
202.77	526.39	217.1	-0.1145	202.75	-0.183	199.6	-0.1527
202.85	525.02	215.7	-0.1163	202.83	-0.185	198.5	-0.1544
202.93	523.45	215.4	-0.1181	202.92	-0.186	197.7	-0.1562
203.02	520.7	214.5	-0.1198	203.00	-0.187	197	-0.158
203.10	522.21	214.3	-0.1198	203.08	-0.189	196	-0.1598
203.18	520.43	213.6	-0.1216	203.17	-0.191	194.9	-0.1607
203.27	520	212.9	-0.1225	203.25	-0.191	194.4	-0.1624
203.35	519.36	212.4	-0.1234	203.33	-0.192	193.9	-0.1633
203.43	518.29	211.7	-0.1252	203.42	-0.194	193.1	-0.1651
203.52	517.38	211.3	-0.126	203.50	-0.195	192.2	-0.1669
203.60	516.95	210.7	-0.1269	203.58	-0.195	192	-0.1678
203.68	517.71	210	-0.1278	203.67	-0.197	191.5	-0.1687
203.77	514.74	209.5	-0.1287	203.75	-0.196	191	-0.1695
203.85	515.94	209.4	-0.1287	203.83	-0.197	190.4	-0.1713
203.93	515.74	209.2	-0.1296	203.92	-0.198	189.9	-0.1722
204.02	515.34	208.8	-0.1305	204.02	-0.198	189.9	-0.1722
204.10	515.8	208.5	-0.1305	204.08	-0.2	188.9	-0.1731
204.18	515.5	208.2	-0.1305	204.17	-0.197	189.4	-0.174
204.27	514.73	207.9	-0.1314	204.25	-0.197	189.3	-0.174

Prova triassiale ciclica SNGR03-C4							
tensione di confinamento (kPa)	450			tensione di confinamento (kPa)	450		
deviatore ciclico (kPa)	150			deviatore ciclico (kPa)	180		
frequenza (hz)	0.0007143			frequenza (hz)	0.0007143		
204.35	515.17	207.8	-0.1314	204.33	-0.198	188.9	-0.1749
204.43	514.9	207.6	-0.1323	204.42	-0.198	188.9	-0.1749
204.52	515.67	207.5	-0.1323	204.50	-0.197	189	-0.1758
204.60	515.63	207.4	-0.1323	204.58	-0.197	188.8	-0.1758
204.70	516.27	207.3	-0.1323	204.67	-0.196	188.9	-0.1758
204.77	516.33	207.1	-0.1323	204.75	-0.196	188.9	-0.1758
204.85	516.94	207.1	-0.1323	204.83	-0.195	189.1	-0.1758
204.93	517.64	207.2	-0.1323	204.92	-0.194	189.3	-0.1758
205.02	518.57	207.3	-0.1323	205.00	-0.194	189.5	-0.1758
205.10	519.18	207.3	-0.1323	205.08	-0.192	189.8	-0.1758
205.18	520.11	207.5	-0.1314	205.17	-0.191	190.2	-0.1749
205.27	521.18	207.7	-0.1314	205.25	-0.19	190.6	-0.1749
205.35	520.68	207.5	-0.1314	205.33	-0.189	191	-0.1749
205.43	522.15	207.7	-0.1305	205.43	-0.187	191.5	-0.174
205.52	523.96	208.1	-0.1305	205.50	-0.185	191.7	-0.174
205.60	525.53	208.4	-0.1296	205.58	-0.184	192.6	-0.1731
205.68	526.84	208.8	-0.1296	205.67	-0.182	193.2	-0.1722
205.77	528.34	209.1	-0.1287	205.75	-0.181	193.7	-0.1722
205.85	529.41	209.4	-0.1278	205.83	-0.178	194.5	-0.1713
205.93	530.52	209.7	-0.1278	205.92	-0.177	195.1	-0.1704
206.02	531.82	210	-0.1269	206.00	-0.174	195.9	-0.1695
206.12	534.2	210.7	-0.1252	206.08	-0.172	196.3	-0.1695
206.18	535.44	211	-0.1252	206.17	-0.169	197.8	-0.1678
206.27	537.51	211.7	-0.1234	206.25	-0.168	198.3	-0.1669
206.35	540.05	212.3	-0.1225	206.33	-0.166	199.1	-0.166
206.43	539.69	212.4	-0.1225	206.42	-0.162	200.3	-0.1642
206.52	543.09	213.3	-0.1216	206.50	-0.158	201.8	-0.1624
206.60	545.24	213.9	-0.1198	206.58	-0.158	202.1	-0.1624
206.68	546.78	214.4	-0.1189	206.67	-0.154	203.3	-0.1607
206.77	549.09	215.1	-0.1172	206.75	-0.151	204.9	-0.1598
206.85	551.36	215.8	-0.1163	206.83	-0.149	205.6	-0.158
206.93	552.87	216.4	-0.1145	206.93	-0.146	206.7	-0.1571
207.02	555.67	217.3	-0.1136	207.00	-0.143	208	-0.1553
207.10	558.58	218.2	-0.1127	207.08	-0.138	209.7	-0.1536
207.18	560.99	219.1	-0.111	207.17	-0.137	210.5	-0.1518
207.27	562.33	219.6	-0.1092	207.25	-0.134	211.5	-0.1509
207.35	565.91	220.7	-0.1074	207.33	-0.129	213.4	-0.1482
207.43	568.25	221.5	-0.1056	207.42	-0.127	214.4	-0.1465
207.52	569.63	222.2	-0.1039	207.50	-0.124	215.6	-0.1447
207.62	575.38	224	-0.1003	207.58	-0.119	217.6	-0.1429
207.68	575.94	224.5	-0.0994	207.67	-0.114	219.6	-0.1402
207.77	577.95	225.3	-0.0976	207.75	-0.112	220.9	-0.1376
207.85	581.06	226.2	-0.0959	207.83	-0.108	222.2	-0.1358
207.93	584.07	227.2	-0.095	207.92	-0.104	223.9	-0.1331
208.02	587.71	228.7	-0.0923	208.00	-0.102	225.2	-0.1314
208.10	590.69	229.8	-0.0897	208.08	-0.097	226.9	-0.1296
208.18	593.03	230.6	-0.087	208.17	-0.091	228.4	-0.1269
208.27	595.91	231.7	-0.0843	208.25	-0.085	231.8	-0.1243
208.35	598.78	232.9	-0.0826	208.35	-0.084	232.5	-0.1198
208.43	601.66	233.9	-0.0799	208.42	-0.083	233.4	-0.1189
208.52	604.23	235	-0.0772	208.50	-0.075	235.8	-0.1154
208.60	609.41	236.8	-0.0746	208.58	-0.071	238.3	-0.1127
208.68	611.48	237.9	-0.0728	208.67	-0.068	239.5	-0.1092
208.77	614.39	239	-0.0683	208.75	-0.063	241.5	-0.1056
208.85	618.2	240.3	-0.0657	208.83	-0.059	243.3	-0.103
208.93	621.48	241.6	-0.0621	208.92	-0.055	245	-0.0994
209.03	624.62	243.1	-0.0595	209.00	-0.051	246.8	-0.0976
209.10	626.09	243.8	-0.0568	209.08	-0.044	248.7	-0.0941
209.18	630.9	245.5	-0.0533	209.17	-0.041	251.3	-0.0914
209.27	633.87	246.7	-0.0497	209.25	-0.037	253	-0.0861

Prova triassiale ciclica SNGR03-C4							
tensione di confinamento (kPa)	450			tensione di confinamento (kPa)	450		
deviatore ciclico (kPa)	150			deviatore ciclico (kPa)	180		
frequenza (hz)	0.0007143			frequenza (hz)	0.0007143		
209.35	636.28	247.8	-0.0479	209.33	-0.033	254.9	-0.0826
209.43	639.72	249.1	-0.0444	209.42	-0.028	256.9	-0.079
209.52	644.73	251	-0.0408	209.50	-0.024	258.6	-0.0754
209.60	647.87	252.4	-0.0382	209.58	-0.019	260.6	-0.071
209.68	650.67	253.5	-0.0328	209.67	-0.013	262.7	-0.0675
209.77	654.31	254.9	-0.0293	209.75	-0.008	265.4	-0.0639
209.85	656.62	256.1	-0.0257	209.85	-0.005	267.1	-0.0577
209.93	659.66	257.3	-0.0222	209.92	-0.001	268.7	-0.0541
210.02	663.39	259	-0.0169	210.00	0.003	270.7	-0.0497
210.10	668.17	260.7	-0.0142	210.08	0.01	273.3	-0.0462
210.18	671.04	262	-0.0107	210.17	0.013	274.9	-0.0399
210.27	673.71	263.2	-0.0053	210.25	0.018	276.9	-0.0355
210.35	677.21	264.6	-0.0009	210.33	0.022	278.8	-0.0311
210.43	680.58	266	0.0036	210.42	0.026	280.5	-0.0266
210.52	684.38	267.8	0.0071	210.50	0.031	282.5	-0.0222
210.60	687.05	268.9	0.0133	210.58	0.038	284.2	-0.0178
210.68	691.62	270.5	0.0178	210.67	0.041	287	-0.0133
210.77	693.52	271.7	0.0222	210.75	0.044	288.6	-0.0062
210.85	696.32	272.9	0.0257	210.83	0.049	290.4	-0.0009
210.93	700.26	274.4	0.032	210.92	0.055	292.7	0.0044
211.02	705.12	276.3	0.0355	211.00	0.057	294.1	0.0098
211.10	707.32	277.5	0.0391	211.08	0.062	296	0.0142
211.18	710.12	278.7	0.0462	211.17	0.068	297.9	0.0204
211.27	713.65	280.1	0.0506	211.27	0.071	300.2	0.0275
211.35	716.38	281.5	0.0559	211.33	0.075	301.7	0.032
211.43	718.91	282.5	0.0595	211.42	0.079	303.4	0.0373
211.52	722.85	283.9	0.0648	211.50	0.084	305.4	0.0435
211.60	727.21	285.8	0.0692	211.58	0.09	307.9	0.0479
211.68	728.54	286.9	0.0754	211.67	0.093	309.3	0.0559
211.77	731.97	288.2	0.0808	211.75	0.097	310.9	0.0604
211.85	735.46	289.5	0.0861	211.83	0.101	312.5	0.0666
211.95	738.39	291.1	0.0897	211.92	0.104	314	0.071
212.02	741.25	292.3	0.0941	212.00	0.109	315.7	0.0763
212.10	743.55	293.4	0.1003	212.08	0.114	318	0.0817
212.18	745.78	294.5	0.1047	212.17	0.118	319.7	0.087
212.27	749.03	295.7	0.1101	212.25	0.12	320.8	0.095
212.35	751.63	296.8	0.1136	212.33	0.124	322.5	0.1003
212.43	754.46	298	0.1181	212.42	0.128	324.1	0.1056
212.52	760.38	300.1	0.1225	212.50	0.131	325.3	0.1101
212.60	760.04	300.8	0.1269	212.58	0.135	326.8	0.1154
212.68	762.37	301.6	0.1331	212.68	0.143	329.5	0.1243
212.77	765.59	302.9	0.1376	212.75	0.14	329.8	0.126
212.85	767.02	303.9	0.1411	212.83	0.144	331.1	0.1305
212.93	769.35	304.9	0.1447	212.92	0.149	332.7	0.1367
213.02	772.34	306	0.1491	213.00	0.153	334.6	0.1411
213.10	775.5	307.4	0.1527	213.08	0.157	335.9	0.1456
213.18	779.12	308.8	0.158	213.17	0.159	336.9	0.1527
213.27	778.85	309.2	0.1616	213.25	0.162	338.2	0.158
213.35	781.27	310.2	0.1651	213.33	0.164	339.3	0.1616
213.43	784.07	311.5	0.1678	213.42	0.167	340.3	0.166
213.52	785.39	312.4	0.1722	213.50	0.17	341.5	0.1704
213.60	786.98	313.2	0.1758	213.58	0.173	343.1	0.1749
213.68	789.31	314.1	0.1793	213.67	0.176	344.2	0.1784
213.77	791.3	314.9	0.182	213.75	0.178	345	0.1846
213.85	792.69	315.7	0.1846	213.83	0.181	346.1	0.1891
213.93	794.25	316.5	0.1873	213.92	0.182	347	0.1926
214.02	796.97	317.7	0.1917	214.00	0.185	347.9	0.1962
214.10	797.31	318.2	0.1935	214.08	0.186	348.7	0.1997
214.18	799.36	319	0.1971	214.18	0.19	350.1	0.205
214.27	801.09	319.8	0.1997	214.25	0.191	350.8	0.2077

Prova triassiale ciclica SNGR03-C4							
tensione di confinamento (kPa)	450			tensione di confinamento (kPa)	450		
deviatore ciclico (kPa)	150			deviatore ciclico (kPa)	180		
frequenza (hz)	0.0007143			frequenza (hz)	0.0007143		
214.35	802.51	320.4	0.2024	214.33	0.193	351.5	0.2104
214.43	803.54	321.1	0.2042	214.42	0.195	352.3	0.2139
214.52	804.94	321.7	0.2059	214.50	0.197	353.4	0.2166
214.60	805	322.5	0.2095	214.58	0.198	354.1	0.2201
214.68	807.72	323.3	0.2121	214.67	0.2	354.8	0.2237
214.77	808.05	323.7	0.213	214.75	0.201	355.3	0.2255
214.87	811.44	324.7	0.2157	214.83	0.203	356	0.2281
214.93	809.85	324.9	0.2157	214.92	0.203	356.4	0.2299
215.02	811.27	325.5	0.2192	215.00	0.206	357	0.2334
215.10	811.63	326.2	0.221	215.08	0.205	357.6	0.2343
215.18	812.13	326.3	0.2219	215.17	0.207	358.2	0.237
215.27	813.46	326.9	0.2237	215.25	0.208	358.6	0.2388
215.35	812.36	327	0.2237	215.33	0.209	359	0.2406
215.43	813.55	327.5	0.2255	215.42	0.208	359.3	0.2432
215.52	814.38	328	0.2263	215.50	0.209	359.6	0.2441
215.60	816.51	328.7	0.229	215.58	0.21	359.9	0.245
215.68	814.28	328.6	0.229	215.67	0.211	360.4	0.2468
215.77	814.74	328.8	0.229	215.75	0.209	360.3	0.2477
215.85	814.77	329.1	0.2299	215.83	0.213	361	0.2494
215.93	815.01	329.3	0.2308	215.92	0.21	360.8	0.2494
216.02	814.84	329.5	0.2308	216.00	0.21	360.8	0.2494
216.10	814.7	329.8	0.2317	216.08	0.211	361.3	0.2512
216.18	814.54	329.9	0.2317	216.17	0.21	361.1	0.2512
216.28	813.61	330.1	0.2317	216.25	0.209	361	0.2512
216.35	813.61	330	0.2317	216.33	0.208	360.9	0.2512
216.43	813.4	330.2	0.2326	216.42	0.21	361.2	0.2521
216.52	813.04	330.3	0.2326	216.50	0.208	361	0.2521
216.60	812.51	330.4	0.2326	216.58	0.206	360.8	0.2521
216.68	811.94	330.3	0.2326	216.67	0.206	360.8	0.2512
216.77	811.11	330.3	0.2317	216.75	0.205	360.6	0.2512
216.85	809.95	330.2	0.2317	216.83	0.204	360.4	0.2512
216.93	808.91	330.1	0.2317	216.92	0.202	360.1	0.2503
217.02	807.59	329.9	0.2308	217.00	0.202	359.9	0.2503
217.10	807.19	329.8	0.2299	217.10	0.2	359.5	0.2494
217.18	806.16	329.7	0.2299	217.17	0.198	359.2	0.2485
217.27	804.86	329.5	0.229	217.25	0.196	358.7	0.2477
217.35	803.86	329.3	0.2281	217.33	0.195	358.4	0.2468
217.43	802.44	329.1	0.2272	217.42	0.193	357.9	0.2459
217.52	800.77	328.8	0.2263	217.50	0.19	357.3	0.245
217.60	798.98	328.4	0.2255	217.58	0.188	356.6	0.245
217.68	798.11	328.1	0.2246	217.67	0.186	356.2	0.2414
217.78	796.59	327.8	0.2228	217.75	0.184	355.6	0.2406
217.85	794.13	327.4	0.2219	217.83	0.182	355.1	0.2388
217.93	792.2	326.9	0.221	217.92	0.181	354.7	0.2379
218.02	790.41	326.4	0.2184	218.00	0.178	353.8	0.2361
218.10	788.68	326.1	0.2175	218.08	0.175	353	0.2343
218.18	786.58	325.6	0.2157	218.17	0.172	352.2	0.2326
218.27	785.65	325.1	0.2148	218.25	0.17	351.6	0.2299
218.35	783.09	324.7	0.213	218.33	0.167	350.8	0.2281
218.43	780.13	324.2	0.2113	218.42	0.164	349.9	0.2263
218.52	780.2	323.7	0.2095	218.52	0.161	348.9	0.2246
218.60	774.62	322.5	0.2059	218.58	0.158	348.2	0.221
218.68	774.22	322.2	0.2042	218.67	0.155	347.1	0.2184
218.77	771.79	321.5	0.2024	218.75	0.152	346.3	0.2166
218.85	770.03	320.9	0.2006	218.83	0.149	345.4	0.2139
218.93	767.7	320.3	0.1988	218.92	0.145	344.3	0.2104
219.02	763.45	319.6	0.1962	219.00	0.14	342.9	0.2077
219.10	762.02	318.7	0.1935	219.08	0.138	341.9	0.205
219.20	759.29	317.9	0.19	219.17	0.135	341	0.1997
219.27	757.43	317.3	0.1882	219.25	0.131	339.8	0.1962

Prova triassiale ciclica SNGR03-C4

tensione di confinamento (kPa)	450			tensione di confinamento (kPa)	450		
deviatore ciclico (kPa)	150			deviatore ciclico (kPa)	180		
frequenza (hz)	0.0007143			frequenza (hz)	0.0007143		
219.35	753.17	316.5	0.1855	219.33	0.127	338.5	0.1926
219.43	751.05	315.3	0.1829	219.42	0.124	337.6	0.1891
219.52	748.02	314.4	0.1793	219.50	0.121	336.4	0.1864
219.60	745.86	313.7	0.1766	219.58	0.115	334.6	0.1829
219.68	742.73	312.7	0.1731	219.67	0.112	333.4	0.1784
219.77	740.91	311.8	0.1695	219.75	0.108	332.1	0.1731
219.85	737.95	311	0.1669	219.83	0.104	330.8	0.1695
219.93	733.52	309.9	0.1633	219.92	0.1	329.3	0.1651
220.02	730.23	308.6	0.1598	220.02	0.095	327.6	0.1624
220.10	728.43	307.7	0.1544	220.08	0.091	326.2	0.1553
220.18	725.24	306.7	0.1518	220.17	0.087	324.8	0.1518
220.27	721.68	305.6	0.1473	220.25	0.083	323.4	0.1482
220.35	719.62	304.6	0.1438	220.33	0.081	322.2	0.1438
220.43	716.39	303.6	0.1402	220.42	0.075	320.4	0.1394
220.52	711.79	302.5	0.1358	220.50	0.069	318.2	0.1349
220.60	708.56	300.9	0.1323	220.58	0.066	316.8	0.1287
220.68	706.97	299.9	0.126	220.67	0.062	315.5	0.1243
220.77	702.97	298.8	0.1225	220.75	0.057	313.6	0.1189
220.85	699.34	297.6	0.1181	220.83	0.053	312	0.1145
220.93	694.58	295.9	0.1145	220.92	0.049	310.5	0.1092
221.02	692.85	294.9	0.1074	221.00	0.046	309.2	0.1056
221.10	689.85	293.7	0.103	221.08	0.038	306.3	0.0976
221.18	686.25	292.4	0.0985	221.17	0.034	304.6	0.0914
221.27	684.09	291.3	0.0941	221.25	0.031	303.1	0.0861
221.35	679.86	290.1	0.0897	221.33	0.024	301.1	0.0808
221.43	675.59	288.7	0.0852	221.43	0.02	298.9	0.0763
221.52	671.89	286.8	0.0808	221.50	0.016	297.1	0.0683
221.60	669.56	285.7	0.0737	221.58	0.013	295.7	0.0639
221.68	666.19	284.5	0.0692	221.67	0.007	293.6	0.0586
221.77	662.29	283	0.063	221.75	0.003	291.9	0.0533
221.85	660.46	282	0.0586	221.83	0	290.3	0.0479
221.93	656.62	280.6	0.0541	221.92	-0.004	288.7	0.0435
222.02	652.02	279.2	0.0488	222.00	-0.013	285.4	0.0373
222.12	649.18	277.3	0.0426	222.08	-0.017	283.4	0.0284
222.18	646.81	276.1	0.0382	222.17	-0.02	282	0.024
222.27	643.34	274.9	0.0337	222.25	-0.026	279.8	0.0186
222.35	639.17	273.6	0.0293	222.33	-0.029	278.1	0.0133
222.43	634.1	271.2	0.0249	222.42	-0.033	276.4	0.008
222.52	632.33	270.4	0.0169	222.50	-0.038	274.3	0.0036
222.60	629.59	269.5	0.0133	222.58	-0.044	271.4	-0.0018
222.68	625.75	268	0.0089	222.67	-0.048	269.4	-0.0089
222.77	623.85	266.8	0.0044	222.75	-0.051	268	-0.0133
222.85	620.28	265.4	0	222.83	-0.056	265.9	-0.0178
222.93	615.67	264	-0.0044	222.92	-0.062	263.5	-0.0222
223.02	612.53	262.1	-0.008	223.00	-0.064	261.5	-0.0284
223.10	610.49	260.9	-0.0142	223.08	-0.069	259.9	-0.0328
223.18	607.01	259.5	-0.0186	223.17	-0.074	257.7	-0.0373
223.27	604.11	258.1	-0.0222	223.25	-0.075	256.2	-0.0408
223.35	601.97	256.9	-0.0257	223.33	-0.082	253.9	-0.0462
223.43	598.72	255.5	-0.0302	223.42	-0.086	252.3	-0.0497
223.52	593.71	254.1	-0.0337	223.50	-0.091	249.3	-0.0533
223.60	591.84	252.2	-0.0382	223.58	-0.093	247.7	-0.0595
223.68	589.63	251	-0.0417	223.67	-0.097	246.1	-0.063
223.77	587.23	249.9	-0.0444	223.75	-0.102	243.8	-0.0675
223.85	582.55	248.3	-0.0479	223.83	-0.105	242.1	-0.0719
223.93	579.47	246.3	-0.0506	223.92	-0.108	240.6	-0.0746
224.02	577.93	245.2	-0.055	224.00	-0.113	238.6	-0.079
224.10	575.72	244	-0.0577	224.08	-0.118	236.1	-0.0826
224.18	572.35	242.5	-0.0612	224.17	-0.12	234.4	-0.087
224.27	570.51	241.4	-0.0639	224.25	-0.124	232.7	-0.0905

Prova triassiale ciclica SNGR03-C4

tensione di confinamento (kPa)	450			tensione di confinamento (kPa)	450		
deviatore ciclico (kPa)	150			deviatore ciclico (kPa)	180		
frequenza (hz)	0.0007143			frequenza (hz)	0.0007143		
224.35	568	240.1	-0.0666	224.35	-0.128	231.1	-0.0941
224.43	564.09	238.7	-0.0701	224.42	-0.131	229	-0.0968
224.52	561.31	236.9	-0.0728	224.50	-0.134	227.1	-0.1003
224.60	559.93	235.9	-0.0763	224.58	-0.138	225.4	-0.1039
224.68	557.66	234.8	-0.0781	224.67	-0.141	223.9	-0.1065
224.77	554.48	233.4	-0.0817	224.75	-0.143	222.4	-0.1101
224.85	553.24	232.4	-0.0834	224.83	-0.146	221	-0.1127
224.93	551.34	231.4	-0.0861	224.92	-0.151	219.3	-0.1163
225.03	548.39	229.9	-0.0888	225.00	-0.153	217.1	-0.1181
225.10	546.75	228.9	-0.0914	225.08	-0.155	215.6	-0.1234
225.18	545.11	227.9	-0.0932	225.17	-0.158	214.3	-0.126
225.27	542.17	226.7	-0.0959	225.25	-0.161	212.8	-0.1287
225.35	540.66	225.8	-0.0976	225.33	-0.163	211.6	-0.1314
225.43	538.25	224.3	-0.0994	225.42	-0.166	210.3	-0.134
225.52	536.81	223.5	-0.1021	225.50	-0.169	208.7	-0.1367
225.60	535.47	222.7	-0.1039	225.58	-0.171	207.1	-0.1385
225.68	533.26	221.7	-0.1056	225.67	-0.175	205.3	-0.1429
225.77	532.26	220.7	-0.1074	225.75	-0.175	204.8	-0.1447
225.85	530.55	220	-0.1092	225.83	-0.177	203.9	-0.1465
225.93	528.77	219.1	-0.111	225.92	-0.18	202.2	-0.1482
226.02	527.53	217.8	-0.1127	226.00	-0.181	201.3	-0.1509
226.10	526.16	217.3	-0.1145	226.08	-0.183	200.3	-0.1536
226.18	524.39	216.5	-0.1163	226.17	-0.185	199.3	-0.1553
226.27	524.35	215.9	-0.1172	226.25	-0.186	198.4	-0.1571
226.35	524.45	215.5	-0.1172	226.33	-0.187	197.6	-0.158
226.45	521.64	214.4	-0.1198	226.42	-0.189	196.7	-0.1598
226.52	520.47	213.7	-0.1207	226.50	-0.19	195.9	-0.1616
226.60	519.6	213.2	-0.1225	226.58	-0.192	194.9	-0.1633
226.68	519.56	212.7	-0.1234	226.67	-0.193	194.3	-0.1651
226.77	517.79	212	-0.1243	226.75	-0.192	193.9	-0.166
226.85	517.85	211.6	-0.1252	226.83	-0.195	193	-0.1678
226.93	517.12	211	-0.126	226.92	-0.194	192.9	-0.1678
227.02	516.38	210.5	-0.1269	227.00	-0.196	192.1	-0.1695
227.10	516.08	210.1	-0.1278	227.08	-0.197	191.4	-0.1704
227.18	515.41	209.7	-0.1287	227.17	-0.198	191	-0.1722
227.27	515.64	209.5	-0.1287	227.27	-0.197	190.8	-0.1722
227.35	515.44	209.2	-0.1296	227.33	-0.198	190.2	-0.1731
227.43	515.04	208.9	-0.1296	227.42	-0.198	190.1	-0.174
227.52	514.43	208.4	-0.1305	227.50	-0.198	189.8	-0.1749
227.60	515.2	208.3	-0.1305	227.58	-0.197	189.9	-0.1749
227.68	515.27	208.1	-0.1314	227.67	-0.198	189.5	-0.1758
227.77	515.06	207.9	-0.1314	227.75	-0.198	189.5	-0.1766
227.85	515.47	207.8	-0.1314	227.83	-0.198	189.3	-0.1766
227.95	515.8	207.7	-0.1314	227.92	-0.197	189.5	-0.1766
228.02	515.93	207.5	-0.1323	228.00	-0.196	189.7	-0.1766
228.10	516.53	207.5	-0.1323	228.08	-0.195	189.7	-0.1766
228.18	517	207.5	-0.1314	228.17	-0.195	189.8	-0.1766
228.27	517.87	207.6	-0.1314	228.25	-0.195	189.9	-0.1766
228.35	518.68	207.6	-0.1314	228.33	-0.194	190.1	-0.1766
228.43	519.18	207.7	-0.1314	228.42	-0.192	190.4	-0.1766
228.52	520.08	207.8	-0.1314	228.50	-0.191	190.7	-0.1766
228.60	520.92	207.9	-0.1305	228.58	-0.189	191.4	-0.1758
228.68	521.95	208.1	-0.1305	228.68	-0.189	191.6	-0.1758
228.77	521.82	208.1	-0.1305	228.75	-0.188	191.9	-0.1758
228.85	523.49	208.3	-0.1296	228.83	-0.185	192.4	-0.1749
228.93	525.53	208.8	-0.1287	228.92	-0.183	193.3	-0.174
229.02	526.84	209.1	-0.1287	229.00	-0.182	193.7	-0.1731
229.10	527.84	209.4	-0.1278	229.08	-0.18	194.4	-0.1731
229.18	529.58	209.8	-0.1269	229.17	-0.179	195.1	-0.1722
229.27	530.72	210	-0.1269	229.25	-0.177	195.6	-0.1713

Prova triassiale ciclica SNGR03-C4

tensione di confinamento (kPa)		450			tensione di confinamento (kPa)		450
deviatore ciclico (kPa)		150			deviatore ciclico (kPa)		180
frequenza (hz)		0.0007143			frequenza (hz)		0.0007143
229.37	532.76	210.6	-0.126	229.33	-0.175	196.3	-0.1704
229.43	533.93	211	-0.1252	229.42	-0.171	197.1	-0.1695
229.52	535.67	211.4	-0.1243	229.50	-0.169	198.3	-0.1687
229.60	537.51	212	-0.1234	229.58	-0.168	198.9	-0.1678
229.68	539.15	212.4	-0.1225	229.67	-0.166	199.8	-0.1669
229.77	540.92	212.9	-0.1216	229.75	-0.162	200.9	-0.1651
229.85	543.4	213.4	-0.1207	229.83	-0.16	201.8	-0.1642
229.93	544.74	214.1	-0.1198	229.92	-0.158	202.6	-0.1633
230.02	546.91	214.7	-0.1181	230.00	-0.154	203.9	-0.1616
230.10	550.79	215.8	-0.1163	230.08	-0.151	205.4	-0.1607
230.18	550.46	216	-0.1163	230.18	-0.15	206.2	-0.1589
230.27	553	216.8	-0.1145	230.25	-0.145	207.4	-0.158
230.35	555.51	217.5	-0.1127	230.33	-0.143	208	-0.1571
230.43	558.62	218.2	-0.1118	230.42	-0.138	210.4	-0.1544
230.52	560.39	219.2	-0.111	230.50	-0.137	211.2	-0.1527
230.60	562.57	220	-0.1083	230.58	-0.134	212.5	-0.1509
230.68	565.41	220.9	-0.1065	230.67	-0.129	214.2	-0.1491
230.77	568.09	221.8	-0.1047	230.75	-0.127	215.2	-0.1473
230.87	571.16	223	-0.1039	230.83	-0.123	216.6	-0.1456
230.93	573.54	223.7	-0.1012	230.92	-0.118	218.2	-0.1438
231.02	576.25	224.7	-0.0994	231.00	-0.114	220.4	-0.142
231.10	578.09	225.6	-0.0976	231.08	-0.112	221.6	-0.1385
231.18	580.96	226.5	-0.095	231.17	-0.108	223.1	-0.1367
231.27	583.57	227.5	-0.0932	231.25	-0.104	224.7	-0.134
231.35	587.98	228.7	-0.0914	231.33	-0.101	226.1	-0.1323
231.43	590.56	230.1	-0.0897	231.42	-0.096	228	-0.1296
231.52	592.9	231	-0.0861	231.50	-0.092	228.9	-0.1287
231.60	596.14	232.1	-0.0843	231.60	-0.088	231.5	-0.1243
231.68	599.05	233.3	-0.0817	231.67	-0.085	233.1	-0.1216
231.77	600.69	234.2	-0.079	231.75	-0.081	234.7	-0.1189
231.85	606.81	235.9	-0.0763	231.83	-0.075	236.5	-0.1163
231.93	608.91	236.3	-0.0754	231.92	-0.071	238.9	-0.1136
232.02	612.35	238.4	-0.0719	232.00	-0.068	240.5	-0.1092
232.10	613.86	239.3	-0.0683	232.08	-0.064	242.1	-0.1065
232.18	617.74	240.5	-0.0657	232.17	-0.058	244.4	-0.103
232.28	621.34	242.1	-0.063	232.25	-0.056	245.8	-0.1003
232.35	624.32	243.3	-0.0604	232.33	-0.051	247.6	-0.0985
232.43	626.93	244.4	-0.0559	232.42	-0.045	249.6	-0.095
232.52	630.77	245.9	-0.0524	232.50	-0.04	252.4	-0.0914
232.60	633.71	247.1	-0.0497	232.58	-0.037	253.9	-0.087
232.68	636.58	248.2	-0.047	232.67	-0.033	255.7	-0.0834
232.77	639.95	249.5	-0.0444	232.75	-0.027	257.9	-0.079
232.85	644.36	251.3	-0.0408	232.83	-0.023	259.6	-0.0754
232.93	647.44	252.6	-0.0373	232.92	-0.019	261.4	-0.0719
233.02	651.91	254.1	-0.032	233.00	-0.013	263.4	-0.0683
233.10	653.65	255.1	-0.0293	233.08	-0.01	265.6	-0.063
233.18	657.18	256.6	-0.0249	233.17	-0.006	267.6	-0.0595
233.27	659.66	257.7	-0.0213	233.25	-0.002	269.2	-0.055
233.35	662.76	259.1	-0.0178	233.33	0.005	271.5	-0.0515
233.43	667.53	261.1	-0.0133	233.42	0.01	274.3	-0.047
233.52	671.61	262.6	-0.0098	233.50	0.013	275.8	-0.0408
233.60	673.77	263.7	-0.0036	233.58	0.018	277.8	-0.0355
233.68	677.28	265.1	0	233.67	0.023	279.8	-0.032
233.77	681.51	266.9	0.0036	233.75	0.025	281.4	-0.0275
233.85	684.62	268.3	0.0071	233.83	0.03	283.3	-0.0231
233.93	686.92	269.4	0.0142	233.92	0.036	285.3	-0.0178
234.02	690.89	270.9	0.0178	234.00	0.042	288.1	-0.0124
234.10	694.15	272.2	0.0231	234.08	0.045	289.6	-0.0062
234.18	696.89	273.5	0.0266	234.17	0.05	291.6	-0.0009
234.27	700.12	274.7	0.0311	234.25	0.054	293.3	0.0036

Prova triassiale ciclica SNGR03-C4							
tensione di confinamento (kPa)	450			tensione di confinamento (kPa)	450		
deviatore ciclico (kPa)	150			deviatore ciclico (kPa)	180		
frequenza (hz)	0.0007143			frequenza (hz)	0.0007143		
234.35	704.42	276.6	0.0355	234.33	0.057	294.9	0.0089
234.43	707.52	278	0.0399	234.42	0.062	296.8	0.0133
234.52	709.89	279.2	0.0462	234.52	0.068	299.3	0.0222
234.60	714.09	280.8	0.0524	234.58	0.072	301.2	0.0266
234.68	716.02	281.8	0.0559	234.67	0.074	302.4	0.032
234.77	719.08	283	0.0604	234.75	0.079	304.3	0.0373
234.85	722.08	284.3	0.0648	234.83	0.085	306.2	0.0426
234.93	726.74	286.3	0.071	234.92	0.09	308.7	0.047
235.02	729.6	287.6	0.0754	235.00	0.092	310.1	0.055
235.10	731.43	288.6	0.0817	235.08	0.097	311.9	0.0612
235.20	734.23	289.8	0.0861	235.17	0.101	313.6	0.0666
235.27	738.66	291.6	0.0905	235.25	0.104	314.9	0.071
235.35	741.45	292.8	0.095	235.33	0.109	316.7	0.0763
235.43	745.11	294.3	0.103	235.42	0.114	318.2	0.0817
235.52	745.94	295	0.1056	235.50	0.117	320.3	0.0888
235.60	749.1	296.4	0.1101	235.58	0.12	321.9	0.095
235.68	751.6	297.3	0.1145	235.67	0.125	323.6	0.1003
235.77	754.29	298.5	0.1189	235.75	0.128	325	0.1056
235.85	758.08	300.2	0.1234	235.83	0.131	326.4	0.111
235.93	760.64	301.3	0.1278	235.92	0.135	327.7	0.1154
236.02	762.9	302.3	0.134	236.00	0.139	329.6	0.1225
236.10	765.53	303.4	0.1376	236.08	0.142	331	0.1278
236.18	767.75	304.5	0.142	236.17	0.145	332.3	0.1314
236.27	769.95	305.5	0.1456	236.25	0.149	333.7	0.1367
236.35	772.34	306.5	0.15	236.33	0.153	335	0.1411
236.43	775.46	308	0.1536	236.42	0.156	336.8	0.1456
236.52	777.55	308.9	0.1571	236.50	0.159	338	0.1536
236.62	779.68	309.9	0.1624	236.58	0.162	339.1	0.158
236.68	780.71	310.7	0.166	236.67	0.163	340.1	0.1624
236.77	784.16	312	0.1687	236.75	0.166	341.4	0.1669
236.85	786.12	313	0.1722	236.83	0.17	342.5	0.1713
236.93	787.28	313.8	0.1766	236.92	0.173	343.6	0.1758
237.02	789.54	314.7	0.1793	237.00	0.177	345.3	0.1802
237.10	791.17	315.5	0.182	237.08	0.178	346.1	0.1855
237.18	792.76	316.3	0.1855	237.17	0.181	347.2	0.19
237.27	794.82	317.1	0.1882	237.25	0.182	348	0.1935
237.35	796.45	318.2	0.1908	237.33	0.185	348.8	0.1971
237.43	801.27	319.4	0.1935	237.43	0.187	350	0.2015
237.52	798	319.4	0.1971	237.50	0.19	351	0.205
237.60	801.19	320.3	0.1997	237.58	0.191	351.7	0.2077
237.68	801.95	320.9	0.2024	237.67	0.192	352.4	0.2104
237.77	803.41	321.6	0.2042	237.75	0.195	353.5	0.2148
237.85	804.64	322.2	0.2068	237.83	0.196	353.8	0.2166
237.93	807.83	323.4	0.2086	237.92	0.198	354.9	0.2201
238.02	806.43	323.6	0.2113	238.00	0.2	355.6	0.2237
238.12	807.95	324.2	0.2139	238.08	0.201	356.3	0.2263
238.18	808.95	324.8	0.2148	238.17	0.204	357.2	0.2299
238.27	810.34	325.6	0.2175	238.25	0.202	357.2	0.2308
238.35	811.04	326	0.2192	238.33	0.205	358	0.2326
238.43	811.76	326.5	0.221	238.42	0.206	358.3	0.2343
238.52	812.59	326.9	0.2219	238.50	0.207	359.1	0.237
238.60	812.66	327.3	0.2237	238.58	0.208	359.5	0.2397
238.68	813.52	327.7	0.2246	238.67	0.208	359.8	0.2406
238.77	813.69	328	0.2255	238.75	0.209	360.2	0.2432
238.85	815.38	328.7	0.2281	238.85	0.212	361.1	0.245
238.93	813.41	328.7	0.2281	238.92	0.209	360.8	0.2459
239.02	814.54	329.1	0.229	239.00	0.21	361	0.2468
239.10	815.07	329.4	0.2299	239.08	0.211	361.3	0.2485
239.18	814.81	329.6	0.2308	239.17	0.21	361.5	0.2494
239.27	814.91	329.8	0.2308	239.25	0.212	361.9	0.2503

Prova triassiale ciclica SNGR03-C4

tensione di confinamento (kPa)		450		tensione di confinamento (kPa)		450	
deviatore ciclico (kPa)		150		deviatore ciclico (kPa)		180	
frequenza (hz)		0.0007143		frequenza (hz)		0.0007143	
239.35	814.7	330.1	0.2317	239.33	0.209	361.7	0.2503
239.43	815.24	330.4	0.2317	239.42	0.21	361.8	0.2503
239.53	815.27	330.6	0.2326	239.50	0.21	361.9	0.2512
239.60	814.6	330.6	0.2326	239.58	0.209	362	0.2521
239.68	813.8	330.7	0.2326	239.67	0.211	362.3	0.253
239.77	813.47	330.8	0.2326	239.75	0.209	362.1	0.253
239.85	813.04	330.9	0.2326	239.83	0.207	361.8	0.2521
239.93	812.44	330.9	0.2326	239.92	0.207	361.7	0.2521
240.02	811.34	330.8	0.2326	240.00	0.205	361.5	0.2521
240.10	811.08	330.9	0.2326	240.08	0.205	361.4	0.2521
240.18	810.64	330.8	0.2326	240.17	0.204	361.2	0.2521
240.27	808.38	330.5	0.2317	240.25	0.202	360.9	0.2512
240.35	808.02	330.5	0.2317	240.35	0.201	360.6	0.2503
240.43	806.96	330.3	0.2299	240.42	0.199	360.3	0.2503
240.52	806.89	330.3	0.2308	240.50	0.198	360	0.2494
240.60	804.13	329.9	0.229	240.58	0.197	359.5	0.2485
240.68	803.86	329.8	0.229	240.67	0.195	359.2	0.2477
240.77	802.63	329.6	0.2281	240.75	0.193	358.8	0.2468
240.85	800.5	329.3	0.2272	240.83	0.19	358	0.2459
240.93	798.88	328.8	0.2255	240.92	0.19	357.9	0.245
241.03	798.18	328.7	0.2246	241.00	0.186	357	0.2414
241.10	796.05	328.3	0.2237	241.08	0.184	356.5	0.2406
241.18	794.13	328	0.2228	241.17	0.183	356	0.2397
241.27	792.06	327.3	0.221	241.25	0.18	355.4	0.2388
241.35	790.57	327	0.2192	241.33	0.177	354.6	0.237
241.43	789.11	326.6	0.2184	241.42	0.175	354	0.2352
241.52	787.15	326.2	0.2166	241.50	0.17	352.8	0.2334
241.60	785.65	325.8	0.2148	241.58	0.17	352.5	0.2308
241.68	783.99	325.3	0.2139	241.67	0.167	351.6	0.229
241.77	780.13	324.6	0.2113	241.77	0.163	350.6	0.2263
241.85	778.21	323.8	0.2095	241.83	0.16	349.5	0.2255
241.93	776.58	323.4	0.2077	241.92	0.158	348.9	0.221
242.02	774.49	322.8	0.205	242.00	0.155	348.1	0.2192
242.10	772.12	322.1	0.2033	242.08	0.152	347.1	0.2166
242.18	770.4	321.5	0.2015	242.17	0.149	346.3	0.2139
242.27	767.07	320.7	0.1988	242.25	0.146	345.4	0.2113
242.35	764.44	320.2	0.1971	242.33	0.141	343.8	0.2068
242.45	762.19	319.1	0.1935	242.42	0.138	342.8	0.205
242.52	759.39	318.3	0.1908	242.50	0.135	341.8	0.1997
242.60	757.13	317.7	0.1882	242.58	0.133	340.9	0.1979
242.68	753.74	316.9	0.1855	242.67	0.127	339.4	0.1926
242.77	750.95	315.8	0.1837	242.75	0.126	338.5	0.19
242.85	747.19	314.7	0.1784	242.83	0.12	337.1	0.1864
242.93	745.93	314.1	0.1766	242.92	0.115	335.5	0.1829
243.02	742.63	313.2	0.174	243.00	0.114	334.5	0.1793
243.10	740.84	312.4	0.1704	243.08	0.109	333.2	0.174
243.18	737.28	311.4	0.1669	243.17	0.103	331.4	0.1695
243.27	733.52	310.1	0.1633	243.27	0.099	329.9	0.1669
243.35	730.02	308.9	0.1607	243.33	0.095	328.3	0.1624
243.43	728.4	308.2	0.1553	243.42	0.092	327.3	0.1571
243.52	725.01	307.1	0.1518	243.50	0.087	326	0.1536
243.60	721.31	305.9	0.1473	243.58	0.082	324	0.1473
243.68	719.71	305.1	0.1447	243.67	0.08	323	0.1447
243.77	715.72	304	0.1402	243.75	0.075	321.3	0.1402
243.85	711.89	302.9	0.1367	243.83	0.069	319.3	0.1358
243.93	709.3	301.5	0.1305	243.92	0.066	317.7	0.1314
244.02	707.1	300.5	0.1269	244.00	0.062	316.3	0.1243
244.10	705.07	299.7	0.1243	244.08	0.057	314.6	0.1198
244.18	698.78	297.7	0.1172	244.17	0.052	312.4	0.1145
244.27	695.11	296.4	0.1136	244.25	0.05	311.4	0.1092

Prova triassiale ciclica SNGR03-C4							
tensione di confinamento (kPa)	450			tensione di confinamento (kPa)	450		
deviatore ciclico (kPa)	150			deviatore ciclico (kPa)	180		
frequenza (hz)	0.0007143			frequenza (hz)	0.0007143		
244.35	695.35	295.7	0.1092	244.33	0.044	309.6	0.1047
244.43	689.88	294.1	0.1039	244.42	0.038	307.2	0.0994
244.52	685.92	292.8	0.0985	244.50	0.032	305	0.095
244.60	684.29	291.9	0.095	244.58	0.03	303.9	0.0861
244.68	680.69	290.6	0.0905	244.68	0.026	302.3	0.0817
244.77	675.89	289.1	0.0852	244.75	0.019	299.6	0.0763
244.85	671.63	287.2	0.0808	244.83	0.016	298	0.0719
244.93	669.76	286.1	0.0737	244.92	0.012	296.5	0.063
245.02	666.69	284.9	0.0692	245.00	0.006	294.4	0.0577
245.10	662.32	283.4	0.063	245.08	0.003	292.8	0.0541
245.18	660.02	282.3	0.0586	245.17	-0.002	290.8	0.047
245.27	656.76	281	0.0541	245.25	-0.006	289	0.0426
245.37	652.52	279.1	0.047	245.33	-0.013	286.1	0.0373
245.43	649.38	277.8	0.0426	245.42	-0.016	284.3	0.032
245.52	647.25	276.6	0.0382	245.50	-0.02	282.7	0.024
245.60	643.48	275.3	0.0337	245.58	-0.025	280.7	0.0186
245.68	638.91	273.9	0.0293	245.67	-0.029	278.8	0.0133
245.77	634.83	271.8	0.0249	245.75	-0.032	277.3	0.0089
245.85	634.06	270.8	0.0186	245.83	-0.035	275.8	0.0044
245.93	629.92	269.9	0.0133	245.92	-0.044	272.3	-0.0018
246.02	625.08	268.2	0.008	246.00	-0.049	270.2	-0.0071
246.10	624.45	267.3	0.0044	246.08	-0.051	268.6	-0.0133
246.18	620.48	265.8	0	246.17	-0.055	267.1	-0.0178
246.27	615.7	264.2	-0.0044	246.25	-0.061	264.1	-0.0222
246.35	614.1	262.7	-0.0071	246.33	-0.066	262	-0.0266
246.43	610.85	261.3	-0.0142	246.42	-0.069	260.5	-0.0328
246.52	606.78	259.8	-0.0186	246.50	-0.074	258.4	-0.0373
246.60	603.57	258.4	-0.0222	246.58	-0.076	256.7	-0.0417
246.68	599.23	256.7	-0.0275	246.67	-0.081	254.9	-0.0462
246.78	597.12	255.2	-0.032	246.75	-0.085	253	-0.0497
246.85	596.25	254.4	-0.0346	246.83	-0.092	250.1	-0.0533
246.93	590.87	252.4	-0.0391	246.92	-0.093	248.5	-0.0595
247.02	591.74	251.7	-0.0408	247.00	-0.097	246.9	-0.0639
247.10	587.26	250.2	-0.0444	247.08	-0.104	244.1	-0.0692
247.18	582.75	248.6	-0.0479	247.17	-0.105	243	-0.0719
247.27	579.84	246.7	-0.0506	247.25	-0.109	241.2	-0.0754
247.35	577.93	245.6	-0.055	247.33	-0.113	239.3	-0.079
247.43	574.65	244.2	-0.0586	247.42	-0.118	236.6	-0.0826
247.52	572.65	242.9	-0.0612	247.50	-0.122	234.5	-0.0879
247.60	570.54	241.7	-0.0639	247.60	-0.123	233.4	-0.0914
247.68	567.53	240.4	-0.0675	247.67	-0.127	231.8	-0.0941
247.77	563.32	239.2	-0.0701	247.75	-0.131	229.6	-0.0968
247.85	562.05	237	-0.0719	247.83	-0.135	227.7	-0.1012
247.93	559.27	236.1	-0.0763	247.92	-0.137	226.2	-0.1047
248.02	557.46	235.1	-0.079	248.00	-0.141	224.6	-0.1074
248.10	554.42	233.7	-0.0817	248.08	-0.145	222.6	-0.1118
248.18	553.28	232.6	-0.0843	248.17	-0.149	220.6	-0.1154
248.28	550.93	231.3	-0.087	248.25	-0.149	219.8	-0.1172
248.35	549.06	230.3	-0.0888	248.33	-0.154	217.3	-0.1207
248.43	546.48	229.1	-0.0914	248.42	-0.156	215.9	-0.1243
248.52	544.18	228.1	-0.0941	248.50	-0.159	214.8	-0.1269
248.60	543	227.2	-0.0959	248.58	-0.161	213.5	-0.1296
248.68	539.82	226	-0.0976	248.67	-0.163	212	-0.1323
248.77	538.05	224.6	-0.0994	248.75	-0.165	211	-0.1349
248.85	537.01	223.8	-0.1021	248.83	-0.168	209.4	-0.1367
248.93	534.67	222.8	-0.1047	248.92	-0.173	207	-0.1394
249.02	533.33	222	-0.1056	249.02	-0.173	206.5	-0.1429
249.10	532.62	221.3	-0.1074	249.08	-0.175	205.7	-0.1447
249.18	530.38	220.1	-0.1092	249.17	-0.177	204.4	-0.1473
249.27	527.97	219.5	-0.111	249.25	-0.18	202.8	-0.1491

Prova triassiale ciclica SNGR03-C4							
tensione di confinamento (kPa)	450			tensione di confinamento (kPa)	450		
deviatore ciclico (kPa)	150			deviatore ciclico (kPa)	180		
frequenza (hz)	0.0007143			frequenza (hz)	0.0007143		
249.35	527.23	218.4	-0.1127	249.33	-0.181	202	-0.1518
249.43	526.56	217.7	-0.1145	249.42	-0.183	200.9	-0.1544
249.52	524.79	216.8	-0.1163	249.50	-0.185	199.9	-0.1562
249.60	524.38	216.3	-0.1172	249.58	-0.185	199.4	-0.1571
249.70	522.34	215.2	-0.1189	249.67	-0.187	198.4	-0.1589
249.77	520.93	214.5	-0.1207	249.75	-0.189	197.3	-0.1607
249.85	520.77	214.1	-0.1216	249.83	-0.191	196.3	-0.1624
249.93	519.96	213.6	-0.1225	249.92	-0.193	195.1	-0.1651
250.02	519.02	213	-0.1234	250.00	-0.192	194.9	-0.166
250.10	518.02	212.4	-0.1243	250.08	-0.192	194.4	-0.1669
250.18	517.75	212.1	-0.1252	250.17	-0.194	193.7	-0.1687
250.27	516.65	211.2	-0.126	250.25	-0.195	193.2	-0.1695
250.35	516.71	210.9	-0.1269	250.33	-0.196	192.6	-0.1704
250.43	514.84	210.3	-0.1278	250.42	-0.196	192	-0.1713
250.52	516.31	210.3	-0.1287	250.52	-0.197	191.7	-0.1722
250.60	516.01	209.9	-0.1287	250.58	-0.197	191.4	-0.1731
250.68	514.87	209.4	-0.1296	250.67	-0.198	190.9	-0.174
250.77	515.23	209.1	-0.1305	250.75	-0.198	190.6	-0.1749
250.85	514.97	208.8	-0.1305	250.83	-0.198	190.5	-0.1758
250.93	513.22	208.2	-0.1323	250.92	-0.198	190.4	-0.1758
251.02	515.03	208.3	-0.1314	251.00	-0.198	190	-0.1766
251.10	515.6	208.3	-0.1314	251.08	-0.198	190.1	-0.1766
251.20	515.8	208.1	-0.1314	251.17	-0.197	190.1	-0.1766
251.27	515.57	208	-0.1323	251.25	-0.197	190	-0.1775
251.35	516.37	207.9	-0.1323	251.33	-0.197	190.1	-0.1775
251.43	516.57	207.9	-0.1323	251.42	-0.196	190.3	-0.1775
251.52	518.17	208.1	-0.1314	251.50	-0.196	190.2	-0.1775
251.60	517.77	207.9	-0.1323	251.58	-0.194	190.6	-0.1775
251.68	518.14	207.9	-0.1323	251.67	-0.193	190.8	-0.1775
251.77	519.34	208	-0.1323	251.75	-0.192	191.1	-0.1775
251.85	520.11	208.1	-0.1314	251.83	-0.191	191.3	-0.1766
251.93	519.44	207.9	-0.1314	251.93	-0.19	191.8	-0.1766
252.02	522.12	208.5	-0.1305	252.00	-0.188	192.3	-0.1758
252.10	523.39	208.7	-0.1305	252.08	-0.187	192.6	-0.1758
252.18	525.97	209.2	-0.1296	252.17	-0.186	193.1	-0.1758
252.27	525	209.1	-0.1296	252.25	-0.183	194	-0.1749
252.35	526.7	209.4	-0.1296	252.33	-0.182	194.5	-0.174
252.43	527.64	209.7	-0.1278	252.42	-0.182	194.7	-0.174
252.52	529.28	210.1	-0.1278	252.50	-0.178	195.7	-0.1722
252.62	530.82	210.5	-0.1269	252.58	-0.177	196.3	-0.1722
252.68	532.59	211	-0.126	252.67	-0.175	197.1	-0.1713
252.77	534.03	211.3	-0.1252	252.75	-0.172	197.9	-0.1704
252.85	535.6	211.8	-0.1243	252.83	-0.17	199	-0.1695
252.93	537.64	212.4	-0.1234	252.92	-0.166	200.4	-0.1669
253.02	538.58	212.7	-0.1225	253.00	-0.166	200.7	-0.1669
253.10	540.49	213.2	-0.1216	253.08	-0.161	202	-0.1651
253.18	543.3	214	-0.1207	253.17	-0.162	202.4	-0.1651
253.27	545.77	214.7	-0.1198	253.25	-0.158	203.3	-0.1633
253.35	546.74	215.1	-0.1181	253.33	-0.154	204.6	-0.1624
253.43	549.79	215.9	-0.1172	253.43	-0.152	205.7	-0.1607
253.52	550.69	216.4	-0.1163	253.50	-0.15	206.7	-0.1598
253.60	552.8	217.1	-0.1145	253.58	-0.147	208.2	-0.158
253.68	555.64	218	-0.1136	253.67	-0.143	209.7	-0.1562
253.77	559.02	218.7	-0.1118	253.75	-0.139	211	-0.1544
253.85	560.59	219.7	-0.111	253.83	-0.136	212.3	-0.1527
253.93	562.7	220.5	-0.1083	253.92	-0.135	212.8	-0.1518
254.02	565.64	221.4	-0.1065	254.00	-0.128	215	-0.1491
254.10	568.45	222.5	-0.1056	254.08	-0.127	216.1	-0.1473
254.18	570.63	223.3	-0.1039	254.17	-0.123	217.3	-0.1465
254.27	573.27	224.1	-0.1012	254.25	-0.119	218.8	-0.1438

Prova triassiale ciclica SNGR03-C4								
tensione di confinamento (kPa)	450				tensione di confinamento (kPa)	450		
deviatore ciclico (kPa)	150				deviatore ciclico (kPa)	180		
frequenza (hz)	0.0007143				frequenza (hz)	0.0007143		
254.35	576.11	225.1	-0.0994	254.33	-0.114	221.2	-0.142	
254.43	578.22	226	-0.0976	254.42	-0.112	222.4	-0.1385	
254.52	580.99	227	-0.0959	254.50	-0.108	223.8	-0.1367	
254.60	583.47	227.9	-0.0941	254.58	-0.103	225.6	-0.134	
254.68	587.68	229.5	-0.0923	254.67	-0.101	226.7	-0.1323	
254.77	590.76	230.6	-0.0897	254.75	-0.094	229.2	-0.1287	
254.85	592.7	231.4	-0.087	254.85	-0.094	230.2	-0.1269	
254.93	595.97	232.5	-0.0843	254.92	-0.086	232.6	-0.1243	
255.02	598.48	233.6	-0.0817	255.00	-0.085	234	-0.1216	
255.10	600.96	234.6	-0.0799	255.08	-0.082	235.2	-0.1198	
255.18	604.2	235.8	-0.0772	255.17	-0.076	237.6	-0.1163	
255.27	608.58	237.5	-0.0746	255.25	-0.07	239.9	-0.1136	
255.35	613.72	239.2	-0.0728	255.33	-0.068	241.5	-0.1092	
255.43	613.79	239.8	-0.0683	255.42	-0.064	243	-0.1065	
255.53	617.23	240.9	-0.0657	255.50	-0.058	245.2	-0.103	
255.60	621.44	242.5	-0.0639	255.58	-0.056	246.5	-0.1003	
255.68	623.78	243.7	-0.0595	255.67	-0.051	248.6	-0.0976	
255.77	626.46	244.8	-0.0559	255.75	-0.045	250.7	-0.0941	
255.85	630.83	246.2	-0.0533	255.83	-0.04	253.1	-0.0923	
255.93	634.34	247.7	-0.0497	255.92	-0.037	254.8	-0.0861	
256.02	636.45	248.7	-0.047	256.00	-0.032	256.6	-0.0834	
256.10	638.55	249.7	-0.0453	256.08	-0.027	258.7	-0.079	
256.18	644.56	251.8	-0.0408	256.17	-0.024	260.4	-0.0754	
256.27	647.97	253.3	-0.0373	256.25	-0.019	262.4	-0.0719	
256.35	650.31	254.4	-0.0328	256.33	-0.014	264.7	-0.0666	
256.43	653.48	255.6	-0.0293	256.42	-0.009	266.9	-0.0621	
256.52	656.42	257.1	-0.0257	256.50	-0.006	268.5	-0.0586	
256.60	659.56	258.2	-0.0222	256.58	-0.002	270.2	-0.055	
256.68	663.03	259.6	-0.0178	256.67	0.005	272.6	-0.0497	
256.77	667.63	261.5	-0.0133	256.75	0.011	275.3	-0.0462	
256.85	671.1	263	-0.0107	256.83	0.013	276.8	-0.0399	
256.95	673.64	264.1	-0.0044	256.92	0.018	278.6	-0.0355	
257.02	677.04	265.5	-0.0009	257.00	0.023	280.8	-0.0311	
257.10	681.92	267.4	0.0036	257.08	0.028	283.1	-0.0249	
257.18	683.28	268.5	0.0053	257.17	0.029	284	-0.0222	
257.27	687.22	269.9	0.0133	257.25	0.037	286.3	-0.0169	
257.35	690.95	271.4	0.0178	257.33	0.042	289	-0.0124	
257.43	696.02	273.1	0.024	257.42	0.045	290.7	-0.0053	
257.52	696.82	274	0.0266	257.50	0.05	292.5	0	
257.60	699.22	275.1	0.0302	257.58	0.055	294.5	0.0053	
257.68	704.59	277.2	0.0355	257.67	0.057	296	0.0098	
257.77	706.89	278.4	0.0391	257.77	0.063	298.5	0.0178	
257.85	710.69	279.8	0.047	257.83	0.067	300.1	0.0222	
257.93	714.12	281.2	0.0515	257.92	0.075	302.7	0.0284	
258.02	717.78	282.7	0.0568	258.00	0.073	303.5	0.032	
258.10	719.18	283.6	0.0604	258.08	0.079	305.2	0.0373	
258.18	720.75	284.6	0.0639	258.17	0.085	307.1	0.0435	
258.27	726.74	286.8	0.0701	258.25	0.089	309.7	0.0479	
258.35	729.84	288.1	0.0746	258.33	0.092	311	0.0559	
258.45	731.04	289.1	0.0808	258.42	0.097	312.7	0.0612	
258.52	735.36	290.6	0.0861	258.50	0.101	314.4	0.0666	
258.60	738.76	292.1	0.0888	258.58	0.104	316	0.0719	
258.68	741.15	293.3	0.0941	258.67	0.106	317.2	0.0772	
258.77	744.38	294.5	0.1012	258.75	0.114	319.4	0.0834	
258.85	747.47	295.7	0.1056	258.83	0.118	321.6	0.0888	
258.93	748.54	296.7	0.1092	258.92	0.12	322.9	0.0959	
259.02	752.06	298.1	0.1145	259.00	0.124	324.4	0.1012	
259.10	753.16	298.8	0.1172	259.08	0.128	326	0.1065	
259.18	758.35	300.8	0.1225	259.18	0.131	327.5	0.111	
259.27	760.48	301.9	0.1269	259.25	0.135	329.1	0.1181	

Prova triassiale ciclica SNGR03-C4							
tensione di confinamento (kPa)	450			tensione di confinamento (kPa)	450		
deviatore ciclico (kPa)	150			deviatore ciclico (kPa)	180		
frequenza (hz)	0.0007143			frequenza (hz)	0.0007143		
259.35	762.7	302.8	0.1331	259.33	0.139	330.5	0.1234
259.43	765.09	303.9	0.1376	259.42	0.142	332	0.1287
259.52	767.35	305	0.142	259.50	0.145	333.3	0.1331
259.60	768.95	305.9	0.1456	259.58	0.148	334.6	0.1376
259.68	772.34	307.1	0.1491	259.67	0.153	336.1	0.1438
259.77	775.03	308.5	0.1527	259.75	0.157	337.9	0.1482
259.87	777.12	309.5	0.1589	259.83	0.159	338.9	0.1544
259.93	778.68	310.2	0.1616	259.92	0.161	340	0.1589
260.02	781.47	311.3	0.166	260.00	0.166	341.5	0.1651
260.10	784.36	312.7	0.1687	260.08	0.167	342.4	0.1687
260.18	785.66	313.5	0.1713	260.17	0.17	343.5	0.1731
260.27	787.41	314.3	0.1766	260.25	0.173	344.7	0.1775
260.35	790.14	315.3	0.1793	260.33	0.176	346.1	0.1811
260.43	790.43	315.9	0.182	260.42	0.178	347.1	0.1873
260.52	793.02	316.8	0.1855	260.50	0.18	348	0.1908
260.60	796.09	318	0.1891	260.58	0.185	349.5	0.1962
260.68	797.91	318.8	0.19	260.68	0.185	350.2	0.1979
260.77	798.04	319.4	0.1926	260.75	0.187	351	0.2033
260.85	799.3	320.1	0.1971	260.83	0.19	351.9	0.2068
260.93	801.39	320.8	0.1997	260.92	0.191	352.7	0.2095
261.02	802.35	321.5	0.2024	261.00	0.195	353.9	0.2139
261.10	803.81	322.2	0.2042	261.08	0.193	354	0.2157
261.18	804.34	322.7	0.2068	261.17	0.196	355.3	0.2201
261.27	806.13	323.6	0.2086	261.25	0.199	356.2	0.2228
261.37	807.59	324.4	0.213	261.33	0.2	356.7	0.2263
261.43	807.32	324.7	0.213	261.42	0.202	357.3	0.2281
261.52	808.88	325.3	0.2148	261.50	0.201	357.6	0.2299
261.60	809.04	325.9	0.2175	261.58	0.203	358.1	0.2326
261.68	811.17	326.5	0.2192	261.67	0.207	359.2	0.2361
261.77	811.83	327	0.221	261.75	0.205	359.3	0.237
261.85	812.23	327.4	0.2219	261.83	0.206	359.9	0.2388
261.93	814.72	328.1	0.2237	261.92	0.208	360.4	0.2414
262.02	812.46	328.1	0.2237	262.00	0.208	360.8	0.2441
262.10	814.12	328.6	0.2255	262.10	0.209	361.1	0.245
262.18	815.41	329.3	0.2281	262.17	0.21	361.6	0.2459
262.27	813.38	329.2	0.2272	262.25	0.21	361.8	0.2485
262.35	814.41	329.6	0.229	262.33	0.209	361.7	0.2485
262.43	814.97	329.9	0.2299	262.42	0.212	362.5	0.2512
262.52	817.04	330.6	0.2317	262.50	0.211	362.5	0.2512
262.60	814.57	330.4	0.2308	262.58	0.209	362.5	0.2521
262.68	814.8	330.5	0.2317	262.67	0.211	363.1	0.2539
262.78	814.57	330.8	0.2317	262.75	0.21	362.8	0.253
262.85	814.34	330.9	0.2317	262.83	0.209	362.8	0.2539
262.93	814.14	331.1	0.2326	262.92	0.21	362.9	0.2539
263.02	813.73	331.6	0.2334	263.00	0.209	362.9	0.2539
263.10	812.77	331.3	0.2326	263.08	0.208	362.8	0.2539
263.18	812.57	331.3	0.2326	263.17	0.208	362.8	0.2539
263.27	812.47	331.4	0.2326	263.25	0.206	362.8	0.2548
263.35	811.61	331.4	0.2334	263.33	0.205	362.5	0.2539
263.43	811.08	331.4	0.2326	263.42	0.205	362.4	0.2539
263.52	810.05	331.2	0.2317	263.50	0.203	362	0.253
263.60	808.58	331.3	0.2317	263.60	0.203	361.9	0.253
263.68	807.68	331	0.2317	263.67	0.2	361.3	0.253
263.77	807.05	330.9	0.2308	263.75	0.2	361.2	0.2521
263.85	806.92	330.8	0.2308	263.83	0.199	361	0.2512
263.93	804.26	330.4	0.229	263.92	0.197	360.7	0.2512
264.02	804.69	330.5	0.229	264.00	0.193	359.8	0.2494
264.10	802.37	330.1	0.2281	264.08	0.193	359.6	0.2485
264.18	799.25	329.5	0.2255	264.17	0.191	359.2	0.2477
264.27	800.81	329.7	0.2263	264.25	0.187	358.2	0.2477

Prova triassiale ciclica SNGR03-C4							
tensione di confinamento (kPa)	450			tensione di confinamento (kPa)	450		
deviatore ciclico (kPa)	150			deviatore ciclico (kPa)	180		
frequenza (hz)	0.0007143			frequenza (hz)	0.0007143		
264.35	797.75	329.1	0.2246	264.33	0.187	358.1	0.245
264.43	796.35	328.8	0.2237	264.42	0.183	357.2	0.2432
264.52	794.62	328.7	0.2237	264.50	0.183	357	0.2432
264.60	790.03	327.5	0.2219	264.58	0.179	356	0.2397
264.68	790.57	327.5	0.2192	264.67	0.179	355.9	0.2388
264.77	789.24	327.1	0.2184	264.75	0.174	354.8	0.237
264.85	786.71	326.5	0.2166	264.83	0.172	354	0.2352
264.93	785.29	326.1	0.2148	264.92	0.168	353	0.2326
265.02	783.53	325.7	0.213	265.02	0.169	352.9	0.2317
265.10	778.73	325.5	0.2121	265.08	0.163	351.3	0.2281
265.18	780.24	324.7	0.2095	265.17	0.161	350.8	0.2272
265.27	774.68	323.3	0.2059	265.25	0.156	349.5	0.2228
265.35	774.18	323.1	0.205	265.33	0.155	348.9	0.221
265.43	771.76	322.7	0.2033	265.42	0.152	348.2	0.2192
265.52	768.54	321.5	0.1997	265.50	0.148	346.9	0.2157
265.60	767.04	321.1	0.1979	265.58	0.146	346.2	0.213
265.70	765.35	320.4	0.1953	265.67	0.141	345.1	0.2095
265.77	762.82	319.7	0.1935	265.75	0.137	343.5	0.2068
265.85	760.29	318.9	0.1908	265.83	0.134	342.5	0.2015
265.93	756.7	318	0.1873	265.92	0.13	341.3	0.1988
266.02	754.17	317.7	0.1864	266.00	0.129	340.8	0.1971
266.10	749.78	316	0.182	266.08	0.125	339.5	0.1926
266.18	748.32	315.3	0.1784	266.17	0.121	338.2	0.1891
266.27	745.26	314.4	0.1758	266.25	0.115	336.9	0.1846
266.35	742.34	313.5	0.1731	266.33	0.111	334.9	0.1802
266.43	742.47	313.2	0.1713	266.42	0.107	333.6	0.1749
266.52	735.92	311.6	0.1669	266.50	0.106	333	0.1731
266.60	735.79	310.9	0.1633	266.58	0.101	331.2	0.1678
266.68	729.8	309.5	0.1589	266.67	0.094	328.9	0.1633
266.77	726.44	308.1	0.1536	266.75	0.092	328.2	0.1589
266.85	726.74	307.8	0.1518	266.83	0.087	326.7	0.1544
266.93	721.08	306.3	0.1465	266.92	0.086	325.8	0.1518
267.02	719.22	305.5	0.1438	267.00	0.08	324	0.1465
267.12	717.52	304.5	0.1402	267.08	0.074	322	0.1411
267.18	711.2	302.8	0.134	267.17	0.07	321.2	0.1385
267.27	709.9	302	0.1314	267.25	0.062	317.9	0.1331
267.35	707.03	300.9	0.1269	267.33	0.064	317.6	0.1278
267.43	704.24	299.9	0.1225	267.42	0.056	315.2	0.1207
267.52	698.51	298.2	0.1172	267.50	0.052	313.8	0.1163
267.60	695.45	296.8	0.1136	267.58	0.05	312.7	0.1127
267.68	691.82	295.2	0.1056	267.67	0.042	310.1	0.1056
267.77	688.92	294.3	0.1021	267.75	0.041	309	0.1021
267.85	687.29	293.5	0.0994	267.83	0.032	306	0.0959
267.93	682.22	291.9	0.0932	267.93	0.031	305	0.0888
268.02	680.39	290.9	0.0897	268.00	0.027	303.5	0.0852
268.10	677.13	289.5	0.0843	268.08	0.02	301.3	0.079
268.18	671.49	287.5	0.079	268.17	0.013	298.2	0.0737
268.27	669.13	286.4	0.0728	268.25	0.012	297.3	0.0657
268.35	666.29	285.3	0.0683	268.33	0.007	295.6	0.0612
268.43	662.69	283.8	0.063	268.42	0.002	293.4	0.0541
268.52	662.42	283.1	0.0595	268.50	-0.001	291.9	0.0497
268.62	654.95	280.7	0.0506	268.58	-0.006	289.9	0.0444
268.68	652.75	279.6	0.047	268.67	-0.012	287.7	0.0382
268.77	651.25	278.6	0.0435	268.75	-0.016	285.6	0.0346
268.85	645.48	276.7	0.0373	268.83	-0.019	283.6	0.0266
268.93	643.28	275.6	0.0328	268.92	-0.025	281.4	0.0204
269.02	638.34	274.2	0.0284	269.00	-0.029	279.8	0.016
269.10	637.44	272.8	0.024	269.08	-0.033	278	0.0098
269.18	631.36	270.7	0.0169	269.17	-0.038	275.8	0.0044
269.27	629.72	270.2	0.0124	269.25	-0.045	274.4	0.0009

Prova triassiale ciclica SNGR03-C4							
tensione di confinamento (kPa)	450			tensione di confinamento (kPa)	450		
deviatore ciclico (kPa)	150			deviatore ciclico (kPa)	180		
frequenza (hz)	0.0007143			frequenza (hz)	0.0007143		
269.35	625.39	268.6	0.008	269.35	-0.048	271.2	-0.0071
269.43	623.85	267.5	0.0044	269.42	-0.047	270.7	-0.0098
269.52	620.27	266.1	0	269.50	-0.056	267.7	-0.016
269.60	615.67	264.6	-0.0044	269.58	-0.061	265.1	-0.0204
269.68	612.99	262.8	-0.0089	269.67	-0.064	263.6	-0.024
269.77	611.36	261.7	-0.0142	269.75	-0.069	261.6	-0.0311
269.85	607.18	260.3	-0.0186	269.83	-0.073	259.5	-0.0355
269.93	603.81	258.8	-0.0222	269.92	-0.077	257.5	-0.0408
270.03	597.66	256.3	-0.0266	270.00	-0.081	255.6	-0.0453
270.10	597.89	255.6	-0.032	270.08	-0.084	254.2	-0.0479
270.18	594.85	254.3	-0.0355	270.17	-0.091	251.1	-0.0533
270.27	591.97	252.9	-0.0391	270.25	-0.095	249	-0.0568
270.35	589.57	251.7	-0.0417	270.33	-0.098	247.5	-0.063
270.43	587.26	250.5	-0.0453	270.42	-0.104	244.7	-0.0683
270.52	584.32	248.8	-0.0479	270.50	-0.105	243.5	-0.071
270.60	578.87	246.9	-0.0506	270.58	-0.109	241.8	-0.0746
270.68	578.06	246	-0.0559	270.67	-0.111	240.7	-0.0772
270.77	574.45	244.4	-0.0586	270.75	-0.117	237.6	-0.0817
270.85	572.61	243.2	-0.0612	270.85	-0.12	236	-0.0861
270.93	569.77	242	-0.0648	270.92	-0.125	233.9	-0.0905
271.02	567.56	240.7	-0.0675	271.00	-0.126	232.5	-0.0932
271.10	561.81	239.4	-0.0701	271.08	-0.131	230.2	-0.0968
271.18	562.44	237.8	-0.0728	271.17	-0.134	228.4	-0.0985
271.27	560.57	236.7	-0.0763	271.25	-0.138	226.9	-0.1039
271.35	557.36	235.4	-0.079	271.33	-0.14	225.5	-0.1065
271.43	554.88	234.2	-0.0817	271.42	-0.143	224	-0.1092
271.53	550.94	232.5	-0.0843	271.50	-0.146	222.5	-0.1127
271.60	550.97	231.7	-0.087	271.58	-0.149	220.8	-0.1163
271.68	548.69	230.6	-0.0897	271.67	-0.154	218.4	-0.1189
271.77	546.31	229.4	-0.0914	271.75	-0.156	217	-0.1216
271.85	544.41	228.4	-0.0941	271.83	-0.159	215.4	-0.1269
271.93	542.73	227.5	-0.0959	271.92	-0.161	214.1	-0.1296
272.02	539.19	226.4	-0.0976	272.00	-0.165	212.2	-0.1331
272.10	538.32	225.1	-0.0994	272.08	-0.165	211.7	-0.134
272.18	537.24	224.2	-0.1021	272.17	-0.168	210.1	-0.1367
272.27	534.97	223.2	-0.1039	272.27	-0.171	208.7	-0.1402
272.35	533.33	222.3	-0.1065	272.33	-0.176	206.5	-0.1438
272.43	532.22	221.5	-0.1074	272.42	-0.175	206.2	-0.1447
272.52	530.65	220.7	-0.1092	272.50	-0.176	205.5	-0.1465
272.60	528.77	219.7	-0.111	272.58	-0.18	203.5	-0.1491
272.68	527.33	218.7	-0.1118	272.67	-0.179	203.4	-0.1509
272.77	526.29	217.9	-0.1145	272.75	-0.182	201.8	-0.1536
272.85	524.65	217.2	-0.1163	272.83	-0.185	200.5	-0.1553
272.95	523.92	216.6	-0.1172	272.92	-0.187	199.5	-0.158
273.02	522.61	215.6	-0.1181	273.00	-0.187	198.9	-0.1589
273.10	521.3	214.9	-0.1198	273.08	-0.187	198.5	-0.1598
273.18	520.67	214.4	-0.1216	273.17	-0.193	196.4	-0.1616
273.27	519.56	213.8	-0.1225	273.25	-0.19	196.6	-0.1633
273.35	519.16	213.3	-0.1234	273.33	-0.194	195.2	-0.1669
273.43	518.22	212.7	-0.1243	273.42	-0.194	194.9	-0.1669
273.52	517.68	212.3	-0.1252	273.50	-0.195	194.4	-0.1678
273.60	516.88	211.6	-0.126	273.58	-0.194	194.2	-0.1687
273.68	516.58	211.2	-0.1269	273.67	-0.195	193.7	-0.1695
273.77	516.11	210.8	-0.1278	273.77	-0.197	192.8	-0.1713
273.85	515.77	210.4	-0.1287	273.83	-0.197	192.6	-0.1722
273.93	515.44	210.1	-0.1287	273.92	-0.197	192.2	-0.1731
274.02	515.37	209.8	-0.1296	274.00	-0.198	191.8	-0.174
274.10	515.1	209.5	-0.1305	274.08	-0.198	191.5	-0.1749
274.18	514.7	209.1	-0.1305	274.17	-0.198	191.3	-0.1749
274.27	515	208.9	-0.1305	274.25	-0.198	191.1	-0.1758

Prova triassiale ciclica SNGR03-C4							
tensione di confinamento (kPa)	450			tensione di confinamento (kPa)	450		
deviatore ciclico (kPa)	150			deviatore ciclico (kPa)	180		
frequenza (hz)	0.0007143			frequenza (hz)	0.0007143		
274.35	515.47	208.8	-0.1314	274.33	-0.198	190.9	-0.1766
274.43	515.16	208.5	-0.1314	274.42	-0.197	191	-0.1766
274.52	515.67	208.4	-0.1314	274.50	-0.197	190.9	-0.1766
274.60	515.87	208.3	-0.1323	274.58	-0.197	191	-0.1766
274.68	516.07	208.2	-0.1323	274.67	-0.197	190.9	-0.1766
274.77	516.47	208.1	-0.1323	274.75	-0.196	191	-0.1775
274.85	517	208.1	-0.1323	274.83	-0.195	191.3	-0.1775
274.93	517.47	208.1	-0.1323	274.92	-0.195	191.2	-0.1775
275.02	518.61	208.3	-0.1314	275.00	-0.194	191.6	-0.1775
275.10	518.94	208.3	-0.1314	275.08	-0.192	191.9	-0.1766
275.18	520.18	208.5	-0.1314	275.18	-0.191	192.3	-0.1766
275.27	520.88	208.5	-0.1314	275.25	-0.188	193.2	-0.1758
275.35	522.05	208.8	-0.1305	275.33	-0.188	193.2	-0.1758
275.43	522.69	208.9	-0.1305	275.42	-0.189	192.9	-0.1758
275.52	524.29	209.2	-0.1296	275.50	-0.185	194.1	-0.1749
275.60	525.53	209.3	-0.1296	275.58	-0.182	195.2	-0.174
275.68	526.3	209.7	-0.1287	275.67	-0.182	195.3	-0.174
275.77	527.77	210	-0.1278	275.75	-0.181	195.8	-0.1731
275.87	529.65	210.5	-0.1269	275.83	-0.179	196.5	-0.1722
275.93	530.88	210.7	-0.1269	275.92	-0.177	197.3	-0.1713
276.02	532.73	211.3	-0.126	276.00	-0.175	197.8	-0.1704
276.10	534.03	211.7	-0.1243	276.08	-0.173	198.6	-0.1704
276.18	536.91	212.4	-0.1234	276.17	-0.171	199.4	-0.1695
276.27	537.34	212.6	-0.1234	276.25	-0.167	200.8	-0.1678
276.35	538.92	213.1	-0.1225	276.33	-0.165	201.4	-0.1669
276.43	540.79	213.6	-0.1216	276.42	-0.162	202.5	-0.166
276.52	542.8	213.9	-0.1207	276.50	-0.16	203.4	-0.1642
276.60	545.77	215.1	-0.1198	276.58	-0.159	204.1	-0.1633
276.68	546.74	215.5	-0.1181	276.67	-0.154	205.6	-0.1616
276.77	549.19	216.2	-0.1172	276.75	-0.152	206.5	-0.1607
276.85	551.46	216.9	-0.1154	276.83	-0.148	208.5	-0.158
276.93	552.56	217.4	-0.1145	276.92	-0.146	209	-0.158
277.02	557.18	218.6	-0.1118	277.00	-0.145	209.6	-0.1571
277.10	557.65	219	-0.1118	277.08	-0.138	212.1	-0.1544
277.18	561.63	220.4	-0.1101	277.17	-0.136	213.3	-0.1527
277.28	563.04	220.9	-0.1074	277.25	-0.132	214.5	-0.15
277.35	565.21	221.7	-0.1065	277.33	-0.129	215.9	-0.1491
277.43	568.69	222.9	-0.1047	277.42	-0.126	217.1	-0.1473
277.52	570.83	223.7	-0.1039	277.50	-0.125	217.7	-0.1465
277.60	573.14	224.5	-0.1012	277.58	-0.119	219.8	-0.1438
277.68	575.88	225.5	-0.0994	277.67	-0.115	221.8	-0.1411
277.77	577.19	226.3	-0.0985	277.75	-0.111	223.3	-0.1385
277.85	581.43	227.3	-0.095	277.83	-0.108	224.7	-0.1367
277.93	582.9	228.1	-0.0941	277.92	-0.103	226.9	-0.1331
278.02	587.61	229.9	-0.0914	278.00	-0.102	227.5	-0.1331
278.10	590.36	230.8	-0.0897	278.10	-0.096	230	-0.1287
278.18	592.43	231.7	-0.0861	278.17	-0.093	231.2	-0.1269
278.27	596.51	233.1	-0.0834	278.25	-0.087	233.4	-0.1243
278.35	598.45	234	-0.0817	278.33	-0.085	234.8	-0.1216
278.43	600.72	235	-0.0799	278.42	-0.081	236.3	-0.1189
278.52	604.33	236.2	-0.0772	278.50	-0.075	238.5	-0.1163
278.60	609.28	238	-0.0746	278.58	-0.07	240.7	-0.1136
278.68	612.02	239.1	-0.0728	278.67	-0.067	242.3	-0.1092
278.78	612.86	239.8	-0.0692	278.75	-0.064	243.9	-0.1065
278.85	617.37	241.4	-0.0657	278.83	-0.057	246.3	-0.103
278.93	619.74	242.7	-0.063	278.92	-0.056	247.6	-0.1012
279.02	624.99	244.3	-0.0604	279.00	-0.051	249.3	-0.0976
279.10	626.99	245.3	-0.0559	279.08	-0.047	251.7	-0.0941
279.18	630.83	246.7	-0.0533	279.17	-0.038	254.4	-0.0914
279.27	635.51	248.3	-0.0488	279.25	-0.036	255.8	-0.0861

Prova triassiale ciclica SNGR03-C4							
tensione di confinamento (kPa)	450			tensione di confinamento (kPa)	450		
deviatore ciclico (kPa)	150			deviatore ciclico (kPa)	180		
frequenza (hz)	0.0007143			frequenza (hz)	0.0007143		
279.35	635.88	249	-0.047	279.33	-0.032	257.6	-0.0826
279.43	640.09	250.4	-0.0444	279.42	-0.027	259.7	-0.079
279.52	644.8	252.3	-0.0408	279.52	-0.022	262.3	-0.0754
279.60	648.17	253.7	-0.0364	279.58	-0.019	263.8	-0.071
279.68	649.77	254.7	-0.0328	279.67	-0.015	265.4	-0.0675
279.77	653.78	256.2	-0.0293	279.75	-0.008	267.7	-0.063
279.85	655.42	257.2	-0.0266	279.83	-0.006	269.4	-0.0586
279.93	659.39	258.6	-0.0222	279.92	-0.001	271.2	-0.055
280.02	663.06	260	-0.0178	280.00	0.005	274	-0.0488
280.10	668.57	262.2	-0.0142	280.08	0.01	276	-0.047
280.20	670.3	263.2	-0.0089	280.17	0.013	277.7	-0.0399
280.27	672.54	264.3	-0.0053	280.25	0.02	280.2	-0.0346
280.35	676.81	265.8	-0.0009	280.33	0.022	281.4	-0.032
280.43	681.78	267.9	0.0044	280.42	0.026	283.3	-0.0266
280.52	684.75	269.2	0.008	280.50	0.031	285.4	-0.0213
280.60	686.52	270.2	0.0133	280.58	0.036	287.4	-0.0169
280.68	690.69	271.8	0.0178	280.67	0.042	289.9	-0.0124
280.77	693.89	273.2	0.0222	280.75	0.045	291.7	-0.0044
280.85	696.72	274.4	0.0266	280.83	0.049	293.4	0
280.93	700.36	275.7	0.0311	280.92	0.054	295.4	0.0053
281.02	704.89	277.7	0.0355	281.02	0.059	297.8	0.0089
281.10	707.52	279	0.0391	281.08	0.065	299.8	0.0178
281.18	710.18	280.4	0.0488	281.17	0.066	300.8	0.0222
281.27	713.82	281.8	0.0524	281.25	0.073	303.2	0.0275
281.35	715.32	282.7	0.055	281.33	0.075	304.7	0.0328
281.43	719.21	284	0.0604	281.42	0.079	306.4	0.0373
281.52	722.38	285.4	0.0648	281.50	0.086	308.3	0.0435
281.60	726.68	287.3	0.0701	281.58	0.093	311.1	0.0488
281.70	730.77	288.7	0.0781	281.67	0.092	312.3	0.0568
281.77	731.43	289.6	0.0808	281.75	0.097	313.8	0.0621
281.85	733.9	290.7	0.0852	281.83	0.102	315.7	0.0675
281.93	738.62	292.6	0.0897	281.92	0.104	317.2	0.0728
282.02	741.02	294	0.0941	282.00	0.108	318.5	0.0772
282.10	744.64	295.1	0.1021	282.08	0.114	320.4	0.0843
282.18	745.34	295.9	0.1047	282.17	0.119	323	0.0888
282.27	748.93	297.2	0.1101	282.25	0.119	323.8	0.0959
282.35	751.4	298.3	0.1145	282.33	0.124	325.4	0.1021
282.43	754.32	299.6	0.1189	282.43	0.129	326.9	0.1074
282.52	760.88	301.7	0.1234	282.50	0.134	329.1	0.1127
282.60	758.84	302.1	0.1269	282.58	0.135	330.3	0.1198
282.68	762.87	303.3	0.1331	282.67	0.138	331.5	0.1243
282.77	765.06	304.4	0.1376	282.75	0.146	333.7	0.1305
282.85	769.55	305.8	0.1429	282.83	0.144	334.5	0.1331
282.93	769.61	306.5	0.1456	282.92	0.148	335.7	0.1376
283.02	772.04	307.4	0.1491	283.00	0.152	336.8	0.1429
283.12	775.66	309	0.1553	283.08	0.158	339.1	0.1482
283.18	776.59	309.7	0.158	283.17	0.158	340	0.1553
283.27	779.11	311	0.1633	283.25	0.162	341.2	0.1607
283.35	780.94	311.7	0.1651	283.33	0.164	342.3	0.1651
283.43	784.1	313.1	0.1695	283.42	0.166	343.3	0.1687
283.52	785.79	313.9	0.1722	283.50	0.169	344.4	0.1731
283.60	787.28	314.7	0.1766	283.58	0.174	345.5	0.1775
283.68	789.17	315.6	0.1793	283.67	0.176	347.1	0.182
283.77	791.6	316.6	0.1829	283.75	0.176	347.7	0.1873
283.85	792.96	317.4	0.1855	283.83	0.18	349	0.1917
283.93	794.82	318.1	0.1882	283.93	0.184	349.9	0.1953
284.02	795.65	319	0.1908	284.00	0.185	351.1	0.1988
284.10	798.47	319.9	0.1935	284.08	0.187	352	0.2042
284.18	799.5	320.5	0.1971	284.17	0.188	352.9	0.2077
284.27	801.22	321.4	0.1997	284.25	0.192	353.8	0.2113

Prova triassiale ciclica SNGR03-C4							
tensione di confinamento (kPa)	450			tensione di confinamento (kPa)	450		
deviatore ciclico (kPa)	150			deviatore ciclico (kPa)	180		
frequenza (hz)	0.0007143			frequenza (hz)	0.0007143		
284.35	803.45	322.4	0.2033	284.33	0.193	354.4	0.2139
284.43	803.08	322.6	0.2042	284.42	0.195	355.2	0.2175
284.52	804.84	323.3	0.2068	284.50	0.197	355.9	0.2201
284.62	806.13	324.1	0.2095	284.58	0.199	357.3	0.2228
284.68	806.86	324.6	0.2113	284.67	0.2	357.7	0.2272
284.77	810.41	325.6	0.2148	284.75	0.201	358.3	0.2299
284.85	807.65	325.6	0.2148	284.83	0.202	358.9	0.2317
284.93	810.37	326.5	0.2175	284.92	0.204	359.4	0.2343
285.02	813.13	327.3	0.2201	285.00	0.204	359.8	0.2361
285.10	810.53	327.2	0.2201	285.08	0.206	360.4	0.2379
285.18	814.49	328.1	0.2228	285.17	0.207	361.1	0.2406
285.27	811.93	328.1	0.2228	285.25	0.208	361.4	0.2432
285.35	814.92	328.8	0.2255	285.35	0.208	361.7	0.245
285.43	812.79	328.8	0.2255	285.42	0.209	362.1	0.2468
285.52	813.65	329.5	0.2272	285.50	0.21	362.6	0.2477
285.60	813.81	329.7	0.2281	285.58	0.21	363	0.2503
285.68	816.5	330.3	0.2299	285.67	0.209	362.8	0.2503
285.77	814.64	330.3	0.2299	285.75	0.211	363.4	0.2521
285.85	816.87	330.9	0.2308	285.83	0.211	363.6	0.253
285.93	814.61	330.8	0.2308	285.92	0.21	363.5	0.253
286.03	815.17	331.2	0.2317	286.00	0.211	364	0.2548
286.10	814.64	331.2	0.2317	286.08	0.212	364.2	0.2548
286.18	813.57	331.2	0.2317	286.17	0.209	363.9	0.2548
286.27	814.97	331.6	0.2326	286.25	0.209	363.9	0.2556
286.35	813.34	331.5	0.2326	286.33	0.208	363.8	0.2556
286.43	812.84	331.6	0.2326	286.42	0.209	364	0.2556
286.52	813.04	331.8	0.2326	286.50	0.207	363.7	0.2556
286.60	812.11	331.8	0.2326	286.58	0.206	363.7	0.2556
286.68	811.64	331.9	0.2326	286.67	0.206	363.5	0.2556
286.77	810.98	331.7	0.2326	286.75	0.205	363.3	0.2548
286.85	810.18	331.6	0.2317	286.83	0.204	363.2	0.2548
286.93	808.68	331.5	0.2317	286.92	0.202	362.9	0.2548
287.02	807.88	331.4	0.2317	287.00	0.201	362.5	0.2539
287.10	806.89	331.3	0.2299	287.08	0.2	362.3	0.2539
287.18	805.69	331.1	0.2299	287.17	0.197	361.8	0.2521
287.27	804.66	330.9	0.229	287.25	0.197	361.7	0.2521
287.35	803.6	330.7	0.2281	287.33	0.195	361.2	0.2512
287.45	801.97	330.4	0.2272	287.42	0.194	360.9	0.2503
287.52	799.81	330	0.2255	287.50	0.19	360.2	0.2485
287.60	799.45	329.9	0.2246	287.58	0.189	359.6	0.2477
287.68	798.25	329.6	0.2237	287.67	0.186	359	0.2459
287.77	796.55	329.2	0.2228	287.75	0.185	358.6	0.245
287.85	793.39	328.8	0.2219	287.83	0.182	357.9	0.2432
287.93	791.7	328.2	0.221	287.92	0.181	357.4	0.2414
288.02	790.74	327.9	0.2184	288.00	0.177	356.5	0.2397
288.10	789.04	327.5	0.2175	288.08	0.175	356.1	0.2388
288.18	787.18	327.1	0.2157	288.17	0.172	354.9	0.237
288.27	786.89	326.8	0.2139	288.27	0.17	354.4	0.2343
288.35	783.09	326.1	0.2121	288.33	0.169	354	0.2326
288.43	780.1	325.6	0.2104	288.42	0.163	352.6	0.2299
288.52	778.61	324.8	0.2095	288.50	0.161	351.6	0.229
288.60	776.18	324.2	0.2059	288.58	0.157	350.8	0.2246
288.68	773.59	323.5	0.2042	288.67	0.155	349.9	0.2219
288.77	772.13	323	0.2024	288.75	0.154	349.4	0.221
288.85	770.3	322.4	0.1997	288.83	0.149	348.2	0.2175
288.95	767.14	321.5	0.1971	288.92	0.146	347.3	0.2148
289.02	766.44	321.1	0.1953	289.00	0.141	346.4	0.2121
289.10	760.62	319.7	0.1917	289.08	0.137	344.5	0.2077
289.18	760	319.3	0.1891	289.17	0.134	343.6	0.2033
289.27	757.2	318.6	0.1873	289.25	0.13	342.4	0.1997

Prova triassiale ciclica SNGR03-C4							
tensione di confinamento (kPa)	450			tensione di confinamento (kPa)	450		
deviatore ciclico (kPa)	150			deviatore ciclico (kPa)	180		
frequenza (hz)	0.0007143			frequenza (hz)	0.0007143		
289.35	756.04	317.7	0.1846	289.33	0.127	341.2	0.1962
289.43	748.52	316	0.1811	289.42	0.127	340.7	0.1944
289.52	748.55	315.7	0.1784	289.50	0.121	339.3	0.19
289.60	745.83	314.9	0.1749	289.58	0.114	337.6	0.1855
289.68	741.04	313.8	0.1713	289.68	0.111	336	0.1802
289.77	740.78	313.2	0.1687	289.75	0.111	335.5	0.1784
289.85	737.52	312.3	0.166	289.83	0.103	333.7	0.174
289.93	734.02	311.3	0.1624	289.92	0.1	332.4	0.1704
290.02	730.36	309.9	0.1598	290.00	0.095	330.3	0.166
290.10	727.87	309	0.1536	290.08	0.094	329.5	0.1607
290.18	724.97	308	0.1509	290.17	0.085	327.3	0.1553
290.27	721.88	307	0.1473	290.25	0.084	326.3	0.1518
290.37	717.35	305.2	0.142	290.33	0.081	324.9	0.1473
290.43	715.46	304.4	0.1376	290.42	0.075	323.2	0.142
290.52	712.2	303.4	0.1331	290.50	0.069	322.1	0.1394
290.60	708.83	302.3	0.1296	290.58	0.065	319.6	0.134
290.68	708.67	301.6	0.1269	290.67	0.062	318	0.1278
290.77	703.71	300.3	0.1207	290.75	0.057	316.5	0.1225
290.85	698.91	298.7	0.1163	290.83	0.05	314.1	0.1163
290.93	695.31	297.2	0.1127	290.92	0.051	313.7	0.1136
291.02	692.62	296.1	0.1065	291.00	0.045	311.7	0.1083
291.10	689.75	295	0.1021	291.08	0.038	309.5	0.1012
291.18	685.69	293.6	0.0976	291.18	0.035	307.7	0.095
291.27	683.96	292.5	0.0932	291.25	0.032	306	0.0905
291.35	682.52	291.8	0.0897	291.33	0.026	304.3	0.0852
291.43	675.43	289.2	0.0817	291.42	0.021	303	0.0817
291.52	671.72	287.9	0.079	291.50	0.015	299.9	0.0754
291.60	670.03	286.8	0.0719	291.58	0.011	297.8	0.0657
291.68	665.56	285.5	0.0675	291.67	0.007	296.5	0.0621
291.77	663.89	284.6	0.063	291.75	-0.001	293.8	0.055
291.87	656.42	282	0.0577	291.83	0.001	293.2	0.0506
291.93	655.82	281.2	0.0515	291.92	-0.005	291.2	0.0462
292.02	652.62	280	0.047	292.00	-0.012	288.8	0.0399
292.10	649.25	278.6	0.0426	292.08	-0.015	286.7	0.0355
292.18	647.28	277.4	0.0382	292.17	-0.019	284.7	0.0275
292.27	643.78	276.1	0.0337	292.25	-0.025	282.5	0.0213
292.35	638.54	274.5	0.0284	292.33	-0.029	280.7	0.0169
292.43	634.67	272.5	0.024	292.42	-0.033	278.9	0.0107
292.52	633.13	271.5	0.0178	292.50	-0.04	276.3	0.0044
292.60	629.52	270.6	0.0133	292.60	-0.042	274.5	-0.0009
292.68	627.92	269.5	0.0098	292.67	-0.047	272.5	-0.0053
292.77	624.15	267.9	0.0044	292.75	-0.052	270.2	-0.0115
292.85	620.18	266.5	0	292.83	-0.055	268.6	-0.016
292.93	615.57	265.1	-0.0044	292.92	-0.063	267.3	-0.0186
293.02	612.56	263.1	-0.008	293.00	-0.063	264.7	-0.024
293.10	610.05	261.8	-0.0151	293.08	-0.071	261.9	-0.032
293.18	606.91	260.5	-0.0186	293.17	-0.071	260.9	-0.0355
293.28	603.34	259.1	-0.0231	293.25	-0.079	258	-0.0408
293.35	600.03	257.2	-0.0257	293.33	-0.08	256.5	-0.0444
293.43	597.99	256	-0.032	293.42	-0.085	254.6	-0.0488
293.52	594.65	254.7	-0.0355	293.50	-0.091	252.6	-0.0524
293.60	591.97	253.3	-0.0391	293.58	-0.095	249.6	-0.0577
293.68	589.6	252	-0.0417	293.67	-0.095	248.8	-0.0621
293.77	586.29	250.6	-0.0453	293.75	-0.101	246.6	-0.0657
293.85	582.61	249.4	-0.0479	293.83	-0.106	244.3	-0.0701
293.93	580.31	247.6	-0.0497	293.92	-0.109	242.8	-0.0737
294.02	578.2	246.2	-0.0559	294.00	-0.112	240.8	-0.0781
294.10	574.45	244.7	-0.0586	294.10	-0.115	239.3	-0.0817
294.18	571.84	243.5	-0.0621	294.17	-0.124	235.7	-0.0879
294.27	570.47	242.3	-0.0648	294.25	-0.123	235.1	-0.0897

Prova triassiale ciclica SNGR03-C4							
tensione di confinamento (kPa)	450			tensione di confinamento (kPa)	450		
deviatore ciclico (kPa)	150			deviatore ciclico (kPa)	180		
frequenza (hz)	0.0007143			frequenza (hz)	0.0007143		
294.35	567.3	241	-0.0675	294.33	-0.128	233.1	-0.0932
294.43	563.99	239.8	-0.0701	294.42	-0.129	231.8	-0.0959
294.52	561.88	238.1	-0.0728	294.50	-0.136	229	-0.0985
294.60	560.03	237	-0.0763	294.58	-0.137	227.8	-0.1039
294.68	556.69	235.6	-0.079	294.67	-0.141	226	-0.1074
294.78	554.45	234.8	-0.0808	294.75	-0.144	224.4	-0.1101
294.85	552.38	233.1	-0.0834	294.83	-0.146	223.1	-0.1136
294.93	550.73	231.9	-0.087	294.92	-0.149	221.4	-0.1163
295.02	548.06	230.8	-0.0897	295.00	-0.153	219.7	-0.1189
295.10	546.42	229.8	-0.0914	295.08	-0.155	217.8	-0.1234
295.18	544.71	228.8	-0.0941	295.17	-0.158	216.4	-0.126
295.27	542.6	227.7	-0.0959	295.25	-0.161	214.8	-0.1296
295.35	540.09	226.7	-0.0976	295.33	-0.163	213.5	-0.1314
295.43	537.88	225.2	-0.0994	295.42	-0.165	212.5	-0.134
295.52	536.84	224.4	-0.103	295.52	-0.169	210.5	-0.1376
295.60	535.07	223.5	-0.1047	295.58	-0.17	209.6	-0.1402
295.68	533.63	222.7	-0.1056	295.67	-0.174	208.1	-0.142
295.77	532.56	221.8	-0.1083	295.75	-0.174	207.2	-0.1447
295.85	530.31	220.9	-0.1101	295.83	-0.177	206	-0.1465
295.93	528.61	220.1	-0.111	295.92	-0.179	204.4	-0.1491
296.02	527.23	219	-0.1127	296.00	-0.184	202.5	-0.1509
296.10	525.66	218.2	-0.1145	296.08	-0.182	202.3	-0.1536
296.20	525.39	217.6	-0.1163	296.17	-0.182	201.8	-0.1553
296.27	523.45	216.8	-0.1172	296.25	-0.187	200.2	-0.158
296.35	522.61	215.9	-0.1189	296.33	-0.19	198.9	-0.1607
296.43	521.57	215.2	-0.1207	296.42	-0.187	199.3	-0.1607
296.52	520.8	214.7	-0.1216	296.50	-0.193	197.7	-0.1624
296.60	519.43	214	-0.1225	296.58	-0.191	197	-0.1642
296.68	519.26	213.6	-0.1234	296.67	-0.192	196.5	-0.166
296.77	518.09	213	-0.1243	296.75	-0.193	195.9	-0.1669
296.85	517.45	212.6	-0.1252	296.83	-0.195	195.1	-0.1687
296.93	516.98	211.9	-0.126	296.92	-0.196	194.6	-0.1695
297.02	516.31	211.5	-0.1278	297.02	-0.196	193.8	-0.1713
297.10	516.11	211.1	-0.1278	297.08	-0.196	193.6	-0.1722
297.18	515.84	210.8	-0.1287	297.17	-0.197	193.2	-0.1722
297.27	515.47	210.4	-0.1296	297.25	-0.197	192.8	-0.1731
297.35	515.17	210.1	-0.1296	297.33	-0.198	192.6	-0.1749
297.43	515.07	209.9	-0.1305	297.42	-0.198	191.9	-0.1758
297.52	514.2	209.3	-0.1305	297.50	-0.197	192.1	-0.1758
297.62	515.13	209.2	-0.1314	297.58	-0.198	191.7	-0.1766
297.68	515.63	209.2	-0.1314	297.67	-0.198	191.6	-0.1766
297.77	515.27	209	-0.1314	297.75	-0.197	192	-0.1766
297.85	515.63	208.7	-0.1323	297.83	-0.196	192	-0.1766
297.93	515.83	208.6	-0.1323	297.92	-0.199	191.1	-0.1784
298.02	515.8	208.4	-0.1323	298.00	-0.196	191.7	-0.1775
298.10	516.37	208.4	-0.1323	298.08	-0.195	192	-0.1775
298.18	516.8	208.4	-0.1323	298.17	-0.195	192.1	-0.1775
298.27	517.47	208.5	-0.1323	298.25	-0.195	192.1	-0.1775
298.35	518.94	208.6	-0.1323	298.33	-0.192	192.9	-0.1766
298.43	519.21	208.6	-0.1314	298.43	-0.192	192.8	-0.1775
298.52	520.01	208.8	-0.1314	298.50	-0.192	193	-0.1775
298.60	521.02	208.9	-0.1314	298.58	-0.19	193.3	-0.1766
298.68	521.99	209.1	-0.1305	298.67	-0.188	193.9	-0.1766
298.77	522.72	209.2	-0.1305	298.75	-0.188	194.2	-0.1758
298.85	523.89	209.5	-0.1305	298.83	-0.185	194.8	-0.1749
298.93	525.67	209.7	-0.1296	298.92	-0.185	195.5	-0.1749
299.02	526.8	210.1	-0.1296	299.00	-0.181	196.3	-0.174
299.12	527.54	210.3	-0.1287	299.08	-0.181	196.5	-0.1731
299.18	529.45	210.8	-0.1278	299.17	-0.178	197.4	-0.1722
299.27	531.29	211	-0.1269	299.25	-0.177	198	-0.1722

Prova triassiale ciclica SNGR03-C4

tensione di confinamento (kPa)	450			tensione di confinamento (kPa)	450		
deviatore ciclico (kPa)	150			deviatore ciclico (kPa)	180		
frequenza (hz)	0.0007143			frequenza (hz)	0.0007143		
299.35	532.62	211.6	-0.1269	299.33	-0.175	198.7	-0.1713
299.43	535.96	212	-0.1252	299.42	-0.172	199.6	-0.1704
299.52	535.97	212.5	-0.1243	299.50	-0.17	200.6	-0.1695
299.60	537.24	212.9	-0.1234	299.58	-0.167	201.5	-0.1687
299.68	538.98	213.4	-0.1234	299.67	-0.165	202.3	-0.1669
299.77	540.39	213.9	-0.1225	299.75	-0.162	203.4	-0.166
299.85	543.4	214.6	-0.1207	299.85	-0.159	204.8	-0.1651
299.93	545.3	215.3	-0.1198	299.92	-0.156	205.8	-0.1633
300.02	546.98	215.9	-0.1181	300.00	-0.156	205.9	-0.1633
300.10	549.65	216.6	-0.1172	300.08	-0.152	207.5	-0.1607
300.18	551.19	217.3	-0.1163	300.17	-0.149	208.9	-0.1598
300.27	552.7	217.8	-0.1145	300.25	-0.147	209.7	-0.158
300.35	555.34	218.6	-0.1136	300.33	-0.143	211.1	-0.1562
300.43	558.59	219.4	-0.1118	300.42	-0.137	213.5	-0.1553
300.53	561.33	220.6	-0.1101	300.50	-0.135	214.2	-0.1527
300.60	562.6	221.2	-0.1083	300.58	-0.135	214.5	-0.1518
300.68	565.54	222.1	-0.1074	300.67	-0.13	216.3	-0.15
300.77	569.32	222.8	-0.1056	300.75	-0.126	217.9	-0.1473
300.85	570.73	224	-0.1047	300.83	-0.121	219.8	-0.1447
300.93	572.87	224.8	-0.1021	300.92	-0.12	220.8	-0.1438
301.02	576.01	225.9	-0.0994	301.00	-0.116	222.4	-0.142
301.10	577.99	226.7	-0.0976	301.08	-0.111	224.5	-0.1402
301.18	580.06	227.6	-0.0959	301.17	-0.108	225.5	-0.1367
301.27	583.87	228.8	-0.0941	301.25	-0.102	228	-0.1331
301.35	587.68	230.3	-0.0923	301.35	-0.102	228.8	-0.1331
301.43	591.06	231.4	-0.0897	301.42	-0.094	231.3	-0.1305
301.52	591.06	231.9	-0.0879	301.50	-0.092	232.3	-0.1269
301.60	596.38	233.3	-0.0852	301.58	-0.085	234.9	-0.1234
301.68	598.68	234.5	-0.0817	301.67	-0.088	235	-0.1234
301.77	601.32	235.5	-0.0799	301.75	-0.082	237.1	-0.1198
301.85	604.2	236.6	-0.0781	301.83	-0.073	240	-0.1154
301.93	609.08	238.5	-0.0754	301.92	-0.07	241.6	-0.1145
302.03	610.38	239.2	-0.0719	302.00	-0.067	243.4	-0.111
302.10	613.73	240.5	-0.0692	302.08	-0.063	245	-0.1065
302.18	616.57	241.6	-0.0666	302.17	-0.058	246.9	-0.1039
302.27	621.51	243.5	-0.063	302.25	-0.053	249.2	-0.0994
302.35	624.55	244.8	-0.0612	302.33	-0.052	250.3	-0.0976
302.43	626.49	245.6	-0.0568	302.42	-0.046	252.4	-0.095
302.52	630.8	247.1	-0.0533	302.50	-0.041	254.9	-0.0914
302.60	633.51	248.3	-0.0497	302.58	-0.037	257	-0.0879
302.68	636.11	249.4	-0.0479	302.67	-0.032	258.7	-0.0826
302.77	639.49	250.7	-0.0453	302.77	-0.027	260.7	-0.079
302.85	644.6	252.7	-0.0408	302.83	-0.019	263.8	-0.0754
302.93	647.7	254.1	-0.0382	302.92	-0.019	264.8	-0.0719
303.02	650.47	255.2	-0.0328	303.00	-0.015	266.3	-0.0666
303.10	655.72	257	-0.0284	303.08	-0.009	268.8	-0.0621
303.18	655.78	257.7	-0.0266	303.17	-0.006	270.6	-0.0586
303.27	658.85	259	-0.0222	303.25	-0.002	272.2	-0.055
303.35	662.96	260.5	-0.0186	303.33	0.004	274.3	-0.0506
303.45	667.87	262.5	-0.0124	303.42	0.013	277.7	-0.0462
303.52	670.44	263.7	-0.0089	303.50	0.012	278.6	-0.0435
303.60	672.97	264.8	-0.0062	303.58	0.018	280.6	-0.0355
303.68	678.34	266.6	0	303.67	0.022	282.6	-0.0311
303.77	681.18	268.2	0.0027	303.75	0.027	284.7	-0.0257
303.85	683.62	269.5	0.0053	303.83	0.031	286.3	-0.0213
303.93	687.22	270.9	0.0133	303.92	0.033	287.9	-0.0178
304.02	690.32	272.3	0.0169	304.00	0.042	291.1	-0.0115
304.10	694.25	273.7	0.0222	304.08	0.046	293	-0.0071
304.18	696.59	274.8	0.0266	304.17	0.049	294.5	-0.0009
304.27	700.66	276.2	0.0302	304.27	0.052	295.8	0.0036

Prova triassiale ciclica SNGR03-C4							
tensione di confinamento (kPa)	450			tensione di confinamento (kPa)	450		
deviatore ciclico (kPa)	150			deviatore ciclico (kPa)	180		
frequenza (hz)	0.0007143			frequenza (hz)	0.0007143		
304.35	704.56	278.2	0.0364	304.33	0.06	298.9	0.0089
304.43	706.42	279.3	0.0391	304.42	0.063	300.6	0.0178
304.52	709.68	280.6	0.0462	304.50	0.067	302.2	0.0231
304.60	713.09	282	0.0506	304.58	0.07	303.8	0.0275
304.68	716.65	283.4	0.0559	304.67	0.077	306.2	0.0337
304.77	719.11	284.5	0.0595	304.75	0.079	307.5	0.0382
304.85	722.68	285.9	0.0648	304.83	0.084	309.2	0.0435
304.95	725.81	287.6	0.0719	304.92	0.088	311.5	0.0506
305.02	730.94	289.3	0.0781	305.00	0.094	313.7	0.055
305.10	730.47	289.9	0.0799	305.08	0.097	315	0.063
305.18	734.83	291.3	0.0843	305.17	0.101	316.8	0.0683
305.27	738.89	293.1	0.0897	305.25	0.105	318.3	0.0728
305.35	741.42	294.3	0.0941	305.33	0.109	319.8	0.0781
305.43	743.65	295.3	0.1003	305.42	0.112	321.4	0.0843
305.52	748.18	296.9	0.1047	305.50	0.117	323.6	0.0897
305.60	749.17	297.8	0.1092	305.58	0.122	325.4	0.095
305.68	751.73	298.8	0.1136	305.68	0.124	326.5	0.103
305.77	754.52	300.1	0.1181	305.75	0.128	328	0.1074
305.85	758.18	301.7	0.1234	305.83	0.133	330.2	0.1127
305.93	761.64	303.1	0.1287	305.92	0.136	331.5	0.1198
306.02	763.07	303.9	0.134	306.00	0.141	333.1	0.126
306.10	764.06	304.7	0.1367	306.08	0.142	334.2	0.1296
306.18	767.95	306.1	0.142	306.17	0.146	335.6	0.1349
306.27	769.48	307	0.1447	306.25	0.149	336.8	0.1394
306.37	772.74	308.5	0.1509	306.33	0.152	338.3	0.1447
306.43	775.23	309.4	0.1544	306.42	0.156	340	0.1491
306.52	777.05	310.3	0.158	306.50	0.159	341.2	0.1562
306.60	778.52	311.2	0.1607	306.58	0.162	342.3	0.1616
306.68	782.7	312.6	0.166	306.67	0.165	343.5	0.166
306.77	783.87	313.6	0.1678	306.75	0.167	344.6	0.1704
306.85	786.09	314.5	0.1722	306.83	0.17	345.7	0.1749
306.93	787.51	315.3	0.1766	306.92	0.172	346.8	0.1793
307.02	789.51	316.2	0.1793	307.00	0.176	348.4	0.1837
307.10	791.3	317	0.1829	307.08	0.178	349.3	0.1891
307.18	792.16	317.8	0.1846	307.18	0.18	350.1	0.1926
307.27	794.52	318.6	0.1882	307.25	0.183	351.4	0.1971
307.35	797.11	319.7	0.1908	307.33	0.185	352.4	0.1997
307.43	797.87	320.4	0.1944	307.42	0.187	353.1	0.205
307.52	799.43	321.1	0.1971	307.50	0.189	354	0.2086
307.60	801.22	321.8	0.1997	307.58	0.193	355.3	0.213
307.68	801.55	322.5	0.2015	307.67	0.192	355.7	0.2148
307.78	805.04	323.8	0.2059	307.75	0.195	356.4	0.2184
307.85	803.97	323.9	0.2068	307.83	0.197	357.2	0.221
307.93	806.49	324.7	0.2095	307.92	0.199	358.2	0.2237
308.02	808.89	325.5	0.2121	308.00	0.2	358.8	0.2281
308.10	807.85	325.8	0.213	308.08	0.203	359.7	0.2308
308.18	808.28	326.1	0.2148	308.17	0.202	359.9	0.2326
308.27	810.31	327	0.2166	308.25	0.204	360.5	0.2352
308.35	811.2	327.5	0.2184	308.33	0.205	361	0.237
308.43	812.46	328.1	0.221	308.42	0.206	361.6	0.2397
308.52	810.5	328.2	0.221	308.50	0.207	362.2	0.2414
308.60	813.46	328.8	0.2237	308.60	0.207	362.5	0.245
308.68	815.18	329.5	0.2255	308.67	0.208	362.8	0.2459
308.77	813.29	329.5	0.2255	308.75	0.209	363.3	0.2477
308.85	814.28	330.1	0.2272	308.83	0.21	363.7	0.2485
308.93	815.51	330.5	0.2281	308.92	0.211	364.3	0.2512
309.02	814.11	330.5	0.2281	309.00	0.21	364.1	0.2512
309.10	815.67	331.1	0.2299	309.08	0.211	364.5	0.253
309.18	814.54	331.2	0.2308	309.17	0.213	365	0.2548
309.28	815.77	331.6	0.2317	309.25	0.21	364.7	0.2539

Prova triassiale ciclica SNGR03-C4							
tensione di confinamento (kPa)	450			tensione di confinamento (kPa)	450		
deviatore ciclico (kPa)	150			deviatore ciclico (kPa)	180		
frequenza (hz)	0.0007143			frequenza (hz)	0.0007143		
309.35	813.84	331.5	0.2308	309.33	0.21	364.7	0.2548
309.43	815.9	332	0.2326	309.42	0.211	365.3	0.2565
309.52	813.74	331.9	0.2326	309.50	0.21	365.1	0.2565
309.60	814.7	332.1	0.2326	309.58	0.209	364.9	0.2565
309.68	814.2	332.2	0.2326	309.67	0.208	364.9	0.2565
309.77	812.37	332.1	0.2326	309.75	0.208	364.9	0.2565
309.85	813.84	332.4	0.2326	309.83	0.208	364.9	0.2565
309.93	811.61	332.3	0.2326	309.92	0.207	364.9	0.2565
310.02	811.38	332.2	0.2317	310.02	0.206	364.6	0.2565
310.10	811.51	332.3	0.2326	310.08	0.205	364.5	0.2565
310.18	809.12	332	0.2308	310.17	0.204	364.3	0.2565
310.27	809.48	332.1	0.2317	310.25	0.202	364	0.2556
310.35	808.72	332	0.2308	310.33	0.201	363.6	0.2548
310.43	807.12	331.6	0.2299	310.42	0.2	363.3	0.2548
310.52	805.46	331.5	0.2299	310.50	0.197	362.8	0.253
310.60	805.19	331.5	0.229	310.58	0.197	362.6	0.253
310.68	804.33	331.2	0.2281	310.67	0.195	362.2	0.2521
310.77	801.34	330.7	0.2263	310.75	0.193	361.7	0.2512
310.85	802.4	330.9	0.2272	310.83	0.19	361.3	0.2503
310.93	798.08	330.1	0.2246	310.92	0.189	360.7	0.2494
311.02	799.11	330.1	0.2246	311.00	0.187	360	0.2468
311.10	795.76	329.6	0.2228	311.08	0.185	359.6	0.2459
311.18	796.55	329.6	0.2228	311.17	0.182	358.9	0.245
311.27	791.44	328.6	0.2192	311.25	0.18	358.5	0.2432
311.35	790.14	328.2	0.2184	311.33	0.178	357.8	0.2414
311.43	788.74	327.9	0.2175	311.42	0.174	357.2	0.2397
311.52	786.18	327.3	0.2157	311.52	0.172	356.2	0.237
311.60	786.82	327.2	0.2148	311.58	0.17	355.5	0.2352
311.68	782.96	326.5	0.213	311.67	0.167	354.6	0.2334
311.77	780.53	325.8	0.2104	311.75	0.165	353.8	0.2308
311.85	779.37	325.4	0.2104	311.83	0.16	352.5	0.229
311.93	777.01	324.7	0.2068	311.92	0.158	351.9	0.2255
312.02	773.72	323.9	0.2042	312.00	0.155	351.1	0.2237
312.10	772.22	323.4	0.2024	312.08	0.152	350.1	0.221
312.20	769.46	322.5	0.2015	312.17	0.149	349.2	0.2184
312.27	766.61	321.9	0.1971	312.25	0.147	348.5	0.2157
312.35	766.28	321.5	0.1953	312.33	0.141	347	0.2121
312.43	761.29	320.3	0.1917	312.42	0.138	345.6	0.2095
312.52	760.29	319.8	0.1908	312.50	0.135	344.6	0.2042
312.60	757.13	319	0.1873	312.58	0.132	343.7	0.2015
312.68	753.44	318	0.1846	312.67	0.127	342.3	0.1971
312.77	750.35	317	0.182	312.75	0.124	341.3	0.1944
312.85	750.28	316.5	0.1793	312.83	0.121	340.3	0.1908
312.93	746.36	315.5	0.1766	312.93	0.117	338.7	0.1855
313.02	741.57	314.2	0.1722	313.00	0.111	337.1	0.182
313.10	740.87	313.6	0.1695	313.08	0.109	336.2	0.1784
313.18	737.71	312.7	0.1669	313.17	0.105	334.9	0.1749
313.27	734.42	312.1	0.1642	313.25	0.1	333.3	0.1704
313.35	728.7	309.9	0.1598	313.33	0.094	331.2	0.166
313.43	728	309.2	0.1544	313.42	0.092	330.4	0.1616
313.52	724.97	308.3	0.1509	313.50	0.088	328.9	0.1571
313.62	722.24	307.6	0.1482	313.58	0.083	327.1	0.1518
313.68	717.08	305.8	0.1438	313.67	0.08	325.8	0.1473
313.77	714.19	304.5	0.1367	313.75	0.075	324.3	0.1438
313.85	712.66	303.8	0.134	313.83	0.072	322.7	0.1394
313.93	709.17	302.7	0.1296	313.92	0.064	320.2	0.134
314.02	706.74	301.7	0.126	314.00	0.062	318.9	0.1278
314.10	705.1	300.9	0.1234	314.08	0.058	317.6	0.1234
314.18	698.74	298.9	0.1163	314.17	0.052	315.6	0.1181
314.27	695.38	297.6	0.1136	314.25	0.049	314.2	0.1127

Prova triassiale ciclica SNGR03-C4							
tensione di confinamento (kPa)	450			tensione di confinamento (kPa)	450		
deviatore ciclico (kPa)	150			deviatore ciclico (kPa)	180		
frequenza (hz)	0.0007143			frequenza (hz)	0.0007143		
314.35	692.72	296.5	0.1065	314.33	0.045	312.5	0.1083
314.43	689.35	295.3	0.1021	314.43	0.04	310.4	0.1012
314.52	686.58	294.2	0.0994	314.50	0.036	309	0.0968
314.60	684.36	293	0.0941	314.58	0.031	307.1	0.0905
314.68	680.39	291.8	0.0897	314.67	0.027	305.5	0.0861
314.77	674.96	290.4	0.0843	314.75	0.02	303.4	0.0799
314.85	670.42	288.1	0.0799	314.83	0.015	300.8	0.0746
314.93	669.56	287.2	0.0719	314.92	0.012	299.3	0.0666
315.02	666.03	286	0.0683	315.00	0.008	297.6	0.0621
315.12	662.62	284.9	0.063	315.08	0.002	295.4	0.0559
315.18	660.32	283.3	0.0586	315.17	-0.001	293.8	0.0506
315.27	655.82	281.7	0.0515	315.25	-0.005	292.1	0.0462
315.35	652.22	280.3	0.047	315.33	-0.012	289.9	0.0399
315.43	648.95	278.9	0.0426	315.42	-0.017	287	0.0346
315.52	647.35	277.6	0.0373	315.50	-0.02	285.5	0.0266
315.60	642.68	276.2	0.032	315.58	-0.024	283.8	0.0222
315.68	639.01	274.9	0.0275	315.67	-0.032	281.1	0.0142
315.77	634.5	272.9	0.0231	315.75	-0.033	279.8	0.0098
315.85	633.2	272	0.0178	315.85	-0.039	277.1	0.0036
315.93	629.96	270.7	0.0133	315.92	-0.043	275.4	-0.0009
316.02	626.65	269.6	0.008	316.00	-0.048	273.3	-0.0062
316.10	624.15	268.3	0.0036	316.08	-0.051	271.6	-0.0115
316.18	620.64	266.9	-0.0009	316.17	-0.055	269.9	-0.0151
316.27	615.93	265.4	-0.0053	316.25	-0.061	267.6	-0.0204
316.35	612.76	263.5	-0.0098	316.33	-0.066	264.8	-0.0249
316.43	610.09	262.1	-0.016	316.42	-0.069	263.1	-0.032
316.53	607.15	260.8	-0.0195	316.50	-0.074	261.1	-0.0364
316.60	603.74	259.5	-0.0231	316.58	-0.077	259.6	-0.0399
316.68	600.73	257.7	-0.0266	316.67	-0.08	257.8	-0.0444
316.77	599.46	256.6	-0.0311	316.75	-0.084	256	-0.0488
316.85	594.98	255.1	-0.0355	316.83	-0.092	253.4	-0.0541
316.93	591.71	253.6	-0.0391	316.92	-0.094	251	-0.0577
317.02	589.43	252.3	-0.0426	317.00	-0.097	249.1	-0.063
317.10	587.56	251.2	-0.0453	317.08	-0.101	247.4	-0.0675
317.18	582.45	249.6	-0.0488	317.17	-0.106	245.3	-0.071
317.27	580.14	247.8	-0.0515	317.25	-0.106	243.9	-0.0746
317.35	577.86	246.5	-0.0559	317.35	-0.113	241.2	-0.0808
317.43	575.16	245.2	-0.0586	317.42	-0.117	239.6	-0.0834
317.52	572.08	243.7	-0.0621	317.50	-0.122	237.5	-0.0879
317.60	570.64	242.6	-0.0648	317.58	-0.123	236.1	-0.0905
317.68	567.5	241.3	-0.0683	317.67	-0.127	234.4	-0.0941
317.77	561.48	240.1	-0.071	317.75	-0.132	232.6	-0.0968
317.85	562.81	238.6	-0.0728	317.83	-0.135	230.1	-0.0994
317.93	559.87	237.2	-0.0772	317.92	-0.136	229	-0.1047
318.02	557.83	236.2	-0.079	318.00	-0.141	227	-0.1083
318.10	556.32	234.9	-0.0817	318.08	-0.144	225.5	-0.111
318.18	551.67	233.2	-0.0834	318.17	-0.146	224.1	-0.1145
318.27	550.8	232.3	-0.0879	318.25	-0.149	222.5	-0.1172
318.35	548.52	231.2	-0.0905	318.33	-0.152	220.9	-0.1198
318.43	546.21	230	-0.0923	318.42	-0.157	218.5	-0.1234
318.52	544.81	229.1	-0.0941	318.50	-0.159	217.1	-0.1278
318.60	542.6	228	-0.0968	318.58	-0.161	215.7	-0.1305
318.68	540.06	226.9	-0.0985	318.67	-0.163	214.4	-0.1331
318.77	537.85	225.5	-0.1003	318.77	-0.168	212.1	-0.1367
318.85	534.3	224.2	-0.1039	318.83	-0.169	211.3	-0.1394
318.93	535.23	223.8	-0.1047	318.92	-0.17	210	-0.142
319.02	533.53	222.9	-0.1065	319.00	-0.172	209.3	-0.1438
319.10	532.76	222.1	-0.1083	319.08	-0.176	207.4	-0.1473
319.18	530.45	221.2	-0.1101	319.17	-0.177	206.6	-0.1491
319.27	528.54	220.4	-0.1118	319.25	-0.18	205.6	-0.1509

Prova triassiale ciclica SNGR03-C4								
tensione di confinamento (kPa)	450			tensione di confinamento (kPa)	450			
deviatore ciclico (kPa)	150			deviatore ciclico (kPa)	180			
frequenza (hz)	0.0007143			frequenza (hz)	0.0007143			
319.35	527.3	219.2	-0.1127	319.33	-0.18	204.7	-0.1518	
319.45	526.59	218.6	-0.1154	319.42	-0.186	202.6	-0.1562	
319.52	525.19	217.9	-0.1163	319.50	-0.184	202.5	-0.158	
319.60	523.11	217.1	-0.1181	319.58	-0.187	201.4	-0.1589	
319.68	522.48	216.2	-0.1189	319.67	-0.186	200.8	-0.1616	
319.77	522.17	215.7	-0.1207	319.75	-0.19	199.4	-0.1633	
319.85	520.57	214.9	-0.1216	319.83	-0.19	199	-0.1642	
319.93	519.76	214.4	-0.1234	319.92	-0.19	198.4	-0.1651	
320.02	519.19	213.8	-0.1243	320.00	-0.193	197.2	-0.1678	
320.10	519.22	213.6	-0.1252	320.08	-0.194	196.6	-0.1687	
320.18	517.01	212.5	-0.1269	320.18	-0.193	196.3	-0.1695	
320.27	517.18	212.2	-0.1269	320.25	-0.196	195.3	-0.1713	
320.35	517.71	212	-0.1278	320.33	-0.198	194.3	-0.174	
320.43	516.34	211.5	-0.1287	320.42	-0.197	194.4	-0.174	
320.52	515.74	211	-0.1296	320.50	-0.197	194.1	-0.1749	
320.60	515.44	210.1	-0.1305	320.58	-0.198	193.7	-0.1758	
320.68	514.83	210.2	-0.1305	320.67	-0.198	193.5	-0.1758	
320.77	515.7	210.2	-0.1305	320.75	-0.197	193.5	-0.1766	
320.85	514.76	209.7	-0.1314	320.83	-0.198	193.1	-0.1766	
320.93	514.66	209.4	-0.1323	320.92	-0.199	192.5	-0.1784	
321.02	515.43	209.4	-0.1323	321.00	-0.198	192.7	-0.1784	
321.10	514.83	209	-0.1323	321.08	-0.197	192.8	-0.1784	
321.18	515.5	209	-0.1323	321.17	-0.198	192.5	-0.1793	
321.27	516.07	208.9	-0.1323	321.25	-0.197	192.7	-0.1793	
321.35	516.47	208.9	-0.1323	321.33	-0.196	192.7	-0.1793	
321.43	516.73	208.8	-0.1331	321.42	-0.196	192.6	-0.1793	
321.52	516.23	208.6	-0.1331	321.50	-0.195	192.9	-0.1793	
321.60	517.54	208.8	-0.1331	321.58	-0.195	192.7	-0.1793	
321.68	517.64	208.7	-0.1331	321.68	-0.193	193.1	-0.1793	
321.77	519.21	208.9	-0.1331	321.75	-0.192	193.8	-0.1793	
321.85	520.08	209	-0.1323	321.83	-0.191	194	-0.1784	
321.93	520.95	209.2	-0.1314	321.92	-0.19	194.5	-0.1784	
322.02	524.03	209.8	-0.1305	322.00	-0.189	194.7	-0.1784	
322.10	523.56	209.7	-0.1305	322.08	-0.187	195.1	-0.1775	
322.18	522.72	209.5	-0.1314	322.17	-0.183	196.3	-0.1766	
322.27	525.46	210.1	-0.1296	322.25	-0.185	195.9	-0.1775	
322.37	526.1	210.3	-0.1296	322.33	-0.182	197	-0.1766	
322.43	527.94	210.7	-0.1287	322.42	-0.18	197.6	-0.1758	
322.52	529.21	211.1	-0.1278	322.50	-0.179	198.2	-0.1749	
322.60	531.29	211.4	-0.1278	322.58	-0.176	199	-0.174	
322.68	532.12	211.9	-0.1269	322.67	-0.175	199.6	-0.1731	
322.77	534	212.4	-0.126	322.75	-0.173	200.4	-0.1722	
322.85	535.6	212.8	-0.1252	322.83	-0.17	201.3	-0.1713	
322.93	537.21	213.3	-0.1243	322.92	-0.167	202.5	-0.1704	
323.02	538.81	213.7	-0.1234	323.00	-0.163	203.8	-0.1687	
323.10	540.46	214.2	-0.1225	323.08	-0.163	204.2	-0.1678	
323.18	543.56	214.8	-0.1216	323.17	-0.159	204.8	-0.1669	
323.27	544.13	215.3	-0.1207	323.25	-0.157	206.4	-0.166	
323.35	546.74	216.1	-0.1189	323.33	-0.155	207.3	-0.1642	
323.43	549.08	216.9	-0.1181	323.42	-0.153	208.1	-0.1633	
323.52	551.33	217.6	-0.1163	323.50	-0.149	209.7	-0.1616	
323.60	552.93	218.2	-0.1154	323.58	-0.147	210.6	-0.1607	
323.68	555.41	219	-0.1136	323.67	-0.143	212.1	-0.1589	
323.78	558.82	220.1	-0.1118	323.75	-0.139	213.3	-0.1571	
323.85	561.43	221	-0.1101	323.83	-0.135	215.1	-0.1553	
323.93	562.47	221.5	-0.1092	323.92	-0.132	216.7	-0.1527	
324.02	563.7	222.1	-0.1083	324.00	-0.129	217.6	-0.1509	
324.10	568.45	223.2	-0.1065	324.08	-0.128	218.5	-0.15	
324.18	571.23	224.5	-0.1047	324.17	-0.124	220	-0.1482	
324.27	573.7	225.3	-0.1012	324.25	-0.12	221.7	-0.1456	

Prova triassiale ciclica SNGR03-C4							
tensione di confinamento (kPa)	450			tensione di confinamento (kPa)	450		
deviatore ciclico (kPa)	150			deviatore ciclico (kPa)	180		
frequenza (hz)	0.0007143			frequenza (hz)	0.0007143		
324.35	575.41	226.2	-0.1003	324.33	-0.115	223.3	-0.1438
324.43	578.18	227.1	-0.0985	324.42	-0.111	225.4	-0.142
324.52	580.46	228.1	-0.0968	324.50	-0.108	226.6	-0.1385
324.60	583.67	229.2	-0.095	324.60	-0.104	228.2	-0.1367
324.68	587.55	230.5	-0.0914	324.67	-0.099	230.3	-0.134
324.77	590.69	231.8	-0.0905	324.75	-0.095	232.2	-0.1323
324.85	593.03	232.7	-0.087	324.83	-0.092	233.4	-0.1287
324.93	595.84	233.7	-0.0852	324.92	-0.086	235.5	-0.126
325.02	598.48	234.8	-0.0826	325.00	-0.085	236.7	-0.1243
325.10	600.66	235.8	-0.0808	325.08	-0.081	238.2	-0.1207
325.18	603.56	236.9	-0.0781	325.17	-0.076	240.2	-0.1181
325.28	607.71	238.6	-0.0754	325.25	-0.071	242.7	-0.1154
325.35	611.15	239.8	-0.0719	325.33	-0.066	244.7	-0.1127
325.43	613.76	240.8	-0.0692	325.42	-0.064	246	-0.1083
325.52	617.03	242.1	-0.0666	325.50	-0.058	248	-0.1047
325.60	621.38	243.3	-0.0639	325.58	-0.054	250	-0.1021
325.68	624.12	245	-0.0621	325.67	-0.052	251.3	-0.0985
325.77	627.09	246.1	-0.0577	325.75	-0.046	253.6	-0.0959
325.85	630.43	247.4	-0.0541	325.83	-0.04	256.1	-0.0941
325.93	634.01	248.8	-0.0506	325.92	-0.036	258	-0.0905
326.02	636.11	249.9	-0.0479	326.02	-0.032	259.7	-0.0843
326.10	640.09	251.2	-0.0453	326.08	-0.029	261.4	-0.0817
326.18	644.03	252.5	-0.0426	326.17	-0.022	264.2	-0.0781
326.27	647.57	254.5	-0.0391	326.25	-0.018	266	-0.0746
326.35	653.04	256.1	-0.032	326.33	-0.015	267.5	-0.0692
326.43	653.21	257	-0.0302	326.42	-0.01	269.6	-0.0648
326.52	657.15	258.4	-0.0257	326.50	-0.006	271.8	-0.0604
326.60	659.56	259.6	-0.0231	326.58	-0.002	273.4	-0.0559
326.70	663.96	261.5	-0.0169	326.67	0.003	275.4	-0.0524
326.77	666.3	262.6	-0.0142	326.75	0.01	278.2	-0.0479
326.85	670.54	264.2	-0.0098	326.83	0.015	280.3	-0.0444
326.93	673.01	265.4	-0.0062	326.92	0.016	281.7	-0.0373
327.02	676.38	266.6	-0.0027	327.00	0.023	283.8	-0.0328
327.10	681.55	268.9	0.0036	327.08	0.027	285.7	-0.0275
327.18	684.28	270.1	0.0071	327.17	0.03	287.5	-0.0231
327.27	685.25	271	0.0115	327.25	0.036	289.6	-0.0178
327.35	690.25	272.6	0.016	327.33	0.042	292.2	-0.0133
327.43	694.42	274.1	0.0213	327.42	0.046	294.1	-0.0089
327.52	696.09	275.2	0.0249	327.52	0.049	295.5	-0.0018
327.60	700.06	276.7	0.0293	327.58	0.054	297.4	0.0027
327.68	701.99	278.2	0.0346	327.67	0.059	300	0.008
327.77	708.02	280.1	0.0391	327.75	0.065	302.3	0.0133
327.85	710.25	281.2	0.0462	327.83	0.067	303.5	0.0222
327.93	712.92	282.5	0.0497	327.92	0.072	305.3	0.0266
328.02	716.48	284	0.0568	328.00	0.077	307.7	0.0337
328.10	718.52	285.1	0.0595	328.08	0.079	308.8	0.0382
328.18	723.08	286.8	0.0666	328.17	0.084	310.6	0.0435
328.27	724.51	287.9	0.0701	328.25	0.09	313	0.0488
328.35	729.14	289.4	0.0754	328.33	0.094	314.9	0.0533
328.43	730.04	290.3	0.079	328.42	0.097	316.2	0.0612
328.52	734.33	291.7	0.0843	328.50	0.101	317.9	0.0666
328.60	737.06	293.4	0.0905	328.58	0.105	319.6	0.0728
328.68	741.35	294.8	0.0932	328.67	0.108	320.9	0.0781
328.77	746.11	296.4	0.1021	328.75	0.113	322.7	0.0834
328.85	746.34	297.1	0.1056	328.83	0.118	325.2	0.0897
328.93	747.6	298	0.1083	328.93	0.12	326.1	0.0959
329.02	751.26	299.3	0.1127	329.00	0.123	327.4	0.1003
329.10	754.69	300.6	0.1181	329.08	0.128	329.2	0.1065
329.18	758.25	302.3	0.1234	329.17	0.133	331.3	0.1118
329.27	759.74	303.2	0.1252	329.25	0.136	332.7	0.1163

Prova triassiale ciclica SNGR03-C4							
tensione di confinamento (kPa)	450			tensione di confinamento (kPa)	450		
deviatore ciclico (kPa)	150			deviatore ciclico (kPa)	180		
frequenza (hz)	0.0007143			frequenza (hz)	0.0007143		
329.35	762.67	304.3	0.1331	329.33	0.139	333.9	0.1243
329.43	765.39	305.5	0.1367	329.42	0.143	335.4	0.1287
329.52	767.15	306.5	0.1411	329.50	0.145	336.7	0.134
329.62	773.01	308.2	0.1447	329.58	0.148	337.9	0.1385
329.68	772.3	309	0.1509	329.67	0.154	339.6	0.1438
329.77	774.36	309.8	0.1536	329.75	0.156	341.1	0.1473
329.85	778.95	311.2	0.1598	329.83	0.159	342.3	0.1527
329.93	777.05	311.5	0.1607	329.92	0.161	343.3	0.1598
330.02	781.31	312.7	0.1642	330.00	0.165	344.6	0.1651
330.10	784.17	314.1	0.1678	330.08	0.17	346.2	0.1704
330.18	784.76	314.8	0.1722	330.17	0.168	346.5	0.1731
330.27	787.31	315.7	0.1766	330.25	0.173	348.1	0.1784
330.35	789.77	316.7	0.1793	330.33	0.176	349.6	0.182
330.43	791.1	317.7	0.1829	330.42	0.177	350.4	0.1882
330.52	792.16	318.2	0.1846	330.50	0.18	351.3	0.1926
330.60	794.62	319.1	0.1873	330.58	0.185	352.6	0.1971
330.68	796.41	320.1	0.19	330.67	0.184	353.4	0.1988
330.77	798.27	320.9	0.1926	330.75	0.188	354.5	0.2024
330.85	799.66	321.6	0.1971	330.83	0.189	355.1	0.2086
330.93	800.86	322.4	0.1988	330.92	0.192	356	0.2113
331.02	804.81	323.4	0.2033	331.00	0.192	356.7	0.2148
331.10	806.38	324.4	0.2033	331.08	0.195	357.5	0.2175
331.18	803.84	324.3	0.2068	331.17	0.198	358.7	0.2219
331.27	806.56	325.1	0.2086	331.25	0.199	359.3	0.2228
331.35	806.79	325.7	0.2104	331.33	0.2	359.8	0.2255
331.43	807.69	326.2	0.2121	331.42	0.201	360.5	0.2299
331.52	808.15	326.6	0.2139	331.50	0.202	361	0.2326
331.60	813.6	327.9	0.2157	331.58	0.203	361.6	0.2352
331.68	808.78	327.5	0.2175	331.67	0.205	362.2	0.2379
331.77	811.3	328.3	0.2192	331.75	0.206	362.6	0.2397
331.85	812.9	328.9	0.221	331.85	0.207	363.4	0.2432
331.93	812.46	329.5	0.2237	331.92	0.207	363.5	0.2441
332.02	813.42	329.7	0.2237	332.00	0.209	364.2	0.2468
332.10	812.55	329.8	0.2246	332.08	0.207	364	0.2468
332.18	814.45	330.5	0.2263	332.17	0.209	364.7	0.2494
332.27	814.41	330.8	0.2272	332.25	0.21	365	0.2503
332.35	817.5	331.5	0.229	332.33	0.21	365.3	0.2521
332.43	814.05	331.3	0.2281	332.42	0.211	365.7	0.253
332.53	814.67	331.7	0.2299	332.50	0.209	365.5	0.253
332.60	814.31	331.8	0.2299	332.58	0.213	366.2	0.2548
332.68	814.81	332.1	0.2308	332.67	0.21	366	0.2548
332.77	814.51	332.3	0.2317	332.75	0.209	365.9	0.2556
332.85	814.21	332.4	0.2317	332.83	0.209	366	0.2556
332.93	813.84	332.4	0.2317	332.92	0.21	366.3	0.2565
333.02	816.23	332.9	0.2326	333.00	0.209	366.2	0.2565
333.10	812.31	332.5	0.2317	333.08	0.208	366	0.2565
333.18	814.44	332.9	0.2326	333.17	0.207	365.9	0.2565
333.27	811.29	332.7	0.2308	333.25	0.207	365.8	0.2565
333.35	811.44	332.5	0.2317	333.33	0.206	365.7	0.2556
333.43	812.01	332.9	0.2317	333.42	0.205	365.6	0.2565
333.52	810.12	332.7	0.2308	333.50	0.205	365.5	0.2556
333.60	809.25	332.5	0.2308	333.58	0.203	365.3	0.2556
333.68	807.85	332.3	0.2308	333.67	0.2	364.5	0.2539
333.77	806.42	332.1	0.2299	333.75	0.201	364.5	0.2539
333.85	805.99	332.1	0.229	333.83	0.198	364.1	0.253
333.95	805.03	331.9	0.229	333.92	0.196	363.5	0.2521
334.02	802.87	331.5	0.2281	334.00	0.195	363.2	0.2512
334.10	801.14	331.2	0.2263	334.08	0.194	363	0.2512
334.18	800.58	331.1	0.2255	334.17	0.191	362.3	0.2494
334.27	798.98	330.8	0.2255	334.25	0.188	361.5	0.2485

Prova triassiale ciclica SNGR03-C4							
tensione di confinamento (kPa)	450			tensione di confinamento (kPa)	450		
deviatore ciclico (kPa)	150			deviatore ciclico (kPa)	180		
frequenza (hz)	0.0007143			frequenza (hz)	0.0007143		
334.35	798.02	330.5	0.2237	334.33	0.187	361.1	0.2468
334.43	797.52	330.4	0.2237	334.42	0.185	360.7	0.2459
334.52	791.47	329.7	0.221	334.50	0.183	360.1	0.245
334.60	792.76	329.2	0.2201	334.58	0.18	359.5	0.2432
334.68	791.6	328.9	0.2184	334.67	0.176	358.3	0.2388
334.77	788.78	328.4	0.2175	334.77	0.175	357.9	0.2379
334.85	786.22	327.8	0.2148	334.83	0.172	357.1	0.2361
334.93	785.35	327.5	0.2139	334.92	0.17	356.6	0.2343
335.02	783.59	327	0.2121	335.00	0.169	356.1	0.2334
335.10	780.14	326.5	0.2104	335.08	0.164	354.7	0.2299
335.18	778.64	325.7	0.2086	335.17	0.158	353.2	0.229
335.27	776.21	325	0.2059	335.25	0.16	353	0.2246
335.35	774.52	324.5	0.2042	335.33	0.156	352.3	0.2228
335.45	772.23	324	0.2024	335.42	0.148	350.5	0.2192
335.52	768.14	322.8	0.1997	335.50	0.151	350.5	0.2184
335.60	767.27	322.4	0.1971	335.58	0.146	349.4	0.2148
335.68	764.42	321.6	0.1944	335.67	0.139	348.2	0.2113
335.77	762.29	320.9	0.1917	335.75	0.139	347	0.2077
335.85	760	320.1	0.1891	335.83	0.135	345.8	0.2042
335.93	757.27	319.4	0.1873	335.92	0.13	344.3	0.1997
336.02	753.98	318.5	0.1837	336.00	0.128	343.5	0.1971
336.10	751.11	317.5	0.182	336.08	0.126	342.6	0.1944
336.18	747.46	316.2	0.1775	336.18	0.12	340.8	0.1891
336.27	745.6	315.7	0.1749	336.25	0.118	340.1	0.1864
336.35	744.03	314.9	0.1722	336.33	0.111	338.2	0.1811
336.43	740.41	314.1	0.1687	336.42	0.107	336.6	0.1766
336.52	738.11	313.2	0.166	336.50	0.105	335.7	0.1731
336.60	733.62	312	0.1624	336.58	0.098	334.6	0.1704
336.68	730.63	310.8	0.1607	336.67	0.093	332	0.1669
336.77	727.93	309.8	0.1536	336.75	0.092	331.2	0.1607
336.87	725.27	308.9	0.1509	336.83	0.088	329.8	0.1562
336.93	721.11	307.9	0.1473	336.92	0.083	328	0.1509
337.02	719.78	306.8	0.1438	337.00	0.082	327.3	0.1482
337.10	714.29	305.1	0.1367	337.08	0.076	325.5	0.1429
337.18	712.49	304.3	0.1331	337.17	0.07	323.8	0.1385
337.27	708.03	302.9	0.1287	337.25	0.065	321.5	0.1331
337.35	707	302.1	0.126	337.33	0.062	320.1	0.1278
337.43	703.11	300.9	0.1216	337.42	0.058	318.6	0.1225
337.52	698.78	299.8	0.1172	337.50	0.053	316.8	0.1172
337.60	695.41	298.1	0.1145	337.58	0.05	315.3	0.1127
337.68	692.75	296.9	0.1065	337.68	0.045	313	0.1056
337.77	689.59	295.7	0.1021	337.75	0.039	311.4	0.1003
337.85	686.75	294.7	0.0976	337.83	0.034	309.4	0.095
337.93	683.79	293.4	0.0932	337.92	0.031	307.9	0.0897
338.02	680.49	292.2	0.0888	338.00	0.026	306.1	0.0843
338.10	674.16	291.3	0.0852	338.08	0.02	304.3	0.079
338.18	672.49	289	0.079	338.17	0.014	301.4	0.0737
338.27	669.73	287.8	0.0719	338.25	0.013	300.5	0.0666
338.35	666.73	286.6	0.0675	338.33	0.008	298.7	0.0612
338.43	662.36	285.2	0.0621	338.42	0.001	296.1	0.0541
338.52	658.19	283.3	0.0577	338.50	0	294.6	0.0497
338.60	658.59	282.6	0.0524	338.58	-0.005	292.9	0.0444
338.68	652.85	280.8	0.0462	338.67	-0.013	291.3	0.0391
338.77	649.32	279.5	0.0417	338.75	-0.014	288.8	0.0337
338.85	647.38	278.1	0.0364	338.83	-0.02	286.3	0.0257
338.93	641.04	276.2	0.0302	338.92	-0.024	284.8	0.0204
339.02	638.4	275.4	0.0266	339.00	-0.03	282.4	0.0142
339.10	635.1	273.4	0.0231	339.10	-0.035	279.9	0.0089
339.18	633.13	272.2	0.016	339.17	-0.038	278.2	0.0027
339.27	629.06	270.7	0.0115	339.25	-0.045	275.8	-0.0036

Prova triassiale ciclica SNGR03-C4							
tensione di confinamento (kPa)	450			tensione di confinamento (kPa)	450 <th colspan="2"></th>		
deviatore ciclico (kPa)	150			deviatore ciclico (kPa)	180		
frequenza (hz)	0.0007143			frequenza (hz)	0.0007143		
339.35	627.09	270	0.008	339.33	-0.047	274.4	-0.0071
339.43	621.44	268.2	0.0018	339.42	-0.05	272.8	-0.0115
339.52	620.17	267.1	-0.0018	339.50	-0.055	270.9	-0.0178
339.60	615.47	265.7	-0.0062	339.58	-0.061	268.4	-0.0231
339.68	612.53	263.8	-0.0098	339.67	-0.066	265.8	-0.0266
339.78	612.36	263.2	-0.0142	339.75	-0.069	263.9	-0.0337
339.85	607.18	261.5	-0.0186	339.83	-0.075	261.8	-0.0382
339.93	602.47	259.7	-0.024	339.92	-0.079	260	-0.0426
340.02	600.63	258	-0.0275	340.00	-0.08	258.4	-0.0462
340.10	598.09	256.8	-0.0328	340.08	-0.084	256.9	-0.0497
340.18	595.38	255.5	-0.0364	340.17	-0.09	254.7	-0.0541
340.27	591.87	254	-0.0399	340.25	-0.095	251.6	-0.0595
340.35	589.73	252.7	-0.0435	340.33	-0.097	250.1	-0.0648
340.43	586.92	251.4	-0.0462	340.42	-0.101	248.4	-0.0683
340.52	582.75	250	-0.0488	340.50	-0.106	246.1	-0.0728
340.60	579.14	247.9	-0.0524	340.58	-0.113	243.1	-0.0763
340.68	578.1	246.8	-0.0577	340.67	-0.111	242.5	-0.0808
340.77	574.95	245.5	-0.0604	340.75	-0.119	240	-0.0861
340.85	572.55	244.2	-0.0621	340.83	-0.12	238.6	-0.0888
340.93	570.64	243.1	-0.0657	340.92	-0.12	237.8	-0.0914
341.02	567.66	241.7	-0.0683	341.00	-0.127	235.3	-0.0968
341.10	563.62	240.4	-0.0719	341.08	-0.131	233.1	-0.0994
341.18	562.11	238.8	-0.0746	341.17	-0.135	231.2	-0.1012
341.27	560.27	237.7	-0.0772	341.25	-0.137	229.6	-0.1065
341.35	557.63	236.5	-0.0799	341.33	-0.14	228	-0.1101
341.43	554.38	235.4	-0.0826	341.42	-0.144	226.2	-0.1136
341.52	552.27	233.6	-0.0852	341.50	-0.146	224.9	-0.1163
341.60	550.53	232.4	-0.0888	341.58	-0.149	223.1	-0.1198
341.68	548.39	231.5	-0.0905	341.67	-0.153	221.5	-0.1225
341.77	546.01	230.3	-0.0932	341.75	-0.156	219.3	-0.126
341.85	544.74	229.4	-0.0959	341.83	-0.159	217.5	-0.1305
341.93	541.96	228.1	-0.0976	341.92	-0.161	216.7	-0.1323
342.02	539.72	227.3	-0.0994	342.02	-0.166	214.4	-0.1367
342.10	538.32	225.9	-0.1012	342.08	-0.166	213.4	-0.1376
342.18	536.54	225	-0.1039	342.17	-0.168	212.5	-0.1411
342.27	534.36	224	-0.1056	342.25	-0.17	211.2	-0.1438
342.35	533.86	223.3	-0.1074	342.33	-0.174	209.3	-0.1465
342.43	532.89	222.4	-0.1092	342.42	-0.173	209.1	-0.1491
342.52	530.58	221.6	-0.111	342.50	-0.178	207.3	-0.1518
342.60	529.24	220.7	-0.1127	342.58	-0.179	206.4	-0.1527
342.70	529.27	220.1	-0.1136	342.67	-0.18	205.6	-0.1544
342.77	526.9	219.1	-0.1154	342.75	-0.182	204.1	-0.158
342.85	525.15	218.2	-0.1172	342.83	-0.184	203.3	-0.1598
342.93	523.58	217.4	-0.1189	342.92	-0.187	202.1	-0.1616
343.02	522.61	216.5	-0.1198	343.00	-0.187	201.4	-0.1633
343.10	521.37	215.8	-0.1216	343.08	-0.189	200.5	-0.1651
343.18	520.66	215.3	-0.1225	343.17	-0.19	199.6	-0.1669
343.27	520.03	214.2	-0.1252	343.25	-0.192	198.7	-0.1678
343.35	518.49	214	-0.1252	343.33	-0.193	197.9	-0.1704
343.43	518.89	213.8	-0.126	343.42	-0.193	197.5	-0.1713
343.52	517.91	213.2	-0.1269	343.50	-0.195	197	-0.1722
343.60	516.81	212.5	-0.1278	343.58	-0.195	196.2	-0.174
343.68	516.51	212.1	-0.1287	343.67	-0.196	195.8	-0.1749
343.77	517.08	211.9	-0.1287	343.75	-0.197	194.9	-0.1766
343.85	515.27	210.8	-0.1305	343.83	-0.197	194.8	-0.1766
343.93	515.3	210.9	-0.1305	343.92	-0.197	194.6	-0.1775
344.02	515.77	210.8	-0.1305	344.00	-0.197	194.3	-0.1784
344.12	514.66	210.2	-0.1323	344.08	-0.197	194.3	-0.1784
344.18	515.3	210.1	-0.1323	344.17	-0.198	193.7	-0.1793
344.27	514.93	209.8	-0.1323	344.25	-0.198	193.5	-0.1802

Prova triassiale ciclica SNGR03-C4							
tensione di confinamento (kPa)	450			tensione di confinamento (kPa)	450		
deviatore ciclico (kPa)	150			deviatore ciclico (kPa)	180		
frequenza (hz)	0.0007143			frequenza (hz)	0.0007143		
344.35	514.96	209.6	-0.1331	344.33	-0.197	193.5	-0.1811
344.43	515.3	209.5	-0.1331	344.42	-0.198	193.3	-0.1811
344.52	515.43	209.3	-0.1331	344.50	-0.197	193.4	-0.1811
344.60	515.8	209.2	-0.1331	344.58	-0.197	193.3	-0.182
344.68	516.03	209.1	-0.1331	344.67	-0.196	193.4	-0.182
344.77	516.5	209.1	-0.1331	344.75	-0.195	193.6	-0.182
344.85	517	209	-0.1331	344.83	-0.195	193.7	-0.182
344.93	517.37	209	-0.1331	344.93	-0.195	193.6	-0.182
345.02	518.57	209.1	-0.1331	345.00	-0.193	194.1	-0.182
345.10	518.57	209.1	-0.1331	345.08	-0.192	194.5	-0.1811
345.18	519.98	209.3	-0.1331	345.17	-0.191	194.7	-0.1811
345.27	521.01	209.5	-0.1323	345.25	-0.19	195.2	-0.1811
345.35	521.68	209.6	-0.1323	345.33	-0.188	195.8	-0.1802
345.43	522.55	209.8	-0.1314	345.42	-0.187	196	-0.1802
345.52	523.92	210.1	-0.1314	345.50	-0.186	196.4	-0.1793
345.62	525.03	210.3	-0.1305	345.58	-0.184	197.1	-0.1793
345.68	526.4	210.7	-0.1305	345.67	-0.181	198	-0.1784
345.77	527.74	210.9	-0.1296	345.75	-0.181	198.3	-0.1775
345.85	530.95	211.7	-0.1287	345.83	-0.18	198.7	-0.1775
345.93	530.38	211.7	-0.1287	345.92	-0.176	199.9	-0.1758
346.02	532.99	212.4	-0.1278	346.00	-0.175	200.3	-0.1758
346.10	533.69	212.6	-0.1269	346.08	-0.172	201.3	-0.1749
346.18	535.7	213.1	-0.126	346.17	-0.17	201.9	-0.174
346.27	537.27	213.6	-0.1252	346.25	-0.165	203.8	-0.1713
346.35	538.85	214.1	-0.1243	346.35	-0.166	204	-0.1713
346.43	540.69	214.6	-0.1234	346.42	-0.163	204.9	-0.1704
346.52	542.83	215.1	-0.1225	346.50	-0.159	205.8	-0.1695
346.60	544.83	215.8	-0.1216	346.58	-0.157	207.3	-0.1678
346.68	546.57	216.5	-0.1198	346.67	-0.155	208.1	-0.1669
346.77	548.95	217.1	-0.1189	346.75	-0.152	209.2	-0.1651
346.85	551.06	217.8	-0.1172	346.83	-0.148	210.6	-0.1633
346.93	552.6	218.5	-0.1154	346.92	-0.148	211.2	-0.1624
347.03	555.74	219.5	-0.1145	347.00	-0.143	212.7	-0.1607
347.10	558.32	220.4	-0.1127	347.08	-0.139	214	-0.1589
347.18	560.66	221.2	-0.111	347.17	-0.133	216.6	-0.158
347.27	562.63	221.8	-0.1101	347.25	-0.133	217.1	-0.1553
347.35	564.87	222.7	-0.1083	347.33	-0.129	218.3	-0.1536
347.43	569.59	224.1	-0.1056	347.42	-0.126	219.9	-0.1518
347.52	568.82	224.3	-0.1065	347.50	-0.124	220.9	-0.1509
347.60	573.07	225.5	-0.103	347.58	-0.12	222.2	-0.1482
347.68	575.84	226.5	-0.1012	347.67	-0.114	223.9	-0.1456
347.77	578.52	227.6	-0.0994	347.75	-0.112	226	-0.1438
347.85	581.03	228.5	-0.0976	347.85	-0.107	227.8	-0.1402
347.93	583.37	229.5	-0.095	347.92	-0.105	228.6	-0.1394
348.02	588.32	230.5	-0.0932	348.00	-0.099	230.6	-0.1367
348.10	590.52	232	-0.0914	348.08	-0.096	232.7	-0.134
348.18	593.33	233.2	-0.0879	348.17	-0.092	234.1	-0.1305
348.27	595.34	234	-0.0861	348.25	-0.088	235.8	-0.1287
348.35	599.32	235.4	-0.0834	348.33	-0.082	238.3	-0.1243
348.43	599.19	235.9	-0.0817	348.42	-0.08	239.3	-0.1225
348.53	604.57	237.7	-0.0781	348.50	-0.078	240.5	-0.1207
348.60	608.61	239	-0.0746	348.58	-0.071	242.8	-0.1172
348.68	610.78	240	-0.0728	348.67	-0.067	245.4	-0.1145
348.77	612.99	241	-0.071	348.75	-0.064	246.9	-0.1101
348.85	616.87	242.4	-0.0675	348.83	-0.059	248.8	-0.1074
348.93	621.14	243.6	-0.0648	348.92	-0.054	251.1	-0.103
349.02	624.69	245.5	-0.0621	349.00	-0.052	252.1	-0.1012
349.10	626.36	246.5	-0.0577	349.08	-0.046	254.2	-0.0985
349.18	630.6	247.9	-0.0541	349.17	-0.04	256.2	-0.095
349.27	636.35	249.8	-0.0497	349.27	-0.036	258.8	-0.0897

Prova triassiale ciclica SNGR03-C4								
tensione di confinamento (kPa)	450				tensione di confinamento (kPa)	450		
deviatore ciclico (kPa)	150				deviatore ciclico (kPa)	180		
frequenza (hz)	0.0007143				frequenza (hz)	0.0007143		
349.35	634.31	250.1	-0.0488	349.33	-0.031	260.7	-0.0861	
349.43	639.75	251.6	-0.0462	349.42	-0.029	262.2	-0.0834	
349.52	644.16	252.9	-0.0426	349.50	-0.023	264.8	-0.0799	
349.60	647.84	255	-0.0391	349.58	-0.017	267.1	-0.0754	
349.68	650.44	256.2	-0.0337	349.67	-0.014	268.5	-0.0701	
349.77	654.25	257.5	-0.0302	349.75	-0.007	271.2	-0.0657	
349.85	656.85	258.8	-0.0266	349.83	-0.006	272.3	-0.063	
349.95	659.49	260.4	-0.0222	349.92	-0.002	274.1	-0.0586	
350.02	663.86	261.8	-0.0178	350.00	0.004	276.2	-0.0541	
350.10	667.4	263.2	-0.0142	350.08	0.01	278.9	-0.0497	
350.18	670.34	264.6	-0.0107	350.17	0.016	281.5	-0.0453	
350.27	674.68	266.1	-0.0053	350.25	0.016	282.3	-0.0399	
350.35	676.34	267.1	-0.0027	350.33	0.022	284.4	-0.0346	
350.43	681.18	268.5	0.0018	350.42	0.027	286.6	-0.0293	
350.52	684.15	270.5	0.0053	350.50	0.031	288.3	-0.0249	
350.60	687.42	271.9	0.0124	350.58	0.035	290.3	-0.0204	
350.68	691.12	273.3	0.0169	350.67	0.04	292.7	-0.0142	
350.77	694.12	274.5	0.0213	350.77	0.044	294.4	-0.0089	
350.85	696.22	275.7	0.0249	350.83	0.048	296.1	-0.0044	
350.93	699.86	277.1	0.0293	350.92	0.054	298.2	0.0009	
351.02	704.72	278.6	0.0346	351.00	0.061	301.1	0.0062	
351.10	707.59	280.5	0.0391	351.08	0.066	303.2	0.0107	
351.18	710.05	281.7	0.0453	351.17	0.067	304.1	0.0195	
351.27	712.02	282.7	0.0488	351.25	0.071	305.9	0.0249	
351.35	716.58	284.3	0.0541	351.33	0.076	308	0.0311	
351.43	719.82	286	0.0586	351.42	0.079	309.3	0.0355	
351.52	723.08	287.3	0.0648	351.50	0.084	311.3	0.0408	
351.60	725.81	288.5	0.0701	351.58	0.09	314	0.047	
351.68	728.97	289.9	0.0754	351.67	0.092	315.4	0.0533	
351.77	733.67	291.5	0.0817	351.75	0.096	316.9	0.0595	
351.85	733.96	292.3	0.0843	351.83	0.101	318.7	0.0648	
351.93	739.19	294.2	0.0888	351.92	0.105	320.4	0.071	
352.02	741.32	295.3	0.0932	352.00	0.108	321.8	0.0763	
352.10	743.55	296.4	0.1003	352.08	0.115	324.1	0.0834	
352.18	746.51	297.6	0.1047	352.18	0.116	325.3	0.0879	
352.27	749.5	298.8	0.1092	352.25	0.12	327.1	0.0941	
352.35	752.03	299.9	0.1136	352.33	0.124	328.5	0.0994	
352.43	754.49	301.1	0.1181	352.42	0.128	330.1	0.1047	
352.52	758.18	302.8	0.1225	352.50	0.132	332	0.111	
352.60	760.58	303.8	0.126	352.58	0.136	333.7	0.1154	
352.68	764.17	305.2	0.1331	352.67	0.139	334.9	0.1234	
352.77	764.93	305.9	0.1367	352.75	0.143	336.3	0.1287	
352.87	768.05	307.4	0.1402	352.83	0.144	337.2	0.1314	
352.93	770.68	308.5	0.1438	352.92	0.148	338.6	0.1367	
353.02	772.84	309.4	0.15	353.00	0.151	340.1	0.142	
353.10	774.79	310.3	0.1544	353.08	0.156	342.1	0.1482	
353.18	778.15	311.5	0.158	353.17	0.159	343.3	0.1527	
353.27	777.98	312.1	0.1607	353.25	0.161	344.3	0.1598	
353.35	781.57	313.3	0.1651	353.33	0.165	345.5	0.1642	
353.43	784.03	314.6	0.1678	353.42	0.168	346.8	0.1687	
353.52	785.83	315.5	0.1713	353.50	0.168	347.4	0.1722	
353.60	786.88	316.2	0.1758	353.58	0.172	348.8	0.1766	
353.68	788.81	317	0.1784	353.67	0.178	350.5	0.1837	
353.77	791.3	318	0.1811	353.75	0.176	351	0.1864	
353.85	792.33	318.6	0.1846	353.83	0.179	351.9	0.1908	
353.93	795.58	319.8	0.1882	353.92	0.183	353.1	0.1953	
354.02	796.98	320.6	0.19	354.00	0.185	354.4	0.2006	
354.10	798.24	321.4	0.1926	354.08	0.187	355.3	0.2033	
354.18	799.36	322.1	0.1962	354.17	0.189	356.1	0.2086	
354.28	802.85	323.1	0.2006	354.25	0.191	357.1	0.2113	

Prova triassiale ciclica SNGR03-C4							
tensione di confinamento (kPa)	450			tensione di confinamento (kPa)	450		
deviatore ciclico (kPa)	150			deviatore ciclico (kPa)	180		
frequenza (hz)	0.0007143			frequenza (hz)	0.0007143		
354.35	802.62	323.7	0.2006	354.33	0.193	357.7	0.2148
354.43	804.18	324.4	0.2033	354.42	0.195	358.4	0.2175
354.52	804.8	325	0.2068	354.50	0.197	359.3	0.221
354.60	806.06	325.6	0.2086	354.58	0.199	360.4	0.2246
354.68	806.49	326.1	0.2104	354.67	0.199	360.8	0.2255
354.77	810.08	327	0.2139	354.75	0.2	361.7	0.229
354.85	807.95	327.1	0.2139	354.83	0.204	362.1	0.2326
354.93	811.07	328.2	0.2175	354.92	0.205	362.7	0.2361
355.02	809.41	328.2	0.2175	355.00	0.203	362.9	0.237
355.10	811.6	328.9	0.2201	355.10	0.206	363.7	0.2397
355.18	813.86	329.6	0.2219	355.17	0.208	364.5	0.2432
355.27	811.83	329.6	0.2219	355.25	0.206	364.4	0.2441
355.35	813.22	330.1	0.2237	355.33	0.208	364.9	0.2459
355.43	814.02	330.5	0.2255	355.42	0.209	365.3	0.2468
355.52	815.98	331.3	0.2263	355.50	0.21	365.9	0.2494
355.60	813.85	331.2	0.2272	355.58	0.209	365.9	0.2503
355.68	814.91	331.6	0.2281	355.67	0.213	366.7	0.2521
355.78	814.67	331.8	0.229	355.75	0.21	366.4	0.2521
355.85	815.64	332.3	0.2308	355.83	0.21	366.5	0.253
355.93	814.64	332.4	0.2299	355.92	0.211	366.7	0.2539
356.02	814.4	332.4	0.2308	356.00	0.211	367	0.2548
356.10	814.87	332.7	0.2317	356.08	0.21	367.1	0.2548
356.18	815.83	333.1	0.2326	356.17	0.21	367	0.2556
356.27	814.24	333	0.2317	356.25	0.209	366.9	0.2556
356.35	813.71	333	0.2317	356.33	0.208	366.9	0.2556
356.43	813.11	333.1	0.2317	356.42	0.209	367.2	0.2565
356.52	813.4	333.3	0.2326	356.52	0.207	366.9	0.2565
356.60	812.14	333.2	0.2317	356.58	0.207	366.8	0.2565
356.68	811.31	333.1	0.2317	356.67	0.206	366.6	0.2556
356.77	810.98	333.1	0.2317	356.75	0.205	366.4	0.2556
356.85	810.21	333.1	0.2317	356.83	0.204	366.2	0.2556
356.93	809.22	332.9	0.2308	356.92	0.202	366	0.2548
357.02	807.82	332.8	0.2299	357.00	0.201	365.6	0.2548
357.10	807.52	332.7	0.2299	357.08	0.199	365.3	0.2539
357.20	805.89	332.5	0.229	357.17	0.198	364.9	0.253
357.27	804.73	332.3	0.2281	357.25	0.196	364.5	0.2521
357.35	803.17	332.1	0.2272	357.33	0.195	364.2	0.2512
357.43	802.17	331.8	0.2263	357.42	0.193	363.8	0.2503
357.52	799.91	331.4	0.2255	357.50	0.191	363.2	0.2494
357.60	799.15	331.2	0.2246	357.58	0.188	362.5	0.2485
357.68	797.42	330.9	0.2237	357.67	0.187	362	0.2468
357.77	796.19	330.6	0.2228	357.75	0.185	361.5	0.2459
357.85	794.89	330.2	0.221	357.83	0.182	360.8	0.2441
357.93	792.17	329.6	0.2201	357.92	0.18	360.3	0.2414
358.02	790.8	329.2	0.2184	358.02	0.177	359.5	0.2397
358.10	789.21	328.8	0.2166	358.08	0.175	358.9	0.2379
358.18	786.25	328.2	0.2148	358.17	0.172	358	0.2361
358.27	785.29	327.9	0.2139	358.25	0.17	357.4	0.2343
358.35	783.59	327.4	0.2121	358.33	0.167	356.7	0.2326
358.43	781	326.8	0.2104	358.42	0.164	355.7	0.2299
358.52	778.01	326	0.2086	358.50	0.161	354.6	0.2281
358.60	776.31	325.5	0.2059	358.58	0.157	353.6	0.2246
358.70	774.72	325	0.2042	358.67	0.154	352.8	0.2219
358.77	771.86	324.2	0.2015	358.75	0.151	352	0.2201
358.85	768.23	323.3	0.1997	358.83	0.149	351	0.2175
358.93	766.84	322.8	0.1971	358.92	0.148	350.6	0.2157
359.02	763.98	322	0.1944	359.00	0.14	348.7	0.2104
359.10	761.99	321.3	0.1917	359.08	0.137	347.4	0.2086
359.18	759.26	320.5	0.1891	359.17	0.135	346.5	0.2033
359.27	756.87	319.8	0.1864	359.25	0.131	345.5	0.1997

Prova triassiale ciclica SNGR03-C4								
tensione di confinamento (kPa)	450			tensione di confinamento (kPa)	450			
deviatore ciclico (kPa)	150			deviatore ciclico (kPa)	180			
frequenza (hz)	0.0007143			frequenza (hz)	0.0007143			
359.35	754.61	319	0.1837	359.33	0.127	344.2	0.1962	
359.43	750.58	317.8	0.1811	359.43	0.123	342.7	0.1935	
359.52	748.59	317	0.1775	359.50	0.119	341.5	0.1882	
359.60	746.23	316.3	0.1749	359.58	0.116	340.5	0.1846	
359.68	742.57	315.2	0.1722	359.67	0.112	339.1	0.1811	
359.77	740.18	314.3	0.1687	359.75	0.109	337.9	0.1775	
359.85	739.54	313.9	0.1669	359.83	0.105	336.7	0.1731	
359.93	733.59	312.2	0.1616	359.92	0.098	335.6	0.1695	
360.02	730.73	311.1	0.1589	360.00	0.096	333.4	0.166	
360.12	728.2	310.2	0.1536	360.08	0.092	332.1	0.1598	
360.18	725.54	309.4	0.1509	360.17	0.088	330.8	0.1562	
360.27	721.71	308.3	0.1473	360.25	0.083	329.1	0.1509	
360.35	718.32	306.8	0.1429	360.33	0.08	327.7	0.1465	
360.43	716.22	305.9	0.1385	360.42	0.076	326.3	0.142	
360.52	713.09	304.8	0.134	360.50	0.07	324.5	0.1376	
360.60	708.63	303.4	0.1296	360.58	0.065	322.3	0.1323	
360.68	706.9	302.5	0.126	360.67	0.062	320.6	0.1269	
360.77	703.64	301.4	0.1216	360.75	0.057	319.3	0.1216	
360.85	699.01	300.2	0.1172	360.83	0.052	317.5	0.1172	
360.93	694.91	298.3	0.1127	360.93	0.047	315.5	0.1127	
361.02	692.75	297.4	0.1065	361.00	0.045	314	0.1056	
361.10	690.05	296.2	0.1021	361.08	0.039	312.3	0.1003	
361.18	685.52	294.7	0.0968	361.17	0.036	310.9	0.0959	
361.27	683.69	293.7	0.0923	361.25	0.031	309	0.0897	
361.35	680.89	292.6	0.0888	361.33	0.027	307.4	0.0843	
361.43	674.39	291.2	0.0834	361.42	0.021	305.3	0.079	
361.52	671.79	289.3	0.079	361.50	0.015	302.5	0.0737	
361.60	670.63	288.2	0.0728	361.58	0.012	301	0.0657	
361.68	666.86	287	0.0683	361.67	0.007	299.4	0.0604	
361.77	662.06	285.6	0.0621	361.75	0.002	297.2	0.055	
361.85	658.82	283.7	0.0577	361.83	0	295.7	0.0506	
361.93	656.42	282.4	0.0506	361.92	-0.005	294	0.0444	
362.02	653.02	281.2	0.0462	362.00	-0.011	291.5	0.0373	
362.10	649.32	279.7	0.0408	362.08	-0.017	288.8	0.0328	
362.18	646.65	278.4	0.0364	362.17	-0.02	287.2	0.0249	
362.27	644.01	277.2	0.032	362.25	-0.025	285.2	0.0195	
362.35	639.27	275.5	0.0266	362.35	-0.031	283.7	0.0142	
362.43	635.37	273.7	0.0222	362.42	-0.033	281.5	0.0089	
362.52	632.73	272.4	0.016	362.50	-0.037	279.2	0.0018	
362.60	629.66	271.2	0.0107	362.58	-0.043	277.1	-0.0036	
362.68	626.52	270.2	0.0062	362.67	-0.048	275.1	-0.0089	
362.77	623.91	268.9	0.0027	362.75	-0.05	273.6	-0.0133	
362.85	620.54	267.6	-0.0018	362.83	-0.055	271.6	-0.0178	
362.93	616.03	266	-0.0062	362.92	-0.061	269.2	-0.0231	
363.03	613.39	264.3	-0.0115	363.00	-0.067	266.5	-0.0275	
363.10	610.89	263	-0.016	363.08	-0.069	264.8	-0.0346	
363.18	607.75	261.7	-0.0195	363.17	-0.073	263.1	-0.0382	
363.27	603.4	260.2	-0.024	363.25	-0.078	260.7	-0.0435	
363.35	600.03	258.2	-0.0275	363.33	-0.081	259.1	-0.0479	
363.43	598.12	257.1	-0.0328	363.42	-0.084	257.5	-0.0515	
363.52	594.81	255.7	-0.0364	363.50	-0.091	255.3	-0.0559	
363.60	591.54	254.2	-0.0408	363.58	-0.094	252.9	-0.0586	
363.68	589.73	252.9	-0.0435	363.67	-0.1	250	-0.0675	
363.77	585.96	251.6	-0.0462	363.75	-0.102	248.9	-0.0701	
363.85	581.28	250.5	-0.0479	363.83	-0.106	247.4	-0.0737	
363.93	579.74	248.3	-0.0524	363.92	-0.11	244.7	-0.0772	
364.02	578.16	247.3	-0.0568	364.00	-0.112	243	-0.0826	
364.10	575.19	245.9	-0.0595	364.08	-0.116	241.4	-0.0861	
364.18	572.55	244.5	-0.063	364.17	-0.121	239.3	-0.0905	
364.27	570.24	243.1	-0.0657	364.25	-0.123	237.6	-0.0941	

Prova triassiale ciclica SNGR03-C4							
tensione di confinamento (kPa)	450			tensione di confinamento (kPa)	450		
deviatore ciclico (kPa)	150			deviatore ciclico (kPa)	180		
frequenza (hz)	0.0007143			frequenza (hz)	0.0007143		
364.35	567.19	241.9	-0.0692	364.33	-0.127	235.9	-0.0976
364.45	564.08	240.2	-0.0728	364.42	-0.131	234.1	-0.1003
364.52	561.94	239	-0.0754	364.50	-0.135	231.7	-0.1039
364.60	560.44	238	-0.0772	364.58	-0.137	230.3	-0.1083
364.68	557.93	236.8	-0.0799	364.67	-0.14	228.8	-0.111
364.77	554.95	235.4	-0.0826	364.75	-0.145	226.9	-0.1145
364.85	551.94	233.9	-0.0843	364.83	-0.143	226.2	-0.1163
364.93	551.37	233	-0.0879	364.92	-0.151	223.3	-0.1216
365.02	548.46	231.8	-0.0905	365.00	-0.153	222.5	-0.1243
365.10	546.21	230.7	-0.0932	365.08	-0.157	220	-0.1269
365.18	544.74	229.7	-0.095	365.17	-0.158	218.8	-0.1314
365.27	542.93	228.7	-0.0968	365.27	-0.16	217.6	-0.134
365.35	540.29	227.6	-0.0994	365.33	-0.164	216.1	-0.1367
365.43	538.78	226.3	-0.1012	365.42	-0.166	214.3	-0.1394
365.52	537.34	225.3	-0.1039	365.50	-0.168	213.1	-0.1429
365.60	534.53	224.2	-0.1056	365.58	-0.171	211.9	-0.1456
365.68	533.56	223.5	-0.1074	365.67	-0.174	210.5	-0.1482
365.77	532.42	222.7	-0.1092	365.75	-0.175	209.4	-0.1509
365.85	530.58	221.8	-0.111	365.83	-0.176	208.5	-0.1518
365.95	528.54	220.7	-0.1136	365.92	-0.18	207	-0.1553
366.02	525.89	219.5	-0.1154	366.00	-0.182	205.6	-0.1571
366.10	526.53	219.1	-0.1163	366.08	-0.183	204.7	-0.1598
366.18	525.32	218.4	-0.1172	366.17	-0.185	203.8	-0.1616
366.27	523.75	217.9	-0.1181	366.25	-0.186	202.9	-0.1633
366.35	522.58	216.7	-0.1198	366.33	-0.187	201.9	-0.1651
366.43	521.77	216.2	-0.1216	366.42	-0.189	201.2	-0.1669
366.52	520.67	215.5	-0.1225	366.50	-0.191	200.4	-0.1687
366.60	519.46	214.9	-0.1243	366.58	-0.191	199.3	-0.1695
366.68	519.26	214.5	-0.1252	366.68	-0.192	198.8	-0.1713
366.77	518.85	214	-0.126	366.75	-0.193	198.1	-0.1731
366.85	517.35	213.3	-0.1269	366.83	-0.196	196.9	-0.1758
366.93	515.14	212.3	-0.1278	366.92	-0.195	196.8	-0.1758
367.02	516.51	212.3	-0.1287	367.00	-0.196	196.4	-0.1766
367.10	516.21	212	-0.1296	367.08	-0.197	195.9	-0.1784
367.18	515.67	211.6	-0.1305	367.17	-0.197	195.4	-0.1793
367.27	515.53	211.2	-0.1305	367.25	-0.197	195.2	-0.1793
367.37	515.3	210.8	-0.1314	367.33	-0.198	194.8	-0.1802
367.43	515.03	210.5	-0.1323	367.42	-0.198	194.7	-0.1811
367.52	514.93	210.3	-0.1323	367.50	-0.198	194.3	-0.1811
367.60	515.93	210.3	-0.1323	367.58	-0.198	194.1	-0.1829
367.68	513.93	209.6	-0.1331	367.67	-0.197	194.4	-0.182
367.77	515.46	209.7	-0.1331	367.75	-0.197	194.1	-0.1829
367.85	517.4	210	-0.1331	367.83	-0.197	194	-0.1829
367.93	516.03	209.6	-0.1331	367.92	-0.197	194.2	-0.1829
368.02	515.9	209.4	-0.1331	368.00	-0.196	194.2	-0.1837
368.10	516.57	209.4	-0.1331	368.08	-0.196	194.3	-0.1837
368.18	516.47	209.3	-0.134	368.18	-0.195	194.4	-0.1837
368.27	517.74	209.4	-0.1331	368.25	-0.195	194.5	-0.1837
368.35	518.61	209.4	-0.1331	368.33	-0.193	194.7	-0.1837
368.43	519.41	209.5	-0.1331	368.42	-0.192	195.3	-0.1829
368.52	519.98	209.6	-0.1331	368.50	-0.191	195.5	-0.1829
368.60	520.01	209.5	-0.1331	368.58	-0.19	195.9	-0.1829
368.68	521.58	209.9	-0.1323	368.67	-0.188	196.4	-0.182
368.77	522.85	210.1	-0.1323	368.75	-0.188	196.7	-0.182
368.87	524.43	210.4	-0.1314	368.83	-0.186	197.2	-0.1811
368.93	525.2	210.6	-0.1305	368.92	-0.184	197.8	-0.1811
369.02	526.47	211	-0.1305	369.00	-0.182	198.6	-0.1802
369.10	529.78	211.7	-0.1287	369.08	-0.18	199.3	-0.1793
369.18	529.85	211.9	-0.1287	369.17	-0.179	199.8	-0.1784
369.27	530.01	211.9	-0.1287	369.25	-0.177	200.6	-0.1775

Prova triassiale ciclica SNGR03-C4								
tensione di confinamento (kPa)	450				tensione di confinamento (kPa)	450		
deviatore ciclico (kPa)	150				deviatore ciclico (kPa)	180		
frequenza (hz)	0.0007143				frequenza (hz)	0.0007143		
369.35	532.59	212.7	-0.1278	369.33	-0.175	201.1	-0.1775	
369.43	533.99	213	-0.1269	369.42	-0.172	202.1	-0.1766	
369.52	535.63	213.4	-0.126	369.50	-0.171	202.3	-0.1766	
369.60	535.94	213.6	-0.1252	369.60	-0.167	204	-0.174	
369.68	538.21	214.3	-0.1243	369.67	-0.166	204.6	-0.1731	
369.77	540.65	214.8	-0.1234	369.75	-0.163	205.6	-0.1722	
369.85	543.5	215.4	-0.1225	369.83	-0.16	206.6	-0.1713	
369.93	545.2	216.3	-0.1207	369.92	-0.157	208.1	-0.1695	
370.02	547.88	217.1	-0.1189	370.00	-0.155	208.9	-0.1687	
370.10	548.95	217.5	-0.1189	370.08	-0.151	210.1	-0.1669	
370.18	551.09	218.2	-0.1172	370.17	-0.149	211.3	-0.1651	
370.28	553.63	219.1	-0.1163	370.25	-0.147	212.2	-0.1642	
370.35	555.61	219.8	-0.1145	370.33	-0.142	213.8	-0.1624	
370.43	558.25	220.7	-0.1127	370.42	-0.139	214.4	-0.1616	
370.52	560.12	221.4	-0.111	370.50	-0.135	216.6	-0.1598	
370.60	562.23	222.1	-0.1101	370.58	-0.133	217.8	-0.1571	
370.68	565.31	223	-0.1083	370.67	-0.132	218.4	-0.1562	
370.77	568.35	223.7	-0.1065	370.75	-0.124	221.2	-0.1527	
370.85	571.23	225.1	-0.1056	370.83	-0.124	221.8	-0.1518	
370.93	573.8	226	-0.1021	370.92	-0.12	223.2	-0.15	
371.02	576.11	226.9	-0.1012	371.00	-0.114	224.9	-0.1473	
371.10	579.05	228	-0.0985	371.10	-0.113	226.5	-0.1456	
371.18	580.86	228.8	-0.0968	371.17	-0.109	228.1	-0.1429	
371.27	583.5	229.8	-0.095	371.25	-0.105	229.6	-0.1411	
371.35	588.52	230.9	-0.0932	371.33	-0.098	231.4	-0.1385	
371.43	589.95	232.2	-0.0923	371.42	-0.095	233.7	-0.1358	
371.52	592.73	233.4	-0.0879	371.50	-0.093	234.9	-0.1331	
371.60	596.11	234.5	-0.0852	371.58	-0.089	236.5	-0.1305	
371.68	598.82	235.6	-0.0834	371.67	-0.084	238.7	-0.1278	
371.77	603.06	237.2	-0.0817	371.75	-0.081	240.1	-0.1252	
371.85	604.8	238.1	-0.0781	371.83	-0.077	241.7	-0.1225	
371.93	608.38	239.4	-0.0754	371.92	-0.071	243.9	-0.1189	
372.02	610.88	240.4	-0.0728	372.00	-0.066	246.4	-0.1163	
372.10	613.19	241.5	-0.0701	372.08	-0.064	247.8	-0.1127	
372.18	617.13	242.8	-0.0675	372.17	-0.059	249.6	-0.1092	
372.27	620.88	243.9	-0.0648	372.25	-0.055	251.5	-0.1056	
372.35	624.88	245.9	-0.0621	372.33	-0.051	253.1	-0.103	
372.43	626.62	246.9	-0.0577	372.42	-0.046	255.1	-0.0994	
372.52	630.17	248.2	-0.055	372.52	-0.041	257.5	-0.0959	
372.60	633.84	249.6	-0.0506	372.58	-0.036	259.7	-0.0923	
372.68	635.88	250.6	-0.0479	372.67	-0.034	261.2	-0.0888	
372.77	639.59	252	-0.0462	372.75	-0.028	263.3	-0.0852	
372.85	644.63	253.4	-0.0426	372.83	-0.022	265.2	-0.0817	
372.93	650.04	255.8	-0.0391	372.92	-0.017	268	-0.0781	
373.02	648.7	256.2	-0.0346	373.00	-0.012	270.2	-0.0701	
373.10	653.41	257.7	-0.0311	373.08	-0.012	271.1	-0.0683	
373.20	657.95	259.3	-0.0266	373.17	-0.004	273.9	-0.0639	
373.27	660.26	260.9	-0.024	373.25	-0.002	275.3	-0.0595	
373.35	663.43	262.2	-0.0186	373.33	0.003	277.2	-0.0559	
373.43	667.6	263.7	-0.0142	373.42	0.01	279.4	-0.0506	
373.52	670.4	265	-0.0107	373.50	0.014	282.1	-0.047	
373.60	673.24	266.1	-0.0062	373.58	0.018	283.8	-0.0399	
373.68	677.08	267.7	-0.0018	373.67	0.023	285.7	-0.0355	
373.77	680.21	268.9	0.0018	373.75	0.027	287.8	-0.0311	
373.85	684.48	270.9	0.0053	373.83	0.03	289.4	-0.0266	
373.93	686.95	272.2	0.0115	373.92	0.035	291.3	-0.0213	
374.02	690.56	273.6	0.016	374.00	0.041	293.8	-0.0151	
374.10	694.59	275.1	0.0213	374.08	0.048	296.4	-0.0089	
374.18	696.29	276.1	0.0249	374.17	0.048	297.5	-0.0044	
374.27	700.05	277.6	0.0302	374.25	0.055	299.6	0.0009	

Prova triassiale ciclica SNGR03-C4							
tensione di confinamento (kPa)	450			tensione di confinamento (kPa)	450		
deviatore ciclico (kPa)	150			deviatore ciclico (kPa)	180		
frequenza (hz)	0.0007143			frequenza (hz)	0.0007143		
374.35	704.36	279	0.0346	374.33	0.059	301.2	0.0053
374.43	707.76	281	0.0382	374.42	0.064	303.8	0.0107
374.52	710.22	282.2	0.0453	374.50	0.067	305.5	0.0186
374.62	714.12	283.5	0.0497	374.58	0.072	307.2	0.024
374.68	717.05	284.4	0.0533	374.67	0.076	309.2	0.0293
374.77	720.38	286.5	0.0586	374.75	0.079	310.4	0.0346
374.85	723.21	287.8	0.0648	374.83	0.084	312.4	0.0408
374.93	726.01	289	0.0701	374.92	0.09	314.2	0.0462
375.02	729.1	290.3	0.0754	375.00	0.093	316.7	0.0506
375.10	731.83	291.5	0.0799	375.08	0.097	318.2	0.0595
375.18	734.26	292.7	0.0843	375.17	0.101	319.8	0.0648
375.27	739.09	294.5	0.0905	375.25	0.106	321.7	0.0701
375.35	740.32	295.7	0.0932	375.33	0.108	322.9	0.0754
375.43	743.08	296.8	0.0994	375.43	0.113	325.1	0.0826
375.52	746.81	298.1	0.1047	375.50	0.117	326.7	0.0879
375.60	749.33	299.3	0.1092	375.58	0.121	328.2	0.0932
375.68	752	300.4	0.1136	375.67	0.124	329.5	0.0985
375.77	756.32	301.9	0.1189	375.75	0.127	331	0.1039
375.85	757.85	302.5	0.1225	375.83	0.133	332.7	0.1101
375.93	760.08	304.3	0.1252	375.92	0.137	334.8	0.1145
376.02	762.47	305.3	0.1323	376.00	0.138	335.8	0.1216
376.12	765.33	306.4	0.1367	376.08	0.142	337.3	0.1269
376.18	770.28	308.2	0.1402	376.17	0.146	338.8	0.1323
376.27	770.11	308.9	0.1447	376.25	0.148	339.9	0.1367
376.35	771.97	309.6	0.1491	376.33	0.152	341.3	0.142
376.43	774.66	310.7	0.1527	376.42	0.156	342.2	0.1465
376.52	776.92	311.8	0.1571	376.50	0.16	344.4	0.1518
376.60	779.01	312.7	0.1607	376.58	0.162	345.4	0.1589
376.68	781.24	313.7	0.1642	376.67	0.164	346.6	0.1633
376.77	783.7	314.9	0.1669	376.75	0.17	348.4	0.1695
376.85	788.22	316.3	0.1704	376.85	0.171	349.3	0.1731
376.93	786.15	316.5	0.1758	376.92	0.173	350.3	0.1793
377.02	788.78	317.5	0.1793	377.00	0.175	351.3	0.1829
377.10	793.46	318.9	0.1829	377.08	0.177	352.2	0.1873
377.18	793.19	319.3	0.1846	377.17	0.18	353.1	0.1908
377.27	793.29	319.7	0.1864	377.25	0.185	354.6	0.1971
377.35	797.34	321.3	0.1917	377.33	0.185	355.4	0.1979
377.43	796.61	321.6	0.1926	377.42	0.188	356.4	0.2024
377.53	801.56	322.8	0.1971	377.50	0.189	357.1	0.2077
377.60	799.16	322.9	0.1979	377.58	0.191	358	0.2113
377.68	801.88	324.1	0.2024	377.67	0.194	358.9	0.2148
377.77	803.61	324.8	0.2033	377.75	0.194	359.4	0.2175
377.85	805.3	325.5	0.2068	377.83	0.196	360.3	0.221
377.93	805	325.8	0.2086	377.92	0.197	361	0.2237
378.02	807.62	326.6	0.2113	378.00	0.2	361.8	0.2255
378.10	808.95	327.3	0.2139	378.08	0.201	362.4	0.2299
378.18	807.68	327.4	0.2139	378.17	0.203	363	0.2326
378.27	810.91	328.5	0.2157	378.25	0.204	363.7	0.2352
378.35	812.43	329.2	0.2184	378.35	0.204	364.1	0.2361
378.43	810.87	329.2	0.2201	378.42	0.206	364.7	0.2397
378.52	811.86	330	0.2228	378.50	0.206	365.2	0.2432
378.60	813.96	330.4	0.2237	378.58	0.207	365.5	0.2441
378.68	812.03	330.5	0.2237	378.67	0.208	365.9	0.2459
378.77	813.65	331	0.2255	378.75	0.209	366.3	0.2477
378.85	816.18	331.8	0.2263	378.83	0.211	367.1	0.2485
378.93	813.95	331.6	0.2272	378.92	0.209	366.8	0.2503
379.03	815.08	332.1	0.2281	379.00	0.212	367.5	0.2521
379.10	814.31	332.2	0.229	379.08	0.211	367.6	0.2521
379.18	815.14	332.6	0.2308	379.17	0.209	367.3	0.2521
379.27	814.21	332.6	0.2299	379.25	0.21	367.6	0.253

Prova triassiale ciclica SNGR03-C4							
tensione di confinamento (kPa)	450			tensione di confinamento (kPa)	450		
deviatore ciclico (kPa)	150			deviatore ciclico (kPa)	180		
frequenza (hz)	0.0007143			frequenza (hz)	0.0007143		
379.35	816.6	333.2	0.2317	379.33	0.212	368.2	0.2548
379.43	815.54	333.3	0.2317	379.42	0.21	367.8	0.2548
379.52	814.47	333.3	0.2317	379.50	0.209	367.9	0.2548
379.60	812.74	333.2	0.2326	379.58	0.209	368	0.2556
379.68	814.14	333.5	0.2326	379.67	0.21	368.2	0.2565
379.77	812.8	333.5	0.2326	379.77	0.208	367.8	0.2556
379.85	813.24	333.7	0.2317	379.83	0.207	367.8	0.2556
379.93	812.71	333.7	0.2317	379.92	0.207	367.7	0.2556
380.02	810.65	333.4	0.2308	380.00	0.206	367.6	0.2556
380.10	812.07	333.8	0.2317	380.08	0.205	367.4	0.2556
380.18	810.94	333.7	0.2317	380.17	0.204	367.2	0.2556
380.27	809.41	333.3	0.2308	380.25	0.203	366.9	0.2548
380.35	806.92	333	0.2299	380.33	0.2	366.4	0.2539
380.45	807.92	333.2	0.2299	380.42	0.2	366.3	0.2539
380.52	805.89	332.9	0.229	380.50	0.198	365.9	0.253
380.60	805.86	332.9	0.229	380.58	0.196	365.5	0.2521
380.68	802.24	332.3	0.2272	380.67	0.195	365	0.2512
380.77	802.73	332.3	0.2263	380.75	0.192	364.5	0.2503
380.85	801.47	332.1	0.2255	380.83	0.191	364.1	0.2494
380.93	797.78	331.4	0.2237	380.92	0.188	363.4	0.2485
381.02	799.58	331.6	0.2246	381.00	0.186	362.8	0.2468
381.10	796.39	331	0.2228	381.08	0.185	362.4	0.245
381.18	795.99	330.9	0.2219	381.17	0.182	361.8	0.2441
381.27	792.46	330.2	0.2201	381.27	0.18	361.1	0.2414
381.35	790.41	329.7	0.2184	381.33	0.177	360.3	0.2406
381.43	789.01	329.3	0.2166	381.42	0.175	359.8	0.2379
381.52	787.28	328.8	0.2157	381.50	0.172	358.9	0.2361
381.60	785.35	328.3	0.2139	381.58	0.169	358.2	0.2343
381.68	783.39	327.8	0.2121	381.67	0.167	357.5	0.2326
381.77	782.56	327.5	0.2113	381.75	0.165	356.7	0.2308
381.85	777.58	326.3	0.2077	381.83	0.16	355.4	0.2281
381.93	776.71	325.9	0.2059	381.92	0.158	354.5	0.2255
382.02	776.08	325.7	0.205	382.00	0.155	353.7	0.2219
382.10	771.56	324.7	0.2015	382.08	0.151	352.8	0.2201
382.18	768.83	323.8	0.2006	382.17	0.148	351.8	0.2166
382.27	766.74	323.1	0.1962	382.25	0.146	351.1	0.2139
382.35	763.62	322.4	0.1935	382.33	0.142	350	0.2113
382.43	761.99	321.7	0.1917	382.42	0.138	348.5	0.2077
382.52	761.16	321.1	0.1891	382.50	0.134	347.3	0.205
382.60	757.4	320.2	0.1864	382.58	0.131	346.3	0.1997
382.68	754.87	319.5	0.1846	382.68	0.13	345.6	0.1979
382.77	750.58	318.2	0.182	382.75	0.123	343.6	0.1926
382.85	747.29	317.2	0.1766	382.83	0.119	342.6	0.19
382.93	745.9	316.6	0.1749	382.92	0.116	341.4	0.1837
383.02	742.5	315.6	0.1722	383.00	0.112	340	0.1802
383.10	739.84	314.6	0.1678	383.08	0.109	338.8	0.1766
383.18	738.58	313.9	0.1651	383.17	0.106	337.7	0.1731
383.27	734.35	312.9	0.1616	383.25	0.101	336.2	0.1695
383.37	731.16	311.7	0.1571	383.33	0.094	334	0.166
383.43	728.93	310.7	0.1544	383.42	0.092	332.7	0.1616
383.52	725.37	309.6	0.1509	383.50	0.088	331.6	0.1553
383.60	721.68	308.5	0.1465	383.58	0.083	329.8	0.1509
383.68	718.08	307.2	0.1429	383.67	0.082	328.9	0.1473
383.77	715.59	306.1	0.1376	383.75	0.076	327.1	0.142
383.85	712.59	305.1	0.1331	383.83	0.071	325.3	0.1376
383.93	709	303.9	0.1296	383.92	0.065	323.1	0.1331
384.02	706.87	302.9	0.1252	384.00	0.062	321.8	0.1287
384.10	703.44	301.8	0.1207	384.08	0.057	320.1	0.1216
384.18	699.38	300.5	0.1172	384.17	0.054	318.8	0.1172
384.27	693.45	298.5	0.1136	384.25	0.046	316	0.1118

Prova triassiale ciclica SNGR03-C4							
tensione di confinamento (kPa)	450			tensione di confinamento (kPa)	450		
deviatore ciclico (kPa)	150			deviatore ciclico (kPa)	180		
frequenza (hz)	0.0007143			frequenza (hz)	0.0007143		
384.35	692.92	297.7	0.1056	384.33	0.044	314.7	0.1083
384.43	689.55	296.6	0.1021	384.42	0.039	313.2	0.0994
384.52	686.19	295.2	0.0968	384.50	0.035	311.3	0.0941
384.60	682.09	293.6	0.0914	384.58	0.03	309.5	0.0888
384.68	680.09	292.7	0.0879	384.67	0.027	308.2	0.0843
384.78	675.33	290.9	0.0808	384.75	0.022	306.2	0.079
384.85	673.09	290	0.0772	384.83	0.016	303.5	0.0728
384.93	670.39	288.7	0.0719	384.92	0.011	301.6	0.0675
385.02	666.79	287.3	0.0675	385.00	0.007	300.1	0.0595
385.10	662.52	285.9	0.0621	385.08	0.002	298.2	0.055
385.18	658.36	283.9	0.0577	385.17	-0.001	296.3	0.0488
385.27	656.19	282.8	0.0506	385.25	-0.006	294.4	0.0435
385.35	654.52	281.8	0.047	385.33	-0.01	292.6	0.0382
385.43	648.82	280	0.0408	385.42	-0.017	289.7	0.032
385.52	646.65	278.8	0.0364	385.50	-0.02	287.9	0.0266
385.60	641.07	277	0.0311	385.60	-0.025	286.1	0.0195
385.68	638.6	276.1	0.0275	385.67	-0.029	284.6	0.0133
385.77	634.9	274	0.0231	385.75	-0.035	281.6	0.008
385.85	633.2	272.8	0.0151	385.83	-0.039	279.6	0
385.93	629.63	271.5	0.0115	385.92	-0.042	278.1	-0.0044
386.02	626.59	270.6	0.0062	386.00	-0.047	276.1	-0.0089
386.10	625.35	269.4	0.0027	386.08	-0.052	273.8	-0.0151
386.18	620.71	267.9	-0.0018	386.17	-0.053	272.9	-0.0178
386.28	616.3	265.9	-0.008	386.25	-0.06	270.3	-0.0231
386.35	613.46	264.6	-0.0124	386.33	-0.066	267.2	-0.0293
386.43	611.06	263.4	-0.016	386.42	-0.069	265.3	-0.0364
386.52	607.98	262.1	-0.0195	386.50	-0.073	263.9	-0.0399
386.60	603.47	260.6	-0.024	386.58	-0.078	261.7	-0.0444
386.68	601.46	258.9	-0.0275	386.67	-0.081	259.7	-0.0488
386.77	593.31	256.5	-0.0346	386.75	-0.084	258.1	-0.0533
386.85	596.35	256.2	-0.0364	386.83	-0.089	256.1	-0.0577
386.93	590.7	254.5	-0.0399	386.92	-0.095	253.2	-0.0621
387.02	589.93	253.3	-0.0435	387.02	-0.099	251.2	-0.0675
387.10	586.96	252.1	-0.0462	387.08	-0.101	249.9	-0.071
387.18	583.42	250.9	-0.0479	387.17	-0.108	248.5	-0.0737
387.27	578.8	248.5	-0.0524	387.25	-0.111	245.4	-0.0781
387.35	578	247.5	-0.0568	387.33	-0.113	243.6	-0.0834
387.43	574.96	246.1	-0.0595	387.42	-0.117	242	-0.0879
387.52	572.31	244.8	-0.063	387.50	-0.121	240.1	-0.0914
387.60	570.67	243.6	-0.0657	387.58	-0.123	238.3	-0.095
387.70	567.16	241.8	-0.0692	387.67	-0.126	236.8	-0.0985
387.77	564.45	240.5	-0.0728	387.75	-0.132	234.9	-0.1012
387.85	562.08	239.3	-0.0754	387.83	-0.135	232.4	-0.1039
387.93	560.14	238.2	-0.0781	387.92	-0.137	231.2	-0.1083
388.02	558.23	237.2	-0.0799	388.00	-0.141	229.6	-0.1118
388.10	554.25	235.7	-0.0826	388.08	-0.144	227.7	-0.1163
388.18	552.91	234.4	-0.0834	388.17	-0.146	226.1	-0.1189
388.27	551.07	233.2	-0.0888	388.25	-0.149	224.7	-0.1225
388.35	548.93	232.2	-0.0905	388.33	-0.153	223	-0.1252
388.43	546.25	230.9	-0.0932	388.42	-0.156	220.9	-0.1287
388.52	544.81	229.9	-0.0959	388.52	-0.158	219.7	-0.1323
388.60	542.93	229	-0.0968	388.58	-0.161	218.3	-0.1349
388.68	539.62	227.3	-0.1003	388.67	-0.164	216.9	-0.1376
388.77	538.68	226.4	-0.1021	388.75	-0.165	215.3	-0.1402
388.85	538.21	225.9	-0.1039	388.83	-0.168	213.7	-0.1438
388.93	535.5	224.8	-0.1056	388.92	-0.171	212.6	-0.1465
389.02	532.29	223.5	-0.1083	389.00	-0.173	211.3	-0.1491
389.10	532.25	222.9	-0.1092	389.08	-0.174	210.4	-0.1509
389.20	530.51	221.7	-0.1118	389.17	-0.177	209.1	-0.1536
389.27	528.97	221	-0.1127	389.25	-0.179	207.8	-0.1562

Prova triassiale ciclica SNGR03-C4								
tensione di confinamento (kPa)	450			tensione di confinamento (kPa)	450			
deviatore ciclico (kPa)	150			deviatore ciclico (kPa)	180			
frequenza (hz)	0.0007143			frequenza (hz)	0.0007143			
389.35	527.36	220.1	-0.1154	389.33	-0.181	206.4	-0.158	
389.43	526.49	219.4	-0.1163	389.42	-0.183	205.4	-0.1616	
389.52	525.52	218.7	-0.1172	389.50	-0.185	204.4	-0.1633	
389.60	523.41	217.9	-0.1189	389.58	-0.186	203.7	-0.1651	
389.68	522.48	217	-0.1198	389.67	-0.187	202.8	-0.1669	
389.77	521.34	216.3	-0.1216	389.75	-0.189	201.9	-0.1687	
389.85	520.43	215.5	-0.1243	389.83	-0.19	200.8	-0.1704	
389.93	519.33	215	-0.1243	389.93	-0.192	199.8	-0.1722	
390.02	519.29	214.6	-0.1252	390.00	-0.194	198.9	-0.174	
390.10	519.59	214.4	-0.1252	390.08	-0.194	198.6	-0.1749	
390.18	517.42	213.6	-0.1269	390.17	-0.195	198.1	-0.1758	
390.27	517.11	213	-0.1278	390.25	-0.196	197.3	-0.1775	
390.35	516.41	212.6	-0.1287	390.33	-0.196	197	-0.1784	
390.43	516.04	212.2	-0.1296	390.42	-0.197	196.6	-0.1793	
390.52	515.84	211.9	-0.1305	390.50	-0.197	196.3	-0.1802	
390.62	515.74	211.4	-0.1305	390.58	-0.197	195.9	-0.1811	
390.68	514.93	211	-0.1314	390.67	-0.198	195.6	-0.182	
390.77	515.13	210.8	-0.1314	390.75	-0.197	195.6	-0.182	
390.85	515.03	210.5	-0.1323	390.83	-0.198	195.2	-0.1829	
390.93	515	210.4	-0.1323	390.92	-0.199	194.6	-0.1846	
391.02	515.13	210	-0.1331	391.00	-0.198	194.9	-0.1846	
391.10	515.26	209.9	-0.1331	391.08	-0.197	195	-0.1846	
391.18	515.73	209.8	-0.1331	391.17	-0.198	194.7	-0.1846	
391.27	515.6	209.7	-0.1331	391.25	-0.197	194.8	-0.1846	
391.35	516.2	209.6	-0.1331	391.33	-0.196	194.8	-0.1855	
391.43	516.67	209.6	-0.1331	391.43	-0.196	194.9	-0.1855	
391.52	517.07	209.6	-0.1331	391.50	-0.195	195.1	-0.1855	
391.60	517.5	209.6	-0.1331	391.58	-0.194	195.3	-0.1855	
391.68	518.57	209.7	-0.1331	391.67	-0.193	195.6	-0.1855	
391.77	519.81	209.9	-0.1331	391.75	-0.192	196	-0.1846	
391.85	520.81	210.1	-0.1323	391.83	-0.191	196.4	-0.1846	
391.93	521.42	210.2	-0.1323	391.92	-0.19	196.6	-0.1846	
392.02	521.55	210.2	-0.1323	392.00	-0.189	197	-0.1837	
392.10	522.99	210.5	-0.1323	392.08	-0.187	197.6	-0.1837	
392.18	523.99	210.7	-0.1314	392.17	-0.186	198	-0.1829	
392.27	525.4	210.9	-0.1305	392.25	-0.184	198.5	-0.1829	
392.35	526.3	211.2	-0.1305	392.33	-0.182	199.2	-0.182	
392.43	527.57	211.5	-0.1296	392.42	-0.181	200	-0.1811	
392.52	529.14	211.9	-0.1287	392.50	-0.179	200.3	-0.1811	
392.60	529.91	212.3	-0.1287	392.58	-0.177	201.2	-0.1793	
392.68	532.86	212.9	-0.1278	392.67	-0.175	202	-0.1793	
392.77	533.93	213.2	-0.1269	392.75	-0.173	202.6	-0.1784	
392.85	536.04	213.7	-0.126	392.85	-0.17	203.8	-0.1775	
392.93	537.34	214.1	-0.1252	392.92	-0.167	204.9	-0.1758	
393.02	538.61	214.5	-0.1243	393.00	-0.166	205.5	-0.1749	
393.10	540.59	215.1	-0.1234	393.08	-0.163	206.3	-0.174	
393.18	543.3	215.8	-0.1225	393.17	-0.159	207.4	-0.1731	
393.27	545.2	216.6	-0.1207	393.25	-0.156	209	-0.1722	
393.35	548.11	217.5	-0.1189	393.33	-0.154	210	-0.1704	
393.43	547.78	217.4	-0.1189	393.42	-0.153	210.4	-0.1695	
393.53	552.53	218.8	-0.1163	393.50	-0.148	212.3	-0.1669	
393.60	554.2	219.6	-0.1163	393.58	-0.146	213.3	-0.166	
393.68	555.27	220.1	-0.1145	393.67	-0.143	214.4	-0.1642	
393.77	557.45	220.8	-0.1136	393.75	-0.139	215.7	-0.1633	
393.85	560.93	221.8	-0.111	393.83	-0.135	217.6	-0.1616	
393.93	562.33	222.4	-0.1101	393.92	-0.133	218.6	-0.1589	
394.02	565.01	223.2	-0.1083	394.00	-0.13	219.9	-0.1571	
394.10	568.42	224.1	-0.1074	394.08	-0.126	221.6	-0.1553	
394.18	571.33	225.5	-0.1056	394.17	-0.123	222.8	-0.1536	
394.27	573.34	226.3	-0.1021	394.25	-0.12	224.1	-0.1518	

Prova triassiale ciclica SNGR03-C4							
tensione di confinamento (kPa)	450			tensione di confinamento (kPa)	450		
deviatore ciclico (kPa)	150			deviatore ciclico (kPa)	180		
frequenza (hz)	0.0007143			frequenza (hz)	0.0007143		
394.35	575.84	227.2	-0.1012	394.33	-0.115	226.2	-0.1491
394.43	578.45	228.3	-0.0985	394.42	-0.111	227.8	-0.1473
394.52	580.66	229.1	-0.0976	394.50	-0.106	229.8	-0.1438
394.60	583.44	230.1	-0.095	394.58	-0.105	230.6	-0.1429
394.68	587.25	231.4	-0.0932	394.67	-0.1	231.9	-0.1411
394.77	591.32	232.8	-0.0905	394.75	-0.095	234.5	-0.1385
394.85	592.73	233.6	-0.0879	394.83	-0.093	236	-0.1349
394.95	595.97	234.8	-0.0861	394.92	-0.088	237.8	-0.1323
395.02	599.78	235.7	-0.0843	395.00	-0.084	239.5	-0.1296
395.10	602.89	237.5	-0.0817	395.08	-0.081	240.9	-0.1269
395.18	604.87	238.4	-0.0781	395.17	-0.076	242.7	-0.1243
395.27	608.31	239.7	-0.0754	395.25	-0.071	244.6	-0.1216
395.35	611.52	240.8	-0.0728	395.33	-0.066	247.4	-0.1181
395.43	613.39	241.9	-0.0701	395.42	-0.063	248.9	-0.1136
395.52	617.57	243.2	-0.0675	395.50	-0.059	250.6	-0.111
395.60	621.54	244.5	-0.0648	395.58	-0.053	252.7	-0.1074
395.68	625.15	246.2	-0.063	395.67	-0.051	254.4	-0.1047
395.77	626.86	247.3	-0.0577	395.77	-0.046	256.7	-0.1003
395.85	630.8	248.7	-0.0541	395.83	-0.04	258.6	-0.0976
395.93	633.74	249.9	-0.0515	395.92	-0.036	260.7	-0.0941
396.02	635.81	251	-0.0479	396.00	-0.035	261.6	-0.0923
396.10	639.69	252.4	-0.0462	396.08	-0.029	263.8	-0.0879
396.18	644.39	253.8	-0.0426	396.17	-0.022	266.2	-0.0834
396.27	648.14	255.8	-0.0391	396.25	-0.016	269.1	-0.0799
396.35	650.04	256.9	-0.0337	396.33	-0.015	270.6	-0.0737
396.45	653.55	258.2	-0.0311	396.42	-0.01	272.5	-0.0701
396.52	657.65	259.4	-0.0275	396.50	-0.005	274.5	-0.0657
396.60	660.76	261.3	-0.024	396.58	-0.001	276.2	-0.0621
396.68	663.96	262.7	-0.0186	396.67	0.003	278.2	-0.0577
396.77	666.93	264	-0.0151	396.75	0.01	280.2	-0.0533
396.85	671	265.4	-0.0107	396.83	0.014	283.1	-0.0488
396.93	673.14	266.7	-0.0062	396.92	0.018	284.7	-0.0417
397.02	676.68	268	-0.0027	397.00	0.022	286.5	-0.0382
397.10	681.55	269.3	0.0018	397.08	0.027	288.8	-0.032
397.18	684.72	271.5	0.0053	397.18	0.033	291.3	-0.0284
397.27	687.72	272.7	0.0115	397.25	0.036	292.8	-0.0213
397.35	690.85	274	0.016	397.33	0.04	294.6	-0.0169
397.43	694.45	275.5	0.0213	397.42	0.045	296.6	-0.0115
397.52	696.42	276.5	0.0249	397.50	0.049	298.4	-0.0062
397.60	700.02	278	0.0293	397.58	0.053	300.2	-0.0018
397.68	704.63	279.4	0.0337	397.67	0.059	302.2	0.0036
397.77	707.82	281.4	0.0382	397.75	0.064	304.8	0.008
397.87	712.65	283	0.047	397.83	0.067	306.2	0.0169
397.93	712.22	283.7	0.0488	397.92	0.072	308.1	0.0222
398.02	718.29	284.9	0.0533	398.00	0.076	309.8	0.0275
398.10	719.95	286.8	0.0577	398.08	0.08	311.6	0.0328
398.18	722.91	288.1	0.0648	398.17	0.083	313.3	0.0382
398.27	725.97	289.4	0.0701	398.25	0.09	315.2	0.0444
398.35	729.27	290.8	0.0754	398.33	0.094	317.7	0.0488
398.43	731.13	291.8	0.079	398.42	0.097	319.1	0.0577
398.52	734.2	293	0.0834	398.50	0.101	320.6	0.063
398.60	739.09	294.4	0.0888	398.58	0.105	322.5	0.0683
398.68	741.56	296.3	0.0923	398.68	0.109	324.3	0.0737
398.77	744.31	297.4	0.0994	398.75	0.113	326.3	0.0826
398.85	746.88	298.5	0.1039	398.83	0.117	327.5	0.0861
398.93	751.93	300.2	0.1101	398.92	0.121	329.1	0.0923
399.02	751	300.7	0.1127	399.00	0.123	330.3	0.0968
399.10	754.76	302	0.1172	399.08	0.128	332.1	0.103
399.18	757.75	303	0.1216	399.17	0.134	333.4	0.1074
399.27	760.94	304.7	0.126	399.25	0.136	335.7	0.1136

Prova triassiale ciclica SNGR03-C4							
tensione di confinamento (kPa)	450			tensione di confinamento (kPa)	450		
deviatore ciclico (kPa)	150			deviatore ciclico (kPa)	180		
frequenza (hz)	0.0007143			frequenza (hz)	0.0007143		
399.37	762.27	305.7	0.1314	399.33	0.138	336.7	0.1207
399.43	765.03	306.8	0.1358	399.42	0.142	338.2	0.126
399.52	768.29	308.3	0.1402	399.50	0.146	339.7	0.1305
399.60	770.61	309.4	0.1438	399.58	0.149	340.9	0.1358
399.68	772.24	310.2	0.1491	399.67	0.151	342.2	0.1411
399.77	774.66	311.1	0.1527	399.75	0.156	343.5	0.1465
399.85	776.79	312.1	0.1571	399.83	0.162	345.7	0.1509
399.93	778.78	313	0.1607	399.92	0.16	346	0.1571
400.02	780.81	314	0.1642	400.00	0.165	347.5	0.1624
400.10	784.23	315.6	0.1678	400.10	0.168	348.7	0.1669
400.18	785.55	316.3	0.1722	400.17	0.171	350.2	0.1713
400.27	787.18	317.1	0.1758	400.25	0.174	351.3	0.1784
400.35	789.41	318	0.1793	400.33	0.174	351.9	0.182
400.43	791.73	319	0.182	400.42	0.178	353.3	0.1864
400.52	792.53	319.6	0.1837	400.50	0.181	354.2	0.1908
400.60	794.42	320.4	0.1873	400.58	0.182	355.1	0.1944
400.68	798.88	321.9	0.19	400.67	0.186	356	0.1979
400.78	796.81	322.1	0.1935	400.75	0.188	357.3	0.2015
400.85	801.46	323.2	0.1971	400.83	0.189	358	0.2068
400.93	799.59	323.4	0.1979	400.92	0.193	359.4	0.2113
401.02	802.88	324.6	0.2015	401.00	0.192	359.5	0.213
401.10	805.77	325.5	0.2033	401.08	0.194	360.3	0.2166
401.18	804.41	325.7	0.2059	401.17	0.196	361	0.2192
401.27	806.49	326.6	0.2095	401.25	0.198	362.1	0.2237
401.35	806.69	326.9	0.2104	401.33	0.2	362.7	0.2255
401.43	807.59	327.4	0.2121	401.42	0.201	363.3	0.229
401.52	810.38	328.2	0.2148	401.50	0.203	364.1	0.2326
401.60	810.11	328.7	0.2157	401.60	0.204	364.1	0.2334
401.68	811.3	329.3	0.2175	401.67	0.205	365.2	0.2352
401.77	811.93	329.7	0.2201	401.75	0.206	365.6	0.2388
401.85	812.36	330.1	0.221	401.83	0.209	366.3	0.2414
401.93	813.59	330.8	0.2228	401.92	0.206	366.2	0.2414
402.02	812.46	330.8	0.2228	402.00	0.208	366.7	0.245
402.10	813.95	331.3	0.2246	402.08	0.209	367.1	0.2468
402.18	814.38	331.9	0.2272	402.17	0.21	367.5	0.2477
402.28	813.61	331.9	0.2272	402.25	0.21	367.9	0.2485
402.35	815.11	332.3	0.2281	402.33	0.212	368.5	0.2512
402.43	816.01	332.9	0.2299	402.42	0.21	368.3	0.2512
402.52	814.05	332.8	0.2281	402.50	0.21	368.3	0.2521
402.60	817.37	333.6	0.2299	402.58	0.211	368.6	0.253
402.68	814.97	333.4	0.2308	402.67	0.211	368.9	0.2539
402.77	814.21	333.4	0.2308	402.75	0.209	368.7	0.2539
402.85	814.04	333.5	0.2308	402.83	0.21	368.8	0.2539
402.93	814.1	333.7	0.2317	402.92	0.21	368.9	0.2556
403.02	815.9	334.2	0.2326	403.02	0.209	369	0.2556
403.10	812.64	333.8	0.2317	403.08	0.208	368.8	0.2556
403.18	812.44	333.9	0.2317	403.17	0.207	368.6	0.2556
403.27	812.11	333.9	0.2317	403.25	0.207	368.5	0.2556
403.35	811.41	333.9	0.2317	403.33	0.206	368.5	0.2556
403.43	810.81	333.9	0.2308	403.42	0.206	368.4	0.2556
403.52	810.01	333.8	0.2308	403.50	0.203	368	0.2548
403.60	809.48	333.8	0.2308	403.58	0.203	367.9	0.2548
403.70	807.82	333.5	0.2299	403.67	0.201	367.5	0.2539
403.77	807.55	333.5	0.229	403.75	0.2	367.2	0.2539
403.85	806.12	333.3	0.229	403.83	0.197	366.5	0.2521
403.93	804.8	333.1	0.2281	403.92	0.197	366.5	0.2521
404.02	803.66	332.8	0.2281	404.00	0.194	365.7	0.2503
404.10	801.57	332.5	0.2263	404.08	0.193	365.4	0.2494
404.18	800.51	332.3	0.2255	404.17	0.191	365	0.2485
404.27	799.18	332	0.2246	404.25	0.19	364.6	0.2485

Prova triassiale ciclica SNGR03-C4							
tensione di confinamento (kPa)	450			tensione di confinamento (kPa)	450		
deviatore ciclico (kPa)	150			deviatore ciclico (kPa)	180		
frequenza (hz)	0.0007143			frequenza (hz)	0.0007143		
404.35	797.68	331.7	0.2237	404.33	0.186	363.7	0.2468
404.43	796.12	331.4	0.2228	404.42	0.183	362.9	0.2441
404.52	794.79	331.1	0.2219	404.52	0.181	362.3	0.2432
404.60	791.2	330.3	0.221	404.58	0.18	361.9	0.2432
404.68	790.8	330.1	0.2192	404.67	0.177	361.2	0.2406
404.77	788.91	329.6	0.2166	404.75	0.175	360.6	0.2379
404.85	787.15	329.2	0.2157	404.83	0.174	360.2	0.237
404.93	784.96	328.5	0.213	404.92	0.167	358.6	0.2326
405.02	783.49	328.2	0.2121	405.00	0.168	358.5	0.2326
405.12	780.54	327.4	0.2095	405.08	0.165	357.7	0.2299
405.18	777.74	326.7	0.2077	405.17	0.16	356.3	0.2263
405.27	776.68	326.3	0.2059	405.25	0.159	355.5	0.2263
405.35	775.12	325.8	0.2042	405.33	0.155	354.4	0.221
405.43	771.96	325	0.2015	405.42	0.152	353.7	0.2192
405.52	768.47	324	0.1997	405.50	0.147	352.4	0.2157
405.60	766.97	323.5	0.1971	405.58	0.148	352.2	0.2148
405.68	764.55	322.8	0.1944	405.67	0.14	350.4	0.2104
405.77	762.12	322.1	0.1917	405.75	0.138	349.4	0.2086
405.85	761.49	321.6	0.19	405.83	0.134	348.2	0.2042
405.93	757.1	320.5	0.1864	405.93	0.131	347.2	0.1997
406.02	754.94	319.8	0.1846	406.00	0.128	346.2	0.1971
406.10	750.25	318.4	0.1811	406.08	0.122	344.2	0.1917
406.18	748.46	317.7	0.1775	406.17	0.121	343.5	0.1908
406.27	746.26	317.1	0.1749	406.25	0.116	342.3	0.1846
406.35	744.9	316.4	0.1731	406.33	0.112	341	0.1802
406.43	738.98	314.9	0.1678	406.42	0.108	339.4	0.1758
406.52	738.18	314.4	0.166	406.50	0.105	338.4	0.1731
406.62	732.63	312.7	0.1598	406.58	0.102	337.4	0.1695
406.68	731.29	312	0.1571	406.67	0.097	335.2	0.1642
406.77	728.5	310.9	0.1536	406.75	0.09	333.2	0.1598
406.85	725.64	310	0.15	406.83	0.09	332.7	0.1553
406.93	722.28	309	0.1465	406.92	0.081	330.2	0.1491
407.02	718.02	307.5	0.1429	407.00	0.082	329.8	0.1473
407.10	715.42	306.4	0.1376	407.08	0.076	328	0.142
407.18	712.06	305.4	0.1331	407.17	0.071	326.1	0.1367
407.27	709.06	304.2	0.1296	407.25	0.063	323.5	0.1331
407.35	706.4	303.1	0.1252	407.35	0.063	322.9	0.1269
407.43	703.3	302	0.1216	407.42	0.059	321.4	0.1225
407.52	699.34	301.2	0.1181	407.50	0.052	319.2	0.1154
407.60	695.31	299.1	0.1118	407.58	0.047	317.2	0.1127
407.68	693.08	298	0.1056	407.67	0.043	315.5	0.1074
407.77	689.59	296.9	0.1021	407.75	0.039	313.7	0.0985
407.85	685.66	295.4	0.0968	407.83	0.034	311.9	0.0941
407.93	683.99	294.5	0.0932	407.92	0.032	310.6	0.0897
408.03	681.42	293.1	0.0879	408.00	0.027	309	0.0843
408.10	674.99	291.3	0.0817	408.08	0.019	306.4	0.0763
408.18	672.53	290.1	0.0772	408.17	0.017	304.8	0.0728
408.27	670.46	288.9	0.0728	408.25	0.011	302.2	0.0675
408.35	666.69	287.6	0.0675	408.33	0.008	300.8	0.0586
408.43	661.19	286	0.0621	408.42	0.002	298.9	0.0541
408.52	657.89	284.3	0.0577	408.50	-0.001	297.2	0.0488
408.60	656.15	283.1	0.0506	408.58	-0.006	295.4	0.0426
408.68	654.32	282.2	0.047	408.67	-0.01	293.5	0.0373
408.77	648.45	280.3	0.0408	408.75	-0.017	290.4	0.032
408.85	646.61	278.9	0.0364	408.85	-0.019	289.2	0.024
408.93	643.31	277.7	0.032	408.92	-0.026	286.8	0.0178
409.02	638.5	276.4	0.0275	409.00	-0.028	285.3	0.0124
409.10	635.5	274.4	0.0222	409.08	-0.035	282.3	0.0062
409.18	632.66	273	0.016	409.17	-0.036	281	0.0027
409.27	629.49	271.7	0.0115	409.25	-0.044	278.4	-0.0062

Prova triassiale ciclica SNGR03-C4							
tensione di confinamento (kPa)	450			tensione di confinamento (kPa)	450		
deviatore ciclico (kPa)	150			deviatore ciclico (kPa)	180		
frequenza (hz)	0.0007143			frequenza (hz)	0.0007143		
409.35	625.82	270.2	0.0071	409.33	-0.048	276.5	-0.0107
409.43	626.05	269.9	0.0036	409.42	-0.051	274.7	-0.0151
409.53	619.61	267.6	-0.0036	409.50	-0.054	273.4	-0.0195
409.60	616.57	266.3	-0.0071	409.58	-0.06	270.8	-0.0257
409.68	613.13	264.9	-0.0115	409.67	-0.066	268.1	-0.0302
409.77	611.29	263.8	-0.0151	409.75	-0.07	266.1	-0.0373
409.85	607.98	262.5	-0.0195	409.83	-0.072	264.9	-0.0417
409.93	604.1	260.9	-0.0231	409.92	-0.079	262	-0.0462
410.02	599.76	258.8	-0.0275	410.00	-0.081	260.7	-0.0497
410.10	597.96	257.5	-0.0328	410.08	-0.082	259.5	-0.0533
410.18	595.01	256.3	-0.0364	410.17	-0.09	256.7	-0.0586
410.27	591.74	254.9	-0.0399	410.27	-0.095	253.7	-0.0648
410.35	589.97	253.7	-0.0435	410.33	-0.097	252.4	-0.0683
410.43	589.03	252.8	-0.0453	410.42	-0.101	250.8	-0.0719
410.52	582.88	250.7	-0.0497	410.50	-0.104	248.8	-0.0754
410.60	579.34	248.8	-0.0524	410.58	-0.11	246.3	-0.0799
410.68	577.5	247.6	-0.0568	410.67	-0.115	243.9	-0.0861
410.77	574.69	246.3	-0.0604	410.75	-0.117	242.6	-0.0897
410.85	572.28	245	-0.063	410.83	-0.121	240.6	-0.0932
410.95	568.9	243.2	-0.0657	410.92	-0.123	239.1	-0.0968
411.02	567.49	242.1	-0.0692	411.00	-0.125	237.9	-0.0985
411.10	564.42	240.8	-0.0719	411.08	-0.131	235.5	-0.103
411.18	562.04	239.6	-0.0746	411.17	-0.135	233	-0.1074
411.27	560.44	238.4	-0.0772	411.25	-0.138	231.3	-0.1118
411.35	557.83	237.3	-0.0799	411.33	-0.141	230.1	-0.1145
411.43	554.75	236.1	-0.0826	411.42	-0.144	228.3	-0.1181
411.52	553.58	234.7	-0.0852	411.50	-0.145	227.1	-0.1207
411.60	551.07	233.5	-0.0879	411.58	-0.148	225.6	-0.1234
411.68	548.32	232.3	-0.0905	411.67	-0.153	223.7	-0.1269
411.77	546.52	231.2	-0.0923	411.77	-0.155	222	-0.1305
411.85	544.87	230.2	-0.095	411.83	-0.159	220	-0.1349
411.93	542.8	229.2	-0.0968	411.92	-0.16	219.1	-0.1376
412.02	539.82	228.1	-0.0994	412.00	-0.163	217.5	-0.1402
412.10	538.25	226.7	-0.1012	412.08	-0.167	215.5	-0.1429
412.18	536.84	225.8	-0.1039	412.17	-0.17	213.7	-0.1473
412.27	535.4	224.9	-0.1056	412.25	-0.174	212.3	-0.15
412.35	533.56	224	-0.1074	412.33	-0.173	211.9	-0.1518
412.45	531.12	222.7	-0.1092	412.42	-0.176	210.6	-0.1544
412.52	530.28	221.9	-0.1118	412.50	-0.177	209.7	-0.1562
412.60	528.67	221.2	-0.1127	412.58	-0.179	208.5	-0.158
412.68	527.47	220.5	-0.1145	412.67	-0.18	207.4	-0.1607
412.77	526.73	219.8	-0.1154	412.75	-0.182	206.1	-0.1633
412.85	525.15	219	-0.1172	412.83	-0.185	205.1	-0.1651
412.93	523.35	218.2	-0.1181	412.92	-0.186	204.2	-0.1669
413.02	523.88	217.6	-0.1198	413.00	-0.188	203.3	-0.1687
413.10	521.84	216.7	-0.1216	413.08	-0.189	202.6	-0.1704
413.18	520.5	216	-0.1225	413.18	-0.19	201.4	-0.1731
413.27	520.2	215.5	-0.1234	413.25	-0.191	200.7	-0.174
413.35	519.29	214.9	-0.1243	413.33	-0.193	199.9	-0.1758
413.43	518.32	214.4	-0.1252	413.42	-0.193	199.6	-0.1766
413.52	517.48	214	-0.126	413.50	-0.195	198.8	-0.1775
413.60	516.75	213.2	-0.1269	413.58	-0.195	198.2	-0.1793
413.68	516.07	212.8	-0.1287	413.67	-0.196	197.7	-0.1802
413.77	516.37	212.5	-0.1287	413.75	-0.197	197	-0.182
413.87	515.37	212	-0.1296	413.83	-0.197	196.9	-0.182
413.93	514.5	211.5	-0.1305	413.92	-0.197	196.6	-0.1829
414.02	514.7	211.2	-0.1314	414.00	-0.197	196.4	-0.1837
414.10	515.54	211.2	-0.1314	414.08	-0.198	196	-0.1846
414.18	514.9	210.8	-0.1314	414.17	-0.198	195.7	-0.1855
414.27	515.1	210.6	-0.1323	414.25	-0.198	195	-0.1864

Prova triassiale ciclica SNGR03-C4							
tensione di confinamento (kPa)	450			tensione di confinamento (kPa)	450		
deviatore ciclico (kPa)	150			deviatore ciclico (kPa)	180		
frequenza (hz)	0.0007143			frequenza (hz)	0.0007143		
414.35	513.89	210.1	-0.1331	414.33	-0.198	195.4	-0.1864
414.43	515.67	210.3	-0.1323	414.42	-0.197	195.5	-0.1864
414.52	515.87	210.2	-0.1331	414.50	-0.197	195.6	-0.1864
414.60	515.97	210	-0.1331	414.58	-0.197	195.3	-0.1873
414.68	516	209.9	-0.1331	414.68	-0.196	195.7	-0.1873
414.77	516.6	209.9	-0.1331	414.75	-0.196	195.7	-0.1873
414.85	516.94	209.8	-0.1331	414.83	-0.196	195.6	-0.1873
414.93	517.37	209.8	-0.1331	414.92	-0.194	196	-0.1873
415.02	518.54	209.9	-0.1331	415.00	-0.193	196.2	-0.1873
415.10	521.68	210.6	-0.1331	415.08	-0.192	196.7	-0.1873
415.18	521.02	210.4	-0.1323	415.17	-0.193	196.4	-0.1873
415.28	520.35	210.2	-0.1323	415.25	-0.19	197	-0.1864
415.35	522.05	210.4	-0.1323	415.33	-0.188	197.6	-0.1855
415.43	522.02	210.5	-0.1323	415.42	-0.187	198.4	-0.1846
415.52	524.6	211	-0.1305	415.50	-0.185	199	-0.1846
415.60	525.06	211.1	-0.1305	415.58	-0.184	199	-0.1846
415.68	526.4	211.5	-0.1296	415.67	-0.182	200	-0.1837
415.77	527.41	211.7	-0.1296	415.75	-0.18	200.5	-0.1829
415.85	529.51	212.2	-0.1287	415.83	-0.179	201.2	-0.1829
415.93	530.89	212.5	-0.1278	415.92	-0.177	201.7	-0.182
416.02	534.93	213.6	-0.1269	416.00	-0.175	202.8	-0.1811
416.10	534.43	213.6	-0.126	416.10	-0.172	203.6	-0.1802
416.18	534.8	213.8	-0.126	416.17	-0.17	204.5	-0.1793
416.27	537.58	214.5	-0.1243	416.25	-0.168	205.3	-0.1784
416.35	538.75	214.9	-0.1243	416.33	-0.165	206.5	-0.1766
416.43	540.59	215.4	-0.1225	416.42	-0.163	207	-0.1758
416.52	541.59	216	-0.1216	416.50	-0.16	208	-0.1749
416.60	546.87	217.2	-0.1207	416.58	-0.157	209.5	-0.174
416.68	546.81	217.4	-0.1189	416.67	-0.155	210.5	-0.1722
416.78	548.52	217.9	-0.1181	416.75	-0.152	211.5	-0.1704
416.85	551.29	218.3	-0.1181	416.83	-0.148	212.9	-0.1695
416.93	554.17	219.8	-0.1163	416.92	-0.147	213.8	-0.1678
417.02	555.47	220.4	-0.1145	417.00	-0.141	215.6	-0.1651
417.10	557.92	221.2	-0.1127	417.08	-0.139	216.4	-0.1642
417.18	560.59	222	-0.111	417.17	-0.136	217.9	-0.1642
417.27	562.43	222.7	-0.1092	417.25	-0.133	219.4	-0.1607
417.35	564.94	223.5	-0.1083	417.33	-0.127	221.4	-0.158
417.43	569.02	224.5	-0.1065	417.42	-0.127	222	-0.1571
417.52	571.03	225.7	-0.1047	417.52	-0.121	224.1	-0.1553
417.60	573.5	226.6	-0.1021	417.58	-0.119	225.4	-0.1527
417.68	575.58	227.4	-0.1012	417.67	-0.116	226.6	-0.1509
417.77	579.09	228.7	-0.0985	417.75	-0.113	227.9	-0.1491
417.85	581.06	229.6	-0.0968	417.83	-0.109	229.6	-0.1465
417.93	581.93	230.1	-0.0959	417.92	-0.105	231.1	-0.1447
418.02	587.72	231.8	-0.0923	418.00	-0.1	233	-0.142
418.10	591.22	233.2	-0.0905	418.08	-0.093	235.7	-0.1385
418.18	592.66	233.9	-0.0879	418.17	-0.094	236.5	-0.1367
418.27	594.7	234.8	-0.0861	418.25	-0.088	238.4	-0.134
418.35	599.38	236.2	-0.0834	418.33	-0.083	240.3	-0.1314
418.43	602.73	237.8	-0.0808	418.42	-0.082	241.7	-0.1287
418.52	604.87	238.8	-0.0781	418.50	-0.077	243.4	-0.126
418.60	607.91	239.9	-0.0754	418.58	-0.069	245.5	-0.1216
418.68	611.08	241.1	-0.0728	418.67	-0.067	247.8	-0.1207
418.77	616.46	242.8	-0.0683	418.75	-0.064	249.3	-0.1154
418.85	616.43	243.4	-0.0675	418.83	-0.059	251.2	-0.1127
418.93	621.38	244.8	-0.0648	418.92	-0.053	253.4	-0.1092
419.02	624.15	246.5	-0.0621	419.02	-0.049	255.6	-0.1065
419.10	627.29	247.7	-0.0577	419.08	-0.046	257.4	-0.1012
419.18	629.96	248.9	-0.055	419.17	-0.041	259.2	-0.0985
419.27	634.11	250.4	-0.0506	419.25	-0.034	262	-0.0941

Prova triassiale ciclica SNGR03-C4								
tensione di confinamento (kPa)	450				tensione di confinamento (kPa)	450		
deviatore ciclico (kPa)	150				deviatore ciclico (kPa)	180		
frequenza (hz)	0.0007143				frequenza (hz)	0.0007143		
419.35	636.38	251.5	-0.0479	419.33	-0.034	262.9	-0.0923	
419.43	639.62	252.8	-0.0462	419.42	-0.029	264.8	-0.0888	
419.52	644.26	254.2	-0.0426	419.50	-0.022	266.9	-0.0843	
419.60	647.94	256.1	-0.0391	419.58	-0.017	269.6	-0.0808	
419.70	649.44	257.1	-0.0346	419.67	-0.014	271.4	-0.0746	
419.77	651.91	258.3	-0.0311	419.75	-0.01	273.5	-0.0701	
419.85	658.12	259.9	-0.0275	419.83	-0.004	275.6	-0.0657	
419.93	661.49	261.8	-0.0231	419.92	-0.004	276.5	-0.0639	
420.02	663.06	262.9	-0.0186	420.00	0.003	278.7	-0.0595	
420.10	666.67	264.3	-0.0151	420.08	0.009	281	-0.0541	
420.18	670.84	265.8	-0.0107	420.17	0.015	283.8	-0.0497	
420.27	672.97	267	-0.0062	420.25	0.018	285.5	-0.0435	
420.35	676.78	268.4	-0.0027	420.33	0.023	287.4	-0.0382	
420.43	682.38	269.7	0.0018	420.43	0.027	289.5	-0.0337	
420.52	685.02	271.9	0.0053	420.50	0.031	291.7	-0.0293	
420.60	689.29	273.5	0.0142	420.58	0.036	293.5	-0.0231	
420.68	689.15	274.2	0.016	420.67	0.04	295.3	-0.0186	
420.77	694.29	276	0.0213	420.75	0.046	297.7	-0.0124	
420.85	696.15	277	0.0257	420.83	0.048	299.1	-0.008	
420.93	699.99	278.4	0.0293	420.92	0.053	300.9	-0.0027	
421.02	704.26	279.9	0.0346	421.00	0.059	302.9	0.0027	
421.12	707.59	281.7	0.0408	421.08	0.064	305.6	0.0071	
421.18	709.72	282.8	0.0444	421.17	0.07	307.7	0.0178	
421.27	712.92	284.2	0.0488	421.25	0.072	309	0.0213	
421.35	717.38	285.5	0.0541	421.33	0.076	310.6	0.0266	
421.43	720.31	287.3	0.0586	421.42	0.079	312.2	0.032	
421.52	722.44	288.6	0.0666	421.50	0.083	314	0.0373	
421.60	726.17	289.9	0.071	421.58	0.089	316	0.0435	
421.68	728.6	291.1	0.0754	421.67	0.094	318.3	0.0488	
421.77	731.04	292.3	0.079	421.75	0.097	320	0.0568	
421.85	734.76	293.6	0.0843	421.83	0.101	321.5	0.0621	
421.93	738.96	294.8	0.0888	421.93	0.109	323	0.0675	
422.02	741.35	296.7	0.0932	422.00	0.107	324.9	0.0728	
422.10	743.88	297.8	0.1003	422.08	0.113	326.7	0.0799	
422.18	746.31	298.9	0.1047	422.17	0.117	328.3	0.0861	
422.27	749.34	300.2	0.1092	422.25	0.121	329.9	0.0914	
422.35	750.9	301.1	0.1127	422.33	0.124	331.4	0.0968	
422.43	754.22	302.3	0.1172	422.42	0.127	332.8	0.1021	
422.52	757.75	303.4	0.1216	422.50	0.133	334.4	0.1083	
422.62	759.78	305.1	0.1278	422.58	0.136	336.3	0.1127	
422.68	762	306.1	0.1314	422.67	0.141	337.9	0.1216	
422.77	765.06	307.2	0.1358	422.75	0.142	339.1	0.126	
422.85	768.42	308.2	0.1402	422.83	0.146	340.5	0.1305	
422.93	770.88	309.8	0.1438	422.92	0.148	341.7	0.1358	
423.02	772.44	310.7	0.15	423.00	0.152	343	0.1411	
423.10	775.53	311.9	0.1544	423.08	0.158	344.3	0.1456	
423.18	775.46	312.4	0.1571	423.17	0.158	346	0.1518	
423.27	778.58	313.5	0.1607	423.25	0.16	346.9	0.1571	
423.35	780.94	314.5	0.1642	423.35	0.164	348.2	0.1616	
423.43	783.4	315.8	0.1678	423.42	0.168	349.4	0.1669	
423.52	786.06	316.8	0.1713	423.50	0.171	351.1	0.1704	
423.60	787.35	317.6	0.1758	423.58	0.172	352	0.1775	
423.68	789.74	318.5	0.1793	423.67	0.176	353	0.182	
423.77	791.27	319.3	0.1811	423.75	0.178	354	0.1864	
423.85	793.02	320.1	0.1855	423.83	0.18	355	0.19	
423.93	794.02	320.9	0.1873	423.92	0.182	355.9	0.1944	
424.03	796.91	322.1	0.1917	424.00	0.186	357	0.1988	
424.10	797.4	322.7	0.1935	424.08	0.188	358.2	0.2015	
424.18	801.92	323.8	0.1979	424.17	0.189	358.9	0.2068	
424.27	799.23	323.9	0.1979	424.25	0.192	359.9	0.2104	

Prova triassiale ciclica SNGR03-C4							
tensione di confinamento (kPa)	450			tensione di confinamento (kPa)	450		
deviatore ciclico (kPa)	150			deviatore ciclico (kPa)	180		
frequenza (hz)	0.0007143			frequenza (hz)	0.0007143		
424.35	802.88	325.1	0.2015	424.33	0.193	360.6	0.213
424.43	803.91	325.7	0.2033	424.42	0.197	361.6	0.2175
424.52	804.77	326.3	0.2068	424.50	0.196	362	0.2201
424.60	806.13	326.9	0.2086	424.58	0.197	362.7	0.2228
424.68	807.16	327.4	0.2104	424.67	0.2	363.7	0.2255
424.77	807.76	327.9	0.2121	424.75	0.201	364.2	0.229
424.85	809.65	328.6	0.2148	424.85	0.201	364.7	0.2308
424.93	810.41	329.2	0.2157	424.92	0.204	365.3	0.2334
425.02	811.1	329.8	0.2175	425.00	0.205	366	0.2361
425.10	811.63	330.5	0.221	425.08	0.208	366.8	0.2397
425.18	812.13	330.7	0.2219	425.17	0.207	366.8	0.2406
425.27	812.89	331.1	0.2228	425.25	0.207	367.2	0.2414
425.35	813.32	331.5	0.2237	425.33	0.208	367.6	0.2441
425.45	813.98	332	0.2255	425.42	0.208	367.9	0.2459
425.52	814.45	332.3	0.2263	425.50	0.209	368.5	0.2477
425.60	814.31	332.5	0.2272	425.58	0.212	369.1	0.2485
425.68	814.75	332.9	0.2281	425.67	0.21	369	0.2503
425.77	814.81	333.2	0.229	425.75	0.209	368.9	0.2503
425.85	815.24	333.5	0.2299	425.83	0.212	369.5	0.253
425.93	814.84	333.7	0.2299	425.92	0.21	369.3	0.2521
426.02	814.64	333.8	0.2308	426.00	0.211	369.6	0.2539
426.10	815.2	334.1	0.2317	426.08	0.211	369.5	0.2539
426.18	816.26	334.4	0.2326	426.17	0.209	369.6	0.2539
426.27	813.74	334.2	0.2317	426.27	0.209	369.5	0.2548
426.35	812.94	334.2	0.2317	426.33	0.209	369.6	0.2548
426.43	813.17	334.4	0.2317	426.42	0.208	369.6	0.2556
426.52	812.91	334.4	0.2317	426.50	0.208	369.5	0.2548
426.60	812.47	334.5	0.2317	426.58	0.207	369.4	0.2548
426.68	811.87	334.5	0.2317	426.67	0.206	369.2	0.2548
426.77	810.91	334.4	0.2317	426.75	0.205	369	0.2539
426.85	810.11	334.3	0.2308	426.83	0.204	368.9	0.2539
426.95	809.68	334.3	0.2308	426.92	0.202	368.5	0.253
427.02	807.89	334	0.2299	427.00	0.201	368.2	0.253
427.10	808.32	333.9	0.2299	427.08	0.2	368	0.2521
427.18	805.49	333.6	0.229	427.17	0.197	367.3	0.2512
427.27	805.13	333.6	0.229	427.25	0.196	367	0.2503
427.35	801.23	332.9	0.2281	427.33	0.196	366.9	0.2503
427.43	801.84	333	0.2263	427.42	0.193	366.2	0.2485
427.52	801.24	332.9	0.2255	427.50	0.192	365.8	0.2477
427.60	799.71	332.6	0.2255	427.58	0.189	365.1	0.2468
427.68	796.19	331.9	0.2228	427.68	0.187	364.5	0.245
427.77	796.39	331.8	0.2228	427.75	0.185	364.1	0.2441
427.85	794.26	331.3	0.221	427.83	0.183	363.5	0.2414
427.93	792.9	331	0.2201	427.92	0.179	362.5	0.2406
428.02	791.1	330.6	0.2184	428.00	0.179	362.3	0.2388
428.10	787.25	329.8	0.2157	428.08	0.175	361.4	0.237
428.18	787.95	329.7	0.2157	428.17	0.171	360.6	0.2343
428.27	783.92	328.8	0.213	428.25	0.171	360	0.2334
428.35	784.46	328.5	0.2113	428.33	0.167	359.2	0.2308
428.43	781.93	328	0.2095	428.42	0.164	358.3	0.229
428.52	778.37	327.2	0.2077	428.50	0.16	357	0.2263
428.60	778.54	327	0.2068	428.58	0.158	356.2	0.2246
428.68	773.92	326	0.2042	428.67	0.155	355.4	0.221
428.77	773.36	325.7	0.2024	428.75	0.152	354.4	0.2184
428.85	770.17	324.7	0.1997	428.83	0.149	353.5	0.2157
428.93	764.81	323.6	0.1962	428.92	0.146	352.5	0.213
429.02	764.08	323.1	0.1935	429.00	0.143	351.6	0.2104
429.10	763.62	322.8	0.1926	429.08	0.138	350	0.2068
429.18	758.26	321.3	0.1882	429.18	0.134	348.8	0.2015
429.27	759.03	321.3	0.1873	429.25	0.134	348.5	0.1997

Prova triassiale ciclica SNGR03-C4							
tensione di confinamento (kPa)	450			tensione di confinamento (kPa)	450		
deviatore ciclico (kPa)	150			deviatore ciclico (kPa)	180		
frequenza (hz)	0.0007143			frequenza (hz)	0.0007143		
429.35	754.24	320	0.1837	429.33	0.126	346.5	0.1944
429.43	749.92	318.8	0.1802	429.42	0.123	345.2	0.1917
429.52	747.63	317.9	0.1766	429.50	0.119	343.8	0.1882
429.60	745.79	317.4	0.1758	429.58	0.116	343	0.1837
429.68	742.7	316.3	0.1713	429.67	0.112	341.7	0.1793
429.77	741.84	315.7	0.1695	429.75	0.108	340.2	0.1749
429.87	737.35	314.4	0.1651	429.83	0.105	339.2	0.1722
429.93	732.32	313.1	0.1607	429.92	0.1	337.4	0.1678
430.02	731.43	312.4	0.158	430.00	0.095	335.7	0.1633
430.10	727.37	310.9	0.1527	430.08	0.092	334.6	0.1589
430.18	727.5	310.7	0.1509	430.17	0.088	333.1	0.1527
430.27	721.18	309.3	0.1465	430.25	0.081	331	0.1473
430.35	717.15	307.7	0.1411	430.33	0.08	329.9	0.1438
430.43	714.29	306.4	0.1358	430.42	0.075	328.5	0.1394
430.52	714.49	306.2	0.134	430.50	0.071	326.9	0.1349
430.60	708.37	304.5	0.1287	430.58	0.065	324.8	0.1296
430.68	706.9	303.5	0.1252	430.67	0.065	323.8	0.126
430.77	703.14	302.3	0.1207	430.75	0.06	322.3	0.1207
430.85	698.14	300.9	0.1163	430.83	0.053	320.2	0.1154
430.93	695.95	299.7	0.1136	430.92	0.048	317.8	0.1092
431.02	693.15	298.2	0.1056	431.00	0.043	316	0.1047
431.10	687.95	296.7	0.0994	431.08	0.039	314.6	0.0968
431.18	686.75	295.9	0.0968	431.17	0.034	312.7	0.0914
431.28	681.62	293.9	0.0914	431.25	0.03	311	0.0861
431.35	680.26	292.9	0.0861	431.33	0.026	309.5	0.0808
431.43	673.96	291.3	0.0799	431.42	0.022	307.5	0.0754
431.52	673.09	290.4	0.0763	431.50	0.017	305.3	0.0692
431.60	670.86	289.1	0.0719	431.58	0.008	302.2	0.0639
431.68	664.79	287.5	0.0648	431.67	0.007	301.4	0.0559
431.77	662.66	287	0.063	431.75	0.002	299.5	0.0506
431.85	654.95	284.1	0.0577	431.83	-0.002	297.5	0.0444
431.93	656.12	283.3	0.0497	431.92	-0.006	296	0.0399
432.02	653.35	282.2	0.0462	432.00	-0.011	293.8	0.0337
432.10	649.32	280.7	0.0408	432.10	-0.016	291.5	0.0275
432.18	646.75	279.3	0.0355	432.17	-0.021	289.2	0.0213
432.27	643.34	278	0.0311	432.25	-0.024	287.9	0.016
432.35	639.67	276.5	0.0266	432.33	-0.029	285.8	0.0098
432.43	634.9	274.5	0.0222	432.42	-0.035	283	0.0053
432.52	633.3	273.4	0.0151	432.50	-0.038	281.1	0
432.60	627.56	271.6	0.0107	432.58	-0.042	279.4	-0.008
432.68	625.99	270.5	0.0062	432.67	-0.048	277.2	-0.0133
432.78	622.81	269.4	0.0036	432.75	-0.051	275.6	-0.0178
432.85	620.24	268	-0.0036	432.83	-0.056	273.2	-0.024
432.93	616.5	266.6	-0.008	432.92	-0.06	271.4	-0.0284
433.02	612.66	265.1	-0.0124	433.00	-0.066	268.7	-0.0328
433.10	611.02	263.9	-0.016	433.08	-0.07	266.4	-0.0373
433.18	607.81	262.7	-0.0195	433.17	-0.073	265.1	-0.0444
433.27	603.97	261.3	-0.024	433.25	-0.078	262.9	-0.0488
433.35	599.56	258.4	-0.0275	433.33	-0.081	261.2	-0.0533
433.43	597.15	257.6	-0.0337	433.42	-0.084	259.5	-0.0577
433.52	595.75	256.8	-0.0364	433.52	-0.088	257.1	-0.0621
433.60	592.67	255.3	-0.0399	433.58	-0.095	254.8	-0.0666
433.68	589.36	253.7	-0.0435	433.67	-0.098	252.9	-0.0719
433.77	586.56	252.5	-0.047	433.75	-0.101	251.2	-0.0754
433.85	582.78	251.1	-0.0497	433.83	-0.106	249.1	-0.079
433.93	580.01	249.1	-0.0524	433.92	-0.11	246.8	-0.0826
434.02	577.66	247.9	-0.0577	434.00	-0.114	244.8	-0.0888
434.10	575.02	246.6	-0.0604	434.08	-0.117	243.2	-0.0923
434.20	571.95	245.3	-0.063	434.17	-0.121	241.3	-0.0959
434.27	568.97	243.4	-0.0657	434.25	-0.123	239.6	-0.0985

Prova triassiale ciclica SNGR03-C4							
tensione di confinamento (kPa)	450			tensione di confinamento (kPa)	450 <th colspan="2"></th>		
deviatore ciclico (kPa)	150			deviatore ciclico (kPa)	180		
frequenza (hz)	0.0007143			frequenza (hz)	0.0007143		
434.35	566.93	242.2	-0.0701	434.33	-0.124	238.7	-0.1012
434.43	564.32	241	-0.0728	434.42	-0.131	236.1	-0.1056
434.52	561.84	239.7	-0.0754	434.50	-0.135	233.7	-0.1092
434.60	562.78	239.3	-0.0763	434.58	-0.138	231.8	-0.1145
434.68	558.29	237.8	-0.0799	434.67	-0.143	229.8	-0.1189
434.77	554.68	236.4	-0.0826	434.75	-0.144	228.8	-0.1216
434.85	552.27	234.7	-0.0852	434.83	-0.147	227.1	-0.1252
434.93	550.56	233.6	-0.0888	434.92	-0.15	225.7	-0.1278
435.02	548.56	232.5	-0.0905	435.02	-0.153	223.6	-0.1314
435.10	546.15	231.4	-0.0932	435.08	-0.156	222.2	-0.1349
435.18	544.74	230.4	-0.095	435.17	-0.156	221.1	-0.1367
435.27	542.5	229.4	-0.0976	435.25	-0.16	219.7	-0.1402
435.35	540.09	228.4	-0.0994	435.33	-0.163	217.7	-0.1438
435.43	537.65	226.7	-0.1021	435.42	-0.167	215.9	-0.1465
435.52	537.04	226	-0.1047	435.50	-0.169	214.7	-0.15
435.60	536.77	225.5	-0.1056	435.58	-0.171	213.7	-0.1527
435.68	533.33	224.3	-0.1074	435.67	-0.173	212.6	-0.1544
435.77	531.59	223	-0.1092	435.75	-0.175	211	-0.1571
435.85	530.41	222.3	-0.1118	435.83	-0.177	210.1	-0.1589
435.93	528.74	221.4	-0.1127	435.92	-0.179	208.9	-0.1616
436.02	527.93	220.7	-0.1145	436.00	-0.182	207.2	-0.1633
436.10	526.02	219.9	-0.1163	436.08	-0.185	205.8	-0.1678
436.18	525.75	219.3	-0.1189	436.17	-0.185	205.4	-0.1687
436.27	524.35	218.2	-0.1189	436.25	-0.186	204.5	-0.1704
436.35	521.77	217.3	-0.1198	436.33	-0.187	203.7	-0.1722
436.43	519.63	216.4	-0.1225	436.43	-0.189	202.5	-0.1749
436.52	522.07	216.5	-0.1225	436.50	-0.19	202	-0.1758
436.60	519.69	215.6	-0.1243	436.58	-0.19	201.7	-0.1766
436.68	519.19	215.1	-0.1252	436.67	-0.192	200.5	-0.1784
436.77	518.52	214.5	-0.126	436.75	-0.193	200	-0.1802
436.85	517.25	214.1	-0.1269	436.83	-0.194	199.1	-0.182
436.93	517.05	213.5	-0.1278	436.92	-0.198	197.8	-0.1829
437.02	516.54	213	-0.1287	437.00	-0.196	198.1	-0.1846
437.12	516.34	212.7	-0.1296	437.08	-0.196	197.8	-0.1855
437.18	515	212.2	-0.1305	437.17	-0.198	197.1	-0.1864
437.27	515.8	211.9	-0.1305	437.25	-0.197	197.2	-0.1864
437.35	515.13	211.5	-0.1314	437.33	-0.197	196.9	-0.1873
437.43	514.96	211.2	-0.1323	437.42	-0.198	196.6	-0.1882
437.52	515	211	-0.1323	437.50	-0.198	196.2	-0.1891
437.60	515.03	210.8	-0.1323	437.58	-0.198	196	-0.1891
437.68	514.93	210.5	-0.1331	437.67	-0.198	195.7	-0.19
437.77	515.33	210.3	-0.1331	437.75	-0.197	195.7	-0.19
437.85	515.56	210.3	-0.1331	437.83	-0.197	195.8	-0.19
437.93	516.03	210.2	-0.1331	437.92	-0.197	195.6	-0.1908
438.02	516.16	209.6	-0.134	438.00	-0.196	195.8	-0.1908
438.10	517.2	210.2	-0.1331	438.08	-0.196	196	-0.1908
438.18	517.54	210.2	-0.1331	438.17	-0.195	196.1	-0.1908
438.27	517.67	210.1	-0.1331	438.25	-0.195	196.4	-0.1908
438.35	518.31	210.1	-0.1331	438.33	-0.193	196.4	-0.1908
438.43	519.34	210.3	-0.1331	438.42	-0.192	196.8	-0.1908
438.52	520.41	210.5	-0.1323	438.50	-0.191	197.3	-0.19
438.60	520.61	210.5	-0.1323	438.58	-0.19	197.4	-0.19
438.68	521.99	210.7	-0.1323	438.67	-0.189	197.8	-0.19
438.77	522.29	210.7	-0.1323	438.75	-0.188	198.3	-0.1891
438.85	523.52	211	-0.1314	438.83	-0.186	198.9	-0.1891
438.93	525.37	211.4	-0.1305	438.92	-0.183	199.5	-0.1882
439.02	527.97	212.1	-0.1296	439.00	-0.182	200.3	-0.1873
439.10	527.57	212.1	-0.1296	439.08	-0.181	200.9	-0.1864
439.18	529.14	212.4	-0.1287	439.17	-0.178	201.7	-0.1855
439.27	530.78	212.7	-0.1287	439.25	-0.175	202.9	-0.1846

Prova triassiale ciclica SNGR03-C4							
tensione di confinamento (kPa)	450			tensione di confinamento (kPa)	450		
deviatore ciclico (kPa)	150			deviatore ciclico (kPa)	180		
frequenza (hz)	0.0007143			frequenza (hz)	0.0007143		
439.35	532.82	213.4	-0.1278	439.35	-0.174	203.2	-0.1846
439.43	533.46	213.7	-0.1269	439.42	-0.172	204.2	-0.1829
439.52	535.97	214.2	-0.126	439.50	-0.17	204.9	-0.182
439.60	537.27	214.6	-0.1252	439.58	-0.167	205.8	-0.1811
439.68	540.02	215.4	-0.1234	439.67	-0.165	206.5	-0.1802
439.77	541.19	215.8	-0.1234	439.75	-0.163	207.4	-0.1793
439.85	543.53	216.2	-0.1225	439.83	-0.16	208.6	-0.1784
439.93	545.14	217.1	-0.1207	439.92	-0.156	210	-0.1766
440.03	546.41	217.5	-0.1198	440.00	-0.155	210.8	-0.1758
440.10	548.58	218.2	-0.1189	440.08	-0.151	212	-0.174
440.18	551.66	218.9	-0.1172	440.17	-0.15	212.9	-0.1731
440.27	554.23	220	-0.1163	440.25	-0.146	214.4	-0.1713
440.35	555.41	220.6	-0.1145	440.33	-0.143	215.4	-0.1695
440.43	558.62	221.5	-0.1127	440.42	-0.139	216.8	-0.1678
440.52	560.09	222.2	-0.1118	440.50	-0.135	218.6	-0.1669
440.60	562.23	222.9	-0.1101	440.58	-0.133	219.6	-0.1642
440.68	564.1	223.5	-0.1092	440.67	-0.13	221	-0.1624
440.77	568.82	224.6	-0.1074	440.75	-0.126	222.6	-0.1607
440.85	570.66	225.9	-0.1056	440.83	-0.122	224.4	-0.1589
440.93	574.24	227.1	-0.1021	440.92	-0.118	226	-0.1562
441.02	575.08	227.6	-0.1012	441.00	-0.115	227.2	-0.1544
441.10	578.38	228.7	-0.0994	441.08	-0.113	228.2	-0.1536
441.18	581.39	229.9	-0.0976	441.17	-0.109	230.1	-0.15
441.27	582.53	230.5	-0.0959	441.25	-0.105	231.7	-0.1482
441.35	587.62	232.1	-0.0923	441.33	-0.099	233.3	-0.1456
441.45	590.76	233.4	-0.0897	441.42	-0.095	235.8	-0.1438
441.52	592.13	234.1	-0.0879	441.50	-0.092	237.2	-0.1394
441.60	595.24	235.2	-0.0861	441.58	-0.089	238.8	-0.1376
441.68	596.84	236.4	-0.0834	441.67	-0.083	240.8	-0.1349
441.77	603.26	238.2	-0.0808	441.75	-0.081	242.2	-0.1323
441.85	607.17	239.6	-0.0763	441.83	-0.077	243.8	-0.1296
441.93	607.71	240.3	-0.0754	441.92	-0.072	246	-0.126
442.02	610.75	241.4	-0.0728	442.00	-0.065	248.7	-0.1234
442.10	613.16	242.5	-0.0701	442.08	-0.064	250.1	-0.1189
442.18	617.13	243.8	-0.0675	442.17	-0.058	251.9	-0.1154
442.27	621.01	245.1	-0.0648	442.27	-0.053	253.6	-0.1127
442.35	624.72	246.9	-0.0621	442.33	-0.047	257	-0.1101
442.43	627.03	248	-0.0577	442.42	-0.046	258.1	-0.1047
442.52	630.5	249.3	-0.055	442.50	-0.043	259.3	-0.103
442.60	632.04	250.2	-0.0524	442.58	-0.036	261.8	-0.0985
442.68	635.81	251.6	-0.0488	442.67	-0.033	263.6	-0.0959
442.77	639.65	253	-0.0462	442.75	-0.029	265.3	-0.0923
442.85	644.7	254.5	-0.0426	442.83	-0.022	267.4	-0.0879
442.95	646.73	256.1	-0.0382	442.92	-0.017	270.2	-0.0843
443.02	649.64	257.3	-0.0346	443.00	-0.014	272	-0.079
443.10	653.48	258.7	-0.032	443.08	-0.01	273.7	-0.0746
443.18	658.35	260.6	-0.0257	443.17	-0.005	275.9	-0.071
443.27	660.89	262.2	-0.024	443.25	-0.002	277.6	-0.0666
443.35	663.19	263.2	-0.0186	443.33	0.003	279.4	-0.0621
443.43	667.23	264.7	-0.0142	443.42	0.01	281.6	-0.0577
443.52	670.4	266.1	-0.0107	443.50	0.014	284.3	-0.0541
443.60	673.11	267.3	-0.0071	443.58	0.018	286	-0.047
443.68	676.55	268.7	-0.0027	443.68	0.022	287.9	-0.0426
443.77	683.68	270.2	0.0027	443.75	0.031	289.7	-0.0382
443.85	683.12	271.9	0.0044	443.83	0.03	292	-0.0337
443.93	686.42	273.2	0.0115	443.92	0.035	293.8	-0.0275
444.02	692.42	275.1	0.0178	444.00	0.041	295.9	-0.0222
444.10	693.39	276	0.0204	444.08	0.045	297.9	-0.0169
444.18	695.89	277.1	0.0249	444.17	0.048	299.5	-0.0124
444.27	702.5	279.3	0.0302	444.25	0.053	301.5	-0.0071

Prova triassiale ciclica SNGR03-C4							
tensione di confinamento (kPa)	450			tensione di confinamento (kPa)	450		
deviatore ciclico (kPa)	150			deviatore ciclico (kPa)	180		
frequenza (hz)	0.0007143			frequenza (hz)	0.0007143		
444.37	702.99	280.4	0.0355	444.33	0.059	303.3	-0.0018
444.43	709.06	282.4	0.0417	444.42	0.064	306	0.0036
444.52	709.32	283	0.0444	444.50	0.067	307.7	0.0115
444.60	713.32	284.5	0.0497	444.58	0.072	309.4	0.0178
444.68	717.22	286.3	0.0533	444.67	0.077	311.4	0.024
444.77	720.05	287.7	0.0577	444.75	0.079	312.9	0.0284
444.85	722.34	289	0.0648	444.83	0.083	314.6	0.0337
444.93	725.91	290.2	0.0701	444.92	0.09	316.4	0.0399
445.02	729.54	291.6	0.0754	445.00	0.094	319.1	0.0444
445.10	730.97	292.5	0.0799	445.08	0.096	320.3	0.0533
445.18	735.23	294.1	0.0843	445.18	0.1	321.7	0.0577
445.27	738.96	295.7	0.0879	445.25	0.106	323.5	0.0639
445.35	740.69	296.9	0.0932	445.33	0.109	325.8	0.0683
445.43	743.61	298.1	0.0994	445.42	0.113	327.2	0.0763
445.52	745.24	299.1	0.1039	445.50	0.117	328.8	0.0826
445.60	749.3	300.5	0.1092	445.58	0.12	330.4	0.0879
445.68	751.33	301.5	0.1127	445.67	0.124	331.8	0.0932
445.77	754.03	302.7	0.1172	445.75	0.127	333.3	0.0985
445.85	757.38	304.3	0.1234	445.83	0.133	334.9	0.1039
445.93	759.81	305.4	0.1278	445.92	0.137	337	0.1092
446.02	764.4	306.8	0.1331	446.00	0.139	338.2	0.1172
446.10	764.23	307.4	0.1358	446.08	0.143	339.6	0.1225
446.18	768.25	309.1	0.1402	446.17	0.146	341	0.1278
446.27	770.91	310.2	0.1438	446.25	0.148	342.2	0.1323
446.35	774.73	311.5	0.1509	446.33	0.153	343.9	0.1385
446.43	774.6	312.1	0.1536	446.42	0.156	344.6	0.142
446.52	776.45	313	0.1571	446.50	0.159	346.5	0.1473
446.60	778.71	313.9	0.1607	446.60	0.161	347.6	0.1544
446.68	780.37	314.9	0.1642	446.67	0.164	348.7	0.1589
446.77	784.36	316.3	0.1678	446.75	0.168	349.9	0.1633
446.85	785.23	317.2	0.1713	446.83	0.171	351.6	0.1678
446.93	786.82	318	0.1758	446.92	0.173	352.5	0.1749
447.02	789.44	318.8	0.1793	447.00	0.175	353.4	0.1784
447.10	790.9	319.6	0.1811	447.08	0.18	354.9	0.1846
447.18	794.69	320.8	0.1864	447.17	0.179	355.3	0.1873
447.28	794.28	321.5	0.1882	447.25	0.182	356.3	0.1917
447.35	796.67	322.4	0.1917	447.33	0.186	357.3	0.1953
447.43	797.9	323	0.1944	447.42	0.188	358.6	0.1988
447.52	799.06	323.7	0.1962	447.50	0.189	359.4	0.2042
447.60	802.58	324.8	0.2006	447.58	0.192	360.4	0.2086
447.68	804.58	325.8	0.2015	447.67	0.192	360.8	0.2104
447.77	802.28	325.8	0.2033	447.75	0.195	361.6	0.2139
447.85	804.47	326.6	0.2068	447.83	0.197	362.3	0.2166
447.93	805.43	327.1	0.2086	447.92	0.199	363	0.2201
448.02	807.09	327.8	0.2113	448.00	0.2	364	0.2228
448.10	807.62	328.2	0.2121	448.08	0.202	364.7	0.2272
448.18	810.91	329.3	0.2157	448.17	0.2	364.8	0.2281
448.27	810.11	329.6	0.2157	448.25	0.204	365.9	0.2308
448.35	810.84	330.1	0.2175	448.33	0.207	366.7	0.2334
448.43	811.66	330.6	0.2201	448.42	0.205	366.6	0.2361
448.52	812.53	331.1	0.2219	448.50	0.207	367.3	0.2379
448.60	812.99	331.4	0.2228	448.58	0.207	367.5	0.2397
448.68	813.42	331.8	0.2237	448.67	0.209	368.1	0.2414
448.77	813.82	332.3	0.2255	448.75	0.209	368.3	0.2441
448.85	814.55	332.7	0.2263	448.83	0.21	368.8	0.2459
448.93	814.45	333	0.2272	448.92	0.208	368.7	0.2468
449.02	814.98	333.2	0.2281	449.00	0.212	369.5	0.2494
449.10	814.91	333.5	0.229	449.08	0.21	369.3	0.2494
449.18	815.11	333.9	0.229	449.17	0.212	369.8	0.2503
449.27	815.41	334.1	0.2299	449.25	0.211	369.7	0.2512

Prova triassiale ciclica SNGR03-C4							
tensione di confinamento (kPa)	450			tensione di confinamento (kPa)	450		
deviatore ciclico (kPa)	150			deviatore ciclico (kPa)	180		
frequenza (hz)	0.0007143			frequenza (hz)	0.0007143		
449.35	814.04	334.1	0.2308	449.33	0.209	369.5	0.2512
449.43	814.77	334.3	0.2308	449.42	0.211	370.2	0.253
449.52	814.54	334.5	0.2317	449.52	0.209	369.8	0.2521
449.60	814.24	334.7	0.2317	449.58	0.209	369.7	0.2521
449.68	814.27	334.8	0.2317	449.67	0.211	370.2	0.2539
449.77	813.3	334.8	0.2317	449.75	0.208	369.7	0.253
449.85	812.94	334.8	0.2317	449.83	0.207	369.6	0.253
449.93	812.41	334.8	0.2317	449.92	0.207	369.6	0.253
450.02	811.44	334.8	0.2317	450.00	0.206	369.5	0.253
450.10	811.21	334.8	0.2317	450.08	0.205	369.3	0.2521
450.20	810.05	334.7	0.2308	450.17	0.204	369.1	0.2521
450.27	808.91	334.6	0.2308	450.25	0.203	369	0.2521
450.35	807.85	334.4	0.2299	450.33	0.201	368.4	0.2512
450.43	807.09	334.3	0.2299	450.42	0.199	368	0.2512
450.52	806.39	334.2	0.229	450.50	0.198	367.8	0.2503
450.60	804.79	333.9	0.2281	450.58	0.197	367.5	0.2494
450.68	803.03	333.5	0.2272	450.67	0.194	366.8	0.2477
450.77	801.67	333.3	0.2263	450.75	0.193	366.5	0.2477
450.85	800.44	333.1	0.2255	450.83	0.191	366.1	0.2468
450.93	799.18	332.8	0.2246	450.92	0.189	365.4	0.245
451.02	797.52	332.4	0.2237	451.00	0.187	364.9	0.2441
451.10	795.85	332.1	0.2219	451.08	0.185	364.4	0.2414
451.18	794.16	331.7	0.221	451.17	0.183	363.8	0.2406
451.27	792.03	331.2	0.2201	451.25	0.18	362.9	0.2388
451.35	790.84	330.8	0.2184	451.33	0.177	362.1	0.2379
451.43	788.71	330.3	0.2166	451.42	0.175	361.6	0.2352
451.52	786.48	329.9	0.2148	451.50	0.171	360.6	0.2326
451.62	784.89	329.3	0.2139	451.58	0.17	360.2	0.2317
451.68	783.09	328.8	0.2121	451.67	0.168	359.5	0.2299
451.77	780.53	328.2	0.2095	451.75	0.165	358.6	0.2272
451.85	779.04	327.7	0.2086	451.83	0.16	357.3	0.2255
451.93	775.75	326.9	0.2059	451.92	0.158	356.5	0.2237
452.02	774.49	326.5	0.2042	452.00	0.155	355.6	0.2192
452.10	771.16	326	0.2024	452.08	0.151	354.6	0.2166
452.18	768.73	324.9	0.2006	452.17	0.148	353.7	0.2139
452.27	767.17	324.3	0.1971	452.25	0.146	352.9	0.2113
452.35	764.88	323.7	0.1944	452.33	0.143	351.9	0.2086
452.43	762.29	322.9	0.1917	452.43	0.138	350.5	0.2042
452.52	759.93	322.1	0.1891	452.50	0.134	349.2	0.2006
452.60	757.57	321.4	0.1873	452.58	0.132	348.3	0.1979
452.68	753.74	320.5	0.1837	452.67	0.128	347.1	0.1944
452.77	750.48	319.2	0.1811	452.75	0.123	345.4	0.1908
452.85	748.39	318.5	0.1775	452.83	0.119	344.3	0.1873
452.93	744.56	317.5	0.1749	452.92	0.116	343.2	0.182
453.02	743.03	316.8	0.1722	453.00	0.112	341.8	0.1784
453.12	739.48	315.6	0.1687	453.08	0.11	340.8	0.1749
453.18	737.55	314.8	0.1651	453.17	0.104	339.3	0.1704
453.27	734.19	313.8	0.1616	453.25	0.101	338	0.1669
453.35	730.86	312.7	0.1571	453.33	0.094	335.7	0.1624
453.43	729.66	311.9	0.1544	453.42	0.092	334.6	0.1589
453.52	725.64	310.7	0.15	453.50	0.088	333.3	0.1518
453.60	721.51	309.6	0.1465	453.58	0.083	331.6	0.1473
453.68	718.18	308.1	0.1429	453.67	0.08	330.3	0.1438
453.77	715.72	307.2	0.1376	453.75	0.076	328.8	0.1385
453.85	714.09	306.5	0.1349	453.85	0.07	326.5	0.1323
453.93	707	304.5	0.1278	453.92	0.065	325	0.1287
454.02	706.74	303.9	0.1252	454.00	0.062	323.6	0.1243
454.10	703.74	302.8	0.1216	454.08	0.059	322.3	0.1189
454.18	700.84	301.5	0.1163	454.17	0.053	320.4	0.1145
454.27	694.55	299.6	0.1127	454.25	0.047	318	0.1092

Prova triassiale ciclica SNGR03-C4							
tensione di confinamento (kPa)	450			tensione di confinamento (kPa)	450		
deviatore ciclico (kPa)	150			deviatore ciclico (kPa)	180		
frequenza (hz)	0.0007143			frequenza (hz)	0.0007143		
454.35	692.68	298.6	0.1056	454.33	0.043	316.3	0.1039
454.43	689.49	297.5	0.1012	454.42	0.039	314.8	0.0959
454.53	685.75	296.2	0.0968	454.50	0.035	313	0.0905
454.60	681.66	294.4	0.0932	454.58	0.03	311.2	0.0852
454.68	679.72	293.3	0.0861	454.67	0.026	309.7	0.0799
454.77	676.79	292.1	0.0817	454.75	0.022	307.9	0.0746
454.85	672.42	290.6	0.0763	454.83	0.015	305.1	0.0683
454.93	669.93	289.5	0.0719	454.92	0.011	303.2	0.063
455.02	668.89	288.7	0.0683	455.00	0.008	301.7	0.0559
455.10	659.69	286.7	0.0612	455.08	0.002	299.8	0.0506
455.18	658.79	284.9	0.0568	455.17	-0.001	297.9	0.0444
455.27	655.72	283.3	0.0497	455.25	-0.006	296.2	0.0391
455.35	652.62	282.3	0.0453	455.35	-0.01	293.7	0.032
455.43	648.58	280.8	0.0408	455.42	-0.017	291.5	0.0257
455.52	647.65	279.9	0.0364	455.50	-0.018	290.4	0.0213
455.60	641.27	277.8	0.0302	455.58	-0.024	288.1	0.016
455.68	638.97	276.8	0.0266	455.67	-0.028	286.1	0.0098
455.77	634.73	274.8	0.0222	455.75	-0.035	283.2	0.0044
455.85	634.3	273.6	0.016	455.83	-0.039	281.2	-0.0009
455.93	629.69	272.4	0.0107	455.92	-0.042	279.7	-0.008
456.03	625.79	271.4	0.0062	456.00	-0.047	277.5	-0.0133
456.10	622.01	269.4	0.0027	456.08	-0.048	276.1	-0.0169
456.18	619.71	268.2	-0.0036	456.17	-0.056	273.4	-0.024
456.27	613.13	266.1	-0.0098	456.25	-0.06	271.8	-0.0284
456.35	614.56	265.7	-0.0115	456.33	-0.065	268.9	-0.0328
456.43	611.09	264.2	-0.016	456.42	-0.069	266.9	-0.0382
456.52	607.75	262.9	-0.0195	456.50	-0.073	265.4	-0.0444
456.60	603.84	261.9	-0.0222	456.58	-0.078	263.2	-0.0488
456.68	599.86	259.3	-0.0266	456.67	-0.081	261.3	-0.0533
456.77	597.69	258.1	-0.0328	456.77	-0.086	258.7	-0.0595
456.85	595.15	256.8	-0.0373	456.83	-0.089	257.2	-0.0639
456.93	591.84	255.3	-0.0399	456.92	-0.094	255	-0.0675
457.02	589.43	254.1	-0.0444	457.00	-0.097	253.2	-0.0719
457.10	587.06	252.8	-0.047	457.08	-0.1	251.5	-0.0754
457.18	582.35	251.3	-0.0497	457.17	-0.105	249.4	-0.0799
457.27	579.54	249.1	-0.0524	457.25	-0.111	246.6	-0.0834
457.35	578.26	248.2	-0.0568	457.33	-0.113	245.1	-0.0897
457.45	575.46	247	-0.0595	457.42	-0.116	243.6	-0.0932
457.52	571.41	245.6	-0.063	457.50	-0.122	241.4	-0.0968
457.60	569.33	243.7	-0.0666	457.58	-0.123	239.8	-0.1003
457.68	567.16	242.5	-0.0701	457.67	-0.126	238.3	-0.103
457.77	564.18	241.2	-0.0728	457.75	-0.131	236.2	-0.1074
457.85	562.04	240	-0.0754	457.83	-0.135	233.7	-0.1101
457.93	560.54	239	-0.0781	457.92	-0.138	232.1	-0.1154
458.02	557.73	237.8	-0.0808	458.00	-0.14	230.8	-0.1181
458.10	555.82	236.7	-0.0826	458.08	-0.145	228.8	-0.1225
458.18	551.97	234.8	-0.0852	458.17	-0.148	227	-0.126
458.27	550.26	233.7	-0.0888	458.25	-0.15	225.2	-0.1296
458.35	548.56	232.7	-0.0914	458.33	-0.153	223.8	-0.1323
458.43	545.51	231.4	-0.0941	458.42	-0.155	222.5	-0.1358
458.52	544.41	230.5	-0.0959	458.50	-0.158	220.9	-0.1394
458.60	543.17	229.6	-0.0976	458.58	-0.161	219.5	-0.142
458.68	539.95	228.4	-0.1003	458.67	-0.164	218	-0.1447
458.77	538.15	227	-0.1012	458.75	-0.167	216	-0.1473
458.85	537.11	226.2	-0.1039	458.83	-0.168	215.1	-0.1509
458.93	534.03	225	-0.1065	458.92	-0.17	213.9	-0.1536
459.02	533.59	224.4	-0.1074	459.00	-0.174	212.4	-0.1562
459.10	531.39	223.1	-0.1092	459.08	-0.175	211.1	-0.1589
459.18	530.58	222.5	-0.1118	459.17	-0.177	210.3	-0.1607
459.27	528.44	221.6	-0.1136	459.25	-0.18	208.9	-0.1633

Prova triassiale ciclica SNGR03-C4							
tensione di confinamento (kPa)	450			tensione di confinamento (kPa)	450		
deviatore ciclico (kPa)	150			deviatore ciclico (kPa)	180		
frequenza (hz)	0.0007143			frequenza (hz)	0.0007143		
459.35	527.67	220.9	-0.1145	459.33	-0.181	207.6	-0.1651
459.43	527.97	220.5	-0.1154	459.42	-0.183	206.6	-0.1687
459.52	525.29	219.5	-0.1172	459.50	-0.185	205.3	-0.1713
459.60	523.38	218.7	-0.1189	459.58	-0.185	205	-0.1722
459.68	522.34	217.6	-0.1198	459.68	-0.188	203.7	-0.174
459.77	521.23	216.9	-0.1225	459.75	-0.189	202.7	-0.1766
459.85	520.26	216.3	-0.1234	459.83	-0.19	202.1	-0.1775
459.93	519.39	215.7	-0.1243	459.92	-0.191	201.3	-0.1793
460.02	519.26	215.3	-0.1252	460.00	-0.192	200.6	-0.1811
460.10	517.75	214.6	-0.126	460.08	-0.194	199.8	-0.182
460.18	517.68	214.4	-0.1269	460.17	-0.194	199.4	-0.1829
460.27	517.05	213.6	-0.1278	460.25	-0.195	198.6	-0.1846
460.37	516.28	213.2	-0.1287	460.33	-0.196	198.3	-0.1855
460.43	516.47	212.9	-0.1296	460.42	-0.197	197.7	-0.1873
460.52	515.94	212.5	-0.1305	460.50	-0.197	197.5	-0.1873
460.60	514.93	211.9	-0.1305	460.58	-0.197	197.3	-0.1882
460.68	515.17	211.7	-0.1314	460.67	-0.198	196.8	-0.1891
460.77	515.5	211.5	-0.1314	460.75	-0.198	196.6	-0.19
460.85	514.8	211.2	-0.1323	460.83	-0.198	196.3	-0.19
460.93	515.03	211	-0.1323	460.92	-0.198	196.1	-0.1908
461.02	515.13	210.8	-0.1331	461.00	-0.198	196	-0.1917
461.10	515.4	210.7	-0.1331	461.08	-0.198	196	-0.1917
461.18	515.73	210.5	-0.1331	461.17	-0.197	195.9	-0.1917
461.27	516	210.5	-0.1331	461.25	-0.197	196	-0.1926
461.35	516.26	210.3	-0.134	461.33	-0.196	196.1	-0.1926
461.43	516.33	210.2	-0.134	461.42	-0.196	196.1	-0.1926
461.52	516.77	210.2	-0.134	461.50	-0.195	196.3	-0.1926
461.60	517.67	210.3	-0.1331	461.58	-0.194	196.4	-0.1926
461.68	518.71	210.4	-0.1331	461.67	-0.193	196.7	-0.1926
461.78	519.54	210.5	-0.1331	461.75	-0.192	197.2	-0.1926
461.85	519.88	210.6	-0.1331	461.83	-0.191	197.4	-0.1917
461.93	520.55	210.6	-0.1331	461.92	-0.19	197.8	-0.1917
462.02	522.55	210.9	-0.1323	462.00	-0.189	198.2	-0.1917
462.10	522.89	211.1	-0.1314	462.08	-0.187	198.6	-0.1908
462.18	524.19	211.4	-0.1314	462.17	-0.186	199.1	-0.1908
462.27	525.97	211.8	-0.1305	462.25	-0.184	199.7	-0.19
462.35	525.97	211.8	-0.1305	462.33	-0.182	200.6	-0.1891
462.43	527.37	212.3	-0.1296	462.42	-0.181	201.1	-0.1882
462.52	528.74	212.5	-0.1296	462.50	-0.178	201.8	-0.1882
462.60	531.25	213.2	-0.1278	462.60	-0.176	202.3	-0.1873
462.68	532.62	213.6	-0.1278	462.67	-0.174	203.6	-0.1864
462.77	533.76	213.9	-0.126	462.75	-0.172	204.1	-0.1855
462.85	535.9	214.4	-0.126	462.83	-0.17	205	-0.1846
462.93	537.11	214.9	-0.1252	462.92	-0.167	206	-0.1829
463.02	538.55	215.3	-0.1243	463.00	-0.166	206.8	-0.182
463.10	540.45	215.8	-0.1234	463.08	-0.163	207.6	-0.182
463.18	543.86	216.8	-0.1225	463.17	-0.16	208.6	-0.1802
463.28	544.57	217.1	-0.1207	463.25	-0.157	209.9	-0.1802
463.35	546.44	217.7	-0.1198	463.33	-0.155	211.2	-0.1775
463.43	549.18	218.6	-0.1189	463.42	-0.152	212.1	-0.1766
463.52	551.59	219.4	-0.1172	463.50	-0.148	213.7	-0.174
463.60	554.1	220.3	-0.1163	463.58	-0.146	214.5	-0.1731
463.68	555.14	220.9	-0.1145	463.67	-0.143	215.5	-0.1722
463.77	558.55	221.8	-0.1127	463.75	-0.139	217	-0.1704
463.85	559.89	222.3	-0.1118	463.83	-0.135	219	-0.1687
463.93	563.13	223.3	-0.1101	463.92	-0.133	220.2	-0.166
464.02	566.24	224.3	-0.1083	464.02	-0.129	221.4	-0.1642
464.10	568.35	225.3	-0.1074	464.08	-0.125	222.6	-0.1633
464.18	571.43	226.3	-0.1056	464.17	-0.121	224.7	-0.1616
464.27	572.97	226.9	-0.103	464.25	-0.119	226	-0.158

Prova triassiale ciclica SNGR03-C4							
tensione di confinamento (kPa)	450			tensione di confinamento (kPa)	450		
deviatore ciclico (kPa)	150			deviatore ciclico (kPa)	180		
frequenza (hz)	0.0007143			frequenza (hz)	0.0007143		
464.35	576.24	228	-0.1012	464.33	-0.115	227.4	-0.1562
464.43	578.05	228.9	-0.0994	464.42	-0.112	229	-0.1544
464.52	580.96	230	-0.0968	464.50	-0.109	230.4	-0.1527
464.60	584.2	231.2	-0.095	464.58	-0.105	231.8	-0.15
464.70	587.18	232.4	-0.0923	464.67	-0.101	233.5	-0.1482
464.77	589.59	233.4	-0.0905	464.75	-0.095	236	-0.1456
464.85	592.4	234.4	-0.0888	464.83	-0.092	237.4	-0.142
464.93	595.61	235.5	-0.0861	464.92	-0.088	239.1	-0.1394
465.02	600.22	237.3	-0.0843	465.00	-0.084	241	-0.1367
465.10	601.99	238.2	-0.0817	465.08	-0.081	242.3	-0.134
465.18	604.67	239.3	-0.0781	465.17	-0.077	244	-0.1314
465.27	606.41	240.1	-0.0763	465.25	-0.07	246.1	-0.1278
465.35	611.72	241.9	-0.0728	465.33	-0.066	248.8	-0.1252
465.43	613.29	242.7	-0.071	465.42	-0.064	250.2	-0.1207
465.52	616.97	244	-0.0675	465.52	-0.059	251.9	-0.1181
465.60	622.18	246	-0.0648	465.58	-0.053	253.9	-0.1154
465.68	624.29	247.2	-0.063	465.67	-0.049	256.5	-0.1118
465.77	628.06	248.5	-0.0568	465.75	-0.046	257.9	-0.1074
465.85	630.06	249.5	-0.055	465.83	-0.041	259.9	-0.1039
465.93	633.01	250.9	-0.0515	465.92	-0.036	262.1	-0.1003
466.02	636.31	252	-0.0479	466.00	-0.033	263.5	-0.0976
466.10	640.22	253.5	-0.0453	466.08	-0.029	265.5	-0.0941
466.20	643.09	255.1	-0.0417	466.17	-0.024	268.1	-0.0888
466.27	646.93	256.5	-0.0382	466.25	-0.017	270.5	-0.0861
466.35	649.27	257.6	-0.0346	466.33	-0.014	272.1	-0.0799
466.43	653.41	259.1	-0.0311	466.42	-0.007	274.2	-0.0754
466.52	658.25	261.1	-0.0275	466.50	-0.006	275.8	-0.0728
466.60	660.73	262.5	-0.024	466.58	-0.002	277.6	-0.0683
466.68	666.13	264.2	-0.0169	466.67	0.003	279.7	-0.0639
466.77	665.2	264.7	-0.016	466.75	0.006	281.3	-0.0604
466.85	664.83	265	-0.0151	466.83	0.006	282.1	-0.0586
466.93	664.56	265.4	-0.0142	466.93	0.006	282.6	-0.0577
467.02	665.16	266	-0.0133	467.00	0.006	282.9	-0.0568
467.10	665	266.3	-0.0124	467.08	0.006	283.3	-0.0559
467.18	664.96	266.7	-0.0115	467.17	0.006	283.7	-0.0559
467.27	664.83	267	-0.0115	467.25	0.006	284	-0.055
467.35	664.8	267.3	-0.0107	467.33	0.086	224.3	0.9853
467.43	665.4	267.6	-0.0107	467.42	0.086	225	0.9986
467.52	665	267.7	-0.0107	467.50	0.083	225.3	0.9995
467.62	664.93	268	-0.0098	467.58	0.078	225.2	0.9871
467.68	664.93	268.3	-0.0098	467.67	0.07	224.9	0.9684
467.77	666.13	268.7	-0.0089	467.75	0.054	224	0.9285
467.85	663.56	268.4	-0.0098	467.83	0.039	222.2	0.8708
467.93	666	269	-0.008	467.92	0.028	220.3	0.7199
468.02	664.7	269.1	-0.0089	468.02	0.017	218.9	0.6134
468.10	665.06	269.3	-0.008	468.08	-0.006	216.3	0.4305
468.18	664.86	269.4	-0.008	468.17	-0.021	211.5	0.2281
468.27	664.73	269.6	-0.008	468.25	-0.032	208	-0.0923
468.35	665.4	269.8	-0.008	468.33	-0.045	204.4	-0.2849
468.43	665.1	269.9	-0.008	468.42	-0.057	200.5	-0.4429
468.52	664.83	270	-0.008	468.50	-0.062	197.5	-0.5415
468.60	667.27	270.7	-0.0071	468.58	-0.069	194.7	-0.6276
468.68	663.66	270	-0.008	468.67	-0.073	192.7	-0.6773
468.77	664.73	270.4	-0.0071	468.75	-0.073	191.3	-0.6968
468.85	665.1	270.7	-0.0071	468.83	-0.07	191.2	-0.6986
468.93	664.86	270.7	-0.0071	468.92	-0.064	191.6	-0.6853
469.02	664.83	271.1	-0.0053	469.00	-0.054	193	-0.656
469.10	664.76	271	-0.0071	469.08	-0.046	194.5	-0.6116
469.18	664.69	271.1	-0.0062	469.17	-0.033	197	-0.5432
469.27	665.06	271.2	-0.0062	469.25	-0.013	199.8	-0.4367

Prova triassiale ciclica SNGR03-C4							
tensione di confinamento (kPa)	450			tensione di confinamento (kPa)	450		
deviatore ciclico (kPa)	150			deviatore ciclico (kPa)	180		
frequenza (hz)	0.0007143			frequenza (hz)	0.0007143		
469.35	664.86	271.3	-0.0062	469.33	0.001	204.5	-0.3027
469.43	664.83	271.4	-0.0062	469.43	0.013	207.6	-0.0586
469.52	665.13	271.6	-0.0062	469.50	0.026	210.4	0.1207
469.60	665.13	271.7	-0.0062	469.58	0.048	215	0.3506
469.68	664.86	271.7	-0.0062	469.67	0.059	217.7	0.5344
469.77	664.86	271.8	-0.0062	469.75	0.068	219.7	0.7616
469.85	664.93	271.9	-0.0053	469.83	0.078	221.6	0.8708
469.93	665	272	-0.0062	469.92	0.083	223.1	0.94
470.02	665.1	272.1	-0.0053	470.00	0.085	224.1	0.9791
470.10	666.7	272.6	-0.0044	470.08	0.087	224.9	0.9995
470.18	665.36	272.3	-0.0062	470.17	0.082	225.4	1.0013
470.27	664.03	272.2	-0.0062	470.25	0.075	225.2	0.9933
470.35	665.06	272.4	-0.0053	470.33	0.068	224.9	0.9622
470.43	665.13	272.5	-0.0053	470.42	0.055	223.9	0.9196
470.53	664.86	272.6	-0.0053	470.50	0.044	222.6	0.8477
470.60	665.5	272.8	-0.0053	470.58	0.032	221.2	0.7554
470.68	664.93	272.7	-0.0053	470.67	0.015	218.8	0.6054
470.77	664.93	272.8	-0.0053	470.75	-0.007	214.8	0.4296
470.85	664.86	272.9	-0.0053	470.83	-0.02	211.5	0.2228
470.93	664.9	272.9	-0.0053	470.92	-0.03	208.8	-0.0612
471.02	665.03	273	-0.0053	471.00	-0.044	205.1	-0.2397
471.10	665.03	273.1	-0.0044	471.08	-0.06	199.4	-0.4057
471.18	665	273.2	-0.0044	471.17	-0.065	196.5	-0.5734
471.27	665.06	273.2	-0.0044	471.25	-0.071	194	-0.6435
471.35	666.93	273.6	-0.0036	471.33	-0.073	192.5	-0.6799
471.43	665.3	273.4	-0.0053	471.42	-0.073	191.5	-0.6968
471.52	664.4	273.2	-0.0053	471.50	-0.071	191.2	-0.6977
471.60	665.2	273.4	-0.0044	471.58	-0.063	191.6	-0.6879
471.68	665.03	273.5	-0.0044	471.67	-0.051	193.3	-0.6666
471.77	665.23	273.6	-0.0044	471.75	-0.044	195.2	-0.5974
471.85	664.96	273.6	-0.0044	471.83	-0.031	197.6	-0.5228
471.95	664.86	273.6	-0.0044	471.92	-0.016	200.6	-0.4021
472.02	664.83	273.7	-0.0044	472.00	-0.005	203.5	-0.2636
472.10	664.86	273.8	-0.0044	472.08	0.011	206.7	-0.0826
472.18	665.43	273.8	-0.0044	472.17	0.032	210.2	0.1305
472.27	665.16	273.9	-0.0044	472.25	0.047	214.8	0.3311
472.35	664.8	273.8	-0.0044	472.35	0.055	217.1	0.5858
472.43	666.7	273.9	-0.0044	472.42	0.066	219.3	0.7261
472.52	665.13	274	-0.0036	472.50	0.079	221.3	0.853
472.60	664.7	274	-0.0044	472.58	0.084	223.4	0.9276
472.68	664.06	273.9	-0.0044	472.67	0.086	224.4	0.9871
472.77	665.06	274.1	-0.0044	472.75	0.086	225	1.0021
472.85	665.13	274.1	-0.0036	472.83	0.083	225.4	1.0039
472.93	665	274.2	-0.0044	472.92	0.079	225.4	0.9933
473.02	665	274.2	-0.0044	473.00	0.07	225	0.9729
473.10	664.93	274.2	-0.0044	473.08	0.053	223.7	0.932
473.18	664.86	274.3	-0.0044	473.17	0.04	222.3	0.877
473.27	664.9	274.4	-0.0044	473.25	0.029	220.8	0.7296
473.35	664.8	274.4	-0.0044	473.33	0.013	218.4	0.5814
473.45	665.16	274.4	-0.0036	473.42	-0.002	215.8	0.3879
473.52	665.13	274.5	-0.0036	473.50	-0.015	212.9	0.1811
473.60	665	274.5	-0.0036	473.58	-0.031	209	-0.0435
473.68	664.9	274.5	-0.0036	473.67	-0.049	203.5	-0.2352
473.77	665	274.5	-0.0036	473.75	-0.058	199.8	-0.3897
473.85	664.9	274.6	-0.0036	473.83	-0.063	197.4	-0.5468
473.93	665.23	274.7	-0.0036	473.92	-0.07	194.5	-0.6249
474.02	665.13	274.7	-0.0036	474.00	-0.073	192.1	-0.6702
474.10	664.96	274.7	-0.0036	474.08	-0.072	191.4	-0.6924
474.18	666.63	275	-0.0027	474.17	-0.07	191.2	-0.6941
474.27	663.16	274.4	-0.0044	474.25	-0.063	191.8	-0.6808

Prova triassiale ciclica SNGR03-C4							
tensione di confinamento (kPa)	450			tensione di confinamento (kPa)	450		
deviatore ciclico (kPa)	150			deviatore ciclico (kPa)	180		
frequenza (hz)	0.0007143			frequenza (hz)	0.0007143		
474.35	664.5	274.6	-0.0036	474.33	-0.056	193	-0.6524
474.43	665.33	274.9	-0.0036	474.42	-0.046	194.5	-0.6089
474.52	664.8	274.8	-0.0036	474.50	-0.032	197.2	-0.5352
474.60	664.86	274.8	-0.0036	474.58	-0.012	201.3	-0.4323
474.68	665.03	274.9	-0.0036	474.67	0	204.6	-0.213
474.77	665	274.9	-0.0036	474.75	0.014	207.6	-0.032
474.87	665.03	275	-0.0036	474.83	0.03	211.1	0.1917
474.93	665.26	275	-0.0036	474.92	0.043	214.3	0.4057
475.02	665.3	275.3	-0.0027	475.00	0.055	216.8	0.5796
475.10	664.16	274.9	-0.0036	475.08	0.07	219.1	0.7279
475.18	664.43	274.9	-0.0036	475.17	0.079	222	0.8415
475.27	665.23	275.1	-0.0036	475.27	0.082	223.2	0.9427
475.35	665.06	275.1	-0.0036	475.33	0.085	224.2	0.98
475.43	665	275.1	-0.0036	475.42	0.086	225	1.0013
475.52	665	275.1	-0.0036	475.50	0.082	225.5	1.0048
475.60	664.93	275.2	-0.0036	475.58	0.077	225.3	0.9897
475.68	664.9	275.2	-0.0036	475.67	0.068	224.9	0.9675
475.77	664.96	275.2	-0.0036	475.75	0.055	223.9	0.9223
475.85	665.2	275.3	-0.0027	475.83	0.046	222.7	0.8583
475.93	665	275.3	-0.0036	475.92	0.031	221.2	0.7634
476.02	664.93	275.3	-0.0036	476.00	0.01	219.1	0.6196

Prova triassiale ciclica SNGR03-C4							
tensione di confinamento (kPa)		450		tensione di confinamento (kPa)		450	
deviatore ciclico (kPa)		230		deviatore ciclico (kPa)		260	
frequenza (hz)		0.007143		frequenza (hz)		0.007143	
tempo	cella di carico	u	LVDT	tempo	cella di carico	u	LVDT
(min)	kN	(kPa)	δ (mm)	(min)	kN	(kPa)	δ (mm)
0.00	665.26	290.6	0	0.00	0.006	335.9	0
0.08	666.56	291	0.0009	0.08	0.01	336	0
0.18	674.04	293	0.0027	0.17	0.017	339	0.0027
0.25	678.01	294.3	0.0062	0.25	0.023	340.5	0.0053
0.33	683.82	296.1	0.0089	0.33	0.029	342.3	0.0071
0.42	688.72	297.9	0.0115	0.42	0.036	344.4	0.0107
0.50	692.16	299	0.0142	0.50	0.039	345.7	0.0133
0.58	699.36	301.2	0.0178	0.58	0.047	348.1	0.016
0.67	705.83	303.8	0.0213	0.67	0.057	351.6	0.0204
0.75	710.07	305.7	0.0249	0.75	0.062	353.8	0.024
0.83	713.9	307.1	0.0311	0.83	0.069	356.3	0.0328
0.92	718.27	309	0.0355	0.92	0.075	358.4	0.0382
1.00	724.93	311.4	0.0417	1.00	0.079	361.1	0.0453
1.08	728.1	312.9	0.0462	1.08	0.086	363.7	0.055
1.17	733.1	315	0.0515	1.17	0.097	366.9	0.0639
1.25	740.73	318.2	0.0586	1.27	0.099	370.7	0.0808
1.33	744.59	320.2	0.0639	1.33	0.104	373.5	0.0923
1.42	749.21	322.1	0.0737	1.42	0.111	376.6	0.1074
1.50	754.07	324.2	0.0799	1.50	0.118	379.7	0.1225
1.58	758.53	326.4	0.087	1.58	0.127	384.3	0.1394
1.68	763.26	329	0.0923	1.67	0.13	386.7	0.1678
1.75	765.55	330.5	0.1021	1.75	0.137	389.9	0.1935
1.83	772.97	333	0.1092	1.83	0.141	392.3	0.213
1.92	776.29	335	0.1172	1.92	0.146	395.1	0.2361
2.00	780.04	336.7	0.1243	2.00	0.153	398.1	0.2654
2.08	785.06	338.9	0.1314	2.08	0.161	402.1	0.2938
2.17	791.71	341.9	0.1394	2.17	0.168	405.2	0.3249
2.25	794.96	343.9	0.1473	2.25	0.171	406.9	0.3737
2.33	798.37	345.4	0.1589	2.33	0.177	409.8	0.4136
2.42	803.39	347.5	0.1669	2.42	0.182	412.2	0.4509
2.50	806.47	349.4	0.1731	2.50	0.188	414.6	0.4918
2.58	809.62	350.9	0.1802	2.58	0.195	416.3	0.5219
2.67	814.1	352.9	0.1873	2.67	0.199	419.9	0.5539
2.75	819.71	355.4	0.1944	2.77	0.2	421.2	0.5974
2.83	822.95	357.3	0.205	2.83	0.207	423.6	0.632
2.92	825.2	358.5	0.2113	2.92	0.215	425.8	0.6648
3.00	830.11	360.3	0.2184	3.00	0.219	428.4	0.695
3.10	833.19	362.3	0.2255	3.08	0.223	430.4	0.7403
3.17	836.93	364	0.2352	3.17	0.228	432.1	0.7722
3.25	839.91	365.4	0.2414	3.25	0.23	433.4	0.7971
3.33	842.09	366.8	0.2477	3.33	0.236	435.5	0.8273
3.42	848.06	368.8	0.2556	3.42	0.239	436.7	0.853
3.50	850.47	370	0.2619	3.50	0.246	439.4	0.8797
3.58	852.55	371.2	0.2672	3.58	0.249	440.7	0.9001
3.67	855	373.1	0.2725	3.67	0.252	442	0.9356
3.75	859.89	374.6	0.2832	3.75	0.255	443.3	0.9578
3.83	861.47	375.5	0.2885	3.83	0.261	445	0.9808
3.92	864.02	376.7	0.2938	3.92	0.264	446.3	1.0021
4.00	866.37	377.8	0.2991	4.00	0.267	447.3	1.0199
4.08	868.81	378.8	0.3053	4.08	0.272	449	1.0377
4.17	871.22	379.7	0.3107	4.18	0.273	449.8	1.0625
4.25	874.33	381.3	0.3169	4.25	0.276	450.8	1.0794

Prova triassiale ciclica SNGR03-C4							
tensione di confinamento (kPa)	450			tensione di confinamento (kPa)	450		
deviatore ciclico (kPa)	230			deviatore ciclico (kPa)	260		
frequenza (hz)	0.007143			frequenza (hz)	0.007143		
4.33	875.83	382.2	0.3249	4.33	0.281	451.6	1.0927
4.42	878.14	383.1	0.3311	4.42	0.283	453.2	1.1087
4.50	878.32	383.7	0.3364	4.50	0.285	454	1.1291
4.60	880.86	384.9	0.3444	4.58	0.288	454.9	1.1424
4.67	883.79	386	0.3533	4.67	0.29	455.6	1.1548
4.75	884.7	386.6	0.3586	4.75	0.291	456.2	1.1672
4.83	886.81	387.4	0.3648	4.83	0.29	456.5	1.177
4.92	887.09	387.8	0.371	4.92	0.296	457.7	1.1903
5.00	888.3	388.4	0.3772	5.00	0.298	458.4	1.2001
5.08	890.08	389.1	0.3835	5.08	0.299	458.8	1.2143
5.17	889.73	389.5	0.3897	5.17	0.299	459.1	1.2232
5.25	892.32	390.4	0.3994	5.25	0.301	459.8	1.232
5.33	894.02	390.9	0.4083	5.33	0.304	460.3	1.2409
5.42	893.51	391.1	0.4128	5.42	0.303	460.2	1.2471
5.50	891.67	391	0.4172	5.50	0.304	460.7	1.2551
5.58	894.71	391.9	0.4216	5.58	0.304	460.8	1.2649
5.67	894.56	392.1	0.4252	5.67	0.305	461	1.272
5.75	894.91	392.5	0.4296	5.75	0.305	461.1	1.2773
5.83	894.67	392.6	0.4341	5.83	0.306	461.2	1.2835
5.92	894.96	392.8	0.4376	5.92	0.308	461.5	1.2915
6.02	894.62	392.9	0.4403	6.00	0.306	461.2	1.296
6.08	895.27	393.1	0.442	6.08	0.306	461.1	1.2995
6.17	895.26	393.3	0.4456	6.17	0.305	461	1.3031
6.25	893.83	393	0.4474	6.25	0.305	460.8	1.3066
6.33	893.29	393	0.4491	6.33	0.303	460.4	1.3093
6.42	892.59	392.8	0.45	6.42	0.303	460.1	1.311
6.50	892.13	392.8	0.4509	6.50	0.302	459.8	1.3137
6.58	890.86	392.5	0.4518	6.58	0.3	459.3	1.3155
6.67	889.5	392.1	0.4518	6.67	0.3	459	1.3164
6.75	888.9	392	0.4527	6.75	0.298	458.5	1.3173
6.83	887.45	391.7	0.4518	6.83	0.296	458	1.3173
6.92	886.05	391.3	0.4527	6.92	0.294	457.1	1.3181
7.00	885.06	391	0.4518	7.00	0.293	456.7	1.3181
7.08	883.1	390.4	0.4518	7.10	0.29	456.1	1.3173
7.17	881.08	389.9	0.4509	7.17	0.288	455.6	1.3173
7.25	879.19	389.4	0.4509	7.25	0.285	454.5	1.3173
7.33	877.83	388.8	0.4491	7.33	0.283	453.8	1.3164
7.42	875.18	388.1	0.4491	7.42	0.281	453	1.3155
7.50	872.79	387.4	0.4483	7.50	0.278	452.1	1.3146
7.58	871.3	386.8	0.4474	7.58	0.275	451.3	1.3137
7.67	869.15	386.1	0.4456	7.67	0.273	450.5	1.3128
7.75	867.53	385.6	0.4447	7.75	0.268	449	1.3119
7.83	861.53	384.1	0.442	7.83	0.265	448.1	1.3102
7.92	862.13	383.5	0.4412	7.92	0.262	446.9	1.3084
8.00	857.02	382.5	0.4394	8.00	0.258	445.9	1.3075
8.08	855.97	381.6	0.4376	8.08	0.256	445	1.3066
8.17	853.15	380.8	0.4367	8.17	0.252	443.9	1.3039
8.25	850.24	379.9	0.4332	8.25	0.246	442.5	1.3022
8.33	847.06	378.8	0.4314	8.33	0.242	440.7	1.3004
8.42	841.16	377.2	0.4278	8.42	0.236	439	1.2968
8.50	842.12	377	0.4278	8.52	0.235	438.3	1.296
8.58	835.69	375.2	0.4234	8.58	0.229	437	1.2933
8.67	831.61	374.4	0.4216	8.67	0.225	435	1.2915
8.75	829.07	372.6	0.4172	8.75	0.221	433.7	1.288
8.83	827.22	371.6	0.4136	8.83	0.216	432.1	1.2853
8.93	821.65	370	0.411	8.92	0.209	430	1.2818
9.00	815.98	368.8	0.4074	9.00	0.208	429.3	1.28
9.08	814.76	367	0.4039	9.08	0.203	427.7	1.2773
9.17	808.59	365.3	0.3977	9.17	0.194	424.8	1.2738
9.25	805.91	364.2	0.3941	9.25	0.19	423.2	1.2711

Prova triassiale ciclica SNGR03-C4							
tensione di confinamento (kPa)	450			tensione di confinamento (kPa)	450		
deviatore ciclico (kPa)	230			deviatore ciclico (kPa)	260		
frequenza (hz)	0.007143			frequenza (hz)	0.007143		
9.33	801	362.5	0.3914	9.33	0.185	421.7	1.2667
9.42	798.16	360.8	0.3861	9.42	0.179	419.7	1.2622
9.50	794.84	359.8	0.3817	9.50	0.175	418	1.2587
9.58	788.14	357.9	0.3772	9.58	0.17	416.3	1.256
9.67	781.61	355.5	0.3737	9.67	0.16	413.7	1.2507
9.75	783.11	355	0.3666	9.75	0.156	411.6	1.2471
9.83	774.85	352.5	0.3604	9.83	0.152	409.6	1.2409
9.92	770.18	350.9	0.3542	9.92	0.145	407.5	1.2365
10.00	769.25	349.7	0.3506	10.02	0.139	405.6	1.232
10.08	760.99	347.1	0.3435	10.08	0.132	402.5	1.2267
10.17	754.52	345.7	0.3391	10.17	0.126	400.2	1.2178
10.25	753.92	343.5	0.3329	10.25	0.121	398.3	1.2134
10.35	747.82	341.2	0.324	10.33	0.117	396.5	1.2081
10.42	743.38	339.5	0.3178	10.42	0.108	393.8	1.201
10.50	737.4	337.5	0.3124	10.50	0.103	391.8	1.1948
10.58	731.26	334.4	0.3053	10.58	0.095	388.7	1.1894
10.67	726.61	332.2	0.2947	10.67	0.084	385.4	1.1814
10.75	722.76	330.7	0.2885	10.75	0.085	384.6	1.1708
10.83	716.75	328.5	0.2823	10.83	0.075	381.2	1.1619
10.92	712.83	326.1	0.2734	10.92	0.071	379.2	1.1539
11.00	708.28	324.5	0.2681	11.00	0.067	377.8	1.1468
11.08	701.67	322.4	0.261	11.08	0.057	374.7	1.1371
11.17	696.51	319.2	0.2556	11.17	0.045	370.3	1.1273
11.25	692.13	317	0.2432	11.25	0.044	368.9	1.1122
11.33	688.04	315.2	0.2379	11.33	0.038	366.8	1.1016
11.42	680.49	312.2	0.229	11.43	0.029	363.6	1.0909
11.50	680.06	310.6	0.2237	11.50	0.02	359.9	1.0794
11.58	673.73	308.4	0.2166	11.58	0.016	358	1.0616
11.67	666.55	305	0.2068	11.67	0.01	355.7	1.0492
11.75	659.92	301.9	0.2015	11.75	0.002	352.5	1.0359
11.85	657.56	300	0.1908	11.83	-0.002	350.2	1.0226
11.92	652.96	298.1	0.1855	11.92	-0.009	347.7	1.0084
12.00	645.24	295.2	0.1775	12.00	-0.018	344.4	0.9924
12.08	638.31	291.7	0.1713	12.08	-0.026	340.5	0.9764
12.17	636.54	289.7	0.1616	12.17	-0.03	338.6	0.9471
12.25	631.21	287.4	0.1553	12.25	-0.037	335.6	0.9276
12.33	624.55	284.4	0.1482	12.33	-0.044	332.4	0.9045
12.42	622.48	282.5	0.142	12.42	-0.047	330.4	0.8841
12.50	616.91	280	0.1358	12.50	-0.056	327	0.8601
12.58	609.71	277	0.1287	12.58	-0.066	322.4	0.8362
12.67	603.41	273.5	0.1225	12.67	-0.07	319.5	0.806
12.75	600.87	270.9	0.1136	12.75	-0.075	317.2	0.7882
12.83	595.7	268.6	0.1074	12.83	-0.084	313.5	0.766
12.92	589.9	265.9	0.1012	12.93	-0.091	309.6	0.7492
13.00	586.99	263.6	0.095	13.00	-0.094	306.8	0.7217
13.08	582.15	261.2	0.0897	13.08	-0.102	303.8	0.6986
13.17	575.78	258.4	0.0834	13.17	-0.109	300.3	0.6755
13.27	571.2	254.9	0.0746	13.25	-0.113	297.5	0.6542
13.33	568.46	252.7	0.0692	13.33	-0.118	294.4	0.6311
13.42	563.58	250.4	0.0639	13.42	-0.128	290.4	0.6054
13.50	557.34	247.4	0.0568	13.50	-0.134	285.5	0.5823
13.58	550.66	243.6	0.0506	13.58	-0.138	282.6	0.5459
13.67	549.15	241.2	0.0417	13.67	-0.143	279.2	0.521
13.75	544.1	238.8	0.0355	13.75	-0.15	275	0.4953
13.83	538.65	236	0.0293	13.83	-0.154	272.2	0.4713
13.92	536.38	233.8	0.024	13.92	-0.159	268.4	0.4456
14.00	532.36	231.5	0.0186	14.00	-0.169	262.4	0.419
14.08	526.21	228.3	0.0115	14.08	-0.172	258.8	0.379
14.17	520.9	224.7	0.0062	14.17	-0.177	256	0.3559
14.25	518.98	222.8	-0.0018	14.25	-0.182	251.9	0.3311

Prova triassiale ciclica SNGR03-C4							
tensione di confinamento (kPa)	450			tensione di confinamento (kPa)	450		
deviatore ciclico (kPa)	230			deviatore ciclico (kPa)	260		
frequenza (hz)	0.007143			frequenza (hz)	0.007143		
14.33	515.03	220.4	-0.008	14.35	-0.188	246.9	0.308
14.42	509.68	217.8	-0.0133	14.42	-0.191	243.8	0.2769
14.50	508.27	215.7	-0.0186	14.50	-0.196	240.4	0.253
14.58	504.58	213.7	-0.024	14.58	-0.202	236.7	0.2299
14.67	498.9	211.1	-0.0293	14.67	-0.204	233.3	0.2077
14.77	496.64	208.5	-0.0364	14.75	-0.209	229.8	0.1837
14.83	493.93	206.3	-0.0417	14.83	-0.215	225.9	0.1607
14.92	490.28	204.3	-0.047	14.92	-0.22	220.8	0.1385
15.00	486.09	201.9	-0.0524	15.00	-0.223	217.7	0.1056
15.08	481.93	198.8	-0.0577	15.08	-0.227	214.5	0.0843
15.17	479.92	197.3	-0.0639	15.17	-0.231	211.1	0.0639
15.25	477.23	195.5	-0.0701	15.25	-0.233	208.3	0.0453
15.33	473.57	193.2	-0.0754	15.33	-0.238	205.2	0.0257
15.42	471.66	191.5	-0.0808	15.42	-0.243	200.8	0.0062
15.50	469.24	189.9	-0.0861	15.50	-0.247	197.6	-0.0133
15.58	465.35	188	-0.0914	15.58	-0.249	195.1	-0.0426
15.67	463.1	185.7	-0.0968	15.67	-0.253	192.5	-0.0621
15.75	460.67	184.1	-0.1056	15.75	-0.255	190.1	-0.0799
15.83	458.04	182.6	-0.1118	15.83	-0.258	187.1	-0.1047
15.92	456.16	180.8	-0.1172	15.92	-0.261	185.3	-0.1216
16.00	454.8	179.8	-0.1234	16.00	-0.264	182.9	-0.1385
16.08	452.78	178.3	-0.1296	16.08	-0.265	180.8	-0.1562
16.18	449.54	175.9	-0.1394	16.17	-0.268	179.1	-0.1722
16.25	448.73	174.9	-0.1447	16.25	-0.272	176.9	-0.19
16.33	447.27	173.8	-0.1509	16.33	-0.273	174.8	-0.2059
16.42	444.98	172.5	-0.1571	16.42	-0.275	172.8	-0.2317
16.50	442.99	171.3	-0.1633	16.50	-0.277	171.1	-0.2494
16.58	442.2	169.8	-0.1704	16.58	-0.278	169.8	-0.2672
16.67	441.44	169	-0.1802	16.67	-0.279	168.5	-0.2832
16.75	440.58	167.9	-0.1864	16.75	-0.281	167	-0.3009
16.83	438.76	166.9	-0.1926	16.83	-0.283	165.3	-0.3169
16.92	437.64	166.1	-0.1988	16.92	-0.284	164.4	-0.332
17.00	437.62	165.6	-0.2042	17.00	-0.285	163.5	-0.3533
17.08	437.2	164.8	-0.2095	17.08	-0.285	162.6	-0.3666
17.17	435.34	163.8	-0.2157	17.17	-0.286	161.8	-0.3799
17.25	435.66	163.7	-0.2228	17.27	-0.287	160.7	-0.3986
17.33	435.08	163.1	-0.2272	17.33	-0.287	160.3	-0.4092
17.42	435.1	162.9	-0.2308	17.42	-0.287	159.8	-0.419
17.50	435.29	162.7	-0.2352	17.50	-0.288	159.4	-0.4296
17.58	434.87	162.4	-0.2388	17.58	-0.287	159.3	-0.4385
17.67	435.26	162.3	-0.2432	17.67	-0.287	159.1	-0.4465
17.75	435.56	162.2	-0.2459	17.75	-0.287	159	-0.4545
17.83	435.55	162.2	-0.2485	17.83	-0.287	159.1	-0.4633
17.92	436.21	162.4	-0.2503	17.92	-0.286	159.3	-0.4687
18.00	437.28	162.4	-0.2521	18.00	-0.285	159.8	-0.4722
18.08	437.37	162.8	-0.2539	18.08	-0.285	159.8	-0.4767
18.17	438.17	163.1	-0.2556	18.17	-0.283	160.6	-0.4793
18.25	439.61	163.6	-0.2556	18.25	-0.283	161.1	-0.482
18.33	439.98	163.9	-0.2565	18.33	-0.28	162.2	-0.4838
18.42	441.69	164.5	-0.2565	18.42	-0.28	162.6	-0.4855
18.50	442.62	165	-0.2565	18.50	-0.278	163.5	-0.4864
18.58	444.2	165.5	-0.2565	18.58	-0.277	164.2	-0.4864
18.67	445.77	166.5	-0.2565	18.68	-0.274	165.5	-0.4864
18.75	447.35	167.2	-0.2565	18.75	-0.272	166.4	-0.4864
18.83	449.09	168	-0.2556	18.83	-0.27	167.6	-0.4855
18.92	451.03	169	-0.2556	18.92	-0.268	168.7	-0.4855
19.00	452.81	169.7	-0.2548	19.00	-0.266	169.9	-0.4847
19.10	455.09	171	-0.2539	19.08	-0.262	171.2	-0.4838
19.17	457.47	171.9	-0.253	19.17	-0.26	173	-0.4829
19.25	458.88	172.7	-0.2521	19.25	-0.257	174.3	-0.482

Prova triassiale ciclica SNGR03-C4							
tensione di confinamento (kPa)	450			tensione di confinamento (kPa)	450		
deviatore ciclico (kPa)	230			deviatore ciclico (kPa)	260		
frequenza (hz)	0.007143			frequenza (hz)	0.007143		
19.33	460.89	173.7	-0.2512	19.33	-0.254	175.9	-0.4802
19.42	464.11	175.1	-0.2503	19.42	-0.251	177.3	-0.4793
19.50	467.29	176.7	-0.2494	19.50	-0.248	178.8	-0.4776
19.58	469.6	178	-0.2477	19.58	-0.244	180.6	-0.4758
19.67	471.95	179.1	-0.2459	19.67	-0.239	183.2	-0.4749
19.75	474.93	180.5	-0.245	19.75	-0.237	184.8	-0.4722
19.83	478.29	182.2	-0.2432	19.83	-0.234	186.2	-0.4704
19.92	479.93	183.1	-0.2414	19.92	-0.23	188.4	-0.4687
20.00	482.71	184.6	-0.2406	20.00	-0.227	190.4	-0.466
20.08	487.94	187	-0.2379	20.08	-0.222	192	-0.4642
20.17	491.89	188.9	-0.237	20.18	-0.218	194.8	-0.4616
20.25	494.28	190.2	-0.2343	20.25	-0.212	197.2	-0.4589
20.33	497.36	191.8	-0.2317	20.33	-0.21	198.9	-0.4562
20.42	501.25	193.7	-0.2299	20.42	-0.205	201.1	-0.4545
20.52	505.77	196.2	-0.2281	20.50	-0.198	203.5	-0.4509
20.58	508.15	197.5	-0.2255	20.58	-0.193	207	-0.4491
20.67	512.24	199.6	-0.2228	20.67	-0.19	209.1	-0.4438
20.75	516.53	201.9	-0.2201	20.75	-0.184	211.7	-0.4412
20.83	519.75	203.5	-0.2175	20.83	-0.179	214.4	-0.4376
20.92	523.33	205.3	-0.2157	20.92	-0.176	216.5	-0.4349
21.00	529.53	208.4	-0.213	21.00	-0.17	219.3	-0.4314
21.08	533.65	210.6	-0.2104	21.08	-0.162	223.2	-0.427
21.17	536.57	212.3	-0.2059	21.17	-0.159	226	-0.4216
21.25	540.93	214.4	-0.2033	21.25	-0.154	228.1	-0.4181
21.33	545.85	216.9	-0.1997	21.33	-0.147	231.2	-0.4145
21.42	548.73	218.7	-0.1971	21.42	-0.143	234.2	-0.4101
21.50	553.65	221.1	-0.1944	21.50	-0.138	236.5	-0.4057
21.58	560.18	224.5	-0.19	21.60	-0.131	240.3	-0.4003
21.67	565.14	227.2	-0.1873	21.67	-0.123	243.6	-0.3959
21.75	567.99	229	-0.182	21.75	-0.121	246.3	-0.3923
21.83	573.01	231.4	-0.1784	21.83	-0.115	248.7	-0.3879
21.92	578.13	234.1	-0.1749	21.92	-0.105	252.5	-0.3817
22.02	582.79	237.1	-0.1704	22.00	-0.099	256.7	-0.3772
22.08	587.04	239.2	-0.1651	22.08	-0.095	259.2	-0.3701
22.17	592.97	241.9	-0.1607	22.17	-0.088	262.3	-0.3648
22.25	597.95	244.5	-0.1571	22.25	-0.081	265.9	-0.3586
22.33	601.03	246.5	-0.1527	22.33	-0.077	268.3	-0.3533
22.42	606.59	249.2	-0.1482	22.42	-0.071	271.6	-0.348
22.50	613.44	252.8	-0.1438	22.50	-0.061	276.4	-0.3417
22.58	618.13	255.5	-0.1402	22.58	-0.054	279.7	-0.3355
22.67	622.28	257.6	-0.1331	22.67	-0.052	282.1	-0.3267
22.75	628.03	260.4	-0.1287	22.75	-0.042	285.8	-0.3196
22.83	632.71	263.1	-0.1243	22.83	-0.037	289.2	-0.3133
22.92	636.32	265.2	-0.1189	22.92	-0.032	291.4	-0.308
23.00	642.11	268	-0.1145	23.00	-0.024	294.9	-0.3009
23.08	648.76	271.6	-0.1092	23.10	-0.018	299.1	-0.2911
23.17	654.84	274.6	-0.1039	23.17	-0.013	302.3	-0.2832
23.25	657.42	276.5	-0.0959	23.25	-0.006	305.2	-0.2761
23.33	662.76	279.2	-0.0914	23.33	0.003	309.1	-0.2681
23.43	669.24	282.7	-0.0852	23.42	0.011	313.7	-0.261
23.50	674.82	285.5	-0.0808	23.50	0.016	316.7	-0.2494
23.58	678.8	287.6	-0.0728	23.58	0.02	319.2	-0.2414
23.67	683.77	290.1	-0.0675	23.67	0.029	323.1	-0.2326
23.75	688.81	292.8	-0.0612	23.75	0.033	325.8	-0.2237
23.83	692.75	294.8	-0.0559	23.83	0.041	329.6	-0.213
23.92	698.3	297.6	-0.0497	23.92	0.05	334	-0.205
24.00	705.44	301.2	-0.0435	24.00	0.056	337.5	-0.1935
24.08	710.61	304	-0.0373	24.08	0.061	340.6	-0.174
24.17	714.38	306	-0.0275	24.17	0.068	344.2	-0.1616
24.25	719.78	308.6	-0.0213	24.25	0.076	348.5	-0.1447

Prova triassiale ciclica SNGR03-C4							
tensione di confinamento (kPa)	450			tensione di confinamento (kPa)	450		
deviatore ciclico (kPa)	230			deviatore ciclico (kPa)	260		
frequenza (hz)	0.007143			frequenza (hz)	0.007143		
24.33	724.55	311.2	-0.0151	24.33	0.076	350.5	-0.134
24.42	728.05	313.2	-0.008	24.42	0.088	354.5	-0.1163
24.50	733.48	315.8	-0.0009	24.52	0.093	359.1	-0.0932
24.58	740.98	319.4	0.0062	24.58	0.098	362.1	-0.0781
24.67	747.05	322.5	0.0133	24.67	0.105	365.1	-0.0595
24.75	748.2	323.7	0.024	24.75	0.115	368.7	-0.0391
24.83	754.87	326.4	0.032	24.83	0.119	373.4	-0.0186
24.93	761.51	329.6	0.0364	24.92	0.124	376.6	0.0169
25.00	764.38	331.6	0.0462	25.00	0.129	379.6	0.0426
25.08	766.84	333.5	0.0577	25.08	0.137	383.3	0.071
25.17	774.96	336.5	0.0666	25.17	0.141	386.1	0.0985
25.25	775.62	338	0.0728	25.25	0.147	389.3	0.1314
25.33	782.11	340.5	0.0834	25.33	0.154	392.4	0.1633
25.42	785.2	342.3	0.0897	25.42	0.161	397	0.1997
25.50	791.41	345.5	0.0994	25.50	0.165	399.2	0.2548
25.58	795.26	347.9	0.1083	25.58	0.171	402.1	0.2929
25.67	798.64	349.4	0.1216	25.67	0.178	405.1	0.3338
25.75	804.68	352.2	0.1323	25.75	0.181	407.1	0.3701
25.83	805.24	353.4	0.1385	25.83	0.187	410	0.411
25.92	810.15	355.4	0.1491	25.92	0.195	413.8	0.4465
26.00	816.12	358.1	0.1607	26.00	0.196	415.3	0.4971
26.08	819.3	360.2	0.1669	26.08	0.202	417.7	0.5273
26.17	823.45	362.2	0.1758	26.17	0.208	420.3	0.5628
26.25	825.88	363.7	0.1908	26.25	0.214	423.5	0.5974
26.35	829.52	365.5	0.1997	26.33	0.218	425.5	0.648
26.42	834.49	368	0.2095	26.42	0.222	427.3	0.6782
26.50	836.13	369.3	0.2192	26.50	0.226	429	0.7154
26.58	839.96	370.9	0.2317	26.58	0.229	431	0.7456
26.67	845.56	373.1	0.2423	26.67	0.237	433.4	0.774
26.75	845.28	373.9	0.2494	26.75	0.24	435	0.798
26.83	848.98	375.4	0.2592	26.83	0.245	437.9	0.8255
26.92	852.44	377	0.2698	26.92	0.249	439.4	0.8646
27.00	856.48	379.1	0.2796	27.00	0.254	441.4	0.8885
27.08	858.12	380.1	0.2894	27.08	0.257	443.1	0.9098
27.17	863.16	381.8	0.3036	27.17	0.259	444.4	0.9311
27.25	863.27	382.7	0.3116	27.25	0.263	445.9	0.9551
27.33	865.31	383.7	0.3196	27.33	0.267	447.8	0.9737
27.42	868.01	384.9	0.3275	27.43	0.271	449.3	1.0013
27.50	869.69	385.7	0.3355	27.50	0.273	450.4	1.0172
27.58	873.61	387.4	0.3462	27.58	0.277	451.6	1.0332
27.67	875.98	388.5	0.3533	27.67	0.28	453.5	1.0492
27.75	877.44	389.3	0.3657	27.75	0.282	454.6	1.0723
27.85	878.62	390.1	0.3728	27.83	0.284	455.6	1.0874
27.92	880.88	391.3	0.3808	27.92	0.287	456.6	1.1016
28.00	884.95	392.7	0.387	28.00	0.289	457.6	1.1158
28.08	883.23	392.8	0.3959	28.08	0.291	458.4	1.1282
28.17	886	393.7	0.403	28.17	0.294	459.2	1.1406
28.25	888.47	394.7	0.4101	28.25	0.296	460.5	1.1522
28.33	888.91	395	0.4163	28.33	0.295	460.6	1.1672
28.42	889.4	395.3	0.4207	28.42	0.299	461.8	1.1797
28.50	891.8	396.3	0.427	28.50	0.3	462.3	1.1886
28.58	891.69	396.6	0.4323	28.58	0.3	462.7	1.1965
28.67	893.32	397.2	0.4403	28.67	0.302	463.2	1.2045
28.75	893.57	397.4	0.4456	28.75	0.303	463.8	1.2125
28.83	893.59	397.6	0.4491	28.85	0.304	464	1.2223
28.92	894.38	398	0.4536	28.92	0.304	464.3	1.2285
29.00	894.46	398.2	0.458	29.00	0.304	464.3	1.2347
29.08	895.11	398.5	0.4616	29.08	0.305	464.9	1.2409
29.17	895.14	398.6	0.4651	29.17	0.305	464.8	1.2471
29.27	894.92	398.7	0.4696	29.25	0.306	465	1.2516

Prova triassiale ciclica SNGR03-C4							
tensione di confinamento (kPa)	450			tensione di confinamento (kPa)	450 <th colspan="2"></th>		
deviatore ciclico (kPa)	230			deviatore ciclico (kPa)	260		
frequenza (hz)	0.007143			frequenza (hz)	0.007143		
29.33	894.72	398.7	0.4722	29.33	0.305	464.9	1.2551
29.42	894.71	398.9	0.4749	29.42	0.305	464.9	1.2587
29.50	893.84	398.8	0.4776	29.50	0.305	464.8	1.2613
29.58	894	398.8	0.4793	29.58	0.304	464.6	1.2631
29.67	893.2	398.7	0.4811	29.67	0.303	464.3	1.2649
29.75	892.46	398.4	0.482	29.75	0.302	464	1.2676
29.83	892.06	398.5	0.4829	29.83	0.302	463.9	1.2684
29.92	890.8	398.2	0.4829	29.92	0.3	463.5	1.2693
30.00	889.44	397.8	0.4838	30.00	0.299	463.1	1.2702
30.08	888.34	397.5	0.4838	30.08	0.298	462.7	1.2702
30.17	887.22	397.2	0.4838	30.17	0.295	462.2	1.2702
30.25	885.92	396.8	0.4838	30.25	0.294	461.6	1.2702
30.33	884.5	396.3	0.4838	30.35	0.293	461.1	1.2702
30.42	883.8	396	0.4838	30.42	0.29	460.3	1.2702
30.50	879.96	395.2	0.482	30.50	0.288	459.5	1.2702
30.58	879.79	394.9	0.482	30.58	0.285	458.8	1.2693
30.68	877.61	394.3	0.4811	30.67	0.283	458.2	1.2684
30.75	874	393.5	0.4802	30.75	0.28	457.3	1.2676
30.83	870.91	393.4	0.4802	30.83	0.276	456.2	1.2658
30.92	871.78	392.4	0.4784	30.92	0.277	456	1.2658
31.00	869.46	391.7	0.4776	31.00	0.271	454.4	1.264
31.08	866.02	390.7	0.4758	31.08	0.268	453.6	1.264
31.17	863.13	389.7	0.474	31.17	0.265	452.7	1.2622
31.25	859.46	388.7	0.4722	31.25	0.262	451.7	1.2604
31.33	858.03	388.1	0.4713	31.33	0.258	450.5	1.2587
31.42	855.25	387.1	0.4696	31.42	0.256	449.7	1.2578
31.50	851.44	385.9	0.4687	31.50	0.251	448.5	1.256
31.58	849.72	385	0.4651	31.58	0.246	447.3	1.2542
31.67	846.11	384	0.4633	31.67	0.241	445.4	1.2525
31.75	843.7	383	0.4607	31.77	0.24	444.7	1.2507
31.83	840.49	381.8	0.458	31.83	0.235	443.3	1.2489
31.92	838.07	381	0.4554	31.92	0.228	441.1	1.2462
32.00	831.84	379.4	0.4527	32.00	0.224	439.8	1.2445
32.08	828.16	377.8	0.45	32.08	0.22	438.5	1.24
32.18	824.36	376.4	0.4447	32.17	0.216	436.9	1.2383
32.25	823	375.7	0.442	32.25	0.212	435.6	1.2356
32.33	815.15	374.2	0.4385	32.33	0.207	434.1	1.2329
32.42	813.92	372.4	0.4358	32.42	0.2	432.2	1.2303
32.50	810.29	371.1	0.4296	32.50	0.191	429.2	1.2276
32.58	806.61	369.7	0.4252	32.58	0.191	428.2	1.2223
32.67	802.41	368.3	0.4207	32.67	0.183	426.1	1.2187
32.75	798.76	366.8	0.4163	32.75	0.181	424.8	1.217
32.83	792.83	365	0.411	32.83	0.175	423	1.2125
32.92	788.99	363.7	0.4074	32.92	0.17	421	1.209
33.00	783.22	361.1	0.4021	33.00	0.16	419	1.2054
33.08	780.28	359.6	0.3941	33.08	0.158	416.4	1.201
33.17	773.55	357.6	0.3888	33.17	0.151	414.4	1.1957
33.25	771.63	356.4	0.3843	33.27	0.146	412.5	1.1921
33.33	769.51	355.2	0.379	33.33	0.139	409.7	1.1877
33.42	763.11	353	0.3728	33.42	0.13	406.5	1.1806
33.50	757.97	350.7	0.3648	33.50	0.129	405.6	1.1779
33.60	752	348.5	0.3568	33.58	0.12	402.7	1.1717
33.67	748.85	346.8	0.3515	33.67	0.116	400.6	1.1672
33.75	743.94	345.1	0.3453	33.75	0.109	398.4	1.1628
33.83	736.38	342.9	0.3382	33.83	0.1	395.8	1.1566
33.92	732.63	340.2	0.3311	33.92	0.093	392.5	1.1513
34.00	727.19	337.8	0.3204	34.00	0.09	390	1.1433
34.08	722.74	336	0.3142	34.08	0.082	387.5	1.1362
34.17	718.96	334.1	0.3071	34.17	0.075	384.9	1.13
34.25	713.61	332.1	0.2991	34.25	0.072	383.3	1.1255

Prova triassiale ciclica SNGR03-C4							
tensione di confinamento (kPa)	450			tensione di confinamento (kPa)	450		
deviatore ciclico (kPa)	230			deviatore ciclico (kPa)	260		
frequenza (hz)	0.007143			frequenza (hz)	0.007143		
34.33	709.53	330.3	0.2929	34.33	0.064	380.7	1.1184
34.42	701.59	327.6	0.284	34.42	0.054	377.3	1.1096
34.50	696.04	324.5	0.2761	34.50	0.051	374.5	1.1033
34.58	691.85	322.1	0.2645	34.58	0.043	371.8	1.0918
34.67	687.7	320.4	0.2574	34.68	0.041	370.1	1.0856
34.75	680.68	317.7	0.2494	34.75	0.026	365.1	1.074
34.83	679.32	315.9	0.2423	34.83	0.024	363.4	1.0652
34.92	673.03	313.6	0.2334	34.92	0.015	360.6	1.0501
35.00	666.34	311	0.2255	35.00	0.01	357.9	1.0412
35.10	662.69	308.4	0.2157	35.08	0.002	354.9	1.0288
35.17	658.13	305.9	0.2077	35.17	-0.003	353	1.0181
35.25	652.53	303.6	0.1997	35.25	-0.011	350.4	1.0057
35.33	645.61	300.9	0.1917	35.33	-0.021	346	0.9915
35.42	638.48	297.1	0.1846	35.42	-0.024	343.7	0.9702
35.50	636.28	295.1	0.1731	35.50	-0.03	341.4	0.9542
35.58	630.79	292.7	0.1669	35.58	-0.039	338.2	0.9356
35.67	625.15	290	0.1589	35.67	-0.042	335.7	0.9178
35.75	621.82	287.3	0.1509	35.75	-0.048	333.2	0.893
35.83	616.82	285.4	0.1447	35.83	-0.058	329.7	0.8628
35.92	609.79	282.5	0.1367	35.92	-0.067	325.5	0.8344
36.00	603.65	278.9	0.1305	36.00	-0.069	322.9	0.7927
36.08	601.34	276.5	0.1198	36.08	-0.077	319.8	0.7651
36.17	596.34	274.3	0.1118	36.17	-0.083	316.1	0.7447
36.25	589.23	271.1	0.1047	36.25	-0.091	312.3	0.7243
36.33	587.53	268.9	0.0985	36.33	-0.095	310.1	0.6915
36.42	582.35	266.6	0.0923	36.42	-0.102	306.8	0.6684
36.52	575.51	262.9	0.0826	36.50	-0.107	303.4	0.6444
36.58	570.53	260.3	0.0754	36.58	-0.112	300.9	0.6178
36.67	568.39	257.9	0.0692	36.67	-0.12	297.1	0.5885
36.75	562.55	255.5	0.0621	36.75	-0.128	292.3	0.5628
36.83	556.14	252.2	0.0541	36.83	-0.132	289	0.5246
36.92	551.89	249.1	0.047	36.92	-0.137	286	0.498
37.00	549.07	246.7	0.0373	37.00	-0.144	281.9	0.4696
37.08	544.32	244.2	0.0293	37.08	-0.148	278.5	0.442
37.17	539.18	241.3	0.0222	37.17	-0.153	275.3	0.4145
37.25	535.83	238.4	0.0142	37.25	-0.162	271.2	0.3843
37.33	532.25	236.6	0.008	37.33	-0.166	266	0.3559
37.42	526.06	233.7	0	37.42	-0.171	262.6	0.3133
37.50	521.87	230	-0.0071	37.50	-0.176	258.6	0.2858
37.58	519.18	227.6	-0.0178	37.60	-0.183	253.4	0.2583
37.67	515.26	225.4	-0.0249	37.67	-0.188	249.5	0.2334
37.75	510.14	222.5	-0.0328	37.75	-0.191	246.8	0.1917
37.83	507.99	220.1	-0.0399	37.83	-0.196	242.8	0.1624
37.92	504.47	218.3	-0.047	37.92	-0.201	238.6	0.1349
38.02	500.11	215.1	-0.0568	38.00	-0.205	235.4	0.1065
38.08	495.68	212.6	-0.063	38.08	-0.21	231.8	0.0817
38.17	493.56	210.2	-0.071	38.17	-0.216	226.4	0.0559
38.25	490.14	208.2	-0.0781	38.25	-0.218	223.3	0.0178
38.33	485.98	205.8	-0.0852	38.33	-0.222	220	-0.008
38.42	482.29	202.7	-0.0914	38.42	-0.227	216.1	-0.0346
38.50	480.26	200.7	-0.1021	38.50	-0.23	212.8	-0.0595
38.58	477.47	198.9	-0.1092	38.58	-0.233	209.9	-0.0834
38.67	473.28	196.5	-0.1163	38.67	-0.239	206.6	-0.1065
38.75	472.56	194.8	-0.1234	38.75	-0.244	201.8	-0.1296
38.83	469.13	192.8	-0.1305	38.83	-0.245	199.3	-0.1633
38.92	465.6	191.1	-0.1367	38.92	-0.249	196.3	-0.1846
39.00	462.37	188.1	-0.1438	39.02	-0.252	193.4	-0.2059
39.08	460.88	186.2	-0.1536	39.08	-0.256	190	-0.2246
39.17	458.82	185.2	-0.1598	39.17	-0.258	187.7	-0.2548
39.25	455.82	183.2	-0.1669	39.25	-0.26	185.5	-0.2734

Prova triassiale ciclica SNGR03-C4							
tensione di confinamento (kPa)	450			tensione di confinamento (kPa)	450		
deviatore ciclico (kPa)	230			deviatore ciclico (kPa)	260		
frequenza (hz)	0.007143			frequenza (hz)	0.007143		
39.33	454.14	181.7	-0.1731	39.33	-0.263	183.1	-0.2929
39.43	452.27	180	-0.182	39.42	-0.265	181.2	-0.3107
39.50	449.82	178.5	-0.1873	39.50	-0.268	179.2	-0.3275
39.58	448.23	177.2	-0.1935	39.58	-0.271	176	-0.3453
39.67	447.47	176.3	-0.1988	39.67	-0.272	174.6	-0.3693
39.75	445.79	175.1	-0.2042	39.75	-0.274	172.7	-0.3852
39.83	443.4	173.6	-0.2095	39.83	-0.276	171	-0.4012
39.92	441.81	172.1	-0.2148	39.92	-0.278	169.5	-0.4163
40.00	441.58	171.5	-0.2228	40.00	-0.279	168.2	-0.4305
40.08	440.43	170.8	-0.2272	40.08	-0.281	166.9	-0.4438
40.17	438.17	169.5	-0.2326	40.17	-0.283	165.1	-0.4571
40.25	438.06	169	-0.237	40.25	-0.283	164.4	-0.4749
40.33	438.22	168.5	-0.2406	40.33	-0.284	163.3	-0.4873
40.42	436.83	167.6	-0.2459	40.42	-0.285	162.5	-0.498
40.50	435.65	166.8	-0.2494	40.52	-0.285	161.5	-0.5086
40.58	435.6	166.5	-0.2548	40.58	-0.286	160.9	-0.5237
40.67	435.15	166.1	-0.2583	40.67	-0.286	160.4	-0.5335
40.75	435.35	166	-0.261	40.75	-0.287	159.9	-0.5423
40.85	434.93	165.5	-0.2645	40.83	-0.287	159.5	-0.5503
40.92	435.12	165.5	-0.2681	40.92	-0.287	159.5	-0.5574
41.00	435.29	165.4	-0.2698	41.00	-0.285	159.5	-0.5699
41.08	435.62	165.5	-0.2716	41.08	-0.286	159.2	-0.5761
41.17	435.71	165.4	-0.2734	41.17	-0.286	159.2	-0.5805
41.25	436.58	165.6	-0.2752	41.25	-0.286	159.4	-0.585
41.33	436.81	165.6	-0.2769	41.33	-0.285	159.7	-0.5885
41.42	437.1	165.8	-0.2778	41.42	-0.284	160.1	-0.5912
41.50	438.78	166.4	-0.2787	41.50	-0.283	160.7	-0.5929
41.58	439.21	166.7	-0.2787	41.58	-0.281	161.7	-0.5947
41.67	440.11	167.1	-0.2796	41.67	-0.28	162.1	-0.5965
41.75	441.29	167.6	-0.2796	41.75	-0.279	162.8	-0.5974
41.83	442.53	168.2	-0.2796	41.83	-0.277	163.6	-0.5974
41.92	444.44	168.7	-0.2796	41.93	-0.276	164.7	-0.5983
42.00	446.21	169.9	-0.2796	42.00	-0.274	165.7	-0.5983
42.08	447.12	170.4	-0.2787	42.08	-0.271	166.8	-0.5974
42.17	448.76	171.2	-0.2778	42.17	-0.27	167.9	-0.5974
42.25	451.18	172.2	-0.2769	42.25	-0.268	169	-0.5965
42.35	452.88	173.2	-0.2769	42.33	-0.265	170.4	-0.5956
42.42	455.06	174.3	-0.2761	42.42	-0.261	172	-0.5947
42.50	457.54	175.2	-0.2752	42.50	-0.26	173.3	-0.5938
42.58	458.59	176.1	-0.2743	42.58	-0.256	174.8	-0.5929
42.67	461.27	177.2	-0.2734	42.67	-0.253	176.4	-0.5912
42.75	463.88	178.3	-0.2725	42.75	-0.252	177.6	-0.5894
42.83	466.83	179.6	-0.2707	42.83	-0.248	179.1	-0.5885
42.92	470.59	181.4	-0.2698	42.92	-0.243	181	-0.5867
43.00	471.3	182.1	-0.2681	43.00	-0.24	183.3	-0.5858
43.08	474.58	183.7	-0.2663	43.08	-0.237	185	-0.5832
43.17	478.64	185.5	-0.2645	43.17	-0.234	186.7	-0.5814
43.25	479.78	186.5	-0.2636	43.25	-0.228	189.2	-0.5787
43.33	483.13	188.1	-0.2619	43.33	-0.227	190.4	-0.577
43.42	487.79	190.1	-0.2592	43.43	-0.221	193.2	-0.5743
43.50	491.18	192.2	-0.2583	43.50	-0.217	195.4	-0.5716
43.58	493.63	193.5	-0.2556	43.58	-0.213	197.7	-0.5699
43.67	497.88	195.5	-0.2539	43.67	-0.21	199.2	-0.5672
43.75	501.41	197.2	-0.2512	43.75	-0.204	201.8	-0.5645
43.83	505.59	199.7	-0.2503	43.83	-0.198	205.2	-0.5619
43.92	508.35	201.2	-0.2468	43.92	-0.193	207.8	-0.5574
44.00	511.93	203	-0.2441	44.00	-0.19	209.6	-0.5548
44.08	516.83	205.4	-0.2414	44.08	-0.184	212.6	-0.5512
44.17	519.44	207.2	-0.2388	44.17	-0.181	214.5	-0.5486
44.25	523.3	208.9	-0.237	44.25	-0.176	217.1	-0.545

Prova triassiale ciclica SNGR03-C4							
tensione di confinamento (kPa)	450			tensione di confinamento (kPa)	450		
deviatore ciclico (kPa)	230			deviatore ciclico (kPa)	260		
frequenza (hz)	0.007143			frequenza (hz)	0.007143		
44.33	529.4	211.3	-0.2334	44.33	-0.17	220	-0.5415
44.42	534.19	214.4	-0.2317	44.42	-0.161	224.3	-0.5379
44.50	536.84	216.3	-0.2272	44.50	-0.159	226.5	-0.5317
44.58	540.83	218.2	-0.2246	44.58	-0.154	228.9	-0.5281
44.67	546.12	220.9	-0.221	44.67	-0.146	232.5	-0.5237
44.75	548.9	222.8	-0.2175	44.75	-0.144	234.7	-0.5202
44.83	553.36	224.9	-0.2148	44.85	-0.137	238.6	-0.5139
44.92	559.39	227.7	-0.2113	44.92	-0.13	241.3	-0.5095
45.00	565.78	231.4	-0.2077	45.00	-0.124	244.3	-0.5042
45.08	568.03	233	-0.2024	45.08	-0.12	246.8	-0.4997
45.17	572.99	235.4	-0.1988	45.17	-0.113	250	-0.4953
45.27	578.15	237.7	-0.1953	45.25	-0.105	254.5	-0.49
45.33	584.51	241.5	-0.1917	45.33	-0.099	257.8	-0.4847
45.42	587.02	243.4	-0.1855	45.42	-0.095	260.3	-0.4767
45.50	591.88	245.8	-0.182	45.50	-0.087	263.8	-0.4713
45.58	597.63	248.7	-0.1775	45.58	-0.083	266.9	-0.466
45.67	600.58	250.7	-0.1731	45.67	-0.077	269.3	-0.4607
45.75	605.17	253.1	-0.1687	45.75	-0.069	273	-0.4545
45.83	613.47	256.3	-0.1633	45.83	-0.06	278	-0.4483
45.92	619.66	260.3	-0.1589	45.92	-0.057	280.7	-0.4385
46.00	621.97	262.3	-0.1527	46.00	-0.051	283.4	-0.4332
46.08	627.42	264.8	-0.1482	46.08	-0.043	287.2	-0.4261
46.17	633.57	267.6	-0.1429	46.17	-0.039	289.8	-0.4199
46.25	636.05	269.7	-0.1376	46.25	-0.033	292.9	-0.4128
46.33	641.43	272.5	-0.1331	46.33	-0.024	297.5	-0.403
46.42	648.39	275.3	-0.1278	46.42	-0.016	301	-0.3968
46.50	654.64	279.3	-0.1234	46.50	-0.014	303.2	-0.3906
46.58	656.41	281	-0.1154	46.58	-0.005	306.9	-0.3826
46.68	662.4	283.8	-0.1092	46.67	0.002	311.3	-0.3737
46.75	668.75	286.4	-0.1047	46.75	0.011	315.4	-0.3675
46.83	675.63	290.4	-0.0994	46.83	0.015	317.8	-0.3551
46.92	677.83	292.1	-0.0905	46.92	0.022	321.3	-0.3462
47.00	683.04	294.7	-0.0852	47.00	0.028	324.7	-0.3373
47.08	689.59	297.9	-0.0781	47.08	0.034	327.8	-0.3275
47.17	691.86	299.8	-0.0728	47.17	0.042	331.5	-0.3178
47.25	697.87	302.4	-0.0666	47.25	0.051	336.4	-0.3071
47.33	705.41	305.4	-0.0604	47.33	0.054	339.4	-0.2885
47.42	709.82	308.9	-0.055	47.42	0.059	342.5	-0.2743
47.50	713.82	311.1	-0.0444	47.50	0.069	347	-0.2574
47.58	719.66	313.7	-0.0382	47.58	0.072	350	-0.2432
47.67	724.93	316.3	-0.0311	47.67	0.078	353.2	-0.2281
47.75	726.73	318.1	-0.0249	47.77	0.087	358.1	-0.2024
47.83	732.7	320.8	-0.0169	47.83	0.092	361.2	-0.1855
47.92	740.46	323.6	-0.0089	47.92	0.098	364.3	-0.1678
48.00	745.86	327.1	-0.0018	48.00	0.105	368	-0.1465
48.08	749.92	329.6	0.0107	48.08	0.113	372.9	-0.1252
48.18	753.05	331.3	0.0169	48.17	0.119	376.6	-0.1012
48.25	759.21	333.7	0.024	48.25	0.123	378.9	-0.0648
48.33	763.87	337	0.032	48.33	0.131	382.7	-0.0346
48.42	767.46	339	0.0444	48.42	0.137	386.6	-0.0018
48.50	772.38	341.4	0.0541	48.50	0.14	388.7	0.0249
48.58	777	343.8	0.063	48.58	0.147	393	0.0657
48.67	779.82	345.5	0.0719	48.67	0.157	397.1	0.0985
48.75	784.81	347.9	0.0817	48.75	0.159	399.6	0.158
48.83	790.59	350.3	0.0914	48.83	0.165	402.4	0.1988
48.92	795.14	353.4	0.1012	48.92	0.171	405.2	0.2414
49.00	798.38	355.3	0.1163	49.00	0.175	407.8	0.2832
49.08	802.76	357.4	0.126	49.08	0.181	410.3	0.3204
49.17	808.77	360.1	0.1394	49.18	0.188	414.3	0.3817
49.25	809.92	361.3	0.1482	49.25	0.191	416.3	0.4154

Prova triassiale ciclica SNGR03-C4							
tensione di confinamento (kPa)	450			tensione di confinamento (kPa)	450		
deviatore ciclico (kPa)	230			deviatore ciclico (kPa)	260		
frequenza (hz)	0.007143			frequenza (hz)	0.007143		
49.33	814.52	363.4	0.1589	49.33	0.196	418.6	0.45
49.42	818.6	366	0.1704	49.42	0.203	421.6	0.4918
49.50	823.97	368.2	0.1793	49.50	0.209	424.8	0.5228
49.60	825.33	369.4	0.1953	49.58	0.215	427.6	0.5574
49.67	830.31	371.2	0.2059	49.67	0.219	429.5	0.6116
49.75	834.11	373.6	0.2148	49.75	0.222	431.2	0.6498
49.83	837.75	375.4	0.2263	49.83	0.227	433.5	0.6844
49.92	839.64	376.7	0.2432	49.92	0.231	435.5	0.711
50.00	842.84	378.2	0.2539	50.00	0.239	437.5	0.7376
50.08	847.17	380	0.2654	50.08	0.24	440	0.7634
50.17	848.17	381	0.2752	50.17	0.245	442.3	0.8015
50.25	853.23	382.9	0.2876	50.25	0.25	444.1	0.8255
50.33	857.86	384.9	0.2965	50.33	0.252	445.6	0.8468
50.42	858.4	385.7	0.308	50.42	0.254	447	0.8699
50.50	861.21	387	0.3231	50.50	0.258	448.7	0.893
50.58	864.54	388.4	0.3338	50.58	0.263	450.6	0.9169
50.67	865.88	389.4	0.3435	50.68	0.268	452.8	0.9471
50.75	870.06	390.8	0.3551	50.75	0.269	453.8	0.9631
50.83	870.54	391.5	0.363	50.83	0.273	455.2	0.9817
50.92	873.97	393.1	0.3728	50.92	0.277	456.6	0.9986
51.02	877.35	394.2	0.3861	51.00	0.279	458	1.0146
51.08	877.03	394.7	0.3932	51.08	0.283	459.2	1.0385
51.17	879.73	395.6	0.4012	51.17	0.285	460.5	1.0545
51.25	882.96	396.9	0.4074	51.25	0.285	461.2	1.0687
51.33	883.74	397.5	0.4154	51.33	0.288	462.2	1.0838
51.42	885.43	398.2	0.4261	51.42	0.292	463.4	1.098
51.50	886.67	398.8	0.4332	51.50	0.294	464.5	1.1096
51.58	887.12	399.3	0.4394	51.58	0.294	465	1.1291
51.67	888.52	400.1	0.4474	51.67	0.297	465.9	1.1415
51.75	890.06	400.5	0.4536	51.75	0.297	466.4	1.1504
51.83	891.64	401.4	0.4589	51.83	0.3	467.2	1.161
51.92	891.55	401.7	0.4651	51.92	0.3	467.5	1.1699
52.00	893.72	402.3	0.4731	52.00	0.303	468	1.1779
52.08	891.85	402.2	0.4776	52.10	0.304	468.6	1.1903
52.17	895.24	403.1	0.4838	52.17	0.303	468.8	1.1957
52.25	894.14	403	0.4873	52.25	0.305	469.2	1.2019
52.33	894.65	403.3	0.4918	52.33	0.306	469.5	1.2072
52.42	894.84	403.5	0.4953	52.42	0.305	469.3	1.2134
52.52	895.29	403.7	0.5006	52.50	0.305	469.5	1.2196
52.58	894.39	403.6	0.5033	52.58	0.306	469.6	1.2241
52.67	894.97	403.8	0.506	52.67	0.306	469.7	1.2285
52.75	895.53	403.8	0.5095	52.75	0.305	469.5	1.2312
52.83	893.76	403.6	0.5131	52.83	0.305	469.4	1.2338
52.92	893.09	403.5	0.5139	52.92	0.305	469.3	1.2365
53.00	892.99	403.5	0.5157	53.00	0.302	468.8	1.2391
53.08	892.45	403.4	0.5166	53.08	0.302	468.7	1.2409
53.17	892.38	403.4	0.5184	53.17	0.302	468.5	1.2427
53.25	890.83	403	0.5184	53.25	0.3	468	1.2427
53.33	889.6	402.6	0.5184	53.33	0.299	467.6	1.2436
53.42	888.4	402.3	0.5193	53.42	0.297	467.2	1.2436
53.50	887.31	402	0.5193	53.50	0.296	466.6	1.2445
53.58	885.85	401.6	0.5193	53.60	0.294	466.1	1.2445
53.67	885.02	401.3	0.5184	53.67	0.292	465.6	1.2436
53.75	881.98	400.6	0.5175	53.75	0.29	465.2	1.2436
53.83	880.98	400.2	0.5175	53.83	0.286	464	1.2427
53.92	878.43	399.4	0.5166	53.92	0.286	463.6	1.2427
54.00	877.81	399.1	0.5157	54.00	0.284	462.8	1.2418
54.08	876.74	398.6	0.5157	54.08	0.281	462.1	1.2409
54.17	873.17	397.7	0.5139	54.17	0.278	461.3	1.24
54.25	870.12	396.7	0.5131	54.25	0.275	460.4	1.2391

Prova triassiale ciclica SNGR03-C4								
tensione di confinamento (kPa)		450		tensione di confinamento (kPa)		450		
deviatore ciclico (kPa)		230		deviatore ciclico (kPa)		260		
frequenza (hz)		0.007143		frequenza (hz)		0.007143		
54.33	868.43	396.2	0.5122	54.33	0.271	459.1	1.2383	
54.42	866.09	395.4	0.5104	54.42	0.268	458.3	1.2365	
54.50	863.04	394.4	0.5086	54.50	0.265	457.4	1.2356	
54.58	861.02	393.7	0.5068	54.58	0.262	456.3	1.2338	
54.67	858.61	392.9	0.5051	54.67	0.259	455.3	1.2329	
54.75	856.36	392.1	0.5033	54.75	0.255	454.3	1.2312	
54.83	851.52	390.5	0.5015	54.83	0.25	453.1	1.2303	
54.92	849.01	389.6	0.4997	54.92	0.246	451.4	1.2276	
55.00	846.6	388.8	0.4962	55.02	0.242	450.1	1.2249	
55.08	842.39	387.4	0.4935	55.08	0.239	449.3	1.2232	
55.17	840.18	386.5	0.4909	55.17	0.233	448.1	1.2214	
55.25	835.08	385.1	0.4873	55.25	0.23	446.2	1.2196	
55.33	834.81	384.5	0.4864	55.33	0.225	444.8	1.2161	
55.43	829.06	382.6	0.4811	55.42	0.22	443.3	1.2134	
55.50	827.21	381.5	0.4784	55.50	0.215	441.6	1.2107	
55.58	822.14	380.1	0.4749	55.58	0.212	440.4	1.209	
55.67	819.66	379.1	0.4713	55.67	0.206	438.6	1.2054	
55.75	812.8	376.8	0.4669	55.75	0.198	436.2	1.2028	
55.83	808.99	375.4	0.4633	55.83	0.197	435	1.1992	
55.92	805.39	374.2	0.4562	55.92	0.19	433.2	1.1957	
56.00	802.38	372.8	0.4527	56.00	0.185	431.3	1.1921	
56.08	797.05	370.9	0.4474	56.08	0.182	429.9	1.1903	
56.17	793.9	369.8	0.442	56.17	0.175	428	1.1868	
56.25	789.67	368.2	0.4376	56.25	0.167	425.9	1.1823	
56.33	783.6	365.9	0.4332	56.33	0.161	423	1.1788	
56.42	778.1	363.7	0.427	56.42	0.159	421.5	1.1735	
56.50	773.93	362.3	0.419	56.52	0.154	420	1.1699	
56.58	770.56	360.8	0.4136	56.58	0.142	417.3	1.1646	
56.67	765.32	358.7	0.4074	56.67	0.137	414	1.1619	
56.75	761.25	357.2	0.4003	56.75	0.135	412.9	1.1557	
56.85	758.56	355.4	0.3941	56.83	0.127	410.2	1.1495	
56.92	751.9	353.3	0.3879	56.92	0.119	407.3	1.1433	
57.00	746.26	350.9	0.3799	57.00	0.117	406.2	1.1397	
57.08	743.18	349.6	0.3746	57.08	0.109	403.6	1.1344	
57.17	740.56	348.2	0.3693	57.17	0.102	400.3	1.1282	
57.25	731.31	344.5	0.3595	57.25	0.092	397	1.1193	
57.33	728.25	342.9	0.3542	57.33	0.09	395.5	1.1149	
57.42	723.41	341	0.3426	57.42	0.082	392.7	1.1096	
57.50	718.04	338.8	0.3346	57.50	0.076	390	1.1024	
57.58	714.95	337	0.3293	57.58	0.071	387.9	1.0962	
57.67	707.25	334.5	0.3196	57.67	0.062	385.1	1.09	
57.75	705.69	333.1	0.3133	57.75	0.053	381.2	1.0829	
57.83	696.62	329.3	0.3036	57.83	0.05	379.2	1.0723	
57.92	689.71	326.4	0.2965	57.93	0.044	376.9	1.0652	
58.00	687.89	325.3	0.2849	58.00	0.035	374.2	1.0581	
58.08	682.3	322.9	0.2761	58.08	0.025	369.6	1.0501	
58.17	676.82	320	0.2663	58.17	0.022	367.8	1.0359	
58.25	673.86	318.5	0.2592	58.25	0.016	365.4	1.027	
58.35	667.27	315.5	0.2477	58.33	0.009	362.2	1.0172	
58.42	661.59	313	0.2397	58.42	0.005	360.1	1.0066	
58.50	654.03	309.4	0.2281	58.50	-0.003	357.5	0.9959	
58.58	653.3	308.3	0.2228	58.58	-0.013	353.3	0.9826	
58.67	647.04	305.8	0.2148	58.67	-0.018	350.6	0.9702	
58.75	638.72	301.9	0.2059	58.75	-0.024	348.5	0.9516	
58.83	635.09	299.5	0.1988	58.83	-0.031	345.4	0.9365	
58.92	632.06	297.9	0.1873	58.92	-0.036	342.6	0.9187	
59.00	625.23	294.9	0.1784	59.00	-0.041	340.7	0.8974	
59.08	620.76	292.1	0.1704	59.08	-0.052	337	0.8708	
59.17	616.03	290	0.1624	59.17	-0.059	332.8	0.8459	
59.25	610.73	287.3	0.1553	59.25	-0.063	330.2	0.8051	

Prova triassiale ciclica SNGR03-C4							
tensione di confinamento (kPa)	450			tensione di confinamento (kPa)	450		
deviatore ciclico (kPa)	230			deviatore ciclico (kPa)	260		
frequenza (hz)	0.007143			frequenza (hz)	0.007143		
59.33	603.93	283.7	0.1473	59.35	-0.07	327.3	0.7776
59.42	600.13	281	0.1402	59.42	-0.077	324.4	0.7536
59.50	595.35	278.6	0.1287	59.50	-0.087	319.6	0.7296
59.58	589.92	276.1	0.1216	59.58	-0.088	317.3	0.695
59.67	586.24	273.4	0.1136	59.67	-0.095	314.3	0.6719
59.77	580.83	270	0.1039	59.75	-0.103	310.7	0.6471
59.83	576.46	267.9	0.0968	59.83	-0.106	308.1	0.6222
59.92	570.89	265.2	0.0897	59.92	-0.112	305.1	0.5956
60.00	567.24	262.4	0.0817	60.00	-0.123	299.5	0.5654
60.08	563.3	260.3	0.0737	60.08	-0.128	296.1	0.5361
60.17	557.62	257.4	0.0657	60.17	-0.131	293.4	0.4944
60.25	551.71	253.4	0.0577	60.25	-0.138	289.8	0.4642
60.33	547.52	250.7	0.0444	60.33	-0.144	285.7	0.4341
60.42	544.27	248.5	0.0364	60.42	-0.148	282.8	0.4057
60.50	538.98	245.6	0.0275	60.50	-0.157	279.2	0.3755
60.58	535.94	243	0.0195	60.58	-0.161	273.9	0.3462
60.67	531.95	240.7	0.0115	60.67	-0.165	270	0.3009
60.75	527.2	238.1	0.0036	60.75	-0.171	266.4	0.2707
60.83	521.55	234	-0.0044	60.85	-0.176	262.9	0.2414
60.92	518.02	231.3	-0.0178	60.92	-0.183	257.2	0.213
61.00	514.39	229.1	-0.0266	61.00	-0.186	253.6	0.1651
61.08	510.37	226.3	-0.0355	61.08	-0.191	249.9	0.134
61.17	507.35	223.9	-0.0444	61.17	-0.197	245.9	0.1039
61.25	503.18	220.9	-0.055	61.25	-0.2	242.5	0.0737
61.33	499.39	218.6	-0.0621	61.33	-0.205	238.8	0.0444
61.42	496.71	216.5	-0.0692	61.42	-0.21	234.9	0.0142
61.50	493.48	214	-0.0772	61.50	-0.216	229.5	-0.0133
61.58	489.59	211.9	-0.0852	61.58	-0.218	226.5	-0.0568
61.67	485.76	209.7	-0.0932	61.67	-0.223	222.6	-0.087
61.75	482.5	206.4	-0.1012	61.75	-0.227	218.6	-0.1163
61.83	479.73	204.1	-0.1136	61.83	-0.23	215.8	-0.1438
61.92	476.84	202.3	-0.1216	61.92	-0.233	212.7	-0.1687
62.00	473.75	200.2	-0.1287	62.00	-0.239	207.5	-0.1944
62.08	472.06	198.2	-0.1358	62.08	-0.242	204.6	-0.2317
62.17	469.23	196.6	-0.1438	62.17	-0.244	202	-0.2539
62.25	465.7	194.2	-0.1518	62.27	-0.251	198.2	-0.2805
62.33	459.36	190.4	-0.158	62.33	-0.252	195.2	-0.3018
62.42	460.33	189.6	-0.1695	62.42	-0.254	192.5	-0.3311
62.50	459.01	188.5	-0.1766	62.50	-0.257	190.1	-0.3524
62.58	455.48	186.8	-0.1829	62.58	-0.26	187.7	-0.3719
62.68	453.42	184.5	-0.1891	62.67	-0.262	185.7	-0.3906
62.75	452.7	183.6	-0.1979	62.75	-0.264	183.7	-0.4083
62.83	450.2	182	-0.2042	62.83	-0.268	181.2	-0.427
62.92	448.78	180.8	-0.2095	62.92	-0.27	178.2	-0.4447
63.00	447.83	179.6	-0.2148	63.00	-0.272	176.6	-0.4704
63.08	445.14	178.1	-0.221	63.08	-0.274	174.6	-0.4873
63.17	443.92	177	-0.2263	63.17	-0.276	172.9	-0.5033
63.25	442.46	175.6	-0.2317	63.25	-0.277	171.8	-0.5175
63.33	441.57	174.6	-0.2388	63.33	-0.279	170.1	-0.5326
63.42	439.88	173.7	-0.2441	63.42	-0.281	168.1	-0.5459
63.50	438.9	172.8	-0.2485	63.50	-0.283	166.6	-0.5663
63.58	438.35	172.3	-0.253	63.58	-0.283	166	-0.5779
63.67	437.5	171.5	-0.2565	63.67	-0.284	164.9	-0.5894
63.75	436.55	170.9	-0.261	63.77	-0.285	163.8	-0.5992
63.83	435.74	170.2	-0.2645	63.83	-0.286	163.1	-0.6142
63.92	435.52	169.9	-0.2698	63.92	-0.286	162.6	-0.6231
64.00	434.88	169.3	-0.2725	64.00	-0.286	162.1	-0.6311
64.08	435.4	169.2	-0.2752	64.08	-0.287	161.7	-0.6382
64.17	434.62	168.7	-0.2787	64.17	-0.287	161.5	-0.6453
64.25	435.29	168.7	-0.2814	64.25	-0.286	161.2	-0.6524

Prova triassiale ciclica SNGR03-C4							
tensione di confinamento (kPa)	450			tensione di confinamento (kPa)	450		
deviatore ciclico (kPa)	230			deviatore ciclico (kPa)	260		
frequenza (hz)	0.007143			frequenza (hz)	0.007143		
64.33	435.28	168.6	-0.284	64.33	-0.287	161	-0.6586
64.42	435.64	168.6	-0.2858	64.42	-0.286	160.9	-0.6666
64.50	435.47	168.5	-0.2876	64.50	-0.286	161.2	-0.6702
64.58	436.27	168.7	-0.2876	64.58	-0.285	161.3	-0.6746
64.67	436.64	168.9	-0.2885	64.67	-0.284	161.7	-0.6773
64.75	437.77	169.2	-0.2894	64.75	-0.284	162.1	-0.6799
64.83	438.27	169.5	-0.2903	64.83	-0.282	162.9	-0.6826
64.92	439.65	170	-0.2911	64.92	-0.281	163.3	-0.6844
65.00	440.28	170.3	-0.2911	65.00	-0.28	164	-0.6861
65.08	441.19	170.8	-0.2911	65.08	-0.279	164.6	-0.687
65.17	442.29	171.3	-0.2911	65.18	-0.277	165.8	-0.687
65.25	444.37	171.9	-0.2911	65.25	-0.275	166.7	-0.687
65.33	445.71	172.8	-0.2911	65.33	-0.274	167.6	-0.687
65.42	447.55	173.7	-0.2903	65.42	-0.271	168.8	-0.6861
65.50	449.2	174.4	-0.2894	65.50	-0.27	169.8	-0.6861
65.60	451.44	175	-0.2894	65.58	-0.268	170.9	-0.6853
65.67	453.46	176.5	-0.2885	65.67	-0.263	172.8	-0.6844
65.75	454.76	177.3	-0.2876	65.75	-0.261	174.3	-0.6844
65.83	457.08	178.3	-0.2876	65.83	-0.258	175.4	-0.6826
65.92	459.69	179.5	-0.2867	65.92	-0.256	176.6	-0.6817
66.00	460.83	180.3	-0.2858	66.00	-0.254	178.3	-0.6799
66.08	463.48	181.5	-0.2849	66.08	-0.251	179.7	-0.6782
66.17	467.57	182.9	-0.2832	66.17	-0.248	181.2	-0.6773
66.25	470.42	184.7	-0.2823	66.25	-0.242	183.9	-0.6755
66.33	471.8	185.9	-0.2805	66.33	-0.24	185.3	-0.6737
66.42	475.09	187.2	-0.2787	66.42	-0.237	187	-0.6719
66.50	478.07	188.7	-0.2769	66.50	-0.233	189.1	-0.6693
66.58	479.88	190	-0.2761	66.58	-0.23	191.1	-0.6675
66.67	483.3	191.5	-0.2743	66.68	-0.225	193.5	-0.6648
66.75	487.53	193.4	-0.2725	66.75	-0.222	195.2	-0.6631
66.83	492.09	195.8	-0.2707	66.83	-0.216	197.7	-0.6604
66.92	493.97	197.2	-0.2672	66.92	-0.214	199.3	-0.6586
67.02	497.46	198.7	-0.2654	67.00	-0.209	201.5	-0.656
67.08	501.65	200.5	-0.2636	67.08	-0.202	204.2	-0.6524
67.17	506.07	203.2	-0.2619	67.17	-0.198	207.5	-0.6498
67.25	508.29	204.9	-0.2583	67.25	-0.194	209.5	-0.6453
67.33	512.61	206.6	-0.2565	67.33	-0.189	212.1	-0.6427
67.42	516.57	208.8	-0.2539	67.42	-0.185	214.6	-0.64
67.50	519.42	210.7	-0.2512	67.50	-0.181	216.8	-0.6364
67.58	523.21	212.4	-0.2485	67.58	-0.175	219.5	-0.6329
67.67	528.67	214.8	-0.2459	67.67	-0.167	223.6	-0.6293
67.75	534.54	218.1	-0.2432	67.75	-0.164	226	-0.6249
67.83	536.45	219.9	-0.2388	67.83	-0.16	228.2	-0.6213
67.92	540.87	222	-0.2361	67.92	-0.152	231.7	-0.6169
68.00	546.51	224.6	-0.2326	68.00	-0.149	234.3	-0.6134
68.08	548.92	226.6	-0.229	68.10	-0.143	237.8	-0.6071
68.17	552.94	228.5	-0.2263	68.17	-0.136	240.4	-0.6036
68.25	559.87	231.5	-0.2228	68.25	-0.129	244	-0.5983
68.33	565.5	234.8	-0.2192	68.33	-0.127	246.4	-0.5938
68.42	567.75	236.8	-0.2139	68.42	-0.12	249.1	-0.5894
68.52	572.17	238.8	-0.2113	68.50	-0.111	253.9	-0.5841
68.58	578.33	241.4	-0.2068	68.58	-0.105	257.2	-0.5787
68.67	584.83	245.2	-0.2033	68.67	-0.101	259.6	-0.5708
68.75	586.61	247.2	-0.1971	68.75	-0.094	262.9	-0.5663
68.83	592.23	249.7	-0.1935	68.83	-0.088	266.1	-0.5601
68.92	598.7	252.6	-0.1882	68.92	-0.084	268.6	-0.5548
69.00	600.77	254.8	-0.1846	69.00	-0.076	272.1	-0.5494
69.08	606.13	257.3	-0.1802	69.08	-0.066	277.1	-0.5423
69.17	613.22	260.1	-0.1758	69.17	-0.063	280	-0.5335
69.25	619.18	263.9	-0.1704	69.25	-0.057	282.6	-0.5273

Prova triassiale ciclica SNGR03-C4							
tensione di confinamento (kPa)	450			tensione di confinamento (kPa)	450		
deviatore ciclico (kPa)	230			deviatore ciclico (kPa)	260		
frequenza (hz)	0.007143			frequenza (hz)	0.007143		
69.33	621.73	266.2	-0.1633	69.33	-0.049	286.3	-0.521
69.42	626.88	268.6	-0.1589	69.42	-0.046	289	-0.5148
69.50	633.2	271.7	-0.1536	69.52	-0.037	293.5	-0.5042
69.58	636.45	273.9	-0.1482	69.58	-0.031	296.3	-0.4989
69.67	641.33	276.4	-0.1438	69.67	-0.023	300.1	-0.4909
69.75	648.99	279.5	-0.1376	69.75	-0.019	302.9	-0.4829
69.83	654.94	283.3	-0.1331	69.83	-0.013	306	-0.4767
69.93	657.58	285.2	-0.126	69.92	-0.003	309.7	-0.4678
70.00	662.1	287.6	-0.1207	70.00	0.004	314.6	-0.4598
70.08	668.88	290.6	-0.1154	70.08	0.009	317.4	-0.4474
70.17	675.7	294.5	-0.1092	70.17	0.017	321.2	-0.4376
70.25	677.7	296.7	-0.1012	70.25	0.02	323.8	-0.4314
70.33	683.18	299	-0.095	70.33	0.026	326.7	-0.4216
70.42	689.93	302.1	-0.0879	70.42	0.034	330.7	-0.411
70.50	692.87	304.4	-0.0826	70.50	0.043	335.7	-0.4003
70.58	697.94	306.8	-0.0763	70.58	0.049	339.1	-0.3826
70.67	704.22	310.4	-0.0675	70.67	0.054	342.4	-0.3684
70.75	711.8	313.8	-0.063	70.75	0.062	346.2	-0.3542
70.83	714.26	315.7	-0.0533	70.83	0.066	349.6	-0.3391
70.92	719.2	318	-0.047	70.92	0.071	352.6	-0.3231
71.00	724.7	320.7	-0.0391	71.02	0.081	357.8	-0.2974
71.08	728.47	323.1	-0.032	71.08	0.087	361.4	-0.2787
71.17	733.67	325.4	-0.0257	71.17	0.091	364.5	-0.261
71.25	739.91	327.6	-0.0178	71.25	0.098	367.7	-0.2397
71.33	745.54	331.6	-0.0098	71.33	0.106	371.2	-0.2184
71.42	747.26	333.3	0.0009	71.42	0.114	376.7	-0.1908
71.50	752.36	335.5	0.008	71.50	0.117	379.4	-0.1553
71.58	759.05	338.4	0.0178	71.58	0.124	382.9	-0.1269
71.67	765.05	341.9	0.0257	71.67	0.13	386.5	-0.0959
71.75	767.07	343.7	0.0391	71.75	0.134	389.4	-0.063
71.83	772.32	345.9	0.0479	71.83	0.141	392.8	-0.0293
71.92	777.11	348.4	0.0586	71.92	0.149	397.4	0.0071
72.00	779.93	350.4	0.0692	72.00	0.155	400.7	0.047
72.08	785.01	352.7	0.079	72.08	0.16	403.3	0.1101
72.17	791.2	354.8	0.0897	72.17	0.166	406.3	0.1518
72.25	795.28	358.2	0.1003	72.25	0.17	409	0.1935
72.33	799.55	360.3	0.1181	72.33	0.177	411.9	0.2468
72.42	802.56	362.1	0.1278	72.43	0.182	415.4	0.3062
72.50	806.97	364.3	0.1402	72.50	0.188	418	0.3417
72.58	809.97	366.2	0.1518	72.58	0.191	420.3	0.3755
72.67	813.78	368	0.1624	72.67	0.199	423.2	0.4172
72.75	819.62	370	0.174	72.75	0.203	425.3	0.45
72.85	822.21	372.4	0.1917	72.83	0.209	429.1	0.4873
72.92	823.92	373.8	0.2024	72.92	0.212	431	0.5379
73.00	828.52	375.7	0.2148	73.00	0.217	433.4	0.5716
73.08	834.05	377.7	0.2272	73.08	0.222	435.7	0.6054
73.17	837.48	380	0.2388	73.17	0.226	438	0.64
73.25	841.26	381.8	0.2583	73.25	0.23	439.9	0.6666
73.33	843.2	382.9	0.269	73.33	0.237	442.5	0.7021
73.42	846.92	384.5	0.2823	73.42	0.241	444.9	0.7323
73.50	848.69	385.7	0.2938	73.50	0.244	446.6	0.7731
73.58	851.32	386.9	0.3062	73.58	0.25	448.7	0.798
73.67	856.27	388.8	0.3187	73.67	0.251	450.1	0.8193
73.75	858.87	390.5	0.3293	73.75	0.256	452.1	0.845
73.83	861.45	391.6	0.3462	73.83	0.259	453.7	0.8699
73.92	864.21	392.9	0.3577	73.93	0.263	455.7	0.901
74.00	866.34	393.9	0.3684	74.00	0.266	457.1	0.9187
74.08	868.5	395.1	0.3799	74.08	0.271	458.7	0.94
74.17	870.7	396	0.3888	74.17	0.275	459.7	0.9551
74.25	874.33	397.1	0.3986	74.25	0.276	461.5	0.9729

Prova triassiale ciclica SNGR03-C4							
tensione di confinamento (kPa)	450			tensione di confinamento (kPa)	450 <th colspan="2"></th>		
deviatore ciclico (kPa)	230			deviatore ciclico (kPa)	260		
frequenza (hz)	0.007143			frequenza (hz)	0.007143		
74.33	875.41	398.3	0.4128	74.33	0.28	463	1.0004
74.42	877.05	399	0.4216	74.42	0.281	463.9	1.0155
74.50	881.4	400.3	0.4314	74.50	0.286	465.3	1.0341
74.58	881.92	400.4	0.4367	74.58	0.285	465.8	1.0483
74.67	883.54	401.8	0.4465	74.67	0.288	467	1.0643
74.75	884.74	402.5	0.4589	74.75	0.29	467.9	1.0785
74.83	885.35	403	0.466	74.83	0.294	469.2	1.09
74.92	887.81	403.7	0.474	74.92	0.294	469.7	1.1096
75.00	887.49	404	0.4802	75.00	0.297	470.5	1.1211
75.08	889.89	404.6	0.4864	75.08	0.297	470.8	1.1317
75.17	891.07	405.3	0.4926	75.17	0.3	471.7	1.1433
75.25	892.11	405.9	0.4989	75.25	0.3	471.9	1.1522
75.33	892.91	406.4	0.5086	75.35	0.303	472.6	1.1655
75.42	893.72	406.6	0.5139	75.42	0.301	472.7	1.1717
75.50	894.3	407.1	0.5193	75.50	0.304	473.4	1.1814
75.58	895.48	407.4	0.5237	75.58	0.304	473.5	1.1877
75.67	895.24	407.4	0.5273	75.67	0.305	473.8	1.1921
75.77	893.73	407.2	0.5326	75.75	0.305	473.8	1.2001
75.83	895.41	407.6	0.5361	75.83	0.305	473.8	1.2045
75.92	895.26	407.7	0.5397	75.92	0.306	474	1.2099
76.00	895.02	407.6	0.5423	76.00	0.305	473.9	1.2134
76.08	896.54	407.5	0.5441	76.08	0.304	473.7	1.2161
76.17	893.79	407.6	0.5459	76.17	0.305	473.7	1.2196
76.25	893.55	407.5	0.5486	76.25	0.304	473.5	1.2223
76.33	893.18	407.4	0.5494	76.33	0.302	473.2	1.2249
76.42	892.54	407.3	0.5512	76.42	0.303	473	1.2267
76.50	892.04	407.1	0.5521	76.50	0.301	472.6	1.2276
76.58	889.86	406.6	0.5521	76.58	0.301	472.4	1.2285
76.67	890.15	406.7	0.553	76.67	0.299	471.9	1.2285
76.75	888.43	406.2	0.553	76.75	0.297	471.3	1.2294
76.83	887.4	405.9	0.553	76.85	0.296	470.9	1.2294
76.92	886.44	405.6	0.553	76.93	0.294	470.5	1.2294
77.00	884.76	405.1	0.553	77.00	0.292	469.6	1.2294
77.08	882.7	404.5	0.5521	77.08	0.29	469	1.2285
77.18	880.65	403.8	0.5512	77.17	0.288	468.4	1.2285
77.25	879.43	403.5	0.5512	77.25	0.286	467.7	1.2276
77.33	877.08	402.6	0.5494	77.33	0.284	467	1.2267
77.42	875.98	402.4	0.5494	77.42	0.279	465.8	1.2258
77.50	874.06	401.8	0.5486	77.50	0.277	465.2	1.2258
77.58	870.42	400.9	0.5477	77.58	0.275	464.4	1.2241
77.67	868.07	399.9	0.5468	77.67	0.271	463.5	1.2232
77.75	866.06	399.2	0.545	77.75	0.268	462.5	1.2214
77.83	863.11	398.4	0.5432	77.83	0.266	461.7	1.2205
77.92	859.84	397.4	0.5415	77.92	0.26	460.4	1.2187
78.00	857.82	396.6	0.5397	78.00	0.257	459.7	1.2178
78.08	856.57	395.9	0.5379	78.08	0.253	457.9	1.2161
78.17	851.4	394.8	0.5361	78.17	0.25	456.9	1.2134
78.25	849.91	393.7	0.5335	78.27	0.246	455.8	1.2125
78.33	846.58	392.6	0.5308	78.35	0.239	454.8	1.2107
78.42	841.58	391.2	0.5273	78.42	0.238	453.1	1.2099
78.50	840.62	390.4	0.5255	78.50	0.233	451.7	1.2054
78.58	837.48	389.5	0.5228	78.58	0.23	450.3	1.2036
78.68	832.78	387.7	0.5184	78.67	0.225	449	1.201
78.75	828.61	386.5	0.5157	78.75	0.221	447.6	1.1983
78.83	825.9	385.4	0.5122	78.83	0.218	446.3	1.1965
78.92	823.92	384.4	0.5086	78.92	0.21	444.5	1.1939
79.00	819.62	382.8	0.5033	79.00	0.204	442.2	1.1912
79.08	812.97	381.5	0.4997	79.08	0.201	440.7	1.1877
79.17	807.64	378.9	0.4962	79.17	0.196	439.3	1.1841
79.25	807.35	378.4	0.49	79.25	0.19	437.4	1.1814

Prova triassiale ciclica SNGR03-C4							
tensione di confinamento (kPa)	450			tensione di confinamento (kPa)	450		
deviatore ciclico (kPa)	230			deviatore ciclico (kPa)	260		
frequenza (hz)	0.007143			frequenza (hz)	0.007143		
79.33	803.71	377	0.4847	79.33	0.186	435.7	1.1779
79.42	798.12	375.2	0.4802	79.42	0.18	433.9	1.1743
79.50	794.77	373.7	0.4758	79.50	0.174	431.8	1.1708
79.58	789.54	372	0.4704	79.58	0.167	429.3	1.1672
79.67	784.11	370.4	0.4651	79.68	0.162	427.7	1.1619
79.75	779.08	368	0.4598	79.75	0.159	426.1	1.1584
79.83	773.72	366	0.45	79.83	0.15	423.8	1.1539
79.92	771.5	364.9	0.4456	79.92	0.144	420.9	1.1495
80.00	766.24	362.9	0.4394	80.00	0.14	419.1	1.1433
80.10	761.7	360.8	0.4332	80.08	0.133	416.8	1.138
80.17	757.93	359.4	0.4252	80.17	0.126	414.5	1.1335
80.25	751.7	357.1	0.4172	80.25	0.122	412.5	1.1291
80.33	747.89	355.2	0.411	80.33	0.116	410.2	1.1238
80.42	743.35	353.6	0.4048	80.42	0.108	407.8	1.1184
80.50	737.74	351.6	0.3986	80.50	0.099	404.1	1.1122
80.58	732.91	349.7	0.3923	80.58	0.097	402.6	1.1042
80.67	725.3	346.2	0.3852	80.67	0.089	399.9	1.0989
80.75	722.86	344.7	0.3737	80.75	0.079	396.8	1.0909
80.83	717.52	342.9	0.3666	80.83	0.078	395.1	1.0865
80.92	710.98	340	0.3568	80.92	0.071	392.6	1.0794
81.00	708.66	338.5	0.3497	81.00	0.062	389.7	1.0714
81.08	704.58	336.6	0.3417	81.08	0.055	386.2	1.0643
81.17	696.57	334.5	0.3346	81.18	0.052	384.2	1.0545
81.25	690.07	330.5	0.3249	81.25	0.045	382	1.0465
81.33	688.11	329.1	0.3133	81.33	0.034	378.7	1.0368
81.42	680.76	326.4	0.3045	81.42	0.027	374.8	1.0288
81.50	677.74	324.5	0.2965	81.50	0.025	372.5	1.0172
81.60	671.16	321.3	0.2885	81.58	0.018	370	1.0066
81.67	666.11	319.2	0.2752	81.67	0.008	366.6	0.9959
81.75	661.29	317	0.2672	81.75	0.005	364.4	0.9862
81.83	656.23	314.3	0.2583	81.83	-0.002	361.9	0.9737
81.92	652.77	312.4	0.2494	81.92	-0.013	359	0.9595
82.00	647.28	309.9	0.2406	82.00	-0.02	354.9	0.948
82.08	639.86	306.2	0.2317	82.08	-0.023	352.5	0.9267
82.17	634.3	303.3	0.2237	82.17	-0.03	349.8	0.9116
82.25	630.8	301.4	0.2104	82.25	-0.038	346.6	0.8939
82.33	625.37	298.8	0.2015	82.33	-0.041	344.1	0.8752
82.42	620.18	296.2	0.1926	82.42	-0.049	341.3	0.8521
82.50	616.94	294.1	0.1846	82.50	-0.058	337.9	0.8255
82.58	611.54	291.6	0.1766	82.58	-0.066	333.4	0.8007
82.67	604.24	287.7	0.1687	82.67	-0.068	331.2	0.7625
82.75	599.41	285	0.1616	82.75	-0.074	328.6	0.7376
82.83	595.64	282.6	0.1491	82.83	-0.084	324.9	0.7128
82.92	590.2	280.1	0.1411	82.92	-0.091	320.4	0.6897
83.02	585.13	277	0.134	83.00	-0.096	317.4	0.6524
83.08	579.06	274	0.1269	83.08	-0.102	314.5	0.6276
83.17	577.15	272	0.1145	83.17	-0.109	311.1	0.5983
83.25	570.97	269	0.1056	83.25	-0.112	308.6	0.5734
83.33	566.59	266.3	0.0976	83.33	-0.118	305.4	0.5423
83.42	563.35	264.2	0.0888	83.42	-0.127	301.2	0.5095
83.50	557.91	261.3	0.0799	83.50	-0.135	295.8	0.4811
83.58	551.49	257.2	0.0701	83.58	-0.137	292.9	0.4349
83.67	546.78	254.5	0.0621	83.67	-0.143	289.6	0.403
83.75	544.55	252.1	0.047	83.75	-0.15	285	0.3684
83.83	539	249.3	0.0382	83.83	-0.153	281.8	0.3382
83.92	535.62	246.6	0.0293	83.92	-0.159	278.2	0.3053
84.00	532.3	244.3	0.0195	84.00	-0.166	274.3	0.2734
84.08	528.18	241.7	0.0107	84.10	-0.171	269.4	0.2299
84.17	521.99	237.6	0.0009	84.17	-0.175	265.9	0.1979
84.25	517.63	234.7	-0.0089	84.25	-0.18	262	0.1616

Prova triassiale ciclica SNGR03-C4								
tensione di confinamento (kPa)		450		tensione di confinamento (kPa)		450		
deviatore ciclico (kPa)		230		deviatore ciclico (kPa)		260		
frequenza (hz)		0.007143		frequenza (hz)		0.007143		
84.33	514.6	232.5	-0.0222	84.33	-0.187	257.6	0.126	
84.42	511.05	230.2	-0.0311	84.42	-0.193	251.9	0.095	
84.50	506.76	227.1	-0.0382	84.50	-0.196	248.1	0.0426	
84.58	502.73	224.3	-0.047	84.58	-0.2	244.6	0.0098	
84.67	500.23	222.4	-0.0604	84.67	-0.206	240.4	-0.0231	
84.75	496.44	219.8	-0.0683	84.75	-0.208	237.2	-0.0533	
84.83	492.65	217.1	-0.0781	84.83	-0.213	233.5	-0.087	
84.92	490.26	215.3	-0.0861	84.92	-0.219	229.5	-0.1181	
85.00	486.19	212.7	-0.0959	85.00	-0.223	224	-0.1482	
85.08	482.36	209.6	-0.1039	85.08	-0.226	220.7	-0.1935	
85.17	479.2	207.1	-0.1127	85.17	-0.23	217.5	-0.2219	
85.25	477.2	205.7	-0.1252	85.25	-0.234	214.2	-0.2485	
85.33	474	203.3	-0.1331	85.33	-0.237	211	-0.2761	
85.42	471.21	201.2	-0.142	85.42	-0.241	207.8	-0.3045	
85.50	469.25	199.5	-0.1491	85.52	-0.245	203.4	-0.3426	
85.58	465.92	197.3	-0.1571	85.58	-0.248	200.8	-0.3639	
85.67	463.39	194.9	-0.1642	85.67	-0.251	198.2	-0.387	
85.75	460.13	192.7	-0.1722	85.75	-0.254	195.7	-0.4083	
85.83	458.92	191.5	-0.1837	85.83	-0.258	192.7	-0.4305	
85.93	457.14	189.9	-0.19	85.92	-0.26	189.3	-0.4509	
86.00	453.44	187.6	-0.1971	86.00	-0.262	187.1	-0.482	
86.08	451.61	185.9	-0.2033	86.08	-0.266	184.2	-0.5042	
86.17	450.41	184.9	-0.213	86.17	-0.267	182.5	-0.5237	
86.25	448.32	183.5	-0.2184	86.25	-0.269	180.5	-0.5415	
86.33	447.03	181.9	-0.2246	86.33	-0.272	178.6	-0.5583	
86.42	445.51	181	-0.2308	86.42	-0.274	176.7	-0.5743	
86.50	443.99	179.8	-0.2361	86.50	-0.276	174.2	-0.5903	
86.58	441.87	178.2	-0.2414	86.58	-0.277	173	-0.6134	
86.67	441.11	177.4	-0.2468	86.67	-0.279	171.6	-0.6267	
86.75	440.19	176.5	-0.2539	86.75	-0.279	170.6	-0.6382	
86.83	438.87	175.6	-0.2583	86.83	-0.281	169.2	-0.6506	
86.92	438.35	174.9	-0.2627	86.92	-0.282	168.4	-0.6622	
87.00	437.34	174.1	-0.2672	87.02	-0.284	166.6	-0.6782	
87.08	436.86	173.6	-0.2707	87.08	-0.285	166.1	-0.6879	
87.17	436.31	172.9	-0.2743	87.17	-0.285	165.4	-0.6977	
87.25	435.5	172.3	-0.2778	87.25	-0.286	164.7	-0.7066	
87.35	435.12	172	-0.2823	87.33	-0.286	164.1	-0.7154	
87.42	435.14	171.7	-0.2849	87.42	-0.286	163.6	-0.7225	
87.50	435.07	171.4	-0.2876	87.50	-0.287	163.2	-0.7332	
87.58	434.89	171.2	-0.2894	87.58	-0.286	163.1	-0.7394	
87.67	435.32	171.2	-0.292	87.67	-0.286	163	-0.7456	
87.75	435.92	171.3	-0.2938	87.75	-0.286	163.1	-0.7509	
87.83	434.94	171	-0.2956	87.83	-0.286	163.1	-0.7554	
87.92	436.38	171.3	-0.2965	87.92	-0.285	163.3	-0.7589	
88.00	436.65	171.5	-0.2974	88.00	-0.284	163.8	-0.7616	
88.08	437.35	171.7	-0.2982	88.08	-0.283	164.3	-0.7651	
88.17	438.65	172.2	-0.2991	88.17	-0.282	164.6	-0.7678	
88.25	439.25	172.5	-0.3	88.25	-0.281	165.2	-0.7687	
88.33	440.56	173.1	-0.3	88.33	-0.28	165.9	-0.7696	
88.42	441.16	173.4	-0.3	88.43	-0.278	166.9	-0.7714	
88.50	442.17	173.8	-0.3	88.50	-0.277	167.7	-0.7714	
88.58	443.98	174.6	-0.3	88.58	-0.275	168.6	-0.7714	
88.67	445.89	175.6	-0.2991	88.67	-0.274	169.4	-0.7714	
88.75	447.8	176.6	-0.2991	88.75	-0.272	170.5	-0.7714	
88.85	448.71	177.1	-0.2982	88.83	-0.268	171.8	-0.7705	
88.92	450.22	177.8	-0.2974	88.92	-0.267	173.4	-0.7696	
89.00	453.47	179.3	-0.2965	89.00	-0.264	174.7	-0.7687	
89.08	455.15	180.2	-0.2956	89.08	-0.262	176	-0.7678	
89.17	456.76	181	-0.2947	89.17	-0.259	177.2	-0.7669	
89.25	459.57	182.2	-0.2938	89.25	-0.257	178.6	-0.7651	

Prova triassiale ciclica SNGR03-C4

tensione di confinamento (kPa)	450			tensione di confinamento (kPa)	450		
deviatore ciclico (kPa)	230			deviatore ciclico (kPa)	260		
frequenza (hz)	0.007143			frequenza (hz)	0.007143		
89.33	461.15	183.2	-0.2929	89.33	-0.254	180	-0.7643
89.42	463.23	184.2	-0.292	89.42	-0.249	181.8	-0.7625
89.50	466.22	185.6	-0.2903	89.50	-0.246	184.2	-0.7616
89.58	469.7	187.4	-0.2894	89.58	-0.244	185.4	-0.7589
89.67	472.32	188.8	-0.2885	89.67	-0.24	187.4	-0.758
89.75	474.46	189.8	-0.2876	89.75	-0.235	189.4	-0.7554
89.83	477.85	191.6	-0.2858	89.83	-0.234	190.7	-0.7536
89.92	480.94	193.1	-0.284	89.92	-0.229	193.5	-0.7509
90.00	483.52	194.4	-0.2823	90.00	-0.225	195.4	-0.7492
90.08	487.48	196.3	-0.2805	90.08	-0.22	197.7	-0.7465
90.17	491.57	198.5	-0.2787	90.17	-0.218	199.4	-0.7447
90.27	494.19	199.9	-0.2761	90.25	-0.213	201.7	-0.7421
90.33	496.8	201.4	-0.2743	90.33	-0.207	204.9	-0.7385
90.42	500.73	203.3	-0.2725	90.42	-0.202	207.4	-0.7359
90.50	505.76	206	-0.2698	90.50	-0.199	209.4	-0.7323
90.58	509.04	208.1	-0.2681	90.58	-0.195	211.8	-0.7288
90.67	512.53	209.6	-0.2645	90.67	-0.188	214.7	-0.7261
90.75	516.45	211.7	-0.2619	90.75	-0.186	216.3	-0.7234
90.83	520.41	213.8	-0.2592	90.83	-0.181	218.9	-0.7199
90.92	523.23	215.4	-0.2565	90.92	-0.173	222.9	-0.7154
91.00	528.19	217.8	-0.2539	91.00	-0.167	226	-0.7128
91.08	533.82	220.9	-0.2512	91.08	-0.164	227.9	-0.7074
91.17	537.14	223.2	-0.2485	91.17	-0.158	230.8	-0.703
91.25	540.93	225	-0.2432	91.25	-0.151	234.2	-0.6986
91.33	545.86	227.4	-0.2406	91.35	-0.147	237.4	-0.6959
91.42	549.61	230.1	-0.237	91.42	-0.141	240.3	-0.6888
91.50	553.03	231.7	-0.2343	91.50	-0.135	243.1	-0.6844
91.58	558.93	234.4	-0.2308	91.58	-0.13	246.4	-0.6799
91.67	564.86	237.9	-0.2272	91.67	-0.126	248.5	-0.6755
91.77	567.51	240	-0.2219	91.75	-0.119	251.7	-0.6711
91.83	572.23	242	-0.2184	91.83	-0.11	256.4	-0.6666
91.92	577.66	244.8	-0.2148	91.92	-0.104	259.3	-0.6613
92.00	584.49	248.4	-0.2104	92.00	-0.1	261.9	-0.6533
92.08	587.87	250.7	-0.2042	92.08	-0.094	265.3	-0.648
92.17	591.69	252.8	-0.2006	92.17	-0.087	268.7	-0.6418
92.25	598.39	255.9	-0.1962	92.25	-0.083	271.1	-0.6364
92.33	601.91	258.4	-0.1917	92.33	-0.077	274.6	-0.6302
92.42	607.3	260.8	-0.1873	92.42	-0.068	279.1	-0.6249
92.50	611.21	263.4	-0.1829	92.50	-0.06	282.8	-0.6187
92.58	619.41	267.5	-0.1784	92.58	-0.057	285.3	-0.6089
92.67	622.33	269.8	-0.1704	92.67	-0.049	288.9	-0.6027
92.75	626.54	271.9	-0.166	92.75	-0.044	292.1	-0.5956
92.83	633.17	275.1	-0.1607	92.83	-0.036	296.4	-0.5903
92.92	636.85	277.6	-0.1553	92.92	-0.031	299.1	-0.5796
93.00	641.87	280	-0.1509	93.00	-0.025	302.3	-0.5725
93.08	647.89	282.9	-0.1456	93.08	-0.017	306.1	-0.5645
93.18	652.2	285.9	-0.1385	93.17	-0.014	308.5	-0.5583
93.25	657.75	289.1	-0.1323	93.25	-0.005	312.1	-0.5494
93.33	662.33	291.3	-0.1269	93.33	0.005	317.2	-0.5415
93.42	668.88	294.2	-0.1216	93.42	0.01	320.5	-0.5344
93.50	675.3	297.9	-0.1163	93.50	0.014	323	-0.5202
93.58	679.01	300.6	-0.1065	93.58	0.018	326.5	-0.5104
93.67	684.12	302.9	-0.1003	93.67	0.032	331.3	-0.4953
93.75	689.33	305.7	-0.095	93.75	0.033	333.9	-0.4864
93.83	693.64	308.2	-0.0879	93.83	0.041	337.3	-0.4758
93.92	697.91	310.4	-0.0817	93.92	0.049	342.2	-0.4633
94.00	703.92	313.3	-0.0754	94.00	0.056	345.9	-0.4491
94.08	711.4	317.4	-0.0692	94.08	0.061	349.1	-0.4261
94.17	713.3	319.2	-0.0595	94.17	0.067	352.7	-0.411
94.25	718.2	321.5	-0.0533	94.27	0.076	357.6	-0.3968

Prova triassiale ciclica SNGR03-C4

tensione di confinamento (kPa)		450		tensione di confinamento (kPa)		450	
deviatore ciclico (kPa)		230		deviatore ciclico (kPa)		260	
frequenza (hz)		0.007143		frequenza (hz)		0.007143	
94.33	725.21	324.4	-0.0453	94.33	0.08	360.8	-0.3772
94.42	728.84	326.9	-0.0382	94.42	0.086	363.9	-0.3515
94.50	732.74	329.1	-0.0302	94.50	0.092	367.7	-0.3293
94.58	739.14	332	-0.0222	94.58	0.099	371.4	-0.3053
94.67	744.37	335.1	-0.0115	94.67	0.104	374.4	-0.2796
94.75	747.57	337.2	-0.0036	94.75	0.11	378.2	-0.253
94.83	751.83	339.3	0.0044	94.83	0.119	383.4	-0.2246
94.92	758.46	342.3	0.0133	94.92	0.124	386.7	-0.1908
95.00	764.59	345.6	0.0222	95.00	0.129	389.6	-0.1509
95.08	768.27	348	0.0364	95.08	0.136	393.2	-0.1145
95.17	771.59	349.9	0.0462	95.17	0.141	396.4	-0.0772
95.25	777.68	352.6	0.0586	95.25	0.145	399.3	-0.0373
95.33	780.46	354.7	0.0692	95.33	0.153	403	0.0071
95.42	784.68	356.8	0.0808	95.42	0.161	407.2	0.0559
95.50	790.69	359.2	0.0923	95.50	0.166	410	0.0994
95.58	795.84	362.4	0.103	95.58	0.17	412.6	0.1624
95.67	799.07	364.5	0.1216	95.68	0.177	415.9	0.2139
95.75	802.88	366.3	0.134	95.75	0.184	419.7	0.2494
95.83	807.39	368.5	0.1465	95.83	0.187	422.2	0.2894
95.92	810.69	370.8	0.1598	95.92	0.192	424.5	0.3471
96.00	813.54	372	0.1695	96.00	0.198	427.5	0.3914
96.10	817.76	374.4	0.1882	96.08	0.203	429.9	0.4296
96.17	823.09	376.7	0.2015	96.17	0.208	432.5	0.4696
96.25	826.59	378.6	0.2157	96.25	0.213	434.8	0.5024
96.33	828.59	379.7	0.2272	96.33	0.219	438.1	0.5335
96.42	833.52	381.7	0.2406	96.42	0.222	440.3	0.5725
96.50	838.41	384.2	0.2539	96.50	0.227	442.3	0.6187
96.58	839.23	385.2	0.2725	96.58	0.232	444.9	0.6551
96.67	843.32	386.8	0.2867	96.67	0.235	446.6	0.6808
96.75	846.45	388.3	0.3009	96.75	0.238	448.3	0.711
96.83	848.58	389.7	0.3133	96.83	0.243	450.3	0.7394
96.92	852.03	391.1	0.3267	96.92	0.25	453.4	0.7669
97.00	857.72	392.5	0.3391	97.00	0.253	455.1	0.7909
97.08	858.88	394.3	0.3515	97.08	0.257	456.7	0.8291
97.17	860.82	395.4	0.3693	97.18	0.26	458.2	0.8521
97.25	865.87	396.9	0.3817	97.25	0.264	460.3	0.8708
97.33	865.95	397.5	0.3906	97.33	0.267	461.7	0.893
97.42	868.27	398.6	0.4021	97.42	0.27	463.1	0.9267
97.52	871.51	400.1	0.419	97.50	0.273	464.2	0.9436
97.58	873.15	401	0.4287	97.58	0.276	465.7	0.9631
97.67	875.24	401.9	0.4394	97.67	0.278	466.6	0.98
97.75	877.23	402.8	0.4491	97.75	0.281	467.9	0.9995
97.83	879.33	403.5	0.458	97.83	0.285	469.4	1.0163
97.92	880.8	404.7	0.4678	97.92	0.286	470.4	1.0332
98.00	883.8	405.5	0.4749	98.00	0.289	471.3	1.0554
98.08	884.75	406	0.4882	98.08	0.29	471.9	1.0678
98.17	885.69	406.6	0.4962	98.17	0.294	473	1.0838
98.25	888.18	407.4	0.5051	98.25	0.294	473.4	1.0953
98.33	888.26	407.8	0.5131	98.33	0.297	474.4	1.1104
98.42	891.05	408.6	0.5202	98.42	0.3	475.2	1.1193
98.50	890.97	408.6	0.5255	98.50	0.299	475.5	1.1353
98.58	892.08	409.4	0.5317	98.60	0.301	476.1	1.1459
98.67	893.94	410.1	0.5415	98.67	0.301	476.2	1.153
98.75	892.76	410	0.5459	98.75	0.304	477.1	1.1628
98.83	894.14	410.4	0.5503	98.83	0.303	477	1.1726
98.92	894.19	410.5	0.5548	98.92	0.303	477.2	1.1806
99.02	893.71	410.7	0.561	99.00	0.304	477.4	1.1859
99.08	895.22	411	0.5654	99.08	0.305	477.6	1.1912
99.17	894.85	411	0.5681	99.17	0.306	477.7	1.1957
99.25	895	411.1	0.5716	99.25	0.304	477.5	1.1992

Prova triassiale ciclica SNGR03-C4							
tensione di confinamento (kPa)	450			tensione di confinamento (kPa)	450		
deviatore ciclico (kPa)	230			deviatore ciclico (kPa)	260		
frequenza (hz)	0.007143			frequenza (hz)	0.007143		
99.33	895.23	411.3	0.5743	99.33	0.306	477.8	1.2045
99.42	894.72	411.2	0.577	99.42	0.305	477.7	1.2099
99.50	894.28	411.1	0.5796	99.50	0.305	477.5	1.2125
99.58	893.48	411	0.5823	99.58	0.303	477.1	1.2143
99.67	893.31	410.9	0.5832	99.67	0.304	477.1	1.217
99.75	893.7	410.9	0.585	99.75	0.303	476.7	1.2178
99.83	891.05	410.4	0.585	99.83	0.301	476.3	1.2196
99.92	891.02	410.3	0.5858	99.92	0.299	475.9	1.2205
100.00	888.93	410	0.5867	100.00	0.299	475.6	1.2214
100.08	888.13	409.5	0.5867	100.08	0.298	475.2	1.2223
100.17	887.04	409.2	0.5867	100.17	0.295	474.8	1.2223
100.25	885.75	408.8	0.5867	100.25	0.294	474	1.2223
100.33	884.23	408.3	0.5858	100.33	0.292	473.5	1.2223
100.43	882.17	407.7	0.5858	100.42	0.289	472.8	1.2214
100.50	880.89	407.1	0.585	100.50	0.288	472.3	1.2214
100.58	879.13	406.7	0.5841	100.58	0.286	471.5	1.2205
100.67	877.41	406.2	0.5841	100.67	0.282	470.5	1.2187
100.75	875.76	405.6	0.5832	100.75	0.282	470.2	1.2187
100.83	874.5	405.2	0.5823	100.83	0.278	469	1.2178
100.92	869.54	403.9	0.5805	100.92	0.275	468.2	1.217
101.00	867.12	403	0.5805	101.00	0.272	467.3	1.2152
101.08	867.36	402.8	0.5779	101.08	0.267	466.1	1.2143
101.17	863.26	401.7	0.5761	101.17	0.266	465.4	1.2134
101.25	860.45	400.8	0.5743	101.25	0.262	464.5	1.2116
101.33	858.86	400	0.5734	101.33	0.257	463.2	1.2099
101.42	855.75	399.1	0.5708	101.42	0.252	461.5	1.209
101.50	851.82	398	0.569	101.52	0.251	460.9	1.2063
101.58	848.28	396.5	0.5672	101.58	0.246	459.8	1.2045
101.67	846.86	395.8	0.5628	101.67	0.243	458.7	1.2036
101.75	842.13	394.6	0.561	101.75	0.236	456.5	1.2001
101.83	839.85	393.7	0.5583	101.83	0.235	455.6	1.1983
101.93	834.72	392	0.5557	101.92	0.229	454.3	1.1957
102.00	833.04	391.1	0.5512	102.00	0.225	452.9	1.1939
102.08	828.21	389.7	0.5477	102.08	0.221	451.4	1.1912
102.17	825.14	388.5	0.545	102.17	0.216	450	1.1894
102.25	824.22	387.7	0.5415	102.25	0.207	448.4	1.1868
102.33	817.96	386.1	0.537	102.33	0.206	446.5	1.1841
102.42	811.54	385	0.5335	102.42	0.201	444.8	1.1797
102.50	809.56	382.8	0.529	102.50	0.193	442.8	1.1761
102.58	805.99	381.5	0.5228	102.58	0.192	441.6	1.1743
102.67	801.63	380	0.5184	102.67	0.186	439.6	1.1699
102.75	797.69	378.4	0.5131	102.75	0.18	437.9	1.1664
102.83	795.08	377.1	0.5086	102.83	0.173	436	1.1628
102.92	789.62	375.6	0.5024	102.92	0.165	432.9	1.1584
103.00	783.73	373.8	0.4962	103.00	0.164	431.8	1.1539
103.08	778.17	371.3	0.4918	103.08	0.161	430.4	1.1504
103.17	776.22	369.9	0.4829	103.17	0.15	427.3	1.1442
103.25	769.87	367.9	0.4767	103.25	0.143	424.6	1.1415
103.35	765.93	366.8	0.4713	103.33	0.14	423	1.1353
103.42	758.77	363.7	0.4669	103.42	0.134	421.1	1.1309
103.50	757.55	362.5	0.4562	103.50	0.127	418.5	1.1255
103.58	752.29	360.7	0.4491	103.58	0.122	416.3	1.1202
103.67	747.85	358.8	0.4429	103.67	0.115	414.2	1.1149
103.75	744.04	357.1	0.4367	103.75	0.107	411.9	1.1096
103.83	738.84	355.3	0.4296	103.83	0.1	408.2	1.1042
103.92	733.11	353	0.4216	103.92	0.094	405.5	1.0945
104.00	727.63	350.3	0.4145	104.00	0.089	403.6	1.0891
104.08	722.9	348.2	0.403	104.08	0.081	401	1.0838
104.17	717.93	346.2	0.3959	104.17	0.079	399	1.0785
104.25	712.62	344	0.3888	104.25	0.072	396.4	1.0705

Prova triassiale ciclica SNGR03-C4							
tensione di confinamento (kPa)	450			tensione di confinamento (kPa)	450		
deviatore ciclico (kPa)	230			deviatore ciclico (kPa)	260		
frequenza (hz)	0.007143			frequenza (hz)	0.007143		
104.33	709.54	342.1	0.3808	104.33	0.062	393.5	1.0634
104.42	703.46	339.9	0.3728	104.43	0.057	390.5	1.0545
104.50	697.56	337.5	0.3639	104.50	0.052	387.9	1.0465
104.58	690.52	334.2	0.3559	104.58	0.045	385.3	1.0377
104.67	687.37	332.2	0.3426	104.67	0.038	382.2	1.0297
104.75	681.85	330.1	0.3346	104.75	0.026	378.3	1.0226
104.83	677.2	328	0.3267	104.83	0.021	375.4	1.0084
104.92	669.06	324.3	0.3178	104.92	0.015	373.2	1.0004
105.00	667.24	322.4	0.3045	105.00	0.009	370.4	0.9906
105.08	661.65	320.3	0.2956	105.08	0.005	368.1	0.9817
105.17	655.3	317.6	0.2858	105.17	-0.001	365.8	0.972
105.25	652.24	315.4	0.2761	105.25	-0.012	362.4	0.9613
105.33	647.72	313.3	0.2672	105.33	-0.02	358.1	0.9489
105.42	640.4	310.3	0.2574	105.42	-0.023	355.6	0.9294
105.50	633.78	306.8	0.2494	105.50	-0.03	353.2	0.9152
105.58	631.24	304.8	0.2361	105.58	-0.039	349.7	0.8992
105.67	625.48	302.3	0.2263	105.67	-0.042	347.3	0.8841
105.75	619.89	299.5	0.2175	105.75	-0.047	344.8	0.8637
105.83	616.56	297.6	0.2095	105.85	-0.058	340.4	0.8282
105.92	611.16	294.9	0.2006	105.92	-0.064	337.7	0.8033
106.00	604.5	292.2	0.1926	106.00	-0.068	334.8	0.7767
106.08	598.9	288.3	0.1846	106.08	-0.074	332.4	0.7474
106.17	596.89	286.3	0.1713	106.17	-0.084	328.2	0.7163
106.27	591.02	283.8	0.1642	106.25	-0.092	324	0.6915
106.33	585.72	281.2	0.1553	106.33	-0.095	320.9	0.6542
106.42	578.75	277.3	0.1465	106.42	-0.101	318.3	0.6267
106.50	576.7	274.9	0.1331	106.50	-0.109	314.4	0.5956
106.58	571.32	272.4	0.1234	106.58	-0.112	311.5	0.5672
106.67	565.95	269.3	0.1136	106.67	-0.119	308.3	0.5361
106.75	563.24	267.1	0.1047	106.75	-0.127	304.3	0.5042
106.83	558.89	264.6	0.0959	106.83	-0.134	299.1	0.474
106.92	552.08	261.2	0.0852	106.92	-0.137	295.8	0.4261
107.00	546.8	257.3	0.0763	107.00	-0.143	292.5	0.3914
107.08	544.28	254.8	0.0621	107.08	-0.151	288.1	0.3533
107.17	539.62	252.2	0.0515	107.17	-0.153	284.6	0.3204
107.25	534.44	249.3	0.0408	107.25	-0.159	280.9	0.2832
107.33	532.59	246.9	0.032	107.35	-0.165	276.1	0.2379
107.42	527.67	244.4	0.0222	107.42	-0.171	271.9	0.2024
107.50	523.04	241.8	0.0124	107.50	-0.175	268.5	0.1695
107.58	516.65	237.6	0.0027	107.58	-0.179	264.8	0.1331
107.68	514.92	235.1	-0.0133	107.67	-0.187	260.2	0.0932
107.75	511.16	233.1	-0.0222	107.75	-0.193	254.3	0.0586
107.83	505.87	230.6	-0.032	107.83	-0.195	250.6	0.0053
107.92	502.21	227.1	-0.0408	107.92	-0.2	247.1	-0.0302
108.00	500.38	224.9	-0.055	108.00	-0.206	242.6	-0.0675
108.08	496.55	222.6	-0.0639	108.08	-0.207	239.6	-0.0994
108.17	492.12	219.6	-0.0746	108.17	-0.213	235.5	-0.1367
108.25	489.86	217.5	-0.0834	108.25	-0.219	231.3	-0.1704
108.33	486.37	215.3	-0.0932	108.33	-0.223	226	-0.2006
108.42	482.77	213.5	-0.1012	108.42	-0.227	222.6	-0.2485
108.50	478.84	209.8	-0.1101	108.50	-0.23	219.2	-0.2805
108.58	477.2	208.1	-0.1234	108.58	-0.234	215.8	-0.3098
108.67	474.44	206.2	-0.1323	108.67	-0.237	212.7	-0.3373
108.75	470.74	203.6	-0.1411	108.77	-0.241	208.4	-0.3772
108.83	468.88	201.9	-0.15	108.83	-0.244	205.7	-0.4003
108.92	466.08	199.7	-0.158	108.92	-0.248	202.3	-0.427
109.00	462.55	197.9	-0.166	109.00	-0.25	199.8	-0.45
109.08	460.19	195.2	-0.1749	109.08	-0.253	197.4	-0.474
109.18	459.46	194.1	-0.1855	109.17	-0.257	194.3	-0.498
109.25	456.46	192.2	-0.1926	109.25	-0.261	190.8	-0.5202

Prova triassiale ciclica SNGR03-C4

tensione di confinamento (kPa)	450			tensione di confinamento (kPa)	450		
deviatore ciclico (kPa)	230			deviatore ciclico (kPa)	260		
frequenza (hz)	0.007143			frequenza (hz)	0.007143		
109.33	453.39	190.6	-0.1997	109.33	-0.261	188.8	-0.5512
109.42	451.71	188.3	-0.2059	109.42	-0.265	186.3	-0.5725
109.50	449.97	187	-0.2166	109.50	-0.267	184.2	-0.5912
109.58	447.94	185.5	-0.2228	109.58	-0.269	182.3	-0.6089
109.67	446.39	184.2	-0.229	109.67	-0.271	180.3	-0.6267
109.75	446.1	183.2	-0.2343	109.75	-0.274	178.6	-0.6427
109.83	443.68	181.8	-0.2406	109.83	-0.276	176.1	-0.6586
109.92	442.59	180.7	-0.2459	109.92	-0.277	174.5	-0.6817
110.00	440.83	179.4	-0.2512	110.00	-0.278	173.3	-0.6959
110.08	440.11	178.4	-0.2583	110.08	-0.28	171.8	-0.7092
110.17	439.46	178	-0.2627	110.17	-0.281	170.7	-0.7225
110.25	437.54	176.9	-0.2672	110.27	-0.283	169.1	-0.7394
110.33	436.92	176.3	-0.2716	110.33	-0.283	168.4	-0.7509
110.42	436.81	175.7	-0.2761	110.42	-0.284	167.6	-0.7607
110.50	436.5	174.9	-0.2796	110.50	-0.285	166.9	-0.7705
110.60	435.41	174.4	-0.284	110.58	-0.285	166.2	-0.7793
110.67	435.5	174.3	-0.2876	110.67	-0.286	165.6	-0.7873
110.75	434.86	173.8	-0.2894	110.75	-0.287	164.9	-0.7953
110.83	434.75	173.7	-0.292	110.83	-0.286	164.9	-0.8051
110.92	434.95	173.4	-0.2938	110.92	-0.286	164.6	-0.8113
111.00	435.47	173.4	-0.2974	111.00	-0.286	164.4	-0.8175
111.08	435.23	173.3	-0.2991	111.08	-0.285	164.6	-0.822
111.17	436.03	173.5	-0.3	111.17	-0.285	164.7	-0.8264
111.25	435.96	173.4	-0.3018	111.25	-0.285	164.7	-0.8299
111.33	436.7	173.6	-0.3027	111.33	-0.284	165.4	-0.8326
111.42	437.93	173.7	-0.3036	111.42	-0.283	165.8	-0.8362
111.50	438.54	174.4	-0.3045	111.50	-0.282	166.1	-0.8379
111.58	439.24	174.7	-0.3045	111.58	-0.281	166.9	-0.8397
111.67	440.34	175.2	-0.3045	111.68	-0.28	167.6	-0.8406
111.75	441.31	175.6	-0.3053	111.75	-0.283	166.7	-0.845
111.83	442.35	176.2	-0.3045	111.83	-0.276	169.1	-0.8441
111.92	443.63	176.8	-0.3045	111.92	-0.274	170.3	-0.8433
112.00	446.58	177.6	-0.3045	112.00	-0.273	171	-0.8433
112.10	447.58	178.6	-0.3036	112.08	-0.271	172.2	-0.8433
112.17	448.29	179	-0.3036	112.17	-0.268	173.1	-0.8424
112.25	450.9	180.2	-0.3027	112.25	-0.266	175	-0.8415
112.33	453.19	181	-0.3018	112.33	-0.264	176.2	-0.8406
112.42	455.13	182.4	-0.3009	112.42	-0.261	177.7	-0.8397
112.50	456.81	183.3	-0.3	112.50	-0.259	178.8	-0.8388
112.58	459.69	184.5	-0.2991	112.58	-0.256	180.2	-0.837
112.67	462.08	185.6	-0.2974	112.67	-0.253	181.8	-0.8362
112.75	463.45	186.5	-0.2965	112.75	-0.25	183.4	-0.8353
112.83	466	187.8	-0.2956	112.83	-0.246	185.7	-0.8335
112.92	470.19	189.3	-0.2947	112.92	-0.243	187.4	-0.8308
113.00	472.94	191.3	-0.2929	113.00	-0.24	188.9	-0.8299
113.08	474.96	192.3	-0.2911	113.08	-0.236	190.9	-0.8273
113.17	477.91	193.8	-0.2894	113.17	-0.232	193.4	-0.8264
113.25	480.53	195.5	-0.2876	113.25	-0.229	195	-0.8237
113.33	482.94	196.7	-0.2876	113.33	-0.225	197.1	-0.8211
113.42	486.83	198.5	-0.2858	113.42	-0.219	199.4	-0.8184
113.52	490.35	200.6	-0.2832	113.50	-0.217	201.3	-0.8166
113.58	494.38	202.6	-0.2805	113.58	-0.213	203.2	-0.814
113.67	496.76	203.9	-0.2787	113.67	-0.207	205.9	-0.8113
113.75	500.88	205.8	-0.2769	113.75	-0.201	209.3	-0.8086
113.83	505.04	208.2	-0.2752	113.83	-0.198	211.5	-0.8042
113.92	510.34	210.7	-0.2725	113.92	-0.194	213.6	-0.8015
114.00	512.12	212.1	-0.269	114.00	-0.188	216.5	-0.798
114.08	516.48	214.1	-0.2672	114.08	-0.185	218.6	-0.7953
114.17	519.66	216.3	-0.2645	114.17	-0.181	220.8	-0.7918
114.25	523.25	218.1	-0.2619	114.25	-0.173	223.8	-0.7882

Prova triassiale ciclica SNGR03-C4							
tensione di confinamento (kPa)	450			tensione di confinamento (kPa)	450		
deviatore ciclico (kPa)	230			deviatore ciclico (kPa)	260		
frequenza (hz)	0.007143			frequenza (hz)	0.007143		
114.33	527.58	220.1	-0.2592	114.33	-0.166	227.9	-0.7847
114.42	533.58	222.7	-0.2556	114.42	-0.164	230.2	-0.7793
114.50	537.8	225.6	-0.253	114.50	-0.159	232.5	-0.7758
114.58	540.92	227.7	-0.2485	114.60	-0.152	235.3	-0.7722
114.67	545.75	230.1	-0.2459	114.67	-0.145	239.7	-0.7678
114.75	551.04	232.7	-0.2414	114.75	-0.141	241.9	-0.7616
114.83	552.59	234.2	-0.2388	114.83	-0.136	244.7	-0.758
114.92	557.55	236.7	-0.2352	114.92	-0.129	248.4	-0.7518
115.00	563.55	240.1	-0.2308	115.00	-0.126	250.7	-0.7474
115.08	568.84	242.8	-0.2263	115.08	-0.119	253.5	-0.743
115.17	571.79	244.6	-0.2228	115.17	-0.112	257	-0.7367
115.25	576.95	247.3	-0.2192	115.25	-0.104	261.6	-0.7314
115.33	583.24	250.8	-0.2157	115.33	-0.101	264.3	-0.7234
115.42	588.44	253.6	-0.2113	115.42	-0.094	267.1	-0.7181
115.50	592.02	255.8	-0.205	115.50	-0.087	270.9	-0.7119
115.58	597.45	258.6	-0.2006	115.58	-0.083	273.7	-0.7066
115.67	602.97	261.5	-0.1962	115.67	-0.076	276.6	-0.7003
115.75	605.15	263.3	-0.1917	115.75	-0.069	280.2	-0.6941
115.83	611.38	266.1	-0.1873	115.83	-0.06	284.9	-0.6879
115.92	617.87	269.8	-0.182	115.92	-0.057	287.6	-0.6782
116.00	622.99	272.7	-0.1775	116.02	-0.05	290.9	-0.6719
116.08	626.68	274.8	-0.1695	116.08	-0.042	293.8	-0.6657
116.17	633.53	278	-0.1642	116.17	-0.035	298.9	-0.6586
116.25	637.45	280.6	-0.1598	116.25	-0.031	301.3	-0.648
116.33	642	282.8	-0.1544	116.33	-0.023	304.9	-0.6409
116.43	646.88	286.1	-0.1482	116.42	-0.017	308.3	-0.6338
116.50	654	289.4	-0.142	116.50	-0.012	311.1	-0.6258
116.58	658.42	291.9	-0.1367	116.58	-0.005	314.7	-0.6178
116.67	661.56	294.1	-0.1305	116.67	0.003	318.1	-0.6098
116.75	666.81	296.9	-0.1252	116.75	0.011	323	-0.6009
116.83	674.63	300.9	-0.1189	116.83	0.016	326.1	-0.5867
116.92	679.84	303.6	-0.1136	116.92	0.021	328.8	-0.5779
117.00	683.18	305.9	-0.1047	117.00	0.029	333	-0.5663
117.08	689.23	308.6	-0.0994	117.08	0.033	336.1	-0.5557
117.17	694.31	311.5	-0.0923	117.17	0.038	339	-0.5432
117.25	697.78	313.6	-0.0861	117.25	0.05	343.8	-0.5264
117.33	702.89	316.2	-0.0799	117.33	0.056	348.8	-0.5113
117.42	710.9	320.2	-0.0728	117.42	0.061	352	-0.4882
117.50	715.81	322.9	-0.0666	117.52	0.066	355.2	-0.4722
117.58	719.51	325.1	-0.0559	117.58	0.075	358.6	-0.4562
117.67	723.88	327.6	-0.0488	117.67	0.084	364.6	-0.4367
117.75	729.91	330.8	-0.0399	117.75	0.087	367.3	-0.4039
117.85	735.31	333.8	-0.0328	117.83	0.093	370.4	-0.3861
117.92	738.81	335.7	-0.0231	117.92	0.099	374.3	-0.3604
118.00	744.74	338.3	-0.0151	118.00	0.103	377.3	-0.3346
118.08	748.71	340.7	-0.0062	118.08	0.108	380.7	-0.308
118.17	752.34	342.9	0.0018	118.17	0.12	385.2	-0.2734
118.25	760.1	346	0.0124	118.25	0.125	390.1	-0.2432
118.33	764.03	348.8	0.0195	118.33	0.129	392.9	-0.1953
118.42	768.81	351.5	0.0302	118.42	0.137	397	-0.1527
118.50	771.83	353.4	0.047	118.50	0.14	399.5	-0.1207
118.58	777.21	356	0.0595	118.58	0.146	402.7	-0.0799
118.67	781.39	358.3	0.071	118.67	0.152	406.1	-0.0346
118.75	784.04	360.2	0.0817	118.75	0.162	409.5	0.0115
118.83	789.32	362.6	0.0941	118.83	0.165	413.6	0.0586
118.92	796.17	366.1	0.1074	118.93	0.17	416.4	0.1207
119.00	798.94	368	0.1198	119.00	0.175	418.9	0.1731
119.08	802.27	369.7	0.1385	119.08	0.183	423.1	0.2166
119.17	807.31	372	0.1527	119.17	0.188	426	0.2574
119.25	810.94	374.1	0.1669	119.25	0.191	428.2	0.3151

Prova triassiale ciclica SNGR03-C4							
tensione di confinamento (kPa)	450			tensione di confinamento (kPa)	450		
deviatore ciclico (kPa)	230			deviatore ciclico (kPa)	260		
frequenza (hz)	0.007143			frequenza (hz)	0.007143		
119.35	814.92	376.4	0.1793	119.33	0.197	431.1	0.3542
119.42	817.34	377.9	0.1971	119.42	0.203	433.8	0.3941
119.50	822.64	380	0.2121	119.50	0.207	436.2	0.4341
119.58	825.93	382	0.2272	119.58	0.212	438.8	0.4722
119.67	828.9	383.4	0.2406	119.67	0.219	442.2	0.5051
119.75	832.99	385.2	0.2556	119.75	0.223	444.5	0.5379
119.83	836.51	387.3	0.2707	119.83	0.228	446.8	0.5947
119.92	841.1	389.1	0.284	119.92	0.231	448.7	0.6258
120.00	842.98	390.3	0.3053	120.00	0.235	450.8	0.6569
120.08	847.36	392.1	0.3204	120.08	0.238	452.5	0.6853
120.17	850.95	393.6	0.3346	120.17	0.244	454.7	0.7154
120.25	852.18	394.5	0.3471	120.25	0.249	457.5	0.7421
120.33	855.79	396	0.3622	120.33	0.251	458.9	0.7687
120.42	858.32	397.5	0.3755	120.43	0.256	461	0.806
120.50	862.67	399.1	0.387	120.50	0.258	462.1	0.8264
120.58	863.85	399.9	0.4065	120.58	0.264	464.4	0.8512
120.67	866.8	401.3	0.4207	120.67	0.267	465.9	0.8743
120.77	869.65	402.6	0.4314	120.75	0.27	467.5	0.9072
120.83	872.84	403.7	0.4429	120.83	0.274	468.9	0.9294
120.92	873.1	404.2	0.458	120.92	0.275	469.6	0.9471
121.00	875.69	405.2	0.4687	121.00	0.278	470.7	0.9649
121.08	879.07	406.3	0.4802	121.08	0.281	471.9	0.9817
121.17	879.67	406.8	0.4891	121.17	0.284	473.2	1.0004
121.25	881.17	407.6	0.4989	121.25	0.287	474.2	1.0163
121.33	882.87	408.5	0.5068	121.33	0.289	475.2	1.043
121.42	883.93	409.4	0.5175	121.42	0.291	475.9	1.0563
121.50	887.44	410.2	0.5308	121.50	0.294	477.3	1.0723
121.58	887.25	410.5	0.5379	121.58	0.295	477.6	1.0874
121.67	888.69	411	0.545	121.67	0.298	478.4	1.1016
121.75	889.53	411.4	0.5521	121.75	0.298	478.9	1.1113
121.83	890.87	411.9	0.5583	121.85	0.298	479.3	1.1273
121.92	891.98	412.4	0.5637	121.92	0.299	479.7	1.1371
122.00	892.82	412.8	0.5699	122.00	0.302	480.2	1.1459
122.08	892.93	413	0.5779	122.08	0.304	480.8	1.1548
122.17	894.07	413.4	0.5832	122.17	0.302	480.7	1.1619
122.27	894.45	413.7	0.5876	122.25	0.303	481.1	1.1726
122.33	894.18	413.7	0.5921	122.33	0.305	481.4	1.1797
122.42	894.62	413.9	0.5974	122.42	0.305	481.3	1.1841
122.50	894.71	414	0.6009	122.50	0.305	481.4	1.1903
122.58	895.03	414.1	0.6045	122.58	0.305	481.3	1.193
122.67	895.22	414.2	0.608	122.67	0.305	481.4	1.1983
122.75	894.78	414.1	0.6107	122.75	0.306	481.4	1.201
122.83	894.61	414.2	0.6134	122.83	0.305	481.2	1.2063
122.92	894.17	414	0.6151	122.92	0.304	480.8	1.2081
123.00	892.8	413.7	0.6178	123.00	0.304	480.7	1.2107
123.08	892.96	413.7	0.6196	123.08	0.302	480.4	1.2116
123.17	891.7	413.4	0.6205	123.17	0.302	480.2	1.2134
123.25	891.11	413.2	0.6205	123.25	0.3	479.5	1.2143
123.33	890.28	413	0.6213	123.33	0.299	479.2	1.2152
123.42	888.19	412.4	0.6213	123.42	0.298	478.9	1.2152
123.50	887.17	412.1	0.6213	123.50	0.296	478.3	1.2152
123.58	886.11	411.8	0.6213	123.58	0.294	477.6	1.2152
123.68	884.62	411.3	0.6213	123.67	0.292	477	1.2152
123.75	882.57	410.7	0.6205	123.75	0.291	476.4	1.2143
123.83	878.67	409.8	0.6196	123.83	0.287	475.6	1.2143
123.92	879.72	409.8	0.6196	123.92	0.286	475.2	1.2134
124.00	878	409.3	0.6187	124.00	0.284	474.5	1.2134
124.08	875.63	408.5	0.6169	124.08	0.28	473.5	1.2116
124.17	873.74	407.9	0.6169	124.17	0.275	472.1	1.2116
124.25	871.43	407.1	0.6151	124.25	0.274	471.6	1.2099

Prova triassiale ciclica SNGR03-C4							
tensione di confinamento (kPa)	450			tensione di confinamento (kPa)	450		
deviatore ciclico (kPa)	230			deviatore ciclico (kPa)	260		
frequenza (hz)	0.007143			frequenza (hz)	0.007143		
124.33	867.92	406.1	0.6142	124.33	0.273	471.1	1.209
124.42	865.68	405.4	0.6125	124.42	0.268	469.9	1.2072
124.50	864.09	404.7	0.6107	124.50	0.264	468.7	1.2054
124.58	859.99	403.6	0.6089	124.58	0.262	467.9	1.2045
124.67	858.57	402.8	0.6071	124.67	0.26	467.1	1.2036
124.75	856.55	402.2	0.6054	124.77	0.254	465.4	1.201
124.83	852.16	401	0.6027	124.83	0.25	464.3	1.1992
124.92	848.49	399.6	0.6009	124.92	0.247	463.4	1.1983
125.00	845.74	398.6	0.5992	125.00	0.243	462.1	1.1957
125.08	842.74	397.6	0.5947	125.08	0.238	460.4	1.1939
125.17	840.59	396.8	0.5929	125.17	0.234	459	1.1921
125.25	836.3	395.2	0.5894	125.25	0.23	457.7	1.1894
125.33	832.96	394.1	0.585	125.33	0.223	455.9	1.1868
125.42	829.69	393	0.5814	125.42	0.22	454.8	1.185
125.50	823.74	391.1	0.5779	125.50	0.217	453.6	1.1823
125.58	822.32	390.2	0.5743	125.58	0.212	452.1	1.1797
125.67	818.59	389.2	0.5708	125.67	0.204	449.7	1.177
125.75	814.72	387.7	0.5663	125.75	0.199	448	1.1735
125.83	810.13	386	0.5619	125.83	0.194	446.3	1.169
125.92	805.43	384.2	0.5557	125.92	0.191	445	1.1664
126.00	802.29	383	0.5512	126.00	0.185	443	1.1619
126.08	796.87	381.2	0.5459	126.08	0.181	441.5	1.1593
126.17	793.93	379.7	0.5406	126.18	0.173	438.9	1.1539
126.25	789.93	378.5	0.5361	126.25	0.165	436.6	1.1495
126.33	784.93	376.8	0.5308	126.33	0.164	435.5	1.1468
126.42	778.98	374.5	0.5246	126.42	0.159	433.6	1.1424
126.50	774.01	372.4	0.5202	126.50	0.15	430.9	1.1371
126.60	770.88	371.3	0.5113	126.58	0.145	428.6	1.1344
126.67	765.48	369.3	0.5042	126.67	0.137	425.9	1.1291
126.75	760.35	367.3	0.4997	126.75	0.133	424.1	1.122
126.83	756.88	365.5	0.4891	126.83	0.127	422	1.1175
126.92	753.47	364	0.4829	126.92	0.12	419.3	1.1113
127.00	746.75	361.7	0.4758	127.00	0.116	417.7	1.1069
127.08	743.48	359.8	0.4687	127.08	0.111	415.7	1.1016
127.17	739.14	358.2	0.4616	127.17	0.1	411.6	1.0945
127.25	733.21	355.9	0.4527	127.25	0.093	409	1.0891
127.33	725.65	352.8	0.4456	127.33	0.089	407.2	1.0811
127.42	723.2	351.2	0.4358	127.42	0.082	404.6	1.0749
127.50	717.67	349.2	0.427	127.50	0.076	401.9	1.0678
127.58	711.83	346.8	0.419	127.58	0.072	400	1.0616
127.67	709.95	345.4	0.4119	127.68	0.062	396.2	1.0519
127.75	704.64	343.3	0.4021	127.75	0.055	393.5	1.0448
127.83	698.84	340.8	0.3941	127.83	0.052	391.6	1.0394
127.92	689.08	336.9	0.3861	127.92	0.045	389	1.0314
128.02	688.58	335.4	0.3746	128.00	0.035	385.4	1.0208
128.08	683.6	333.7	0.3657	128.08	0.027	382	1.0128
128.17	677.7	331.1	0.3568	128.17	0.022	379.5	1.003
128.25	669.96	327.6	0.348	128.25	0.017	377.3	0.9897
128.33	666.54	325.5	0.3338	128.33	0.009	374.2	0.98
128.42	662.22	323.5	0.3249	128.42	0.003	371	0.9702
128.50	655.5	320.7	0.3151	128.50	-0.002	368.8	0.9604
128.58	651.58	318.3	0.3045	128.58	-0.01	365.9	0.9507
128.67	647.75	316.3	0.2956	128.67	-0.019	361.8	0.9382
128.75	643.03	314.1	0.2867	128.75	-0.025	358.7	0.9267
128.83	632.02	309.3	0.2752	128.83	-0.03	356.5	0.9054
128.92	630.89	307.6	0.2619	128.92	-0.038	353.2	0.8903
129.00	626.79	305.7	0.253	129.00	-0.042	350.6	0.8734
129.08	619.4	302.6	0.2432	129.10	-0.05	346.7	0.8539
129.17	616.04	300.3	0.2343	129.17	-0.055	344.3	0.8211
129.25	611.47	298	0.2255	129.25	-0.064	340.8	0.7927

Prova triassiale ciclica SNGR03-C4							
tensione di confinamento (kPa)	450			tensione di confinamento (kPa)	450		
deviatore ciclico (kPa)	230			deviatore ciclico (kPa)	260		
frequenza (hz)	0.007143			frequenza (hz)	0.007143		
129.33	605.48	295.3	0.2166	129.33	-0.07	337.5	0.7651
129.42	598.65	291.5	0.2068	129.42	-0.074	335.1	0.7367
129.52	596.64	289.5	0.1944	129.50	-0.083	331.5	0.7074
129.58	591.61	287.1	0.1855	129.58	-0.091	327.2	0.6826
129.67	584.54	284.5	0.1766	129.67	-0.096	323.8	0.6577
129.75	579.87	280.6	0.1678	129.75	-0.101	321.2	0.6151
129.83	576.22	277.7	0.1544	129.83	-0.108	317.5	0.5832
129.92	572.12	275.5	0.1447	129.92	-0.113	314.3	0.5512
130.00	566.27	272.4	0.134	130.00	-0.12	310.7	0.5148
130.08	562.46	269.6	0.1243	130.08	-0.125	307.3	0.4829
130.17	558.55	267.2	0.1136	130.17	-0.134	301.7	0.4509
130.25	552.87	264.4	0.1039	130.25	-0.138	298.2	0.4172
130.33	548.09	260.3	0.0932	130.33	-0.144	294.7	0.3604
130.42	543.73	257.4	0.0772	130.42	-0.15	290.9	0.3249
130.50	539.98	255.1	0.0675	130.50	-0.154	286.7	0.2876
130.58	534.8	252.2	0.0559	130.60	-0.16	281.8	0.2379
130.67	532.51	249.8	0.0453	130.67	-0.165	278.6	0.2024
130.75	528.12	247.4	0.0346	130.75	-0.171	274.2	0.1642
130.83	522.16	244.3	0.024	130.83	-0.175	270.6	0.1269
130.93	518.8	240.9	0.008	130.92	-0.18	266.9	0.087
131.00	516.28	238.5	-0.0018	131.00	-0.185	262.5	0.0479
131.08	512.29	236.2	-0.0115	131.08	-0.193	256.2	0.0089
131.17	505.85	233.2	-0.0231	131.17	-0.196	252.5	-0.0293
131.25	501.93	229.4	-0.0328	131.25	-0.2	249	-0.0861
131.33	499.96	227.1	-0.0488	131.33	-0.205	244.8	-0.1243
131.42	496.46	224.8	-0.0604	131.42	-0.209	240.8	-0.1616
131.50	492.47	222.5	-0.0683	131.50	-0.212	237.6	-0.1953
131.58	490.24	220.1	-0.0781	131.58	-0.217	233.1	-0.2334
131.67	486.77	218	-0.0888	131.67	-0.224	227.2	-0.2681
131.75	482.41	215.7	-0.0976	131.75	-0.226	224.2	-0.3053
131.83	478.95	212.5	-0.1065	131.83	-0.23	221	-0.3506
131.92	477.28	210.5	-0.1207	131.92	-0.234	217.5	-0.3808
132.00	474.01	208.3	-0.1305	132.02	-0.238	213.3	-0.4083
132.08	471.01	206.1	-0.1394	132.08	-0.241	210	-0.4491
132.17	469.02	204.1	-0.1482	132.17	-0.244	207.2	-0.4758
132.25	466.75	202.3	-0.1571	132.25	-0.248	204.2	-0.5015
132.33	462.85	200.2	-0.166	132.33	-0.25	201.4	-0.5264
132.43	461.21	197.9	-0.1784	132.42	-0.252	199.2	-0.5494
132.50	458.79	196.1	-0.1855	132.50	-0.256	196.3	-0.5743
132.58	456.12	194.4	-0.1935	132.58	-0.26	192.8	-0.5965
132.67	454	193	-0.1997	132.67	-0.262	190.2	-0.6284
132.75	451.1	190.3	-0.2077	132.75	-0.265	188.1	-0.6498
132.83	450.54	189.2	-0.2175	132.83	-0.267	186.1	-0.6684
132.92	448.51	187.8	-0.2237	132.92	-0.269	183.6	-0.6879
133.00	446.01	186.3	-0.2308	133.00	-0.271	182	-0.7057
133.08	445.66	185.2	-0.2361	133.08	-0.273	180	-0.7234
133.17	443.13	184	-0.2423	133.17	-0.276	177.6	-0.7394
133.25	442.48	183.1	-0.2477	133.25	-0.277	176.4	-0.7616
133.33	440.79	181.5	-0.253	133.33	-0.279	174.9	-0.7758
133.42	440.1	180.6	-0.261	133.42	-0.28	173.7	-0.7891
133.50	439.25	179.8	-0.2654	133.50	-0.281	172.2	-0.8007
133.58	437.86	179	-0.2707	133.58	-0.282	171.2	-0.8175
133.67	437.11	178.2	-0.2752	133.67	-0.283	170.4	-0.8282
133.75	436.7	177.7	-0.2787	133.75	-0.284	169.5	-0.8379
133.85	436.28	176.9	-0.284	133.83	-0.284	168.7	-0.8477
133.92	434.97	176.3	-0.2876	133.92	-0.285	168	-0.8557
134.00	435.33	176.2	-0.2894	134.00	-0.285	167.5	-0.8646
134.08	435.46	176	-0.292	134.08	-0.286	167	-0.8717
134.17	434.94	175.6	-0.2956	134.17	-0.286	166.6	-0.8823
134.25	434.74	175.3	-0.2974	134.25	-0.286	166.3	-0.8885

Prova triassiale ciclica SNGR03-C4							
tensione di confinamento (kPa)	450			tensione di confinamento (kPa)	450		
deviatore ciclico (kPa)	230			deviatore ciclico (kPa)	260		
frequenza (hz)	0.007143			frequenza (hz)	0.007143		
134.33	434.86	175.2	-0.3009	134.33	-0.285	166.6	-0.893
134.42	434.79	175.2	-0.3027	134.42	-0.286	166.4	-0.8983
134.50	436.66	175.6	-0.3036	134.50	-0.285	166.4	-0.9018
134.58	435.55	175.3	-0.3053	134.58	-0.285	166.8	-0.9054
134.67	436.89	175.7	-0.3062	134.67	-0.284	167.2	-0.9089
134.75	438.09	175.9	-0.3071	134.75	-0.283	167.5	-0.9125
134.83	438.49	176.4	-0.308	134.83	-0.282	168	-0.9143
134.92	439.23	176.8	-0.308	134.93	-0.281	168.6	-0.916
135.00	440.37	177.3	-0.308	135.00	-0.278	169.9	-0.9169
135.08	441.34	177.6	-0.308	135.08	-0.278	170.4	-0.9178
135.17	442.38	178.3	-0.308	135.17	-0.276	171.2	-0.9178
135.25	444.02	179	-0.308	135.25	-0.274	172.2	-0.9178
135.35	445.53	179.8	-0.308	135.33	-0.273	173.1	-0.9178
135.42	447.47	180.7	-0.3071	135.42	-0.271	174.2	-0.9169
135.50	448.88	181.4	-0.3062	135.50	-0.268	175.3	-0.916
135.58	450.66	182.2	-0.3062	135.58	-0.266	177	-0.916
135.67	453.01	183.3	-0.3053	135.67	-0.264	178.2	-0.9143
135.75	456.09	184.8	-0.3045	135.75	-0.261	179.6	-0.9134
135.83	456.36	185.5	-0.3036	135.83	-0.258	181.1	-0.9125
135.92	459.28	186.7	-0.3027	135.92	-0.256	182.5	-0.9116
136.00	462.64	188	-0.3009	136.00	-0.254	183.8	-0.9098
136.08	463.88	188.8	-0.3	136.08	-0.249	185.6	-0.9089
136.17	466.53	190.1	-0.2991	136.17	-0.244	188.2	-0.9072
136.25	469.85	191.5	-0.2974	136.25	-0.243	189.6	-0.9045
136.33	472.56	193.3	-0.2965	136.35	-0.239	191.2	-0.9036
136.42	474.51	194.5	-0.2947	136.42	-0.235	192.6	-0.9018
136.50	477.93	196.1	-0.2929	136.50	-0.23	195.7	-0.9001
136.58	481.42	197.7	-0.2911	136.58	-0.229	197.6	-0.8965
136.67	483.24	199.1	-0.2894	136.67	-0.224	199.4	-0.8947
136.77	487.03	201.2	-0.2876	136.75	-0.22	201.4	-0.893
136.83	490.38	202.7	-0.2867	136.83	-0.218	203.1	-0.8903
136.92	494.34	204.6	-0.284	136.92	-0.213	205.3	-0.8876
137.00	496.42	206.1	-0.2823	137.00	-0.207	207.9	-0.885
137.08	500.04	207.8	-0.2805	137.08	-0.202	211.2	-0.8823
137.17	505.77	210	-0.2778	137.17	-0.198	213.5	-0.8779
137.25	510.2	213.1	-0.2761	137.25	-0.194	215.6	-0.8752
137.33	512.15	214.7	-0.2716	137.33	-0.188	218.3	-0.8726
137.42	515.94	216.4	-0.2698	137.42	-0.185	220.6	-0.8699
137.50	521.17	218.9	-0.2672	137.50	-0.181	222.9	-0.8663
137.58	522.85	220.4	-0.2645	137.58	-0.173	226.6	-0.861
137.67	526.94	222.4	-0.2619	137.67	-0.166	230.3	-0.8583
137.75	532.77	225.3	-0.2583	137.75	-0.164	232.3	-0.8539
137.83	538.67	228.6	-0.2556	137.85	-0.159	234.6	-0.8504
137.92	540.99	230.4	-0.2512	137.92	-0.151	237.7	-0.8459
138.00	545.28	232.4	-0.2477	138.00	-0.145	241.9	-0.8424
138.08	550.14	235	-0.245	138.08	-0.141	244.5	-0.8353
138.18	555.26	238	-0.2414	138.17	-0.135	247.4	-0.8308
138.25	558.52	240	-0.237	138.25	-0.129	250.3	-0.8264
138.33	563.21	242.3	-0.2334	138.33	-0.126	253	-0.822
138.42	569.67	245.4	-0.229	138.42	-0.12	255.8	-0.8166
138.50	571.49	247.4	-0.2255	138.50	-0.112	259.4	-0.8113
138.58	576.54	249.7	-0.2219	138.58	-0.104	264.1	-0.806
138.67	583.24	252.7	-0.2175	138.67	-0.1	266.9	-0.798
138.75	588.8	256.3	-0.2139	138.75	-0.094	269.6	-0.7927
138.83	591.79	258.6	-0.2077	138.83	-0.087	273	-0.7864
138.92	597.48	261.1	-0.2033	138.92	-0.083	276.2	-0.7811
139.00	603.04	264.1	-0.1988	139.00	-0.077	278.7	-0.7749
139.08	605.22	266.2	-0.1944	139.08	-0.068	282.7	-0.7687
139.17	611.04	268.7	-0.1891	139.17	-0.06	287.5	-0.7625
139.25	618.27	271.9	-0.1846	139.27	-0.057	289.7	-0.7536

Prova triassiale ciclica SNGR03-C4							
tensione di confinamento (kPa)	450			tensione di confinamento (kPa)	450		
deviatore ciclico (kPa)	230			deviatore ciclico (kPa)	260		
frequenza (hz)	0.007143			frequenza (hz)	0.007143		
139.33	623.19	275.5	-0.1802	139.33	-0.051	292.5	-0.7474
139.42	626.54	277.8	-0.1722	139.42	-0.043	296.3	-0.7394
139.50	632.6	280.7	-0.1669	139.50	-0.035	300.8	-0.7323
139.58	637.78	283.5	-0.1616	139.58	-0.03	304.3	-0.7217
139.68	643.3	286.6	-0.1571	139.67	-0.024	307	-0.7137
139.75	647.42	289.1	-0.1491	139.75	-0.017	310.4	-0.7066
139.83	651.83	291.6	-0.1438	139.83	-0.013	313.8	-0.6986
139.92	659.15	295.1	-0.1376	139.92	-0.006	316.6	-0.6906
140.00	661.86	297.4	-0.1323	140.00	0.003	320.4	-0.6817
140.08	666.11	299.6	-0.1278	140.08	0.012	325.4	-0.6737
140.17	674.2	302.8	-0.1207	140.17	0.015	328.3	-0.6586
140.25	680.35	306.7	-0.1154	140.25	0.023	332.1	-0.648
140.33	683.35	309.1	-0.1065	140.33	0.028	335	-0.6382
140.42	688.8	311.5	-0.0994	140.42	0.033	338.4	-0.6267
140.50	694.98	314.6	-0.0932	140.50	0.039	342	-0.6125
140.58	697.51	316.7	-0.087	140.58	0.049	345.9	-0.5974
140.67	703.12	319.2	-0.0808	140.67	0.057	351.5	-0.5814
140.75	710.57	322.1	-0.0737	140.77	0.059	354	-0.5592
140.83	715.41	325.8	-0.0666	140.83	0.068	358.2	-0.5397
140.92	719.47	328.2	-0.0568	140.92	0.075	360.9	-0.5246
141.00	724.18	330.7	-0.0497	141.00	0.082	366.5	-0.5042
141.10	730.58	333.7	-0.0417	141.08	0.086	369.8	-0.4696
141.17	736.05	337	-0.0328	141.17	0.092	373.3	-0.4438
141.25	738.88	339.1	-0.0222	141.25	0.1	377.6	-0.4145
141.33	744.11	341.5	-0.0142	141.33	0.103	380.6	-0.3914
141.42	749.21	344	-0.0053	141.42	0.11	384.1	-0.3622
141.50	752.07	346.1	0.0027	141.50	0.12	387.8	-0.3311
141.58	757.09	348.6	0.0133	141.58	0.125	392.9	-0.3009
141.67	764.22	351.3	0.024	141.67	0.129	396.1	-0.245
141.75	769.58	354.9	0.0337	141.75	0.136	399.7	-0.2024
141.83	771.85	356.9	0.0506	141.83	0.141	403.1	-0.1598
141.92	775.74	359.1	0.0639	141.92	0.146	406	-0.1198
142.00	781.32	361.8	0.0772	142.00	0.152	409.2	-0.0719
142.08	786.43	363.7	0.0897	142.08	0.158	413.1	-0.0142
142.17	791.71	367.1	0.1003	142.18	0.166	417	0.0462
142.25	793.91	368.9	0.1198	142.25	0.169	419.5	0.087
142.33	799.12	370.9	0.1331	142.33	0.176	422.9	0.1376
142.42	802.92	373	0.1473	142.42	0.182	425.5	0.1775
142.50	805.43	374.9	0.1616	142.50	0.188	429.5	0.2192
142.60	809.78	377.4	0.1811	142.58	0.194	432.6	0.2894
142.68	814.32	379.3	0.1953	142.67	0.197	434.8	0.3267
142.75	819.11	381.4	0.2104	142.75	0.203	437.5	0.3666
142.83	823.44	383.5	0.2272	142.83	0.207	440	0.4092
142.92	824.77	384.7	0.2406	142.92	0.213	442.6	0.4527
143.00	829.85	386.8	0.2583	143.00	0.219	444.9	0.4847
143.08	834.94	389.3	0.2734	143.08	0.223	448.1	0.5175
143.17	837.13	390.6	0.2894	143.17	0.227	450.3	0.5699
143.25	837.98	391.6	0.3107	143.25	0.232	452.8	0.6071
143.33	844.72	393.7	0.3258	143.33	0.236	454.7	0.6391
143.42	846.15	395	0.3409	143.42	0.238	456.4	0.6684
143.50	848.67	396.1	0.3559	143.50	0.243	458.2	0.6959
143.58	853.01	397.9	0.3728	143.58	0.249	460.1	0.7234
143.67	857.26	398.9	0.3852	143.67	0.251	462.6	0.7607
143.75	859.88	401	0.3994	143.75	0.254	464	0.7864
143.83	862.21	402.2	0.4225	143.83	0.258	465.6	0.8122
143.92	865.46	403.3	0.4358	143.92	0.264	467.2	0.837
144.02	867.12	404.2	0.4483	144.00	0.267	469.4	0.8619
144.10	869.01	405.4	0.4598	144.08	0.27	470.6	0.8939
144.17	872.23	406.5	0.4722	144.17	0.272	471.9	0.9187
144.25	872.09	406.9	0.4864	144.25	0.277	473.4	0.9409

Prova triassiale ciclica SNGR03-C4

tensione di confinamento (kPa)		450		tensione di confinamento (kPa)		450	
deviatore ciclico (kPa)		230		deviatore ciclico (kPa)		260	
frequenza (hz)		0.007143		frequenza (hz)		0.007143	
144.33	874.55	407.9	0.4971	144.33	0.278	474.3	0.9595
144.42	877.07	409	0.5086	144.42	0.281	475.2	0.9755
144.50	880.38	410.1	0.521	144.50	0.286	476.4	0.9933
144.58	880.68	410.5	0.5308	144.58	0.288	477.9	1.011
144.67	883.23	411.6	0.5415	144.67	0.289	478.6	1.0368
144.75	884.53	412.2	0.5512	144.75	0.29	479.3	1.0501
144.83	887.3	413	0.5645	144.83	0.294	480.4	1.0687
144.92	887.22	413.3	0.5716	144.92	0.294	480.8	1.082
145.00	887.99	413.8	0.5787	145.00	0.297	481.6	1.0962
145.08	889.42	414.4	0.5867	145.10	0.298	482.2	1.1122
145.17	892.08	415	0.5947	145.17	0.3	482.6	1.122
145.25	890.97	415.3	0.6009	145.25	0.3	483	1.1326
145.33	893.37	415.9	0.6063	145.33	0.301	483.3	1.1424
145.42	892.91	416	0.6151	145.42	0.303	483.7	1.1504
145.52	893.76	416.2	0.6196	145.50	0.303	483.8	1.1584
145.60	894.64	416.3	0.6231	145.58	0.304	484.1	1.1681
145.67	895.39	416.7	0.6284	145.67	0.305	484.4	1.1752
145.75	894.09	416.7	0.632	145.75	0.305	484.4	1.1814
145.83	894.2	416.8	0.6373	145.83	0.305	484.5	1.1859
145.92	894.09	416.8	0.6409	145.92	0.305	484.4	1.1903
146.00	894.77	417	0.6444	146.00	0.306	484.6	1.1948
146.08	893.64	416.8	0.6471	146.08	0.305	484.3	1.1983
146.17	893.8	416.8	0.6489	146.17	0.304	484.1	1.2028
146.25	893.86	416.7	0.6506	146.25	0.304	483.9	1.2045
146.33	894.05	416.8	0.6524	146.33	0.304	483.7	1.2072
146.42	892.86	416.5	0.6551	146.42	0.302	483.3	1.2081
146.50	891.69	416.2	0.656	146.52	0.302	483	1.2107
146.58	891.36	416.1	0.6569	146.58	0.301	482.7	1.2116
146.67	889.21	415.6	0.6569	146.67	0.298	482.2	1.2125
146.75	889.47	415.5	0.6569	146.75	0.297	482	1.2125
146.83	887.82	415.1	0.6569	146.83	0.297	481.5	1.2125
146.93	885.94	414.5	0.6569	146.92	0.294	480.9	1.2125
147.02	884.64	414.1	0.6569	147.00	0.291	480	1.2125
147.08	883.42	413.7	0.6569	147.08	0.29	479.5	1.2125
147.17	880.02	413	0.656	147.17	0.288	478.9	1.2116
147.25	879.82	412.5	0.6551	147.25	0.285	478	1.2107
147.33	875.85	411.7	0.6542	147.33	0.284	477.6	1.2107
147.42	874.83	411.2	0.6524	147.42	0.281	476.7	1.209
147.50	873.21	410.3	0.6515	147.50	0.276	475.9	1.2081
147.58	871.23	409.9	0.6506	147.58	0.275	474.7	1.2072
147.67	869.15	409.2	0.6498	147.67	0.272	473.9	1.2054
147.75	865.48	408.2	0.648	147.75	0.268	472.9	1.2045
147.83	861.91	407.7	0.6471	147.83	0.265	471.9	1.2028
147.92	861.02	406.5	0.6462	147.92	0.262	471	1.2019
148.00	856.79	405.3	0.6427	148.02	0.258	469.7	1.2001
148.08	854.84	404.5	0.6409	148.08	0.254	468.6	1.2001
148.17	852.07	403.6	0.6382	148.17	0.248	466.9	1.1957
148.25	849.63	402.6	0.6356	148.25	0.248	466.5	1.1957
148.35	845.82	401.3	0.6329	148.33	0.242	464.9	1.193
148.43	842.2	400.2	0.6293	148.42	0.237	463.8	1.1912
148.50	840.45	399.3	0.6267	148.50	0.233	461.9	1.1903
148.58	834.04	397.5	0.6231	148.58	0.23	460.8	1.1868
148.67	832.22	396.8	0.6213	148.67	0.225	459.3	1.1841
148.75	828.42	395.5	0.6178	148.75	0.22	457.8	1.1814
148.83	824.62	395.1	0.616	148.83	0.217	456.6	1.1797
148.92	821.02	392.8	0.6107	148.92	0.21	454.8	1.1761
149.00	818.08	391.6	0.6054	149.00	0.205	453.9	1.1743
149.08	815.44	390.6	0.6018	149.08	0.199	451.1	1.1708
149.17	810.78	389	0.5974	149.17	0.195	449.5	1.1664
149.25	806.13	387.3	0.5921	149.25	0.192	448.2	1.1637

Prova triassiale ciclica SNGR03-C4							
tensione di confinamento (kPa)	450			tensione di confinamento (kPa)	450		
deviatore ciclico (kPa)	230			deviatore ciclico (kPa)	260		
frequenza (hz)	0.007143			frequenza (hz)	0.007143		
149.33	802.69	386.1	0.5876	149.33	0.184	445.6	1.1584
149.42	795.88	384	0.5814	149.43	0.178	443.6	1.1557
149.50	791.94	382.3	0.5779	149.50	0.174	442.1	1.1513
149.58	787.18	380.4	0.5725	149.58	0.168	440.2	1.1477
149.67	786.27	379.6	0.5645	149.67	0.162	438.1	1.1424
149.75	779.59	377.4	0.5574	149.75	0.159	436.4	1.1388
149.85	773.66	376.4	0.553	149.83	0.152	434.4	1.1344
149.93	770.86	374	0.5468	149.92	0.144	432.4	1.1309
150.00	766.56	372.1	0.537	150.00	0.136	428.9	1.1264
150.08	761.93	370.4	0.5308	150.08	0.132	427.2	1.1184
150.17	756.47	368.4	0.5246	150.17	0.128	425.3	1.114
150.25	754.26	367	0.5184	150.25	0.12	422.6	1.1087
150.33	748.7	365.1	0.5113	150.33	0.115	420.8	1.1033
150.42	740.42	363.1	0.5042	150.42	0.109	418.4	1.098
150.50	738.24	360.6	0.4971	150.50	0.1	415.9	1.0918
150.58	732.18	358.2	0.4847	150.58	0.094	412.3	1.0865
150.67	727.55	356.2	0.4767	150.67	0.088	410	1.0758
150.75	722.68	354.2	0.4696	150.75	0.084	408.1	1.0714
150.83	717.91	352.2	0.4616	150.83	0.075	404.7	1.0634
150.92	713.53	350.3	0.4536	150.93	0.068	401.7	1.0581
151.00	709.09	348.3	0.4456	151.00	0.063	399.6	1.0492
151.08	701.47	345.7	0.4367	151.08	0.056	396.8	1.0421
151.17	698.22	343.2	0.4278	151.17	0.05	394.1	1.0341
151.25	693.25	340.9	0.4154	151.25	0.042	391.1	1.0261
151.35	688.6	339	0.4074	151.33	0.036	388.7	1.0199
151.42	681.5	336.3	0.3977	151.42	0.026	386.5	1.0137
151.50	676.26	333.3	0.3914	151.50	0.021	382.1	1.0048
151.58	671.98	331	0.3764	151.58	0.017	379.8	0.9924
151.67	667.1	328.8	0.3666	151.67	0.009	376.8	0.9835
151.75	661.12	326.3	0.3568	151.75	0.002	373.8	0.9737
151.83	657	323.9	0.3462	151.83	-0.002	371.4	0.964
151.92	653.88	322.1	0.3364	151.92	-0.01	368.4	0.9542
152.00	646.3	319.1	0.3258	152.00	-0.019	365.8	0.9444
152.08	639.28	315.6	0.316	152.08	-0.027	361	0.932
152.17	634.33	313	0.3062	152.17	-0.03	358.9	0.9116
152.25	632	310.9	0.292	152.25	-0.038	355.8	0.8956
152.33	625.67	308.3	0.2814	152.35	-0.045	352.2	0.8797
152.42	619.65	305.5	0.2707	152.42	-0.052	349.3	0.8628
152.50	616.85	303.3	0.2601	152.50	-0.057	346.7	0.8273
152.58	612.09	301.2	0.2503	152.58	-0.064	343.7	0.7998
152.67	605.2	298.1	0.2397	152.67	-0.07	340.4	0.7696
152.77	601.13	295.2	0.2272	152.75	-0.074	337.7	0.7385
152.85	596.66	292.6	0.2175	152.83	-0.082	334.5	0.7092
152.92	592.39	290.3	0.2086	152.92	-0.091	329.7	0.6782
153.00	585.83	286.9	0.1979	153.00	-0.096	326.6	0.6515
153.08	579.49	283.2	0.1891	153.08	-0.101	323.9	0.6071
153.17	575.25	280.3	0.1784	153.17	-0.107	320.5	0.5761
153.25	571.74	278.1	0.1633	153.25	-0.114	316.6	0.5397
153.33	566.9	275.2	0.1527	153.33	-0.118	313.7	0.5077
153.42	561.98	272.1	0.142	153.42	-0.125	309.9	0.4722
153.50	559.24	269.9	0.1314	153.50	-0.133	304.7	0.4376
153.58	554.06	267	0.1198	153.58	-0.139	300.4	0.3994
153.67	548.14	264	0.1083	153.67	-0.143	297.5	0.3417
153.75	541.99	259.7	0.0968	153.75	-0.149	293.6	0.3027
153.83	539.57	257.5	0.0799	153.83	-0.155	288.4	0.2672
153.92	535.68	255.1	0.0683	153.92	-0.162	284	0.2326
154.00	530.66	252.1	0.0568	154.00	-0.165	280.8	0.1722
154.08	528.51	249.7	0.0453	154.08	-0.17	276.5	0.1296
154.18	522.14	246	0.0275	154.17	-0.176	272.1	0.0861
154.27	519.55	243.9	0.0178	154.25	-0.18	268.6	0.047

Prova triassiale ciclica SNGR03-C4							
tensione di confinamento (kPa)	450			tensione di confinamento (kPa)	450		
deviatore ciclico (kPa)	230			deviatore ciclico (kPa)	260		
frequenza (hz)	0.007143			frequenza (hz)	0.007143		
154.33	513.95	240.7	0.0053	154.33	-0.185	264.5	0.0062
154.42	511	238.2	-0.0053	154.42	-0.192	258.2	-0.0355
154.50	507.84	235.9	-0.016	154.50	-0.196	254.2	-0.0754
154.58	504.01	233.3	-0.0284	154.58	-0.2	250.5	-0.1376
154.67	498.57	230.5	-0.0391	154.67	-0.205	246.3	-0.1775
154.75	493.57	226.1	-0.0506	154.75	-0.209	242.6	-0.213
154.83	493	224.5	-0.0666	154.83	-0.212	239.1	-0.2521
154.92	489.94	222.5	-0.0763	154.92	-0.217	235.1	-0.2903
155.00	485.11	219.8	-0.0879	155.00	-0.223	229.4	-0.3267
155.08	483.98	217.8	-0.0968	155.08	-0.226	226.2	-0.3604
155.17	480.62	215.6	-0.1074	155.17	-0.229	222.9	-0.4083
155.25	477.02	213.3	-0.1172	155.27	-0.234	219.1	-0.442
155.33	473.11	210	-0.1269	155.33	-0.237	215.1	-0.4696
155.42	470.01	208	-0.1367	155.42	-0.242	211.5	-0.4971
155.50	468.11	206.1	-0.1509	155.50	-0.244	209	-0.5415
155.58	465.58	204	-0.1598	155.58	-0.248	205.7	-0.569
155.68	462.31	201.6	-0.1678	155.67	-0.25	202.9	-0.5947
155.77	459.81	199.4	-0.1766	155.75	-0.252	200.6	-0.6187
155.83	459.04	198.2	-0.1891	155.83	-0.256	197.8	-0.6427
155.92	456.14	196.4	-0.1971	155.92	-0.261	193.8	-0.6657
156.00	454.18	194.7	-0.2042	156.00	-0.262	191.9	-0.687
156.08	452.46	193.3	-0.2121	156.08	-0.264	189.8	-0.7181
156.17	450.66	191.9	-0.2192	156.17	-0.267	187.6	-0.7385
156.25	448.33	190	-0.2263	156.25	-0.269	185.3	-0.7589
156.33	446.24	188.3	-0.2326	156.33	-0.27	183.7	-0.7767
156.42	445.09	187.2	-0.2388	156.42	-0.273	181.7	-0.7944
156.50	443.82	186	-0.2485	156.50	-0.275	179.3	-0.8095
156.58	442.23	184.9	-0.2548	156.58	-0.277	177.9	-0.8264
156.67	441.27	183.9	-0.2601	156.68	-0.278	176.4	-0.8477
156.75	440.05	182.9	-0.2654	156.75	-0.279	175.2	-0.8601
156.83	439.27	182.1	-0.2698	156.83	-0.281	173.6	-0.8726
156.92	437.75	181.3	-0.2743	156.92	-0.281	172.7	-0.8841
157.00	437.44	180.3	-0.2787	157.00	-0.283	171.6	-0.901
157.10	436.98	179.9	-0.2849	157.08	-0.284	170.8	-0.9107
157.18	435.97	179.1	-0.2876	157.17	-0.284	170.1	-0.9196
157.25	435.29	178.8	-0.2911	157.25	-0.285	169.6	-0.9285
157.33	435.18	178.2	-0.2947	157.33	-0.285	169	-0.9373
157.42	435.13	177.9	-0.2991	157.42	-0.286	168.4	-0.9444
157.50	434.92	177.7	-0.3018	157.50	-0.285	168.3	-0.9516
157.58	434.82	177.5	-0.3036	157.58	-0.285	168	-0.9604
157.67	434.98	177.4	-0.3062	157.67	-0.286	167.7	-0.9666
157.75	435.51	177.5	-0.308	157.75	-0.285	168	-0.9711
157.83	435.6	177.4	-0.3098	157.83	-0.285	168.1	-0.9755
157.92	436.5	177.6	-0.3107	157.92	-0.285	168.1	-0.98
158.00	436.64	177.8	-0.3116	158.00	-0.284	168.6	-0.9826
158.08	436.97	177.9	-0.3133	158.08	-0.282	169.3	-0.9844
158.17	438.41	178.4	-0.3133	158.18	-0.281	169.6	-0.9879
158.25	439.28	178.9	-0.3142	158.25	-0.28	170	-0.9897
158.33	440.11	179.4	-0.3142	158.33	-0.278	171.3	-0.9906
158.42	441.02	179.8	-0.3142	158.42	-0.277	171.9	-0.9906
158.52	442.83	180.6	-0.3142	158.50	-0.276	172.7	-0.9915
158.60	444.44	181.2	-0.3133	158.58	-0.274	173.7	-0.9915
158.67	445.21	181.8	-0.3133	158.67	-0.273	174.5	-0.9915
158.75	446.85	182.6	-0.3133	158.75	-0.271	175.6	-0.9906
158.83	448.66	183.5	-0.3124	158.83	-0.268	177	-0.9897
158.92	451.25	184.6	-0.3116	158.92	-0.265	179	-0.9897
159.00	452.72	185.5	-0.3116	159.00	-0.263	179.9	-0.9879
159.08	454.67	186.7	-0.3098	159.08	-0.261	181.2	-0.9871
159.17	457.02	187.7	-0.3089	159.17	-0.257	182.8	-0.9862
159.25	459.53	189	-0.308	159.25	-0.256	184	-0.9844

Prova triassiale ciclica SNGR03-C4							
tensione di confinamento (kPa)	450			tensione di confinamento (kPa)	450		
deviatore ciclico (kPa)	230			deviatore ciclico (kPa)	260		
frequenza (hz)	0.007143			frequenza (hz)	0.007143		
159.33	461.08	189.8	-0.3071	159.33	-0.253	185.5	-0.9835
159.42	463.56	191.1	-0.3062	159.42	-0.25	187.1	-0.9826
159.50	466.98	192.4	-0.3045	159.50	-0.245	189.6	-0.9808
159.58	470.54	194.5	-0.3036	159.60	-0.243	190.9	-0.9791
159.67	471.11	195.5	-0.3018	159.67	-0.24	192.3	-0.9773
159.75	474.9	196.9	-0.3	159.75	-0.237	194.4	-0.9755
159.83	478.32	198.5	-0.2982	159.83	-0.231	197.3	-0.9729
159.92	480.2	199.9	-0.2974	159.92	-0.228	199.4	-0.9702
160.02	484.19	202.1	-0.2956	160.00	-0.224	200.9	-0.9684
160.10	486.98	203.3	-0.2929	160.08	-0.22	203.2	-0.9649
160.17	490.5	205.1	-0.2911	160.17	-0.217	205.5	-0.9622
160.25	494.09	206.9	-0.2894	160.25	-0.213	207.1	-0.9604
160.33	496.44	208.5	-0.2876	160.33	-0.208	209.6	-0.9578
160.42	500.29	210.2	-0.2858	160.42	-0.201	213.4	-0.9551
160.50	505.39	212.4	-0.284	160.50	-0.198	215.3	-0.9507
160.58	509.58	215.2	-0.2814	160.58	-0.193	217.4	-0.948
160.67	512.04	217.2	-0.2778	160.67	-0.188	220.4	-0.9444
160.75	516.13	218.8	-0.2761	160.75	-0.184	222.7	-0.9409
160.83	520.82	221.3	-0.2725	160.83	-0.18	225	-0.9373
160.92	523.77	223.3	-0.2698	160.92	-0.174	228.1	-0.9338
161.00	527.96	225.3	-0.2672	161.00	-0.167	231.8	-0.9302
161.08	532.59	227.6	-0.2645	161.10	-0.165	233.8	-0.9258
161.17	537.45	230.6	-0.2619	161.17	-0.16	236	-0.9214
161.25	542.21	233	-0.2583	161.25	-0.152	239.6	-0.9169
161.33	545.27	234.9	-0.2539	161.33	-0.145	243.7	-0.9134
161.42	549.96	237.3	-0.2503	161.42	-0.141	246.4	-0.9072
161.52	555.49	240.4	-0.2477	161.50	-0.135	249.1	-0.9018
161.58	560.52	243.3	-0.2441	161.58	-0.129	252.2	-0.8974
161.67	562.9	245.3	-0.2388	161.67	-0.125	255	-0.893
161.75	568.23	247.6	-0.2352	161.75	-0.12	257.5	-0.8876
161.83	573.62	250.6	-0.2308	161.83	-0.111	261.1	-0.8823
161.92	576.74	252.4	-0.2272	161.92	-0.104	265.8	-0.877
162.00	580.99	254.9	-0.2228	162.00	-0.099	268.5	-0.869
162.08	588.2	258.3	-0.2184	162.08	-0.095	271.3	-0.8628
162.17	594.69	262	-0.2148	162.17	-0.087	275	-0.8575
162.25	596.54	264	-0.2086	162.25	-0.083	278.1	-0.8521
162.33	602.3	266.6	-0.2042	162.33	-0.077	280.6	-0.8468
162.42	608.39	269.4	-0.1988	162.42	-0.068	284.6	-0.8397
162.50	611.57	271.9	-0.1944	162.52	-0.061	289	-0.8299
162.58	615.62	274.2	-0.19	162.58	-0.057	291.9	-0.8246
162.67	621.58	277	-0.1855	162.67	-0.052	294.7	-0.8175
162.75	628.44	281	-0.1802	162.75	-0.042	298.3	-0.8113
162.83	633.76	284.1	-0.1749	162.83	-0.035	302.8	-0.8042
162.93	635.64	285.7	-0.1678	162.92	-0.031	306	-0.7927
163.02	641.46	288.6	-0.1624	163.00	-0.024	309	-0.7856
163.08	648.52	291.8	-0.1562	163.08	-0.017	312.6	-0.7767
163.17	654.67	295.3	-0.1518	163.17	-0.012	315.5	-0.7696
163.25	657.11	297.8	-0.1429	163.25	-0.007	318.5	-0.7616
163.33	663.17	300.4	-0.1376	163.33	0.003	322.2	-0.7527
163.42	669.62	303.4	-0.1314	163.42	0.011	327.4	-0.743
163.50	671.69	305.8	-0.126	163.50	0.016	330.5	-0.7279
163.58	677.17	308.2	-0.1198	163.58	0.021	333.7	-0.7172
163.67	683.29	311.1	-0.1127	163.67	0.029	337.4	-0.7048
163.75	691.77	315.7	-0.1065	163.75	0.034	341.5	-0.6906
163.83	694.11	317.6	-0.1012	163.83	0.038	343.9	-0.6782
163.92	698.58	319.9	-0.0905	163.92	0.049	348.5	-0.6604
164.00	704.26	322.7	-0.0834	164.02	0.054	353	-0.6409
164.08	709.2	325.6	-0.0763	164.08	0.059	356.4	-0.6249
164.17	713.37	327.8	-0.0701	164.17	0.066	359.9	-0.6063
164.25	718.14	330.3	-0.063	164.25	0.074	363.6	-0.5867

Prova triassiale ciclica SNGR03-C4							
tensione di confinamento (kPa)	450			tensione di confinamento (kPa)	450		
deviatore ciclico (kPa)	230			deviatore ciclico (kPa)	260		
frequenza (hz)	0.007143			frequenza (hz)	0.007143		
164.35	724.81	334.2	-0.0524	164.33	0.083	369	-0.5663
164.43	730.32	336.7	-0.0453	164.42	0.086	372.2	-0.5308
164.50	732.35	338.9	-0.0373	164.50	0.095	376.7	-0.4989
164.58	736.72	341.1	-0.0293	164.58	0.1	379.6	-0.4767
164.67	744.52	344.2	-0.0195	164.67	0.104	383.1	-0.4483
164.75	749.92	347.6	-0.0115	164.75	0.11	386.8	-0.4145
164.83	753.63	349.9	0.0036	164.83	0.119	390.5	-0.3835
164.92	757.96	352.2	0.0133	164.92	0.126	395.8	-0.3488
165.00	765.68	355.6	0.0275	165.00	0.13	399.2	-0.2885
165.08	765.9	357.2	0.0364	165.08	0.135	402.1	-0.2521
165.17	770.89	359.4	0.0479	165.17	0.142	405.8	-0.205
165.25	776.64	362	0.0612	165.25	0.146	409.2	-0.158
165.33	782.66	364.2	0.0737	165.33	0.153	412.5	-0.1012
165.42	787.07	367.7	0.0879	165.43	0.158	416.3	-0.0346
165.50	789.57	369.6	0.1074	165.50	0.166	419.7	0.0098
165.58	794.57	371.9	0.1234	165.58	0.169	422.4	0.0541
165.67	799.41	374.2	0.1376	165.67	0.175	425.4	0.1021
165.75	801.51	376	0.1527	165.75	0.182	428.6	0.1482
165.85	806.9	378.9	0.1749	165.83	0.188	432.7	0.1926
165.93	810.9	380.6	0.1891	165.92	0.191	435	0.2565
166.00	815.23	382.7	0.205	166.00	0.197	437.9	0.2974
166.08	818.89	384.6	0.2228	166.08	0.203	440.8	0.3426
166.17	821.82	386.1	0.2361	166.17	0.206	443	0.3808
166.25	825.71	387.8	0.2521	166.25	0.212	445.6	0.4234
166.33	832.36	390.5	0.269	166.33	0.22	448.1	0.4625
166.42	832.77	391.8	0.2938	166.42	0.223	451.4	0.4971
166.50	836.45	393.4	0.3116	166.50	0.228	453.9	0.553
166.58	840.5	395.1	0.3284	166.58	0.23	455.5	0.5841
166.67	842.59	396.4	0.3444	166.67	0.237	458.1	0.6222
166.75	847.92	398.2	0.363	166.75	0.239	460	0.6542
166.83	848.85	399.2	0.3772	166.85	0.243	462.4	0.6959
166.92	853.49	400.6	0.3932	166.92	0.247	464	0.7208
167.00	855.51	402.3	0.4092	167.00	0.253	466.2	0.7527
167.08	858.34	403.6	0.4296	167.08	0.256	467.7	0.7776
167.17	861.59	404.8	0.4447	167.17	0.259	469	0.8024
167.27	863.68	405.7	0.4571	167.25	0.265	470.5	0.8282
167.35	866.29	407.2	0.4713	167.33	0.266	472.5	0.853
167.42	868.9	408.3	0.4891	167.42	0.268	473.6	0.885
167.50	872.61	409.7	0.5024	167.50	0.272	474.9	0.9081
167.58	873.11	410.1	0.5131	167.58	0.277	476.4	0.9329
167.67	876.02	411.1	0.5264	167.67	0.278	477.5	0.9524
167.75	876.19	411.6	0.537	167.75	0.281	478.5	0.9711
167.83	881.65	412.6	0.5486	167.83	0.285	479.3	0.9879
167.92	880.36	413.5	0.561	167.92	0.286	480.6	1.0075
168.00	884.16	414.4	0.5752	168.00	0.288	481.5	1.0314
168.08	882.98	414.7	0.5841	168.08	0.291	482.5	1.0483
168.17	885.23	415.5	0.5929	168.17	0.293	483.2	1.0634
168.25	888.55	416.4	0.6036	168.25	0.295	483.8	1.0794
168.33	889.45	416.9	0.6125	168.35	0.296	484.3	1.0962
168.42	890.25	417.3	0.6196	168.42	0.298	485	1.1087
168.50	890.56	417.7	0.6258	168.50	0.299	485.5	1.1202
168.58	892.9	418.4	0.6311	168.58	0.302	486.1	1.1326
168.67	893.82	418.8	0.6418	168.67	0.301	486.2	1.1406
168.75	893.68	419	0.6471	168.75	0.303	486.6	1.1504
168.83	894.42	419.2	0.6524	168.83	0.303	486.9	1.1584
168.92	894.27	419.3	0.6569	168.92	0.305	487.2	1.1699
169.00	894.62	419.5	0.6631	169.00	0.304	487.2	1.1752
169.08	892.95	419.3	0.6666	169.08	0.305	487.2	1.1823
169.17	895.15	419.7	0.6719	169.17	0.305	487.4	1.1877
169.25	895.11	419.7	0.6746	169.25	0.305	487.4	1.1921

Prova triassiale ciclica SNGR03-C4							
tensione di confinamento (kPa)	450			tensione di confinamento (kPa)	450		
deviatore ciclico (kPa)	230			deviatore ciclico (kPa)	260		
frequenza (hz)	0.007143			frequenza (hz)	0.007143		
169.33	894.87	419.7	0.6782	169.33	0.304	487.5	1.1965
169.42	894.69	419.7	0.6808	169.42	0.306	487.5	1.2001
169.50	894.19	419.6	0.6835	169.50	0.305	487	1.2045
169.58	893.56	419.5	0.6853	169.58	0.303	486.7	1.2072
169.67	893.35	419.4	0.6879	169.67	0.304	486.7	1.2099
169.75	892.59	419.2	0.6888	169.77	0.303	486.3	1.2116
169.83	891.59	418.9	0.6897	169.83	0.301	485.8	1.2134
169.92	891.16	418.8	0.6906	169.92	0.301	485.5	1.2143
170.00	890.2	418.5	0.6915	170.00	0.299	485.1	1.2152
170.08	887.98	418.2	0.6915	170.08	0.297	484.5	1.2152
170.18	886.03	417.6	0.6915	170.17	0.296	484.1	1.2152
170.27	887.19	417.5	0.6924	170.25	0.294	483.5	1.2152
170.33	884.78	416.9	0.6906	170.33	0.293	482.9	1.2152
170.42	882.92	416.4	0.6915	170.42	0.29	482.2	1.2143
170.50	878.99	415.2	0.6906	170.50	0.288	481.6	1.2143
170.58	879.85	415	0.6888	170.58	0.285	480.8	1.2125
170.67	876.91	414.4	0.6888	170.67	0.284	480.2	1.2125
170.75	874.57	413.7	0.6879	170.75	0.281	479.5	1.2116
170.83	871.66	412.9	0.6861	170.83	0.277	478.6	1.2107
170.92	870.8	412.4	0.6853	170.92	0.274	477.4	1.2099
171.00	869.81	412	0.6853	171.00	0.272	476.6	1.2081
171.08	864.43	411.1	0.6826	171.08	0.267	475.5	1.2063
171.17	861.72	409.6	0.6817	171.17	0.267	474.8	1.2054
171.25	861.53	409.2	0.679	171.27	0.263	473.6	1.2045
171.33	859.15	408.4	0.6782	171.33	0.257	472.3	1.2019
171.42	854.92	407.2	0.6755	171.42	0.256	471.5	1.201
171.50	852.41	406.3	0.6737	171.50	0.249	469.9	1.1983
171.58	850.53	405.6	0.6711	171.58	0.247	468.9	1.1965
171.68	845.41	403.9	0.6675	171.67	0.245	468.2	1.1957
171.75	841.65	402.7	0.6648	171.75	0.238	466.7	1.1939
171.83	841.55	402.2	0.6631	171.83	0.234	464.9	1.1912
171.92	836.93	401	0.6595	171.92	0.23	463.6	1.1894
172.00	832.37	399.5	0.656	172.00	0.224	462	1.1859
172.08	827.98	398	0.6533	172.08	0.22	460.7	1.1841
172.17	825.54	397	0.6489	172.17	0.219	459.8	1.1823
172.25	819.99	395.3	0.6427	172.25	0.211	457.8	1.1788
172.33	818.41	394.5	0.64	172.33	0.204	456.2	1.1761
172.42	812.6	392.6	0.6347	172.42	0.198	453.6	1.1735
172.50	811.01	391.7	0.6302	172.50	0.197	452.5	1.1681
172.58	806.65	390.2	0.6267	172.58	0.191	450.7	1.1646
172.67	801.07	388.4	0.6213	172.68	0.183	448.8	1.161
172.75	796.14	386.4	0.6178	172.75	0.177	446.2	1.1584
172.83	793.18	385.1	0.6098	172.83	0.175	445.1	1.153
172.92	789.02	383.7	0.6054	172.92	0.168	443.1	1.1495
173.00	785.45	382.3	0.6	173.00	0.161	440.5	1.1442
173.10	778.24	379.7	0.5947	173.08	0.16	439.5	1.1415
173.18	775.6	378.2	0.5885	173.17	0.152	437.1	1.1362
173.25	770.35	376.4	0.5787	173.25	0.145	435.1	1.1317
173.33	766.12	374.8	0.5725	173.33	0.136	431.4	1.1264
173.42	761.09	372.6	0.5654	173.42	0.135	430.3	1.1202
173.50	757.62	371.4	0.5592	173.50	0.125	427.5	1.114
173.58	753.92	369.8	0.553	173.58	0.121	425.7	1.1104
173.67	747.4	367.1	0.545	173.67	0.116	423.4	1.1042
173.75	743.07	365.2	0.5379	173.75	0.11	421.2	1.0989
173.83	738.08	363.1	0.5273	173.83	0.101	418.5	1.0927
173.92	732.51	361.1	0.5184	173.92	0.093	414.9	1.0856
174.00	728.11	359.2	0.5104	174.00	0.089	412.9	1.0785
174.08	725.97	357.7	0.5033	174.08	0.081	410.2	1.0714
174.17	718.18	355.2	0.4944	174.18	0.076	408.8	1.0669
174.25	713.68	353.1	0.4864	174.25	0.067	404.3	1.0598

Prova triassiale ciclica SNGR03-C4							
tensione di confinamento (kPa)	450			tensione di confinamento (kPa)	450		
deviatore ciclico (kPa)	230			deviatore ciclico (kPa)	260		
frequenza (hz)	0.007143			frequenza (hz)	0.007143		
174.33	706.25	349.9	0.4784	174.33	0.063	401.9	1.0483
174.42	701.25	347.6	0.4678	174.42	0.056	399.3	1.0412
174.52	698.31	345.9	0.4554	174.50	0.049	396.8	1.0341
174.60	696.02	344.6	0.4491	174.58	0.045	394.5	1.0279
174.67	685.71	340.9	0.4376	174.67	0.038	392	1.0208
174.75	682.13	338.7	0.4296	174.75	0.026	388.7	1.011
174.83	676.39	335.9	0.4145	174.83	0.023	385.3	1.0021
174.92	672.11	334	0.4057	174.92	0.017	382.6	0.9888
175.00	666.4	331.5	0.3959	175.00	0.009	379.5	0.9791
175.08	663.81	329.6	0.3879	175.08	0.002	376.7	0.9693
175.17	657.36	327	0.3764	175.17	-0.003	373.7	0.9595
175.25	650.16	324.4	0.3657	175.25	-0.01	371.2	0.9489
175.33	644.71	320.9	0.3559	175.33	-0.019	368	0.9373
175.42	641.78	318.7	0.3409	175.42	-0.026	363.9	0.9258
175.50	636.76	316.6	0.3311	175.50	-0.031	361.4	0.9063
175.58	629.78	313.6	0.3187	175.60	-0.036	359.1	0.8921
175.67	627.28	311.2	0.3089	175.67	-0.045	355.6	0.8761
175.75	621.96	309.4	0.2991	175.75	-0.052	351.7	0.8583
175.83	615.94	306.3	0.2867	175.83	-0.057	349.1	0.822
175.92	607.98	302.5	0.2752	175.92	-0.062	346.3	0.7953
176.02	606.71	300.7	0.261	176.00	-0.071	342.4	0.7625
176.10	602.08	298.5	0.2512	176.08	-0.074	339.9	0.735
176.17	595.91	295.5	0.2414	176.17	-0.081	336.9	0.7048
176.25	588.55	291.7	0.2308	176.25	-0.091	333.5	0.6755
176.33	585.65	289.3	0.221	176.33	-0.097	328.6	0.6489
176.42	581.21	286.7	0.2059	176.42	-0.101	325.9	0.6018
176.50	577	284.1	0.1953	176.50	-0.108	322.5	0.5672
176.58	570.46	280.5	0.182	176.58	-0.114	318.8	0.5317
176.67	567.42	278	0.1704	176.67	-0.118	316.1	0.498
176.75	563.67	275.5	0.1607	176.75	-0.125	312.3	0.4598
176.83	557.33	272.1	0.1482	176.83	-0.133	308.5	0.4225
176.92	550.42	268	0.1376	176.92	-0.139	302.8	0.3843
177.00	549.26	265.9	0.1198	177.02	-0.143	299.4	0.3231
177.08	544.51	263.4	0.1083	177.08	-0.148	296	0.2867
177.17	538.73	260.2	0.095	177.17	-0.153	292	0.2477
177.25	535.8	257.5	0.0826	177.25	-0.162	285.2	0.2015
177.33	532.38	255.5	0.071	177.33	-0.165	282	0.1331
177.43	527.08	251.7	0.0524	177.42	-0.17	278.3	0.0932
177.52	522.33	249	0.0408	177.50	-0.176	274	0.0515
177.58	519.4	246.4	0.0293	177.58	-0.179	270.5	0.0098
177.67	515.48	243.8	0.016	177.67	-0.185	266.3	-0.0346
177.75	511.88	241.3	0.0044	177.75	-0.191	261.9	-0.0799
177.83	506.08	238.4	-0.008	177.83	-0.197	255.5	-0.1225
177.92	502.69	234.9	-0.0186	177.92	-0.199	252.1	-0.1837
178.00	500.11	232.2	-0.0373	178.00	-0.205	248	-0.2272
178.08	495.38	229.7	-0.0488	178.08	-0.21	243.8	-0.2681
178.17	492.49	227.2	-0.0595	178.17	-0.212	240.4	-0.308
178.25	490.02	224.9	-0.0701	178.25	-0.217	236.5	-0.3471
178.33	487.66	223.2	-0.0799	178.33	-0.223	232.5	-0.3843
178.42	482.32	220	-0.0923	178.42	-0.227	227.2	-0.4181
178.50	478.12	216.7	-0.1021	178.52	-0.228	224.9	-0.466
178.58	476.91	214.8	-0.1181	178.58	-0.233	221.2	-0.498
178.67	474.35	213	-0.1278	178.67	-0.238	216.9	-0.5379
178.75	470.51	210.5	-0.1385	178.75	-0.241	213.1	-0.5645
178.83	468.82	208.4	-0.1482	178.83	-0.243	210.6	-0.6063
178.93	465.45	205.8	-0.1571	178.92	-0.247	207.3	-0.6338
179.00	463.17	204	-0.1704	179.00	-0.25	204.2	-0.6613
179.08	460.17	201.9	-0.1802	179.08	-0.253	201.7	-0.687
179.17	459.08	200.3	-0.1882	179.17	-0.256	199.1	-0.7119
179.25	456.72	198.7	-0.1962	179.25	-0.26	196.3	-0.7359

Prova triassiale ciclica SNGR03-C4

tensione di confinamento (kPa)		450		tensione di confinamento (kPa)		450	
deviatore ciclico (kPa)		230		deviatore ciclico (kPa)		260	
frequenza (hz)		0.007143		frequenza (hz)		0.007143	
179.33	454.92	197.3	-0.2033	179.33	-0.262	193.2	-0.758
179.42	451.59	195.3	-0.2121	179.42	-0.264	191.1	-0.79
179.50	450.33	193.4	-0.2192	179.50	-0.266	189.2	-0.8095
179.58	448.22	191.8	-0.2308	179.58	-0.268	186.9	-0.8299
179.67	446.6	190.4	-0.237	179.67	-0.27	185	-0.8486
179.75	445.27	189.1	-0.2432	179.75	-0.272	183.3	-0.8646
179.83	444.15	188.1	-0.2494	179.83	-0.275	181.7	-0.8805
179.92	442.69	187	-0.2556	179.93	-0.277	179.1	-0.9036
180.00	441.14	185.8	-0.2619	180.00	-0.277	178.2	-0.9169
180.08	439.21	184.4	-0.2672	180.08	-0.279	176.8	-0.9311
180.17	439.26	183.8	-0.2725	180.17	-0.281	175.5	-0.9444
180.25	438.74	183.1	-0.2787	180.25	-0.282	173.9	-0.956
180.35	437.25	182.1	-0.284	180.33	-0.282	173.1	-0.9737
180.43	436.51	181.3	-0.2876	180.42	-0.283	172.6	-0.9826
180.50	435.76	180.7	-0.2911	180.50	-0.284	171.4	-0.9933
180.58	435.71	180.3	-0.2965	180.58	-0.284	171	-1.0021
180.67	435.43	180	-0.2991	180.67	-0.285	170.4	-1.0101
180.75	435.12	179.7	-0.3027	180.75	-0.285	169.8	-1.0181
180.83	434.81	179.3	-0.3053	180.83	-0.285	169.6	-1.0252
180.92	434.13	178.9	-0.3089	180.92	-0.285	169.4	-1.0341
181.00	434.97	179.3	-0.3098	181.00	-0.285	169.3	-1.0394
181.08	435.56	179.2	-0.3124	181.08	-0.285	169.4	-1.0439
181.17	435.19	179.1	-0.3142	181.17	-0.285	169.4	-1.0483
181.25	436.49	179.4	-0.316	181.25	-0.284	169.6	-1.0519
181.33	436.49	179.4	-0.3169	181.33	-0.283	170.1	-1.0545
181.42	437.39	179.8	-0.3178	181.43	-0.282	170.6	-1.0581
181.50	438.19	180.1	-0.3178	181.50	-0.281	171	-1.0607
181.58	439.56	180.5	-0.3187	181.58	-0.28	171.7	-1.0616
181.67	440.47	181.2	-0.3187	181.67	-0.279	172.6	-1.0625
181.75	441.21	181.5	-0.3187	181.75	-0.277	173.5	-1.0634
181.85	442.41	182.1	-0.3187	181.83	-0.276	174.2	-1.0634
181.92	444.29	182.9	-0.3187	181.92	-0.274	175.2	-1.0634
182.00	445.87	183.8	-0.3187	182.00	-0.272	176.2	-1.0634
182.08	447.88	184.7	-0.3178	182.08	-0.271	177.1	-1.0634
182.17	448.72	185.4	-0.3169	182.17	-0.268	178.4	-1.0625
182.25	450.9	186.4	-0.316	182.25	-0.265	180.1	-1.0616
182.33	452.48	187.2	-0.316	182.33	-0.262	181.6	-1.0607
182.42	454.02	188.1	-0.3151	182.42	-0.261	182.8	-1.0598
182.50	456.6	189.3	-0.3142	182.50	-0.258	184.3	-1.0581
182.58	459.75	190.4	-0.3133	182.58	-0.255	185.7	-1.0572
182.67	462.24	192.1	-0.3116	182.67	-0.253	187.1	-1.0563
182.75	464.05	193.3	-0.3098	182.75	-0.249	188.6	-1.0545
182.83	466.8	194.4	-0.3089	182.85	-0.245	191	-1.0527
182.92	469.69	195.8	-0.308	182.92	-0.243	192.6	-1.051
183.00	471.13	197.3	-0.3062	183.00	-0.239	194.2	-1.0492
183.08	474.22	198.3	-0.3053	183.08	-0.236	196.1	-1.0474
183.17	477.71	200	-0.3036	183.17	-0.231	198.9	-1.0456
183.27	480.73	202	-0.3018	183.25	-0.227	201	-1.0439
183.35	483.48	203.4	-0.3	183.33	-0.224	202.6	-1.0403
183.42	486.67	204.9	-0.2982	183.42	-0.22	204.8	-1.0385
183.50	490.56	206.8	-0.2965	183.50	-0.216	207.2	-1.0359
183.58	495.18	209.4	-0.2947	183.58	-0.213	208.8	-1.0332
183.67	498.64	211.4	-0.292	183.67	-0.207	211.3	-1.0306
183.75	500.89	212.7	-0.2894	183.75	-0.201	214.7	-1.0279
183.83	504.88	214.7	-0.2876	183.83	-0.197	217.4	-1.0252
183.92	509.34	216.9	-0.2858	183.92	-0.193	219.2	-1.0199
184.00	511.62	218.6	-0.2832	184.00	-0.188	222	-1.0172
184.08	515.68	220.6	-0.2805	184.08	-0.183	224.6	-1.0137
184.17	520.58	222.9	-0.2778	184.17	-0.18	226.6	-1.0101
184.25	526.54	226	-0.2752	184.25	-0.174	229.7	-1.0066

Prova triassiale ciclica SNGR03-C4								
tensione di confinamento (kPa)			450	tensione di confinamento (kPa)			450	
deviatore ciclico (kPa)			230	deviatore ciclico (kPa)			260	
frequenza (hz)			0.007143	frequenza (hz)			0.007143	
184.33	528.56	227.9	-0.2707	184.35	-0.168	232.9	-1.0021	
184.42	532.05	229.7	-0.2681	184.42	-0.163	236.1	-0.9977	
184.50	537.11	232.3	-0.2654	184.50	-0.159	238.2	-0.9933	
184.58	541.3	234.8	-0.2619	184.58	-0.153	241	-0.9897	
184.68	546.1	237.5	-0.2583	184.67	-0.145	245.3	-0.9853	
184.77	549.55	239.5	-0.2539	184.75	-0.139	248.9	-0.9808	
184.83	554.78	242.2	-0.2512	184.83	-0.135	250.9	-0.9737	
184.92	559.17	244.6	-0.2468	184.92	-0.13	253.9	-0.9693	
185.00	562.39	246.8	-0.2441	185.00	-0.124	257.3	-0.9631	
185.08	566.41	248.9	-0.2406	185.08	-0.119	259.8	-0.9578	
185.17	573.45	252	-0.2361	185.17	-0.113	262.9	-0.9533	
185.25	579.95	255.8	-0.2326	185.25	-0.104	267.7	-0.9471	
185.33	582.93	258.4	-0.2255	185.33	-0.099	270.9	-0.9427	
185.42	587.29	260.5	-0.2219	185.42	-0.095	273.1	-0.9347	
185.50	593.28	263.4	-0.2175	185.50	-0.088	276.7	-0.9285	
185.58	596.5	266.2	-0.213	185.58	-0.081	280.3	-0.9223	
185.67	600.96	268	-0.2086	185.67	-0.077	282.7	-0.916	
185.75	607.15	271.1	-0.2042	185.77	-0.069	287	-0.9072	
185.83	614.11	275	-0.1997	185.83	-0.061	290.5	-0.901	
185.92	617.56	277.7	-0.1953	185.92	-0.057	293.7	-0.8947	
186.00	622.12	280.1	-0.1873	186.00	-0.052	296.1	-0.8876	
186.08	627.77	283	-0.1829	186.08	-0.045	299.8	-0.8805	
186.18	634.03	286.4	-0.1784	186.17	-0.035	304.7	-0.8726	
186.27	638.58	289.1	-0.1731	186.25	-0.029	308.2	-0.8654	
186.33	642.13	291.4	-0.1642	186.33	-0.025	311	-0.8539	
186.42	647.95	294.2	-0.1598	186.42	-0.015	314.9	-0.8459	
186.50	653	297.2	-0.1527	186.50	-0.012	317.6	-0.8397	
186.58	656.78	299.6	-0.1482	186.58	-0.006	320.5	-0.8299	
186.67	662.53	302.4	-0.1429	186.67	0.003	324.9	-0.8193	
186.75	669.22	305.5	-0.1358	186.75	0.01	329.1	-0.8131	
186.83	674.7	309.1	-0.1305	186.83	0.016	332.7	-0.8033	
186.92	678.41	311.4	-0.1216	186.92	0.021	335.6	-0.7864	
187.00	683.92	314.2	-0.1154	187.00	0.028	339.5	-0.774	
187.08	689.57	317.2	-0.1083	187.08	0.035	343.3	-0.7598	
187.17	694.18	320.1	-0.1012	187.18	0.042	348	-0.7376	
187.25	698.42	322.1	-0.0959	187.25	0.047	351.1	-0.7243	
187.33	705.87	324.8	-0.0888	187.33	0.055	355.1	-0.7057	
187.42	711.41	328.7	-0.0826	187.42	0.062	359.5	-0.6835	
187.50	714.78	331.2	-0.071	187.50	0.064	361.7	-0.6693	
187.60	719.48	333.6	-0.0639	187.58	0.073	366	-0.6471	
187.68	723.58	335.7	-0.0586	187.67	0.082	371.2	-0.6258	
187.75	730.99	339.8	-0.0506	187.75	0.087	374.9	-0.5894	
187.83	733.66	342	-0.0408	187.83	0.092	378.1	-0.5628	
187.92	739.25	344.4	-0.0293	187.92	0.099	382.2	-0.5317	
188.00	744.92	347.2	-0.0204	188.00	0.105	385.9	-0.5006	
188.08	749.11	349.7	-0.0107	188.08	0.111	389.7	-0.4625	
188.17	752.21	352	-0.0009	188.17	0.117	393.3	-0.4287	
188.25	757.5	354.4	0.0107	188.25	0.125	398.2	-0.3977	
188.33	763.99	357.2	0.0222	188.33	0.13	401.8	-0.3373	
188.42	768.71	360.7	0.0337	188.42	0.136	405	-0.2929	
188.50	772.02	362.9	0.0524	188.50	0.143	409.1	-0.2388	
188.58	776.53	365.3	0.0666	188.58	0.145	411.6	-0.1971	
188.67	781.31	367.7	0.0808	188.68	0.152	415.8	-0.1305	
188.75	785.49	370	0.0959	188.75	0.16	419.1	-0.079	
188.83	789.26	372	0.1101	188.83	0.164	422.2	-0.0257	
188.92	793.93	374.4	0.126	188.92	0.17	425.5	0.0222	
189.00	799.34	376.6	0.1411	189.00	0.175	428.4	0.0719	
189.10	802.23	379	0.1624	189.08	0.181	431.8	0.126	
189.17	805.07	380.6	0.1766	189.17	0.188	435.6	0.1633	
189.25	809.49	382.8	0.1944	189.25	0.191	438	0.229	

Prova triassiale ciclica SNGR03-C4							
tensione di confinamento (kPa)	450			tensione di confinamento (kPa)	450		
deviatore ciclico (kPa)	230			deviatore ciclico (kPa)	260		
frequenza (hz)	0.007143			frequenza (hz)	0.007143		
189.33	815.85	385.1	0.2121	189.33	0.197	440.6	0.2734
189.42	819.31	387.6	0.229	189.42	0.204	444.1	0.324
189.50	821.98	389.3	0.2556	189.50	0.206	445.9	0.3586
189.58	826.2	391	0.2725	189.58	0.211	448.4	0.3994
189.67	830.25	392.8	0.292	189.67	0.216	450.9	0.4429
189.75	831.47	394	0.308	189.75	0.223	454.5	0.4811
189.83	836.15	395.7	0.3267	189.83	0.227	456.6	0.5335
189.92	839.63	397.4	0.3444	189.92	0.23	458.6	0.5681
190.00	844.27	399.6	0.363	190.00	0.235	460.8	0.6045
190.08	847.48	401.2	0.379	190.08	0.241	463.3	0.6409
190.17	848.49	402.1	0.4021	190.17	0.244	465.3	0.6817
190.25	853.06	403.7	0.4181	190.25	0.248	467.1	0.711
190.33	855.64	404.9	0.4341	190.33	0.252	468.7	0.7367
190.42	858.52	406.1	0.4509	190.42	0.255	470.3	0.7616
190.52	861.09	407.6	0.4713	190.50	0.259	472	0.7927
190.60	863.27	408.6	0.4855	190.58	0.264	473.3	0.8175
190.67	866.88	410	0.5006	190.67	0.269	475.7	0.8441
190.75	870.18	411.2	0.5166	190.75	0.269	476.6	0.8814
190.83	870.38	411.7	0.5273	190.83	0.273	477.9	0.9054
190.92	873.89	412.6	0.5406	190.92	0.275	479	0.9276
191.00	875.94	414	0.553	191.00	0.279	480.3	0.9489
191.08	878.74	415	0.5716	191.08	0.281	481.2	0.9675
191.17	879.11	415.4	0.5814	191.17	0.284	482.3	0.9862
191.25	883.17	416.6	0.5947	191.25	0.286	483.3	1.0048
191.33	881.43	416.6	0.6027	191.33	0.288	484	1.0306
191.42	884.48	417.4	0.6125	191.42	0.291	485	1.0483
191.50	885.68	418.1	0.6213	191.50	0.294	485.9	1.0643
191.58	890.33	419.5	0.6302	191.60	0.295	486.6	1.0785
191.67	888.78	419.2	0.6453	191.67	0.297	487.5	1.1007
191.75	889.33	419.7	0.6515	191.75	0.297	487.6	1.1113
191.83	890.63	420.3	0.6586	191.83	0.301	488.4	1.1255
191.92	891.63	420.7	0.6666	191.92	0.302	488.8	1.1362
192.00	892.59	421	0.6764	192.00	0.302	489	1.1451
192.08	892.28	421.1	0.6817	192.08	0.303	489.3	1.1539
192.17	892.89	421.4	0.687	192.17	0.304	489.5	1.1619
192.25	894.26	421.9	0.6932	192.25	0.305	489.8	1.1735
192.33	894.97	421.9	0.6977	192.33	0.305	489.9	1.1806
192.42	894.47	421.9	0.7012	192.42	0.305	489.8	1.1859
192.50	894.78	422.1	0.7057	192.50	0.305	489.9	1.1912
192.58	895	422.2	0.711	192.58	0.305	489.9	1.1957
192.67	894.69	422.1	0.7137	192.67	0.305	489.8	1.1992
192.75	895.24	422.4	0.7172	192.75	0.305	489.6	1.2028
192.83	895.1	422.2	0.719	192.83	0.305	489.5	1.2072
192.92	892.68	421.7	0.7217	192.92	0.304	489.3	1.2099
193.00	892.88	421.6	0.7234	193.02	0.303	489.1	1.2116
193.08	891.85	421.5	0.7252	193.08	0.302	488.6	1.2134
193.17	891.51	421.3	0.7261	193.17	0.302	488.3	1.2161
193.25	891.54	421.2	0.727	193.25	0.3	487.9	1.217
193.33	889.2	421	0.7279	193.33	0.298	487.3	1.217
193.43	888.67	420.5	0.7279	193.42	0.298	487.1	1.2178
193.52	888.17	420.1	0.7279	193.50	0.296	486.6	1.2178
193.58	886.28	419.7	0.7279	193.58	0.294	486.2	1.2178
193.67	883.87	419.2	0.7279	193.67	0.292	485.3	1.2178
193.75	882.02	418.5	0.727	193.75	0.29	484.6	1.217
193.83	882.29	418.3	0.727	193.83	0.287	484	1.2161
193.92	877.86	417.4	0.7252	193.92	0.284	483.1	1.2152
194.00	877.1	416.8	0.7252	194.00	0.284	482.8	1.2152
194.08	875.72	416.3	0.7234	194.08	0.281	482	1.2143
194.17	873.94	415.6	0.7225	194.17	0.277	480.8	1.2125
194.25	871.66	415	0.7217	194.25	0.275	480	1.2125

Prova triassiale ciclica SNGR03-C4							
tensione di confinamento (kPa)	450			tensione di confinamento (kPa)	450		
deviatore ciclico (kPa)	230			deviatore ciclico (kPa)	260		
frequenza (hz)	0.007143			frequenza (hz)	0.007143		
194.33	868.23	413.9	0.7199	194.33	0.27	478.9	1.2107
194.42	865.02	412.9	0.719	194.42	0.268	478.2	1.2099
194.50	862.58	412.1	0.7163	194.52	0.265	477.5	1.209
194.58	860.47	411.4	0.7154	194.58	0.26	475.8	1.2072
194.67	858.36	410.7	0.7137	194.67	0.258	474.8	1.2054
194.75	855.82	409.8	0.7119	194.75	0.255	473.9	1.2036
194.85	852.05	408.6	0.7092	194.83	0.249	472.3	1.201
194.92	848.32	407.4	0.7066	194.92	0.249	471.8	1.2001
195.00	846.15	406.6	0.7039	195.00	0.244	470.6	1.1983
195.08	843.68	405.7	0.7012	195.08	0.237	468.9	1.1957
195.17	840.18	404.5	0.6986	195.17	0.233	467.1	1.1948
195.25	835.13	402.8	0.695	195.25	0.231	466.2	1.1912
195.33	831.69	401.6	0.6915	195.33	0.226	464.7	1.1894
195.42	827.44	400.3	0.6861	195.42	0.221	463.2	1.1868
195.50	825.33	399.3	0.6844	195.50	0.216	461.7	1.1841
195.58	822.13	398.1	0.6799	195.58	0.211	460.3	1.1814
195.67	817.57	396.8	0.6764	195.67	0.203	458.8	1.1779
195.75	813.54	395.5	0.6728	195.75	0.2	456.5	1.1752
195.83	809.32	393.2	0.6684	195.83	0.196	455	1.1708
195.92	804.67	391.8	0.6604	195.93	0.19	453.1	1.1672
196.00	802.86	391	0.656	196.00	0.183	451.3	1.1637
196.08	797.67	389.2	0.6506	196.08	0.179	449.2	1.1601
196.17	794.08	387.5	0.6444	196.17	0.174	447.4	1.1557
196.25	790.8	386.5	0.6409	196.25	0.168	445.4	1.1513
196.35	782.32	383.8	0.632	196.33	0.163	443.7	1.1477
196.42	779.88	382.4	0.6267	196.42	0.158	441.8	1.1433
196.50	778.95	381.7	0.6231	196.50	0.152	439.8	1.1388
196.58	773.24	379.7	0.616	196.58	0.143	437.1	1.1326
196.67	765.43	376.9	0.6098	196.67	0.136	434.1	1.1291
196.75	762.77	375.6	0.6009	196.75	0.133	432.3	1.122
196.83	757.41	373.7	0.5947	196.83	0.124	429.8	1.1158
196.92	751.92	371.5	0.5867	196.92	0.119	427.9	1.1113
197.00	748.82	369.9	0.5796	197.00	0.118	426.4	1.1069
197.08	742.07	367.8	0.5725	197.08	0.11	423.7	1.1007
197.17	738.86	366.1	0.5654	197.17	0.102	421.1	1.0953
197.25	730.89	363	0.5566	197.25	0.093	417.6	1.09
197.33	728.08	361.4	0.545	197.33	0.09	415.3	1.0794
197.42	723.95	359.8	0.5379	197.42	0.084	413.3	1.074
197.50	717.96	357.3	0.5281	197.50	0.074	411	1.0678
197.58	714.52	355.7	0.5202	197.58	0.067	406.8	1.0616
197.67	708.89	353.4	0.5113	197.67	0.061	404	1.0501
197.77	701.63	350.2	0.4962	197.75	0.056	402.1	1.0439
197.83	698.16	348.2	0.4882	197.83	0.049	399	1.0359
197.92	694.61	346.7	0.4802	197.92	0.045	396.6	1.0288
198.00	686.03	343.7	0.4704	198.00	0.038	394.3	1.0226
198.08	680.29	340.7	0.4625	198.08	0.027	391.4	1.0146
198.17	677.64	338.9	0.4483	198.17	0.021	387.1	1.0057
198.25	672.2	336.7	0.4385	198.25	0.016	384.5	0.9933
198.33	666.53	334.1	0.4278	198.33	0.011	382.3	0.9844
198.42	663.18	332.1	0.4181	198.42	0.003	379.1	0.9746
198.50	659.03	330.1	0.4074	198.50	-0.002	376.5	0.964
198.58	649.96	326.8	0.395	198.58	-0.009	373.6	0.9516
198.67	644.62	323.3	0.3861	198.67	-0.018	370.7	0.9409
198.75	641.49	321.4	0.3693	198.75	-0.027	366.1	0.9285
198.83	636.17	318.9	0.3586	198.85	-0.029	364	0.9107
198.92	630.36	316.1	0.3471	198.92	-0.034	361.8	0.8974
199.00	627.13	314.5	0.3364	199.00	-0.044	357.9	0.8797
199.08	621.54	311.9	0.3249	199.08	-0.053	353.8	0.8619
199.17	613.19	307.8	0.3124	199.17	-0.056	351.4	0.8273
199.27	612.12	306	0.2982	199.25	-0.063	348.5	0.8007

Prova triassiale ciclica SNGR03-C4							
tensione di confinamento (kPa)	450			tensione di confinamento (kPa)	450		
deviatore ciclico (kPa)	230			deviatore ciclico (kPa)	260		
frequenza (hz)	0.007143			frequenza (hz)	0.007143		
199.33	607.39	303.8	0.2876	199.33	-0.07	345	0.7696
199.42	599.77	300.5	0.2752	199.42	-0.073	342.2	0.7376
199.50	594.24	297	0.2654	199.50	-0.081	339.1	0.7057
199.58	590.97	294.2	0.2494	199.58	-0.09	335.5	0.6737
199.67	587	292	0.2388	199.67	-0.097	330.8	0.6444
199.75	579.4	288.7	0.2263	199.75	-0.101	327.9	0.5956
199.83	578.19	286.5	0.2166	199.83	-0.108	324.7	0.5601
199.92	572.38	283.6	0.2042	199.92	-0.114	321.1	0.5237
200.00	564.42	280.9	0.1935	200.00	-0.118	318	0.4882
200.08	561.6	276.7	0.1802	200.08	-0.125	314.2	0.4483
200.17	558.32	274.5	0.1651	200.17	-0.132	310.2	0.4074
200.25	552.97	271.7	0.1527	200.25	-0.14	304.6	0.3666
200.33	548.65	268.4	0.1376	200.33	-0.142	301.6	0.3071
200.42	546.07	266.5	0.1269	200.42	-0.148	297.9	0.2672
200.50	540.69	263.4	0.1127	200.50	-0.156	293.9	0.2255
200.58	535.13	259.7	0.0994	200.58	-0.161	287.9	0.182
200.68	531.37	256.9	0.0808	200.67	-0.165	284.4	0.1127
200.75	528.08	254.9	0.0692	200.75	-0.17	280.2	0.0657
200.83	522.39	251.9	0.0559	200.83	-0.176	275.5	0.0178
200.92	517.13	248	0.0435	200.92	-0.179	271.8	-0.0266
201.00	514.99	245.2	0.024	201.00	-0.184	267.9	-0.0737
201.08	510.99	242.9	0.0107	201.08	-0.192	263.3	-0.1234
201.17	506.16	240	-0.0018	201.17	-0.197	256.9	-0.1695
201.25	504.57	237.8	-0.0133	201.25	-0.2	253.1	-0.2343
201.33	500.64	235.3	-0.0257	201.33	-0.204	249.3	-0.2778
201.42	494.8	232.4	-0.0391	201.42	-0.21	244.7	-0.3231
201.50	492.37	229	-0.0506	201.50	-0.212	241.3	-0.3613
201.58	490.37	226.9	-0.0666	201.58	-0.217	237.6	-0.4012
201.67	486.1	224.5	-0.0781	201.67	-0.222	233.7	-0.4403
201.75	483.03	221.8	-0.0897	201.77	-0.225	228.9	-0.4926
201.83	481.03	220.1	-0.1003	201.83	-0.228	225.7	-0.5255
201.92	476.59	217.6	-0.1118	201.92	-0.232	222.8	-0.5592
202.00	473.36	214.4	-0.1216	202.00	-0.238	218.8	-0.5929
202.08	471.72	212.4	-0.1376	202.08	-0.241	214.4	-0.624
202.17	469.49	210.7	-0.1465	202.17	-0.244	211.2	-0.6684
202.25	465.18	208.2	-0.1562	202.25	-0.248	207.4	-0.7021
202.33	463.02	205.6	-0.1651	202.33	-0.25	205.2	-0.7279
202.42	461.18	204	-0.1793	202.42	-0.252	202.7	-0.7536
202.50	458.61	202.1	-0.1882	202.50	-0.255	200.2	-0.7785
202.58	456.18	200.3	-0.1971	202.58	-0.259	197.5	-0.8033
202.67	454.75	198.7	-0.205	202.67	-0.262	194.1	-0.8255
202.75	452.42	197	-0.2139	202.75	-0.264	192.1	-0.8566
202.83	449.72	195.3	-0.221	202.83	-0.266	190	-0.877
202.92	447.93	193.2	-0.2281	202.92	-0.268	187.7	-0.8974
203.00	447.02	192.1	-0.2397	203.00	-0.27	186.1	-0.916
203.08	445.4	190.8	-0.2459	203.08	-0.272	184.1	-0.9338
203.17	443.77	189.2	-0.253	203.18	-0.274	181.9	-0.9578
203.25	442.58	188.3	-0.2592	203.25	-0.275	180.5	-0.9729
203.33	440.76	187.2	-0.2654	203.33	-0.276	179.4	-0.9862
203.42	439.54	185.8	-0.2707	203.42	-0.279	177.5	-1.0013
203.50	439.04	185.2	-0.2787	203.50	-0.28	176.8	-1.0137
203.60	438.29	184.4	-0.2832	203.58	-0.281	175.1	-1.0252
203.67	437.18	183.7	-0.2876	203.67	-0.282	174.4	-1.0421
203.75	436.66	182.8	-0.2911	203.75	-0.284	173.1	-1.0527
203.83	435.77	182.1	-0.2974	203.83	-0.283	172.8	-1.0625
203.92	435.7	181.8	-0.3009	203.92	-0.284	172.1	-1.0714
204.00	435.02	181.4	-0.3045	204.00	-0.285	171.4	-1.0803
204.08	435.11	181.1	-0.3071	204.08	-0.285	171	-1.0865
204.17	435	180.9	-0.3098	204.17	-0.285	170.7	-1.0936
204.25	434.93	180.6	-0.3116	204.25	-0.285	170.6	-1.1024

Prova triassiale ciclica SNGR03-C4

tensione di confinamento (kPa)	450			tensione di confinamento (kPa)	450		
deviatore ciclico (kPa)	230			deviatore ciclico (kPa)	260		
frequenza (hz)	0.007143			frequenza (hz)	0.007143		
204.33	435.09	180.6	-0.3142	204.33	-0.285	170.5	-1.1078
204.42	435.58	180.6	-0.3169	204.42	-0.284	170.6	-1.1122
204.50	435.88	180.6	-0.3187	204.50	-0.284	170.5	-1.1167
204.58	436.07	180.7	-0.3204	204.58	-0.284	170.8	-1.1202
204.67	436.71	180.9	-0.3213	204.68	-0.283	171.4	-1.1246
204.75	437.68	181.2	-0.3222	204.75	-0.282	171.7	-1.1264
204.83	437.98	181.5	-0.3231	204.83	-0.281	172.1	-1.1291
204.92	439.25	182.1	-0.3231	204.92	-0.28	172.7	-1.13
205.02	440.52	182.7	-0.3231	205.00	-0.278	173.4	-1.1309
205.08	441.69	183	-0.324	205.08	-0.277	174.6	-1.1317
205.17	442.8	183.8	-0.324	205.17	-0.276	175.3	-1.1326
205.25	444.31	184.6	-0.3231	205.25	-0.273	176.6	-1.1317
205.33	445.69	185.3	-0.3231	205.33	-0.272	177.4	-1.1317
205.42	447.26	186.1	-0.3222	205.42	-0.27	178.4	-1.1317
205.50	448.47	186.7	-0.3222	205.50	-0.268	179.7	-1.1309
205.58	450.35	187.7	-0.3213	205.58	-0.265	180.8	-1.13
205.67	453.07	189.1	-0.3204	205.67	-0.262	183	-1.1291
205.75	455.18	190.3	-0.3196	205.75	-0.26	183.9	-1.1273
205.83	456.62	190.9	-0.3187	205.83	-0.258	185.5	-1.1264
205.92	459.68	192.2	-0.3178	205.92	-0.254	187.1	-1.1255
206.00	461.09	193.3	-0.316	206.00	-0.253	188.3	-1.1238
206.08	463.94	194.4	-0.3151	206.10	-0.249	190.5	-1.122
206.17	466.79	195.9	-0.3142	206.17	-0.245	192	-1.1211
206.25	470.28	197.8	-0.3133	206.25	-0.242	193.8	-1.1193
206.33	471.42	198.6	-0.3116	206.33	-0.239	195.5	-1.1175
206.42	474.91	200.2	-0.3098	206.42	-0.236	197.4	-1.1158
206.52	478.5	202.3	-0.308	206.50	-0.231	199.4	-1.1131
206.58	482.05	204.1	-0.3071	206.58	-0.227	202.4	-1.1113
206.67	483.77	205.3	-0.3045	206.67	-0.224	203.9	-1.1087
206.75	486.92	206.8	-0.3027	206.75	-0.219	206.2	-1.106
206.83	490.78	208.9	-0.3	206.83	-0.216	208.4	-1.1033
206.92	493.23	210.3	-0.2982	206.92	-0.212	210.3	-1.1007
207.00	497.79	212.3	-0.2965	207.00	-0.207	212.7	-1.0989
207.08	502.59	215	-0.2947	207.08	-0.202	215.2	-1.0953
207.17	504.34	216.5	-0.2911	207.17	-0.196	218.7	-1.0927
207.25	508.26	218.4	-0.2894	207.25	-0.193	220.8	-1.0882
207.33	513.19	220.8	-0.2876	207.33	-0.188	223.2	-1.0847
207.42	515.17	222.5	-0.2849	207.42	-0.182	226.3	-1.0811
207.50	519.63	224.5	-0.2823	207.50	-0.18	228.3	-1.0785
207.58	524.96	226.9	-0.2796	207.58	-0.174	231.9	-1.074
207.67	530.02	230.2	-0.2769	207.67	-0.168	234.4	-1.0705
207.75	532.41	231.7	-0.2725	207.75	-0.162	237.4	-1.0661
207.83	537.51	234.2	-0.2698	207.83	-0.16	239.6	-1.0625
207.93	541.46	236.9	-0.2663	207.92	-0.153	242.5	-1.0581
208.00	547.09	239.7	-0.2627	208.00	-0.146	245.8	-1.0536
208.08	549.65	241.3	-0.2592	208.08	-0.139	250.2	-1.0492
208.17	554.98	244	-0.2556	208.17	-0.135	252.6	-1.0421
208.25	558.93	246.7	-0.2521	208.25	-0.129	255.4	-1.0377
208.33	562.55	248.6	-0.2485	208.33	-0.123	258.6	-1.0323
208.42	568.65	251.4	-0.2441	208.42	-0.119	261.4	-1.027
208.50	575.25	255	-0.2414	208.50	-0.113	264.6	-1.0217
208.58	577.4	257.1	-0.2352	208.58	-0.105	267.9	-1.0163
208.67	582.59	259.6	-0.2308	208.67	-0.098	272.5	-1.011
208.75	588.09	262.8	-0.2263	208.75	-0.094	274.9	-1.003
208.83	591.61	264.8	-0.2219	208.83	-0.087	278.3	-0.9968
208.92	596.23	267.3	-0.2184	208.92	-0.08	281.6	-0.9906
209.00	603.16	270.3	-0.213	209.02	-0.075	285.4	-0.9853
209.08	608.35	274.3	-0.2086	209.08	-0.07	288.2	-0.9764
209.17	611.8	276.3	-0.2015	209.17	-0.062	291.8	-0.9693
209.25	618.23	279.4	-0.1971	209.25	-0.056	295.3	-0.9604

Prova triassiale ciclica SNGR03-C4							
tensione di confinamento (kPa)	450			tensione di confinamento (kPa)	450		
deviatore ciclico (kPa)	230			deviatore ciclico (kPa)	260		
frequenza (hz)	0.007143			frequenza (hz)	0.007143		
209.33	621.24	281.7	-0.1926	209.33	-0.052	297.8	-0.9551
209.43	626.77	285.2	-0.1855	209.42	-0.044	301.4	-0.9471
209.50	631.65	287.6	-0.1811	209.50	-0.036	306	-0.94
209.58	638.38	290.8	-0.1758	209.58	-0.029	309.9	-0.932
209.67	640.92	293.1	-0.1695	209.67	-0.023	312.8	-0.9196
209.75	646.85	295.7	-0.1642	209.75	-0.017	316.2	-0.9116
209.83	654.07	298.7	-0.158	209.83	-0.01	319.5	-0.9036
209.92	660.32	302.7	-0.1536	209.92	-0.007	322.2	-0.8956
210.00	662.13	305	-0.1447	210.00	0	325.9	-0.8859
210.08	669.39	307.9	-0.1385	210.08	0.012	331.5	-0.8752
210.17	674.2	310.7	-0.1323	210.17	0.016	334.6	-0.8672
210.25	676.97	312.7	-0.1269	210.25	0.022	337.5	-0.8512
210.33	683.49	315.8	-0.1207	210.33	0.03	341.5	-0.8379
210.42	690.44	319.8	-0.1145	210.42	0.033	344.3	-0.8255
210.50	694.48	322.4	-0.1074	210.52	0.043	350.1	-0.8015
210.58	699.16	324.9	-0.0976	210.58	0.048	353	-0.7882
210.67	705.27	327.7	-0.0897	210.67	0.051	355.4	-0.7749
210.75	709.3	330.4	-0.0834	210.75	0.062	361.6	-0.7527
210.85	713.27	333.4	-0.0746	210.83	0.067	364.9	-0.7243
210.92	719.22	335.8	-0.0675	210.92	0.073	368.5	-0.7021
211.00	724.55	338.6	-0.0595	211.00	0.081	372.6	-0.6764
211.08	727.39	341.1	-0.0524	211.08	0.085	376	-0.6506
211.17	733.36	343.6	-0.0435	211.17	0.091	379.6	-0.6231
211.25	743.1	346.4	-0.0337	211.25	0.1	383.5	-0.5921
211.33	744.26	349.7	-0.0266	211.33	0.107	389	-0.5628
211.42	748.01	352	-0.0115	211.42	0.111	392.4	-0.5113
211.50	753.71	354.9	0	211.50	0.118	396	-0.4722
211.58	758.1	357.4	0.0115	211.58	0.124	400	-0.4314
211.67	761.75	359.7	0.0231	211.67	0.128	403.2	-0.3923
211.75	768.01	362.2	0.0355	211.75	0.134	406.5	-0.3462
211.83	773.73	365.8	0.0479	211.83	0.142	410.3	-0.2956
211.92	777.09	368.1	0.0701	211.93	0.147	414.6	-0.229
212.00	780.74	370	0.0834	212.02	0.151	417.6	-0.1811
212.08	786.35	372.6	0.0994	212.08	0.158	420.9	-0.1269
212.17	788.96	374.7	0.1145	212.17	0.164	424.2	-0.0692
212.25	793.75	376.9	0.1331	212.25	0.172	429.2	-0.0115
212.33	797.95	379.4	0.1518	212.33	0.176	431.9	0.032
212.42	803.15	381.8	0.1687	212.42	0.181	434.8	0.103
212.50	805.85	383.3	0.1855	212.50	0.187	437.9	0.1553
212.58	810.27	385.5	0.2042	212.58	0.193	441	0.2059
212.67	815.62	387.3	0.2228	212.67	0.197	443.5	0.2503
212.75	819.61	390.2	0.2406	212.75	0.2	445.8	0.2885
212.83	822.31	391.7	0.2707	212.83	0.209	448.7	0.332
212.92	826.33	393.5	0.2903	212.92	0.215	452.7	0.3755
213.00	829.87	395.2	0.3089	213.00	0.216	454.5	0.4376
213.08	832.53	396.6	0.3267	213.08	0.222	456.9	0.4776
213.17	836.47	398.3	0.3444	213.17	0.227	459.3	0.5139
213.25	841.21	400.6	0.363	213.25	0.23	461.4	0.5494
213.33	843.67	402.1	0.3897	213.35	0.236	464.2	0.6
213.42	846.78	403.4	0.4065	213.43	0.238	465.7	0.632
213.50	850.49	404.8	0.4243	213.50	0.244	467.8	0.6631
213.58	853.93	406.4	0.4429	213.58	0.249	470	0.7003
213.67	855.19	407	0.4562	213.67	0.251	471.3	0.7296
213.77	858.48	408.8	0.4793	213.75	0.254	472.7	0.7536
213.83	860.59	409.9	0.4944	213.83	0.262	474.5	0.7829
213.92	863.04	410.9	0.5104	213.92	0.263	476.5	0.8113
214.00	865.91	412	0.5255	214.00	0.268	478.2	0.8539
214.08	871.21	413.1	0.5397	214.08	0.271	479.4	0.8779
214.17	871.01	414.3	0.553	214.17	0.273	480.5	0.901
214.25	875.03	415.5	0.5734	214.25	0.276	481.7	0.9249

Prova triassiale ciclica SNGR03-C4							
tensione di confinamento (kPa)	450			tensione di confinamento (kPa)	450		
deviatore ciclico (kPa)	230			deviatore ciclico (kPa)	260		
frequenza (hz)	0.007143			frequenza (hz)	0.007143		
214.33	875.75	416.2	0.5858	214.33	0.278	482.5	0.9453
214.42	877.5	417	0.5983	214.42	0.28	483.7	0.9675
214.50	879.09	417.6	0.6089	214.50	0.284	484.8	0.9879
214.58	881.01	418.5	0.6213	214.58	0.288	486.3	1.0066
214.67	883.3	419.5	0.632	214.67	0.288	486.9	1.0341
214.75	884.55	420	0.6462	214.75	0.293	487.9	1.0545
214.83	885.84	420.6	0.656	214.85	0.294	488.3	1.0669
214.92	887.7	421.2	0.6657	214.93	0.295	489.1	1.0803
215.00	888.37	421.6	0.6737	215.00	0.298	489.8	1.1016
215.08	889.93	422.1	0.6826	215.08	0.299	490.3	1.1149
215.18	891.08	422.7	0.6941	215.17	0.299	490.4	1.1246
215.25	891.69	422.9	0.7003	215.25	0.301	491	1.1362
215.33	894.08	423.6	0.7083	215.33	0.302	491.3	1.1468
215.42	892.74	423.5	0.7137	215.42	0.302	491.6	1.1557
215.50	893.98	423.9	0.719	215.50	0.304	491.8	1.1646
215.58	894.49	424.1	0.7252	215.58	0.304	491.9	1.1726
215.67	894.3	424.2	0.7323	215.67	0.304	492.1	1.1832
215.75	895.51	424.4	0.7376	215.75	0.305	492.3	1.1894
215.83	894.41	424.3	0.7412	215.83	0.306	492.2	1.1948
215.92	894.76	424.4	0.7447	215.92	0.305	492.2	1.2001
216.00	894.52	424.3	0.7483	216.00	0.305	492.1	1.2036
216.08	894.47	424.4	0.7518	216.08	0.306	492.1	1.2081
216.17	894.33	424.3	0.7554	216.17	0.304	491.7	1.2107
216.25	893.76	424.2	0.7572	216.27	0.305	491.7	1.2161
216.33	893.16	424	0.7598	216.35	0.303	491.3	1.2178
216.42	892.27	423.8	0.7607	216.42	0.303	491.1	1.2196
216.50	892	423.8	0.7625	216.50	0.3	490.7	1.2214
216.58	890.61	423.4	0.7634	216.58	0.301	490.4	1.2223
216.68	889.45	422.9	0.7643	216.67	0.298	489.7	1.2232
216.75	888.82	422.7	0.7643	216.75	0.297	489.3	1.2232
216.83	887.03	422.3	0.7643	216.83	0.297	489.1	1.2241
216.92	885.64	421.7	0.7643	216.92	0.294	488.4	1.2241
217.00	884.3	421.3	0.7634	217.00	0.292	487.9	1.2232
217.08	882.78	420.8	0.7634	217.08	0.29	487.2	1.2232
217.17	880.47	420.2	0.7625	217.17	0.287	486.7	1.2223
217.25	879.61	419.8	0.7625	217.25	0.285	485.6	1.2223
217.33	878.68	419.5	0.7616	217.33	0.283	484.8	1.2205
217.42	874.1	418.3	0.7598	217.42	0.28	484	1.2196
217.50	873.93	417.9	0.7589	217.50	0.277	483.1	1.2187
217.58	871.1	417.1	0.758	217.58	0.275	482.5	1.2178
217.67	868.59	416.3	0.7572	217.67	0.272	481.6	1.217
217.75	866.01	415.4	0.7554	217.77	0.27	480.7	1.2161
217.83	863.44	414.6	0.7536	217.83	0.263	479.2	1.2134
217.92	861.07	413.9	0.7518	217.92	0.262	478.5	1.2125
218.00	857.7	412.7	0.7501	218.00	0.259	477.5	1.2107
218.10	855.16	411.8	0.7474	218.08	0.255	476.3	1.209
218.17	853.28	411.1	0.7456	218.17	0.251	474.9	1.2081
218.25	849.82	410	0.7438	218.25	0.245	473.3	1.2054
218.33	844.67	408.3	0.7412	218.33	0.241	472.2	1.2028
218.42	843.13	407.5	0.7367	218.42	0.238	471.2	1.201
218.50	841.61	406.9	0.7341	218.50	0.233	469.6	1.1983
218.58	835.04	405.1	0.7296	218.58	0.231	468.6	1.1965
218.67	832.97	404	0.727	218.67	0.227	467.5	1.1948
218.75	829.28	403	0.7234	218.75	0.221	465.6	1.1912
218.83	824.22	401.8	0.7208	218.83	0.216	463.8	1.1894
218.92	820.76	399.9	0.7172	218.92	0.209	461.9	1.1868
219.00	820.01	399.3	0.7119	219.00	0.205	460.6	1.1823
219.08	813.67	397.4	0.7066	219.08	0.2	458.9	1.1797
219.17	809.65	396	0.7021	219.18	0.195	457.5	1.177
219.25	809.25	395.2	0.6986	219.27	0.188	454.8	1.1735

Prova triassiale ciclica SNGR03-C4							
tensione di confinamento (kPa)	450			tensione di confinamento (kPa)	450		
deviatore ciclico (kPa)	230			deviatore ciclico (kPa)	260		
frequenza (hz)	0.007143			frequenza (hz)	0.007143		
219.33	801.4	393	0.6924	219.33	0.185	453.4	1.1681
219.42	795.36	390.9	0.6888	219.42	0.18	451.7	1.1646
219.50	792.88	389.5	0.6826	219.50	0.172	449.4	1.1601
219.60	790.18	388.6	0.6755	219.58	0.17	448.1	1.1575
219.67	783.71	386.6	0.6693	219.67	0.164	446.3	1.153
219.75	777.33	384.2	0.6648	219.75	0.157	443.9	1.1486
219.83	775.96	382.8	0.6551	219.83	0.149	440.8	1.1442
219.92	770.64	381.5	0.6498	219.92	0.143	439	1.1397
220.00	766.05	379.4	0.6427	220.00	0.139	437	1.1317
220.08	764.8	378.5	0.6373	220.08	0.133	434.8	1.1273
220.17	757.4	376.1	0.6293	220.17	0.126	432.6	1.122
220.25	750.92	374.3	0.6222	220.25	0.12	430.1	1.1158
220.33	745.43	371.3	0.6169	220.33	0.116	428.3	1.1113
220.42	742.76	369.8	0.6045	220.42	0.107	425.8	1.1051
220.50	740.02	368.5	0.5983	220.50	0.1	422.3	1.0998
220.58	732.55	365.8	0.5894	220.58	0.095	420	1.0945
220.67	728.55	363.9	0.5805	220.68	0.091	418.3	1.0856
220.75	724.02	362	0.5734	220.75	0.083	415.5	1.0794
220.83	717.07	359.1	0.5645	220.83	0.074	411.8	1.0723
220.92	712.54	357	0.5521	220.92	0.068	409.4	1.0661
221.02	708.4	355.2	0.5441	221.00	0.063	406.9	1.0554
221.08	702.48	353	0.5352	221.08	0.055	404.3	1.0483
221.17	694.43	349.6	0.5281	221.17	0.049	401.6	1.0412
221.25	692.61	347.9	0.5131	221.25	0.046	399	1.0341
221.33	687.77	346	0.5024	221.33	0.036	396	1.0243
221.42	681.84	343.5	0.4918	221.42	0.03	393.5	1.0172
221.50	678.66	341.5	0.4829	221.50	0.02	389.2	1.0101
221.58	675.28	339.9	0.4731	221.58	0.015	386.5	1.0013
221.67	667.95	336.2	0.4607	221.67	0.01	384.3	0.9879
221.75	659.23	332.9	0.45	221.75	0.003	381.3	0.9764
221.83	656.5	331.2	0.4349	221.83	-0.005	378	0.9658
221.92	650.16	328.5	0.4234	221.92	-0.009	375.7	0.956
222.00	647.54	326.6	0.4128	222.00	-0.016	372.8	0.9453
222.08	642.59	324.3	0.4012	222.10	-0.024	369	0.9294
222.17	636.55	321.6	0.3906	222.18	-0.033	365.7	0.9152
222.25	629.01	318	0.379	222.25	-0.035	363.5	0.9027
222.33	626.51	315.8	0.3604	222.33	-0.042	360.8	0.8868
222.42	620.55	313.3	0.348	222.42	-0.05	357.5	0.8681
222.50	615.7	311.1	0.3373	222.50	-0.059	353.2	0.8424
222.58	607.72	307.1	0.3258	222.58	-0.064	350	0.8175
222.67	605.84	304.7	0.3089	222.67	-0.068	347.3	0.7731
222.75	600.58	302.4	0.2982	222.75	-0.076	344.2	0.7394
222.83	594.29	299.4	0.2867	222.83	-0.085	340	0.7003
222.92	591.85	297.4	0.2752	222.92	-0.088	337.6	0.6702
223.00	586.69	294.5	0.2636	223.00	-0.094	334.6	0.6391
223.08	579.56	290.5	0.2521	223.08	-0.102	330.9	0.6054
223.17	574.29	287.5	0.2406	223.17	-0.11	325.9	0.5716
223.25	572.04	285.3	0.2219	223.25	-0.116	322.1	0.5326
223.33	566.57	282.2	0.2095	223.33	-0.119	319.4	0.4722
223.42	562.09	279.3	0.1971	223.42	-0.127	315.3	0.4296
223.50	558.44	277.1	0.1846	223.52	-0.133	311.5	0.3888
223.58	552.23	274.4	0.1722	223.60	-0.14	306.3	0.3488
223.67	546.72	269.8	0.1598	223.67	-0.143	302.7	0.2867
223.75	544.29	267.1	0.1385	223.75	-0.149	299.2	0.2406
223.83	540.54	265.1	0.1243	223.83	-0.155	294.6	0.1926
223.93	534.05	261.7	0.1092	223.92	-0.159	290.8	0.1447
224.00	529.93	258.5	0.0976	224.00	-0.164	286.9	0.095
224.08	527.26	256.2	0.0781	224.08	-0.17	282.4	0.0462
224.17	523	253.6	0.0648	224.17	-0.177	276.1	-0.0036
224.25	518.38	250.4	0.0506	224.25	-0.181	272.3	-0.0488

Prova triassiale ciclica SNGR03-C4							
tensione di confinamento (kPa)	450			tensione di confinamento (kPa)	450		
deviatore ciclico (kPa)	230			deviatore ciclico (kPa)	260		
frequenza (hz)	0.007143			frequenza (hz)	0.007143		
224.33	516.32	248.4	0.0373	224.33	-0.185	268.3	-0.1234
224.42	511.85	245.6	0.0231	224.42	-0.19	263.8	-0.1704
224.50	506.22	241.5	0.0089	224.50	-0.197	258.8	-0.2299
224.58	503.19	239.1	-0.0027	224.58	-0.198	255.6	-0.2698
224.67	499.78	236.5	-0.0231	224.67	-0.202	251.9	-0.3107
224.75	495.67	233.7	-0.0364	224.75	-0.21	246.6	-0.363
224.83	493.08	231.2	-0.0488	224.83	-0.214	241.4	-0.4048
224.92	490.05	229.2	-0.0604	224.92	-0.216	238.2	-0.4598
225.00	485.24	226.4	-0.0719	225.02	-0.22	234.7	-0.4989
225.08	482.01	223.2	-0.0826	225.10	-0.226	230.6	-0.5388
225.17	480.13	221.3	-0.0985	225.17	-0.23	225.8	-0.5725
225.25	477.3	219	-0.1101	225.25	-0.234	222.3	-0.6071
225.35	472.86	216.4	-0.1216	225.33	-0.236	219.6	-0.6586
225.42	470.06	213.5	-0.1314	225.42	-0.241	216.1	-0.6906
225.50	468.95	211.7	-0.1465	225.50	-0.244	212.9	-0.7243
225.58	465.45	209.6	-0.1562	225.58	-0.245	210.4	-0.7509
225.67	462.81	207.6	-0.1669	225.67	-0.249	207.4	-0.7802
225.75	461.28	206.1	-0.1766	225.75	-0.254	204.1	-0.8122
225.83	458.58	203.9	-0.1864	225.83	-0.256	200.5	-0.8353
225.92	455.61	201.3	-0.1953	225.92	-0.259	198.1	-0.8583
226.00	454.61	199.8	-0.2077	226.00	-0.261	195.9	-0.8947
226.08	452.55	198.4	-0.2157	226.08	-0.265	193.2	-0.9187
226.17	449.95	196.6	-0.2246	226.17	-0.264	191.8	-0.9347
226.25	448.89	195.4	-0.2317	226.25	-0.269	189.1	-0.9595
226.33	447.23	194	-0.2388	226.33	-0.27	187.5	-0.98
226.42	445.1	192.4	-0.2459	226.43	-0.272	185.1	-1.0057
226.50	443.24	190.6	-0.253	226.52	-0.274	183.3	-1.0208
226.58	442.1	189.7	-0.2627	226.58	-0.275	181.8	-1.0377
226.67	441.75	188.8	-0.269	226.67	-0.277	180.4	-1.0536
226.75	439.66	187.5	-0.2752	226.75	-0.279	179	-1.0678
226.85	439.27	186.5	-0.2805	226.83	-0.28	177.4	-1.0811
226.92	437.85	185.7	-0.2876	226.92	-0.281	176.2	-1.0918
227.00	437.6	184.9	-0.2911	227.00	-0.283	174.6	-1.1131
227.08	436.31	184.2	-0.2956	227.08	-0.282	174.6	-1.1211
227.17	436.94	184.1	-0.2991	227.17	-0.284	173.3	-1.1317
227.25	434.85	183.3	-0.3027	227.25	-0.283	173.1	-1.1397
227.33	435.68	183	-0.3062	227.33	-0.285	172.3	-1.1495
227.42	435.4	182.6	-0.3107	227.42	-0.285	171.9	-1.1566
227.50	434.99	182.3	-0.3133	227.50	-0.284	171.7	-1.1637
227.58	434.98	182.1	-0.316	227.58	-0.285	171.4	-1.1735
227.67	434.87	182	-0.3187	227.67	-0.284	171.7	-1.177
227.75	434.9	181.9	-0.3204	227.75	-0.284	171.6	-1.1823
227.83	435.63	182.1	-0.3222	227.83	-0.286	171.5	-1.1877
227.92	436.67	182.4	-0.3231	227.93	-0.282	172.2	-1.1894
228.00	437.07	182.6	-0.3249	228.00	-0.283	172.1	-1.1957
228.08	437.57	182.7	-0.3258	228.08	-0.282	172.8	-1.1974
228.17	438.47	183.1	-0.3258	228.17	-0.28	173.4	-1.1992
228.27	439.37	183.6	-0.3267	228.25	-0.28	173.9	-1.2001
228.33	440.31	184	-0.3275	228.33	-0.279	174.4	-1.2019
228.42	441.48	184.6	-0.3275	228.42	-0.277	175.5	-1.2019
228.50	442.56	185.2	-0.3275	228.50	-0.275	176.8	-1.2028
228.58	444	185.8	-0.3267	228.58	-0.274	177.7	-1.2028
228.67	445.91	186.5	-0.3267	228.67	-0.272	178.6	-1.2028
228.75	447.35	187.7	-0.3258	228.75	-0.268	180.1	-1.2019
228.83	448.93	188.4	-0.3258	228.83	-0.268	180.9	-1.201
228.92	450.84	189.3	-0.3249	228.92	-0.266	182	-1.201
229.00	452.69	190.4	-0.324	229.00	-0.263	183.3	-1.1992
229.08	454.17	191.3	-0.3231	229.08	-0.26	184.9	-1.1983
229.17	456.92	192.5	-0.3222	229.17	-0.256	187.1	-1.1974
229.25	459.9	193.5	-0.3213	229.25	-0.254	188.5	-1.1965

Prova triassiale ciclica SNGR03-C4							
tensione di confinamento (kPa)	450			tensione di confinamento (kPa)	450		
deviatore ciclico (kPa)	230			deviatore ciclico (kPa)	260		
frequenza (hz)	0.007143			frequenza (hz)	0.007143		
229.33	461.81	195	-0.3204	229.35	-0.252	189.5	-1.1939
229.42	463.9	196.2	-0.3187	229.43	-0.249	191.3	-1.1921
229.50	466.48	197.4	-0.3178	229.50	-0.245	192.9	-1.1903
229.58	469.37	199.1	-0.316	229.58	-0.242	195.4	-1.1894
229.67	471.72	200.1	-0.3142	229.67	-0.238	197.1	-1.1859
229.77	474.47	201.8	-0.3133	229.75	-0.235	199	-1.185
229.83	477.82	203.6	-0.3116	229.83	-0.231	201	-1.1823
229.92	479.94	205	-0.3098	229.92	-0.228	203	-1.1806
230.00	483.36	206.4	-0.308	230.00	-0.224	204.8	-1.1788
230.08	488.32	208.3	-0.3062	230.08	-0.22	207.2	-1.1761
230.17	491.31	210.5	-0.3045	230.17	-0.213	210.5	-1.1735
230.25	494.03	212.4	-0.3018	230.25	-0.211	212.4	-1.1708
230.33	497.58	214	-0.3	230.33	-0.207	214.3	-1.1672
230.42	501.41	216.1	-0.2974	230.42	-0.202	216.9	-1.1637
230.50	504.2	217.7	-0.2947	230.50	-0.198	219.5	-1.161
230.58	507.95	219.7	-0.2929	230.58	-0.194	221.7	-1.1575
230.67	513.52	222.9	-0.2903	230.67	-0.189	223.9	-1.1548
230.75	517.11	225	-0.2876	230.75	-0.182	227	-1.1513
230.83	520.2	226.6	-0.2849	230.85	-0.178	230	-1.1468
230.92	524.25	228.8	-0.2823	230.92	-0.173	233	-1.1424
231.00	528.11	231.2	-0.2796	231.00	-0.168	235.4	-1.1397
231.08	531.33	232.8	-0.2769	231.08	-0.163	238.2	-1.1353
231.18	536.83	236	-0.2725	231.17	-0.155	242.5	-1.1309
231.25	542.73	238.7	-0.269	231.25	-0.151	245.2	-1.1273
231.33	544.34	240.5	-0.2663	231.33	-0.147	247.7	-1.1202
231.42	548.7	242.5	-0.2627	231.42	-0.14	251	-1.1158
231.50	555.1	245.3	-0.2592	231.50	-0.133	254.4	-1.1104
231.58	561.54	249.1	-0.2556	231.58	-0.131	256.6	-1.106
231.67	563.52	251.2	-0.2503	231.67	-0.125	259.3	-1.1016
231.75	568.65	253.6	-0.2468	231.75	-0.118	263	-1.0953
231.83	573.58	256.2	-0.2423	231.83	-0.109	267.5	-1.09
231.92	576.86	258.3	-0.2388	231.92	-0.105	270.5	-1.082
232.00	582.66	261.2	-0.2343	232.00	-0.1	273.2	-1.0776
232.08	588.45	264.7	-0.2308	232.08	-0.094	276.5	-1.0714
232.17	594.05	267.7	-0.2263	232.17	-0.087	280.3	-1.0652
232.25	596.73	269.6	-0.2201	232.27	-0.08	284.1	-1.0598
232.33	602.42	272.6	-0.2157	232.35	-0.076	286.5	-1.051
232.42	607.04	275.4	-0.2104	232.42	-0.07	289.8	-1.0448
232.50	610.43	277.5	-0.2059	232.50	-0.061	293.9	-1.0368
232.58	616.89	280.5	-0.2006	232.58	-0.058	296.4	-1.0306
232.67	623.25	284.1	-0.1944	232.67	-0.051	299.5	-1.0234
232.75	625.83	286.6	-0.19	232.75	-0.043	303.2	-1.0155
232.83	631.35	289.1	-0.1846	232.83	-0.034	308.2	-1.0084
232.92	638.61	292	-0.1793	232.92	-0.029	311.3	-1.0013
233.00	644.2	296	-0.1749	233.00	-0.025	314.3	-0.9888
233.08	647.35	298.4	-0.1651	233.08	-0.016	317.8	-0.9791
233.17	652.46	301	-0.1598	233.17	-0.011	321.2	-0.9711
233.25	659.72	304.4	-0.1536	233.25	-0.005	324.4	-0.9613
233.33	662.33	306.8	-0.1473	233.33	0	327.4	-0.9533
233.42	667.91	309.3	-0.142	233.42	0.01	331.4	-0.9427
233.50	674.73	313.1	-0.1358	233.50	0.017	336.4	-0.9329
233.58	680.15	316.2	-0.1296	233.58	0.021	339.7	-0.9152
233.67	684.02	318.4	-0.1207	233.68	0.028	343	-0.901
233.75	689.4	321.3	-0.1145	233.77	0.034	346.4	-0.8876
233.83	694.25	324.1	-0.1065	233.83	0.044	352.3	-0.8699
233.92	696.85	326.1	-0.1012	233.92	0.048	355.5	-0.8566
234.00	705.23	329.1	-0.0941	234.00	0.054	358.8	-0.8308
234.10	709.14	332.6	-0.0843	234.08	0.06	362.5	-0.8104
234.17	712.54	335	-0.0772	234.17	0.067	366.5	-0.7891
234.25	717.88	337.4	-0.0701	234.25	0.072	369.9	-0.766

Prova triassiale ciclica SNGR03-C4							
tensione di confinamento (kPa)	450			tensione di confinamento (kPa)	450		
deviatore ciclico (kPa)	230			deviatore ciclico (kPa)	260		
frequenza (hz)	0.007143			frequenza (hz)	0.007143		
234.33	724.82	340.5	-0.0621	234.33	0.078	373.6	-0.7412
234.42	731.2	344.2	-0.055	234.42	0.086	377.8	-0.7119
234.50	734.06	346.4	-0.0417	234.50	0.095	383.3	-0.6826
234.58	741.76	349.7	-0.0311	234.58	0.1	386.9	-0.6542
234.67	743.42	351.4	-0.024	234.67	0.105	390.4	-0.6036
234.75	747.88	353.7	-0.0142	234.75	0.112	394.4	-0.5654
234.83	752.94	356.6	-0.0018	234.83	0.116	398.1	-0.5237
234.92	760.07	360.5	0.0098	234.92	0.122	401.6	-0.4838
235.00	762.94	362.8	0.0284	235.00	0.128	405.1	-0.4385
235.08	767.76	365.1	0.0408	235.08	0.137	409	-0.3888
235.17	774.44	368.2	0.0586	235.18	0.141	413.3	-0.3169
235.25	774.29	369.5	0.0692	235.27	0.146	416.4	-0.2672
235.33	779.74	371.8	0.0834	235.33	0.152	419.8	-0.213
235.42	786.78	374.6	0.1012	235.42	0.158	423.3	-0.1598
235.52	792.53	378.1	0.1278	235.50	0.167	427	-0.1047
235.58	793.51	379.3	0.1411	235.58	0.171	431.2	-0.055
235.67	797.71	381.4	0.158	235.67	0.175	434.2	0.0204
235.75	803.9	383.5	0.1749	235.75	0.182	437.3	0.0728
235.83	807.96	386.5	0.1926	235.83	0.187	440.4	0.1234
235.92	812.53	388.6	0.2237	235.92	0.191	443.1	0.1704
236.00	814.92	390.1	0.2406	236.00	0.195	445.6	0.2192
236.08	818.34	392	0.2601	236.08	0.204	448.7	0.2672
236.17	822.06	393.6	0.2796	236.17	0.209	452.5	0.3089
236.25	827.93	395.7	0.3018	236.25	0.213	454.9	0.3772
236.33	831.42	398	0.3169	236.33	0.217	457	0.4172
236.42	833.14	399.3	0.3471	236.42	0.223	459.7	0.4598
236.50	837.61	401.3	0.3684	236.50	0.226	461.9	0.4997
236.58	840.33	402.6	0.3852	236.60	0.232	464.8	0.5361
236.67	844.13	404.1	0.4048	236.68	0.235	466.5	0.585
236.75	846.08	405.2	0.4234	236.75	0.241	468.9	0.6222
236.83	850.65	406.6	0.4412	236.83	0.244	470.4	0.6524
236.92	854.15	408.8	0.4598	236.92	0.247	472.1	0.6844
237.02	855.01	409.7	0.4864	237.00	0.253	474.1	0.7217
237.08	858.28	410.9	0.5024	237.08	0.256	475.2	0.7465
237.17	861.85	412	0.5202	237.17	0.261	477.8	0.7758
237.25	866.25	414.1	0.5352	237.25	0.263	479.2	0.822
237.33	866.35	414.5	0.5583	237.33	0.266	480.5	0.8495
237.42	868.43	415.5	0.5734	237.42	0.27	481.8	0.8761
237.50	871.47	416.8	0.5885	237.50	0.273	483	0.901
237.58	873.19	417.4	0.6018	237.58	0.275	484	0.924
237.67	875.69	418.4	0.6169	237.67	0.279	485.4	0.9498
237.75	878.57	419.6	0.6293	237.75	0.282	486.1	0.9666
237.83	878.79	420.1	0.6453	237.83	0.283	487.4	0.9888
237.92	880.41	420.7	0.6577	237.92	0.288	488.6	1.0181
238.00	884.18	421.8	0.6702	238.00	0.289	489.2	1.0368
238.08	882.86	422	0.679	238.10	0.29	489.7	1.051
238.17	886.4	422.8	0.6897	238.18	0.293	490.9	1.0669
238.25	888.62	423.2	0.6986	238.25	0.295	491.4	1.0838
238.33	888.73	423.9	0.7074	238.33	0.297	492	1.1051
238.43	890.93	424.6	0.7208	238.42	0.297	492.3	1.1184
238.50	890.35	424.6	0.7279	238.50	0.3	492.9	1.1309
238.58	892.47	425.3	0.7359	238.58	0.302	493.5	1.1433
238.67	893.48	425.8	0.743	238.67	0.302	493.5	1.1522
238.75	893.38	425.9	0.7527	238.75	0.303	493.7	1.1619
238.83	894.12	426.1	0.758	238.83	0.304	494.2	1.1708
238.92	894.01	426.2	0.7634	238.92	0.304	494.4	1.1832
239.00	894.65	426.4	0.7678	239.00	0.305	494.5	1.1903
239.08	893.22	426.5	0.7731	239.08	0.305	494.5	1.1957
239.17	896.21	426.9	0.7785	239.17	0.305	494.6	1.2019
239.25	894.8	426.7	0.7838	239.25	0.305	494.6	1.2063

Prova triassiale ciclica SNGR03-C4							
tensione di confinamento (kPa)	450			tensione di confinamento (kPa)	450		
deviatore ciclico (kPa)	230			deviatore ciclico (kPa)	260		
frequenza (hz)	0.007143			frequenza (hz)	0.007143		
239.33	894.86	426.7	0.7864	239.33	0.307	494.5	1.2107
239.42	893.7	426.4	0.7891	239.42	0.305	494.2	1.2143
239.50	894.41	426.5	0.7918	239.52	0.304	494	1.2187
239.58	892.69	426.2	0.7944	239.60	0.305	494	1.2223
239.67	892.82	426.3	0.7962	239.67	0.303	493.6	1.2241
239.75	892.84	426.1	0.7989	239.75	0.302	493.5	1.2267
239.83	890.99	425.6	0.7998	239.83	0.3	492.7	1.2276
239.93	891.15	425.6	0.8007	239.92	0.3	492.4	1.2285
240.00	889.23	425	0.8015	240.00	0.3	492.2	1.2303
240.08	887.91	424.6	0.8015	240.08	0.297	491.5	1.2303
240.17	887.68	424.4	0.8015	240.17	0.296	491	1.2303
240.25	885.2	423.9	0.8015	240.25	0.295	490.6	1.2303
240.33	885.5	423.6	0.8015	240.33	0.293	490.3	1.2303
240.42	883.23	423.1	0.8007	240.42	0.29	489.5	1.2294
240.50	881.54	422.7	0.8007	240.50	0.286	488.3	1.2294
240.58	879.07	421.7	0.7998	240.58	0.285	487.8	1.2285
240.67	877.35	421.2	0.7989	240.67	0.284	487.3	1.2276
240.75	873.69	420.3	0.7971	240.75	0.28	486.3	1.2267
240.83	872.57	419.8	0.7962	240.83	0.276	485.2	1.2249
240.92	871.71	419.3	0.7962	240.92	0.276	484.8	1.2249
241.00	869.87	418.7	0.7944	241.00	0.27	483.2	1.2223
241.08	865.64	417.9	0.7936	241.08	0.269	482.7	1.2223
241.17	863.43	416.6	0.7927	241.17	0.265	481.6	1.2205
241.25	860.57	415.7	0.7891	241.25	0.262	480.7	1.2187
241.35	858.26	414.9	0.7882	241.33	0.26	479.8	1.2178
241.42	854.27	413.5	0.7856	241.42	0.255	478.5	1.2152
241.50	853.35	412.9	0.7829	241.50	0.249	476.8	1.2143
241.58	849.66	411.9	0.7811	241.58	0.247	475.8	1.2116
241.67	846.19	410.8	0.7785	241.67	0.243	474.7	1.2099
241.75	843.26	409.7	0.7758	241.75	0.237	473.2	1.2072
241.83	840.29	408.8	0.7731	241.83	0.234	472.1	1.2054
241.92	833.86	407.6	0.7696	241.92	0.229	470.8	1.2028
242.00	831.85	405.8	0.7669	242.00	0.227	469.6	1.201
242.08	830.77	405.1	0.7625	242.08	0.218	467	1.1974
242.17	824.67	403.5	0.758	242.17	0.216	466	1.1957
242.25	821.18	402.1	0.7536	242.25	0.211	464.4	1.1912
242.33	820.06	401.5	0.7509	242.33	0.206	462.9	1.1886
242.42	815.74	400.1	0.7465	242.43	0.2	461.5	1.1868
242.50	808.71	397.5	0.7403	242.52	0.194	458.9	1.1832
242.58	804.49	396	0.7376	242.58	0.19	457.3	1.1779
242.67	803.18	395.4	0.7296	242.67	0.185	455.5	1.1743
242.75	795.46	393.1	0.7234	242.75	0.179	453.8	1.1708
242.85	792.68	391.7	0.7208	242.83	0.173	451.9	1.1664
242.92	789.36	390.2	0.7119	242.92	0.17	450.4	1.1628
243.00	785.43	388.8	0.7066	243.00	0.163	448.3	1.1584
243.08	777.48	386.4	0.6995	243.08	0.155	445.4	1.1539
243.17	778.38	385.7	0.695	243.17	0.15	443.3	1.1504
243.25	772.07	383.8	0.6879	243.25	0.147	441.8	1.1442
243.33	767.35	381.5	0.6808	243.33	0.139	439.4	1.1388
243.42	757.9	378.7	0.6746	243.42	0.132	437	1.1335
243.50	759.73	378	0.6648	243.50	0.127	434.8	1.1273
243.58	753.16	376.3	0.6577	243.58	0.121	432.9	1.1229
243.67	745.59	373.4	0.6489	243.67	0.115	430.2	1.1167
243.75	746.39	373	0.6427	243.75	0.103	426.6	1.1122
243.83	739.42	370.6	0.6347	243.85	0.102	424.8	1.1033
243.92	731.32	367.4	0.6276	243.93	0.098	423.3	1.0989
244.00	727.09	365.4	0.6196	244.00	0.088	420.5	1.0927
244.08	724.25	364	0.608	244.08	0.081	416.9	1.0865
244.17	715.06	360.9	0.5983	244.17	0.074	414	1.0785
244.27	712.94	359.3	0.5921	244.25	0.071	412.3	1.0687

Prova triassiale ciclica SNGR03-C4							
tensione di confinamento (kPa)	450			tensione di confinamento (kPa)	450		
deviatore ciclico (kPa)	230			deviatore ciclico (kPa)	260		
frequenza (hz)	0.007143			frequenza (hz)	0.007143		
244.33	707.78	357	0.5787	244.33	0.061	409.1	1.0607
244.42	702.16	354.8	0.569	244.42	0.056	406.5	1.0536
244.50	696.8	352.4	0.5592	244.50	0.051	404	1.0465
244.58	694.65	350.8	0.5503	244.58	0.045	401.7	1.0394
244.67	690.04	349	0.5406	244.67	0.036	398.2	1.0297
244.75	680.9	345.1	0.5273	244.75	0.027	394.5	1.0234
244.83	674.64	342.6	0.5193	244.83	0.022	391.7	1.0155
244.92	673.35	340.8	0.5042	244.92	0.015	388.8	1.0013
245.00	667.35	338.5	0.4935	245.00	0.009	386.1	0.9924
245.08	660.42	335.8	0.482	245.08	0.002	383.1	0.9835
245.17	658.07	333.9	0.4704	245.17	-0.002	380.9	0.9746
245.25	651.56	331.3	0.4589	245.25	-0.011	377.9	0.964
245.33	644.63	327.8	0.4474	245.35	-0.017	374.2	0.948
245.42	640.41	325.3	0.4367	245.43	-0.025	370.7	0.9365
245.50	636.36	323.7	0.4181	245.50	-0.029	367.8	0.924
245.58	629.68	320.7	0.4048	245.58	-0.036	365.5	0.9098
245.68	623.9	317.4	0.3923	245.67	-0.044	362.4	0.8947
245.75	621.6	315.1	0.3737	245.75	-0.053	358.1	0.877
245.83	616.14	312.9	0.3613	245.83	-0.058	355.2	0.8548
245.92	609.39	309.9	0.3488	245.92	-0.063	352.7	0.814
246.00	606.66	307.6	0.3382	246.00	-0.07	349.4	0.7802
246.08	601.4	305.1	0.3267	246.08	-0.077	345.8	0.7438
246.17	595.41	302.2	0.3151	246.17	-0.081	343.1	0.711
246.25	588.32	297.9	0.3036	246.25	-0.088	339.7	0.6764
246.33	585.84	296	0.2858	246.33	-0.096	336.1	0.6418
246.42	580.68	293	0.2725	246.42	-0.104	331	0.6098
246.50	576.64	290.1	0.2601	246.50	-0.108	328.1	0.5503
246.58	572.67	287.9	0.2477	246.58	-0.113	325.2	0.5095
246.67	567.06	284.8	0.2343	246.67	-0.121	320.8	0.4651
246.75	560.46	280.9	0.2219	246.77	-0.127	316.2	0.4252
246.83	557.57	278.1	0.2024	246.85	-0.133	312	0.3852
246.92	552.99	275.8	0.1891	246.92	-0.137	309.1	0.3196
247.00	547.57	272.8	0.1731	247.00	-0.144	304.9	0.2734
247.08	545.36	270.2	0.1598	247.08	-0.15	300.3	0.2201
247.18	540.09	266.3	0.1385	247.17	-0.153	297.2	0.1775
247.25	535.64	264.1	0.1243	247.25	-0.158	293.1	0.1252
247.33	529.95	260.9	0.1092	247.33	-0.166	288.4	0.0728
247.42	528.33	258.9	0.0959	247.42	-0.172	282.2	0.0231
247.50	523.37	256.1	0.0808	247.50	-0.177	277.5	-0.0612
247.58	518.81	252.4	0.0675	247.58	-0.181	273.6	-0.1136
247.67	512.74	248.7	0.0515	247.67	-0.187	269.2	-0.166
247.75	511.57	246.8	0.0311	247.75	-0.19	265.1	-0.213
247.83	506.57	244	0.0169	247.83	-0.194	261.3	-0.2619
247.92	502.7	241.7	0.0044	247.92	-0.198	257.3	-0.3116
248.00	500.94	239.4	-0.008	248.00	-0.204	252.5	-0.3595
248.08	495.04	236.6	-0.0231	248.08	-0.21	246.6	-0.403
248.17	491.84	232.6	-0.0355	248.17	-0.213	242.9	-0.4722
248.25	489.66	230.1	-0.055	248.27	-0.216	239.7	-0.5139
248.33	485.89	227.9	-0.0666	248.35	-0.221	235.9	-0.5521
248.42	482.62	225.5	-0.079	248.42	-0.227	230.6	-0.5903
248.50	480.82	223.4	-0.0905	248.50	-0.229	227.4	-0.6267
248.60	476.64	220.1	-0.1083	248.58	-0.232	224.4	-0.6773
248.67	474.87	218.2	-0.1189	248.67	-0.237	220.6	-0.7146
248.75	470.83	215.5	-0.1305	248.75	-0.24	217.5	-0.7474
248.83	469.17	213.9	-0.1411	248.83	-0.242	214.7	-0.7785
248.92	466.06	211.5	-0.1518	248.92	-0.246	211.6	-0.8113
249.00	462.7	208.6	-0.1616	249.00	-0.25	208.4	-0.8415
249.08	460.5	206.7	-0.1713	249.08	-0.254	204.3	-0.8681
249.17	459.25	205.3	-0.1864	249.17	-0.255	201.8	-0.9081
249.25	456.05	203.1	-0.1962	249.25	-0.258	199.5	-0.9338

Prova triassiale ciclica SNGR03-C4

tensione di confinamento (kPa)	450			tensione di confinamento (kPa)	450		
deviatore ciclico (kPa)	230			deviatore ciclico (kPa)	260		
frequenza (hz)	0.007143			frequenza (hz)	0.007143		
249.33	454.32	201.4	-0.205	249.33	-0.261	197.2	-0.9569
249.42	452.35	200.1	-0.2139	249.42	-0.263	194.7	-0.9817
249.50	449.95	198.5	-0.2219	249.50	-0.265	192.8	-1.0021
249.58	447.52	195.9	-0.2299	249.58	-0.267	190.9	-1.0226
249.67	446.85	194.8	-0.2414	249.68	-0.27	187.9	-1.0527
249.75	445.12	193.5	-0.2494	249.77	-0.272	186.2	-1.0705
249.83	443.23	192.1	-0.2556	249.83	-0.274	184.5	-1.0865
249.92	442.74	191.2	-0.2619	249.92	-0.275	183	-1.1024
250.00	441.35	190	-0.269	250.00	-0.277	181.4	-1.1184
250.10	440.25	188.8	-0.2769	250.08	-0.279	179.5	-1.1326
250.17	439.3	187.8	-0.2823	250.17	-0.28	178.5	-1.1522
250.25	438.52	187	-0.2876	250.25	-0.28	177.7	-1.1637
250.33	438.07	186.7	-0.2911	250.33	-0.282	176.5	-1.1752
250.42	436.35	185.5	-0.2965	250.42	-0.282	175.7	-1.1859
250.50	436.26	184.8	-0.3027	250.50	-0.283	175	-1.1974
250.58	435.34	184.3	-0.3062	250.58	-0.284	174.4	-1.2063
250.67	434.9	184.1	-0.3098	250.67	-0.284	173.8	-1.2143
250.75	435.03	183.6	-0.3124	250.75	-0.285	173.1	-1.2223
250.83	434.88	183.5	-0.316	250.83	-0.285	172.9	-1.2329
250.92	434.84	183.4	-0.3187	250.92	-0.285	172.8	-1.2391
251.00	435.47	183.1	-0.3204	251.00	-0.285	172.7	-1.2445
251.08	435.33	183.3	-0.324	251.08	-0.284	172.8	-1.2489
251.17	436.5	183.6	-0.3249	251.18	-0.284	172.7	-1.2533
251.25	436.32	183.4	-0.3267	251.25	-0.283	172.9	-1.2587
251.33	436.32	183.5	-0.3275	251.33	-0.283	173.4	-1.2622
251.42	437.46	183.9	-0.3284	251.42	-0.281	174.1	-1.264
251.52	438.8	184.5	-0.3293	251.50	-0.28	174.5	-1.2658
251.58	439.33	184.8	-0.3302	251.58	-0.279	175	-1.2676
251.67	439.93	185.2	-0.3302	251.67	-0.278	175.7	-1.2684
251.75	441.74	185.8	-0.3302	251.75	-0.276	177.1	-1.2693
251.83	443.05	186.7	-0.3302	251.83	-0.275	177.9	-1.2693
251.92	444.19	187.3	-0.3302	251.92	-0.273	178.8	-1.2693
252.00	445.7	188.1	-0.3293	252.00	-0.271	180	-1.2684
252.08	447.91	188.9	-0.3293	252.08	-0.27	180.9	-1.2684
252.17	448.25	189.4	-0.3284	252.17	-0.268	182	-1.2684
252.25	450.5	190.4	-0.3275	252.25	-0.266	183.3	-1.2676
252.33	452.88	191.3	-0.3275	252.33	-0.261	185.4	-1.2658
252.42	455.53	193.1	-0.3258	252.42	-0.259	186.8	-1.2649
252.50	457.08	193.9	-0.3249	252.50	-0.258	187.9	-1.264
252.58	459.69	195.2	-0.324	252.60	-0.254	189.4	-1.2622
252.67	461.27	196.2	-0.3231	252.68	-0.251	190.9	-1.2613
252.75	463.28	197.2	-0.3222	252.75	-0.247	193.2	-1.2596
252.83	466.4	198.7	-0.3204	252.83	-0.245	194.8	-1.2578
252.92	470.29	200.8	-0.3196	252.92	-0.243	196.1	-1.2569
253.02	471.61	201.7	-0.3178	253.00	-0.238	198.4	-1.2542
253.08	474.29	203	-0.316	253.08	-0.236	200.1	-1.2525
253.17	478.72	204.6	-0.3142	253.17	-0.233	201.8	-1.2507
253.25	481.5	206.8	-0.3133	253.25	-0.228	204	-1.2489
253.33	484.22	208.4	-0.3107	253.33	-0.222	206.2	-1.2462
253.42	487.08	209.9	-0.3089	253.42	-0.218	209.2	-1.2436
253.50	491.27	212	-0.3071	253.50	-0.216	210.9	-1.24
253.58	493.45	213.5	-0.3053	253.58	-0.211	213.4	-1.2374
253.67	497.34	215.2	-0.3027	253.67	-0.206	215.8	-1.2347
253.75	501.77	217.1	-0.3009	253.75	-0.203	218.2	-1.232
253.83	505.93	220	-0.2982	253.83	-0.199	220.1	-1.2294
253.92	508.11	221.5	-0.2956	253.92	-0.193	222.8	-1.2258
254.00	512.17	223.8	-0.2929	254.02	-0.187	226.4	-1.2214
254.08	516.74	226.3	-0.2894	254.10	-0.183	228.8	-1.2178
254.17	519.95	227.8	-0.2876	254.17	-0.179	231	-1.2143
254.25	524.58	230.1	-0.2858	254.25	-0.175	233.5	-1.2116

Prova triassiale ciclica SNGR03-C4							
tensione di confinamento (kPa)	450			tensione di confinamento (kPa)	450		
deviatore ciclico (kPa)	230			deviatore ciclico (kPa)	260		
frequenza (hz)	0.007143			frequenza (hz)	0.007143		
254.33	530.65	233.4	-0.2832	254.33	-0.166	236.7	-1.2072
254.43	532.7	234.9	-0.2787	254.42	-0.16	240.6	-1.2036
254.50	535.75	236.8	-0.2761	254.50	-0.157	243.5	-1.1965
254.58	542.32	239.4	-0.2725	254.58	-0.152	246	-1.1912
254.67	546.48	242.8	-0.2698	254.67	-0.146	249.1	-1.1868
254.75	549.64	245.1	-0.2645	254.75	-0.141	252.2	-1.1823
254.83	554.03	247.1	-0.261	254.83	-0.136	254.6	-1.1779
254.92	559.89	250.2	-0.2574	254.92	-0.13	257.6	-1.1726
255.00	562.24	251.8	-0.2539	255.00	-0.123	261.1	-1.1672
255.08	566.83	254.4	-0.2503	255.08	-0.115	265.7	-1.1628
255.17	573.91	258.2	-0.2459	255.17	-0.112	268.7	-1.1539
255.25	579.5	261.3	-0.2414	255.25	-0.107	271.2	-1.1486
255.33	582.99	263.4	-0.2361	255.33	-0.099	274.8	-1.1424
255.42	588.58	266.1	-0.2317	255.42	-0.094	278	-1.1371
255.50	591.47	268.7	-0.2272	255.52	-0.088	281.9	-1.1291
255.58	595.99	271	-0.2237	255.60	-0.082	284.8	-1.1229
255.67	602.65	273.8	-0.2184	255.67	-0.075	288.3	-1.1158
255.75	608.65	277.8	-0.2139	255.75	-0.069	291.5	-1.1096
255.85	611.53	280.1	-0.2068	255.83	-0.065	294.2	-1.1033
255.92	615.82	282.2	-0.2033	255.92	-0.058	297.4	-1.0962
256.00	623.75	285.2	-0.1979	256.00	-0.048	301.6	-1.0874
256.08	628.17	289.1	-0.1935	256.08	-0.04	306.6	-1.0811
256.17	632.25	291.4	-0.1855	256.17	-0.037	309.2	-1.0696
256.25	637.07	294.1	-0.1802	256.25	-0.03	312.4	-1.0625
256.33	643.57	297.4	-0.1731	256.33	-0.023	315.7	-1.0545
256.42	646.88	299.6	-0.1678	256.42	-0.018	319.3	-1.0456
256.50	652.03	302.5	-0.1624	256.50	-0.013	321.9	-1.0377
256.58	659.22	306.4	-0.1562	256.58	-0.006	325.7	-1.0279
256.67	663.94	309.5	-0.1482	256.67	0.003	329.2	-1.0181
256.75	668.95	311.8	-0.142	256.75	0.011	334.6	-1.0084
256.83	675.17	314.7	-0.1358	256.83	0.013	337.1	-0.9933
256.92	677.11	317	-0.1305	256.93	0.023	341.3	-0.9791
257.00	682.89	319.5	-0.1234	257.02	0.028	343.7	-0.9693
257.08	690.27	322.5	-0.1172	257.08	0.037	349.9	-0.9524
257.17	697.16	326.9	-0.111	257.17	0.042	353.4	-0.9356
257.25	696.89	328.5	-0.1021	257.25	0.047	356.5	-0.9107
257.35	703.5	331.2	-0.095	257.33	0.055	360.5	-0.8912
257.42	710.28	333.9	-0.0879	257.42	0.061	364.5	-0.8699
257.50	716.32	337.9	-0.0808	257.50	0.066	367.8	-0.8486
257.58	719.42	340.1	-0.0683	257.58	0.072	371.6	-0.8246
257.67	724.59	342.8	-0.0612	257.67	0.081	375.6	-0.798
257.75	729.43	345.4	-0.0533	257.75	0.088	381.1	-0.7722
257.83	733.12	347.7	-0.0444	257.83	0.092	384.7	-0.7261
257.92	740.96	351.3	-0.0328	257.92	0.1	388.9	-0.6888
258.00	745.36	354.2	-0.0257	258.00	0.105	392.1	-0.6577
258.08	749.28	356.9	-0.008	258.08	0.111	396	-0.6196
258.17	753.1	359.2	0.0027	258.17	0.115	399.5	-0.5796
258.25	759.16	362.1	0.016	258.25	0.123	403.5	-0.5335
258.33	762.11	364.4	0.0284	258.33	0.131	407.2	-0.4847
258.42	766.66	366.7	0.0417	258.43	0.136	412.1	-0.411
258.50	772.61	369.4	0.0568	258.52	0.139	415.1	-0.363
258.58	776.72	372.4	0.0737	258.58	0.146	418.6	-0.3089
258.67	780.16	374.6	0.0941	258.67	0.154	422.2	-0.253
258.77	785.63	377	0.1127	258.75	0.16	427.1	-0.2015
258.83	791.07	379	0.1278	258.83	0.165	430.4	-0.1473
258.92	794.76	382.2	0.1473	258.92	0.17	433.3	-0.0639
259.00	798.25	384	0.1713	259.00	0.175	436.4	-0.0089
259.08	802.58	386.1	0.1908	259.08	0.182	439.9	0.047
259.17	806.63	388.2	0.2113	259.17	0.186	442.5	0.0968
259.25	810.02	389.9	0.2308	259.25	0.191	445.4	0.1465

Prova triassiale ciclica SNGR03-C4							
tensione di confinamento (kPa)	450			tensione di confinamento (kPa)	450		
deviatore ciclico (kPa)	230			deviatore ciclico (kPa)	260		
frequenza (hz)	0.007143			frequenza (hz)	0.007143		
259.33	814.47	392	0.2512	259.33	0.199	448.1	0.1926
259.42	819.62	394.7	0.2725	259.42	0.203	452	0.2414
259.50	822.48	396.3	0.3036	259.50	0.206	454.5	0.3062
259.58	826.09	398	0.324	259.58	0.213	457.2	0.3551
259.67	831.42	400	0.3453	259.67	0.218	459.7	0.4003
259.75	832.28	401.4	0.3639	259.75	0.222	462	0.4412
259.83	835.95	402.8	0.3861	259.85	0.227	464.9	0.4793
259.92	840.31	404.8	0.4074	259.93	0.232	467	0.5326
260.00	844.12	406.5	0.4243	260.00	0.235	468.9	0.569
260.08	846.73	407.9	0.4554	260.08	0.24	471	0.6071
260.17	850.04	409.3	0.474	260.17	0.243	472.6	0.6435
260.27	854.4	411.2	0.4909	260.25	0.248	474.6	0.6808
260.33	855.75	412.1	0.5086	260.33	0.252	476.1	0.7092
260.42	858.1	413.1	0.5352	260.42	0.256	478.6	0.7403
260.50	860.44	414.3	0.5521	260.50	0.259	480	0.7864
260.58	864.37	415.7	0.5708	260.58	0.262	481.2	0.8184
260.67	867.6	416.8	0.5876	260.67	0.267	482.8	0.8459
260.75	869.19	417.4	0.6	260.75	0.269	484.5	0.8743
260.83	871.29	418.9	0.6169	260.83	0.272	484.8	0.8992
260.92	873.42	419.8	0.6356	260.92	0.277	486.4	0.9258
261.00	875.96	420.7	0.6506	261.00	0.279	487.9	0.9444
261.08	878.22	421.6	0.6622	261.08	0.283	488.9	0.9666
261.17	878.97	422.2	0.6746	261.17	0.283	489.6	0.9977
261.25	882.4	423.2	0.6897	261.25	0.288	490.7	1.0181
261.33	883.2	423.4	0.6986	261.35	0.29	491.3	1.035
261.42	885.51	424.6	0.711	261.42	0.291	492.2	1.051
261.50	886.26	425.2	0.727	261.50	0.293	492.9	1.0785
261.58	888.3	425.7	0.7385	261.58	0.293	493.3	1.0918
261.68	889.9	426.5	0.7474	261.67	0.297	494.2	1.1078
261.75	888.75	426.3	0.7554	261.75	0.3	494.9	1.1246
261.83	890.76	426.9	0.7669	261.83	0.298	494.9	1.1344
261.92	891.17	427.2	0.7749	261.92	0.301	495.5	1.1477
262.00	893.78	427.9	0.7838	262.00	0.303	495.6	1.1575
262.08	892.54	427.8	0.7891	262.08	0.303	496.2	1.1664
262.17	894.17	428.1	0.7962	262.17	0.303	496.3	1.1797
262.25	893.33	428.2	0.8024	262.25	0.305	496.5	1.1886
262.33	894.62	428.6	0.8122	262.33	0.305	496.6	1.1948
262.42	896.32	428.8	0.8175	262.42	0.304	496.6	1.201
262.50	894.03	428.4	0.8211	262.50	0.305	496.5	1.2072
262.58	895.7	428.7	0.8255	262.58	0.305	496.6	1.2125
262.67	894.66	428.6	0.8291	262.67	0.304	496.4	1.217
262.75	894.36	428.5	0.8317	262.77	0.305	496.4	1.2232
262.83	894.02	428.4	0.8344	262.85	0.304	496.2	1.2267
262.92	894.11	428.4	0.837	262.92	0.304	496	1.2294
263.00	893.02	428.2	0.8388	263.00	0.304	495.8	1.232
263.08	892.12	427.9	0.8406	263.08	0.301	495.2	1.2329
263.18	890.93	427.6	0.8415	263.17	0.301	495	1.2356
263.25	890.53	427.4	0.8433	263.25	0.301	494.7	1.2365
263.33	889.5	427.1	0.8433	263.33	0.298	494	1.2365
263.42	888.71	426.8	0.8433	263.42	0.299	493.9	1.2383
263.50	887.36	426.4	0.8433	263.50	0.296	493.3	1.2383
263.58	885.87	426.1	0.8441	263.58	0.295	492.8	1.2383
263.67	884.69	425.5	0.8433	263.67	0.292	491.9	1.2374
263.75	882.61	424.8	0.8424	263.75	0.29	491.5	1.2374
263.83	881.32	424.4	0.8424	263.83	0.288	490.6	1.2365
263.92	879.81	423.9	0.8415	263.92	0.286	490	1.2356
264.00	877.8	423.3	0.8406	264.00	0.282	489.1	1.2347
264.08	875.19	422.5	0.8397	264.08	0.281	488.5	1.2347
264.17	872.82	421.7	0.8397	264.18	0.277	487.3	1.2329
264.25	870.58	421	0.837	264.27	0.275	486.6	1.232

Prova triassiale ciclica SNGR03-C4

tensione di confinamento (kPa)	450			tensione di confinamento (kPa)	450		
deviatore ciclico (kPa)	230			deviatore ciclico (kPa)	260		
frequenza (hz)	0.007143			frequenza (hz)	0.007143		
264.33	869.33	420.5	0.8362	264.33	0.272	485.7	1.2312
264.42	865.73	419.5	0.8344	264.42	0.269	484.8	1.2294
264.50	863.3	418.6	0.8326	264.50	0.264	483.7	1.2276
264.60	860.86	417.7	0.8308	264.58	0.262	482.8	1.2267
264.67	857.89	416.8	0.8291	264.67	0.257	481.8	1.2258
264.75	856.08	416	0.8273	264.75	0.254	480.3	1.2241
264.83	852.65	415	0.8246	264.83	0.25	479.1	1.2214
264.92	849.39	414	0.8228	264.92	0.246	477.9	1.2196
265.00	845.5	413	0.8202	265.00	0.242	476.7	1.217
265.08	841.64	411.4	0.8175	265.08	0.24	475.7	1.2161
265.17	839.67	410.6	0.8131	265.17	0.234	474.1	1.2125
265.25	837.14	409.5	0.8104	265.25	0.231	473	1.2107
265.33	832	408.1	0.806	265.33	0.223	470.7	1.2081
265.42	828.47	407	0.8024	265.42	0.22	469.5	1.2054
265.50	826.04	405.9	0.7989	265.50	0.216	468.2	1.2019
265.58	822.54	404.4	0.7953	265.58	0.21	466.5	1.1992
265.67	815.82	402.5	0.7891	265.68	0.205	465.1	1.1965
265.75	813.68	401.5	0.7856	265.77	0.199	462.7	1.193
265.83	809.82	400.1	0.7811	265.83	0.196	461.4	1.1894
265.92	807.06	398.9	0.7767	265.92	0.19	459.6	1.1868
266.02	799.91	396.5	0.7687	266.00	0.184	457.7	1.1823
266.08	799.18	395.7	0.7651	266.08	0.18	456.1	1.1788
266.17	792.39	393.7	0.7589	266.17	0.175	454.3	1.1752
266.25	789.59	392.6	0.7545	266.25	0.169	452.3	1.1708
266.33	785.73	391	0.7492	266.33	0.161	449.4	1.1664
266.42	778.4	388.4	0.743	266.42	0.156	447.7	1.1619
266.50	775.6	386.9	0.7376	266.50	0.151	445.8	1.1557
266.58	773.73	386	0.7288	266.58	0.145	443.7	1.1513
266.67	765.45	383.4	0.7208	266.67	0.138	441.3	1.1459
266.75	762.25	381.9	0.7146	266.75	0.135	439.4	1.1406
266.83	758.29	380.3	0.7083	266.83	0.128	437.2	1.1353
266.92	752.58	378.3	0.7012	266.92	0.119	434.9	1.13
267.00	746.11	375.5	0.6932	267.00	0.112	431.5	1.1255
267.08	742.88	373.9	0.6817	267.10	0.109	429.7	1.1175
267.17	737.69	372	0.6746	267.18	0.103	427.6	1.1113
267.25	730.36	369.5	0.6657	267.25	0.096	424.9	1.1051
267.33	729.01	368.2	0.6586	267.33	0.088	421.5	1.0989
267.42	723.85	366.2	0.6498	267.42	0.082	418.9	1.0936
267.52	717.64	363.4	0.6373	267.50	0.076	416.6	1.082
267.58	713.48	361.3	0.6293	267.58	0.069	414	1.0749
267.67	707.72	359.4	0.6205	267.67	0.063	411.3	1.0678
267.75	703.79	357.3	0.6116	267.75	0.058	408.9	1.0607
267.83	695.82	354	0.6009	267.83	0.051	406.4	1.0536
267.92	692.38	352.1	0.5867	267.92	0.042	403.3	1.0456
268.00	687.15	350	0.577	268.00	0.034	399.2	1.0377
268.08	682.02	347.7	0.5672	268.08	0.03	396.8	1.0261
268.17	678.11	345.4	0.5566	268.17	0.023	394.3	1.0181
268.25	673.01	343.4	0.5459	268.25	0.015	391.1	1.0092
268.33	665.86	340.7	0.5352	268.33	0.009	387.9	0.9995
268.42	659.82	337.3	0.5237	268.42	0.005	385.9	0.9915
268.50	657.2	335.4	0.506	268.50	-0.003	382.9	0.98
268.58	651.07	332.9	0.4935	268.60	-0.01	379.1	0.9658
268.67	645.43	330.2	0.4811	268.68	-0.019	376	0.956
268.75	641.48	328.2	0.4687	268.75	-0.023	373.5	0.9444
268.83	636.63	326.1	0.4554	268.83	-0.028	371	0.932
268.92	629.36	322.4	0.442	268.92	-0.038	367.3	0.916
269.00	626.77	320.4	0.4216	269.00	-0.047	362.8	0.901
269.08	621.95	318.1	0.4083	269.08	-0.051	360.3	0.8734
269.17	615.2	315.3	0.3941	269.17	-0.056	358	0.8495
269.25	608.45	311.3	0.3835	269.25	-0.064	354.3	0.8202

Prova triassiale ciclica SNGR03-C4								
tensione di confinamento (kPa)	450				tensione di confinamento (kPa)	450		
deviatore ciclico (kPa)	230				deviatore ciclico (kPa)	260		
frequenza (hz)	0.007143				frequenza (hz)	0.007143		
269.33	606.58	309.1	0.3648	269.33	-0.07	351.2	0.7882	
269.42	599.23	306.1	0.3506	269.42	-0.074	348.3	0.7527	
269.50	596.16	303.9	0.3409	269.50	-0.082	344.9	0.7163	
269.58	592.27	301.3	0.3293	269.58	-0.09	341.4	0.6799	
269.67	586.8	298.7	0.316	269.67	-0.098	336.4	0.6453	
269.75	579.61	295.8	0.3036	269.75	-0.101	333.7	0.5912	
269.83	575.44	291.9	0.2911	269.83	-0.107	330.5	0.5512	
269.92	571.39	289.3	0.2698	269.92	-0.115	326.5	0.5077	
270.00	567.39	286.7	0.2565	270.02	-0.121	321.9	0.466	
270.08	561.71	283.4	0.2414	270.10	-0.126	318.1	0.427	
270.17	558.7	281.3	0.2272	270.17	-0.131	314.8	0.3568	
270.25	551.92	278.2	0.2121	270.25	-0.139	310.4	0.308	
270.33	546.81	274.1	0.1979	270.33	-0.143	306.7	0.2627	
270.43	545.61	272.4	0.1766	270.42	-0.147	303.4	0.2157	
270.50	541.13	269.8	0.1633	270.50	-0.153	299	0.1624	
270.58	534.57	266.4	0.1465	270.58	-0.161	294	0.1039	
270.67	529.39	262.8	0.1323	270.67	-0.168	287.2	0.0515	
270.75	527.51	260.6	0.1092	270.75	-0.17	283.9	-0.032	
270.83	523.15	257.7	0.0941	270.83	-0.175	280	-0.0852	
270.92	518.62	254.6	0.0772	270.92	-0.181	275.5	-0.1394	
271.00	515.73	252.2	0.0621	271.00	-0.185	271.2	-0.1917	
271.08	511.09	249.2	0.0462	271.08	-0.19	266.9	-0.2477	
271.17	506.16	245.4	0.0328	271.17	-0.194	262.8	-0.3018	
271.25	504.85	243.3	0.0098	271.25	-0.201	258.1	-0.3542	
271.33	500.42	240.8	-0.0009	271.33	-0.205	252.2	-0.3994	
271.42	495.61	237.5	-0.0169	271.42	-0.208	248.7	-0.4687	
271.50	493.75	235.1	-0.0302	271.52	-0.212	245.5	-0.5095	
271.58	489.78	232.7	-0.0444	271.58	-0.217	241.4	-0.5539	
271.67	485.27	229.9	-0.0577	271.67	-0.223	235.3	-0.5974	
271.75	481.6	226.6	-0.0692	271.75	-0.225	232	-0.6586	
271.85	480.39	224.6	-0.0879	271.83	-0.229	228.8	-0.6968	
271.92	477.46	222.5	-0.0994	271.92	-0.234	225.2	-0.7341	
272.00	473.08	219.1	-0.111	272.00	-0.235	222.1	-0.7696	
272.08	469.98	216.6	-0.1225	272.08	-0.239	219	-0.8042	
272.17	468.47	214.9	-0.1402	272.17	-0.242	215.7	-0.8379	
272.25	465.8	212.7	-0.1509	272.25	-0.248	212.4	-0.8699	
272.33	463.43	210.6	-0.1616	272.33	-0.25	208.5	-0.9001	
272.42	461.69	208.9	-0.1722	272.42	-0.252	205.9	-0.9409	
272.50	458.59	206.7	-0.1829	272.50	-0.255	203.3	-0.9693	
272.58	455.79	204.3	-0.1917	272.58	-0.258	200.8	-0.995	
272.67	454.41	202.7	-0.2059	272.67	-0.26	198.6	-1.0181	
272.75	452.38	201.1	-0.2148	272.75	-0.263	196	-1.043	
272.83	449.84	199.2	-0.2237	272.83	-0.265	193.9	-1.0661	
272.92	449.19	198.1	-0.2317	272.93	-0.268	191	-1.0953	
273.00	447.39	196.7	-0.2397	273.02	-0.27	189	-1.1149	
273.08	444.62	195	-0.2477	273.08	-0.271	187.5	-1.1335	
273.17	443.5	193.3	-0.2548	273.17	-0.273	185.7	-1.1513	
273.25	442.39	192.2	-0.2654	273.25	-0.276	184.1	-1.1672	
273.35	441.71	191.3	-0.2707	273.33	-0.277	182.1	-1.1823	
273.42	439.31	189.7	-0.2778	273.42	-0.278	180.9	-1.2054	
273.50	438.75	188.9	-0.2849	273.50	-0.279	179.7	-1.2187	
273.58	438.37	188.3	-0.2894	273.58	-0.281	178.4	-1.232	
273.67	437.02	187.4	-0.2947	273.67	-0.281	177.6	-1.2436	
273.75	437.14	187	-0.2982	273.75	-0.283	176.7	-1.2542	
273.83	436.62	186.5	-0.3027	273.83	-0.283	176	-1.2649	
273.92	435.54	185.7	-0.3071	273.92	-0.283	175.3	-1.2738	
274.00	435.13	185.2	-0.3107	274.00	-0.283	175	-1.2818	
274.08	434.98	184.9	-0.316	274.08	-0.285	174.4	-1.2933	
274.17	434.26	184.5	-0.3196	274.17	-0.284	174.3	-1.2995	
274.25	435.56	184.6	-0.3213	274.25	-0.284	173.9	-1.3066	

Prova triassiale ciclica SNGR03-C4

tensione di confinamento (kPa)		450		tensione di confinamento (kPa)		450	
deviatore ciclico (kPa)		230		deviatore ciclico (kPa)		260	
frequenza (hz)		0.007143		frequenza (hz)		0.007143	
274.33	434.82	184.2	-0.324	274.35	-0.284	174	-1.311
274.42	435.08	184.2	-0.3267	274.43	-0.284	173.7	-1.3181
274.50	435.95	184.4	-0.3275	274.50	-0.284	173.9	-1.3226
274.58	435.71	184.6	-0.3293	274.58	-0.283	174.4	-1.3261
274.67	436.94	184.9	-0.3311	274.67	-0.282	174.6	-1.3288
274.77	437.48	185.2	-0.332	274.75	-0.282	174.8	-1.3315
274.83	438.55	185.7	-0.3329	274.83	-0.28	175.7	-1.3332
274.92	439.48	186.1	-0.3338	274.92	-0.279	176.1	-1.335
275.00	440.32	186.5	-0.3338	275.00	-0.277	177.4	-1.3359
275.08	441.46	187.1	-0.3338	275.08	-0.276	178.1	-1.3368
275.17	442.47	187.7	-0.3338	275.17	-0.275	179	-1.3368
275.25	444.08	188.4	-0.3338	275.25	-0.273	180	-1.3368
275.33	446.19	189	-0.3329	275.33	-0.272	180.9	-1.3359
275.42	448.07	190.3	-0.3329	275.42	-0.27	181.9	-1.3359
275.50	448.71	190.9	-0.332	275.50	-0.267	183.3	-1.335
275.58	450.89	192	-0.3311	275.58	-0.264	185.2	-1.3341
275.67	452.6	193.1	-0.3302	275.67	-0.262	186.6	-1.3332
275.75	454.01	193.7	-0.3293	275.75	-0.26	187.5	-1.3323
275.83	456.69	194.9	-0.3284	275.85	-0.257	189	-1.3315
275.92	459.51	196.6	-0.3275	275.93	-0.253	190.4	-1.3297
276.00	462.5	198	-0.3267	276.00	-0.251	192.7	-1.3288
276.08	463.68	198.8	-0.3249	276.08	-0.249	194.2	-1.327
276.17	466.49	200.2	-0.324	276.17	-0.245	195.9	-1.3252
276.25	470.12	202	-0.3231	276.25	-0.241	197.7	-1.3235
276.33	472	203.3	-0.3204	276.33	-0.239	199.6	-1.3208
276.42	474.58	204.6	-0.3196	276.42	-0.235	201.4	-1.319
276.50	478.61	206.5	-0.3178	276.50	-0.231	203.3	-1.3173
276.58	480.29	207.8	-0.316	276.58	-0.227	205.9	-1.3155
276.67	483.71	209.4	-0.3142	276.67	-0.222	208.5	-1.3128
276.75	487.7	211.1	-0.3124	276.75	-0.22	210	-1.3093
276.83	491.56	213.8	-0.3107	276.83	-0.215	212.2	-1.3084
276.92	493.38	215	-0.308	276.92	-0.21	215	-1.3048
277.00	497.13	216.8	-0.3062	277.00	-0.208	216.8	-1.3022
277.08	501.43	219.1	-0.3036	277.08	-0.204	218.9	-1.2995
277.17	503.91	220.6	-0.3018	277.17	-0.197	221.9	-1.296
277.25	507.8	222.6	-0.2991	277.27	-0.193	224.6	-1.2924
277.33	514.21	225.8	-0.2965	277.35	-0.188	227.7	-1.2889
277.42	516.46	227.7	-0.2947	277.42	-0.184	229.6	-1.2853
277.50	520.35	229.5	-0.2903	277.50	-0.179	232.5	-1.2818
277.58	524.81	231.9	-0.2876	277.58	-0.171	235	-1.2782
277.68	529.81	234.8	-0.2858	277.67	-0.166	239	-1.2747
277.75	532.26	236.9	-0.2814	277.75	-0.164	241.7	-1.2684
277.83	536.12	238.8	-0.2787	277.83	-0.158	244.2	-1.2649
277.92	542.05	241.7	-0.2752	277.92	-0.151	247.7	-1.2596
278.00	544.77	243.5	-0.2725	278.00	-0.147	250.4	-1.2551
278.08	549.13	245.8	-0.269	278.08	-0.141	252.9	-1.2507
278.17	555.33	248.6	-0.2654	278.17	-0.134	256.1	-1.2462
278.25	560.73	252.2	-0.2619	278.25	-0.127	260.4	-1.2409
278.33	563.11	254.1	-0.2565	278.33	-0.123	263.6	-1.2365
278.42	568.34	256.6	-0.253	278.42	-0.118	266.1	-1.2276
278.50	572.56	259.3	-0.2485	278.50	-0.111	269.4	-1.2223
278.58	576.72	261.5	-0.245	278.58	-0.105	272.9	-1.217
278.67	581.74	264.2	-0.2406	278.67	-0.101	275.5	-1.2107
278.75	589.08	268.2	-0.2361	278.77	-0.094	280.1	-1.2019
278.83	593	270.8	-0.2299	278.85	-0.087	283.1	-1.1965
278.92	596.49	272.8	-0.2263	278.92	-0.081	286.4	-1.1894
279.00	602.38	275.9	-0.221	279.00	-0.076	289.5	-1.1823
279.08	605.67	278.3	-0.2166	279.08	-0.069	292.6	-1.1752
279.17	611.93	282.1	-0.2095	279.17	-0.063	296	-1.169
279.25	616.55	284.3	-0.2059	279.25	-0.056	300.3	-1.1619

Prova triassiale ciclica SNGR03-C4							
tensione di confinamento (kPa)	450			tensione di confinamento (kPa)	450		
deviatore ciclico (kPa)	230			deviatore ciclico (kPa)	260		
frequenza (hz)	0.007143			frequenza (hz)	0.007143		
279.33	622.38	287.4	-0.1997	279.33	-0.048	304.3	-1.1548
279.42	624.79	289.4	-0.1962	279.42	-0.043	307.1	-1.1433
279.50	631.08	292.4	-0.1908	279.50	-0.037	310.4	-1.1353
279.58	637.54	295.6	-0.1846	279.58	-0.03	314.1	-1.1273
279.67	645.47	299.7	-0.1793	279.67	-0.026	317	-1.1193
279.75	646.74	301.6	-0.1704	279.75	-0.019	320.1	-1.1113
279.83	652.67	304.6	-0.1651	279.83	-0.011	323.9	-1.1016
279.92	657.55	307.5	-0.1589	279.92	-0.003	328.6	-1.0927
280.00	662	309.9	-0.1527	280.00	0.003	332.1	-1.0829
280.08	667.78	312.9	-0.1473	280.08	0.008	335.2	-1.0678
280.17	673.7	316.8	-0.1402	280.18	0.015	338.9	-1.0563
280.25	678.61	319.5	-0.1314	280.27	0.023	342.2	-1.0456
280.33	683.59	322	-0.1252	280.33	0.031	347.6	-1.0332
280.42	689.64	325.1	-0.1181	280.42	0.035	351	-1.0084
280.50	693.11	327.4	-0.1118	280.50	0.041	354.3	-0.9915
280.60	699.22	331.1	-0.103	280.58	0.049	358.4	-0.9737
280.67	704.03	333.5	-0.0959	280.67	0.052	361.9	-0.9533
280.75	710.11	336.5	-0.0879	280.75	0.06	365.7	-0.9302
280.83	713.28	338.7	-0.0817	280.83	0.066	369.6	-0.9081
280.92	718.49	341.4	-0.0737	280.92	0.076	375.2	-0.8841
281.00	724.86	344.2	-0.0657	281.00	0.081	379	-0.8575
281.08	730.7	348.2	-0.0577	281.08	0.086	382.4	-0.814
281.17	734.59	350.5	-0.0444	281.17	0.093	386.5	-0.7811
281.25	739.89	353.3	-0.0328	281.25	0.097	389.9	-0.7509
281.33	743.65	355.8	-0.0231	281.33	0.103	393.6	-0.7146
281.42	747.98	358.2	-0.0124	281.42	0.109	397.4	-0.6746
281.50	753.04	360.9	-0.0009	281.50	0.118	401.8	-0.6276
281.58	759.63	364.8	0.0124	281.58	0.125	407.2	-0.5867
281.67	763.21	367.2	0.032	281.68	0.131	410.8	-0.5113
281.75	767.53	369.4	0.0462	281.75	0.134	413.2	-0.4678
281.83	772.64	372.1	0.0621	281.83	0.14	416.9	-0.4048
281.92	775.45	374.3	0.0772	281.92	0.149	422.3	-0.3444
282.02	781.61	377.2	0.1012	282.00	0.154	425.7	-0.292
282.08	785.42	379.2	0.1172	282.08	0.158	428.6	-0.2113
282.17	790.32	381.7	0.1358	282.17	0.165	432	-0.1562
282.25	793.55	383.6	0.1544	282.25	0.17	435.3	-0.1012
282.33	797.65	385.8	0.174	282.33	0.174	438.3	-0.0453
282.42	804.2	388.9	0.1953	282.42	0.18	441.3	0.0089
282.50	807.42	391	0.2166	282.50	0.188	444.8	0.0666
282.58	810.59	392.6	0.2477	282.58	0.193	448.9	0.1243
282.67	815.03	394.7	0.2707	282.67	0.198	451.9	0.1695
282.75	817.75	396.3	0.2911	282.75	0.202	454.2	0.2441
282.83	822.02	398.1	0.3133	282.83	0.208	456.9	0.2911
282.92	826.23	399.9	0.3346	282.92	0.212	459.3	0.3338
283.00	831.17	402.5	0.3559	283.00	0.216	461.5	0.3772
283.08	832.75	403.7	0.3879	283.10	0.222	464.9	0.4412
283.17	835.76	405.2	0.4092	283.18	0.227	467	0.4793
283.25	840.68	407.1	0.4323	283.25	0.231	469	0.5157
283.33	842.79	408.3	0.4518	283.33	0.234	471	0.5557
283.42	845.56	409.7	0.4722	283.42	0.239	472.9	0.5947
283.52	848.74	411.4	0.5015	283.50	0.244	474.8	0.632
283.58	852.96	413	0.5219	283.58	0.251	477.8	0.6657
283.67	855.27	414	0.5397	283.67	0.251	478.9	0.7163
283.75	857.98	415.2	0.5574	283.75	0.255	480.3	0.7492
283.83	862.23	417	0.577	283.83	0.26	482.1	0.7829
283.92	864.44	418.1	0.6036	283.92	0.262	483.3	0.8131
284.00	866.52	419	0.6205	284.00	0.265	484.6	0.8424
284.08	869.05	420	0.6373	284.08	0.271	486	0.8699
284.17	871.32	421	0.6542	284.17	0.275	488	0.8974
284.25	872.74	421.5	0.6693	284.25	0.275	488.7	0.9329

Prova triassiale ciclica SNGR03-C4

tensione di confinamento (kPa)		450		tensione di confinamento (kPa)		450	
deviatore ciclico (kPa)		230		deviatore ciclico (kPa)		260	
frequenza (hz)		0.007143		frequenza (hz)		0.007143	
284.33	876.09	422.4	0.687				
284.42	878.2	423.6	0.7012				
284.50	880.86	424.5	0.7199				
284.58	881.22	424.9	0.7296				
284.67	882.58	425.5	0.7421				
284.75	884.39	426.2	0.7536				
284.83	884.96	426.6	0.7643				
284.93	887.65	427.5	0.7793				
285.00	888.58	427.9	0.7882				
285.08	889.71	428.4	0.7971				
285.17	890.65	428.7	0.8051				
285.25	893.46	429.5	0.8131				
285.33	891.84	429.5	0.8237				
285.42	892.45	429.6	0.8299				
285.50	893.98	430	0.8362				
285.58	894.26	430.1	0.8415				
285.67	894.64	430.3	0.8468				
285.75	894.57	430.4	0.8504				
285.83	895.27	430.5	0.8557				
285.92	895.03	430.5	0.861				
286.00	893.96	430.3	0.8646				
286.08	895.56	430.7	0.869				
286.17	894.99	430.5	0.8717				
286.25	893.24	430.1	0.8726				
286.33	892.41	429.8	0.8743				
286.42	892.54	429.8	0.877				
286.50	891.48	429.6	0.8779				
286.58	891.64	429.3	0.8788				
286.67	889.73	428.9	0.8788				
286.75	888.54	428.6	0.8797				
286.83	887.32	428.2	0.8797				
286.92	885.77	427.7	0.8797				
287.00	884.94	427.5	0.8797				
287.08	883.46	427	0.8788				
287.17	879.24	426.4	0.8779				
287.25	879.34	425.6	0.8779				
287.33	878.71	425.3	0.877				
287.42	875.65	424.4	0.8761				
287.50	873.25	423.7	0.8743				
287.58	871.63	423.1	0.8734				
287.67	868.47	422.3	0.8726				
287.75	866	421.3	0.8717				
287.85	863.92	420.6	0.869				
287.92	861.85	419.9	0.8681				
288.00	856.15	418.9	0.8654				
288.08	854.8	417.4	0.8646				
288.17	851.9	416.5	0.861				
288.25	850.26	415.6	0.8583				
288.33	846.01	414.6	0.8557				
288.42	843.6	413.8	0.853				
288.50	840.31	412.6	0.8504				
288.58	834.61	411.5	0.8468				
288.67	831.35	409.7	0.845				
288.75	829.74	409	0.8388				
288.83	823.12	407.1	0.8335				
288.92	824.21	406.8	0.8317				
289.00	818.32	405.2	0.8264				
289.08	812.98	403.6	0.8228				
289.17	810.31	402.1	0.8202				
289.25	805.37	400.5	0.8122				

Prova triassiale ciclica SNGR03-C4

tensione di confinamento (kPa)		450		tensione di confinamento (kPa)		450	
deviatore ciclico (kPa)		230		deviatore ciclico (kPa)		260	
frequenza (hz)		0.007143		frequenza (hz)		0.007143	
289.33	804.78	399.8	0.8095				
289.42	794.69	397.5	0.8033				
289.50	792.88	395.7	0.7989				
289.58	789.59	394.2	0.7918				
289.67	784.61	392.6	0.7856				
289.75	780.39	390.8	0.7793				
289.83	775.52	389.1	0.7722				
289.92	773.91	388.3	0.766				
290.00	764.6	385	0.7572				
290.08	760.34	383.1	0.7527				
290.17	758.47	382.3	0.743				
290.25	750.59	379.5	0.7332				
290.33	749.21	378.3	0.7279				
290.42	743.93	376.5	0.7199				
290.50	737.88	374.4	0.7128				
290.58	730.59	371	0.703				
290.67	730.2	370	0.6941				
290.77	722.87	367.7	0.6844				
290.83	717.05	365.9	0.6764				
290.92	711.56	362.7	0.6675				
291.00	708.56	361.1	0.6542				
291.08	702.15	358.7	0.6453				
291.17	697.92	356.7	0.6356				
291.25	692.16	354.2	0.6249				
291.33	688.1	352.3	0.616				
291.42	680.88	349.3	0.608				
291.50	676.12	346.7	0.5956				
291.58	675.06	345.6	0.5814				
291.67	664.23	341.9	0.5681				
291.75	662.77	340.1	0.5574				
291.83	658.8	338.3	0.545				
291.92	650.84	335.4	0.5326				
292.00	644.01	331.6	0.5202				
292.08	641.29	330.1	0.4997				
292.18	635.95	327.5	0.4855				
292.25	629.67	325.3	0.4722				
292.33	624.23	321.4	0.4571				
292.42	621.1	319.5	0.4341				
292.50	615.85	317.1	0.4199				
292.58	609.76	313.8	0.4057				
292.67	607.16	311.9	0.3941				
292.75	601.34	309.1	0.3817				
292.83	594.06	305.2	0.3684				
292.92	589.93	302.1	0.3568				
293.00	586.56	300.2	0.3373				
293.08	580.56	297	0.3222				
293.17	577.42	294.6	0.3098				
293.25	573.32	292.3	0.2965				
293.33	566.38	288.8	0.2796				
293.42	560.05	284.7	0.2654				
293.50	557.82	282.5	0.2432				
293.58	553.24	279.9	0.2281				
293.68	547.9	277.5	0.2139				
293.75	543.61	273.4	0.1979				
293.83	540.05	271.1	0.174				
293.92	535.59	268.4	0.1571				
294.00	531.07	265.3	0.1402				
294.08	528.04	263.1	0.1234				
294.17	523.91	260.2	0.1083				
294.25	517.12	255.7	0.0914				

Prova triassiale ciclica SNGR03-C4

tensione di confinamento (kPa)		450		tensione di confinamento (kPa)		450	
deviatore ciclico (kPa)		230		deviatore ciclico (kPa)		260	
frequenza (hz)		0.007143		frequenza (hz)		0.007143	
294.33	514.57	253.2	0.0683				
294.42	511.34	250.9	0.0524				
294.50	506.7	247.7	0.0355				
294.58	503.87	245.2	0.0213				
294.67	500.94	242.8	0.0071				
294.75	495.16	239.3	-0.0107				
294.83	491.86	235.9	-0.0231				
294.92	489.98	233.9	-0.0435				
295.00	486.14	231.3	-0.0577				
295.10	482.31	228.6	-0.0701				
295.17	478.4	225.2	-0.0817				
295.25	476.89	223.5	-0.1003				
295.33	473.82	221.1	-0.1127				
295.42	471.15	218.9	-0.1243				
295.50	468.98	217	-0.1358				
295.58	466.14	214.6	-0.1473				
295.67	462.93	211.5	-0.1589				
295.75	460.98	209.7	-0.1758				
295.83	458.52	207.9	-0.1855				
295.92	455.68	205.7	-0.1962				
296.00	454.75	204.4	-0.2059				
296.08	453.05	202.9	-0.2139				
296.17	449.91	200.8	-0.2237				
296.25	448.65	198.9	-0.2326				
296.33	446.57	197.2	-0.245				
296.42	445.58	196.3	-0.2521				
296.50	444.15	194.8	-0.2601				
296.60	442.46	193.2	-0.2672				
296.67	441.33	192.2	-0.2761				
296.75	440.14	191.2	-0.2823				
296.83	438.55	190	-0.2876				
296.92	438.63	189.6	-0.2929				
297.00	436.94	188.5	-0.2982				
297.08	436.66	187.9	-0.3027				
297.17	435.94	187.2	-0.3098				
297.25	435.59	186.9	-0.3133				
297.33	435.48	186.5	-0.3169				
297.42	435.37	186.2	-0.3204				
297.50	434.92	185.9	-0.3231				
297.58	435.15	185.8	-0.3258				
297.67	435.14	185.7	-0.3284				
297.75	435.54	185.7	-0.3311				
297.83	436	185.8	-0.3329				
297.92	436.03	185.8	-0.3346				
298.02	436.66	186.1	-0.3355				
298.08	437.43	186.4	-0.3373				
298.17	437.76	186.7	-0.3382				
298.25	439.64	187.5	-0.3382				
298.33	439.74	187.6	-0.3382				
298.42	442.02	188.3	-0.3382				
298.50	442.86	189.1	-0.3382				
298.58	443.96	189.7	-0.3382				
298.67	446.01	190.6	-0.3373				
298.75	447.86	191.5	-0.3373				
298.83	448.33	192	-0.3364				
298.92	450.31	193	-0.3364				
299.00	452.99	194.4	-0.3346				
299.08	455.64	195.8	-0.3346				
299.17	456.69	196.5	-0.3329				
299.25	459.6	197.8	-0.332				

Prova triassiale ciclica SNGR03-C4

tensione di confinamento (kPa)		450		tensione di confinamento (kPa)		450	
deviatore ciclico (kPa)		230		deviatore ciclico (kPa)		260	
frequenza (hz)		0.007143		frequenza (hz)		0.007143	
299.33	461.15	198.8	-0.3311				
299.42	463.63	200	-0.3302				
299.50	466.72	201.7	-0.3284				
299.58	469.13	203	-0.3275				
299.67	471.85	204.5	-0.3258				
299.75	473.97	205.7	-0.3249				
299.83	478.16	207.4	-0.3231				
299.92	481.72	209.8	-0.3213				
300.00	483.94	211.2	-0.3187				
300.08	487.76	212.8	-0.3169				
300.17	491.05	214.7	-0.3151				
300.25	493.37	216.2	-0.3133				
300.33	496.72	218	-0.3116				
300.42	502.32	220.1	-0.3089				
300.50	505.38	222.8	-0.3071				
300.58	507.96	224.3	-0.3036				
300.67	512.56	226.6	-0.3009				
300.75	515.98	228.9	-0.2982				
300.83	518.97	230.4	-0.2956				
300.93	523.83	233.2	-0.292				
301.00	529.03	235.8	-0.2885				
301.08	532.08	238.1	-0.2867				
301.17	535.77	239.9	-0.284				
301.25	541.61	242.6	-0.2805				
301.33	547.61	246.1	-0.2778				
301.42	549.86	248.2	-0.2725				
301.50	553.55	250.1	-0.269				
301.58	560.12	253.4	-0.2645				
301.67	562.27	255.2	-0.2619				
301.75	568.07	258	-0.2574				
301.83	574.23	261.4	-0.2539				
301.92	577.99	264	-0.2503				
302.00	582.15	266.3	-0.2441				
302.08	587.51	269.1	-0.2397				
302.17	591.6	272	-0.2352				
302.25	595.71	274	-0.2308				
302.35	603.02	278.1	-0.2237				
302.42	607.64	280.6	-0.2201				
302.50	610.96	283	-0.2148				
302.58	615.61	285.5	-0.2113				
302.67	623.58	288.8	-0.205				
302.75	628.37	292.5	-0.2006				
302.83	632.52	295.1	-0.1926				
302.92	637.44	297.7	-0.1873				
303.00	644.67	301	-0.1811				
303.08	646.31	303.1	-0.1758				
303.17	651.79	305.9	-0.1695				
303.25	659.69	310.1	-0.1642				
303.33	663.94	312.7	-0.158				
303.42	667.78	315	-0.1491				
303.50	673.7	318.2	-0.1429				
303.58	678.78	321.1	-0.1358				
303.67	682.42	323.2	-0.1305				
303.75	689.88	326.2	-0.1234				
303.85	697.12	330.6	-0.1127				
303.92	697.46	332.4	-0.1074				
304.00	703	334.8	-0.1003				
304.08	709.85	337.7	-0.0932				
304.17	715.82	341.7	-0.0861				
304.25	717.69	343.5	-0.0754				

Prova triassiale ciclica SNGR03-C4

tensione di confinamento (kPa)		450		tensione di confinamento (kPa)		450	
deviatore ciclico (kPa)		230		deviatore ciclico (kPa)		260	
frequenza (hz)		0.007143		frequenza (hz)		0.007143	
304.33	724.49	346.4	-0.0666				
304.42	729.6	349.3	-0.0577				
304.50	733.46	351.8	-0.0479				
304.58	738.22	354.5	-0.0382				
304.67	744.86	358.5	-0.0257				
304.75	752.42	362.1	-0.0151				
304.83	752.1	363.2	0.0027				
304.92	758.86	366.3	0.0169				
305.00	761.81	368.8	0.0293				
305.08	767.23	371	0.0444				
305.17	771.57	373.8	0.0612				
305.27	777.3	376.8	0.0852				
305.33	780.04	378.7	0.1003				
305.42	784.08	380.8	0.1172				
305.50	791.04	383.5	0.1394				
305.58	795.97	386.7	0.158				
305.67	799.21	388.6	0.19				
305.75	802.57	390.4	0.2104				
305.83	806.92	392.6	0.2334				
305.92	809.87	394.3	0.2556				
306.00	813.94	396.3	0.2796				
306.08	822.3	399.7	0.3053				
306.17	821.59	400.6	0.3267				
306.25	826.16	402.3	0.3639				
306.33	830.32	404.1	0.3906				
306.42	832.4	405.6	0.4119				
306.50	835.83	407	0.4341				
306.58	840.92	408.6	0.4554				
306.67	844.01	410.9	0.4802				
306.77	844.88	411.9	0.5068				
306.83	849.23	413.3	0.529				
306.92	852.36	415	0.5512				
307.00	856.88	416.6	0.569				
307.08	858.59	417.4	0.5992				
307.17	861.06	418.6	0.6187				
307.25	864.05	419.9	0.6364				
307.33	867.05	420.9	0.6524				
307.42	867.97	421.7	0.6666				
307.50	872.23	423.3	0.6826				
307.58	873.69	424	0.7057				
307.67	876.21	424.8	0.7243				
307.75	877.1	425.3	0.7376				
307.83	878.68	426.3	0.7518				
307.92	882.47	427.3	0.7643				
308.00	884.23	427.5	0.7731				
308.08	883.31	428.4	0.7847				
308.18	885.05	428.9	0.798				
308.25	887.33	429.5	0.8078				
308.33	888.98	430.3	0.8175				
308.42	891.01	430.9	0.8255				
308.50	890.4	431	0.8397				
308.58	891.9	431.5	0.8477				
308.67	891.71	431.5	0.8548				
308.75	893.69	432	0.8637				
308.83	893.77	432	0.8699				
308.92	894.48	432.3	0.877				
309.00	893.66	432.2	0.8841				
309.08	896.05	432.7	0.8894				
309.17	894.13	432.5	0.8921				
309.25	893.89	432.5	0.8956				

Prova triassiale ciclica SNGR03-C4

tensione di confinamento (kPa)		450		tensione di confinamento (kPa)		450	
deviatore ciclico (kPa)		230		deviatore ciclico (kPa)		260	
frequenza (hz)		0.007143		frequenza (hz)		0.007143	
309.33	894.44	432.5	0.8983				
309.42	894.37	432.9	0.9018				
309.50	894.13	432.5	0.9036				
309.58	893.79	432.4	0.9072				
309.67	892.57	432.2	0.9081				
309.75	892.33	432	0.9098				
309.83	891.89	431.8	0.9116				
309.92	890.9	431.5	0.9125				
310.00	889.29	431.1	0.9125				
310.08	888.59	430.8	0.9134				
310.17	888.89	430.8	0.9143				
310.25	885.06	429.9	0.9134				
310.33	884.67	429.5	0.9134				
310.42	883.12	429	0.9125				
310.50	881.18	428.5	0.9116				
310.58	879.14	427.8	0.9107				
310.67	877.82	427.4	0.9107				
310.75	875.78	426.7	0.9098				
310.83	872.81	425.7	0.9081				
310.92	870.51	425	0.9081				
311.00	868.17	424.3	0.9063				
311.10	866.62	423.7	0.9054				
311.17	862.41	422.3	0.9036				
311.25	860.77	421.7	0.901				
311.33	858.16	420.8	0.9001				
311.42	855.1	419.8	0.8974				
311.50	851.94	418.8	0.8956				
311.58	849.34	417.9	0.8939				
311.67	844.83	417	0.8912				
311.75	842.09	415.4	0.8894				
311.83	839.7	414.5	0.885				
311.92	835.58	413.2	0.8814				
312.00	833.48	412.3	0.8788				
312.08	830.12	411.2	0.8752				
312.17	825.9	409.8	0.8717				
312.25	819.78	407.8	0.8681				
312.33	817.44	406.8	0.8646				
312.42	814.09	405.6	0.8575				
312.52	808.85	404.1	0.853				
312.58	805.13	402.3	0.8486				
312.67	801.87	401	0.8433				
312.75	797.46	399.5	0.8379				
312.83	792.82	397.9	0.8326				
312.92	789.76	396.5	0.8282				
313.00	785.54	395	0.8228				
313.08	779.57	393.2	0.8166				
313.17	774.63	390.8	0.8104				
313.25	772	389.5	0.8024				
313.33	765.6	387.5	0.7953				
313.42	762.61	386	0.7873				
313.50	758.99	384.6	0.7802				
313.58	752.45	382.4	0.7714				
313.67	746.79	379.9	0.7634				
313.75	743.06	378.2	0.7509				
313.83	737.75	376.3	0.743				
313.92	733.43	374.4	0.7341				
314.02	727.52	371.7	0.727				
314.08	723.37	369.6	0.7154				
314.17	717.69	367.7	0.7074				
314.25	712.5	365.4	0.6986				

Prova triassiale ciclica SNGR03-C4

tensione di confinamento (kPa)		450		tensione di confinamento (kPa)		450	
deviatore ciclico (kPa)		230		deviatore ciclico (kPa)		260	
frequenza (hz)		0.007143		frequenza (hz)		0.007143	
314.33	709.27	363.7	0.6906				
314.42	704.34	361.7	0.6808				
314.50	697.17	359.3	0.6702				
314.58	691.32	356	0.6595				
314.67	688.28	354.4	0.6444				
314.75	682.73	352	0.6338				
314.83	676.71	349.3	0.6222				
314.92	673.33	347.5	0.6134				
315.00	667.14	344.9	0.6018				
315.08	659.69	341.4	0.5903				
315.17	656.74	339	0.5725				
315.25	651.77	337.1	0.5592				
315.33	644.91	334.6	0.545				
315.43	639.41	331.7	0.5335				
315.50	636.35	329.2	0.5122				
315.58	631.47	327.1	0.4953				
315.67	624.11	324	0.4776				
315.75	621.91	322	0.4607				
315.83	617.09	319.6	0.4465				
315.92	609.15	315.5	0.4323				
316.00	604.66	312.9	0.419				
316.08	600.83	310.7	0.4003				
316.17	595.34	307.7	0.3879				
316.25	591.41	304.9	0.3746				
316.33	587.28	302.8	0.3613				
316.42	581.35	299.7	0.3471				
316.50	574.19	295.5	0.3329				
316.58	571.45	292.9	0.3116				
316.67	566.67	290.6	0.2965				
316.75	560.96	287.5	0.2796				
316.83	559.12	285.2	0.2645				
316.93	552.83	281.4	0.2406				
317.00	549.31	279.1	0.2255				
317.08	542.86	275.6	0.2068				
317.17	540.64	273.5	0.19				
317.25	535.92	270.9	0.1722				
317.33	530.43	266.8	0.1553				
317.42	525.8	263.7	0.1376				
317.50	523.22	261.4	0.111				
317.58	518.62	258.5	0.095				
317.67	514.79	255.6	0.0781				
317.75	511.26	253.2	0.0621				
317.83	506.86	250.5	0.0462				
317.92	501.49	246.1	0.0311				
318.00	500.01	244	0.008				
318.08	496.27	241.5	-0.0071				
318.17	492.57	238.7	-0.0222				
318.25	490.5	236.2	-0.0373				
318.35	486.81	232.9	-0.0577				
318.42	483.34	230.6	-0.0701				
318.50	479.34	227.8	-0.0834				
318.58	477.97	226	-0.0959				
318.67	474.49	223.3	-0.1092				
318.75	470.08	219.8	-0.1225				
318.83	467.8	217.6	-0.1402				
318.92	466.16	216	-0.1518				
319.00	463.12	213.6	-0.1642				
319.08	461.32	211.7	-0.1758				
319.17	458.92	209.7	-0.1864				
319.25	455.88	207.9	-0.1971				

Prova triassiale ciclica SNGR03-C4

tensione di confinamento (kPa)	450		tensione di confinamento (kPa)	450	
deviatore ciclico (kPa)	230		deviatore ciclico (kPa)	260	
frequenza (hz)	0.007143		frequenza (hz)	0.007143	
319.33	453.34	205.1	-0.2059		
319.42	452.7	203.8	-0.221		
319.50	451.07	202.4	-0.2299		
319.58	448.9	200.5	-0.2388		
319.67	447.2	199.1	-0.2477		
319.75	444.97	197.5	-0.2556		
319.83	443.8	196.1	-0.2663		
319.92	442.34	194.8	-0.2734		
320.00	441.32	193.8	-0.2796		
320.08	440.03	192.7	-0.2867		
320.17	438.67	191.5	-0.292		
320.25	438.41	190.7	-0.3		
320.33	437.06	189.9	-0.3053		
320.42	436.71	189.3	-0.3098		
320.50	436.19	188.8	-0.3142		
320.58	435.51	188.3	-0.3187		
320.67	435.16	188	-0.3222		
320.75	435.25	187.5	-0.3258		
320.83	434.74	187.2	-0.3302		
320.92	435.13	187.1	-0.3329		
321.00	435.12	187	-0.3355		
321.08	435.42	187	-0.3373		
321.17	435.82	187.1	-0.3391		
321.27	435.94	187.1	-0.3417		
321.33	437.08	187.6	-0.3426		
321.42	437.52	187.7	-0.3435		
321.50	438.62	188	-0.3444		
321.58	439.66	188.7	-0.3444		
321.67	440.43	189.2	-0.3453		
321.75	441.47	189.7	-0.3453		
321.83	443.01	190.4	-0.3453		
321.92	443.88	191	-0.3444		
322.00	445.39	191.7	-0.3444		
322.08	447.57	192.7	-0.3435		
322.17	449.35	193.9	-0.3435		
322.25	451.26	194.8	-0.3426		
322.33	452.74	195.6	-0.3417		
322.42	454.92	196.8	-0.3409		
322.50	456.47	197.5	-0.34		
322.58	458.82	198.8	-0.3391		
322.68	462.61	200.7	-0.3373		
322.75	463.38	201.4	-0.3364		
322.83	465.73	202.6	-0.3355		
322.92	470.33	204.2	-0.3338		
323.00	472.81	206.2	-0.3329		
323.08	474.73	207.5	-0.3311		
323.17	478.15	209.2	-0.3293		
323.25	481.44	210.8	-0.3275		
323.33	483.39	212.2	-0.3258		
323.42	487.04	214	-0.324		
323.50	491.27	216.4	-0.3222		
323.58	494.66	218.2	-0.3204		
323.67	497.25	219.8	-0.3169		
323.75	501.24	221.8	-0.3151		
323.83	504.43	223.9	-0.3124		
323.92	507.58	225.5	-0.3107		
324.00	513.52	227.8	-0.308		
324.08	517.98	230.8	-0.3053		
324.18	518.46	232.3	-0.3018		
324.25	523.75	234.4	-0.2991		

Prova triassiale ciclica SNGR03-C4

tensione di confinamento (kPa)		450		tensione di confinamento (kPa)		450	
deviatore ciclico (kPa)		230		deviatore ciclico (kPa)		260	
frequenza (hz)		0.007143		frequenza (hz)		0.007143	
324.33	529.62	236.7	-0.2965				
324.42	533.55	240.1	-0.2938				
324.50	536.54	242	-0.2885				
324.58	541.36	244.4	-0.2867				
324.67	545.62	247.1	-0.2832				
324.75	548.98	248.9	-0.2796				
324.83	554.58	251.7	-0.2761				
324.92	560.98	255.3	-0.2725				
325.00	564.07	257.7	-0.2672				
325.08	567.69	259.6	-0.2636				
325.17	572.95	262.4	-0.2592				
325.25	576.71	265	-0.2556				
325.33	581.27	267.4	-0.2512				
325.42	588.97	270.5	-0.2468				
325.50	593.5	274.2	-0.2423				
325.60	596.82	276.3	-0.2361				
325.67	599.87	278.3	-0.2326				
325.75	608.87	281.7	-0.2272				
325.83	613.4	285.7	-0.2228				
325.92	616.55	287.7	-0.2157				
326.00	622.37	290.8	-0.2104				
326.08	627.06	293.6	-0.205				
326.17	631.28	296	-0.1997				
326.25	636.9	298.8	-0.1944				
326.33	644.73	303	-0.1891				
326.42	648.21	305.8	-0.1802				
326.50	653.27	308.1	-0.1749				
326.58	658.69	311.1	-0.1678				
326.67	662	313.7	-0.1624				
326.75	666.81	316.1	-0.1562				
326.83	674.4	319.3	-0.15				
326.92	680.35	323.6	-0.1438				
327.00	683.43	325.9	-0.134				
327.10	687.94	328.2	-0.1278				
327.17	696.29	331.2	-0.1207				
327.25	699.3	334.6	-0.1154				
327.33	703.77	337.1	-0.1047				
327.42	709.61	340	-0.0968				
327.50	713.35	342.6	-0.0888				
327.58	717.99	344.9	-0.0817				
327.67	723.36	347.7	-0.0728				
327.75	730.64	351.9	-0.063				
327.83	735.06	354.7	-0.0488				
327.92	739.43	357	-0.0391				
328.00	744.39	359.8	-0.0275				
328.08	747.55	362.1	-0.016				
328.17	752.91	364.8	-0.0027				
328.25	759.23	367.6	0.0107				
328.33	764.92	371.7	0.0257				
328.42	767.22	373.6	0.0488				
328.52	770.97	375.6	0.0648				
328.58	777.88	378.1	0.0817				
328.67	782.28	381.5	0.0985				
328.75	785.5	383.4	0.1269				
328.83	790.1	385.6	0.1482				
328.92	792.99	387.6	0.1695				
329.00	797.52	389.7	0.1908				
329.08	802.6	392.2	0.2157				
329.17	808.47	395	0.2406				
329.25	811.38	396.9	0.2814				

Prova triassiale ciclica SNGR03-C4

tensione di confinamento (kPa)		450		tensione di confinamento (kPa)		450	
deviatore ciclico (kPa)		230		deviatore ciclico (kPa)		260	
frequenza (hz)		0.007143		frequenza (hz)		0.007143	
329.33	814.86	398.6	0.3062				
329.42	820.58	401	0.3329				
329.50	821.87	402.4	0.3542				
329.58	825.17	403.8	0.3764				
329.67	830.2	405.8	0.4003				
329.75	834.63	408.2	0.4225				
329.83	835.66	409.8	0.4554				
329.92	840.62	411.1	0.4829				
330.00	843.85	412.1	0.506				
330.08	847.67	414.5	0.529				
330.17	849.92	415.6	0.5592				
330.25	852.95	417.1	0.5796				
330.33	855.61	418.2	0.5992				
330.42	857.98	419.3	0.6196				
330.50	860.77	420.4	0.6382				
330.58	864.79	422.1	0.6586				
330.67	866.67	423.1	0.6835				
330.75	867.76	423.8	0.6986				
330.83	871.64	425	0.7154				
330.92	872.56	425.7	0.7305				
331.00	875.22	426.6	0.7465				
331.08	877.75	427.2	0.7643				
331.17	879.22	428.3	0.7802				
331.25	882.08	429.2	0.798				
331.33	882.88	429.7	0.8078				
331.43	884.92	430.5	0.8193				
331.50	886.22	431.2	0.8282				
331.58	886.83	431.5	0.8424				
331.67	887.53	431.9	0.8504				
331.75	891.3	432.9	0.8601				
331.83	890.35	432.8	0.8681				
331.92	891.94	433.3	0.877				
332.00	892.11	433.4	0.8859				
332.08	893.46	433.7	0.8983				
332.17	893.97	434	0.9045				
332.25	895.2	434.3	0.9098				
332.33	894.63	434.5	0.9143				
332.42	894.91	434.6	0.9187				
332.50	895.26	434.6	0.9223				
332.58	894.2	434.5	0.9258				
332.67	894.58	434.6	0.9294				
332.75	893.81	434.5	0.932				
332.85	893.31	434.3	0.9347				
332.92	893.3	434.3	0.9373				
333.00	893.46	434.2	0.94				
333.08	891.71	433.8	0.9409				
333.17	892.76	433.9	0.9427				
333.25	889.92	433.3	0.9427				
333.33	889.82	433.2	0.9436				
333.42	888.64	432.7	0.9436				
333.50	887.41	432.3	0.9444				
333.58	885.37	431.8	0.9436				
333.67	884.09	431.4	0.9436				
333.75	883.2	430.9	0.9427				
333.83	881.98	430.6	0.9427				
333.92	877.93	429.9	0.9427				
334.00	877.37	429.1	0.9418				
334.08	874.37	428.3	0.94				
334.17	873.59	427.9	0.9391				
334.25	870.1	426.9	0.9373				

Prova triassiale ciclica SNGR03-C4

tensione di confinamento (kPa)		450		tensione di confinamento (kPa)		450	
deviatore ciclico (kPa)		230		deviatore ciclico (kPa)		260	
frequenza (hz)		0.007143		frequenza (hz)		0.007143	
334.35	869.37	426.4	0.9373				
334.42	865.49	425.3	0.9347				
334.50	863.58	424.6	0.9338				
334.58	862.03	424	0.9329				
334.67	858.21	422.9	0.9311				
334.75	856.21	422	0.9294				
334.83	849.91	420.2	0.9276				
334.92	848.15	419.3	0.9231				
335.00	846.93	418.9	0.9214				
335.08	842.26	417.4	0.9187				
335.17	839.26	416.3	0.916				
335.25	837.02	415.4	0.9143				
335.33	832.28	414	0.9107				
335.42	829.12	412.7	0.9072				
335.50	826.4	411.6	0.9027				
335.58	820.47	409.9	0.8983				
335.67	816.95	408.5	0.8939				
335.77	815.51	407.5	0.8903				
335.83	809.12	405.8	0.8841				
335.92	804.11	404.1	0.8788				
336.00	802.08	402.9	0.8734				
336.08	799.65	402.2	0.8681				
336.17	793.99	400.2	0.861				
336.25	786.97	397.8	0.8557				
336.33	783.25	396.1	0.8468				
336.42	779.3	394.8	0.8424				
336.50	777.03	393.6	0.8379				
336.58	771.83	391.7	0.8317				
336.67	768.5	390.2	0.8273				
336.75	760.68	388.1	0.8202				
336.83	754.78	385.2	0.8149				
336.92	752.88	383.9	0.8033				
337.00	748.53	382.4	0.7971				
337.08	742.33	379.9	0.7882				
337.17	738.8	378.3	0.7802				
337.27	733.27	376	0.7687				
337.33	726.4	373.6	0.7589				
337.42	724.1	371.9	0.7501				
337.50	718.78	370	0.7421				
337.58	711.85	367.9	0.7323				
337.67	704.78	364.4	0.7243				
337.75	702.34	362.7	0.7101				
337.83	697.36	360.6	0.7003				
337.92	692.17	358.5	0.6906				
338.00	688.6	356.5	0.6782				
338.08	682.95	354.3	0.6657				
338.17	676.17	351.7	0.6533				
338.25	670.02	348.5	0.6435				
338.33	667.11	346.5	0.6267				
338.42	661.71	344.2	0.6151				
338.50	656.68	341.6	0.6018				
338.58	652.24	339.4	0.5885				
338.68	646.97	336.9	0.5708				
338.75	640.08	333.9	0.5548				
338.83	636.49	331.4	0.5397				
338.92	632.11	329.5	0.5228				
339.00	623.55	327.3	0.5051				
339.08	618.64	322.9	0.4864				
339.17	616.27	320.3	0.4633				
339.25	610.49	318.2	0.45				

Prova triassiale ciclica SNGR03-C4

tensione di confinamento (kPa)		450		tensione di confinamento (kPa)		450	
deviatore ciclico (kPa)		230		deviatore ciclico (kPa)		260	
frequenza (hz)		0.007143		frequenza (hz)		0.007143	
339.33	605.84	315.5	0.4367				
339.42	601.28	313	0.4225				
339.50	596.52	310.3	0.4101				
339.58	589.9	307.5	0.3959				
339.67	584.35	303.2	0.3826				
339.75	581.27	301.2	0.3613				
339.83	576.17	298.4	0.3471				
339.92	571.4	295.1	0.3311				
340.00	568.33	293.2	0.316				
340.08	560.99	289.8	0.2982				
340.17	556.71	286.4	0.2752				
340.25	553.59	283.7	0.2592				
340.33	549.8	281.5	0.2414				
340.42	543.22	278.3	0.2228				
340.50	537.77	274.2	0.2059				
340.58	536.16	272	0.1784				
340.67	531.37	269.2	0.1598				
340.75	526.87	266.2	0.1402				
340.83	524.04	263.9	0.1225				
340.92	519.41	260.7	0.1039				
341.00	513.97	256.7	0.0852				
341.08	510.08	253.9	0.0701				
341.17	507.33	251.6	0.0453				
341.25	503.15	248.7	0.0284				
341.33	500.42	246	0.0124				
341.42	496.88	243.5	-0.0027				
341.50	492.51	240.6	-0.0186				
341.60	489.02	237	-0.0408				
341.67	486.99	235.1	-0.0541				
341.75	484.15	232.7	-0.0666				
341.83	478.94	229.8	-0.0817				
341.92	476.3	226.4	-0.095				
342.00	474.58	224.4	-0.1145				
342.08	470.74	221.7	-0.1287				
342.17	468.97	219.7	-0.1411				
342.25	466.83	217.7	-0.1527				
342.33	463.52	215.3	-0.1651				
342.42	459.61	212.2	-0.1766				
342.50	459.17	210.7	-0.1926				
342.58	456.9	209	-0.2033				
342.67	453.96	206.9	-0.2139				
342.75	452.63	205.3	-0.2237				
342.83	450.39	203.6	-0.2334				
342.92	447.85	202.1	-0.2423				
343.02	446.71	200	-0.2548				
343.08	445.42	198.7	-0.2627				
343.17	443.89	197.4	-0.2707				
343.25	442.13	195.7	-0.2778				
343.33	440.6	194.5	-0.284				
343.42	440.31	193.9	-0.2929				
343.50	438.65	192.7	-0.2991				
343.58	437.63	191.7	-0.3053				
343.67	437.31	191.2	-0.3107				
343.75	436.83	190.5	-0.3151				
343.83	435.1	189.5	-0.3204				
343.92	436.43	189.5	-0.3258				
344.00	435.08	188.8	-0.3302				
344.08	435.64	188.8	-0.3329				
344.17	435.26	188.5	-0.3364				
344.25	434.88	188.2	-0.3391				

Prova triassiale ciclica SNGR03-C4

tensione di confinamento (kPa)		450		tensione di confinamento (kPa)		450	
deviatore ciclico (kPa)		230		deviatore ciclico (kPa)		260	
frequenza (hz)		0.007143		frequenza (hz)		0.007143	
344.33	435.51	188.2	-0.3417				
344.42	435.5	188.2	-0.3444				
344.52	435.8	188.3	-0.3462				
344.58	436.5	188.5	-0.348				
344.67	436.89	188.6	-0.3497				
344.75	437.6	189	-0.3506				
344.83	438.3	189.3	-0.3515				
344.92	439.3	189.6	-0.3515				
345.00	440.07	190.1	-0.3524				
345.08	441.11	190.7	-0.3524				
345.17	443.32	191.3	-0.3524				
345.25	444.4	192.4	-0.3515				
345.33	445.91	193.2	-0.3506				
345.42	447.18	193.9	-0.3506				
345.50	449.06	194.9	-0.3497				
345.58	450.78	195.7	-0.3497				
345.67	452.29	196.7	-0.3488				
345.75	455.37	198.2	-0.348				
345.83	457.69	199.4	-0.3471				
345.93	459.17	200.2	-0.3462				
346.00	461.59	201.4	-0.3444				
346.08	464.94	203.2	-0.3435				
346.17	466.79	204.5	-0.3417				
346.25	469.2	205.7	-0.3409				
346.33	472.49	207.2	-0.3391				
346.42	474.34	208.5	-0.3382				
346.50	477.29	210	-0.3364				
346.58	481.05	211.9	-0.3346				
346.67	485.48	214.3	-0.3329				
346.75	486.96	215.6	-0.3302				
346.83	491.46	217.5	-0.3284				
346.92	493.47	219	-0.3267				
347.00	496.93	220.9	-0.324				
347.08	500.69	222.8	-0.3222				
347.17	505.82	225.7	-0.3196				
347.25	509.65	227.9	-0.3178				
347.33	512.33	229.5	-0.3142				
347.43	516.09	231.5	-0.3116				
347.50	522.23	234.6	-0.3089				
347.58	524.52	236.7	-0.3045				
347.67	528.27	238.6	-0.3018				
347.75	533.44	241.2	-0.2991				
347.83	535.62	243.2	-0.2965				
347.92	540.45	245.5	-0.2929				
348.00	546.29	248	-0.2894				
348.08	551.82	251.5	-0.2867				
348.17	553.67	253.6	-0.2823				
348.25	558.93	255.9	-0.2778				
348.33	564.63	258.8	-0.2743				
348.42	567.52	261.1	-0.2698				
348.50	572.04	263.5	-0.2663				
348.58	579.15	267.4	-0.2619				
348.67	583.1	269.8	-0.2583				
348.75	586.79	272.1	-0.2521				
348.85	592.89	275.1	-0.2477				
348.92	598.05	278.5	-0.2441				
349.00	602.04	281.1	-0.237				
349.08	605.89	283.6	-0.2326				
349.17	613.59	286.7	-0.2263				
349.25	615.57	289	-0.2219				

Prova triassiale ciclica SNGR03-C4

tensione di confinamento (kPa)		450		tensione di confinamento (kPa)		450	
deviatore ciclico (kPa)		230		deviatore ciclico (kPa)		260	
frequenza (hz)		0.007143		frequenza (hz)		0.007143	
349.33	620.29	291.4	-0.2175				
349.42	628.09	294.7	-0.2113				
349.50	634.22	298.8	-0.2068				
349.58	636.77	301.1	-0.1988				
349.67	641.79	303.5	-0.1935				
349.75	648.05	306.9	-0.1873				
349.83	651.19	309.1	-0.182				
349.92	657.21	312	-0.1766				
350.00	664.54	316.2	-0.1687				
350.08	670.73	319.6	-0.1624				
350.17	673.33	321.3	-0.1536				
350.25	679.79	324.4	-0.1473				
350.35	685.5	328	-0.142				
350.42	688.78	330.7	-0.1323				
350.50	693.62	332.9	-0.1252				
350.58	699.9	336	-0.1181				
350.67	702.81	338.5	-0.111				
350.75	708.08	341	-0.1039				
350.83	715.53	344.1	-0.095				
350.92	721.24	348	-0.0879				
351.00	723.76	350.5	-0.0746				
351.08	731.94	353.8	-0.0621				
351.17	733.23	355.6	-0.0559				
351.25	737.6	358.2	-0.0444				
351.33	743.09	361.1	-0.032				
351.42	750.26	365.2	-0.0186				
351.50	754.58	367.9	-0.0062				
351.58	758.16	370.1	0.0151				
351.67	763.38	372.9	0.0311				
351.77	770.76	376.8	0.0479				
351.83	772.36	378.5	0.071				
351.92	776.73	380.5	0.0897				
352.00	781.5	382.9	0.1092				
352.08	784.74	385	0.1278				
352.17	787.83	387	0.1509				
352.25	795.55	389.6	0.174				
352.33	799.13	392.7	0.1997				
352.42	802.16	394.4	0.2343				
352.50	806.83	396.5	0.2619				
352.58	809.83	398.3	0.2911				
352.67	813.54	400.1	0.316				
352.75	818.07	402.2	0.3426				
352.83	825.39	405.4	0.3701				
352.92	825.28	406.4	0.4048				
353.00	831.59	408.5	0.4323				
353.08	831.81	409.5	0.4536				
353.18	837.58	411.7	0.4793				
353.25	839.42	413	0.5148				
353.33	843.81	414.6	0.5361				
353.42	847.87	416.5	0.5592				
353.50	848.05	417.2	0.5779				
353.58	851.87	418.6	0.6				
353.67	856.14	419.7	0.6249				
353.75	858.73	421.4	0.648				
353.83	861.17	422.6	0.6746				
353.92	863.97	423.8	0.6924				
354.00	865.35	424.7	0.7092				
354.08	868.87	425.8	0.727				
354.17	872.88	426.5	0.7456				
354.25	873.67	427.9	0.7589				

Prova triassiale ciclica SNGR03-C4

tensione di confinamento (kPa)		450		tensione di confinamento (kPa)		450	
deviatore ciclico (kPa)		230		deviatore ciclico (kPa)		260	
frequenza (hz)		0.007143		frequenza (hz)		0.007143	
354.33	876.44	429	0.7838				
354.42	876.34	429.3	0.7962				
354.50	881.94	430.9	0.8122				
354.58	880.39	431	0.8228				
354.68	884.19	432.1	0.8424				
354.75	884.63	432.4	0.8504				
354.83	885.13	432.8	0.8601				
354.92	887.08	433.5	0.8699				
355.00	888.7	434.3	0.8805				
355.08	890.46	434.8	0.8885				
355.17	890.23	435	0.8983				
355.25	892.76	435.7	0.9098				
355.33	893.99	436	0.9169				
355.42	891.96	435.7	0.9223				
355.50	894.75	436.2	0.9285				
355.58	894.01	436.1	0.9338				
355.67	894.98	436.8	0.9382				
355.75	894.07	436.5	0.9444				
355.83	894.91	436.7	0.9489				
355.92	894.28	436.6	0.9524				
356.00	894.63	436.8	0.9551				
356.10	894.85	436.8	0.9604				
356.17	895.85	436.9	0.964				
356.25	892.62	436.3	0.9649				
356.33	895.18	436.7	0.9684				
356.42	891.72	436	0.9684				
356.50	893.07	436.1	0.9702				
356.58	889.61	435.3	0.9711				
356.67	890.79	435.4	0.972				
356.75	888.25	434.9	0.972				
356.83	888.05	434.7	0.972				
356.92	885.55	434	0.972				
357.00	883.8	433.9	0.972				
357.08	882.32	432.8	0.9711				
357.17	881.17	432.3	0.9702				
357.25	878.64	431.7	0.9702				
357.33	877.62	431.3	0.9693				
357.42	875.55	430.6	0.9684				
357.50	872.95	430	0.9675				
357.60	870.9	429	0.9666				
357.67	866.86	428	0.9649				
357.75	866.46	427.6	0.964				
357.83	865.28	427	0.9631				
357.92	859.36	425.4	0.9604				
358.00	857.94	424.6	0.9587				
358.08	854.55	423.6	0.956				
358.17	851.36	422.5	0.9542				
358.25	848.83	421.5	0.9516				
358.33	846.63	420.8	0.9498				
358.42	841.62	419.4	0.9471				
358.50	840.05	418.4	0.9453				
358.58	835.51	417	0.9409				
358.67	832.61	415.9	0.9382				
358.75	829.29	414.7	0.9347				
358.83	827.75	413.9	0.932				
358.92	821.53	412.1	0.9285				
359.02	815.48	410.1	0.9223				
359.08	814.43	409.3	0.9196				
359.17	810.68	408.1	0.9152				
359.25	806.43	406.5	0.9107				

Prova triassiale ciclica SNGR03-C4

tensione di confinamento (kPa)		450		tensione di confinamento (kPa)		450	
deviatore ciclico (kPa)		230		deviatore ciclico (kPa)		260	
frequenza (hz)		0.007143		frequenza (hz)		0.007143	
359.33	800.6	404.4	0.9063				
359.42	797.74	403.2	0.9001				
359.50	792.08	401.5	0.8947				
359.58	788.4	400	0.8894				
359.67	786.49	398.7	0.885				
359.75	781.68	397.2	0.8788				
359.83	774.77	395.2	0.8726				
359.92	770.49	392.9	0.8672				
360.00	766.94	391.4	0.8575				
360.08	762.32	389.6	0.8512				
360.17	757.35	387.6	0.845				
360.25	753.4	386.1	0.8379				
360.33	747.67	384.1	0.8299				
360.42	739.69	381.1	0.822				
360.52	738.81	380	0.8078				
360.58	734.23	378.4	0.7989				
360.67	727.3	376.2	0.7882				
360.75	720.41	372.9	0.7793				
360.83	717.31	371.2	0.7651				
360.92	713.59	369.5	0.7563				
361.00	707.21	367	0.7483				
361.08	703.98	365.3	0.7394				
361.17	698.04	363.1	0.7288				
361.25	689.71	361.4	0.719				
361.33	687.1	357.8	0.7074				
361.42	684	356.2	0.6932				
361.50	676.86	353.2	0.6799				
361.58	671.93	350.7	0.6684				
361.67	668.16	349	0.6551				
361.75	661.84	346.3	0.64				
361.83	654.56	343	0.6276				
361.93	651.45	341.5	0.6116				
362.00	647.54	339.3	0.6009				
362.08	638.76	336.6	0.5867				
362.17	634.62	332.8	0.569				
362.25	631.09	330.8	0.5415				
362.33	625.82	328.2	0.5228				
362.42	620.47	325.4	0.5042				
362.50	616.32	323.1	0.4891				
362.58	611.86	321.1	0.4758				
362.67	604.53	316.8	0.4598				
362.75	598.84	313.6	0.4474				
362.83	597.23	311.8	0.427				
362.92	589.95	308.4	0.4092				
363.00	586.25	305.7	0.3959				
363.08	582.02	303.5	0.3835				
363.17	575.93	300.5	0.3675				
363.25	569.9	296.4	0.3524				
363.35	567.01	294.2	0.3275				
363.42	562.74	291.8	0.3133				
363.50	557.03	289.2	0.2974				
363.58	551.49	284.9	0.2787				
363.67	548.95	282.6	0.2503				
363.75	544.06	279.8	0.2308				
363.83	539.14	276.7	0.2113				
363.92	537.25	274.6	0.1926				
364.00	531.69	271.7	0.1722				
364.08	526.43	267.7	0.1527				
364.17	522	264.5	0.1349				
364.25	518.88	262.1	0.1065				

Prova triassiale ciclica SNGR03-C4

tensione di confinamento (kPa)		450		tensione di confinamento (kPa)		450	
deviatore ciclico (kPa)		230		deviatore ciclico (kPa)		260	
frequenza (hz)		0.007143		frequenza (hz)		0.007143	
364.33	514.21	259	0.0879				
364.42	511.21	256.3	0.0719				
364.50	507.48	253.8	0.0541				
364.58	503.86	249.6	0.032				
364.67	498.96	247	0.0195				
364.75	496.01	243.9	-0.0053				
364.85	493.51	241.9	-0.0195				
364.92	489.1	239.4	-0.0337				
365.00	484.86	235.3	-0.0479				
365.08	483.54	233.3	-0.0692				
365.17	480.4	231.1	-0.0834				
365.25	476.39	228.1	-0.0985				
365.33	475.16	226.3	-0.1118				
365.42	471.95	223.8	-0.1252				
365.50	467.97	220.3	-0.1394				
365.58	464.76	217.9	-0.1518				
365.67	463.98	216.6	-0.1695				
365.75	460.63	214	-0.182				
365.83	458.46	211.9	-0.1935				
365.92	456.86	210.4	-0.205				
366.00	453.39	208.4	-0.2148				
366.08	451.18	206	-0.2246				
366.17	450.41	204.7	-0.2388				
366.27	448.88	203	-0.2477				
366.33	446.71	201.4	-0.2565				
366.42	445.21	199.6	-0.2645				
366.50	444.04	198.4	-0.2761				
366.58	441.04	196.9	-0.284				
366.67	442.1	196.4	-0.2885				
366.75	440.2	195.2	-0.2956				
366.83	439.14	194	-0.3018				
366.92	438.29	193.1	-0.308				
367.00	437.83	192.4	-0.316				
367.08	436.54	191.5	-0.3213				
367.17	435.65	190.7	-0.3267				
367.25	435.94	190.5	-0.3302				
367.33	435.33	190	-0.3338				
367.42	435.22	189.7	-0.3373				
367.50	434.91	189.3	-0.3409				
367.58	434.99	189.2	-0.3453				
367.67	435.42	189.1	-0.348				
367.77	435.48	189.1	-0.3497				
367.83	435.78	189.1	-0.3515				
367.92	436.28	189.3	-0.3542				
368.00	437.28	189.7	-0.3551				
368.08	437.44	189.8	-0.3559				
368.17	437.94	190.1	-0.3577				
368.25	439.79	190.6	-0.3577				
368.33	440.42	191.4	-0.3577				
368.42	441.33	191.8	-0.3577				
368.50	442.57	192.5	-0.3577				
368.58	444.31	193.4	-0.3577				
368.67	445.39	194	-0.3568				
368.75	447.17	194.9	-0.3568				
368.83	449.45	195.7	-0.3568				
368.92	450.92	197.1	-0.3559				
369.00	452.7	197.9	-0.3542				
369.08	454.72	198.9	-0.3542				
369.18	457.91	200.6	-0.3524				
369.25	459.38	201.7	-0.3515				

Prova triassiale ciclica SNGR03-C4

tensione di confinamento (kPa)		450		tensione di confinamento (kPa)		450	
deviatore ciclico (kPa)		230		deviatore ciclico (kPa)		260	
frequenza (hz)		0.007143		frequenza (hz)		0.007143	
369.33	461.4	202.8	-0.3506				
369.42	464.89	204.3	-0.3488				
369.50	466	205.5	-0.348				
369.58	468.45	206.4	-0.3471				
369.67	472.48	208.2	-0.3453				
369.75	475.86	210.4	-0.3444				
369.83	477.58	211.5	-0.3417				
369.92	480.97	213.2	-0.34				
370.00	484.06	214.9	-0.3382				
370.08	486.41	216.4	-0.3364				
370.17	490.1	218.1	-0.3346				
370.25	494.6	220.2	-0.3329				
370.33	498.72	222.9	-0.3311				
370.42	500.81	224.5	-0.3275				
370.50	504.3	226.2	-0.3258				
370.58	509.13	228.9	-0.3222				
370.68	512.15	231.2	-0.3196				
370.75	516.28	233	-0.3169				
370.83	520.78	235.2	-0.3142				
370.92	523.03	237.4	-0.3116				
371.00	528.03	239.4	-0.3089				
371.08	533.46	241.7	-0.3053				
371.17	538.56	245.5	-0.3027				
371.25	541.15	247.3	-0.2974				
371.33	545.77	249.6	-0.2947				
371.42	550.27	252.2	-0.2911				
371.50	553.49	254.3	-0.2876				
371.58	558.28	257	-0.2849				
371.67	564.32	260.5	-0.2805				
371.75	570.05	263.6	-0.2769				
371.83	572.5	265.2	-0.2707				
371.92	579.04	268.3	-0.2672				
372.00	581.45	270.9	-0.2627				
372.10	587.32	274	-0.2574				
372.17	592.31	276.5	-0.253				
372.25	597.88	279.4	-0.2477				
372.33	601.36	281.9	-0.2432				
372.42	606.35	284.6	-0.2388				
372.50	614.03	287.2	-0.2334				
372.58	618.45	291.3	-0.229				
372.67	621.7	293.6	-0.221				
372.75	627.09	296.5	-0.2166				
372.83	632.21	299.7	-0.2104				
372.92	635.26	301.6	-0.2059				
373.00	642.39	304.8	-0.1997				
373.08	649.92	309.2	-0.1944				
373.17	653.26	311.6	-0.1855				
373.25	657.61	314.2	-0.1793				
373.33	662.26	316.8	-0.1731				
373.42	666.58	319.6	-0.1669				
373.52	674.2	323.4	-0.158				
373.58	678.48	325.7	-0.1527				
373.67	684.77	329	-0.1447				
373.75	687.81	331.2	-0.1385				
373.83	693.19	334.1	-0.1314				
373.92	700.74	338.2	-0.1243				
374.00	705.28	340.9	-0.1181				
374.08	709.22	343.2	-0.1056				
374.17	715.26	346.1	-0.0976				
374.25	718.6	348.9	-0.0888				

Prova triassiale ciclica SNGR03-C4

tensione di confinamento (kPa)		450		tensione di confinamento (kPa)		450	
deviatore ciclico (kPa)		230		deviatore ciclico (kPa)		260	
frequenza (hz)		0.007143		frequenza (hz)		0.007143	
374.33	723.44	351.2	-0.0808				
374.42	729.94	354.1	-0.0701				
374.50	736.01	358.1	-0.0604				
374.58	738.63	360.6	-0.0444				
374.67	742.73	363.3	-0.0302				
374.75	750.09	366.7	-0.016				
374.83	752.28	368.7	-0.0044				
374.92	757.5	371.3	0.0107				
375.02	765.27	375.4	0.0355				
375.08	767.26	377.2	0.047				
375.17	771.23	379.2	0.0657				
375.25	776.37	381.9	0.0861				
375.33	782.01	385.2	0.1056				
375.42	786.2	387.5	0.126				
375.50	789.91	389.6	0.1624				
375.58	796.75	392.7	0.1908				
375.67	797.58	394.1	0.2121				
375.75	801.42	395.9	0.2379				
375.83	809.25	398.2	0.2654				
375.92	811.57	401	0.2903				
376.00	814.4	402.7	0.3346				
376.08	819.22	404.6	0.3675				
376.17	821.68	406.2	0.395				
376.25	825.04	407.8	0.4207				
376.33	829.23	409.7	0.45				
376.42	834.32	411.1	0.4722				
376.50	838.37	413.8	0.5131				
376.58	839.68	414.8	0.5335				
376.67	842.41	416.2	0.5557				
376.75	848.45	418.6	0.5779				
376.83	849.31	419.6	0.6063				
376.92	852.83	420.9	0.6267				
377.00	855.02	422.2	0.6498				
377.08	857.89	423.3	0.6675				
377.17	860.21	424.4	0.6897				
377.25	864.96	425.6	0.7074				
377.33	866.79	427.2	0.7252				
377.42	868.66	428.4	0.7536				
377.50	873.44	429.5	0.7714				
377.58	872.94	429.8	0.7847				
377.67	874.09	430.5	0.7989				
377.75	877.58	431.6	0.8131				
377.83	882.07	433	0.8255				
377.93	881.08	433.3	0.8459				
378.00	882.37	433.9	0.8575				
378.08	884.58	434.8	0.869				
378.17	887.52	435.8	0.8788				
378.25	888.82	436.3	0.8956				
378.33	889.12	436.5	0.9045				
378.42	889.39	436.8	0.9125				
378.50	891.47	437.4	0.9214				
378.58	891.25	437.5	0.9294				
378.67	892.78	438	0.9365				
378.75	893.88	438.3	0.9418				
378.83	894.05	438.4	0.9516				
378.92	894.23	438.5	0.9569				
379.00	894.74	438.8	0.9631				
379.08	894.73	438.9	0.9675				
379.17	894.94	438.9	0.972				
379.25	895.2	439	0.9755				

Prova triassiale ciclica SNGR03-C4

tensione di confinamento (kPa)		450		tensione di confinamento (kPa)		450	
deviatore ciclico (kPa)		230		deviatore ciclico (kPa)		260	
frequenza (hz)		0.007143		frequenza (hz)		0.007143	
379.35	894.62	438.9	0.9808				
379.42	894.61	438.8	0.9835				
379.50	893.45	438.5	0.9862				
379.58	893.8	438.6	0.9888				
379.67	892.94	438.3	0.9915				
379.75	891.72	438	0.9924				
379.83	892.14	437.9	0.9942				
379.92	890.96	437.6	0.9942				
380.00	889.17	437.2	0.995				
380.08	888.35	437.1	0.9959				
380.17	887.1	436.5	0.9959				
380.25	886.27	436.1	0.9959				
380.33	883.64	435.4	0.9959				
380.42	882.95	435.1	0.995				
380.50	882.16	434.7	0.995				
380.58	879.59	434	0.9942				
380.67	877.62	433.2	0.9933				
380.75	875.11	432.4	0.9933				
380.85	874.16	432	0.9924				
380.92	870.78	430.8	0.9897				
381.00	867.61	430	0.9906				
381.08	865.71	429.3	0.9879				
381.17	862.98	428.6	0.9871				
381.25	861.27	427.8	0.9853				
381.33	858.21	426.9	0.9835				
381.42	856.99	426.2	0.9826				
381.50	851.53	424.6	0.98				
381.58	850.06	423.8	0.9773				
381.67	845.29	422.3	0.9746				
381.75	843.08	421.5	0.9729				
381.83	837.95	420.1	0.9702				
381.92	837.16	419.4	0.9675				
382.00	833.38	418.2	0.9649				
382.08	827.85	416.2	0.9613				
382.17	826.81	415.5	0.9569				
382.27	823.42	414.3	0.9542				
382.33	815.78	412.8	0.9507				
382.42	814.73	411.2	0.9471				
382.50	811.91	410.1	0.9418				
382.58	805.62	408.2	0.9373				
382.67	803.35	407	0.9329				
382.75	797.11	404.9	0.9267				
382.83	794.28	403.9	0.9231				
382.92	788.48	402	0.9178				
383.00	783.94	400	0.9134				
383.08	780.89	398.6	0.9054				
383.17	773.38	396.1	0.8974				
383.25	772.59	395.2	0.893				
383.33	766.24	393.3	0.8859				
383.42	762.88	391.7	0.8797				
383.50	754.45	388.6	0.8726				
383.58	753.11	387.2	0.8619				
383.67	748.1	385.7	0.8548				
383.75	743.22	384.2	0.8486				
383.83	736.56	381.1	0.8424				
383.92	733.11	379.3	0.8299				
384.00	727.74	377.3	0.8202				
384.08	720.84	374.8	0.8113				
384.17	719.86	373.9	0.8042				
384.25	714.16	371.4	0.7936				

Prova triassiale ciclica SNGR03-C4

tensione di confinamento (kPa)		450		tensione di confinamento (kPa)		450	
deviatore ciclico (kPa)		230		deviatore ciclico (kPa)		260	
frequenza (hz)		0.007143		frequenza (hz)		0.007143	
384.33	706.2	368.2	0.7838				
384.42	701.05	365.8	0.7758				
384.50	697.66	364.3	0.7572				
384.58	693.24	362.5	0.7456				
384.67	686.4	359.6	0.7305				
384.75	682.7	357.9	0.7172				
384.83	679.5	356.1	0.7066				
384.92	669.85	351.9	0.6897				
385.00	668.62	350.3	0.6755				
385.08	662.67	348.1	0.6631				
385.18	655.39	345	0.648				
385.25	649.7	342.4	0.6382				
385.33	647.18	340.2	0.6196				
385.42	640.39	337.7	0.6036				
385.50	634.36	334.7	0.5841				
385.58	632.36	333	0.5645				
385.67	626.92	330.5	0.5459				
385.75	620.38	326.8	0.529				
385.83	613.68	323.6	0.5122				
385.92	611.11	321.9	0.4909				
386.00	605.53	319	0.4776				
386.08	600.45	316	0.4625				
386.17	596.52	313.9	0.4483				
386.25	590.27	311	0.4332				
386.33	584.28	307.1	0.4199				
386.42	581.14	304.5	0.3968				
386.50	575.91	301.8	0.3808				
386.58	570.81	299	0.3648				
386.67	565.01	295.4	0.3497				
386.75	562.98	292.9	0.324				
386.83	557.77	290.4	0.3053				
386.92	552.23	287.1	0.2858				
387.00	549.74	285	0.2672				
387.08	544.49	282.3	0.2477				
387.17	538.33	278.1	0.2272				
387.25	535.24	275.4	0.2086				
387.33	531.76	273	0.1775				
387.42	526.56	269.6	0.1553				
387.50	523.53	267.1	0.1367				
387.58	519.73	264.5	0.1189				
387.67	514.5	261.2	0.0994				
387.75	509.66	257	0.0826				
387.83	507.21	254.6	0.055				
387.92	503.27	251.8	0.0373				
388.00	499.46	248.8	0.0204				
388.10	495.36	245	0.0036				
388.17	493.1	242.9	-0.0195				
388.25	489.06	240.1	-0.0355				
388.33	485.49	237.3	-0.0515				
388.42	483.58	235.4	-0.0648				
388.50	480.68	232.6	-0.079				
388.58	476.06	228.9	-0.095				
388.67	473.84	226.6	-0.1154				
388.75	471.17	224.5	-0.1287				
388.83	468.02	222	-0.1429				
388.92	466.35	220.1	-0.1544				
389.00	463.71	217.9	-0.1669				
389.08	460.3	215.6	-0.1811				
389.17	457.73	212.8	-0.1917				
389.25	456.41	211.2	-0.2077				

Prova triassiale ciclica SNGR03-C4

tensione di confinamento (kPa)		450		tensione di confinamento (kPa)		450	
deviatore ciclico (kPa)		230		deviatore ciclico (kPa)		260	
frequenza (hz)		0.007143		frequenza (hz)		0.007143	
389.33	454.38	209.4	-0.2184				
389.42	451.74	207.3	-0.229				
389.52	449.77	205.2	-0.2388				
389.58	448.66	203.9	-0.2521				
389.67	446.59	202.2	-0.261				
389.75	446	201	-0.269				
389.83	443.94	199.7	-0.2769				
389.92	442.34	198.3	-0.2849				
390.00	441.01	196.8	-0.2911				
390.08	439.85	195.8	-0.3009				
390.17	438.72	194.8	-0.308				
390.25	438.4	194.1	-0.3133				
390.33	437.38	193.3	-0.3196				
390.42	436.69	192.5	-0.3249				
390.50	435.98	192	-0.3293				
390.58	434.66	190.9	-0.3338				
390.67	435.21	190.7	-0.34				
390.75	434.9	190.5	-0.3435				
390.83	435.29	190.4	-0.3471				
390.92	434.98	190.1	-0.3497				
391.02	434.97	190	-0.3533				
391.08	435.36	190	-0.3559				
391.17	435.86	190.1	-0.3577				
391.25	435.86	190.1	-0.3586				
391.33	436.72	190.5	-0.3604				
391.42	437.86	190.9	-0.3613				
391.50	438.16	191.1	-0.3622				
391.58	439.26	191.6	-0.363				
391.67	440.14	192.1	-0.363				
391.75	441.38	192.8	-0.363				
391.83	442.42	193.3	-0.363				
391.92	444.29	194	-0.363				
392.00	446.11	195.3	-0.3622				
392.08	447.58	196.1	-0.3622				
392.17	448.99	196.8	-0.3613				
392.25	450.41	197.7	-0.3604				
392.33	452.25	198.7	-0.3595				
392.43	454.7	200	-0.3586				
392.50	457.52	201.3	-0.3577				
392.58	458.6	202.2	-0.3568				
392.67	461.01	203.4	-0.3559				
392.75	464.3	204.9	-0.3551				
392.83	467.19	206.7	-0.3542				
392.92	469.37	207.9	-0.3515				
393.00	472.03	209.2	-0.3506				
393.08	475.08	210.9	-0.3488				
393.17	477.3	212.2	-0.3471				
393.25	480.59	214	-0.3453				
393.33	484.98	216.3	-0.3444				
393.42	487.77	218	-0.3417				
393.50	490.29	219.4	-0.3391				
393.58	494.82	221.7	-0.3373				
393.67	496.9	223.4	-0.3355				
393.75	499.93	224.8	-0.3329				
393.83	505.26	227.3	-0.3302				
393.92	508.38	229.7	-0.3275				
394.00	511.71	231.9	-0.3249				
394.08	515.6	233.6	-0.3231				
394.17	520.83	235.9	-0.3196				
394.25	525.83	239.4	-0.3169				

Prova triassiale ciclica SNGR03-C4

tensione di confinamento (kPa)		450		tensione di confinamento (kPa)		450	
deviatore ciclico (kPa)		230		deviatore ciclico (kPa)		260	
frequenza (hz)		0.007143		frequenza (hz)		0.007143	
394.33	528.42	241.3	-0.3124				
394.42	532.24	243.4	-0.3098				
394.50	536.94	245.9	-0.3062				
394.58	540.06	247.7	-0.3036				
394.67	545.56	250.5	-0.3				
394.75	551.73	254	-0.2965				
394.83	554.82	256.3	-0.2929				
394.92	558.85	258.5	-0.2876				
395.00	564.65	261.3	-0.2849				
395.08	567.8	263.9	-0.2805				
395.17	572.09	266.1	-0.2769				
395.25	578.2	268.9	-0.2725				
395.35	583.43	272.5	-0.2663				
395.42	586.01	274.9	-0.2619				
395.50	591.1	277	-0.2583				
395.58	598.61	279.9	-0.2539				
395.67	603.64	284.2	-0.2485				
395.75	606.89	286.5	-0.2414				
395.83	611.31	288.9	-0.237				
395.92	617.98	292.4	-0.2308				
396.00	621.39	294.4	-0.2263				
396.08	627.59	297.6	-0.221				
396.17	633.65	301.4	-0.2166				
396.25	637.37	304.3	-0.2077				
396.33	642.66	306.5	-0.2024				
396.42	648.95	309.6	-0.1971				
396.50	650.89	312	-0.1908				
396.58	656.54	314.8	-0.1846				
396.67	663.57	318	-0.1784				
396.75	670.93	322.2	-0.1713				
396.83	672.33	324.1	-0.1633				
396.92	677.18	326.6	-0.1571				
397.00	685.51	331	-0.15				
397.08	689.88	333.7	-0.1438				
397.17	694.33	336.1	-0.1331				
397.25	699.5	339	-0.126				
397.33	703.81	341.6	-0.1181				
397.42	708.62	344.2	-0.1101				
397.50	715.13	347.3	-0.1012				
397.58	722.01	351.3	-0.0941				
397.67	724.1	353.6	-0.0799				
397.75	728.84	356.1	-0.0692				
397.83	734.74	359.4	-0.0577				
397.92	738.2	361.9	-0.0462				
398.00	745.23	365.2	-0.0311				
398.08	749.19	367.1	-0.0213				
398.17	755.22	371.3	-0.008				
398.27	757.23	373.2	0.0133				
398.33	761.91	375.8	0.0284				
398.42	768.32	379.5	0.047				
398.50	773.67	382.1	0.0657				
398.58	776.79	384.1	0.0959				
398.67	781.06	386.5	0.1172				
398.75	786.18	389.5	0.1438				
398.83	788.57	390.9	0.1642				
398.92	794.56	393.4	0.1891				
399.00	800.14	396.5	0.2139				
399.08	802.86	398.4	0.2539				
399.17	807.62	400.7	0.2867				
399.25	810.66	402.3	0.3107				

Prova triassiale ciclica SNGR03-C4

tensione di confinamento (kPa)		450		tensione di confinamento (kPa)		450	
deviatore ciclico (kPa)		230		deviatore ciclico (kPa)		260	
frequenza (hz)		0.007143		frequenza (hz)		0.007143	
399.33	813.96	404.1	0.34				
399.42	817.95	406	0.3693				
399.50	825.4	408	0.3968				
399.58	826.27	410.4	0.4234				
399.68	829.97	412	0.4607				
399.75	833.26	413.7	0.4864				
399.83	837.82	415	0.5086				
399.92	841.44	417.5	0.5326				
400.00	842.74	418.6	0.5699				
400.08	846.62	420.2	0.5947				
400.17	849.41	421.5	0.6187				
400.25	852.1	422.8	0.64				
400.33	856.21	424	0.6622				
400.42	861.19	426.3	0.6835				
400.50	861.21	426.9	0.7137				
400.58	863.47	427.8	0.7314				
400.67	865.66	428.8	0.7518				
400.75	868.06	429.8	0.7687				
400.83	870.95	430.9	0.7864				
400.92	875.07	431.7	0.8024				
401.00	874.86	432.7	0.8193				
401.08	878.39	433.9	0.8424				
401.18	878.62	434.2	0.8539				
401.25	881.25	434.9	0.869				
401.33	883.65	435.9	0.8832				
401.42	885.42	436.6	0.9063				
401.50	885.59	436.9	0.9169				
401.58	887.37	437.7	0.9267				
401.67	888.83	438.1	0.9356				
401.75	889.4	438.5	0.9436				
401.83	890.2	439.1	0.9524				
401.92	891.81	439.4	0.9631				
402.00	891.89	439.6	0.9711				
402.08	894.89	440.1	0.9791				
402.17	892.87	439.9	0.9844				
402.25	895.28	440.5	0.9906				
402.33	894.91	440.2	0.9942				
402.42	894.8	440.5	0.9986				
402.50	894.19	440.4	1.0039				
402.60	894.83	440.6	1.0075				
402.67	896.34	440.8	1.011				
402.75	894.52	440.6	1.0146				
402.83	894.4	440.4	1.019				
402.92	892.59	440	1.0199				
403.00	894.29	440.2	1.0226				
403.08	893.04	439.9	1.0243				
403.17	890.99	439.5	1.0252				
403.25	891.22	439.3	1.0261				
403.33	888.82	438.7	1.027				
403.42	889.34	438.6	1.027				
403.50	887.6	438.2	1.027				
403.58	886.41	437.8	1.027				
403.67	884.47	437.1	1.027				
403.75	882.99	436.6	1.0261				
403.83	879.34	435.7	1.0261				
403.92	879.04	435.4	1.0252				
404.00	876.31	434.8	1.0243				
404.10	874.11	433.8	1.0234				
404.17	873.52	433.3	1.0234				
404.25	870.43	432.6	1.0217				

Prova triassiale ciclica SNGR03-C4

tensione di confinamento (kPa)		450		tensione di confinamento (kPa)		450	
deviatore ciclico (kPa)		230		deviatore ciclico (kPa)		260	
frequenza (hz)		0.007143		frequenza (hz)		0.007143	
404.33	868.16	431.8	1.0199				
404.42	866.15	431.1	1.019				
404.50	862.96	430.1	1.0172				
404.58	861.25	429.6	1.0172				
404.67	857.74	428.2	1.0146				
404.75	855.1	427.3	1.0128				
404.83	852.84	426.6	1.011				
404.92	848.96	425.2	1.0084				
405.00	845.9	424.1	1.0066				
405.08	843.01	423.2	1.0039				
405.17	838.4	422	1.0013				
405.25	835.28	420.4	0.9995				
405.33	832.46	419.4	0.995				
405.42	830.05	418.5	0.9933				
405.52	825.22	416.7	0.9897				
405.58	820.46	415.1	0.9853				
405.67	818.22	414.2	0.9826				
405.75	814.57	412.9	0.9782				
405.83	810.69	411.5	0.9746				
405.92	807.1	410.1	0.9711				
406.00	798.97	408.6	0.9666				
406.08	795.56	406	0.9613				
406.17	793.3	404.7	0.9533				
406.25	790.44	403.7	0.9498				
406.33	782.41	401.2	0.9427				
406.42	782.12	400.5	0.9382				
406.50	776.49	398.7	0.9329				
406.58	769.41	395.9	0.9267				
406.67	764.71	394	0.9205				
406.75	763.56	393.3	0.9125				
406.83	756.74	390.8	0.9054				
406.92	752.7	389	0.8983				
407.00	746.25	386.3	0.8876				
407.08	743.42	385.2	0.8814				
407.17	736.07	382.6	0.8726				
407.25	734.59	381.2	0.8654				
407.33	731.2	379.9	0.8583				
407.42	721.61	376.7	0.8486				
407.50	717.22	374.3	0.8406				
407.58	715.08	372.9	0.8282				
407.67	706.74	370	0.8175				
407.75	703.31	368.2	0.8078				
407.83	699.03	366.2	0.798				
407.92	693.88	364	0.7873				
408.00	684.2	360.3	0.7767				
408.08	682.13	358.5	0.7651				
408.17	677.64	356.6	0.7474				
408.25	671.63	354	0.7332				
408.33	667.5	351.7	0.7181				
408.43	659.86	348	0.6959				
408.50	656.68	346.6	0.6835				
408.58	650.73	344.4	0.6693				
408.67	648.15	341.6	0.656				
408.75	641.92	339.7	0.64				
408.83	634.93	336.9	0.624				
408.92	629.63	333.4	0.6071				
409.00	625.97	331.3	0.5796				
409.08	620.93	328.8	0.5619				
409.17	614.1	325.7	0.545				
409.25	611.47	323.7	0.5308				

Prova triassiale ciclica SNGR03-C4

tensione di confinamento (kPa)		450		tensione di confinamento (kPa)		450	
deviatore ciclico (kPa)		230		deviatore ciclico (kPa)		260	
frequenza (hz)		0.007143		frequenza (hz)		0.007143	
409.33	606.95	321.4	0.5175				
409.42	599.22	317.2	0.5006				
409.50	594.89	314.4	0.4793				
409.58	590.16	312	0.4651				
409.67	585.11	309.3	0.45				
409.75	582.41	306.8	0.4349				
409.85	576.24	303.1	0.411				
409.92	572.14	300.9	0.3959				
410.00	564.98	297.4	0.3772				
410.08	563.76	295.4	0.3604				
410.17	558.49	292.6	0.3409				
410.25	551.98	289.5	0.3204				
410.33	547.46	285.4	0.3018				
410.42	544.66	283.2	0.2698				
410.50	540.07	280.4	0.2494				
410.58	535.34	277	0.2272				
410.67	532.18	274.8	0.2068				
410.75	527.22	271.6	0.1873				
410.83	520.99	267.3	0.1695				
410.92	519.15	264.9	0.1438				
411.00	514.85	261.9	0.1252				
411.08	510.44	258.9	0.1056				
411.17	508.14	256.5	0.0888				
411.25	504.07	253.6	0.071				
411.35	499.52	249.8	0.0453				
411.42	495.98	246.6	0.0275				
411.50	493.74	244.3	0.0107				
411.58	490.26	241.6	-0.0053				
411.67	486.71	237.9	-0.0275				
411.75	481.81	234.9	-0.0391				
411.83	480.56	233	-0.0604				
411.92	476.68	230.3	-0.0746				
412.00	474.98	227.7	-0.0888				
412.08	471.83	225.5	-0.103				
412.17	468.22	222.9	-0.1172				
412.25	464.45	219.4	-0.1296				
412.33	463.59	217.5	-0.1491				
412.42	461.12	215.7	-0.1616				
412.50	457.97	213.3	-0.1749				
412.58	456.44	211.6	-0.1855				
412.67	453.9	209.6	-0.1979				
412.77	452.69	207.7	-0.2104				
412.83	449.55	205.4	-0.2219				
412.92	448.99	204.4	-0.2308				
413.00	446.38	202.5	-0.2406				
413.08	445.05	200.7	-0.2494				
413.17	443.61	199.2	-0.2619				
413.25	442.62	198.3	-0.2698				
413.33	441.02	197	-0.2778				
413.42	440.19	196	-0.2849				
413.50	439.37	195.2	-0.2903				
413.58	437.85	194.2	-0.2965				
413.67	437.03	193	-0.3027				
413.75	436.74	192.4	-0.3107				
413.83	436.08	191.8	-0.316				
413.92	435.47	191.3	-0.3204				
414.00	434.95	190.8	-0.3249				
414.08	435.88	190.7	-0.3284				
414.17	434.83	190.1	-0.3329				
414.27	434.61	190	-0.3373				

Prova triassiale ciclica SNGR03-C4

tensione di confinamento (kPa)		450		tensione di confinamento (kPa)		450	
deviatore ciclico (kPa)		230		deviatore ciclico (kPa)		260	
frequenza (hz)		0.007143		frequenza (hz)		0.007143	
414.33	434.91	190.1	-0.34				
414.42	435.47	190.1	-0.3426				
414.50	435.8	190.1	-0.3444				
414.58	435.59	190.2	-0.3471				
414.67	436.99	190.6	-0.348				
414.75	437.39	190.8	-0.3497				
414.83	438.3	191.3	-0.3497				
414.92	439.3	191.8	-0.3506				
415.00	440.68	192.3	-0.3506				
415.08	441.61	193.1	-0.3506				
415.17	442.69	193.7	-0.3506				
415.25	443.96	194.3	-0.3506				
415.33	445.24	195.3	-0.3506				
415.42	446.88	196	-0.3497				
415.50	448.46	196.8	-0.3497				
415.58	450.87	198.2	-0.3488				
415.68	452.99	199.3	-0.348				
415.75	454.2	200	-0.3471				
415.83	456.51	201.2	-0.3462				
415.92	459.83	203	-0.3453				
416.00	461.95	204.3	-0.3435				
416.08	463.93	205.3	-0.3426				
416.17	466.88	206.7	-0.3417				
416.25	468.67	208	-0.34				
416.33	471.62	209.4	-0.3391				
416.42	475.31	210.9	-0.3373				
416.50	479.03	213.4	-0.3355				
416.58	480.88	214.7	-0.3329				
416.67	483.94	216.3	-0.332				
416.75	487.8	218.3	-0.3293				
416.83	489.71	219.7	-0.3275				
416.92	493.74	221.6	-0.3258				
417.00	499.14	224.4	-0.324				
417.08	501.69	226.3	-0.3213				
417.17	503.91	227.6	-0.3178				
417.25	507.9	229.8	-0.316				
417.33	513.37	232.9	-0.3133				
417.42	516.03	235	-0.3098				
417.50	519.95	236.7	-0.3071				
417.58	525.79	239.4	-0.3036				
417.67	527.03	241.3	-0.3009				
417.75	532.06	243.4	-0.2982				
417.83	537.43	246.1	-0.2947				
417.92	542.73	249.5	-0.292				
418.00	544.95	251.3	-0.2876				
418.08	549.67	253.8	-0.284				
418.17	555.51	256.8	-0.2805				
418.25	557.66	258.6	-0.2769				
418.33	562.82	261.2	-0.2734				
418.42	569.39	265.1	-0.269				
418.50	574.15	267.7	-0.2654				
418.60	576.27	269.5	-0.2601				
418.67	583.3	272.7	-0.2548				
418.75	589.77	276.6	-0.2512				
418.83	592.82	278.9	-0.2441				
418.92	597.18	281.3	-0.2397				
419.00	602.78	284.2	-0.2352				
419.08	606.13	286.6	-0.2299				
419.17	611.39	289.4	-0.2255				
419.25	618.35	292.2	-0.2201				

Prova triassiale ciclica SNGR03-C4

tensione di confinamento (kPa)	450		tensione di confinamento (kPa)	450	
deviatore ciclico (kPa)	230		deviatore ciclico (kPa)	260	
frequenza (hz)	0.007143		frequenza (hz)	0.007143	
419.33	623.74	296.6	-0.2157		
419.42	626.83	298.5	-0.2077		
419.50	632.11	301.4	-0.2024		
419.58	636.5	304.1	-0.1962		
419.67	641.39	306.9	-0.1908		
419.75	647.44	309.9	-0.1846		
419.83	654.6	314.1	-0.1784		
419.92	658.32	317.1	-0.1687		
420.02	663.37	319.3	-0.1633		
420.08	669.32	321.9	-0.158		
420.17	674.6	325.9	-0.1509		
420.25	677.78	328.4	-0.142		
420.33	683.43	330.9	-0.1358		
420.42	688.64	334	-0.1278		
420.50	692.35	336.3	-0.1216		
420.58	698.06	339.2	-0.1145		
420.67	707.48	342.2	-0.1065		
420.75	709.18	345.8	-0.1003		
420.83	713.59	348.3	-0.0879		
420.92	719.43	351.4	-0.0781		
421.00	724.29	354.3	-0.0675		
421.08	728.39	356.8	-0.0577		
421.17	734.83	360.1	-0.0453		
421.25	740.79	364.3	-0.0328		
421.33	743.91	366.7	-0.0142		
421.42	748.47	369.2	-0.0018		
421.52	753.09	372.3	0.0142		
421.58	760.55	375.9	0.0257		
421.67	762.72	377.9	0.0497		
421.75	767.66	380.5	0.0683		
421.83	772.3	383	0.087		
421.92	775.81	385.2	0.1065		
422.00	779.87	387.4	0.1269		
422.08	786.9	391.2	0.1509		
422.17	790.36	393.3	0.174		
422.25	793.15	395.2	0.2139		
422.33	799.36	397.9	0.2397		
422.42	802.1	399.7	0.2663		
422.50	805.87	401.7	0.2956		
422.58	811.23	404	0.3249		
422.67	815.99	406.8	0.3542		
422.75	818.23	408.5	0.3941		
422.83	822.32	410.1	0.4225		
422.93	825.61	411.9	0.4527		
423.00	831	414.3	0.4758		
423.08	833.22	415.7	0.5184		
423.17	836.34	417.3	0.5432		
423.25	840.49	419.1	0.5681		
423.33	841.56	420	0.5921		
423.42	847.69	422.1	0.6178		
423.50	850.39	423.6	0.6373		
423.58	853.5	425	0.6746		
423.67	856.72	426.4	0.6977		
423.75	857.5	427.1	0.7154		
423.83	860.25	428.3	0.7367		
423.92	862.61	429.3	0.7589		
424.00	866.24	430.5	0.782		
424.08	869.33	431.7	0.8007		
424.17	871.88	432.9	0.8308		
424.25	875.11	433.9	0.8468		

Prova triassiale ciclica SNGR03-C4

tensione di confinamento (kPa)		450		tensione di confinamento (kPa)		450	
deviatore ciclico (kPa)		230		deviatore ciclico (kPa)		260	
frequenza (hz)		0.007143		frequenza (hz)		0.007143	
424.33	874.55	434.3	0.8557				
424.43	877.35	435.4	0.8708				
424.50	879.41	436.2	0.8894				
424.58	880.72	436.7	0.9018				
424.67	884.01	437.8	0.916				
424.75	883.62	438.2	0.9249				
424.83	887.35	438.9	0.9356				
424.92	887.42	439.7	0.9436				
425.00	889.42	440.2	0.9578				
425.08	888.12	440.1	0.9649				
425.17	891.57	441	0.9773				
425.25	892.83	441.4	0.9862				
425.33	892.41	441.5	0.9924				
425.42	892	442	0.9986				
425.50	894.19	442.3	1.003				
425.58	894.62	442.5	1.0119				
425.67	893.62	442.5	1.0155				
425.75	895.42	442.6	1.0199				
425.85	895.38	442.8	1.0234				
425.92	895.16	442.7	1.0288				
426.00	894.96	442.7	1.0314				
426.08	894.75	442.6	1.035				
426.17	894.28	442.4	1.0385				
426.25	893.68	442.2	1.0412				
426.33	892.49	441.9	1.043				
426.42	892.94	441.8	1.0456				
426.50	891.69	441.5	1.0465				
426.58	890.2	441.1	1.0474				
426.67	891.02	441.1	1.0483				
426.75	888.45	440.5	1.0483				
426.83	885.98	440.2	1.0483				
426.92	886.54	439.8	1.0483				
427.00	883.32	439	1.0474				
427.08	882.01	438.4	1.0474				
427.17	881.65	438.1	1.0465				
427.25	879.61	437.6	1.0456				
427.33	877.89	436.9	1.0456				
427.42	873.92	435.8	1.0439				
427.50	874.05	435.6	1.0439				
427.58	871.42	434.9	1.0421				
427.67	866.55	434.1	1.0421				
427.75	866.91	433.2	1.0412				
427.83	863.43	432	1.0385				
427.92	858.93	430.9	1.0368				
428.00	857.45	430.1	1.035				
428.08	856.43	429.6	1.0341				
428.17	851.83	428.3	1.0323				
428.25	849.66	427.3	1.0306				
428.33	845.52	425.9	1.0288				
428.42	842	424.7	1.0252				
428.50	838.88	423.7	1.0234				
428.58	837.04	422.8	1.0208				
428.67	835	422.1	1.0181				
428.77	829.45	420.1	1.0137				
428.83	824.85	418.7	1.0101				
428.92	824.03	418	1.0075				
429.00	820.22	416.7	1.0039				
429.08	813.11	414.8	0.9995				
429.17	808.67	412.8	0.995				
429.25	806.18	411.7	0.9897				

Prova triassiale ciclica SNGR03-C4

tensione di confinamento (kPa)		450		tensione di confinamento (kPa)		450	
deviatore ciclico (kPa)		230		deviatore ciclico (kPa)		260	
frequenza (hz)		0.007143		frequenza (hz)		0.007143	
429.33	801.18	410.3	0.9853				
429.42	797.86	408.8	0.98				
429.50	794.15	407.4	0.9746				
429.58	791.72	406.4	0.9693				
429.67	782.45	403.4	0.9595				
429.75	781.57	402.6	0.9533				
429.83	775.81	400.7	0.9462				
429.92	770.71	398.8	0.9391				
430.00	767.26	397.1	0.9338				
430.08	762.35	395.5	0.9285				
430.18	756.23	392.9	0.9205				
430.25	752.45	391.2	0.9143				
430.33	747.81	389.3	0.9072				
430.42	743.1	387.4	0.9001				
430.50	739.08	385.7	0.8939				
430.58	730.35	382.2	0.8859				
430.67	729.43	381.3	0.8761				
430.75	720.21	378.1	0.8663				
430.83	719.15	377	0.8601				
430.92	712.86	374.6	0.8495				
431.00	708.67	372.6	0.8415				
431.08	701.22	369.3	0.8317				
431.17	698.39	367.6	0.8184				
431.25	691.13	365	0.8078				
431.33	687.76	363.2	0.798				
431.42	685.39	361.5	0.7882				
431.50	676.9	358.4	0.7758				
431.58	672.91	356.6	0.7651				
431.68	665.54	352.9	0.7456				
431.75	662.8	351.2	0.7332				
431.83	657.87	349.1	0.7217				
431.92	651.39	346.3	0.7066				
432.00	644.25	342.5	0.6915				
432.08	641.13	341.2	0.6684				
432.17	635.74	338.4	0.6524				
432.25	631.03	335.8	0.6347				
432.33	625.99	333.7	0.616				
432.42	620.98	331	0.5965				
432.50	613.52	326.9	0.5779				
432.58	610.56	324.7	0.5539				
432.67	606.01	322.4	0.5397				
432.75	600.06	319.4	0.5246				
432.83	597.37	317	0.5095				
432.92	592.88	314.7	0.4935				
433.00	584.87	311.2	0.4758				
433.10	580.7	307.8	0.4527				
433.17	577.13	305.5	0.4376				
433.25	572.4	302.9	0.4207				
433.33	565.61	298.7	0.403				
433.42	560.9	295.7	0.3843				
433.50	557.94	293.6	0.3559				
433.58	552.63	290.5	0.3338				
433.67	549.11	287.5	0.3133				
433.75	545.45	285.3	0.2929				
433.83	538.9	282.1	0.2698				
433.92	533.78	277.8	0.2521				
434.00	531.47	275.3	0.2228				
434.08	527.31	272.6	0.2033				
434.17	521.99	269.3	0.1846				
434.25	520.19	266.9	0.1669				

Prova triassiale ciclica SNGR03-C4

tensione di confinamento (kPa)		450		tensione di confinamento (kPa)		450	
deviatore ciclico (kPa)		230		deviatore ciclico (kPa)		260	
frequenza (hz)		0.007143		frequenza (hz)		0.007143	
434.33	515.42	263.7	0.1473				
434.42	509.99	260.4	0.1278				
434.50	505.92	256.3	0.1092				
434.60	503.56	253.9	0.0826				
434.67	500.46	251.3	0.0666				
434.75	495.49	247.5	0.0479				
434.83	492.45	244.4	0.0328				
434.92	489.72	242	0.0071				
435.00	485.75	239.3	-0.0089				
435.08	484.15	236.8	-0.0249				
435.17	480.1	234	-0.0417				
435.25	476.62	231.6	-0.0568				
435.33	472.88	227.7	-0.071				
435.42	471.26	225.5	-0.0932				
435.50	468.21	223.2	-0.1074				
435.58	465.44	221.2	-0.1207				
435.67	463.9	219	-0.1331				
435.75	461.22	216.8	-0.1465				
435.83	458.25	214.6	-0.1589				
435.92	455.81	211.4	-0.1704				
436.02	454.39	210	-0.1891				
436.08	452.72	208.4	-0.1988				
436.17	449.61	205.9	-0.2095				
436.25	448.67	204.2	-0.2237				
436.33	446.84	202.9	-0.2334				
436.42	445.44	201.5	-0.2414				
436.50	443.91	200.2	-0.2503				
436.58	442.61	198.9	-0.2592				
436.67	440.92	198.1	-0.2663				
436.75	438.95	196.2	-0.2734				
436.83	438.62	195.3	-0.284				
436.92	438.27	194.5	-0.2903				
437.00	437.04	193.7	-0.2965				
437.08	436.12	192.7	-0.3027				
437.17	435.67	192.2	-0.308				
437.25	435.59	191.7	-0.3116				
437.33	435.55	191.3	-0.316				
437.42	434.99	191	-0.3222				
437.50	435.22	190.7	-0.3258				
437.58	434.8	190.5	-0.3293				
437.67	435.13	190.4	-0.3338				
437.75	435.49	190.6	-0.3355				
437.83	436.02	190.5	-0.3382				
437.92	436.18	190.7	-0.34				
438.00	436.78	191.1	-0.3409				
438.08	437.65	191.4	-0.3417				
438.17	438.38	191.9	-0.3426				
438.25	439.69	192.4	-0.3435				
438.33	440.49	192.9	-0.3444				
438.42	441.23	193.4	-0.3444				
438.50	442.3	194	-0.3444				
438.58	443.88	194.8	-0.3444				
438.67	446.06	196	-0.3435				
438.75	447.27	196.7	-0.3435				
438.83	448.71	197.6	-0.3426				
438.93	451.6	198.6	-0.3417				
439.00	453.51	200.1	-0.3417				
439.08	454.45	200.9	-0.34				
439.17	457.03	202.1	-0.3391				
439.25	458.65	203.2	-0.3382				

Prova triassiale ciclica SNGR03-C4

tensione di confinamento (kPa)		450		tensione di confinamento (kPa)		450	
deviatore ciclico (kPa)		230		deviatore ciclico (kPa)		260	
frequenza (hz)		0.007143		frequenza (hz)		0.007143	
439.33	460.89	204.4	-0.3373				
439.42	463.78	205.7	-0.3364				
439.50	467.44	207.7	-0.3346				
439.58	469.69	208.9	-0.3338				
439.67	471.7	210.2	-0.3311				
439.75	475.13	212	-0.3302				
439.83	477.58	213.6	-0.3284				
439.92	480.36	214.9	-0.3267				
440.00	484.56	216.9	-0.3249				
440.08	488.38	219.3	-0.3231				
440.17	490.53	221.1	-0.3204				
440.25	492.89	222.5	-0.3187				
440.35	498.49	225.1	-0.3151				
440.42	501.81	227.2	-0.3142				
440.50	504.39	229	-0.3107				
440.58	508.52	230.8	-0.3089				
440.67	513.52	233.2	-0.3053				
440.75	515.54	234.9	-0.3027				
440.83	519.86	237.1	-0.3009				
440.92	525.87	240.5	-0.2974				
441.00	529.12	242.8	-0.2947				
441.08	532.68	244.6	-0.2903				
441.17	537.91	247.3	-0.2876				
441.25	540.09	249.1	-0.2849				
441.33	544.35	251.4	-0.2814				
441.42	550.15	254.2	-0.2778				
441.50	556.92	258.1	-0.2743				
441.58	558.74	260.2	-0.269				
441.67	563.37	262.6	-0.2654				
441.75	570.1	265.7	-0.2601				
441.85	573.96	268.6	-0.2574				
441.92	577.21	271	-0.2512				
442.00	583.48	273.8	-0.2468				
442.08	587.94	276.6	-0.2423				
442.17	591.69	278.9	-0.2379				
442.25	596.68	281.6	-0.2334				
442.33	602.38	285.3	-0.229				
442.42	608.64	288.8	-0.2237				
442.50	611.69	290.8	-0.2166				
442.58	618.02	293.7	-0.2113				
442.67	621	296.4	-0.2068				
442.75	625.22	298.6	-0.2015				
442.83	632.95	302	-0.1953				
442.92	639.68	306.2	-0.1908				
443.00	642.12	308.5	-0.182				
443.08	647.78	311.1	-0.1758				
443.17	653.43	314.4	-0.1687				
443.27	658.79	318	-0.1633				
443.33	663.33	320.4	-0.1553				
443.42	668.75	323.3	-0.1482				
443.50	674.1	326.5	-0.142				
443.58	677.04	328.5	-0.1358				
443.67	684.16	332	-0.1278				
443.75	690.91	335.7	-0.1216				
443.83	694.85	338.5	-0.1101				
443.92	697.29	340.5	-0.1047				
444.00	705.6	344.2	-0.0959				
444.08	707.94	346.6	-0.0879				
444.17	713.31	349.2	-0.079				
444.25	719.65	352.3	-0.0701				

Prova triassiale ciclica SNGR03-C4

tensione di confinamento (kPa)		450		tensione di confinamento (kPa)		450	
deviatore ciclico (kPa)		230		deviatore ciclico (kPa)		260	
frequenza (hz)		0.007143		frequenza (hz)		0.007143	
444.33	727.03	356.6	-0.0604				
444.42	729.15	359.1	-0.0435				
444.50	733.75	361.7	-0.032				
444.58	739.14	364.9	-0.0195				
444.67	742.4	367.5	-0.0053				
444.77	749.05	371.1	0.0124				
444.83	753.81	373.7	0.0266				
444.92	757.99	376.3	0.0417				
445.00	761.77	378.5	0.0577				
445.08	766.32	381.2	0.0754				
445.17	772.12	385	0.0985				
445.25	776.14	387.2	0.1252				
445.33	780.77	389.6	0.1473				
445.42	786.79	392.3	0.1722				
445.50	789.15	394.4	0.1953				
445.58	793.86	396.7	0.2237				
445.67	799.47	398.8	0.2494				
445.75	804.15	402.2	0.2761				
445.83	806.28	403.8	0.3222				
445.92	810.64	405.8	0.3524				
446.00	814.34	407.8	0.3826				
446.08	817.43	409.4	0.4136				
446.18	822.54	412	0.4589				
446.25	826.8	413.8	0.4847				
446.33	829.56	415.4	0.5095				
446.42	832.81	417.1	0.5361				
446.50	836.8	418.6	0.5619				
446.58	840.67	420.7	0.5894				
446.67	844.32	422.4	0.6293				
446.75	847.31	423.6	0.6498				
446.83	849.44	424.8	0.6711				
446.92	852	426.2	0.6941				
447.00	856.79	427.7	0.7217				
447.08	858.56	428.5	0.7385				
447.17	862.28	430.5	0.7572				
447.25	864.05	431.5	0.7882				
447.33	866.28	432.5	0.806				
447.42	870.12	433.9	0.8237				
447.50	871.37	434.8	0.8388				
447.58	872.35	435.3	0.8521				
447.67	875.15	436.4	0.8761				
447.75	878.99	437.5	0.8939				
447.83	880.38	438.1	0.9063				
447.92	881.83	438.6	0.9152				
448.00	882.68	439.5	0.9276				
448.08	884.69	440.4	0.9427				
448.17	885.52	440.8	0.9524				
448.25	887.52	441.4	0.9658				
448.33	887.56	441.6	0.9755				
448.42	889.34	442.3	0.9835				
448.50	891	443	0.9915				
448.58	891.97	443.4	0.9977				
448.67	892.46	443.6	1.0075				
448.75	893.3	444	1.0137				
448.83	893.75	444.3	1.019				
448.92	894.32	444.5	1.0243				
449.00	894.67	444.6	1.0288				
449.10	896.49	445	1.0359				
449.17	894.67	444.8	1.0385				
449.25	895.25	444.9	1.0421				

Prova triassiale ciclica SNGR03-C4

tensione di confinamento (kPa)		450		tensione di confinamento (kPa)		450	
deviatore ciclico (kPa)		230		deviatore ciclico (kPa)		260	
frequenza (hz)		0.007143		frequenza (hz)		0.007143	
449.33	895.05	444.8	1.0456				
449.42	894.51	444.7	1.0483				
449.50	894.04	444.5	1.0527				
449.58	893.53	444.3	1.0563				
449.67	892.9	444	1.059				
449.75	892.4	443.9	1.0607				
449.83	892.13	443.7	1.0625				
449.92	890.25	443.2	1.0634				
450.00	889.69	442.9	1.0643				
450.08	888.96	442.6	1.0643				
450.17	887.19	442.1	1.0643				
450.25	885.9	441.6	1.0643				
450.33	884.66	441.2	1.0634				
450.42	883.24	440.7	1.0634				
450.52	880.08	439.8	1.0625				
450.58	880.68	439.6	1.0625				
450.67	878.47	439.1	1.0616				
450.75	874.76	438.1	1.0607				
450.83	872.98	437.1	1.0598				
450.92	870.61	436.6	1.059				
451.00	867.1	435.6	1.0572				
451.08	866.31	435	1.0563				
451.17	863.55	434.2	1.0554				
451.25	860.46	433.2	1.0536				
451.33	856.87	431.9	1.0527				
451.42	854.68	431	1.0501				
451.50	852.37	430.4	1.0492				
451.58	850.07	429.4	1.0474				
451.67	847.52	428.2	1.0448				
451.75	843.27	427.2	1.043				
451.83	840.61	425.8	1.0403				
451.92	833.44	423.9	1.0385				
452.02	834.3	423.6	1.0341				
452.08	829.37	422.2	1.0314				
452.17	826.13	420.8	1.0279				
452.25	820.77	419.1	1.0243				
452.33	816.53	417.6	1.0181				
452.42	811.47	416.1	1.0155				
452.50	811.93	415.4	1.0128				
452.58	806.77	414	1.0092				
452.67	802.62	412.1	1.0048				
452.75	793.54	409.4	1.0013				
452.83	794.61	408.8	0.9942				
452.92	788.46	407.1	0.9897				
453.00	784.68	405.3	0.9844				
453.08	781.33	404	0.9791				
453.17	774.88	402	0.9729				
453.25	769.71	400.2	0.9675				
453.33	764.78	397.8	0.9613				
453.43	762.91	396.8	0.9542				
453.50	756.99	394.7	0.9471				
453.58	752.97	392.8	0.9418				
453.67	744.44	389.6	0.9347				
453.75	744.85	389.1	0.924				
453.83	736.72	386.3	0.916				
453.92	732.41	384.2	0.9089				
454.00	730.27	383.2	0.9027				
454.08	722.1	380.7	0.8939				
454.17	715.14	377.2	0.885				
454.25	713.3	375.9	0.8717				

Prova triassiale ciclica SNGR03-C4

tensione di confinamento (kPa)		450		tensione di confinamento (kPa)		450	
deviatore ciclico (kPa)		230		deviatore ciclico (kPa)		260	
frequenza (hz)		0.007143		frequenza (hz)		0.007143	
454.33	707.31	373.8	0.8592				
454.42	703.03	372	0.8486				
454.50	699.37	370	0.8335				
454.58	696.04	368.4	0.8228				
454.67	685.91	365.1	0.8095				
454.75	679.28	361.5	0.8015				
454.83	677.23	359.9	0.7847				
454.93	671.85	357.8	0.774				
455.00	666.86	354.9	0.7634				
455.08	660.29	352	0.7501				
455.17	656.29	350.1	0.7296				
455.25	651.46	347.7	0.7172				
455.33	647.29	345.7	0.7021				
455.42	641.73	343.5	0.6879				
455.50	635.74	340.9	0.6728				
455.58	629.15	336.8	0.6551				
455.67	626.13	334.5	0.6249				
455.75	621.09	332.4	0.6071				
455.83	615.02	329.3	0.5894				
455.92	611.6	327	0.5743				
456.00	606.09	324.4	0.5592				
456.08	599.38	321.6	0.5441				
456.17	593.81	317.3	0.5299				
456.25	591.03	315.5	0.5042				
456.35	586.31	312.7	0.4882				
456.42	579.82	309	0.4722				
456.50	576.51	306.5	0.4483				
456.58	571.95	304	0.4305				
456.67	565.65	300.7	0.4101				
456.75	563.2	298.5	0.3923				
456.83	558.46	295.7	0.371				
456.92	552.48	292.5	0.3488				
457.00	547.27	288.7	0.3302				
457.08	545	285.8	0.2974				
457.17	539.94	283.2	0.2752				
457.25	534.52	279.8	0.2539				
457.33	532.19	277.3	0.2361				
457.42	528.83	274.8	0.2166				
457.50	521.87	271.1	0.1944				
457.58	517.84	266.9	0.1766				
457.67	514.56	264.3	0.1491				
457.75	510.96	261.4	0.1305				
457.85	506.33	257.5	0.1136				
457.92	502.62	254.5	0.095				
458.00	499.53	251.7	0.0666				
458.08	495.89	248.7	0.047				
458.17	492.38	245.6	0.0284				
458.25	490.3	243.5	0.0124				
458.33	485.29	240.5	-0.0053				
458.42	482.25	236.8	-0.0204				
458.50	479.93	234.6	-0.0435				
458.58	477.02	232.1	-0.0586				
458.67	473.41	229.1	-0.0746				
458.75	471.76	226.5	-0.0905				
458.83	469.09	224.5	-0.1047				
458.92	465.48	221.8	-0.1189				
459.00	462.7	218.8	-0.1323				
459.08	461.05	217	-0.1509				
459.17	458.57	214.7	-0.1633				
459.27	455.36	212	-0.1766				

Prova triassiale ciclica SNGR03-C4

tensione di confinamento (kPa)		450		tensione di confinamento (kPa)		450	
deviatore ciclico (kPa)		230		deviatore ciclico (kPa)		260	
frequenza (hz)		0.007143		frequenza (hz)		0.007143	
459.33	454.21	210.4	-0.1926				
459.42	452.18	208.8	-0.2024				
459.50	449.71	206.9	-0.2121				
459.58	449.05	205.8	-0.2219				
459.67	446.71	203.9	-0.2317				
459.75	444.94	202.6	-0.2406				
459.83	443.38	200.6	-0.2494				
459.92	442.71	199.5	-0.2619				
460.00	440.06	197.9	-0.2716				
460.08	440.92	197.4	-0.2769				
460.17	439.73	196.6	-0.284				
460.25	438.77	195.8	-0.2894				
460.33	437.48	194.7	-0.2965				
460.42	436.49	193.6	-0.3027				
460.50	436.3	193.2	-0.3107				
460.58	435.31	192.5	-0.3151				
460.68	435.1	191.9	-0.3196				
460.75	434.44	191.4	-0.3267				
460.83	434.84	191.5	-0.3293				
460.92	435.43	191.6	-0.332				
461.00	435.12	191.4	-0.3346				
461.08	435.32	191.4	-0.3373				
461.17	435.91	191.5	-0.3391				
461.25	436.51	191.7	-0.3417				
461.33	436.81	191.8	-0.3435				
461.42	437.68	192.2	-0.3444				
461.50	438.41	192.7	-0.3453				
461.58	439.01	193.1	-0.3453				
461.67	440.05	193.6	-0.3462				
461.75	441.83	194.5	-0.3462				
461.83	442.83	195.2	-0.3462				
461.92	444.04	195.8	-0.3462				
462.00	446.32	196.9	-0.3453				
462.08	446.76	197.4	-0.3453				
462.18	448.84	198.6	-0.3444				
462.25	450.99	199.7	-0.3435				
462.33	452.94	200.7	-0.3426				
462.42	454.51	201.7	-0.3417				
462.50	456.36	202.6	-0.3417				
462.58	459.85	204.1	-0.34				
462.67	461.96	205.7	-0.3391				
462.75	464.05	206.8	-0.3373				
462.83	466.6	208.2	-0.3364				
462.92	469.35	209.7	-0.3346				
463.00	471.13	210.9	-0.3338				
463.08	475.52	212.6	-0.332				
463.17	479.18	215.1	-0.3302				
463.25	480.79	216.4	-0.3284				
463.33	483.51	217.8	-0.3267				
463.42	488.41	220.1	-0.324				
463.50	489.46	221.8	-0.3222				
463.60	493.78	223.7	-0.3204				
463.67	496.91	225.4	-0.3178				
463.75	501.7	227.9	-0.3151				
463.83	504.16	229.4	-0.3133				
463.92	507.51	231.4	-0.3107				
464.00	512.88	234.4	-0.308				
464.08	517.34	236.8	-0.3053				
464.17	520.06	238.6	-0.3018				
464.25	525.06	241	-0.2991				

Prova triassiale ciclica SNGR03-C4

tensione di confinamento (kPa)		450		tensione di confinamento (kPa)		450	
deviatore ciclico (kPa)		230		deviatore ciclico (kPa)		260	
frequenza (hz)		0.007143		frequenza (hz)		0.007143	
464.33	528.11	243.2	-0.2956				
464.42	531.03	244.9	-0.2929				
464.50	537.24	248	-0.2894				
464.58	543.17	251.4	-0.2867				
464.67	545.22	253.4	-0.2823				
464.75	550.79	256	-0.2787				
464.83	555.15	258.4	-0.2752				
464.92	557.8	260.7	-0.2716				
465.00	563	263.3	-0.2672				
465.10	568.29	266.5	-0.2619				
465.17	573.79	269.4	-0.2574				
465.25	576.21	271.2	-0.2539				
465.33	582.14	274.3	-0.2494				
465.42	588.47	278.1	-0.245				
465.50	592.86	280.9	-0.2379				
465.58	597.05	283.2	-0.2343				
465.67	603.01	286.2	-0.229				
465.75	606	288.9	-0.2237				
465.83	610.69	291.2	-0.2192				
465.92	617.95	294.5	-0.2139				
466.00	623.44	298.3	-0.2095				
466.08	626.73	300.8	-0.2006				
466.17	631.95	303.4	-0.1962				
466.25	638.78	306.9	-0.1891				
466.33	641.92	309.1	-0.1837				
466.42	646.01	311.6	-0.1784				
466.52	654.64	316.4	-0.1678				
466.58	657.82	318.7	-0.1624				
466.67	661.53	320.8	-0.1562				
466.75	665.41	323.2	-0.1518				
466.83	664.94	324.3	-0.15				
466.92	665.14	324.9	-0.1482				
467.00	664.97	325.4	-0.1465				
467.08	665.01	325.9	-0.1456				
467.17	665.04	326.3	-0.1447				
467.25	667.25	327.3	-0.1429				

SNGR03-C4 prova TXC

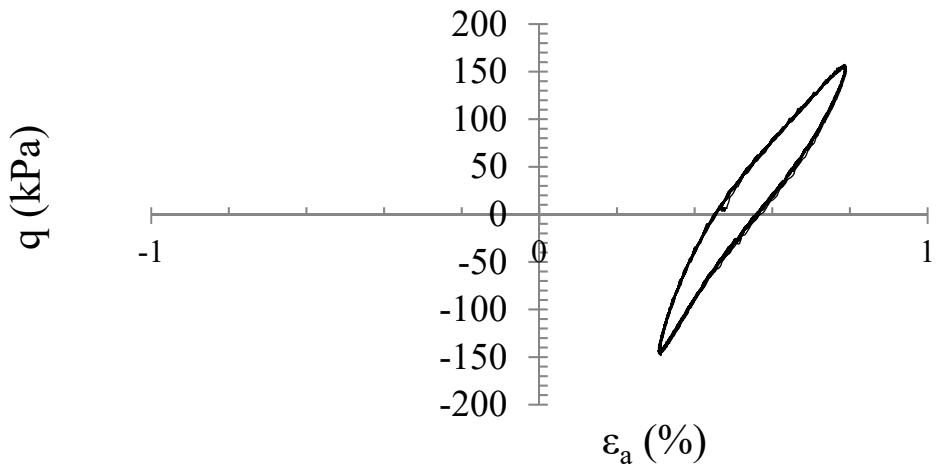
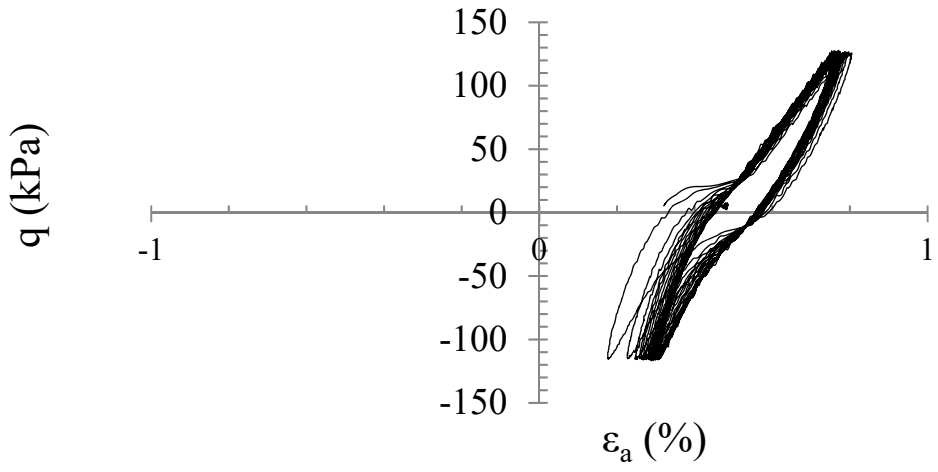
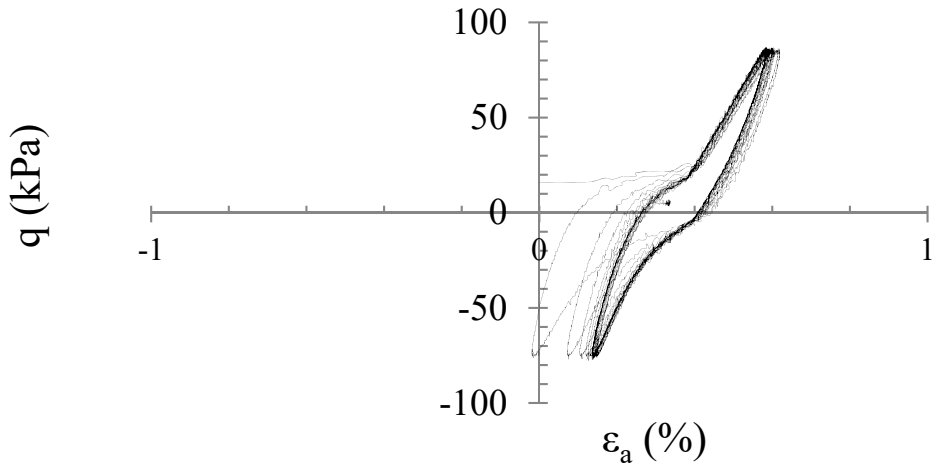

SNGR03-C4 prova TXC

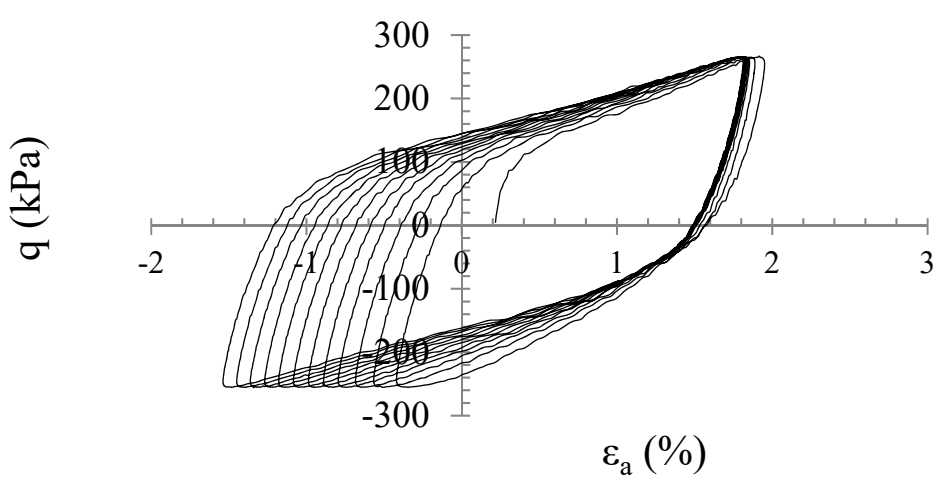
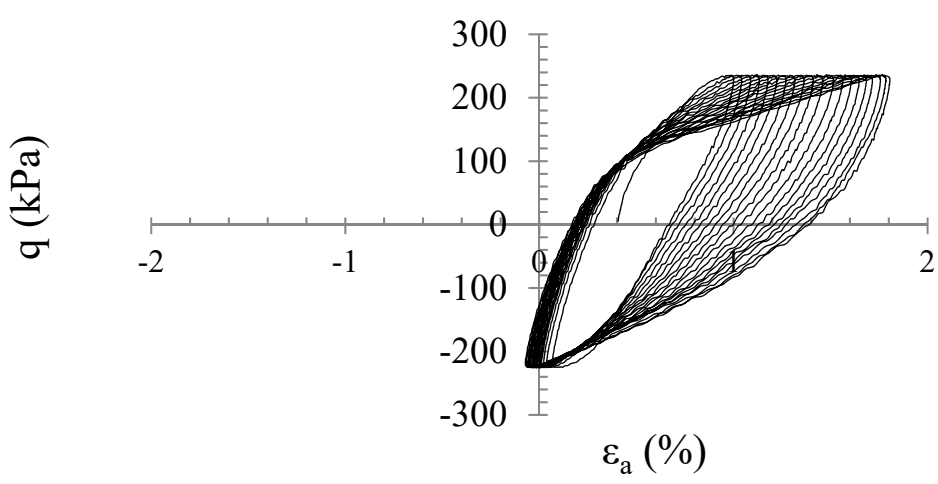
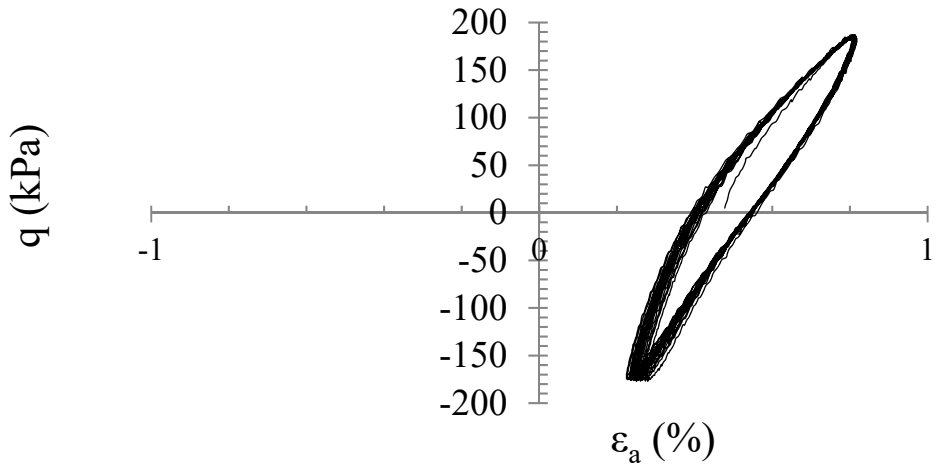

SNGR03-C4 prova TXC

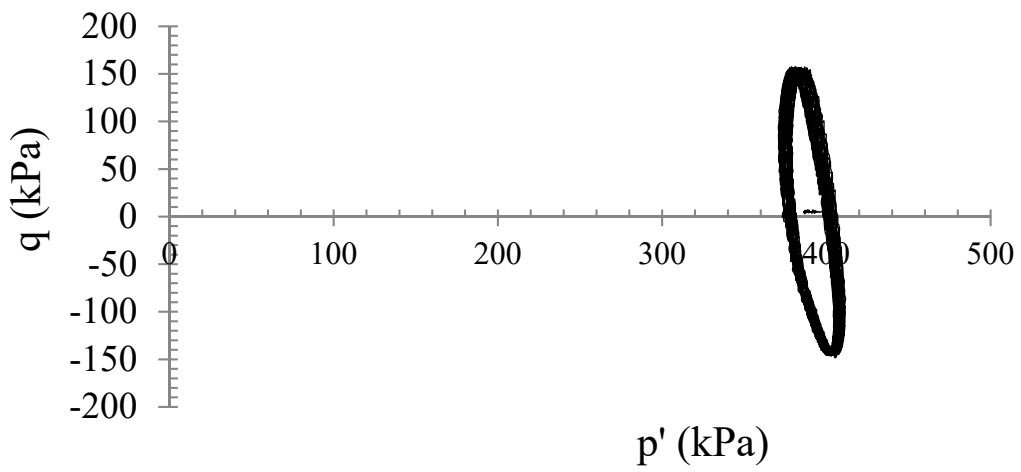
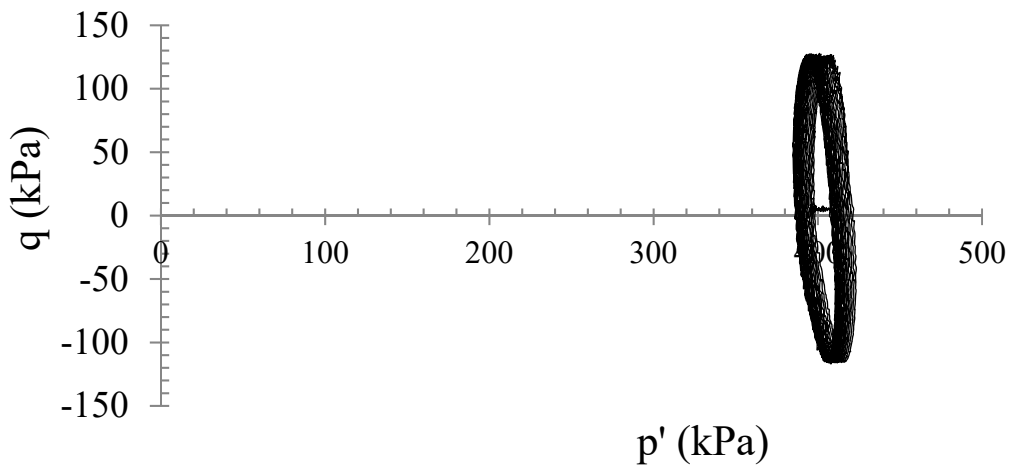
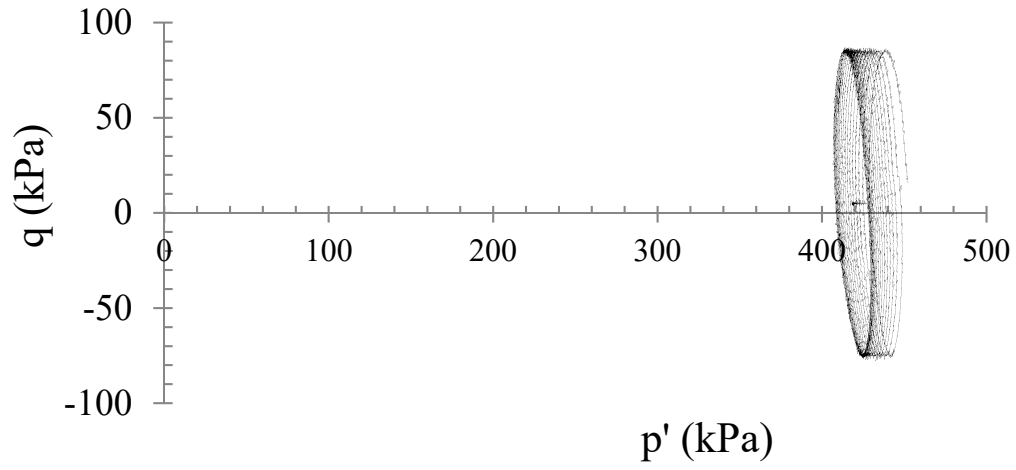

SNGR03-C4 prova TXC

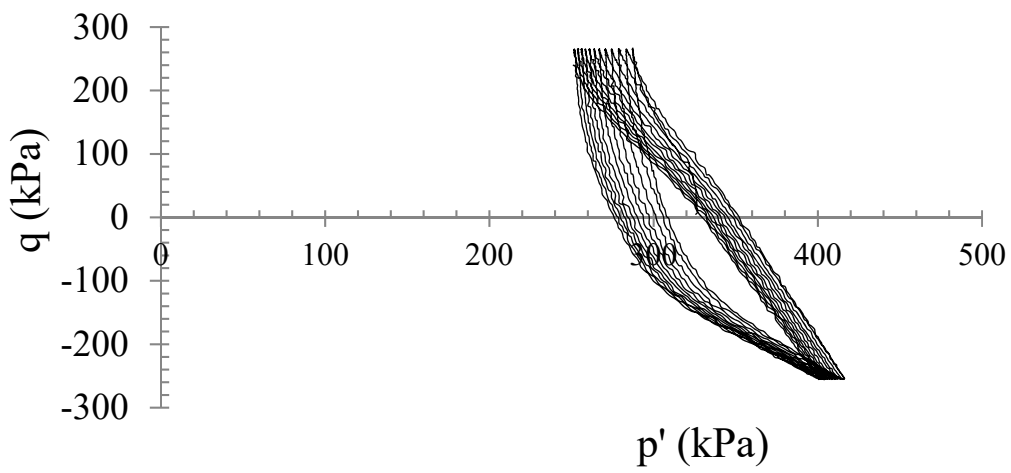
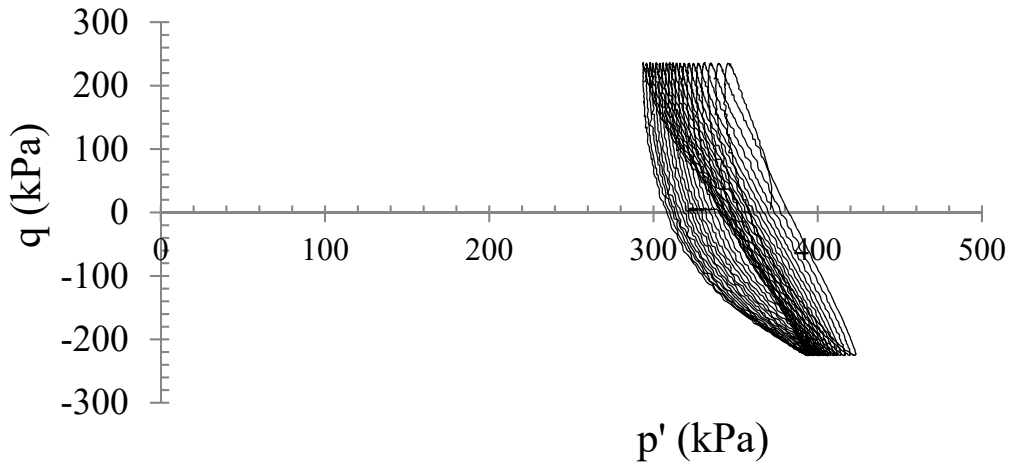
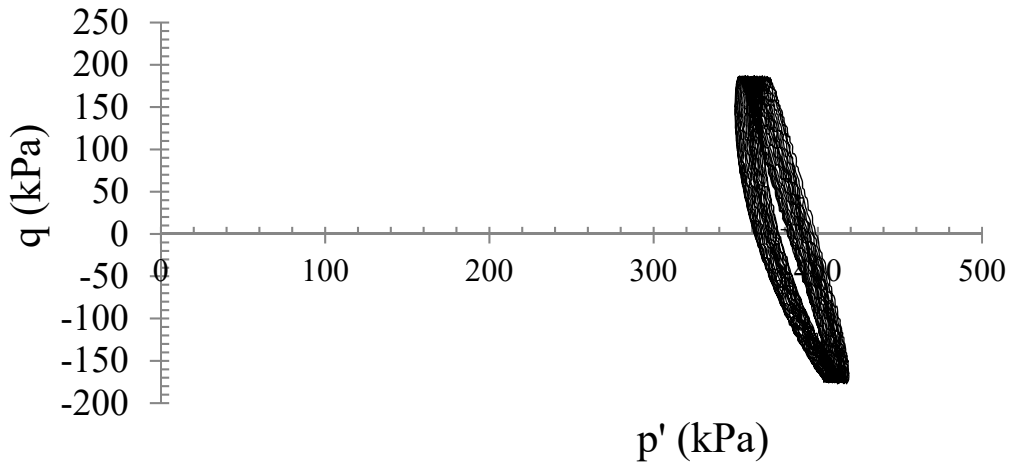



<u>Committente</u>	Consorzio HirpiniaAV
<u>Indagine</u>	I lotto funzionale Apice-Hirpinia
<u>Sondaggio</u>	SNRG03
<u>Campione</u>	C4
<u>Profondità</u>	37.40 ÷ 37.90 m
<u>Data apertura</u>	26/11/19
<u>Operatore</u>	

Prova di TAGLIO TORSIONALE

Dati iniziali								
D (mm)	H (mm)	V (cm ³)	γ (kN/m ³)	w (%)	γ_s (kN/m ³)	e (/)	S _r (%)	p' (kPa)
35.69	72.04	72.03	21.29	16.90	27.24	0.495	0.95	434

Dati fine consolidazione								
D (mm)	H (mm)	V (cm ³)	γ (kN/m ³)	w (%)	γ_d (kN/m ³)	e (/)	S _r (%)	p' (kPa)
35.69	72.04	72.03	21.29	16.90	18.21	0.495	0.95	434

TAGLIO TORSIONALE					
γ (%)	G (MPa)	D (%)	f _r (Hz)	G/G ₀ (/)	Du/p'
2.88E-04	151.96	3.62	0.5	1.00	
4.48E-04	151.96	3.13	0.5	1.00	
6.11E-04	151.96	3.18	0.5	1.00	
9.58E-04	151.96	3.82	0.5	1.00	
1.41E-03	151.96	3.56	0.5	1.00	
2.13E-03	151.96	3.43	0.5	1.00	
3.18E-03	151.96	3.38	0.5	1.00	
3.17E-03	151.96	3.66	0.5	1.00	
4.85E-03	150.94	3.62	0.5	0.99	
5.09E-03	150.94	3.77	0.5	0.99	
6.98E-03	145.84	3.96	0.5	0.96	
9.22E-03	143.80	4.13	0.5	0.95	
1.21E-02	139.72	4.46	0.5	0.92	
1.57E-02	136.66	4.87	0.5	0.90	
2.18E-02	129.53	5.61	0.5	0.85	
2.96E-02	124.43	6.39	0.5	0.82	
3.45E-02	121.37	7.19	0.5	0.80	
4.36E-02	119.33	6.8	0.5	0.79	
6.27E-02	113.21	8.46	0.5	0.74	
6.99E-02	109.13	9.31	0.5	0.72	
6.91E-02	111.17	9.55	0.5	0.73	
7.01E-02	110.15	9.44	0.5	0.72	
7.85E-02	108.11	9.58	0.5	0.71	
8.90E-02	104.03	10.3	0.5	0.68	
1.02E-01	97.78	11.3	0.5	0.64	
1.16E-01	92.41	12.44	0.5	0.61	
1.37E-01	81.70	16.46	0.5	0.54	
2.38E-01	42.82	52.33	0.5	0.28	



<u>Committente</u>	Consorzio HirpiniaAV
<u>Indagine</u>	I lotto funzionale Apice-Hirpinia
<u>Sondaggio</u>	SNGR03
<u>Campione</u>	C4
<u>Profondità</u>	37.40 ÷ 37.90 m
<u>Data apertura</u>	26/11/19
<u>Operatore</u>	

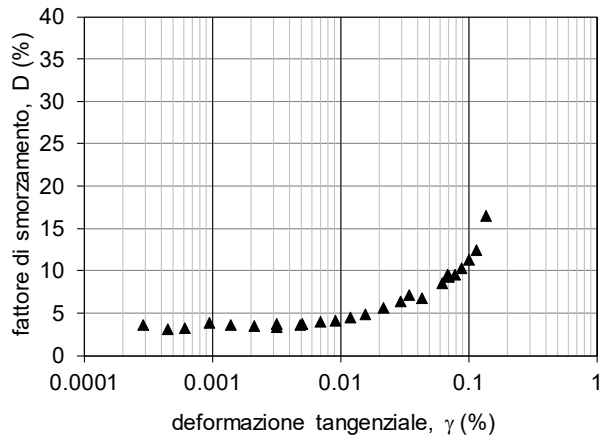
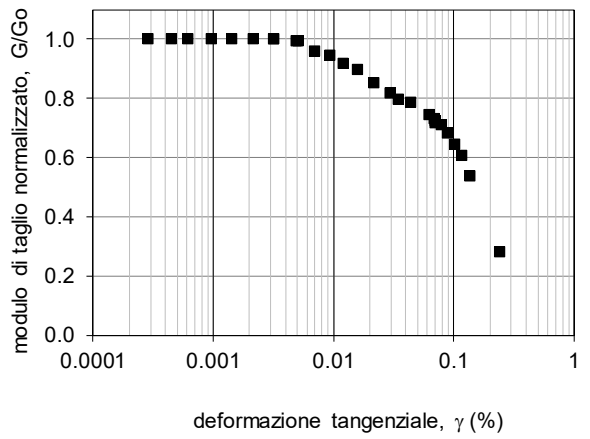
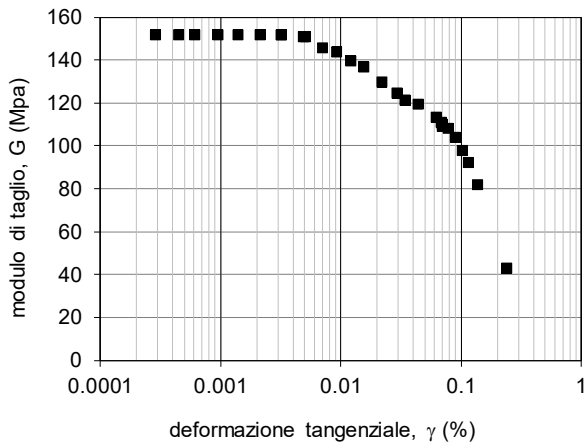



<u>Committente</u>	Consorzio HirpiniaAV
<u>Indagine</u>	I lotto funzionale Apice-Hirpinia
<u>Sondaggio</u>	SNGR03
<u>Campione</u>	C4
<u>Profondità</u>	37.40 ÷ 37.90 m
<u>Data apertura</u>	26/11/19
<u>Operatore</u>	

APPENDICE

1. L'attrezzatura sperimentale per prove di taglio torsionale

L'apparecchiatura utilizzata è la cella di taglio torsionale THOR (Figura A.1), progettata e realizzata presso l'Università di Napoli Federico II (d'Onofrio, 1996) sulla base del prototipo originario di colonna risonante 'fixed-free' messo a punto presso l'Università del Texas di Austin (Isenhower, 1979; Ni, 1987). Le caratteristiche tecniche dell'apparecchiatura sono dettagliate da d'Onofrio et al. (1999). In Tabella A.1 sono sintetizzate le principali caratteristiche del sistema, ed in Figura A.2 uno schema della catena strumentale per il controllo e l'acquisizione.

Tipo di prova		Colonna risonante / Taglio torsionale
Nome dell'apparecchiatura		THOR
Provino	Diametro esterno	36mm
	Altezza	72mm
	Accuratezza nella misura delle dimensioni e del peso del provino	0.1 mm, 0.1gr
	Metodo di preparazione del provino	Fustellamento
	Saturazione	In cella via back-pressure
	Test di B	B > 0.95 mediando i valori ottenuti incrementando e decrementando la pressione di cella
	Contatto tra provino e apparecchiatura	Piastra rugosa avvitata nella testa di carico e pietra porosa di carburo di silicio avvitata al piedistallo
Sistema di applicazione dei carichi torcenti	Tipo	Motore elettromagnetico
Accuratezza del sistema di controllo	Pressione di cella	40 Pa attraverso convertitore E/P
	Contropressione	Senza controllo
	Sistema di applicazione dei carichi torcenti	Controllo in corrente risoluzione $1.6 \cdot 10^{-5}$ Nm (2 Pa per il provino \varnothing 36 mm) Fondo scala 5 Nm Non c'è effetto della forza elettromotrice indotta
Tipo di trasduttori utilizzati	Pressione di cella	Sensore di pressione di elevate prestazioni con membrana al silicone
	Contropressione	Trasduttore miniaturizzato con diaframma al silicone
	Pressione neutra	Trasduttore miniaturizzato con diaframma al silicone
	Coppia torcente	Cella torsionale a strain-gage
	Spostamenti assiali	LVDT in corrente continua
	Variazioni di volume	Trasduttore differenziale di pressione/ volumometro
	Accelerazioni	Accelerometro piezoelettrico
	Rotazioni	Laser /Proximitor
Accuratezza delle misure	Pressione di cella	1.5 Pa
	Contropressione	0.7 Pa
	Pressione interstiziale	0.7 Pa
	Coppia torcente	$6 \cdot 10^{-3}$ Nm
	Spostamenti assiali	1 μ m
	Variazioni di volume	0.0014 cm ³
	Rotazioni	$2.5 \cdot 10^{-7}$ rad (prox)

Tabella A.1. Principali caratteristiche della cella di taglio torsionale THOR.



Università degli Studi di Napoli Federico II
Dipartimento di Ingegneria Civile, Edile ed Ambientale
Laboratorio di Geotecnica

<u>Committente</u>	Consorzio HirpiniaAV
<u>Indagine</u>	I lotto funzionale Apice-Hirpinia
<u>Sondaggio</u>	SNGR03
<u>Campione</u>	C4
<u>Profondità</u>	37.40 ÷ 37.90 m
<u>Data apertura</u>	26/11/19
<u>Operatore</u>	



Figura A.1. L'apparecchiatura di taglio torsionale THOR.



Figura A.2. Diagramma schematico del sistema di controllo e acquisizione di THOR



<u>Committente</u>	Consorzio HirpiniaAV
<u>Indagine</u>	I lotto funzionale Apice-Hirpinia
<u>Sondaggio</u>	SNGR03
<u>Campione</u>	C4
<u>Profondità</u>	37.40 ÷ 37.90 m
<u>Data apertura</u>	26/11/19
<u>Operatore</u>	

2. Procedure sperimentali per le prove RC e CTS

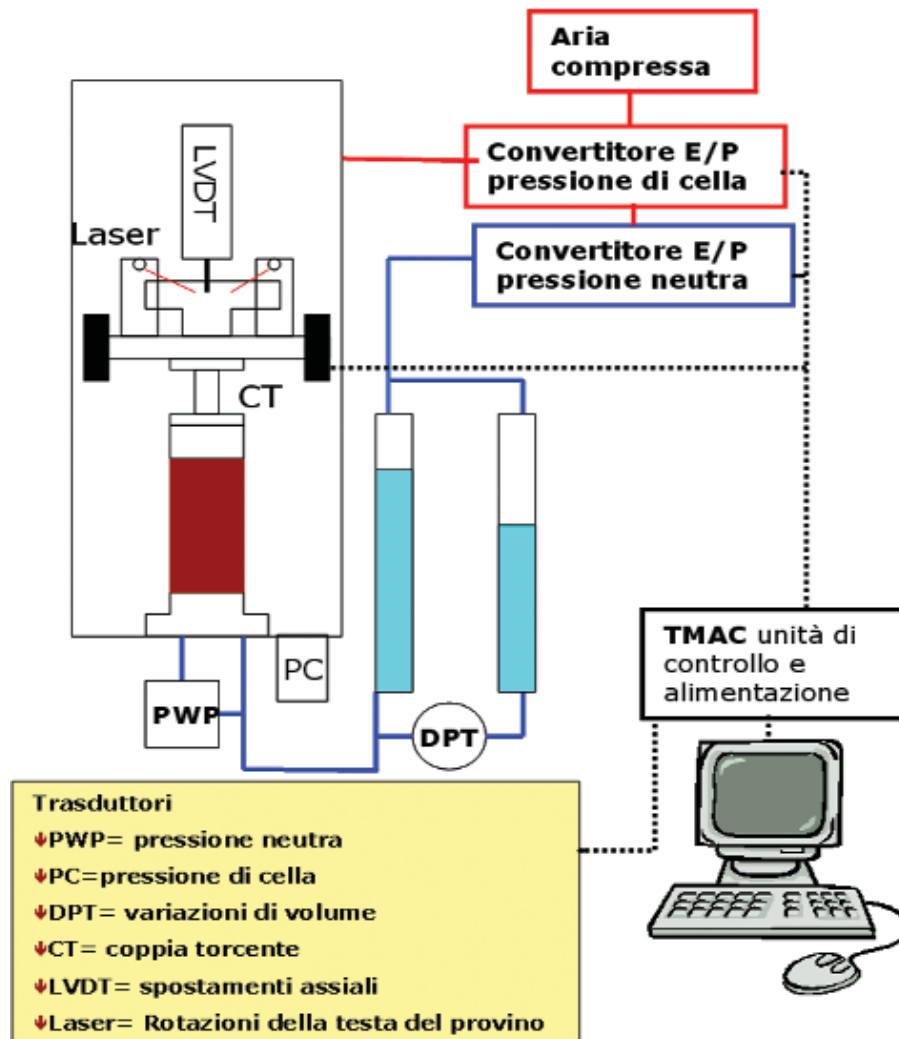
Ciascun provino è stato sottoposto ad una prima fase di applicazione della sollecitazione sferica per ricondurre il provino alla tensione efficace stimata agente in sito.

Al termine di questa fase è stato poi applicato il carico torsionale $M(t)$, avente caratteristiche diverse in funzione del tipo di prova. In particolare, in relazione alla frequenza con la quale vengono fatte variare le sollecitazioni nel tempo, è possibile distinguere due tipi di prova: prove «cicliche» (torsione ciclica, CTS) e prove «dinamiche» propriamente dette (colonna risonante, RC).

I criteri di interpretazione delle prove in termini di rigidità e smorzamento sono variabili a seconda delle caratteristiche della sollecitazione torsionale applicata. Infatti, nelle prove TS l'effetto delle forze di inerzia è trascurabile e quindi l'interpretazione è di tipo «quasi statico», mentre per le prove RC è necessario fare riferimento a modelli d'analisi dinamici. I criteri descritti in seguito sono quelli pressoché universalmente adottati per l'interpretazione delle prove RC e CTS, conformi alle norme ASTM (ASTM D4015/92). Presso il DIGA sono state messe a punto, e vengono normalmente utilizzate, procedure di interpretazione più complesse, che si avvalgono della completa automazione e digitalizzazione delle prove. Queste procedure, ampiamente descritte altrove (Papa et al., 1988; Silvestri, 1991, d'Onofrio, 1996), tra l'altro consentono di aumentare l'affidabilità dei risultati anche quando il livello di deformazioni indagato è basso e quindi si è in presenza di un rapporto segnale/rumore non elevato. Per approfondimenti si rimanda a Silvestri (1991).

2.1 Prove di colonna risonante (RC)

Durante una prova di colonna risonante (Figura A.3) il provino è sottoposto ad una sollecitazione torsionale di ampiezza M costante e frequenza f variabile nel tempo:

$$M(t) = M \sin[2\pi ft]$$

Nell'attrezzatura utilizzata, l'estremità superiore del provino è libera, mentre la base è rigidamente vincolata al piedistallo fisso; in tal modo lo schema dinamico di riferimento è del tipo «a base fissa» o «fixed-free» (Woods, 1978).

Durante la prova, viene registrata la vibrazione della testa del provino in termini di rotazione, θ , rilevata a seconda dei casi da una coppia di sensori laser oppure da due coppie di trasduttori di prossimità. Tale misura viene convertita in deformazioni tangenziali, γ , mediante le opportune costanti di taratura (d'Onofrio, 1996). La risposta del provino risulta in ogni istante isofrequenziale con la sollecitazione, mentre l'ampiezza (θ o γ) varia in relazione alla frequenza, ed attinge il valore massimo quando vengono raggiunte le cosiddette "condizioni di risonanza" ($f = f_R$).

Il modulo tangenziale G viene dedotto dalla misura della velocità delle onde di taglio, V_s , ottenuta analizzando la risposta del sistema composto da provino e dispositivo di carico torsionale, sulla base di classici modelli teorici di vibrazione torsionale di solidi cilindrici (Richart et al, 1970). Dalla conoscenza delle caratteristiche fisico-geometriche del sistema, V_s e G si ricavano applicando le espressioni:

$$V_s = \frac{2\pi f L}{\beta}$$

$$G = \rho V_s^2$$

dove L indica l'altezza del provino e ρ la densità del terreno. La costante adimensionale β è funzione dell'inerzia polare di massa del provino, I , e di quella del sistema di eccitazione, I_0 , secondo l'equazione:

$$\frac{I}{I_0} = \beta \tan \beta$$

Dalla curva di risposta è possibile anche ricavare il fattore di smorzamento D , individuando i valori di frequenza (f_1, f_2) corrispondenti ad un'ampiezza di vibrazione pari a $\gamma_{\max}/\sqrt{2}$ (metodo della "semibanda di potenza"):

$$D_{hp} = \frac{f_2 - f_1}{2 f_R}$$

A causa della non linearità e della degradazione ciclica, questo criterio non sempre fornisce una valutazione attendibile del fattore di smorzamento D . In casi del genere si può, in alternativa, ricorrere al metodo basato sull'espressione analitica del



<u>Committente</u>	Consorzio HirpiniaAV
<u>Indagine</u>	I lotto funzionale Apice-Hirpinia
<u>Sondaggio</u>	SNGR03
<u>Campione</u>	C4
<u>Profondità</u>	37.40 ÷ 37.90 m
<u>Data apertura</u>	26/11/19
<u>Operatore</u>	

fattore di risonanza (metodo del fattore di risonanza), cioè il rapporto tra il valore di picco, γ_{\max} , della curva di risposta $\gamma(f)$ e la rotazione statica corrispondente ad una coppia di eguale ampiezza M . Da esso si ricava D , una volta noti le ampiezze M e γ_{\max} , ed il valore di G già calcolato, con l'espressione seguente:

$$D_{rf} = \frac{M_0 \bar{R}}{2G\gamma_{\max}}$$

Questo metodo appare in genere più attendibile di quello precedente, perché meno sensibile agli effetti della non linearità e della degradazione ciclica del terreno.



Figura A.3: Interpretazione delle prove di colonna risonante.



<u>Committente</u>	Consorzio HirpiniaAV
<u>Indagine</u>	I lotto funzionale Apice-Hirpinia
<u>Sondaggio</u>	SNGR03
<u>Campione</u>	C4
<u>Profondità</u>	37.40 ÷ 37.90 m
<u>Data apertura</u>	26/11/19
<u>Operatore</u>	

2.2 Prova di torsione ciclica (CTS)

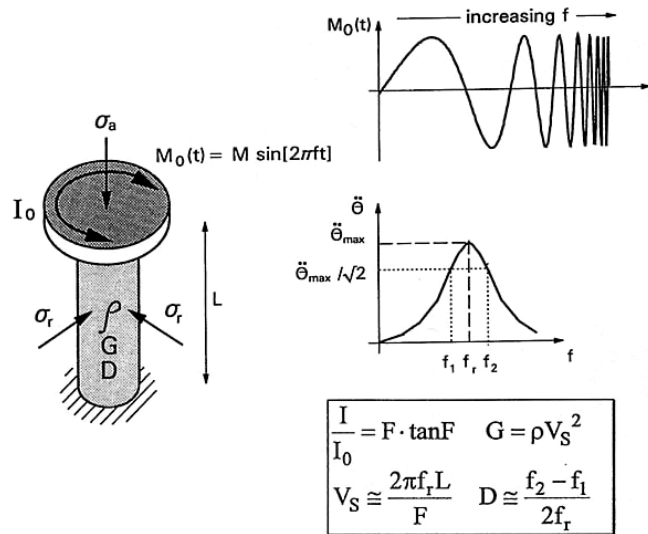
Durante una prova di torsione ciclica (Figura A.4), il provino viene sottoposto ad un momento torcente $M(t)$ variabile nel tempo con legge sinusoidale (di ampiezza e frequenza costanti) e si misura la rotazione della testa $\theta(t)$.

Le tracce temporali rappresentative di momenti e rotazioni vengono tradotte in termini di andamenti $\tau(t)$ e $\gamma(t)$, mediante le opportune costanti di taratura ed assumendo alcune ipotesi semplificative sulla distribuzione dello stato tensio-deformativo all'interno del provino.

Per ciascun ciclo di carico si individuano quindi i valori di picco della tensione e della deformazione tangenziali (τ_{max} e γ_{max}), e l'andamento del ciclo di isteresi risultante dall'accoppiamento di $\tau(t)$ e $\gamma(t)$.

I valori di G e D vengono calcolati utilizzando le relazioni:

$$G = \frac{\tau_{pp}}{\gamma_{pp}} \qquad D = \frac{W_d}{4\pi W_s}$$

Per l'interpretazione dei risultati relativi alle prove di torsione ciclica si è attribuita maggiore affidabilità a tecniche di regressione statistica ai bassi livelli di deformazione (adoperando una regressione sinusoidale, cfr. Papa et al., 1988); non appena i disturbi elettrici sono apparsi senz'altro trascurabili, si è ricorsi ai criteri ordinari (ampiezze picco-picco, area del ciclo di isteresi).



Figura A.4: Interpretazione delle prove di torsione ciclica.



Università degli Studi di Napoli Federico II
Dipartimento di Ingegneria Civile, Edile ed Ambientale
Laboratorio di Geotecnica

<u>Committente</u>	Consorzio HirpiniaAV
<u>Indagine</u>	I lotto funzionale Apice-Hirpinia
<u>Sondaggio</u>	SNGR03
<u>Campione</u>	C4
<u>Profondità</u>	37.40 ÷ 37.90 m
<u>Data apertura</u>	26/11/19
<u>Operatore</u>	

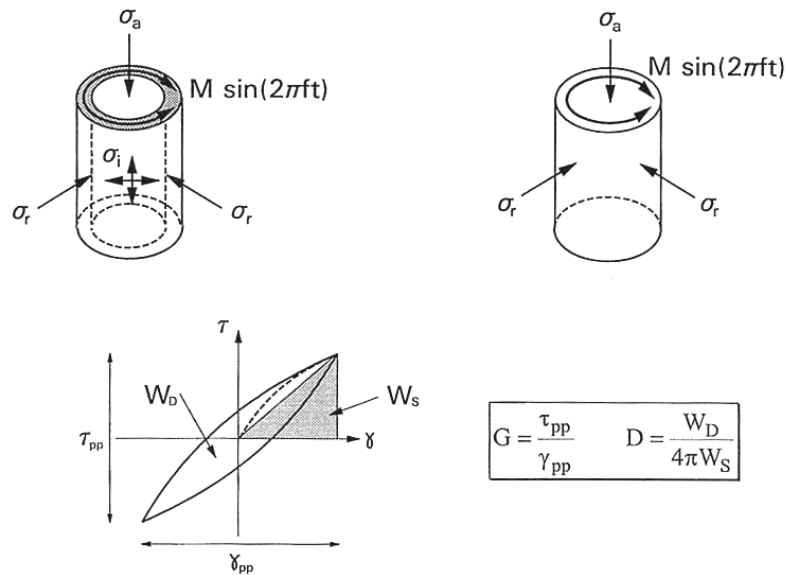
Riferimenti

AGI (1994) - *Raccomandazioni sulle prove geotecniche di laboratorio*

ASTM D422/90 - *Standard Test Method for particle-size analysis of soils.*

ASTM D4318 - *Standard Test Methods for liquid limit, plastic limit, and plasticity index of Soils.*

ASTM D2435/96 - *Standard Test Methods for one-dimensional consolidation properties of soils using incremental loading.*

ASTM D4015/92 - *Standard Test Methods for modulus and damping of soils by Resonant-Column method.*

d'Onofrio A. (1996) – *Comportamento meccanico dell'argilla di Vallericca in condizioni lontane dalla rottura* – Tesi di dottorato in Ingegneria Geotecnica, Università degli Studi di Napoli.

d'Onofrio A., Silvestri F., Vinale F. (1999) - *A new torsional shear device* - ASTM Geotechnical Testing Journal, Vol 22-2 pp.107-117.

Isenhour W.M. (1979) - *Torsional Simple Shear/Resonant Column properties of San Francisco Bay Mud* - M.S. Thesis, The University of Texas at Austin.

Ni S. H. (1987) *Dynamic properties of sand under true triaxial stress states from Resonant Column/Torsional Shear tests* - Ph. D. dissertation, The University of Texas at Austin.

Papa V., Silvestri F., Vinale F. (1988) - *Recenti sviluppi e prospettive nelle tecniche di interpretazione di prove dinamiche di taglio semplice* - Atti del Convegno del Gruppo Nazionale di Coordinamento per gli Studi di Ingegneria Geotecnica, Monselice.

Richart F.E., Hall J.R., Woods R.D. (1970) - *Vibrations of soils and foundations* - Prentice-Hall Inc., Englewood Cliffs, New Jersey.

Silvestri F. (1991) - *Analisi del comportamento dei terreni naturali in prove cicliche e dinamiche di taglio torsionale* - Tesi di Dottorato in Ingegneria Geotecnica, Università degli Studi di Napoli.

Woods R.D. (1978) - *Measurement of dynamic soil properties* - Proc. "Geotechnical Engineering Division Specialty Conference on Earthquake Engineering and Soil Dynamics", ASCE, Pasadena (California).

Il responsabile della sperimentazione
Prof. Ing. Anna d'Onofrio



Università degli Studi di Napoli Federico II
 Dipartimento di Ingegneria Civile, Edile ed Ambientale
Laboratorio di Geotecnica

<u>Committente</u>	Consorzio HirpiniaAV
<u>Indagine</u>	I lotto funzionale Apice-Hirpinia
<u>Sondaggio</u>	SNGR03
<u>Campione</u>	C5
<u>Profondità</u>	46.30 ÷ 46.80 m
<u>Data apertura</u>	03/12/19
<u>Operatore</u>	Alfredo Ponso

Diametro (mm):	82
Lunghezza (mm):	400
Data di apertura:	03/12/2019

Stato del Campione	Indisturbato	
	Parzialmente Rimaneggiato	x
	Rimaneggiato	

Descrizione: Argilla grigia marnosa scagliosa. Scaglie di dimensione centimetrica					
Colore	Grigio				
Plasticità	Non Plastico	<input type="checkbox"/> Bassa	<input checked="" type="checkbox"/> Media alta	Elevata	
Addensamento (Terreni granulari)	<input type="checkbox"/> Molto sciolto ($D_f=0.0\div0.2$)	<input type="checkbox"/> Sciolto ($D_f=0.2\div0.4$)	<input type="checkbox"/> Medio ($D_f=0.4\div0.6$)	Denso ($D_f=0.6\div0.8$)	<input type="checkbox"/> Molto denso ($D_f=0.8\div1.0$)
Consistenza (Terreni coesivi)	<input type="checkbox"/> Molto molle ($I_c < 0.0$)	<input type="checkbox"/> Molle ($I_c=0.0\div0.5$)	<input type="checkbox"/> Media ($I_c=0.5\div1.0$)	Consistente ($I_c > 1.0$)	<input checked="" type="checkbox"/> Molto consist. ($I_c >> 1.0$)
Grado di umidità	<input type="checkbox"/> Asciutto	<input type="checkbox"/> Poco Umido	<input checked="" type="checkbox"/> Umido	<input type="checkbox"/> Molto Umido	
Alterazione	Assente	<input type="checkbox"/> Debole	<input type="checkbox"/> Media	<input type="checkbox"/> Elevata	
Struttura	Omogenea	<input type="checkbox"/> Stratificata	<input checked="" type="checkbox"/> Scagliosa	<input type="checkbox"/> Laminata	Caotica
Fratturazione	<input checked="" type="checkbox"/> Assente	Moderata	<input type="checkbox"/> Elevata		
Cementazione	<input checked="" type="checkbox"/> Assente	<input type="checkbox"/> Debole	<input type="checkbox"/> Media	<input type="checkbox"/> Elevata	

Proprietà fisiche			Proprietà meccaniche	
n,γ,w	X		Compressione uniaassiale	
Analisi granulometrica	X		TX-UU	
Limiti	x		TX-CIU	
CaCO ₃			TX-CID	
Sostanze organiche			TX-Ciclica	
Peso specifico del solido	x		Taglio anulare	
Proctor			Taglio diretto	
CBR			RC TS	
Altro _____			Altro _____	

Non è stato possibile confezionare provini per le prove meccaniche



Università degli Studi di Napoli Federico II

Dipartimento di Ingegneria Civile, Edile ed Ambientale

Laboratorio di Geotecnica

<u>Committente</u>	Consorzio HirpiniaAV
<u>Indagine</u>	I lotto funzionale Apice-Hirpinia
<u>Sondaggio</u>	SNGR03
<u>Campione</u>	C5
<u>Profondità</u>	46.30 ÷ 46.80 m
<u>Data apertura</u>	03/12/19
<u>Operatore</u>	Alfredo Ponzio

FOTO CAMPIONE





Committente	Consorzio HirpiniaAV
Indagine	I lotto funzionale Apice-Hirpinia
Sondaggio	SNGR03
Campione	C5
Profondità	46.30-46.80
Data	03/12/2019
Operatore	Alfredo Ponzo

LIMITE DI PLASTICITA'				
pesafiltro n°	Tara	Peso lordo umido (P _u)	Peso lordo secco (P _s)	Contenuto d'acqua (w)
[-]	[gr]	[gr]	[gr]	[-]
21	14.04	49.91	41.44	0.309
w_P				0.309

LIMITE DI LIQUIDITA' (Metodo di Casagrande ASTM)					
Pesafiltro n°	N° colpi (N)	Tara (P _c)	Peso lordo umido (P _u)	Peso lordo secco (P _s)	Contenuto d'acqua (w)
[-]	[-]	[g]	[g]	[g]	[g]
42	30	8.64	34.29	22.81	0.810
151	24	11.43	43.14	28.83	0.822
186	14	12.13	45.35	30.03	0.856
25	Limite di liquidità ASTM (w_L)				0.822

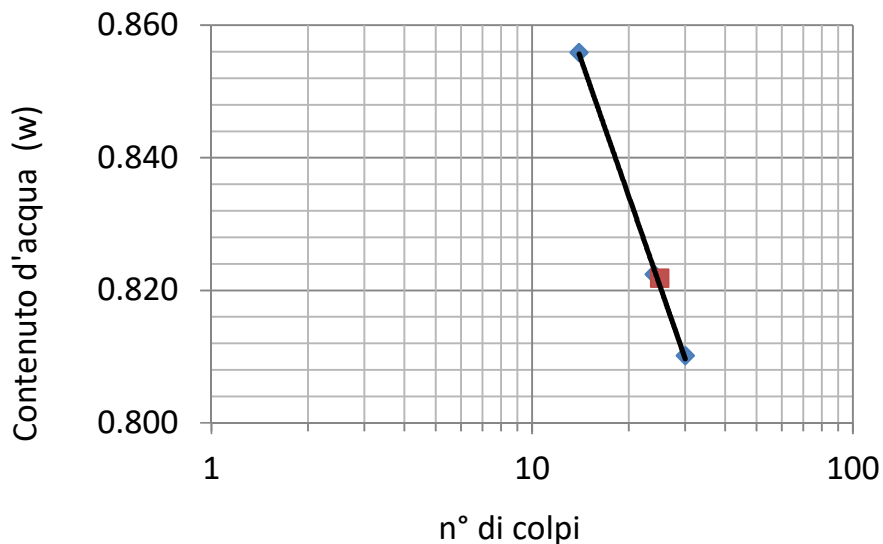

Indice di plasticità (I _p)	Frazione argillosa CF (d < 2 μm)	Indice di attività (I _A)
[%]	[%]	[-]
51.26	50.000	1.03

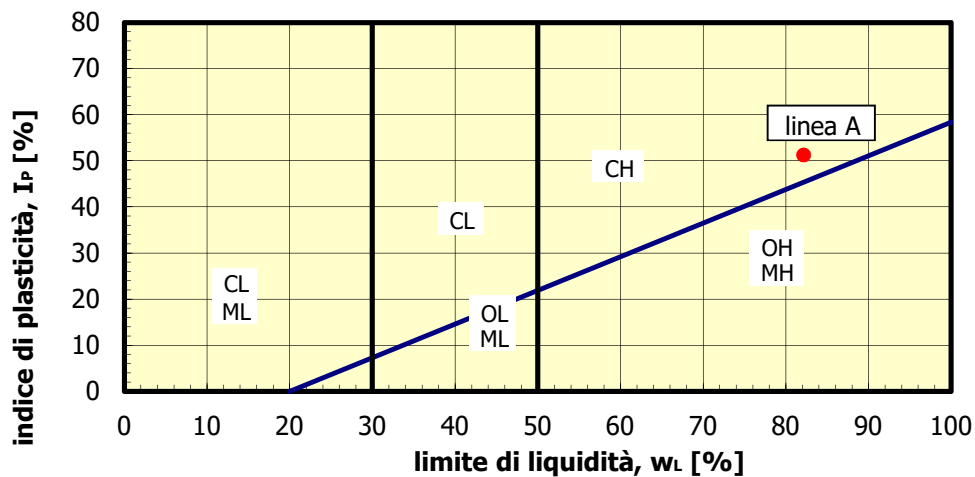

ML	Limi inorganici da bassa a media plasticità	M = limi
CL	Argille inorganiche da bassa a media plasticità	C = argille
OL	Limi e argille organiche di bassa plasticità	O = sostanze organiche
MH	Limi inorganici di alta plasticità	L = bassa plasticità
CH	Argille inorganiche di alta plasticità	H = alta plasticità
OH	Argille organiche da media ad alta plasticità	

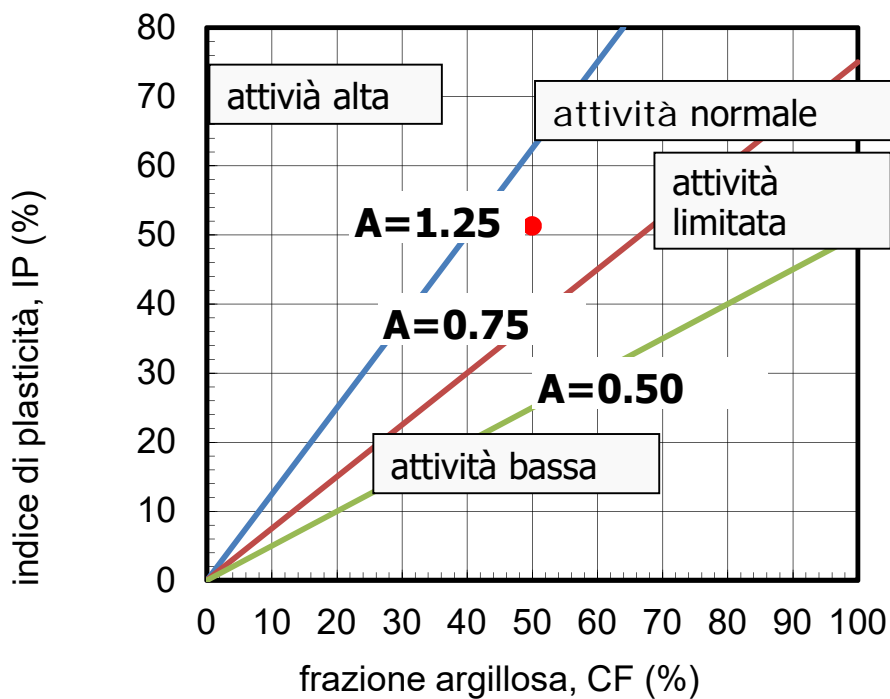

CONSISTENZA TERRENO A GRANA FINE		
w_L	I_p	I_c
[-]	[-]	[-]
82.177	51.26	1.60
COMPATTEZZA TERRENO A GRANA GROSSA		
e_{max}	e_{min}	D_r
[-]	[-]	[-]



Università degli Studi di Napoli

Dipartimento di Ingegneria Civile, Edile e Ambientale
Laboratorio di Geotecnica

Committente	Consorzio HirpiniaAV
Indagine	I lotto funzionale Apice-Hirpinia
Sondaggio	SNGR03
Campione	C5
Profondità	46.30-46.80
Data	03/12/2019
Operatore	Alfredo Ponzo

Peso specifico del solido	
Peso specifico dell'acqua (γ_w) (g/cm ³)	1.000
picnometro n°	18.000
Peso picnometro (P_p) (g)	59.77
Peso picnometro + acqua (P_{pw}) (g)	158.150
Volume picnometro (V_p) (cm ³)	98.38
Peso picnometro + terreno (P_{ps}) (g)	79.88
Peso terreno (P_s)	20.11
Peso picnometro + terreno + acqua (P_{psw}) (g)	170.990
Volume acqua aggiunta (V_w) (cm ³)	91.11
Volume terreno (V_s) (cm ³)	7.270
Peso specifico del terreno (γ_s) (kN/m ³)	27.125

Caratteristiche Fisiche Generali			
pesafiltro n°	28	82	
Peso contenitore (P_c) (g)	8.530	11.350	
Diametro (D) (mm)			
Altezza (H) (mm)			
Volume (V) (cm ³)			
Peso lordo umido (P_u) (g)	52.44	52.84	
Peso lordo secco (P_s) (g)	45.84	46.72	
Contenuto d'acqua (w)	0.177	0.173	
Peso umido unità di volume (γ) (kN/m ³)			
Peso secco unità di volume (γ_d) (kN/m ³)			
Peso specifico del solido (γ_s) (kN/m ³)			
Porosità (n)			
Indice dei vuoti (e)			
Grado di Saturazione (S _v)			

il responsabile della sperimentazione

Anna d'Onofrio
Prof. Ing. Anna d'Onofrio



Università degli Studi di Napoli
 Dipartimento di Ingegneria Civile, Edile e Ambientale
 Laboratorio di Geotecnica

Committente	Consorzio HirpiniaAV
Indagine	I lotto funzionale Apice-Hirpinia
Sondaggio	SNGR03
Campione	C5
Profondità	46.30 ÷ 46.80 m
Data	05/12/2019
Operatore	Alfredo Ponzo

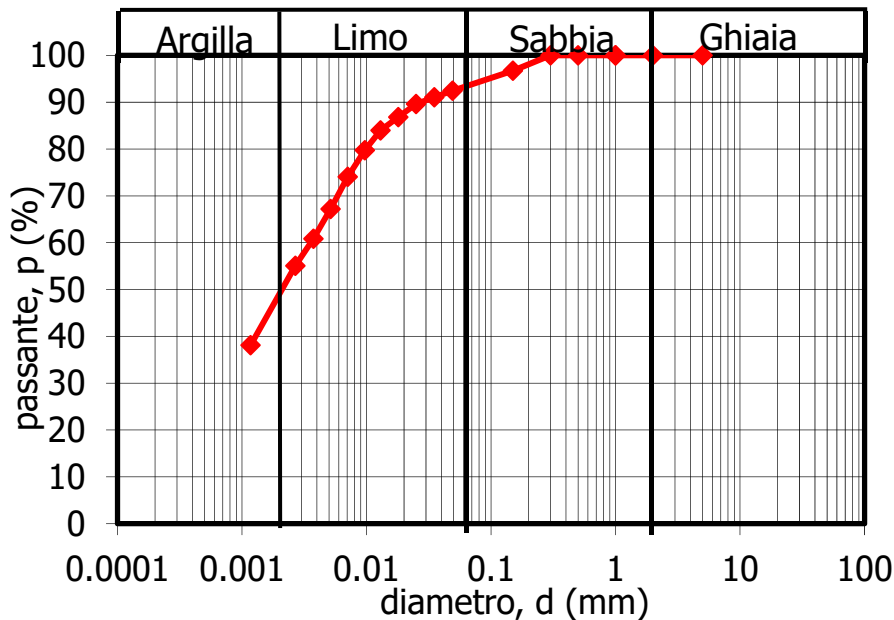

Curva granulometrica	
diametro (mm)	passante (%)
1.000	100.00
0.500	100.00
0.300	100.00
0.150	96.71
0.049	92.46
0.035	91.04
0.025	89.63
0.018	86.80
0.013	83.97
0.010	79.73
0.007	74.08
0.005	67.20
0.004	60.84
0.003	55.08
0.001	38.11

Argilla con limo debolmente sabbiosa

peso secco totale (g)	peso secco sediment. (g)
55.39	55.39

STACCIATURA			SEDIMENTAZIONE		
d (mm)	peso trattenuto (g)	peso passante (g)	tempo (min)	temperatura (°C)	lettura areometro (g/cm ³)
1.00	0.00	55.39		21	
0.50	0.00	55.39	0.5	21.5	1.034
0.30	0.00	55.39	1	21.5	1.0335
0.15	1.82	53.57	2	21.5	1.033
			4	21.5	1.032
			8	21.5	1.031
			15	21.5	1.0295
			30	21.5	1.0275
			60	22	1.025
			120	22	1.02275
			240	23.5	1.0205
			1440	23.5	1.0145

Gs= 2.766

%<0.075mm	%ghiaia	%sabbia	%limo	%argilla	D _{max} (mm)	D ₆₀ (mm)	D ₁₀ (mm)
95	0	8	42	50	0.30	0.0040	

Normativa di riferimento : ASTM 422/90

il responsabile della sperimentazione
 prof. Ing. Anna d'Onofrio



Università degli Studi di Napoli Federico II
 Dipartimento di Ingegneria Civile, Edile ed Ambientale
 Laboratorio di Geotecnica

<u>Committente</u>	Consorzio HirpiniaAV
<u>Indagine</u>	I lotto funzionale Apice-Hirpinia
<u>Sondaggio</u>	SNGR03
<u>Campione</u>	C7
<u>Profondità</u>	67.50 ÷ 68.00 m
<u>Data apertura</u>	03/12/19
<u>Operatore</u>	Alfredo Ponzo

Diametro (mm):	80
Lunghezza (mm):	500
Data di apertura:	03/12/2019

Stato del Campione	Indisturbato	x
	Parzialmente Rimaneggiato	
	Rimaneggiato	

Descrizione: Argilla grigio azzurra. Parte superiore, circa 20cm: presenza di inclusi calcarei marnosi. Parte inferiore: argilla grigia con presenza di venature calcaree (dichite)

Colore	Grigio				
Plasticità	Non Plastico	<input type="checkbox"/> Bassa	<input checked="" type="checkbox"/> Media alta	Elevata	
Addensamento (Terreni granulari)	<input type="checkbox"/> Molto sciolto ($D_r=0.0\div 0.2$)	<input type="checkbox"/> Sciolto ($D_r=0.2\div 0.4$)	<input type="checkbox"/> Medio ($D_r=0.4\div 0.6$)	Denso ($D_r=0.6\div 0.8$)	<input type="checkbox"/> Molto denso ($D_r=0.8\div 1.0$)
Consistenza (Terreni coesivi)	<input type="checkbox"/> Molto molle ($I_c < 0.0$)	<input type="checkbox"/> Molle ($I_c=0.0\div 0.5$)	<input type="checkbox"/> Media ($I_c=0.5\div 1.0$)	Consistente ($I_c > 1.0$)	<input checked="" type="checkbox"/> Molto consist. ($I_c >> 1.0$)
Grado di umidità	<input type="checkbox"/> Asciutto	<input type="checkbox"/> Poco Umido	<input checked="" type="checkbox"/> Umido	<input type="checkbox"/> Molto Umido	
Alterazione	Assente	<input type="checkbox"/> Debole	<input type="checkbox"/> Media	<input type="checkbox"/> Elevata	
Struttura	Omogenea	<input type="checkbox"/> Stratificata	<input checked="" type="checkbox"/> Scagliosa	<input type="checkbox"/> Laminata	Caotica
Fratturazione	<input checked="" type="checkbox"/> Assente	Moderata	<input type="checkbox"/> Elevata		
Cementazione	<input checked="" type="checkbox"/> Assente	<input type="checkbox"/> Debole	<input type="checkbox"/> Media	<input type="checkbox"/> Elevata	

Proprietà fisiche			Proprietà meccaniche	
n, γ, w	X		Compressione uniassiale	
Analisi granulometrica	X		TX-UU	
Limiti	x		TX-CIU	
CaCO ₃			TX-CID	
Sostanze organiche			TX-Ciclica	
Peso specifico del solido	x		Taglio anulare	
Proctor			Taglio diretto	
CBR			RC TS	x
Altro _____			Altro _____	



Università degli Studi di Napoli Federico II

Dipartimento di Ingegneria Civile, Edile ed Ambientale

Laboratorio di Geotecnica

<u>Committente</u>	Consorzio HirpiniaAV
<u>Indagine</u>	I lotto funzionale Apice-Hirpinia
<u>Sondaggio</u>	SNGR03
<u>Campione</u>	C7
<u>Profondità</u>	67.50 ÷ 68.00 m
<u>Data apertura</u>	03/12/19
<u>Operatore</u>	Alfredo Ponzio

FOTO CAMPIONE





Committente	Consorzio HirpiniaAV
Indagine	I lotto funzionale Apice-Hirpinia
Sondaggio	SNGR03
Campione	C7
Profondità	67.50-68.00
Data	03/12/2019
Operatore	Alfredo Ponzo

LIMITE DI PLASTICITA'				
pesafiltro n°	Tara	Peso lordo umido (P _u)	Peso lordo secco (P _s)	Contenuto d'acqua (w)
[-]	[gr]	[gr]	[gr]	[-]
29	15.01	52.91	43.24	0.343
w_P				0.343

LIMITE DI LIQUIDITA' (Metodo di Casagrande ASTM)					
Pesafiltro n°	N° colpi (N)	Tara (P _c)	Peso lordo umido (P _u)	Peso lordo secco (P _s)	Contenuto d'acqua (w)
[-]	[-]	[g]	[g]	[g]	[g]
85	16	11.58	43.94	28.87	0.872
184	24	10.05	41.42	27.13	0.837
40	32	9.03	39.85	26.03	0.813
25	Limite di liquidità ASTM (w_L)				0.833

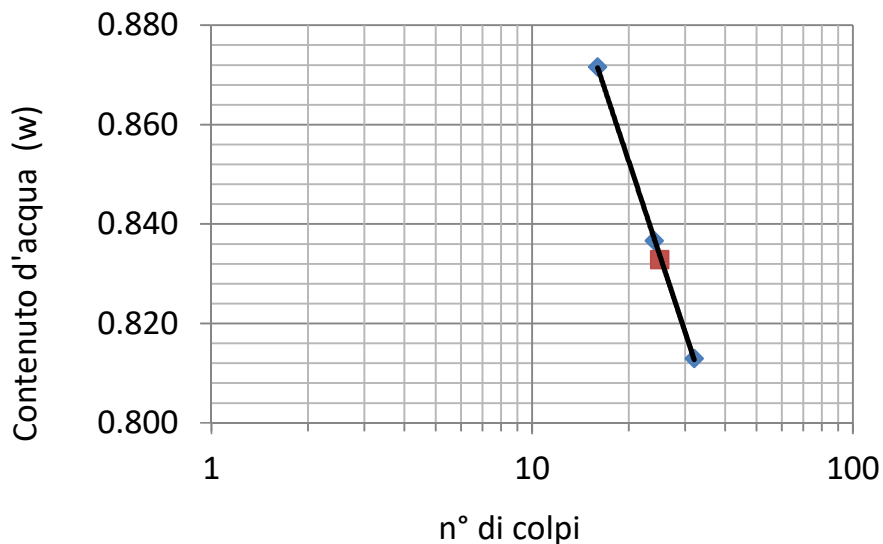

Indice di plasticità (I _p)	Frazione argillosa CF (d < 2 μm)	Indice di attività (I _A)
[%]	[%]	[-]
49.03	38.000	1.29

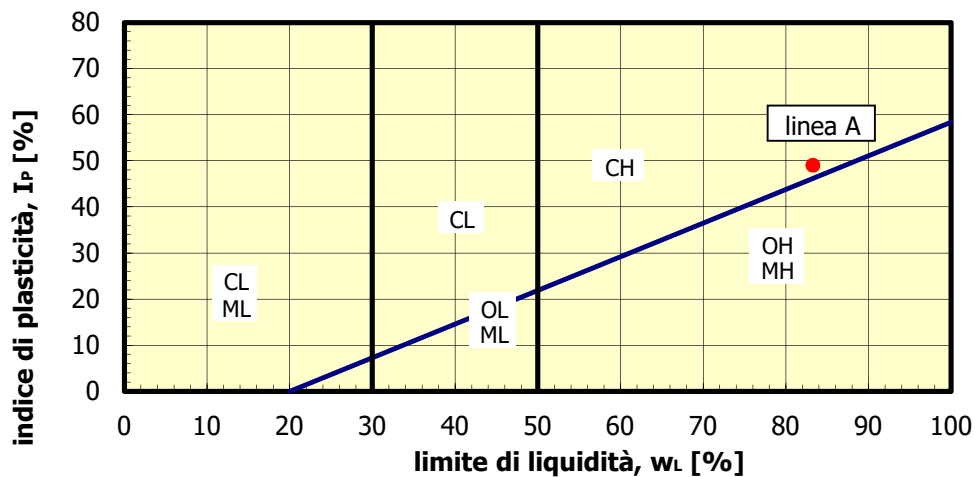

ML	Limi inorganici da bassa a media plasticità	M = limi
CL	Argille inorganiche da bassa a media plasticità	C = argille
OL	Limi e argille organiche di bassa plasticità	O = sostanze organiche
MH	Limi inorganici di alta plasticità	L = bassa plasticità
CH	Argille inorganiche di alta plasticità	H = alta plasticità
OH	Argille organiche da media ad alta plasticità	

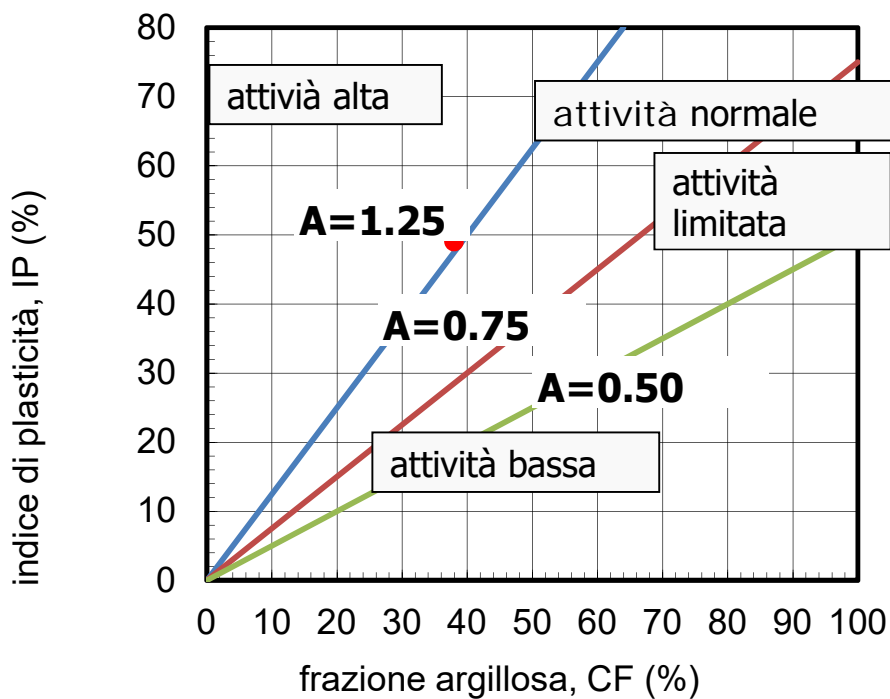

CONSISTENZA TERRENO A GRANA FINE		
w_L	I_p	I_c
[-]	[-]	[-]
83.280	49.03	1.70
COMPATTEZZA TERRENO A GRANA GROSSA		
e_{max}	e_{min}	D_r
[-]	[-]	[-]



Università degli Studi di Napoli
Dipartimento di Ingegneria Civile, Edile e Ambientale
Laboratorio di Geotecnica

Committente	Consorzio HirpiniaAV
Indagine	Apice-Hirpinia
Sondaggio	SNGR03
Campione	C7
Profondità	67.50-68.00
Data	03/12/2019
Operatore	Alfredo Ponzo

Peso specifico del solido	
Peso specifico dell'acqua (γ_w) (g/cm ³)	1.000
picnometro n°	xx
Peso picnometro (P_p) (g)	42.54
Peso picnometro + acqua (P_{pw}) (g)	140.260
Volume picnometro (V_p) (cm ³)	97.72
Peso picnometro + terreno (P_{ps}) (g)	63.06
Peso terreno (P_s)	20.52
Peso picnometro + terreno + acqua (P_{psw}) (g)	153.290
Volume acqua aggiunta (V_w) (cm ³)	90.23
Volume terreno (V_s) (cm ³)	7.490
Peso specifico del terreno (γ_s) (kN/m ³)	26.865

Caratteristiche Fisiche Generali		
pesafiltro n°	99	81
Peso contenitore (P_c) (g)	12.080	11.410
Diametro (D) (mm)		
Altezza (H) (mm)		
Volume (V) (cm ³)		
Peso lordo umido (P_u) (g)	53.08	47.15
Peso lordo secco (P_s) (g)	47.28	42.15
Contenuto d'acqua (w)	0.165	0.163
Peso umido unità di volume (γ) (kN/m ³)		
Peso secco unità di volume (γ_d) (kN/m ³)		
Peso specifico del solido (γ_s) (kN/m ³)		
Porosità (n)		
Indice dei vuoti (e)		
Grado di Saturazione (S_r)		

il responsabile della sperimentazione
prof. Ing. Anna d'Onofrio



Università degli Studi di Napoli
 Dipartimento di Ingegneria Civile, Edile e Ambientale
 Laboratorio di Geotecnica

Committente	Consorzio HirpiniaAV
Indagine	I lotto funzionale Apice-Hirpinia
Sondaggio	SNGR03
Campione	C7
Profondità	67.50 + 68.00 m
Data	21/10/2019
Operatore	Alfredo Pozzo

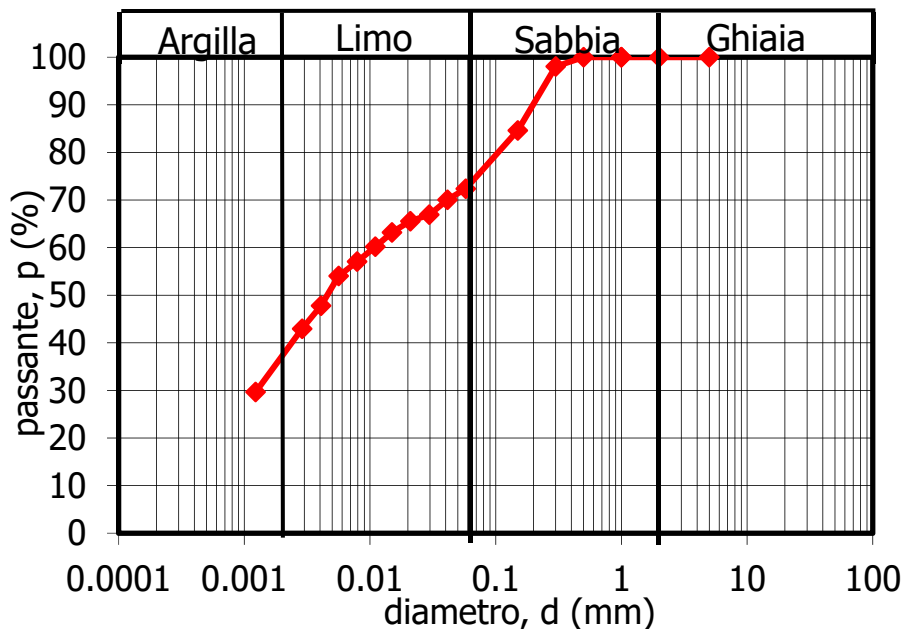

diametro (mm)	passante (%)
1.000	100.00
0.500	100.00
0.300	98.05
0.150	84.62
0.058	72.38
0.041	70.04
0.030	66.91
0.021	65.55
0.015	63.21
0.011	60.19
0.008	57.06
0.006	54.03
0.004	47.78
0.003	42.96
0.001	29.66

Argilla con limo e sabbia

peso secco totale (g)	peso secco sediment. (g)
50.32	50.32

STACCIATURA			SEDIMENTAZIONE		
d (mm)	peso trattenuto (g)	peso passante (g)	tempo (min)	temperatura (°C)	lettura areometro (g/cm^3)
1.00	0.00	50.32		21	
0.50	0.00	50.32	0.5	21	1.0245
0.30	0.98	49.34	1	21	1.02375
0.15	7.74	42.58	2	21	1.02275
			4	21.5	1.02225
			8	21.5	1.0215
			15	21.75	1.0205
			30	21.75	1.0195
			60	22	1.0185
			120	22	1.0165
			240	23.5	1.01475
			1440	23.5	1.0105

Gs= 2.740

%<math>< 0.075\text{ mm}</math>	%ghiaia	%sabbia	%limo	%argilla	D_{max} (mm)	D_{60} (mm)	D_{10} (mm)
75	0	28	34	38	0.50	0.0110	

Normativa di riferimento : ASTM 422/90

il responsabile della sperimentazione
 Prof. Ing. Anna d'Onofrio



Università degli Studi di Napoli Federico II

Dipartimento di Ingegneria Civile, Edile ed Ambientale

Laboratorio di Geotecnica

<u>Committente</u>	Consorzio HirpiniaAV
<u>Indagine</u>	I lotto funzionale Apice-Hirpinia
<u>Sondaggio</u>	SNGR03
<u>Campione</u>	C7
<u>Profondità</u>	67.50 ÷ 68.00 m
<u>Data apertura</u>	03/12/19
<u>Operatore</u>	

Prova di TAGLIO TORSIONALE

Dati iniziali								
D (mm)	H (mm)	V (cm ³)	γ (kN/m ³)	w (%)	γ_s (kN/m ³)	e (/)	S _r (%)	p' (kPa)
35.68	71.89	71.84	20.54	13.93	26.87	0.490	0.78	568

Dati fine consolidazione								
D (mm)	H (mm)	V (cm ³)	γ (kN/m ³)	w (%)	γ_d (kN/m ³)	e (/)	S _r (%)	p' (kPa)
35.60	71.79	71.44	20.60	16.90	18.1	0.481	0.78	568



Università degli Studi di Napoli Federico II

Dipartimento di Ingegneria Civile, Edile ed Ambientale

Laboratorio di Geotecnica

<u>Committente</u>	Consorzio HirpiniaAV
<u>Indagine</u>	I lotto funzionale Apice-Hirpinia
<u>Sondaggio</u>	SNGR03
<u>Campione</u>	C7
<u>Profondità</u>	67.50 ÷ 68.00 m
<u>Data apertura</u>	03/12/19
<u>Operatore</u>	

TAGLIO TORSIONALE					
γ (%)	G (MPa)	D (%)	f_r (Hz)	G/G ₀ (/)	Du/p'
2.74E-04	206.02	2.67	0.5	1.00	0.00
3.93E-04	206.02	2.7	0.5	1.00	0.00
6.18E-04	206.02	2.22	0.5	1.00	0.00
9.20E-04	206.02	2.36	0.5	1.00	0.00
1.34E-03	206.02	2.13	0.5	1.00	0.00
1.99E-03	207.04	2.89	0.5	1.00	0.00
3.00E-03	206.02	2.48	0.5	1.00	0.00
3.35E-03	205.00	2.85	0.5	1.00	0.00
3.37E-03	205.00	2.77	0.5	1.00	0.00
5.72E-03	205.00	2.91	0.5	1.00	0.00
7.42E-03	203.94	2.9	0.5	0.99	0.00
9.85E-03	200.77	3.27	0.5	0.97	0.00
1.28E-02	197.60	3.59	0.5	0.96	0.00
1.71E-02	192.32	4.08	0.5	0.93	0.00
2.34E-02	184.92	4.91	0.5	0.90	0.00
3.23E-02	173.30	6.12	0.5	0.84	0.00
4.21E-02	162.73	7.19	0.5	0.79	0.00
4.21E-02	163.93	7.5	0.5	0.80	0.00
4.75E-02	159.98	7.87	0.5	0.78	0.00
5.35E-02	155.05	8.15	0.5	0.75	0.00
6.01E-02	150.11	8.06	0.5	0.73	0.00
6.70E-02	143.20	9.41	0.5	0.70	0.00
8.16E-02	135.30	10.73	0.5	0.66	0.00
9.77E-02	125.42	11.74	0.5	0.61	0.00
1.12E-01	119.49	12.2	0.5	0.58	0.01
1.22E-01	115.54	12.63	0.5	0.56	0.01
1.32E-01	111.59	12.84	0.5	0.54	0.01
1.52E-01	104.68	14.18	0.5	0.51	0.01
1.74E-01	98.76	14.93	0.5	0.48	0.01
1.98E-01	92.48	15.77	0.5	0.45	0.01
2.23E-01	87.81	16.78	0.5	0.43	0.02
2.55E-01	81.46	18.4	0.5	0.40	0.02
2.76E-01	77.52	18.82	0.5	0.38	0.02
2.98E-01	74.17	19.48	0.5	0.36	0.02
3.21E-01	70.06	20.45	0.5	0.34	0.02
3.49E-01	65.80	21.79	0.5	0.32	0.03
3.88E-01	60.19	23.8	0.5	0.29	0.03
4.68E-01	51.11	27.22	0.5	0.25	0.03



<u>Committente</u>	Consorzio HirpiniaAV
<u>Indagine</u>	I lotto funzionale Apice-Hirpinia
<u>Sondaggio</u>	SNGR03
<u>Campione</u>	C7
<u>Profondità</u>	67.50 ÷ 68.00 m
<u>Data apertura</u>	03/12/19
<u>Operatore</u>	

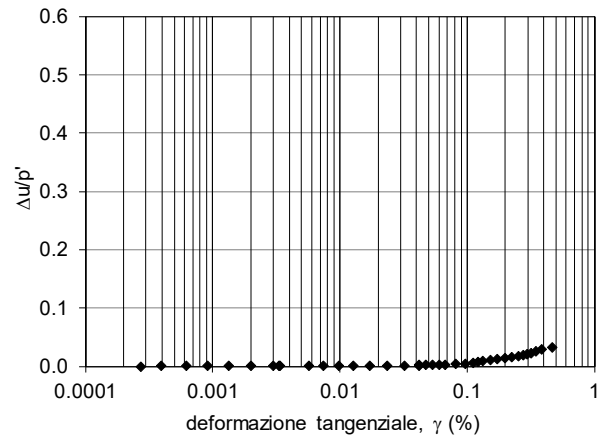
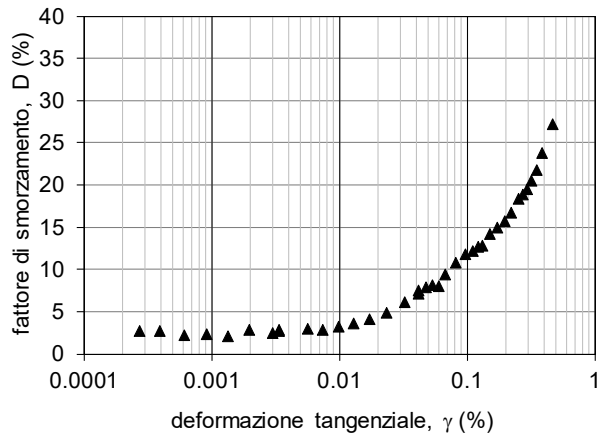
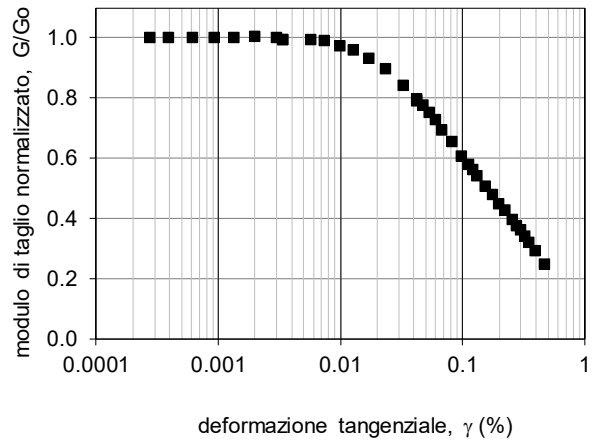
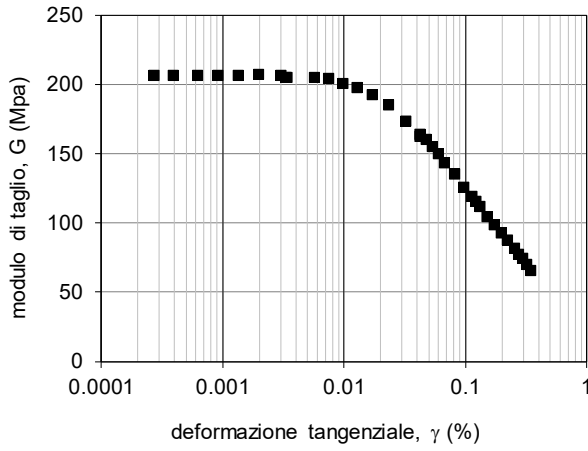



<u>Committente</u>	Consorzio HirpiniaAV
<u>Indagine</u>	I lotto funzionale Apice-Hirpinia
<u>Sondaggio</u>	SNGR03
<u>Campione</u>	C7
<u>Profondità</u>	67.50 ÷ 68.00 m
<u>Data apertura</u>	03/12/19
<u>Operatore</u>	

APPENDICE

1. L'attrezzatura sperimentale per prove di taglio torsionale

L'apparecchiatura utilizzata è la cella di taglio torsionale THOR (Figura A.1), progettata e realizzata presso l'Università di Napoli Federico II (d'Onofrio, 1996) sulla base del prototipo originario di colonna risonante 'fixed-free' messo a punto presso l'Università del Texas di Austin (Isenhower, 1979; Ni, 1987). Le caratteristiche tecniche dell'apparecchiatura sono dettagliate da d'Onofrio et al. (1999). In Tabella A.1 sono sintetizzate le principali caratteristiche del sistema, ed in Figura A.2 uno schema della catena strumentale per il controllo e l'acquisizione.

Tipo di prova		Colonna risonante / Taglio torsionale
Nome dell'apparecchiatura		THOR
Provino	Diametro esterno	36mm
	Altezza	72mm
	Accuratezza nella misura delle dimensioni e del peso del provino	0.1 mm, 0.1gr
	Metodo di preparazione del provino	Fustellamento
	Saturazione	In cella via back-pressure
	Test di B	B > 0.95 mediando i valori ottenuti incrementando e decrementando la pressione di cella
	Contatto tra provino e apparecchiatura	Piastra rugosa avvitata nella testa di carico e pietra porosa di carburo di silicio avvitata al piedistallo
Sistema di applicazione dei carichi torcenti	Tipo	Motore elettromagnetico
Accuratezza del sistema di controllo	Pressione di cella	40 Pa attraverso convertitore E/P
	Contropressione	Senza controllo
	Sistema di applicazione dei carichi torcenti	Controllo in corrente risoluzione $1.6 \cdot 10^{-5}$ Nm (2 Pa per il provino \varnothing 36 mm) Fondo scala 5 Nm Non c'è effetto della forza elettromotrice indotta
Tipo di trasduttori utilizzati	Pressione di cella	Sensore di pressione di elevate prestazioni con membrana al silicone
	Contropressione	Trasduttore miniaturizzato con diaframma al silicone
	Pressione neutra	Trasduttore miniaturizzato con diaframma al silicone
	Coppia torcente	Cella torsionale a strain-gage
	Spostamenti assiali	LVDT in corrente continua
	Variazioni di volume	Trasduttore differenziale di pressione/ volumometro
	Accelerazioni	Accelerometro piezoelettrico
	Rotazioni	Laser /Proximitor
Accuratezza delle misure	Pressione di cella	1.5 Pa
	Contropressione	0.7 Pa
	Pressione interstiziale	0.7 Pa
	Coppia torcente	$6 \cdot 10^{-3}$ Nm
	Spostamenti assiali	1 μ m
	Variazioni di volume	0.0014 cm ³
	Rotazioni	$2.5 \cdot 10^{-7}$ rad (prox)

Tabella A.1. Principali caratteristiche della cella di taglio torsionale THOR.



Università degli Studi di Napoli Federico II
Dipartimento di Ingegneria Civile, Edile ed Ambientale
Laboratorio di Geotecnica

<u>Committente</u>	Consorzio HirpiniaAV
<u>Indagine</u>	I lotto funzionale Apice-Hirpinia
<u>Sondaggio</u>	SNGR03
<u>Campione</u>	C7
<u>Profondità</u>	67.50 ÷ 68.00 m
<u>Data apertura</u>	03/12/19
<u>Operatore</u>	



Figura A.1. L'apparecchiatura di taglio torsionale THOR.



Figura A.2. Diagramma schematico del sistema di controllo e acquisizione di THOR



<u>Committente</u>	Consorzio HirpiniaAV
<u>Indagine</u>	I lotto funzionale Apice-Hirpinia
<u>Sondaggio</u>	SNGR03
<u>Campione</u>	C7
<u>Profondità</u>	67.50 ÷ 68.00 m
<u>Data apertura</u>	03/12/19
<u>Operatore</u>	

2. Procedure sperimentali per le prove RC e CTS

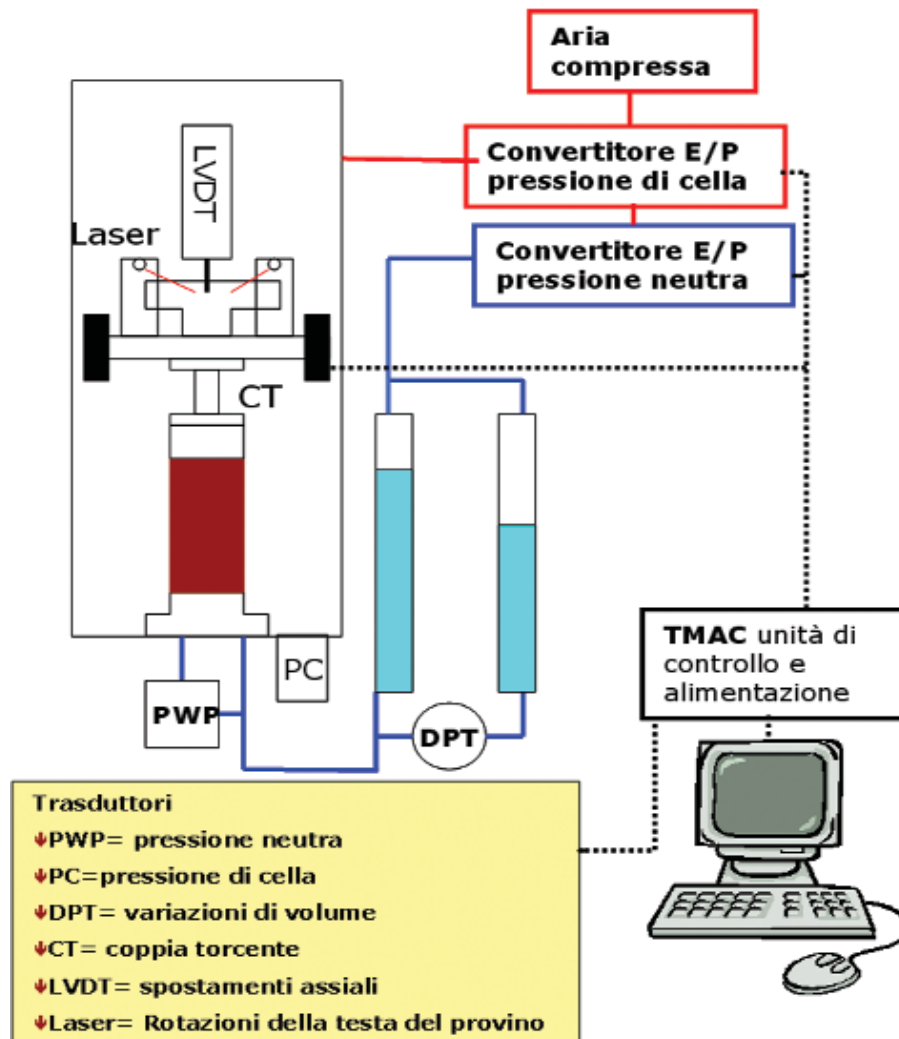
Ciascun provino è stato sottoposto ad una prima fase di applicazione della sollecitazione sferica per ricondurre il provino alla tensione efficace stimata agente in sito.

Al termine di questa fase è stato poi applicato il carico torsionale $M(t)$, avente caratteristiche diverse in funzione del tipo di prova. In particolare, in relazione alla frequenza con la quale vengono fatte variare le sollecitazioni nel tempo, è possibile distinguere due tipi di prova: prove «cicliche» (torsione ciclica, CTS) e prove «dinamiche» propriamente dette (colonna risonante, RC).

I criteri di interpretazione delle prove in termini di rigidità e smorzamento sono variabili a seconda delle caratteristiche della sollecitazione torsionale applicata. Infatti, nelle prove TS l'effetto delle forze di inerzia è trascurabile e quindi l'interpretazione è di tipo «quasi statico», mentre per le prove RC è necessario fare riferimento a modelli d'analisi dinamici. I criteri descritti in seguito sono quelli pressoché universalmente adottati per l'interpretazione delle prove RC e CTS, conformi alle norme ASTM (ASTM D4015/92). Presso il DIGA sono state messe a punto, e vengono normalmente utilizzate, procedure di interpretazione più complesse, che si avvalgono della completa automazione e digitalizzazione delle prove. Queste procedure, ampiamente descritte altrove (Papa et al., 1988; Silvestri, 1991, d'Onofrio, 1996), tra l'altro consentono di aumentare l'affidabilità dei risultati anche quando il livello di deformazioni indagato è basso e quindi si è in presenza di un rapporto segnale/rumore non elevato. Per approfondimenti si rimanda a Silvestri (1991).

2.1 Prove di colonna risonante (RC)

Durante una prova di colonna risonante (Figura A.3) il provino è sottoposto ad una sollecitazione torsionale di ampiezza M costante e frequenza f variabile nel tempo:

$$M(t) = M \sin[2\pi ft]$$

Nell'attrezzatura utilizzata, l'estremità superiore del provino è libera, mentre la base è rigidamente vincolata al piedistallo fisso; in tal modo lo schema dinamico di riferimento è del tipo «a base fissa» o «fixed-free» (Woods, 1978).

Durante la prova, viene registrata la vibrazione della testa del provino in termini di rotazione, θ , rilevata a seconda dei casi da una coppia di sensori laser oppure da due coppie di trasduttori di prossimità. Tale misura viene convertita in deformazioni tangenziali, γ , mediante le opportune costanti di taratura (d'Onofrio, 1996). La risposta del provino risulta in ogni istante isofrequenziale con la sollecitazione, mentre l'ampiezza (θ o γ) varia in relazione alla frequenza, ed attinge il valore massimo quando vengono raggiunte le cosiddette "condizioni di risonanza" ($f = f_R$).

Il modulo tangenziale G viene dedotto dalla misura della velocità delle onde di taglio, V_s , ottenuta analizzando la risposta del sistema composto da provino e dispositivo di carico torsionale, sulla base di classici modelli teorici di vibrazione torsionale di solidi cilindrici (Richart et al, 1970). Dalla conoscenza delle caratteristiche fisico-geometriche del sistema, V_s e G si ricavano applicando le espressioni:

$$V_s = \frac{2\pi f L}{\beta}$$

$$G = \rho V_s^2$$

dove L indica l'altezza del provino e ρ la densità del terreno. La costante adimensionale β è funzione dell'inerzia polare di massa del provino, I , e di quella del sistema di eccitazione, I_0 , secondo l'equazione:

$$\frac{I}{I_0} = \beta \tan \beta$$

Dalla curva di risposta è possibile anche ricavare il fattore di smorzamento D , individuando i valori di frequenza (f_1, f_2) corrispondenti ad un'ampiezza di vibrazione pari a $\gamma_{\max}/\sqrt{2}$ (metodo della "semibanda di potenza"):

$$D_{hp} = \frac{f_2 - f_1}{2 f_R}$$

A causa della non linearità e della degradazione ciclica, questo criterio non sempre fornisce una valutazione attendibile del fattore di smorzamento D . In casi del genere si può, in alternativa, ricorrere al metodo basato sull'espressione analitica del



<u>Committente</u>	Consorzio HirpiniaAV
<u>Indagine</u>	I lotto funzionale Apice-Hirpinia
<u>Sondaggio</u>	SNGR03
<u>Campione</u>	C7
<u>Profondità</u>	67.50 ÷ 68.00 m
<u>Data apertura</u>	03/12/19
<u>Operatore</u>	

fattore di risonanza (metodo del fattore di risonanza), cioè il rapporto tra il valore di picco, γ_{\max} , della curva di risposta $\gamma(f)$ e la rotazione statica corrispondente ad una coppia di eguale ampiezza M. Da esso si ricava D, una volta noti le ampiezze M e γ_{\max} , ed il valore di G già calcolato, con l'espressione seguente:

$$D_{rf} = \frac{M_0 \bar{R}}{2G\gamma_{\max}}$$

Questo metodo appare in genere più attendibile di quello precedente, perché meno sensibile agli effetti della non linearità e della degradazione ciclica del terreno.



Figura A.3: Interpretazione delle prove di colonna risonante.



<u>Committente</u>	Consorzio HirpiniaAV
<u>Indagine</u>	I lotto funzionale Apice-Hirpinia
<u>Sondaggio</u>	SNGR03
<u>Campione</u>	C7
<u>Profondità</u>	67.50 ÷ 68.00 m
<u>Data apertura</u>	03/12/19
<u>Operatore</u>	

2.2 Prova di torsione ciclica (CTS)

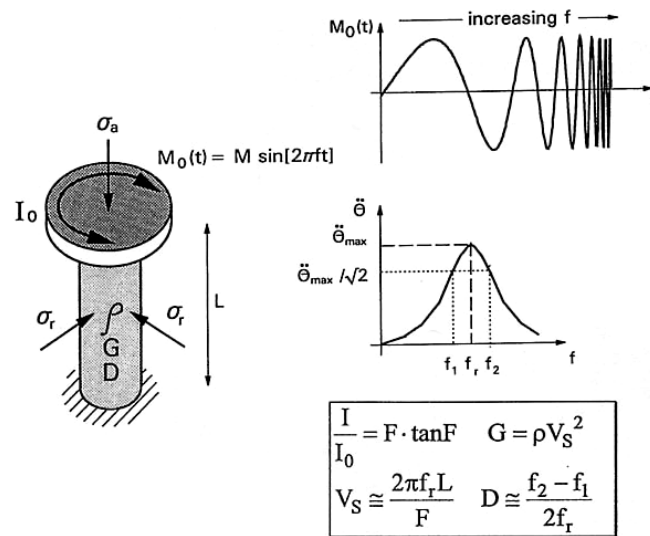
Durante una prova di torsione ciclica (Figura A.4), il provino viene sottoposto ad un momento torcente $M(t)$ variabile nel tempo con legge sinusoidale (di ampiezza e frequenza costanti) e si misura la rotazione della testa $\theta(t)$.

Le tracce temporali rappresentative di momenti e rotazioni vengono tradotte in termini di andamenti $\tau(t)$ e $\gamma(t)$, mediante le opportune costanti di taratura ed assumendo alcune ipotesi semplificative sulla distribuzione dello stato tensio-deformativo all'interno del provino.

Per ciascun ciclo di carico si individuano quindi i valori di picco della tensione e della deformazione tangenziali (τ_{max} e γ_{max}), e l'andamento del ciclo di isteresi risultante dall'accoppiamento di $\tau(t)$ e $\gamma(t)$.

I valori di G e D vengono calcolati utilizzando le relazioni:

$$G = \frac{\tau_{pp}}{\gamma_{pp}} \qquad D = \frac{W_d}{4\pi W_s}$$

Per l'interpretazione dei risultati relativi alle prove di torsione ciclica si è attribuita maggiore affidabilità a tecniche di regressione statistica ai bassi livelli di deformazione (adoperando una regressione sinusoidale, cfr. Papa et al., 1988); non appena i disturbi elettrici sono apparsi senz'altro trascurabili, si è ricorsi ai criteri ordinari (ampiezze picco-picco, area del ciclo di isteresi).



Figura A.4: Interpretazione delle prove di torsione ciclica.



Università degli Studi di Napoli Federico II
Dipartimento di Ingegneria Civile, Edile ed Ambientale
Laboratorio di Geotecnica

<u>Committente</u>	Consorzio HirpiniaAV
<u>Indagine</u>	I lotto funzionale Apice-Hirpinia
<u>Sondaggio</u>	SNGR03
<u>Campione</u>	C7
<u>Profondità</u>	67.50 ÷ 68.00 m
<u>Data apertura</u>	03/12/19
<u>Operatore</u>	

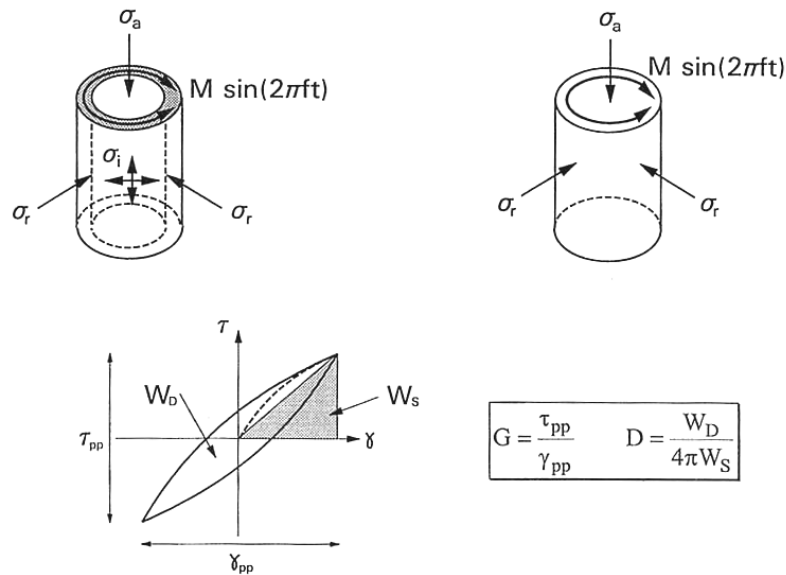
Riferimenti

AGI (1994) - *Raccomandazioni sulle prove geotecniche di laboratorio*

ASTM D422/90 - *Standard Test Method for particle-size analysis of soils.*

ASTM D4318 - *Standard Test Methods for liquid limit, plastic limit, and plasticity index of Soils.*

ASTM D2435/96 - *Standard Test Methods for one-dimensional consolidation properties of soils using incremental loading.*

ASTM D4015/92 - *Standard Test Methods for modulus and damping of soils by Resonant-Column method.*

d'Onofrio A. (1996) – *Comportamento meccanico dell'argilla di Vallericca in condizioni lontane dalla rottura* – Tesi di dottorato in Ingegneria Geotecnica, Università degli Studi di Napoli.

d'Onofrio A., Silvestri F., Vinale F. (1999) - *A new torsional shear device* - ASTM Geotechnical Testing Journal, Vol 22-2 pp.107-117.

Isenhower W.M. (1979) - *Torsional Simple Shear/Resonant Column properties of San Francisco Bay Mud* - M.S. Thesis, The University of Texas at Austin.

Ni S. H. (1987) *Dynamic properties of sand under true triaxial stress states from Resonant Column/Torsional Shear tests* - Ph. D. dissertation, The University of Texas at Austin.

Papa V., Silvestri F., Vinale F. (1988) - *Recenti sviluppi e prospettive nelle tecniche di interpretazione di prove dinamiche di taglio semplice* - Atti del Convegno del Gruppo Nazionale di Coordinamento per gli Studi di Ingegneria Geotecnica, Monselice.

Richart F.E., Hall J.R., Woods R.D. (1970) - *Vibrations of soils and foundations* - Prentice-Hall Inc., Englewood Cliffs, New Jersey.

Silvestri F. (1991) - *Analisi del comportamento dei terreni naturali in prove cicliche e dinamiche di taglio torsionale* - Tesi di Dottorato in Ingegneria Geotecnica, Università degli Studi di Napoli.

Woods R.D. (1978) - *Measurement of dynamic soil properties* - Proc. "Geotechnical Engineering Division Specialty Conference on Earthquake Engineering and Soil Dynamics", ASCE, Pasadena (California).

Il responsabile della sperimentazione
Prof. Ing. Anna d'Onofrio