



REGIONE  
PUGLIA



CUP:E97B15000170005 PIANO DEGLI INTERVENTI  
DELL'ACQUEDOTTO PUGLIESE S.p.A.  
2016 - 2019

**PROGETTO DEFINITIVO**  
ACQUEDOTTO DEL FORTORE, LOCONO ED OFANTO - OPERE DI  
INTERCONNESSIONE - II LOTTO: CONDOTTA DALL'OPERA DI  
DISCONNESSIONE DI CANOSA AL SERBATOIO DI FOGGIA

Il Responsabile del Procedimento  
*ing. Massimo Pellegrini*

**PROGETTAZIONE**

Progettisti

*ing. Rosario ESPOSITO (Responsabile del progetto)*

*ing. Tommaso DI LERNIA*

*ing. Michelangelo GUASTAMACCHIA*

*ing. M. Alessandro SALIOLA*

*geom. Giuseppe VALENTINO*

*ing. Roberto LAVOPA*

Collaborazione alla progettazione  
*geom. Pietro SIMONE*

Il Responsabile Ingegneria di Progettazione  
*ing. Massimo PELLEGRINI*



Direzione Ingegneria

Il Direttore  
*ing. Andrea VOLPE*

Elaborato

**G.3.1.1**

**Planimetria di rilievo su base CTR**

Codice Intervento P1292

Codice SAP: 21/16650

Prot. N. 45215  
Data 14/07/2020

Scala: 1:2000

N. Rev.	Data	Descrizione	Disegnato	Controllato	Approvato
00	OTT. 2020	Emesso per Progetto definitivo			-

Acquedotto Pugliese S.p.A. - 70121 Bari Via Cognetti, 36 - www.aqp.it - Telefono +39.080.5723111 C.F. e P.IVA 00347000721 REA C.C.I.A.A. di Bari n. 414092



1

**Legenda**

- Condotta di progetto
- 490 Numero picchetto
- 76.23 Quota assoluta rilevata

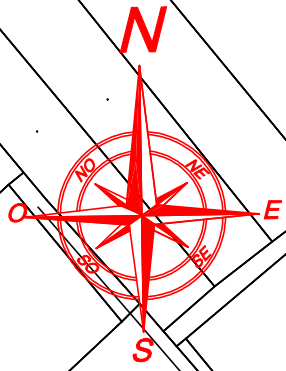
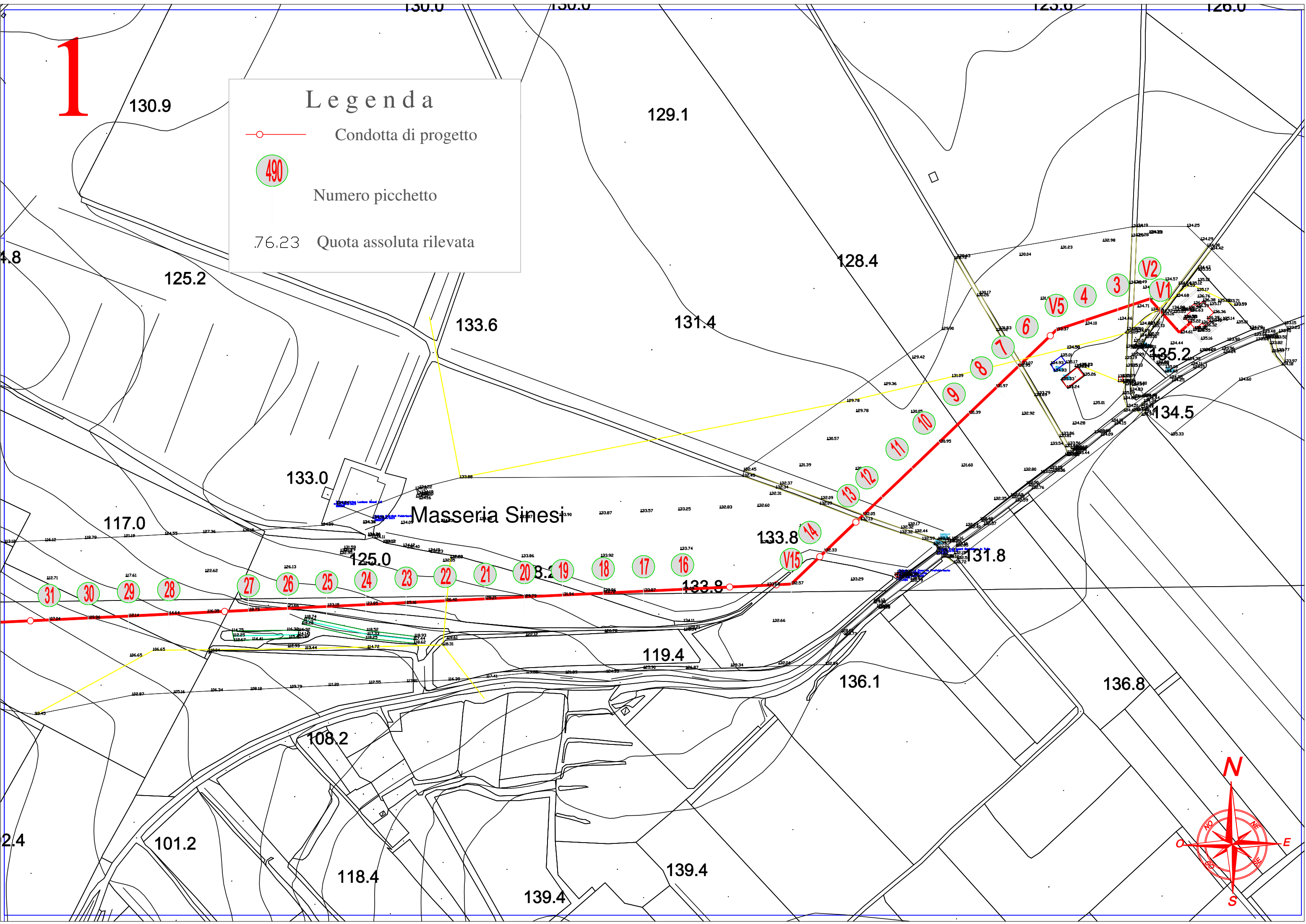

2

**Legenda**

- Condotta di progetto
- 490 Numero picchetto
- 76.23 Quota assoluta rilevata

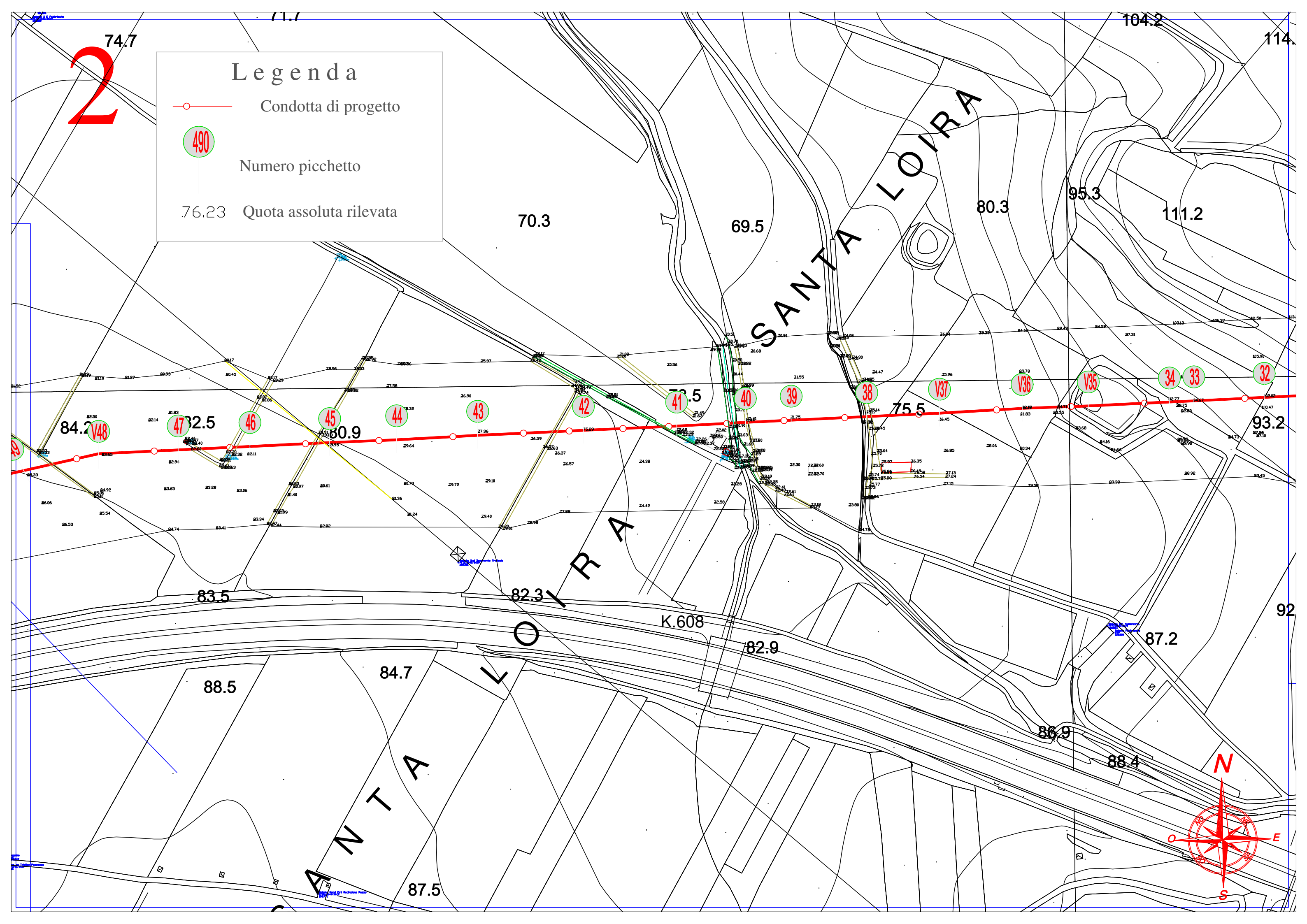



3

49.6

**Legenda**

- Condotta di progetto
- 490 Numero picchetto
- 76.23 Quota assoluta rilevata

67.8

73.0

79.6

62.3

70.9

83.0

76.8

82.8

64.5

78.6

76.5.607

73.7

86.8

96.2

91.8

77.7

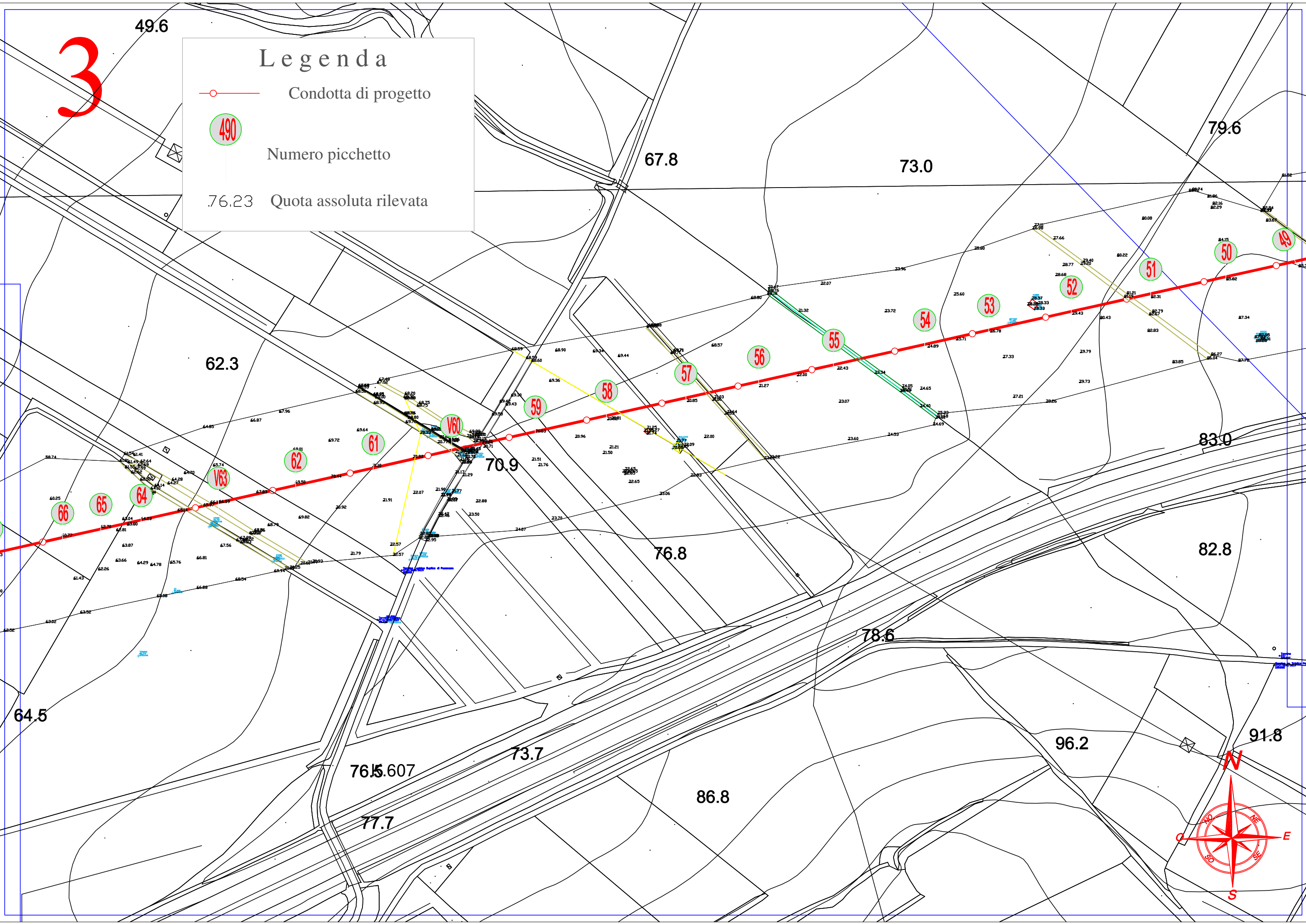
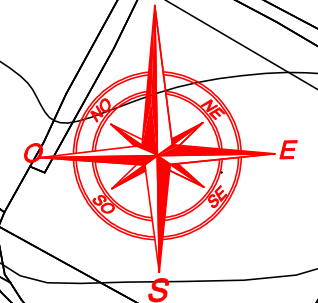



**Legenda**

- Condotta di progetto
- ④⑨⑩ Numero picchetto
- 76.23 Quota assoluta rilevata

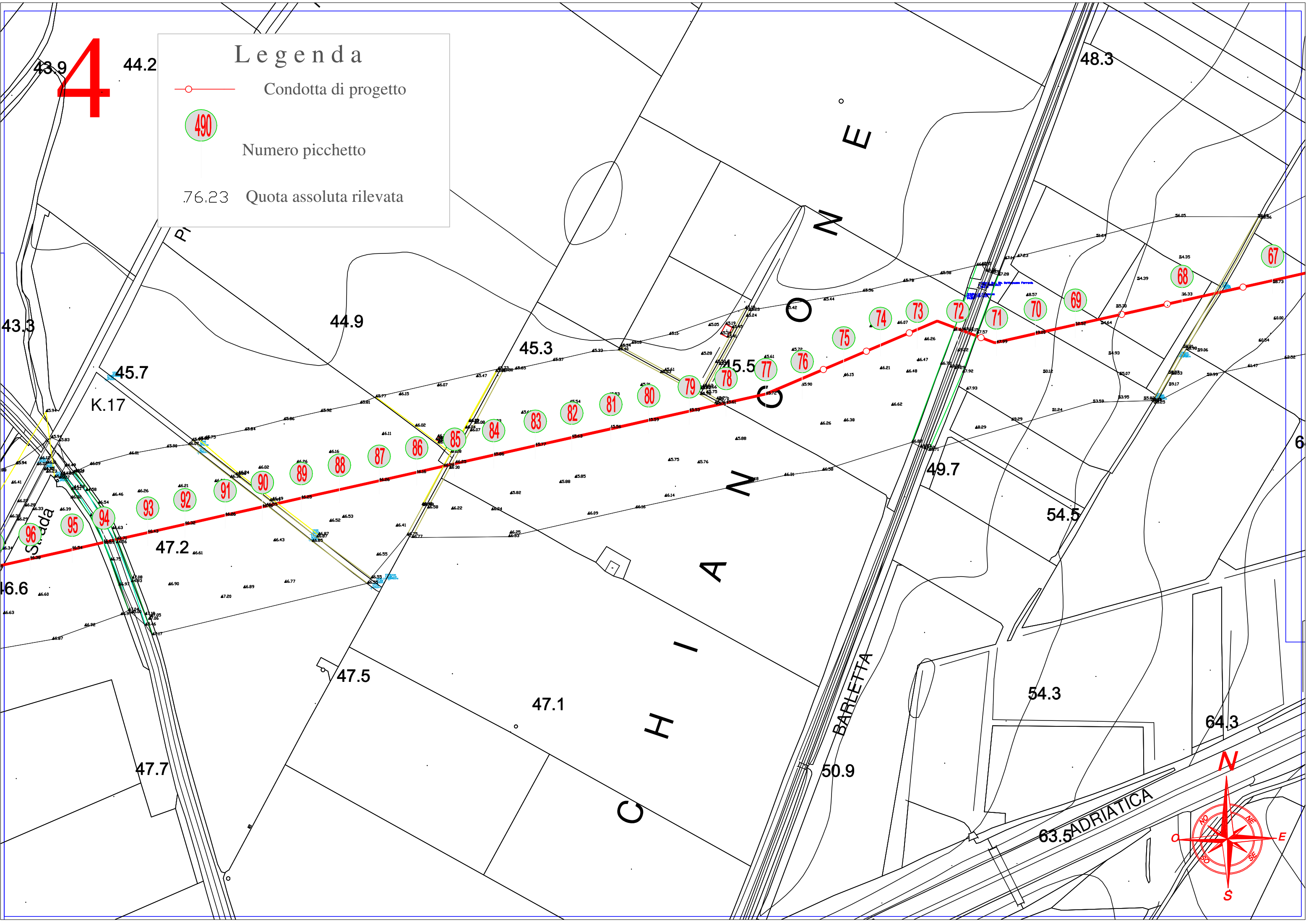

5

**Legenda**

- Condotta di progetto
- ④ 490 Numero picchetto
- 76.23 Quota assoluta rilevata

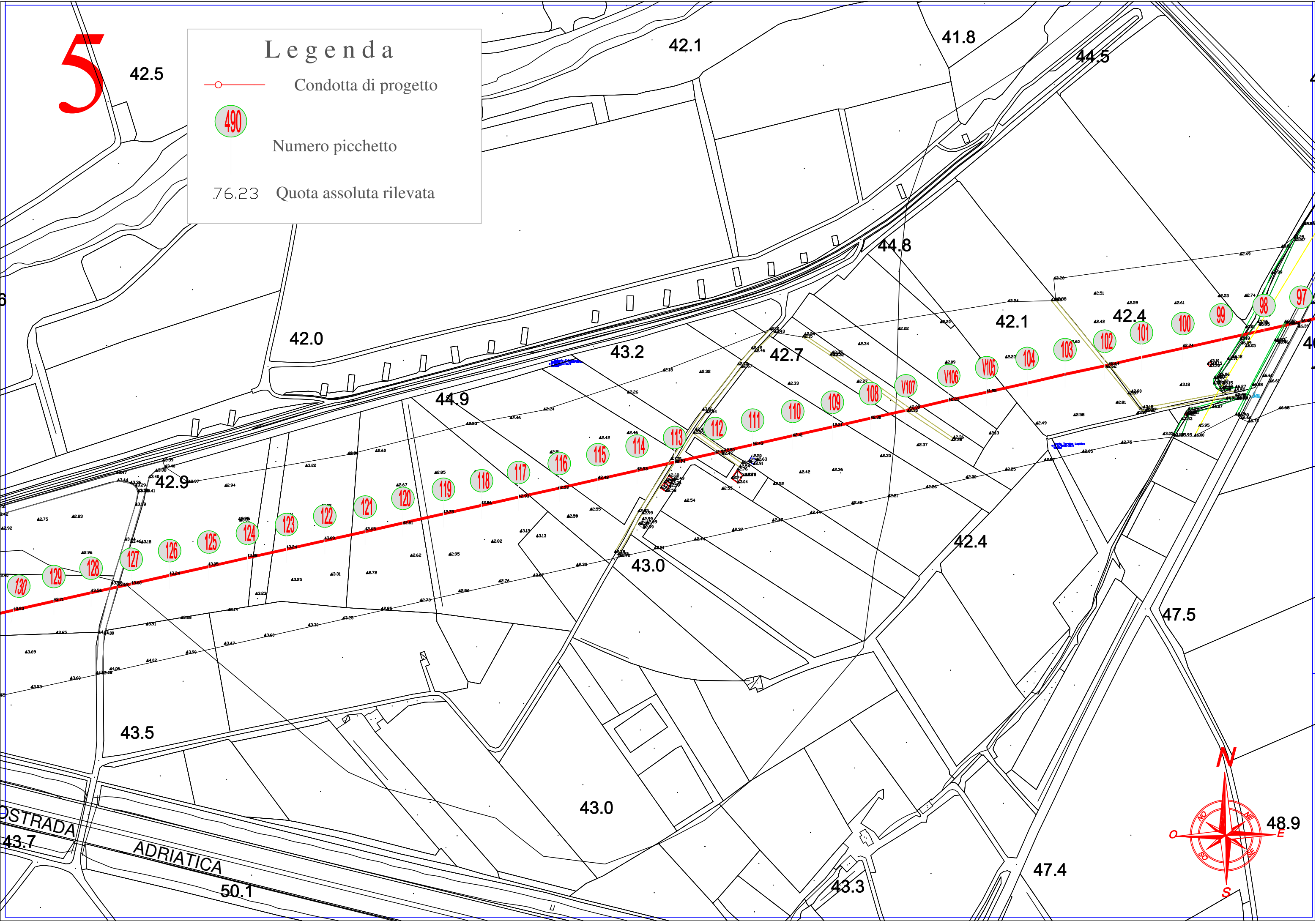



6

**Legenda**

- Condotta di progetto
- 490 Numero picchetto
- 76.23 Quota assoluta rilevata

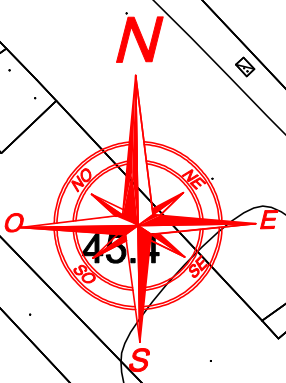
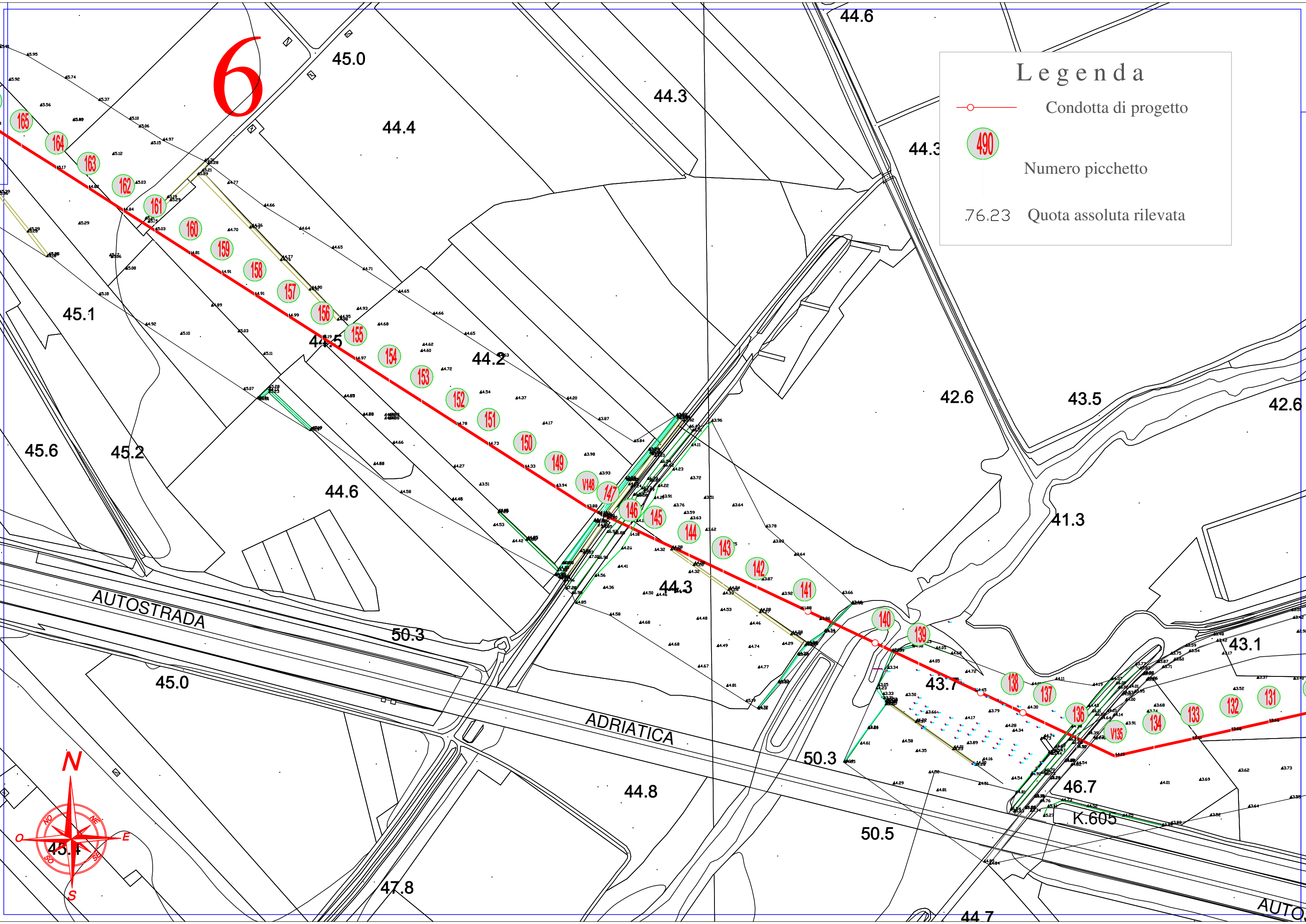

AUTOSTRADA

ADRIATICA

K.605

AUTO





7

### Legenda

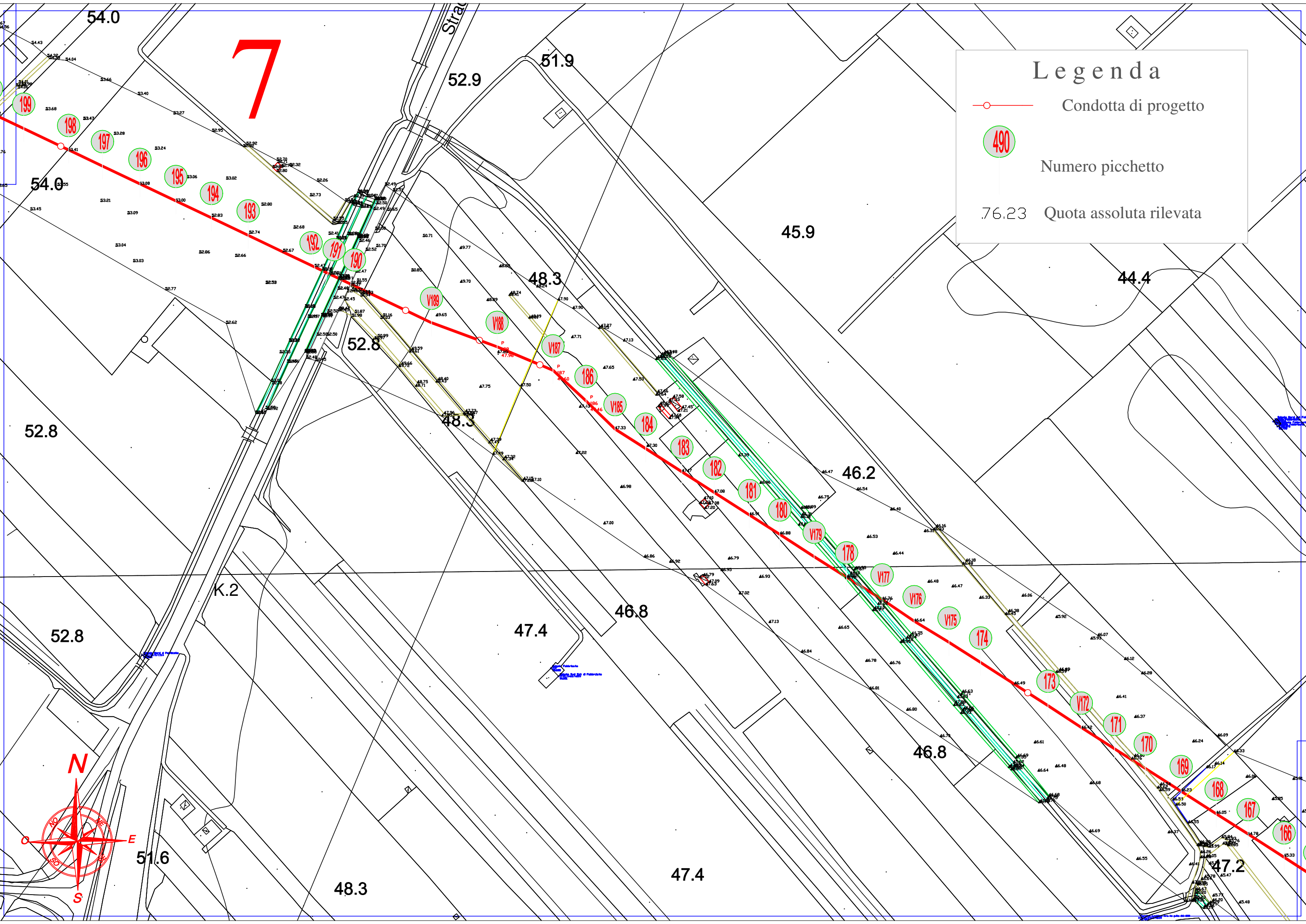
- Condotta di progetto
- 490 Numero picchetto
- 76.23 Quota assoluta rilevata

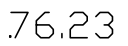

### Legenda

-  Condotta di progetto
-  Numero picchetto
-  Quota assoluta rilevata

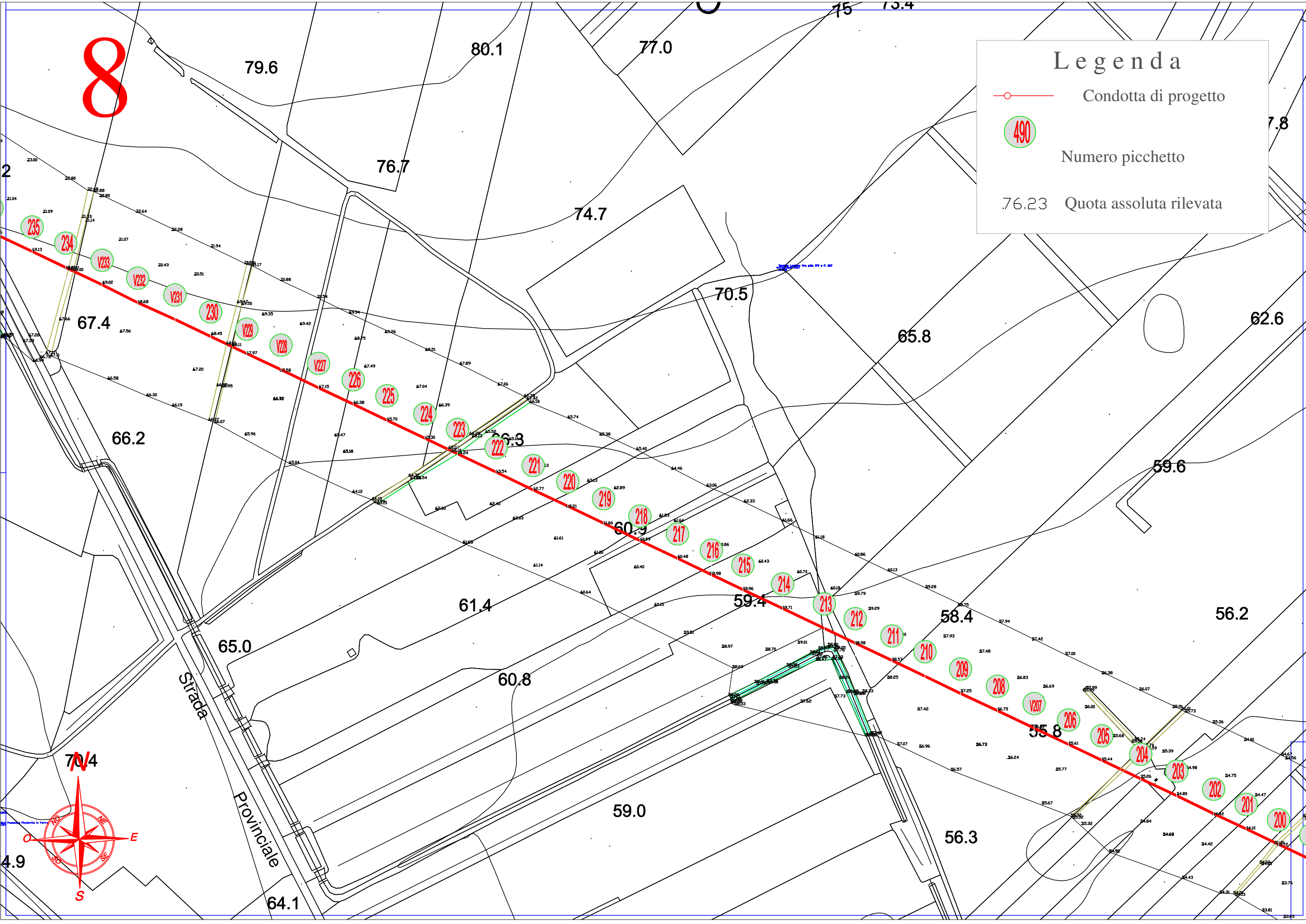

8

2

4.9

70.4

Strada

Provinciale

64.1

### Legenda

 Condotta di progetto

 Numero picchetto

 Quota assoluta rilevata

79.6

80.1

77.0

76.7

74.7

70.5

67.4

66.2

65.0

61.4

60.8

59.0

59.4

56.3

58.4

56.2

59.6

62.6

235

234

V233

V232

V231

230

V229

V228

V227

226

225

224

223

222

221

220

219

218

217

216

215

214

213

212

211

210

209

208

V207

206

205

204

203

202

201

200

7.8



4.67

33.45



9

# Legenda

-  Condotta di progetto
-  Numero picchetto
-  76.23 Quota assoluta rilevata

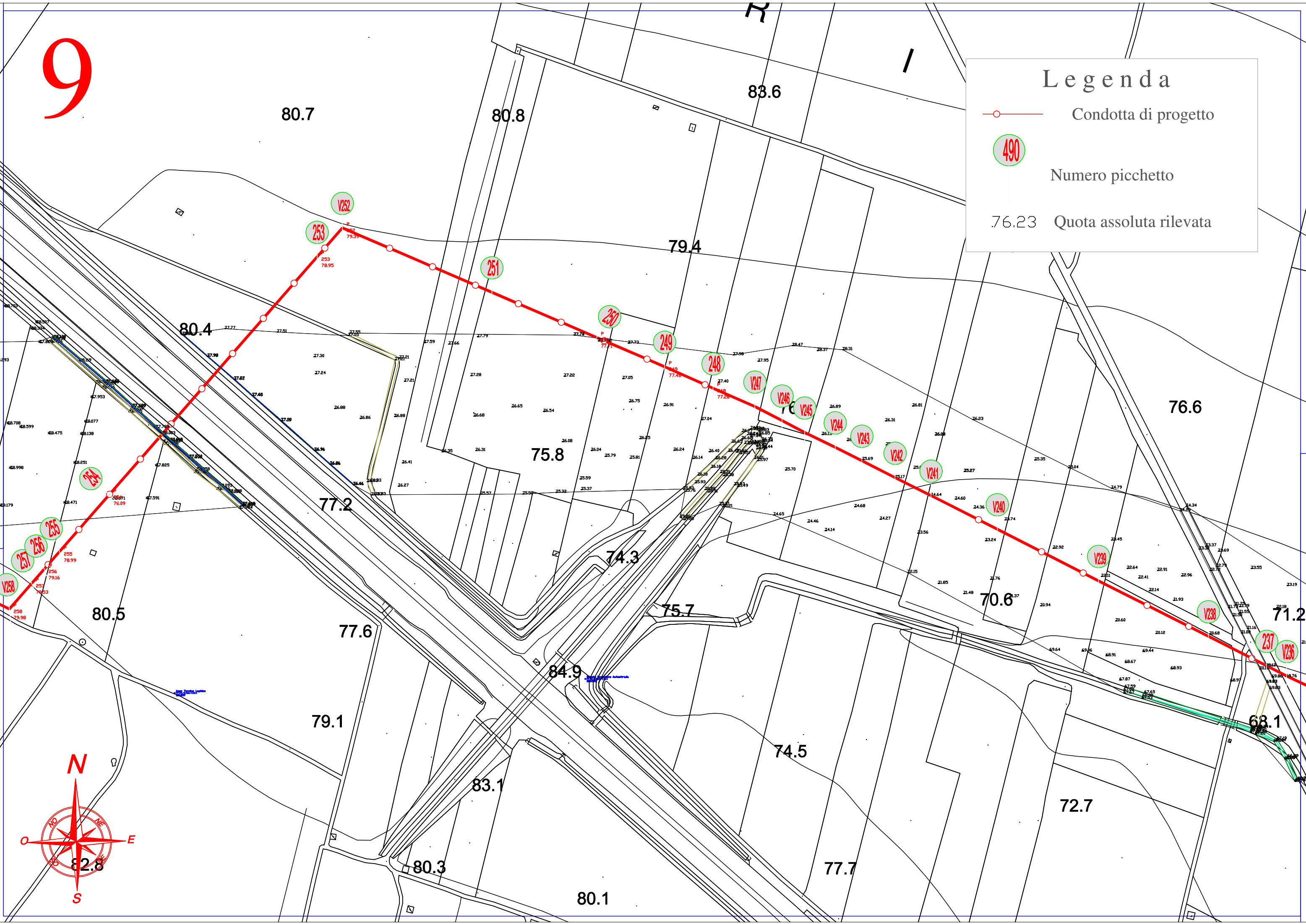





# 11

## Legenda

—○— Condotta di progetto

490

Numero picchetto

76.23 Quota assoluta rilevata

89.4

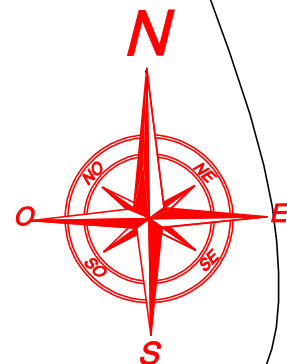
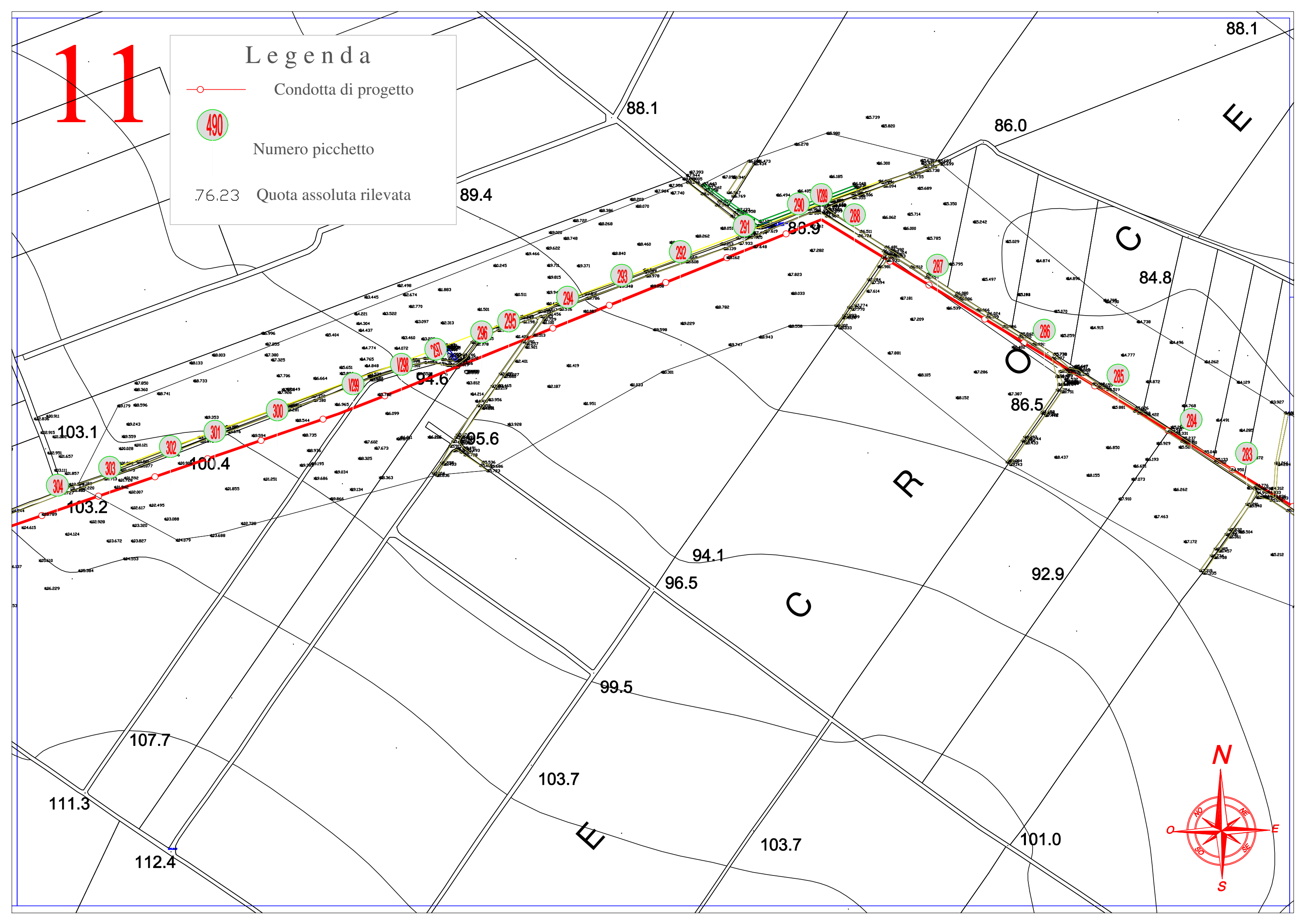

# 12

**Legenda**

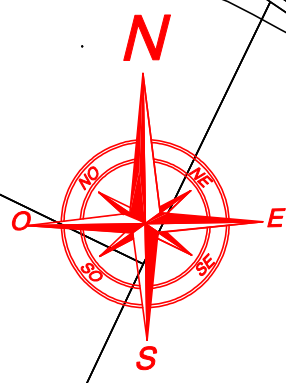
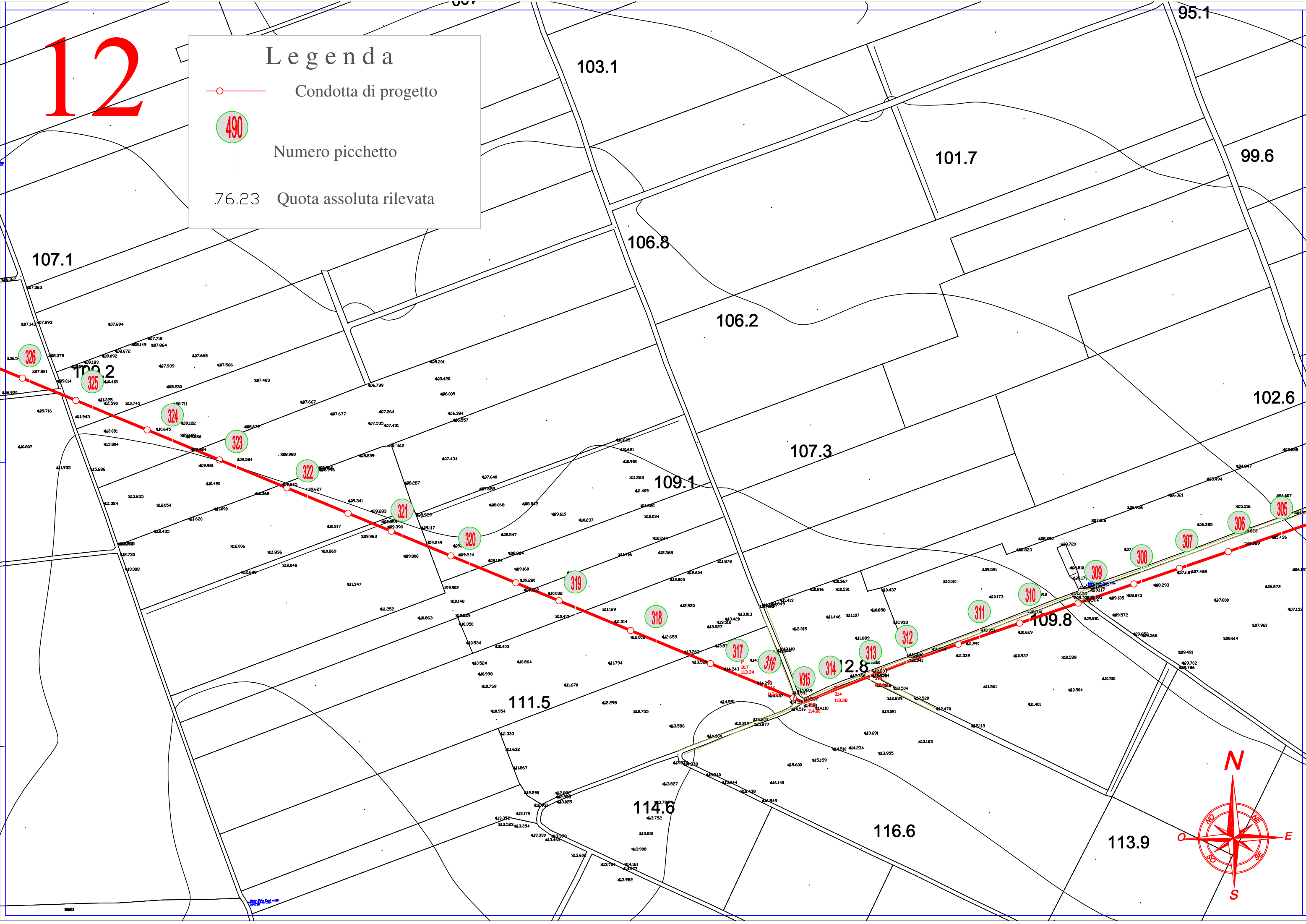

- Condotta di progetto
- 490 Numero picchetto
- 76.23 Quota assoluta rilevata





# 13

### Legenda

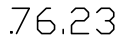
-  Condotta di progetto
-  Numero picchetto
-  Quota assoluta rilevata

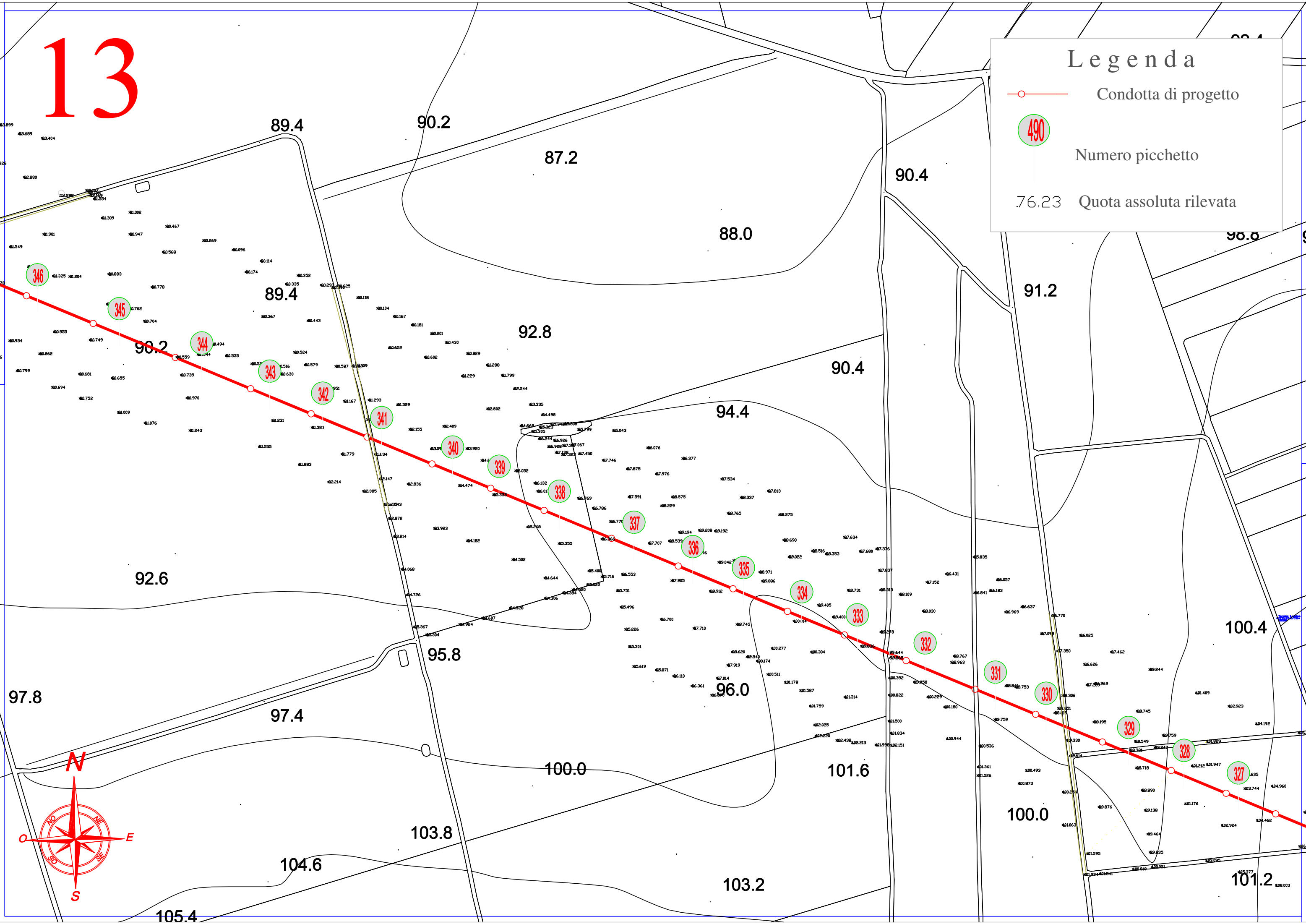

# 14

## Consorzio di Bonifica Capitanato

## Casa Tammarice di Ceci

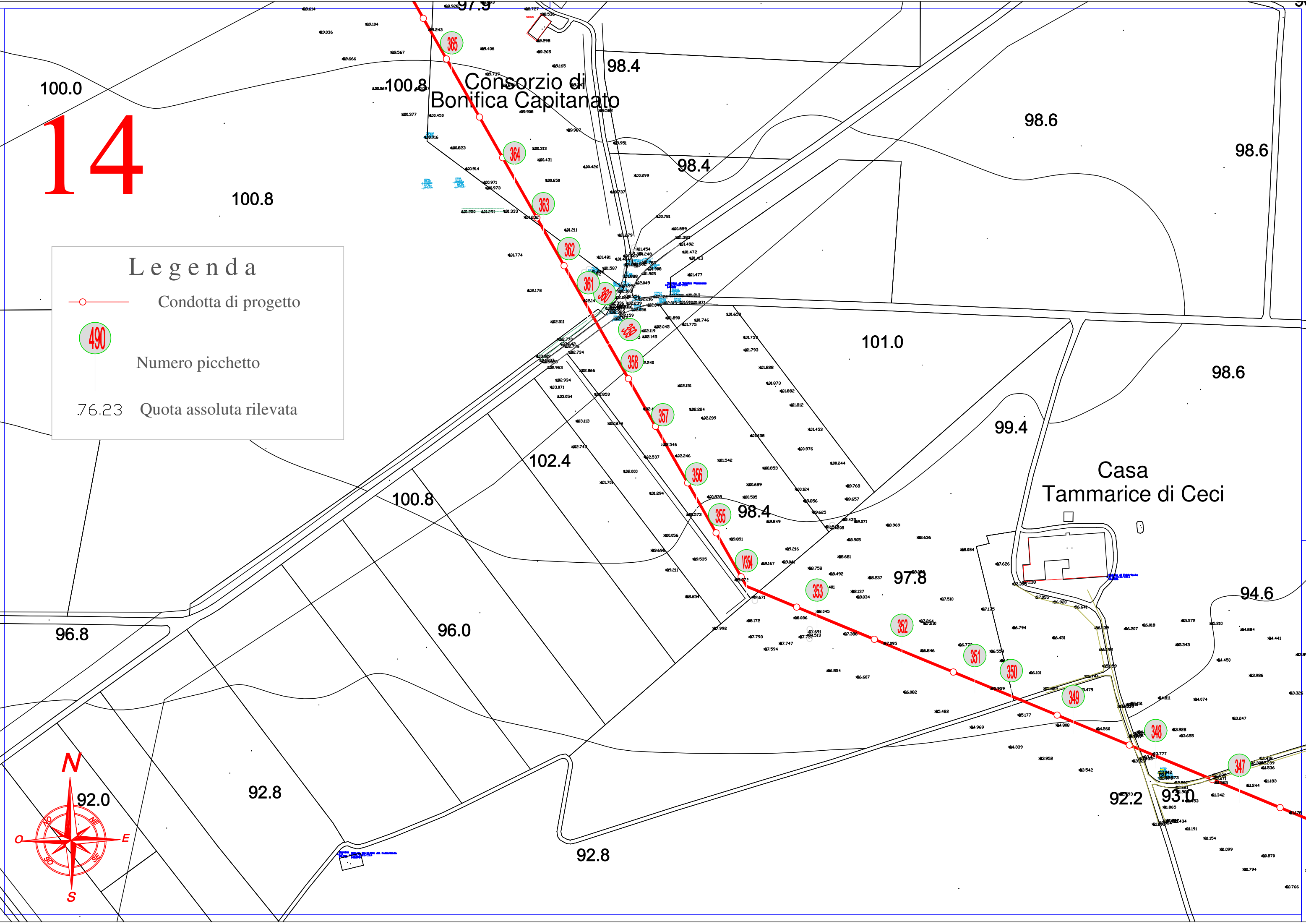
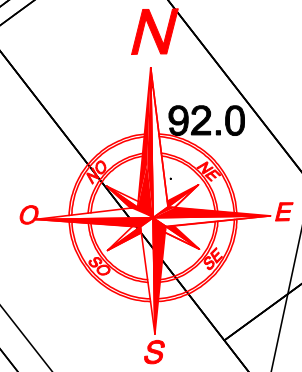

**Legenda**

- Condotta di progetto
- 490 Numero picchetto
- 76.23 Quota assoluta rilevata



# 15

**Legenda**

-  Condotta di progetto
-  Numero picchetto
-  76.23 Quota assoluta rilevata

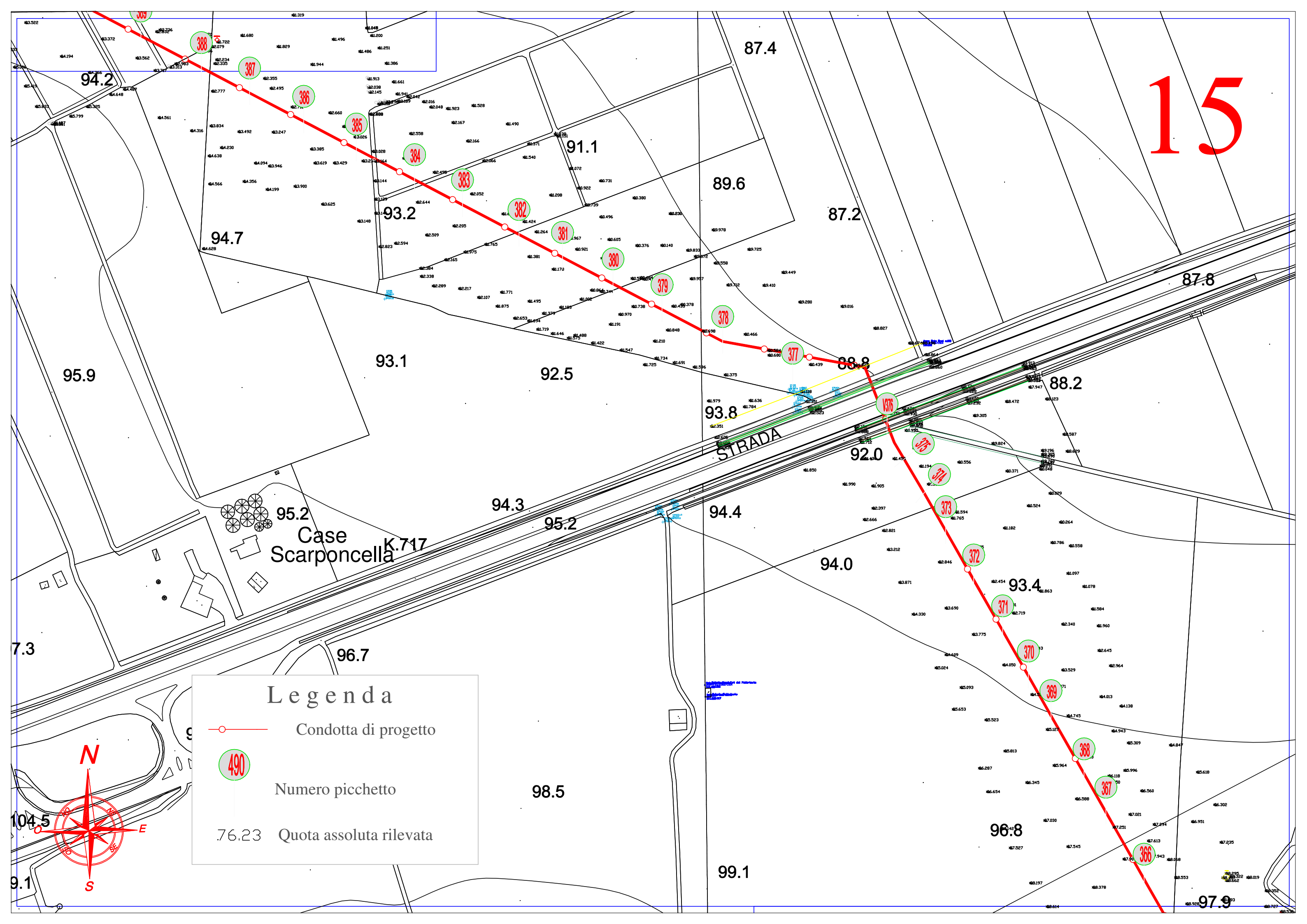
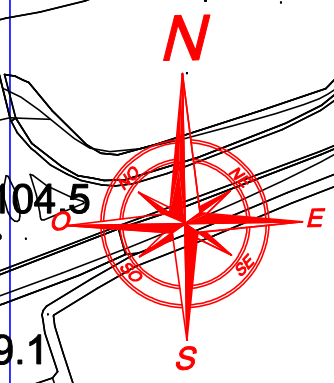



# 16

## Legenda

- Condotta di progetto
- 490 Numero picchetto
- 76.23 Quota assoluta rilevata

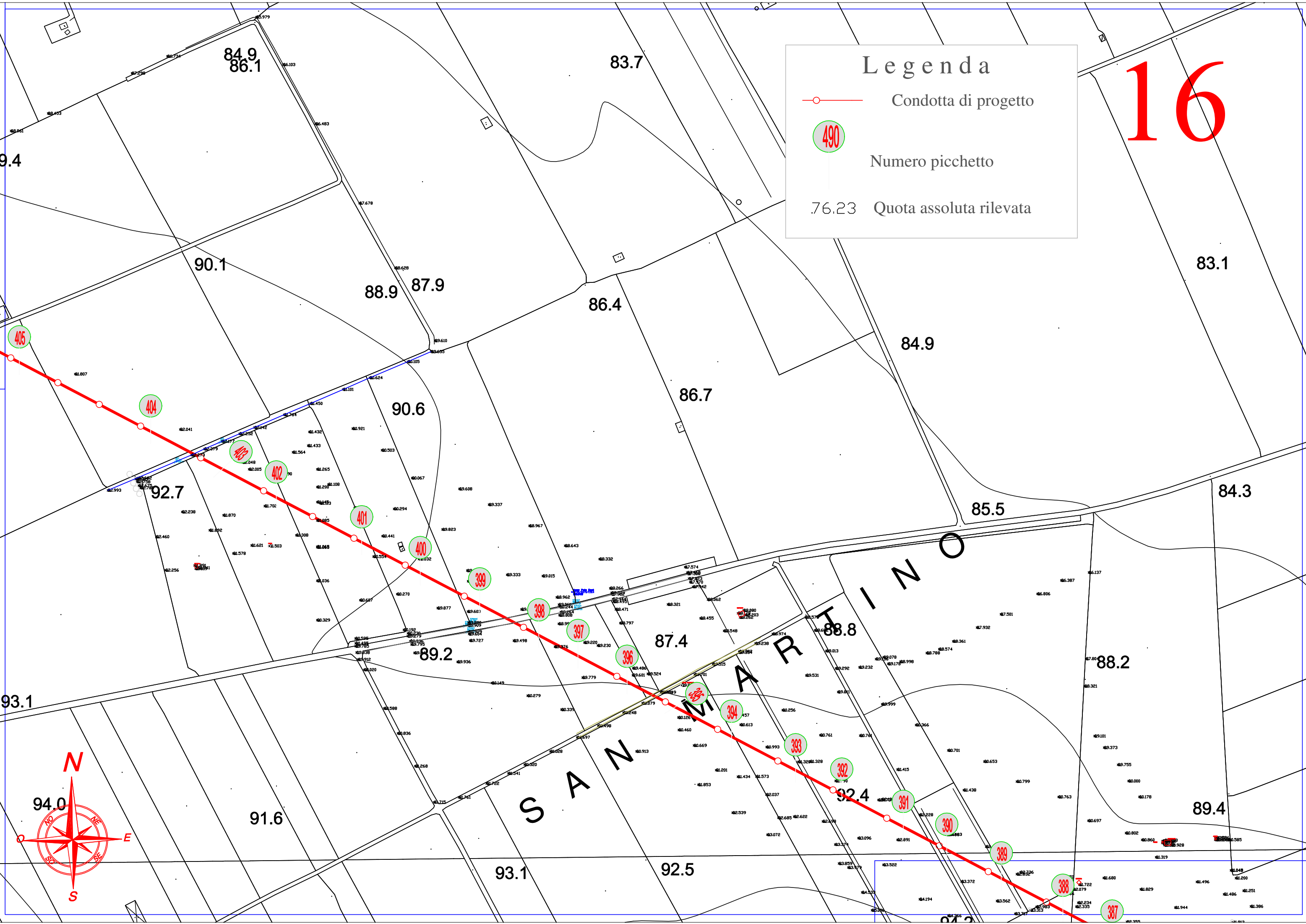

9.4

84.9  
86.1

83.7

90.1

88.9 87.9

86.4

83.1

84.9

90.6

86.7

92.7

85.5

84.3

89.2

87.4

88.8

88.2

93.1

SAN MARTINO

89.4

91.6

93.1



92.5

92.4

94.0

94.2

## Legenda

-  Condotta di progetto
-  Numero picchetto
-  76.23 Quota assoluta rilevata

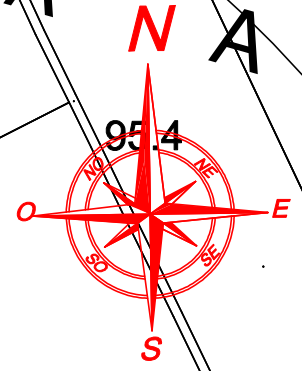
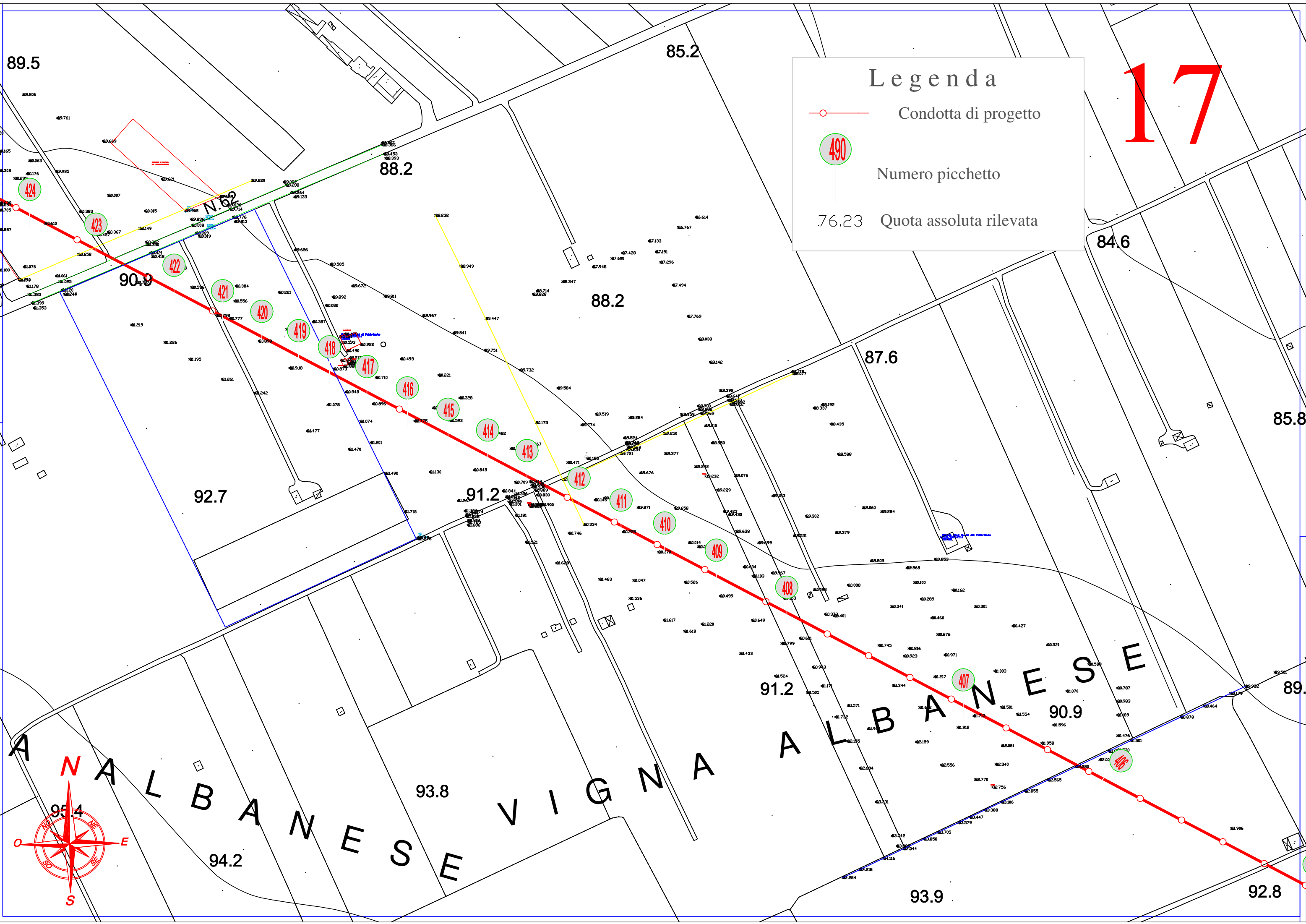

# 18

**Legenda**

- Condotta di progetto
- ④ Numero picchetto
- 76.23 Quota assoluta rilevata

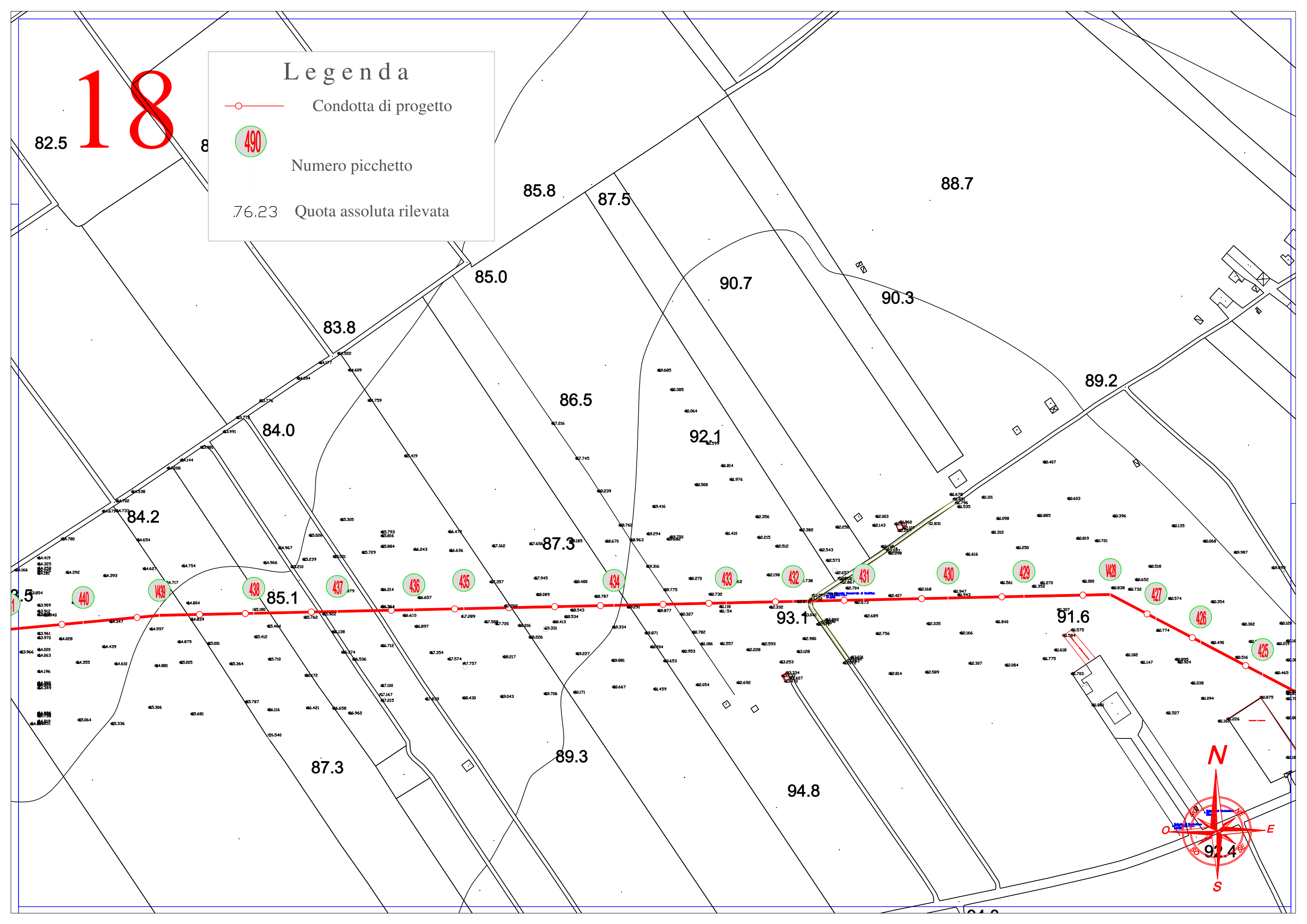



# 19

**Legenda**

- Condotta di progetto
- Numero picchetto
- 76.23 Quota assoluta rilevata

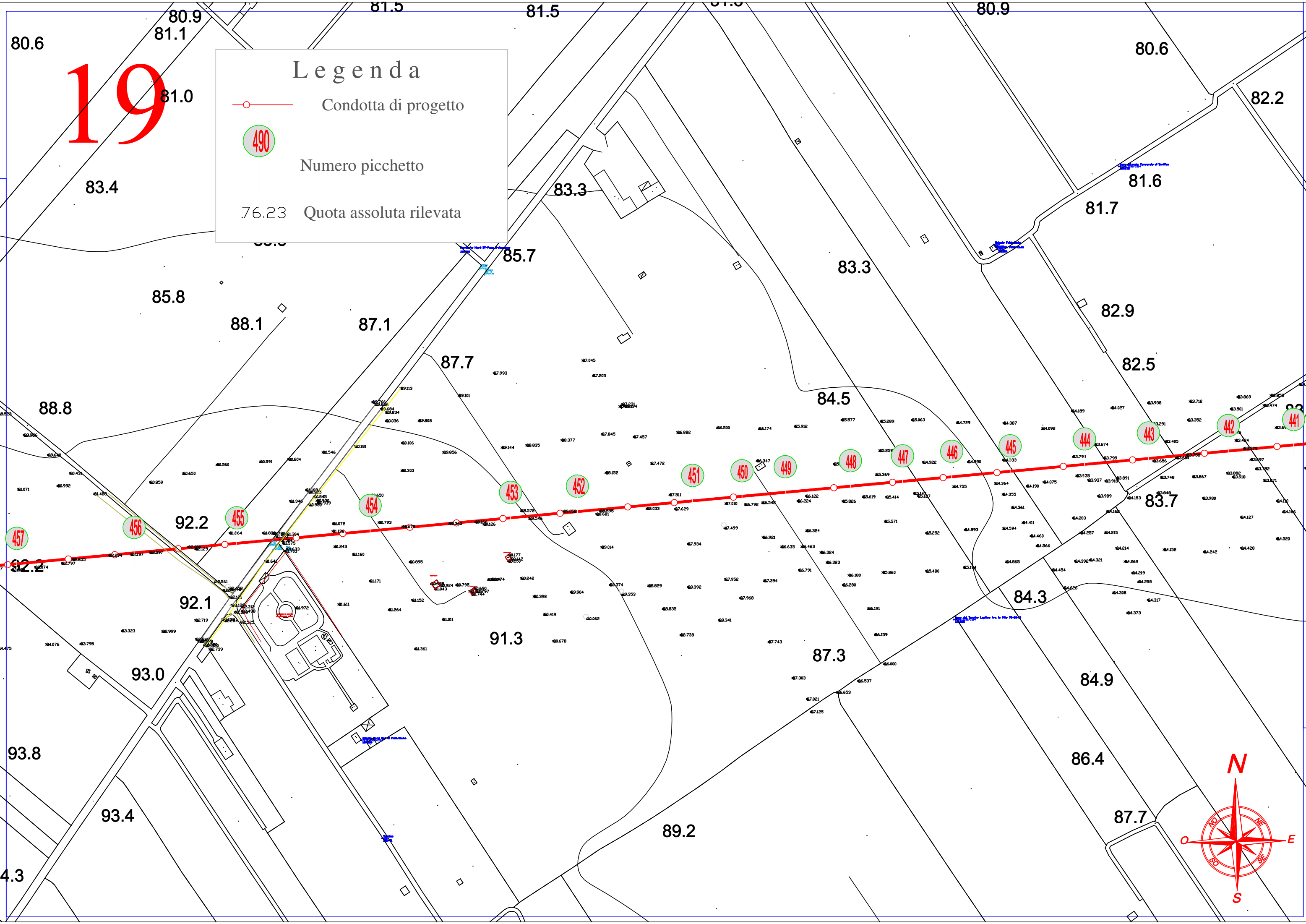

20

Depuratore

Depuratore

**Legenda**

- Condotta di progetto
- 490 Numero picchetto
- 76.23 Quota assoluta rilevata

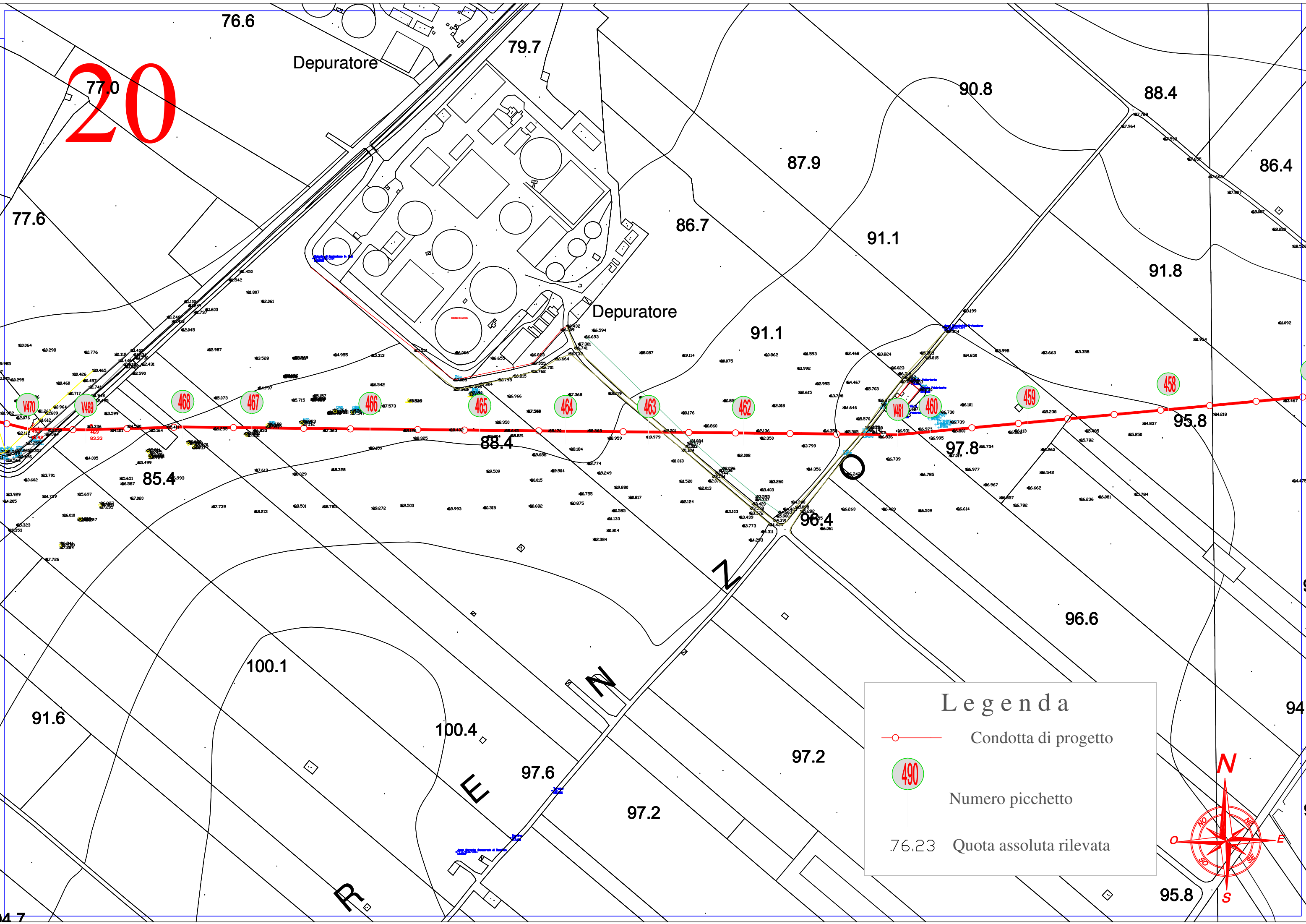

# 21

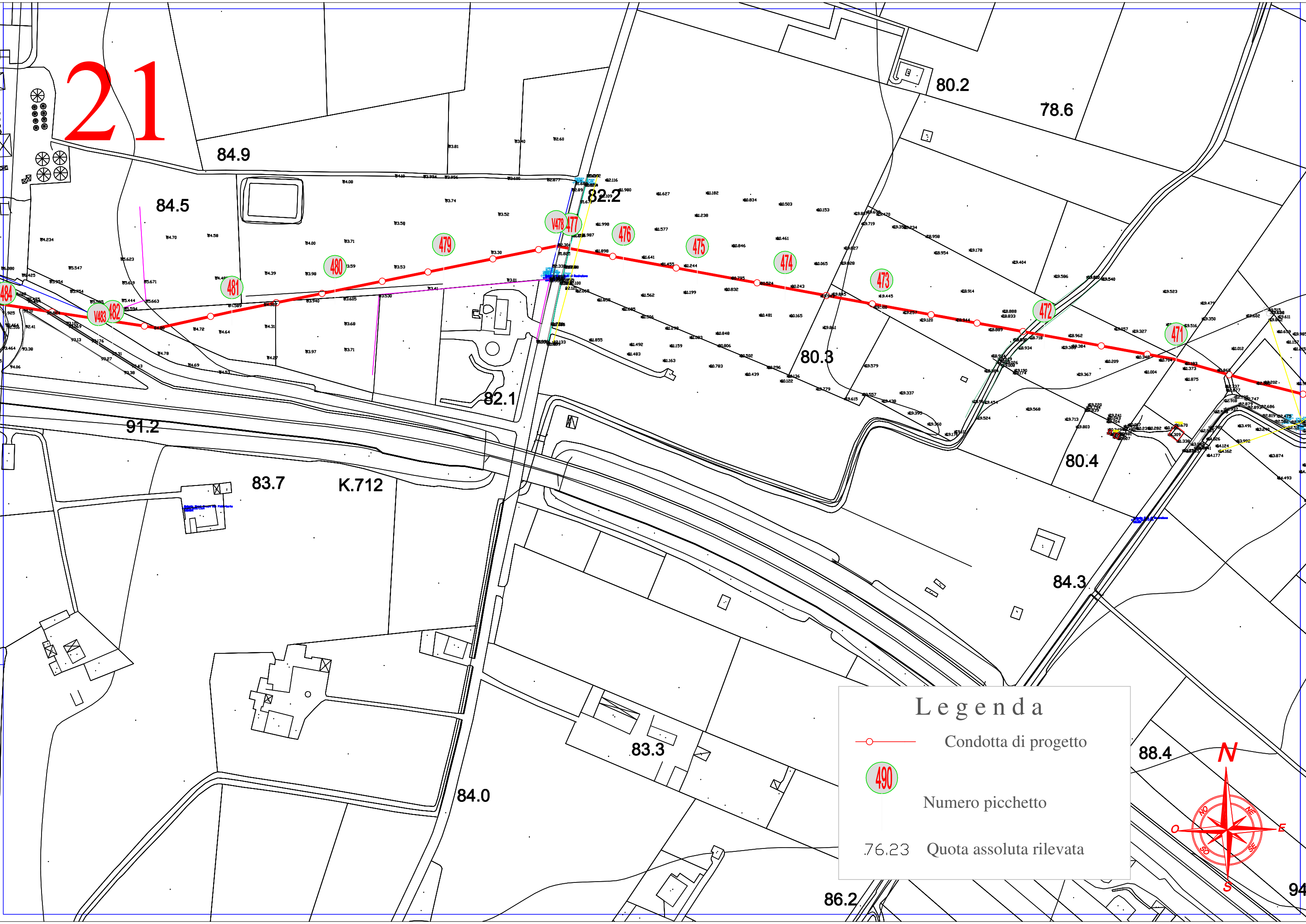

**Legenda**

- Condotta di progetto
- (490) Numero picchetto
- 76.23 Quota assoluta rilevata

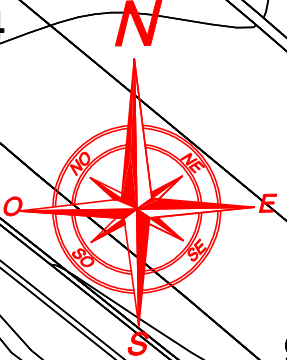



22

**Legenda**

- Condotta di progetto
- 490 Numero picchetto
- 76.23 Quota assoluta rilevata

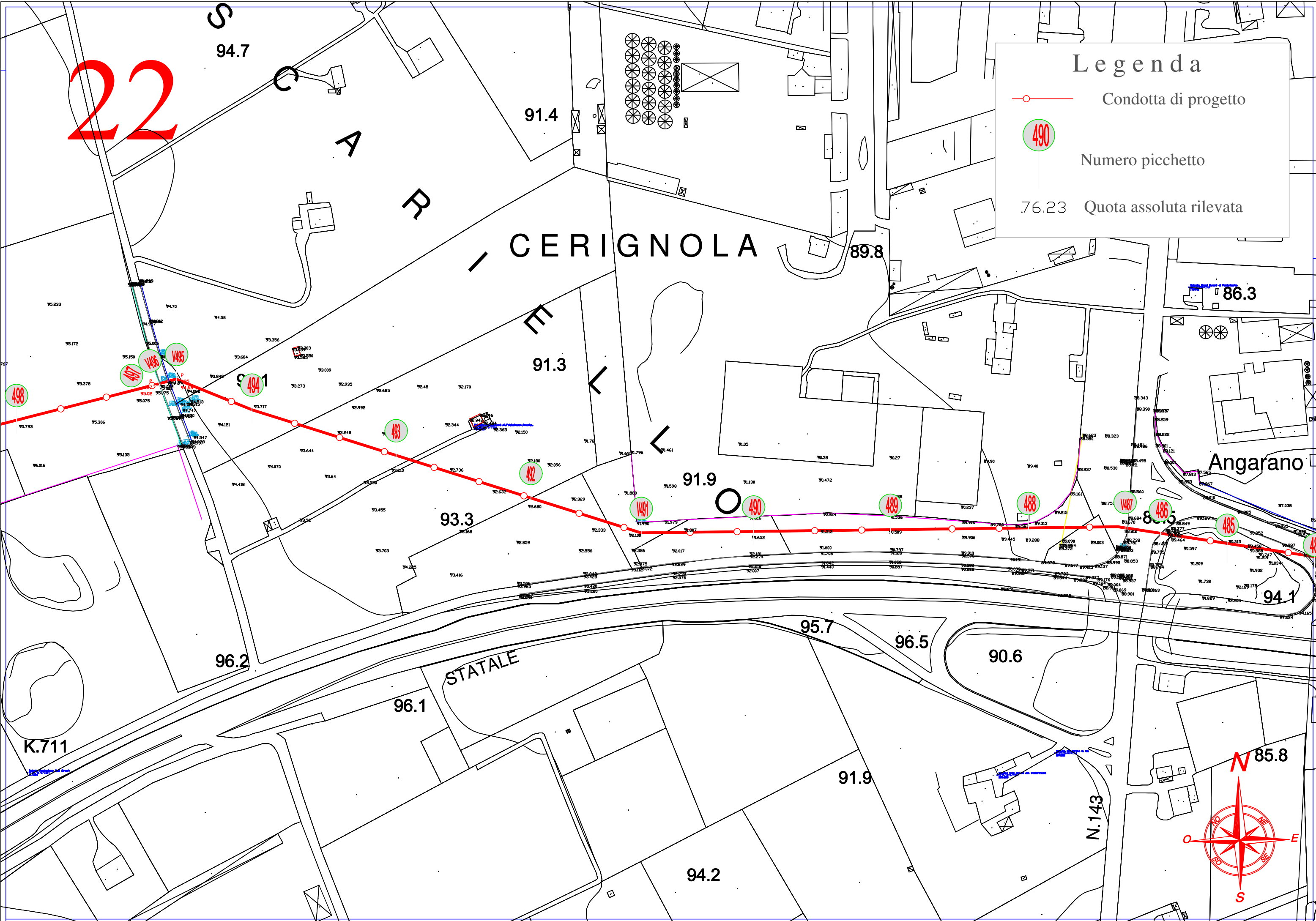

94.7

91.4

89.8

86.3

CERIGNOLA

91.3

Angarano

91.9

93.3

84.5

94.1

96.2

STATALE

95.7

96.5

90.6

K.711

96.1

91.9



85.8

N.143

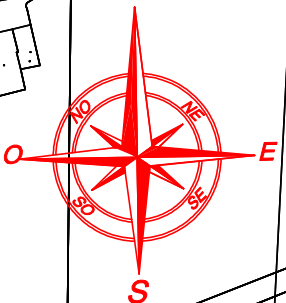
94.2



# Legenda

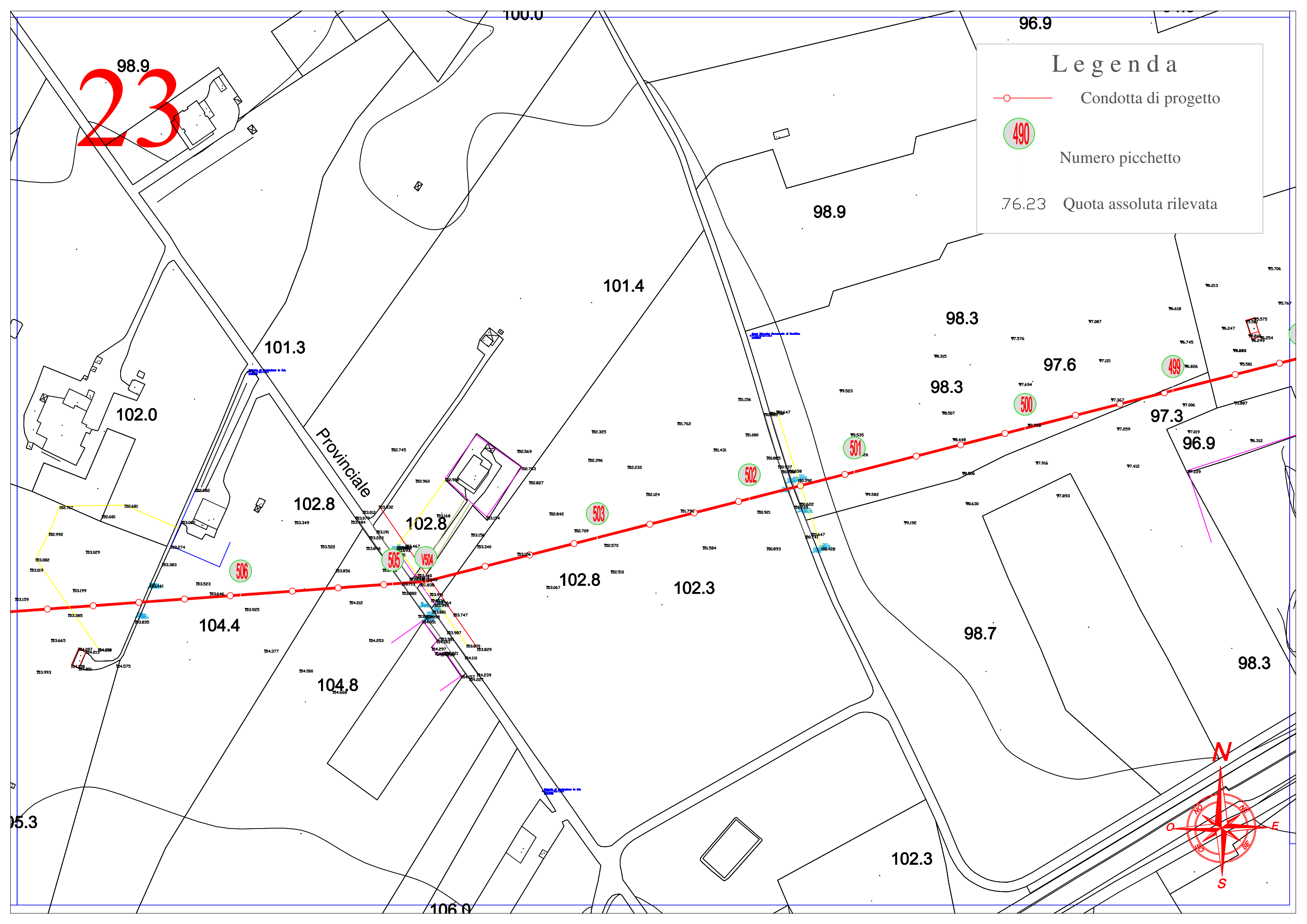

-  Condotta di progetto
-  Numero picchetto
- 76.23 Quota assoluta rilevata

# 23



# 24

## Legenda

-  Condotta di progetto
-  Numero picchetto
-  Quota assoluta rilevata

.76.23 Quota assoluta rilevata

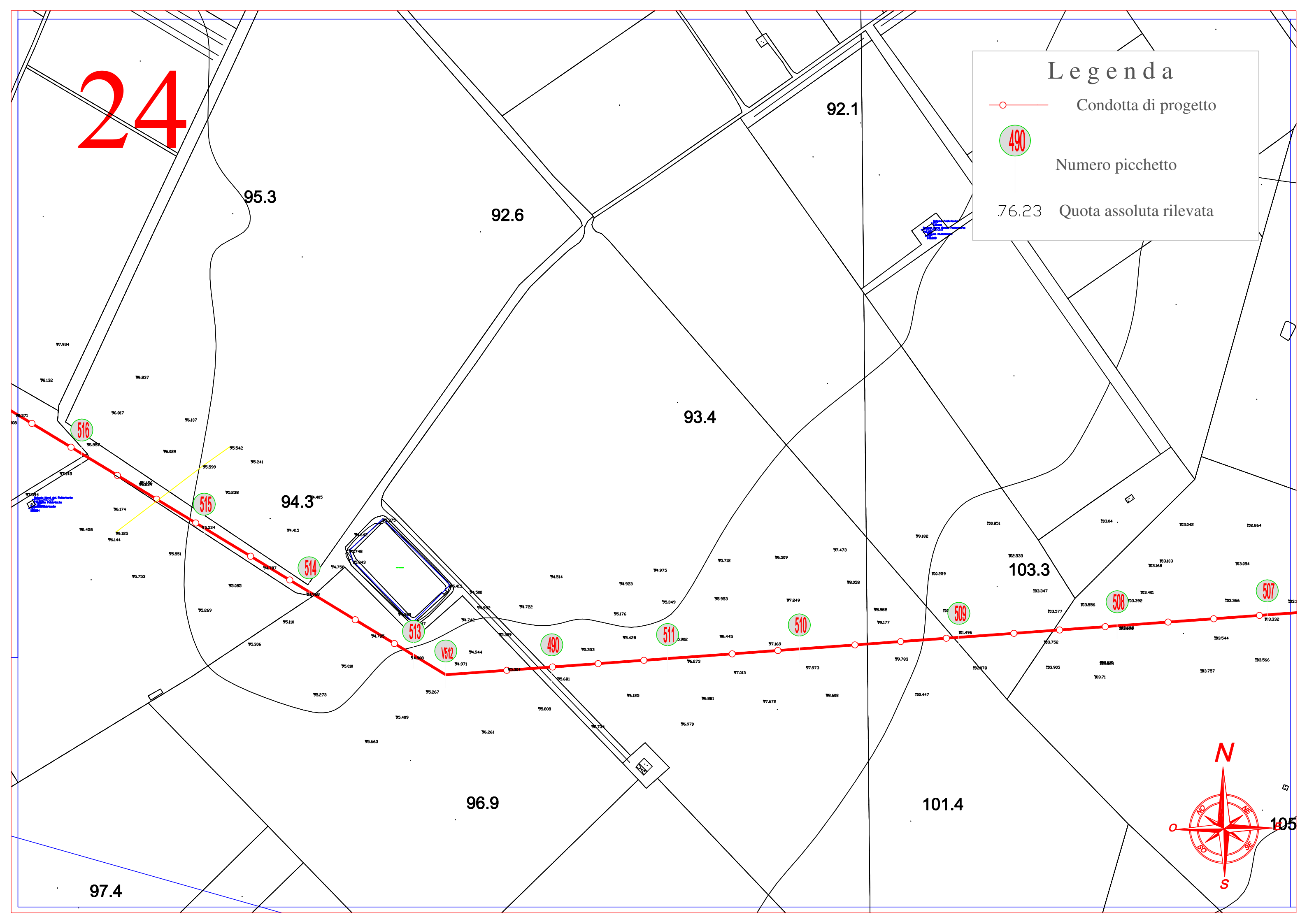

97.4

96.9

101.4

105



# 25

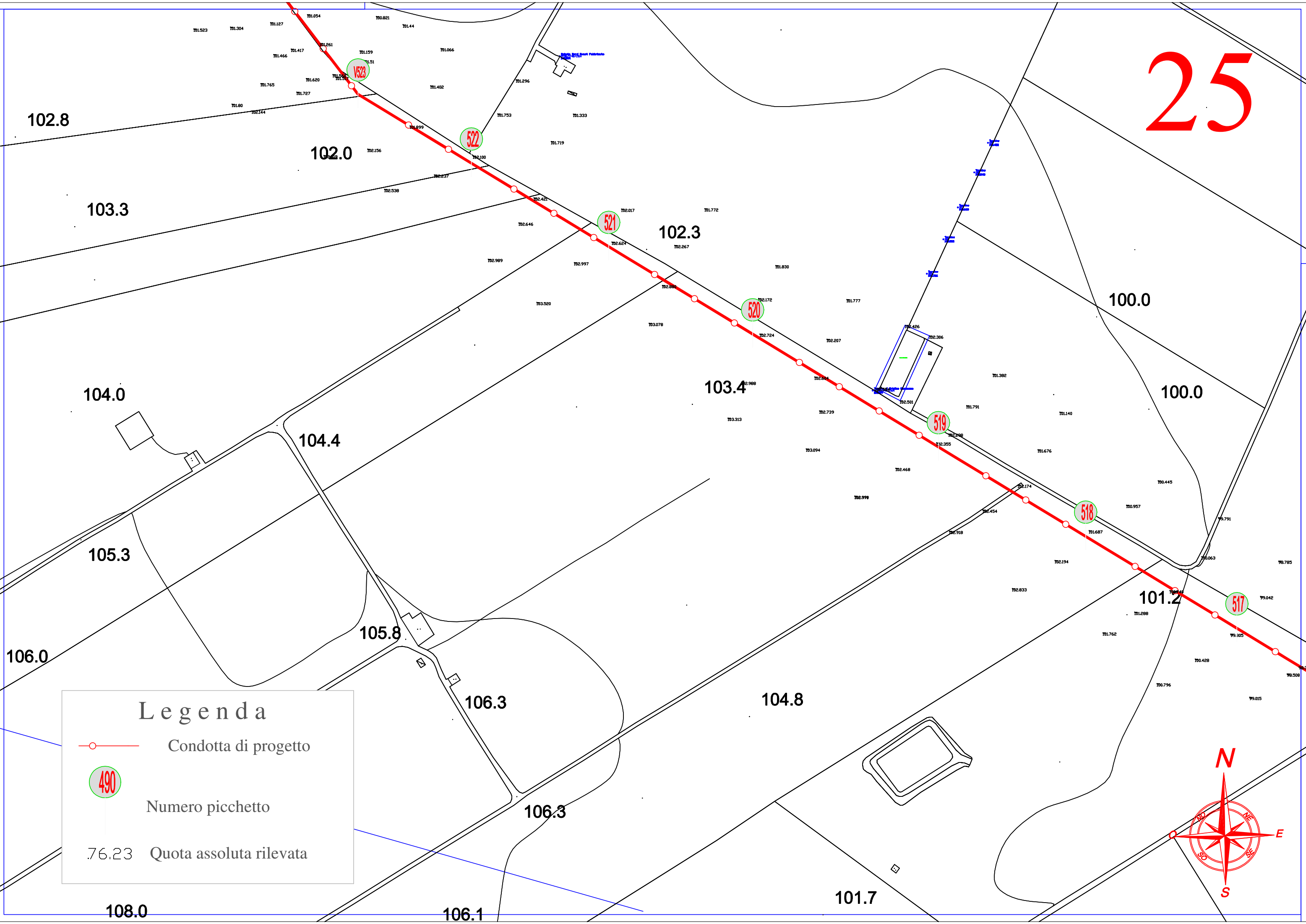

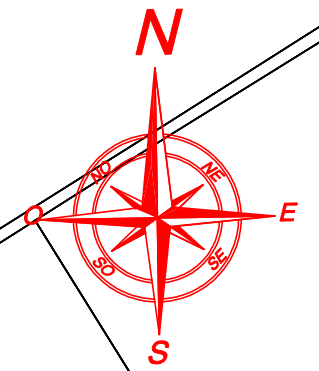

**Legenda**

- Condotta di progetto
- 490 Numero picchetto
- 76.23 Quota assoluta rilevata



26

# Legenda

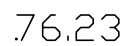
-  Condotta di progetto
-  Numero picchetto
-  Quota assoluta rilevata

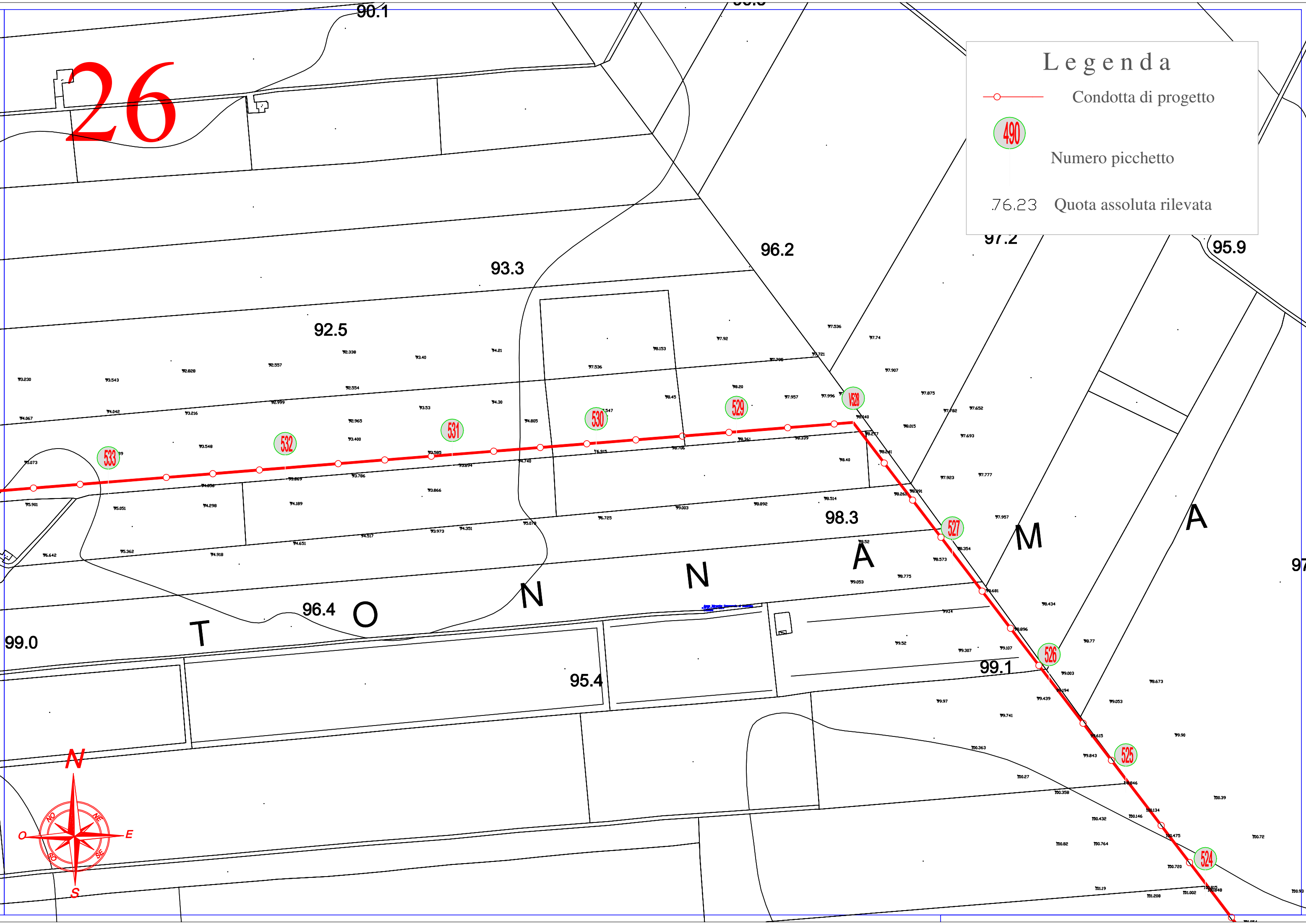

27

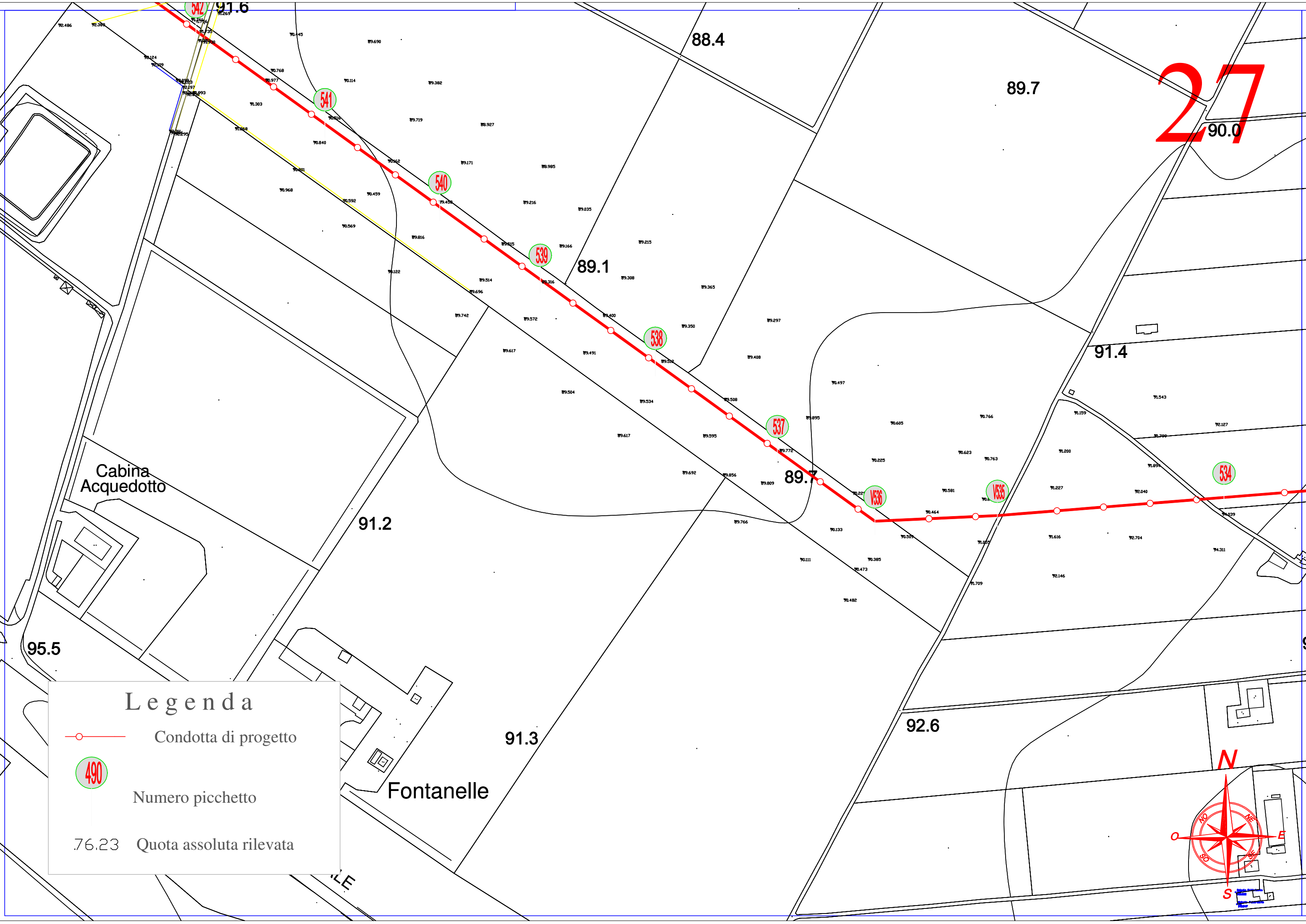

**Legenda**



- Condotta di progetto
- 490 Numero picchetto
- 76.23 Quota assoluta rilevata





# 28

## Legenda

-  Condotta di progetto
-  Numero picchetto
-  76.23 Quota assoluta rilevata

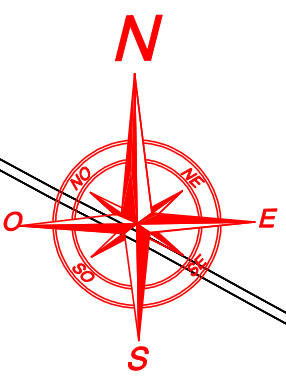
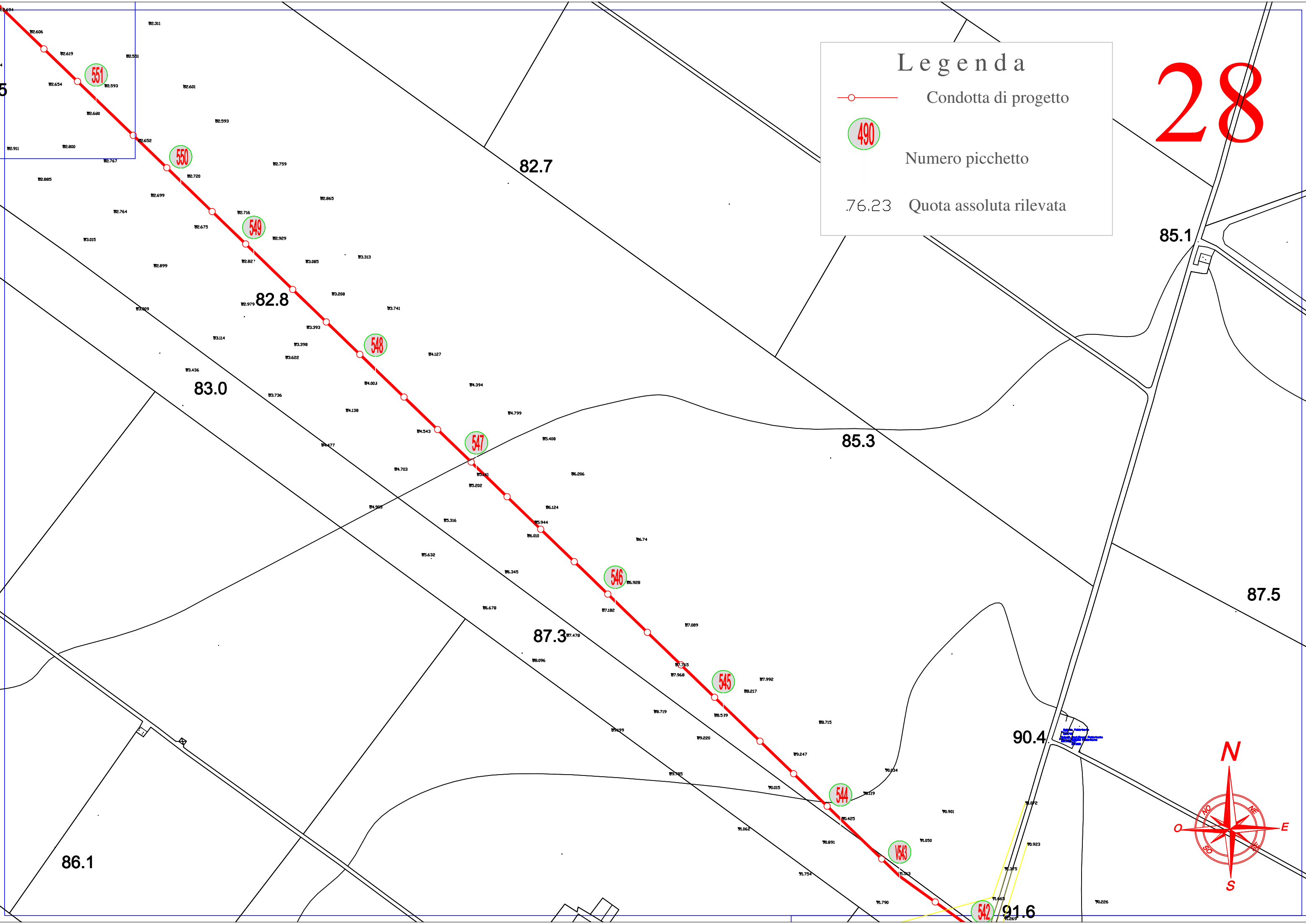

86.1

83.0

82.8

82.7

85.3

87.5

87.3

90.4

91.6

Marana

77.1

TORRE GIULLIA

**Legenda**

- Condotta di progetto
- 490 Numero picchetto
- 76.23 Quota assoluta rilevata

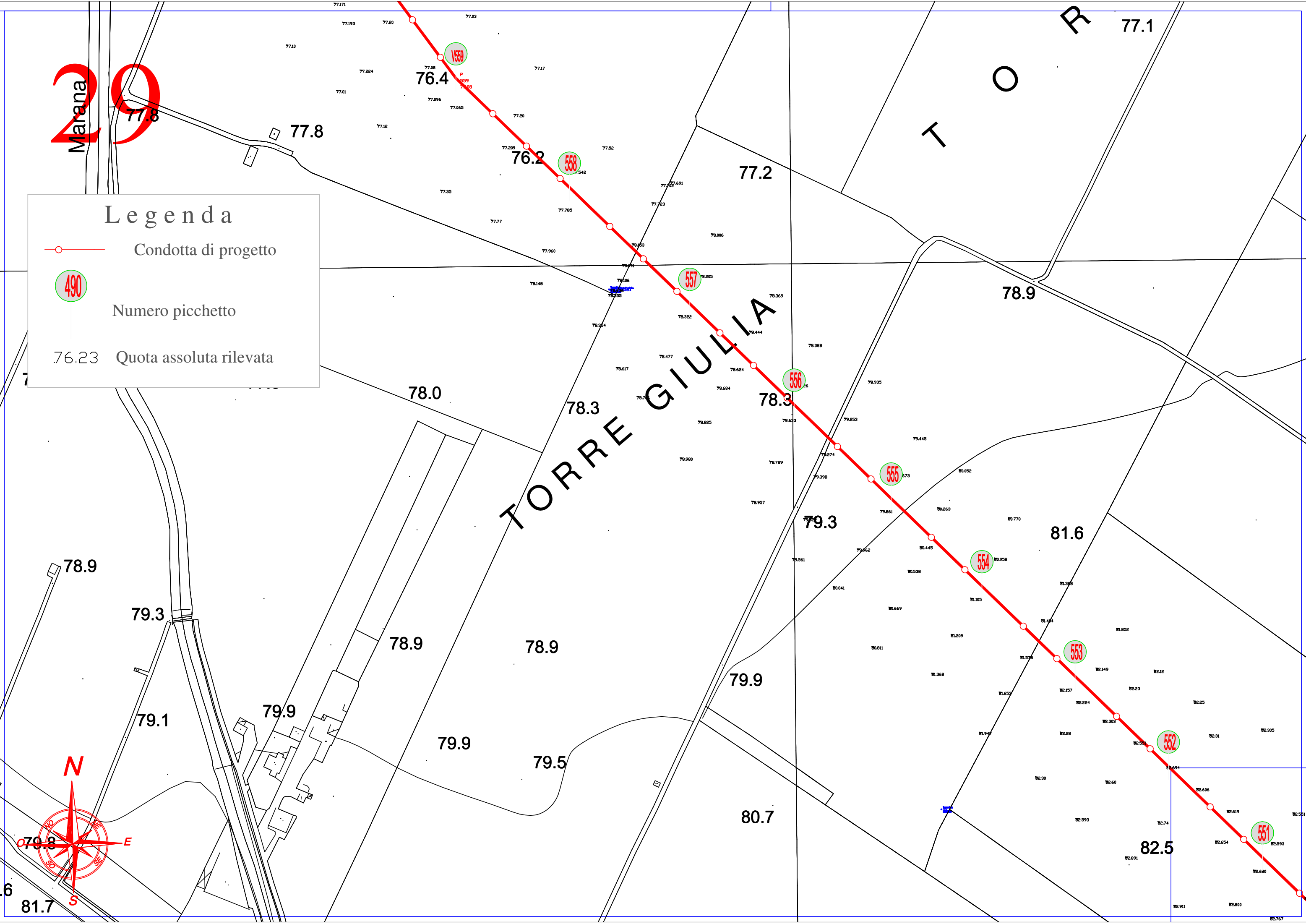
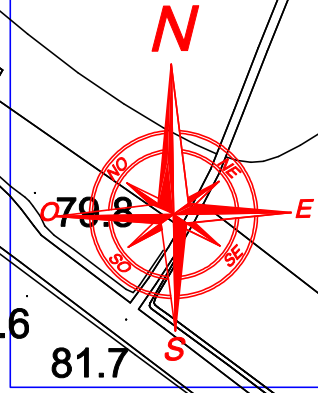

30

Legenda

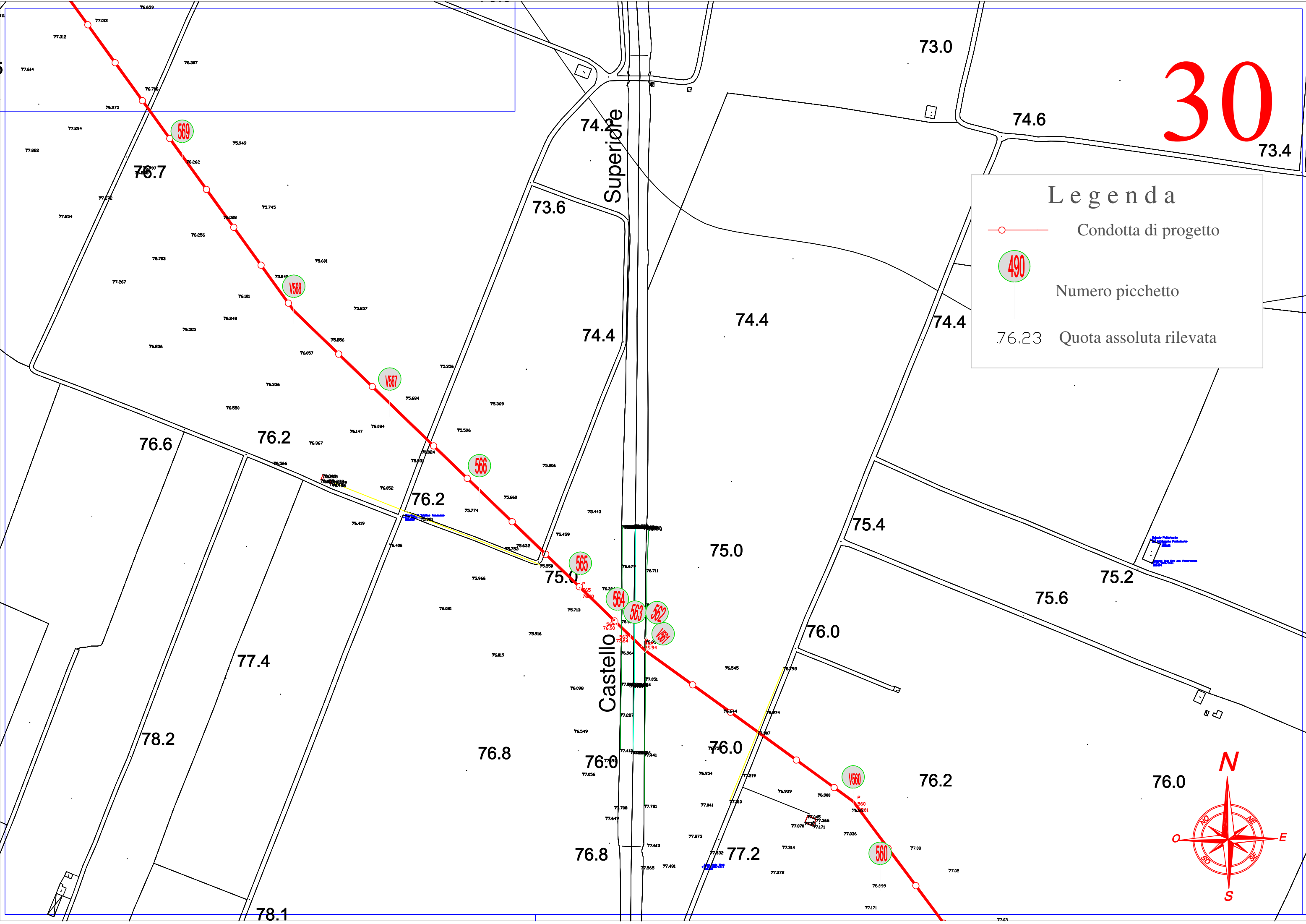

- Condotta di progetto
- ④ 490 Numero picchetto
- 76.23 Quota assoluta rilevata





# 31

## Legenda

-  Condotta di progetto
-  Numero picchetto
-  Quota assoluta rilevata

73.5

73.1

73.7

71.1

75.3

73.1

76.3

76.3

78.1

78.7

78.7

76.1

74.5

72.3

Masseria  
Salpitello di Tonti

82.5

80.9

80.5

79.3

77.3

75.5

81.5

80.1

78.5

73.5

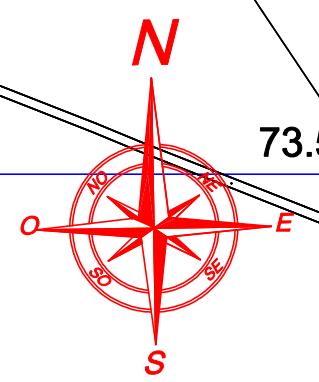

0.0

70.9

73.5

76.307

76.975

77.785

78.411

79.218

79.539

79.539

79.539

79.539

79.539

79.539

79.539

79.539

79.539

79.539

79.539

79.539

79.539

79.539

79.539

79.539

79.539

79.539

79.539

79.539

79.539

79.539

79.539

79.539

79.539

79.539

79.539

79.539

79.539

79.539

79.539

79.539

79.539

79.539

79.539

79.539

79.539

79.539

79.539

79.539

79.539

79.539

79.539

79.539

79.539

79.539

79.539

79.539

79.539

79.539

79.539

79.539

79.539

79.539

79.539

79.539

79.539

79.539

79.539

79.539

79.539

79.539

79.539

79.539

79.539

79.539

79.539

79.539

79.539

79.539

79.539

79.539

79.539

79.539

79.539

79.539

79.539

79.539

79.539

79.539

79.539

79.539

79.539

79.539

79.539

79.539

79.539

79.539

79.539

79.539

79.539

79.539

79.539

79.539

79.539

79.539

79.539

79.539

79.539

79.539

79.539

79.539

79.539

79.539

79.539

79.539

79.539

79.539

79.539

79.539

79.539

79.539

79.539

79.539

79.539

79.539

79.539

79.539

79.539

79.539

79.539

79.539

79.539

79.539

79.539

79.539

79.539

79.539

79.539

79.539

79.539

79.539

79.539

79.539

79.539

79.539

79.539

79.539

79.539

79.539

79.539

79.539

79.539

79.539

79.539

79.539

79.539

79.539

79.539

79.539

79.539

79.539

79.539

79.539

79.539

79.539

79.539

79.539

79.539

79.539

79.539

79.539

79.539

79.539

79.539

79.539

79.539

79.539

79.539

79.539

79.539

79.539

79.539

79.539

79.539

79.539

79.539

79.539

79.539

79.539

79.539

79.539

79.539

79.539

79.539

79.539

79.539

79.539

79.539

79.539

79.539

79.539

79.539

79.539

79.539

79.539

79.539

79.539

79.539

79.539

79.539

79.539

79.539

79.539

79.539

79.539

79.539

79.539

79.539

79.539

79.539

79.539

79.539

79.539

79.539

79.539

79.539

79.539

79.539

79.539

79.539

79.539

79.539

79.539

79.539

79.539

79.539

79.539

79.539

79.539

79.539

79.539

79.539

79.539

79.539

79.539

79.539

79.539

79.539

79.539

79.539

79.539

79.539

79.539

79.539

79.539

79.539

79.539

79.539

79.539

79.539

79.539

79.539

79.539

79.539

79.539

79.539

79.539

79.539

79.539

79.539

79.539

79.539

79.539

79.539

32

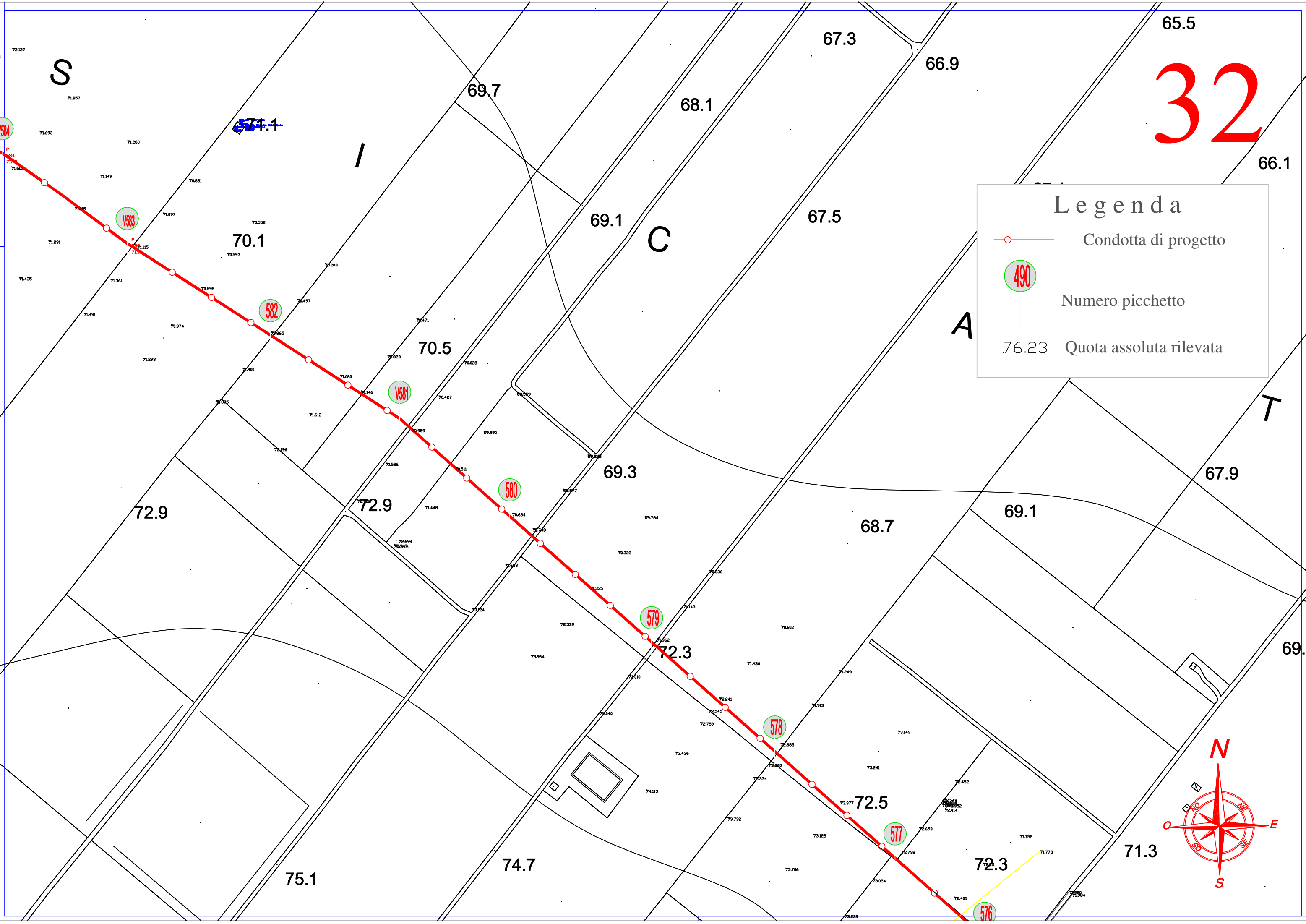
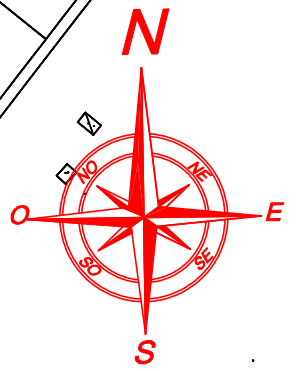

### Legenda

- Condotta di progetto
- 490 Numero picchetto
- 76.23 Quota assoluta rilevata



# 33

## Legenda

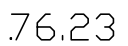
-  Condotta di progetto
-  Numero picchetto
-  Quota assoluta rilevata

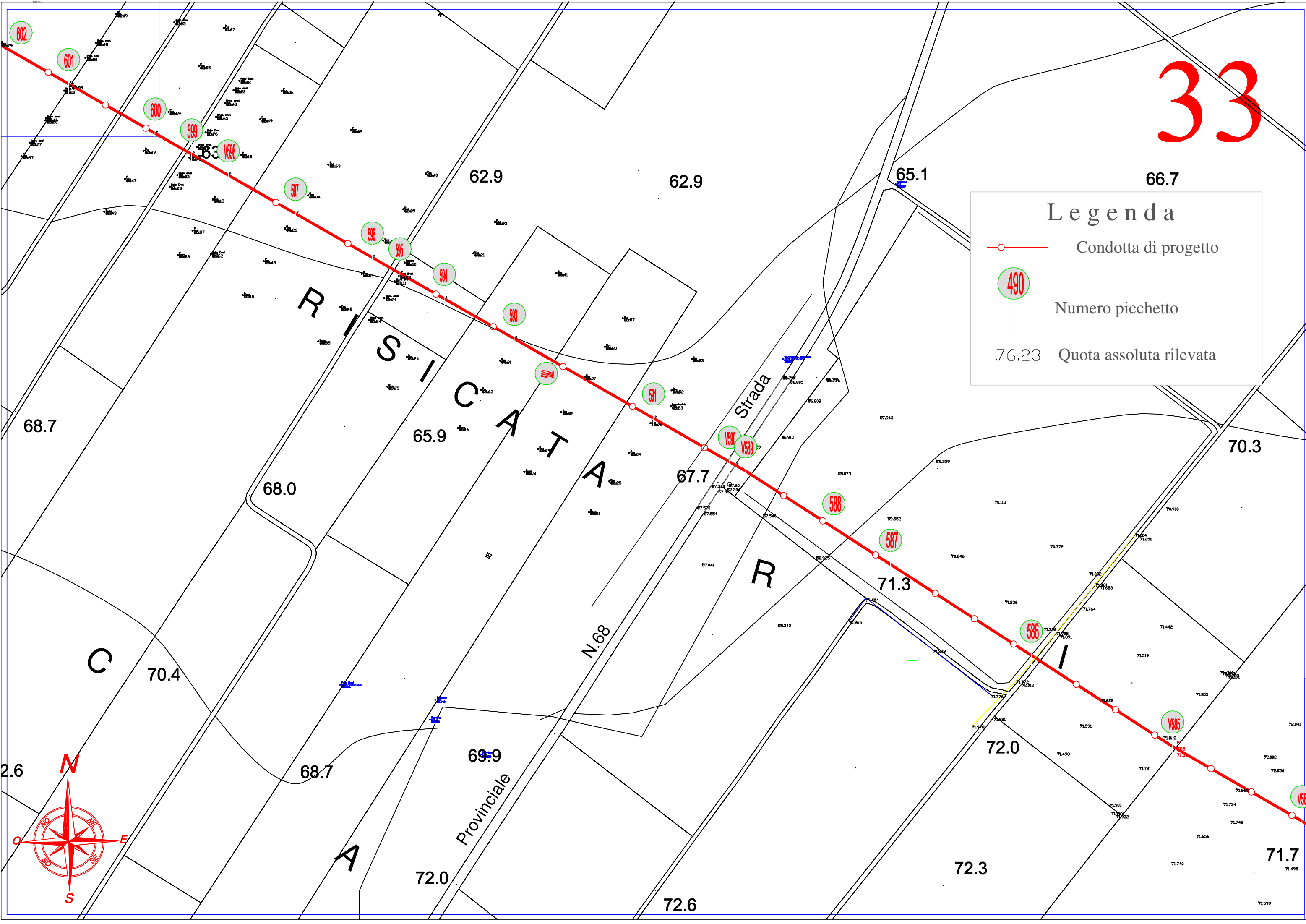



A  
P  
34  
C  
L

**Legenda**

- Condotta di progetto
- 490 Numero picchetto
- 76.23 Quota assoluta rilevata

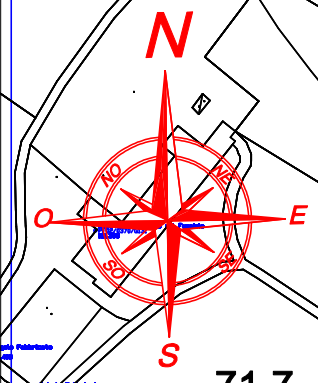
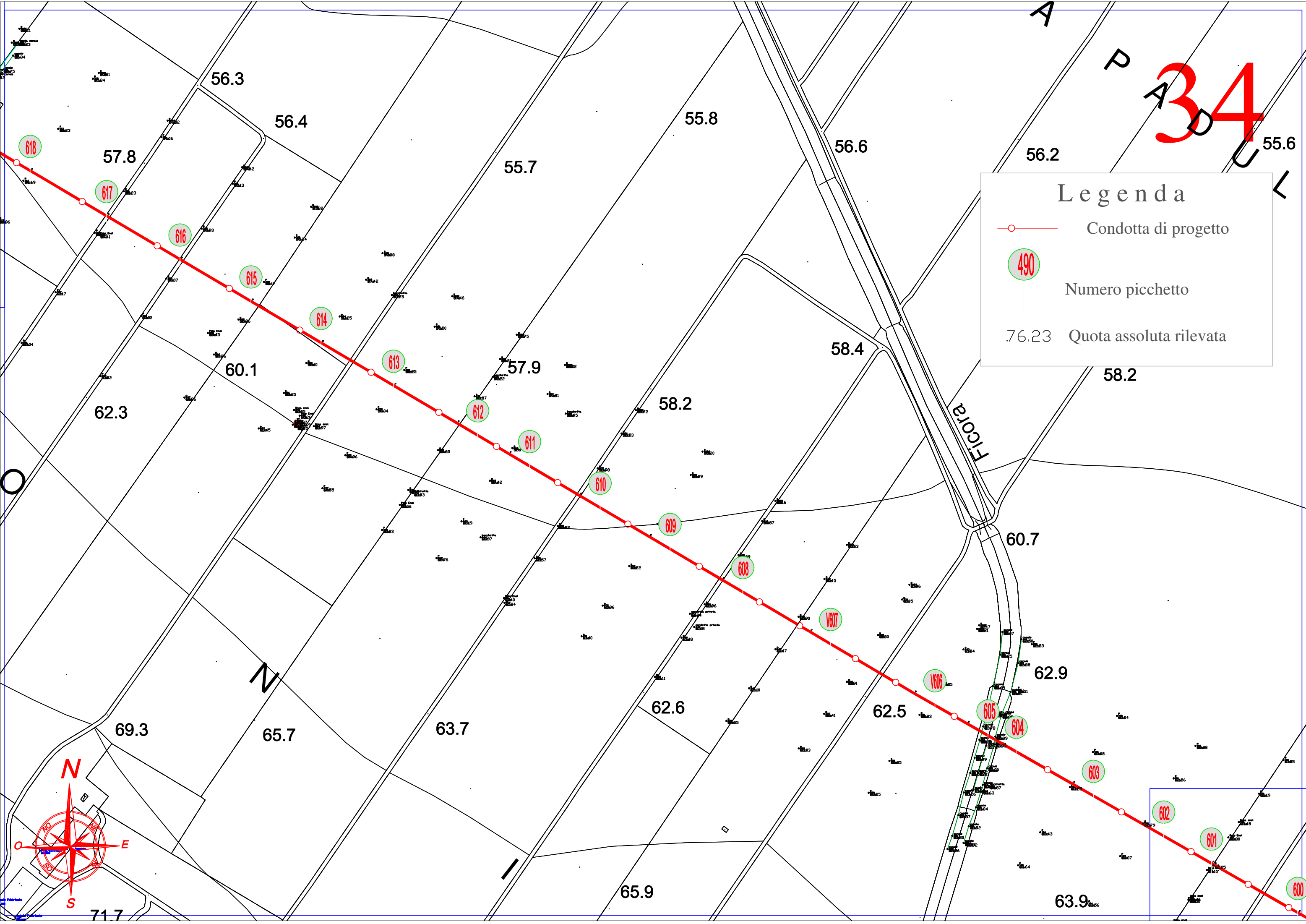

56.3

56.4

55.8

56.6

56.2

55.6

57.8

55.7

616

615

614

613

57.9

58.4

62.3

60.1

57.9

612

611

58.2

610

609

608

607

606

605

604

62.9

603

602

601

600

69.3

65.7

63.7

62.6

62.5

65.9

63.9

71.7

FIGORA

35

Masseria Paduletta

64.2

63.7

61.9

59.3

55.6

65.0

65.7

64.8

63.1

59.7

64.0

63.4

### Legenda

—○— Condotta di progetto

490  
Numero picchetto

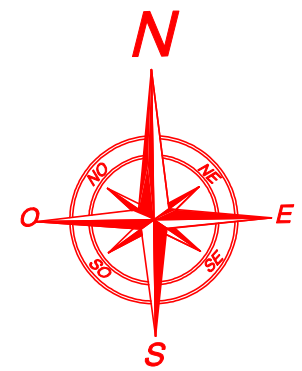

76.23  
Quota assoluta rilevata



B

# 36

## Legenda

-  Condotta di progetto
-  Numero picchetto
-  76.23 Quota assoluta rilevata

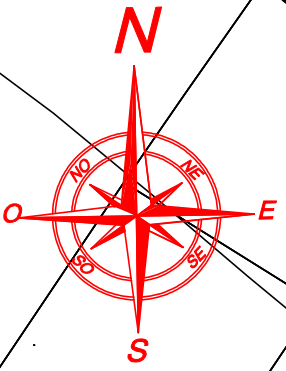
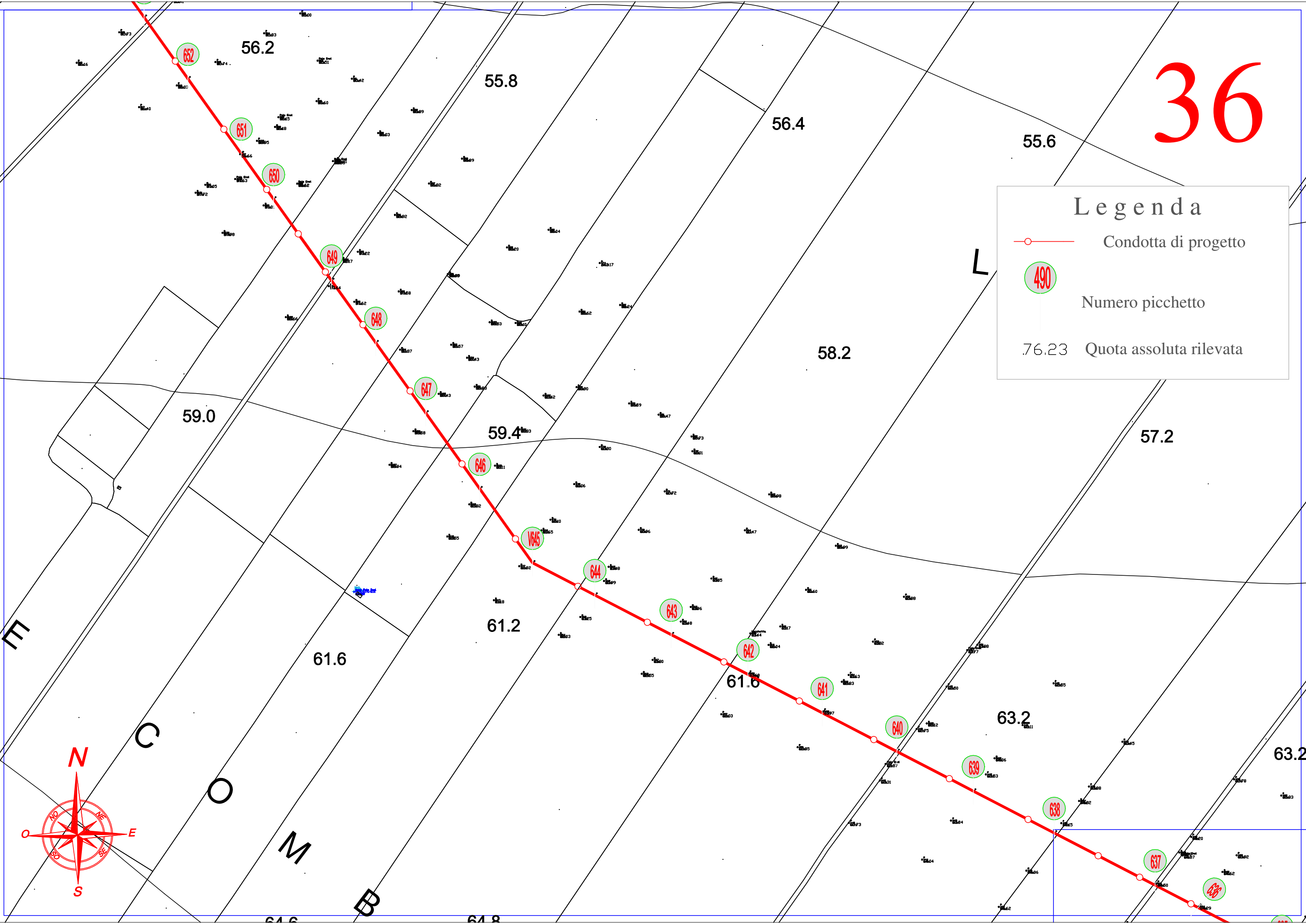



37

**Legenda**

- Condotta di progetto
- ④ 490 Numero picchetto
- 76.23 Quota assoluta rilevata

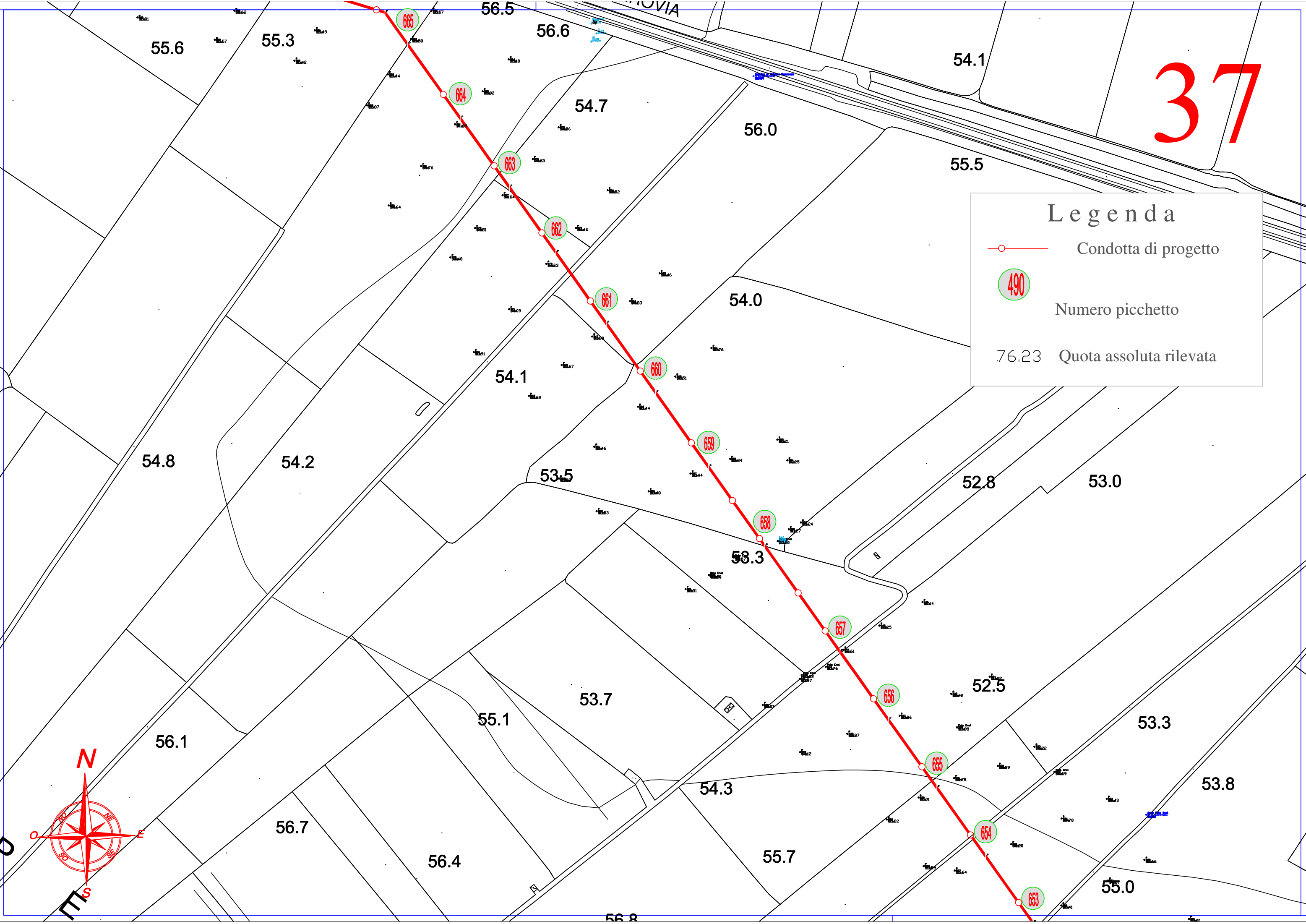
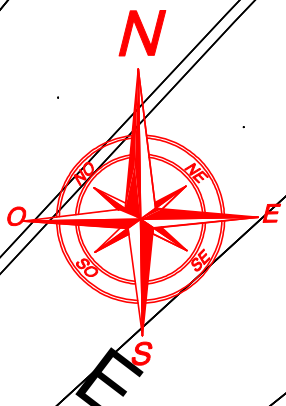

38

**Legenda**

- Condotta di progetto
- 490 Numero picchetto
- 76.23 Quota assoluta rilevata

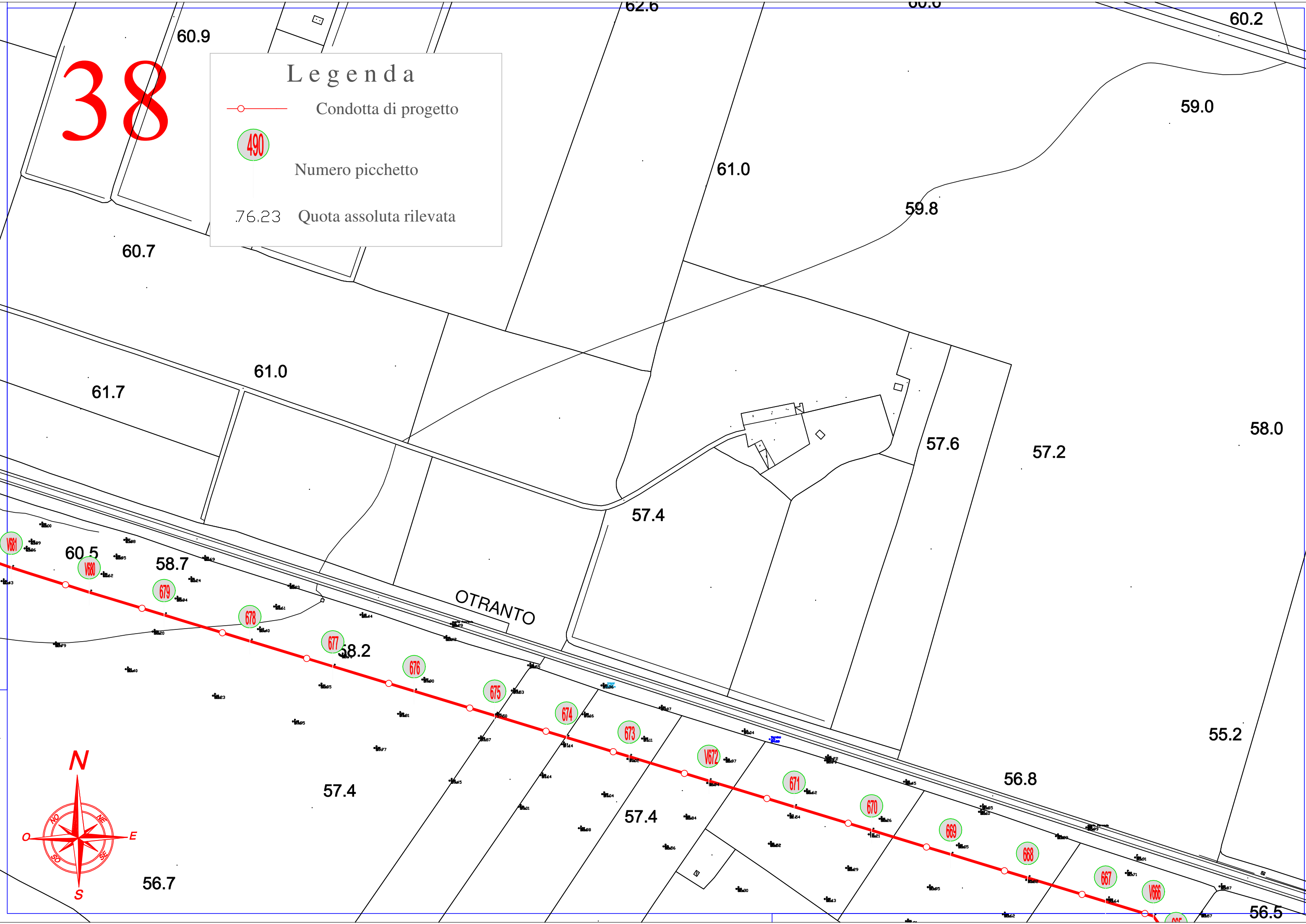

# 39

**Legenda**

- Condotta di progetto
- 490 Numero picchetto
- 76.23 Quota assoluta rilevata

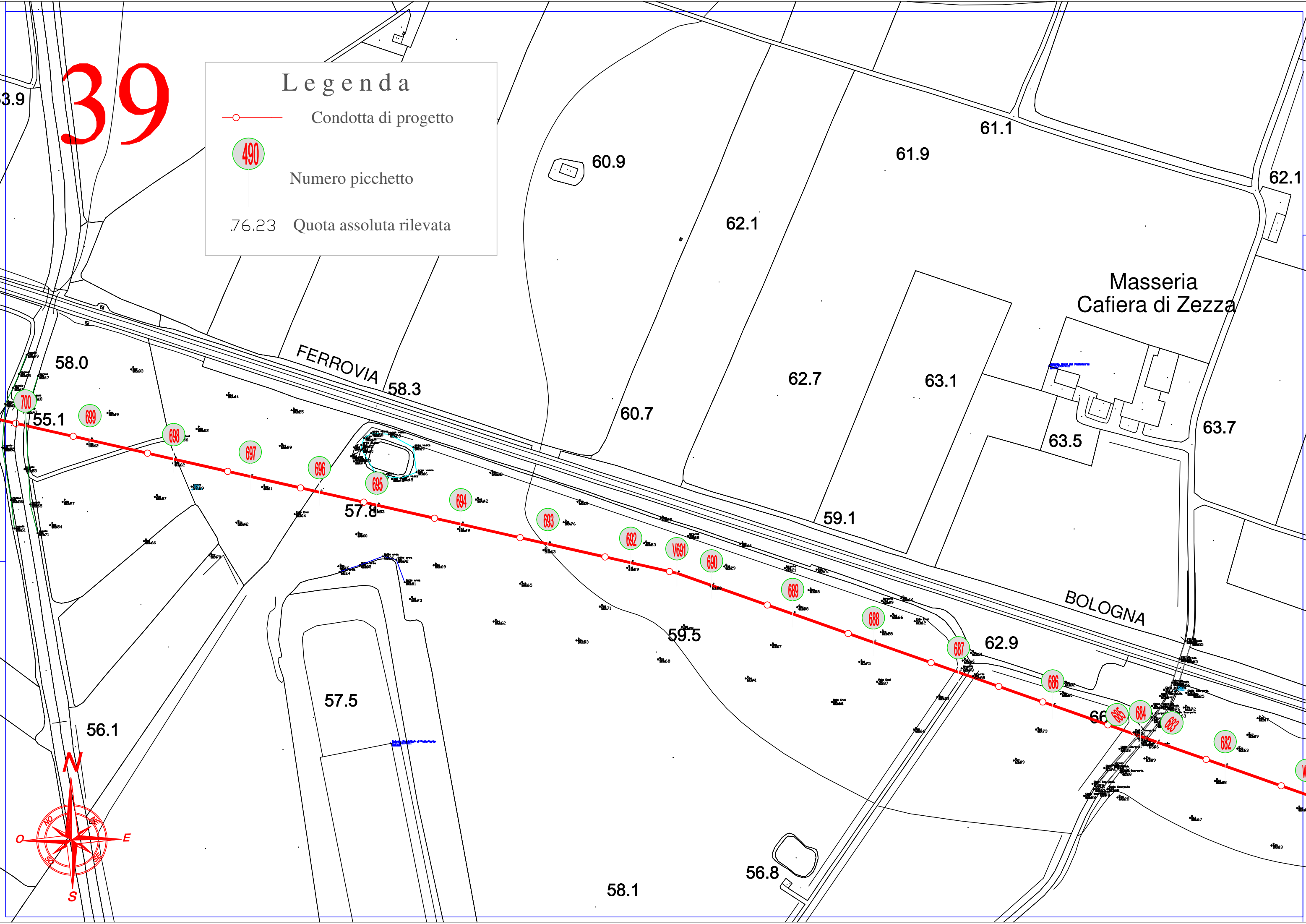

## Legenda

- Condotta di progetto
- 490 Numero picchetto
- 76.23 Quota assoluta rilevata

Masseria  
Cafiera di Zezza

FERROVIA

BOLOGNA

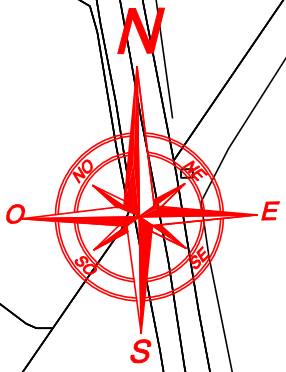

58.0

55.1

699

698

697

696

695

694

693

692

691

690

689

688

687

686

685

684

683

682

681

60.9

62.1

61.9

61.1

62.1

60.7

62.7

63.1

63.7

58.3

57.8

59.1

59.5

62.9

57.5

56.1

58.1

56.8



# 40

**Legenda**

- Condotta di progetto
- (490) Numero picchetto
- 76.23 Quota assoluta rilevata

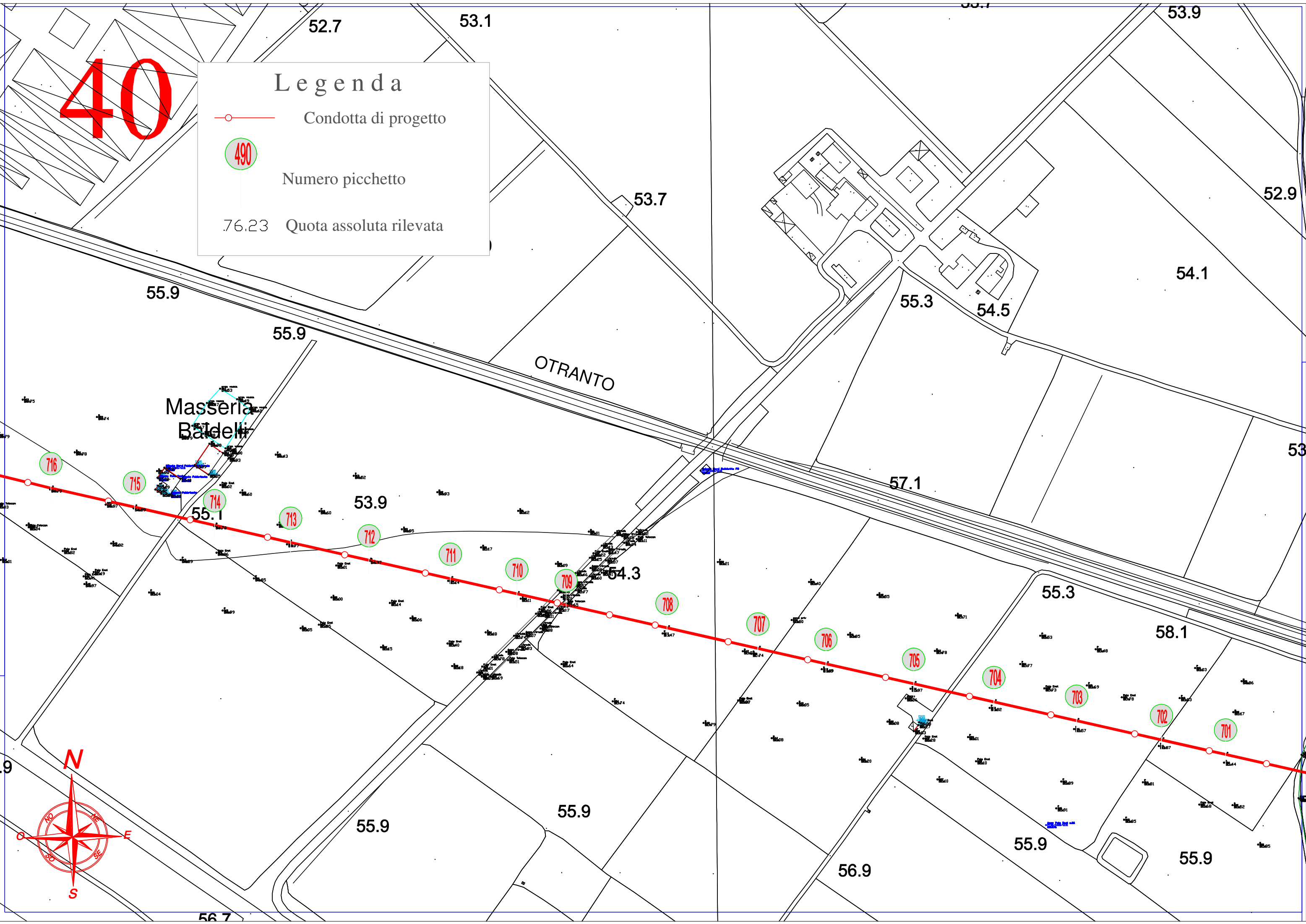

# 41

**Legenda**

- Condotta di progetto
- 490 Numero picchetto
- 76.23 Quota assoluta rilevata

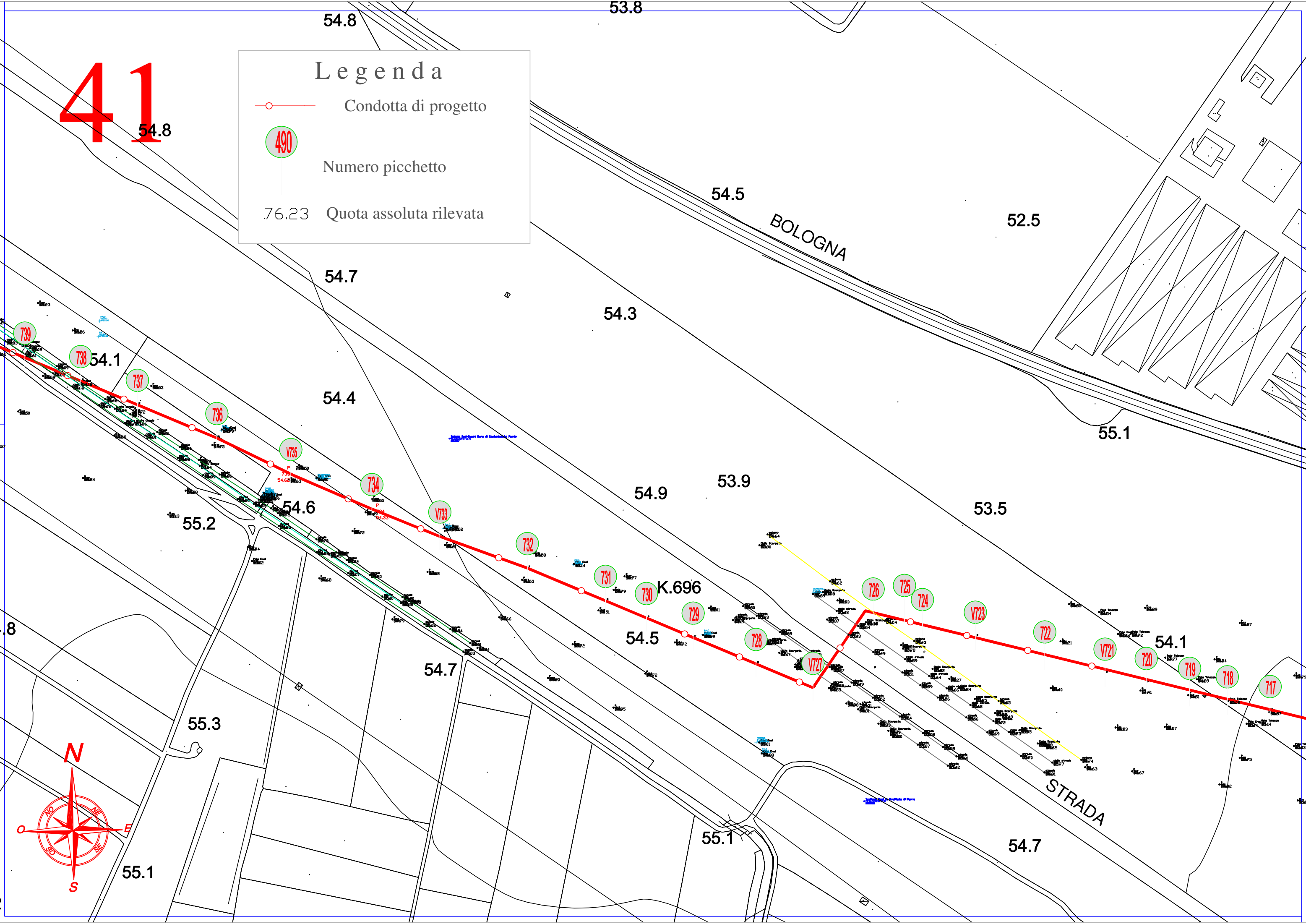

42

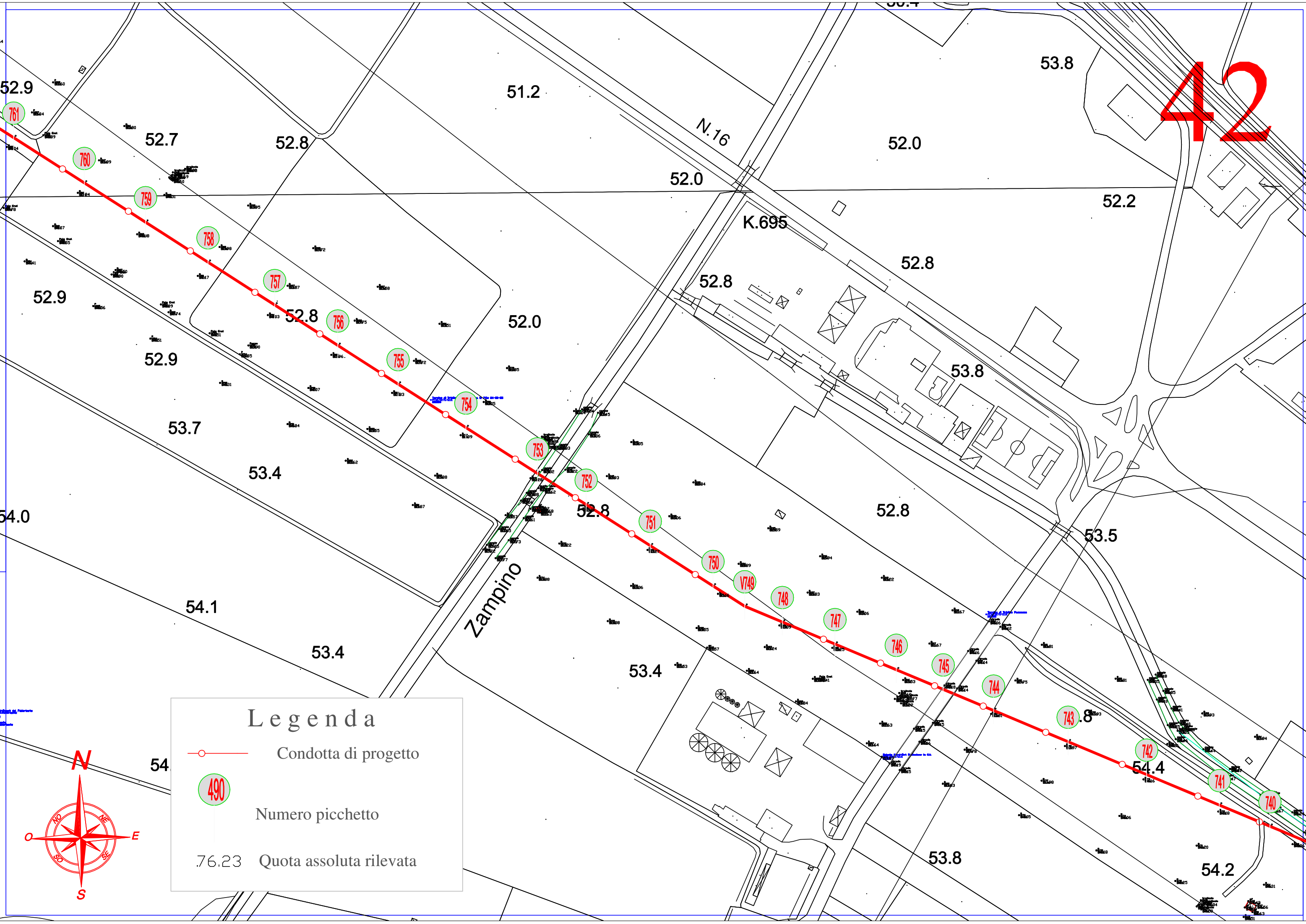

**Legenda**

- Condotta di progetto
- 490 Numero picchetto
- 76.23 Quota assoluta rilevata

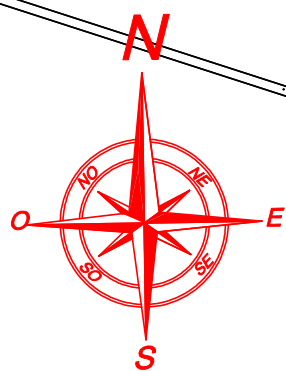



43

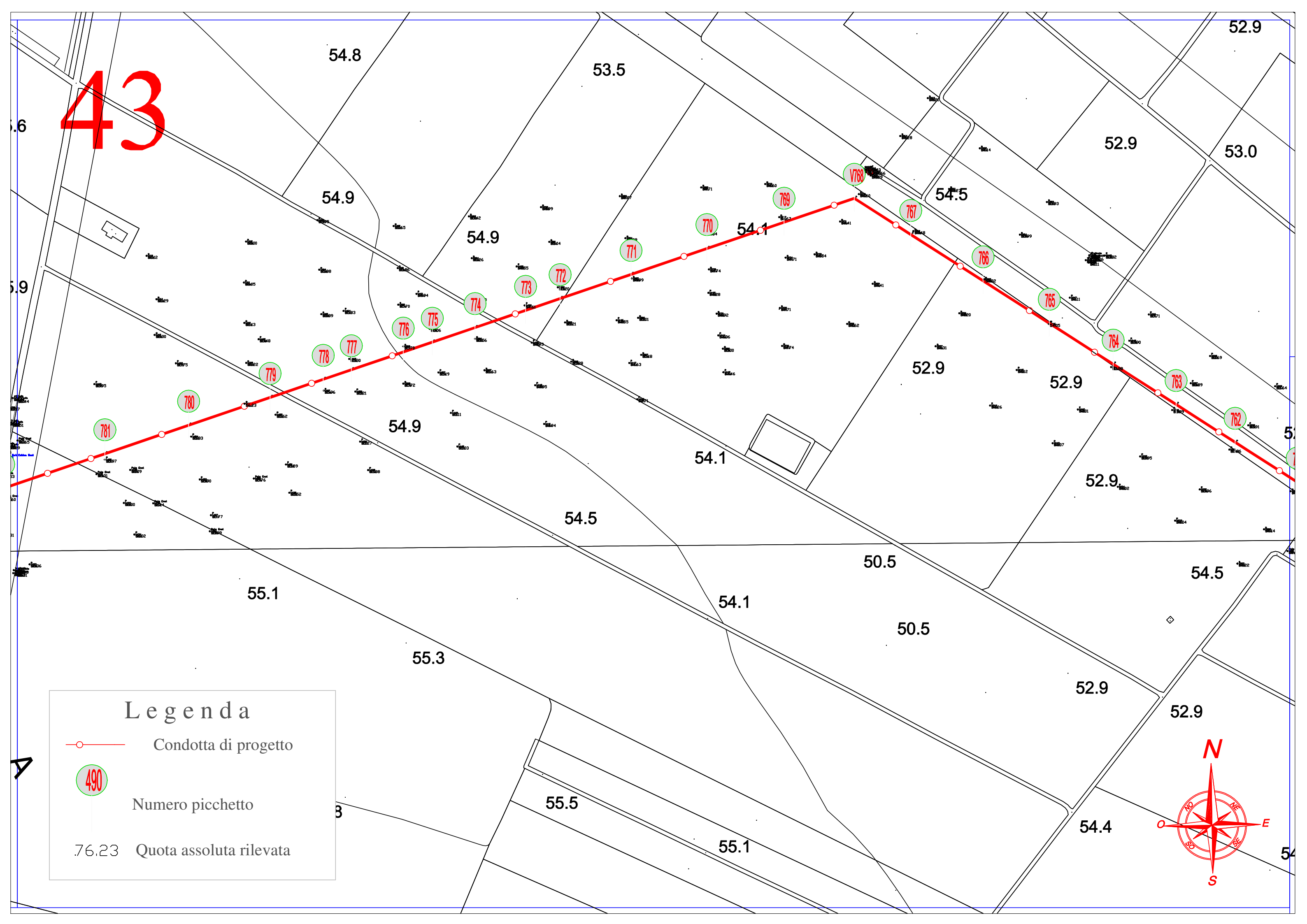

**Legenda**

- Condotta di progetto
- (490) Numero picchetto
- 76.23 Quota assoluta rilevata

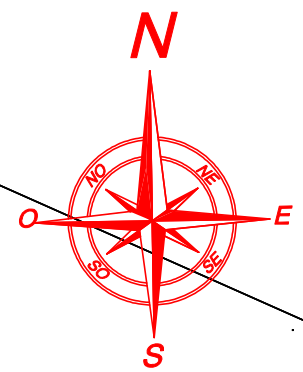

44

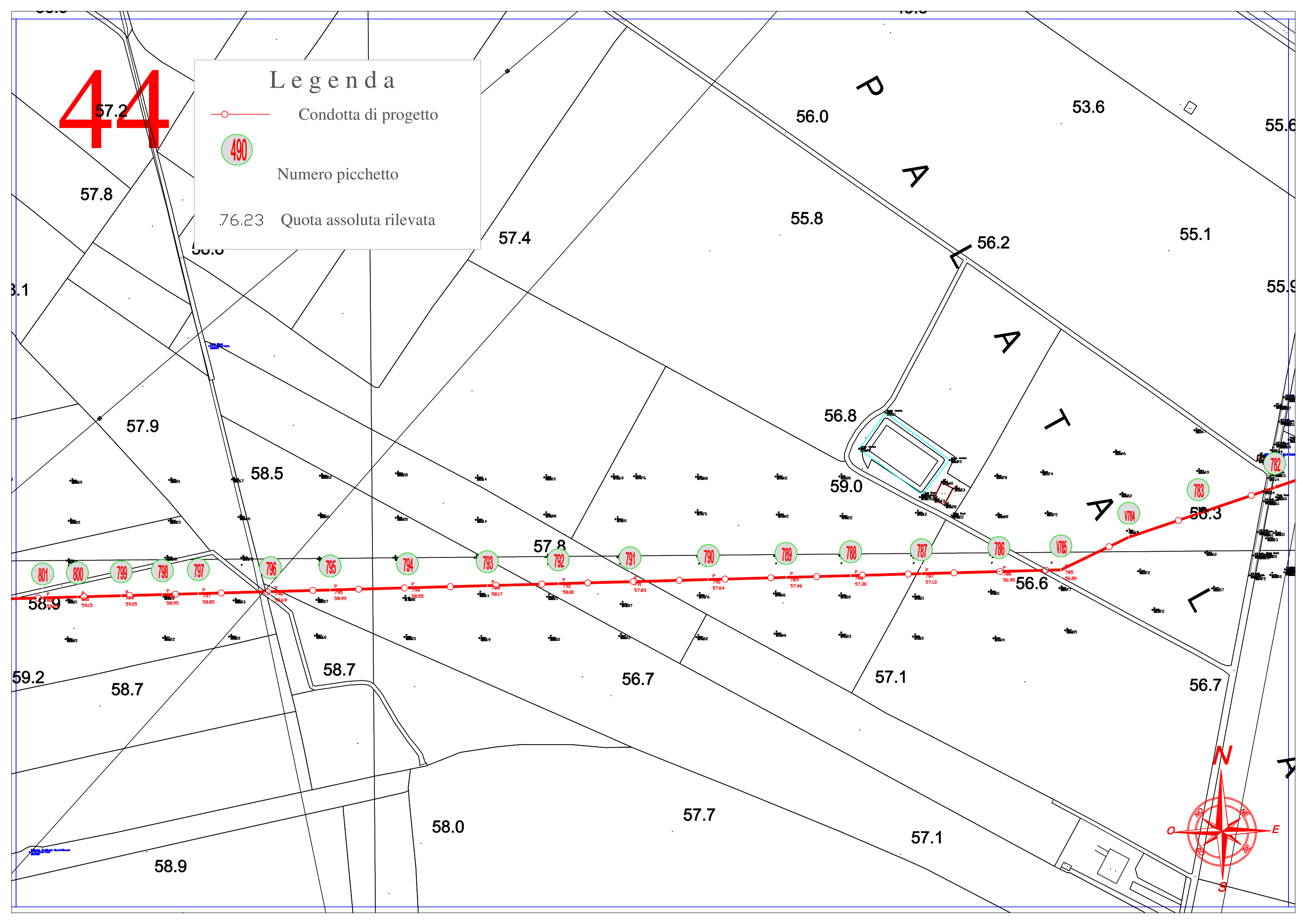

**Legenda**

- Condotta di progetto
- ④ 490 Numero picchetto
- 76.23 Quota assoluta rilevata



# 45

### Legenda

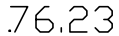
-  Condotta di progetto
-  Numero picchetto
-  Quota assoluta rilevata

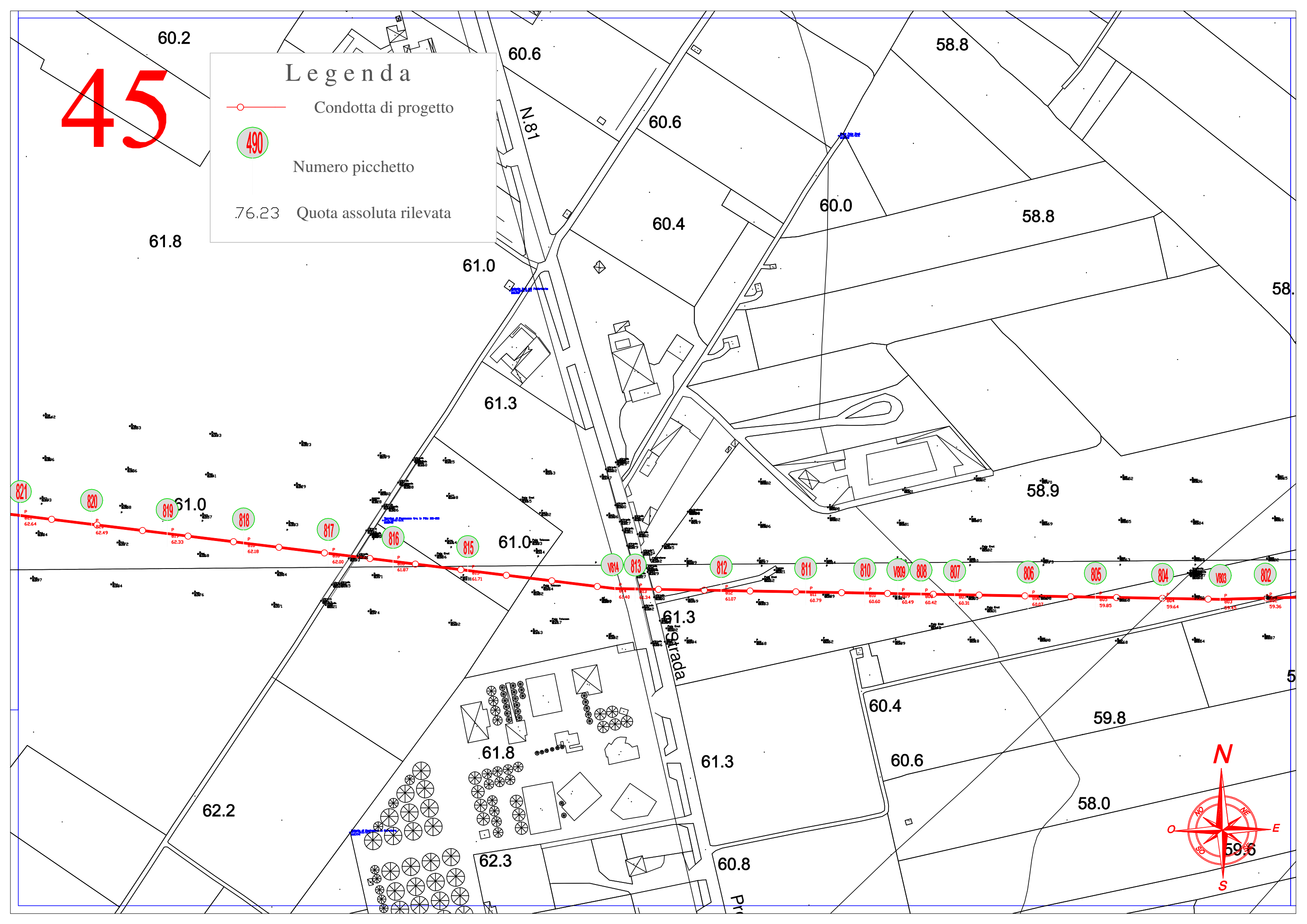



**Legenda**

- Condotta di progetto
- 490 Numero picchetto
- 76.23 Quota assoluta rilevata

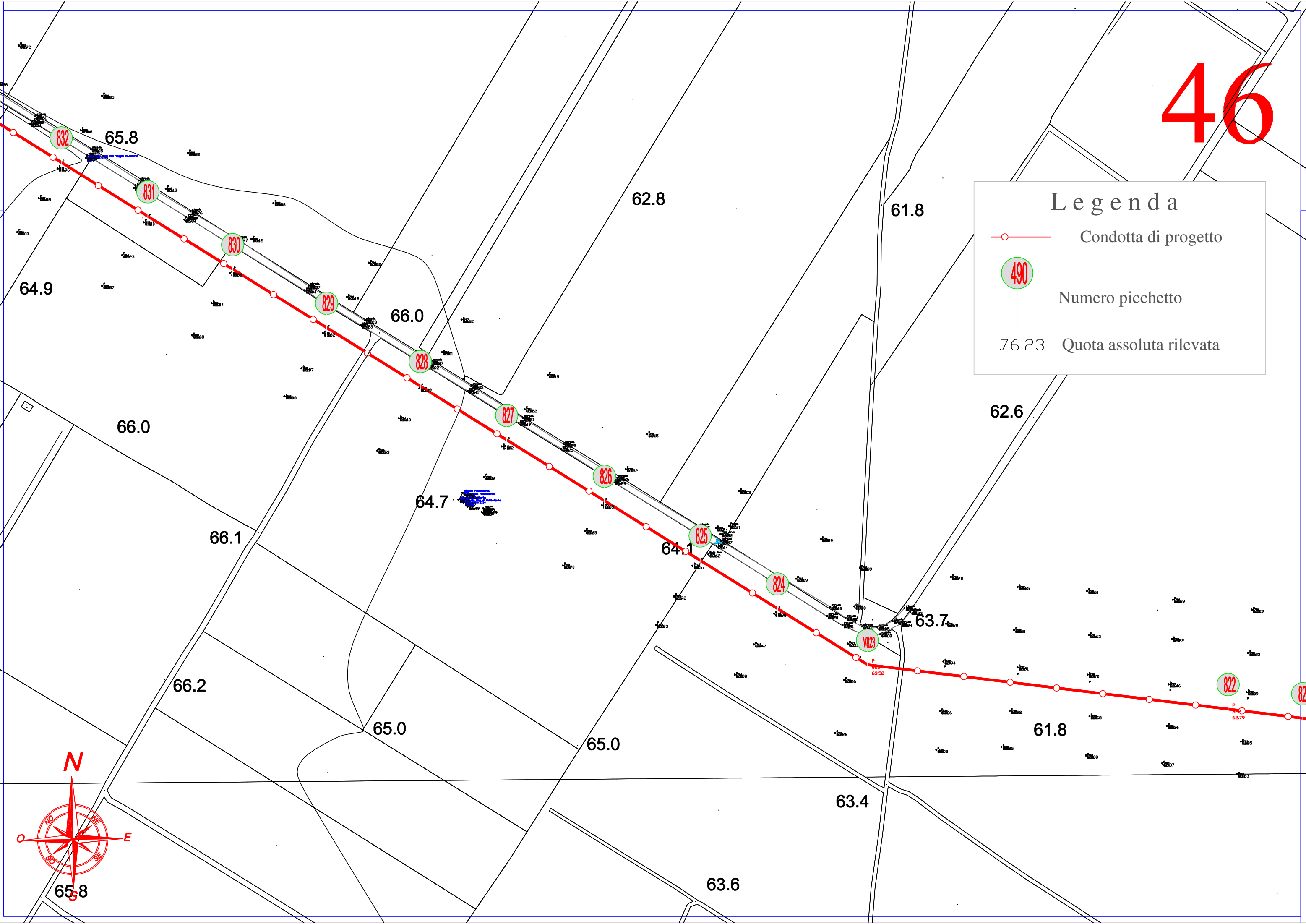

47

**Legenda**

- Condotta di progetto
- ④⑨⑩ Numero picchetto
- 76.23 Quota assoluta rilevata

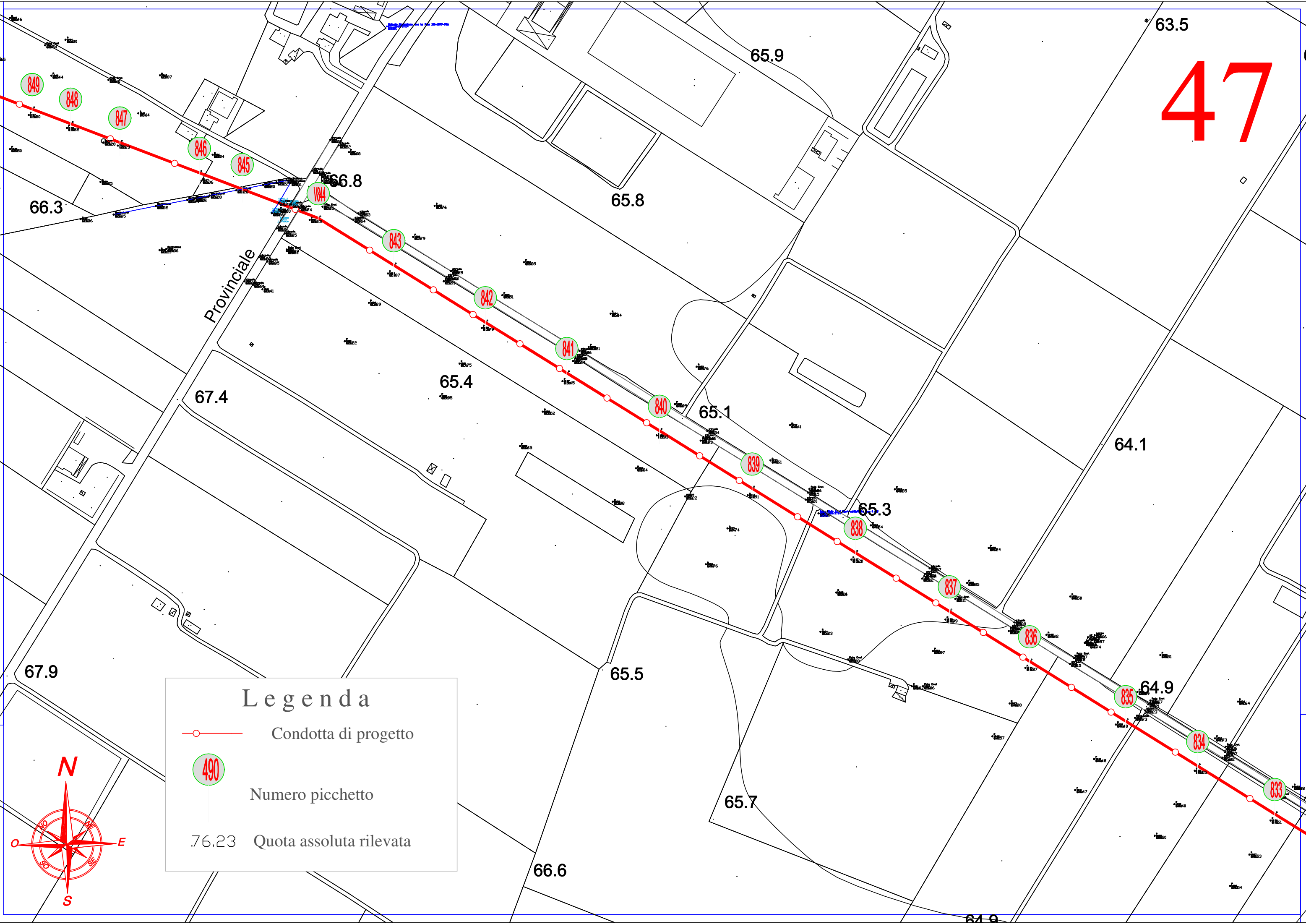
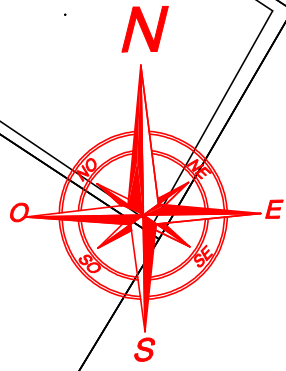

# 48

**Legenda**

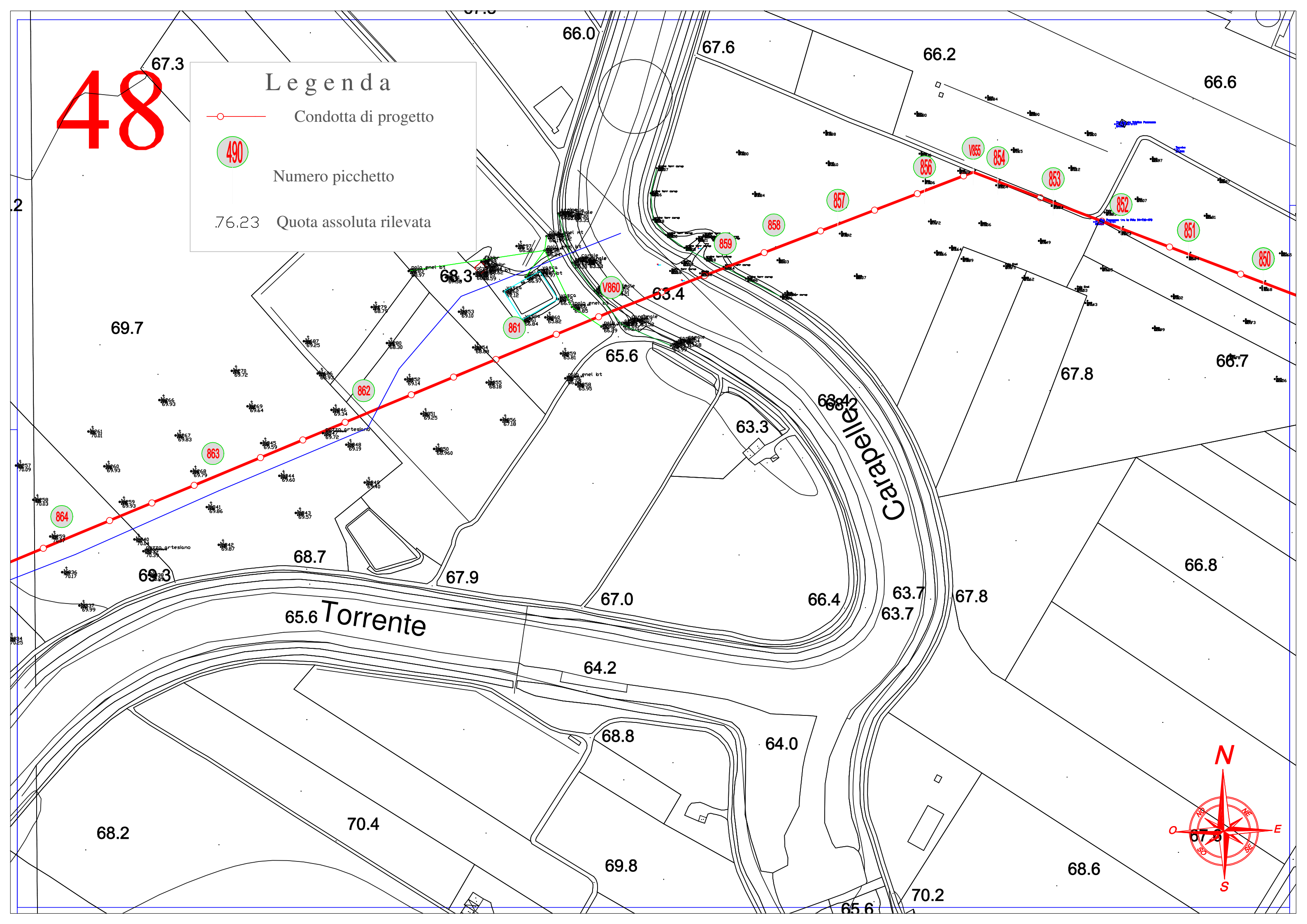

- Condotta di progetto
- 490 Numero picchetto
- 76.23 Quota assoluta rilevata





# 49

**Legenda**

-  Condotta di progetto
-  Numero picchetto
-  Quota assoluta rilevata

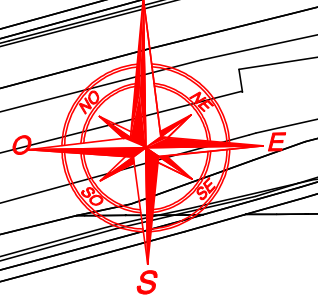
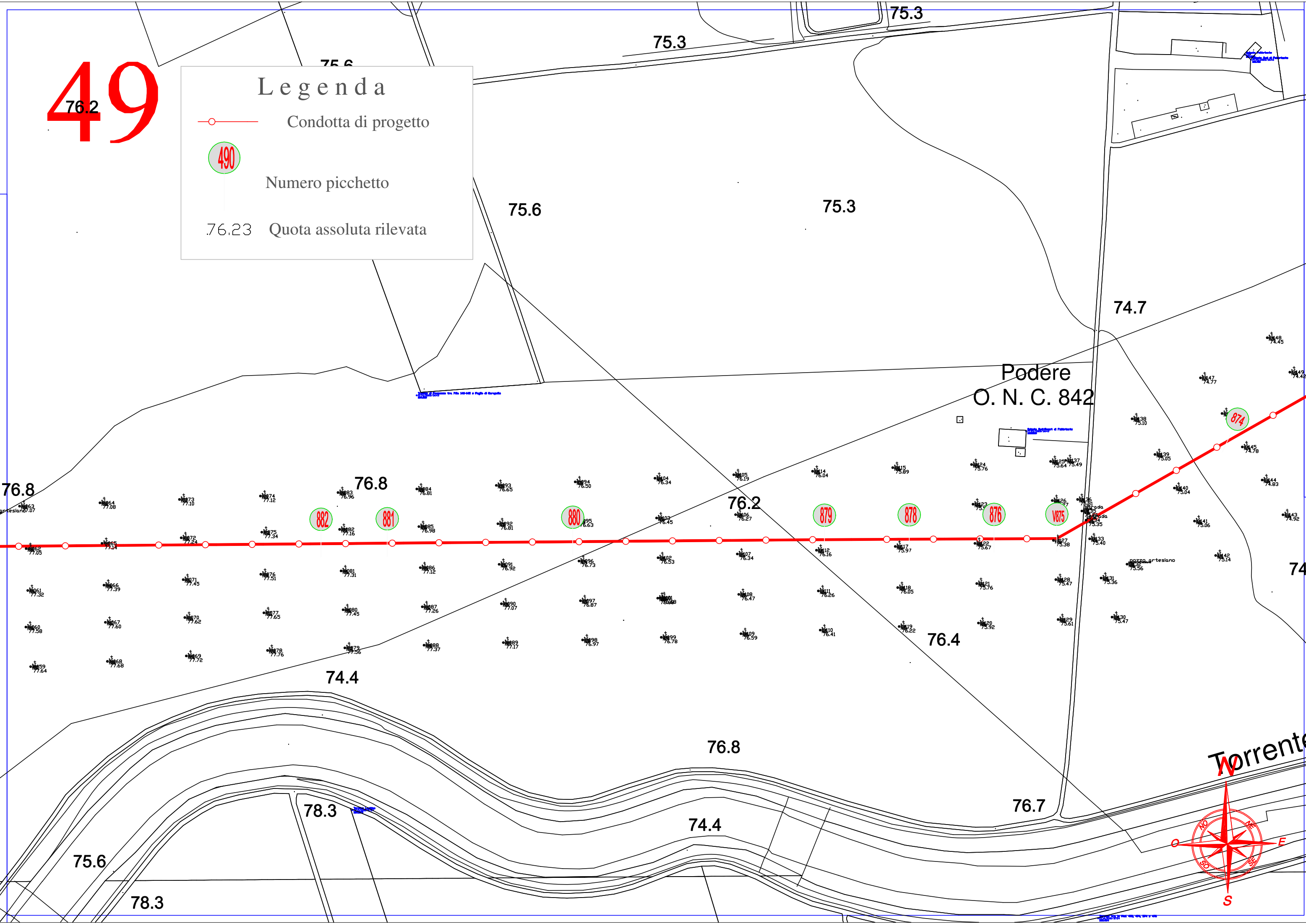

# 50

**Legenda**

- Condotta di progetto
- 490 Numero picchetto
- 76.23 Quota assoluta rilevata

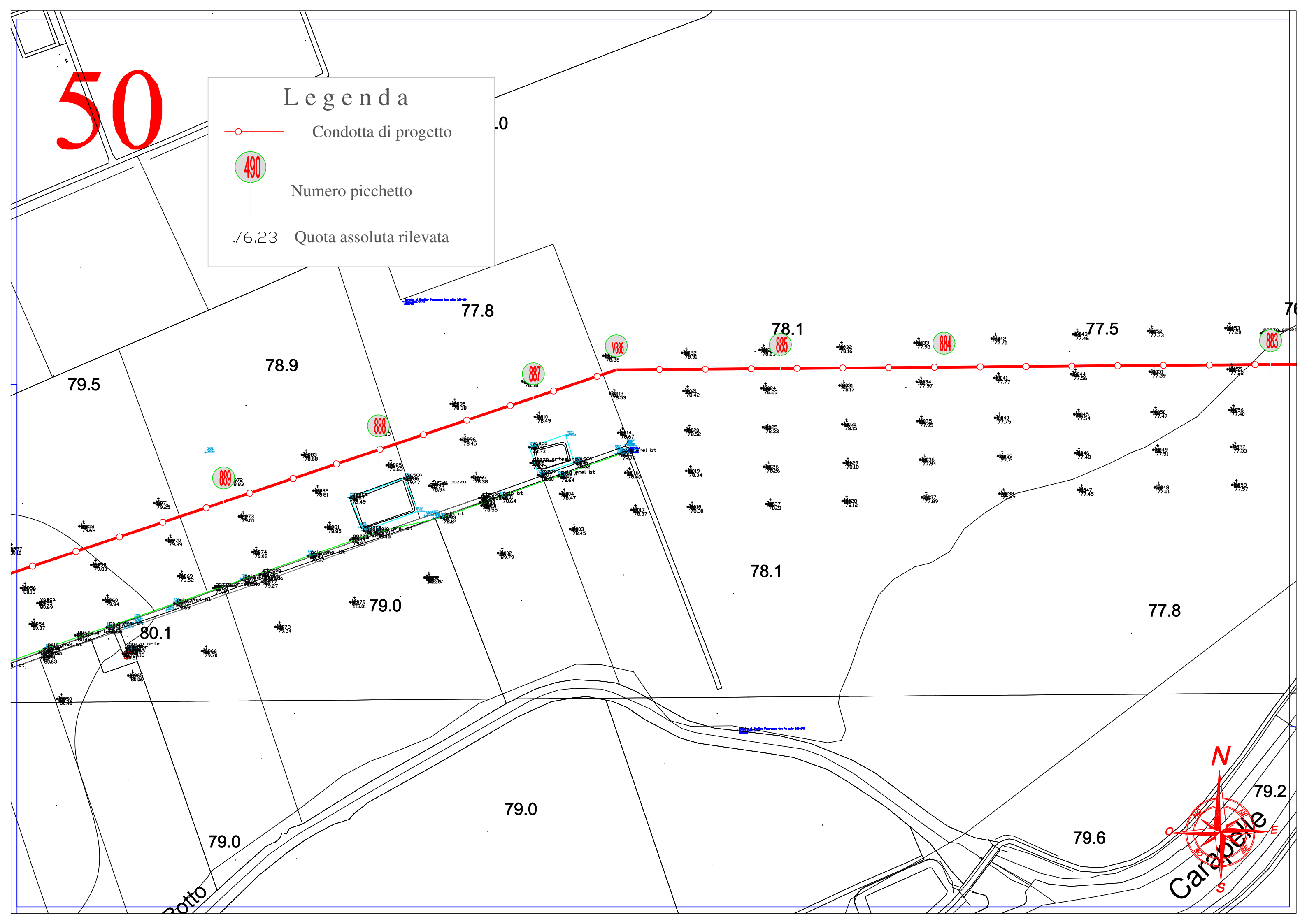

# 51

**Legenda**

- Condotta di progetto
- ④ 490 Numero picchetto
- 76.23 Quota assoluta rilevata

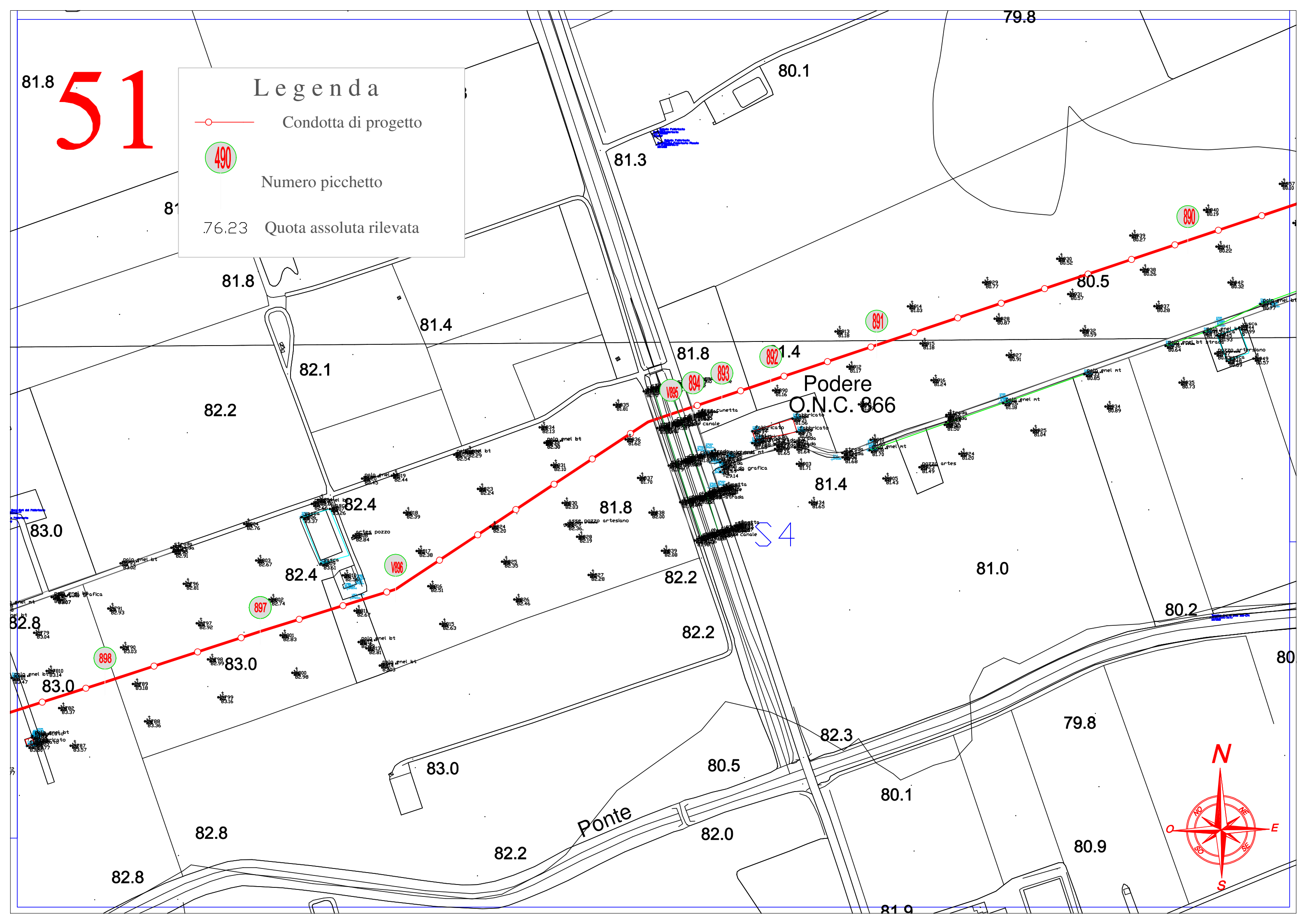



52

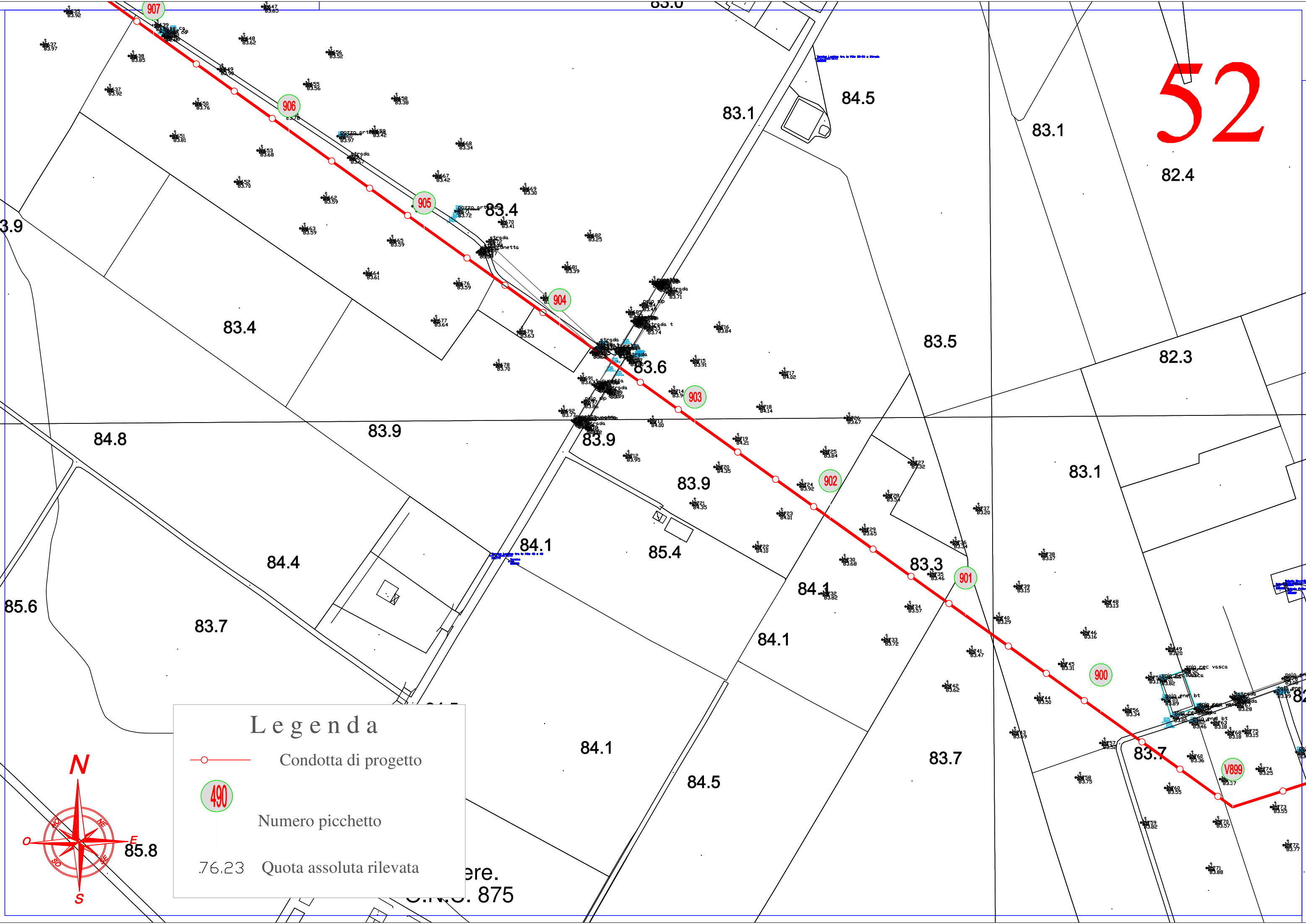

**Legenda**

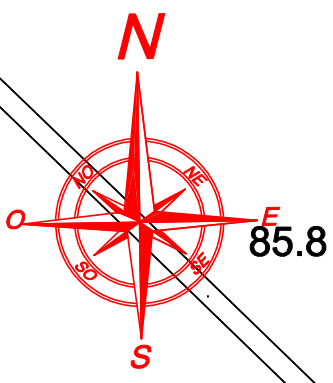

- Condotta di progetto
- 490 Numero picchetto
- 76.23 Quota assoluta rilevata



ere.  
875

# 53

## Legenda

-  Condotta di progetto
-  Numero picchetto
-  Quota assoluta rilevata

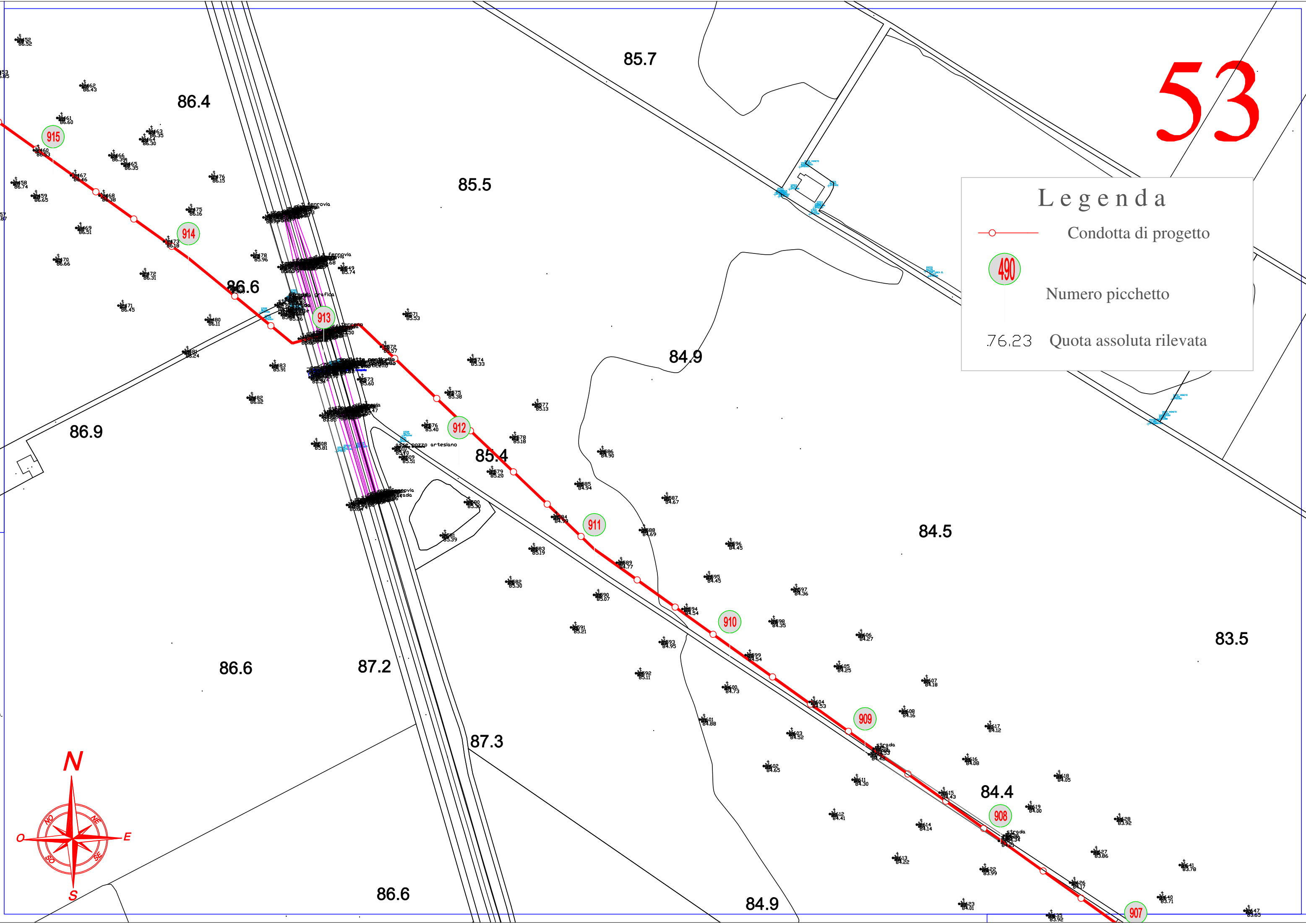
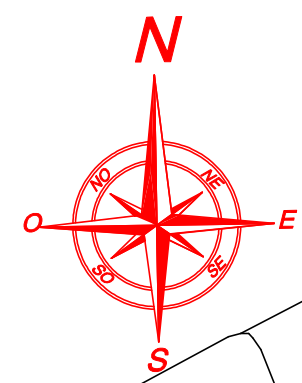

54°

**Legenda**

- Condotta di progetto
- 490 Numero picchetto
- 76.23 Quota assoluta rilevata

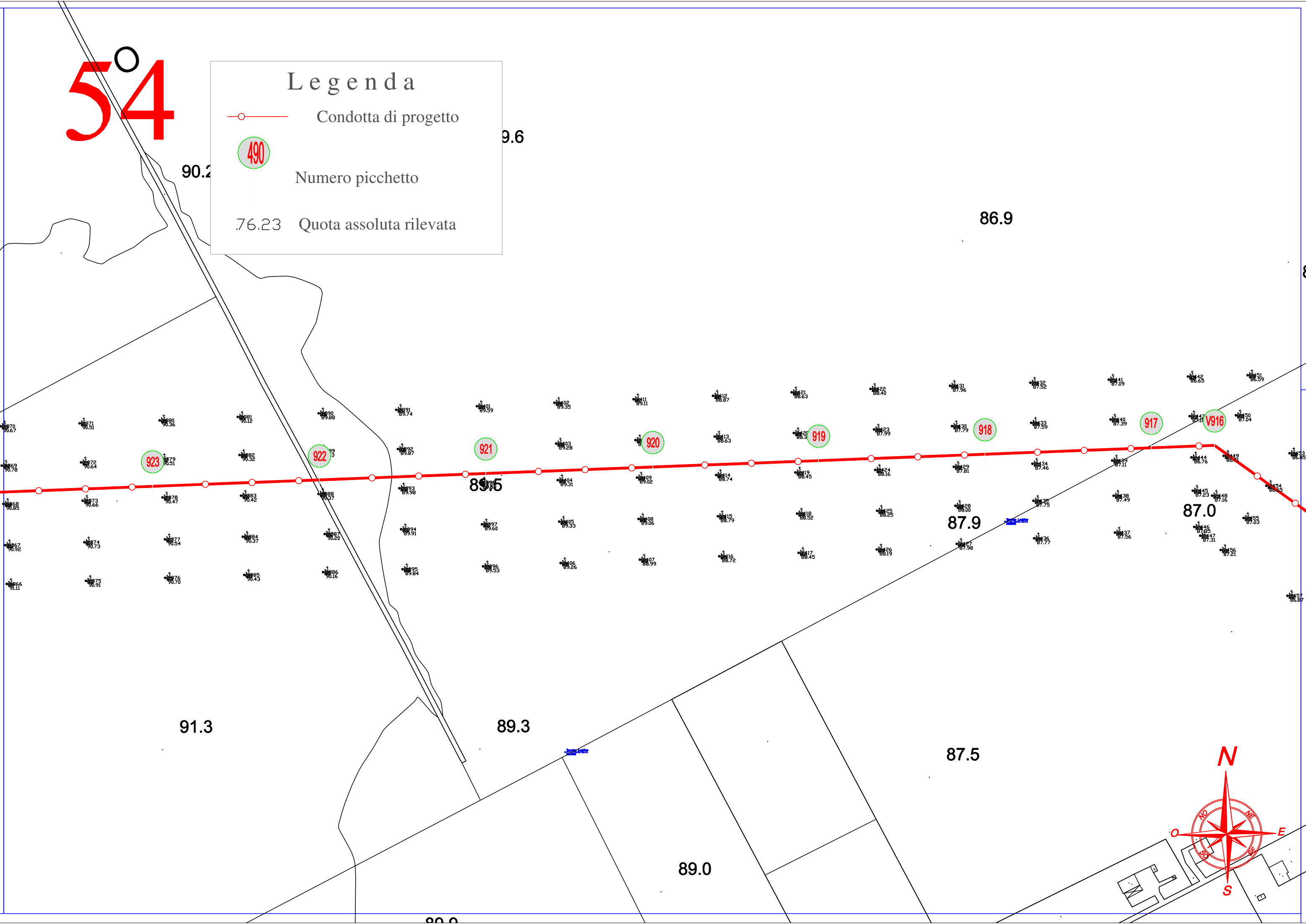



# 55

**Legenda**

- Condotta di progetto
- 490 Numero picchetto
- 76.23 Quota assoluta rilevata

89.7

90.0

N

91.8

90.3

90.6

R

92.4

A

93.4

931

930

929

928

927

926

925

924

O G

93.3

91.8

92.4

94.0

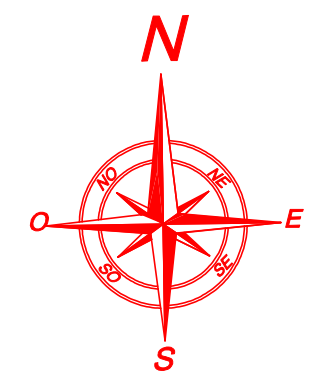

# 56

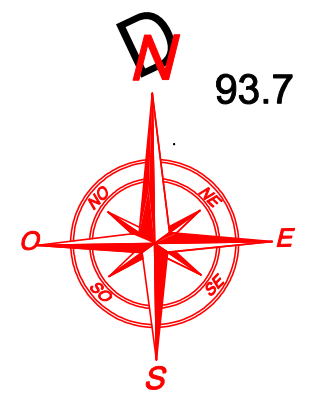
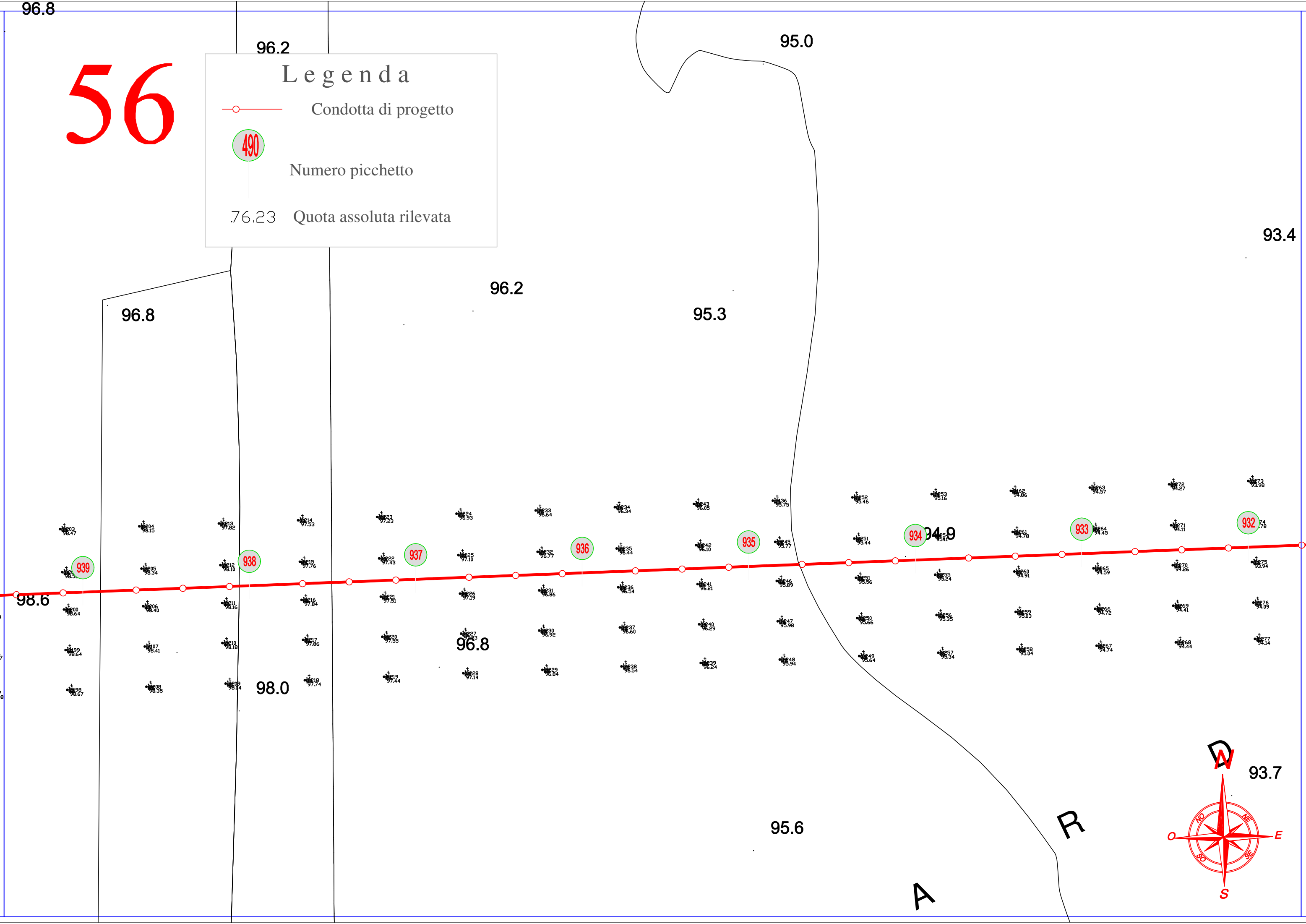

**Legenda**

- Condotta di progetto
- (490) Numero picchetto
- 76.23 Quota assoluta rilevata



# 57

### Legenda

-  Condotta di progetto
-  Numero picchetto
-  Quota assoluta rilevata

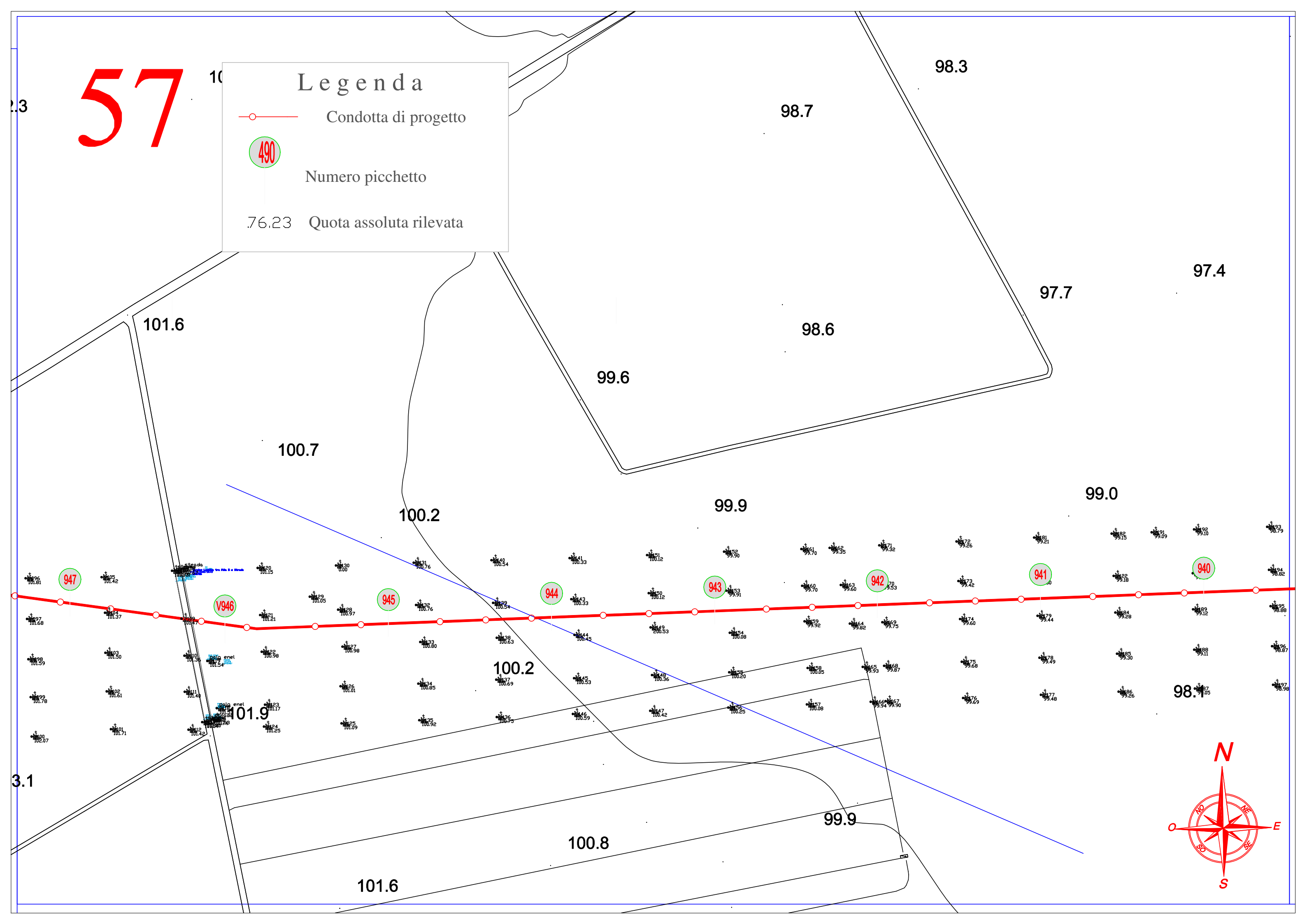



58

111.3

102.3

### Legenda

- Condotta di progetto
- ④ 490 Numero picchetto
- 76.23 Quota assoluta rilevata

FERROVIA

K.7

110.5

103.

109.9

102.5

N.655

102.1

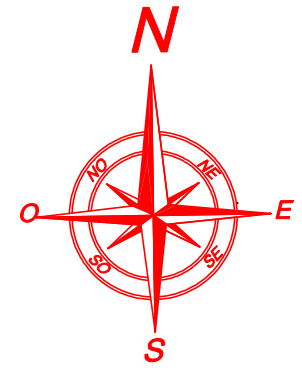

108.9

106.1

104.5

107.3

106.9

104.5

104.5

104.1

104.3

104.1

102.9

103.3

105.3

111.3

961

960

959

958

957

956

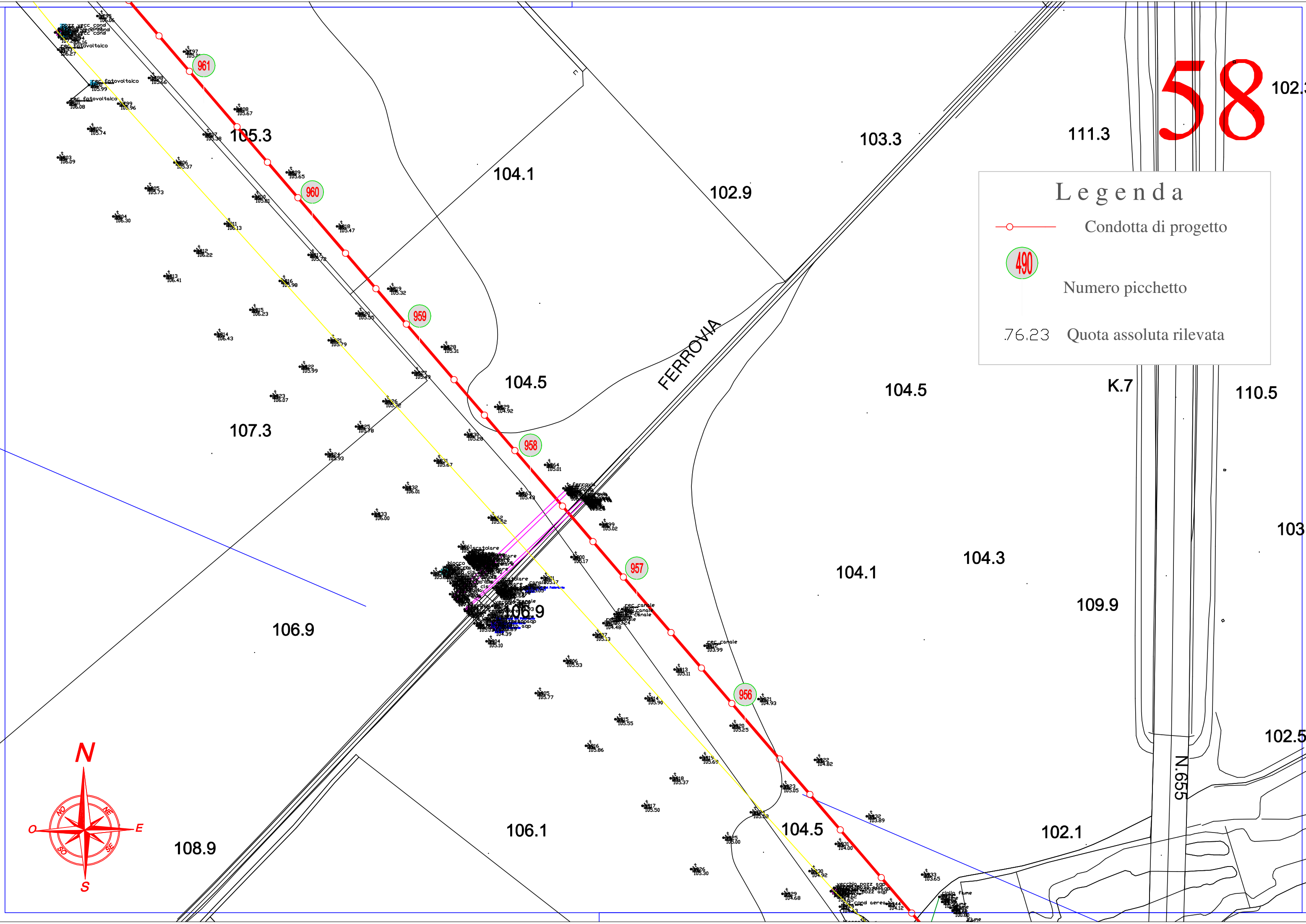



60  
107.7

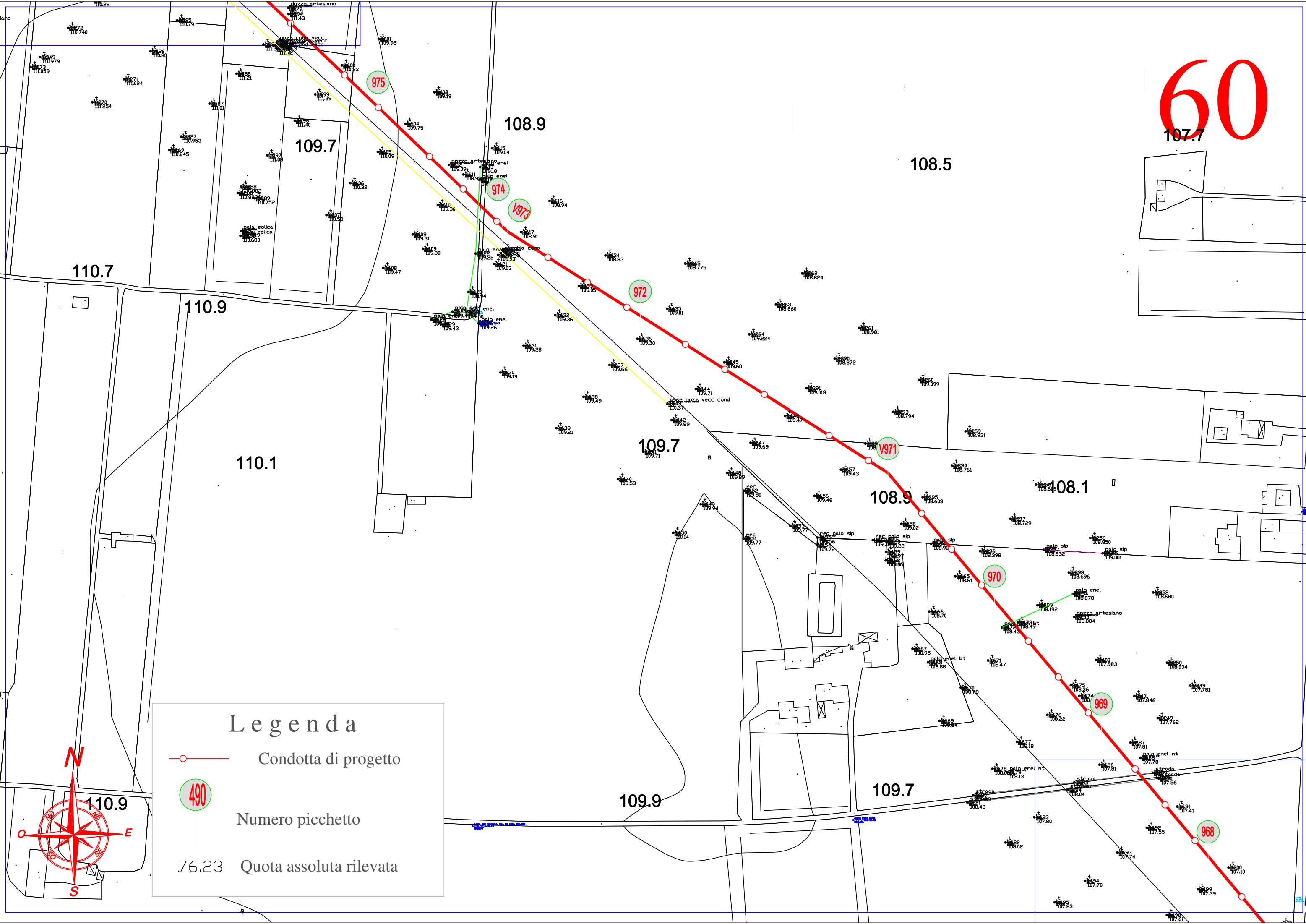

**Legenda**

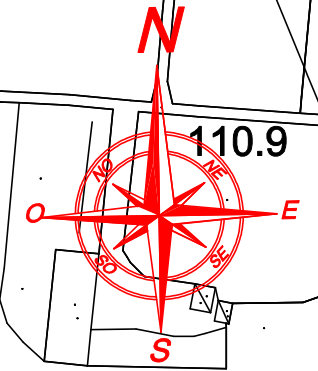

- Condotta di progetto
- 490 Numero picchetto
- 76.23 Quota assoluta rilevata





# 61

### Legenda

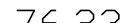
-  Condotta di progetto
-  Numero picchetto
-  Quota assoluta rilevata

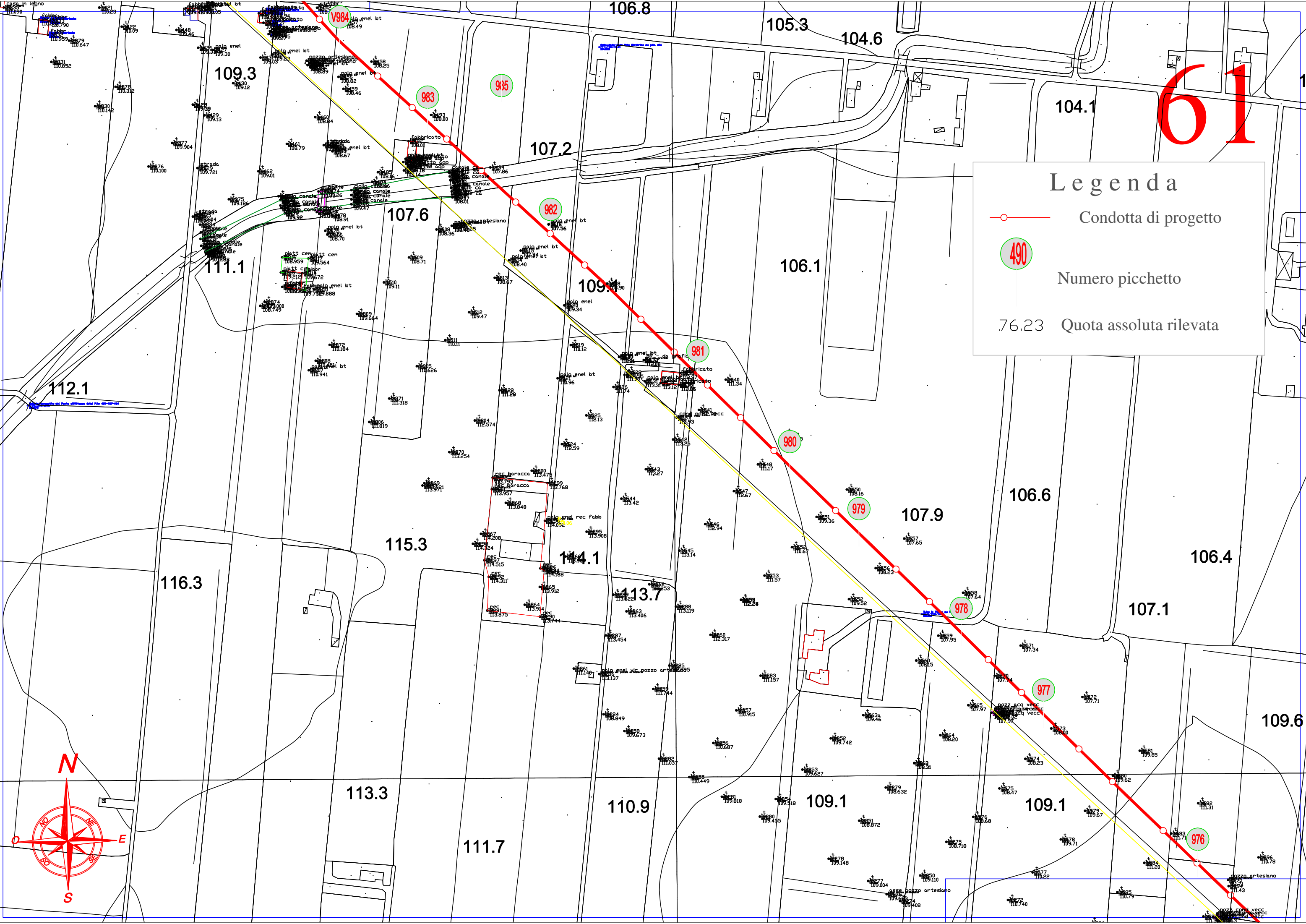

62

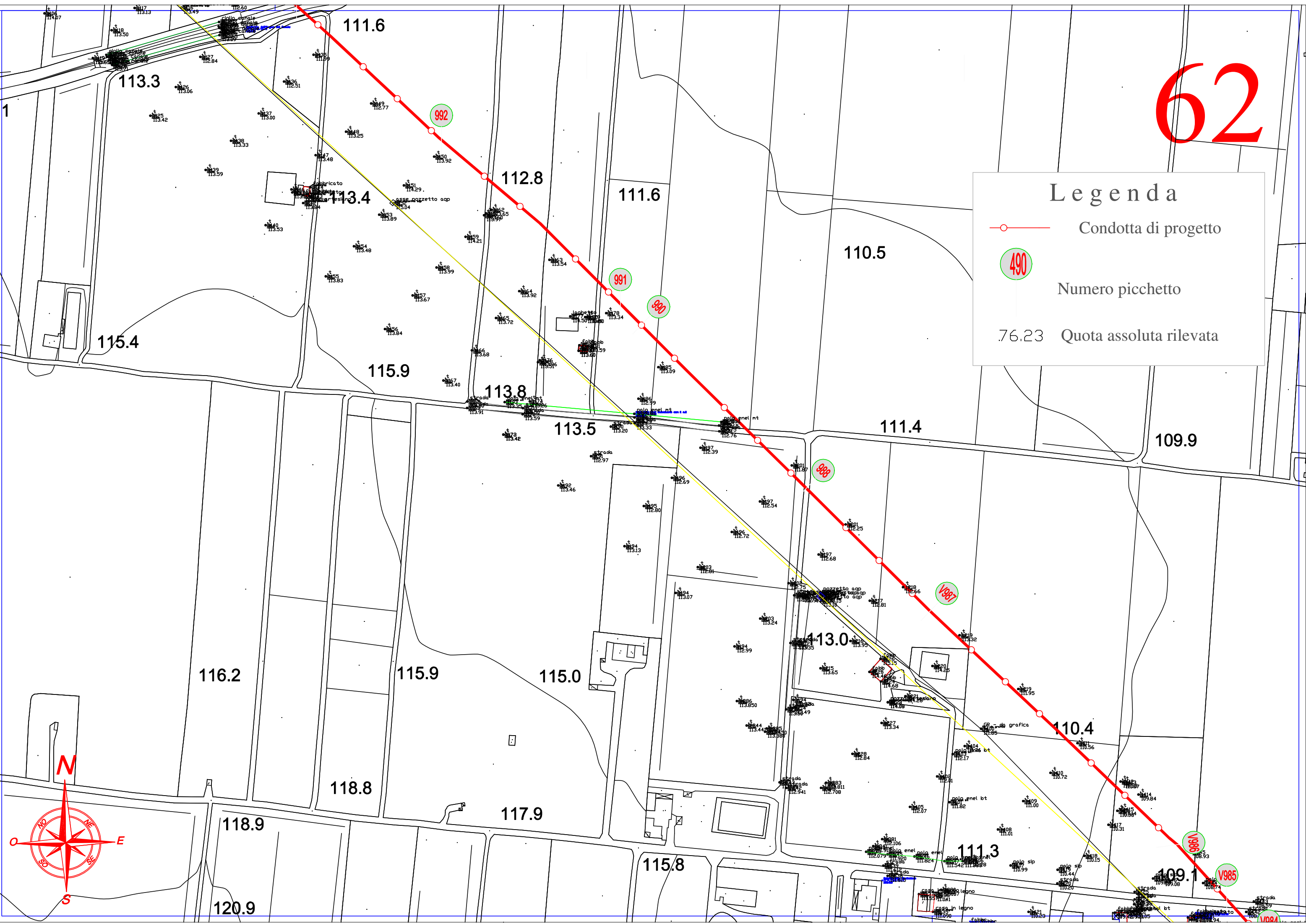

**Legenda**

- Condotta di progetto
- 490 Numero picchetto
- 76.23 Quota assoluta rilevata



63

### Legenda

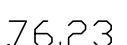

-  Condotta di progetto
-  Numero picchetto
-  76.23 Quota assoluta rilevata

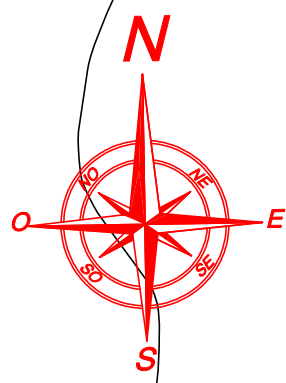
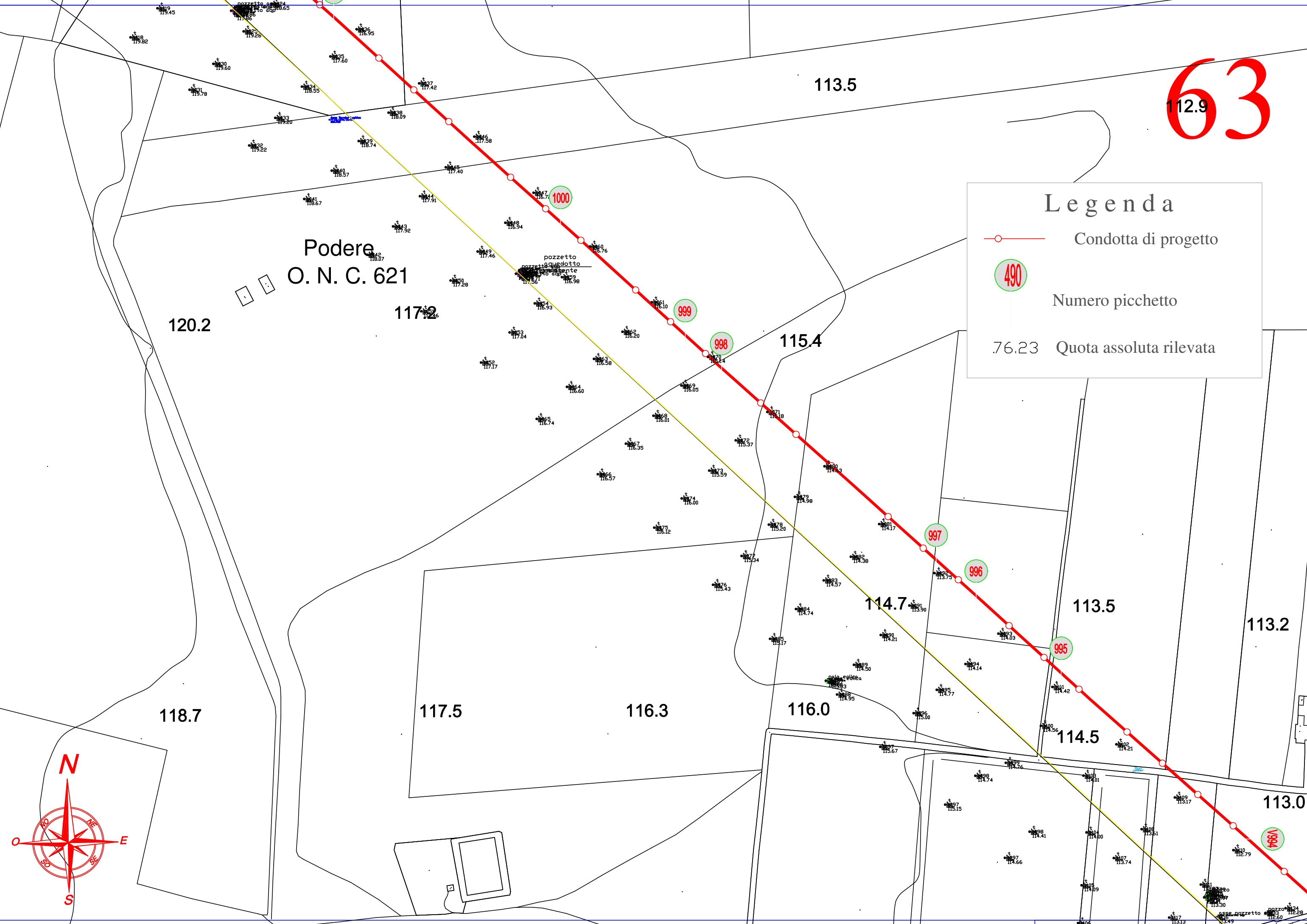
Podere  
O. N. C. 621



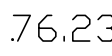

## Legenda

-  Condotta di progetto
-  Numero picchetto
-  Quota assoluta rilevata

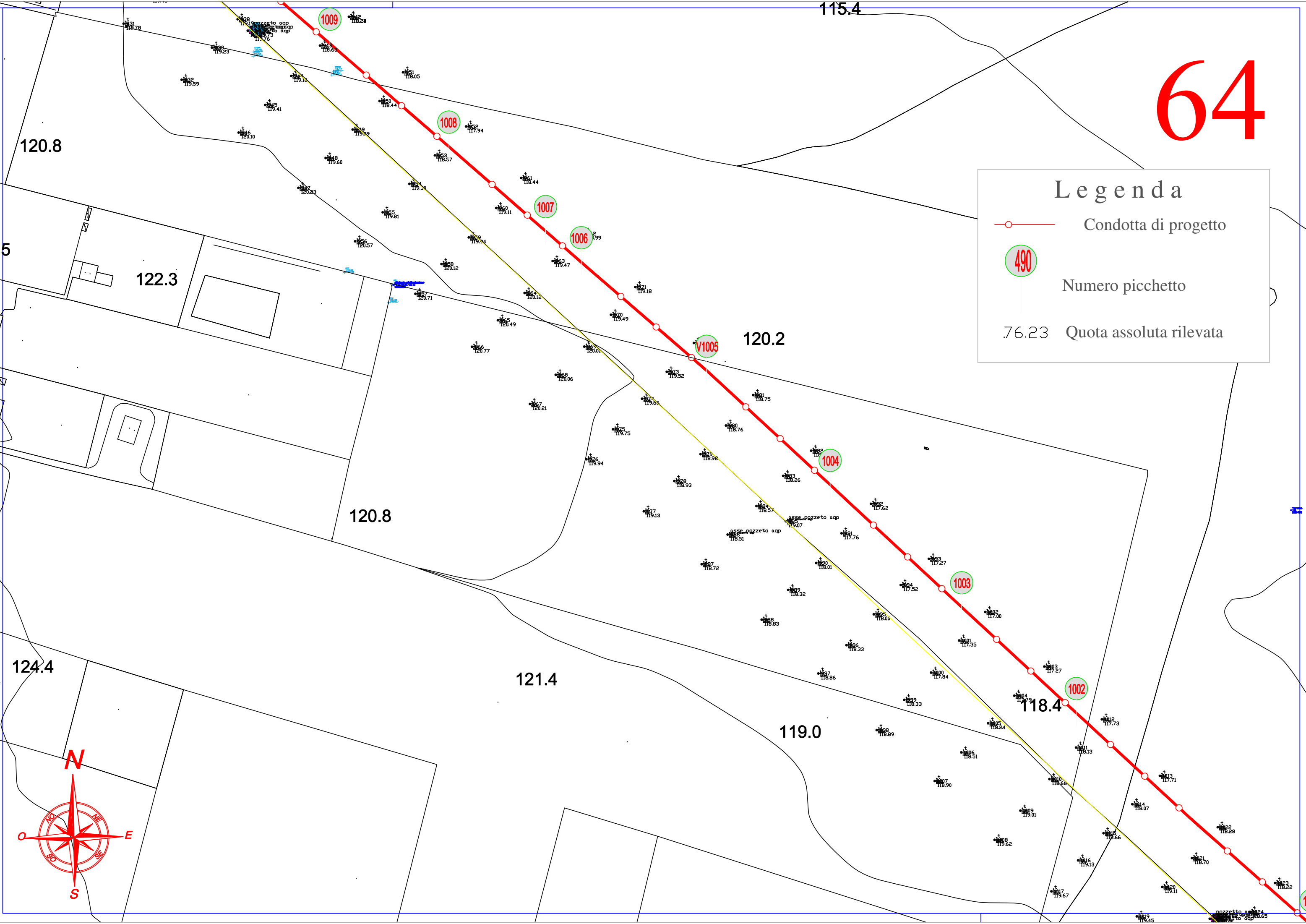



65

Podere  
O. N. C. 614

Masseria  
Tuoro di Massella

**Legenda**

-  Condotta di progetto
-  Numero picchetto
-  76.23 Quota assoluta rilevata

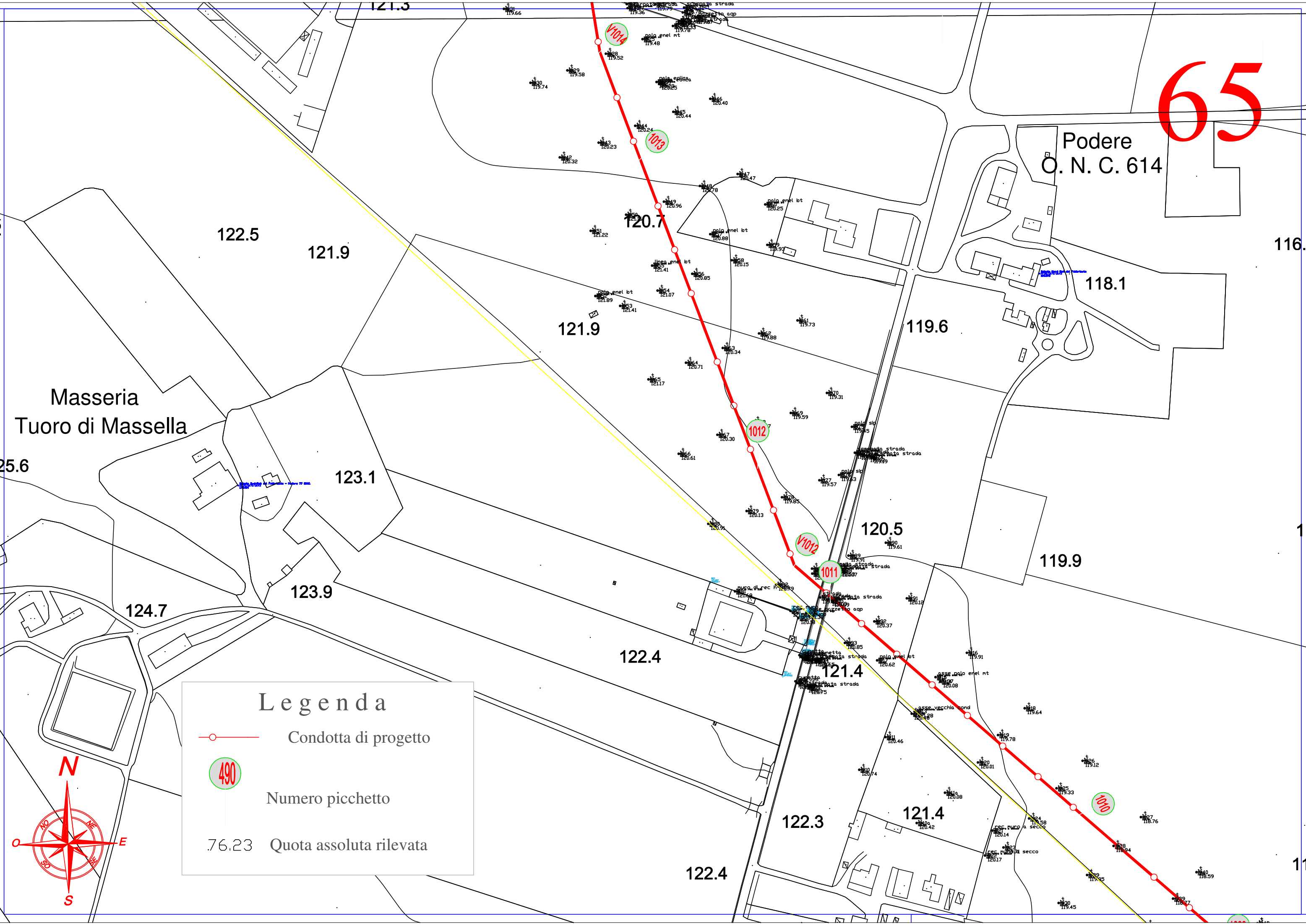
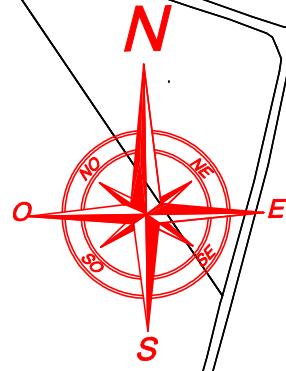

66 114.7

### Legenda

- Condotta di progetto
- 490 Numero picchetto
- 76.23 Quota assoluta rilevata

dere O. N. C. N. 72

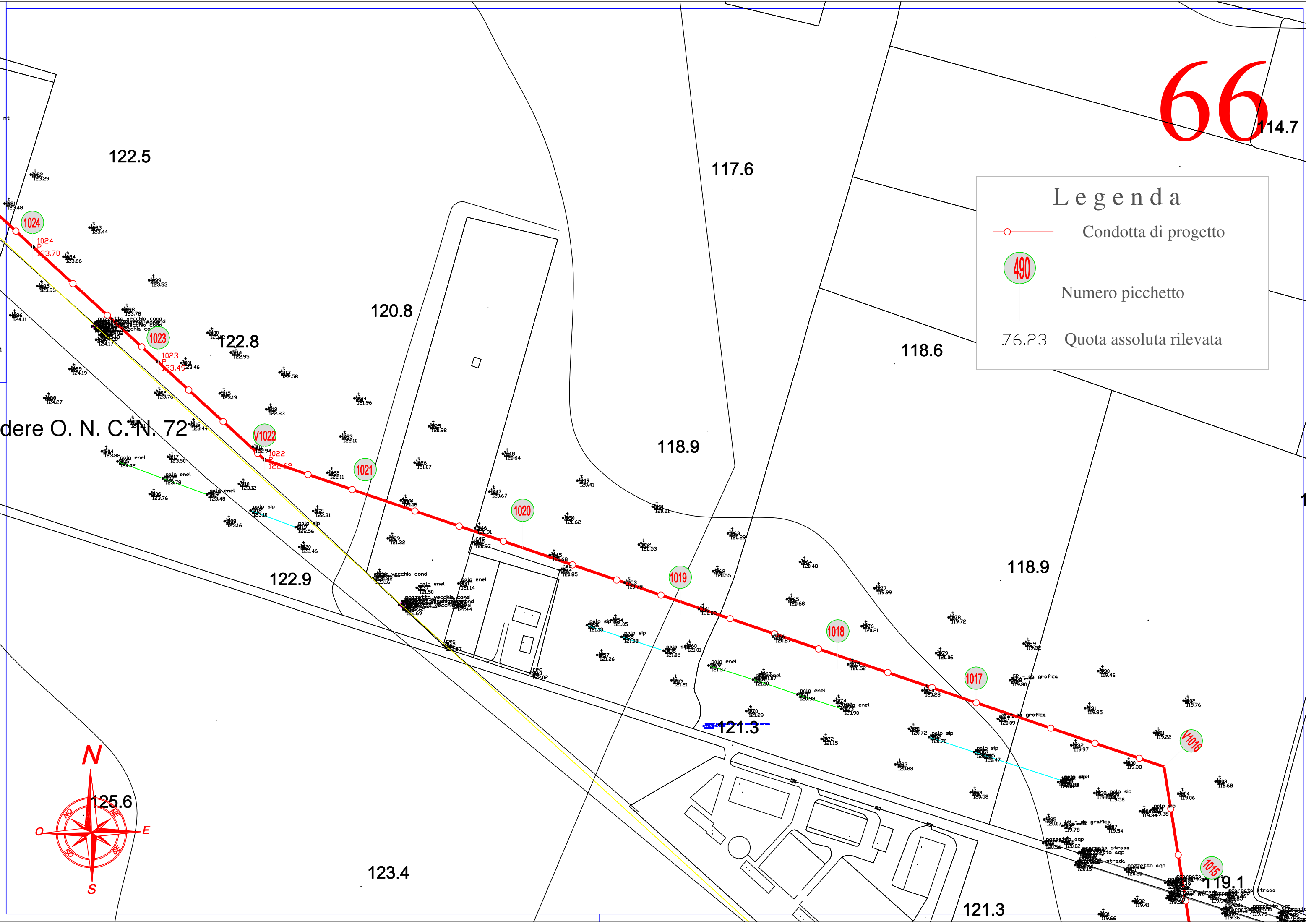
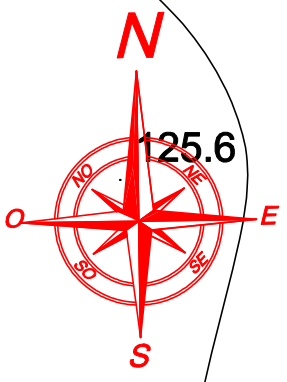



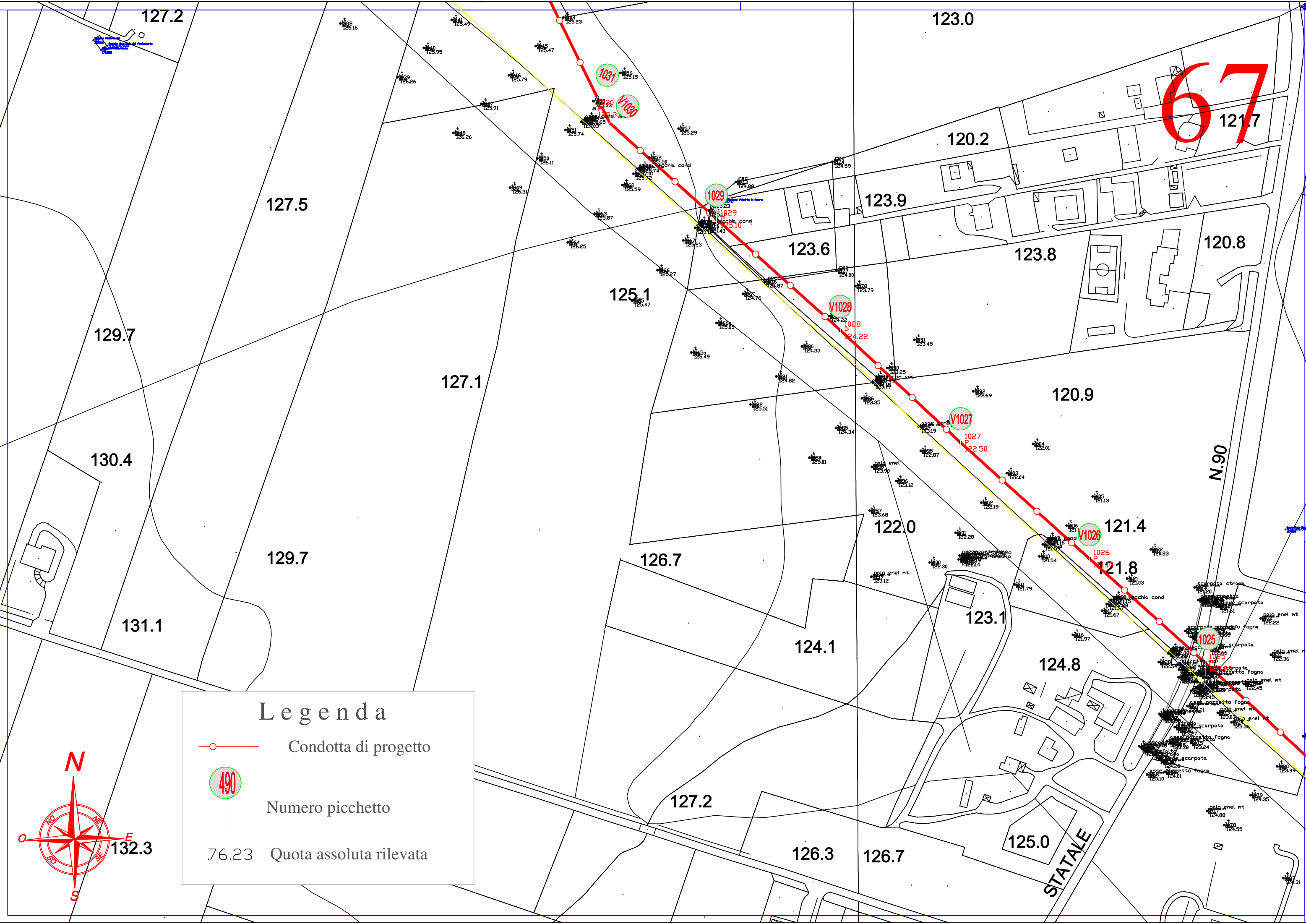

67

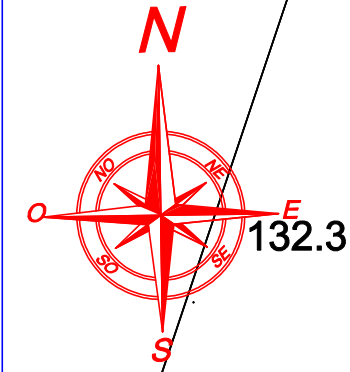

### Legenda

	Condotta di progetto
	Numero picchetto
76.23	Quota assoluta rilevata



68

### Legenda

-  Condotta di progetto
-  Numero picchetto
-  Quota assoluta rilevata

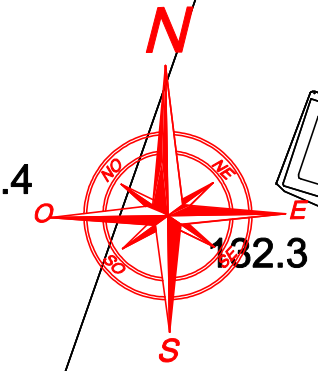
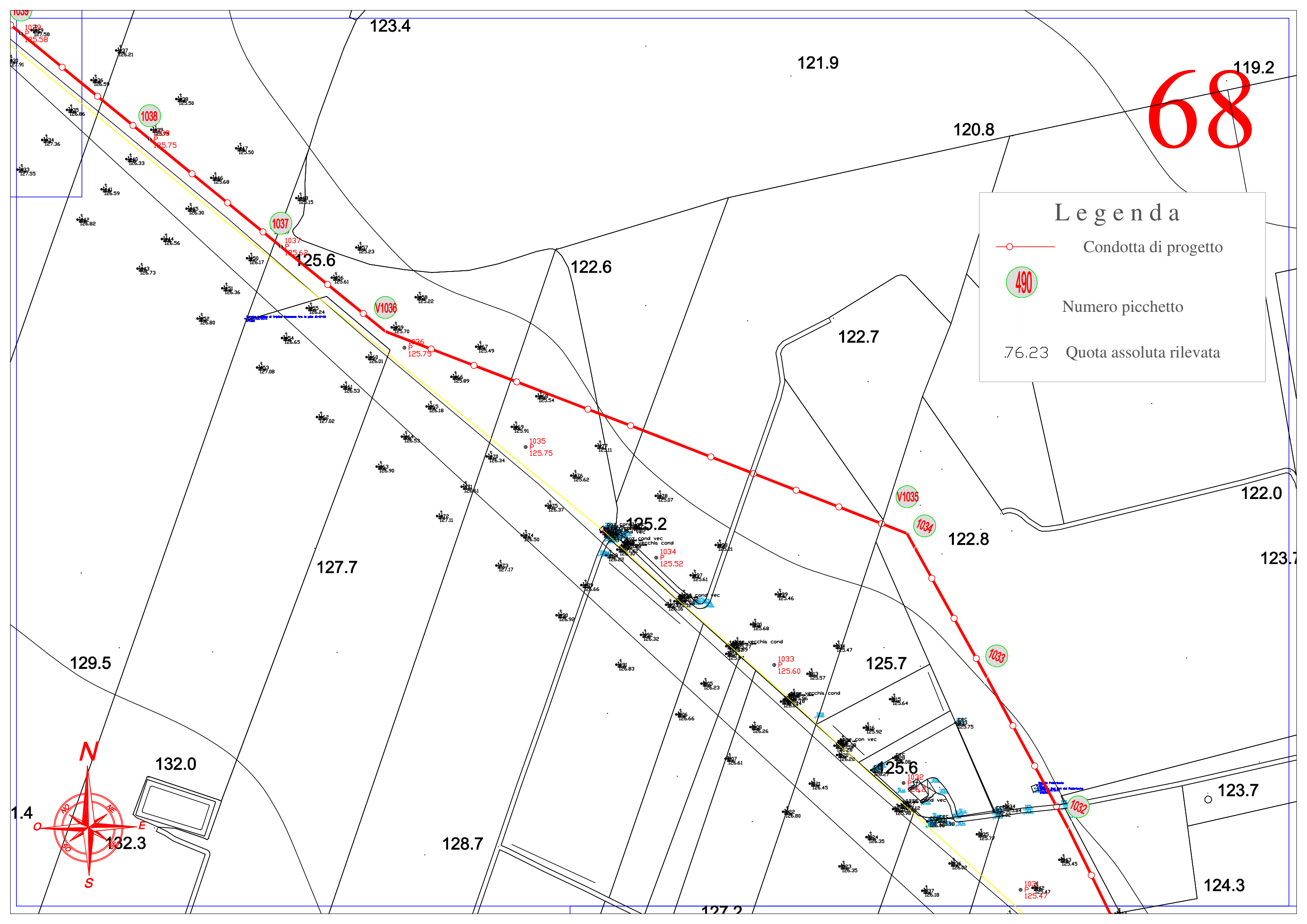

1.4  
132.3

123.4

121.9

119.2

120.8

1038

1037

125.6

122.6

V1036

125.75

122.7

122.0

125.2

V1035

1034

122.8

123.7

127.7

1033

129.5

125.7

132.0

128.7

125.6

123.7

124.3



127.2

28.6

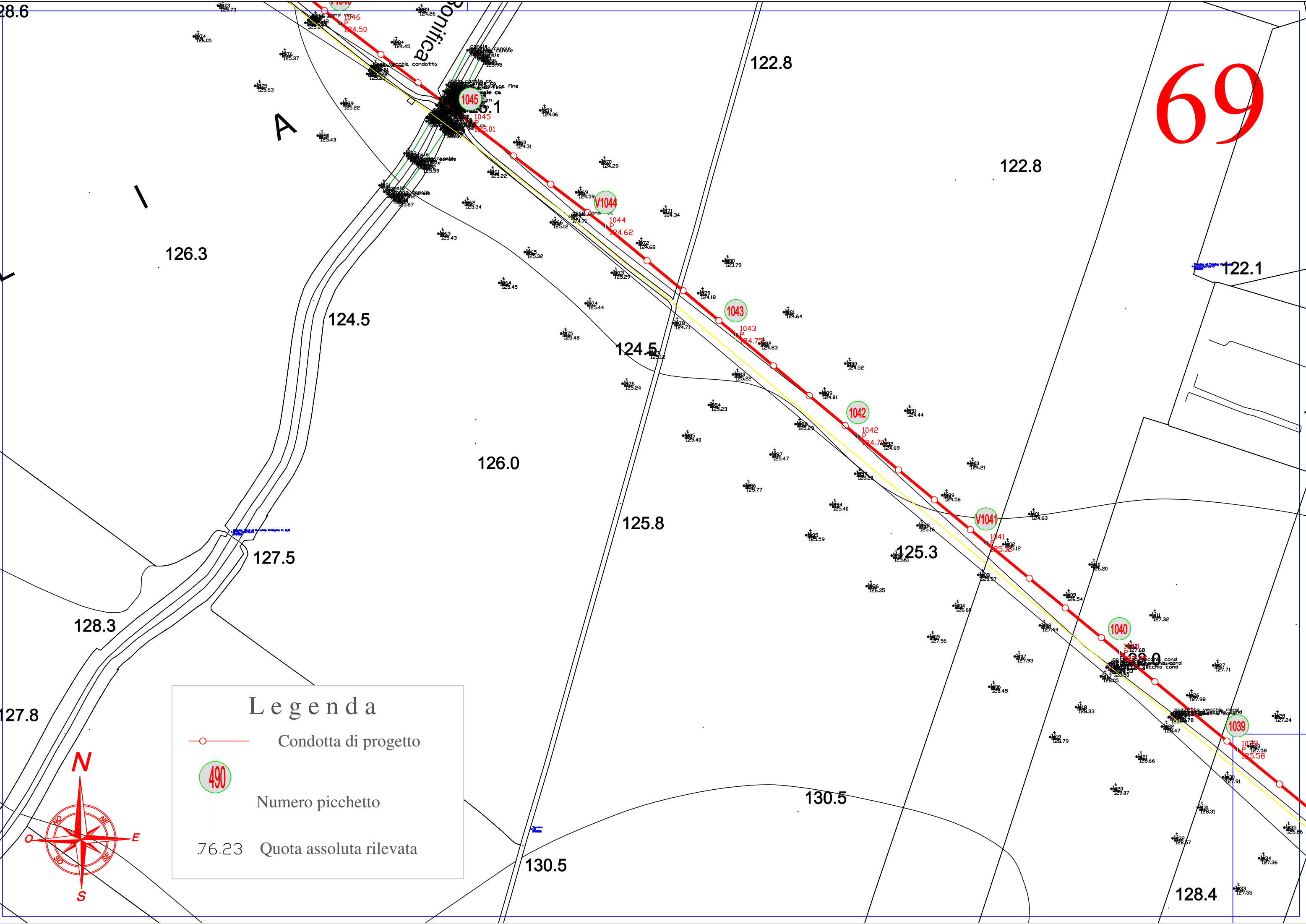
69



**Legenda**

-  Condotta di progetto
-  Numero picchetto
-  Quota assoluta rilevata

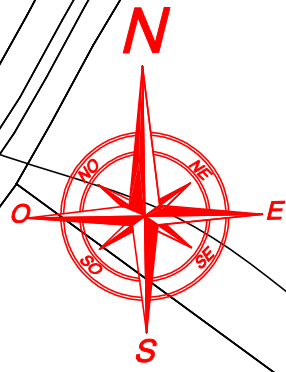



121.7  
**70**

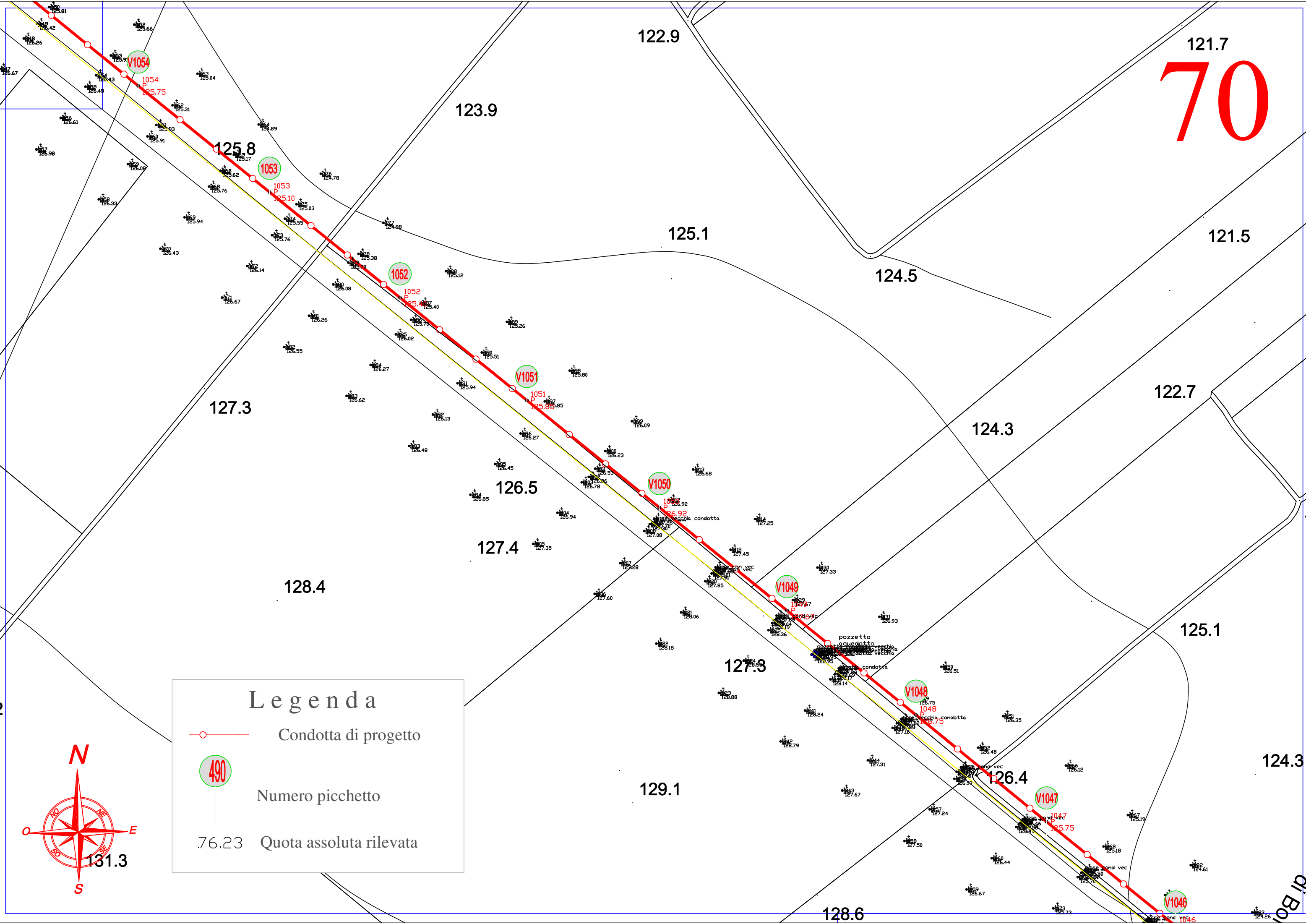

**Legenda**

- Condotta di progetto
- 490 Numero picchetto
- 76.23 Quota assoluta rilevata



di Boi

71

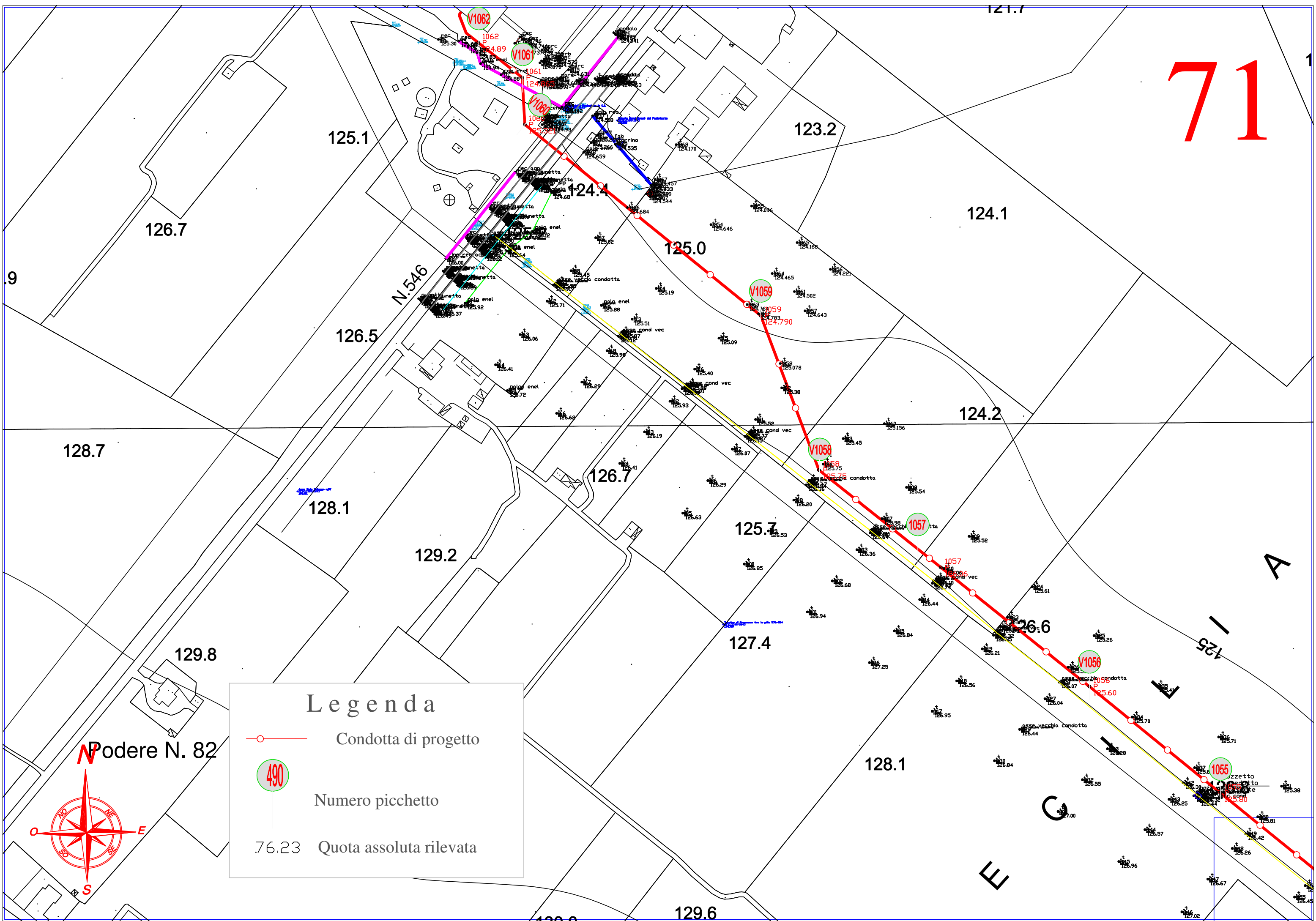

### Legenda

- Condotta di progetto
- 490 Numero picchetto
- .76.23 Quota assoluta rilevata

Podere N. 82

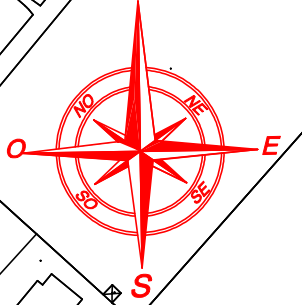

A

125

E

129.6

128.1

127.4

125.7

126.7

129.2

128.1

128.7

129.8

124.2

124.1

125.0

123.2

125.1

126.7

126.5

N.546

124.4

V1062

V1061

V1060

V1059

V1058

V1057

V1056

V1055

125.00

125.92

125.92

125.92

125.92

125.92

125.92

125.92

125.92

125.92

125.92

125.92

125.92

125.92

125.92

125.92

125.92

125.92

125.92

125.92

125.92

125.92

125.92