

ANAS S.p.A.

DIREZIONE CENTRALE PROGRAMMAZIONE PROGETTAZIONE

PA 12/09

CORRIDOIO PLURIMODALE TIRRENICO - NORD EUROPA

ITINERARIO AGRIGENTO - CALTANISSETTA - A19

S.S. N° 640 "DI PORTO EMPEDOCLE"

AMMODERNAMENTO E ADEGUAMENTO ALLA CAT. B DEL D.M. 5.11.2001

Dal km 44+000 allo svincolo con l'A19

PROGETTO ESECUTIVO

Contraente Generale:



OPERE D'ARTE MAGGIORI

GALLERIE ARTIFICIALI

Galleria Rovetello:

progr.2+720,00 (Ldx= 280,67 m; Lsx= 277,92 m)

Relazione di Calcolo

Codice Unico Progetto (CUP) : F91B09000070001

Codice Elaborato:

PA12_09 - E 1 0 8 GA 2 0 1 GA 0 1 Z C L 0 0 2 C

Scala:

F						
E						
D						
C	Ottobre 2011	Rif. Istruttoria prot. CDG-0141142-P del 19/10/11	E.MEDICO	R. CAPOCCHI	M. LITI	P. PAGLINI
B	Luglio 2011	Revisione a seguito di incontri con il Committente	L.BOCCUNI	R. CAPOCCHI	M. LITI	P. PAGLINI
A	Aprile 2011	EMISSIONE	L.BOCCUNI	A.TURSO	M. LITI	P. PAGLINI
REV.	DATA	DESCRIZIONE	REDATTO	VERIFICATO	APPROVATO	AUTORIZZATO
Responsabile del procedimento:			Ing. MAURIZIO ARAMINI			

Il Progettista:



Il Consulente Specialista:

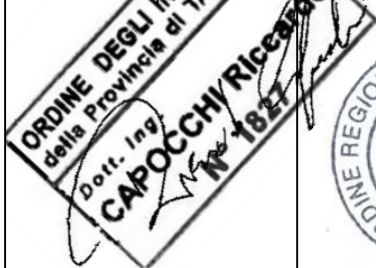

Geologo:



Il Coordinatore per la sicurezza in fase di progetto:



Il Direttore dei lavori:



**S.S. N° 640 "DI PORTO EMPEDOCLE"
AMMODERNAMENTO E ADEGUAMENTO
ALLA CAT. B DEL D.M. 5.11.2001
Dal km 44+000 allo svincolo con l'A19**

PROGETTO ESECUTIVO

OPERE D'ARTE MAGGIORI
GALLERIE ARTIFICIALI
GALLERIA ARTIFICIALE ROVETELLO
RELAZIONE DI CALCOLO

INDICE

INDICE.....	2
1. DESCRIZIONE DELLE OPERE.....	4
1.1. LE OPERE PROGETTATE.....	4
1.2. NORMATIVE DI RIFERIMENTO	5
1.3. DURABILITÀ E PRESCRIZIONI DEI MATERIALI	5
1.3.1. CLASSI DI ESPOSIZIONE AMBIENTALE.....	5
1.3.2. COPRIFERRO MINIMO E COPRIFERRO NOMINALE	8
1.3.3. CARATTERISTICHE DEI COSTITUENTI IL CALCESTRUZZO.....	9
1.3.4. CARATTERISTICHE DELLE MISCELE	10
1.4. CARATTERISTICHE GEOTECNICHE DEI TERRENI	11
1.4.1. TERRENO DI RICOPRIMENTO	11
1.4.2. TERRENI DI FONDAZIONE.....	11
1.5. DATI SISMICI.....	12
2. SCHEMATIZZAZIONE DEL MODELLO DI CALCOLO.....	14
2.1. ANALISI DELLA STRUTTURA	15
2.1.1. SEZIONE DI RIFERIMENTO	15
2.1.2. CALCOLO DELLE SPINTE	16
2.1.3. CONDIZIONI DI CARICO	17
2.2. COMBINAZIONI DI CARICO	21
2.2.1. DIAGRAMMI DELLE SOLLECITAZIONI	22
2.2.2. RIEPILOGO SOLLECITAZIONI MASSIME	23
2.2.3. ARMATURA DI CALCOLO.....	25
2.3. VERIFICHE.....	26
2.3.1. VERIFICA DI RESISTENZA	26
2.3.2. VERIFICA A FESSURAZIONE.....	26
2.3.3. VERIFICA DELLE TENSIONI DI ESERCIZIO.....	27
2.3.4. VERIFICHE A PRESSO-FLESSIONE	28
2.3.5. VERIFICHE A TAGLIO.....	55

<i>Cod. elab.:</i> 108GA201-GA01-Z-CL-002 C	<i>Titolo:</i> OPERE D'ARTE MAGGIORI- GALLERIE	<i>Data:</i> Ottobre 2011
<i>Nome file:</i> 108GA201-GA01-Z-CL -002_C.docx	ARTIFICIALI – GALLERIA ROVETELLO Relazione di calcolo	<i>Pagina</i> 2 di 452

3. VERIFICA DI STABILITÀ DELLO SCAVO	57
3.1.1. GENERALITÀ	57
3.1.2. DESCRIZIONE METODO DI CALCOLO	57
3.1.3. DESCRIZIONE TERRENO	59
3.1.4. PROFILO DEL PIANO CAMPAGNA	59
3.1.5. DESCRIZIONE STRATIGRAFIA	60
3.1.6. VERIFICA IN TERMINI DI TENSIONI EFFICACI.....	62
3.1.7. VERIFICA IN TERMINI DI TENSIONI TOTALI	63
4. CALCOLO PARATIA PROVVISORIALE	64
4.1. CARATTERISTICHE DEL SOFTWARE PAC10.0.....	64
4.1.1. SCHEMATIZZAZIONE DI CALCOLO.....	64
4.1.2. VERIFICHE.....	65
4.2. SINTESI DEI RISULTATI.....	65

<i>Cod. elab.:</i> 108GA201-GA01-Z-CL-002_C	<i>Titolo:</i> OPERE D'ARTE MAGGIORI- GALLERIE	<i>Data:</i> Ottobre 2011
<i>Nome file:</i> 108GA201-GA01-Z-CL -002_C.docx	ARTIFICIALI – GALLERIA ROVETELLO Relazione di calcolo	<i>Pagina</i> 3 di 452

1. DESCRIZIONE DELLE OPERE

Nel seguito si tratterà delle strutture in calcestruzzo armato relative alla realizzazione della Galleria artificiale Rovetello ubicata al km 2+720,00.

Nella relazione si descrivono i problemi di carattere strutturale che sono stati affrontati nel corso della progettazione e per essi vengono espone le modalità di soluzione e le procedure di calcolo adottate per la determinazione delle dimensioni delle strutture principali.

La relazione si completa mediante una serie di elaborati che consistono in tabelle schematiche riportanti le caratteristiche della sollecitazione utilizzate alla base della verifica degli elementi strutturali costituenti il manufatto, nonché le verifiche di resistenza dei materiali, eseguite nelle sezioni più significative e maggiormente sollecitate dei manufatti.

1.1. LE OPERE PROGETTATE

La galleria artificiale Rovetello si sviluppa tra il km 2+720.00 ed il km 2+999.55 lungo la carreggiata Agrigento – Caltanissetta per una lunghezza di 280.67 metri e tra il km 2+722.05 ed il km 3+001.09 lungo la carreggiata Caltanissetta - Agrigento per una lunghezza di 277.92 metri.

La geometria della galleria risulta del tutto simile a quella prevista nel progetto definitivo, infatti la sezione trasversale di ciascuna carreggiata è del tipo policentrica, composta da un arco superiore, (volta e piedritti) di raggio $R=6.45$ m, angolo di apertura pari a circa $119,49^\circ$ e spessore pari a 110 cm.

La fondazione è costituita da un solettone a spessore costante pari a 160 cm.

Il ritto centrale è a sezione variabile con un minimo di 110 cm.

L'altezza massima interna, posta in corrispondenza dell'asse della galleria, è di 9.70 m, mentre la massima larghezza interna risulta di 12.90 m.

L'imbocco presenta, in senso longitudinale, una conformazione a becco di flauto, in senso trasversale la stessa geometria della sezione corrente.

In corrispondenza dell'imbocco lato Agrigento la paratia MP14 si attesta con una quota della testa del cordolo coincidente con la quota di testa nella sezione di inizio del becco di flauto, pertanto la scarpata a monte della paratia si raccorderà con la scarpata a tergo della struttura di imbocco. In corrispondenza dell'imbocco lato Caltanissetta la paratia MP17 si attesta ad una quota coincidente con quella di testa del muro del becco di flauto dell'imbocco della galleria.

La realizzazione della galleria è prevista con scavo a cielo aperto su entrambi i lati nella parte iniziale e finale, mentre nel tratto centrale è prevista una paratia tipo berlinese con pali $\varnothing 1200$ posti ad interasse $i = 1.40$ m posta a protezione del terreno a monte della galleria per una lunghezza di 178.15 m tra le progressive km 2+772.03 e km 2+951.29 lungo la carreggiate Caltanissetta-Agrigento, mentre sul lato destro della galleria è previsto uno scavo a cielo aperto. Poiché tale opera risulta provvisoria si è trascurata l'azione sismica ed ai fini delle verifiche strutturali sono state trascurate le verifiche SLE.

<i>Cod. elab.:</i> 108GA201-GA01-Z-CL-002 C	<i>Titolo:</i> OPERE D'ARTE MAGGIORI- GALLERIE	<i>Data:</i> Ottobre 2011
<i>Nome file:</i> 108GA201-GA01-Z-CL -002_C.docx	ARTIFICIALI – GALLERIA ROVETELLO Relazione di calcolo	<i>Pagina</i> 4 di 452

1.2. NORMATIVE DI RIFERIMENTO

La progettazione degli elementi strutturali è stata condotta in conformità al quadro legislativo attualmente vigente in merito al dimensionamento delle strutture e per quanto riguarda la classificazione sismica del territorio nazionale. Le norme di riferimento adottate sono riportate nel seguito:

- D.M. 14/01/2008 « Norme Tecniche delle costruzioni »;
- Circolare n. 617/2009 « Istruzioni per l'applicazione delle Norme tecniche per le costruzioni »;
- O.P.C.M. n.3274 20/03/2003 « Primi elementi in materia di criteri generali per la classificazione sismica del territorio nazionale e di normative tecniche per le costruzioni in zona sismica » e s.m.i.;
- UNI EN 206-1:2006 « Calcestruzzo – Parte 1: Specificazione, prestazione, produzione e conformità »;
- UNI 11104:2004 « Calcestruzzo – Specificazione, prestazione, produzione e conformità – Istruzioni complementari per l'applicazione della EN 206-1 »;
- UNI EN 1992-1-1:2005 « Eurocodice 2 Progettazione delle strutture di calcestruzzo »;

1.3. DURABILITÀ E PRESCRIZIONI DEI MATERIALI

La forte importanza che riveste la durabilità dell'opera in funzione dell'ambiente nel quale è inserita, ha comportato una notevole attenzione alle tipologie dei materiali da utilizzarsi per le strutture da realizzare. Si consideri, infatti, che il manufatto deve garantire adeguati livelli di sicurezza anche dopo l'inevitabile degrado dei materiali dovuto al tempo ed all'azione degli agenti atmosferici.

Tutti questi elementi ambientali costituiscono dei fattori importantissimi dai quali non è possibile esulare quando si stabilisce la tipologia dei materiali che saranno impiegati per la realizzazione dell'opera, pensando questo nell'ottica di garantire alla stessa una vita media compatibile con l'investimento che si sta realizzando.

1.3.1. Classi di esposizione ambientale

Ai fini di una corretta prescrizione del calcestruzzo, occorre classificare l'ambiente nel quale ciascun elemento strutturale sarà inserito. Per "ambiente", in questo contesto, si intende l'insieme delle azioni chimico-fisiche alle quali si presume che potrà essere esposto il calcestruzzo durante il periodo di vita delle opere e che causa effetti che non possono essere classificati come dovuti a carichi o ad azioni indirette quali deformazioni impresse, cedimenti e variazioni termiche.

In funzione di tali azioni, sono individuate le classi e sottoclassi di esposizione ambientale del calcestruzzo elencate nella tabella che segue.

<i>Cod. elab.:</i> 108GA201-GA01-Z-CL-002 C	<i>Titolo:</i> OPERE D'ARTE MAGGIORI- GALLERIE	<i>Data:</i> Ottobre 2011
<i>Nome file:</i> 108GA201-GA01-Z-CL -002_C.docx	ARTIFICIALI – GALLERIA ROVETELLO Relazione di calcolo	<i>Pagina</i> 5 di 452

PROGETTO ESECUTIVO

Classi di esposizione per calcestruzzo strutturale, in funzione delle condizioni ambientali secondo norma UNI 11104:2004 e UNI EN 206-1:2006

Classe esposizione norma UNI 9858	Classe esposizione norma UNI 11104 UNI EN 206 -1	Descrizione dell'ambiente	Esempio	Massimo rapporto a/c	Minima Classe di resistenza	Contenuto minimo in aria (%)
1 Assenza di rischio di corrosione o attacco						
1	X0	Per calcestruzzo privo di armatura o inserti metallici: tutte le esposizioni eccetto dove c'è gelo/disgelo, o attacco chimico. Calcestruzzi con armatura o inserti metallici: in ambiente molto asciutto.	Interno di edifici con umidità relativa molto bassa. Calcestruzzo non armato all'interno di edifici. Calcestruzzo non armato immerso in suolo non aggressivo o in acqua non aggressiva. Calcestruzzo non armato soggetto a cicli di bagnato asciutto ma non soggetto ad abrasione, gelo o attacco chimico.	-	C 12/15	
2 Corrosione indotta da carbonatazione						
Nota - Le condizioni di umidità si riferiscono a quelle presenti nel copriferro o nel ricoprimento di inserti metallici, ma in molti casi su può considerare che tali condizioni riflettano quelle dell'ambiente circostante. In questi casi la classificazione dell'ambiente circostante può essere adeguata. Questo può non essere il caso se c'è una barriera fra il calcestruzzo e il suo ambiente.						
2 a	XC1	Asciutto o permanentemente bagnato.	Interni di edifici con umidità relativa bassa. Calcestruzzo armato ordinario o precompresso con le superfici all'interno di strutture con eccezione delle parti esposte a condensa, o immerse in acqua.	0,60	C 25/30	
2 a	XC2	Bagnato, raramente asciutto.	Parti di strutture di contenimento liquidi, fondazioni. Calcestruzzo armato ordinario o precompresso prevalentemente immerso in acqua o terreno non aggressivo.	0,60	C 25/30	
5 a	XC3	Umidità moderata.	Calcestruzzo armato ordinario o precompresso in esterni con superfici esterne riparate dalla pioggia, o in interni con umidità da moderata ad alta.	0,55	C 28/35	
4 a 5 b	XC4	Ciclicamente asciutto e bagnato.	Calcestruzzo armato ordinario o precompresso in esterni con superfici soggette a alternanze di asciutto ed umido. Calcestruzzi a vista in ambienti urbani. Superfici a contatto con l'acqua non comprese nella classe XC2.	0,50	C 32/40	
3 Corrosione indotta da cloruri esclusi quelli provenienti dall'acqua di mare						
5 a	XD1	Umidità moderata.	Calcestruzzo armato ordinario o precompresso in superfici o parti di ponti e viadotti esposti a spruzzi d'acqua contenenti cloruri.	0,55	C 28/35	
4 a 5 b	XD2	Bagnato, raramente asciutto.	Calcestruzzo armato ordinario o precompresso in elementi strutturali totalmente immersi in acqua anche industriale contenete cloruri (Piscine).	0,50	C 32/40	
5 c	XD3	Ciclicamente bagnato e asciutto.	Calcestruzzo armato ordinario o precompresso, di elementi strutturali direttamente soggetti agli agenti disgelanti o agli spruzzi contenenti agenti disgelanti. Calcestruzzo armato ordinario o precompresso, elementi con una superficie immersa in acqua contenente cloruri e l'altra esposta all'aria. Parti di ponti, pavimentazioni e parcheggi per auto.	0,45	C 35/45	

Cod. elab.: 108GA201-GA01-Z-CL-002_C	Titolo: OPERE D'ARTE MAGGIORI- GALLERIE	Data: Ottobre 2011
Nome file: 108GA201-GA01-Z-CL -002_C.docx	ARTIFICIALI – GALLERIA ROVETELLO	Pagina 6 di 452
Relazione di calcolo		

PROGETTO ESECUTIVO

Classe esposizione norma UNI 9858	Classe esposizione norma UNI 11104 UNI EN 206 -1	Descrizione dell'ambiente	Esempio	Massimo rapporto a/c	Minima Classe di resistenza	Contenuto minimo in aria (%)
4 Corrosione indotta da cloruri presenti nell'acqua di mare						
4 a 5 b	XS1	Esposto alla salsedine marina ma non direttamente in contatto con l'acqua di mare .	Calcestruzzo armato ordinario o precompresso con elementi strutturali sulle coste o in prossimità.	0,50	C 32/40	
	XS2	Permanentemente sommerso.	Calcestruzzo armato ordinario o precompresso di strutture marine completamente immersi in acqua.	0,45	C 35/45	
	XS3	Zone esposte agli spruzzi o alle marea.	Calcestruzzo armato ordinario o precompresso con elementi strutturali esposti alla battigia o alle zone soggette agli spruzzi ed onde del mare.	0,45	C 35/45	
5 Attacco dei cicli di gelo/disgelo con o senza disgelanti *						
2 b	XF1	Moderata saturazione d'acqua, in assenza di agente disgelante.	Superfici verticali di calcestruzzo come facciate e colonne esposte alla pioggia ed al gelo. Superfici non verticali e non soggette alla completa saturazione ma esposte al gelo, alla pioggia o all'acqua.	0,50	C 32/40	
3	XF2	Moderata saturazione d'acqua, in presenza di agente disgelante.	Elementi come parti di ponti che in altro modo sarebbero classificati come XF1 ma che sono esposti direttamente o indirettamente agli agenti disgelanti.	0,50	C 25/30	3,0
2 b	XF3	Elevata saturazione d'acqua, in assenza di agente disgelante	Superfici orizzontali in edifici dove l'acqua può accumularsi e che possono essere soggetti ai fenomeni di gelo, elementi soggetti a frequenti bagnature ed esposti al gelo.	0,50	C 25/30	3,0
3	XF4	Elevata saturazione d'acqua, con presenza di agente antigelo oppure acqua di mare.	Superfici orizzontali quali strade o pavimentazioni esposte al gelo ed ai sali disgelanti in modo diretto o indiretto, elementi esposti al gelo e soggetti a frequenti bagnature in presenza di agenti disgelanti o di acqua di mare.	0,45	C 28/35	3,0
6 Attacco chimico**						
5 a	XA1	Ambiente chimicamente debolmente aggressivo secondo il prospetto 2 della UNI EN 206-1	Contenitori di fanghi e vasche di decantazione. Contenitori e vasche per acque reflue.	0,55	C 28/35	
4 a 5 b	XA2	Ambiente chimicamente moderatamente aggressivo secondo il prospetto 2 della UNI EN 206-1	Elementi strutturali o pareti a contatto di terreni aggressivi.	0,50	C 32/40	
5 c	XA3	Ambiente chimicamente fortemente aggressivo secondo il prospetto 2 della UNI EN 206-1	Elementi strutturali o pareti a contatto di acque industriali fortemente aggressive. Contenitori di foraggi, mangimi e liquame provenienti dall'allevamento animale. Torri di raffreddamento di fumi di gas di scarico industriali.	0,45	C 35/45	
*) Il grado di saturazione della seconda colonna riflette la relativa frequenza con cui si verifica il gelo in condizioni di saturazione: - moderato: occasionalmente gelato in condizione di saturazione; - elevato: alta frequenza di gelo in condizioni di saturazione. **) Da parte di acque del terreno e acque fluenti.						

Tabella 1.1: Classi di esposizione e requisiti minimi del calcestruzzo in funzione della classe d'esposizione

Le resistenze caratteristiche R_{ck} della tabella precedente sono da considerarsi quelle minime in relazione agli usi indicati in funzione della classe di esposizione. Le miscele non presenteranno un contenuto di cemento minore di 280 kg/m^3 . La definizione di una soglia minima per il dosaggio di cemento, risponde all'esigenza di garantire in ogni caso una sufficiente quantità di pasta di cemento, condizione essenziale per ottenere un calcestruzzo indurito a struttura chiusa e poco permeabile. Nelle normali condizioni operative, il rispetto dei valori di R_{ck} e a/c della tabella precedente può comportare dosaggi di cemento anche sensibilmente più elevati del valore minimo indicato.

Cod. elab.: 108GA201-GA01-Z-CL-002 C	Titolo: OPERE D'ARTE MAGGIORI- GALLERIE	Data: Ottobre 2011
Nome file: 108GA201-GA01-Z-CL -002_C.docx	ARTIFICIALI – GALLERIA ROVETELLO	Pagina 7 di 452
Relazione di calcolo		

Facendo riferimento alla tabella precedente, la classe di esposizione attribuita ai vari elementi strutturali costituenti le opere è così riassunta:

- Elemento della galleria: XA2;
- Pali paratie: XA2.

CARATTERISTICHE DEI MATERIALI

- Elementi della galleria: C 35/45 N/mm² ;
- Pali paratie: C 32/40 N/mm²;
- Miscele per iniezioni tiranti: C 20/25 N/mm².

Acciaio per armature ordinarie: Tipo B450C

- Modulo di elasticità di Joung (E) 210.000 N/mm²;
- Tensione caratteristica di snervamento $f_{y\text{nom}}$ 450 N/mm²;
- Tensione caratteristica di rottura $f_{t\text{nom}}$ 540 N/mm².

Acciaio per trefoli:

- Tensione caratteristica all'1% della deformazione totale $f_{p(1)k}$ 1670 N/mm²;
- Tensione caratteristica di rottura f_{pk} 1860 N/mm²;
- Diametro trefoli 0.6''.

Acciaio per carpenterie metalliche: Tipo S355J0

- Tensione caratteristica di snervamento f_{yk} 355 N/mm² (per spessori ≤ 40 mm);
- Tensione caratteristica di rottura f_{tk} 510 N/mm² (per spessori ≤ 40 mm).
- Tensione caratteristica di snervamento f_{yk} 335 N/mm² (per spessori > 40 mm);
- Tensione caratteristica di rottura f_{tk} 470 N/mm² (per spessori > 40 mm).

1.3.2. Copriferro minimo e copriferro nominale

Ai fini di preservare le armature dai fenomeni di aggressione ambientale, dovrà essere previsto un idoneo copriferro; il suo valore, misurato tra la parete interna del cassero e la generatrice dell'armatura metallica più vicina, individua il cosiddetto "copriferro nominale" c_{nom} , che vale:

$$c_{\text{nom}} = c_{\text{min}} + h.$$

dove:

c_{min} e il copriferro minimo derivante da esigenze di durabilità,

Cod. elab.: 108GA201-GA01-Z-CL-002 C	Titolo: OPERE D'ARTE MAGGIORI- GALLERIE	Data: Ottobre 2011
Nome file: 108GA201-GA01-Z-CL -002_C.docx	ARTIFICIALI – GALLERIA ROVETELLO	Pagina 8 di 452
Relazione di calcolo		

h è la tolleranza di posizionamento.

I valori di copriferro minimo sono indicati nella tabella seguente in funzione di:

- classe di esposizione ambientale,
- resistenza caratteristica del calcestruzzo a 28 gg,
- tipo di elemento strutturale

La tolleranza di posizionamento delle armature h viene assunta pari a 10 mm.

CONDIZIONI AMBIENTALI	CLASSE DI ESPOSIZIONE
Ordinarie	XC0, XC1, XC2, XC3, XF1
Aggressive	XC4, XD1, XS1, XA1, XA2, XF2, XF3
Molto aggressive	XD2, XD3, XS2, XS3, XA3, XF4

Tabella 1.2: Descrizione delle condizioni ambientali

C _{min}	C _e	ambiente	barre da c.a. elementi a piastra		barre da c.a. altri elementi		cavi da c.a.p. elementi a piastra		cavi da c.a.p. altri elementi	
			C _e > C _{min}	C _{min} ≤ C _e < C _e	C _e > C _{min}	C _{min} ≤ C _e < C _e	C _e > C _{min}	C _{min} ≤ C _e < C _e	C _e > C _{min}	C _{min} ≤ C _e < C _e
C25/30	C35/45	ordinario	15	20	20	25	25	30	30	35
C28/35	C40/50	aggressivo	25	30	30	35	35	40	40	45
C35/45	C45/55	molto ag.	35	40	40	45	45	50	50	50

Tabella 1.3: Copriferri minimi in mm

Considerando la classe di esposizione ambientale delle diverse sottostrutture, si dovranno adoperare dei copriferri adeguati come prescritti nella tavola delle prescrizioni dei materiali allegata al progetto. Nel caso specifico sarà:

- Copriferro elementi galleria: 6 cm;
- Copriferro pali paratia: 5 cm.

1.3.3. Caratteristiche dei costituenti il calcestruzzo

Cemento

Si utilizzeranno unicamente i cementi previsti nella Legge 26 Maggio 1965 n° 595 che soddisfino i requisiti di accettazione elencati nella norma UNI ENV 197/1, con esclusione del cemento alluminoso e dei cementi per sbarramenti di ritenuta.

Acqua d'impasto

L'acqua d'impasto, di provenienza nota, dovrà avere caratteristiche costanti nel tempo, conformi a quelle della norma UNI EN 1008.

Cod. elab.: 108GA201-GA01-Z-CL-002_C	Titolo: OPERE D'ARTE MAGGIORI- GALLERIE	Data: Ottobre 2011
Nome file: 108GA201-GA01-Z-CL -002_C.docx	ARTIFICIALI – GALLERIA ROVETELLO	Pagina 9 di 452
Relazione di calcolo		

Aggregati

Gli aggregati impiegati per il confezionamento del calcestruzzo dovranno avere caratteristiche conformi a quelle previste nella parte 1^a della norma UNI 8520. Le caratteristiche dovranno essere verificate in fase di qualifica delle miscele. In caso di fornitura di aggregati da parte di azienda dotata di Sistema Qualità certificato secondo norme UNI EN ISO 9000, saranno ritenuti validi i risultati delle prove effettuate dall'Azienda.

1.3.4. Caratteristiche delle miscele

Granulometria degli aggregati

Per la realizzazione di calcestruzzi con classi di resistenza maggiori di C 12/15 gli aggregati dovranno appartenere ad almeno tre classi granulometriche diverse. Nella composizione della curva granulometrica nessuna frazione sarà dosata in percentuale maggiore del 55%, salvo preventiva autorizzazione del Direttore dei Lavori.

Le classi granulometriche saranno mescolate tra loro in percentuali tali da formare miscele rispondenti ai criteri di curve granulometriche di riferimento, teoriche o sperimentali, scelte in modo che l'impasto fresco e indurito abbia i prescritti requisiti di resistenza, consistenza, omogeneità, aria inglobata, permeabilità, ritiro e acqua essudata. Si dovrà adottare una curva granulometrica che, in relazione al dosaggio di cemento, garantisca la massima compattezza e la migliore lavorabilità del calcestruzzo.

Dimensione massima nominale dell'aggregato

La massima dimensione nominale dell'aggregato è scelta in funzione dei valori di copriferro ed interferro, delle dimensioni minime dei getti, delle modalità di getto e del tipo di mezzi d'opera utilizzati per la compattazione dei getti; come previsto nel punto 5.4. della norma UNI 9858, la dimensione massima nominale dell'aggregato non dovrà essere maggiore:

- di un quarto della dimensione minima dell'elemento strutturale;
- della distanza tra le singole barre di armatura o tra gruppi di barre d'armatura (interferro) diminuita di 5 mm;
- di 1,3 volte lo spessore del copriferro che vale 30 mm.

Dalla analisi dei dati citati si evince che la massima dimensione dell'inerte non potrà superare i 40 mm di diametro.

Rapporto acqua/cemento

La quantità d'acqua totale da impiegare per il confezionamento dell'impasto dovrà essere calcolata tenendo conto dell'acqua libera contenuta negli aggregati. Si dovrà fare riferimento alla norma UNI 8520 parti 13^a e 16^a per la condizione "satura a superficie asciutta", nella quale l'aggregato non assorbe né cede acqua all'impasto. Facendo riferimento inoltre alla classe di esposizione ambientale, il rapporto acqua cemento non potrà superare il valore $a/c = 0,60$.

<i>Cod. elab.:</i> 108GA201-GA01-Z-CL-002_C	<i>Titolo:</i> OPERE D'ARTE MAGGIORI- GALLERIE	<i>Data:</i> Ottobre 2011
<i>Nome file:</i> 108GA201-GA01-Z-CL -002_C.docx	ARTIFICIALI – GALLERIA ROVETELLO Relazione di calcolo	<i>Pagina</i> 10 di 452

1.4. CARATTERISTICHE GEOTECNICHE DEI TERRENI

In questo paragrafo, sono indicate le caratteristiche fisiche e meccaniche dei terreni in sito e di riporto per la realizzazione del rilevato stradale (utilizzati per la determinazione della spinta agente sulle strutture).

1.4.1. Terreno di ricoprimento

▶ Peso di volume del terreno.....	19,00	kN/m ³
▶ Peso di volume saturo del terreno.....	20,00	kN/m ³
▶ Angolo di attrito interno.....	35°	
▶ Angolo di attrito terra- muro.....	23.33°	
▶ Coesione	0.00	Mpa

1.4.2. Terreni di fondazione

I terreni di fondazione interessanti l'opera possono essere caratterizzati con i parametri seguenti:

Profondità (m)	Litotipo	Parametri Geotecnici
0.00 ÷ 7.00	<u>Complesso argilloso sommitale – AL1:</u> argilla limo - sabbiosa alterata, plastica	$\gamma = 1.80$ T/mc
		$C_u = 0.4$ Kg/cmq
		$c' = 0.1$ Kg/cmq
		$\phi' = 17.4^\circ$
7.0 ÷ 15.00	<u>Complesso argilloso intermedio – AL2:</u> argilla limo- sabbiosa di colore grigio az- zurro consistente a tratti scagliosa.	$\gamma = 1.88$ T/mc
		$C_u = 1.10$ Kg/cmq
		$c' = 0.24$ Kg/cmq
		$\phi' = 21^\circ$
15.00 ÷ in prof.	<u>Complesso argilloso profondo – AL3:</u> argilla limo- sabbiosa di colore grigio az- zurro consistente a tratti scagliosa.	$\gamma = 1.92$ T/mc
		$C_u = 1.19$ Kg/cmq
		$c' = 0.34$ Kg/cmq
		$\phi' = 16.9^\circ$

Per il calcolo della resistenza caratteristica dei pali di fondazioni profonde, occorre utilizzare i fattori di correlazione desumibili dalla tabella 6.4.IV allegata al D.M. 14/01/2008 di seguito riportata, in funzione dei sondaggi eseguiti.

Numero di verticali indagate	1	2	3	4	5	7	>=10
ξ_3	1,70	1,65	1,60	1,55	1,50	1,45	1,40
ξ_4	1,70	1,55	1,48	1,42	1,34	1,28	1,21

Tab. 6.4.IV

(n.10 sondaggi utilizzati per il calcolo dei parametri AL1-AL2-AL3, n.1 sondaggio per il calcolo dei parametri CL2)

Così come indicato nella relazione geologica, si ha che in corrispondenza di tale opera non sussistono le condizioni per la formazione di acquiferi e relativa falda.

Cod. elab.: 108GA201-GA01-Z-CL-002 C	Titolo: OPERE D'ARTE MAGGIORI- GALLERIE	Data: Ottobre 2011
Nome file: 108GA201-GA01-Z-CL -002_C.docx	ARTIFICIALI – GALLERIA ROVETELLO	Pagina 11 di 452
Relazione di calcolo		

1.5. DATI SISMICI

DATI SISMICI DI CALCOLO

VITA NOMINALE:

VN = 100 anni

TIPI DI COSTRUZIONE		Vita Nominale V _N (in anni)
1	Opere provvisorie – Opere provvisionali - Strutture in fase costruttiva ¹	≤ 10
2	Opere ordinarie, ponti, opere infrastrutturali e dighe di dimensioni contenute o di importanza normale	≥ 50
3	Grandi opere, ponti, opere infrastrutturali e dighe di grandi dimensioni o di importanza strategica	≥ 100

CLASSE D'USO: IV
 COEFFICIENTE D'USO 2.00

Tab. 2.4.II – Valori del coefficiente d'uso C_U

CLASSE D'USO	I	II	III	IV
COEFFICIENTE C _U	0,7	1,0	1,5	2,0

Risposta sismica locale

Categoria di sottosuolo **B** info S_B = 1.200 C_C = 1.247 info
 Categoria topografica **T1** info h/H = 0.000 S_T = 1.000 info
(h=quota sito, H=altezza rilievo topografico)

Compon. orizzontale

Spettro di progetto elastico (SLE) Smorzamento ξ (%) 5 γ = 1.000 info
 Spettro di progetto inelastico (SLU) Fattore q₀ 1 Regol. in altezza **no** info

Compon. verticale

Spettro di progetto Fattore q 1 γ = 1.000 info

Categoria	Descrizione
A	Ammassi rocciosi affioranti o terreni molto rigidi caratterizzati da valori di V _{s,30} superiori a 800 m/s, eventualmente comprendenti in superficie uno strato di alterazione, con spessore massimo pari a 3 m.
B	Rocce tenere e depositi di terreni a grana grossa molto addensati o terreni a grana fina molto consistenti con spessori superiori a 30 m, caratterizzati da un graduale miglioramento delle proprietà meccaniche con la profondità e da valori di V _{s,30} compresi tra 360 m/s e 800 m/s (ovvero N _{SPT,30} > 50 nei terreni a grana grossa e c _{u,30} > 250 kPa nei terreni a grana fina).
C	Depositi di terreni a grana grossa mediamente addensati o terreni a grana fina mediamente consistenti con spessori superiori a 30 m, caratterizzati da un graduale miglioramento delle proprietà meccaniche con la profondità e da valori di V _{s,30} compresi tra 180 m/s e 360 m/s (ovvero 15 < N _{SPT,30} < 50 nei terreni a grana grossa e 70 < c _{u,30} < 250 kPa nei terreni a grana fina).
D	Depositi di terreni a grana grossa scarsamente addensati o di terreni a grana fina scarsamente consistenti, con spessori superiori a 30 m, caratterizzati da un graduale miglioramento delle proprietà meccaniche con la profondità e da valori di V _{s,30} inferiori a 180 m/s (ovvero N _{SPT,30} < 15 nei terreni a grana grossa e c _{u,30} < 70 kPa nei terreni a grana fina).
E	Terreni dei sottosuoli di tipo C o D per spessore non superiore a 20 m, posti sul substrato di riferimento (con V _s > 800 m/s).

Tabella 1.4: Categorie di sottosuolo

Cod. elab.: 108GA201-GA01-Z-CL-002_C	Titolo: OPERE D'ARTE MAGGIORI- GALLERIE	Data: Ottobre 2011
Nome file: 108GA201-GA01-Z-CL-002_C.docx	ARTIFICIALI – GALLERIA ROVETELLO	Pagina 12 di 452
Relazione di calcolo		

PARAMETRI SPETTRO DI RISPOSTA

Per la verifica sismica delle strutture si prende in considerazione lo stato limite ultimo di salvaguardia della Vita (SLV).

Parametri indipendenti

STATO LIMITE	SLV
a_d	0.108 g
F_{o_x}	2.748
T_C	0.535 s
S_s	1.200
C_C	1.247
S_T	1.000
q	0.800

Parametri dipendenti

S	1.200
γ	1.250
T_B	0.222 s
T_C	0.667 s
T_D	2.033 s

<i>Cod. elab.:</i> 108GA201-GA01-Z-CL-002_C	<i>Titolo:</i> OPERE D'ARTE MAGGIORI- GALLERIE	<i>Data:</i> Ottobre 2011
<i>Nome file:</i> 108GA201-GA01-Z-CL -002_C.docx	ARTIFICIALI – GALLERIA ROVETELLO Relazione di calcolo	<i>Pagina</i> 13 di 452

2. SCHEMATIZZAZIONE DEL MODELLO DI CALCOLO

L'analisi strutturale per la galleria è stata eseguita considerando la fase definitiva, quando cioè il ritombamento della galleria risulta già avvenuto. Pertanto, oltre ai pesi propri ed alle spinte dei terreni, si considera agente sulla galleria nella fase finale anche i sovraccarichi stradali e le azioni sismiche opportunamente combinate come indicato dalla normativa vigente.

Il calcolo delle sollecitazioni agenti nell'elemento strutturale viene eseguito mediante l'ausilio di un software di calcolo dedicato: SAP 2000 V10.

Per le verifiche strutturali si utilizza un modello tridimensionale f.e.m., schematizzando tutti gli elementi della galleria con elementi di tipo "frame" posizionati in corrispondenza dell'asse del relativo elemento strutturale e dotati ciascuno della corrispondente area ed inerzia, secondo il metodo degli elementi finiti. Il terreno viene modellato mediante molle alla Winkler con proprietà variabili in funzione della quota dal piano compagna.

Nella configurazione iniziale indeformata si suppongono agenti sui piedritti le spinte del terreno esistente sia nella combinazione A1-M1 che nella combinazione A2-M2 per le varie fasi definite. Nelle figure seguenti si riporta una vista 3d del modello e la corrispondente vista piana. Il sistema di riferimento presenta l'asse Z verticale, l'asse X è l'asse orizzontale nel piano che contiene il modello che schematizza la galleria artificiale e l'asse Y è ortogonale al piano XZ.



Figura 2.1: Vista 3D del modello di calcolo della galleria

<i>Cod. elab.:</i> 108GA201-GA01-Z-CL-002_C	<i>Titolo:</i> OPERE D'ARTE MAGGIORI- GALLERIE	<i>Data:</i> Ottobre 2011
<i>Nome file:</i> 108GA201-GA01-Z-CL -002_C.docx	ARTIFICIALI – GALLERIA ROVETELLO	<i>Pagina</i> 14 di 452
	Relazione di calcolo	

PROGETTO ESECUTIVO

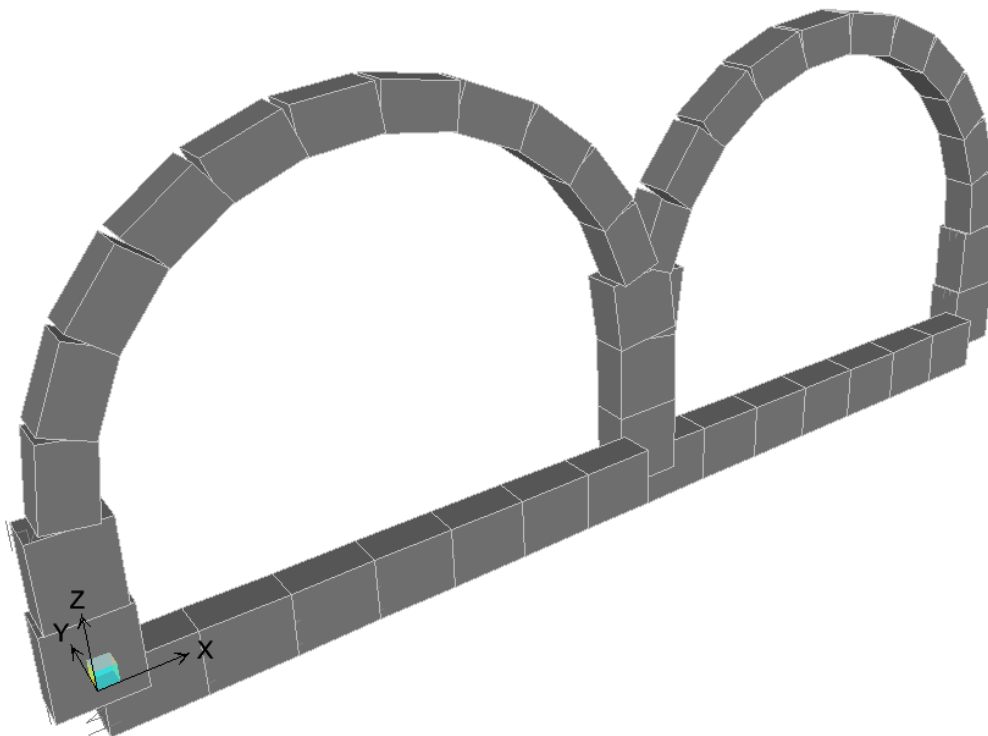

Figura 2.2: Vista frontale del modello di calcolo della galleria

2.1. ANALISI DELLA STRUTTURA

2.1.1. SEZIONE DI RIFERIMENTO

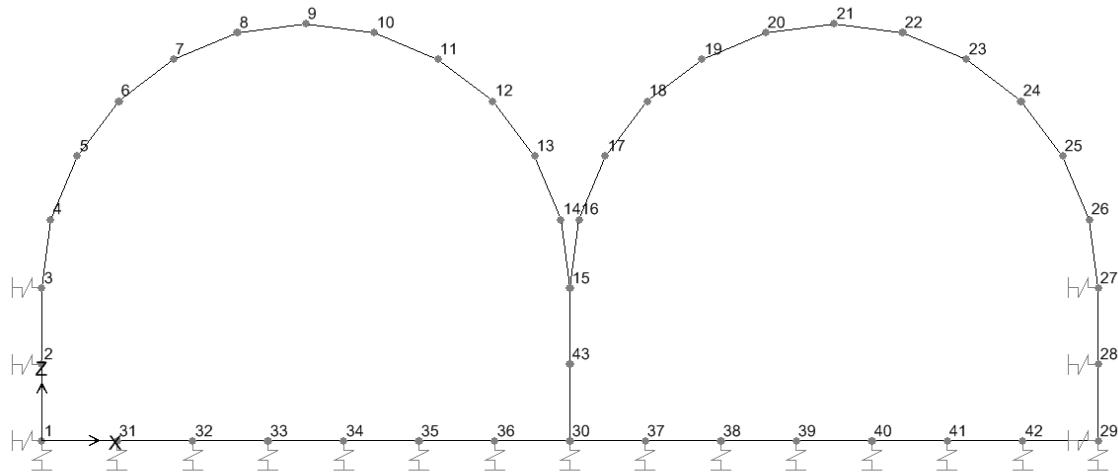
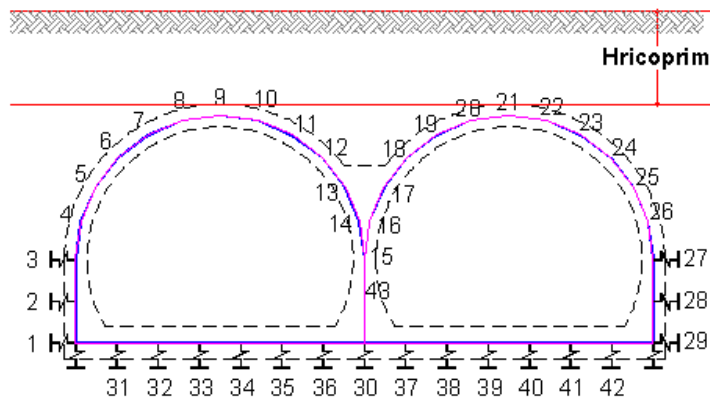
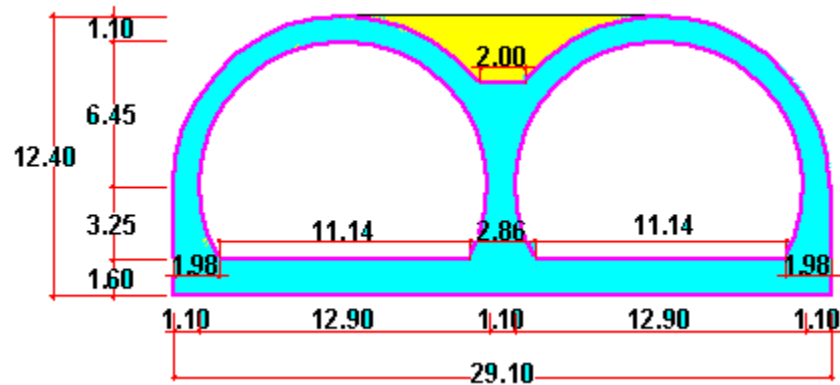

Cod. elab.: 108GA201-GA01-Z-CL-002 C	Titolo: OPERE D'ARTE MAGGIORI- GALLERIE	Data: Ottobre 2011
Nome file: 108GA201-GA01-Z-CL -002_C.docx	ARTIFICIALI – GALLERIA ROVETELLO	Pagina 15 di 452
Relazione di calcolo		

PROGETTO ESECUTIVO

2.1.2. Calcolo delle spinte

DATI	
γ	20.00 kN/mc
φ	35.00 °
δ	0.00 °
incl	0 °
H ricopri	4.50 m
ΔZ falda	-3.00 m da p.c.

PARAMETRI SISMICI	
ag / g	0.108
S = S _s - St	1.200
kh	0.130
kv	0.065

CAR. ACCID. SU TERRENO	
q	20.000 kN/mq

PARAM. CALCOLATI	
$\mu\phi$	1.25
H spinta	15.55 m
ϕ prog	29.26 °
R ^{stat}	559.99 kN
R ^{sis} Z ⁺	842.86 kN
R ^{sis} Z ⁻	902.73 kN

	COEFF DI SPINTA			
	SENZA FALDA		SOTTO FALDA	
	STR	GEO	STR	GEO
θ^-	0.138	0.138	0.270	0.270
θ^+	0.121	0.121	0.239	0.239
ka	0.271	0.343	0.271	0.343
kae- (Z ⁻)	0.352	0.436	0.458	0.560
kae+ (Z ⁻)	0.341	0.423	0.429	0.526
ko	0.426	0.511	0.426	0.511

NOME CONDIZIONE SAP	
PESO-TERR	
S ATTIVA 1	
S ATTIVA 2	
S RIPOSO 1	
S ACCID 1	
S ACCID 2	
S SISM Z ⁺	
S SISM Z ⁻	

Joint	XorR m	Y m	Z m	Δx m	Δz m	PESI			SPINTE											
						u kPa	σ_v kPa	σ_v kPa	terreno		accid.		S. terr attiva		S. terr. a riposo		S. accid a riposo		IncrS. sismica	
									σ_{a1} kPa	σ_{a2} kPa	σ_{o1} kPa	σ_{o2} kPa	$\sigma' q1$ kPa	$\sigma' q2$ kPa	$\sigma' EZ^+$ kPa	$\sigma' EZ^-$ kPa				
1	0.00	0.00	0.00	0.00	1.01	125.50	311.00	20.00	175.77	189.21	204.60	220.34	8.53	10.23	18.19	22.04				
2	0.00	0.00	2.03	0.00	2.03	105.25	270.50	20.00	150.03	162.00	175.72	189.74	8.53	10.23	18.19	22.04				
3	0.00	0.00	4.05	0.12	1.92	95.00	230.00	20.00	124.29	134.80	146.83	159.14	8.53	10.23	18.19	22.04				
4	0.24	0.00	5.86	0.47	1.75	66.88	193.77	20.00	101.27	110.46	120.99	131.76	8.53	10.23	18.19	22.04				
5	0.94	0.00	7.55	0.91	1.57	50.00	160.00	20.00	79.81	87.78	96.91	106.24	8.53	10.23	18.19	22.04				
6	2.05	0.00	9.00	1.28	1.28	35.50	131.01	20.00	61.38	68.30	76.23	84.33	8.53	10.23	18.19	22.04				
7	3.50	0.00	10.11	1.57	0.91	24.38	108.76	20.00	47.24	53.36	60.36	67.52	8.53	10.23	18.19	22.04				
8	5.19	0.00	10.81	1.75	0.47	17.39	94.77	20.00	38.36	43.96	50.38	56.95	8.53	10.23	18.19	22.04				
9	7.00	0.00	11.05	1.81	0.00	15.00	90.00	20.00	35.32	40.76	46.98	53.35	8.53	10.23	18.19	22.04				
10	8.81	0.00	10.81	1.75	-0.47	17.39	94.77	20.00	38.36	43.96	50.38	56.95	8.53	10.23	18.19	22.04				
11	10.50	0.00	10.11	1.57	-0.91	24.38	108.76	20.00	47.24	53.36	60.36	67.52	8.53	10.23	18.19	22.04				
12	11.95	0.00	9.00	1.28	-1.28	35.50	131.01	20.00	61.38	68.30	76.23	84.33	8.53	10.23	18.19	22.04				
13	13.06	0.00	7.55	0.91	-1.57	50.00	160.00	20.00	79.81	87.78	96.91	106.24	8.53	10.23	18.19	22.04				
14	13.76	0.00	5.86	0.47	-1.75	66.88	193.77	20.00	101.27	110.46	120.99	131.76	8.53	10.23	18.19	22.04				
15	14.00	0.00	4.05	0.24	0.00	95.00	230.00	20.00	124.29	134.80	146.83	159.14	8.53	10.23	18.19	22.04				
16	14.24	0.00	5.86	0.47	1.75	66.88	193.77	20.00	101.27	110.46	120.99	131.76	8.53	10.23	18.19	22.04				
17	14.94	0.00	7.55	0.91	1.57	50.00	160.00	20.00	79.81	87.78	96.91	106.24	8.53	10.23	18.19	22.04				
18	16.05	0.00	9.00	1.28	1.28	35.50	131.01	20.00	61.38	68.30	76.23	84.33	8.53	10.23	18.19	22.04				
19	17.50	0.00	10.11	1.57	0.91	24.38	108.76	20.00	47.24	53.36	60.36	67.52	8.53	10.23	18.19	22.04				
20	19.19	0.00	10.81	1.75	0.47	17.39	94.77	20.00	38.36	43.96	50.38	56.95	8.53	10.23	18.19	22.04				
21	21.00	0.00	11.05	1.81	0.00	15.00	90.00	20.00	35.32	40.76	46.98	53.35	8.53	10.23	18.19	22.04				
22	22.81	0.00	10.81	1.75	-0.47	17.39	94.77	20.00	38.36	43.96	50.38	56.95	8.53	10.23	18.19	22.04				
23	24.50	0.00	10.11	1.57	-0.91	24.38	108.76	20.00	47.24	53.36	60.36	67.52	8.53	10.23	18.19	22.04				
24	25.95	0.00	9.00	1.28	-1.28	35.50	131.01	20.00	61.38	68.30	76.23	84.33	8.53	10.23	18.19	22.04				
25	27.06	0.00	7.55	0.91	-1.57	50.00	160.00	20.00	79.81	87.78	96.91	106.24	8.53	10.23	18.19	22.04				
26	27.76	0.00	5.86	0.47	-1.75	66.88	193.77	20.00	101.27	110.46	120.99	131.76	8.53	10.23	18.19	22.04				
27	28.00	0.00	4.05	0.12	-1.92	95.00	230.00	20.00	124.29	134.80	146.83	159.14	8.53	10.23	18.19	22.04				
28	28.00	0.00	2.03	0.00	-2.02	105.25	270.50	20.00	150.03	162.00	175.72	189.74	8.53	10.23	18.19	22.04				
29	28.00	0.00	0.00	0.00	-1.01	125.50	311.00	20.00	175.77	189.21	204.60	220.34	8.53	10.23	18.19	22.04				

Cod. elab.: 108GA201-GA01-Z-CL-002 C	Titolo: OPERE D'ARTE MAGGIORI- GALLERIE	Data: Ottobre 2011
Nome file: 108GA201-GA01-Z-CL -002_C.docx	ARTIFICIALI – GALLERIA ROVETELLO	Pagina 16 di 452
Relazione di calcolo		

	P. terr	P. accid	S. terr attiva		S. terr. a riposo		S. accid a riposo		S. sismica	
Joint	F3	F3	F1	F1	F1	F1	F1	F1	F1	F1
Text	kN	kN	kN	kN	kN	kN	kN	kN	kN	kN
1	0	0	178	192	207	223	9	10	18	22
2	0	0	304	328	356	384	17	21	37	45
3	-27	-2	238	259	282	305	16	20	35	42
4	-91	-9	177	193	212	231	15	18	32	39
5	-145	-18	125	138	152	167	13	16	29	35
6	-168	-26	79	88	98	108	11	13	23	28
7	-171	-31	43	48	55	61	8	9	16	20
8	-166	-35	18	21	24	27	4	5	9	10
9	-163	-36	0	0	0	0	0	0	0	0
10	-166	-35	-18	-21	-24	-27	-4	-5	0	0
11	-171	-31	-43	-48	-55	-61	-8	-9	0	0
12	-168	-26	-79	-88	-98	-108	-11	-13	0	0
13	-145	-18	-125	-138	-152	-167	-13	-16	0	0
14	-91	-9	-177	-193	-212	-231	-15	-18	0	0
15	-55	-5	0	0	0	0	0	0	0	0
16	-91	-9	177	193	212	231	15	18	0	0
17	-145	-18	125	138	152	167	13	16	0	0
18	-168	-26	79	88	98	108	11	13	0	0
19	-171	-31	43	48	55	61	8	9	0	0
20	-166	-35	18	21	24	27	4	5	0	0
21	-163	-36	0	0	0	0	0	0	0	0
22	-166	-35	-18	-21	-24	-27	-4	-5	0	0
23	-171	-31	-43	-48	-55	-61	-8	-9	0	0
24	-168	-26	-79	-88	-98	-108	-11	-13	0	0
25	-145	-18	-125	-138	-152	-167	-13	-16	0	0
26	-91	-9	-177	-193	-212	-231	-15	-18	0	0
27	-27	-2	-238	-259	-282	-305	-16	-20	0	0
28	0	0	-304	-328	-356	-384	-17	-21	0	0
29	0	0	-178	-192	-207	-223	-9	-10	0	0

2.1.3. Condizioni di carico

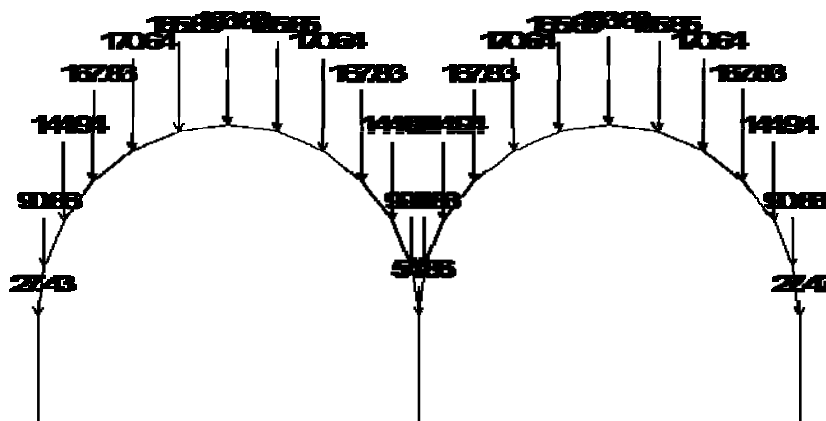

FEDEER

Cod. elab.: 108GA201-GA01-Z-CL-002_C	Titolo: OPERE D'ARTE MAGGIORI- GALLERIE	Data: Ottobre 2011
Nome file: 108GA201-GA01-Z-CL -002_C.docx	ARTIFICIALI – GALLERIA ROVETELLO	Pagina 17 di 452
Relazione di calcolo		

PROGETTO ESECUTIVO

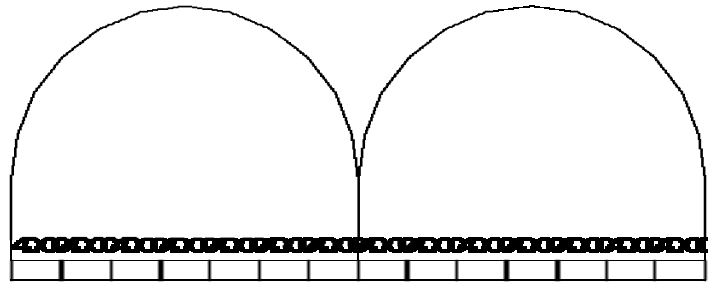

PERMANENT

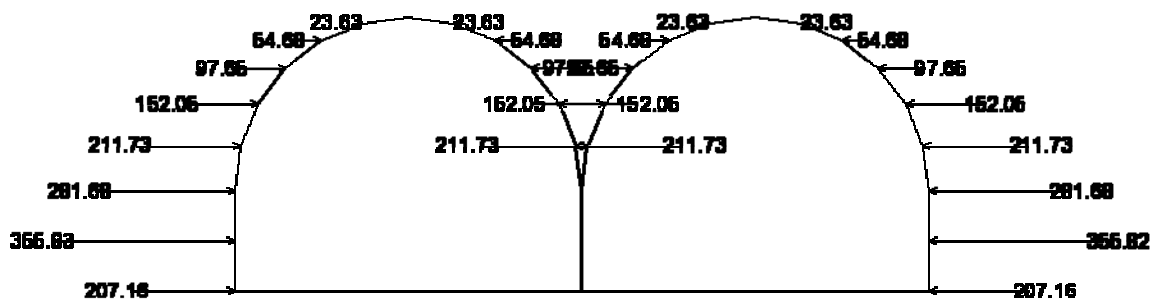

S RIPOSO 1

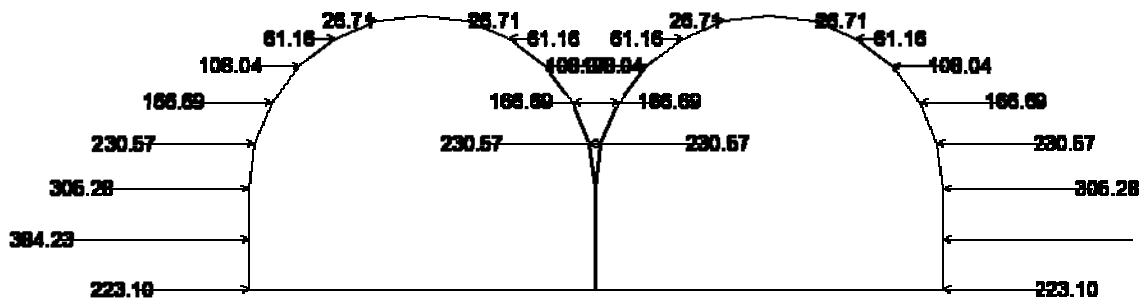

S RIPOSO 2

Cod. elab.: 108GA201-GA01-Z-CL-002_C	Titolo: OPERE D'ARTE MAGGIORI- GALLERIE	Data: Ottobre 2011
Nome file: 108GA201-GA01-Z-CL -002_C.docx	ARTIFICIALI – GALLERIA ROVETELLO	Pagina 18 di 452
Relazione di calcolo		

PROGETTO ESECUTIVO

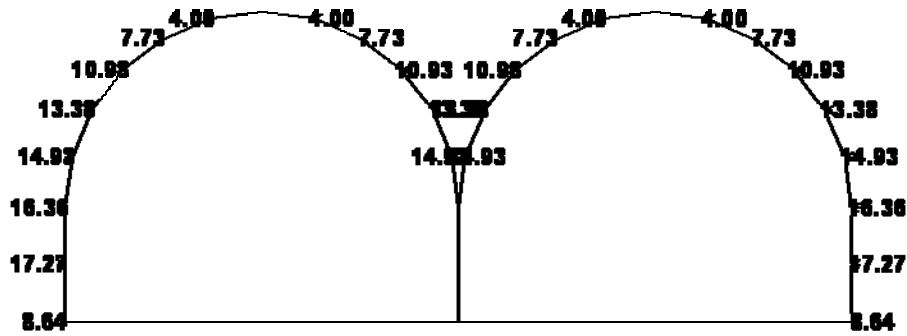

S ACCID 1

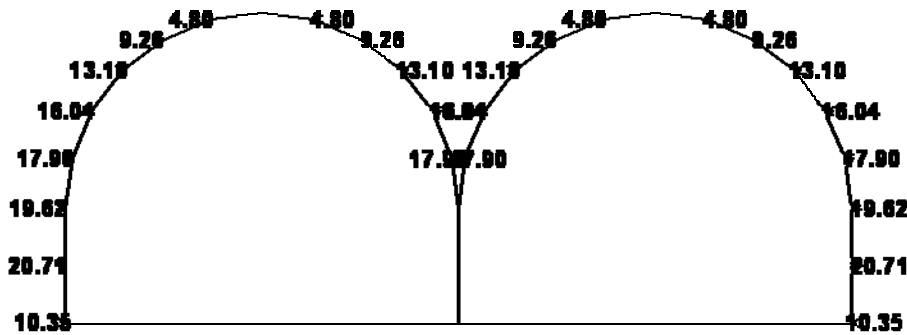

S ACCID 2

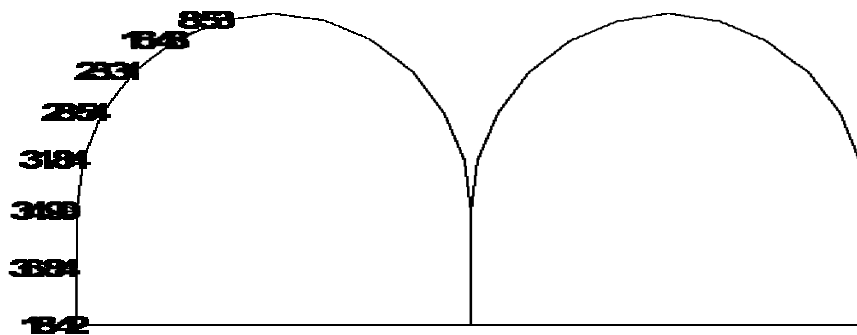

S ACCID 3

Cod. elab.: 108GA201-GA01-Z-CL-002_C	Titolo: OPERE D'ARTE MAGGIORI- GALLERIE	Data: Ottobre 2011
Nome file: 108GA201-GA01-Z-CL -002_C.docx	ARTIFICIALI – GALLERIA ROVETELLO	Pagina 19 di 452
Relazione di calcolo		

PROGETTO ESECUTIVO

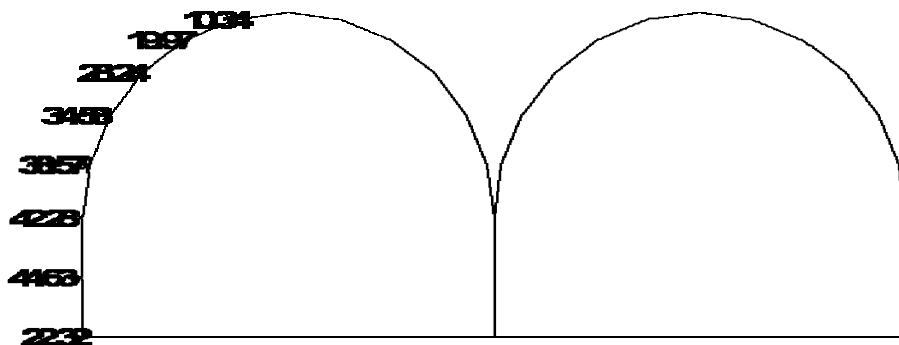

SBSMZ

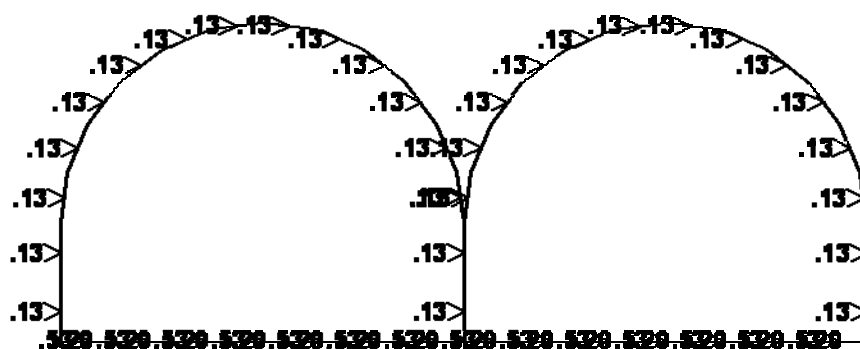

SISMA_X+

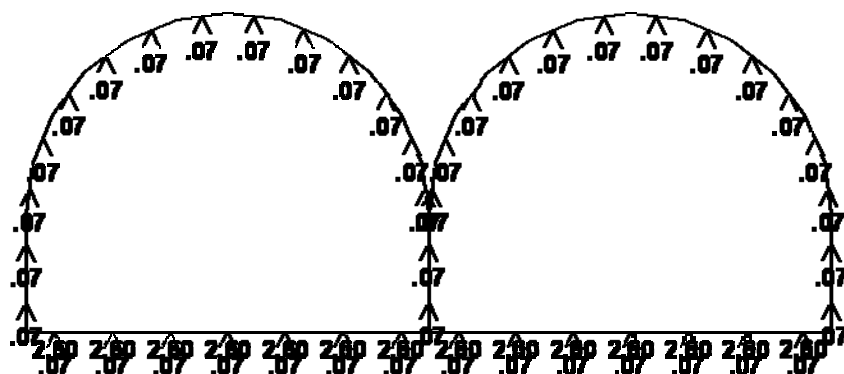

SISMA_Z+

Cod. elab.: 108GA201-GA01-Z-CL-002_C	Titolo: OPERE D'ARTE MAGGIORI- GALLERIE	Data: Ottobre 2011
Nome file: 108GA201-GA01-Z-CL -002_C.docx	ARTIFICIALI – GALLERIA ROVETTOLO	Pagina 20 di 452
Relazione di calcolo		

2.2. COMBINAZIONI DI CARICO

Di seguito si riportano i coefficienti parziali di sicurezza per le azioni definite nel capitolo 6 associata alla progettazione geotecnica.

Tabella 6.2.I – Coefficienti parziali per le azioni o per l'effetto delle azioni.

CARICHI	EFFETTO	Coefficiente Parziale γ_F (o γ_E)	EQU	(A1) STR	(A2) GEO
Permanenti	Favorevole	γ_{G1}	0,9	1,0	1,0
	Sfavorevole		1,1	1,3	1,0
Permanenti non strutturali ⁽¹⁾	Favorevole	γ_{G2}	0,0	0,0	0,0
	Sfavorevole		1,5	1,5	1,3
Variabili	Favorevole	γ_{Qi}	0,0	0,0	0,0
	Sfavorevole		1,5	1,5	1,3

(1) Nel caso in cui i carichi permanenti non strutturali (ad es. i carichi permanenti portati) siano compiutamente definiti, si potranno adottare gli stessi coefficienti validi per le azioni permanenti.

Di seguito si riportano invece i coefficienti parziali per i parametri geotecnici del terreno.

Tabella 6.2.II – Coefficienti parziali per i parametri geotecnici del terreno

PARAMETRO	GRANDEZZA ALLA QUALE APPLICARE IL COEFFICIENTE PARZIALE	COEFFICIENTE PARZIALE γ_M	(M1)	(M2)
Tangente dell'angolo di resistenza al taglio	$\tan \phi'_k$	$\gamma_{\phi'}$	1,0	1,25
Coesione efficace	c'_k	$\gamma_{c'}$	1,0	1,25
Resistenza non drenata	c_{uk}	γ_{cu}	1,0	1,4
Peso dell'unità di volume	γ	γ_f	1,0	1,0

Coefficienti parziali per le verifiche di sicurezza di opere di materiali sciolti e di fronti di scavo.

Coefficiente	R2
γ_R	1.1

Le verifiche vengono condotte definendo diverse combinazioni di gruppi di coefficienti parziali, rispettivamente definite per le azioni (A1 e A2) e per i parametri geotecnici (M1 e M2).

COMBINAZIONI DI CARICO

	STR			GEO		SISMA GEO				SLE		
	A	B	C	AC	B	X+ Z+	X+ Z-	Z+ X+	Z- X+	RARA	FREQ	Q.PERM
PESO	1.30	1.00	1.30	1.00	1.00	1.00	1.00	1.00	1.00	1.00	1.00	1.00
PESO-TERR	1.30	1.00	1.30	1.00	1.00	1.00	1.00	1.00	1.00	1.00	1.00	1.00
PERMANENTI	1.30	1.00	1.30	1.00	1.00	1.00	1.00	1.00	1.00	1.00	1.00	1.00
ACCIDENTALI	1.35	-	1.35	1.15	-	-	-	-	-	1.00	0.75	-
S RIPOSO 1	1.00	1.30	1.30	-	-	-	-	-	-	1.00	1.00	1.00
S RIPOSO 2	-	-	-	1.00	1.00	1.00	1.00	1.00	1.00	-	-	-
S ACCID 1	1.00	-	1.35	-	-	-	-	-	-	1.00	0.75	-
S ACCID 2	-	-	-	1.15	-	-	-	-	-	-	-	-
S SISMA Z+	-	-	-	-	-	1.00	-	1.00	-	-	-	-
S SISMA Z-	-	-	-	-	-	-	1.00	-	1.00	-	-	-
SISMA X+	-	-	-	-	-	1.00	1.00	0.30	0.30	-	-	-
SISMA Z+	-	-	-	-	-	0.30	-0.30	1.00	-1.00	-	-	-

Cod. elab.: 108GA201-GA01-Z-CL-002 C	Titolo: OPERE D'ARTE MAGGIORI- GALLERIE	Data: Ottobre 2011
Nome file: 108GA201-GA01-Z-CL -002_C.docx	ARTIFICIALI – GALLERIA ROVETELLO	Pagina 21 di 452
Relazione di calcolo		

2.2.1. DIAGRAMMI DELLE SOLLECITAZIONI

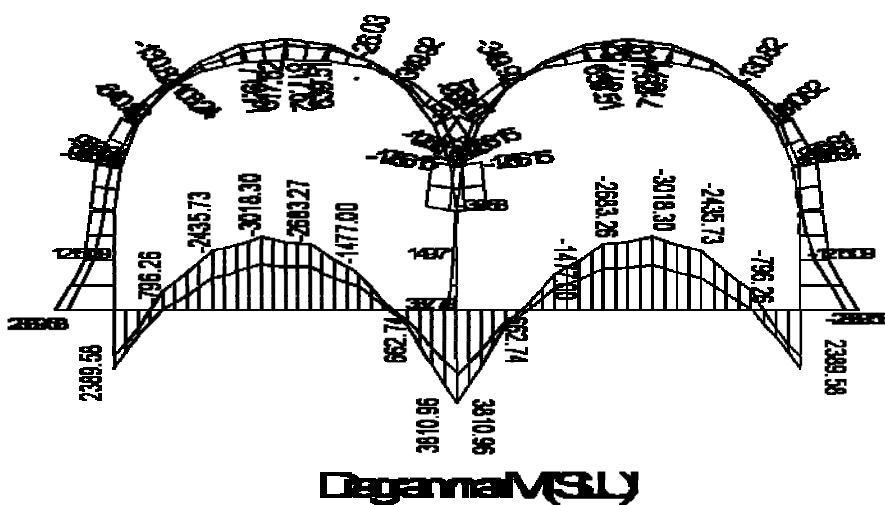
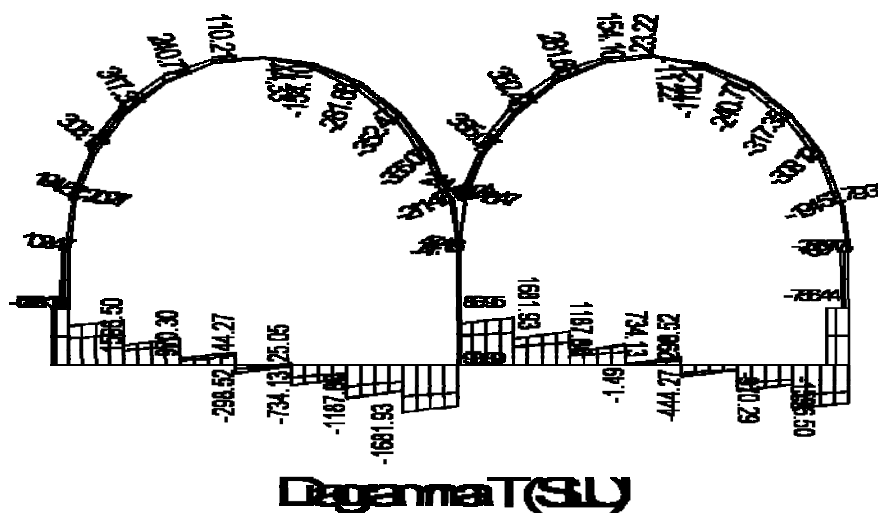
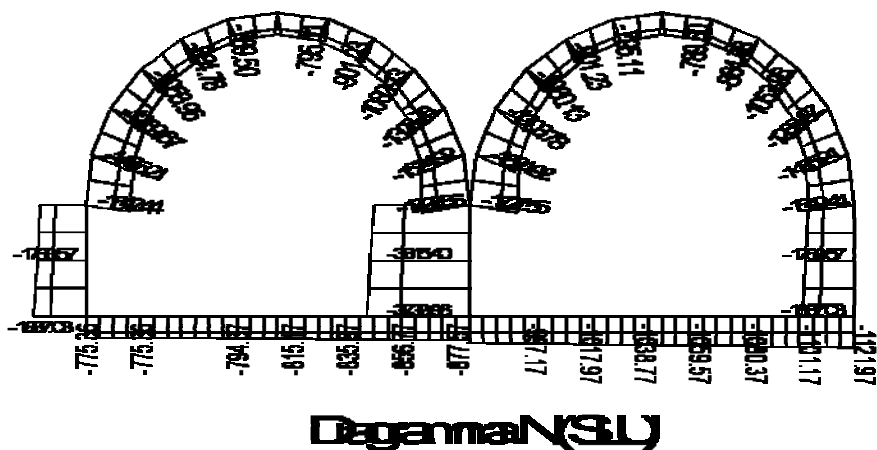

Cod. elab.: 108GA201-GA01-Z-CL-002_C	Titolo: OPERE D'ARTE MAGGIORI- GALLERIE ARTIFICIALI – GALLERIA ROVETELLO	Data: Ottobre 2011
Nome file: 108GA201-GA01-Z-CL -002_C.docx	Relazione di calcolo	Pagina 22 di 452

PROGETTO ESECUTIVO

2.2.2. Riepilogo sollecitazioni massime

Group: CALOTTA

Case Text		P kN	V2 kN	V3 kN	T kNm	M2 kNm	M3 kNm	N Sax kN
INV-SLU	min	-1'641	-282	0	0	0	-1'000	1'641
	max	-689	282	0	0	0	626	689
SLE-RARA	min	-1'254	-158	0	0	0	-561	1'254
	max	-724	158	0	0	0	328	724
SLE-FREQ	min	-1'219	-148	0	0	0	-538	1'219
	max	-704	148	0	0	0	310	704
SLE-QPERM	min	-1'113	-119	0	0	0	-468	1'113
	max	-645	119	0	0	0	256	645

SEZIONE CALOTTA

Base: 1.00 m
 Altezza: 1.10 m
 A. sup: 10 Ø 24
 A. inf: 10 Ø 24

Group: PIED-LAT

Case Text		P kN	V2 kN	V3 kN	T kNm	M2 kNm	M3 kNm	N Sax kN
INV-SLU	min	-1'889	-971	0	0	0	-2'797	1'889
	max	-1'099	-214	0	0	0	2'797	1'099
SLE-RARA	min	-1'448	-631	0	0	0	-2'148	1'448
	max	-1'275	-227	0	0	0	2'148	1'275
SLE-FREQ	min	-1'413	-625	0	0	0	-2'120	1'413
	max	-1'241	-227	0	0	0	2'120	1'241
SLE-QPERM	min	-1'309	-607	0	0	0	-2'037	1'309
	max	-1'136	-227	0	0	0	2'037	1'136

SEZIONE PIEDRITTI LAT

Base: 1.00 m
 Altezza: 1.50 m
 A. sup: 15 Ø 24
 A. inf: 10 Ø 24

Group: SOL-BORDO

Case Text		P kN	V2 kN	V3 kN	T kNm	M2 kNm	M3 kNm	N Sax kN
INV-SLU	min	-1'426	-1'616	0	0	0	-512	1'426
	max	-865	-1'616	0	0	0	2'797	865
SLE-RARA	min	-847	-1'239	0	0	0	-171	847
	max	-847	1'239	0	0	0	2'148	847
SLE-FREQ	min	-838	-1'215	0	0	0	-150	838
	max	-838	1'215	0	0	0	2'120	838
SLE-QPERM	min	-814	-1'142	0	0	0	-87	814
	max	-814	1'142	0	0	0	2'037	814

SEZIONE SOLET ESTREMI

Base: 1.00 m
 Altezza: 1.60 m
 A. sup: 10 Ø 26
 A. inf: 15 Ø 26

Group: SOL-CAMP

Case Text		P kN	V2 kN	V3 kN	T kNm	M2 kNm	M3 kNm	N Sax kN
INV-SLU	min	-1'405	-1'173	0	0	0	-2'852	1'405
	max	-865	-1'173	0	0	0	711	865
SLE-RARA	min	-847	-888	0	0	0	-2'058	847
	max	-847	888	0	0	0	544	847
SLE-FREQ	min	-838	-868	0	0	0	-2'010	838
	max	-838	868	0	0	0	538	838
SLE-QPERM	min	-814	-808	0	0	0	-1'868	814
	max	-814	808	0	0	0	517	814

SEZIONE SOLET CAMPATA

Base: 1.00 m
 Altezza: 1.60 m
 A. sup: 15 Ø 26
 A. inf: 10 Ø 26

Cod. elab.: 108GA201-GA01-Z-CL-002 C	Titolo: OPERE D'ARTE MAGGIORI- GALLERIE	Data: Ottobre 2011
Nome file: 108GA201-GA01-Z-CL -002_C.docx	ARTIFICIALI – GALLERIA ROVETELLO	Pagina 23 di 452
Relazione di calcolo		

PROGETTO ESECUTIVO

Group: SOL-CENTRO

Case Text		P kN	V2 kN	V3 kN	T kNm	M2 kNm	M3 kNm	N Sax kN
INV-SLU	min	-1'301	-1'676	0	0	0	447	1'301
	max	-865	1'676	0	0	0	3'842	865
SLE-RARA	min	-847	-1'281	0	0	0	544	847
	max	-847	1'281	0	0	0	2'946	847
SLE-FREQ	min	-838	-1'254	0	0	0	538	838
	max	-838	1'254	0	0	0	2'886	838
SLE-QPERM	min	-814	-1'174	0	0	0	517	814
	max	-814	1'174	0	0	0	2'706	814

SEZIONE SOLET CENTRO

Base: 1.00 m
 Altezza: 1.60 m
 A. sup: 10 Ø 26
 A. inf: 30 Ø 26

Group: PIED-CEN

Case Text		P kN	V2 kN	V3 kN	T kNm	M2 kNm	M3 kNm	N Sax kN
INV-SLU	min	-3'731	-77	0	0	0	-1'029	3'731
	max	-1'066	113	0	0	0	425	1'066
SLE-RARA	min	-2'858	-42	0	0	0	-627	2'858
	max	-1'230	42	0	0	0	0	1'230
SLE-FREQ	min	-2'787	-44	0	0	0	-608	2'787
	max	-1'195	44	0	0	0	0	1'195
SLE-QPERM	min	-2'576	-51	0	0	0	-551	2'576
	max	-1'091	51	0	0	0	0	1'091

SEZIONE PIEDRIT CEN

Base: 1.00 m
 Altezza: 1.10 m
 A. sup: 10 Ø 24
 A. inf: 10 Ø 24

Cod. elab.: 108GA201-GA01-Z-CL-002_C	Titolo: OPERE D'ARTE MAGGIORI- GALLERIE ARTIFICIALI – GALLERIA ROVETELLO	Data: Ottobre 2011
Nome file: 108GA201-GA01-Z-CL -002_C.docx	Relazione di calcolo	Pagina 24 di 452

2.2.3. Armatura di calcolo

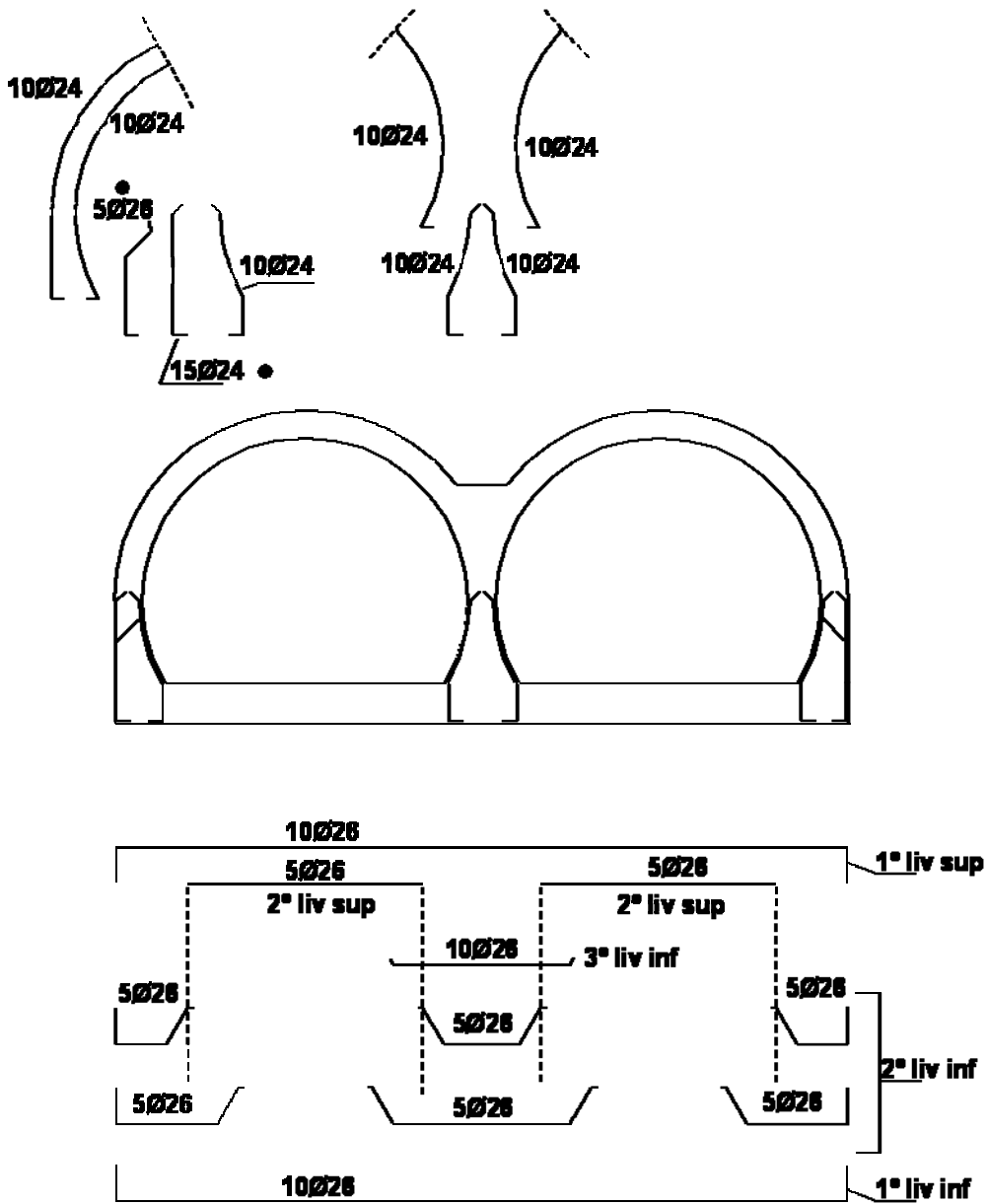

Cod. elab.: 108GA201-GA01-Z-CL-002_C	Titolo: OPERE D'ARTE MAGGIORI- GALLERIE ARTIFICIALI – GALLERIA ROVETELLO	Data: Ottobre 2011
Nome file: 108GA201-GA01-Z-CL -002_C.docx	Relazione di calcolo	Pagina 25 di 452

2.3. VERIFICHE

2.3.1. Verifica di resistenza

La verifica consiste nel controllare che il valore della resistenza di calcolo risulti superiore alla sollecitazione agente.

$$R_d \geq A$$

2.3.2. Verifica a fessurazione

La verifica consiste nel controllare che il valore di calcolo dell'apertura delle fessure rispetti le limitazioni imposte dalla normativa. La normativa definisce lo stato limite di apertura delle fessure, nel quale, per la combinazione di azioni prescelta, il valore limite di apertura della fessura calcolato al livello considerato è pari ad uno dei seguenti valori nominali:

Tabella 4.1.III – Descrizione delle condizioni ambientali

	CONDIZIONI AMBIENTALI	CLASSE DI ESPOSIZIONE
$w_1 = 0,2 \text{ mm}$	Ordinarie	X0, XC1, XC2, XC3, XF1
$w_2 = 0,3 \text{ mm}$	Aggressive	XC4, XD1, XS1, XA1, XA2, XF2, XF3
$w_3 = 0,4 \text{ mm}$	Molto aggressive	XD2, XD3, XS2, XS3, XA3, XF4

Tabella 4.1.IV – Criteri di scelta dello stato limite di fessurazione

Gruppi di esigenze	Condizioni ambientali	Combinazione di azioni	Armatura			
			Sensibile		Poco sensibile	
			Stato limite	w_d	Stato limite	w_d
a	Ordinarie	frequente	ap. fessure	$\leq w_2$	ap. fessure	$\leq w_3$
		quasi permanente	ap. fessure	$\leq w_1$	ap. fessure	$\leq w_2$
b	Aggressive	frequente	ap. fessure	$\leq w_1$	ap. fessure	$\leq w_2$
		quasi permanente	decompressione	-	ap. fessure	$\leq w_1$
c	Molto aggressive	frequente	formazione fessure	-	ap. fessure	$\leq w_1$
		quasi permanente	decompressione	-	ap. fessure	$\leq w_1$

w_1, w_2, w_3 sono definiti al § 4.1.2.2.4.1, il valore di calcolo w_d , è definito al § 4.1.2.2.4.6.

Si osserva che per le verifiche di fessurazione, per la parte esterna dello scatolare a contatto con l'ambiente aggressivo (XA2) si dovranno considerare delle condizioni ambientali aggressive, pertanto i limiti di apertura delle fessure sarà sia per la combinazione frequente pari a $w_2 = 0.300 \text{ mm}$, mentre per la quasi permanente sarà pari a $w_1 = 0.200 \text{ mm}$. Per la parte interna dello scatolare si dovrà considerare una condizione ambientale ordinaria, pertanto i limiti di apertura delle fessure saranno per la combinazione frequente $w_3 = 0.400 \text{ mm}$ e per la combinazione quasi permanente pari a $w_2 = 0.300 \text{ mm}$.

Cod. elab.: 108GA201-GA01-Z-CL-002_C	Titolo: OPERE D'ARTE MAGGIORI- GALLERIE	Data: Ottobre 2011
Nome file: 108GA201-GA01-Z-CL -002_C.docx	ARTIFICIALI – GALLERIA ROVETELLO	Pagina 26 di 452
Relazione di calcolo		

2.3.3. Verifica delle tensioni di esercizio

Valutate le azioni interne nelle varie parti della struttura, dovute alle combinazioni caratteristica e quasi permanente delle azioni, si calcolano le massime tensioni sia nel calcestruzzo sia nelle armature; si deve verificare che tali tensioni siano inferiori ai massimi valori consentiti di seguito riportati:

$$\sigma_c < 0,60 f_{ck} \text{ per combinazione caratteristica (rara)}$$

$$\sigma_c < 0,45 f_{ck} \text{ per combinazione quasi permanente}$$

$$\sigma_s < 0,8 f_{yk}$$

<i>Cod. elab.:</i> 108GA201-GA01-Z-CL-002_C	<i>Titolo:</i> OPERE D'ARTE MAGGIORI- GALLERIE	<i>Data:</i> Ottobre 2011
<i>Nome file:</i> 108GA201-GA01-Z-CL -002_C.docx	ARTIFICIALI – GALLERIA ROVETELLO Relazione di calcolo	<i>Pagina</i> 27 di 452

2.3.4. Verifiche a presso-flessione

Impostazioni verifiche SLU

Coefficienti di sicurezza del c.a.

Coefficienti sicurezza calcestruzzo a compressione	1.50
Coefficienti sicurezza calcestruzzo a trazione	1.50
Coefficienti sicurezza dell'acciaio	1.15
Fattore di riduzione da resistenza cubica a cilindrica	0.83
Fattore di riduzione per carichi di lungo periodo	0.85
Coefficienti di sicurezza della sezione	1.00

Impostazioni verifiche SLE

Condizioni ambientali Aggressive

Armatura ad aderenza migliorata

Verifica fessurazione

Metodo di calcolo aperture delle fessure: Circolare Ministeriale 252 (15/10/1996) / NTC 2008 I° Formulazione

Sensibilità delle armature	Poco sensibile
Valori limite delle aperture delle fessure	$w_1 = 0.20$
	$w_2 = 0.30$
	$w_3 = 0.40$

Verifica delle tensioni

Combinazione di carico	Rara	$\sigma_c < 0.60 f_{ck}$	$\sigma_r < 0.80 f_{yk}$
Combinazione di carico	Quasi permanente	$\sigma_c < 0.45 f_{ck}$	$\sigma_r < 1.00 f_{yk}$
Combinazione di carico	Frequente	$\sigma_c < 1.00 f_{ck}$	$\sigma_r < 1.00 f_{yk}$

2.3.4.1. Calotta

Dati

Nome sezione:	CALOTTA
Tipo sezione	Rettangolare
Base	1.000 [m]
Altezza	1.100 [m]

Caratteristiche geometriche

Area sezione	1.100000 [mq]
Inerzia in direzione X	0.091666667 [m ⁴]

Cod. elab.: 108GA201-GA01-Z-CL-002_C	Titolo: OPERE D'ARTE MAGGIORI- GALLERIE	Data: Ottobre 2011
Nome file: 108GA201-GA01-Z-CL -002_C.docx	ARTIFICIALI – GALLERIA ROVETELLO	Pagina 28 di 452
Relazione di calcolo		

PROGETTO ESECUTIVO

Inerzia in direzione Y	0.110916667	[m ⁴]
Inerzia in direzione XY	0.000000000	[m ⁴]
Ascissa baricentro sezione	X _G = 0.5000 [m]	
Ordinata baricentro sezione	Y _G = 0.5500 [m]	

Elenco ferri

Simbologia adottata

Posizione riferita all'origine

N° numero d'ordine

X Ascissa posizione ferro espresso in [m]

Y Ordinata posizione ferro espresso in [m]

d Diametro ferro espresso in [mm]

ω Area del ferro espresso in [mq]

N°	X	Y	d	ω
1	0.9580	1.0280	24	0.000452
2	0.8562	1.0280	24	0.000452
3	0.7544	1.0280	24	0.000452
4	0.6527	1.0280	24	0.000452
5	0.5509	1.0280	24	0.000452
6	0.4491	1.0280	24	0.000452
7	0.3473	1.0280	24	0.000452
8	0.2456	1.0280	24	0.000452
9	0.1438	1.0280	24	0.000452
10	0.0420	1.0280	24	0.000452
11	0.0420	0.0720	24	0.000452
12	0.1438	0.0720	24	0.000452
13	0.2456	0.0720	24	0.000452
14	0.3473	0.0720	24	0.000452
15	0.4491	0.0720	24	0.000452
16	0.5509	0.0720	24	0.000452
17	0.6527	0.0720	24	0.000452
18	0.7544	0.0720	24	0.000452
19	0.8562	0.0720	24	0.000452
20	0.9580	0.0720	24	0.000452

<i>Cod. elab.:</i> 108GA201-GA01-Z-CL-002_C	<i>Titolo:</i> OPERE D'ARTE MAGGIORI- GALLERIE	<i>Data:</i> Ottobre 2011
<i>Nome file:</i> 108GA201-GA01-Z-CL -002_C.docx	ARTIFICIALI – GALLERIA ROVETELLO	<i>Pagina</i> 29 di 452
Relazione di calcolo		

PROGETTO ESECUTIVO

Combinazioni

Simbologia adottata

N° numero d'ordine della combinazione

N sforzo normale espresso in [kN]

M_Y momento lungo Y espresso in [kNm]

M_X momento lungo X espresso in [kNm]

M_t momento torcente espresso in [kNm]

T_Y taglio lungo Y espresso in [kN]

T_X taglio lungo X espresso in [kN]

VD verifica di dominio

VT verifica tensionale (SLER - Combinazione rara, SLEF - Combinazione frequente, SLEQP - Combinazione quasi permanente, TAMM - Verifica a tensioni ammissibili)

N°	N	M _Y	M _X	M _t	T _Y	T _X	VD	VT
1	689.0000	-1000.0000	0.0000	0.0000	282.0000	0.0000	SI	NO
2	689.0000	626.0000	0.0000	0.0000	282.0000	0.0000	SI	NO
3	724.0000	-561.0000	0.0000	0.0000	0.0000	0.0000	NO	SLER
4	724.0000	328.0000	0.0000	0.0000	0.0000	0.0000	NO	SLER
5	704.0000	-538.0000	0.0000	0.0000	0.0000	0.0000	NO	SLEF
6	704.0000	310.0000	0.0000	0.0000	0.0000	0.0000	NO	SLEF
7	645.0000	-468.0000	0.0000	0.0000	0.0000	0.0000	NO	SLEQP
8	645.0000	256.0000	0.0000	0.0000	0.0000	0.0000	NO	SLEQP

Risultati analisi

Caratteristiche asse neutro

Simbologia adottata

N° numero d'ordine della combinazione

Xc posizione asse neutro espresso in [m]

α inclinazione asse neutro rispetto all'orizzontale, espressa in [°]

(xi; yi) - (xf; yf) Punti di intersezione dell'asse neutro con il perimetro della sezione, espressi in [m]

N°	Xc	α	(xi; yi)	(xf; yf)
3	0.4615	0.00	(1.0000; 0.4615)	(0.0000; 0.4615)
4	0.6480	0.00	(0.0000; 0.4520)	(1.0000; 0.4520)
5	0.4647	0.00	(1.0000; 0.4647)	(0.0000; 0.4647)
6	0.6620	0.00	(0.0000; 0.4380)	(1.0000; 0.4380)
7	0.4775	0.00	(1.0000; 0.4775)	(0.0000; 0.4775)

Cod. elab.: 108GA201-GA01-Z-CL-002_C	Titolo: OPERE D'ARTE MAGGIORI- GALLERIE	Data: Ottobre 2011
Nome file: 108GA201-GA01-Z-CL -002_C.docx	ARTIFICIALI – GALLERIA ROVETELLO	Pagina 30 di 452
Relazione di calcolo		

PROGETTO ESECUTIVO

8 0.7167 0.00 (0.0000; 0.3833) (1.0000; 0.3833)

Risultati tensionali

Simbologia adottata

N° numero d'ordine della combinazione

σ_{c-max} Tensione massima nel calcestruzzo espresso in [MPa]

σ_{c-min} Tensione minima nel calcestruzzo espresso in [MPa]

σ_{f-max} Tensione massima nel ferro espresso in [MPa]

σ_{f-min} Tensione minima nel ferro espresso in [MPa]

τ_c Tensione tangenziale nel calcestruzzo espresso in [MPa]

N°	σ_{c-max}	σ_{c-min}	τ_c	σ_{f-max}	σ_{f-min}
3	3.537	0.000	0.000	44.777	-65.136
4	2.102	0.000	0.000	28.021	-18.490
5	3.394	0.000	0.000	43.018	-61.704
6	1.989	0.000	0.000	26.591	-16.498
7	2.957	0.000	0.000	37.670	-51.150
8	1.654	0.000	0.000	22.321	-10.780

Sollecitazioni ultime

Simbologia adottata

N° numero d'ordine della combinazione

N_u Sforzo normale ultimo, espresso in [kN]

M_{Xu} Momento ultimo in direzione X, espresso in [kNm]

M_{Yu} Momento ultimo in direzione Y, espresso in [kNm]

FS Fattore di sicurezza

Combinazione n° 1

N_u	M_{Xu}	M_{Yu}	FS
<u>1757.0568</u>	0.0000	<u>-2550.1549</u>	2.55
<u>24582.4419</u>	0.0000	-1000.0000	35.68
689.0000	0.0000	<u>-2057.9490</u>	2.06

Combinazione n° 2

N_u	M_{Xu}	M_{Yu}	FS
<u>3751.0192</u>	0.0000	<u>3408.0378</u>	5.44

<i>Cod. elab.:</i> 108GA201-GA01-Z-CL-002 C	<i>Titolo:</i> OPERE D'ARTE MAGGIORI- GALLERIE	<i>Data:</i> Ottobre 2011
<i>Nome file:</i> 108GA201-GA01-Z-CL -002_C.docx	ARTIFICIALI – GALLERIA ROVETELLO	<i>Pagina</i> 31 di 452
Relazione di calcolo		

PROGETTO ESECUTIVO

25459.6001	0.0000	626.0000	36.95
689.0000	0.0000	2057.9490	3.29

Risultati taglio

Simbologia adottata

N° numero d'ordine della combinazione

V_{Rd} Resistenza di calcolo dell'elemento privo di armatura trasversali a taglio, espresso in [kN]

V_{Rcd} Resistenza di calcolo a "taglio compressione", espresso in [kN]

V_{Rsd} resistenza di calcolo a "taglio trazione", espresso in [kN]

N°	T	V _{Rd}	V _{Rcd}	V _{Rsd}	Diametro e passo staffe
1	282.0000	561.9425	3618.1178	1065.4507	φ12.00 - 0.2000 [m]
2	282.0000	561.9425	3618.1178	1065.4507	φ12.00 - 0.2000 [m]

Risultati fessurazione

Simbologia adottata

N° numero d'ordine della combinazione

M_X Momento di prima fessurazione in direzione X, espresso in [kNm]

M_Y Momento di prima fessurazione in direzione Y, espresso in [kNm]

σ_f Tensione nell'acciaio, espressa in [MPa]

σ_c Tensione nel calcestruzzo, espressa in [MPa]

A_{eff} Area efficace a trazione, espressa in [mq]

ε Deformazione media acciaio teso, espressa in [°]

S_m Distanza media tra le fessure, espresso in [mm]

w Ampiezza delle fessure, espressa in [mm]

N°	M _X	M _Y	σ _f	σ _c	A _{eff}	ε	S _m	w
5	0.0000	-841.0611	-96.462	-7.253	0.252000	0.0000	0	0.0000
6	0.0000	1162.5576	-61.872	-4.936	0.219020	0.0000	0	0.0000
7	0.0000	-858.2385	-93.802	-7.071	0.252000	0.0000	0	0.0000
8	0.0000	1289.9019	-54.315	-4.458	0.191665	0.0000	0	0.0000

2.3.4.2. Piedritti laterali

Dati

Nome sezione: PIEDRITTI LAT

Tipo sezione Rettangolare

Cod. elab.: 108GA201-GA01-Z-CL-002_C	Titolo: OPERE D'ARTE MAGGIORI- GALLERIE	Data: Ottobre 2011
Nome file: 108GA201-GA01-Z-CL -002_C.docx	ARTIFICIALI – GALLERIA ROVETELLO	Pagina 32 di 452
Relazione di calcolo		

PROGETTO ESECUTIVO

Base	1.000	[m]
Altezza	1.500	[m]

Caratteristiche geometriche

Area sezione	1.500000	[mq]
Inerzia in direzione X	0.125000000	[m^4]
Inerzia in direzione Y	0.281250000	[m^4]
Inerzia in direzione XY	0.000000000	[m^4]
Ascissa baricentro sezione	$X_G = 0.5000$	[m]
Ordinata baricentro sezione	$Y_G = 0.7500$	[m]

Elenco ferri

Simbologia adottata

Posizione riferita all'origine

N° numero d'ordine

X Ascissa posizione ferro espresso in [m]

Y Ordinata posizione ferro espresso in [m]

d Diametro ferro espresso in [mm]

ω Area del ferro espresso in [mq]

N°	X	Y	d	ω
1	0.0420	0.0720	24	0.000452
2	0.1438	0.0720	24	0.000452
3	0.2456	0.0720	24	0.000452
4	0.3473	0.0720	24	0.000452
5	0.4491	0.0720	24	0.000452
6	0.5509	0.0720	24	0.000452
7	0.6527	0.0720	24	0.000452
8	0.7544	0.0720	24	0.000452
9	0.8562	0.0720	24	0.000452
10	0.9580	0.0720	24	0.000452
11	0.9580	1.4280	24	0.000452
12	0.8562	1.4280	24	0.000452
13	0.7544	1.4280	24	0.000452
14	0.6527	1.4280	24	0.000452
15	0.5509	1.4280	24	0.000452

<i>Cod. elab.:</i> 108GA201-GA01-Z-CL-002 C	<i>Titolo:</i> OPERE D'ARTE MAGGIORI- GALLERIE	<i>Data:</i> Ottobre 2011
<i>Nome file:</i> 108GA201-GA01-Z-CL -002_C.docx	ARTIFICIALI – GALLERIA ROVETELLO	<i>Pagina</i> 33 di 452
Relazione di calcolo		

PROGETTO ESECUTIVO

16	0.4491	1.4280	24	0.000452
17	0.3473	1.4280	24	0.000452
18	0.2456	1.4280	24	0.000452
19	0.1438	1.4280	24	0.000452
20	0.0420	1.4280	24	0.000452
21	0.9580	1.3680	24	0.000452
22	0.7290	1.3680	24	0.000452
23	0.5000	1.3680	24	0.000452
24	0.2710	1.3680	24	0.000452
25	0.0420	1.3680	24	0.000452

Combinazioni

Simbologia adottata

N° numero d'ordine della combinazione

N sforzo normale espresso in[kN]

M_Y momento lungo Y espresso in [kNm]

M_X momento lungo X espresso in [kNm]

M_t momento torcente espresso in [kNm]

T_Y taglio lungo Y espresso in [kN]

T_X taglio lungo X espresso in [kN]

VD verifica di dominio

VT verifica tensionale (SLER - Combinazione rara, SLEF - Combinazione frequente, SLEQP - Combinazione quasi permanente, TAMM - Verifica a tensioni ammissibili)

N°	N	M _Y	M _X	M _t	T _Y	T _X	VD	VT
1	1099.0000	-2797.0000	0.0000	0.0000	971.0000	0.0000	SI	NO
2	1889.0000	-2797.0000	0.0000	0.0000	971.0000	0.0000	SI	NO
3	1275.0000	2148.0000	0.0000	0.0000	0.0000	0.0000	NO	SLER
4	1241.0000	-2120.0000	0.0000	0.0000	0.0000	0.0000	NO	SLEF
5	1136.0000	-2037.0000	0.0000	0.0000	0.0000	0.0000	NO	SLEQP

Risultati analisi

Caratteristiche asse neutro

Simbologia adottata

N° numero d'ordine della combinazione

Xc posizione asse neutro espresso in [m]

α inclinazione asse neutro rispetto all'orizzontale, espressa in [°]

Cod. elab.: 108GA201-GA01-Z-CL-002_C	Titolo: OPERE D'ARTE MAGGIORI- GALLERIE	Data: Ottobre 2011
Nome file: 108GA201-GA01-Z-CL -002_C.docx	ARTIFICIALI – GALLERIA ROVETELLO	Pagina 34 di 452
Relazione di calcolo		

PROGETTO ESECUTIVO

(xi; yi) - (xf; yf) Punti di intersezione dell'asse neutro con il perimetro della sezione, espressi in [m]

N°	Xc	α	(xi; yi)	(xf; yf)
3	0.4621	0.00	(0.0000; 1.0379)	(1.0000; 1.0379)
4	0.5507	0.00	(1.0000; 0.5507)	(0.0000; 0.5507)
5	0.5428	0.00	(1.0000; 0.5428)	(0.0000; 0.5428)

Risultati tensionali

Simbologia adottata

N° numero d'ordine della combinazione

σ_{c-max} Tensione massima nel calcestruzzo espresso in [MPa]

σ_{c-min} Tensione minima nel calcestruzzo espresso in [MPa]

σ_{f-max} Tensione massima nel ferro espresso in [MPa]

σ_{f-min} Tensione minima nel ferro espresso in [MPa]

τ_c Tensione tangenziale nel calcestruzzo espresso in [MPa]

N°	σ_{c-max}	σ_{c-min}	τ_c	σ_{f-max}	σ_{f-min}
3	7.467	0.000	0.000	94.549	-234.082
4	7.058	0.000	0.000	92.024	-168.675
5	6.762	0.000	0.000	87.971	-165.407

Sollecitazioni ultime

Simbologia adottata

N° numero d'ordine della combinazione

N_u Sforzo normale ultimo, espresso in [kN]

M_{Xu} Momento ultimo in direzione X, espresso in [kNm]

M_{Yu} Momento ultimo in direzione Y, espresso in [kNm]

FS Fattore di sicurezza

Combinazione n° 1

N_u	M_{Xu}	M_{Yu}	FS
<u>1873.1255</u>	0.0000	<u>-4767.1811</u>	1.70
<u>30494.0305</u>	0.0000	-2797.0000	27.75
1099.0000	0.0000	<u>-4280.1379</u>	1.53

Combinazione n° 2

<i>Cod. elab.:</i> 108GA201-GA01-Z-CL-002_C	<i>Titolo:</i> OPERE D'ARTE MAGGIORI- GALLERIE	<i>Data:</i> Ottobre 2011
<i>Nome file:</i> 108GA201-GA01-Z-CL -002_C.docx	ARTIFICIALI – GALLERIA ROVETELLO	<i>Pagina</i> 35 di 452
Relazione di calcolo		

PROGETTO ESECUTIVO

N_u	M_{Xu}	M_{Yu}	FS
4098.9552	0.0000	-6069.2312	2.17
30494.0299	0.0000	-2797.0000	16.14
1889.0000	0.0000	-4777.0307	1.71

Risultati taglio

Simbologia adottata

N° numero d'ordine della combinazione

V_{Rd} Resistenza di calcolo dell'elemento privo di armatura trasversali a taglio, espresso in [kN]

V_{Rcd} Resistenza di calcolo a "taglio compressione", espresso in [kN]

V_{Rsd} resistenza di calcolo a "taglio trazione", espresso in [kN]

N°	T	V_{Rd}	V_{Rcd}	V_{Rsd}	Diametro e passo staffe
1	971.0000	785.3641	4994.9333	1463.7500	φ12.00 - 0.2000 [m]
2	971.0000	901.4941	5115.0678	1463.7500	φ12.00 - 0.2000 [m]

Risultati fessurazione

Simbologia adottata

N° numero d'ordine della combinazione

M_X Momento di prima fessurazione in direzione X, espresso in [kNm]

M_Y Momento di prima fessurazione in direzione Y, espresso in [kNm]

σ_f Tensione nell'acciaio, espressa in [MPa]

σ_c Tensione nel calcestruzzo, espressa in [MPa]

A_{eff} Area efficace a trazione, espressa in [mq]

ϵ Deformazione media acciaio teso, espressa in [°]

S_m Distanza media tra le fessure, espresso in [mm]

w Ampiezza delle fessure, espressa in [mm]

N°	M_X	M_Y	σ_f	σ_c	A_{eff}	ϵ	S_m	w
4	0.0000	-1365.9147	-108.677	-7.840	0.272000	0.0649	186	0.2057
5	0.0000	-1353.5301	-109.908	-7.923	0.272000	0.0626	186	0.1983

2.3.4.3. Soletta campata

Cod. elab.: 108GA201-GA01-Z-CL-002_C	Titolo: OPERE D'ARTE MAGGIORI- GALLERIE	Data: Ottobre 2011
Nome file: 108GA201-GA01-Z-CL -002_C.docx	ARTIFICIALI – GALLERIA ROVETELLO	Pagina 36 di 452
Relazione di calcolo		

PROGETTO ESECUTIVO

Dati

Nome sezione:	SOLET CAMPATA	
Tipo sezione	Rettangolare	
Base	1.000	[m]
Altezza	1.600	[m]

Caratteristiche geometriche

Area sezione	1.600000	[mq]
Inerzia in direzione X	0.133333333	[m^4]
Inerzia in direzione Y	0.341333333	[m^4]
Inerzia in direzione XY	0.000000000	[m^4]
Ascissa baricentro sezione	X _G = 0.5000 [m]	
Ordinata baricentro sezione	Y _G = 0.8000 [m]	

Elenco ferri

Simbologia adottata

Posizione riferita all'origine

N° numero d'ordine

X Ascissa posizione ferro espresso in [m]

Y Ordinata posizione ferro espresso in [m]

d Diametro ferro espresso in [mm]

ω Area del ferro espresso in [mq]

N°	X	Y	d	ω
1	0.9570	1.5270	26	0.000531
2	0.8554	1.5270	26	0.000531
3	0.7539	1.5270	26	0.000531
4	0.6523	1.5270	26	0.000531
5	0.5508	1.5270	26	0.000531
6	0.4492	1.5270	26	0.000531
7	0.3477	1.5270	26	0.000531
8	0.2461	1.5270	26	0.000531
9	0.1446	1.5270	26	0.000531
10	0.0430	1.5270	26	0.000531
11	0.0430	0.0730	26	0.000531
12	0.1446	0.0730	26	0.000531

<i>Cod. elab.:</i> 108GA201-GA01-Z-CL-002_C	<i>Titolo:</i> OPERE D'ARTE MAGGIORI- GALLERIE	<i>Data:</i> Ottobre 2011
<i>Nome file:</i> 108GA201-GA01-Z-CL -002_C.docx	ARTIFICIALI – GALLERIA ROVETELLO	<i>Pagina</i> 37 di 452
Relazione di calcolo		

PROGETTO ESECUTIVO

13	0.2461	0.0730	26	0.000531
14	0.3477	0.0730	26	0.000531
15	0.4492	0.0730	26	0.000531
16	0.5508	0.0730	26	0.000531
17	0.6523	0.0730	26	0.000531
18	0.7539	0.0730	26	0.000531
19	0.8554	0.0730	26	0.000531
20	0.9570	0.0730	26	0.000531
21	0.9570	1.4670	26	0.000531
22	0.7285	1.4670	26	0.000531
23	0.5000	1.4670	26	0.000531
24	0.2715	1.4670	26	0.000531
25	0.0430	1.4670	26	0.000531

Combinazioni

Simbologia adottata

N° numero d'ordine della combinazione

N sforzo normale espresso in[kN]

M_Y momento lungo Y espresso in [kNm]

M_X momento lungo X espresso in [kNm]

M_t momento torcente espresso in [kNm]

T_Y taglio lungo Y espresso in [kN]

T_X taglio lungo X espresso in [kN]

VD verifica di dominio

VT verifica tensionale (SLER - Combinazione rara, SLEF - Combinazione frequente, SLEQP - Combinazione quasi permanente, TAMM - Verifica a tensioni ammissibili)

N°	N	M _Y	M _X	M _t	T _Y	T _X	VD	VT
1	865.0000	-2852.0000	0.0000	0.0000	1173.0000	0.0000	SI	NO
2	847.0000	-2058.0000	0.0000	0.0000	0.0000	0.0000	NO	SLER
3	838.0000	-2010.0000	0.0000	0.0000	0.0000	0.0000	NO	SLEF
4	814.0000	-1868.0000	0.0000	0.0000	0.0000	0.0000	NO	SLEQP

Risultati analisi

Caratteristiche asse neutro

<i>Cod. elab.:</i> 108GA201-GA01-Z-CL-002_C	<i>Titolo:</i> OPERE D'ARTE MAGGIORI- GALLERIE	<i>Data:</i> Ottobre 2011
<i>Nome file:</i> 108GA201-GA01-Z-CL -002_C.docx	ARTIFICIALI – GALLERIA ROVETELLO	<i>Pagina</i> 38 di 452
Relazione di calcolo		

PROGETTO ESECUTIVO

Simbologia adottata

N° numero d'ordine della combinazione

Xc posizione asse neutro espresso in [m]

α inclinazione asse neutro rispetto all'orizzontale, espressa in [°]

(xi; yi) - (xf; yf) Punti di intersezione dell'asse neutro con il perimetro della sezione, espressi in [m]

N°	Xc	α	(xi; yi)	(xf; yf)
2	0.5626	0.00	(1.0000; 0.5626)	(0.0000; 0.5626)
3	0.5643	0.00	(1.0000; 0.5643)	(0.0000; 0.5643)
4	0.5702	0.00	(1.0000; 0.5702)	(0.0000; 0.5702)

Risultati tensionali

Simbologia adottata

N° numero d'ordine della combinazione

σ_{c-max} Tensione massima nel calcestruzzo espresso in [MPa]

σ_{c-min} Tensione minima nel calcestruzzo espresso in [MPa]

σ_{f-max} Tensione massima nel ferro espresso in [MPa]

σ_{f-min} Tensione minima nel ferro espresso in [MPa]

τ_c Tensione tangenziale nel calcestruzzo espresso in [MPa]

N°	σ_{c-max}	σ_{c-min}	τ_c	σ_{f-max}	σ_{f-min}
2	5.644	0.000	0.000	73.678	-145.135
3	5.517	0.000	0.000	72.050	-141.195
4	5.142	0.000	0.000	67.253	-129.409

Sollecitazioni ultime

Simbologia adottata

N° numero d'ordine della combinazione

N_u Sforzo normale ultimo, espresso in [kN]

M_{Xu} Momento ultimo in direzione X, espresso in [kNm]

M_{Yu} Momento ultimo in direzione Y, espresso in [kNm]

FS Fattore di sicurezza

Combinazione n° 1

N_u M_{Xu} M_{Yu} FS

Cod. elab.: 108GA201-GA01-Z-CL-002_C	Titolo: OPERE D'ARTE MAGGIORI- GALLERIE	Data: Ottobre 2011
Nome file: 108GA201-GA01-Z-CL -002_C.docx	ARTIFICIALI – GALLERIA ROVETELLO	Pagina 39 di 452
Relazione di calcolo		

PROGETTO ESECUTIVO

<u>1715.1174</u>	0.0000	<u>-5654.9304</u>	1.98
<u>33507.0645</u>	0.0000	-2852.0000	38.74
865.0000	0.0000	<u>-5079.4437</u>	1.78

Risultati taglio

Simbologia adottata

N° numero d'ordine della combinazione

V_{Rd} Resistenza di calcolo dell'elemento privo di armatura trasversali a taglio, espresso in [kN]

V_{Rcd} Resistenza di calcolo a "taglio compressione", espresso in [kN]

V_{Rsd} resistenza di calcolo a "taglio trazione", espresso in [kN]

N°	T	V _{Rd}	V _{Rcd}	V _{Rsd}	Diametro e passo staffe
1	1173.0000	808.8360	5287.9393	1563.3248	φ12.00 - 0.2000 [m]

Risultati fessurazione

Simbologia adottata

N° numero d'ordine della combinazione

M_X Momento di prima fessurazione in direzione X, espresso in [kNm]

M_Y Momento di prima fessurazione in direzione Y, espresso in [kNm]

σ_f Tensione nell'acciaio, espressa in [MPa]

σ_c Tensione nel calcestruzzo, espressa in [MPa]

A_{eff} Area efficace a trazione, espressa in [mq]

ε Deformazione media acciaio teso, espressa in [°]

S_m Distanza media tra le fessure, espresso in [mm]

w Ampiezza delle fessure, espressa in [mm]

N°	M _X	M _Y	σ _f	σ _c	A _{eff}	ε	S _m	w
3	0.0000	-1525.8682	-107.186	-7.688	0.288000	0.0488	185	0.1534
4	0.0000	-1535.7426	-106.391	-7.634	0.288000	0.0416	185	0.1308

2.3.4.4. Soletta estremità

Cod. elab.: 108GA201-GA01-Z-CL-002_C	Titolo: OPERE D'ARTE MAGGIORI- GALLERIE	Data: Ottobre 2011
Nome file: 108GA201-GA01-Z-CL -002_C.docx	ARTIFICIALI – GALLERIA ROVETELLO	Pagina 40 di 452
Relazione di calcolo		

PROGETTO ESECUTIVO

Dati

Nome sezione:	SOLET ESTREMI	
Tipo sezione	Rettangolare	
Base	1.000	[m]
Altezza	1.600	[m]

Caratteristiche geometriche

Area sezione	1.600000	[mq]
Inerzia in direzione X	0.133333333	[m^4]
Inerzia in direzione Y	0.341333333	[m^4]
Inerzia in direzione XY	0.000000000	[m^4]
Ascissa baricentro sezione	X _G = 0.5000 [m]	
Ordinata baricentro sezione	Y _G = 0.8000 [m]	

Elenco ferri

Simbologia adottata

Posizione riferita all'origine

N° numero d'ordine

X Ascissa posizione ferro espresso in [m]

Y Ordinata posizione ferro espresso in [m]

d Diametro ferro espresso in [mm]

ω Area del ferro espresso in [mq]

N°	X	Y	d	ω
1	0.9570	1.5270	26	0.000531
2	0.8554	1.5270	26	0.000531
3	0.7539	1.5270	26	0.000531
4	0.6523	1.5270	26	0.000531
5	0.5508	1.5270	26	0.000531
6	0.4492	1.5270	26	0.000531
7	0.3477	1.5270	26	0.000531
8	0.2461	1.5270	26	0.000531
9	0.1446	1.5270	26	0.000531
10	0.0430	1.5270	26	0.000531
11	0.0430	0.0730	26	0.000531
12	0.1446	0.0730	26	0.000531

<i>Cod. elab.:</i> 108GA201-GA01-Z-CL-002_C	<i>Titolo:</i> OPERE D'ARTE MAGGIORI- GALLERIE	<i>Data:</i> Ottobre 2011
<i>Nome file:</i> 108GA201-GA01-Z-CL -002_C.docx	ARTIFICIALI – GALLERIA ROVETELLO	<i>Pagina</i> 41 di 452
Relazione di calcolo		

PROGETTO ESECUTIVO

13	0.2461	0.0730	26	0.000531
14	0.3477	0.0730	26	0.000531
15	0.4492	0.0730	26	0.000531
16	0.5508	0.0730	26	0.000531
17	0.6523	0.0730	26	0.000531
18	0.7539	0.0730	26	0.000531
19	0.8554	0.0730	26	0.000531
20	0.9570	0.0730	26	0.000531
21	0.0430	0.1330	26	0.000531
22	0.2715	0.1330	26	0.000531
23	0.5000	0.1330	26	0.000531
24	0.7285	0.1330	26	0.000531
25	0.9570	0.1330	26	0.000531

Combinazioni

Simbologia adottata

N° numero d'ordine della combinazione

N sforzo normale espresso in[kN]

M_Y momento lungo Y espresso in [kNm]

M_X momento lungo X espresso in [kNm]

M_t momento torcente espresso in [kNm]

T_Y taglio lungo Y espresso in [kN]

T_X taglio lungo X espresso in [kN]

VD verifica di dominio

VT verifica tensionale (SLER - Combinazione rara, SLEF - Combinazione frequente, SLEQP - Combinazione quasi permanente, TAMM - Verifica a tensioni ammissibili)

N°	N	M _Y	M _X	M _t	T _Y	T _X	VD	VT
1	865.0000	2797.0000	0.0000	0.0000	1616.0000	0.0000	SI	NO
2	847.0000	2148.0000	0.0000	0.0000	0.0000	0.0000	NO	SLER
3	838.0000	2120.0000	0.0000	0.0000	0.0000	0.0000	NO	SLEF
4	814.0000	2037.0000	0.0000	0.0000	0.0000	0.0000	NO	SLEQP

Risultati analisi

Caratteristiche asse neutro

<i>Cod. elab.:</i> 108GA201-GA01-Z-CL-002_C	<i>Titolo:</i> OPERE D'ARTE MAGGIORI- GALLERIE	<i>Data:</i> Ottobre 2011
<i>Nome file:</i> 108GA201-GA01-Z-CL -002_C.docx	ARTIFICIALI – GALLERIA ROVETELLO	<i>Pagina</i> 42 di 452
Relazione di calcolo		

PROGETTO ESECUTIVO

Simbologia adottata

N° numero d'ordine della combinazione

Xc posizione asse neutro espresso in [m]

α inclinazione asse neutro rispetto all'orizzontale, espressa in [°]

(xi; yi) - (xf; yf) Punti di intersezione dell'asse neutro con il perimetro della sezione, espressi in [m]

N°	Xc	α	(xi; yi)	(xf; yf)
2	0.5572	0.00	(0.0000; 1.0428)	(1.0000; 1.0428)
3	0.5575	0.00	(0.0000; 1.0425)	(1.0000; 1.0425)
4	0.5588	0.00	(0.0000; 1.0412)	(1.0000; 1.0412)

Risultati tensionali

Simbologia adottata

N° numero d'ordine della combinazione

σ_{c-max} Tensione massima nel calcestruzzo espresso in [MPa]

σ_{c-min} Tensione minima nel calcestruzzo espresso in [MPa]

σ_{f-max} Tensione massima nel ferro espresso in [MPa]

σ_{f-min} Tensione minima nel ferro espresso in [MPa]

τ_c Tensione tangenziale nel calcestruzzo espresso in [MPa]

N°	σ_{c-max}	σ_{c-min}	τ_c	σ_{f-max}	σ_{f-min}
2	5.875	0.000	0.000	76.585	-153.400
3	5.800	0.000	0.000	75.605	-151.294
4	5.576	0.000	0.000	72.720	-144.914

Sollecitazioni ultime

Simbologia adottata

N° numero d'ordine della combinazione

N_u Sforzo normale ultimo, espresso in [kN]

M_{Xu} Momento ultimo in direzione X, espresso in [kNm]

M_{Yu} Momento ultimo in direzione Y, espresso in [kNm]

FS Fattore di sicurezza

Combinazione n° 1

N_u

M_{Xu}

M_{Yu}

FS

Cod. elab.: 108GA201-GA01-Z-CL-002_C	Titolo: OPERE D'ARTE MAGGIORI- GALLERIE	Data: Ottobre 2011
Nome file: 108GA201-GA01-Z-CL -002_C.docx	ARTIFICIALI – GALLERIA ROVETELLO	Pagina 43 di 452
Relazione di calcolo		

PROGETTO ESECUTIVO

<u>1757.6230</u>	0.0000	<u>5683.3196</u>	2.03
<u>33600.3109</u>	0.0000	2797.0000	38.84
865.0000	0.0000	<u>5079.4437</u>	1.82

Risultati taglio

Simbologia adottata

N° numero d'ordine della combinazione

V_{Rd} Resistenza di calcolo dell'elemento privo di armatura trasversali a taglio, espresso in [kN]

V_{Rcd} Resistenza di calcolo a "taglio compressione", espresso in [kN]

V_{Rsd} resistenza di calcolo a "taglio trazione", espresso in [kN]

N°	T	V _{Rd}	V _{Rcd}	V _{Rsd}	Diametro e passo staffe
1	1616.0000	808.8360	5287.9393	1645.6051	φ12.00 - 0.1900 [m]

Risultati fessurazione

Simbologia adottata

N° numero d'ordine della combinazione

M_X Momento di prima fessurazione in direzione X, espresso in [kNm]

M_Y Momento di prima fessurazione in direzione Y, espresso in [kNm]

σ_f Tensione nell'acciaio, espressa in [MPa]

σ_c Tensione nel calcestruzzo, espressa in [MPa]

A_{eff} Area efficace a trazione, espressa in [mq]

ε Deformazione media acciaio teso, espressa in [°]

S_m Distanza media tra le fessure, espresso in [mm]

w Ampiezza delle fessure, espressa in [mm]

N°	M _X	M _Y	σ _f	σ _c	A _{eff}	ε	S _m	w
3	0.0000	1514.6885	-108.096	-7.749	0.288000	0.0547	185	0.1720
4	0.0000	1516.9102	-107.915	-7.737	0.288000	0.0509	185	0.1599

2.3.4.5. Soletta centro

Dati

Nome sezione:

SOLET CENTRO

<i>Cod. elab.:</i> 108GA201-GA01-Z-CL-002_C	<i>Titolo:</i> OPERE D'ARTE MAGGIORI- GALLERIE	<i>Data:</i> Ottobre 2011
<i>Nome file:</i> 108GA201-GA01-Z-CL -002_C.docx	ARTIFICIALI – GALLERIA ROVETELLO	<i>Pagina</i> 44 di 452
Relazione di calcolo		

PROGETTO ESECUTIVO

Tipo sezione	Rettangolare	
Base	1.000	[m]
Altezza	1.600	[m]

Caratteristiche geometriche

Area sezione	1.600000	[mq]
Inerzia in direzione X	0.133333333	[m ⁴]
Inerzia in direzione Y	0.341333333	[m ⁴]
Inerzia in direzione XY	0.000000000	[m ⁴]
Ascissa baricentro sezione	X _G = 0.5000 [m]	
Ordinata baricentro sezione	Y _G = 0.8000 [m]	

Elenco ferri

Simbologia adottata

Posizione riferita all'origine

N° numero d'ordine

X Ascissa posizione ferro espresso in [m]

Y Ordinata posizione ferro espresso in [m]

d Diametro ferro espresso in [mm]

ω Area del ferro espresso in [mq]

N°	X	Y	d	ω
1	0.9570	1.5270	26	0.000531
2	0.8554	1.5270	26	0.000531
3	0.7539	1.5270	26	0.000531
4	0.6523	1.5270	26	0.000531
5	0.5508	1.5270	26	0.000531
6	0.4492	1.5270	26	0.000531
7	0.3477	1.5270	26	0.000531
8	0.2461	1.5270	26	0.000531
9	0.1446	1.5270	26	0.000531
10	0.0430	1.5270	26	0.000531
11	0.0430	0.0730	26	0.000531
12	0.1446	0.0730	26	0.000531
13	0.2461	0.0730	26	0.000531
14	0.3477	0.0730	26	0.000531

<i>Cod. elab.:</i> 108GA201-GA01-Z-CL-002 C	<i>Titolo:</i> OPERE D'ARTE MAGGIORI- GALLERIE	<i>Data:</i> Ottobre 2011
<i>Nome file:</i> 108GA201-GA01-Z-CL -002_C.docx	ARTIFICIALI – GALLERIA ROVETELLO	<i>Pagina</i> 45 di 452
Relazione di calcolo		

PROGETTO ESECUTIVO

15	0.4492	0.0730	26	0.000531
16	0.5508	0.0730	26	0.000531
17	0.6523	0.0730	26	0.000531
18	0.7539	0.0730	26	0.000531
19	0.8554	0.0730	26	0.000531
20	0.9570	0.0730	26	0.000531
21	0.0430	0.1330	26	0.000531
22	0.1446	0.1330	26	0.000531
23	0.2461	0.1330	26	0.000531
24	0.3477	0.1330	26	0.000531
25	0.4492	0.1330	26	0.000531
26	0.5508	0.1330	26	0.000531
27	0.6523	0.1330	26	0.000531
28	0.7539	0.1330	26	0.000531
29	0.8554	0.1330	26	0.000531
30	0.9570	0.1330	26	0.000531
31	0.0430	0.1930	26	0.000531
32	0.1446	0.1930	26	0.000531
33	0.2461	0.1930	26	0.000531
34	0.3477	0.1930	26	0.000531
35	0.4492	0.1930	26	0.000531
36	0.5508	0.1930	26	0.000531
37	0.6523	0.1930	26	0.000531
38	0.7539	0.1930	26	0.000531
39	0.8554	0.1930	26	0.000531
40	0.9570	0.1930	26	0.000531

Combinazioni

Simbologia adottata

N° numero d'ordine della combinazione

N sforzo normale espresso in[kN]

M_Y momento lungo Y espresso in [kNm]

M_X momento lungo X espresso in [kNm]

M_t momento torcente espresso in [kNm]

T_Y taglio lungo Y espresso in [kN]

T_X taglio lungo X espresso in [kN]

<i>Cod. elab.:</i> 108GA201-GA01-Z-CL-002 C	<i>Titolo:</i> OPERE D'ARTE MAGGIORI- GALLERIE	<i>Data:</i> Ottobre 2011
<i>Nome file:</i> 108GA201-GA01-Z-CL -002_C.docx	ARTIFICIALI – GALLERIA ROVETELLO	<i>Pagina</i> 46 di 452
Relazione di calcolo		

PROGETTO ESECUTIVO

VD verifica di dominio

VT verifica tensionale (SLER - Combinazione rara, SLEF - Combinazione frequente, SLEQP - Combinazione quasi permanente, TAMM - Verifica a tensioni ammissibili)

N°	N	M _Y	M _X	M _t	T _Y	T _X	VD	VT
1	865.0000	3842.0000	0.0000	0.0000	1676.0000	0.0000	SI	NO
2	847.0000	2946.0000	0.0000	0.0000	0.0000	0.0000	NO	SLER
3	838.0000	2886.0000	0.0000	0.0000	0.0000	0.0000	NO	SLEF
4	814.0000	2706.0000	0.0000	0.0000	0.0000	0.0000	NO	SLEQP

Risultati analisi

Caratteristiche asse neutro

Simbologia adottata

N° numero d'ordine della combinazione

Xc posizione asse neutro espresso in [m]

α inclinazione asse neutro rispetto all'orizzontale, espressa in [°]

(xi; yi) - (xf; yf) Punti di intersezione dell'asse neutro con il perimetro della sezione, espressi in [m]

N°	Xc	α	(xi; yi)	(xf; yf)
2	0.6724	0.00	(0.0000; 0.9276)	(1.0000; 0.9276)
3	0.6733	0.00	(0.0000; 0.9267)	(1.0000; 0.9267)
4	0.6766	0.00	(0.0000; 0.9234)	(1.0000; 0.9234)

Risultati tensionali

Simbologia adottata

N° numero d'ordine della combinazione

σ_{c-max} Tensione massima nel calcestruzzo espresso in [MPa]

σ_{c-min} Tensione minima nel calcestruzzo espresso in [MPa]

σ_{f-max} Tensione massima nel ferro espresso in [MPa]

σ_{f-min} Tensione minima nel ferro espresso in [MPa]

τ_c Tensione tangenziale nel calcestruzzo espresso in [MPa]

N°	σ_{c-max}	σ_{c-min}	τ_c	σ_{f-max}	σ_{f-min}
2	6.782	0.000	0.000	90.687	-129.288
3	6.648	0.000	0.000	88.915	-126.440
4	6.249	0.000	0.000	83.627	-117.819

<i>Cod. elab.:</i> 108GA201-GA01-Z-CL-002_C	<i>Titolo:</i> OPERE D'ARTE MAGGIORI- GALLERIE	<i>Data:</i> Ottobre 2011
<i>Nome file:</i> 108GA201-GA01-Z-CL -002_C.docx	ARTIFICIALI – GALLERIA ROVETELLO	<i>Pagina</i> 47 di 452
Relazione di calcolo		

PROGETTO ESECUTIVO

Sollecitazioni ultime

Simbologia adottata

- N° numero d'ordine della combinazione
 N_u Sforzo normale ultimo, espresso in [kN]
 M_{Xu} Momento ultimo in direzione X, espresso in [kNm]
 M_{Yu} Momento ultimo in direzione Y, espresso in [kNm]
 FS Fattore di sicurezza

Combinazione n° 1

	N_u	M_{Xu}	M_{Yu}	FS
	<u>2198.6956</u>	0.0000	<u>9765.7672</u>	2.54
	<u>31729.2679</u>	0.0000	3842.0000	36.68
	865.0000	0.0000	<u>9053.8913</u>	2.36

Risultati taglio

Simbologia adottata

- N° numero d'ordine della combinazione
 V_{Rd} Resistenza di calcolo dell'elemento privo di armatura trasversali a taglio, espresso in [kN]
 V_{Rcd} Resistenza di calcolo a "taglio compressione", espresso in [kN]
 V_{Rsd} resistenza di calcolo a "taglio trazione", espresso in [kN]

N°	T	V_{Rd}	V_{Rcd}	V_{Rsd}	Diametro e passo staffe
1	1676.0000	985.9771	5287.9393	1737.0276	φ12.00 - 0.1800 [m]

Risultati fessurazione

Simbologia adottata

- N° numero d'ordine della combinazione
 M_X Momento di prima fessurazione in direzione X, espresso in [kNm]
 M_Y Momento di prima fessurazione in direzione Y, espresso in [kNm]
 σ_f Tensione nell'acciaio, espressa in [MPa]
 σ_c Tensione nel calcestruzzo, espressa in [MPa]
 A_{eff} Area efficace a trazione, espressa in [mq]
 ε Deformazione media acciaio teso, espressa in [°]
 S_m Distanza media tra le fessure, espresso in [mm]
 w Ampiezza delle fessure, espressa in [mm]

<i>Cod. elab.:</i> 108GA201-GA01-Z-CL-002 C	<i>Titolo:</i> OPERE D'ARTE MAGGIORI- GALLERIE	<i>Data:</i> Ottobre 2011
<i>Nome file:</i> 108GA201-GA01-Z-CL -002_C.docx	ARTIFICIALI – GALLERIA ROVETELLO	<i>Pagina</i> 48 di 452
Relazione di calcolo		

PROGETTO ESECUTIVO

N°	M _X	M _Y	σ _r	σ _c	A _{eff}	ε	S _{rm}	w
3	0.0000	1676.3677	-73.444	-5.315	0.328000	0.0510	231	0.2005
4	0.0000	1681.8351	-73.227	-5.301	0.328000	0.0462	231	0.1814

2.3.4.6. Piedritto centrale

Dati

Nome sezione:	PIEDRIT CEN
Tipo sezione	Rettangolare
Base	1.000 [m]
Altezza	1.100 [m]

Caratteristiche geometriche

Area sezione	1.100000 [mq]
Inerzia in direzione X	0.091666667 [m ⁴]
Inerzia in direzione Y	0.110916667 [m ⁴]
Inerzia in direzione XY	0.000000000 [m ⁴]
Ascissa baricentro sezione	X _G = 0.5000 [m]
Ordinata baricentro sezione	Y _G = 0.5500 [m]

Elenco ferri

Simbologia adottata

Posizione riferita all'origine

N° numero d'ordine

X Ascissa posizione ferro espresso in [m]

Y Ordinata posizione ferro espresso in [m]

d Diametro ferro espresso in [mm]

ω Area del ferro espresso in [mq]

N°	X	Y	d	ω
1	0.0420	0.0720	24	0.000452
2	0.1438	0.0720	24	0.000452
3	0.2456	0.0720	24	0.000452
4	0.3473	0.0720	24	0.000452
5	0.4491	0.0720	24	0.000452
6	0.5509	0.0720	24	0.000452

Cod. elab.: 108GA201-GA01-Z-CL-002 C	Titolo: OPERE D'ARTE MAGGIORI- GALLERIE	Data: Ottobre 2011
Nome file: 108GA201-GA01-Z-CL -002_C.docx	ARTIFICIALI – GALLERIA ROVETELLO	Pagina 49 di 452
Relazione di calcolo		

PROGETTO ESECUTIVO

7	0.6527	0.0720	24	0.000452
8	0.7544	0.0720	24	0.000452
9	0.8562	0.0720	24	0.000452
10	0.9580	0.0720	24	0.000452
11	0.9580	1.0280	24	0.000452
12	0.8562	1.0280	24	0.000452
13	0.7544	1.0280	24	0.000452
14	0.6527	1.0280	24	0.000452
15	0.5509	1.0280	24	0.000452
16	0.4491	1.0280	24	0.000452
17	0.3473	1.0280	24	0.000452
18	0.2456	1.0280	24	0.000452
19	0.1438	1.0280	24	0.000452
20	0.0420	1.0280	24	0.000452

Combinazioni

Simbologia adottata

N° numero d'ordine della combinazione

N sforzo normale espresso in[kN]

M_Y momento lungo Y espresso in [kNm]

M_X momento lungo X espresso in [kNm]

M_t momento torcente espresso in [kNm]

T_Y taglio lungo Y espresso in [kN]

T_X taglio lungo X espresso in [kN]

VD verifica di dominio

VT verifica tensionale (SLER - Combinazione rara, SLEF - Combinazione frequente, SLEQP - Combinazione quasi permanente, TAMM - Verifica a tensioni ammissibili)

N°	N	M _Y	M _X	M _t	T _Y	T _X	VD	VT
1	3731.0000	-1029.0000	0.0000	0.0000	113.0000	0.0000	SI	NO
2	2858.0000	-627.0000	0.0000	0.0000	0.0000	0.0000	NO	SLER
3	2787.0000	-608.0000	0.0000	0.0000	0.0000	0.0000	NO	SLEF
4	2576.0000	-551.0000	0.0000	0.0000	0.0000	0.0000	NO	SLEQP

Risultati analisi

Caratteristiche asse neutro

Simbologia adottata

<i>Cod. elab.:</i> 108GA201-GA01-Z-CL-002_C	<i>Titolo:</i> OPERE D'ARTE MAGGIORI- GALLERIE	<i>Data:</i> Ottobre 2011
<i>Nome file:</i> 108GA201-GA01-Z-CL -002_C.docx	ARTIFICIALI – GALLERIA ROVETELLO	<i>Pagina</i> 50 di 452
Relazione di calcolo		

PROGETTO ESECUTIVO

N° numero d'ordine della combinazione

Xc posizione asse neutro espresso in [m]

α inclinazione asse neutro rispetto all'orizzontale, espressa in [°]

(xi; yi) - (xf; yf) Punti di intersezione dell'asse neutro con il perimetro della sezione, espressi in [m]

N°	Xc	α	(xi; yi)	(xf; yf)
2	1.0725	0.00	(1.0000; 1.0725)	(0.0000; 1.0725)
3	1.0756	0.00	(1.0000; 1.0756)	(0.0000; 1.0756)
4	1.0867	0.00	(1.0000; 1.0867)	(0.0000; 1.0867)

Risultati tensionali

Simbologia adottata

N° numero d'ordine della combinazione

σ_{c-max} Tensione massima nel calcestruzzo espresso in [MPa]

σ_{c-min} Tensione minima nel calcestruzzo espresso in [MPa]

σ_{f-max} Tensione massima nel ferro espresso in [MPa]

σ_{f-min} Tensione minima nel ferro espresso in [MPa]

τ_c Tensione tangenziale nel calcestruzzo espresso in [MPa]

N°	σ_{c-max}	σ_{c-min}	τ_c	σ_{f-max}	σ_{f-min}
2	4.745	0.000	0.000	66.394	2.951
3	4.613	0.000	0.000	64.566	3.064
4	4.220	0.000	0.000	59.111	3.419

Sollecitazioni ultime

Simbologia adottata

N° numero d'ordine della combinazione

N_u Sforzo normale ultimo, espresso in [kN]

M_{Xu} Momento ultimo in direzione X, espresso in [kNm]

M_{Yu} Momento ultimo in direzione Y, espresso in [kNm]

FS Fattore di sicurezza

Combinazione n° 1

N_u	M_{Xu}	M_{Yu}	FS
<u>15078.1864</u>	0.0000	<u>-4158.5242</u>	4.04

Cod. elab.: 108GA201-GA01-Z-CL-002_C	Titolo: OPERE D'ARTE MAGGIORI- GALLERIE	Data: Ottobre 2011
Nome file: 108GA201-GA01-Z-CL -002_C.docx	ARTIFICIALI – GALLERIA ROVETELLO	Pagina 51 di 452
Relazione di calcolo		

PROGETTO ESECUTIVO

24512.9453	0.0000	-1029.0000	6.57
3731.0000	0.0000	-3400.5324	3.30

Risultati taglio

Simbologia adottata

N° numero d'ordine della combinazione

V_{Rd} Resistenza di calcolo dell'elemento privo di armatura trasversali a taglio, espresso in [kN]

V_{Rcd} Resistenza di calcolo a "taglio compressione", espresso in [kN]

V_{Rsd} resistenza di calcolo a "taglio trazione", espresso in [kN]

N°	T	V _{Rd}	V _{Rcd}	V _{Rsd}	Diametro e passo staffe
1	113.0000	1005.7980	4077.2786	1065.4507	φ12.00 - 0.2000 [m]

Risultati fessurazione

Simbologia adottata

N° numero d'ordine della combinazione

M_X Momento di prima fessurazione in direzione X, espresso in [kNm]

M_Y Momento di prima fessurazione in direzione Y, espresso in [kNm]

σ_r Tensione nell'acciaio, espressa in [MPa]

σ_c Tensione nel calcestruzzo, espressa in [MPa]

A_{eff} Area efficace a trazione, espressa in [mq]

ε Deformazione media acciaio teso, espressa in [°]

S_m Distanza media tra le fessure, espresso in [mm]

w Ampiezza delle fessure, espressa in [mm]

N°	M _X	M _Y	σ _r	σ _c	A _{eff}	ε	S _m	w
3	0.0000	-14288.8370	72.020	-2.456	0.000000	0.0000	0	0.0000
4	0.0000	-25767.6496	159.913	-2.416	0.000000	0.0000	0	0.0000

2.3.4.7. Soletta corrente

Dati

Nome sezione:	SOLET CORR
Tipo sezione	Rettangolare
Base	1.000 [m]
Altezza	1.600 [m]

Cod. elab.: 108GA201-GA01-Z-CL-002_C	Titolo: OPERE D'ARTE MAGGIORI- GALLERIE	Data: Ottobre 2011
Nome file: 108GA201-GA01-Z-CL -002_C.docx	ARTIFICIALI – GALLERIA ROVETELLO	Pagina 52 di 452
Relazione di calcolo		

PROGETTO ESECUTIVO

Caratteristiche geometriche

Area sezione	1.600000	[mq]
Inerzia in direzione X	0.133333333	[m^4]
Inerzia in direzione Y	0.341333333	[m^4]
Inerzia in direzione XY	0.000000000	[m^4]
Ascissa baricentro sezione	$X_G = 0.5000$	[m]
Ordinata baricentro sezione	$Y_G = 0.8000$	[m]

Elenco ferri

Simbologia adottata

Posizione riferita all'origine

N° numero d'ordine

X Ascissa posizione ferro espresso in [m]

Y Ordinata posizione ferro espresso in [m]

d Diametro ferro espresso in [mm]

ω Area del ferro espresso in [mq]

N°	X	Y	d	ω
1	0.9570	1.5270	26	0.000531
2	0.8554	1.5270	26	0.000531
3	0.7539	1.5270	26	0.000531
4	0.6523	1.5270	26	0.000531
5	0.5508	1.5270	26	0.000531
6	0.4492	1.5270	26	0.000531
7	0.3477	1.5270	26	0.000531
8	0.2461	1.5270	26	0.000531
9	0.1446	1.5270	26	0.000531
10	0.0430	1.5270	26	0.000531
11	0.0430	0.0730	26	0.000531
12	0.1446	0.0730	26	0.000531
13	0.2461	0.0730	26	0.000531
14	0.3477	0.0730	26	0.000531
15	0.4492	0.0730	26	0.000531
16	0.5508	0.0730	26	0.000531
17	0.6523	0.0730	26	0.000531
18	0.7539	0.0730	26	0.000531

<i>Cod. elab.:</i> 108GA201-GA01-Z-CL-002_C	<i>Titolo:</i> OPERE D'ARTE MAGGIORI- GALLERIE	<i>Data:</i> Ottobre 2011
<i>Nome file:</i> 108GA201-GA01-Z-CL -002_C.docx	ARTIFICIALI – GALLERIA ROVETELLO	<i>Pagina</i> 53 di 452
Relazione di calcolo		

PROGETTO ESECUTIVO

19	0.8554	0.0730	26	0.000531
20	0.9570	0.0730	26	0.000531

Combinazioni

Simbologia adottata

N° numero d'ordine della combinazione

N sforzo normale espresso in[kN]

M_Y momento lungo Y espresso in [kNm]

M_X momento lungo X espresso in [kNm]

M_t momento torcente espresso in [kNm]

T_Y taglio lungo Y espresso in [kN]

T_X taglio lungo X espresso in [kN]

VD verifica di dominio

VT verifica tensionale (SLER - Combinazione rara, SLEF - Combinazione frequente, SLEQP - Combinazione quasi permanente, TAMM - Verifica a tensioni ammissibili)

N°	N	M _Y	M _X	M _t	T _Y	T _X	VD	VT
1	614.0000	-3018.0000	0.0000	0.0000	1188.0000	0.0000	SI	NO

Risultati analisi

Sollecitazioni ultime

Simbologia adottata

N° numero d'ordine della combinazione

N_u Sforzo normale ultimo, espresso in [kN]

M_{Xu} Momento ultimo in direzione X, espresso in [kNm]

M_{Yu} Momento ultimo in direzione Y, espresso in [kNm]

FS Fattore di sicurezza

Combinazione n° 1

N _u	M _{Xu}	M _{Yu}	FS
<u>725.5629</u>	0.0000	<u>-3566.3660</u>	1.18
<u>33277.2152</u>	0.0000	-3018.0000	54.20
614.0000	0.0000	<u>-3487.4115</u>	1.16

Risultati taglio

Simbologia adottata

N° numero d'ordine della combinazione

Cod. elab.: 108GA201-GA01-Z-CL-002 C	Titolo: OPERE D'ARTE MAGGIORI- GALLERIE ARTIFICIALI – GALLERIA ROVETELLO	Data: Ottobre 2011
Nome file: 108GA201-GA01-Z-CL -002_C.docx	Relazione di calcolo	Pagina 54 di 452

PROGETTO ESECUTIVO

V_{Rd} Resistenza di calcolo dell'elemento privo di armatura trasversali a taglio, espresso in [kN]

V_{Rcd} Resistenza di calcolo a "taglio compressione", espresso in [kN]

V_{Rsd} resistenza di calcolo a "taglio trazione", espresso in [kN]

N°	T	V_{Rd}	V_{Rcd}	V_{Rsd}	Diametro e passo staffe
1	1188.0000	685.7346	5249.7213	1563.3248	Ø12.00 - 0.2000 [m]

2.3.5. Verifiche a taglio

DATI	
Rck	45 MPa
fck	37.4 MPa
fcd	21.2 MPa
cotg θ	2.5
fyk	450
fyd	391 MPa

$1 \leq \cotg \theta \leq 2.5$

VERIFICA A TAGLIO (NTC 2008) SEZ.RETTANGOLARI

SEZIONE: CALOTTA

$V_{Ed} = 282$ kN

GEOMETRIA:	STAFFE	PIEGATI	ARMATURA TESA	AZIONE ASSIALE	VERIFICA					
B (m) :	1.00	Ø 2 bracci	0	Ø 26	10	Ø 24	Ned (kN):	577	Vrd (kN):	537
H (m) :	1.10	/ 20 cm		/ 100 cm			+trazione		Vrsd(kN):	0
cop (m) :	0.06		incl.	60 °					Vrcd(kN):	3'500
		0 mmq/m		0 mmq/m		4'524 mmq/m			VRD (kN):	537
ProL arm long (m) :										1.17

SEZIONE: PIED- LAT

$V_{Ed} = 971$ kN

GEOMETRIA:	STAFFE	PIEGATI	ARMATURA TESA	AZIONE ASSIALE	VERIFICA					
B (m) :	1.00	Ø 2 bracci	5	Ø 26	10	Ø 24	Ned (kN):	-1104	Vrd (kN):	698
H (m) :	1.50	/ 20 cm		/ 325 cm			+trazione		Vrsd(kN):	1'025
cop (m) :	0.06		incl.	45 °					Vrcd(kN):	6'851
		0 mmq/m		817 mmq/m		4'524 mmq/m			VRD (kN):	1'025
ProL arm long (m) :										0.97

SEZIONE: SOL-ESTREMI

$V_{Ed} = 1616$ kN

GEOMETRIA:	STAFFE	PIEGATI	ARMATURA TESA	AZIONE ASSIALE	VERIFICA					
B (m) :	1.00	Ø 2 bracci	5	Ø 26	15	Ø 26	Ned (kN):	-614	Vrd (kN):	763
H (m) :	1.60	/ 20 cm		/ 200 cm			+trazione		Vrsd(kN):	1'919
cop (m) :	0.06		incl.	60 °					Vrcd(kN):	6'339
		0 mmq/m		1'327 mmq/m		7'964 mmq/m			VRD (kN):	1'919
ProL arm long (m) :										1.33

Cod. elab.: 108GA201-GA01-Z-CL-002 C	Titolo: OPERE D'ARTE MAGGIORI- GALLERIE	Data: Ottobre 2011
Nome file: 108GA201-GA01-Z-CL -002_C.docx	ARTIFICIALI – GALLERIA ROVETELLO	Pagina 55 di 452
Relazione di calcolo		

PROGETTO ESECUTIVO

SEZIONE: SOLETTONE SENZA ARMATURA

VEd = 0 kN

GEOMETRIA:	STAFFE	PIEGATI	ARMATURA TESA	AZIONE ASSIALE	VERIFICA
B (m) : 1.00	∅ 2 bracci	0 ∅ 26	15 ∅ 26	Ned (kN): -614	Vrd (kN): 763
H (m) : 1.60	/ 20 cm	/ 60 cm		+trazione	Vrsd(kN): 0
cop (m) : 0.06		incl. 60 °			Vrcd(kN): 5'149
	0 mmq/m	0 mmq/m	7'964 mmq/m		VRD (kN): 763
					ProL arm long (m) : 1.73

SEZIONE: SOL-CENTRO

VEd = 1676 kN

GEOMETRIA:	STAFFE	PIEGATI	ARMATURA TESA	AZIONE ASSIALE	VERIFICA
B (m) : 1.00	∅ 2 bracci	5 ∅ 26	20 ∅ 26	Ned (kN): -614	Vrd (kN): 831
H (m) : 1.60	/ 20 cm	/ 200 cm		+trazione	Vrsd(kN): 1'919
cop (m) : 0.06		incl. 60 °			Vrcd(kN): 6'339
	0 mmq/m	1'327 mmq/m	10'619 mmq/m		VRD (kN): 1'919
					ProL arm long (m) : 1.33

SEZIONE: PIED-CEN

VEd = 113 kN

GEOMETRIA:	STAFFE	PIEGATI	ARMATURA TESA	AZIONE ASSIALE	VERIFICA
B (m) : 1.00	∅ 2 bracci	0 ∅ 24	10 ∅ 24	Ned (kN): -1071	Vrd (kN): 607
H (m) : 1.10	/ 20 cm	/ 20 cm		+trazione	Vrsd(kN): 0
cop (m) : 0.06		incl. 60 °			Vrcd(kN): 3'573
	0 mmq/m	0 mmq/m	4'524 mmq/m		VRD (kN): 607
					ProL arm long (m) : 1.17

Cod. elab.: 108GA201-GA01-Z-CL-002_C	Titolo: OPERE D'ARTE MAGGIORI- GALLERIE	Data: Ottobre 2011
Nome file: 108GA201-GA01-Z-CL -002_C.docx	ARTIFICIALI – GALLERIA ROVETELLO	Pagina 56 di 452
Relazione di calcolo		

3. VERIFICA DI STABILITÀ DELLO SCAVO

3.1.1. Generalità

Di seguito si riporta la verifica di stabilità del terreno durante la fase di scavo. Tale fase risulta provvisoria, per tale motivo ai fini delle verifiche non viene preso in considerazione l'azione sismica. Lo scavo parte con una banca orizzontale di 3 m a partire dal piede della soletta di fondazione della galleria artificiale e prosegue con scarpate 3/2 di altezza complessiva pari a 5 m e successive banche orizzontali di larghezza pari a 2 m.

3.1.2. Descrizione metodo di calcolo

La verifica alla stabilità del pendio deve fornire un coefficiente di sicurezza non inferiore a **1.10**.

Viene usata la tecnica della suddivisione a strisce della superficie di scorrimento da analizzare.

In particolare il programma esamina un numero di superfici che dipende dalle impostazioni fornite e che sono riportate nella corrispondente sezione. Il processo iterativo permette di determinare il coefficiente di sicurezza di tutte le superfici analizzate.

Nella descrizione dei metodi di calcolo si adatterà la seguente simbologia:

l lunghezza della base della striscia

α angolo della base della striscia rispetto all'orizzontale

b larghezza della striscia $b=l \times \cos(\alpha)$

ϕ angolo di attrito lungo la base della striscia

c coesione lungo la base della striscia

γ peso di volume del terreno

u pressione neutra

W peso della striscia

N sforzo normale alla base della striscia

T sforzo di taglio alla base della striscia

E_s, E_d forze normali di interstriscia a sinistra e a destra

X_s, X_d forze tangenziali di interstriscia a sinistra e a destra

E_a, E_b forze normali di interstriscia alla base ed alla sommità del pendio

ΔX variazione delle forze tangenziali sulla striscia $\Delta X = X_d - X_s$

ΔE variazione delle forze normali sulla striscia $\Delta E = E_d - E_s$

Metodo di Fellenius (metodo svedese)

Il coefficiente di sicurezza fornito da **Fellenius** si esprime secondo la seguente formula:

Cod. elab.: 108GA201-GA01-Z-CL-002_C	Titolo: OPERE D'ARTE MAGGIORI- GALLERIE	Data: Ottobre 2011
Nome file: 108GA201-GA01-Z-CL -002_C.docx	ARTIFICIALI – GALLERIA ROVETELLO	Pagina 57 di 452
Relazione di calcolo		

PROGETTO ESECUTIVO

$$F = \frac{\sum_i \left(\frac{c_i b_i}{\cos \alpha_i} + [W_i \cos \alpha_i - u_i l_i] \operatorname{tg} \phi_i \right)}{\sum_i W_i \sin \alpha_i}$$

dove n è il numero delle strisce considerate, b_i e α_i sono la larghezza e l'inclinazione della base della striscia i -esima rispetto all'orizzontale, W_i è il peso della striscia i -esima e c_i e ϕ_i sono le caratteristiche del terreno (coesione ed angolo di attrito) lungo la base della striscia.

Inoltre u_i ed l_i rappresentano la pressione neutra lungo la base della striscia e la lunghezza della base della striscia ($l_i = b_i / \cos \alpha_i$).

Quindi, assunto un cerchio di tentativo lo si suddivide in n strisce e dalla formula precedente si ricava F . Questo procedimento viene eseguito per il numero di centri prefissato e viene assunto come coefficiente di sicurezza del pendio il minimo dei coefficienti così determinati.

Metodo di Bishop

Il coefficiente di sicurezza nel metodo di **Bishop semplificato** si esprime secondo la seguente formula:

$$F = \frac{\sum_i \left(\frac{c_i b_i + (N_i / \cos(\alpha_i) - u_i b_i) \operatorname{tg} \phi_i}{m} \right)}{\sum_i W_i \sin \alpha_i}$$

dove il termine m è espresso da

$$m = \left(1 + \frac{\operatorname{tg} \phi_i \operatorname{tg} \alpha_i}{F} \right) \cos \alpha_i$$

In questa espressione n è il numero delle strisce considerate, b_i e α_i sono la larghezza e l'inclinazione della base della striscia i -esima rispetto all'orizzontale, W_i è il peso della striscia i -esima, c_i e ϕ_i sono le caratteristiche del terreno (coesione ed angolo di attrito) lungo la base della striscia ed u_i è la pressione neutra lungo la base della striscia.

L'espressione del coefficiente di sicurezza di **Bishop semplificato** contiene al secondo membro il termine m che è funzione di F . Quindi essa viene risolta per successive approssimazioni assumendo un valore iniziale per F da inserire nell'espressione di m ed iterare finquando il valore calcolato coincide con il valore assunto.

Cod. elab.: 108GA201-GA01-Z-CL-002_C	Titolo: OPERE D'ARTE MAGGIORI- GALLERIE	Data: Ottobre 2011
Nome file: 108GA201-GA01-Z-CL -002_C.docx	ARTIFICIALI – GALLERIA ROVETELLO	Pagina 58 di 452
Relazione di calcolo		

3.1.3. Descrizione terreno

Simbologia adottata

<i>Nr.</i>	Indice del terreno
<i>Descrizione</i>	Descrizione terreno
γ	Peso di volume del terreno espresso in kN/mc
γ_w	Peso di volume saturo del terreno espresso in kN/mc
ϕ	Angolo d'attrito interno 'efficace' del terreno espresso in gradi
c	Coesione 'efficace' del terreno espressa in N/mm ²
ϕ_u	Angolo d'attrito interno 'totale' del terreno espresso gradi
c_u	Coesione 'totale' del terreno espressa in N/mm ²

Nr.	Descrizione	γ	γ_w	ϕ'	c'	ϕ_u	c_u
13	AL1	18,00	19,00	17.40	0,0100	0.00	0,0400
14	AL2	18,80	19,80	21.00	0,0240	0.00	0,1100
15	AL3	19,20	20,20	16.90	0,0340	0.00	0,1190

3.1.4. Profilo del piano campagna

Simbologia e convenzioni di segno adottate

L'ascissa è intesa positiva da sinistra verso destra e l'ordinata positiva verso l'alto.

<i>Nr.</i>	Identificativo del punto
X	Ascissa del punto del profilo espressa in m
Y	Ordinata del punto del profilo espressa in m

Nr.	X [m]	Y [m]
1	0,00	25,00
2	30,00	25,00
3	32,20	26,47
4	37,50	30,00
5	39,50	30,00
6	46,20	34,47
7	47,00	35,00
8	49,00	35,00
9	56,50	40,00
10	58,50	40,00
11	60,70	41,47
12	100,00	41,47

<i>Cod. elab.:</i> 108GA201-GA01-Z-CL-002 C	<i>Titolo:</i> OPERE D'ARTE MAGGIORI- GALLERIE	<i>Data:</i> Ottobre 2011
<i>Nome file:</i> 108GA201-GA01-Z-CL -002_C.docx	ARTIFICIALI – GALLERIA ROVETELLO	<i>Pagina</i> 59 di 452
Relazione di calcolo		

3.1.5. Descrizione stratigrafia

Simbologia e convenzioni di segno adottate

Gli strati sono descritti mediante i punti di contorno (in senso antiorario) e l'indice del terreno di cui è costituito

Strato N° 1 costituito da terreno n° 15 (AL3)

Coordinate dei vertici dello strato n° 1

N°	X[m]	Y[m]
1	32,20	26,47
2	30,00	25,00
3	0,00	25,00
4	0,00	0,00
5	100,00	0,00
6	100,00	26,47
7	50,00	26,47

Strato N° 2 costituito da terreno n° 13 (AL1)

Coordinate dei vertici dello strato n° 2

N°	X[m]	Y[m]
1	100,00	34,47
2	100,00	41,47
3	60,70	41,47
4	58,50	40,00
5	56,50	40,00
6	49,00	35,00
7	47,00	35,00
8	46,20	34,47

Strato N° 3 costituito da terreno n° 14 (AL2)

Coordinate dei vertici dello strato n° 3

N°	X[m]	Y[m]
1	100,00	26,47
2	100,00	34,47
3	46,20	34,47
4	39,50	30,00
5	37,50	30,00
6	32,20	26,47
7	50,00	26,47

<i>Cod. elab.:</i> 108GA201-GA01-Z-CL-002_C	<i>Titolo:</i> OPERE D'ARTE MAGGIORI- GALLERIE	<i>Data:</i> Ottobre 2011
<i>Nome file:</i> 108GA201-GA01-Z-CL -002_C.docx	ARTIFICIALI – GALLERIA ROVETELLO	<i>Pagina</i> 60 di 452
Relazione di calcolo		

PROGETTO ESECUTIVO

Nella figura seguente si riporta la schematizzazione del modello di calcolo che rappresenta il pendio da verificare ed inoltre si riporta la mappatura dei centri delle superfici di rottura.



Figura 3.1: Schematizzazione del pendio



Figura 3.2: Mappa dei centri delle superfici di rottura

Cod. elab.: 108GA201-GA01-Z-CL-002 C	Titolo: OPERE D'ARTE MAGGIORI- GALLERIE	Data: Ottobre 2011
Nome file: 108GA201-GA01-Z-CL -002_C.docx	ARTIFICIALI – GALLERIA ROVETELLO	Pagina 61 di 452
Relazione di calcolo		

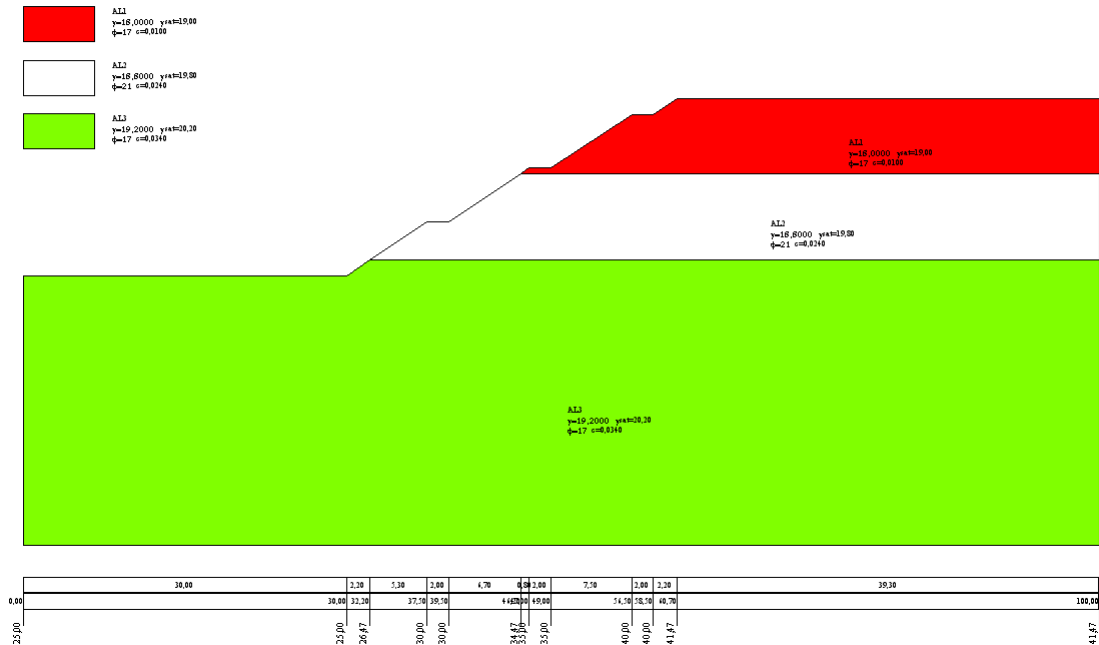
Maglia dei centri				Raggio		
Origine	X [m]	26,00	Y [m]	23,00	Raggio [m]	5,00 <input checked="" type="checkbox"/> Variabile
Passo	DX [m]	1,50	DY [m]	1,50	Incrementi del raggio [m]	1,00
Nr. punti	Nx	28	Ny	28	Numero di incrementi	30

3.1.6. Verifica in termini di tensioni efficaci

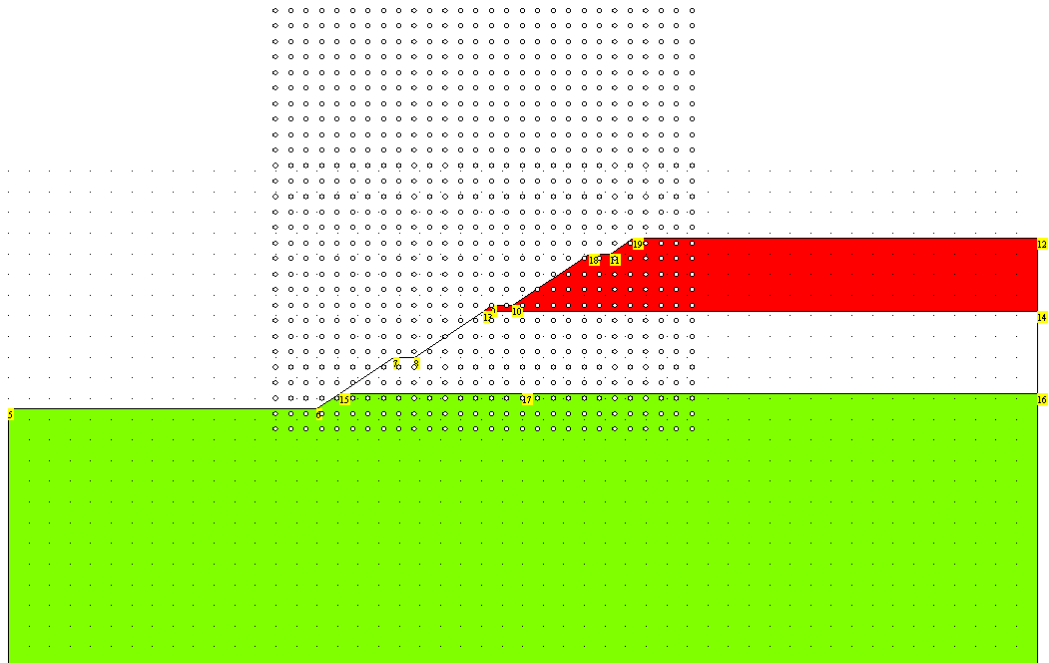
Si riporta di seguito il cerchio critico relativamente alla verifica in termini di tensioni efficaci.



Figura 3.3: Cerchio di rottura in termini di tensioni efficaci

Cod. elab.: 108GA201-GA01-Z-CL-002 C	Titolo: OPERE D'ARTE MAGGIORI- GALLERIE	Data: Ottobre 2011
Nome file: 108GA201-GA01-Z-CL -002_C.docx	ARTIFICIALI – GALLERIA ROVETELLO	Pagina 62 di 452
Relazione di calcolo		

3.1.7. Verifica in termini di tensioni totali

Si riporta di seguito il cerchio critico relativamente alla verifica in termini di tensioni totali.

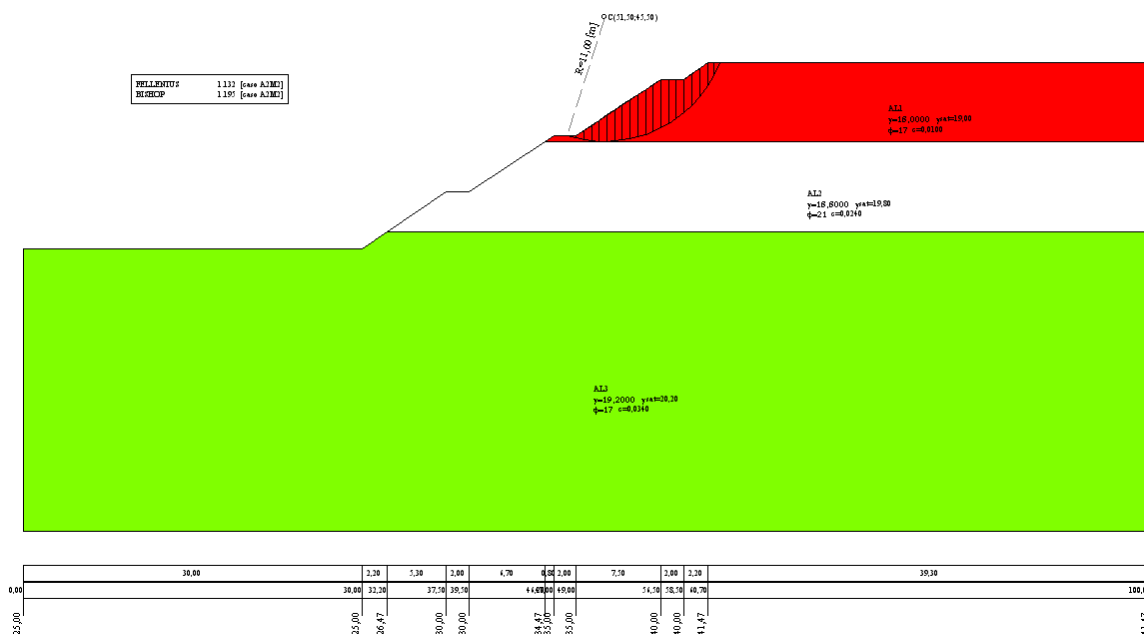
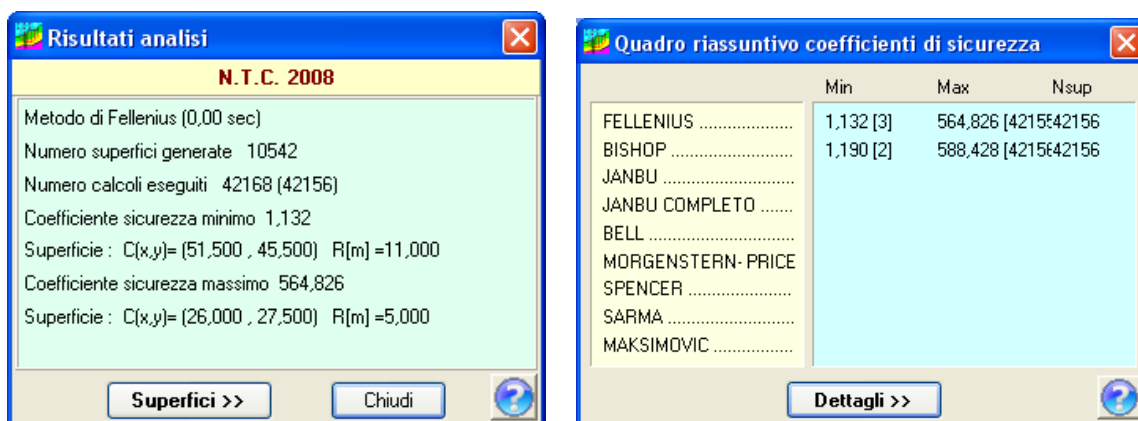

Figura 3.4: Cerchio di rottura in termini di tensioni totali

Cod. elab.: 108GA201-GA01-Z-CL-002_C	Titolo: OPERE D'ARTE MAGGIORI- GALLERIE ARTIFICIALI – GALLERIA ROVETELLO	Data: Ottobre 2011
Nome file: 108GA201-GA01-Z-CL -002_C.docx	Relazione di calcolo	Pagina 63 di 452

4. CALCOLO PARATIA PROVVISIONALE

4.1. CARATTERISTICHE DEL SOFTWARE PAC10.0

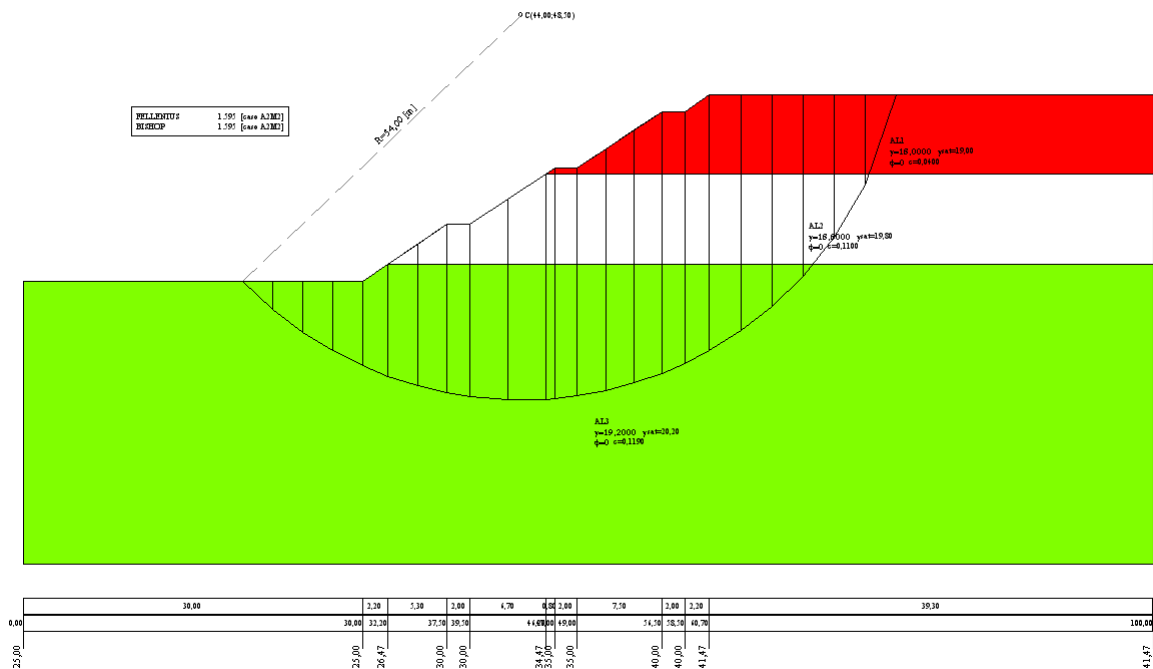
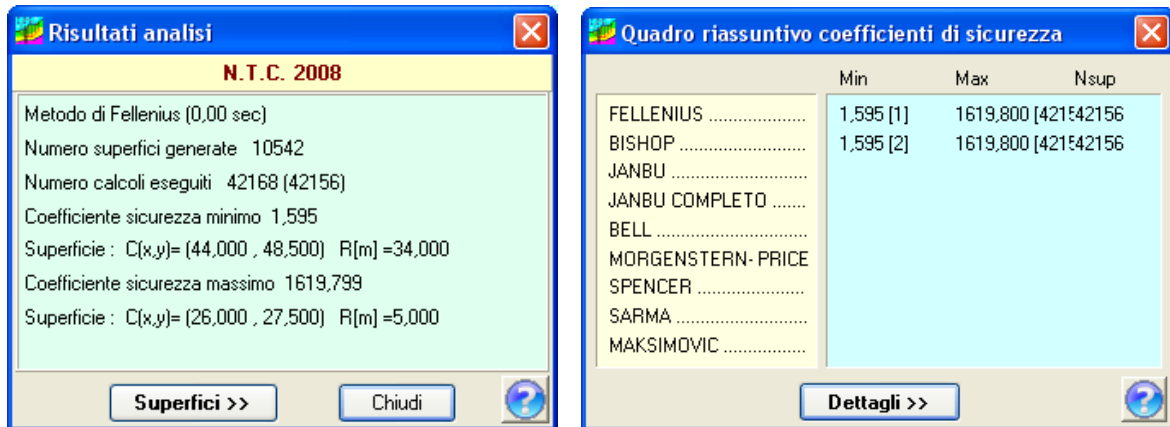
Il programma **PAC10.0**® è dedicato all'analisi e al calcolo di paratie. La versione del programma utilizzata è la Rel. 10.07a del 2010, distribuita dalla società AZTEC, nella forma originale commercializzata senza alcuna modifica apportata da parte dell'utente.

4.1.1. Schematizzazione di calcolo

Partendo dalle caratteristiche meccaniche del terreno, dalla geometria e dai sovraccarichi agenti, il programma esegue le verifiche dei diaframmi considerando tratti di lunghezza unitaria, restituendo le armature necessarie per metro lineare di opera.

Il calcolo della spinta attiva esercitata dal terrapieno a ridosso del muro, è stato condotto utilizzando il metodo di Culmann, noto anche come "metodo del cuneo di tentativo".

Il metodo in questione considera una superficie di rottura del terrapieno di tipo piano. Il valore della spinta viene determinato per iterazioni successive come segue:

- si impone una superficie di rottura inclinata di un angolo arbitrario ρ rispetto all'orizzontale e si considera il cuneo di spinta delimitato dalla superficie di rottura stessa, dalla parete su cui si calcola la spinta, e dal profilo del terreno;
- si valutano tutte le forze agenti sul cuneo di spinta e cioè peso proprio W , carichi agenti sulla superficie del terreno, siano essi concentrati che distribuiti, resistenza per attrito R e per coesione c lungo la superficie di rottura e resistenza per coesione lungo la parete di contatto terra muro A ;
- dalle equazioni di equilibrio si ricava quindi il valore della spinta S sulla parete, inclinata dell'angolo d'attrito terreno–muro δ rispetto alla normale alla parete.

Per determinare il punto di applicazione della spinta, i passi elementari su esposti vengono applicati discretizzando l'altezza del muro in tanti tratti di ampiezza dz . In corrispondenza di ogni ordinata z_i , si determina il cuneo di rottura e la spinta elementare S_i , ottenendo quindi la distribuzione della spinta $S(z)$ lungo l'altezza della parete. Sulla base della distribuzione delle spinte lungo l'altezza della parete, è possibile determinare la pressione ad una generica profondità z , rispetto alla sommità della parete ponendo:

$$\sigma(z) = \frac{dS}{dz}$$

Nota quindi il diagramma delle pressioni è possibile ricavare il punto di applicazione della spinta. Inoltre dal diagramma delle pressioni è facile ricavare anche l'andamento delle sollecitazioni lungo la parete.

<i>Cod. elab.:</i> 108GA201-GA01-Z-CL-002_C	<i>Titolo:</i> OPERE D'ARTE MAGGIORI- GALLERIE	<i>Data:</i> Ottobre 2011
<i>Nome file:</i> 108GA201-GA01-Z-CL -002_C.docx	ARTIFICIALI – GALLERIA ROVETELLO Relazione di calcolo	<i>Pagina</i> 64 di 452

4.1.2. Verifiche

Le verifiche vengono condotte tenendo conto delle condizioni più gravose che si individuano dall'involuppo delle sollecitazioni agenti nelle diverse combinazioni di carico.

4.2. SINTESI DEI RISULTATI

Di seguito si riporta la verifica della paratia provvisoria.

par-provv

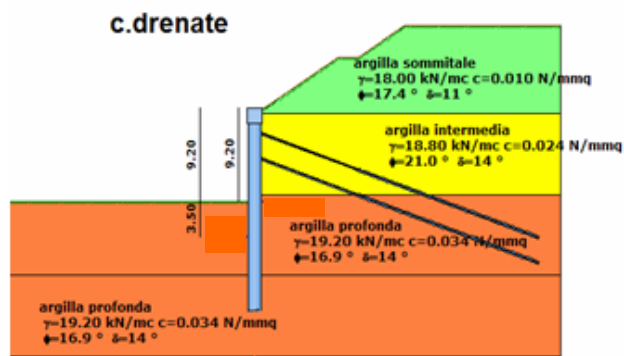

par-provv

Tipo paratia: Paratia di pali

Hfuori ter	9.20	[m]
H infis:	10.80	[m]
H tot:	20.00	[m]
Diam:	1.20	[m]
Inter:	1.40	[m]
incl terr:	15	°

CORDOLO SUP

Base:	1.60	m
Altezza:	1.50	m
TRAVI COLLEGAM		
	2xUPN 280	
Area	10'680	mmq
W:	896'000	mm^3

MATERIALI

Calcestruzzo:	C32/40
Malta per tiranti:	C20/25
Acciaio pali:	B450C
Acciaio Armatura:	B450C
Acciaio Travi coll:	B450C
Acciaio Tiranti:	1300.00 [N/mmq]

DATI SISMICI

ag/g:	0.00
ST:	0.00
SS:	0.00
kv/kh:	0.00

PARAMETRI TIRANTI

Ce:	1.3
aliq fi:	100%
aliq C:	50%
fi med:	21

CARICHI

ARMATURA

longit:	24 Ø 24	==> FS =	1.28
staffe:	Ø 12 / 20 cm	==> FS =	2.11
Coprif:	6 cm		

TIRANTI

N	Y m	inter m	incl °	D m	Ltotale m	Lbulbo m	At mmq	nt	Tiro kN	FS
1	2.5	2.8	20	0.18	33	20	0.6"	6	200	1.25
2	5	2.8	20	0.18	33	20	0.6"	6	300	1.23

Cod. elab.: 108GA201-GA01-Z-CL-002_C	Titolo: OPERE D'ARTE MAGGIORI- GALLERIE	Data: Ottobre 2011
Nome file: 108GA201-GA01-Z-CL -002_C.docx	ARTIFICIALI – GALLERIA ROVETELLO	Pagina 65 di 452
Relazione di calcolo		

PROGETTO ESECUTIVO

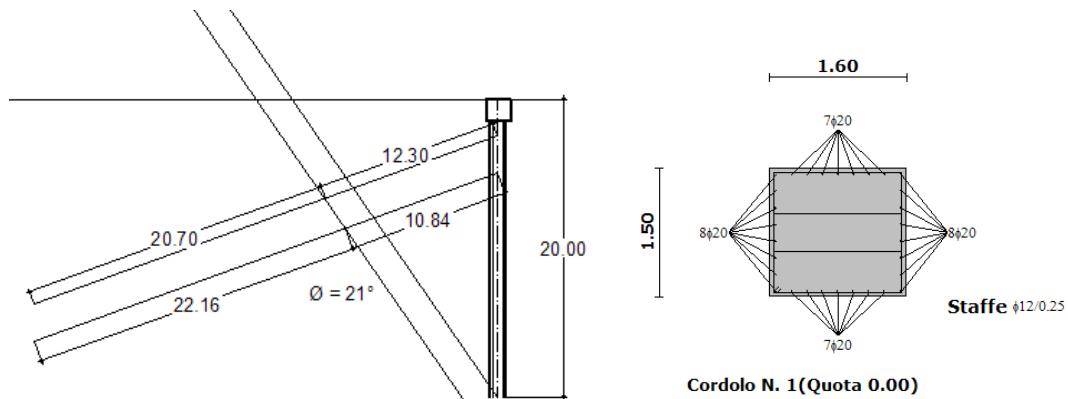

Geometria paratia

Tipo paratia: **Paratia di pali**

Altezza fuori terra	9.20	[m]
Profondità di infissione	10.80	[m]
Altezza totale della paratia	20.00	[m]
Lunghezza paratia	28.00	[m]
Numero di file di pali	1	
Interasse fra i pali della fila	1.40	[m]
Diametro dei pali	1.2000	[m]
Numero totale di pali	19	
Numero di pali per metro lineare	0.68	

Geometria cordoli

Simbologia adottata

n° numero d'ordine del cordolo

Y posizione del cordolo sull'asse della paratia espresso in [m]

Cordoli in calcestruzzo

B Base della sezione del cordolo espresso in [m]

H Altezza della sezione del cordolo espresso in [m]

Cordoli in acciaio

A Area della sezione in acciaio del cordolo espresso in [mq]

W Modulo di resistenza della sezione del cordolo espresso in [m³]

Cod. elab.: 108GA201-GA01-Z-CL-002_C	Titolo: OPERE D'ARTE MAGGIORI- GALLERIE	Data: Ottobre 2011
Nome file: 108GA201-GA01-Z-CL -002_C.docx	ARTIFICIALI – GALLERIA ROVETELLO	Pagina 66 di 452
Relazione di calcolo		

PROGETTO ESECUTIVO

n°	Y	Tipo	B	H	A	W
1	0.00	Calcestruzzo	1.6000	1.5000	--	--
2	2.50	Acciaio	--	--	0.010680	0.00089600
3	5.00	Acciaio	--	--	0.010680	0.00089600
4	7.50	Acciaio	--	--	0.010680	0.00089600

Geometria profilo terreno

Simbologia adottata e sistema di riferimento

(Sistema di riferimento con origine in testa alla paratia, ascissa X positiva verso monte, ordinata Y positiva verso l'alto)

N numero ordine del punto

X ascissa del punto espressa in [m]

Y ordinata del punto espressa in [m]

A inclinazione del tratto espressa in [°]

Profilo di monte

N	X	Y	A
2	1.00	0.00	0.00
3	8.50	5.00	33.69
4	10.50	5.00	0.00
5	15.17	8.11	33.66
6	30.96	8.11	0.00

Profilo di valle - Fase n° 1

N	X	Y	A
1	-30.00	-2.50	0.00
2	0.00	-2.50	0.00

Profilo di valle - Fase n° 3

N	X	Y	A
1	-30.00	-5.00	0.00
2	0.00	-5.00	0.00

Cod. elab.: 108GA201-GA01-Z-CL-002_C	Titolo: OPERE D'ARTE MAGGIORI- GALLERIE	Data: Ottobre 2011
Nome file: 108GA201-GA01-Z-CL -002_C.docx	ARTIFICIALI – GALLERIA ROVETELLO	Pagina 67 di 452
Relazione di calcolo		

PROGETTO ESECUTIVO

Profilo di valle - Fase n° 5

N	X	Y	A
1	-30.00	-7.50	0.00
2	0.00	-7.50	0.00

Profilo di valle - Fase n° 6

N	X	Y	A
1	-30.00	-9.20	0.00
2	0.00	-9.20	0.00

Descrizione terreni

Simbologia adottata

n°	numero d'ordine dello strato a partire dalla sommità della paratia
Descrizione	Descrizione del terreno
γ	peso di volume del terreno espresso in [kN/mc]
γ_s	peso di volume saturo del terreno espresso [kN/mc]
ϕ	angolo d'attrito interno del terreno espresso in [°]
δ	angolo d'attrito terreno/paratia espresso in [°]
c	coesione del terreno espressa in [N/mm ²]

n°	Descrizione	γ	γ_s	ϕ	δ	c
1	argilla sommitale	18.0000	18.0000	17.40	11.00	0.0100
2	argilla intermedia	18.8000	18.8000	21.00	14.00	0.0240
3	argilla profonda	19.2000	19.2000	16.90	14.00	0.0340

Parametri per il calcolo dei tiranti

Simbologia adottata

ϕ_{\min}	angolo d'attrito minimo interno del terreno espresso in [°]
δ_{\min}	angolo d'attrito minimo terreno/paratia espresso in [°]
c _{min}	coesione minima del terreno espressa in [N/mm ²]
ϕ_{med}	angolo d'attrito medio interno del terreno espresso in [°]
δ_{med}	angolo d'attrito medio terreno/paratia espresso in [°]
c _{med}	coesione media del terreno espressa in [N/mm ²]

Cod. elab.: 108GA201-GA01-Z-CL-002_C	Titolo: OPERE D'ARTE MAGGIORI- GALLERIE	Data: Ottobre 2011
Nome file: 108GA201-GA01-Z-CL -002_C.docx	ARTIFICIALI – GALLERIA ROVETELLO	Pagina 68 di 452
Relazione di calcolo		

PROGETTO ESECUTIVO

N°	Descrizione	ϕ_{\min}	ϕ_{med}	δ_{\min}	δ_{med}	c_{\min}	c_{med}
1	argilla sommitale	17.40	17.40	11.00	11.00	0.0100	0.0100
2	argilla intermedia	21.00	21.00	14.00	14.00	0.0240	0.0240
3	argilla profonda	16.90	16.90	14.00	14.00	0.0340	0.0340

Descrizione stratigrafia

Simbologia adottata

n° numero d'ordine dello strato a partire dalla sommità della paratia

sp spessore dello strato in corrispondenza dell'asse della paratia espresso in [m]

kw costante di Winkler orizzontale espressa in Kg/cm²/cm

α inclinazione dello strato espressa in GRADI(°)

Terreno Terreno associato allo strato

n°	sp	α	kw	Terreno
1	0.50	0.00	0.33	argilla sommitale
2	8.00	0.00	1.64	argilla intermedia
3	8.00	0.00	3.01	argilla profonda
4	8.00	0.00	4.33	argilla profonda
5	8.00	0.00	5.66	argilla profonda

Falda

Profondità della falda a monte rispetto alla sommità della paratia 9.20 [m]

Profondità della falda a valle rispetto alla sommità della paratia 12.70 [m]

Regime delle pressioni neutre: **Idrostatico**

Condizioni di carico

Simbologia e convenzioni adottate

Le ascisse dei punti di applicazione del carico sono espresse in [m] rispetto alla testa della paratia

Le ordinate dei punti di applicazione del carico sono espresse in [m] rispetto alla testa della paratia

F_x Forza orizzontale espressa in [kN], positiva da monte verso valle

F_y Forza verticale espressa in [kN], positiva verso il basso

M Momento espresso in [kNm], positivo ribaltante

Q_i, Q_f Intensità dei carichi distribuiti sul profilo espresse in [kN/mq]

V_i, V_s Intensità dei carichi distribuiti sulla paratia espresse in [kN/mq], positivi da monte verso valle

Cod. elab.: 108GA201-GA01-Z-CL-002_C	Titolo: OPERE D'ARTE MAGGIORI- GALLERIE	Data: Ottobre 2011
Nome file: 108GA201-GA01-Z-CL -002_C.docx	ARTIFICIALI – GALLERIA ROVETELLO	Pagina 69 di 452
Relazione di calcolo		

PROGETTO ESECUTIVO

R Risultante carico distribuito sulla paratia espressa in [kN]

Condizione n° 1

Condizione n° 2

Condizione n° 3

Caratteristiche tiranti di ancoraggio

Calcolo tiranti: VERIFICA

I parametri di interazione tiranti-terreno sono stati definiti come percentuale di angolo di attrito e coesione dello strato:

- Aliquota angolo di attrito	100.00 %
- Aliquota coesione	50.00 %
Numero di file di tiranti	2

Tiranti attivi armati con trefoli

Coefficiente cadute di tensione	1.30
Coefficiente di spinta	Definito pari a 1.00
Franco laterale	0.20 [m]

Descrizione tiranti di ancoraggio

Simbologia adottata - Caratteristiche geometriche

N numero d'ordine della fila

Y ordinata della fila espressa in [m] misurata dalla testa della paratia

I interasse tra le file di tiranti espressa in [m]

alfa inclinazione dei tiranti della fila rispetto all'orizzontale espressa in [°]

D diametro della perforazione espresso in [m]

Cesp coeff. di espansione laterale

ALL allineamento dei tiranti della fila (CENTRATI o SFALSATI)

nr numero di tiranti della fila

Lt lunghezza totale del tirante espresso in [m]

Lf lunghezza di fondazione del tirante espresso in [m]

Cod. elab.: 108GA201-GA01-Z-CL-002_C	Titolo: OPERE D'ARTE MAGGIORI- GALLERIE	Data: Ottobre 2011
Nome file: 108GA201-GA01-Z-CL -002_C.docx	ARTIFICIALI – GALLERIA ROVETELLO Relazione di calcolo	Pagina 70 di 452

PROGETTO ESECUTIVO

Simbologia adottata - Caratteristiche armatura e di interazione con il terreno

N numero d'ordine della fila

At area del singolo trefolo espressa in [mq]

nt numero di trefoli del tirante

T tiro iniziale espresso in [kN]

Caratteristiche geometriche

N	Y	I	Alfa	D	Cesp	ALL	nr	Lt	Lf
1	2.50	2.80	20.00	0.1800	1.30	Centrati	9	33.00	20.00
2	5.00	2.80	20.00	0.1800	1.30	Centrati	9	33.00	20.00

Caratteristiche armatura e di interazione con il terreno

N	At	nt	T
10.000139		6	200.00
20.000139		6	300.00

Fasi di scavo

Simbologia adottata

n° identificativo della fase nell'elenco definito

Fase Descrizione dell'i-esima fase

Tempo Tempo in cui avviene la fase di scavo

n°	Fase	Tempo
1	Scavo fino alla profondità di 2.50 metri	0
2	Quota falda valle 12.70 metri - Quota falda monte 9.20 metri [Hscavo=2.50]	0
3	Tesatura tirante 1 N=20394 [Hscavo=2.50]	1
4	Inserimento tirante 1 (X=2.50) [Hscavo=2.50]	1
5	Scavo fino alla profondità di 5.00 metri	2
6	Tesatura tirante 2 N=30591 [Hscavo=5.00]	3
7	Inserimento tirante 2 (X=5.00) [Hscavo=5.00]	3
8	Scavo fino alla profondità di 7.50 metri	4
9	Scavo fino alla profondità di 9.20 metri	5
10		Cadute di tensione
	tirante 2 [Hscavo=9.20]	6

Cod. elab.: 108GA201-GA01-Z-CL-002_C	Titolo: OPERE D'ARTE MAGGIORI- GALLERIE	Data: Ottobre 2011
Nome file: 108GA201-GA01-Z-CL -002_C.docx	ARTIFICIALI – GALLERIA ROVETELLO	Pagina 71 di 452
Relazione di calcolo		

PROGETTO ESECUTIVO

11	Cadute di tensione
tirante 1 [Hscavo=9.20]	6

Impostazioni di progetto

Spinte e verifiche secondo :

Norme Tecniche sulle Costruzioni 14/01/2008

Coefficienti di partecipazione combinazioni statiche

Coefficienti parziali per le azioni o per l'effetto delle azioni:

<i>Carichi</i>	<i>Effetto</i>		<i>A1</i>	<i>A2</i>
Permanenti	Favorevole	γ_{Gfav}	1.00	1.00
Permanenti	Sfavorevole	γ_{Gsfav}	1.30	1.00
Variabili	Favorevole	γ_{Qfav}	0.00	0.00
Variabili	Sfavorevole	γ_{Qsfav}	1.50	1.30

Coefficienti parziali per i parametri geotecnici del terreno:

<i>Parametri</i>			<i>M1</i>	<i>M2</i>
Tangente dell'angolo di attrito	$\gamma_{\tan\phi'}$		1.00	1.25
Coesione efficace	$\gamma_{c'}$		1.00	1.25
Resistenza non drenata	γ_{cu}		1.00	1.40
Resistenza a compressione uniassiale	γ_{qu}		1.00	1.60
Peso dell'unità di volume	γ_{γ}		1.00	1.00

Coefficienti di partecipazione combinazioni sismiche

Coefficienti parziali per le azioni o per l'effetto delle azioni:

<i>Carichi</i>	<i>Effetto</i>		<i>A1</i>	<i>A2</i>
Permanenti	Favorevole	γ_{Gfav}	1.00	1.00
Permanenti	Sfavorevole	γ_{Gsfav}	1.00	1.00
Variabili	Favorevole	γ_{Qfav}	1.00	1.00
Variabili	Sfavorevole	γ_{Qsfav}	1.00	1.00

Coefficienti parziali per i parametri geotecnici del terreno:

<i>Parametri</i>			<i>M1</i>	<i>M2</i>
Tangente dell'angolo di attrito	$\gamma_{\tan\phi'}$		1.00	1.00

<i>Cod. elab.:</i> 108GA201-GA01-Z-CL-002_C	<i>Titolo:</i> OPERE D'ARTE MAGGIORI- GALLERIE	<i>Data:</i> Ottobre 2011
<i>Nome file:</i> 108GA201-GA01-Z-CL -002_C.docx	ARTIFICIALI – GALLERIA ROVETELLO	<i>Pagina</i> 72 di 452
Relazione di calcolo		

PROGETTO ESECUTIVO

Coesione efficace	$\gamma_{c'}$	1.00	1.00
Resistenza non drenata	γ_{cu}	1.00	1.00
Resistenza a compressione uniassiale	γ_{qu}	1.00	1.00
Peso dell'unità di volume	γ_{γ}	1.00	1.00

Verifica materiali : Stato Limite Ultimo

Impostazioni di analisi

Analisi per Fasi di Scavo.

Rottura del terreno: Pressione passiva

Impostazioni analisi per fasi di scavo:

Analisi per coefficienti tipo A1-M1

Analisi per coefficienti tipo A2-M2

Influenza δ (angolo di attrito terreno-paratia): Nel calcolo del coefficiente di spinta attiva K_a e nell'inclinazione della spinta attiva (non viene considerato per la spinta passiva)

Stabilità globale: Metodo di Bishop

Impostazioni analisi sismica

Non sono state analizzate Combinazioni/Fasi sismiche.

Analisi della paratia

L'analisi è stata eseguita per fasi di scavo

La paratia è analizzata con il metodo degli elementi finiti.

Essa è discretizzata in 184 elementi fuori terra e 216 elementi al di sotto della linea di fondo scavo.

Le molle che simulano il terreno hanno un comportamento elastoplastico: una volta raggiunta la pressione passiva non reagiscono ad ulteriori incremento di carico.

Altezza fuori terra della paratia	9.20	[m]
Profondità di infissione	10.80	[m]

<i>Cod. elab.:</i> 108GA201-GA01-Z-CL-002_C	<i>Titolo:</i> OPERE D'ARTE MAGGIORI- GALLERIE	<i>Data:</i> Ottobre 2011
<i>Nome file:</i> 108GA201-GA01-Z-CL -002_C.docx	ARTIFICIALI – GALLERIA ROVETELLO Relazione di calcolo	<i>Pagina</i> 73 di 452

PROGETTO ESECUTIVO

Altezza totale della paratia 20.00 [m]

Forze agenti sulla paratia

Tutte le forze si intendono positive se dirette da monte verso valle. Esse sono riferite ad un metro di larghezza della paratia. Le Y hanno come origine la testa della paratia, e sono espresse in [m]

Simbologia adottata

n° Indice della Combinazione/Fase

Tipo Tipo della Combinazione/Fase

Pa Spinta attiva, espressa in [kN]

Is Incremento sismico della spinta, espressa in [kN]

Pw Spinta della falda, espressa in [kN]

Pp Resistenza passiva, espressa in [kN]

Pc Controspinta, espressa in [kN]

n°	Tipo	Pa	Y _{Pa}	Is	Y _{Is}	Pw	Y _{Pw}	Pp	Y _{Pp}	Pc	Y _{Pc}
1	[A1-M1]	4.51	1.31	--	--	310.63	15.42	-316.37	15.17	1.23	3.08
2	[A1-M1]	31.48	1.37	--	--	310.63	15.42	-310.85	15.44	29.15	4.04
3	[A1-M1]	101.11	4.11	--	--	310.63	15.42	-347.96	14.50	0.00	0.00
4	[A1-M1]	144.39	3.74	--	--	310.63	15.42	-307.28	15.45	4.48	5.40
5	[A1-M1]	350.50	5.80	--	--	310.63	15.42	-453.39	13.26	0.00	0.00
6	[A1-M1]	563.95	6.85	--	--	310.63	15.42	-611.18	14.63	82.90	19.44
7	[A1-M1]	563.95	6.85	--	--	310.63	15.42	-632.10	14.69	98.87	19.42
1	[A2-M2]	4.51	1.31	--	--	310.63	15.42	-316.37	15.17	1.23	3.08
2	[A2-M2]	31.48	1.37	--	--	310.63	15.42	-310.85	15.44	29.15	4.04
3	[A2-M2]	138.05	4.08	--	--	310.63	15.42	-375.86	13.76	0.00	0.00
4	[A2-M2]	184.80	3.86	--	--	310.63	15.42	-343.15	14.35	9.08	5.53
5	[A2-M2]	387.21	5.73	--	--	310.63	15.42	-451.55	13.75	8.81	19.66
6	[A2-M2]	591.05	6.82	--	--	310.63	15.42	-449.12	16.34	14.63	19.87
7	[A2-M2]	591.05	6.82	--	--	310.63	15.42	-452.77	16.36	16.36	19.87

Simbologia adottata

n° Indice della Combinazione/Fase

Tipo Tipo della Combinazione/Fase

Rc Risultante carichi esterni applicati, espressa in [kN]

Cod. elab.: 108GA201-GA01-Z-CL-002 C	Titolo: OPERE D'ARTE MAGGIORI- GALLERIE	Data: Ottobre 2011
Nome file: 108GA201-GA01-Z-CL -002_C.docx	ARTIFICIALI – GALLERIA ROVETELLO	Pagina 74 di 452
Relazione di calcolo		

PROGETTO ESECUTIVO

Rt Risultante delle reazioni dei tiranti (componente orizzontale), espressa in [kN]

Rv Risultante delle reazioni dei vincoli, espressa in [kN]

Rp Risultante delle reazioni dei puntoni, espressa in [kN]

n°	Tipo	Rc	Y _{Rc}	Rt	Y _{Rt}	Rv	Y _{Rv}	Rp	Y _{Rp}
1	[A1-M1]	0.00	0.00	0.00	0.00	--	--	--	--
2	[A1-M1]	0.00	0.00	60.41	2.50	--	--	--	--
3	[A1-M1]	0.00	0.00	63.77	2.50	--	--	--	--
4	[A1-M1]	0.00	0.00	152.23	3.99	--	--	--	--
5	[A1-M1]	0.00	0.00	207.67	3.89	--	--	--	--
6	[A1-M1]	0.00	0.00	346.65	3.82	--	--	--	--
7	[A1-M1]	0.00	0.00	342.20	3.79	--	--	--	--
1	[A2-M2]	0.00	0.00	0.00	0.00	--	--	--	--
2	[A2-M2]	0.00	0.00	60.41	2.50	--	--	--	--
3	[A2-M2]	0.00	0.00	72.79	2.50	--	--	--	--
4	[A2-M2]	0.00	0.00	161.37	3.90	--	--	--	--
5	[A2-M2]	0.00	0.00	254.99	3.82	--	--	--	--
6	[A2-M2]	0.00	0.00	467.92	3.80	--	--	--	--
7	[A2-M2]	0.00	0.00	466.84	3.75	--	--	--	--

Simbologia adottata

n° Indice della Combinazione/Fase

Tipo Tipo della Combinazione/Fase

P_{NUL} Punto di nullo del diagramma, espresso in [m]

P_{INV} Punto di inversione del diagramma, espresso in [m]

C_{ROT} Punto Centro di rotazione, espresso in [m]

MP Percentuale molle plasticizzate, espressa in [%]

R/R_{MAX} Rapporto tra lo sforzo reale nelle molle e lo sforzo che le molle sarebbero in grado di esplicare, espresso in [%]

Pp Portanza di punta, espressa in [kN]

n°	Tipo	P _{NUL}	P _{INV}	C _{ROT}	MP	R/R _{MAX}	Pp
1	[A1-M1]	2.50	16.80	4.22	0.00	5.16	1409.95
2	[A1-M1]	2.50	16.55	7.13	0.00	4.42	1409.95
3	[A1-M1]	5.19	16.55	-10.00	2.66	9.84	1409.95
4	[A1-M1]	5.19	16.75	6.70	0.00	6.68	1409.95

Cod. elab.: 108GA201-GA01-Z-CL-002_C	Titolo: OPERE D'ARTE MAGGIORI- GALLERIE	Data: Ottobre 2011
Nome file: 108GA201-GA01-Z-CL -002_C.docx	ARTIFICIALI – GALLERIA ROVETELLO	Pagina 75 di 452
Relazione di calcolo		

PROGETTO ESECUTIVO

5	[A1-M1]	8.48	10.60	-5.00	25.10	22.19	1409.95
6	[A1-M1]	10.42	15.35	18.31	57.14	25.48	1409.95
7	[A1-M1]	10.42	15.55	18.27	58.99	26.40	1409.95
1	[A2-M2]	2.50	16.80	4.22	0.00	8.61	1065.68
2	[A2-M2]	2.50	16.55	7.13	0.00	7.16	1065.68
3	[A2-M2]	5.89	17.25	-10.00	12.96	19.06	1065.68
4	[A2-M2]	5.89	19.05	6.23	0.00	13.93	1065.68
5	[A2-M2]	9.22	13.50	18.97	48.21	28.74	1065.68
6	[A2-M2]	11.36	19.05	19.59	91.24	59.02	1065.68
7	[A2-M2]	11.36	19.10	19.60	91.71	59.70	1065.68

Risultati tiranti

Caratteristiche dei tiranti utilizzati

Simbologia adottata

Y	ordinata della fila rispetto alla testa della paratia espressa in [m]
nt	numero di tiranti della fila
N	sforzo su ogni tirante della fila espresso in [kN]
L	lunghezza totale di progetto del tirante espressa in [m]
L _f	lunghezza di fondazione di progetto del tirante espressa in [m]
L _d	lunghezza totale definita del tirante espressa in [m]
L _{d_f}	lunghezza di fondazione definita del tirante espressa in [m]
FS	Fattore di sicurezza. Rapporto tra lunghezza di fondazione di progetto e lunghezza di fondazione definita.
A _f	area di armatura in ogni tirante espressa in [mq]
Rt/ml	reazione a metro lineare del tirante della fila espresso in [kN]
σ _f	tensione di trazione nell'acciaio del tirante espressa in [N/mm ²]
u	spostamento orizzontale del tirante della fila, positivo verso valle, espresso in [m]

2 file di tiranti attivi armati con trefoli

n°	Y	nt	A _f	L	L _f	L _d	L _{d_f}	FS
1	2.50	9	0.000834	29.00	16.00	33.00	20.00	1.25
2	5.00	9	0.000834	29.20	16.20	33.00	20.00	1.23

Cod. elab.: 108GA201-GA01-Z-CL-002_C	Titolo: OPERE D'ARTE MAGGIORI- GALLERIE	Data: Ottobre 2011
Nome file: 108GA201-GA01-Z-CL -002_C.docx	ARTIFICIALI – GALLERIA ROVETELLO	Pagina 76 di 452
Relazione di calcolo		

PROGETTO ESECUTIVO

Fase n° 1 - [A1-M1] - sono presenti tiranti.

Fase n° 2 - [A1-M1] - numero di tiranti presenti nella fase sono 1.

N°	N	Rt/ml	σ_f	u
1	200.00	64.2857	239.808	-0.0007826

Fase n° 3 - [A1-M1] - numero di tiranti presenti nella fase sono 1.

N°	N	Rt/ml	σ_f	u
1	211.14	67.8667	253.166	0.0001151

Fase n° 4 - [A1-M1] - numero di tiranti presenti nella fase sono 2.

N°	N	Rt/ml	σ_f	u
1	204.01	65.5731	244.611	-0.0004524
2	300.00	96.4286	359.712	-0.0001916

Fase n° 5 - [A1-M1] - numero di tiranti presenti nella fase sono 2.

N°	N	Rt/ml	σ_f	u
1	303.91	97.6845	364.397	0.0075993
2	383.63	123.3107	459.992	0.0065493

Fase n° 6 - [A1-M1] - numero di tiranti presenti nella fase sono 2.

N°	N	Rt/ml	σ_f	u
1	540.20	173.6358	647.722	0.0266442
2	607.47	195.2574	728.378	0.0245897

Fase n° 7 - [A1-M1] - numero di tiranti presenti nella fase sono 2.

N°	N	Rt/ml	σ_f	u
1	549.34	176.5745	658.684	0.0310977
2	583.61	187.5883	699.770	0.0282438

Fase n° 1 - [A2-M2] - sono presenti tiranti.

Fase n° 2 - [A2-M2] - numero di tiranti presenti nella fase sono 1.

N°	N	Rt/ml	σ_f	u
1	200.00	64.2857	239.808	-0.0007826

<i>Cod. elab.:</i> 108GA201-GA01-Z-CL-002_C	<i>Titolo:</i> OPERE D'ARTE MAGGIORI- GALLERIE	<i>Data:</i> Ottobre 2011
<i>Nome file:</i> 108GA201-GA01-Z-CL -002_C.docx	ARTIFICIALI – GALLERIA ROVETELLO	<i>Pagina</i> 77 di 452
Relazione di calcolo		

PROGETTO ESECUTIVO

Fase n° 3 - [A2-M2] - numero di tiranti presenti nella fase sono 1.

N°	N	Rt/ml	σ_f	u
1	241.00	77.4629	288.964	0.0025206

Fase n° 4 - [A2-M2] - numero di tiranti presenti nella fase sono 2.

N°	N	Rt/ml	σ_f	u
1	234.26	75.2986	280.890	0.0019855
2	300.00	96.4286	359.712	0.0014159

Fase n° 5 - [A2-M2] - numero di tiranti presenti nella fase sono 2.

N°	N	Rt/ml	σ_f	u
1	398.93	128.2282	478.336	0.0152574
2	445.28	143.1272	533.914	0.0131257

Fase n° 6 - [A2-M2] - numero di tiranti presenti nella fase sono 2.

N°	N	Rt/ml	σ_f	u
1	741.23	238.2519	888.763	0.0428470
2	807.97	259.7033	968.784	0.0423558

Fase n° 7 - [A2-M2] - numero di tiranti presenti nella fase sono 2.

N°	N	Rt/ml	σ_f	u
1	770.61	247.6975	923.998	0.0526490
2	775.00	249.1063	929.253	0.0508528

Valori massimi e minimi sollecitazioni per metro di paratia

Simbologia adottata

n° Indice della combinazione/fase

Tipo Tipo della combinazione/fase

Y ordinata della sezione rispetto alla testa espressa in [m]

M momento flettente massimo e minimo espresso in [kNm]

N sforzo normale massimo e minimo espresso in [kN] (positivo di compressione)

T taglio massimo e minimo espresso in [kN]

n°	Tipo	M	Y _M	T	Y _T	N	Y _N	MAX
1	[A1-M1]	27.53	7.55	17.25	16.50	376.31	20.00	MAX

Cod. elab.: 108GA201-GA01-Z-CL-002_C	Titolo: OPERE D'ARTE MAGGIORI- GALLERIE	Data: Ottobre 2011
Nome file: 108GA201-GA01-Z-CL -002_C.docx	ARTIFICIALI – GALLERIA ROVETELLO	Pagina 78 di 452
Relazione di calcolo		

PROGETTO ESECUTIVO

--	--	-54.45	14.00	-22.81	11.05	0.00	0.00	MIN
2	[A1-M1]	35.51	2.50	31.48	2.50	398.30	20.00	MAX
--	--	-64.69	13.55	-28.62	2.50	0.00	0.00	MIN
3	[A1-M1]	25.01	9.15	37.32	5.15	399.52	20.00	MAX
--	--	-78.96	4.45	-62.02	3.00	0.00	0.00	MIN
4	[A1-M1]	28.05	5.00	80.41	5.00	431.72	20.00	MAX
--	--	-61.46	13.75	-42.01	2.50	0.00	0.00	MIN
5	[A1-M1]	246.96	11.60	142.77	8.45	451.89	20.00	MAX
--	--	-219.31	6.30	-109.07	5.00	0.00	0.00	MIN
6	[A1-M1]	470.29	15.15	227.11	10.85	502.48	20.00	MAX
--	--	-671.67	7.65	-247.89	5.00	0.00	0.00	MIN
7	[A1-M1]	512.49	15.20	231.94	10.85	500.86	20.00	MAX
--	--	-666.07	7.60	-243.29	5.00	0.00	0.00	MIN
1	[A2-M2]	27.53	7.55	17.25	16.50	376.31	20.00	MAX
--	--	-54.45	14.00	-22.81	11.05	0.00	0.00	MIN
2	[A2-M2]	35.51	2.50	31.48	2.50	398.30	20.00	MAX
--	--	-64.69	13.55	-28.62	2.50	0.00	0.00	MIN
3	[A2-M2]	129.08	9.15	65.23	5.85	402.80	20.00	MAX
--	--	-75.29	4.15	-72.81	2.70	0.00	0.00	MIN
4	[A2-M2]	113.85	8.65	97.27	5.00	435.04	20.00	MAX
--	--	-25.50	15.30	-53.87	2.50	0.00	0.00	MIN
5	[A2-M2]	351.34	13.50	132.13	9.20	469.12	20.00	MAX
--	--	-273.43	6.55	-126.23	5.00	0.00	0.00	MIN
6	[A2-M2]	26.85	18.65	160.67	12.80	546.62	20.00	MAX
--	--	-1092.53	8.65	-338.99	5.00	0.00	0.00	MIN
7	[A2-M2]	26.82	18.70	162.37	12.80	546.23	20.00	MAX
--	--	-1109.65	8.65	-337.75	5.00	0.00	0.00	MIN

Spostamenti massimi e minimi della paratia

Simbologia adottata

n° Indice della combinazione/fase

Tipo Tipo della combinazione/fase

Y ordinata della sezione rispetto alla testa della paratia espressa in [m]

U spostamento orizzontale massimo e minimo espresso in [m] positivo verso valle

V spostamento verticale massimo e minimo espresso in [m] positivo verso il basso

Cod. elab.: 108GA201-GA01-Z-CL-002_C	Titolo: OPERE D'ARTE MAGGIORI- GALLERIE	Data: Ottobre 2011
Nome file: 108GA201-GA01-Z-CL -002_C.docx	ARTIFICIALI – GALLERIA ROVETELLO	Pagina 79 di 452
Relazione di calcolo		

PROGETTO ESECUTIVO

n°	Tipo	U	Y _U	V	Y _V	
1	[A1-M1]	0.000942	16.80	0.000156	0.00	MAX
--	--	-0.000200	0.00	0.000000	0.00	MIN
2	[A1-M1]	0.000963	16.40	0.000172	0.00	MAX
--	--	-0.001158	0.00	0.000000	0.00	MIN
3	[A1-M1]	0.000931	16.15	0.000173	0.00	MAX
--	--	-0.000225	0.00	0.000000	0.00	MIN
4	[A1-M1]	0.000953	16.75	0.000193	0.00	MAX
--	--	-0.000701	0.00	0.000000	0.00	MIN
5	[A1-M1]	0.008550	0.00	0.000206	0.00	MAX
--	--	0.000000	0.00	0.000000	0.00	MIN
6	[A1-M1]	0.028514	0.00	0.000240	0.00	MAX
--	--	-0.002299	20.00	0.000000	0.00	MIN
7	[A1-M1]	0.033764	0.00	0.000240	0.00	MAX
--	--	-0.002677	20.00	0.000000	0.00	MIN
1	[A2-M2]	0.000942	16.80	0.000156	0.00	MAX
--	--	-0.000200	0.00	0.000000	0.00	MIN
2	[A2-M2]	0.000963	16.40	0.000172	0.00	MAX
--	--	-0.001158	0.00	0.000000	0.00	MIN
3	[A2-M2]	0.003008	0.00	0.000175	0.00	MAX
--	--	0.000000	0.00	0.000000	0.00	MIN
4	[A2-M2]	0.002555	0.00	0.000195	0.00	MAX
--	--	0.000000	0.00	0.000000	0.00	MIN
5	[A2-M2]	0.017267	0.00	0.000218	0.00	MAX
--	--	-0.000403	20.00	0.000000	0.00	MIN
6	[A2-M2]	0.043092	0.00	0.000270	0.00	MAX
--	--	-0.001680	20.00	0.000000	0.00	MIN
7	[A2-M2]	0.054189	0.00	0.000270	0.00	MAX
--	--	-0.001904	20.00	0.000000	0.00	MIN

Stabilità globale

Metodo di Bishop

Numero di cerchi analizzati 100

Cod. elab.: 108GA201-GA01-Z-CL-002_C	Titolo: OPERE D'ARTE MAGGIORI- GALLERIE	Data: Ottobre 2011
Nome file: 108GA201-GA01-Z-CL -002_C.docx	ARTIFICIALI – GALLERIA ROVETELLO	Pagina 80 di 452
Relazione di calcolo		

PROGETTO ESECUTIVO

Simbologia adottata

- n° Indice della combinazione/fase
 Tipo Tipo della combinazione/fase
 (X_C; Y_C) Coordinate centro cerchio superficie di scorrimento, espresse in [m]
 R Raggio cerchio superficie di scorrimento, espresso in [m]
 (X_V; Y_V) Coordinate intersezione del cerchio con il pendio a valle, espresse in [m]
 (X_M; Y_M) Coordinate intersezione del cerchio con il pendio a monte, espresse in [m]
 FS Coefficiente di sicurezza

n°	Tipo	(X _C , Y _C)	R	(X _V , Y _V)	(X _M , Y _M)	FS
1	[A2-M2]	(0.00; 18.00)	38.00	(-32.00; -2.49)	(36.70; 8.11)	2.46
2	[A2-M2]	(0.00; 18.00)	38.00	(-32.00; -2.49)	(36.70; 8.11)	2.47
3	[A2-M2]	(0.00; 16.00)	36.00	(-29.25; -4.99)	(35.13; 8.11)	1.88
4	[A2-M2]	(0.00; 16.00)	36.00	(-29.25; -4.99)	(35.13; 8.11)	1.89
5	[A2-M2]	(0.00; 14.00)	34.00	(-26.35; -7.49)	(33.49; 8.11)	1.50
6	[A2-M2]	(0.00; 14.00)	34.00	(-24.87; -9.19)	(33.49; 8.11)	1.32
7	[A2-M2]	(0.00; 14.00)	34.00	(-24.87; -9.19)	(33.49; 8.11)	1.32

Fase n° 7 - [A2-M2]

Numero di strisce 50

Simbologia adottata

- Le ascisse X sono considerate positive verso monte
 Le ordinate Y sono considerate positive verso l'alto
 Origine in testa alla paratia (spigolo contro terra)
 Le strisce sono numerate da monte verso valle
- N° numero d'ordine della striscia
 W peso della striscia espresso in [kN]
 α angolo fra la base della striscia e l'orizzontale espresso in gradi (positivo antiorario)
 φ angolo d'attrito del terreno lungo la base della striscia
 c coesione del terreno lungo la base della striscia espressa in [N/mm²]
 b larghezza della striscia espressa in [m]
 L sviluppo della base della striscia espressa in [m] (L=b/cosα)
 u pressione neutra lungo la base della striscia espressa in [N/mm²]
 C_{tn}, C_{tt} contributo alla striscia normale e tangenziale del tirante espresse in [kN]

Cod. elab.: 108GA201-GA01-Z-CL-002_C	Titolo: OPERE D'ARTE MAGGIORI- GALLERIE	Data: Ottobre 2011
Nome file: 108GA201-GA01-Z-CL -002_C.docx	ARTIFICIALI – GALLERIA ROVETELLO	Pagina 81 di 452
Relazione di calcolo		

PROGETTO ESECUTIVO

Caratteristiche delle strisce

N°	W	$\alpha(^{\circ})$	$W\sin\alpha$	L	ϕ	c	u	(Ctn; Ctt)
1	13.4813	-45.57	-981.71	1.69	13.66	0.0272	0.0000	(0.00; 0.00)
2	39.6692	-42.79	-2747.73	1.61	13.66	0.0272	0.0000	(0.00; 0.00)
3	63.4693	-40.12	-4170.72	1.55	13.66	0.0272	0.0000	(0.00; 0.00)
4	85.1615	-37.56	-5293.57	1.49	13.66	0.0272	0.0024	(0.00; 0.00)
5	104.9637	-35.08	-6151.54	1.45	13.66	0.0272	0.0110	(0.00; 0.00)
6	123.0491	-32.68	-6774.32	1.41	13.66	0.0272	0.0188	(0.00; 0.00)
7	139.5579	-30.34	-7187.43	1.37	13.66	0.0272	0.0259	(0.00; 0.00)
8	154.6049	-28.05	-7413.17	1.34	13.66	0.0272	0.0324	(0.00; 0.00)
9	168.2852	-25.81	-7471.36	1.32	13.66	0.0272	0.0383	(0.00; 0.00)
10	180.6782	-23.61	-7379.80	1.29	13.66	0.0272	0.0436	(0.00; 0.00)
11	191.8505	-21.45	-7154.69	1.27	13.66	0.0272	0.0484	(0.00; 0.00)
12	201.8585	-19.32	-6810.94	1.25	13.66	0.0272	0.0528	(0.00; 0.00)
13	210.7495	-17.22	-6362.39	1.24	13.66	0.0272	0.0566	(0.00; 0.00)
14	218.5635	-15.14	-5822.00	1.23	13.66	0.0272	0.0600	(0.00; 0.00)
15	225.3341	-13.09	-5202.02	1.22	13.66	0.0272	0.0629	(0.00; 0.00)
16	231.0894	-11.04	-4514.13	1.21	13.66	0.0272	0.0654	(0.00; 0.00)
17	235.8522	-9.02	-3769.49	1.20	13.66	0.0272	0.0674	(0.00; 0.00)
18	239.6411	-7.00	-2978.92	1.19	13.66	0.0272	0.0691	(0.00; 0.00)
19	242.4706	-5.00	-2152.92	1.19	13.66	0.0272	0.0703	(0.00; 0.00)
20	244.3511	-2.99	-1301.77	1.19	13.66	0.0272	0.0711	(0.00; 0.00)
21	245.2897	-1.00	-435.59	1.18	13.66	0.0272	0.0715	(0.00; 0.00)
22	439.0576	0.97	760.55	1.16	13.66	0.0272	0.1058	(0.00; 0.00)
23	448.1948	2.92	2329.14	1.16	13.66	0.0272	0.1054	(0.00; 0.00)
24	462.4578	4.87	4005.44	1.16	13.66	0.0272	0.1047	(0.00; 0.00)
25	475.8406	6.83	5769.90	1.16	13.66	0.0272	0.1035	(0.00; 0.00)
26	488.3338	8.79	7613.23	1.17	13.66	0.0272	0.1019	(0.00; 0.00)
27	499.9248	10.77	9525.94	1.18	13.66	0.0272	0.1000	(0.00; 0.00)
28	510.5972	12.76	11498.29	1.18	13.66	0.0272	0.0976	(0.00; 0.00)
29	517.0453	14.76	13434.83	1.19	13.66	0.0272	0.0949	(0.00; 0.00)
30	510.8407	16.79	15043.48	1.21	13.66	0.0272	0.0917	(0.00; 0.00)
31	509.2182	18.83	16759.96	1.22	13.66	0.0272	0.0880	(0.00; 0.00)
32	515.8853	20.90	18766.78	1.24	13.66	0.0272	0.0839	(0.00; 0.00)
33	521.5498	23.00	20779.88	1.25	13.66	0.0272	0.0794	(0.00; 0.00)

<i>Cod. elab.:</i> 108GA201-GA01-Z-CL-002 C	<i>Titolo:</i> OPERE D'ARTE MAGGIORI- GALLERIE	<i>Data:</i> Ottobre 2011
<i>Nome file:</i> 108GA201-GA01-Z-CL -002_C.docx	ARTIFICIALI – GALLERIA ROVETELLO	<i>Pagina</i> 82 di 452
Relazione di calcolo		

PROGETTO ESECUTIVO

34	526.0971	25.13	22783.89	1.28	13.66	0.0272	0.0743	(0.00; 0.00)
35	523.4762	27.30	24484.18	1.30	13.66	0.0272	0.0687	(0.00; 0.00)
36	509.7591	29.52	25608.92	1.33	13.66	0.0272	0.0626	(0.00; 0.00)
37	494.5747	31.78	26559.86	1.36	13.66	0.0272	0.0559	(0.00; 0.00)
38	477.9700	34.10	27324.45	1.39	13.66	0.0272	0.0485	(0.00; 0.00)
39	459.8280	36.49	27880.84	1.44	13.66	0.0272	0.0405	(0.00; 0.00)
40	440.0055	38.95	28203.89	1.49	13.66	0.0272	0.0317	(86.76; 52.24)
41	418.3248	41.50	28264.11	1.54	13.66	0.0272	0.0222	(0.00; 0.00)
42	394.5611	44.15	28026.27	1.61	13.66	0.0272	0.0116	(71.90; 34.83)
43	368.4242	46.94	27447.11	1.69	13.66	0.0272	0.0001	(0.00; 0.00)
44	339.8043	49.87	26493.41	1.79	17.07	0.0192	0.0000	(0.00; 0.00)
45	308.2859	53.00	25105.57	1.92	17.07	0.0192	0.0000	(0.00; 0.00)
46	272.7900	56.37	23161.91	2.09	17.07	0.0192	0.0000	(0.00; 0.00)
47	232.1416	60.08	20517.32	2.32	17.07	0.0192	0.0000	(0.00; 0.00)
48	184.4937	64.28	16948.68	2.66	15.57	0.0136	0.0000	(0.00; 0.00)
49	127.4435	69.27	12154.21	3.26	14.07	0.0080	0.0000	(0.00; 0.00)
50	47.8588	75.92	4733.48	4.75	14.07	0.0080	0.0000	(0.00; 0.00)

Resistenza a taglio paratia= 0.0000 [kN]

$\Sigma W_i = 15584.7550$ [kN]

$\Sigma W_i \sin \alpha_i = 4117.9690$ [kN]

$\Sigma W_i \tan \phi_i = 3869.7541$ [kN]

$\Sigma \tan \alpha_i \tan \phi_i = 4.19$

Descrizione armatura pali e caratteristiche sezione

Diametro del palo	1.2000	[m]
Area della sezione trasversale	1.130973	[mq]
Copriferro	0.0600	[m]

L'armatura del palo è costituita da 24 ϕ 0.024($A_f=0.010857$ mq) longitudinali e staffe ϕ 0.012/0.200 m.

Verifica armatura paratia (Sezioni critiche)

Simbologia adottata

n° Indice della combinazione/fase

Cod. elab.: 108GA201-GA01-Z-CL-002_C	Titolo: OPERE D'ARTE MAGGIORI- GALLERIE	Data: Ottobre 2011
Nome file: 108GA201-GA01-Z-CL -002_C.docx	ARTIFICIALI – GALLERIA ROVETELLO	Pagina 83 di 452
Relazione di calcolo		

PROGETTO ESECUTIVO

Tipo Tipo della Combinazione/Fase

Y ordinata della sezione rispetto alla testa della paratia espressa in [m]

M momento flettente espresso in [kNm]

N sforzo normale espresso in [kN] (positivo di compressione)

Mu momento ultimo di riferimento espresso in [kNm]

Nusforzo normale ultimo di riferimento espresso in [kN]

FS fattore di sicurezza (rapporto fra la sollecitazione ultima e la sollecitazione di esercizio)

n°	Tipo	Y	M	N	Mu	Nu	FS
1	[A1-M1]	19.95	-0.01	375.37	-0.24	16216.88	29.32
2	[A1-M1]	13.95	-63.96	284.46	-2528.07	11243.91	26.82
3	[A1-M1]	4.40	-78.84	106.00	-2864.13	3850.62	24.65
4	[A1-M1]	19.95	-0.01	430.78	-0.22	16216.90	25.55
5	[A1-M1]	11.55	246.88	292.90	2782.58	3301.35	7.65
6	[A1-M1]	7.60	-671.60	269.17	-2170.87	870.05	2.19
7	[A1-M1]	7.55	-665.96	266.61	-2170.55	868.94	2.21
1	[A2-M2]	19.95	-0.01	375.37	-0.24	16216.88	29.32
2	[A2-M2]	13.95	-63.96	284.46	-2528.07	11243.91	26.82
3	[A2-M2]	9.10	129.04	197.71	2952.53	4523.92	15.53
4	[A2-M2]	8.65	113.85	221.49	3050.76	5934.97	18.18
5	[A2-M2]	13.45	351.24	345.88	2641.14	2600.81	5.10
6	[A2-M2]	8.60	-1092.43	332.12	-2103.11	639.40	1.31
7	[A2-M2]	8.60	-1109.62	331.73	-2099.68	627.72	1.28

Verifica armatura paratia (Inviluppo)

Simbologia adottata

n° Indice della Combinazione/Fase

Tipo Tipo della Combinazione/Fase

Y ordinata della sezione con fattore di sicurezza minimo, espressa in [m]

M momento flettente, espresso in [kNm]

N sforzo normale, espresso in [kN] (positivo di compressione)

Mu momento ultimo di riferimento, espresso in [kNm]

Nusforzo normale ultimo di riferimento, espresso in [kN]

FS fattore di sicurezza (rapporto fra la sollecitazione ultima e la sollecitazione di esercizio)

Cod. elab.: 108GA201-GA01-Z-CL-002_C	Titolo: OPERE D'ARTE MAGGIORI- GALLERIE	Data: Ottobre 2011
Nome file: 108GA201-GA01-Z-CL -002_C.docx	ARTIFICIALI – GALLERIA ROVETELLO	Pagina 84 di 452
Relazione di calcolo		

PROGETTO ESECUTIVO

n°	Tipo	Y	M	N	Mu	Nu	FS
1	[A1-M1]	0.00	0.00	0.00	0.00	0.00	1000.00
2	[A1-M1]	0.05	0.00	0.94	0.00	-4248.53	3064.42
2	[A1-M1]	0.10	0.01	1.88	78.80	16161.80	5828.67
2	[A1-M1]	0.15	0.03	2.82	156.74	16107.15	3872.64
2	[A1-M1]	0.20	0.05	3.76	233.81	16053.10	2894.74
2	[A1-M1]	0.25	0.09	4.70	310.05	15999.65	2308.08
2	[A1-M1]	0.30	0.14	5.64	385.45	15946.78	1917.04
2	[A1-M1]	0.35	0.19	6.59	460.02	15894.48	1637.79
2	[A1-M1]	0.40	0.25	7.53	533.79	15842.76	1428.40
2	[A1-M1]	0.45	0.33	8.47	606.76	15791.59	1265.59
2	[A1-M1]	0.50	0.41	9.41	678.94	15740.98	1135.38
2	[A1-M1]	0.55	0.51	10.35	775.97	15672.95	1027.70
2	[A1-M1]	0.60	0.66	11.29	913.74	15576.34	936.26
2	[A1-M1]	0.65	0.86	12.23	1080.95	15459.09	857.73
2	[A1-M1]	0.70	1.09	13.17	1269.37	15326.97	789.66
2	[A1-M1]	0.75	1.37	14.11	1472.92	15184.24	730.15
2	[A1-M1]	0.80	1.69	15.05	1656.66	14763.64	665.55
2	[A1-M1]	0.85	2.05	15.99	1823.88	14221.49	603.40
2	[A1-M1]	0.90	2.45	16.93	1980.13	13660.31	547.39
2	[A1-M1]	0.95	2.90	17.87	2126.49	13109.54	497.67
2	[A1-M1]	1.00	3.39	18.82	2257.68	12548.60	452.56
2	[A1-M1]	1.05	3.91	19.76	2378.01	12010.66	412.53
2	[A1-M1]	1.10	4.48	20.70	2483.49	11477.77	376.31
2	[A1-M1]	1.15	5.09	21.64	2579.28	10975.25	344.19
2	[A1-M1]	1.20	5.73	22.58	2662.67	10489.12	315.24
2	[A1-M1]	1.25	6.42	23.52	2736.92	10030.38	289.39
2	[A1-M1]	1.30	7.14	24.46	2803.40	9600.26	266.33
2	[A1-M1]	1.35	7.91	25.40	2860.14	9188.47	245.46
2	[A1-M1]	1.40	8.71	26.34	2912.43	8808.90	226.92
2	[A1-M1]	1.45	9.55	27.28	2955.02	8441.94	209.97
2	[A1-M1]	1.50	10.43	28.22	2989.84	8091.41	194.54
2	[A1-M1]	1.55	11.35	29.16	3021.94	7768.27	180.75
2	[A1-M1]	1.60	12.30	30.10	3044.82	7453.04	167.99
2	[A1-M1]	1.65	13.29	31.05	3053.17	7132.43	155.90

Cod. elab.: 108GA201-GA01-Z-CL-002_C	Titolo: OPERE D'ARTE MAGGIORI- GALLERIE	Data: Ottobre 2011
Nome file: 108GA201-GA01-Z-CL -002_C.docx	ARTIFICIALI – GALLERIA ROVETELLO	Pagina 85 di 452
Relazione di calcolo		

PROGETTO ESECUTIVO

2	[A1-M1]	1.70	14.32	31.99	3060.83	6838.27	145.07
2	[A1-M1]	1.75	15.38	32.93	3067.88	6567.53	135.35
2	[A1-M1]	1.80	16.48	33.87	3063.29	6294.84	126.12
2	[A1-M1]	1.85	17.62	34.81	3054.23	6034.62	117.64
2	[A1-M1]	1.90	18.79	35.75	3045.90	5795.43	110.00
2	[A1-M1]	1.95	20.00	36.69	3038.21	5574.89	103.11
2	[A1-M1]	2.00	21.24	37.63	3028.81	5366.86	96.78
2	[A1-M1]	2.05	22.51	38.57	3009.78	5156.58	90.72
2	[A1-M1]	2.10	23.82	39.51	2992.23	4962.66	85.23
2	[A1-M1]	2.15	25.17	40.45	2976.00	4783.30	80.24
2	[A1-M1]	2.20	26.55	41.39	2960.95	4616.96	75.69
2	[A1-M1]	2.25	27.96	42.33	2946.95	4462.28	71.52
2	[A1-M1]	2.30	29.40	43.28	2933.43	4317.42	67.70
2	[A1-M1]	2.35	30.88	44.22	2911.33	4168.59	63.97
2	[A1-M1]	2.40	32.39	45.16	2890.79	4030.19	60.56
2	[A1-M1]	2.45	33.93	46.10	2871.63	3901.17	57.43
2	[A1-M1]	2.50	35.51	47.04	2853.74	3780.63	54.54
2	[A1-M1]	2.55	34.08	69.97	3063.10	6289.43	61.00
2	[A1-M1]	2.60	32.68	70.91	3065.66	6652.61	63.66
7	[A2-M2]	2.65	-34.75	134.58	-2680.41	10379.51	52.34
7	[A2-M2]	2.70	-46.38	135.52	-2940.27	8590.45	43.01
7	[A2-M2]	2.75	-58.01	136.46	-3051.94	7179.59	35.70
7	[A2-M2]	2.80	-69.60	137.40	-3054.04	6029.27	29.78
7	[A2-M2]	2.85	-81.13	138.34	-3007.16	5127.65	25.15
7	[A2-M2]	2.90	-92.59	139.28	-2943.88	4428.40	21.57
7	[A2-M2]	2.95	-103.97	140.22	-2866.42	3866.05	18.71
7	[A2-M2]	3.00	-115.25	141.16	-2802.00	3432.16	16.50
7	[A2-M2]	3.05	-126.42	142.10	-2740.25	3080.23	14.71
7	[A2-M2]	3.10	-137.48	143.05	-2679.93	2788.44	13.23
7	[A2-M2]	3.15	-148.42	143.99	-2631.18	2552.65	12.03
7	[A2-M2]	3.20	-159.23	144.93	-2591.00	2358.30	11.04
7	[A2-M2]	3.25	-169.91	145.87	-2557.33	2195.44	10.21
7	[A2-M2]	3.30	-180.47	146.81	-2516.70	2047.30	9.46
7	[A2-M2]	3.35	-190.89	147.75	-2478.90	1918.63	8.81
7	[A2-M2]	3.40	-201.19	148.69	-2446.42	1808.04	8.25
7	[A2-M2]	3.45	-211.35	149.63	-2418.21	1712.04	7.76

Cod. elab.: 108GA201-GA01-Z-CL-002 C	Titolo: OPERE D'ARTE MAGGIORI- GALLERIE	Data: Ottobre 2011
Nome file: 108GA201-GA01-Z-CL -002_C.docx	ARTIFICIALI – GALLERIA ROVETELLO	Pagina 86 di 452
Relazione di calcolo		

PROGETTO ESECUTIVO

7	[A2-M2]	3.50	-221.38	150.57	-2393.52	1627.98	7.34
7	[A2-M2]	3.55	-231.27	151.51	-2371.74	1553.82	6.96
7	[A2-M2]	3.60	-241.02	152.45	-2352.39	1487.97	6.62
7	[A2-M2]	3.65	-250.63	153.39	-2335.12	1429.16	6.32
7	[A2-M2]	3.70	-260.10	154.33	-2319.61	1376.36	6.05
7	[A2-M2]	3.75	-269.43	155.28	-2305.62	1328.74	5.81
7	[A2-M2]	3.80	-278.62	156.22	-2292.95	1285.62	5.58
7	[A2-M2]	3.85	-287.66	157.16	-2281.44	1246.43	5.38
7	[A2-M2]	3.90	-296.55	158.10	-2270.94	1210.70	5.20
7	[A2-M2]	3.95	-305.29	159.04	-2261.34	1178.02	5.03
7	[A2-M2]	4.00	-313.89	159.98	-2252.54	1148.06	4.87
7	[A2-M2]	4.05	-322.33	160.92	-2244.45	1120.53	4.73
7	[A2-M2]	4.10	-330.62	161.86	-2237.01	1095.18	4.59
7	[A2-M2]	4.15	-338.75	162.80	-2230.14	1071.80	4.47
7	[A2-M2]	4.20	-346.73	163.74	-2223.79	1050.19	4.35
7	[A2-M2]	4.25	-354.55	164.68	-2217.92	1030.20	4.24
7	[A2-M2]	4.30	-362.21	165.62	-2212.48	1011.69	4.14
7	[A2-M2]	4.35	-369.70	166.56	-2207.44	994.53	4.05
7	[A2-M2]	4.40	-377.04	167.51	-2202.76	978.60	3.96
7	[A2-M2]	4.45	-384.21	168.45	-2198.42	963.82	3.88
7	[A2-M2]	4.50	-391.22	169.39	-2194.39	950.10	3.81
7	[A2-M2]	4.55	-398.06	170.33	-2190.64	937.36	3.73
7	[A2-M2]	4.60	-404.74	171.27	-2187.17	925.52	3.67
7	[A2-M2]	4.65	-411.24	172.21	-2183.94	914.54	3.60
7	[A2-M2]	4.70	-417.57	173.15	-2180.95	904.35	3.54
7	[A2-M2]	4.75	-423.73	174.09	-2178.17	894.91	3.49
7	[A2-M2]	4.80	-429.72	175.03	-2175.60	886.17	3.44
7	[A2-M2]	4.85	-435.53	175.97	-2173.23	878.09	3.39
7	[A2-M2]	4.90	-441.16	176.91	-2171.04	870.63	3.34
7	[A2-M2]	4.95	-446.61	177.85	-2169.02	863.77	3.30
7	[A2-M2]	5.00	-451.89	178.79	-2167.17	857.47	3.25
7	[A2-M2]	5.05	-468.68	264.94	-2296.66	1298.24	3.33
7	[A2-M2]	5.10	-485.30	265.88	-2282.66	1250.58	3.19
7	[A2-M2]	5.15	-501.73	266.82	-2269.89	1207.12	3.07
7	[A2-M2]	5.20	-517.97	267.76	-2258.21	1167.35	2.96
7	[A2-M2]	5.25	-534.03	268.70	-2247.48	1130.83	2.86

Cod. elab.: 108GA201-GA01-Z-CL-002 C	Titolo: OPERE D'ARTE MAGGIORI- GALLERIE	Data: Ottobre 2011
Nome file: 108GA201-GA01-Z-CL -002_C.docx	ARTIFICIALI – GALLERIA ROVETELLO	Pagina 87 di 452
Relazione di calcolo		

PROGETTO ESECUTIVO

7	[A2-M2]	5.30	-549.89	269.64	-2237.60	1097.20	2.76
7	[A2-M2]	5.35	-565.57	270.58	-2228.47	1066.14	2.67
7	[A2-M2]	5.40	-581.06	271.52	-2220.03	1037.39	2.59
7	[A2-M2]	5.45	-596.35	272.46	-2212.19	1010.71	2.52
7	[A2-M2]	5.50	-611.45	273.40	-2204.90	985.90	2.45
7	[A2-M2]	5.55	-626.35	274.34	-2198.11	962.78	2.38
7	[A2-M2]	5.60	-641.06	275.28	-2191.77	941.19	2.32
7	[A2-M2]	5.65	-655.56	276.22	-2185.84	921.01	2.26
7	[A2-M2]	5.70	-669.87	277.17	-2180.29	902.12	2.21
7	[A2-M2]	5.75	-683.97	278.11	-2175.08	884.39	2.16
7	[A2-M2]	5.80	-697.88	279.05	-2170.20	867.76	2.11
7	[A2-M2]	5.85	-711.57	279.99	-2165.60	852.11	2.07
7	[A2-M2]	5.90	-725.07	280.93	-2161.28	837.39	2.02
7	[A2-M2]	5.95	-738.35	281.87	-2157.20	823.52	1.98
7	[A2-M2]	6.00	-751.43	282.81	-2153.36	810.45	1.94
7	[A2-M2]	6.05	-764.29	283.75	-2149.74	798.11	1.91
7	[A2-M2]	6.10	-776.95	284.69	-2146.31	786.46	1.87
7	[A2-M2]	6.15	-789.39	285.63	-2143.08	775.45	1.84
7	[A2-M2]	6.20	-801.62	286.57	-2140.02	765.04	1.81
7	[A2-M2]	6.25	-813.63	287.51	-2137.13	755.20	1.78
7	[A2-M2]	6.30	-825.43	288.45	-2134.40	745.89	1.75
7	[A2-M2]	6.35	-837.00	289.40	-2131.81	737.08	1.73
7	[A2-M2]	6.40	-848.36	290.34	-2129.36	728.73	1.70
7	[A2-M2]	6.45	-859.50	291.28	-2127.04	720.84	1.68
7	[A2-M2]	6.50	-870.41	292.22	-2124.84	713.36	1.66
7	[A2-M2]	6.55	-881.10	293.16	-2122.76	706.28	1.63
7	[A2-M2]	6.60	-891.56	294.10	-2120.79	699.58	1.61
7	[A2-M2]	6.65	-901.80	295.04	-2118.93	693.25	1.59
7	[A2-M2]	6.70	-911.81	295.98	-2117.17	687.25	1.58
7	[A2-M2]	6.75	-921.59	296.92	-2115.50	681.58	1.56
7	[A2-M2]	6.80	-931.14	297.86	-2113.93	676.22	1.54
7	[A2-M2]	6.85	-940.46	298.80	-2112.45	671.17	1.52
7	[A2-M2]	6.90	-949.54	299.74	-2111.04	666.40	1.51
7	[A2-M2]	6.95	-958.39	300.68	-2109.72	661.90	1.49
7	[A2-M2]	7.00	-967.00	301.63	-2108.48	657.67	1.48
7	[A2-M2]	7.05	-975.38	302.57	-2107.31	653.70	1.47

Cod. elab.: 108GA201-GA01-Z-CL-002 C	Titolo: OPERE D'ARTE MAGGIORI- GALLERIE	Data: Ottobre 2011
Nome file: 108GA201-GA01-Z-CL -002_C.docx	ARTIFICIALI – GALLERIA ROVETELLO	Pagina 88 di 452
Relazione di calcolo		

PROGETTO ESECUTIVO

7	[A2-M2]	7.10	-983.52	303.51	-2106.22	649.97	1.45
7	[A2-M2]	7.15	-991.41	304.45	-2105.19	646.47	1.44
7	[A2-M2]	7.20	-999.07	305.39	-2104.23	643.21	1.43
7	[A2-M2]	7.25	-1006.48	306.33	-2103.34	640.17	1.42
7	[A2-M2]	7.30	-1013.64	307.27	-2102.51	637.34	1.41
7	[A2-M2]	7.35	-1020.56	308.21	-2101.74	634.73	1.40
7	[A2-M2]	7.40	-1027.23	309.15	-2101.03	632.32	1.39
7	[A2-M2]	7.45	-1033.66	310.09	-2100.38	630.10	1.38
7	[A2-M2]	7.50	-1039.83	311.03	-2099.79	628.09	1.37
7	[A2-M2]	7.55	-1045.75	311.97	-2099.25	626.26	1.36
7	[A2-M2]	7.60	-1051.42	312.91	-2098.77	624.62	1.35
7	[A2-M2]	7.65	-1056.84	313.86	-2098.34	623.16	1.35
7	[A2-M2]	7.70	-1062.00	314.80	-2097.97	621.88	1.34
7	[A2-M2]	7.75	-1066.90	315.74	-2097.64	620.77	1.33
7	[A2-M2]	7.80	-1071.55	316.68	-2097.37	619.84	1.33
7	[A2-M2]	7.85	-1075.93	317.62	-2097.15	619.08	1.32
7	[A2-M2]	7.90	-1080.05	318.56	-2096.97	618.50	1.32
7	[A2-M2]	7.95	-1083.92	319.50	-2096.85	618.08	1.31
7	[A2-M2]	8.00	-1087.51	320.44	-2096.78	617.82	1.31
7	[A2-M2]	8.05	-1090.85	321.38	-2096.75	617.74	1.30
7	[A2-M2]	8.10	-1093.91	322.32	-2096.77	617.82	1.30
7	[A2-M2]	8.15	-1096.71	323.26	-2096.84	618.06	1.30
7	[A2-M2]	8.20	-1099.24	324.20	-2096.96	618.47	1.29
7	[A2-M2]	8.25	-1101.50	325.14	-2097.13	619.04	1.29
7	[A2-M2]	8.30	-1103.49	326.09	-2097.35	619.78	1.29
7	[A2-M2]	8.35	-1105.20	327.03	-2097.61	620.68	1.29
7	[A2-M2]	8.40	-1106.64	327.97	-2097.93	621.75	1.29
7	[A2-M2]	8.45	-1107.80	328.91	-2098.29	622.98	1.29
7	[A2-M2]	8.50	-1108.69	329.85	-2098.70	624.39	1.28
7	[A2-M2]	8.55	-1109.30	330.79	-2099.17	625.97	1.28
7	[A2-M2]	8.60	-1109.62	331.73	-2099.68	627.72	1.28
7	[A2-M2]	8.65	-1109.65	332.67	-2100.25	629.65	1.28
7	[A2-M2]	8.70	-1109.40	333.61	-2100.87	631.76	1.29
7	[A2-M2]	8.75	-1108.85	334.55	-2101.54	634.06	1.29
7	[A2-M2]	8.80	-1108.02	335.49	-2102.27	636.54	1.29
7	[A2-M2]	8.85	-1106.89	336.43	-2103.06	639.21	1.29

Cod. elab.: 108GA201-GA01-Z-CL-002 C	Titolo: OPERE D'ARTE MAGGIORI- GALLERIE	Data: Ottobre 2011
Nome file: 108GA201-GA01-Z-CL -002_C.docx	ARTIFICIALI – GALLERIA ROVETELLO	Pagina 89 di 452
Relazione di calcolo		

PROGETTO ESECUTIVO

7	[A2-M2]	8.90	-1105.47	337.37	-2103.90	642.08	1.29
7	[A2-M2]	8.95	-1103.76	338.32	-2104.80	645.15	1.29
7	[A2-M2]	9.00	-1101.74	339.26	-2105.76	648.42	1.30
7	[A2-M2]	9.05	-1099.43	340.20	-2106.79	651.91	1.30
7	[A2-M2]	9.10	-1096.81	341.14	-2107.87	655.60	1.30
7	[A2-M2]	9.15	-1093.90	342.08	-2109.02	659.52	1.31
7	[A2-M2]	9.20	-1090.68	343.02	-2110.24	663.67	1.31
7	[A2-M2]	9.25	-1087.24	343.96	-2111.51	668.00	1.32
7	[A2-M2]	9.30	-1083.67	344.90	-2112.82	672.45	1.32
7	[A2-M2]	9.35	-1079.97	345.84	-2114.17	677.02	1.33
7	[A2-M2]	9.40	-1076.15	346.78	-2115.55	681.72	1.33
7	[A2-M2]	9.45	-1072.20	347.72	-2116.96	686.55	1.34
7	[A2-M2]	9.50	-1068.12	348.66	-2118.42	691.51	1.35
7	[A2-M2]	9.55	-1063.93	349.60	-2119.92	696.60	1.35
7	[A2-M2]	9.60	-1059.61	350.55	-2121.45	701.83	1.36
7	[A2-M2]	9.65	-1055.17	351.49	-2123.03	707.20	1.37
7	[A2-M2]	9.70	-1050.62	352.43	-2124.65	712.70	1.37
7	[A2-M2]	9.75	-1045.96	353.37	-2126.31	718.35	1.38
7	[A2-M2]	9.80	-1041.18	354.31	-2128.01	724.15	1.39
7	[A2-M2]	9.85	-1036.29	355.25	-2129.76	730.10	1.39
7	[A2-M2]	9.90	-1031.29	356.19	-2131.55	736.20	1.40
7	[A2-M2]	9.95	-1026.19	357.13	-2133.39	742.46	1.41
7	[A2-M2]	10.00	-1020.98	358.07	-2135.27	748.87	1.42
7	[A2-M2]	10.05	-1015.66	359.01	-2137.20	755.45	1.43
7	[A2-M2]	10.10	-1010.25	359.95	-2139.19	762.20	1.44
7	[A2-M2]	10.15	-1004.73	360.89	-2141.22	769.12	1.45
7	[A2-M2]	10.20	-999.11	361.83	-2143.30	776.21	1.46
7	[A2-M2]	10.25	-993.40	362.78	-2145.44	783.48	1.47
7	[A2-M2]	10.30	-987.60	363.72	-2147.63	790.94	1.48
7	[A2-M2]	10.35	-981.70	364.66	-2149.88	798.58	1.49
7	[A2-M2]	10.40	-975.71	365.60	-2152.18	806.42	1.50
7	[A2-M2]	10.45	-969.63	366.54	-2154.54	814.46	1.51
7	[A2-M2]	10.50	-963.46	367.48	-2156.96	822.70	1.52
7	[A2-M2]	10.55	-957.21	368.42	-2159.44	831.15	1.53
7	[A2-M2]	10.60	-950.88	369.36	-2161.99	839.81	1.54
7	[A2-M2]	10.65	-944.46	370.30	-2164.60	848.69	1.56

Cod. elab.: 108GA201-GA01-Z-CL-002 C	Titolo: OPERE D'ARTE MAGGIORI- GALLERIE	Data: Ottobre 2011
Nome file: 108GA201-GA01-Z-CL -002_C.docx	ARTIFICIALI – GALLERIA ROVETELLO	Pagina 90 di 452
Relazione di calcolo		

PROGETTO ESECUTIVO

7	[A2-M2]	10.70	-937.96	371.24	-2167.27	857.80	1.57
7	[A2-M2]	10.75	-931.39	372.18	-2170.02	867.14	1.58
7	[A2-M2]	10.80	-924.73	373.12	-2172.83	876.72	1.59
7	[A2-M2]	10.85	-918.01	374.06	-2175.72	886.55	1.61
7	[A2-M2]	10.90	-911.21	375.01	-2178.68	896.63	1.62
7	[A2-M2]	10.95	-904.34	375.95	-2181.71	906.97	1.64
7	[A2-M2]	11.00	-897.40	376.89	-2184.83	917.58	1.65
7	[A2-M2]	11.05	-890.40	377.83	-2188.03	928.46	1.67
7	[A2-M2]	11.10	-883.33	378.77	-2191.31	939.63	1.68
7	[A2-M2]	11.15	-876.19	379.71	-2194.68	951.09	1.70
7	[A2-M2]	11.20	-869.00	380.65	-2198.13	962.85	1.72
7	[A2-M2]	11.25	-861.75	381.59	-2201.68	974.93	1.73
7	[A2-M2]	11.30	-854.43	382.53	-2205.32	987.33	1.75
7	[A2-M2]	11.35	-847.07	383.47	-2209.06	1000.06	1.77
7	[A2-M2]	11.40	-839.64	384.41	-2212.90	1013.13	1.79
7	[A2-M2]	11.45	-832.17	385.35	-2216.85	1026.56	1.81
7	[A2-M2]	11.50	-824.64	386.30	-2220.90	1040.35	1.83
7	[A2-M2]	11.55	-817.07	387.24	-2225.06	1054.52	1.85
7	[A2-M2]	11.60	-809.45	388.18	-2229.34	1069.09	1.87
7	[A2-M2]	11.65	-801.79	389.12	-2233.74	1084.05	1.89
7	[A2-M2]	11.70	-794.09	390.06	-2238.26	1099.44	1.91
7	[A2-M2]	11.75	-786.34	391.00	-2242.90	1115.26	1.94
7	[A2-M2]	11.80	-778.56	391.94	-2247.68	1131.52	1.96
7	[A2-M2]	11.85	-770.74	392.88	-2252.60	1148.25	1.98
7	[A2-M2]	11.90	-762.88	393.82	-2257.65	1165.47	2.01
7	[A2-M2]	11.95	-754.99	394.76	-2262.85	1183.18	2.03
7	[A2-M2]	12.00	-747.07	395.70	-2268.21	1201.41	2.06
7	[A2-M2]	12.05	-739.12	396.64	-2273.72	1220.17	2.09
7	[A2-M2]	12.10	-731.15	397.58	-2279.40	1239.50	2.12
7	[A2-M2]	12.15	-723.15	398.53	-2285.25	1259.40	2.14
7	[A2-M2]	12.20	-715.12	399.47	-2291.27	1279.90	2.17
7	[A2-M2]	12.25	-707.07	400.41	-2297.48	1301.03	2.20
7	[A2-M2]	12.30	-699.01	401.35	-2303.87	1322.81	2.24
7	[A2-M2]	12.35	-690.92	402.29	-2310.47	1345.27	2.27
7	[A2-M2]	12.40	-682.82	403.23	-2317.27	1368.43	2.30
7	[A2-M2]	12.45	-674.71	404.17	-2324.29	1392.32	2.34

Cod. elab.: 108GA201-GA01-Z-CL-002 C	Titolo: OPERE D'ARTE MAGGIORI- GALLERIE	Data: Ottobre 2011
Nome file: 108GA201-GA01-Z-CL -002_C.docx	ARTIFICIALI – GALLERIA ROVETELLO	Pagina 91 di 452
Relazione di calcolo		

PROGETTO ESECUTIVO

7	[A2-M2]	12.50	-666.58	405.11	-2331.54	1416.98	2.37
7	[A2-M2]	12.55	-658.44	406.05	-2339.01	1442.43	2.41
7	[A2-M2]	12.60	-650.30	406.99	-2346.73	1468.71	2.45
7	[A2-M2]	12.65	-642.15	407.93	-2354.71	1495.86	2.49
7	[A2-M2]	12.70	-633.99	408.87	-2362.95	1523.91	2.53
7	[A2-M2]	12.75	-625.83	409.81	-2371.47	1552.91	2.57
7	[A2-M2]	12.80	-617.67	410.76	-2380.28	1582.90	2.61
7	[A2-M2]	12.85	-609.51	411.70	-2389.39	1613.92	2.66
7	[A2-M2]	12.90	-601.35	412.64	-2398.83	1646.04	2.71
7	[A2-M2]	12.95	-593.19	413.58	-2408.59	1679.29	2.76
7	[A2-M2]	13.00	-585.04	414.52	-2418.72	1713.74	2.81
7	[A2-M2]	13.05	-576.89	415.46	-2429.21	1749.45	2.86
7	[A2-M2]	13.10	-568.74	416.40	-2440.09	1786.49	2.91
7	[A2-M2]	13.15	-560.60	417.34	-2451.38	1824.93	2.97
7	[A2-M2]	13.20	-552.47	418.28	-2463.10	1864.84	3.03
7	[A2-M2]	13.25	-544.35	419.22	-2475.28	1906.29	3.09
7	[A2-M2]	13.30	-536.24	420.16	-2487.94	1949.39	3.15
7	[A2-M2]	13.35	-528.14	421.10	-2501.11	1994.22	3.21
7	[A2-M2]	13.40	-520.05	422.04	-2514.82	2040.88	3.28
7	[A2-M2]	13.45	-511.98	422.99	-2529.09	2089.48	3.35
7	[A2-M2]	13.50	-503.92	423.93	-2543.97	2140.13	3.43
7	[A2-M2]	13.55	-495.88	424.87	-2556.25	2190.18	3.50
7	[A2-M2]	13.60	-487.85	425.81	-2566.58	2240.15	3.57
7	[A2-M2]	13.65	-479.85	426.75	-2577.32	2292.12	3.64
7	[A2-M2]	13.70	-471.86	427.69	-2588.50	2346.18	3.72
7	[A2-M2]	13.75	-463.89	428.63	-2600.14	2402.48	3.80
7	[A2-M2]	13.80	-455.95	429.57	-2612.26	2461.12	3.89
7	[A2-M2]	13.85	-448.03	430.51	-2624.90	2522.26	3.98
7	[A1-M1]	13.90	433.40	386.09	2578.30	2296.85	4.04
7	[A1-M1]	13.95	438.99	387.03	2572.29	2267.81	3.98
7	[A1-M1]	14.00	444.40	387.97	2566.70	2240.76	3.92
7	[A1-M1]	14.05	449.63	388.91	2561.50	2215.60	3.87
7	[A1-M1]	14.10	454.66	389.85	2556.67	2192.23	3.82
7	[A1-M1]	14.15	459.50	390.79	2552.19	2170.55	3.77
7	[A1-M1]	14.20	464.15	391.73	2546.68	2149.34	3.72
7	[A1-M1]	14.25	468.60	392.67	2540.72	2129.04	3.68

Cod. elab.: 108GA201-GA01-Z-CL-002 C	Titolo: OPERE D'ARTE MAGGIORI- GALLERIE	Data: Ottobre 2011
Nome file: 108GA201-GA01-Z-CL -002_C.docx	ARTIFICIALI – GALLERIA ROVETELLO	Pagina 92 di 452
Relazione di calcolo		

PROGETTO ESECUTIVO

7	[A1-M1]	14.30	472.85	393.61	2535.24	2110.39	3.64
7	[A1-M1]	14.35	476.90	394.55	2530.22	2093.33	3.60
7	[A1-M1]	14.40	480.75	395.49	2525.66	2077.78	3.56
7	[A1-M1]	14.45	484.38	396.43	2521.52	2063.69	3.53
7	[A1-M1]	14.50	487.81	397.38	2517.79	2051.01	3.50
7	[A1-M1]	14.55	491.03	398.32	2514.47	2039.69	3.47
7	[A1-M1]	14.60	494.04	399.26	2511.54	2029.71	3.45
7	[A1-M1]	14.65	496.82	400.20	2508.98	2021.02	3.43
7	[A1-M1]	14.70	499.39	401.14	2506.80	2013.60	3.41
7	[A1-M1]	14.75	501.74	402.08	2504.99	2007.43	3.39
7	[A1-M1]	14.80	503.86	403.02	2503.54	2002.49	3.37
7	[A1-M1]	14.85	505.76	403.96	2502.45	1998.77	3.36
7	[A1-M1]	14.90	507.43	404.90	2501.70	1996.24	3.35
7	[A1-M1]	14.95	508.86	405.84	2501.32	1994.93	3.34
7	[A1-M1]	15.00	510.06	406.78	2501.28	1994.81	3.33
7	[A1-M1]	15.05	511.03	407.72	2501.60	1995.89	3.32
7	[A1-M1]	15.10	511.76	408.66	2502.28	1998.20	3.32
7	[A1-M1]	15.15	512.24	409.61	2503.31	2001.72	3.32
7	[A1-M1]	15.20	512.49	410.55	2504.71	2006.49	3.32
7	[A1-M1]	15.25	512.48	411.49	2506.49	2012.52	3.32
7	[A1-M1]	15.30	512.23	412.43	2508.64	2019.85	3.32
7	[A1-M1]	15.35	511.73	413.37	2511.18	2028.50	3.33
7	[A1-M1]	15.40	510.97	414.31	2514.12	2038.51	3.34
7	[A1-M1]	15.45	509.96	415.25	2517.47	2049.92	3.35
7	[A1-M1]	15.50	508.69	416.19	2521.25	2062.79	3.36
7	[A1-M1]	15.55	507.16	417.13	2525.48	2077.17	3.38
7	[A1-M1]	15.60	505.37	418.07	2530.16	2093.12	3.40
7	[A1-M1]	15.65	503.31	419.01	2535.33	2110.70	3.42
7	[A1-M1]	15.70	501.00	419.95	2540.98	2129.94	3.44
7	[A1-M1]	15.75	498.44	420.89	2547.12	2150.86	3.47
7	[A1-M1]	15.80	495.64	421.84	2552.59	2172.49	3.49
7	[A1-M1]	15.85	492.61	422.78	2557.17	2194.67	3.52
7	[A1-M1]	15.90	489.35	423.72	2562.09	2218.44	3.55
7	[A1-M1]	15.95	485.88	424.66	2567.34	2243.86	3.59
7	[A1-M1]	16.00	482.19	425.60	2572.95	2270.97	3.62
7	[A1-M1]	16.05	478.30	426.54	2578.91	2299.81	3.66

Cod. elab.: 108GA201-GA01-Z-CL-002 C	Titolo: OPERE D'ARTE MAGGIORI- GALLERIE	Data: Ottobre 2011
Nome file: 108GA201-GA01-Z-CL -002_C.docx	ARTIFICIALI – GALLERIA ROVETELLO	Pagina 93 di 452
Relazione di calcolo		

PROGETTO ESECUTIVO

7	[A1-M1]	16.10	474.22	427.48	2585.25	2330.46	3.70
7	[A1-M1]	16.15	469.94	428.42	2591.97	2362.96	3.74
7	[A1-M1]	16.20	465.48	429.36	2599.09	2397.40	3.79
7	[A1-M1]	16.25	460.85	430.30	2606.62	2433.84	3.84
7	[A1-M1]	16.30	456.05	431.24	2614.59	2472.38	3.89
7	[A1-M1]	16.35	451.08	432.18	2623.01	2513.11	3.95
7	[A1-M1]	16.40	445.96	433.13	2631.90	2556.12	4.00
7	[A1-M1]	16.45	440.70	434.07	2641.29	2601.53	4.07
7	[A1-M1]	16.50	435.29	435.01	2651.20	2649.46	4.13
7	[A1-M1]	16.55	429.70	435.95	2661.73	2700.43	4.20
7	[A1-M1]	16.60	423.89	436.89	2673.01	2754.99	4.28
7	[A1-M1]	16.65	417.86	437.83	2685.08	2813.37	4.36
7	[A1-M1]	16.70	411.64	438.77	2697.99	2875.83	4.45
7	[A1-M1]	16.75	405.22	439.71	2711.80	2942.64	4.54
7	[A1-M1]	16.80	398.61	440.65	2726.58	3014.12	4.64
7	[A1-M1]	16.85	391.84	441.59	2742.40	3090.63	4.75
7	[A1-M1]	16.90	384.89	442.53	2759.33	3172.54	4.86
7	[A1-M1]	16.95	377.80	443.47	2776.28	3258.91	4.99
7	[A1-M1]	17.00	370.55	444.41	2789.06	3344.99	5.11
7	[A1-M1]	17.05	363.17	445.36	2802.71	3436.92	5.24
7	[A1-M1]	17.10	355.67	446.30	2817.30	3535.18	5.38
7	[A1-M1]	17.15	348.04	447.24	2832.91	3640.31	5.52
7	[A1-M1]	17.20	340.31	448.18	2849.62	3752.89	5.68
7	[A1-M1]	17.25	332.47	449.12	2867.54	3873.61	5.85
7	[A1-M1]	17.30	324.55	450.06	2886.78	4003.20	6.04
7	[A1-M1]	17.35	316.54	451.00	2907.46	4142.53	6.23
7	[A1-M1]	17.40	308.46	451.94	2929.74	4292.56	6.45
7	[A1-M1]	17.45	300.31	452.88	2945.05	4441.25	6.65
7	[A1-M1]	17.50	292.11	453.82	2959.17	4597.37	6.87
7	[A1-M1]	17.55	283.86	454.76	2974.35	4765.05	7.11
7	[A1-M1]	17.60	275.58	455.70	2990.67	4945.46	7.36
7	[A1-M1]	17.65	267.26	456.64	3008.27	5139.88	7.64
7	[A1-M1]	17.70	258.93	457.59	3027.26	5349.81	7.93
7	[A1-M1]	17.75	250.59	458.53	3037.64	5558.32	8.23
7	[A1-M1]	17.80	242.24	459.47	3045.22	5776.05	8.53
7	[A1-M1]	17.85	233.90	460.41	3053.38	6010.37	8.86

Cod. elab.: 108GA201-GA01-Z-CL-002 C	Titolo: OPERE D'ARTE MAGGIORI- GALLERIE	Data: Ottobre 2011
Nome file: 108GA201-GA01-Z-CL -002_C.docx	ARTIFICIALI – GALLERIA ROVETELLO	Pagina 94 di 452
Relazione di calcolo		

PROGETTO ESECUTIVO

7	[A1-M1]	17.90	225.57	461.35	3062.18	6263.00	9.21
7	[A1-M1]	17.95	217.26	462.29	3068.86	6529.85	9.58
7	[A1-M1]	18.00	208.99	463.23	3062.16	6787.29	9.94
7	[A1-M1]	18.05	200.76	464.17	3054.97	7063.34	10.33
7	[A1-M1]	18.10	192.57	465.11	3047.25	7359.79	10.74
7	[A1-M1]	18.15	184.45	466.05	3032.47	7662.24	11.16
7	[A1-M1]	18.20	176.39	466.99	3003.66	7952.30	11.56
7	[A1-M1]	18.25	168.40	467.93	2972.99	8261.02	11.98
7	[A1-M1]	18.30	160.50	468.87	2940.33	8589.87	12.43
7	[A1-M1]	18.35	152.68	469.82	2897.65	8916.21	12.88
7	[A1-M1]	18.40	144.97	470.76	2850.70	9256.99	13.34
7	[A1-M1]	18.45	137.36	471.70	2800.93	9618.21	13.84
7	[A1-M1]	18.50	129.87	472.64	2744.06	9986.25	14.34
7	[A1-M1]	18.55	122.51	473.58	2682.18	10368.56	14.86
7	[A1-M1]	18.60	115.27	474.52	2616.86	10772.16	15.40
7	[A1-M1]	18.65	108.18	475.46	2541.87	11171.52	15.94
7	[A1-M1]	18.70	101.24	476.40	2462.51	11587.85	16.51
7	[A1-M1]	18.75	94.45	477.34	2377.26	12014.02	17.08
7	[A1-M1]	18.80	87.83	478.28	2283.37	12433.74	17.64
7	[A1-M1]	18.85	81.39	479.22	2185.77	12870.13	18.22
7	[A1-M1]	18.90	75.12	480.16	2079.01	13288.22	18.78
7	[A1-M1]	18.95	69.05	481.10	1967.45	13708.00	19.33
7	[A1-M1]	19.00	63.18	482.05	1851.93	14130.52	19.89
7	[A2-M2]	19.05	23.47	528.35	698.50	15727.26	20.20
7	[A2-M2]	19.10	22.40	529.29	666.67	15749.58	20.19
7	[A2-M2]	19.15	21.19	530.23	630.55	15774.91	20.19
7	[A2-M2]	19.20	19.85	531.17	590.46	15803.02	20.19
7	[A2-M2]	19.25	18.39	532.12	547.09	15833.43	20.19
7	[A2-M2]	19.30	16.84	533.06	501.16	15865.64	20.20
7	[A2-M2]	19.35	15.23	534.00	453.38	15899.14	20.20
7	[A2-M2]	19.40	13.58	534.94	404.48	15933.43	20.21
7	[A2-M2]	19.45	11.92	535.88	355.17	15968.00	20.22
7	[A2-M2]	19.50	10.27	536.82	306.20	16002.35	20.23
7	[A2-M2]	19.55	8.66	537.76	258.30	16035.93	20.23
6	[A2-M2]	19.60	6.62	539.09	197.55	16078.53	20.24
6	[A2-M2]	19.65	5.25	540.04	156.66	16107.20	20.24

Cod. elab.: 108GA201-GA01-Z-CL-002 C	Titolo: OPERE D'ARTE MAGGIORI- GALLERIE	Data: Ottobre 2011
Nome file: 108GA201-GA01-Z-CL -002_C.docx	ARTIFICIALI – GALLERIA ROVETELLO	Pagina 95 di 452
Relazione di calcolo		

PROGETTO ESECUTIVO

6	[A2-M2]	19.70	3.99	540.98	119.09	16133.55	20.24
6	[A2-M2]	19.75	2.87	541.92	85.48	16157.11	20.23
6	[A2-M2]	19.80	1.90	542.86	56.50	16177.43	20.22
6	[A2-M2]	19.85	1.10	543.80	32.82	16194.04	20.21
6	[A2-M2]	19.90	0.51	544.74	15.08	16206.48	20.19
6	[A2-M2]	19.95	0.13	545.68	3.93	16214.30	20.16

Verifica armatura pali

Simbologia adottata

n° numero d'ordine della sezione

Y ordinata della sezione rispetto alla testa espressa in [m]

A_f area di armatura espressa in [mq]

Presso-flessione

M momento flettente agente sul palo espresso in [kNm]

N sforzo normale agente sul palo espresso in [kN] (positivo di compressione)

M_u momento ultimo di riferimento espresso in [kNm]

N_u sforzo normale ultimo di riferimento espresso in [kN]

CS coefficiente di sicurezza (rapporto fra la sollecitazione ultima e la sollecitazione di esercizio)

Fase n° 1 - [A1-M1]

n°	Y	A _f	M	N	M _u	N _u	CS
1	0.00	0.010857	0.00	0.00	0.00	0.00	1000.000
2	0.05	0.010857	0.00	1.39	0.00	-4248.53	3064.420
3	0.10	0.010857	0.00	2.77	13.60	16207.51	5845.160
4	0.15	0.010857	0.01	4.16	27.09	16198.06	3894.500
5	0.20	0.010857	0.01	5.55	40.46	16188.68	2919.185
6	0.25	0.010857	0.02	6.93	53.70	16179.39	2334.008
7	0.30	0.010857	0.03	8.32	66.83	16170.19	1943.900
8	0.35	0.010857	0.05	9.70	79.85	16161.06	1665.260
9	0.40	0.010857	0.06	11.09	92.74	16152.02	1456.287
10	0.45	0.010857	0.08	12.48	105.52	16143.06	1293.759
11	0.50	0.010857	0.10	13.86	118.18	16134.18	1163.743
12	0.55	0.010857	0.13	15.25	135.17	16122.27	1057.167

Cod. elab.: 108GA201-GA01-Z-CL-002_C	Titolo: OPERE D'ARTE MAGGIORI- GALLERIE	Data: Ottobre 2011
Nome file: 108GA201-GA01-Z-CL -002_C.docx	ARTIFICIALI – GALLERIA ROVETELLO	Pagina 96 di 452
Relazione di calcolo		

PROGETTO ESECUTIVO

13	0.60	0.010857	0.16	16.64	159.31	16105.34	968.052
14	0.65	0.010857	0.21	18.02	188.79	16084.67	892.440
15	0.70	0.010857	0.27	19.41	222.31	16061.17	827.483
16	0.75	0.010857	0.34	20.80	258.92	16035.50	771.083
17	0.80	0.010857	0.41	22.18	297.88	16008.18	721.659
18	0.85	0.010857	0.50	23.57	338.65	15979.59	677.995
19	0.90	0.010857	0.60	24.96	380.81	15950.03	639.144
20	0.95	0.010857	0.70	26.34	424.02	15919.73	604.355
21	1.00	0.010857	0.82	27.73	468.01	15888.89	573.025
22	1.05	0.010857	0.94	29.11	512.56	15857.65	544.665
23	1.10	0.010857	1.07	30.50	557.50	15826.14	518.874
24	1.15	0.010857	1.22	31.89	602.68	15794.45	495.321
25	1.20	0.010857	1.37	33.27	648.00	15762.68	473.728
26	1.25	0.010857	1.53	34.66	693.34	15730.88	453.861
27	1.30	0.010857	1.70	36.05	738.63	15699.13	435.524
28	1.35	0.010857	1.87	37.43	783.79	15667.46	418.548
29	1.40	0.010857	2.06	38.82	828.77	15635.92	402.787
30	1.45	0.010857	2.25	40.21	873.53	15604.54	388.117
31	1.50	0.010857	2.45	41.59	918.01	15573.34	374.430
32	1.55	0.010857	2.66	42.98	962.19	15542.37	361.631
33	1.60	0.010857	2.88	44.36	1006.02	15511.63	349.637
34	1.65	0.010857	3.10	45.75	1049.49	15481.15	338.376
35	1.70	0.010857	3.33	47.14	1092.58	15450.94	327.783
36	1.75	0.010857	3.57	48.52	1135.26	15421.01	317.801
37	1.80	0.010857	3.82	49.91	1177.52	15391.37	308.379
38	1.85	0.010857	4.07	51.30	1219.35	15362.05	299.473
39	1.90	0.010857	4.33	52.68	1260.73	15333.03	291.041
40	1.95	0.010857	4.60	54.07	1301.65	15304.34	283.048
41	2.00	0.010857	4.87	55.46	1342.11	15275.97	275.460
42	2.05	0.010857	5.15	56.84	1382.09	15247.93	268.248
43	2.10	0.010857	5.44	58.23	1421.60	15220.23	261.386
44	2.15	0.010857	5.73	59.62	1460.62	15192.87	254.848
45	2.20	0.010857	6.03	61.00	1499.15	15165.85	248.613
46	2.25	0.010857	6.33	62.39	1537.19	15139.18	242.661
47	2.30	0.010857	6.65	63.77	1568.23	15050.37	235.993
48	2.35	0.010857	6.96	65.16	1597.68	14954.86	229.506

<i>Cod. elab.:</i> 108GA201-GA01-Z-CL-002_C	<i>Titolo:</i> OPERE D'ARTE MAGGIORI- GALLERIE	<i>Data:</i> Ottobre 2011
<i>Nome file:</i> 108GA201-GA01-Z-CL -002_C.docx	ARTIFICIALI – GALLERIA ROVETELLO Relazione di calcolo	<i>Pagina</i> 97 di 452

PROGETTO ESECUTIVO

49	2.40	0.010857	7.28	66.55	1626.48	14861.51	223.322
50	2.45	0.010857	7.61	67.93	1654.62	14770.26	217.421
51	2.50	0.010857	7.94	69.32	1682.13	14681.07	211.786
52	2.50	0.010857	7.94	69.32	1682.13	14681.07	211.786
53	2.55	0.010857	8.28	70.71	1708.63	14595.14	206.418
54	2.60	0.010857	8.62	72.09	1734.55	14511.12	201.283
55	2.65	0.010857	8.96	73.48	1759.88	14428.97	196.367
56	2.70	0.010857	9.31	74.87	1784.66	14348.65	191.658
57	2.75	0.010857	9.67	76.25	1808.87	14270.13	187.144
58	2.80	0.010857	10.02	77.64	1832.55	14193.38	182.813
59	2.85	0.010857	10.39	79.03	1855.68	14118.36	178.657
60	2.90	0.010857	10.75	80.41	1878.16	14044.01	174.652
61	2.95	0.010857	11.12	81.80	1899.22	13964.76	170.723
62	3.00	0.010857	11.50	83.18	1919.78	13887.40	166.947
63	3.05	0.010857	11.88	84.57	1939.84	13811.90	163.318
64	3.10	0.010857	12.26	85.96	1959.42	13738.22	159.826
65	3.15	0.010857	12.65	87.34	1978.53	13666.31	156.466
66	3.20	0.010857	13.03	88.73	1997.17	13596.16	153.231
67	3.25	0.010857	13.43	90.12	2015.36	13527.71	150.114
68	3.30	0.010857	13.82	91.50	2033.11	13460.94	147.110
69	3.35	0.010857	14.22	92.89	2050.42	13395.82	144.213
70	3.40	0.010857	14.62	94.28	2067.29	13332.31	141.419
71	3.45	0.010857	15.02	95.66	2083.75	13270.37	138.722
72	3.50	0.010857	15.43	97.05	2099.80	13210.00	136.118
73	3.55	0.010857	15.83	98.43	2115.44	13151.14	133.603
74	3.60	0.010857	16.24	99.82	2130.68	13093.78	131.172
75	3.65	0.010857	16.65	101.21	2145.54	13037.89	128.823
76	3.70	0.010857	17.07	102.59	2160.01	12983.44	126.552
77	3.75	0.010857	17.48	103.98	2173.32	12925.77	124.310
78	3.80	0.010857	17.90	105.37	2186.10	12868.64	122.132
79	3.85	0.010857	18.32	106.75	2198.53	12813.07	120.025
80	3.90	0.010857	18.74	108.14	2210.61	12759.03	117.987
81	3.95	0.010857	19.16	109.53	2222.36	12706.51	116.014
82	4.00	0.010857	19.58	110.91	2233.78	12655.47	114.103
83	4.05	0.010857	20.00	112.30	2244.87	12605.89	112.253
84	4.10	0.010857	20.42	113.69	2255.64	12557.74	110.461

Cod. elab.: 108GA201-GA01-Z-CL-002_C	Titolo: OPERE D'ARTE MAGGIORI- GALLERIE	Data: Ottobre 2011
Nome file: 108GA201-GA01-Z-CL -002_C.docx	ARTIFICIALI – GALLERIA ROVETELLO Relazione di calcolo	Pagina 98 di 452

PROGETTO ESECUTIVO

85	4.15	0.010857	20.84	115.07	2266.09	12511.00	108.724
86	4.20	0.010857	21.27	116.46	2276.24	12465.65	107.040
87	4.25	0.010857	21.69	117.84	2286.07	12421.67	105.407
88	4.30	0.010857	22.11	119.23	2295.61	12379.04	103.824
89	4.35	0.010857	22.53	120.62	2304.85	12337.73	102.288
90	4.40	0.010857	22.95	122.00	2313.79	12297.74	100.798
91	4.45	0.010857	23.38	123.39	2322.45	12259.03	99.352
92	4.50	0.010857	23.80	124.78	2330.82	12221.60	97.948
93	4.55	0.010857	24.22	126.16	2338.91	12185.43	96.585
94	4.60	0.010857	24.63	127.55	2346.73	12150.51	95.261
95	4.65	0.010857	25.05	128.94	2354.26	12116.81	93.976
96	4.70	0.010857	25.47	130.32	2361.53	12084.33	92.727
97	4.75	0.010857	25.88	131.71	2368.52	12053.05	91.513
98	4.80	0.010857	26.29	133.09	2375.25	12022.97	90.334
99	4.85	0.010857	26.70	134.48	2381.72	11994.06	89.188
100	4.90	0.010857	27.11	135.87	2387.92	11966.32	88.073
101	4.95	0.010857	27.52	137.25	2393.87	11939.74	86.990
102	5.00	0.010857	27.92	138.64	2399.56	11914.31	85.937
103	5.05	0.010857	28.32	140.03	2404.95	11889.81	84.911
104	5.10	0.010857	28.72	141.41	2409.73	11864.71	83.901
105	5.15	0.010857	29.12	142.80	2414.28	11840.84	82.919
106	5.20	0.010857	29.51	144.19	2418.60	11818.19	81.965
107	5.25	0.010857	29.90	145.57	2422.69	11796.75	81.037
108	5.30	0.010857	30.28	146.96	2426.55	11776.51	80.135
109	5.35	0.010857	30.66	148.35	2430.17	11757.47	79.257
110	5.40	0.010857	31.04	149.73	2433.58	11739.63	78.404
111	5.45	0.010857	31.41	151.12	2436.75	11722.97	77.575
112	5.50	0.010857	31.78	152.50	2439.70	11707.50	76.768
113	5.55	0.010857	32.14	153.89	2442.42	11693.21	75.984
114	5.60	0.010857	32.50	155.28	2444.92	11680.10	75.221
115	5.65	0.010857	32.86	156.66	2447.20	11668.17	74.479
116	5.70	0.010857	33.21	158.05	2449.25	11657.41	73.758
117	5.75	0.010857	33.55	159.44	2451.07	11647.84	73.056
118	5.80	0.010857	33.89	160.82	2452.67	11639.44	72.374
119	5.85	0.010857	34.22	162.21	2454.05	11632.21	71.711
120	5.90	0.010857	34.55	163.60	2455.20	11626.17	71.066

Cod. elab.: 108GA201-GA01-Z-CL-002_C	Titolo: OPERE D'ARTE MAGGIORI- GALLERIE	Data: Ottobre 2011
Nome file: 108GA201-GA01-Z-CL -002_C.docx	ARTIFICIALI – GALLERIA ROVETELLO Relazione di calcolo	Pagina 99 di 452

PROGETTO ESECUTIVO

121 5.95	0.010857	34.87	164.98	2456.13	11621.32	70.440
122 6.00	0.010857	35.18	166.37	2456.83	11617.65	69.831
123 6.05	0.010857	35.49	167.75	2457.30	11615.17	69.239
124 6.10	0.010857	35.79	169.14	2457.54	11613.89	68.664
125 6.15	0.010857	36.08	170.53	2457.56	11613.81	68.105
126 6.20	0.010857	36.37	171.91	2457.34	11614.94	67.562
127 6.25	0.010857	36.65	173.30	2456.90	11617.28	67.035
128 6.30	0.010857	36.92	174.69	2456.21	11620.86	66.524
129 6.35	0.010857	37.19	176.07	2455.30	11625.66	66.027
130 6.40	0.010857	37.44	177.46	2454.14	11631.72	65.546
131 6.45	0.010857	37.69	178.85	2452.75	11639.02	65.078
132 6.50	0.010857	37.93	180.23	2451.12	11647.60	64.625
133 6.55	0.010857	38.16	181.62	2449.24	11657.46	64.186
134 6.60	0.010857	38.38	183.01	2447.11	11668.61	63.761
135 6.65	0.010857	38.59	184.39	2444.74	11681.07	63.349
136 6.70	0.010857	38.79	185.78	2442.11	11694.85	62.951
137 6.75	0.010857	38.99	187.16	2439.23	11709.98	62.565
138 6.80	0.010857	39.17	188.55	2436.09	11726.46	62.193
139 6.85	0.010857	39.34	189.94	2432.68	11744.33	61.833
140 6.90	0.010857	39.51	191.32	2429.01	11763.59	61.485
141 6.95	0.010857	39.66	192.71	2425.07	11784.27	61.150
142 7.00	0.010857	39.80	194.10	2420.85	11806.40	60.827
143 7.05	0.010857	39.93	195.48	2416.35	11830.00	60.517
144 7.10	0.010857	40.05	196.87	2411.57	11855.08	60.218
145 7.15	0.010857	40.15	198.26	2406.50	11881.69	59.931
146 7.20	0.010857	40.25	199.64	2400.86	11908.49	59.649
147 7.25	0.010857	40.33	201.03	2394.73	11935.90	59.374
148 7.30	0.010857	40.40	202.42	2388.27	11964.78	59.110
149 7.35	0.010857	40.46	203.80	2381.47	11995.16	58.857
150 7.40	0.010857	40.51	205.19	2374.34	12027.07	58.615
151 7.45	0.010857	40.54	206.57	2366.85	12060.54	58.384
152 7.50	0.010857	40.56	207.96	2359.01	12095.60	58.163
153 7.55	0.010857	40.56	209.35	2350.80	12132.29	57.953
154 7.60	0.010857	40.56	210.73	2342.22	12170.64	57.754
155 7.65	0.010857	40.53	212.12	2333.26	12210.70	57.565
156 7.70	0.010857	40.50	213.51	2323.91	12252.49	57.387

Cod. elab.: 108GA201-GA01-Z-CL-002_C	Titolo: OPERE D'ARTE MAGGIORI- GALLERIE	Data: Ottobre 2011
Nome file: 108GA201-GA01-Z-CL -002_C.docx	ARTIFICIALI – GALLERIA ROVETELLO Relazione di calcolo	Pagina 100 di 452

PROGETTO ESECUTIVO

1577.75	0.010857	40.44	214.89	2314.17	12296.08	57.220
1587.80	0.010857	40.38	216.28	2304.01	12341.48	57.063
1597.85	0.010857	40.29	217.67	2293.43	12388.76	56.917
1607.90	0.010857	40.20	219.05	2282.43	12437.97	56.781
1617.95	0.010857	40.08	220.44	2270.98	12489.14	56.656
1628.00	0.010857	39.95	221.82	2259.08	12542.34	56.542
1638.05	0.010857	39.81	223.21	2246.72	12597.62	56.438
1648.10	0.010857	39.65	224.60	2233.87	12655.05	56.345
1658.15	0.010857	39.47	225.98	2220.54	12714.67	56.264
1668.20	0.010857	39.27	227.37	2206.69	12776.56	56.193
1678.25	0.010857	39.06	228.76	2192.33	12840.78	56.133
1688.30	0.010857	38.82	230.14	2177.43	12907.41	56.084
1698.35	0.010857	38.57	231.53	2161.92	12976.23	56.046
1708.40	0.010857	38.31	232.92	2144.74	13040.89	55.990
1718.45	0.010857	38.02	234.30	2126.94	13107.86	55.944
1728.50	0.010857	37.71	235.69	2108.51	13177.20	55.909
1738.55	0.010857	37.38	237.08	2089.15	13250.06	55.890
1748.60	0.010857	37.01	238.46	2068.54	13327.63	55.890
1758.65	0.010857	36.61	239.85	2046.63	13410.06	55.911
1768.70	0.010857	36.16	241.23	2023.39	13497.52	55.952
1778.75	0.010857	35.68	242.62	1998.76	13590.20	56.014
1788.80	0.010857	35.17	244.01	1972.69	13688.30	56.098
1798.85	0.010857	34.61	245.39	1945.12	13792.03	56.204
1808.90	0.010857	34.01	246.78	1916.00	13901.63	56.332
1818.95	0.010857	33.38	248.17	1885.25	14017.34	56.484
1829.00	0.010857	32.70	249.55	1851.72	14131.21	56.626
1839.05	0.010857	31.98	250.94	1815.91	14247.31	56.776
1849.10	0.010857	31.23	252.33	1778.23	14369.49	56.948
1859.15	0.010857	30.42	253.71	1738.58	14498.04	57.144
1869.20	0.010857	29.58	255.10	1696.88	14633.23	57.363
1879.25	0.010857	28.70	256.48	1653.05	14775.34	57.607
1889.30	0.010857	27.77	257.87	1607.04	14924.51	57.876
1899.35	0.010857	26.80	259.26	1558.83	15080.85	58.169
1909.40	0.010857	25.79	260.64	1500.49	15164.91	58.182
1919.45	0.010857	24.74	262.03	1436.20	15209.99	58.047
1929.50	0.010857	23.66	263.42	1370.19	15256.28	57.917

Cod. elab.: 108GA201-GA01-Z-CL-002_C	Titolo: OPERE D'ARTE MAGGIORI- GALLERIE	Data: Ottobre 2011
Nome file: 108GA201-GA01-Z-CL -002_C.docx	ARTIFICIALI – GALLERIA ROVETELLO Relazione di calcolo	Pagina 101 di 452

PROGETTO ESECUTIVO

1939.55	0.010857	22.54	264.80	1302.50	15303.74	57.793
1949.60	0.010857	21.38	266.19	1233.21	15352.33	57.674
1959.65	0.010857	20.19	267.58	1162.35	15402.01	57.561
1969.70	0.010857	18.97	268.96	1090.00	15452.74	57.453
1979.75	0.010857	17.72	270.35	1016.21	15504.48	57.350
1989.80	0.010857	16.44	271.74	941.04	15557.20	57.251
1999.85	0.010857	15.13	273.12	864.53	15610.84	57.157
2009.90	0.010857	13.79	274.51	786.76	15665.38	57.067
2019.95	0.010857	12.42	275.89	707.76	15720.77	56.981
20210.00	0.010857	11.03	277.28	627.61	15776.97	56.899
20310.05	0.010857	9.62	278.67	546.35	15833.95	56.820
20410.10	0.010857	8.18	280.05	464.04	15891.67	56.745
20510.15	0.010857	6.72	281.44	380.74	15950.08	56.673
20610.20	0.010857	5.24	282.83	296.50	16009.15	56.604
20710.25	0.010857	3.74	284.21	211.38	16068.83	56.538
20810.30	0.010857	2.22	285.60	125.44	16129.09	56.475
20910.35	0.010857	0.69	286.99	38.74	16189.88	56.414
21010.40	0.010857	-0.86	288.37	-48.46	16183.07	56.119
21110.45	0.010857	-2.43	289.76	-135.11	16122.31	55.641
21210.50	0.010857	-4.01	291.14	-221.04	16062.06	55.169
21310.55	0.010857	-5.60	292.53	-306.18	16002.36	54.703
21410.60	0.010857	-7.20	293.92	-390.48	15943.25	54.244
21510.65	0.010857	-8.81	295.30	-473.90	15884.75	53.791
21610.70	0.010857	-10.43	296.69	-556.40	15826.91	53.345
21710.75	0.010857	-12.06	298.08	-637.92	15769.75	52.905
21810.80	0.010857	-13.69	299.46	-718.42	15713.30	52.472
21910.85	0.010857	-15.33	300.85	-797.88	15657.58	52.045
22010.90	0.010857	-16.97	302.24	-876.24	15602.63	51.624
22110.95	0.010857	-18.62	303.62	-953.49	15548.47	51.210
22211.00	0.010857	-20.27	305.01	-1029.58	15495.11	50.802
22311.05	0.010857	-21.91	306.40	-1104.48	15442.59	50.401
22411.10	0.010857	-23.56	307.78	-1178.18	15390.92	50.006
22511.15	0.010857	-25.21	309.17	-1250.62	15340.12	49.617
22611.20	0.010857	-26.85	310.55	-1321.80	15290.20	49.235
22711.25	0.010857	-28.48	311.94	-1391.69	15241.20	48.859
22811.30	0.010857	-30.12	313.33	-1460.27	15193.12	48.490

Cod. elab.: 108GA201-GA01-Z-CL-002_C	Titolo: OPERE D'ARTE MAGGIORI- GALLERIE	Data: Ottobre 2011
Nome file: 108GA201-GA01-Z-CL -002_C.docx	ARTIFICIALI – GALLERIA ROVETELLO Relazione di calcolo	Pagina 102 di 452

PROGETTO ESECUTIVO

22911.35	0.010857	-31.74	314.71	-1527.50	15145.97	48.126
23011.40	0.010857	-33.36	316.10	-1583.08	15002.22	47.460
23111.45	0.010857	-34.96	317.49	-1633.94	14837.30	46.734
23211.50	0.010857	-36.56	318.87	-1682.92	14678.49	46.032
23311.55	0.010857	-38.14	320.26	-1730.07	14525.63	45.356
23411.60	0.010857	-39.72	321.65	-1775.44	14378.53	44.703
23511.65	0.010857	-41.27	323.03	-1819.08	14237.03	44.073
23611.70	0.010857	-42.82	324.42	-1861.04	14100.99	43.465
23711.75	0.010857	-44.34	325.81	-1900.14	13961.27	42.852
23811.80	0.010857	-45.85	327.19	-1937.00	13822.58	42.246
23911.85	0.010857	-47.34	328.58	-1972.32	13689.69	41.663
24011.90	0.010857	-48.81	329.96	-2006.13	13562.44	41.103
24111.95	0.010857	-50.25	331.35	-2038.50	13440.67	40.563
24212.00	0.010857	-51.68	332.74	-2069.44	13324.22	40.044
24312.05	0.010857	-53.08	334.12	-2099.01	13212.95	39.545
24412.10	0.010857	-54.45	335.51	-2127.24	13106.74	39.065
24512.15	0.010857	-55.80	336.90	-2154.16	13005.46	38.604
24612.20	0.010857	-57.12	338.28	-2178.62	12902.05	38.140
24712.25	0.010857	-58.41	339.67	-2201.32	12800.57	37.685
24812.30	0.010857	-59.67	341.06	-2222.85	12704.33	37.250
24912.35	0.010857	-60.90	342.44	-2243.24	12613.19	36.833
25012.40	0.010857	-62.10	343.83	-2262.51	12527.04	36.434
25112.45	0.010857	-63.26	345.21	-2280.68	12445.77	36.052
25212.50	0.010857	-64.39	346.60	-2297.79	12369.29	35.687
25312.55	0.010857	-65.48	347.99	-2313.85	12297.51	35.339
25412.60	0.010857	-66.53	349.37	-2328.87	12230.34	35.006
25512.65	0.010857	-67.54	350.76	-2342.88	12167.72	34.690
25612.70	0.010857	-68.51	352.15	-2355.88	12109.57	34.388
25712.75	0.010857	-69.44	353.53	-2367.91	12055.81	34.101
25812.80	0.010857	-70.33	354.92	-2378.98	12006.29	33.828
25912.85	0.010857	-71.17	356.31	-2389.16	11960.81	33.569
26012.90	0.010857	-71.98	357.69	-2398.46	11919.23	33.323
26112.95	0.010857	-72.74	359.08	-2406.74	11880.44	33.086
26213.00	0.010857	-73.47	360.47	-2413.81	11843.30	32.856
26313.05	0.010857	-74.15	361.85	-2420.17	11809.93	32.638
26413.10	0.010857	-74.80	363.24	-2425.84	11780.19	32.431

Cod. elab.: 108GA201-GA01-Z-CL-002_C	Titolo: OPERE D'ARTE MAGGIORI- GALLERIE	Data: Ottobre 2011
Nome file: 108GA201-GA01-Z-CL -002_C.docx	ARTIFICIALI – GALLERIA ROVETELLO	Pagina 103 di 452
	Relazione di calcolo	

PROGETTO ESECUTIVO

26513.15	0.010857	-75.41	364.62	-2430.85	11753.94	32.236
26613.20	0.010857	-75.98	366.01	-2435.21	11731.07	32.051
26713.25	0.010857	-76.51	367.40	-2438.94	11711.47	31.877
26813.30	0.010857	-77.01	368.78	-2442.07	11695.05	31.712
26913.35	0.010857	-77.47	370.17	-2444.62	11681.69	31.558
27013.40	0.010857	-77.89	371.56	-2446.59	11671.33	31.412
27113.45	0.010857	-78.27	372.94	-2448.01	11663.88	31.275
27213.50	0.010857	-78.62	374.33	-2448.89	11659.27	31.147
27313.55	0.010857	-78.94	375.72	-2449.24	11657.43	31.027
27413.60	0.010857	-79.22	377.10	-2449.08	11658.29	30.915
27513.65	0.010857	-79.46	378.49	-2448.41	11661.81	30.812
27613.70	0.010857	-79.68	379.87	-2447.24	11667.93	30.715
27713.75	0.010857	-79.85	381.26	-2445.59	11676.60	30.626
27813.80	0.010857	-80.00	382.65	-2443.46	11687.77	30.544
27913.85	0.010857	-80.11	384.03	-2440.86	11701.42	30.470
28013.90	0.010857	-80.19	385.42	-2437.79	11717.51	30.402
28113.95	0.010857	-80.23	386.81	-2434.27	11736.00	30.341
28214.00	0.010857	-80.24	388.19	-2430.29	11756.86	30.286
28314.05	0.010857	-80.23	389.58	-2425.86	11780.09	30.238
28414.10	0.010857	-80.18	390.97	-2420.99	11805.64	30.196
28514.15	0.010857	-80.09	392.35	-2415.68	11833.51	30.160
28614.20	0.010857	-79.98	393.74	-2409.93	11863.69	30.131
28714.25	0.010857	-79.84	395.13	-2403.68	11895.88	30.107
28814.30	0.010857	-79.67	396.51	-2396.51	11927.92	30.082
28914.35	0.010857	-79.46	397.90	-2388.88	11962.06	30.063
29014.40	0.010857	-79.23	399.28	-2380.78	11998.28	30.049
29114.45	0.010857	-78.97	400.67	-2372.21	12036.57	30.041
29214.50	0.010857	-78.67	402.06	-2363.18	12076.95	30.038
29314.55	0.010857	-78.35	403.44	-2353.68	12119.42	30.040
29414.60	0.010857	-78.00	404.83	-2343.72	12163.97	30.047
29514.65	0.010857	-77.62	406.22	-2333.28	12210.62	30.059
29614.70	0.010857	-77.22	407.60	-2322.38	12259.37	30.077
29714.75	0.010857	-76.78	408.99	-2311.00	12310.24	30.099
29814.80	0.010857	-76.32	410.38	-2299.14	12363.25	30.127
29914.85	0.010857	-75.82	411.76	-2286.80	12418.41	30.159
30014.90	0.010857	-75.31	413.15	-2273.98	12475.74	30.197

Cod. elab.: 108GA201-GA01-Z-CL-002_C	Titolo: OPERE D'ARTE MAGGIORI- GALLERIE	Data: Ottobre 2011
Nome file: 108GA201-GA01-Z-CL -002_C.docx	ARTIFICIALI – GALLERIA ROVETELLO	Pagina 104 di 452
Relazione di calcolo		

PROGETTO ESECUTIVO

30114.95	0.010857	-74.76	414.53	-2260.67	12535.26	30.239
30215.00	0.010857	-74.19	415.92	-2246.86	12597.00	30.287
30315.05	0.010857	-73.58	417.31	-2232.55	12660.98	30.340
30415.10	0.010857	-72.96	418.69	-2217.73	12727.24	30.397
30515.15	0.010857	-72.30	420.08	-2202.39	12795.80	30.460
30615.20	0.010857	-71.62	421.47	-2186.53	12866.71	30.528
30715.25	0.010857	-70.92	422.85	-2170.14	12939.99	30.602
30815.30	0.010857	-70.18	424.24	-2152.53	13011.59	30.670
30915.35	0.010857	-69.42	425.63	-2133.80	13082.06	30.736
31015.40	0.010857	-68.64	427.01	-2114.49	13154.71	30.806
31115.45	0.010857	-67.83	428.40	-2094.60	13229.57	30.881
31215.50	0.010857	-66.99	429.79	-2074.11	13306.68	30.961
31315.55	0.010857	-66.13	431.17	-2053.00	13386.08	31.046
31415.60	0.010857	-65.24	432.56	-2031.28	13467.82	31.135
31515.65	0.010857	-64.33	433.94	-2008.92	13551.95	31.230
31615.70	0.010857	-63.39	435.33	-1985.92	13638.50	31.329
31715.75	0.010857	-62.43	436.72	-1962.26	13727.55	31.433
31815.80	0.010857	-61.44	438.10	-1937.92	13819.13	31.543
31915.85	0.010857	-60.42	439.49	-1912.89	13913.32	31.658
32015.90	0.010857	-59.39	440.88	-1887.15	14010.16	31.778
32115.95	0.010857	-58.32	442.26	-1859.99	14104.41	31.891
32216.00	0.010857	-57.23	443.65	-1831.50	14196.76	32.000
32316.05	0.010857	-56.12	445.04	-1802.26	14291.56	32.113
32416.10	0.010857	-54.98	446.42	-1772.25	14388.88	32.232
32516.15	0.010857	-53.82	447.81	-1741.44	14488.77	32.355
32616.20	0.010857	-52.64	449.20	-1709.82	14591.29	32.483
32716.25	0.010857	-51.43	450.58	-1677.37	14696.51	32.617
32816.30	0.010857	-50.19	451.97	-1644.06	14804.52	32.756
32916.35	0.010857	-48.93	453.35	-1609.87	14915.37	32.900
33016.40	0.010857	-47.65	454.74	-1574.77	15029.14	33.050
33116.45	0.010857	-46.34	456.13	-1538.01	15138.60	33.189
33216.50	0.010857	-45.01	457.51	-1492.41	15170.58	33.159
33316.55	0.010857	-43.67	458.90	-1446.84	15202.53	33.128
33416.60	0.010857	-42.36	460.29	-1402.01	15233.97	33.097
33516.65	0.010857	-41.07	461.67	-1357.90	15264.89	33.064
33616.70	0.010857	-39.80	463.06	-1314.54	15295.30	33.031

Cod. elab.: 108GA201-GA01-Z-CL-002_C	Titolo: OPERE D'ARTE MAGGIORI- GALLERIE	Data: Ottobre 2011
Nome file: 108GA201-GA01-Z-CL -002_C.docx	ARTIFICIALI – GALLERIA ROVETELLO	Pagina 105 di 452
	Relazione di calcolo	

PROGETTO ESECUTIVO

33716.75	0.010857	-38.55	464.45	-1271.92	15325.19	32.997
33816.80	0.010857	-37.32	465.83	-1230.04	15354.55	32.962
33916.85	0.010857	-36.11	467.22	-1188.90	15383.40	32.926
34016.90	0.010857	-34.92	468.60	-1148.50	15411.73	32.889
34116.95	0.010857	-33.75	469.99	-1108.85	15439.53	32.851
34217.00	0.010857	-32.61	471.38	-1069.94	15466.81	32.812
34317.05	0.010857	-31.48	472.76	-1031.78	15493.57	32.772
34417.10	0.010857	-30.38	474.15	-994.37	15519.80	32.732
34517.15	0.010857	-29.30	475.54	-957.70	15545.52	32.690
34617.20	0.010857	-28.23	476.92	-921.77	15570.71	32.648
34717.25	0.010857	-27.19	478.31	-886.59	15595.38	32.605
34817.30	0.010857	-26.17	479.70	-852.15	15619.52	32.561
34917.35	0.010857	-25.17	481.08	-818.46	15643.15	32.517
35017.40	0.010857	-24.19	482.47	-785.50	15666.26	32.471
35117.45	0.010857	-23.23	483.86	-753.29	15688.85	32.425
35217.50	0.010857	-22.29	485.24	-721.81	15710.92	32.378
35317.55	0.010857	-21.38	486.63	-691.07	15732.48	32.330
35417.60	0.010857	-20.48	488.01	-661.06	15753.52	32.281
35517.65	0.010857	-19.60	489.40	-631.78	15774.05	32.231
35617.70	0.010857	-18.74	490.79	-603.22	15794.07	32.181
35717.75	0.010857	-17.91	492.17	-575.40	15813.59	32.130
35817.80	0.010857	-17.09	493.56	-548.29	15832.59	32.078
35917.85	0.010857	-16.30	494.95	-521.90	15851.09	32.026
36017.90	0.010857	-15.52	496.33	-496.23	15869.10	31.973
36117.95	0.010857	-14.76	497.72	-471.27	15886.60	31.919
36218.00	0.010857	-14.03	499.11	-447.02	15903.60	31.864
36318.05	0.010857	-13.31	500.49	-423.47	15920.12	31.809
36418.10	0.010857	-12.62	501.88	-400.62	15936.14	31.753
36518.15	0.010857	-11.94	503.26	-378.46	15951.67	31.696
36618.20	0.010857	-11.28	504.65	-357.00	15966.72	31.639
36718.25	0.010857	-10.65	506.04	-336.23	15981.29	31.581
36818.30	0.010857	-10.03	507.42	-316.13	15995.38	31.523
36918.35	0.010857	-9.43	508.81	-296.72	16008.99	31.464
37018.40	0.010857	-8.85	510.20	-277.98	16022.14	31.404
37118.45	0.010857	-8.29	511.58	-259.90	16034.81	31.343
37218.50	0.010857	-7.75	512.97	-242.49	16047.02	31.283

Cod. elab.: 108GA201-GA01-Z-CL-002_C	Titolo: OPERE D'ARTE MAGGIORI- GALLERIE	Data: Ottobre 2011
Nome file: 108GA201-GA01-Z-CL -002_C.docx	ARTIFICIALI – GALLERIA ROVETELLO Relazione di calcolo	Pagina 106 di 452

PROGETTO ESECUTIVO

37318.55	0.010857	-7.23	514.36	-225.73	16058.77	31.221
37418.60	0.010857	-6.73	515.74	-209.63	16070.06	31.159
37518.65	0.010857	-6.24	517.13	-194.18	16080.90	31.096
37618.70	0.010857	-5.78	518.52	-179.36	16091.28	31.033
37718.75	0.010857	-5.33	519.90	-165.18	16101.23	30.970
37818.80	0.010857	-4.91	521.29	-151.64	16110.73	30.906
37918.85	0.010857	-4.50	522.67	-138.71	16119.79	30.841
38018.90	0.010857	-4.11	524.06	-126.41	16128.42	30.776
38118.95	0.010857	-3.74	525.45	-114.72	16136.61	30.710
38219.00	0.010857	-3.38	526.83	-103.63	16144.39	30.644
38319.05	0.010857	-3.05	528.22	-93.15	16151.74	30.578
38419.10	0.010857	-2.73	529.61	-83.26	16158.67	30.511
38519.15	0.010857	-2.43	530.99	-73.96	16165.19	30.443
38619.20	0.010857	-2.15	532.38	-65.25	16171.30	30.376
38719.25	0.010857	-1.88	533.77	-57.11	16177.01	30.307
38819.30	0.010857	-1.64	535.15	-49.54	16182.32	30.239
38919.35	0.010857	-1.41	536.54	-42.53	16187.23	30.170
39019.40	0.010857	-1.20	537.92	-36.09	16191.75	30.100
39119.45	0.010857	-1.01	539.31	-30.20	16195.88	30.031
39219.50	0.010857	-0.83	540.70	-24.85	16199.63	29.961
39319.55	0.010857	-0.67	542.08	-20.04	16203.00	29.890
39419.60	0.010857	-0.53	543.47	-15.77	16206.00	29.819
39519.65	0.010857	-0.40	544.86	-12.02	16208.62	29.748
39619.70	0.010857	-0.30	546.24	-8.79	16210.89	29.677
39719.75	0.010857	-0.21	547.63	-6.08	16212.79	29.605
39819.80	0.010857	-0.13	549.02	-3.87	16214.34	29.533
39919.85	0.010857	-0.07	550.40	-2.17	16215.53	29.461
40019.90	0.010857	-0.03	551.79	-0.96	16216.38	29.389
40119.95	0.010857	-0.01	553.18	-0.24	16216.88	29.316
40220.00	0.010857	0.00	554.56	0.00	-4248.53	7.661

Fase n° 2 - [A1-M1]

n°	Y	A _f	M	N	M _u	N _u	CS
1	0.00	0.010857	0.00	0.00	0.00	0.00	1000.000
2	0.05	0.010857	0.00	1.39	0.00	-4248.53	3064.420

Cod. elab.: 108GA201-GA01-Z-CL-002_C	Titolo: OPERE D'ARTE MAGGIORI- GALLERIE	Data: Ottobre 2011
Nome file: 108GA201-GA01-Z-CL -002_C.docx	ARTIFICIALI – GALLERIA ROVETELLO	Pagina 107 di 452
Relazione di calcolo		

PROGETTO ESECUTIVO

3	0.10	0.010857	0.01	2.77	78.80	16161.80	5828.672
4	0.15	0.010857	0.04	4.16	156.74	16107.15	3872.643
5	0.20	0.010857	0.08	5.55	233.81	16053.10	2894.736
6	0.25	0.010857	0.13	6.93	310.05	15999.65	2308.078
7	0.30	0.010857	0.20	8.32	385.45	15946.78	1917.042
8	0.35	0.010857	0.28	9.70	460.02	15894.48	1637.791
9	0.40	0.010857	0.37	11.09	533.79	15842.76	1428.403
10	0.45	0.010857	0.48	12.48	606.76	15791.59	1265.591
11	0.50	0.010857	0.60	13.86	678.94	15740.98	1135.381
12	0.55	0.010857	0.76	15.25	775.97	15672.95	1027.704
13	0.60	0.010857	0.98	16.64	913.74	15576.34	936.255
14	0.65	0.010857	1.26	18.02	1080.95	15459.09	857.730
15	0.70	0.010857	1.61	19.41	1269.37	15326.97	789.657
16	0.75	0.010857	2.02	20.80	1472.92	15184.24	730.150
17	0.80	0.010857	2.49	22.18	1656.66	14763.64	665.554
18	0.85	0.010857	3.02	23.57	1823.88	14221.49	603.401
19	0.90	0.010857	3.62	24.96	1980.13	13660.31	547.392
20	0.95	0.010857	4.27	26.34	2126.49	13109.54	497.673
21	1.00	0.010857	4.99	27.73	2257.68	12548.60	452.559
22	1.05	0.010857	5.76	29.11	2378.01	12010.66	412.532
23	1.10	0.010857	6.60	30.50	2483.49	11477.77	376.309
24	1.15	0.010857	7.49	31.89	2579.28	10975.25	344.189
25	1.20	0.010857	8.45	33.27	2662.67	10489.12	315.237
26	1.25	0.010857	9.46	34.66	2736.92	10030.38	289.393
27	1.30	0.010857	10.53	36.05	2803.40	9600.26	266.330
28	1.35	0.010857	11.65	37.43	2860.14	9188.47	245.465
29	1.40	0.010857	12.83	38.82	2912.43	8808.90	226.920
30	1.45	0.010857	14.07	40.21	2955.02	8441.94	209.969
31	1.50	0.010857	15.37	41.59	2989.84	8091.41	194.542
32	1.55	0.010857	16.72	42.98	3021.94	7768.27	180.748
33	1.60	0.010857	18.12	44.36	3044.82	7453.04	167.994
34	1.65	0.010857	19.58	45.75	3053.17	7132.43	155.895
35	1.70	0.010857	21.10	47.14	3060.83	6838.27	145.070
36	1.75	0.010857	22.67	48.52	3067.88	6567.53	135.346
37	1.80	0.010857	24.29	49.91	3063.29	6294.84	126.122
38	1.85	0.010857	25.96	51.30	3054.23	6034.62	117.641

<i>Cod. elab.:</i> 108GA201-GA01-Z-CL-002_C	<i>Titolo:</i> OPERE D'ARTE MAGGIORI- GALLERIE	<i>Data:</i> Ottobre 2011
<i>Nome file:</i> 108GA201-GA01-Z-CL -002_C.docx	ARTIFICIALI – GALLERIA ROVETELLO Relazione di calcolo	<i>Pagina</i> 108 di 452

PROGETTO ESECUTIVO

39	1.90	0.010857	27.69	52.68	3045.90	5795.43	110.005
40	1.95	0.010857	29.47	54.07	3038.21	5574.89	103.105
41	2.00	0.010857	31.30	55.46	3028.81	5366.86	96.777
42	2.05	0.010857	33.18	56.84	3009.78	5156.58	90.717
43	2.10	0.010857	35.11	58.23	2992.23	4962.66	85.227
44	2.15	0.010857	37.09	59.62	2976.00	4783.30	80.236
45	2.20	0.010857	39.12	61.00	2960.95	4616.96	75.686
46	2.25	0.010857	41.20	62.39	2946.95	4462.28	71.524
47	2.30	0.010857	43.33	63.77	2933.43	4317.42	67.698
48	2.35	0.010857	45.51	65.16	2911.33	4168.59	63.974
49	2.40	0.010857	47.73	66.55	2890.79	4030.19	60.561
50	2.45	0.010857	50.01	67.93	2871.63	3901.17	57.426
51	2.50	0.010857	52.33	69.32	2853.74	3780.63	54.539
52	2.50	0.010857	52.33	101.72	3050.60	5930.50	58.301
53	2.55	0.010857	50.22	103.11	3063.10	6289.43	60.998
54	2.60	0.010857	48.15	104.49	3065.66	6652.61	63.664
55	2.65	0.010857	46.14	105.88	3056.25	7014.03	66.244
56	2.70	0.010857	44.16	107.27	3046.23	7398.89	68.976
57	2.75	0.010857	42.24	108.65	3021.47	7772.93	71.538
58	2.80	0.010857	40.35	110.04	2985.00	8140.17	73.974
59	2.85	0.010857	38.51	111.43	2946.69	8525.81	76.515
60	2.90	0.010857	36.71	112.81	2898.85	8907.48	78.958
61	2.95	0.010857	34.96	114.20	2845.44	9295.12	81.394
62	3.00	0.010857	33.25	115.59	2789.78	9699.14	83.913
63	3.05	0.010857	31.57	116.97	2725.91	10098.40	86.331
64	3.10	0.010857	29.94	118.36	2659.19	10510.65	88.803
65	3.15	0.010857	28.36	119.75	2588.02	10929.38	91.272
66	3.20	0.010857	26.81	121.13	2509.61	11340.73	93.623
67	3.25	0.010857	25.30	122.52	2428.88	11764.25	96.020
68	3.30	0.010857	23.82	123.90	2341.13	12175.55	98.265
69	3.35	0.010857	22.39	125.29	2249.35	12585.84	100.453
70	3.40	0.010857	21.00	126.68	2155.14	13001.74	102.637
71	3.45	0.010857	19.64	128.06	2053.01	13386.06	104.526
72	3.50	0.010857	18.32	129.45	1949.62	13775.10	106.412
73	3.55	0.010857	17.04	130.84	1843.65	14157.38	108.207
74	3.60	0.010857	15.79	132.22	1733.46	14514.64	109.774

Cod. elab.: 108GA201-GA01-Z-CL-002_C	Titolo: OPERE D'ARTE MAGGIORI- GALLERIE	Data: Ottobre 2011
Nome file: 108GA201-GA01-Z-CL -002_C.docx	ARTIFICIALI – GALLERIA ROVETELLO Relazione di calcolo	Pagina 109 di 452

PROGETTO ESECUTIVO

75	3.65	0.010857	14.58	133.61	1622.96	14872.93	111.316
76	3.70	0.010857	13.40	135.00	1505.33	15161.52	112.311
77	3.75	0.010857	12.26	136.38	1371.51	15255.35	111.857
78	3.80	0.010857	11.15	137.77	1242.36	15345.91	111.389
79	3.85	0.010857	10.08	139.16	1117.83	15433.23	110.907
80	3.90	0.010857	9.04	140.54	997.85	15517.36	110.411
81	3.95	0.010857	8.03	141.93	882.39	15598.32	109.903
82	4.00	0.010857	7.05	143.31	771.36	15676.18	109.383
83	4.05	0.010857	6.11	144.70	664.71	15750.96	108.852
84	4.10	0.010857	5.19	146.09	562.36	15822.73	108.310
85	4.15	0.010857	4.31	147.47	464.24	15891.53	107.759
86	4.20	0.010857	3.45	148.86	370.28	15957.41	107.198
87	4.25	0.010857	2.63	150.25	280.39	16020.44	106.628
88	4.30	0.010857	1.83	151.63	194.50	16080.67	106.050
89	4.35	0.010857	1.07	153.02	112.51	16138.16	105.465
90	4.40	0.010857	0.33	154.41	34.35	16192.97	104.873
91	4.45	0.010857	-0.38	155.79	-39.94	16189.05	103.915
92	4.50	0.010857	-1.07	157.18	-109.81	16140.06	102.686
93	4.55	0.010857	-1.73	158.56	-175.39	16094.07	101.498
94	4.60	0.010857	-2.36	159.95	-236.90	16050.94	100.349
95	4.65	0.010857	-2.97	161.34	-294.55	16010.52	99.236
96	4.70	0.010857	-3.55	162.72	-348.53	15972.66	98.158
97	4.75	0.010857	-4.11	164.11	-399.03	15937.25	97.113
98	4.80	0.010857	-4.64	165.50	-446.23	15904.16	96.100
99	4.85	0.010857	-5.15	166.88	-490.27	15873.27	95.116
100	4.90	0.010857	-5.64	168.27	-531.33	15844.48	94.161
101	4.95	0.010857	-6.11	169.66	-569.55	15817.69	93.234
102	5.00	0.010857	-6.55	171.04	-605.06	15792.78	92.333
103	5.05	0.010857	-6.98	172.43	-638.00	15769.69	91.456
104	5.10	0.010857	-7.38	173.82	-668.50	15748.30	90.604
105	5.15	0.010857	-7.76	175.20	-696.67	15728.55	89.774
106	5.20	0.010857	-8.12	176.59	-722.62	15710.35	88.966
107	5.25	0.010857	-8.47	177.97	-746.47	15693.63	88.179
108	5.30	0.010857	-8.79	179.36	-768.33	15678.30	87.412
109	5.35	0.010857	-9.10	180.75	-788.28	15664.31	86.664
110	5.40	0.010857	-9.38	182.13	-806.42	15651.59	85.935

Cod. elab.: 108GA201-GA01-Z-CL-002_C	Titolo: OPERE D'ARTE MAGGIORI- GALLERIE	Data: Ottobre 2011
Nome file: 108GA201-GA01-Z-CL -002_C.docx	ARTIFICIALI – GALLERIA ROVETELLO	Pagina 110 di 452
	Relazione di calcolo	

PROGETTO ESECUTIVO

111 5.45	0.010857	-9.66	183.52	-822.84	15640.07	85.223
112 5.50	0.010857	-9.91	184.91	-837.64	15629.70	84.528
113 5.55	0.010857	-10.15	186.29	-850.89	15620.41	83.849
114 5.60	0.010857	-10.37	187.68	-862.67	15612.15	83.185
115 5.65	0.010857	-10.58	189.07	-873.06	15604.86	82.537
116 5.70	0.010857	-10.77	190.45	-882.13	15598.50	81.903
117 5.75	0.010857	-10.95	191.84	-889.96	15593.01	81.282
118 5.80	0.010857	-11.11	193.22	-896.61	15588.35	80.675
119 5.85	0.010857	-11.27	194.61	-902.15	15584.47	80.080
120 5.90	0.010857	-11.40	196.00	-906.64	15581.32	79.497
121 5.95	0.010857	-11.53	197.38	-910.14	15578.86	78.927
122 6.00	0.010857	-11.65	198.77	-912.72	15577.06	78.367
123 6.05	0.010857	-11.75	200.16	-914.42	15575.86	77.818
124 6.10	0.010857	-11.84	201.54	-915.31	15575.24	77.280
125 6.15	0.010857	-11.93	202.93	-915.44	15575.15	76.751
126 6.20	0.010857	-12.00	204.32	-914.86	15575.55	76.233
127 6.25	0.010857	-12.07	205.70	-913.62	15576.42	75.723
128 6.30	0.010857	-12.12	207.09	-911.77	15577.72	75.222
129 6.35	0.010857	-12.17	208.48	-909.36	15579.41	74.730
130 6.40	0.010857	-12.21	209.86	-906.44	15581.46	74.246
131 6.45	0.010857	-12.24	211.25	-903.04	15583.84	73.770
132 6.50	0.010857	-12.27	212.63	-899.21	15586.52	73.302
133 6.55	0.010857	-12.29	214.02	-895.00	15589.48	72.841
134 6.60	0.010857	-12.30	215.41	-890.45	15592.67	72.387
135 6.65	0.010857	-12.31	216.79	-885.60	15596.07	71.940
136 6.70	0.010857	-12.31	218.18	-880.48	15599.66	71.499
137 6.75	0.010857	-12.31	219.57	-875.13	15603.41	71.065
138 6.80	0.010857	-12.31	220.95	-869.60	15607.29	70.636
139 6.85	0.010857	-12.30	222.34	-863.92	15611.27	70.214
140 6.90	0.010857	-12.29	223.73	-858.12	15615.34	69.797
141 6.95	0.010857	-12.28	225.11	-852.24	15619.46	69.385
142 7.00	0.010857	-12.27	226.50	-846.31	15623.62	68.979
143 7.05	0.010857	-12.25	227.88	-840.37	15627.79	68.578
144 7.10	0.010857	-12.24	229.27	-834.44	15631.94	68.181
145 7.15	0.010857	-12.22	230.66	-828.57	15636.06	67.789
146 7.20	0.010857	-12.21	232.04	-822.77	15640.12	67.402

Cod. elab.: 108GA201-GA01-Z-CL-002 C	Titolo: OPERE D'ARTE MAGGIORI- GALLERIE	Data: Ottobre 2011
Nome file: 108GA201-GA01-Z-CL -002_C.docx	ARTIFICIALI – GALLERIA ROVETELLO Relazione di calcolo	Pagina 111 di 452

PROGETTO ESECUTIVO

1477.25	0.010857	-12.19	233.43	-817.09	15644.11	67.018
1487.30	0.010857	-12.18	234.82	-811.55	15648.00	66.639
1497.35	0.010857	-12.17	236.20	-806.17	15651.77	66.264
1507.40	0.010857	-12.16	237.59	-800.99	15655.40	65.893
1517.45	0.010857	-12.15	238.98	-796.04	15658.87	65.525
1527.50	0.010857	-12.14	240.36	-791.34	15662.17	65.161
1537.55	0.010857	-12.14	241.75	-786.91	15665.27	64.800
1547.60	0.010857	-12.15	243.14	-782.79	15668.16	64.442
1557.65	0.010857	-12.16	244.52	-779.00	15670.82	64.088
1567.70	0.010857	-12.17	245.91	-775.56	15673.23	63.736
1577.75	0.010857	-12.19	247.29	-772.49	15675.38	63.387
1587.80	0.010857	-12.21	248.68	-769.83	15677.25	63.042
1597.85	0.010857	-12.24	250.07	-767.59	15678.82	62.698
1607.90	0.010857	-12.28	251.45	-765.79	15680.08	62.358
1617.95	0.010857	-12.33	252.84	-764.46	15681.01	62.019
1628.00	0.010857	-12.38	254.23	-763.62	15681.60	61.684
1638.05	0.010857	-12.44	255.61	-763.29	15681.84	61.350
1648.10	0.010857	-12.51	257.00	-763.48	15681.70	61.018
1658.15	0.010857	-12.59	258.39	-764.22	15681.18	60.689
1668.20	0.010857	-12.68	259.77	-765.53	15680.26	60.362
1678.25	0.010857	-12.78	261.16	-767.42	15678.94	60.036
1688.30	0.010857	-12.89	262.55	-769.92	15677.19	59.712
1698.35	0.010857	-13.02	263.93	-773.03	15675.00	59.390
1708.40	0.010857	-13.15	265.32	-776.79	15672.37	59.070
1718.45	0.010857	-13.30	266.70	-781.19	15669.28	58.752
1728.50	0.010857	-13.46	268.09	-786.27	15665.72	58.434
1738.55	0.010857	-13.63	269.48	-792.34	15661.47	58.118
1748.60	0.010857	-13.84	270.86	-799.73	15656.28	57.801
1758.65	0.010857	-14.06	272.25	-808.48	15650.14	57.484
1768.70	0.010857	-14.32	273.64	-818.61	15643.04	57.167
1778.75	0.010857	-14.60	275.02	-830.14	15634.96	56.850
1788.80	0.010857	-14.91	276.41	-843.09	15625.88	56.532
1798.85	0.010857	-15.25	277.80	-857.48	15615.79	56.213
1808.90	0.010857	-15.62	279.18	-873.33	15604.68	55.894
1818.95	0.010857	-16.03	280.57	-890.66	15592.53	55.575
1829.00	0.010857	-16.46	281.95	-909.48	15579.33	55.255

Cod. elab.: 108GA201-GA01-Z-CL-002_C	Titolo: OPERE D'ARTE MAGGIORI- GALLERIE	Data: Ottobre 2011
Nome file: 108GA201-GA01-Z-CL -002_C.docx	ARTIFICIALI – GALLERIA ROVETELLO	Pagina 112 di 452
	Relazione di calcolo	

PROGETTO ESECUTIVO

1839.05	0.010857	-16.93	283.34	-929.81	15565.07	54.934
1849.10	0.010857	-17.43	284.73	-951.66	15549.75	54.613
1859.15	0.010857	-17.96	286.11	-975.05	15533.35	54.291
1869.20	0.010857	-18.53	287.50	-999.99	15515.86	53.968
1879.25	0.010857	-19.13	288.89	-1026.45	15497.30	53.645
1889.30	0.010857	-19.77	290.27	-1054.40	15477.71	53.321
1899.35	0.010857	-20.45	291.66	-1083.73	15457.14	52.997
1909.40	0.010857	-21.16	293.05	-1114.38	15435.65	52.673
1919.45	0.010857	-21.90	294.43	-1146.25	15413.30	52.349
1929.50	0.010857	-22.67	295.82	-1179.29	15390.14	52.026
1939.55	0.010857	-23.47	297.21	-1213.40	15366.22	51.702
1949.60	0.010857	-24.30	298.59	-1248.51	15341.60	51.380
1959.65	0.010857	-25.16	299.98	-1284.56	15316.32	51.058
1969.70	0.010857	-26.05	301.36	-1321.48	15290.44	50.737
1979.75	0.010857	-26.96	302.75	-1359.18	15264.00	50.418
1989.80	0.010857	-27.90	304.14	-1397.61	15237.05	50.099
1999.85	0.010857	-28.86	305.52	-1436.70	15209.64	49.782
2009.90	0.010857	-29.85	306.91	-1476.38	15181.81	49.467
2019.95	0.010857	-30.85	308.30	-1516.60	15153.61	49.153
20210.00	0.010857	-31.89	309.68	-1554.26	15095.65	48.746
20310.05	0.010857	-32.94	311.07	-1587.07	14989.29	48.186
20410.10	0.010857	-34.01	312.46	-1619.81	14883.11	47.633
20510.15	0.010857	-35.10	313.84	-1652.46	14777.27	47.085
20610.20	0.010857	-36.20	315.23	-1684.95	14671.91	46.544
20710.25	0.010857	-37.32	316.61	-1717.26	14567.16	46.009
20810.30	0.010857	-38.46	318.00	-1749.34	14463.15	45.481
20910.35	0.010857	-39.62	319.39	-1781.16	14359.99	44.961
21010.40	0.010857	-40.78	320.77	-1812.68	14257.79	44.448
21110.45	0.010857	-41.96	322.16	-1843.87	14156.65	43.943
21210.50	0.010857	-43.15	323.55	-1874.71	14056.66	43.446
21310.55	0.010857	-44.35	324.93	-1903.77	13947.62	42.925
21410.60	0.010857	-45.56	326.32	-1932.38	13839.99	42.412
21510.65	0.010857	-46.78	327.71	-1960.53	13734.04	41.910
21610.70	0.010857	-48.01	329.09	-1988.23	13629.83	41.416
21710.75	0.010857	-49.24	330.48	-2015.44	13527.43	40.933
21810.80	0.010857	-50.48	331.87	-2042.16	13426.88	40.459

Cod. elab.: 108GA201-GA01-Z-CL-002_C	Titolo: OPERE D'ARTE MAGGIORI- GALLERIE	Data: Ottobre 2011
Nome file: 108GA201-GA01-Z-CL -002_C.docx	ARTIFICIALI – GALLERIA ROVETELLO Relazione di calcolo	Pagina 113 di 452

PROGETTO ESECUTIVO

21910.85	0.010857	-51.72	333.25	-2068.38	13328.24	39.995
22010.90	0.010857	-52.96	334.64	-2094.07	13231.54	39.540
22110.95	0.010857	-54.21	336.02	-2119.24	13136.82	39.095
22211.00	0.010857	-55.46	337.41	-2143.88	13044.12	38.659
22311.05	0.010857	-56.70	338.80	-2167.61	12951.30	38.227
22411.10	0.010857	-57.95	340.18	-2189.54	12853.27	37.783
22511.15	0.010857	-59.19	341.57	-2210.91	12757.70	37.350
22611.20	0.010857	-60.44	342.96	-2231.74	12664.59	36.928
22711.25	0.010857	-61.67	344.34	-2252.01	12573.96	36.516
22811.30	0.010857	-62.90	345.73	-2271.73	12485.81	36.114
22911.35	0.010857	-64.13	347.12	-2290.89	12400.15	35.723
23011.40	0.010857	-65.35	348.50	-2309.49	12316.98	35.343
23111.45	0.010857	-66.55	349.89	-2327.54	12236.31	34.972
23211.50	0.010857	-67.75	351.27	-2345.02	12158.12	34.611
23311.55	0.010857	-68.94	352.66	-2361.95	12082.43	34.261
23411.60	0.010857	-70.12	354.05	-2378.33	12009.22	33.920
23511.65	0.010857	-71.28	355.43	-2394.15	11938.50	33.589
23611.70	0.010857	-72.43	356.82	-2409.03	11868.41	33.262
23711.75	0.010857	-73.56	358.21	-2422.61	11797.18	32.934
23811.80	0.010857	-74.68	359.59	-2435.66	11728.70	32.617
23911.85	0.010857	-75.77	360.98	-2448.19	11662.97	32.309
24011.90	0.010857	-76.85	362.37	-2460.20	11599.97	32.012
24111.95	0.010857	-77.91	363.75	-2471.69	11539.69	31.724
24212.00	0.010857	-78.95	365.14	-2482.66	11482.13	31.446
24312.05	0.010857	-79.97	366.53	-2493.11	11427.28	31.177
24412.10	0.010857	-80.96	367.91	-2503.05	11375.14	30.918
24512.15	0.010857	-81.92	369.30	-2512.47	11325.71	30.668
24612.20	0.010857	-82.87	370.68	-2521.38	11278.98	30.427
24712.25	0.010857	-83.78	372.07	-2529.77	11234.96	30.196
24812.30	0.010857	-84.66	373.46	-2537.65	11193.64	29.973
24912.35	0.010857	-85.52	374.84	-2545.01	11155.04	29.759
25012.40	0.010857	-86.34	376.23	-2551.85	11119.15	29.554
25112.45	0.010857	-87.14	377.62	-2558.17	11086.00	29.358
25212.50	0.010857	-87.90	379.00	-2563.96	11055.58	29.170
25312.55	0.010857	-88.62	380.39	-2569.24	11027.92	28.991
25412.60	0.010857	-89.31	381.78	-2573.98	11003.03	28.821

Cod. elab.: 108GA201-GA01-Z-CL-002_C	Titolo: OPERE D'ARTE MAGGIORI- GALLERIE	Data: Ottobre 2011
Nome file: 108GA201-GA01-Z-CL -002_C.docx	ARTIFICIALI – GALLERIA ROVETELLO	Pagina 114 di 452
	Relazione di calcolo	

PROGETTO ESECUTIVO

25512.65	0.010857	-89.96	383.16	-2578.19	10980.94	28.659
25612.70	0.010857	-90.58	384.55	-2581.87	10961.66	28.505
25712.75	0.010857	-91.15	385.94	-2585.01	10945.19	28.360
25812.80	0.010857	-91.68	387.32	-2587.62	10931.47	28.223
25912.85	0.010857	-92.18	388.71	-2589.73	10920.43	28.094
26012.90	0.010857	-92.64	390.09	-2591.34	10911.97	27.973
26112.95	0.010857	-93.06	391.48	-2592.47	10906.04	27.858
26213.00	0.010857	-93.44	392.87	-2593.13	10902.56	27.751
26313.05	0.010857	-93.79	394.25	-2593.34	10901.48	27.651
26413.10	0.010857	-94.10	395.64	-2593.10	10902.73	27.557
26513.15	0.010857	-94.37	397.03	-2592.43	10906.26	27.470
26613.20	0.010857	-94.61	398.41	-2591.33	10912.03	27.389
26713.25	0.010857	-94.82	399.80	-2589.81	10919.99	27.314
26813.30	0.010857	-94.99	401.19	-2587.88	10930.10	27.245
26913.35	0.010857	-95.12	402.57	-2585.55	10942.32	27.181
27013.40	0.010857	-95.23	403.96	-2582.83	10956.62	27.123
27113.45	0.010857	-95.30	405.34	-2579.71	10972.96	27.071
27213.50	0.010857	-95.33	406.73	-2576.21	10991.31	27.024
27313.55	0.010857	-95.34	408.12	-2572.34	11011.66	26.982
27413.60	0.010857	-95.31	409.50	-2568.08	11033.98	26.945
27513.65	0.010857	-95.25	410.89	-2563.46	11058.24	26.913
27613.70	0.010857	-95.16	412.28	-2558.46	11084.44	26.886
27713.75	0.010857	-95.04	413.66	-2553.11	11112.55	26.864
27813.80	0.010857	-94.89	415.05	-2547.38	11142.56	26.846
27913.85	0.010857	-94.71	416.44	-2541.30	11174.46	26.834
28013.90	0.010857	-94.49	417.82	-2534.86	11208.25	26.825
28113.95	0.010857	-94.25	419.21	-2528.07	11243.91	26.822
28214.00	0.010857	-93.98	420.60	-2520.91	11281.45	26.823
28314.05	0.010857	-93.69	421.98	-2513.40	11320.86	26.828
28414.10	0.010857	-93.36	423.37	-2505.53	11362.14	26.837
28514.15	0.010857	-93.00	424.75	-2497.30	11405.29	26.851
28614.20	0.010857	-92.62	426.14	-2488.72	11450.32	26.870
28714.25	0.010857	-92.21	427.53	-2479.78	11497.24	26.892
28814.30	0.010857	-91.77	428.91	-2470.47	11546.05	26.919
28914.35	0.010857	-91.31	430.30	-2460.81	11596.76	26.950
29014.40	0.010857	-90.82	431.69	-2450.78	11649.39	26.986

Cod. elab.: 108GA201-GA01-Z-CL-002_C	Titolo: OPERE D'ARTE MAGGIORI- GALLERIE	Data: Ottobre 2011
Nome file: 108GA201-GA01-Z-CL -002_C.docx	ARTIFICIALI – GALLERIA ROVETELLO Relazione di calcolo	Pagina 115 di 452

PROGETTO ESECUTIVO

29114.45	0.010857	-90.30	433.07	-2440.38	11703.95	27.025
29214.50	0.010857	-89.76	434.46	-2429.60	11760.46	27.069
29314.55	0.010857	-89.19	435.85	-2418.46	11818.93	27.117
29414.60	0.010857	-88.59	437.23	-2406.93	11879.39	27.170
29514.65	0.010857	-87.97	438.62	-2394.26	11938.02	27.217
29614.70	0.010857	-87.32	440.00	-2380.96	11997.45	27.267
29714.75	0.010857	-86.65	441.39	-2367.25	12058.73	27.320
29814.80	0.010857	-85.95	442.78	-2353.13	12121.88	27.377
29914.85	0.010857	-85.23	444.16	-2338.58	12186.93	27.438
30014.90	0.010857	-84.49	445.55	-2323.60	12253.90	27.503
30114.95	0.010857	-83.72	446.94	-2308.19	12322.81	27.572
30215.00	0.010857	-82.92	448.32	-2292.33	12393.71	27.645
30315.05	0.010857	-82.10	449.71	-2276.02	12466.61	27.721
30415.10	0.010857	-81.26	451.10	-2259.26	12541.57	27.802
30515.15	0.010857	-80.40	452.48	-2242.02	12618.60	27.887
30615.20	0.010857	-79.51	453.87	-2224.32	12697.76	27.977
30715.25	0.010857	-78.59	455.26	-2206.13	12779.08	28.070
30815.30	0.010857	-77.66	456.64	-2187.45	12862.61	28.168
30915.35	0.010857	-76.70	458.03	-2168.26	12948.39	28.270
31015.40	0.010857	-75.72	459.41	-2147.54	13030.34	28.363
31115.45	0.010857	-74.71	460.80	-2125.88	13111.85	28.454
31215.50	0.010857	-73.68	462.19	-2103.67	13195.41	28.550
31315.55	0.010857	-72.63	463.57	-2080.91	13281.08	28.649
31415.60	0.010857	-71.56	464.96	-2057.57	13368.89	28.753
31515.65	0.010857	-70.47	466.35	-2033.65	13458.89	28.860
31615.70	0.010857	-69.35	467.73	-2009.14	13551.14	28.972
31715.75	0.010857	-68.21	469.12	-1984.01	13645.68	29.088
31815.80	0.010857	-67.05	470.51	-1958.26	13742.57	29.208
31915.85	0.010857	-65.86	471.89	-1931.87	13841.88	29.333
32015.90	0.010857	-64.65	473.28	-1904.83	13943.65	29.462
32115.95	0.010857	-63.43	474.66	-1877.10	14047.97	29.596
32216.00	0.010857	-62.17	476.05	-1847.42	14145.15	29.714
32316.05	0.010857	-60.90	477.44	-1816.95	14243.95	29.834
32416.10	0.010857	-59.61	478.82	-1785.76	14345.07	29.959
32516.15	0.010857	-58.29	480.21	-1753.84	14448.57	30.088
32616.20	0.010857	-56.95	481.60	-1721.16	14554.52	30.221

<i>Cod. elab.:</i> 108GA201-GA01-Z-CL-002_C	<i>Titolo:</i> OPERE D'ARTE MAGGIORI- GALLERIE	<i>Data:</i> Ottobre 2011
<i>Nome file:</i> 108GA201-GA01-Z-CL -002_C.docx	ARTIFICIALI – GALLERIA ROVETELLO Relazione di calcolo	<i>Pagina</i> 116 di 452

PROGETTO ESECUTIVO

32716.25	0.010857	-55.59	482.98	-1687.71	14662.98	30.359
32816.30	0.010857	-54.21	484.37	-1653.46	14774.03	30.502
32916.35	0.010857	-52.80	485.76	-1618.39	14887.72	30.649
33016.40	0.010857	-51.38	487.14	-1582.49	15004.13	30.800
33116.45	0.010857	-49.93	488.53	-1545.72	15123.35	30.957
33216.50	0.010857	-48.46	489.92	-1500.11	15165.17	30.955
33316.55	0.010857	-46.99	491.30	-1453.67	15197.74	30.934
33416.60	0.010857	-45.55	492.69	-1408.00	15229.77	30.912
33516.65	0.010857	-44.13	494.07	-1363.10	15261.25	30.889
33616.70	0.010857	-42.73	495.46	-1318.97	15292.19	30.865
33716.75	0.010857	-41.36	496.85	-1275.62	15322.59	30.840
33816.80	0.010857	-40.02	498.23	-1233.04	15352.45	30.814
33916.85	0.010857	-38.69	499.62	-1191.24	15381.76	30.787
34016.90	0.010857	-37.39	501.01	-1150.22	15410.52	30.759
34116.95	0.010857	-36.12	502.39	-1109.98	15438.74	30.730
34217.00	0.010857	-34.87	503.78	-1070.51	15466.41	30.701
34317.05	0.010857	-33.64	505.17	-1031.82	15493.54	30.670
34417.10	0.010857	-32.44	506.55	-993.92	15520.12	30.639
34517.15	0.010857	-31.26	507.94	-956.78	15546.16	30.606
34617.20	0.010857	-30.11	509.33	-920.43	15571.65	30.573
34717.25	0.010857	-28.97	510.71	-884.85	15596.60	30.539
34817.30	0.010857	-27.87	512.10	-850.04	15621.00	30.504
34917.35	0.010857	-26.78	513.48	-816.00	15644.87	30.468
35017.40	0.010857	-25.72	514.87	-782.74	15668.20	30.431
35117.45	0.010857	-24.68	516.26	-750.24	15690.99	30.394
35217.50	0.010857	-23.67	517.64	-718.50	15713.24	30.355
35317.55	0.010857	-22.68	519.03	-687.53	15734.96	30.316
35417.60	0.010857	-21.71	520.42	-657.31	15756.14	30.276
35517.65	0.010857	-20.77	521.80	-627.85	15776.80	30.235
35617.70	0.010857	-19.84	523.19	-599.15	15796.93	30.194
35717.75	0.010857	-18.94	524.58	-571.19	15816.54	30.151
35817.80	0.010857	-18.07	525.96	-543.97	15835.62	30.108
35917.85	0.010857	-17.21	527.35	-517.50	15854.18	30.064
36017.90	0.010857	-16.38	528.73	-491.76	15872.23	30.019
36117.95	0.010857	-15.57	530.12	-466.75	15889.77	29.974
36218.00	0.010857	-14.78	531.51	-442.47	15906.79	29.928

Cod. elab.: 108GA201-GA01-Z-CL-002_C	Titolo: OPERE D'ARTE MAGGIORI- GALLERIE	Data: Ottobre 2011
Nome file: 108GA201-GA01-Z-CL -002_C.docx	ARTIFICIALI – GALLERIA ROVETELLO	Pagina 117 di 452
	Relazione di calcolo	

PROGETTO ESECUTIVO

36318.05	0.010857	-14.02	532.89	-418.92	15923.31	29.881
36418.10	0.010857	-13.28	534.28	-396.08	15939.32	29.833
36518.15	0.010857	-12.55	535.67	-373.95	15954.84	29.785
36618.20	0.010857	-11.86	537.05	-352.53	15969.86	29.736
36718.25	0.010857	-11.18	538.44	-331.81	15984.38	29.686
36818.30	0.010857	-10.52	539.83	-311.79	15998.42	29.636
36918.35	0.010857	-9.89	541.21	-292.46	16011.98	29.585
37018.40	0.010857	-9.27	542.60	-273.82	16025.05	29.534
37118.45	0.010857	-8.68	543.99	-255.85	16037.65	29.482
37218.50	0.010857	-8.11	545.37	-238.56	16049.77	29.429
37318.55	0.010857	-7.56	546.76	-221.94	16061.43	29.376
37418.60	0.010857	-7.02	548.14	-205.97	16072.62	29.322
37518.65	0.010857	-6.51	549.53	-190.66	16083.36	29.267
37618.70	0.010857	-6.02	550.92	-176.00	16093.64	29.212
37718.75	0.010857	-5.56	552.30	-161.98	16103.47	29.157
37818.80	0.010857	-5.11	553.69	-148.60	16112.85	29.101
37918.85	0.010857	-4.68	555.08	-135.84	16121.80	29.044
38018.90	0.010857	-4.27	556.46	-123.71	16130.31	28.987
38118.95	0.010857	-3.88	557.85	-112.19	16138.38	28.930
38219.00	0.010857	-3.51	559.24	-101.28	16146.03	28.872
38319.05	0.010857	-3.16	560.62	-90.97	16153.26	28.813
38419.10	0.010857	-2.83	562.01	-81.26	16160.07	28.754
38519.15	0.010857	-2.51	563.39	-72.14	16166.47	28.695
38619.20	0.010857	-2.22	564.78	-63.59	16172.46	28.635
38719.25	0.010857	-1.95	566.17	-55.62	16178.05	28.575
38819.30	0.010857	-1.69	567.55	-48.21	16183.24	28.514
38919.35	0.010857	-1.45	568.94	-41.37	16188.04	28.453
39019.40	0.010857	-1.24	570.33	-35.07	16192.46	28.392
39119.45	0.010857	-1.04	571.71	-29.33	16196.49	28.330
39219.50	0.010857	-0.85	573.10	-24.11	16200.14	28.268
39319.55	0.010857	-0.69	574.49	-19.43	16203.42	28.205
39419.60	0.010857	-0.54	575.87	-15.28	16206.34	28.142
39519.65	0.010857	-0.41	577.26	-11.64	16208.89	28.079
39619.70	0.010857	-0.30	578.65	-8.51	16211.09	28.016
39719.75	0.010857	-0.21	580.03	-5.88	16212.93	27.952
39819.80	0.010857	-0.13	581.42	-3.74	16214.43	27.888

Cod. elab.: 108GA201-GA01-Z-CL-002_C	Titolo: OPERE D'ARTE MAGGIORI- GALLERIE	Data: Ottobre 2011
Nome file: 108GA201-GA01-Z-CL -002_C.docx	ARTIFICIALI – GALLERIA ROVETELLO	Pagina 118 di 452
	Relazione di calcolo	

PROGETTO ESECUTIVO

39919.85	0.010857	-0.08	582.80	-2.09	16215.58	27.823
40019.90	0.010857	-0.03	584.19	-0.92	16216.40	27.759
40119.95	0.010857	-0.01	585.58	-0.23	16216.89	27.694
40220.00	0.010857	0.00	586.96	0.00	-4248.53	7.238

Fase n° 3 - [A1-M1]

n°	Y	A _f	M	N	M _u	N _u	CS
1	0.00	0.010857	0.00	0.00	0.00	0.00	1000.000
2	0.05	0.010857	0.00	1.39	-0.01	16217.04	11697.193
3	0.10	0.010857	0.00	2.77	14.99	16206.54	5844.810
4	0.15	0.010857	0.01	4.16	29.66	16196.25	3894.066
5	0.20	0.010857	0.02	5.55	44.01	16186.20	2918.736
6	0.25	0.010857	0.02	6.93	58.02	16176.37	2333.571
7	0.30	0.010857	0.04	8.32	71.71	16166.77	1943.488
8	0.35	0.010857	0.05	9.70	85.08	16157.39	1664.881
9	0.40	0.010857	0.07	11.09	98.12	16148.25	1455.947
10	0.45	0.010857	0.09	12.48	110.84	16139.33	1293.460
11	0.50	0.010857	0.11	13.86	123.24	16130.64	1163.487
12	0.55	0.010857	0.13	15.25	139.24	16119.41	1056.980
13	0.60	0.010857	0.17	16.64	161.15	16104.06	967.975
14	0.65	0.010857	0.21	18.02	187.19	16085.79	892.502
15	0.70	0.010857	0.26	19.41	216.13	16065.50	827.706
16	0.75	0.010857	0.32	20.80	247.05	16043.82	771.483
17	0.80	0.010857	0.39	22.18	279.25	16021.24	722.248
18	0.85	0.010857	0.46	23.57	312.22	15998.13	678.782
19	0.90	0.010857	0.54	24.96	345.55	15974.75	640.135
20	0.95	0.010857	0.63	26.34	378.93	15951.35	605.555
21	1.00	0.010857	0.72	27.73	412.10	15928.09	574.439
22	1.05	0.010857	0.81	29.11	444.87	15905.11	546.295
23	1.10	0.010857	0.92	30.50	477.08	15882.52	520.723
24	1.15	0.010857	1.02	31.89	508.60	15860.42	497.390
25	1.20	0.010857	1.13	33.27	539.32	15838.88	476.018
26	1.25	0.010857	1.25	34.66	569.14	15817.97	456.374
27	1.30	0.010857	1.36	36.05	598.01	15797.73	438.259
28	1.35	0.010857	1.48	37.43	625.86	15778.20	421.506

Cod. elab.: 108GA201-GA01-Z-CL-002_C	Titolo: OPERE D'ARTE MAGGIORI- GALLERIE	Data: Ottobre 2011
Nome file: 108GA201-GA01-Z-CL -002_C.docx	ARTIFICIALI – GALLERIA ROVETELLO	Pagina 119 di 452
Relazione di calcolo		

PROGETTO ESECUTIVO

29	1.40	0.010857	1.61	38.82	652.63	15759.43	405.969
30	1.45	0.010857	1.73	40.21	678.29	15741.43	391.522
31	1.50	0.010857	1.86	41.59	702.81	15724.25	378.058
32	1.55	0.010857	1.99	42.98	726.14	15707.89	365.482
33	1.60	0.010857	2.12	44.36	748.26	15692.37	353.711
34	1.65	0.010857	2.24	45.75	769.16	15677.72	342.672
35	1.70	0.010857	2.37	47.14	788.82	15663.93	332.301
36	1.75	0.010857	2.50	48.52	807.32	15650.96	322.540
37	1.80	0.010857	2.63	49.91	824.75	15638.74	313.335
38	1.85	0.010857	2.76	51.30	841.22	15627.19	304.642
39	1.90	0.010857	2.89	52.68	856.79	15616.27	296.417
40	1.95	0.010857	3.02	54.07	871.55	15605.92	288.626
41	2.00	0.010857	3.15	55.46	885.54	15596.11	281.233
42	2.05	0.010857	3.28	56.84	898.83	15586.79	274.210
43	2.10	0.010857	3.41	58.23	911.48	15577.93	267.529
44	2.15	0.010857	3.54	59.62	923.51	15569.48	261.166
45	2.20	0.010857	3.67	61.00	934.99	15561.44	255.098
46	2.25	0.010857	3.79	62.39	945.94	15553.76	249.306
47	2.30	0.010857	3.92	63.77	956.41	15546.42	243.771
48	2.35	0.010857	4.05	65.16	966.41	15539.40	238.477
49	2.40	0.010857	4.18	66.55	975.99	15532.69	233.408
50	2.45	0.010857	4.31	67.93	985.17	15526.25	228.550
51	2.50	0.010857	4.44	69.32	993.97	15520.08	223.890
52	2.50	0.010857	4.44	103.53	675.14	15743.65	152.073
53	2.55	0.010857	-0.13	104.91	-20.16	16202.92	154.441
54	2.60	0.010857	-4.70	106.30	-695.56	15729.33	147.971
55	2.65	0.010857	-9.27	107.69	-1316.65	15293.82	142.022
56	2.70	0.010857	-13.84	109.07	-1810.26	14265.65	130.790
57	2.75	0.010857	-18.41	110.46	-2162.49	12974.10	117.456
58	2.80	0.010857	-22.98	111.85	-2423.28	11793.66	105.446
59	2.85	0.010857	-27.55	113.23	-2618.54	10761.79	95.042
60	2.90	0.010857	-32.12	114.62	-2764.04	9862.83	86.049
61	2.95	0.010857	-36.69	116.00	-2874.13	9086.87	78.332
62	3.00	0.010857	-41.26	117.39	-2957.72	8414.78	71.682
63	3.05	0.010857	-45.82	118.78	-3016.78	7820.17	65.839
64	3.10	0.010857	-50.33	120.16	-3049.34	7279.77	60.582

Cod. elab.: 108GA201-GA01-Z-CL-002_C	Titolo: OPERE D'ARTE MAGGIORI- GALLERIE	Data: Ottobre 2011
Nome file: 108GA201-GA01-Z-CL -002_C.docx	ARTIFICIALI – GALLERIA ROVETELLO Relazione di calcolo	Pagina 120 di 452

PROGETTO ESECUTIVO

65	3.15	0.010857	-54.76	121.55	-3061.93	6796.01	55.911
66	3.20	0.010857	-59.09	122.94	-3066.24	6379.36	51.891
67	3.25	0.010857	-63.30	124.32	-3052.90	5996.38	48.232
68	3.30	0.010857	-67.37	125.71	-3041.73	5675.80	45.150
69	3.35	0.010857	-71.30	127.10	-3032.28	5405.29	42.529
70	3.40	0.010857	-75.08	128.48	-3009.14	5149.50	40.079
71	3.45	0.010857	-78.71	129.87	-2989.52	4932.70	37.982
72	3.50	0.010857	-82.18	131.26	-2972.79	4747.80	36.172
73	3.55	0.010857	-85.50	132.64	-2958.45	4589.41	34.600
74	3.60	0.010857	-88.67	134.03	-2946.14	4453.38	33.227
75	3.65	0.010857	-91.67	135.41	-2935.56	4336.42	32.023
76	3.70	0.010857	-94.51	136.80	-2919.93	4226.50	30.895
77	3.75	0.010857	-97.19	138.19	-2905.86	4131.71	29.899
78	3.80	0.010857	-99.70	139.57	-2893.92	4051.31	29.026
79	3.85	0.010857	-102.04	140.96	-2883.88	3983.69	28.261
80	3.90	0.010857	-104.22	142.35	-2875.55	3927.55	27.591
81	3.95	0.010857	-106.22	143.73	-2868.76	3881.85	27.007
82	4.00	0.010857	-108.05	145.12	-2863.41	3845.77	26.501
83	4.05	0.010857	-109.70	146.51	-2859.38	3818.64	26.065
84	4.10	0.010857	-111.18	147.89	-2856.60	3799.94	25.694
85	4.15	0.010857	-112.47	149.28	-2855.02	3789.28	25.384
86	4.20	0.010857	-113.59	150.66	-2854.59	3786.38	25.131
87	4.25	0.010857	-114.52	152.05	-2855.29	3791.09	24.933
88	4.30	0.010857	-115.26	153.44	-2857.11	3803.33	24.787
89	4.35	0.010857	-115.82	154.82	-2860.05	3823.13	24.693
90	4.40	0.010857	-116.19	156.21	-2864.13	3850.62	24.650
91	4.45	0.010857	-116.37	157.60	-2869.38	3885.98	24.658
92	4.50	0.010857	-116.35	158.98	-2875.84	3929.51	24.717
93	4.55	0.010857	-116.14	160.37	-2883.60	3981.82	24.829
94	4.60	0.010857	-115.71	161.76	-2892.83	4043.98	25.001
95	4.65	0.010857	-115.05	163.14	-2903.75	4117.50	25.239
96	4.70	0.010857	-114.14	164.53	-2916.61	4204.13	25.553
97	4.75	0.010857	-112.97	165.92	-2931.71	4305.82	25.952
98	4.80	0.010857	-111.52	167.30	-2942.62	4414.49	26.386
99	4.85	0.010857	-109.80	168.69	-2953.80	4537.97	26.902
100	4.90	0.010857	-107.80	170.07	-2966.68	4680.32	27.519

<i>Cod. elab.:</i> 108GA201-GA01-Z-CL-002_C	<i>Titolo:</i> OPERE D'ARTE MAGGIORI- GALLERIE	<i>Data:</i> Ottobre 2011
<i>Nome file:</i> 108GA201-GA01-Z-CL -002_C.docx	ARTIFICIALI – GALLERIA ROVETELLO Relazione di calcolo	<i>Pagina</i> 121 di 452

PROGETTO ESECUTIVO

101 4.95	0.010857	-105.53	171.46	-2981.52	4844.33	28.253
102 5.00	0.010857	-102.97	172.85	-2998.64	5033.48	29.121
103 5.05	0.010857	-100.26	174.23	-3017.70	5244.15	30.098
104 5.10	0.010857	-97.53	175.62	-3034.35	5463.91	31.112
105 5.15	0.010857	-94.78	177.01	-3041.90	5680.66	32.093
106 5.20	0.010857	-92.03	178.39	-3049.95	5911.84	33.139
107 5.25	0.010857	-89.29	179.78	-3058.54	6158.48	34.256
108 5.30	0.010857	-86.55	181.17	-3067.71	6421.59	35.446
109 5.35	0.010857	-83.82	182.55	-3065.07	6675.22	36.566
110 5.40	0.010857	-81.12	183.94	-3058.32	6934.48	37.700
111 5.45	0.010857	-78.45	185.32	-3051.20	7208.14	38.895
112 5.50	0.010857	-75.80	186.71	-3043.67	7497.35	40.155
113 5.55	0.010857	-73.17	188.10	-3021.96	7768.05	41.298
114 5.60	0.010857	-70.58	189.48	-2994.88	8040.67	42.435
115 5.65	0.010857	-68.00	190.87	-2966.52	8326.24	43.622
116 5.70	0.010857	-65.46	192.26	-2936.78	8625.60	44.865
117 5.75	0.010857	-62.94	193.64	-2897.74	8915.51	46.041
118 5.80	0.010857	-60.45	195.03	-2856.33	9216.12	47.255
119 5.85	0.010857	-57.98	196.42	-2813.08	9530.02	48.520
120 5.90	0.010857	-55.54	197.80	-2765.94	9851.05	49.802
121 5.95	0.010857	-53.13	199.19	-2713.60	10174.45	51.079
122 6.00	0.010857	-50.74	200.58	-2659.06	10511.44	52.406
123 6.05	0.010857	-48.38	201.96	-2601.37	10859.33	53.769
124 6.10	0.010857	-46.05	203.35	-2536.36	11200.39	55.080
125 6.15	0.010857	-43.74	204.73	-2468.84	11554.65	56.437
126 6.20	0.010857	-41.47	206.12	-2398.20	11920.37	57.832
127 6.25	0.010857	-39.22	207.51	-2319.51	12272.20	59.141
128 6.30	0.010857	-37.00	208.89	-2238.11	12636.10	60.491
129 6.35	0.010857	-34.81	210.28	-2153.28	13008.75	61.864
130 6.40	0.010857	-32.64	211.67	-2060.18	13359.06	63.114
131 6.45	0.010857	-30.51	213.05	-1964.43	13719.36	64.394
132 6.50	0.010857	-28.40	214.44	-1865.52	14086.48	65.690
133 6.55	0.010857	-26.32	215.83	-1759.69	14429.61	66.858
134 6.60	0.010857	-24.27	217.21	-1651.46	14780.49	68.046
135 6.65	0.010857	-22.25	218.60	-1540.58	15136.80	69.245
136 6.70	0.010857	-20.26	219.99	-1402.68	15233.49	69.248

Cod. elab.: 108GA201-GA01-Z-CL-002_C	Titolo: OPERE D'ARTE MAGGIORI- GALLERIE	Data: Ottobre 2011
Nome file: 108GA201-GA01-Z-CL -002_C.docx	ARTIFICIALI – GALLERIA ROVETELLO Relazione di calcolo	Pagina 122 di 452

PROGETTO ESECUTIVO

1376.75	0.010857	-18.29	221.37	-1266.68	15328.86	69.245
1386.80	0.010857	-16.36	222.76	-1132.61	15422.87	69.236
1396.85	0.010857	-14.45	224.14	-1000.52	15515.49	69.221
1406.90	0.010857	-12.58	225.53	-870.46	15606.69	69.200
1416.95	0.010857	-10.73	226.92	-742.45	15696.45	69.173
1427.00	0.010857	-8.92	228.30	-616.55	15784.73	69.139
1437.05	0.010857	-7.13	229.69	-492.79	15871.51	69.100
1447.10	0.010857	-5.38	231.08	-371.21	15956.76	69.054
1457.15	0.010857	-3.65	232.46	-251.84	16040.46	69.002
1467.20	0.010857	-1.95	233.85	-134.72	16122.58	68.944
1477.25	0.010857	-0.29	235.24	-19.89	16203.11	68.880
1487.30	0.010857	1.35	236.62	91.89	16152.62	68.263
1497.35	0.010857	2.95	238.01	199.29	16077.31	67.549
1507.40	0.010857	4.52	239.39	302.45	16004.97	66.856
1517.45	0.010857	6.07	240.78	401.50	15935.52	66.183
1527.50	0.010857	7.58	242.17	496.60	15868.84	65.528
1537.55	0.010857	9.06	243.55	587.87	15804.84	64.893
1547.60	0.010857	10.51	244.94	675.43	15743.44	64.275
1557.65	0.010857	11.93	246.33	759.42	15684.55	63.674
1567.70	0.010857	13.31	247.71	839.94	15628.09	63.089
1577.75	0.010857	14.67	249.10	917.10	15573.98	62.521
1587.80	0.010857	15.99	250.49	991.00	15522.16	61.968
1597.85	0.010857	17.28	251.87	1061.75	15472.56	61.430
1607.90	0.010857	18.54	253.26	1129.42	15425.10	60.906
1617.95	0.010857	19.77	254.65	1194.12	15379.74	60.397
1628.00	0.010857	20.97	256.03	1255.91	15336.41	59.900
1638.05	0.010857	22.13	257.42	1314.89	15295.05	59.417
1648.10	0.010857	23.26	258.80	1371.13	15255.62	58.947
1658.15	0.010857	24.36	260.19	1424.69	15218.06	58.488
1668.20	0.010857	25.42	261.58	1475.65	15182.33	58.041
1678.25	0.010857	26.46	262.96	1524.07	15148.38	57.606
1688.30	0.010857	27.46	264.35	1564.45	15062.63	56.980
1698.35	0.010857	28.42	265.74	1599.06	14950.40	56.260
1708.40	0.010857	29.36	267.12	1631.45	14845.38	55.575
1718.45	0.010857	30.26	268.51	1661.72	14747.24	54.923
1728.50	0.010857	31.12	269.90	1689.96	14655.68	54.301

Cod. elab.: 108GA201-GA01-Z-CL-002_C	Titolo: OPERE D'ARTE MAGGIORI- GALLERIE	Data: Ottobre 2011
Nome file: 108GA201-GA01-Z-CL -002_C.docx	ARTIFICIALI – GALLERIA ROVETELLO	Pagina 123 di 452
	Relazione di calcolo	

PROGETTO ESECUTIVO

1738.55	0.010857	31.94	271.28	1715.72	14572.17	53.716
1748.60	0.010857	32.70	272.67	1738.55	14498.13	53.171
1758.65	0.010857	33.39	274.05	1758.58	14433.19	52.665
1768.70	0.010857	34.02	275.44	1775.91	14377.01	52.196
1778.75	0.010857	34.59	276.83	1790.62	14329.32	51.763
1788.80	0.010857	35.10	278.21	1802.79	14289.86	51.363
1798.85	0.010857	35.54	279.60	1812.49	14258.41	50.996
1808.90	0.010857	35.92	280.99	1819.78	14234.78	50.660
1818.95	0.010857	36.24	282.37	1824.70	14218.81	50.355
1829.00	0.010857	36.49	283.76	1827.30	14210.39	50.079
1839.05	0.010857	36.68	285.15	1827.61	14209.39	49.832
1849.10	0.010857	36.80	286.53	1825.65	14215.75	49.613
1859.15	0.010857	36.85	287.92	1821.43	14229.41	49.422
1869.20	0.010857	36.85	289.31	1814.98	14250.34	49.257
1879.25	0.010857	36.77	290.69	1806.30	14278.49	49.119
1889.30	0.010857	36.64	292.08	1795.43	14313.71	49.006
1899.35	0.010857	36.44	293.46	1782.44	14355.84	48.918
1909.40	0.010857	36.18	294.85	1767.36	14404.74	48.854
1919.45	0.010857	35.86	296.24	1750.23	14460.28	48.813
1929.50	0.010857	35.48	297.62	1731.08	14522.36	48.794
1939.55	0.010857	35.04	299.01	1709.95	14590.87	48.797
1949.60	0.010857	34.55	300.40	1686.86	14665.74	48.821
1959.65	0.010857	34.01	301.78	1661.82	14746.91	48.866
1969.70	0.010857	33.41	303.17	1634.86	14834.32	48.931
1979.75	0.010857	32.77	304.56	1605.99	14927.92	49.015
1989.80	0.010857	32.07	305.94	1575.22	15027.70	49.119
1999.85	0.010857	31.33	307.33	1542.55	15133.63	49.243
2009.90	0.010857	30.54	308.71	1500.02	15165.24	49.124
2019.95	0.010857	29.70	310.10	1455.49	15196.47	49.005
20210.00	0.010857	28.82	311.49	1409.18	15228.94	48.891
20310.05	0.010857	27.90	312.87	1361.16	15262.61	48.782
20410.10	0.010857	26.94	314.26	1311.51	15297.43	48.678
20510.15	0.010857	25.94	315.65	1260.27	15333.35	48.578
20610.20	0.010857	24.91	317.03	1207.53	15370.34	48.482
20710.25	0.010857	23.83	318.42	1153.33	15408.34	48.390
20810.30	0.010857	22.73	319.81	1097.75	15447.31	48.302

Cod. elab.: 108GA201-GA01-Z-CL-002_C	Titolo: OPERE D'ARTE MAGGIORI- GALLERIE	Data: Ottobre 2011
Nome file: 108GA201-GA01-Z-CL -002_C.docx	ARTIFICIALI – GALLERIA ROVETELLO Relazione di calcolo	Pagina 124 di 452

PROGETTO ESECUTIVO

20910.35	0.010857	21.59	321.19	1040.84	15487.22	48.218
21010.40	0.010857	20.41	322.58	982.67	15528.00	48.137
21110.45	0.010857	19.21	323.97	923.30	15569.63	48.060
21210.50	0.010857	17.98	325.35	862.79	15612.06	47.985
21310.55	0.010857	16.72	326.74	801.20	15655.25	47.914
21410.60	0.010857	15.44	328.12	738.60	15699.15	47.845
21510.65	0.010857	14.13	329.51	675.03	15743.72	47.779
21610.70	0.010857	12.80	330.90	610.57	15788.92	47.715
21710.75	0.010857	11.44	332.28	545.28	15834.70	47.654
21810.80	0.010857	10.07	333.67	479.21	15881.03	47.595
21910.85	0.010857	8.68	335.06	412.43	15927.85	47.538
22010.90	0.010857	7.27	336.44	345.01	15975.13	47.482
22110.95	0.010857	5.84	337.83	276.99	16022.83	47.429
22211.00	0.010857	4.40	339.22	208.45	16070.89	47.377
22311.05	0.010857	2.95	340.60	139.45	16119.27	47.326
22411.10	0.010857	1.48	341.99	70.05	16167.93	47.276
22511.15	0.010857	0.01	343.38	0.31	16216.83	47.228
22611.20	0.010857	-1.48	344.76	-69.27	16168.48	46.898
22711.25	0.010857	-2.97	346.15	-138.23	16120.13	46.570
22811.30	0.010857	-4.47	347.53	-206.50	16072.26	46.247
22911.35	0.010857	-5.97	348.92	-274.02	16024.91	45.927
23011.40	0.010857	-7.47	350.31	-340.76	15978.11	45.612
23111.45	0.010857	-8.98	351.69	-406.66	15931.91	45.301
23211.50	0.010857	-10.48	353.08	-471.66	15886.32	44.994
23311.55	0.010857	-11.99	354.47	-535.74	15841.39	44.691
23411.60	0.010857	-13.49	355.85	-598.85	15797.14	44.392
23511.65	0.010857	-14.99	357.24	-660.93	15753.61	44.098
23611.70	0.010857	-16.48	358.63	-721.97	15710.81	43.808
23711.75	0.010857	-17.97	360.01	-781.91	15668.78	43.523
23811.80	0.010857	-19.44	361.40	-840.72	15627.54	43.242
23911.85	0.010857	-20.91	362.78	-898.37	15587.12	42.965
24011.90	0.010857	-22.36	364.17	-954.82	15547.54	42.693
24111.95	0.010857	-23.81	365.56	-1010.04	15508.82	42.425
24212.00	0.010857	-25.24	366.94	-1063.99	15470.98	42.162
24312.05	0.010857	-26.65	368.33	-1116.66	15434.05	41.903
24412.10	0.010857	-28.04	369.72	-1168.01	15398.05	41.648

Cod. elab.: 108GA201-GA01-Z-CL-002_C	Titolo: OPERE D'ARTE MAGGIORI- GALLERIE	Data: Ottobre 2011
Nome file: 108GA201-GA01-Z-CL -002_C.docx	ARTIFICIALI – GALLERIA ROVETELLO Relazione di calcolo	Pagina 125 di 452

PROGETTO ESECUTIVO

24512.15	0.010857	-29.42	371.10	-1218.00	15362.99	41.398
24612.20	0.010857	-30.78	372.49	-1266.62	15328.90	41.153
24712.25	0.010857	-32.11	373.88	-1313.84	15295.79	40.911
24812.30	0.010857	-33.43	375.26	-1359.63	15263.68	40.675
24912.35	0.010857	-34.72	376.65	-1403.96	15232.60	40.442
25012.40	0.010857	-35.98	378.04	-1446.82	15202.55	40.215
25112.45	0.010857	-37.21	379.42	-1488.17	15173.55	39.991
25212.50	0.010857	-38.42	380.81	-1527.99	15145.63	39.772
25312.55	0.010857	-39.59	382.19	-1561.45	15072.34	39.436
25412.60	0.010857	-40.74	383.58	-1590.69	14977.53	39.047
25512.65	0.010857	-41.85	384.97	-1618.41	14887.66	38.673
25612.70	0.010857	-42.93	386.35	-1644.62	14802.67	38.314
25712.75	0.010857	-43.97	387.74	-1669.36	14722.47	37.970
25812.80	0.010857	-44.97	389.13	-1692.68	14646.87	37.640
25912.85	0.010857	-45.94	390.51	-1714.63	14575.70	37.325
26012.90	0.010857	-46.87	391.90	-1735.27	14508.76	37.022
26112.95	0.010857	-47.77	393.29	-1754.66	14445.89	36.731
26213.00	0.010857	-48.63	394.67	-1772.85	14386.93	36.453
26313.05	0.010857	-49.46	396.06	-1789.88	14331.73	36.186
26413.10	0.010857	-50.26	397.44	-1805.78	14280.15	35.930
26513.15	0.010857	-51.02	398.83	-1820.62	14232.05	35.684
26613.20	0.010857	-51.75	400.22	-1834.41	14187.33	35.449
26713.25	0.010857	-52.44	401.60	-1847.20	14145.86	35.223
26813.30	0.010857	-53.10	402.99	-1859.02	14107.54	35.007
26913.35	0.010857	-53.73	404.38	-1869.90	14072.26	34.800
27013.40	0.010857	-54.33	405.76	-1879.66	14038.35	34.597
27113.45	0.010857	-54.89	407.15	-1888.32	14005.76	34.400
27213.50	0.010857	-55.43	408.54	-1896.16	13976.26	34.211
27313.55	0.010857	-55.93	409.92	-1903.20	13949.76	34.030
27413.60	0.010857	-56.40	411.31	-1909.47	13926.18	33.858
27513.65	0.010857	-56.83	412.70	-1914.98	13905.44	33.694
27613.70	0.010857	-57.24	414.08	-1919.76	13887.47	33.538
27713.75	0.010857	-57.62	415.47	-1923.82	13872.20	33.389
27813.80	0.010857	-57.96	416.85	-1927.17	13859.57	33.248
27913.85	0.010857	-58.28	418.24	-1929.84	13849.52	33.114
28013.90	0.010857	-58.56	419.63	-1931.84	13842.00	32.986

Cod. elab.: 108GA201-GA01-Z-CL-002_C	Titolo: OPERE D'ARTE MAGGIORI- GALLERIE	Data: Ottobre 2011
Nome file: 108GA201-GA01-Z-CL -002_C.docx	ARTIFICIALI – GALLERIA ROVETELLO	Pagina 126 di 452
	Relazione di calcolo	

PROGETTO ESECUTIVO

28113.95	0.010857	-58.82	421.01	-1933.18	13836.95	32.866
28214.00	0.010857	-59.05	422.40	-1933.88	13834.33	32.752
28314.05	0.010857	-59.24	423.79	-1933.94	13834.10	32.644
28414.10	0.010857	-59.41	425.17	-1933.38	13836.21	32.543
28514.15	0.010857	-59.55	426.56	-1932.20	13840.64	32.447
28614.20	0.010857	-59.66	427.95	-1930.42	13847.34	32.358
28714.25	0.010857	-59.74	429.33	-1928.04	13856.30	32.274
28814.30	0.010857	-59.79	430.72	-1925.07	13867.47	32.196
28914.35	0.010857	-59.82	432.10	-1921.52	13880.84	32.124
29014.40	0.010857	-59.81	433.49	-1917.39	13896.38	32.057
29114.45	0.010857	-59.78	434.88	-1912.69	13914.08	31.995
29214.50	0.010857	-59.72	436.26	-1907.41	13933.92	31.939
29314.55	0.010857	-59.63	437.65	-1901.58	13955.88	31.888
29414.60	0.010857	-59.52	439.04	-1895.18	13979.96	31.842
29514.65	0.010857	-59.38	440.42	-1888.22	14006.14	31.802
29614.70	0.010857	-59.21	441.81	-1880.71	14034.42	31.766
29714.75	0.010857	-59.01	443.20	-1872.50	14063.82	31.733
29814.80	0.010857	-58.78	444.58	-1863.46	14093.14	31.700
29914.85	0.010857	-58.53	445.97	-1853.84	14124.33	31.671
30014.90	0.010857	-58.26	447.36	-1843.64	14157.40	31.647
30114.95	0.010857	-57.95	448.74	-1832.87	14192.34	31.627
30215.00	0.010857	-57.62	450.13	-1821.51	14229.16	31.611
30315.05	0.010857	-57.27	451.51	-1809.58	14267.86	31.600
30415.10	0.010857	-56.88	452.90	-1797.06	14308.45	31.593
30515.15	0.010857	-56.47	454.29	-1783.95	14350.93	31.590
30615.20	0.010857	-56.04	455.67	-1770.26	14395.32	31.591
30715.25	0.010857	-55.57	457.06	-1755.98	14441.63	31.597
30815.30	0.010857	-55.09	458.45	-1741.10	14489.88	31.606
30915.35	0.010857	-54.57	459.83	-1725.62	14540.07	31.620
31015.40	0.010857	-54.03	461.22	-1709.53	14592.22	31.638
31115.45	0.010857	-53.47	462.61	-1692.83	14646.36	31.661
31215.50	0.010857	-52.88	463.99	-1675.52	14702.51	31.687
31315.55	0.010857	-52.26	465.38	-1657.57	14760.68	31.718
31415.60	0.010857	-51.62	466.77	-1639.00	14820.91	31.752
31515.65	0.010857	-50.95	468.15	-1619.78	14883.22	31.791
31615.70	0.010857	-50.26	469.54	-1599.91	14947.64	31.835

Cod. elab.: 108GA201-GA01-Z-CL-002_C	Titolo: OPERE D'ARTE MAGGIORI- GALLERIE	Data: Ottobre 2011
Nome file: 108GA201-GA01-Z-CL -002_C.docx	ARTIFICIALI – GALLERIA ROVETELLO	Pagina 127 di 452
Relazione di calcolo		

PROGETTO ESECUTIVO

31715.75	0.010857	-49.54	470.92	-1579.38	15014.20	31.882
31815.80	0.010857	-48.79	472.31	-1558.19	15082.93	31.934
31915.85	0.010857	-48.02	473.70	-1534.97	15140.73	31.963
32015.90	0.010857	-47.23	475.08	-1507.09	15160.28	31.911
32115.95	0.010857	-46.41	476.47	-1478.55	15180.30	31.860
32216.00	0.010857	-45.56	477.86	-1449.34	15200.78	31.810
32316.05	0.010857	-44.69	479.24	-1419.46	15221.73	31.762
32416.10	0.010857	-43.79	480.63	-1388.92	15243.14	31.715
32516.15	0.010857	-42.87	482.02	-1357.72	15265.02	31.669
32616.20	0.010857	-41.92	483.40	-1325.84	15287.37	31.625
32716.25	0.010857	-40.95	484.79	-1293.31	15310.19	31.581
32816.30	0.010857	-39.95	486.17	-1260.10	15333.47	31.539
32916.35	0.010857	-38.93	487.56	-1226.23	15357.22	31.498
33016.40	0.010857	-37.88	488.95	-1191.69	15381.44	31.458
33116.45	0.010857	-36.81	490.33	-1156.48	15406.13	31.420
33216.50	0.010857	-35.71	491.72	-1120.60	15431.29	31.382
33316.55	0.010857	-34.61	493.11	-1084.71	15456.46	31.345
33416.60	0.010857	-33.52	494.49	-1049.47	15481.16	31.307
33516.65	0.010857	-32.46	495.88	-1014.89	15505.41	31.269
33616.70	0.010857	-31.41	497.27	-980.97	15529.20	31.229
33716.75	0.010857	-30.39	498.65	-947.70	15552.53	31.189
33816.80	0.010857	-29.38	500.04	-915.08	15575.40	31.148
33916.85	0.010857	-28.39	501.43	-883.11	15597.82	31.107
34016.90	0.010857	-27.42	502.81	-851.79	15619.78	31.065
34116.95	0.010857	-26.47	504.20	-821.11	15641.29	31.022
34217.00	0.010857	-25.54	505.58	-791.08	15662.35	30.979
34317.05	0.010857	-24.62	506.97	-761.69	15682.96	30.935
34417.10	0.010857	-23.73	508.36	-732.93	15703.12	30.890
34517.15	0.010857	-22.85	509.74	-704.82	15722.84	30.845
34617.20	0.010857	-21.99	511.13	-677.33	15742.11	30.799
34717.25	0.010857	-21.15	512.52	-650.47	15760.94	30.752
34817.30	0.010857	-20.33	513.90	-624.24	15779.33	30.705
34917.35	0.010857	-19.53	515.29	-598.63	15797.29	30.657
35017.40	0.010857	-18.74	516.68	-573.64	15814.81	30.609
35117.45	0.010857	-17.97	518.06	-549.27	15831.91	30.560
35217.50	0.010857	-17.22	519.45	-525.50	15848.57	30.510

Cod. elab.: 108GA201-GA01-Z-CL-002_C	Titolo: OPERE D'ARTE MAGGIORI- GALLERIE	Data: Ottobre 2011
Nome file: 108GA201-GA01-Z-CL -002_C.docx	ARTIFICIALI – GALLERIA ROVETELLO Relazione di calcolo	Pagina 128 di 452

PROGETTO ESECUTIVO

35317.55	0.010857	-16.49	520.83	-502.34	15864.81	30.460
35417.60	0.010857	-15.78	522.22	-479.78	15880.63	30.410
35517.65	0.010857	-15.08	523.61	-457.82	15896.03	30.359
35617.70	0.010857	-14.40	524.99	-436.45	15911.01	30.307
35717.75	0.010857	-13.74	526.38	-415.68	15925.58	30.255
35817.80	0.010857	-13.09	527.77	-395.48	15939.74	30.202
35917.85	0.010857	-12.47	529.15	-375.86	15953.50	30.149
36017.90	0.010857	-11.86	530.54	-356.82	15966.85	30.095
36117.95	0.010857	-11.26	531.93	-338.35	15979.80	30.041
36218.00	0.010857	-10.69	533.31	-320.44	15992.36	29.987
36318.05	0.010857	-10.13	534.70	-303.09	16004.53	29.932
36418.10	0.010857	-9.58	536.09	-286.29	16016.31	29.876
36518.15	0.010857	-9.06	537.47	-270.03	16027.70	29.821
36618.20	0.010857	-8.54	538.86	-254.32	16038.72	29.764
36718.25	0.010857	-8.05	540.24	-239.15	16049.36	29.708
36818.30	0.010857	-7.57	541.63	-224.51	16059.63	29.650
36918.35	0.010857	-7.11	543.02	-210.39	16069.53	29.593
37018.40	0.010857	-6.66	544.40	-196.79	16079.06	29.535
37118.45	0.010857	-6.23	545.79	-183.71	16088.23	29.477
37218.50	0.010857	-5.82	547.18	-171.13	16097.05	29.418
37318.55	0.010857	-5.42	548.56	-159.06	16105.52	29.359
37418.60	0.010857	-5.03	549.95	-147.48	16113.64	29.300
37518.65	0.010857	-4.66	551.34	-136.39	16121.41	29.241
37618.70	0.010857	-4.31	552.72	-125.79	16128.85	29.181
37718.75	0.010857	-3.97	554.11	-115.66	16135.95	29.121
37818.80	0.010857	-3.65	555.49	-106.01	16142.72	29.060
37918.85	0.010857	-3.34	556.88	-96.82	16149.16	28.999
38018.90	0.010857	-3.04	558.27	-88.09	16155.28	28.938
38118.95	0.010857	-2.76	559.65	-79.82	16161.08	28.877
38219.00	0.010857	-2.50	561.04	-71.99	16166.57	28.815
38319.05	0.010857	-2.25	562.43	-64.61	16171.75	28.754
38419.10	0.010857	-2.01	563.81	-57.66	16176.62	28.691
38519.15	0.010857	-1.79	565.20	-51.14	16181.20	28.629
38619.20	0.010857	-1.58	566.59	-45.04	16185.47	28.567
38719.25	0.010857	-1.38	567.97	-39.36	16189.46	28.504
38819.30	0.010857	-1.20	569.36	-34.09	16193.15	28.441

Cod. elab.: 108GA201-GA01-Z-CL-002_C	Titolo: OPERE D'ARTE MAGGIORI- GALLERIE	Data: Ottobre 2011
Nome file: 108GA201-GA01-Z-CL -002_C.docx	ARTIFICIALI – GALLERIA ROVETELLO	Pagina 129 di 452
Relazione di calcolo		

PROGETTO ESECUTIVO

38919.35	0.010857	-1.03	570.75	-29.22	16196.56	28.378
39019.40	0.010857	-0.87	572.13	-24.75	16199.70	28.315
39119.45	0.010857	-0.73	573.52	-20.68	16202.55	28.251
39219.50	0.010857	-0.60	574.90	-16.99	16205.14	28.188
39319.55	0.010857	-0.49	576.29	-13.68	16207.46	28.124
39419.60	0.010857	-0.38	577.68	-10.74	16209.52	28.060
39519.65	0.010857	-0.29	579.06	-8.18	16211.32	27.996
39619.70	0.010857	-0.21	580.45	-5.97	16212.86	27.932
39719.75	0.010857	-0.15	581.84	-4.12	16214.16	27.867
39819.80	0.010857	-0.09	583.22	-2.62	16215.21	27.803
39919.85	0.010857	-0.05	584.61	-1.47	16216.02	27.738
40019.90	0.010857	-0.02	586.00	-0.65	16216.60	27.674
40119.95	0.010857	-0.01	587.38	-0.16	16216.94	27.609
40220.00	0.010857	0.00	588.77	0.00	-4248.53	7.216

Fase n° 4 - [A1-M1]

n°	Y	A _f	M	N	M _u	N _u	CS
1	0.00	0.010857	0.00	0.00	0.00	0.00	1000.000
2	0.05	0.010857	0.00	1.39	0.00	-4248.53	3064.420
3	0.10	0.010857	0.01	2.77	47.75	16183.57	5836.525
4	0.15	0.010857	0.02	4.16	95.08	16150.38	3883.038
5	0.20	0.010857	0.05	5.55	141.99	16117.49	2906.346
6	0.25	0.010857	0.08	6.93	188.50	16084.88	2320.373
7	0.30	0.010857	0.12	8.32	234.59	16052.56	1929.759
8	0.35	0.010857	0.17	9.70	280.28	16020.52	1650.778
9	0.40	0.010857	0.23	11.09	325.57	15988.76	1441.567
10	0.45	0.010857	0.29	12.48	370.47	15957.28	1278.870
11	0.50	0.010857	0.36	13.86	414.97	15926.08	1148.732
12	0.55	0.010857	0.46	15.25	474.90	15884.05	1041.546
13	0.60	0.010857	0.59	16.64	560.28	15824.18	951.152
14	0.65	0.010857	0.76	18.02	664.39	15751.18	873.936
15	0.70	0.010857	0.97	19.41	782.38	15668.45	807.250
16	0.75	0.010857	1.22	20.80	910.66	15578.50	749.108
17	0.80	0.010857	1.50	22.18	1046.53	15483.23	697.994
18	0.85	0.010857	1.82	23.57	1187.92	15384.08	652.729

Cod. elab.: 108GA201-GA01-Z-CL-002_C	Titolo: OPERE D'ARTE MAGGIORI- GALLERIE	Data: Ottobre 2011
Nome file: 108GA201-GA01-Z-CL -002_C.docx	ARTIFICIALI – GALLERIA ROVETELLO	Pagina 130 di 452
Relazione di calcolo		

PROGETTO ESECUTIVO

19	0.90	0.010857	2.18	24.96	1333.25	15282.18	612.383
20	0.95	0.010857	2.57	26.34	1481.28	15178.38	576.212
21	1.00	0.010857	3.00	27.73	1612.87	14905.63	537.564
22	1.05	0.010857	3.47	29.11	1729.36	14527.94	498.993
23	1.10	0.010857	3.97	30.50	1841.87	14163.17	464.352
24	1.15	0.010857	4.50	31.89	1946.64	13786.30	432.344
25	1.20	0.010857	5.07	33.27	2045.41	13414.67	403.161
26	1.25	0.010857	5.68	34.66	2139.76	13059.63	376.791
27	1.30	0.010857	6.32	36.05	2225.16	12694.00	352.156
28	1.35	0.010857	6.99	37.43	2304.76	12338.13	329.606
29	1.40	0.010857	7.70	38.82	2380.31	12000.35	309.133
30	1.45	0.010857	8.44	40.21	2448.36	11662.07	290.060
31	1.50	0.010857	9.21	41.59	2510.99	11333.50	272.491
32	1.55	0.010857	10.02	42.98	2570.26	11022.56	256.467
33	1.60	0.010857	10.86	44.36	2624.95	10722.16	241.681
34	1.65	0.010857	11.73	45.75	2673.22	10423.96	227.839
35	1.70	0.010857	12.64	47.14	2718.84	10142.05	215.158
36	1.75	0.010857	13.57	48.52	2762.05	9875.10	203.509
37	1.80	0.010857	14.54	49.91	2801.26	9615.81	192.661
38	1.85	0.010857	15.54	51.30	2836.19	9362.28	182.511
39	1.90	0.010857	16.57	52.68	2869.33	9121.74	173.143
40	1.95	0.010857	17.64	54.07	2900.82	8893.17	164.476
41	2.00	0.010857	18.73	55.46	2930.78	8675.69	156.442
42	2.05	0.010857	19.86	56.84	2953.93	8452.99	148.709
43	2.10	0.010857	21.03	58.23	2975.16	8239.19	141.496
44	2.15	0.010857	22.22	59.62	2995.37	8035.78	134.794
45	2.20	0.010857	23.45	61.00	3014.61	7842.00	128.554
46	2.25	0.010857	24.71	62.39	3032.97	7657.18	122.734
47	2.30	0.010857	26.01	63.77	3044.49	7465.94	117.068
48	2.35	0.010857	27.33	65.16	3049.59	7269.85	111.568
49	2.40	0.010857	28.70	66.55	3054.44	7083.59	106.444
50	2.45	0.010857	30.09	67.93	3059.06	6906.43	101.664
51	2.50	0.010857	31.52	69.32	3063.45	6737.70	97.197
52	2.50	0.010857	31.52	102.37	2850.49	9258.46	90.440
53	2.55	0.010857	28.44	103.76	2741.51	10002.01	96.398
54	2.60	0.010857	25.39	105.14	2610.79	10809.68	102.808

Cod. elab.: 108GA201-GA01-Z-CL-002_C	Titolo: OPERE D'ARTE MAGGIORI- GALLERIE	Data: Ottobre 2011
Nome file: 108GA201-GA01-Z-CL -002_C.docx	ARTIFICIALI – GALLERIA ROVETELLO Relazione di calcolo	Pagina 131 di 452

PROGETTO ESECUTIVO

55	2.65	0.010857	22.38	106.53	2449.32	11657.01	109.424
56	2.70	0.010857	19.41	107.92	2257.09	12551.25	116.305
57	2.75	0.010857	16.46	109.30	2029.55	13474.34	123.275
58	2.80	0.010857	13.55	110.69	1764.92	14412.65	130.208
59	2.85	0.010857	10.68	112.08	1448.55	15201.33	135.634
60	2.90	0.010857	7.84	113.46	1068.69	15467.69	136.325
61	2.95	0.010857	5.03	114.85	689.51	15733.57	136.994
62	3.00	0.010857	2.26	116.24	311.26	15998.80	137.642
63	3.05	0.010857	-0.46	117.62	-63.87	16172.27	137.494
64	3.10	0.010857	-3.11	119.01	-416.21	15925.21	133.816
65	3.15	0.010857	-5.64	120.39	-735.32	15701.44	130.417
66	3.20	0.010857	-8.03	121.78	-1021.64	15500.68	127.284
67	3.25	0.010857	-10.26	123.17	-1276.48	15321.99	124.400
68	3.30	0.010857	-12.33	124.55	-1500.94	15164.60	121.752
69	3.35	0.010857	-14.22	125.94	-1663.86	14740.30	117.042
70	3.40	0.010857	-15.92	127.33	-1791.32	14327.03	112.522
71	3.45	0.010857	-17.44	128.71	-1894.34	13983.11	108.638
72	3.50	0.010857	-18.77	130.10	-1973.83	13684.00	105.181
73	3.55	0.010857	-19.90	131.49	-2036.03	13449.95	102.292
74	3.60	0.010857	-20.85	132.87	-2082.83	13273.85	99.900
75	3.65	0.010857	-21.60	134.26	-2115.64	13150.40	97.949
76	3.70	0.010857	-22.15	135.64	-2135.47	13075.79	96.397
77	3.75	0.010857	-22.51	137.03	-2143.01	13047.42	95.215
78	3.80	0.010857	-22.66	138.42	-2138.66	13063.75	94.379
79	3.85	0.010857	-22.61	139.80	-2122.59	13124.25	93.876
80	3.90	0.010857	-22.36	141.19	-2094.67	13229.30	93.698
81	3.95	0.010857	-21.89	142.58	-2054.56	13380.23	93.846
82	4.00	0.010857	-21.22	143.96	-2001.66	13579.29	94.325
83	4.05	0.010857	-20.34	145.35	-1935.09	13829.79	95.148
84	4.10	0.010857	-19.24	146.74	-1852.60	14128.37	96.284
85	4.15	0.010857	-17.93	148.12	-1750.29	14460.07	97.622
86	4.20	0.010857	-16.40	149.51	-1629.26	14852.50	99.342
87	4.25	0.010857	-14.65	150.90	-1474.39	15183.21	100.621
88	4.30	0.010857	-12.68	152.28	-1276.26	15322.14	100.617
89	4.35	0.010857	-10.49	153.67	-1056.72	15476.08	100.711
90	4.40	0.010857	-8.08	155.05	-814.89	15645.65	100.904

<i>Cod. elab.:</i> 108GA201-GA01-Z-CL-002_C	<i>Titolo:</i> OPERE D'ARTE MAGGIORI- GALLERIE	<i>Data:</i> Ottobre 2011
<i>Nome file:</i> 108GA201-GA01-Z-CL -002_C.docx	ARTIFICIALI – GALLERIA ROVETELLO Relazione di calcolo	<i>Pagina</i> 132 di 452

PROGETTO ESECUTIVO

91	4.45	0.010857	-5.43	156.44	-549.76	15831.56	101.198
92	4.50	0.010857	-2.56	157.83	-260.14	16034.64	101.596
93	4.55	0.010857	0.55	159.21	55.45	16178.17	101.613
94	4.60	0.010857	3.90	160.60	387.30	15945.48	99.287
95	4.65	0.010857	7.52	161.99	729.43	15705.58	96.956
96	4.70	0.010857	11.43	163.37	1081.67	15458.59	94.622
97	4.75	0.010857	15.64	164.76	1443.36	15204.97	92.286
98	4.80	0.010857	20.16	166.15	1753.08	14451.03	86.978
99	4.85	0.010857	24.98	167.53	2016.44	13523.65	80.723
100	4.90	0.010857	30.12	168.92	2246.31	12599.43	74.589
101	4.95	0.010857	35.57	170.30	2442.21	11694.34	68.667
102	5.00	0.010857	41.33	171.69	2607.06	10829.51	63.075
103	5.00	0.010857	41.33	220.29	2310.29	12313.42	55.895
104	5.05	0.010857	40.63	221.68	2280.85	12445.03	56.139
105	5.10	0.010857	40.02	223.07	2254.00	12565.05	56.329
106	5.15	0.010857	39.49	224.45	2229.61	12674.13	56.467
107	5.20	0.010857	39.03	225.84	2207.46	12773.14	56.558
108	5.25	0.010857	38.61	227.23	2186.29	12867.78	56.630
109	5.30	0.010857	38.21	228.61	2165.90	12958.96	56.685
110	5.35	0.010857	37.83	230.00	2144.87	13040.41	56.698
111	5.40	0.010857	37.46	231.39	2123.98	13118.99	56.698
112	5.45	0.010857	37.10	232.77	2103.41	13196.40	56.692
113	5.50	0.010857	36.75	234.16	2083.15	13272.64	56.682
114	5.55	0.010857	36.41	235.54	2063.19	13347.76	56.668
115	5.60	0.010857	36.07	236.93	2043.52	13421.76	56.648
116	5.65	0.010857	35.75	238.32	2024.14	13494.69	56.625
117	5.70	0.010857	35.43	239.70	2005.04	13566.57	56.597
118	5.75	0.010857	35.11	241.09	1986.21	13637.43	56.566
119	5.80	0.010857	34.81	242.48	1967.64	13707.31	56.530
120	5.85	0.010857	34.51	243.86	1949.32	13776.23	56.492
121	5.90	0.010857	34.21	245.25	1931.25	13844.24	56.450
122	5.95	0.010857	33.92	246.64	1913.40	13911.37	56.405
123	6.00	0.010857	33.64	248.02	1895.79	13977.67	56.357
124	6.05	0.010857	33.36	249.41	1878.38	14043.16	56.306
125	6.10	0.010857	33.09	250.80	1860.50	14102.74	56.232
126	6.15	0.010857	32.82	252.18	1842.69	14160.51	56.152

Cod. elab.: 108GA201-GA01-Z-CL-002_C	Titolo: OPERE D'ARTE MAGGIORI- GALLERIE	Data: Ottobre 2011
Nome file: 108GA201-GA01-Z-CL -002_C.docx	ARTIFICIALI – GALLERIA ROVETELLO	Pagina 133 di 452
	Relazione di calcolo	

PROGETTO ESECUTIVO

1276.20	0.010857	32.55	253.57	1825.07	14217.61	56.070
1286.25	0.010857	32.29	254.95	1807.65	14274.10	55.987
1296.30	0.010857	32.03	256.34	1790.40	14330.02	55.902
1306.35	0.010857	31.77	257.73	1773.32	14385.40	55.816
1316.40	0.010857	31.52	259.11	1756.39	14440.29	55.730
1326.45	0.010857	31.26	260.50	1739.60	14494.74	55.642
1336.50	0.010857	31.01	261.89	1722.93	14548.79	55.554
1346.55	0.010857	30.76	263.27	1706.37	14602.49	55.465
1356.60	0.010857	30.52	264.66	1689.90	14655.88	55.376
1366.65	0.010857	30.27	266.05	1673.51	14709.01	55.288
1376.70	0.010857	30.02	267.43	1657.19	14761.93	55.199
1386.75	0.010857	29.78	268.82	1640.92	14814.68	55.110
1396.80	0.010857	29.53	270.20	1624.69	14867.32	55.022
1406.85	0.010857	29.28	271.59	1608.47	14919.89	54.935
1416.90	0.010857	29.03	272.98	1592.26	14972.44	54.849
1426.95	0.010857	28.78	274.36	1576.05	15025.02	54.763
1437.00	0.010857	28.53	275.75	1559.80	15077.69	54.679
1447.05	0.010857	28.27	277.14	1543.52	15130.49	54.596
1457.10	0.010857	28.01	278.52	1523.67	15148.66	54.389
1467.15	0.010857	27.75	279.91	1503.44	15162.85	54.171
1477.20	0.010857	27.49	281.30	1483.19	15177.04	53.954
1487.25	0.010857	27.22	282.68	1462.92	15191.25	53.740
1497.30	0.010857	26.95	284.07	1442.61	15205.50	53.528
1507.35	0.010857	26.67	285.46	1422.23	15219.79	53.318
1517.40	0.010857	26.39	286.84	1401.77	15234.13	53.110
1527.45	0.010857	26.11	288.23	1381.21	15248.55	52.904
1537.50	0.010857	25.82	289.61	1360.53	15263.05	52.701
1547.55	0.010857	25.52	291.00	1339.71	15277.65	52.500
1557.60	0.010857	25.21	292.39	1318.74	15292.35	52.302
1567.65	0.010857	24.90	293.77	1297.59	15307.18	52.105
1577.70	0.010857	24.59	295.16	1276.25	15322.15	51.911
1587.75	0.010857	24.26	296.55	1254.70	15337.26	51.720
1597.80	0.010857	23.93	297.93	1232.93	15352.52	51.530
1607.85	0.010857	23.58	299.32	1210.91	15367.96	51.343
1617.90	0.010857	23.23	300.71	1188.63	15383.59	51.158
1627.95	0.010857	22.87	302.09	1166.06	15399.41	50.976

Cod. elab.: 108GA201-GA01-Z-CL-002_C	Titolo: OPERE D'ARTE MAGGIORI- GALLERIE	Data: Ottobre 2011
Nome file: 108GA201-GA01-Z-CL -002_C.docx	ARTIFICIALI – GALLERIA ROVETELLO Relazione di calcolo	Pagina 134 di 452

PROGETTO ESECUTIVO

1638.00	0.010857	22.51	303.48	1143.21	15415.44	50.796
1648.05	0.010857	22.13	304.86	1120.03	15431.69	50.618
1658.10	0.010857	21.74	306.25	1096.53	15448.17	50.443
1668.15	0.010857	21.34	307.64	1072.68	15464.89	50.270
1678.20	0.010857	20.93	309.02	1048.46	15481.87	50.099
1688.25	0.010857	20.51	310.41	1023.86	15499.12	49.931
1698.30	0.010857	20.07	311.80	998.87	15516.65	49.765
1708.35	0.010857	19.63	313.18	973.45	15534.47	49.602
1718.40	0.010857	19.17	314.57	947.61	15552.59	49.441
1728.45	0.010857	18.69	315.96	921.31	15571.03	49.282
1738.50	0.010857	18.21	317.34	894.55	15589.80	49.126
1748.55	0.010857	17.70	318.73	867.03	15609.09	48.973
1758.60	0.010857	17.17	320.12	838.46	15629.13	48.823
1768.65	0.010857	16.62	321.50	808.80	15649.92	48.678
1778.70	0.010857	16.03	322.89	778.02	15671.50	48.535
1788.75	0.010857	15.42	324.27	746.10	15693.89	48.397
1798.80	0.010857	14.77	325.66	713.00	15717.10	48.262
1808.85	0.010857	14.10	327.05	678.69	15741.15	48.131
1818.90	0.010857	13.40	328.43	643.14	15766.08	48.004
1828.95	0.010857	12.66	329.82	606.32	15791.90	47.880
1839.00	0.010857	11.90	331.21	568.20	15818.63	47.761
1849.05	0.010857	11.10	332.59	528.74	15846.30	47.645
1859.10	0.010857	10.26	333.98	487.91	15874.93	47.533
1869.15	0.010857	9.40	335.37	445.67	15904.55	47.424
1879.20	0.010857	8.50	336.75	402.00	15935.17	47.320
1889.25	0.010857	7.56	338.14	356.87	15966.81	47.220
1899.30	0.010857	6.59	339.52	310.33	15999.45	47.123
1909.35	0.010857	5.58	340.91	262.40	16033.06	47.030
1919.40	0.010857	4.54	342.30	213.14	16067.60	46.940
1929.45	0.010857	3.47	343.68	162.61	16103.03	46.854
1939.50	0.010857	2.37	345.07	110.83	16139.34	46.771
1949.55	0.010857	1.24	346.46	57.87	16176.48	46.691
1959.60	0.010857	0.08	347.84	3.76	16214.42	46.614
1969.65	0.010857	-1.11	349.23	-51.23	16181.13	46.334
1979.70	0.010857	-2.32	350.62	-106.72	16142.22	46.040
1989.75	0.010857	-3.56	352.00	-162.67	16102.99	45.747

Cod. elab.: 108GA201-GA01-Z-CL-002_C	Titolo: OPERE D'ARTE MAGGIORI- GALLERIE	Data: Ottobre 2011
Nome file: 108GA201-GA01-Z-CL -002_C.docx	ARTIFICIALI – GALLERIA ROVETELLO	Pagina 135 di 452
Relazione di calcolo		

PROGETTO ESECUTIVO

1999.80	0.010857	-4.82	353.39	-219.00	16063.49	45.456
2009.85	0.010857	-6.10	354.78	-275.66	16023.76	45.166
2019.90	0.010857	-7.41	356.16	-332.58	15983.85	44.878
2029.95	0.010857	-8.74	357.55	-389.70	15943.79	44.592
20310.00	0.010857	-10.09	358.93	-446.97	15903.64	44.308
20410.05	0.010857	-11.46	360.32	-504.33	15863.42	44.026
20510.10	0.010857	-12.84	361.71	-561.73	15823.16	43.746
20610.15	0.010857	-14.24	363.09	-619.13	15782.92	43.468
20710.20	0.010857	-15.66	364.48	-676.46	15742.72	43.192
20810.25	0.010857	-17.09	365.87	-733.68	15702.60	42.919
20910.30	0.010857	-18.54	367.25	-790.75	15662.58	42.648
21010.35	0.010857	-20.00	368.64	-847.62	15622.71	42.379
21110.40	0.010857	-21.47	370.03	-904.24	15583.00	42.113
21210.45	0.010857	-22.95	371.41	-960.58	15543.49	41.850
21310.50	0.010857	-24.44	372.80	-1016.60	15504.21	41.589
21410.55	0.010857	-25.94	374.19	-1072.26	15465.19	41.330
21510.60	0.010857	-27.45	375.57	-1127.51	15426.44	41.075
21610.65	0.010857	-28.96	376.96	-1182.33	15388.01	40.822
21710.70	0.010857	-30.48	378.34	-1236.67	15349.90	40.571
21810.75	0.010857	-32.00	379.73	-1290.51	15312.15	40.324
21910.80	0.010857	-33.53	381.12	-1343.81	15274.77	40.079
22010.85	0.010857	-35.06	382.50	-1396.55	15237.80	39.837
22110.90	0.010857	-36.58	383.89	-1448.68	15201.24	39.598
22210.95	0.010857	-38.11	385.28	-1500.18	15165.13	39.362
22311.00	0.010857	-39.64	386.66	-1549.23	15111.97	39.083
22411.05	0.010857	-41.16	388.05	-1589.28	14982.12	38.609
22511.10	0.010857	-42.68	389.44	-1628.27	14855.70	38.147
22611.15	0.010857	-44.20	390.82	-1666.21	14732.67	37.697
22711.20	0.010857	-45.71	392.21	-1703.12	14613.02	37.258
22811.25	0.010857	-47.21	393.59	-1738.99	14496.70	36.832
22911.30	0.010857	-48.71	394.98	-1773.85	14383.69	36.416
23011.35	0.010857	-50.20	396.37	-1807.70	14273.94	36.012
23111.40	0.010857	-51.67	397.75	-1840.55	14167.43	35.619
23211.45	0.010857	-53.14	399.14	-1872.41	14064.12	35.236
23311.50	0.010857	-54.59	400.53	-1901.99	13954.33	34.840
23411.55	0.010857	-56.03	401.91	-1930.47	13847.18	34.453

Cod. elab.: 108GA201-GA01-Z-CL-002_C	Titolo: OPERE D'ARTE MAGGIORI- GALLERIE	Data: Ottobre 2011
Nome file: 108GA201-GA01-Z-CL -002_C.docx	ARTIFICIALI – GALLERIA ROVETELLO Relazione di calcolo	Pagina 136 di 452

PROGETTO ESECUTIVO

23511.60	0.010857	-57.46	403.30	-1957.99	13743.60	34.078
23611.65	0.010857	-58.87	404.69	-1984.58	13643.55	33.714
23711.70	0.010857	-60.26	406.07	-2010.24	13546.99	33.361
23811.75	0.010857	-61.63	407.46	-2034.99	13453.85	33.019
23911.80	0.010857	-62.99	408.85	-2058.84	13364.11	32.687
24011.85	0.010857	-64.32	410.23	-2081.80	13277.72	32.366
24111.90	0.010857	-65.63	411.62	-2103.88	13194.63	32.056
24211.95	0.010857	-66.92	413.00	-2125.09	13114.81	31.755
24312.00	0.010857	-68.19	414.39	-2145.45	13038.23	31.464
24412.05	0.010857	-69.43	415.78	-2164.79	12963.91	31.180
24512.10	0.010857	-70.64	417.16	-2182.17	12886.19	30.890
24612.15	0.010857	-71.83	418.55	-2198.76	12812.03	30.611
24712.20	0.010857	-72.99	419.94	-2214.56	12741.39	30.341
24812.25	0.010857	-74.12	421.32	-2229.58	12674.24	30.082
24912.30	0.010857	-75.21	422.71	-2243.83	12610.54	29.833
25012.35	0.010857	-76.28	424.10	-2257.31	12550.26	29.593
25112.40	0.010857	-77.31	425.48	-2270.04	12493.37	29.363
25212.45	0.010857	-78.31	426.87	-2282.01	12439.85	29.142
25312.50	0.010857	-79.27	428.25	-2293.23	12389.68	28.931
25412.55	0.010857	-80.19	429.64	-2303.71	12342.84	28.728
25512.60	0.010857	-81.07	431.03	-2313.44	12299.33	28.535
25612.65	0.010857	-81.92	432.41	-2322.43	12259.13	28.350
25712.70	0.010857	-82.72	433.80	-2330.68	12222.24	28.175
25812.75	0.010857	-83.48	435.19	-2338.20	12188.63	28.008
25912.80	0.010857	-84.20	436.57	-2345.00	12158.21	27.849
26012.85	0.010857	-84.88	437.96	-2351.12	12130.87	27.699
26112.90	0.010857	-85.52	439.35	-2356.57	12106.51	27.556
26212.95	0.010857	-86.12	440.73	-2361.37	12085.04	27.420
26313.00	0.010857	-86.67	442.12	-2365.55	12066.37	27.292
26413.05	0.010857	-87.19	443.51	-2369.12	12050.41	27.171
26513.10	0.010857	-87.67	444.89	-2372.09	12037.09	27.056
26613.15	0.010857	-88.11	446.28	-2374.50	12026.33	26.948
26713.20	0.010857	-88.52	447.66	-2376.35	12018.08	26.846
26813.25	0.010857	-88.88	449.05	-2377.65	12012.26	26.750
26913.30	0.010857	-89.21	450.44	-2378.42	12008.81	26.660
27013.35	0.010857	-89.50	451.82	-2378.67	12007.69	26.576

Cod. elab.: 108GA201-GA01-Z-CL-002_C	Titolo: OPERE D'ARTE MAGGIORI- GALLERIE	Data: Ottobre 2011
Nome file: 108GA201-GA01-Z-CL -002_C.docx	ARTIFICIALI – GALLERIA ROVETELLO Relazione di calcolo	Pagina 137 di 452

PROGETTO ESECUTIVO

27113.40	0.010857	-89.76	453.21	-2378.41	12008.85	26.497
27213.45	0.010857	-89.98	454.60	-2377.66	12012.23	26.424
27313.50	0.010857	-90.17	455.98	-2376.41	12017.80	26.356
27413.55	0.010857	-90.32	457.37	-2374.69	12025.51	26.293
27513.60	0.010857	-90.43	458.76	-2372.49	12035.33	26.235
27613.65	0.010857	-90.52	460.14	-2369.83	12047.22	26.182
27713.70	0.010857	-90.56	461.53	-2366.71	12061.16	26.133
27813.75	0.010857	-90.58	462.91	-2363.14	12077.12	26.089
27913.80	0.010857	-90.56	464.30	-2359.13	12095.06	26.050
28013.85	0.010857	-90.51	465.69	-2354.67	12114.98	26.015
28113.90	0.010857	-90.43	467.07	-2349.78	12136.84	25.985
28213.95	0.010857	-90.32	468.46	-2344.46	12160.62	25.959
28314.00	0.010857	-90.17	469.85	-2338.71	12186.33	25.937
28414.05	0.010857	-89.99	471.23	-2332.54	12213.93	25.919
28514.10	0.010857	-89.79	472.62	-2325.94	12243.42	25.905
28614.15	0.010857	-89.55	474.01	-2318.93	12274.79	25.896
28714.20	0.010857	-89.28	475.39	-2311.49	12308.04	25.890
28814.25	0.010857	-88.98	476.78	-2303.64	12343.15	25.889
28914.30	0.010857	-88.66	478.17	-2295.37	12380.12	25.891
29014.35	0.010857	-88.30	479.55	-2286.68	12418.95	25.897
29114.40	0.010857	-87.91	480.94	-2277.58	12459.65	25.907
29214.45	0.010857	-87.50	482.32	-2268.06	12502.21	25.921
29314.50	0.010857	-87.06	483.71	-2258.12	12546.64	25.938
29414.55	0.010857	-86.59	485.10	-2247.76	12592.95	25.960
29514.60	0.010857	-86.09	486.48	-2236.98	12641.14	25.985
29614.65	0.010857	-85.56	487.87	-2225.78	12691.23	26.014
29714.70	0.010857	-85.01	489.26	-2214.15	12743.22	26.046
29814.75	0.010857	-84.43	490.64	-2202.09	12797.13	26.082
29914.80	0.010857	-83.82	492.03	-2189.60	12852.98	26.122
30014.85	0.010857	-83.19	493.42	-2176.67	12910.78	26.166
30114.90	0.010857	-82.53	494.80	-2163.30	12970.55	26.214
30214.95	0.010857	-81.84	496.19	-2148.54	13026.58	26.253
30315.00	0.010857	-81.13	497.58	-2133.26	13084.08	26.296
30415.05	0.010857	-80.39	498.96	-2117.51	13143.36	26.341
30515.10	0.010857	-79.62	500.35	-2101.27	13204.45	26.391
30615.15	0.010857	-78.83	501.73	-2084.55	13267.36	26.443

Cod. elab.: 108GA201-GA01-Z-CL-002_C	Titolo: OPERE D'ARTE MAGGIORI- GALLERIE	Data: Ottobre 2011
Nome file: 108GA201-GA01-Z-CL -002_C.docx	ARTIFICIALI – GALLERIA ROVETELLO	Pagina 138 di 452
Relazione di calcolo		

PROGETTO ESECUTIVO

30715.20	0.010857	-78.02	503.12	-2067.34	13332.12	26.499
30815.25	0.010857	-77.18	504.51	-2049.64	13398.75	26.558
30915.30	0.010857	-76.31	505.89	-2031.42	13467.29	26.621
31015.35	0.010857	-75.42	507.28	-2012.70	13537.74	26.687
31115.40	0.010857	-74.50	508.67	-1993.45	13610.16	26.757
31215.45	0.010857	-73.56	510.05	-1973.68	13684.57	26.830
31315.50	0.010857	-72.60	511.44	-1953.37	13761.00	26.906
31415.55	0.010857	-71.61	512.83	-1932.51	13839.49	26.987
31515.60	0.010857	-70.60	514.21	-1911.09	13920.08	27.071
31615.65	0.010857	-69.56	515.60	-1889.11	14002.81	27.158
31715.70	0.010857	-68.50	516.98	-1866.12	14084.53	27.244
31815.75	0.010857	-67.41	518.37	-1841.87	14163.16	27.322
31915.80	0.010857	-66.30	519.76	-1817.01	14243.75	27.405
32015.85	0.010857	-65.17	521.14	-1791.54	14326.33	27.490
32115.90	0.010857	-64.01	522.53	-1765.44	14410.95	27.579
32215.95	0.010857	-62.83	523.92	-1738.71	14497.63	27.672
32316.00	0.010857	-61.63	525.30	-1711.32	14586.43	27.768
32416.05	0.010857	-60.40	526.69	-1683.26	14677.39	27.867
32516.10	0.010857	-59.15	528.08	-1654.53	14770.57	27.971
32616.15	0.010857	-57.88	529.46	-1625.09	14866.00	28.078
32716.20	0.010857	-56.58	530.85	-1594.94	14963.75	28.188
32816.25	0.010857	-55.26	532.24	-1564.07	15063.86	28.303
32916.30	0.010857	-53.92	533.62	-1530.19	15144.09	28.380
33016.35	0.010857	-52.55	535.01	-1490.29	15172.07	28.359
33116.40	0.010857	-51.16	536.39	-1449.83	15200.43	28.338
33216.45	0.010857	-49.75	537.78	-1408.83	15229.19	28.319
33316.50	0.010857	-48.31	539.17	-1367.26	15258.33	28.300
33416.55	0.010857	-46.88	540.55	-1325.75	15287.44	28.281
33516.60	0.010857	-45.46	541.94	-1284.89	15316.09	28.262
33616.65	0.010857	-44.07	543.33	-1244.69	15344.27	28.241
33716.70	0.010857	-42.71	544.71	-1205.16	15371.99	28.220
33816.75	0.010857	-41.36	546.10	-1166.30	15399.25	28.199
33916.80	0.010857	-40.04	547.49	-1128.10	15426.03	28.176
34016.85	0.010857	-38.74	548.87	-1090.57	15452.35	28.153
34116.90	0.010857	-37.46	550.26	-1053.71	15478.19	28.129
34216.95	0.010857	-36.21	551.64	-1017.52	15503.57	28.104

Cod. elab.: 108GA201-GA01-Z-CL-002_C	Titolo: OPERE D'ARTE MAGGIORI- GALLERIE	Data: Ottobre 2011
Nome file: 108GA201-GA01-Z-CL -002_C.docx	ARTIFICIALI – GALLERIA ROVETELLO	Pagina 139 di 452
	Relazione di calcolo	

PROGETTO ESECUTIVO

34317.00	0.010857	-34.97	553.03	-982.00	15528.47	28.079
34417.05	0.010857	-33.76	554.42	-947.16	15552.91	28.053
34517.10	0.010857	-32.58	555.80	-912.99	15576.87	28.026
34617.15	0.010857	-31.41	557.19	-879.49	15600.36	27.998
34717.20	0.010857	-30.27	558.58	-846.66	15623.38	27.970
34817.25	0.010857	-29.15	559.96	-814.50	15645.92	27.941
34917.30	0.010857	-28.05	561.35	-783.02	15668.00	27.911
35017.35	0.010857	-26.98	562.74	-752.21	15689.61	27.881
35117.40	0.010857	-25.93	564.12	-722.06	15710.74	27.850
35217.45	0.010857	-24.90	565.51	-692.59	15731.41	27.818
35317.50	0.010857	-23.89	566.90	-663.78	15751.61	27.786
35417.55	0.010857	-22.90	568.28	-635.63	15771.35	27.753
35517.60	0.010857	-21.94	569.67	-608.15	15790.62	27.719
35617.65	0.010857	-21.00	571.05	-581.33	15809.42	27.685
35717.70	0.010857	-20.08	572.44	-555.18	15827.76	27.650
35817.75	0.010857	-19.18	573.83	-529.67	15845.65	27.614
35917.80	0.010857	-18.31	575.21	-504.82	15863.07	27.578
36017.85	0.010857	-17.45	576.60	-480.63	15880.04	27.541
36117.90	0.010857	-16.62	577.99	-457.08	15896.55	27.503
36217.95	0.010857	-15.81	579.37	-434.18	15912.60	27.465
36318.00	0.010857	-15.02	580.76	-411.92	15928.21	27.427
36418.05	0.010857	-14.25	582.15	-390.30	15943.37	27.387
36518.10	0.010857	-13.50	583.53	-369.32	15958.08	27.347
36618.15	0.010857	-12.78	584.92	-348.97	15972.35	27.307
36718.20	0.010857	-12.08	586.30	-329.25	15986.18	27.266
36818.25	0.010857	-11.39	587.69	-310.16	15999.57	27.224
36918.30	0.010857	-10.73	589.08	-291.69	16012.52	27.182
37018.35	0.010857	-10.09	590.46	-273.83	16025.04	27.140
37118.40	0.010857	-9.47	591.85	-256.59	16037.13	27.097
37218.45	0.010857	-8.87	593.24	-239.96	16048.80	27.053
37318.50	0.010857	-8.29	594.62	-223.93	16060.03	27.009
37418.55	0.010857	-7.73	596.01	-208.50	16070.85	26.964
37518.60	0.010857	-7.19	597.40	-193.67	16081.25	26.919
37618.65	0.010857	-6.68	598.78	-179.43	16091.24	26.873
37718.70	0.010857	-6.18	600.17	-165.78	16100.81	26.827
37818.75	0.010857	-5.70	601.56	-152.70	16109.98	26.781

Cod. elab.: 108GA201-GA01-Z-CL-002_C	Titolo: OPERE D'ARTE MAGGIORI- GALLERIE	Data: Ottobre 2011
Nome file: 108GA201-GA01-Z-CL -002_C.docx	ARTIFICIALI – GALLERIA ROVETELLO Relazione di calcolo	Pagina 140 di 452

PROGETTO ESECUTIVO

37918.80	0.010857	-5.24	602.94	-140.21	16118.74	26.733
38018.85	0.010857	-4.81	604.33	-128.29	16127.10	26.686
38118.90	0.010857	-4.39	605.71	-116.93	16135.06	26.638
38218.95	0.010857	-3.99	607.10	-106.14	16142.63	26.590
38319.00	0.010857	-3.61	608.49	-95.91	16149.80	26.541
38419.05	0.010857	-3.25	609.87	-86.22	16156.59	26.492
38519.10	0.010857	-2.92	611.26	-77.09	16163.00	26.442
38619.15	0.010857	-2.60	612.65	-68.49	16169.03	26.392
38719.20	0.010857	-2.29	614.03	-60.43	16174.68	26.342
38819.25	0.010857	-2.01	615.42	-52.91	16179.95	26.291
38919.30	0.010857	-1.75	616.81	-45.91	16184.86	26.240
39019.35	0.010857	-1.51	618.19	-39.42	16189.41	26.188
39119.40	0.010857	-1.28	619.58	-33.46	16193.59	26.136
39219.45	0.010857	-1.07	620.97	-28.00	16197.42	26.084
39319.50	0.010857	-0.89	622.35	-23.05	16200.89	26.032
39419.55	0.010857	-0.72	623.74	-18.59	16204.02	25.979
39519.60	0.010857	-0.56	625.12	-14.63	16206.79	25.926
39619.65	0.010857	-0.43	626.51	-11.15	16209.23	25.872
39719.70	0.010857	-0.32	627.90	-8.16	16211.33	25.818
39819.75	0.010857	-0.22	629.28	-5.64	16213.09	25.764
39919.80	0.010857	-0.14	630.67	-3.60	16214.53	25.710
40019.85	0.010857	-0.08	632.06	-2.01	16215.64	25.655
40119.90	0.010857	-0.03	633.44	-0.89	16216.43	25.600
40219.95	0.010857	-0.01	634.83	-0.22	16216.90	25.545
40320.00	0.010857	0.00	636.22	0.00	-4248.53	6.678

Fase n° 5 - [A1-M1]

n°	Y	A _f	M	N	M _u	N _u	CS
1	0.00	0.010857	0.00	0.00	0.00	0.00	1000.000
2	0.05	0.010857	0.00	1.39	-0.05	16217.01	11697.174
3	0.10	0.010857	0.00	2.77	-0.11	16216.98	5848.573
4	0.15	0.010857	0.00	4.16	-0.16	16216.94	3899.040
5	0.20	0.010857	0.00	5.55	-0.21	16216.90	2924.273
6	0.25	0.010857	0.00	6.93	-0.26	16216.87	2339.413
7	0.30	0.010857	0.00	8.32	-0.32	16216.83	1949.507

Cod. elab.: 108GA201-GA01-Z-CL-002_C	Titolo: OPERE D'ARTE MAGGIORI- GALLERIE	Data: Ottobre 2011
Nome file: 108GA201-GA01-Z-CL -002_C.docx	ARTIFICIALI – GALLERIA ROVETELLO	Pagina 141 di 452
Relazione di calcolo		

PROGETTO ESECUTIVO

8	0.35	0.010857	0.00	9.70	-0.37	16216.79	1671.002
9	0.40	0.010857	0.00	11.09	-0.42	16216.76	1462.124
10	0.45	0.010857	0.00	12.48	-0.47	16216.72	1299.662
11	0.50	0.010857	0.00	13.86	-0.52	16216.69	1169.694
12	0.55	0.010857	0.00	15.25	-0.59	16216.64	1063.355
13	0.60	0.010857	0.00	16.64	-0.69	16216.57	974.737
14	0.65	0.010857	0.00	18.02	-0.82	16216.48	899.753
15	0.70	0.010857	0.00	19.41	-0.96	16216.38	835.480
16	0.75	0.010857	0.00	20.80	-1.12	16216.27	779.776
17	0.80	0.010857	0.00	22.18	-1.28	16216.15	731.034
18	0.85	0.010857	0.00	23.57	-1.46	16216.03	688.027
19	0.90	0.010857	0.00	24.96	-1.65	16215.90	649.798
20	0.95	0.010857	0.00	26.34	-1.84	16215.76	615.593
21	1.00	0.010857	0.00	27.73	-2.04	16215.62	584.809
22	1.05	0.010857	0.00	29.11	-2.24	16215.48	556.956
23	1.10	0.010857	0.00	30.50	-2.44	16215.34	531.635
24	1.15	0.010857	-0.01	31.89	-2.65	16215.19	508.516
25	1.20	0.010857	-0.01	33.27	-2.86	16215.04	487.323
26	1.25	0.010857	-0.01	34.66	-3.08	16214.89	467.826
27	1.30	0.010857	-0.01	36.05	-3.29	16214.74	449.828
28	1.35	0.010857	-0.01	37.43	-3.51	16214.59	433.164
29	1.40	0.010857	-0.01	38.82	-3.73	16214.44	417.690
30	1.45	0.010857	-0.01	40.21	-3.94	16214.29	403.283
31	1.50	0.010857	-0.01	41.59	-4.16	16214.13	389.836
32	1.55	0.010857	-0.01	42.98	-4.39	16213.98	377.257
33	1.60	0.010857	-0.01	44.36	-4.61	16213.82	365.465
34	1.65	0.010857	-0.01	45.75	-4.83	16213.67	354.387
35	1.70	0.010857	-0.01	47.14	-5.05	16213.51	343.960
36	1.75	0.010857	-0.02	48.52	-5.27	16213.35	334.130
37	1.80	0.010857	-0.02	49.91	-5.50	16213.20	324.845
38	1.85	0.010857	-0.02	51.30	-5.72	16213.04	316.062
39	1.90	0.010857	-0.02	52.68	-5.94	16212.89	307.742
40	1.95	0.010857	-0.02	54.07	-6.16	16212.73	299.848
41	2.00	0.010857	-0.02	55.46	-6.39	16212.57	292.349
42	2.05	0.010857	-0.02	56.84	-6.61	16212.42	285.216
43	2.10	0.010857	-0.02	58.23	-6.83	16212.26	278.423

<i>Cod. elab.:</i> 108GA201-GA01-Z-CL-002_C	<i>Titolo:</i> OPERE D'ARTE MAGGIORI- GALLERIE	<i>Data:</i> Ottobre 2011
<i>Nome file:</i> 108GA201-GA01-Z-CL -002_C.docx	ARTIFICIALI – GALLERIA ROVETELLO Relazione di calcolo	<i>Pagina</i> 142 di 452

PROGETTO ESECUTIVO

44	2.15	0.010857	-0.03	59.62	-7.05	16212.11	271.945
45	2.20	0.010857	-0.03	61.00	-7.27	16211.95	265.762
46	2.25	0.010857	-0.03	62.39	-7.50	16211.80	259.854
47	2.30	0.010857	-0.03	63.77	-7.72	16211.64	254.202
48	2.35	0.010857	-0.03	65.16	-7.94	16211.49	248.791
49	2.40	0.010857	-0.03	66.55	-8.16	16211.33	243.606
50	2.45	0.010857	-0.04	67.93	-8.38	16211.18	238.632
51	2.50	0.010857	-0.04	69.32	-8.60	16211.02	233.857
52	2.50	0.010857	-0.04	118.56	-5.03	16213.53	136.758
53	2.55	0.010857	-6.80	119.94	-884.53	15596.82	130.036
54	2.60	0.010857	-13.57	121.33	-1652.47	14777.24	121.795
55	2.65	0.010857	-20.33	122.72	-2154.63	13003.69	105.966
56	2.70	0.010857	-27.10	124.10	-2494.10	11422.08	92.038
57	2.75	0.010857	-33.86	125.49	-2725.63	10100.16	80.487
58	2.80	0.010857	-40.63	126.87	-2884.91	9008.69	71.005
59	2.85	0.010857	-47.40	128.26	-2989.87	8091.15	63.083
60	2.90	0.010857	-54.16	129.65	-3048.86	7298.16	56.292
61	2.95	0.010857	-60.93	131.03	-3067.13	6596.40	50.341
62	3.00	0.010857	-67.69	132.42	-3051.99	5970.30	45.086
63	3.05	0.010857	-74.45	133.81	-3033.97	5453.09	40.754
64	3.10	0.010857	-81.16	135.19	-2994.57	4988.49	36.899
65	3.15	0.010857	-87.78	136.58	-2959.89	4605.30	33.719
66	3.20	0.010857	-94.30	137.97	-2928.54	4284.50	31.055
67	3.25	0.010857	-100.70	139.35	-2885.18	3992.44	28.650
68	3.30	0.010857	-106.97	140.74	-2848.91	3748.14	26.632
69	3.35	0.010857	-113.10	142.12	-2818.24	3541.52	24.918
70	3.40	0.010857	-119.08	143.51	-2792.04	3365.01	23.448
71	3.45	0.010857	-124.90	144.90	-2767.11	3210.15	22.155
72	3.50	0.010857	-130.57	146.28	-2737.50	3066.93	20.966
73	3.55	0.010857	-136.09	147.67	-2711.80	2942.62	19.927
74	3.60	0.010857	-141.45	149.06	-2689.36	2834.09	19.013
75	3.65	0.010857	-146.64	150.44	-2669.67	2738.84	18.205
76	3.70	0.010857	-151.68	151.83	-2652.32	2654.93	17.486
77	3.75	0.010857	-156.55	153.22	-2636.99	2580.77	16.844
78	3.80	0.010857	-161.26	154.60	-2623.41	2515.08	16.268
79	3.85	0.010857	-165.80	155.99	-2611.37	2456.81	15.750

Cod. elab.: 108GA201-GA01-Z-CL-002_C	Titolo: OPERE D'ARTE MAGGIORI- GALLERIE	Data: Ottobre 2011
Nome file: 108GA201-GA01-Z-CL -002_C.docx	ARTIFICIALI – GALLERIA ROVETELLO	Pagina 143 di 452
Relazione di calcolo		

PROGETTO ESECUTIVO

80	3.90	0.010857	-170.17	157.38	-2600.68	2405.10	15.283
81	3.95	0.010857	-174.37	158.76	-2591.20	2359.24	14.860
82	4.00	0.010857	-178.40	160.15	-2582.80	2318.61	14.478
83	4.05	0.010857	-182.24	161.53	-2575.38	2282.71	14.131
84	4.10	0.010857	-185.92	162.92	-2568.84	2251.12	13.817
85	4.15	0.010857	-189.41	164.31	-2563.13	2223.46	13.532
86	4.20	0.010857	-192.72	165.69	-2558.16	2199.44	13.274
87	4.25	0.010857	-195.85	167.08	-2553.89	2178.79	13.040
88	4.30	0.010857	-198.79	168.47	-2550.16	2161.20	12.829
89	4.35	0.010857	-201.54	169.85	-2545.48	2145.26	12.630
90	4.40	0.010857	-204.11	171.24	-2541.71	2132.43	12.453
91	4.45	0.010857	-206.48	172.63	-2538.81	2122.56	12.296
92	4.50	0.010857	-208.66	174.01	-2536.74	2115.52	12.157
93	4.55	0.010857	-210.64	175.40	-2535.50	2111.27	12.037
94	4.60	0.010857	-212.41	176.79	-2535.10	2109.91	11.935
95	4.65	0.010857	-213.95	178.17	-2535.59	2111.59	11.851
96	4.70	0.010857	-215.23	179.56	-2537.03	2116.51	11.787
97	4.75	0.010857	-216.26	180.94	-2539.48	2124.82	11.743
98	4.80	0.010857	-217.01	182.33	-2542.94	2136.61	11.718
99	4.85	0.010857	-217.48	183.72	-2547.45	2151.95	11.713
100	4.90	0.010857	-217.68	185.10	-2552.11	2170.17	11.724
101	4.95	0.010857	-217.60	186.49	-2556.39	2190.89	11.748
102	5.00	0.010857	-217.24	187.88	-2561.41	2215.18	11.791
103	5.00	0.010857	-217.24	250.03	-2760.21	3176.79	12.706
104	5.05	0.010857	-225.14	251.41	-2734.84	3054.06	12.147
105	5.10	0.010857	-232.74	252.80	-2712.57	2946.33	11.655
106	5.15	0.010857	-240.06	254.19	-2692.94	2851.38	11.218
107	5.20	0.010857	-247.09	255.57	-2675.58	2767.44	10.828
108	5.25	0.010857	-253.83	256.96	-2660.21	2693.06	10.480
109	5.30	0.010857	-260.26	258.35	-2646.57	2627.07	10.169
110	5.35	0.010857	-266.40	259.73	-2634.45	2568.48	9.889
111	5.40	0.010857	-272.24	261.12	-2623.71	2516.50	9.637
112	5.45	0.010857	-277.78	262.51	-2614.19	2470.44	9.411
113	5.50	0.010857	-283.01	263.89	-2605.77	2429.74	9.207
114	5.55	0.010857	-287.93	265.28	-2598.37	2393.93	9.024
115	5.60	0.010857	-292.55	266.67	-2591.89	2362.60	8.860

Cod. elab.: 108GA201-GA01-Z-CL-002_C	Titolo: OPERE D'ARTE MAGGIORI- GALLERIE	Data: Ottobre 2011
Nome file: 108GA201-GA01-Z-CL -002_C.docx	ARTIFICIALI – GALLERIA ROVETELLO	Pagina 144 di 452
Relazione di calcolo		

PROGETTO ESECUTIVO

1165.65	0.010857	-296.85	268.05	-2586.27	2335.41	8.713
1175.70	0.010857	-300.83	269.44	-2581.45	2312.08	8.581
1185.75	0.010857	-304.50	270.82	-2577.37	2292.36	8.464
1195.80	0.010857	-307.84	272.21	-2574.00	2276.07	8.361
1205.85	0.010857	-310.87	273.60	-2571.31	2263.04	8.271
1215.90	0.010857	-313.57	274.98	-2569.26	2253.13	8.194
1225.95	0.010857	-315.94	276.37	-2567.84	2246.23	8.128
1236.00	0.010857	-317.98	277.76	-2567.02	2242.28	8.073
1246.05	0.010857	-319.69	279.14	-2566.80	2241.22	8.029
1256.10	0.010857	-321.07	280.53	-2567.17	2243.02	7.996
1266.15	0.010857	-322.11	281.92	-2568.13	2247.66	7.973
1276.20	0.010857	-322.81	283.30	-2569.68	2255.16	7.960
1286.25	0.010857	-323.17	284.69	-2571.83	2265.56	7.958
1296.30	0.010857	-323.19	286.08	-2574.59	2278.91	7.966
1306.35	0.010857	-322.86	287.46	-2577.98	2295.30	7.985
1316.40	0.010857	-322.19	288.85	-2582.02	2314.84	8.014
1326.45	0.010857	-321.16	290.23	-2586.73	2337.65	8.054
1336.50	0.010857	-319.78	291.62	-2592.16	2363.89	8.106
1346.55	0.010857	-318.05	293.01	-2598.34	2393.78	8.170
1356.60	0.010857	-315.95	294.39	-2605.31	2427.53	8.246
1366.65	0.010857	-313.50	295.78	-2613.15	2465.43	8.335
1376.70	0.010857	-310.69	297.17	-2621.91	2507.79	8.439
1386.75	0.010857	-307.51	298.55	-2631.67	2555.00	8.558
1396.80	0.010857	-303.97	299.94	-2642.52	2607.50	8.693
1406.85	0.010857	-300.05	301.33	-2654.58	2665.83	8.847
1416.90	0.010857	-295.77	302.71	-2667.96	2730.58	9.020
1426.95	0.010857	-291.11	304.10	-2682.83	2802.50	9.216
1437.00	0.010857	-286.08	305.48	-2699.36	2882.46	9.436
1447.05	0.010857	-280.67	306.87	-2717.77	2971.48	9.683
1457.10	0.010857	-274.88	308.26	-2738.30	3070.82	9.962
1467.15	0.010857	-268.71	309.64	-2761.28	3181.97	10.276
1477.20	0.010857	-262.15	311.03	-2782.60	3301.47	10.615
1487.25	0.010857	-255.20	312.42	-2801.64	3429.74	10.978
1497.30	0.010857	-247.87	313.80	-2823.06	3574.00	11.389
1507.35	0.010857	-240.14	315.19	-2847.26	3737.03	11.856
1517.40	0.010857	-232.03	316.58	-2874.77	3922.34	12.390

Cod. elab.: 108GA201-GA01-Z-CL-002_C	Titolo: OPERE D'ARTE MAGGIORI- GALLERIE	Data: Ottobre 2011
Nome file: 108GA201-GA01-Z-CL -002_C.docx	ARTIFICIALI – GALLERIA ROVETELLO Relazione di calcolo	Pagina 145 di 452

PROGETTO ESECUTIVO

1527.45	0.010857	-223.51	317.96	-2906.25	4134.36	13.003
1537.50	0.010857	-214.60	319.35	-2938.91	4373.44	13.695
1547.55	0.010857	-205.42	320.74	-2961.60	4624.21	14.418
1557.60	0.010857	-196.10	322.12	-2987.19	4906.96	15.233
1567.65	0.010857	-186.65	323.51	-3016.23	5227.93	16.160
1577.70	0.010857	-177.08	324.89	-3038.20	5574.43	17.158
1587.75	0.010857	-167.39	326.28	-3051.19	5947.47	18.228
1597.80	0.010857	-157.60	327.67	-3066.08	6374.79	19.455
1607.85	0.010857	-147.71	329.05	-3061.31	6819.84	20.726
1617.90	0.010857	-137.72	330.44	-3048.44	7314.14	22.135
1627.95	0.010857	-127.66	331.83	-3015.07	7837.36	23.619
1638.00	0.010857	-117.51	333.21	-2959.88	8393.06	25.188
1648.05	0.010857	-107.29	334.60	-2886.07	9000.23	26.899
1658.10	0.010857	-97.02	335.99	-2793.29	9673.67	28.792
1668.15	0.010857	-86.68	337.37	-2675.17	10411.87	30.862
1678.20	0.010857	-76.30	338.76	-2530.11	11233.17	33.160
1688.25	0.010857	-65.88	340.14	-2350.22	12134.88	35.676
1698.30	0.010857	-55.42	341.53	-2127.00	13107.64	38.379
1708.35	0.010857	-44.94	342.92	-1851.80	14130.96	41.208
1718.40	0.010857	-34.44	344.30	-1515.64	15154.29	44.014
1728.45	0.010857	-23.92	345.69	-1070.22	15466.62	44.741
1738.50	0.010857	-13.40	347.08	-609.63	15789.58	45.493
1748.55	0.010857	-2.90	348.46	-134.31	16122.87	46.268
1758.60	0.010857	7.55	349.85	344.59	15975.43	45.664
1768.65	0.010857	17.94	351.24	799.78	15656.25	44.575
1778.70	0.010857	28.28	352.62	1231.35	15353.63	43.541
1788.75	0.010857	38.55	354.01	1620.60	14880.57	42.034
1798.80	0.010857	48.76	355.40	1910.22	13923.36	39.177
1808.85	0.010857	58.89	356.78	2149.49	13023.02	36.501
1818.90	0.010857	68.94	358.17	2342.36	12170.02	33.979
1828.95	0.010857	78.90	359.55	2499.82	11392.09	31.684
1839.00	0.010857	88.77	360.94	2629.73	10692.67	29.624
1849.05	0.010857	98.54	362.33	2733.56	10051.10	27.740
1859.10	0.010857	108.21	363.71	2820.12	9478.96	26.062
1869.15	0.010857	117.77	365.10	2891.19	8963.07	24.550
1879.20	0.010857	127.21	366.49	2949.53	8497.23	23.186

Cod. elab.: 108GA201-GA01-Z-CL-002_C	Titolo: OPERE D'ARTE MAGGIORI- GALLERIE	Data: Ottobre 2011
Nome file: 108GA201-GA01-Z-CL -002_C.docx	ARTIFICIALI – GALLERIA ROVETELLO	Pagina 146 di 452
Relazione di calcolo		

PROGETTO ESECUTIVO

1889.25	0.010857	136.54	367.87	2992.65	8063.10	21.918
1899.30	0.010857	145.74	369.26	3030.78	7679.26	20.796
1909.35	0.010857	154.80	370.65	3048.82	7299.75	19.695
1919.40	0.010857	163.74	372.03	3057.97	6948.10	18.676
1929.45	0.010857	172.53	373.42	3066.09	6636.10	17.771
1939.50	0.010857	181.18	374.80	3064.87	6340.22	16.916
1949.55	0.010857	189.68	376.19	3055.08	6059.05	16.106
1959.60	0.010857	198.03	377.58	3046.35	5808.39	15.383
1969.65	0.010857	206.22	378.96	3038.53	5583.84	14.734
1979.70	0.010857	214.24	380.35	3029.91	5379.02	14.142
1989.75	0.010857	222.10	381.74	3011.54	5176.05	13.559
1999.80	0.010857	229.79	383.12	2995.03	4993.56	13.034
2009.85	0.010857	237.30	384.51	2980.13	4828.91	12.559
2019.90	0.010857	244.62	385.90	2966.64	4679.91	12.127
2029.95	0.010857	251.76	387.28	2954.41	4544.71	11.735
20310.00	0.010857	258.71	388.67	2943.28	4421.78	11.377
20410.05	0.010857	265.46	390.06	2932.06	4308.20	11.045
20510.10	0.010857	272.01	391.44	2915.30	4195.28	10.718
20610.15	0.010857	278.36	392.83	2900.07	4092.70	10.419
20710.20	0.010857	284.49	394.21	2886.22	3999.42	10.145
20810.25	0.010857	290.41	395.60	2873.62	3914.56	9.895
20910.30	0.010857	296.10	396.99	2862.16	3837.34	9.666
21010.35	0.010857	301.57	398.37	2851.73	3767.12	9.456
21110.40	0.010857	306.81	399.76	2842.26	3703.34	9.264
21210.45	0.010857	311.81	401.15	2833.67	3645.49	9.088
21310.50	0.010857	316.58	402.53	2825.91	3593.17	8.926
21410.55	0.010857	321.10	403.92	2818.90	3545.99	8.779
21510.60	0.010857	325.37	405.31	2812.62	3503.65	8.644
21610.65	0.010857	329.38	406.69	2807.01	3465.87	8.522
21710.70	0.010857	333.14	408.08	2802.02	3432.29	8.411
21810.75	0.010857	336.66	409.47	2797.61	3402.59	8.310
21910.80	0.010857	339.94	410.85	2793.74	3376.49	8.218
22010.85	0.010857	342.99	412.24	2790.36	3353.75	8.135
22110.90	0.010857	345.80	413.62	2787.45	3334.15	8.061
22210.95	0.010857	348.39	415.01	2784.98	3317.49	7.994
22311.00	0.010857	350.77	416.40	2782.92	3303.61	7.934

Cod. elab.: 108GA201-GA01-Z-CL-002_C	Titolo: OPERE D'ARTE MAGGIORI- GALLERIE	Data: Ottobre 2011
Nome file: 108GA201-GA01-Z-CL -002_C.docx	ARTIFICIALI – GALLERIA ROVETELLO Relazione di calcolo	Pagina 147 di 452

PROGETTO ESECUTIVO

22411.05	0.010857	352.93	417.78	2781.25	3292.36	7.881
22511.10	0.010857	354.88	419.17	2779.95	3283.61	7.834
22611.15	0.010857	356.62	420.56	2779.00	3277.23	7.793
22711.20	0.010857	358.17	421.94	2778.39	3273.12	7.757
22811.25	0.010857	359.52	423.33	2778.11	3271.19	7.727
22911.30	0.010857	360.68	424.72	2778.13	3271.36	7.702
23011.35	0.010857	361.66	426.10	2778.46	3273.55	7.683
23111.40	0.010857	362.46	427.49	2779.07	3277.69	7.667
23211.45	0.010857	363.08	428.87	2779.97	3283.74	7.657
23311.50	0.010857	363.53	430.26	2781.14	3291.64	7.650
23411.55	0.010857	363.82	431.65	2782.58	3301.35	7.648
23511.60	0.010857	363.95	433.03	2784.29	3312.83	7.650
23611.65	0.010857	363.92	434.42	2786.25	3326.04	7.656
23711.70	0.010857	363.74	435.81	2788.47	3340.97	7.666
23811.75	0.010857	363.41	437.19	2790.93	3357.59	7.680
23911.80	0.010857	362.94	438.58	2793.65	3375.88	7.697
24011.85	0.010857	362.33	439.97	2796.61	3395.83	7.718
24111.90	0.010857	361.59	441.35	2799.82	3417.43	7.743
24211.95	0.010857	360.72	442.74	2803.27	3440.66	7.771
24312.00	0.010857	359.73	444.13	2806.96	3465.53	7.803
24412.05	0.010857	358.61	445.51	2810.89	3492.04	7.838
24512.10	0.010857	357.38	446.90	2815.07	3520.18	7.877
24612.15	0.010857	356.04	448.28	2819.49	3549.96	7.919
24712.20	0.010857	354.59	449.67	2824.16	3581.40	7.964
24812.25	0.010857	353.04	451.06	2829.07	3614.49	8.013
24912.30	0.010857	351.40	452.44	2834.23	3649.25	8.066
25012.35	0.010857	349.65	453.83	2839.64	3685.69	8.121
25112.40	0.010857	347.82	455.22	2845.31	3723.84	8.180
25212.45	0.010857	345.90	456.60	2851.22	3763.70	8.243
25312.50	0.010857	343.90	457.99	2857.40	3805.30	8.309
25412.55	0.010857	341.83	459.38	2863.84	3848.65	8.378
25512.60	0.010857	339.68	460.76	2870.54	3893.79	8.451
25612.65	0.010857	337.46	462.15	2877.50	3940.73	8.527
25712.70	0.010857	335.17	463.53	2884.75	3989.50	8.607
25812.75	0.010857	332.83	464.92	2892.26	4040.14	8.690
25912.80	0.010857	330.42	466.31	2900.06	4092.69	8.777

<i>Cod. elab.:</i> 108GA201-GA01-Z-CL-002_C	<i>Titolo:</i> OPERE D'ARTE MAGGIORI- GALLERIE	<i>Data:</i> Ottobre 2011
<i>Nome file:</i> 108GA201-GA01-Z-CL -002_C.docx	ARTIFICIALI – GALLERIA ROVETELLO Relazione di calcolo	<i>Pagina</i> 148 di 452

PROGETTO ESECUTIVO

26012.85	0.010857	327.96	467.69	2908.16	4147.22	8.867
26112.90	0.010857	325.45	469.08	2916.56	4203.78	8.962
26212.95	0.010857	322.88	470.47	2925.27	4262.44	9.060
26313.00	0.010857	320.26	471.85	2934.30	4323.28	9.162
26413.05	0.010857	317.59	473.24	2939.52	4380.20	9.256
26513.10	0.010857	314.87	474.63	2944.84	4438.92	9.352
26613.15	0.010857	312.11	476.01	2950.33	4499.63	9.453
26713.20	0.010857	309.31	477.40	2956.01	4562.39	9.557
26813.25	0.010857	306.47	478.79	2961.88	4627.26	9.665
26913.30	0.010857	303.59	480.17	2967.95	4694.30	9.776
27013.35	0.010857	300.67	481.56	2974.22	4763.61	9.892
27113.40	0.010857	297.71	482.94	2980.70	4835.24	10.012
27213.45	0.010857	294.73	484.33	2987.40	4909.28	10.136
27313.50	0.010857	291.71	485.72	2994.33	4985.82	10.265
27413.55	0.010857	288.66	487.10	3001.49	5064.94	10.398
27513.60	0.010857	285.58	488.49	3008.89	5146.74	10.536
27613.65	0.010857	282.48	489.88	3016.54	5231.32	10.679
27713.70	0.010857	279.35	491.26	3024.46	5318.78	10.827
27813.75	0.010857	276.20	492.65	3032.43	5408.86	10.979
27913.80	0.010857	273.03	494.04	3035.34	5492.35	11.117
28013.85	0.010857	269.84	495.42	3038.34	5578.41	11.260
28113.90	0.010857	266.63	496.81	3041.43	5667.12	11.407
28213.95	0.010857	263.40	498.19	3044.61	5758.56	11.559
28314.00	0.010857	260.16	499.58	3047.90	5852.83	11.715
28414.05	0.010857	256.91	500.97	3051.28	5950.02	11.877
28514.10	0.010857	253.64	502.35	3054.77	6050.23	12.044
28614.15	0.010857	250.36	503.74	3058.37	6153.57	12.216
28714.20	0.010857	247.08	505.13	3062.08	6260.15	12.393
28814.25	0.010857	243.78	506.51	3065.91	6370.08	12.576
28914.30	0.010857	240.49	507.90	3069.86	6483.49	12.765
29014.35	0.010857	237.18	509.29	3067.39	6586.42	12.933
29114.40	0.010857	233.87	510.67	3064.64	6691.75	13.104
29214.45	0.010857	230.57	512.06	3061.83	6799.96	13.280
29314.50	0.010857	227.26	513.45	3058.93	6911.13	13.460
29414.55	0.010857	223.95	514.83	3055.96	7025.34	13.646
29514.60	0.010857	220.64	516.22	3052.90	7142.68	13.837

Cod. elab.: 108GA201-GA01-Z-CL-002_C	Titolo: OPERE D'ARTE MAGGIORI- GALLERIE	Data: Ottobre 2011
Nome file: 108GA201-GA01-Z-CL -002_C.docx	ARTIFICIALI – GALLERIA ROVETELLO Relazione di calcolo	Pagina 149 di 452

PROGETTO ESECUTIVO

29614.65	0.010857	217.34	517.60	3049.77	7263.24	14.032
29714.70	0.010857	214.04	518.99	3046.54	7387.11	14.234
29814.75	0.010857	210.75	520.38	3043.23	7514.39	14.440
29914.80	0.010857	207.46	521.76	3035.29	7633.79	14.631
30014.85	0.010857	204.18	523.15	3023.96	7747.89	14.810
30114.90	0.010857	200.91	524.54	3012.37	7864.53	14.993
30214.95	0.010857	197.66	525.92	3000.53	7983.76	15.180
30315.00	0.010857	194.41	527.31	2988.43	8105.60	15.372
30415.05	0.010857	191.18	528.70	2976.06	8230.12	15.567
30515.10	0.010857	187.96	530.08	2963.43	8357.34	15.766
30615.15	0.010857	184.76	531.47	2950.52	8487.33	15.970
30715.20	0.010857	181.57	532.86	2937.33	8620.11	16.177
30815.25	0.010857	178.40	534.24	2920.95	8747.04	16.373
30915.30	0.010857	175.25	535.63	2903.47	8873.96	16.567
31015.35	0.010857	172.12	537.01	2885.66	9003.23	16.765
31115.40	0.010857	169.01	538.40	2867.53	9134.84	16.967
31215.45	0.010857	165.92	539.79	2849.07	9268.83	17.171
31315.50	0.010857	162.85	541.17	2830.28	9405.19	17.379
31415.55	0.010857	159.81	542.56	2811.17	9543.93	17.591
31515.60	0.010857	156.79	543.95	2791.72	9685.06	17.805
31615.65	0.010857	153.80	545.33	2770.44	9823.25	18.013
31715.70	0.010857	150.83	546.72	2748.14	9961.06	18.220
31815.75	0.010857	147.89	548.11	2725.50	10100.90	18.429
31915.80	0.010857	144.98	549.49	2702.55	10242.74	18.640
32015.85	0.010857	142.10	550.88	2679.27	10386.57	18.855
32115.90	0.010857	139.25	552.26	2655.67	10532.35	19.071
32215.95	0.010857	136.43	553.65	2631.77	10680.05	19.290
32316.00	0.010857	133.64	555.04	2607.26	10828.42	19.509
32416.05	0.010857	130.89	556.42	2580.35	10969.60	19.714
32516.10	0.010857	128.16	557.81	2553.17	11112.20	19.921
32616.15	0.010857	125.48	559.20	2525.73	11256.14	20.129
32716.20	0.010857	122.82	560.58	2498.05	11401.37	20.338
32816.25	0.010857	120.21	561.97	2470.14	11547.81	20.549
32916.30	0.010857	117.63	563.36	2442.01	11695.40	20.760
33016.35	0.010857	115.09	564.74	2413.67	11844.05	20.972
33116.40	0.010857	112.58	566.13	2383.58	11985.75	21.171

<i>Cod. elab.:</i> 108GA201-GA01-Z-CL-002_C	<i>Titolo:</i> OPERE D'ARTE MAGGIORI- GALLERIE	<i>Data:</i> Ottobre 2011
<i>Nome file:</i> 108GA201-GA01-Z-CL -002_C.docx	ARTIFICIALI – GALLERIA ROVETELLO Relazione di calcolo	<i>Pagina</i> 150 di 452

PROGETTO ESECUTIVO

33216.45	0.010857	110.12	567.52	2352.60	12124.26	21.364
33316.50	0.010857	107.70	568.90	2321.52	12263.21	21.556
33416.55	0.010857	105.30	570.29	2290.14	12403.51	21.750
33516.60	0.010857	102.90	571.67	2258.24	12546.13	21.946
33616.65	0.010857	100.51	573.06	2225.82	12691.07	22.146
33716.70	0.010857	98.12	574.45	2192.88	12838.31	22.349
33816.75	0.010857	95.74	575.83	2159.20	12986.47	22.552
33916.80	0.010857	93.37	577.22	2122.83	13123.34	22.735
34016.85	0.010857	91.01	578.61	2085.99	13261.95	22.920
34116.90	0.010857	88.66	579.99	2048.71	13402.25	23.108
34216.95	0.010857	86.32	581.38	2010.98	13544.23	23.297
34317.00	0.010857	83.99	582.77	1972.81	13687.84	23.488
34417.05	0.010857	81.68	584.15	1934.22	13833.04	23.681
34517.10	0.010857	79.38	585.54	1895.22	13979.80	23.875
34617.15	0.010857	77.10	586.92	1854.89	14120.95	24.059
34717.20	0.010857	74.83	588.31	1813.25	14255.93	24.232
34817.25	0.010857	72.58	589.70	1771.32	14391.89	24.406
34917.30	0.010857	70.35	591.08	1729.10	14528.77	24.580
35017.35	0.010857	68.13	592.47	1686.62	14666.52	24.755
35117.40	0.010857	65.94	593.86	1643.89	14805.05	24.930
35217.45	0.010857	63.77	595.24	1600.94	14944.30	25.106
35317.50	0.010857	61.62	596.63	1557.80	15084.19	25.282
35417.55	0.010857	59.49	598.02	1508.01	15159.64	25.350
35517.60	0.010857	57.38	599.40	1454.86	15196.91	25.353
35617.65	0.010857	55.30	600.79	1402.27	15233.78	25.356
35717.70	0.010857	53.25	602.18	1350.28	15270.24	25.358
35817.75	0.010857	51.22	603.56	1298.90	15306.26	25.360
35917.80	0.010857	49.22	604.95	1248.16	15341.84	25.361
36017.85	0.010857	47.24	606.33	1198.09	15376.95	25.361
36117.90	0.010857	45.30	607.72	1148.71	15411.58	25.360
36217.95	0.010857	43.38	609.11	1100.05	15445.70	25.358
36318.00	0.010857	41.50	610.49	1052.13	15479.30	25.355
36418.05	0.010857	39.64	611.88	1004.97	15512.37	25.352
36518.10	0.010857	37.82	613.27	958.60	15544.89	25.348
36618.15	0.010857	36.03	614.65	913.04	15576.83	25.342
36718.20	0.010857	34.27	616.04	868.32	15608.19	25.336

Cod. elab.: 108GA201-GA01-Z-CL-002_C	Titolo: OPERE D'ARTE MAGGIORI- GALLERIE	Data: Ottobre 2011
Nome file: 108GA201-GA01-Z-CL -002_C.docx	ARTIFICIALI – GALLERIA ROVETELLO Relazione di calcolo	Pagina 151 di 452

PROGETTO ESECUTIVO

36818.25	0.010857	32.55	617.43	824.47	15638.94	25.329
36918.30	0.010857	30.86	618.81	781.50	15669.07	25.321
37018.35	0.010857	29.21	620.20	739.43	15698.56	25.312
37118.40	0.010857	27.60	621.58	698.31	15727.40	25.302
37218.45	0.010857	26.02	622.97	658.13	15755.57	25.291
37318.50	0.010857	24.48	624.36	618.94	15783.05	25.279
37418.55	0.010857	22.99	625.74	580.75	15809.83	25.266
37518.60	0.010857	21.53	627.13	543.58	15835.89	25.251
37618.65	0.010857	20.11	628.52	507.46	15861.22	25.236
37718.70	0.010857	18.73	629.90	472.41	15885.80	25.219
37818.75	0.010857	17.40	631.29	438.45	15909.61	25.202
37918.80	0.010857	16.11	632.68	405.60	15932.64	25.183
38018.85	0.010857	14.86	634.06	373.89	15954.88	25.163
38118.90	0.010857	13.66	635.45	343.33	15976.31	25.142
38218.95	0.010857	12.50	636.84	313.94	15996.92	25.119
38319.00	0.010857	11.39	638.22	285.75	16016.68	25.096
38419.05	0.010857	10.32	639.61	258.77	16035.60	25.071
38519.10	0.010857	9.30	640.99	233.03	16053.65	25.045
38619.15	0.010857	8.34	642.38	208.54	16070.82	25.018
38719.20	0.010857	7.42	643.77	185.32	16087.10	24.989
38819.25	0.010857	6.55	645.15	163.39	16102.48	24.959
38919.30	0.010857	5.73	646.54	142.77	16116.94	24.928
39019.35	0.010857	4.96	647.93	123.47	16130.47	24.896
39119.40	0.010857	4.24	649.31	105.52	16143.06	24.862
39219.45	0.010857	3.58	650.70	88.92	16154.70	24.827
39319.50	0.010857	2.97	652.09	73.69	16165.38	24.790
39419.55	0.010857	2.42	653.47	59.85	16175.08	24.753
39519.60	0.010857	1.92	654.86	47.42	16183.80	24.713
39619.65	0.010857	1.48	656.25	36.40	16191.53	24.673
39719.70	0.010857	1.09	657.63	26.81	16198.25	24.631
39819.75	0.010857	0.76	659.02	18.67	16203.96	24.588
39919.80	0.010857	0.49	660.40	11.98	16208.65	24.544
40019.85	0.010857	0.28	661.79	6.75	16212.32	24.498
40119.90	0.010857	0.12	663.18	3.01	16214.94	24.450
40219.95	0.010857	0.03	664.56	0.76	16216.52	24.402
40320.00	0.010857	0.00	665.95	0.00	-4248.53	6.380

Cod. elab.: 108GA201-GA01-Z-CL-002_C	Titolo: OPERE D'ARTE MAGGIORI- GALLERIE	Data: Ottobre 2011
Nome file: 108GA201-GA01-Z-CL -002_C.docx	ARTIFICIALI – GALLERIA ROVETELLO	Pagina 152 di 452
Relazione di calcolo		

PROGETTO ESECUTIVO

Fase n° 6 - [A1-M1]

n°	Y	A_f	M	N	M_u	N_u	CS
1	0.00	0.010857	0.00	0.00	0.00	0.00	1000.000
2	0.05	0.010857	0.00	1.39	0.12	16216.97	11697.139
3	0.10	0.010857	0.00	2.77	0.24	16216.88	5848.539
4	0.15	0.010857	0.00	4.16	0.36	16216.80	3899.005
5	0.20	0.010857	0.00	5.55	0.49	16216.71	2924.239
6	0.25	0.010857	0.00	6.93	0.61	16216.63	2339.379
7	0.30	0.010857	0.00	8.32	0.73	16216.54	1949.472
8	0.35	0.010857	0.00	9.70	0.85	16216.46	1670.967
9	0.40	0.010857	0.00	11.09	0.97	16216.37	1462.089
10	0.45	0.010857	0.00	12.48	1.09	16216.29	1299.628
11	0.50	0.010857	0.00	13.86	1.21	16216.20	1169.659
12	0.55	0.010857	0.00	15.25	1.37	16216.09	1063.319
13	0.55	0.010857	0.00	15.25	1.37	16216.09	1063.319
14	0.60	0.010857	0.00	16.64	1.61	16215.92	974.699
15	0.60	0.010857	0.00	16.64	1.61	16215.92	974.699
16	0.65	0.010857	0.00	18.02	1.90	16215.72	899.711
17	0.65	0.010857	0.00	18.02	1.90	16215.72	899.711
18	0.70	0.010857	0.00	19.41	2.23	16215.48	835.434
19	0.70	0.010857	0.00	19.41	2.23	16215.48	835.434
20	0.75	0.010857	0.00	20.80	2.60	16215.23	779.726
21	0.75	0.010857	0.00	20.80	2.60	16215.23	779.726
22	0.80	0.010857	0.00	22.18	3.00	16214.95	730.980
23	0.80	0.010857	0.00	22.18	3.00	16214.95	730.980
24	0.85	0.010857	0.00	23.57	3.42	16214.65	687.969
25	0.85	0.010857	0.00	23.57	3.42	16214.65	687.969
26	0.90	0.010857	0.01	24.96	3.86	16214.35	649.736
27	0.90	0.010857	0.01	24.96	3.86	16214.35	649.736
28	0.95	0.010857	0.01	26.34	4.31	16214.03	615.527
29	0.95	0.010857	0.01	26.34	4.31	16214.03	615.527
30	1.00	0.010857	0.01	27.73	4.78	16213.70	584.739
31	1.00	0.010857	0.01	27.73	4.78	16213.70	584.739
32	1.05	0.010857	0.01	29.11	5.26	16213.36	556.883

<i>Cod. elab.:</i> 108GA201-GA01-Z-CL-002_C	<i>Titolo:</i> OPERE D'ARTE MAGGIORI- GALLERIE	<i>Data:</i> Ottobre 2011
<i>Nome file:</i> 108GA201-GA01-Z-CL -002_C.docx	ARTIFICIALI – GALLERIA ROVETELLO	<i>Pagina</i> 153 di 452
Relazione di calcolo		

PROGETTO ESECUTIVO

33	1.05	0.010857	0.01	29.11	5.26	16213.36	556.883
34	1.10	0.010857	0.01	30.50	5.75	16213.02	531.559
35	1.10	0.010857	0.01	30.50	5.75	16213.02	531.559
36	1.15	0.010857	0.01	31.89	6.25	16212.67	508.437
37	1.15	0.010857	0.01	31.89	6.25	16212.67	508.437
38	1.20	0.010857	0.01	33.27	6.75	16212.32	487.241
39	1.20	0.010857	0.01	33.27	6.75	16212.32	487.241
40	1.25	0.010857	0.02	34.66	7.26	16211.96	467.741
41	1.25	0.010857	0.02	34.66	7.26	16211.96	467.741
42	1.30	0.010857	0.02	36.05	7.77	16211.60	449.741
43	1.30	0.010857	0.02	36.05	7.77	16211.60	449.741
44	1.35	0.010857	0.02	37.43	8.29	16211.24	433.074
45	1.35	0.010857	0.02	37.43	8.29	16211.24	433.074
46	1.40	0.010857	0.02	38.82	8.82	16210.87	417.598
47	1.40	0.010857	0.02	38.82	8.82	16210.87	417.598
48	1.45	0.010857	0.02	40.21	9.34	16210.50	403.189
49	1.45	0.010857	0.02	40.21	9.34	16210.50	403.189
50	1.50	0.010857	0.03	41.59	9.87	16210.13	389.740
51	1.50	0.010857	0.03	41.59	9.87	16210.13	389.740
52	1.55	0.010857	0.03	42.98	10.40	16209.76	377.159
53	1.55	0.010857	0.03	42.98	10.40	16209.76	377.159
54	1.60	0.010857	0.03	44.36	10.94	16209.38	365.365
55	1.60	0.010857	0.03	44.36	10.94	16209.38	365.365
56	1.65	0.010857	0.03	45.75	11.47	16209.01	354.285
57	1.65	0.010857	0.03	45.75	11.47	16209.01	354.285
58	1.70	0.010857	0.03	47.14	12.01	16208.63	343.857
59	1.70	0.010857	0.03	47.14	12.01	16208.63	343.857
60	1.75	0.010857	0.04	48.52	12.55	16208.25	334.024
61	1.75	0.010857	0.04	48.52	12.55	16208.25	334.024
62	1.80	0.010857	0.04	49.91	13.09	16207.87	324.738
63	1.80	0.010857	0.04	49.91	13.09	16207.87	324.738
64	1.85	0.010857	0.04	51.30	13.63	16207.49	315.954
65	1.85	0.010857	0.04	51.30	13.63	16207.49	315.954
66	1.90	0.010857	0.05	52.68	14.18	16207.11	307.632
67	1.90	0.010857	0.05	52.68	14.18	16207.11	307.632
68	1.95	0.010857	0.05	54.07	14.72	16206.73	299.737

Cod. elab.: 108GA201-GA01-Z-CL-002_C	Titolo: OPERE D'ARTE MAGGIORI- GALLERIE	Data: Ottobre 2011
Nome file: 108GA201-GA01-Z-CL -002_C.docx	ARTIFICIALI – GALLERIA ROVETELLO Relazione di calcolo	Pagina 154 di 452

PROGETTO ESECUTIVO

69	1.95	0.010857	0.05	54.07	14.72	16206.73	299.737
70	2.00	0.010857	0.05	55.46	15.26	16206.35	292.237
71	2.00	0.010857	0.05	55.46	15.26	16206.35	292.237
72	2.05	0.010857	0.06	56.84	15.81	16205.97	285.103
73	2.05	0.010857	0.06	56.84	15.81	16205.97	285.103
74	2.10	0.010857	0.06	58.23	16.35	16205.58	278.308
75	2.10	0.010857	0.06	58.23	16.35	16205.58	278.308
76	2.15	0.010857	0.06	59.62	16.90	16205.20	271.829
77	2.15	0.010857	0.06	59.62	16.90	16205.20	271.829
78	2.20	0.010857	0.07	61.00	17.45	16204.82	265.645
79	2.20	0.010857	0.07	61.00	17.45	16204.82	265.645
80	2.25	0.010857	0.07	62.39	17.99	16204.44	259.736
81	2.25	0.010857	0.07	62.39	17.99	16204.44	259.736
82	2.30	0.010857	0.07	63.77	18.54	16204.05	254.083
83	2.30	0.010857	0.07	63.77	18.54	16204.05	254.083
84	2.35	0.010857	0.08	65.16	19.08	16203.67	248.671
85	2.35	0.010857	0.08	65.16	19.08	16203.67	248.671
86	2.40	0.010857	0.08	66.55	19.63	16203.29	243.485
87	2.40	0.010857	0.08	66.55	19.63	16203.29	243.485
88	2.45	0.010857	0.08	67.93	20.17	16202.91	238.510
89	2.45	0.010857	0.08	67.93	20.17	16202.91	238.510
90	2.50	0.010857	0.09	69.32	20.72	16202.52	233.734
91	2.50	0.010857	0.09	156.84	9.16	16210.63	103.359
92	2.55	0.010857	-11.93	158.22	-1161.34	15402.72	97.347
93	2.55	0.010857	-11.93	158.22	-1161.34	15402.72	97.347
94	2.60	0.010857	-23.95	159.61	-2024.54	13493.19	84.538
95	2.60	0.010857	-23.95	159.61	-2024.54	13493.19	84.538
96	2.65	0.010857	-35.97	161.00	-2520.61	11283.02	70.082
97	2.65	0.010857	-35.97	161.00	-2520.61	11283.02	70.082
98	2.70	0.010857	-47.98	162.38	-2814.06	9522.95	58.645
99	2.70	0.010857	-47.98	162.38	-2814.06	9522.95	58.645
100	2.75	0.010857	-60.00	163.77	-2984.45	8145.67	49.739
101	2.75	0.010857	-60.00	163.77	-2984.45	8145.67	49.739
102	2.80	0.010857	-72.02	165.16	-3056.39	7008.83	42.438
103	2.80	0.010857	-72.02	165.16	-3056.39	7008.83	42.438
104	2.85	0.010857	-84.04	166.54	-3054.90	6054.01	36.351

<i>Cod. elab.:</i> 108GA201-GA01-Z-CL-002_C	<i>Titolo:</i> OPERE D'ARTE MAGGIORI- GALLERIE	<i>Data:</i> Ottobre 2011
<i>Nome file:</i> 108GA201-GA01-Z-CL -002_C.docx	ARTIFICIALI – GALLERIA ROVETELLO Relazione di calcolo	<i>Pagina</i> 155 di 452

PROGETTO ESECUTIVO

1052.85	0.010857	-84.04	166.54	-3054.90	6054.01	36.351
1062.90	0.010857	-96.06	167.93	-3021.09	5281.56	31.451
1072.90	0.010857	-96.06	167.93	-3021.09	5281.56	31.451
1082.95	0.010857	-108.07	169.32	-2963.25	4642.39	27.419
1092.95	0.010857	-108.07	169.32	-2963.25	4642.39	27.419
1103.00	0.010857	-120.09	170.70	-2905.62	4130.13	24.195
1113.00	0.010857	-120.09	170.70	-2905.62	4130.13	24.195
1123.05	0.010857	-132.10	172.09	-2842.14	3702.55	21.515
1133.05	0.010857	-132.10	172.09	-2842.14	3702.55	21.515
1143.10	0.010857	-144.06	173.47	-2791.52	3361.53	19.378
1153.10	0.010857	-144.06	173.47	-2791.52	3361.53	19.378
1163.15	0.010857	-155.94	174.86	-2738.25	3070.58	17.560
1173.15	0.010857	-155.94	174.86	-2738.25	3070.58	17.560
1183.20	0.010857	-167.71	176.25	-2687.30	2824.13	16.024
1193.20	0.010857	-167.71	176.25	-2687.30	2824.13	16.024
1203.25	0.010857	-179.36	177.63	-2645.01	2619.53	14.747
1213.25	0.010857	-179.36	177.63	-2645.01	2619.53	14.747
1223.30	0.010857	-190.88	179.02	-2609.39	2447.24	13.670
1233.30	0.010857	-190.88	179.02	-2609.39	2447.24	13.670
1243.35	0.010857	-202.26	180.41	-2579.03	2300.40	12.751
1253.35	0.010857	-202.26	180.41	-2579.03	2300.40	12.751
1263.40	0.010857	-213.49	181.79	-2552.88	2173.90	11.958
1273.40	0.010857	-213.49	181.79	-2552.88	2173.90	11.958
1283.45	0.010857	-224.56	183.18	-2518.88	2054.70	11.217
1293.45	0.010857	-224.56	183.18	-2518.88	2054.70	11.217
1303.50	0.010857	-235.48	184.57	-2488.17	1950.16	10.566
1313.50	0.010857	-235.48	184.57	-2488.17	1950.16	10.566
1323.55	0.010857	-246.25	185.95	-2461.27	1858.59	9.995
1333.55	0.010857	-246.25	185.95	-2461.27	1858.59	9.995
1343.60	0.010857	-256.86	187.34	-2437.54	1777.81	9.490
1353.60	0.010857	-256.86	187.34	-2437.54	1777.81	9.490
1363.65	0.010857	-267.31	188.73	-2416.46	1706.08	9.040
1373.65	0.010857	-267.31	188.73	-2416.46	1706.08	9.040
1383.70	0.010857	-277.59	190.11	-2397.65	1642.04	8.637
1393.70	0.010857	-277.59	190.11	-2397.65	1642.04	8.637
1403.75	0.010857	-287.72	191.50	-2380.77	1584.58	8.275

Cod. elab.: 108GA201-GA01-Z-CL-002_C	Titolo: OPERE D'ARTE MAGGIORI- GALLERIE	Data: Ottobre 2011
Nome file: 108GA201-GA01-Z-CL -002_C.docx	ARTIFICIALI – GALLERIA ROVETELLO	Pagina 156 di 452
Relazione di calcolo		

PROGETTO ESECUTIVO

1413.75	0.010857	-287.72	191.50	-2380.77	1584.58	8.275
1423.80	0.010857	-297.68	192.88	-2365.56	1532.81	7.947
1433.80	0.010857	-297.68	192.88	-2365.56	1532.81	7.947
1443.85	0.010857	-307.47	194.27	-2351.81	1485.98	7.649
1453.85	0.010857	-307.47	194.27	-2351.81	1485.98	7.649
1463.90	0.010857	-317.09	195.66	-2339.32	1443.47	7.378
1473.90	0.010857	-317.09	195.66	-2339.32	1443.47	7.378
1483.95	0.010857	-326.53	197.04	-2327.95	1404.78	7.129
1493.95	0.010857	-326.53	197.04	-2327.95	1404.78	7.129
1504.00	0.010857	-335.81	198.43	-2317.58	1369.46	6.901
1514.00	0.010857	-335.81	198.43	-2317.58	1369.46	6.901
1524.05	0.010857	-344.91	199.82	-2308.09	1337.15	6.692
1534.05	0.010857	-344.91	199.82	-2308.09	1337.15	6.692
1544.10	0.010857	-353.83	201.20	-2299.39	1307.54	6.499
1554.10	0.010857	-353.83	201.20	-2299.39	1307.54	6.499
1564.15	0.010857	-362.57	202.59	-2291.40	1280.35	6.320
1574.15	0.010857	-362.57	202.59	-2291.40	1280.35	6.320
1584.20	0.010857	-371.13	203.98	-2284.05	1255.34	6.154
1594.20	0.010857	-371.13	203.98	-2284.05	1255.34	6.154
1604.25	0.010857	-379.50	205.36	-2277.29	1232.32	6.001
1614.25	0.010857	-379.50	205.36	-2277.29	1232.32	6.001
1624.30	0.010857	-387.69	206.75	-2271.06	1211.10	5.858
1634.30	0.010857	-387.69	206.75	-2271.06	1211.10	5.858
1644.35	0.010857	-395.70	208.13	-2265.31	1191.54	5.725
1654.35	0.010857	-395.70	208.13	-2265.31	1191.54	5.725
1664.40	0.010857	-403.51	209.52	-2260.01	1173.50	5.601
1674.40	0.010857	-403.51	209.52	-2260.01	1173.50	5.601
1684.45	0.010857	-411.13	210.91	-2255.12	1156.86	5.485
1694.45	0.010857	-411.13	210.91	-2255.12	1156.86	5.485
1704.50	0.010857	-418.56	212.29	-2250.61	1141.51	5.377
1714.50	0.010857	-418.56	212.29	-2250.61	1141.51	5.377
1724.55	0.010857	-425.79	213.68	-2246.46	1127.37	5.276
1734.55	0.010857	-425.79	213.68	-2246.46	1127.37	5.276
1744.60	0.010857	-432.81	215.07	-2242.65	1114.39	5.182
1754.60	0.010857	-432.81	215.07	-2242.65	1114.39	5.182
1764.65	0.010857	-439.59	216.45	-2239.17	1102.55	5.094

Cod. elab.: 108GA201-GA01-Z-CL-002_C	Titolo: OPERE D'ARTE MAGGIORI- GALLERIE	Data: Ottobre 2011
Nome file: 108GA201-GA01-Z-CL -002_C.docx	ARTIFICIALI – GALLERIA ROVETELLO	Pagina 157 di 452
Relazione di calcolo		

PROGETTO ESECUTIVO

1774.65	0.010857	-439.59	216.45	-2239.17	1102.55	5.094
1784.70	0.010857	-446.13	217.84	-2236.02	1091.82	5.012
1794.70	0.010857	-446.13	217.84	-2236.02	1091.82	5.012
1804.75	0.010857	-452.40	219.23	-2233.18	1082.17	4.936
1814.75	0.010857	-452.40	219.23	-2233.18	1082.17	4.936
1824.80	0.010857	-458.40	220.61	-2230.65	1073.55	4.866
1834.80	0.010857	-458.40	220.61	-2230.65	1073.55	4.866
1844.85	0.010857	-464.12	222.00	-2228.40	1065.90	4.801
1854.85	0.010857	-464.12	222.00	-2228.40	1065.90	4.801
1864.90	0.010857	-469.57	223.39	-2226.43	1059.17	4.741
1874.90	0.010857	-469.57	223.39	-2226.43	1059.17	4.741
1884.95	0.010857	-474.73	224.77	-2224.71	1053.33	4.686
1894.95	0.010857	-474.73	224.77	-2224.71	1053.33	4.686
1905.00	0.010857	-479.62	226.16	-2223.24	1048.33	4.635
1915.00	0.010857	-479.62	324.57	-2390.51	1617.72	4.984
1925.05	0.010857	-497.74	325.96	-2371.51	1553.04	4.765
1935.05	0.010857	-497.74	325.96	-2371.51	1553.04	4.765
1945.10	0.010857	-515.58	327.35	-2354.41	1494.83	4.567
1955.10	0.010857	-515.58	327.35	-2354.41	1494.83	4.567
1965.15	0.010857	-533.13	328.73	-2338.95	1442.22	4.387
1975.15	0.010857	-533.13	328.73	-2338.95	1442.22	4.387
1985.20	0.010857	-550.39	330.12	-2324.93	1394.48	4.224
1995.20	0.010857	-550.39	330.12	-2324.93	1394.48	4.224
2005.25	0.010857	-567.35	331.51	-2312.16	1351.01	4.075
2015.25	0.010857	-567.35	331.51	-2312.16	1351.01	4.075
2025.30	0.010857	-584.02	332.89	-2300.49	1311.29	3.939
2035.30	0.010857	-584.02	332.89	-2300.49	1311.29	3.939
2045.35	0.010857	-600.38	334.28	-2289.80	1274.90	3.814
2055.35	0.010857	-600.38	334.28	-2289.80	1274.90	3.814
2065.40	0.010857	-616.45	335.66	-2279.98	1241.47	3.699
2075.40	0.010857	-616.45	335.66	-2279.98	1241.47	3.699
2085.45	0.010857	-632.22	337.05	-2270.94	1210.70	3.592
2095.45	0.010857	-632.22	337.05	-2270.94	1210.70	3.592
2105.50	0.010857	-647.68	338.44	-2262.60	1182.30	3.493
2115.50	0.010857	-647.68	338.44	-2262.60	1182.30	3.493
2125.55	0.010857	-662.83	339.82	-2254.89	1156.06	3.402

Cod. elab.: 108GA201-GA01-Z-CL-002_C	Titolo: OPERE D'ARTE MAGGIORI- GALLERIE	Data: Ottobre 2011
Nome file: 108GA201-GA01-Z-CL -002_C.docx	ARTIFICIALI – GALLERIA ROVETELLO	Pagina 158 di 452
Relazione di calcolo		

PROGETTO ESECUTIVO

213 5.55	0.010857	-662.83	339.82	-2254.89	1156.06	3.402
214 5.60	0.010857	-677.67	341.21	-2247.75	1131.76	3.317
215 5.60	0.010857	-677.67	341.21	-2247.75	1131.76	3.317
216 5.65	0.010857	-692.19	342.60	-2241.13	1109.24	3.238
217 5.65	0.010857	-692.19	342.60	-2241.13	1109.24	3.238
218 5.70	0.010857	-706.40	343.98	-2234.99	1088.33	3.164
219 5.70	0.010857	-706.40	343.98	-2234.99	1088.33	3.164
220 5.75	0.010857	-720.30	345.37	-2229.28	1068.90	3.095
221 5.75	0.010857	-720.30	345.37	-2229.28	1068.90	3.095
222 5.80	0.010857	-733.87	346.76	-2223.98	1050.83	3.030
223 5.80	0.010857	-733.87	346.76	-2223.98	1050.83	3.030
224 5.85	0.010857	-747.12	348.14	-2219.04	1034.02	2.970
225 5.85	0.010857	-747.12	348.14	-2219.04	1034.02	2.970
226 5.90	0.010857	-760.05	349.53	-2214.44	1018.37	2.914
227 5.90	0.010857	-760.05	349.53	-2214.44	1018.37	2.914
228 5.95	0.010857	-772.65	350.92	-2210.16	1003.79	2.860
229 5.95	0.010857	-772.65	350.92	-2210.16	1003.79	2.860
230 6.00	0.010857	-784.92	352.30	-2206.17	990.21	2.811
231 6.00	0.010857	-784.92	352.30	-2206.17	990.21	2.811
232 6.05	0.010857	-796.86	353.69	-2202.45	977.57	2.764
233 6.05	0.010857	-796.86	353.69	-2202.45	977.57	2.764
234 6.10	0.010857	-808.46	355.07	-2199.00	965.79	2.720
235 6.10	0.010857	-808.46	355.07	-2199.00	965.79	2.720
236 6.15	0.010857	-819.73	356.46	-2195.78	954.84	2.679
237 6.15	0.010857	-819.73	356.46	-2195.78	954.84	2.679
238 6.20	0.010857	-830.66	357.85	-2192.78	944.65	2.640
239 6.20	0.010857	-830.66	357.85	-2192.78	944.65	2.640
240 6.25	0.010857	-841.25	359.23	-2190.01	935.19	2.603
241 6.25	0.010857	-841.25	359.23	-2190.01	935.19	2.603
242 6.30	0.010857	-851.49	360.62	-2187.43	926.41	2.569
243 6.30	0.010857	-851.49	360.62	-2187.43	926.41	2.569
244 6.35	0.010857	-861.39	362.01	-2185.04	918.28	2.537
245 6.35	0.010857	-861.39	362.01	-2185.04	918.28	2.537
246 6.40	0.010857	-870.94	363.39	-2182.83	910.77	2.506
247 6.40	0.010857	-870.94	363.39	-2182.83	910.77	2.506
248 6.45	0.010857	-880.14	364.78	-2180.80	903.85	2.478

Cod. elab.: 108GA201-GA01-Z-CL-002_C	Titolo: OPERE D'ARTE MAGGIORI- GALLERIE	Data: Ottobre 2011
Nome file: 108GA201-GA01-Z-CL -002_C.docx	ARTIFICIALI – GALLERIA ROVETELLO Relazione di calcolo	Pagina 159 di 452

PROGETTO ESECUTIVO

249 6.45	0.010857	-880.14	364.78	-2180.80	903.85	2.478
250 6.50	0.010857	-888.98	366.17	-2178.93	897.49	2.451
251 6.50	0.010857	-888.98	366.17	-2178.93	897.49	2.451
252 6.55	0.010857	-897.47	367.55	-2177.22	891.66	2.426
253 6.55	0.010857	-897.47	367.55	-2177.22	891.66	2.426
254 6.60	0.010857	-905.61	368.94	-2175.66	886.35	2.402
255 6.65	0.010857	-913.38	370.32	-2174.24	881.53	2.380
256 6.70	0.010857	-920.79	371.71	-2172.97	877.20	2.360
257 6.75	0.010857	-927.84	373.10	-2171.83	873.32	2.341
258 6.80	0.010857	-934.52	374.48	-2170.83	869.90	2.323
259 6.85	0.010857	-940.84	375.87	-2169.95	866.91	2.306
260 6.90	0.010857	-946.78	377.26	-2169.19	864.35	2.291
261 6.95	0.010857	-952.34	378.64	-2168.56	862.20	2.277
262 7.00	0.010857	-957.54	380.03	-2168.05	860.46	2.264
263 7.05	0.010857	-962.35	381.42	-2167.66	859.13	2.252
264 7.10	0.010857	-966.78	382.80	-2167.38	858.18	2.242
265 7.15	0.010857	-970.84	384.19	-2167.22	857.63	2.232
266 7.20	0.010857	-974.50	385.58	-2167.17	857.47	2.224
267 7.25	0.010857	-977.78	386.96	-2167.24	857.69	2.216
268 7.30	0.010857	-980.67	388.35	-2167.42	858.30	2.210
269 7.35	0.010857	-983.17	389.73	-2167.71	859.29	2.205
270 7.40	0.010857	-985.28	391.12	-2168.11	860.66	2.201
271 7.45	0.010857	-986.99	392.51	-2168.63	862.42	2.197
272 7.50	0.010857	-988.30	393.89	-2169.26	864.57	2.195
273 7.55	0.010857	-989.21	395.28	-2170.01	867.11	2.194
274 7.60	0.010857	-989.72	396.67	-2170.87	870.05	2.193
275 7.65	0.010857	-989.83	398.05	-2171.85	873.40	2.194
276 7.70	0.010857	-989.52	399.44	-2172.96	877.15	2.196
277 7.75	0.010857	-988.81	400.83	-2174.18	881.33	2.199
278 7.80	0.010857	-987.69	402.21	-2175.54	885.94	2.203
279 7.85	0.010857	-986.15	403.60	-2177.02	890.98	2.208
280 7.90	0.010857	-984.20	404.99	-2178.63	896.48	2.214
281 7.95	0.010857	-981.82	406.37	-2180.39	902.45	2.221
282 8.00	0.010857	-979.03	407.76	-2182.28	908.90	2.229
283 8.05	0.010857	-975.82	409.14	-2184.32	915.85	2.238
284 8.10	0.010857	-972.18	410.53	-2186.52	923.32	2.249

Cod. elab.: 108GA201-GA01-Z-CL-002_C	Titolo: OPERE D'ARTE MAGGIORI- GALLERIE	Data: Ottobre 2011
Nome file: 108GA201-GA01-Z-CL -002_C.docx	ARTIFICIALI – GALLERIA ROVETELLO	Pagina 160 di 452
Relazione di calcolo		

PROGETTO ESECUTIVO

2858.15	0.010857	-968.11	411.92	-2188.87	931.34	2.261
2868.20	0.010857	-963.61	413.30	-2191.39	939.91	2.274
2878.25	0.010857	-958.68	414.69	-2194.09	949.08	2.289
2888.30	0.010857	-953.32	416.08	-2196.96	958.87	2.305
2898.35	0.010857	-947.52	417.46	-2200.03	969.30	2.322
2908.40	0.010857	-941.28	418.85	-2203.29	980.42	2.341
2918.45	0.010857	-934.60	420.24	-2206.77	992.25	2.361
2928.50	0.010857	-927.48	421.62	-2210.47	1004.85	2.383
2938.50	0.010857	-927.48	421.62	-2210.47	1004.85	2.383
2948.55	0.010857	-919.91	423.01	-2214.41	1018.27	2.407
2958.55	0.010857	-919.91	423.01	-2214.41	1018.27	2.407
2968.60	0.010857	-911.87	424.39	-2218.61	1032.57	2.433
2978.60	0.010857	-911.87	424.39	-2218.61	1032.57	2.433
2988.65	0.010857	-903.37	425.78	-2223.09	1047.80	2.461
2998.65	0.010857	-903.37	425.78	-2223.09	1047.80	2.461
3008.70	0.010857	-894.39	427.17	-2227.86	1064.04	2.491
3018.70	0.010857	-894.39	427.17	-2227.86	1064.04	2.491
3028.75	0.010857	-884.95	428.55	-2232.94	1081.35	2.523
3038.75	0.010857	-884.95	428.55	-2232.94	1081.35	2.523
3048.80	0.010857	-875.03	429.94	-2238.36	1099.81	2.558
3058.80	0.010857	-875.03	429.94	-2238.36	1099.81	2.558
3068.85	0.010857	-864.63	431.33	-2244.15	1119.50	2.595
3078.85	0.010857	-864.63	431.33	-2244.15	1119.50	2.595
3088.90	0.010857	-853.76	432.71	-2250.33	1140.54	2.636
3098.90	0.010857	-853.76	432.71	-2250.33	1140.54	2.636
3108.95	0.010857	-842.40	434.10	-2256.94	1163.03	2.679
3118.95	0.010857	-842.40	434.10	-2256.94	1163.03	2.679
3129.00	0.010857	-830.56	435.49	-2264.00	1187.08	2.726
3139.00	0.010857	-830.56	435.49	-2264.00	1187.08	2.726
3149.05	0.010857	-818.23	436.87	-2271.57	1212.85	2.776
3159.05	0.010857	-818.23	436.87	-2271.57	1212.85	2.776
3169.10	0.010857	-805.40	438.26	-2279.69	1240.49	2.830
3179.10	0.010857	-805.40	438.26	-2279.69	1240.49	2.830
3189.15	0.010857	-792.09	439.65	-2288.41	1270.17	2.889
3199.15	0.010857	-792.09	439.65	-2288.41	1270.17	2.889
3209.20	0.010857	-778.28	441.03	-2297.79	1302.10	2.952

Cod. elab.: 108GA201-GA01-Z-CL-002_C	Titolo: OPERE D'ARTE MAGGIORI- GALLERIE	Data: Ottobre 2011
Nome file: 108GA201-GA01-Z-CL -002_C.docx	ARTIFICIALI – GALLERIA ROVETELLO	Pagina 161 di 452
Relazione di calcolo		

PROGETTO ESECUTIVO

3219.20	0.010857	-778.28	441.03	-2297.79	1302.10	2.952
3229.25	0.010857	-764.14	442.42	-2307.79	1336.15	3.020
3239.30	0.010857	-749.84	443.80	-2318.37	1372.16	3.092
3249.35	0.010857	-735.39	445.19	-2329.57	1410.27	3.168
3259.40	0.010857	-720.80	446.58	-2341.43	1450.66	3.248
3269.45	0.010857	-706.06	447.96	-2354.02	1493.53	3.334
3279.50	0.010857	-691.18	449.35	-2367.41	1539.10	3.425
3289.55	0.010857	-676.17	450.74	-2381.66	1587.62	3.522
3299.60	0.010857	-661.04	452.12	-2396.86	1639.36	3.626
3309.65	0.010857	-645.78	453.51	-2413.11	1694.65	3.737
3319.70	0.010857	-630.40	454.90	-2430.49	1753.84	3.855
3329.75	0.010857	-614.91	456.28	-2449.15	1817.35	3.983
3339.80	0.010857	-599.31	457.67	-2469.21	1885.63	4.120
3349.85	0.010857	-583.61	459.05	-2490.84	1959.25	4.268
3359.90	0.010857	-567.80	460.44	-2514.21	2038.81	4.428
3369.95	0.010857	-551.91	461.83	-2539.54	2125.05	4.601
33710.00	0.010857	-535.92	463.21	-2561.10	2213.64	4.779
33810.05	0.010857	-519.85	464.60	-2580.18	2305.96	4.963
33910.10	0.010857	-503.70	465.99	-2600.90	2406.16	5.164
34010.15	0.010857	-487.47	467.37	-2623.45	2515.27	5.382
34110.20	0.010857	-471.18	468.76	-2648.10	2634.50	5.620
34210.25	0.010857	-454.82	470.15	-2675.14	2765.30	5.882
34310.30	0.010857	-438.40	471.53	-2704.93	2909.37	6.170
34410.35	0.010857	-421.92	472.92	-2737.89	3068.83	6.489
34510.40	0.010857	-405.39	474.31	-2774.36	3245.98	6.844
34610.45	0.010857	-388.82	475.69	-2801.26	3427.14	7.205
34710.50	0.010857	-372.20	477.08	-2831.22	3628.96	7.607
34810.55	0.010857	-355.55	478.46	-2864.80	3855.12	8.057
34910.60	0.010857	-338.87	479.85	-2902.67	4110.25	8.566
35010.65	0.010857	-322.16	481.24	-2940.65	4392.63	9.128
35110.70	0.010857	-305.44	482.62	-2967.46	4688.93	9.716
35210.75	0.010857	-288.69	484.01	-2997.99	5026.35	10.385
35310.80	0.010857	-271.93	485.40	-3032.58	5413.10	11.152
35410.85	0.010857	-255.17	486.78	-3046.46	5811.67	11.939
35510.90	0.010857	-238.41	488.17	-3062.45	6270.81	12.846
35610.95	0.010857	-221.64	489.56	-3062.74	6764.82	13.818

Cod. elab.: 108GA201-GA01-Z-CL-002_C	Titolo: OPERE D'ARTE MAGGIORI- GALLERIE	Data: Ottobre 2011
Nome file: 108GA201-GA01-Z-CL -002_C.docx	ARTIFICIALI – GALLERIA ROVETELLO	Pagina 162 di 452
	Relazione di calcolo	

PROGETTO ESECUTIVO

35711.00	0.010857	-204.89	490.94	-3048.68	7304.98	14.880
35811.05	0.010857	-188.15	492.33	-3010.97	7878.70	16.003
35911.10	0.010857	-171.43	493.71	-2949.73	8495.21	17.207
36011.15	0.010857	-154.73	495.10	-2863.65	9163.00	18.507
36111.20	0.010857	-138.06	496.49	-2756.14	9911.60	19.963
36211.25	0.010857	-121.42	497.87	-2620.95	10746.89	21.586
36311.30	0.010857	-104.82	499.26	-2448.42	11661.74	23.358
36411.35	0.010857	-88.26	500.65	-2232.32	12662.01	25.291
36511.40	0.010857	-71.75	502.03	-1962.12	13728.05	27.345
36611.45	0.010857	-55.30	503.42	-1630.89	14847.22	29.493
36711.50	0.010857	-38.90	504.81	-1185.58	15385.73	30.478
36811.55	0.010857	-22.56	506.19	-700.93	15725.56	31.066
36911.60	0.010857	-6.29	507.58	-199.34	16077.27	31.674
37011.65	0.010857	9.90	508.97	311.28	15998.78	31.434
37111.70	0.010857	26.02	510.35	798.32	15657.27	30.679
37211.75	0.010857	42.06	511.74	1260.19	15333.41	29.963
37311.80	0.010857	58.01	513.12	1665.66	14734.47	28.715
37411.85	0.010857	73.86	514.51	1967.74	13706.92	26.641
37511.90	0.010857	89.62	515.90	2213.92	12744.27	24.703
37611.95	0.010857	105.28	517.28	2412.13	11852.13	22.912
37712.00	0.010857	120.83	518.67	2569.12	11028.51	21.263
37812.05	0.010857	136.26	520.06	2695.37	10287.11	19.781
37912.10	0.010857	151.58	521.44	2799.33	9629.80	18.468
38012.15	0.010857	166.78	522.83	2881.52	9033.27	17.278
38112.20	0.010857	181.85	524.22	2949.11	8501.52	16.218
38212.25	0.010857	196.78	525.60	2998.13	8007.95	15.236
38312.30	0.010857	211.58	526.99	3041.17	7574.67	14.374
38412.35	0.010857	226.24	528.38	3053.22	7130.74	13.496
38512.40	0.010857	240.75	529.76	3063.36	6740.91	12.724
38612.45	0.010857	255.10	531.15	3066.42	6384.56	12.020
38712.50	0.010857	269.30	532.53	3054.41	6039.98	11.342
38812.55	0.010857	283.34	533.92	3043.82	5735.75	10.743
38912.60	0.010857	297.21	535.31	3034.40	5465.33	10.210
39012.65	0.010857	310.90	536.69	3013.96	5202.82	9.694
39112.70	0.010857	324.42	538.08	2992.25	4962.88	9.223
39212.75	0.010857	337.76	539.47	2972.82	4748.14	8.802

Cod. elab.: 108GA201-GA01-Z-CL-002_C	Titolo: OPERE D'ARTE MAGGIORI- GALLERIE	Data: Ottobre 2011
Nome file: 108GA201-GA01-Z-CL -002_C.docx	ARTIFICIALI – GALLERIA ROVETELLO Relazione di calcolo	Pagina 163 di 452

PROGETTO ESECUTIVO

39312.80	0.010857	350.91	540.85	2955.34	4554.98	8.422
39412.85	0.010857	363.88	542.24	2939.54	4380.44	8.078
39512.90	0.010857	376.64	543.63	2917.65	4211.15	7.746
39612.95	0.010857	389.22	545.01	2894.10	4052.55	7.436
39713.00	0.010857	401.59	546.40	2872.74	3908.62	7.153
39813.05	0.010857	413.76	547.78	2853.28	3777.53	6.896
39913.10	0.010857	425.72	549.17	2835.50	3657.76	6.661
40013.15	0.010857	437.47	550.56	2819.20	3548.00	6.444
40113.20	0.010857	449.00	551.94	2804.23	3447.16	6.245
40213.25	0.010857	460.32	553.33	2790.44	3354.29	6.062
40313.30	0.010857	471.41	554.72	2777.72	3268.58	5.892
40413.35	0.010857	482.28	556.10	2761.82	3184.57	5.727
40513.40	0.010857	492.92	557.49	2745.37	3104.99	5.570
40613.45	0.010857	503.33	558.88	2730.17	3031.48	5.424
40713.50	0.010857	513.50	560.26	2716.11	2963.46	5.289
40813.55	0.010857	523.43	561.65	2703.08	2900.45	5.164
40913.60	0.010857	533.12	563.04	2691.00	2842.02	5.048
41013.65	0.010857	542.56	564.42	2679.79	2787.78	4.939
41113.70	0.010857	551.75	565.81	2669.37	2737.40	4.838
41213.75	0.010857	560.68	567.19	2659.69	2690.58	4.744
41313.80	0.010857	569.36	568.58	2650.70	2647.06	4.656
41413.85	0.010857	577.78	569.97	2642.34	2606.61	4.573
41513.90	0.010857	585.93	571.35	2634.56	2569.02	4.496
41613.95	0.010857	593.81	572.74	2627.35	2534.10	4.425
41714.00	0.010857	601.43	574.13	2620.65	2501.69	4.357
41814.05	0.010857	608.76	575.51	2614.43	2471.64	4.295
41914.10	0.010857	615.82	576.90	2608.68	2443.82	4.236
42014.15	0.010857	622.59	578.29	2603.37	2418.10	4.182
42114.20	0.010857	629.08	579.67	2598.46	2394.39	4.131
42214.25	0.010857	635.27	581.06	2593.96	2372.58	4.083
42314.30	0.010857	641.18	582.44	2589.82	2352.60	4.039
42414.35	0.010857	646.78	583.83	2586.05	2334.36	3.998
42514.40	0.010857	652.09	585.22	2582.63	2317.79	3.961
42614.45	0.010857	657.09	586.60	2579.54	2302.85	3.926
42714.50	0.010857	661.78	587.99	2576.77	2289.47	3.894
42814.55	0.010857	666.16	589.38	2574.32	2277.62	3.864

Cod. elab.: 108GA201-GA01-Z-CL-002 C	Titolo: OPERE D'ARTE MAGGIORI- GALLERIE	Data: Ottobre 2011
Nome file: 108GA201-GA01-Z-CL -002_C.docx	ARTIFICIALI – GALLERIA ROVETELLO	Pagina 164 di 452
Relazione di calcolo		

PROGETTO ESECUTIVO

42914.60	0.010857	670.22	590.76	2572.18	2267.24	3.838
43014.65	0.010857	673.96	592.15	2570.33	2258.31	3.814
43114.70	0.010857	677.39	593.54	2568.78	2250.81	3.792
43214.75	0.010857	680.48	594.92	2567.52	2244.70	3.773
43314.80	0.010857	683.25	596.31	2566.54	2239.97	3.756
43414.85	0.010857	685.68	597.70	2565.85	2236.61	3.742
43514.90	0.010857	687.77	599.08	2565.43	2234.61	3.730
43614.95	0.010857	689.53	600.47	2565.30	2233.97	3.720
43715.00	0.010857	690.93	601.85	2565.45	2234.69	3.713
43815.05	0.010857	692.00	603.24	2565.88	2236.78	3.708
43915.10	0.010857	692.70	604.63	2566.60	2240.26	3.705
44015.15	0.010857	693.06	606.01	2567.61	2245.13	3.705
44115.20	0.010857	693.05	607.40	2568.91	2251.43	3.707
44215.25	0.010857	692.68	608.79	2570.51	2259.17	3.711
44315.30	0.010857	691.95	610.17	2572.42	2268.40	3.718
44415.35	0.010857	690.84	611.56	2574.64	2279.16	3.727
44515.40	0.010857	689.37	612.95	2577.19	2291.50	3.738
44615.45	0.010857	687.52	614.33	2580.07	2305.43	3.753
44715.50	0.010857	685.30	615.72	2583.29	2320.98	3.770
44815.55	0.010857	682.74	617.10	2586.84	2338.16	3.789
44915.60	0.010857	679.83	618.49	2590.73	2356.96	3.811
45015.65	0.010857	676.59	619.88	2594.96	2377.43	3.835
45115.70	0.010857	673.03	621.26	2599.54	2399.59	3.862
45215.75	0.010857	669.16	622.65	2604.47	2423.46	3.892
45315.80	0.010857	664.98	624.04	2609.77	2449.09	3.925
45415.85	0.010857	660.51	625.42	2615.44	2476.52	3.960
45515.90	0.010857	655.75	626.81	2621.49	2505.80	3.998
45615.95	0.010857	650.72	628.20	2627.94	2536.98	4.039
45716.00	0.010857	645.42	629.58	2634.79	2570.13	4.082
45816.05	0.010857	639.87	630.97	2642.07	2605.31	4.129
45916.10	0.010857	634.07	632.36	2649.78	2642.61	4.179
46016.15	0.010857	628.03	633.74	2657.94	2682.11	4.232
46116.20	0.010857	621.77	635.13	2666.58	2723.88	4.289
46216.25	0.010857	615.28	636.51	2675.71	2768.05	4.349
46316.30	0.010857	608.59	637.90	2685.36	2814.71	4.412
46416.35	0.010857	601.69	639.29	2695.54	2863.99	4.480

Cod. elab.: 108GA201-GA01-Z-CL-002_C	Titolo: OPERE D'ARTE MAGGIORI- GALLERIE	Data: Ottobre 2011
Nome file: 108GA201-GA01-Z-CL -002_C.docx	ARTIFICIALI – GALLERIA ROVETELLO Relazione di calcolo	Pagina 165 di 452

PROGETTO ESECUTIVO

46516.40	0.010857	594.60	640.67	2706.30	2916.01	4.551
46616.45	0.010857	587.33	642.06	2717.65	2970.91	4.627
46716.50	0.010857	579.88	643.45	2729.63	3028.86	4.707
46816.55	0.010857	572.20	644.83	2742.36	3090.47	4.793
46916.60	0.010857	564.24	646.22	2756.00	3156.42	4.884
47016.65	0.010857	556.01	647.61	2770.59	3227.00	4.983
47116.70	0.010857	547.53	648.99	2782.03	3297.59	5.081
47216.75	0.010857	538.79	650.38	2792.99	3371.42	5.184
47316.80	0.010857	529.83	651.77	2804.67	3450.13	5.294
47416.85	0.010857	520.65	653.15	2817.14	3534.09	5.411
47516.90	0.010857	511.26	654.54	2830.44	3623.67	5.536
47616.95	0.010857	501.67	655.92	2844.63	3719.30	5.670
47717.00	0.010857	491.90	657.31	2859.80	3821.46	5.814
47817.05	0.010857	481.96	658.70	2876.01	3930.67	5.967
47917.10	0.010857	471.86	660.08	2893.36	4047.53	6.132
48017.15	0.010857	461.61	661.47	2911.94	4172.71	6.308
48117.20	0.010857	451.23	662.86	2931.88	4306.96	6.498
48217.25	0.010857	440.72	664.24	2944.78	4438.33	6.682
48317.30	0.010857	430.10	665.63	2957.31	4576.81	6.876
48417.35	0.010857	419.38	667.02	2970.71	4724.90	7.084
48517.40	0.010857	408.57	668.40	2985.06	4883.46	7.306
48617.45	0.010857	397.68	669.79	3000.45	5053.46	7.545
48717.50	0.010857	386.73	671.17	3016.97	5236.00	7.801
48817.55	0.010857	375.72	672.56	3033.15	5429.49	8.073
48917.60	0.010857	364.67	673.95	3039.70	5617.64	8.335
49017.65	0.010857	353.59	675.33	3046.72	5818.99	8.616
49117.70	0.010857	342.49	676.72	3054.23	6034.77	8.918
49217.75	0.010857	331.38	678.11	3062.30	6266.36	9.241
49317.80	0.010857	320.28	679.49	3069.33	6511.83	9.583
49417.85	0.010857	309.18	680.88	3063.24	6745.81	9.907
49517.90	0.010857	298.12	682.27	3056.73	6995.61	10.253
49617.95	0.010857	287.08	683.65	3049.78	7262.63	10.623
49718.00	0.010857	276.10	685.04	3042.34	7548.41	11.019
49818.05	0.010857	265.18	686.43	3017.65	7811.41	11.380
49918.10	0.010857	254.32	687.81	2990.26	8087.22	11.758
50018.15	0.010857	243.54	689.20	2961.19	8379.83	12.159

Cod. elab.: 108GA201-GA01-Z-CL-002_C	Titolo: OPERE D'ARTE MAGGIORI- GALLERIE	Data: Ottobre 2011
Nome file: 108GA201-GA01-Z-CL -002_C.docx	ARTIFICIALI – GALLERIA ROVETELLO Relazione di calcolo	Pagina 166 di 452

PROGETTO ESECUTIVO

50118.20	0.010857	232.86	690.58	2929.21	8687.11	12.579
50218.25	0.010857	222.28	691.97	2887.57	8989.34	12.991
50318.30	0.010857	211.81	693.36	2843.59	9308.57	13.425
50418.35	0.010857	201.46	694.74	2797.12	9645.86	13.884
50518.40	0.010857	191.25	696.13	2743.89	9987.31	14.347
50618.45	0.010857	181.19	697.52	2686.48	10342.01	14.827
50718.50	0.010857	171.28	698.90	2626.05	10715.36	15.332
50818.55	0.010857	161.54	700.29	2557.79	11087.99	15.833
50918.60	0.010857	151.98	701.68	2484.70	11471.42	16.349
51018.65	0.010857	142.61	703.06	2408.24	11872.52	16.887
51118.70	0.010857	133.44	704.45	2322.28	12259.80	17.403
51218.75	0.010857	124.48	705.83	2232.70	12660.31	17.937
51318.80	0.010857	115.74	707.22	2138.18	13065.59	18.475
51418.85	0.010857	107.23	708.61	2035.55	13451.76	18.983
51518.90	0.010857	98.96	709.99	1930.22	13848.12	19.505
51618.95	0.010857	90.95	711.38	1819.87	14234.46	20.010
51719.00	0.010857	83.20	712.77	1705.05	14606.75	20.493
51819.05	0.010857	75.73	714.15	1588.83	14983.56	20.981
51919.10	0.010857	68.54	715.54	1455.61	15196.38	21.238
52019.15	0.010857	61.65	716.93	1315.16	15294.87	21.334
52119.20	0.010857	55.06	718.31	1179.66	15389.88	21.425
52219.25	0.010857	48.79	719.70	1049.51	15481.13	21.511
52319.30	0.010857	42.85	721.09	925.12	15568.36	21.590
52419.35	0.010857	37.25	722.47	806.88	15651.27	21.664
52519.40	0.010857	31.99	723.86	695.18	15729.59	21.730
52619.45	0.010857	27.10	725.24	590.43	15803.04	21.790
52719.50	0.010857	22.57	726.63	493.02	15871.35	21.842
52819.55	0.010857	18.43	728.02	403.32	15934.24	21.887
52919.60	0.010857	14.67	729.40	321.71	15991.47	21.924
53019.65	0.010857	11.32	730.79	248.56	16042.76	21.953
53119.70	0.010857	8.38	732.18	184.21	16087.88	21.973
53219.75	0.010857	5.87	733.56	128.99	16126.60	21.984
53319.80	0.010857	3.78	734.95	83.21	16158.70	21.986
53419.85	0.010857	2.15	736.34	47.17	16183.98	21.979
53519.90	0.010857	0.96	737.72	21.13	16202.24	21.963
53619.95	0.010857	0.24	739.11	5.33	16213.31	21.936

Cod. elab.: 108GA201-GA01-Z-CL-002 C	Titolo: OPERE D'ARTE MAGGIORI- GALLERIE	Data: Ottobre 2011
Nome file: 108GA201-GA01-Z-CL -002_C.docx	ARTIFICIALI – GALLERIA ROVETELLO	Pagina 167 di 452
	Relazione di calcolo	

PROGETTO ESECUTIVO

53720.00 0.010857 0.00 740.49 0.00 -4248.53 5.737

Fase n° 7 - [A1-M1]

n°	Y	A _f	M	N	M _u	N _u	CS
1	0.00	0.010857	0.00	0.00	0.00	0.00	1000.000
2	0.05	0.010857	0.00	1.39	0.28	16216.85	11697.056
3	0.10	0.010857	0.00	2.77	0.57	16216.65	5848.456
4	0.15	0.010857	0.00	4.16	0.85	16216.45	3898.923
5	0.20	0.010857	0.00	5.55	1.14	16216.25	2924.156
6	0.25	0.010857	0.00	6.93	1.42	16216.06	2339.296
7	0.30	0.010857	0.00	8.32	1.70	16215.86	1949.390
8	0.35	0.010857	0.00	9.70	1.98	16215.66	1670.885
9	0.40	0.010857	0.00	11.09	2.27	16215.46	1462.007
10	0.45	0.010857	0.00	12.48	2.55	16215.27	1299.546
11	0.50	0.010857	0.00	13.86	2.83	16215.07	1169.577
12	0.50	0.010857	0.00	13.86	2.83	16215.07	1169.577
13	0.55	0.010857	0.00	15.25	3.21	16214.80	1063.234
14	0.55	0.010857	0.00	15.25	3.21	16214.80	1063.234
15	0.60	0.010857	0.00	16.64	3.76	16214.41	974.608
16	0.60	0.010857	0.00	16.64	3.76	16214.41	974.608
17	0.65	0.010857	0.00	18.02	4.45	16213.93	899.612
18	0.65	0.010857	0.00	18.02	4.45	16213.93	899.612
19	0.70	0.010857	0.01	19.41	5.23	16213.38	835.325
20	0.70	0.010857	0.01	19.41	5.23	16213.38	835.325
21	0.75	0.010857	0.01	20.80	6.10	16212.78	779.608
22	0.75	0.010857	0.01	20.80	6.10	16212.78	779.608
23	0.80	0.010857	0.01	22.18	7.03	16212.13	730.853
24	0.80	0.010857	0.01	22.18	7.03	16212.13	730.853
25	0.85	0.010857	0.01	23.57	8.01	16211.44	687.832
26	0.85	0.010857	0.01	23.57	8.01	16211.44	687.832
27	0.90	0.010857	0.01	24.96	9.04	16210.71	649.591
28	0.90	0.010857	0.01	24.96	9.04	16210.71	649.591
29	0.95	0.010857	0.02	26.34	10.10	16209.97	615.373
30	0.95	0.010857	0.02	26.34	10.10	16209.97	615.373
31	1.00	0.010857	0.02	27.73	11.20	16209.20	584.577

Cod. elab.: 108GA201-GA01-Z-CL-002_C	Titolo: OPERE D'ARTE MAGGIORI- GALLERIE	Data: Ottobre 2011
Nome file: 108GA201-GA01-Z-CL -002_C.docx	ARTIFICIALI – GALLERIA ROVETELLO	Pagina 168 di 452
Relazione di calcolo		

PROGETTO ESECUTIVO

32	1.00	0.010857	0.02	27.73	11.20	16209.20	584.577
33	1.05	0.010857	0.02	29.11	12.32	16208.41	556.713
34	1.05	0.010857	0.02	29.11	12.32	16208.41	556.713
35	1.10	0.010857	0.03	30.50	13.46	16207.61	531.381
36	1.10	0.010857	0.03	30.50	13.46	16207.61	531.381
37	1.15	0.010857	0.03	31.89	14.63	16206.80	508.252
38	1.15	0.010857	0.03	31.89	14.63	16206.80	508.252
39	1.20	0.010857	0.03	33.27	15.80	16205.97	487.050
40	1.20	0.010857	0.03	33.27	15.80	16205.97	487.050
41	1.25	0.010857	0.04	34.66	17.00	16205.13	467.544
42	1.25	0.010857	0.04	34.66	17.00	16205.13	467.544
43	1.30	0.010857	0.04	36.05	18.20	16204.29	449.538
44	1.30	0.010857	0.04	36.05	18.20	16204.29	449.538
45	1.35	0.010857	0.04	37.43	19.42	16203.43	432.866
46	1.35	0.010857	0.04	37.43	19.42	16203.43	432.866
47	1.40	0.010857	0.05	38.82	20.64	16202.58	417.384
48	1.40	0.010857	0.05	38.82	20.64	16202.58	417.384
49	1.45	0.010857	0.05	40.21	21.88	16201.71	402.970
50	1.45	0.010857	0.05	40.21	21.88	16201.71	402.970
51	1.50	0.010857	0.06	41.59	23.12	16200.84	389.517
52	1.50	0.010857	0.06	41.59	23.12	16200.84	389.517
53	1.55	0.010857	0.06	42.98	24.36	16199.97	376.932
54	1.55	0.010857	0.06	42.98	24.36	16199.97	376.932
55	1.60	0.010857	0.07	44.36	25.62	16199.09	365.133
56	1.60	0.010857	0.07	44.36	25.62	16199.09	365.133
57	1.65	0.010857	0.08	45.75	26.87	16198.21	354.049
58	1.65	0.010857	0.08	45.75	26.87	16198.21	354.049
59	1.70	0.010857	0.08	47.14	28.13	16197.33	343.617
60	1.70	0.010857	0.08	47.14	28.13	16197.33	343.617
61	1.75	0.010857	0.09	48.52	29.40	16196.44	333.781
62	1.75	0.010857	0.09	48.52	29.40	16196.44	333.781
63	1.80	0.010857	0.09	49.91	30.66	16195.55	324.491
64	1.80	0.010857	0.09	49.91	30.66	16195.55	324.491
65	1.85	0.010857	0.10	51.30	31.93	16194.66	315.704
66	1.85	0.010857	0.10	51.30	31.93	16194.66	315.704
67	1.90	0.010857	0.11	52.68	33.20	16193.77	307.379

<i>Cod. elab.:</i> 108GA201-GA01-Z-CL-002_C	<i>Titolo:</i> OPERE D'ARTE MAGGIORI- GALLERIE	<i>Data:</i> Ottobre 2011
<i>Nome file:</i> 108GA201-GA01-Z-CL -002_C.docx	ARTIFICIALI – GALLERIA ROVETELLO Relazione di calcolo	<i>Pagina</i> 169 di 452

PROGETTO ESECUTIVO

68	1.90	0.010857	0.11	52.68	33.20	16193.77	307.379
69	1.95	0.010857	0.12	54.07	34.48	16192.88	299.481
70	1.95	0.010857	0.12	54.07	34.48	16192.88	299.481
71	2.00	0.010857	0.12	55.46	35.75	16191.98	291.978
72	2.00	0.010857	0.12	55.46	35.75	16191.98	291.978
73	2.05	0.010857	0.13	56.84	37.03	16191.09	284.841
74	2.05	0.010857	0.13	56.84	37.03	16191.09	284.841
75	2.10	0.010857	0.14	58.23	38.30	16190.19	278.044
76	2.10	0.010857	0.14	58.23	38.30	16190.19	278.044
77	2.15	0.010857	0.15	59.62	39.58	16189.30	271.562
78	2.15	0.010857	0.15	59.62	39.58	16189.30	271.562
79	2.20	0.010857	0.15	61.00	40.86	16188.40	265.376
80	2.20	0.010857	0.15	61.00	40.86	16188.40	265.376
81	2.25	0.010857	0.16	62.39	42.14	16187.50	259.464
82	2.25	0.010857	0.16	62.39	42.14	16187.50	259.464
83	2.30	0.010857	0.17	63.77	43.42	16186.61	253.810
84	2.30	0.010857	0.17	63.77	43.42	16186.61	253.810
85	2.35	0.010857	0.18	65.16	44.69	16185.71	248.396
86	2.35	0.010857	0.18	65.16	44.69	16185.71	248.396
87	2.40	0.010857	0.19	66.55	45.97	16184.82	243.207
88	2.40	0.010857	0.19	66.55	45.97	16184.82	243.207
89	2.45	0.010857	0.20	67.93	47.25	16183.92	238.231
90	2.45	0.010857	0.20	67.93	47.25	16183.92	238.231
91	2.50	0.010857	0.21	69.32	48.53	16183.02	233.453
92	2.50	0.010857	0.21	158.32	21.27	16202.13	102.339
93	2.55	0.010857	-12.01	159.71	-1158.31	15404.85	96.458
94	2.55	0.010857	-12.01	159.71	-1158.31	15404.85	96.458
95	2.60	0.010857	-24.22	161.09	-2027.44	13482.29	83.693
96	2.60	0.010857	-24.22	161.09	-2027.44	13482.29	83.693
97	2.65	0.010857	-36.44	162.48	-2525.18	11259.06	69.296
98	2.65	0.010857	-36.44	162.48	-2525.18	11259.06	69.296
99	2.70	0.010857	-48.66	163.86	-2818.36	9491.69	57.924
100	2.70	0.010857	-48.66	163.86	-2818.36	9491.69	57.924
101	2.75	0.010857	-60.87	165.25	-2987.87	8111.28	49.085
102	2.75	0.010857	-60.87	165.25	-2987.87	8111.28	49.085
103	2.80	0.010857	-73.09	166.64	-3057.38	6970.79	41.832

<i>Cod. elab.:</i> 108GA201-GA01-Z-CL-002_C	<i>Titolo:</i> OPERE D'ARTE MAGGIORI- GALLERIE	<i>Data:</i> Ottobre 2011
<i>Nome file:</i> 108GA201-GA01-Z-CL -002_C.docx	ARTIFICIALI – GALLERIA ROVETELLO Relazione di calcolo	<i>Pagina</i> 170 di 452

PROGETTO ESECUTIVO

1042.80	0.010857	-73.09	166.64	-3057.38	6970.79	41.832
1052.85	0.010857	-85.30	168.02	-3053.53	6014.70	35.797
1062.85	0.010857	-85.30	168.02	-3053.53	6014.70	35.797
1072.90	0.010857	-97.52	169.41	-3017.52	5242.16	30.944
1082.90	0.010857	-97.52	169.41	-3017.52	5242.16	30.944
1092.95	0.010857	-109.73	170.80	-2960.08	4607.35	26.976
1102.95	0.010857	-109.73	170.80	-2960.08	4607.35	26.976
1113.00	0.010857	-121.95	172.18	-2900.46	4095.33	23.785
1123.00	0.010857	-121.95	172.18	-2900.46	4095.33	23.785
1133.05	0.010857	-134.15	173.57	-2837.51	3671.34	21.152
1143.05	0.010857	-134.15	173.57	-2837.51	3671.34	21.152
1153.10	0.010857	-146.31	174.96	-2787.30	3333.12	19.051
1163.10	0.010857	-146.31	174.96	-2787.30	3333.12	19.051
1173.15	0.010857	-158.38	176.34	-2732.41	3042.30	17.252
1183.15	0.010857	-158.38	176.34	-2732.41	3042.30	17.252
1193.20	0.010857	-170.35	177.73	-2681.93	2798.12	15.744
1203.20	0.010857	-170.35	177.73	-2681.93	2798.12	15.744
1213.25	0.010857	-182.20	179.12	-2640.01	2595.34	14.490
1223.25	0.010857	-182.20	179.12	-2640.01	2595.34	14.490
1233.30	0.010857	-193.91	180.50	-2604.70	2424.53	13.432
1243.30	0.010857	-193.91	180.50	-2604.70	2424.53	13.432
1253.35	0.010857	-205.49	181.89	-2574.59	2278.92	12.529
1263.35	0.010857	-205.49	181.89	-2574.59	2278.92	12.529
1273.40	0.010857	-216.91	183.27	-2547.63	2152.58	11.745
1283.40	0.010857	-216.91	183.27	-2547.63	2152.58	11.745
1293.45	0.010857	-228.18	184.66	-2512.62	2033.40	11.012
1303.45	0.010857	-228.18	184.66	-2512.62	2033.40	11.012
1313.50	0.010857	-239.30	186.05	-2482.19	1929.83	10.373
1323.50	0.010857	-239.30	186.05	-2482.19	1929.83	10.373
1333.55	0.010857	-250.26	187.43	-2455.54	1839.09	9.812
1343.55	0.010857	-250.26	187.43	-2455.54	1839.09	9.812
1353.60	0.010857	-261.06	188.82	-2432.01	1759.00	9.316
1363.60	0.010857	-261.06	188.82	-2432.01	1759.00	9.316
1373.65	0.010857	-271.71	190.21	-2411.12	1687.87	8.874
1383.65	0.010857	-271.71	190.21	-2411.12	1687.87	8.874
1393.70	0.010857	-282.19	191.59	-2392.46	1624.35	8.478

<i>Cod. elab.:</i> 108GA201-GA01-Z-CL-002_C	<i>Titolo:</i> OPERE D'ARTE MAGGIORI- GALLERIE	<i>Data:</i> Ottobre 2011
<i>Nome file:</i> 108GA201-GA01-Z-CL -002_C.docx	ARTIFICIALI – GALLERIA ROVETELLO Relazione di calcolo	<i>Pagina</i> 171 di 452

PROGETTO ESECUTIVO

1403.70	0.010857	-282.19	191.59	-2392.46	1624.35	8.478
1413.75	0.010857	-292.51	192.98	-2375.71	1567.34	8.122
1423.75	0.010857	-292.51	192.98	-2375.71	1567.34	8.122
1433.80	0.010857	-302.66	194.37	-2360.61	1515.96	7.800
1443.80	0.010857	-302.66	194.37	-2360.61	1515.96	7.800
1453.85	0.010857	-312.65	195.75	-2346.95	1469.46	7.507
1463.85	0.010857	-312.65	195.75	-2346.95	1469.46	7.507
1473.90	0.010857	-322.46	197.14	-2334.55	1427.24	7.240
1483.90	0.010857	-322.46	197.14	-2334.55	1427.24	7.240
1493.95	0.010857	-332.10	198.52	-2323.26	1388.79	6.996
1503.95	0.010857	-332.10	198.52	-2323.26	1388.79	6.996
1514.00	0.010857	-341.57	199.91	-2312.95	1353.69	6.771
1524.00	0.010857	-341.57	199.91	-2312.95	1353.69	6.771
1534.05	0.010857	-350.87	201.30	-2303.51	1321.56	6.565
1544.05	0.010857	-350.87	201.30	-2303.51	1321.56	6.565
1554.10	0.010857	-359.98	202.68	-2294.85	1292.10	6.375
1564.10	0.010857	-359.98	202.68	-2294.85	1292.10	6.375
1574.15	0.010857	-368.91	204.07	-2286.90	1265.03	6.199
1584.15	0.010857	-368.91	204.07	-2286.90	1265.03	6.199
1594.20	0.010857	-377.67	205.46	-2279.58	1240.13	6.036
1604.20	0.010857	-377.67	205.46	-2279.58	1240.13	6.036
1614.25	0.010857	-386.24	206.84	-2272.84	1217.18	5.885
1624.25	0.010857	-386.24	206.84	-2272.84	1217.18	5.885
1634.30	0.010857	-394.62	208.23	-2266.63	1196.03	5.744
1644.30	0.010857	-394.62	208.23	-2266.63	1196.03	5.744
1654.35	0.010857	-402.82	209.62	-2260.90	1176.51	5.613
1664.35	0.010857	-402.82	209.62	-2260.90	1176.51	5.613
1674.40	0.010857	-410.83	211.00	-2255.60	1158.49	5.490
1684.40	0.010857	-410.83	211.00	-2255.60	1158.49	5.490
1694.45	0.010857	-418.64	212.39	-2250.72	1141.85	5.376
1704.45	0.010857	-418.64	212.39	-2250.72	1141.85	5.376
1714.50	0.010857	-426.26	213.78	-2246.20	1126.49	5.270
1724.50	0.010857	-426.26	213.78	-2246.20	1126.49	5.270
1734.55	0.010857	-433.69	215.16	-2242.04	1112.33	5.170
1744.55	0.010857	-433.69	215.16	-2242.04	1112.33	5.170
1754.60	0.010857	-440.90	216.55	-2238.22	1099.31	5.077

<i>Cod. elab.:</i> 108GA201-GA01-Z-CL-002_C	<i>Titolo:</i> OPERE D'ARTE MAGGIORI- GALLERIE	<i>Data:</i> Ottobre 2011
<i>Nome file:</i> 108GA201-GA01-Z-CL -002_C.docx	ARTIFICIALI – GALLERIA ROVETELLO Relazione di calcolo	<i>Pagina</i> 172 di 452

PROGETTO ESECUTIVO

1764.60	0.010857	-440.90	216.55	-2238.22	1099.31	5.077
1774.65	0.010857	-447.87	217.93	-2234.72	1087.41	4.990
1784.65	0.010857	-447.87	217.93	-2234.72	1087.41	4.990
1794.70	0.010857	-454.60	219.32	-2231.55	1076.60	4.909
1804.70	0.010857	-454.60	219.32	-2231.55	1076.60	4.909
1814.75	0.010857	-461.06	220.71	-2228.68	1066.85	4.834
1824.75	0.010857	-461.06	220.71	-2228.68	1066.85	4.834
1834.80	0.010857	-467.25	222.09	-2226.11	1058.11	4.764
1844.80	0.010857	-467.25	222.09	-2226.11	1058.11	4.764
1854.85	0.010857	-473.17	223.48	-2223.83	1050.32	4.700
1864.85	0.010857	-473.17	223.48	-2223.83	1050.32	4.700
1874.90	0.010857	-478.81	224.87	-2221.81	1043.44	4.640
1884.90	0.010857	-478.81	224.87	-2221.81	1043.44	4.640
1894.95	0.010857	-484.17	226.25	-2220.04	1037.42	4.585
1904.95	0.010857	-484.17	226.25	-2220.04	1037.42	4.585
1915.00	0.010857	-489.25	227.64	-2218.51	1032.24	4.535
1925.00	0.010857	-489.25	322.19	-2374.67	1563.81	4.854
1935.05	0.010857	-507.03	323.58	-2357.19	1504.30	4.649
1945.05	0.010857	-507.03	323.58	-2357.19	1504.30	4.649
1955.10	0.010857	-524.53	324.96	-2341.40	1450.57	4.464
1965.10	0.010857	-524.53	324.96	-2341.40	1450.57	4.464
1975.15	0.010857	-541.74	326.35	-2327.10	1401.86	4.296
1985.15	0.010857	-541.74	326.35	-2327.10	1401.86	4.296
1995.20	0.010857	-558.66	327.73	-2314.08	1357.55	4.142
2005.20	0.010857	-558.66	327.73	-2314.08	1357.55	4.142
2015.25	0.010857	-575.28	329.12	-2302.20	1317.10	4.002
2025.25	0.010857	-575.28	329.12	-2302.20	1317.10	4.002
2035.30	0.010857	-591.61	330.51	-2291.32	1280.07	3.873
2045.30	0.010857	-591.61	330.51	-2291.32	1280.07	3.873
2055.35	0.010857	-607.64	331.89	-2281.33	1246.07	3.754
2065.35	0.010857	-607.64	331.89	-2281.33	1246.07	3.754
2075.40	0.010857	-623.36	333.28	-2272.14	1214.80	3.645
2085.40	0.010857	-623.36	333.28	-2272.14	1214.80	3.645
2095.45	0.010857	-638.79	334.67	-2263.67	1185.96	3.544
2105.45	0.010857	-638.79	334.67	-2263.67	1185.96	3.544
2115.50	0.010857	-653.91	336.05	-2255.84	1159.31	3.450

Cod. elab.: 108GA201-GA01-Z-CL-002_C	Titolo: OPERE D'ARTE MAGGIORI- GALLERIE	Data: Ottobre 2011
Nome file: 108GA201-GA01-Z-CL -002_C.docx	ARTIFICIALI – GALLERIA ROVETELLO	Pagina 173 di 452
Relazione di calcolo		

PROGETTO ESECUTIVO

2125.50	0.010857	-653.91	336.05	-2255.84	1159.31	3.450
2135.55	0.010857	-668.72	337.44	-2248.60	1134.66	3.363
2145.55	0.010857	-668.72	337.44	-2248.60	1134.66	3.363
2155.60	0.010857	-683.22	338.83	-2241.89	1111.81	3.281
2165.60	0.010857	-683.22	338.83	-2241.89	1111.81	3.281
2175.65	0.010857	-697.40	340.21	-2235.66	1090.62	3.206
2185.65	0.010857	-697.40	340.21	-2235.66	1090.62	3.206
2195.70	0.010857	-711.28	341.60	-2229.88	1070.93	3.135
2205.70	0.010857	-711.28	341.60	-2229.88	1070.93	3.135
2215.75	0.010857	-724.83	342.99	-2224.50	1052.62	3.069
2225.75	0.010857	-724.83	342.99	-2224.50	1052.62	3.069
2235.80	0.010857	-738.06	344.37	-2219.50	1035.59	3.007
2245.80	0.010857	-738.06	344.37	-2219.50	1035.59	3.007
2255.85	0.010857	-750.97	345.76	-2214.84	1019.74	2.949
2265.85	0.010857	-750.97	345.76	-2214.84	1019.74	2.949
2275.90	0.010857	-763.56	347.14	-2210.51	1004.99	2.895
2285.90	0.010857	-763.56	347.14	-2210.51	1004.99	2.895
2295.95	0.010857	-775.82	348.53	-2206.47	991.24	2.844
2305.95	0.010857	-775.82	348.53	-2206.47	991.24	2.844
2316.00	0.010857	-787.75	349.92	-2202.71	978.45	2.796
2326.00	0.010857	-787.75	349.92	-2202.71	978.45	2.796
2336.05	0.010857	-799.34	351.30	-2199.21	966.53	2.751
2346.05	0.010857	-799.34	351.30	-2199.21	966.53	2.751
2356.10	0.010857	-810.61	352.69	-2195.96	955.45	2.709
2366.10	0.010857	-810.61	352.69	-2195.96	955.45	2.709
2376.15	0.010857	-821.53	354.08	-2192.93	945.14	2.669
2386.15	0.010857	-821.53	354.08	-2192.93	945.14	2.669
2396.20	0.010857	-832.12	355.46	-2190.12	935.57	2.632
2406.20	0.010857	-832.12	355.46	-2190.12	935.57	2.632
2416.25	0.010857	-842.37	356.85	-2187.51	926.69	2.597
2426.25	0.010857	-842.37	356.85	-2187.51	926.69	2.597
2436.30	0.010857	-852.27	358.24	-2185.09	918.47	2.564
2446.30	0.010857	-852.27	358.24	-2185.09	918.47	2.564
2456.35	0.010857	-861.82	359.62	-2182.86	910.86	2.533
2466.35	0.010857	-861.82	359.62	-2182.86	910.86	2.533
2476.40	0.010857	-871.03	361.01	-2180.80	903.86	2.504

<i>Cod. elab.:</i> 108GA201-GA01-Z-CL-002_C	<i>Titolo:</i> OPERE D'ARTE MAGGIORI- GALLERIE	<i>Data:</i> Ottobre 2011
<i>Nome file:</i> 108GA201-GA01-Z-CL -002_C.docx	ARTIFICIALI – GALLERIA ROVETELLO Relazione di calcolo	<i>Pagina</i> 174 di 452

PROGETTO ESECUTIVO

248 6.40	0.010857	-871.03	361.01	-2180.80	903.86	2.504
249 6.45	0.010857	-879.89	362.40	-2178.91	897.42	2.476
250 6.45	0.010857	-879.89	362.40	-2178.91	897.42	2.476
251 6.50	0.010857	-888.39	363.78	-2177.18	891.52	2.451
252 6.50	0.010857	-888.39	363.78	-2177.18	891.52	2.451
253 6.55	0.010857	-896.54	365.17	-2175.59	886.13	2.427
254 6.55	0.010857	-896.54	365.17	-2175.59	886.13	2.427
255 6.60	0.010857	-904.33	366.55	-2174.16	881.25	2.404
256 6.60	0.010857	-904.33	366.55	-2174.16	881.25	2.404
257 6.65	0.010857	-911.77	367.94	-2172.87	876.86	2.383
258 6.65	0.010857	-911.77	367.94	-2172.87	876.86	2.383
259 6.70	0.010857	-918.84	369.33	-2171.71	872.92	2.364
260 6.70	0.010857	-918.84	369.33	-2171.71	872.92	2.364
261 6.75	0.010857	-925.54	370.71	-2170.69	869.44	2.345
262 6.75	0.010857	-925.54	370.71	-2170.69	869.44	2.345
263 6.80	0.010857	-931.88	372.10	-2169.80	866.40	2.328
264 6.80	0.010857	-931.88	372.10	-2169.80	866.40	2.328
265 6.85	0.010857	-937.85	373.49	-2169.03	863.79	2.313
266 6.85	0.010857	-937.85	373.49	-2169.03	863.79	2.313
267 6.90	0.010857	-943.45	374.87	-2168.39	861.59	2.298
268 6.90	0.010857	-943.45	374.87	-2168.39	861.59	2.298
269 6.95	0.010857	-948.67	376.26	-2167.86	859.81	2.285
270 6.95	0.010857	-948.67	376.26	-2167.86	859.81	2.285
271 7.00	0.010857	-953.52	377.65	-2167.46	858.43	2.273
272 7.00	0.010857	-953.52	377.65	-2167.46	858.43	2.273
273 7.05	0.010857	-957.99	379.03	-2167.17	857.44	2.262
274 7.05	0.010857	-957.99	379.03	-2167.17	857.44	2.262
275 7.10	0.010857	-962.08	380.42	-2166.99	856.85	2.252
276 7.10	0.010857	-962.08	380.42	-2166.99	856.85	2.252
277 7.15	0.010857	-965.79	381.80	-2166.93	856.65	2.244
278 7.15	0.010857	-965.79	381.80	-2166.93	856.65	2.244
279 7.20	0.010857	-969.12	383.19	-2166.99	856.83	2.236
280 7.20	0.010857	-969.12	383.19	-2166.99	856.83	2.236
281 7.25	0.010857	-972.05	384.58	-2167.15	857.40	2.229
282 7.25	0.010857	-972.05	384.58	-2167.15	857.40	2.229
283 7.30	0.010857	-974.60	385.96	-2167.43	858.35	2.224

Cod. elab.: 108GA201-GA01-Z-CL-002_C	Titolo: OPERE D'ARTE MAGGIORI- GALLERIE	Data: Ottobre 2011
Nome file: 108GA201-GA01-Z-CL -002_C.docx	ARTIFICIALI – GALLERIA ROVETELLO Relazione di calcolo	Pagina 175 di 452

PROGETTO ESECUTIVO

2847.30	0.010857	-974.60	385.96	-2167.43	858.35	2.224
2857.35	0.010857	-976.75	387.35	-2167.83	859.69	2.219
2867.35	0.010857	-976.75	387.35	-2167.83	859.69	2.219
2877.40	0.010857	-978.52	388.74	-2168.33	861.42	2.216
2887.40	0.010857	-978.52	388.74	-2168.33	861.42	2.216
2897.45	0.010857	-979.88	390.12	-2168.95	863.53	2.213
2907.45	0.010857	-979.88	390.12	-2168.95	863.53	2.213
2917.50	0.010857	-980.85	391.51	-2169.69	866.04	2.212
2927.50	0.010857	-980.85	391.51	-2169.69	866.04	2.212
2937.55	0.010857	-981.42	392.90	-2170.55	868.94	2.212
2947.55	0.010857	-981.42	392.90	-2170.55	868.94	2.212
2957.60	0.010857	-981.58	394.28	-2171.52	872.26	2.212
2967.60	0.010857	-981.58	394.28	-2171.52	872.26	2.212
2977.65	0.010857	-981.34	395.67	-2172.61	875.98	2.214
2987.65	0.010857	-981.34	395.67	-2172.61	875.98	2.214
2997.70	0.010857	-980.70	397.06	-2173.83	880.12	2.217
3007.70	0.010857	-980.70	397.06	-2173.83	880.12	2.217
3017.75	0.010857	-979.64	398.44	-2175.17	884.69	2.220
3027.75	0.010857	-979.64	398.44	-2175.17	884.69	2.220
3037.80	0.010857	-978.17	399.83	-2176.64	889.70	2.225
3047.80	0.010857	-978.17	399.83	-2176.64	889.70	2.225
3057.85	0.010857	-976.29	401.21	-2178.25	895.17	2.231
3067.85	0.010857	-976.29	401.21	-2178.25	895.17	2.231
3077.90	0.010857	-973.99	402.60	-2179.99	901.10	2.238
3087.90	0.010857	-973.99	402.60	-2179.99	901.10	2.238
3097.95	0.010857	-971.27	403.99	-2181.88	907.52	2.246
3107.95	0.010857	-971.27	403.99	-2181.88	907.52	2.246
3118.00	0.010857	-968.14	405.37	-2183.91	914.44	2.256
3128.00	0.010857	-968.14	405.37	-2183.91	914.44	2.256
3138.05	0.010857	-964.57	406.76	-2186.09	921.87	2.266
3148.05	0.010857	-964.57	406.76	-2186.09	921.87	2.266
3158.10	0.010857	-960.59	408.15	-2188.44	929.85	2.278
3168.10	0.010857	-960.59	408.15	-2188.44	929.85	2.278
3178.15	0.010857	-956.18	409.53	-2190.94	938.39	2.291
3188.15	0.010857	-956.18	409.53	-2190.94	938.39	2.291
3198.20	0.010857	-951.33	410.92	-2193.63	947.52	2.306

Cod. elab.: 108GA201-GA01-Z-CL-002_C	Titolo: OPERE D'ARTE MAGGIORI- GALLERIE	Data: Ottobre 2011
Nome file: 108GA201-GA01-Z-CL -002_C.docx	ARTIFICIALI – GALLERIA ROVETELLO	Pagina 176 di 452
Relazione di calcolo		

PROGETTO ESECUTIVO

3208.20	0.010857	-951.33	410.92	-2193.63	947.52	2.306
3218.25	0.010857	-946.06	412.31	-2196.49	957.26	2.322
3228.25	0.010857	-946.06	412.31	-2196.49	957.26	2.322
3238.30	0.010857	-940.35	413.69	-2199.54	967.65	2.339
3248.30	0.010857	-940.35	413.69	-2199.54	967.65	2.339
3258.35	0.010857	-934.21	415.08	-2202.80	978.73	2.358
3268.35	0.010857	-934.21	415.08	-2202.80	978.73	2.358
3278.40	0.010857	-927.62	416.46	-2206.26	990.52	2.378
3288.40	0.010857	-927.62	416.46	-2206.26	990.52	2.378
3298.45	0.010857	-920.60	417.85	-2209.95	1003.08	2.401
3308.45	0.010857	-920.60	417.85	-2209.95	1003.08	2.401
3318.50	0.010857	-913.13	419.24	-2213.87	1016.43	2.424
3328.50	0.010857	-913.13	419.24	-2213.87	1016.43	2.424
3338.55	0.010857	-905.21	420.62	-2218.05	1030.66	2.450
3348.55	0.010857	-905.21	420.62	-2218.05	1030.66	2.450
3358.60	0.010857	-896.83	422.01	-2222.50	1045.82	2.478
3368.60	0.010857	-896.83	422.01	-2222.50	1045.82	2.478
3378.65	0.010857	-887.98	423.40	-2227.25	1061.98	2.508
3388.65	0.010857	-887.98	423.40	-2227.25	1061.98	2.508
3398.70	0.010857	-878.66	424.78	-2232.31	1079.20	2.541
3408.70	0.010857	-878.66	424.78	-2232.31	1079.20	2.541
3418.75	0.010857	-868.87	426.17	-2237.71	1097.57	2.575
3428.75	0.010857	-868.87	426.17	-2237.71	1097.57	2.575
3438.80	0.010857	-858.60	427.56	-2243.47	1117.17	2.613
3448.80	0.010857	-858.60	427.56	-2243.47	1117.17	2.613
3458.85	0.010857	-847.86	428.94	-2249.62	1138.11	2.653
3468.85	0.010857	-847.86	428.94	-2249.62	1138.11	2.653
3478.90	0.010857	-836.64	430.33	-2256.19	1160.48	2.697
3488.90	0.010857	-836.64	430.33	-2256.19	1160.48	2.697
3498.95	0.010857	-824.93	431.72	-2263.22	1184.42	2.744
3508.95	0.010857	-824.93	431.72	-2263.22	1184.42	2.744
3519.00	0.010857	-812.74	433.10	-2270.75	1210.06	2.794
3529.00	0.010857	-812.74	433.10	-2270.75	1210.06	2.794
3539.05	0.010857	-800.06	434.49	-2278.83	1237.56	2.848
3549.05	0.010857	-800.06	434.49	-2278.83	1237.56	2.848
3559.10	0.010857	-786.89	435.87	-2287.51	1267.09	2.907

Cod. elab.: 108GA201-GA01-Z-CL-002_C	Titolo: OPERE D'ARTE MAGGIORI- GALLERIE	Data: Ottobre 2011
Nome file: 108GA201-GA01-Z-CL -002_C.docx	ARTIFICIALI – GALLERIA ROVETELLO	Pagina 177 di 452
Relazione di calcolo		

PROGETTO ESECUTIVO

3569.10	0.010857	-786.89	435.87	-2287.51	1267.09	2.907
3579.15	0.010857	-773.23	437.26	-2296.84	1298.86	2.970
3589.15	0.010857	-773.23	437.26	-2296.84	1298.86	2.970
3599.20	0.010857	-759.07	438.65	-2306.89	1333.09	3.039
3609.20	0.010857	-759.07	438.65	-2306.89	1333.09	3.039
3619.25	0.010857	-744.59	440.03	-2317.64	1369.68	3.113
3629.30	0.010857	-729.94	441.42	-2329.03	1408.45	3.191
3639.35	0.010857	-715.14	442.81	-2341.12	1449.59	3.274
3649.40	0.010857	-700.19	444.19	-2353.96	1493.32	3.362
3659.45	0.010857	-685.11	445.58	-2367.64	1539.86	3.456
3669.50	0.010857	-669.88	446.97	-2382.22	1589.49	3.556
3679.55	0.010857	-654.52	448.35	-2397.79	1642.50	3.663
3689.60	0.010857	-639.04	449.74	-2414.45	1699.24	3.778
3699.65	0.010857	-623.43	451.12	-2432.33	1760.09	3.902
3709.70	0.010857	-607.70	452.51	-2451.55	1825.50	4.034
3719.75	0.010857	-591.86	453.90	-2472.25	1895.98	4.177
3729.80	0.010857	-575.91	455.28	-2494.62	1972.13	4.332
3739.85	0.010857	-559.85	456.67	-2518.86	2054.63	4.499
3749.90	0.010857	-543.70	458.06	-2545.20	2144.30	4.681
3759.95	0.010857	-527.45	459.44	-2565.45	2234.68	4.864
37610.00	0.010857	-511.11	460.83	-2585.37	2331.04	5.058
37710.05	0.010857	-494.68	462.22	-2607.05	2435.94	5.270
37810.10	0.010857	-478.18	463.60	-2630.74	2550.54	5.502
37910.15	0.010857	-461.60	464.99	-2656.73	2676.22	5.755
38010.20	0.010857	-444.95	466.38	-2685.34	2814.62	6.035
38110.25	0.010857	-428.24	467.76	-2717.00	2967.76	6.345
38210.30	0.010857	-411.46	469.15	-2752.20	3138.05	6.689
38310.35	0.010857	-394.63	470.53	-2785.55	3321.32	7.059
38410.40	0.010857	-377.75	471.92	-2814.47	3516.10	7.451
38510.45	0.010857	-360.82	473.31	-2846.87	3734.39	7.890
38610.50	0.010857	-343.85	474.69	-2883.43	3980.63	8.386
38710.55	0.010857	-326.85	476.08	-2924.98	4260.49	8.949
38810.60	0.010857	-309.81	477.47	-2955.30	4554.62	9.539
38910.65	0.010857	-292.75	478.85	-2984.99	4882.64	10.197
39010.70	0.010857	-275.66	480.24	-3019.11	5259.70	10.952
39110.75	0.010857	-258.56	481.63	-3041.36	5665.21	11.763

Cod. elab.: 108GA201-GA01-Z-CL-002_C	Titolo: OPERE D'ARTE MAGGIORI- GALLERIE	Data: Ottobre 2011
Nome file: 108GA201-GA01-Z-CL -002_C.docx	ARTIFICIALI – GALLERIA ROVETELLO	Pagina 178 di 452
Relazione di calcolo		

PROGETTO ESECUTIVO

39210.80	0.010857	-241.45	483.01	-3057.05	6115.57	12.661
39310.85	0.010857	-224.33	484.40	-3066.47	6621.51	13.670
39410.90	0.010857	-207.21	485.79	-3052.54	7156.49	14.732
39510.95	0.010857	-190.09	487.17	-3023.80	7749.52	15.907
39611.00	0.010857	-172.98	488.56	-2962.46	8367.03	17.126
39711.05	0.010857	-155.88	489.94	-2879.28	9049.56	18.471
39811.10	0.010857	-138.81	491.33	-2772.16	9812.62	19.972
39911.15	0.010857	-121.75	492.72	-2634.65	10662.27	21.640
40011.20	0.010857	-104.72	494.10	-2459.42	11604.05	23.485
40111.25	0.010857	-87.73	495.49	-2237.63	12638.23	25.507
40211.30	0.010857	-70.77	496.88	-1957.68	13744.76	27.662
40311.35	0.010857	-53.86	498.26	-1611.58	14909.82	29.924
40411.40	0.010857	-36.99	499.65	-1141.32	15416.76	30.855
40511.45	0.010857	-20.18	501.04	-635.09	15771.73	31.478
40611.50	0.010857	-3.42	502.42	-109.83	16140.04	32.124
40711.55	0.010857	13.28	503.81	419.56	15922.86	31.605
40811.60	0.010857	29.90	505.19	921.61	15570.82	30.821
40911.65	0.010857	46.46	506.58	1397.32	15237.25	30.079
41011.70	0.010857	62.93	507.97	1779.67	14364.83	28.279
41111.75	0.010857	79.33	509.35	2073.02	13310.78	26.133
41211.80	0.010857	95.63	510.74	2307.75	12324.77	24.131
41311.85	0.010857	111.85	512.13	2494.32	11420.95	22.301
41411.90	0.010857	127.96	513.51	2643.44	10607.93	20.658
41511.95	0.010857	143.98	514.90	2761.79	9876.72	19.182
41612.00	0.010857	159.89	516.29	2855.64	9221.08	17.860
41712.05	0.010857	175.68	517.67	2934.62	8647.31	16.704
41812.10	0.010857	191.36	519.06	2988.39	8105.97	15.617
41912.15	0.010857	206.91	520.45	3035.23	7634.42	14.669
42012.20	0.010857	222.34	521.83	3052.35	7163.80	13.728
42112.25	0.010857	237.64	523.22	3063.27	6744.54	12.890
42212.30	0.010857	252.80	524.60	3065.62	6361.81	12.127
42312.35	0.010857	267.81	525.99	3052.88	5995.95	11.399
42412.40	0.010857	282.68	527.38	3041.69	5674.68	10.760
42512.45	0.010857	297.40	528.76	3030.78	5388.66	10.191
42612.50	0.010857	311.95	530.15	3005.33	5107.39	9.634
42712.55	0.010857	326.35	531.54	2982.77	4858.12	9.140

Cod. elab.: 108GA201-GA01-Z-CL-002_C	Titolo: OPERE D'ARTE MAGGIORI- GALLERIE	Data: Ottobre 2011
Nome file: 108GA201-GA01-Z-CL -002_C.docx	ARTIFICIALI – GALLERIA ROVETELLO	Pagina 179 di 452
	Relazione di calcolo	

PROGETTO ESECUTIVO

42812.60	0.010857	340.58	532.92	2962.65	4635.83	8.699
42912.65	0.010857	354.64	534.31	2944.62	4436.49	8.303
43012.70	0.010857	368.51	535.70	2923.35	4249.57	7.933
43112.75	0.010857	382.21	537.08	2896.77	4070.52	7.579
43212.80	0.010857	395.73	538.47	2872.80	3909.06	7.260
43312.85	0.010857	409.05	539.85	2851.09	3762.83	6.970
43412.90	0.010857	422.18	541.24	2831.35	3629.86	6.707
43512.95	0.010857	435.11	542.63	2813.34	3508.52	6.466
43613.00	0.010857	447.84	544.01	2796.85	3397.45	6.245
43713.05	0.010857	460.37	545.40	2781.71	3295.48	6.042
43813.10	0.010857	472.69	546.79	2764.58	3197.92	5.849
43913.15	0.010857	484.80	548.17	2745.16	3103.99	5.662
44013.20	0.010857	496.70	549.56	2727.29	3017.54	5.491
44113.25	0.010857	508.38	550.95	2710.80	2937.80	5.332
44213.30	0.010857	519.83	552.33	2695.57	2864.11	5.185
44313.35	0.010857	531.06	553.72	2681.46	2795.87	5.049
44413.40	0.010857	542.06	555.11	2668.38	2732.59	4.923
44513.45	0.010857	552.83	556.49	2656.23	2673.83	4.805
44613.50	0.010857	563.36	557.88	2644.94	2619.19	4.695
44713.55	0.010857	573.65	559.26	2634.42	2568.34	4.592
44813.60	0.010857	583.70	560.65	2624.63	2520.97	4.497
44913.65	0.010857	593.51	562.04	2615.51	2476.82	4.407
45013.70	0.010857	603.06	563.42	2606.99	2435.66	4.323
45113.75	0.010857	612.36	564.81	2599.06	2397.25	4.244
45213.80	0.010857	621.40	566.20	2591.65	2361.43	4.171
45313.85	0.010857	630.18	567.58	2584.74	2328.01	4.102
45413.90	0.010857	638.69	568.97	2578.30	2296.85	4.037
45513.95	0.010857	646.93	570.36	2572.29	2267.81	3.976
45614.00	0.010857	654.91	571.74	2566.70	2240.76	3.919
45714.05	0.010857	662.61	573.13	2561.50	2215.60	3.866
45814.10	0.010857	670.02	574.51	2556.67	2192.23	3.816
45914.15	0.010857	677.16	575.90	2552.19	2170.55	3.769
46014.20	0.010857	684.01	577.29	2546.68	2149.34	3.723
46114.25	0.010857	690.57	578.67	2540.72	2129.04	3.679
46214.30	0.010857	696.83	580.06	2535.24	2110.39	3.638
46314.35	0.010857	702.80	581.45	2530.22	2093.33	3.600

Cod. elab.: 108GA201-GA01-Z-CL-002_C	Titolo: OPERE D'ARTE MAGGIORI- GALLERIE	Data: Ottobre 2011
Nome file: 108GA201-GA01-Z-CL -002_C.docx	ARTIFICIALI – GALLERIA ROVETELLO Relazione di calcolo	Pagina 180 di 452

PROGETTO ESECUTIVO

46414.40	0.010857	708.47	582.83	2525.66	2077.78	3.565
46514.45	0.010857	713.83	584.22	2521.52	2063.69	3.532
46614.50	0.010857	718.88	585.61	2517.79	2051.01	3.502
46714.55	0.010857	723.63	586.99	2514.47	2039.69	3.475
46814.60	0.010857	728.05	588.38	2511.54	2029.71	3.450
46914.65	0.010857	732.16	589.77	2508.98	2021.02	3.427
47014.70	0.010857	735.94	591.15	2506.80	2013.60	3.406
47114.75	0.010857	739.40	592.54	2504.99	2007.43	3.388
47214.80	0.010857	742.53	593.92	2503.54	2002.49	3.372
47314.85	0.010857	745.33	595.31	2502.45	1998.77	3.358
47414.90	0.010857	747.78	596.70	2501.70	1996.24	3.345
47514.95	0.010857	749.90	598.08	2501.32	1994.93	3.336
47615.00	0.010857	751.67	599.47	2501.28	1994.81	3.328
47715.05	0.010857	753.10	600.86	2501.60	1995.89	3.322
47815.10	0.010857	754.17	602.24	2502.28	1998.20	3.318
47915.15	0.010857	754.89	603.63	2503.31	2001.72	3.316
48015.20	0.010857	755.25	605.02	2504.71	2006.49	3.316
48115.25	0.010857	755.24	606.40	2506.49	2012.52	3.319
48215.30	0.010857	754.87	607.79	2508.64	2019.85	3.323
48315.35	0.010857	754.13	609.18	2511.18	2028.50	3.330
48415.40	0.010857	753.01	610.56	2514.12	2038.51	3.339
48515.45	0.010857	751.52	611.95	2517.47	2049.92	3.350
48615.50	0.010857	749.65	613.33	2521.25	2062.79	3.363
48715.55	0.010857	747.39	614.72	2525.48	2077.17	3.379
48815.60	0.010857	744.75	616.11	2530.16	2093.12	3.397
48915.65	0.010857	741.72	617.49	2535.33	2110.70	3.418
49015.70	0.010857	738.31	618.88	2540.98	2129.94	3.442
49115.75	0.010857	734.54	620.27	2547.12	2150.86	3.468
49215.80	0.010857	730.42	621.65	2552.59	2172.49	3.495
49315.85	0.010857	725.95	623.04	2557.17	2194.67	3.523
49415.90	0.010857	721.15	624.43	2562.09	2218.44	3.553
49515.95	0.010857	716.03	625.81	2567.34	2243.86	3.586
49616.00	0.010857	710.60	627.20	2572.95	2270.97	3.621
49716.05	0.010857	704.87	628.58	2578.91	2299.81	3.659
49816.10	0.010857	698.85	629.97	2585.25	2330.46	3.699
49916.15	0.010857	692.55	631.36	2591.97	2362.96	3.743

Cod. elab.: 108GA201-GA01-Z-CL-002 C	Titolo: OPERE D'ARTE MAGGIORI- GALLERIE	Data: Ottobre 2011
Nome file: 108GA201-GA01-Z-CL -002_C.docx	ARTIFICIALI – GALLERIA ROVETELLO Relazione di calcolo	Pagina 181 di 452

PROGETTO ESECUTIVO

50016.20	0.010857	685.98	632.74	2599.09	2397.40	3.789
50116.25	0.010857	679.15	634.13	2606.62	2433.84	3.838
50216.30	0.010857	672.07	635.52	2614.59	2472.38	3.890
50316.35	0.010857	664.75	636.90	2623.01	2513.11	3.946
50416.40	0.010857	657.21	638.29	2631.90	2556.12	4.005
50516.45	0.010857	649.45	639.68	2641.29	2601.53	4.067
50616.50	0.010857	641.48	641.06	2651.20	2649.46	4.133
50716.55	0.010857	633.24	642.45	2661.73	2700.43	4.203
50816.60	0.010857	624.68	643.84	2673.01	2754.99	4.279
50916.65	0.010857	615.80	645.22	2685.08	2813.37	4.360
51016.70	0.010857	606.62	646.61	2697.99	2875.83	4.448
51116.75	0.010857	597.16	647.99	2711.80	2942.64	4.541
51216.80	0.010857	587.43	649.38	2726.58	3014.12	4.642
51316.85	0.010857	577.44	650.77	2742.40	3090.63	4.749
51416.90	0.010857	567.21	652.15	2759.33	3172.54	4.865
51516.95	0.010857	556.75	653.54	2776.28	3258.91	4.987
51617.00	0.010857	546.08	654.93	2789.06	3344.99	5.107
51717.05	0.010857	535.20	656.31	2802.71	3436.92	5.237
51817.10	0.010857	524.14	657.70	2817.30	3535.18	5.375
51917.15	0.010857	512.90	659.09	2832.91	3640.31	5.523
52017.20	0.010857	501.50	660.47	2849.62	3752.89	5.682
52117.25	0.010857	489.96	661.86	2867.54	3873.61	5.853
52217.30	0.010857	478.28	663.24	2886.78	4003.20	6.036
52317.35	0.010857	466.48	664.63	2907.46	4142.53	6.233
52417.40	0.010857	454.57	666.02	2929.74	4292.56	6.445
52517.45	0.010857	442.56	667.40	2945.05	4441.25	6.655
52617.50	0.010857	430.48	668.79	2959.17	4597.37	6.874
52717.55	0.010857	418.32	670.18	2974.35	4765.05	7.110
52817.60	0.010857	406.12	671.56	2990.67	4945.46	7.364
52917.65	0.010857	393.86	672.95	3008.27	5139.88	7.638
53017.70	0.010857	381.58	674.34	3027.26	5349.81	7.933
53117.75	0.010857	369.28	675.72	3037.64	5558.32	8.226
53217.80	0.010857	356.98	677.11	3045.22	5776.05	8.530
53317.85	0.010857	344.69	678.50	3053.38	6010.37	8.858
53417.90	0.010857	332.42	679.88	3062.18	6263.00	9.212
53517.95	0.010857	320.18	681.27	3068.86	6529.85	9.585

Cod. elab.: 108GA201-GA01-Z-CL-002_C	Titolo: OPERE D'ARTE MAGGIORI- GALLERIE	Data: Ottobre 2011
Nome file: 108GA201-GA01-Z-CL -002_C.docx	ARTIFICIALI – GALLERIA ROVETELLO Relazione di calcolo	Pagina 182 di 452

PROGETTO ESECUTIVO

53618.00	0.010857	307.99	682.65	3062.16	6787.29	9.942
53718.05	0.010857	295.85	684.04	3054.97	7063.34	10.326
53818.10	0.010857	283.79	685.43	3047.25	7359.79	10.738
53918.15	0.010857	271.82	686.81	3032.47	7662.24	11.156
54018.20	0.010857	259.94	688.20	3003.66	7952.30	11.555
54118.25	0.010857	248.17	689.59	2972.99	8261.02	11.980
54218.30	0.010857	236.52	690.97	2940.33	8589.87	12.432
54318.35	0.010857	225.01	692.36	2897.65	8916.21	12.878
54418.40	0.010857	213.64	693.75	2850.70	9256.99	13.343
54518.45	0.010857	202.43	695.13	2800.93	9618.21	13.837
54618.50	0.010857	191.39	696.52	2744.06	9986.25	14.337
54718.55	0.010857	180.54	697.90	2682.18	10368.56	14.857
54818.60	0.010857	169.88	699.29	2616.86	10772.16	15.404
54918.65	0.010857	159.43	700.68	2541.87	11171.52	15.944
55018.70	0.010857	149.19	702.06	2462.51	11587.85	16.505
55118.75	0.010857	139.19	703.45	2377.26	12014.02	17.079
55218.80	0.010857	129.44	704.84	2283.37	12433.74	17.641
55318.85	0.010857	119.94	706.22	2185.77	12870.13	18.224
55418.90	0.010857	110.71	707.61	2079.01	13288.22	18.779
55518.95	0.010857	101.76	709.00	1967.45	13708.00	19.334
55619.00	0.010857	93.10	710.38	1851.93	14130.52	19.891
55719.05	0.010857	84.75	711.77	1729.70	14526.83	20.409
55819.10	0.010857	76.71	713.16	1605.85	14928.38	20.933
55919.15	0.010857	69.01	714.54	1466.86	15188.50	21.256
56019.20	0.010857	61.64	715.93	1316.82	15293.70	21.362
56119.25	0.010857	54.63	717.31	1172.48	15394.91	21.462
56219.30	0.010857	47.98	718.70	1034.30	15491.80	21.555
56319.35	0.010857	41.71	720.09	902.77	15584.03	21.642
56419.40	0.010857	35.83	721.47	778.34	15671.28	21.721
56519.45	0.010857	30.35	722.86	661.50	15753.21	21.793
56619.50	0.010857	25.29	724.25	552.70	15829.50	21.857
56719.55	0.010857	20.65	725.63	452.41	15899.82	21.912
56819.60	0.010857	16.44	727.02	361.07	15963.87	21.958
56919.65	0.010857	12.69	728.41	279.10	16021.34	21.995
57019.70	0.010857	9.40	729.79	206.94	16071.95	22.023
57119.75	0.010857	6.58	731.18	144.96	16115.40	22.040

Cod. elab.: 108GA201-GA01-Z-CL-002_C	Titolo: OPERE D'ARTE MAGGIORI- GALLERIE	Data: Ottobre 2011
Nome file: 108GA201-GA01-Z-CL -002_C.docx	ARTIFICIALI – GALLERIA ROVETELLO	Pagina 183 di 452
	Relazione di calcolo	

PROGETTO ESECUTIVO

57219.80	0.010857	4.24	732.57	93.55	16151.46	22.048
57319.85	0.010857	2.41	733.95	53.04	16179.86	22.045
57419.90	0.010857	1.08	735.34	23.77	16200.39	22.031
57519.95	0.010857	0.27	736.72	6.00	16212.84	22.007
57620.00	0.010857	0.00	738.11	0.00	-4248.53	5.756

Fase n° 1 - [A2-M2]

n°	Y	A _f	M	N	M _u	N _u	CS
1	0.00	0.010857	0.00	0.00	0.00	0.00	1000.000
2	0.05	0.010857	0.00	1.39	0.00	-4248.53	3064.420
3	0.10	0.010857	0.00	2.77	13.60	16207.51	5845.160
4	0.15	0.010857	0.01	4.16	27.09	16198.06	3894.500
5	0.20	0.010857	0.01	5.55	40.46	16188.68	2919.185
6	0.25	0.010857	0.02	6.93	53.70	16179.39	2334.008
7	0.30	0.010857	0.03	8.32	66.83	16170.19	1943.900
8	0.35	0.010857	0.05	9.70	79.85	16161.06	1665.260
9	0.40	0.010857	0.06	11.09	92.74	16152.02	1456.287
10	0.45	0.010857	0.08	12.48	105.52	16143.06	1293.759
11	0.50	0.010857	0.10	13.86	118.18	16134.18	1163.743
12	0.55	0.010857	0.13	15.25	135.17	16122.27	1057.167
13	0.60	0.010857	0.16	16.64	159.31	16105.34	968.052
14	0.65	0.010857	0.21	18.02	188.79	16084.67	892.440
15	0.70	0.010857	0.27	19.41	222.31	16061.17	827.483
16	0.75	0.010857	0.34	20.80	258.92	16035.50	771.083
17	0.80	0.010857	0.41	22.18	297.88	16008.18	721.659
18	0.85	0.010857	0.50	23.57	338.65	15979.59	677.995
19	0.90	0.010857	0.60	24.96	380.81	15950.03	639.144
20	0.95	0.010857	0.70	26.34	424.02	15919.73	604.355
21	1.00	0.010857	0.82	27.73	468.01	15888.89	573.025
22	1.05	0.010857	0.94	29.11	512.56	15857.65	544.665
23	1.10	0.010857	1.07	30.50	557.50	15826.14	518.874
24	1.15	0.010857	1.22	31.89	602.68	15794.45	495.321
25	1.20	0.010857	1.37	33.27	648.00	15762.68	473.728
26	1.25	0.010857	1.53	34.66	693.34	15730.88	453.861
27	1.30	0.010857	1.70	36.05	738.63	15699.13	435.524

Cod. elab.: 108GA201-GA01-Z-CL-002_C	Titolo: OPERE D'ARTE MAGGIORI- GALLERIE	Data: Ottobre 2011
Nome file: 108GA201-GA01-Z-CL -002_C.docx	ARTIFICIALI – GALLERIA ROVETELLO	Pagina 184 di 452
Relazione di calcolo		

PROGETTO ESECUTIVO

28	1.35	0.010857	1.87	37.43	783.79	15667.46	418.548
29	1.40	0.010857	2.06	38.82	828.77	15635.92	402.787
30	1.45	0.010857	2.25	40.21	873.53	15604.54	388.117
31	1.50	0.010857	2.45	41.59	918.01	15573.34	374.430
32	1.55	0.010857	2.66	42.98	962.19	15542.37	361.631
33	1.60	0.010857	2.88	44.36	1006.02	15511.63	349.637
34	1.65	0.010857	3.10	45.75	1049.49	15481.15	338.376
35	1.70	0.010857	3.33	47.14	1092.58	15450.94	327.783
36	1.75	0.010857	3.57	48.52	1135.26	15421.01	317.801
37	1.80	0.010857	3.82	49.91	1177.52	15391.37	308.379
38	1.85	0.010857	4.07	51.30	1219.35	15362.05	299.473
39	1.90	0.010857	4.33	52.68	1260.73	15333.03	291.041
40	1.95	0.010857	4.60	54.07	1301.65	15304.34	283.048
41	2.00	0.010857	4.87	55.46	1342.11	15275.97	275.460
42	2.05	0.010857	5.15	56.84	1382.09	15247.93	268.248
43	2.10	0.010857	5.44	58.23	1421.60	15220.23	261.386
44	2.15	0.010857	5.73	59.62	1460.62	15192.87	254.848
45	2.20	0.010857	6.03	61.00	1499.15	15165.85	248.613
46	2.25	0.010857	6.33	62.39	1537.19	15139.18	242.661
47	2.30	0.010857	6.65	63.77	1568.23	15050.37	235.993
48	2.35	0.010857	6.96	65.16	1597.68	14954.86	229.506
49	2.40	0.010857	7.28	66.55	1626.48	14861.51	223.322
50	2.45	0.010857	7.61	67.93	1654.62	14770.26	217.421
51	2.50	0.010857	7.94	69.32	1682.13	14681.07	211.786
52	2.50	0.010857	7.94	69.32	1682.13	14681.07	211.786
53	2.55	0.010857	8.28	70.71	1708.63	14595.14	206.418
54	2.60	0.010857	8.62	72.09	1734.55	14511.12	201.283
55	2.65	0.010857	8.96	73.48	1759.88	14428.97	196.367
56	2.70	0.010857	9.31	74.87	1784.66	14348.65	191.658
57	2.75	0.010857	9.67	76.25	1808.87	14270.13	187.144
58	2.80	0.010857	10.02	77.64	1832.55	14193.38	182.813
59	2.85	0.010857	10.39	79.03	1855.68	14118.36	178.657
60	2.90	0.010857	10.75	80.41	1878.16	14044.01	174.652
61	2.95	0.010857	11.12	81.80	1899.22	13964.76	170.723
62	3.00	0.010857	11.50	83.18	1919.78	13887.40	166.947
63	3.05	0.010857	11.88	84.57	1939.84	13811.90	163.318

<i>Cod. elab.:</i> 108GA201-GA01-Z-CL-002_C	<i>Titolo:</i> OPERE D'ARTE MAGGIORI- GALLERIE	<i>Data:</i> Ottobre 2011
<i>Nome file:</i> 108GA201-GA01-Z-CL -002_C.docx	ARTIFICIALI – GALLERIA ROVETELLO Relazione di calcolo	<i>Pagina</i> 185 di 452

PROGETTO ESECUTIVO

64	3.10	0.010857	12.26	85.96	1959.42	13738.22	159.826
65	3.15	0.010857	12.65	87.34	1978.53	13666.31	156.466
66	3.20	0.010857	13.03	88.73	1997.17	13596.16	153.231
67	3.25	0.010857	13.43	90.12	2015.36	13527.71	150.114
68	3.30	0.010857	13.82	91.50	2033.11	13460.94	147.110
69	3.35	0.010857	14.22	92.89	2050.42	13395.82	144.213
70	3.40	0.010857	14.62	94.28	2067.29	13332.31	141.419
71	3.45	0.010857	15.02	95.66	2083.75	13270.37	138.722
72	3.50	0.010857	15.43	97.05	2099.80	13210.00	136.118
73	3.55	0.010857	15.83	98.43	2115.44	13151.14	133.603
74	3.60	0.010857	16.24	99.82	2130.68	13093.78	131.172
75	3.65	0.010857	16.65	101.21	2145.54	13037.89	128.823
76	3.70	0.010857	17.07	102.59	2160.01	12983.44	126.552
77	3.75	0.010857	17.48	103.98	2173.32	12925.77	124.310
78	3.80	0.010857	17.90	105.37	2186.10	12868.64	122.132
79	3.85	0.010857	18.32	106.75	2198.53	12813.07	120.025
80	3.90	0.010857	18.74	108.14	2210.61	12759.03	117.987
81	3.95	0.010857	19.16	109.53	2222.36	12706.51	116.014
82	4.00	0.010857	19.58	110.91	2233.78	12655.47	114.103
83	4.05	0.010857	20.00	112.30	2244.87	12605.89	112.253
84	4.10	0.010857	20.42	113.69	2255.64	12557.74	110.461
85	4.15	0.010857	20.84	115.07	2266.09	12511.00	108.724
86	4.20	0.010857	21.27	116.46	2276.24	12465.65	107.040
87	4.25	0.010857	21.69	117.84	2286.07	12421.67	105.407
88	4.30	0.010857	22.11	119.23	2295.61	12379.04	103.824
89	4.35	0.010857	22.53	120.62	2304.85	12337.73	102.288
90	4.40	0.010857	22.95	122.00	2313.79	12297.74	100.798
91	4.45	0.010857	23.38	123.39	2322.45	12259.03	99.352
92	4.50	0.010857	23.80	124.78	2330.82	12221.60	97.948
93	4.55	0.010857	24.22	126.16	2338.91	12185.43	96.585
94	4.60	0.010857	24.63	127.55	2346.73	12150.51	95.261
95	4.65	0.010857	25.05	128.94	2354.26	12116.81	93.976
96	4.70	0.010857	25.47	130.32	2361.53	12084.33	92.727
97	4.75	0.010857	25.88	131.71	2368.52	12053.05	91.513
98	4.80	0.010857	26.29	133.09	2375.25	12022.97	90.334
99	4.85	0.010857	26.70	134.48	2381.72	11994.06	89.188

<i>Cod. elab.:</i> 108GA201-GA01-Z-CL-002_C	<i>Titolo:</i> OPERE D'ARTE MAGGIORI- GALLERIE	<i>Data:</i> Ottobre 2011
<i>Nome file:</i> 108GA201-GA01-Z-CL -002_C.docx	ARTIFICIALI – GALLERIA ROVETELLO Relazione di calcolo	<i>Pagina</i> 186 di 452

PROGETTO ESECUTIVO

1004.90	0.010857	27.11	135.87	2387.92	11966.32	88.073
1014.95	0.010857	27.52	137.25	2393.87	11939.74	86.990
1025.00	0.010857	27.92	138.64	2399.56	11914.31	85.937
1035.05	0.010857	28.32	140.03	2404.95	11889.81	84.911
1045.10	0.010857	28.72	141.41	2409.73	11864.71	83.901
1055.15	0.010857	29.12	142.80	2414.28	11840.84	82.919
1065.20	0.010857	29.51	144.19	2418.60	11818.19	81.965
1075.25	0.010857	29.90	145.57	2422.69	11796.75	81.037
1085.30	0.010857	30.28	146.96	2426.55	11776.51	80.135
1095.35	0.010857	30.66	148.35	2430.17	11757.47	79.257
1105.40	0.010857	31.04	149.73	2433.58	11739.63	78.404
1115.45	0.010857	31.41	151.12	2436.75	11722.97	77.575
1125.50	0.010857	31.78	152.50	2439.70	11707.50	76.768
1135.55	0.010857	32.14	153.89	2442.42	11693.21	75.984
1145.60	0.010857	32.50	155.28	2444.92	11680.10	75.221
1155.65	0.010857	32.86	156.66	2447.20	11668.17	74.479
1165.70	0.010857	33.21	158.05	2449.25	11657.41	73.758
1175.75	0.010857	33.55	159.44	2451.07	11647.84	73.056
1185.80	0.010857	33.89	160.82	2452.67	11639.44	72.374
1195.85	0.010857	34.22	162.21	2454.05	11632.21	71.711
1205.90	0.010857	34.55	163.60	2455.20	11626.17	71.066
1215.95	0.010857	34.87	164.98	2456.13	11621.32	70.440
1226.00	0.010857	35.18	166.37	2456.83	11617.65	69.831
1236.05	0.010857	35.49	167.75	2457.30	11615.17	69.239
1246.10	0.010857	35.79	169.14	2457.54	11613.89	68.664
1256.15	0.010857	36.08	170.53	2457.56	11613.81	68.105
1266.20	0.010857	36.37	171.91	2457.34	11614.94	67.562
1276.25	0.010857	36.65	173.30	2456.90	11617.28	67.035
1286.30	0.010857	36.92	174.69	2456.21	11620.86	66.524
1296.35	0.010857	37.19	176.07	2455.30	11625.66	66.027
1306.40	0.010857	37.44	177.46	2454.14	11631.72	65.546
1316.45	0.010857	37.69	178.85	2452.75	11639.02	65.078
1326.50	0.010857	37.93	180.23	2451.12	11647.60	64.625
1336.55	0.010857	38.16	181.62	2449.24	11657.46	64.186
1346.60	0.010857	38.38	183.01	2447.11	11668.61	63.761
1356.65	0.010857	38.59	184.39	2444.74	11681.07	63.349

Cod. elab.: 108GA201-GA01-Z-CL-002_C	Titolo: OPERE D'ARTE MAGGIORI- GALLERIE	Data: Ottobre 2011
Nome file: 108GA201-GA01-Z-CL -002_C.docx	ARTIFICIALI – GALLERIA ROVETELLO Relazione di calcolo	Pagina 187 di 452

PROGETTO ESECUTIVO

1366.70	0.010857	38.79	185.78	2442.11	11694.85	62.951
1376.75	0.010857	38.99	187.16	2439.23	11709.98	62.565
1386.80	0.010857	39.17	188.55	2436.09	11726.46	62.193
1396.85	0.010857	39.34	189.94	2432.68	11744.33	61.833
1406.90	0.010857	39.51	191.32	2429.01	11763.59	61.485
1416.95	0.010857	39.66	192.71	2425.07	11784.27	61.150
1427.00	0.010857	39.80	194.10	2420.85	11806.40	60.827
1437.05	0.010857	39.93	195.48	2416.35	11830.00	60.517
1447.10	0.010857	40.05	196.87	2411.57	11855.08	60.218
1457.15	0.010857	40.15	198.26	2406.50	11881.69	59.931
1467.20	0.010857	40.25	199.64	2400.86	11908.49	59.649
1477.25	0.010857	40.33	201.03	2394.73	11935.90	59.374
1487.30	0.010857	40.40	202.42	2388.27	11964.78	59.110
1497.35	0.010857	40.46	203.80	2381.47	11995.16	58.857
1507.40	0.010857	40.51	205.19	2374.34	12027.07	58.615
1517.45	0.010857	40.54	206.57	2366.85	12060.54	58.384
1527.50	0.010857	40.56	207.96	2359.01	12095.60	58.163
1537.55	0.010857	40.56	209.35	2350.80	12132.29	57.953
1547.60	0.010857	40.56	210.73	2342.22	12170.64	57.754
1557.65	0.010857	40.53	212.12	2333.26	12210.70	57.565
1567.70	0.010857	40.50	213.51	2323.91	12252.49	57.387
1577.75	0.010857	40.44	214.89	2314.17	12296.08	57.220
1587.80	0.010857	40.38	216.28	2304.01	12341.48	57.063
1597.85	0.010857	40.29	217.67	2293.43	12388.76	56.917
1607.90	0.010857	40.20	219.05	2282.43	12437.97	56.781
1617.95	0.010857	40.08	220.44	2270.98	12489.14	56.656
1628.00	0.010857	39.95	221.82	2259.08	12542.34	56.542
1638.05	0.010857	39.81	223.21	2246.72	12597.62	56.438
1648.10	0.010857	39.65	224.60	2233.87	12655.05	56.345
1658.15	0.010857	39.47	225.98	2220.54	12714.67	56.264
1668.20	0.010857	39.27	227.37	2206.69	12776.56	56.193
1678.25	0.010857	39.06	228.76	2192.33	12840.78	56.133
1688.30	0.010857	38.82	230.14	2177.43	12907.41	56.084
1698.35	0.010857	38.57	231.53	2161.92	12976.23	56.046
1708.40	0.010857	38.31	232.92	2144.74	13040.89	55.990
1718.45	0.010857	38.02	234.30	2126.94	13107.86	55.944

Cod. elab.: 108GA201-GA01-Z-CL-002_C	Titolo: OPERE D'ARTE MAGGIORI- GALLERIE	Data: Ottobre 2011
Nome file: 108GA201-GA01-Z-CL -002_C.docx	ARTIFICIALI – GALLERIA ROVETELLO Relazione di calcolo	Pagina 188 di 452

PROGETTO ESECUTIVO

1728.50	0.010857	37.71	235.69	2108.51	13177.20	55.909
1738.55	0.010857	37.38	237.08	2089.15	13250.06	55.890
1748.60	0.010857	37.01	238.46	2068.54	13327.63	55.890
1758.65	0.010857	36.61	239.85	2046.63	13410.06	55.911
1768.70	0.010857	36.16	241.23	2023.39	13497.52	55.952
1778.75	0.010857	35.68	242.62	1998.76	13590.20	56.014
1788.80	0.010857	35.17	244.01	1972.69	13688.30	56.098
1798.85	0.010857	34.61	245.39	1945.12	13792.03	56.204
1808.90	0.010857	34.01	246.78	1916.00	13901.63	56.332
1818.95	0.010857	33.38	248.17	1885.25	14017.34	56.484
1829.00	0.010857	32.70	249.55	1851.72	14131.21	56.626
1839.05	0.010857	31.98	250.94	1815.91	14247.31	56.776
1849.10	0.010857	31.23	252.33	1778.23	14369.49	56.948
1859.15	0.010857	30.42	253.71	1738.58	14498.04	57.144
1869.20	0.010857	29.58	255.10	1696.88	14633.23	57.363
1879.25	0.010857	28.70	256.48	1653.05	14775.34	57.607
1889.30	0.010857	27.77	257.87	1607.04	14924.51	57.876
1899.35	0.010857	26.80	259.26	1558.83	15080.85	58.169
1909.40	0.010857	25.79	260.64	1500.49	15164.91	58.182
1919.45	0.010857	24.74	262.03	1436.20	15209.99	58.047
1929.50	0.010857	23.66	263.42	1370.19	15256.28	57.917
1939.55	0.010857	22.54	264.80	1302.50	15303.74	57.793
1949.60	0.010857	21.38	266.19	1233.21	15352.33	57.674
1959.65	0.010857	20.19	267.58	1162.35	15402.01	57.561
1969.70	0.010857	18.97	268.96	1090.00	15452.74	57.453
1979.75	0.010857	17.72	270.35	1016.21	15504.48	57.350
1989.80	0.010857	16.44	271.74	941.04	15557.20	57.251
1999.85	0.010857	15.13	273.12	864.53	15610.84	57.157
2009.90	0.010857	13.79	274.51	786.76	15665.38	57.067
2019.95	0.010857	12.42	275.89	707.76	15720.77	56.981
20210.00	0.010857	11.03	277.28	627.61	15776.97	56.899
20310.05	0.010857	9.62	278.67	546.35	15833.95	56.820
20410.10	0.010857	8.18	280.05	464.04	15891.67	56.745
20510.15	0.010857	6.72	281.44	380.74	15950.08	56.673
20610.20	0.010857	5.24	282.83	296.50	16009.15	56.604
20710.25	0.010857	3.74	284.21	211.38	16068.83	56.538

<i>Cod. elab.:</i> 108GA201-GA01-Z-CL-002_C	<i>Titolo:</i> OPERE D'ARTE MAGGIORI- GALLERIE	<i>Data:</i> Ottobre 2011
<i>Nome file:</i> 108GA201-GA01-Z-CL -002_C.docx	ARTIFICIALI – GALLERIA ROVETELLO Relazione di calcolo	<i>Pagina</i> 189 di 452

PROGETTO ESECUTIVO

20810.30	0.010857	2.22	285.60	125.44	16129.09	56.475
20910.35	0.010857	0.69	286.99	38.74	16189.88	56.414
21010.40	0.010857	-0.86	288.37	-48.46	16183.07	56.119
21110.45	0.010857	-2.43	289.76	-135.11	16122.31	55.641
21210.50	0.010857	-4.01	291.14	-221.04	16062.06	55.169
21310.55	0.010857	-5.60	292.53	-306.18	16002.36	54.703
21410.60	0.010857	-7.20	293.92	-390.48	15943.25	54.244
21510.65	0.010857	-8.81	295.30	-473.90	15884.75	53.791
21610.70	0.010857	-10.43	296.69	-556.40	15826.91	53.345
21710.75	0.010857	-12.06	298.08	-637.92	15769.75	52.905
21810.80	0.010857	-13.69	299.46	-718.42	15713.30	52.472
21910.85	0.010857	-15.33	300.85	-797.88	15657.58	52.045
22010.90	0.010857	-16.97	302.24	-876.24	15602.63	51.624
22110.95	0.010857	-18.62	303.62	-953.49	15548.47	51.210
22211.00	0.010857	-20.27	305.01	-1029.58	15495.11	50.802
22311.05	0.010857	-21.91	306.40	-1104.48	15442.59	50.401
22411.10	0.010857	-23.56	307.78	-1178.18	15390.92	50.006
22511.15	0.010857	-25.21	309.17	-1250.62	15340.12	49.617
22611.20	0.010857	-26.85	310.55	-1321.80	15290.20	49.235
22711.25	0.010857	-28.48	311.94	-1391.69	15241.20	48.859
22811.30	0.010857	-30.12	313.33	-1460.27	15193.12	48.490
22911.35	0.010857	-31.74	314.71	-1527.50	15145.97	48.126
23011.40	0.010857	-33.36	316.10	-1583.08	15002.22	47.460
23111.45	0.010857	-34.96	317.49	-1633.94	14837.30	46.734
23211.50	0.010857	-36.56	318.87	-1682.92	14678.49	46.032
23311.55	0.010857	-38.14	320.26	-1730.07	14525.63	45.356
23411.60	0.010857	-39.72	321.65	-1775.44	14378.53	44.703
23511.65	0.010857	-41.27	323.03	-1819.08	14237.03	44.073
23611.70	0.010857	-42.82	324.42	-1861.04	14100.99	43.465
23711.75	0.010857	-44.34	325.81	-1900.14	13961.27	42.852
23811.80	0.010857	-45.85	327.19	-1937.00	13822.58	42.246
23911.85	0.010857	-47.34	328.58	-1972.32	13689.69	41.663
24011.90	0.010857	-48.81	329.96	-2006.13	13562.44	41.103
24111.95	0.010857	-50.25	331.35	-2038.50	13440.67	40.563
24212.00	0.010857	-51.68	332.74	-2069.44	13324.22	40.044
24312.05	0.010857	-53.08	334.12	-2099.01	13212.95	39.545

Cod. elab.: 108GA201-GA01-Z-CL-002_C	Titolo: OPERE D'ARTE MAGGIORI- GALLERIE	Data: Ottobre 2011
Nome file: 108GA201-GA01-Z-CL -002_C.docx	ARTIFICIALI – GALLERIA ROVETELLO Relazione di calcolo	Pagina 190 di 452

PROGETTO ESECUTIVO

24412.10	0.010857	-54.45	335.51	-2127.24	13106.74	39.065
24512.15	0.010857	-55.80	336.90	-2154.16	13005.46	38.604
24612.20	0.010857	-57.12	338.28	-2178.62	12902.05	38.140
24712.25	0.010857	-58.41	339.67	-2201.32	12800.57	37.685
24812.30	0.010857	-59.67	341.06	-2222.85	12704.33	37.250
24912.35	0.010857	-60.90	342.44	-2243.24	12613.19	36.833
25012.40	0.010857	-62.10	343.83	-2262.51	12527.04	36.434
25112.45	0.010857	-63.26	345.21	-2280.68	12445.77	36.052
25212.50	0.010857	-64.39	346.60	-2297.79	12369.29	35.687
25312.55	0.010857	-65.48	347.99	-2313.85	12297.51	35.339
25412.60	0.010857	-66.53	349.37	-2328.87	12230.34	35.006
25512.65	0.010857	-67.54	350.76	-2342.88	12167.72	34.690
25612.70	0.010857	-68.51	352.15	-2355.88	12109.57	34.388
25712.75	0.010857	-69.44	353.53	-2367.91	12055.81	34.101
25812.80	0.010857	-70.33	354.92	-2378.98	12006.29	33.828
25912.85	0.010857	-71.17	356.31	-2389.16	11960.81	33.569
26012.90	0.010857	-71.98	357.69	-2398.46	11919.23	33.323
26112.95	0.010857	-72.74	359.08	-2406.74	11880.44	33.086
26213.00	0.010857	-73.47	360.47	-2413.81	11843.30	32.856
26313.05	0.010857	-74.15	361.85	-2420.17	11809.93	32.638
26413.10	0.010857	-74.80	363.24	-2425.84	11780.19	32.431
26513.15	0.010857	-75.41	364.62	-2430.85	11753.94	32.236
26613.20	0.010857	-75.98	366.01	-2435.21	11731.07	32.051
26713.25	0.010857	-76.51	367.40	-2438.94	11711.47	31.877
26813.30	0.010857	-77.01	368.78	-2442.07	11695.05	31.712
26913.35	0.010857	-77.47	370.17	-2444.62	11681.69	31.558
27013.40	0.010857	-77.89	371.56	-2446.59	11671.33	31.412
27113.45	0.010857	-78.27	372.94	-2448.01	11663.88	31.275
27213.50	0.010857	-78.62	374.33	-2448.89	11659.27	31.147
27313.55	0.010857	-78.94	375.72	-2449.24	11657.43	31.027
27413.60	0.010857	-79.22	377.10	-2449.08	11658.29	30.915
27513.65	0.010857	-79.46	378.49	-2448.41	11661.81	30.812
27613.70	0.010857	-79.68	379.87	-2447.24	11667.93	30.715
27713.75	0.010857	-79.85	381.26	-2445.59	11676.60	30.626
27813.80	0.010857	-80.00	382.65	-2443.46	11687.77	30.544
27913.85	0.010857	-80.11	384.03	-2440.86	11701.42	30.470

Cod. elab.: 108GA201-GA01-Z-CL-002_C	Titolo: OPERE D'ARTE MAGGIORI- GALLERIE	Data: Ottobre 2011
Nome file: 108GA201-GA01-Z-CL -002_C.docx	ARTIFICIALI – GALLERIA ROVETELLO	Pagina 191 di 452
Relazione di calcolo		

PROGETTO ESECUTIVO

28013.90	0.010857	-80.19	385.42	-2437.79	11717.51	30.402
28113.95	0.010857	-80.23	386.81	-2434.27	11736.00	30.341
28214.00	0.010857	-80.24	388.19	-2430.29	11756.86	30.286
28314.05	0.010857	-80.23	389.58	-2425.86	11780.09	30.238
28414.10	0.010857	-80.18	390.97	-2420.99	11805.64	30.196
28514.15	0.010857	-80.09	392.35	-2415.68	11833.51	30.160
28614.20	0.010857	-79.98	393.74	-2409.93	11863.69	30.131
28714.25	0.010857	-79.84	395.13	-2403.68	11895.88	30.107
28814.30	0.010857	-79.67	396.51	-2396.51	11927.92	30.082
28914.35	0.010857	-79.46	397.90	-2388.88	11962.06	30.063
29014.40	0.010857	-79.23	399.28	-2380.78	11998.28	30.049
29114.45	0.010857	-78.97	400.67	-2372.21	12036.57	30.041
29214.50	0.010857	-78.67	402.06	-2363.18	12076.95	30.038
29314.55	0.010857	-78.35	403.44	-2353.68	12119.42	30.040
29414.60	0.010857	-78.00	404.83	-2343.72	12163.97	30.047
29514.65	0.010857	-77.62	406.22	-2333.28	12210.62	30.059
29614.70	0.010857	-77.22	407.60	-2322.38	12259.37	30.077
29714.75	0.010857	-76.78	408.99	-2311.00	12310.24	30.099
29814.80	0.010857	-76.32	410.38	-2299.14	12363.25	30.127
29914.85	0.010857	-75.82	411.76	-2286.80	12418.41	30.159
30014.90	0.010857	-75.31	413.15	-2273.98	12475.74	30.197
30114.95	0.010857	-74.76	414.53	-2260.67	12535.26	30.239
30215.00	0.010857	-74.19	415.92	-2246.86	12597.00	30.287
30315.05	0.010857	-73.58	417.31	-2232.55	12660.98	30.340
30415.10	0.010857	-72.96	418.69	-2217.73	12727.24	30.397
30515.15	0.010857	-72.30	420.08	-2202.39	12795.80	30.460
30615.20	0.010857	-71.62	421.47	-2186.53	12866.71	30.528
30715.25	0.010857	-70.92	422.85	-2170.14	12939.99	30.602
30815.30	0.010857	-70.18	424.24	-2152.53	13011.59	30.670
30915.35	0.010857	-69.42	425.63	-2133.80	13082.06	30.736
31015.40	0.010857	-68.64	427.01	-2114.49	13154.71	30.806
31115.45	0.010857	-67.83	428.40	-2094.60	13229.57	30.881
31215.50	0.010857	-66.99	429.79	-2074.11	13306.68	30.961
31315.55	0.010857	-66.13	431.17	-2053.00	13386.08	31.046
31415.60	0.010857	-65.24	432.56	-2031.28	13467.82	31.135
31515.65	0.010857	-64.33	433.94	-2008.92	13551.95	31.230

<i>Cod. elab.:</i> 108GA201-GA01-Z-CL-002_C	<i>Titolo:</i> OPERE D'ARTE MAGGIORI- GALLERIE	<i>Data:</i> Ottobre 2011
<i>Nome file:</i> 108GA201-GA01-Z-CL -002_C.docx	ARTIFICIALI – GALLERIA ROVETELLO Relazione di calcolo	<i>Pagina</i> 192 di 452

PROGETTO ESECUTIVO

31615.70	0.010857	-63.39	435.33	-1985.92	13638.50	31.329
31715.75	0.010857	-62.43	436.72	-1962.26	13727.55	31.433
31815.80	0.010857	-61.44	438.10	-1937.92	13819.13	31.543
31915.85	0.010857	-60.42	439.49	-1912.89	13913.32	31.658
32015.90	0.010857	-59.39	440.88	-1887.15	14010.16	31.778
32115.95	0.010857	-58.32	442.26	-1859.99	14104.41	31.891
32216.00	0.010857	-57.23	443.65	-1831.50	14196.76	32.000
32316.05	0.010857	-56.12	445.04	-1802.26	14291.56	32.113
32416.10	0.010857	-54.98	446.42	-1772.25	14388.88	32.232
32516.15	0.010857	-53.82	447.81	-1741.44	14488.77	32.355
32616.20	0.010857	-52.64	449.20	-1709.82	14591.29	32.483
32716.25	0.010857	-51.43	450.58	-1677.37	14696.51	32.617
32816.30	0.010857	-50.19	451.97	-1644.06	14804.52	32.756
32916.35	0.010857	-48.93	453.35	-1609.87	14915.37	32.900
33016.40	0.010857	-47.65	454.74	-1574.77	15029.14	33.050
33116.45	0.010857	-46.34	456.13	-1538.01	15138.60	33.189
33216.50	0.010857	-45.01	457.51	-1492.41	15170.58	33.159
33316.55	0.010857	-43.67	458.90	-1446.84	15202.53	33.128
33416.60	0.010857	-42.36	460.29	-1402.01	15233.97	33.097
33516.65	0.010857	-41.07	461.67	-1357.90	15264.89	33.064
33616.70	0.010857	-39.80	463.06	-1314.54	15295.30	33.031
33716.75	0.010857	-38.55	464.45	-1271.92	15325.19	32.997
33816.80	0.010857	-37.32	465.83	-1230.04	15354.55	32.962
33916.85	0.010857	-36.11	467.22	-1188.90	15383.40	32.926
34016.90	0.010857	-34.92	468.60	-1148.50	15411.73	32.889
34116.95	0.010857	-33.75	469.99	-1108.85	15439.53	32.851
34217.00	0.010857	-32.61	471.38	-1069.94	15466.81	32.812
34317.05	0.010857	-31.48	472.76	-1031.78	15493.57	32.772
34417.10	0.010857	-30.38	474.15	-994.37	15519.80	32.732
34517.15	0.010857	-29.30	475.54	-957.70	15545.52	32.690
34617.20	0.010857	-28.23	476.92	-921.77	15570.71	32.648
34717.25	0.010857	-27.19	478.31	-886.59	15595.38	32.605
34817.30	0.010857	-26.17	479.70	-852.15	15619.52	32.561
34917.35	0.010857	-25.17	481.08	-818.46	15643.15	32.517
35017.40	0.010857	-24.19	482.47	-785.50	15666.26	32.471
35117.45	0.010857	-23.23	483.86	-753.29	15688.85	32.425

Cod. elab.: 108GA201-GA01-Z-CL-002_C	Titolo: OPERE D'ARTE MAGGIORI- GALLERIE	Data: Ottobre 2011
Nome file: 108GA201-GA01-Z-CL -002_C.docx	ARTIFICIALI – GALLERIA ROVETELLO Relazione di calcolo	Pagina 193 di 452

PROGETTO ESECUTIVO

35217.50	0.010857	-22.29	485.24	-721.81	15710.92	32.378
35317.55	0.010857	-21.38	486.63	-691.07	15732.48	32.330
35417.60	0.010857	-20.48	488.01	-661.06	15753.52	32.281
35517.65	0.010857	-19.60	489.40	-631.78	15774.05	32.231
35617.70	0.010857	-18.74	490.79	-603.22	15794.07	32.181
35717.75	0.010857	-17.91	492.17	-575.40	15813.59	32.130
35817.80	0.010857	-17.09	493.56	-548.29	15832.59	32.078
35917.85	0.010857	-16.30	494.95	-521.90	15851.09	32.026
36017.90	0.010857	-15.52	496.33	-496.23	15869.10	31.973
36117.95	0.010857	-14.76	497.72	-471.27	15886.60	31.919
36218.00	0.010857	-14.03	499.11	-447.02	15903.60	31.864
36318.05	0.010857	-13.31	500.49	-423.47	15920.12	31.809
36418.10	0.010857	-12.62	501.88	-400.62	15936.14	31.753
36518.15	0.010857	-11.94	503.26	-378.46	15951.67	31.696
36618.20	0.010857	-11.28	504.65	-357.00	15966.72	31.639
36718.25	0.010857	-10.65	506.04	-336.23	15981.29	31.581
36818.30	0.010857	-10.03	507.42	-316.13	15995.38	31.523
36918.35	0.010857	-9.43	508.81	-296.72	16008.99	31.464
37018.40	0.010857	-8.85	510.20	-277.98	16022.14	31.404
37118.45	0.010857	-8.29	511.58	-259.90	16034.81	31.343
37218.50	0.010857	-7.75	512.97	-242.49	16047.02	31.283
37318.55	0.010857	-7.23	514.36	-225.73	16058.77	31.221
37418.60	0.010857	-6.73	515.74	-209.63	16070.06	31.159
37518.65	0.010857	-6.24	517.13	-194.18	16080.90	31.096
37618.70	0.010857	-5.78	518.52	-179.36	16091.28	31.033
37718.75	0.010857	-5.33	519.90	-165.18	16101.23	30.970
37818.80	0.010857	-4.91	521.29	-151.64	16110.73	30.906
37918.85	0.010857	-4.50	522.67	-138.71	16119.79	30.841
38018.90	0.010857	-4.11	524.06	-126.41	16128.42	30.776
38118.95	0.010857	-3.74	525.45	-114.72	16136.61	30.710
38219.00	0.010857	-3.38	526.83	-103.63	16144.39	30.644
38319.05	0.010857	-3.05	528.22	-93.15	16151.74	30.578
38419.10	0.010857	-2.73	529.61	-83.26	16158.67	30.511
38519.15	0.010857	-2.43	530.99	-73.96	16165.19	30.443
38619.20	0.010857	-2.15	532.38	-65.25	16171.30	30.376
38719.25	0.010857	-1.88	533.77	-57.11	16177.01	30.307

Cod. elab.: 108GA201-GA01-Z-CL-002_C	Titolo: OPERE D'ARTE MAGGIORI- GALLERIE	Data: Ottobre 2011
Nome file: 108GA201-GA01-Z-CL -002_C.docx	ARTIFICIALI – GALLERIA ROVETELLO	Pagina 194 di 452
	Relazione di calcolo	

PROGETTO ESECUTIVO

38819.30	0.010857	-1.64	535.15	-49.54	16182.32	30.239
38919.35	0.010857	-1.41	536.54	-42.53	16187.23	30.170
39019.40	0.010857	-1.20	537.92	-36.09	16191.75	30.100
39119.45	0.010857	-1.01	539.31	-30.20	16195.88	30.031
39219.50	0.010857	-0.83	540.70	-24.85	16199.63	29.961
39319.55	0.010857	-0.67	542.08	-20.04	16203.00	29.890
39419.60	0.010857	-0.53	543.47	-15.77	16206.00	29.819
39519.65	0.010857	-0.40	544.86	-12.02	16208.62	29.748
39619.70	0.010857	-0.30	546.24	-8.79	16210.89	29.677
39719.75	0.010857	-0.21	547.63	-6.08	16212.79	29.605
39819.80	0.010857	-0.13	549.02	-3.87	16214.34	29.533
39919.85	0.010857	-0.07	550.40	-2.17	16215.53	29.461
40019.90	0.010857	-0.03	551.79	-0.96	16216.38	29.389
40119.95	0.010857	-0.01	553.18	-0.24	16216.88	29.316
40220.00	0.010857	0.00	554.56	0.00	-4248.53	7.661

Fase n° 2 - [A2-M2]

n°	Y	A _f	M	N	M _u	N _u	CS
1	0.00	0.010857	0.00	0.00	0.00	0.00	1000.000
2	0.05	0.010857	0.00	1.39	0.00	-4248.53	3064.420
3	0.10	0.010857	0.01	2.77	78.79	16161.80	5828.674
4	0.15	0.010857	0.04	4.16	156.73	16107.15	3872.644
5	0.20	0.010857	0.08	5.55	233.81	16053.11	2894.737
6	0.25	0.010857	0.13	6.93	310.04	15999.65	2308.079
7	0.30	0.010857	0.20	8.32	385.44	15946.78	1917.043
8	0.35	0.010857	0.28	9.70	460.02	15894.49	1637.791
9	0.40	0.010857	0.37	11.09	533.79	15842.76	1428.404
10	0.45	0.010857	0.48	12.48	606.75	15791.60	1265.592
11	0.50	0.010857	0.60	13.86	678.93	15740.98	1135.382
12	0.55	0.010857	0.76	15.25	775.96	15672.95	1027.704
13	0.60	0.010857	0.98	16.64	913.73	15576.35	936.256
14	0.65	0.010857	1.26	18.02	1080.94	15459.10	857.730
15	0.70	0.010857	1.61	19.41	1269.37	15326.97	789.657
16	0.75	0.010857	2.02	20.80	1472.91	15184.25	730.150
17	0.80	0.010857	2.49	22.18	1656.66	14763.65	665.555

Cod. elab.: 108GA201-GA01-Z-CL-002_C	Titolo: OPERE D'ARTE MAGGIORI- GALLERIE	Data: Ottobre 2011
Nome file: 108GA201-GA01-Z-CL -002_C.docx	ARTIFICIALI – GALLERIA ROVETELLO	Pagina 195 di 452
Relazione di calcolo		

PROGETTO ESECUTIVO

18	0.85	0.010857	3.02	23.57	1823.87	14221.50	603.402
19	0.90	0.010857	3.62	24.96	1980.12	13660.33	547.392
20	0.95	0.010857	4.27	26.34	2126.49	13109.56	497.673
21	1.00	0.010857	4.99	27.73	2257.68	12548.61	452.560
22	1.05	0.010857	5.76	29.11	2378.00	12010.67	412.532
23	1.10	0.010857	6.60	30.50	2483.49	11477.78	376.310
24	1.15	0.010857	7.49	31.89	2579.27	10975.26	344.189
25	1.20	0.010857	8.45	33.27	2662.67	10489.13	315.238
26	1.25	0.010857	9.46	34.66	2736.92	10030.39	289.393
27	1.30	0.010857	10.53	36.05	2803.40	9600.27	266.330
28	1.35	0.010857	11.65	37.43	2860.14	9188.48	245.465
29	1.40	0.010857	12.83	38.82	2912.43	8808.90	226.921
30	1.45	0.010857	14.07	40.21	2955.02	8441.95	209.969
31	1.50	0.010857	15.37	41.59	2989.84	8091.42	194.542
32	1.55	0.010857	16.72	42.98	3021.94	7768.27	180.748
33	1.60	0.010857	18.12	44.36	3044.82	7453.05	167.994
34	1.65	0.010857	19.58	45.75	3053.17	7132.44	155.896
35	1.70	0.010857	21.10	47.14	3060.83	6838.27	145.070
36	1.75	0.010857	22.67	48.52	3067.88	6567.54	135.346
37	1.80	0.010857	24.29	49.91	3063.29	6294.85	126.123
38	1.85	0.010857	25.96	51.30	3054.23	6034.63	117.641
39	1.90	0.010857	27.69	52.68	3045.90	5795.43	110.005
40	1.95	0.010857	29.47	54.07	3038.21	5574.89	103.105
41	2.00	0.010857	31.30	55.46	3028.81	5366.87	96.777
42	2.05	0.010857	33.18	56.84	3009.78	5156.59	90.717
43	2.10	0.010857	35.11	58.23	2992.23	4962.67	85.227
44	2.15	0.010857	37.09	59.62	2976.00	4783.31	80.236
45	2.20	0.010857	39.12	61.00	2960.95	4616.96	75.686
46	2.25	0.010857	41.20	62.39	2946.95	4462.29	71.525
47	2.30	0.010857	43.33	63.77	2933.43	4317.42	67.698
48	2.35	0.010857	45.51	65.16	2911.33	4168.59	63.974
49	2.40	0.010857	47.73	66.55	2890.79	4030.19	60.561
50	2.45	0.010857	50.01	67.93	2871.63	3901.17	57.426
51	2.50	0.010857	52.33	69.32	2853.74	3780.63	54.539
52	2.50	0.010857	52.33	101.72	3050.60	5930.50	58.301
53	2.55	0.010857	50.22	103.11	3063.10	6289.44	60.998

Cod. elab.: 108GA201-GA01-Z-CL-002_C	Titolo: OPERE D'ARTE MAGGIORI- GALLERIE	Data: Ottobre 2011
Nome file: 108GA201-GA01-Z-CL -002_C.docx	ARTIFICIALI – GALLERIA ROVETELLO Relazione di calcolo	Pagina 196 di 452

PROGETTO ESECUTIVO

54	2.60	0.010857	48.15	104.49	3065.66	6652.61	63.664
55	2.65	0.010857	46.14	105.88	3056.25	7014.03	66.244
56	2.70	0.010857	44.16	107.27	3046.23	7398.90	68.976
57	2.75	0.010857	42.24	108.65	3021.47	7772.93	71.538
58	2.80	0.010857	40.35	110.04	2985.00	8140.17	73.974
59	2.85	0.010857	38.51	111.43	2946.69	8525.82	76.515
60	2.90	0.010857	36.71	112.81	2898.85	8907.48	78.958
61	2.95	0.010857	34.96	114.20	2845.44	9295.12	81.394
62	3.00	0.010857	33.25	115.59	2789.78	9699.15	83.913
63	3.05	0.010857	31.57	116.97	2725.91	10098.40	86.331
64	3.10	0.010857	29.94	118.36	2659.19	10510.65	88.803
65	3.15	0.010857	28.36	119.75	2588.02	10929.38	91.272
66	3.20	0.010857	26.81	121.13	2509.61	11340.73	93.623
67	3.25	0.010857	25.30	122.52	2428.88	11764.26	96.021
68	3.30	0.010857	23.82	123.90	2341.12	12175.55	98.266
69	3.35	0.010857	22.39	125.29	2249.35	12585.85	100.453
70	3.40	0.010857	21.00	126.68	2155.14	13001.75	102.637
71	3.45	0.010857	19.64	128.06	2053.01	13386.07	104.527
72	3.50	0.010857	18.32	129.45	1949.62	13775.11	106.412
73	3.55	0.010857	17.04	130.84	1843.65	14157.39	108.207
74	3.60	0.010857	15.79	132.22	1733.46	14514.65	109.774
75	3.65	0.010857	14.58	133.61	1622.95	14872.93	111.316
76	3.70	0.010857	13.40	135.00	1505.32	15161.52	112.311
77	3.75	0.010857	12.26	136.38	1371.51	15255.35	111.857
78	3.80	0.010857	11.15	137.77	1242.36	15345.91	111.389
79	3.85	0.010857	10.08	139.16	1117.82	15433.24	110.907
80	3.90	0.010857	9.04	140.54	997.85	15517.36	110.411
81	3.95	0.010857	8.03	141.93	882.38	15598.33	109.903
82	4.00	0.010857	7.05	143.31	771.36	15676.18	109.383
83	4.05	0.010857	6.11	144.70	664.70	15750.96	108.852
84	4.10	0.010857	5.19	146.09	562.36	15822.73	108.310
85	4.15	0.010857	4.31	147.47	464.24	15891.53	107.759
86	4.20	0.010857	3.45	148.86	370.28	15957.41	107.198
87	4.25	0.010857	2.63	150.25	280.39	16020.44	106.628
88	4.30	0.010857	1.83	151.63	194.50	16080.67	106.050
89	4.35	0.010857	1.07	153.02	112.51	16138.16	105.465

Cod. elab.: 108GA201-GA01-Z-CL-002_C	Titolo: OPERE D'ARTE MAGGIORI- GALLERIE	Data: Ottobre 2011
Nome file: 108GA201-GA01-Z-CL -002_C.docx	ARTIFICIALI – GALLERIA ROVETELLO	Pagina 197 di 452
Relazione di calcolo		

PROGETTO ESECUTIVO

90	4.40	0.010857	0.33	154.41	34.35	16192.97	104.873
91	4.45	0.010857	-0.38	155.79	-39.94	16189.04	103.915
92	4.50	0.010857	-1.07	157.18	-109.81	16140.05	102.686
93	4.55	0.010857	-1.73	158.56	-175.39	16094.07	101.498
94	4.60	0.010857	-2.36	159.95	-236.90	16050.94	100.349
95	4.65	0.010857	-2.97	161.34	-294.55	16010.51	99.236
96	4.70	0.010857	-3.55	162.72	-348.53	15972.66	98.158
97	4.75	0.010857	-4.11	164.11	-399.03	15937.25	97.113
98	4.80	0.010857	-4.64	165.50	-446.23	15904.16	96.100
99	4.85	0.010857	-5.15	166.88	-490.28	15873.27	95.116
100	4.90	0.010857	-5.64	168.27	-531.33	15844.48	94.161
101	4.95	0.010857	-6.11	169.66	-569.55	15817.68	93.234
102	5.00	0.010857	-6.55	171.04	-605.06	15792.78	92.333
103	5.05	0.010857	-6.98	172.43	-638.00	15769.68	91.456
104	5.10	0.010857	-7.38	173.82	-668.50	15748.30	90.604
105	5.15	0.010857	-7.76	175.20	-696.67	15728.55	89.774
106	5.20	0.010857	-8.12	176.59	-722.62	15710.35	88.966
107	5.25	0.010857	-8.47	177.97	-746.48	15693.62	88.179
108	5.30	0.010857	-8.79	179.36	-768.33	15678.30	87.412
109	5.35	0.010857	-9.10	180.75	-788.28	15664.31	86.664
110	5.40	0.010857	-9.38	182.13	-806.42	15651.59	85.935
111	5.45	0.010857	-9.66	183.52	-822.85	15640.07	85.223
112	5.50	0.010857	-9.91	184.91	-837.64	15629.70	84.528
113	5.55	0.010857	-10.15	186.29	-850.89	15620.41	83.849
114	5.60	0.010857	-10.37	187.68	-862.67	15612.15	83.185
115	5.65	0.010857	-10.58	189.07	-873.06	15604.86	82.537
116	5.70	0.010857	-10.77	190.45	-882.14	15598.50	81.903
117	5.75	0.010857	-10.95	191.84	-889.96	15593.01	81.282
118	5.80	0.010857	-11.11	193.22	-896.61	15588.35	80.675
119	5.85	0.010857	-11.27	194.61	-902.15	15584.46	80.080
120	5.90	0.010857	-11.40	196.00	-906.64	15581.32	79.497
121	5.95	0.010857	-11.53	197.38	-910.14	15578.86	78.927
122	6.00	0.010857	-11.65	198.77	-912.72	15577.06	78.367
123	6.05	0.010857	-11.75	200.16	-914.42	15575.86	77.818
124	6.10	0.010857	-11.84	201.54	-915.31	15575.24	77.280
125	6.15	0.010857	-11.93	202.93	-915.44	15575.15	76.751

<i>Cod. elab.:</i> 108GA201-GA01-Z-CL-002_C	<i>Titolo:</i> OPERE D'ARTE MAGGIORI- GALLERIE	<i>Data:</i> Ottobre 2011
<i>Nome file:</i> 108GA201-GA01-Z-CL -002_C.docx	ARTIFICIALI – GALLERIA ROVETELLO Relazione di calcolo	<i>Pagina</i> 198 di 452

PROGETTO ESECUTIVO

126.6.20	0.010857	-12.00	204.32	-914.86	15575.55	76.233
127.6.25	0.010857	-12.07	205.70	-913.62	15576.42	75.723
128.6.30	0.010857	-12.12	207.09	-911.77	15577.72	75.222
129.6.35	0.010857	-12.17	208.48	-909.36	15579.41	74.730
130.6.40	0.010857	-12.21	209.86	-906.44	15581.46	74.246
131.6.45	0.010857	-12.24	211.25	-903.04	15583.84	73.770
132.6.50	0.010857	-12.27	212.63	-899.21	15586.52	73.302
133.6.55	0.010857	-12.29	214.02	-895.01	15589.48	72.841
134.6.60	0.010857	-12.30	215.41	-890.45	15592.67	72.387
135.6.65	0.010857	-12.31	216.79	-885.60	15596.07	71.940
136.6.70	0.010857	-12.31	218.18	-880.48	15599.66	71.499
137.6.75	0.010857	-12.31	219.57	-875.14	15603.41	71.065
138.6.80	0.010857	-12.31	220.95	-869.60	15607.29	70.636
139.6.85	0.010857	-12.30	222.34	-863.92	15611.27	70.214
140.6.90	0.010857	-12.29	223.73	-858.12	15615.34	69.797
141.6.95	0.010857	-12.28	225.11	-852.24	15619.46	69.385
142.7.00	0.010857	-12.27	226.50	-846.31	15623.62	68.979
143.7.05	0.010857	-12.25	227.88	-840.37	15627.79	68.578
144.7.10	0.010857	-12.24	229.27	-834.44	15631.94	68.181
145.7.15	0.010857	-12.22	230.66	-828.57	15636.06	67.789
146.7.20	0.010857	-12.21	232.04	-822.77	15640.12	67.401
147.7.25	0.010857	-12.19	233.43	-817.09	15644.11	67.018
148.7.30	0.010857	-12.18	234.82	-811.55	15648.00	66.639
149.7.35	0.010857	-12.17	236.20	-806.17	15651.77	66.264
150.7.40	0.010857	-12.16	237.59	-800.99	15655.40	65.893
151.7.45	0.010857	-12.15	238.98	-796.04	15658.87	65.525
152.7.50	0.010857	-12.14	240.36	-791.34	15662.17	65.161
153.7.55	0.010857	-12.14	241.75	-786.91	15665.27	64.800
154.7.60	0.010857	-12.15	243.14	-782.79	15668.16	64.442
155.7.65	0.010857	-12.16	244.52	-779.00	15670.82	64.088
156.7.70	0.010857	-12.17	245.91	-775.56	15673.23	63.736
157.7.75	0.010857	-12.19	247.29	-772.49	15675.38	63.387
158.7.80	0.010857	-12.21	248.68	-769.83	15677.25	63.042
159.7.85	0.010857	-12.24	250.07	-767.59	15678.82	62.698
160.7.90	0.010857	-12.28	251.45	-765.79	15680.08	62.358
161.7.95	0.010857	-12.33	252.84	-764.46	15681.01	62.019

<i>Cod. elab.:</i> 108GA201-GA01-Z-CL-002_C	<i>Titolo:</i> OPERE D'ARTE MAGGIORI- GALLERIE	<i>Data:</i> Ottobre 2011
<i>Nome file:</i> 108GA201-GA01-Z-CL -002_C.docx	ARTIFICIALI – GALLERIA ROVETELLO Relazione di calcolo	<i>Pagina</i> 199 di 452

PROGETTO ESECUTIVO

1628.00	0.010857	-12.38	254.23	-763.62	15681.60	61.684
1638.05	0.010857	-12.44	255.61	-763.29	15681.84	61.350
1648.10	0.010857	-12.51	257.00	-763.48	15681.70	61.018
1658.15	0.010857	-12.59	258.39	-764.22	15681.18	60.689
1668.20	0.010857	-12.68	259.77	-765.53	15680.26	60.362
1678.25	0.010857	-12.78	261.16	-767.42	15678.94	60.036
1688.30	0.010857	-12.89	262.55	-769.92	15677.19	59.712
1698.35	0.010857	-13.02	263.93	-773.04	15675.00	59.390
1708.40	0.010857	-13.15	265.32	-776.79	15672.37	59.070
1718.45	0.010857	-13.30	266.70	-781.20	15669.28	58.752
1728.50	0.010857	-13.46	268.09	-786.27	15665.72	58.434
1738.55	0.010857	-13.63	269.48	-792.34	15661.47	58.118
1748.60	0.010857	-13.84	270.86	-799.73	15656.28	57.801
1758.65	0.010857	-14.06	272.25	-808.48	15650.14	57.484
1768.70	0.010857	-14.32	273.64	-818.61	15643.04	57.167
1778.75	0.010857	-14.60	275.02	-830.14	15634.96	56.850
1788.80	0.010857	-14.91	276.41	-843.09	15625.88	56.532
1798.85	0.010857	-15.25	277.80	-857.48	15615.79	56.213
1808.90	0.010857	-15.62	279.18	-873.33	15604.68	55.894
1818.95	0.010857	-16.03	280.57	-890.66	15592.53	55.575
1829.00	0.010857	-16.46	281.95	-909.48	15579.33	55.255
1839.05	0.010857	-16.93	283.34	-929.81	15565.07	54.934
1849.10	0.010857	-17.43	284.73	-951.66	15549.75	54.613
1859.15	0.010857	-17.96	286.11	-975.05	15533.35	54.291
1869.20	0.010857	-18.53	287.50	-999.99	15515.86	53.968
1879.25	0.010857	-19.13	288.89	-1026.46	15497.30	53.645
1889.30	0.010857	-19.77	290.27	-1054.40	15477.71	53.321
1899.35	0.010857	-20.45	291.66	-1083.73	15457.14	52.997
1909.40	0.010857	-21.16	293.05	-1114.38	15435.65	52.673
1919.45	0.010857	-21.90	294.43	-1146.25	15413.30	52.349
1929.50	0.010857	-22.67	295.82	-1179.29	15390.14	52.026
1939.55	0.010857	-23.47	297.21	-1213.40	15366.22	51.702
1949.60	0.010857	-24.30	298.59	-1248.51	15341.60	51.380
1959.65	0.010857	-25.16	299.98	-1284.56	15316.32	51.058
1969.70	0.010857	-26.05	301.36	-1321.48	15290.44	50.737
1979.75	0.010857	-26.96	302.75	-1359.18	15264.00	50.418

Cod. elab.: 108GA201-GA01-Z-CL-002_C	Titolo: OPERE D'ARTE MAGGIORI- GALLERIE	Data: Ottobre 2011
Nome file: 108GA201-GA01-Z-CL -002_C.docx	ARTIFICIALI – GALLERIA ROVETELLO	Pagina 200 di 452
Relazione di calcolo		

PROGETTO ESECUTIVO

1989.80	0.010857	-27.90	304.14	-1397.61	15237.05	50.099
1999.85	0.010857	-28.86	305.52	-1436.70	15209.64	49.782
2009.90	0.010857	-29.85	306.91	-1476.38	15181.81	49.467
2019.95	0.010857	-30.85	308.30	-1516.60	15153.61	49.153
20210.00	0.010857	-31.89	309.68	-1554.26	15095.65	48.746
20310.05	0.010857	-32.94	311.07	-1587.07	14989.29	48.186
20410.10	0.010857	-34.01	312.46	-1619.81	14883.11	47.633
20510.15	0.010857	-35.10	313.84	-1652.46	14777.27	47.085
20610.20	0.010857	-36.20	315.23	-1684.95	14671.91	46.544
20710.25	0.010857	-37.32	316.61	-1717.26	14567.16	46.009
20810.30	0.010857	-38.46	318.00	-1749.34	14463.15	45.481
20910.35	0.010857	-39.62	319.39	-1781.16	14359.99	44.961
21010.40	0.010857	-40.78	320.77	-1812.68	14257.79	44.448
21110.45	0.010857	-41.96	322.16	-1843.87	14156.65	43.943
21210.50	0.010857	-43.15	323.55	-1874.71	14056.66	43.446
21310.55	0.010857	-44.35	324.93	-1903.77	13947.62	42.925
21410.60	0.010857	-45.56	326.32	-1932.38	13839.99	42.412
21510.65	0.010857	-46.78	327.71	-1960.53	13734.04	41.910
21610.70	0.010857	-48.01	329.09	-1988.23	13629.83	41.416
21710.75	0.010857	-49.24	330.48	-2015.44	13527.43	40.933
21810.80	0.010857	-50.48	331.87	-2042.16	13426.88	40.459
21910.85	0.010857	-51.72	333.25	-2068.38	13328.24	39.995
22010.90	0.010857	-52.96	334.64	-2094.07	13231.54	39.540
22110.95	0.010857	-54.21	336.02	-2119.24	13136.82	39.095
22211.00	0.010857	-55.46	337.41	-2143.88	13044.12	38.659
22311.05	0.010857	-56.70	338.80	-2167.61	12951.30	38.227
22411.10	0.010857	-57.95	340.18	-2189.54	12853.27	37.783
22511.15	0.010857	-59.19	341.57	-2210.91	12757.70	37.350
22611.20	0.010857	-60.44	342.96	-2231.74	12664.59	36.928
22711.25	0.010857	-61.67	344.34	-2252.01	12573.96	36.516
22811.30	0.010857	-62.90	345.73	-2271.73	12485.81	36.114
22911.35	0.010857	-64.13	347.12	-2290.89	12400.15	35.723
23011.40	0.010857	-65.35	348.50	-2309.49	12316.98	35.343
23111.45	0.010857	-66.55	349.89	-2327.54	12236.31	34.972
23211.50	0.010857	-67.75	351.27	-2345.02	12158.12	34.611
23311.55	0.010857	-68.94	352.66	-2361.95	12082.43	34.261

Cod. elab.: 108GA201-GA01-Z-CL-002_C	Titolo: OPERE D'ARTE MAGGIORI- GALLERIE	Data: Ottobre 2011
Nome file: 108GA201-GA01-Z-CL -002_C.docx	ARTIFICIALI – GALLERIA ROVETELLO	Pagina 201 di 452
Relazione di calcolo		

PROGETTO ESECUTIVO

23411.60	0.010857	-70.12	354.05	-2378.33	12009.22	33.920
23511.65	0.010857	-71.28	355.43	-2394.15	11938.50	33.589
23611.70	0.010857	-72.43	356.82	-2409.03	11868.40	33.262
23711.75	0.010857	-73.56	358.21	-2422.61	11797.18	32.934
23811.80	0.010857	-74.68	359.59	-2435.66	11728.70	32.617
23911.85	0.010857	-75.77	360.98	-2448.19	11662.97	32.309
24011.90	0.010857	-76.85	362.37	-2460.20	11599.97	32.012
24111.95	0.010857	-77.91	363.75	-2471.69	11539.69	31.724
24212.00	0.010857	-78.95	365.14	-2482.66	11482.13	31.446
24312.05	0.010857	-79.97	366.53	-2493.11	11427.28	31.177
24412.10	0.010857	-80.96	367.91	-2503.05	11375.14	30.918
24512.15	0.010857	-81.92	369.30	-2512.47	11325.71	30.668
24612.20	0.010857	-82.87	370.68	-2521.38	11278.98	30.427
24712.25	0.010857	-83.78	372.07	-2529.77	11234.96	30.196
24812.30	0.010857	-84.66	373.46	-2537.65	11193.64	29.973
24912.35	0.010857	-85.52	374.84	-2545.01	11155.04	29.759
25012.40	0.010857	-86.34	376.23	-2551.85	11119.15	29.554
25112.45	0.010857	-87.14	377.62	-2558.17	11086.00	29.358
25212.50	0.010857	-87.90	379.00	-2563.96	11055.58	29.170
25312.55	0.010857	-88.62	380.39	-2569.24	11027.92	28.991
25412.60	0.010857	-89.31	381.78	-2573.98	11003.03	28.821
25512.65	0.010857	-89.96	383.16	-2578.19	10980.94	28.659
25612.70	0.010857	-90.58	384.55	-2581.87	10961.66	28.505
25712.75	0.010857	-91.15	385.94	-2585.01	10945.19	28.360
25812.80	0.010857	-91.68	387.32	-2587.62	10931.47	28.223
25912.85	0.010857	-92.18	388.71	-2589.73	10920.43	28.094
26012.90	0.010857	-92.64	390.09	-2591.34	10911.97	27.973
26112.95	0.010857	-93.06	391.48	-2592.47	10906.04	27.858
26213.00	0.010857	-93.44	392.87	-2593.13	10902.56	27.751
26313.05	0.010857	-93.79	394.25	-2593.34	10901.48	27.651
26413.10	0.010857	-94.10	395.64	-2593.10	10902.73	27.557
26513.15	0.010857	-94.37	397.03	-2592.43	10906.26	27.470
26613.20	0.010857	-94.61	398.41	-2591.33	10912.03	27.389
26713.25	0.010857	-94.82	399.80	-2589.81	10919.99	27.314
26813.30	0.010857	-94.99	401.19	-2587.88	10930.10	27.245
26913.35	0.010857	-95.12	402.57	-2585.55	10942.32	27.181

Cod. elab.: 108GA201-GA01-Z-CL-002_C	Titolo: OPERE D'ARTE MAGGIORI- GALLERIE	Data: Ottobre 2011
Nome file: 108GA201-GA01-Z-CL -002_C.docx	ARTIFICIALI – GALLERIA ROVETELLO	Pagina 202 di 452
Relazione di calcolo		

PROGETTO ESECUTIVO

27013.40	0.010857	-95.23	403.96	-2582.83	10956.62	27.123
27113.45	0.010857	-95.30	405.34	-2579.71	10972.96	27.071
27213.50	0.010857	-95.33	406.73	-2576.21	10991.31	27.024
27313.55	0.010857	-95.34	408.12	-2572.34	11011.66	26.982
27413.60	0.010857	-95.31	409.50	-2568.08	11033.98	26.945
27513.65	0.010857	-95.25	410.89	-2563.46	11058.24	26.913
27613.70	0.010857	-95.16	412.28	-2558.46	11084.44	26.886
27713.75	0.010857	-95.04	413.66	-2553.11	11112.55	26.864
27813.80	0.010857	-94.89	415.05	-2547.38	11142.56	26.846
27913.85	0.010857	-94.71	416.44	-2541.30	11174.46	26.834
28013.90	0.010857	-94.49	417.82	-2534.86	11208.25	26.825
28113.95	0.010857	-94.25	419.21	-2528.07	11243.91	26.822
28214.00	0.010857	-93.98	420.60	-2520.91	11281.45	26.823
28314.05	0.010857	-93.69	421.98	-2513.40	11320.86	26.828
28414.10	0.010857	-93.36	423.37	-2505.53	11362.14	26.837
28514.15	0.010857	-93.00	424.75	-2497.30	11405.29	26.851
28614.20	0.010857	-92.62	426.14	-2488.72	11450.32	26.870
28714.25	0.010857	-92.21	427.53	-2479.78	11497.24	26.892
28814.30	0.010857	-91.77	428.91	-2470.47	11546.05	26.919
28914.35	0.010857	-91.31	430.30	-2460.81	11596.76	26.950
29014.40	0.010857	-90.82	431.69	-2450.78	11649.39	26.986
29114.45	0.010857	-90.30	433.07	-2440.38	11703.95	27.025
29214.50	0.010857	-89.76	434.46	-2429.60	11760.46	27.069
29314.55	0.010857	-89.19	435.85	-2418.46	11818.93	27.117
29414.60	0.010857	-88.59	437.23	-2406.93	11879.39	27.170
29514.65	0.010857	-87.97	438.62	-2394.26	11938.02	27.217
29614.70	0.010857	-87.32	440.00	-2380.96	11997.45	27.267
29714.75	0.010857	-86.65	441.39	-2367.25	12058.73	27.320
29814.80	0.010857	-85.95	442.78	-2353.13	12121.88	27.377
29914.85	0.010857	-85.23	444.16	-2338.58	12186.93	27.438
30014.90	0.010857	-84.49	445.55	-2323.60	12253.90	27.503
30114.95	0.010857	-83.72	446.94	-2308.19	12322.81	27.572
30215.00	0.010857	-82.92	448.32	-2292.33	12393.71	27.645
30315.05	0.010857	-82.10	449.71	-2276.02	12466.61	27.721
30415.10	0.010857	-81.26	451.10	-2259.26	12541.57	27.802
30515.15	0.010857	-80.40	452.48	-2242.02	12618.60	27.887

Cod. elab.: 108GA201-GA01-Z-CL-002_C	Titolo: OPERE D'ARTE MAGGIORI- GALLERIE	Data: Ottobre 2011
Nome file: 108GA201-GA01-Z-CL -002_C.docx	ARTIFICIALI – GALLERIA ROVETELLO Relazione di calcolo	Pagina 203 di 452

PROGETTO ESECUTIVO

30615.20	0.010857	-79.51	453.87	-2224.32	12697.76	27.977
30715.25	0.010857	-78.59	455.26	-2206.13	12779.08	28.070
30815.30	0.010857	-77.66	456.64	-2187.45	12862.61	28.168
30915.35	0.010857	-76.70	458.03	-2168.26	12948.39	28.270
31015.40	0.010857	-75.72	459.41	-2147.54	13030.34	28.363
31115.45	0.010857	-74.71	460.80	-2125.88	13111.85	28.454
31215.50	0.010857	-73.68	462.19	-2103.67	13195.41	28.550
31315.55	0.010857	-72.63	463.57	-2080.91	13281.08	28.649
31415.60	0.010857	-71.56	464.96	-2057.57	13368.89	28.753
31515.65	0.010857	-70.47	466.35	-2033.65	13458.89	28.860
31615.70	0.010857	-69.35	467.73	-2009.14	13551.14	28.972
31715.75	0.010857	-68.21	469.12	-1984.01	13645.68	29.088
31815.80	0.010857	-67.05	470.51	-1958.26	13742.57	29.208
31915.85	0.010857	-65.86	471.89	-1931.87	13841.88	29.333
32015.90	0.010857	-64.65	473.28	-1904.83	13943.65	29.462
32115.95	0.010857	-63.43	474.66	-1877.10	14047.97	29.596
32216.00	0.010857	-62.17	476.05	-1847.42	14145.15	29.714
32316.05	0.010857	-60.90	477.44	-1816.95	14243.95	29.834
32416.10	0.010857	-59.61	478.82	-1785.76	14345.07	29.959
32516.15	0.010857	-58.29	480.21	-1753.84	14448.57	30.088
32616.20	0.010857	-56.95	481.60	-1721.16	14554.52	30.221
32716.25	0.010857	-55.59	482.98	-1687.71	14662.98	30.359
32816.30	0.010857	-54.21	484.37	-1653.46	14774.03	30.502
32916.35	0.010857	-52.80	485.76	-1618.39	14887.72	30.649
33016.40	0.010857	-51.38	487.14	-1582.49	15004.13	30.800
33116.45	0.010857	-49.93	488.53	-1545.72	15123.35	30.957
33216.50	0.010857	-48.46	489.92	-1500.11	15165.17	30.955
33316.55	0.010857	-46.99	491.30	-1453.67	15197.74	30.934
33416.60	0.010857	-45.55	492.69	-1408.00	15229.77	30.912
33516.65	0.010857	-44.13	494.07	-1363.10	15261.25	30.889
33616.70	0.010857	-42.73	495.46	-1318.97	15292.19	30.865
33716.75	0.010857	-41.36	496.85	-1275.62	15322.59	30.840
33816.80	0.010857	-40.02	498.23	-1233.04	15352.45	30.814
33916.85	0.010857	-38.69	499.62	-1191.24	15381.76	30.787
34016.90	0.010857	-37.39	501.01	-1150.22	15410.52	30.759
34116.95	0.010857	-36.12	502.39	-1109.98	15438.74	30.730

Cod. elab.: 108GA201-GA01-Z-CL-002_C	Titolo: OPERE D'ARTE MAGGIORI- GALLERIE	Data: Ottobre 2011
Nome file: 108GA201-GA01-Z-CL -002_C.docx	ARTIFICIALI – GALLERIA ROVETELLO	Pagina 204 di 452
Relazione di calcolo		

PROGETTO ESECUTIVO

34217.00	0.010857	-34.87	503.78	-1070.51	15466.41	30.701
34317.05	0.010857	-33.64	505.17	-1031.82	15493.54	30.670
34417.10	0.010857	-32.44	506.55	-993.92	15520.12	30.639
34517.15	0.010857	-31.26	507.94	-956.78	15546.16	30.606
34617.20	0.010857	-30.11	509.33	-920.43	15571.65	30.573
34717.25	0.010857	-28.97	510.71	-884.85	15596.60	30.539
34817.30	0.010857	-27.87	512.10	-850.04	15621.00	30.504
34917.35	0.010857	-26.78	513.48	-816.00	15644.87	30.468
35017.40	0.010857	-25.72	514.87	-782.74	15668.20	30.431
35117.45	0.010857	-24.68	516.26	-750.24	15690.99	30.394
35217.50	0.010857	-23.67	517.64	-718.50	15713.24	30.355
35317.55	0.010857	-22.68	519.03	-687.53	15734.96	30.316
35417.60	0.010857	-21.71	520.42	-657.31	15756.14	30.276
35517.65	0.010857	-20.77	521.80	-627.85	15776.80	30.235
35617.70	0.010857	-19.84	523.19	-599.15	15796.93	30.194
35717.75	0.010857	-18.94	524.58	-571.19	15816.54	30.151
35817.80	0.010857	-18.07	525.96	-543.97	15835.62	30.108
35917.85	0.010857	-17.21	527.35	-517.50	15854.18	30.064
36017.90	0.010857	-16.38	528.73	-491.76	15872.23	30.019
36117.95	0.010857	-15.57	530.12	-466.75	15889.77	29.974
36218.00	0.010857	-14.78	531.51	-442.47	15906.79	29.928
36318.05	0.010857	-14.02	532.89	-418.92	15923.31	29.881
36418.10	0.010857	-13.28	534.28	-396.08	15939.32	29.833
36518.15	0.010857	-12.55	535.67	-373.95	15954.84	29.785
36618.20	0.010857	-11.86	537.05	-352.53	15969.86	29.736
36718.25	0.010857	-11.18	538.44	-331.81	15984.38	29.686
36818.30	0.010857	-10.52	539.83	-311.79	15998.42	29.636
36918.35	0.010857	-9.89	541.21	-292.46	16011.98	29.585
37018.40	0.010857	-9.27	542.60	-273.82	16025.05	29.534
37118.45	0.010857	-8.68	543.99	-255.85	16037.65	29.482
37218.50	0.010857	-8.11	545.37	-238.56	16049.77	29.429
37318.55	0.010857	-7.56	546.76	-221.94	16061.43	29.376
37418.60	0.010857	-7.02	548.14	-205.97	16072.62	29.322
37518.65	0.010857	-6.51	549.53	-190.66	16083.36	29.267
37618.70	0.010857	-6.02	550.92	-176.00	16093.64	29.212
37718.75	0.010857	-5.56	552.30	-161.98	16103.47	29.157

Cod. elab.: 108GA201-GA01-Z-CL-002_C	Titolo: OPERE D'ARTE MAGGIORI- GALLERIE	Data: Ottobre 2011
Nome file: 108GA201-GA01-Z-CL -002_C.docx	ARTIFICIALI – GALLERIA ROVETELLO Relazione di calcolo	Pagina 205 di 452

PROGETTO ESECUTIVO

37818.80	0.010857	-5.11	553.69	-148.60	16112.85	29.101
37918.85	0.010857	-4.68	555.08	-135.84	16121.80	29.044
38018.90	0.010857	-4.27	556.46	-123.71	16130.31	28.987
38118.95	0.010857	-3.88	557.85	-112.19	16138.38	28.930
38219.00	0.010857	-3.51	559.24	-101.28	16146.03	28.872
38319.05	0.010857	-3.16	560.62	-90.97	16153.26	28.813
38419.10	0.010857	-2.83	562.01	-81.26	16160.07	28.754
38519.15	0.010857	-2.51	563.39	-72.14	16166.47	28.695
38619.20	0.010857	-2.22	564.78	-63.59	16172.46	28.635
38719.25	0.010857	-1.95	566.17	-55.62	16178.05	28.575
38819.30	0.010857	-1.69	567.55	-48.21	16183.24	28.514
38919.35	0.010857	-1.45	568.94	-41.37	16188.04	28.453
39019.40	0.010857	-1.24	570.33	-35.07	16192.46	28.392
39119.45	0.010857	-1.04	571.71	-29.33	16196.49	28.330
39219.50	0.010857	-0.85	573.10	-24.11	16200.14	28.268
39319.55	0.010857	-0.69	574.49	-19.43	16203.42	28.205
39419.60	0.010857	-0.54	575.87	-15.28	16206.34	28.142
39519.65	0.010857	-0.41	577.26	-11.64	16208.89	28.079
39619.70	0.010857	-0.30	578.65	-8.51	16211.09	28.016
39719.75	0.010857	-0.21	580.03	-5.88	16212.93	27.952
39819.80	0.010857	-0.13	581.42	-3.74	16214.43	27.888
39919.85	0.010857	-0.08	582.80	-2.09	16215.58	27.823
40019.90	0.010857	-0.03	584.19	-0.92	16216.40	27.759
40119.95	0.010857	-0.01	585.58	-0.23	16216.89	27.694
40220.00	0.010857	0.00	586.96	0.00	-4248.53	7.238

Fase n° 3 - [A2-M2]

n°	Y	A _f	M	N	M _u	N _u	CS
1	0.00	0.010857	0.00	0.00	0.00	0.00	1000.000
2	0.05	0.010857	0.00	1.39	-0.03	16217.03	11697.185
3	0.10	0.010857	0.00	2.77	-0.06	16217.01	5848.585
4	0.15	0.010857	0.00	4.16	-0.09	16216.99	3899.051
5	0.20	0.010857	0.00	5.55	-0.12	16216.97	2924.285
6	0.25	0.010857	0.00	6.93	-0.15	16216.95	2339.425
7	0.30	0.010857	0.00	8.32	-0.18	16216.92	1949.518

Cod. elab.: 108GA201-GA01-Z-CL-002_C	Titolo: OPERE D'ARTE MAGGIORI- GALLERIE	Data: Ottobre 2011
Nome file: 108GA201-GA01-Z-CL -002_C.docx	ARTIFICIALI – GALLERIA ROVETELLO	Pagina 206 di 452
Relazione di calcolo		

PROGETTO ESECUTIVO

8	0.35	0.010857	0.00	9.70	-0.21	16216.90	1671.013
9	0.40	0.010857	0.00	11.09	-0.24	16216.88	1462.135
10	0.45	0.010857	0.00	12.48	-0.27	16216.86	1299.674
11	0.50	0.010857	0.00	13.86	-0.30	16216.84	1169.705
12	0.55	0.010857	0.00	15.25	-0.34	16216.81	1063.366
13	0.60	0.010857	0.00	16.64	-0.40	16216.77	974.750
14	0.65	0.010857	0.00	18.02	-0.47	16216.72	899.766
15	0.70	0.010857	0.00	19.41	-0.55	16216.67	835.494
16	0.75	0.010857	0.00	20.80	-0.64	16216.60	779.792
17	0.80	0.010857	0.00	22.18	-0.74	16216.54	731.052
18	0.85	0.010857	0.00	23.57	-0.84	16216.46	688.046
19	0.90	0.010857	0.00	24.96	-0.94	16216.39	649.818
20	0.95	0.010857	0.00	26.34	-1.05	16216.31	615.614
21	1.00	0.010857	0.00	27.73	-1.16	16216.24	584.831
22	1.05	0.010857	0.00	29.11	-1.28	16216.16	556.979
23	1.10	0.010857	0.00	30.50	-1.39	16216.07	531.659
24	1.15	0.010857	0.00	31.89	-1.51	16215.99	508.541
25	1.20	0.010857	0.00	33.27	-1.63	16215.91	487.349
26	1.25	0.010857	0.00	34.66	-1.75	16215.82	467.853
27	1.30	0.010857	0.00	36.05	-1.87	16215.74	449.856
28	1.35	0.010857	0.00	37.43	-1.99	16215.65	433.192
29	1.40	0.010857	-0.01	38.82	-2.12	16215.57	417.719
30	1.45	0.010857	-0.01	40.21	-2.24	16215.48	403.313
31	1.50	0.010857	-0.01	41.59	-2.36	16215.39	389.867
32	1.55	0.010857	-0.01	42.98	-2.49	16215.31	377.288
33	1.60	0.010857	-0.01	44.36	-2.61	16215.22	365.496
34	1.65	0.010857	-0.01	45.75	-2.74	16215.13	354.419
35	1.70	0.010857	-0.01	47.14	-2.86	16215.04	343.993
36	1.75	0.010857	-0.01	48.52	-2.99	16214.96	334.163
37	1.80	0.010857	-0.01	49.91	-3.11	16214.87	324.879
38	1.85	0.010857	-0.01	51.30	-3.24	16214.78	316.096
39	1.90	0.010857	-0.01	52.68	-3.36	16214.70	307.776
40	1.95	0.010857	-0.01	54.07	-3.48	16214.61	299.883
41	2.00	0.010857	-0.01	55.46	-3.61	16214.52	292.384
42	2.05	0.010857	-0.01	56.84	-3.73	16214.43	285.252
43	2.10	0.010857	-0.01	58.23	-3.86	16214.35	278.458

<i>Cod. elab.:</i> 108GA201-GA01-Z-CL-002_C	<i>Titolo:</i> OPERE D'ARTE MAGGIORI- GALLERIE	<i>Data:</i> Ottobre 2011
<i>Nome file:</i> 108GA201-GA01-Z-CL -002_C.docx	ARTIFICIALI – GALLERIA ROVETELLO Relazione di calcolo	<i>Pagina</i> 207 di 452

PROGETTO ESECUTIVO

44	2.15	0.010857	-0.01	59.62	-3.98	16214.26	271.981
45	2.20	0.010857	-0.02	61.00	-4.10	16214.18	265.798
46	2.25	0.010857	-0.02	62.39	-4.22	16214.09	259.890
47	2.30	0.010857	-0.02	63.77	-4.35	16214.00	254.239
48	2.35	0.010857	-0.02	65.16	-4.47	16213.92	248.829
49	2.40	0.010857	-0.02	66.55	-4.59	16213.83	243.643
50	2.45	0.010857	-0.02	67.93	-4.71	16213.75	238.670
51	2.50	0.010857	-0.02	69.32	-4.83	16213.66	233.895
52	2.50	0.010857	-0.02	108.36	-3.09	16214.88	149.634
53	2.55	0.010857	-5.39	109.75	-769.26	15677.65	142.848
54	2.60	0.010857	-10.75	111.14	-1468.97	15187.02	136.652
55	2.65	0.010857	-16.11	112.52	-1964.63	13718.64	121.918
56	2.70	0.010857	-21.48	113.91	-2316.55	12285.43	107.853
57	2.75	0.010857	-26.83	115.30	-2567.97	11034.54	95.706
58	2.80	0.010857	-32.14	116.68	-2746.47	9971.36	85.457
59	2.85	0.010857	-37.36	118.07	-2874.50	9084.25	76.940
60	2.90	0.010857	-42.47	119.46	-2965.19	8339.57	69.813
61	2.95	0.010857	-47.46	120.84	-3027.82	7709.07	63.795
62	3.00	0.010857	-52.31	122.23	-3053.13	7133.94	58.366
63	3.05	0.010857	-57.00	123.61	-3065.78	6648.28	53.782
64	3.10	0.010857	-61.53	125.00	-3060.62	6218.04	49.744
65	3.15	0.010857	-65.87	126.39	-3047.71	5847.59	46.267
66	3.20	0.010857	-70.03	127.77	-3037.04	5541.10	43.367
67	3.25	0.010857	-74.00	129.16	-3020.13	5271.00	40.810
68	3.30	0.010857	-77.79	130.55	-2998.52	5032.15	38.547
69	3.35	0.010857	-81.38	131.93	-2980.38	4831.69	36.622
70	3.40	0.010857	-84.78	133.32	-2965.08	4662.69	34.974
71	3.45	0.010857	-87.98	134.71	-2952.16	4519.91	33.554
72	3.50	0.010857	-90.99	136.09	-2941.25	4399.34	32.326
73	3.55	0.010857	-93.79	137.48	-2930.09	4294.96	31.241
74	3.60	0.010857	-96.39	138.86	-2916.17	4201.18	30.254
75	3.65	0.010857	-98.79	140.25	-2904.71	4123.97	29.404
76	3.70	0.010857	-100.97	141.64	-2895.43	4061.50	28.675
77	3.75	0.010857	-102.95	143.02	-2888.13	4012.33	28.054
78	3.80	0.010857	-104.72	144.41	-2882.64	3975.35	27.528
79	3.85	0.010857	-106.27	145.80	-2878.84	3949.70	27.090

Cod. elab.: 108GA201-GA01-Z-CL-002_C	Titolo: OPERE D'ARTE MAGGIORI- GALLERIE	Data: Ottobre 2011
Nome file: 108GA201-GA01-Z-CL -002_C.docx	ARTIFICIALI – GALLERIA ROVETELLO	Pagina 208 di 452
Relazione di calcolo		

PROGETTO ESECUTIVO

80	3.90	0.010857	-107.60	147.18	-2876.62	3934.77	26.734
81	3.95	0.010857	-108.72	148.57	-2875.93	3930.14	26.453
82	4.00	0.010857	-109.61	149.96	-2876.73	3935.53	26.245
83	4.05	0.010857	-110.28	151.34	-2879.01	3950.87	26.106
84	4.10	0.010857	-110.73	152.73	-2882.77	3976.21	26.034
85	4.15	0.010857	-110.95	154.12	-2888.05	4011.76	26.031
86	4.20	0.010857	-110.93	155.50	-2894.90	4057.90	26.096
87	4.25	0.010857	-110.69	156.89	-2903.40	4115.18	26.230
88	4.30	0.010857	-110.21	158.27	-2913.67	4184.33	26.437
89	4.35	0.010857	-109.50	159.66	-2925.84	4266.33	26.721
90	4.40	0.010857	-108.54	161.05	-2937.57	4358.63	27.064
91	4.45	0.010857	-107.34	162.43	-2946.64	4458.85	27.450
92	4.50	0.010857	-105.91	163.82	-2957.07	4574.16	27.922
93	4.55	0.010857	-104.22	165.21	-2969.04	4706.41	28.488
94	4.60	0.010857	-102.29	166.59	-2982.75	4857.89	29.160
95	4.65	0.010857	-100.11	167.98	-2998.46	5031.45	29.953
96	4.70	0.010857	-97.67	169.37	-3016.48	5230.68	30.884
97	4.75	0.010857	-94.98	170.75	-3034.01	5454.28	31.943
98	4.80	0.010857	-92.04	172.14	-3042.22	5689.85	33.054
99	4.85	0.010857	-88.83	173.52	-3051.66	5960.96	34.352
100	4.90	0.010857	-85.37	174.91	-3062.59	6274.81	35.874
101	4.95	0.010857	-81.64	176.30	-3066.47	6621.63	37.559
102	5.00	0.010857	-77.65	177.68	-3056.76	6994.59	39.365
103	5.05	0.010857	-73.49	179.07	-3045.65	7421.40	41.444
104	5.10	0.010857	-69.25	180.46	-3013.55	7852.67	43.515
105	5.15	0.010857	-64.95	181.84	-2968.11	8310.16	45.700
106	5.20	0.010857	-60.58	183.23	-2912.44	8808.83	48.075
107	5.25	0.010857	-56.15	184.62	-2839.78	9336.25	50.571
108	5.30	0.010857	-51.67	186.00	-2755.17	9917.59	53.320
109	5.35	0.010857	-47.14	187.39	-2653.29	10547.05	56.284
110	5.40	0.010857	-42.56	188.78	-2531.31	11226.88	59.472
111	5.45	0.010857	-37.94	190.16	-2387.77	11967.00	62.931
112	5.50	0.010857	-33.29	191.55	-2214.28	12742.65	66.525
113	5.55	0.010857	-28.59	192.93	-2008.63	13553.06	70.247
114	5.60	0.010857	-23.87	194.32	-1769.02	14399.34	74.101
115	5.65	0.010857	-19.13	195.71	-1483.33	15176.95	77.549

<i>Cod. elab.:</i> 108GA201-GA01-Z-CL-002_C	<i>Titolo:</i> OPERE D'ARTE MAGGIORI- GALLERIE	<i>Data:</i> Ottobre 2011
<i>Nome file:</i> 108GA201-GA01-Z-CL -002_C.docx	ARTIFICIALI – GALLERIA ROVETELLO Relazione di calcolo	<i>Pagina</i> 209 di 452

PROGETTO ESECUTIVO

1165.70	0.010857	-14.36	197.09	-1124.21	15428.76	78.281
1175.75	0.010857	-9.58	198.48	-756.98	15686.26	79.032
1185.80	0.010857	-4.78	199.87	-381.68	15949.42	79.800
1195.85	0.010857	0.02	201.25	1.64	16215.90	80.575
1205.90	0.010857	4.83	202.64	379.92	15950.65	78.714
1215.95	0.010857	9.63	204.03	741.09	15697.40	76.938
1226.00	0.010857	14.43	205.41	1085.98	15455.56	75.242
1236.05	0.010857	19.23	206.80	1415.36	15224.60	73.620
1246.10	0.010857	24.00	208.18	1689.84	14656.07	70.399
1256.15	0.010857	28.76	209.57	1910.76	13921.33	66.428
1266.20	0.010857	33.50	210.96	2098.65	13214.32	62.640
1276.25	0.010857	38.22	212.34	2258.09	12546.78	59.087
1286.30	0.010857	42.90	213.73	2395.24	11933.61	55.835
1296.35	0.010857	47.55	215.12	2508.21	11348.08	52.753
1306.40	0.010857	52.15	216.50	2607.82	10825.51	50.002
1316.45	0.010857	56.72	217.89	2688.66	10328.53	47.403
1326.50	0.010857	61.24	219.28	2760.50	9884.70	45.079
1336.55	0.010857	65.70	220.66	2820.83	9473.78	42.933
1346.60	0.010857	70.11	222.05	2872.62	9097.83	40.972
1356.65	0.010857	74.46	223.44	2919.20	8759.77	39.205
1366.70	0.010857	78.74	224.82	2955.41	8438.04	37.532
1376.75	0.010857	82.96	226.21	2985.05	8139.62	35.983
1386.80	0.010857	87.10	227.59	3011.82	7870.13	34.580
1396.85	0.010857	91.16	228.98	3036.06	7626.08	33.304
1406.90	0.010857	95.14	230.37	3046.80	7377.26	32.024
1416.95	0.010857	99.04	231.75	3052.87	7144.05	30.826
1427.00	0.010857	102.84	233.14	3058.36	6933.14	29.738
1437.05	0.010857	106.57	234.53	3063.34	6741.71	28.746
1447.10	0.010857	110.20	235.91	3067.88	6567.42	27.838
1457.15	0.010857	113.76	237.30	3066.87	6397.53	26.960
1467.20	0.010857	117.23	238.69	3061.13	6232.71	26.113
1477.25	0.010857	120.62	240.07	3055.89	6082.39	25.336
1487.30	0.010857	123.92	241.46	3051.10	5944.97	24.621
1497.35	0.010857	127.15	242.85	3046.72	5819.06	23.962
1507.40	0.010857	130.29	244.23	3042.69	5703.47	23.353
1517.45	0.010857	133.36	245.62	3038.99	5597.19	22.788

Cod. elab.: 108GA201-GA01-Z-CL-002_C	Titolo: OPERE D'ARTE MAGGIORI- GALLERIE	Data: Ottobre 2011
Nome file: 108GA201-GA01-Z-CL -002_C.docx	ARTIFICIALI – GALLERIA ROVETELLO	Pagina 210 di 452
	Relazione di calcolo	

PROGETTO ESECUTIVO

1527.50	0.010857	136.34	247.00	3035.58	5499.32	22.264
1537.55	0.010857	139.25	248.39	3032.44	5409.10	21.777
1547.60	0.010857	142.08	249.78	3024.25	5316.54	21.285
1557.65	0.010857	144.84	251.16	3016.51	5230.99	20.827
1567.70	0.010857	147.51	252.55	3009.38	5152.20	20.401
1577.75	0.010857	150.12	253.94	3002.81	5079.58	20.003
1587.80	0.010857	152.64	255.32	2996.75	5012.64	19.633
1597.85	0.010857	155.09	256.71	2991.17	4950.92	19.286
1607.90	0.010857	157.47	258.10	2986.02	4894.03	18.962
1617.95	0.010857	159.78	259.48	2981.28	4841.62	18.659
1628.00	0.010857	162.01	260.87	2976.91	4793.36	18.375
1638.05	0.010857	164.17	262.25	2972.89	4748.97	18.108
1648.10	0.010857	166.26	263.64	2969.20	4708.20	17.858
1658.15	0.010857	168.28	265.03	2965.82	4670.83	17.624
1668.20	0.010857	170.23	266.41	2962.73	4636.64	17.404
1678.25	0.010857	172.11	267.80	2959.91	4605.46	17.197
1688.30	0.010857	173.93	269.19	2957.34	4577.11	17.003
1698.35	0.010857	175.67	270.57	2955.02	4551.45	16.821
1708.40	0.010857	177.34	271.96	2952.93	4528.33	16.651
1718.45	0.010857	178.95	273.35	2951.05	4507.64	16.491
1728.50	0.010857	180.50	274.73	2949.39	4489.27	16.341
1738.55	0.010857	181.94	276.12	2948.00	4473.89	16.203
1748.60	0.010857	183.27	277.51	2946.94	4462.15	16.080
1758.65	0.010857	184.48	278.89	2946.19	4453.91	15.970
1768.70	0.010857	185.57	280.28	2945.75	4449.07	15.874
1778.75	0.010857	186.55	281.66	2945.61	4447.51	15.790
1788.80	0.010857	187.41	283.05	2945.76	4449.17	15.719
1798.85	0.010857	188.15	284.44	2946.20	4453.97	15.659
1808.90	0.010857	188.78	285.82	2946.91	4461.87	15.611
1818.95	0.010857	189.29	287.21	2947.90	4472.83	15.573
1829.00	0.010857	189.69	288.60	2949.17	4486.83	15.547
1839.05	0.010857	189.98	289.98	2950.71	4503.86	15.531
1849.10	0.010857	190.16	291.37	2952.53	4523.92	15.526
1859.15	0.010857	190.23	292.76	2954.62	4547.04	15.532
1869.20	0.010857	190.19	294.14	2956.99	4573.23	15.548
1879.25	0.010857	190.04	295.53	2959.64	4602.52	15.574

Cod. elab.: 108GA201-GA01-Z-CL-002_C	Titolo: OPERE D'ARTE MAGGIORI- GALLERIE	Data: Ottobre 2011
Nome file: 108GA201-GA01-Z-CL -002_C.docx	ARTIFICIALI – GALLERIA ROVETELLO Relazione di calcolo	Pagina 211 di 452

PROGETTO ESECUTIVO

1889.30	0.010857	189.78	296.91	2962.57	4634.93	15.610
1899.35	0.010857	189.42	298.30	2965.79	4670.48	15.657
1909.40	0.010857	188.96	299.69	2969.29	4709.18	15.714
1919.45	0.010857	188.40	301.07	2973.08	4751.07	15.780
1929.50	0.010857	187.75	302.46	2977.17	4796.19	15.857
1939.55	0.010857	187.00	303.85	2981.55	4844.60	15.944
1949.60	0.010857	186.16	305.23	2986.23	4896.35	16.041
1959.65	0.010857	185.23	306.62	2991.22	4951.53	16.149
1969.70	0.010857	184.21	308.01	2996.53	5010.22	16.267
1979.75	0.010857	183.11	309.39	3002.17	5072.52	16.395
1989.80	0.010857	181.93	310.78	3008.15	5138.53	16.534
1999.85	0.010857	180.67	312.17	3014.47	5208.38	16.685
2009.90	0.010857	179.34	313.55	3021.15	5282.20	16.846
2019.95	0.010857	177.92	314.94	3028.20	5360.12	17.020
20210.00	0.010857	176.44	316.32	3033.46	5438.43	17.193
20310.05	0.010857	174.89	317.71	3036.15	5515.67	17.361
20410.10	0.010857	173.27	319.10	3038.98	5596.76	17.539
20510.15	0.010857	171.58	320.48	3041.94	5681.85	17.729
20610.20	0.010857	169.83	321.87	3045.05	5771.09	17.930
20710.25	0.010857	168.02	323.26	3048.31	5864.64	18.142
20810.30	0.010857	166.15	324.64	3051.72	5962.69	18.367
20910.35	0.010857	164.23	326.03	3055.30	6065.42	18.604
21010.40	0.010857	162.25	327.42	3059.05	6173.04	18.854
21110.45	0.010857	160.22	328.80	3062.98	6285.78	19.117
21210.50	0.010857	158.14	330.19	3067.09	6403.88	19.395
21310.55	0.010857	156.01	331.57	3069.05	6522.60	19.672
21410.60	0.010857	153.84	332.96	3066.10	6635.96	19.930
21510.65	0.010857	151.63	334.35	3063.02	6754.16	20.201
21610.70	0.010857	149.37	335.73	3059.81	6877.40	20.485
21710.75	0.010857	147.08	337.12	3056.47	7005.88	20.782
21810.80	0.010857	144.74	338.51	3052.98	7139.86	21.092
21910.85	0.010857	142.38	339.89	3049.34	7279.56	21.417
22010.90	0.010857	139.98	341.28	3045.55	7425.26	21.757
22110.95	0.010857	137.55	342.67	3041.05	7575.88	22.109
22211.00	0.010857	135.09	344.05	3027.65	7710.78	22.412
22311.05	0.010857	132.61	345.44	3013.75	7850.66	22.727

Cod. elab.: 108GA201-GA01-Z-CL-002_C	Titolo: OPERE D'ARTE MAGGIORI- GALLERIE	Data: Ottobre 2011
Nome file: 108GA201-GA01-Z-CL -002_C.docx	ARTIFICIALI – GALLERIA ROVETELLO Relazione di calcolo	Pagina 212 di 452

PROGETTO ESECUTIVO

22411.10	0.010857	130.10	346.83	2999.34	7995.72	23.054
22511.15	0.010857	127.57	348.21	2984.41	8146.13	23.394
22611.20	0.010857	125.02	349.60	2968.91	8302.10	23.748
22711.25	0.010857	122.45	350.98	2952.85	8463.83	24.115
22811.30	0.010857	119.87	352.37	2936.19	8631.54	24.496
22911.35	0.010857	117.27	353.76	2914.67	8792.65	24.855
23011.40	0.010857	114.66	355.14	2891.93	8957.72	25.223
23111.45	0.010857	112.03	356.53	2868.42	9128.34	25.603
23211.50	0.010857	109.40	357.92	2844.13	9304.66	25.997
23311.55	0.010857	106.77	359.30	2819.02	9486.88	26.404
23411.60	0.010857	104.13	360.69	2793.08	9675.18	26.824
23511.65	0.010857	101.48	362.08	2764.15	9862.13	27.238
23611.70	0.010857	98.84	363.46	2733.45	10051.83	27.656
23711.75	0.010857	96.20	364.85	2701.80	10247.35	28.087
23811.80	0.010857	93.56	366.24	2669.19	10448.84	28.530
23911.85	0.010857	90.92	367.62	2635.59	10656.45	28.988
24011.90	0.010857	88.29	369.01	2600.03	10866.35	29.447
24111.95	0.010857	85.68	370.39	2560.93	11071.49	29.891
24212.00	0.010857	83.07	371.78	2520.78	11282.13	30.346
24312.05	0.010857	80.47	373.17	2479.57	11498.31	30.813
24412.10	0.010857	77.89	374.55	2437.29	11720.11	31.291
24512.15	0.010857	75.33	375.94	2393.08	11943.29	31.769
24612.20	0.010857	72.78	377.33	2345.08	12157.88	32.221
24712.25	0.010857	70.25	378.71	2296.05	12377.06	32.682
24812.30	0.010857	67.75	380.10	2246.01	12600.80	33.151
24912.35	0.010857	65.27	381.49	2194.95	12829.05	33.629
25012.40	0.010857	62.81	382.87	2141.49	13053.11	34.093
25112.45	0.010857	60.39	384.26	2084.81	13266.41	34.525
25212.50	0.010857	57.99	385.64	2027.32	13482.74	34.962
25312.55	0.010857	55.62	387.03	1969.06	13701.94	35.403
25412.60	0.010857	53.28	388.42	1910.09	13923.84	35.848
25512.65	0.010857	50.98	389.80	1849.27	14139.15	36.272
25612.70	0.010857	48.72	391.19	1786.30	14343.32	36.666
25712.75	0.010857	46.49	392.58	1722.95	14548.71	37.060
25812.80	0.010857	44.30	393.96	1659.27	14755.18	37.453
25912.85	0.010857	42.15	395.35	1595.30	14962.60	37.847

Cod. elab.: 108GA201-GA01-Z-CL-002_C	Titolo: OPERE D'ARTE MAGGIORI- GALLERIE	Data: Ottobre 2011
Nome file: 108GA201-GA01-Z-CL -002_C.docx	ARTIFICIALI – GALLERIA ROVETELLO Relazione di calcolo	Pagina 213 di 452

PROGETTO ESECUTIVO

26012.90	0.010857	40.04	396.74	1528.47	15145.29	38.175
26112.95	0.010857	37.96	398.12	1449.50	15200.67	38.181
26213.00	0.010857	35.93	399.51	1371.86	15255.11	38.185
26313.05	0.010857	33.93	400.90	1295.57	15308.60	38.186
26413.10	0.010857	31.97	402.28	1220.64	15361.14	38.185
26513.15	0.010857	30.04	403.67	1147.09	15412.71	38.182
26613.20	0.010857	28.16	405.05	1074.93	15463.32	38.176
26713.25	0.010857	26.31	406.44	1004.16	15512.94	38.168
26813.30	0.010857	24.50	407.83	934.80	15561.57	38.157
26913.35	0.010857	22.73	409.21	866.85	15609.22	38.144
27013.40	0.010857	20.99	410.60	800.33	15655.86	38.129
27113.45	0.010857	19.29	411.99	735.25	15701.50	38.112
27213.50	0.010857	17.63	413.37	671.60	15746.12	38.092
27313.55	0.010857	16.01	414.76	609.41	15789.74	38.070
27413.60	0.010857	14.42	416.15	548.67	15832.33	38.045
27513.65	0.010857	12.87	417.53	489.39	15873.89	38.018
27613.70	0.010857	11.36	418.92	431.58	15914.43	37.989
27713.75	0.010857	9.89	420.30	375.23	15953.94	37.958
27813.80	0.010857	8.45	421.69	320.37	15992.41	37.924
27913.85	0.010857	7.05	423.08	266.98	16029.85	37.889
28013.90	0.010857	5.68	424.46	215.07	16066.25	37.851
28113.95	0.010857	4.35	425.85	164.64	16101.61	37.810
28214.00	0.010857	3.06	427.24	115.70	16135.93	37.768
28314.05	0.010857	1.81	428.62	68.24	16169.20	37.724
28414.10	0.010857	0.59	430.01	22.27	16201.44	37.677
28514.15	0.010857	-0.59	431.40	-22.18	16201.50	37.556
28614.20	0.010857	-1.74	432.78	-64.86	16171.57	37.367
28714.25	0.010857	-2.84	434.17	-105.77	16142.89	37.181
28814.30	0.010857	-3.92	435.56	-144.94	16115.42	37.000
28914.35	0.010857	-4.95	436.94	-182.42	16089.14	36.822
29014.40	0.010857	-5.95	438.33	-218.23	16064.03	36.648
29114.45	0.010857	-6.92	439.71	-252.40	16040.07	36.478
29214.50	0.010857	-7.85	441.10	-284.97	16017.23	36.312
29314.55	0.010857	-8.74	442.49	-315.97	15995.49	36.149
29414.60	0.010857	-9.60	443.87	-345.43	15974.84	35.990
29514.65	0.010857	-10.42	445.26	-373.37	15955.25	35.834

Cod. elab.: 108GA201-GA01-Z-CL-002_C	Titolo: OPERE D'ARTE MAGGIORI- GALLERIE	Data: Ottobre 2011
Nome file: 108GA201-GA01-Z-CL -002_C.docx	ARTIFICIALI – GALLERIA ROVETELLO	Pagina 214 di 452
	Relazione di calcolo	

PROGETTO ESECUTIVO

29614.70	0.010857	-11.21	446.65	-399.82	15936.70	35.681
29714.75	0.010857	-11.96	448.03	-424.80	15919.18	35.531
29814.80	0.010857	-12.67	449.42	-448.35	15902.67	35.385
29914.85	0.010857	-13.35	450.81	-470.49	15887.15	35.242
30014.90	0.010857	-13.99	452.19	-491.23	15872.60	35.101
30114.95	0.010857	-14.60	453.58	-510.60	15859.02	34.964
30215.00	0.010857	-15.18	454.96	-528.62	15846.38	34.830
30315.05	0.010857	-15.72	456.35	-545.31	15834.68	34.698
30415.10	0.010857	-16.22	457.74	-560.70	15823.89	34.570
30515.15	0.010857	-16.69	459.12	-574.80	15814.00	34.444
30615.20	0.010857	-17.12	460.51	-587.63	15805.01	34.321
30715.25	0.010857	-17.52	461.90	-599.20	15796.89	34.200
30815.30	0.010857	-17.88	463.28	-609.54	15789.65	34.082
30915.35	0.010857	-18.21	464.67	-618.65	15783.25	33.967
31015.40	0.010857	-18.51	466.06	-626.56	15777.71	33.854
31115.45	0.010857	-18.77	467.44	-633.28	15772.99	33.743
31215.50	0.010857	-18.99	468.83	-638.83	15769.11	33.635
31315.55	0.010857	-19.18	470.22	-643.21	15766.03	33.529
31415.60	0.010857	-19.34	471.60	-646.45	15763.76	33.426
31515.65	0.010857	-19.46	472.99	-648.55	15762.29	33.325
31615.70	0.010857	-19.55	474.37	-649.52	15761.61	33.226
31715.75	0.010857	-19.60	475.76	-649.38	15761.71	33.129
31815.80	0.010857	-19.62	477.15	-648.14	15762.58	33.035
31915.85	0.010857	-19.60	478.53	-645.81	15764.21	32.943
32015.90	0.010857	-19.55	479.92	-642.40	15766.60	32.853
32115.95	0.010857	-19.47	481.31	-637.91	15769.75	32.764
32216.00	0.010857	-19.35	482.69	-632.37	15773.64	32.678
32316.05	0.010857	-19.20	484.08	-625.76	15778.27	32.594
32416.10	0.010857	-19.01	485.47	-618.12	15783.63	32.512
32516.15	0.010857	-18.79	486.85	-609.43	15789.72	32.432
32616.20	0.010857	-18.54	488.24	-599.71	15796.53	32.354
32716.25	0.010857	-18.25	489.63	-588.97	15804.06	32.278
32816.30	0.010857	-17.92	491.01	-577.22	15812.31	32.204
32916.35	0.010857	-17.57	492.40	-564.45	15821.26	32.131
33016.40	0.010857	-17.18	493.78	-550.67	15830.92	32.060
33116.45	0.010857	-16.75	495.17	-535.89	15841.28	31.992

Cod. elab.: 108GA201-GA01-Z-CL-002_C	Titolo: OPERE D'ARTE MAGGIORI- GALLERIE	Data: Ottobre 2011
Nome file: 108GA201-GA01-Z-CL -002_C.docx	ARTIFICIALI – GALLERIA ROVETELLO Relazione di calcolo	Pagina 215 di 452

PROGETTO ESECUTIVO

33216.50	0.010857	-16.29	496.56	-520.12	15852.34	31.925
33316.55	0.010857	-15.82	497.94	-504.00	15863.65	31.858
33416.60	0.010857	-15.35	499.33	-488.15	15874.76	31.792
33516.65	0.010857	-14.90	500.72	-472.59	15885.67	31.726
33616.70	0.010857	-14.44	502.10	-457.31	15896.38	31.660
33716.75	0.010857	-14.00	503.49	-442.31	15906.90	31.593
33816.80	0.010857	-13.56	504.88	-427.59	15917.22	31.527
33916.85	0.010857	-13.13	506.26	-413.15	15927.35	31.461
34016.90	0.010857	-12.71	507.65	-398.99	15937.28	31.394
34116.95	0.010857	-12.29	509.03	-385.10	15947.02	31.328
34217.00	0.010857	-11.88	510.42	-371.49	15956.56	31.262
34317.05	0.010857	-11.48	511.81	-358.16	15965.91	31.195
34417.10	0.010857	-11.09	513.19	-345.10	15975.07	31.129
34517.15	0.010857	-10.70	514.58	-332.31	15984.04	31.062
34617.20	0.010857	-10.32	515.97	-319.79	15992.82	30.996
34717.25	0.010857	-9.94	517.35	-307.54	16001.40	30.929
34817.30	0.010857	-9.58	518.74	-295.56	16009.81	30.863
34917.35	0.010857	-9.22	520.13	-283.85	16018.02	30.796
35017.40	0.010857	-8.86	521.51	-272.40	16026.05	30.730
35117.45	0.010857	-8.52	522.90	-261.22	16033.89	30.663
35217.50	0.010857	-8.18	524.29	-250.29	16041.55	30.597
35317.55	0.010857	-7.85	525.67	-239.63	16049.02	30.531
35417.60	0.010857	-7.52	527.06	-229.23	16056.31	30.464
35517.65	0.010857	-7.21	528.44	-219.09	16063.43	30.398
35617.70	0.010857	-6.90	529.83	-209.20	16070.36	30.331
35717.75	0.010857	-6.59	531.22	-199.57	16077.11	30.265
35817.80	0.010857	-6.30	532.60	-190.19	16083.69	30.198
35917.85	0.010857	-6.01	533.99	-181.07	16090.09	30.132
36017.90	0.010857	-5.73	535.38	-172.19	16096.31	30.065
36117.95	0.010857	-5.45	536.76	-163.56	16102.37	29.999
36218.00	0.010857	-5.18	538.15	-155.17	16108.25	29.933
36318.05	0.010857	-4.92	539.54	-147.03	16113.95	29.866
36418.10	0.010857	-4.67	540.92	-139.13	16119.49	29.800
36518.15	0.010857	-4.42	542.31	-131.48	16124.86	29.734
36618.20	0.010857	-4.18	543.69	-124.06	16130.06	29.667
36718.25	0.010857	-3.95	545.08	-116.87	16135.10	29.601

Cod. elab.: 108GA201-GA01-Z-CL-002_C	Titolo: OPERE D'ARTE MAGGIORI- GALLERIE	Data: Ottobre 2011
Nome file: 108GA201-GA01-Z-CL -002_C.docx	ARTIFICIALI – GALLERIA ROVETELLO	Pagina 216 di 452
	Relazione di calcolo	

PROGETTO ESECUTIVO

36818.30	0.010857	-3.72	546.47	-109.93	16139.97	29.535
36918.35	0.010857	-3.50	547.85	-103.21	16144.68	29.469
37018.40	0.010857	-3.29	549.24	-96.73	16149.22	29.403
37118.45	0.010857	-3.08	550.63	-90.48	16153.61	29.337
37218.50	0.010857	-2.89	552.01	-84.45	16157.83	29.271
37318.55	0.010857	-2.69	553.40	-78.65	16161.90	29.205
37418.60	0.010857	-2.51	554.79	-73.07	16165.81	29.139
37518.65	0.010857	-2.33	556.17	-67.72	16169.57	29.073
37618.70	0.010857	-2.16	557.56	-62.58	16173.17	29.007
37718.75	0.010857	-1.99	558.95	-57.67	16176.62	28.941
37818.80	0.010857	-1.83	560.33	-52.97	16179.91	28.876
37918.85	0.010857	-1.68	561.72	-48.48	16183.06	28.810
38018.90	0.010857	-1.54	563.10	-44.21	16186.06	28.744
38118.95	0.010857	-1.40	564.49	-40.14	16188.90	28.679
38219.00	0.010857	-1.27	565.88	-36.28	16191.61	28.613
38319.05	0.010857	-1.14	567.26	-32.63	16194.17	28.548
38419.10	0.010857	-1.02	568.65	-29.19	16196.58	28.483
38519.15	0.010857	-0.91	570.04	-25.95	16198.86	28.417
38619.20	0.010857	-0.81	571.42	-22.91	16200.99	28.352
38719.25	0.010857	-0.71	572.81	-20.06	16202.98	28.287
38819.30	0.010857	-0.62	574.20	-17.42	16204.84	28.222
38919.35	0.010857	-0.53	575.58	-14.97	16206.56	28.157
39019.40	0.010857	-0.45	576.97	-12.71	16208.14	28.092
39119.45	0.010857	-0.38	578.35	-10.64	16209.59	28.027
39219.50	0.010857	-0.31	579.74	-8.76	16210.91	27.962
39319.55	0.010857	-0.25	581.13	-7.07	16212.09	27.898
39419.60	0.010857	-0.20	582.51	-5.57	16213.15	27.833
39519.65	0.010857	-0.15	583.90	-4.25	16214.07	27.769
39619.70	0.010857	-0.11	585.29	-3.11	16214.87	27.704
39719.75	0.010857	-0.08	586.67	-2.15	16215.54	27.640
39819.80	0.010857	-0.05	588.06	-1.37	16216.09	27.576
39919.85	0.010857	-0.03	589.45	-0.77	16216.51	27.511
40019.90	0.010857	-0.01	590.83	-0.34	16216.81	27.447
40119.95	0.010857	0.00	592.22	-0.08	16216.99	27.383
40220.00	0.010857	0.00	593.61	0.00	-4248.53	7.157

<i>Cod. elab.:</i> 108GA201-GA01-Z-CL-002_C	<i>Titolo:</i> OPERE D'ARTE MAGGIORI- GALLERIE	<i>Data:</i> Ottobre 2011
<i>Nome file:</i> 108GA201-GA01-Z-CL -002_C.docx	ARTIFICIALI – GALLERIA ROVETELLO Relazione di calcolo	<i>Pagina</i> 217 di 452

PROGETTO ESECUTIVO

Fase n° 4 - [A2-M2]

n°	Y	A _f	M	N	M _u	N _u	CS
1	0.00	0.010857	0.00	0.00	0.00	0.00	1000.000
2	0.05	0.010857	0.00	1.39	0.05	16217.02	11697.177
3	0.10	0.010857	0.01	2.77	31.21	16195.16	5840.707
4	0.15	0.010857	0.02	4.16	62.38	16173.31	3888.551
5	0.20	0.010857	0.03	5.55	93.53	16151.47	2912.474
6	0.25	0.010857	0.05	6.93	124.68	16129.63	2326.828
7	0.30	0.010857	0.08	8.32	155.82	16107.79	1936.398
8	0.35	0.010857	0.11	9.70	186.96	16085.96	1657.521
9	0.40	0.010857	0.15	11.09	218.08	16064.13	1448.363
10	0.45	0.010857	0.19	12.48	249.20	16042.31	1285.685
11	0.50	0.010857	0.24	13.86	280.32	16020.49	1155.543
12	0.55	0.010857	0.31	15.25	322.96	15990.59	1048.532
13	0.60	0.010857	0.40	16.64	384.75	15947.27	958.551
14	0.65	0.010857	0.52	18.02	461.02	15893.79	881.849
15	0.70	0.010857	0.67	19.41	548.42	15832.50	815.702
16	0.75	0.010857	0.85	20.80	644.46	15765.16	758.083
17	0.80	0.010857	1.06	22.18	747.25	15693.08	707.454
18	0.85	0.010857	1.29	23.57	855.33	15617.30	662.624
19	0.90	0.010857	1.55	24.96	967.57	15538.59	622.657
20	0.95	0.010857	1.85	26.34	1083.08	15457.60	586.811
21	1.00	0.010857	2.17	27.73	1201.14	15374.82	554.485
22	1.05	0.010857	2.52	29.11	1321.16	15290.66	525.191
23	1.10	0.010857	2.89	30.50	1442.67	15205.45	498.525
24	1.15	0.010857	3.30	31.89	1560.68	15074.85	472.754
25	1.20	0.010857	3.74	33.27	1657.97	14759.39	443.575
26	1.25	0.010857	4.20	34.66	1752.73	14452.17	416.968
27	1.30	0.010857	4.70	36.05	1844.88	14153.40	392.643
28	1.35	0.010857	5.22	37.43	1931.57	13843.00	369.808
29	1.40	0.010857	5.78	38.82	2014.02	13532.78	348.609
30	1.45	0.010857	6.36	40.21	2093.65	13233.14	329.136
31	1.50	0.010857	6.97	41.59	2170.00	12940.59	311.131
32	1.55	0.010857	7.62	42.98	2239.02	12632.03	293.915

<i>Cod. elab.:</i> 108GA201-GA01-Z-CL-002_C	<i>Titolo:</i> OPERE D'ARTE MAGGIORI- GALLERIE	<i>Data:</i> Ottobre 2011
<i>Nome file:</i> 108GA201-GA01-Z-CL -002_C.docx	ARTIFICIALI – GALLERIA ROVETELLO	<i>Pagina</i> 218 di 452
Relazione di calcolo		

PROGETTO ESECUTIVO

33	1.60	0.010857	8.29	44.36	2305.35	12335.50	278.046
34	1.65	0.010857	8.99	45.75	2369.10	12050.49	263.391
35	1.70	0.010857	9.73	47.14	2428.39	11766.83	249.626
36	1.75	0.010857	10.49	48.52	2482.66	11482.14	236.627
37	1.80	0.010857	11.29	49.91	2534.67	11209.26	224.587
38	1.85	0.010857	12.11	51.30	2584.55	10947.56	213.415
39	1.90	0.010857	12.97	52.68	2630.43	10688.35	202.879
40	1.95	0.010857	13.85	54.07	2672.10	10430.87	192.915
41	2.00	0.010857	14.77	55.46	2712.01	10184.30	183.646
42	2.05	0.010857	15.71	56.84	2750.25	9948.03	175.010
43	2.10	0.010857	16.69	58.23	2786.78	9720.96	166.944
44	2.15	0.010857	17.70	59.62	2818.39	9491.51	159.212
45	2.20	0.010857	18.74	61.00	2848.66	9271.74	151.991
46	2.25	0.010857	19.81	62.39	2877.69	9061.09	145.237
47	2.30	0.010857	20.92	63.77	2905.53	8859.02	138.911
48	2.35	0.010857	22.05	65.16	2932.25	8665.05	132.979
49	2.40	0.010857	23.22	66.55	2952.82	8464.11	127.189
50	2.45	0.010857	24.41	67.93	2972.07	8270.34	121.741
51	2.50	0.010857	25.64	69.32	2990.52	8084.61	116.627
52	2.50	0.010857	25.64	107.27	2598.87	10872.46	101.353
53	2.55	0.010857	21.69	108.66	2388.22	11965.01	110.115
54	2.60	0.010857	17.77	110.05	2120.30	13132.85	119.340
55	2.65	0.010857	13.88	111.43	1786.27	14343.43	128.719
56	2.70	0.010857	10.02	112.82	1355.83	15266.35	135.318
57	2.75	0.010857	6.21	114.20	848.85	15621.84	136.788
58	2.80	0.010857	2.47	115.59	341.42	15977.65	138.225
59	2.85	0.010857	-1.15	116.98	-158.09	16106.20	137.686
60	2.90	0.010857	-4.63	118.36	-616.85	15784.52	133.356
61	2.95	0.010857	-7.95	119.75	-1028.27	15496.03	129.403
62	3.00	0.010857	-11.09	121.14	-1395.61	15238.45	125.795
63	3.05	0.010857	-14.05	122.52	-1683.53	14676.54	119.786
64	3.10	0.010857	-16.81	123.91	-1896.32	13975.66	112.789
65	3.15	0.010857	-19.36	125.30	-2062.65	13349.77	106.546
66	3.20	0.010857	-21.69	126.68	-2195.76	12825.45	101.241
67	3.25	0.010857	-23.80	128.07	-2298.17	12367.61	96.570
68	3.30	0.010857	-25.69	129.46	-2380.68	11998.71	92.686

Cod. elab.: 108GA201-GA01-Z-CL-002_C	Titolo: OPERE D'ARTE MAGGIORI- GALLERIE	Data: Ottobre 2011
Nome file: 108GA201-GA01-Z-CL -002_C.docx	ARTIFICIALI – GALLERIA ROVETELLO Relazione di calcolo	Pagina 219 di 452

PROGETTO ESECUTIVO

69	3.35	0.010857	-27.35	130.84	-2443.23	11688.98	89.337
70	3.40	0.010857	-28.78	132.23	-2490.55	11440.75	86.523
71	3.45	0.010857	-29.99	133.61	-2526.15	11253.97	84.227
72	3.50	0.010857	-30.97	135.00	-2551.29	11122.07	82.385
73	3.55	0.010857	-31.71	136.39	-2566.87	11040.36	80.949
74	3.60	0.010857	-32.22	137.77	-2573.47	11005.72	79.882
75	3.65	0.010857	-32.48	139.16	-2571.45	11016.32	79.163
76	3.70	0.010857	-32.51	140.55	-2560.93	11071.50	78.775
77	3.75	0.010857	-32.29	141.93	-2541.83	11171.72	78.711
78	3.80	0.010857	-31.83	143.32	-2513.84	11318.54	78.974
79	3.85	0.010857	-31.12	144.71	-2476.45	11514.72	79.573
80	3.90	0.010857	-30.16	146.09	-2428.86	11764.39	80.527
81	3.95	0.010857	-28.95	147.48	-2367.19	12059.01	81.768
82	4.00	0.010857	-27.48	148.87	-2290.04	12403.93	83.323
83	4.05	0.010857	-25.76	150.25	-2197.55	12817.42	85.306
84	4.10	0.010857	-23.78	151.64	-2081.99	13277.01	87.557
85	4.15	0.010857	-21.54	153.02	-1942.40	13802.27	90.197
86	4.20	0.010857	-19.03	154.41	-1772.91	14386.75	93.172
87	4.25	0.010857	-16.26	155.80	-1569.81	15045.24	96.569
88	4.30	0.010857	-13.22	157.18	-1287.55	15314.23	97.429
89	4.35	0.010857	-9.90	158.57	-970.45	15536.57	97.979
90	4.40	0.010857	-6.32	159.96	-623.64	15779.76	98.650
91	4.45	0.010857	-2.46	161.34	-245.07	16045.21	99.448
92	4.50	0.010857	1.67	162.73	165.22	16101.20	98.945
93	4.55	0.010857	6.08	164.12	585.83	15806.27	96.312
94	4.60	0.010857	10.78	165.50	1009.86	15508.94	93.709
95	4.65	0.010857	15.75	166.89	1435.79	15210.28	91.140
96	4.70	0.010857	21.02	168.27	1789.89	14331.69	85.168
97	4.75	0.010857	26.57	169.66	2080.06	13284.29	78.299
98	4.80	0.010857	32.40	171.05	2322.45	12259.02	71.670
99	4.85	0.010857	38.54	172.43	2521.03	11280.81	65.421
100	4.90	0.010857	44.96	173.82	2682.08	10369.21	59.655
101	4.95	0.010857	51.68	175.21	2812.43	9534.73	54.420
102	5.00	0.010857	58.70	176.59	2917.00	8775.75	49.695
103	5.00	0.010857	58.70	225.20	2690.01	10320.21	45.828
104	5.05	0.010857	59.26	226.58	2693.49	10298.72	45.452

Cod. elab.: 108GA201-GA01-Z-CL-002_C	Titolo: OPERE D'ARTE MAGGIORI- GALLERIE	Data: Ottobre 2011
Nome file: 108GA201-GA01-Z-CL -002_C.docx	ARTIFICIALI – GALLERIA ROVETELLO	Pagina 220 di 452
Relazione di calcolo		

PROGETTO ESECUTIVO

105.5.10	0.010857	59.96	227.97	2699.28	10262.91	45.019
106.5.15	0.010857	60.79	229.36	2707.23	10213.83	44.533
107.5.20	0.010857	61.75	230.74	2717.13	10152.63	44.000
108.5.25	0.010857	62.84	232.13	2728.82	10080.44	43.426
109.5.30	0.010857	64.04	233.51	2742.10	9998.40	42.817
110.5.35	0.010857	65.36	234.90	2756.79	9907.62	42.178
111.5.40	0.010857	66.79	236.29	2772.72	9809.21	41.514
112.5.45	0.010857	68.32	237.67	2789.28	9702.76	40.824
113.5.50	0.010857	69.96	239.06	2805.36	9586.07	40.099
114.5.55	0.010857	71.69	240.45	2822.08	9464.72	39.363
115.5.60	0.010857	73.52	241.83	2839.31	9339.68	38.620
116.5.65	0.010857	75.43	243.22	2856.92	9211.85	37.875
117.5.70	0.010857	77.43	244.61	2874.80	9082.07	37.129
118.5.75	0.010857	79.50	245.99	2892.84	8951.10	36.388
119.5.80	0.010857	81.65	247.38	2910.95	8819.62	35.652
120.5.85	0.010857	83.87	248.76	2929.05	8688.25	34.926
121.5.90	0.010857	86.15	250.15	2944.32	8549.66	34.178
122.5.95	0.010857	88.46	251.54	2958.05	8411.48	33.440
123.6.00	0.010857	90.79	252.92	2971.37	8277.32	32.726
124.6.05	0.010857	93.15	254.31	2984.29	8147.33	32.037
125.6.10	0.010857	95.53	255.70	2996.77	8021.62	31.372
126.6.15	0.010857	97.91	257.08	3008.83	7900.26	30.730
127.6.20	0.010857	100.30	258.47	3020.44	7783.29	30.113
128.6.25	0.010857	102.70	259.86	3031.62	7670.76	29.519
129.6.30	0.010857	105.09	261.24	3041.99	7561.76	28.945
130.6.35	0.010857	107.48	262.63	3045.15	7440.65	28.331
131.6.40	0.010857	109.86	264.02	3048.15	7325.24	27.746
132.6.45	0.010857	112.22	265.40	3051.01	7215.41	27.187
133.6.50	0.010857	114.57	266.79	3053.73	7111.07	26.654
134.6.55	0.010857	116.89	268.17	3056.30	7012.09	26.147
135.6.60	0.010857	119.18	269.56	3058.74	6918.37	25.665
136.6.65	0.010857	121.44	270.95	3061.05	6829.81	25.207
137.6.70	0.010857	123.66	272.33	3063.22	6746.29	24.772
138.6.75	0.010857	125.83	273.72	3065.27	6667.73	24.360
139.6.80	0.010857	127.97	275.11	3067.19	6594.01	23.969
140.6.85	0.010857	130.05	276.49	3068.98	6525.07	23.599

<i>Cod. elab.:</i> 108GA201-GA01-Z-CL-002_C	<i>Titolo:</i> OPERE D'ARTE MAGGIORI- GALLERIE	<i>Data:</i> Ottobre 2011
<i>Nome file:</i> 108GA201-GA01-Z-CL -002_C.docx	ARTIFICIALI – GALLERIA ROVETELLO Relazione di calcolo	<i>Pagina</i> 221 di 452

PROGETTO ESECUTIVO

141 6.90	0.010857	132.07	277.88	3068.95	6457.20	23.237
142 6.95	0.010857	134.03	279.27	3066.59	6389.41	22.879
143 7.00	0.010857	135.94	280.65	3064.40	6326.70	22.543
144 7.05	0.010857	137.78	282.04	3062.38	6268.73	22.226
145 7.10	0.010857	139.57	283.43	3060.52	6215.20	21.929
146 7.15	0.010857	141.29	284.81	3058.80	6165.84	21.649
147 7.20	0.010857	142.96	286.20	3057.22	6120.40	21.385
148 7.25	0.010857	144.57	287.58	3055.76	6078.66	21.137
149 7.30	0.010857	146.12	288.97	3054.43	6040.42	20.903
150 7.35	0.010857	147.62	290.36	3053.21	6005.50	20.683
151 7.40	0.010857	149.06	291.74	3052.11	5973.72	20.476
152 7.45	0.010857	150.44	293.13	3051.10	5944.95	20.281
153 7.50	0.010857	151.77	294.52	3050.20	5919.03	20.097
154 7.55	0.010857	153.04	295.90	3049.39	5895.85	19.925
155 7.60	0.010857	154.26	297.29	3048.68	5875.28	19.763
156 7.65	0.010857	155.43	298.68	3048.05	5857.24	19.611
157 7.70	0.010857	156.54	300.06	3047.50	5841.61	19.468
158 7.75	0.010857	157.60	301.45	3047.04	5828.32	19.334
159 7.80	0.010857	158.60	302.83	3046.66	5817.29	19.209
160 7.85	0.010857	159.55	304.22	3046.35	5808.44	19.093
161 7.90	0.010857	160.46	305.61	3046.12	5801.72	18.984
162 7.95	0.010857	161.30	306.99	3045.95	5797.06	18.883
163 8.00	0.010857	162.10	308.38	3045.86	5794.42	18.790
164 8.05	0.010857	162.85	309.77	3045.84	5793.74	18.704
165 8.10	0.010857	163.54	311.15	3045.88	5794.98	18.624
166 8.15	0.010857	164.19	312.54	3045.99	5798.12	18.552
167 8.20	0.010857	164.79	313.93	3046.16	5803.11	18.486
168 8.25	0.010857	165.33	315.31	3046.40	5809.92	18.426
169 8.30	0.010857	165.83	316.70	3046.70	5818.55	18.372
170 8.35	0.010857	166.28	318.09	3047.06	5828.95	18.325
171 8.40	0.010857	166.68	319.47	3047.49	5841.13	18.284
172 8.45	0.010857	167.03	320.86	3047.97	5855.06	18.248
173 8.50	0.010857	167.33	322.24	3048.52	5870.74	18.218
174 8.55	0.010857	167.57	323.63	3049.15	5888.91	18.196
175 8.60	0.010857	167.72	325.02	3049.90	5910.32	18.185
176 8.65	0.010857	167.78	326.40	3050.76	5934.97	18.183

<i>Cod. elab.:</i> 108GA201-GA01-Z-CL-002_C	<i>Titolo:</i> OPERE D'ARTE MAGGIORI- GALLERIE	<i>Data:</i> Ottobre 2011
<i>Nome file:</i> 108GA201-GA01-Z-CL -002_C.docx	ARTIFICIALI – GALLERIA ROVETELLO Relazione di calcolo	<i>Pagina</i> 222 di 452

PROGETTO ESECUTIVO

1778.70	0.010857	167.76	327.79	3051.73	5962.88	18.191
1788.75	0.010857	167.65	329.18	3052.82	5994.09	18.209
1798.80	0.010857	167.46	330.56	3054.02	6028.64	18.238
1808.85	0.010857	167.18	331.95	3055.34	6066.58	18.276
1818.90	0.010857	166.82	333.34	3056.78	6107.99	18.324
1828.95	0.010857	166.38	334.72	3058.35	6152.93	18.382
1839.00	0.010857	165.85	336.11	3060.04	6201.50	18.451
1849.05	0.010857	165.24	337.49	3061.86	6253.80	18.530
1859.10	0.010857	164.55	338.88	3063.82	6309.95	18.620
1869.15	0.010857	163.77	340.27	3065.91	6370.08	18.721
1879.20	0.010857	162.91	341.65	3068.15	6434.34	18.833
1889.25	0.010857	161.98	343.04	3069.61	6500.91	18.951
1899.30	0.010857	160.96	344.43	3067.95	6564.83	19.060
1909.35	0.010857	159.87	345.81	3066.19	6632.50	19.179
1919.40	0.010857	158.70	347.20	3064.32	6704.02	19.309
1929.45	0.010857	157.46	348.59	3062.36	6779.48	19.449
1939.50	0.010857	156.15	349.97	3060.29	6858.97	19.599
1949.55	0.010857	154.77	351.36	3058.11	6942.60	19.759
1959.60	0.010857	153.32	352.75	3055.83	7030.49	19.931
1969.65	0.010857	151.81	354.13	3053.42	7122.78	20.113
1979.70	0.010857	150.24	355.52	3050.90	7219.60	20.307
1989.75	0.010857	148.60	356.90	3048.26	7321.11	20.513
1999.80	0.010857	146.91	358.29	3045.49	7427.47	20.730
2009.85	0.010857	145.16	359.68	3042.59	7538.88	20.960
2019.90	0.010857	143.36	361.06	3034.42	7642.58	21.167
2029.95	0.010857	141.50	362.45	3024.13	7746.21	21.372
20310.00	0.010857	139.59	363.84	3013.41	7854.12	21.587
20410.05	0.010857	137.64	365.22	3002.25	7966.46	21.813
20510.10	0.010857	135.64	366.61	2990.64	8083.37	22.049
20610.15	0.010857	133.59	368.00	2978.56	8205.01	22.296
20710.20	0.010857	131.50	369.38	2965.99	8331.53	22.555
20810.25	0.010857	129.37	370.77	2952.92	8463.11	22.826
20910.30	0.010857	127.20	372.15	2939.33	8599.94	23.108
21010.35	0.010857	124.99	373.54	2922.66	8734.63	23.383
21110.40	0.010857	122.75	374.93	2903.98	8870.21	23.658
21210.45	0.010857	120.47	376.31	2884.62	9010.77	23.945

Cod. elab.: 108GA201-GA01-Z-CL-002_C	Titolo: OPERE D'ARTE MAGGIORI- GALLERIE	Data: Ottobre 2011
Nome file: 108GA201-GA01-Z-CL -002_C.docx	ARTIFICIALI – GALLERIA ROVETELLO Relazione di calcolo	Pagina 223 di 452

PROGETTO ESECUTIVO

21310.50	0.010857	118.16	377.70	2864.54	9156.48	24.243
21410.55	0.010857	115.82	379.09	2843.74	9307.52	24.552
21510.60	0.010857	113.46	380.47	2822.17	9464.08	24.874
21610.65	0.010857	111.06	381.86	2799.81	9626.33	25.209
21710.70	0.010857	108.65	383.25	2775.66	9791.03	25.548
21810.75	0.010857	106.21	384.63	2749.01	9955.68	25.884
21910.80	0.010857	103.75	386.02	2721.44	10125.99	26.232
22010.85	0.010857	101.27	387.41	2692.93	10302.15	26.593
22110.90	0.010857	98.77	388.79	2663.44	10484.36	26.967
22210.95	0.010857	96.26	390.18	2632.94	10672.80	27.354
22311.00	0.010857	93.73	391.56	2600.50	10863.92	27.745
22411.05	0.010857	91.19	392.95	2564.70	11051.70	28.125
22511.10	0.010857	88.64	394.34	2527.78	11245.41	28.517
22611.15	0.010857	86.08	395.72	2489.70	11445.21	28.922
22711.20	0.010857	83.52	397.11	2450.42	11651.28	29.340
22811.25	0.010857	80.95	398.50	2409.91	11863.79	29.771
22911.30	0.010857	78.37	399.88	2365.20	12067.92	30.179
23011.35	0.010857	75.80	401.27	2318.77	12275.48	30.592
23111.40	0.010857	73.22	402.66	2271.05	12488.82	31.016
23211.45	0.010857	70.65	404.04	2222.02	12708.04	31.452
23311.50	0.010857	68.08	405.43	2171.64	12933.26	31.900
23411.55	0.010857	65.51	406.82	2116.87	13145.75	32.314
23511.60	0.010857	62.95	408.20	2060.16	13359.17	32.727
23611.65	0.010857	60.40	409.59	2002.15	13577.45	33.149
23711.70	0.010857	57.86	410.97	1942.83	13800.64	33.580
23811.75	0.010857	55.33	412.36	1882.22	14028.73	34.021
23911.80	0.010857	52.81	413.75	1817.71	14241.48	34.421
24011.85	0.010857	50.31	415.13	1751.72	14455.45	34.821
24111.90	0.010857	47.82	416.52	1684.59	14673.09	35.228
24211.95	0.010857	45.35	417.91	1616.35	14894.34	35.640
24312.00	0.010857	42.90	419.29	1547.03	15119.11	36.059
24412.05	0.010857	40.48	420.68	1461.71	15192.10	36.113
24512.10	0.010857	38.07	422.07	1375.80	15252.35	36.137
24612.15	0.010857	35.69	423.45	1290.60	15312.08	36.160
24712.20	0.010857	33.34	424.84	1206.19	15371.27	36.181
24812.25	0.010857	31.01	426.22	1122.64	15429.86	36.201

<i>Cod. elab.:</i> 108GA201-GA01-Z-CL-002_C	<i>Titolo:</i> OPERE D'ARTE MAGGIORI- GALLERIE	<i>Data:</i> Ottobre 2011
<i>Nome file:</i> 108GA201-GA01-Z-CL -002_C.docx	ARTIFICIALI – GALLERIA ROVETELLO Relazione di calcolo	<i>Pagina</i> 224 di 452

PROGETTO ESECUTIVO

24912.30	0.010857	28.71	427.61	1040.01	15487.80	36.219
25012.35	0.010857	26.45	429.00	958.37	15545.04	36.236
25112.40	0.010857	24.21	430.38	877.79	15601.55	36.250
25212.45	0.010857	22.02	431.77	798.34	15657.26	36.263
25312.50	0.010857	19.85	433.16	720.08	15712.13	36.274
25412.55	0.010857	17.73	434.54	643.10	15766.11	36.282
25512.60	0.010857	15.64	435.93	567.46	15819.15	36.288
25612.65	0.010857	13.59	437.32	493.22	15871.20	36.292
25712.70	0.010857	11.59	438.70	420.47	15922.22	36.294
25812.75	0.010857	9.62	440.09	349.26	15972.15	36.293
25912.80	0.010857	7.70	441.48	279.61	16020.99	36.290
26012.85	0.010857	5.83	442.86	211.52	16068.73	36.284
26112.90	0.010857	4.00	444.25	145.00	16115.37	36.276
26212.95	0.010857	2.21	445.63	80.06	16160.91	36.265
26313.00	0.010857	0.46	447.02	16.70	16205.34	36.252
26413.05	0.010857	-1.24	448.41	-44.90	16185.57	36.096
26513.10	0.010857	-2.91	449.79	-104.32	16143.90	35.892
26613.15	0.010857	-4.53	451.18	-161.59	16103.74	35.693
26713.20	0.010857	-6.11	452.57	-216.76	16065.06	35.498
26813.25	0.010857	-7.64	453.95	-269.89	16027.80	35.307
26913.30	0.010857	-9.14	455.34	-321.03	15991.95	35.121
27013.35	0.010857	-10.60	456.73	-370.21	15957.46	34.939
27113.40	0.010857	-12.01	458.11	-417.51	15924.30	34.761
27213.45	0.010857	-13.39	459.50	-462.94	15892.44	34.586
27313.50	0.010857	-14.72	460.88	-506.57	15861.85	34.416
27413.55	0.010857	-16.01	462.27	-548.43	15832.50	34.249
27513.60	0.010857	-17.27	463.66	-588.56	15804.36	34.086
27613.65	0.010857	-18.48	465.04	-626.99	15777.40	33.927
27713.70	0.010857	-19.66	466.43	-663.78	15751.61	33.771
27813.75	0.010857	-20.79	467.82	-698.95	15726.95	33.618
27913.80	0.010857	-21.89	469.20	-732.54	15703.40	33.468
28013.85	0.010857	-22.95	470.59	-764.58	15680.93	33.322
28113.90	0.010857	-23.96	471.98	-795.10	15659.53	33.179
28213.95	0.010857	-24.94	473.36	-824.14	15639.17	33.038
28314.00	0.010857	-25.89	474.75	-851.72	15619.82	32.901
28414.05	0.010857	-26.79	476.14	-877.88	15601.48	32.767

Cod. elab.: 108GA201-GA01-Z-CL-002_C	Titolo: OPERE D'ARTE MAGGIORI- GALLERIE	Data: Ottobre 2011
Nome file: 108GA201-GA01-Z-CL -002_C.docx	ARTIFICIALI – GALLERIA ROVETELLO Relazione di calcolo	Pagina 225 di 452

PROGETTO ESECUTIVO

28514.10	0.010857	-27.66	477.52	-902.64	15584.12	32.635
28614.15	0.010857	-28.49	478.91	-926.02	15567.73	32.507
28714.20	0.010857	-29.28	480.29	-948.06	15552.27	32.381
28814.25	0.010857	-30.03	481.68	-968.78	15537.75	32.257
28914.30	0.010857	-30.75	483.07	-988.20	15524.13	32.137
29014.35	0.010857	-31.43	484.45	-1006.35	15511.40	32.018
29114.40	0.010857	-32.07	485.84	-1023.24	15499.56	31.903
29214.45	0.010857	-32.68	487.23	-1038.91	15488.57	31.789
29314.50	0.010857	-33.25	488.61	-1053.36	15478.43	31.678
29414.55	0.010857	-33.79	490.00	-1066.63	15469.13	31.570
29514.60	0.010857	-34.29	491.39	-1078.73	15460.65	31.463
29614.65	0.010857	-34.75	492.77	-1089.67	15452.97	31.359
29714.70	0.010857	-35.18	494.16	-1099.49	15446.09	31.257
29814.75	0.010857	-35.57	495.54	-1108.18	15440.00	31.158
29914.80	0.010857	-35.92	496.93	-1115.78	15434.67	31.060
30014.85	0.010857	-36.24	498.32	-1122.29	15430.10	30.964
30114.90	0.010857	-36.53	499.70	-1127.74	15426.28	30.871
30214.95	0.010857	-36.78	501.09	-1132.13	15423.20	30.779
30315.00	0.010857	-37.00	502.48	-1135.48	15420.85	30.690
30415.05	0.010857	-37.18	503.86	-1137.81	15419.22	30.602
30515.10	0.010857	-37.33	505.25	-1139.13	15418.30	30.516
30615.15	0.010857	-37.44	506.64	-1139.45	15418.07	30.432
30715.20	0.010857	-37.52	508.02	-1138.78	15418.54	30.350
30815.25	0.010857	-37.57	509.41	-1137.13	15419.70	30.270
30915.30	0.010857	-37.58	510.80	-1134.52	15421.53	30.191
31015.35	0.010857	-37.56	512.18	-1130.96	15424.03	30.114
31115.40	0.010857	-37.50	513.57	-1126.45	15427.19	30.039
31215.45	0.010857	-37.41	514.95	-1121.01	15431.00	29.966
31315.50	0.010857	-37.29	516.34	-1114.65	15435.46	29.894
31415.55	0.010857	-37.13	517.73	-1107.37	15440.57	29.824
31515.60	0.010857	-36.94	519.11	-1099.19	15446.30	29.755
31615.65	0.010857	-36.72	520.50	-1090.10	15452.67	29.688
31715.70	0.010857	-36.46	521.89	-1080.13	15459.66	29.623
31815.75	0.010857	-36.17	523.27	-1069.28	15467.28	29.559
31915.80	0.010857	-35.85	524.66	-1057.55	15475.50	29.496
32015.85	0.010857	-35.50	526.05	-1044.95	15484.34	29.435

<i>Cod. elab.:</i> 108GA201-GA01-Z-CL-002_C	<i>Titolo:</i> OPERE D'ARTE MAGGIORI- GALLERIE	<i>Data:</i> Ottobre 2011
<i>Nome file:</i> 108GA201-GA01-Z-CL -002_C.docx	ARTIFICIALI – GALLERIA ROVETELLO Relazione di calcolo	<i>Pagina</i> 226 di 452

PROGETTO ESECUTIVO

32115.90	0.010857	-35.11	527.43	-1031.49	15493.78	29.376
32215.95	0.010857	-34.69	528.82	-1017.17	15503.82	29.318
32316.00	0.010857	-34.24	530.21	-1002.00	15514.45	29.261
32416.05	0.010857	-33.76	531.59	-985.98	15525.68	29.206
32516.10	0.010857	-33.24	532.98	-969.13	15537.50	29.152
32616.15	0.010857	-32.70	534.36	-951.44	15549.91	29.100
32716.20	0.010857	-32.12	535.75	-932.91	15562.89	29.049
32816.25	0.010857	-31.50	537.14	-913.57	15576.46	28.999
32916.30	0.010857	-30.86	538.52	-893.39	15590.61	28.951
33016.35	0.010857	-30.18	539.91	-872.40	15605.33	28.904
33116.40	0.010857	-29.48	541.30	-850.59	15620.62	28.858
33216.45	0.010857	-28.74	542.68	-827.97	15636.48	28.813
33316.50	0.010857	-27.96	544.07	-804.54	15652.91	28.770
33416.55	0.010857	-27.18	545.46	-780.88	15669.50	28.727
33516.60	0.010857	-26.41	546.84	-757.57	15685.85	28.684
33616.65	0.010857	-25.65	548.23	-734.62	15701.94	28.641
33716.70	0.010857	-24.90	549.61	-712.03	15717.78	28.598
33816.75	0.010857	-24.16	551.00	-689.79	15733.37	28.554
33916.80	0.010857	-23.43	552.39	-667.92	15748.71	28.510
34016.85	0.010857	-22.71	553.77	-646.40	15763.80	28.466
34116.90	0.010857	-22.00	555.16	-625.25	15778.63	28.422
34216.95	0.010857	-21.30	556.55	-604.45	15793.21	28.377
34317.00	0.010857	-20.61	557.93	-584.02	15807.54	28.332
34417.05	0.010857	-19.94	559.32	-563.96	15821.61	28.287
34517.10	0.010857	-19.27	560.71	-544.25	15835.42	28.242
34617.15	0.010857	-18.62	562.09	-524.91	15848.99	28.196
34717.20	0.010857	-17.97	563.48	-505.93	15862.29	28.151
34817.25	0.010857	-17.34	564.87	-487.32	15875.34	28.105
34917.30	0.010857	-16.72	566.25	-469.07	15888.14	28.058
35017.35	0.010857	-16.11	567.64	-451.18	15900.68	28.012
35117.40	0.010857	-15.51	569.02	-433.66	15912.97	27.965
35217.45	0.010857	-14.92	570.41	-416.50	15925.00	27.918
35317.50	0.010857	-14.34	571.80	-399.70	15936.78	27.871
35417.55	0.010857	-13.77	573.18	-383.27	15948.31	27.824
35517.60	0.010857	-13.22	574.57	-367.20	15959.57	27.777
35617.65	0.010857	-12.68	575.96	-351.48	15970.59	27.729

Cod. elab.: 108GA201-GA01-Z-CL-002_C	Titolo: OPERE D'ARTE MAGGIORI- GALLERIE	Data: Ottobre 2011
Nome file: 108GA201-GA01-Z-CL -002_C.docx	ARTIFICIALI – GALLERIA ROVETELLO	Pagina 227 di 452
	Relazione di calcolo	

PROGETTO ESECUTIVO

35717.70	0.010857	-12.14	577.34	-336.14	15981.35	27.681
35817.75	0.010857	-11.62	578.73	-321.15	15991.86	27.633
35917.80	0.010857	-11.11	580.12	-306.52	16002.12	27.584
36017.85	0.010857	-10.61	581.50	-292.25	16012.13	27.536
36117.90	0.010857	-10.13	582.89	-278.33	16021.88	27.487
36217.95	0.010857	-9.65	584.27	-264.78	16031.39	27.438
36318.00	0.010857	-9.19	585.66	-251.58	16040.64	27.389
36418.05	0.010857	-8.73	587.05	-238.74	16049.65	27.340
36518.10	0.010857	-8.29	588.43	-226.25	16058.41	27.290
36618.15	0.010857	-7.86	589.82	-214.11	16066.92	27.240
36718.20	0.010857	-7.44	591.21	-202.33	16075.18	27.190
36818.25	0.010857	-7.03	592.59	-190.89	16083.20	27.140
36918.30	0.010857	-6.64	593.98	-179.81	16090.97	27.090
37018.35	0.010857	-6.25	595.37	-169.07	16098.50	27.040
37118.40	0.010857	-5.88	596.75	-158.68	16105.78	26.989
37218.45	0.010857	-5.52	598.14	-148.64	16112.83	26.938
37318.50	0.010857	-5.17	599.53	-138.94	16119.63	26.887
37418.55	0.010857	-4.83	600.91	-129.58	16126.19	26.836
37518.60	0.010857	-4.50	602.30	-120.57	16132.51	26.785
37618.65	0.010857	-4.19	603.68	-111.89	16138.59	26.733
37718.70	0.010857	-3.88	605.07	-103.56	16144.44	26.682
37818.75	0.010857	-3.59	606.46	-95.55	16150.05	26.630
37918.80	0.010857	-3.31	607.84	-87.89	16155.42	26.578
38018.85	0.010857	-3.04	609.23	-80.56	16160.56	26.526
38118.90	0.010857	-2.78	610.62	-73.56	16165.47	26.474
38218.95	0.010857	-2.53	612.00	-66.89	16170.15	26.422
38319.00	0.010857	-2.30	613.39	-60.55	16174.60	26.369
38419.05	0.010857	-2.07	614.78	-54.53	16178.81	26.317
38519.10	0.010857	-1.86	616.16	-48.84	16182.80	26.264
38619.15	0.010857	-1.66	617.55	-43.48	16186.57	26.211
38719.20	0.010857	-1.47	618.93	-38.43	16190.10	26.158
38819.25	0.010857	-1.29	620.32	-33.71	16193.41	26.105
38919.30	0.010857	-1.12	621.71	-29.30	16196.50	26.052
39019.35	0.010857	-0.97	623.09	-25.21	16199.37	25.998
39119.40	0.010857	-0.83	624.48	-21.44	16202.02	25.945
39219.45	0.010857	-0.69	625.87	-17.98	16204.45	25.891

Cod. elab.: 108GA201-GA01-Z-CL-002_C	Titolo: OPERE D'ARTE MAGGIORI- GALLERIE	Data: Ottobre 2011
Nome file: 108GA201-GA01-Z-CL -002_C.docx	ARTIFICIALI – GALLERIA ROVETELLO	Pagina 228 di 452
	Relazione di calcolo	

PROGETTO ESECUTIVO

39319.50	0.010857	-0.57	627.25	-14.83	16206.66	25.837
39419.55	0.010857	-0.46	628.64	-11.98	16208.65	25.784
39519.60	0.010857	-0.37	630.03	-9.45	16210.43	25.730
39619.65	0.010857	-0.28	631.41	-7.22	16211.99	25.676
39719.70	0.010857	-0.21	632.80	-5.29	16213.34	25.622
39819.75	0.010857	-0.14	634.19	-3.67	16214.48	25.567
39919.80	0.010857	-0.09	635.57	-2.34	16215.41	25.513
40019.85	0.010857	-0.05	636.96	-1.31	16216.13	25.459
40119.90	0.010857	-0.02	638.34	-0.58	16216.64	25.404
40219.95	0.010857	-0.01	639.73	-0.15	16216.95	25.350
40320.00	0.010857	0.00	641.12	0.00	-4248.53	6.627

Fase n° 5 - [A2-M2]

n°	Y	A _f	M	N	M _u	N _u	CS
1	0.00	0.010857	0.00	0.00	0.00	0.00	1000.000
2	0.05	0.010857	0.00	1.39	-0.05	16217.02	11697.176
3	0.10	0.010857	0.00	2.77	-0.09	16216.99	5848.576
4	0.15	0.010857	0.00	4.16	-0.14	16216.95	3899.043
5	0.20	0.010857	0.00	5.55	-0.19	16216.92	2924.276
6	0.25	0.010857	0.00	6.93	-0.24	16216.89	2339.416
7	0.30	0.010857	0.00	8.32	-0.28	16216.85	1949.510
8	0.35	0.010857	0.00	9.70	-0.33	16216.82	1671.005
9	0.40	0.010857	0.00	11.09	-0.38	16216.79	1462.126
10	0.45	0.010857	0.00	12.48	-0.42	16216.76	1299.665
11	0.50	0.010857	0.00	13.86	-0.47	16216.72	1169.696
12	0.55	0.010857	0.00	15.25	-0.53	16216.68	1063.357
13	0.60	0.010857	0.00	16.64	-0.62	16216.62	974.740
14	0.65	0.010857	0.00	18.02	-0.73	16216.54	899.756
15	0.70	0.010857	0.00	19.41	-0.86	16216.45	835.483
16	0.75	0.010857	0.00	20.80	-1.00	16216.35	779.779
17	0.80	0.010857	0.00	22.18	-1.16	16216.24	731.038
18	0.85	0.010857	0.00	23.57	-1.32	16216.13	688.031
19	0.90	0.010857	0.00	24.96	-1.49	16216.01	649.803
20	0.95	0.010857	0.00	26.34	-1.66	16215.89	615.598
21	1.00	0.010857	0.00	27.73	-1.84	16215.76	584.813

Cod. elab.: 108GA201-GA01-Z-CL-002_C	Titolo: OPERE D'ARTE MAGGIORI- GALLERIE	Data: Ottobre 2011
Nome file: 108GA201-GA01-Z-CL -002_C.docx	ARTIFICIALI – GALLERIA ROVETELLO	Pagina 229 di 452
Relazione di calcolo		

PROGETTO ESECUTIVO

22	1.05	0.010857	0.00	29.11	-2.02	16215.63	556.961
23	1.10	0.010857	0.00	30.50	-2.21	16215.50	531.640
24	1.15	0.010857	0.00	31.89	-2.40	16215.37	508.521
25	1.20	0.010857	-0.01	33.27	-2.59	16215.23	487.329
26	1.25	0.010857	-0.01	34.66	-2.79	16215.10	467.832
27	1.30	0.010857	-0.01	36.05	-2.99	16214.96	449.834
28	1.35	0.010857	-0.01	37.43	-3.18	16214.82	433.170
29	1.40	0.010857	-0.01	38.82	-3.38	16214.68	417.696
30	1.45	0.010857	-0.01	40.21	-3.58	16214.54	403.289
31	1.50	0.010857	-0.01	41.59	-3.79	16214.40	389.843
32	1.55	0.010857	-0.01	42.98	-3.99	16214.25	377.264
33	1.60	0.010857	-0.01	44.36	-4.19	16214.11	365.471
34	1.65	0.010857	-0.01	45.75	-4.40	16213.97	354.393
35	1.70	0.010857	-0.01	47.14	-4.60	16213.83	343.967
36	1.75	0.010857	-0.01	48.52	-4.81	16213.68	334.136
37	1.80	0.010857	-0.02	49.91	-5.01	16213.54	324.852
38	1.85	0.010857	-0.02	51.30	-5.22	16213.39	316.069
39	1.90	0.010857	-0.02	52.68	-5.42	16213.25	307.749
40	1.95	0.010857	-0.02	54.07	-5.63	16213.10	299.855
41	2.00	0.010857	-0.02	55.46	-5.84	16212.96	292.356
42	2.05	0.010857	-0.02	56.84	-6.04	16212.82	285.223
43	2.10	0.010857	-0.02	58.23	-6.25	16212.67	278.430
44	2.15	0.010857	-0.02	59.62	-6.45	16212.53	271.952
45	2.20	0.010857	-0.03	61.00	-6.66	16212.38	265.769
46	2.25	0.010857	-0.03	62.39	-6.87	16212.24	259.861
47	2.30	0.010857	-0.03	63.77	-7.07	16212.09	254.209
48	2.35	0.010857	-0.03	65.16	-7.28	16211.95	248.798
49	2.40	0.010857	-0.03	66.55	-7.48	16211.80	243.613
50	2.45	0.010857	-0.03	67.93	-7.69	16211.66	238.639
51	2.50	0.010857	-0.03	69.32	-7.90	16211.52	233.864
52	2.50	0.010857	-0.03	133.95	-4.09	16214.19	121.046
53	2.55	0.010857	-8.91	135.34	-1020.97	15501.15	114.537
54	2.60	0.010857	-17.79	136.72	-1842.86	14159.93	103.566
55	2.65	0.010857	-26.67	138.11	-2346.73	12150.51	87.977
56	2.70	0.010857	-35.55	139.50	-2666.85	10463.27	75.007
57	2.75	0.010857	-44.42	140.88	-2871.44	9106.42	64.638

Cod. elab.: 108GA201-GA01-Z-CL-002_C	Titolo: OPERE D'ARTE MAGGIORI- GALLERIE	Data: Ottobre 2011
Nome file: 108GA201-GA01-Z-CL -002_C.docx	ARTIFICIALI – GALLERIA ROVETELLO	Pagina 230 di 452
Relazione di calcolo		

PROGETTO ESECUTIVO

58	2.80	0.010857	-53.25	142.27	-2997.90	8010.23	56.303
59	2.85	0.010857	-61.98	143.66	-3054.55	7079.43	49.280
60	2.90	0.010857	-70.61	145.04	-3063.19	6292.05	43.381
61	2.95	0.010857	-79.12	146.43	-3040.01	5626.47	38.425
62	3.00	0.010857	-87.48	147.82	-3002.20	5072.79	34.318
63	3.05	0.010857	-95.69	149.20	-2960.93	4616.76	30.943
64	3.10	0.010857	-103.73	150.59	-2922.29	4242.41	28.172
65	3.15	0.010857	-111.59	151.97	-2873.44	3913.35	25.750
66	3.20	0.010857	-119.27	153.36	-2833.36	3643.35	23.757
67	3.25	0.010857	-126.75	154.75	-2799.95	3418.29	22.090
68	3.30	0.010857	-134.05	156.13	-2770.57	3226.89	20.668
69	3.35	0.010857	-141.16	157.52	-2734.21	3051.05	19.369
70	3.40	0.010857	-148.08	158.91	-2703.17	2900.86	18.255
71	3.45	0.010857	-154.80	160.29	-2676.42	2771.46	17.290
72	3.50	0.010857	-161.32	161.68	-2653.21	2659.19	16.447
73	3.55	0.010857	-167.63	163.07	-2632.94	2561.18	15.706
74	3.60	0.010857	-173.75	164.45	-2615.17	2475.20	15.051
75	3.65	0.010857	-179.66	165.84	-2599.52	2399.50	14.469
76	3.70	0.010857	-185.37	167.22	-2585.70	2332.65	13.949
77	3.75	0.010857	-190.86	168.61	-2573.47	2273.48	13.484
78	3.80	0.010857	-196.14	170.00	-2562.63	2221.06	13.065
79	3.85	0.010857	-201.21	171.38	-2553.03	2174.60	12.688
80	3.90	0.010857	-206.06	172.77	-2541.19	2130.66	12.332
81	3.95	0.010857	-210.69	174.16	-2529.51	2090.89	12.006
82	4.00	0.010857	-215.10	175.54	-2519.24	2055.94	11.712
83	4.05	0.010857	-219.29	176.93	-2510.26	2025.36	11.447
84	4.10	0.010857	-223.25	178.32	-2502.45	1998.77	11.209
85	4.15	0.010857	-226.98	179.70	-2495.71	1975.84	10.995
86	4.20	0.010857	-230.49	181.09	-2489.97	1956.31	10.803
87	4.25	0.010857	-233.76	182.48	-2485.17	1939.94	10.631
88	4.30	0.010857	-236.80	183.86	-2481.23	1926.56	10.478
89	4.35	0.010857	-239.60	185.25	-2478.13	1916.00	10.343
90	4.40	0.010857	-242.16	186.63	-2475.82	1908.14	10.224
91	4.45	0.010857	-244.48	188.02	-2474.28	1902.89	10.121
92	4.50	0.010857	-246.56	189.41	-2473.48	1900.15	10.032
93	4.55	0.010857	-248.39	190.79	-2473.40	1899.89	9.958

<i>Cod. elab.:</i> 108GA201-GA01-Z-CL-002_C	<i>Titolo:</i> OPERE D'ARTE MAGGIORI- GALLERIE	<i>Data:</i> Ottobre 2011
<i>Nome file:</i> 108GA201-GA01-Z-CL -002_C.docx	ARTIFICIALI – GALLERIA ROVETELLO Relazione di calcolo	<i>Pagina</i> 231 di 452

PROGETTO ESECUTIVO

94	4.60	0.010857	-249.97	192.18	-2474.04	1902.06	9.897
95	4.65	0.010857	-251.31	193.57	-2475.38	1906.65	9.850
96	4.70	0.010857	-252.39	194.95	-2477.45	1913.66	9.816
97	4.75	0.010857	-253.22	196.34	-2480.23	1923.13	9.795
98	4.80	0.010857	-253.79	197.73	-2483.74	1935.08	9.787
99	4.85	0.010857	-254.10	199.11	-2488.00	1949.59	9.791
100	4.90	0.010857	-254.15	200.50	-2493.04	1966.74	9.809
101	4.95	0.010857	-253.94	201.88	-2498.88	1986.63	9.840
102	5.00	0.010857	-253.47	203.27	-2505.56	2009.38	9.885
103	5.00	0.010857	-253.47	275.41	-2712.86	2947.75	10.703
104	5.05	0.010857	-262.63	276.80	-2689.45	2834.51	10.240
105	5.10	0.010857	-271.53	278.18	-2668.69	2734.08	9.828
106	5.15	0.010857	-280.16	279.57	-2650.20	2644.65	9.460
107	5.20	0.010857	-288.51	280.96	-2633.68	2564.73	9.129
108	5.25	0.010857	-296.59	282.34	-2618.87	2493.10	8.830
109	5.30	0.010857	-304.39	283.73	-2605.56	2428.74	8.560
110	5.35	0.010857	-311.91	285.12	-2593.59	2370.82	8.315
111	5.40	0.010857	-319.14	286.50	-2582.80	2318.64	8.093
112	5.45	0.010857	-326.10	287.89	-2573.08	2271.60	7.891
113	5.50	0.010857	-332.76	289.28	-2564.31	2229.18	7.706
114	5.55	0.010857	-339.14	290.66	-2556.41	2190.97	7.538
115	5.60	0.010857	-345.23	292.05	-2548.64	2156.02	7.382
116	5.65	0.010857	-351.03	293.43	-2538.70	2122.18	7.232
117	5.70	0.010857	-356.53	294.82	-2529.83	2091.97	7.096
118	5.75	0.010857	-361.73	296.21	-2521.93	2065.11	6.972
119	5.80	0.010857	-366.64	297.59	-2514.95	2041.35	6.860
120	5.85	0.010857	-371.24	298.98	-2508.83	2020.49	6.758
121	5.90	0.010857	-375.54	300.37	-2503.50	2002.34	6.666
122	5.95	0.010857	-379.54	301.75	-2498.92	1986.77	6.584
123	6.00	0.010857	-383.23	303.14	-2495.06	1973.63	6.511
124	6.05	0.010857	-386.61	304.53	-2491.88	1962.82	6.445
125	6.10	0.010857	-389.68	305.91	-2489.37	1954.25	6.388
126	6.15	0.010857	-392.43	307.30	-2487.49	1947.85	6.339
127	6.20	0.010857	-394.87	308.69	-2486.23	1943.56	6.296
128	6.25	0.010857	-397.00	310.07	-2485.58	1941.34	6.261
129	6.30	0.010857	-398.80	311.46	-2485.52	1941.16	6.233

Cod. elab.: 108GA201-GA01-Z-CL-002_C	Titolo: OPERE D'ARTE MAGGIORI- GALLERIE	Data: Ottobre 2011
Nome file: 108GA201-GA01-Z-CL -002_C.docx	ARTIFICIALI – GALLERIA ROVETELLO	Pagina 232 di 452
Relazione di calcolo		

PROGETTO ESECUTIVO

1306.35	0.010857	-400.28	312.84	-2486.07	1943.01	6.211
1316.40	0.010857	-401.44	314.23	-2487.20	1946.88	6.196
1326.45	0.010857	-402.27	315.62	-2488.94	1952.78	6.187
1336.50	0.010857	-402.78	317.00	-2491.28	1960.74	6.185
1346.55	0.010857	-402.95	318.39	-2494.23	1970.80	6.190
1356.60	0.010857	-402.80	319.78	-2497.81	1982.99	6.201
1366.65	0.010857	-402.31	321.16	-2502.04	1997.39	6.219
1376.70	0.010857	-401.48	322.55	-2506.94	2014.08	6.244
1386.75	0.010857	-400.32	323.94	-2512.54	2033.15	6.276
1396.80	0.010857	-398.81	325.32	-2518.88	2054.71	6.316
1406.85	0.010857	-396.97	326.71	-2525.99	2078.91	6.363
1416.90	0.010857	-394.78	328.10	-2533.92	2105.90	6.419
1426.95	0.010857	-392.24	329.48	-2542.72	2135.86	6.482
1437.00	0.010857	-389.36	330.87	-2551.74	2168.39	6.554
1447.05	0.010857	-386.13	332.25	-2558.61	2201.62	6.626
1457.10	0.010857	-382.54	333.64	-2566.15	2238.11	6.708
1467.15	0.010857	-378.60	335.03	-2574.42	2278.11	6.800
1477.20	0.010857	-374.31	336.41	-2583.48	2321.93	6.902
1487.25	0.010857	-369.66	337.80	-2593.40	2369.91	7.016
1497.30	0.010857	-364.64	339.19	-2604.27	2422.46	7.142
1507.35	0.010857	-359.27	340.57	-2616.17	2480.05	7.282
1517.40	0.010857	-353.53	341.96	-2629.23	2543.21	7.437
1527.45	0.010857	-347.42	343.35	-2643.57	2612.58	7.609
1537.50	0.010857	-340.94	344.73	-2659.35	2688.90	7.800
1547.55	0.010857	-334.19	346.12	-2676.53	2772.03	8.009
1557.60	0.010857	-327.27	347.50	-2695.07	2861.71	8.235
1567.65	0.010857	-320.17	348.89	-2715.11	2958.64	8.480
1577.70	0.010857	-312.91	350.28	-2736.82	3063.64	8.746
1587.75	0.010857	-305.49	351.66	-2760.39	3177.65	9.036
1597.80	0.010857	-297.91	353.05	-2781.92	3296.88	9.338
1607.85	0.010857	-290.17	354.44	-2800.27	3420.46	9.650
1617.90	0.010857	-282.29	355.82	-2820.22	3554.88	9.991
1627.95	0.010857	-274.26	357.21	-2842.00	3701.54	10.362
1638.00	0.010857	-266.09	358.60	-2865.83	3862.07	10.770
1648.05	0.010857	-257.79	359.98	-2892.01	4038.43	11.218
1658.10	0.010857	-249.36	361.37	-2920.89	4232.94	11.714

<i>Cod. elab.:</i> 108GA201-GA01-Z-CL-002_C	<i>Titolo:</i> OPERE D'ARTE MAGGIORI- GALLERIE	<i>Data:</i> Ottobre 2011
<i>Nome file:</i> 108GA201-GA01-Z-CL -002_C.docx	ARTIFICIALI – GALLERIA ROVETELLO Relazione di calcolo	<i>Pagina</i> 233 di 452

PROGETTO ESECUTIVO

1668.15	0.010857	-240.80	362.76	-2944.56	4435.91	12.228
1678.20	0.010857	-232.11	364.14	-2963.92	4649.80	12.769
1688.25	0.010857	-223.31	365.53	-2985.34	4886.52	13.368
1698.30	0.010857	-214.40	366.91	-3009.16	5149.77	14.035
1708.35	0.010857	-205.37	368.30	-3033.52	5440.04	14.771
1718.40	0.010857	-196.25	369.69	-3043.75	5733.82	15.510
1728.45	0.010857	-187.02	371.07	-3055.18	6062.07	16.337
1738.50	0.010857	-177.69	372.46	-3068.04	6431.07	17.266
1748.55	0.010857	-168.29	373.85	-3061.78	6801.62	18.194
1758.60	0.010857	-158.84	375.23	-3051.21	7207.76	19.209
1768.65	0.010857	-149.36	376.62	-3033.71	7649.77	20.312
1778.70	0.010857	-139.83	378.01	-2990.54	8084.32	21.387
1788.75	0.010857	-130.27	379.39	-2942.37	8569.29	22.587
1798.80	0.010857	-120.67	380.78	-2875.83	9074.53	23.832
1808.85	0.010857	-111.05	382.16	-2798.97	9632.43	25.205
1818.90	0.010857	-101.40	383.55	-2704.55	10230.36	26.673
1828.95	0.010857	-91.72	384.94	-2595.25	10891.46	28.294
1839.00	0.010857	-82.03	386.32	-2461.58	11592.73	30.008
1849.05	0.010857	-72.32	387.71	-2303.00	12346.00	31.843
1859.10	0.010857	-62.60	389.10	-2115.72	13150.07	33.796
1869.15	0.010857	-52.87	390.48	-1893.69	13985.57	35.816
1879.20	0.010857	-43.14	391.87	-1633.49	14838.78	37.867
1889.25	0.010857	-33.40	393.26	-1299.98	15305.51	38.920
1899.30	0.010857	-23.67	394.64	-933.25	15562.66	39.435
1909.35	0.010857	-13.93	396.03	-556.82	15826.61	39.963
1919.40	0.010857	-4.21	397.42	-170.40	16097.57	40.506
1929.45	0.010857	5.51	398.80	221.96	16061.42	40.274
1939.50	0.010857	15.22	400.19	600.67	15795.86	39.471
1949.55	0.010857	24.91	401.57	964.06	15541.05	38.700
1959.60	0.010857	34.59	402.96	1312.95	15296.41	37.960
1969.65	0.010857	44.25	404.35	1626.28	14862.15	36.756
1979.70	0.010857	53.88	405.73	1869.13	14074.78	34.690
1989.75	0.010857	63.49	407.12	2074.84	13303.93	32.678
1999.80	0.010857	73.08	408.51	2250.54	12580.54	30.796
2009.85	0.010857	82.63	409.89	2400.78	11908.83	29.054
2019.90	0.010857	92.16	411.28	2524.10	11264.70	27.389

<i>Cod. elab.:</i> 108GA201-GA01-Z-CL-002_C	<i>Titolo:</i> OPERE D'ARTE MAGGIORI- GALLERIE	<i>Data:</i> Ottobre 2011
<i>Nome file:</i> 108GA201-GA01-Z-CL -002_C.docx	ARTIFICIALI – GALLERIA ROVETELLO Relazione di calcolo	<i>Pagina</i> 234 di 452

PROGETTO ESECUTIVO

2029.95	0.010857	101.64	412.67	2631.31	10682.86	25.887
20310.00	0.010857	111.09	414.05	2719.74	10136.51	24.481
20410.05	0.010857	120.51	415.44	2797.39	9643.91	23.214
20510.10	0.010857	129.87	416.82	2860.99	9182.29	22.029
20610.15	0.010857	139.19	418.21	2918.13	8767.53	20.964
20710.20	0.010857	148.47	419.60	2962.05	8371.24	19.951
20810.25	0.010857	157.69	420.98	2998.44	8004.83	19.015
20910.30	0.010857	166.86	422.37	3031.38	7673.24	18.167
21010.35	0.010857	175.97	423.76	3047.79	7339.27	17.320
21110.40	0.010857	185.03	425.14	3056.05	7021.95	16.517
21210.45	0.010857	194.02	426.53	3063.52	6734.77	15.790
21310.50	0.010857	202.95	427.92	3069.46	6471.94	15.124
21410.55	0.010857	211.81	429.30	3060.07	6202.24	14.447
21510.60	0.010857	220.60	430.69	3051.55	5957.67	13.833
21610.65	0.010857	229.32	432.08	3043.79	5734.99	13.273
21710.70	0.010857	237.96	433.46	3036.70	5531.50	12.761
21810.75	0.010857	246.53	434.85	3026.18	5337.82	12.275
21910.80	0.010857	255.01	436.23	3008.92	5147.15	11.799
22010.85	0.010857	263.42	437.62	2993.13	4972.57	11.363
22110.90	0.010857	271.73	439.01	2978.62	4812.23	10.962
22210.95	0.010857	279.96	440.39	2965.25	4664.54	10.592
22311.00	0.010857	288.09	441.78	2952.91	4528.17	10.250
22411.05	0.010857	296.14	443.17	2941.49	4401.94	9.933
22511.10	0.010857	304.08	444.55	2927.96	4280.57	9.629
22611.15	0.010857	311.92	445.94	2910.12	4160.44	9.330
22711.20	0.010857	319.67	447.33	2893.61	4049.19	9.052
22811.25	0.010857	327.30	448.71	2878.28	3945.96	8.794
22911.30	0.010857	334.83	450.10	2864.04	3850.00	8.554
23011.35	0.010857	342.25	451.49	2850.77	3760.67	8.330
23111.40	0.010857	349.55	452.87	2838.41	3677.37	8.120
23211.45	0.010857	356.74	454.26	2826.86	3599.60	7.924
23311.50	0.010857	363.81	455.64	2816.07	3526.92	7.741
23411.55	0.010857	370.76	457.03	2805.98	3458.91	7.568
23511.60	0.010857	377.58	458.42	2796.52	3395.24	7.406
23611.65	0.010857	384.28	459.80	2787.66	3335.57	7.254
23711.70	0.010857	390.84	461.19	2779.36	3279.63	7.111

Cod. elab.: 108GA201-GA01-Z-CL-002_C	Titolo: OPERE D'ARTE MAGGIORI- GALLERIE	Data: Ottobre 2011
Nome file: 108GA201-GA01-Z-CL -002_C.docx	ARTIFICIALI – GALLERIA ROVETELLO	Pagina 235 di 452
	Relazione di calcolo	

PROGETTO ESECUTIVO

23811.75	0.010857	397.27	462.58	2770.32	3225.71	6.973
23911.80	0.010857	403.57	463.96	2759.25	3172.17	6.837
24011.85	0.010857	409.73	465.35	2748.90	3122.06	6.709
24111.90	0.010857	415.75	466.74	2739.20	3075.16	6.589
24211.95	0.010857	421.62	468.12	2730.12	3031.25	6.475
24312.00	0.010857	427.34	469.51	2721.63	2990.15	6.369
24412.05	0.010857	432.92	470.89	2713.68	2951.71	6.268
24512.10	0.010857	438.35	472.28	2706.25	2915.76	6.174
24612.15	0.010857	443.61	473.67	2699.30	2882.16	6.085
24712.20	0.010857	448.73	475.05	2692.82	2850.81	6.001
24812.25	0.010857	453.68	476.44	2686.78	2821.59	5.922
24912.30	0.010857	458.46	477.83	2681.16	2794.39	5.848
25012.35	0.010857	463.08	479.21	2675.93	2769.13	5.779
25112.40	0.010857	467.54	480.60	2671.10	2745.73	5.713
25212.45	0.010857	471.82	481.99	2666.63	2724.11	5.652
25312.50	0.010857	475.92	483.37	2662.51	2704.20	5.594
25412.55	0.010857	479.85	484.76	2658.74	2685.95	5.541
25512.60	0.010857	483.59	486.15	2655.30	2669.30	5.491
25612.65	0.010857	487.16	487.53	2652.18	2654.21	5.444
25712.70	0.010857	490.54	488.92	2649.37	2640.63	5.401
25812.75	0.010857	493.73	490.30	2646.87	2628.52	5.361
25912.80	0.010857	496.73	491.69	2644.66	2617.84	5.324
26012.85	0.010857	499.54	493.08	2642.74	2608.57	5.290
26112.90	0.010857	502.15	494.46	2641.11	2600.68	5.260
26212.95	0.010857	504.57	495.85	2639.76	2594.14	5.232
26313.00	0.010857	506.79	497.24	2638.68	2588.94	5.207
26413.05	0.010857	508.81	498.62	2637.88	2585.05	5.184
26513.10	0.010857	510.63	500.01	2637.35	2582.47	5.165
26613.15	0.010857	512.25	501.40	2637.08	2581.19	5.148
26713.20	0.010857	513.67	502.78	2637.08	2581.20	5.134
26813.25	0.010857	514.88	504.17	2637.35	2582.50	5.122
26913.30	0.010857	515.88	505.55	2637.89	2585.11	5.113
27013.35	0.010857	516.67	506.94	2638.70	2589.02	5.107
27113.40	0.010857	517.25	508.33	2639.78	2594.24	5.103
27213.45	0.010857	517.62	509.71	2641.14	2600.81	5.102
27313.50	0.010857	517.77	511.10	2642.77	2608.73	5.104

Cod. elab.: 108GA201-GA01-Z-CL-002_C	Titolo: OPERE D'ARTE MAGGIORI- GALLERIE	Data: Ottobre 2011
Nome file: 108GA201-GA01-Z-CL -002_C.docx	ARTIFICIALI – GALLERIA ROVETELLO Relazione di calcolo	Pagina 236 di 452

PROGETTO ESECUTIVO

27413.55	0.010857	517.71	512.49	2644.70	2618.03	5.108
27513.60	0.010857	517.43	513.87	2646.90	2628.69	5.115
27613.65	0.010857	516.95	515.26	2649.39	2640.72	5.125
27713.70	0.010857	516.27	516.65	2652.15	2654.10	5.137
27813.75	0.010857	515.39	518.03	2655.20	2668.83	5.152
27913.80	0.010857	514.31	519.42	2658.52	2684.91	5.169
28013.85	0.010857	513.05	520.81	2662.13	2702.35	5.189
28113.90	0.010857	511.61	522.19	2666.02	2721.16	5.211
28213.95	0.010857	509.99	523.58	2670.19	2741.35	5.236
28314.00	0.010857	508.19	524.96	2674.65	2762.93	5.263
28414.05	0.010857	506.23	526.35	2679.41	2785.92	5.293
28514.10	0.010857	504.10	527.74	2684.46	2810.35	5.325
28614.15	0.010857	501.81	529.12	2689.81	2836.23	5.360
28714.20	0.010857	499.36	530.51	2695.46	2863.60	5.398
28814.25	0.010857	496.76	531.90	2701.44	2892.49	5.438
28914.30	0.010857	494.02	533.28	2707.73	2922.94	5.481
29014.35	0.010857	491.13	534.67	2714.35	2954.97	5.527
29114.40	0.010857	488.11	536.06	2721.31	2988.65	5.575
29214.45	0.010857	484.95	537.44	2728.62	3024.00	5.627
29314.50	0.010857	481.66	538.83	2736.29	3061.09	5.681
29414.55	0.010857	478.24	540.21	2744.33	3099.97	5.738
29514.60	0.010857	474.70	541.60	2752.75	3140.70	5.799
29614.65	0.010857	471.04	542.99	2761.56	3183.34	5.863
29714.70	0.010857	467.27	544.37	2770.79	3227.97	5.930
29814.75	0.010857	463.39	545.76	2778.24	3272.06	5.995
29914.80	0.010857	459.41	547.15	2784.87	3316.73	6.062
30014.85	0.010857	455.32	548.53	2791.79	3363.33	6.131
30114.90	0.010857	451.13	549.92	2799.00	3411.92	6.204
30214.95	0.010857	446.85	551.31	2806.52	3462.57	6.281
30315.00	0.010857	442.48	552.69	2814.36	3515.37	6.360
30415.05	0.010857	438.02	554.08	2822.53	3570.40	6.444
30515.10	0.010857	433.48	555.47	2831.04	3627.75	6.531
30615.15	0.010857	428.85	556.85	2839.91	3687.53	6.622
30715.20	0.010857	424.16	558.24	2849.16	3749.83	6.717
30815.25	0.010857	419.39	559.62	2858.80	3814.77	6.817
30915.30	0.010857	414.55	561.01	2868.86	3882.47	6.920

Cod. elab.: 108GA201-GA01-Z-CL-002_C	Titolo: OPERE D'ARTE MAGGIORI- GALLERIE	Data: Ottobre 2011
Nome file: 108GA201-GA01-Z-CL -002_C.docx	ARTIFICIALI – GALLERIA ROVETELLO Relazione di calcolo	Pagina 237 di 452

PROGETTO ESECUTIVO

31015.35	0.010857	409.64	562.40	2879.33	3953.05	7.029
31115.40	0.010857	404.67	563.78	2890.26	4026.66	7.142
31215.45	0.010857	399.65	565.17	2901.66	4103.44	7.261
31315.50	0.010857	394.57	566.56	2913.55	4183.55	7.384
31415.55	0.010857	389.43	567.94	2925.97	4267.16	7.513
31515.60	0.010857	384.25	569.33	2936.92	4351.49	7.643
31615.65	0.010857	379.03	570.72	2944.33	4433.39	7.768
31715.70	0.010857	373.76	572.10	2952.05	4518.59	7.898
31815.75	0.010857	368.45	573.49	2960.07	4607.26	8.034
31915.80	0.010857	363.11	574.88	2968.42	4699.56	8.175
32015.85	0.010857	357.74	576.26	2977.12	4795.67	8.322
32115.90	0.010857	352.34	577.65	2986.18	4895.78	8.475
32215.95	0.010857	346.91	579.03	2995.62	5000.08	8.635
32316.00	0.010857	341.46	580.42	3005.45	5108.79	8.802
32416.05	0.010857	335.98	581.81	3015.71	5222.15	8.976
32516.10	0.010857	330.50	583.19	3026.41	5340.40	9.157
32616.15	0.010857	324.99	584.58	3034.13	5457.59	9.336
32716.20	0.010857	319.48	585.97	3038.12	5572.25	9.510
32816.25	0.010857	313.96	587.35	3042.27	5691.41	9.690
32916.30	0.010857	308.44	588.74	3046.59	5815.27	9.878
33016.35	0.010857	302.91	590.13	3051.07	5944.07	10.073
33116.40	0.010857	297.38	591.51	3055.74	6078.04	10.275
33216.45	0.010857	291.86	592.90	3060.60	6217.42	10.486
33316.50	0.010857	286.34	594.28	3065.65	6362.50	10.706
33416.55	0.010857	280.81	595.67	3069.35	6510.85	10.930
33516.60	0.010857	275.24	597.06	3065.72	6650.23	11.138
33616.65	0.010857	269.64	598.44	3061.93	6795.83	11.356
33716.70	0.010857	264.00	599.83	3057.97	6948.00	11.583
33816.75	0.010857	258.34	601.22	3053.83	7107.07	11.821
33916.80	0.010857	252.65	602.60	3049.50	7273.43	12.070
34016.85	0.010857	246.95	603.99	3044.97	7447.48	12.330
34116.90	0.010857	241.23	605.38	3036.61	7620.58	12.588
34216.95	0.010857	235.50	606.76	3020.52	7782.48	12.826
34317.00	0.010857	229.76	608.15	3003.80	7950.84	13.074
34417.05	0.010857	224.01	609.54	2986.41	8125.93	13.331
34517.10	0.010857	218.27	610.92	2968.32	8308.07	13.599

Cod. elab.: 108GA201-GA01-Z-CL-002_C	Titolo: OPERE D'ARTE MAGGIORI- GALLERIE	Data: Ottobre 2011
Nome file: 108GA201-GA01-Z-CL -002_C.docx	ARTIFICIALI – GALLERIA ROVETELLO	Pagina 238 di 452
	Relazione di calcolo	

PROGETTO ESECUTIVO

34617.15	0.010857	212.53	612.31	2949.50	8497.58	13.878
34717.20	0.010857	206.80	613.69	2928.66	8691.10	14.162
34817.25	0.010857	201.08	615.08	2902.73	8879.31	14.436
34917.30	0.010857	195.37	616.47	2875.84	9074.49	14.720
35017.35	0.010857	189.68	617.85	2847.95	9276.91	15.015
35117.40	0.010857	184.01	619.24	2819.03	9486.86	15.320
35217.45	0.010857	178.36	620.63	2789.03	9704.62	15.637
35317.50	0.010857	172.75	622.01	2754.86	9919.51	15.947
35417.55	0.010857	167.16	623.40	2719.11	10140.44	16.266
35517.60	0.010857	161.61	624.79	2682.11	10368.99	16.596
35617.65	0.010857	156.10	626.17	2643.85	10605.42	16.937
35717.70	0.010857	150.63	627.56	2603.65	10847.39	17.285
35817.75	0.010857	145.21	628.94	2558.74	11082.97	17.622
35917.80	0.010857	139.83	630.33	2512.46	11325.80	17.968
36017.85	0.010857	134.51	631.72	2464.76	11576.01	18.325
36117.90	0.010857	129.24	633.10	2415.64	11833.73	18.692
36217.95	0.010857	124.03	634.49	2361.87	12082.81	19.043
36318.00	0.010857	118.88	635.88	2305.77	12333.60	19.396
36418.05	0.010857	113.79	637.26	2248.27	12590.67	19.757
36518.10	0.010857	108.78	638.65	2189.37	12854.01	20.127
36618.15	0.010857	103.83	640.04	2126.68	13108.83	20.481
36718.20	0.010857	98.97	641.42	2060.82	13356.67	20.824
36818.25	0.010857	94.18	642.81	1993.78	13608.92	21.171
36918.30	0.010857	89.47	644.20	1925.62	13865.41	21.524
37018.35	0.010857	84.84	645.58	1855.48	14119.03	21.870
37118.40	0.010857	80.30	646.97	1782.03	14357.17	22.191
37218.45	0.010857	75.86	648.35	1707.88	14597.59	22.515
37318.50	0.010857	71.50	649.74	1633.11	14840.00	22.840
37418.55	0.010857	67.25	651.13	1557.84	15084.05	23.166
37518.60	0.010857	63.09	652.51	1468.45	15187.38	23.275
37618.65	0.010857	59.04	653.90	1377.01	15251.50	23.324
37718.70	0.010857	55.09	655.29	1287.53	15314.24	23.370
37818.75	0.010857	51.26	656.67	1200.13	15375.52	23.414
37918.80	0.010857	47.53	658.06	1114.92	15435.27	23.456
38018.85	0.010857	43.93	659.45	1032.00	15493.41	23.495
38118.90	0.010857	40.44	660.83	951.49	15549.87	23.531

<i>Cod. elab.:</i> 108GA201-GA01-Z-CL-002_C	<i>Titolo:</i> OPERE D'ARTE MAGGIORI- GALLERIE	<i>Data:</i> Ottobre 2011
<i>Nome file:</i> 108GA201-GA01-Z-CL -002_C.docx	ARTIFICIALI – GALLERIA ROVETELLO Relazione di calcolo	<i>Pagina</i> 239 di 452

PROGETTO ESECUTIVO

38218.95	0.010857	37.07	662.22	873.51	15604.55	23.564
38319.00	0.010857	33.83	663.60	798.15	15657.39	23.594
38419.05	0.010857	30.71	664.99	725.53	15708.31	23.622
38519.10	0.010857	27.73	666.38	655.75	15757.24	23.646
38619.15	0.010857	24.88	667.76	588.94	15804.09	23.667
38719.20	0.010857	22.17	669.15	525.18	15848.79	23.685
38819.25	0.010857	19.60	670.54	464.60	15891.28	23.699
38919.30	0.010857	17.18	671.92	407.28	15931.47	23.710
39019.35	0.010857	14.90	673.31	353.34	15969.29	23.718
39119.40	0.010857	12.77	674.70	302.87	16004.68	23.721
39219.45	0.010857	10.79	676.08	255.97	16037.57	23.721
39319.50	0.010857	8.97	677.47	212.73	16067.88	23.718
39419.55	0.010857	7.31	678.86	173.25	16095.57	23.710
39519.60	0.010857	5.81	680.24	137.60	16120.57	23.698
39619.65	0.010857	4.47	681.63	105.88	16142.81	23.683
39719.70	0.010857	3.30	683.01	78.17	16162.24	23.663
39819.75	0.010857	2.31	684.40	54.54	16178.81	23.639
39919.80	0.010857	1.49	685.79	35.07	16192.46	23.611
40019.85	0.010857	0.84	687.17	19.82	16203.16	23.579
40119.90	0.010857	0.38	688.56	8.85	16210.85	23.543
40219.95	0.010857	0.09	689.95	2.23	16215.49	23.503
40320.00	0.010857	0.00	691.33	0.00	-4248.53	6.145

Fase n° 6 - [A2-M2]

n°	Y	A _f	M	N	M _u	N _u	CS
1	0.00	0.010857	0.00	0.00	0.00	0.00	1000.000
2	0.05	0.010857	0.00	1.39	0.13	16216.96	11697.135
3	0.10	0.010857	0.00	2.77	0.26	16216.87	5848.535
4	0.15	0.010857	0.00	4.16	0.39	16216.78	3899.002
5	0.20	0.010857	0.00	5.55	0.51	16216.69	2924.235
6	0.25	0.010857	0.00	6.93	0.64	16216.60	2339.375
7	0.30	0.010857	0.00	8.32	0.77	16216.51	1949.468
8	0.35	0.010857	0.00	9.70	0.90	16216.42	1670.964
9	0.40	0.010857	0.00	11.09	1.03	16216.33	1462.085
10	0.45	0.010857	0.00	12.48	1.16	16216.24	1299.624

Cod. elab.: 108GA201-GA01-Z-CL-002_C	Titolo: OPERE D'ARTE MAGGIORI- GALLERIE	Data: Ottobre 2011
Nome file: 108GA201-GA01-Z-CL -002_C.docx	ARTIFICIALI – GALLERIA ROVETELLO	Pagina 240 di 452
Relazione di calcolo		

PROGETTO ESECUTIVO

11	0.50	0.010857	0.00	13.86	1.28	16216.15	1169.655
12	0.55	0.010857	0.00	15.25	1.46	16216.03	1063.315
13	0.55	0.010857	0.00	15.25	1.46	16216.03	1063.315
14	0.60	0.010857	0.00	16.64	1.71	16215.85	974.695
15	0.60	0.010857	0.00	16.64	1.71	16215.85	974.695
16	0.65	0.010857	0.00	18.02	2.03	16215.63	899.706
17	0.65	0.010857	0.00	18.02	2.03	16215.63	899.706
18	0.70	0.010857	0.00	19.41	2.39	16215.38	835.428
19	0.70	0.010857	0.00	19.41	2.39	16215.38	835.428
20	0.75	0.010857	0.00	20.80	2.79	16215.10	779.719
21	0.75	0.010857	0.00	20.80	2.79	16215.10	779.719
22	0.80	0.010857	0.00	22.18	3.22	16214.79	730.973
23	0.80	0.010857	0.00	22.18	3.22	16214.79	730.973
24	0.85	0.010857	0.01	23.57	3.68	16214.47	687.961
25	0.85	0.010857	0.01	23.57	3.68	16214.47	687.961
26	0.90	0.010857	0.01	24.96	4.15	16214.14	649.728
27	0.90	0.010857	0.01	24.96	4.15	16214.14	649.728
28	0.95	0.010857	0.01	26.34	4.65	16213.79	615.518
29	0.95	0.010857	0.01	26.34	4.65	16213.79	615.518
30	1.00	0.010857	0.01	27.73	5.16	16213.43	584.730
31	1.00	0.010857	0.01	27.73	5.16	16213.43	584.730
32	1.05	0.010857	0.01	29.11	5.68	16213.07	556.873
33	1.05	0.010857	0.01	29.11	5.68	16213.07	556.873
34	1.10	0.010857	0.01	30.50	6.22	16212.69	531.548
35	1.10	0.010857	0.01	30.50	6.22	16212.69	531.548
36	1.15	0.010857	0.01	31.89	6.76	16212.31	508.425
37	1.15	0.010857	0.01	31.89	6.76	16212.31	508.425
38	1.20	0.010857	0.02	33.27	7.31	16211.92	487.229
39	1.20	0.010857	0.02	33.27	7.31	16211.92	487.229
40	1.25	0.010857	0.02	34.66	7.87	16211.53	467.729
41	1.25	0.010857	0.02	34.66	7.87	16211.53	467.729
42	1.30	0.010857	0.02	36.05	8.44	16211.13	449.728
43	1.30	0.010857	0.02	36.05	8.44	16211.13	449.728
44	1.35	0.010857	0.02	37.43	9.01	16210.73	433.061
45	1.35	0.010857	0.02	37.43	9.01	16210.73	433.061
46	1.40	0.010857	0.02	38.82	9.59	16210.33	417.584

Cod. elab.: 108GA201-GA01-Z-CL-002_C	Titolo: OPERE D'ARTE MAGGIORI- GALLERIE	Data: Ottobre 2011
Nome file: 108GA201-GA01-Z-CL -002_C.docx	ARTIFICIALI – GALLERIA ROVETELLO	Pagina 241 di 452
Relazione di calcolo		

PROGETTO ESECUTIVO

47	1.40	0.010857	0.02	38.82	9.59	16210.33	417.584
48	1.45	0.010857	0.03	40.21	10.17	16209.92	403.174
49	1.45	0.010857	0.03	40.21	10.17	16209.92	403.174
50	1.50	0.010857	0.03	41.59	10.76	16209.51	389.725
51	1.50	0.010857	0.03	41.59	10.76	16209.51	389.725
52	1.55	0.010857	0.03	42.98	11.35	16209.10	377.144
53	1.55	0.010857	0.03	42.98	11.35	16209.10	377.144
54	1.60	0.010857	0.03	44.36	11.94	16208.68	365.349
55	1.60	0.010857	0.03	44.36	11.94	16208.68	365.349
56	1.65	0.010857	0.04	45.75	12.54	16208.26	354.268
57	1.65	0.010857	0.04	45.75	12.54	16208.26	354.268
58	1.70	0.010857	0.04	47.14	13.14	16207.84	343.840
59	1.70	0.010857	0.04	47.14	13.14	16207.84	343.840
60	1.75	0.010857	0.04	48.52	13.74	16207.42	334.007
61	1.75	0.010857	0.04	48.52	13.74	16207.42	334.007
62	1.80	0.010857	0.04	49.91	14.34	16206.99	324.721
63	1.80	0.010857	0.04	49.91	14.34	16206.99	324.721
64	1.85	0.010857	0.05	51.30	14.95	16206.57	315.936
65	1.85	0.010857	0.05	51.30	14.95	16206.57	315.936
66	1.90	0.010857	0.05	52.68	15.56	16206.14	307.614
67	1.90	0.010857	0.05	52.68	15.56	16206.14	307.614
68	1.95	0.010857	0.05	54.07	16.17	16205.71	299.719
69	1.95	0.010857	0.05	54.07	16.17	16205.71	299.719
70	2.00	0.010857	0.06	55.46	16.78	16205.29	292.218
71	2.00	0.010857	0.06	55.46	16.78	16205.29	292.218
72	2.05	0.010857	0.06	56.84	17.39	16204.86	285.083
73	2.05	0.010857	0.06	56.84	17.39	16204.86	285.083
74	2.10	0.010857	0.06	58.23	18.01	16204.42	278.288
75	2.10	0.010857	0.06	58.23	18.01	16204.42	278.288
76	2.15	0.010857	0.07	59.62	18.62	16203.99	271.809
77	2.15	0.010857	0.07	59.62	18.62	16203.99	271.809
78	2.20	0.010857	0.07	61.00	19.24	16203.56	265.624
79	2.20	0.010857	0.07	61.00	19.24	16203.56	265.624
80	2.25	0.010857	0.08	62.39	19.86	16203.12	259.715
81	2.25	0.010857	0.08	62.39	19.86	16203.12	259.715
82	2.30	0.010857	0.08	63.77	20.48	16202.69	254.062

<i>Cod. elab.:</i> 108GA201-GA01-Z-CL-002_C	<i>Titolo:</i> OPERE D'ARTE MAGGIORI- GALLERIE	<i>Data:</i> Ottobre 2011
<i>Nome file:</i> 108GA201-GA01-Z-CL -002_C.docx	ARTIFICIALI – GALLERIA ROVETELLO Relazione di calcolo	<i>Pagina</i> 242 di 452

PROGETTO ESECUTIVO

83	2.30	0.010857	0.08	63.77	20.48	16202.69	254.062
84	2.35	0.010857	0.08	65.16	21.10	16202.26	248.650
85	2.35	0.010857	0.08	65.16	21.10	16202.26	248.650
86	2.40	0.010857	0.09	66.55	21.72	16201.82	243.463
87	2.40	0.010857	0.09	66.55	21.72	16201.82	243.463
88	2.45	0.010857	0.09	67.93	22.35	16201.38	238.488
89	2.45	0.010857	0.09	67.93	22.35	16201.38	238.488
90	2.50	0.010857	0.10	69.32	22.97	16200.95	233.712
91	2.50	0.010857	0.10	189.41	8.41	16211.15	85.589
92	2.55	0.010857	-16.39	190.79	-1314.25	15295.50	80.168
93	2.55	0.010857	-16.39	190.79	-1314.25	15295.50	80.168
94	2.60	0.010857	-32.89	192.18	-2195.15	12828.17	66.751
95	2.60	0.010857	-32.89	192.18	-2195.15	12828.17	66.751
96	2.65	0.010857	-49.38	193.57	-2667.73	10457.85	54.027
97	2.65	0.010857	-49.38	193.57	-2667.73	10457.85	54.027
98	2.70	0.010857	-65.87	194.95	-2930.93	8674.64	44.496
99	2.70	0.010857	-65.87	194.95	-2930.93	8674.64	44.496
100	2.75	0.010857	-82.35	196.34	-3049.57	7270.85	37.032
101	2.75	0.010857	-82.35	196.34	-3049.57	7270.85	37.032
102	2.80	0.010857	-98.78	197.72	-3057.18	6119.30	30.949
103	2.80	0.010857	-98.78	197.72	-3057.18	6119.30	30.949
104	2.85	0.010857	-115.13	199.11	-3015.00	5214.24	26.188
105	2.85	0.010857	-115.13	199.11	-3015.00	5214.24	26.188
106	2.90	0.010857	-131.37	200.50	-2950.66	4503.30	22.461
107	2.90	0.010857	-131.37	200.50	-2950.66	4503.30	22.461
108	2.95	0.010857	-147.49	201.88	-2877.15	3938.36	19.508
109	2.95	0.010857	-147.49	201.88	-2877.15	3938.36	19.508
110	3.00	0.010857	-163.46	203.27	-2811.52	3496.25	17.200
111	3.00	0.010857	-163.46	203.27	-2811.52	3496.25	17.200
112	3.05	0.010857	-179.28	204.66	-2753.21	3142.93	15.357
113	3.05	0.010857	-179.28	204.66	-2753.21	3142.93	15.357
114	3.10	0.010857	-194.93	206.04	-2691.64	2845.10	13.808
115	3.10	0.010857	-194.93	206.04	-2691.64	2845.10	13.808
116	3.15	0.010857	-210.40	207.43	-2641.93	2604.63	12.557
117	3.15	0.010857	-210.40	207.43	-2641.93	2604.63	12.557
118	3.20	0.010857	-225.69	208.82	-2600.98	2406.56	11.525

Cod. elab.: 108GA201-GA01-Z-CL-002_C	Titolo: OPERE D'ARTE MAGGIORI- GALLERIE	Data: Ottobre 2011
Nome file: 108GA201-GA01-Z-CL -002_C.docx	ARTIFICIALI – GALLERIA ROVETELLO	Pagina 243 di 452
Relazione di calcolo		

PROGETTO ESECUTIVO

1193.20	0.010857	-225.69	208.82	-2600.98	2406.56	11.525
1203.25	0.010857	-240.78	210.20	-2566.69	2240.69	10.660
1213.25	0.010857	-240.78	210.20	-2566.69	2240.69	10.660
1223.30	0.010857	-255.69	211.59	-2530.40	2093.92	9.896
1233.30	0.010857	-255.69	211.59	-2530.40	2093.92	9.896
1243.35	0.010857	-270.41	212.98	-2491.80	1962.53	9.215
1253.35	0.010857	-270.41	212.98	-2491.80	1962.53	9.215
1263.40	0.010857	-284.94	214.36	-2458.65	1849.68	8.629
1273.40	0.010857	-284.94	214.36	-2458.65	1849.68	8.629
1283.45	0.010857	-299.26	215.75	-2429.89	1751.78	8.120
1293.45	0.010857	-299.26	215.75	-2429.89	1751.78	8.120
1303.50	0.010857	-313.39	217.13	-2404.72	1666.11	7.673
1313.50	0.010857	-313.39	217.13	-2404.72	1666.11	7.673
1323.55	0.010857	-327.32	218.52	-2382.54	1590.59	7.279
1333.55	0.010857	-327.32	218.52	-2382.54	1590.59	7.279
1343.60	0.010857	-341.05	219.91	-2362.85	1523.57	6.928
1353.60	0.010857	-341.05	219.91	-2362.85	1523.57	6.928
1363.65	0.010857	-354.57	221.29	-2345.28	1463.74	6.614
1373.65	0.010857	-354.57	221.29	-2345.28	1463.74	6.614
1383.70	0.010857	-367.88	222.68	-2329.51	1410.07	6.332
1393.70	0.010857	-367.88	222.68	-2329.51	1410.07	6.332
1403.75	0.010857	-380.98	224.07	-2315.30	1361.70	6.077
1413.75	0.010857	-380.98	224.07	-2315.30	1361.70	6.077
1423.80	0.010857	-393.87	225.45	-2302.44	1317.92	5.846
1433.80	0.010857	-393.87	225.45	-2302.44	1317.92	5.846
1443.85	0.010857	-406.55	226.84	-2290.76	1278.17	5.635
1453.85	0.010857	-406.55	226.84	-2290.76	1278.17	5.635
1463.90	0.010857	-419.00	228.23	-2280.12	1241.95	5.442
1473.90	0.010857	-419.00	228.23	-2280.12	1241.95	5.442
1483.95	0.010857	-431.24	229.61	-2270.40	1208.85	5.265
1493.95	0.010857	-431.24	229.61	-2270.40	1208.85	5.265
1504.00	0.010857	-443.26	231.00	-2261.49	1178.54	5.102
1514.00	0.010857	-443.26	231.00	-2261.49	1178.54	5.102
1524.05	0.010857	-455.06	232.38	-2253.32	1150.70	4.952
1534.05	0.010857	-455.06	232.38	-2253.32	1150.70	4.952
1544.10	0.010857	-466.63	233.77	-2245.79	1125.10	4.813

Cod. elab.: 108GA201-GA01-Z-CL-002_C	Titolo: OPERE D'ARTE MAGGIORI- GALLERIE	Data: Ottobre 2011
Nome file: 108GA201-GA01-Z-CL -002_C.docx	ARTIFICIALI – GALLERIA ROVETELLO	Pagina 244 di 452
Relazione di calcolo		

PROGETTO ESECUTIVO

1554.10	0.010857	-466.63	233.77	-2245.79	1125.10	4.813
1564.15	0.010857	-477.97	235.16	-2238.86	1101.51	4.684
1574.15	0.010857	-477.97	235.16	-2238.86	1101.51	4.684
1584.20	0.010857	-489.08	236.54	-2232.47	1079.74	4.565
1594.20	0.010857	-489.08	236.54	-2232.47	1079.74	4.565
1604.25	0.010857	-499.96	237.93	-2226.56	1059.62	4.454
1614.25	0.010857	-499.96	237.93	-2226.56	1059.62	4.454
1624.30	0.010857	-510.60	239.32	-2221.09	1041.02	4.350
1634.30	0.010857	-510.60	239.32	-2221.09	1041.02	4.350
1644.35	0.010857	-521.01	240.70	-2216.04	1023.80	4.253
1654.35	0.010857	-521.01	240.70	-2216.04	1023.80	4.253
1664.40	0.010857	-531.18	242.09	-2211.35	1007.85	4.163
1674.40	0.010857	-531.18	242.09	-2211.35	1007.85	4.163
1684.45	0.010857	-541.10	243.48	-2207.01	993.07	4.079
1694.45	0.010857	-541.10	243.48	-2207.01	993.07	4.079
1704.50	0.010857	-550.79	244.86	-2202.99	979.38	4.000
1714.50	0.010857	-550.79	244.86	-2202.99	979.38	4.000
1724.55	0.010857	-560.22	246.25	-2199.26	966.69	3.926
1734.55	0.010857	-560.22	246.25	-2199.26	966.69	3.926
1744.60	0.010857	-569.41	247.64	-2195.81	954.95	3.856
1754.60	0.010857	-569.41	247.64	-2195.81	954.95	3.856
1764.65	0.010857	-578.35	249.02	-2192.62	944.07	3.791
1774.65	0.010857	-578.35	249.02	-2192.62	944.07	3.791
1784.70	0.010857	-587.04	250.41	-2189.66	934.02	3.730
1794.70	0.010857	-587.04	250.41	-2189.66	934.02	3.730
1804.75	0.010857	-595.48	251.79	-2186.93	924.74	3.673
1814.75	0.010857	-595.48	251.79	-2186.93	924.74	3.673
1824.80	0.010857	-603.65	253.18	-2184.42	916.18	3.619
1834.80	0.010857	-603.65	253.18	-2184.42	916.18	3.619
1844.85	0.010857	-611.57	254.57	-2182.11	908.31	3.568
1854.85	0.010857	-611.57	254.57	-2182.11	908.31	3.568
1864.90	0.010857	-619.23	255.95	-2179.99	901.08	3.520
1874.90	0.010857	-619.23	255.95	-2179.99	901.08	3.520
1884.95	0.010857	-626.62	257.34	-2178.05	894.48	3.476
1894.95	0.010857	-626.62	257.34	-2178.05	894.48	3.476
1905.00	0.010857	-633.75	258.73	-2176.28	888.46	3.434

Cod. elab.: 108GA201-GA01-Z-CL-002_C	Titolo: OPERE D'ARTE MAGGIORI- GALLERIE	Data: Ottobre 2011
Nome file: 108GA201-GA01-Z-CL -002_C.docx	ARTIFICIALI – GALLERIA ROVETELLO Relazione di calcolo	Pagina 245 di 452

PROGETTO ESECUTIVO

191 5.00	0.010857	-633.75	389.62	-2337.43	1437.03	3.688
192 5.05	0.010857	-658.59	391.01	-2319.89	1377.33	3.522
193 5.05	0.010857	-658.59	391.01	-2319.89	1377.33	3.522
194 5.10	0.010857	-683.17	392.40	-2304.05	1323.39	3.373
195 5.10	0.010857	-683.17	392.40	-2304.05	1323.39	3.373
196 5.15	0.010857	-707.47	393.78	-2289.67	1274.44	3.236
197 5.15	0.010857	-707.47	393.78	-2289.67	1274.44	3.236
198 5.20	0.010857	-731.50	395.17	-2276.56	1229.84	3.112
199 5.20	0.010857	-731.50	395.17	-2276.56	1229.84	3.112
200 5.25	0.010857	-755.25	396.56	-2264.58	1189.05	2.998
201 5.25	0.010857	-755.25	396.56	-2264.58	1189.05	2.998
202 5.30	0.010857	-778.73	397.94	-2253.58	1151.62	2.894
203 5.30	0.010857	-778.73	397.94	-2253.58	1151.62	2.894
204 5.35	0.010857	-801.93	399.33	-2243.46	1117.16	2.798
205 5.35	0.010857	-801.93	399.33	-2243.46	1117.16	2.798
206 5.40	0.010857	-824.84	400.72	-2234.12	1085.36	2.709
207 5.40	0.010857	-824.84	400.72	-2234.12	1085.36	2.709
208 5.45	0.010857	-847.47	402.10	-2225.48	1055.93	2.626
209 5.45	0.010857	-847.47	402.10	-2225.48	1055.93	2.626
210 5.50	0.010857	-869.81	403.49	-2217.46	1028.64	2.549
211 5.50	0.010857	-869.81	403.49	-2217.46	1028.64	2.549
212 5.55	0.010857	-891.86	404.88	-2210.00	1003.26	2.478
213 5.55	0.010857	-891.86	404.88	-2210.00	1003.26	2.478
214 5.60	0.010857	-913.63	406.26	-2203.06	979.63	2.411
215 5.60	0.010857	-913.63	406.26	-2203.06	979.63	2.411
216 5.65	0.010857	-935.10	407.65	-2196.58	957.58	2.349
217 5.65	0.010857	-935.10	407.65	-2196.58	957.58	2.349
218 5.70	0.010857	-956.27	409.03	-2190.53	936.97	2.291
219 5.70	0.010857	-956.27	409.03	-2190.53	936.97	2.291
220 5.75	0.010857	-977.15	410.42	-2184.86	917.68	2.236
221 5.75	0.010857	-977.15	410.42	-2184.86	917.68	2.236
222 5.80	0.010857	-997.73	411.81	-2179.55	899.59	2.185
223 5.80	0.010857	-997.73	411.81	-2179.55	899.59	2.185
224 5.85	0.010857	-1018.01	413.19	-2174.56	882.62	2.136
225 5.85	0.010857	-1018.01	413.19	-2174.56	882.62	2.136
226 5.90	0.010857	-1037.99	414.58	-2169.88	866.66	2.090

Cod. elab.: 108GA201-GA01-Z-CL-002_C	Titolo: OPERE D'ARTE MAGGIORI- GALLERIE	Data: Ottobre 2011
Nome file: 108GA201-GA01-Z-CL -002_C.docx	ARTIFICIALI – GALLERIA ROVETELLO	Pagina 246 di 452
Relazione di calcolo		

PROGETTO ESECUTIVO

2275.90	0.010857	-1037.99	414.58	-2169.88	866.66	2.090
2285.95	0.010857	-1057.66	415.97	-2165.47	851.66	2.047
2295.95	0.010857	-1057.66	415.97	-2165.47	851.66	2.047
2306.00	0.010857	-1077.02	417.35	-2161.31	837.52	2.007
2316.00	0.010857	-1077.02	417.35	-2161.31	837.52	2.007
2326.05	0.010857	-1096.07	418.74	-2157.40	824.20	1.968
2336.05	0.010857	-1096.07	418.74	-2157.40	824.20	1.968
2346.10	0.010857	-1114.82	420.13	-2153.71	811.64	1.932
2356.10	0.010857	-1114.82	420.13	-2153.71	811.64	1.932
2366.15	0.010857	-1133.25	421.51	-2150.23	799.78	1.897
2376.15	0.010857	-1133.25	421.51	-2150.23	799.78	1.897
2386.20	0.010857	-1151.36	422.90	-2146.94	788.58	1.865
2396.20	0.010857	-1151.36	422.90	-2146.94	788.58	1.865
2406.25	0.010857	-1169.16	424.28	-2143.83	777.99	1.834
2416.25	0.010857	-1169.16	424.28	-2143.83	777.99	1.834
2426.30	0.010857	-1186.63	425.67	-2140.89	767.98	1.804
2436.30	0.010857	-1186.63	425.67	-2140.89	767.98	1.804
2446.35	0.010857	-1203.79	427.06	-2138.11	758.52	1.776
2456.35	0.010857	-1203.79	427.06	-2138.11	758.52	1.776
2466.40	0.010857	-1220.62	428.44	-2135.48	749.56	1.750
2476.40	0.010857	-1220.62	428.44	-2135.48	749.56	1.750
2486.45	0.010857	-1237.12	429.83	-2132.99	741.09	1.724
2496.45	0.010857	-1237.12	429.83	-2132.99	741.09	1.724
2506.50	0.010857	-1253.30	431.22	-2130.63	733.08	1.700
2516.50	0.010857	-1253.30	431.22	-2130.63	733.08	1.700
2526.55	0.010857	-1269.15	432.60	-2128.40	725.49	1.677
2536.55	0.010857	-1269.15	432.60	-2128.40	725.49	1.677
2546.60	0.010857	-1284.67	433.99	-2126.29	718.31	1.655
2556.60	0.010857	-1284.67	433.99	-2126.29	718.31	1.655
2566.65	0.010857	-1299.85	435.38	-2124.30	711.52	1.634
2576.65	0.010857	-1299.85	435.38	-2124.30	711.52	1.634
2586.70	0.010857	-1314.69	436.76	-2122.41	705.10	1.614
2596.70	0.010857	-1314.69	436.76	-2122.41	705.10	1.614
2606.75	0.010857	-1329.20	438.15	-2120.63	699.03	1.595
2616.75	0.010857	-1329.20	438.15	-2120.63	699.03	1.595
2626.80	0.010857	-1343.37	439.54	-2118.95	693.29	1.577

Cod. elab.: 108GA201-GA01-Z-CL-002_C	Titolo: OPERE D'ARTE MAGGIORI- GALLERIE	Data: Ottobre 2011
Nome file: 108GA201-GA01-Z-CL -002_C.docx	ARTIFICIALI – GALLERIA ROVETELLO	Pagina 247 di 452
Relazione di calcolo		

PROGETTO ESECUTIVO

263 6.80	0.010857	-1343.37	439.54	-2118.95	693.29	1.577
264 6.85	0.010857	-1357.20	440.92	-2117.35	687.88	1.560
265 6.85	0.010857	-1357.20	440.92	-2117.35	687.88	1.560
266 6.90	0.010857	-1370.68	442.31	-2115.85	682.77	1.544
267 6.90	0.010857	-1370.68	442.31	-2115.85	682.77	1.544
268 6.95	0.010857	-1383.82	443.69	-2114.44	677.95	1.528
269 6.95	0.010857	-1383.82	443.69	-2114.44	677.95	1.528
270 7.00	0.010857	-1396.60	445.08	-2113.11	673.42	1.513
271 7.00	0.010857	-1396.60	445.08	-2113.11	673.42	1.513
272 7.05	0.010857	-1409.04	446.47	-2111.86	669.16	1.499
273 7.05	0.010857	-1409.04	446.47	-2111.86	669.16	1.499
274 7.10	0.010857	-1421.13	447.85	-2110.68	665.16	1.485
275 7.10	0.010857	-1421.13	447.85	-2110.68	665.16	1.485
276 7.15	0.010857	-1432.86	449.24	-2109.58	661.41	1.472
277 7.15	0.010857	-1432.86	449.24	-2109.58	661.41	1.472
278 7.20	0.010857	-1444.24	450.63	-2108.55	657.90	1.460
279 7.20	0.010857	-1444.24	450.63	-2108.55	657.90	1.460
280 7.25	0.010857	-1455.25	452.01	-2107.59	654.63	1.448
281 7.25	0.010857	-1455.25	452.01	-2107.59	654.63	1.448
282 7.30	0.010857	-1465.91	453.40	-2106.69	651.59	1.437
283 7.30	0.010857	-1465.91	453.40	-2106.69	651.59	1.437
284 7.35	0.010857	-1476.20	454.79	-2105.87	648.77	1.427
285 7.35	0.010857	-1476.20	454.79	-2105.87	648.77	1.427
286 7.40	0.010857	-1486.13	456.17	-2105.10	646.17	1.416
287 7.40	0.010857	-1486.13	456.17	-2105.10	646.17	1.416
288 7.45	0.010857	-1495.70	457.56	-2104.40	643.77	1.407
289 7.45	0.010857	-1495.70	457.56	-2104.40	643.77	1.407
290 7.50	0.010857	-1504.89	458.94	-2103.75	641.58	1.398
291 7.50	0.010857	-1504.89	458.94	-2103.75	641.58	1.398
292 7.55	0.010857	-1513.72	460.33	-2103.17	639.59	1.389
293 7.55	0.010857	-1513.72	460.33	-2103.17	639.59	1.389
294 7.60	0.010857	-1522.17	461.72	-2102.64	637.79	1.381
295 7.60	0.010857	-1522.17	461.72	-2102.64	637.79	1.381
296 7.65	0.010857	-1530.25	463.10	-2102.17	636.19	1.374
297 7.65	0.010857	-1530.25	463.10	-2102.17	636.19	1.374
298 7.70	0.010857	-1537.95	464.49	-2101.75	634.77	1.367

Cod. elab.: 108GA201-GA01-Z-CL-002_C	Titolo: OPERE D'ARTE MAGGIORI- GALLERIE	Data: Ottobre 2011
Nome file: 108GA201-GA01-Z-CL -002_C.docx	ARTIFICIALI – GALLERIA ROVETELLO	Pagina 248 di 452
Relazione di calcolo		

PROGETTO ESECUTIVO

2997.70	0.010857	-1537.95	464.49	-2101.75	634.77	1.367
3007.75	0.010857	-1545.27	465.88	-2101.39	633.54	1.360
3017.75	0.010857	-1545.27	465.88	-2101.39	633.54	1.360
3027.80	0.010857	-1552.21	467.26	-2101.08	632.49	1.354
3037.80	0.010857	-1552.21	467.26	-2101.08	632.49	1.354
3047.85	0.010857	-1558.77	468.65	-2100.83	631.62	1.348
3057.85	0.010857	-1558.77	468.65	-2100.83	631.62	1.348
3067.90	0.010857	-1564.95	470.04	-2100.62	630.93	1.342
3077.90	0.010857	-1564.95	470.04	-2100.62	630.93	1.342
3087.95	0.010857	-1570.73	471.42	-2100.47	630.41	1.337
3097.95	0.010857	-1570.73	471.42	-2100.47	630.41	1.337
3108.00	0.010857	-1576.13	472.81	-2100.37	630.07	1.333
3118.00	0.010857	-1576.13	472.81	-2100.37	630.07	1.333
3128.05	0.010857	-1581.14	474.20	-2100.32	629.90	1.328
3138.05	0.010857	-1581.14	474.20	-2100.32	629.90	1.328
3148.10	0.010857	-1585.76	475.58	-2100.32	629.90	1.324
3158.10	0.010857	-1585.76	475.58	-2100.32	629.90	1.324
3168.15	0.010857	-1589.98	476.97	-2100.37	630.08	1.321
3178.15	0.010857	-1589.98	476.97	-2100.37	630.08	1.321
3188.20	0.010857	-1593.81	478.35	-2100.48	630.42	1.318
3198.20	0.010857	-1593.81	478.35	-2100.48	630.42	1.318
3208.25	0.010857	-1597.24	479.74	-2100.63	630.94	1.315
3218.25	0.010857	-1597.24	479.74	-2100.63	630.94	1.315
3228.30	0.010857	-1600.26	481.13	-2100.83	631.63	1.313
3238.30	0.010857	-1600.26	481.13	-2100.83	631.63	1.313
3248.35	0.010857	-1602.89	482.51	-2101.08	632.48	1.311
3258.35	0.010857	-1602.89	482.51	-2101.08	632.48	1.311
3268.40	0.010857	-1605.11	483.90	-2101.38	633.52	1.309
3278.40	0.010857	-1605.11	483.90	-2101.38	633.52	1.309
3288.45	0.010857	-1606.92	485.29	-2101.74	634.72	1.308
3298.45	0.010857	-1606.92	485.29	-2101.74	634.72	1.308
3308.50	0.010857	-1608.33	486.67	-2102.14	636.10	1.307
3318.50	0.010857	-1608.33	486.67	-2102.14	636.10	1.307
3328.55	0.010857	-1609.32	488.06	-2102.60	637.66	1.307
3338.55	0.010857	-1609.32	488.06	-2102.60	637.66	1.307
3348.60	0.010857	-1609.89	489.45	-2103.11	639.40	1.306

Cod. elab.: 108GA201-GA01-Z-CL-002_C	Titolo: OPERE D'ARTE MAGGIORI- GALLERIE	Data: Ottobre 2011
Nome file: 108GA201-GA01-Z-CL -002_C.docx	ARTIFICIALI – GALLERIA ROVETELLO	Pagina 249 di 452
Relazione di calcolo		

PROGETTO ESECUTIVO

3358.60	0.010857	-1609.89	489.45	-2103.11	639.40	1.306
3368.65	0.010857	-1610.04	490.83	-2103.68	641.32	1.307
3378.65	0.010857	-1610.04	490.83	-2103.68	641.32	1.307
3388.70	0.010857	-1609.77	492.22	-2104.30	643.43	1.307
3398.70	0.010857	-1609.77	492.22	-2104.30	643.43	1.307
3408.75	0.010857	-1609.07	493.60	-2104.97	645.73	1.308
3418.75	0.010857	-1609.07	493.60	-2104.97	645.73	1.308
3428.80	0.010857	-1607.94	494.99	-2105.71	648.22	1.310
3438.80	0.010857	-1607.94	494.99	-2105.71	648.22	1.310
3448.85	0.010857	-1606.38	496.38	-2106.50	650.91	1.311
3458.85	0.010857	-1606.38	496.38	-2106.50	650.91	1.311
3468.90	0.010857	-1604.39	497.76	-2107.35	653.81	1.313
3478.90	0.010857	-1604.39	497.76	-2107.35	653.81	1.313
3488.95	0.010857	-1601.96	499.15	-2108.26	656.91	1.316
3498.95	0.010857	-1601.96	499.15	-2108.26	656.91	1.316
3509.00	0.010857	-1599.09	500.54	-2109.23	660.22	1.319
3519.00	0.010857	-1599.09	500.54	-2109.23	660.22	1.319
3529.05	0.010857	-1595.78	501.92	-2110.26	663.74	1.322
3539.05	0.010857	-1595.78	501.92	-2110.26	663.74	1.322
3549.10	0.010857	-1592.03	503.31	-2111.37	667.49	1.326
3559.10	0.010857	-1592.03	503.31	-2111.37	667.49	1.326
3569.15	0.010857	-1587.84	504.70	-2112.53	671.47	1.330
3579.15	0.010857	-1587.84	504.70	-2112.53	671.47	1.330
3589.20	0.010857	-1583.20	506.08	-2113.77	675.69	1.335
3599.20	0.010857	-1583.20	506.08	-2113.77	675.69	1.335
3609.25	0.010857	-1578.23	507.47	-2115.06	680.08	1.340
3619.30	0.010857	-1573.08	508.86	-2116.39	684.61	1.345
3629.35	0.010857	-1567.73	510.24	-2117.76	689.26	1.351
3639.40	0.010857	-1562.20	511.63	-2119.16	694.04	1.357
3649.45	0.010857	-1556.48	513.01	-2120.61	698.95	1.362
3659.50	0.010857	-1550.58	514.40	-2122.09	704.00	1.369
3669.55	0.010857	-1544.50	515.79	-2123.61	709.18	1.375
3679.60	0.010857	-1538.24	517.17	-2125.18	714.51	1.382
3689.65	0.010857	-1531.81	518.56	-2126.78	719.97	1.388
3699.70	0.010857	-1525.21	519.95	-2128.43	725.58	1.395
3709.75	0.010857	-1518.44	521.33	-2130.12	731.34	1.403

Cod. elab.: 108GA201-GA01-Z-CL-002_C	Titolo: OPERE D'ARTE MAGGIORI- GALLERIE	Data: Ottobre 2011
Nome file: 108GA201-GA01-Z-CL -002_C.docx	ARTIFICIALI – GALLERIA ROVETELLO	Pagina 250 di 452
Relazione di calcolo		

PROGETTO ESECUTIVO

3719.80	0.010857	-1511.51	522.72	-2131.86	737.25	1.410
3729.85	0.010857	-1504.41	524.11	-2133.64	743.32	1.418
3739.90	0.010857	-1497.15	525.49	-2135.47	749.54	1.426
3749.95	0.010857	-1489.74	526.88	-2137.34	755.92	1.435
37510.00	0.010857	-1482.17	528.27	-2139.26	762.46	1.443
37610.05	0.010857	-1474.45	529.65	-2141.24	769.18	1.452
37710.10	0.010857	-1466.57	531.04	-2143.26	776.06	1.461
37810.15	0.010857	-1458.55	532.42	-2145.33	783.12	1.471
37910.20	0.010857	-1450.39	533.81	-2147.46	790.37	1.481
38010.25	0.010857	-1442.08	535.20	-2149.64	797.79	1.491
38110.30	0.010857	-1433.64	536.58	-2151.88	805.41	1.501
38210.35	0.010857	-1425.06	537.97	-2154.17	813.22	1.512
38310.40	0.010857	-1416.34	539.36	-2156.53	821.23	1.523
38410.45	0.010857	-1407.49	540.74	-2158.94	829.44	1.534
38510.50	0.010857	-1398.52	542.13	-2161.41	837.86	1.546
38610.55	0.010857	-1389.42	543.52	-2163.95	846.50	1.557
38710.60	0.010857	-1380.20	544.90	-2166.55	855.35	1.570
38810.65	0.010857	-1370.86	546.29	-2169.22	864.44	1.582
38910.70	0.010857	-1361.39	547.67	-2171.96	873.76	1.595
39010.75	0.010857	-1351.82	549.06	-2174.77	883.31	1.609
39110.80	0.010857	-1342.13	550.45	-2177.65	893.12	1.623
39210.85	0.010857	-1332.34	551.83	-2180.60	903.17	1.637
39310.90	0.010857	-1322.43	553.22	-2183.63	913.49	1.651
39410.95	0.010857	-1312.43	554.61	-2186.74	924.07	1.666
39511.00	0.010857	-1302.32	555.99	-2189.93	934.94	1.682
39611.05	0.010857	-1292.11	557.38	-2193.21	946.08	1.697
39711.10	0.010857	-1281.81	558.77	-2196.57	957.52	1.714
39811.15	0.010857	-1271.42	560.15	-2200.02	969.27	1.730
39911.20	0.010857	-1260.93	561.54	-2203.56	981.32	1.748
40011.25	0.010857	-1250.36	562.93	-2207.19	993.70	1.765
40111.30	0.010857	-1239.70	564.31	-2210.93	1006.41	1.783
40211.35	0.010857	-1228.97	565.70	-2214.76	1019.46	1.802
40311.40	0.010857	-1218.15	567.08	-2218.70	1032.87	1.821
40411.45	0.010857	-1207.25	568.47	-2222.75	1046.65	1.841
40511.50	0.010857	-1196.29	569.86	-2226.90	1060.80	1.862
40611.55	0.010857	-1185.25	571.24	-2231.18	1075.34	1.882

Cod. elab.: 108GA201-GA01-Z-CL-002_C	Titolo: OPERE D'ARTE MAGGIORI- GALLERIE	Data: Ottobre 2011
Nome file: 108GA201-GA01-Z-CL -002_C.docx	ARTIFICIALI – GALLERIA ROVETELLO	Pagina 251 di 452
Relazione di calcolo		

PROGETTO ESECUTIVO

40711.60	0.010857	-1174.14	572.63	-2235.57	1090.29	1.904
40811.65	0.010857	-1162.97	574.02	-2240.08	1105.66	1.926
40911.70	0.010857	-1151.74	575.40	-2244.72	1121.45	1.949
41011.75	0.010857	-1140.44	576.79	-2249.50	1137.70	1.972
41111.80	0.010857	-1129.09	578.18	-2254.41	1154.42	1.997
41211.85	0.010857	-1117.69	579.56	-2259.46	1171.61	2.022
41311.90	0.010857	-1106.23	580.95	-2264.65	1189.30	2.047
41411.95	0.010857	-1094.73	582.33	-2270.00	1207.51	2.074
41512.00	0.010857	-1083.18	583.72	-2275.51	1226.26	2.101
41612.05	0.010857	-1071.59	585.11	-2281.18	1245.57	2.129
41712.10	0.010857	-1059.96	586.49	-2287.02	1265.45	2.158
41812.15	0.010857	-1048.29	587.88	-2293.04	1285.94	2.187
41912.20	0.010857	-1036.58	589.27	-2299.24	1307.05	2.218
42012.25	0.010857	-1024.85	590.65	-2305.64	1328.81	2.250
42112.30	0.010857	-1013.08	592.04	-2312.23	1351.25	2.282
42212.35	0.010857	-1001.29	593.43	-2319.03	1374.39	2.316
42312.40	0.010857	-989.48	594.81	-2326.04	1398.27	2.351
42412.45	0.010857	-977.65	596.20	-2333.28	1422.91	2.387
42512.50	0.010857	-965.79	597.59	-2340.75	1448.34	2.424
42612.55	0.010857	-953.93	598.97	-2348.46	1474.60	2.462
42712.60	0.010857	-942.05	600.36	-2356.43	1501.73	2.501
42812.65	0.010857	-930.16	601.74	-2364.67	1529.76	2.542
42912.70	0.010857	-918.27	603.13	-2373.18	1558.74	2.584
43012.75	0.010857	-906.37	604.52	-2381.98	1588.71	2.628
43112.80	0.010857	-894.47	605.90	-2391.09	1619.71	2.673
43212.85	0.010857	-882.56	607.29	-2400.52	1651.79	2.720
43312.90	0.010857	-870.66	608.68	-2410.28	1685.01	2.768
43412.95	0.010857	-858.77	610.06	-2420.39	1719.43	2.818
43513.00	0.010857	-846.87	611.45	-2430.87	1755.11	2.870
43613.05	0.010857	-834.99	612.84	-2441.74	1792.10	2.924
43713.10	0.010857	-823.11	614.22	-2453.01	1830.49	2.980
43813.15	0.010857	-811.24	615.61	-2464.72	1870.34	3.038
43913.20	0.010857	-799.39	616.99	-2476.88	1911.74	3.098
44013.25	0.010857	-787.55	618.38	-2489.52	1954.77	3.161
44113.30	0.010857	-775.72	619.77	-2502.67	1999.53	3.226
44213.35	0.010857	-763.91	621.15	-2516.35	2046.11	3.294

Cod. elab.: 108GA201-GA01-Z-CL-002_C	Titolo: OPERE D'ARTE MAGGIORI- GALLERIE	Data: Ottobre 2011
Nome file: 108GA201-GA01-Z-CL -002_C.docx	ARTIFICIALI – GALLERIA ROVETELLO Relazione di calcolo	Pagina 252 di 452

PROGETTO ESECUTIVO

44313.40	0.010857	-752.12	622.54	-2530.60	2094.62	3.365
44413.45	0.010857	-740.35	623.93	-2545.46	2145.18	3.438
44513.50	0.010857	-728.60	625.31	-2557.17	2194.67	3.510
44613.55	0.010857	-716.88	626.70	-2567.48	2244.51	3.581
44713.60	0.010857	-705.18	628.09	-2578.19	2296.34	3.656
44813.65	0.010857	-693.51	629.47	-2589.34	2350.26	3.734
44913.70	0.010857	-681.86	630.86	-2600.94	2406.38	3.814
45013.75	0.010857	-670.25	632.25	-2613.03	2464.85	3.899
45113.80	0.010857	-658.67	633.63	-2625.63	2525.80	3.986
45213.85	0.010857	-647.13	635.02	-2638.78	2589.39	4.078
45313.90	0.010857	-635.62	636.40	-2652.50	2655.76	4.173
45413.95	0.010857	-624.15	637.79	-2666.83	2725.11	4.273
45514.00	0.010857	-612.72	639.18	-2681.83	2797.63	4.377
45614.05	0.010857	-601.33	640.56	-2697.51	2873.52	4.486
45714.10	0.010857	-589.98	641.95	-2713.95	2953.00	4.600
45814.15	0.010857	-578.68	643.34	-2731.17	3036.34	4.720
45914.20	0.010857	-567.42	644.72	-2749.25	3123.79	4.845
46014.25	0.010857	-556.21	646.11	-2768.24	3215.66	4.977
46114.30	0.010857	-545.05	647.50	-2783.34	3306.47	5.107
46214.35	0.010857	-533.94	648.88	-2797.11	3399.22	5.239
46314.40	0.010857	-522.89	650.27	-2811.55	3496.46	5.377
46414.45	0.010857	-511.89	651.66	-2826.70	3598.50	5.522
46514.50	0.010857	-500.94	653.04	-2842.61	3705.68	5.675
46614.55	0.010857	-490.06	654.43	-2859.34	3818.39	5.835
46714.60	0.010857	-479.23	655.81	-2876.95	3937.02	6.003
46814.65	0.010857	-468.47	657.20	-2895.51	4062.04	6.181
46914.70	0.010857	-457.77	658.59	-2915.10	4193.95	6.368
47014.75	0.010857	-447.13	659.97	-2935.20	4332.43	6.565
47114.80	0.010857	-436.56	661.36	-2947.18	4464.79	6.751
47214.85	0.010857	-426.06	662.75	-2959.78	4604.03	6.947
47314.90	0.010857	-415.63	664.13	-2973.05	4750.66	7.153
47414.95	0.010857	-405.27	665.52	-2987.03	4905.25	7.371
47515.00	0.010857	-394.98	666.91	-3001.80	5068.41	7.600
47615.05	0.010857	-384.77	668.29	-3017.40	5240.83	7.842
47715.10	0.010857	-374.63	669.68	-3032.87	5421.41	8.096
47815.15	0.010857	-364.58	671.06	-3038.86	5593.50	8.335

Cod. elab.: 108GA201-GA01-Z-CL-002_C	Titolo: OPERE D'ARTE MAGGIORI- GALLERIE	Data: Ottobre 2011
Nome file: 108GA201-GA01-Z-CL -002_C.docx	ARTIFICIALI – GALLERIA ROVETELLO	Pagina 253 di 452
	Relazione di calcolo	

PROGETTO ESECUTIVO

47915.20	0.010857	-354.60	672.45	-3045.17	5774.70	8.588
48015.25	0.010857	-344.71	673.84	-3051.83	5965.67	8.853
48115.30	0.010857	-334.90	675.22	-3058.85	6167.19	9.134
48215.35	0.010857	-325.18	676.61	-3066.26	6380.06	9.429
48315.40	0.010857	-315.54	678.00	-3067.28	6590.56	9.721
48415.45	0.010857	-306.00	679.38	-3061.88	6798.08	10.006
48515.50	0.010857	-296.54	680.77	-3056.20	7016.14	10.306
48615.55	0.010857	-287.18	682.16	-3050.23	7245.48	10.621
48715.60	0.010857	-277.91	683.54	-3043.94	7486.90	10.953
48815.65	0.010857	-268.73	684.93	-3027.18	7715.46	11.265
48915.70	0.010857	-259.66	686.32	-3004.69	7941.86	11.572
49015.75	0.010857	-250.68	687.70	-2981.20	8178.40	11.892
49115.80	0.010857	-241.81	689.09	-2956.64	8425.67	12.227
49215.85	0.010857	-233.03	690.47	-2929.99	8681.46	12.573
49315.90	0.010857	-224.37	691.86	-2895.81	8929.54	12.907
49415.95	0.010857	-215.81	693.25	-2860.20	9187.99	13.254
49516.00	0.010857	-207.35	694.63	-2823.09	9457.34	13.615
49616.05	0.010857	-199.01	696.02	-2784.28	9737.73	13.991
49716.10	0.010857	-190.78	697.41	-2739.50	10014.40	14.359
49816.15	0.010857	-182.66	698.79	-2692.94	10302.10	14.743
49916.20	0.010857	-174.66	700.18	-2644.51	10601.34	15.141
50016.25	0.010857	-166.77	701.57	-2592.51	10905.83	15.545
50116.30	0.010857	-159.01	702.95	-2535.07	11207.18	15.943
50216.35	0.010857	-151.36	704.34	-2475.53	11519.51	16.355
50316.40	0.010857	-143.84	705.72	-2413.83	11843.21	16.782
50416.45	0.010857	-136.44	707.11	-2345.50	12155.97	17.191
50516.50	0.010857	-129.16	708.50	-2274.21	12474.72	17.607
50616.55	0.010857	-122.02	709.88	-2200.67	12803.48	18.036
50716.60	0.010857	-115.00	711.27	-2122.17	13125.80	18.454
50816.65	0.010857	-108.11	712.66	-2038.80	13439.52	18.858
50916.70	0.010857	-101.36	714.04	-1953.37	13761.01	19.272
51016.75	0.010857	-94.74	715.43	-1865.41	14086.82	19.690
51116.80	0.010857	-88.26	716.82	-1771.78	14390.39	20.075
51216.85	0.010857	-81.91	718.20	-1676.48	14699.39	20.467
51316.90	0.010857	-75.71	719.59	-1579.56	15013.62	20.864
51416.95	0.010857	-69.64	720.98	-1467.14	15188.30	21.066

Cod. elab.: 108GA201-GA01-Z-CL-002_C	Titolo: OPERE D'ARTE MAGGIORI- GALLERIE	Data: Ottobre 2011
Nome file: 108GA201-GA01-Z-CL -002_C.docx	ARTIFICIALI – GALLERIA ROVETELLO	Pagina 254 di 452
Relazione di calcolo		

PROGETTO ESECUTIVO

51517.00	0.010857	-63.72	722.36	-1347.27	15272.35	21.142
51617.05	0.010857	-57.95	723.75	-1229.45	15354.96	21.216
51717.10	0.010857	-52.32	725.13	-1113.79	15436.06	21.287
51817.15	0.010857	-46.84	726.52	-1000.38	15515.58	21.356
51917.20	0.010857	-41.51	727.91	-889.34	15593.45	21.422
52017.25	0.010857	-36.34	729.29	-780.77	15669.58	21.486
52117.30	0.010857	-31.32	730.68	-674.78	15743.90	21.547
52217.35	0.010857	-26.45	732.07	-571.46	15816.34	21.605
52317.40	0.010857	-21.74	733.45	-470.93	15886.84	21.660
52417.45	0.010857	-17.19	734.84	-373.29	15955.30	21.713
52517.50	0.010857	-12.80	736.23	-278.64	16021.67	21.762
52617.55	0.010857	-8.58	737.61	-187.08	16085.87	21.808
52717.60	0.010857	-4.52	739.00	-98.72	16147.83	21.851
52817.65	0.010857	-0.62	740.39	-13.66	16207.48	21.891
52917.70	0.010857	3.10	741.77	67.62	16169.64	21.799
53017.75	0.010857	6.66	743.16	144.38	16115.81	21.686
53117.80	0.010857	10.04	744.54	216.68	16065.12	21.577
53217.85	0.010857	13.25	745.93	284.58	16017.51	21.473
53317.90	0.010857	16.29	747.32	348.13	15972.94	21.374
53417.95	0.010857	19.15	748.70	407.40	15931.38	21.279
53518.00	0.010857	21.83	750.09	462.43	15892.79	21.188
53618.05	0.010857	24.32	751.48	513.27	15857.15	21.101
53718.10	0.010857	26.64	752.86	559.95	15824.41	21.019
53818.15	0.010857	28.77	754.25	602.52	15794.57	20.941
53918.20	0.010857	30.72	755.64	640.99	15767.59	20.867
54018.25	0.010857	32.48	757.02	675.41	15743.46	20.797
54118.30	0.010857	34.05	758.41	705.78	15722.16	20.730
54218.35	0.010857	35.42	759.79	732.14	15703.68	20.668
54318.40	0.010857	36.61	761.18	754.49	15688.00	20.610
54418.45	0.010857	37.60	762.57	772.85	15675.13	20.556
54518.50	0.010857	38.39	763.95	787.21	15665.06	20.505
54618.55	0.010857	38.99	765.34	797.59	15657.78	20.459
54718.60	0.010857	39.38	766.73	803.97	15653.31	20.416
54818.65	0.010857	39.57	768.11	806.36	15651.63	20.377
54918.70	0.010857	39.56	769.50	804.74	15652.77	20.341
55018.75	0.010857	39.35	770.89	799.10	15656.72	20.310

Cod. elab.: 108GA201-GA01-Z-CL-002_C	Titolo: OPERE D'ARTE MAGGIORI- GALLERIE	Data: Ottobre 2011
Nome file: 108GA201-GA01-Z-CL -002_C.docx	ARTIFICIALI – GALLERIA ROVETELLO	Pagina 255 di 452
	Relazione di calcolo	

PROGETTO ESECUTIVO

55118.80	0.010857	38.92	772.27	789.42	15663.51	20.282
55218.85	0.010857	38.29	773.66	775.67	15673.16	20.258
55318.90	0.010857	37.44	775.05	757.82	15685.67	20.238
55418.95	0.010857	36.39	776.43	735.85	15701.07	20.222
55519.00	0.010857	35.12	777.82	709.72	15719.40	20.210
55619.05	0.010857	33.63	779.20	679.38	15740.67	20.201
55719.10	0.010857	31.93	780.59	644.79	15764.93	20.196
55819.15	0.010857	30.03	781.98	606.49	15791.79	20.195
55919.20	0.010857	27.98	783.36	565.09	15820.81	20.196
56019.25	0.010857	25.80	784.75	521.21	15851.58	20.200
56119.30	0.010857	23.53	786.14	475.48	15883.65	20.205
56219.35	0.010857	21.20	787.52	428.52	15916.58	20.211
56319.40	0.010857	18.84	788.91	380.96	15949.93	20.218
56419.45	0.010857	16.49	790.30	333.43	15983.25	20.224
56519.50	0.010857	14.17	791.68	286.59	16016.10	20.230
56619.55	0.010857	11.91	793.07	241.08	16048.01	20.235
56719.60	0.010857	9.76	794.45	197.55	16078.53	20.238
56819.65	0.010857	7.74	795.84	156.66	16107.20	20.239
56919.70	0.010857	5.88	797.23	119.09	16133.55	20.237
57019.75	0.010857	4.22	798.61	85.48	16157.11	20.231
57119.80	0.010857	2.79	800.00	56.50	16177.43	20.222
57219.85	0.010857	1.62	801.39	32.82	16194.04	20.208
57319.90	0.010857	0.75	802.77	15.08	16206.48	20.188
57419.95	0.010857	0.19	804.16	3.93	16214.30	20.163
57520.00	0.010857	0.00	805.55	0.00	-4248.53	5.274

Fase n° 7 - [A2-M2]

n°	Y	A _f	M	N	M _u	N _u	CS
1	0.00	0.010857	0.00	0.00	0.00	0.00	1000.000
2	0.05	0.010857	0.00	1.39	0.27	16216.86	11697.064
3	0.10	0.010857	0.00	2.77	0.54	16216.67	5848.464
4	0.15	0.010857	0.00	4.16	0.81	16216.49	3898.931
5	0.20	0.010857	0.00	5.55	1.07	16216.30	2924.164
6	0.25	0.010857	0.00	6.93	1.34	16216.11	2339.304
7	0.30	0.010857	0.00	8.32	1.61	16215.92	1949.398

Cod. elab.: 108GA201-GA01-Z-CL-002 C	Titolo: OPERE D'ARTE MAGGIORI- GALLERIE	Data: Ottobre 2011
Nome file: 108GA201-GA01-Z-CL -002_C.docx	ARTIFICIALI – GALLERIA ROVETELLO	Pagina 256 di 452
Relazione di calcolo		

PROGETTO ESECUTIVO

8	0.35	0.010857	0.00	9.70	1.88	16215.73	1670.893
9	0.40	0.010857	0.00	11.09	2.15	16215.54	1462.014
10	0.45	0.010857	0.00	12.48	2.42	16215.36	1299.553
11	0.50	0.010857	0.00	13.86	2.69	16215.17	1169.584
12	0.50	0.010857	0.00	13.86	2.69	16215.17	1169.584
13	0.55	0.010857	0.00	15.25	3.05	16214.91	1063.241
14	0.55	0.010857	0.00	15.25	3.05	16214.91	1063.241
15	0.60	0.010857	0.00	16.64	3.59	16214.54	974.616
16	0.60	0.010857	0.00	16.64	3.59	16214.54	974.616
17	0.65	0.010857	0.00	18.02	4.24	16214.08	899.620
18	0.65	0.010857	0.00	18.02	4.24	16214.08	899.620
19	0.70	0.010857	0.01	19.41	5.00	16213.54	835.334
20	0.70	0.010857	0.01	19.41	5.00	16213.54	835.334
21	0.75	0.010857	0.01	20.80	5.84	16212.96	779.616
22	0.75	0.010857	0.01	20.80	5.84	16212.96	779.616
23	0.80	0.010857	0.01	22.18	6.74	16212.32	730.862
24	0.80	0.010857	0.01	22.18	6.74	16212.32	730.862
25	0.85	0.010857	0.01	23.57	7.70	16211.65	687.842
26	0.85	0.010857	0.01	23.57	7.70	16211.65	687.842
27	0.90	0.010857	0.01	24.96	8.70	16210.95	649.600
28	0.90	0.010857	0.01	24.96	8.70	16210.95	649.600
29	0.95	0.010857	0.02	26.34	9.73	16210.23	615.383
30	0.95	0.010857	0.02	26.34	9.73	16210.23	615.383
31	1.00	0.010857	0.02	27.73	10.80	16209.48	584.587
32	1.00	0.010857	0.02	27.73	10.80	16209.48	584.587
33	1.05	0.010857	0.02	29.11	11.90	16208.71	556.723
34	1.05	0.010857	0.02	29.11	11.90	16208.71	556.723
35	1.10	0.010857	0.02	30.50	13.01	16207.93	531.392
36	1.10	0.010857	0.02	30.50	13.01	16207.93	531.392
37	1.15	0.010857	0.03	31.89	14.15	16207.13	508.263
38	1.15	0.010857	0.03	31.89	14.15	16207.13	508.263
39	1.20	0.010857	0.03	33.27	15.31	16206.32	487.061
40	1.20	0.010857	0.03	33.27	15.31	16206.32	487.061
41	1.25	0.010857	0.04	34.66	16.48	16205.49	467.555
42	1.25	0.010857	0.04	34.66	16.48	16205.49	467.555
43	1.30	0.010857	0.04	36.05	17.67	16204.66	449.549

Cod. elab.: 108GA201-GA01-Z-CL-002_C	Titolo: OPERE D'ARTE MAGGIORI- GALLERIE	Data: Ottobre 2011
Nome file: 108GA201-GA01-Z-CL -002_C.docx	ARTIFICIALI – GALLERIA ROVETELLO	Pagina 257 di 452
Relazione di calcolo		

PROGETTO ESECUTIVO

44	1.30	0.010857	0.04	36.05	17.67	16204.66	449.549
45	1.35	0.010857	0.04	37.43	18.87	16203.82	432.876
46	1.35	0.010857	0.04	37.43	18.87	16203.82	432.876
47	1.40	0.010857	0.05	38.82	20.08	16202.97	417.395
48	1.40	0.010857	0.05	38.82	20.08	16202.97	417.395
49	1.45	0.010857	0.05	40.21	21.29	16202.12	402.980
50	1.45	0.010857	0.05	40.21	21.29	16202.12	402.980
51	1.50	0.010857	0.06	41.59	22.52	16201.26	389.527
52	1.50	0.010857	0.06	41.59	22.52	16201.26	389.527
53	1.55	0.010857	0.06	42.98	23.76	16200.39	376.941
54	1.55	0.010857	0.06	42.98	23.76	16200.39	376.941
55	1.60	0.010857	0.07	44.36	25.00	16199.52	365.142
56	1.60	0.010857	0.07	44.36	25.00	16199.52	365.142
57	1.65	0.010857	0.07	45.75	26.25	16198.65	354.058
58	1.65	0.010857	0.07	45.75	26.25	16198.65	354.058
59	1.70	0.010857	0.08	47.14	27.50	16197.77	343.626
60	1.70	0.010857	0.08	47.14	27.50	16197.77	343.626
61	1.75	0.010857	0.09	48.52	28.76	16196.88	333.790
62	1.75	0.010857	0.09	48.52	28.76	16196.88	333.790
63	1.80	0.010857	0.09	49.91	30.03	16196.00	324.500
64	1.80	0.010857	0.09	49.91	30.03	16196.00	324.500
65	1.85	0.010857	0.10	51.30	31.30	16195.10	315.713
66	1.85	0.010857	0.10	51.30	31.30	16195.10	315.713
67	1.90	0.010857	0.11	52.68	32.57	16194.21	307.388
68	1.90	0.010857	0.11	52.68	32.57	16194.21	307.388
69	1.95	0.010857	0.11	54.07	33.85	16193.32	299.489
70	1.95	0.010857	0.11	54.07	33.85	16193.32	299.489
71	2.00	0.010857	0.12	55.46	35.13	16192.42	291.986
72	2.00	0.010857	0.12	55.46	35.13	16192.42	291.986
73	2.05	0.010857	0.13	56.84	36.42	16191.52	284.848
74	2.05	0.010857	0.13	56.84	36.42	16191.52	284.848
75	2.10	0.010857	0.14	58.23	37.70	16190.61	278.051
76	2.10	0.010857	0.14	58.23	37.70	16190.61	278.051
77	2.15	0.010857	0.14	59.62	38.99	16189.71	271.569
78	2.15	0.010857	0.14	59.62	38.99	16189.71	271.569
79	2.20	0.010857	0.15	61.00	40.29	16188.80	265.382

Cod. elab.: 108GA201-GA01-Z-CL-002 C	Titolo: OPERE D'ARTE MAGGIORI- GALLERIE	Data: Ottobre 2011
Nome file: 108GA201-GA01-Z-CL -002_C.docx	ARTIFICIALI – GALLERIA ROVETELLO Relazione di calcolo	Pagina 258 di 452

PROGETTO ESECUTIVO

80	2.20	0.010857	0.15	61.00	40.29	16188.80	265.382
81	2.25	0.010857	0.16	62.39	41.58	16187.90	259.470
82	2.25	0.010857	0.16	62.39	41.58	16187.90	259.470
83	2.30	0.010857	0.17	63.77	42.88	16186.99	253.816
84	2.30	0.010857	0.17	63.77	42.88	16186.99	253.816
85	2.35	0.010857	0.18	65.16	44.18	16186.07	248.401
86	2.35	0.010857	0.18	65.16	44.18	16186.07	248.401
87	2.40	0.010857	0.19	66.55	45.48	16185.16	243.212
88	2.40	0.010857	0.19	66.55	45.48	16185.16	243.212
89	2.45	0.010857	0.20	67.93	46.78	16184.25	238.236
90	2.45	0.010857	0.20	67.93	46.78	16184.25	238.236
91	2.50	0.010857	0.21	69.32	48.09	16183.33	233.458
92	2.50	0.010857	0.21	194.17	17.19	16205.00	83.459
93	2.55	0.010857	-16.93	195.55	-1324.00	15288.67	78.182
94	2.55	0.010857	-16.93	195.55	-1324.00	15288.67	78.182
95	2.60	0.010857	-34.08	196.94	-2208.93	12766.55	64.825
96	2.60	0.010857	-34.08	196.94	-2208.93	12766.55	64.825
97	2.65	0.010857	-51.22	198.33	-2680.41	10379.51	52.336
98	2.65	0.010857	-51.22	198.33	-2680.41	10379.51	52.336
99	2.70	0.010857	-68.36	199.71	-2940.27	8590.45	43.014
100	2.70	0.010857	-68.36	199.71	-2940.27	8590.45	43.014
101	2.75	0.010857	-85.48	201.10	-3051.94	7179.59	35.702
102	2.75	0.010857	-85.48	201.10	-3051.94	7179.59	35.702
103	2.80	0.010857	-102.57	202.49	-3054.04	6029.27	29.776
104	2.80	0.010857	-102.57	202.49	-3054.04	6029.27	29.776
105	2.85	0.010857	-119.56	203.87	-3007.16	5127.65	25.151
106	2.85	0.010857	-119.56	203.87	-3007.16	5127.65	25.151
107	2.90	0.010857	-136.45	205.26	-2943.88	4428.40	21.575
108	2.90	0.010857	-136.45	205.26	-2943.88	4428.40	21.575
109	2.95	0.010857	-153.21	206.64	-2866.42	3866.05	18.709
110	2.95	0.010857	-153.21	206.64	-2866.42	3866.05	18.709
111	3.00	0.010857	-169.84	208.03	-2802.00	3432.16	16.498
112	3.00	0.010857	-169.84	208.03	-2802.00	3432.16	16.498
113	3.05	0.010857	-186.30	209.42	-2740.25	3080.23	14.709
114	3.05	0.010857	-186.30	209.42	-2740.25	3080.23	14.709
115	3.10	0.010857	-202.60	210.80	-2679.93	2788.44	13.228

Cod. elab.: 108GA201-GA01-Z-CL-002_C	Titolo: OPERE D'ARTE MAGGIORI- GALLERIE	Data: Ottobre 2011
Nome file: 108GA201-GA01-Z-CL -002_C.docx	ARTIFICIALI – GALLERIA ROVETELLO	Pagina 259 di 452
Relazione di calcolo		

PROGETTO ESECUTIVO

1163.10	0.010857	-202.60	210.80	-2679.93	2788.44	13.228
1173.15	0.010857	-218.72	212.19	-2631.18	2552.65	12.030
1183.15	0.010857	-218.72	212.19	-2631.18	2552.65	12.030
1193.20	0.010857	-234.65	213.58	-2591.00	2358.30	11.042
1203.20	0.010857	-234.65	213.58	-2591.00	2358.30	11.042
1213.25	0.010857	-250.40	214.96	-2557.33	2195.44	10.213
1223.25	0.010857	-250.40	214.96	-2557.33	2195.44	10.213
1233.30	0.010857	-265.95	216.35	-2516.70	2047.30	9.463
1243.30	0.010857	-265.95	216.35	-2516.70	2047.30	9.463
1253.35	0.010857	-281.32	217.74	-2478.90	1918.63	8.812
1263.35	0.010857	-281.32	217.74	-2478.90	1918.63	8.812
1273.40	0.010857	-296.49	219.12	-2446.42	1808.04	8.251
1283.40	0.010857	-296.49	219.12	-2446.42	1808.04	8.251
1293.45	0.010857	-311.46	220.51	-2418.21	1712.04	7.764
1303.45	0.010857	-311.46	220.51	-2418.21	1712.04	7.764
1313.50	0.010857	-326.24	221.90	-2393.52	1627.98	7.337
1323.50	0.010857	-326.24	221.90	-2393.52	1627.98	7.337
1333.55	0.010857	-340.81	223.28	-2371.74	1553.82	6.959
1343.55	0.010857	-340.81	223.28	-2371.74	1553.82	6.959
1353.60	0.010857	-355.19	224.67	-2352.39	1487.97	6.623
1363.60	0.010857	-355.19	224.67	-2352.39	1487.97	6.623
1373.65	0.010857	-369.35	226.05	-2335.12	1429.16	6.322
1383.65	0.010857	-369.35	226.05	-2335.12	1429.16	6.322
1393.70	0.010857	-383.31	227.44	-2319.61	1376.36	6.052
1403.70	0.010857	-383.31	227.44	-2319.61	1376.36	6.052
1413.75	0.010857	-397.06	228.83	-2305.62	1328.74	5.807
1423.75	0.010857	-397.06	228.83	-2305.62	1328.74	5.807
1433.80	0.010857	-410.59	230.21	-2292.95	1285.62	5.584
1443.80	0.010857	-410.59	230.21	-2292.95	1285.62	5.584
1453.85	0.010857	-423.91	231.60	-2281.44	1246.43	5.382
1463.85	0.010857	-423.91	231.60	-2281.44	1246.43	5.382
1473.90	0.010857	-437.02	232.99	-2270.94	1210.70	5.196
1483.90	0.010857	-437.02	232.99	-2270.94	1210.70	5.196
1493.95	0.010857	-449.90	234.37	-2261.34	1178.02	5.026
1503.95	0.010857	-449.90	234.37	-2261.34	1178.02	5.026
1514.00	0.010857	-462.57	235.76	-2252.54	1148.06	4.870

Cod. elab.: 108GA201-GA01-Z-CL-002_C	Titolo: OPERE D'ARTE MAGGIORI- GALLERIE	Data: Ottobre 2011
Nome file: 108GA201-GA01-Z-CL -002_C.docx	ARTIFICIALI – GALLERIA ROVETELLO Relazione di calcolo	Pagina 260 di 452

PROGETTO ESECUTIVO

1524.00	0.010857	-462.57	235.76	-2252.54	1148.06	4.870
1534.05	0.010857	-475.01	237.15	-2244.45	1120.53	4.725
1544.05	0.010857	-475.01	237.15	-2244.45	1120.53	4.725
1554.10	0.010857	-487.22	238.53	-2237.01	1095.18	4.591
1564.10	0.010857	-487.22	238.53	-2237.01	1095.18	4.591
1574.15	0.010857	-499.21	239.92	-2230.14	1071.80	4.467
1584.15	0.010857	-499.21	239.92	-2230.14	1071.80	4.467
1594.20	0.010857	-510.96	241.30	-2223.79	1050.19	4.352
1604.20	0.010857	-510.96	241.30	-2223.79	1050.19	4.352
1614.25	0.010857	-522.49	242.69	-2217.92	1030.20	4.245
1624.25	0.010857	-522.49	242.69	-2217.92	1030.20	4.245
1634.30	0.010857	-533.78	244.08	-2212.48	1011.69	4.145
1644.30	0.010857	-533.78	244.08	-2212.48	1011.69	4.145
1654.35	0.010857	-544.83	245.46	-2207.44	994.53	4.052
1664.35	0.010857	-544.83	245.46	-2207.44	994.53	4.052
1674.40	0.010857	-555.64	246.85	-2202.76	978.60	3.964
1684.40	0.010857	-555.64	246.85	-2202.76	978.60	3.964
1694.45	0.010857	-566.21	248.24	-2198.42	963.82	3.883
1704.45	0.010857	-566.21	248.24	-2198.42	963.82	3.883
1714.50	0.010857	-576.54	249.62	-2194.39	950.10	3.806
1724.50	0.010857	-576.54	249.62	-2194.39	950.10	3.806
1734.55	0.010857	-586.62	251.01	-2190.64	937.36	3.734
1744.55	0.010857	-586.62	251.01	-2190.64	937.36	3.734
1754.60	0.010857	-596.45	252.40	-2187.17	925.52	3.667
1764.60	0.010857	-596.45	252.40	-2187.17	925.52	3.667
1774.65	0.010857	-606.04	253.78	-2183.94	914.54	3.604
1784.65	0.010857	-606.04	253.78	-2183.94	914.54	3.604
1794.70	0.010857	-615.37	255.17	-2180.95	904.35	3.544
1804.70	0.010857	-615.37	255.17	-2180.95	904.35	3.544
1814.75	0.010857	-624.45	256.56	-2178.17	894.91	3.488
1824.75	0.010857	-624.45	256.56	-2178.17	894.91	3.488
1834.80	0.010857	-633.27	257.94	-2175.60	886.17	3.436
1844.80	0.010857	-633.27	257.94	-2175.60	886.17	3.436
1854.85	0.010857	-641.83	259.33	-2173.23	878.09	3.386
1864.85	0.010857	-641.83	259.33	-2173.23	878.09	3.386
1874.90	0.010857	-650.13	260.71	-2171.04	870.63	3.339

Cod. elab.: 108GA201-GA01-Z-CL-002_C	Titolo: OPERE D'ARTE MAGGIORI- GALLERIE	Data: Ottobre 2011
Nome file: 108GA201-GA01-Z-CL -002_C.docx	ARTIFICIALI – GALLERIA ROVETELLO	Pagina 261 di 452
Relazione di calcolo		

PROGETTO ESECUTIVO

1884.90	0.010857	-650.13	260.71	-2171.04	870.63	3.339
1894.95	0.010857	-658.17	262.10	-2169.02	863.77	3.296
1904.95	0.010857	-658.17	262.10	-2169.02	863.77	3.296
1915.00	0.010857	-665.94	263.49	-2167.17	857.47	3.254
1925.00	0.010857	-665.94	389.04	-2312.07	1350.73	3.472
1935.05	0.010857	-690.69	390.43	-2296.66	1298.24	3.325
1945.05	0.010857	-690.69	390.43	-2296.66	1298.24	3.325
1955.10	0.010857	-715.17	391.82	-2282.66	1250.58	3.192
1965.10	0.010857	-715.17	391.82	-2282.66	1250.58	3.192
1975.15	0.010857	-739.39	393.20	-2269.89	1207.12	3.070
1985.15	0.010857	-739.39	393.20	-2269.89	1207.12	3.070
1995.20	0.010857	-763.32	394.59	-2258.21	1167.35	2.958
2005.20	0.010857	-763.32	394.59	-2258.21	1167.35	2.958
2015.25	0.010857	-786.99	395.98	-2247.48	1130.83	2.856
2025.25	0.010857	-786.99	395.98	-2247.48	1130.83	2.856
2035.30	0.010857	-810.37	397.36	-2237.60	1097.20	2.761
2045.30	0.010857	-810.37	397.36	-2237.60	1097.20	2.761
2055.35	0.010857	-833.47	398.75	-2228.47	1066.14	2.674
2065.35	0.010857	-833.47	398.75	-2228.47	1066.14	2.674
2075.40	0.010857	-856.29	400.14	-2220.03	1037.39	2.593
2085.40	0.010857	-856.29	400.14	-2220.03	1037.39	2.593
2095.45	0.010857	-878.83	401.52	-2212.19	1010.71	2.517
2105.45	0.010857	-878.83	401.52	-2212.19	1010.71	2.517
2115.50	0.010857	-901.08	402.91	-2204.90	985.90	2.447
2125.50	0.010857	-901.08	402.91	-2204.90	985.90	2.447
2135.55	0.010857	-923.04	404.29	-2198.11	962.78	2.381
2145.55	0.010857	-923.04	404.29	-2198.11	962.78	2.381
2155.60	0.010857	-944.71	405.68	-2191.77	941.19	2.320
2165.60	0.010857	-944.71	405.68	-2191.77	941.19	2.320
2175.65	0.010857	-966.09	407.07	-2185.84	921.01	2.263
2185.65	0.010857	-966.09	407.07	-2185.84	921.01	2.263
2195.70	0.010857	-987.18	408.45	-2180.29	902.12	2.209
2205.70	0.010857	-987.18	408.45	-2180.29	902.12	2.209
2215.75	0.010857	-1007.96	409.84	-2175.08	884.39	2.158
2225.75	0.010857	-1007.96	409.84	-2175.08	884.39	2.158
2235.80	0.010857	-1028.45	411.23	-2170.20	867.76	2.110

Cod. elab.: 108GA201-GA01-Z-CL-002_C	Titolo: OPERE D'ARTE MAGGIORI- GALLERIE	Data: Ottobre 2011
Nome file: 108GA201-GA01-Z-CL -002_C.docx	ARTIFICIALI – GALLERIA ROVETELLO	Pagina 262 di 452
Relazione di calcolo		

PROGETTO ESECUTIVO

224 5.80	0.010857	-1028.45	411.23	-2170.20	867.76	2.110
225 5.85	0.010857	-1048.64	412.61	-2165.60	852.11	2.065
226 5.85	0.010857	-1048.64	412.61	-2165.60	852.11	2.065
227 5.90	0.010857	-1068.52	414.00	-2161.28	837.39	2.023
228 5.90	0.010857	-1068.52	414.00	-2161.28	837.39	2.023
229 5.95	0.010857	-1088.10	415.39	-2157.20	823.52	1.983
230 5.95	0.010857	-1088.10	415.39	-2157.20	823.52	1.983
231 6.00	0.010857	-1107.37	416.77	-2153.36	810.45	1.945
232 6.00	0.010857	-1107.37	416.77	-2153.36	810.45	1.945
233 6.05	0.010857	-1126.33	418.16	-2149.74	798.11	1.909
234 6.05	0.010857	-1126.33	418.16	-2149.74	798.11	1.909
235 6.10	0.010857	-1144.98	419.55	-2146.31	786.46	1.875
236 6.10	0.010857	-1144.98	419.55	-2146.31	786.46	1.875
237 6.15	0.010857	-1163.31	420.93	-2143.08	775.45	1.842
238 6.15	0.010857	-1163.31	420.93	-2143.08	775.45	1.842
239 6.20	0.010857	-1181.33	422.32	-2140.02	765.04	1.812
240 6.20	0.010857	-1181.33	422.32	-2140.02	765.04	1.812
241 6.25	0.010857	-1199.03	423.70	-2137.13	755.20	1.782
242 6.25	0.010857	-1199.03	423.70	-2137.13	755.20	1.782
243 6.30	0.010857	-1216.42	425.09	-2134.40	745.89	1.755
244 6.30	0.010857	-1216.42	425.09	-2134.40	745.89	1.755
245 6.35	0.010857	-1233.48	426.48	-2131.81	737.08	1.728
246 6.35	0.010857	-1233.48	426.48	-2131.81	737.08	1.728
247 6.40	0.010857	-1250.21	427.86	-2129.36	728.73	1.703
248 6.40	0.010857	-1250.21	427.86	-2129.36	728.73	1.703
249 6.45	0.010857	-1266.62	429.25	-2127.04	720.84	1.679
250 6.45	0.010857	-1266.62	429.25	-2127.04	720.84	1.679
251 6.50	0.010857	-1282.71	430.64	-2124.84	713.36	1.657
252 6.50	0.010857	-1282.71	430.64	-2124.84	713.36	1.657
253 6.55	0.010857	-1298.46	432.02	-2122.76	706.28	1.635
254 6.55	0.010857	-1298.46	432.02	-2122.76	706.28	1.635
255 6.60	0.010857	-1313.88	433.41	-2120.79	699.58	1.614
256 6.60	0.010857	-1313.88	433.41	-2120.79	699.58	1.614
257 6.65	0.010857	-1328.97	434.80	-2118.93	693.25	1.594
258 6.65	0.010857	-1328.97	434.80	-2118.93	693.25	1.594
259 6.70	0.010857	-1343.72	436.18	-2117.17	687.25	1.576

Cod. elab.: 108GA201-GA01-Z-CL-002_C	Titolo: OPERE D'ARTE MAGGIORI- GALLERIE	Data: Ottobre 2011
Nome file: 108GA201-GA01-Z-CL -002_C.docx	ARTIFICIALI – GALLERIA ROVETELLO Relazione di calcolo	Pagina 263 di 452

PROGETTO ESECUTIVO

260 6.70	0.010857	-1343.72	436.18	-2117.17	687.25	1.576
261 6.75	0.010857	-1358.13	437.57	-2115.50	681.58	1.558
262 6.75	0.010857	-1358.13	437.57	-2115.50	681.58	1.558
263 6.80	0.010857	-1372.21	438.95	-2113.93	676.22	1.541
264 6.80	0.010857	-1372.21	438.95	-2113.93	676.22	1.541
265 6.85	0.010857	-1385.94	440.34	-2112.45	671.17	1.524
266 6.85	0.010857	-1385.94	440.34	-2112.45	671.17	1.524
267 6.90	0.010857	-1399.33	441.73	-2111.04	666.40	1.509
268 6.90	0.010857	-1399.33	441.73	-2111.04	666.40	1.509
269 6.95	0.010857	-1412.37	443.11	-2109.72	661.90	1.494
270 6.95	0.010857	-1412.37	443.11	-2109.72	661.90	1.494
271 7.00	0.010857	-1425.06	444.50	-2108.48	657.67	1.480
272 7.00	0.010857	-1425.06	444.50	-2108.48	657.67	1.480
273 7.05	0.010857	-1437.40	445.89	-2107.31	653.70	1.466
274 7.05	0.010857	-1437.40	445.89	-2107.31	653.70	1.466
275 7.10	0.010857	-1449.39	447.27	-2106.22	649.97	1.453
276 7.10	0.010857	-1449.39	447.27	-2106.22	649.97	1.453
277 7.15	0.010857	-1461.03	448.66	-2105.19	646.47	1.441
278 7.15	0.010857	-1461.03	448.66	-2105.19	646.47	1.441
279 7.20	0.010857	-1472.31	450.05	-2104.23	643.21	1.429
280 7.20	0.010857	-1472.31	450.05	-2104.23	643.21	1.429
281 7.25	0.010857	-1483.23	451.43	-2103.34	640.17	1.418
282 7.25	0.010857	-1483.23	451.43	-2103.34	640.17	1.418
283 7.30	0.010857	-1493.79	452.82	-2102.51	637.34	1.408
284 7.30	0.010857	-1493.79	452.82	-2102.51	637.34	1.408
285 7.35	0.010857	-1503.99	454.21	-2101.74	634.73	1.397
286 7.35	0.010857	-1503.99	454.21	-2101.74	634.73	1.397
287 7.40	0.010857	-1513.82	455.59	-2101.03	632.32	1.388
288 7.40	0.010857	-1513.82	455.59	-2101.03	632.32	1.388
289 7.45	0.010857	-1523.29	456.98	-2100.38	630.10	1.379
290 7.45	0.010857	-1523.29	456.98	-2100.38	630.10	1.379
291 7.50	0.010857	-1532.38	458.36	-2099.79	628.09	1.370
292 7.50	0.010857	-1532.38	458.36	-2099.79	628.09	1.370
293 7.55	0.010857	-1541.11	459.75	-2099.25	626.26	1.362
294 7.55	0.010857	-1541.11	459.75	-2099.25	626.26	1.362
295 7.60	0.010857	-1549.47	461.14	-2098.77	624.62	1.355

Cod. elab.: 108GA201-GA01-Z-CL-002_C	Titolo: OPERE D'ARTE MAGGIORI- GALLERIE	Data: Ottobre 2011
Nome file: 108GA201-GA01-Z-CL -002_C.docx	ARTIFICIALI – GALLERIA ROVETELLO Relazione di calcolo	Pagina 264 di 452

PROGETTO ESECUTIVO

2967.60	0.010857	-1549.47	461.14	-2098.77	624.62	1.355
2977.65	0.010857	-1557.45	462.52	-2098.34	623.16	1.347
2987.65	0.010857	-1557.45	462.52	-2098.34	623.16	1.347
2997.70	0.010857	-1565.05	463.91	-2097.97	621.88	1.341
3007.70	0.010857	-1565.05	463.91	-2097.97	621.88	1.341
3017.75	0.010857	-1572.28	465.30	-2097.64	620.77	1.334
3027.75	0.010857	-1572.28	465.30	-2097.64	620.77	1.334
3037.80	0.010857	-1579.12	466.68	-2097.37	619.84	1.328
3047.80	0.010857	-1579.12	466.68	-2097.37	619.84	1.328
3057.85	0.010857	-1585.58	468.07	-2097.15	619.08	1.323
3067.85	0.010857	-1585.58	468.07	-2097.15	619.08	1.323
3077.90	0.010857	-1591.66	469.46	-2096.97	618.50	1.317
3087.90	0.010857	-1591.66	469.46	-2096.97	618.50	1.317
3097.95	0.010857	-1597.35	470.84	-2096.85	618.08	1.313
3107.95	0.010857	-1597.35	470.84	-2096.85	618.08	1.313
3118.00	0.010857	-1602.65	472.23	-2096.78	617.82	1.308
3128.00	0.010857	-1602.65	472.23	-2096.78	617.82	1.308
3138.05	0.010857	-1607.56	473.61	-2096.75	617.74	1.304
3148.05	0.010857	-1607.56	473.61	-2096.75	617.74	1.304
3158.10	0.010857	-1612.08	475.00	-2096.77	617.82	1.301
3168.10	0.010857	-1612.08	475.00	-2096.77	617.82	1.301
3178.15	0.010857	-1616.20	476.39	-2096.84	618.06	1.297
3188.15	0.010857	-1616.20	476.39	-2096.84	618.06	1.297
3198.20	0.010857	-1619.93	477.77	-2096.96	618.47	1.294
3208.20	0.010857	-1619.93	477.77	-2096.96	618.47	1.294
3218.25	0.010857	-1623.26	479.16	-2097.13	619.04	1.292
3228.25	0.010857	-1623.26	479.16	-2097.13	619.04	1.292
3238.30	0.010857	-1626.19	480.55	-2097.35	619.78	1.290
3248.30	0.010857	-1626.19	480.55	-2097.35	619.78	1.290
3258.35	0.010857	-1628.71	481.93	-2097.61	620.68	1.288
3268.35	0.010857	-1628.71	481.93	-2097.61	620.68	1.288
3278.40	0.010857	-1630.84	483.32	-2097.93	621.75	1.286
3288.40	0.010857	-1630.84	483.32	-2097.93	621.75	1.286
3298.45	0.010857	-1632.55	484.71	-2098.29	622.98	1.285
3308.45	0.010857	-1632.55	484.71	-2098.29	622.98	1.285
3318.50	0.010857	-1633.86	486.09	-2098.70	624.39	1.285

Cod. elab.: 108GA201-GA01-Z-CL-002_C	Titolo: OPERE D'ARTE MAGGIORI- GALLERIE	Data: Ottobre 2011
Nome file: 108GA201-GA01-Z-CL -002_C.docx	ARTIFICIALI – GALLERIA ROVETELLO	Pagina 265 di 452
Relazione di calcolo		

PROGETTO ESECUTIVO

3328.50	0.010857	-1633.86	486.09	-2098.70	624.39	1.285
3338.55	0.010857	-1634.75	487.48	-2099.17	625.97	1.284
3348.55	0.010857	-1634.75	487.48	-2099.17	625.97	1.284
3358.60	0.010857	-1635.22	488.87	-2099.68	627.72	1.284
3368.60	0.010857	-1635.22	488.87	-2099.68	627.72	1.284
3378.65	0.010857	-1635.28	490.25	-2100.25	629.65	1.284
3388.65	0.010857	-1635.28	490.25	-2100.25	629.65	1.284
3398.70	0.010857	-1634.90	491.64	-2100.87	631.76	1.285
3408.70	0.010857	-1634.90	491.64	-2100.87	631.76	1.285
3418.75	0.010857	-1634.10	493.02	-2101.54	634.06	1.286
3428.75	0.010857	-1634.10	493.02	-2101.54	634.06	1.286
3438.80	0.010857	-1632.87	494.41	-2102.27	636.54	1.287
3448.80	0.010857	-1632.87	494.41	-2102.27	636.54	1.287
3458.85	0.010857	-1631.21	495.80	-2103.06	639.21	1.289
3468.85	0.010857	-1631.21	495.80	-2103.06	639.21	1.289
3478.90	0.010857	-1629.12	497.18	-2103.90	642.08	1.291
3488.90	0.010857	-1629.12	497.18	-2103.90	642.08	1.291
3498.95	0.010857	-1626.59	498.57	-2104.80	645.15	1.294
3508.95	0.010857	-1626.59	498.57	-2104.80	645.15	1.294
3519.00	0.010857	-1623.62	499.96	-2105.76	648.42	1.297
3529.00	0.010857	-1623.62	499.96	-2105.76	648.42	1.297
3539.05	0.010857	-1620.21	501.34	-2106.79	651.91	1.300
3549.05	0.010857	-1620.21	501.34	-2106.79	651.91	1.300
3559.10	0.010857	-1616.36	502.73	-2107.87	655.60	1.304
3569.10	0.010857	-1616.36	502.73	-2107.87	655.60	1.304
3579.15	0.010857	-1612.06	504.12	-2109.02	659.52	1.308
3589.15	0.010857	-1612.06	504.12	-2109.02	659.52	1.308
3599.20	0.010857	-1607.32	505.50	-2110.24	663.67	1.313
3609.20	0.010857	-1607.32	505.50	-2110.24	663.67	1.313
3619.25	0.010857	-1602.25	506.89	-2111.51	668.00	1.318
3629.30	0.010857	-1596.99	508.28	-2112.82	672.45	1.323
3639.35	0.010857	-1591.54	509.66	-2114.17	677.02	1.328
3649.40	0.010857	-1585.90	511.05	-2115.55	681.72	1.334
3659.45	0.010857	-1580.08	512.43	-2116.96	686.55	1.340
3669.50	0.010857	-1574.07	513.82	-2118.42	691.51	1.346
3679.55	0.010857	-1567.89	515.21	-2119.92	696.60	1.352

Cod. elab.: 108GA201-GA01-Z-CL-002_C	Titolo: OPERE D'ARTE MAGGIORI- GALLERIE	Data: Ottobre 2011
Nome file: 108GA201-GA01-Z-CL -002_C.docx	ARTIFICIALI – GALLERIA ROVETELLO	Pagina 266 di 452
Relazione di calcolo		

PROGETTO ESECUTIVO

3689.60	0.010857	-1561.53	516.59	-2121.45	701.83	1.359
3699.65	0.010857	-1554.99	517.98	-2123.03	707.20	1.365
3709.70	0.010857	-1548.29	519.37	-2124.65	712.70	1.372
3719.75	0.010857	-1541.41	520.75	-2126.31	718.35	1.379
3729.80	0.010857	-1534.37	522.14	-2128.01	724.15	1.387
3739.85	0.010857	-1527.17	523.53	-2129.76	730.10	1.395
3749.90	0.010857	-1519.80	524.91	-2131.55	736.20	1.403
3759.95	0.010857	-1512.28	526.30	-2133.39	742.46	1.411
37610.00	0.010857	-1504.60	527.68	-2135.27	748.87	1.419
37710.05	0.010857	-1496.77	529.07	-2137.20	755.45	1.428
37810.10	0.010857	-1488.78	530.46	-2139.19	762.20	1.437
37910.15	0.010857	-1480.65	531.84	-2141.22	769.12	1.446
38010.20	0.010857	-1472.38	533.23	-2143.30	776.21	1.456
38110.25	0.010857	-1463.96	534.62	-2145.44	783.48	1.466
38210.30	0.010857	-1455.41	536.00	-2147.63	790.94	1.476
38310.35	0.010857	-1446.71	537.39	-2149.88	798.58	1.486
38410.40	0.010857	-1437.89	538.78	-2152.18	806.42	1.497
38510.45	0.010857	-1428.93	540.16	-2154.54	814.46	1.508
38610.50	0.010857	-1419.84	541.55	-2156.96	822.70	1.519
38710.55	0.010857	-1410.63	542.94	-2159.44	831.15	1.531
38810.60	0.010857	-1401.29	544.32	-2161.99	839.81	1.543
38910.65	0.010857	-1391.83	545.71	-2164.60	848.69	1.555
39010.70	0.010857	-1382.26	547.09	-2167.27	857.80	1.568
39110.75	0.010857	-1372.57	548.48	-2170.02	867.14	1.581
39210.80	0.010857	-1362.77	549.87	-2172.83	876.72	1.594
39310.85	0.010857	-1352.85	551.25	-2175.72	886.55	1.608
39410.90	0.010857	-1342.84	552.64	-2178.68	896.63	1.622
39510.95	0.010857	-1332.71	554.03	-2181.71	906.97	1.637
39611.00	0.010857	-1322.49	555.41	-2184.83	917.58	1.652
39711.05	0.010857	-1312.17	556.80	-2188.03	928.46	1.667
39811.10	0.010857	-1301.75	558.19	-2191.31	939.63	1.683
39911.15	0.010857	-1291.23	559.57	-2194.68	951.09	1.700
40011.20	0.010857	-1280.63	560.96	-2198.13	962.85	1.716
40111.25	0.010857	-1269.94	562.34	-2201.68	974.93	1.734
40211.30	0.010857	-1259.16	563.73	-2205.32	987.33	1.751
40311.35	0.010857	-1248.31	565.12	-2209.06	1000.06	1.770

Cod. elab.: 108GA201-GA01-Z-CL-002_C	Titolo: OPERE D'ARTE MAGGIORI- GALLERIE	Data: Ottobre 2011
Nome file: 108GA201-GA01-Z-CL -002_C.docx	ARTIFICIALI – GALLERIA ROVETELLO Relazione di calcolo	Pagina 267 di 452

PROGETTO ESECUTIVO

40411.40	0.010857	-1237.37	566.50	-2212.90	1013.13	1.788
40511.45	0.010857	-1226.35	567.89	-2216.85	1026.56	1.808
40611.50	0.010857	-1215.27	569.28	-2220.90	1040.35	1.827
40711.55	0.010857	-1204.11	570.66	-2225.06	1054.52	1.848
40811.60	0.010857	-1192.88	572.05	-2229.34	1069.09	1.869
40911.65	0.010857	-1181.59	573.44	-2233.74	1084.05	1.890
41011.70	0.010857	-1170.23	574.82	-2238.26	1099.44	1.913
41111.75	0.010857	-1158.82	576.21	-2242.90	1115.26	1.936
41211.80	0.010857	-1147.35	577.60	-2247.68	1131.52	1.959
41311.85	0.010857	-1135.82	578.98	-2252.60	1148.25	1.983
41411.90	0.010857	-1124.25	580.37	-2257.65	1165.47	2.008
41511.95	0.010857	-1112.62	581.75	-2262.85	1183.18	2.034
41612.00	0.010857	-1100.95	583.14	-2268.21	1201.41	2.060
41712.05	0.010857	-1089.23	584.53	-2273.72	1220.17	2.087
41812.10	0.010857	-1077.48	585.91	-2279.40	1239.50	2.115
41912.15	0.010857	-1065.69	587.30	-2285.25	1259.40	2.144
42012.20	0.010857	-1053.86	588.69	-2291.27	1279.90	2.174
42112.25	0.010857	-1042.00	590.07	-2297.48	1301.03	2.205
42212.30	0.010857	-1030.12	591.46	-2303.87	1322.81	2.237
42312.35	0.010857	-1018.20	592.85	-2310.47	1345.27	2.269
42412.40	0.010857	-1006.26	594.23	-2317.27	1368.43	2.303
42512.45	0.010857	-994.31	595.62	-2324.29	1392.32	2.338
42612.50	0.010857	-982.33	597.00	-2331.54	1416.98	2.373
42712.55	0.010857	-970.34	598.39	-2339.01	1442.43	2.411
42812.60	0.010857	-958.34	599.78	-2346.73	1468.71	2.449
42912.65	0.010857	-946.32	601.16	-2354.71	1495.86	2.488
43012.70	0.010857	-934.31	602.55	-2362.95	1523.91	2.529
43112.75	0.010857	-922.28	603.94	-2371.47	1552.91	2.571
43212.80	0.010857	-910.25	605.32	-2380.28	1582.90	2.615
43312.85	0.010857	-898.23	606.71	-2389.39	1613.92	2.660
43412.90	0.010857	-886.20	608.10	-2398.83	1646.04	2.707
43512.95	0.010857	-874.18	609.48	-2408.59	1679.29	2.755
43613.00	0.010857	-862.16	610.87	-2418.72	1713.74	2.805
43713.05	0.010857	-850.15	612.26	-2429.21	1749.45	2.857
43813.10	0.010857	-838.14	613.64	-2440.09	1786.49	2.911
43913.15	0.010857	-826.15	615.03	-2451.38	1824.93	2.967

Cod. elab.: 108GA201-GA01-Z-CL-002_C	Titolo: OPERE D'ARTE MAGGIORI- GALLERIE	Data: Ottobre 2011
Nome file: 108GA201-GA01-Z-CL -002_C.docx	ARTIFICIALI – GALLERIA ROVETELLO Relazione di calcolo	Pagina 268 di 452

PROGETTO ESECUTIVO

44013.20	0.010857	-814.17	616.41	-2463.10	1864.84	3.025
44113.25	0.010857	-802.20	617.80	-2475.28	1906.29	3.086
44213.30	0.010857	-790.25	619.19	-2487.94	1949.39	3.148
44313.35	0.010857	-778.31	620.57	-2501.11	1994.22	3.214
44413.40	0.010857	-766.39	621.96	-2514.82	2040.88	3.281
44513.45	0.010857	-754.50	623.35	-2529.09	2089.48	3.352
44613.50	0.010857	-742.62	624.73	-2543.97	2140.13	3.426
44713.55	0.010857	-730.77	626.12	-2556.25	2190.18	3.498
44813.60	0.010857	-718.94	627.51	-2566.58	2240.15	3.570
44913.65	0.010857	-707.14	628.89	-2577.32	2292.12	3.645
45013.70	0.010857	-695.37	630.28	-2588.50	2346.18	3.722
45113.75	0.010857	-683.63	631.67	-2600.14	2402.48	3.803
45213.80	0.010857	-671.93	633.05	-2612.26	2461.12	3.888
45313.85	0.010857	-660.25	634.44	-2624.90	2522.26	3.976
45413.90	0.010857	-648.62	635.82	-2638.09	2586.05	4.067
45513.95	0.010857	-637.02	637.21	-2651.86	2652.66	4.163
45614.00	0.010857	-625.46	638.60	-2666.24	2722.26	4.263
45714.05	0.010857	-613.94	639.98	-2681.29	2795.04	4.367
45814.10	0.010857	-602.46	641.37	-2697.04	2871.22	4.477
45914.15	0.010857	-591.03	642.76	-2713.54	2951.03	4.591
46014.20	0.010857	-579.64	644.14	-2730.84	3034.72	4.711
46114.25	0.010857	-568.30	645.53	-2749.00	3122.55	4.837
46214.30	0.010857	-557.01	646.92	-2768.08	3214.84	4.969
46314.35	0.010857	-545.78	648.30	-2783.30	3306.15	5.100
46414.40	0.010857	-534.59	649.69	-2797.13	3399.36	5.232
46514.45	0.010857	-523.46	651.07	-2811.65	3497.10	5.371
46614.50	0.010857	-512.38	652.46	-2826.88	3599.69	5.517
46714.55	0.010857	-501.37	653.85	-2842.88	3707.47	5.670
46814.60	0.010857	-490.41	655.23	-2859.70	3820.83	5.831
46914.65	0.010857	-479.51	656.62	-2877.42	3940.18	6.001
47014.70	0.010857	-468.68	658.01	-2896.10	4065.98	6.179
47114.75	0.010857	-457.91	659.39	-2915.81	4198.74	6.368
47214.80	0.010857	-447.21	660.78	-2935.67	4337.59	6.564
47314.85	0.010857	-436.58	662.17	-2947.72	4470.85	6.752
47414.90	0.010857	-426.02	663.55	-2960.41	4611.06	6.949
47514.95	0.010857	-415.53	664.94	-2973.78	4758.75	7.157

Cod. elab.: 108GA201-GA01-Z-CL-002_C	Titolo: OPERE D'ARTE MAGGIORI- GALLERIE	Data: Ottobre 2011
Nome file: 108GA201-GA01-Z-CL -002_C.docx	ARTIFICIALI – GALLERIA ROVETELLO	Pagina 269 di 452
	Relazione di calcolo	

PROGETTO ESECUTIVO

47615.00	0.010857	-405.11	666.33	-2987.87	4914.49	7.376
47715.05	0.010857	-394.76	667.71	-3002.75	5078.91	7.606
47815.10	0.010857	-384.50	669.10	-3018.48	5252.71	7.850
47915.15	0.010857	-374.31	670.48	-3033.28	5433.38	8.104
48015.20	0.010857	-364.20	671.87	-3039.33	5606.86	8.345
48115.25	0.010857	-354.18	673.26	-3045.69	5789.56	8.599
48215.30	0.010857	-344.24	674.64	-3052.40	5982.18	8.867
48315.35	0.010857	-334.38	676.03	-3059.48	6185.48	9.150
48415.40	0.010857	-324.61	677.42	-3066.97	6400.31	9.448
48515.45	0.010857	-314.93	678.80	-3066.77	6610.11	9.738
48615.50	0.010857	-305.34	680.19	-3061.32	6819.48	10.026
48715.55	0.010857	-295.85	681.58	-3055.59	7039.54	10.328
48815.60	0.010857	-286.44	682.96	-3049.56	7271.04	10.646
48915.65	0.010857	-277.14	684.35	-3043.22	7514.80	10.981
49015.70	0.010857	-267.93	685.73	-3024.62	7741.25	11.289
49115.75	0.010857	-258.82	687.12	-3001.93	7969.70	11.599
49215.80	0.010857	-249.81	688.51	-2978.22	8208.42	11.922
49315.85	0.010857	-240.90	689.89	-2953.43	8458.02	12.260
49415.90	0.010857	-232.10	691.28	-2925.58	8713.46	12.605
49515.95	0.010857	-223.41	692.67	-2891.09	8963.81	12.941
49616.00	0.010857	-214.82	694.05	-2855.15	9224.67	13.291
49716.05	0.010857	-206.34	695.44	-2817.69	9496.58	13.656
49816.10	0.010857	-197.98	696.83	-2777.86	9777.42	14.031
49916.15	0.010857	-189.72	698.21	-2732.66	10056.67	14.403
50016.20	0.010857	-181.59	699.60	-2685.66	10347.09	14.790
50116.25	0.010857	-173.57	700.99	-2636.76	10649.19	15.192
50216.30	0.010857	-165.66	702.37	-2583.47	10953.25	15.595
50316.35	0.010857	-157.88	703.76	-2525.50	11257.37	15.996
50416.40	0.010857	-150.22	705.14	-2465.41	11572.60	16.412
50516.45	0.010857	-142.69	706.53	-2403.03	11898.80	16.841
50616.50	0.010857	-135.28	707.92	-2333.32	12210.44	17.248
50716.55	0.010857	-127.99	709.30	-2261.41	12531.95	17.668
50816.60	0.010857	-120.84	710.69	-2187.24	12863.54	18.100
50916.65	0.010857	-113.82	712.08	-2107.11	13182.50	18.513
51016.70	0.010857	-106.93	713.46	-2023.09	13498.63	18.920
51116.75	0.010857	-100.17	714.85	-1937.01	13822.56	19.336

Cod. elab.: 108GA201-GA01-Z-CL-002_C	Titolo: OPERE D'ARTE MAGGIORI- GALLERIE	Data: Ottobre 2011
Nome file: 108GA201-GA01-Z-CL -002_C.docx	ARTIFICIALI – GALLERIA ROVETELLO	Pagina 270 di 452
	Relazione di calcolo	

PROGETTO ESECUTIVO

51216.80	0.010857	-93.56	716.24	-1847.59	14144.62	19.749
51316.85	0.010857	-87.07	717.62	-1753.35	14450.16	20.136
51416.90	0.010857	-80.73	719.01	-1657.44	14761.12	20.530
51516.95	0.010857	-74.53	720.39	-1559.93	15077.28	20.929
51617.00	0.010857	-68.48	721.78	-1442.58	15205.52	21.067
51717.05	0.010857	-62.57	723.17	-1322.79	15289.52	21.142
51817.10	0.010857	-56.80	724.55	-1205.08	15372.05	21.216
51917.15	0.010857	-51.18	725.94	-1089.57	15453.05	21.287
52017.20	0.010857	-45.72	727.33	-976.36	15532.43	21.356
52117.25	0.010857	-40.41	728.71	-865.55	15610.13	21.421
52217.30	0.010857	-35.25	730.10	-757.25	15686.07	21.485
52317.35	0.010857	-30.24	731.49	-651.57	15760.17	21.545
52417.40	0.010857	-25.40	732.87	-548.62	15832.36	21.603
52517.45	0.010857	-20.71	734.26	-448.50	15902.57	21.658
52617.50	0.010857	-16.18	735.65	-351.30	15970.72	21.710
52717.55	0.010857	-11.82	737.03	-257.15	16036.74	21.759
52817.60	0.010857	-7.62	738.42	-166.13	16100.56	21.804
52917.65	0.010857	-3.59	739.80	-78.36	16162.11	21.846
53017.70	0.010857	0.28	741.19	6.07	16212.79	21.874
53117.75	0.010857	3.97	742.58	86.42	16156.45	21.757
53217.80	0.010857	7.49	743.96	162.23	16103.30	21.645
53317.85	0.010857	10.84	745.35	233.56	16053.28	21.538
53417.90	0.010857	14.02	746.74	300.49	16006.35	21.435
53517.95	0.010857	17.02	748.12	363.06	15962.48	21.337
53618.00	0.010857	19.83	749.51	421.33	15921.62	21.243
53718.05	0.010857	22.47	750.90	475.35	15883.74	21.153
53818.10	0.010857	24.93	752.28	525.16	15848.81	21.068
53918.15	0.010857	27.20	753.67	570.81	15816.80	20.986
54018.20	0.010857	29.28	755.06	612.32	15787.69	20.909
54118.25	0.010857	31.18	756.44	649.73	15761.46	20.836
54218.30	0.010857	32.89	757.83	683.06	15738.09	20.767
54318.35	0.010857	34.41	759.21	712.34	15717.56	20.702
54418.40	0.010857	35.73	760.60	737.58	15699.86	20.641
54518.45	0.010857	36.86	761.99	758.79	15684.99	20.584
54618.50	0.010857	37.80	763.37	775.99	15672.93	20.531
54718.55	0.010857	38.53	764.76	789.18	15663.68	20.482

Cod. elab.: 108GA201-GA01-Z-CL-002_C	Titolo: OPERE D'ARTE MAGGIORI- GALLERIE	Data: Ottobre 2011
Nome file: 108GA201-GA01-Z-CL -002_C.docx	ARTIFICIALI – GALLERIA ROVETELLO Relazione di calcolo	Pagina 271 di 452

PROGETTO ESECUTIVO

54818.60	0.010857	39.07	766.15	798.36	15657.25	20.436
54918.65	0.010857	39.40	767.53	803.52	15653.63	20.395
55018.70	0.010857	39.53	768.92	804.66	15652.82	20.357
55118.75	0.010857	39.45	770.31	801.77	15654.85	20.323
55218.80	0.010857	39.17	771.69	794.83	15659.72	20.293
55318.85	0.010857	38.68	773.08	783.82	15667.44	20.266
55418.90	0.010857	37.97	774.46	768.71	15678.03	20.244
55518.95	0.010857	37.06	775.85	749.48	15691.52	20.225
55619.00	0.010857	35.93	777.24	726.09	15707.92	20.210
55719.05	0.010857	34.58	778.62	698.50	15727.26	20.199
55819.10	0.010857	33.02	780.01	666.67	15749.58	20.192
55919.15	0.010857	31.23	781.40	630.55	15774.91	20.188
56019.20	0.010857	29.25	782.78	590.46	15803.02	20.188
56119.25	0.010857	27.10	784.17	547.09	15833.43	20.191
56219.30	0.010857	24.81	785.56	501.16	15865.64	20.197
56319.35	0.010857	22.44	786.94	453.38	15899.14	20.204
56419.40	0.010857	20.01	788.33	404.48	15933.43	20.212
56519.45	0.010857	17.57	789.72	355.17	15968.00	20.220
56619.50	0.010857	15.14	791.10	306.20	16002.35	20.228
56719.55	0.010857	12.76	792.49	258.30	16035.93	20.235
56819.60	0.010857	10.48	793.87	212.22	16068.25	20.240
56919.65	0.010857	8.33	795.26	168.71	16098.75	20.243
57019.70	0.010857	6.35	796.65	128.54	16126.92	20.243
57119.75	0.010857	4.57	798.03	92.46	16152.22	20.240
57219.80	0.010857	3.03	799.42	61.24	16174.11	20.232
57319.85	0.010857	1.76	800.81	35.64	16192.06	20.220
57419.90	0.010857	0.81	802.19	16.41	16205.55	20.202
57519.95	0.010857	0.21	803.58	4.28	16214.05	20.177
57620.00	0.010857	0.00	804.97	0.00	-4248.53	5.278

Simbologia adottata

n° numero d'ordine della sezione

Y ordinata della sezione rispetto alla testa, espressa in [m]

Taglio

T taglio agente sul palo, espresso in [kN]

Cod. elab.: 108GA201-GA01-Z-CL-002_C	Titolo: OPERE D'ARTE MAGGIORI- GALLERIE	Data: Ottobre 2011
Nome file: 108GA201-GA01-Z-CL -002_C.docx	ARTIFICIALI – GALLERIA ROVETELLO	Pagina 272 di 452
Relazione di calcolo		

PROGETTO ESECUTIVO

T_R taglio resistente, espresso in [kN]

CS_T coefficiente di sicurezza a taglio

Fase n° 1 - [A1-M1]

n°	Y	T	T_R	CS_T
1	0.00	0.00	1053.57	1000.000
2	0.05	0.02	1053.57	45266.817
3	0.10	0.07	1053.57	15146.488
4	0.15	0.12	1053.57	9136.677
5	0.20	0.16	1053.57	6562.866
6	0.25	0.21	1053.57	5133.672
7	0.30	0.25	1053.57	4224.604
8	0.35	0.29	1053.57	3595.554
9	0.40	0.34	1053.57	3134.498
10	0.45	0.38	1053.57	2782.139
11	0.50	0.46	1053.57	2275.643
12	0.55	0.63	1053.57	1671.928
13	0.60	0.84	1053.57	1258.898
14	0.65	1.04	1053.57	1012.107
15	0.70	1.24	1053.57	848.041
16	0.75	1.44	1053.57	731.103
17	0.80	1.64	1053.57	643.557
18	0.85	1.83	1053.57	575.577
19	0.90	2.02	1053.57	521.276
20	0.95	2.21	1053.57	476.915
21	1.00	2.39	1053.57	440.004
22	1.05	2.58	1053.57	408.822
23	1.10	2.76	1053.57	382.137
24	1.15	2.93	1053.57	359.051
25	1.20	3.11	1053.57	338.888
26	1.25	3.28	1053.57	321.131
27	1.30	3.45	1053.57	305.380
28	1.35	3.62	1053.57	291.318
29	1.40	3.78	1053.57	278.692
30	1.45	3.94	1053.57	267.298

Cod. elab.: 108GA201-GA01-Z-CL-002 C	Titolo: OPERE D'ARTE MAGGIORI- GALLERIE	Data: Ottobre 2011
Nome file: 108GA201-GA01-Z-CL -002_C.docx	ARTIFICIALI – GALLERIA ROVETELLO	Pagina 273 di 452
Relazione di calcolo		

PROGETTO ESECUTIVO

31	1.50	4.10	1053.57	256.967
32	1.55	4.26	1053.57	247.562
33	1.60	4.41	1053.57	238.968
34	1.65	4.56	1053.57	231.086
35	1.70	4.71	1053.57	223.837
36	1.75	4.85	1053.57	217.149
37	1.80	4.99	1053.57	210.964
38	1.85	5.13	1053.57	205.230
39	1.90	5.27	1053.57	199.902
40	1.95	5.40	1053.57	194.942
41	2.00	5.54	1053.57	190.316
42	2.05	5.66	1053.57	185.994
43	2.10	5.79	1053.57	181.950
44	2.15	5.91	1053.57	178.160
45	2.20	6.03	1053.57	174.604
46	2.25	6.15	1053.57	171.264
47	2.30	6.27	1053.57	168.123
48	2.35	6.38	1053.57	165.167
49	2.40	6.49	1053.57	162.382
50	2.45	6.59	1053.57	159.756
51	2.50	6.65	1053.57	158.492
52	2.50	6.70	1053.57	157.280
53	2.55	6.80	1053.57	154.974
54	2.60	6.90	1053.57	152.797
55	2.65	6.99	1053.57	150.741
56	2.70	7.08	1053.57	148.798
57	2.75	7.17	1053.57	146.963
58	2.80	7.25	1053.57	145.229
59	2.85	7.34	1053.57	143.591
60	2.90	7.42	1053.57	142.045
61	2.95	7.49	1053.57	140.584
62	3.00	7.57	1053.57	139.207
63	3.05	7.64	1053.57	137.908
64	3.10	7.71	1053.57	136.685
65	3.15	7.77	1053.57	135.533
66	3.20	7.84	1053.57	134.451

<i>Cod. elab.:</i> 108GA201-GA01-Z-CL-002_C	<i>Titolo:</i> OPERE D'ARTE MAGGIORI- GALLERIE	<i>Data:</i> Ottobre 2011
<i>Nome file:</i> 108GA201-GA01-Z-CL -002_C.docx	ARTIFICIALI – GALLERIA ROVETELLO Relazione di calcolo	<i>Pagina</i> 274 di 452

PROGETTO ESECUTIVO

67	3.25	7.90	1053.57	133.436
68	3.30	7.95	1053.57	132.484
69	3.35	8.01	1053.57	131.595
70	3.40	8.06	1053.57	130.766
71	3.45	8.10	1053.57	129.995
72	3.50	8.15	1053.57	129.280
73	3.55	8.19	1053.57	128.621
74	3.60	8.23	1053.57	128.015
75	3.65	8.27	1053.57	127.462
76	3.70	8.30	1053.57	126.960
77	3.75	8.33	1053.57	126.508
78	3.80	8.35	1053.57	126.107
79	3.85	8.38	1053.57	125.754
80	3.90	8.40	1053.57	125.451
81	3.95	8.42	1053.57	125.195
82	4.00	8.43	1053.57	124.987
83	4.05	8.44	1053.57	124.826
84	4.10	8.45	1053.57	124.713
85	4.15	8.45	1053.57	124.648
86	4.20	8.45	1053.57	124.630
87	4.25	8.45	1053.57	124.661
88	4.30	8.45	1053.57	124.739
89	4.35	8.44	1053.57	124.866
90	4.40	8.43	1053.57	125.043
91	4.45	8.41	1053.57	125.269
92	4.50	8.39	1053.57	125.547
93	4.55	8.37	1053.57	125.877
94	4.60	8.34	1053.57	126.260
95	4.65	8.32	1053.57	126.697
96	4.70	8.28	1053.57	127.190
97	4.75	8.25	1053.57	127.740
98	4.80	8.21	1053.57	128.350
99	4.85	8.17	1053.57	129.022
100	4.90	8.12	1053.57	129.757
101	4.95	8.07	1053.57	130.558
102	5.00	8.02	1053.57	131.428

<i>Cod. elab.:</i> 108GA201-GA01-Z-CL-002_C	<i>Titolo:</i> OPERE D'ARTE MAGGIORI- GALLERIE	<i>Data:</i> Ottobre 2011
<i>Nome file:</i> 108GA201-GA01-Z-CL -002_C.docx	ARTIFICIALI – GALLERIA ROVETELLO Relazione di calcolo	<i>Pagina</i> 275 di 452

PROGETTO ESECUTIVO

103 5.05	7.96	1053.57	132.369
104 5.10	7.90	1053.57	133.386
105 5.15	7.83	1053.57	134.481
106 5.20	7.77	1053.57	135.659
107 5.25	7.69	1053.57	136.925
108 5.30	7.62	1053.57	138.282
109 5.35	7.54	1053.57	139.736
110 5.40	7.46	1053.57	141.293
111 5.45	7.37	1053.57	142.960
112 5.50	7.28	1053.57	144.743
113 5.55	7.18	1053.57	146.651
114 5.60	7.09	1053.57	148.692
115 5.65	6.98	1053.57	150.876
116 5.70	6.88	1053.57	153.214
117 5.75	6.77	1053.57	155.718
118 5.80	6.65	1053.57	158.402
119 5.85	6.53	1053.57	161.280
120 5.90	6.41	1053.57	164.370
121 5.95	6.28	1053.57	167.692
122 6.00	6.15	1053.57	171.266
123 6.05	6.02	1053.57	175.119
124 6.10	5.88	1053.57	179.278
125 6.15	5.73	1053.57	183.776
126 6.20	5.58	1053.57	188.652
127 6.25	5.43	1053.57	193.948
128 6.30	5.28	1053.57	199.715
129 6.35	5.11	1053.57	206.013
130 6.40	4.95	1053.57	212.913
131 6.45	4.78	1053.57	220.497
132 6.50	4.60	1053.57	228.865
133 6.55	4.42	1053.57	238.138
134 6.60	4.24	1053.57	248.463
135 6.65	4.05	1053.57	260.019
136 6.70	3.86	1053.57	273.032
137 6.75	3.66	1053.57	287.784
138 6.80	3.46	1053.57	304.637

<i>Cod. elab.:</i> 108GA201-GA01-Z-CL-002 C	<i>Titolo:</i> OPERE D'ARTE MAGGIORI- GALLERIE	<i>Data:</i> Ottobre 2011
<i>Nome file:</i> 108GA201-GA01-Z-CL -002_C.docx	ARTIFICIALI – GALLERIA ROVETELLO Relazione di calcolo	<i>Pagina</i> 276 di 452

PROGETTO ESECUTIVO

1396.85	3.25	1053.57	324.060
1406.90	3.04	1053.57	346.676
1416.95	2.82	1053.57	373.323
1427.00	2.60	1053.57	405.166
1437.05	2.37	1053.57	443.864
1447.10	2.14	1053.57	491.867
1457.15	1.91	1053.57	552.955
1467.20	1.66	1053.57	633.273
1477.25	1.42	1053.57	743.533
1487.30	1.17	1053.57	904.220
1497.35	0.91	1053.57	1160.024
1507.40	0.65	1053.57	1630.606
1517.45	0.38	1053.57	2781.293
1527.50	0.11	1053.57	9916.398
1537.55	-0.17	1053.57	6139.777
1547.60	-0.45	1053.57	2316.762
1557.65	-0.74	1053.57	1417.462
1567.70	-1.04	1053.57	1015.789
1577.75	-1.34	1053.57	788.282
1587.80	-1.64	1053.57	641.890
1597.85	-1.95	1053.57	539.827
1607.90	-2.27	1053.57	464.630
1617.95	-2.59	1053.57	406.942
1628.00	-2.92	1053.57	361.299
1638.05	-3.25	1053.57	324.296
1648.10	-3.59	1053.57	293.702
1658.15	-3.93	1053.57	267.992
1668.20	-4.28	1053.57	246.089
1678.25	-4.64	1053.57	227.211
1688.30	-5.00	1053.57	210.776
1698.35	-5.37	1053.57	196.344
1708.40	-5.74	1053.57	183.572
1718.45	-6.12	1053.57	172.192
1728.50	-6.66	1053.57	158.095
1738.55	-7.38	1053.57	142.740
1748.60	-8.11	1053.57	129.925

<i>Cod. elab.:</i> 108GA201-GA01-Z-CL-002_C	<i>Titolo:</i> OPERE D'ARTE MAGGIORI- GALLERIE	<i>Data:</i> Ottobre 2011
<i>Nome file:</i> 108GA201-GA01-Z-CL -002_C.docx	ARTIFICIALI – GALLERIA ROVETELLO Relazione di calcolo	<i>Pagina</i> 277 di 452

PROGETTO ESECUTIVO

1758.65	-8.85	1053.57	119.072
1768.70	-9.60	1053.57	109.763
1778.75	-10.36	1053.57	101.694
1788.80	-11.13	1053.57	94.633
1798.85	-11.92	1053.57	88.405
1808.90	-12.71	1053.57	82.871
1818.95	-13.52	1053.57	77.923
1829.00	-14.34	1053.57	73.473
1839.05	-15.17	1053.57	69.451
1849.10	-16.01	1053.57	65.798
1859.15	-16.87	1053.57	62.467
1869.20	-17.73	1053.57	59.417
1879.25	-18.59	1053.57	56.670
1889.30	-19.43	1053.57	54.234
1899.35	-20.24	1053.57	52.061
1909.40	-21.02	1053.57	50.112
1919.45	-21.79	1053.57	48.358
1929.50	-22.53	1053.57	46.772
1939.55	-23.24	1053.57	45.334
1949.60	-23.93	1053.57	44.026
1959.65	-24.60	1053.57	42.833
1969.70	-25.24	1053.57	41.742
1979.75	-25.86	1053.57	40.743
1989.80	-26.45	1053.57	39.827
1999.85	-27.02	1053.57	38.985
2009.90	-27.57	1053.57	38.211
2019.95	-28.10	1053.57	37.499
20210.00	-28.60	1053.57	36.844
20310.05	-29.07	1053.57	36.240
20410.10	-29.52	1053.57	35.685
20510.15	-29.95	1053.57	35.175
20610.20	-30.36	1053.57	34.706
20710.25	-30.74	1053.57	34.275
20810.30	-31.10	1053.57	33.881
20910.35	-31.43	1053.57	33.521
21010.40	-31.74	1053.57	33.194

<i>Cod. elab.:</i> 108GA201-GA01-Z-CL-002_C	<i>Titolo:</i> OPERE D'ARTE MAGGIORI- GALLERIE	<i>Data:</i> Ottobre 2011
<i>Nome file:</i> 108GA201-GA01-Z-CL -002_C.docx	ARTIFICIALI – GALLERIA ROVETELLO Relazione di calcolo	<i>Pagina</i> 278 di 452

PROGETTO ESECUTIVO

21110.45	-32.03	1053.57	32.897
21210.50	-32.29	1053.57	32.629
21310.55	-32.53	1053.57	32.390
21410.60	-32.74	1053.57	32.177
21510.65	-32.93	1053.57	31.989
21610.70	-33.10	1053.57	31.827
21710.75	-33.25	1053.57	31.689
21810.80	-33.37	1053.57	31.575
21910.85	-33.46	1053.57	31.484
22010.90	-33.54	1053.57	31.416
22110.95	-33.59	1053.57	31.370
22211.00	-33.61	1053.57	31.346
22311.05	-33.61	1053.57	31.345
22411.10	-33.59	1053.57	31.367
22511.15	-33.54	1053.57	31.411
22611.20	-33.47	1053.57	31.477
22711.25	-33.38	1053.57	31.567
22811.30	-33.26	1053.57	31.680
22911.35	-33.11	1053.57	31.817
23011.40	-32.95	1053.57	31.979
23111.45	-32.75	1053.57	32.166
23211.50	-32.54	1053.57	32.380
23311.55	-32.30	1053.57	32.621
23411.60	-32.03	1053.57	32.891
23511.65	-31.74	1053.57	33.191
23611.70	-31.43	1053.57	33.523
23711.75	-31.09	1053.57	33.888
23811.80	-30.73	1053.57	34.289
23911.85	-30.34	1053.57	34.728
24011.90	-29.92	1053.57	35.208
24111.95	-29.49	1053.57	35.732
24212.00	-29.02	1053.57	36.303
24312.05	-28.53	1053.57	36.924
24412.10	-28.02	1053.57	37.602
24512.15	-27.48	1053.57	38.340
24612.20	-26.92	1053.57	39.144

<i>Cod. elab.:</i> 108GA201-GA01-Z-CL-002_C	<i>Titolo:</i> OPERE D'ARTE MAGGIORI- GALLERIE	<i>Data:</i> Ottobre 2011
<i>Nome file:</i> 108GA201-GA01-Z-CL -002_C.docx	ARTIFICIALI – GALLERIA ROVETELLO Relazione di calcolo	<i>Pagina</i> 279 di 452

PROGETTO ESECUTIVO

24712.25	-26.32	1053.57	40.022
24812.30	-25.71	1053.57	40.981
24912.35	-25.07	1053.57	42.030
25012.40	-24.40	1053.57	43.180
25112.45	-23.71	1053.57	44.443
25212.50	-22.99	1053.57	45.835
25312.55	-22.24	1053.57	47.372
25412.60	-21.47	1053.57	49.075
25512.65	-20.67	1053.57	50.971
25612.70	-19.84	1053.57	53.090
25712.75	-19.01	1053.57	55.418
25812.80	-18.19	1053.57	57.930
25912.85	-17.37	1053.57	60.647
26012.90	-16.57	1053.57	63.597
26112.95	-15.77	1053.57	66.810
26213.00	-14.98	1053.57	70.324
26313.05	-14.20	1053.57	74.181
26413.10	-13.43	1053.57	78.436
26513.15	-12.67	1053.57	83.153
26613.20	-11.92	1053.57	88.411
26713.25	-11.17	1053.57	94.309
26813.30	-10.43	1053.57	100.972
26913.35	-9.71	1053.57	108.558
27013.40	-8.98	1053.57	117.274
27113.45	-8.27	1053.57	127.392
27213.50	-7.56	1053.57	139.281
27313.55	-6.87	1053.57	153.450
27413.60	-6.17	1053.57	170.626
27513.65	-5.49	1053.57	191.878
27613.70	-4.81	1053.57	218.857
27713.75	-4.14	1053.57	254.237
27813.80	-3.48	1053.57	302.670
27913.85	-2.82	1053.57	373.018
28013.90	-2.17	1053.57	484.508
28113.95	-1.53	1053.57	688.173
28214.00	-0.89	1053.57	1178.922

Cod. elab.: 108GA201-GA01-Z-CL-002 C	Titolo: OPERE D'ARTE MAGGIORI- GALLERIE	Data: Ottobre 2011
Nome file: 108GA201-GA01-Z-CL -002_C.docx	ARTIFICIALI – GALLERIA ROVETELLO	Pagina 280 di 452
Relazione di calcolo		

PROGETTO ESECUTIVO

28314.05	-0.26	1053.57	4013.651
28414.10	0.36	1053.57	2904.819
28514.15	0.98	1053.57	1072.832
28614.20	1.60	1053.57	660.263
28714.25	2.20	1053.57	478.081
28814.30	2.81	1053.57	375.421
28914.35	3.40	1053.57	309.537
29014.40	4.00	1053.57	263.666
29114.45	4.58	1053.57	229.888
29214.50	5.17	1053.57	203.975
29314.55	5.74	1053.57	183.465
29414.60	6.32	1053.57	166.824
29514.65	6.88	1053.57	153.051
29614.70	7.45	1053.57	141.462
29714.75	8.01	1053.57	131.574
29814.80	8.56	1053.57	123.037
29914.85	9.11	1053.57	115.591
30014.90	9.66	1053.57	109.038
30114.95	10.21	1053.57	103.226
30215.00	10.75	1053.57	98.035
30315.05	11.28	1053.57	93.370
30415.10	11.82	1053.57	89.153
30515.15	12.35	1053.57	85.324
30615.20	12.88	1053.57	81.829
30715.25	13.40	1053.57	78.627
30815.30	13.92	1053.57	75.682
30915.35	14.44	1053.57	72.963
31015.40	14.96	1053.57	70.445
31115.45	15.47	1053.57	68.106
31215.50	15.98	1053.57	65.928
31315.55	16.49	1053.57	63.893
31415.60	17.00	1053.57	61.988
31515.65	17.50	1053.57	60.200
31615.70	18.00	1053.57	58.519
31715.75	18.50	1053.57	56.935
31815.80	19.00	1053.57	55.439

<i>Cod. elab.:</i> 108GA201-GA01-Z-CL-002_C	<i>Titolo:</i> OPERE D'ARTE MAGGIORI- GALLERIE	<i>Data:</i> Ottobre 2011
<i>Nome file:</i> 108GA201-GA01-Z-CL -002_C.docx	ARTIFICIALI – GALLERIA ROVETELLO	<i>Pagina</i> 281 di 452
Relazione di calcolo		

PROGETTO ESECUTIVO

31915.85	19.50	1053.57	54.024
32015.90	20.00	1053.57	52.684
32115.95	20.49	1053.57	51.413
32216.00	20.99	1053.57	50.204
32316.05	21.48	1053.57	49.054
32416.10	21.97	1053.57	47.957
32516.15	22.46	1053.57	46.911
32616.20	22.95	1053.57	45.912
32716.25	23.44	1053.57	44.955
32816.30	23.92	1053.57	44.039
32916.35	24.41	1053.57	43.161
33016.40	24.90	1053.57	42.319
33116.45	25.38	1053.57	41.509
33216.50	25.42	1053.57	41.453
33316.55	25.00	1053.57	42.145
33416.60	24.58	1053.57	42.862
33516.65	24.16	1053.57	43.603
33616.70	23.74	1053.57	44.371
33716.75	23.33	1053.57	45.167
33816.80	22.91	1053.57	45.992
33916.85	22.49	1053.57	46.848
34016.90	22.07	1053.57	47.735
34116.95	21.65	1053.57	48.657
34217.00	21.24	1053.57	49.614
34317.05	20.82	1053.57	50.608
34417.10	20.40	1053.57	51.642
34517.15	19.99	1053.57	52.717
34617.20	19.57	1053.57	53.837
34717.25	19.15	1053.57	55.003
34817.30	18.74	1053.57	56.218
34917.35	18.33	1053.57	57.486
35017.40	17.91	1053.57	58.810
35117.45	17.50	1053.57	60.192
35217.50	17.09	1053.57	61.638
35317.55	16.68	1053.57	63.150
35417.60	16.28	1053.57	64.734

<i>Cod. elab.:</i> 108GA201-GA01-Z-CL-002 C	<i>Titolo:</i> OPERE D'ARTE MAGGIORI- GALLERIE	<i>Data:</i> Ottobre 2011
<i>Nome file:</i> 108GA201-GA01-Z-CL -002_C.docx	ARTIFICIALI – GALLERIA ROVETELLO Relazione di calcolo	<i>Pagina</i> 282 di 452

PROGETTO ESECUTIVO

35517.65	15.87	1053.57	66.395
35617.70	15.46	1053.57	68.138
35717.75	15.06	1053.57	69.969
35817.80	14.65	1053.57	71.895
35917.85	14.25	1053.57	73.924
36017.90	13.85	1053.57	76.062
36117.95	13.45	1053.57	78.319
36218.00	13.05	1053.57	80.706
36318.05	12.66	1053.57	83.232
36418.10	12.26	1053.57	85.912
36518.15	11.87	1053.57	88.758
36618.20	11.48	1053.57	91.786
36718.25	11.09	1053.57	95.015
36818.30	10.70	1053.57	98.464
36918.35	10.31	1053.57	102.157
37018.40	9.93	1053.57	106.119
37118.45	9.54	1053.57	110.381
37218.50	9.16	1053.57	114.978
37318.55	8.78	1053.57	119.951
37418.60	8.41	1053.57	125.348
37518.65	8.03	1053.57	131.224
37618.70	7.65	1053.57	137.646
37718.75	7.28	1053.57	144.692
37818.80	6.91	1053.57	152.459
37918.85	6.54	1053.57	161.062
38018.90	6.17	1053.57	170.643
38118.95	5.81	1053.57	181.378
38219.00	5.45	1053.57	193.488
38319.05	5.08	1053.57	207.255
38419.10	4.72	1053.57	223.042
38519.15	4.37	1053.57	241.329
38619.20	4.01	1053.57	262.758
38719.25	3.66	1053.57	288.214
38819.30	3.30	1053.57	318.948
38919.35	2.95	1053.57	356.789
39019.40	2.60	1053.57	404.521

<i>Cod. elab.:</i> 108GA201-GA01-Z-CL-002_C	<i>Titolo:</i> OPERE D'ARTE MAGGIORI- GALLERIE	<i>Data:</i> Ottobre 2011
<i>Nome file:</i> 108GA201-GA01-Z-CL -002_C.docx	ARTIFICIALI – GALLERIA ROVETELLO Relazione di calcolo	<i>Pagina</i> 283 di 452

PROGETTO ESECUTIVO

39119.45	2.26	1053.57	466.602
39219.50	1.91	1053.57	550.641
39319.55	1.57	1053.57	670.784
39419.60	1.23	1053.57	856.650
39519.65	0.89	1053.57	1182.445
39619.70	0.55	1053.57	1901.527
39719.75	0.22	1053.57	4809.938
39819.80	-0.11	1053.57	9236.613
39919.85	-0.45	1053.57	2366.249
40019.90	-0.77	1053.57	1360.300
40119.95	-1.10	1053.57	956.178
40220.00	-1.43	1053.57	738.167

Fase n° 2 - [A1-M1]

n°	Y	T	T _R	CS _T
1	0.00	0.00	1053.57	1000.000
2	0.05	0.14	1053.57	7792.761
3	0.10	0.40	1053.57	2603.151
4	0.15	0.67	1053.57	1566.590
5	0.20	0.94	1053.57	1122.508
6	0.25	1.20	1053.57	875.849
7	0.30	1.47	1053.57	718.912
8	0.35	1.73	1053.57	610.282
9	0.40	1.99	1053.57	530.635
10	0.45	2.24	1053.57	469.740
11	0.50	2.76	1053.57	382.254
12	0.55	3.78	1053.57	278.749
13	0.60	5.05	1053.57	208.546
14	0.65	6.32	1053.57	166.821
15	0.70	7.57	1053.57	139.169
16	0.75	8.82	1053.57	119.500
17	0.80	10.05	1053.57	104.793
18	0.85	11.28	1053.57	93.382
19	0.90	12.50	1053.57	84.271
20	0.95	13.71	1053.57	76.829

Cod. elab.: 108GA201-GA01-Z-CL-002_C	Titolo: OPERE D'ARTE MAGGIORI- GALLERIE	Data: Ottobre 2011
Nome file: 108GA201-GA01-Z-CL -002_C.docx	ARTIFICIALI – GALLERIA ROVETELLO	Pagina 284 di 452
Relazione di calcolo		

PROGETTO ESECUTIVO

21	1.00	14.92	1053.57	70.636
22	1.05	16.11	1053.57	65.403
23	1.10	17.29	1053.57	60.922
24	1.15	18.47	1053.57	57.043
25	1.20	19.64	1053.57	53.653
26	1.25	20.80	1053.57	50.664
27	1.30	21.94	1053.57	48.010
28	1.35	23.09	1053.57	45.638
29	1.40	24.22	1053.57	43.505
30	1.45	25.34	1053.57	41.577
31	1.50	26.45	1053.57	39.826
32	1.55	27.56	1053.57	38.228
33	1.60	28.66	1053.57	36.766
34	1.65	29.74	1053.57	35.421
35	1.70	30.82	1053.57	34.182
36	1.75	31.89	1053.57	33.035
37	1.80	32.95	1053.57	31.972
38	1.85	34.00	1053.57	30.983
39	1.90	35.05	1053.57	30.061
40	1.95	36.08	1053.57	29.200
41	2.00	37.11	1053.57	28.393
42	2.05	38.12	1053.57	27.637
43	2.10	39.13	1053.57	26.926
44	2.15	40.13	1053.57	26.256
45	2.20	41.11	1053.57	25.625
46	2.25	42.09	1053.57	25.029
47	2.30	43.06	1053.57	24.466
48	2.35	44.02	1053.57	23.932
49	2.40	44.97	1053.57	23.426
50	2.45	45.92	1053.57	22.945
51	2.50	46.39	1053.57	22.713
52	2.50	-42.17	1053.57	24.981
53	2.55	-41.26	1053.57	25.537
54	2.60	-40.35	1053.57	26.112
55	2.65	-39.45	1053.57	26.708
56	2.70	-38.56	1053.57	27.324

<i>Cod. elab.:</i> 108GA201-GA01-Z-CL-002_C	<i>Titolo:</i> OPERE D'ARTE MAGGIORI- GALLERIE	<i>Data:</i> Ottobre 2011
<i>Nome file:</i> 108GA201-GA01-Z-CL -002_C.docx	ARTIFICIALI – GALLERIA ROVETELLO	<i>Pagina</i> 285 di 452
Relazione di calcolo		

PROGETTO ESECUTIVO

57	2.75	-37.68	1053.57	27.962
58	2.80	-36.81	1053.57	28.623
59	2.85	-35.95	1053.57	29.308
60	2.90	-35.10	1053.57	30.018
61	2.95	-34.26	1053.57	30.755
62	3.00	-33.43	1053.57	31.520
63	3.05	-32.60	1053.57	32.313
64	3.10	-31.79	1053.57	33.138
65	3.15	-30.99	1053.57	33.995
66	3.20	-30.20	1053.57	34.886
67	3.25	-29.42	1053.57	35.812
68	3.30	-28.65	1053.57	36.777
69	3.35	-27.89	1053.57	37.781
70	3.40	-27.13	1053.57	38.827
71	3.45	-26.39	1053.57	39.917
72	3.50	-25.66	1053.57	41.055
73	3.55	-24.94	1053.57	42.242
74	3.60	-24.23	1053.57	43.481
75	3.65	-23.53	1053.57	44.777
76	3.70	-22.84	1053.57	46.131
77	3.75	-22.16	1053.57	47.548
78	3.80	-21.49	1053.57	49.031
79	3.85	-20.83	1053.57	50.586
80	3.90	-20.18	1053.57	52.216
81	3.95	-19.54	1053.57	53.926
82	4.00	-18.91	1053.57	55.722
83	4.05	-18.29	1053.57	57.609
84	4.10	-17.68	1053.57	59.595
85	4.15	-17.08	1053.57	61.685
86	4.20	-16.49	1053.57	63.888
87	4.25	-15.91	1053.57	66.211
88	4.30	-15.34	1053.57	68.664
89	4.35	-14.79	1053.57	71.256
90	4.40	-14.24	1053.57	73.998
91	4.45	-13.70	1053.57	76.903
92	4.50	-13.17	1053.57	79.982

<i>Cod. elab.:</i> 108GA201-GA01-Z-CL-002_C	<i>Titolo:</i> OPERE D'ARTE MAGGIORI- GALLERIE	<i>Data:</i> Ottobre 2011
<i>Nome file:</i> 108GA201-GA01-Z-CL -002_C.docx	ARTIFICIALI – GALLERIA ROVETELLO Relazione di calcolo	<i>Pagina</i> 286 di 452

PROGETTO ESECUTIVO

93	4.55	-12.66	1053.57	83.251
94	4.60	-12.15	1053.57	86.726
95	4.65	-11.65	1053.57	90.424
96	4.70	-11.16	1053.57	94.365
97	4.75	-10.69	1053.57	98.571
98	4.80	-10.22	1053.57	103.066
99	4.85	-9.77	1053.57	107.878
100	4.90	-9.32	1053.57	113.038
101	4.95	-8.88	1053.57	118.579
102	5.00	-8.46	1053.57	124.542
103	5.05	-8.04	1053.57	130.970
104	5.10	-7.64	1053.57	137.913
105	5.15	-7.24	1053.57	145.430
106	5.20	-6.86	1053.57	153.585
107	5.25	-6.49	1053.57	162.454
108	5.30	-6.12	1053.57	172.124
109	5.35	-5.77	1053.57	182.696
110	5.40	-5.42	1053.57	194.289
111	5.45	-5.09	1053.57	207.039
112	5.50	-4.76	1053.57	221.110
113	5.55	-4.45	1053.57	236.695
114	5.60	-4.15	1053.57	254.023
115	5.65	-3.85	1053.57	273.371
116	5.70	-3.57	1053.57	295.074
117	5.75	-3.30	1053.57	319.541
118	5.80	-3.03	1053.57	347.278
119	5.85	-2.78	1053.57	378.913
120	5.90	-2.54	1053.57	415.240
121	5.95	-2.30	1053.57	457.273
122	6.00	-2.08	1053.57	506.324
123	6.05	-1.87	1053.57	564.125
124	6.10	-1.66	1053.57	632.998
125	6.15	-1.47	1053.57	716.135
126	6.20	-1.29	1053.57	818.028
127	6.25	-1.11	1053.57	945.203
128	6.30	-0.95	1053.57	1107.491

<i>Cod. elab.:</i> 108GA201-GA01-Z-CL-002_C	<i>Titolo:</i> OPERE D'ARTE MAGGIORI- GALLERIE	<i>Data:</i> Ottobre 2011
<i>Nome file:</i> 108GA201-GA01-Z-CL -002_C.docx	ARTIFICIALI – GALLERIA ROVETELLO Relazione di calcolo	<i>Pagina</i> 287 di 452

PROGETTO ESECUTIVO

1296.35	-0.80	1053.57	1320.405
1306.40	-0.65	1053.57	1609.870
1316.45	-0.52	1053.57	2022.629
1326.50	-0.40	1053.57	2652.199
1336.55	-0.28	1053.57	3716.417
1346.60	-0.18	1053.57	5865.531
1356.65	-0.09	1053.57	12304.922
1366.70	0.00	1053.57	710328.111
1376.75	0.07	1053.57	14470.779
1386.80	0.14	1053.57	7675.761
1396.85	0.19	1053.57	5490.601
1406.90	0.24	1053.57	4451.109
1416.95	0.27	1053.57	3877.590
1427.00	0.30	1053.57	3548.273
1437.05	0.31	1053.57	3372.916
1447.10	0.32	1053.57	3312.805
1457.15	0.31	1053.57	3355.962
1467.20	0.30	1053.57	3510.688
1477.25	0.28	1053.57	3809.935
1487.30	0.24	1053.57	4331.452
1497.35	0.20	1053.57	5261.813
1507.40	0.15	1053.57	7141.854
1517.45	0.09	1053.57	12377.242
1527.50	0.01	1053.57	80771.656
1537.55	-0.07	1053.57	15335.484
1547.60	-0.16	1053.57	6580.576
1557.65	-0.26	1053.57	4034.354
1567.70	-0.37	1053.57	2833.473
1577.75	-0.49	1053.57	2140.824
1587.80	-0.62	1053.57	1693.715
1597.85	-0.76	1053.57	1383.435
1607.90	-0.91	1053.57	1156.926
1617.95	-1.07	1053.57	985.249
1628.00	-1.24	1053.57	851.308
1638.05	-1.42	1053.57	744.368
1648.10	-1.60	1053.57	657.359

<i>Cod. elab.:</i> 108GA201-GA01-Z-CL-002_C	<i>Titolo:</i> OPERE D'ARTE MAGGIORI- GALLERIE	<i>Data:</i> Ottobre 2011
<i>Nome file:</i> 108GA201-GA01-Z-CL -002_C.docx	ARTIFICIALI – GALLERIA ROVETELLO	<i>Pagina</i> 288 di 452
Relazione di calcolo		

PROGETTO ESECUTIVO

1658.15	-1.80	1053.57	585.445
1668.20	-2.01	1053.57	525.209
1678.25	-2.22	1053.57	474.175
1688.30	-2.45	1053.57	430.503
1698.35	-2.68	1053.57	392.804
1708.40	-2.93	1053.57	360.006
1718.45	-3.18	1053.57	331.275
1728.50	-3.55	1053.57	296.517
1738.55	-4.05	1053.57	259.961
1748.60	-4.57	1053.57	230.555
1758.65	-5.10	1053.57	206.426
1768.70	-5.66	1053.57	186.300
1778.75	-6.22	1053.57	169.281
1788.80	-6.81	1053.57	154.720
1798.85	-7.41	1053.57	142.136
1808.90	-8.03	1053.57	131.165
1818.95	-8.67	1053.57	121.526
1829.00	-9.32	1053.57	113.000
1839.05	-9.99	1053.57	105.412
1849.10	-10.68	1053.57	98.621
1859.15	-11.39	1053.57	92.515
1869.20	-12.11	1053.57	86.998
1879.25	-12.83	1053.57	82.110
1889.30	-13.53	1053.57	77.852
1899.35	-14.22	1053.57	74.115
1909.40	-14.88	1053.57	70.812
1919.45	-15.52	1053.57	67.875
1929.50	-16.15	1053.57	65.250
1939.55	-16.75	1053.57	62.894
1949.60	-17.34	1053.57	60.770
1959.65	-17.90	1053.57	58.849
1969.70	-18.45	1053.57	57.106
1979.75	-18.98	1053.57	55.521
1989.80	-19.48	1053.57	54.075
1999.85	-19.97	1053.57	52.755
2009.90	-20.44	1053.57	51.548

<i>Cod. elab.:</i> 108GA201-GA01-Z-CL-002 C	<i>Titolo:</i> OPERE D'ARTE MAGGIORI- GALLERIE	<i>Data:</i> Ottobre 2011
<i>Nome file:</i> 108GA201-GA01-Z-CL -002_C.docx	ARTIFICIALI – GALLERIA ROVETELLO	<i>Pagina</i> 289 di 452
Relazione di calcolo		

PROGETTO ESECUTIVO

2019.95	-20.89	1053.57	50.443
20210.00	-21.31	1053.57	49.429
20310.05	-21.72	1053.57	48.500
20410.10	-22.11	1053.57	47.649
20510.15	-22.48	1053.57	46.868
20610.20	-22.83	1053.57	46.153
20710.25	-23.16	1053.57	45.499
20810.30	-23.46	1053.57	44.902
20910.35	-23.75	1053.57	44.359
21010.40	-24.02	1053.57	43.865
21110.45	-24.27	1053.57	43.419
21210.50	-24.49	1053.57	43.017
21310.55	-24.70	1053.57	42.659
21410.60	-24.88	1053.57	42.341
21510.65	-25.05	1053.57	42.063
21610.70	-25.19	1053.57	41.823
21710.75	-25.31	1053.57	41.620
21810.80	-25.42	1053.57	41.452
21910.85	-25.50	1053.57	41.321
22010.90	-25.56	1053.57	41.224
22110.95	-25.60	1053.57	41.162
22211.00	-25.61	1053.57	41.134
22311.05	-25.61	1053.57	41.140
22411.10	-25.58	1053.57	41.181
22511.15	-25.54	1053.57	41.257
22611.20	-25.47	1053.57	41.368
22711.25	-25.38	1053.57	41.516
22811.30	-25.27	1053.57	41.700
22911.35	-25.13	1053.57	41.923
23011.40	-24.97	1053.57	42.186
23111.45	-24.80	1053.57	42.490
23211.50	-24.59	1053.57	42.837
23311.55	-24.37	1053.57	43.230
23411.60	-24.13	1053.57	43.671
23511.65	-23.86	1053.57	44.163
23611.70	-23.56	1053.57	44.709

<i>Cod. elab.:</i> 108GA201-GA01-Z-CL-002_C	<i>Titolo:</i> OPERE D'ARTE MAGGIORI- GALLERIE	<i>Data:</i> Ottobre 2011
<i>Nome file:</i> 108GA201-GA01-Z-CL -002_C.docx	ARTIFICIALI – GALLERIA ROVETELLO Relazione di calcolo	<i>Pagina</i> 290 di 452

PROGETTO ESECUTIVO

23711.75	-23.25	1053.57	45.314
23811.80	-22.91	1053.57	45.981
23911.85	-22.55	1053.57	46.716
24011.90	-22.17	1053.57	47.526
24111.95	-21.76	1053.57	48.415
24212.00	-21.33	1053.57	49.393
24312.05	-20.88	1053.57	50.469
24412.10	-20.40	1053.57	51.653
24512.15	-19.89	1053.57	52.957
24612.20	-19.37	1053.57	54.397
24712.25	-18.82	1053.57	55.989
24812.30	-18.24	1053.57	57.755
24912.35	-17.64	1053.57	59.718
25012.40	-17.02	1053.57	61.909
25112.45	-16.37	1053.57	64.365
25212.50	-15.69	1053.57	67.130
25312.55	-15.00	1053.57	70.260
25412.60	-14.27	1053.57	73.828
25512.65	-13.52	1053.57	77.924
25612.70	-12.74	1053.57	82.666
25712.75	-11.96	1053.57	88.079
25812.80	-11.19	1053.57	94.164
25912.85	-10.43	1053.57	101.055
26012.90	-9.67	1053.57	108.922
26112.95	-8.93	1053.57	117.989
26213.00	-8.20	1053.57	128.550
26313.05	-7.47	1053.57	141.010
26413.10	-6.76	1053.57	155.928
26513.15	-6.05	1053.57	174.114
26613.20	-5.35	1053.57	196.772
26713.25	-4.67	1053.57	225.781
26813.30	-3.99	1053.57	264.247
26913.35	-3.32	1053.57	317.697
27013.40	-2.65	1053.57	396.999
27113.45	-2.00	1053.57	526.900
27213.50	-1.35	1053.57	778.517

<i>Cod. elab.:</i> 108GA201-GA01-Z-CL-002 C	<i>Titolo:</i> OPERE D'ARTE MAGGIORI- GALLERIE	<i>Data:</i> Ottobre 2011
<i>Nome file:</i> 108GA201-GA01-Z-CL -002_C.docx	ARTIFICIALI – GALLERIA ROVETELLO	<i>Pagina</i> 291 di 452
Relazione di calcolo		

PROGETTO ESECUTIVO

27313.55	-0.71	1053.57	1473.740
27413.60	-0.08	1053.57	12516.354
27513.65	0.54	1053.57	1954.611
27613.70	1.15	1053.57	912.304
27713.75	1.76	1053.57	597.441
27813.80	2.37	1053.57	445.474
27913.85	2.96	1053.57	355.966
28013.90	3.55	1053.57	296.970
28113.95	4.13	1053.57	255.154
28214.00	4.70	1053.57	223.965
28314.05	5.27	1053.57	199.807
28414.10	5.84	1053.57	180.541
28514.15	6.39	1053.57	164.816
28614.20	6.94	1053.57	151.737
28714.25	7.49	1053.57	140.686
28814.30	8.03	1053.57	131.225
28914.35	8.56	1053.57	123.032
29014.40	9.09	1053.57	115.867
29114.45	9.62	1053.57	109.548
29214.50	10.14	1053.57	103.932
29314.55	10.65	1053.57	98.907
29414.60	11.16	1053.57	94.384
29514.65	11.67	1053.57	90.291
29614.70	12.17	1053.57	86.568
29714.75	12.67	1053.57	83.166
29814.80	13.16	1053.57	80.046
29914.85	13.65	1053.57	77.173
30014.90	14.14	1053.57	74.518
30114.95	14.62	1053.57	72.057
30215.00	15.10	1053.57	69.768
30315.05	15.58	1053.57	67.635
30415.10	16.05	1053.57	65.641
30515.15	16.52	1053.57	63.772
30615.20	16.99	1053.57	62.017
30715.25	17.45	1053.57	60.366
30815.30	17.92	1053.57	58.808

Cod. elab.: 108GA201-GA01-Z-CL-002_C	Titolo: OPERE D'ARTE MAGGIORI- GALLERIE	Data: Ottobre 2011
Nome file: 108GA201-GA01-Z-CL -002_C.docx	ARTIFICIALI – GALLERIA ROVETELLO	Pagina 292 di 452
Relazione di calcolo		

PROGETTO ESECUTIVO

30915.35	18.38	1053.57	57.336
31015.40	18.83	1053.57	55.943
31115.45	19.29	1053.57	54.622
31215.50	19.74	1053.57	53.368
31315.55	20.19	1053.57	52.174
31415.60	20.64	1053.57	51.038
31515.65	21.09	1053.57	49.953
31615.70	21.54	1053.57	48.918
31715.75	21.98	1053.57	47.927
31815.80	22.43	1053.57	46.979
31915.85	22.87	1053.57	46.069
32015.90	23.31	1053.57	45.196
32115.95	23.75	1053.57	44.358
32216.00	24.19	1053.57	43.552
32316.05	24.63	1053.57	42.775
32416.10	25.07	1053.57	42.027
32516.15	25.51	1053.57	41.306
32616.20	25.94	1053.57	40.610
32716.25	26.38	1053.57	39.937
32816.30	26.82	1053.57	39.286
32916.35	27.25	1053.57	38.657
33016.40	27.69	1053.57	38.048
33116.45	28.13	1053.57	37.457
33216.50	28.10	1053.57	37.490
33316.55	27.62	1053.57	38.151
33416.60	27.13	1053.57	38.834
33516.65	26.64	1053.57	39.542
33616.70	26.16	1053.57	40.275
33716.75	25.68	1053.57	41.034
33816.80	25.19	1053.57	41.822
33916.85	24.71	1053.57	42.639
34016.90	24.23	1053.57	43.486
34116.95	23.75	1053.57	44.366
34217.00	23.27	1053.57	45.280
34317.05	22.79	1053.57	46.230
34417.10	22.31	1053.57	47.217

<i>Cod. elab.:</i> 108GA201-GA01-Z-CL-002_C	<i>Titolo:</i> OPERE D'ARTE MAGGIORI- GALLERIE	<i>Data:</i> Ottobre 2011
<i>Nome file:</i> 108GA201-GA01-Z-CL -002_C.docx	ARTIFICIALI – GALLERIA ROVETELLO Relazione di calcolo	<i>Pagina</i> 293 di 452

PROGETTO ESECUTIVO

34517.15	21.84	1053.57	48.245
34617.20	21.36	1053.57	49.315
34717.25	20.89	1053.57	50.429
34817.30	20.42	1053.57	51.592
34917.35	19.95	1053.57	52.804
35017.40	19.49	1053.57	54.070
35117.45	19.02	1053.57	55.392
35217.50	18.56	1053.57	56.776
35317.55	18.10	1053.57	58.223
35417.60	17.64	1053.57	59.740
35517.65	17.18	1053.57	61.331
35617.70	16.72	1053.57	63.000
35717.75	16.27	1053.57	64.755
35817.80	15.82	1053.57	66.600
35917.85	15.37	1053.57	68.544
36017.90	14.92	1053.57	70.594
36117.95	14.48	1053.57	72.758
36218.00	14.04	1053.57	75.047
36318.05	13.60	1053.57	77.471
36418.10	13.16	1053.57	80.041
36518.15	12.73	1053.57	82.772
36618.20	12.30	1053.57	85.679
36718.25	11.87	1053.57	88.778
36818.30	11.44	1053.57	92.089
36918.35	11.02	1053.57	95.634
37018.40	10.60	1053.57	99.438
37118.45	10.18	1053.57	103.531
37218.50	9.76	1053.57	107.946
37318.55	9.35	1053.57	112.721
37418.60	8.94	1053.57	117.904
37518.65	8.53	1053.57	123.546
37618.70	8.12	1053.57	129.712
37718.75	7.72	1053.57	136.478
37818.80	7.32	1053.57	143.933
37918.85	6.92	1053.57	152.190
38018.90	6.53	1053.57	161.383

<i>Cod. elab.:</i> 108GA201-GA01-Z-CL-002_C	<i>Titolo:</i> OPERE D'ARTE MAGGIORI- GALLERIE	<i>Data:</i> Ottobre 2011
<i>Nome file:</i> 108GA201-GA01-Z-CL -002_C.docx	ARTIFICIALI – GALLERIA ROVETELLO	<i>Pagina</i> 294 di 452
Relazione di calcolo		

PROGETTO ESECUTIVO

38118.95	6.14	1053.57	171.679
38219.00	5.75	1053.57	183.290
38319.05	5.36	1053.57	196.482
38419.10	4.98	1053.57	211.600
38519.15	4.60	1053.57	229.098
38619.20	4.22	1053.57	249.584
38719.25	3.85	1053.57	273.891
38819.30	3.47	1053.57	303.195
38919.35	3.11	1053.57	339.211
39019.40	2.74	1053.57	384.536
39119.45	2.38	1053.57	443.309
39219.50	2.02	1053.57	522.549
39319.55	1.66	1053.57	635.187
39419.60	1.30	1053.57	807.954
39519.65	0.95	1053.57	1106.484
39619.70	0.60	1053.57	1746.585
39719.75	0.26	1053.57	4097.627
39819.80	-0.09	1053.57	12233.455
39919.85	-0.43	1053.57	2470.271
40019.90	-0.76	1053.57	1378.990
40119.95	-1.10	1053.57	958.950
40220.00	-1.43	1053.57	736.524

Fase n° 3 - [A1-M1]

n°	Y	T	T _R	CS _T
1	0.00	0.00	1053.57	2649688.511
2	0.05	0.03	1053.57	41085.029
3	0.10	0.08	1053.57	13829.550
4	0.15	0.13	1053.57	8420.092
5	0.20	0.17	1053.57	6108.604
6	0.25	0.22	1053.57	4827.909
7	0.30	0.26	1053.57	4015.419
8	0.35	0.30	1053.57	3454.991
9	0.40	0.35	1053.57	3045.827
10	0.45	0.39	1053.57	2734.592

Cod. elab.: 108GA201-GA01-Z-CL-002_C	Titolo: OPERE D'ARTE MAGGIORI- GALLERIE	Data: Ottobre 2011
Nome file: 108GA201-GA01-Z-CL -002_C.docx	ARTIFICIALI – GALLERIA ROVETELLO	Pagina 295 di 452
Relazione di calcolo		

PROGETTO ESECUTIVO

11	0.50	0.46	1053.57	2288.170
12	0.55	0.61	1053.57	1739.788
13	0.60	0.78	1053.57	1350.648
14	0.65	0.95	1053.57	1113.156
15	0.70	1.10	1053.57	953.593
16	0.75	1.26	1053.57	839.389
17	0.80	1.40	1053.57	753.934
18	0.85	1.53	1053.57	687.868
19	0.90	1.66	1053.57	635.519
20	0.95	1.78	1053.57	593.253
21	1.00	1.89	1053.57	558.634
22	1.05	1.99	1053.57	529.971
23	1.10	2.08	1053.57	506.056
24	1.15	2.17	1053.57	486.005
25	1.20	2.25	1053.57	469.160
26	1.25	2.32	1053.57	455.022
27	1.30	2.38	1053.57	443.208
28	1.35	2.43	1053.57	433.425
29	1.40	2.48	1053.57	425.444
30	1.45	2.51	1053.57	419.092
31	1.50	2.54	1053.57	414.236
32	1.55	2.56	1053.57	410.779
33	1.60	2.58	1053.57	408.655
34	1.65	2.58	1053.57	407.822
35	1.70	2.58	1053.57	407.759
36	1.75	2.58	1053.57	407.793
37	1.80	2.58	1053.57	407.827
38	1.85	2.58	1053.57	407.861
39	1.90	2.58	1053.57	407.895
40	1.95	2.58	1053.57	407.929
41	2.00	2.58	1053.57	407.962
42	2.05	2.58	1053.57	407.996
43	2.10	2.58	1053.57	408.029
44	2.15	2.58	1053.57	408.062
45	2.20	2.58	1053.57	408.095
46	2.25	2.58	1053.57	408.128

<i>Cod. elab.:</i> 108GA201-GA01-Z-CL-002_C	<i>Titolo:</i> OPERE D'ARTE MAGGIORI- GALLERIE	<i>Data:</i> Ottobre 2011
<i>Nome file:</i> 108GA201-GA01-Z-CL -002_C.docx	ARTIFICIALI – GALLERIA ROVETELLO Relazione di calcolo	<i>Pagina</i> 296 di 452

PROGETTO ESECUTIVO

47	2.30	2.58	1053.57	408.160
48	2.35	2.58	1053.57	408.193
49	2.40	2.58	1053.57	408.225
50	2.45	2.58	1053.57	408.257
51	2.50	2.58	1053.57	408.257
52	2.50	-91.40	1053.57	11.527
53	2.55	-91.40	1053.57	11.527
54	2.60	-91.40	1053.57	11.527
55	2.65	-91.40	1053.57	11.527
56	2.70	-91.40	1053.57	11.527
57	2.75	-91.40	1053.57	11.527
58	2.80	-91.40	1053.57	11.527
59	2.85	-91.40	1053.57	11.527
60	2.90	-91.40	1053.57	11.527
61	2.95	-91.40	1053.57	11.526
62	3.00	-91.40	1053.57	11.526
63	3.05	-90.95	1053.57	11.584
64	3.10	-89.58	1053.57	11.761
65	3.15	-87.62	1053.57	12.024
66	3.20	-85.39	1053.57	12.339
67	3.25	-82.87	1053.57	12.714
68	3.30	-80.07	1053.57	13.158
69	3.35	-77.11	1053.57	13.663
70	3.40	-74.11	1053.57	14.217
71	3.45	-71.06	1053.57	14.827
72	3.50	-67.97	1053.57	15.501
73	3.55	-64.84	1053.57	16.250
74	3.60	-61.66	1053.57	17.086
75	3.65	-58.45	1053.57	18.025
76	3.70	-55.20	1053.57	19.088
77	3.75	-51.90	1053.57	20.298
78	3.80	-48.57	1053.57	21.690
79	3.85	-45.20	1053.57	23.309
80	3.90	-41.78	1053.57	25.216
81	3.95	-38.32	1053.57	27.493
82	4.00	-34.82	1053.57	30.254

<i>Cod. elab.:</i> 108GA201-GA01-Z-CL-002_C	<i>Titolo:</i> OPERE D'ARTE MAGGIORI- GALLERIE	<i>Data:</i> Ottobre 2011
<i>Nome file:</i> 108GA201-GA01-Z-CL -002_C.docx	ARTIFICIALI – GALLERIA ROVETELLO Relazione di calcolo	<i>Pagina</i> 297 di 452

PROGETTO ESECUTIVO

83	4.05	-31.29	1053.57	33.672
84	4.10	-27.72	1053.57	38.012
85	4.15	-24.11	1053.57	43.703
86	4.20	-20.46	1053.57	51.488
87	4.25	-16.78	1053.57	62.799
88	4.30	-13.05	1053.57	80.757
89	4.35	-9.28	1053.57	113.589
90	4.40	-5.47	1053.57	192.622
91	4.45	-1.63	1053.57	646.778
92	4.50	2.25	1053.57	468.941
93	4.55	6.33	1053.57	166.543
94	4.60	10.78	1053.57	97.751
95	4.65	15.60	1053.57	67.530
96	4.70	20.79	1053.57	50.665
97	4.75	26.20	1053.57	40.215
98	4.80	31.65	1053.57	33.287
99	4.85	37.15	1053.57	28.357
100	4.90	42.71	1053.57	24.670
101	4.95	48.31	1053.57	21.809
102	5.00	53.96	1053.57	19.525
103	5.05	54.46	1053.57	19.345
104	5.10	54.81	1053.57	19.222
105	5.15	55.00	1053.57	19.154
106	5.20	54.97	1053.57	19.167
107	5.25	54.79	1053.57	19.230
108	5.30	54.47	1053.57	19.344
109	5.35	54.00	1053.57	19.510
110	5.40	53.50	1053.57	19.694
111	5.45	52.99	1053.57	19.883
112	5.50	52.48	1053.57	20.077
113	5.55	51.96	1053.57	20.276
114	5.60	51.44	1053.57	20.480
115	5.65	50.92	1053.57	20.690
116	5.70	50.40	1053.57	20.906
117	5.75	49.87	1053.57	21.127
118	5.80	49.34	1053.57	21.355

<i>Cod. elab.:</i> 108GA201-GA01-Z-CL-002_C	<i>Titolo:</i> OPERE D'ARTE MAGGIORI- GALLERIE	<i>Data:</i> Ottobre 2011
<i>Nome file:</i> 108GA201-GA01-Z-CL -002_C.docx	ARTIFICIALI – GALLERIA ROVETELLO Relazione di calcolo	<i>Pagina</i> 298 di 452

PROGETTO ESECUTIVO

1195.85	48.80	1053.57	21.589
1205.90	48.26	1053.57	21.830
1215.95	47.72	1053.57	22.078
1226.00	47.18	1053.57	22.332
1236.05	46.63	1053.57	22.594
1246.10	46.08	1053.57	22.864
1256.15	45.53	1053.57	23.142
1266.20	44.97	1053.57	23.428
1276.25	44.41	1053.57	23.722
1286.30	43.85	1053.57	24.026
1296.35	43.29	1053.57	24.339
1306.40	42.72	1053.57	24.662
1316.45	42.15	1053.57	24.995
1326.50	41.58	1053.57	25.339
1336.55	41.00	1053.57	25.694
1346.60	40.43	1053.57	26.061
1356.65	39.85	1053.57	26.440
1366.70	39.27	1053.57	26.832
1376.75	38.68	1053.57	27.238
1386.80	38.09	1053.57	27.658
1396.85	37.50	1053.57	28.093
1406.90	36.91	1053.57	28.543
1416.95	36.32	1053.57	29.011
1427.00	35.72	1053.57	29.496
1437.05	35.12	1053.57	29.999
1447.10	34.52	1053.57	30.523
1457.15	33.91	1053.57	31.067
1467.20	33.31	1053.57	31.633
1477.25	32.70	1053.57	32.222
1487.30	32.09	1053.57	32.837
1497.35	31.47	1053.57	33.477
1507.40	30.85	1053.57	34.146
1517.45	30.24	1053.57	34.846
1527.50	29.61	1053.57	35.577
1537.55	28.99	1053.57	36.342
1547.60	28.36	1053.57	37.145

<i>Cod. elab.:</i> 108GA201-GA01-Z-CL-002_C	<i>Titolo:</i> OPERE D'ARTE MAGGIORI- GALLERIE	<i>Data:</i> Ottobre 2011
<i>Nome file:</i> 108GA201-GA01-Z-CL -002_C.docx	ARTIFICIALI – GALLERIA ROVETELLO Relazione di calcolo	<i>Pagina</i> 299 di 452

PROGETTO ESECUTIVO

1557.65	27.73	1053.57	37.987
1567.70	27.10	1053.57	38.872
1577.75	26.47	1053.57	39.803
1587.80	25.83	1053.57	40.783
1597.85	25.19	1053.57	41.817
1607.90	24.55	1053.57	42.909
1617.95	23.91	1053.57	44.065
1628.00	23.26	1053.57	45.290
1638.05	22.61	1053.57	46.589
1648.10	21.96	1053.57	47.972
1658.15	21.31	1053.57	49.445
1668.20	20.65	1053.57	51.018
1678.25	19.99	1053.57	52.701
1688.30	19.33	1053.57	54.507
1698.35	18.66	1053.57	56.449
1708.40	18.00	1053.57	58.543
1718.45	17.33	1053.57	60.809
1728.50	16.37	1053.57	64.350
1738.55	15.13	1053.57	69.619
1748.60	13.89	1053.57	75.855
1758.65	12.64	1053.57	83.354
1768.70	11.38	1053.57	92.541
1778.75	10.12	1053.57	104.060
1788.80	8.86	1053.57	118.928
1798.85	7.59	1053.57	138.853
1808.90	6.31	1053.57	166.948
1818.95	5.03	1053.57	209.530
1829.00	3.74	1053.57	281.703
1839.05	2.45	1053.57	430.734
1849.10	1.15	1053.57	919.246
1859.15	-0.16	1053.57	6599.501
1869.20	-1.47	1053.57	716.043
1879.25	-2.77	1053.57	380.203
1889.30	-4.04	1053.57	260.737
1899.35	-5.28	1053.57	199.524
1909.40	-6.49	1053.57	162.333

<i>Cod. elab.:</i> 108GA201-GA01-Z-CL-002_C	<i>Titolo:</i> OPERE D'ARTE MAGGIORI- GALLERIE	<i>Data:</i> Ottobre 2011
<i>Nome file:</i> 108GA201-GA01-Z-CL -002_C.docx	ARTIFICIALI – GALLERIA ROVETELLO Relazione di calcolo	<i>Pagina</i> 300 di 452

PROGETTO ESECUTIVO

1919.45	-7.67	1053.57	137.361
1929.50	-8.82	1053.57	119.449
1939.55	-9.94	1053.57	105.987
1949.60	-11.03	1053.57	95.507
1959.65	-12.09	1053.57	87.127
1969.70	-13.12	1053.57	80.278
1979.75	-14.13	1053.57	74.584
1989.80	-15.10	1053.57	69.779
1999.85	-16.04	1053.57	65.677
2009.90	-16.96	1053.57	62.137
2019.95	-17.84	1053.57	59.056
20210.00	-18.70	1053.57	56.354
20310.05	-19.52	1053.57	53.969
20410.10	-20.32	1053.57	51.852
20510.15	-21.09	1053.57	49.964
20610.20	-21.83	1053.57	48.272
20710.25	-22.54	1053.57	46.752
20810.30	-23.22	1053.57	45.380
20910.35	-23.87	1053.57	44.141
21010.40	-24.49	1053.57	43.018
21110.45	-25.09	1053.57	41.999
21210.50	-25.65	1053.57	41.073
21310.55	-26.19	1053.57	40.232
21410.60	-26.70	1053.57	39.466
21510.65	-27.17	1053.57	38.770
21610.70	-27.62	1053.57	38.138
21710.75	-28.05	1053.57	37.565
21810.80	-28.44	1053.57	37.046
21910.85	-28.80	1053.57	36.577
22010.90	-29.14	1053.57	36.156
22110.95	-29.45	1053.57	35.779
22211.00	-29.73	1053.57	35.443
22311.05	-29.98	1053.57	35.148
22411.10	-30.20	1053.57	34.890
22511.15	-30.39	1053.57	34.669
22611.20	-30.55	1053.57	34.483

<i>Cod. elab.:</i> 108GA201-GA01-Z-CL-002_C	<i>Titolo:</i> OPERE D'ARTE MAGGIORI- GALLERIE	<i>Data:</i> Ottobre 2011
<i>Nome file:</i> 108GA201-GA01-Z-CL -002_C.docx	ARTIFICIALI – GALLERIA ROVETELLO Relazione di calcolo	<i>Pagina</i> 301 di 452

PROGETTO ESECUTIVO

22711.25	-30.69	1053.57	34.331
22811.30	-30.80	1053.57	34.212
22911.35	-30.87	1053.57	34.125
23011.40	-30.92	1053.57	34.071
23111.45	-30.94	1053.57	34.048
23211.50	-30.94	1053.57	34.056
23311.55	-30.90	1053.57	34.096
23411.60	-30.83	1053.57	34.168
23511.65	-30.74	1053.57	34.272
23611.70	-30.62	1053.57	34.410
23711.75	-30.47	1053.57	34.581
23811.80	-30.29	1053.57	34.786
23911.85	-30.08	1053.57	35.028
24011.90	-29.84	1053.57	35.307
24111.95	-29.57	1053.57	35.626
24212.00	-29.28	1053.57	35.985
24312.05	-28.95	1053.57	36.389
24412.10	-28.60	1053.57	36.839
24512.15	-28.22	1053.57	37.339
24612.20	-27.80	1053.57	37.892
24712.25	-27.36	1053.57	38.503
24812.30	-26.89	1053.57	39.177
24912.35	-26.39	1053.57	39.918
25012.40	-25.86	1053.57	40.735
25112.45	-25.31	1053.57	41.634
25212.50	-24.72	1053.57	42.624
25312.55	-24.10	1053.57	43.716
25412.60	-23.45	1053.57	44.923
25512.65	-22.78	1053.57	46.258
25612.70	-22.07	1053.57	47.739
25712.75	-21.35	1053.57	49.345
25812.80	-20.64	1053.57	51.047
25912.85	-19.93	1053.57	52.855
26012.90	-19.23	1053.57	54.778
26112.95	-18.54	1053.57	56.828
26213.00	-17.85	1053.57	59.019

<i>Cod. elab.:</i> 108GA201-GA01-Z-CL-002 C	<i>Titolo:</i> OPERE D'ARTE MAGGIORI- GALLERIE	<i>Data:</i> Ottobre 2011
<i>Nome file:</i> 108GA201-GA01-Z-CL -002_C.docx	ARTIFICIALI – GALLERIA ROVETELLO	<i>Pagina</i> 302 di 452
Relazione di calcolo		

PROGETTO ESECUTIVO

26313.05	-17.17	1053.57	61.363
26413.10	-16.49	1053.57	63.880
26513.15	-15.82	1053.57	66.588
26613.20	-15.16	1053.57	69.510
26713.25	-14.50	1053.57	72.673
26813.30	-13.84	1053.57	76.107
26913.35	-13.19	1053.57	79.851
27013.40	-12.55	1053.57	83.946
27113.45	-11.91	1053.57	88.447
27213.50	-11.28	1053.57	93.416
27313.55	-10.65	1053.57	98.930
27413.60	-10.03	1053.57	105.085
27513.65	-9.41	1053.57	112.001
27613.70	-8.79	1053.57	119.827
27713.75	-8.18	1053.57	128.758
27813.80	-7.58	1053.57	139.045
27913.85	-6.98	1053.57	151.025
28013.90	-6.38	1053.57	165.153
28113.95	-5.79	1053.57	182.066
28214.00	-5.20	1053.57	202.680
28314.05	-4.61	1053.57	228.362
28414.10	-4.03	1053.57	261.247
28514.15	-3.46	1053.57	304.864
28614.20	-2.88	1053.57	365.499
28714.25	-2.31	1053.57	455.542
28814.30	-1.75	1053.57	603.257
28914.35	-1.18	1053.57	890.208
29014.40	-0.62	1053.57	1688.950
29114.45	-0.07	1053.57	15667.812
29214.50	0.49	1053.57	2166.660
29314.55	1.04	1053.57	1016.149
29414.60	1.58	1053.57	664.905
29514.65	2.13	1053.57	494.747
29614.70	2.67	1053.57	394.324
29714.75	3.21	1053.57	328.050
29814.80	3.75	1053.57	281.030

<i>Cod. elab.:</i> 108GA201-GA01-Z-CL-002_C	<i>Titolo:</i> OPERE D'ARTE MAGGIORI- GALLERIE	<i>Data:</i> Ottobre 2011
<i>Nome file:</i> 108GA201-GA01-Z-CL -002_C.docx	ARTIFICIALI – GALLERIA ROVETELLO Relazione di calcolo	<i>Pagina</i> 303 di 452

PROGETTO ESECUTIVO

29914.85	4.28	1053.57	245.934
30014.90	4.82	1053.57	218.733
30114.95	5.35	1053.57	197.028
30215.00	5.88	1053.57	179.305
30315.05	6.40	1053.57	164.557
30415.10	6.93	1053.57	152.092
30515.15	7.45	1053.57	141.415
30615.20	7.97	1053.57	132.167
30715.25	8.49	1053.57	124.076
30815.30	9.01	1053.57	116.939
30915.35	9.53	1053.57	110.593
31015.40	10.04	1053.57	104.915
31115.45	10.56	1053.57	99.802
31215.50	11.07	1053.57	95.174
31315.55	11.58	1053.57	90.964
31415.60	12.09	1053.57	87.118
31515.65	12.60	1053.57	83.589
31615.70	13.11	1053.57	80.339
31715.75	13.62	1053.57	77.337
31815.80	14.13	1053.57	74.553
31915.85	14.64	1053.57	71.966
32015.90	15.15	1053.57	69.554
32115.95	15.65	1053.57	67.300
32216.00	16.16	1053.57	65.189
32316.05	16.67	1053.57	63.206
32416.10	17.18	1053.57	61.341
32516.15	17.68	1053.57	59.584
32616.20	18.19	1053.57	57.923
32716.25	18.70	1053.57	56.353
32816.30	19.20	1053.57	54.865
32916.35	19.71	1053.57	53.453
33016.40	20.22	1053.57	52.111
33116.45	20.73	1053.57	50.833
33216.50	20.79	1053.57	50.680
33316.55	20.41	1053.57	51.630
33416.60	20.02	1053.57	52.614

<i>Cod. elab.:</i> 108GA201-GA01-Z-CL-002_C	<i>Titolo:</i> OPERE D'ARTE MAGGIORI- GALLERIE	<i>Data:</i> Ottobre 2011
<i>Nome file:</i> 108GA201-GA01-Z-CL -002_C.docx	ARTIFICIALI – GALLERIA ROVETELLO Relazione di calcolo	<i>Pagina</i> 304 di 452

PROGETTO ESECUTIVO

33516.65	19.64	1053.57	53.633
33616.70	19.26	1053.57	54.691
33716.75	18.89	1053.57	55.787
33816.80	18.51	1053.57	56.925
33916.85	18.13	1053.57	58.107
34016.90	17.76	1053.57	59.334
34116.95	17.38	1053.57	60.610
34217.00	17.01	1053.57	61.937
34317.05	16.64	1053.57	63.318
34417.10	16.27	1053.57	64.755
34517.15	15.90	1053.57	66.253
34617.20	15.54	1053.57	67.814
34717.25	15.17	1053.57	69.444
34817.30	14.81	1053.57	71.145
34917.35	14.45	1053.57	72.922
35017.40	14.09	1053.57	74.781
35117.45	13.73	1053.57	76.727
35217.50	13.38	1053.57	78.765
35317.55	13.02	1053.57	80.902
35417.60	12.67	1053.57	83.145
35517.65	12.32	1053.57	85.502
35617.70	11.97	1053.57	87.981
35717.75	11.63	1053.57	90.592
35817.80	11.29	1053.57	93.345
35917.85	10.95	1053.57	96.251
36017.90	10.61	1053.57	99.322
36117.95	10.27	1053.57	102.574
36218.00	9.94	1053.57	106.022
36318.05	9.61	1053.57	109.684
36418.10	9.28	1053.57	113.579
36518.15	8.95	1053.57	117.730
36618.20	8.62	1053.57	122.162
36718.25	8.30	1053.57	126.905
36818.30	7.98	1053.57	131.991
36918.35	7.66	1053.57	137.457
37018.40	7.35	1053.57	143.349

<i>Cod. elab.:</i> 108GA201-GA01-Z-CL-002_C	<i>Titolo:</i> OPERE D'ARTE MAGGIORI- GALLERIE	<i>Data:</i> Ottobre 2011
<i>Nome file:</i> 108GA201-GA01-Z-CL -002_C.docx	ARTIFICIALI – GALLERIA ROVETELLO	<i>Pagina</i> 305 di 452
Relazione di calcolo		

PROGETTO ESECUTIVO

37118.45	7.04	1053.57	149.716
37218.50	6.73	1053.57	156.617
37318.55	6.42	1053.57	164.121
37418.60	6.11	1053.57	172.310
37518.65	5.81	1053.57	181.281
37618.70	5.51	1053.57	191.149
37718.75	5.21	1053.57	202.055
37818.80	4.92	1053.57	214.170
37918.85	4.63	1053.57	227.705
38018.90	4.34	1053.57	242.921
38118.95	4.05	1053.57	260.152
38219.00	3.77	1053.57	279.822
38319.05	3.48	1053.57	302.484
38419.10	3.20	1053.57	328.875
38519.15	2.93	1053.57	359.991
38619.20	2.65	1053.57	397.221
38719.25	2.38	1053.57	442.554
38819.30	2.11	1053.57	498.951
38919.35	1.85	1053.57	571.012
39019.40	1.58	1053.57	666.299
39119.45	1.32	1053.57	798.172
39219.50	1.06	1053.57	992.671
39319.55	0.81	1053.57	1308.235
39419.60	0.55	1053.57	1908.828
39519.65	0.30	1053.57	3498.183
39619.70	0.05	1053.57	19867.896
39719.75	-0.19	1053.57	5473.203
39819.80	-0.44	1053.57	2419.787
39919.85	-0.68	1053.57	1559.282
40019.90	-0.91	1053.57	1153.546
40119.95	-1.15	1053.57	917.454
40220.00	-1.38	1053.57	763.030

Fase n° 4 - [A1-M1]

n°	Y	T	T _R	CS _T
1	0.00	0.00	1053.57	1000.000

Cod. elab.: 108GA201-GA01-Z-CL-002_C	Titolo: OPERE D'ARTE MAGGIORI- GALLERIE	Data: Ottobre 2011
Nome file: 108GA201-GA01-Z-CL -002_C.docx	ARTIFICIALI – GALLERIA ROVETELLO	Pagina 306 di 452
Relazione di calcolo		

PROGETTO ESECUTIVO

2	0.05	0.08	1053.57	12878.208
3	0.10	0.24	1053.57	4302.808
4	0.15	0.41	1053.57	2590.206
5	0.20	0.57	1053.57	1856.525
6	0.25	0.73	1053.57	1449.025
7	0.30	0.89	1053.57	1189.761
8	0.35	1.04	1053.57	1010.306
9	0.40	1.20	1053.57	878.735
10	0.45	1.35	1053.57	778.144
11	0.50	1.66	1053.57	633.617
12	0.55	2.28	1053.57	462.470
13	0.60	3.04	1053.57	346.264
14	0.65	3.80	1053.57	277.153
15	0.70	4.55	1053.57	231.334
16	0.75	5.30	1053.57	198.733
17	0.80	6.04	1053.57	174.353
18	0.85	6.78	1053.57	155.434
19	0.90	7.51	1053.57	140.328
20	0.95	8.23	1053.57	127.989
21	1.00	8.95	1053.57	117.720
22	1.05	9.66	1053.57	109.043
23	1.10	10.37	1053.57	101.614
24	1.15	11.07	1053.57	95.182
25	1.20	11.76	1053.57	89.561
26	1.25	12.45	1053.57	84.606
27	1.30	13.14	1053.57	80.207
28	1.35	13.81	1053.57	76.274
29	1.40	14.48	1053.57	72.739
30	1.45	15.15	1053.57	69.544
31	1.50	15.81	1053.57	66.642
32	1.55	16.46	1053.57	63.996
33	1.60	17.11	1053.57	61.573
34	1.65	17.75	1053.57	59.346
35	1.70	18.39	1053.57	57.283
36	1.75	19.03	1053.57	55.353
37	1.80	19.68	1053.57	53.544

<i>Cod. elab.:</i> 108GA201-GA01-Z-CL-002_C	<i>Titolo:</i> OPERE D'ARTE MAGGIORI- GALLERIE	<i>Data:</i> Ottobre 2011
<i>Nome file:</i> 108GA201-GA01-Z-CL -002_C.docx	ARTIFICIALI – GALLERIA ROVETELLO Relazione di calcolo	<i>Pagina</i> 307 di 452

PROGETTO ESECUTIVO

38	1.85	20.32	1053.57	51.844
39	1.90	20.97	1053.57	50.243
40	1.95	21.62	1053.57	48.733
41	2.00	22.27	1053.57	47.307
42	2.05	22.92	1053.57	45.958
43	2.10	23.58	1053.57	44.680
44	2.15	24.24	1053.57	43.467
45	2.20	24.90	1053.57	42.315
46	2.25	25.56	1053.57	41.219
47	2.30	26.22	1053.57	40.176
48	2.35	26.89	1053.57	39.181
49	2.40	27.56	1053.57	38.231
50	2.45	28.23	1053.57	37.324
51	2.50	28.90	1053.57	36.456
52	2.50	-61.91	1053.57	17.019
53	2.55	-61.23	1053.57	17.206
54	2.60	-60.56	1053.57	17.398
55	2.65	-59.88	1053.57	17.595
56	2.70	-59.20	1053.57	17.796
57	2.75	-58.52	1053.57	18.003
58	2.80	-57.84	1053.57	18.216
59	2.85	-57.15	1053.57	18.434
60	2.90	-56.47	1053.57	18.658
61	2.95	-55.78	1053.57	18.888
62	3.00	-55.09	1053.57	19.124
63	3.05	-53.94	1053.57	19.531
64	3.10	-51.89	1053.57	20.305
65	3.15	-49.23	1053.57	21.400
66	3.20	-46.30	1053.57	22.756
67	3.25	-43.08	1053.57	24.454
68	3.30	-39.59	1053.57	26.613
69	3.35	-35.93	1053.57	29.323
70	3.40	-32.22	1053.57	32.695
71	3.45	-28.47	1053.57	37.003
72	3.50	-24.68	1053.57	42.691
73	3.55	-20.84	1053.57	50.548

<i>Cod. elab.:</i> 108GA201-GA01-Z-CL-002_C	<i>Titolo:</i> OPERE D'ARTE MAGGIORI- GALLERIE	<i>Data:</i> Ottobre 2011
<i>Nome file:</i> 108GA201-GA01-Z-CL -002_C.docx	ARTIFICIALI – GALLERIA ROVETELLO Relazione di calcolo	<i>Pagina</i> 308 di 452

PROGETTO ESECUTIVO

74	3.60	-16.96	1053.57	62.104
75	3.65	-13.04	1053.57	80.764
76	3.70	-9.09	1053.57	115.965
77	3.75	-5.09	1053.57	207.176
78	3.80	-1.05	1053.57	1007.841
79	3.85	3.04	1053.57	346.865
80	3.90	7.17	1053.57	147.032
81	3.95	11.34	1053.57	92.943
82	4.00	15.54	1053.57	67.779
83	4.05	19.79	1053.57	53.235
84	4.10	24.07	1053.57	43.762
85	4.15	28.40	1053.57	37.103
86	4.20	32.75	1053.57	32.168
87	4.25	37.15	1053.57	28.360
88	4.30	41.59	1053.57	25.330
89	4.35	46.08	1053.57	22.866
90	4.40	50.59	1053.57	20.824
91	4.45	55.14	1053.57	19.105
92	4.50	59.73	1053.57	17.638
93	4.55	64.52	1053.57	16.329
94	4.60	69.68	1053.57	15.120
95	4.65	75.21	1053.57	14.007
96	4.70	81.12	1053.57	12.988
97	4.75	87.23	1053.57	12.079
98	4.80	93.39	1053.57	11.282
99	4.85	99.59	1053.57	10.579
100	4.90	105.85	1053.57	9.954
101	4.95	112.15	1053.57	9.394
102	5.00	118.50	1053.57	8.891
103	5.00	-14.68	1053.57	71.754
104	5.05	-12.78	1053.57	82.415
105	5.10	-11.04	1053.57	95.410
106	5.15	-9.46	1053.57	111.370
107	5.20	-8.46	1053.57	124.539
108	5.25	-7.95	1053.57	132.517
109	5.30	-7.59	1053.57	138.891

<i>Cod. elab.:</i> 108GA201-GA01-Z-CL-002_C	<i>Titolo:</i> OPERE D'ARTE MAGGIORI- GALLERIE	<i>Data:</i> Ottobre 2011
<i>Nome file:</i> 108GA201-GA01-Z-CL -002_C.docx	ARTIFICIALI – GALLERIA ROVETELLO Relazione di calcolo	<i>Pagina</i> 309 di 452

PROGETTO ESECUTIVO

1105.35	-7.37	1053.57	143.039
1115.40	-7.19	1053.57	146.560
1125.45	-7.02	1053.57	150.121
1135.50	-6.85	1053.57	153.715
1145.55	-6.70	1053.57	157.331
1155.60	-6.55	1053.57	160.961
1165.65	-6.40	1053.57	164.594
1175.70	-6.26	1053.57	168.216
1185.75	-6.13	1053.57	171.816
1195.80	-6.01	1053.57	175.378
1205.85	-5.89	1053.57	178.887
1215.90	-5.78	1053.57	182.327
1225.95	-5.67	1053.57	185.680
1236.00	-5.58	1053.57	188.929
1246.05	-5.49	1053.57	192.054
1256.10	-5.40	1053.57	195.036
1266.15	-5.32	1053.57	197.856
1276.20	-5.25	1053.57	200.495
1286.25	-5.19	1053.57	202.933
1296.30	-5.14	1053.57	205.151
1306.35	-5.09	1053.57	207.134
1316.40	-5.04	1053.57	208.863
1326.45	-5.01	1053.57	210.324
1336.50	-4.98	1053.57	211.504
1346.55	-4.96	1053.57	212.392
1356.60	-4.95	1053.57	212.979
1366.65	-4.94	1053.57	213.260
1376.70	-4.94	1053.57	213.229
1386.75	-4.95	1053.57	212.887
1396.80	-4.96	1053.57	212.234
1406.85	-4.99	1053.57	211.277
1416.90	-5.02	1053.57	210.021
1426.95	-5.05	1053.57	208.476
1437.00	-5.10	1053.57	206.655
1447.05	-5.15	1053.57	204.572
1457.10	-5.21	1053.57	202.241

<i>Cod. elab.:</i> 108GA201-GA01-Z-CL-002_C	<i>Titolo:</i> OPERE D'ARTE MAGGIORI- GALLERIE	<i>Data:</i> Ottobre 2011
<i>Nome file:</i> 108GA201-GA01-Z-CL -002_C.docx	ARTIFICIALI – GALLERIA ROVETELLO Relazione di calcolo	<i>Pagina</i> 310 di 452

PROGETTO ESECUTIVO

1467.15	-5.28	1053.57	199.680
1477.20	-5.35	1053.57	196.908
1487.25	-5.43	1053.57	193.944
1497.30	-5.52	1053.57	190.807
1507.35	-5.62	1053.57	187.518
1517.40	-5.72	1053.57	184.096
1527.45	-5.83	1053.57	180.561
1537.50	-5.95	1053.57	176.933
1547.55	-6.08	1053.57	173.230
1557.60	-6.22	1053.57	169.469
1567.65	-6.36	1053.57	165.667
1577.70	-6.51	1053.57	161.840
1587.75	-6.67	1053.57	158.002
1597.80	-6.83	1053.57	154.166
1607.85	-7.01	1053.57	150.345
1617.90	-7.19	1053.57	146.550
1627.95	-7.38	1053.57	142.790
1638.00	-7.58	1053.57	139.074
1648.05	-7.78	1053.57	135.409
1658.10	-7.99	1053.57	131.802
1668.15	-8.21	1053.57	128.259
1678.20	-8.44	1053.57	124.783
1688.25	-8.68	1053.57	121.380
1698.30	-8.92	1053.57	118.052
1708.35	-9.18	1053.57	114.802
1718.40	-9.44	1053.57	111.631
1728.45	-9.71	1053.57	108.541
1738.50	-10.10	1053.57	104.329
1748.55	-10.62	1053.57	99.202
1758.60	-11.16	1053.57	94.431
1768.65	-11.71	1053.57	89.983
1778.70	-12.27	1053.57	85.832
1788.75	-12.86	1053.57	81.952
1798.80	-13.45	1053.57	78.320
1808.85	-14.06	1053.57	74.917
1818.90	-14.69	1053.57	71.725

<i>Cod. elab.:</i> 108GA201-GA01-Z-CL-002_C	<i>Titolo:</i> OPERE D'ARTE MAGGIORI- GALLERIE	<i>Data:</i> Ottobre 2011
<i>Nome file:</i> 108GA201-GA01-Z-CL -002_C.docx	ARTIFICIALI – GALLERIA ROVETELLO Relazione di calcolo	<i>Pagina</i> 311 di 452

PROGETTO ESECUTIVO

1828.95	-15.33	1053.57	68.726
1839.00	-15.99	1053.57	65.906
1849.05	-16.66	1053.57	63.251
1859.10	-17.34	1053.57	60.749
1869.15	-18.04	1053.57	58.389
1879.20	-18.76	1053.57	56.160
1889.25	-19.47	1053.57	54.103
1899.30	-20.17	1053.57	52.246
1909.35	-20.84	1053.57	50.564
1919.40	-21.49	1053.57	49.034
1929.45	-22.12	1053.57	47.639
1939.50	-22.72	1053.57	46.364
1949.55	-23.31	1053.57	45.196
1959.60	-23.88	1053.57	44.125
1969.65	-24.42	1053.57	43.140
1979.70	-24.95	1053.57	42.234
1989.75	-25.45	1053.57	41.399
1999.80	-25.93	1053.57	40.629
2009.85	-26.39	1053.57	39.919
2019.90	-26.83	1053.57	39.265
2029.95	-27.25	1053.57	38.661
20310.00	-27.65	1053.57	38.104
20410.05	-28.03	1053.57	37.592
20510.10	-28.38	1053.57	37.121
20610.15	-28.72	1053.57	36.688
20710.20	-29.03	1053.57	36.292
20810.25	-29.32	1053.57	35.930
20910.30	-29.59	1053.57	35.600
21010.35	-29.84	1053.57	35.302
21110.40	-30.07	1053.57	35.033
21210.45	-30.28	1053.57	34.793
21310.50	-30.47	1053.57	34.581
21410.55	-30.63	1053.57	34.395
21510.60	-30.77	1053.57	34.235
21610.65	-30.90	1053.57	34.099
21710.70	-31.00	1053.57	33.989

<i>Cod. elab.:</i> 108GA201-GA01-Z-CL-002_C	<i>Titolo:</i> OPERE D'ARTE MAGGIORI- GALLERIE	<i>Data:</i> Ottobre 2011
<i>Nome file:</i> 108GA201-GA01-Z-CL -002_C.docx	ARTIFICIALI – GALLERIA ROVETELLO Relazione di calcolo	<i>Pagina</i> 312 di 452

PROGETTO ESECUTIVO

21810.75	-31.08	1053.57	33.903
21910.80	-31.13	1053.57	33.840
22010.85	-31.17	1053.57	33.802
22110.90	-31.18	1053.57	33.787
22210.95	-31.17	1053.57	33.796
22311.00	-31.14	1053.57	33.828
22411.05	-31.09	1053.57	33.884
22511.10	-31.02	1053.57	33.965
22611.15	-30.92	1053.57	34.070
22711.20	-30.81	1053.57	34.201
22811.25	-30.67	1053.57	34.357
22911.30	-30.50	1053.57	34.540
23011.35	-30.32	1053.57	34.751
23111.40	-30.11	1053.57	34.990
23211.45	-29.88	1053.57	35.259
23311.50	-29.63	1053.57	35.560
23411.55	-29.35	1053.57	35.893
23511.60	-29.05	1053.57	36.261
23611.65	-28.73	1053.57	36.667
23711.70	-28.39	1053.57	37.111
23811.75	-28.02	1053.57	37.597
23911.80	-27.63	1053.57	38.129
24011.85	-27.22	1053.57	38.708
24111.90	-26.78	1053.57	39.340
24211.95	-26.32	1053.57	40.029
24312.00	-25.84	1053.57	40.780
24412.05	-25.33	1053.57	41.598
24512.10	-24.80	1053.57	42.491
24612.15	-24.24	1053.57	43.466
24712.20	-23.66	1053.57	44.532
24812.25	-23.05	1053.57	45.700
24912.30	-22.42	1053.57	46.982
25012.35	-21.77	1053.57	48.393
25112.40	-21.09	1053.57	49.949
25212.45	-20.39	1053.57	51.671
25312.50	-19.66	1053.57	53.585

<i>Cod. elab.:</i> 108GA201-GA01-Z-CL-002_C	<i>Titolo:</i> OPERE D'ARTE MAGGIORI- GALLERIE	<i>Data:</i> Ottobre 2011
<i>Nome file:</i> 108GA201-GA01-Z-CL -002_C.docx	ARTIFICIALI – GALLERIA ROVETELLO Relazione di calcolo	<i>Pagina</i> 313 di 452

PROGETTO ESECUTIVO

25412.55	-18.91	1053.57	55.719
25512.60	-18.13	1053.57	58.110
25612.65	-17.33	1053.57	60.806
25712.70	-16.50	1053.57	63.861
25812.75	-15.66	1053.57	67.273
25912.80	-14.83	1053.57	71.019
26012.85	-14.02	1053.57	75.153
26112.90	-13.21	1053.57	79.737
26212.95	-12.42	1053.57	84.848
26313.00	-11.63	1053.57	90.583
26413.05	-10.85	1053.57	97.063
26513.10	-10.09	1053.57	104.444
26613.15	-9.33	1053.57	112.925
26713.20	-8.58	1053.57	122.774
26813.25	-7.84	1053.57	134.350
26913.30	-7.11	1053.57	148.151
27013.35	-6.39	1053.57	164.885
27113.40	-5.68	1053.57	185.599
27213.45	-4.97	1053.57	211.904
27313.50	-4.28	1053.57	246.419
27413.55	-3.59	1053.57	293.696
27513.60	-2.91	1053.57	362.422
27613.65	-2.23	1053.57	471.480
27713.70	-1.57	1053.57	671.123
27813.75	-0.91	1053.57	1154.403
27913.80	-0.26	1053.57	4008.718
28013.85	0.38	1053.57	2774.071
28113.90	1.02	1053.57	1037.657
28213.95	1.64	1053.57	640.872
28314.00	2.27	1053.57	464.982
28414.05	2.88	1053.57	365.685
28514.10	3.49	1053.57	301.892
28614.15	4.09	1053.57	257.446
28714.20	4.69	1053.57	224.703
28814.25	5.28	1053.57	199.575
28914.30	5.86	1053.57	179.681

Cod. elab.: 108GA201-GA01-Z-CL-002 C	Titolo: OPERE D'ARTE MAGGIORI- GALLERIE	Data: Ottobre 2011
Nome file: 108GA201-GA01-Z-CL -002_C.docx	ARTIFICIALI – GALLERIA ROVETELLO	Pagina 314 di 452
Relazione di calcolo		

PROGETTO ESECUTIVO

29014.35	6.44	1053.57	163.538
29114.40	7.02	1053.57	150.175
29214.45	7.58	1053.57	138.930
29314.50	8.15	1053.57	129.335
29414.55	8.70	1053.57	121.051
29514.60	9.26	1053.57	113.825
29614.65	9.80	1053.57	107.465
29714.70	10.35	1053.57	101.825
29814.75	10.89	1053.57	96.787
29914.80	11.42	1053.57	92.260
30014.85	11.95	1053.57	88.169
30114.90	12.48	1053.57	84.452
30214.95	13.00	1053.57	81.061
30315.00	13.52	1053.57	77.954
30415.05	14.03	1053.57	75.096
30515.10	14.54	1053.57	72.458
30615.15	15.05	1053.57	70.015
30715.20	15.55	1053.57	67.745
30815.25	16.05	1053.57	65.631
30915.30	16.55	1053.57	63.656
31015.35	17.05	1053.57	61.807
31115.40	17.54	1053.57	60.072
31215.45	18.03	1053.57	58.440
31315.50	18.52	1053.57	56.902
31415.55	19.00	1053.57	55.450
31515.60	19.48	1053.57	54.076
31615.65	19.96	1053.57	52.775
31715.70	20.44	1053.57	51.540
31815.75	20.92	1053.57	50.366
31915.80	21.39	1053.57	49.248
32015.85	21.87	1053.57	48.182
32115.90	22.34	1053.57	47.165
32215.95	22.81	1053.57	46.193
32316.00	23.28	1053.57	45.263
32416.05	23.74	1053.57	44.372
32516.10	24.21	1053.57	43.517

<i>Cod. elab.:</i> 108GA201-GA01-Z-CL-002_C	<i>Titolo:</i> OPERE D'ARTE MAGGIORI- GALLERIE	<i>Data:</i> Ottobre 2011
<i>Nome file:</i> 108GA201-GA01-Z-CL -002_C.docx	ARTIFICIALI – GALLERIA ROVETELLO Relazione di calcolo	<i>Pagina</i> 315 di 452

PROGETTO ESECUTIVO

32616.15	24.68	1053.57	42.697
32716.20	25.14	1053.57	41.908
32816.25	25.60	1053.57	41.150
32916.30	26.07	1053.57	40.419
33016.35	26.53	1053.57	39.715
33116.40	26.99	1053.57	39.036
33216.45	27.45	1053.57	38.380
33316.50	27.45	1053.57	38.375
33416.55	27.00	1053.57	39.018
33516.60	26.55	1053.57	39.683
33616.65	26.10	1053.57	40.372
33716.70	25.64	1053.57	41.086
33816.75	25.19	1053.57	41.826
33916.80	24.74	1053.57	42.592
34016.85	24.28	1053.57	43.387
34116.90	23.83	1053.57	44.211
34216.95	23.38	1053.57	45.067
34317.00	22.93	1053.57	45.955
34417.05	22.47	1053.57	46.878
34517.10	22.02	1053.57	47.838
34617.15	21.57	1053.57	48.836
34717.20	21.12	1053.57	49.875
34817.25	20.68	1053.57	50.957
34917.30	20.23	1053.57	52.085
35017.35	19.78	1053.57	53.261
35117.40	19.34	1053.57	54.488
35217.45	18.89	1053.57	55.770
35317.50	18.45	1053.57	57.110
35417.55	18.01	1053.57	58.512
35517.60	17.57	1053.57	59.980
35617.65	17.13	1053.57	61.519
35717.70	16.69	1053.57	63.134
35817.75	16.25	1053.57	64.830
35917.80	15.82	1053.57	66.613
36017.85	15.38	1053.57	68.490
36117.90	14.95	1053.57	70.469

<i>Cod. elab.:</i> 108GA201-GA01-Z-CL-002 C	<i>Titolo:</i> OPERE D'ARTE MAGGIORI- GALLERIE	<i>Data:</i> Ottobre 2011
<i>Nome file:</i> 108GA201-GA01-Z-CL -002_C.docx	ARTIFICIALI – GALLERIA ROVETELLO Relazione di calcolo	<i>Pagina</i> 316 di 452

PROGETTO ESECUTIVO

36217.95	14.52	1053.57	72.558
36318.00	14.09	1053.57	74.765
36418.05	13.66	1053.57	77.101
36518.10	13.24	1053.57	79.577
36618.15	12.82	1053.57	82.207
36718.20	12.39	1053.57	85.003
36818.25	11.97	1053.57	87.984
36918.30	11.56	1053.57	91.166
37018.35	11.14	1053.57	94.571
37118.40	10.73	1053.57	98.223
37218.45	10.31	1053.57	102.149
37318.50	9.90	1053.57	106.381
37418.55	9.50	1053.57	110.956
37518.60	9.09	1053.57	115.917
37618.65	8.68	1053.57	121.314
37718.70	8.28	1053.57	127.208
37818.75	7.88	1053.57	133.668
37918.80	7.48	1053.57	140.781
38018.85	7.09	1053.57	148.651
38118.90	6.69	1053.57	157.403
38218.95	6.30	1053.57	167.196
38319.00	5.91	1053.57	178.224
38419.05	5.52	1053.57	190.737
38519.10	5.14	1053.57	205.056
38619.15	4.75	1053.57	221.599
38719.20	4.37	1053.57	240.930
38819.25	3.99	1053.57	263.813
38919.30	3.62	1053.57	291.328
39019.35	3.24	1053.57	325.036
39119.40	2.87	1053.57	367.289
39219.45	2.50	1053.57	421.806
39319.50	2.13	1053.57	494.827
39419.55	1.76	1053.57	597.692
39519.60	1.40	1053.57	753.385
39619.65	1.04	1053.57	1016.640
39719.70	0.68	1053.57	1557.705

<i>Cod. elab.:</i> 108GA201-GA01-Z-CL-002_C	<i>Titolo:</i> OPERE D'ARTE MAGGIORI- GALLERIE	<i>Data:</i> Ottobre 2011
<i>Nome file:</i> 108GA201-GA01-Z-CL -002_C.docx	ARTIFICIALI – GALLERIA ROVETELLO Relazione di calcolo	<i>Pagina</i> 317 di 452

PROGETTO ESECUTIVO

39819.75	0.32	1053.57	3307.344
39919.80	-0.04	1053.57	28405.033
40019.85	-0.39	1053.57	2697.475
40119.90	-0.74	1053.57	1420.095
40219.95	-1.09	1053.57	965.634
40320.00	-1.44	1053.57	732.629

Fase n° 5 - [A1-M1]

n°	Y	T	T _R	CS _T
1	0.00	0.00	1053.57	11655234.775
2	0.05	0.00	1053.57	3886367.870
3	0.10	0.00	1053.57	2337564.393
4	0.15	0.00	1053.57	1673818.150
5	0.20	0.00	1053.57	1304868.852
6	0.25	0.00	1053.57	1069491.742
7	0.30	0.00	1053.57	907510.439
8	0.35	0.00	1053.57	788103.851
9	0.40	0.00	1053.57	697156.135
10	0.45	0.00	1053.57	625015.380
11	0.50	0.00	1053.57	476951.096
12	0.55	0.00	1053.57	342315.303
13	0.60	0.00	1053.57	267108.807
14	0.65	0.00	1053.57	219253.828
15	0.70	-0.01	1053.57	186062.574
16	0.75	-0.01	1053.57	161690.332
17	0.80	-0.01	1053.57	143047.658
18	0.85	-0.01	1053.57	128323.780
19	0.90	-0.01	1053.57	116399.563
20	0.95	-0.01	1053.57	106552.084
21	1.00	-0.01	1053.57	98270.949
22	1.05	-0.01	1053.57	91220.759
23	1.10	-0.01	1053.57	85143.334
24	1.15	-0.01	1053.57	79848.213
25	1.20	-0.01	1053.57	75192.891
26	1.25	-0.01	1053.57	71072.922

Cod. elab.: 108GA201-GA01-Z-CL-002_C	Titolo: OPERE D'ARTE MAGGIORI- GALLERIE	Data: Ottobre 2011
Nome file: 108GA201-GA01-Z-CL -002_C.docx	ARTIFICIALI – GALLERIA ROVETELLO	Pagina 318 di 452
Relazione di calcolo		

PROGETTO ESECUTIVO

27	1.30	-0.02	1053.57	67400.322
28	1.35	-0.02	1053.57	64099.970
29	1.40	-0.02	1053.57	61123.713
30	1.45	-0.02	1053.57	58426.454
31	1.50	-0.02	1053.57	55966.964
32	1.55	-0.02	1053.57	53719.680
33	1.60	-0.02	1053.57	51654.637
34	1.65	-0.02	1053.57	49752.236
35	1.70	-0.02	1053.57	47993.154
36	1.75	-0.02	1053.57	46364.078
37	1.80	-0.02	1053.57	44849.606
38	1.85	-0.02	1053.57	43436.730
39	1.90	-0.03	1053.57	42117.586
40	1.95	-0.03	1053.57	40883.673
41	2.00	-0.03	1053.57	39725.700
42	2.05	-0.03	1053.57	38636.403
43	2.10	-0.03	1053.57	37610.967
44	2.15	-0.03	1053.57	36644.082
45	2.20	-0.03	1053.57	35730.902
46	2.25	-0.03	1053.57	34866.137
47	2.30	-0.03	1053.57	34046.326
48	2.35	-0.03	1053.57	33269.443
49	2.40	-0.03	1053.57	32531.154
50	2.45	-0.03	1053.57	31828.519
51	2.50	-0.03	1053.57	31828.519
52	2.50	-135.31	1053.57	7.786
53	2.55	-135.31	1053.57	7.786
54	2.60	-135.31	1053.57	7.786
55	2.65	-135.31	1053.57	7.786
56	2.70	-135.31	1053.57	7.786
57	2.75	-135.31	1053.57	7.786
58	2.80	-135.31	1053.57	7.786
59	2.85	-135.31	1053.57	7.786
60	2.90	-135.31	1053.57	7.786
61	2.95	-135.31	1053.57	7.786
62	3.00	-135.32	1053.57	7.786

<i>Cod. elab.:</i> 108GA201-GA01-Z-CL-002 C	<i>Titolo:</i> OPERE D'ARTE MAGGIORI- GALLERIE	<i>Data:</i> Ottobre 2011
<i>Nome file:</i> 108GA201-GA01-Z-CL -002_C.docx	ARTIFICIALI – GALLERIA ROVETELLO	<i>Pagina</i> 319 di 452
Relazione di calcolo		

PROGETTO ESECUTIVO

63	3.05	-134.86	1053.57	7.812
64	3.10	-133.50	1053.57	7.892
65	3.15	-131.54	1053.57	8.010
66	3.20	-129.30	1053.57	8.148
67	3.25	-126.78	1053.57	8.310
68	3.30	-123.99	1053.57	8.497
69	3.35	-121.03	1053.57	8.705
70	3.40	-118.02	1053.57	8.927
71	3.45	-114.97	1053.57	9.164
72	3.50	-111.88	1053.57	9.417
73	3.55	-108.75	1053.57	9.688
74	3.60	-105.58	1053.57	9.979
75	3.65	-102.37	1053.57	10.292
76	3.70	-99.11	1053.57	10.630
77	3.75	-95.82	1053.57	10.995
78	3.80	-92.49	1053.57	11.391
79	3.85	-89.12	1053.57	11.822
80	3.90	-85.70	1053.57	12.294
81	3.95	-82.24	1053.57	12.811
82	4.00	-78.74	1053.57	13.380
83	4.05	-75.21	1053.57	14.008
84	4.10	-71.64	1053.57	14.707
85	4.15	-68.03	1053.57	15.487
86	4.20	-64.38	1053.57	16.364
87	4.25	-60.70	1053.57	17.357
88	4.30	-56.97	1053.57	18.494
89	4.35	-53.20	1053.57	19.804
90	4.40	-49.39	1053.57	21.330
91	4.45	-45.55	1053.57	23.128
92	4.50	-41.68	1053.57	25.279
93	4.55	-37.60	1053.57	28.021
94	4.60	-33.15	1053.57	31.785
95	4.65	-28.32	1053.57	37.197
96	4.70	-23.13	1053.57	45.548
97	4.75	-17.73	1053.57	59.430
98	4.80	-12.28	1053.57	85.829

<i>Cod. elab.:</i> 108GA201-GA01-Z-CL-002_C	<i>Titolo:</i> OPERE D'ARTE MAGGIORI- GALLERIE	<i>Data:</i> Ottobre 2011
<i>Nome file:</i> 108GA201-GA01-Z-CL -002_C.docx	ARTIFICIALI – GALLERIA ROVETELLO Relazione di calcolo	<i>Pagina</i> 320 di 452

PROGETTO ESECUTIVO

99 4.85	-6.77	1053.57	155.558
100 4.90	-1.22	1053.57	862.854
101 4.95	4.38	1053.57	240.532
102 5.00	10.03	1053.57	105.030
103 5.00	-160.73	1053.57	6.555
104 5.05	-155.03	1053.57	6.796
105 5.10	-149.28	1053.57	7.057
106 5.15	-143.49	1053.57	7.343
107 5.20	-137.64	1053.57	7.655
108 5.25	-131.74	1053.57	7.997
109 5.30	-125.80	1053.57	8.375
110 5.35	-119.81	1053.57	8.794
111 5.40	-113.77	1053.57	9.261
112 5.45	-107.68	1053.57	9.784
113 5.50	-101.54	1053.57	10.375
114 5.55	-95.36	1053.57	11.048
115 5.60	-89.13	1053.57	11.821
116 5.65	-82.85	1053.57	12.717
117 5.70	-76.52	1053.57	13.769
118 5.75	-70.14	1053.57	15.020
119 5.80	-63.72	1053.57	16.534
120 5.85	-57.25	1053.57	18.403
121 5.90	-50.73	1053.57	20.767
122 5.95	-44.17	1053.57	23.853
123 6.00	-37.56	1053.57	28.053
124 6.05	-30.90	1053.57	34.098
125 6.10	-24.19	1053.57	43.550
126 6.15	-17.44	1053.57	60.412
127 6.20	-10.64	1053.57	99.016
128 6.25	-3.79	1053.57	277.648
129 6.30	3.10	1053.57	340.113
130 6.35	10.04	1053.57	104.974
131 6.40	17.02	1053.57	61.896
132 6.45	24.05	1053.57	43.802
133 6.50	31.13	1053.57	33.844
134 6.55	38.25	1053.57	27.541

<i>Cod. elab.:</i> 108GA201-GA01-Z-CL-002 C	<i>Titolo:</i> OPERE D'ARTE MAGGIORI- GALLERIE	<i>Data:</i> Ottobre 2011
<i>Nome file:</i> 108GA201-GA01-Z-CL -002_C.docx	ARTIFICIALI – GALLERIA ROVETELLO Relazione di calcolo	<i>Pagina</i> 321 di 452

PROGETTO ESECUTIVO

135 6.60	45.42	1053.57	23.194
136 6.65	52.64	1053.57	20.015
137 6.70	59.90	1053.57	17.589
138 6.75	67.21	1053.57	15.676
139 6.80	74.56	1053.57	14.131
140 6.85	81.96	1053.57	12.855
141 6.90	89.40	1053.57	11.785
142 6.95	96.89	1053.57	10.874
143 7.00	104.42	1053.57	10.089
144 7.05	112.00	1053.57	9.407
145 7.10	119.63	1053.57	8.807
146 7.15	127.30	1053.57	8.276
147 7.20	135.01	1053.57	7.804
148 7.25	142.77	1053.57	7.379
149 7.30	150.57	1053.57	6.997
150 7.35	158.42	1053.57	6.650
151 7.40	166.32	1053.57	6.335
152 7.45	174.26	1053.57	6.046
153 7.50	182.24	1053.57	5.781
154 7.55	185.07	1053.57	5.693
155 7.60	187.74	1053.57	5.612
156 7.65	190.25	1053.57	5.538
157 7.70	192.61	1053.57	5.470
158 7.75	194.81	1053.57	5.408
159 7.80	196.87	1053.57	5.352
160 7.85	198.78	1053.57	5.300
161 7.90	200.55	1053.57	5.253
162 7.95	202.17	1053.57	5.211
163 8.00	203.64	1053.57	5.174
164 8.05	204.97	1053.57	5.140
165 8.10	206.16	1053.57	5.111
166 8.15	207.19	1053.57	5.085
167 8.20	208.09	1053.57	5.063
168 8.25	208.83	1053.57	5.045
169 8.30	209.43	1053.57	5.031
170 8.35	209.89	1053.57	5.020

<i>Cod. elab.:</i> 108GA201-GA01-Z-CL-002 C	<i>Titolo:</i> OPERE D'ARTE MAGGIORI- GALLERIE	<i>Data:</i> Ottobre 2011
<i>Nome file:</i> 108GA201-GA01-Z-CL -002_C.docx	ARTIFICIALI – GALLERIA ROVETELLO Relazione di calcolo	<i>Pagina</i> 322 di 452

PROGETTO ESECUTIVO

171 8.40	210.21	1053.57	5.012
172 8.45	210.39	1053.57	5.008
173 8.50	209.95	1053.57	5.018
174 8.55	208.98	1053.57	5.041
175 8.60	207.92	1053.57	5.067
176 8.65	206.75	1053.57	5.096
177 8.70	205.48	1053.57	5.127
178 8.75	204.09	1053.57	5.162
179 8.80	202.59	1053.57	5.201
180 8.85	200.97	1053.57	5.242
181 8.90	199.24	1053.57	5.288
182 8.95	197.40	1053.57	5.337
183 9.00	195.44	1053.57	5.391
184 9.05	193.37	1053.57	5.448
185 9.10	191.19	1053.57	5.511
186 9.15	188.89	1053.57	5.578
187 9.20	186.47	1053.57	5.650
188 9.25	183.94	1053.57	5.728
189 9.30	181.32	1053.57	5.811
190 9.35	178.61	1053.57	5.899
191 9.40	175.80	1053.57	5.993
192 9.45	172.90	1053.57	6.094
193 9.50	169.90	1053.57	6.201
194 9.55	166.81	1053.57	6.316
195 9.60	163.63	1053.57	6.439
196 9.65	160.35	1053.57	6.570
197 9.70	156.98	1053.57	6.712
198 9.75	153.51	1053.57	6.863
199 9.80	149.94	1053.57	7.026
200 9.85	146.28	1053.57	7.202
201 9.90	142.53	1053.57	7.392
202 9.95	138.68	1053.57	7.597
203 10.00	134.73	1053.57	7.820
204 10.05	130.68	1053.57	8.062
205 10.10	126.54	1053.57	8.326
206 10.15	122.30	1053.57	8.615

<i>Cod. elab.:</i> 108GA201-GA01-Z-CL-002_C	<i>Titolo:</i> OPERE D'ARTE MAGGIORI- GALLERIE	<i>Data:</i> Ottobre 2011
<i>Nome file:</i> 108GA201-GA01-Z-CL -002_C.docx	ARTIFICIALI – GALLERIA ROVETELLO	<i>Pagina</i> 323 di 452
Relazione di calcolo		

PROGETTO ESECUTIVO

20710.20	117.96	1053.57	8.931
20810.25	113.53	1053.57	9.280
20910.30	109.00	1053.57	9.666
21010.35	104.37	1053.57	10.095
21110.40	99.64	1053.57	10.574
21210.45	94.82	1053.57	11.112
21310.50	89.90	1053.57	11.720
21410.55	84.88	1053.57	12.413
21510.60	79.76	1053.57	13.209
21610.65	74.74	1053.57	14.096
21710.70	69.83	1053.57	15.087
21810.75	65.02	1053.57	16.203
21910.80	60.32	1053.57	17.468
22010.85	55.71	1053.57	18.911
22110.90	51.21	1053.57	20.573
22210.95	46.81	1053.57	22.508
22311.00	42.51	1053.57	24.784
22411.05	38.31	1053.57	27.502
22511.10	34.21	1053.57	30.798
22611.15	30.21	1053.57	34.879
22711.20	26.30	1053.57	40.055
22811.25	22.50	1053.57	46.832
22911.30	18.79	1053.57	56.077
23011.35	15.18	1053.57	69.427
23111.40	11.66	1053.57	90.371
23211.45	8.24	1053.57	127.917
23311.50	4.91	1053.57	214.617
23411.55	1.68	1053.57	628.741
23511.60	-1.46	1053.57	719.443
23611.65	-4.51	1053.57	233.511
23711.70	-7.47	1053.57	141.092
23811.75	-10.33	1053.57	101.980
23911.80	-13.10	1053.57	80.399
24011.85	-15.79	1053.57	66.736
24111.90	-18.38	1053.57	57.320
24211.95	-20.88	1053.57	50.447

Cod. elab.: 108GA201-GA01-Z-CL-002_C	Titolo: OPERE D'ARTE MAGGIORI- GALLERIE	Data: Ottobre 2011
Nome file: 108GA201-GA01-Z-CL -002_C.docx	ARTIFICIALI – GALLERIA ROVETELLO	Pagina 324 di 452
Relazione di calcolo		

PROGETTO ESECUTIVO

24312.00	-23.30	1053.57	45.216
24412.05	-25.63	1053.57	41.109
24512.10	-27.87	1053.57	37.803
24612.15	-30.02	1053.57	35.090
24712.20	-32.09	1053.57	32.829
24812.25	-34.08	1053.57	30.918
24912.30	-35.97	1053.57	29.286
25012.35	-37.79	1053.57	27.880
25112.40	-39.52	1053.57	26.659
25212.45	-41.17	1053.57	25.592
25312.50	-42.73	1053.57	24.655
25412.55	-44.22	1053.57	23.827
25512.60	-45.62	1053.57	23.095
25612.65	-46.94	1053.57	22.444
25712.70	-48.18	1053.57	21.866
25812.75	-49.36	1053.57	21.343
25912.80	-50.50	1053.57	20.862
26012.85	-51.60	1053.57	20.420
26112.90	-52.65	1053.57	20.011
26212.95	-53.66	1053.57	19.633
26313.00	-54.63	1053.57	19.284
26413.05	-55.57	1053.57	18.961
26513.10	-56.46	1053.57	18.661
26613.15	-57.31	1053.57	18.383
26713.20	-58.13	1053.57	18.125
26813.25	-58.90	1053.57	17.886
26913.30	-59.64	1053.57	17.664
27013.35	-60.35	1053.57	17.459
27113.40	-61.01	1053.57	17.268
27213.45	-61.64	1053.57	17.091
27313.50	-62.24	1053.57	16.928
27413.55	-62.80	1053.57	16.777
27513.60	-63.32	1053.57	16.638
27613.65	-63.82	1053.57	16.509
27713.70	-64.28	1053.57	16.391
27813.75	-64.70	1053.57	16.284

Cod. elab.: 108GA201-GA01-Z-CL-002 C	Titolo: OPERE D'ARTE MAGGIORI- GALLERIE	Data: Ottobre 2011
Nome file: 108GA201-GA01-Z-CL -002_C.docx	ARTIFICIALI – GALLERIA ROVETELLO	Pagina 325 di 452
Relazione di calcolo		

PROGETTO ESECUTIVO

27913.80	-65.09	1053.57	16.185
28013.85	-65.46	1053.57	16.096
28113.90	-65.78	1053.57	16.015
28213.95	-66.08	1053.57	15.943
28314.00	-66.35	1053.57	15.879
28414.05	-66.59	1053.57	15.822
28514.10	-66.80	1053.57	15.773
28614.15	-66.98	1053.57	15.731
28714.20	-67.13	1053.57	15.695
28814.25	-67.25	1053.57	15.667
28914.30	-67.34	1053.57	15.646
29014.35	-67.41	1053.57	15.630
29114.40	-67.44	1053.57	15.622
29214.45	-67.45	1053.57	15.619
29314.50	-67.44	1053.57	15.622
29414.55	-67.40	1053.57	15.632
29514.60	-67.33	1053.57	15.648
29614.65	-67.24	1053.57	15.669
29714.70	-67.12	1053.57	15.697
29814.75	-66.98	1053.57	15.730
29914.80	-66.81	1053.57	15.769
30014.85	-66.62	1053.57	15.814
30114.90	-66.41	1053.57	15.865
30214.95	-66.17	1053.57	15.922
30315.00	-65.91	1053.57	15.984
30415.05	-65.63	1053.57	16.053
30515.10	-65.32	1053.57	16.128
30615.15	-65.00	1053.57	16.209
30715.20	-64.65	1053.57	16.296
30815.25	-64.28	1053.57	16.390
30915.30	-63.89	1053.57	16.490
31015.35	-63.48	1053.57	16.597
31115.40	-63.05	1053.57	16.711
31215.45	-62.60	1053.57	16.831
31315.50	-62.12	1053.57	16.959
31415.55	-61.63	1053.57	17.094

<i>Cod. elab.:</i> 108GA201-GA01-Z-CL-002 C	<i>Titolo:</i> OPERE D'ARTE MAGGIORI- GALLERIE	<i>Data:</i> Ottobre 2011
<i>Nome file:</i> 108GA201-GA01-Z-CL -002_C.docx	ARTIFICIALI – GALLERIA ROVETELLO	<i>Pagina</i> 326 di 452
Relazione di calcolo		

PROGETTO ESECUTIVO

31515.60	-61.12	1053.57	17.237
31615.65	-60.59	1053.57	17.387
31715.70	-60.05	1053.57	17.546
31815.75	-59.48	1053.57	17.713
31915.80	-58.89	1053.57	17.889
32015.85	-58.29	1053.57	18.074
32115.90	-57.67	1053.57	18.269
32215.95	-57.03	1053.57	18.473
32316.00	-56.38	1053.57	18.688
32416.05	-55.70	1053.57	18.913
32516.10	-55.02	1053.57	19.150
32616.15	-54.31	1053.57	19.399
32716.20	-53.59	1053.57	19.661
32816.25	-52.85	1053.57	19.936
32916.30	-52.09	1053.57	20.224
33016.35	-51.32	1053.57	20.528
33116.40	-50.54	1053.57	20.847
33216.45	-49.74	1053.57	21.183
33316.50	-49.30	1053.57	21.372
33416.55	-49.21	1053.57	21.408
33516.60	-49.11	1053.57	21.453
33616.65	-48.98	1053.57	21.508
33716.70	-48.84	1053.57	21.572
33816.75	-48.67	1053.57	21.646
33916.80	-48.48	1053.57	21.730
34016.85	-48.28	1053.57	21.824
34116.90	-48.05	1053.57	21.927
34216.95	-47.80	1053.57	22.040
34317.00	-47.53	1053.57	22.164
34417.05	-47.25	1053.57	22.299
34517.10	-46.94	1053.57	22.444
34617.15	-46.62	1053.57	22.600
34717.20	-46.27	1053.57	22.768
34817.25	-45.91	1053.57	22.947
34917.30	-45.53	1053.57	23.139
35017.35	-45.13	1053.57	23.344

<i>Cod. elab.:</i> 108GA201-GA01-Z-CL-002 C	<i>Titolo:</i> OPERE D'ARTE MAGGIORI- GALLERIE	<i>Data:</i> Ottobre 2011
<i>Nome file:</i> 108GA201-GA01-Z-CL -002_C.docx	ARTIFICIALI – GALLERIA ROVETELLO Relazione di calcolo	<i>Pagina</i> 327 di 452

PROGETTO ESECUTIVO

35117.40	-44.72	1053.57	23.561
35217.45	-44.28	1053.57	23.792
35317.50	-43.83	1053.57	24.038
35417.55	-43.36	1053.57	24.299
35517.60	-42.87	1053.57	24.575
35617.65	-42.37	1053.57	24.868
35717.70	-41.84	1053.57	25.178
35817.75	-41.30	1053.57	25.507
35917.80	-40.75	1053.57	25.855
36017.85	-40.18	1053.57	26.224
36117.90	-39.59	1053.57	26.615
36217.95	-38.98	1053.57	27.029
36318.00	-38.36	1053.57	27.468
36418.05	-37.72	1053.57	27.933
36518.10	-37.06	1053.57	28.427
36618.15	-36.39	1053.57	28.952
36718.20	-35.70	1053.57	29.510
36818.25	-35.00	1053.57	30.104
36918.30	-34.28	1053.57	30.736
37018.35	-33.54	1053.57	31.410
37118.40	-32.79	1053.57	32.130
37218.45	-32.02	1053.57	32.900
37318.50	-31.24	1053.57	33.725
37418.55	-30.44	1053.57	34.609
37518.60	-29.63	1053.57	35.560
37618.65	-28.80	1053.57	36.585
37718.70	-27.95	1053.57	37.691
37818.75	-27.09	1053.57	38.888
37918.80	-26.22	1053.57	40.188
38018.85	-25.32	1053.57	41.602
38118.90	-24.42	1053.57	43.147
38218.95	-23.50	1053.57	44.840
38319.00	-22.56	1053.57	46.702
38419.05	-21.61	1053.57	48.761
38519.10	-20.64	1053.57	51.046
38619.15	-19.66	1053.57	53.598

<i>Cod. elab.:</i> 108GA201-GA01-Z-CL-002 C	<i>Titolo:</i> OPERE D'ARTE MAGGIORI- GALLERIE	<i>Data:</i> Ottobre 2011
<i>Nome file:</i> 108GA201-GA01-Z-CL -002_C.docx	ARTIFICIALI – GALLERIA ROVETELLO Relazione di calcolo	<i>Pagina</i> 328 di 452

PROGETTO ESECUTIVO

38719.20	-18.66	1053.57	56.464
38819.25	-17.65	1053.57	59.705
38919.30	-16.62	1053.57	63.399
39019.35	-15.58	1053.57	67.645
39119.40	-14.52	1053.57	72.575
39219.45	-13.44	1053.57	78.369
39319.50	-12.36	1053.57	85.272
39419.55	-11.25	1053.57	93.634
39519.60	-10.13	1053.57	103.968
39619.65	-9.00	1053.57	117.061
39719.70	-7.85	1053.57	134.183
39819.75	-6.69	1053.57	157.526
39919.80	-5.51	1053.57	191.221
40019.85	-4.32	1053.57	244.101
40119.90	-3.11	1053.57	339.038
40219.95	-1.88	1053.57	559.250
40320.00	-0.65	1053.57	1632.843

Fase n° 6 - [A1-M1]

n°	Y	T	T _R	CS _T
1	0.00	0.00	1053.57	5064303.317
2	0.05	0.00	1053.57	1686515.379
3	0.10	0.00	1053.57	1014864.435
4	0.15	0.00	1053.57	725604.276
5	0.20	0.00	1053.57	564877.174
6	0.25	0.00	1053.57	462802.129
7	0.30	0.00	1053.57	392179.841
8	0.35	0.00	1053.57	340310.174
9	0.40	0.00	1053.57	300627.431
10	0.45	0.00	1053.57	269346.604
11	0.50	0.01	1053.57	204935.512
12	0.55	0.01	1053.57	204935.512
13	0.55	0.01	1053.57	146591.516
14	0.60	0.01	1053.57	146591.516
15	0.60	0.01	1053.57	114150.765

Cod. elab.: 108GA201-GA01-Z-CL-002_C	Titolo: OPERE D'ARTE MAGGIORI- GALLERIE	Data: Ottobre 2011
Nome file: 108GA201-GA01-Z-CL -002_C.docx	ARTIFICIALI – GALLERIA ROVETELLO	Pagina 329 di 452
Relazione di calcolo		

PROGETTO ESECUTIVO

16	0.65	0.01	1053.57	114150.765
17	0.65	0.01	1053.57	93523.765
18	0.70	0.01	1053.57	93523.765
19	0.70	0.01	1053.57	79244.817
20	0.75	0.01	1053.57	79244.817
21	0.75	0.02	1053.57	68754.441
22	0.80	0.02	1053.57	68754.441
23	0.80	0.02	1053.57	60744.959
24	0.85	0.02	1053.57	60744.959
25	0.85	0.02	1053.57	54417.452
26	0.90	0.02	1053.57	54417.452
27	0.90	0.02	1053.57	49302.065
28	0.95	0.02	1053.57	49302.065
29	0.95	0.02	1053.57	45066.176
30	1.00	0.02	1053.57	45066.176
31	1.00	0.03	1053.57	41513.462
32	1.05	0.03	1053.57	41513.462
33	1.05	0.03	1053.57	38486.036
34	1.10	0.03	1053.57	38486.036
35	1.10	0.03	1053.57	35877.822
36	1.15	0.03	1053.57	35877.822
37	1.15	0.03	1053.57	33602.928
38	1.20	0.03	1053.57	33602.928
39	1.20	0.03	1053.57	31606.950
40	1.25	0.03	1053.57	31606.950
41	1.25	0.04	1053.57	29837.856
42	1.30	0.04	1053.57	29837.856
43	1.30	0.04	1053.57	28260.278
44	1.35	0.04	1053.57	28260.278
45	1.35	0.04	1053.57	26844.966
46	1.40	0.04	1053.57	26844.966
47	1.40	0.04	1053.57	25566.747
48	1.45	0.04	1053.57	25566.747
49	1.45	0.04	1053.57	24408.794
50	1.50	0.04	1053.57	24408.794
51	1.50	0.05	1053.57	23352.718

<i>Cod. elab.:</i> 108GA201-GA01-Z-CL-002_C	<i>Titolo:</i> OPERE D'ARTE MAGGIORI- GALLERIE	<i>Data:</i> Ottobre 2011
<i>Nome file:</i> 108GA201-GA01-Z-CL -002_C.docx	ARTIFICIALI – GALLERIA ROVETELLO Relazione di calcolo	<i>Pagina</i> 330 di 452

PROGETTO ESECUTIVO

52	1.55	0.05	1053.57	23352.718
53	1.55	0.05	1053.57	22387.185
54	1.60	0.05	1053.57	22387.185
55	1.60	0.05	1053.57	21500.647
56	1.65	0.05	1053.57	21500.647
57	1.65	0.05	1053.57	20682.551
58	1.70	0.05	1053.57	20682.551
59	1.70	0.05	1053.57	19927.928
60	1.75	0.05	1053.57	19927.928
61	1.75	0.05	1053.57	19227.206
62	1.80	0.05	1053.57	19227.206
63	1.80	0.06	1053.57	18576.224
64	1.85	0.06	1053.57	18576.224
65	1.85	0.06	1053.57	17969.246
66	1.90	0.06	1053.57	17969.246
67	1.90	0.06	1053.57	17401.881
68	1.95	0.06	1053.57	17401.881
69	1.95	0.06	1053.57	16870.353
70	2.00	0.06	1053.57	16870.353
71	2.00	0.06	1053.57	16372.144
72	2.05	0.06	1053.57	16372.144
73	2.05	0.07	1053.57	15903.706
74	2.10	0.07	1053.57	15903.706
75	2.10	0.07	1053.57	15461.944
76	2.15	0.07	1053.57	15461.944
77	2.15	0.07	1053.57	15045.592
78	2.20	0.07	1053.57	15045.592
79	2.20	0.07	1053.57	14652.184
80	2.25	0.07	1053.57	14652.184
81	2.25	0.07	1053.57	14279.551
82	2.30	0.07	1053.57	14279.551
83	2.30	0.08	1053.57	13926.299
84	2.35	0.08	1053.57	13926.299
85	2.35	0.08	1053.57	13590.985
86	2.40	0.08	1053.57	13590.985
87	2.40	0.08	1053.57	13272.308

<i>Cod. elab.:</i> 108GA201-GA01-Z-CL-002_C	<i>Titolo:</i> OPERE D'ARTE MAGGIORI- GALLERIE	<i>Data:</i> Ottobre 2011
<i>Nome file:</i> 108GA201-GA01-Z-CL -002_C.docx	ARTIFICIALI – GALLERIA ROVETELLO Relazione di calcolo	<i>Pagina</i> 331 di 452

PROGETTO ESECUTIVO

88	2.45	0.08	1053.57	13272.308
89	2.45	0.08	1053.57	12969.122
90	2.50	0.08	1053.57	12969.122
91	2.50	-240.37	1053.57	4.383
92	2.55	-240.37	1053.57	4.383
93	2.55	-240.37	1053.57	4.383
94	2.60	-240.37	1053.57	4.383
95	2.60	-240.37	1053.57	4.383
96	2.65	-240.37	1053.57	4.383
97	2.65	-240.36	1053.57	4.383
98	2.70	-240.36	1053.57	4.383
99	2.70	-240.36	1053.57	4.383
100	2.75	-240.36	1053.57	4.383
101	2.75	-240.36	1053.57	4.383
102	2.80	-240.36	1053.57	4.383
103	2.80	-240.36	1053.57	4.383
104	2.85	-240.36	1053.57	4.383
105	2.85	-240.36	1053.57	4.383
106	2.90	-240.36	1053.57	4.383
107	2.90	-240.35	1053.57	4.383
108	2.95	-240.35	1053.57	4.383
109	2.95	-240.35	1053.57	4.383
110	3.00	-240.35	1053.57	4.383
111	3.00	-240.35	1053.57	4.383
112	3.05	-239.90	1053.57	4.392
113	3.05	-239.89	1053.57	4.392
114	3.10	-238.53	1053.57	4.417
115	3.10	-238.53	1053.57	4.417
116	3.15	-236.57	1053.57	4.454
117	3.15	-236.57	1053.57	4.454
118	3.20	-234.33	1053.57	4.496
119	3.20	-234.32	1053.57	4.496
120	3.25	-231.81	1053.57	4.545
121	3.25	-231.81	1053.57	4.545
122	3.30	-229.01	1053.57	4.601
123	3.30	-229.01	1053.57	4.601

Cod. elab.: 108GA201-GA01-Z-CL-002_C	Titolo: OPERE D'ARTE MAGGIORI- GALLERIE	Data: Ottobre 2011
Nome file: 108GA201-GA01-Z-CL -002_C.docx	ARTIFICIALI – GALLERIA ROVETELLO Relazione di calcolo	Pagina 332 di 452

PROGETTO ESECUTIVO

1243.35	-226.05	1053.57	4.661
1253.35	-226.05	1053.57	4.661
1263.40	-223.04	1053.57	4.724
1273.40	-223.04	1053.57	4.724
1283.45	-219.99	1053.57	4.789
1293.45	-219.99	1053.57	4.789
1303.50	-216.90	1053.57	4.857
1313.50	-216.89	1053.57	4.857
1323.55	-213.76	1053.57	4.929
1333.55	-213.76	1053.57	4.929
1343.60	-210.59	1053.57	5.003
1353.60	-210.59	1053.57	5.003
1363.65	-207.37	1053.57	5.081
1373.65	-207.37	1053.57	5.081
1383.70	-204.12	1053.57	5.162
1393.70	-204.12	1053.57	5.162
1403.75	-200.82	1053.57	5.246
1413.75	-200.82	1053.57	5.246
1423.80	-197.49	1053.57	5.335
1433.80	-197.49	1053.57	5.335
1443.85	-194.12	1053.57	5.428
1453.85	-194.11	1053.57	5.428
1463.90	-190.70	1053.57	5.525
1473.90	-190.69	1053.57	5.525
1483.95	-187.23	1053.57	5.627
1493.95	-187.23	1053.57	5.627
1504.00	-183.73	1053.57	5.734
1514.00	-183.73	1053.57	5.734
1524.05	-180.20	1053.57	5.847
1534.05	-180.20	1053.57	5.847
1544.10	-176.62	1053.57	5.965
1554.10	-176.62	1053.57	5.965
1564.15	-173.01	1053.57	6.090
1574.15	-173.01	1053.57	6.090
1584.20	-169.37	1053.57	6.221
1594.20	-169.36	1053.57	6.221

<i>Cod. elab.:</i> 108GA201-GA01-Z-CL-002_C	<i>Titolo:</i> OPERE D'ARTE MAGGIORI- GALLERIE	<i>Data:</i> Ottobre 2011
<i>Nome file:</i> 108GA201-GA01-Z-CL -002_C.docx	ARTIFICIALI – GALLERIA ROVETELLO	<i>Pagina</i> 333 di 452
Relazione di calcolo		

PROGETTO ESECUTIVO

1604.25	-165.68	1053.57	6.359
1614.25	-165.68	1053.57	6.359
1624.30	-161.95	1053.57	6.506
1634.30	-161.94	1053.57	6.506
1644.35	-158.17	1053.57	6.661
1654.35	-158.17	1053.57	6.661
1664.40	-154.37	1053.57	6.825
1674.40	-154.36	1053.57	6.825
1684.45	-150.52	1053.57	6.999
1694.45	-150.52	1053.57	6.999
1704.50	-146.65	1053.57	7.184
1714.50	-146.64	1053.57	7.185
1724.55	-142.56	1053.57	7.390
1734.55	-142.56	1053.57	7.390
1744.60	-138.11	1053.57	7.628
1754.60	-138.11	1053.57	7.629
1764.65	-133.29	1053.57	7.905
1774.65	-133.28	1053.57	7.905
1784.70	-128.09	1053.57	8.225
1794.70	-128.09	1053.57	8.225
1804.75	-122.68	1053.57	8.588
1814.75	-122.68	1053.57	8.588
1824.80	-117.23	1053.57	8.987
1834.80	-117.23	1053.57	8.987
1844.85	-111.73	1053.57	9.430
1854.85	-111.72	1053.57	9.430
1864.90	-106.17	1053.57	9.923
1874.90	-106.17	1053.57	9.923
1884.95	-100.57	1053.57	10.476
1894.95	-100.57	1053.57	10.476
1905.00	-94.92	1053.57	11.100
1915.00	-365.31	1053.57	2.884
1925.05	-359.61	1053.57	2.930
1935.05	-359.61	1053.57	2.930
1945.10	-353.86	1053.57	2.977
1955.10	-353.86	1053.57	2.977

<i>Cod. elab.:</i> 108GA201-GA01-Z-CL-002_C	<i>Titolo:</i> OPERE D'ARTE MAGGIORI- GALLERIE	<i>Data:</i> Ottobre 2011
<i>Nome file:</i> 108GA201-GA01-Z-CL -002_C.docx	ARTIFICIALI – GALLERIA ROVETELLO Relazione di calcolo	<i>Pagina</i> 334 di 452

PROGETTO ESECUTIVO

196 5.15	-348.06	1053.57	3.027
197 5.15	-348.06	1053.57	3.027
198 5.20	-342.21	1053.57	3.079
199 5.20	-342.21	1053.57	3.079
200 5.25	-336.31	1053.57	3.133
201 5.25	-336.31	1053.57	3.133
202 5.30	-330.37	1053.57	3.189
203 5.30	-330.37	1053.57	3.189
204 5.35	-324.37	1053.57	3.248
205 5.35	-324.37	1053.57	3.248
206 5.40	-318.33	1053.57	3.310
207 5.40	-318.33	1053.57	3.310
208 5.45	-312.24	1053.57	3.374
209 5.45	-312.24	1053.57	3.374
210 5.50	-306.10	1053.57	3.442
211 5.50	-306.10	1053.57	3.442
212 5.55	-299.92	1053.57	3.513
213 5.55	-299.91	1053.57	3.513
214 5.60	-293.68	1053.57	3.587
215 5.60	-293.68	1053.57	3.587
216 5.65	-287.40	1053.57	3.666
217 5.65	-287.40	1053.57	3.666
218 5.70	-281.07	1053.57	3.748
219 5.70	-281.07	1053.57	3.748
220 5.75	-274.69	1053.57	3.835
221 5.75	-274.69	1053.57	3.835
222 5.80	-268.27	1053.57	3.927
223 5.80	-268.27	1053.57	3.927
224 5.85	-261.80	1053.57	4.024
225 5.85	-261.79	1053.57	4.024
226 5.90	-255.28	1053.57	4.127
227 5.90	-255.27	1053.57	4.127
228 5.95	-248.71	1053.57	4.236
229 5.95	-248.71	1053.57	4.236
230 6.00	-242.09	1053.57	4.352
231 6.00	-242.09	1053.57	4.352

<i>Cod. elab.:</i> 108GA201-GA01-Z-CL-002 C	<i>Titolo:</i> OPERE D'ARTE MAGGIORI- GALLERIE	<i>Data:</i> Ottobre 2011
<i>Nome file:</i> 108GA201-GA01-Z-CL -002_C.docx	ARTIFICIALI – GALLERIA ROVETELLO Relazione di calcolo	<i>Pagina</i> 335 di 452

PROGETTO ESECUTIVO

232 6.05	-235.43	1053.57	4.475
233 6.05	-235.43	1053.57	4.475
234 6.10	-228.73	1053.57	4.606
235 6.10	-228.72	1053.57	4.606
236 6.15	-221.97	1053.57	4.746
237 6.15	-221.97	1053.57	4.746
238 6.20	-215.17	1053.57	4.896
239 6.20	-215.17	1053.57	4.896
240 6.25	-208.32	1053.57	5.057
241 6.25	-208.32	1053.57	5.057
242 6.30	-201.43	1053.57	5.230
243 6.30	-201.43	1053.57	5.230
244 6.35	-194.49	1053.57	5.417
245 6.35	-194.49	1053.57	5.417
246 6.40	-187.50	1053.57	5.619
247 6.40	-187.50	1053.57	5.619
248 6.45	-180.47	1053.57	5.838
249 6.45	-180.47	1053.57	5.838
250 6.50	-173.39	1053.57	6.076
251 6.50	-173.39	1053.57	6.076
252 6.55	-166.26	1053.57	6.337
253 6.55	-166.26	1053.57	6.337
254 6.60	-159.09	1053.57	6.622
255 6.65	-151.87	1053.57	6.937
256 6.70	-144.61	1053.57	7.286
257 6.75	-137.30	1053.57	7.673
258 6.80	-129.95	1053.57	8.108
259 6.85	-122.55	1053.57	8.597
260 6.90	-115.10	1053.57	9.153
261 6.95	-107.61	1053.57	9.790
262 7.00	-100.08	1053.57	10.528
263 7.05	-92.49	1053.57	11.391
264 7.10	-84.87	1053.57	12.414
265 7.15	-77.20	1053.57	13.648
266 7.20	-69.48	1053.57	15.163
267 7.25	-61.72	1053.57	17.070

<i>Cod. elab.:</i> 108GA201-GA01-Z-CL-002 C	<i>Titolo:</i> OPERE D'ARTE MAGGIORI- GALLERIE	<i>Data:</i> Ottobre 2011
<i>Nome file:</i> 108GA201-GA01-Z-CL -002_C.docx	ARTIFICIALI – GALLERIA ROVETELLO Relazione di calcolo	<i>Pagina</i> 336 di 452

PROGETTO ESECUTIVO

2687.30	-53.91	1053.57	19.542
2697.35	-46.06	1053.57	22.872
2707.40	-38.17	1053.57	27.603
2717.45	-30.23	1053.57	34.853
2727.50	-22.24	1053.57	47.364
2737.55	-14.22	1053.57	74.116
2747.60	-6.14	1053.57	171.544
2757.65	1.98	1053.57	532.985
2767.70	10.14	1053.57	103.899
2777.75	18.35	1053.57	57.418
2787.80	26.60	1053.57	39.603
2797.85	34.90	1053.57	30.186
2807.90	43.25	1053.57	24.362
2817.95	51.64	1053.57	20.404
2828.00	60.07	1053.57	17.539
2838.05	68.55	1053.57	15.369
2848.10	77.07	1053.57	13.670
2858.15	85.64	1053.57	12.302
2868.20	94.26	1053.57	11.178
2878.25	102.91	1053.57	10.237
2888.30	111.62	1053.57	9.439
2898.35	120.36	1053.57	8.753
2908.40	129.15	1053.57	8.158
2918.45	137.98	1053.57	7.636
2928.50	146.85	1053.57	7.175
2938.50	146.85	1053.57	7.175
2948.55	156.10	1053.57	6.749
2958.55	156.10	1053.57	6.749
2968.60	165.40	1053.57	6.370
2978.60	165.40	1053.57	6.370
2988.65	174.75	1053.57	6.029
2998.65	174.76	1053.57	6.029
3008.70	184.16	1053.57	5.721
3018.70	184.16	1053.57	5.721
3028.75	193.62	1053.57	5.441
3038.75	193.62	1053.57	5.441

<i>Cod. elab.:</i> 108GA201-GA01-Z-CL-002_C	<i>Titolo:</i> OPERE D'ARTE MAGGIORI- GALLERIE	<i>Data:</i> Ottobre 2011
<i>Nome file:</i> 108GA201-GA01-Z-CL -002_C.docx	ARTIFICIALI – GALLERIA ROVETELLO Relazione di calcolo	<i>Pagina</i> 337 di 452

PROGETTO ESECUTIVO

3048.80	203.13	1053.57	5.187
3058.80	203.14	1053.57	5.186
3068.85	212.70	1053.57	4.953
3078.85	212.70	1053.57	4.953
3088.90	222.32	1053.57	4.739
3098.90	222.33	1053.57	4.739
3108.95	232.00	1053.57	4.541
3118.95	232.00	1053.57	4.541
3129.00	241.73	1053.57	4.358
3139.00	241.73	1053.57	4.358
3149.05	251.51	1053.57	4.189
3159.05	251.51	1053.57	4.189
3169.10	261.35	1053.57	4.031
3179.10	261.35	1053.57	4.031
3189.15	271.23	1053.57	3.884
3199.15	271.23	1053.57	3.884
3209.20	281.17	1053.57	3.747
3219.20	281.17	1053.57	3.747
3229.25	284.39	1053.57	3.705
3239.30	287.50	1053.57	3.665
3249.35	290.50	1053.57	3.627
3259.40	293.39	1053.57	3.591
3269.45	296.18	1053.57	3.557
3279.50	298.87	1053.57	3.525
3289.55	301.47	1053.57	3.495
3299.60	303.98	1053.57	3.466
3309.65	306.39	1053.57	3.439
3319.70	308.71	1053.57	3.413
3329.75	310.93	1053.57	3.388
3339.80	313.05	1053.57	3.365
3349.85	315.08	1053.57	3.344
3359.90	317.02	1053.57	3.323
3369.95	318.85	1053.57	3.304
33710.00	320.60	1053.57	3.286
33810.05	322.24	1053.57	3.270
33910.10	323.79	1053.57	3.254

<i>Cod. elab.:</i> 108GA201-GA01-Z-CL-002_C	<i>Titolo:</i> OPERE D'ARTE MAGGIORI- GALLERIE	<i>Data:</i> Ottobre 2011
<i>Nome file:</i> 108GA201-GA01-Z-CL -002_C.docx	ARTIFICIALI – GALLERIA ROVETELLO Relazione di calcolo	<i>Pagina</i> 338 di 452

PROGETTO ESECUTIVO

34010.15	325.24	1053.57	3.239
34110.20	326.59	1053.57	3.226
34210.25	327.85	1053.57	3.214
34310.30	329.01	1053.57	3.202
34410.35	330.07	1053.57	3.192
34510.40	331.03	1053.57	3.183
34610.45	331.83	1053.57	3.175
34710.50	332.53	1053.57	3.168
34810.55	333.13	1053.57	3.163
34910.60	333.64	1053.57	3.158
35010.65	334.05	1053.57	3.154
35110.70	334.35	1053.57	3.151
35210.75	334.56	1053.57	3.149
35310.80	334.68	1053.57	3.148
35410.85	334.69	1053.57	3.148
35510.90	334.61	1053.57	3.149
35610.95	334.42	1053.57	3.150
35711.00	334.14	1053.57	3.153
35811.05	333.76	1053.57	3.157
35911.10	333.28	1053.57	3.161
36011.15	332.70	1053.57	3.167
36111.20	332.03	1053.57	3.173
36211.25	331.25	1053.57	3.181
36311.30	330.38	1053.57	3.189
36411.35	329.40	1053.57	3.198
36511.40	328.33	1053.57	3.209
36611.45	327.16	1053.57	3.220
36711.50	325.89	1053.57	3.233
36811.55	324.52	1053.57	3.247
36911.60	323.05	1053.57	3.261
37011.65	321.48	1053.57	3.277
37111.70	319.81	1053.57	3.294
37211.75	318.04	1053.57	3.313
37311.80	316.17	1053.57	3.332
37411.85	314.21	1053.57	3.353
37511.90	312.14	1053.57	3.375

<i>Cod. elab.:</i> 108GA201-GA01-Z-CL-002 C	<i>Titolo:</i> OPERE D'ARTE MAGGIORI- GALLERIE	<i>Data:</i> Ottobre 2011
<i>Nome file:</i> 108GA201-GA01-Z-CL -002_C.docx	ARTIFICIALI – GALLERIA ROVETELLO Relazione di calcolo	<i>Pagina</i> 339 di 452

PROGETTO ESECUTIVO

37611.95	309.97	1053.57	3.399
37712.00	307.70	1053.57	3.424
37812.05	305.34	1053.57	3.451
37912.10	302.87	1053.57	3.479
38012.15	300.30	1053.57	3.508
38112.20	297.64	1053.57	3.540
38212.25	294.87	1053.57	3.573
38312.30	292.00	1053.57	3.608
38412.35	289.03	1053.57	3.645
38512.40	285.96	1053.57	3.684
38612.45	282.79	1053.57	3.726
38712.50	279.53	1053.57	3.769
38812.55	276.16	1053.57	3.815
38912.60	272.69	1053.57	3.864
39012.65	269.13	1053.57	3.915
39112.70	265.49	1053.57	3.968
39212.75	261.78	1053.57	4.025
39312.80	257.99	1053.57	4.084
39412.85	254.12	1053.57	4.146
39512.90	250.18	1053.57	4.211
39612.95	246.17	1053.57	4.280
39713.00	242.09	1053.57	4.352
39813.05	237.94	1053.57	4.428
39913.10	233.72	1053.57	4.508
40013.15	229.42	1053.57	4.592
40113.20	225.06	1053.57	4.681
40213.25	220.62	1053.57	4.775
40313.30	216.11	1053.57	4.875
40413.35	211.53	1053.57	4.981
40513.40	206.88	1053.57	5.093
40613.45	202.15	1053.57	5.212
40713.50	197.36	1053.57	5.338
40813.55	192.49	1053.57	5.473
40913.60	187.55	1053.57	5.617
41013.65	182.54	1053.57	5.772
41113.70	177.46	1053.57	5.937

<i>Cod. elab.:</i> 108GA201-GA01-Z-CL-002_C	<i>Titolo:</i> OPERE D'ARTE MAGGIORI- GALLERIE	<i>Data:</i> Ottobre 2011
<i>Nome file:</i> 108GA201-GA01-Z-CL -002_C.docx	ARTIFICIALI – GALLERIA ROVETELLO Relazione di calcolo	<i>Pagina</i> 340 di 452

PROGETTO ESECUTIVO

41213.75	172.30	1053.57	6.115
41313.80	167.07	1053.57	6.306
41413.85	161.78	1053.57	6.513
41513.90	156.40	1053.57	6.736
41613.95	150.96	1053.57	6.979
41714.00	145.45	1053.57	7.244
41814.05	139.86	1053.57	7.533
41914.10	134.20	1053.57	7.851
42014.15	128.47	1053.57	8.201
42114.20	122.66	1053.57	8.589
42214.25	116.79	1053.57	9.021
42314.30	110.84	1053.57	9.505
42414.35	104.82	1053.57	10.051
42514.40	98.72	1053.57	10.672
42614.45	92.56	1053.57	11.383
42714.50	86.32	1053.57	12.205
42814.55	80.01	1053.57	13.168
42914.60	73.63	1053.57	14.309
43014.65	67.17	1053.57	15.685
43114.70	60.64	1053.57	17.373
43214.75	54.04	1053.57	19.495
43314.80	47.37	1053.57	22.241
43414.85	40.62	1053.57	25.935
43514.90	33.81	1053.57	31.166
43614.95	26.91	1053.57	39.146
43715.00	19.95	1053.57	52.811
43815.05	12.91	1053.57	81.589
43915.10	5.80	1053.57	181.539
44015.15	-1.38	1053.57	764.210
44115.20	-8.63	1053.57	122.033
44215.25	-15.96	1053.57	66.012
44315.30	-23.36	1053.57	45.103
44415.35	-30.83	1053.57	34.174
44515.40	-38.27	1053.57	27.531
44615.45	-45.51	1053.57	23.151
44715.50	-52.55	1053.57	20.049

<i>Cod. elab.:</i> 108GA201-GA01-Z-CL-002_C	<i>Titolo:</i> OPERE D'ARTE MAGGIORI- GALLERIE	<i>Data:</i> Ottobre 2011
<i>Nome file:</i> 108GA201-GA01-Z-CL -002_C.docx	ARTIFICIALI – GALLERIA ROVETELLO Relazione di calcolo	<i>Pagina</i> 341 di 452

PROGETTO ESECUTIVO

44815.55	-59.39	1053.57	17.739
44915.60	-66.04	1053.57	15.953
45015.65	-72.50	1053.57	14.532
45115.70	-78.76	1053.57	13.377
45215.75	-84.83	1053.57	12.420
45315.80	-90.70	1053.57	11.615
45415.85	-96.39	1053.57	10.930
45515.90	-101.89	1053.57	10.340
45615.95	-107.20	1053.57	9.828
45716.00	-112.32	1053.57	9.380
45816.05	-117.26	1053.57	8.985
45916.10	-122.02	1053.57	8.635
46016.15	-126.59	1053.57	8.323
46116.20	-130.97	1053.57	8.044
46216.25	-135.18	1053.57	7.794
46316.30	-139.21	1053.57	7.568
46416.35	-143.05	1053.57	7.365
46516.40	-146.72	1053.57	7.181
46616.45	-150.21	1053.57	7.014
46716.50	-154.82	1053.57	6.805
46816.55	-160.46	1053.57	6.566
46916.60	-165.85	1053.57	6.352
47016.65	-170.99	1053.57	6.162
47116.70	-175.88	1053.57	5.990
47216.75	-180.53	1053.57	5.836
47316.80	-184.93	1053.57	5.697
47416.85	-189.08	1053.57	5.572
47516.90	-192.99	1053.57	5.459
47616.95	-196.66	1053.57	5.357
47717.00	-200.09	1053.57	5.265
47817.05	-203.28	1053.57	5.183
47917.10	-206.23	1053.57	5.109
48017.15	-208.95	1053.57	5.042
48117.20	-211.42	1053.57	4.983
48217.25	-213.67	1053.57	4.931
48317.30	-215.68	1053.57	4.885

<i>Cod. elab.:</i> 108GA201-GA01-Z-CL-002_C	<i>Titolo:</i> OPERE D'ARTE MAGGIORI- GALLERIE	<i>Data:</i> Ottobre 2011
<i>Nome file:</i> 108GA201-GA01-Z-CL -002_C.docx	ARTIFICIALI – GALLERIA ROVETELLO	<i>Pagina</i> 342 di 452
Relazione di calcolo		

PROGETTO ESECUTIVO

48417.35	-217.45	1053.57	4.845
48517.40	-219.00	1053.57	4.811
48617.45	-220.31	1053.57	4.782
48717.50	-221.39	1053.57	4.759
48817.55	-222.25	1053.57	4.741
48917.60	-222.87	1053.57	4.727
49017.65	-223.27	1053.57	4.719
49117.70	-223.45	1053.57	4.715
49217.75	-223.39	1053.57	4.716
49317.80	-223.12	1053.57	4.722
49417.85	-222.62	1053.57	4.733
49517.90	-221.89	1053.57	4.748
49617.95	-220.95	1053.57	4.768
49718.00	-219.78	1053.57	4.794
49818.05	-218.39	1053.57	4.824
49918.10	-216.78	1053.57	4.860
50018.15	-214.95	1053.57	4.901
50118.20	-212.91	1053.57	4.948
50218.25	-210.64	1053.57	5.002
50318.30	-208.16	1053.57	5.061
50418.35	-205.46	1053.57	5.128
50518.40	-202.54	1053.57	5.202
50618.45	-199.40	1053.57	5.284
50718.50	-196.05	1053.57	5.374
50818.55	-192.49	1053.57	5.473
50918.60	-188.70	1053.57	5.583
51018.65	-184.71	1053.57	5.704
51118.70	-180.50	1053.57	5.837
51218.75	-176.07	1053.57	5.984
51318.80	-171.43	1053.57	6.146
51418.85	-166.58	1053.57	6.325
51518.90	-161.51	1053.57	6.523
51618.95	-156.23	1053.57	6.744
51719.00	-150.74	1053.57	6.989
51819.05	-145.04	1053.57	7.264
51919.10	-139.12	1053.57	7.573

<i>Cod. elab.:</i> 108GA201-GA01-Z-CL-002 C	<i>Titolo:</i> OPERE D'ARTE MAGGIORI- GALLERIE	<i>Data:</i> Ottobre 2011
<i>Nome file:</i> 108GA201-GA01-Z-CL -002_C.docx	ARTIFICIALI – GALLERIA ROVETELLO	<i>Pagina</i> 343 di 452
Relazione di calcolo		

PROGETTO ESECUTIVO

52019.15	-132.99	1053.57	7.922
52119.20	-126.65	1053.57	8.319
52219.25	-120.10	1053.57	8.773
52319.30	-113.33	1053.57	9.296
52419.35	-106.35	1053.57	9.906
52519.40	-99.16	1053.57	10.624
52619.45	-91.76	1053.57	11.481
52719.50	-84.15	1053.57	12.520
52819.55	-76.33	1053.57	13.803
52919.60	-68.29	1053.57	15.427
53019.65	-60.05	1053.57	17.546
53119.70	-51.59	1053.57	20.423
53219.75	-42.92	1053.57	24.548
53319.80	-34.04	1053.57	30.953
53419.85	-24.95	1053.57	42.234
53519.90	-15.64	1053.57	67.354
53619.95	-6.13	1053.57	171.938
53720.00	3.60	1053.57	292.781

Fase n° 7 - [A1-M1]

n°	Y	T	T _R	CS _T
1	0.00	0.00	1053.57	2159683.831
2	0.05	0.00	1053.57	721703.551
3	0.10	0.00	1053.57	433530.730
4	0.15	0.00	1053.57	310092.130
5	0.20	0.00	1053.57	241467.677
6	0.25	0.01	1053.57	197786.465
7	0.30	0.01	1053.57	167554.388
8	0.35	0.01	1053.57	145355.454
9	0.40	0.01	1053.57	128432.046
10	0.45	0.01	1053.57	115039.359
11	0.50	0.01	1053.57	115039.359
12	0.50	0.01	1053.57	87526.130
13	0.55	0.01	1053.57	87526.130
14	0.55	0.02	1053.57	62596.638

Cod. elab.: 108GA201-GA01-Z-CL-002_C	Titolo: OPERE D'ARTE MAGGIORI- GALLERIE	Data: Ottobre 2011
Nome file: 108GA201-GA01-Z-CL -002_C.docx	ARTIFICIALI – GALLERIA ROVETELLO	Pagina 344 di 452
Relazione di calcolo		

PROGETTO ESECUTIVO

15	0.60	0.02	1053.57	62596.638
16	0.60	0.02	1053.57	48750.502
17	0.65	0.02	1053.57	48750.502
18	0.65	0.03	1053.57	39931.981
19	0.70	0.03	1053.57	39931.981
20	0.70	0.03	1053.57	33830.314
21	0.75	0.03	1053.57	33830.314
22	0.75	0.04	1053.57	29354.019
23	0.80	0.04	1053.57	29354.019
24	0.80	0.04	1053.57	25931.270
25	0.85	0.04	1053.57	25931.270
26	0.85	0.05	1053.57	23229.727
27	0.90	0.05	1053.57	23229.727
28	0.90	0.05	1053.57	21042.400
29	0.95	0.05	1053.57	21042.400
30	0.95	0.05	1053.57	19235.736
31	1.00	0.05	1053.57	19235.736
32	1.00	0.06	1053.57	17717.678
33	1.05	0.06	1053.57	17717.678
34	1.05	0.06	1053.57	16424.701
35	1.10	0.06	1053.57	16424.701
36	1.10	0.07	1053.57	15310.258
37	1.15	0.07	1053.57	15310.258
38	1.15	0.07	1053.57	14339.310
39	1.20	0.07	1053.57	14339.310
40	1.20	0.08	1053.57	13486.561
41	1.25	0.08	1053.57	13486.561
42	1.25	0.08	1053.57	12731.088
43	1.30	0.08	1053.57	12731.088
44	1.30	0.09	1053.57	12057.220
45	1.35	0.09	1053.57	12057.220
46	1.35	0.09	1053.57	11452.634
47	1.40	0.09	1053.57	11452.634
48	1.40	0.10	1053.57	10907.065
49	1.45	0.10	1053.57	10907.065
50	1.45	0.10	1053.57	10412.131

<i>Cod. elab.:</i> 108GA201-GA01-Z-CL-002_C	<i>Titolo:</i> OPERE D'ARTE MAGGIORI- GALLERIE	<i>Data:</i> Ottobre 2011
<i>Nome file:</i> 108GA201-GA01-Z-CL -002_C.docx	ARTIFICIALI – GALLERIA ROVETELLO Relazione di calcolo	<i>Pagina</i> 345 di 452

PROGETTO ESECUTIVO

51	1.50	0.10	1053.57	10412.131
52	1.50	0.11	1053.57	9961.286
53	1.55	0.11	1053.57	9961.286
54	1.55	0.11	1053.57	9548.882
55	1.60	0.11	1053.57	9548.882
56	1.60	0.11	1053.57	9170.171
57	1.65	0.11	1053.57	9170.171
58	1.65	0.12	1053.57	8821.046
59	1.70	0.12	1053.57	8821.046
60	1.70	0.12	1053.57	8498.491
61	1.75	0.12	1053.57	8498.491
62	1.75	0.13	1053.57	8199.229
63	1.80	0.13	1053.57	8199.229
64	1.80	0.13	1053.57	7921.181
65	1.85	0.13	1053.57	7921.181
66	1.85	0.14	1053.57	7661.825
67	1.90	0.14	1053.57	7661.825
68	1.90	0.14	1053.57	7419.608
69	1.95	0.14	1053.57	7419.608
70	1.95	0.15	1053.57	7192.716
71	2.00	0.15	1053.57	7192.716
72	2.00	0.15	1053.57	6979.837
73	2.05	0.15	1053.57	6979.837
74	2.05	0.16	1053.57	6779.747
75	2.10	0.16	1053.57	6779.747
76	2.10	0.16	1053.57	6591.180
77	2.15	0.16	1053.57	6591.180
78	2.15	0.16	1053.57	6413.301
79	2.20	0.16	1053.57	6413.301
80	2.20	0.17	1053.57	6245.139
81	2.25	0.17	1053.57	6245.139
82	2.25	0.17	1053.57	6086.023
83	2.30	0.17	1053.57	6086.023
84	2.30	0.18	1053.57	5935.199
85	2.35	0.18	1053.57	5935.199
86	2.35	0.18	1053.57	5791.931

Cod. elab.: 108GA201-GA01-Z-CL-002_C	Titolo: OPERE D'ARTE MAGGIORI- GALLERIE	Data: Ottobre 2011
Nome file: 108GA201-GA01-Z-CL -002_C.docx	ARTIFICIALI – GALLERIA ROVETELLO	Pagina 346 di 452
Relazione di calcolo		

PROGETTO ESECUTIVO

87	2.40	0.18	1053.57	5791.931
88	2.40	0.19	1053.57	5655.856
89	2.45	0.19	1053.57	5655.856
90	2.45	0.19	1053.57	5526.287
91	2.50	0.19	1053.57	5526.287
92	2.50	-244.33	1053.57	4.312
93	2.55	-244.33	1053.57	4.312
94	2.55	-244.32	1053.57	4.312
95	2.60	-244.32	1053.57	4.312
96	2.60	-244.32	1053.57	4.312
97	2.65	-244.32	1053.57	4.312
98	2.65	-244.31	1053.57	4.312
99	2.70	-244.31	1053.57	4.312
100	2.70	-244.31	1053.57	4.312
101	2.75	-244.31	1053.57	4.312
102	2.75	-244.31	1053.57	4.312
103	2.80	-244.31	1053.57	4.312
104	2.80	-244.30	1053.57	4.313
105	2.85	-244.30	1053.57	4.313
106	2.85	-244.30	1053.57	4.313
107	2.90	-244.30	1053.57	4.313
108	2.90	-244.29	1053.57	4.313
109	2.95	-244.29	1053.57	4.313
110	2.95	-244.29	1053.57	4.313
111	3.00	-244.29	1053.57	4.313
112	3.00	-244.28	1053.57	4.313
113	3.05	-243.83	1053.57	4.321
114	3.05	-243.82	1053.57	4.321
115	3.10	-242.46	1053.57	4.345
116	3.10	-242.46	1053.57	4.345
117	3.15	-240.50	1053.57	4.381
118	3.15	-240.49	1053.57	4.381
119	3.20	-238.25	1053.57	4.422
120	3.20	-238.25	1053.57	4.422
121	3.25	-235.73	1053.57	4.469
122	3.25	-235.73	1053.57	4.469

Cod. elab.: 108GA201-GA01-Z-CL-002_C	Titolo: OPERE D'ARTE MAGGIORI- GALLERIE	Data: Ottobre 2011
Nome file: 108GA201-GA01-Z-CL -002_C.docx	ARTIFICIALI – GALLERIA ROVETELLO	Pagina 347 di 452
Relazione di calcolo		

PROGETTO ESECUTIVO

1233.30	-232.93	1053.57	4.523
1243.30	-232.93	1053.57	4.523
1253.35	-229.97	1053.57	4.581
1263.35	-229.96	1053.57	4.581
1273.40	-226.96	1053.57	4.642
1283.40	-226.95	1053.57	4.642
1293.45	-223.90	1053.57	4.705
1303.45	-223.90	1053.57	4.706
1313.50	-220.81	1053.57	4.771
1323.50	-220.80	1053.57	4.772
1333.55	-217.67	1053.57	4.840
1343.55	-217.67	1053.57	4.840
1353.60	-214.49	1053.57	4.912
1363.60	-214.49	1053.57	4.912
1373.65	-211.28	1053.57	4.987
1383.65	-211.27	1053.57	4.987
1393.70	-208.02	1053.57	5.065
1403.70	-208.02	1053.57	5.065
1413.75	-204.72	1053.57	5.146
1423.75	-204.72	1053.57	5.146
1433.80	-201.39	1053.57	5.232
1443.80	-201.38	1053.57	5.232
1453.85	-198.01	1053.57	5.321
1463.85	-198.01	1053.57	5.321
1473.90	-194.59	1053.57	5.414
1483.90	-194.58	1053.57	5.414
1493.95	-191.12	1053.57	5.512
1503.95	-191.12	1053.57	5.513
1514.00	-187.62	1053.57	5.615
1524.00	-187.62	1053.57	5.615
1534.05	-184.08	1053.57	5.723
1544.05	-184.08	1053.57	5.723
1554.10	-180.51	1053.57	5.837
1564.10	-180.50	1053.57	5.837
1574.15	-176.89	1053.57	5.956
1584.15	-176.89	1053.57	5.956

<i>Cod. elab.:</i> 108GA201-GA01-Z-CL-002_C	<i>Titolo:</i> OPERE D'ARTE MAGGIORI- GALLERIE	<i>Data:</i> Ottobre 2011
<i>Nome file:</i> 108GA201-GA01-Z-CL -002_C.docx	ARTIFICIALI – GALLERIA ROVETELLO	<i>Pagina</i> 348 di 452
Relazione di calcolo		

PROGETTO ESECUTIVO

1594.20	-173.24	1053.57	6.081
1604.20	-173.24	1053.57	6.082
1614.25	-169.55	1053.57	6.214
1624.25	-169.55	1053.57	6.214
1634.30	-165.82	1053.57	6.354
1644.30	-165.82	1053.57	6.354
1654.35	-162.04	1053.57	6.502
1664.35	-162.04	1053.57	6.502
1674.40	-158.23	1053.57	6.658
1684.40	-158.23	1053.57	6.658
1694.45	-154.39	1053.57	6.824
1704.45	-154.39	1053.57	6.824
1714.50	-150.51	1053.57	7.000
1724.50	-150.51	1053.57	7.000
1734.55	-146.43	1053.57	7.195
1744.55	-146.42	1053.57	7.195
1754.60	-141.97	1053.57	7.421
1764.60	-141.97	1053.57	7.421
1774.65	-137.14	1053.57	7.682
1784.65	-137.14	1053.57	7.682
1794.70	-131.95	1053.57	7.985
1804.70	-131.94	1053.57	7.985
1814.75	-126.54	1053.57	8.326
1824.75	-126.53	1053.57	8.326
1834.80	-121.08	1053.57	8.701
1844.80	-121.08	1053.57	8.702
1854.85	-115.57	1053.57	9.116
1864.85	-115.57	1053.57	9.116
1874.90	-110.02	1053.57	9.576
1884.90	-110.01	1053.57	9.577
1894.95	-104.41	1053.57	10.090
1904.95	-104.41	1053.57	10.091
1915.00	-98.76	1053.57	10.668
1925.00	-358.53	1053.57	2.939
1935.05	-352.83	1053.57	2.986
1945.05	-352.82	1053.57	2.986

<i>Cod. elab.:</i> 108GA201-GA01-Z-CL-002_C	<i>Titolo:</i> OPERE D'ARTE MAGGIORI- GALLERIE	<i>Data:</i> Ottobre 2011
<i>Nome file:</i> 108GA201-GA01-Z-CL -002_C.docx	ARTIFICIALI – GALLERIA ROVETELLO Relazione di calcolo	<i>Pagina</i> 349 di 452

PROGETTO ESECUTIVO

195 5.10	-347.08	1053.57	3.036
196 5.10	-347.07	1053.57	3.036
197 5.15	-341.27	1053.57	3.087
198 5.15	-341.27	1053.57	3.087
199 5.20	-335.42	1053.57	3.141
200 5.20	-335.42	1053.57	3.141
201 5.25	-329.52	1053.57	3.197
202 5.25	-329.52	1053.57	3.197
203 5.30	-323.58	1053.57	3.256
204 5.30	-323.57	1053.57	3.256
205 5.35	-317.58	1053.57	3.317
206 5.35	-317.58	1053.57	3.318
207 5.40	-311.54	1053.57	3.382
208 5.40	-311.53	1053.57	3.382
209 5.45	-305.44	1053.57	3.449
210 5.45	-305.44	1053.57	3.449
211 5.50	-299.30	1053.57	3.520
212 5.50	-299.30	1053.57	3.520
213 5.55	-293.11	1053.57	3.594
214 5.55	-293.11	1053.57	3.594
215 5.60	-286.88	1053.57	3.673
216 5.60	-286.87	1053.57	3.673
217 5.65	-280.59	1053.57	3.755
218 5.65	-280.59	1053.57	3.755
219 5.70	-274.26	1053.57	3.841
220 5.70	-274.26	1053.57	3.842
221 5.75	-267.88	1053.57	3.933
222 5.75	-267.88	1053.57	3.933
223 5.80	-261.45	1053.57	4.030
224 5.80	-261.45	1053.57	4.030
225 5.85	-254.98	1053.57	4.132
226 5.85	-254.98	1053.57	4.132
227 5.90	-248.46	1053.57	4.240
228 5.90	-248.46	1053.57	4.240
229 5.95	-241.89	1053.57	4.356
230 5.95	-241.89	1053.57	4.356

<i>Cod. elab.:</i> 108GA201-GA01-Z-CL-002 C	<i>Titolo:</i> OPERE D'ARTE MAGGIORI- GALLERIE	<i>Data:</i> Ottobre 2011
<i>Nome file:</i> 108GA201-GA01-Z-CL -002_C.docx	ARTIFICIALI – GALLERIA ROVETELLO Relazione di calcolo	<i>Pagina</i> 350 di 452

PROGETTO ESECUTIVO

231 6.00	-235.27	1053.57	4.478
232 6.00	-235.27	1053.57	4.478
233 6.05	-228.61	1053.57	4.609
234 6.05	-228.61	1053.57	4.609
235 6.10	-221.90	1053.57	4.748
236 6.10	-221.90	1053.57	4.748
237 6.15	-215.14	1053.57	4.897
238 6.15	-215.14	1053.57	4.897
239 6.20	-208.34	1053.57	5.057
240 6.20	-208.34	1053.57	5.057
241 6.25	-201.49	1053.57	5.229
242 6.25	-201.49	1053.57	5.229
243 6.30	-194.60	1053.57	5.414
244 6.30	-194.59	1053.57	5.414
245 6.35	-187.65	1053.57	5.614
246 6.35	-187.65	1053.57	5.615
247 6.40	-180.66	1053.57	5.832
248 6.40	-180.66	1053.57	5.832
249 6.45	-173.63	1053.57	6.068
250 6.45	-173.63	1053.57	6.068
251 6.50	-166.55	1053.57	6.326
252 6.50	-166.54	1053.57	6.326
253 6.55	-159.42	1053.57	6.609
254 6.55	-159.42	1053.57	6.609
255 6.60	-152.25	1053.57	6.920
256 6.60	-152.24	1053.57	6.920
257 6.65	-145.03	1053.57	7.265
258 6.65	-145.02	1053.57	7.265
259 6.70	-137.76	1053.57	7.648
260 6.70	-137.76	1053.57	7.648
261 6.75	-130.45	1053.57	8.076
262 6.75	-130.45	1053.57	8.076
263 6.80	-123.10	1053.57	8.559
264 6.80	-123.09	1053.57	8.559
265 6.85	-115.69	1053.57	9.106
266 6.85	-115.69	1053.57	9.107

<i>Cod. elab.:</i> 108GA201-GA01-Z-CL-002 C	<i>Titolo:</i> OPERE D'ARTE MAGGIORI- GALLERIE	<i>Data:</i> Ottobre 2011
<i>Nome file:</i> 108GA201-GA01-Z-CL -002_C.docx	ARTIFICIALI – GALLERIA ROVETELLO Relazione di calcolo	<i>Pagina</i> 351 di 452

PROGETTO ESECUTIVO

2676.90	-108.25	1053.57	9.733
2686.90	-108.24	1053.57	9.733
2696.95	-100.75	1053.57	10.457
2706.95	-100.75	1053.57	10.457
2717.00	-93.22	1053.57	11.302
2727.00	-93.21	1053.57	11.303
2737.05	-85.63	1053.57	12.303
2747.05	-85.63	1053.57	12.304
2757.10	-78.01	1053.57	13.506
2767.10	-78.00	1053.57	13.507
2777.15	-70.33	1053.57	14.980
2787.15	-70.33	1053.57	14.981
2797.20	-62.61	1053.57	16.826
2807.20	-62.61	1053.57	16.827
2817.25	-54.85	1053.57	19.208
2827.25	-54.85	1053.57	19.209
2837.30	-47.04	1053.57	22.396
2847.30	-47.04	1053.57	22.397
2857.35	-39.19	1053.57	26.883
2867.35	-39.19	1053.57	26.885
2877.40	-31.29	1053.57	33.668
2887.40	-31.29	1053.57	33.671
2897.45	-23.35	1053.57	45.118
2907.45	-23.35	1053.57	45.124
2917.50	-15.37	1053.57	68.568
2927.50	-15.36	1053.57	68.583
2937.55	-7.33	1053.57	143.646
2947.55	-7.33	1053.57	143.709
2957.60	0.74	1053.57	1421.953
2967.60	0.74	1053.57	1415.830
2977.65	8.86	1053.57	118.897
2987.65	8.86	1053.57	118.854
2997.70	17.03	1053.57	61.878
3007.70	17.03	1053.57	61.866
3017.75	25.24	1053.57	41.747
3027.75	25.24	1053.57	41.741

<i>Cod. elab.:</i> 108GA201-GA01-Z-CL-002_C	<i>Titolo:</i> OPERE D'ARTE MAGGIORI- GALLERIE	<i>Data:</i> Ottobre 2011
<i>Nome file:</i> 108GA201-GA01-Z-CL -002_C.docx	ARTIFICIALI – GALLERIA ROVETELLO Relazione di calcolo	<i>Pagina</i> 352 di 452

PROGETTO ESECUTIVO

3037.80	33.49	1053.57	31.456
3047.80	33.50	1053.57	31.453
3057.85	41.79	1053.57	25.208
3067.85	41.80	1053.57	25.207
3077.90	50.14	1053.57	21.012
3087.90	50.14	1053.57	21.011
3097.95	58.53	1053.57	18.000
3107.95	58.53	1053.57	17.999
3118.00	66.97	1053.57	15.732
3128.00	66.97	1053.57	15.732
3138.05	75.45	1053.57	13.964
3148.05	75.45	1053.57	13.963
3158.10	83.97	1053.57	12.546
3168.10	83.98	1053.57	12.546
3178.15	92.55	1053.57	11.384
3188.15	92.55	1053.57	11.384
3198.20	101.16	1053.57	10.415
3208.20	101.16	1053.57	10.414
3218.25	109.82	1053.57	9.594
3228.25	109.82	1053.57	9.593
3238.30	118.52	1053.57	8.889
3248.30	118.53	1053.57	8.889
3258.35	127.27	1053.57	8.278
3268.35	127.28	1053.57	8.278
3278.40	136.06	1053.57	7.743
3288.40	136.07	1053.57	7.743
3298.45	144.89	1053.57	7.271
3308.45	144.90	1053.57	7.271
3318.50	153.76	1053.57	6.852
3328.50	153.77	1053.57	6.852
3338.55	163.02	1053.57	6.463
3348.55	163.02	1053.57	6.463
3358.60	172.32	1053.57	6.114
3368.60	172.33	1053.57	6.114
3378.65	181.68	1053.57	5.799
3388.65	181.69	1053.57	5.799

<i>Cod. elab.:</i> 108GA201-GA01-Z-CL-002_C	<i>Titolo:</i> OPERE D'ARTE MAGGIORI- GALLERIE	<i>Data:</i> Ottobre 2011
<i>Nome file:</i> 108GA201-GA01-Z-CL -002_C.docx	ARTIFICIALI – GALLERIA ROVETELLO Relazione di calcolo	<i>Pagina</i> 353 di 452

PROGETTO ESECUTIVO

3398.70	191.09	1053.57	5.513
3408.70	191.09	1053.57	5.513
3418.75	200.55	1053.57	5.253
3428.75	200.56	1053.57	5.253
3438.80	210.07	1053.57	5.015
3448.80	210.07	1053.57	5.015
3458.85	219.64	1053.57	4.797
3468.85	219.64	1053.57	4.797
3478.90	229.26	1053.57	4.595
3488.90	229.27	1053.57	4.595
3498.95	238.94	1053.57	4.409
3508.95	238.95	1053.57	4.409
3519.00	248.67	1053.57	4.237
3529.00	248.68	1053.57	4.237
3539.05	258.46	1053.57	4.076
3549.05	258.46	1053.57	4.076
3559.10	268.30	1053.57	3.927
3569.10	268.30	1053.57	3.927
3579.15	278.19	1053.57	3.787
3589.15	278.19	1053.57	3.787
3599.20	288.13	1053.57	3.657
3609.20	288.14	1053.57	3.657
3619.25	291.36	1053.57	3.616
3629.30	294.48	1053.57	3.578
3639.35	297.48	1053.57	3.542
3649.40	300.38	1053.57	3.507
3659.45	303.17	1053.57	3.475
3669.50	305.87	1053.57	3.444
3679.55	308.48	1053.57	3.415
3689.60	310.99	1053.57	3.388
3699.65	313.41	1053.57	3.362
3709.70	315.73	1053.57	3.337
3719.75	317.95	1053.57	3.314
3729.80	320.08	1053.57	3.292
3739.85	322.12	1053.57	3.271
3749.90	324.06	1053.57	3.251

<i>Cod. elab.:</i> 108GA201-GA01-Z-CL-002_C	<i>Titolo:</i> OPERE D'ARTE MAGGIORI- GALLERIE	<i>Data:</i> Ottobre 2011
<i>Nome file:</i> 108GA201-GA01-Z-CL -002_C.docx	ARTIFICIALI – GALLERIA ROVETELLO	<i>Pagina</i> 354 di 452
Relazione di calcolo		

PROGETTO ESECUTIVO

3759.95	325.90	1053.57	3.233
37610.00	327.65	1053.57	3.216
37710.05	329.30	1053.57	3.199
37810.10	330.85	1053.57	3.184
37910.15	332.31	1053.57	3.170
38010.20	333.67	1053.57	3.158
38110.25	334.93	1053.57	3.146
38210.30	336.10	1053.57	3.135
38310.35	337.16	1053.57	3.125
38410.40	338.13	1053.57	3.116
38510.45	338.93	1053.57	3.108
38610.50	339.64	1053.57	3.102
38710.55	340.24	1053.57	3.097
38810.60	340.75	1053.57	3.092
38910.65	341.16	1053.57	3.088
39010.70	341.47	1053.57	3.085
39110.75	341.68	1053.57	3.083
39210.80	341.79	1053.57	3.082
39310.85	341.81	1053.57	3.082
39410.90	341.73	1053.57	3.083
39510.95	341.55	1053.57	3.085
39611.00	341.27	1053.57	3.087
39711.05	340.89	1053.57	3.091
39811.10	340.41	1053.57	3.095
39911.15	339.84	1053.57	3.100
40011.20	339.17	1053.57	3.106
40111.25	338.39	1053.57	3.113
40211.30	337.52	1053.57	3.121
40311.35	336.55	1053.57	3.130
40411.40	335.48	1053.57	3.140
40511.45	334.31	1053.57	3.151
40611.50	333.04	1053.57	3.163
40711.55	331.67	1053.57	3.177
40811.60	330.21	1053.57	3.191
40911.65	328.64	1053.57	3.206
41011.70	326.97	1053.57	3.222

<i>Cod. elab.:</i> 108GA201-GA01-Z-CL-002_C	<i>Titolo:</i> OPERE D'ARTE MAGGIORI- GALLERIE	<i>Data:</i> Ottobre 2011
<i>Nome file:</i> 108GA201-GA01-Z-CL -002_C.docx	ARTIFICIALI – GALLERIA ROVETELLO Relazione di calcolo	<i>Pagina</i> 355 di 452

PROGETTO ESECUTIVO

41111.75	325.21	1053.57	3.240
41211.80	323.34	1053.57	3.258
41311.85	321.37	1053.57	3.278
41411.90	319.31	1053.57	3.300
41511.95	317.14	1053.57	3.322
41612.00	314.88	1053.57	3.346
41712.05	312.51	1053.57	3.371
41812.10	310.05	1053.57	3.398
41912.15	307.48	1053.57	3.426
42012.20	304.82	1053.57	3.456
42112.25	302.05	1053.57	3.488
42212.30	299.19	1053.57	3.521
42312.35	296.22	1053.57	3.557
42412.40	293.15	1053.57	3.594
42512.45	289.99	1053.57	3.633
42612.50	286.72	1053.57	3.675
42712.55	283.35	1053.57	3.718
42812.60	279.88	1053.57	3.764
42912.65	276.33	1053.57	3.813
43012.70	272.69	1053.57	3.864
43112.75	268.99	1053.57	3.917
43212.80	265.19	1053.57	3.973
43312.85	261.33	1053.57	4.032
43412.90	257.39	1053.57	4.093
43512.95	253.39	1053.57	4.158
43613.00	249.31	1053.57	4.226
43713.05	245.16	1053.57	4.298
43813.10	240.94	1053.57	4.373
43913.15	236.64	1053.57	4.452
44013.20	232.28	1053.57	4.536
44113.25	227.84	1053.57	4.624
44213.30	223.33	1053.57	4.717
44313.35	218.75	1053.57	4.816
44413.40	214.10	1053.57	4.921
44513.45	209.38	1053.57	5.032
44613.50	204.59	1053.57	5.150

<i>Cod. elab.:</i> 108GA201-GA01-Z-CL-002_C	<i>Titolo:</i> OPERE D'ARTE MAGGIORI- GALLERIE	<i>Data:</i> Ottobre 2011
<i>Nome file:</i> 108GA201-GA01-Z-CL -002_C.docx	ARTIFICIALI – GALLERIA ROVETELLO Relazione di calcolo	<i>Pagina</i> 356 di 452

PROGETTO ESECUTIVO

44713.55	199.72	1053.57	5.275
44813.60	194.78	1053.57	5.409
44913.65	189.77	1053.57	5.552
45013.70	184.69	1053.57	5.704
45113.75	179.54	1053.57	5.868
45213.80	174.31	1053.57	6.044
45313.85	169.02	1053.57	6.234
45413.90	163.65	1053.57	6.438
45513.95	158.20	1053.57	6.660
45614.00	152.69	1053.57	6.900
45714.05	147.10	1053.57	7.162
45814.10	141.45	1053.57	7.449
45914.15	135.72	1053.57	7.763
46014.20	129.91	1053.57	8.110
46114.25	124.04	1053.57	8.494
46214.30	118.09	1053.57	8.922
46314.35	112.07	1053.57	9.401
46414.40	105.98	1053.57	9.941
46514.45	99.81	1053.57	10.555
46614.50	93.58	1053.57	11.259
46714.55	87.27	1053.57	12.073
46814.60	80.89	1053.57	13.025
46914.65	74.43	1053.57	14.155
47014.70	67.91	1053.57	15.515
47114.75	61.31	1053.57	17.185
47214.80	54.63	1053.57	19.284
47314.85	47.89	1053.57	22.000
47414.90	41.07	1053.57	25.652
47514.95	34.18	1053.57	30.822
47615.00	27.22	1053.57	38.707
47715.05	20.18	1053.57	52.200
47815.10	13.07	1053.57	80.580
47915.15	5.89	1053.57	178.764
48015.20	-1.36	1053.57	774.576
48115.25	-8.69	1053.57	121.295
48215.30	-16.08	1053.57	65.505

<i>Cod. elab.:</i> 108GA201-GA01-Z-CL-002_C	<i>Titolo:</i> OPERE D'ARTE MAGGIORI- GALLERIE	<i>Data:</i> Ottobre 2011
<i>Nome file:</i> 108GA201-GA01-Z-CL -002_C.docx	ARTIFICIALI – GALLERIA ROVETELLO	<i>Pagina</i> 357 di 452
Relazione di calcolo		

PROGETTO ESECUTIVO

48315.35	-23.55	1053.57	44.731
48415.40	-31.09	1053.57	33.883
48515.45	-38.71	1053.57	27.219
48615.50	-46.39	1053.57	22.710
48715.55	-54.15	1053.57	19.457
48815.60	-61.88	1053.57	17.027
48915.65	-69.39	1053.57	15.184
49015.70	-76.68	1053.57	13.740
49115.75	-83.75	1053.57	12.580
49215.80	-90.61	1053.57	11.628
49315.85	-97.25	1053.57	10.834
49415.90	-103.68	1053.57	10.162
49515.95	-109.89	1053.57	9.587
49616.00	-115.90	1053.57	9.090
49716.05	-121.70	1053.57	8.657
49816.10	-127.28	1053.57	8.277
49916.15	-132.66	1053.57	7.942
50016.20	-137.84	1053.57	7.644
50116.25	-142.80	1053.57	7.378
50216.30	-147.57	1053.57	7.140
50316.35	-152.13	1053.57	6.926
50416.40	-156.49	1053.57	6.733
50516.45	-160.65	1053.57	6.558
50616.50	-166.04	1053.57	6.345
50716.55	-172.57	1053.57	6.105
50816.60	-178.82	1053.57	5.892
50916.65	-184.79	1053.57	5.701
51016.70	-190.48	1053.57	5.531
51116.75	-195.89	1053.57	5.378
51216.80	-201.02	1053.57	5.241
51316.85	-205.87	1053.57	5.118
51416.90	-210.44	1053.57	5.006
51516.95	-214.75	1053.57	4.906
51617.00	-218.78	1053.57	4.816
51717.05	-222.53	1053.57	4.734
51817.10	-226.02	1053.57	4.661

<i>Cod. elab.:</i> 108GA201-GA01-Z-CL-002 C	<i>Titolo:</i> OPERE D'ARTE MAGGIORI- GALLERIE	<i>Data:</i> Ottobre 2011
<i>Nome file:</i> 108GA201-GA01-Z-CL -002_C.docx	ARTIFICIALI – GALLERIA ROVETELLO	<i>Pagina</i> 358 di 452
	Relazione di calcolo	

PROGETTO ESECUTIVO

51917.15	-229.24	1053.57	4.596
52017.20	-232.19	1053.57	4.538
52117.25	-234.87	1053.57	4.486
52217.30	-237.29	1053.57	4.440
52317.35	-239.45	1053.57	4.400
52417.40	-241.34	1053.57	4.365
52517.45	-242.97	1053.57	4.336
52617.50	-244.34	1053.57	4.312
52717.55	-245.45	1053.57	4.292
52817.60	-246.30	1053.57	4.278
52917.65	-246.89	1053.57	4.267
53017.70	-247.23	1053.57	4.262
53117.75	-247.31	1053.57	4.260
53217.80	-247.13	1053.57	4.263
53317.85	-246.71	1053.57	4.271
53417.90	-246.02	1053.57	4.282
53517.95	-245.09	1053.57	4.299
53618.00	-243.91	1053.57	4.320
53718.05	-242.47	1053.57	4.345
53818.10	-240.78	1053.57	4.376
53918.15	-238.85	1053.57	4.411
54018.20	-236.66	1053.57	4.452
54118.25	-234.23	1053.57	4.498
54218.30	-231.55	1053.57	4.550
54318.35	-228.62	1053.57	4.608
54418.40	-225.45	1053.57	4.673
54518.45	-222.03	1053.57	4.745
54618.50	-218.36	1053.57	4.825
54718.55	-214.45	1053.57	4.913
54818.60	-210.30	1053.57	5.010
54918.65	-205.90	1053.57	5.117
55018.70	-201.26	1053.57	5.235
55118.75	-196.37	1053.57	5.365
55218.80	-191.25	1053.57	5.509
55318.85	-185.88	1053.57	5.668
55418.90	-180.26	1053.57	5.845

<i>Cod. elab.:</i> 108GA201-GA01-Z-CL-002 C	<i>Titolo:</i> OPERE D'ARTE MAGGIORI- GALLERIE	<i>Data:</i> Ottobre 2011
<i>Nome file:</i> 108GA201-GA01-Z-CL -002_C.docx	ARTIFICIALI – GALLERIA ROVETELLO Relazione di calcolo	<i>Pagina</i> 359 di 452

PROGETTO ESECUTIVO

55518.95	-174.41	1053.57	6.041
55619.00	-168.31	1053.57	6.260
55719.05	-161.97	1053.57	6.505
55819.10	-155.39	1053.57	6.780
55919.15	-148.57	1053.57	7.091
56019.20	-141.51	1053.57	7.445
56119.25	-134.20	1053.57	7.850
56219.30	-126.66	1053.57	8.318
56319.35	-118.88	1053.57	8.863
56419.40	-110.85	1053.57	9.504
56519.45	-102.59	1053.57	10.270
56619.50	-94.08	1053.57	11.199
56719.55	-85.33	1053.57	12.346
56819.60	-76.35	1053.57	13.800
56919.65	-67.12	1053.57	15.697
57019.70	-57.65	1053.57	18.274
57119.75	-47.95	1053.57	21.973
57219.80	-38.00	1053.57	27.725
57319.85	-27.81	1053.57	37.880
57419.90	-17.39	1053.57	60.599
57519.95	-6.72	1053.57	156.819
57620.00	4.19	1053.57	251.495

Fase n° 1 - [A2-M2]

n°	Y	T	T _R	CS _T
1	0.00	0.00	1053.57	1000.000
2	0.05	0.02	1053.57	45266.807
3	0.10	0.07	1053.57	15146.491
4	0.15	0.12	1053.57	9136.677
5	0.20	0.16	1053.57	6562.866
6	0.25	0.21	1053.57	5133.672
7	0.30	0.25	1053.57	4224.603
8	0.35	0.29	1053.57	3595.554
9	0.40	0.34	1053.57	3134.499
10	0.45	0.38	1053.57	2782.139

Cod. elab.: 108GA201-GA01-Z-CL-002_C	Titolo: OPERE D'ARTE MAGGIORI- GALLERIE	Data: Ottobre 2011
Nome file: 108GA201-GA01-Z-CL -002_C.docx	ARTIFICIALI – GALLERIA ROVETELLO	Pagina 360 di 452
Relazione di calcolo		

PROGETTO ESECUTIVO

11	0.50	0.46	1053.57	2275.643
12	0.55	0.63	1053.57	1671.928
13	0.60	0.84	1053.57	1258.898
14	0.65	1.04	1053.57	1012.107
15	0.70	1.24	1053.57	848.041
16	0.75	1.44	1053.57	731.103
17	0.80	1.64	1053.57	643.557
18	0.85	1.83	1053.57	575.577
19	0.90	2.02	1053.57	521.276
20	0.95	2.21	1053.57	476.915
21	1.00	2.39	1053.57	440.004
22	1.05	2.58	1053.57	408.822
23	1.10	2.76	1053.57	382.137
24	1.15	2.93	1053.57	359.051
25	1.20	3.11	1053.57	338.888
26	1.25	3.28	1053.57	321.131
27	1.30	3.45	1053.57	305.380
28	1.35	3.62	1053.57	291.318
29	1.40	3.78	1053.57	278.692
30	1.45	3.94	1053.57	267.298
31	1.50	4.10	1053.57	256.967
32	1.55	4.26	1053.57	247.562
33	1.60	4.41	1053.57	238.968
34	1.65	4.56	1053.57	231.086
35	1.70	4.71	1053.57	223.837
36	1.75	4.85	1053.57	217.149
37	1.80	4.99	1053.57	210.964
38	1.85	5.13	1053.57	205.230
39	1.90	5.27	1053.57	199.902
40	1.95	5.40	1053.57	194.942
41	2.00	5.54	1053.57	190.316
42	2.05	5.66	1053.57	185.994
43	2.10	5.79	1053.57	181.950
44	2.15	5.91	1053.57	178.160
45	2.20	6.03	1053.57	174.604
46	2.25	6.15	1053.57	171.264

<i>Cod. elab.:</i> 108GA201-GA01-Z-CL-002_C	<i>Titolo:</i> OPERE D'ARTE MAGGIORI- GALLERIE	<i>Data:</i> Ottobre 2011
<i>Nome file:</i> 108GA201-GA01-Z-CL -002_C.docx	ARTIFICIALI – GALLERIA ROVETELLO Relazione di calcolo	<i>Pagina</i> 361 di 452

PROGETTO ESECUTIVO

47	2.30	6.27	1053.57	168.123
48	2.35	6.38	1053.57	165.167
49	2.40	6.49	1053.57	162.382
50	2.45	6.59	1053.57	159.756
51	2.50	6.65	1053.57	158.492
52	2.50	6.70	1053.57	157.280
53	2.55	6.80	1053.57	154.974
54	2.60	6.90	1053.57	152.797
55	2.65	6.99	1053.57	150.741
56	2.70	7.08	1053.57	148.798
57	2.75	7.17	1053.57	146.963
58	2.80	7.25	1053.57	145.229
59	2.85	7.34	1053.57	143.591
60	2.90	7.42	1053.57	142.045
61	2.95	7.49	1053.57	140.584
62	3.00	7.57	1053.57	139.207
63	3.05	7.64	1053.57	137.908
64	3.10	7.71	1053.57	136.685
65	3.15	7.77	1053.57	135.533
66	3.20	7.84	1053.57	134.451
67	3.25	7.90	1053.57	133.436
68	3.30	7.95	1053.57	132.484
69	3.35	8.01	1053.57	131.595
70	3.40	8.06	1053.57	130.766
71	3.45	8.10	1053.57	129.995
72	3.50	8.15	1053.57	129.280
73	3.55	8.19	1053.57	128.621
74	3.60	8.23	1053.57	128.015
75	3.65	8.27	1053.57	127.462
76	3.70	8.30	1053.57	126.960
77	3.75	8.33	1053.57	126.508
78	3.80	8.35	1053.57	126.107
79	3.85	8.38	1053.57	125.754
80	3.90	8.40	1053.57	125.451
81	3.95	8.42	1053.57	125.195
82	4.00	8.43	1053.57	124.987

<i>Cod. elab.:</i> 108GA201-GA01-Z-CL-002_C	<i>Titolo:</i> OPERE D'ARTE MAGGIORI- GALLERIE	<i>Data:</i> Ottobre 2011
<i>Nome file:</i> 108GA201-GA01-Z-CL -002_C.docx	ARTIFICIALI – GALLERIA ROVETELLO Relazione di calcolo	<i>Pagina</i> 362 di 452

PROGETTO ESECUTIVO

83	4.05	8.44	1053.57	124.826
84	4.10	8.45	1053.57	124.713
85	4.15	8.45	1053.57	124.648
86	4.20	8.45	1053.57	124.630
87	4.25	8.45	1053.57	124.661
88	4.30	8.45	1053.57	124.739
89	4.35	8.44	1053.57	124.866
90	4.40	8.43	1053.57	125.043
91	4.45	8.41	1053.57	125.269
92	4.50	8.39	1053.57	125.547
93	4.55	8.37	1053.57	125.877
94	4.60	8.34	1053.57	126.260
95	4.65	8.32	1053.57	126.697
96	4.70	8.28	1053.57	127.190
97	4.75	8.25	1053.57	127.740
98	4.80	8.21	1053.57	128.350
99	4.85	8.17	1053.57	129.022
100	4.90	8.12	1053.57	129.757
101	4.95	8.07	1053.57	130.558
102	5.00	8.02	1053.57	131.428
103	5.05	7.96	1053.57	132.369
104	5.10	7.90	1053.57	133.386
105	5.15	7.83	1053.57	134.481
106	5.20	7.77	1053.57	135.659
107	5.25	7.69	1053.57	136.925
108	5.30	7.62	1053.57	138.282
109	5.35	7.54	1053.57	139.736
110	5.40	7.46	1053.57	141.293
111	5.45	7.37	1053.57	142.960
112	5.50	7.28	1053.57	144.743
113	5.55	7.18	1053.57	146.651
114	5.60	7.09	1053.57	148.692
115	5.65	6.98	1053.57	150.876
116	5.70	6.88	1053.57	153.214
117	5.75	6.77	1053.57	155.718
118	5.80	6.65	1053.57	158.402

<i>Cod. elab.:</i> 108GA201-GA01-Z-CL-002_C	<i>Titolo:</i> OPERE D'ARTE MAGGIORI- GALLERIE	<i>Data:</i> Ottobre 2011
<i>Nome file:</i> 108GA201-GA01-Z-CL -002_C.docx	ARTIFICIALI – GALLERIA ROVETELLO Relazione di calcolo	<i>Pagina</i> 363 di 452

PROGETTO ESECUTIVO

1195.85	6.53	1053.57	161.280
1205.90	6.41	1053.57	164.370
1215.95	6.28	1053.57	167.692
1226.00	6.15	1053.57	171.266
1236.05	6.02	1053.57	175.119
1246.10	5.88	1053.57	179.278
1256.15	5.73	1053.57	183.776
1266.20	5.58	1053.57	188.652
1276.25	5.43	1053.57	193.948
1286.30	5.28	1053.57	199.715
1296.35	5.11	1053.57	206.013
1306.40	4.95	1053.57	212.913
1316.45	4.78	1053.57	220.497
1326.50	4.60	1053.57	228.865
1336.55	4.42	1053.57	238.138
1346.60	4.24	1053.57	248.463
1356.65	4.05	1053.57	260.019
1366.70	3.86	1053.57	273.032
1376.75	3.66	1053.57	287.784
1386.80	3.46	1053.57	304.637
1396.85	3.25	1053.57	324.060
1406.90	3.04	1053.57	346.676
1416.95	2.82	1053.57	373.323
1427.00	2.60	1053.57	405.166
1437.05	2.37	1053.57	443.864
1447.10	2.14	1053.57	491.867
1457.15	1.91	1053.57	552.955
1467.20	1.66	1053.57	633.273
1477.25	1.42	1053.57	743.533
1487.30	1.17	1053.57	904.220
1497.35	0.91	1053.57	1160.024
1507.40	0.65	1053.57	1630.606
1517.45	0.38	1053.57	2781.293
1527.50	0.11	1053.57	9916.397
1537.55	-0.17	1053.57	6139.777
1547.60	-0.45	1053.57	2316.762

<i>Cod. elab.:</i> 108GA201-GA01-Z-CL-002_C	<i>Titolo:</i> OPERE D'ARTE MAGGIORI- GALLERIE	<i>Data:</i> Ottobre 2011
<i>Nome file:</i> 108GA201-GA01-Z-CL -002_C.docx	ARTIFICIALI – GALLERIA ROVETELLO Relazione di calcolo	<i>Pagina</i> 364 di 452

PROGETTO ESECUTIVO

1557.65	-0.74	1053.57	1417.462
1567.70	-1.04	1053.57	1015.789
1577.75	-1.34	1053.57	788.282
1587.80	-1.64	1053.57	641.890
1597.85	-1.95	1053.57	539.827
1607.90	-2.27	1053.57	464.630
1617.95	-2.59	1053.57	406.942
1628.00	-2.92	1053.57	361.299
1638.05	-3.25	1053.57	324.296
1648.10	-3.59	1053.57	293.702
1658.15	-3.93	1053.57	267.992
1668.20	-4.28	1053.57	246.089
1678.25	-4.64	1053.57	227.211
1688.30	-5.00	1053.57	210.776
1698.35	-5.37	1053.57	196.344
1708.40	-5.74	1053.57	183.572
1718.45	-6.12	1053.57	172.192
1728.50	-6.66	1053.57	158.095
1738.55	-7.38	1053.57	142.740
1748.60	-8.11	1053.57	129.925
1758.65	-8.85	1053.57	119.072
1768.70	-9.60	1053.57	109.763
1778.75	-10.36	1053.57	101.694
1788.80	-11.13	1053.57	94.633
1798.85	-11.92	1053.57	88.405
1808.90	-12.71	1053.57	82.871
1818.95	-13.52	1053.57	77.923
1829.00	-14.34	1053.57	73.473
1839.05	-15.17	1053.57	69.451
1849.10	-16.01	1053.57	65.798
1859.15	-16.87	1053.57	62.467
1869.20	-17.73	1053.57	59.417
1879.25	-18.59	1053.57	56.670
1889.30	-19.43	1053.57	54.234
1899.35	-20.24	1053.57	52.061
1909.40	-21.02	1053.57	50.112

<i>Cod. elab.:</i> 108GA201-GA01-Z-CL-002_C	<i>Titolo:</i> OPERE D'ARTE MAGGIORI- GALLERIE	<i>Data:</i> Ottobre 2011
<i>Nome file:</i> 108GA201-GA01-Z-CL -002_C.docx	ARTIFICIALI – GALLERIA ROVETELLO Relazione di calcolo	<i>Pagina</i> 365 di 452

PROGETTO ESECUTIVO

1919.45	-21.79	1053.57	48.358
1929.50	-22.53	1053.57	46.772
1939.55	-23.24	1053.57	45.334
1949.60	-23.93	1053.57	44.026
1959.65	-24.60	1053.57	42.833
1969.70	-25.24	1053.57	41.742
1979.75	-25.86	1053.57	40.743
1989.80	-26.45	1053.57	39.827
1999.85	-27.02	1053.57	38.985
2009.90	-27.57	1053.57	38.211
2019.95	-28.10	1053.57	37.499
20210.00	-28.60	1053.57	36.844
20310.05	-29.07	1053.57	36.240
20410.10	-29.52	1053.57	35.685
20510.15	-29.95	1053.57	35.175
20610.20	-30.36	1053.57	34.706
20710.25	-30.74	1053.57	34.275
20810.30	-31.10	1053.57	33.881
20910.35	-31.43	1053.57	33.521
21010.40	-31.74	1053.57	33.194
21110.45	-32.03	1053.57	32.897
21210.50	-32.29	1053.57	32.629
21310.55	-32.53	1053.57	32.390
21410.60	-32.74	1053.57	32.177
21510.65	-32.93	1053.57	31.989
21610.70	-33.10	1053.57	31.827
21710.75	-33.25	1053.57	31.689
21810.80	-33.37	1053.57	31.575
21910.85	-33.46	1053.57	31.484
22010.90	-33.54	1053.57	31.416
22110.95	-33.59	1053.57	31.370
22211.00	-33.61	1053.57	31.346
22311.05	-33.61	1053.57	31.345
22411.10	-33.59	1053.57	31.367
22511.15	-33.54	1053.57	31.411
22611.20	-33.47	1053.57	31.477

<i>Cod. elab.:</i> 108GA201-GA01-Z-CL-002_C	<i>Titolo:</i> OPERE D'ARTE MAGGIORI- GALLERIE	<i>Data:</i> Ottobre 2011
<i>Nome file:</i> 108GA201-GA01-Z-CL -002_C.docx	ARTIFICIALI – GALLERIA ROVETELLO Relazione di calcolo	<i>Pagina</i> 366 di 452

PROGETTO ESECUTIVO

22711.25	-33.38	1053.57	31.567
22811.30	-33.26	1053.57	31.680
22911.35	-33.11	1053.57	31.817
23011.40	-32.95	1053.57	31.979
23111.45	-32.75	1053.57	32.166
23211.50	-32.54	1053.57	32.380
23311.55	-32.30	1053.57	32.621
23411.60	-32.03	1053.57	32.891
23511.65	-31.74	1053.57	33.191
23611.70	-31.43	1053.57	33.523
23711.75	-31.09	1053.57	33.888
23811.80	-30.73	1053.57	34.289
23911.85	-30.34	1053.57	34.728
24011.90	-29.92	1053.57	35.208
24111.95	-29.49	1053.57	35.732
24212.00	-29.02	1053.57	36.303
24312.05	-28.53	1053.57	36.924
24412.10	-28.02	1053.57	37.602
24512.15	-27.48	1053.57	38.340
24612.20	-26.92	1053.57	39.144
24712.25	-26.32	1053.57	40.022
24812.30	-25.71	1053.57	40.981
24912.35	-25.07	1053.57	42.030
25012.40	-24.40	1053.57	43.180
25112.45	-23.71	1053.57	44.443
25212.50	-22.99	1053.57	45.835
25312.55	-22.24	1053.57	47.372
25412.60	-21.47	1053.57	49.075
25512.65	-20.67	1053.57	50.971
25612.70	-19.84	1053.57	53.090
25712.75	-19.01	1053.57	55.418
25812.80	-18.19	1053.57	57.930
25912.85	-17.37	1053.57	60.647
26012.90	-16.57	1053.57	63.597
26112.95	-15.77	1053.57	66.810
26213.00	-14.98	1053.57	70.324

<i>Cod. elab.:</i> 108GA201-GA01-Z-CL-002 C	<i>Titolo:</i> OPERE D'ARTE MAGGIORI- GALLERIE	<i>Data:</i> Ottobre 2011
<i>Nome file:</i> 108GA201-GA01-Z-CL -002_C.docx	ARTIFICIALI – GALLERIA ROVETELLO Relazione di calcolo	<i>Pagina</i> 367 di 452

PROGETTO ESECUTIVO

26313.05	-14.20	1053.57	74.181
26413.10	-13.43	1053.57	78.436
26513.15	-12.67	1053.57	83.153
26613.20	-11.92	1053.57	88.411
26713.25	-11.17	1053.57	94.309
26813.30	-10.43	1053.57	100.972
26913.35	-9.71	1053.57	108.558
27013.40	-8.98	1053.57	117.274
27113.45	-8.27	1053.57	127.392
27213.50	-7.56	1053.57	139.281
27313.55	-6.87	1053.57	153.450
27413.60	-6.17	1053.57	170.626
27513.65	-5.49	1053.57	191.878
27613.70	-4.81	1053.57	218.857
27713.75	-4.14	1053.57	254.237
27813.80	-3.48	1053.57	302.670
27913.85	-2.82	1053.57	373.018
28013.90	-2.17	1053.57	484.508
28113.95	-1.53	1053.57	688.173
28214.00	-0.89	1053.57	1178.922
28314.05	-0.26	1053.57	4013.652
28414.10	0.36	1053.57	2904.819
28514.15	0.98	1053.57	1072.832
28614.20	1.60	1053.57	660.263
28714.25	2.20	1053.57	478.081
28814.30	2.81	1053.57	375.421
28914.35	3.40	1053.57	309.537
29014.40	4.00	1053.57	263.666
29114.45	4.58	1053.57	229.888
29214.50	5.17	1053.57	203.975
29314.55	5.74	1053.57	183.465
29414.60	6.32	1053.57	166.824
29514.65	6.88	1053.57	153.051
29614.70	7.45	1053.57	141.462
29714.75	8.01	1053.57	131.574
29814.80	8.56	1053.57	123.037

<i>Cod. elab.:</i> 108GA201-GA01-Z-CL-002_C	<i>Titolo:</i> OPERE D'ARTE MAGGIORI- GALLERIE	<i>Data:</i> Ottobre 2011
<i>Nome file:</i> 108GA201-GA01-Z-CL -002_C.docx	ARTIFICIALI – GALLERIA ROVETELLO	<i>Pagina</i> 368 di 452
Relazione di calcolo		

PROGETTO ESECUTIVO

29914.85	9.11	1053.57	115.591
30014.90	9.66	1053.57	109.038
30114.95	10.21	1053.57	103.226
30215.00	10.75	1053.57	98.035
30315.05	11.28	1053.57	93.370
30415.10	11.82	1053.57	89.153
30515.15	12.35	1053.57	85.324
30615.20	12.88	1053.57	81.829
30715.25	13.40	1053.57	78.627
30815.30	13.92	1053.57	75.682
30915.35	14.44	1053.57	72.963
31015.40	14.96	1053.57	70.445
31115.45	15.47	1053.57	68.106
31215.50	15.98	1053.57	65.928
31315.55	16.49	1053.57	63.893
31415.60	17.00	1053.57	61.988
31515.65	17.50	1053.57	60.200
31615.70	18.00	1053.57	58.519
31715.75	18.50	1053.57	56.935
31815.80	19.00	1053.57	55.439
31915.85	19.50	1053.57	54.024
32015.90	20.00	1053.57	52.684
32115.95	20.49	1053.57	51.413
32216.00	20.99	1053.57	50.204
32316.05	21.48	1053.57	49.054
32416.10	21.97	1053.57	47.957
32516.15	22.46	1053.57	46.911
32616.20	22.95	1053.57	45.912
32716.25	23.44	1053.57	44.955
32816.30	23.92	1053.57	44.039
32916.35	24.41	1053.57	43.161
33016.40	24.90	1053.57	42.319
33116.45	25.38	1053.57	41.509
33216.50	25.42	1053.57	41.453
33316.55	25.00	1053.57	42.145
33416.60	24.58	1053.57	42.862

<i>Cod. elab.:</i> 108GA201-GA01-Z-CL-002 C	<i>Titolo:</i> OPERE D'ARTE MAGGIORI- GALLERIE	<i>Data:</i> Ottobre 2011
<i>Nome file:</i> 108GA201-GA01-Z-CL -002_C.docx	ARTIFICIALI – GALLERIA ROVETELLO Relazione di calcolo	<i>Pagina</i> 369 di 452

PROGETTO ESECUTIVO

33516.65	24.16	1053.57	43.603
33616.70	23.74	1053.57	44.371
33716.75	23.33	1053.57	45.167
33816.80	22.91	1053.57	45.992
33916.85	22.49	1053.57	46.848
34016.90	22.07	1053.57	47.735
34116.95	21.65	1053.57	48.657
34217.00	21.24	1053.57	49.614
34317.05	20.82	1053.57	50.608
34417.10	20.40	1053.57	51.642
34517.15	19.99	1053.57	52.717
34617.20	19.57	1053.57	53.837
34717.25	19.15	1053.57	55.003
34817.30	18.74	1053.57	56.218
34917.35	18.33	1053.57	57.486
35017.40	17.91	1053.57	58.810
35117.45	17.50	1053.57	60.192
35217.50	17.09	1053.57	61.638
35317.55	16.68	1053.57	63.150
35417.60	16.28	1053.57	64.734
35517.65	15.87	1053.57	66.395
35617.70	15.46	1053.57	68.138
35717.75	15.06	1053.57	69.969
35817.80	14.65	1053.57	71.895
35917.85	14.25	1053.57	73.924
36017.90	13.85	1053.57	76.062
36117.95	13.45	1053.57	78.319
36218.00	13.05	1053.57	80.706
36318.05	12.66	1053.57	83.232
36418.10	12.26	1053.57	85.912
36518.15	11.87	1053.57	88.758
36618.20	11.48	1053.57	91.786
36718.25	11.09	1053.57	95.015
36818.30	10.70	1053.57	98.464
36918.35	10.31	1053.57	102.157
37018.40	9.93	1053.57	106.119

<i>Cod. elab.:</i> 108GA201-GA01-Z-CL-002 C	<i>Titolo:</i> OPERE D'ARTE MAGGIORI- GALLERIE	<i>Data:</i> Ottobre 2011
<i>Nome file:</i> 108GA201-GA01-Z-CL -002_C.docx	ARTIFICIALI – GALLERIA ROVETELLO Relazione di calcolo	<i>Pagina</i> 370 di 452

PROGETTO ESECUTIVO

37118.45	9.54	1053.57	110.381
37218.50	9.16	1053.57	114.978
37318.55	8.78	1053.57	119.951
37418.60	8.41	1053.57	125.348
37518.65	8.03	1053.57	131.224
37618.70	7.65	1053.57	137.646
37718.75	7.28	1053.57	144.692
37818.80	6.91	1053.57	152.459
37918.85	6.54	1053.57	161.062
38018.90	6.17	1053.57	170.643
38118.95	5.81	1053.57	181.378
38219.00	5.45	1053.57	193.488
38319.05	5.08	1053.57	207.255
38419.10	4.72	1053.57	223.042
38519.15	4.37	1053.57	241.329
38619.20	4.01	1053.57	262.758
38719.25	3.66	1053.57	288.214
38819.30	3.30	1053.57	318.948
38919.35	2.95	1053.57	356.789
39019.40	2.60	1053.57	404.521
39119.45	2.26	1053.57	466.602
39219.50	1.91	1053.57	550.641
39319.55	1.57	1053.57	670.784
39419.60	1.23	1053.57	856.650
39519.65	0.89	1053.57	1182.445
39619.70	0.55	1053.57	1901.527
39719.75	0.22	1053.57	4809.937
39819.80	-0.11	1053.57	9236.603
39919.85	-0.45	1053.57	2366.249
40019.90	-0.77	1053.57	1360.300
40119.95	-1.10	1053.57	956.178
40220.00	-1.43	1053.57	738.167

<i>Cod. elab.:</i> 108GA201-GA01-Z-CL-002_C	<i>Titolo:</i> OPERE D'ARTE MAGGIORI- GALLERIE	<i>Data:</i> Ottobre 2011
<i>Nome file:</i> 108GA201-GA01-Z-CL -002_C.docx	ARTIFICIALI – GALLERIA ROVETELLO Relazione di calcolo	<i>Pagina</i> 371 di 452

PROGETTO ESECUTIVO

Fase n° 2 - [A2-M2]

n°	Y	T	T _R	CS _T
1	0.00	0.00	1053.5780717862.551	
2	0.05	0.14	1053.57	7793.507
3	0.10	0.40	1053.57	2603.234
4	0.15	0.67	1053.57	1566.620
5	0.20	0.94	1053.57	1122.523
6	0.25	1.20	1053.57	875.858
7	0.30	1.47	1053.57	718.918
8	0.35	1.73	1053.57	610.287
9	0.40	1.99	1053.57	530.639
10	0.45	2.24	1053.57	469.743
11	0.50	2.76	1053.57	382.256
12	0.55	3.78	1053.57	278.750
13	0.60	5.05	1053.57	208.546
14	0.65	6.32	1053.57	166.821
15	0.70	7.57	1053.57	139.170
16	0.75	8.82	1053.57	119.500
17	0.80	10.05	1053.57	104.793
18	0.85	11.28	1053.57	93.382
19	0.90	12.50	1053.57	84.271
20	0.95	13.71	1053.57	76.829
21	1.00	14.92	1053.57	70.636
22	1.05	16.11	1053.57	65.403
23	1.10	17.29	1053.57	60.922
24	1.15	18.47	1053.57	57.043
25	1.20	19.64	1053.57	53.653
26	1.25	20.80	1053.57	50.664
27	1.30	21.94	1053.57	48.010
28	1.35	23.09	1053.57	45.638
29	1.40	24.22	1053.57	43.505
30	1.45	25.34	1053.57	41.577
31	1.50	26.45	1053.57	39.826
32	1.55	27.56	1053.57	38.228
33	1.60	28.66	1053.57	36.766

<i>Cod. elab.:</i> 108GA201-GA01-Z-CL-002_C	<i>Titolo:</i> OPERE D'ARTE MAGGIORI- GALLERIE	<i>Data:</i> Ottobre 2011
<i>Nome file:</i> 108GA201-GA01-Z-CL -002_C.docx	ARTIFICIALI – GALLERIA ROVETELLO Relazione di calcolo	<i>Pagina</i> 372 di 452

PROGETTO ESECUTIVO

34	1.65	29.74	1053.57	35.421
35	1.70	30.82	1053.57	34.182
36	1.75	31.89	1053.57	33.035
37	1.80	32.95	1053.57	31.972
38	1.85	34.00	1053.57	30.983
39	1.90	35.05	1053.57	30.061
40	1.95	36.08	1053.57	29.200
41	2.00	37.11	1053.57	28.393
42	2.05	38.12	1053.57	27.637
43	2.10	39.13	1053.57	26.926
44	2.15	40.13	1053.57	26.256
45	2.20	41.11	1053.57	25.625
46	2.25	42.09	1053.57	25.029
47	2.30	43.06	1053.57	24.466
48	2.35	44.02	1053.57	23.932
49	2.40	44.97	1053.57	23.426
50	2.45	45.92	1053.57	22.945
51	2.50	46.39	1053.57	22.713
52	2.50	-42.17	1053.57	24.981
53	2.55	-41.26	1053.57	25.537
54	2.60	-40.35	1053.57	26.112
55	2.65	-39.45	1053.57	26.708
56	2.70	-38.56	1053.57	27.324
57	2.75	-37.68	1053.57	27.962
58	2.80	-36.81	1053.57	28.623
59	2.85	-35.95	1053.57	29.308
60	2.90	-35.10	1053.57	30.018
61	2.95	-34.26	1053.57	30.755
62	3.00	-33.43	1053.57	31.520
63	3.05	-32.60	1053.57	32.313
64	3.10	-31.79	1053.57	33.138
65	3.15	-30.99	1053.57	33.995
66	3.20	-30.20	1053.57	34.886
67	3.25	-29.42	1053.57	35.812
68	3.30	-28.65	1053.57	36.777
69	3.35	-27.89	1053.57	37.781

<i>Cod. elab.:</i> 108GA201-GA01-Z-CL-002_C	<i>Titolo:</i> OPERE D'ARTE MAGGIORI- GALLERIE	<i>Data:</i> Ottobre 2011
<i>Nome file:</i> 108GA201-GA01-Z-CL -002_C.docx	ARTIFICIALI – GALLERIA ROVETELLO Relazione di calcolo	<i>Pagina</i> 373 di 452

PROGETTO ESECUTIVO

70	3.40	-27.13	1053.57	38.827
71	3.45	-26.39	1053.57	39.917
72	3.50	-25.66	1053.57	41.055
73	3.55	-24.94	1053.57	42.242
74	3.60	-24.23	1053.57	43.481
75	3.65	-23.53	1053.57	44.777
76	3.70	-22.84	1053.57	46.131
77	3.75	-22.16	1053.57	47.548
78	3.80	-21.49	1053.57	49.031
79	3.85	-20.83	1053.57	50.586
80	3.90	-20.18	1053.57	52.216
81	3.95	-19.54	1053.57	53.926
82	4.00	-18.91	1053.57	55.722
83	4.05	-18.29	1053.57	57.609
84	4.10	-17.68	1053.57	59.595
85	4.15	-17.08	1053.57	61.685
86	4.20	-16.49	1053.57	63.888
87	4.25	-15.91	1053.57	66.211
88	4.30	-15.34	1053.57	68.664
89	4.35	-14.79	1053.57	71.256
90	4.40	-14.24	1053.57	73.998
91	4.45	-13.70	1053.57	76.903
92	4.50	-13.17	1053.57	79.982
93	4.55	-12.66	1053.57	83.251
94	4.60	-12.15	1053.57	86.726
95	4.65	-11.65	1053.57	90.424
96	4.70	-11.16	1053.57	94.365
97	4.75	-10.69	1053.57	98.571
98	4.80	-10.22	1053.57	103.066
99	4.85	-9.77	1053.57	107.878
100	4.90	-9.32	1053.57	113.038
101	4.95	-8.88	1053.57	118.579
102	5.00	-8.46	1053.57	124.542
103	5.05	-8.04	1053.57	130.970
104	5.10	-7.64	1053.57	137.913
105	5.15	-7.24	1053.57	145.430

<i>Cod. elab.:</i> 108GA201-GA01-Z-CL-002_C	<i>Titolo:</i> OPERE D'ARTE MAGGIORI- GALLERIE	<i>Data:</i> Ottobre 2011
<i>Nome file:</i> 108GA201-GA01-Z-CL -002_C.docx	ARTIFICIALI – GALLERIA ROVETELLO Relazione di calcolo	<i>Pagina</i> 374 di 452

PROGETTO ESECUTIVO

1065.20	-6.86	1053.57	153.585
1075.25	-6.49	1053.57	162.454
1085.30	-6.12	1053.57	172.124
1095.35	-5.77	1053.57	182.696
1105.40	-5.42	1053.57	194.289
1115.45	-5.09	1053.57	207.039
1125.50	-4.76	1053.57	221.110
1135.55	-4.45	1053.57	236.695
1145.60	-4.15	1053.57	254.023
1155.65	-3.85	1053.57	273.371
1165.70	-3.57	1053.57	295.074
1175.75	-3.30	1053.57	319.541
1185.80	-3.03	1053.57	347.278
1195.85	-2.78	1053.57	378.913
1205.90	-2.54	1053.57	415.241
1215.95	-2.30	1053.57	457.273
1226.00	-2.08	1053.57	506.325
1236.05	-1.87	1053.57	564.125
1246.10	-1.66	1053.57	632.999
1256.15	-1.47	1053.57	716.137
1266.20	-1.29	1053.57	818.030
1276.25	-1.11	1053.57	945.205
1286.30	-0.95	1053.57	1107.495
1296.35	-0.80	1053.57	1320.410
1306.40	-0.65	1053.57	1609.877
1316.45	-0.52	1053.57	2022.641
1326.50	-0.40	1053.57	2652.220
1336.55	-0.28	1053.57	3716.457
1346.60	-0.18	1053.57	5865.632
1356.65	-0.09	1053.57	12305.369
1366.70	0.00	1053.57	711832.461
1376.75	0.07	1053.57	14470.154
1386.80	0.14	1053.57	7675.584
1396.85	0.19	1053.57	5490.510
1406.90	0.24	1053.57	4451.049
1416.95	0.27	1053.57	3877.545

Cod. elab.: 108GA201-GA01-Z-CL-002_C	Titolo: OPERE D'ARTE MAGGIORI- GALLERIE	Data: Ottobre 2011
Nome file: 108GA201-GA01-Z-CL -002_C.docx	ARTIFICIALI – GALLERIA ROVETELLO	Pagina 375 di 452
Relazione di calcolo		

PROGETTO ESECUTIVO

1427.00	0.30	1053.57	3548.234
1437.05	0.31	1053.57	3372.881
1447.10	0.32	1053.57	3312.771
1457.15	0.31	1053.57	3355.927
1467.20	0.30	1053.57	3510.650
1477.25	0.28	1053.57	3809.890
1487.30	0.24	1053.57	4331.394
1497.35	0.20	1053.57	5261.727
1507.40	0.15	1053.57	7141.694
1517.45	0.09	1053.57	12376.761
1527.50	0.01	1053.57	80751.129
1537.55	-0.07	1053.57	15336.223
1547.60	-0.16	1053.57	6580.713
1557.65	-0.26	1053.57	4034.406
1567.70	-0.37	1053.57	2833.498
1577.75	-0.49	1053.57	2140.839
1587.80	-0.62	1053.57	1693.724
1597.85	-0.76	1053.57	1383.441
1607.90	-0.91	1053.57	1156.930
1617.95	-1.07	1053.57	985.252
1628.00	-1.24	1053.57	851.311
1638.05	-1.42	1053.57	744.370
1648.10	-1.60	1053.57	657.360
1658.15	-1.80	1053.57	585.446
1668.20	-2.01	1053.57	525.210
1678.25	-2.22	1053.57	474.176
1688.30	-2.45	1053.57	430.504
1698.35	-2.68	1053.57	392.804
1708.40	-2.93	1053.57	360.007
1718.45	-3.18	1053.57	331.276
1728.50	-3.55	1053.57	296.517
1738.55	-4.05	1053.57	259.961
1748.60	-4.57	1053.57	230.555
1758.65	-5.10	1053.57	206.426
1768.70	-5.66	1053.57	186.300
1778.75	-6.22	1053.57	169.281

Cod. elab.: 108GA201-GA01-Z-CL-002_C	Titolo: OPERE D'ARTE MAGGIORI- GALLERIE	Data: Ottobre 2011
Nome file: 108GA201-GA01-Z-CL -002_C.docx	ARTIFICIALI – GALLERIA ROVETELLO	Pagina 376 di 452
Relazione di calcolo		

PROGETTO ESECUTIVO

1788.80	-6.81	1053.57	154.720
1798.85	-7.41	1053.57	142.136
1808.90	-8.03	1053.57	131.165
1818.95	-8.67	1053.57	121.526
1829.00	-9.32	1053.57	113.000
1839.05	-9.99	1053.57	105.412
1849.10	-10.68	1053.57	98.621
1859.15	-11.39	1053.57	92.515
1869.20	-12.11	1053.57	86.998
1879.25	-12.83	1053.57	82.110
1889.30	-13.53	1053.57	77.852
1899.35	-14.22	1053.57	74.115
1909.40	-14.88	1053.57	70.812
1919.45	-15.52	1053.57	67.875
1929.50	-16.15	1053.57	65.250
1939.55	-16.75	1053.57	62.894
1949.60	-17.34	1053.57	60.770
1959.65	-17.90	1053.57	58.849
1969.70	-18.45	1053.57	57.106
1979.75	-18.98	1053.57	55.521
1989.80	-19.48	1053.57	54.075
1999.85	-19.97	1053.57	52.755
2009.90	-20.44	1053.57	51.548
2019.95	-20.89	1053.57	50.443
20210.00	-21.31	1053.57	49.429
20310.05	-21.72	1053.57	48.500
20410.10	-22.11	1053.57	47.649
20510.15	-22.48	1053.57	46.868
20610.20	-22.83	1053.57	46.153
20710.25	-23.16	1053.57	45.499
20810.30	-23.46	1053.57	44.902
20910.35	-23.75	1053.57	44.359
21010.40	-24.02	1053.57	43.865
21110.45	-24.27	1053.57	43.419
21210.50	-24.49	1053.57	43.017
21310.55	-24.70	1053.57	42.659

<i>Cod. elab.:</i> 108GA201-GA01-Z-CL-002_C	<i>Titolo:</i> OPERE D'ARTE MAGGIORI- GALLERIE	<i>Data:</i> Ottobre 2011
<i>Nome file:</i> 108GA201-GA01-Z-CL -002_C.docx	ARTIFICIALI – GALLERIA ROVETELLO Relazione di calcolo	<i>Pagina</i> 377 di 452

PROGETTO ESECUTIVO

21410.60	-24.88	1053.57	42.341
21510.65	-25.05	1053.57	42.063
21610.70	-25.19	1053.57	41.823
21710.75	-25.31	1053.57	41.620
21810.80	-25.42	1053.57	41.452
21910.85	-25.50	1053.57	41.321
22010.90	-25.56	1053.57	41.224
22110.95	-25.60	1053.57	41.162
22211.00	-25.61	1053.57	41.134
22311.05	-25.61	1053.57	41.140
22411.10	-25.58	1053.57	41.181
22511.15	-25.54	1053.57	41.257
22611.20	-25.47	1053.57	41.368
22711.25	-25.38	1053.57	41.516
22811.30	-25.27	1053.57	41.700
22911.35	-25.13	1053.57	41.923
23011.40	-24.97	1053.57	42.186
23111.45	-24.80	1053.57	42.490
23211.50	-24.59	1053.57	42.837
23311.55	-24.37	1053.57	43.230
23411.60	-24.13	1053.57	43.671
23511.65	-23.86	1053.57	44.163
23611.70	-23.56	1053.57	44.709
23711.75	-23.25	1053.57	45.314
23811.80	-22.91	1053.57	45.981
23911.85	-22.55	1053.57	46.716
24011.90	-22.17	1053.57	47.526
24111.95	-21.76	1053.57	48.415
24212.00	-21.33	1053.57	49.393
24312.05	-20.88	1053.57	50.469
24412.10	-20.40	1053.57	51.653
24512.15	-19.89	1053.57	52.957
24612.20	-19.37	1053.57	54.397
24712.25	-18.82	1053.57	55.989
24812.30	-18.24	1053.57	57.755
24912.35	-17.64	1053.57	59.718

<i>Cod. elab.:</i> 108GA201-GA01-Z-CL-002 C	<i>Titolo:</i> OPERE D'ARTE MAGGIORI- GALLERIE	<i>Data:</i> Ottobre 2011
<i>Nome file:</i> 108GA201-GA01-Z-CL -002_C.docx	ARTIFICIALI – GALLERIA ROVETELLO Relazione di calcolo	<i>Pagina</i> 378 di 452

PROGETTO ESECUTIVO

25012.40	-17.02	1053.57	61.909
25112.45	-16.37	1053.57	64.365
25212.50	-15.69	1053.57	67.130
25312.55	-15.00	1053.57	70.260
25412.60	-14.27	1053.57	73.828
25512.65	-13.52	1053.57	77.924
25612.70	-12.74	1053.57	82.666
25712.75	-11.96	1053.57	88.079
25812.80	-11.19	1053.57	94.164
25912.85	-10.43	1053.57	101.055
26012.90	-9.67	1053.57	108.922
26112.95	-8.93	1053.57	117.989
26213.00	-8.20	1053.57	128.550
26313.05	-7.47	1053.57	141.010
26413.10	-6.76	1053.57	155.928
26513.15	-6.05	1053.57	174.114
26613.20	-5.35	1053.57	196.772
26713.25	-4.67	1053.57	225.781
26813.30	-3.99	1053.57	264.248
26913.35	-3.32	1053.57	317.697
27013.40	-2.65	1053.57	396.999
27113.45	-2.00	1053.57	526.900
27213.50	-1.35	1053.57	778.517
27313.55	-0.71	1053.57	1473.742
27413.60	-0.08	1053.57	12516.493
27513.65	0.54	1053.57	1954.608
27613.70	1.15	1053.57	912.303
27713.75	1.76	1053.57	597.441
27813.80	2.37	1053.57	445.474
27913.85	2.96	1053.57	355.966
28013.90	3.55	1053.57	296.970
28113.95	4.13	1053.57	255.154
28214.00	4.70	1053.57	223.965
28314.05	5.27	1053.57	199.807
28414.10	5.84	1053.57	180.541
28514.15	6.39	1053.57	164.816

Cod. elab.: 108GA201-GA01-Z-CL-002 C	Titolo: OPERE D'ARTE MAGGIORI- GALLERIE	Data: Ottobre 2011
Nome file: 108GA201-GA01-Z-CL -002_C.docx	ARTIFICIALI – GALLERIA ROVETELLO	Pagina 379 di 452
Relazione di calcolo		

PROGETTO ESECUTIVO

28614.20	6.94	1053.57	151.737
28714.25	7.49	1053.57	140.686
28814.30	8.03	1053.57	131.225
28914.35	8.56	1053.57	123.032
29014.40	9.09	1053.57	115.867
29114.45	9.62	1053.57	109.548
29214.50	10.14	1053.57	103.932
29314.55	10.65	1053.57	98.907
29414.60	11.16	1053.57	94.384
29514.65	11.67	1053.57	90.291
29614.70	12.17	1053.57	86.568
29714.75	12.67	1053.57	83.166
29814.80	13.16	1053.57	80.046
29914.85	13.65	1053.57	77.173
30014.90	14.14	1053.57	74.518
30114.95	14.62	1053.57	72.057
30215.00	15.10	1053.57	69.768
30315.05	15.58	1053.57	67.635
30415.10	16.05	1053.57	65.641
30515.15	16.52	1053.57	63.772
30615.20	16.99	1053.57	62.017
30715.25	17.45	1053.57	60.366
30815.30	17.92	1053.57	58.808
30915.35	18.38	1053.57	57.336
31015.40	18.83	1053.57	55.943
31115.45	19.29	1053.57	54.622
31215.50	19.74	1053.57	53.368
31315.55	20.19	1053.57	52.174
31415.60	20.64	1053.57	51.038
31515.65	21.09	1053.57	49.953
31615.70	21.54	1053.57	48.918
31715.75	21.98	1053.57	47.927
31815.80	22.43	1053.57	46.979
31915.85	22.87	1053.57	46.069
32015.90	23.31	1053.57	45.196
32115.95	23.75	1053.57	44.358

<i>Cod. elab.:</i> 108GA201-GA01-Z-CL-002_C	<i>Titolo:</i> OPERE D'ARTE MAGGIORI- GALLERIE	<i>Data:</i> Ottobre 2011
<i>Nome file:</i> 108GA201-GA01-Z-CL -002_C.docx	ARTIFICIALI – GALLERIA ROVETELLO Relazione di calcolo	<i>Pagina</i> 380 di 452

PROGETTO ESECUTIVO

32216.00	24.19	1053.57	43.552
32316.05	24.63	1053.57	42.775
32416.10	25.07	1053.57	42.027
32516.15	25.51	1053.57	41.306
32616.20	25.94	1053.57	40.610
32716.25	26.38	1053.57	39.937
32816.30	26.82	1053.57	39.286
32916.35	27.25	1053.57	38.657
33016.40	27.69	1053.57	38.048
33116.45	28.13	1053.57	37.457
33216.50	28.10	1053.57	37.490
33316.55	27.62	1053.57	38.151
33416.60	27.13	1053.57	38.834
33516.65	26.64	1053.57	39.542
33616.70	26.16	1053.57	40.275
33716.75	25.68	1053.57	41.034
33816.80	25.19	1053.57	41.822
33916.85	24.71	1053.57	42.639
34016.90	24.23	1053.57	43.486
34116.95	23.75	1053.57	44.366
34217.00	23.27	1053.57	45.280
34317.05	22.79	1053.57	46.230
34417.10	22.31	1053.57	47.217
34517.15	21.84	1053.57	48.245
34617.20	21.36	1053.57	49.315
34717.25	20.89	1053.57	50.429
34817.30	20.42	1053.57	51.592
34917.35	19.95	1053.57	52.804
35017.40	19.49	1053.57	54.070
35117.45	19.02	1053.57	55.392
35217.50	18.56	1053.57	56.776
35317.55	18.10	1053.57	58.223
35417.60	17.64	1053.57	59.740
35517.65	17.18	1053.57	61.331
35617.70	16.72	1053.57	63.000
35717.75	16.27	1053.57	64.755

<i>Cod. elab.:</i> 108GA201-GA01-Z-CL-002_C	<i>Titolo:</i> OPERE D'ARTE MAGGIORI- GALLERIE	<i>Data:</i> Ottobre 2011
<i>Nome file:</i> 108GA201-GA01-Z-CL -002_C.docx	ARTIFICIALI – GALLERIA ROVETELLO	<i>Pagina</i> 381 di 452
Relazione di calcolo		

PROGETTO ESECUTIVO

35817.80	15.82	1053.57	66.600
35917.85	15.37	1053.57	68.544
36017.90	14.92	1053.57	70.594
36117.95	14.48	1053.57	72.758
36218.00	14.04	1053.57	75.047
36318.05	13.60	1053.57	77.471
36418.10	13.16	1053.57	80.041
36518.15	12.73	1053.57	82.772
36618.20	12.30	1053.57	85.679
36718.25	11.87	1053.57	88.778
36818.30	11.44	1053.57	92.089
36918.35	11.02	1053.57	95.634
37018.40	10.60	1053.57	99.438
37118.45	10.18	1053.57	103.531
37218.50	9.76	1053.57	107.946
37318.55	9.35	1053.57	112.721
37418.60	8.94	1053.57	117.904
37518.65	8.53	1053.57	123.546
37618.70	8.12	1053.57	129.712
37718.75	7.72	1053.57	136.478
37818.80	7.32	1053.57	143.933
37918.85	6.92	1053.57	152.190
38018.90	6.53	1053.57	161.383
38118.95	6.14	1053.57	171.679
38219.00	5.75	1053.57	183.290
38319.05	5.36	1053.57	196.482
38419.10	4.98	1053.57	211.600
38519.15	4.60	1053.57	229.098
38619.20	4.22	1053.57	249.584
38719.25	3.85	1053.57	273.891
38819.30	3.47	1053.57	303.195
38919.35	3.11	1053.57	339.211
39019.40	2.74	1053.57	384.536
39119.45	2.38	1053.57	443.309
39219.50	2.02	1053.57	522.549
39319.55	1.66	1053.57	635.187

<i>Cod. elab.:</i> 108GA201-GA01-Z-CL-002_C	<i>Titolo:</i> OPERE D'ARTE MAGGIORI- GALLERIE	<i>Data:</i> Ottobre 2011
<i>Nome file:</i> 108GA201-GA01-Z-CL -002_C.docx	ARTIFICIALI – GALLERIA ROVETELLO Relazione di calcolo	<i>Pagina</i> 382 di 452

PROGETTO ESECUTIVO

39419.60	1.30	1053.57	807.954
39519.65	0.95	1053.57	1106.485
39619.70	0.60	1053.57	1746.585
39719.75	0.26	1053.57	4097.627
39819.80	-0.09	1053.57	12233.449
39919.85	-0.43	1053.57	2470.271
40019.90	-0.76	1053.57	1378.989
40119.95	-1.10	1053.57	958.950
40220.00	-1.43	1053.57	736.524

Fase n° 3 - [A2-M2]

n°	Y	T	T _R	CS _T
1	0.00	0.00	1053.5720095758.087	
2	0.05	0.00	1053.57 6728768.639	
3	0.10	0.00	1053.57 4052772.410	
4	0.15	0.00	1053.57 2901215.503	
5	0.20	0.00	1053.57 2265011.597	
6	0.25	0.00	1053.57 1856630.861	
7	0.30	0.00	1053.57 1576391.104	
8	0.35	0.00	1053.57 1369790.108	
9	0.40	0.00	1053.57 1212075.666	
10	0.45	0.00	1053.57 1087949.874	
11	0.50	0.00	1053.57 831359.209	
12	0.55	0.00	1053.57 597437.964	
13	0.60	0.00	1053.57 466985.893	
14	0.65	0.00	1053.57 383688.835	
15	0.70	0.00	1053.57 325899.487	
16	0.75	0.00	1053.57 283459.838	
17	0.80	0.00	1053.57 250973.496	
18	0.85	0.00	1053.57 225305.233	
19	0.90	-0.01	1053.57 204542.787	
20	0.95	-0.01	1053.57 187367.047	
21	1.00	-0.01	1053.57 172932.101	
22	1.05	-0.01	1053.57 160640.441	

Cod. elab.: 108GA201-GA01-Z-CL-002_C	Titolo: OPERE D'ARTE MAGGIORI- GALLERIE	Data: Ottobre 2011
Nome file: 108GA201-GA01-Z-CL -002_C.docx	ARTIFICIALI – GALLERIA ROVETELLO	Pagina 383 di 452
Relazione di calcolo		

PROGETTO ESECUTIVO

23	1.10	-0.01	1053.57	150046.913
24	1.15	-0.01	1053.57	140811.378
25	1.20	-0.01	1053.57	132702.556
26	1.25	-0.01	1053.57	125518.643
27	1.30	-0.01	1053.57	119114.714
28	1.35	-0.01	1053.57	113363.871
29	1.40	-0.01	1053.57	108182.132
30	1.45	-0.01	1053.57	103477.631
31	1.50	-0.01	1053.57	99195.201
32	1.55	-0.01	1053.57	95280.715
33	1.60	-0.01	1053.57	91684.479
34	1.65	-0.01	1053.57	88371.831
35	1.70	-0.01	1053.57	85310.956
36	1.75	-0.01	1053.57	82473.932
37	1.80	-0.01	1053.57	79836.691
38	1.85	-0.01	1053.57	77381.498
39	1.90	-0.01	1053.57	75087.223
40	1.95	-0.01	1053.57	72940.165
41	2.00	-0.01	1053.57	70926.684
42	2.05	-0.02	1053.57	69035.107
43	2.10	-0.02	1053.57	67253.231
44	2.15	-0.02	1053.57	65575.275
45	2.20	-0.02	1053.57	63988.594
46	2.25	-0.02	1053.57	62487.891
47	2.30	-0.02	1053.57	61066.106
48	2.35	-0.02	1053.57	59718.798
49	2.40	-0.02	1053.57	58438.362
50	2.45	-0.02	1053.57	57220.138
51	2.50	-0.02	1053.57	57220.138
52	2.50	-107.29	1053.57	9.820
53	2.55	-107.29	1053.57	9.820
54	2.60	-107.29	1053.57	9.820
55	2.65	-107.29	1053.57	9.820
56	2.70	-107.29	1053.57	9.820
57	2.75	-106.83	1053.57	9.862
58	2.80	-105.44	1053.57	9.992

<i>Cod. elab.:</i> 108GA201-GA01-Z-CL-002_C	<i>Titolo:</i> OPERE D'ARTE MAGGIORI- GALLERIE	<i>Data:</i> Ottobre 2011
<i>Nome file:</i> 108GA201-GA01-Z-CL -002_C.docx	ARTIFICIALI – GALLERIA ROVETELLO	<i>Pagina</i> 384 di 452
Relazione di calcolo		

PROGETTO ESECUTIVO

59	2.85	-103.43	1053.57	10.187
60	2.90	-101.10	1053.57	10.421
61	2.95	-98.45	1053.57	10.701
62	3.00	-95.49	1053.57	11.033
63	3.05	-92.24	1053.57	11.422
64	3.10	-88.72	1053.57	11.875
65	3.15	-85.06	1053.57	12.387
66	3.20	-81.34	1053.57	12.952
67	3.25	-77.58	1053.57	13.580
68	3.30	-73.78	1053.57	14.281
69	3.35	-69.92	1053.57	15.068
70	3.40	-66.02	1053.57	15.957
71	3.45	-62.08	1053.57	16.972
72	3.50	-58.09	1053.57	18.138
73	3.55	-54.05	1053.57	19.493
74	3.60	-49.97	1053.57	21.085
75	3.65	-45.84	1053.57	22.985
76	3.70	-41.66	1053.57	25.287
77	3.75	-37.44	1053.57	28.137
78	3.80	-33.18	1053.57	31.754
79	3.85	-28.87	1053.57	36.494
80	3.90	-24.51	1053.57	42.978
81	3.95	-20.11	1053.57	52.380
82	4.00	-15.67	1053.57	67.239
83	4.05	-11.18	1053.57	94.243
84	4.10	-6.64	1053.57	158.557
85	4.15	-2.07	1053.57	510.050
86	4.20	2.56	1053.57	411.871
87	4.25	7.23	1053.57	145.802
88	4.30	11.94	1053.57	88.252
89	4.35	16.69	1053.57	63.108
90	4.40	21.50	1053.57	49.014
91	4.45	26.34	1053.57	40.000
92	4.50	31.23	1053.57	33.738
93	4.55	36.16	1053.57	29.136
94	4.60	41.14	1053.57	25.612

<i>Cod. elab.:</i> 108GA201-GA01-Z-CL-002_C	<i>Titolo:</i> OPERE D'ARTE MAGGIORI- GALLERIE	<i>Data:</i> Ottobre 2011
<i>Nome file:</i> 108GA201-GA01-Z-CL -002_C.docx	ARTIFICIALI – GALLERIA ROVETELLO Relazione di calcolo	<i>Pagina</i> 385 di 452

PROGETTO ESECUTIVO

95	4.65	46.15	1053.57	22.827
96	4.70	51.22	1053.57	20.570
97	4.75	56.32	1053.57	18.705
98	4.80	61.47	1053.57	17.138
99	4.85	66.67	1053.57	15.803
100	4.90	71.90	1053.57	14.653
101	4.95	77.18	1053.57	13.650
102	5.00	82.50	1053.57	12.770
103	5.05	84.01	1053.57	12.541
104	5.10	85.42	1053.57	12.334
105	5.15	86.74	1053.57	12.146
106	5.20	87.97	1053.57	11.977
107	5.25	89.10	1053.57	11.824
108	5.30	90.15	1053.57	11.687
109	5.35	91.12	1053.57	11.563
110	5.40	92.00	1053.57	11.452
111	5.45	92.80	1053.57	11.353
112	5.50	93.51	1053.57	11.267
113	5.55	94.14	1053.57	11.191
114	5.60	94.68	1053.57	11.127
115	5.65	95.14	1053.57	11.074
116	5.70	95.52	1053.57	11.030
117	5.75	95.80	1053.57	10.997
118	5.80	96.01	1053.57	10.974
119	5.85	96.12	1053.57	10.960
120	5.90	96.11	1053.57	10.962
121	5.95	96.02	1053.57	10.973
122	6.00	95.84	1053.57	10.993
123	6.05	95.57	1053.57	11.024
124	6.10	95.22	1053.57	11.065
125	6.15	94.78	1053.57	11.116
126	6.20	94.26	1053.57	11.178
127	6.25	93.65	1053.57	11.250
128	6.30	92.95	1053.57	11.335
129	6.35	92.17	1053.57	11.431
130	6.40	91.30	1053.57	11.539

<i>Cod. elab.:</i> 108GA201-GA01-Z-CL-002_C	<i>Titolo:</i> OPERE D'ARTE MAGGIORI- GALLERIE	<i>Data:</i> Ottobre 2011
<i>Nome file:</i> 108GA201-GA01-Z-CL -002_C.docx	ARTIFICIALI – GALLERIA ROVETELLO Relazione di calcolo	<i>Pagina</i> 386 di 452

PROGETTO ESECUTIVO

131 6.45	90.35	1053.57	11.661
132 6.50	89.31	1053.57	11.797
133 6.55	88.18	1053.57	11.948
134 6.60	86.97	1053.57	12.114
135 6.65	85.67	1053.57	12.298
136 6.70	84.28	1053.57	12.500
137 6.75	82.81	1053.57	12.722
138 6.80	81.25	1053.57	12.966
139 6.85	79.61	1053.57	13.234
140 6.90	77.88	1053.57	13.528
141 6.95	76.16	1053.57	13.834
142 7.00	74.45	1053.57	14.151
143 7.05	72.76	1053.57	14.481
144 7.10	71.08	1053.57	14.823
145 7.15	69.41	1053.57	15.178
146 7.20	67.76	1053.57	15.548
147 7.25	66.13	1053.57	15.932
148 7.30	64.51	1053.57	16.333
149 7.35	62.90	1053.57	16.750
150 7.40	61.31	1053.57	17.186
151 7.45	59.73	1053.57	17.640
152 7.50	58.16	1053.57	18.115
153 7.55	56.61	1053.57	18.611
154 7.60	55.07	1053.57	19.131
155 7.65	53.54	1053.57	19.676
156 7.70	52.03	1053.57	20.248
157 7.75	50.53	1053.57	20.849
158 7.80	49.05	1053.57	21.480
159 7.85	47.57	1053.57	22.145
160 7.90	46.11	1053.57	22.847
161 7.95	44.67	1053.57	23.587
162 8.00	43.23	1053.57	24.371
163 8.05	41.81	1053.57	25.200
164 8.10	40.40	1053.57	26.081
165 8.15	39.00	1053.57	27.017
166 8.20	37.61	1053.57	28.014

<i>Cod. elab.:</i> 108GA201-GA01-Z-CL-002 C	<i>Titolo:</i> OPERE D'ARTE MAGGIORI- GALLERIE	<i>Data:</i> Ottobre 2011
<i>Nome file:</i> 108GA201-GA01-Z-CL -002_C.docx	ARTIFICIALI – GALLERIA ROVETELLO	<i>Pagina</i> 387 di 452
Relazione di calcolo		

PROGETTO ESECUTIVO

1678.25	36.23	1053.57	29.078
1688.30	34.87	1053.57	30.215
1698.35	33.52	1053.57	31.436
1708.40	32.17	1053.57	32.747
1718.45	30.84	1053.57	34.161
1728.50	28.97	1053.57	36.365
1738.55	26.57	1053.57	39.650
1748.60	24.19	1053.57	43.552
1758.65	21.83	1053.57	48.265
1768.70	19.49	1053.57	54.070
1778.75	17.16	1053.57	61.397
1788.80	14.85	1053.57	70.935
1798.85	12.56	1053.57	83.864
1808.90	10.29	1053.57	102.386
1818.95	8.03	1053.57	131.130
1829.00	5.80	1053.57	181.791
1839.05	3.57	1053.57	294.890
1849.10	1.37	1053.57	771.295
1859.15	-0.83	1053.57	1276.809
1869.20	-3.00	1053.57	351.076
1879.25	-5.14	1053.57	204.827
1889.30	-7.24	1053.57	145.608
1899.35	-9.28	1053.57	113.567
1909.40	-11.27	1053.57	93.498
1919.45	-13.21	1053.57	79.757
1929.50	-15.10	1053.57	69.765
1939.55	-16.94	1053.57	62.178
1949.60	-18.74	1053.57	56.226
1959.65	-20.48	1053.57	51.435
1969.70	-22.18	1053.57	47.500
1979.75	-23.83	1053.57	44.213
1989.80	-25.43	1053.57	41.429
1999.85	-26.98	1053.57	39.043
2009.90	-28.49	1053.57	36.978
2019.95	-29.95	1053.57	35.175
20210.00	-31.37	1053.57	33.589

<i>Cod. elab.:</i> 108GA201-GA01-Z-CL-002 C	<i>Titolo:</i> OPERE D'ARTE MAGGIORI- GALLERIE	<i>Data:</i> Ottobre 2011
<i>Nome file:</i> 108GA201-GA01-Z-CL -002_C.docx	ARTIFICIALI – GALLERIA ROVETELLO	<i>Pagina</i> 388 di 452
Relazione di calcolo		

PROGETTO ESECUTIVO

20310.05	-32.73	1053.57	32.186
20410.10	-34.06	1053.57	30.936
20510.15	-35.33	1053.57	29.819
20610.20	-36.56	1053.57	28.815
20710.25	-37.75	1053.57	27.909
20810.30	-38.89	1053.57	27.090
20910.35	-39.99	1053.57	26.347
21010.40	-41.04	1053.57	25.670
21110.45	-42.05	1053.57	25.054
21210.50	-43.02	1053.57	24.492
21310.55	-43.94	1053.57	23.978
21410.60	-44.82	1053.57	23.507
21510.65	-45.66	1053.57	23.076
21610.70	-46.45	1053.57	22.682
21710.75	-47.20	1053.57	22.321
21810.80	-47.91	1053.57	21.990
21910.85	-48.58	1053.57	21.687
22010.90	-49.21	1053.57	21.411
22110.95	-49.79	1053.57	21.159
22211.00	-50.34	1053.57	20.931
22311.05	-50.84	1053.57	20.723
22411.10	-51.30	1053.57	20.536
22511.15	-51.73	1053.57	20.369
22611.20	-52.11	1053.57	20.219
22711.25	-52.45	1053.57	20.087
22811.30	-52.75	1053.57	19.972
22911.35	-53.02	1053.57	19.873
23011.40	-53.24	1053.57	19.789
23111.45	-53.42	1053.57	19.721
23211.50	-53.57	1053.57	19.667
23311.55	-53.68	1053.57	19.628
23411.60	-53.75	1053.57	19.603
23511.65	-53.78	1053.57	19.592
23611.70	-53.77	1053.57	19.595
23711.75	-53.72	1053.57	19.612
23811.80	-53.64	1053.57	19.642

<i>Cod. elab.:</i> 108GA201-GA01-Z-CL-002 C	<i>Titolo:</i> OPERE D'ARTE MAGGIORI- GALLERIE	<i>Data:</i> Ottobre 2011
<i>Nome file:</i> 108GA201-GA01-Z-CL -002_C.docx	ARTIFICIALI – GALLERIA ROVETELLO Relazione di calcolo	<i>Pagina</i> 389 di 452

PROGETTO ESECUTIVO

23911.85	-53.52	1053.57	19.687
24011.90	-53.36	1053.57	19.746
24111.95	-53.16	1053.57	19.819
24212.00	-52.93	1053.57	19.907
24312.05	-52.65	1053.57	20.009
24412.10	-52.35	1053.57	20.127
24512.15	-52.00	1053.57	20.261
24612.20	-51.62	1053.57	20.411
24712.25	-51.20	1053.57	20.577
24812.30	-50.74	1053.57	20.762
24912.35	-50.25	1053.57	20.965
25012.40	-49.73	1053.57	21.188
25112.45	-49.16	1053.57	21.431
25212.50	-48.56	1053.57	21.695
25312.55	-47.93	1053.57	21.983
25412.60	-47.25	1053.57	22.296
25512.65	-46.55	1053.57	22.635
25612.70	-45.80	1053.57	23.002
25712.75	-45.04	1053.57	23.391
25812.80	-44.28	1053.57	23.793
25912.85	-43.52	1053.57	24.208
26012.90	-42.76	1053.57	24.638
26112.95	-42.00	1053.57	25.082
26213.00	-41.25	1053.57	25.543
26313.05	-40.49	1053.57	26.020
26413.10	-39.74	1053.57	26.515
26513.15	-38.98	1053.57	27.028
26613.20	-38.23	1053.57	27.560
26713.25	-37.48	1053.57	28.113
26813.30	-36.72	1053.57	28.688
26913.35	-35.97	1053.57	29.286
27013.40	-35.23	1053.57	29.908
27113.45	-34.48	1053.57	30.557
27213.50	-33.73	1053.57	31.232
27313.55	-32.99	1053.57	31.937
27413.60	-32.25	1053.57	32.673

<i>Cod. elab.:</i> 108GA201-GA01-Z-CL-002 C	<i>Titolo:</i> OPERE D'ARTE MAGGIORI- GALLERIE	<i>Data:</i> Ottobre 2011
<i>Nome file:</i> 108GA201-GA01-Z-CL -002_C.docx	ARTIFICIALI – GALLERIA ROVETELLO Relazione di calcolo	<i>Pagina</i> 390 di 452

PROGETTO ESECUTIVO

27513.65	-31.50	1053.57	33.442
27613.70	-30.76	1053.57	34.247
27713.75	-30.02	1053.57	35.090
27813.80	-29.29	1053.57	35.973
27913.85	-28.55	1053.57	36.900
28013.90	-27.82	1053.57	37.874
28113.95	-27.08	1053.57	38.899
28214.00	-26.35	1053.57	39.979
28314.05	-25.62	1053.57	41.117
28414.10	-24.89	1053.57	42.320
28514.15	-24.17	1053.57	43.593
28614.20	-23.44	1053.57	44.942
28714.25	-22.72	1053.57	46.373
28814.30	-22.00	1053.57	47.896
28914.35	-21.28	1053.57	49.519
29014.40	-20.56	1053.57	51.251
29114.45	-19.84	1053.57	53.105
29214.50	-19.12	1053.57	55.095
29314.55	-18.41	1053.57	57.234
29414.60	-17.69	1053.57	59.541
29514.65	-16.98	1053.57	62.038
29614.70	-16.27	1053.57	64.746
29714.75	-15.56	1053.57	67.697
29814.80	-14.86	1053.57	70.922
29914.85	-14.15	1053.57	74.463
30014.90	-13.44	1053.57	78.368
30114.95	-12.74	1053.57	82.698
30215.00	-12.04	1053.57	87.524
30315.05	-11.34	1053.57	92.938
30415.10	-10.64	1053.57	99.054
30515.15	-9.94	1053.57	106.020
30615.20	-9.24	1053.57	114.025
30715.25	-8.54	1053.57	123.321
30815.30	-7.85	1053.57	134.248
30915.35	-7.15	1053.57	147.278
31015.40	-6.46	1053.57	163.082

Cod. elab.: 108GA201-GA01-Z-CL-002 C	Titolo: OPERE D'ARTE MAGGIORI- GALLERIE	Data: Ottobre 2011
Nome file: 108GA201-GA01-Z-CL -002_C.docx	ARTIFICIALI – GALLERIA ROVETELLO	Pagina 391 di 452
Relazione di calcolo		

PROGETTO ESECUTIVO

31115.45	-5.77	1053.57	182.653
31215.50	-5.08	1053.57	207.522
31315.55	-4.39	1053.57	240.178
31415.60	-3.70	1053.57	284.960
31515.65	-3.01	1053.57	350.164
31615.70	-2.32	1053.57	453.893
31715.75	-1.63	1053.57	644.621
31815.80	-0.95	1053.57	1110.876
31915.85	-0.26	1053.57	4003.195
32015.90	0.42	1053.57	2500.623
32115.95	1.11	1053.57	953.340
32216.00	1.79	1053.57	589.150
32316.05	2.47	1053.57	426.406
32416.10	3.15	1053.57	334.175
32516.15	3.83	1053.57	274.788
32616.20	4.51	1053.57	233.351
32716.25	5.20	1053.57	202.793
32816.30	5.88	1053.57	179.326
32916.35	6.55	1053.57	160.737
33016.40	7.23	1053.57	145.649
33116.45	7.91	1053.57	133.156
33216.50	8.18	1053.57	128.763
33316.55	8.04	1053.57	130.985
33416.60	7.90	1053.57	133.293
33516.65	7.76	1053.57	135.690
33616.70	7.62	1053.57	138.181
33716.75	7.48	1053.57	140.772
33816.80	7.34	1053.57	143.467
33916.85	7.20	1053.57	146.272
34016.90	7.06	1053.57	149.194
34116.95	6.92	1053.57	152.239
34217.00	6.78	1053.57	155.415
34317.05	6.64	1053.57	158.728
34417.10	6.50	1053.57	162.189
34517.15	6.35	1053.57	165.806
34617.20	6.21	1053.57	169.589

Cod. elab.: 108GA201-GA01-Z-CL-002 C	Titolo: OPERE D'ARTE MAGGIORI- GALLERIE	Data: Ottobre 2011
Nome file: 108GA201-GA01-Z-CL -002_C.docx	ARTIFICIALI – GALLERIA ROVETELLO	Pagina 392 di 452
	Relazione di calcolo	

PROGETTO ESECUTIVO

34717.25	6.07	1053.57	173.549
34817.30	5.93	1053.57	177.698
34917.35	5.79	1053.57	182.050
35017.40	5.65	1053.57	186.618
35117.45	5.50	1053.57	191.419
35217.50	5.36	1053.57	196.471
35317.55	5.22	1053.57	201.792
35417.60	5.08	1053.57	207.403
35517.65	4.94	1053.57	213.329
35617.70	4.80	1053.57	219.596
35717.75	4.66	1053.57	226.234
35817.80	4.52	1053.57	233.275
35917.85	4.38	1053.57	240.756
36017.90	4.24	1053.57	248.719
36117.95	4.10	1053.57	257.212
36218.00	3.96	1053.57	266.287
36318.05	3.82	1053.57	276.007
36418.10	3.68	1053.57	286.441
36518.15	3.54	1053.57	297.671
36618.20	3.40	1053.57	309.789
36718.25	3.26	1053.57	322.904
36818.30	3.12	1053.57	337.143
36918.35	2.99	1053.57	352.656
37018.40	2.85	1053.57	369.622
37118.45	2.71	1053.57	388.252
37218.50	2.58	1053.57	408.802
37318.55	2.44	1053.57	431.585
37418.60	2.31	1053.57	456.983
37518.65	2.17	1053.57	485.473
37618.70	2.04	1053.57	517.653
37718.75	1.90	1053.57	554.288
37818.80	1.77	1053.57	596.371
37918.85	1.63	1053.57	645.210
38018.90	1.50	1053.57	702.572
38118.95	1.37	1053.57	770.900
38219.00	1.23	1053.57	853.664

<i>Cod. elab.:</i> 108GA201-GA01-Z-CL-002_C	<i>Titolo:</i> OPERE D'ARTE MAGGIORI- GALLERIE	<i>Data:</i> Ottobre 2011
<i>Nome file:</i> 108GA201-GA01-Z-CL -002_C.docx	ARTIFICIALI – GALLERIA ROVETELLO Relazione di calcolo	<i>Pagina</i> 393 di 452

PROGETTO ESECUTIVO

38319.05	1.10	1053.57	955.979
38419.10	0.97	1053.57	1085.691
38519.15	0.84	1053.57	1255.502
38619.20	0.71	1053.57	1487.394
38719.25	0.58	1053.57	1823.016
38819.30	0.45	1053.57	2351.998
38919.35	0.32	1053.57	3309.015
39019.40	0.19	1053.57	5566.510
39119.45	0.06	1053.57	17392.933
39219.50	-0.07	1053.57	15564.723
39319.55	-0.20	1053.57	5388.487
39419.60	-0.32	1053.57	3262.602
39519.65	-0.45	1053.57	2341.832
39619.70	-0.58	1053.57	1827.761
39719.75	-0.70	1053.57	1499.683
39819.80	-0.83	1053.57	1272.125
39919.85	-0.95	1053.57	1105.029
40019.90	-1.08	1053.57	977.127
40119.95	-1.20	1053.57	876.077
40220.00	-1.33	1053.57	794.228

Fase n° 4 - [A2-M2]

n°	Y	T	T _R	CS _T
1	0.00	0.00	1053.57	13234230.681
2	0.05	0.05	1053.57	19714.099
3	0.10	0.16	1053.57	6569.639
4	0.15	0.27	1053.57	3935.661
5	0.20	0.38	1053.57	2806.306
6	0.25	0.48	1053.57	2178.767
7	0.30	0.59	1053.57	1779.386
8	0.35	0.70	1053.57	1502.879
9	0.40	0.81	1053.57	1300.104
10	0.45	0.92	1053.57	1145.042
11	0.50	1.14	1053.57	922.686
12	0.55	1.59	1053.57	663.462

Cod. elab.: 108GA201-GA01-Z-CL-002_C	Titolo: OPERE D'ARTE MAGGIORI- GALLERIE	Data: Ottobre 2011
Nome file: 108GA201-GA01-Z-CL -002_C.docx	ARTIFICIALI – GALLERIA ROVETELLO	Pagina 394 di 452
Relazione di calcolo		

PROGETTO ESECUTIVO

13	0.60	2.15	1053.57	490.547
14	0.65	2.71	1053.57	388.839
15	0.70	3.27	1053.57	321.864
16	0.75	3.84	1053.57	274.426
17	0.80	4.41	1053.57	239.065
18	0.85	4.98	1053.57	211.691
19	0.90	5.55	1053.57	189.872
20	0.95	6.12	1053.57	172.074
21	1.00	6.70	1053.57	157.279
22	1.05	7.28	1053.57	144.787
23	1.10	7.86	1053.57	134.098
24	1.15	8.44	1053.57	124.850
25	1.20	9.02	1053.57	116.769
26	1.25	9.61	1053.57	109.647
27	1.30	10.20	1053.57	103.324
28	1.35	10.79	1053.57	97.672
29	1.40	11.38	1053.57	92.591
30	1.45	11.97	1053.57	87.997
31	1.50	12.57	1053.57	83.824
32	1.55	13.17	1053.57	80.017
33	1.60	13.77	1053.57	76.530
34	1.65	14.37	1053.57	73.324
35	1.70	14.97	1053.57	70.367
36	1.75	15.58	1053.57	67.631
37	1.80	16.19	1053.57	65.091
38	1.85	16.80	1053.57	62.728
39	1.90	17.41	1053.57	60.524
40	1.95	18.02	1053.57	58.464
41	2.00	18.64	1053.57	56.533
42	2.05	19.25	1053.57	54.721
43	2.10	19.87	1053.57	53.016
44	2.15	20.49	1053.57	51.410
45	2.20	21.12	1053.57	49.893
46	2.25	21.74	1053.57	48.460
47	2.30	22.37	1053.57	47.102
48	2.35	23.00	1053.57	45.816

<i>Cod. elab.:</i> 108GA201-GA01-Z-CL-002_C	<i>Titolo:</i> OPERE D'ARTE MAGGIORI- GALLERIE	<i>Data:</i> Ottobre 2011
<i>Nome file:</i> 108GA201-GA01-Z-CL -002_C.docx	ARTIFICIALI – GALLERIA ROVETELLO Relazione di calcolo	<i>Pagina</i> 395 di 452

PROGETTO ESECUTIVO

49	2.40	23.63	1053.57	44.594
50	2.45	24.26	1053.57	43.433
51	2.50	24.89	1053.57	42.327
52	2.50	-79.38	1053.57	13.272
53	2.55	-78.75	1053.57	13.379
54	2.60	-78.11	1053.57	13.488
55	2.65	-77.47	1053.57	13.599
56	2.70	-76.83	1053.57	13.712
57	2.75	-75.73	1053.57	13.913
58	2.80	-73.69	1053.57	14.297
59	2.85	-71.04	1053.57	14.831
60	2.90	-68.06	1053.57	15.480
61	2.95	-64.77	1053.57	16.267
62	3.00	-61.15	1053.57	17.228
63	3.05	-57.25	1053.57	18.402
64	3.10	-53.09	1053.57	19.846
65	3.15	-48.77	1053.57	21.604
66	3.20	-44.40	1053.57	23.730
67	3.25	-39.98	1053.57	26.351
68	3.30	-35.52	1053.57	29.663
69	3.35	-31.01	1053.57	33.979
70	3.40	-26.45	1053.57	39.836
71	3.45	-21.84	1053.57	48.237
72	3.50	-17.19	1053.57	61.294
73	3.55	-12.49	1053.57	84.357
74	3.60	-7.74	1053.57	136.063
75	3.65	-2.95	1053.57	357.056
76	3.70	1.89	1053.57	557.993
77	3.75	6.77	1053.57	155.552
78	3.80	11.70	1053.57	90.018
79	3.85	16.68	1053.57	63.161
80	3.90	21.70	1053.57	48.545
81	3.95	26.77	1053.57	39.356
82	4.00	31.88	1053.57	33.044
83	4.05	37.04	1053.57	28.443
84	4.10	42.24	1053.57	24.940

<i>Cod. elab.:</i> 108GA201-GA01-Z-CL-002_C	<i>Titolo:</i> OPERE D'ARTE MAGGIORI- GALLERIE	<i>Data:</i> Ottobre 2011
<i>Nome file:</i> 108GA201-GA01-Z-CL -002_C.docx	ARTIFICIALI – GALLERIA ROVETELLO Relazione di calcolo	<i>Pagina</i> 396 di 452

PROGETTO ESECUTIVO

85	4.15	47.49	1053.57	22.184
86	4.20	52.78	1053.57	19.960
87	4.25	58.12	1053.57	18.128
88	4.30	63.50	1053.57	16.592
89	4.35	68.92	1053.57	15.286
90	4.40	74.39	1053.57	14.162
91	4.45	79.90	1053.57	13.185
92	4.50	85.46	1053.57	12.328
93	4.55	91.06	1053.57	11.570
94	4.60	96.70	1053.57	10.895
95	4.65	102.38	1053.57	10.291
96	4.70	108.11	1053.57	9.745
97	4.75	113.88	1053.57	9.252
98	4.80	119.69	1053.57	8.803
99	4.85	125.54	1053.57	8.392
100	4.90	131.44	1053.57	8.016
101	4.95	137.37	1053.57	7.669
102	5.00	143.35	1053.57	7.350
103	5.00	10.14	1053.57	103.875
104	5.05	12.96	1053.57	81.322
105	5.10	15.67	1053.57	67.230
106	5.15	18.29	1053.57	57.607
107	5.20	20.81	1053.57	50.631
108	5.25	23.23	1053.57	45.344
109	5.30	25.57	1053.57	41.200
110	5.35	27.82	1053.57	37.871
111	5.40	29.98	1053.57	35.145
112	5.45	32.05	1053.57	32.877
113	5.50	34.02	1053.57	30.966
114	5.55	35.91	1053.57	29.338
115	5.60	37.71	1053.57	27.941
116	5.65	39.41	1053.57	26.732
117	5.70	41.03	1053.57	25.680
118	5.75	42.55	1053.57	24.761
119	5.80	43.98	1053.57	23.955
120	5.85	45.32	1053.57	23.248

<i>Cod. elab.:</i> 108GA201-GA01-Z-CL-002_C	<i>Titolo:</i> OPERE D'ARTE MAGGIORI- GALLERIE	<i>Data:</i> Ottobre 2011
<i>Nome file:</i> 108GA201-GA01-Z-CL -002_C.docx	ARTIFICIALI – GALLERIA ROVETELLO Relazione di calcolo	<i>Pagina</i> 397 di 452

PROGETTO ESECUTIVO

121 5.90	46.22	1053.57	22.795
122 5.95	46.73	1053.57	22.547
123 6.00	47.14	1053.57	22.348
124 6.05	47.47	1053.57	22.193
125 6.10	47.71	1053.57	22.082
126 6.15	47.86	1053.57	22.013
127 6.20	47.92	1053.57	21.985
128 6.25	47.89	1053.57	21.999
129 6.30	47.77	1053.57	22.054
130 6.35	47.56	1053.57	22.152
131 6.40	47.26	1053.57	22.292
132 6.45	46.87	1053.57	22.478
133 6.50	46.39	1053.57	22.711
134 6.55	45.82	1053.57	22.995
135 6.60	45.16	1053.57	23.332
136 6.65	44.40	1053.57	23.728
137 6.70	43.56	1053.57	24.187
138 6.75	42.62	1053.57	24.718
139 6.80	41.60	1053.57	25.327
140 6.85	40.48	1053.57	26.025
141 6.90	39.28	1053.57	26.824
142 6.95	38.07	1053.57	27.672
143 7.00	36.88	1053.57	28.568
144 7.05	35.70	1053.57	29.516
145 7.10	34.52	1053.57	30.520
146 7.15	33.36	1053.57	31.585
147 7.20	32.20	1053.57	32.717
148 7.25	31.06	1053.57	33.924
149 7.30	29.92	1053.57	35.211
150 7.35	28.79	1053.57	36.589
151 7.40	27.68	1053.57	38.066
152 7.45	26.57	1053.57	39.653
153 7.50	25.47	1053.57	41.365
154 7.55	24.38	1053.57	43.216
155 7.60	23.30	1053.57	45.223
156 7.65	22.22	1053.57	47.408

<i>Cod. elab.:</i> 108GA201-GA01-Z-CL-002_C	<i>Titolo:</i> OPERE D'ARTE MAGGIORI- GALLERIE	<i>Data:</i> Ottobre 2011
<i>Nome file:</i> 108GA201-GA01-Z-CL -002_C.docx	ARTIFICIALI – GALLERIA ROVETELLO Relazione di calcolo	<i>Pagina</i> 398 di 452

PROGETTO ESECUTIVO

1577.70	21.16	1053.57	49.795
1587.75	20.10	1053.57	52.414
1597.80	19.05	1053.57	55.300
1607.85	18.01	1053.57	58.497
1617.90	16.98	1053.57	62.059
1627.95	15.95	1053.57	66.051
1638.00	14.93	1053.57	70.557
1648.05	13.92	1053.57	75.684
1658.10	12.92	1053.57	81.568
1668.15	11.92	1053.57	88.394
1678.20	10.93	1053.57	96.405
1688.25	9.94	1053.57	105.943
1698.30	8.97	1053.57	117.490
1708.35	8.00	1053.57	131.758
1718.40	7.03	1053.57	149.838
1728.45	6.07	1053.57	173.495
1738.50	4.72	1053.57	223.064
1748.55	2.99	1053.57	352.637
1758.60	1.26	1053.57	834.558
1768.65	-0.45	1053.57	2326.248
1778.70	-2.16	1053.57	488.082
1788.75	-3.85	1053.57	273.305
1798.80	-5.54	1053.57	190.101
1808.85	-7.22	1053.57	145.911
1818.90	-8.89	1053.57	118.504
1828.95	-10.55	1053.57	99.843
1839.00	-12.21	1053.57	86.315
1849.05	-13.85	1053.57	76.058
1859.10	-15.49	1053.57	68.012
1869.15	-17.12	1053.57	61.531
1879.20	-18.75	1053.57	56.198
1889.25	-20.35	1053.57	51.779
1899.30	-21.91	1053.57	48.096
1909.35	-23.42	1053.57	44.984
1919.40	-24.89	1053.57	42.321
1929.45	-26.33	1053.57	40.019

<i>Cod. elab.:</i> 108GA201-GA01-Z-CL-002_C	<i>Titolo:</i> OPERE D'ARTE MAGGIORI- GALLERIE	<i>Data:</i> Ottobre 2011
<i>Nome file:</i> 108GA201-GA01-Z-CL -002_C.docx	ARTIFICIALI – GALLERIA ROVETELLO Relazione di calcolo	<i>Pagina</i> 399 di 452

PROGETTO ESECUTIVO

1939.50	-27.72	1053.57	38.010
1949.55	-29.07	1053.57	36.245
1959.60	-30.38	1053.57	34.683
1969.65	-31.65	1053.57	33.293
1979.70	-32.87	1053.57	32.049
1989.75	-34.06	1053.57	30.931
1999.80	-35.21	1053.57	29.922
2009.85	-36.32	1053.57	29.009
2019.90	-37.39	1053.57	28.179
2029.95	-38.42	1053.57	27.423
20310.00	-39.41	1053.57	26.733
20410.05	-40.36	1053.57	26.102
20510.10	-41.28	1053.57	25.523
20610.15	-42.16	1053.57	24.992
20710.20	-42.99	1053.57	24.505
20810.25	-43.80	1053.57	24.056
20910.30	-44.56	1053.57	23.644
21010.35	-45.29	1053.57	23.264
21110.40	-45.98	1053.57	22.915
21210.45	-46.63	1053.57	22.595
21310.50	-47.25	1053.57	22.300
21410.55	-47.83	1053.57	22.029
21510.60	-48.37	1053.57	21.782
21610.65	-48.88	1053.57	21.556
21710.70	-49.35	1053.57	21.349
21810.75	-49.78	1053.57	21.162
21910.80	-50.19	1053.57	20.993
22010.85	-50.55	1053.57	20.841
22110.90	-50.88	1053.57	20.706
22210.95	-51.18	1053.57	20.587
22311.00	-51.44	1053.57	20.482
22411.05	-51.66	1053.57	20.392
22511.10	-51.86	1053.57	20.317
22611.15	-52.01	1053.57	20.256
22711.20	-52.14	1053.57	20.208
22811.25	-52.23	1053.57	20.173

<i>Cod. elab.:</i> 108GA201-GA01-Z-CL-002_C	<i>Titolo:</i> OPERE D'ARTE MAGGIORI- GALLERIE	<i>Data:</i> Ottobre 2011
<i>Nome file:</i> 108GA201-GA01-Z-CL -002_C.docx	ARTIFICIALI – GALLERIA ROVETELLO Relazione di calcolo	<i>Pagina</i> 400 di 452

PROGETTO ESECUTIVO

22911.30	-52.28	1053.57	20.152
23011.35	-52.30	1053.57	20.143
23111.40	-52.29	1053.57	20.148
23211.45	-52.25	1053.57	20.165
23311.50	-52.17	1053.57	20.196
23411.55	-52.06	1053.57	20.239
23511.60	-51.91	1053.57	20.296
23611.65	-51.73	1053.57	20.366
23711.70	-51.52	1053.57	20.449
23811.75	-51.28	1053.57	20.547
23911.80	-51.00	1053.57	20.658
24011.85	-50.69	1053.57	20.784
24111.90	-50.35	1053.57	20.925
24211.95	-49.97	1053.57	21.082
24312.00	-49.57	1053.57	21.255
24412.05	-49.13	1053.57	21.445
24512.10	-48.66	1053.57	21.653
24612.15	-48.15	1053.57	21.879
24712.20	-47.62	1053.57	22.126
24812.25	-47.05	1053.57	22.393
24912.30	-46.45	1053.57	22.682
25012.35	-45.82	1053.57	22.995
25112.40	-45.15	1053.57	23.333
25212.45	-44.46	1053.57	23.698
25312.50	-43.73	1053.57	24.092
25412.55	-42.97	1053.57	24.518
25512.60	-42.18	1053.57	24.978
25612.65	-41.36	1053.57	25.475
25712.70	-40.50	1053.57	26.012
25812.75	-39.63	1053.57	26.582
25912.80	-38.77	1053.57	27.175
26012.85	-37.91	1053.57	27.791
26112.90	-37.06	1053.57	28.432
26212.95	-36.20	1053.57	29.100
26313.00	-35.36	1053.57	29.797
26413.05	-34.52	1053.57	30.523

<i>Cod. elab.:</i> 108GA201-GA01-Z-CL-002 C	<i>Titolo:</i> OPERE D'ARTE MAGGIORI- GALLERIE	<i>Data:</i> Ottobre 2011
<i>Nome file:</i> 108GA201-GA01-Z-CL -002_C.docx	ARTIFICIALI – GALLERIA ROVETELLO Relazione di calcolo	<i>Pagina</i> 401 di 452

PROGETTO ESECUTIVO

26513.10	-33.68	1053.57	31.282
26613.15	-32.85	1053.57	32.075
26713.20	-32.02	1053.57	32.905
26813.25	-31.19	1053.57	33.774
26913.30	-30.37	1053.57	34.686
27013.35	-29.56	1053.57	35.642
27113.40	-28.75	1053.57	36.647
27213.45	-27.94	1053.57	37.705
27313.50	-27.14	1053.57	38.819
27413.55	-26.34	1053.57	39.995
27513.60	-25.55	1053.57	41.237
27613.65	-24.76	1053.57	42.551
27713.70	-23.97	1053.57	43.944
27813.75	-23.19	1053.57	45.424
27913.80	-22.42	1053.57	46.997
28013.85	-21.65	1053.57	48.675
28113.90	-20.88	1053.57	50.466
28213.95	-20.11	1053.57	52.384
28314.00	-19.35	1053.57	54.443
28414.05	-18.60	1053.57	56.657
28514.10	-17.84	1053.57	59.047
28614.15	-17.09	1053.57	61.633
28714.20	-16.35	1053.57	64.441
28814.25	-15.61	1053.57	67.500
28914.30	-14.87	1053.57	70.848
29014.35	-14.14	1053.57	74.524
29114.40	-13.41	1053.57	78.583
29214.45	-12.68	1053.57	83.085
29314.50	-11.96	1053.57	88.109
29414.55	-11.24	1053.57	93.751
29514.60	-10.52	1053.57	100.133
29614.65	-9.81	1053.57	107.411
29714.70	-9.10	1053.57	115.788
29814.75	-8.39	1053.57	125.534
29914.80	-7.69	1053.57	137.016
30014.85	-6.99	1053.57	150.742

<i>Cod. elab.:</i> 108GA201-GA01-Z-CL-002_C	<i>Titolo:</i> OPERE D'ARTE MAGGIORI- GALLERIE	<i>Data:</i> Ottobre 2011
<i>Nome file:</i> 108GA201-GA01-Z-CL -002_C.docx	ARTIFICIALI – GALLERIA ROVETELLO Relazione di calcolo	<i>Pagina</i> 402 di 452

PROGETTO ESECUTIVO

30114.90	-6.29	1053.57	167.445
30214.95	-5.60	1053.57	188.210
30315.00	-4.91	1053.57	214.728
30415.05	-4.22	1053.57	249.776
30515.10	-3.53	1053.57	298.262
30615.15	-2.85	1053.57	369.755
30715.20	-2.17	1053.57	485.732
30815.25	-1.49	1053.57	706.487
30915.30	-0.82	1053.57	1291.071
31015.35	-0.14	1053.57	7354.018
31115.40	0.53	1053.57	1998.721
31215.45	1.20	1053.57	881.516
31315.50	1.86	1053.57	566.140
31415.55	2.52	1053.57	417.328
31515.60	3.19	1053.57	330.686
31615.65	3.85	1053.57	273.983
31715.70	4.50	1053.57	233.984
31815.75	5.16	1053.57	204.253
31915.80	5.81	1053.57	181.285
32015.85	6.46	1053.57	163.007
32115.90	7.11	1053.57	148.113
32215.95	7.76	1053.57	135.744
32316.00	8.41	1053.57	125.305
32416.05	9.05	1053.57	116.378
32516.10	9.70	1053.57	108.656
32616.15	10.34	1053.57	101.909
32716.20	10.98	1053.57	95.963
32816.25	11.62	1053.57	90.684
32916.30	12.26	1053.57	85.965
33016.35	12.89	1053.57	81.720
33116.40	13.53	1053.57	77.882
33216.45	14.16	1053.57	74.394
33316.50	14.38	1053.57	73.283
33416.55	14.17	1053.57	74.343
33516.60	13.97	1053.57	75.443
33616.65	13.76	1053.57	76.583

<i>Cod. elab.:</i> 108GA201-GA01-Z-CL-002 C	<i>Titolo:</i> OPERE D'ARTE MAGGIORI- GALLERIE	<i>Data:</i> Ottobre 2011
<i>Nome file:</i> 108GA201-GA01-Z-CL -002_C.docx	ARTIFICIALI – GALLERIA ROVETELLO Relazione di calcolo	<i>Pagina</i> 403 di 452

PROGETTO ESECUTIVO

33716.70	13.55	1053.57	77.766
33816.75	13.34	1053.57	78.994
33916.80	13.13	1053.57	80.269
34016.85	12.91	1053.57	81.593
34116.90	12.70	1053.57	82.969
34216.95	12.48	1053.57	84.398
34317.00	12.27	1053.57	85.886
34417.05	12.05	1053.57	87.433
34517.10	11.83	1053.57	89.044
34617.15	11.61	1053.57	90.722
34717.20	11.39	1053.57	92.471
34817.25	11.17	1053.57	94.296
34917.30	10.95	1053.57	96.200
35017.35	10.73	1053.57	98.189
35117.40	10.51	1053.57	100.268
35217.45	10.28	1053.57	102.443
35317.50	10.06	1053.57	104.721
35417.55	9.84	1053.57	107.108
35517.60	9.61	1053.57	109.612
35617.65	9.39	1053.57	112.242
35717.70	9.16	1053.57	115.006
35817.75	8.93	1053.57	117.915
35917.80	8.71	1053.57	120.981
36017.85	8.48	1053.57	124.216
36117.90	8.25	1053.57	127.633
36217.95	8.03	1053.57	131.249
36318.00	7.80	1053.57	135.081
36418.05	7.57	1053.57	139.147
36518.10	7.34	1053.57	143.471
36618.15	7.12	1053.57	148.076
36718.20	6.89	1053.57	152.991
36818.25	6.66	1053.57	158.248
36918.30	6.43	1053.57	163.884
37018.35	6.20	1053.57	169.939
37118.40	5.97	1053.57	176.463
37218.45	5.74	1053.57	183.511

<i>Cod. elab.:</i> 108GA201-GA01-Z-CL-002_C	<i>Titolo:</i> OPERE D'ARTE MAGGIORI- GALLERIE	<i>Data:</i> Ottobre 2011
<i>Nome file:</i> 108GA201-GA01-Z-CL -002_C.docx	ARTIFICIALI – GALLERIA ROVETELLO Relazione di calcolo	<i>Pagina</i> 404 di 452

PROGETTO ESECUTIVO

37318.50	5.51	1053.57	191.150
37418.55	5.28	1053.57	199.455
37518.60	5.05	1053.57	208.518
37618.65	4.82	1053.57	218.447
37718.70	4.59	1053.57	229.371
37818.75	4.36	1053.57	241.448
37918.80	4.13	1053.57	254.870
38018.85	3.90	1053.57	269.874
38118.90	3.67	1053.57	286.756
38218.95	3.44	1053.57	305.893
38319.00	3.21	1053.57	327.768
38419.05	2.98	1053.57	353.012
38519.10	2.75	1053.57	382.470
38619.15	2.52	1053.57	417.290
38719.20	2.29	1053.57	459.083
38819.25	2.07	1053.57	510.176
38919.30	1.84	1053.57	574.060
39019.35	1.61	1053.57	656.225
39119.40	1.38	1053.57	765.826
39219.45	1.15	1053.57	919.359
39319.50	0.92	1053.57	1149.855
39419.55	0.69	1053.57	1534.540
39519.60	0.46	1053.57	2305.871
39619.65	0.23	1053.57	4635.668
39719.70	0.00	1053.57	452689.428
39819.75	-0.23	1053.57	4543.245
39919.80	-0.46	1053.57	2283.236
40019.85	-0.69	1053.57	1524.826
40119.90	-0.92	1053.57	1144.663
40219.95	-1.15	1053.57	916.258
40320.00	-1.38	1053.57	763.859

Fase n° 5 - [A2-M2]

n°	Y	T	T _R	CS _T
1	0.00	0.00	1053.5712928150.801	

Cod. elab.: 108GA201-GA01-Z-CL-002 C	Titolo: OPERE D'ARTE MAGGIORI- GALLERIE	Data: Ottobre 2011
Nome file: 108GA201-GA01-Z-CL -002_C.docx	ARTIFICIALI – GALLERIA ROVETELLO	Pagina 405 di 452
Relazione di calcolo		

PROGETTO ESECUTIVO

2	0.05	0.00	1053.57	4369363.603
3	0.10	0.00	1053.57	2611277.447
4	0.15	0.00	1053.57	1873214.134
5	0.20	0.00	1053.57	1458812.307
6	0.25	0.00	1053.57	1194405.104
7	0.30	0.00	1053.57	1012861.425
8	0.35	0.00	1053.57	879536.945
9	0.40	0.00	1053.57	776741.147
10	0.45	0.00	1053.57	696454.077
11	0.50	0.00	1053.57	530504.691
12	0.55	0.00	1053.57	379966.125
13	0.60	0.00	1053.57	296192.705
14	0.65	0.00	1053.57	242824.546
15	0.70	-0.01	1053.57	205843.467
16	0.75	-0.01	1053.57	178738.578
17	0.80	-0.01	1053.57	158000.165
18	0.85	-0.01	1053.57	141621.927
19	0.90	-0.01	1053.57	128363.405
20	0.95	-0.01	1053.57	117400.962
21	1.00	-0.01	1053.57	108204.980
22	1.05	-0.01	1053.57	100370.115
23	1.10	-0.01	1053.57	93605.186
24	1.15	-0.01	1053.57	87719.495
25	1.20	-0.01	1053.57	82541.608
26	1.25	-0.01	1053.57	77969.551
27	1.30	-0.01	1053.57	73878.167
28	1.35	-0.02	1053.57	70210.384
29	1.40	-0.02	1053.57	66910.639
30	1.45	-0.02	1053.57	63899.820
31	1.50	-0.02	1053.57	61171.992
32	1.55	-0.02	1053.57	58670.202
33	1.60	-0.02	1053.57	56372.667
34	1.65	-0.02	1053.57	54255.269
35	1.70	-0.02	1053.57	52300.902
36	1.75	-0.02	1053.57	50487.085
37	1.80	-0.02	1053.57	48802.741

<i>Cod. elab.:</i> 108GA201-GA01-Z-CL-002 C	<i>Titolo:</i> OPERE D'ARTE MAGGIORI- GALLERIE	<i>Data:</i> Ottobre 2011
<i>Nome file:</i> 108GA201-GA01-Z-CL -002_C.docx	ARTIFICIALI – GALLERIA ROVETELLO	<i>Pagina</i> 406 di 452
Relazione di calcolo		

PROGETTO ESECUTIVO

38	1.85	-0.02	1053.57	47229.304
39	1.90	-0.02	1053.57	45762.864
40	1.95	-0.02	1053.57	44387.561
41	2.00	-0.02	1053.57	43095.825
42	2.05	-0.03	1053.57	41884.039
43	2.10	-0.03	1053.57	40742.662
44	2.15	-0.03	1053.57	39663.952
45	2.20	-0.03	1053.57	38646.190
46	2.25	-0.03	1053.57	37683.020
47	2.30	-0.03	1053.57	36768.781
48	2.35	-0.03	1053.57	35901.039
49	2.40	-0.03	1053.57	35078.153
50	2.45	-0.03	1053.57	34292.896
51	2.50	-0.03	1053.57	34292.896
52	2.50	-177.60	1053.57	5.932
53	2.55	-177.60	1053.57	5.932
54	2.60	-177.60	1053.57	5.932
55	2.65	-177.61	1053.57	5.932
56	2.70	-177.61	1053.57	5.932
57	2.75	-177.14	1053.57	5.948
58	2.80	-175.75	1053.57	5.995
59	2.85	-173.74	1053.57	6.064
60	2.90	-171.41	1053.57	6.146
61	2.95	-168.77	1053.57	6.243
62	3.00	-165.80	1053.57	6.354
63	3.05	-162.55	1053.57	6.481
64	3.10	-159.04	1053.57	6.625
65	3.15	-155.37	1053.57	6.781
66	3.20	-151.66	1053.57	6.947
67	3.25	-147.90	1053.57	7.123
68	3.30	-144.09	1053.57	7.312
69	3.35	-140.24	1053.57	7.513
70	3.40	-136.34	1053.57	7.727
71	3.45	-132.40	1053.57	7.958
72	3.50	-128.41	1053.57	8.205
73	3.55	-124.37	1053.57	8.471

Cod. elab.: 108GA201-GA01-Z-CL-002_C	Titolo: OPERE D'ARTE MAGGIORI- GALLERIE	Data: Ottobre 2011
Nome file: 108GA201-GA01-Z-CL -002_C.docx	ARTIFICIALI – GALLERIA ROVETELLO	Pagina 407 di 452
Relazione di calcolo		

PROGETTO ESECUTIVO

74	3.60	-120.29	1053.57	8.759
75	3.65	-116.16	1053.57	9.070
76	3.70	-111.98	1053.57	9.408
77	3.75	-107.76	1053.57	9.777
78	3.80	-103.50	1053.57	10.179
79	3.85	-99.19	1053.57	10.622
80	3.90	-94.84	1053.57	11.109
81	3.95	-90.44	1053.57	11.650
82	4.00	-85.99	1053.57	12.252
83	4.05	-81.50	1053.57	12.927
84	4.10	-76.97	1053.57	13.688
85	4.15	-72.39	1053.57	14.554
86	4.20	-67.77	1053.57	15.547
87	4.25	-63.10	1053.57	16.697
88	4.30	-58.39	1053.57	18.045
89	4.35	-53.63	1053.57	19.645
90	4.40	-48.83	1053.57	21.576
91	4.45	-43.99	1053.57	23.953
92	4.50	-39.10	1053.57	26.947
93	4.55	-34.17	1053.57	30.837
94	4.60	-29.19	1053.57	36.093
95	4.65	-24.17	1053.57	43.588
96	4.70	-19.11	1053.57	55.135
97	4.75	-14.00	1053.57	75.240
98	4.80	-8.85	1053.57	119.002
99	4.85	-3.66	1053.57	287.796
100	4.90	1.57	1053.57	668.990
101	4.95	6.85	1053.57	153.725
102	5.00	12.18	1053.57	86.530
103	5.00	-186.03	1053.57	5.663
104	5.05	-180.66	1053.57	5.832
105	5.10	-175.26	1053.57	6.012
106	5.15	-169.81	1053.57	6.204
107	5.20	-164.31	1053.57	6.412
108	5.25	-158.78	1053.57	6.635
109	5.30	-153.20	1053.57	6.877

<i>Cod. elab.:</i> 108GA201-GA01-Z-CL-002_C	<i>Titolo:</i> OPERE D'ARTE MAGGIORI- GALLERIE	<i>Data:</i> Ottobre 2011
<i>Nome file:</i> 108GA201-GA01-Z-CL -002_C.docx	ARTIFICIALI – GALLERIA ROVETELLO Relazione di calcolo	<i>Pagina</i> 408 di 452

PROGETTO ESECUTIVO

1105.35	-147.58	1053.57	7.139
1115.40	-141.92	1053.57	7.424
1125.45	-136.22	1053.57	7.735
1135.50	-130.47	1053.57	8.075
1145.55	-124.68	1053.57	8.450
1155.60	-118.85	1053.57	8.865
1165.65	-112.98	1053.57	9.325
1175.70	-107.06	1053.57	9.841
1185.75	-101.11	1053.57	10.420
1195.80	-95.11	1053.57	11.077
1205.85	-89.07	1053.57	11.828
1215.90	-82.99	1053.57	12.695
1225.95	-76.87	1053.57	13.706
1236.00	-70.70	1053.57	14.901
1246.05	-64.50	1053.57	16.334
1256.10	-58.25	1053.57	18.086
1266.15	-51.97	1053.57	20.274
1276.20	-45.64	1053.57	23.085
1286.25	-39.27	1053.57	26.828
1296.30	-32.86	1053.57	32.062
1306.35	-26.41	1053.57	39.893
1316.40	-19.92	1053.57	52.894
1326.45	-13.39	1053.57	78.705
1336.50	-6.81	1053.57	154.632
1346.55	-0.20	1053.57	5268.504
1356.60	6.45	1053.57	163.244
1366.65	13.15	1053.57	80.130
1376.70	19.88	1053.57	52.988
1386.75	26.66	1053.57	39.521
1396.80	33.47	1053.57	31.474
1406.85	40.33	1053.57	26.123
1416.90	47.23	1053.57	22.307
1426.95	54.17	1053.57	19.450
1437.00	61.15	1053.57	17.229
1447.05	68.17	1053.57	15.455
1457.10	75.23	1053.57	14.004

<i>Cod. elab.:</i> 108GA201-GA01-Z-CL-002_C	<i>Titolo:</i> OPERE D'ARTE MAGGIORI- GALLERIE	<i>Data:</i> Ottobre 2011
<i>Nome file:</i> 108GA201-GA01-Z-CL -002_C.docx	ARTIFICIALI – GALLERIA ROVETELLO Relazione di calcolo	<i>Pagina</i> 409 di 452

PROGETTO ESECUTIVO

1467.15	82.34	1053.57	12.796
1477.20	89.48	1053.57	11.774
1487.25	96.66	1053.57	10.899
1497.30	103.89	1053.57	10.141
1507.35	111.15	1053.57	9.478
1517.40	118.46	1053.57	8.894
1527.45	125.81	1053.57	8.374
1537.50	133.19	1053.57	7.910
1547.55	136.76	1053.57	7.704
1557.60	140.23	1053.57	7.513
1567.65	143.61	1053.57	7.336
1577.70	146.89	1053.57	7.172
1587.75	150.08	1053.57	7.020
1597.80	153.18	1053.57	6.878
1607.85	156.19	1053.57	6.745
1617.90	159.12	1053.57	6.621
1627.95	161.96	1053.57	6.505
1638.00	164.72	1053.57	6.396
1648.05	167.38	1053.57	6.294
1658.10	169.96	1053.57	6.199
1668.15	172.45	1053.57	6.109
1678.20	174.86	1053.57	6.025
1688.25	177.18	1053.57	5.946
1698.30	179.41	1053.57	5.872
1708.35	181.55	1053.57	5.803
1718.40	183.62	1053.57	5.738
1728.45	185.60	1053.57	5.677
1738.50	187.50	1053.57	5.619
1748.55	188.44	1053.57	5.591
1758.60	189.33	1053.57	5.565
1768.65	190.15	1053.57	5.541
1778.70	190.90	1053.57	5.519
1788.75	191.60	1053.57	5.499
1798.80	192.22	1053.57	5.481
1808.85	192.78	1053.57	5.465
1818.90	193.26	1053.57	5.451

<i>Cod. elab.:</i> 108GA201-GA01-Z-CL-002_C	<i>Titolo:</i> OPERE D'ARTE MAGGIORI- GALLERIE	<i>Data:</i> Ottobre 2011
<i>Nome file:</i> 108GA201-GA01-Z-CL -002_C.docx	ARTIFICIALI – GALLERIA ROVETELLO Relazione di calcolo	<i>Pagina</i> 410 di 452

PROGETTO ESECUTIVO

1828.95	193.68	1053.57	5.440
1839.00	194.03	1053.57	5.430
1849.05	194.31	1053.57	5.422
1859.10	194.52	1053.57	5.416
1869.15	194.66	1053.57	5.412
1879.20	194.72	1053.57	5.411
1889.25	194.69	1053.57	5.412
1899.30	194.60	1053.57	5.414
1909.35	194.47	1053.57	5.418
1919.40	194.28	1053.57	5.423
1929.45	194.04	1053.57	5.430
1939.50	193.74	1053.57	5.438
1949.55	193.40	1053.57	5.448
1959.60	193.00	1053.57	5.459
1969.65	192.55	1053.57	5.472
1979.70	192.04	1053.57	5.486
1989.75	191.49	1053.57	5.502
1999.80	190.88	1053.57	5.520
2009.85	190.22	1053.57	5.539
2019.90	189.50	1053.57	5.560
2029.95	188.73	1053.57	5.582
20310.00	187.91	1053.57	5.607
20410.05	187.04	1053.57	5.633
20510.10	186.11	1053.57	5.661
20610.15	185.12	1053.57	5.691
20710.20	184.09	1053.57	5.723
20810.25	183.00	1053.57	5.757
20910.30	181.85	1053.57	5.793
21010.35	180.66	1053.57	5.832
21110.40	179.41	1053.57	5.873
21210.45	178.10	1053.57	5.916
21310.50	176.74	1053.57	5.961
21410.55	175.33	1053.57	6.009
21510.60	173.86	1053.57	6.060
21610.65	172.34	1053.57	6.113
21710.70	170.76	1053.57	6.170

<i>Cod. elab.:</i> 108GA201-GA01-Z-CL-002_C	<i>Titolo:</i> OPERE D'ARTE MAGGIORI- GALLERIE	<i>Data:</i> Ottobre 2011
<i>Nome file:</i> 108GA201-GA01-Z-CL -002_C.docx	ARTIFICIALI – GALLERIA ROVETELLO Relazione di calcolo	<i>Pagina</i> 411 di 452

PROGETTO ESECUTIVO

21810.75	169.13	1053.57	6.229
21910.80	167.45	1053.57	6.292
22010.85	165.71	1053.57	6.358
22110.90	163.91	1053.57	6.428
22210.95	162.07	1053.57	6.501
22311.00	160.16	1053.57	6.578
22411.05	158.20	1053.57	6.660
22511.10	156.19	1053.57	6.745
22611.15	154.12	1053.57	6.836
22711.20	152.00	1053.57	6.931
22811.25	149.82	1053.57	7.032
22911.30	147.59	1053.57	7.139
23011.35	145.30	1053.57	7.251
23111.40	142.96	1053.57	7.370
23211.45	140.56	1053.57	7.496
23311.50	138.11	1053.57	7.629
23411.55	135.60	1053.57	7.770
23511.60	133.03	1053.57	7.920
23611.65	130.41	1053.57	8.079
23711.70	127.74	1053.57	8.248
23811.75	125.00	1053.57	8.428
23911.80	122.22	1053.57	8.620
24011.85	119.38	1053.57	8.826
24111.90	116.48	1053.57	9.045
24211.95	113.52	1053.57	9.281
24312.00	110.51	1053.57	9.533
24412.05	107.45	1053.57	9.805
24512.10	104.33	1053.57	10.099
24612.15	101.15	1053.57	10.416
24712.20	97.92	1053.57	10.760
24812.25	94.63	1053.57	11.134
24912.30	91.28	1053.57	11.542
25012.35	87.88	1053.57	11.988
25112.40	84.43	1053.57	12.479
25212.45	80.91	1053.57	13.021
25312.50	77.34	1053.57	13.622

<i>Cod. elab.:</i> 108GA201-GA01-Z-CL-002_C	<i>Titolo:</i> OPERE D'ARTE MAGGIORI- GALLERIE	<i>Data:</i> Ottobre 2011
<i>Nome file:</i> 108GA201-GA01-Z-CL -002_C.docx	ARTIFICIALI – GALLERIA ROVETELLO Relazione di calcolo	<i>Pagina</i> 412 di 452

PROGETTO ESECUTIVO

25412.55	73.72	1053.57	14.292
25512.60	70.03	1053.57	15.044
25612.65	66.31	1053.57	15.888
25712.70	62.54	1053.57	16.845
25812.75	58.75	1053.57	17.934
25912.80	54.90	1053.57	19.189
26012.85	51.02	1053.57	20.648
26112.90	47.11	1053.57	22.364
26212.95	43.16	1053.57	24.409
26313.00	39.18	1053.57	26.889
26413.05	35.17	1053.57	29.960
26513.10	31.11	1053.57	33.861
26613.15	27.03	1053.57	38.977
26713.20	22.91	1053.57	45.985
26813.25	18.76	1053.57	56.168
26913.30	14.57	1053.57	72.313
27013.35	10.35	1053.57	101.823
27113.40	6.09	1053.57	173.000
27213.45	1.80	1053.57	585.833
27313.50	-2.53	1053.57	416.810
27413.55	-6.76	1053.57	155.817
27513.60	-10.90	1053.57	96.680
27613.65	-14.94	1053.57	70.537
27713.70	-18.88	1053.57	55.806
27813.75	-22.73	1053.57	46.358
27913.80	-26.48	1053.57	39.788
28013.85	-30.14	1053.57	34.957
28113.90	-33.71	1053.57	31.257
28213.95	-37.18	1053.57	28.336
28314.00	-40.57	1053.57	25.972
28414.05	-43.86	1053.57	24.021
28514.10	-47.06	1053.57	22.386
28614.15	-50.18	1053.57	20.995
28714.20	-53.21	1053.57	19.800
28814.25	-56.15	1053.57	18.763
28914.30	-59.01	1053.57	17.854

<i>Cod. elab.:</i> 108GA201-GA01-Z-CL-002 C	<i>Titolo:</i> OPERE D'ARTE MAGGIORI- GALLERIE	<i>Data:</i> Ottobre 2011
<i>Nome file:</i> 108GA201-GA01-Z-CL -002_C.docx	ARTIFICIALI – GALLERIA ROVETELLO Relazione di calcolo	<i>Pagina</i> 413 di 452

PROGETTO ESECUTIVO

29014.35	-61.78	1053.57	17.053
29114.40	-64.47	1053.57	16.343
29214.45	-67.07	1053.57	15.708
29314.50	-69.59	1053.57	15.139
29414.55	-72.03	1053.57	14.626
29514.60	-74.39	1053.57	14.162
29614.65	-76.67	1053.57	13.741
29714.70	-78.87	1053.57	13.358
29814.75	-80.99	1053.57	13.008
29914.80	-83.04	1053.57	12.688
30014.85	-85.00	1053.57	12.395
30114.90	-86.89	1053.57	12.125
30214.95	-88.71	1053.57	11.877
30315.00	-90.45	1053.57	11.648
30415.05	-92.12	1053.57	11.437
30515.10	-93.71	1053.57	11.243
30615.15	-95.23	1053.57	11.063
30715.20	-96.68	1053.57	10.897
30815.25	-98.06	1053.57	10.744
30915.30	-99.37	1053.57	10.603
31015.35	-100.61	1053.57	10.472
31115.40	-101.78	1053.57	10.352
31215.45	-102.88	1053.57	10.241
31315.50	-103.91	1053.57	10.139
31415.55	-104.88	1053.57	10.045
31515.60	-105.78	1053.57	9.960
31615.65	-106.62	1053.57	9.882
31715.70	-107.39	1053.57	9.811
31815.75	-108.10	1053.57	9.747
31915.80	-108.74	1053.57	9.689
32015.85	-109.32	1053.57	9.637
32115.90	-109.84	1053.57	9.592
32215.95	-110.29	1053.57	9.552
32316.00	-110.69	1053.57	9.518
32416.05	-111.02	1053.57	9.489
32516.10	-111.30	1053.57	9.466

<i>Cod. elab.:</i> 108GA201-GA01-Z-CL-002_C	<i>Titolo:</i> OPERE D'ARTE MAGGIORI- GALLERIE	<i>Data:</i> Ottobre 2011
<i>Nome file:</i> 108GA201-GA01-Z-CL -002_C.docx	ARTIFICIALI – GALLERIA ROVETELLO Relazione di calcolo	<i>Pagina</i> 414 di 452

PROGETTO ESECUTIVO

32616.15	-111.51	1053.57	9.448
32716.20	-111.67	1053.57	9.435
32816.25	-111.77	1053.57	9.426
32916.30	-111.81	1053.57	9.423
33016.35	-111.79	1053.57	9.424
33116.40	-111.72	1053.57	9.431
33216.45	-111.59	1053.57	9.442
33316.50	-111.92	1053.57	9.414
33416.55	-112.69	1053.57	9.350
33516.60	-113.38	1053.57	9.293
33616.65	-113.99	1053.57	9.243
33716.70	-114.52	1053.57	9.200
33816.75	-114.98	1053.57	9.163
33916.80	-115.35	1053.57	9.133
34016.85	-115.66	1053.57	9.109
34116.90	-115.89	1053.57	9.091
34216.95	-116.04	1053.57	9.079
34317.00	-116.12	1053.57	9.073
34417.05	-116.13	1053.57	9.073
34517.10	-116.06	1053.57	9.078
34617.15	-115.92	1053.57	9.089
34717.20	-115.71	1053.57	9.105
34817.25	-115.43	1053.57	9.127
34917.30	-115.08	1053.57	9.155
35017.35	-114.65	1053.57	9.189
35117.40	-114.16	1053.57	9.229
35217.45	-113.60	1053.57	9.275
35317.50	-112.96	1053.57	9.326
35417.55	-112.26	1053.57	9.385
35517.60	-111.50	1053.57	9.449
35617.65	-110.66	1053.57	9.521
35717.70	-109.76	1053.57	9.599
35817.75	-108.78	1053.57	9.685
35917.80	-107.75	1053.57	9.778
36017.85	-106.64	1053.57	9.879
36117.90	-105.47	1053.57	9.989

<i>Cod. elab.:</i> 108GA201-GA01-Z-CL-002 C	<i>Titolo:</i> OPERE D'ARTE MAGGIORI- GALLERIE	<i>Data:</i> Ottobre 2011
<i>Nome file:</i> 108GA201-GA01-Z-CL -002_C.docx	ARTIFICIALI – GALLERIA ROVETELLO Relazione di calcolo	<i>Pagina</i> 415 di 452

PROGETTO ESECUTIVO

36217.95	-104.24	1053.57	10.107
36318.00	-102.94	1053.57	10.235
36418.05	-101.57	1053.57	10.373
36518.10	-100.14	1053.57	10.521
36618.15	-98.64	1053.57	10.681
36718.20	-97.08	1053.57	10.852
36818.25	-95.46	1053.57	11.037
36918.30	-93.77	1053.57	11.236
37018.35	-92.02	1053.57	11.450
37118.40	-90.20	1053.57	11.680
37218.45	-88.32	1053.57	11.928
37318.50	-86.38	1053.57	12.196
37418.55	-84.38	1053.57	12.486
37518.60	-82.31	1053.57	12.800
37618.65	-80.18	1053.57	13.140
37718.70	-77.99	1053.57	13.509
37818.75	-75.74	1053.57	13.911
37918.80	-73.42	1053.57	14.350
38018.85	-71.04	1053.57	14.830
38118.90	-68.60	1053.57	15.358
38218.95	-66.10	1053.57	15.939
38319.00	-63.53	1053.57	16.583
38419.05	-60.91	1053.57	17.297
38519.10	-58.22	1053.57	18.096
38619.15	-55.47	1053.57	18.992
38719.20	-52.66	1053.57	20.006
38819.25	-49.79	1053.57	21.160
38919.30	-46.86	1053.57	22.484
39019.35	-43.86	1053.57	24.019
39119.40	-40.81	1053.57	25.817
39219.45	-37.69	1053.57	27.952
39319.50	-34.51	1053.57	30.526
39419.55	-31.27	1053.57	33.688
39519.60	-27.97	1053.57	37.662
39619.65	-24.61	1053.57	42.806
39719.70	-21.19	1053.57	49.720

Cod. elab.: 108GA201-GA01-Z-CL-002_C	Titolo: OPERE D'ARTE MAGGIORI- GALLERIE	Data: Ottobre 2011
Nome file: 108GA201-GA01-Z-CL -002_C.docx	ARTIFICIALI – GALLERIA ROVETELLO	Pagina 416 di 452
Relazione di calcolo		

PROGETTO ESECUTIVO

39819.75	-17.71	1053.57	59.503
39919.80	-14.16	1053.57	74.399
40019.85	-10.55	1053.57	99.818
40119.90	-6.89	1053.57	152.964
40219.95	-3.16	1053.57	333.480
40320.00	0.63	1053.57	1671.841

Fase n° 6 - [A2-M2]

n°	Y	T	T _R	CS _T
1	0.00	0.00	1053.57	4776216.248
2	0.05	0.00	1053.57	1600920.272
3	0.10	0.00	1053.57	959396.028
4	0.15	0.00	1053.57	686594.285
5	0.20	0.00	1053.57	533502.502
6	0.25	0.00	1053.57	436367.235
7	0.30	0.00	1053.57	369194.720
8	0.35	0.00	1053.57	320235.517
9	0.40	0.00	1053.57	282480.766
10	0.45	0.00	1053.57	252781.425
11	0.50	0.01	1053.57	191718.980
12	0.55	0.01	1053.57	191718.980
13	0.55	0.01	1053.57	136719.158
14	0.60	0.01	1053.57	136719.158
15	0.60	0.01	1053.57	106206.112
16	0.65	0.01	1053.57	106206.112
17	0.65	0.01	1053.57	86845.592
18	0.70	0.01	1053.57	86845.592
19	0.70	0.01	1053.57	73449.429
20	0.75	0.01	1053.57	73449.429
21	0.75	0.02	1053.57	63633.310
22	0.80	0.02	1053.57	63633.310
23	0.80	0.02	1053.57	56140.342
24	0.85	0.02	1053.57	56140.342
25	0.85	0.02	1053.57	50220.397
26	0.90	0.02	1053.57	50220.397

Cod. elab.: 108GA201-GA01-Z-CL-002_C	Titolo: OPERE D'ARTE MAGGIORI- GALLERIE	Data: Ottobre 2011
Nome file: 108GA201-GA01-Z-CL -002_C.docx	ARTIFICIALI – GALLERIA ROVETELLO	Pagina 417 di 452
Relazione di calcolo		

PROGETTO ESECUTIVO

27	0.90	0.02	1053.57	45433.647
28	0.95	0.02	1053.57	45433.647
29	0.95	0.03	1053.57	41478.282
30	1.00	0.03	1053.57	41478.282
31	1.00	0.03	1053.57	38154.299
32	1.05	0.03	1053.57	38154.299
33	1.05	0.03	1053.57	35328.636
34	1.10	0.03	1053.57	35328.636
35	1.10	0.03	1053.57	32891.680
36	1.15	0.03	1053.57	32891.680
37	1.15	0.03	1053.57	30767.142
38	1.20	0.03	1053.57	30767.142
39	1.20	0.04	1053.57	28900.656
40	1.25	0.04	1053.57	28900.656
41	1.25	0.04	1053.57	27250.542
42	1.30	0.04	1053.57	27250.542
43	1.30	0.04	1053.57	25776.334
44	1.35	0.04	1053.57	25776.334
45	1.35	0.04	1053.57	24455.629
46	1.40	0.04	1053.57	24455.629
47	1.40	0.05	1053.57	23261.477
48	1.45	0.05	1053.57	23261.477
49	1.45	0.05	1053.57	22180.283
50	1.50	0.05	1053.57	22180.283
51	1.50	0.05	1053.57	21195.484
52	1.55	0.05	1053.57	21195.484
53	1.55	0.05	1053.57	20292.025
54	1.60	0.05	1053.57	20292.025
55	1.60	0.05	1053.57	19465.102
56	1.65	0.05	1053.57	19465.102
57	1.65	0.06	1053.57	18702.301
58	1.70	0.06	1053.57	18702.301
59	1.70	0.06	1053.57	17996.021
60	1.75	0.06	1053.57	17996.021
61	1.75	0.06	1053.57	17342.224
62	1.80	0.06	1053.57	17342.224

Cod. elab.: 108GA201-GA01-Z-CL-002_C	Titolo: OPERE D'ARTE MAGGIORI- GALLERIE	Data: Ottobre 2011
Nome file: 108GA201-GA01-Z-CL -002_C.docx	ARTIFICIALI – GALLERIA ROVETELLO	Pagina 418 di 452
Relazione di calcolo		

PROGETTO ESECUTIVO

63	1.80	0.06	1053.57	16734.776
64	1.85	0.06	1053.57	16734.776
65	1.85	0.07	1053.57	16167.873
66	1.90	0.07	1053.57	16167.873
67	1.90	0.07	1053.57	15637.640
68	1.95	0.07	1053.57	15637.640
69	1.95	0.07	1053.57	15141.921
70	2.00	0.07	1053.57	15141.921
71	2.00	0.07	1053.57	14676.369
72	2.05	0.07	1053.57	14676.369
73	2.05	0.07	1053.57	14238.568
74	2.10	0.07	1053.57	14238.568
75	2.10	0.08	1053.57	13825.966
76	2.15	0.08	1053.57	13825.966
77	2.15	0.08	1053.57	13437.259
78	2.20	0.08	1053.57	13437.259
79	2.20	0.08	1053.57	13069.458
80	2.25	0.08	1053.57	13069.458
81	2.25	0.08	1053.57	12721.716
82	2.30	0.08	1053.57	12721.716
83	2.30	0.09	1053.57	12391.139
84	2.35	0.09	1053.57	12391.139
85	2.35	0.09	1053.57	12077.868
86	2.40	0.09	1053.57	12077.868
87	2.40	0.09	1053.57	11779.993
88	2.45	0.09	1053.57	11779.993
89	2.45	0.09	1053.57	11496.998
90	2.50	0.09	1053.57	11496.998
91	2.50	-329.84	1053.57	3.194
92	2.55	-329.84	1053.57	3.194
93	2.55	-329.84	1053.57	3.194
94	2.60	-329.84	1053.57	3.194
95	2.60	-329.84	1053.57	3.194
96	2.65	-329.84	1053.57	3.194
97	2.65	-329.83	1053.57	3.194
98	2.70	-329.83	1053.57	3.194

<i>Cod. elab.:</i> 108GA201-GA01-Z-CL-002_C	<i>Titolo:</i> OPERE D'ARTE MAGGIORI- GALLERIE	<i>Data:</i> Ottobre 2011
<i>Nome file:</i> 108GA201-GA01-Z-CL -002_C.docx	ARTIFICIALI – GALLERIA ROVETELLO Relazione di calcolo	<i>Pagina</i> 419 di 452

PROGETTO ESECUTIVO

99 2.70	-329.83	1053.57	3.194
100 2.75	-329.37	1053.57	3.199
101 2.75	-329.37	1053.57	3.199
102 2.80	-327.97	1053.57	3.212
103 2.80	-327.97	1053.57	3.212
104 2.85	-325.96	1053.57	3.232
105 2.85	-325.96	1053.57	3.232
106 2.90	-323.63	1053.57	3.255
107 2.90	-323.63	1053.57	3.256
108 2.95	-320.98	1053.57	3.282
109 2.95	-320.98	1053.57	3.282
110 3.00	-318.01	1053.57	3.313
111 3.00	-318.01	1053.57	3.313
112 3.05	-314.76	1053.57	3.347
113 3.05	-314.76	1053.57	3.347
114 3.10	-311.24	1053.57	3.385
115 3.10	-311.24	1053.57	3.385
116 3.15	-307.58	1053.57	3.425
117 3.15	-307.57	1053.57	3.425
118 3.20	-303.86	1053.57	3.467
119 3.20	-303.86	1053.57	3.467
120 3.25	-300.10	1053.57	3.511
121 3.25	-300.09	1053.57	3.511
122 3.30	-296.29	1053.57	3.556
123 3.30	-296.28	1053.57	3.556
124 3.35	-292.43	1053.57	3.603
125 3.35	-292.43	1053.57	3.603
126 3.40	-288.53	1053.57	3.652
127 3.40	-288.53	1053.57	3.652
128 3.45	-284.58	1053.57	3.702
129 3.45	-284.58	1053.57	3.702
130 3.50	-280.59	1053.57	3.755
131 3.50	-280.59	1053.57	3.755
132 3.55	-276.55	1053.57	3.810
133 3.55	-276.55	1053.57	3.810
134 3.60	-272.46	1053.57	3.867

<i>Cod. elab.:</i> 108GA201-GA01-Z-CL-002 C	<i>Titolo:</i> OPERE D'ARTE MAGGIORI- GALLERIE	<i>Data:</i> Ottobre 2011
<i>Nome file:</i> 108GA201-GA01-Z-CL -002_C.docx	ARTIFICIALI – GALLERIA ROVETELLO Relazione di calcolo	<i>Pagina</i> 420 di 452

PROGETTO ESECUTIVO

1353.60	-272.46	1053.57	3.867
1363.65	-268.33	1053.57	3.926
1373.65	-268.33	1053.57	3.926
1383.70	-264.15	1053.57	3.988
1393.70	-264.15	1053.57	3.988
1403.75	-259.93	1053.57	4.053
1413.75	-259.93	1053.57	4.053
1423.80	-255.67	1053.57	4.121
1433.80	-255.66	1053.57	4.121
1443.85	-251.35	1053.57	4.192
1453.85	-251.35	1053.57	4.192
1463.90	-246.99	1053.57	4.266
1473.90	-246.99	1053.57	4.266
1483.95	-242.59	1053.57	4.343
1493.95	-242.59	1053.57	4.343
1504.00	-238.14	1053.57	4.424
1514.00	-238.14	1053.57	4.424
1524.05	-233.65	1053.57	4.509
1534.05	-233.65	1053.57	4.509
1544.10	-229.12	1053.57	4.598
1554.10	-229.11	1053.57	4.598
1564.15	-224.53	1053.57	4.692
1574.15	-224.53	1053.57	4.692
1584.20	-219.91	1053.57	4.791
1594.20	-219.91	1053.57	4.791
1604.25	-215.24	1053.57	4.895
1614.25	-215.24	1053.57	4.895
1624.30	-210.52	1053.57	5.005
1634.30	-210.52	1053.57	5.005
1644.35	-205.76	1053.57	5.120
1654.35	-205.76	1053.57	5.120
1664.40	-200.96	1053.57	5.243
1674.40	-200.96	1053.57	5.243
1684.45	-196.11	1053.57	5.372
1694.45	-196.11	1053.57	5.372
1704.50	-191.22	1053.57	5.510

<i>Cod. elab.:</i> 108GA201-GA01-Z-CL-002_C	<i>Titolo:</i> OPERE D'ARTE MAGGIORI- GALLERIE	<i>Data:</i> Ottobre 2011
<i>Nome file:</i> 108GA201-GA01-Z-CL -002_C.docx	ARTIFICIALI – GALLERIA ROVETELLO	<i>Pagina</i> 421 di 452
	Relazione di calcolo	

PROGETTO ESECUTIVO

1714.50	-191.22	1053.57	5.510
1724.55	-186.29	1053.57	5.656
1734.55	-186.29	1053.57	5.656
1744.60	-181.31	1053.57	5.811
1754.60	-181.31	1053.57	5.811
1764.65	-176.29	1053.57	5.976
1774.65	-176.29	1053.57	5.976
1784.70	-171.22	1053.57	6.153
1794.70	-171.22	1053.57	6.153
1804.75	-166.11	1053.57	6.342
1814.75	-166.11	1053.57	6.342
1824.80	-160.96	1053.57	6.545
1834.80	-160.96	1053.57	6.546
1844.85	-155.77	1053.57	6.764
1854.85	-155.76	1053.57	6.764
1864.90	-150.53	1053.57	6.999
1874.90	-150.53	1053.57	6.999
1884.95	-145.25	1053.57	7.254
1894.95	-145.24	1053.57	7.254
1905.00	-139.92	1053.57	7.530
1915.00	-499.56	1053.57	2.109
1925.05	-494.20	1053.57	2.132
1935.05	-494.19	1053.57	2.132
1945.10	-488.79	1053.57	2.155
1955.10	-488.78	1053.57	2.155
1965.15	-483.33	1053.57	2.180
1975.15	-483.33	1053.57	2.180
1985.20	-477.84	1053.57	2.205
1995.20	-477.83	1053.57	2.205
2005.25	-472.30	1053.57	2.231
2015.25	-472.30	1053.57	2.231
2025.30	-466.72	1053.57	2.257
2035.30	-466.72	1053.57	2.257
2045.35	-461.10	1053.57	2.285
2055.35	-461.09	1053.57	2.285
2065.40	-455.43	1053.57	2.313

<i>Cod. elab.:</i> 108GA201-GA01-Z-CL-002_C	<i>Titolo:</i> OPERE D'ARTE MAGGIORI- GALLERIE	<i>Data:</i> Ottobre 2011
<i>Nome file:</i> 108GA201-GA01-Z-CL -002_C.docx	ARTIFICIALI – GALLERIA ROVETELLO Relazione di calcolo	<i>Pagina</i> 422 di 452

PROGETTO ESECUTIVO

2075.40	-455.43	1053.57	2.313
2085.45	-449.72	1053.57	2.343
2095.45	-449.72	1053.57	2.343
2105.50	-443.97	1053.57	2.373
2115.50	-443.97	1053.57	2.373
2125.55	-438.18	1053.57	2.404
2135.55	-438.18	1053.57	2.404
2145.60	-432.35	1053.57	2.437
2155.60	-432.35	1053.57	2.437
2165.65	-426.48	1053.57	2.470
2175.65	-426.47	1053.57	2.470
2185.70	-420.56	1053.57	2.505
2195.70	-420.56	1053.57	2.505
2205.75	-414.60	1053.57	2.541
2215.75	-414.60	1053.57	2.541
2225.80	-408.60	1053.57	2.578
2235.80	-408.60	1053.57	2.578
2245.85	-402.56	1053.57	2.617
2255.85	-402.56	1053.57	2.617
2265.90	-396.47	1053.57	2.657
2275.90	-396.47	1053.57	2.657
2285.95	-390.35	1053.57	2.699
2295.95	-390.35	1053.57	2.699
2306.00	-384.18	1053.57	2.742
2316.00	-384.18	1053.57	2.742
2326.05	-377.98	1053.57	2.787
2336.05	-377.97	1053.57	2.787
2346.10	-371.73	1053.57	2.834
2356.10	-371.73	1053.57	2.834
2366.15	-365.44	1053.57	2.883
2376.15	-365.44	1053.57	2.883
2386.20	-359.11	1053.57	2.934
2396.20	-359.11	1053.57	2.934
2406.25	-352.74	1053.57	2.987
2416.25	-352.73	1053.57	2.987
2426.30	-346.32	1053.57	3.042

<i>Cod. elab.:</i> 108GA201-GA01-Z-CL-002_C	<i>Titolo:</i> OPERE D'ARTE MAGGIORI- GALLERIE	<i>Data:</i> Ottobre 2011
<i>Nome file:</i> 108GA201-GA01-Z-CL -002_C.docx	ARTIFICIALI – GALLERIA ROVETELLO Relazione di calcolo	<i>Pagina</i> 423 di 452

PROGETTO ESECUTIVO

243 6.30	-346.32	1053.57	3.042
244 6.35	-339.87	1053.57	3.100
245 6.35	-339.87	1053.57	3.100
246 6.40	-333.38	1053.57	3.160
247 6.40	-333.37	1053.57	3.160
248 6.45	-326.84	1053.57	3.223
249 6.45	-326.84	1053.57	3.223
250 6.50	-320.27	1053.57	3.290
251 6.50	-320.26	1053.57	3.290
252 6.55	-313.65	1053.57	3.359
253 6.55	-313.65	1053.57	3.359
254 6.60	-306.99	1053.57	3.432
255 6.60	-306.99	1053.57	3.432
256 6.65	-300.30	1053.57	3.508
257 6.65	-300.29	1053.57	3.508
258 6.70	-293.56	1053.57	3.589
259 6.70	-293.56	1053.57	3.589
260 6.75	-286.78	1053.57	3.674
261 6.75	-286.78	1053.57	3.674
262 6.80	-279.96	1053.57	3.763
263 6.80	-279.96	1053.57	3.763
264 6.85	-273.10	1053.57	3.858
265 6.85	-273.10	1053.57	3.858
266 6.90	-266.20	1053.57	3.958
267 6.90	-266.20	1053.57	3.958
268 6.95	-259.26	1053.57	4.064
269 6.95	-259.26	1053.57	4.064
270 7.00	-252.28	1053.57	4.176
271 7.00	-252.28	1053.57	4.176
272 7.05	-245.25	1053.57	4.296
273 7.05	-245.25	1053.57	4.296
274 7.10	-238.19	1053.57	4.423
275 7.10	-238.19	1053.57	4.423
276 7.15	-231.08	1053.57	4.559
277 7.15	-231.08	1053.57	4.559
278 7.20	-223.94	1053.57	4.705

<i>Cod. elab.:</i> 108GA201-GA01-Z-CL-002 C	<i>Titolo:</i> OPERE D'ARTE MAGGIORI- GALLERIE	<i>Data:</i> Ottobre 2011
<i>Nome file:</i> 108GA201-GA01-Z-CL -002_C.docx	ARTIFICIALI – GALLERIA ROVETELLO Relazione di calcolo	<i>Pagina</i> 424 di 452

PROGETTO ESECUTIVO

2797.20	-223.93	1053.57	4.705
2807.25	-216.75	1053.57	4.861
2817.25	-216.75	1053.57	4.861
2827.30	-209.52	1053.57	5.028
2837.30	-209.52	1053.57	5.028
2847.35	-202.25	1053.57	5.209
2857.35	-202.25	1053.57	5.209
2867.40	-194.94	1053.57	5.404
2877.40	-194.94	1053.57	5.404
2887.45	-187.60	1053.57	5.616
2897.45	-187.59	1053.57	5.616
2907.50	-180.21	1053.57	5.846
2917.50	-180.20	1053.57	5.847
2927.55	-172.78	1053.57	6.098
2937.55	-172.77	1053.57	6.098
2947.60	-165.31	1053.57	6.373
2957.60	-165.30	1053.57	6.374
2967.65	-157.80	1053.57	6.677
2977.65	-157.79	1053.57	6.677
2987.70	-150.24	1053.57	7.012
2997.70	-150.24	1053.57	7.012
3007.75	-142.65	1053.57	7.385
3017.75	-142.65	1053.57	7.386
3027.80	-135.02	1053.57	7.803
3037.80	-135.02	1053.57	7.803
3047.85	-127.35	1053.57	8.273
3057.85	-127.35	1053.57	8.273
3067.90	-119.64	1053.57	8.806
3077.90	-119.64	1053.57	8.806
3087.95	-111.89	1053.57	9.416
3097.95	-111.89	1053.57	9.416
3108.00	-104.10	1053.57	10.121
3118.00	-104.10	1053.57	10.121
3128.05	-96.27	1053.57	10.944
3138.05	-96.27	1053.57	10.944
3148.10	-88.40	1053.57	11.918

<i>Cod. elab.:</i> 108GA201-GA01-Z-CL-002_C	<i>Titolo:</i> OPERE D'ARTE MAGGIORI- GALLERIE	<i>Data:</i> Ottobre 2011
<i>Nome file:</i> 108GA201-GA01-Z-CL -002_C.docx	ARTIFICIALI – GALLERIA ROVETELLO Relazione di calcolo	<i>Pagina</i> 425 di 452

PROGETTO ESECUTIVO

3158.10	-88.40	1053.57	11.918
3168.15	-80.49	1053.57	13.089
3178.15	-80.49	1053.57	13.089
3188.20	-72.54	1053.57	14.523
3198.20	-72.54	1053.57	14.524
3208.25	-64.55	1053.57	16.320
3218.25	-64.55	1053.57	16.321
3228.30	-56.53	1053.57	18.638
3238.30	-56.52	1053.57	18.639
3248.35	-48.46	1053.57	21.741
3258.35	-48.46	1053.57	21.742
3268.40	-40.36	1053.57	26.106
3278.40	-40.35	1053.57	26.108
3288.45	-32.22	1053.57	32.702
3298.45	-32.22	1053.57	32.704
3308.50	-24.04	1053.57	43.820
3318.50	-24.04	1053.57	43.825
3328.55	-15.67	1053.57	67.245
3338.55	-15.66	1053.57	67.262
3348.60	-7.25	1053.57	145.357
3358.60	-7.24	1053.57	145.434
3368.65	1.21	1053.57	867.226
3378.65	1.22	1053.57	864.491
3388.70	9.72	1053.57	108.364
3398.70	9.73	1053.57	108.321
3408.75	18.28	1053.57	57.648
3418.75	18.28	1053.57	57.636
3428.80	26.88	1053.57	39.201
3438.80	26.88	1053.57	39.196
3448.85	35.52	1053.57	29.660
3458.85	35.53	1053.57	29.656
3468.90	44.21	1053.57	23.829
3478.90	44.22	1053.57	23.827
3488.95	52.95	1053.57	19.897
3498.95	52.96	1053.57	19.895
3509.00	61.73	1053.57	17.066

<i>Cod. elab.:</i> 108GA201-GA01-Z-CL-002_C	<i>Titolo:</i> OPERE D'ARTE MAGGIORI- GALLERIE	<i>Data:</i> Ottobre 2011
<i>Nome file:</i> 108GA201-GA01-Z-CL -002_C.docx	ARTIFICIALI – GALLERIA ROVETELLO Relazione di calcolo	<i>Pagina</i> 426 di 452

PROGETTO ESECUTIVO

3519.00	61.74	1053.57	17.065
3529.05	70.56	1053.57	14.931
3539.05	70.57	1053.57	14.930
3549.10	79.44	1053.57	13.263
3559.10	79.44	1053.57	13.262
3569.15	88.35	1053.57	11.925
3579.15	88.36	1053.57	11.924
3589.20	97.31	1053.57	10.827
3599.20	97.32	1053.57	10.826
3609.25	101.22	1053.57	10.409
3619.30	105.06	1053.57	10.028
3629.35	108.84	1053.57	9.680
3639.40	112.55	1053.57	9.361
3649.45	116.21	1053.57	9.066
3659.50	119.81	1053.57	8.793
3669.55	123.37	1053.57	8.540
3679.60	126.86	1053.57	8.305
3689.65	130.31	1053.57	8.085
3699.70	133.70	1053.57	7.880
3709.75	137.05	1053.57	7.688
3719.80	140.33	1053.57	7.508
3729.85	143.57	1053.57	7.338
3739.90	146.75	1053.57	7.179
3749.95	149.88	1053.57	7.029
37510.00	152.95	1053.57	6.888
37610.05	155.98	1053.57	6.755
37710.10	158.94	1053.57	6.629
37810.15	161.86	1053.57	6.509
37910.20	164.72	1053.57	6.396
38010.25	167.53	1053.57	6.289
38110.30	170.28	1053.57	6.187
38210.35	172.98	1053.57	6.091
38310.40	175.63	1053.57	5.999
38410.45	178.22	1053.57	5.912
38510.50	180.76	1053.57	5.829
38610.55	183.24	1053.57	5.750

<i>Cod. elab.:</i> 108GA201-GA01-Z-CL-002_C	<i>Titolo:</i> OPERE D'ARTE MAGGIORI- GALLERIE	<i>Data:</i> Ottobre 2011
<i>Nome file:</i> 108GA201-GA01-Z-CL -002_C.docx	ARTIFICIALI – GALLERIA ROVETELLO Relazione di calcolo	<i>Pagina</i> 427 di 452

PROGETTO ESECUTIVO

38710.60	185.67	1053.57	5.674
38810.65	188.05	1053.57	5.603
38910.70	190.37	1053.57	5.534
39010.75	192.64	1053.57	5.469
39110.80	194.85	1053.57	5.407
39210.85	197.01	1053.57	5.348
39310.90	199.11	1053.57	5.291
39410.95	201.16	1053.57	5.237
39511.00	203.15	1053.57	5.186
39611.05	205.09	1053.57	5.137
39711.10	206.98	1053.57	5.090
39811.15	208.81	1053.57	5.046
39911.20	210.58	1053.57	5.003
40011.25	212.30	1053.57	4.963
40111.30	213.97	1053.57	4.924
40211.35	215.58	1053.57	4.887
40311.40	217.08	1053.57	4.853
40411.45	218.53	1053.57	4.821
40511.50	219.93	1053.57	4.791
40611.55	221.27	1053.57	4.762
40711.60	222.55	1053.57	4.734
40811.65	223.78	1053.57	4.708
40911.70	224.95	1053.57	4.684
41011.75	226.07	1053.57	4.660
41111.80	227.13	1053.57	4.639
41211.85	228.14	1053.57	4.618
41311.90	229.09	1053.57	4.599
41411.95	229.98	1053.57	4.581
41512.00	230.82	1053.57	4.564
41612.05	231.60	1053.57	4.549
41712.10	232.33	1053.57	4.535
41812.15	233.00	1053.57	4.522
41912.20	233.62	1053.57	4.510
42012.25	234.18	1053.57	4.499
42112.30	234.68	1053.57	4.489
42212.35	235.13	1053.57	4.481

<i>Cod. elab.:</i> 108GA201-GA01-Z-CL-002_C	<i>Titolo:</i> OPERE D'ARTE MAGGIORI- GALLERIE	<i>Data:</i> Ottobre 2011
<i>Nome file:</i> 108GA201-GA01-Z-CL -002_C.docx	ARTIFICIALI – GALLERIA ROVETELLO	<i>Pagina</i> 428 di 452
	Relazione di calcolo	

PROGETTO ESECUTIVO

42312.40	235.52	1053.57	4.473
42412.45	235.85	1053.57	4.467
42512.50	236.13	1053.57	4.462
42612.55	236.35	1053.57	4.458
42712.60	236.52	1053.57	4.454
42812.65	236.64	1053.57	4.452
42912.70	236.72	1053.57	4.451
43012.75	236.78	1053.57	4.450
43112.80	236.78	1053.57	4.450
43212.85	236.75	1053.57	4.450
43312.90	236.68	1053.57	4.451
43412.95	236.58	1053.57	4.453
43513.00	236.45	1053.57	4.456
43613.05	236.28	1053.57	4.459
43713.10	236.08	1053.57	4.463
43813.15	235.84	1053.57	4.467
43913.20	235.57	1053.57	4.472
44013.25	235.27	1053.57	4.478
44113.30	234.92	1053.57	4.485
44213.35	234.55	1053.57	4.492
44313.40	234.14	1053.57	4.500
44413.45	233.70	1053.57	4.508
44513.50	233.22	1053.57	4.517
44613.55	232.71	1053.57	4.527
44713.60	232.16	1053.57	4.538
44813.65	231.58	1053.57	4.550
44913.70	230.96	1053.57	4.562
45013.75	230.31	1053.57	4.575
45113.80	229.62	1053.57	4.588
45213.85	228.90	1053.57	4.603
45313.90	228.15	1053.57	4.618
45413.95	227.36	1053.57	4.634
45514.00	226.54	1053.57	4.651
45614.05	225.69	1053.57	4.668
45714.10	224.80	1053.57	4.687
45814.15	223.87	1053.57	4.706

<i>Cod. elab.:</i> 108GA201-GA01-Z-CL-002 C	<i>Titolo:</i> OPERE D'ARTE MAGGIORI- GALLERIE	<i>Data:</i> Ottobre 2011
<i>Nome file:</i> 108GA201-GA01-Z-CL -002_C.docx	ARTIFICIALI – GALLERIA ROVETELLO	<i>Pagina</i> 429 di 452
	Relazione di calcolo	

PROGETTO ESECUTIVO

45914.20	222.92	1053.57	4.726
46014.25	221.93	1053.57	4.747
46114.30	220.90	1053.57	4.769
46214.35	219.84	1053.57	4.792
46314.40	218.75	1053.57	4.816
46414.45	217.62	1053.57	4.841
46514.50	216.46	1053.57	4.867
46614.55	215.26	1053.57	4.894
46714.60	214.03	1053.57	4.922
46814.65	212.77	1053.57	4.952
46914.70	211.47	1053.57	4.982
47014.75	210.14	1053.57	5.014
47114.80	208.77	1053.57	5.047
47214.85	207.37	1053.57	5.081
47314.90	205.93	1053.57	5.116
47414.95	204.46	1053.57	5.153
47515.00	202.96	1053.57	5.191
47615.05	201.42	1053.57	5.231
47715.10	199.84	1053.57	5.272
47815.15	198.23	1053.57	5.315
47915.20	196.59	1053.57	5.359
48015.25	194.91	1053.57	5.405
48115.30	193.20	1053.57	5.453
48215.35	191.45	1053.57	5.503
48315.40	189.67	1053.57	5.555
48415.45	187.86	1053.57	5.608
48515.50	186.01	1053.57	5.664
48615.55	184.12	1053.57	5.722
48715.60	182.20	1053.57	5.782
48815.65	180.25	1053.57	5.845
48915.70	178.26	1053.57	5.910
49015.75	176.24	1053.57	5.978
49115.80	174.18	1053.57	6.049
49215.85	172.08	1053.57	6.122
49315.90	169.95	1053.57	6.199
49415.95	167.79	1053.57	6.279

<i>Cod. elab.:</i> 108GA201-GA01-Z-CL-002 C	<i>Titolo:</i> OPERE D'ARTE MAGGIORI- GALLERIE	<i>Data:</i> Ottobre 2011
<i>Nome file:</i> 108GA201-GA01-Z-CL -002_C.docx	ARTIFICIALI – GALLERIA ROVETELLO Relazione di calcolo	<i>Pagina</i> 430 di 452

PROGETTO ESECUTIVO

49516.00	165.59	1053.57	6.362
49616.05	163.36	1053.57	6.449
49716.10	161.09	1053.57	6.540
49816.15	158.78	1053.57	6.635
49916.20	156.44	1053.57	6.734
50016.25	154.07	1053.57	6.838
50116.30	151.66	1053.57	6.947
50216.35	149.22	1053.57	7.061
50316.40	146.74	1053.57	7.180
50416.45	144.23	1053.57	7.305
50516.50	141.68	1053.57	7.436
50616.55	139.09	1053.57	7.575
50716.60	136.46	1053.57	7.720
50816.65	133.81	1053.57	7.874
50916.70	131.12	1053.57	8.035
51016.75	128.39	1053.57	8.206
51116.80	125.63	1053.57	8.386
51216.85	122.83	1053.57	8.577
51316.90	120.00	1053.57	8.780
51416.95	117.13	1053.57	8.995
51517.00	114.23	1053.57	9.224
51617.05	111.29	1053.57	9.467
51717.10	108.31	1053.57	9.727
51817.15	105.30	1053.57	10.005
51917.20	102.26	1053.57	10.303
52017.25	99.18	1053.57	10.623
52117.30	96.06	1053.57	10.968
52217.35	92.91	1053.57	11.340
52317.40	89.72	1053.57	11.742
52417.45	86.50	1053.57	12.180
52517.50	83.24	1053.57	12.657
52617.55	79.95	1053.57	13.178
52717.60	76.62	1053.57	13.751
52817.65	73.25	1053.57	14.382
52917.70	69.85	1053.57	15.082
53017.75	66.42	1053.57	15.863

<i>Cod. elab.:</i> 108GA201-GA01-Z-CL-002 C	<i>Titolo:</i> OPERE D'ARTE MAGGIORI- GALLERIE	<i>Data:</i> Ottobre 2011
<i>Nome file:</i> 108GA201-GA01-Z-CL -002_C.docx	ARTIFICIALI – GALLERIA ROVETELLO Relazione di calcolo	<i>Pagina</i> 431 di 452

PROGETTO ESECUTIVO

53117.80	62.95	1053.57	16.737
53217.85	59.44	1053.57	17.725
53317.90	55.90	1053.57	18.848
53417.95	52.32	1053.57	20.137
53518.00	48.71	1053.57	21.630
53618.05	45.06	1053.57	23.381
53718.10	41.38	1053.57	25.463
53818.15	37.66	1053.57	27.978
53918.20	33.90	1053.57	31.076
54018.25	30.11	1053.57	34.987
54118.30	26.29	1053.57	40.079
54218.35	22.43	1053.57	46.979
54318.40	18.53	1053.57	56.857
54418.45	14.60	1053.57	72.171
54518.50	10.63	1053.57	99.107
54618.55	6.63	1053.57	158.970
54718.60	2.59	1053.57	406.978
54818.65	-1.49	1053.57	709.246
54918.70	-5.60	1053.57	188.298
55018.75	-9.74	1053.57	108.163
55118.80	-13.92	1053.57	75.680
55218.85	-18.14	1053.57	58.087
55318.90	-22.39	1053.57	47.055
55418.95	-26.68	1053.57	39.492
55519.00	-31.00	1053.57	33.985
55619.05	-35.36	1053.57	29.795
55719.10	-39.15	1053.57	26.909
55819.15	-42.30	1053.57	24.907
55919.20	-44.80	1053.57	23.515
56019.25	-46.67	1053.57	22.577
56119.30	-47.88	1053.57	22.003
56219.35	-48.46	1053.57	21.743
56319.40	-48.39	1053.57	21.774
56419.45	-47.67	1053.57	22.100
56519.50	-46.32	1053.57	22.747
56619.55	-44.32	1053.57	23.774

<i>Cod. elab.:</i> 108GA201-GA01-Z-CL-002 C	<i>Titolo:</i> OPERE D'ARTE MAGGIORI- GALLERIE	<i>Data:</i> Ottobre 2011
<i>Nome file:</i> 108GA201-GA01-Z-CL -002_C.docx	ARTIFICIALI – GALLERIA ROVETELLO	<i>Pagina</i> 432 di 452
Relazione di calcolo		

PROGETTO ESECUTIVO

56719.60	-41.67	1053.57	25.282
56819.65	-38.39	1053.57	27.446
56919.70	-34.46	1053.57	30.577
57019.75	-29.88	1053.57	35.256
57119.80	-24.67	1053.57	42.711
57219.85	-18.81	1053.57	56.018
57319.90	-12.31	1053.57	85.621
57419.95	-5.16	1053.57	204.214
57520.00	2.63	1053.57	400.596

Fase n° 7 - [A2-M2]

n°	Y	T	T _R	CS _T
1	0.00	0.00	1053.57	2295547.912
2	0.05	0.00	1053.57	764896.047
3	0.10	0.00	1053.57	458642.636
4	0.15	0.00	1053.57	327752.752
5	0.20	0.00	1053.57	254735.503
6	0.25	0.01	1053.57	208528.232
7	0.30	0.01	1053.57	176422.429
8	0.35	0.01	1053.57	152885.810
9	0.40	0.01	1053.57	134910.006
10	0.45	0.01	1053.57	120730.385
11	0.50	0.01	1053.57	120730.385
12	0.50	0.01	1053.57	91583.326
13	0.55	0.01	1053.57	91583.326
14	0.55	0.02	1053.57	65288.026
15	0.60	0.02	1053.57	65288.026
16	0.60	0.02	1053.57	50716.099
17	0.65	0.02	1053.57	50716.099
18	0.65	0.03	1053.57	41469.327
19	0.70	0.03	1053.57	41469.327
20	0.70	0.03	1053.57	35071.147
21	0.75	0.03	1053.57	35071.147
22	0.75	0.03	1053.57	30386.203
23	0.80	0.03	1053.57	30386.203

Cod. elab.: 108GA201-GA01-Z-CL-002_C	Titolo: OPERE D'ARTE MAGGIORI- GALLERIE	Data: Ottobre 2011
Nome file: 108GA201-GA01-Z-CL -002_C.docx	ARTIFICIALI – GALLERIA ROVETELLO	Pagina 433 di 452
Relazione di calcolo		

PROGETTO ESECUTIVO

24	0.80	0.04	1053.57	26803.160
25	0.85	0.04	1053.57	26803.160
26	0.85	0.04	1053.57	23976.932
27	0.90	0.04	1053.57	23976.932
28	0.90	0.05	1053.57	21690.848
29	0.95	0.05	1053.57	21690.848
30	0.95	0.05	1053.57	19801.438
31	1.00	0.05	1053.57	19801.438
32	1.00	0.06	1053.57	18215.122
33	1.05	0.06	1053.57	18215.122
34	1.05	0.06	1053.57	16864.335
35	1.10	0.06	1053.57	16864.335
36	1.10	0.07	1053.57	15700.238
37	1.15	0.07	1053.57	15700.238
38	1.15	0.07	1053.57	14686.263
39	1.20	0.07	1053.57	14686.263
40	1.20	0.08	1053.57	13795.422
41	1.25	0.08	1053.57	13795.422
42	1.25	0.08	1053.57	13006.807
43	1.30	0.08	1053.57	13006.807
44	1.30	0.09	1053.57	12302.911
45	1.35	0.09	1053.57	12302.911
46	1.35	0.09	1053.57	11671.680
47	1.40	0.09	1053.57	11671.680
48	1.40	0.09	1053.57	11102.171
49	1.45	0.09	1053.57	11102.171
50	1.45	0.10	1053.57	10585.331
51	1.50	0.10	1053.57	10585.331
52	1.50	0.10	1053.57	10114.603
53	1.55	0.10	1053.57	10114.603
54	1.55	0.11	1053.57	9684.235
55	1.60	0.11	1053.57	9684.235
56	1.60	0.11	1053.57	9288.544
57	1.65	0.11	1053.57	9288.544
58	1.65	0.12	1053.57	8924.373
59	1.70	0.12	1053.57	8924.373

<i>Cod. elab.:</i> 108GA201-GA01-Z-CL-002_C	<i>Titolo:</i> OPERE D'ARTE MAGGIORI- GALLERIE	<i>Data:</i> Ottobre 2011
<i>Nome file:</i> 108GA201-GA01-Z-CL -002_C.docx	ARTIFICIALI – GALLERIA ROVETELLO	<i>Pagina</i> 434 di 452
Relazione di calcolo		

PROGETTO ESECUTIVO

60	1.70	0.12	1053.57	8587.534
61	1.75	0.12	1053.57	8587.534
62	1.75	0.13	1053.57	8275.092
63	1.80	0.13	1053.57	8275.092
64	1.80	0.13	1053.57	7984.675
65	1.85	0.13	1053.57	7984.675
66	1.85	0.14	1053.57	7713.961
67	1.90	0.14	1053.57	7713.961
68	1.90	0.14	1053.57	7460.913
69	1.95	0.14	1053.57	7460.913
70	1.95	0.15	1053.57	7224.136
71	2.00	0.15	1053.57	7224.136
72	2.00	0.15	1053.57	7001.769
73	2.05	0.15	1053.57	7001.769
74	2.05	0.16	1053.57	6792.736
75	2.10	0.16	1053.57	6792.736
76	2.10	0.16	1053.57	6595.787
77	2.15	0.16	1053.57	6595.787
78	2.15	0.16	1053.57	6410.133
79	2.20	0.16	1053.57	6410.133
80	2.20	0.17	1053.57	6234.383
81	2.25	0.17	1053.57	6234.383
82	2.25	0.17	1053.57	6068.164
83	2.30	0.17	1053.57	6068.164
84	2.30	0.18	1053.57	5910.508
85	2.35	0.18	1053.57	5910.508
86	2.35	0.18	1053.57	5760.934
87	2.40	0.18	1053.57	5760.934
88	2.40	0.19	1053.57	5618.706
89	2.45	0.19	1053.57	5618.706
90	2.45	0.19	1053.57	5483.295
91	2.50	0.19	1053.57	5483.295
92	2.50	-342.82	1053.57	3.073
93	2.55	-342.82	1053.57	3.073
94	2.55	-342.81	1053.57	3.073
95	2.60	-342.81	1053.57	3.073

<i>Cod. elab.:</i> 108GA201-GA01-Z-CL-002_C	<i>Titolo:</i> OPERE D'ARTE MAGGIORI- GALLERIE	<i>Data:</i> Ottobre 2011
<i>Nome file:</i> 108GA201-GA01-Z-CL -002_C.docx	ARTIFICIALI – GALLERIA ROVETELLO	<i>Pagina</i> 435 di 452
Relazione di calcolo		

PROGETTO ESECUTIVO

96	2.60	-342.81	1053.57	3.073
97	2.65	-342.81	1053.57	3.073
98	2.65	-342.80	1053.57	3.073
99	2.70	-342.80	1053.57	3.073
100	2.70	-342.80	1053.57	3.073
101	2.75	-342.34	1053.57	3.078
102	2.75	-342.33	1053.57	3.078
103	2.80	-340.94	1053.57	3.090
104	2.80	-340.93	1053.57	3.090
105	2.85	-338.92	1053.57	3.109
106	2.85	-338.92	1053.57	3.109
107	2.90	-336.59	1053.57	3.130
108	2.90	-336.58	1053.57	3.130
109	2.95	-333.94	1053.57	3.155
110	2.95	-333.93	1053.57	3.155
111	3.00	-330.97	1053.57	3.183
112	3.00	-330.97	1053.57	3.183
113	3.05	-327.71	1053.57	3.215
114	3.05	-327.71	1053.57	3.215
115	3.10	-324.20	1053.57	3.250
116	3.10	-324.19	1053.57	3.250
117	3.15	-320.52	1053.57	3.287
118	3.15	-320.52	1053.57	3.287
119	3.20	-316.80	1053.57	3.326
120	3.20	-316.80	1053.57	3.326
121	3.25	-313.04	1053.57	3.366
122	3.25	-313.03	1053.57	3.366
123	3.30	-309.23	1053.57	3.407
124	3.30	-309.22	1053.57	3.407
125	3.35	-305.37	1053.57	3.450
126	3.35	-305.37	1053.57	3.450
127	3.40	-301.47	1053.57	3.495
128	3.40	-301.46	1053.57	3.495
129	3.45	-297.52	1053.57	3.541
130	3.45	-297.51	1053.57	3.541
131	3.50	-293.52	1053.57	3.589

<i>Cod. elab.:</i> 108GA201-GA01-Z-CL-002_C	<i>Titolo:</i> OPERE D'ARTE MAGGIORI- GALLERIE	<i>Data:</i> Ottobre 2011
<i>Nome file:</i> 108GA201-GA01-Z-CL -002_C.docx	ARTIFICIALI – GALLERIA ROVETELLO Relazione di calcolo	<i>Pagina</i> 436 di 452

PROGETTO ESECUTIVO

1323.50	-293.51	1053.57	3.589
1333.55	-289.48	1053.57	3.640
1343.55	-289.47	1053.57	3.640
1353.60	-285.39	1053.57	3.692
1363.60	-285.38	1053.57	3.692
1373.65	-281.26	1053.57	3.746
1383.65	-281.25	1053.57	3.746
1393.70	-277.08	1053.57	3.802
1403.70	-277.07	1053.57	3.803
1413.75	-272.85	1053.57	3.861
1423.75	-272.85	1053.57	3.861
1433.80	-268.58	1053.57	3.923
1443.80	-268.58	1053.57	3.923
1453.85	-264.27	1053.57	3.987
1463.85	-264.26	1053.57	3.987
1473.90	-259.91	1053.57	4.054
1483.90	-259.90	1053.57	4.054
1493.95	-255.50	1053.57	4.124
1503.95	-255.50	1053.57	4.124
1514.00	-251.05	1053.57	4.197
1524.00	-251.05	1053.57	4.197
1534.05	-246.56	1053.57	4.273
1544.05	-246.55	1053.57	4.273
1554.10	-242.02	1053.57	4.353
1564.10	-242.01	1053.57	4.353
1574.15	-237.43	1053.57	4.437
1584.15	-237.43	1053.57	4.437
1594.20	-232.81	1053.57	4.526
1604.20	-232.80	1053.57	4.526
1614.25	-228.13	1053.57	4.618
1624.25	-228.13	1053.57	4.618
1634.30	-223.42	1053.57	4.716
1644.30	-223.41	1053.57	4.716
1654.35	-218.65	1053.57	4.818
1664.35	-218.65	1053.57	4.819
1674.40	-213.85	1053.57	4.927

<i>Cod. elab.:</i> 108GA201-GA01-Z-CL-002_C	<i>Titolo:</i> OPERE D'ARTE MAGGIORI- GALLERIE	<i>Data:</i> Ottobre 2011
<i>Nome file:</i> 108GA201-GA01-Z-CL -002_C.docx	ARTIFICIALI – GALLERIA ROVETELLO	<i>Pagina</i> 437 di 452
Relazione di calcolo		

PROGETTO ESECUTIVO

1684.40	-213.84	1053.57	4.927
1694.45	-209.00	1053.57	5.041
1704.45	-208.99	1053.57	5.041
1714.50	-204.11	1053.57	5.162
1724.50	-204.10	1053.57	5.162
1734.55	-199.17	1053.57	5.290
1744.55	-199.16	1053.57	5.290
1754.60	-194.19	1053.57	5.425
1764.60	-194.18	1053.57	5.426
1774.65	-189.16	1053.57	5.570
1784.65	-189.16	1053.57	5.570
1794.70	-184.10	1053.57	5.723
1804.70	-184.09	1053.57	5.723
1814.75	-178.99	1053.57	5.886
1824.75	-178.98	1053.57	5.886
1834.80	-173.83	1053.57	6.061
1844.80	-173.83	1053.57	6.061
1854.85	-168.63	1053.57	6.248
1864.85	-168.63	1053.57	6.248
1874.90	-163.39	1053.57	6.448
1884.90	-163.39	1053.57	6.448
1894.95	-158.11	1053.57	6.664
1904.95	-158.10	1053.57	6.664
1915.00	-152.78	1053.57	6.896
1925.00	-497.74	1053.57	2.117
1935.05	-492.38	1053.57	2.140
1945.05	-492.37	1053.57	2.140
1955.10	-486.96	1053.57	2.164
1965.10	-486.96	1053.57	2.164
1975.15	-481.51	1053.57	2.188
1985.15	-481.50	1053.57	2.188
1995.20	-476.01	1053.57	2.213
2005.20	-476.01	1053.57	2.213
2015.25	-470.47	1053.57	2.239
2025.25	-470.47	1053.57	2.239
2035.30	-464.89	1053.57	2.266

<i>Cod. elab.:</i> 108GA201-GA01-Z-CL-002_C	<i>Titolo:</i> OPERE D'ARTE MAGGIORI- GALLERIE	<i>Data:</i> Ottobre 2011
<i>Nome file:</i> 108GA201-GA01-Z-CL -002_C.docx	ARTIFICIALI – GALLERIA ROVETELLO	<i>Pagina</i> 438 di 452
Relazione di calcolo		

PROGETTO ESECUTIVO

204 5.30	-464.88	1053.57	2.266
205 5.35	-459.26	1053.57	2.294
206 5.35	-459.26	1053.57	2.294
207 5.40	-453.60	1053.57	2.323
208 5.40	-453.59	1053.57	2.323
209 5.45	-447.89	1053.57	2.352
210 5.45	-447.88	1053.57	2.352
211 5.50	-442.13	1053.57	2.383
212 5.50	-442.13	1053.57	2.383
213 5.55	-436.34	1053.57	2.415
214 5.55	-436.34	1053.57	2.415
215 5.60	-430.50	1053.57	2.447
216 5.60	-430.50	1053.57	2.447
217 5.65	-424.63	1053.57	2.481
218 5.65	-424.62	1053.57	2.481
219 5.70	-418.71	1053.57	2.516
220 5.70	-418.70	1053.57	2.516
221 5.75	-412.75	1053.57	2.553
222 5.75	-412.74	1053.57	2.553
223 5.80	-406.74	1053.57	2.590
224 5.80	-406.74	1053.57	2.590
225 5.85	-400.70	1053.57	2.629
226 5.85	-400.70	1053.57	2.629
227 5.90	-394.61	1053.57	2.670
228 5.90	-394.61	1053.57	2.670
229 5.95	-388.49	1053.57	2.712
230 5.95	-388.48	1053.57	2.712
231 6.00	-382.32	1053.57	2.756
232 6.00	-382.31	1053.57	2.756
233 6.05	-376.11	1053.57	2.801
234 6.05	-376.10	1053.57	2.801
235 6.10	-369.86	1053.57	2.849
236 6.10	-369.85	1053.57	2.849
237 6.15	-363.57	1053.57	2.898
238 6.15	-363.56	1053.57	2.898
239 6.20	-357.23	1053.57	2.949

<i>Cod. elab.:</i> 108GA201-GA01-Z-CL-002 C	<i>Titolo:</i> OPERE D'ARTE MAGGIORI- GALLERIE	<i>Data:</i> Ottobre 2011
<i>Nome file:</i> 108GA201-GA01-Z-CL -002_C.docx	ARTIFICIALI – GALLERIA ROVETELLO Relazione di calcolo	<i>Pagina</i> 439 di 452

PROGETTO ESECUTIVO

240 6.20	-357.23	1053.57	2.949
241 6.25	-350.86	1053.57	3.003
242 6.25	-350.85	1053.57	3.003
243 6.30	-344.44	1053.57	3.059
244 6.30	-344.44	1053.57	3.059
245 6.35	-337.99	1053.57	3.117
246 6.35	-337.98	1053.57	3.117
247 6.40	-331.49	1053.57	3.178
248 6.40	-331.49	1053.57	3.178
249 6.45	-324.95	1053.57	3.242
250 6.45	-324.95	1053.57	3.242
251 6.50	-318.38	1053.57	3.309
252 6.50	-318.37	1053.57	3.309
253 6.55	-311.76	1053.57	3.379
254 6.55	-311.75	1053.57	3.379
255 6.60	-305.10	1053.57	3.453
256 6.60	-305.09	1053.57	3.453
257 6.65	-298.40	1053.57	3.531
258 6.65	-298.40	1053.57	3.531
259 6.70	-291.66	1053.57	3.612
260 6.70	-291.66	1053.57	3.612
261 6.75	-284.88	1053.57	3.698
262 6.75	-284.88	1053.57	3.698
263 6.80	-278.06	1053.57	3.789
264 6.80	-278.05	1053.57	3.789
265 6.85	-271.20	1053.57	3.885
266 6.85	-271.19	1053.57	3.885
267 6.90	-264.29	1053.57	3.986
268 6.90	-264.29	1053.57	3.986
269 6.95	-257.35	1053.57	4.094
270 6.95	-257.34	1053.57	4.094
271 7.00	-250.36	1053.57	4.208
272 7.00	-250.36	1053.57	4.208
273 7.05	-243.34	1053.57	4.330
274 7.05	-243.33	1053.57	4.330
275 7.10	-236.27	1053.57	4.459

<i>Cod. elab.:</i> 108GA201-GA01-Z-CL-002 C	<i>Titolo:</i> OPERE D'ARTE MAGGIORI- GALLERIE	<i>Data:</i> Ottobre 2011
<i>Nome file:</i> 108GA201-GA01-Z-CL -002_C.docx	ARTIFICIALI – GALLERIA ROVETELLO Relazione di calcolo	<i>Pagina</i> 440 di 452

PROGETTO ESECUTIVO

2767.10	-236.27	1053.57	4.459
2777.15	-229.16	1053.57	4.597
2787.15	-229.16	1053.57	4.598
2797.20	-222.01	1053.57	4.745
2807.20	-222.01	1053.57	4.746
2817.25	-214.82	1053.57	4.904
2827.25	-214.82	1053.57	4.904
2837.30	-207.59	1053.57	5.075
2847.30	-207.59	1053.57	5.075
2857.35	-200.32	1053.57	5.259
2867.35	-200.32	1053.57	5.259
2877.40	-193.01	1053.57	5.459
2887.40	-193.01	1053.57	5.459
2897.45	-185.66	1053.57	5.675
2907.45	-185.66	1053.57	5.675
2917.50	-178.27	1053.57	5.910
2927.50	-178.26	1053.57	5.910
2937.55	-170.84	1053.57	6.167
2947.55	-170.83	1053.57	6.167
2957.60	-163.36	1053.57	6.449
2967.60	-163.36	1053.57	6.449
2977.65	-155.85	1053.57	6.760
2987.65	-155.85	1053.57	6.760
2997.70	-148.30	1053.57	7.104
3007.70	-148.29	1053.57	7.105
3017.75	-140.71	1053.57	7.488
3027.75	-140.70	1053.57	7.488
3037.80	-133.07	1053.57	7.917
3047.80	-133.07	1053.57	7.918
3057.85	-125.40	1053.57	8.402
3067.85	-125.39	1053.57	8.402
3077.90	-117.69	1053.57	8.952
3087.90	-117.68	1053.57	8.953
3097.95	-109.93	1053.57	9.584
3107.95	-109.93	1053.57	9.584
3118.00	-102.14	1053.57	10.315

<i>Cod. elab.:</i> 108GA201-GA01-Z-CL-002_C	<i>Titolo:</i> OPERE D'ARTE MAGGIORI- GALLERIE	<i>Data:</i> Ottobre 2011
<i>Nome file:</i> 108GA201-GA01-Z-CL -002_C.docx	ARTIFICIALI – GALLERIA ROVETELLO Relazione di calcolo	<i>Pagina</i> 441 di 452

PROGETTO ESECUTIVO

3128.00	-102.14	1053.57	10.315
3138.05	-94.31	1053.57	11.172
3148.05	-94.30	1053.57	11.172
3158.10	-86.44	1053.57	12.189
3168.10	-86.43	1053.57	12.190
3178.15	-78.52	1053.57	13.417
3188.15	-78.52	1053.57	13.418
3198.20	-70.57	1053.57	14.929
3208.20	-70.57	1053.57	14.930
3218.25	-62.58	1053.57	16.835
3228.25	-62.58	1053.57	16.836
3238.30	-54.55	1053.57	19.313
3248.30	-54.55	1053.57	19.315
3258.35	-46.48	1053.57	22.666
3268.35	-46.48	1053.57	22.668
3278.40	-38.38	1053.57	27.453
3288.40	-38.37	1053.57	27.456
3298.45	-30.23	1053.57	34.846
3308.45	-30.23	1053.57	34.851
3318.50	-22.06	1053.57	47.762
3328.50	-22.05	1053.57	47.775
3338.55	-13.68	1053.57	77.017
3348.55	-13.67	1053.57	77.063
3358.60	-5.26	1053.57	200.450
3368.60	-5.25	1053.57	200.761
3378.65	3.21	1053.57	328.082
3388.65	3.22	1053.57	327.253
3398.70	11.72	1053.57	89.870
3408.70	11.73	1053.57	89.808
3418.75	20.28	1053.57	51.949
3428.75	20.29	1053.57	51.928
3438.80	28.88	1053.57	36.475
3448.80	28.89	1053.57	36.464
3458.85	37.54	1053.57	28.069
3468.85	37.54	1053.57	28.063
3478.90	46.23	1053.57	22.789

Cod. elab.: 108GA201-GA01-Z-CL-002_C	Titolo: OPERE D'ARTE MAGGIORI- GALLERIE	Data: Ottobre 2011
Nome file: 108GA201-GA01-Z-CL -002_C.docx	ARTIFICIALI – GALLERIA ROVETELLO	Pagina 442 di 452
Relazione di calcolo		

PROGETTO ESECUTIVO

3488.90	46.24	1053.57	22.785
3498.95	54.97	1053.57	19.165
3508.95	54.98	1053.57	19.162
3519.00	63.76	1053.57	16.524
3529.00	63.77	1053.57	16.522
3539.05	72.59	1053.57	14.513
3549.05	72.60	1053.57	14.512
3559.10	81.47	1053.57	12.932
3569.10	81.48	1053.57	12.930
3579.15	90.39	1053.57	11.656
3589.15	90.40	1053.57	11.654
3599.20	99.35	1053.57	10.604
3609.20	99.36	1053.57	10.603
3619.25	103.28	1053.57	10.201
3629.30	107.13	1053.57	9.835
3639.35	110.91	1053.57	9.499
3649.40	114.64	1053.57	9.190
3659.45	118.30	1053.57	8.906
3669.50	121.91	1053.57	8.642
3679.55	125.47	1053.57	8.397
3689.60	128.98	1053.57	8.168
3699.65	132.44	1053.57	7.955
3709.70	135.84	1053.57	7.756
3719.75	139.19	1053.57	7.569
3729.80	142.48	1053.57	7.394
3739.85	145.73	1053.57	7.230
3749.90	148.92	1053.57	7.075
3759.95	152.05	1053.57	6.929
37610.00	155.14	1053.57	6.791
37710.05	158.17	1053.57	6.661
37810.10	161.14	1053.57	6.538
37910.15	164.07	1053.57	6.422
38010.20	166.94	1053.57	6.311
38110.25	169.75	1053.57	6.207
38210.30	172.51	1053.57	6.107
38310.35	175.22	1053.57	6.013

<i>Cod. elab.:</i> 108GA201-GA01-Z-CL-002_C	<i>Titolo:</i> OPERE D'ARTE MAGGIORI- GALLERIE	<i>Data:</i> Ottobre 2011
<i>Nome file:</i> 108GA201-GA01-Z-CL -002_C.docx	ARTIFICIALI – GALLERIA ROVETELLO Relazione di calcolo	<i>Pagina</i> 443 di 452

PROGETTO ESECUTIVO

38410.40	177.88	1053.57	5.923
38510.45	180.48	1053.57	5.838
38610.50	183.02	1053.57	5.756
38710.55	185.52	1053.57	5.679
38810.60	187.95	1053.57	5.605
38910.65	190.34	1053.57	5.535
39010.70	192.67	1053.57	5.468
39110.75	194.94	1053.57	5.405
39210.80	197.16	1053.57	5.344
39310.85	199.33	1053.57	5.286
39410.90	201.44	1053.57	5.230
39510.95	203.50	1053.57	5.177
39611.00	205.50	1053.57	5.127
39711.05	207.45	1053.57	5.079
39811.10	209.34	1053.57	5.033
39911.15	211.17	1053.57	4.989
40011.20	212.96	1053.57	4.947
40111.25	214.68	1053.57	4.908
40211.30	216.36	1053.57	4.870
40311.35	217.97	1053.57	4.833
40411.40	219.48	1053.57	4.800
40511.45	220.94	1053.57	4.769
40611.50	222.34	1053.57	4.739
40711.55	223.68	1053.57	4.710
40811.60	224.97	1053.57	4.683
40911.65	226.20	1053.57	4.658
41011.70	227.38	1053.57	4.634
41111.75	228.50	1053.57	4.611
41211.80	229.56	1053.57	4.589
41311.85	230.57	1053.57	4.569
41411.90	231.53	1053.57	4.551
41511.95	232.42	1053.57	4.533
41612.00	233.27	1053.57	4.517
41712.05	234.05	1053.57	4.501
41812.10	234.78	1053.57	4.487
41912.15	235.46	1053.57	4.475

<i>Cod. elab.:</i> 108GA201-GA01-Z-CL-002_C	<i>Titolo:</i> OPERE D'ARTE MAGGIORI- GALLERIE	<i>Data:</i> Ottobre 2011
<i>Nome file:</i> 108GA201-GA01-Z-CL -002_C.docx	ARTIFICIALI – GALLERIA ROVETELLO Relazione di calcolo	<i>Pagina</i> 444 di 452

PROGETTO ESECUTIVO

42012.20	236.08	1053.57	4.463
42112.25	236.64	1053.57	4.452
42212.30	237.15	1053.57	4.443
42312.35	237.60	1053.57	4.434
42412.40	237.99	1053.57	4.427
42512.45	238.33	1053.57	4.421
42612.50	238.61	1053.57	4.415
42712.55	238.84	1053.57	4.411
42812.60	239.01	1053.57	4.408
42912.65	239.14	1053.57	4.406
43012.70	239.22	1053.57	4.404
43112.75	239.28	1053.57	4.403
43212.80	239.28	1053.57	4.403
43312.85	239.26	1053.57	4.404
43412.90	239.19	1053.57	4.405
43512.95	239.10	1053.57	4.406
43613.00	238.97	1053.57	4.409
43713.05	238.80	1053.57	4.412
43813.10	238.60	1053.57	4.416
43913.15	238.37	1053.57	4.420
44013.20	238.10	1053.57	4.425
44113.25	237.80	1053.57	4.430
44213.30	237.46	1053.57	4.437
44313.35	237.09	1053.57	4.444
44413.40	236.69	1053.57	4.451
44513.45	236.24	1053.57	4.460
44613.50	235.77	1053.57	4.469
44713.55	235.26	1053.57	4.478
44813.60	234.72	1053.57	4.489
44913.65	234.14	1053.57	4.500
45013.70	233.52	1053.57	4.512
45113.75	232.87	1053.57	4.524
45213.80	232.19	1053.57	4.537
45313.85	231.48	1053.57	4.552
45413.90	230.73	1053.57	4.566
45513.95	229.94	1053.57	4.582

<i>Cod. elab.:</i> 108GA201-GA01-Z-CL-002 C	<i>Titolo:</i> OPERE D'ARTE MAGGIORI- GALLERIE	<i>Data:</i> Ottobre 2011
<i>Nome file:</i> 108GA201-GA01-Z-CL -002_C.docx	ARTIFICIALI – GALLERIA ROVETELLO Relazione di calcolo	<i>Pagina</i> 445 di 452

PROGETTO ESECUTIVO

45614.00	229.12	1053.57	4.598
45714.05	228.27	1053.57	4.615
45814.10	227.39	1053.57	4.633
45914.15	226.47	1053.57	4.652
46014.20	225.51	1053.57	4.672
46114.25	224.52	1053.57	4.692
46214.30	223.50	1053.57	4.714
46314.35	222.45	1053.57	4.736
46414.40	221.35	1053.57	4.760
46514.45	220.23	1053.57	4.784
46614.50	219.07	1053.57	4.809
46714.55	217.88	1053.57	4.836
46814.60	216.65	1053.57	4.863
46914.65	215.39	1053.57	4.891
47014.70	214.09	1053.57	4.921
47114.75	212.76	1053.57	4.952
47214.80	211.40	1053.57	4.984
47314.85	210.00	1053.57	5.017
47414.90	208.57	1053.57	5.051
47514.95	207.10	1053.57	5.087
47615.00	205.60	1053.57	5.124
47715.05	204.06	1053.57	5.163
47815.10	202.49	1053.57	5.203
47915.15	200.88	1053.57	5.245
48015.20	199.24	1053.57	5.288
48115.25	197.57	1053.57	5.333
48215.30	195.86	1053.57	5.379
48315.35	194.11	1053.57	5.428
48415.40	192.33	1053.57	5.478
48515.45	190.52	1053.57	5.530
48615.50	188.67	1053.57	5.584
48715.55	186.79	1053.57	5.640
48815.60	184.87	1053.57	5.699
48915.65	182.92	1053.57	5.760
49015.70	180.93	1053.57	5.823
49115.75	178.91	1053.57	5.889

<i>Cod. elab.:</i> 108GA201-GA01-Z-CL-002 C	<i>Titolo:</i> OPERE D'ARTE MAGGIORI- GALLERIE	<i>Data:</i> Ottobre 2011
<i>Nome file:</i> 108GA201-GA01-Z-CL -002_C.docx	ARTIFICIALI – GALLERIA ROVETELLO Relazione di calcolo	<i>Pagina</i> 446 di 452

PROGETTO ESECUTIVO

49215.80	176.86	1053.57	5.957
49315.85	174.76	1053.57	6.028
49415.90	172.64	1053.57	6.103
49515.95	170.48	1053.57	6.180
49616.00	168.28	1053.57	6.261
49716.05	166.05	1053.57	6.345
49816.10	163.78	1053.57	6.433
49916.15	161.48	1053.57	6.524
50016.20	159.14	1053.57	6.620
50116.25	156.77	1053.57	6.721
50216.30	154.36	1053.57	6.825
50316.35	151.92	1053.57	6.935
50416.40	149.45	1053.57	7.050
50516.45	146.94	1053.57	7.170
50616.50	144.39	1053.57	7.297
50716.55	141.80	1053.57	7.430
50816.60	139.18	1053.57	7.570
50916.65	136.53	1053.57	7.717
51016.70	133.84	1053.57	7.872
51116.75	131.11	1053.57	8.035
51216.80	128.35	1053.57	8.208
51316.85	125.56	1053.57	8.391
51416.90	122.73	1053.57	8.584
51516.95	119.87	1053.57	8.790
51617.00	116.96	1053.57	9.008
51717.05	114.03	1053.57	9.240
51817.10	111.06	1053.57	9.487
51917.15	108.05	1053.57	9.751
52017.20	105.01	1053.57	10.033
52117.25	101.93	1053.57	10.336
52217.30	98.82	1053.57	10.662
52317.35	95.67	1053.57	11.013
52417.40	92.48	1053.57	11.392
52517.45	89.26	1053.57	11.803
52617.50	86.01	1053.57	12.250
52717.55	82.71	1053.57	12.737

<i>Cod. elab.:</i> 108GA201-GA01-Z-CL-002_C	<i>Titolo:</i> OPERE D'ARTE MAGGIORI- GALLERIE	<i>Data:</i> Ottobre 2011
<i>Nome file:</i> 108GA201-GA01-Z-CL -002_C.docx	ARTIFICIALI – GALLERIA ROVETELLO Relazione di calcolo	<i>Pagina</i> 447 di 452

PROGETTO ESECUTIVO

52817.60	79.39	1053.57	13.271
52917.65	76.02	1053.57	13.858
53017.70	72.63	1053.57	14.507
53117.75	69.19	1053.57	15.227
53217.80	65.72	1053.57	16.030
53317.85	62.22	1053.57	16.933
53417.90	58.68	1053.57	17.955
53517.95	55.10	1053.57	19.120
53618.00	51.49	1053.57	20.460
53718.05	47.85	1053.57	22.020
53818.10	44.16	1053.57	23.855
53918.15	40.45	1053.57	26.048
54018.20	36.69	1053.57	28.712
54118.25	32.91	1053.57	32.017
54218.30	29.08	1053.57	36.226
54318.35	25.22	1053.57	41.769
54418.40	21.33	1053.57	49.396
54518.45	17.40	1053.57	60.554
54618.50	13.43	1053.57	78.432
54718.55	9.43	1053.57	111.710
54818.60	5.39	1053.57	195.319
54918.65	1.32	1053.57	797.337
55018.70	-2.79	1053.57	378.042
55118.75	-6.93	1053.57	152.013
55218.80	-11.11	1053.57	94.829
55318.85	-15.33	1053.57	68.747
55418.90	-19.58	1053.57	53.819
55518.95	-23.86	1053.57	44.151
55619.00	-28.18	1053.57	37.380
55719.05	-32.54	1053.57	32.375
55819.10	-36.94	1053.57	28.524
55919.15	-40.99	1053.57	25.701
56019.20	-44.31	1053.57	23.777
56119.25	-46.89	1053.57	22.469
56219.30	-48.73	1053.57	21.620
56319.35	-49.83	1053.57	21.142

Cod. elab.: 108GA201-GA01-Z-CL-002 C	Titolo: OPERE D'ARTE MAGGIORI- GALLERIE	Data: Ottobre 2011
Nome file: 108GA201-GA01-Z-CL -002_C.docx	ARTIFICIALI – GALLERIA ROVETELLO	Pagina 448 di 452
Relazione di calcolo		

PROGETTO ESECUTIVO

56419.40	-50.20	1053.57	20.988
56519.45	-49.83	1053.57	21.145
56619.50	-48.71	1053.57	21.627
56719.55	-46.87	1053.57	22.480
56819.60	-44.28	1053.57	23.794
56919.65	-40.95	1053.57	25.726
57019.70	-36.89	1053.57	28.559
57119.75	-32.09	1053.57	32.831
57219.80	-26.55	1053.57	39.679
57319.85	-20.28	1053.57	51.962
57419.90	-13.26	1053.57	79.445
57519.95	-5.51	1053.57	191.227
57620.00	2.98	1053.57	353.500

Verifica a SLU * Diagrammi M-N delle sezioni

Di seguito sono riportati per ogni tratto di armatura i diagrammi di interazione M_u-N_u della sezione; sono stati calcolati 16 punti per ogni sezione analizzata.

Per la costruzione dei diagrammi limiti si sono assunti i seguenti valori:

Tensione caratteristica cubica del cls	$R_{bk} = 30.0$ [N/mmq]
Tensione caratteristica cilindrica del cls ($0.83 \times R_{bk}$)	$R_{ck} = 254$ (Kg/cm ²)
Fattore di riduzione per carico di lunga permanenza	$\psi = 0.85$
Tensione caratteristica di snervamento dell'acciaio	$f_{yk} = 450.0$ [N/mmq]
Coefficiente di sicurezza cls	$\gamma_c = 1.60$
Coefficiente di sicurezza acciaio	$\gamma_s = 1.15$
Resistenza di calcolo del cls ($\psi R_{ck} / \gamma_c$)	$R_c^* = 135$ (Kg/cm ²)
Resistenza di calcolo dell'acciaio (f_{yk} / γ_s)	$R_s^* = 3990$ (Kg/cm ²)
Modulo elastico dell'acciaio	$E_s = 2100000$ (Kg/cm ²)
Deformazione ultima del calcestruzzo	$\epsilon_{cu} = 0.0035$ (0.35%)
Deformazione del calcestruzzo al limite elastoplastico	$\epsilon_{ck} = 0.0020$ (0.20%)
Deformazione ultima dell'acciaio	$\epsilon_{yu} = 0.0100$ (1.00%)
Deformazione dell'acciaio al limite elastico (R_s^* / E_s)	$\epsilon_{yk} = 0.0014$ (0.19%)

Cod. elab.: 108GA201-GA01-Z-CL-002_C	Titolo: OPERE D'ARTE MAGGIORI- GALLERIE	Data: Ottobre 2011
Nome file: 108GA201-GA01-Z-CL -002_C.docx	ARTIFICIALI – GALLERIA ROVETELLO	Pagina 449 di 452
Relazione di calcolo		

Legame costitutivo del calcestruzzo

Per il legame costitutivo del calcestruzzo si assume il diagramma parabola-rettangolo espresso dalle seguenti relazioni:

Tratto parabolico: $0 \leq \varepsilon_c \leq \varepsilon_{ck}$

$$\sigma_c = \frac{R_c^* (2\varepsilon_c \varepsilon_{ck} - \varepsilon_c^2)}{\varepsilon_{ck}^2}$$

Tratto rettangolare: $\varepsilon_{ck} < \varepsilon_c \leq \varepsilon_{cu}$

$$\sigma_c = R_c^*$$

Legame costitutivo dell'acciaio

Per l'acciaio si assume un comportamento elastico-perfettamente plastico espresso dalle seguenti relazioni:

$$\sigma_s = E_s \varepsilon_s \quad \text{per } 0 \leq \varepsilon_s \leq \varepsilon_{sy}$$

$$\sigma_s = R_s^* \quad \text{per } \varepsilon_{sy} < \varepsilon_s \leq \varepsilon_{su}$$

Tratto armatura 1

Nr	N _u	M _u
1	-4248.5260	0.0000
2	0.0000	1915.2807
3	2162.2735	2550.4779
4	3243.4103	2773.9825
5	4324.5471	2934.4854
6	5405.6838	3032.3202
7	6486.8206	3069.9791
8	7567.9574	3041.8327
9	8649.0941	2934.4474
10	9730.2309	2785.4982
11	10811.3677	2610.5144
12	11892.5045	2404.4350
13	12973.6412	2162.6114
14	14054.7780	1875.2947
15	15135.9148	1541.8426
16	16217.0515	0.0000
17	16217.0515	0.0000

Cod. elab.: 108GA201-GA01-Z-CL-002_C	Titolo: OPERE D'ARTE MAGGIORI- GALLERIE	Data: Ottobre 2011
Nome file: 108GA201-GA01-Z-CL -002_C.docx	ARTIFICIALI – GALLERIA ROVETELLO	Pagina 450 di 452
Relazione di calcolo		

PROGETTO ESECUTIVO

18	15135.9148	-1541.8426
19	14054.7780	-1875.2947
20	12973.6412	-2162.6114
21	11892.5045	-2404.4350
22	10811.3677	-2610.5144
23	9730.2309	-2785.4982
24	8649.0941	-2934.4474
25	7567.9574	-3041.8327
26	6486.8206	-3069.9791
27	5405.6838	-3032.3202
28	4324.5471	-2934.4854
29	3243.4103	-2773.9825
30	2162.2735	-2550.4779
31	0.0000	-1915.2807
32	-4248.5260	0.0000

Verifica sezione cordoli

Simbologia adottata

M_h momento flettente espresso in [kNm] nel piano orizzontale

T_h taglio espresso in [kN] nel piano orizzontale

M_v momento flettente espresso in [kNm] nel piano verticale

T_v taglio espresso in [kN] nel piano verticale

Cordolo N° 1 (X=0.00 m) (Cordolo in c.a.)

$B=1.6000$ [m] $H=1.5000$ [m] $A_{fv}=0.002771$ [mq] $A_{fh}=0.002771$ [mq] Staffe $\phi 0.012/0.2300$

$M_h=289.62$ [kNm] $T_h=579.23$ [kN] $M_v=57.66$ [kNm] $T_v=82.38$ [kN]

$\sigma_c = 0.800$ [N/mmq] $\sigma_f = 55.1$ [N/mmq] $\tau_c = 0.284$ [N/mmq]

Cordolo N° 2 (X=2.50 m) (Cordolo in acciaio)

$A=0.010680$ [mq] $W=0.00089600$ [m³]

$M_h=228.10$ [kNm] $T_h=325.86$ [kN] $M_v=89.03$ [kNm] $T_v=127.19$ [kN]

$\sigma_f = 254.581$ [N/mmq] $\sigma_{id} = 260.008$ [N/mmq] $\tau_f = 30.512$

[N/mmq]

<i>Cod. elab.:</i> 108GA201-GA01-Z-CL-002_C	<i>Titolo:</i> OPERE D'ARTE MAGGIORI- GALLERIE	<i>Data:</i> Ottobre 2011
<i>Nome file:</i> 108GA201-GA01-Z-CL -002_C.docx	ARTIFICIALI – GALLERIA ROVETELLO	<i>Pagina</i> 451 di 452
Relazione di calcolo		

PROGETTO ESECUTIVO

Cordolo N° 3 (X=5.00 m) (Cordolo in acciaio)

$A=0.010680$ [mq] $W=0.00089600$ [m³]

$M_h=239.16$ [kNm] $T_h=341.66$ [kN] $M_v=93.05$ [kNm] $T_v=132.93$ [kN]

$\sigma_f = 266.920$ [N/mmq] $\sigma_{id} = 272.611$ [N/mmq] $\tau_f = 31.990$

[N/mmq]

Cordolo N° 4 (X=7.50 m) (Cordolo in acciaio)

$A=0.010680$ [mq] $W=0.00089600$ [m³]

$M_h=289.62$ [kNm] $T_h=579.23$ [kN] $M_v=6.01$ [kNm] $T_v=8.58$ [kN]

$\sigma_f = 323.232$ [N/mmq] $\sigma_{id} = 336.605$ [N/mmq] $\tau_f = 54.235$

[N/mmq]

<i>Cod. elab.:</i> 108GA201-GA01-Z-CL-002_C	<i>Titolo:</i> OPERE D'ARTE MAGGIORI- GALLERIE	<i>Data:</i> Ottobre 2011
<i>Nome file:</i> 108GA201-GA01-Z-CL -002_C.docx	ARTIFICIALI – GALLERIA ROVETELLO Relazione di calcolo	<i>Pagina</i> 452 di 452