

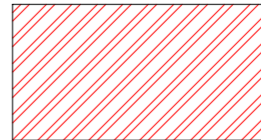

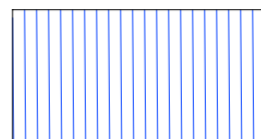



- LEGENDA**
-  FABBRICATI DI NUOVA COSTRUZIONE
 -  FABBRICATI ESISTENTI
 -  PISTA DI VOLO
 -  AREE DI SERVIZIO
 -  FABBRICATI DI FUTURA REALIZZAZIONE
 -  SEZIONI IN SCAVO
 -  INGOMBRO RILEVATI DA REALIZZARE



COMUNE DI COTRONEI
 PROVINCIA DI CROTONE

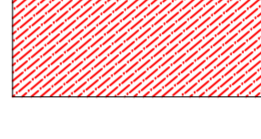

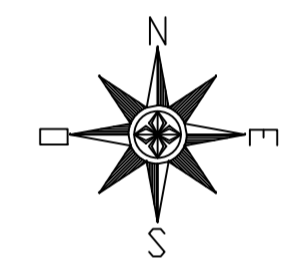
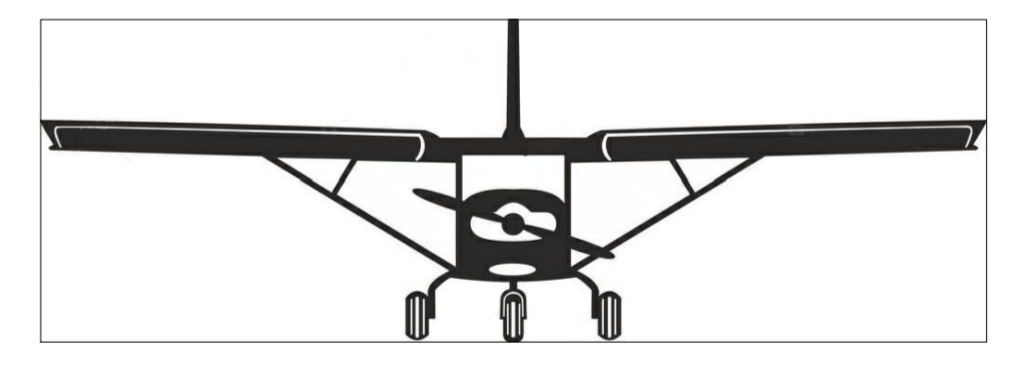
**PROGETTO PER L'AMPLIAMENTO
 DELL'AVIOSUPERFICIE FRANCA**

COD. ELABORATO TAV. 06	TITOLO: PLANIMETRIA GENERALE DI PROGETTO	SCALA:
AMMINISTRATORE DELEGATO PLEGS SRL: Arch. Ing. Giuseppe Antonio BAFFA	COMMITTENTE: Be&B Investments s.r.l.	
DIRETTORE TECNICO PLEGS SRL: Ing. Natale COSTANTINO	PROGETTISTA ARCHITETTONICO: Arch. Giacomino BUONACCORSI	
PROGETTISTA STRUTTURALE:	COLLABORATORE: Dott. Ing. Salvatore DI FALCO	



SOCIETA' DI INGEGNERIA
 PLEGS ENGINEERING AND ARCHITECTURE SRL
 VIA LIBERTA' III TRAVERSA 29 - 88900 CROTONE
 P.I. 03575580794
 PLEGSRL@PEC.IT - PLEGS.SRL@GMAIL.COM

REVISIONE: 0
 SETTEMBRE 2020