

Provincia di Cuneo
S.S. 28 del Colle di Nava
Lavori di realizzazione della Tangenziale di Mondovì con collegamento alla S.S. 28 Dir – 564 e al casello A6 "Torino–Savona" – III Lotto (Variante di Mondovì)



PROGETTO DEFINITIVO

COD. TO08

PROGETTAZIONE: RAGGRUPPAMENTO TEMPORANEO PROGETTISTI	MANDATARIA: 	MANDANTI:  MATILDI+PARTNERS
IL RESPONSABILE DELL'INTEGRAZIONE DELLE PRESTAZIONI SPECIALISTICHE: <i>Ing. Andrea Renso – TECHNITAL Ordine Ingegneri Provincia di Verona n. A2413</i>	IL PROGETTISTA: <i>Ing. Andrea Renso Ordine Ingegneri Verona n. A2413</i>	GRUPPO DI PROGETTAZIONE: COORDINAMENTO PROGETTAZIONE E PROGETTAZIONE STRADALE: <i>Ing. Carlo Vittorio Matildi – MATILDI + PARTNERS Ordine Ingegneri Provincia di Bologna n. 6457/A</i> COORDINAMENTO PROGETTAZIONE E COORDINATORE STUDIO DI IMPATTO AMBIENTALE: <i>Ing. Edoardo Piccoli – TECHNITAL Ordine Ingegneri Provincia di Verona n. A3381</i> OPERE D'ARTE MAGGIORI GALLERIA: <i>Ing. Corrado Pesce – TECHNITAL Ordine Ingegneri Provincia di Verona n. A1984</i> OPERE D'ARTE MAGGIORI PONTI E MINORI: <i>Ing. Stefano Isani – MATILDI + PARTNERS Ordine Ingegneri Provincia di Bologna n. A4550</i> GEOTECNICA: <i>Ing. Alessandro Rizzo – TECHNITAL Ordine Ingegneri Provincia di Milano n. A19598</i> IDROLOGIA ED IDRAULICA: <i>Ing. Simone Venturini – TECHNITAL Ordine Ingegneri Provincia di Verona n. A2515</i>
IL GEOLOGO: <i>Geol. Emanuele Fresia – TECHNITAL Ordine Geologi Veneto n. A501</i>	IL COORDINATORE PER LA SICUREZZA IN FASE DI PROGETTAZIONE: <i>Ing. Paolo Barrasso – MATILDI + PARTNERS Ordine Ingegneri Provincia di Bologna n. A9513</i>	
VISTO: IL RESP. DEL PROCEDIMENTO: <i>Ing. Giuseppe Danilo Malgeri</i>		
PROTOCOLLO:	DATA:	

19 – IMPIANTI TECNOLOGICI

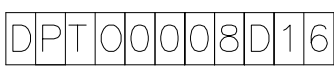
Calcoli illuminotecnici

CODICE PROGETTO 	NOME FILE 19.04_P00_IM00_IMP_RE04_D	PROGR. ELAB. 19.04	REV.	SCALA:		
	CODICE ELAB. 			–		
D	ISTRUTTORIE CSLLPP e VIA	Apr. 2021	Technital	Ampezzan	Piccoli	Renso
REV.	DESCRIZIONE	DATA	SOCIETA'	REDATTO	VERIFICATO	APPROVATO

SOMMARIO

1	PREMESSA.....	1
1.1	Oggetto del documento	1
1.2	Note relative a marchi commerciali	1
1.3	Software di calcolo	1
2	RIEPILOGO DATI DI CALCOLO GALLERIE NATURALE ED ARTIFICIALE	2
3	RIEPILOGO DATI DI CALCOLO VIABILITA' ALL'APERTO.....	3
4	CALCOLI ILLUMINOTECNICI.	4

1 PREMESSA

1.1 Oggetto del documento

Oggetto della presente relazione, allegata alla documentazione di Progetto, è la reportistica dei calcoli illuminotecnici dei nuovi impianti di illuminazione a LED a servizio della galleria Naturale ed artificiale e della viabilità all'aperto della nuova Tangenziale di Mondovì.

1.2 Note relative a marchi commerciali

Le indicazioni di tipi e marche commerciali indicate nel presente documento e nei relativi allegati di calcolo sono da intendersi come dichiarazione di caratteristiche tecniche e come tali non sono vincolanti.

Sono state definite tali tipologie al solo scopo di sviluppo dei calcoli di progetto, al fine di garantire il rispetto e la verifica delle prescrizioni tecniche applicabili all'impianto in oggetto.

1.3 Software di calcolo

Per lo sviluppo dei calcoli illuminotecnici di progetto si sono utilizzati i seguenti software commerciali:

- Galleria naturale S. Lorenzo: LITESTAR di OxyTech s.r.l.
- Cunicolo di fuga: DIALUX EVO
- Galleria artificiale: LITESTAR di OxyTech s.r.l.
- Viabilità esterna: DIALUX EVO

2 RIEPILOGO DATI DI CALCOLO GALLERIE NATURALE ED ARTIFICIALE

Di seguito si riportano i dati di input relativi ai calcoli delle gallerie in oggetto.

I valori illuminotecnici ottenuti con i calcoli allegati sono rispondenti alle normative vigenti ed agli specifici parametri di progetto, riportati nella presente relazione.

I dati di base sono i seguenti:

Scheda galleria Naturale Mondovì

Comune di Mondovì (CN)

Lunghezza galleria:	1412 m bidirezionale
Categoria stradale:	C1 Extraurbana principale
Velocità:	100 km/h
Distanza di arresto:	110 m da imbocco (p=+1,05%)
Categoria illuminotecnica:	M2 - 1,5 cd/mq
Tipologia galleria:	bidirezionale, 1 corsia per senso di marcia
Luminanza interna galleria:	1,5 cd/mq x 2= 3 cd/mq

Ubicazione: <https://goo.gl/maps/55Ur4sAiZv5m1c8j7>

Scheda galleria Artificiale Mondovì

Comune di Mondovì (CN)

Lunghezza galleria:	150 m bidirezionale
Categoria stradale:	C1 Extraurbana principale
Velocità:	100 km/h
Distanza di arresto:	112 m da imbocco (p=3,49%)
Categoria illuminotecnica:	M2 - 1,5 cd/mq
Tipologia galleria:	bidirezionale, 1 corsia per senso di marcia
Luminanza interna galleria:	1,5 cd/mq x 2= 3 cd/mq

La distribuzione dei corpi illuminanti è stata sviluppata su due file, agganciati alle canaline di galleria.

3 RIEPILOGO DATI DI CALCOLO VIABILITA' ALL'APERTO.

Di seguito si riportano i dati di input relativi ai calcoli della viabilità in oggetto.

I valori illuminotecnici ottenuti con i calcoli allegati sono rispondenti alle normative vigenti ed agli specifici parametri di progetto, riportati nella presente relazione.

Classe	Luminanza della carreggiata			Abbagliamento debilitante	Illuminazione di contiguità
	L (cd/m ²)	U0	UL	f _{T1}	REI
Viabilità M2	1,5	0,4	0,7	10	0,35
Rotatorie C1	30 lux	0.40	-	-	-

4 CALCOLI ILLUMINOTECNICI.

Nelle pagine che seguono sono riportati i report dei calcoli illuminotecnici, con il seguente ordine:

1. Calcolo illuminotecnico galleria naturale S. Lorenzo;
2. Calcolo illuminotecnico galleria artificiale L=150 m;
3. Calcolo illuminotecnico viabilità esterna.

1. Calcolo illuminotecnico galleria naturale

Galleria naturale Mondovì

Note Installazione: Permanente

Codice Progetto: 20-061-A00

Note
Li = 3 cd/mq

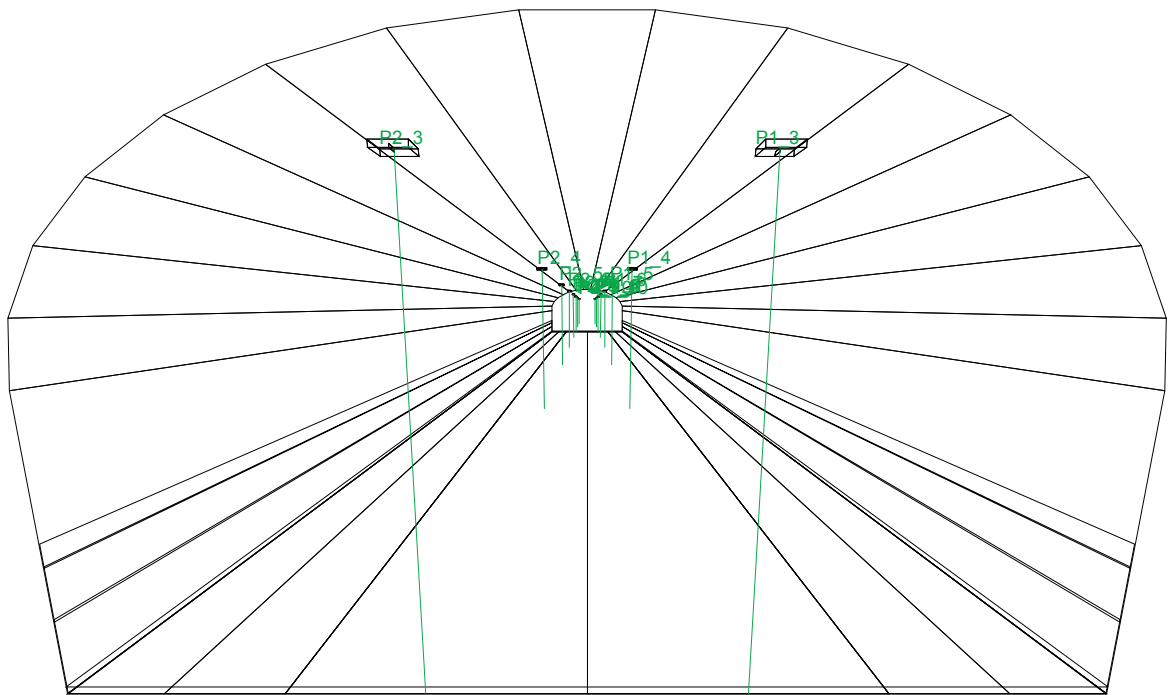

1.1 Informazioni Area

Dati Strada

Zona	Tipo Zona	Corsia	Senso di marcia	Larghezza [m] (W)	y1 [m]	y2 [m]	Pt.Calc.Y (E)	Pt.Calc.Y (L)	Alt. Zona [m] (HC)	Colore	Tabella R	Coeff.Rif. Fattore q0
Marc_dx	Pista Ciclo/Pedonale			2.70	0.00	2.70	3		0.00	RGB=219,54,36		30.00
		Marc_dx	--->	1.20	0.00	1.20		3				
		banchina_dx	--->	1.50	1.20	2.70		3				
Carreggiata Carrabile				7.50	2.70	10.20	5		0.00	RGB=126,126,126	C2	5.60
		Corsia1	--->	3.75	2.70	6.45		3				
		Corsia2	<---	3.75	6.45	10.20		3				
Marc_sx	Pista Ciclo/Pedonale			2.70	10.20	12.90	3		0.00	RGB=219,54,36		30.00
		banchina_sx	--->	1.50	10.20	11.70		3				
		Marc_sx	--->	1.20	11.70	12.90		3				

Dati Installazione Apparecchi

Nome Fila	1° Palo x [m] (XP)	1° Palo y [m] (YP)	Altez.App. [m] (H)	Num. Pali	Interd. [m] (D)	Sbraccio [m] (L)	Ang.Incl. [°] (RY)	Rot.Sbraccio [°] (RZ)	Ang.Incl.Lat. [°] (RX)	Fatt.Manut. [%]	Codice Apparecchio	Flusso [lm]	Rif.
P1	-26.00	4.45	6.40	10	13.00	0.00	0	90	0	80.00	PetV2-48	7100	A
P2	-26.00	8.45	6.40	10	13.00	0.00	0	270	0	80.00	PetV2-48	7100	A

1.2 Calcolo Energetico (Suolo)

Area	487.50 m2
Illuminamento Medio	63.67 lx
Potenza Specifica	2.05 W/m2
Potenza Specifica Illuminotecnica	3.22 W/(m2 * 100lx)
Efficienza Energetica	31.04 (m2*lx)/W
Potenza Totale Utilizzata	1000.00 W

1.3 Parametri di Qualità dell'Impianto

Riepilogo Risultati

Zona	Osservatore	Corsia	Ti	UI	LAv	Uo
Carreggiata			Ti=5.03	0.84	3.22	0.74
	1) (x=-60.00 y=4.58)m	Corsia1		0.84	3.22 *	0.74
	2) (x=125.00 y=8.32)m	Corsia2		0.84 *	3.22	0.74 *
	(x=-39.48 y=4.58)m		Ti=5.02			
	(x=52.48 y=8.32)m		Ti=5.03 *			
Lv=0.24						

Norma

CEN 13201

Inquinamento Luminoso

Rapporto Medio - Rn -

0.00 %

2.1 Vista 2D in Pianta

Scala 1/500

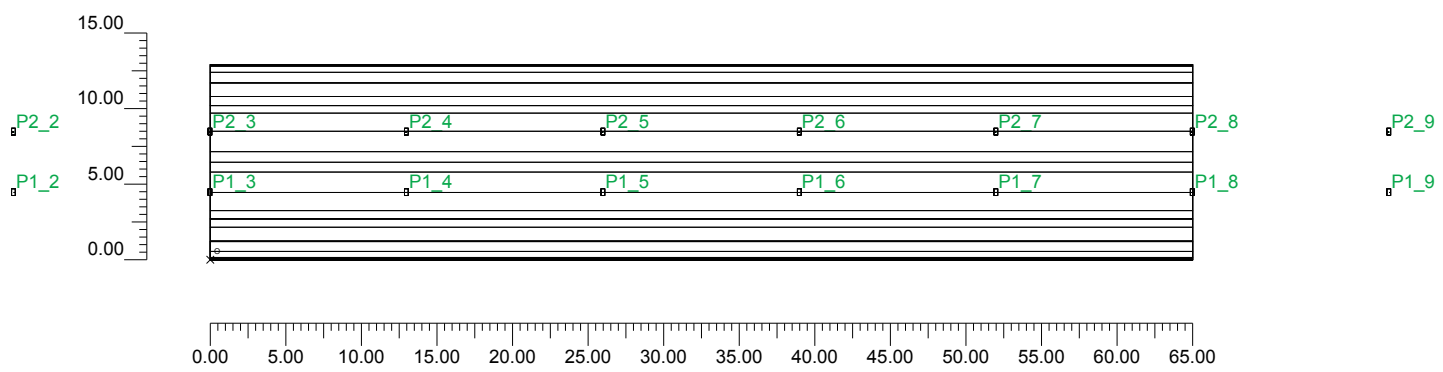

2.2 Vista Laterale

Scala 1/90

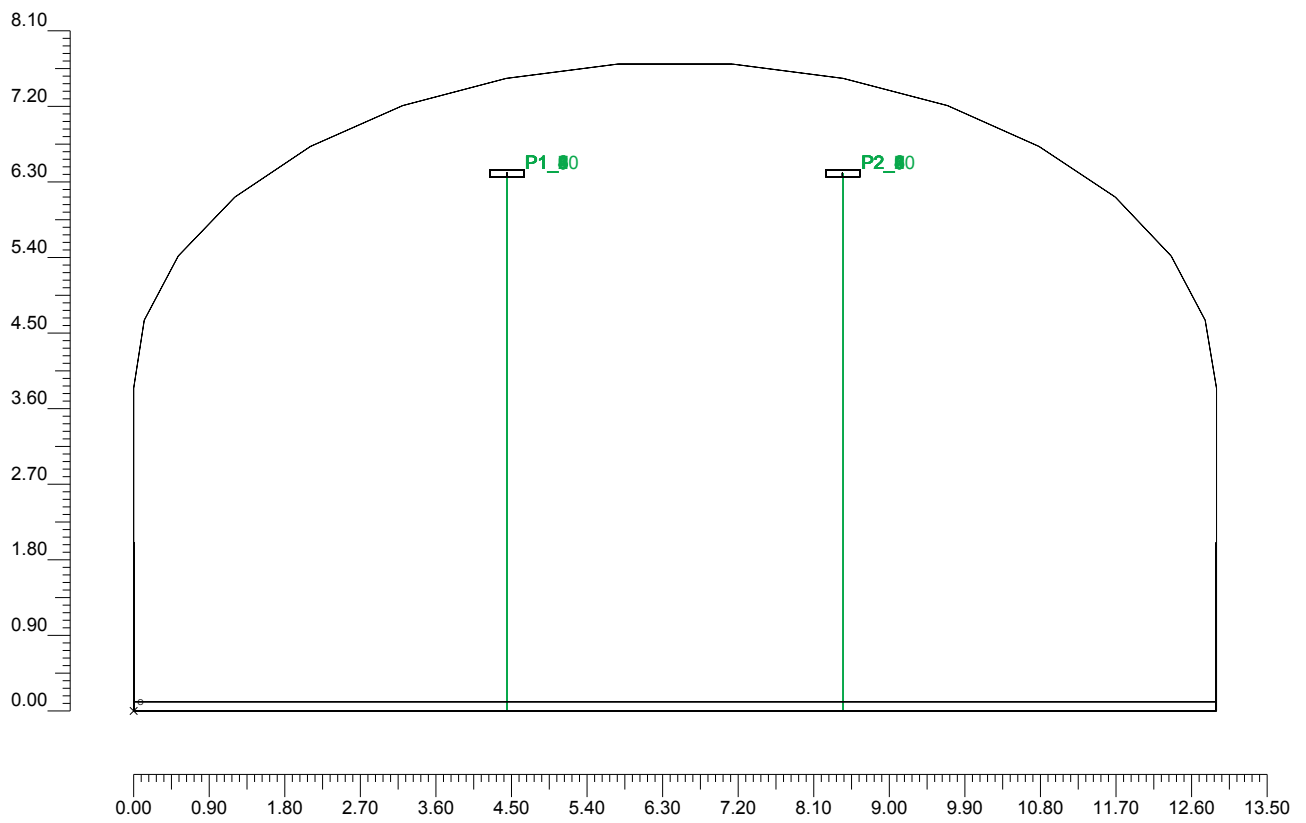

3.1 Informazioni Apparecchi/Rilievi

Rif.	Linea	Nome Apparecchio (Nome Rilievo)	Codice Apparecchio (Codice rilievo)	Apparecchi n.	Rif.Lamp.	Lampade n.
A	Arianna Petrarca	PetV2-48 (PetV2-48)	PetV2-48 (PetV2-48)	20	LMP-A	1

3.2 Informazioni Lampade

Rif.Lamp.	Tipo	Codice	Flusso lm	Potenza W	Colore K	n.
LMP-A	LED	PetrarcaTunnel 7100	7100	50	4000	-

4.1 Valori delle Luminanze su: Carreggiata_oss1 Oss. 1(x=-60.00;y=4.58;z=1.50)m

O (x:0.00 y:2.70 z:0.00)	Risultati	Medio	Minimo	Massimo	Min/Medio	Min/Max	Medio/Max
DX:2.95 DY:1.25	Luminanza (L)	3.22 cd/m ²	2.39 cd/m ²	4.04 cd/m ²	0.74	0.59	0.80

Tipo Calcolo Dir.+Indir.(1 Interriflessioni) + Arredi

Nome Corsia	Largh. Corsia [m] (W)	y1 [m]	y2 [m]	Pt.Calc.Y	Tabella R	Coeff.Rifl. Fattore q0	Osservatore x Assoluto [m]	Osservatore y Assoluto [m]	Luminanza Velante [cd/m ²]	Incremento di Soglia [%]	Uniformità Longitudinale
Corsia1	3.75	2.70	6.45	3	C2	5.60	-60.00	4.58	0.24	5.02	0.84
Corsia2	3.75	6.45	10.20	3	C2	5.60	-60.00	4.58	0.24	---	---

Norma CEN 13201

4.1 Valori delle Luminanze su: Carreggiata_oss1 Oss. 1(x=-60.00;y=4.58;z=1.50)m

Scala 1/500

Totale Parti: 2

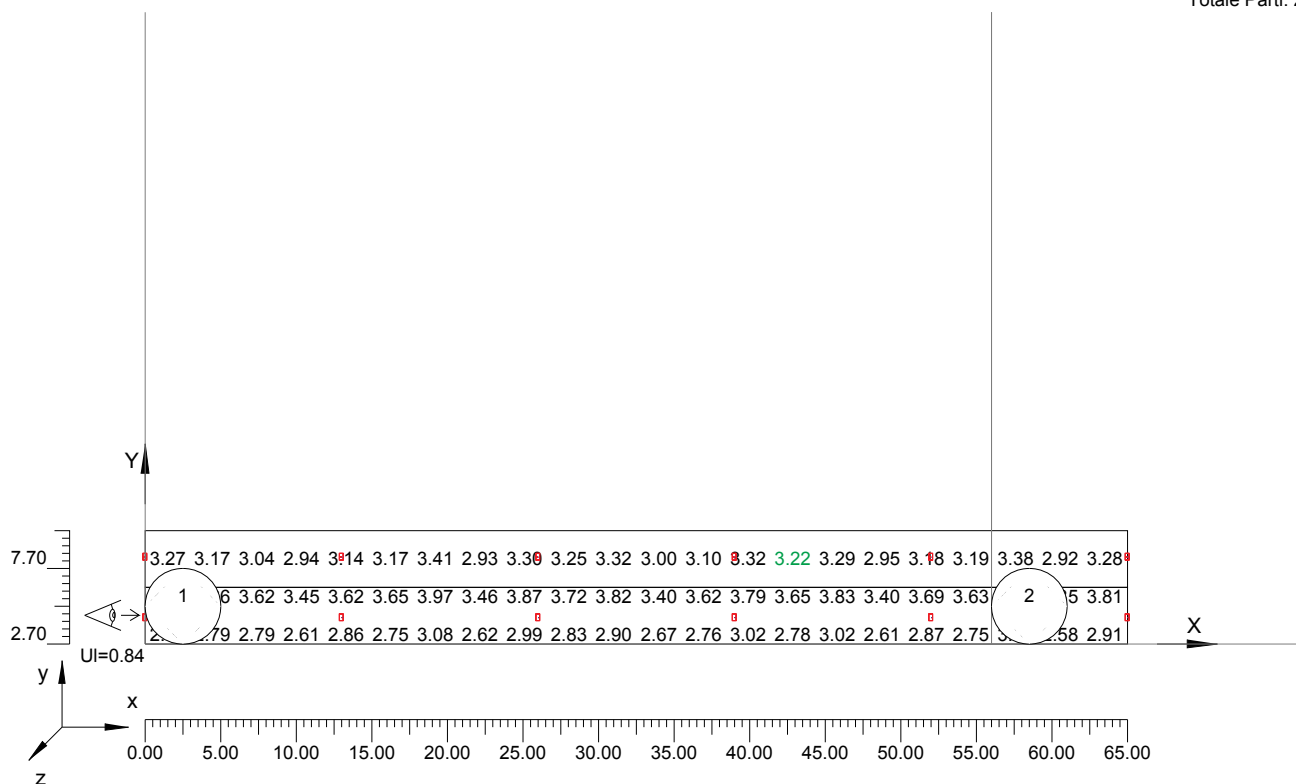

4.1 Valori delle Luminanze su: Carreggiata_oss1 Oss. 1(x=-60.00;y=4.58;z=1.50)m

Scala 1/387

Parte 1 di 2

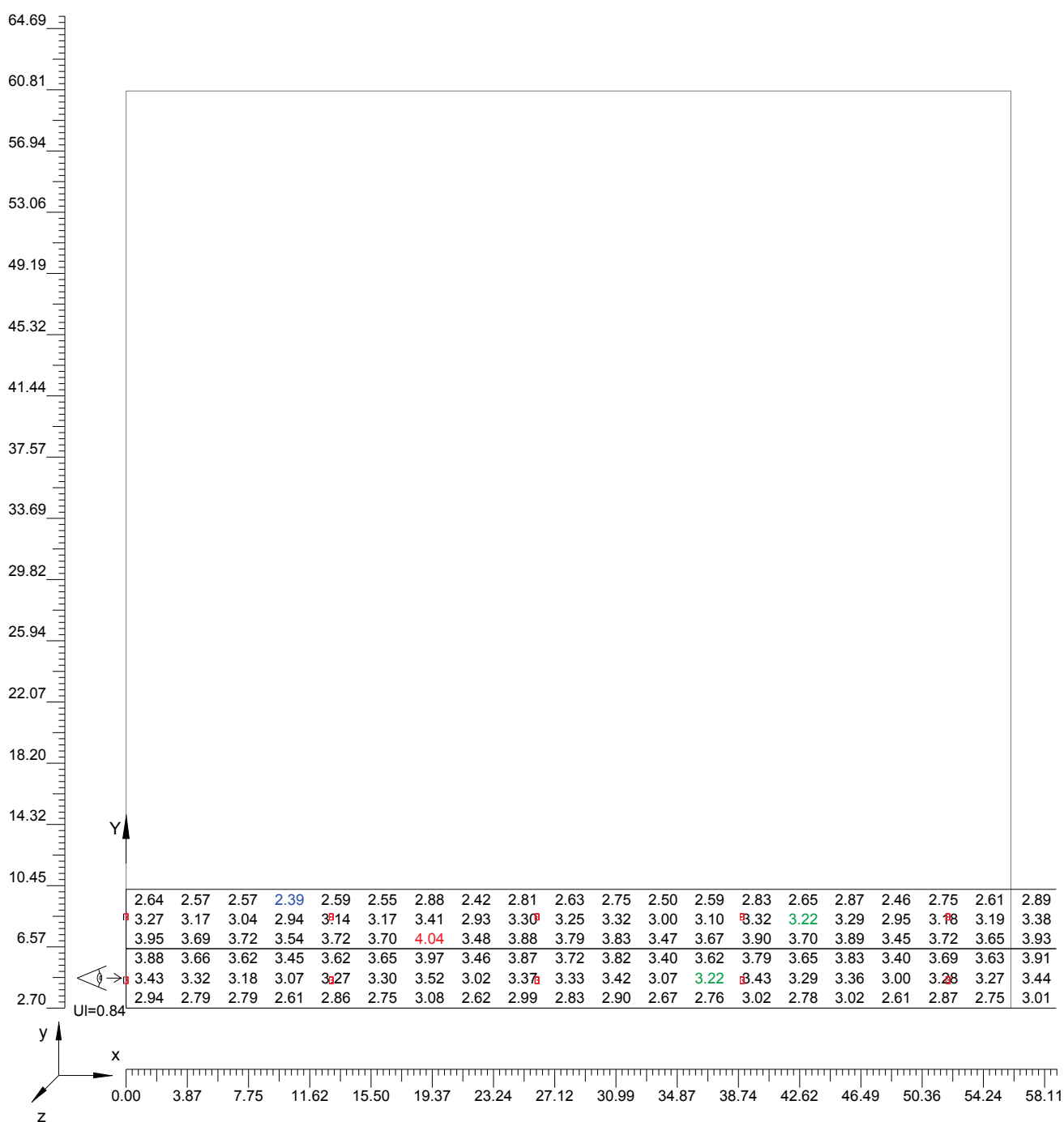

4.1 Valori delle Luminanze su: Carreggiata_oss1 Oss. 1(x=-60.00;y=4.58;z=1.50)m

Scala 1/387

Parte 2 di 2

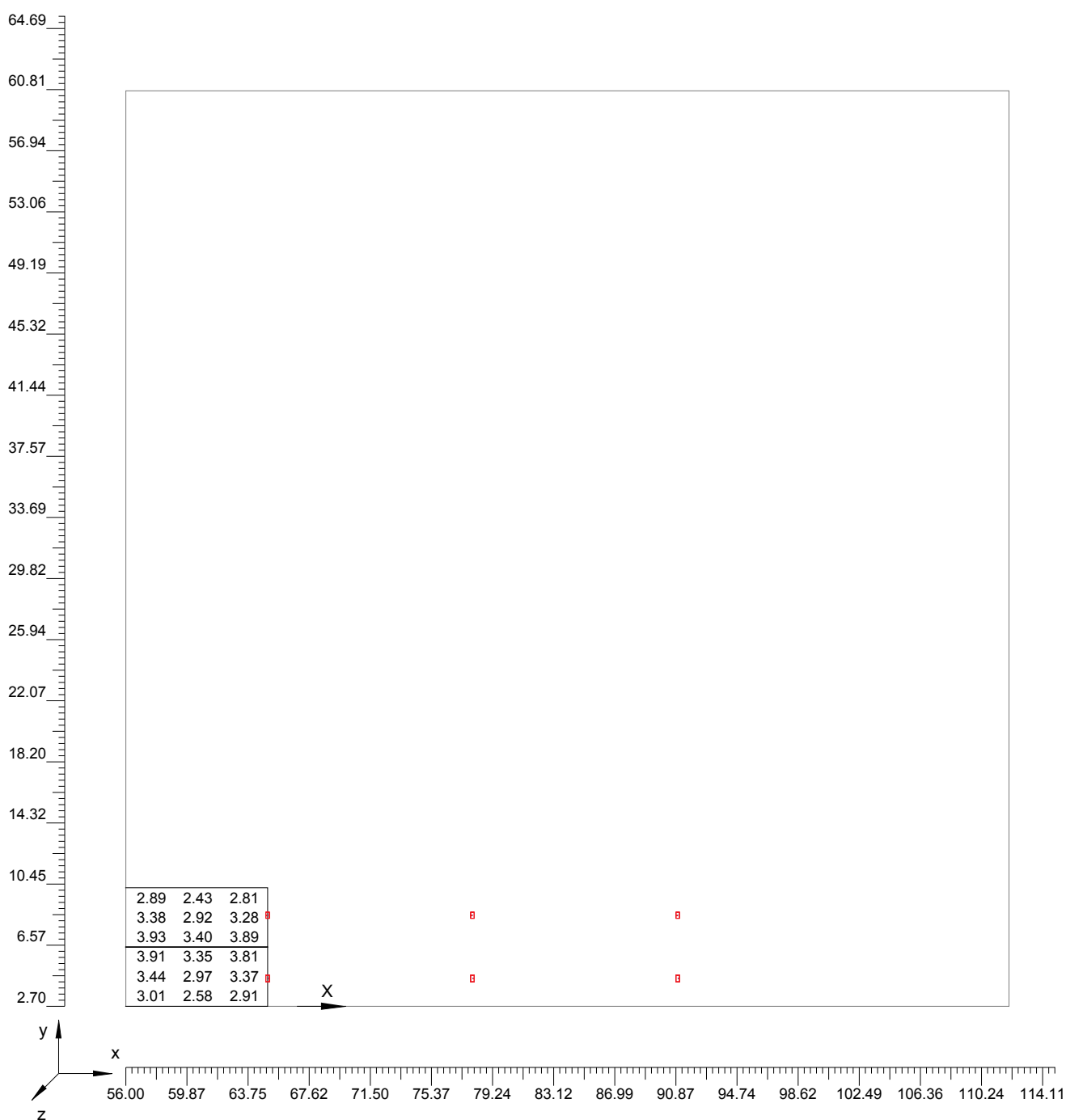

4.2 Valori delle Luminanze su: Carreggiata_oss2 Oss. 2(x=125.00;y=8.32;z=1.50)m

O (x:0.00 y:2.70 z:0.00)	Risultati	Medio	Minimo	Massimo	Min/Medio	Min/Max	Medio/Max
DX:2.95 DY:1.25	Luminanza (L)	3.22 cd/m ²	2.39 cd/m ²	4.04 cd/m ²	0.74	0.59	0.80

Tipo Calcolo

Dir.+Indir.(1 Interriflessioni) + Arredi

Nome Corsia	Largh. Corsia [m] (W)	y1 [m]	y2 [m]	Pt.Calc.Y	Tabella R	Coeff.Rifl. Fattore q0	Osservatore x Assoluto [m]	Osservatore y Assoluto [m]	Luminanza Velante [cd/m ²]	Incremento di Soglia [%]	Uniformità Longitudinale
Corsia1	3.75	2.70	6.45	3	C2	5.60	125.00	8.32	0.24	---	---
Corsia2	3.75	6.45	10.20	3	C2	5.60	125.00	8.32	0.24	5.03	0.84 *

Norma

CEN 13201

4.2
Scala 1/500

4.2 Valori delle Luminanze su: Carreggiata_oss2 Oss. 2(x=125.00;y=8.32;z=1.50)m

Totale Parti: 2

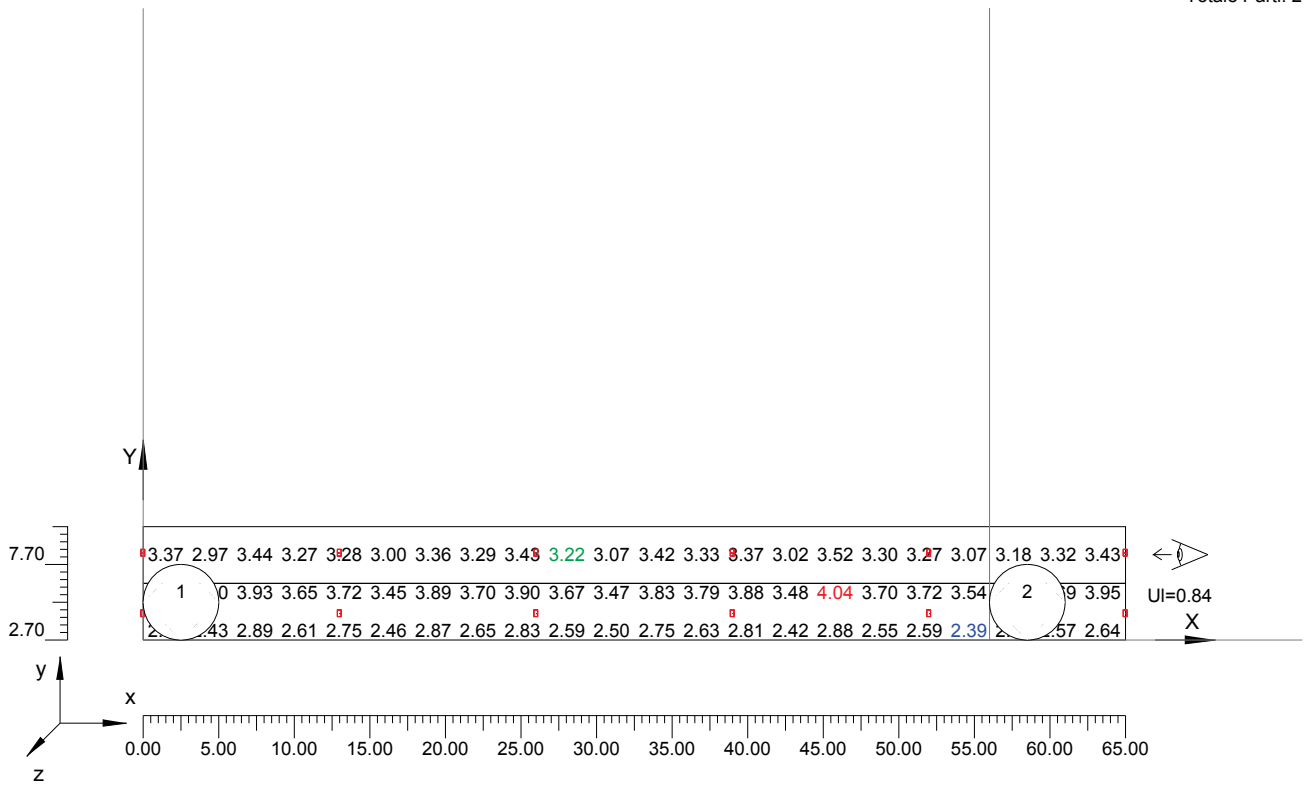

4.2 Valori delle Luminanze su: Carreggiata_oss2 Oss. 2(x=125.00;y=8.32;z=1.50)m

Scala 1/387

Parte 1 di 2

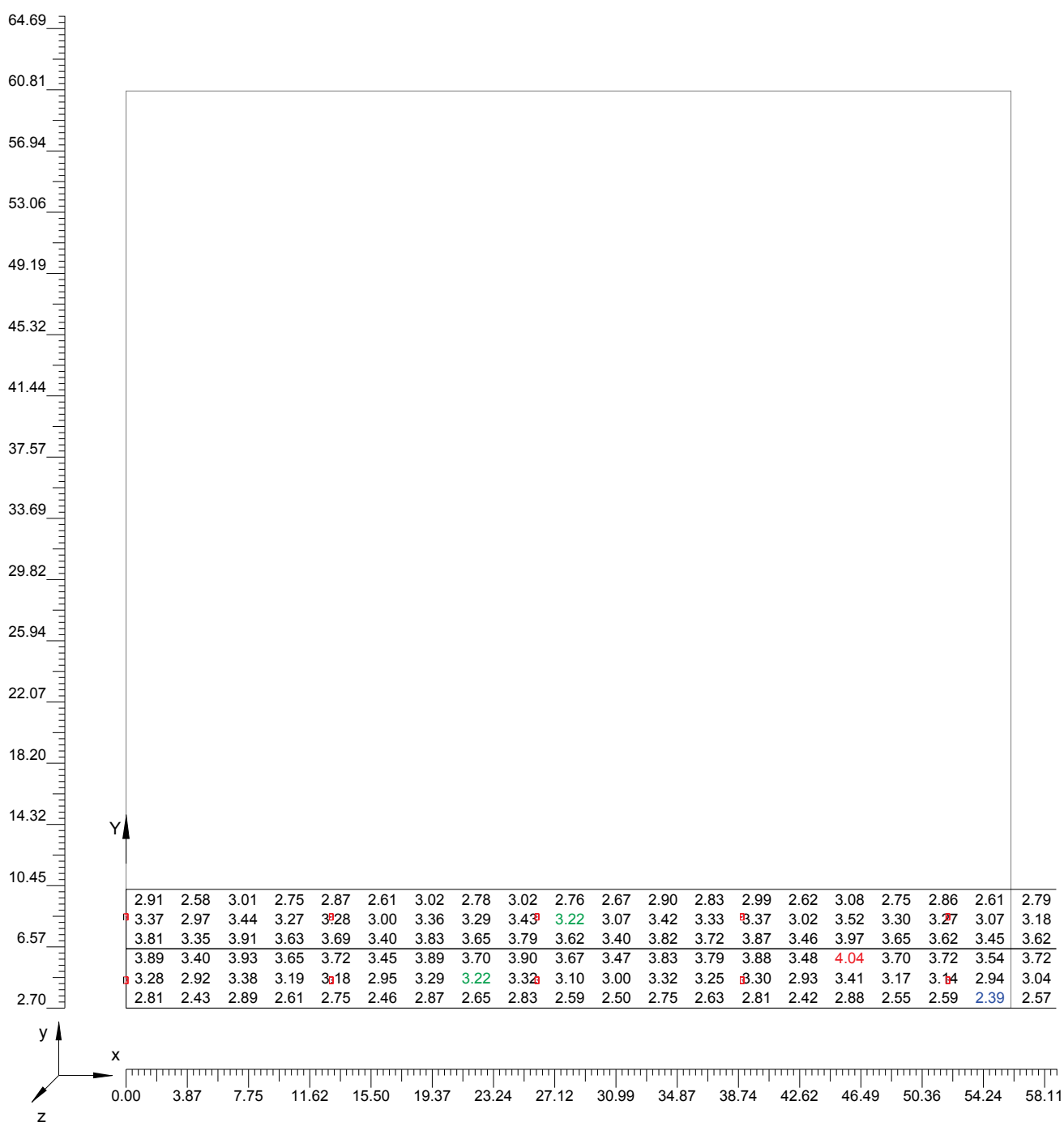

4.2 Valori delle Luminanze su: Carreggiata_oss2 Oss. 2(x=125.00;y=8.32;z=1.50)m

Scala 1/387

Parte 2 di 2

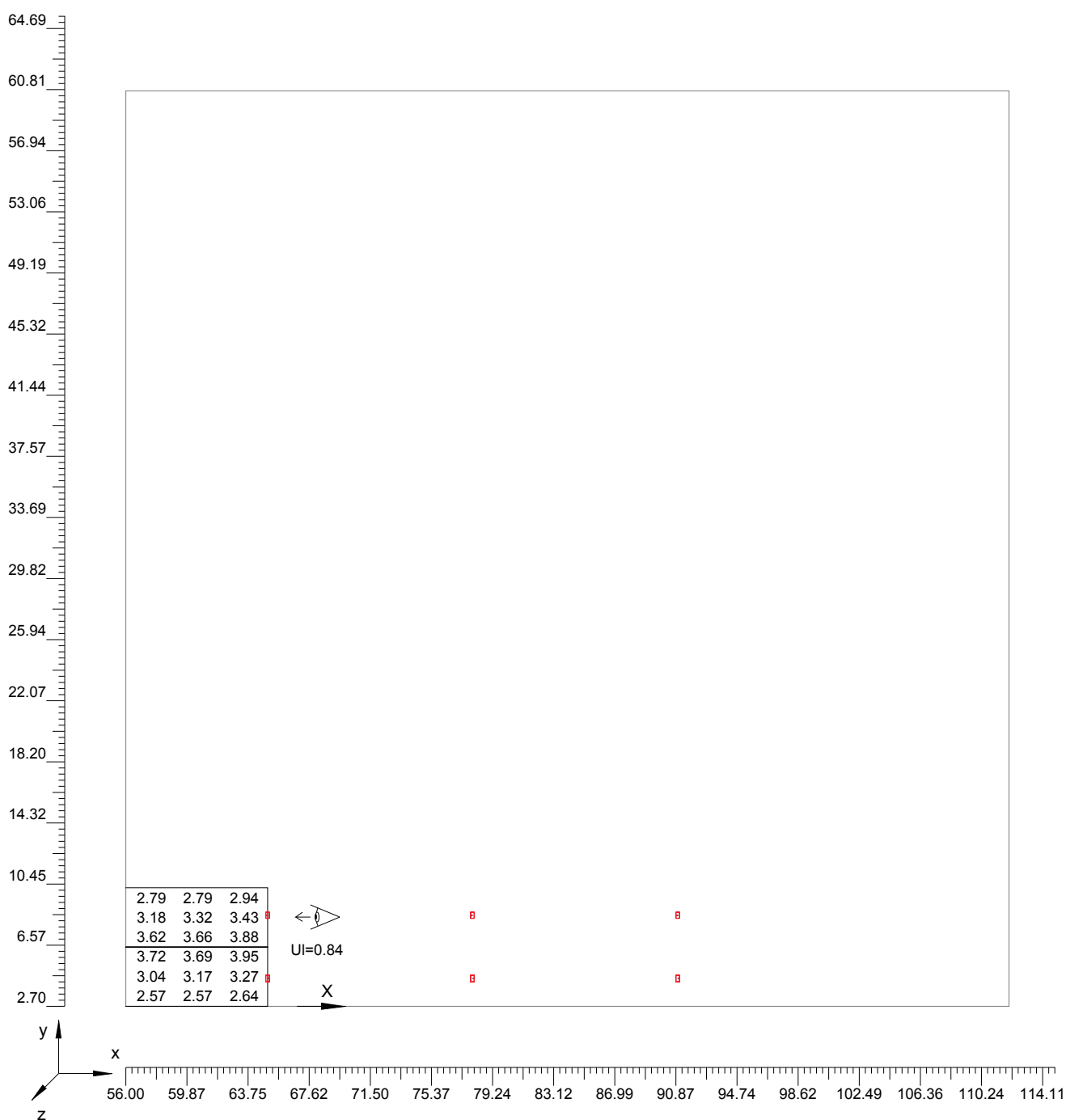

4.3 Valori delle Luminanze su: Parete_Destra (x=-60.00;y=4.58;z=1.50)m ---> (x=30.00;y=4.58;z=0.00)m

O (x:0.00 y:0.01 z:0.00)	Risultati	Medio	Minimo	Massimo	Min/Medio	Min/Max	Medio/Max
DX:2.95 DY:0.70	Luminanza (L)	3.97 cd/m ²	3.46 cd/m ²	4.93 cd/m ²	0.87	0.70	0.81

Tipo Calcolo

Dir.+Indir.(1 Interriflessioni) + Arredi

Scala 1/500

4.3 Valori delle Luminanze su: Parete_Destra (x=-60.00;y=4.58;z=1.50)m ---> (x=30.00;y=4.58;z=0.00)m

Totale Parti: 2

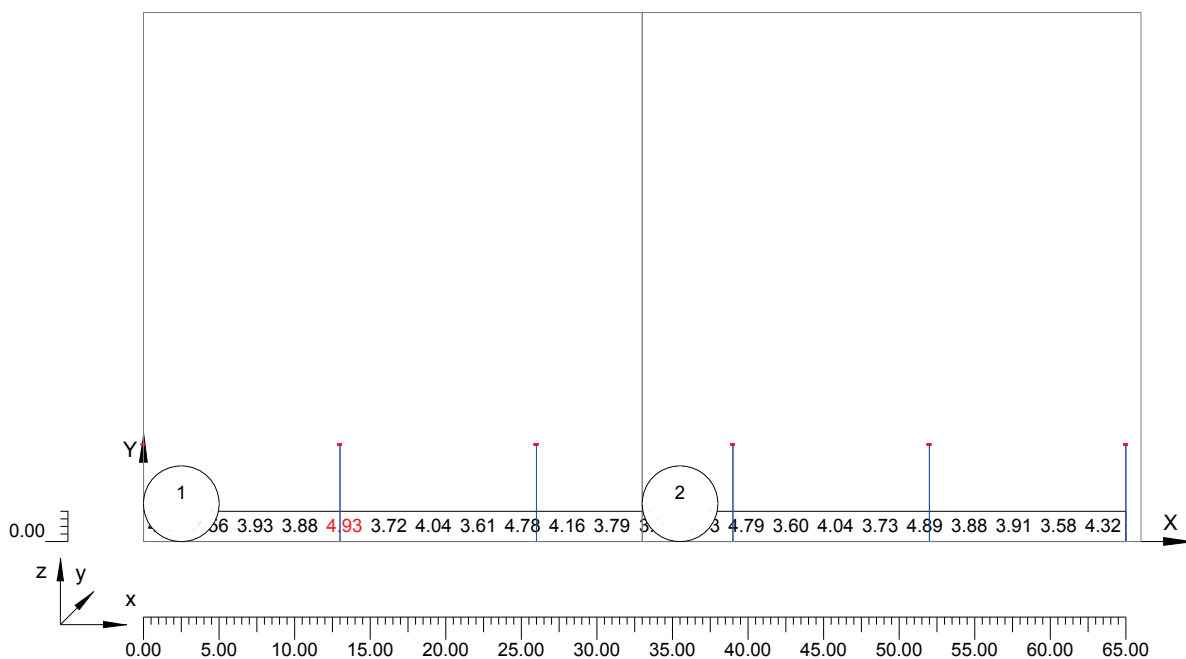

4.3 Valori delle Luminanze su: Parete_Destra (x=-60.00;y=4.58;z=1.50)m ---> (x=30.00;y=4.58;z=0.00)m

Scala 1/230

Parte 1 di 2

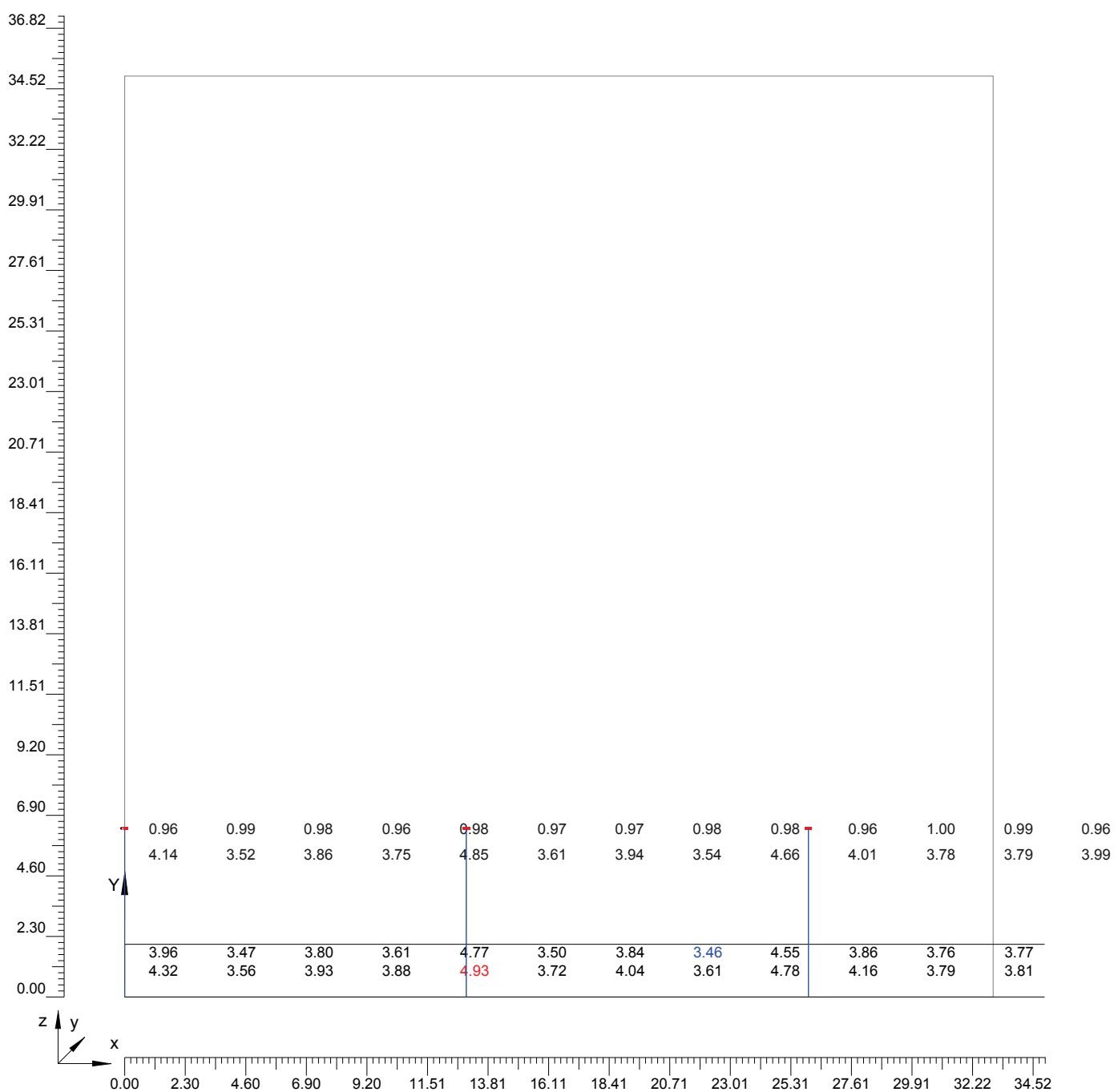

4.3 Valori delle Luminanze su: Parete_Destra (x=-60.00;y=4.58;z=1.50)m ---> (x=30.00;y=4.58;z=0.00)m

Scala 1/230

Parte 2 di 2

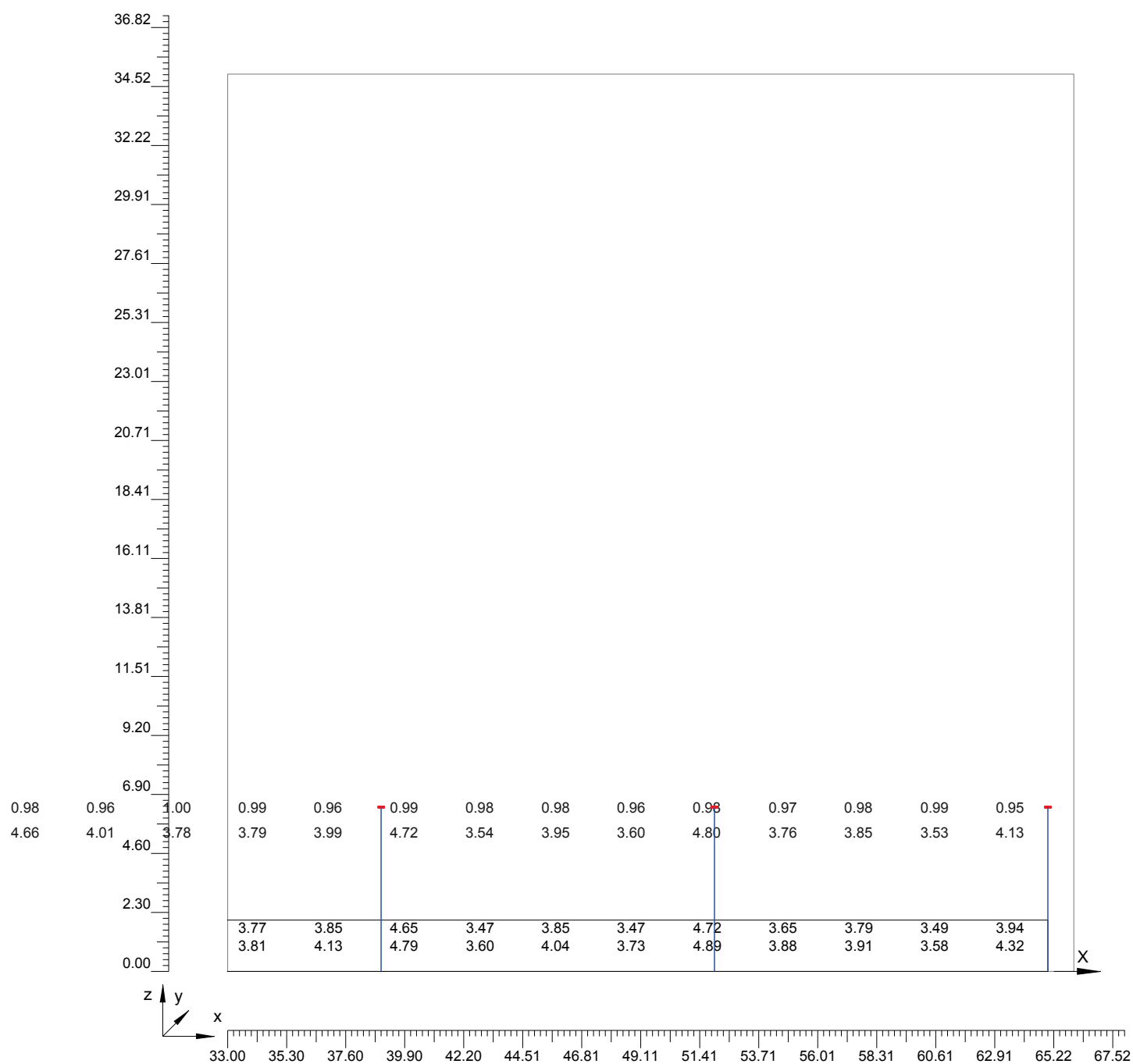

4.4 Valori delle Luminanze su: Striscia_Destra_1_7m (x=-60.00;y=4.58;z=1.50)m ---> (x=30.00;y=4.58;z=0.0

O (x:65.00 y:0.01 z:1.69)	Risultati	Medio	Minimo	Massimo	Min/Medio	Min/Max	Medio/Max
DX:0.02 DY:2.95	Luminanza (L)	3.88 cd/m ²	3.46 cd/m ²	4.77 cd/m ²	0.89	0.73	0.81

Tipo Calcolo

Dir.+Indir.(1 Interriflessioni) + Arredi

Scala 1/500

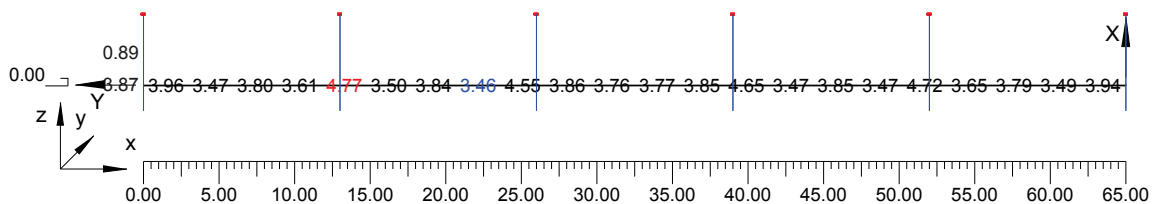

4.5 Valori delle Luminanze su: Parete_Sinistra (x=-60.00;y=4.58;z=1.50)m ---> (x=30.00;y=4.58;z=0.00)m

O (x:0.00 y:12.89 z:0.00)	Risultati	Medio	Minimo	Massimo	Min/Medio	Min/Max	Medio/Max
DX:2.95 DY:0.70	Luminanza (L)	3.97 cd/m ²	3.46 cd/m ²	4.93 cd/m ²	0.87	0.70	0.81

Tipo Calcolo

Dir.+Indir.(1 Interriflessioni) + Arredi

Scala 1/500

4.5 Valori delle Luminanze su: Parete_Sinistra (x=-60.00;y=4.58;z=1.50)m ---> (x=30.00;y=4.58;z=0.00)m

Totale Parti: 2

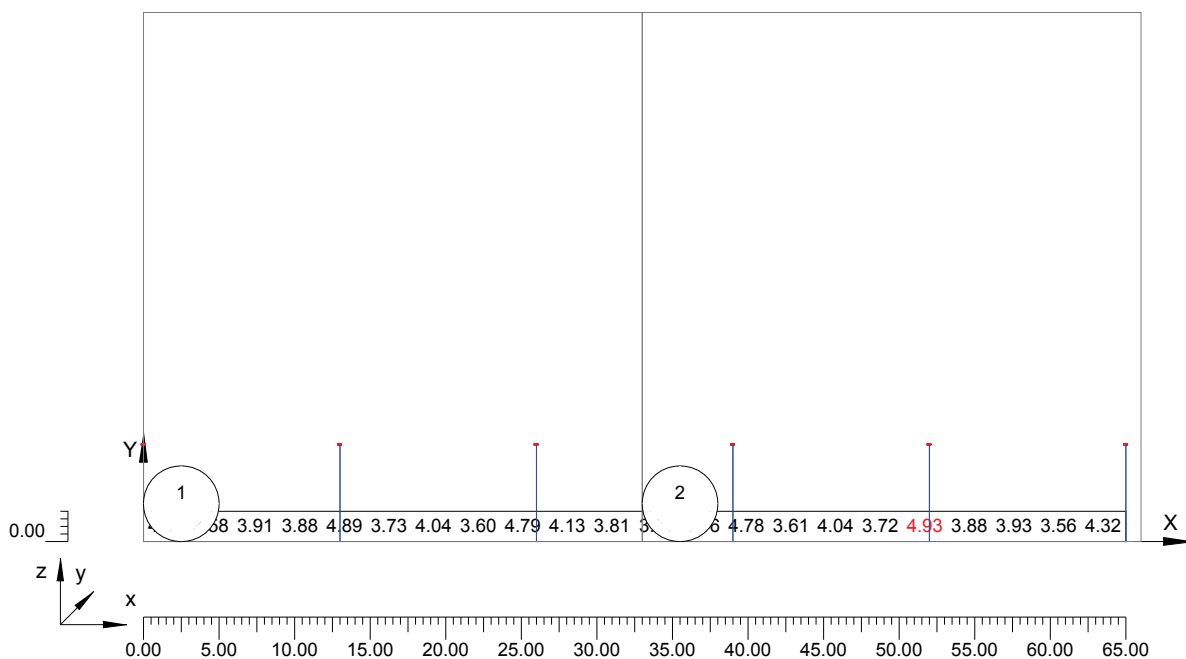

4.5 Valori delle Luminanze su: Parete_Sinistra (x=-60.00;y=4.58;z=1.50)m ---> (x=30.00;y=4.58;z=0.00)m

Scala 1/230

Parte 1 di 2

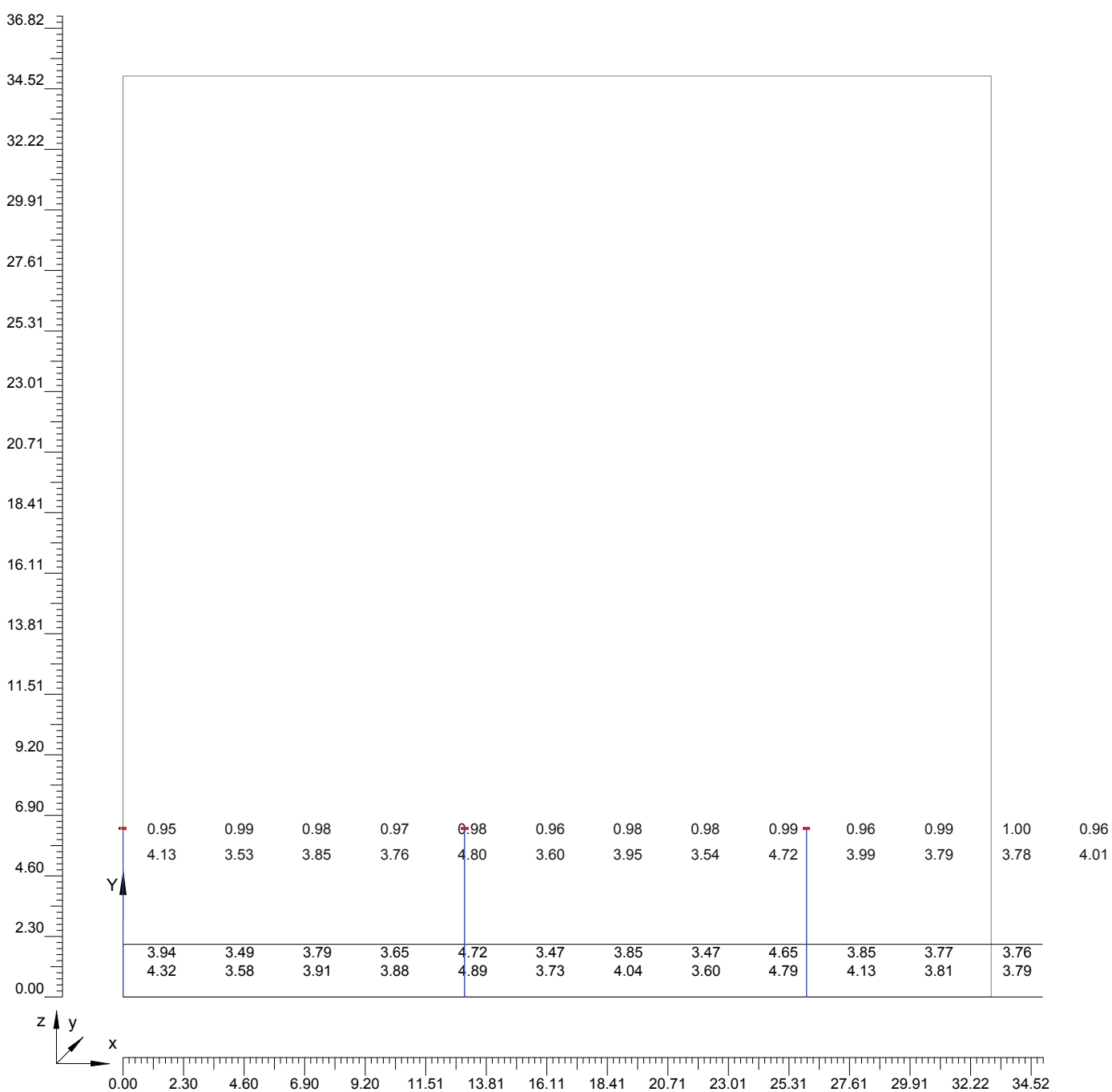

4.5 Valori delle Luminanze su: Parete_Sinistra (x=-60.00;y=4.58;z=1.50)m ---> (x=30.00;y=4.58;z=0.00)m

Scala 1/230

Parte 2 di 2

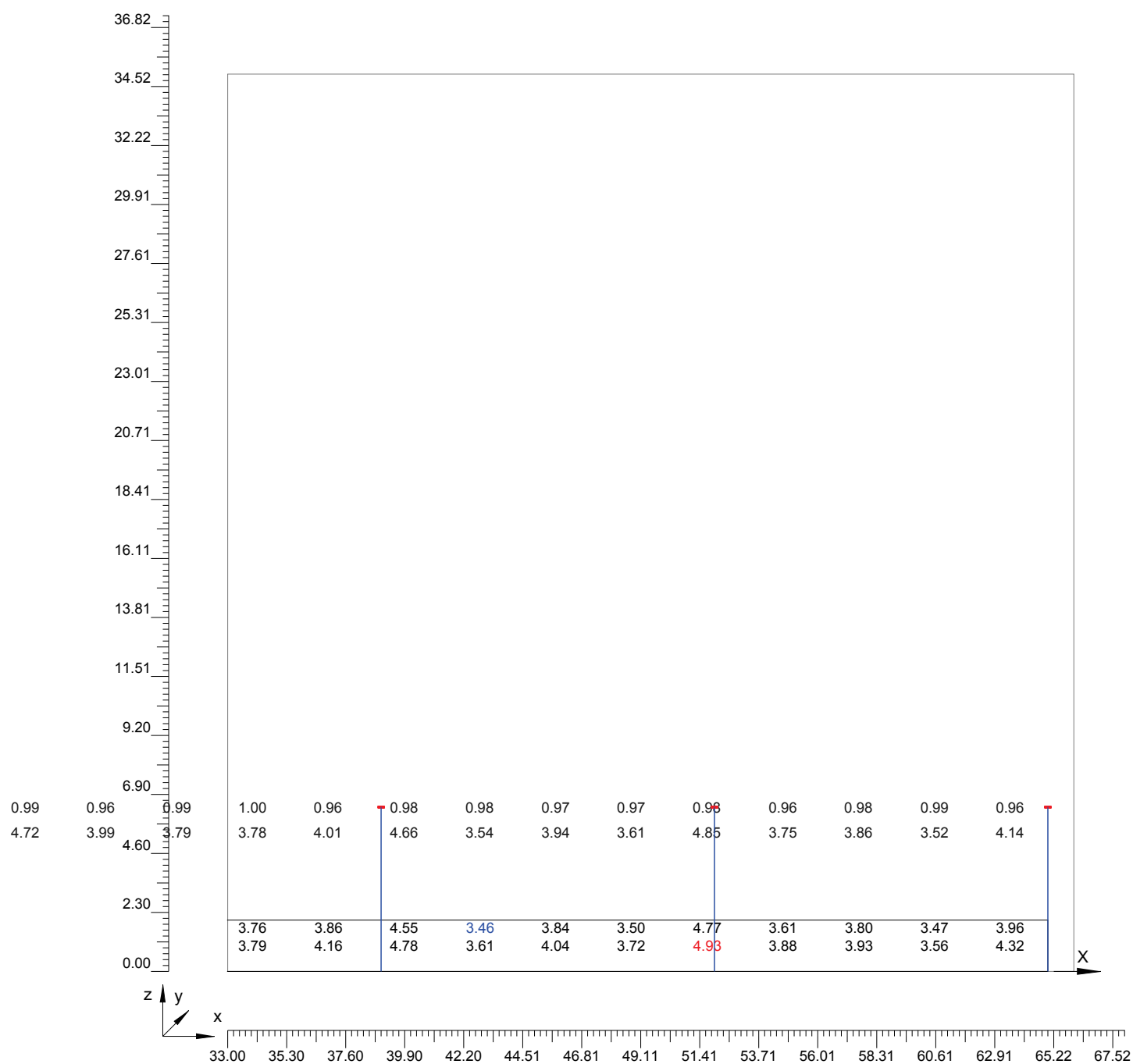

4.6 Valori delle Luminanze su: Striscia_Sinistra_1_7m (x=-60.00;y=4.58;z=1.50)m ---> (x=30.00;y=4.58;z=0

O (x:0.00 y:12.89 z:1.69)	Risultati	Medio	Minimo	Massimo	Min/Medio	Min/Max	Medio/Max
DX:2.95 DY:0.02	Luminanza (L)	3.88 cd/m ²	3.46 cd/m ²	4.77 cd/m ²	0.89	0.73	0.81

Tipo Calcolo

Dir.+Indir.(1 Interriflessioni) + Arredi

Scala 1/500

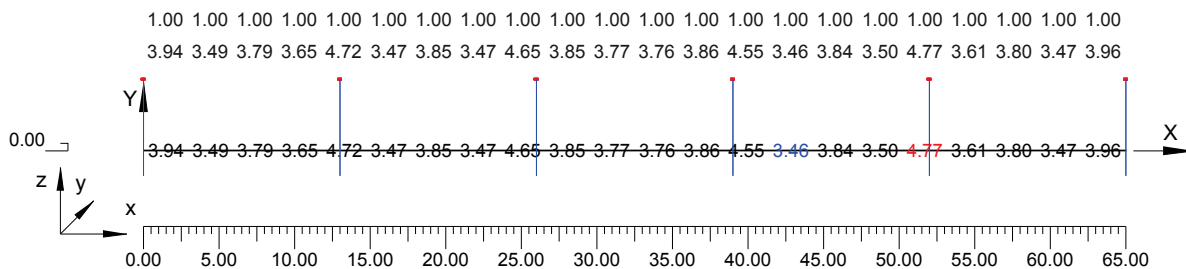

4.7 Valori di Illuminamento su: Carreggiata_LUX

O (x:0.00 y:2.70 z:0.00)	Risultati	Medio	Minimo	Massimo	Min/Medio	Min/Max	Medio/Max
DX:2.95 DY:1.25	Illuminamento Orizzontale (E)	64 lux	49 lux	88 lux	0.77	0.56	0.72

Tipo Calcolo

Dir.+Indir.(1 Interriflessioni) + Arredi

Scala 1/500

4.7 Valori di Illuminamento su: Carreggiata_LUX

Totale Parti: 2

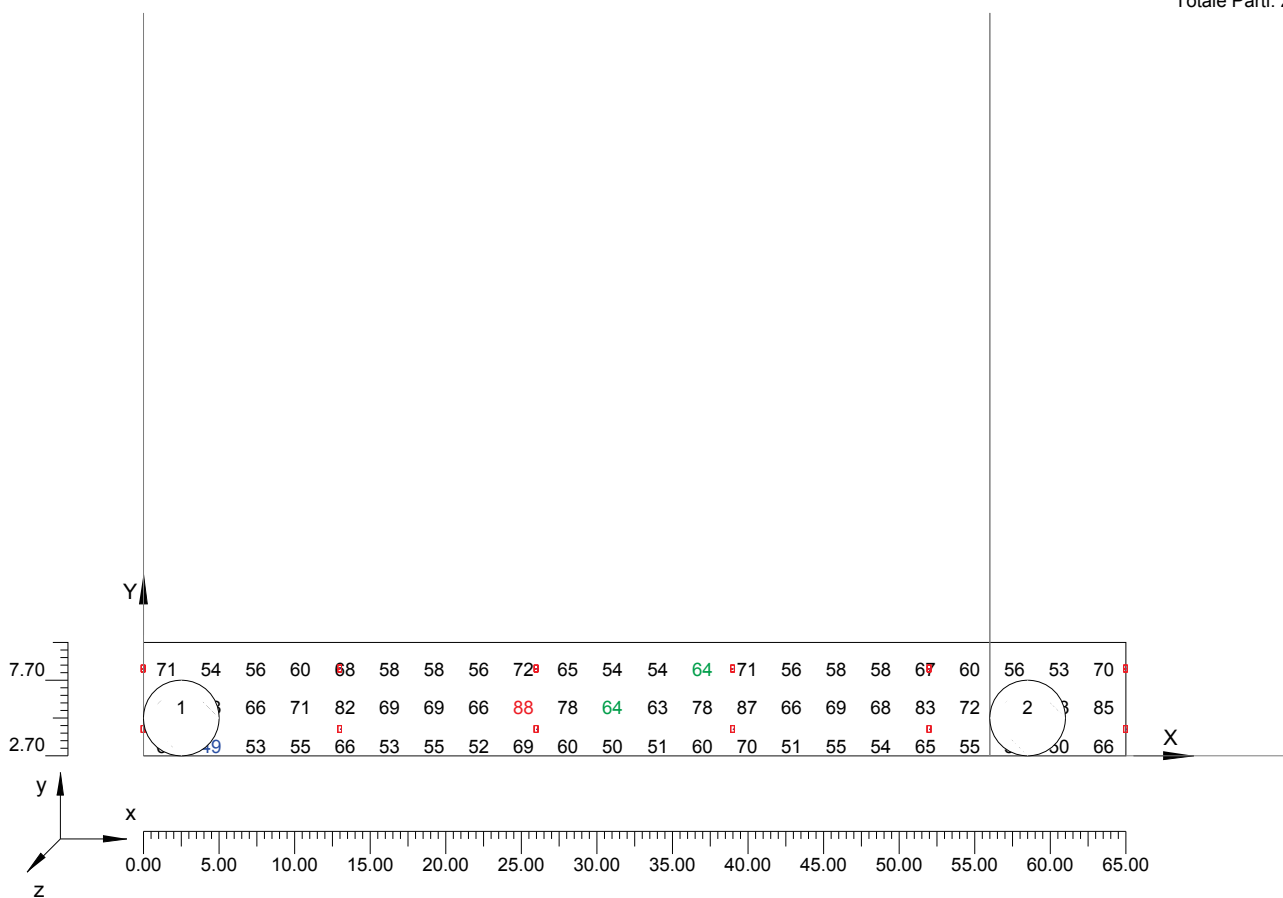

4.7 Valori di Illuminamento su: Carreggiata_LUX

Scala 1/387

Parte 1 di 2

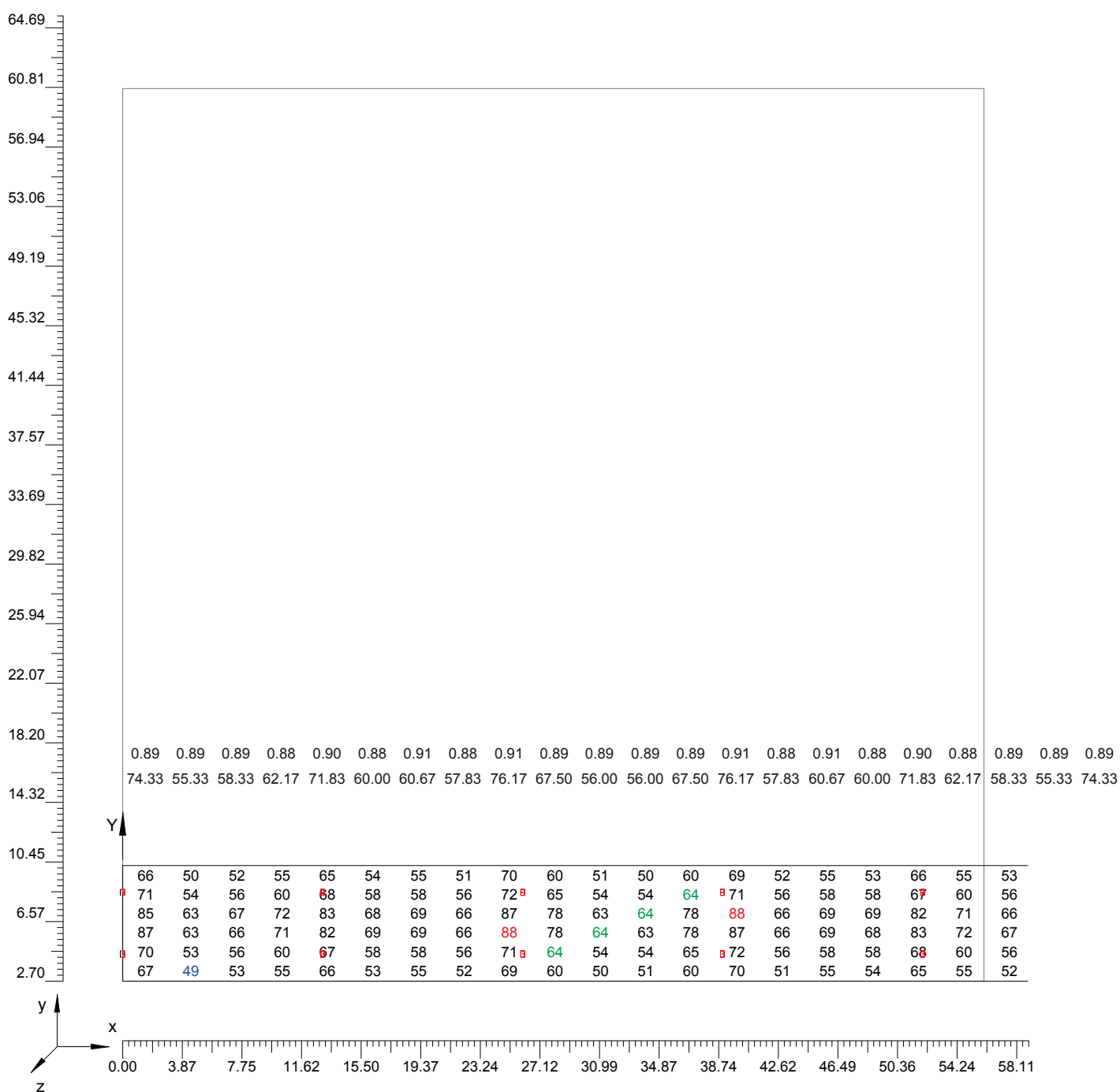

4.7 Valori di Illuminamento su: Carreggiata_LUX

Scala 1/387

Parte 2 di 2

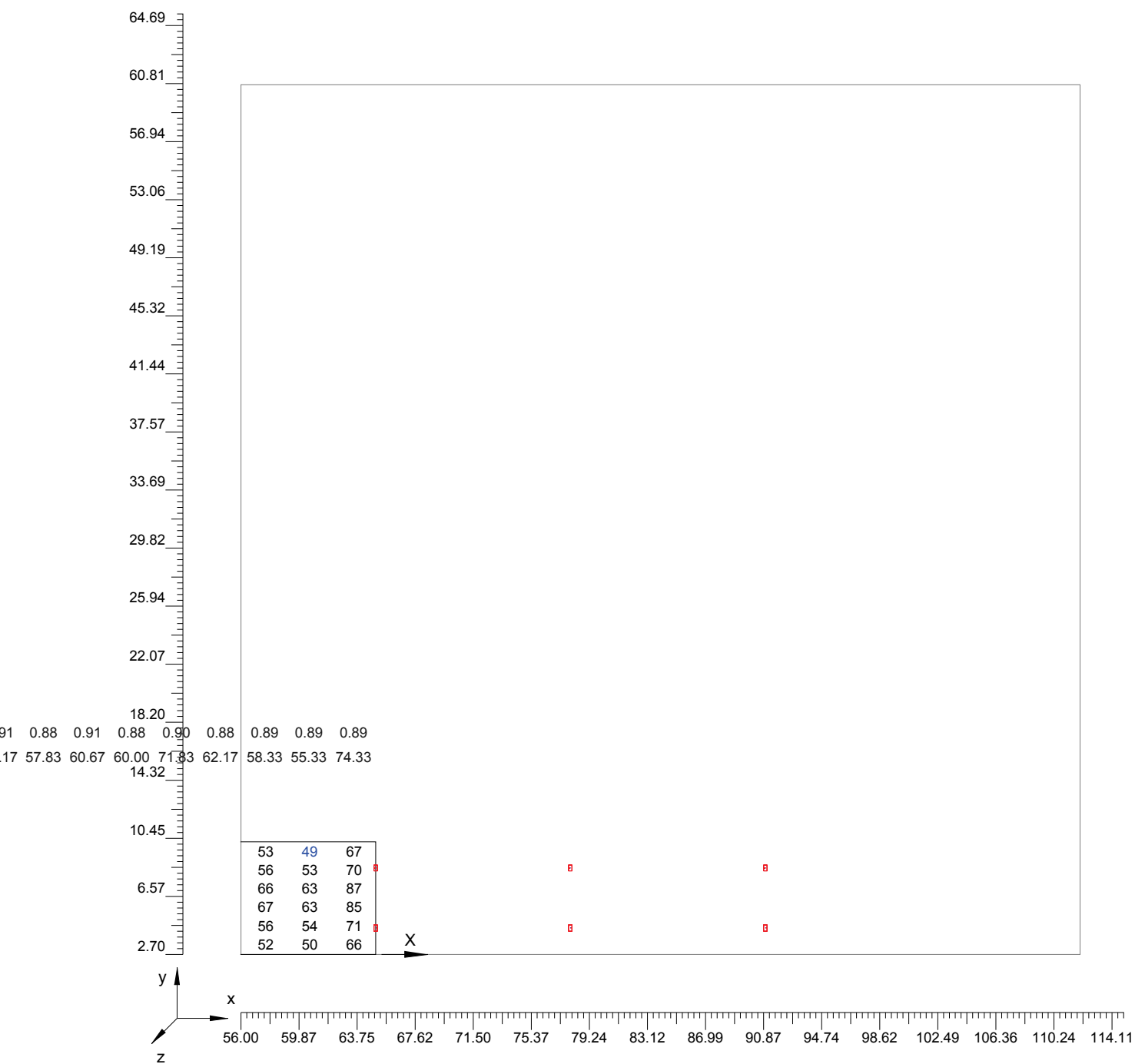

Informazioni Generali	1
1. Dati Riepilogativi Progetto	
1.1 Informazioni Area	2
1.2 Calcolo Energetico	2
1.3 Parametri di Qualità dell'Impianto	2
2. Viste Progetto	
2.1 Vista 2D in Pianta	4
2.2 Vista Laterale	5
3. Dati Riepilogativi Apparecchi	
3.1 Informazioni Apparecchi/Rilievi	6
3.2 Informazioni Lampade	6
4. Tabella Risultati	
4.1 Valori delle Luminanze su: Carreggiata_oss1 Oss. 1(x=-60.00;y=4.58;z=1.50)m	7
4.2 Valori delle Luminanze su: Carreggiata_oss2 Oss. 2(x=125.00;y=8.32;z=1.50)m	10
4.3 Valori delle Luminanze su: Parete_Destra (x=-60.00;y=4.58;z=1.50)m ---> (x=30.00;y=4.58;z=0.00)m	13
4.4 Valori delle Luminanze su: Striscia_Destra_1_7m (x=-60.00;y=4.58;z=1.50)m ---> (x=30.00;y=4.58;z=0.00)m	16
4.5 Valori delle Luminanze su: Parete_Sinistra (x=-60.00;y=4.58;z=1.50)m ---> (x=30.00;y=4.58;z=0.00)m	17
4.6 Valori delle Luminanze su: Striscia_Sinistra_1_7m (x=-60.00;y=4.58;z=1.50)m ---> (x=30.00;y=4.58;z=0.00)m	20
4.7 Valori di Illuminamento su: Carreggiata_LUX	21

Variante di Mondovi'

Calcolo illuminotecnico galleria naturale cunicolo di fuga

Galleria naturale Mondovì

Note Installazione: **Rinforzo**

Codice Progetto: 20-061-A02

Note
Li = 3 cd/mq
Le = 116.3 cd/mq

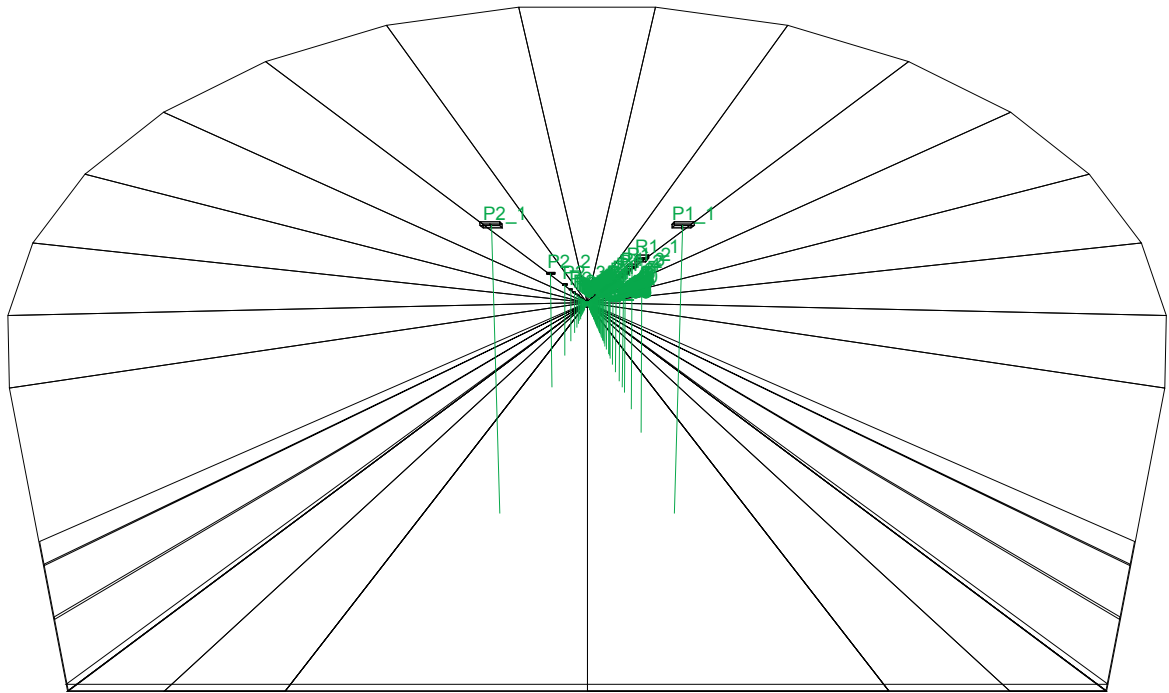

1.1 Informazioni Area

Dati Strada

Zona	Tipo Zona	Corsia	Senso di marcia	Larghezza [m] (W)	y1 [m]	y2 [m]	Pt.Calc.Y (E)	Pt.Calc.Y (L)	Alt. Zona [m] (HC)	Colore	Tabella R	Coeff.Rif. Fattore q0
Marc_dx	Pista Ciclo/Pedonale			2.70	0.00	2.70	3		0.00	RGB=219,54,36		30.00
		Marc_dx	--->	1.20	0.00	1.20		3				
		banchina_dx	--->	1.50	1.20	2.70		3				
Carreggiata Carrabile				7.50	2.70	10.20	5		0.00	RGB=126,126,126	C2	5.60
		Corsia1	--->	3.75	2.70	6.45		3				
		Corsia2	<---	3.75	6.45	10.20		3				
Marc_sx	Pista Ciclo/Pedonale			2.70	10.20	12.90	3		0.00	RGB=219,54,36		30.00
		banchina_sx	--->	1.50	10.20	11.70		3				
		Marc_sx	--->	1.20	11.70	12.90		3				

Dati Installazione Apparecchi

Nome Fila	1° Palo x [m] (XP)	1° Palo y [m] (YP)	Altez.App. [m] (H)	Num. Pali	Interd. [m] (D)	Sbraccio [m] (L)	Ang.Incl. [°] (RY)	Rot.Sbraccio [°] (RZ)	Ang.Incl.Lat. [°] (RX)	Fatt.Manut. [%]	Codice Apparecchio	Flusso [lm]	Rif.
P1	4.00	4.45	6.40	109	13.00	0.00	0	90	0	80.00	PetV2-48	7100	A
P2	4.00	8.45	6.40	109	13.00	0.00	0	270	0	80.00	PetV2-48	7100	A
R1	10.00	4.45	6.40	23	3.10	0.00	-5	0	0	80.00	Pet-T21	46800	B
R2	81.30	4.45	6.40	4	3.70	0.00	-5	0	0	80.00	Pet-T21	46800	B
R3	96.10	4.45	6.40	4	4.50	0.00	-5	0	0	80.00	Pet-T21	46800	B
R4	114.10	4.45	6.40	4	4.50	0.00	-5	0	0	80.00	Pet-T21	33200	C
R5	132.00	4.45	6.40	5	5.50	0.00	-5	0	0	80.00	Pet-T21	23600	D
R6	159.50	4.45	6.40	5	5.50	0.00	-5	0	0	80.00	Pet-T21	14700	E
R7	187.00	4.45	6.40	6	8.00	0.00	-5	0	0	80.00	Pet-T21	14700	E
R8	235.00	4.45	6.40	6	8.00	0.00	-5	0	0	80.00	Pet-T21	9500	F
R9	283.00	4.45	6.40	6	8.00	0.00	-5	0	0	80.00	Pet-T21	4900	G
R10	331.00	4.45	6.40	5	11.00	0.00	-5	0	0	80.00	Pet-T21	4900	G
R11	386.00	4.45	6.40	4	13.00	0.00	-5	0	0	80.00	Pet-T21	4900	G

1.2 Calcolo Energetico (Suolo)

Area	3225.00 m2
Illuminamento Medio	322.70 lx
Potenza Specifica	7.90 W/m2
Potenza Specifica Illuminotecnica	2.45 W/(m2 * 100lx)
Efficienza Energetica	40.83 (m2*lx)/W
Potenza Totale Utilizzata	25490.00 W

2.1 Vista 2D in Pianta

Scala 1/3000

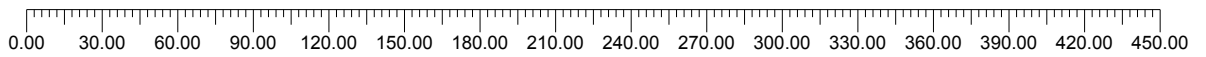
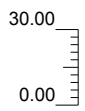

2.2 Vista Laterale

Scala 1/90

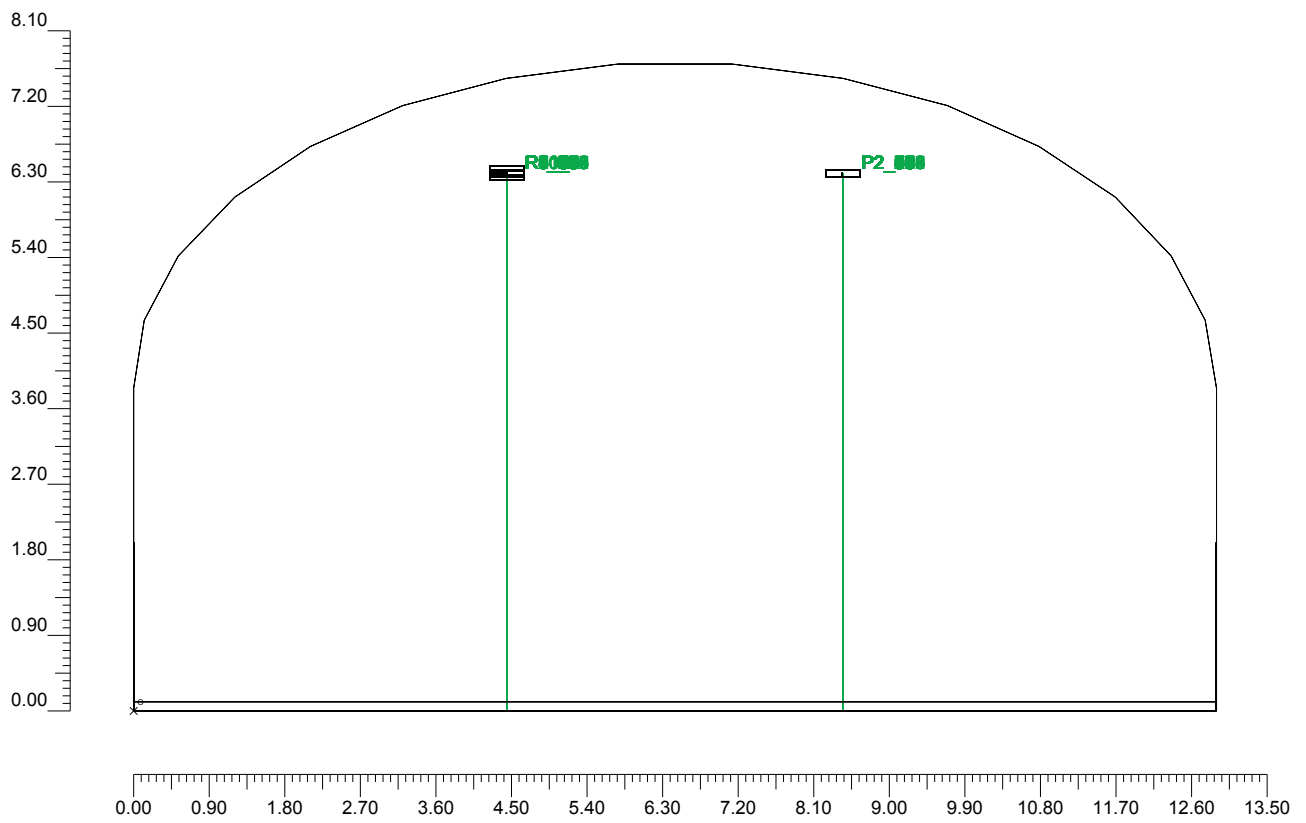

3.1 Informazioni Apparecchi/Rilievi

Rif.	Linea	Nome Apparecchio (Nome Rilievo)	Codice Apparecchio (Codice rilievo)	Apparecchi n.	Rif.Lamp.	Lampade n.
A	Arianna Petrarca	PetV2-48 (PetV2-48)	PetV2-48 (PetV2-48)	218	LMP-A	1
B	Arianna Petrarca	Pet-T21 (Petrarca-T21)	Pet-T21 (Petrarca-T21)	31	LMP-B	1
C	Arianna Petrarca	Pet-T21 (Petrarca-T21)	Pet-T21 (Petrarca-T21)	4	LMP-C	1
D	Arianna Petrarca	Pet-T21 (Petrarca-T21)	Pet-T21 (Petrarca-T21)	5	LMP-D	1
E	Arianna Petrarca	Pet-T21 (Petrarca-T21)	Pet-T21 (Petrarca-T21)	11	LMP-E	1
F	Arianna Petrarca	Pet-T21 (Petrarca-T21)	Pet-T21 (Petrarca-T21)	6	LMP-F	1
G	Arianna Petrarca	Pet-T21 (Petrarca-T21)	Pet-T21 (Petrarca-T21)	15	LMP-G	1

3.2 Informazioni Lampade

Rif.Lamp.	Tipo	Codice	Flusso lm	Potenza W	Colore K	n.
LMP-A	LED	PetrarcaTunnel 7100	7100	50	4000	-
LMP-B	LED	PetrarcaTunnel 46800	46800	341	4000	-
LMP-C	LED	PetrarcaTunnel 33200	33200	246	4000	-
LMP-D	LED	PetrarcaTunnel 23600	23600	173	4000	-
LMP-E	LED	PetrarcaTunnel 14700	14700	110	4000	-
LMP-F	LED	PetrarcaTunnel 9500	9500	70	4000	-
LMP-G	LED	PetrarcaTunnel 4900	4900	36	4000	-

3.3 Tabella Riepilogativa Apparecchi

Rif.	App.	On	Posizione Apparecchi X[m] Y[m] Z[m]	Rotazione Apparecchi X° Y° Z°	Codice Apparecchio	Coeff. Mant.	Codice Lampada	Flusso lm
A	1	X	4.00;4.45;6.40	0.0;0.0;0.0	PetV2-48	0.80	PetrarcaTunnel 7100	1*7100
	2	X	17.00;4.45;6.40	0.0;0.0;0.0		0.80		
	3	X	30.00;4.45;6.40	0.0;0.0;0.0		0.80		
	4	X	43.00;4.45;6.40	0.0;0.0;0.0		0.80		
	5	X	56.00;4.45;6.40	0.0;0.0;0.0		0.80		
	6	X	69.00;4.45;6.40	0.0;0.0;0.0		0.80		
	7	X	82.00;4.45;6.40	0.0;0.0;0.0		0.80		
	8	X	95.00;4.45;6.40	0.0;0.0;0.0		0.80		
	9	X	108.00;4.45;6.40	0.0;0.0;0.0		0.80		
	10	X	121.00;4.45;6.40	0.0;0.0;0.0		0.80		
	11	X	134.00;4.45;6.40	0.0;0.0;0.0		0.80		
	12	X	147.00;4.45;6.40	0.0;0.0;0.0		0.80		
	13	X	160.00;4.45;6.40	0.0;0.0;0.0		0.80		
	14	X	173.00;4.45;6.40	0.0;0.0;0.0		0.80		
	15	X	186.00;4.45;6.40	0.0;0.0;0.0		0.80		
	16	X	199.00;4.45;6.40	0.0;0.0;0.0		0.80		
	17	X	212.00;4.45;6.40	0.0;0.0;0.0		0.80		
	18	X	225.00;4.45;6.40	0.0;0.0;0.0		0.80		
	19	X	238.00;4.45;6.40	0.0;0.0;0.0		0.80		
	20	X	251.00;4.45;6.40	0.0;0.0;0.0		0.80		
	21	X	264.00;4.45;6.40	0.0;0.0;0.0		0.80		
	22	X	277.00;4.45;6.40	0.0;0.0;0.0		0.80		
	23	X	290.00;4.45;6.40	0.0;0.0;0.0		0.80		
	24	X	303.00;4.45;6.40	0.0;0.0;0.0		0.80		
	25	X	316.00;4.45;6.40	0.0;0.0;0.0		0.80		
	26	X	329.00;4.45;6.40	0.0;0.0;0.0		0.80		

Rif.	App.	On	Posizione Apparecchi X[m] Y[m] Z[m]	Rotazione Apparecchi X° Y° Z°	Codice Apparecchio	Coeff. Mant.	Codice Lampada	Flusso lm
A	27	X	342.00;4.45;6.40	0.0;0.0;0.0	PetV2-48	0.80	PetrarcaTunnel 7100	1*7100
	28	X	355.00;4.45;6.40	0.0;0.0;0.0		0.80		
	29	X	368.00;4.45;6.40	0.0;0.0;0.0		0.80		
	30	X	381.00;4.45;6.40	0.0;0.0;0.0		0.80		
	31	X	394.00;4.45;6.40	0.0;0.0;0.0		0.80		
	32	X	407.00;4.45;6.40	0.0;0.0;0.0		0.80		
	33	X	420.00;4.45;6.40	0.0;0.0;0.0		0.80		
	34	X	433.00;4.45;6.40	0.0;0.0;0.0		0.80		
	35	X	446.00;4.45;6.40	0.0;0.0;0.0		0.80		
	36	X	459.00;4.45;6.40	0.0;0.0;0.0		0.80		
	37	X	472.00;4.45;6.40	0.0;0.0;0.0		0.80		
	38	X	485.00;4.45;6.40	0.0;0.0;0.0		0.80		
	39	X	498.00;4.45;6.40	0.0;0.0;0.0		0.80		
	40	X	511.00;4.45;6.40	0.0;0.0;0.0		0.80		
	41	X	524.00;4.45;6.40	0.0;0.0;0.0		0.80		
	42	X	537.00;4.45;6.40	0.0;0.0;0.0		0.80		
	43	X	550.00;4.45;6.40	0.0;0.0;0.0		0.80		
	44	X	563.00;4.45;6.40	0.0;0.0;0.0		0.80		
	45	X	576.00;4.45;6.40	0.0;0.0;0.0		0.80		
	46	X	589.00;4.45;6.40	0.0;0.0;0.0		0.80		
	47	X	602.00;4.45;6.40	0.0;0.0;0.0		0.80		
	48	X	615.00;4.45;6.40	0.0;0.0;0.0		0.80		
	49	X	628.00;4.45;6.40	0.0;0.0;0.0		0.80		
	50	X	641.00;4.45;6.40	0.0;0.0;0.0		0.80		
	51	X	654.00;4.45;6.40	0.0;0.0;0.0		0.80		
	52	X	667.00;4.45;6.40	0.0;0.0;0.0		0.80		
	53	X	680.00;4.45;6.40	0.0;0.0;0.0		0.80		
	54	X	693.00;4.45;6.40	0.0;0.0;0.0		0.80		
	55	X	706.00;4.45;6.40	0.0;0.0;0.0		0.80		
	56	X	719.00;4.45;6.40	0.0;0.0;0.0		0.80		
	57	X	732.00;4.45;6.40	0.0;0.0;0.0		0.80		
	58	X	745.00;4.45;6.40	0.0;0.0;0.0		0.80		
	59	X	758.00;4.45;6.40	0.0;0.0;0.0		0.80		
	60	X	771.00;4.45;6.40	0.0;0.0;0.0		0.80		
	61	X	784.00;4.45;6.40	0.0;0.0;0.0		0.80		
	62	X	797.00;4.45;6.40	0.0;0.0;0.0		0.80		
	63	X	810.00;4.45;6.40	0.0;0.0;0.0		0.80		
	64	X	823.00;4.45;6.40	0.0;0.0;0.0		0.80		
	65	X	836.00;4.45;6.40	0.0;0.0;0.0		0.80		
	66	X	849.00;4.45;6.40	0.0;0.0;0.0		0.80		
	67	X	862.00;4.45;6.40	0.0;0.0;0.0		0.80		
	68	X	875.00;4.45;6.40	0.0;0.0;0.0		0.80		
	69	X	888.00;4.45;6.40	0.0;0.0;0.0		0.80		
	70	X	901.00;4.45;6.40	0.0;0.0;0.0		0.80		
	71	X	914.00;4.45;6.40	0.0;0.0;0.0		0.80		
	72	X	927.00;4.45;6.40	0.0;0.0;0.0		0.80		
	73	X	940.00;4.45;6.40	0.0;0.0;0.0		0.80		
	74	X	953.00;4.45;6.40	0.0;0.0;0.0		0.80		
	75	X	966.00;4.45;6.40	0.0;0.0;0.0		0.80		
	76	X	979.00;4.45;6.40	0.0;0.0;0.0		0.80		
	77	X	992.00;4.45;6.40	0.0;0.0;0.0		0.80		
	78	X	1005.00;4.45;6.40	0.0;0.0;0.0		0.80		
	79	X	1018.00;4.45;6.40	0.0;0.0;0.0		0.80		
	80	X	1031.00;4.45;6.40	0.0;0.0;0.0		0.80		
	81	X	1044.00;4.45;6.40	0.0;0.0;0.0		0.80		
	82	X	1057.00;4.45;6.40	0.0;0.0;0.0		0.80		
	83	X	1070.00;4.45;6.40	0.0;0.0;0.0		0.80		
	84	X	1083.00;4.45;6.40	0.0;0.0;0.0		0.80		
	85	X	1096.00;4.45;6.40	0.0;0.0;0.0		0.80		
	86	X	1109.00;4.45;6.40	0.0;0.0;0.0		0.80		
	87	X	1122.00;4.45;6.40	0.0;0.0;0.0		0.80		
	88	X	1135.00;4.45;6.40	0.0;0.0;0.0		0.80		
	89	X	1148.00;4.45;6.40	0.0;0.0;0.0		0.80		
	90	X	1161.00;4.45;6.40	0.0;0.0;0.0		0.80		
	91	X	1174.00;4.45;6.40	0.0;0.0;0.0		0.80		
	92	X	1187.00;4.45;6.40	0.0;0.0;0.0		0.80		
	93	X	1200.00;4.45;6.40	0.0;0.0;0.0		0.80		
	94	X	1213.00;4.45;6.40	0.0;0.0;0.0		0.80		
	95	X	1226.00;4.45;6.40	0.0;0.0;0.0		0.80		

Rif.	App.	On	Posizione Apparecchi X[m] Y[m] Z[m]	Rotazione Apparecchi X° Y° Z°	Codice Apparecchio	Coeff. Mant.	Codice Lampada	Flusso lm
A	96	X	1239.00;4.45;6.40	0.0;0.0;0.0	PetV2-48	0.80	PetrarcaTunnel 7100	1*7100
	97	X	1252.00;4.45;6.40	0.0;0.0;0.0		0.80		
	98	X	1265.00;4.45;6.40	0.0;0.0;0.0		0.80		
	99	X	1278.00;4.45;6.40	0.0;0.0;0.0		0.80		
	100	X	1291.00;4.45;6.40	0.0;0.0;0.0		0.80		
	101	X	1304.00;4.45;6.40	0.0;0.0;0.0		0.80		
	102	X	1317.00;4.45;6.40	0.0;0.0;0.0		0.80		
	103	X	1330.00;4.45;6.40	0.0;0.0;0.0		0.80		
	104	X	1343.00;4.45;6.40	0.0;0.0;0.0		0.80		
	105	X	1356.00;4.45;6.40	0.0;0.0;0.0		0.80		
	106	X	1369.00;4.45;6.40	0.0;0.0;0.0		0.80		
	107	X	1382.00;4.45;6.40	0.0;0.0;0.0		0.80		
	108	X	1395.00;4.45;6.40	0.0;0.0;0.0		0.80		
	109	X	1408.00;4.45;6.40	0.0;0.0;0.0		0.80		
	110	X	4.00;8.45;6.40	0.0;0.0;180.0		0.80		
	111	X	17.00;8.45;6.40	0.0;0.0;180.0		0.80		
	112	X	30.00;8.45;6.40	0.0;0.0;180.0		0.80		
	113	X	43.00;8.45;6.40	0.0;0.0;180.0		0.80		
	114	X	56.00;8.45;6.40	0.0;0.0;180.0		0.80		
	115	X	69.00;8.45;6.40	0.0;0.0;180.0		0.80		
	116	X	82.00;8.45;6.40	0.0;0.0;180.0		0.80		
	117	X	95.00;8.45;6.40	0.0;0.0;180.0		0.80		
	118	X	108.00;8.45;6.40	0.0;0.0;180.0		0.80		
	119	X	121.00;8.45;6.40	0.0;0.0;180.0		0.80		
	120	X	134.00;8.45;6.40	0.0;0.0;180.0		0.80		
	121	X	147.00;8.45;6.40	0.0;0.0;180.0		0.80		
	122	X	160.00;8.45;6.40	0.0;0.0;180.0		0.80		
	123	X	173.00;8.45;6.40	0.0;0.0;180.0		0.80		
	124	X	186.00;8.45;6.40	0.0;0.0;180.0		0.80		
	125	X	199.00;8.45;6.40	0.0;0.0;180.0		0.80		
	126	X	212.00;8.45;6.40	0.0;0.0;180.0		0.80		
	127	X	225.00;8.45;6.40	0.0;0.0;180.0		0.80		
	128	X	238.00;8.45;6.40	0.0;0.0;180.0		0.80		
	129	X	251.00;8.45;6.40	0.0;0.0;180.0		0.80		
	130	X	264.00;8.45;6.40	0.0;0.0;180.0		0.80		
	131	X	277.00;8.45;6.40	0.0;0.0;180.0		0.80		
	132	X	290.00;8.45;6.40	0.0;0.0;180.0		0.80		
	133	X	303.00;8.45;6.40	0.0;0.0;180.0		0.80		
	134	X	316.00;8.45;6.40	0.0;0.0;180.0		0.80		
	135	X	329.00;8.45;6.40	0.0;0.0;180.0		0.80		
	136	X	342.00;8.45;6.40	0.0;0.0;180.0		0.80		
	137	X	355.00;8.45;6.40	0.0;0.0;180.0		0.80		
	138	X	368.00;8.45;6.40	0.0;0.0;180.0		0.80		
	139	X	381.00;8.45;6.40	0.0;0.0;180.0		0.80		
	140	X	394.00;8.45;6.40	0.0;0.0;180.0		0.80		
	141	X	407.00;8.45;6.40	0.0;0.0;180.0		0.80		
	142	X	420.00;8.45;6.40	0.0;0.0;180.0		0.80		
	143	X	433.00;8.45;6.40	0.0;0.0;180.0		0.80		
	144	X	446.00;8.45;6.40	0.0;0.0;180.0		0.80		
	145	X	459.00;8.45;6.40	0.0;0.0;180.0		0.80		
	146	X	472.00;8.45;6.40	0.0;0.0;180.0		0.80		
	147	X	485.00;8.45;6.40	0.0;0.0;180.0		0.80		
	148	X	498.00;8.45;6.40	0.0;0.0;180.0		0.80		
	149	X	511.00;8.45;6.40	0.0;0.0;180.0		0.80		
	150	X	524.00;8.45;6.40	0.0;0.0;180.0		0.80		
	151	X	537.00;8.45;6.40	0.0;0.0;180.0		0.80		
	152	X	550.00;8.45;6.40	0.0;0.0;180.0		0.80		
	153	X	563.00;8.45;6.40	0.0;0.0;180.0		0.80		
	154	X	576.00;8.45;6.40	0.0;0.0;180.0		0.80		
	155	X	589.00;8.45;6.40	0.0;0.0;180.0		0.80		
	156	X	602.00;8.45;6.40	0.0;0.0;180.0		0.80		
	157	X	615.00;8.45;6.40	0.0;0.0;180.0		0.80		
	158	X	628.00;8.45;6.40	0.0;0.0;180.0		0.80		
	159	X	641.00;8.45;6.40	0.0;0.0;180.0		0.80		
	160	X	654.00;8.45;6.40	0.0;0.0;180.0		0.80		
	161	X	667.00;8.45;6.40	0.0;0.0;180.0		0.80		
	162	X	680.00;8.45;6.40	0.0;0.0;180.0		0.80		
	163	X	693.00;8.45;6.40	0.0;0.0;180.0		0.80		
	164	X	706.00;8.45;6.40	0.0;0.0;180.0		0.80		

Rif.	App.	On	Posizione Apparecchi X[m] Y[m] Z[m]	Rotazione Apparecchi X° Y° Z°	Codice Apparecchio	Coeff. Mant.	Codice Lampada	Flusso lm
A	165	X	719.00;8.45;6.40	0.0;0.0;180.0	PetV2-48	0.80	PetrarcaTunnel 7100	1*7100
	166	X	732.00;8.45;6.40	0.0;0.0;180.0		0.80		
	167	X	745.00;8.45;6.40	0.0;0.0;180.0		0.80		
	168	X	758.00;8.45;6.40	0.0;0.0;180.0		0.80		
	169	X	771.00;8.45;6.40	0.0;0.0;180.0		0.80		
	170	X	784.00;8.45;6.40	0.0;0.0;180.0		0.80		
	171	X	797.00;8.45;6.40	0.0;0.0;180.0		0.80		
	172	X	810.00;8.45;6.40	0.0;0.0;180.0		0.80		
	173	X	823.00;8.45;6.40	0.0;0.0;180.0		0.80		
	174	X	836.00;8.45;6.40	0.0;0.0;180.0		0.80		
	175	X	849.00;8.45;6.40	0.0;0.0;180.0		0.80		
	176	X	862.00;8.45;6.40	0.0;0.0;180.0		0.80		
	177	X	875.00;8.45;6.40	0.0;0.0;180.0		0.80		
	178	X	888.00;8.45;6.40	0.0;0.0;180.0		0.80		
	179	X	901.00;8.45;6.40	0.0;0.0;180.0		0.80		
	180	X	914.00;8.45;6.40	0.0;0.0;180.0		0.80		
	181	X	927.00;8.45;6.40	0.0;0.0;180.0		0.80		
	182	X	940.00;8.45;6.40	0.0;0.0;180.0		0.80		
	183	X	953.00;8.45;6.40	0.0;0.0;180.0		0.80		
	184	X	966.00;8.45;6.40	0.0;0.0;180.0		0.80		
	185	X	979.00;8.45;6.40	0.0;0.0;180.0		0.80		
	186	X	992.00;8.45;6.40	0.0;0.0;180.0		0.80		
	187	X	1005.00;8.45;6.40	0.0;0.0;180.0		0.80		
	188	X	1018.00;8.45;6.40	0.0;0.0;180.0		0.80		
	189	X	1031.00;8.45;6.40	0.0;0.0;180.0		0.80		
	190	X	1044.00;8.45;6.40	0.0;0.0;180.0		0.80		
	191	X	1057.00;8.45;6.40	0.0;0.0;180.0		0.80		
	192	X	1070.00;8.45;6.40	0.0;0.0;180.0		0.80		
	193	X	1083.00;8.45;6.40	0.0;0.0;180.0		0.80		
	194	X	1096.00;8.45;6.40	0.0;0.0;180.0		0.80		
	195	X	1109.00;8.45;6.40	0.0;0.0;180.0		0.80		
	196	X	1122.00;8.45;6.40	0.0;0.0;180.0		0.80		
	197	X	1135.00;8.45;6.40	0.0;0.0;180.0		0.80		
	198	X	1148.00;8.45;6.40	0.0;0.0;180.0		0.80		
	199	X	1161.00;8.45;6.40	0.0;0.0;180.0		0.80		
	200	X	1174.00;8.45;6.40	0.0;0.0;180.0		0.80		
	201	X	1187.00;8.45;6.40	0.0;0.0;180.0		0.80		
	202	X	1200.00;8.45;6.40	0.0;0.0;180.0		0.80		
	203	X	1213.00;8.45;6.40	0.0;0.0;180.0		0.80		
	204	X	1226.00;8.45;6.40	0.0;0.0;180.0		0.80		
	205	X	1239.00;8.45;6.40	0.0;0.0;180.0		0.80		
	206	X	1252.00;8.45;6.40	0.0;0.0;180.0		0.80		
	207	X	1265.00;8.45;6.40	0.0;0.0;180.0		0.80		
	208	X	1278.00;8.45;6.40	0.0;0.0;180.0		0.80		
	209	X	1291.00;8.45;6.40	0.0;0.0;180.0		0.80		
	210	X	1304.00;8.45;6.40	0.0;0.0;180.0		0.80		
	211	X	1317.00;8.45;6.40	0.0;0.0;180.0		0.80		
	212	X	1330.00;8.45;6.40	0.0;0.0;180.0		0.80		
	213	X	1343.00;8.45;6.40	0.0;0.0;180.0		0.80		
	214	X	1356.00;8.45;6.40	0.0;0.0;180.0		0.80		
	215	X	1369.00;8.45;6.40	0.0;0.0;180.0		0.80		
	216	X	1382.00;8.45;6.40	0.0;0.0;180.0		0.80		
	217	X	1395.00;8.45;6.40	0.0;0.0;180.0		0.80		
	218	X	1408.00;8.45;6.40	0.0;0.0;180.0		0.80		
B	1	X	10.00;4.45;6.40	-5.0;0.0;-90.0	Pet-T21	0.80	PetrarcaTunnel 46800	1*46800
	2	X	13.10;4.45;6.40	-5.0;0.0;-90.0		0.80		
	3	X	16.20;4.45;6.40	-5.0;0.0;-90.0		0.80		
	4	X	19.30;4.45;6.40	-5.0;0.0;-90.0		0.80		
	5	X	22.40;4.45;6.40	-5.0;0.0;-90.0		0.80		
	6	X	25.50;4.45;6.40	-5.0;0.0;-90.0		0.80		
	7	X	28.60;4.45;6.40	-5.0;0.0;-90.0		0.80		
	8	X	31.70;4.45;6.40	-5.0;0.0;-90.0		0.80		
	9	X	34.80;4.45;6.40	-5.0;0.0;-90.0		0.80		
	10	X	37.90;4.45;6.40	-5.0;0.0;-90.0		0.80		
	11	X	41.00;4.45;6.40	-5.0;0.0;-90.0		0.80		
	12	X	44.10;4.45;6.40	-5.0;0.0;-90.0		0.80		
	13	X	47.20;4.45;6.40	-5.0;0.0;-90.0		0.80		
	14	X	50.30;4.45;6.40	-5.0;0.0;-90.0		0.80		
	15	X	53.40;4.45;6.40	-5.0;0.0;-90.0		0.80		

Rif.	App.	On	Posizione Apparecchi X[m] Y[m] Z[m]	Rotazione Apparecchi X° Y° Z°	Codice Apparecchio	Coeff. Mant.	Codice Lampada	Flusso lm
B	16	X	56.50;4.45;6.40	-5.0;0.0;-90.0	Pet-T21	0.80	PetarcaTunnel 46800	1*46800
	17	X	59.60;4.45;6.40	-5.0;0.0;-90.0				
	18	X	62.70;4.45;6.40	-5.0;0.0;-90.0				
	19	X	65.80;4.45;6.40	-5.0;0.0;-90.0				
	20	X	68.90;4.45;6.40	-5.0;0.0;-90.0				
	21	X	72.00;4.45;6.40	-5.0;0.0;-90.0				
	22	X	75.10;4.45;6.40	-5.0;0.0;-90.0				
	23	X	78.20;4.45;6.40	-5.0;0.0;-90.0				
	24	X	81.30;4.45;6.40	-5.0;0.0;-90.0				
	25	X	85.00;4.45;6.40	-5.0;0.0;-90.0				
	26	X	88.70;4.45;6.40	-5.0;0.0;-90.0				
	27	X	92.40;4.45;6.40	-5.0;0.0;-90.0				
	28	X	96.10;4.45;6.40	-5.0;0.0;-90.0				
	29	X	100.60;4.45;6.40	-5.0;0.0;-90.0				
30	X	105.10;4.45;6.40	-5.0;0.0;-90.0					
31	X	109.60;4.45;6.40	-5.0;0.0;-90.0					
C	1	X	114.10;4.45;6.40	-5.0;0.0;-90.0	Pet-T21	0.80	PetarcaTunnel 33200	1*33200
	2	X	118.60;4.45;6.40	-5.0;0.0;-90.0				
	3	X	123.10;4.45;6.40	-5.0;0.0;-90.0				
	4	X	127.60;4.45;6.40	-5.0;0.0;-90.0				
D	1	X	132.00;4.45;6.40	-5.0;0.0;-90.0	Pet-T21	0.80	PetarcaTunnel 23600	1*23600
	2	X	137.50;4.45;6.40	-5.0;0.0;-90.0				
	3	X	143.00;4.45;6.40	-5.0;0.0;-90.0				
	4	X	148.50;4.45;6.40	-5.0;0.0;-90.0				
	5	X	154.00;4.45;6.40	-5.0;0.0;-90.0				
E	1	X	159.50;4.45;6.40	-5.0;0.0;-90.0	Pet-T21	0.80	PetarcaTunnel 14700	1*14700
	2	X	165.00;4.45;6.40	-5.0;0.0;-90.0				
	3	X	170.50;4.45;6.40	-5.0;0.0;-90.0				
	4	X	176.00;4.45;6.40	-5.0;0.0;-90.0				
	5	X	181.50;4.45;6.40	-5.0;0.0;-90.0				
	6	X	187.00;4.45;6.40	-5.0;0.0;-90.0				
	7	X	195.00;4.45;6.40	-5.0;0.0;-90.0				
	8	X	203.00;4.45;6.40	-5.0;0.0;-90.0				
	9	X	211.00;4.45;6.40	-5.0;0.0;-90.0				
	10	X	219.00;4.45;6.40	-5.0;0.0;-90.0				
	11	X	227.00;4.45;6.40	-5.0;0.0;-90.0				
F	1	X	235.00;4.45;6.40	-5.0;0.0;-90.0	Pet-T21	0.80	PetarcaTunnel 9500	1*9500
	2	X	243.00;4.45;6.40	-5.0;0.0;-90.0				
	3	X	251.00;4.45;6.40	-5.0;0.0;-90.0				
	4	X	259.00;4.45;6.40	-5.0;0.0;-90.0				
	5	X	267.00;4.45;6.40	-5.0;0.0;-90.0				
	6	X	275.00;4.45;6.40	-5.0;0.0;-90.0				
G	1	X	283.00;4.45;6.40	-5.0;0.0;-90.0	Pet-T21	0.80	PetarcaTunnel 4900	1*4900
	2	X	291.00;4.45;6.40	-5.0;0.0;-90.0				
	3	X	299.00;4.45;6.40	-5.0;0.0;-90.0				
	4	X	307.00;4.45;6.40	-5.0;0.0;-90.0				
	5	X	315.00;4.45;6.40	-5.0;0.0;-90.0				
	6	X	323.00;4.45;6.40	-5.0;0.0;-90.0				
	7	X	331.00;4.45;6.40	-5.0;0.0;-90.0				
	8	X	342.00;4.45;6.40	-5.0;0.0;-90.0				
	9	X	353.00;4.45;6.40	-5.0;0.0;-90.0				
	10	X	364.00;4.45;6.40	-5.0;0.0;-90.0				
	11	X	375.00;4.45;6.40	-5.0;0.0;-90.0				
	12	X	386.00;4.45;6.40	-5.0;0.0;-90.0				
	13	X	399.00;4.45;6.40	-5.0;0.0;-90.0				
	14	X	412.00;4.45;6.40	-5.0;0.0;-90.0				
	15	X	425.00;4.45;6.40	-5.0;0.0;-90.0				

4.1 Valori delle Luminanze su: Corsia1 Oss. 1(x=-60.00;y=4.58;z=1.50)m

O (x:0.00 y:2.70 z:0.00)	Risultati	Medio	Minimo	Massimo	Min/Medio	Min/Max	Medio/Max
DX:2.99 DY:1.25	Luminanza (L)	38 cd/m ²	3 cd/m ²	137 cd/m ²	0.07	0.02	0.28

Tipo Calcolo

Dir.+Indir.(1 Interriflessioni) + Arredi

Nome Corsia	Largh. Corsia [m] (W)	y1 [m]	y2 [m]	Pt.Calc.Y	Tabella R	Coeff.Rifl. Fattore q0	Osservatore x Assoluto [m]	Osservatore y Assoluto [m]	Luminanza Velante [cd/m ²]	Incremento di Soglia [%]	Uniformità Longitudinale
Corsia1	3.75	2.70	6.45	3	C2	5.60	-60.00	4.58	7.25	11.63	0.02 *

Norma

CEN 13201

Scala 1/3000

4.1 Valori delle Luminanze su: Corsia1 Oss. 1(x=-60.00;y=4.58;z=1.50)m

Totale Parti: 8

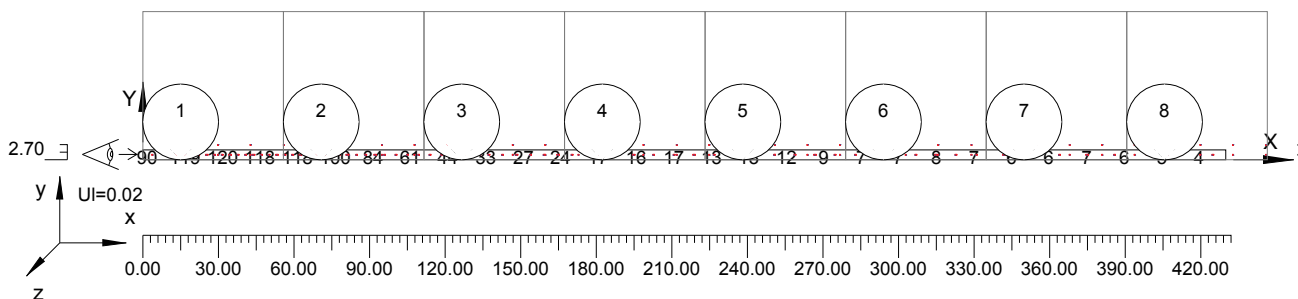

4.1 Valori delle Luminanze su: Corsia1 Oss. 1(x=-60.00;y=4.58;z=1.50)m

Scala 1/392

Parte 1 di 8

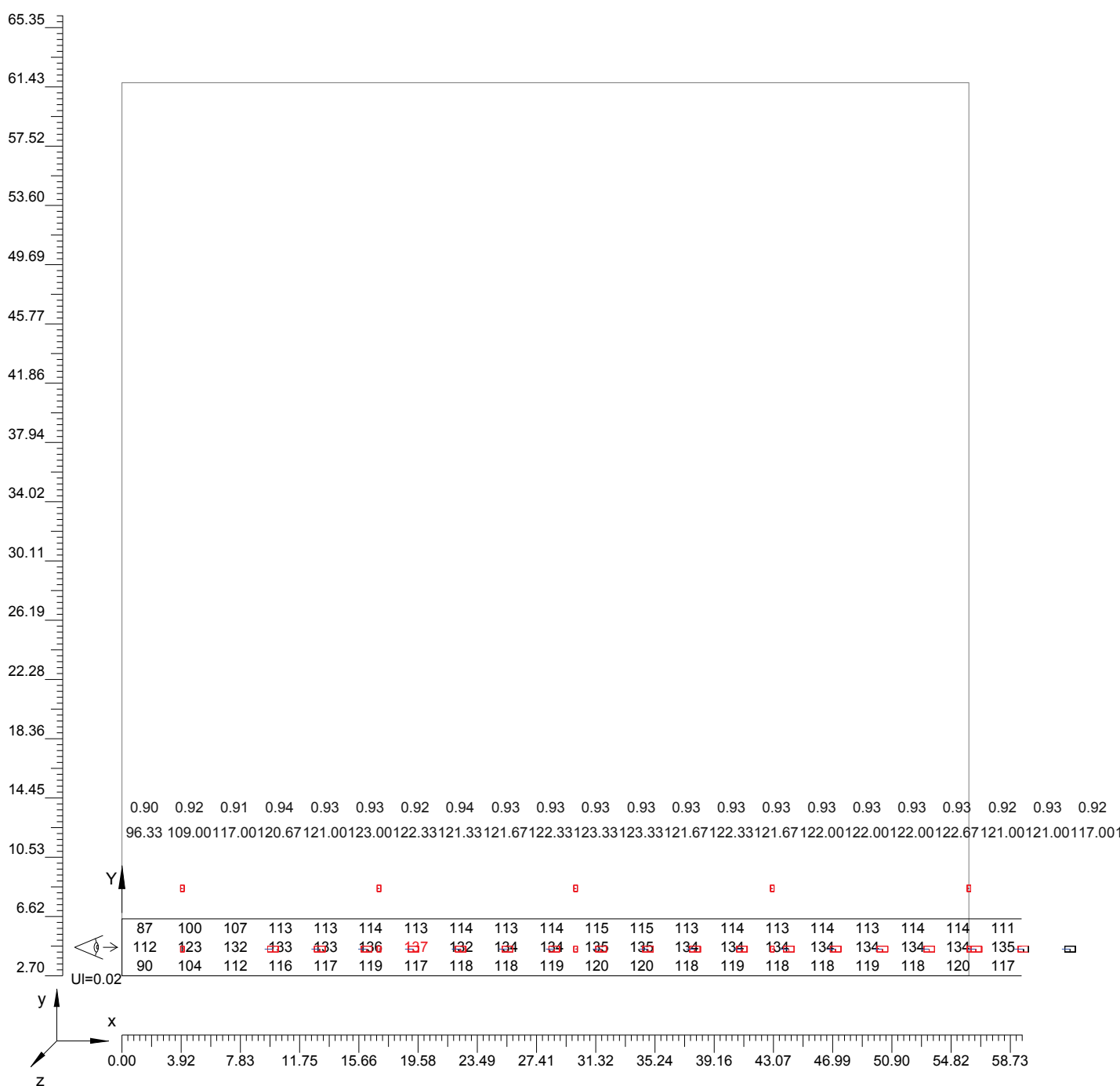

4.1 Valori delle Luminanze su: Corsia1 Oss. 1(x=-60.00;y=4.58;z=1.50)m

Scala 1/392

Parte 2 di 8

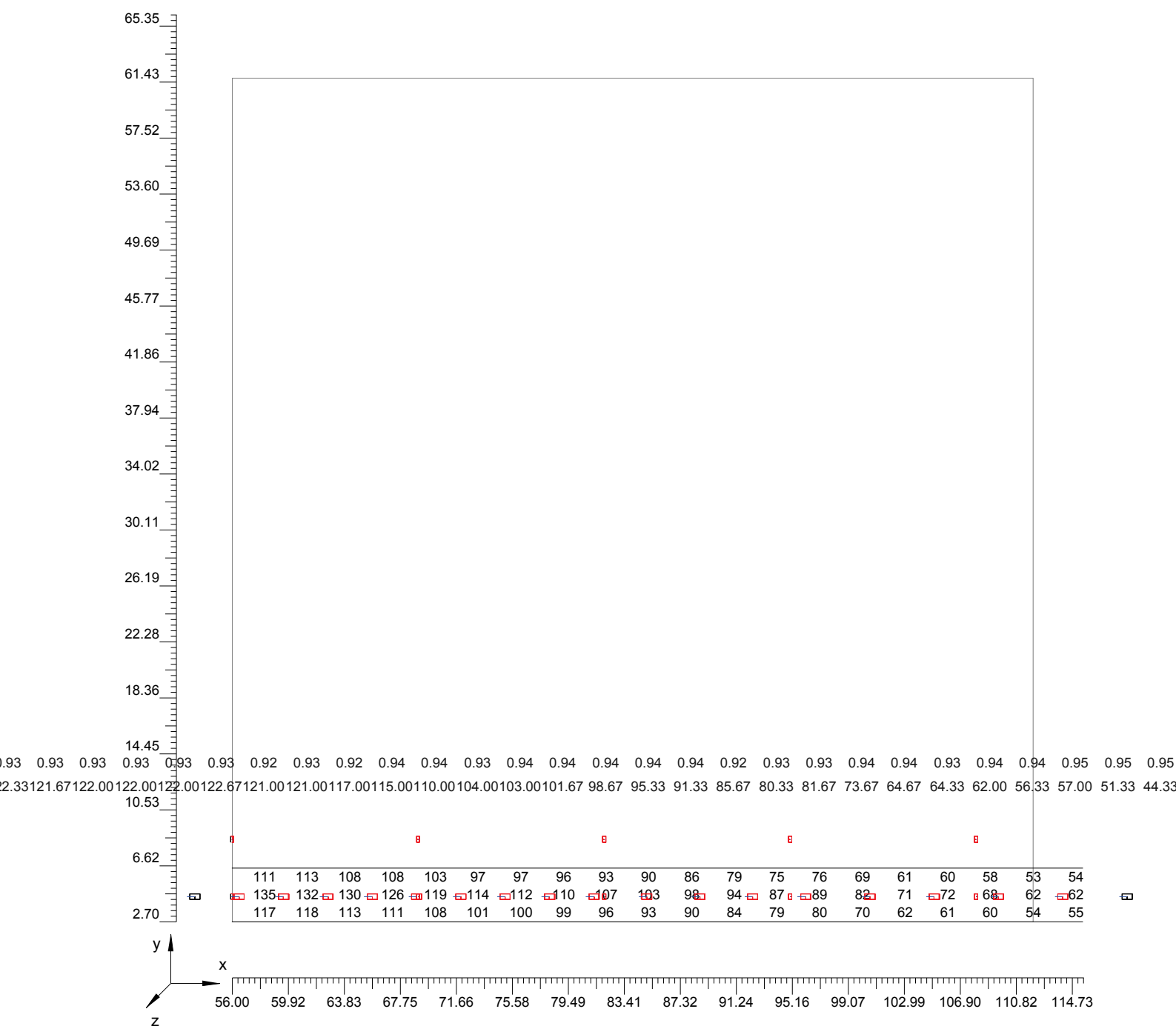

4.1 Valori delle Luminanze su: Corsia1 Oss. 1(x=-60.00;y=4.58;z=1.50)m

Scala 1/392

Parte 3 di 8

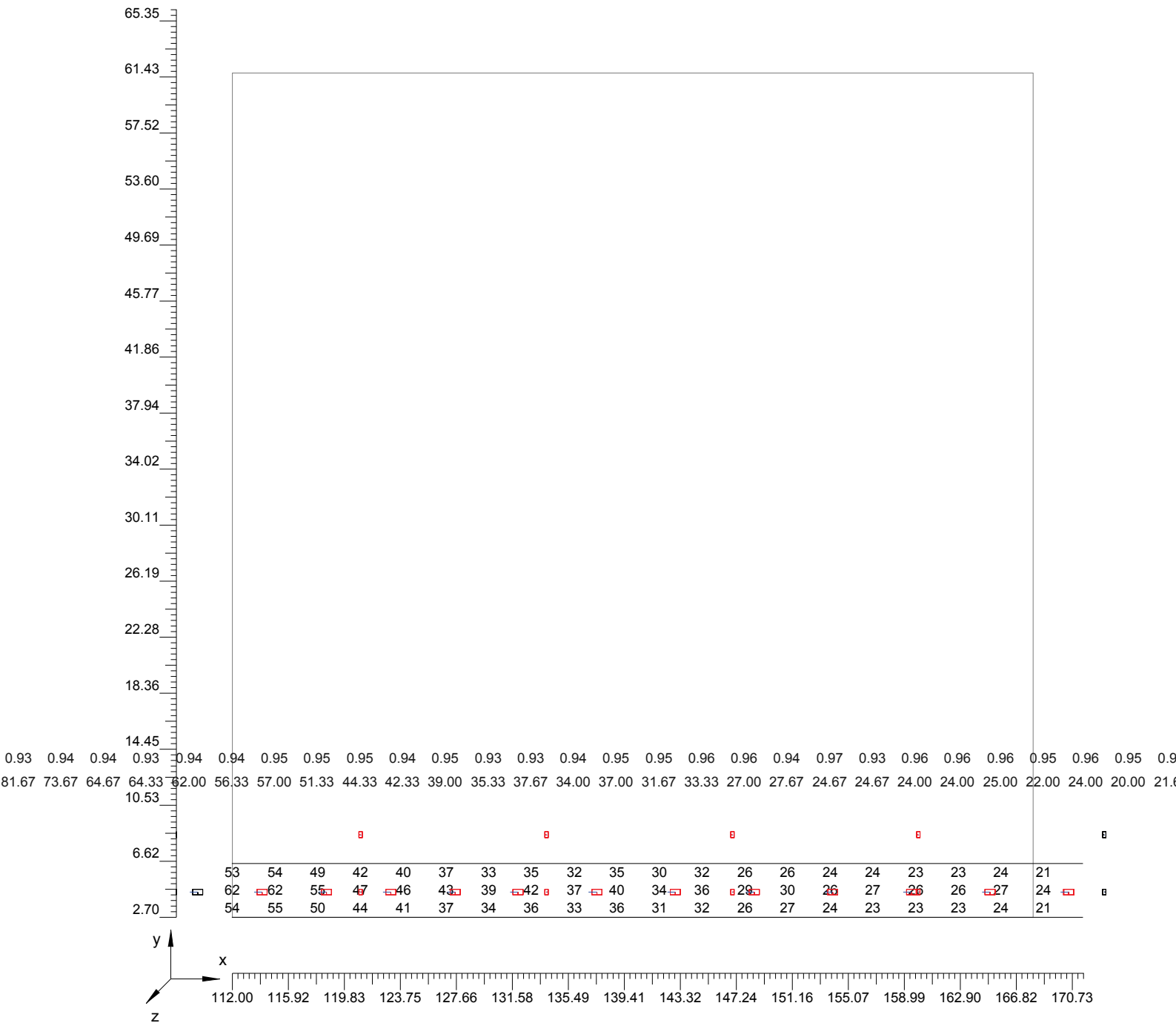

4.1 Valori delle Luminanze su: Corsia1 Oss. 1(x=-60.00;y=4.58;z=1.50)m

Scala 1/392

Parte 4 di 8

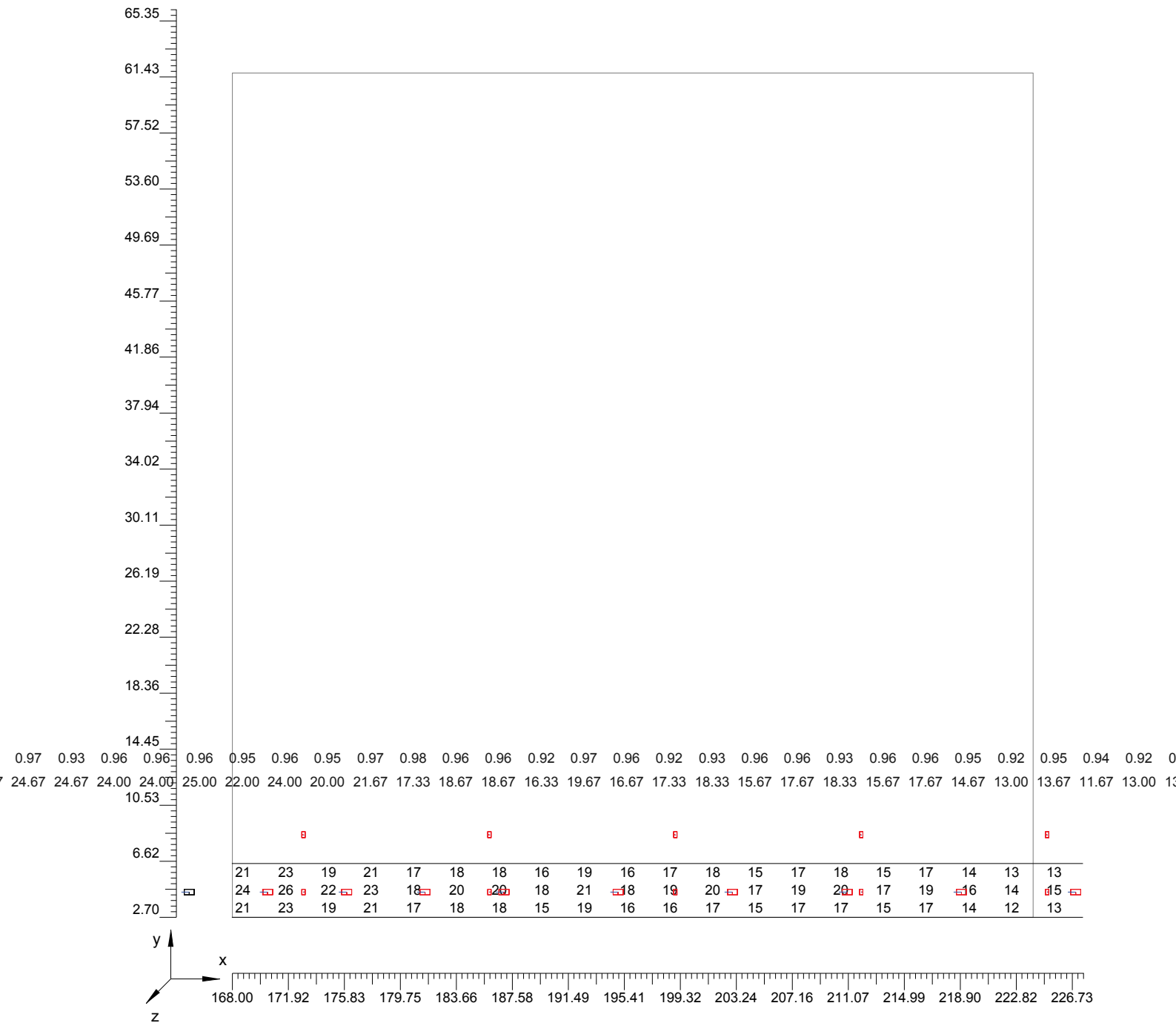

4.1 Valori delle Luminanze su: Corsia1 Oss. 1(x=-60.00;y=4.58;z=1.50)m

Scala 1/392

Parte 5 di 8

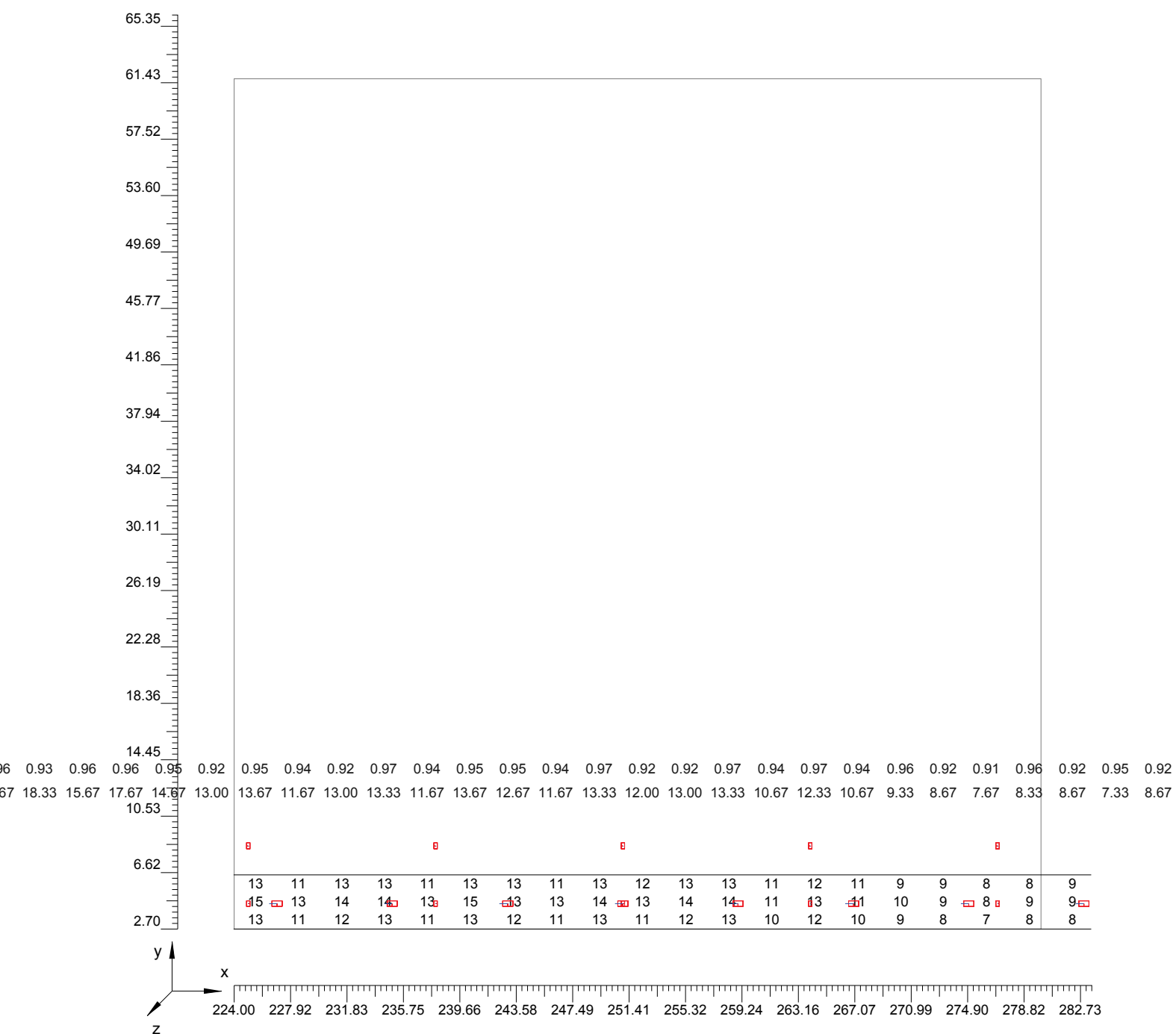

4.1 Valori delle Luminanze su: Corsia1 Oss. 1(x=-60.00;y=4.58;z=1.50)m

Scala 1/392

Parte 6 di 8

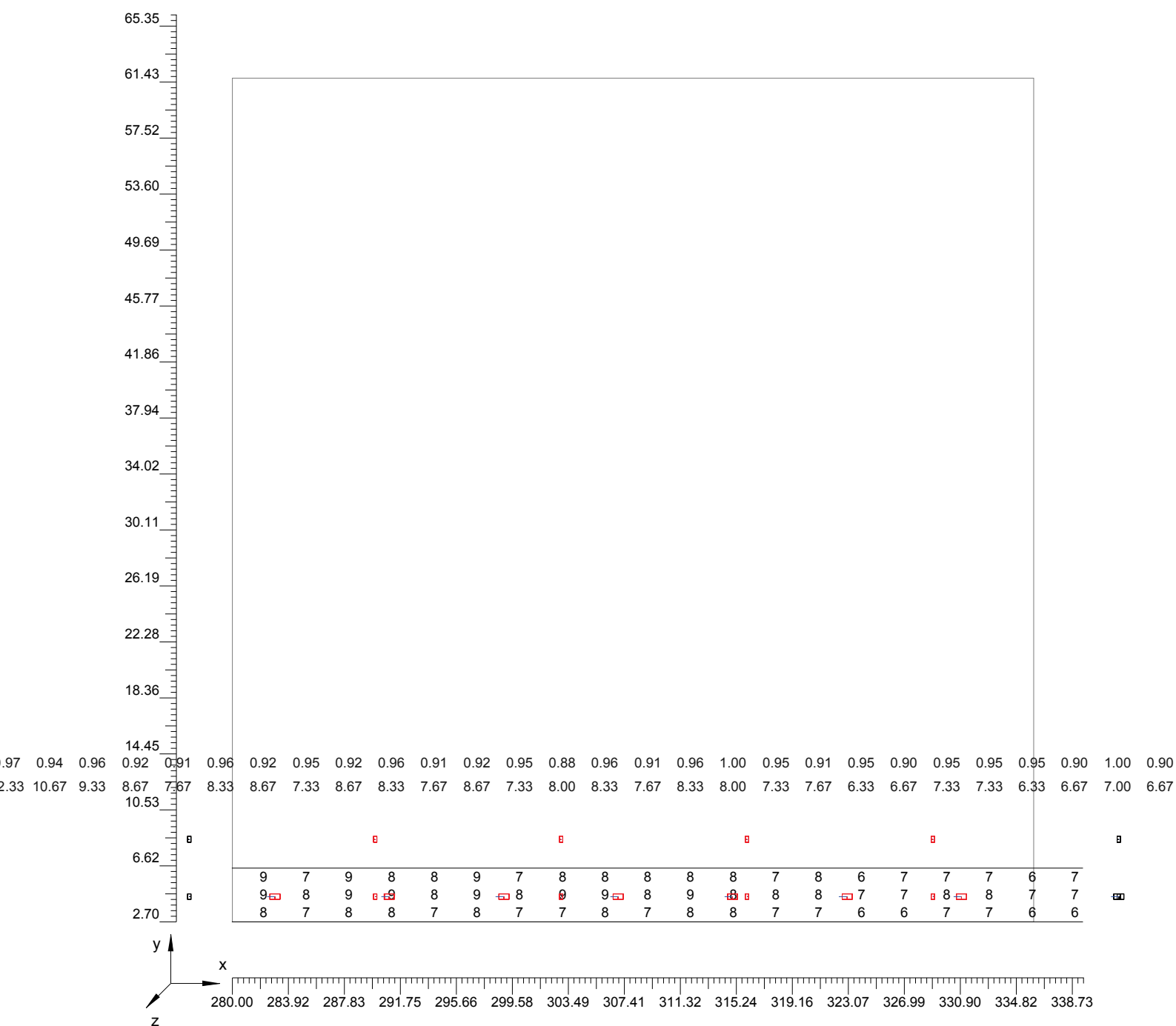

4.1 Valori delle Luminanze su: Corsia1 Oss. 1(x=-60.00;y=4.58;z=1.50)m

Scala 1/392

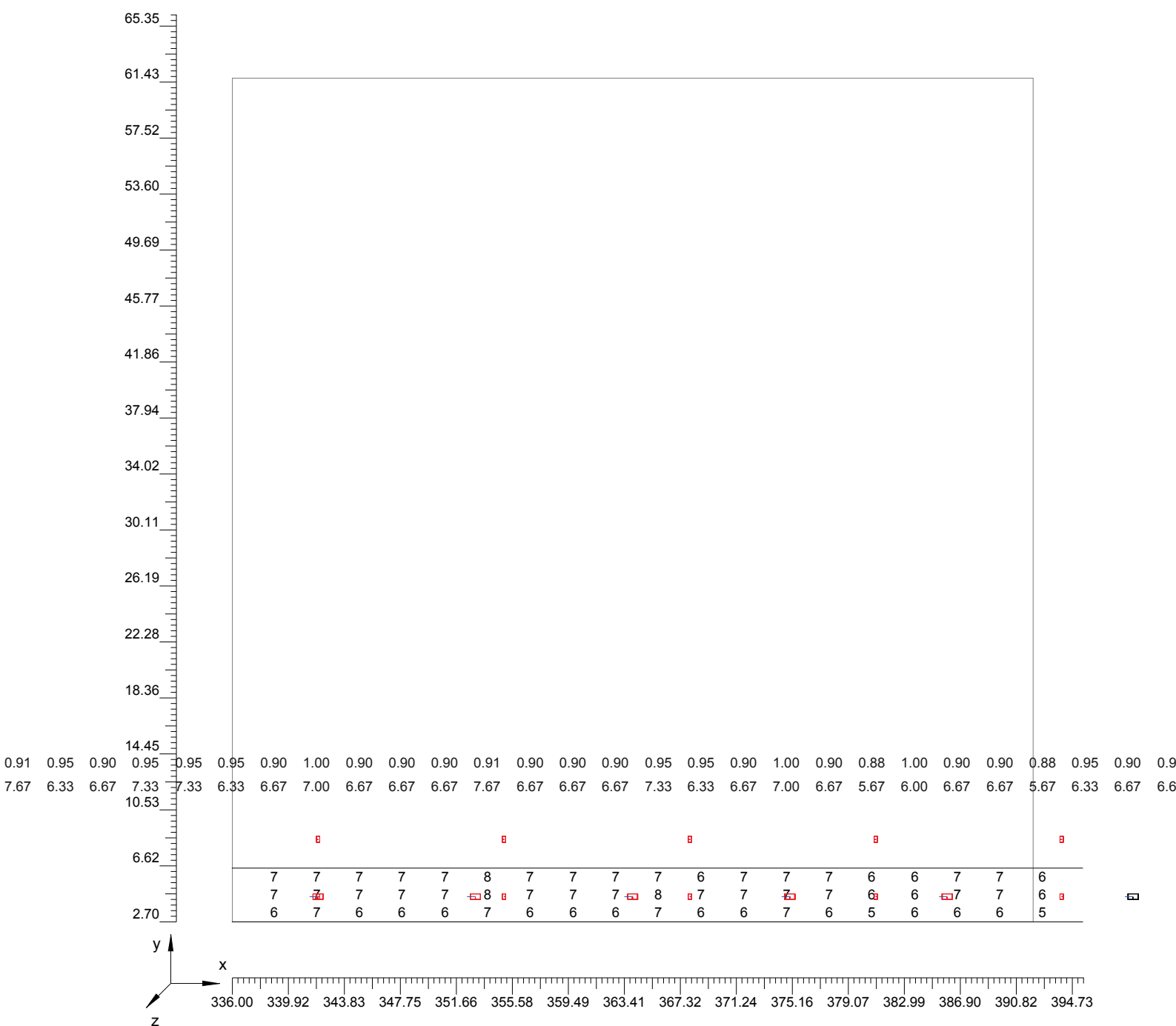

4.1 Valori delle Luminanze su: Corsia1 Oss. 1(x=-60.00;y=4.58;z=1.50)m

Scala 1/392

Parte 8 di 8

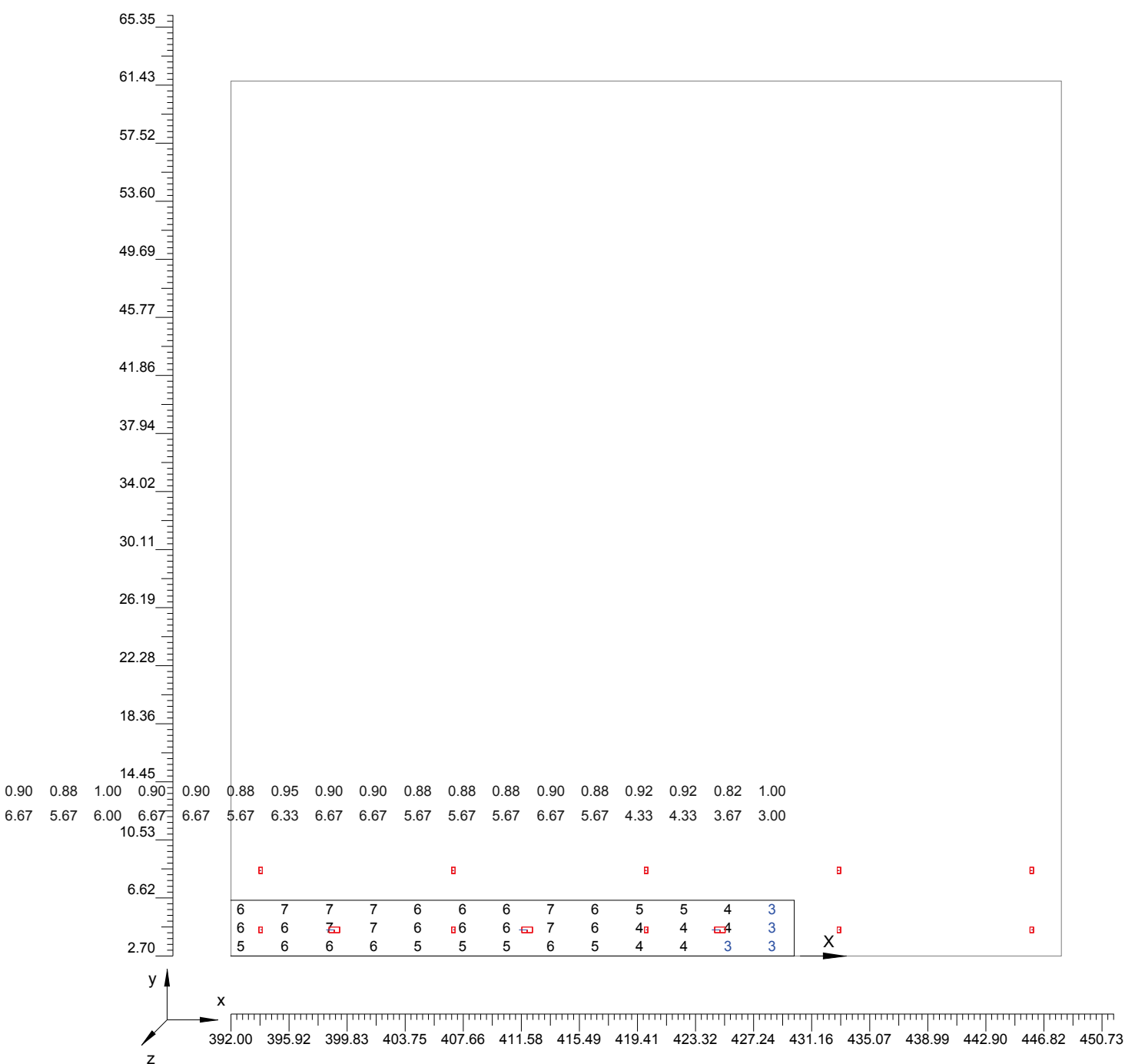

4.2 Curva Luminanza Oss. 1(x=-60.00;y=4.58;z=1.50)m

O (x:0.00 y:2.70 z:0.00)	Risultati	Medio	Minimo	Massimo	Min/Medio	Min/Max	Medio/Max
DX:2.99 DY:1.25	Luminanza (L)	38 cd/m ²	3 cd/m ²	137 cd/m ²	0.07	0.02	0.28

Tipo Calcolo

Dir.+Iindir.(1 Interriflessioni) + Arredi

Nome Corsia	Largh. Corsia [m] (W)	y1 [m]	y2 [m]	Pt.Calc.Y	Tabella R	Coeff.Rifl. Fattore q0	Osservatore x Assoluto [m]	Osservatore y Assoluto [m]	Luminanza Velante [cd/m ²]	Incremento di Soglia [%]	Uniformità Longitudinale
Corsia1	3.75	2.70	6.45	3	C2	5.60	-60.00	4.58	7.25	11.63	0.02 *

Norma

CEN 13201

Zona: Carreggiata
 Luminanza Media 10.655 cd/m² (Corsia2 Obs2)
 Uniformita' Generale 0.068 (Corsia1 Obs1)
 Uniformita' Longitudinale 0.022 (Corsia1 Obs1)

Par. 1 Luminanza Media 28.857 cd/m² (1m e 1,7m)
 Par. 1 Illum. Medio 226.642lx (1m e 1,7m)
 Par. 1 Uniformita Generale 0.119 (1m e 1,7m)
 Par. 1 Uniformita Longitudinale 0.039 (a 1,7m)

Par. 2 Luminanza Media 15.527 cd/m² (1m e 1,7m)
 Par. 2 Illum. Medio 121.945lx (1m e 1,7m)
 Par. 2 Uniformita Generale 0.221 (1m e 1,7m)
 Par. 2 Uniformita Longitudinale 0.089 (a 1,7m)

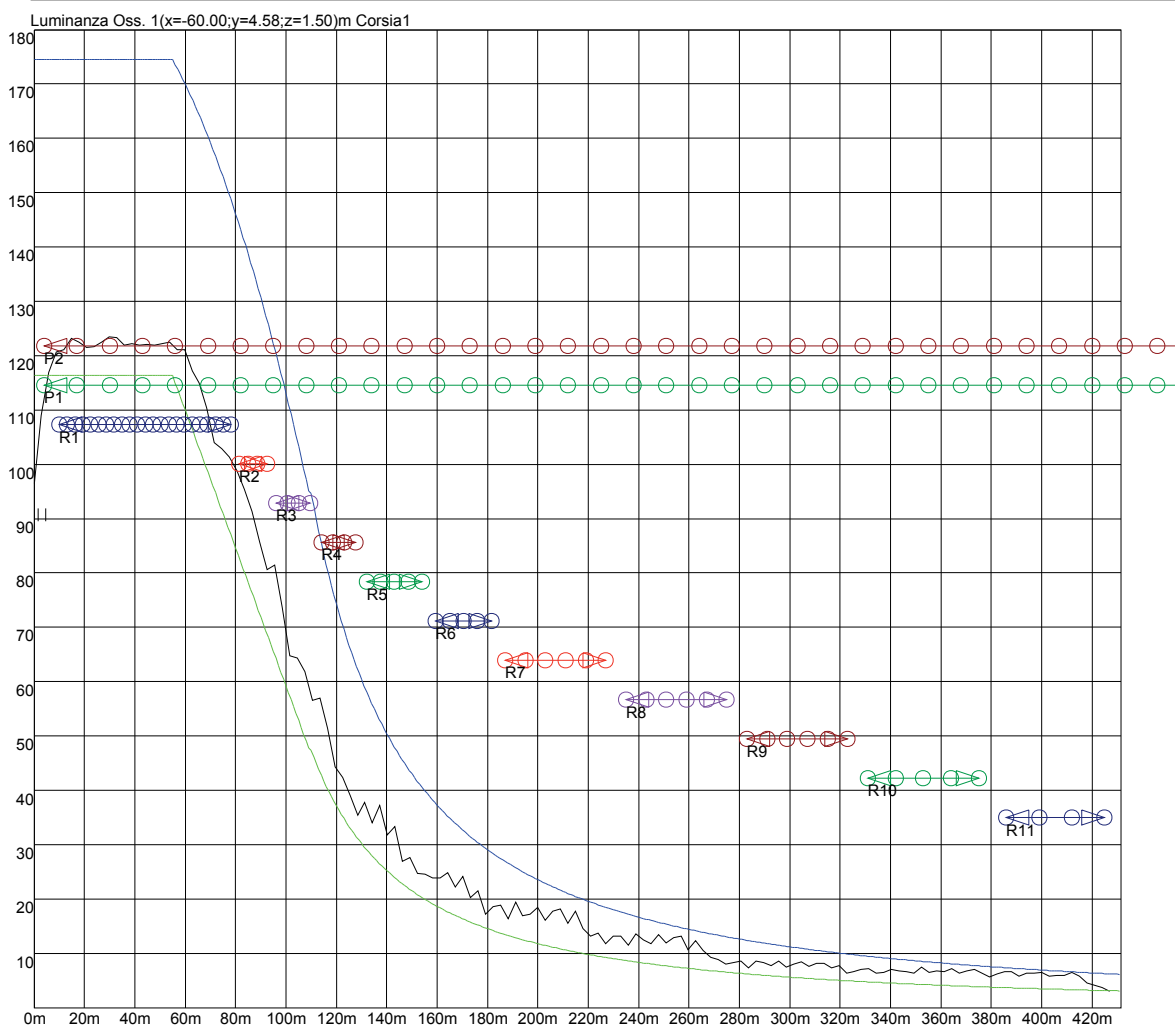

4.3 Valori delle Luminanze su: Parete_Destra (x=-60.00;y=4.58;z=1.50)m ---> (x=30.00;y=4.58;z=0.00)m

O (x:0.00 y:0.01 z:0.00)	Risultati	Medio	Minimo	Massimo	Min/Medio	Min/Max	Medio/Max
DX:2.99 DY:0.70	Luminanza (L)	29 cd/m ²	3 cd/m ²	89 cd/m ²	0.12	0.04	0.32

Tipo Calcolo

Dir.+Indir.(1 Interriflessioni) + Arredi

Scala 1/3000

4.3 Valori delle Luminanze su: Parete_Destra (x=-60.00;y=4.58;z=1.50)m ---> (x=30.00;y=4.58;z=0.00)m

Totale Parti: 14

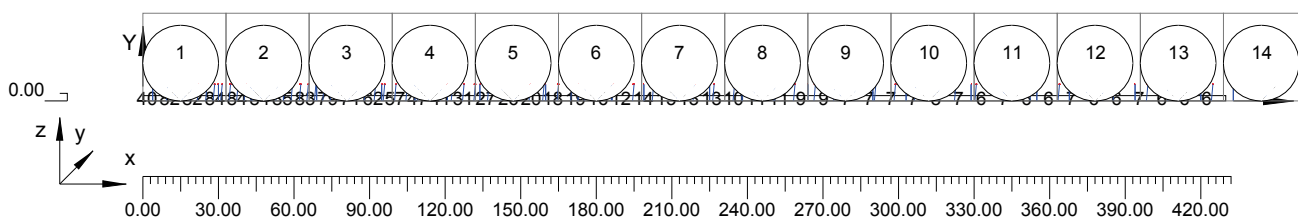

4.3 Valori delle Luminanze su: Parete_Destra (x=-60.00;y=4.58;z=1.50)m ---> (x=30.00;y=4.58;z=0.00)m

Scala 1/230

Parte 1 di 14

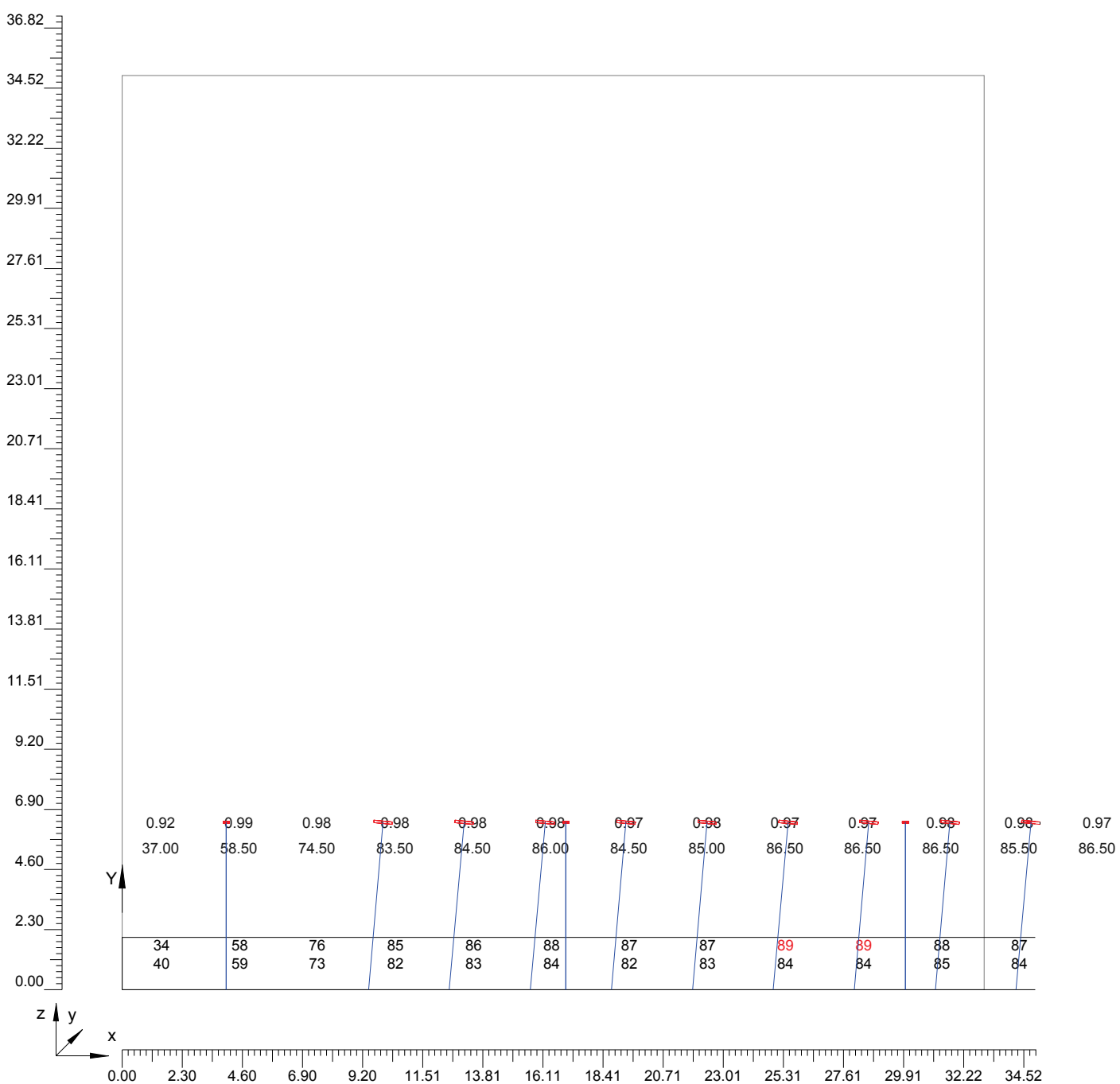

4.3 Valori delle Luminanze su: Parete_Destra (x=-60.00;y=4.58;z=1.50)m ---> (x=30.00;y=4.58;z=0.00)m

Scala 1/230

Parte 2 di 14

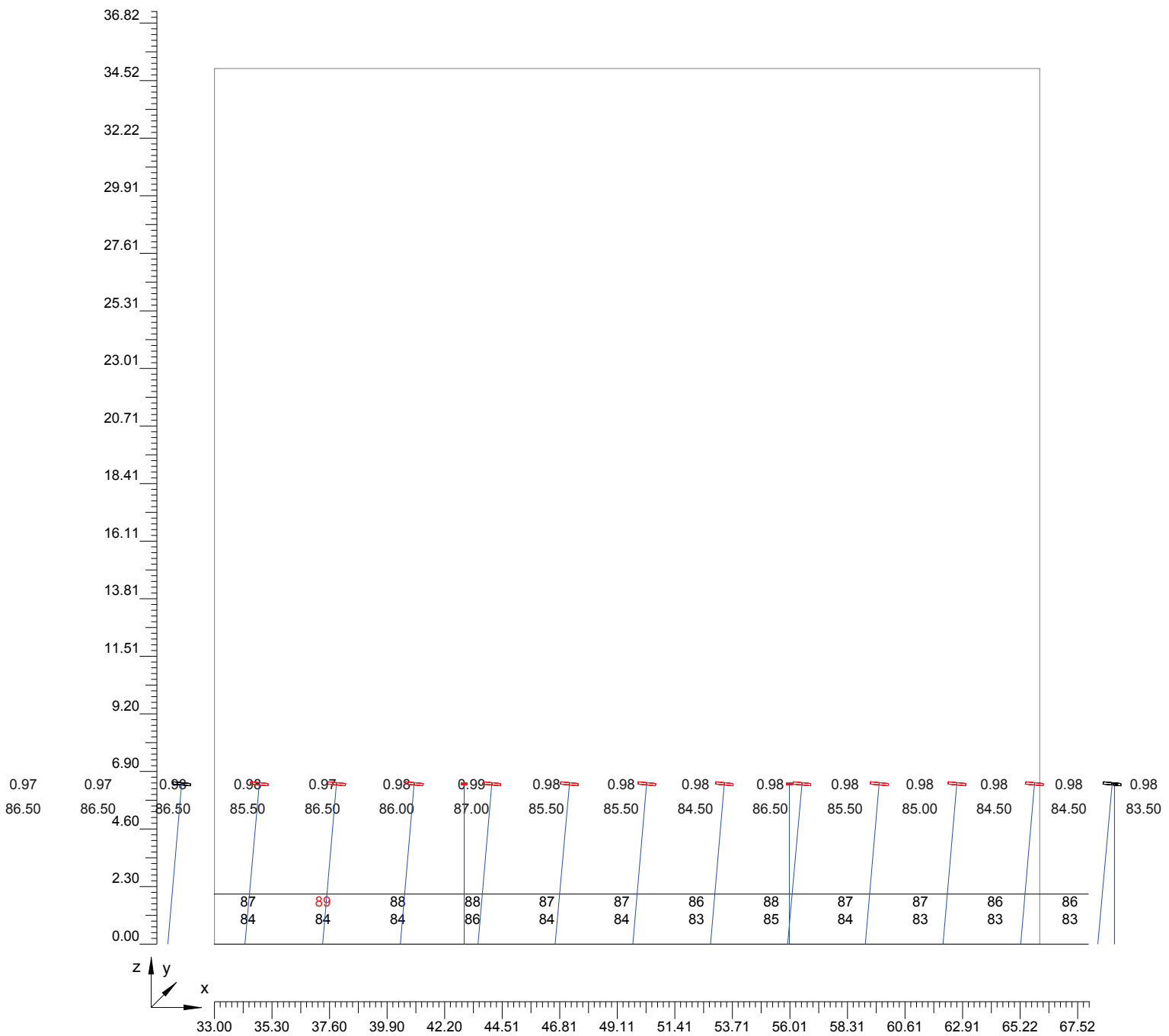

4.3 Valori delle Luminanze su: Parete_Destra (x=-60.00;y=4.58;z=1.50)m ---> (x=30.00;y=4.58;z=0.00)m

Scala 1/230

Parte 3 di 14

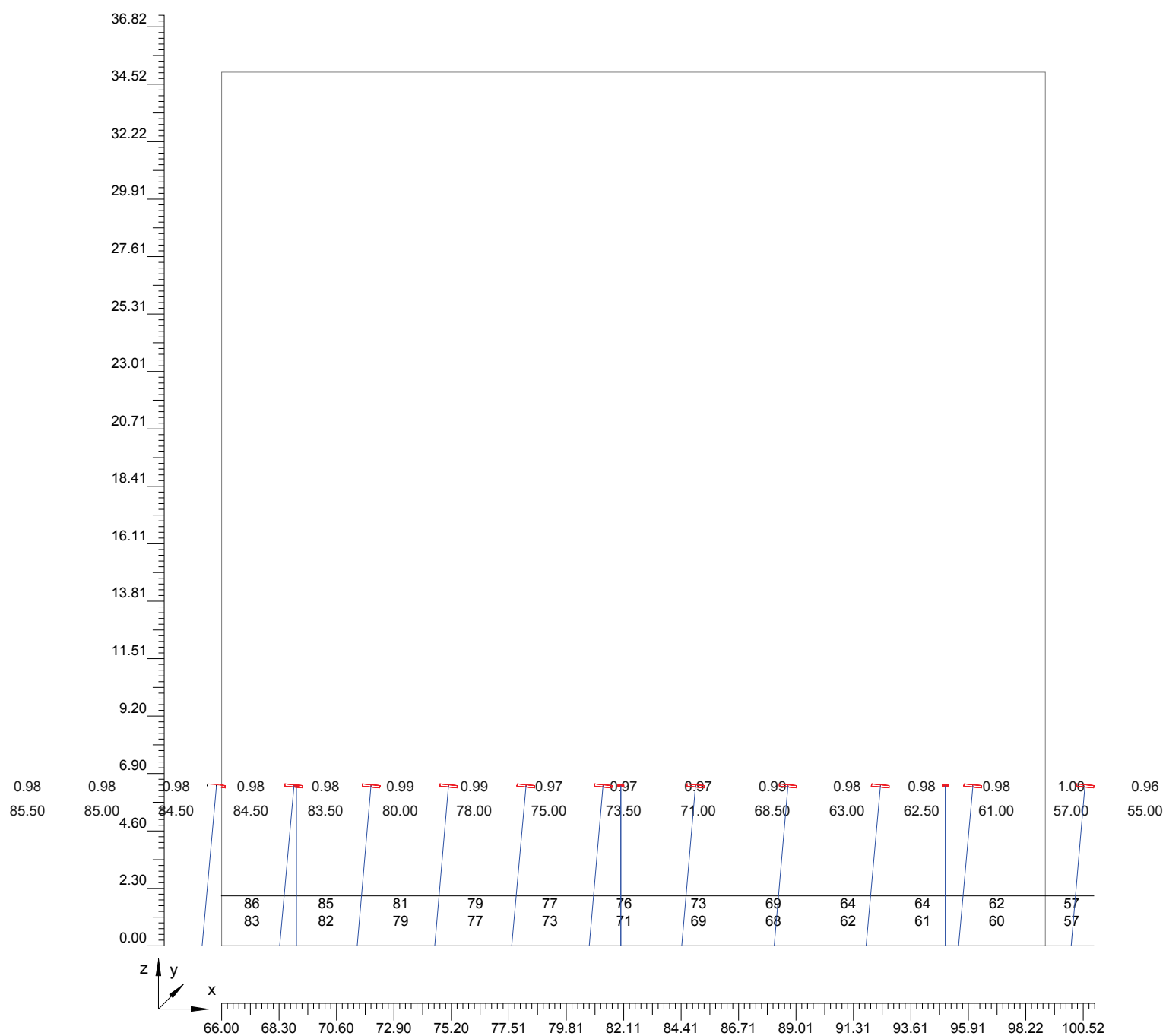

4.3 Valori delle Luminanze su: Parete_Destra (x=-60.00;y=4.58;z=1.50)m ---> (x=30.00;y=4.58;z=0.00)m

Scala 1/230

Parte 4 di 14

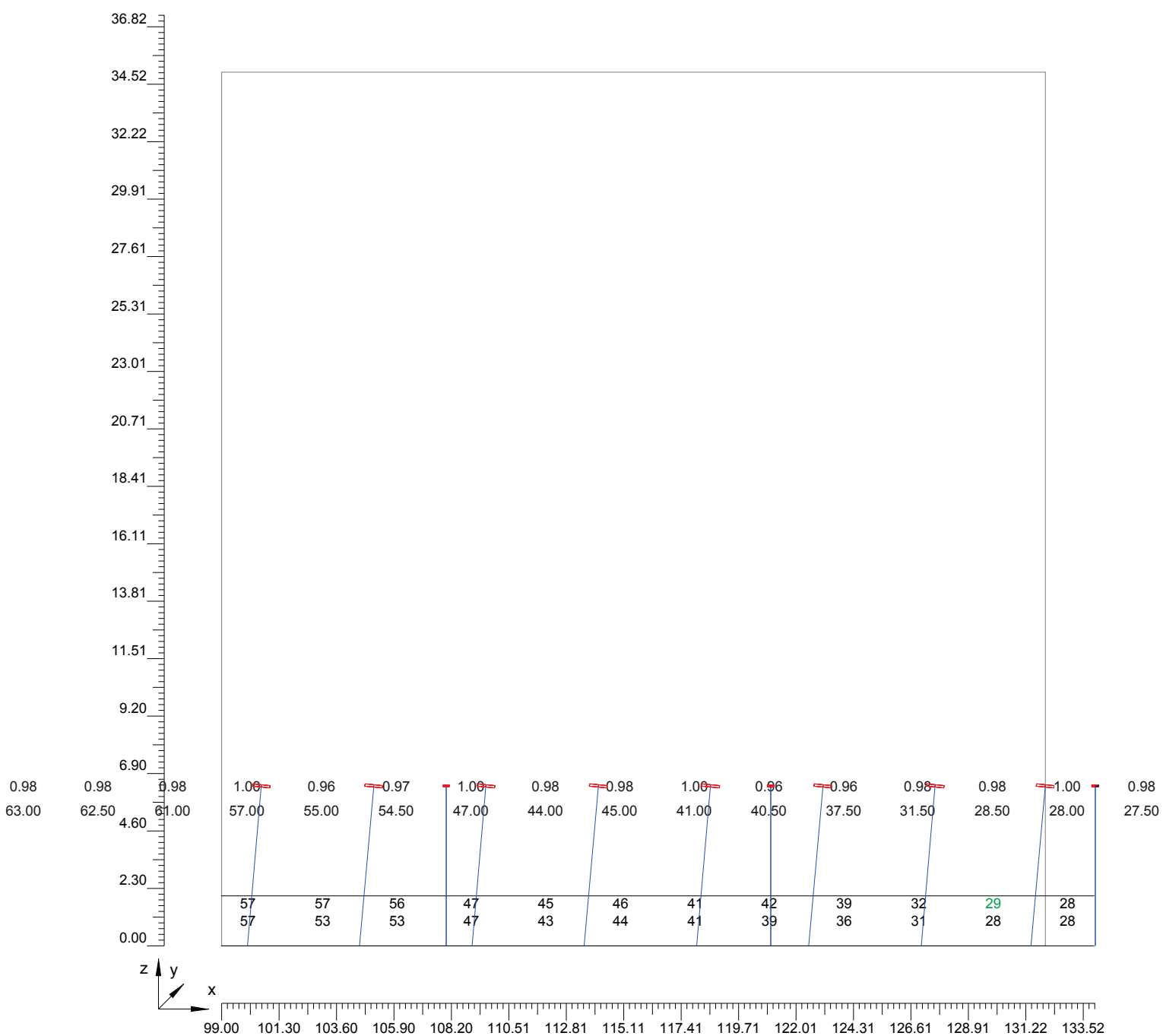

4.3 Valori delle Luminanze su: Parete_Destra (x=-60.00;y=4.58;z=1.50)m ---> (x=30.00;y=4.58;z=0.00)m

Scala 1/230

Parte 5 di 14

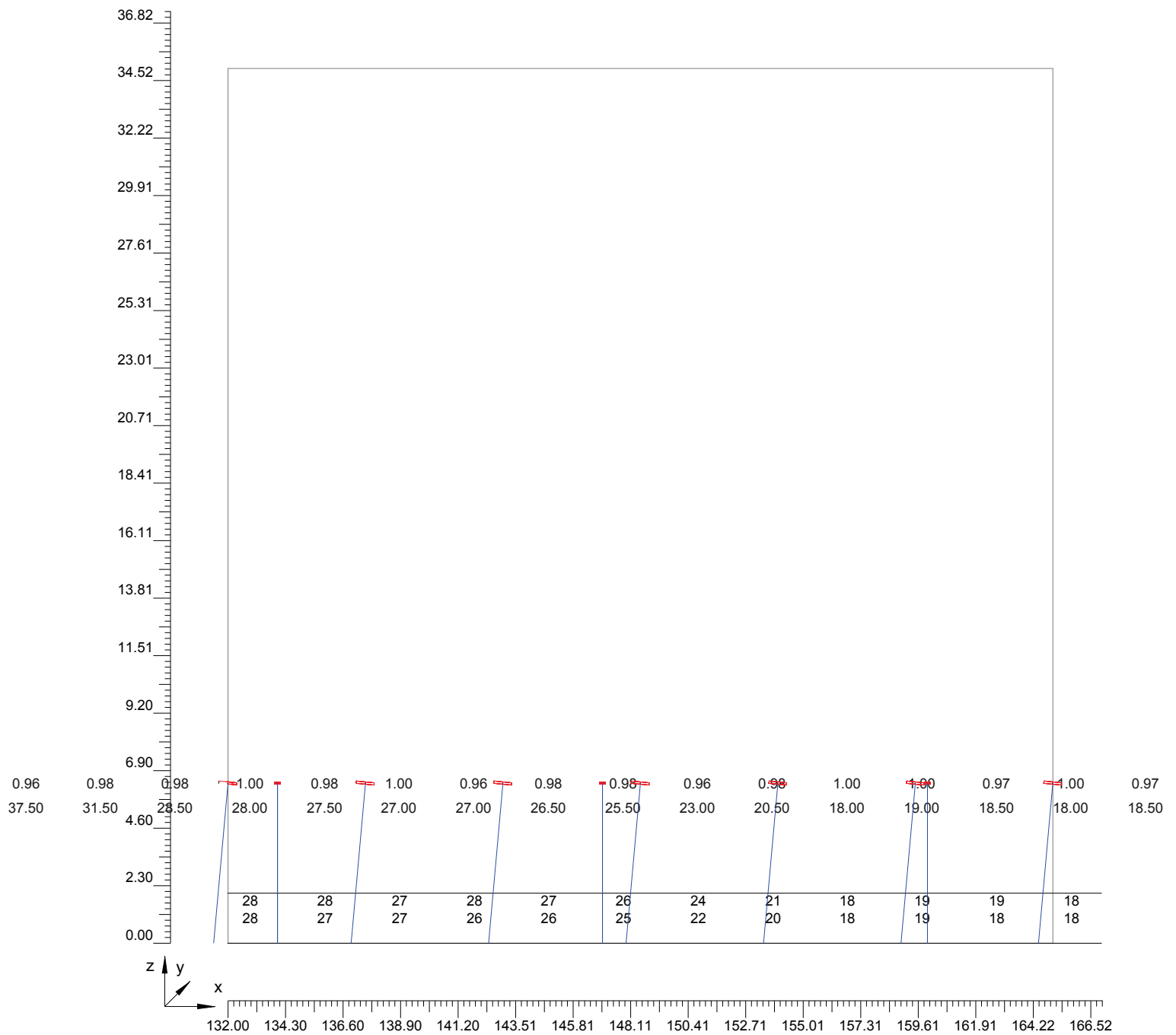

4.3 Valori delle Luminanze su: Parete_Destra (x=-60.00;y=4.58;z=1.50)m ---> (x=30.00;y=4.58;z=0.00)m

Scala 1/230

Parte 6 di 14

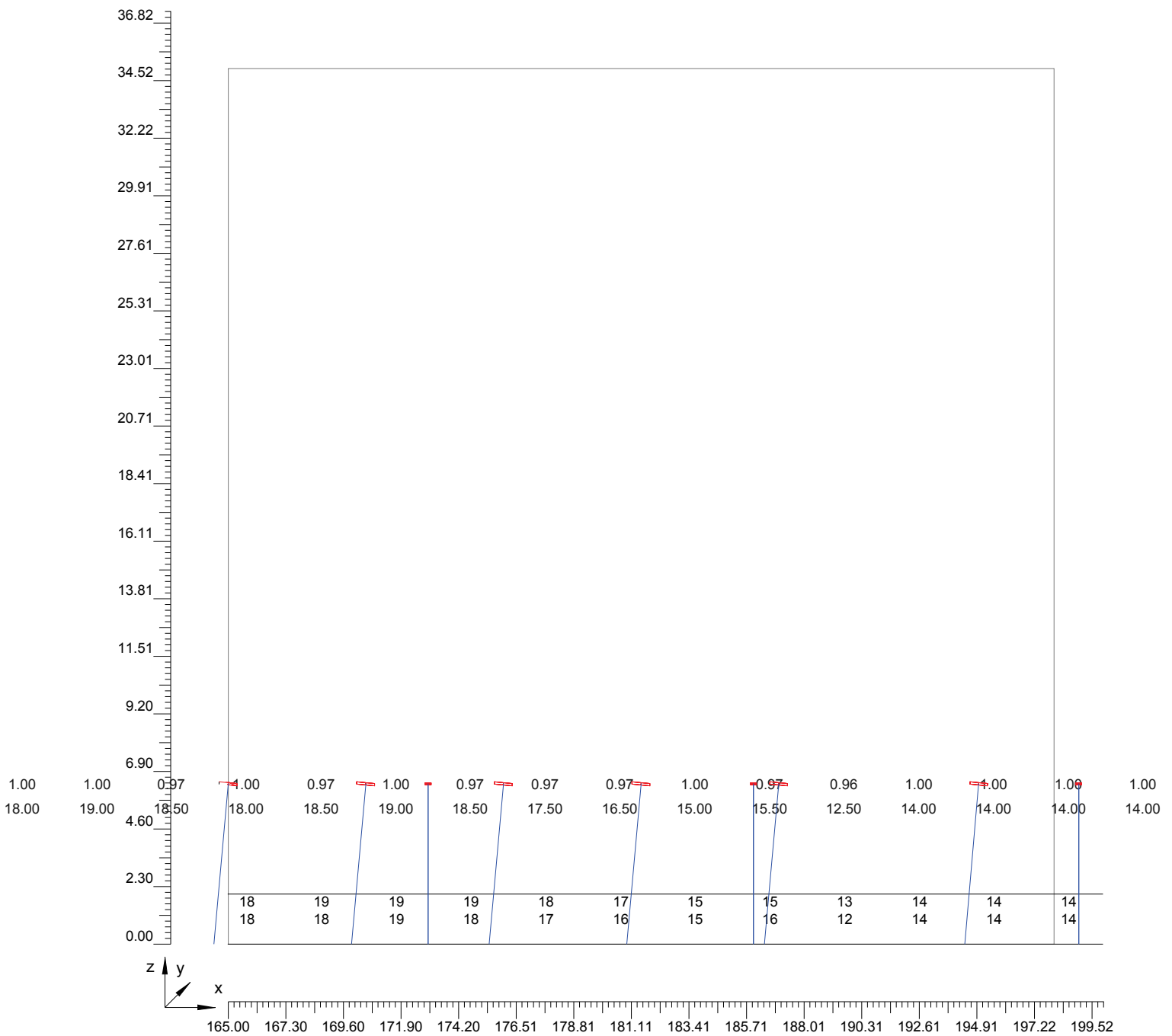

4.3 Valori delle Luminanze su: Parete_Destra (x=-60.00;y=4.58;z=1.50)m ---> (x=30.00;y=4.58;z=0.00)m

Scala 1/230

Parte 7 di 14

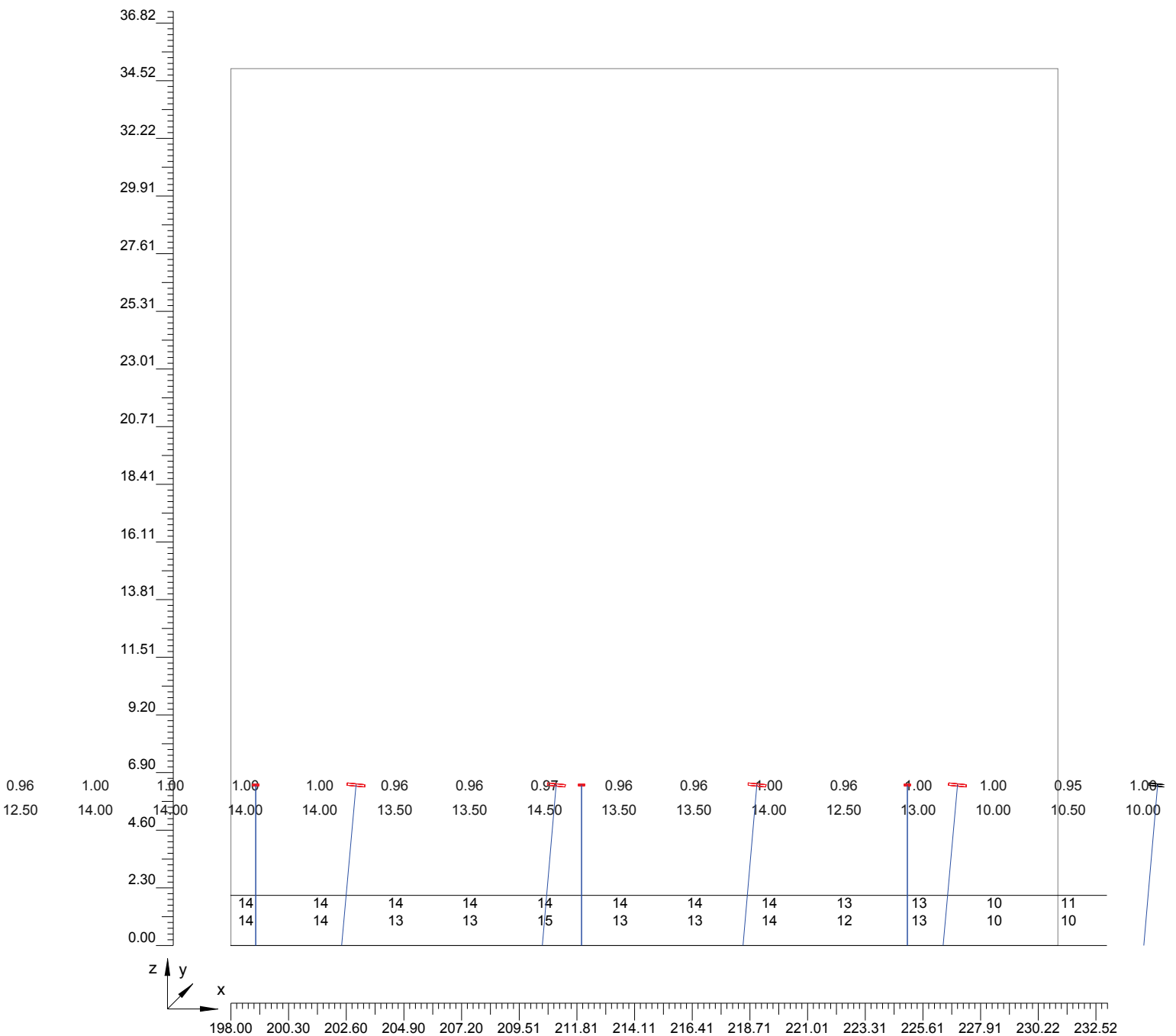

4.3 Valori delle Luminanze su: Parete_Destra (x=-60.00;y=4.58;z=1.50)m ---> (x=30.00;y=4.58;z=0.00)m

Scala 1/230

Parte 8 di 14

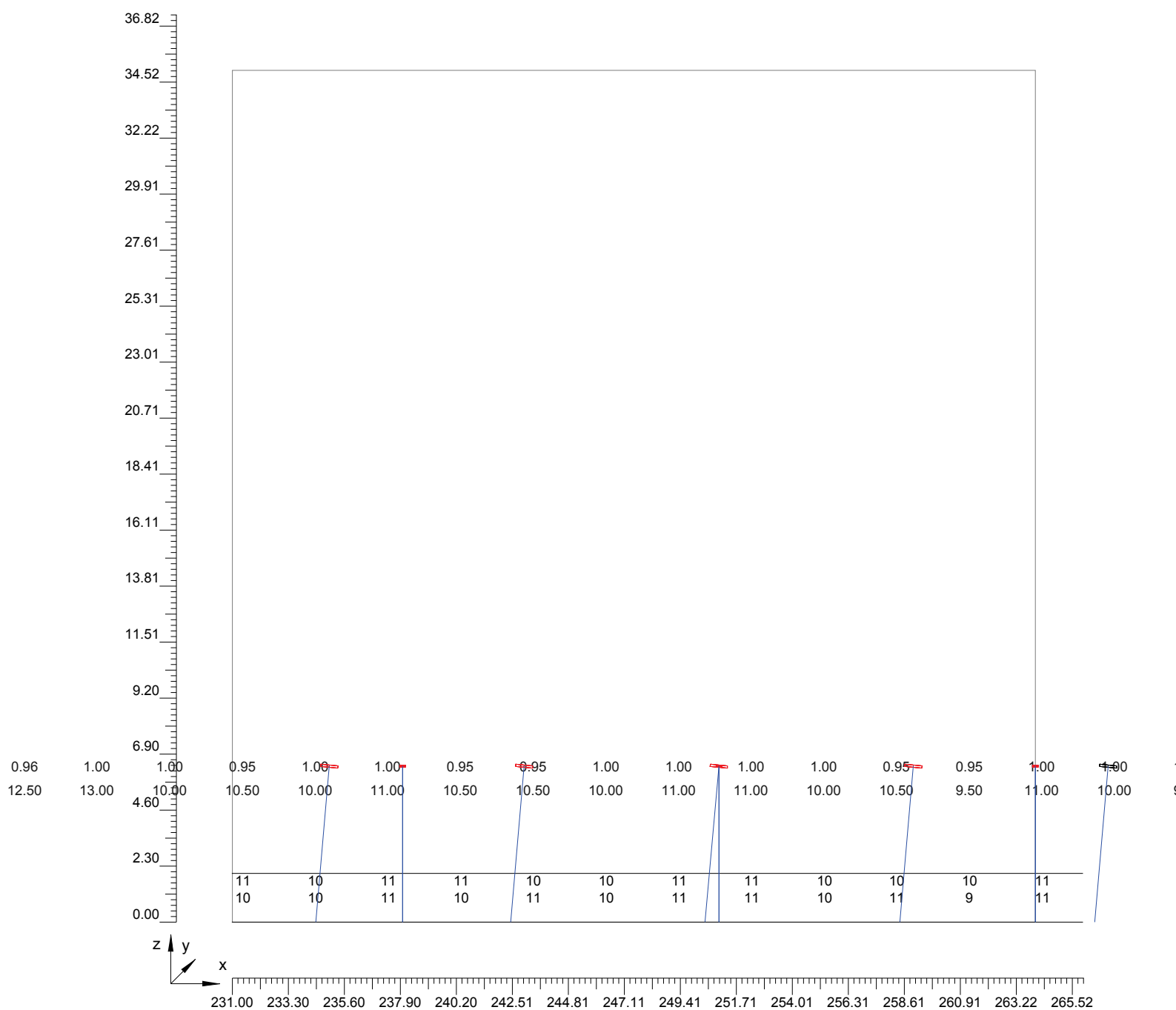

4.3 Valori delle Luminanze su: Parete_Destra (x=-60.00;y=4.58;z=1.50)m ---> (x=30.00;y=4.58;z=0.00)m

Scala 1/230

Parte 9 di 14

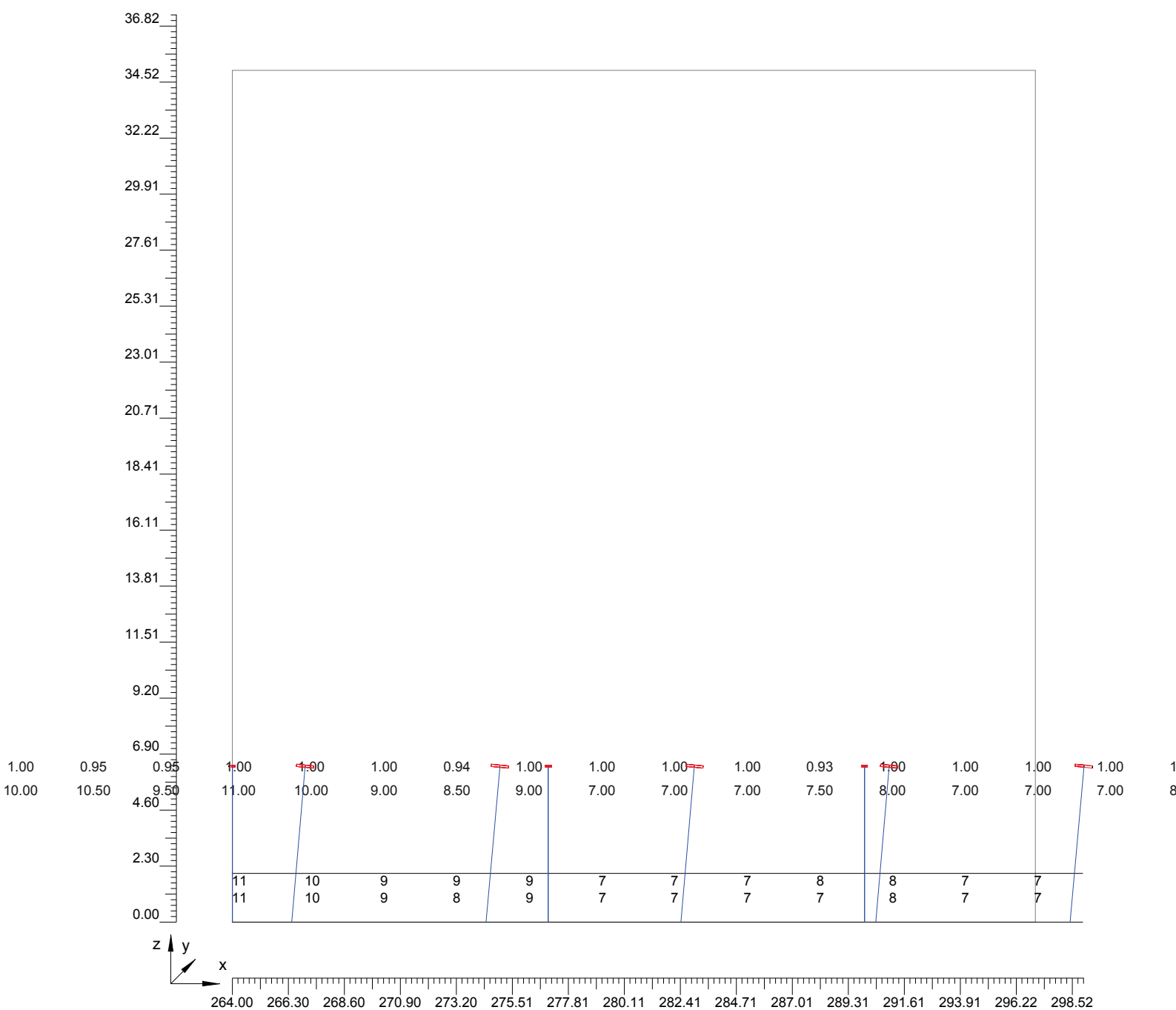

4.3 Valori delle Luminanze su: Parete_Destra (x=-60.00;y=4.58;z=1.50)m ---> (x=30.00;y=4.58;z=0.00)m

Scala 1/230

Parte 10 di 14

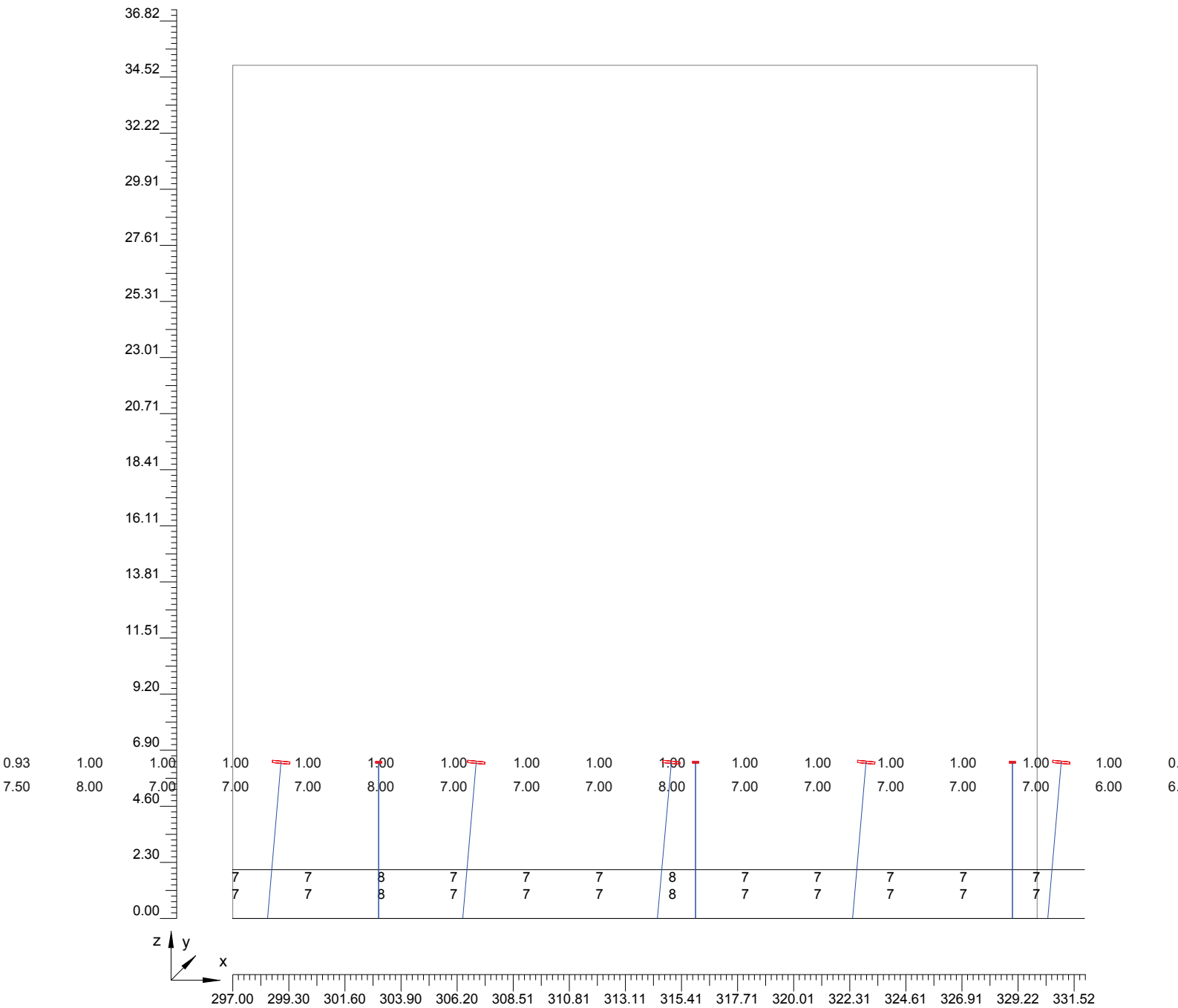

4.3 Valori delle Luminanze su: Parete_Destra (x=-60.00;y=4.58;z=1.50)m ---> (x=30.00;y=4.58;z=0.00)m

Scala 1/230

Parte 11 di 14

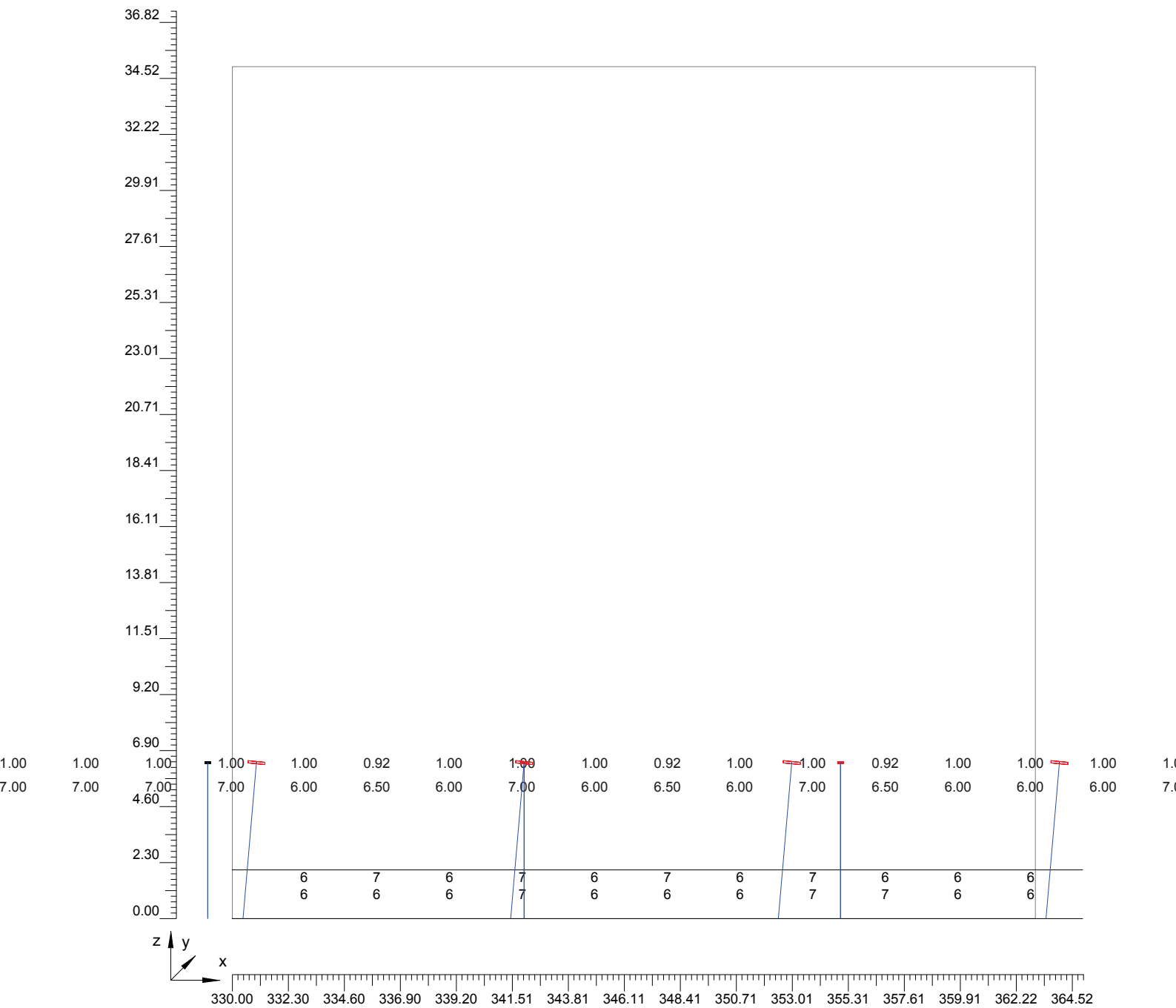

4.3 Valori delle Luminanze su: Parete_Destra (x=-60.00;y=4.58;z=1.50)m ---> (x=30.00;y=4.58;z=0.00)m

Scala 1/230

Parte 12 di 14

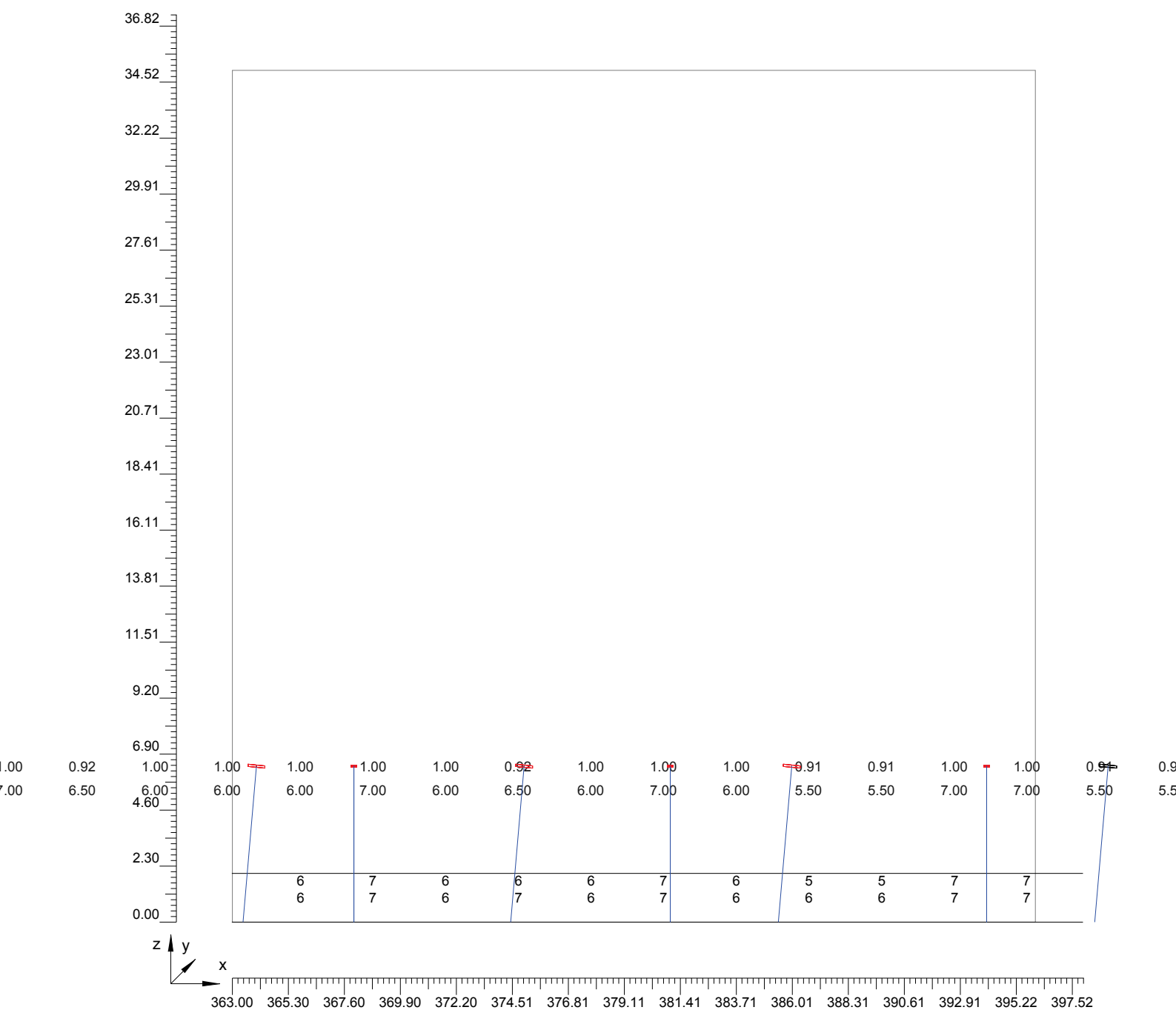

4.3 Valori delle Luminanze su: Parete_Destra (x=-60.00;y=4.58;z=1.50)m ---> (x=30.00;y=4.58;z=0.00)m

Scala 1/230

Parte 13 di 14

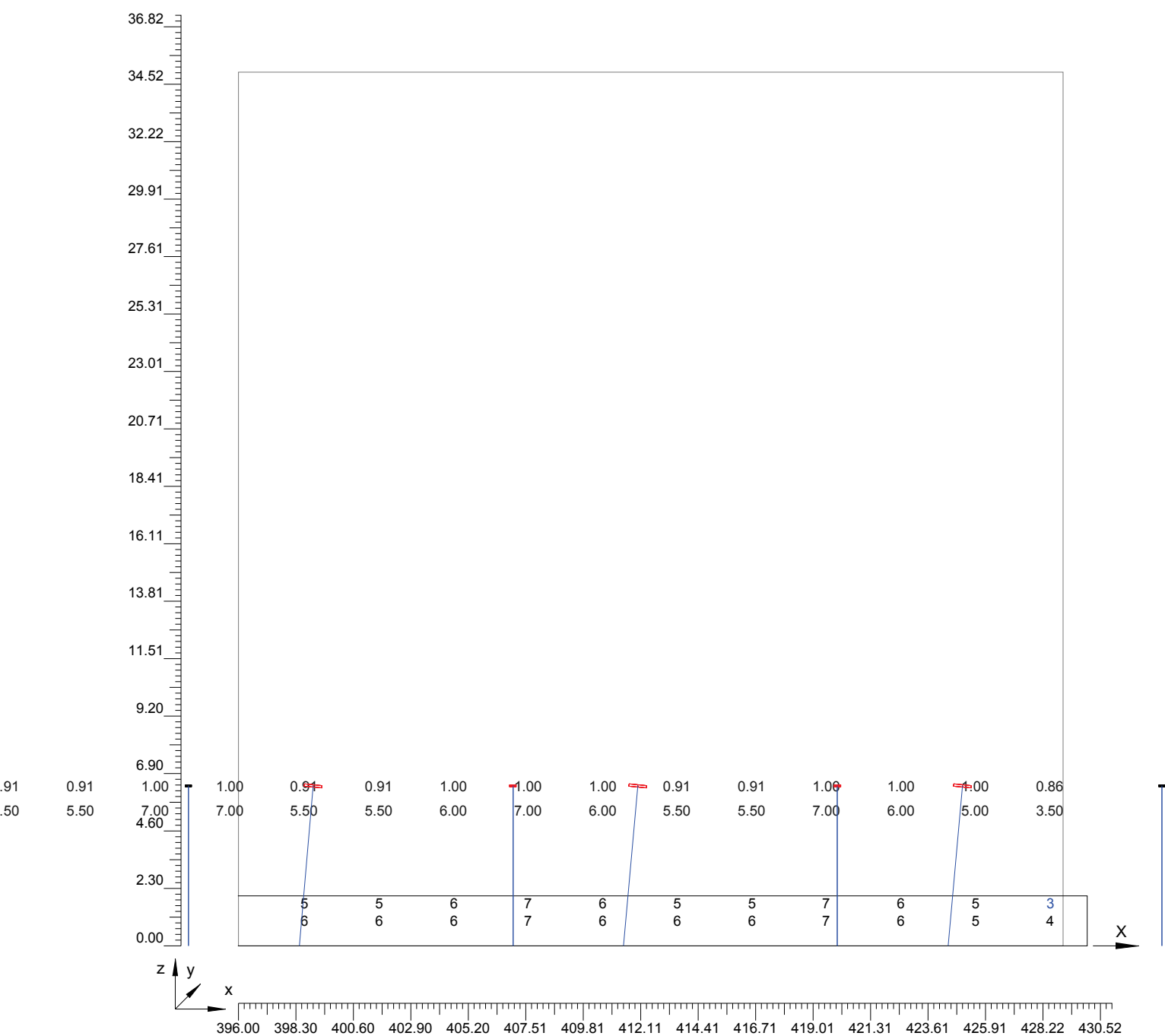

4.3 Valori delle Luminanze su: Parete_Destra (x=-60.00;y=4.58;z=1.50)m ---> (x=30.00;y=4.58;z=0.00)m

Scala 1/230

Parte 14 di 14

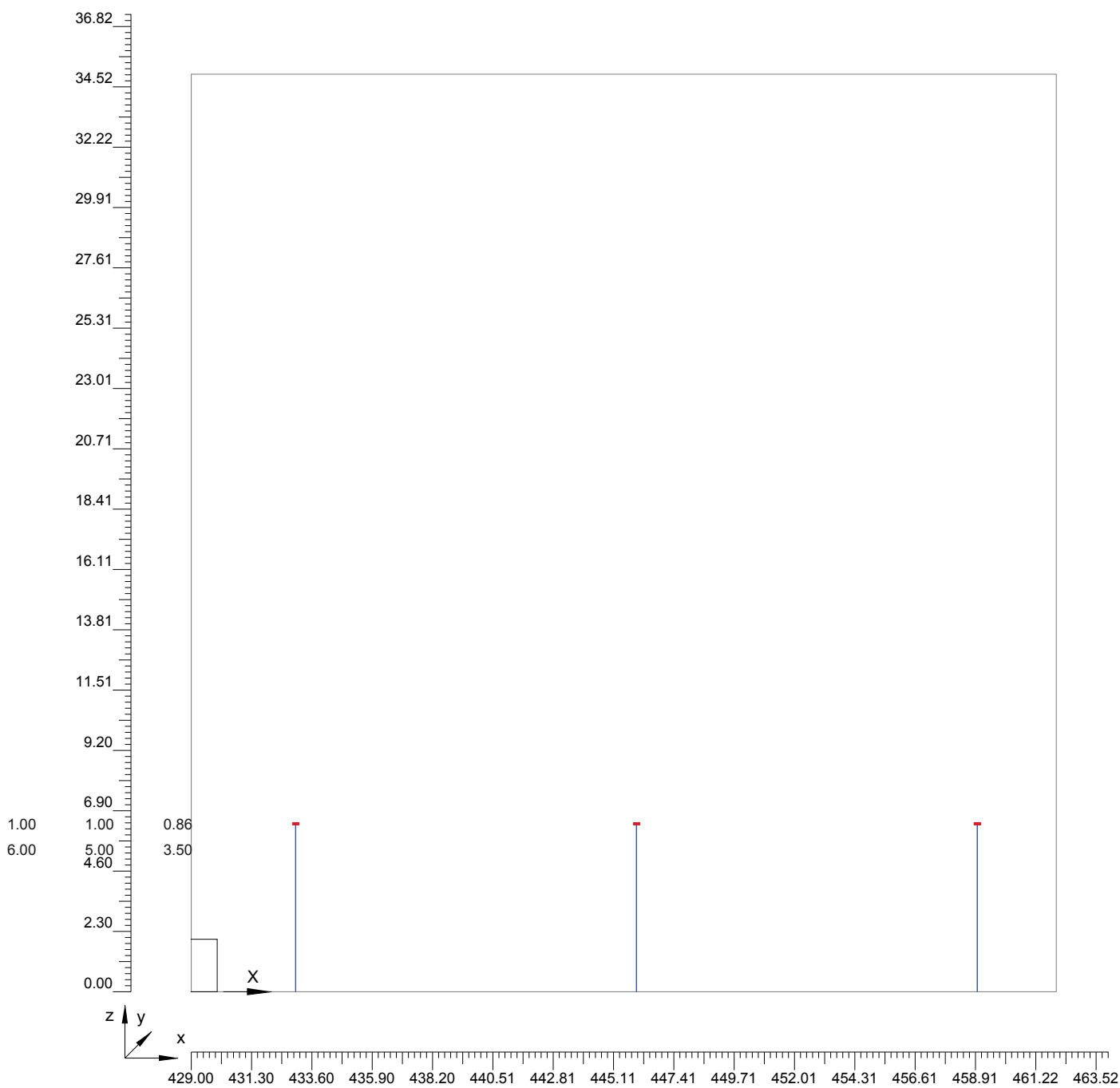

4.4 Valori di Illuminamento su: Carreggiata_LUX

O (x:0.00 y:2.70 z:0.00)	Risultati	Medio	Minimo	Massimo	Min/Medio	Min/Max	Medio/Max
DX:2.99 DY:1.25	Illuminamento Orizzontale (E)	323 lux	49 lux	1133 lux	0.15	0.04	0.28

Tipo Calcolo

Dir.+Indir.(1 Interriflessioni) + Arredi

4.4 Valori di Illuminamento su: Carreggiata_LUX

Scala 1/3000

Totale Parti: 8

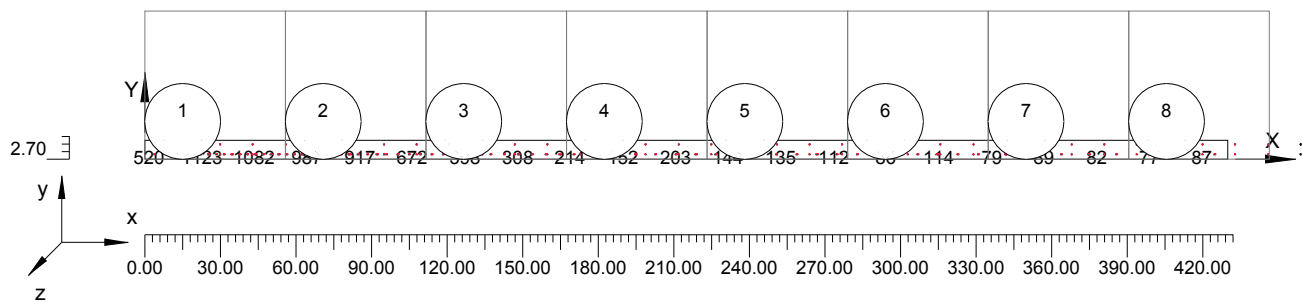

4.4 Valori di Illuminamento su: Carreggiata_LUX

Scala 1/392

Parte 1 di 8

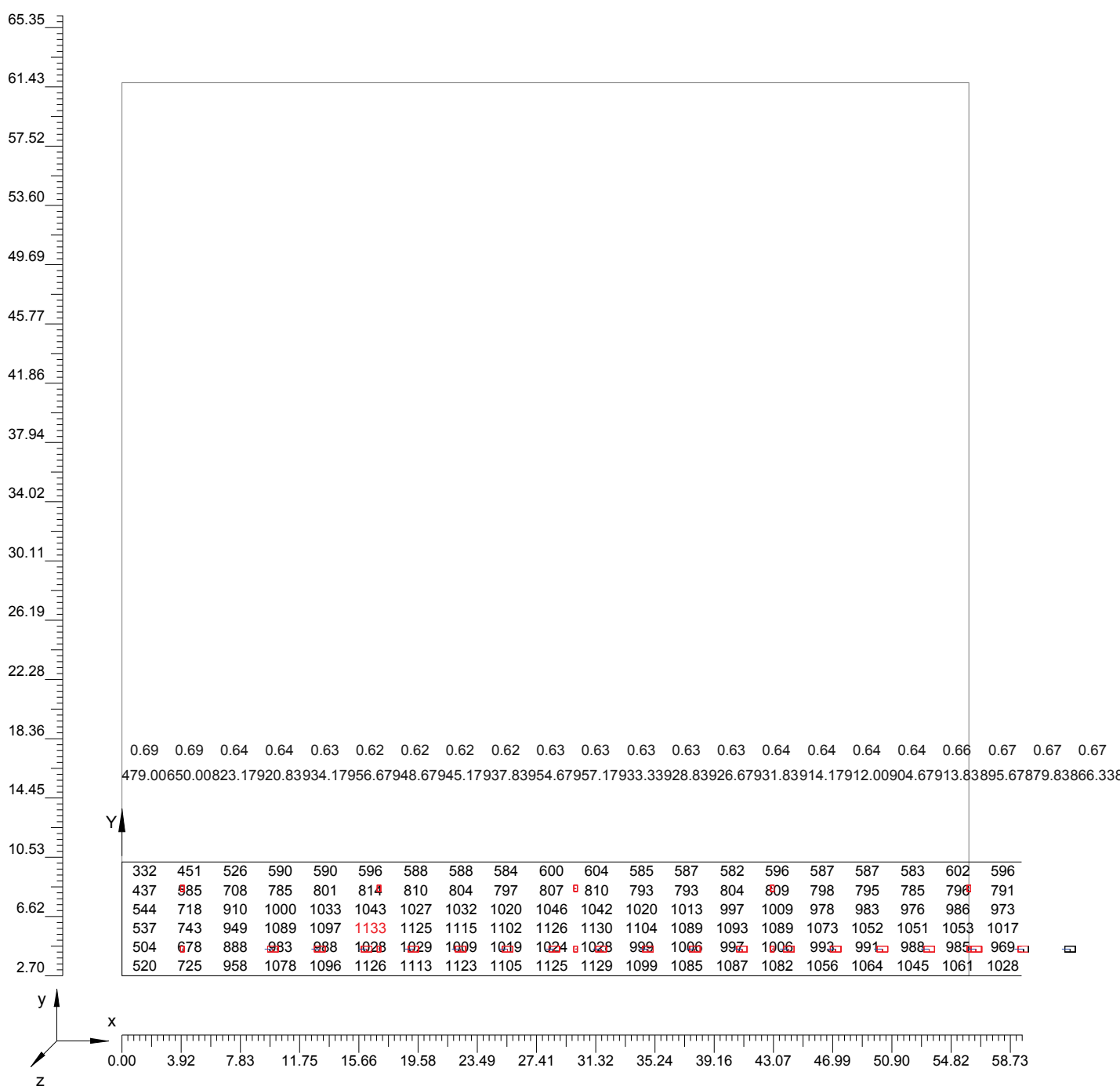

4.4 Valori di Illuminamento su: Carreggiata_LUX

Scala 1/392

Parte 2 di 8

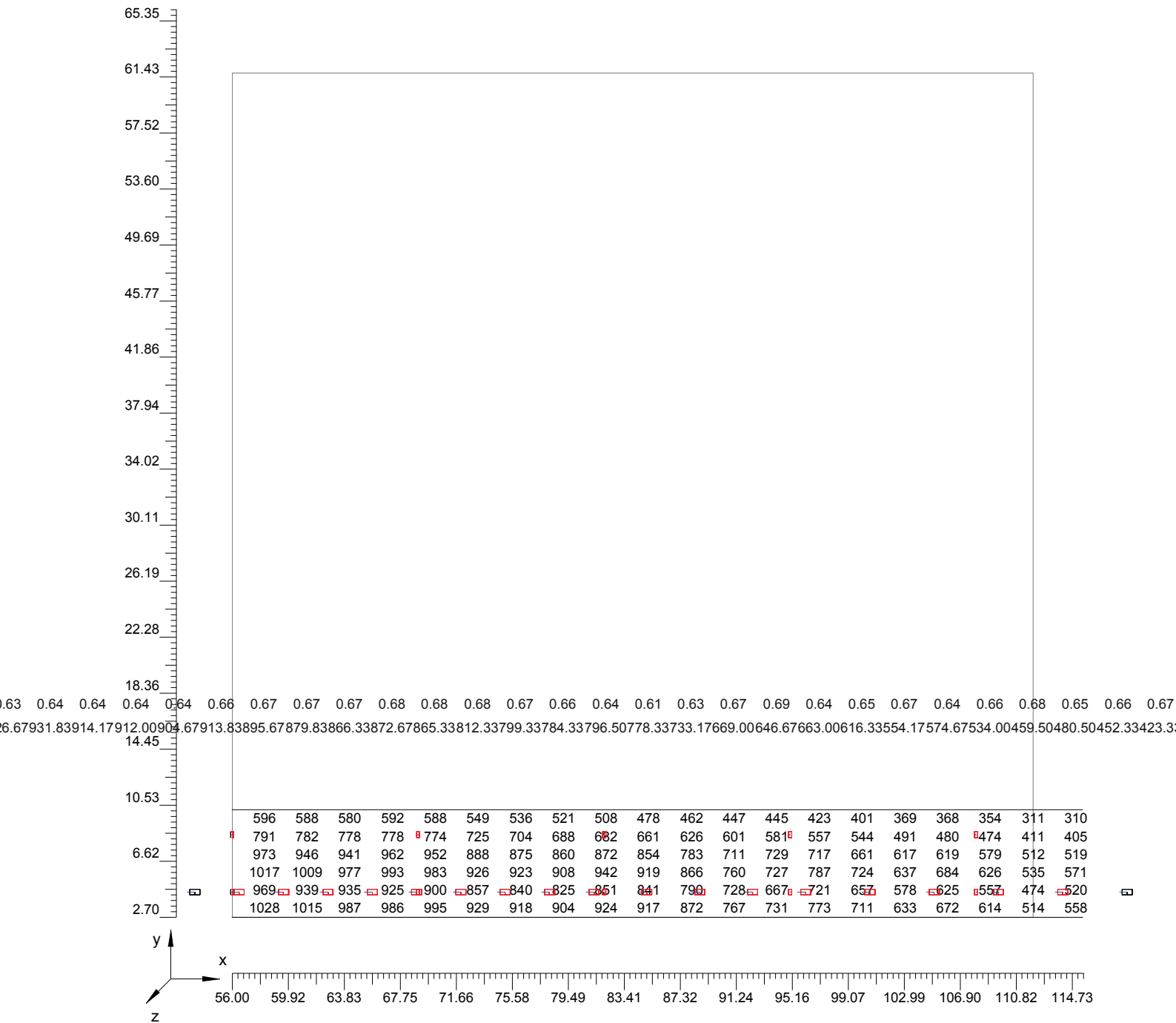

4.4 Valori di Illuminamento su: Carreggiata_LUX

Scala 1/392

Parte 3 di 8

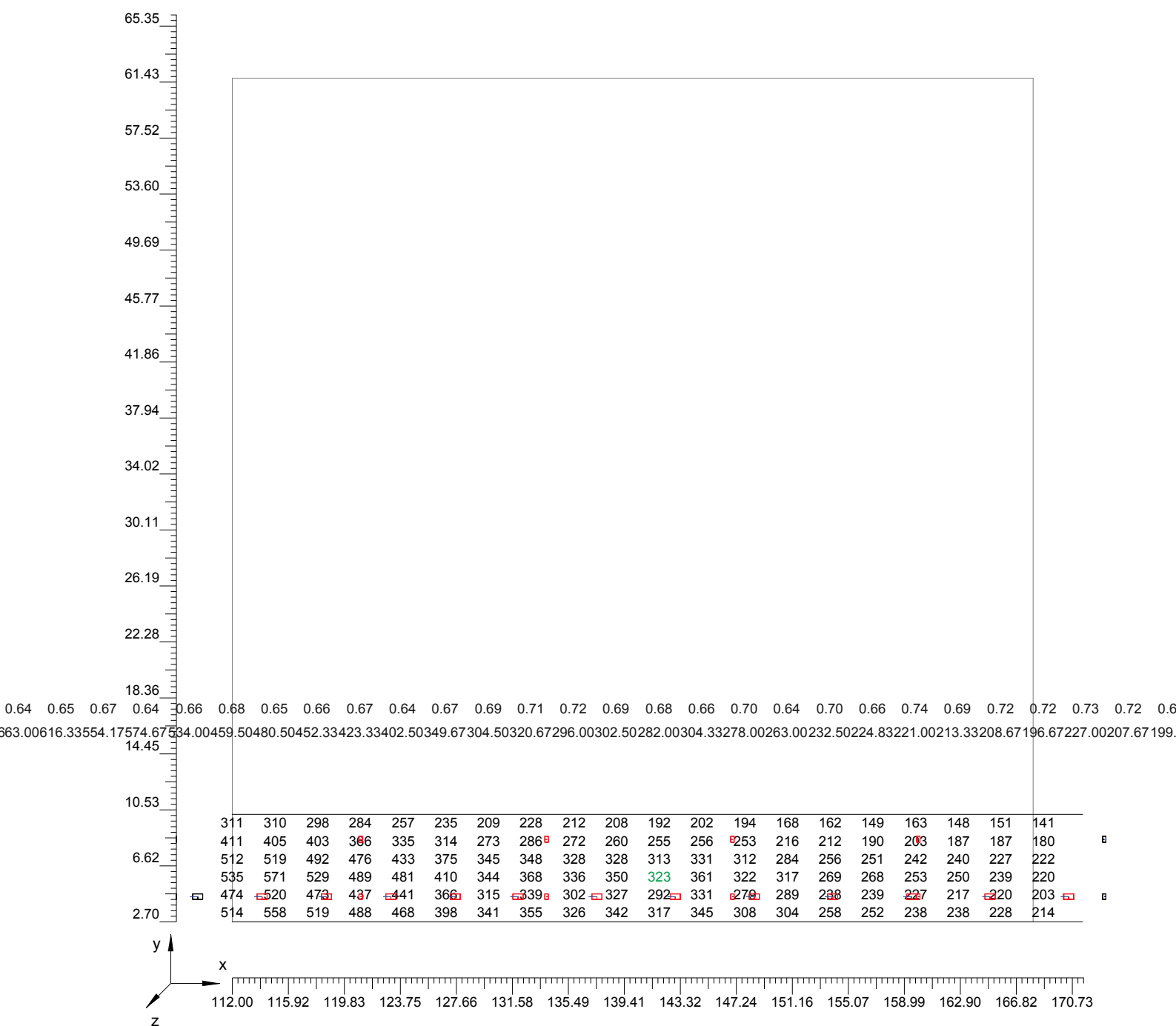

4.4 Valori di Illuminamento su: Carreggiata_LUX

Scala 1/392

Parte 4 di 8

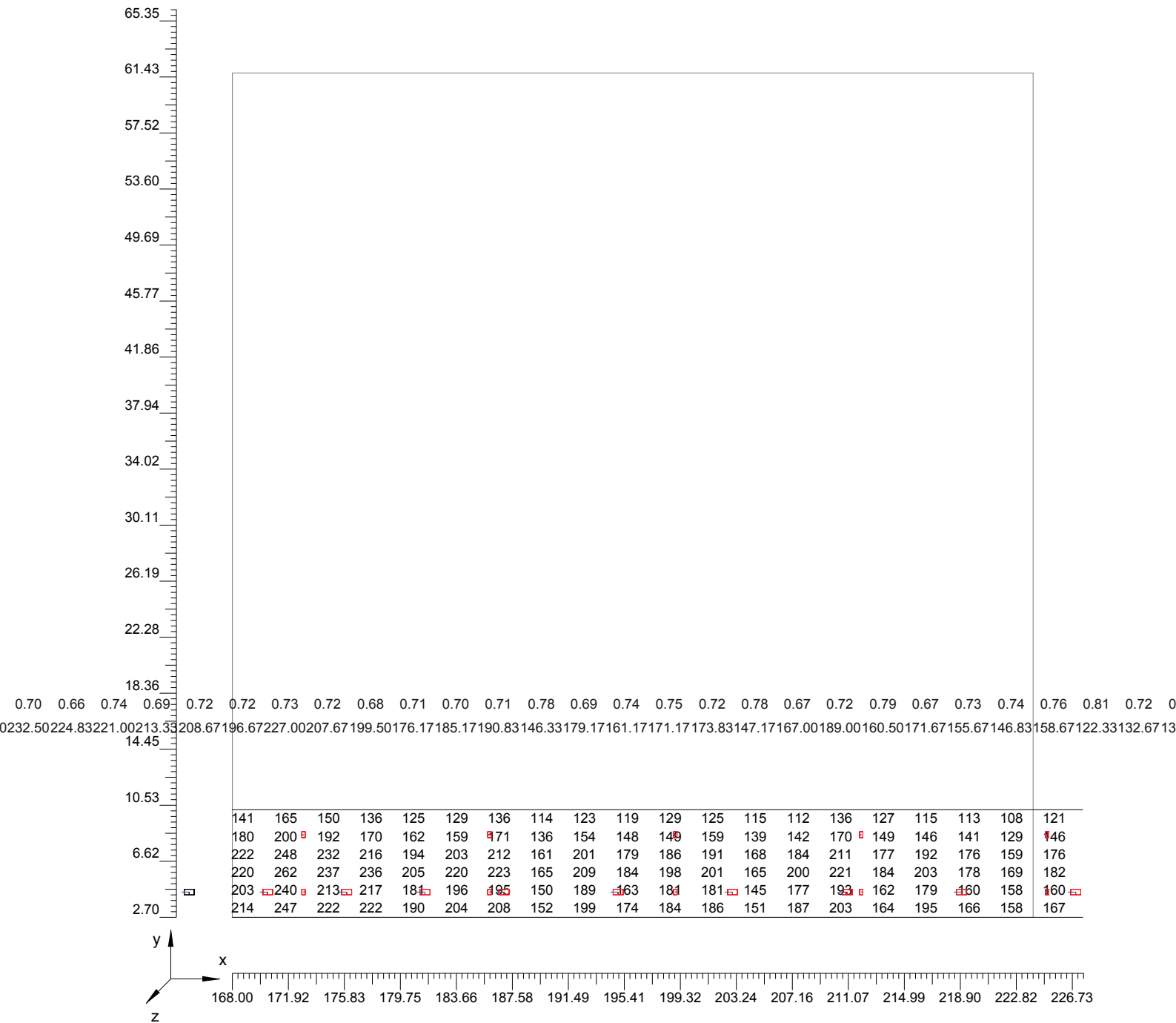

4.4 Valori di Illuminamento su: Carreggiata_LUX

Scala 1/392

Parte 5 di 8

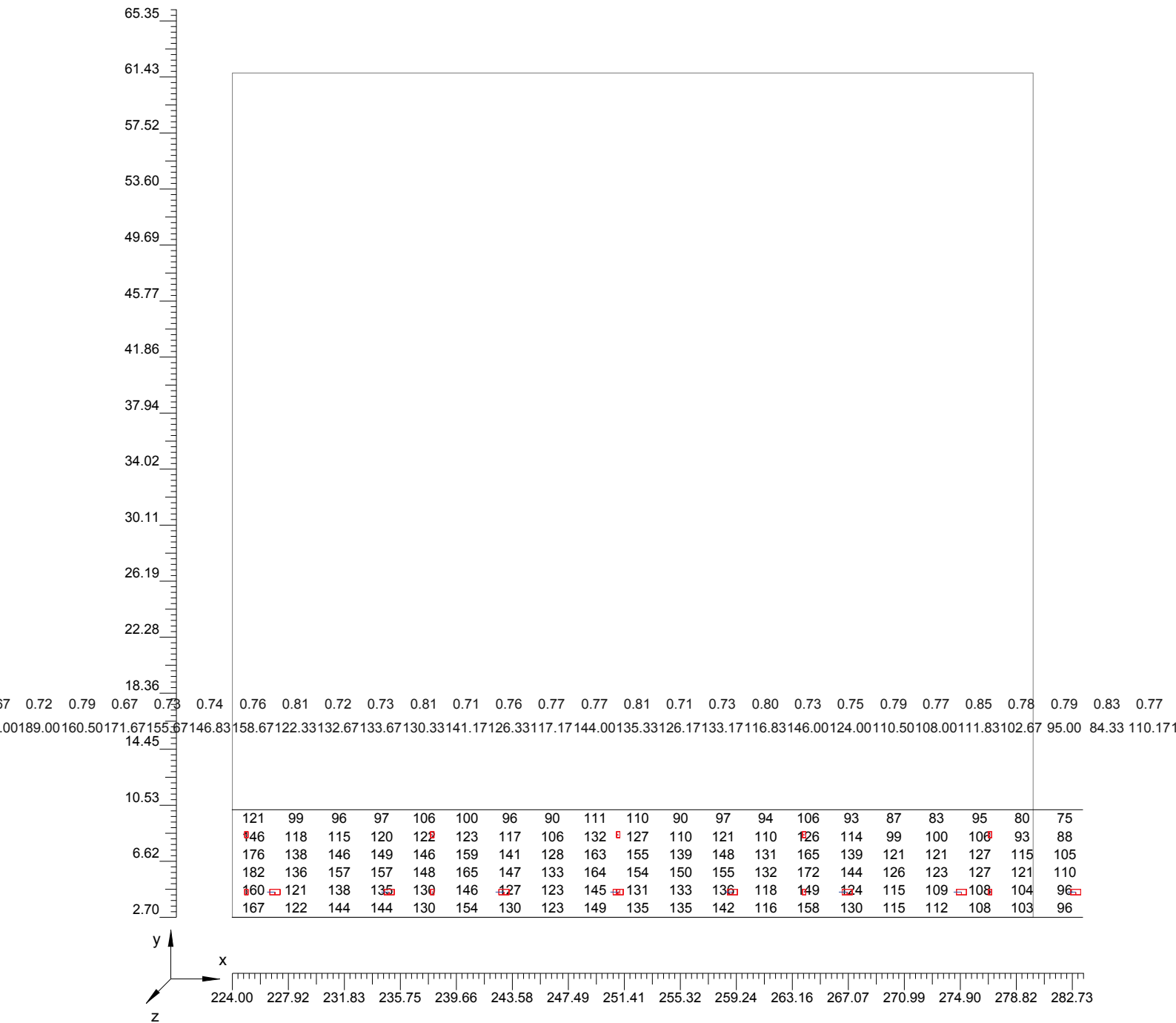

4.4 Valori di Illuminamento su: Carreggiata_LUX

Scala 1/392

Parte 6 di 8

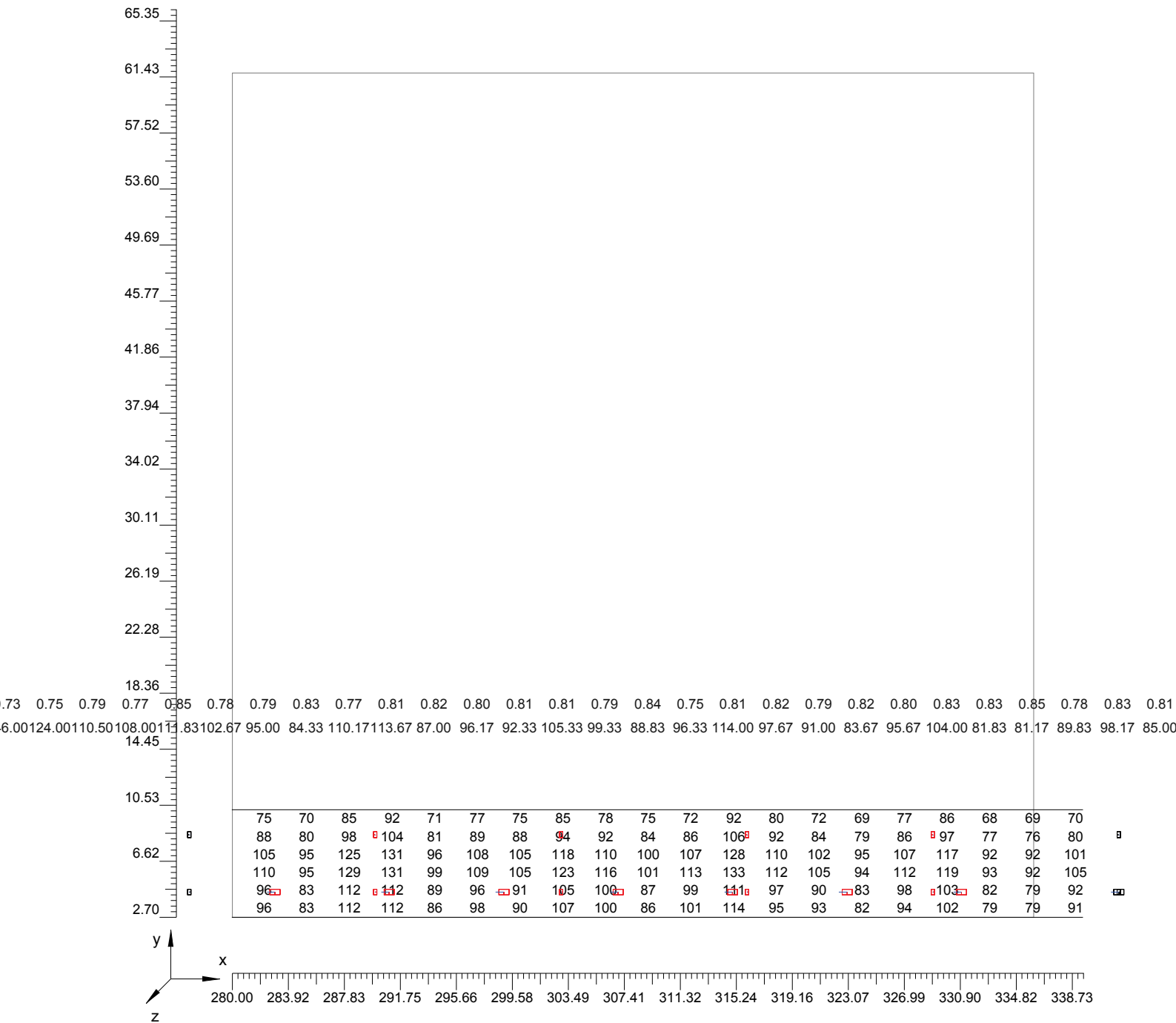

4.4 Valori di Illuminamento su: Carreggiata_LUX

Scala 1/392

Parte 7 di 8

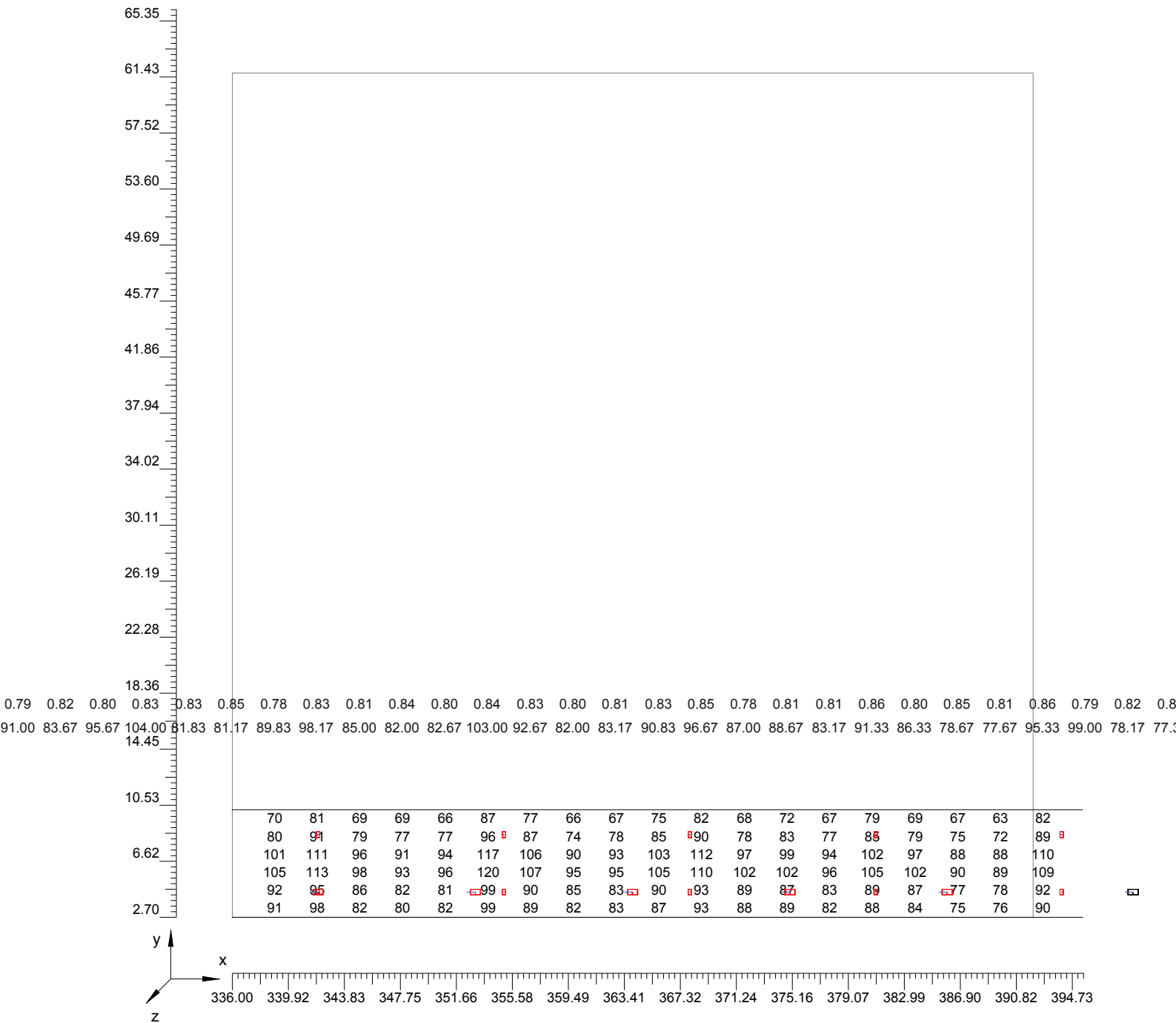

4.4 Valori di Illuminamento su: Carreggiata_LUX

Scala 1/392

Parte 8 di 8

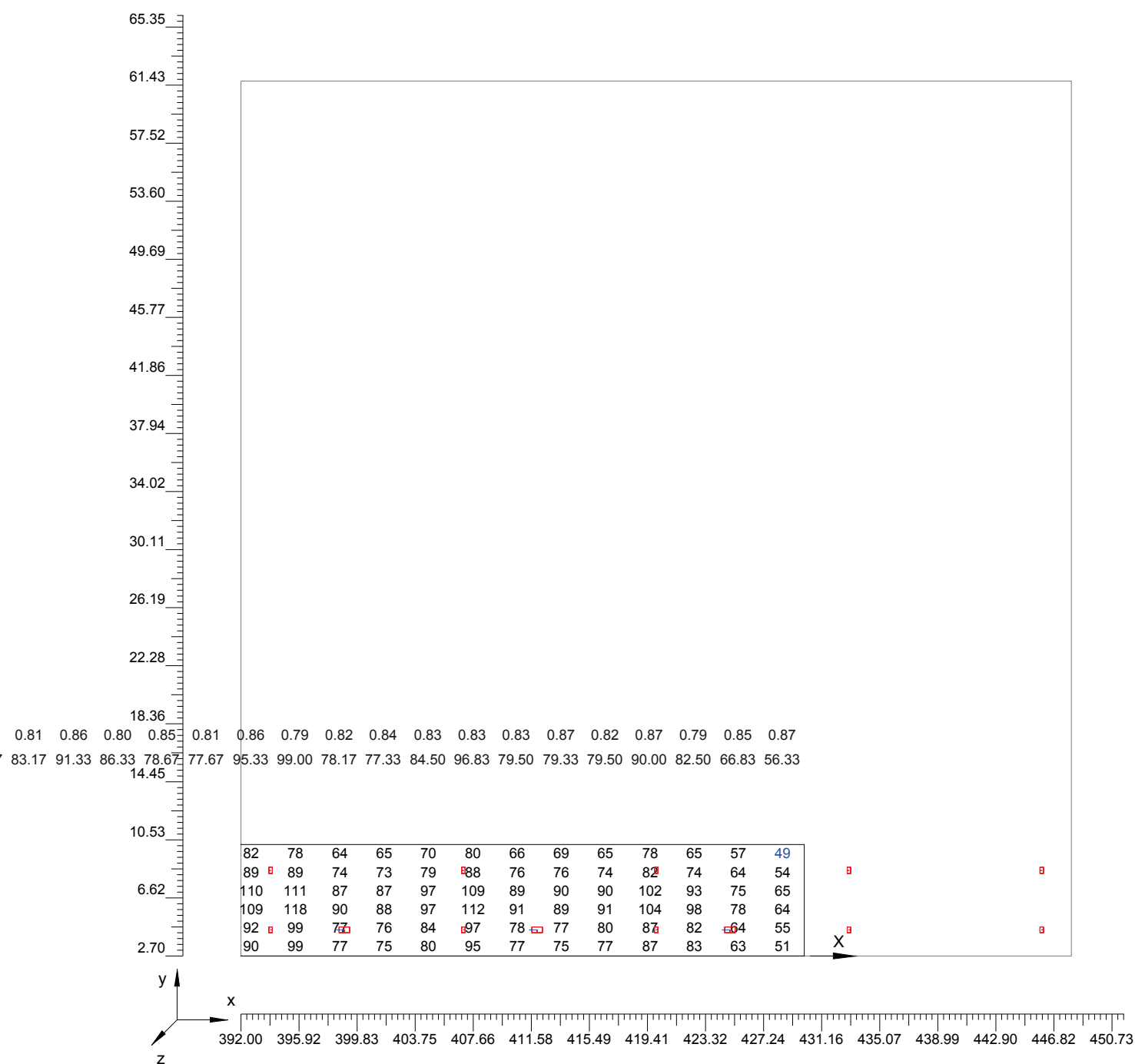

Informazioni Generali	1
1. Dati Riepilogativi Progetto	
1.1 Informazioni Area	2
1.2 Calcolo Energetico	2
2. Viste Progetto	
2.1 Vista 2D in Pianta	3
2.2 Vista Laterale	4
3. Dati Riepilogativi Apparecchi	
3.1 Informazioni Apparecchi/Rilievi	5
3.2 Informazioni Lampade	5
3.3 Tabella Riepilogativa Apparecchi	5
4. Tabella Risultati	
4.1 Valori delle Luminanze su: Corsia1 Oss. 1(x=-60.00;y=4.58;z=1.50)m	10
4.2 Curva Luminanza Oss. 1(x=-60.00;y=4.58;z=1.50)m	19
4.3 Valori delle Luminanze su: Parete_Destra (x=-60.00;y=4.58;z=1.50)m ---> (x=30.00;y=4.58;z=0.00)m	20
4.4 Valori di Illuminamento su: Carreggiata_LUX	35

Contenuto

Variante di Mondovi'

Descrizione.....	3
Variante di Mondovi'	
3F Filippi - Beta 235 LED 932x15 AMPIO VS L655 (1xLED).....	4
Mondovi	
Galleria naturale	
Cunicolo di fuga	
Stralcio	
Riepilogo / Scena luce ordinaria.....	7
Disposizione lampade.....	8
Lista lampade.....	9
Via di fuga / Scena luce emergenza / Illuminamento perpendicolare.....	10
Superficie utile (Stralcio) / Scena luce ordinaria / Illuminamento perpendicolare (adattivo).....	14

Variante di Mondovi'

Calcolo illuminotecnico galleria naturale cunicolo di fuga

3F Filippi 52945 Beta 235 LED 932x15 AMPIO VS L655 1xLED

Per un'immagine della lampada consultare il nostro catalogo lampade.

Rendimento: 100%
Flusso luminoso lampadina: 4294 lm
Flusso luminoso apparecchio: 4294 lm
Potenza: 34.5 W
Rendimento luminoso: 124.5 lm/W

Indicazioni di colorimetria
1x: CCT 4000 K, CRI 80

Emissione luminosa 1 / CDL polare

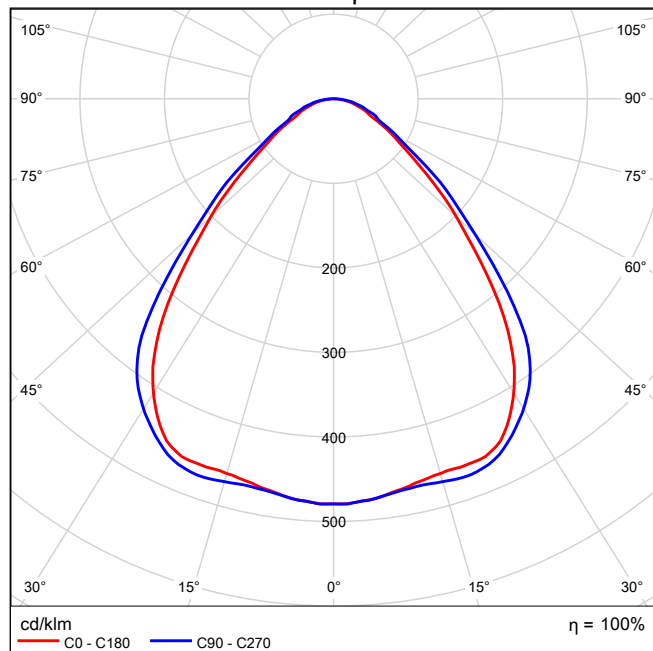

Emissione luminosa 1 / CDL lineare

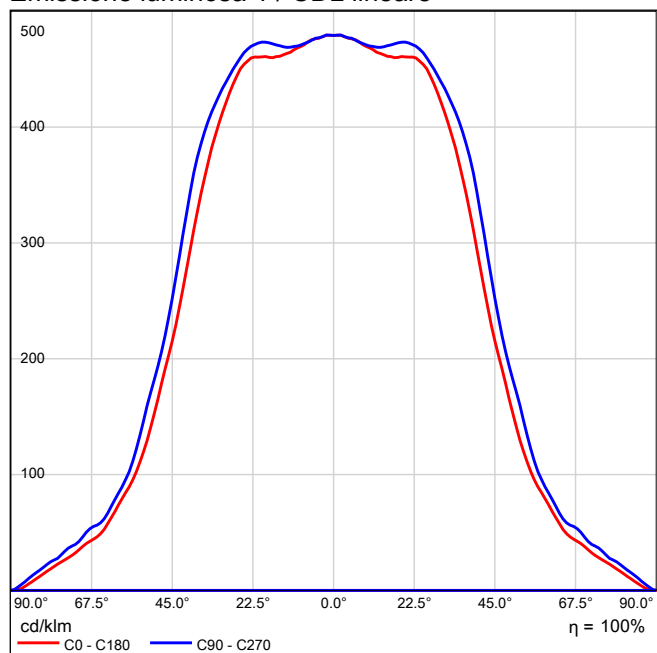

Emissione luminosa 1 / Diagramma conico

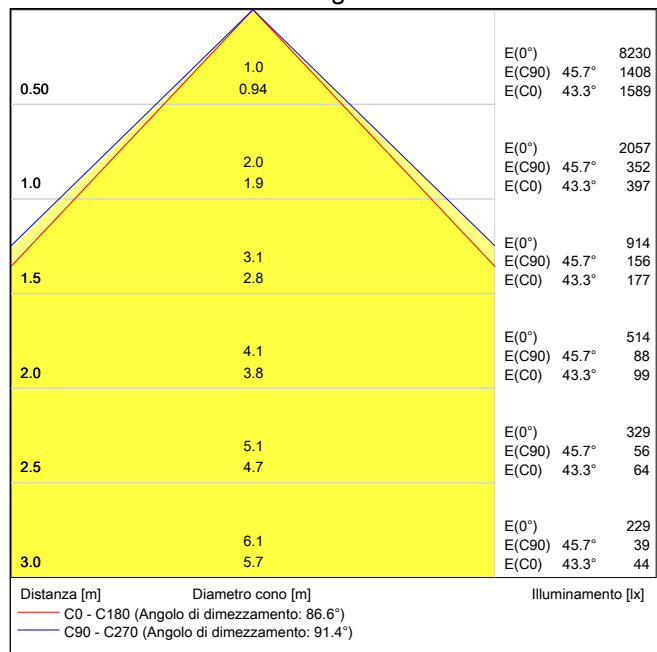

Emissione luminosa 1 / Diagramma della luminanza

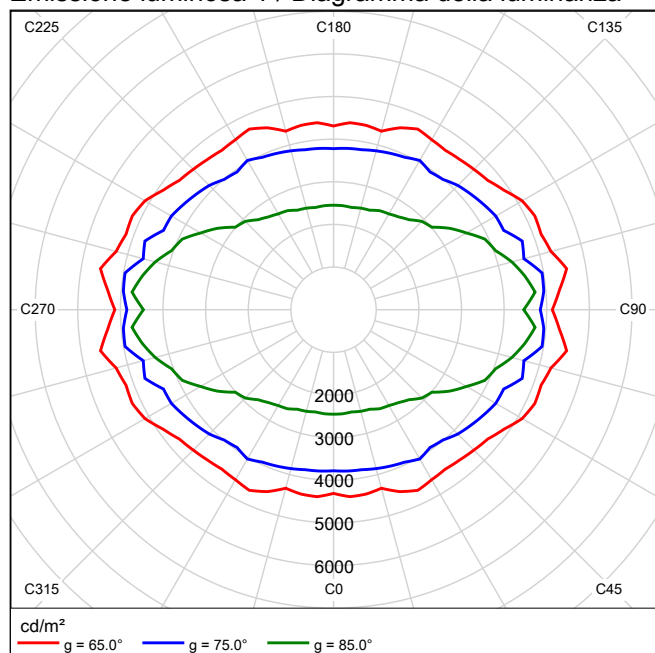

Emissione luminosa 1 / Diagramma UGR

Valutazione di abbagliamento secondo UGR													
ρ Soffitto		70	70	50	50	30	70	70	50	50	30	30	
ρ Pareti		50	30	50	30	30	50	30	50	30	30	30	
ρ Pavimento		20	20	20	20	20	20	20	20	20	20	20	
Dimensioni del locale		Linea di mira perpendicolare all'asse delle lampade					Linea di mira parallela all'asse delle lampade						
X	Y												
2H	2H	18.6	19.6	18.8	19.9	20.1	19.4	20.5	19.7	20.7	20.9		
	3H	19.1	20.1	19.4	20.3	20.6	20.0	21.0	20.4	21.3	21.5		
	4H	19.4	20.3	19.7	20.6	20.8	20.4	21.3	20.7	21.6	21.8		
	6H	19.6	20.4	19.9	20.7	21.0	20.7	21.5	21.0	21.8	22.1		
	8H	19.7	20.5	20.0	20.8	21.1	20.8	21.6	21.2	21.9	22.2		
	12H	19.7	20.5	20.1	20.8	21.1	20.9	21.7	21.3	22.0	22.3		
4H	2H	18.8	19.7	19.2	20.0	20.3	19.6	20.5	19.9	20.7	21.0		
	3H	19.6	20.3	19.9	20.6	21.0	20.4	21.2	20.8	21.5	21.8		
	4H	20.0	20.6	20.3	21.0	21.3	20.9	21.5	21.3	21.9	22.2		
	6H	20.3	20.9	20.7	21.3	21.6	21.3	21.9	21.7	22.3	22.7		
	8H	20.4	20.9	20.8	21.3	21.7	21.5	22.1	21.9	22.4	22.9		
	12H	20.5	20.9	20.9	21.4	21.8	21.7	22.2	22.1	22.6	23.0		
8H	4H	20.1	20.7	20.6	21.1	21.5	21.0	21.5	21.4	21.9	22.3		
	6H	20.6	21.0	21.0	21.4	21.9	21.6	22.0	22.0	22.4	22.9		
	8H	20.8	21.1	21.2	21.6	22.1	21.8	22.2	22.3	22.7	23.1		
	12H	20.9	21.2	21.3	21.6	22.1	22.1	22.4	22.5	22.8	23.3		
12H	4H	20.2	20.6	20.6	21.0	21.5	21.0	21.5	21.4	21.9	22.3		
	6H	20.6	21.0	21.1	21.5	21.9	21.6	22.0	22.1	22.4	22.9		
	8H	20.8	21.2	21.3	21.6	22.1	21.9	22.2	22.4	22.7	23.2		
Variazione della posizione dell'osservatore per le distanze delle lampade S													
S = 1.0H		+0.4 / -0.7					+0.4 / -0.5						
S = 1.5H		+0.9 / -1.3					+1.0 / -1.2						
S = 2.0H		+2.0 / -1.9					+2.0 / -1.6						
Tabella standard		BK03					BK03						
Indice di correzione		2.8					3.8						
Indici di abbagliamento corretti riferiti a 4294lm Flusso luminoso sferico													

I valori UGR vengono calcolati in base a CIE Publ. 117. Rapporto spaziatura/altezza = 0.25

Stralcio



Altezza libera: 2.300 m, Coefficienti di riflessione: Soffitto 70.0%, Pareti 50.0%, Pavimento 20.0%, Fattore di diminuzione: 0.80

Superficie utile

Superficie	Risultato	Medio (Nominale)	Min	Max	Min/Medio	Min/Max
1 Superficie utile (Stralcio)	Illuminamento perpendicolare (adattivo) [lx] Altezza: 0.000 m, Zona margine: 0.200 m	135 (≥ 100)	33.2	327	0.25	0.10

# Lampada	Φ (Lampada) [lm]	Potenza [W]	Rendimento luminoso [lm/W]
7 3F Filippi - 52945 Beta 235 LED 932x15 AMPIO VS L655	4294	34.5	124.5
Somma di tutte le lampade	30058	241.5	124.5

Valore di allacciamento specifico: 1.85 W/m² (Superficie del locale 130.54 m²),
 Valore di allacciamento specifico: 2.18 W/m² = 1.61 W/m²/100 lx (Superficie utile 110.93 m²)

Consumo: 270 kWh/a Da max. 4600 kWh/a

I valori di consumo energetico non tengono conto delle scene di luci e delle relative variazioni di intensità.

Stralcio

3F Filippi 52945 Beta 235 LED 932x15 AMPIO VS L655

No.	X [m]	Y [m]	Altezza di montaggio [m]	Fattore di diminuzione
1	3.500	0.083	2.217	0.80
2	10.500	0.083	2.217	0.80
3	17.500	0.083	2.217	0.80
4	24.500	0.083	2.217	0.80
5	31.500	0.083	2.217	0.80
6	38.500	0.083	2.217	0.80
7	45.500	0.083	2.217	0.80

Stralcio

Numero di pezzi Lampada (Emissione luminosa)

7
3F Filippi - 52945 Beta 235 LED 932x15 AMPIO VS L655
Emissione luminosa 1
Dotazione: 1xLED
Rendimento: 100%
Flusso luminoso lampadina: 4294 lm
Flusso luminoso apparecchio: 4294 lm
Potenza: 34.5 W
Rendimento luminoso: 124.5 lm/W

Indicazioni di colorimetria
1x: CCT 4000 K, CRI 80

Per un'immagine della lampada consultare il nostro catalogo lampade.

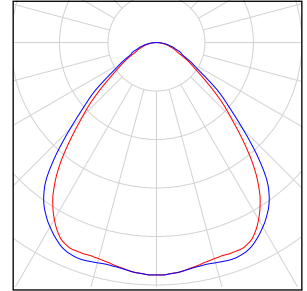

Flusso luminoso lampadine complessivo: 30058 lm, Flusso luminoso lampade complessivo: 30058 lm, Potenza totale: 241.5 W, Rendimento luminoso: 124.5 lm/W

Via di fuga / Scena luce emergenza / Illuminamento perpendicolare



Via di fuga: Illuminamento perpendicolare (Reticolo)
 Scena luce: Scena luce emergenza
 Medio: 75.6 lx, Min: 1.26 lx, Max: 915 lx, Min/Medio: 0.017, Min/Max: 0.001
 Altezza: 1.000 m

Isolinee [lx]



Scala: 1 : 500

Colori sfalsati [lx]

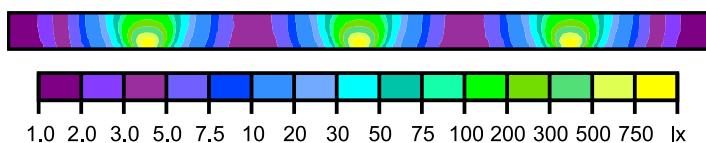

Scala: 1 : 500

Raster dei valori [lx]

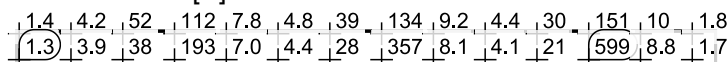

Scala: 1 : 500

Tabella valori [lx]

m	-1.029	-0.686	-0.343	0.000	0.343	0.686	1.029
22.940	1.53	1.52	1.51	1.50	1.45	1.40	1.39
22.598	1.56	1.52	1.53	1.52	1.45	1.41	1.34
22.255	1.59	1.58	1.59	1.54	1.57	1.50	1.39
21.913	1.68	1.72	1.68	1.65	1.65	1.58	1.47
21.571	1.85	1.86	1.84	1.85	1.81	1.72	1.67
21.228	2.09	2.09	2.08	2.07	1.98	1.94	1.90
20.886	2.44	2.34	2.38	2.29	2.32	2.21	2.11
20.543	2.76	2.74	2.79	2.75	2.62	2.59	2.46
20.201	3.25	3.30	3.18	3.19	3.06	3.04	2.86
19.859	3.82	3.80	3.81	3.79	3.64	3.48	3.38
19.516	4.58	4.57	4.54	4.44	4.29	4.22	3.96
19.174	5.51	5.45	5.52	5.37	5.29	4.98	4.71
18.832	6.81	6.63	6.67	6.58	6.29	6.06	5.73
18.489	8.41	8.25	8.06	7.94	7.72	7.31	6.80
18.147	10.5	10.3	9.94	9.77	9.37	8.83	8.28
17.804	13.3	13.0	12.7	12.2	11.8	11.0	10.3
17.462	17.5	16.9	16.3	15.3	14.6	13.7	12.6
17.120	23.5	22.7	21.6	20.1	18.6	17.4	15.4
16.777	31.8	31.4	29.9	27.4	25.0	22.6	19.9
16.435	43.8	44.4	43.5	40.3	35.5	31.4	26.5
16.092	60.5	63.7	65.4	63.2	57.0	46.9	37.1
15.750	80.7	90.7	101	106	100	82.6	59.1
15.408	106	123	149	178	188	164	112
15.065	131	159	204	266	330	332	231

m	-1.029	-0.686	-0.343	0.000	0.343	0.686	1.029
14.723	151	187	250	349	487	599	471
14.380	161	203	279	408	601	841	789
14.038	164	207	288	426	635	909	915
13.696	159	199	273	394	575	784	700
13.353	146	180	239	328	444	515	388
13.011	124	149	188	240	285	273	186
12.668	98.1	114	134	155	157	134	91.7
12.326	74.8	82.1	89.7	91.3	84.4	69.6	50.7
11.984	55.5	57.5	58.3	55.4	49.5	41.7	33.3
11.641	40.4	40.3	39.3	36.1	32.1	28.6	24.6
11.299	29.5	28.9	27.5	25.0	23.3	21.3	18.9
10.957	21.9	21.3	20.1	18.7	17.8	16.4	15.0
10.614	16.5	15.9	15.4	14.6	14.2	13.2	12.2
10.272	12.7	12.6	12.2	11.8	11.5	10.7	10.0
9.929	10.3	10.2	9.87	9.80	9.29	8.91	8.31
9.587	8.41	8.45	8.18	8.18	7.84	7.38	7.09
9.245	7.06	6.96	7.00	6.81	6.62	6.44	6.08
8.902	5.99	6.01	5.99	5.83	5.73	5.59	5.29
8.560	5.30	5.29	5.24	5.16	5.18	4.85	4.68
8.217	4.77	4.83	4.73	4.67	4.56	4.39	4.23
7.875	4.41	4.47	4.37	4.25	4.29	4.07	3.82
7.533	4.24	4.19	4.14	4.10	3.89	3.84	3.69
7.190	4.11	4.06	4.01	3.89	3.82	3.74	3.49
6.848	4.08	4.17	4.07	3.96	3.89	3.77	3.54
6.505	4.26	4.32	4.27	4.16	3.99	3.89	3.66
6.163	4.64	4.51	4.51	4.50	4.28	4.12	3.92
5.821	4.98	4.94	4.91	4.83	4.68	4.59	4.27
5.478	5.55	5.52	5.62	5.45	5.38	5.08	4.83
5.136	6.45	6.47	6.40	6.32	6.07	5.78	5.59
4.793	7.61	7.57	7.47	7.30	7.16	6.79	6.45
4.451	9.20	9.07	8.85	8.79	8.32	8.10	7.44
4.109	11.2	11.1	10.8	10.7	10.1	9.76	8.93
3.766	14.2	13.9	13.6	12.8	12.5	11.7	10.8
3.424	18.5	18.0	17.3	16.3	15.3	14.5	13.2
3.082	24.8	24.1	22.7	21.2	19.6	18.1	16.4
2.739	33.6	33.1	31.7	28.8	26.3	23.8	20.9
2.397	46.0	46.5	45.8	42.4	37.9	32.9	27.4
2.054	62.8	66.6	69.4	67.3	60.6	49.9	39.0
1.712	83.6	94.2	106	113	108	89.3	63.1
1.370	109	127	156	187	202	179	121
1.027	134	163	209	277	347	357	251
0.685	153	190	254	358	502	631	505
0.342	162	203	281	412	610	859	818
0.000	164	207	287	425	632	905	908
-0.342	158	198	270	388	564	760	664
-0.685	144	177	233	319	426	483	358
-1.027	121	145	182	230	268	252	172
-1.370	95.4	110	129	147	147	124	85.4
-1.712	72.5	79.1	85.5	85.9	79.3	65.4	48.5
-2.054	53.4	55.1	55.7	52.8	46.6	39.8	32.5
-2.397	38.9	39.0	37.5	34.4	31.2	27.6	23.8

m	-1.029	-0.686	-0.343	0.000	0.343	0.686	1.029
-2.739	28.5	28.0	26.5	24.2	22.6	20.5	18.3
-3.082	21.2	20.7	19.5	18.4	17.2	16.2	14.7
-3.424	16.2	15.7	15.1	14.4	13.9	13.1	12.0
-3.766	12.6	12.4	12.0	11.7	11.1	10.6	9.85
-4.109	10.1	10.1	9.78	9.66	9.27	8.81	8.27
-4.451	8.33	8.25	8.18	8.04	7.75	7.52	6.93
-4.793	6.99	6.95	6.94	6.75	6.56	6.34	5.98
-5.136	6.04	6.02	5.98	5.84	5.83	5.48	5.22
-5.478	5.37	5.34	5.26	5.18	5.00	4.85	4.66
-5.821	4.85	4.84	4.75	4.67	4.57	4.39	4.22
-6.163	4.42	4.45	4.37	4.36	4.17	4.03	3.83
-6.505	4.16	4.17	4.09	4.04	3.92	3.87	3.65
-6.848	4.12	4.07	4.05	3.92	3.89	3.77	3.53
-7.190	4.09	4.18	4.09	4.05	3.93	3.80	3.53
-7.533	4.35	4.25	4.26	4.20	4.06	3.99	3.71
-7.875	4.55	4.51	4.51	4.44	4.33	4.23	3.99
-8.217	4.95	4.95	5.06	4.93	4.86	4.58	4.53
-8.560	5.64	5.77	5.64	5.47	5.38	5.19	5.00
-8.902	6.52	6.48	6.51	6.28	6.21	6.00	5.72
-9.245	7.79	7.67	7.52	7.47	7.13	7.03	6.55
-9.587	9.32	9.34	9.10	8.92	8.53	8.23	7.61
-9.929	11.5	11.4	11.3	10.8	10.3	9.82	9.15
-10.272	14.6	14.4	13.9	13.2	12.6	11.9	11.0
-10.614	19.1	18.5	17.7	16.6	15.8	14.9	13.4
-10.957	25.9	25.0	23.7	21.7	20.1	18.7	16.7
-11.299	34.8	34.3	32.8	29.9	27.3	24.5	21.2
-11.641	47.7	48.6	48.1	44.9	39.6	34.1	28.4
-11.984	64.9	69.6	72.8	70.7	64.7	53.1	40.9
-12.326	87.1	97.5	111	121	115	95.9	67.8
-12.668	112	132	161	197	216	193	130
-13.011	137	167	216	287	366	384	273
-13.353	154	192	258	366	518	661	541
-13.696	163	205	283	416	617	873	845
-14.038	164	206	287	423	629	899	895
-14.380	157	196	266	382	550	731	627
-14.723	142	175	228	309	409	453	331
-15.065	119	142	176	220	252	233	158
-15.408	92.9	106	124	138	136	115	79.4
-15.750	69.9	75.9	81.5	81.0	73.8	60.8	45.6
-16.092	51.6	53.1	53.0	49.6	44.4	37.7	30.6
-16.435	37.4	37.2	35.8	32.6	29.5	26.3	22.8
-16.777	27.3	26.7	25.1	23.3	21.3	19.6	17.4
-17.120	20.3	19.4	18.6	17.4	16.5	15.3	13.8
-17.462	15.2	14.8	14.3	13.6	12.9	12.2	11.1
-17.804	11.7	11.6	11.2	10.8	10.4	9.81	9.03
-18.147	9.15	9.18	9.03	8.78	8.39	8.08	7.44
-18.489	7.40	7.35	7.32	7.19	6.83	6.69	6.24
-18.832	6.00	6.05	5.98	5.92	5.79	5.50	5.20
-19.174	5.00	5.01	5.01	4.82	4.76	4.56	4.39
-19.516	4.20	4.16	4.24	4.13	3.96	3.92	3.62
-19.859	3.55	3.54	3.53	3.51	3.35	3.22	3.07

m	-1.029	-0.686	-0.343	0.000	0.343	0.686	1.029
-20.201	2.98	2.99	2.94	2.93	2.84	2.72	2.60
-20.543	2.56	2.58	2.56	2.48	2.43	2.33	2.24
-20.886	2.19	2.31	2.19	2.19	2.14	2.03	1.91
-21.228	1.96	1.95	1.99	1.92	1.86	1.81	1.68
-21.571	1.74	1.74	1.74	1.71	1.67	1.62	1.51
-21.913	1.58	1.59	1.57	1.60	1.54	1.46	1.47
-22.255	1.49	1.48	1.49	1.45	1.44	1.38	1.30
-22.598	1.45	1.43	1.46	1.43	1.39	1.32	1.29
-22.940	1.43	1.45	1.52	1.40	1.39	1.31	1.26

Superficie utile (Stralcio) / Scena luce ordinaria / Illuminamento perpendicolare (adattivo)



Superficie utile (Stralcio): Illuminamento perpendicolare (adattivo) (Superficie)
Scena luce: Scena luce ordinaria
Medio: 135 lx (Nominale: ≥ 100 lx), Min: 33.2 lx, Max: 327 lx, Min/Medio: 0.25, Min/Max: 0.10
Altezza: 0.000 m, Zona margine: 0.200 m

Isolinee [lx]

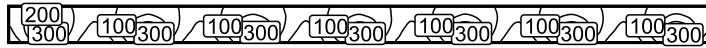

Scala: 1 : 500

Colori sfalsati [lx]

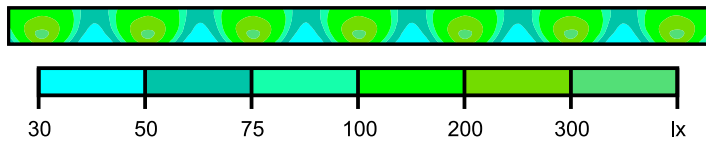

Scala: 1 : 500

Raster dei valori [lx]

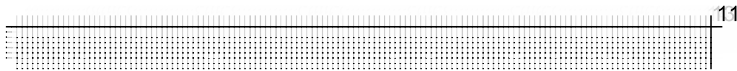

Scala: 1 : 500

2. Calcolo illuminotecnico galleria artificiale

Galleria artificiale Mondovì

Note Installazione: Permanente

Codice Progetto: 20-061-B00

Note
Li = 3 cd/mq

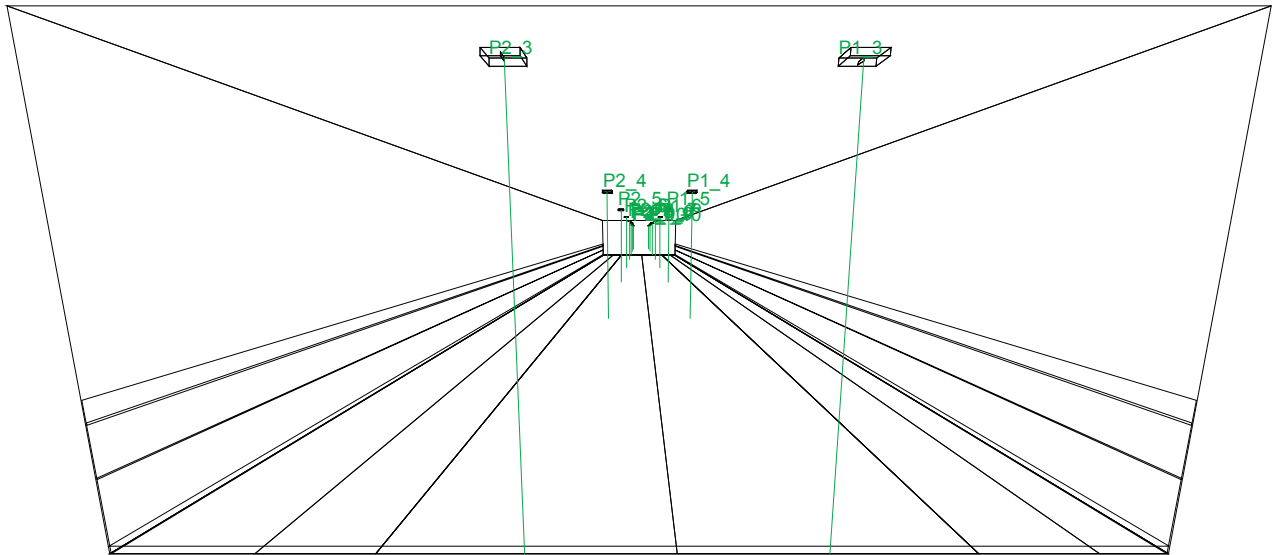

1.1 Informazioni Area

Dati Strada

Zona	Tipo Zona	Corsia	Senso di marcia	Larghezza [m] (W)	y1 [m]	y2 [m]	Pt.Calc.Y (E)	Pt.Calc.Y (L)	Alt. Zona [m] (HC)	Colore	Tabella R	Coeff.Rif. Fattore q0
Marc_dx	Pista Ciclo/Pedonale			2.35	0.00	2.35	3		0.00	RGB=219,54,36		30.00
		Marc_dx	--->	0.85	0.00	0.85		3				
		banchina_dx	--->	1.50	0.85	2.35		3				
Carreggiata Carrabile				7.50	2.35	9.85	5		0.00	RGB=126,126,126	C2	5.60
		Corsia1	--->	3.75	2.35	6.10		3				
		Corsia2	<---	3.75	6.10	9.85		3				
Marc_sx	Pista Ciclo/Pedonale			3.30	9.85	13.15	3		0.00	RGB=219,54,36		30.00
		banchina_sx	--->	1.50	9.85	11.35		3				
		Marc_sx	--->	1.80	11.35	13.15		3				

Dati Installazione Apparecchi

Nome Fila	1° Palo x [m] (XP)	1° Palo y [m] (YP)	Altez.App. [m] (H)	Num. Pali	Interd. [m] (D)	Sbraccio [m] (L)	Ang.Incl. [°] (RY)	Rot.Sbraccio [°] (RZ)	Ang.Incl.Lat. [°] (RX)	Fatt.Manut. [%]	Codice Apparecchio	Flusso [lm]	Rif.
P1	-26.00	4.20	5.80	10	13.00	0.00	0	90	0	80.00	PetV2-48	7100	A
P2	-26.00	8.00	5.80	10	13.00	0.00	0	270	0	80.00	PetV2-48	7100	A

1.2 Calcolo Energetico (Suolo)

Area	487.50 m2
Illuminamento Medio	68.09 lx
Potenza Specifica	2.05 W/m2
Potenza Specifica Illuminotecnica	3.01 W/(m2 * 100lx)
Efficienza Energetica	33.20 (m2*lx)/W
Potenza Totale Utilizzata	1000.00 W

1.3 Parametri di Qualità dell'Impianto

Riepilogo Risultati

Zona	Osservatore	Corsia	Ti	UI	LAv	Uo
Carreggiata			Ti=5.95	0.80	3.42	0.72
	1) (x=-60.00 y=4.22)m	Corsia1		0.80	3.42 *	0.72 *
	2) (x=125.00 y=7.97)m	Corsia2		0.80 *	3.42	0.73
	(x=-37.83 y=4.22)m		Ti=5.95 *			
	(x=50.83 y=7.97)m		Ti=5.92			
Lv=0.30						

Norma

CEN 13201

Inquinamento Luminoso

Rapporto Medio - Rn -

0.00 %

2.1 Vista 2D in Pianta

Scala 1/500

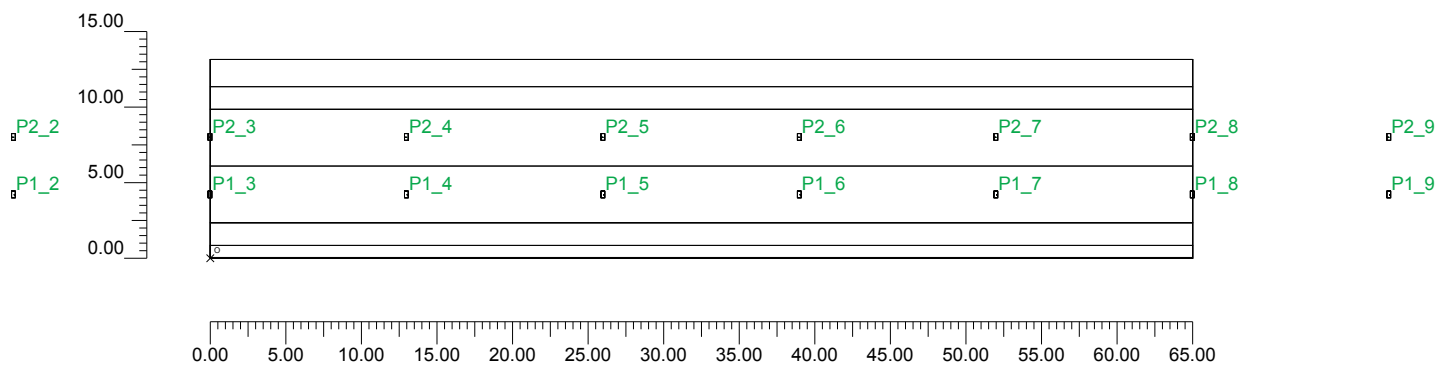

2.2 Vista Laterale

Scala 1/90

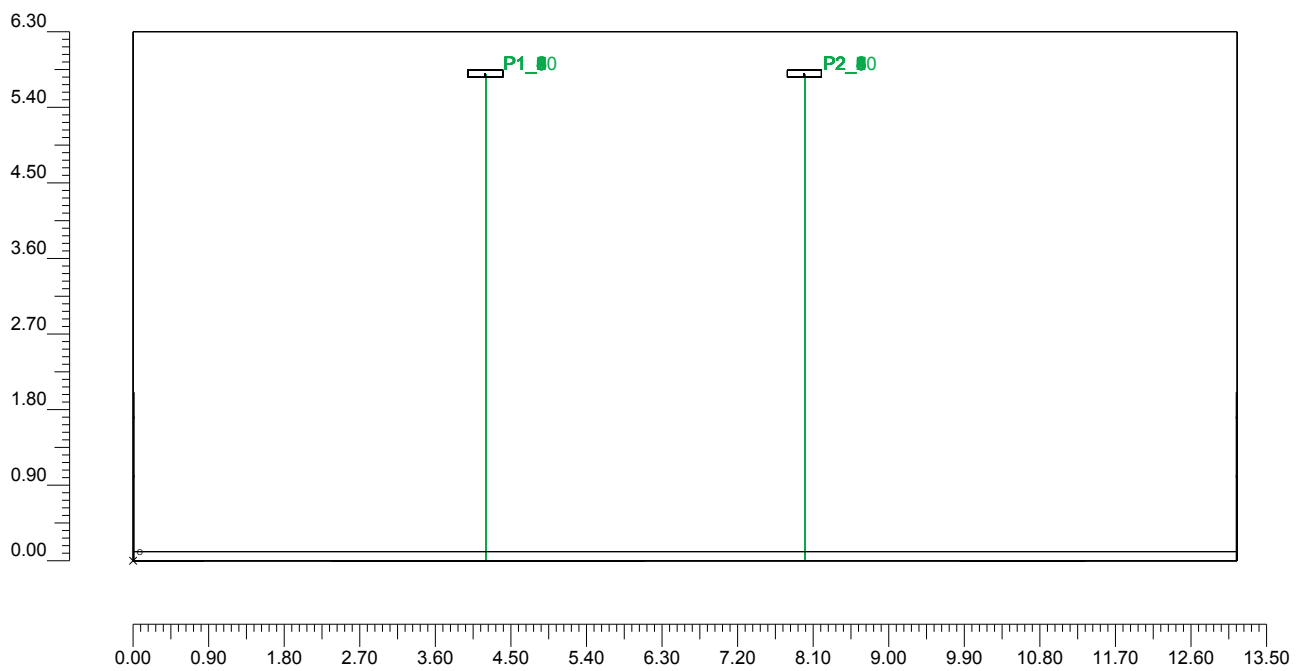

3.1 Informazioni Apparecchi/Rilievi

Rif.	Linea	Nome Apparecchio (Nome Rilievo)	Codice Apparecchio (Codice rilievo)	Apparecchi n.	Rif.Lamp.	Lampade n.
A	Arianna Petrarca	PetV2-48 (PetV2-48)	PetV2-48 (PetV2-48)	20	LMP-A	1

3.2 Informazioni Lampade

Rif.Lamp.	Tipo	Codice	Flusso lm	Potenza W	Colore K	n.
LMP-A	LED	PetrarcaTunnel 7100	7100	50	4000	-

4.1 Valori delle Luminanze su: Carreggiata_oss1 Oss. 1(x=-60.00;y=4.22;z=1.50)m

O (x:0.00 y:2.35 z:0.00)	Risultati	Medio	Minimo	Massimo	Min/Medio	Min/Max	Medio/Max
DX:2.95 DY:1.25	Luminanza (L)	3.42 cd/m ²	2.46 cd/m ²	4.47 cd/m ²	0.72	0.55	0.76

Tipo Calcolo

Dir.+Indir.(1 Interriflessioni) + Arredi

Nome Corsia	Largh. Corsia [m] (W)	y1 [m]	y2 [m]	Pt.Calc.Y	Tabella R	Coeff.Rifl. Fattore q0	Osservatore x Assoluto [m]	Osservatore y Assoluto [m]	Luminanza Velante [cd/m ²]	Incremento di Soglia [%]	Uniformità Longitudinale
Corsia1	3.75	2.35	6.10	3	C2	5.60	-60.00	4.22	0.30	5.95	0.80
Corsia2	3.75	6.10	9.85	3	C2	5.60	-60.00	4.22	0.30	---	---

Norma

CEN 13201

4.1
Scala 1/500

4.1 Valori delle Luminanze su: Carreggiata_oss1 Oss. 1(x=-60.00;y=4.22;z=1.50)m

Totale Parti: 2

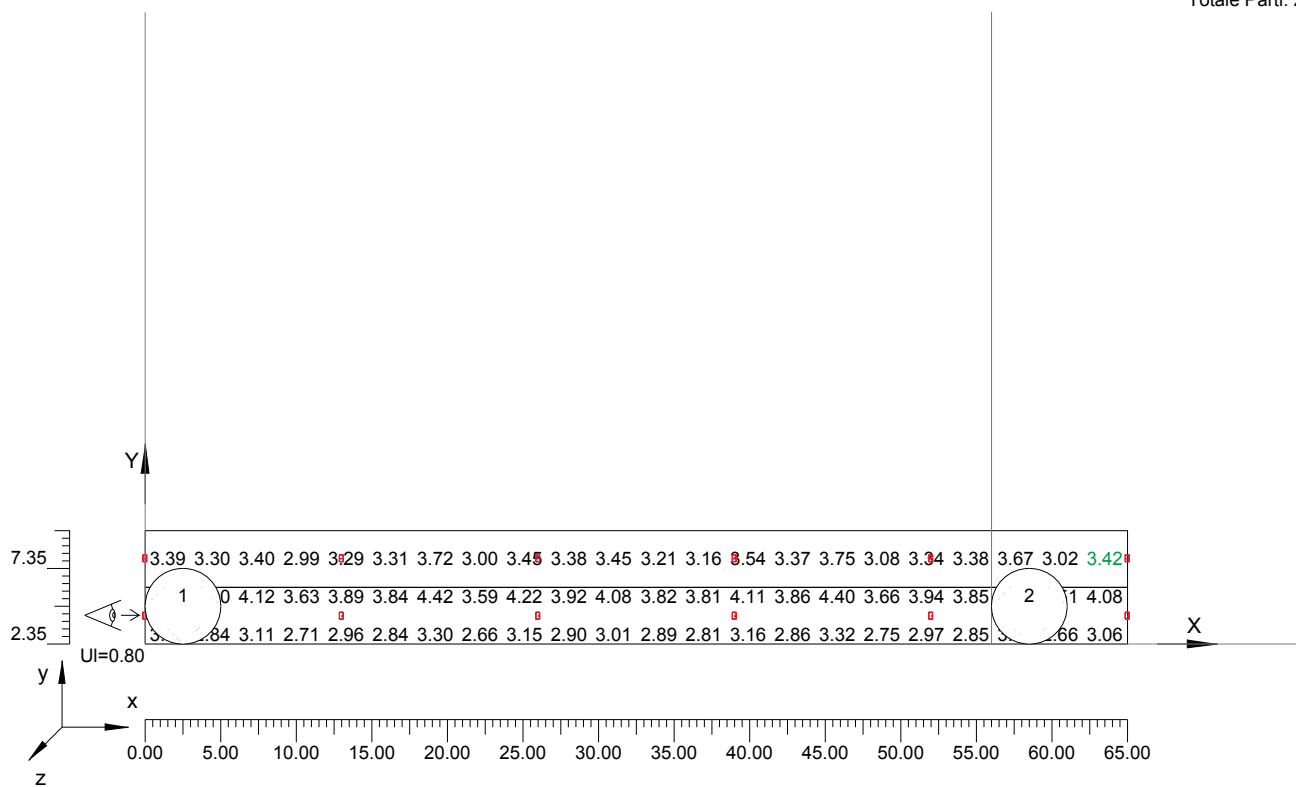

4.1 Valori delle Luminanze su: Carreggiata_oss1 Oss. 1(x=-60.00;y=4.22;z=1.50)m

Scala 1/387

Parte 1 di 2

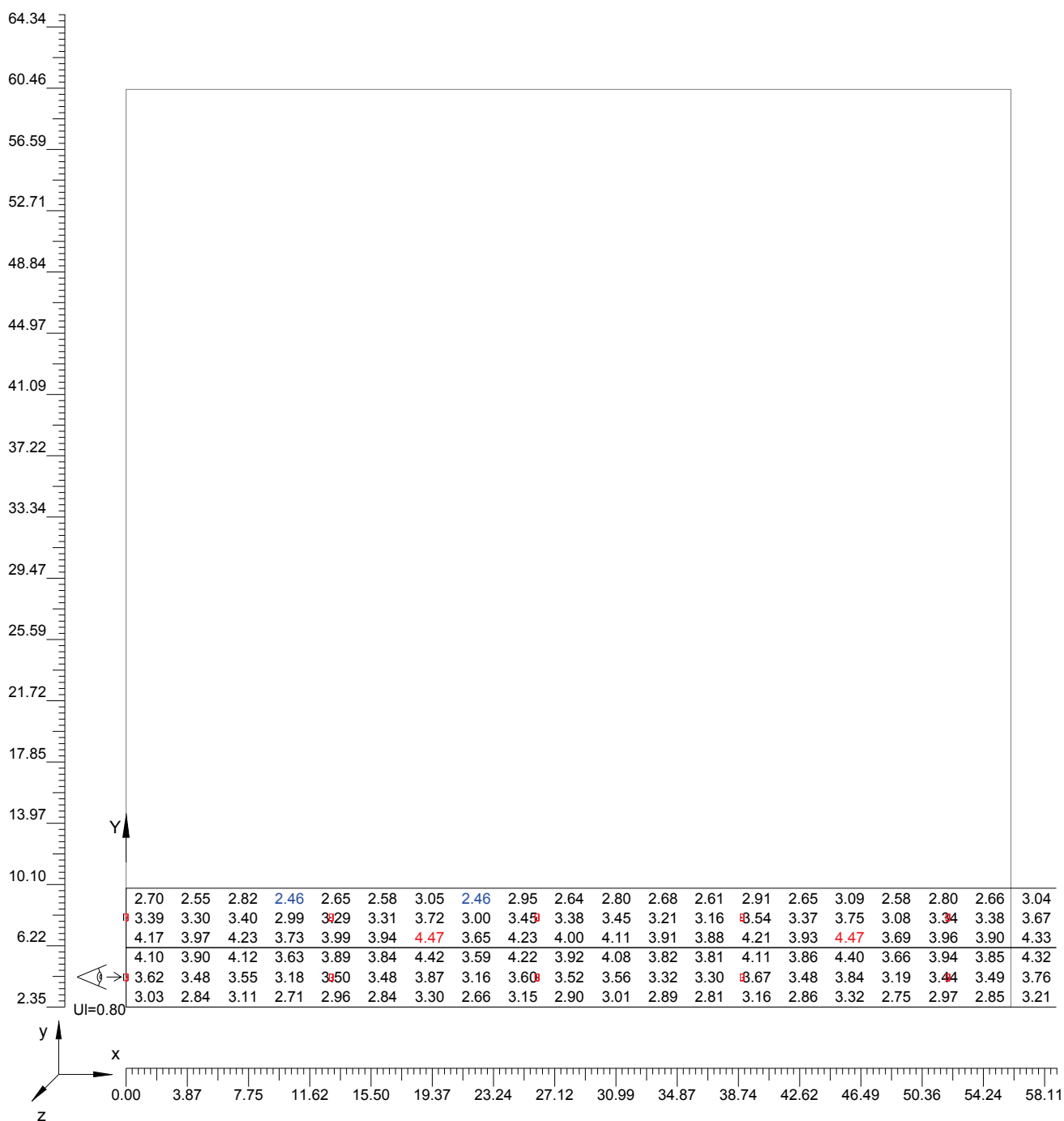

4.1 Valori delle Luminanze su: Carreggiata_oss1 Oss. 1(x=-60.00;y=4.22;z=1.50)m

Scala 1/387

Parte 2 di 2

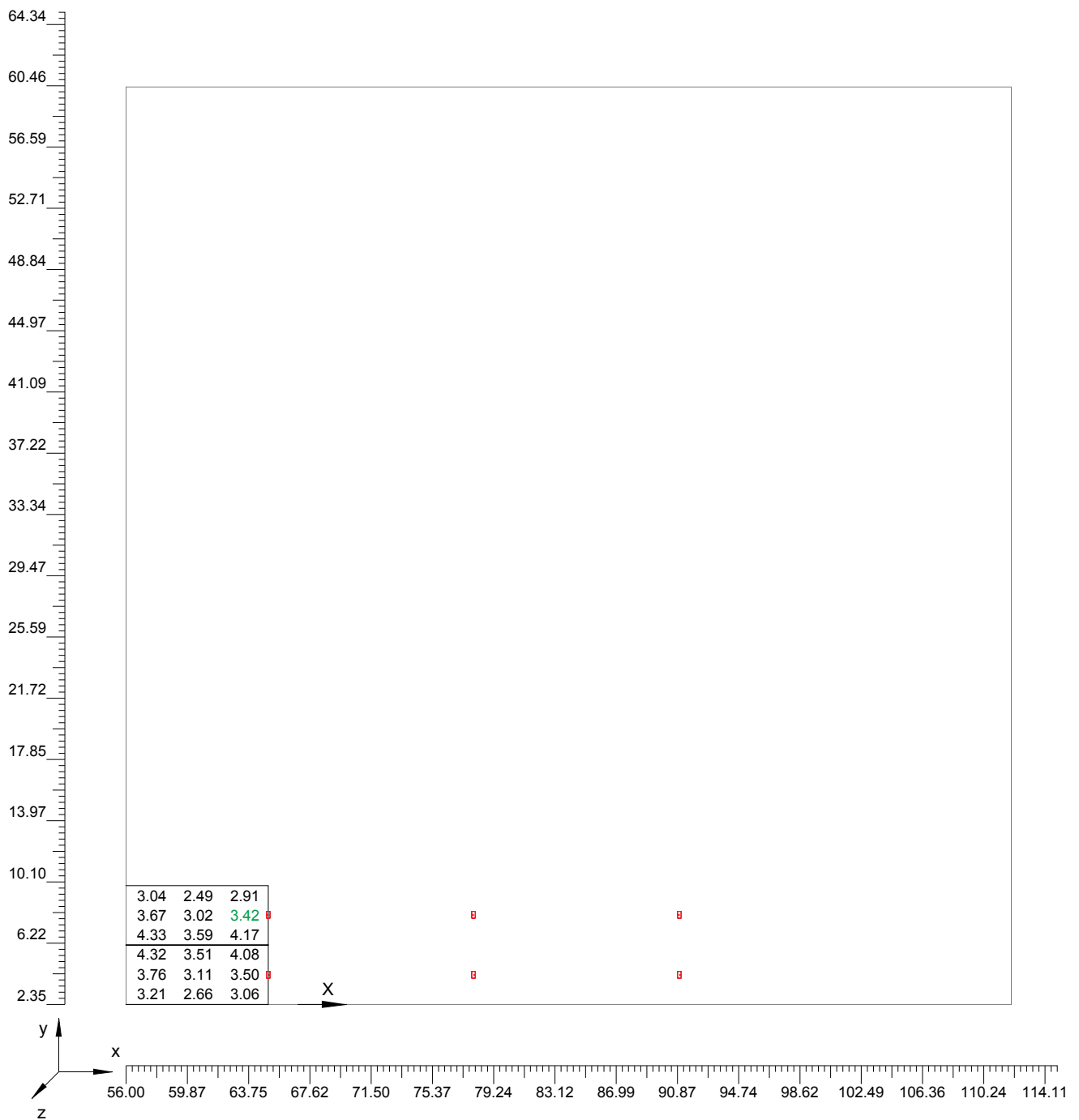

4.2 Valori delle Luminanze su: Carreggiata_oss2 Oss. 2(x=125.00;y=7.97;z=1.50)m

O (x:0.00 y:2.35 z:0.00)	Risultati	Medio	Minimo	Massimo	Min/Medio	Min/Max	Medio/Max
DX:2.95 DY:1.25	Luminanza (L)	3.42 cd/m ²	2.50 cd/m ²	4.48 cd/m ²	0.73	0.56	0.76

Tipo Calcolo

Dir.+Indir.(1 Interriflessioni) + Arredi

Nome Corsia	Largh. Corsia [m] (W)	y1 [m]	y2 [m]	Pt.Calc.Y	Tabella R	Coeff.Rifl. Fattore q0	Osservatore x Assoluto [m]	Osservatore y Assoluto [m]	Luminanza Velante [cd/m ²]	Incremento di Soglia [%]	Uniformità Longitudinale
Corsia1	3.75	2.35	6.10	3	C2	5.60	125.00	7.97	0.30	---	---
Corsia2	3.75	6.10	9.85	3	C2	5.60	125.00	7.97	0.30	5.92	0.80 *

Norma

CEN 13201

4.2
Scala 1/500

4.2 Valori delle Luminanze su: Carreggiata_oss2 Oss. 2(x=125.00;y=7.97;z=1.50)m

Totale Parti: 2

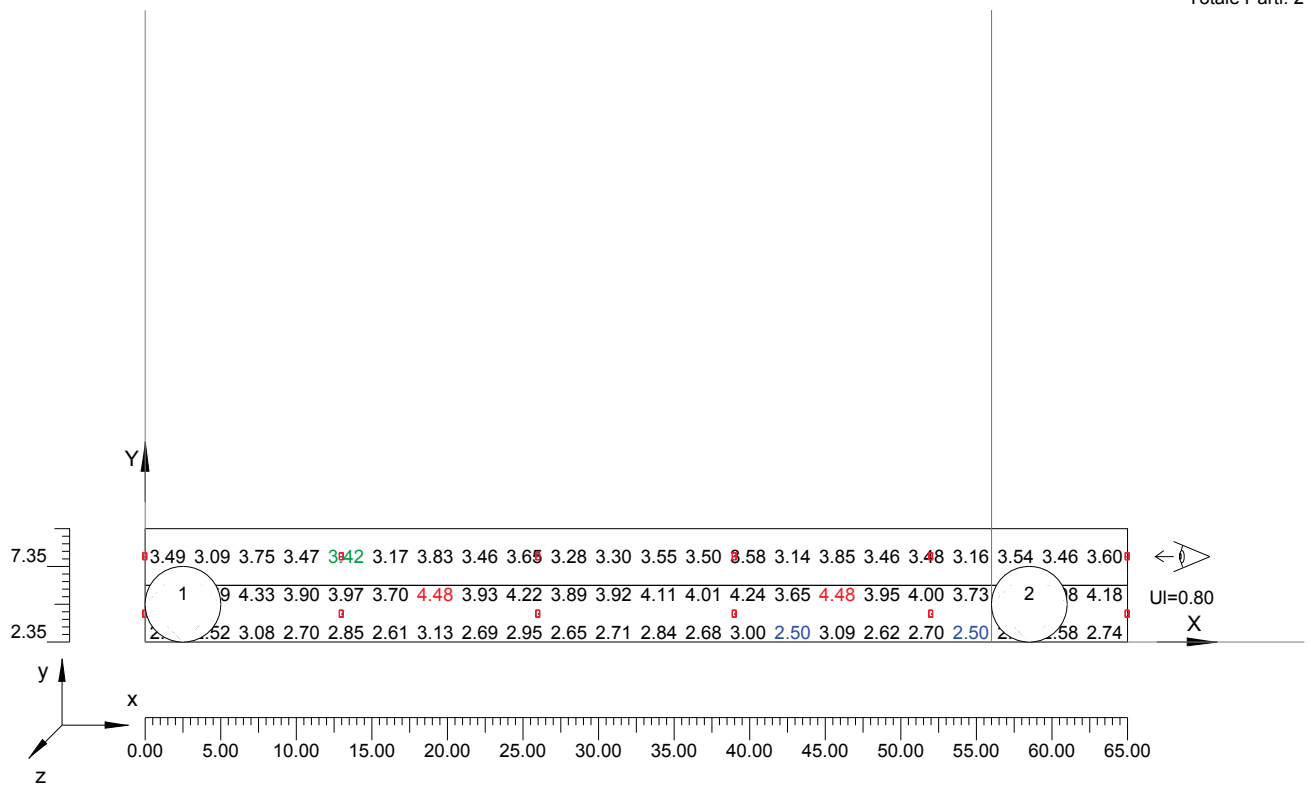

4.2 Valori delle Luminanze su: Carreggiata_oss2 Oss. 2(x=125.00;y=7.97;z=1.50)m

Scala 1/387

Parte 1 di 2

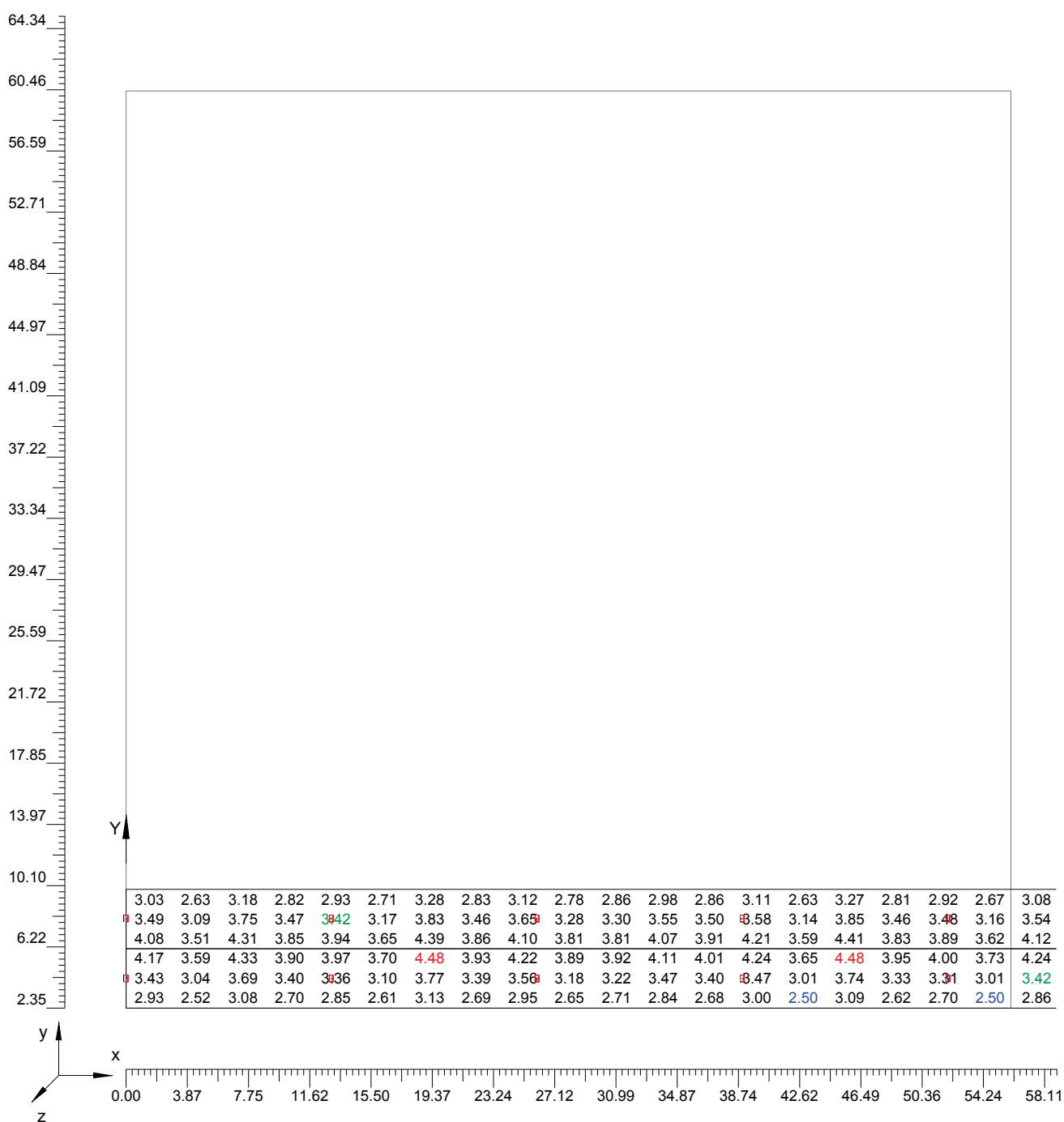

4.2 Valori delle Luminanze su: Carreggiata_oss2 Oss. 2(x=125.00;y=7.97;z=1.50)m

Scala 1/387

Parte 2 di 2

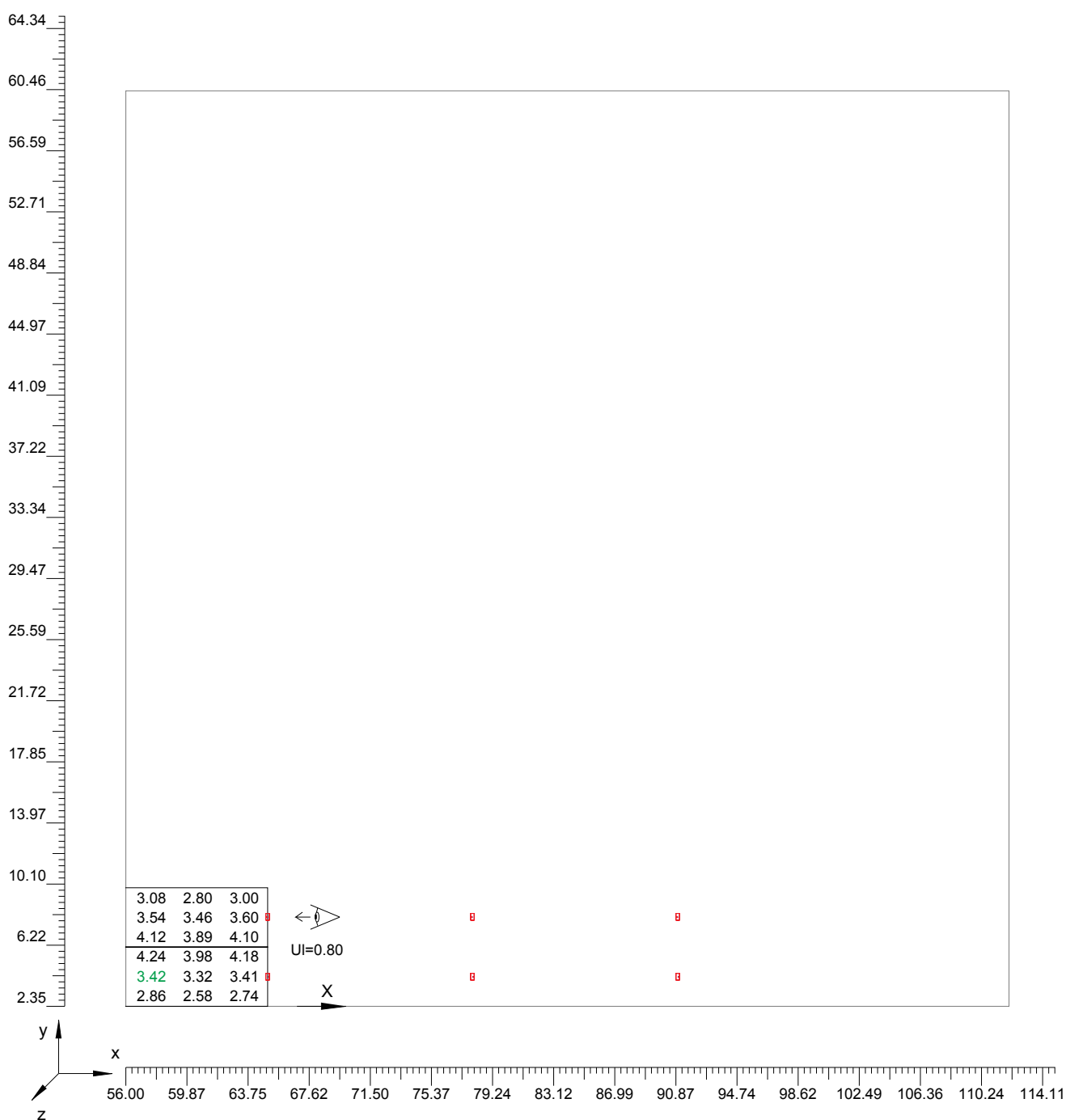

4.3 Valori delle Luminanze su: Parete_Destra (x=-60.00;y=4.23;z=1.50)m ---> (x=30.00;y=4.23;z=0.00)m

O (x:0.00 y:0.01 z:0.00)	Risultati	Medio	Minimo	Massimo	Min/Medio	Min/Max	Medio/Max
DX:2.95 DY:0.70	Luminanza (L)	4.11 cd/m ²	3.51 cd/m ²	5.28 cd/m ²	0.85	0.66	0.78

Tipo Calcolo

Dir.+Indir.(1 Interriflessioni) + Arredi

Scala 1/500

4.3 Valori delle Luminanze su: Parete_Destra (x=-60.00;y=4.23;z=1.50)m ---> (x=30.00;y=4.23;z=0.00)m

Totale Parti: 2

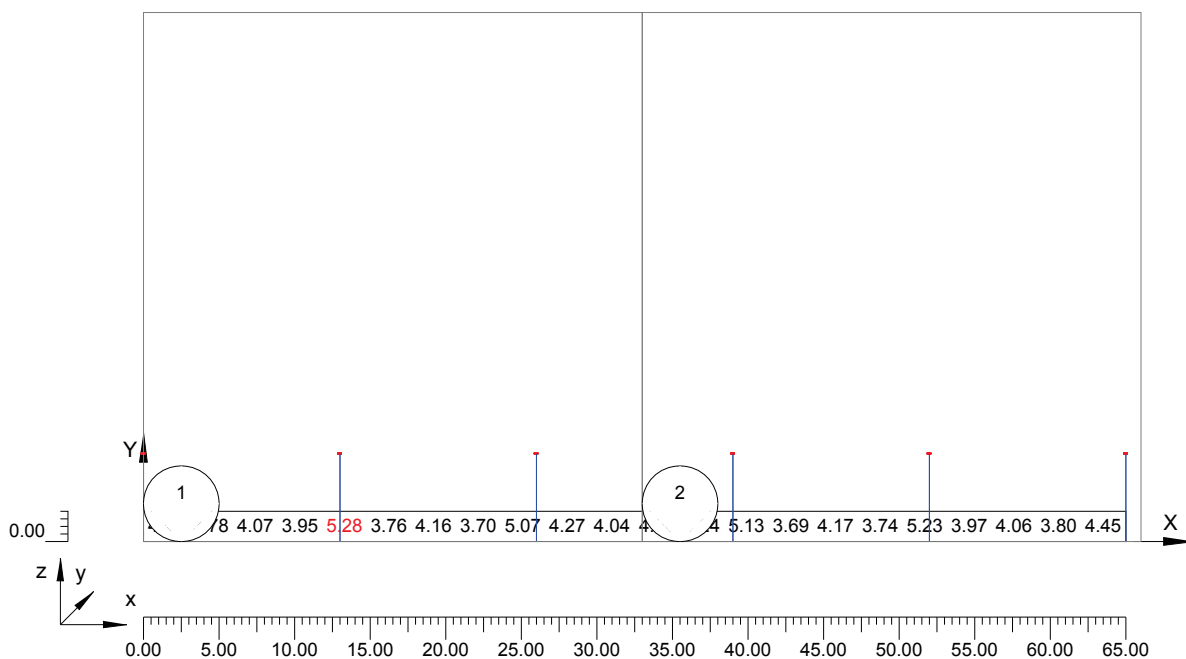

4.3 Valori delle Luminanze su: Parete_Destra (x=-60.00;y=4.23;z=1.50)m ---> (x=30.00;y=4.23;z=0.00)m

Scala 1/230

Parte 1 di 2

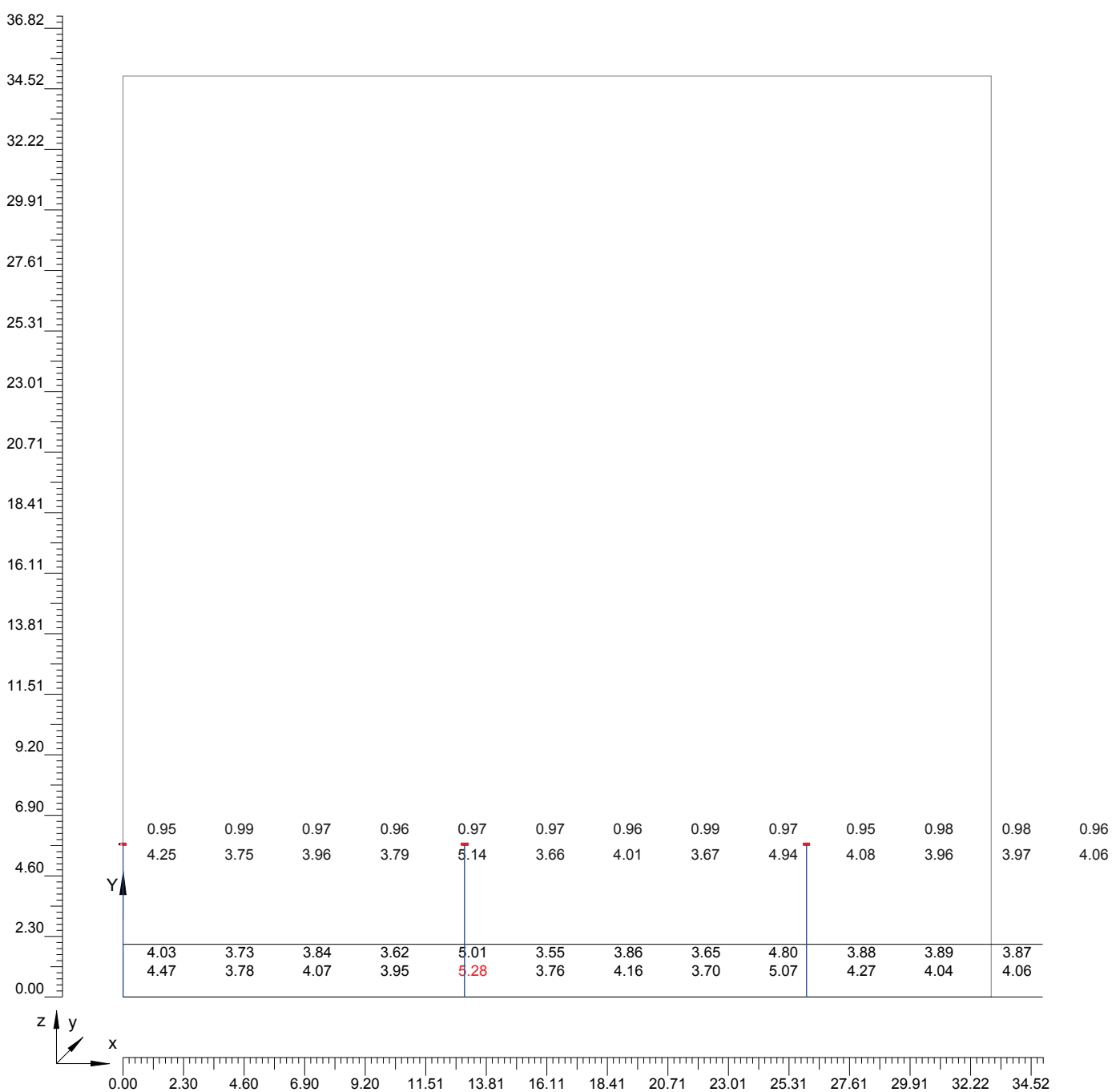

4.3 Valori delle Luminanze su: Parete_Destra (x=-60.00;y=4.23;z=1.50)m ---> (x=30.00;y=4.23;z=0.00)m

Scala 1/230

Parte 2 di 2

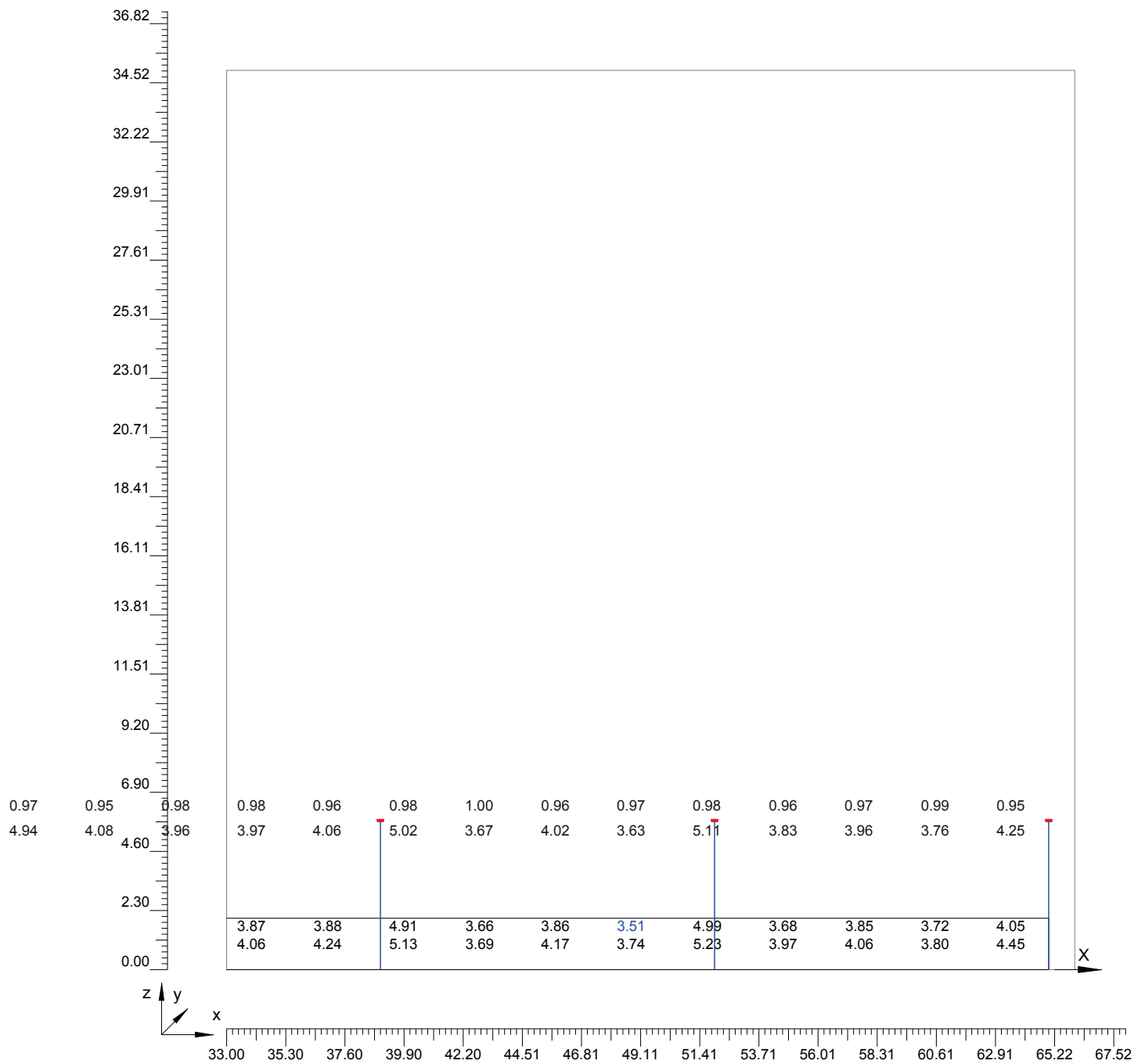

4.4 Valori delle Luminanze su: Striscia_Destra_1_7m (x=-60.00;y=4.23;z=1.50)m ---> (x=30.00;y=4.23;z=0.0

O (x:65.00 y:0.01 z:1.69)	Risultati	Medio	Minimo	Massimo	Min/Medio	Min/Max	Medio/Max
DX:0.02 DY:2.95	Luminanza (L)	3.99 cd/m ²	3.51 cd/m ²	5.01 cd/m ²	0.88	0.70	0.80

Tipo Calcolo

Dir.+Indir.(1 Interriflessioni) + Arredi

Scala 1/500

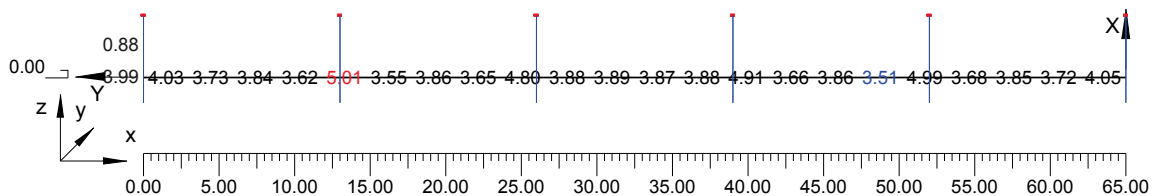

4.5 Valori delle Luminanze su: Parete_Sinistra (x=-60.00;y=4.23;z=1.50)m ---> (x=30.00;y=4.23;z=0.00)m

O (x:0.00 y:13.14 z:0.00)	Risultati	Medio	Minimo	Massimo	Min/Medio	Min/Max	Medio/Max
DX:2.95 DY:0.70	Luminanza (L)	3.53 cd/m ²	3.04 cd/m ²	4.35 cd/m ²	0.86	0.70	0.81

Tipo Calcolo

Dir.+Indir.(1 Interriflessioni) + Arredi

Scala 1/500

4.5 Valori delle Luminanze su: Parete_Sinistra (x=-60.00;y=4.23;z=1.50)m ---> (x=30.00;y=4.23;z=0.00)m

Totale Parti: 2

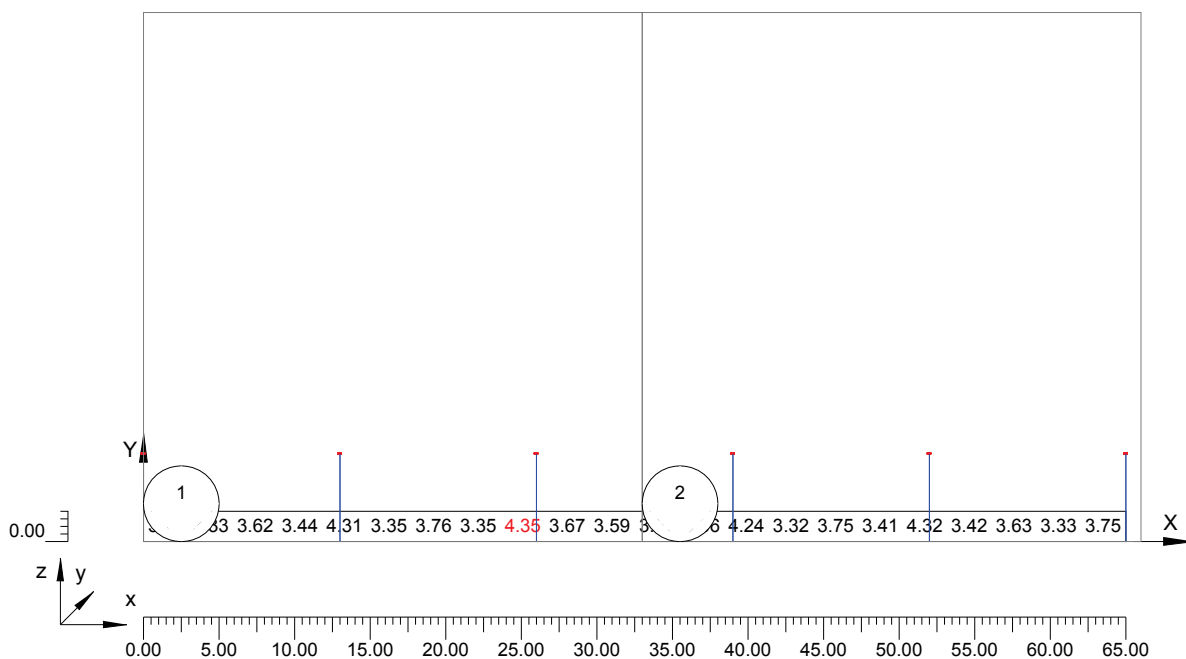

4.5 Valori delle Luminanze su: Parete_Sinistra (x=-60.00;y=4.23;z=1.50)m ---> (x=30.00;y=4.23;z=0.00)m

Scala 1/230

Parte 1 di 2

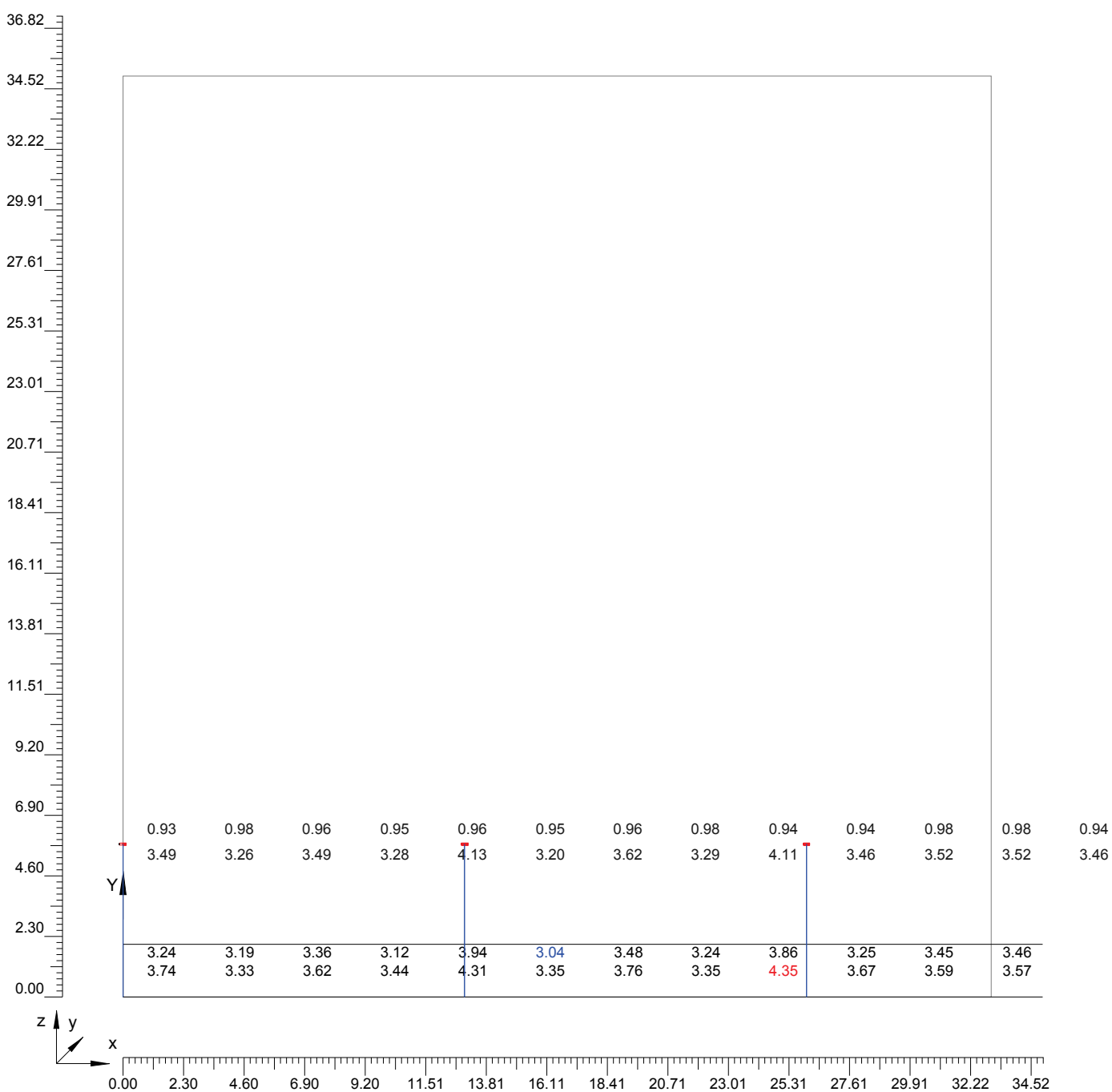

4.5 Valori delle Luminanze su: Parete_Sinistra (x=-60.00;y=4.23;z=1.50)m ---> (x=30.00;y=4.23;z=0.00)m

Scala 1/230

Parte 2 di 2

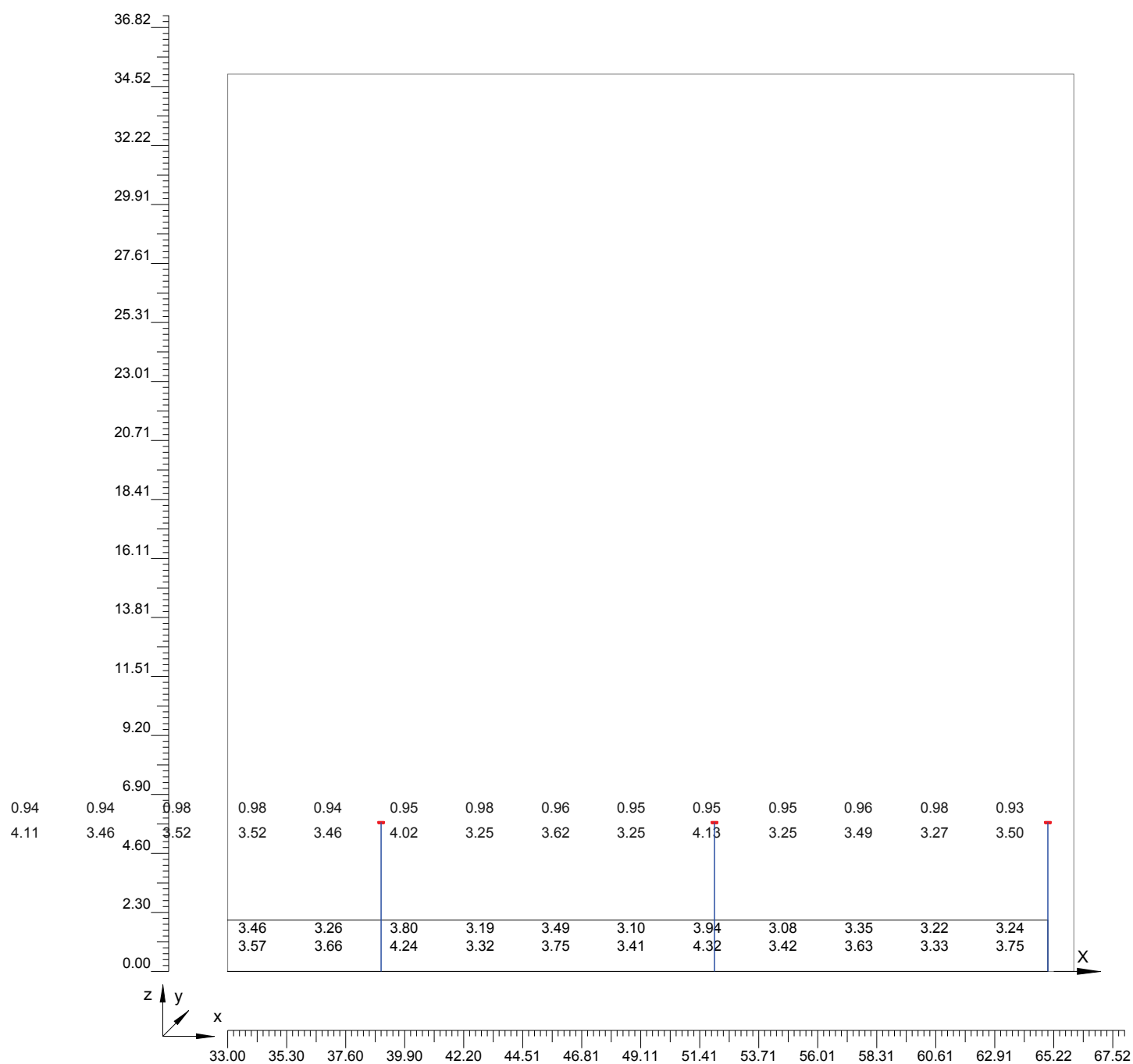

4.6 Valori delle Luminanze su: Striscia_Sinistra_1_7m (x=-60.00;y=4.23;z=1.50)m ---> (x=30.00;y=4.23;z=0

O (x:0.00 y:13.14 z:1.69)	Risultati	Medio	Minimo	Massimo	Min/Medio	Min/Max	Medio/Max
DX:2.95 DY:0.02	Luminanza (L)	3.38 cd/m ²	3.04 cd/m ²	3.94 cd/m ²	0.90	0.77	0.86

Tipo Calcolo

Dir.+Indir.(1 Interriflessioni) + Arredi

Scala 1/500

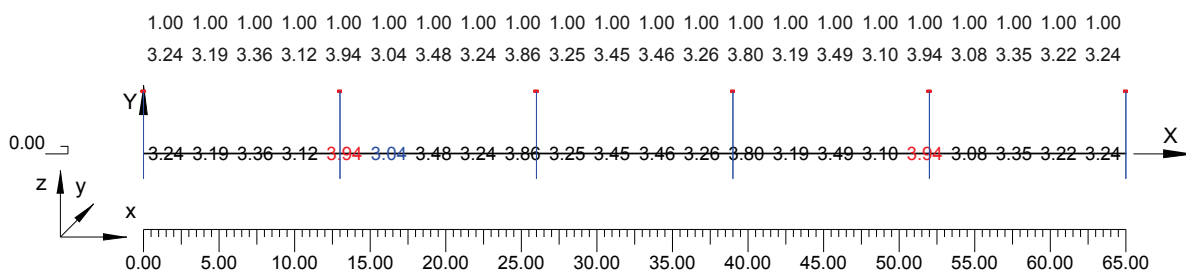

4.7 Valori di Illuminamento su: Carreggiata_LUX

O (x:0.00 y:2.35 z:0.00)	Risultati	Medio	Minimo	Massimo	Min/Medio	Min/Max	Medio/Max
DX:2.95 DY:1.25	Illuminamento Orizzontale (E)	68 lux	50 lux	101 lux	0.73	0.49	0.68

Tipo Calcolo

Dir.+Indir.(1 Interriflessioni) + Arredi

Scala 1/500

4.7 Valori di Illuminamento su: Carreggiata_LUX

Totale Parti: 2

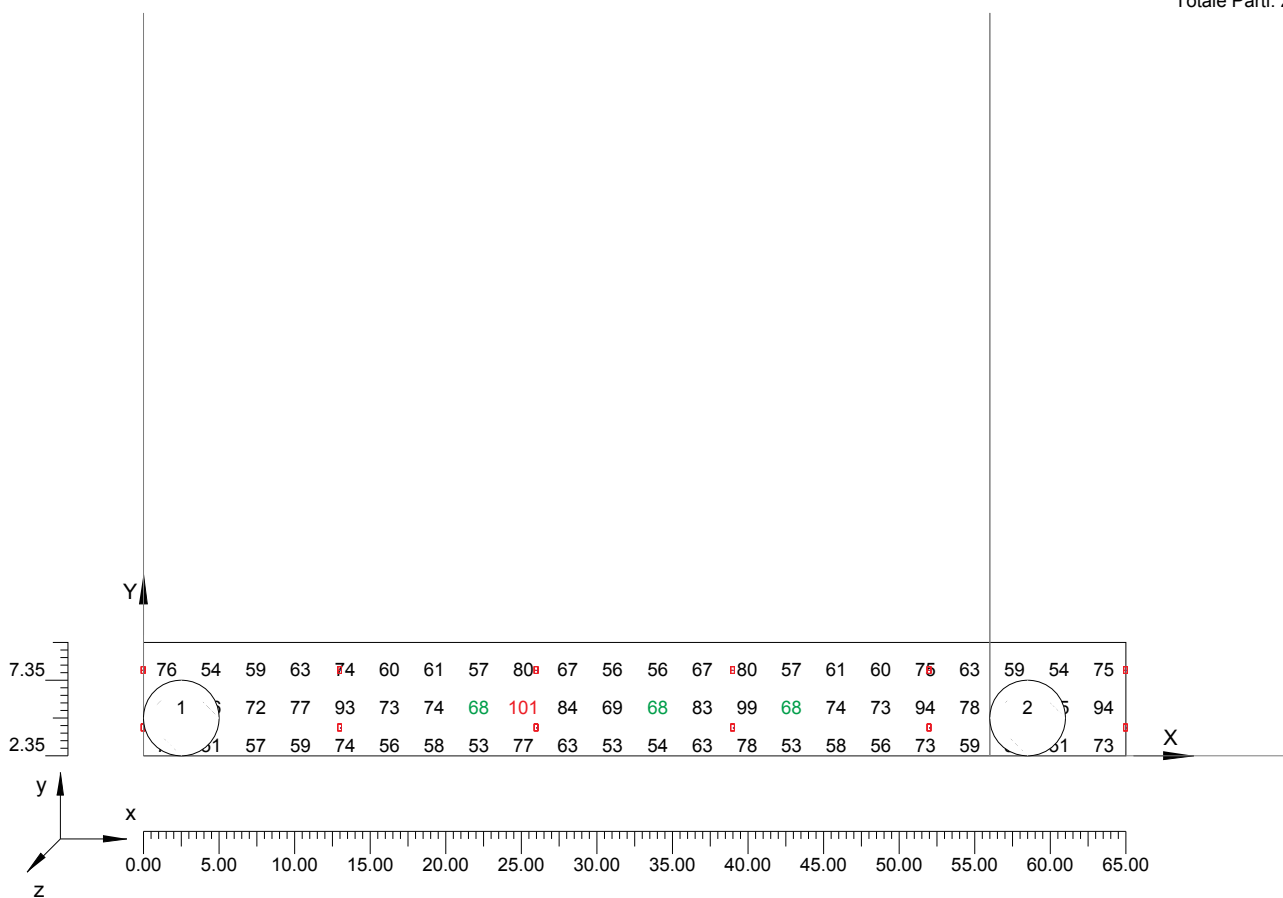

4.7 Valori di Illuminamento su: Carreggiata_LUX

Scala 1/387

Parte 1 di 2

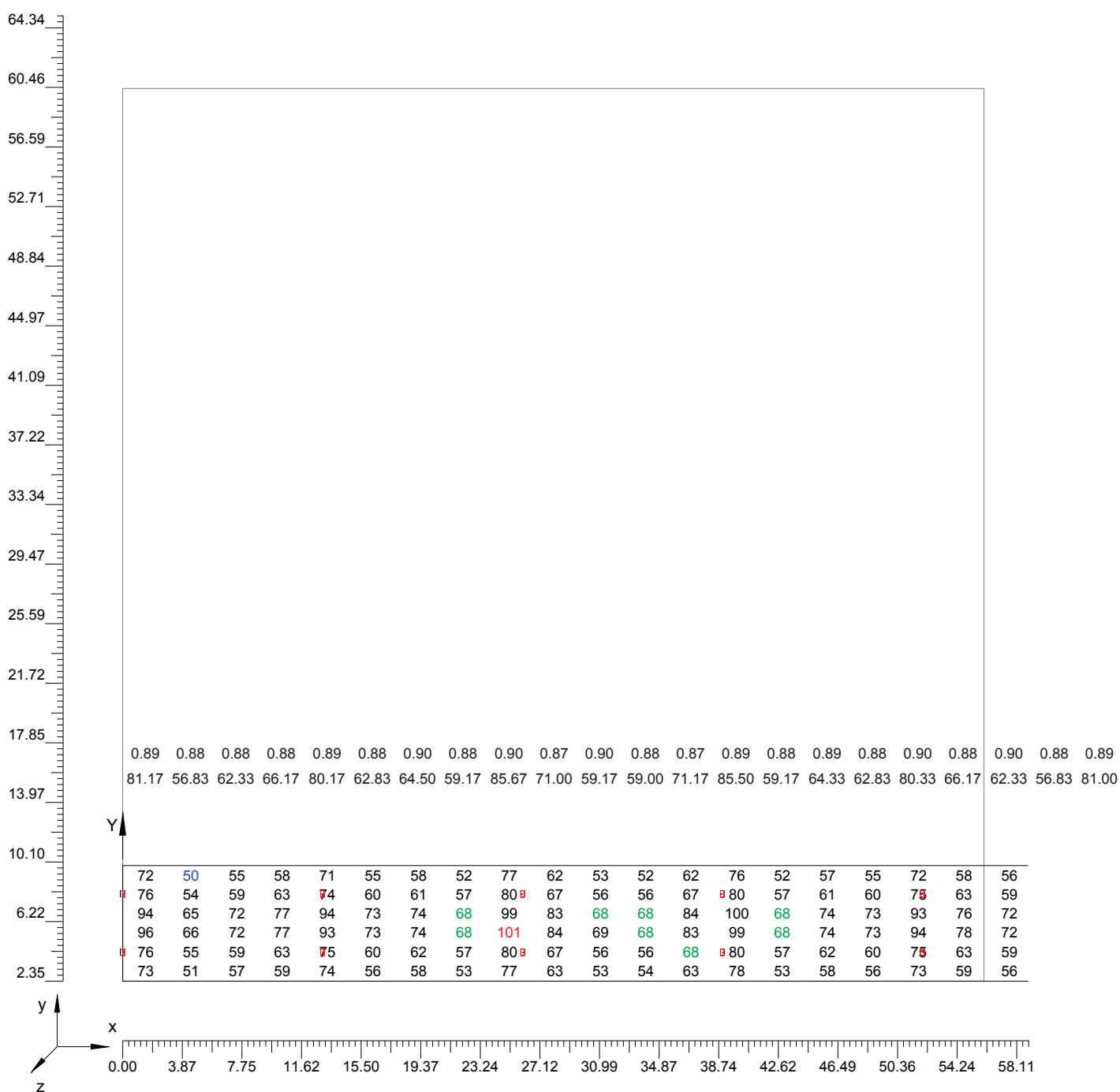

4.7 Valori di Illuminamento su: Carreggiata_LUX

Scala 1/387

Parte 2 di 2

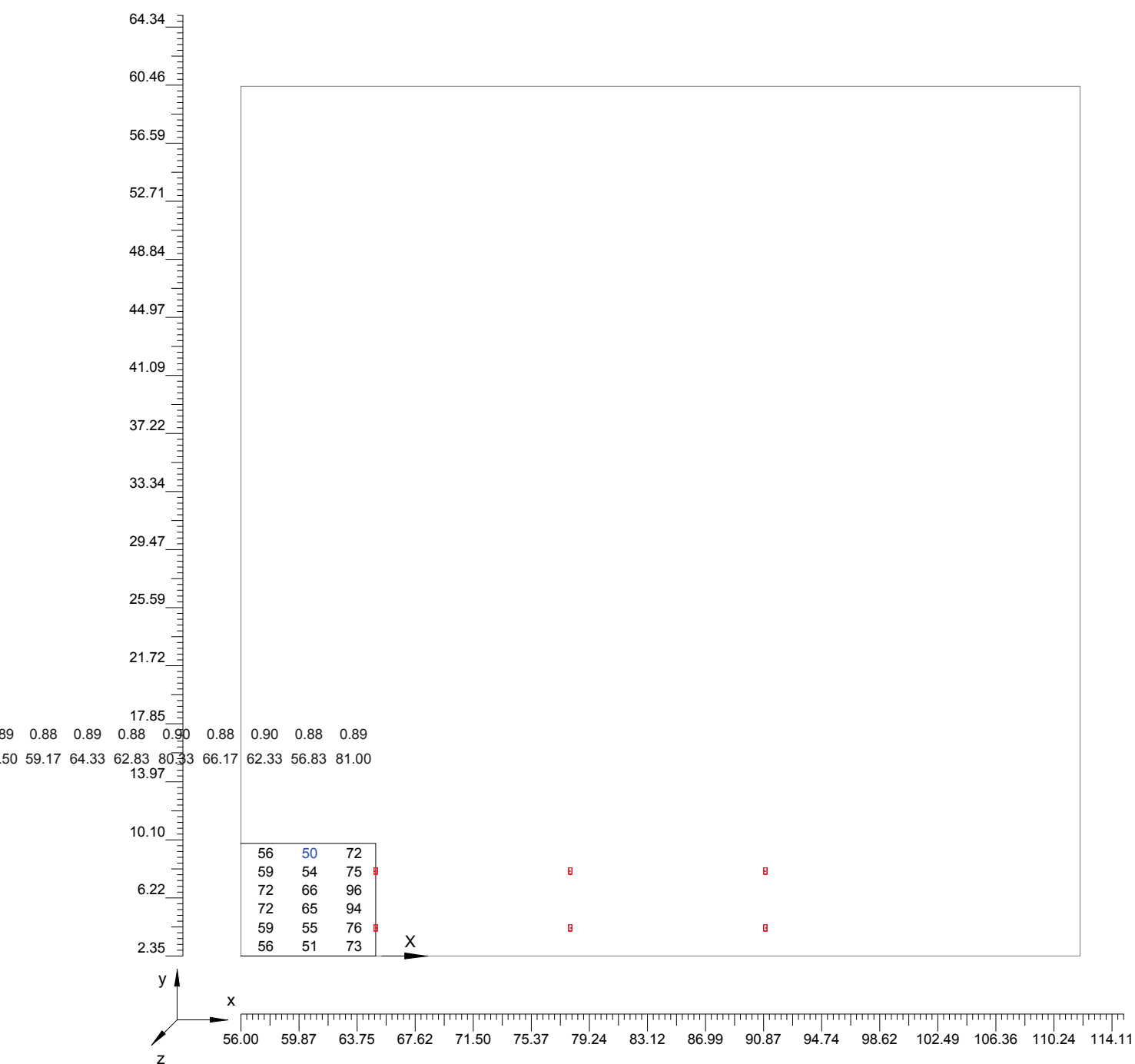

Informazioni Generali	1
1. Dati Riepilogativi Progetto	
1.1 Informazioni Area	2
1.2 Calcolo Energetico	2
1.3 Parametri di Qualità dell'Impianto	2
2. Viste Progetto	
2.1 Vista 2D in Pianta	4
2.2 Vista Laterale	5
3. Dati Riepilogativi Apparecchi	
3.1 Informazioni Apparecchi/Rilievi	6
3.2 Informazioni Lampade	6
4. Tabella Risultati	
4.1 Valori delle Luminanze su: Carreggiata_oss1 Oss. 1(x=-60.00;y=4.22;z=1.50)m	7
4.2 Valori delle Luminanze su: Carreggiata_oss2 Oss. 2(x=125.00;y=7.97;z=1.50)m	10
4.3 Valori delle Luminanze su: Parete_Destra (x=-60.00;y=4.23;z=1.50)m ---> (x=30.00;y=4.23;z=0.00)m	13
4.4 Valori delle Luminanze su: Striscia_Destra_1_7m (x=-60.00;y=4.23;z=1.50)m ---> (x=30.00;y=4.23;z=0.00)m	16
4.5 Valori delle Luminanze su: Parete_Sinistra (x=-60.00;y=4.23;z=1.50)m ---> (x=30.00;y=4.23;z=0.00)m	17
4.6 Valori delle Luminanze su: Striscia_Sinistra_1_7m (x=-60.00;y=4.23;z=1.50)m ---> (x=30.00;y=4.23;z=0.00)m	20
4.7 Valori di Illuminamento su: Carreggiata_LUX	21

Galleria artificiale Mondovì

Note Installazione: **Rinforzo**

Codice Progetto: 20-061-B03

Note
Li = 3 cd/mq
Le = 148.7 cd/mq

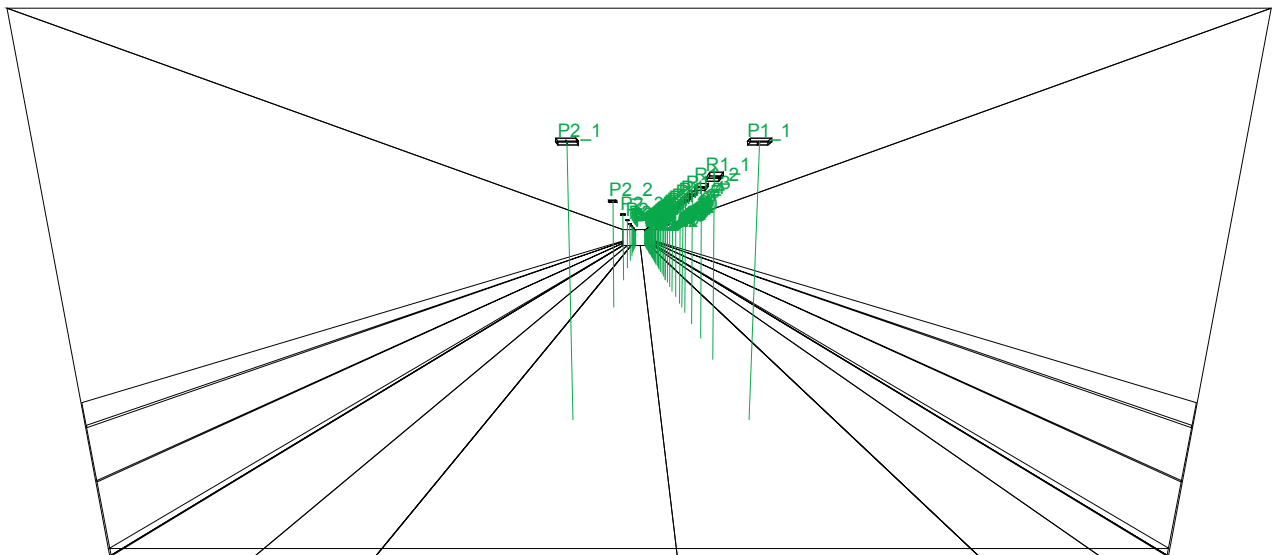

1.1 Informazioni Area

Dati Strada

Zona	Tipo Zona	Corsia	Senso di marcia	Larghezza [m] (W)	y1 [m]	y2 [m]	Pt.Calc.Y (E)	Pt.Calc.Y (L)	Alt. Zona [m] (HC)	Colore	Tabella R	Coeff.Rif. Fattore q0
Marc_dx	Pista Ciclo/Pedonale			2.35	0.00	2.35	3		0.00	RGB=219,54,36		30.00
		Marc_dx	--->	0.85	0.00	0.85		3				
		banchina_dx	--->	1.50	0.85	2.35		3				
Carreggiata Carrabile				7.50	2.35	9.85	5		0.00	RGB=126,126,126	C2	5.60
		Corsia1	--->	3.75	2.35	6.10		3				
		Corsia2	<---	3.75	6.10	9.85		3				
Marc_sx	Pista Ciclo/Pedonale			3.30	9.85	13.15	3		0.00	RGB=219,54,36		30.00
		banchina_sx	<---	1.50	9.85	11.35		3				
		Marc_sx	<---	1.80	11.35	13.15		3				

Dati Installazione Apparecchi

Nome Fila	1° Palo x [m] (XP)	1° Palo y [m] (YP)	Altez.App. [m] (H)	Num. Pali	Interd. [m] (D)	Sbraccio [m] (L)	Ang.Incl. [°] (RY)	Rot.Sbraccio [°] (RZ)	Ang.Incl.Lat. [°] (RX)	Fatt.Manut. [%]	Codice Apparecchio	Flusso [lm]	Rif.
P1	3.50	4.20	5.80	12	13.00	0.00	0	90	0	80.00	PetV2-48	7100	A
P2	3.50	8.00	5.80	12	13.00	0.00	0	270	0	80.00	PetV2-48	7100	A
R1	8.00	4.20	5.80	26	2.50	0.00	-5	0	0	80.00	Pet-T21	46800	B
R2	73.00	4.20	5.80	5	2.80	0.00	-5	0	0	80.00	Pet-T21	46800	B
R3	87.00	4.20	5.80	5	3.40	0.00	-5	0	0	80.00	Pet-T21	46800	B
R4	104.00	4.20	5.80	5	4.60	0.00	-5	0	0	80.00	Pet-T21	46800	B
R5	127.00	4.20	5.80	4	7.50	0.00	-5	0	0	80.00	Pet-T21	46800	B

1.2 Calcolo Energetico (Suolo)

Area	1117.50 m2
Illuminamento Medio	916.56 lx
Potenza Specifica	14.81 W/m2
Potenza Specifica Illuminotecnica	1.62 W/(m2 * 100lx)
Efficienza Energetica	61.91 (m2*lx)/W
Potenza Totale Utilizzata	16545.00 W

2.1 Vista 2D in Pianta

Scala 1/2000

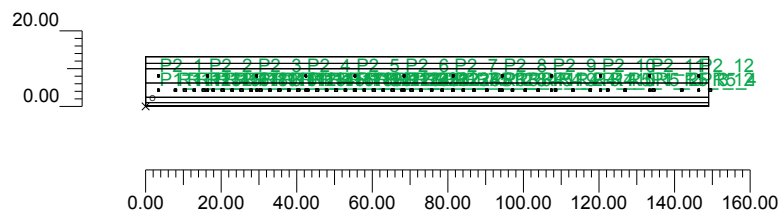

2.2 Vista Laterale

Scala 1/90

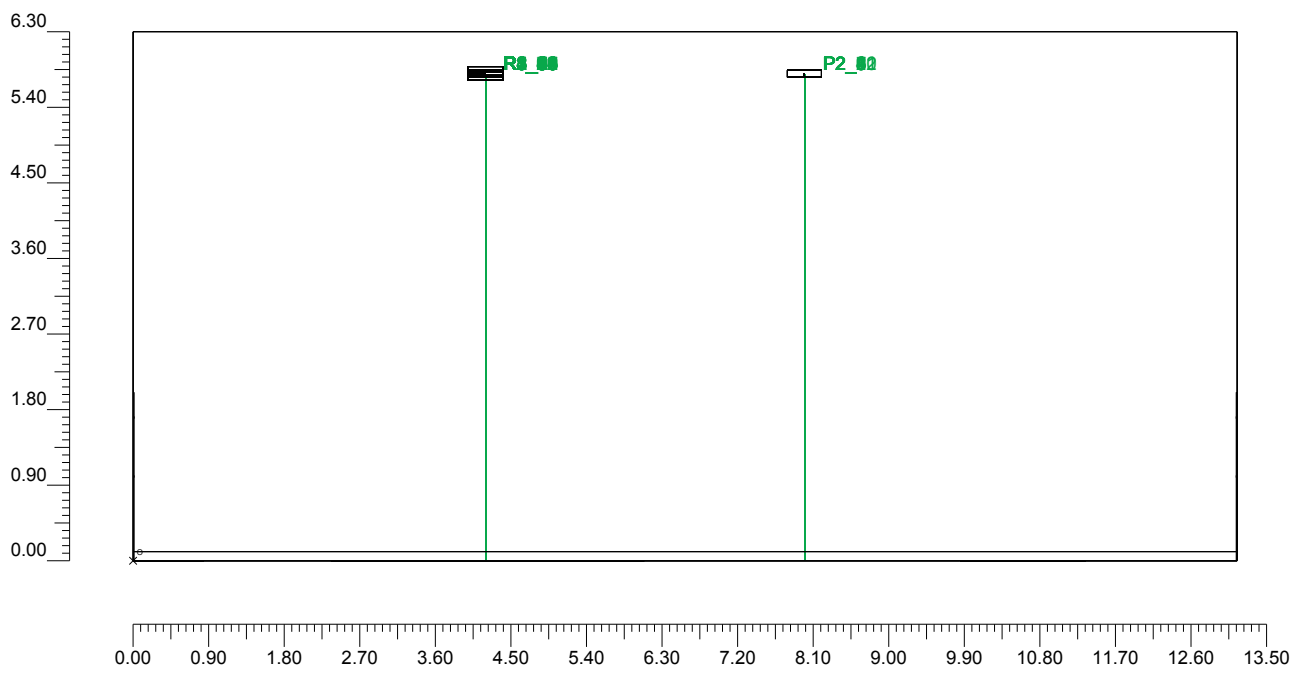

3.1 Informazioni Apparecchi/Rilievi

Rif.	Linea	Nome Apparecchio (Nome Rilievo)	Codice Apparecchio (Codice rilievo)	Apparecchi n.	Rif.Lamp.	Lampade n.
A	Arianna Petrarca	PetV2-48 (PetV2-48)	PetV2-48 (PetV2-48)	24	LMP-A	1
B	Arianna Petrarca	Pet-T21 (Petrarca-T21)	Pet-T21 (Petrarca-T21)	45	LMP-B	1

3.2 Informazioni Lampade

Rif.Lamp.	Tipo	Codice	Flusso lm	Potenza W	Colore K	n.
LMP-A	LED	PetrarcaTunnel 7100	7100	50	4000	-
LMP-B	LED	PetrarcaTunnel 46800	46800	341	4000	-

3.3 Tabella Riepilogativa Apparecchi

Rif.	App.	On	Posizione Apparecchi X[m] Y[m] Z[m]	Rotazione Apparecchi X° Y° Z°	Codice Apparecchio	Coeff. Mant.	Codice Lampada	Flusso lm
A	1	X	3.50;4.20;5.80	0.0;0.0;0.0	PetV2-48	0.80	PetrarcaTunnel 7100	1*7100
	2	X	16.50;4.20;5.80	0.0;0.0;0.0				
	3	X	29.50;4.20;5.80	0.0;0.0;0.0				
	4	X	42.50;4.20;5.80	0.0;0.0;0.0				
	5	X	55.50;4.20;5.80	0.0;0.0;0.0				
	6	X	68.50;4.20;5.80	0.0;0.0;0.0				
	7	X	81.50;4.20;5.80	0.0;0.0;0.0				
	8	X	94.50;4.20;5.80	0.0;0.0;0.0				
	9	X	107.50;4.20;5.80	0.0;0.0;0.0				
	10	X	120.50;4.20;5.80	0.0;0.0;0.0				
	11	X	133.50;4.20;5.80	0.0;0.0;0.0				
	12	X	146.50;4.20;5.80	0.0;0.0;0.0				
	13	X	3.50;8.00;5.80	0.0;0.0;180.0				
	14	X	16.50;8.00;5.80	0.0;0.0;180.0				
	15	X	29.50;8.00;5.80	0.0;0.0;180.0				
	16	X	42.50;8.00;5.80	0.0;0.0;180.0				
	17	X	55.50;8.00;5.80	0.0;0.0;180.0				
	18	X	68.50;8.00;5.80	0.0;0.0;180.0				
	19	X	81.50;8.00;5.80	0.0;0.0;180.0				
	20	X	94.50;8.00;5.80	0.0;0.0;180.0				
	21	X	107.50;8.00;5.80	0.0;0.0;180.0				
	22	X	120.50;8.00;5.80	0.0;0.0;180.0				
	23	X	133.50;8.00;5.80	0.0;0.0;180.0				
	24	X	146.50;8.00;5.80	0.0;0.0;180.0				
B	1	X	8.00;4.20;5.80	-5.0;0.0;-90.0	Pet-T21	0.80	PetrarcaTunnel 46800	1*46800
	2	X	10.50;4.20;5.80	-5.0;0.0;-90.0				
	3	X	13.00;4.20;5.80	-5.0;0.0;-90.0				
	4	X	15.50;4.20;5.80	-5.0;0.0;-90.0				
	5	X	18.00;4.20;5.80	-5.0;0.0;-90.0				
	6	X	20.50;4.20;5.80	-5.0;0.0;-90.0				
	7	X	23.00;4.20;5.80	-5.0;0.0;-90.0				
	8	X	25.50;4.20;5.80	-5.0;0.0;-90.0				
	9	X	28.00;4.20;5.80	-5.0;0.0;-90.0				
	10	X	30.50;4.20;5.80	-5.0;0.0;-90.0				
	11	X	33.00;4.20;5.80	-5.0;0.0;-90.0				
	12	X	35.50;4.20;5.80	-5.0;0.0;-90.0				
	13	X	38.00;4.20;5.80	-5.0;0.0;-90.0				
	14	X	40.50;4.20;5.80	-5.0;0.0;-90.0				
	15	X	43.00;4.20;5.80	-5.0;0.0;-90.0				
	16	X	45.50;4.20;5.80	-5.0;0.0;-90.0				
	17	X	48.00;4.20;5.80	-5.0;0.0;-90.0				

Rif.	App.	On	Posizione Apparecchi X[m] Y[m] Z[m]	Rotazione Apparecchi X° Y° Z°	Codice Apparecchio	Coeff. Mant.	Codice Lampada	Flusso lm
B	18	X	50.50;4.20;5.80	-5.0;0.0;-90.0	Pet-T21	0.80	PetrarcaTunnel 46800	1*46800
	19	X	53.00;4.20;5.80	-5.0;0.0;-90.0		0.80		
	20	X	55.50;4.20;5.80	-5.0;0.0;-90.0		0.80		
	21	X	58.00;4.20;5.80	-5.0;0.0;-90.0		0.80		
	22	X	60.50;4.20;5.80	-5.0;0.0;-90.0		0.80		
	23	X	63.00;4.20;5.80	-5.0;0.0;-90.0		0.80		
	24	X	65.50;4.20;5.80	-5.0;0.0;-90.0		0.80		
	25	X	68.00;4.20;5.80	-5.0;0.0;-90.0		0.80		
	26	X	70.50;4.20;5.80	-5.0;0.0;-90.0		0.80		
	27	X	73.00;4.20;5.80	-5.0;0.0;-90.0		0.80		
	28	X	75.80;4.20;5.80	-5.0;0.0;-90.0		0.80		
	29	X	78.60;4.20;5.80	-5.0;0.0;-90.0		0.80		
	30	X	81.40;4.20;5.80	-5.0;0.0;-90.0		0.80		
	31	X	84.20;4.20;5.80	-5.0;0.0;-90.0		0.80		
	32	X	87.00;4.20;5.80	-5.0;0.0;-90.0		0.80		
	33	X	90.40;4.20;5.80	-5.0;0.0;-90.0		0.80		
	34	X	93.80;4.20;5.80	-5.0;0.0;-90.0		0.80		
	35	X	97.20;4.20;5.80	-5.0;0.0;-90.0		0.80		
	36	X	100.60;4.20;5.80	-5.0;0.0;-90.0		0.80		
	37	X	104.00;4.20;5.80	-5.0;0.0;-90.0		0.80		
	38	X	108.60;4.20;5.80	-5.0;0.0;-90.0		0.80		
	39	X	113.20;4.20;5.80	-5.0;0.0;-90.0		0.80		
	40	X	117.80;4.20;5.80	-5.0;0.0;-90.0		0.80		
	41	X	122.40;4.20;5.80	-5.0;0.0;-90.0		0.80		
	42	X	127.00;4.20;5.80	-5.0;0.0;-90.0		0.80		
	43	X	134.50;4.20;5.80	-5.0;0.0;-90.0		0.80		
	44	X	142.00;4.20;5.80	-5.0;0.0;-90.0		0.80		
	45	X	149.50;4.20;5.80	-5.0;0.0;-90.0		0.80		

4.1 Valori delle Luminanze su: Corsia1 Oss. 1(x=-60.00;y=4.22;z=1.50)m

O (x:0.00 y:2.35 z:0.00)	Risultati	Medio	Minimo	Massimo	Min/Medio	Min/Max	Medio/Max
DX:2.98 DY:1.25	Luminanza (L)	119 cd/m ²	10 cd/m ²	184 cd/m ²	0.08	0.05	0.64

Tipo Calcolo

Dir.+Indir.(1 Interriflessioni) + Arredi

Nome Corsia	Largh. Corsia [m] (W)	y1 [m]	y2 [m]	Pt.Calc.Y	Tabella R	Coeff.Rifl. Fattore q0	Osservatore x Assoluto [m]	Osservatore y Assoluto [m]	Luminanza Velante [cd/m ²]	Incremento di Soglia [%]	Uniformità Longitudinale
Corsia1	3.75	2.35	6.10	3	C2	5.60	-60.00	4.22	10.33	15.46	0.05 *

Norma

CEN 13201

4.1
Scala 1/2000

4.1 Valori delle Luminanze su: Corsia1 Oss. 1(x=-60.00;y=4.22;z=1.50)m

Totale Parti: 3

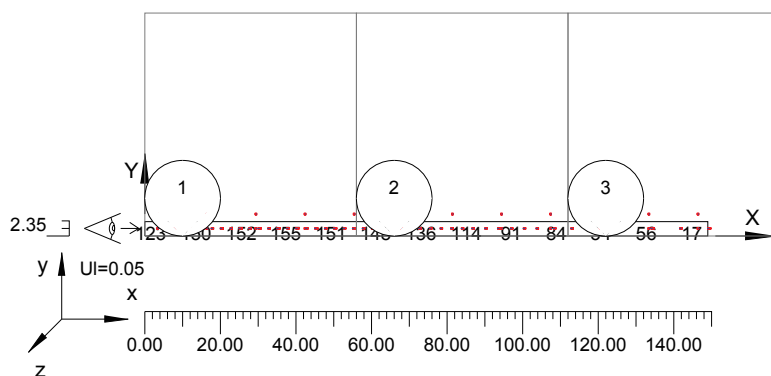

4.1 Valori delle Luminanze su: Corsia1 Oss. 1(x=-60.00;y=4.22;z=1.50)m

Scala 1/391

Parte 1 di 3

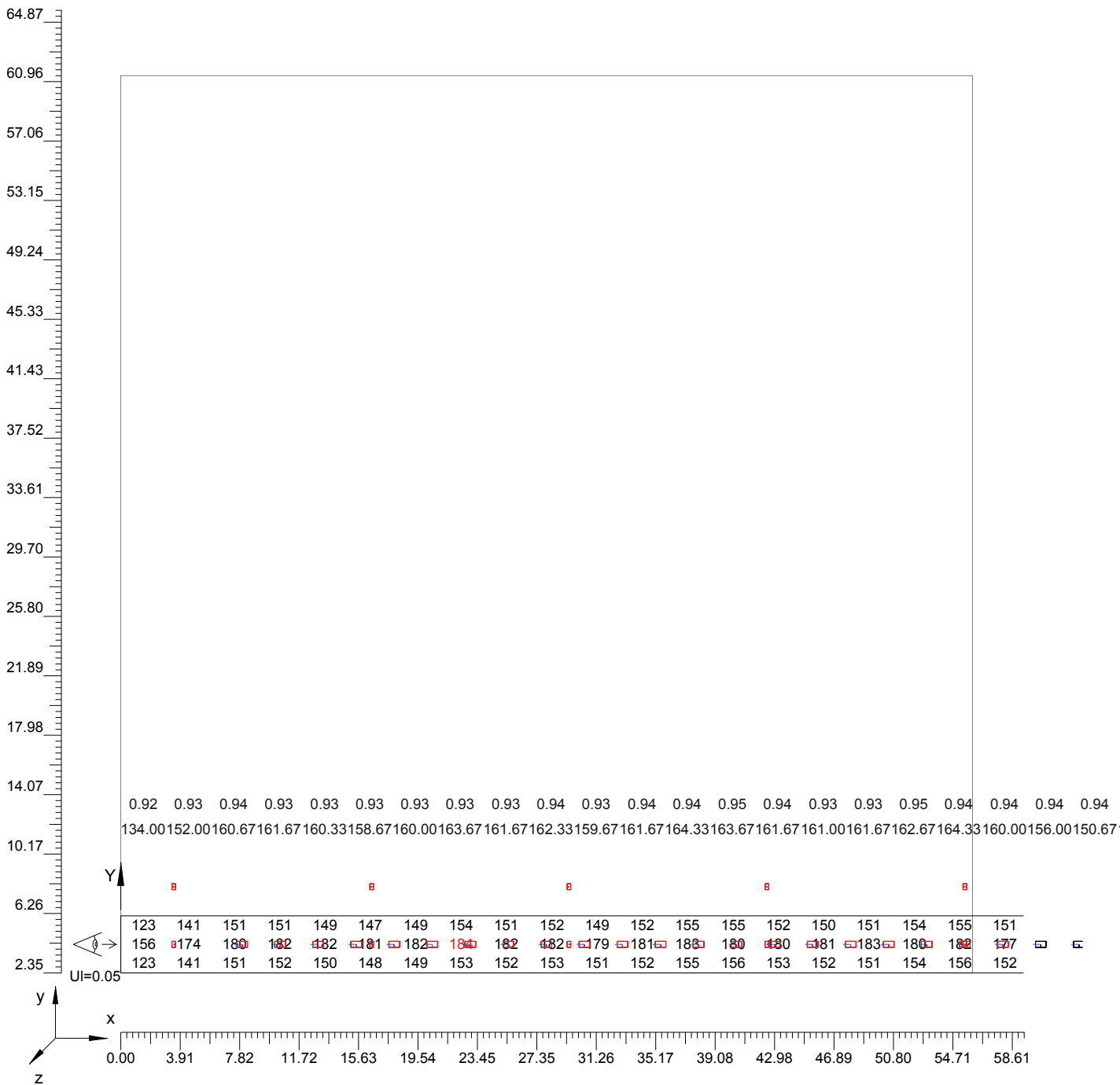

4.1 Valori delle Luminanze su: Corsia1 Oss. 1(x=-60.00;y=4.22;z=1.50)m

Scala 1/391

Parte 2 di 3

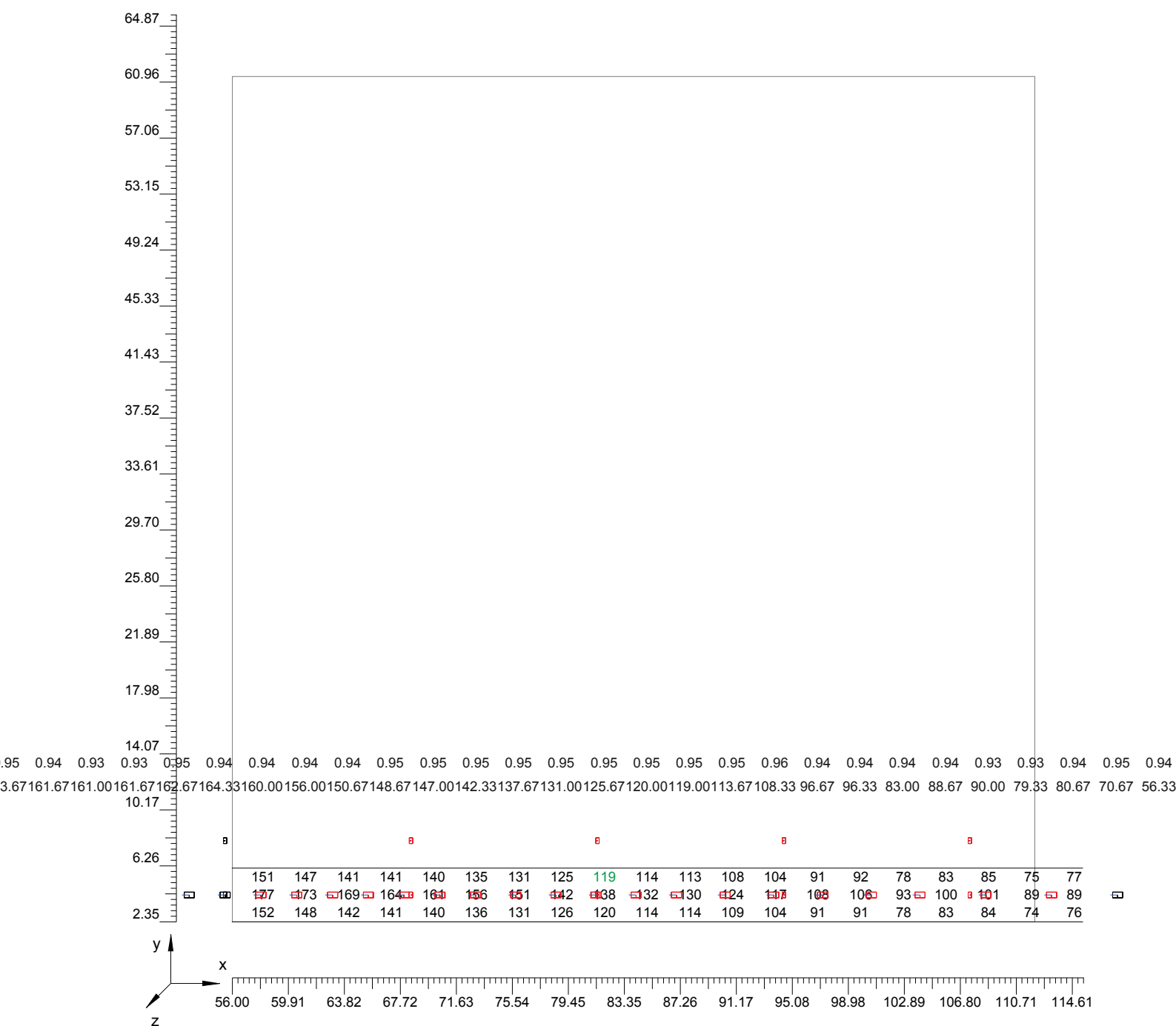

4.1 Valori delle Luminanze su: Corsia1 Oss. 1(x=-60.00;y=4.22;z=1.50)m

Scala 1/391

Parte 3 di 3

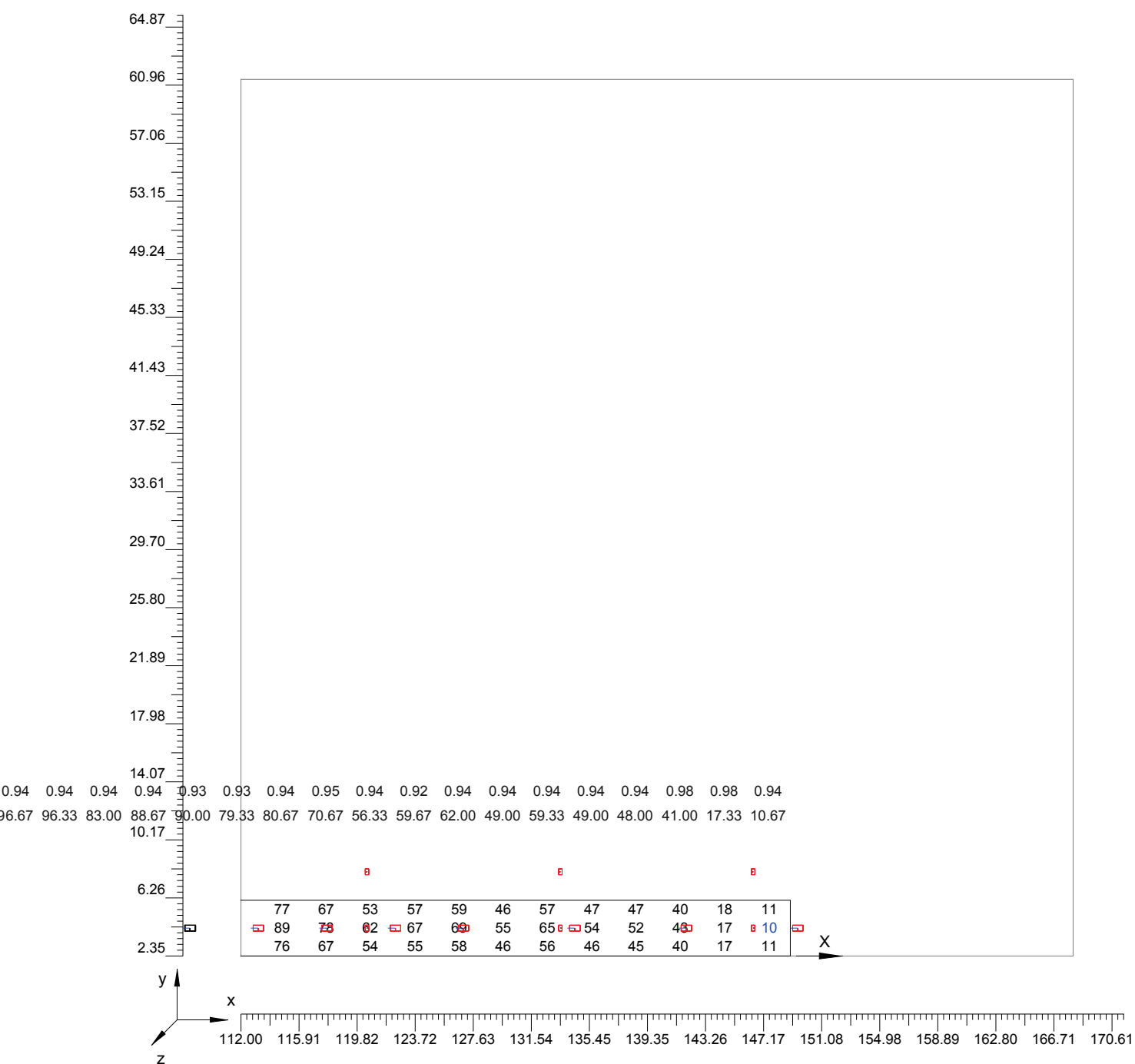

4.2 Curva Luminanza Oss. 1(x=-60.00;y=4.22;z=1.50)m

O (x:0.00 y:2.35 z:0.00)	Risultati	Medio	Minimo	Massimo	Min/Medio	Min/Max	Medio/Max
DX:2.98 DY:1.25	Luminanza (L)	119 cd/m ²	10 cd/m ²	184 cd/m ²	0.08	0.05	0.64

Tipo Calcolo

Dir.+Indir.(1 Interriflessioni) + Arredi

Nome Corsia	Largh. Corsia [m] (W)	y1 [m]	y2 [m]	Pt.Calc.Y	Tabella R	Coeff.Rifl. Fattore q0	Osservatore x Assoluto [m]	Osservatore y Assoluto [m]	Luminanza Velante [cd/m ²]	Incremento di Soglia [%]	Uniformità Longitudinale
Corsia1	3.75	2.35	6.10	3	C2	5.60	-60.00	4.22	10.33	15.46	0.05 *

Norma

CEN 13201

Zona: Carreggiata
 Luminanza Media 26.723 cd/m² (Corsia2 Obs2)
 Uniformita' Generale 0.081 (Corsia1 Obs1)
 Uniformita' Longitudinale 0.052 (Corsia1 Obs1)

Par. 1 Luminanza Media 86.652 cd/m² (1m e 1,7m)
 Par. 1 Illum. Medio 680.564lx (1m e 1,7m)
 Par. 1 Uniformita Generale 0.272 (1m e 1,7m)
 Par. 1 Uniformita Longitudinale 0.248 (a 1,7m)

Par. 2 Luminanza Media 28.464 cd/m² (1m e 1,7m)
 Par. 2 Illum. Medio 223.555lx (1m e 1,7m)
 Par. 2 Uniformita Generale 0.217 (1m e 1,7m)
 Par. 2 Uniformita Longitudinale 0.184 (a 1,7m)

Luminanza Oss. 1(x=-60.00;y=4.22;z=1.50)m Corsia1

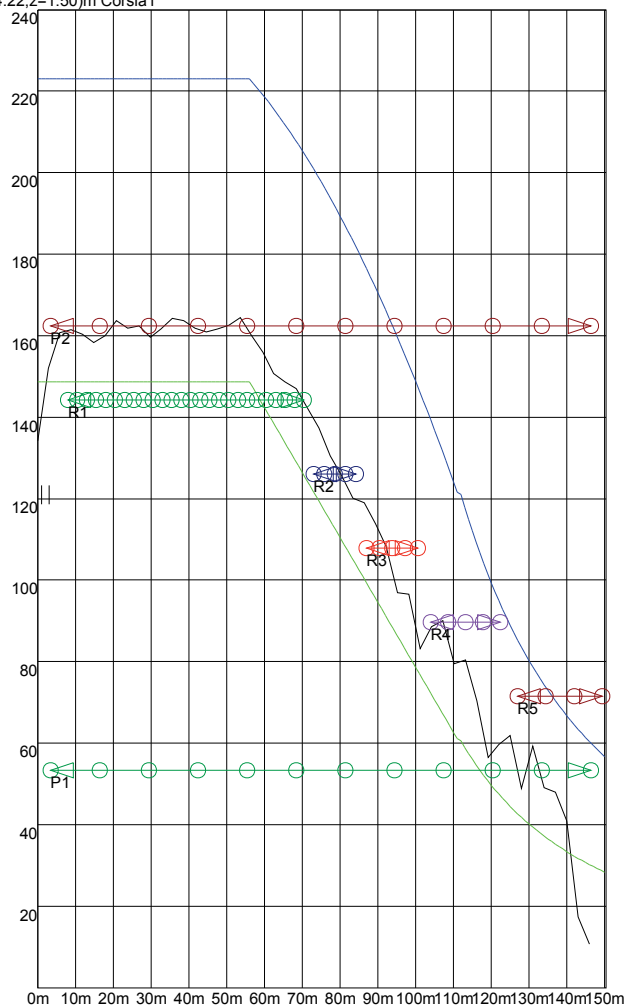

4.3 Valori delle Luminanze su: Parete_Destra (x=-60.00;y=4.23;z=1.50)m ---> (x=30.00;y=4.23;z=0.00)m

O (x:0.00 y:0.01 z:0.00)	Risultati	Medio	Minimo	Massimo	Min/Medio	Min/Max	Medio/Max
DX:2.98 DY:0.70	Luminanza (L)	87 cd/m ²	24 cd/m ²	119 cd/m ²	0.27	0.20	0.73

Tipo Calcolo

Dir.+Indir.(1 Interriflessioni) + Arredi

Scala 1/2000

4.3 Valori delle Luminanze su: Parete_Destra (x=-60.00;y=4.23;z=1.50)m ---> (x=30.00;y=4.23;z=0.00)m

Totale Parti: 5

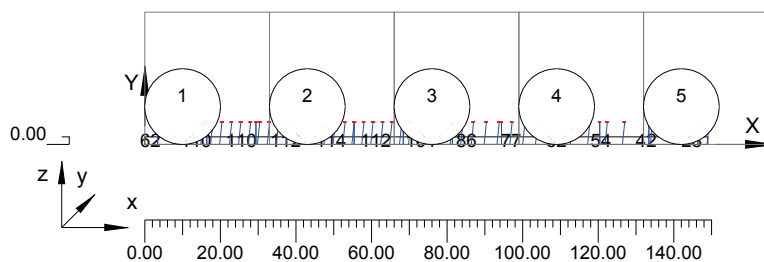

4.3 Valori delle Luminanze su: Parete_Destra (x=-60.00;y=4.23;z=1.50)m ---> (x=30.00;y=4.23;z=0.00)m

Scala 1/230

Parte 1 di 5

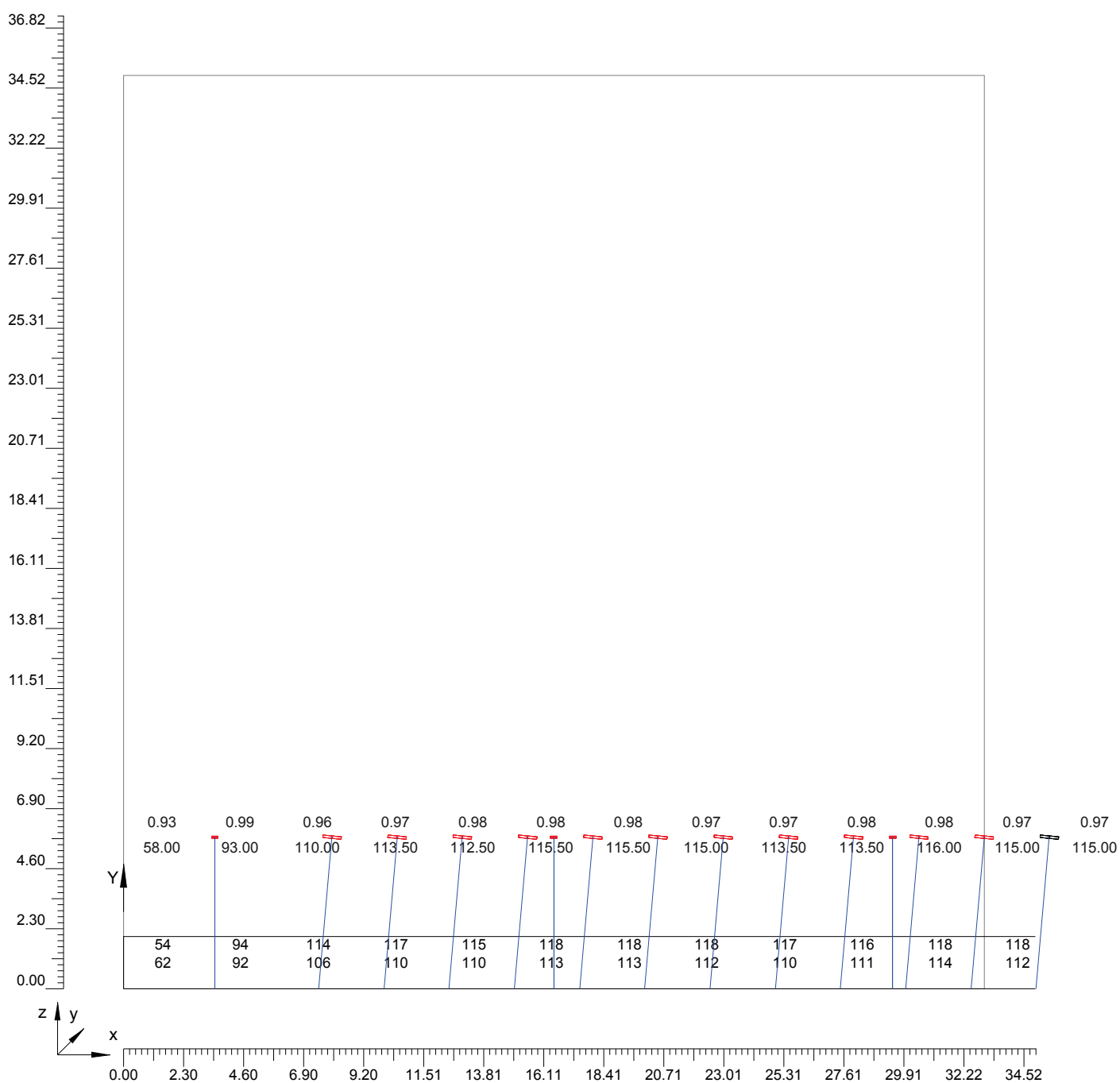

4.3 Valori delle Luminanze su: Parete_Destra (x=-60.00;y=4.23;z=1.50)m ---> (x=30.00;y=4.23;z=0.00)m

Scala 1/230

Parte 2 di 5

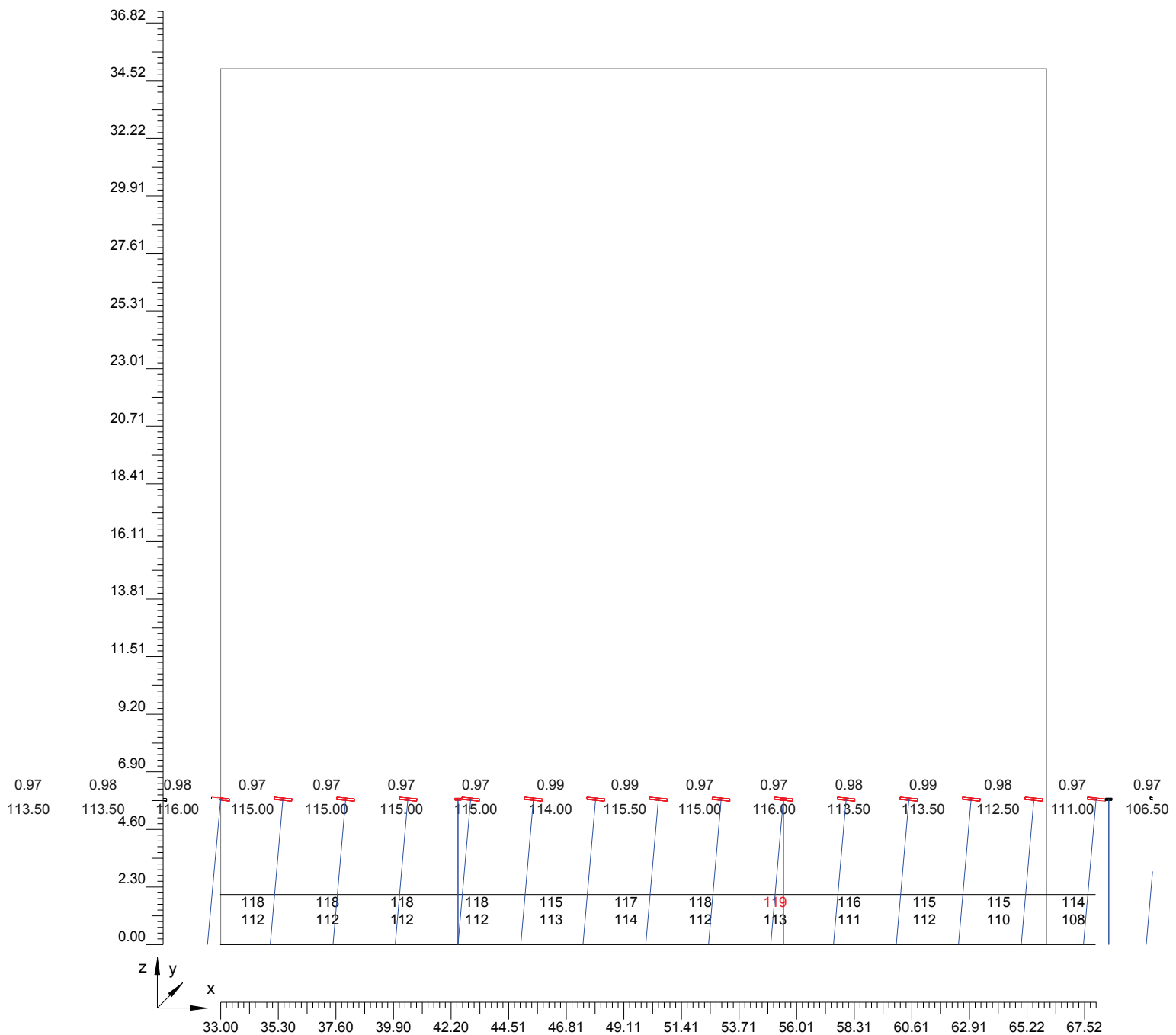

4.3 Valori delle Luminanze su: Parete_Destra (x=-60.00;y=4.23;z=1.50)m ---> (x=30.00;y=4.23;z=0.00)m

Scala 1/230

Parte 3 di 5

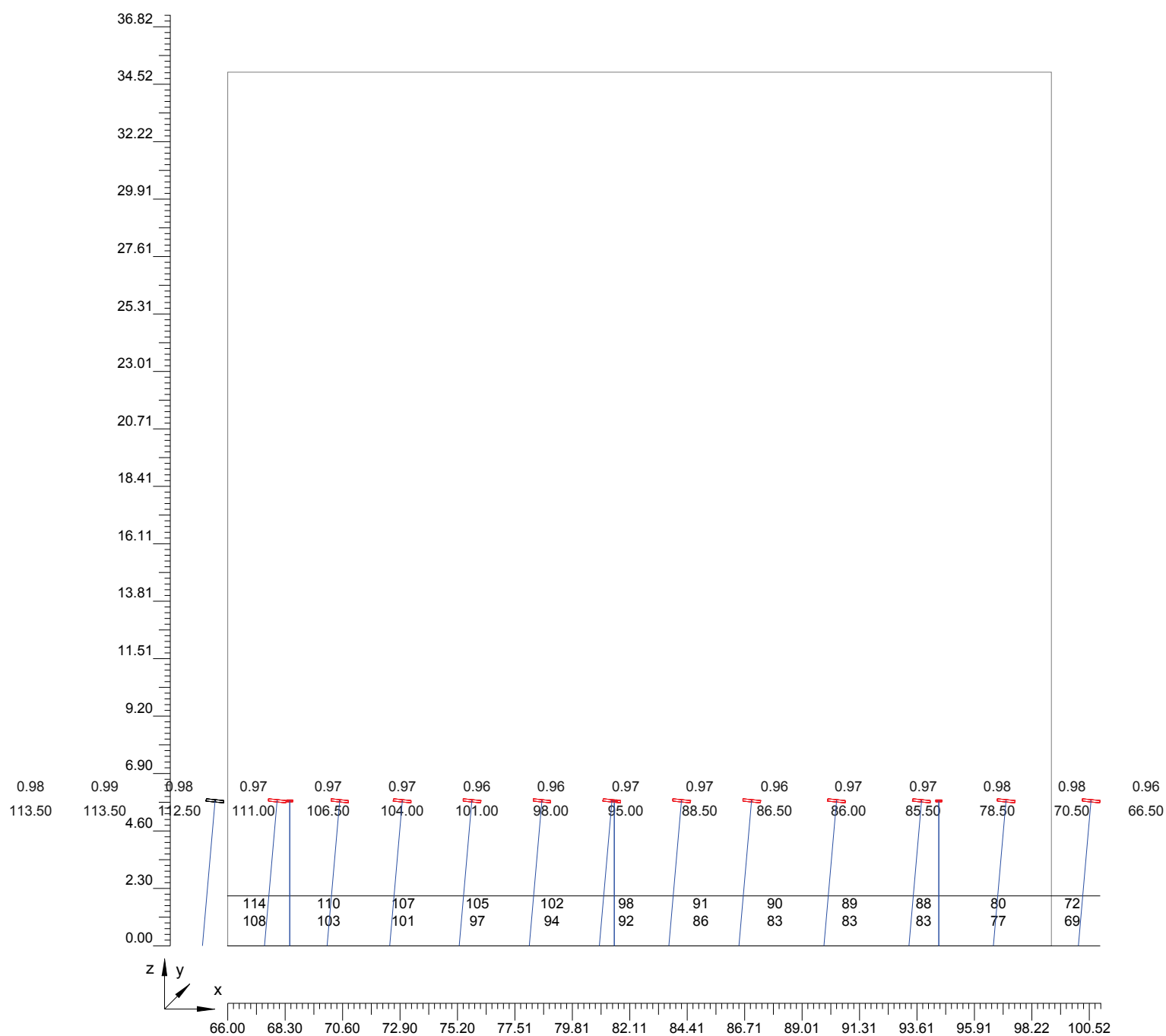

4.3 Valori delle Luminanze su: Parete_Destra (x=-60.00;y=4.23;z=1.50)m ---> (x=30.00;y=4.23;z=0.00)m

Scala 1/230

Parte 4 di 5

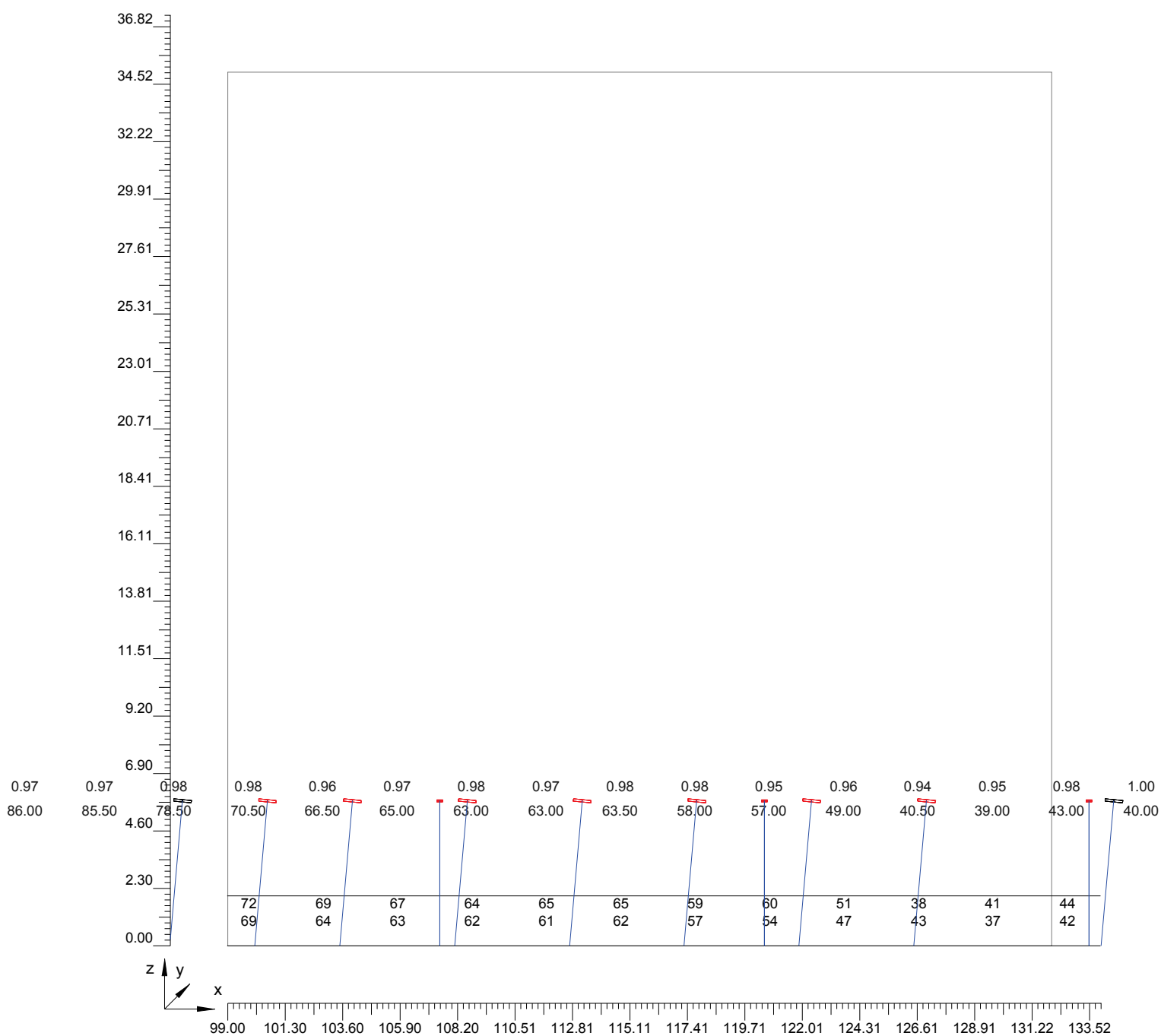

4.3 Valori delle Luminanze su: Parete_Destra (x=-60.00;y=4.23;z=1.50)m ---> (x=30.00;y=4.23;z=0.00)m

Scala 1/230

Parte 5 di 5

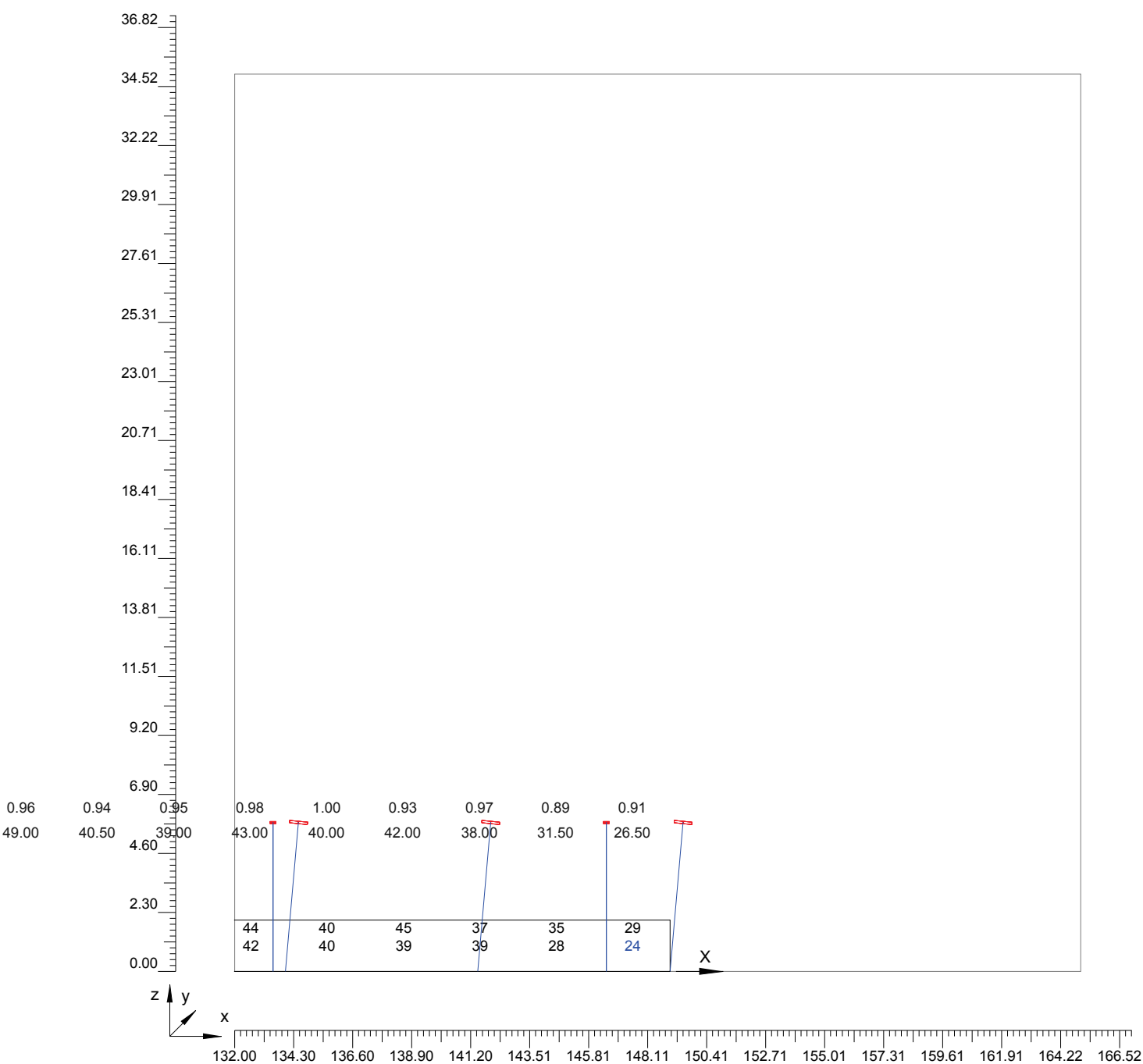

4.4 Valori di Illuminamento su: Carreggiata_LUX

O (x:0.00 y:2.35 z:0.00)	Risultati	Medio	Minimo	Massimo	Min/Medio	Min/Max	Medio/Max
DX:2.98 DY:1.25	Illuminamento Orizzontale (E)	917 lux	166 lux	1524 lux	0.18	0.11	0.60

Tipo Calcolo

Dir.+Indir.(1 Interriflessioni) + Arredi

Scala 4.4
1/2000

4.4 Valori di Illuminamento su: Carreggiata_LUX

Totale Parti: 3

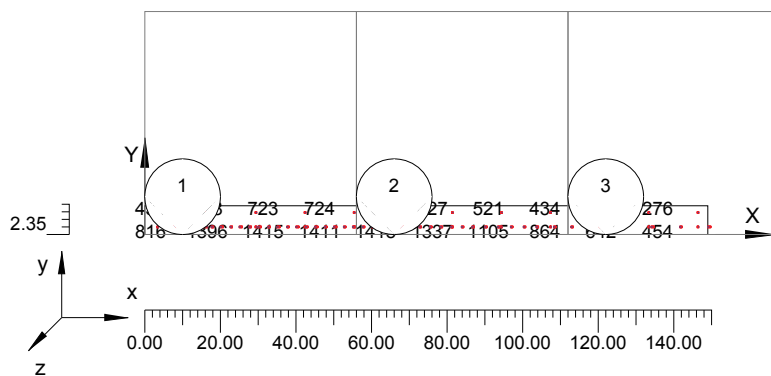

4.4 Valori di Illuminamento su: Carreggiata_LUX

Scala 1/391

Parte 1 di 3

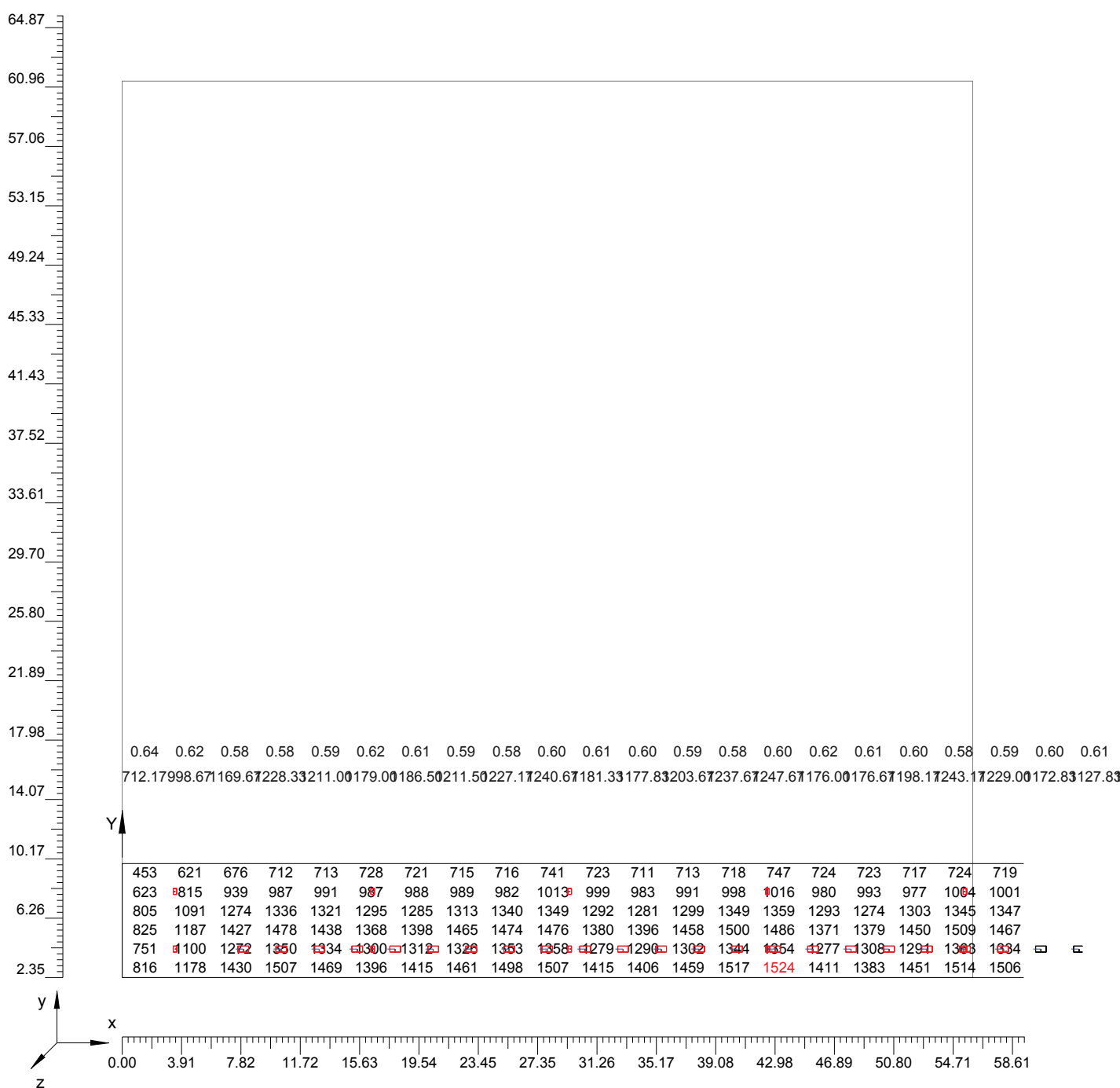

4.4 Valori di Illuminamento su: Carreggiata_LUX

Scala 1/391

Parte 2 di 3

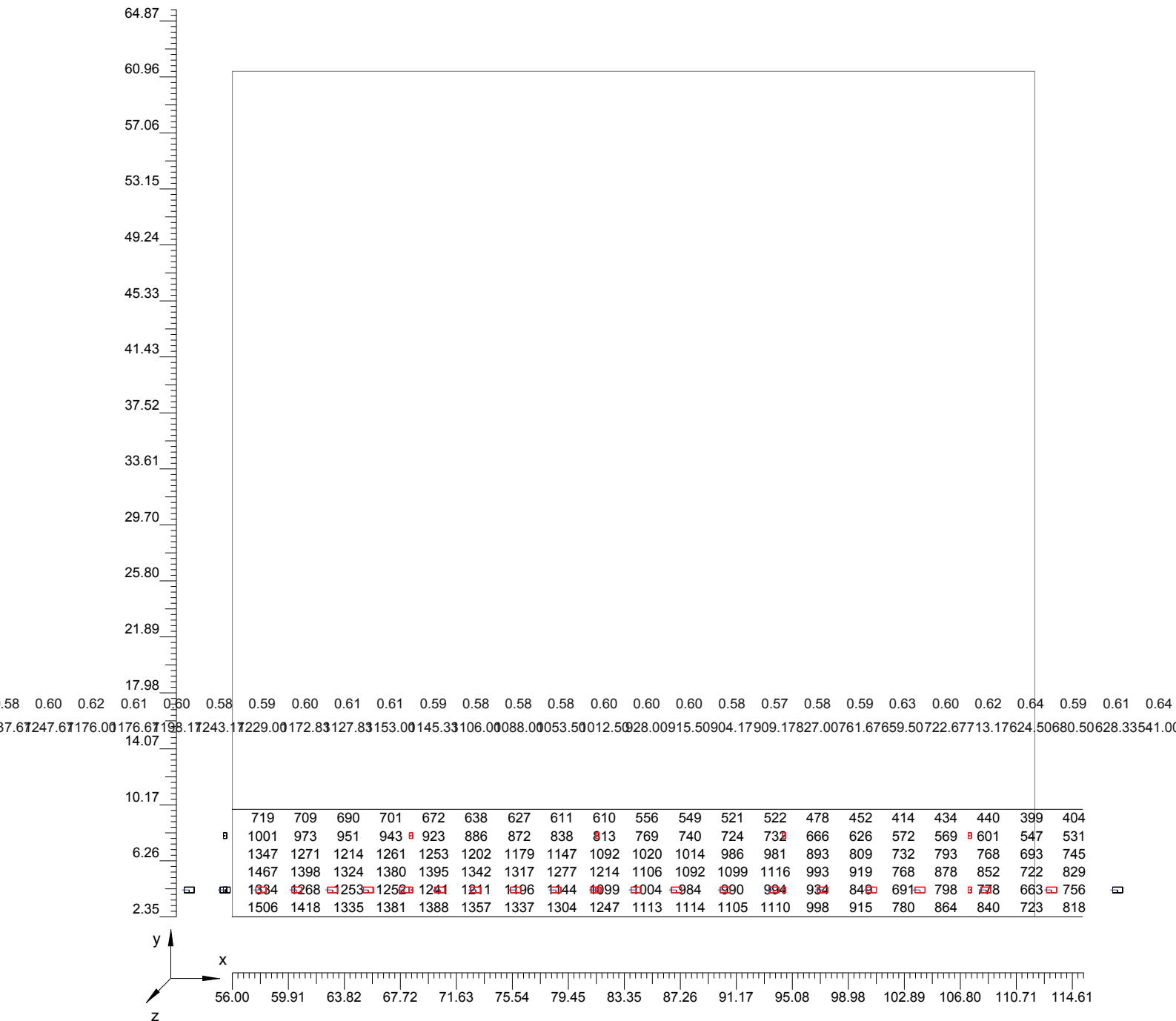

4.4 Valori di Illuminamento su: Carreggiata_LUX

Scala 1/391

Parte 3 di 3

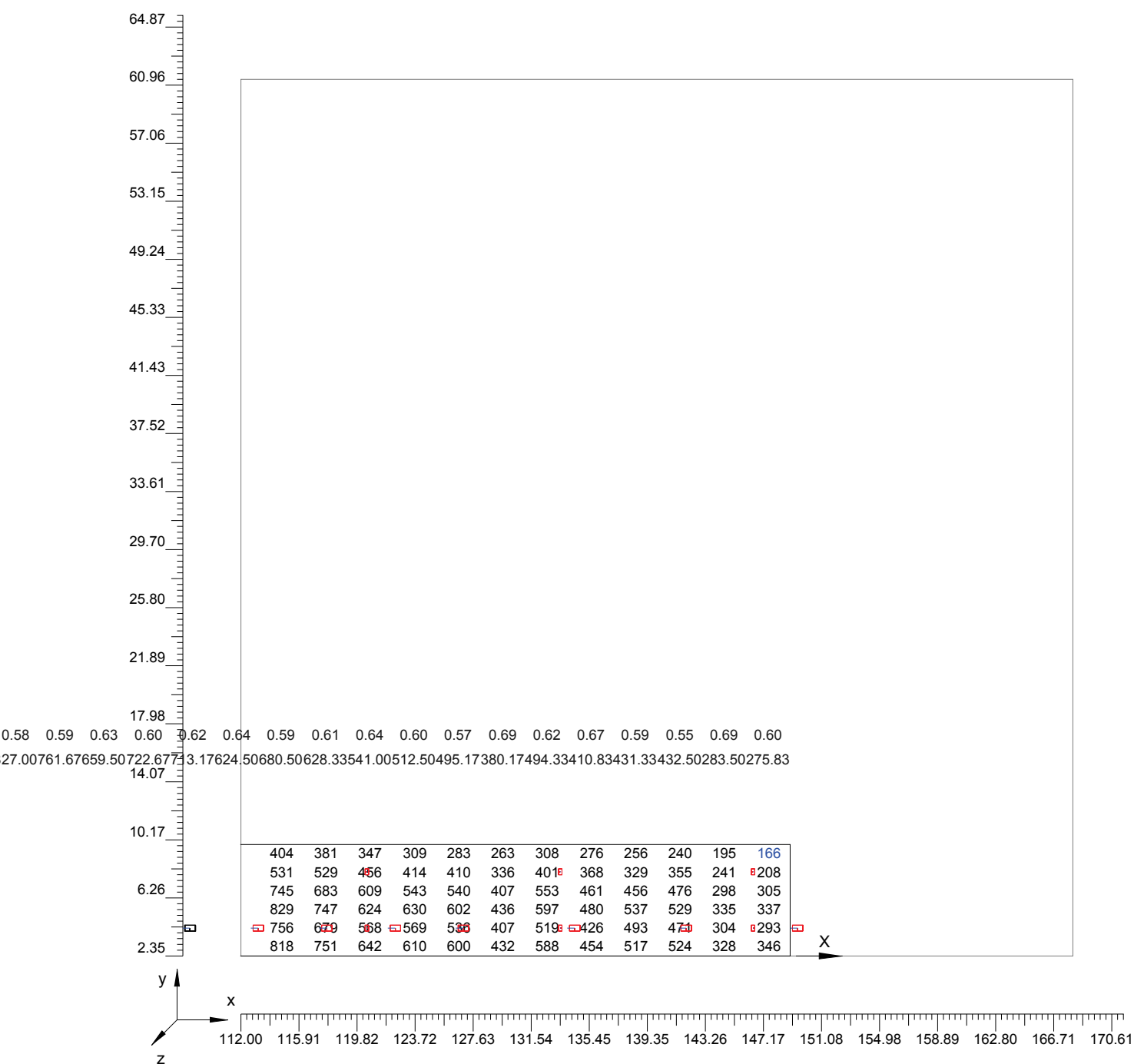

Informazioni Generali	1
1. Dati Riepilogativi Progetto	
1.1 Informazioni Area	2
1.2 Calcolo Energetico	2
2. Viste Progetto	
2.1 Vista 2D in Pianta	3
2.2 Vista Laterale	4
3. Dati Riepilogativi Apparecchi	
3.1 Informazioni Apparecchi/Rilievi	5
3.2 Informazioni Lampade	5
3.3 Tabella Riepilogativa Apparecchi	5
4. Tabella Risultati	
4.1 Valori delle Luminanze su: Corsia1 Oss. 1(x=-60.00;y=4.22;z=1.50)m	7
4.2 Curva Luminanza Oss. 1(x=-60.00;y=4.22;z=1.50)m	11
4.3 Valori delle Luminanze su: Parete_Destra (x=-60.00;y=4.23;z=1.50)m ---> (x=30.00;y=4.23;z=0.00)m	12
4.4 Valori di Illuminamento su: Carreggiata_LUX	18

Galleria artificiale Mondovì

Note Installazione: **Rinforzo**

Codice Progetto: 20-061-B04

Note
Li = 3 cd/mq
Le = 148.7 cd/mq

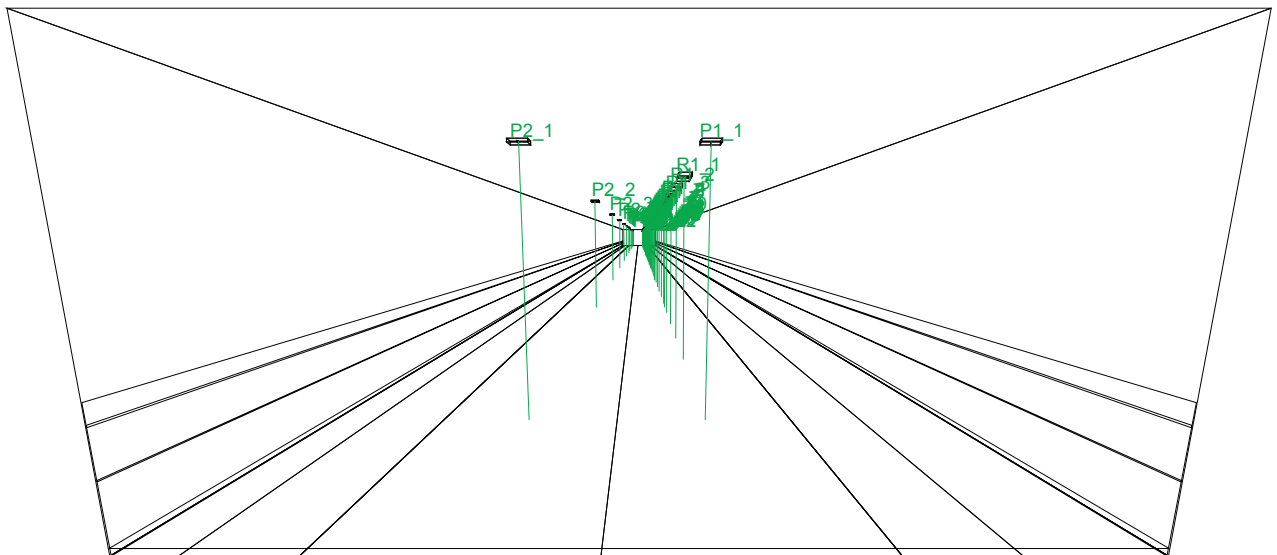

1.1 Informazioni Area

Dati Strada

Zona	Tipo Zona	Corsia	Senso di marcia	Larghezza [m] (W)	y1 [m]	y2 [m]	Pt.Calc.Y (E)	Pt.Calc.Y (L)	Alt. Zona [m] (HC)	Colore	Tabella R	Coeff.Rif. Fattore q0
Marc_dx	Pista Ciclo/Pedonale			3.30	0.00	3.30	3		0.00	RGB=219,54,36		30.00
		Marc_dx	--->	1.80	0.00	1.80		3				
		banchina_dx	--->	1.50	1.80	3.30		3				
Carreggiata Carrabile				7.50	3.30	10.80	5		0.00	RGB=126,126,126	C2	5.60
		Corsia1	--->	3.75	3.30	7.05		3				
		Corsia2	<---	3.75	7.05	10.80		3				
Marc_sx	Pista Ciclo/Pedonale			2.35	10.80	13.15	3		0.00	RGB=219,54,36		30.00
		banchina_sx	<---	1.50	10.80	12.30		3				
		Marc_sx	<---	0.85	12.30	13.15		3				

Dati Installazione Apparecchi

Nome Fila	1° Palo x [m] (XP)	1° Palo y [m] (YP)	Altez.App. [m] (H)	Num. Pali	Interd. [m] (D)	Sbraccio [m] (L)	Ang.Incl. [°] (RY)	Rot.Sbraccio [°] (RZ)	Ang.Incl.Lat. [°] (RX)	Fatt.Manut. [%]	Codice Apparecchio	Flusso [lm]	Rif.
P1	3.50	5.15	5.80	12	13.00	0.00	0	90	0	80.00	PetV2-48	7100	A
P2	3.50	8.95	5.80	12	13.00	0.00	0	270	0	80.00	PetV2-48	7100	A
R1	8.00	5.15	5.80	26	2.50	0.00	-5	0	0	80.00	Pet-T21	46800	B
R2	73.00	5.15	5.80	5	2.80	0.00	-5	0	0	80.00	Pet-T21	46800	B
R3	87.00	5.15	5.80	5	3.40	0.00	-5	0	0	80.00	Pet-T21	46800	B
R4	104.00	5.15	5.80	5	4.60	0.00	-5	0	0	80.00	Pet-T21	46800	B
R5	127.00	5.15	5.80	4	7.50	0.00	-5	0	0	80.00	Pet-T21	46800	B

1.2 Calcolo Energetico (Suolo)

Area	1117.50 m2
Illuminamento Medio	907.47 lx
Potenza Specifica	14.81 W/m2
Potenza Specifica Illuminotecnica	1.63 W/(m2 * 100lx)
Efficienza Energetica	61.29 (m2*lx)/W
Potenza Totale Utilizzata	16545.00 W

2.1 Vista 2D in Pianta

Scala 1/2000

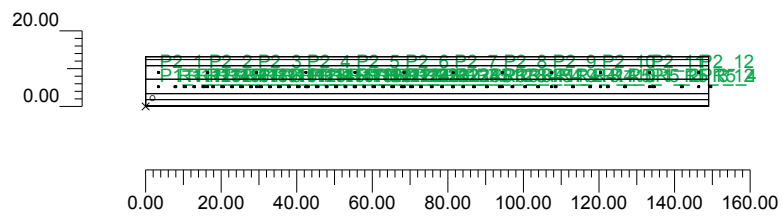

2.2 Vista Laterale

Scala 1/90

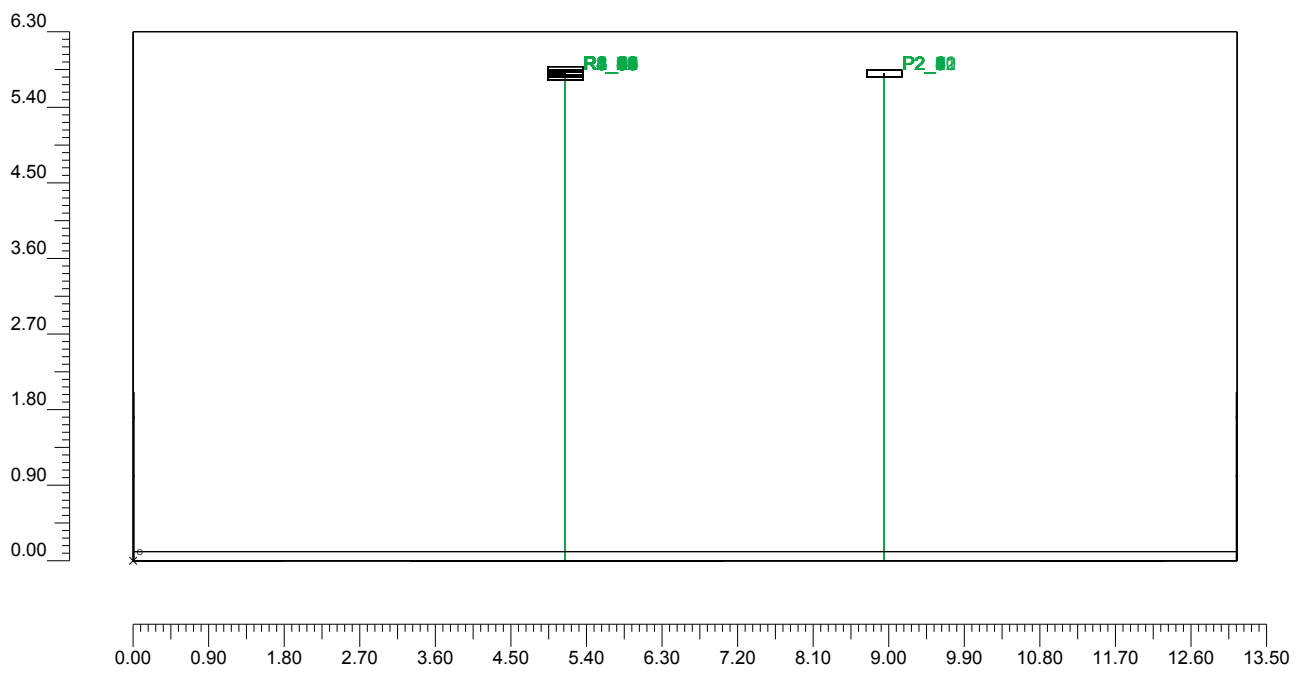

3.1 Informazioni Apparecchi/Rilievi

Rif.	Linea	Nome Apparecchio (Nome Rilievo)	Codice Apparecchio (Codice rilievo)	Apparecchi n.	Rif.Lamp.	Lampade n.
A	Arianna Petrarca	PetV2-48 (PetV2-48)	PetV2-48 (PetV2-48)	24	LMP-A	1
B	Arianna Petrarca	Pet-T21 (Petrarca-T21)	Pet-T21 (Petrarca-T21)	45	LMP-B	1

3.2 Informazioni Lampade

Rif.Lamp.	Tipo	Codice	Flusso lm	Potenza W	Colore K	n.
LMP-A	LED	PetrarcaTunnel 7100	7100	50	4000	-
LMP-B	LED	PetrarcaTunnel 46800	46800	341	4000	-

3.3 Tabella Riepilogativa Apparecchi

Rif.	App.	On	Posizione Apparecchi X[m] Y[m] Z[m]	Rotazione Apparecchi X° Y° Z°	Codice Apparecchio	Coeff. Mant.	Codice Lampada	Flusso lm
A	1	X	3.50;5.15;5.80	0.0;0.0;0.0	PetV2-48	0.80	PetrarcaTunnel 7100	1*7100
	2	X	16.50;5.15;5.80	0.0;0.0;0.0				
	3	X	29.50;5.15;5.80	0.0;0.0;0.0				
	4	X	42.50;5.15;5.80	0.0;0.0;0.0				
	5	X	55.50;5.15;5.80	0.0;0.0;0.0				
	6	X	68.50;5.15;5.80	0.0;0.0;0.0				
	7	X	81.50;5.15;5.80	0.0;0.0;0.0				
	8	X	94.50;5.15;5.80	0.0;0.0;0.0				
	9	X	107.50;5.15;5.80	0.0;0.0;0.0				
	10	X	120.50;5.15;5.80	0.0;0.0;0.0				
	11	X	133.50;5.15;5.80	0.0;0.0;0.0				
	12	X	146.50;5.15;5.80	0.0;0.0;0.0				
	13	X	3.50;8.95;5.80	0.0;0.0;180.0				
	14	X	16.50;8.95;5.80	0.0;0.0;180.0				
	15	X	29.50;8.95;5.80	0.0;0.0;180.0				
	16	X	42.50;8.95;5.80	0.0;0.0;180.0				
	17	X	55.50;8.95;5.80	0.0;0.0;180.0				
	18	X	68.50;8.95;5.80	0.0;0.0;180.0				
	19	X	81.50;8.95;5.80	0.0;0.0;180.0				
	20	X	94.50;8.95;5.80	0.0;0.0;180.0				
	21	X	107.50;8.95;5.80	0.0;0.0;180.0				
	22	X	120.50;8.95;5.80	0.0;0.0;180.0				
	23	X	133.50;8.95;5.80	0.0;0.0;180.0				
	24	X	146.50;8.95;5.80	0.0;0.0;180.0				
B	1	X	8.00;5.15;5.80	-5.0;0.0;-90.0	Pet-T21	0.80	PetrarcaTunnel 46800	1*46800
	2	X	10.50;5.15;5.80	-5.0;0.0;-90.0				
	3	X	13.00;5.15;5.80	-5.0;0.0;-90.0				
	4	X	15.50;5.15;5.80	-5.0;0.0;-90.0				
	5	X	18.00;5.15;5.80	-5.0;0.0;-90.0				
	6	X	20.50;5.15;5.80	-5.0;0.0;-90.0				
	7	X	23.00;5.15;5.80	-5.0;0.0;-90.0				
	8	X	25.50;5.15;5.80	-5.0;0.0;-90.0				
	9	X	28.00;5.15;5.80	-5.0;0.0;-90.0				
	10	X	30.50;5.15;5.80	-5.0;0.0;-90.0				
	11	X	33.00;5.15;5.80	-5.0;0.0;-90.0				
	12	X	35.50;5.15;5.80	-5.0;0.0;-90.0				
	13	X	38.00;5.15;5.80	-5.0;0.0;-90.0				
	14	X	40.50;5.15;5.80	-5.0;0.0;-90.0				
	15	X	43.00;5.15;5.80	-5.0;0.0;-90.0				
	16	X	45.50;5.15;5.80	-5.0;0.0;-90.0				
	17	X	48.00;5.15;5.80	-5.0;0.0;-90.0				

Rif.	App.	On	Posizione Apparecchi X[m] Y[m] Z[m]	Rotazione Apparecchi X° Y° Z°	Codice Apparecchio	Coeff. Mant.	Codice Lampada	Flusso lm
B	18	X	50.50;5.15;5.80	-5.0;0.0;-90.0	Pet-T21	0.80	PetrarcaTunnel 46800	1*46800
	19	X	53.00;5.15;5.80	-5.0;0.0;-90.0		0.80		
	20	X	55.50;5.15;5.80	-5.0;0.0;-90.0		0.80		
	21	X	58.00;5.15;5.80	-5.0;0.0;-90.0		0.80		
	22	X	60.50;5.15;5.80	-5.0;0.0;-90.0		0.80		
	23	X	63.00;5.15;5.80	-5.0;0.0;-90.0		0.80		
	24	X	65.50;5.15;5.80	-5.0;0.0;-90.0		0.80		
	25	X	68.00;5.15;5.80	-5.0;0.0;-90.0		0.80		
	26	X	70.50;5.15;5.80	-5.0;0.0;-90.0		0.80		
	27	X	73.00;5.15;5.80	-5.0;0.0;-90.0		0.80		
	28	X	75.80;5.15;5.80	-5.0;0.0;-90.0		0.80		
	29	X	78.60;5.15;5.80	-5.0;0.0;-90.0		0.80		
	30	X	81.40;5.15;5.80	-5.0;0.0;-90.0		0.80		
	31	X	84.20;5.15;5.80	-5.0;0.0;-90.0		0.80		
	32	X	87.00;5.15;5.80	-5.0;0.0;-90.0		0.80		
	33	X	90.40;5.15;5.80	-5.0;0.0;-90.0		0.80		
	34	X	93.80;5.15;5.80	-5.0;0.0;-90.0		0.80		
	35	X	97.20;5.15;5.80	-5.0;0.0;-90.0		0.80		
	36	X	100.60;5.15;5.80	-5.0;0.0;-90.0		0.80		
	37	X	104.00;5.15;5.80	-5.0;0.0;-90.0		0.80		
	38	X	108.60;5.15;5.80	-5.0;0.0;-90.0		0.80		
	39	X	113.20;5.15;5.80	-5.0;0.0;-90.0		0.80		
	40	X	117.80;5.15;5.80	-5.0;0.0;-90.0		0.80		
	41	X	122.40;5.15;5.80	-5.0;0.0;-90.0		0.80		
	42	X	127.00;5.15;5.80	-5.0;0.0;-90.0		0.80		
	43	X	134.50;5.15;5.80	-5.0;0.0;-90.0		0.80		
	44	X	142.00;5.15;5.80	-5.0;0.0;-90.0		0.80		
	45	X	149.50;5.15;5.80	-5.0;0.0;-90.0		0.80		

4.1 Valori delle Luminanze su: Corsia1 Oss. 1(x=-60.00;y=5.17;z=1.50)m

O (x:0.00 y:3.30 z:0.00)	Risultati	Medio	Minimo	Massimo	Min/Medio	Min/Max	Medio/Max
DX:2.98 DY:1.25	Luminanza (L)	118 cd/m ²	9 cd/m ²	183 cd/m ²	0.08	0.05	0.64

Tipo Calcolo Dir.+Indir.(1 Interriflessioni) + Arredi

Nome Corsia	Largh. Corsia [m] (W)	y1 [m]	y2 [m]	Pt.Calc.Y	Tabella R	Coeff.Rifl. Fattore q0	Osservatore x Assoluto [m]	Osservatore y Assoluto [m]	Luminanza Velante [cd/m ²]	Incremento di Soglia [%]	Uniformità Longitudinale
Corsia1	3.75	3.30	7.05	3	C2	5.60	-60.00	5.17	10.33	15.58	0.05 *

Norma CEN 13201

4.1
Scala 1/2000

4.1 Valori delle Luminanze su: Corsia1 Oss. 1(x=-60.00;y=5.17;z=1.50)m

Totale Parti: 3

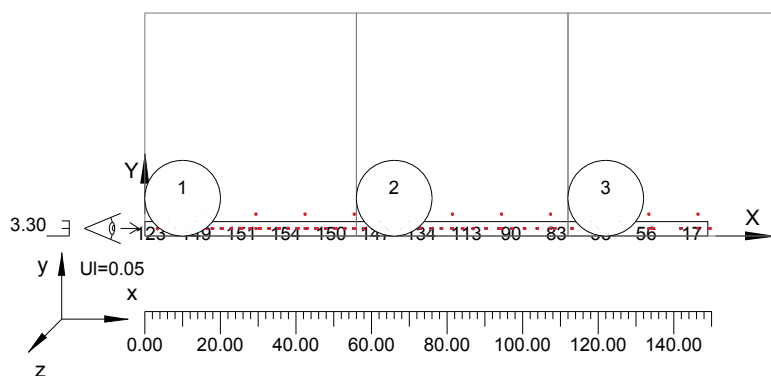

4.1 Valori delle Luminanze su: Corsia1 Oss. 1(x=-60.00;y=5.17;z=1.50)m

Scala 1/391

Parte 1 di 3

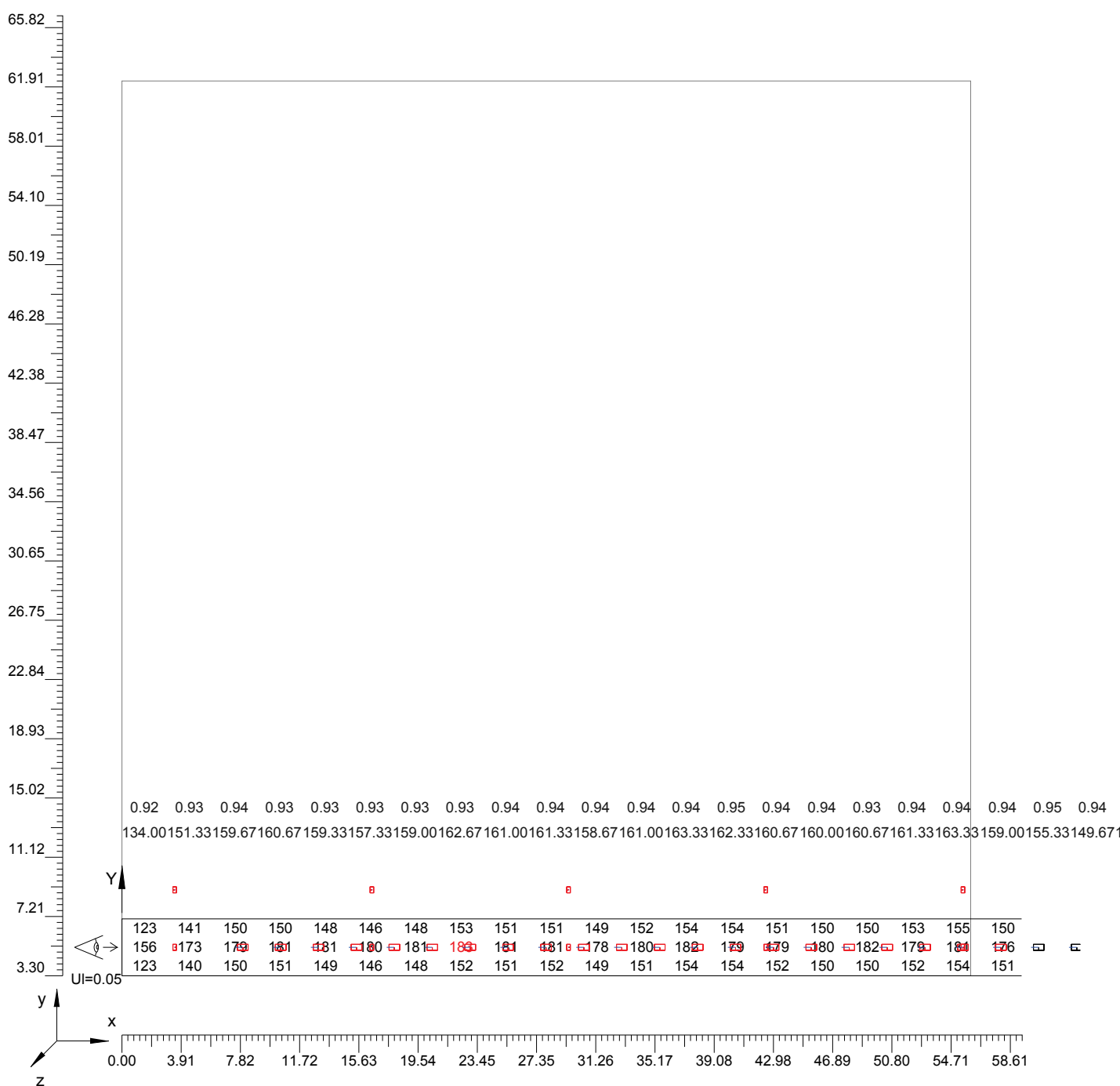

4.1 Valori delle Luminanze su: Corsia1 Oss. 1(x=-60.00;y=5.17;z=1.50)m

Scala 1/391

Parte 2 di 3

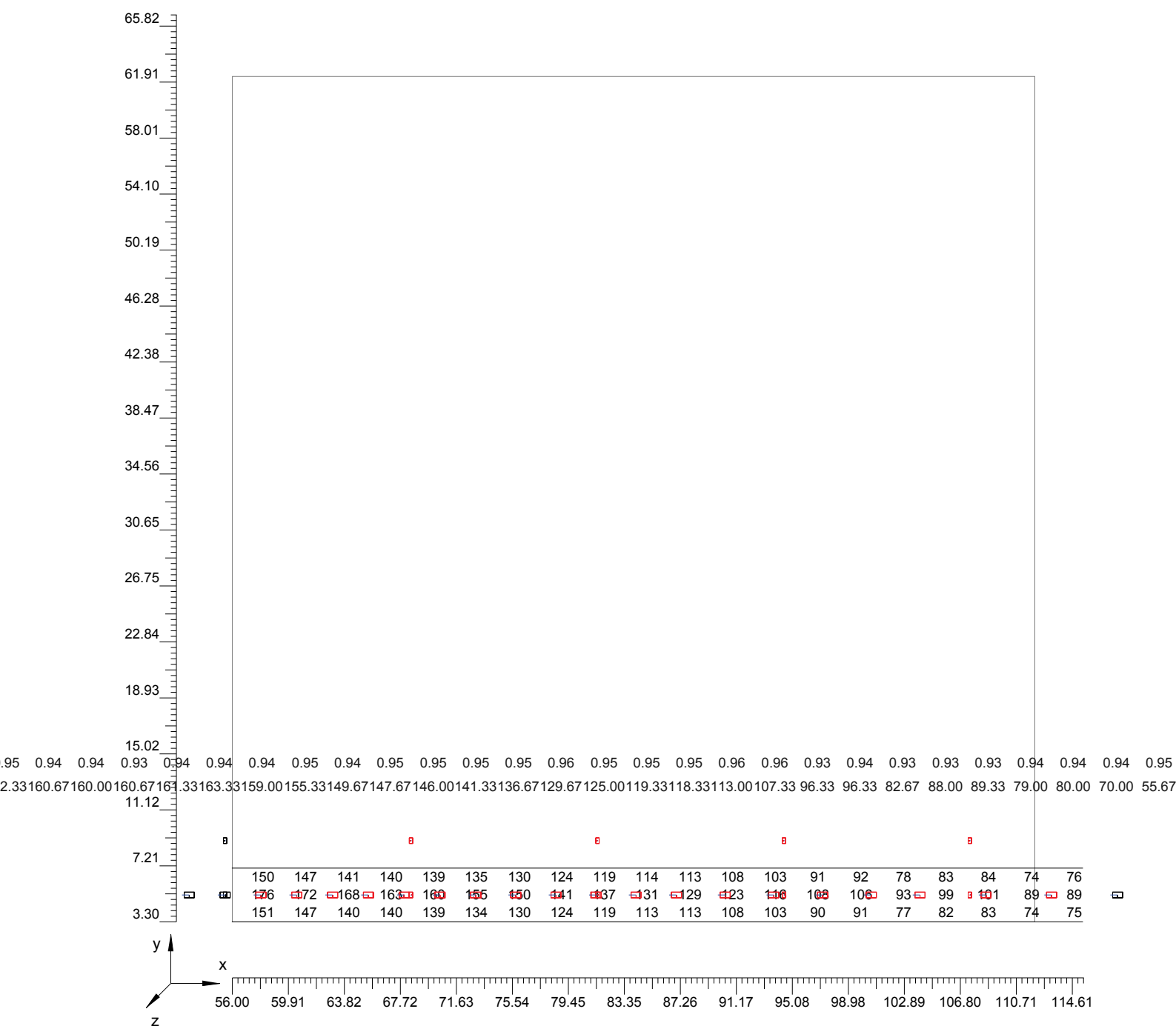

4.1 Valori delle Luminanze su: Corsia1 Oss. 1(x=-60.00;y=5.17;z=1.50)m

Scala 1/391

Parte 3 di 3

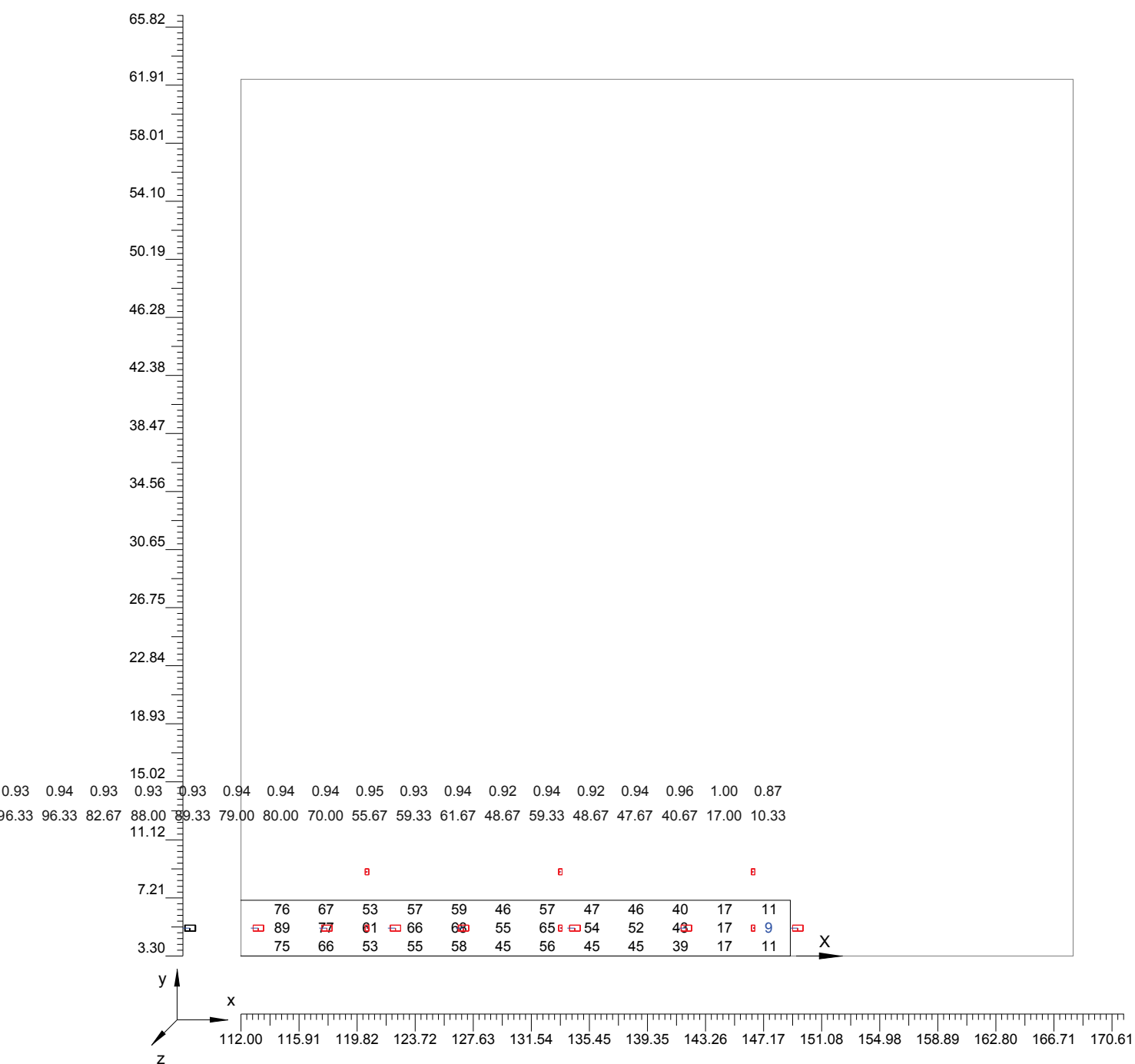

4.2 Curva Luminanza Oss. 1(x=-60.00;y=5.17;z=1.50)m

O (x:0.00 y:3.30 z:0.00)	Risultati	Medio	Minimo	Massimo	Min/Medio	Min/Max	Medio/Max
DX:2.98 DY:1.25	Luminanza (L)	118 cd/m ²	9 cd/m ²	183 cd/m ²	0.08	0.05	0.64

Tipo Calcolo

Dir.+Indir.(1 Interriflessioni) + Arredi

Nome Corsia	Largh. Corsia [m] (W)	y1 [m]	y2 [m]	Pt.Calc.Y	Tabella R	Coeff.Rifl. Fattore q0	Osservatore x Assoluto [m]	Osservatore y Assoluto [m]	Luminanza Velante [cd/m ²]	Incremento di Soglia [%]	Uniformità Longitudinale
Corsia1	3.75	3.30	7.05	3	C2	5.60	-60.00	5.17	10.33	15.58	0.05 *

Norma

CEN 13201

Zona: Carreggiata
 Luminanza Media 26.665 cd/m² (Corsia2 Obs2)
 Uniformita' Generale 0.080 (Corsia1 Obs1)
 Uniformita' Longitudinale 0.051 (Corsia1 Obs1)

Par. 1 Luminanza Media 76.449 cd/m² (1m e 1,7m)
 Par. 1 Illum. Medio 600.428lx (1m e 1,7m)
 Par. 1 Uniformita Generale 0.279 (1m e 1,7m)
 Par. 1 Uniformita Longitudinale 0.230 (a 1,7m)

Par. 2 Luminanza Media 36.131 cd/m² (1m e 1,7m)
 Par. 2 Illum. Medio 283.776lx (1m e 1,7m)
 Par. 2 Uniformita Generale 0.249 (1m e 1,7m)
 Par. 2 Uniformita Longitudinale 0.208 (a 1,7m)

Luminanza Oss. 1(x=-60.00;y=5.17;z=1.50)m Corsia1

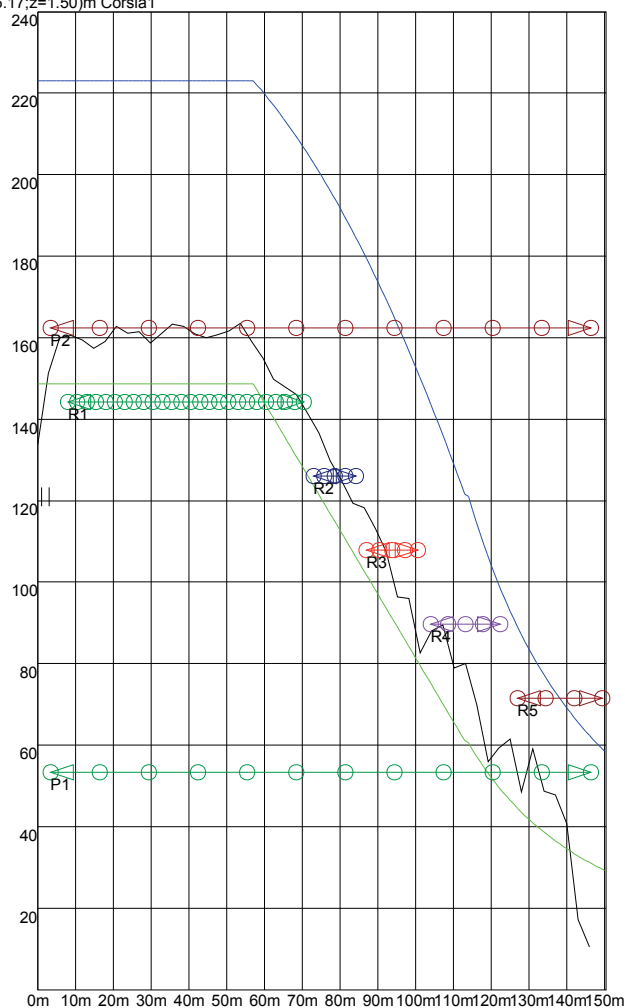

4.3 Valori delle Luminanze su: Parete_Destra (x=-60.00;y=5.18;z=1.50)m ---> (x=30.00;y=5.18;z=0.00)m

O (x:0.00 y:0.01 z:0.00)	Risultati	Medio	Minimo	Massimo	Min/Medio	Min/Max	Medio/Max
DX:2.98 DY:0.70	Luminanza (L)	76 cd/m ²	21 cd/m ²	106 cd/m ²	0.28	0.20	0.72

Tipo Calcolo

Dir.+Indir.(1 Interriflessioni) + Arredi

Scala 1/2000

4.3 Valori delle Luminanze su: Parete_Destra (x=-60.00;y=5.18;z=1.50)m ---> (x=30.00;y=5.18;z=0.00)m

Totale Parti: 5

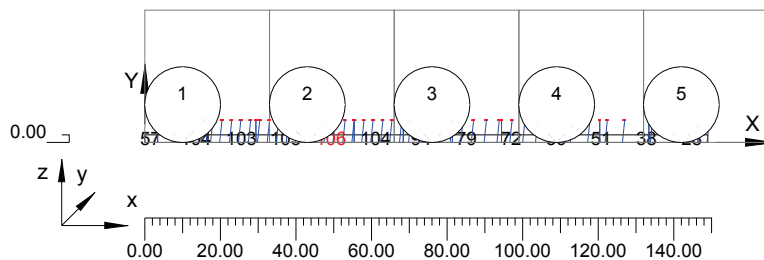

4.3 Valori delle Luminanze su: Parete_Destra (x=-60.00;y=5.18;z=1.50)m ---> (x=30.00;y=5.18;z=0.00)m

Scala 1/230

Parte 1 di 5

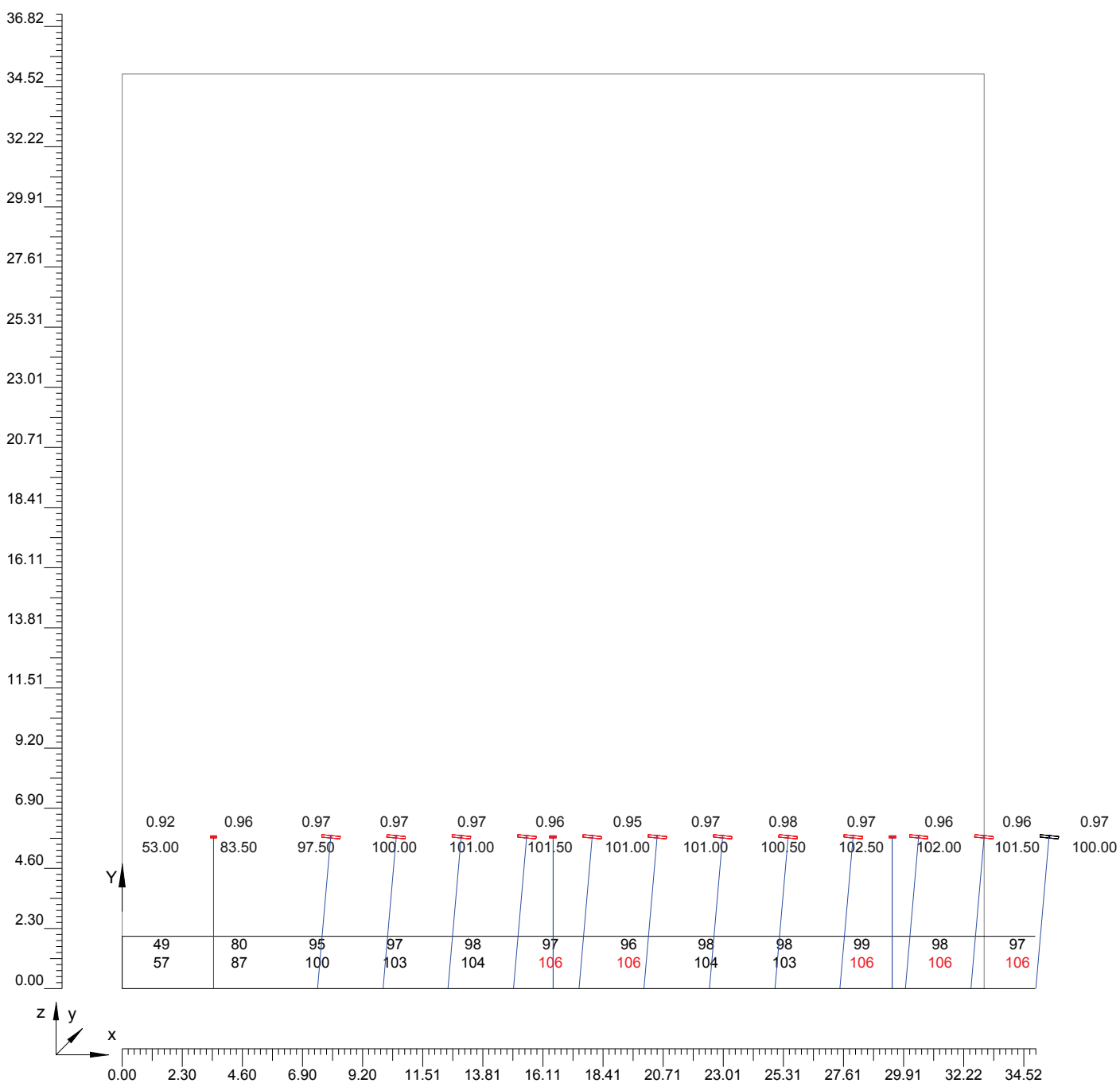

4.3 Valori delle Luminanze su: Parete_Destra (x=-60.00;y=5.18;z=1.50)m ---> (x=30.00;y=5.18;z=0.00)m

Scala 1/230

Parte 2 di 5

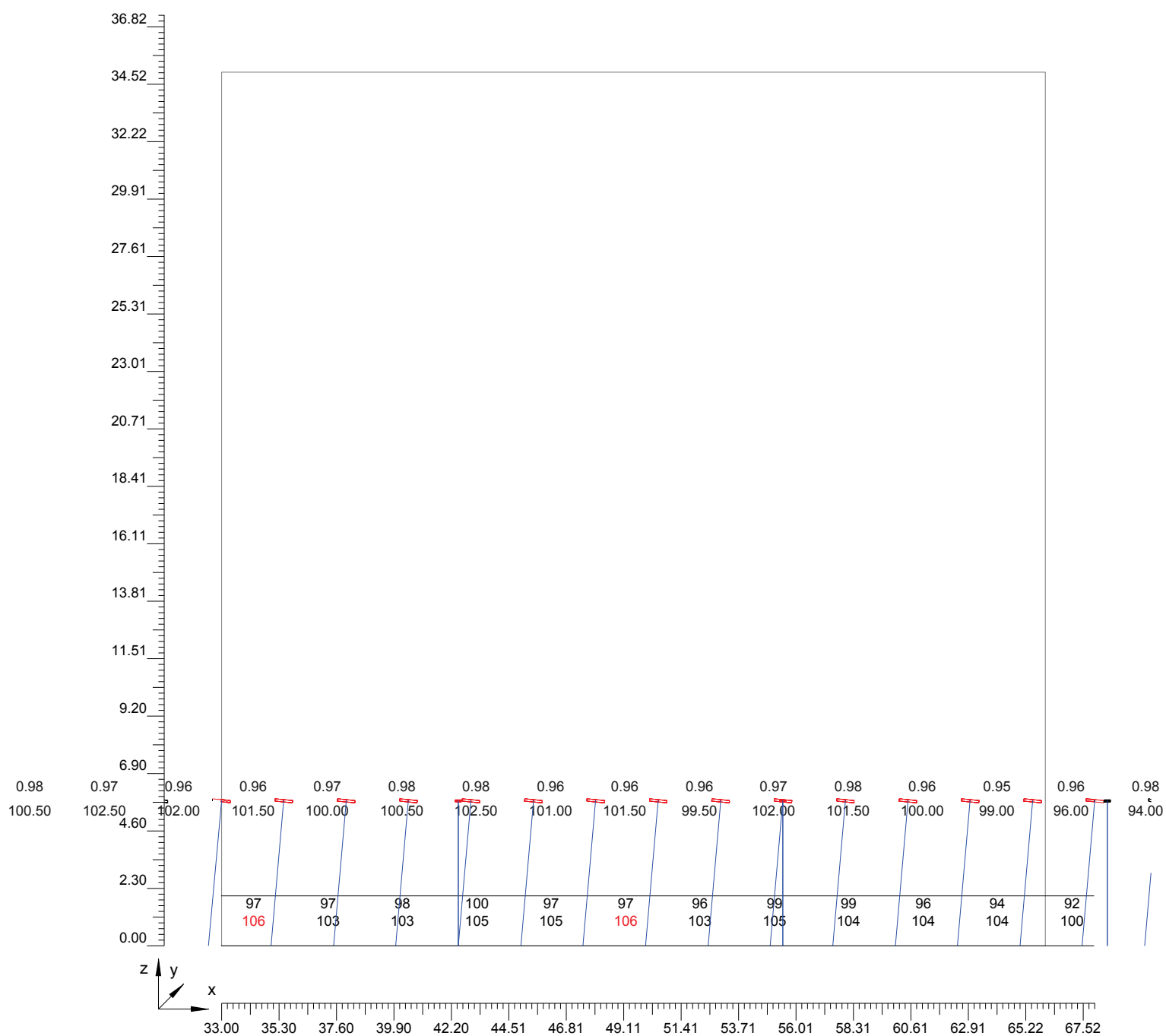

4.3 Valori delle Luminanze su: Parete_Destra (x=-60.00;y=5.18;z=1.50)m ---> (x=30.00;y=5.18;z=0.00)m

Scala 1/230

Parte 3 di 5

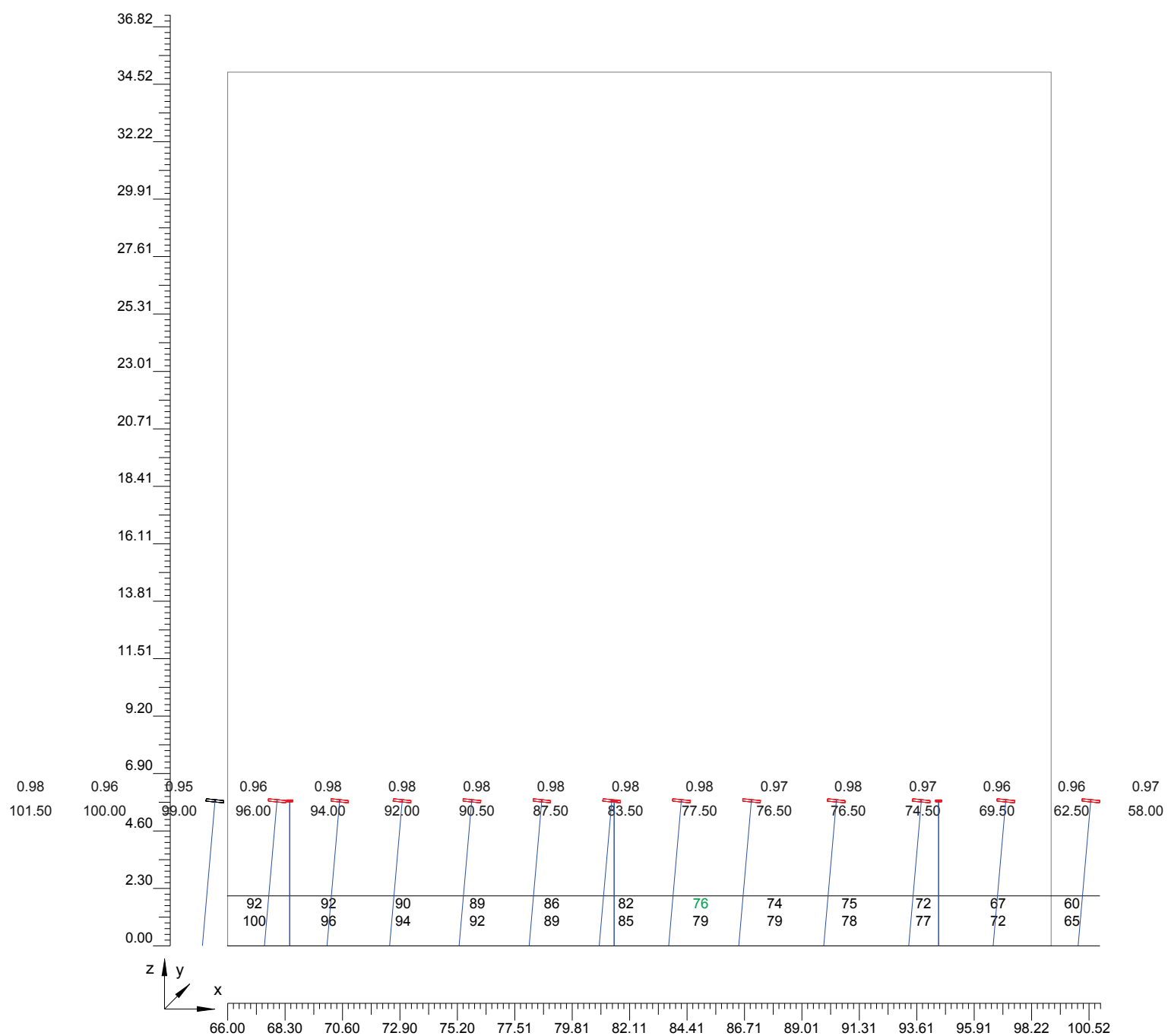

4.3 Valori delle Luminanze su: Parete_Destra (x=-60.00;y=5.18;z=1.50)m ---> (x=30.00;y=5.18;z=0.00)m

Scala 1/230

Parte 4 di 5

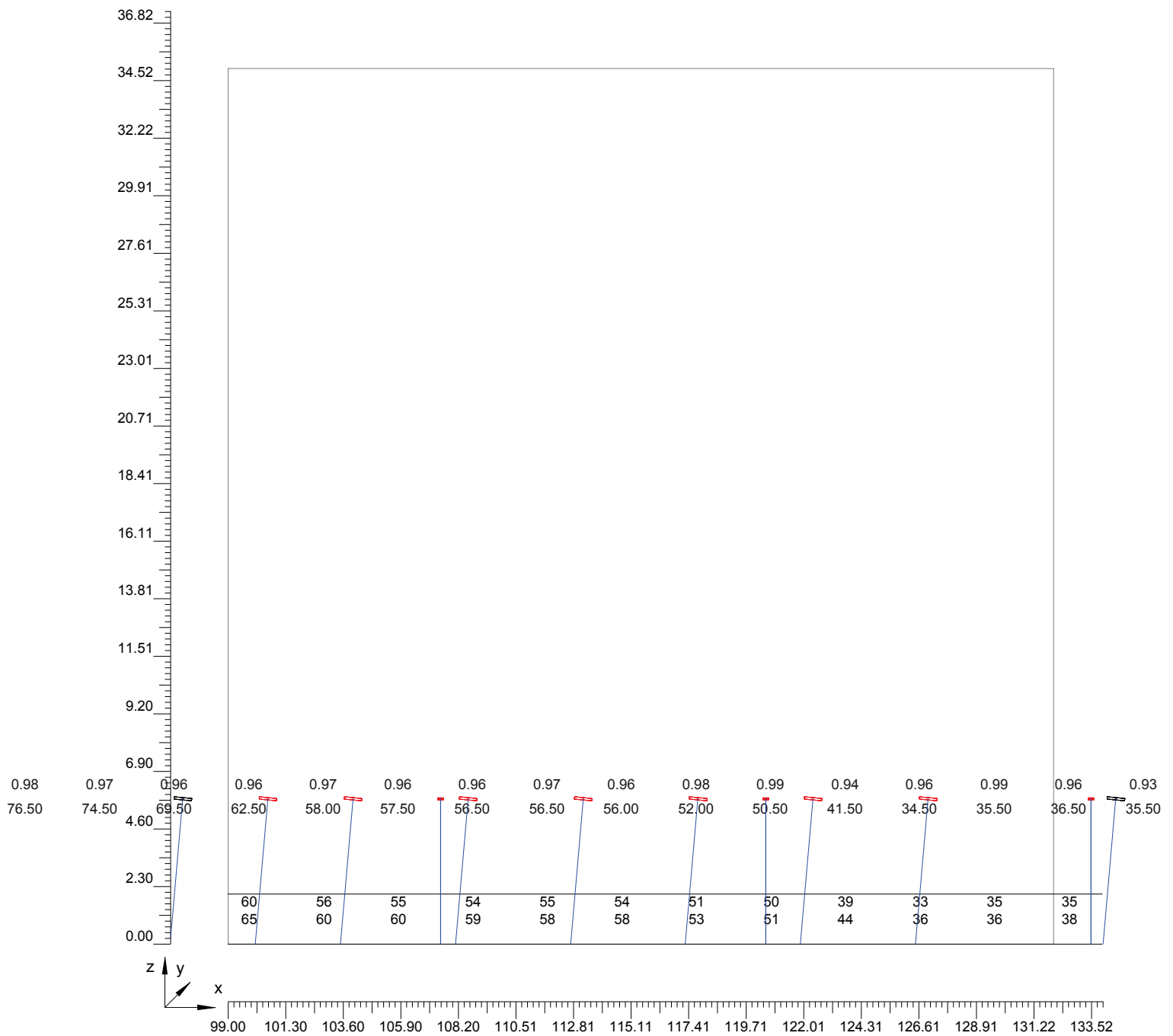

4.3 Valori delle Luminanze su: Parete_Destra (x=-60.00;y=5.18;z=1.50)m ---> (x=30.00;y=5.18;z=0.00)m

Scala 1/230

Parte 5 di 5

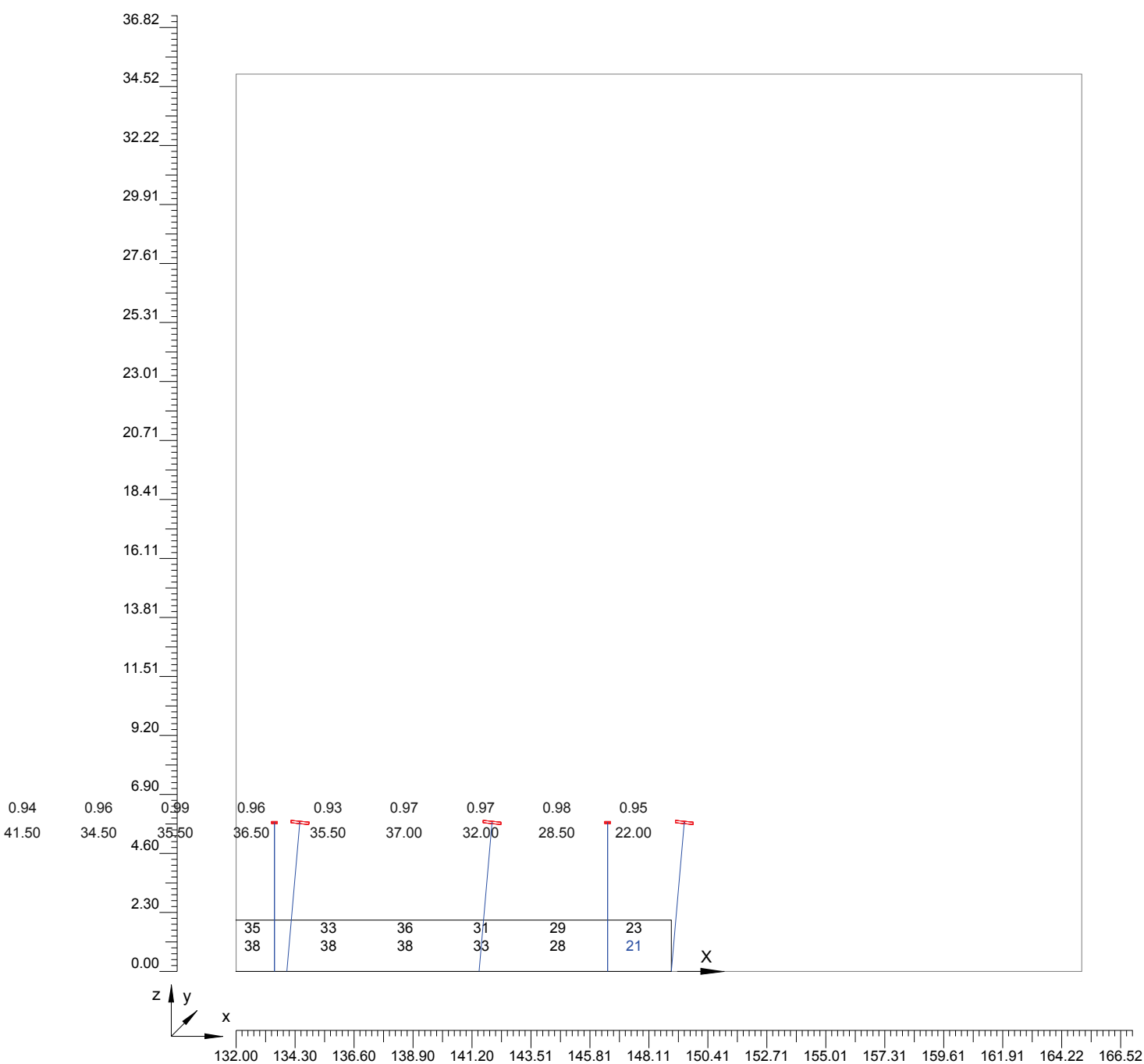

4.4 Valori di Illuminamento su: Carreggiata_LUX

O (x:0.00 y:3.30 z:0.00)	Risultati	Medio	Minimo	Massimo	Min/Medio	Min/Max	Medio/Max
DX:2.98 DY:1.25	Illuminamento Orizzontale (E)	907 lux	168 lux	1496 lux	0.18	0.11	0.61

Tipo Calcolo

Dir.+Indir.(1 Interriflessioni) + Arredi

4.4 Valori di Illuminamento su: Carreggiata_LUX

Scala 1/2000

Totale Parti: 3

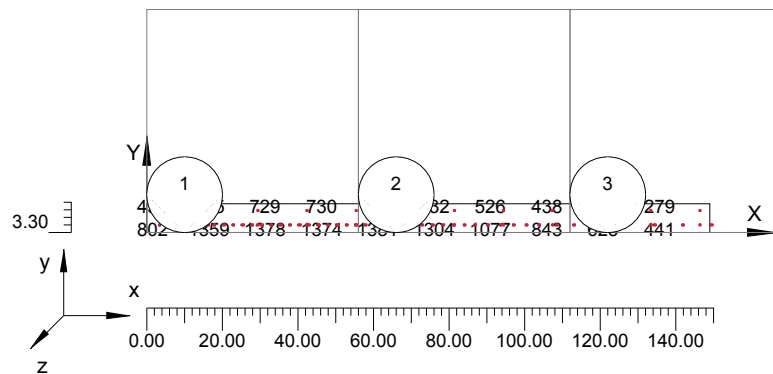

4.4 Valori di Illuminamento su: Carreggiata_LUX

Scala 1/391

Parte 1 di 3

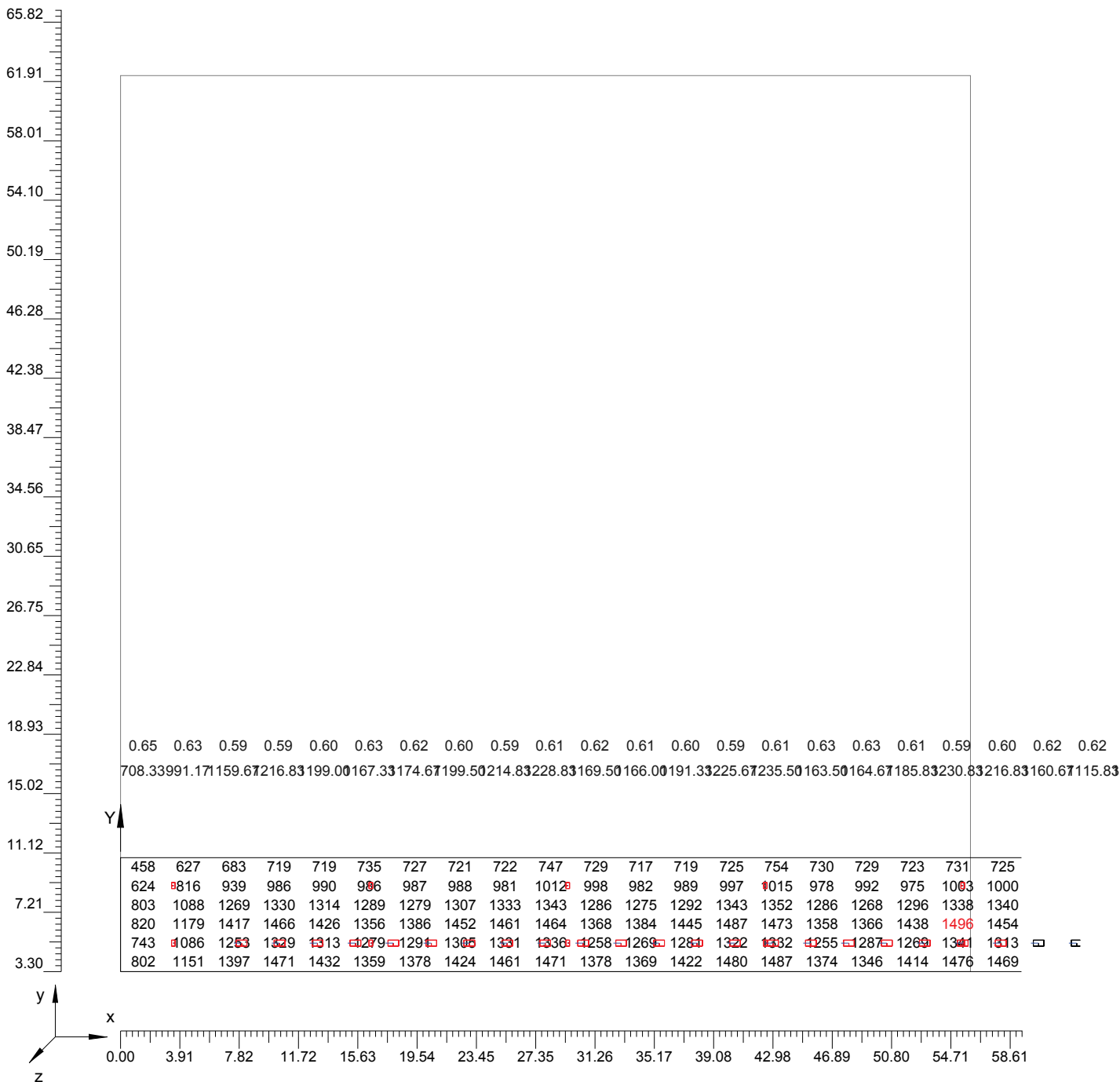

4.4 Valori di Illuminamento su: Carreggiata_LUX

Scala 1/391

Parte 2 di 3

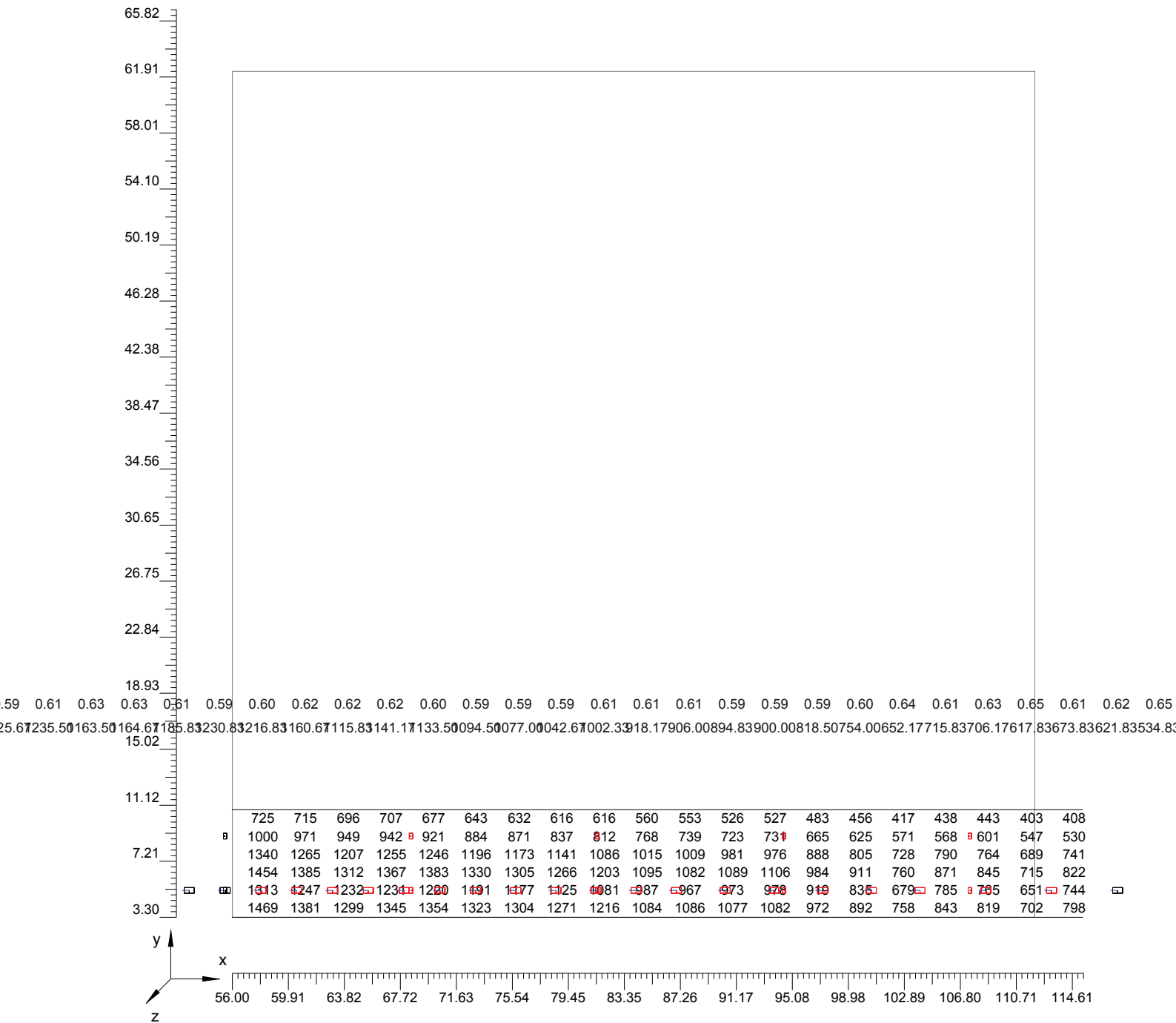

4.4 Valori di Illuminamento su: Carreggiata_LUX

Scala 1/391

Parte 3 di 3

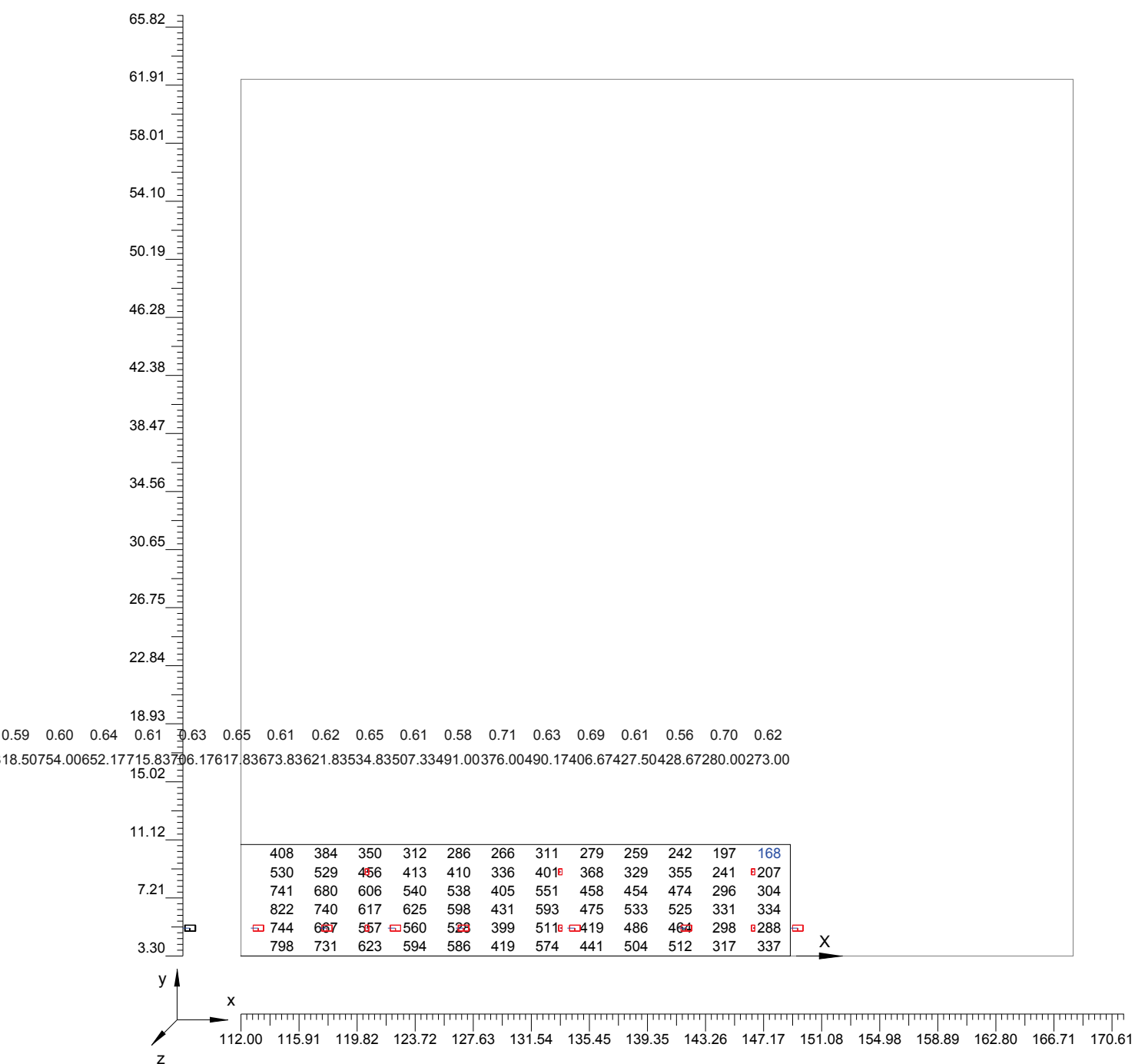

Informazioni Generali	1
1. Dati Riepilogativi Progetto	
1.1 Informazioni Area	2
1.2 Calcolo Energetico	2
2. Viste Progetto	
2.1 Vista 2D in Pianta	3
2.2 Vista Laterale	4
3. Dati Riepilogativi Apparecchi	
3.1 Informazioni Apparecchi/Rilievi	5
3.2 Informazioni Lampade	5
3.3 Tabella Riepilogativa Apparecchi	5
4. Tabella Risultati	
4.1 Valori delle Luminanze su: Corsia1 Oss. 1(x=-60.00;y=5.17;z=1.50)m	7
4.2 Curva Luminanza Oss. 1(x=-60.00;y=5.17;z=1.50)m	11
4.3 Valori delle Luminanze su: Parete_Destra (x=-60.00;y=5.18;z=1.50)m ---> (x=30.00;y=5.18;z=0.00)m	12
4.4 Valori di Illuminamento su: Carreggiata_LUX	18

3. Calcolo illuminotecnico viabilità esterna

Variante di Mondovi'

Calcolo illuminotecnico asse principale rotatoria est

Contenuto

Variante di Mondovi'	
Descrizione.....	3
Lista lampade.....	4
Variante di Mondovi'	
AEC ILLUMINAZIONE SRL - ITALO 2 0F3 STW 4.5-7M (1xL-IT2-0F3-4000-525-7M-70-25).....	5
Asse principale	
Disposizione lampade.....	8
Lista lampade.....	9
Superfici di calcolo.....	10
Rotatoria est / Illuminamento orizzontale.....	11

Variante di Mondovi'

Calcolo illuminotecnico asse principale rotatoria est

Variante di Mondovi'

Numero di pezzi Lampada (Emissione luminosa)

5 AEC ILLUMINAZIONE SRL - ITALO 2 0F3 STW 4.5-7M
ITALO 2 0F3 STW 4.5-7M
Emissione luminosa 1
Dotazione: 1xL-IT2-0F3-4000-525-7M-70-25
Rendimento: 100%
Flusso luminoso lampadina: 17590 lm
Flusso luminoso apparecchio: 17590 lm
Potenza: 131.0 W
Rendimento luminoso: 134.3 lm/W

Indicazioni di colorimetria
1x: CCT 4000 K, CRI 70

Per un'immagine della lampada consultare il nostro catalogo lampade.

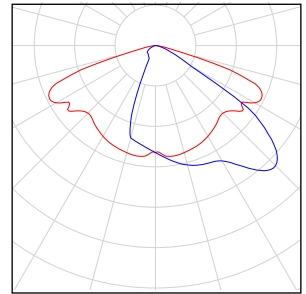

Flusso luminoso lampadine complessivo: 87950 lm, Flusso luminoso lampade complessivo: 87950 lm, Potenza totale: 655.0 W, Rendimento luminoso: 134.3 lm/W

**AEC ILLUMINAZIONE SRL ITALO 2 0F3 STW 4.5-7M ITALO 2 0F3 STW 4.5-7M
1xL-IT2-0F3-4000-525-7M-70-25**

Per un'immagine della
lampada consultare il
nostro catalogo
lampade.

Rendimento: 100%
Flusso luminoso lampadina: 17590 lm
Flusso luminoso apparecchio: 17590 lm
Potenza: 131.0 W
Rendimento luminoso: 134.3 lm/W

Indicazioni di colorimetria
1x: CCT 4000 K, CRI 70

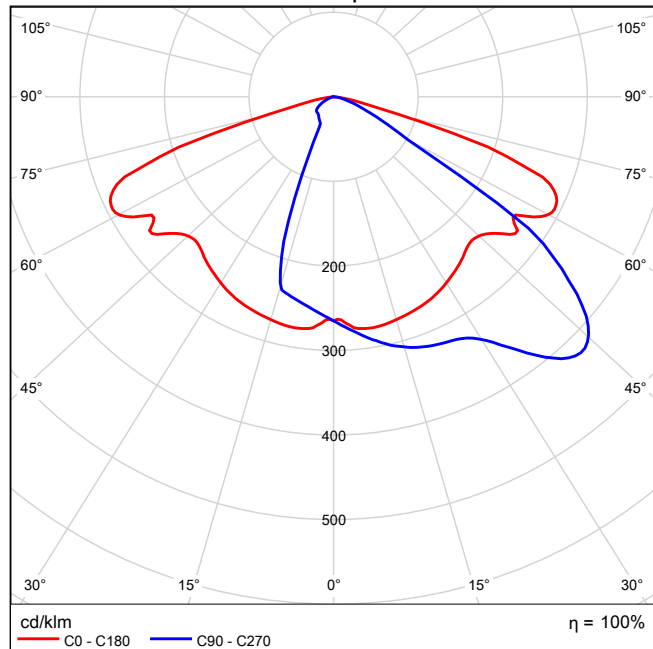
Emissione luminosa 1 / CDL polare

Emissione luminosa 1 / CDL lineare

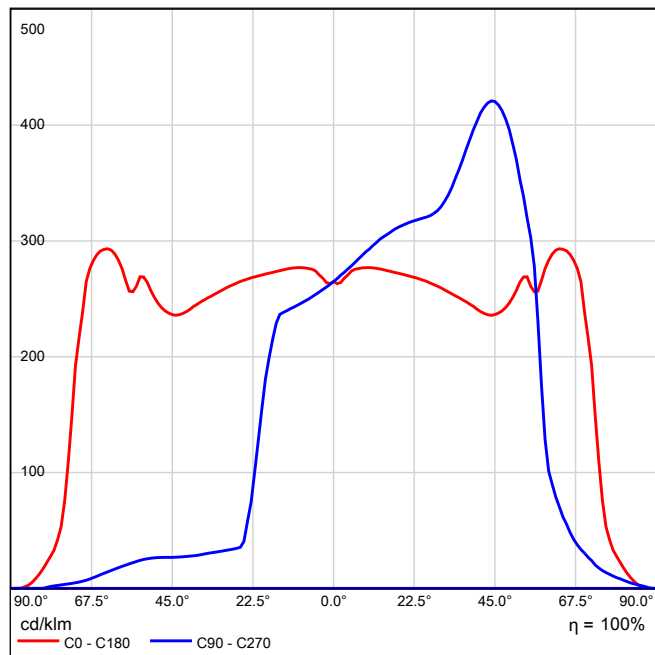

Non è possibile creare un diagramma conico, poiché la diffusione luminosa è asimmetrica.

Emissione luminosa 1 / Diagramma della luminanza

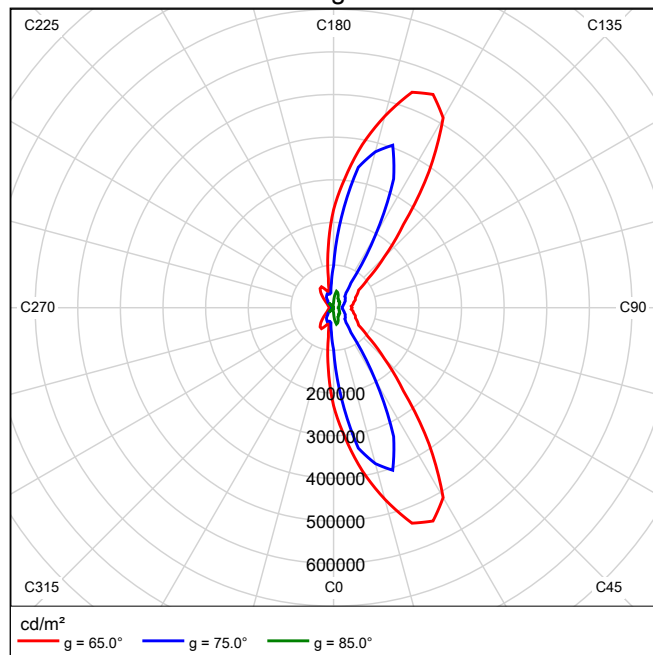

Non è possibile creare un diagramma UGR, poiché la diffusione luminosa è asimmetrica.

Asse principale

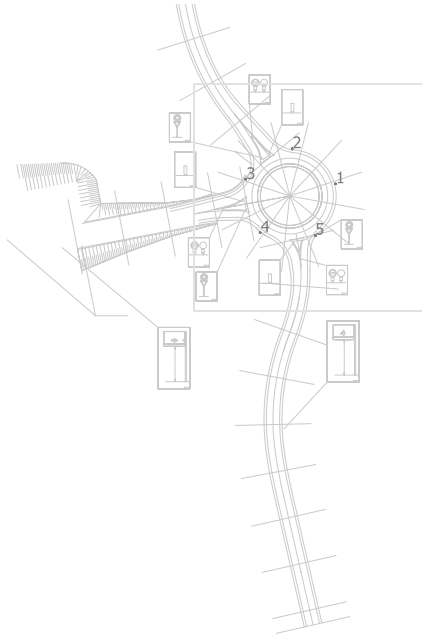

x

AEC ILLUMINAZIONE SRL ITALO 2 0F3 STW 4.5-7M ITALO 2 0F3 STW 4.5-7M

No.	X [m]	Y [m]	Altezza di montaggio [m]	Fattore di diminuzione
1	244.552	285.445	10.000	0.80
2	221.803	303.866	10.000	0.80
3	197.254	287.923	10.000	0.80
4	204.830	259.649	10.000	0.80
5	234.062	258.117	10.000	0.80

Asse principale

Numero di pezzi Lampada (Emissione luminosa)

5	AEC ILLUMINAZIONE SRL - ITALO 2 0F3 STW 4.5-7M ITALO 2 0F3 STW 4.5-7M Emissione luminosa 1 Dotazione: 1xL-IT2-0F3-4000-525-7M-70-25 Rendimento: 100% Flusso luminoso lampadina: 17590 lm Flusso luminoso apparecchio: 17590 lm Potenza: 131.0 W Rendimento luminoso: 134.3 lm/W Indicazioni di colorimetria 1x: CCT 4000 K, CRI 70
---	--

Per un'immagine della lampada consultare il nostro catalogo lampade.

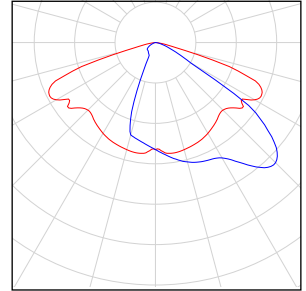

Flusso luminoso lampadine complessivo: 87950 lm, Flusso luminoso lampade complessivo: 87950 lm, Potenza totale: 655.0 W, Rendimento luminoso: 134.3 lm/W

Asse principale

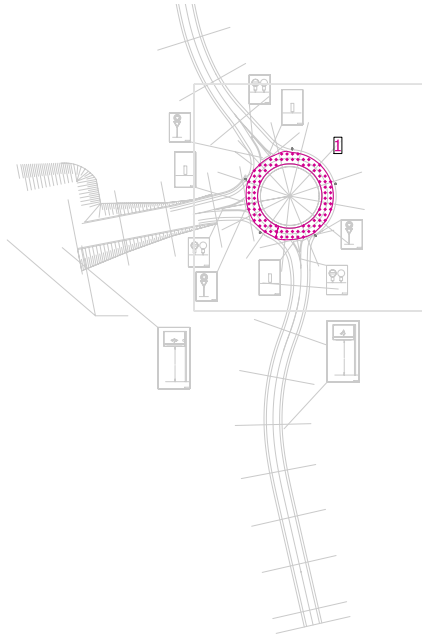

x

Fattore di diminuzione: 0.80

Generalità

Superficie	Risultato	Medio (Nominale)	Min	Max	Min/Medio	Min/Max
1 Rotatoria est	Illuminamento orizzontale [lx] Altezza: 0.000 m	30.9	23.8	42.1	0.77	0.57

Rotatoria est / Illuminamento orizzontale

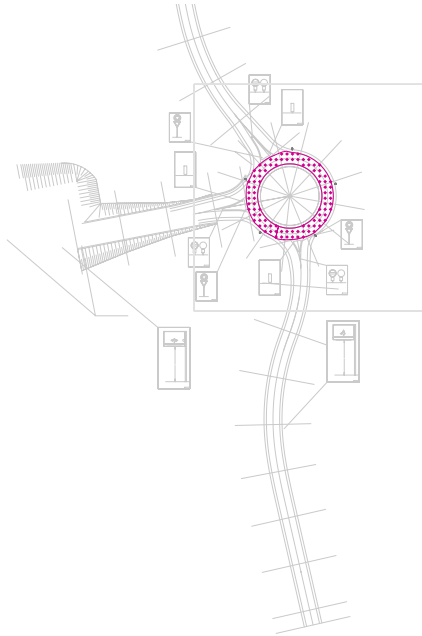

x

Fattore di diminuzione: 0.80

Rotatoria est: Illuminamento orizzontale (Reticolo)

Scena luce: Categoria illuminotecnica C1

Medio: 30.9 lx, Min: 23.8 lx, Max: 42.1 lx, Min/Medio: 0.77, Min/Max: 0.57

Altezza: 0.000 m

Isolinee [lx]

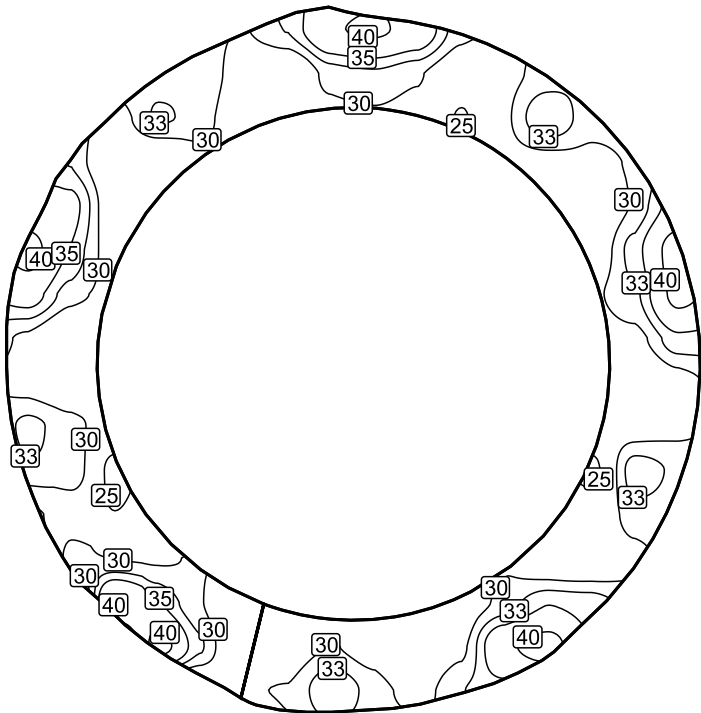

Scala: 1 : 500

Colori sfalsati [lx]

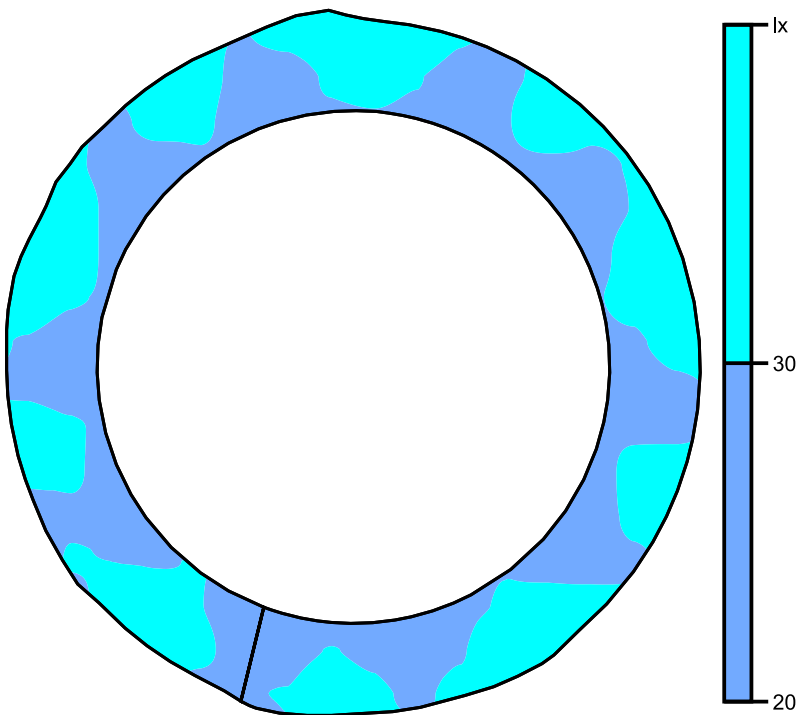

Scala: 1 : 500

Raster dei valori [lx]

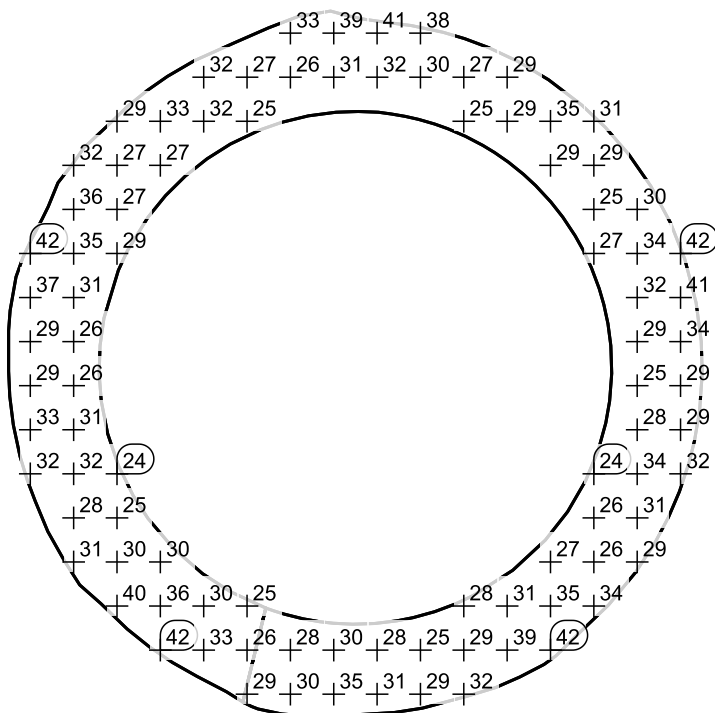

Scala: 1 : 500

Tabella valori [lx]

m	-21.130	-18.255	-15.380	-12.506	-9.631	-6.756	-3.881	-1.007	1.868	4.743	7.617	10.492	13.367	16.242	19.116	21.991
22.297	/	/	/	/	/	/	32.6	39.3	40.7	38.2	/	/	/	/	/	/
19.375	/	/	/	/	32.5	27.3	26.3	31.0	32.0	30.4	26.7	28.8	/	/	/	/
16.452	/	/	28.5	32.9	31.7	25.3	/	/	/	/	24.8	29.2	34.9	31.0	/	/
13.530	/	32.3	26.6	26.6	/	/	/	/	/	/	/	/	28.8	28.8	/	/
10.608	/	36.1	27.3	/	/	/	/	/	/	/	/	/	/	25.2	30.3	/
7.685	41.7	34.7	28.6	/	/	/	/	/	/	/	/	/	/	27.2	33.5	42.1
4.763	36.7	31.0	/	/	/	/	/	/	/	/	/	/	/	/	31.8	41.4
1.841	29.5	25.9	/	/	/	/	/	/	/	/	/	/	/	/	28.8	34.2
-1.082	28.6	26.4	/	/	/	/	/	/	/	/	/	/	/	/	25.2	28.7
-4.004	33.2	31.2	/	/	/	/	/	/	/	/	/	/	/	/	28.3	29.2
-6.926	32.0	31.7	23.8	/	/	/	/	/	/	/	/	/	/	24.1	33.8	32.1
-9.849	/	27.8	25.1	/	/	/	/	/	/	/	/	/	/	26.5	31.5	/
-12.771	/	31.3	29.9	29.7	/	/	/	/	/	/	/	/	27.1	26.3	29.0	/
-15.693	/	/	40.3	35.7	30.2	25.4	/	/	/	/	27.8	30.7	34.9	33.7	/	/
-18.616	/	/	/	42.1	33.0	25.8	27.6	30.2	28.2	25.2	29.1	38.8	41.7	/	/	/
-21.538	/	/	/	/	/	29.4	30.2	34.7	31.5	28.7	32.3	/	/	/	/	/

Variante di Mondovi'

Calcolo illuminotecnico ramo ingresso/uscita asse principale rotatoria est

Contenuto

Variante di Mondovì

Variante di Mondovì

AEC ILLUMINAZIONE SRL - ITALO 3 0F3 STE-M 4.5-13M (1xL-IT3-0F3-4000-525-13M-70-25).....	3
Ramo ingresso/uscita asse principale rotatoria Est: Alternativa 1	
Risultati della pianificazione.....	6
Ramo ingresso/uscita asse principale rotatoria Est: Alternativa 1 / Carreggiata (M2)	
Sintesi dei risultati.....	7
Tabella.....	8
Isolinee.....	11
Grafica dei valori.....	14

AEC ILLUMINAZIONE SRL ITALO 3 0F3 STE-M 4.5-13M ITALO 3 0F3 STE-M 4.5-13M 1xL-IT3-0F3-4000-525-13M-70-25

Per un'immagine della lampada consultare il nostro catalogo lampade.

Rendimento: 100.00%
 Flusso luminoso lampadina: 32840 lm
 Flusso luminoso apparecchio: 32839 lm
 Potenza: 247.0 W
 Rendimento luminoso: 133.0 lm/W

Emissione luminosa 1 / CDL polare

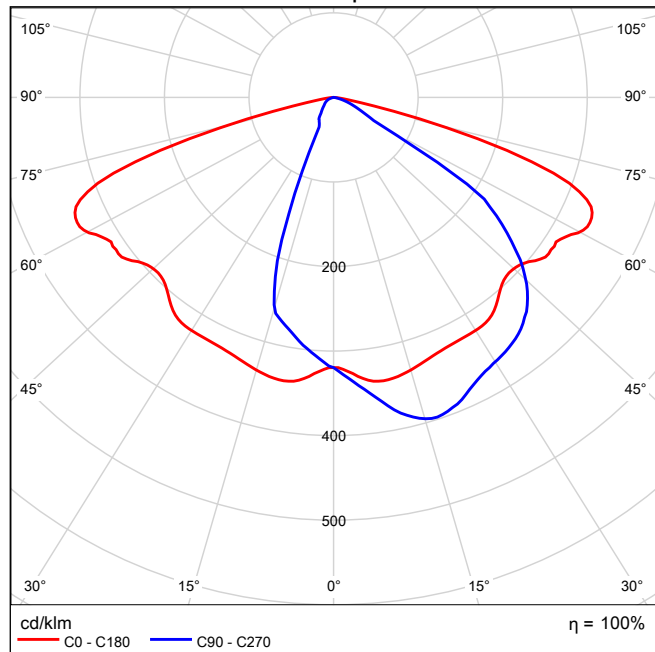

Emissione luminosa 1 / CDL lineare

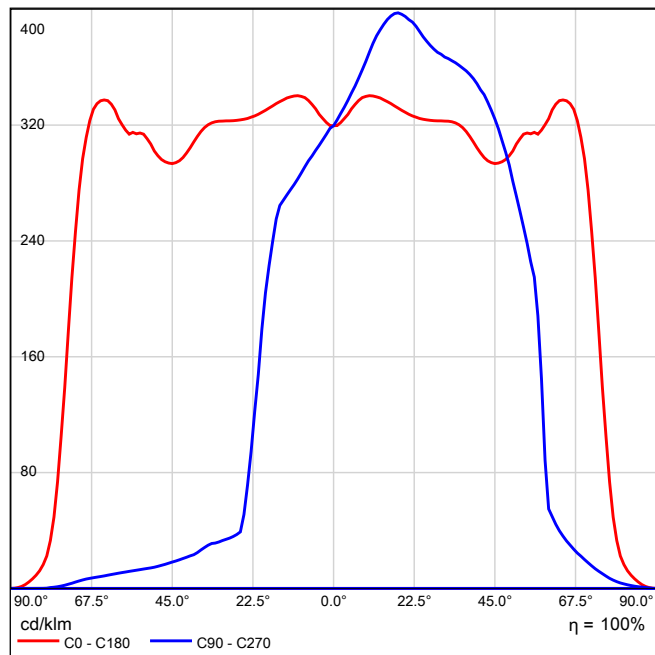

Non è possibile creare un diagramma conico, poiché la diffusione luminosa è asimmetrica.

Emissione luminosa 1 / Diagramma della luminanza

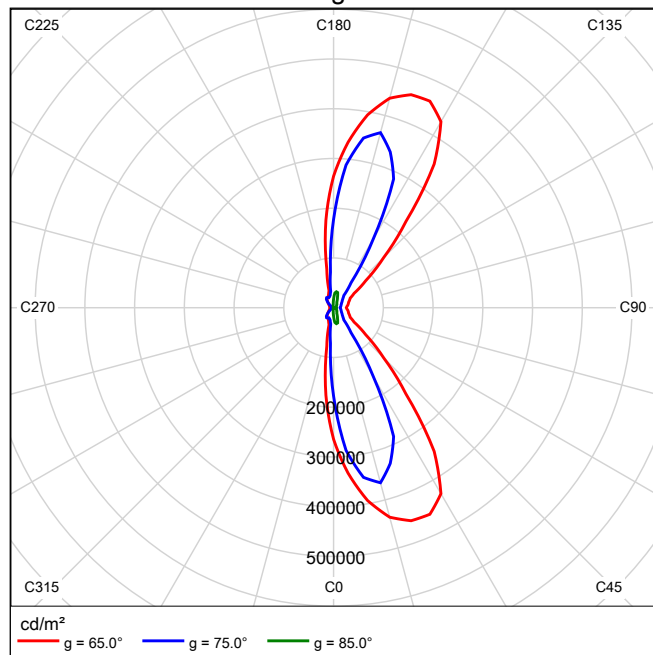

Non è possibile creare un diagramma UGR, poiché la diffusione luminosa è asimmetrica.

Ramo ingresso/uscita asse principale rotonda Est in direzione EN 13201:2015

AEC ILLUMINAZIONE SRL ITALO 3 0F3 STE-M 4.5-13M ITALO 3 0F3 STE-M 4.5-13M

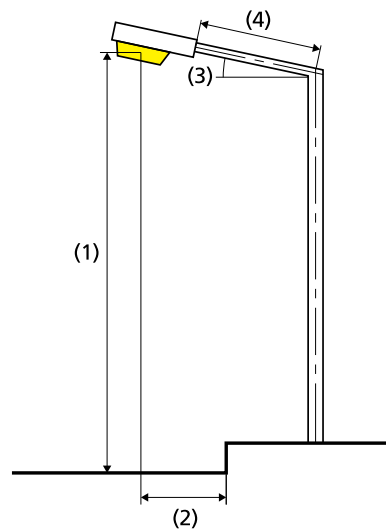
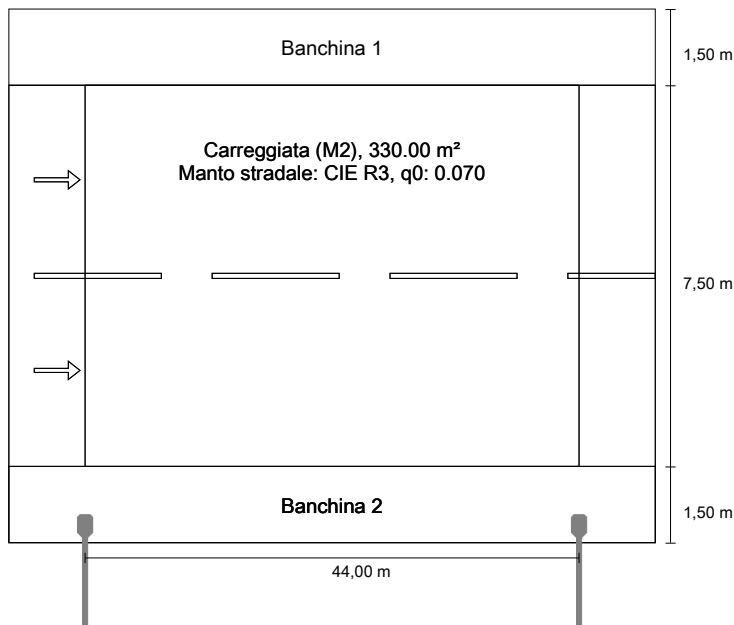

Risultati per i campi di valutazione
Fattore di diminuzione: 0.67

Carreggiata (M2)

Lm [cd/m²] ≥ 1.50	Uo ≥ 0.40	UI ≥ 0.70	TI [%] ≤ 10	EIR ≥ 0.35
✓ 1.61	✓ 0.57	✓ 0.79	✓ 10	✓ 0.78

Risultati per gli indicatori dell'efficienza energetica

Indice della densità di potenza (Dp)	0.028 W/lxm²
Densità di consumo energetico	
Disposizione: ITALO 3 0F3 STE-M 4.5-13M (988.0 kWh/anno)	3.0 kWh/m² anno

Lampadina:	1xL-IT3-0F3-4000-525-13M-70-25
Flusso luminoso (lampada):	32838.74 lm
Flusso luminoso (lampadina):	32840.00 lm
Ore di esercizio	
4000 h:	100.0 %, 247.0 W
W/km:	5681.0
Disposizione:	su un lato sotto
Distanza pali:	44.000 m
Inclinazione braccio (3):	0.0°
Lunghezza braccio (4):	2.000 m
Altezza fuochi (1):	12.000 m
Sporgenza punto luce (2):	-1.200 m

ULR:	-1.00
ULOR:	0.00
Valori massimi dell'intensità luminosa	
a 70° e oltre	495 cd/klm *
a 80° e oltre	56.9 cd/klm *
a 90° e oltre	0.00 cd/klm *
Classe intensità luminose:	G*4

Per tutte le direzioni che, per le lampade installate e utilizzabili, formano l'angolo indicato con le verticali inferiori.

* I valori di intensità luminosa in [cd/klm] per il calcolo della classe di intensità luminosa, si riferiscono al flusso di emissione dell'apparecchio secondo la norma EN 13201:2015.

La disposizione rispetta la classe degli indici di abbagliamento D.3

Carreggiata (M2)

Fattore di diminuzione: 0.67

Reticolo: 15 x 6 Punti

Lm [cd/m ²] ≥ 1.50	Uo ≥ 0.40	UI ≥ 0.70	TI [%] ≤ 10	EIR ≥ 0.35
✓ 1.61	✓ 0.57	✓ 0.79	✓ 10	✓ 0.78

Osservatori corrispondenti (2):

Osservatore	Posizione [m]	Lm [cd/m ²] ≥ 1.50	Uo ≥ 0.40	UI ≥ 0.70	TI [%] ≤ 10
Osservatore 1	(-60.000, 3.375, 1.500)	1.61	0.57	0.85	10
Osservatore 2	(-60.000, 7.125, 1.500)	1.77	0.57	0.79	8

Carreggiata (M2)

Illuminamento orizzontale [lx]

8.375	33.1	30.3	24.5	20.6	19.0	18.4	17.0	16.5	17.0	18.4	19.0	20.6	24.5	30.3	33.1
7.125	38.1	34.2	26.8	21.5	19.3	18.2	16.9	16.4	16.9	18.2	19.3	21.5	26.8	34.2	38.1
5.875	44.1	38.9	29.7	23.3	20.1	18.1	16.5	16.0	16.5	18.1	20.1	23.3	29.7	38.9	44.1
4.625	51.0	44.4	33.6	26.1	21.2	17.9	15.9	15.3	15.9	17.9	21.2	26.1	33.6	44.4	51.0
3.375	55.4	48.1	36.7	28.0	21.4	17.3	15.0	14.4	15.0	17.3	21.4	28.0	36.7	48.1	55.4
2.125	55.7	47.8	36.8	27.4	20.1	16.1	13.8	13.2	13.8	16.1	20.1	27.4	36.8	47.8	55.7
m	1.467	4.400	7.333	10.267	13.200	16.133	19.067	22.000	24.933	27.867	30.800	33.733	36.667	39.600	42.533

Reticolo: 15 x 6 Punti

Em [lx]	Emin [lx]	Emax [lx]	g1	g2
27.2	13.2	55.7	0.487	0.238

Osservatore 1

Luminanza con carreggiata asciutta [cd/m²]

8.375	1.10	1.07	0.95	0.92	1.01	1.10	1.13	1.14	1.17	1.18	1.09	0.99	1.03	1.13	1.14
7.125	1.28	1.24	1.08	1.02	1.10	1.23	1.28	1.26	1.32	1.35	1.22	1.15	1.18	1.31	1.33
5.875	1.49	1.43	1.25	1.21	1.30	1.41	1.45	1.47	1.51	1.54	1.43	1.41	1.46	1.56	1.57
4.625	1.80	1.74	1.55	1.51	1.55	1.61	1.68	1.71	1.75	1.77	1.71	1.73	1.81	1.86	1.85
3.375	2.07	2.00	1.85	1.84	1.90	1.97	2.00	1.98	1.98	2.03	2.01	2.06	2.11	2.15	2.09
2.125	2.21	2.15	2.10	2.09	2.12	2.19	2.22	2.19	2.16	2.21	2.20	2.27	2.25	2.23	2.20
m	1.467	4.400	7.333	10.267	13.200	16.133	19.067	22.000	24.933	27.867	30.800	33.733	36.667	39.600	42.533

Reticolo: 15 x 6 Punti

Lm [cd/m ²]	Lmin [cd/m ²]	Lmax [cd/m ²]	g1	g2
1.61	0.92	2.27	0.575	0.406

Luminanza con lampada nuova [cd/m²]

8.375	1.64	1.59	1.42	1.38	1.50	1.64	1.68	1.70	1.75	1.77	1.63	1.48	1.53	1.69	1.71
7.125	1.91	1.85	1.62	1.53	1.64	1.84	1.90	1.87	1.97	2.02	1.82	1.72	1.76	1.95	1.98
5.875	2.22	2.13	1.86	1.81	1.94	2.10	2.16	2.19	2.26	2.30	2.13	2.10	2.18	2.33	2.34
4.625	2.69	2.60	2.31	2.25	2.31	2.41	2.50	2.56	2.61	2.64	2.55	2.58	2.71	2.78	2.76
3.375	3.09	2.99	2.77	2.74	2.83	2.94	2.98	2.96	2.95	3.03	3.01	3.07	3.15	3.21	3.13
2.125	3.29	3.22	3.13	3.12	3.17	3.27	3.31	3.27	3.22	3.30	3.28	3.39	3.36	3.32	3.29
m	1.467	4.400	7.333	10.267	13.200	16.133	19.067	22.000	24.933	27.867	30.800	33.733	36.667	39.600	42.533

Reticolo: 15 x 6 Punti

Lm [cd/m ²]	Lmin [cd/m ²]	Lmax [cd/m ²]	g1	g2
2.40	1.38	3.39	0.575	0.406

Osservatore 2

Luminanza con carreggiata asciutta [cd/m²]

8.375	1.17	1.16	1.04	1.01	1.10	1.22	1.24	1.23	1.27	1.31	1.17	1.06	1.07	1.17	1.18
7.125	1.39	1.35	1.22	1.18	1.27	1.39	1.43	1.44	1.44	1.48	1.31	1.24	1.27	1.39	1.40
5.875	1.68	1.66	1.52	1.48	1.54	1.62	1.68	1.69	1.70	1.69	1.55	1.50	1.56	1.65	1.66
4.625	2.07	2.03	1.87	1.86	1.95	2.03	2.03	1.98	1.97	1.96	1.86	1.87	1.96	2.01	1.98
3.375	2.33	2.32	2.24	2.25	2.28	2.33	2.34	2.29	2.22	2.23	2.21	2.19	2.23	2.28	2.25
2.125	2.15	2.13	2.10	2.12	2.20	2.31	2.35	2.32	2.27	2.29	2.28	2.32	2.29	2.26	2.24
m	1.467	4.400	7.333	10.267	13.200	16.133	19.067	22.000	24.933	27.867	30.800	33.733	36.667	39.600	42.533

Reticolo: 15 x 6 Punti

Lm [cd/m ²]	Lmin [cd/m ²]	Lmax [cd/m ²]	g1	g2
1.77	1.01	2.35	0.573	0.431

Luminanza con lampada nuova [cd/m²]

8.375	1.75	1.72	1.56	1.51	1.64	1.82	1.85	1.84	1.89	1.95	1.74	1.58	1.59	1.75	1.77
7.125	2.07	2.02	1.82	1.76	1.90	2.08	2.13	2.14	2.15	2.22	1.95	1.86	1.90	2.07	2.09
5.875	2.50	2.48	2.27	2.21	2.30	2.42	2.51	2.53	2.53	2.53	2.31	2.24	2.33	2.46	2.48
4.625	3.08	3.03	2.79	2.77	2.92	3.03	3.03	2.96	2.94	2.93	2.78	2.79	2.92	3.00	2.96
3.375	3.47	3.46	3.34	3.35	3.41	3.48	3.49	3.41	3.31	3.34	3.31	3.27	3.33	3.41	3.36
2.125	3.21	3.19	3.14	3.17	3.28	3.44	3.50	3.46	3.39	3.42	3.41	3.46	3.42	3.37	3.35
m	1.467	4.400	7.333	10.267	13.200	16.133	19.067	22.000	24.933	27.867	30.800	33.733	36.667	39.600	42.533

Reticolo: 15 x 6 Punti

Lm [cd/m ²]	Lmin [cd/m ²]	Lmax [cd/m ²]	g1	g2
2.63	1.51	3.50	0.573	0.431

Carreggiata (M2)

Fattore di diminuzione: 0.67
 Reticolo: 15 x 6 Punti

Lm [cd/m ²]	U _o	U _I	TI [%]	EIR
≥ 1.50	≥ 0.40	≥ 0.70	≤ 10	≥ 0.35
✓ 1.61	✓ 0.57	✓ 0.79	✓ 10	✓ 0.78

Illuminamento orizzontale

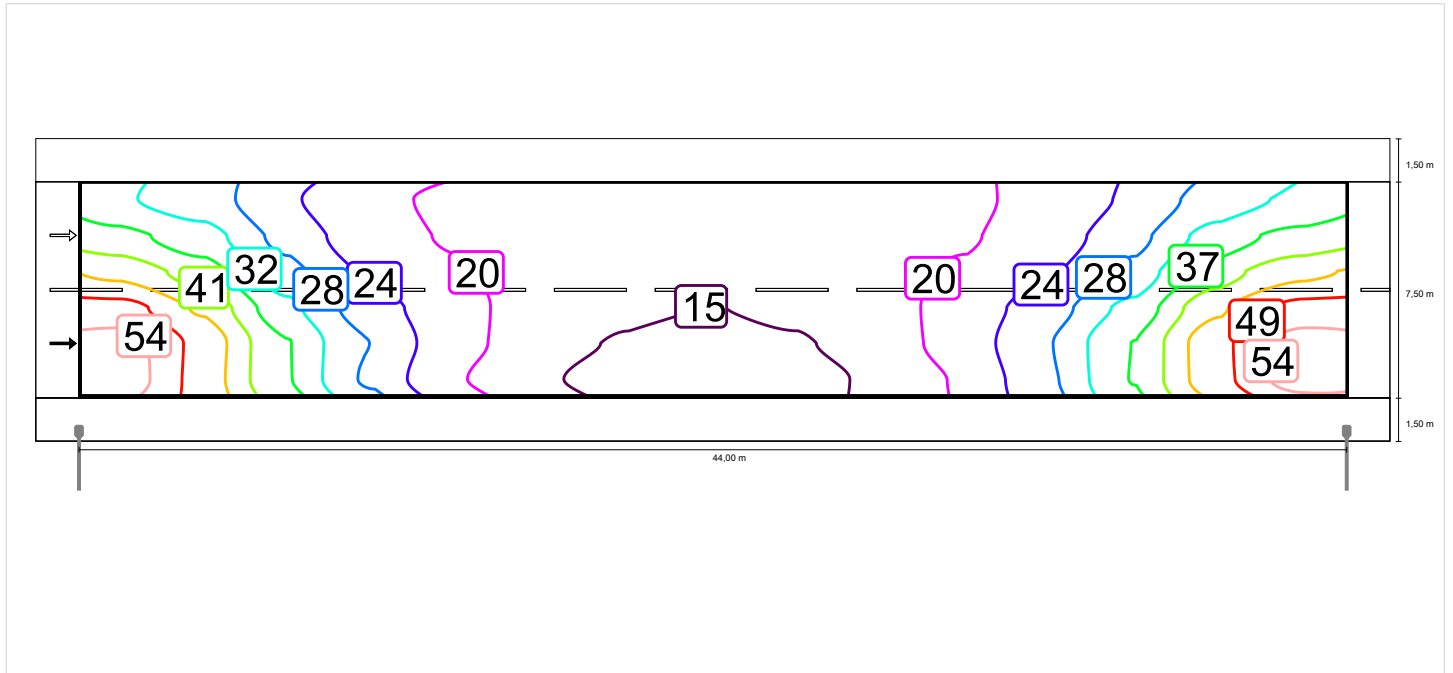

Osservatore 1

Luminanza con carreggiata asciutta

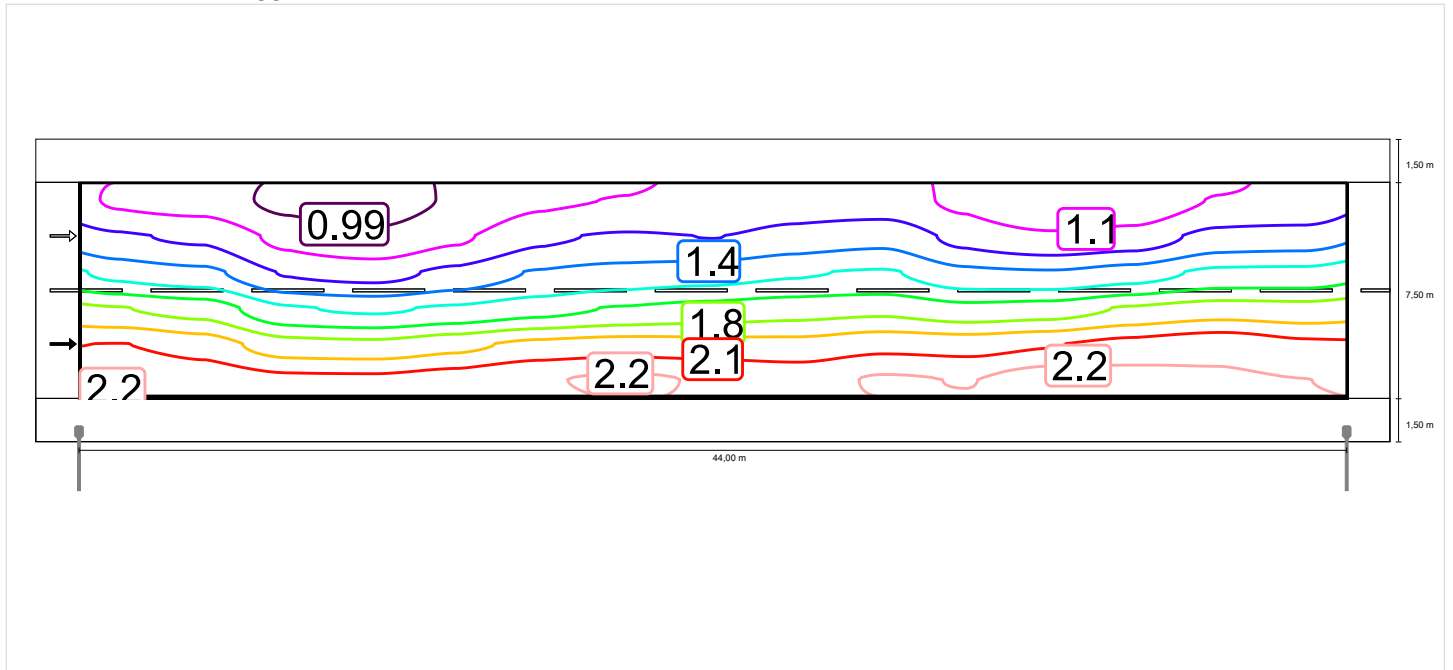

Luminanza con lampada nuova

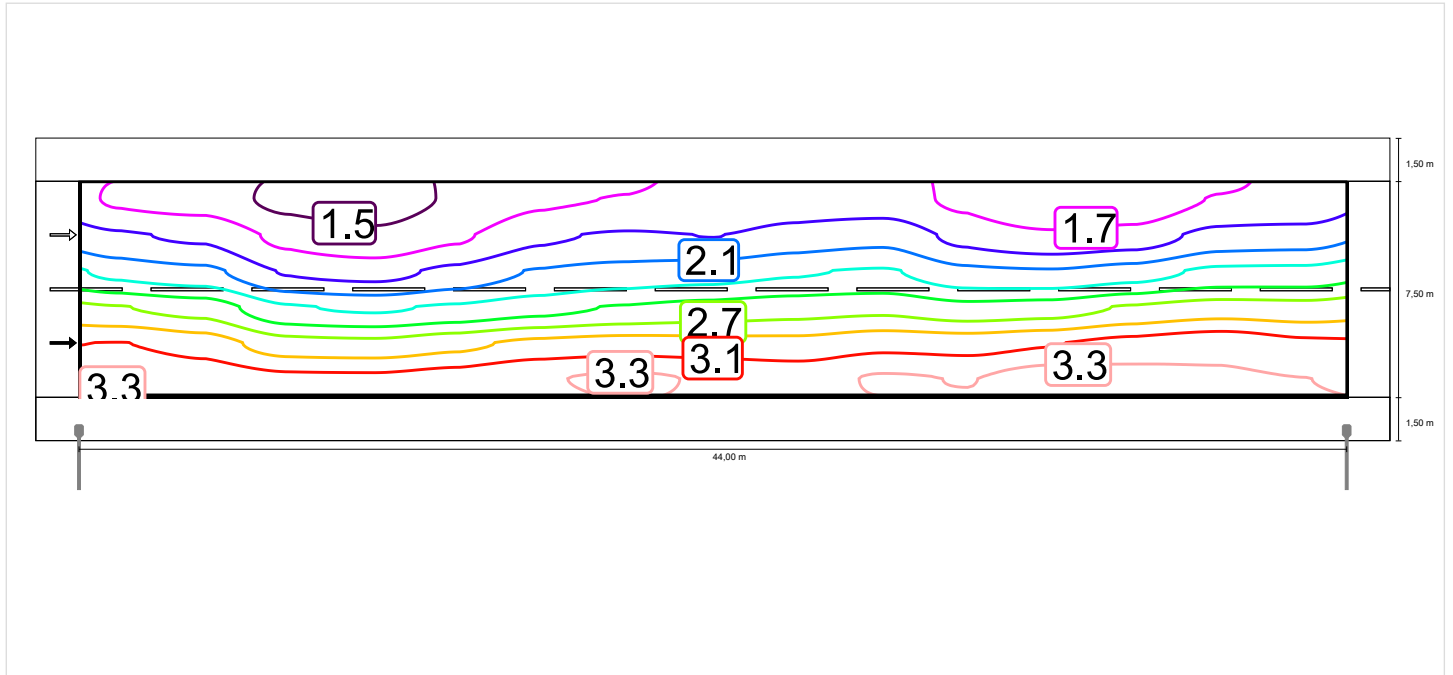

Osservatore 2

Luminanza con carreggiata asciutta

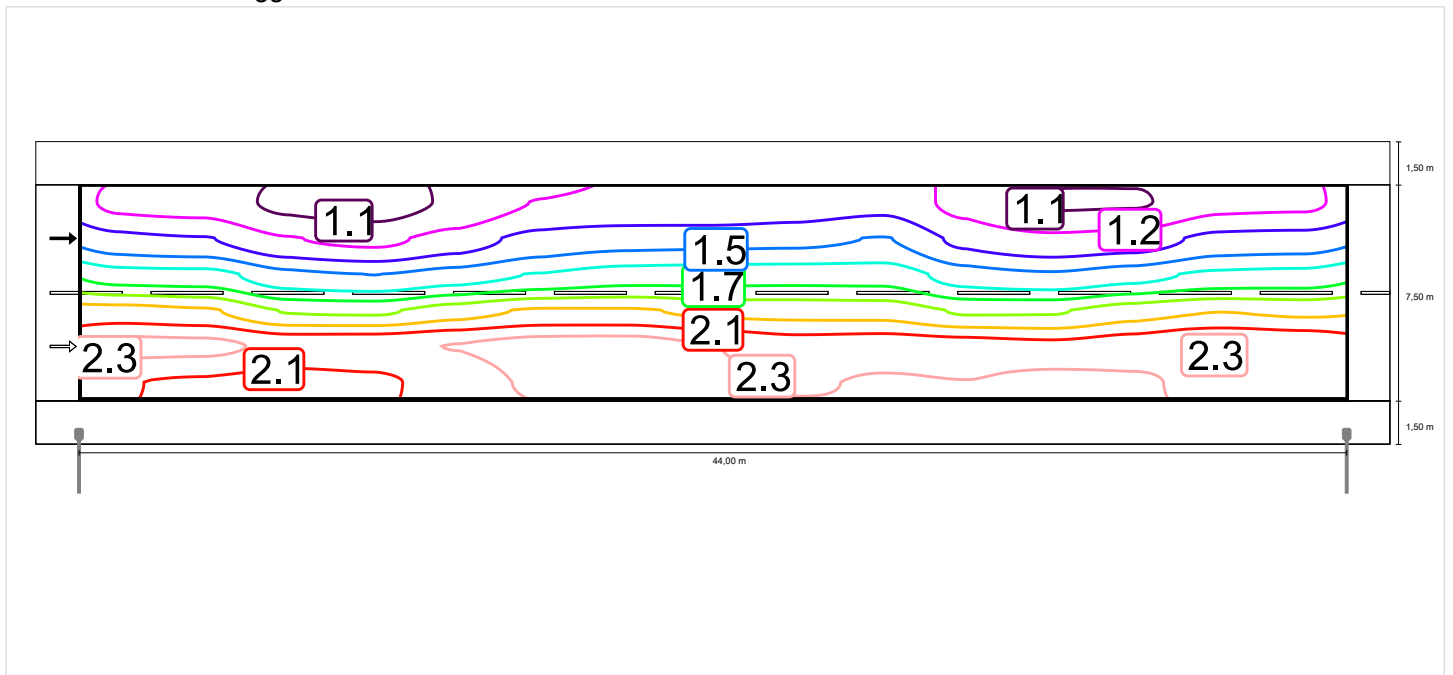

Luminanza con lampada nuova

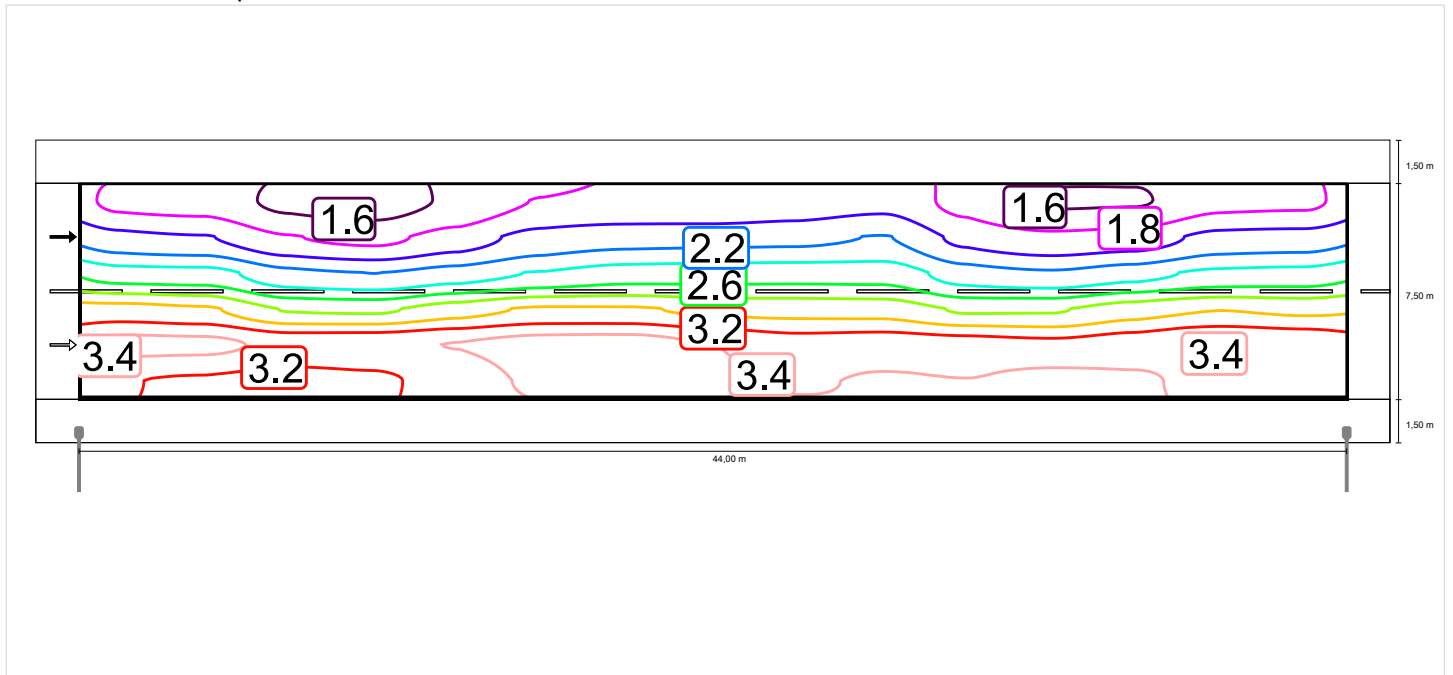

Carreggiata (M2)

Fattore di diminuzione: 0.67
 Reticolo: 15 x 6 Punti

Lm [cd/m²] ≥ 1.50	Uo ≥ 0.40	UI ≥ 0.70	TI [%] ≤ 10	EIR ≥ 0.35
✓ 1.61	✓ 0.57	✓ 0.79	✓ 10	✓ 0.78

Illuminamento orizzontale

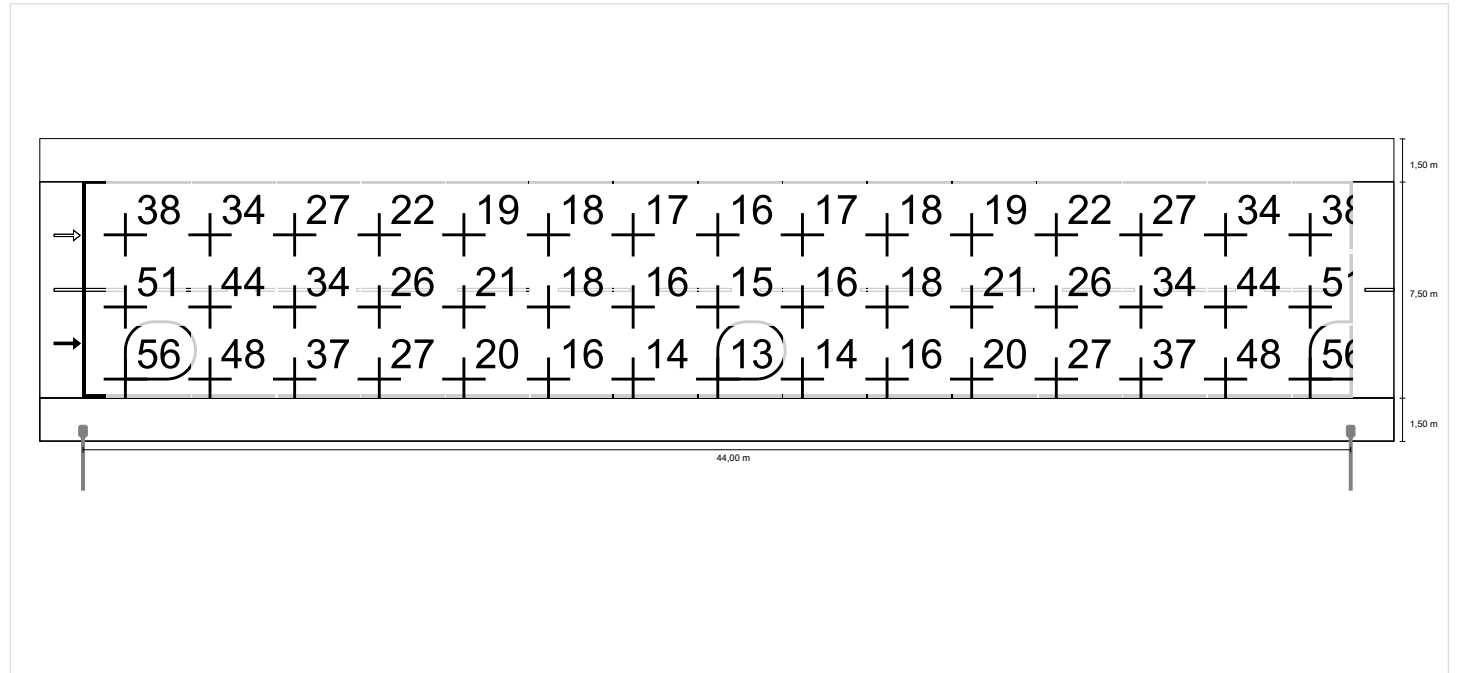

Osservatore 1

Luminanza con carreggiata asciutta

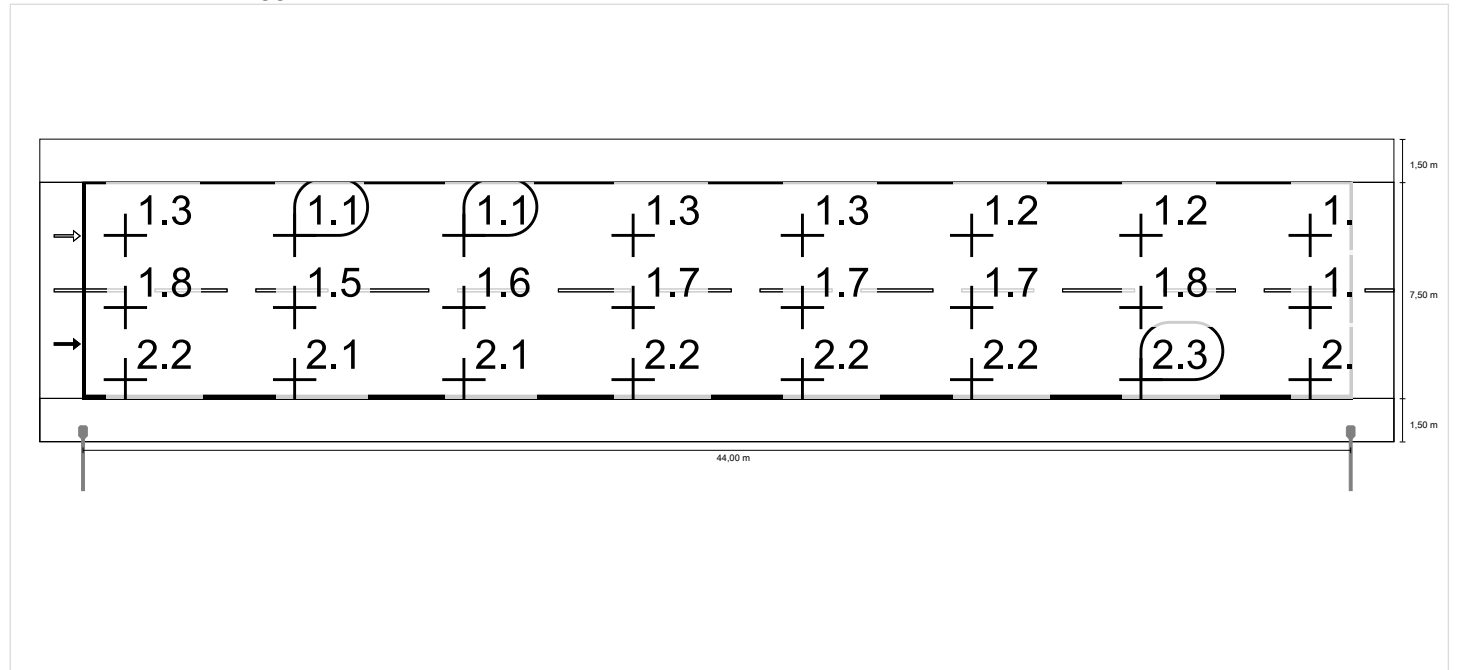

Luminanza con lampada nuova

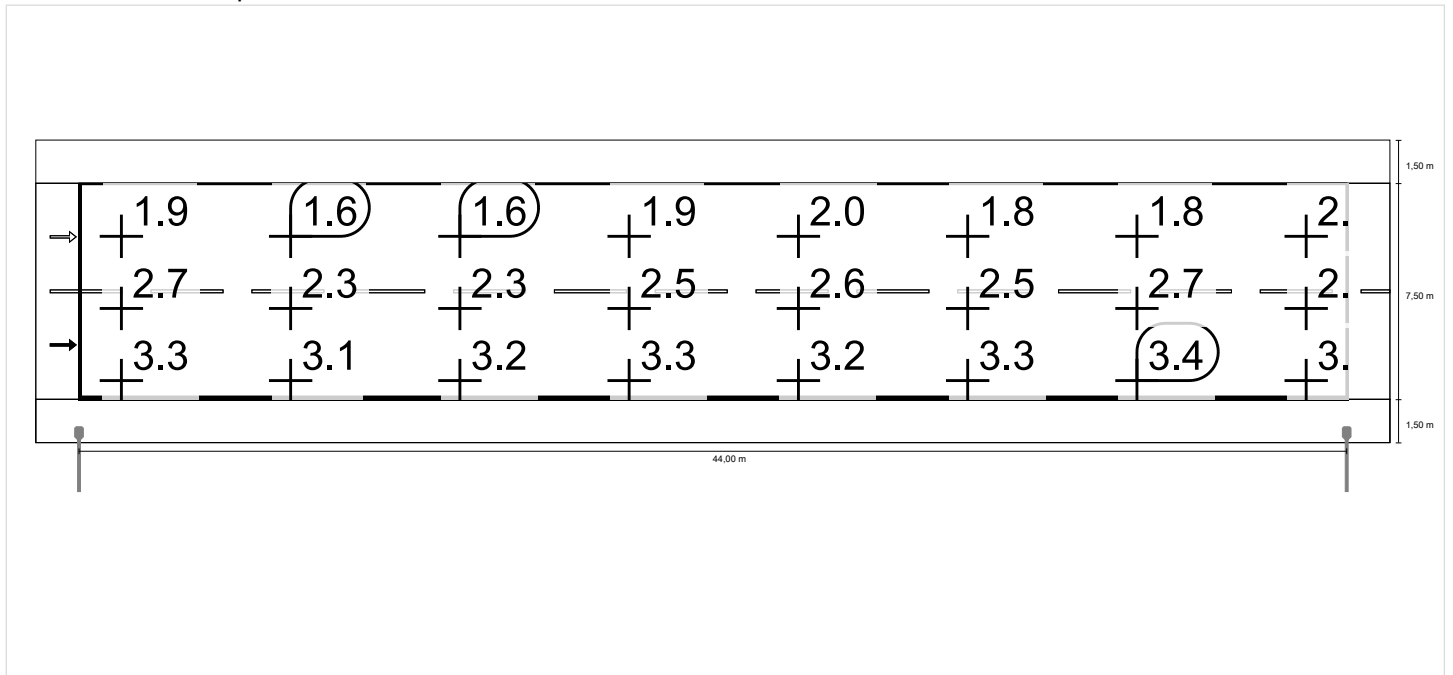

Osservatore 2

Luminanza con carreggiata asciutta

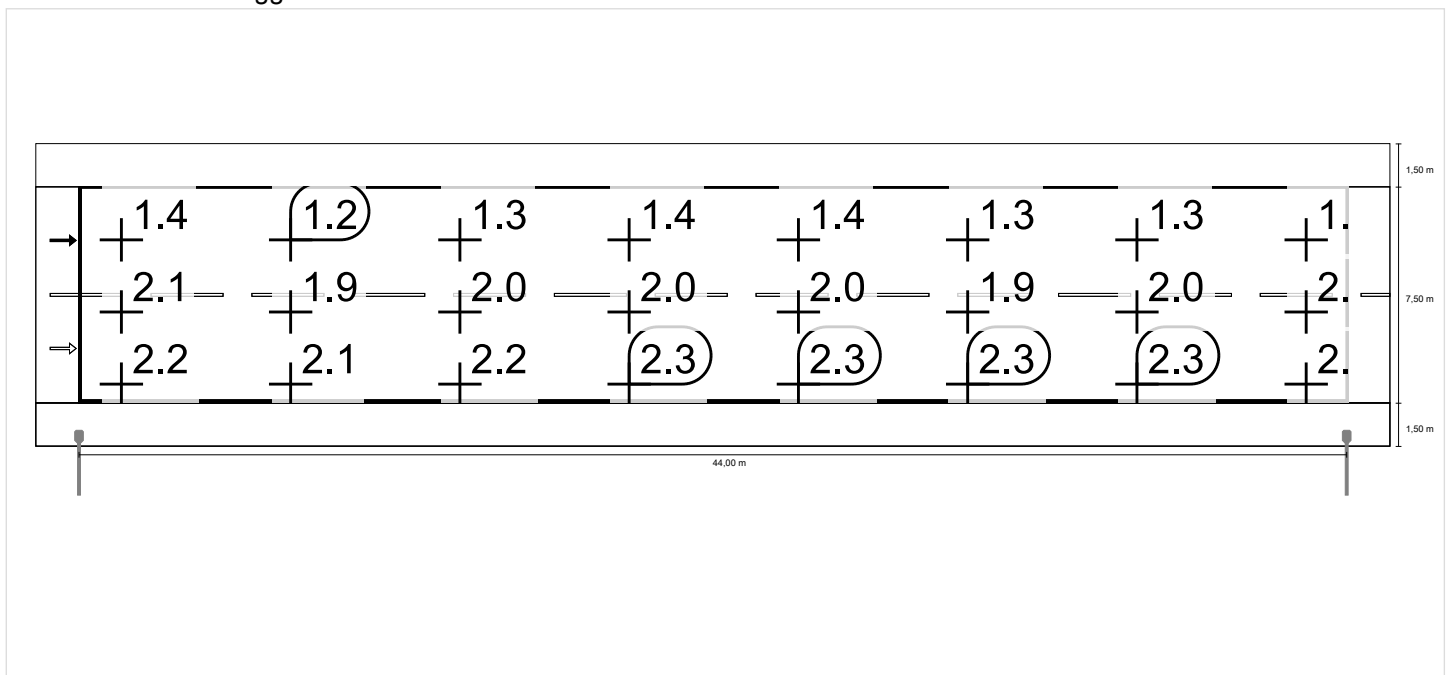

Luminanza con lampada nuova

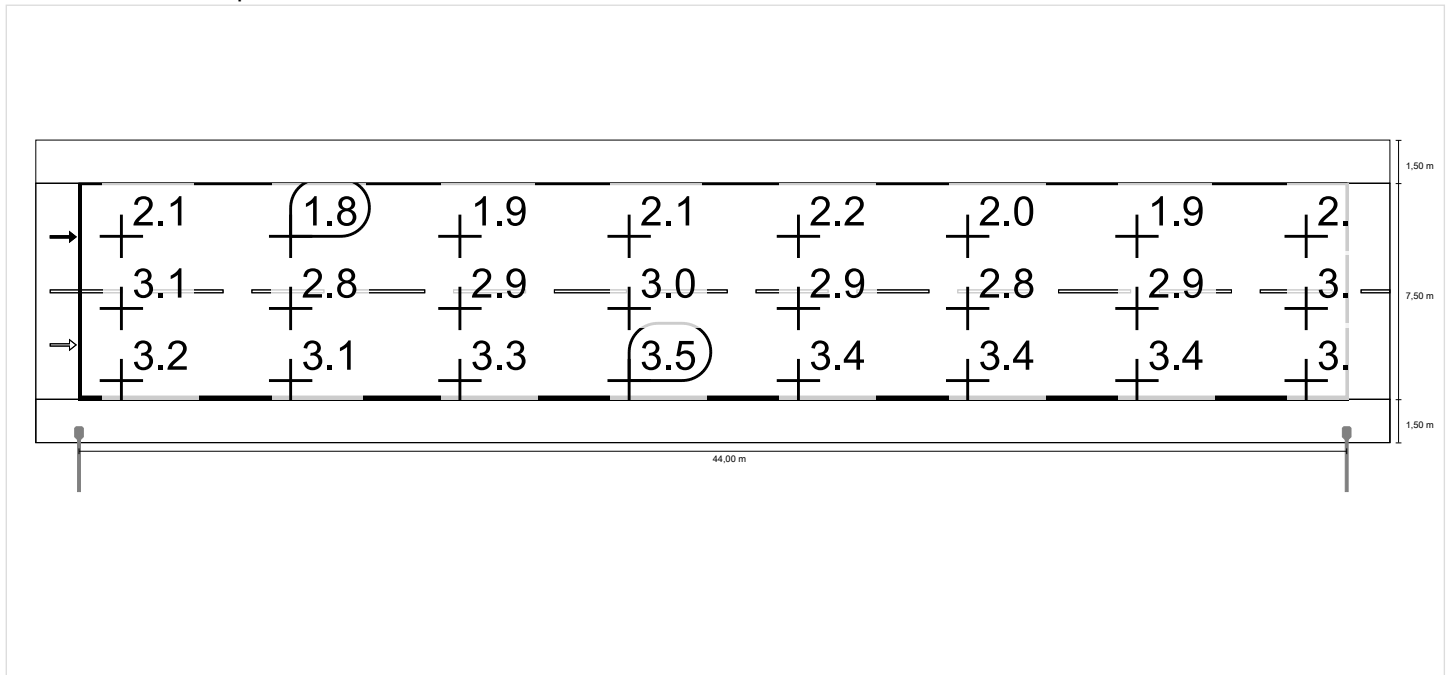

Variante di Mondovi'

Calcolo illuminotecnico ramo ingresso/uscita asse principale rotatoria ovest esistente

Contenuto

Variante di Mondovì

Variante di Mondovì

AEC ILLUMINAZIONE SRL - ITALO 3 0F3 STE-M 4.5-13M (1xL-IT3-0F3-4000-525-13M-70-25)..... 3

Ramo ingresso/uscita asse principale rotatoria Est: Alternativa 1

Risultati della pianificazione.....6

Ramo ingresso/uscita asse principale rotatoria Est: Alternativa 1 / Carreggiata (M2)

Sintesi dei risultati..... 7

Tabella.....8

Isolinee..... 11

Grafica dei valori..... 14

AEC ILLUMINAZIONE SRL ITALO 3 0F3 STE-M 4.5-13M ITALO 3 0F3 STE-M 4.5-13M 1xL-IT3-0F3-4000-525-13M-70-25

Per un'immagine della lampada consultare il nostro catalogo lampade.

Rendimento: 100.00%
 Flusso luminoso lampadina: 32840 lm
 Flusso luminoso apparecchio: 32839 lm
 Potenza: 247.0 W
 Rendimento luminoso: 133.0 lm/W

Emissione luminosa 1 / CDL polare

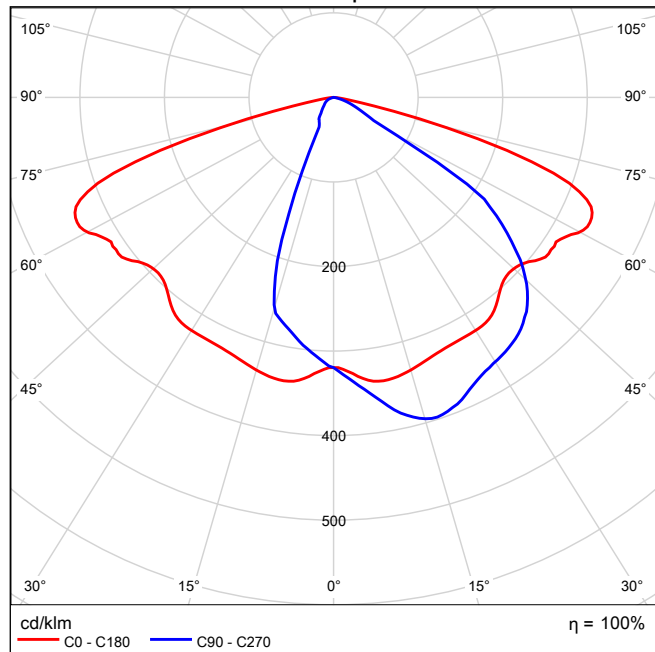

Emissione luminosa 1 / CDL lineare

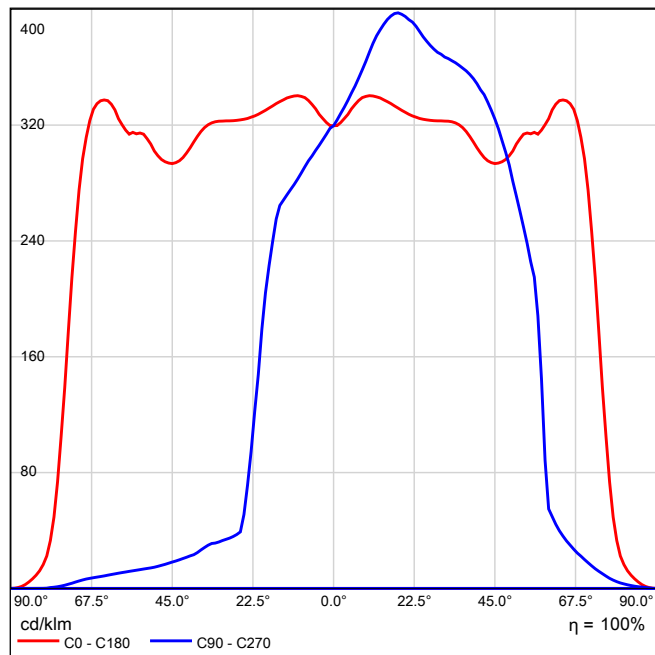

Non è possibile creare un diagramma conico, poiché la diffusione luminosa è asimmetrica.

Emissione luminosa 1 / Diagramma della luminanza

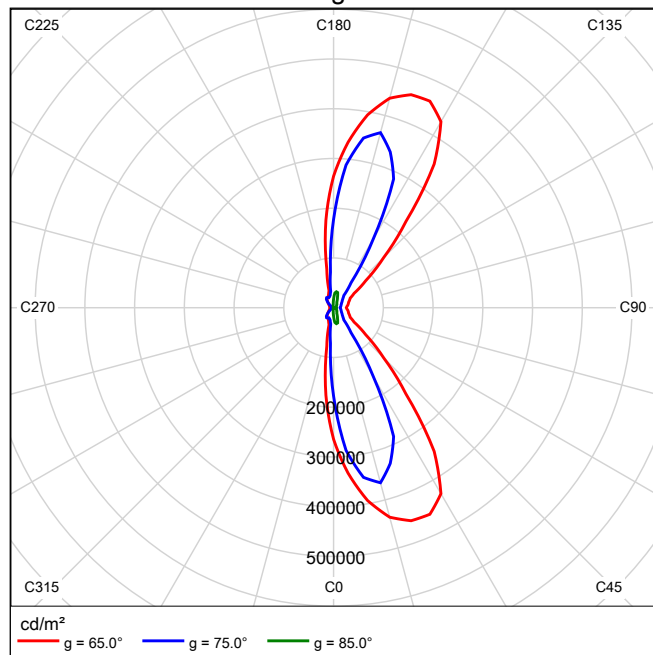

Non è possibile creare un diagramma UGR, poiché la diffusione luminosa è asimmetrica.

Ramo ingresso/uscita asse principale rotatoria Est in direzione EN 13201:2015

AEC ILLUMINAZIONE SRL ITALO 3 0F3 STE-M 4.5-13M ITALO 3 0F3 STE-M 4.5-13M

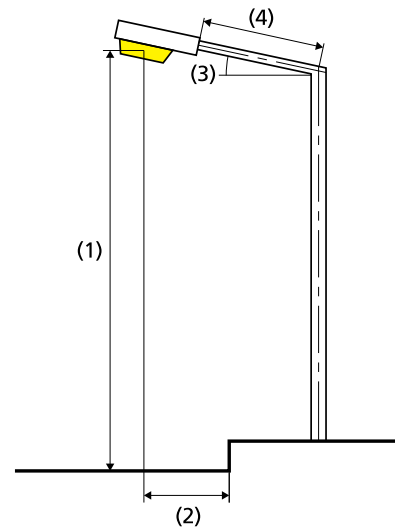
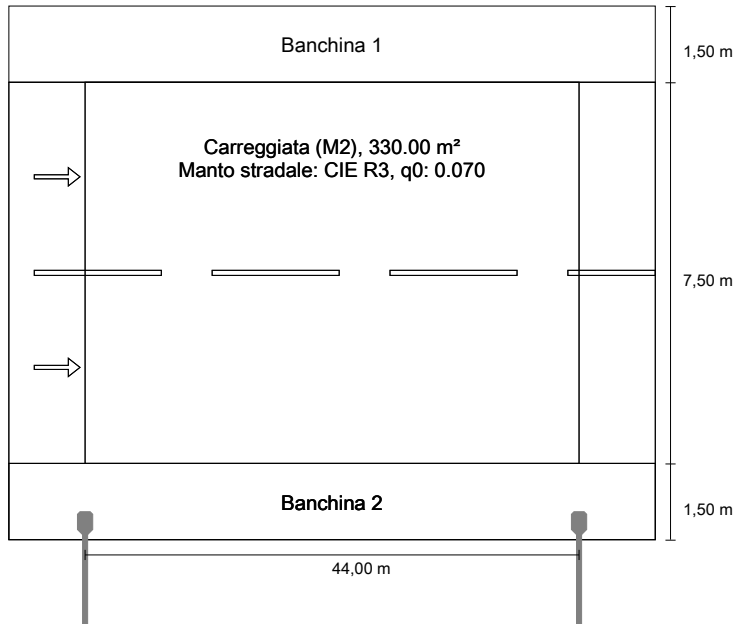

Risultati per i campi di valutazione
Fattore di diminuzione: 0.67

Carreggiata (M2)

Lm [cd/m²] ≥ 1.50	Uo ≥ 0.40	UI ≥ 0.70	TI [%] ≤ 10	EIR ≥ 0.35
✓ 1.61	✓ 0.57	✓ 0.79	✓ 10	✓ 0.78

Risultati per gli indicatori dell'efficienza energetica

Indice della densità di potenza (Dp)	0.028 W/lxm²
Densità di consumo energetico	
Disposizione: ITALO 3 0F3 STE-M 4.5-13M (988.0 kWh/anno)	3.0 kWh/m² anno

Lampadina:	1xL-IT3-0F3-4000-525-13M-70-25
Flusso luminoso (lampada):	32838.74 lm
Flusso luminoso (lampadina):	32840.00 lm
Ore di esercizio	
4000 h:	100.0 %, 247.0 W
W/km:	5681.0
Disposizione:	su un lato sotto
Distanza pali:	44.000 m
Inclinazione braccio (3):	0.0°
Lunghezza braccio (4):	2.000 m
Altezza fuochi (1):	12.000 m
Sporgenza punto luce (2):	-1.200 m

ULR:	-1.00
ULOR:	0.00
Valori massimi dell'intensità luminosa	
a 70° e oltre	495 cd/klm *
a 80° e oltre	56.9 cd/klm *
a 90° e oltre	0.00 cd/klm *
Classe intensità luminose:	G*4

Per tutte le direzioni che, per le lampade installate e utilizzabili, formano l'angolo indicato con le verticali inferiori.

* I valori di intensità luminosa in [cd/klm] per il calcolo della classe di intensità luminosa, si riferiscono al flusso di emissione dell'apparecchio secondo la norma EN 13201:2015.

La disposizione rispetta la classe degli indici di abbagliamento D.3

Carreggiata (M2)

Fattore di diminuzione: 0.67

Reticolo: 15 x 6 Punti

Lm [cd/m ²] ≥ 1.50	Uo ≥ 0.40	UI ≥ 0.70	TI [%] ≤ 10	EIR ≥ 0.35
✓ 1.61	✓ 0.57	✓ 0.79	✓ 10	✓ 0.78

Osservatori corrispondenti (2):

Osservatore	Posizione [m]	Lm [cd/m ²] ≥ 1.50	Uo ≥ 0.40	UI ≥ 0.70	TI [%] ≤ 10
Osservatore 1	(-60.000, 3.375, 1.500)	1.61	0.57	0.85	10
Osservatore 2	(-60.000, 7.125, 1.500)	1.77	0.57	0.79	8

Carreggiata (M2)

Illuminamento orizzontale [lx]

8.375	33.1	30.3	24.5	20.6	19.0	18.4	17.0	16.5	17.0	18.4	19.0	20.6	24.5	30.3	33.1
7.125	38.1	34.2	26.8	21.5	19.3	18.2	16.9	16.4	16.9	18.2	19.3	21.5	26.8	34.2	38.1
5.875	44.1	38.9	29.7	23.3	20.1	18.1	16.5	16.0	16.5	18.1	20.1	23.3	29.7	38.9	44.1
4.625	51.0	44.4	33.6	26.1	21.2	17.9	15.9	15.3	15.9	17.9	21.2	26.1	33.6	44.4	51.0
3.375	55.4	48.1	36.7	28.0	21.4	17.3	15.0	14.4	15.0	17.3	21.4	28.0	36.7	48.1	55.4
2.125	55.7	47.8	36.8	27.4	20.1	16.1	13.8	13.2	13.8	16.1	20.1	27.4	36.8	47.8	55.7
m	1.467	4.400	7.333	10.267	13.200	16.133	19.067	22.000	24.933	27.867	30.800	33.733	36.667	39.600	42.533

Reticolo: 15 x 6 Punti

Em [lx]	Emin [lx]	Emax [lx]	g1	g2
27.2	13.2	55.7	0.487	0.238

Osservatore 1

Luminanza con carreggiata asciutta [cd/m²]

8.375	1.10	1.07	0.95	0.92	1.01	1.10	1.13	1.14	1.17	1.18	1.09	0.99	1.03	1.13	1.14
7.125	1.28	1.24	1.08	1.02	1.10	1.23	1.28	1.26	1.32	1.35	1.22	1.15	1.18	1.31	1.33
5.875	1.49	1.43	1.25	1.21	1.30	1.41	1.45	1.47	1.51	1.54	1.43	1.41	1.46	1.56	1.57
4.625	1.80	1.74	1.55	1.51	1.55	1.61	1.68	1.71	1.75	1.77	1.71	1.73	1.81	1.86	1.85
3.375	2.07	2.00	1.85	1.84	1.90	1.97	2.00	1.98	1.98	2.03	2.01	2.06	2.11	2.15	2.09
2.125	2.21	2.15	2.10	2.09	2.12	2.19	2.22	2.19	2.16	2.21	2.20	2.27	2.25	2.23	2.20
m	1.467	4.400	7.333	10.267	13.200	16.133	19.067	22.000	24.933	27.867	30.800	33.733	36.667	39.600	42.533

Reticolo: 15 x 6 Punti

Lm [cd/m ²]	Lmin [cd/m ²]	Lmax [cd/m ²]	g1	g2
1.61	0.92	2.27	0.575	0.406

Luminanza con lampada nuova [cd/m²]

8.375	1.64	1.59	1.42	1.38	1.50	1.64	1.68	1.70	1.75	1.77	1.63	1.48	1.53	1.69	1.71
7.125	1.91	1.85	1.62	1.53	1.64	1.84	1.90	1.87	1.97	2.02	1.82	1.72	1.76	1.95	1.98
5.875	2.22	2.13	1.86	1.81	1.94	2.10	2.16	2.19	2.26	2.30	2.13	2.10	2.18	2.33	2.34
4.625	2.69	2.60	2.31	2.25	2.31	2.41	2.50	2.56	2.61	2.64	2.55	2.58	2.71	2.78	2.76
3.375	3.09	2.99	2.77	2.74	2.83	2.94	2.98	2.96	2.95	3.03	3.01	3.07	3.15	3.21	3.13
2.125	3.29	3.22	3.13	3.12	3.17	3.27	3.31	3.27	3.22	3.30	3.28	3.39	3.36	3.32	3.29
m	1.467	4.400	7.333	10.267	13.200	16.133	19.067	22.000	24.933	27.867	30.800	33.733	36.667	39.600	42.533

Reticolo: 15 x 6 Punti

Lm [cd/m ²]	Lmin [cd/m ²]	Lmax [cd/m ²]	g1	g2
2.40	1.38	3.39	0.575	0.406

Osservatore 2

Luminanza con carreggiata asciutta [cd/m²]

8.375	1.17	1.16	1.04	1.01	1.10	1.22	1.24	1.23	1.27	1.31	1.17	1.06	1.07	1.17	1.18
7.125	1.39	1.35	1.22	1.18	1.27	1.39	1.43	1.44	1.44	1.48	1.31	1.24	1.27	1.39	1.40
5.875	1.68	1.66	1.52	1.48	1.54	1.62	1.68	1.69	1.70	1.69	1.55	1.50	1.56	1.65	1.66
4.625	2.07	2.03	1.87	1.86	1.95	2.03	2.03	1.98	1.97	1.96	1.86	1.87	1.96	2.01	1.98
3.375	2.33	2.32	2.24	2.25	2.28	2.33	2.34	2.29	2.22	2.23	2.21	2.19	2.23	2.28	2.25
2.125	2.15	2.13	2.10	2.12	2.20	2.31	2.35	2.32	2.27	2.29	2.28	2.32	2.29	2.26	2.24
m	1.467	4.400	7.333	10.267	13.200	16.133	19.067	22.000	24.933	27.867	30.800	33.733	36.667	39.600	42.533

Reticolo: 15 x 6 Punti

Lm [cd/m ²]	Lmin [cd/m ²]	Lmax [cd/m ²]	g1	g2
1.77	1.01	2.35	0.573	0.431

Luminanza con lampada nuova [cd/m²]

8.375	1.75	1.72	1.56	1.51	1.64	1.82	1.85	1.84	1.89	1.95	1.74	1.58	1.59	1.75	1.77
7.125	2.07	2.02	1.82	1.76	1.90	2.08	2.13	2.14	2.15	2.22	1.95	1.86	1.90	2.07	2.09
5.875	2.50	2.48	2.27	2.21	2.30	2.42	2.51	2.53	2.53	2.53	2.31	2.24	2.33	2.46	2.48
4.625	3.08	3.03	2.79	2.77	2.92	3.03	3.03	2.96	2.94	2.93	2.78	2.79	2.92	3.00	2.96
3.375	3.47	3.46	3.34	3.35	3.41	3.48	3.49	3.41	3.31	3.34	3.31	3.27	3.33	3.41	3.36
2.125	3.21	3.19	3.14	3.17	3.28	3.44	3.50	3.46	3.39	3.42	3.41	3.46	3.42	3.37	3.35
m	1.467	4.400	7.333	10.267	13.200	16.133	19.067	22.000	24.933	27.867	30.800	33.733	36.667	39.600	42.533

Reticolo: 15 x 6 Punti

Lm [cd/m ²]	Lmin [cd/m ²]	Lmax [cd/m ²]	g1	g2
2.63	1.51	3.50	0.573	0.431

Carreggiata (M2)

Fattore di diminuzione: 0.67
 Reticolo: 15 x 6 Punti

Lm [cd/m²]	Uo	UI	TI [%]	EIR
≥ 1.50	≥ 0.40	≥ 0.70	≤ 10	≥ 0.35
✓ 1.61	✓ 0.57	✓ 0.79	✓ 10	✓ 0.78

Illuminamento orizzontale

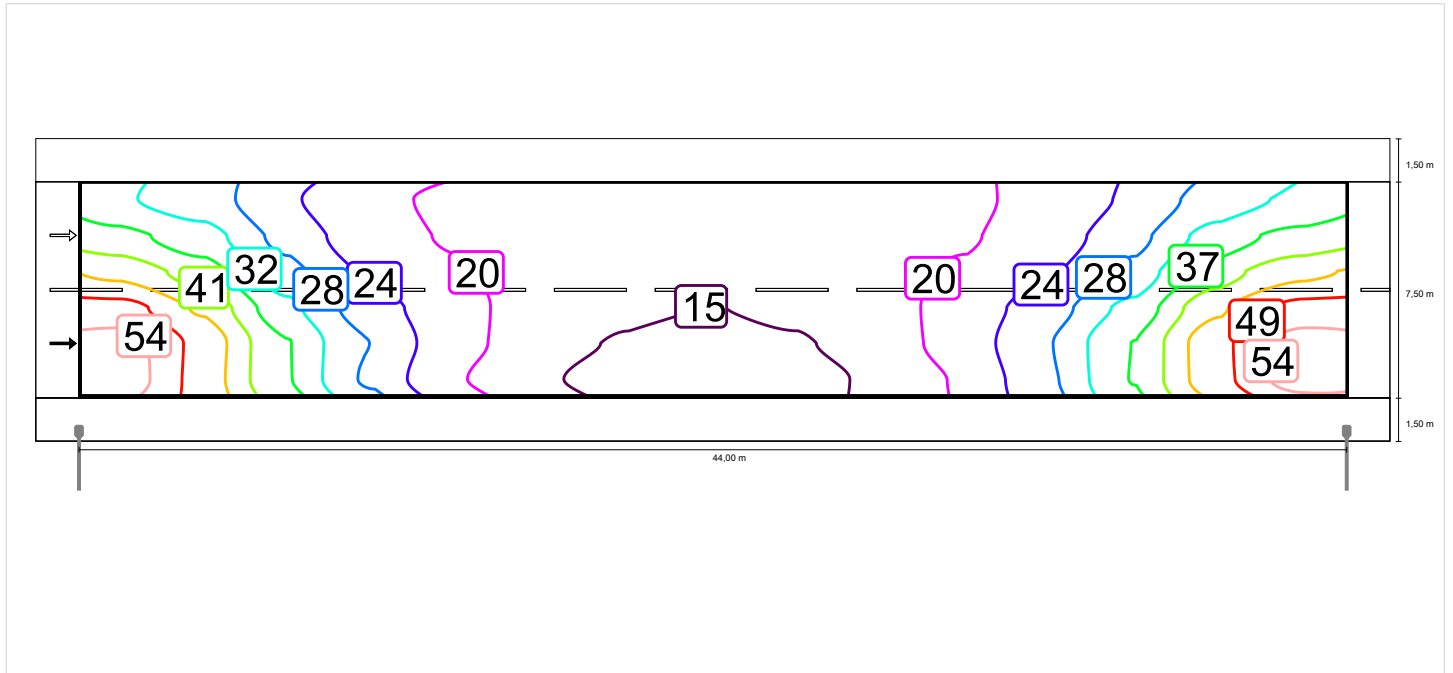

Osservatore 1

Luminanza con carreggiata asciutta

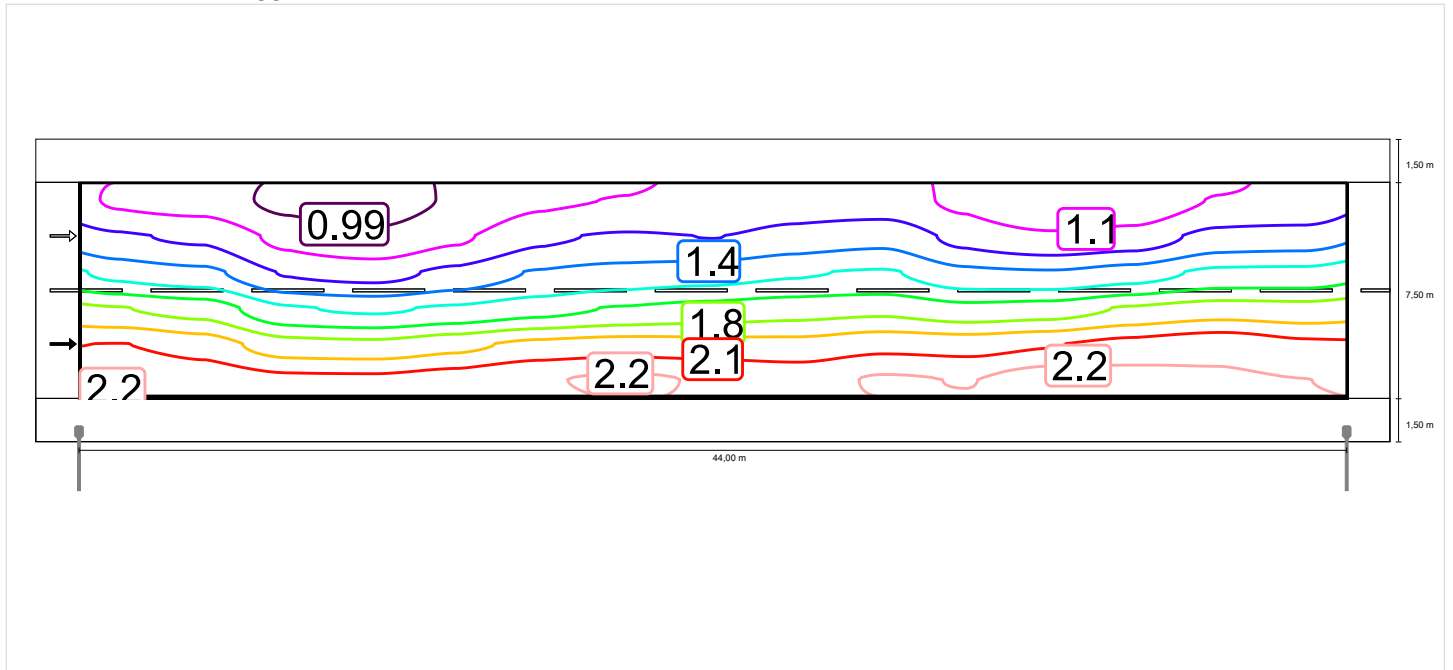

Luminanza con lampada nuova

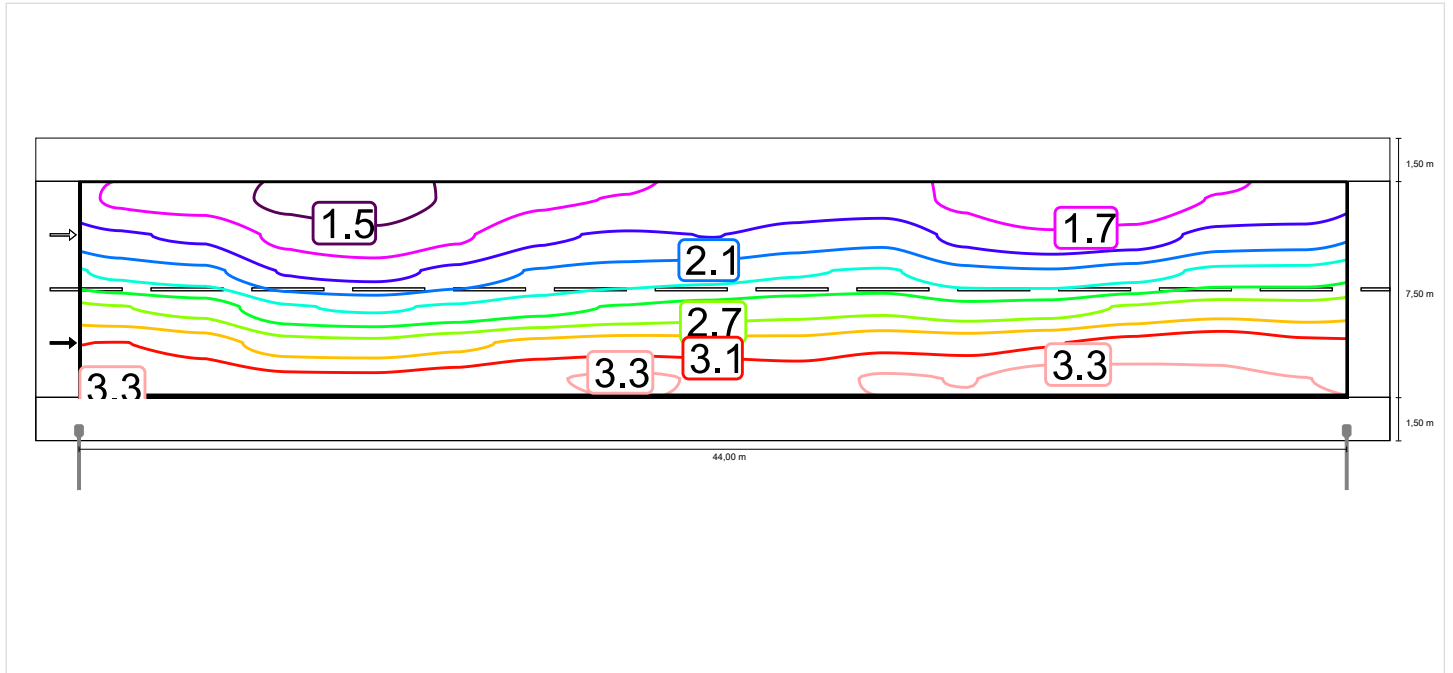

Osservatore 2

Luminanza con carreggiata asciutta

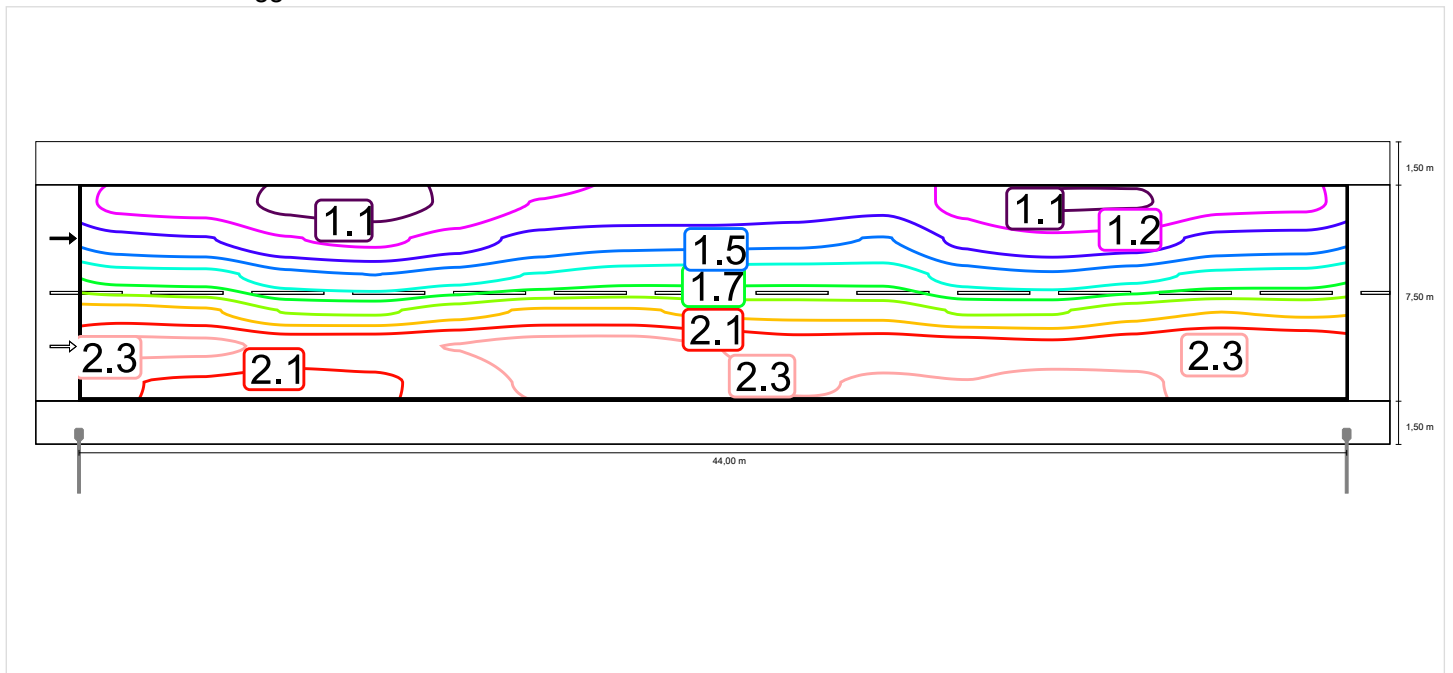

Luminanza con lampada nuova

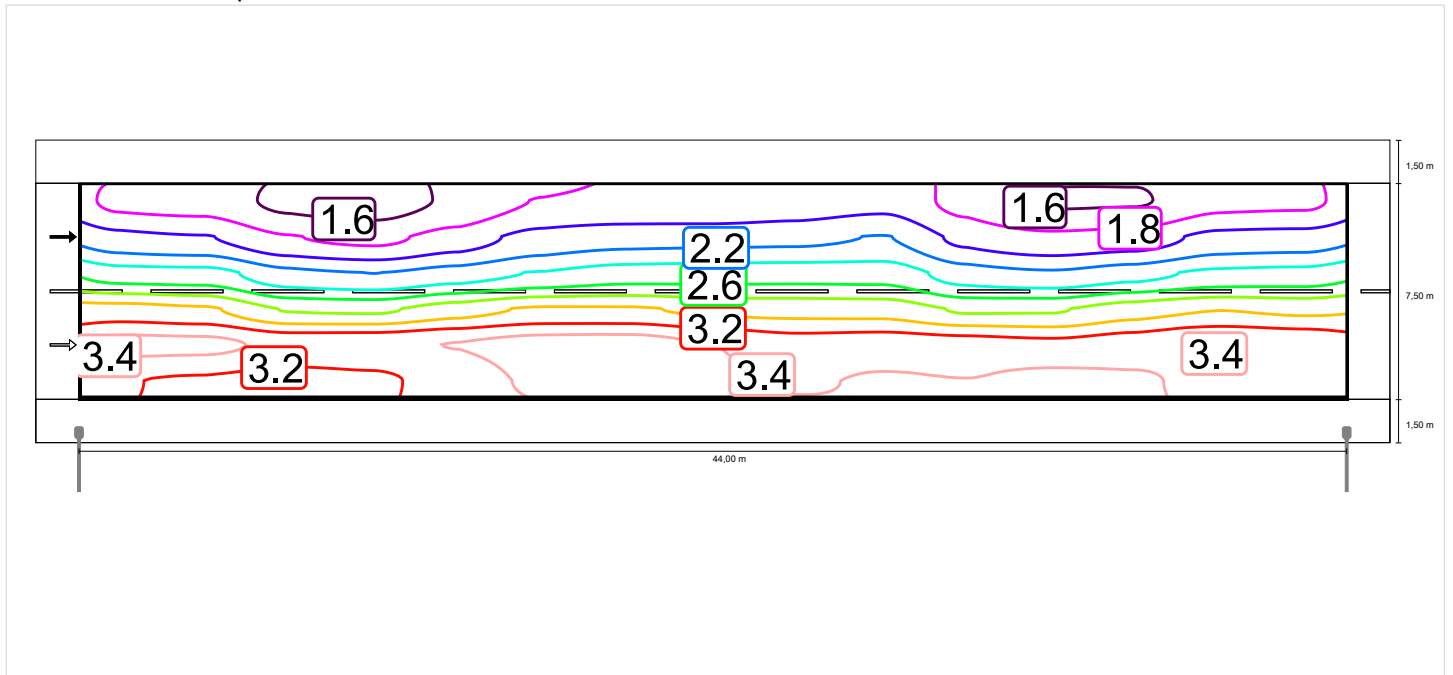

Carreggiata (M2)

Fattore di diminuzione: 0.67
 Reticolo: 15 x 6 Punti

Lm [cd/m²] ≥ 1.50	Uo ≥ 0.40	UI ≥ 0.70	TI [%] ≤ 10	EIR ≥ 0.35
✓ 1.61	✓ 0.57	✓ 0.79	✓ 10	✓ 0.78

Illuminamento orizzontale

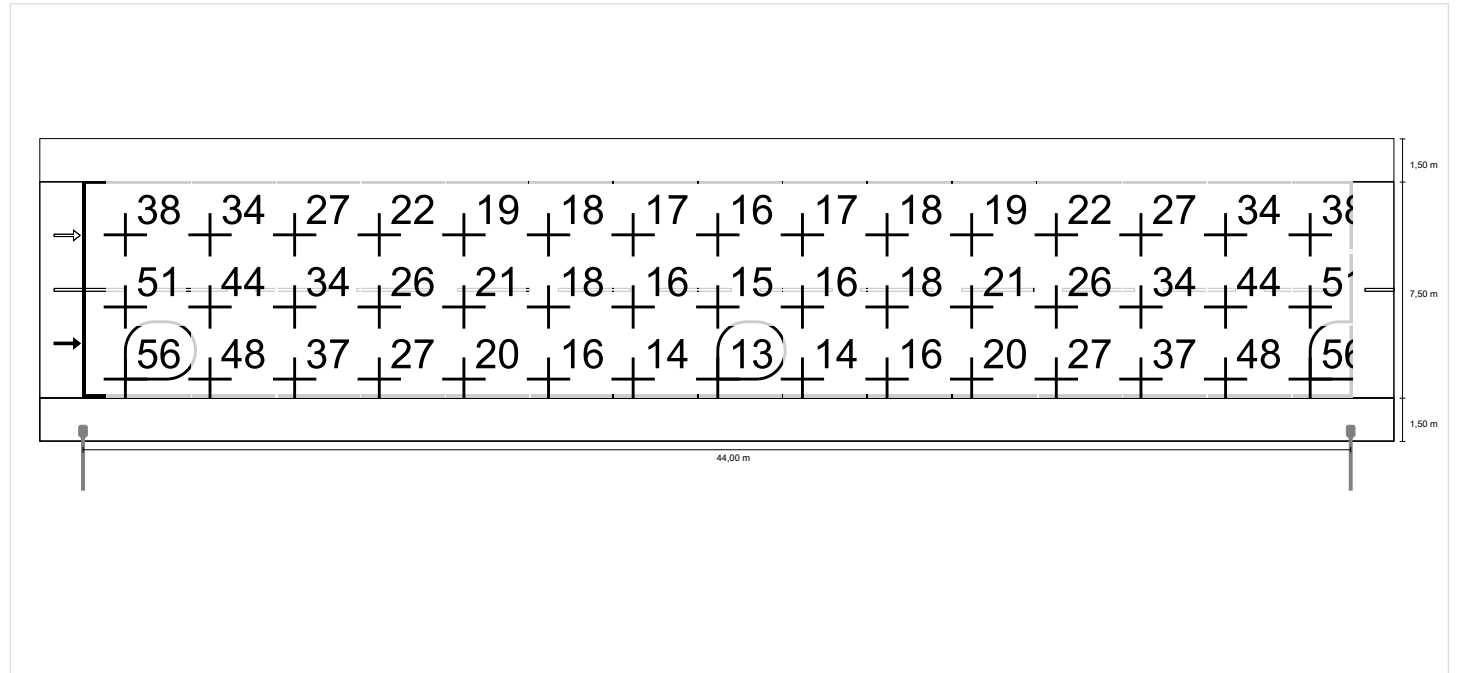

Osservatore 1

Luminanza con carreggiata asciutta

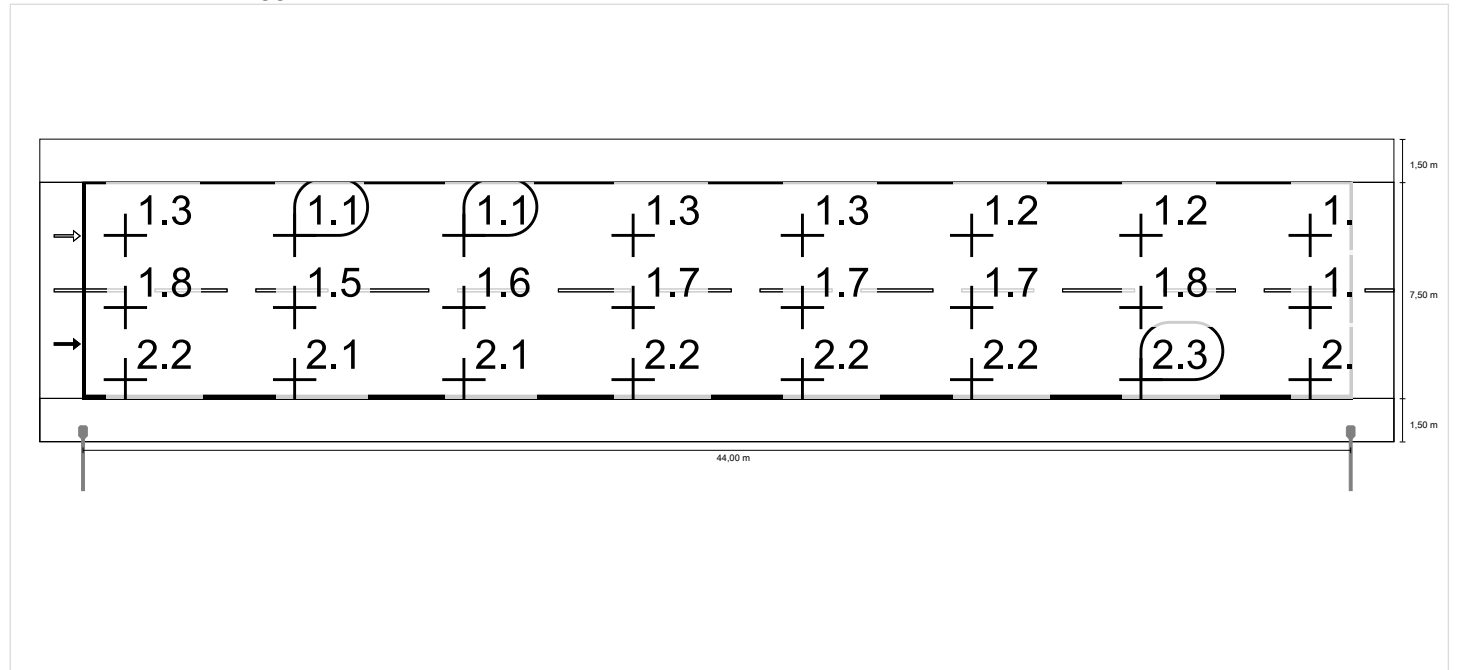

Luminanza con lampada nuova

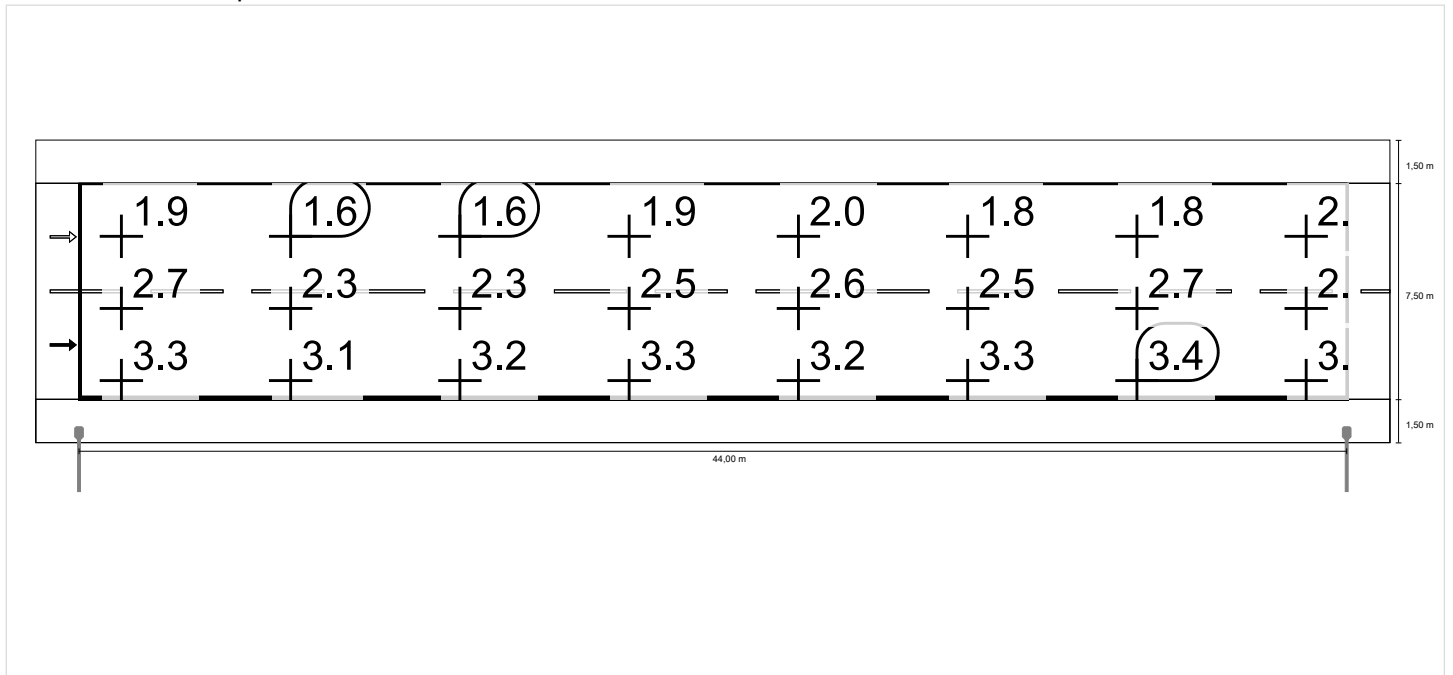

Osservatore 2

Luminanza con carreggiata asciutta

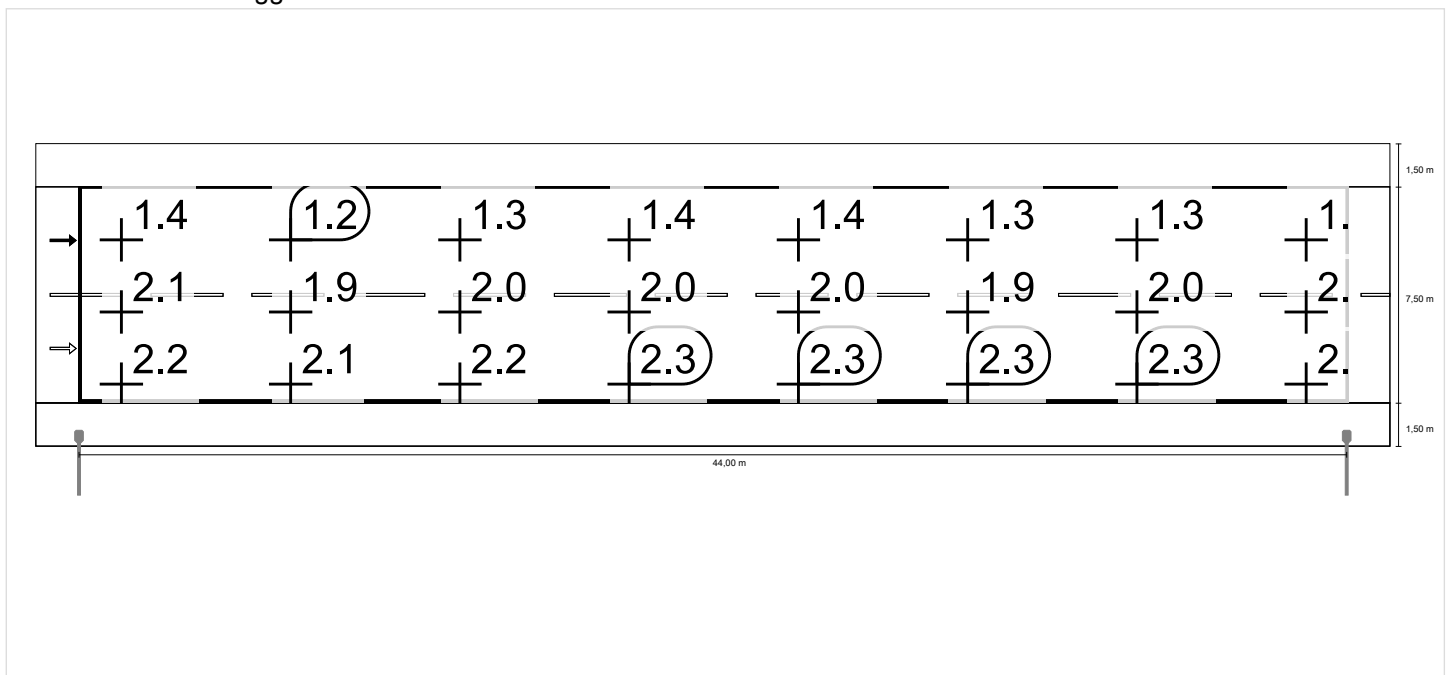

Luminanza con lampada nuova

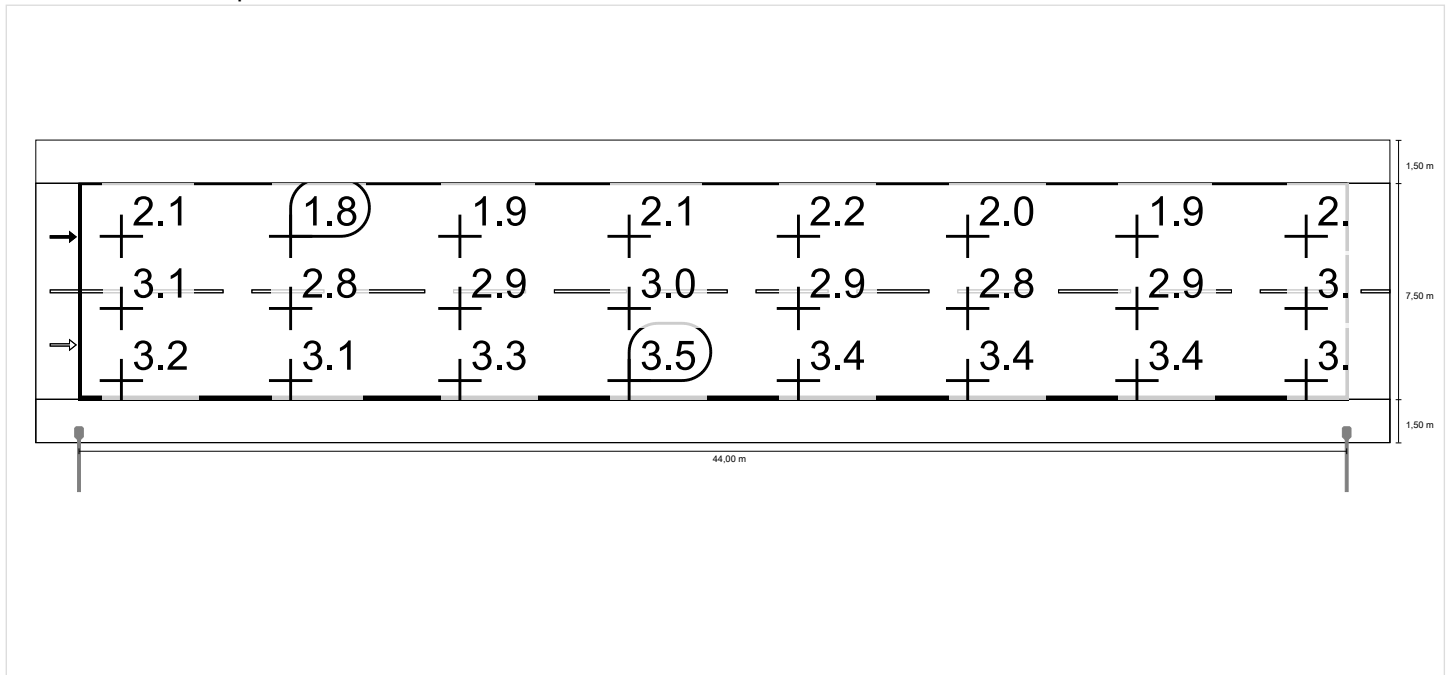

Variante di Mondovi'

Calcolo illuminotecnico asse secondario rotatoria est e ovest

Contenuto

Variante di Mondovi'

Descrizione.....	3
Lista lampade.....	4
Variante di Mondovi'	
AEC ILLUMINAZIONE SRL - ITALO 2 0F3 STW 4.5-6M (1xL-IT2-0F3-4000-525-6M-70-25).....	5
AEC ILLUMINAZIONE SRL - ITALO 2 0F3 STW 4.5-7M (1xL-IT2-0F3-4000-525-7M-70-25).....	8
Asse principale	
Disposizione lampade.....	11
Lista lampade.....	12
Superfici di calcolo.....	13
Rotatoria est / Illuminamento orizzontale.....	14
Rotatoria ovest / Illuminamento orizzontale.....	19

Variante di Mondovi'

Calcolo illuminotecnico asse secondario rotatoria est e ovest

Variante di Mondovi'

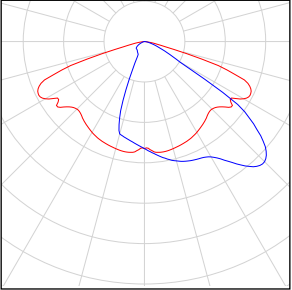
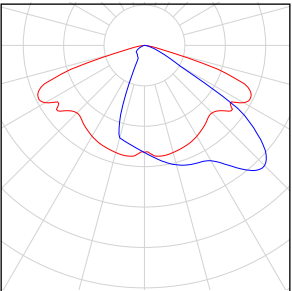
Numero di pezzi	Lampada (Emissione luminosa)		
4	<p>AEC ILLUMINAZIONE SRL - ITALO 2 0F3 STW 4.5-6M ITALO 2 0F3 STW 4.5-6M Emissione luminosa 1 Dotazione: 1xL-IT2-0F3-4000-525-6M-70-25 Rendimento: 100% Flusso luminoso lampadina: 15170 lm Flusso luminoso apparecchio: 15170 lm Potenza: 112.0 W Rendimento luminoso: 135.4 lm/W</p> <p>Indicazioni di colorimetria 1x: CCT 4000 K, CRI 70</p>	<p>Per un'immagine della lampada consultare il nostro catalogo lampade.</p>	
4	<p>AEC ILLUMINAZIONE SRL - ITALO 2 0F3 STW 4.5-7M ITALO 2 0F3 STW 4.5-7M Emissione luminosa 1 Dotazione: 1xL-IT2-0F3-4000-525-7M-70-25 Rendimento: 100% Flusso luminoso lampadina: 17590 lm Flusso luminoso apparecchio: 17590 lm Potenza: 131.0 W Rendimento luminoso: 134.3 lm/W</p> <p>Indicazioni di colorimetria 1x: CCT 4000 K, CRI 70</p>	<p>Per un'immagine della lampada consultare il nostro catalogo lampade.</p>	

Flusso luminoso lampadine complessivo: 131040 lm, Flusso luminoso lampade complessivo: 131040 lm, Potenza totale: 972.0 W, Rendimento luminoso: 134.8 lm/W

**AEC ILLUMINAZIONE SRL ITALO 2 0F3 STW 4.5-6M ITALO 2 0F3 STW 4.5-6M
1xL-IT2-0F3-4000-525-6M-70-25**

Per un'immagine della
lampada consultare il
nostro catalogo
lampade.

Rendimento: 100%
Flusso luminoso lampadina: 15170 lm
Flusso luminoso apparecchio: 15170 lm
Potenza: 112.0 W
Rendimento luminoso: 135.4 lm/W

Indicazioni di colorimetria
1x: CCT 4000 K, CRI 70

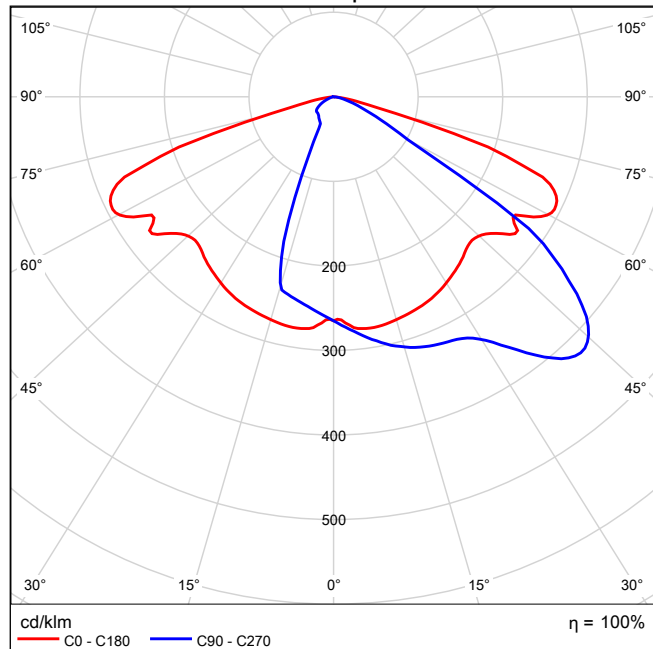
Emissione luminosa 1 / CDL polare

Emissione luminosa 1 / CDL lineare

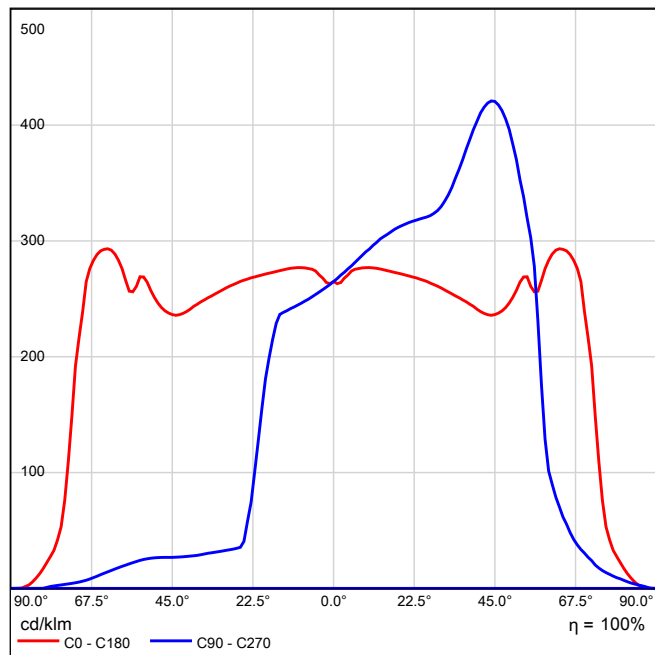

Non è possibile creare un diagramma conico, poiché la diffusione luminosa è asimmetrica.

Emissione luminosa 1 / Diagramma della luminanza

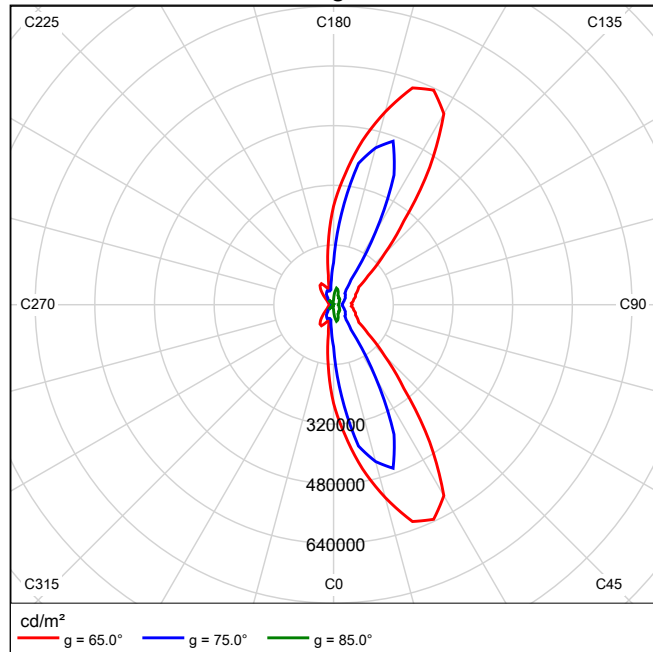

Non è possibile creare un diagramma UGR, poiché la diffusione luminosa è asimmetrica.

**AEC ILLUMINAZIONE SRL ITALO 2 0F3 STW 4.5-7M ITALO 2 0F3 STW 4.5-7M
1xL-IT2-0F3-4000-525-7M-70-25**

Per un'immagine della
lampada consultare il
nostro catalogo
lampade.

Rendimento: 100%
Flusso luminoso lampadina: 17590 lm
Flusso luminoso apparecchio: 17590 lm
Potenza: 131.0 W
Rendimento luminoso: 134.3 lm/W

Indicazioni di colorimetria
1x: CCT 4000 K, CRI 70

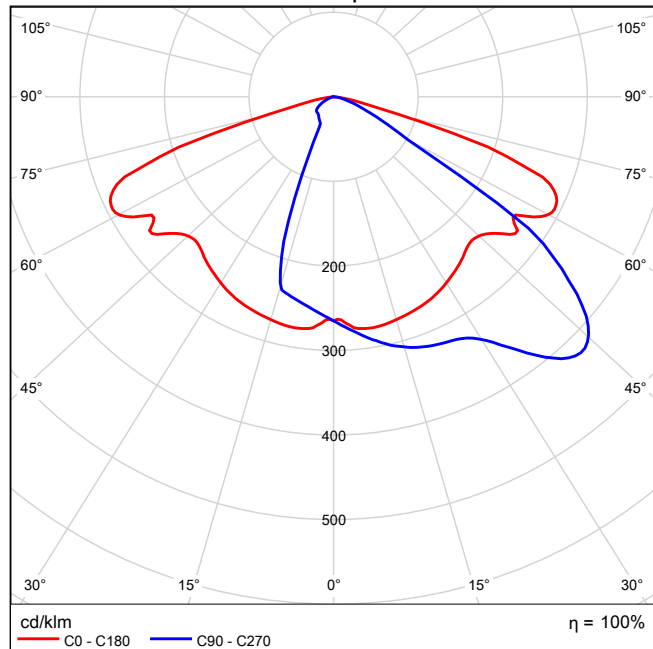
Emissione luminosa 1 / CDL polare

Emissione luminosa 1 / CDL lineare

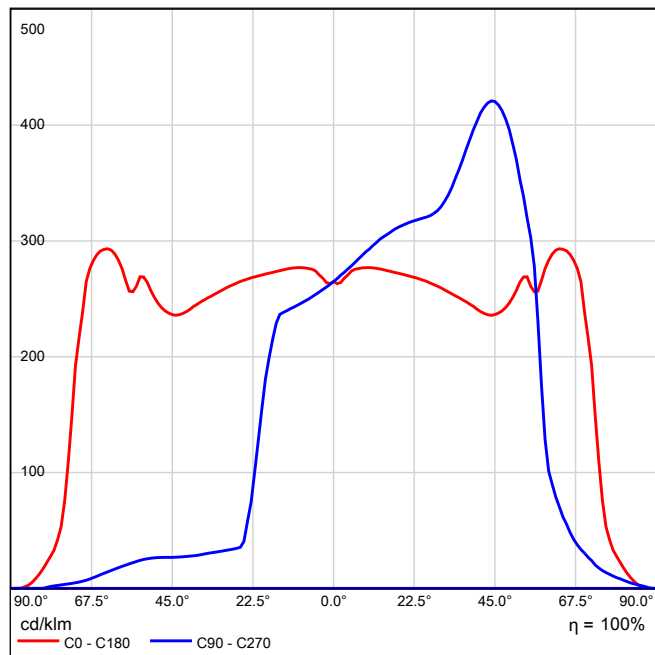

Non è possibile creare un diagramma conico, poiché la diffusione luminosa è asimmetrica.

Emissione luminosa 1 / Diagramma della luminanza

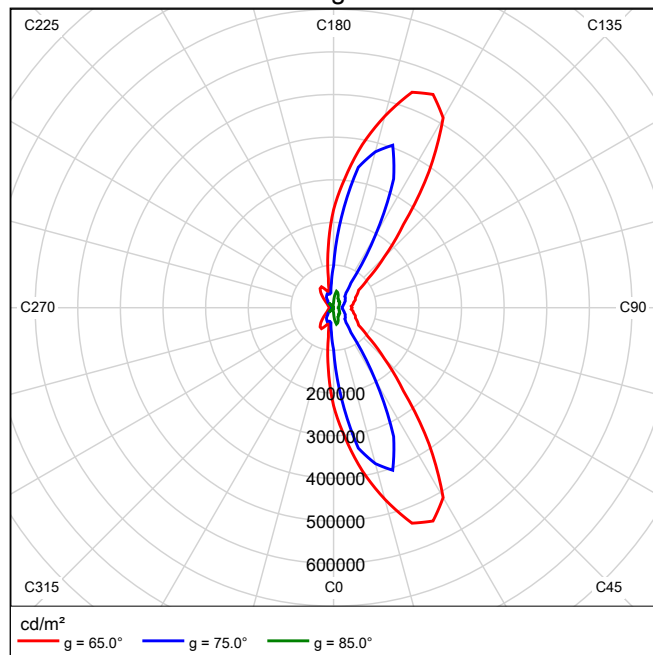

Non è possibile creare un diagramma UGR, poiché la diffusione luminosa è asimmetrica.

Asse principale



x

AEC ILLUMINAZIONE SRL ITALO 2 0F3 STW 4.5-7M ITALO 2 0F3 STW 4.5-7M

No.	X [m]	Y [m]	Altezza di montaggio [m]	Fattore di diminuzione
1	236.887	275.841	10.000	0.80
2	224.159	297.887	10.000	0.80
3	202.113	285.159	10.000	0.80
4	214.841	263.113	10.000	0.80

AEC ILLUMINAZIONE SRL ITALO 2 0F3 STW 4.5-6M ITALO 2 0F3 STW 4.5-6M

No.	X [m]	Y [m]	Altezza di montaggio [m]	Fattore di diminuzione
5	115.915	225.199	10.000	0.80
6	97.544	235.805	10.000	0.80
7	86.937	217.434	10.000	0.80
8	100.437	206.347	10.000	0.80

Asse principale

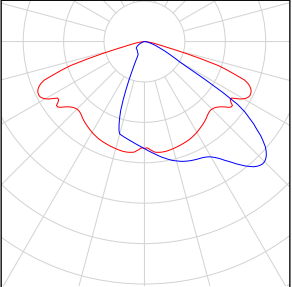
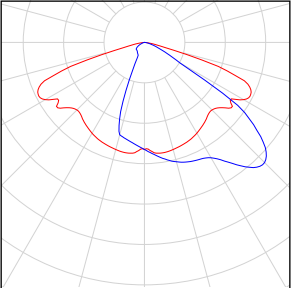
Numero di pezzi	Lampada (Emissione luminosa)		
4	<p>AEC ILLUMINAZIONE SRL - ITALO 2 0F3 STW 4.5-6M ITALO 2 0F3 STW 4.5-6M Emissione luminosa 1 Dotazione: 1xL-IT2-0F3-4000-525-6M-70-25 Rendimento: 100% Flusso luminoso lampadina: 15170 lm Flusso luminoso apparecchio: 15170 lm Potenza: 112.0 W Rendimento luminoso: 135.4 lm/W</p> <p>Indicazioni di colorimetria 1x: CCT 4000 K, CRI 70</p>	<p>Per un'immagine della lampada consultare il nostro catalogo lampade.</p>	
4	<p>AEC ILLUMINAZIONE SRL - ITALO 2 0F3 STW 4.5-7M ITALO 2 0F3 STW 4.5-7M Emissione luminosa 1 Dotazione: 1xL-IT2-0F3-4000-525-7M-70-25 Rendimento: 100% Flusso luminoso lampadina: 17590 lm Flusso luminoso apparecchio: 17590 lm Potenza: 131.0 W Rendimento luminoso: 134.3 lm/W</p> <p>Indicazioni di colorimetria 1x: CCT 4000 K, CRI 70</p>	<p>Per un'immagine della lampada consultare il nostro catalogo lampade.</p>	

Flusso luminoso lampadine complessivo: 131040 lm, Flusso luminoso lampade complessivo: 131040 lm, Potenza totale: 972.0 W, Rendimento luminoso: 134.8 lm/W

Asse principale

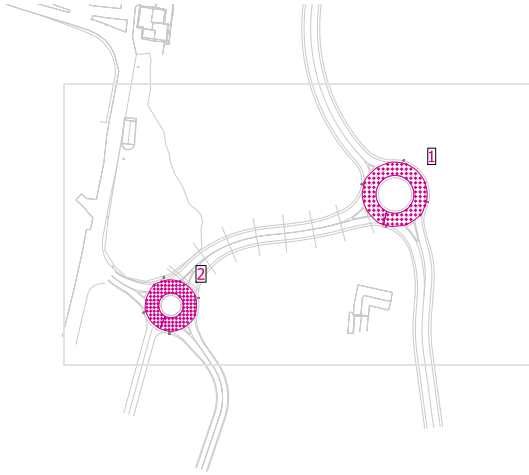

x

Fattore di diminuzione: 0.80

Generalità

Superficie	Risultato	Medio (Nominale)	Min	Max	Min/Medio	Min/Max
1 Rotatoria est	Illuminamento orizzontale [lx] Altezza: 0.000 m	34.0	27.4	42.6	0.81	0.64
2 Rotatoria ovest	Illuminamento orizzontale [lx] Altezza: 0.000 m	35.1	26.7	49.4	0.76	0.54

Rotatoria est / Illuminamento orizzontale

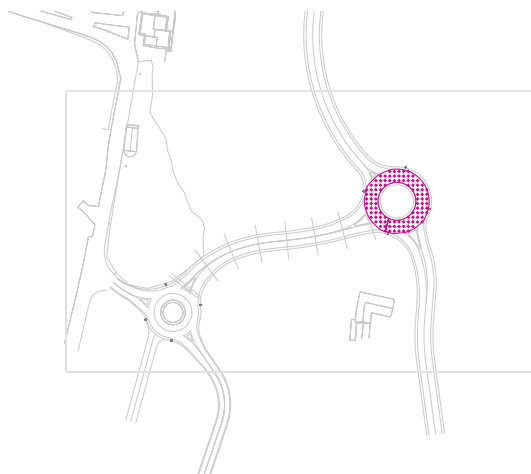

x

Fattore di diminuzione: 0.80

Rotatoria est: Illuminamento orizzontale (Reticolo)

Scena luce: Categoria illuminotecnica C1

Medio: 34.0 lx, Min: 27.4 lx, Max: 42.6 lx, Min/Medio: 0.81, Min/Max: 0.64

Altezza: 0.000 m

Isolinee [lx]

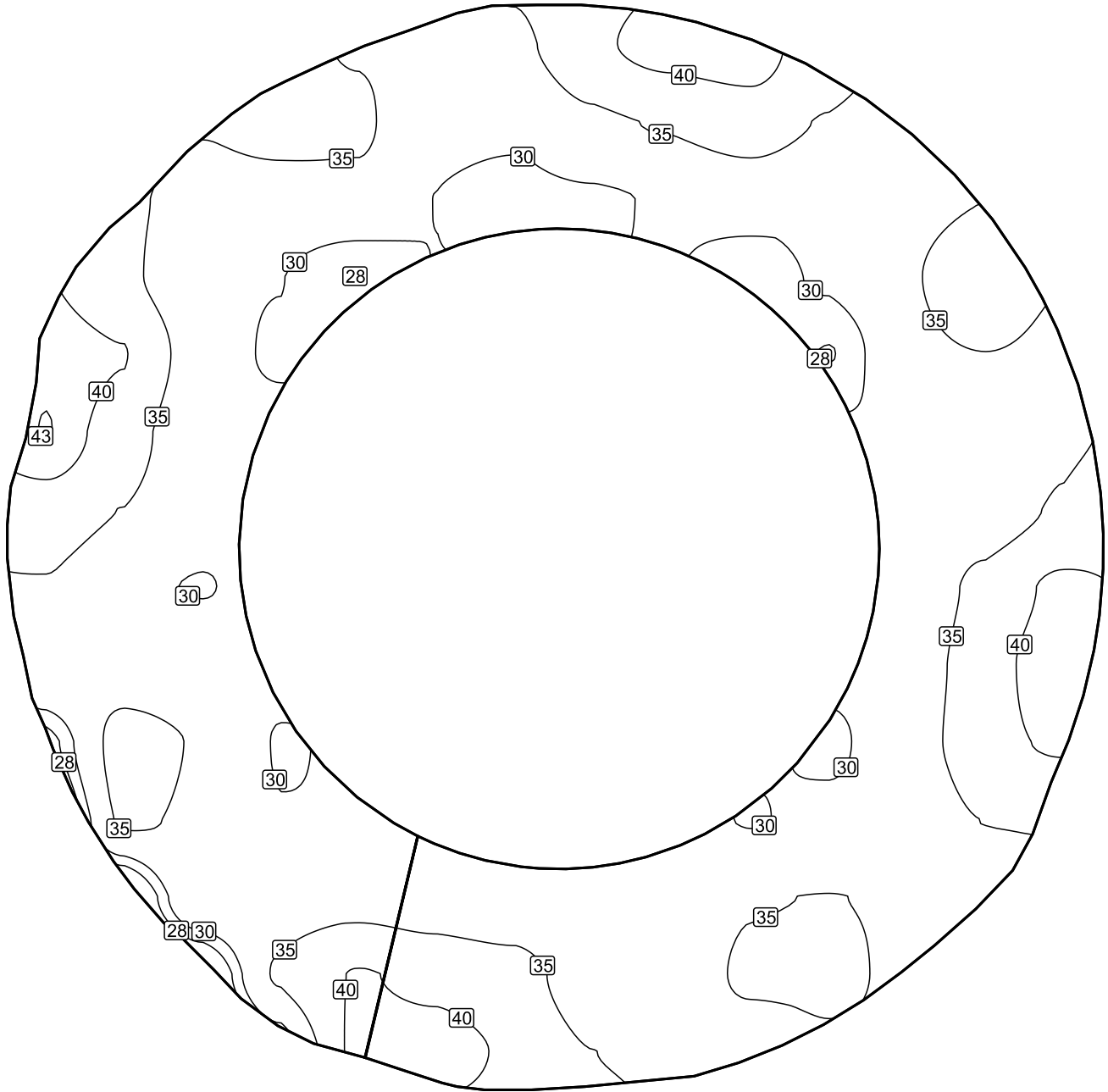

Scala: 1 : 200

Colori sfalsati [lx]

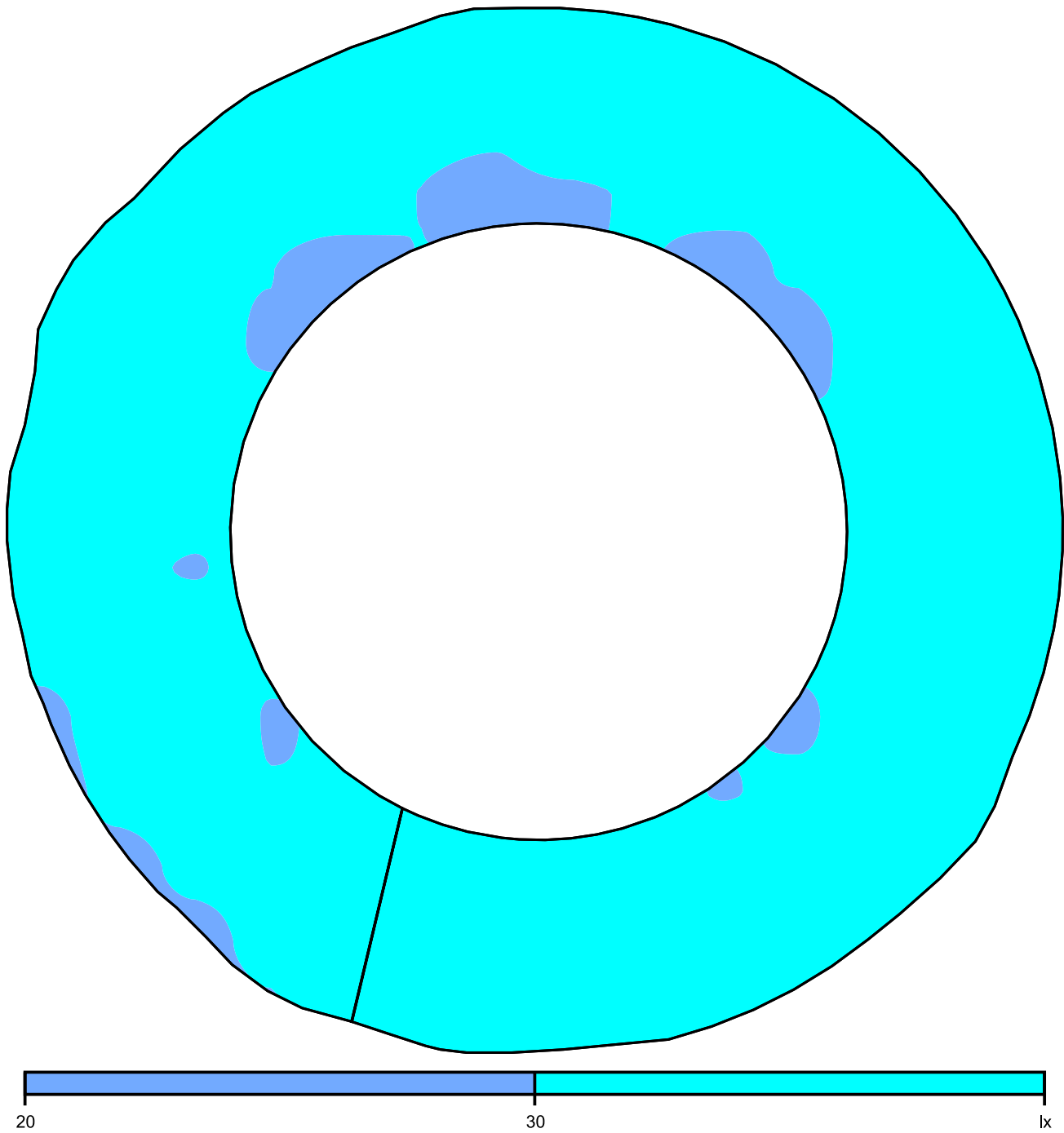

Scala: 1 : 200

Raster dei valori [lx]

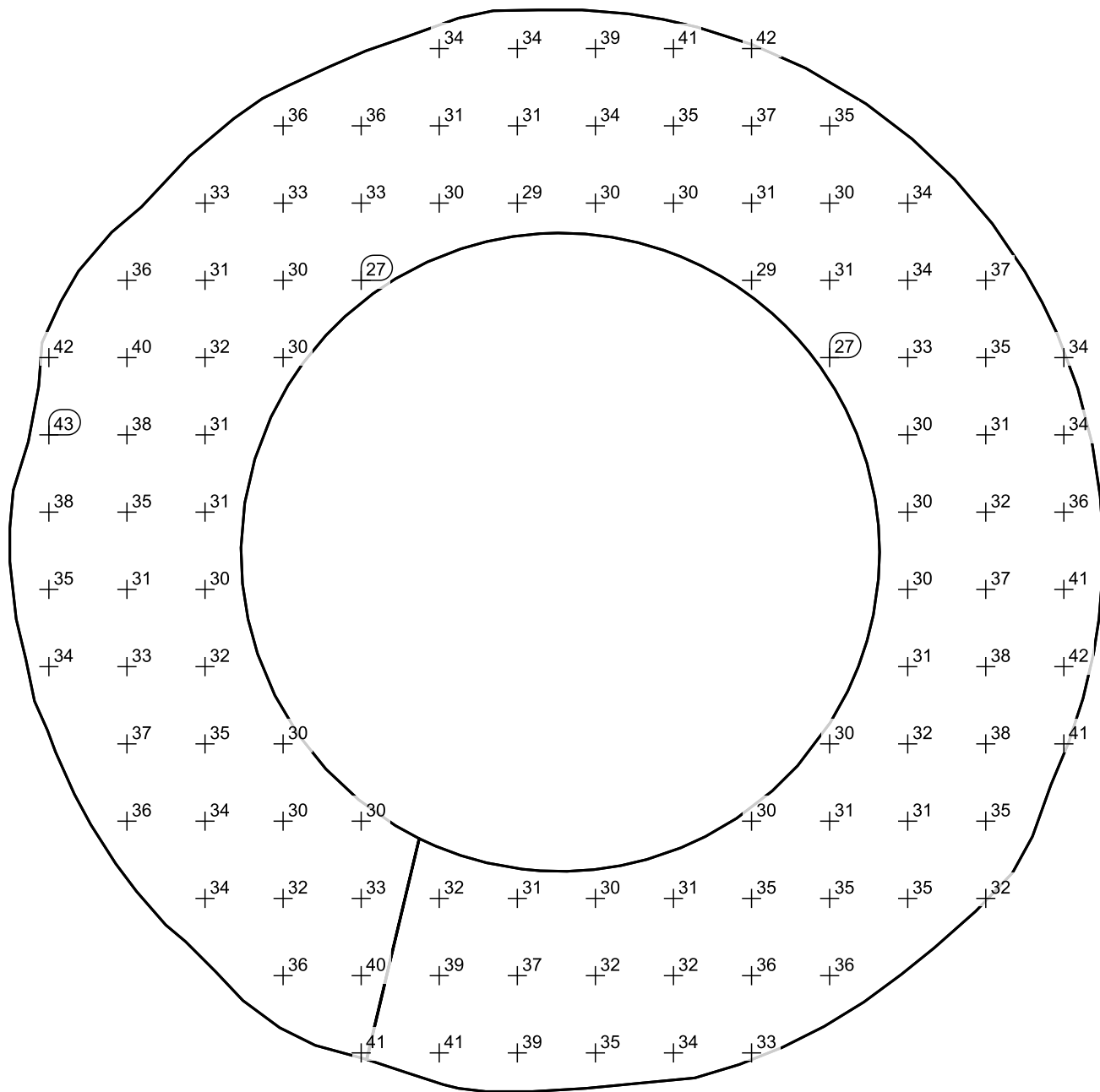

Scala: 1 : 200

Tabella valori [lx]

m	-15.889	-13.444	-10.999	-8.554	-6.109	-3.664	-1.219	1.226	3.671	6.116	8.561	11.006	13.452	15.897
15.901	/	/	/	/	/	34.2	34.1	39.0	41.4	41.9	/	/	/	/
13.481	/	/	/	36.4	35.7	31.2	30.5	33.7	35.4	37.4	34.6	/	/	/
11.061	/	/	33.3	32.8	33.3	30.0	29.3	29.6	30.3	31.3	30.1	33.6	/	/
8.641	/	36.4	31.2	30.1	27.5	/	/	/	/	28.6	30.5	34.4	36.9	/
6.221	42.1	40.2	32.5	29.6	/	/	/	/	/	/	27.4	33.4	34.9	34.0
3.801	42.6	37.7	31.2	/	/	/	/	/	/	/	/	30.2	30.7	34.4
1.381	38.0	34.9	30.8	/	/	/	/	/	/	/	/	30.2	31.9	35.6
-1.039	34.7	30.6	29.9	/	/	/	/	/	/	/	/	30.4	36.6	40.8
-3.460	34.4	32.5	31.7	/	/	/	/	/	/	/	/	31.3	38.2	41.6
-5.880	/	36.6	34.7	29.8	/	/	/	/	/	/	29.6	31.8	38.3	40.5
-8.300	/	35.7	34.2	30.2	30.2	/	/	/	/	29.8	30.9	31.2	35.1	/

Asse principale / Rotatoria est / Illuminamento orizzontale

m	-15.889	-13.444	-10.999	-8.554	-6.109	-3.664	-1.219	1.226	3.671	6.116	8.561	11.006	13.452	15.897
-10.720	/	/	34.4	31.9	33.2	32.0	31.3	30.3	30.9	34.7	35.1	34.5	31.7	/
-13.140	/	/	/	35.6	40.2	39.1	37.2	31.8	31.9	35.8	36.0	/	/	/
-15.560	/	/	/	/	41.0	41.4	39.4	35.0	34.2	32.6	/	/	/	/

Rotatoria ovest / Illuminamento orizzontale

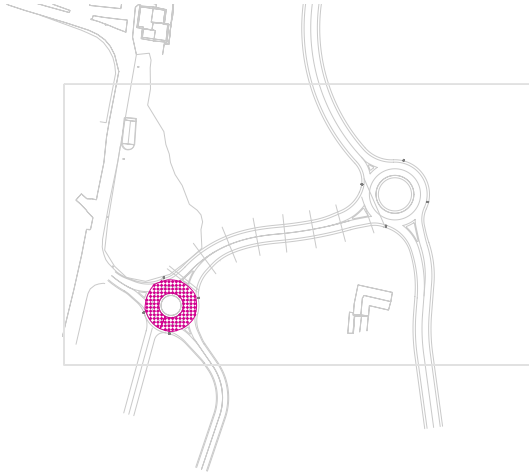

x

Fattore di diminuzione: 0.80

Rotatoria ovest: Illuminamento orizzontale (Reticolo)

Scena luce: Categoria illuminotecnica C1

Medio: 35.1 lx, Min: 26.7 lx, Max: 49.4 lx, Min/Medio: 0.76, Min/Max: 0.54

Altezza: 0.000 m

Isolinee [lx]

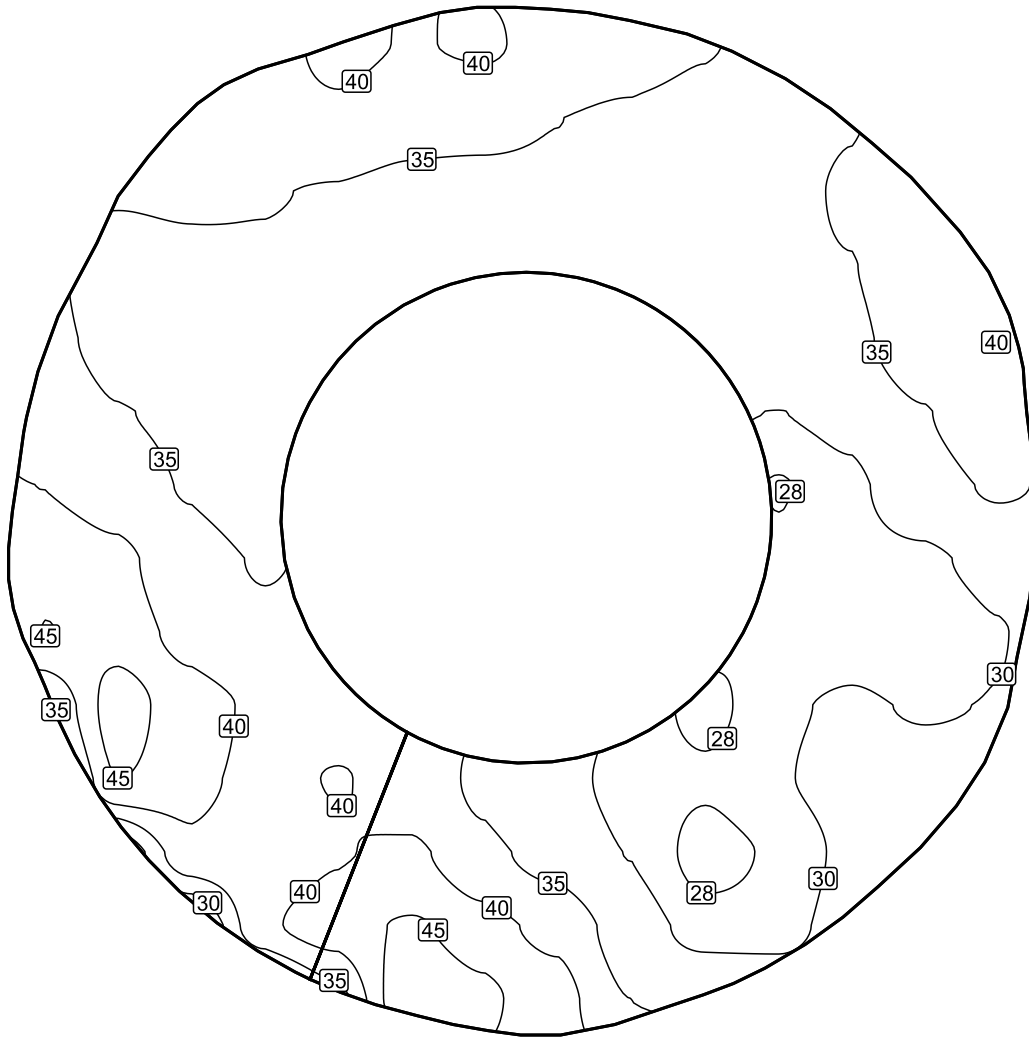

Scala: 1 : 200

Colori sfalsati [lx]

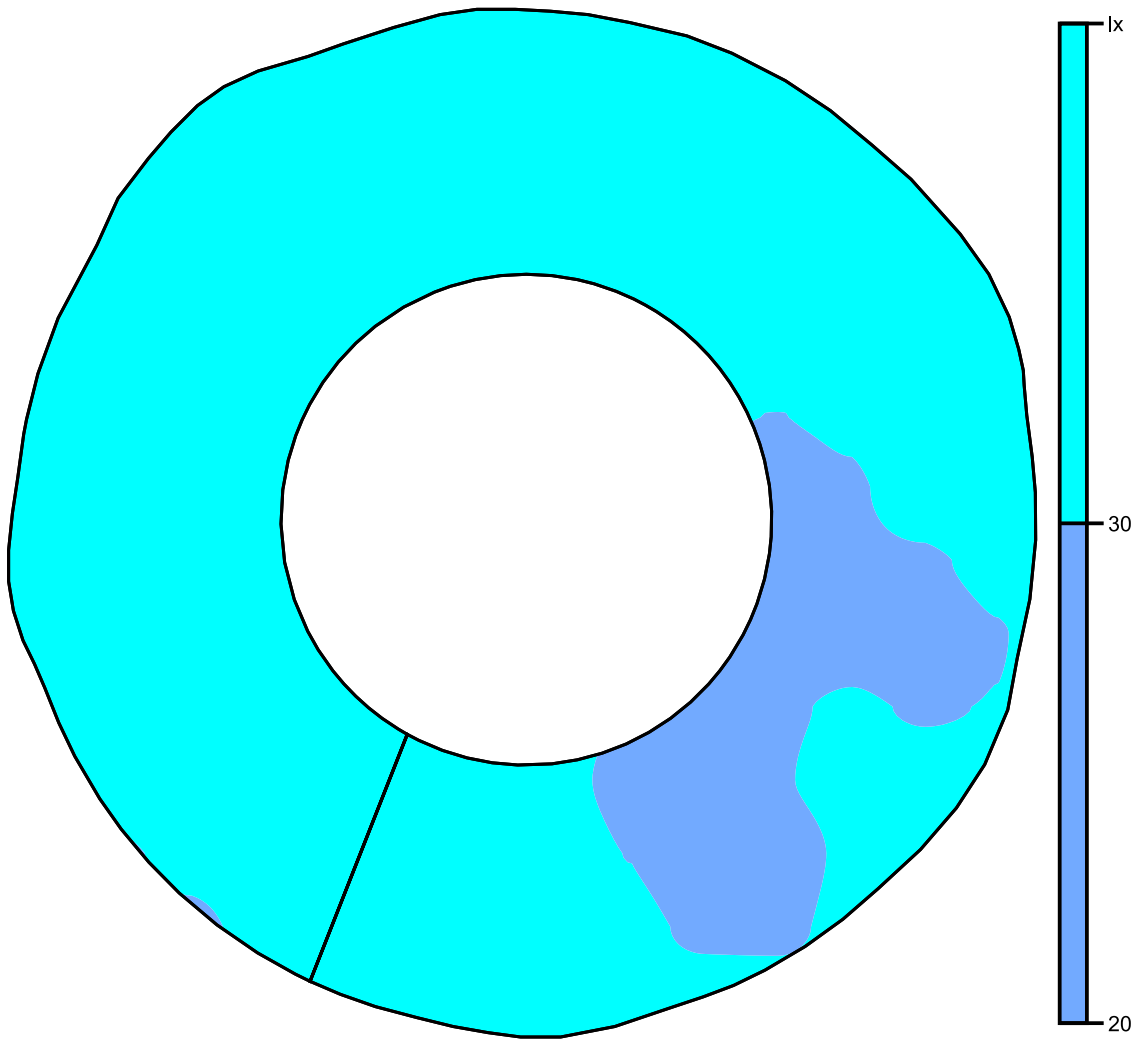

Scala: 1 : 200

Raster dei valori [lx]

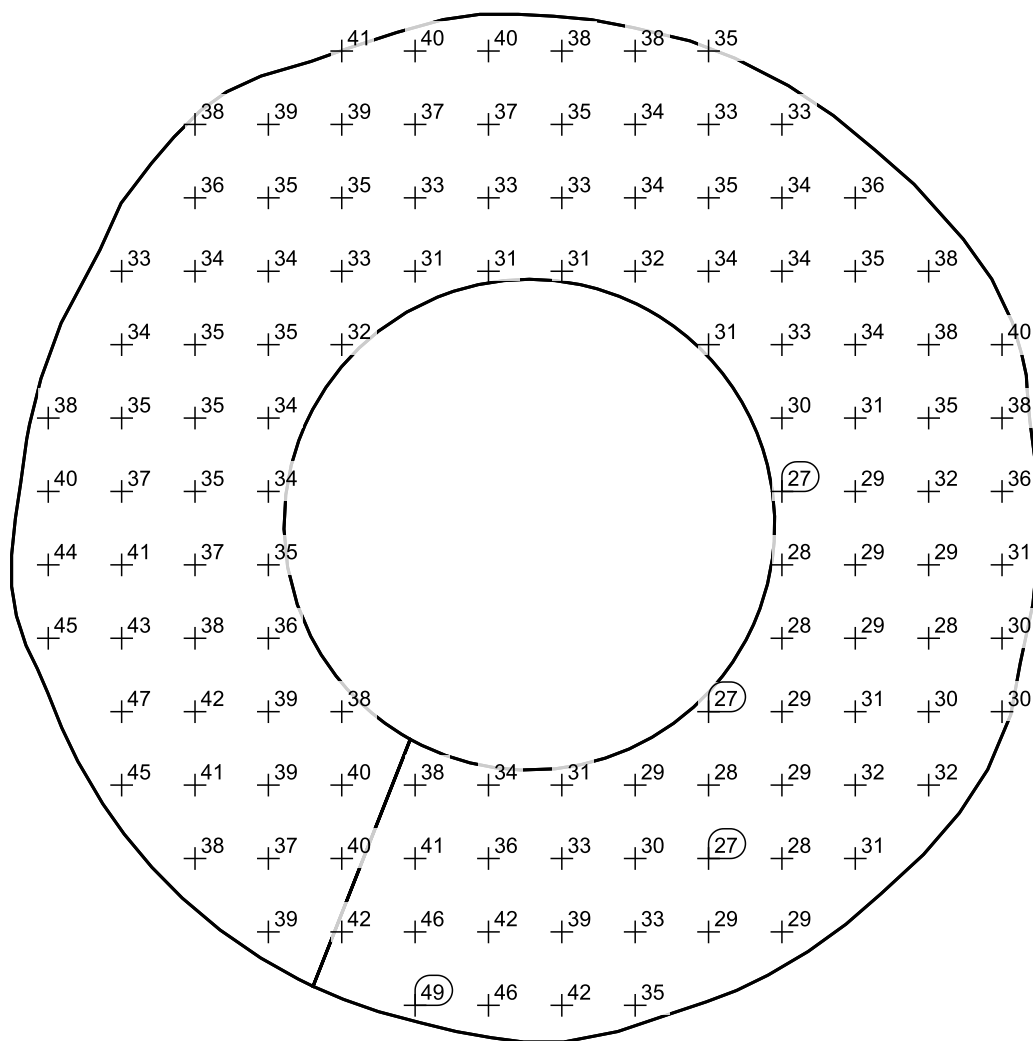

Scala: 1 : 200

Tabella valori [lx]

m	-12.545	-10.602	-8.659	-6.716	-4.773	-2.830	-0.887	1.055	2.998	4.941	6.884	8.827	10.770	12.713
12.777	/	/	/	/	40.6	39.8	40.4	38.4	37.6	35.4	/	/	/	/
10.833	/	/	38.2	38.5	39.2	37.2	36.9	35.1	34.3	33.3	32.8	/	/	/
8.889	/	/	36.0	35.4	34.6	33.2	32.6	33.0	34.0	34.8	33.7	35.6	/	/
6.945	/	32.9	33.7	34.3	33.2	31.5	30.7	31.2	32.3	34.0	33.8	34.8	38.2	/
5.001	/	33.8	34.6	34.9	32.1	/	/	/	/	30.9	32.5	33.7	38.4	40.0
3.057	38.4	35.2	34.6	33.5	/	/	/	/	/	/	30.0	31.2	34.7	37.6
1.113	40.0	37.3	34.7	33.6	/	/	/	/	/	/	27.4	29.2	32.4	35.6
-0.831	43.6	41.3	36.7	34.8	/	/	/	/	/	/	27.8	28.8	29.3	31.3
-2.774	45.1	43.2	38.3	36.0	/	/	/	/	/	/	27.5	28.6	27.7	29.8
-4.718	/	47.1	41.9	39.4	38.1	/	/	/	/	26.7	29.2	30.5	29.6	30.2
-6.662	/	45.0	41.1	39.1	40.2	38.5	34.0	31.3	29.1	27.8	29.5	31.5	32.0	/
-8.606	/	/	38.5	36.6	39.6	40.7	36.4	33.3	29.9	26.8	27.7	30.7	/	/
-10.550	/	/	/	38.7	42.2	45.7	42.0	38.5	32.8	28.6	28.5	/	/	/
-12.494	/	/	/	/	/	49.4	46.1	42.1	35.0	/	/	/	/	/

Variante di Mondovi'

Calcolo illuminotecnico ramo di collegamento tra rotatorie asse secondario

Contenuto

Variante di Mondovì

Variante di Mondovì

AEC ILLUMINAZIONE SRL - ITALO 3 0F3 STE-M 4.5-13M (1xL-IT3-0F3-4000-525-13M-70-25).....	3
Ramo ingresso/uscita asse principale rotatoria Est: Alternativa 1	
Risultati della pianificazione.....	6
Ramo ingresso/uscita asse principale rotatoria Est: Alternativa 1 / Carreggiata (M2)	
Sintesi dei risultati.....	7
Tabella.....	8
Isolinee.....	11
Grafica dei valori.....	14

AEC ILLUMINAZIONE SRL ITALO 3 0F3 STE-M 4.5-13M ITALO 3 0F3 STE-M 4.5-13M 1xL-IT3-0F3-4000-525-13M-70-25

Per un'immagine della lampada consultare il nostro catalogo lampade.

Rendimento: 100.00%
 Flusso luminoso lampadina: 32840 lm
 Flusso luminoso apparecchio: 32839 lm
 Potenza: 247.0 W
 Rendimento luminoso: 133.0 lm/W

Emissione luminosa 1 / CDL polare

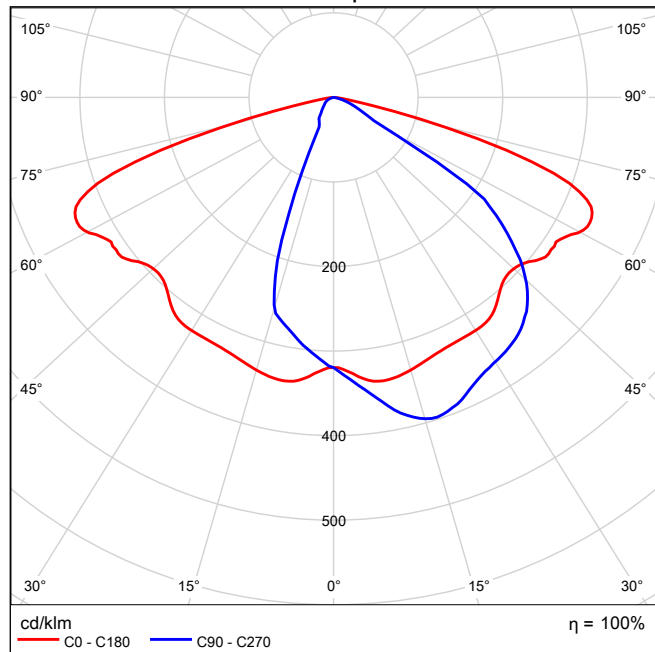

Emissione luminosa 1 / CDL lineare

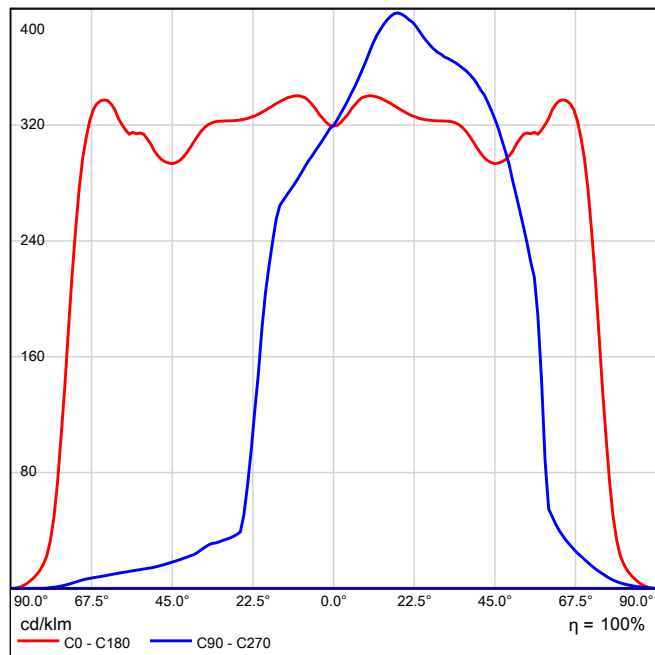

Non è possibile creare un diagramma conico, poiché la diffusione luminosa è asimmetrica.

Emissione luminosa 1 / Diagramma della luminanza

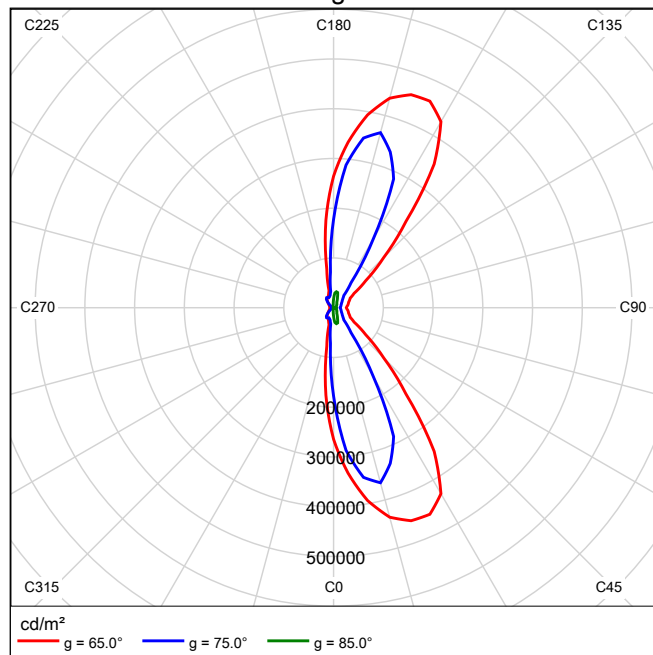

Non è possibile creare un diagramma UGR, poiché la diffusione luminosa è asimmetrica.

Ramo ingresso/uscita asse principale rotatoria Est in direzione EN 13201:2015

AEC ILLUMINAZIONE SRL ITALO 3 0F3 STE-M 4.5-13M ITALO 3 0F3 STE-M 4.5-13M

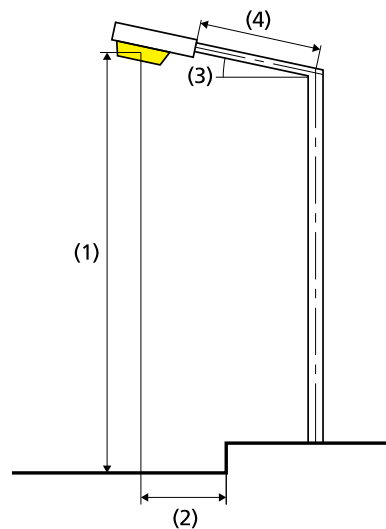
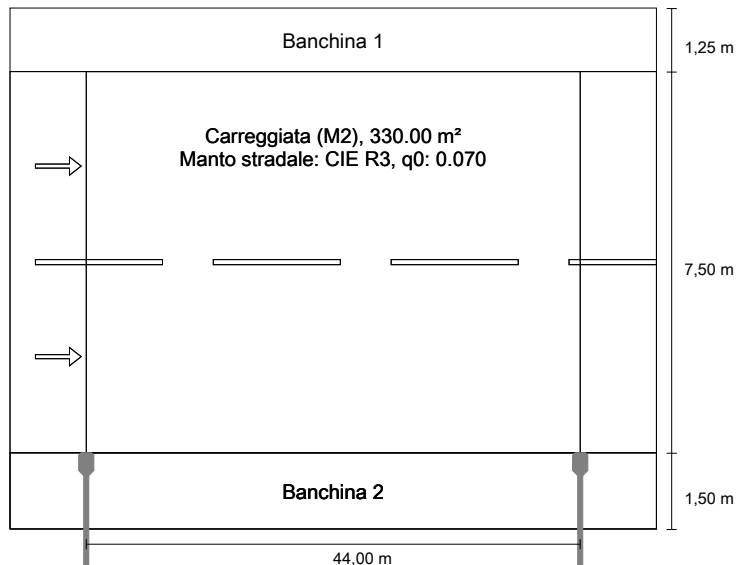

Risultati per i campi di valutazione

Fattore di diminuzione: 0.67

Carreggiata (M2)

Lm [cd/m²] ≥ 1.50	U ₀ ≥ 0.40	U ₁ ≥ 0.70	TI [%] ≤ 10	EIR ≥ 0.35
✓ 1.70	✓ 0.57	✓ 0.81	✓ 9	✓ 0.74

Risultati per gli indicatori dell'efficienza energetica

Indice della densità di potenza (Dp) 0.027 W/lxm²

Densità di consumo energetico

Disposizione: ITALO 3 0F3 STE-M 4.5-13M (988.0 kWh/anno) 3.0 kWh/m² anno

Lampadina:	1xL-IT3-0F3-4000-525-13M-70-25
Flusso luminoso (lampada):	32838.74 lm
Flusso luminoso (lampadina):	32840.00 lm
Ore di esercizio	
4000 h:	100.0 %, 247.0 W
W/km:	5681.0
Disposizione:	su un lato sotto
Distanza pali:	44.000 m
Inclinazione braccio (3):	0.0°
Lunghezza braccio (4):	2.000 m
Altezza fuochi (1):	12.000 m
Sporgenza punto luce (2):	-0.250 m

ULR: -1.00

ULOR: 0.00

Valori massimi dell'intensità luminosa

a 70° e oltre 495 cd/klm *

a 80° e oltre 56.9 cd/klm *

a 90° e oltre 0.00 cd/klm *

Classe intensità luminose: G*4

Per tutte le direzioni che, per le lampade installate e utilizzabili, formano l'angolo indicato con le verticali inferiori.

* I valori di intensità luminosa in [cd/klm] per il calcolo della classe di intensità luminosa, si riferiscono al flusso di emissione dell'apparecchio secondo la norma EN 13201:2015.

La disposizione rispetta la classe degli indici di abbagliamento D.3

Carreggiata (M2)

Fattore di diminuzione: 0.67

Reticolo: 15 x 6 Punti

Lm [cd/m ²] ≥ 1.50	Uo ≥ 0.40	UI ≥ 0.70	TI [%] ≤ 10	EIR ≥ 0.35
✓ 1.70	✓ 0.57	✓ 0.81	✓ 9	✓ 0.74

Osservatori corrispondenti (2):

Osservatore	Posizione [m]	Lm [cd/m ²] ≥ 1.50	Uo ≥ 0.40	UI ≥ 0.70	TI [%] ≤ 10
Osservatore 1	(-60.000, 3.375, 1.500)	1.70	0.57	0.88	9
Osservatore 2	(-60.000, 7.125, 1.500)	1.84	0.60	0.81	8

Carreggiata (M2)

Illuminamento orizzontale [lx]

8.375	36.8	33.2	26.2	21.2	19.2	18.3	16.9	16.4	16.9	18.3	19.2	21.2	26.2	33.2	36.8
7.125	42.5	37.6	28.8	22.7	19.8	18.1	16.6	16.1	16.6	18.1	19.8	22.7	28.8	37.6	42.5
5.875	49.4	43.1	32.7	25.4	21.0	18.0	16.0	15.5	16.0	18.0	21.0	25.4	32.7	43.1	49.4
4.625	54.7	47.5	36.2	27.8	21.6	17.5	15.2	14.7	15.2	17.5	21.6	27.8	36.2	47.5	54.7
3.375	56.1	48.2	37.1	27.7	20.6	16.4	14.1	13.5	14.1	16.4	20.6	27.7	37.1	48.2	56.1
2.125	54.0	45.8	34.8	25.1	18.2	14.8	12.7	12.2	12.7	14.8	18.2	25.1	34.8	45.8	54.0
m	1.467	4.400	7.333	10.267	13.200	16.133	19.067	22.000	24.933	27.867	30.800	33.733	36.667	39.600	42.533

Reticolo: 15 x 6 Punti

Em [lx]	Emin [lx]	Emax [lx]	g1	g2
27.9	12.2	56.1	0.438	0.218

Osservatore 1

Luminanza con carreggiata asciutta [cd/m²]

8.375	1.22	1.17	1.02	0.97	1.05	1.17	1.19	1.20	1.25	1.28	1.16	1.08	1.13	1.26	1.27
7.125	1.41	1.36	1.17	1.12	1.20	1.30	1.36	1.38	1.41	1.46	1.35	1.31	1.36	1.48	1.48
5.875	1.68	1.61	1.39	1.33	1.39	1.51	1.57	1.59	1.63	1.67	1.61	1.63	1.70	1.77	1.76
4.625	1.95	1.88	1.72	1.68	1.73	1.79	1.83	1.84	1.87	1.92	1.89	1.95	2.02	2.05	1.99
3.375	2.14	2.06	1.97	1.94	1.99	2.07	2.12	2.10	2.07	2.13	2.16	2.20	2.21	2.20	2.16
2.125	2.12	2.04	2.00	1.97	2.00	2.10	2.15	2.14	2.10	2.13	2.09	2.16	2.18	2.18	2.15
m	1.467	4.400	7.333	10.267	13.200	16.133	19.067	22.000	24.933	27.867	30.800	33.733	36.667	39.600	42.533

Reticolo: 15 x 6 Punti

Lm [cd/m ²]	Lmin [cd/m ²]	Lmax [cd/m ²]	g1	g2
1.70	0.97	2.21	0.571	0.438

Luminanza con lampada nuova [cd/m²]

8.375	1.82	1.74	1.52	1.44	1.57	1.75	1.78	1.79	1.87	1.92	1.73	1.62	1.69	1.87	1.90
7.125	2.10	2.02	1.75	1.68	1.79	1.94	2.02	2.06	2.10	2.19	2.01	1.95	2.03	2.20	2.21
5.875	2.51	2.40	2.07	1.98	2.08	2.25	2.34	2.38	2.44	2.50	2.41	2.43	2.54	2.64	2.63
4.625	2.91	2.81	2.56	2.51	2.58	2.68	2.72	2.74	2.79	2.86	2.82	2.92	3.01	3.06	2.98
3.375	3.19	3.08	2.94	2.90	2.97	3.09	3.17	3.14	3.10	3.18	3.22	3.29	3.29	3.28	3.23
2.125	3.16	3.05	2.98	2.94	2.99	3.13	3.21	3.20	3.14	3.19	3.12	3.22	3.25	3.26	3.21
m	1.467	4.400	7.333	10.267	13.200	16.133	19.067	22.000	24.933	27.867	30.800	33.733	36.667	39.600	42.533

Reticolo: 15 x 6 Punti

Lm [cd/m ²]	Lmin [cd/m ²]	Lmax [cd/m ²]	g1	g2
2.53	1.44	3.29	0.571	0.438

Osservatore 2

Luminanza con carreggiata asciutta [cd/m²]

8.375	1.30	1.27	1.14	1.10	1.18	1.29	1.34	1.33	1.37	1.41	1.24	1.17	1.19	1.31	1.32
7.125	1.55	1.52	1.36	1.29	1.38	1.51	1.56	1.56	1.59	1.59	1.45	1.40	1.46	1.56	1.57
5.875	1.87	1.85	1.69	1.68	1.76	1.83	1.82	1.84	1.85	1.84	1.75	1.74	1.82	1.86	1.85
4.625	2.25	2.22	2.09	2.06	2.12	2.19	2.20	2.15	2.11	2.12	2.09	2.10	2.16	2.21	2.17
3.375	2.26	2.25	2.21	2.19	2.25	2.34	2.38	2.31	2.25	2.31	2.29	2.32	2.30	2.29	2.27
2.125	1.94	1.86	1.82	1.83	1.92	2.06	2.12	2.12	2.09	2.12	2.07	2.14	2.15	2.14	2.11
m	1.467	4.400	7.333	10.267	13.200	16.133	19.067	22.000	24.933	27.867	30.800	33.733	36.667	39.600	42.533

Reticolo: 15 x 6 Punti

Lm [cd/m ²]	Lmin [cd/m ²]	Lmax [cd/m ²]	g1	g2
1.84	1.10	2.38	0.597	0.461

Luminanza con lampada nuova [cd/m²]

8.375	1.93	1.90	1.71	1.64	1.76	1.93	2.01	1.99	2.04	2.10	1.85	1.75	1.77	1.96	1.97
7.125	2.32	2.28	2.03	1.92	2.07	2.26	2.33	2.32	2.37	2.38	2.16	2.09	2.17	2.33	2.35
5.875	2.79	2.76	2.53	2.51	2.63	2.73	2.72	2.74	2.76	2.74	2.61	2.60	2.72	2.78	2.76
4.625	3.36	3.32	3.12	3.08	3.16	3.26	3.28	3.21	3.14	3.16	3.12	3.13	3.22	3.31	3.24
3.375	3.37	3.36	3.29	3.28	3.36	3.50	3.55	3.45	3.36	3.44	3.42	3.47	3.43	3.41	3.38
2.125	2.89	2.78	2.72	2.73	2.86	3.07	3.16	3.16	3.12	3.16	3.10	3.19	3.21	3.20	3.14
m	1.467	4.400	7.333	10.267	13.200	16.133	19.067	22.000	24.933	27.867	30.800	33.733	36.667	39.600	42.533

Reticolo: 15 x 6 Punti

Lm [cd/m ²]	Lmin [cd/m ²]	Lmax [cd/m ²]	g1	g2
2.74	1.64	3.55	0.597	0.461

Carreggiata (M2)

Fattore di diminuzione: 0.67
 Reticolo: 15 x 6 Punti

Lm [cd/m ²]	U _o	U _I	TI [%]	EIR
≥ 1.50	≥ 0.40	≥ 0.70	≤ 10	≥ 0.35
✓ 1.70	✓ 0.57	✓ 0.81	✓ 9	✓ 0.74

Illuminamento orizzontale

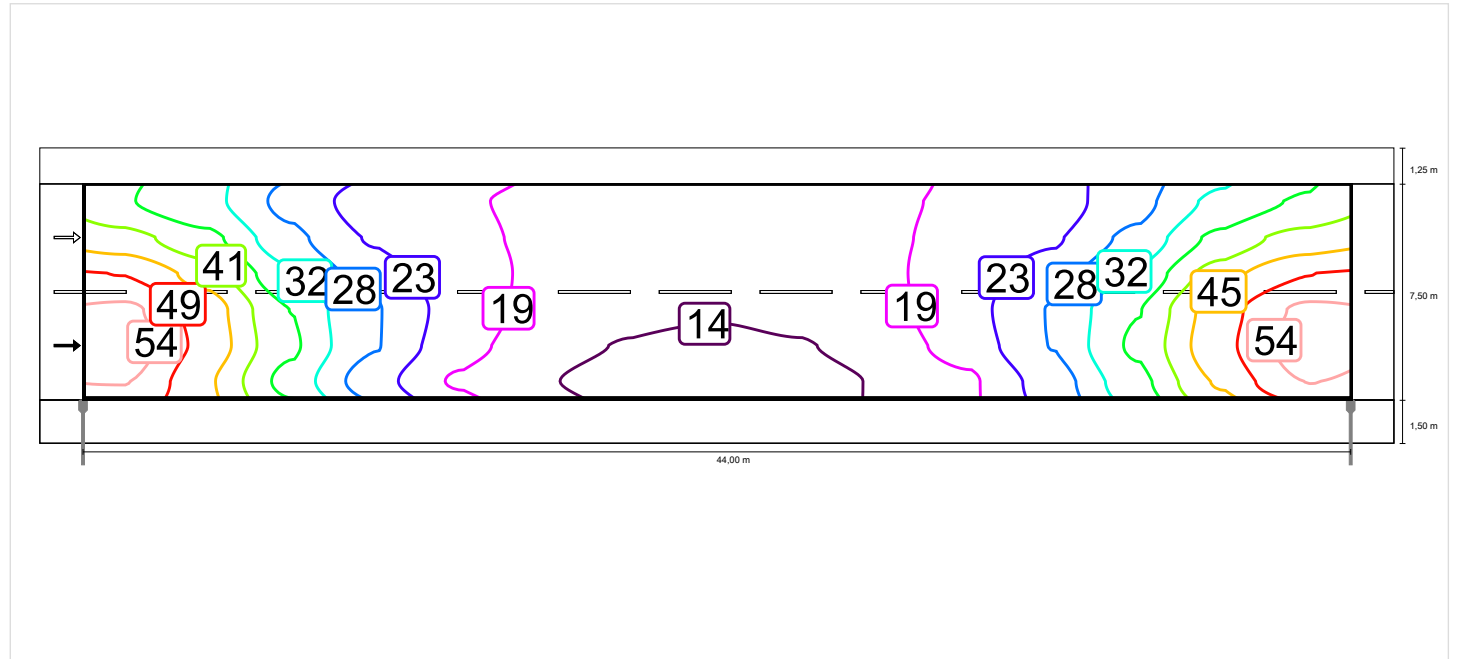

Osservatore 1

Luminanza con carreggiata asciutta

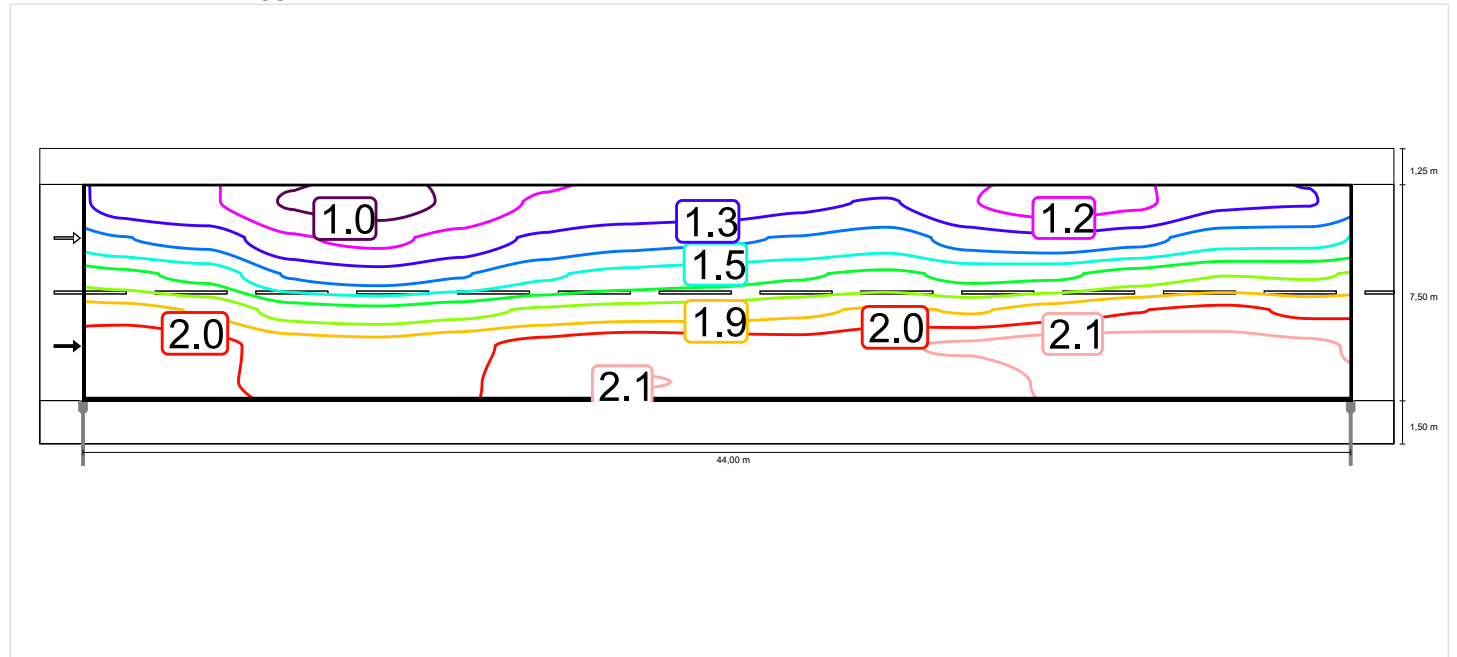

Luminanza con lampada nuova

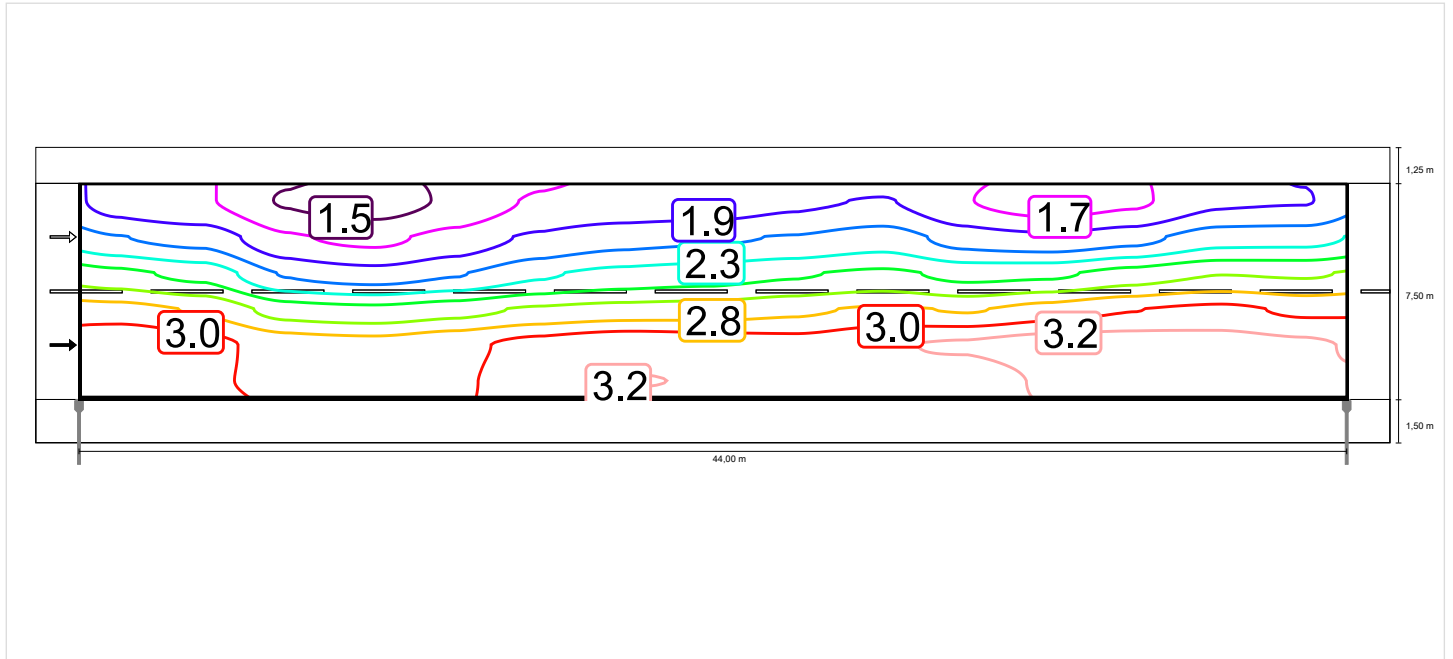

Osservatore 2

Luminanza con carreggiata asciutta

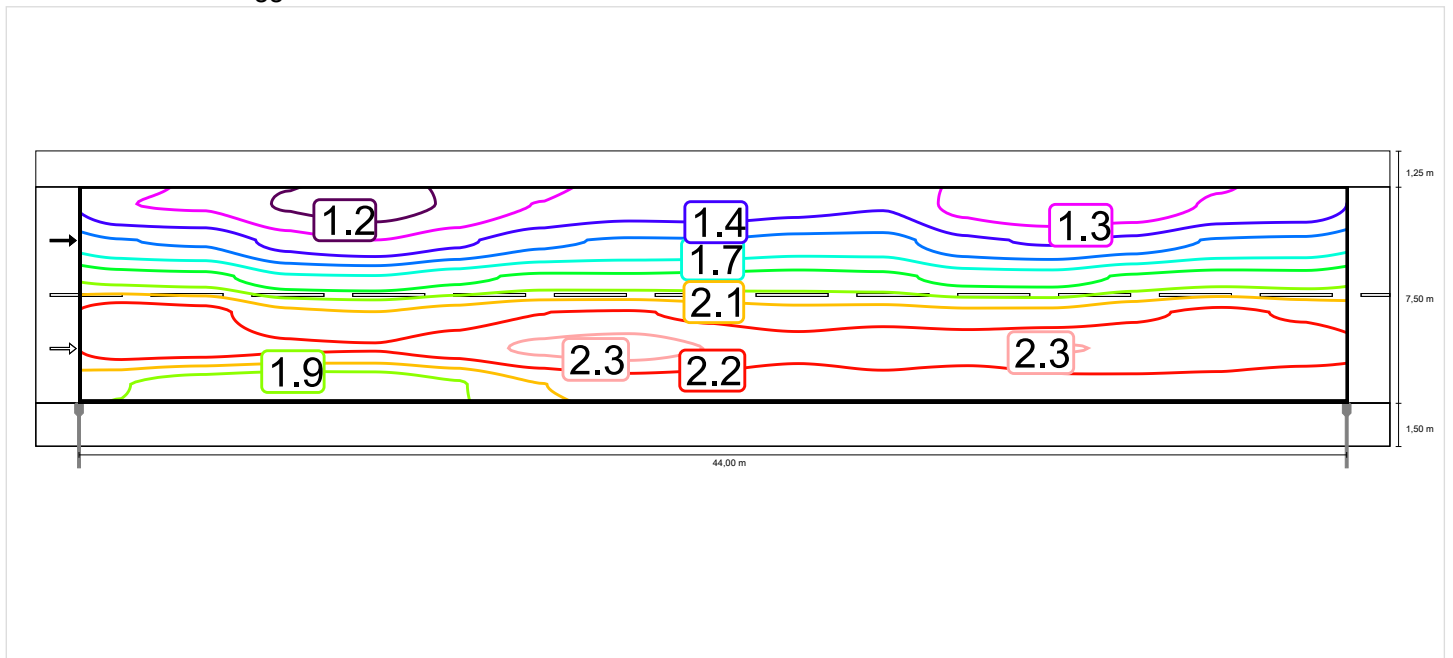

Luminanza con lampada nuova

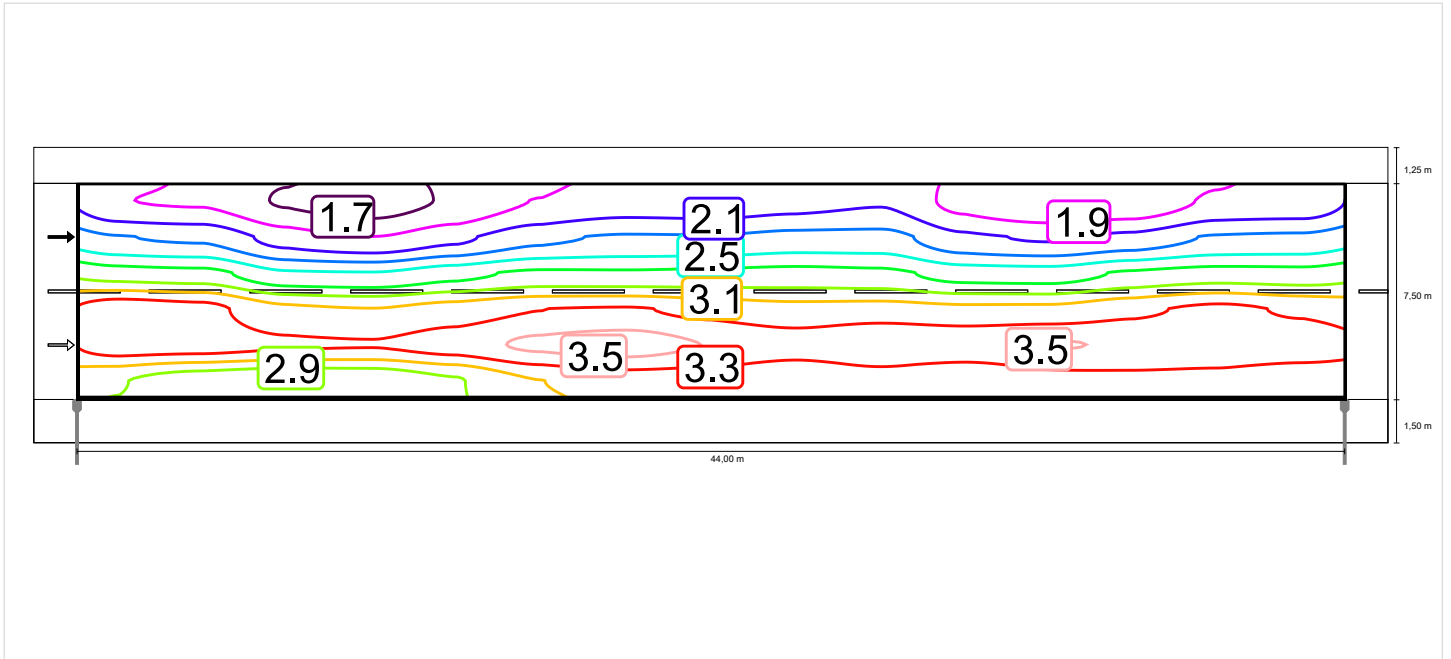

Carreggiata (M2)

Fattore di diminuzione: 0.67
 Reticolo: 15 x 6 Punti

Lm [cd/m ²] ≥ 1.50	Uo ≥ 0.40	UI ≥ 0.70	TI [%] ≤ 10	EIR ≥ 0.35
✓ 1.70	✓ 0.57	✓ 0.81	✓ 9	✓ 0.74

Illuminamento orizzontale

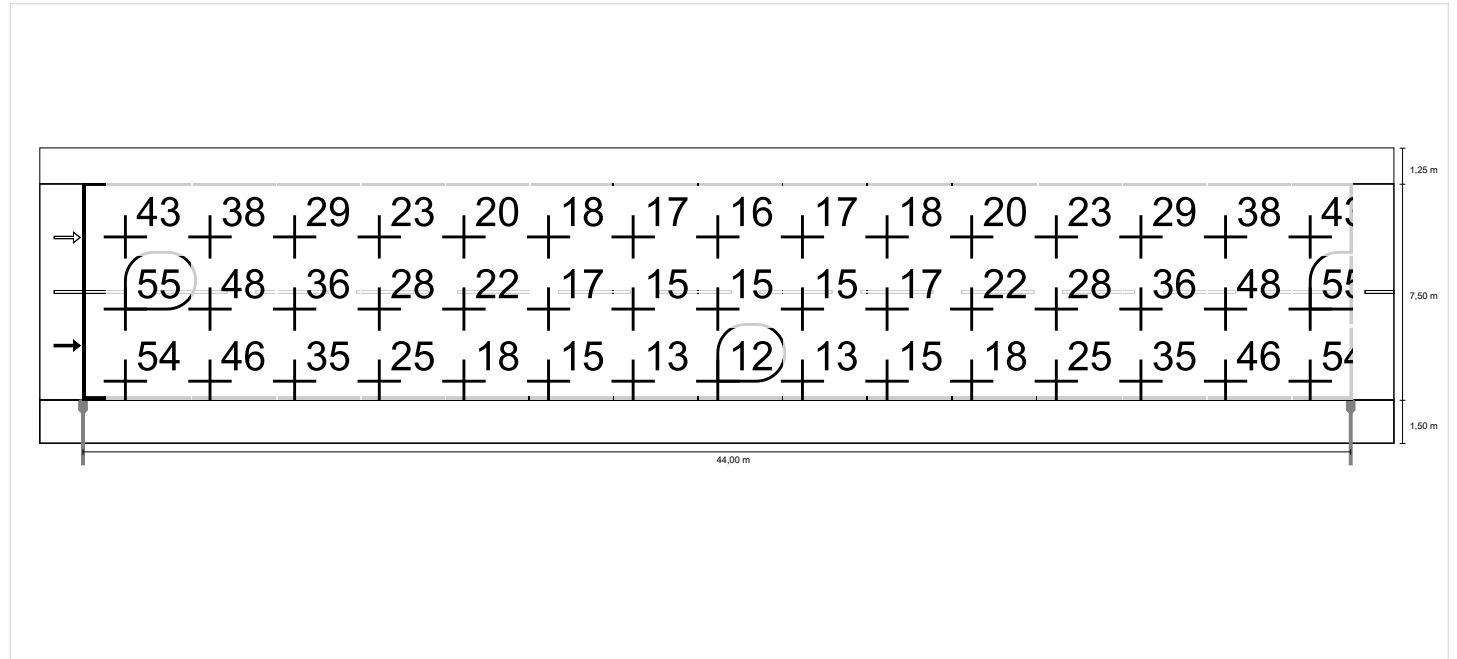

Osservatore 1

Luminanza con carreggiata asciutta

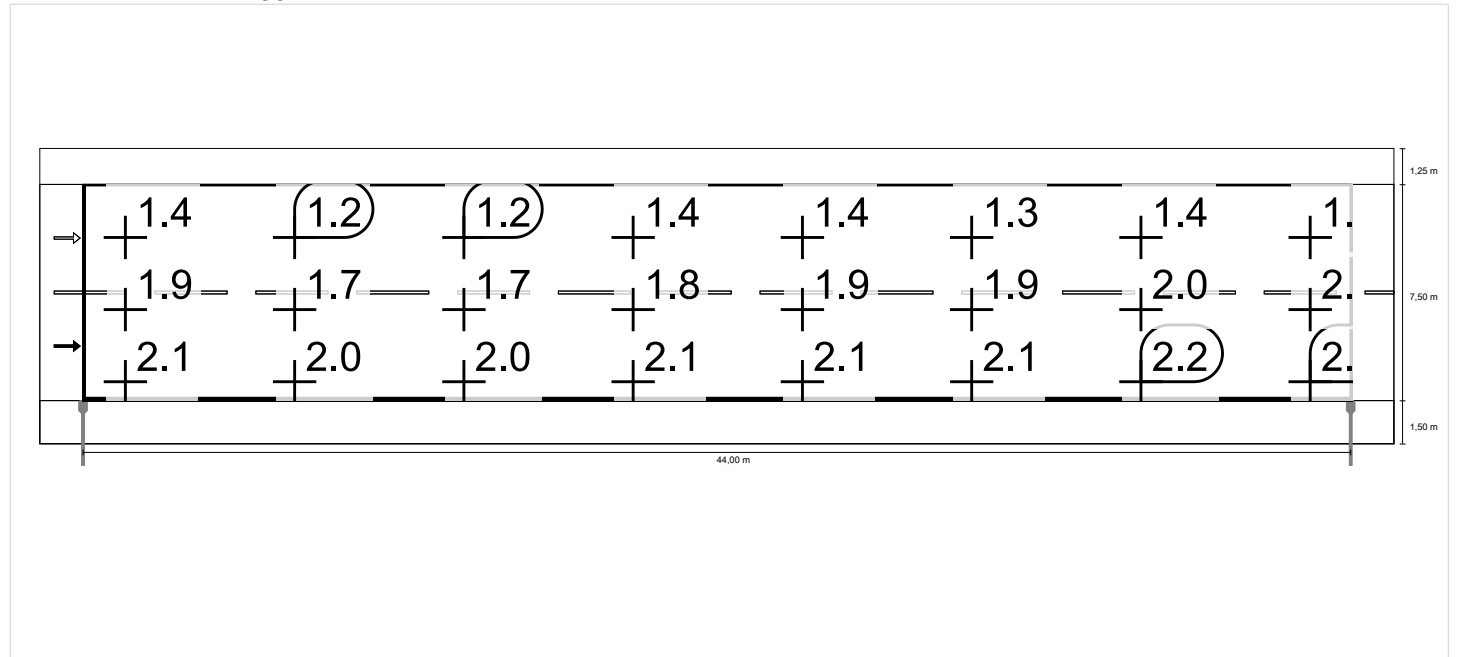

Luminanza con lampada nuova

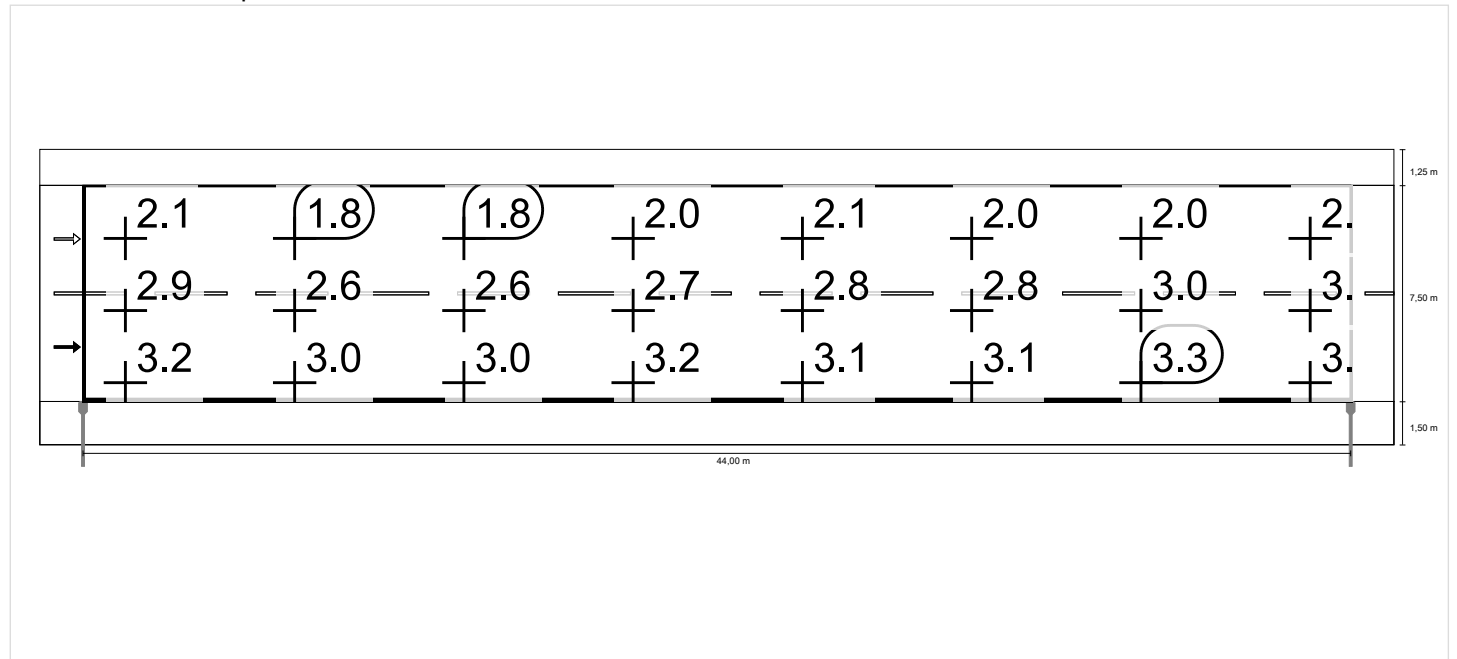

Osservatore 2

Luminanza con carreggiata asciutta

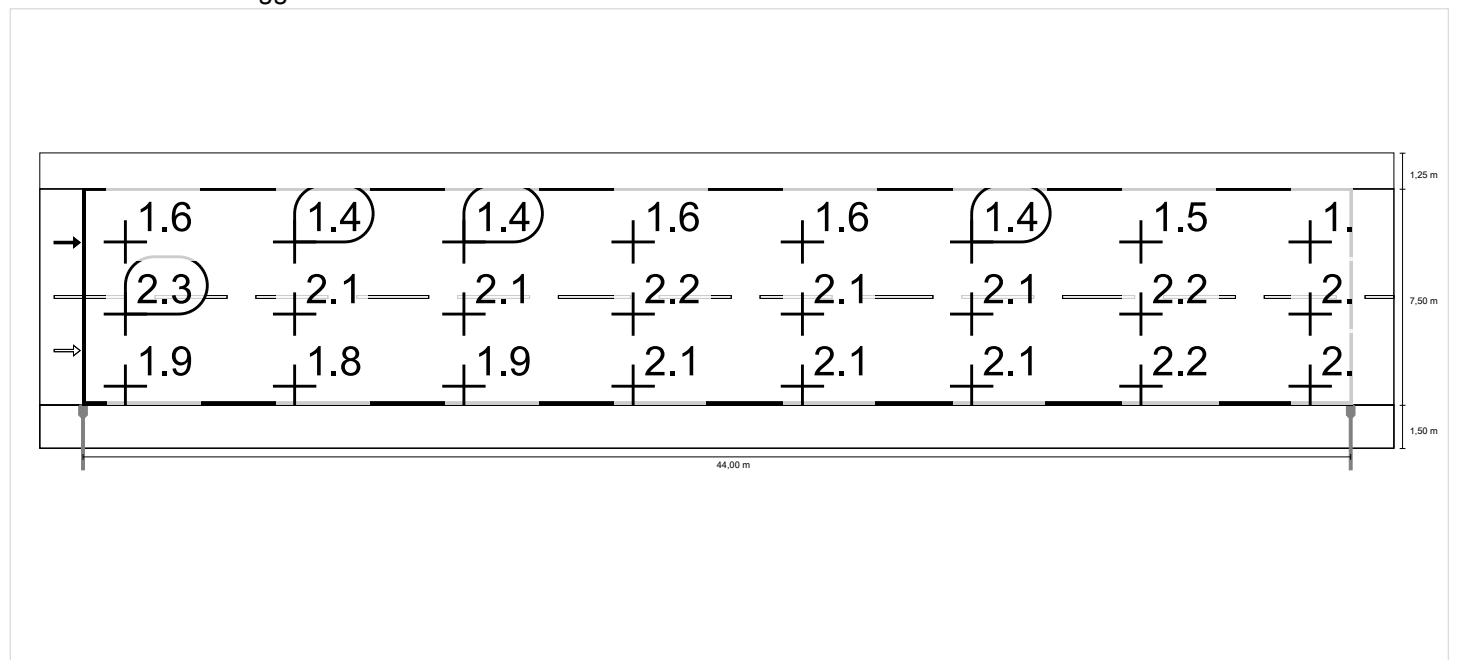

Luminanza con lampada nuova

