

PROFILI TOMBINI SU VIAB. SECONDARIA Scalci 1:200

SEZIONE IMBOCCO SEZ. 1077
SS121 Asse Principale di progetto



TABELLA MATERIALI TOMBINI E OPERE IDRAULICHE

DESCRIZIONE	Q.TA	UNITA'	PREZZO UNITARIO	TOTALE
1. CEMENTO PORTLAND CEM 42,5 N	1000	kg	0,15	150,00
2. SABBIA	2000	kg	0,05	100,00
3. GHIACCIAIO	100	kg	0,02	2,00
4. ACCIAIO IN ARABE	50	kg	0,10	5,00
5. PERI MET	10	kg	0,05	0,50

CONVENZIONI

CONVENZIONI	DESCRIZIONE
1	PROFILI TOMBINI
2	SEZIONI TOMBINI
3	SEZIONI SBICOCCO
4	SEZIONI MURIDALLA
5	SEZIONI POZZETTO
6	SEZIONI ARMATURA
7	SEZIONI Prolungamento

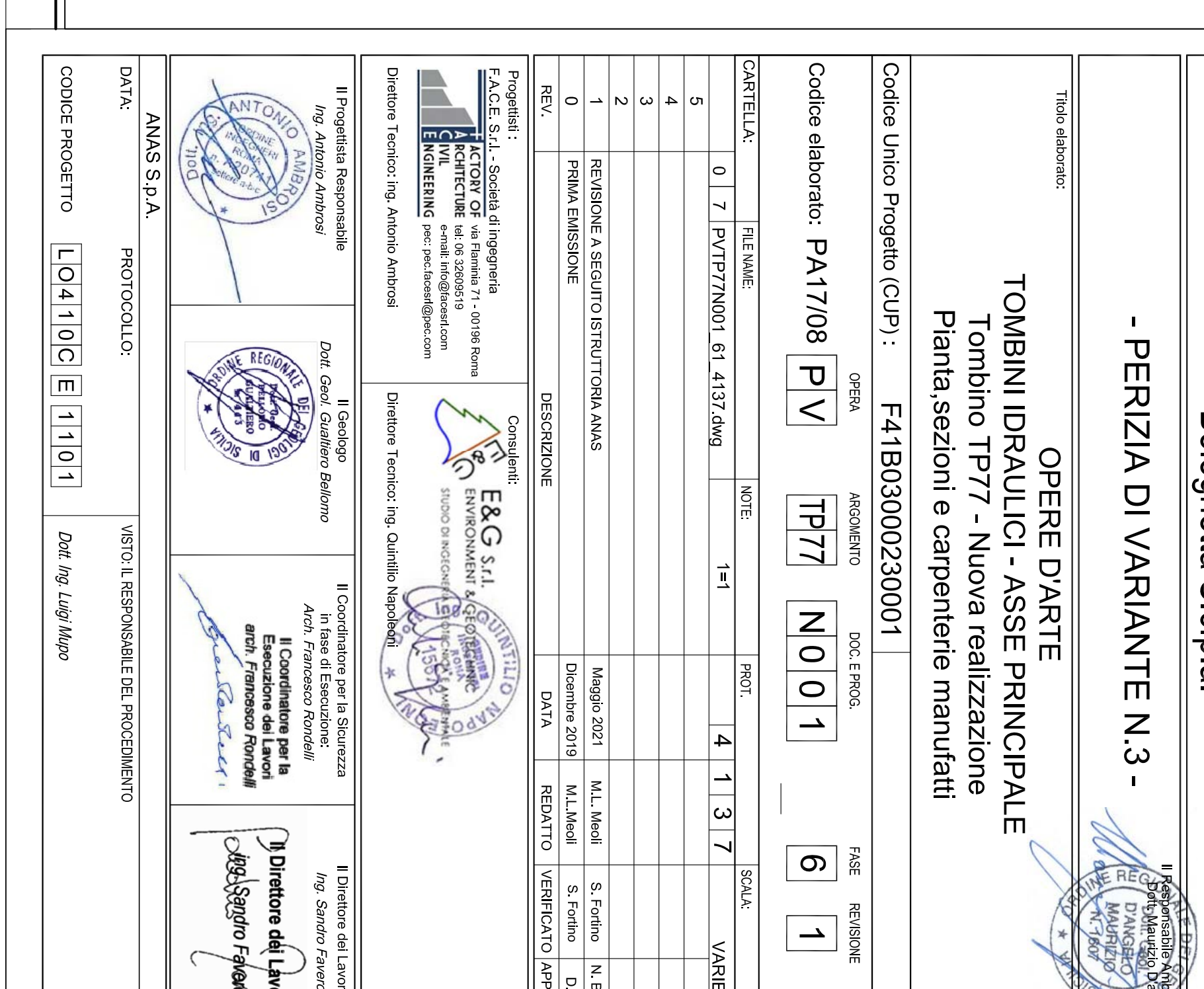
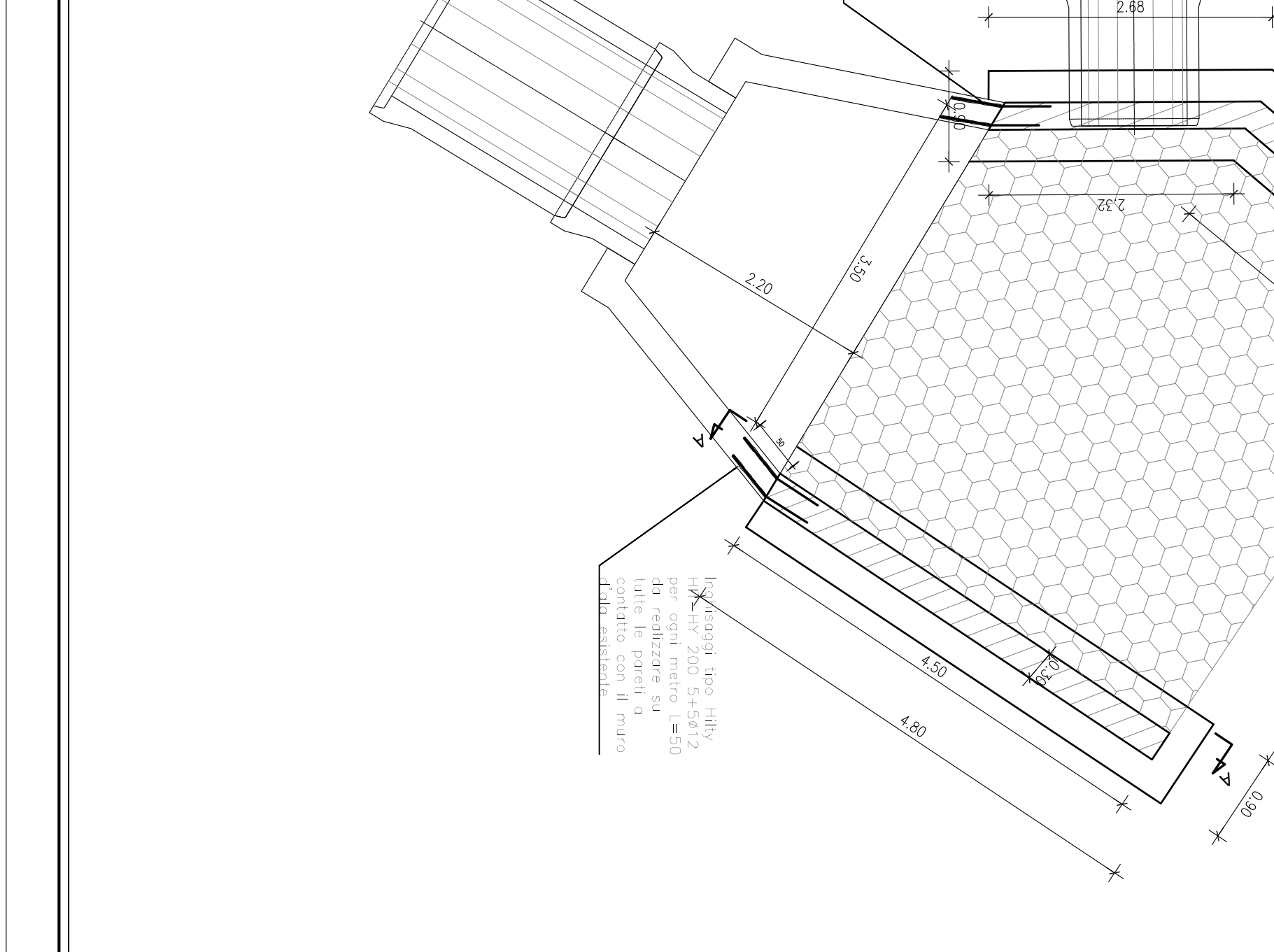
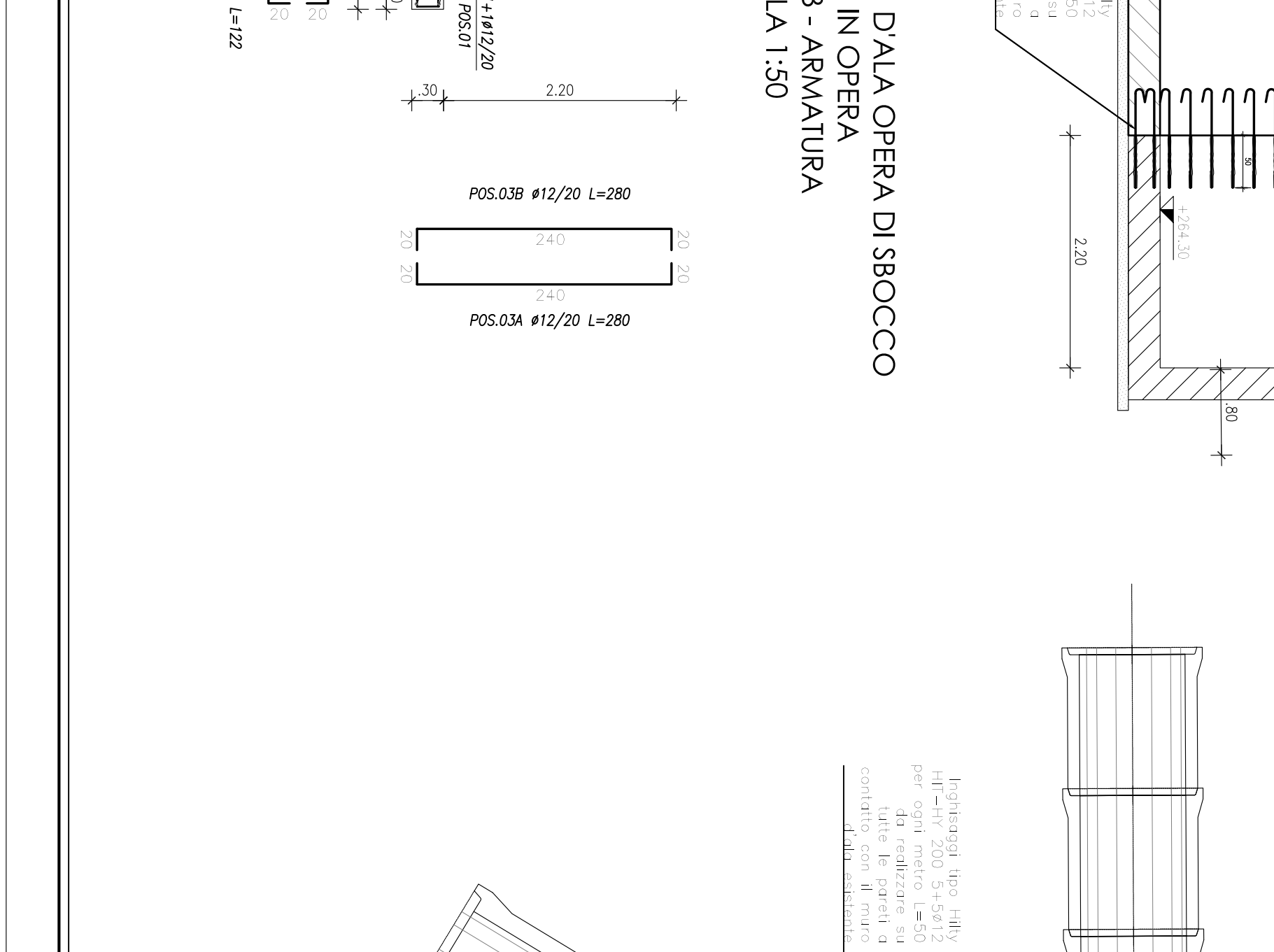
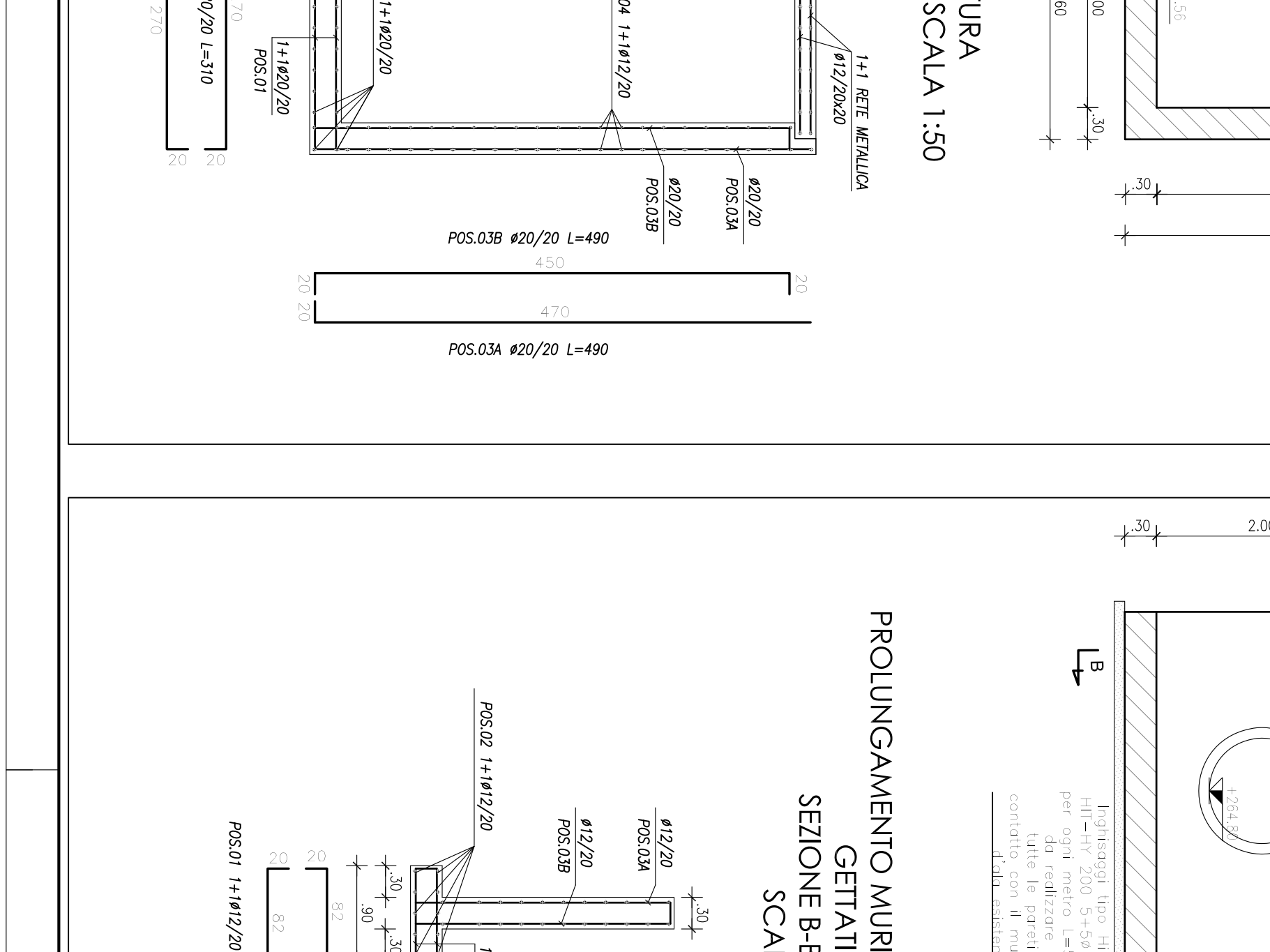
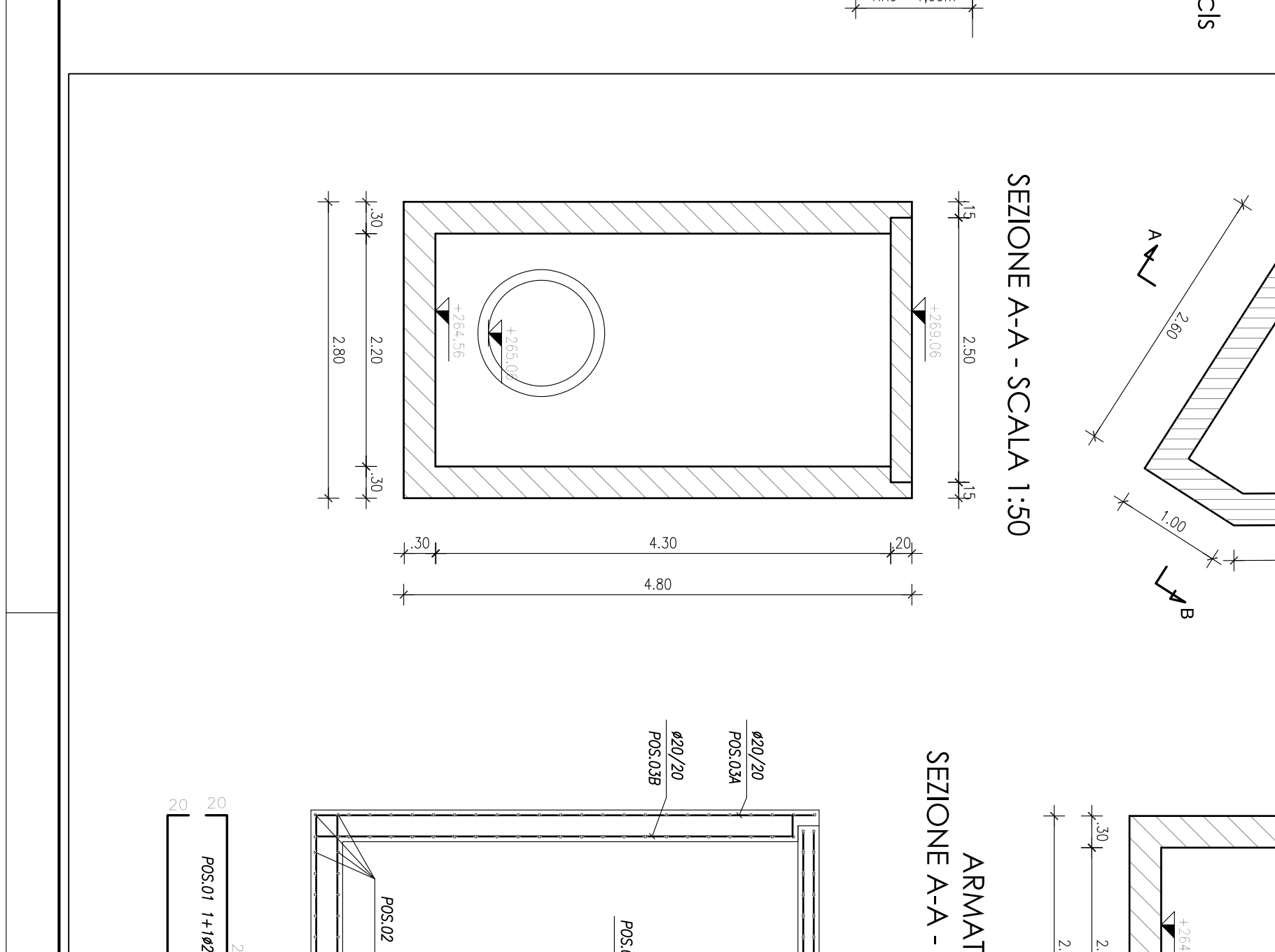
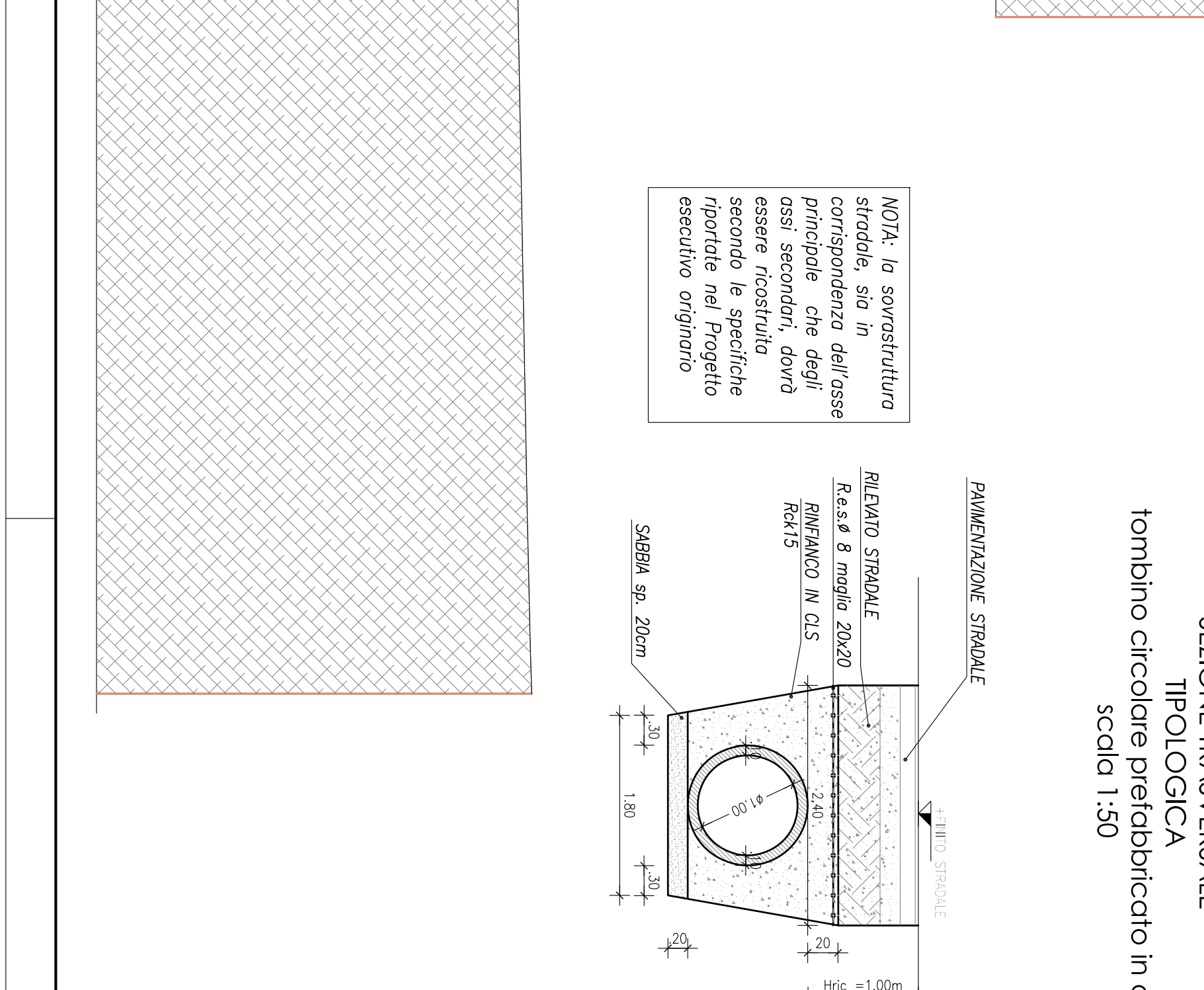
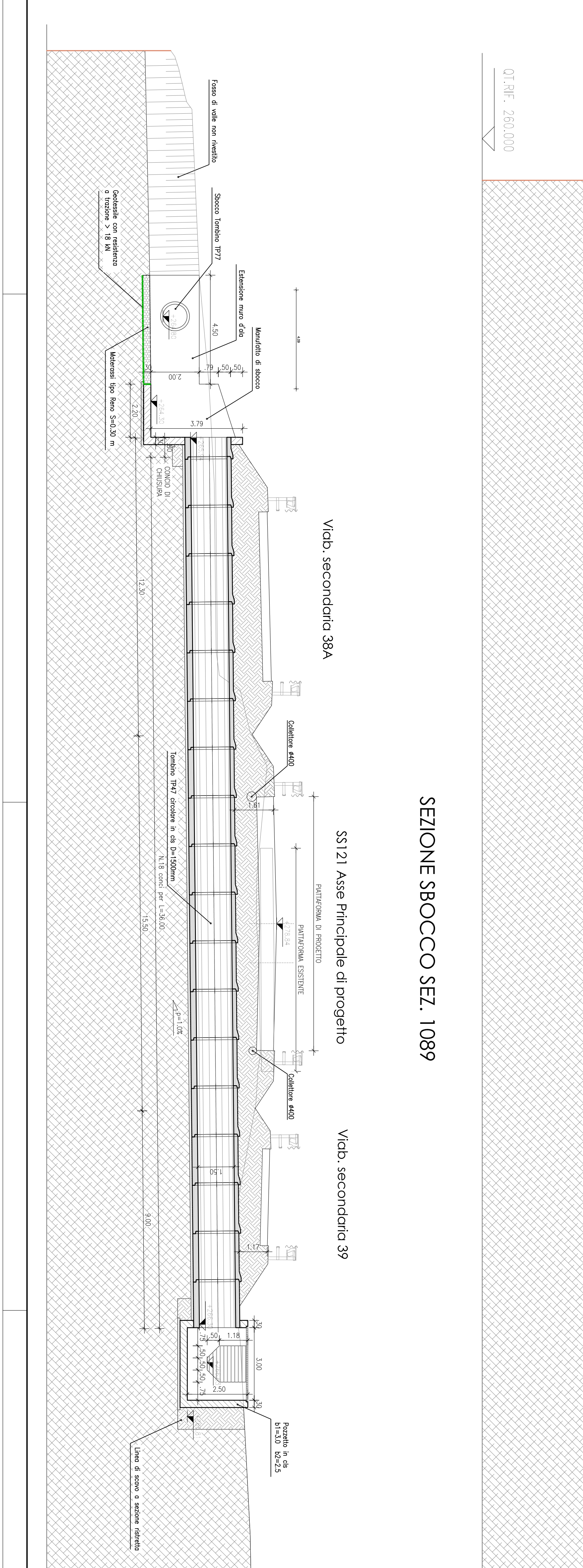
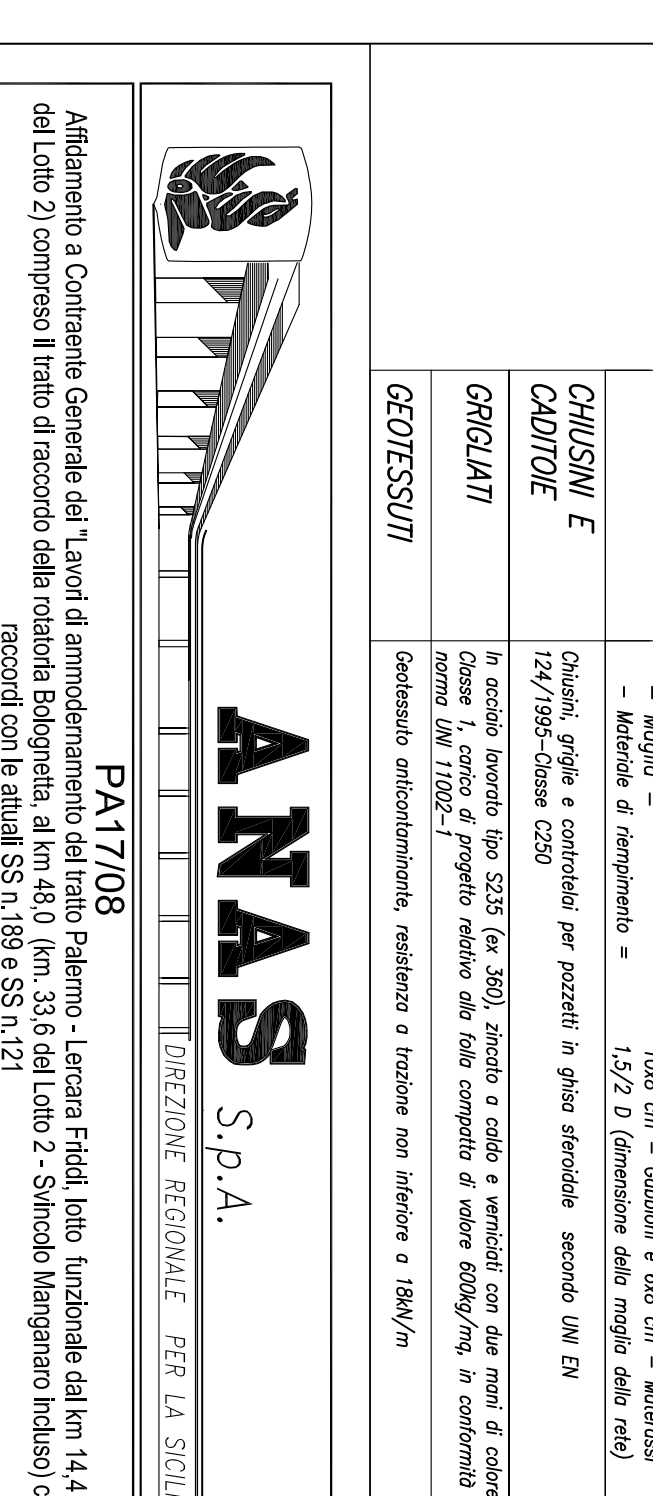
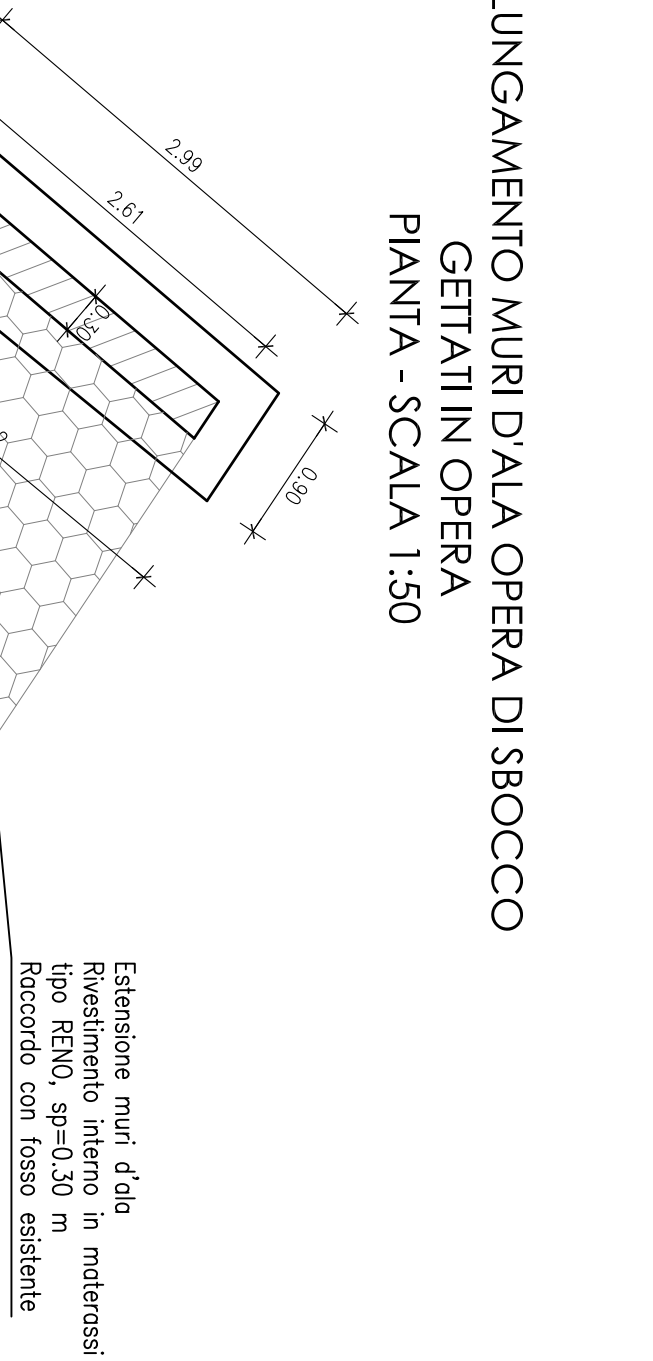
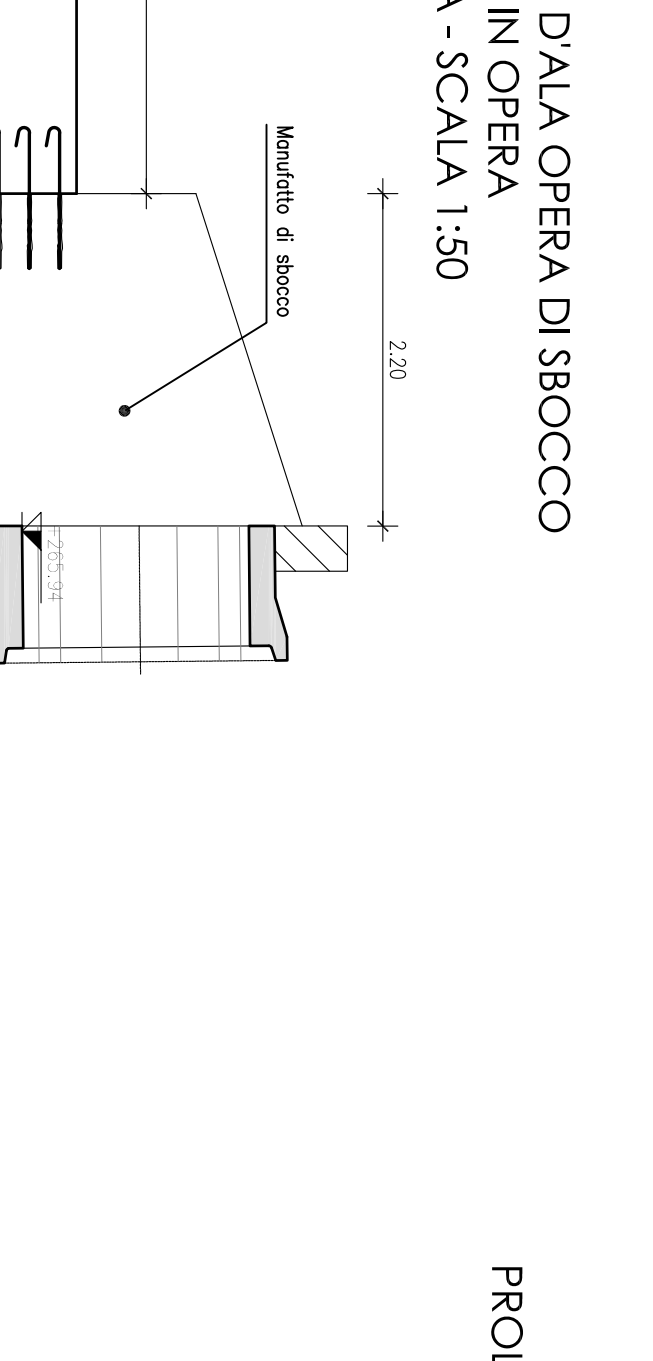
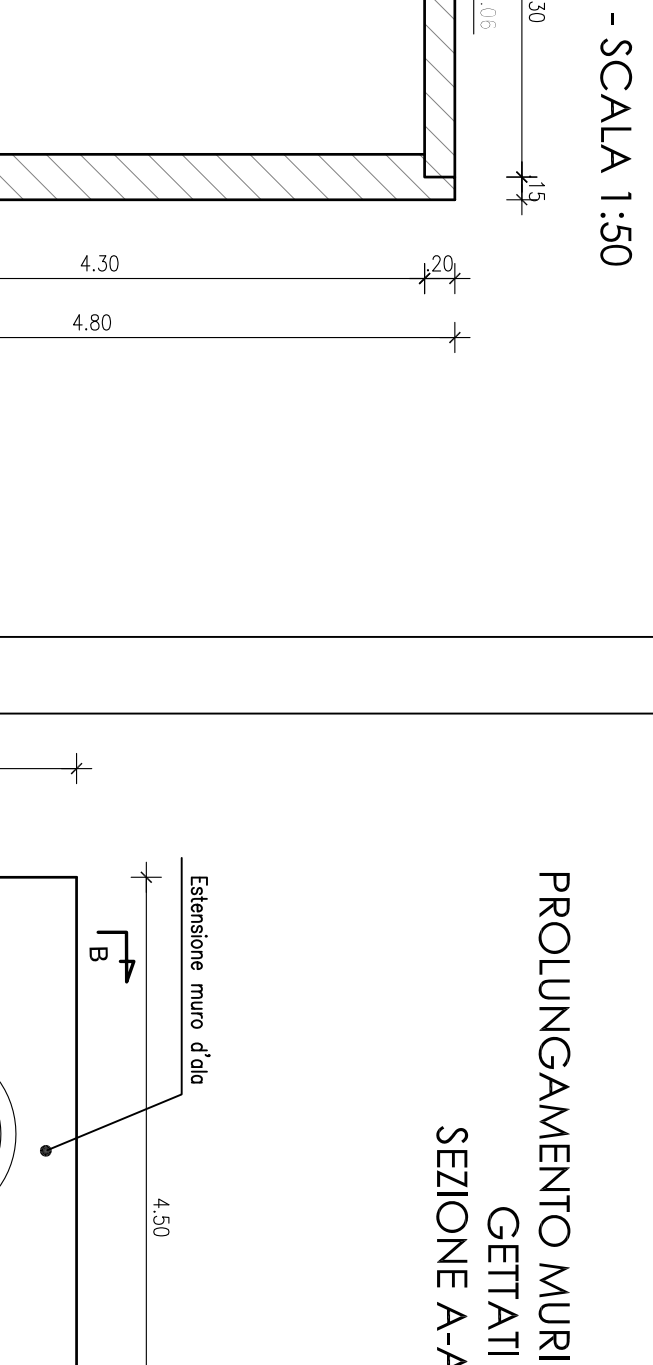
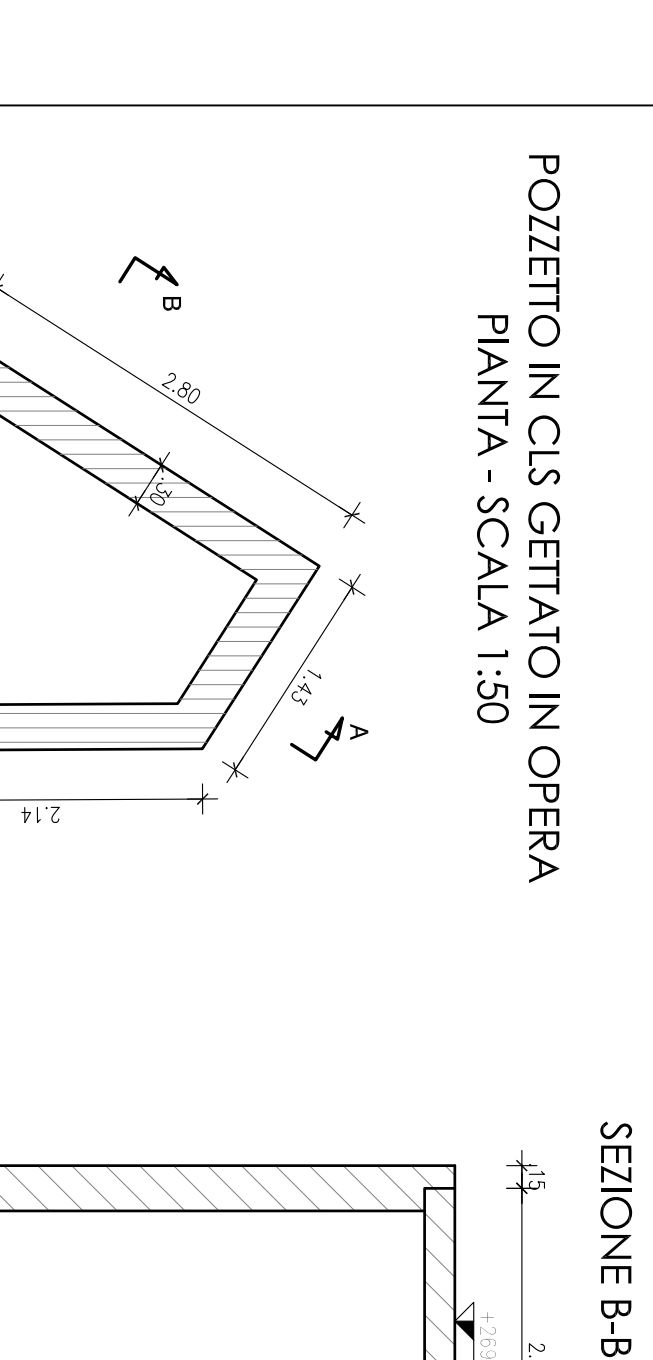
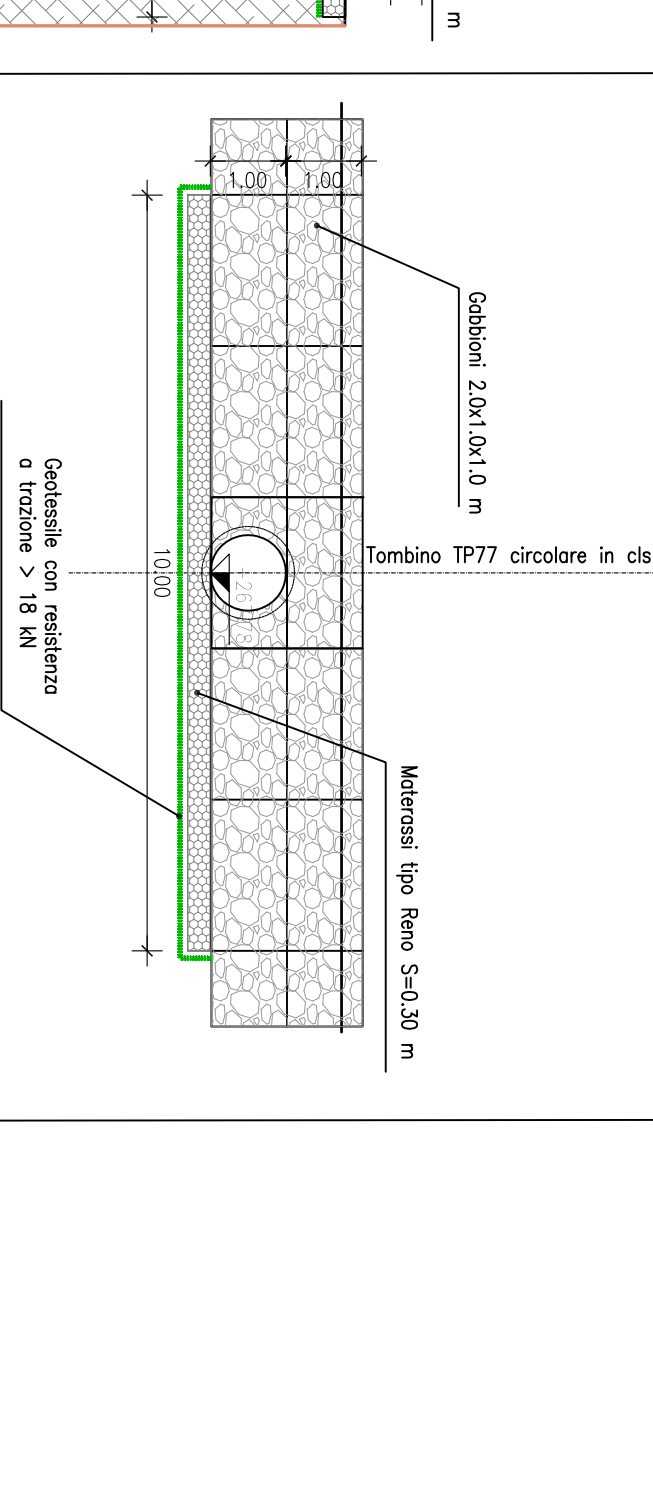
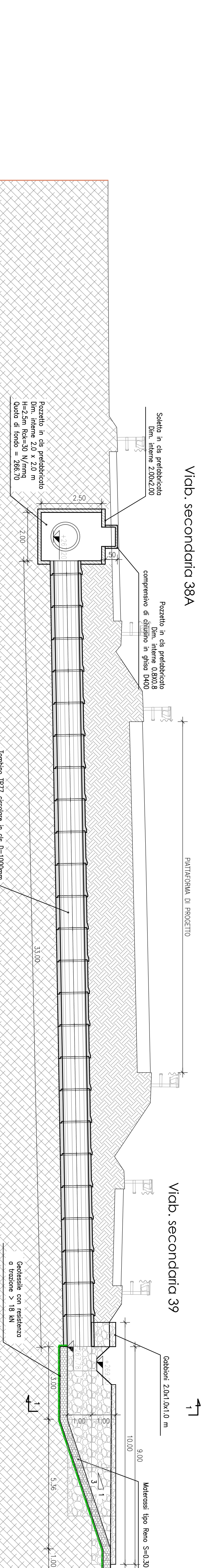
ANAS S.p.A.

PERIZIA DI VARIANTE N.3 -

OPERE D'ARTE

TOMBINI IDRAULICI - ASSE PRINCIPALE

Tombino TP77 - Nuova realizzazione

PIANTA, SEZIONI E CARATTERISTICHE MANUFATTI

Bologneta S.p.A.

PROGETTO

PROGETTO ESECUTIVO

PROGETTO PRELIMINARE

PROGETTO CONCEPT

PROGETTO PRELIMINARE

PROGETTO CONCEPT

PROGETTO PRELIMINARE

PROGETTO CONCEPT

PROGETTO

PROGETTO ESECUTIVO

PROGETTO PRELIMINARE

PROGETTO CONCEPT

PROGETTO PRELIMINARE

PROGETTO CONCEPT

PROGETTO PRELIMINARE

PROGETTO CONCEPT

PROGETTO

PROGETTO ESECUTIVO

PROGETTO PRELIMINARE

PROGETTO CONCEPT

PROGETTO PRELIMINARE

PROGETTO CONCEPT

PROGETTO PRELIMINARE

PROGETTO CONCEPT

PROGETTO

PROGETTO ESECUTIVO

PROGETTO PRELIMINARE

PROGETTO CONCEPT

PROGETTO PRELIMINARE

PROGETTO CONCEPT

PROGETTO PRELIMINARE

PROGETTO CONCEPT