



Autorita' d'ambito -
A.T.O. SARDEGNA



REGIONE
AUTONOMA DELLA
SARDEGNA



Gestore unico del servizio idrico integrato dell'ATO Sardegna

INTERCONNESSIONE CON IL POTABILIZZATORE DI TORPE' REALIZZAZIONE DELLA DORSALE SUD-NORD

CONCORRENTE:

Costituenda A.T.I.



PROGETTISTA INDICATO:

Costituenda A.T.I.



Dott. Geologo
F. CALZOLETTI
(Mandante)



PROGETTO DEFINITIVO

Elaborato:

B.79

PARTITORE SAN SIMONE SCHEMA QE

Data	Rev.	Descrizione	Redatto	Verificato	Approvato
04.03.2020	0	Aggiornamento richiesto in fase di validazione	-	-	-

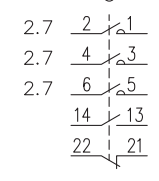
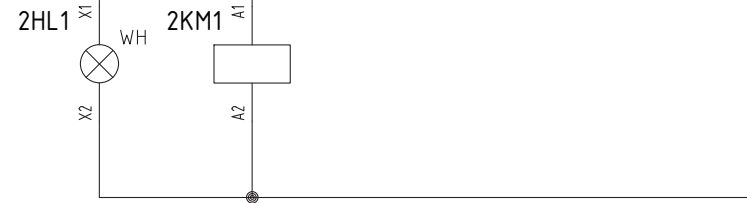
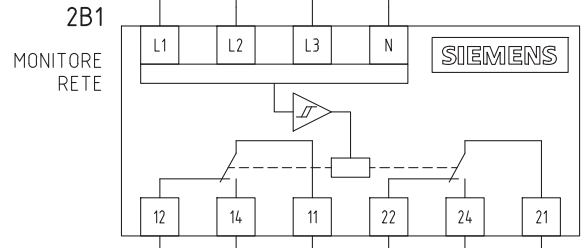
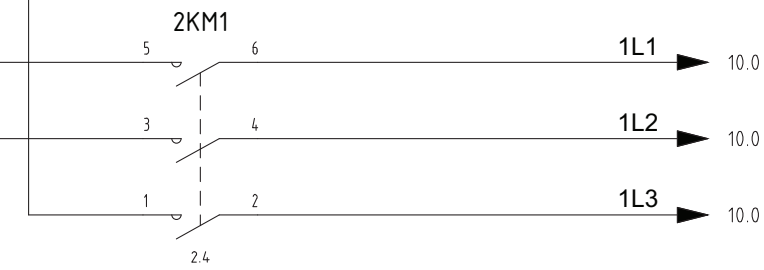
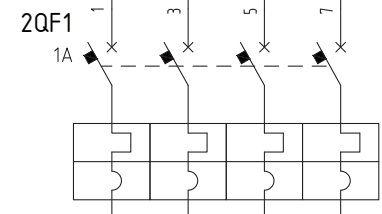
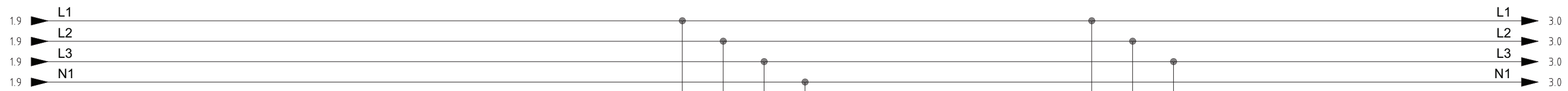

MONITORAGGIO ANOMALIA RETE

CONTATTORE DI LINEA
ALIMENTAZIONE VALVOLE

		DATA	03/03/2020		ABBANOA POTABILIZZATORE TORPE PARTITORE SAN SIMONE					PARTITORE SAN SIMONE SCHEMA QUADRO DI CONTROLLO SCHEMA INDICATIVO MONITORAGGIO RETE					
		DISEGN.	ACCIONA AGUA												
		VISTO													
REV.	MODIFICA	DATA	FIRMA	APPR.	SOST. IL :	SOST. DA :	FILE :					FG.	2		
0		1			3	4	5					F.S.	3		

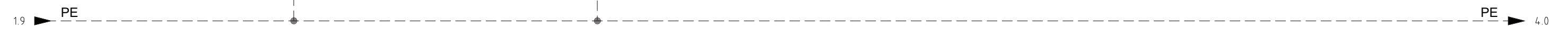
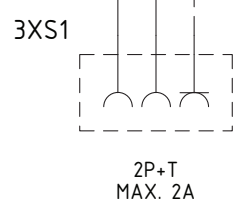
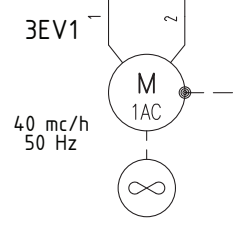
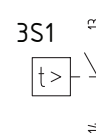
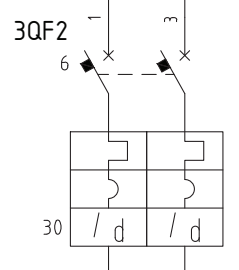
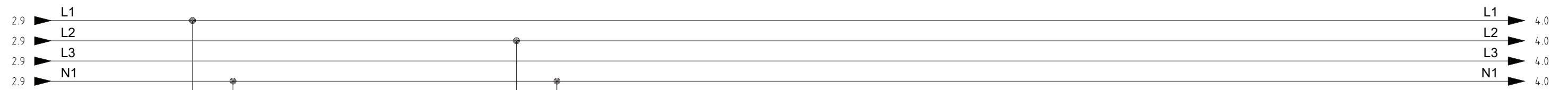

PRESA 230V AC / F+N+T

VENTILAZIONE QUADRO

		DATA	03/03/2020		ABBANO POTABILIZZATORE TORPE PARTITORE SAN SIMONE					PARTITORE SAN SIMONE SCHEMA QUADRO DI CONTROLLO			=	
		DISEGN.	ACCIONA AGUA										+	
		VISTO			SOST. IL : SOST. DA : FILE :			SCHEMA INDICATIVO SERVIZI QUADRO			FG. 3			
REV.	MODIFICA	DATA	FIRMA	APPR.							F.S. 4			
0	1	2	3	4	5	6	7	8	9					

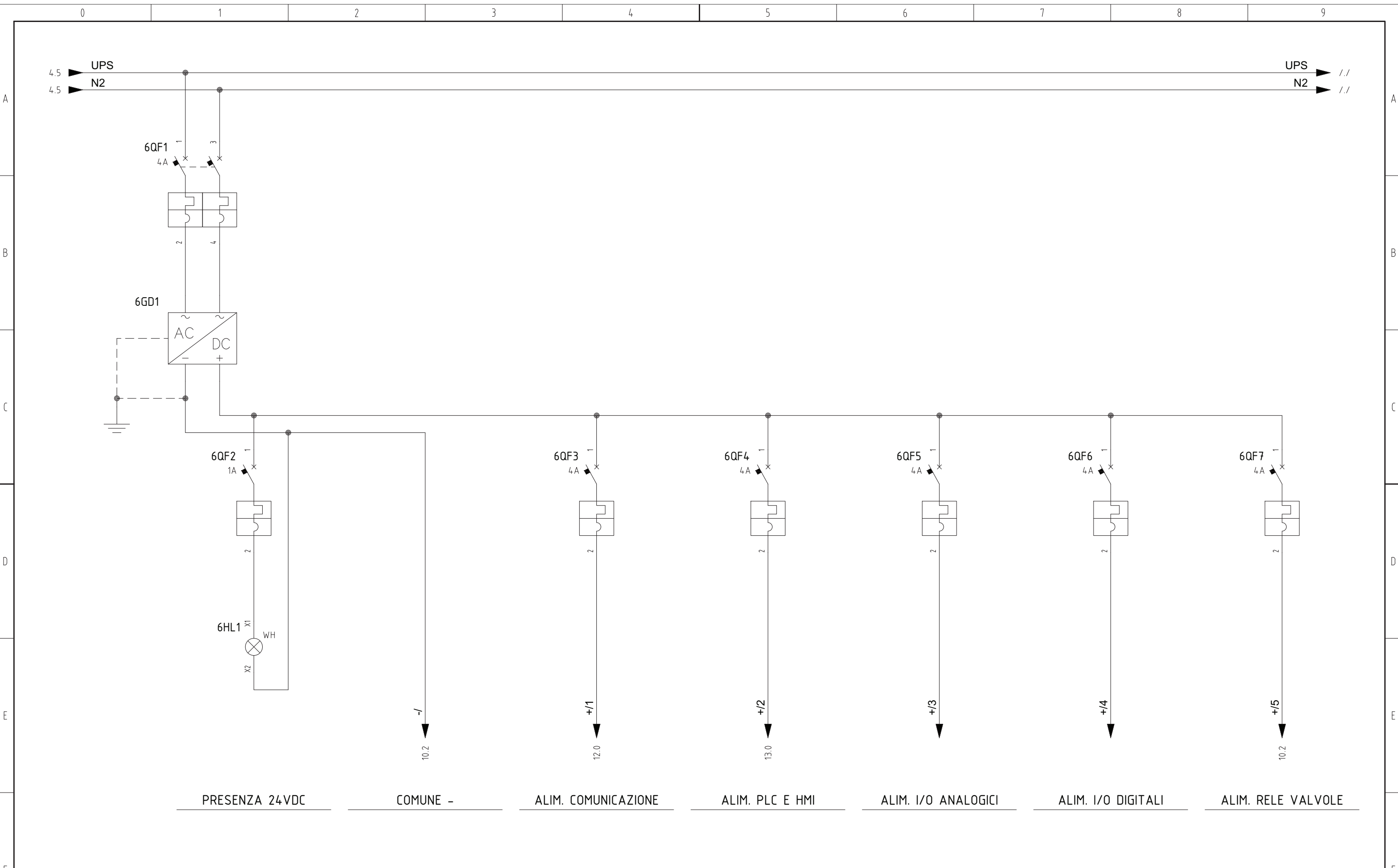

				DATA	03/03/2020	ABBANO POTABILIZZATORE TORPE PARTITORE SAN SIMONE			PARTITORE SAN SIMONE				=		
				DISEGN.	ACCIONA AGUA				SCHEMA QUADRO DI CONTROLLO						+
				VISTO					SCHEMA INDICATIVO						FG. 6
REV.	MODIFICA	DATA	FIRMA	APPR.		SOST. IL :	SOST. DA :	FILE :					F.S. 7		
0		1			2	3	4	5	6	7	8	9			

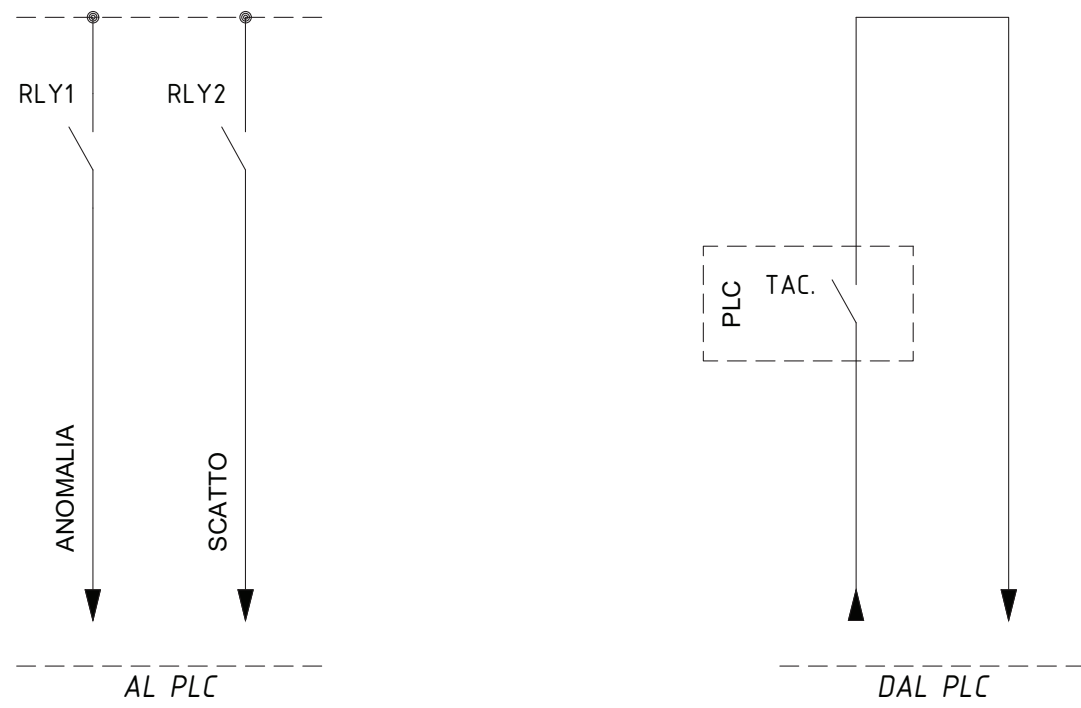

SEGNALAZIONI AL PLC
CENTR. ANTINTRUSIONE

TACITAZIONE ALLARME
CENTR. ANTINTRUSIONE

				DATA	03/03/2020	ABBANOA POTABILIZZATORE TORPE PARTITORE SAN SIMONE		PARTITORE SAN SIMONE			=	
				DISEGN.	ACCIONA AGUA			SCHEMA QUADRO DI CONTROLLO				+
				VISTO				SCHEMA INDICATIVO				
REV.	MODIFICA	DATA	FIRMA	APPR.		SOST. IL :	SOST. DA :	FILE :				F.S. 9
0		1			2	3	4	5	6	7	8	9

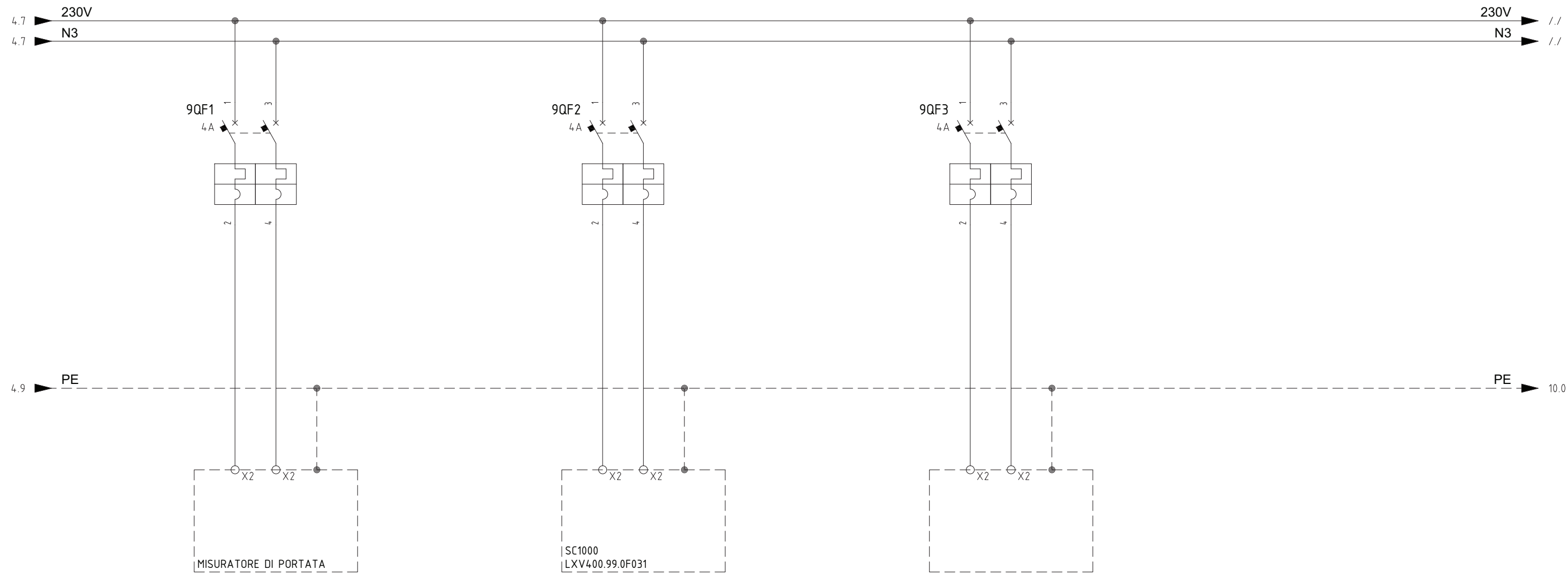

MISURATORE DI PORTATA

SC1000
LXV400.99.0F031

MISURATORE DI PORTATA
030-FIT-101

MISURATORE DI PORTATA
030-FIT-201

SCORTA ALIM. 230VAC

REV.	MODIFICA	DATA	FIRMA	APPR.	DATA	03/03/2020	ABBANO POTABILIZZATORE TORPE PARTITORE SAN SIMONE		PARTITORE SAN SIMONE SCHEMA QUADRO DI CONTROLLO SCHEMA INDICATIVO ALIM. MISURATORI ANALOG.	=		
					SOST. IL :	SOST. DA :	FILE :			FG. 9	F.S. 10	

2.9 1L1
2.9 1L2
2.9 1L3

11.0 1L1
11.0 1L2
11.0 1L3

6.9 +/5

+/5

9.9 PE 11.0 PE

6.2 -/

-/ 12.0

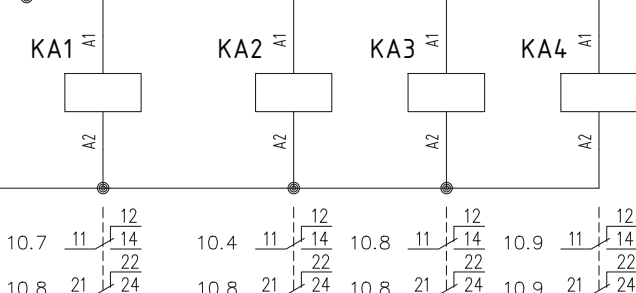
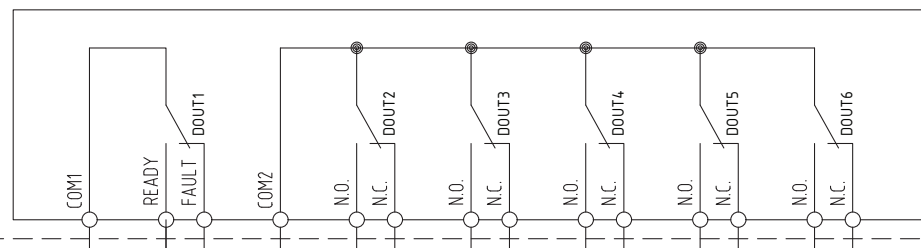
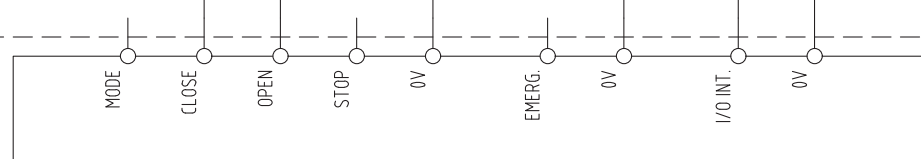
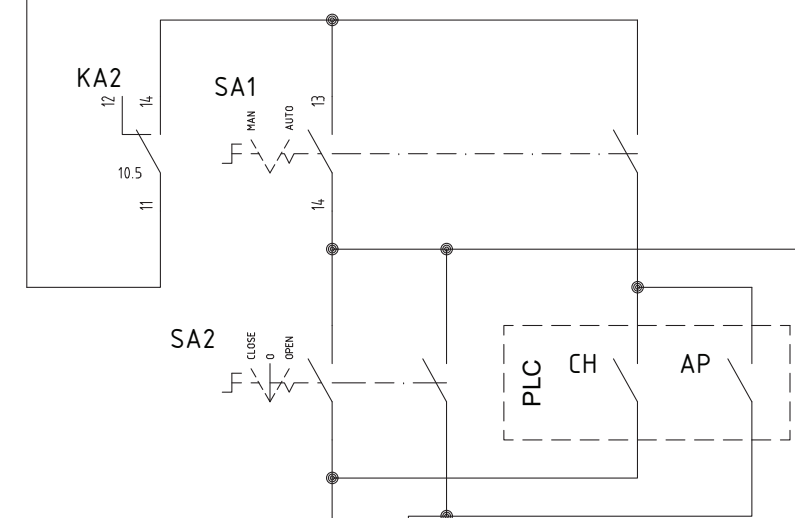
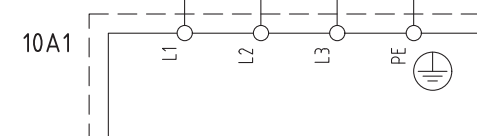
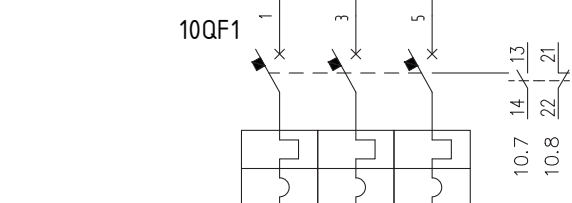
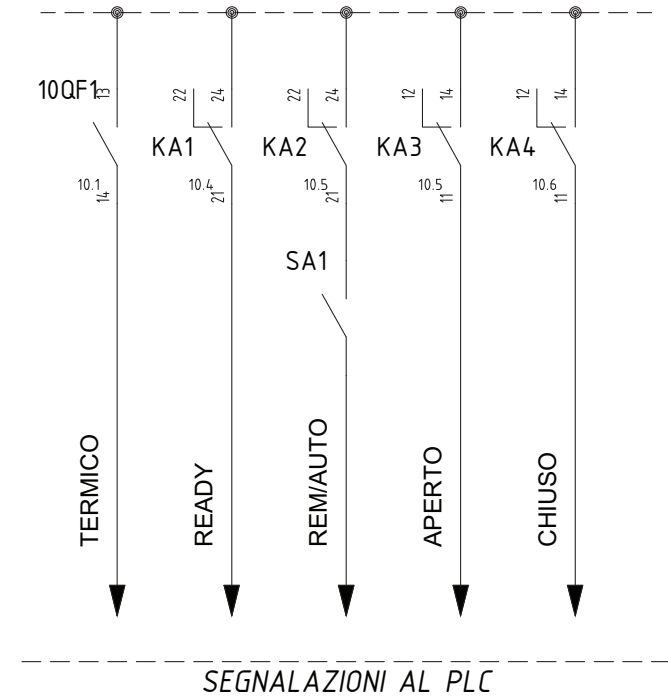
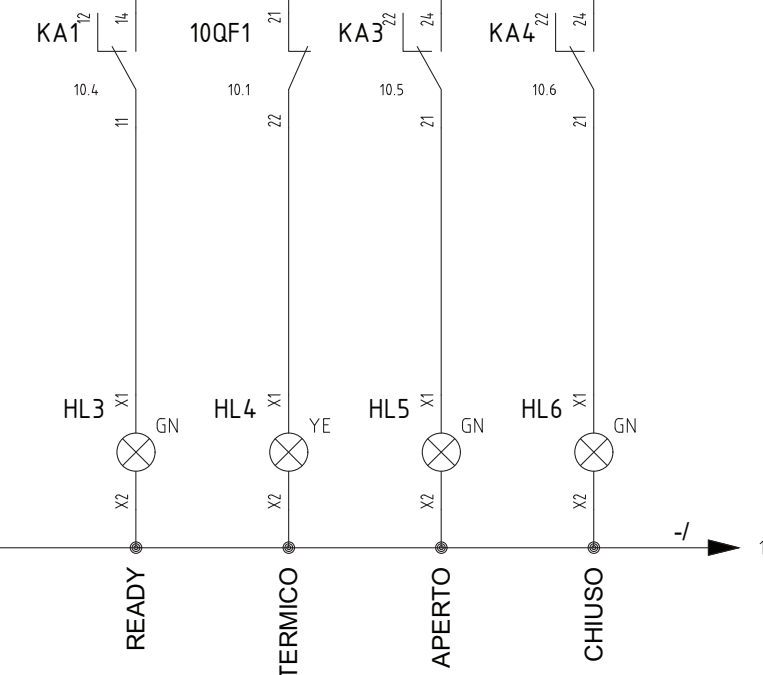

READY
REMOTO
APERTO
CHIUSO

ALIMENTAZIONE 400V AC
ATTUATORE MOTORIZZ.

DATA	03/03/2020	ABBANO POTABILIZZATORE TORPE PARTITORE SAN SIMONE	acciona Agua	PARTITORE SAN SIMONE SCHEMA QUADRO DI CONTROLLO	SCHEMA INDICATIVO ATTUATORI MOTORIZZATI	=	+	
DISEGN.	ACCIONA AGUA							
VISTO								
REV.	MODIFICA	DATA	FIRMA	APPR.	SOST. IL :	SOST. DA :	FILE :	FG. 10
0		1						F.S. 11

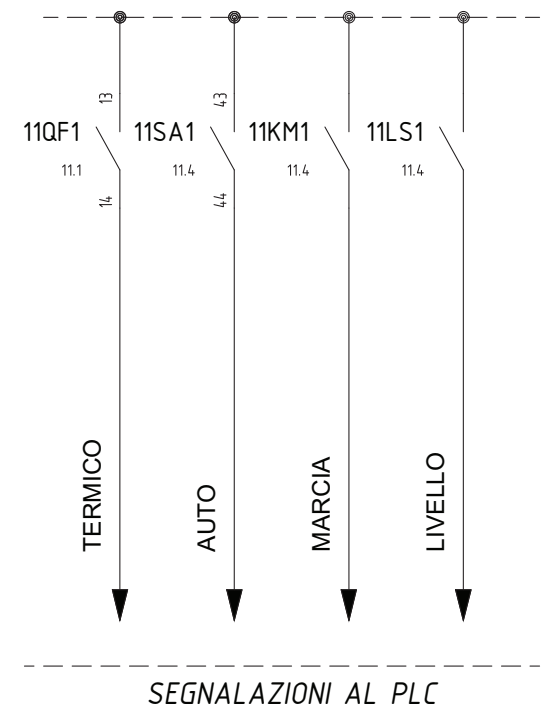
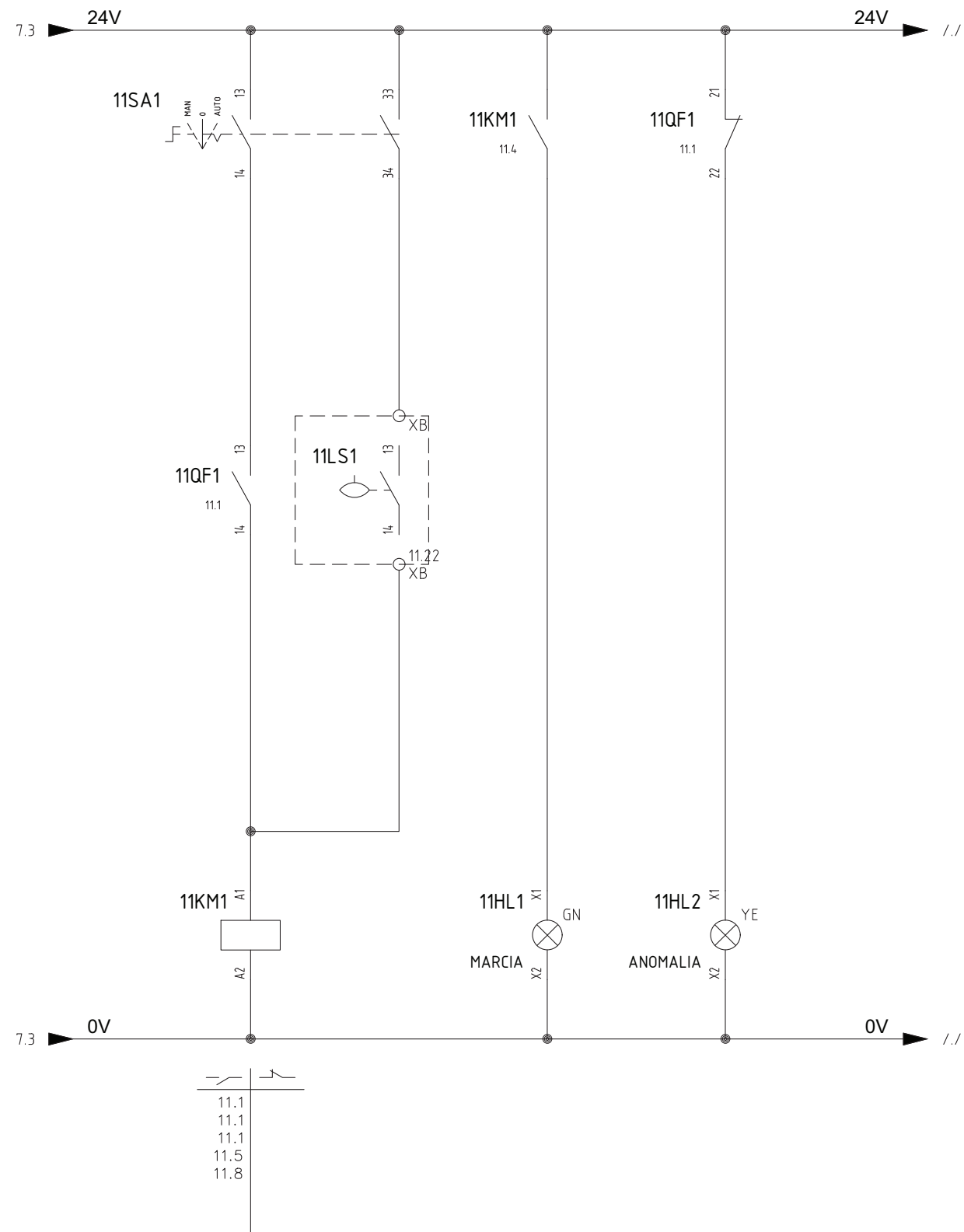
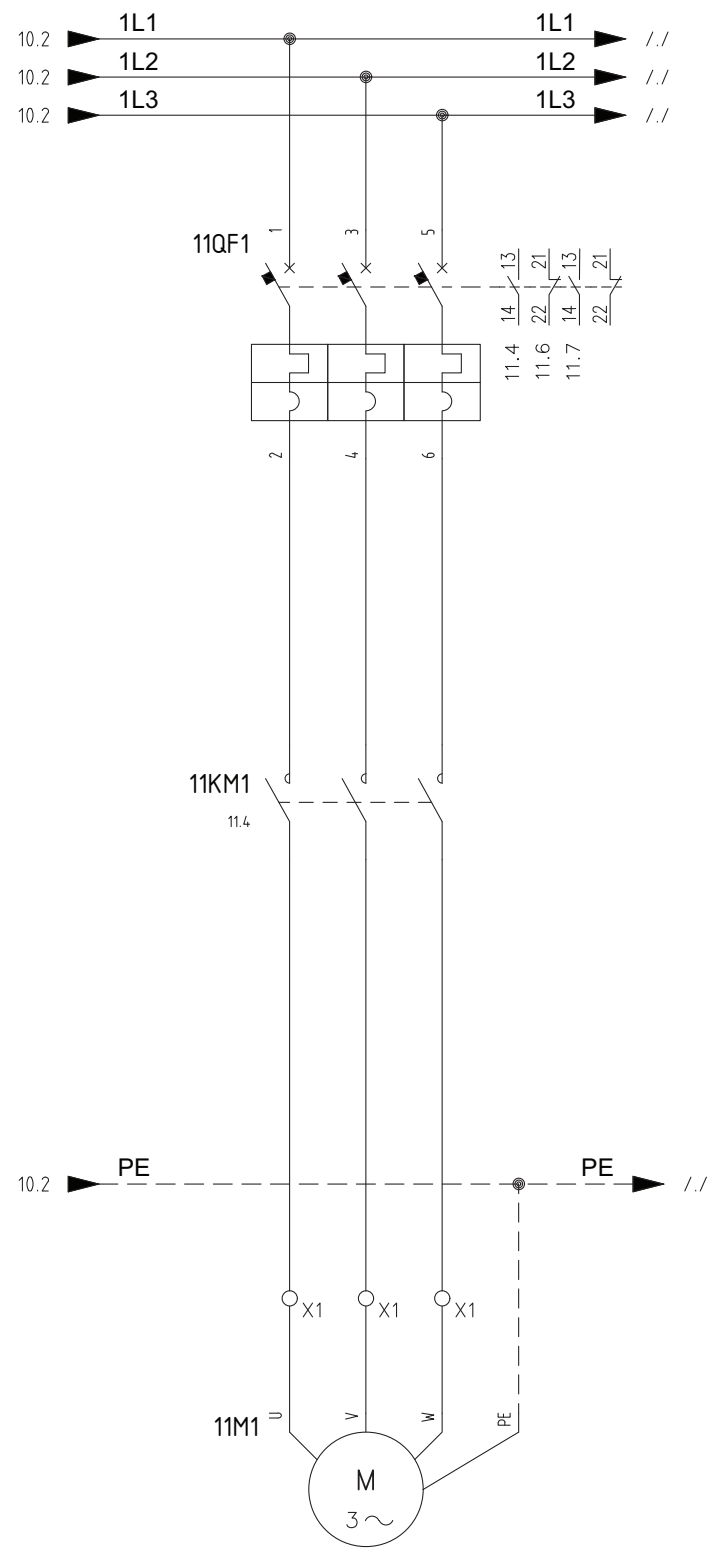

REV.		MODIFICA	DATA	FIRMA	APPR.	SOST. IL :	SOST. DA :	FILE :	PARTITORE SAN SIMONE SCHEMA QUADRO DI CONTROLLO		=
									SCHEMA INDICATIVO POMPA SOMMERSA		+
0		1	2	3	4	5	6	7	8	9	FG. 11 F.S. 12

DATA 03/03/2020
 DISEGN. ACCIONA AGUA
 VISTO
 APPR.

ABBANOA
 POTABILIZZATORE TORPE
 PARTITORE SAN SIMONE



PARTITORE SAN SIMONE
 SCHEMA QUADRO DI CONTROLLO
 SCHEMA INDICATIVO
 POMPA SOMMERSA

FG. 11
 F.S. 12

0 1 2 3 4 5 6 7 8 9

A

A

B

B

C

C

D

D

E

E

F

F

12A1

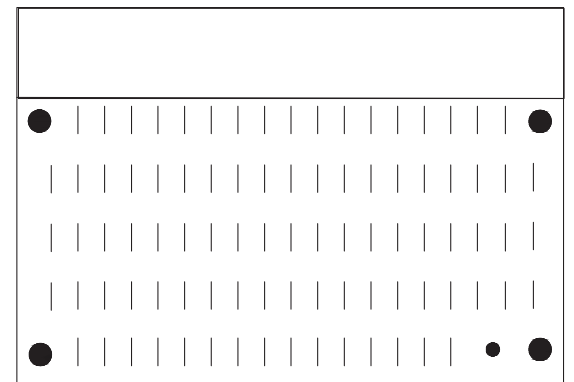

RTU
Wit Redy

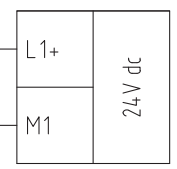

12A2

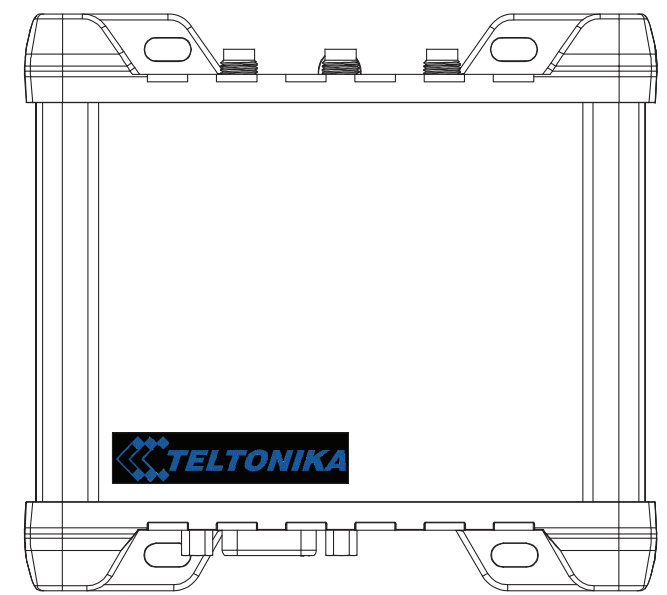

ROUTER
Teltonika RUT955

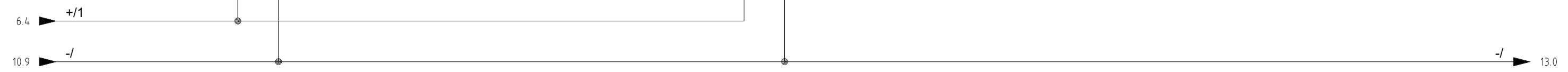
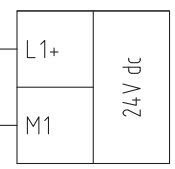

		DATA	03/03/2020		ABBANOA POTABILIZZATORE TORPE PARTITORE SAN SIMONE					PARTITORE SAN SIMONE SCHEMA QUADRO DI CONTROLLO SCHEMA INDICATIVO COMUNICAZIONE #1			=	
		DISEGN.	ACCIONA AGUA										+	
		VISTO												
REV.	MODIFICA	DATA	FIRMA	APPR.	SOST. IL :	SOST. DA :	FILE :				FG. 12			
0		1		2	3	4	5	6	7	8	9	F.S. 13		

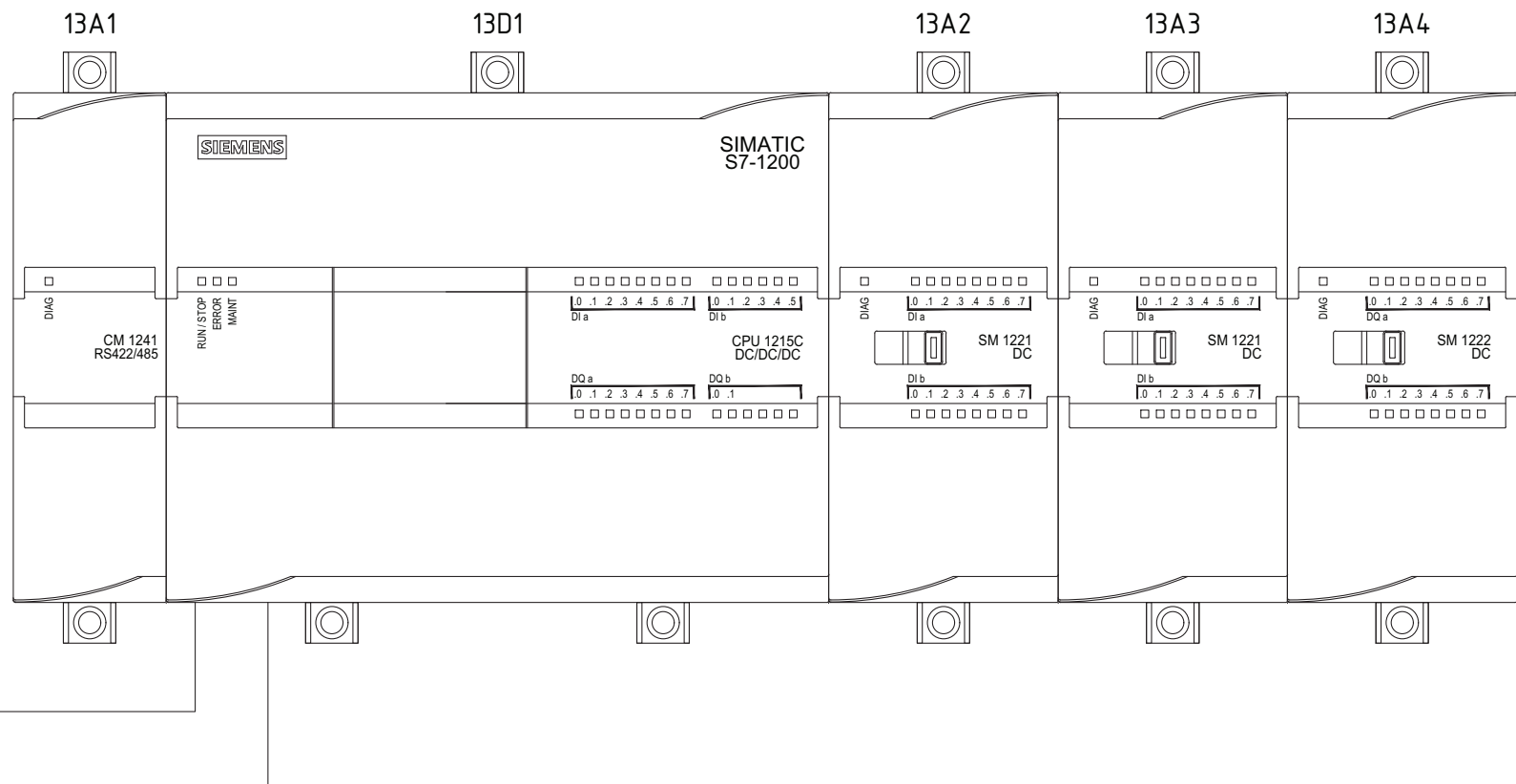

		DATA	03/03/2020		ABBANO POTABILIZZATORE TORPE PARTITORE SAN SIMONE					PARTITORE SAN SIMONE SCHEMA QUADRO DI CONTROLLO SCHEMA INDICATIVO PLC / SCHEDE IO			=				
		DISEGN.	ACCIONA AGUA														+
		VISTO															FG. 13
REV.	MODIFICA	DATA	FIRMA	APPR.	SOST. IL :	SOST. DA :	FILE :				F.S. 14						
0		1			2			3	4	5	6	7	8	9			

14A1

SIEMENS

SIMATIC HMI

TOUCH

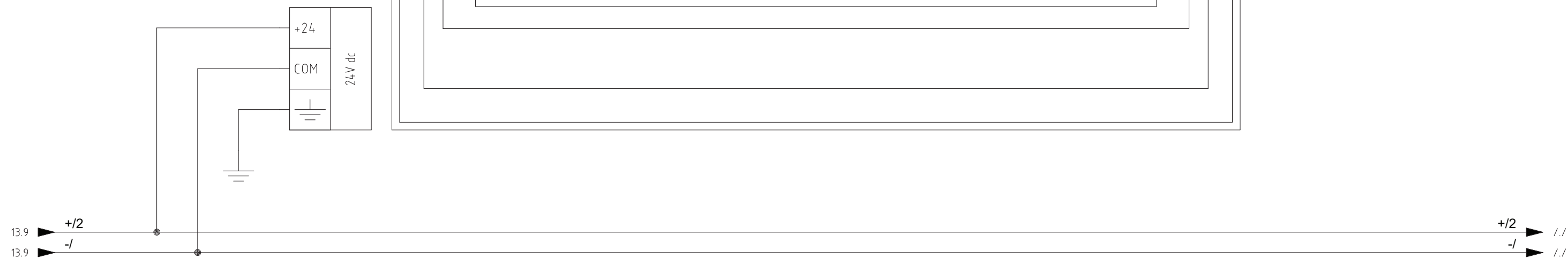

				DATA	03/03/2020
				DISEGN.	ACCIONA AGUA
				VISTO	
REV.	MODIFICA	DATA	FIRMA	APPR.	
0		1			

ABBANO POTABILIZZATORE TORPE PARTITORE SAN SIMONE	
SOST. IL :	SOST. DA :



FILE :

PARTITORE SAN SIMONE SCHEMA QUADRO DI CONTROLLO		=
SCHEMA INDICATIVO PANNELLO OPERATORE HMI		+
		FG. 14
		F.S. /