



A.T.O. SARDEGNA  
A.T.O. SARDEGNA



REGIONE  
AUTONOMA DELLA  
SARDEGNA



Gestore unico del servizio idrico integrato dell'ATO Sardegna

INTERCONNESSIONE CON IL POTABILIZZATORE DI TORPE  
REALIZZAZIONE DELLA DORSALE SUD-NORD

CONCORRENTE:

Concedente A.T.I.



Concedente



Concedente

PROGETTISTA INDICATO

Concedente A.T.I.



Concedente



Dott. G. CALZOLETTI

Dott. G. CALZOLETTI

Concedente



PROGETTO DEFINITIVO

Elaborato

B.81

SERBATOIO TANAUNELLA SCHEMA QE

Da	R	D	R	V	A
04.03.2020	0	A.T.O. SARDEGNA	-	-	-



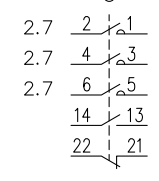
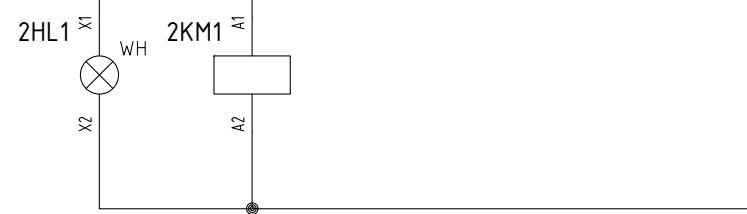
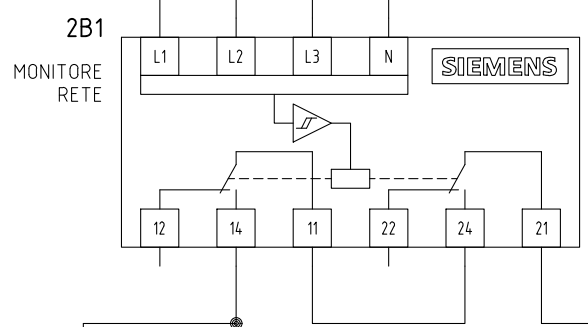
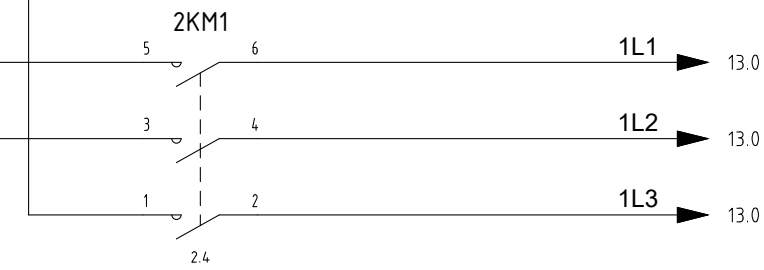
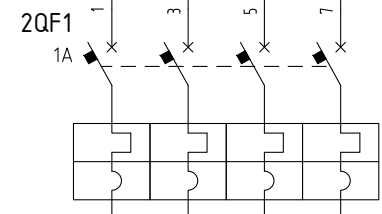
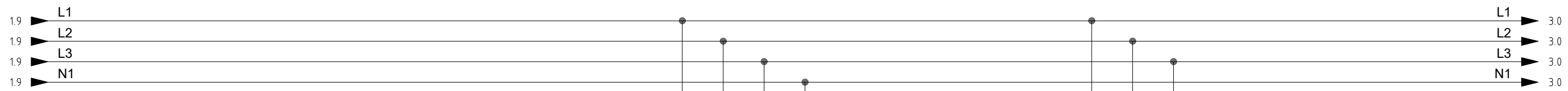

MONITORAGGIO ANOMALIA RETE

CONTATTORE DI LINEA  
ALIMENTAZIONE VALVOLE

REV.		MODIFICA		DATA	03/03/2020	<b>ABBANOA</b> POTABILIZZATORE TORPE SERBATOIO TANAUNELLA		SERBATOIO TANAUNELLA SCHEMA QUADRO DI CONTROLLO		=	
				DISEGN.	ACCIONA AGUA			SCHEMA INDICATIVO MONITORAGGIO RETE		+	
				VISTO							FG. <b>2</b>
				APPR.		SOST. IL :	SOST. DA :	FILE :		F.S. <b>3</b>	
0	1	2	3	4	5	6	7	8	9		

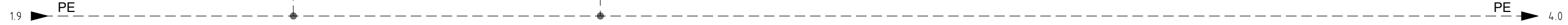
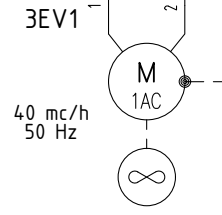
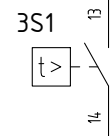
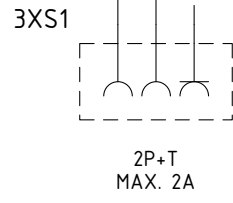
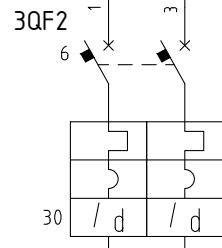
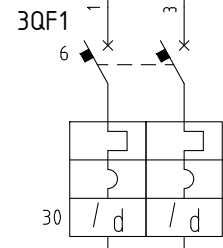
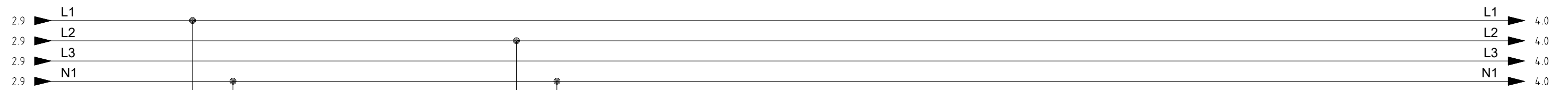

PRESA 230V AC / F+N+T

VENTILAZIONE QUADRO

		DATA	03/03/2020		<b>ABBANO</b> POTABILIZZATORE TORPE SERBATOIO TANAUNELLA					SERBATOIO TANAUNELLA SCHEMA QUADRO DI CONTROLLO			=	
		DISEGN.	ACCIONA AGUA										+	
		VISTO			SOST. IL :                      SOST. DA :                      FILE :			SCHEMA INDICATIVO SERVIZI QUADRO			FG. <b>3</b>			
REV.	MODIFICA	DATA	FIRMA	APPR.							F.S. <b>4</b>			





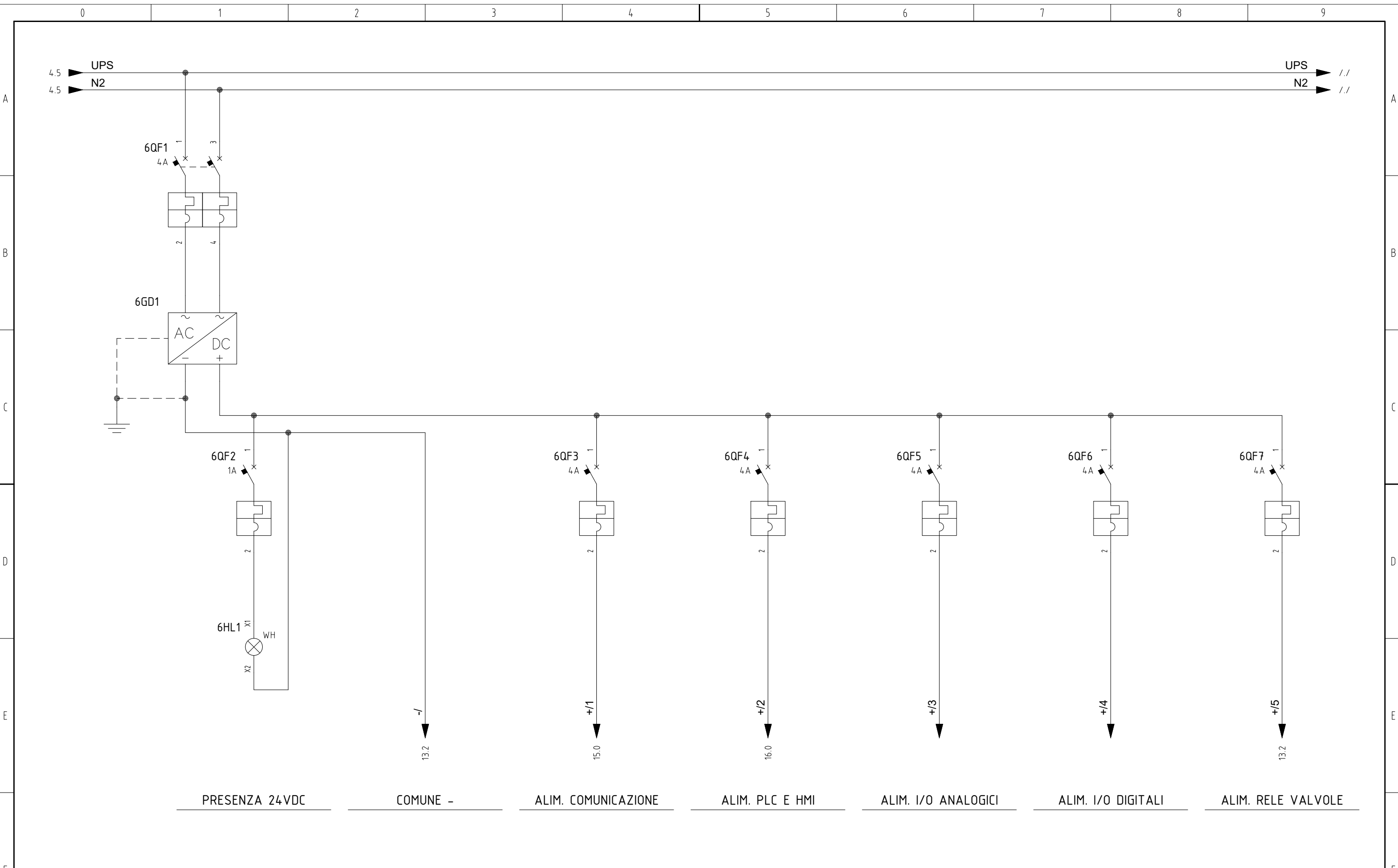

		DATA	03/03/2020		<b>ABBANO</b> POTABILIZZATORE TORPE SERBATOIO TANAUNELLA					SERBATOIO TANAUNELLA SCHEMA QUADRO DI CONTROLLO SCHEMA INDICATIVO ALIMENTAZIONE 24VDC			=	
		DISEGN.	ACCIONA AGUA										+	
		VISTO												
REV.	MODIFICA	DATA	FIRMA	APPR.	SOST. IL :	SOST. DA :	FILE :				FG. <b>6</b>			
0		1			3	4	5				F.S. <b>7</b>			





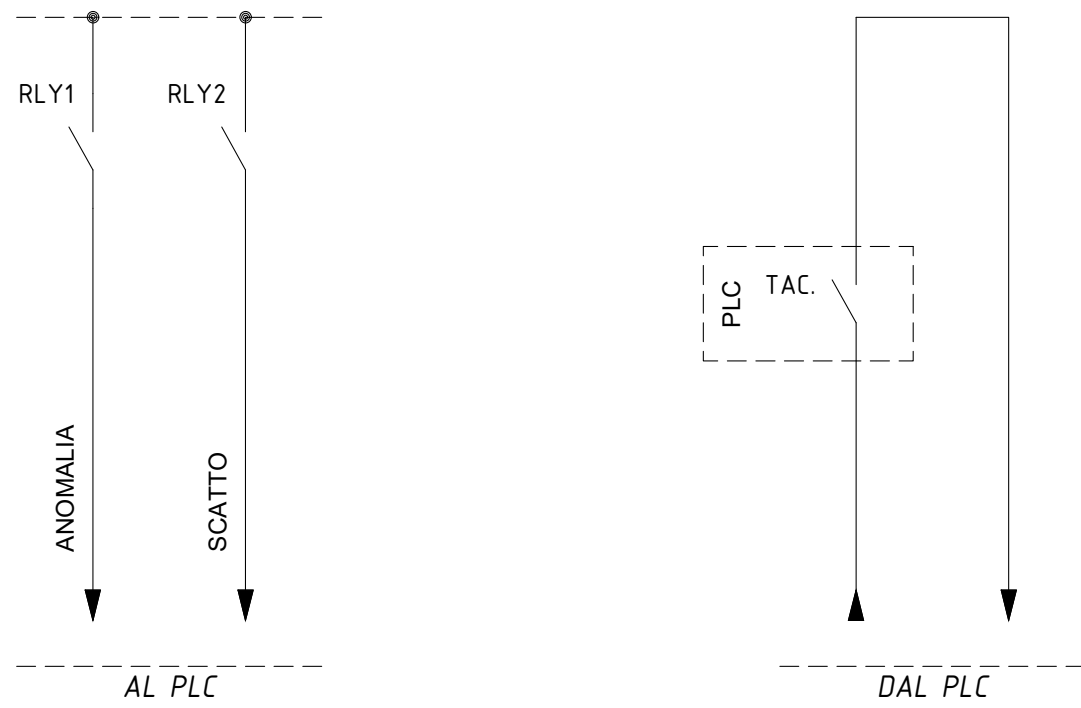

SEGNALAZIONI AL PLC  
CENTR. ANTINTRUSIONE

TACITAZIONE ALLARME  
CENTR. ANTINTRUSIONE

				DATA	03/03/2020	<b>ABBANOA</b> POTABILIZZATORE TORPE SERBATOIO TANAUNELLA		SERBATOIO TANAUNELLA			=	
				DISEGN.	ACCIONA AGUA			SCHEMA QUADRO DI CONTROLLO				+
				VISTO				SCHEMA INDICATIVO				FG. <b>8</b>
REV.	MODIFICA	DATA	FIRMA	APPR.		SOST. IL :	SOST. DA :	FILE :			F.S. <b>9</b>	
0		1			2	3	4	5	6	7	8	9

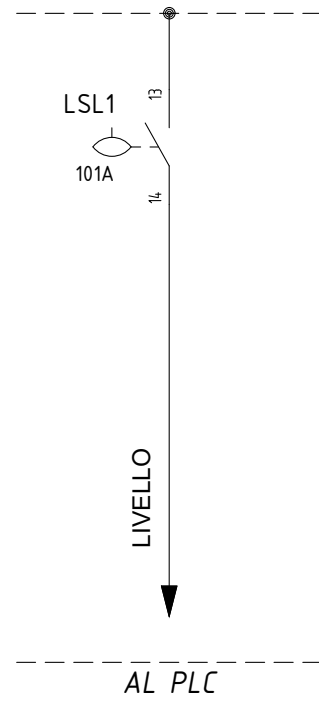

SEGNALAZIONI AL PLC  
LSL - VASCA A

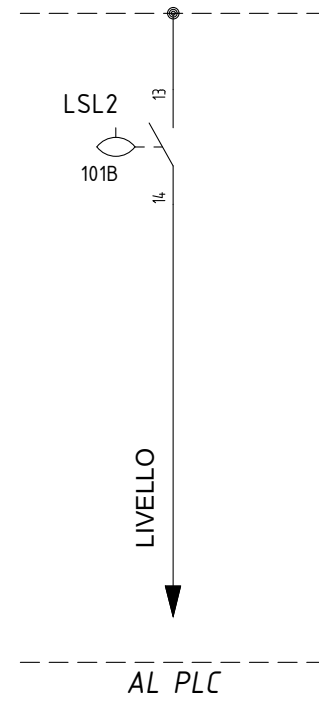

SEGNALAZIONI AL PLC  
LSL - VASCA B

				DATA	03/03/2020	<b>ABBANO</b> POTABILIZZATORE TORPE SERBATOIO TANAUNELLA		SERBATOIO TANAUNELLA			=
				DISEGN.	ACCIONA AGUA			SCHEMA QUADRO DI CONTROLLO			+
				VISTO				SCHEMA INDICATIVO			
REV.	MODIFICA	DATA	FIRMA	APPR.		SOST. IL :	SOST. DA :	FILE :			F.S. <b>10</b>
0		1				2	3	4	5	6	7





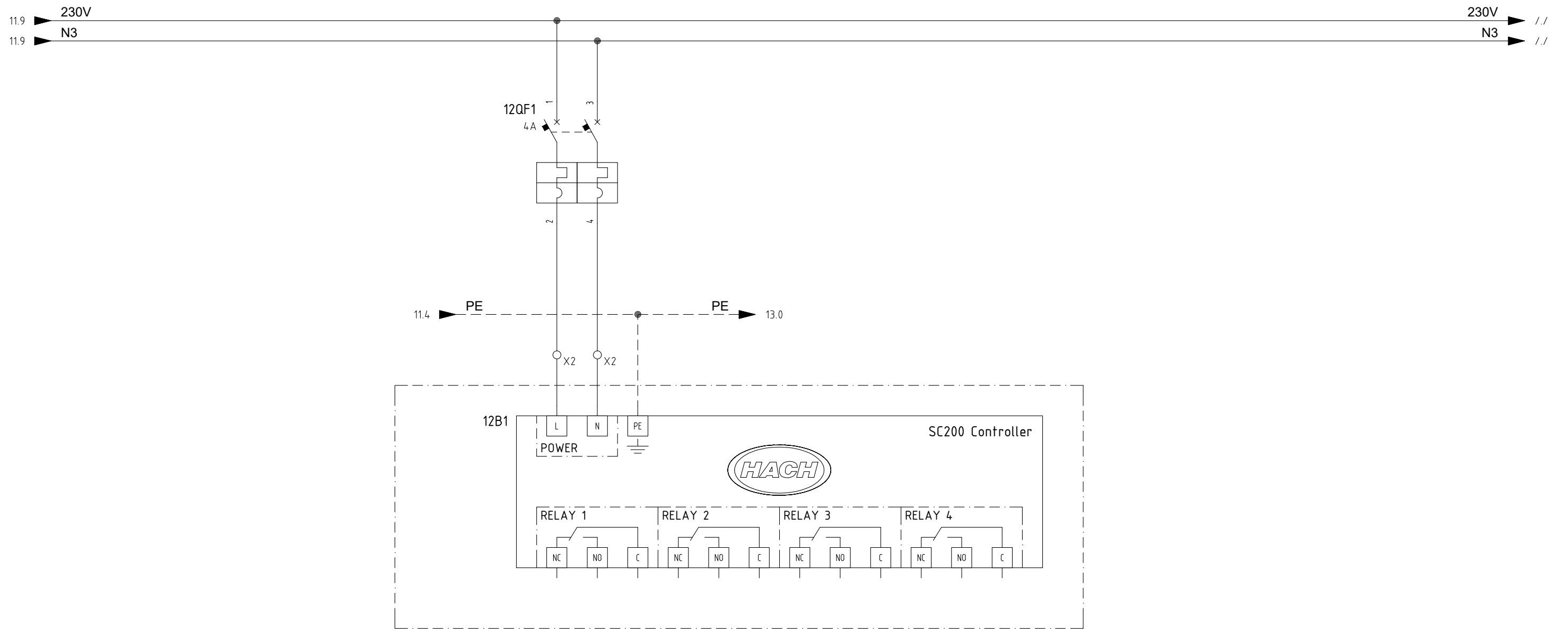

CENTRALINA ANALISI

				DATA	03/03/2020	<b>ABBANO</b> POTABILIZZATORE TORPE SERBATOIO TANAUNELLA		SERBATOIO TANAUNELLA			=
				DISEGN.	ACCIONA AGUA			SCHEMA QUADRO DI CONTROLLO			+
				VISTO				SCHEMA INDICATIVO			
REV.	MODIFICA	DATA	FIRMA	APPR.		SOST. IL :	SOST. DA :	FILE :			F.S. 13
0		1				3	4	5	6	7	9

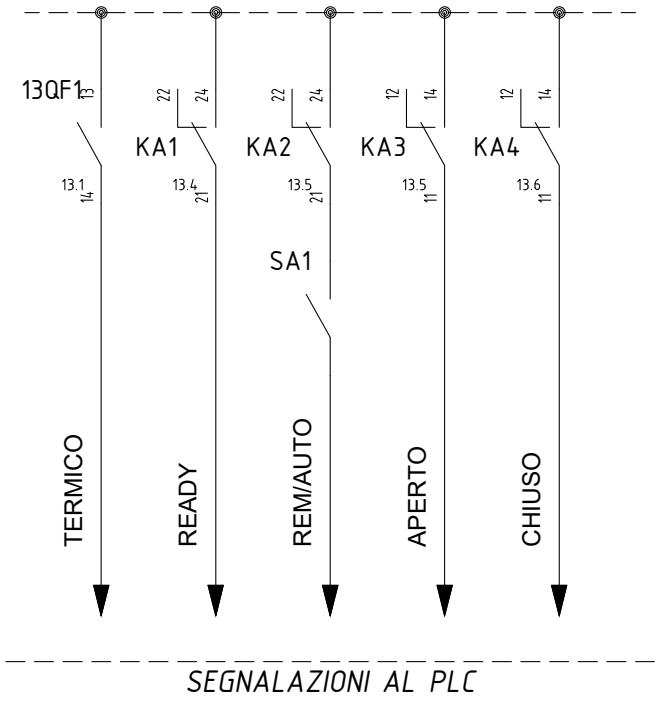
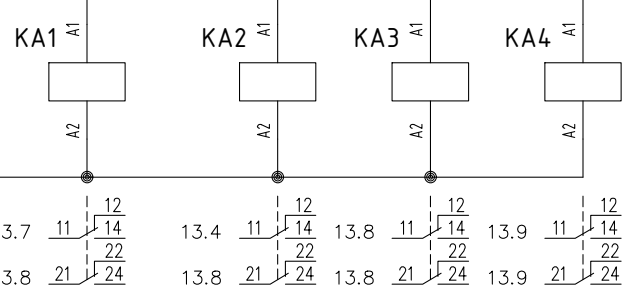
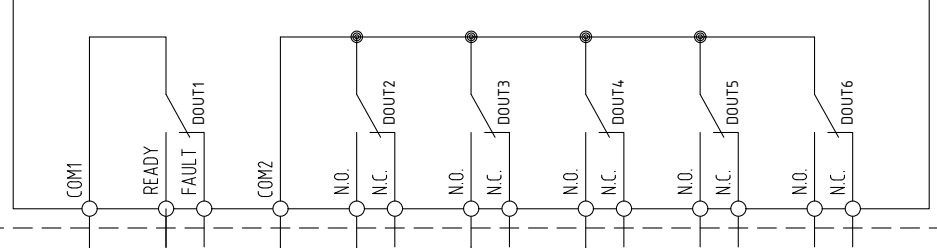
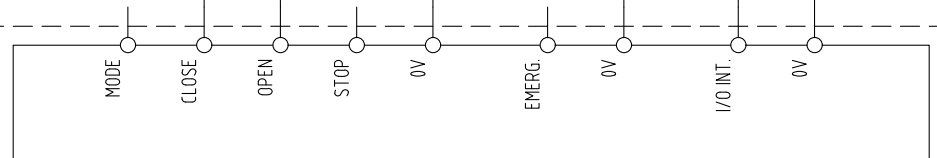
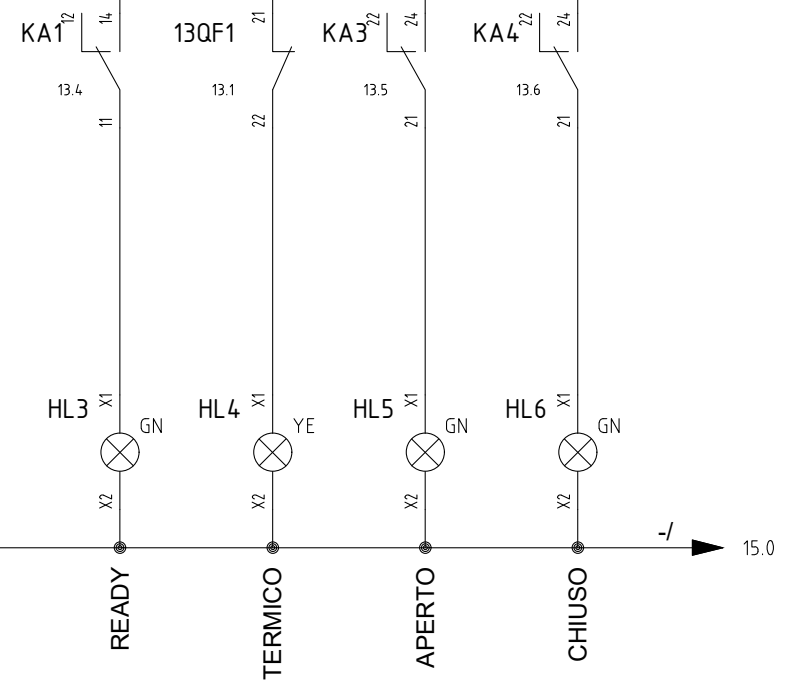
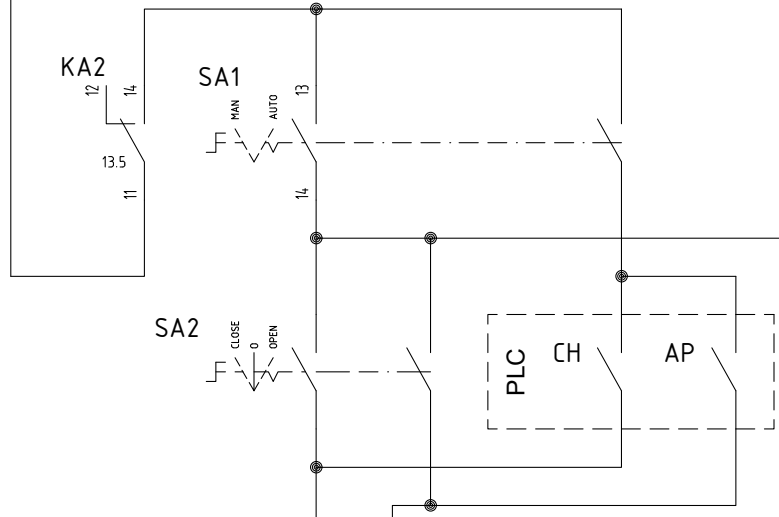
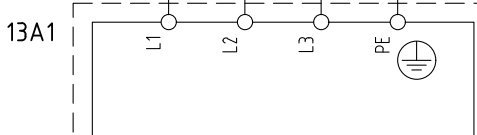
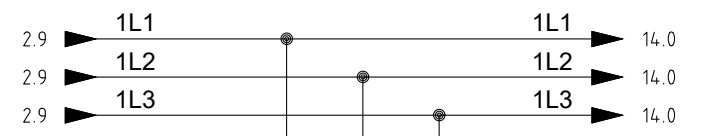

ALIMENTAZIONE 400V AC  
ATTUATORE MOTORIZZ.

DATA	03/03/2020	ABBANO POTABILIZZATORE TORPE SERBATOIO TANAUNELLA	acciona Agua	SERBATOIO TANAUNELLA SCHEMA QUADRO DI CONTROLLO	=				
DISEGN.	ACCIONA AGUA								
VISTO									
REV.	MODIFICA	DATA	FIRMA	APPR.	SOST. IL :	SOST. DA :	FILE :	SCHEMA INDICATIVO ATTUATORI MOTORIZZATI	FG. 13
0		1							F.S. 14

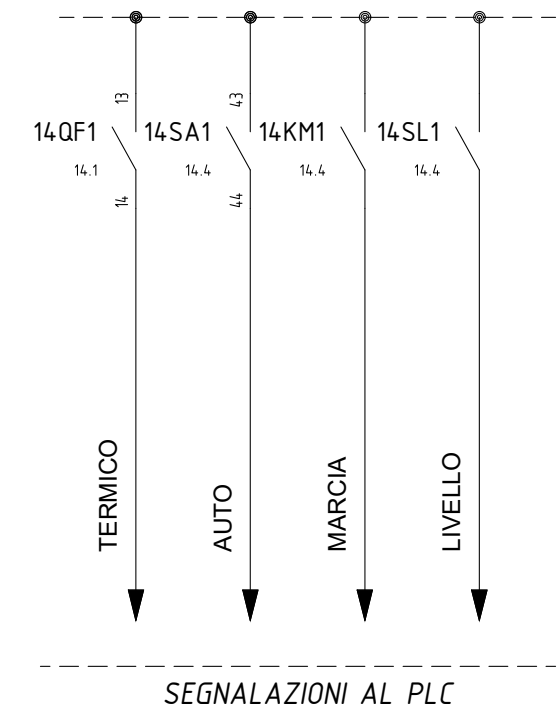
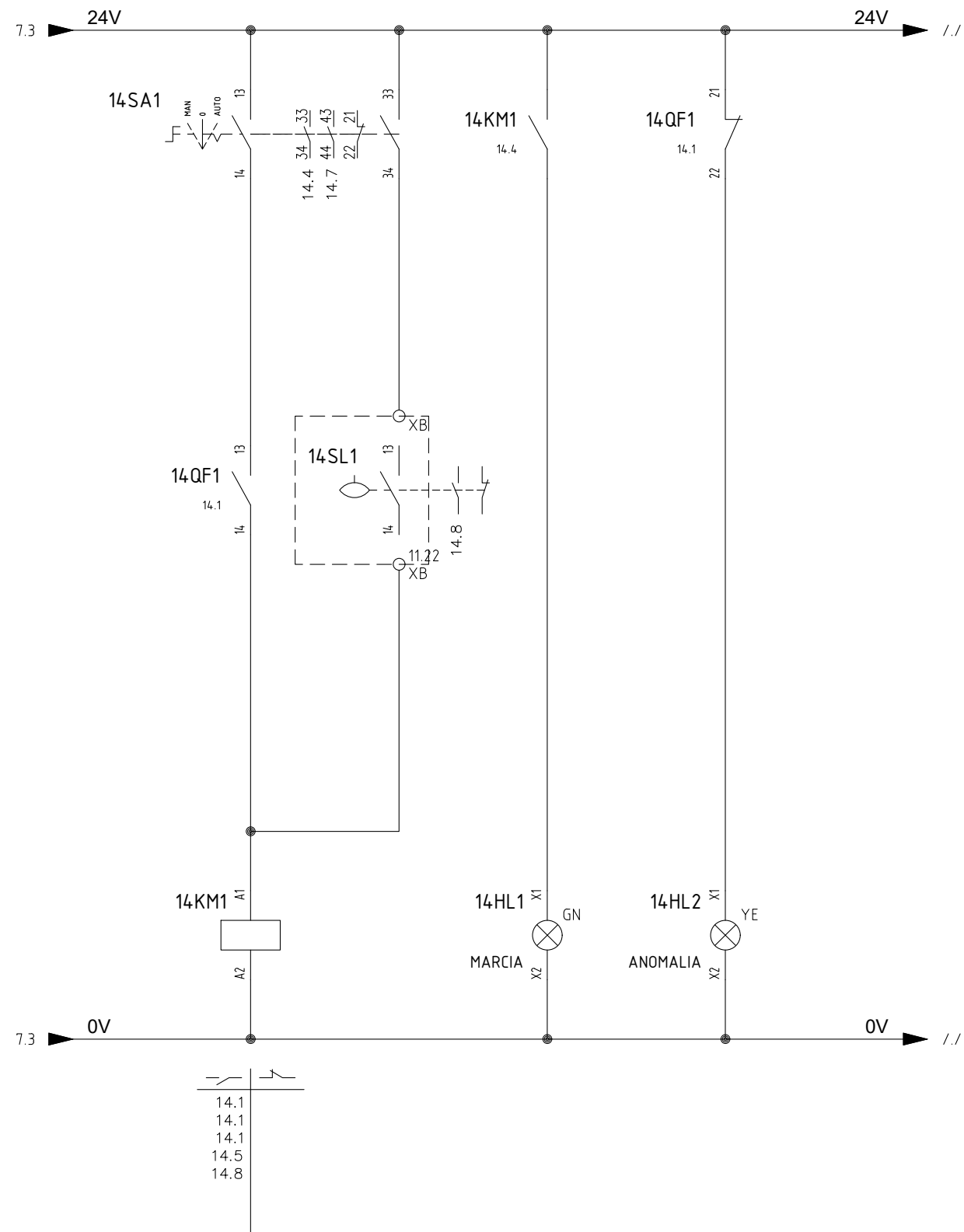
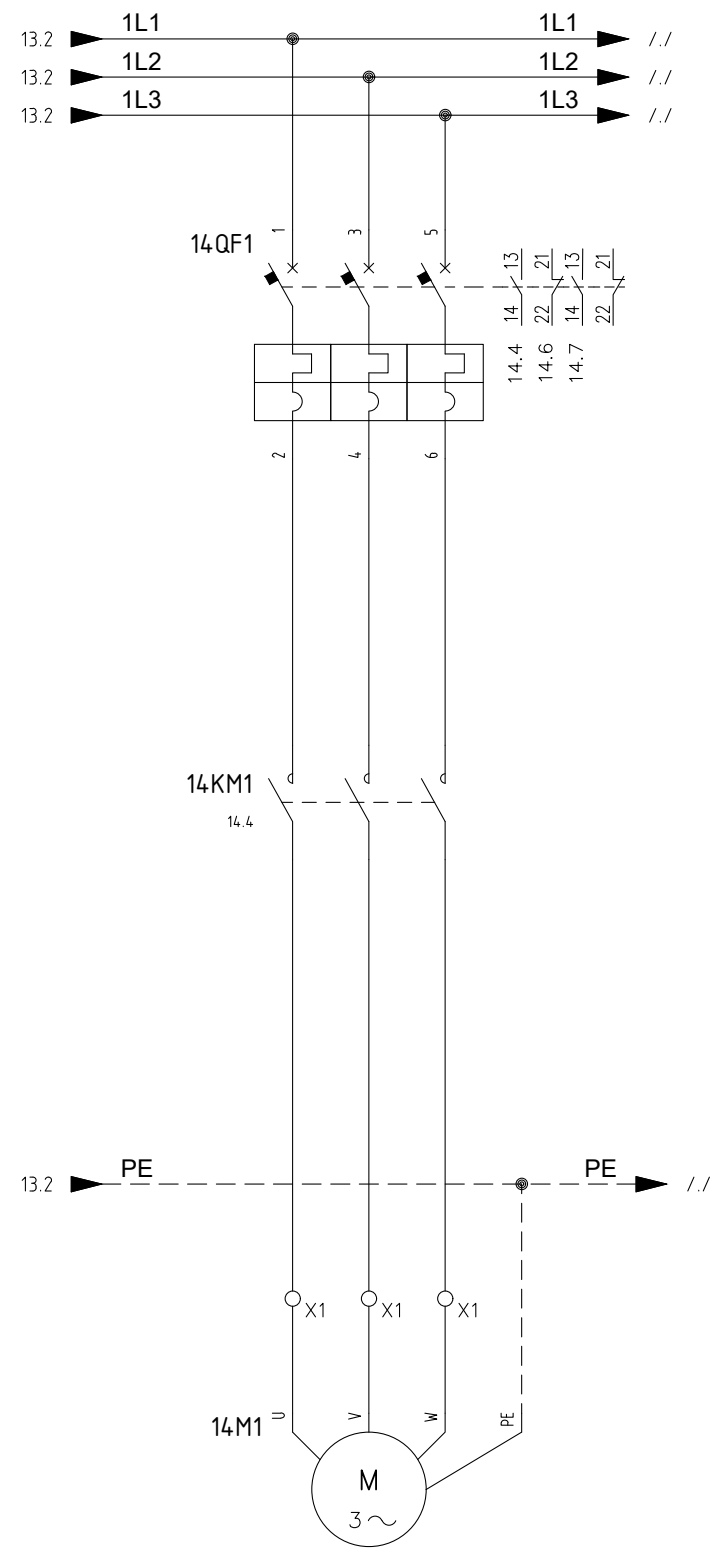

		DATA	03/03/2020		<b>ABBANO</b> POTABILIZZATORE TORPE SERBATOIO TANAUNELLA					SERBATOIO TANAUNELLA SCHEMA QUADRO DI CONTROLLO			
		DISEGN.	ACCIONA AGUA										
		VISTO											
REV.	MODIFICA	DATA	FIRMA	APPR.	SOST. IL :	SOST. DA :	FILE :					FG. 14	
0		1			3	4	5	6	7	8	9	F.S. 15	

0 1 2 3 4 5 6 7 8 9

A  
B  
C  
D  
E  
F

12A1

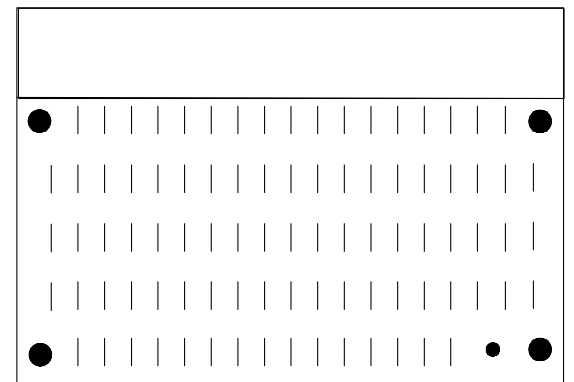

RTU  
Wit Redy

12A2

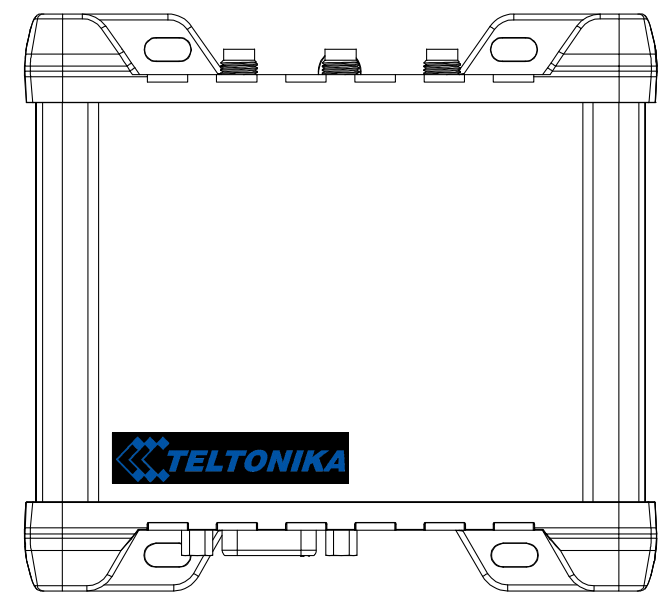

ROUTER  
Teltonika RUT955

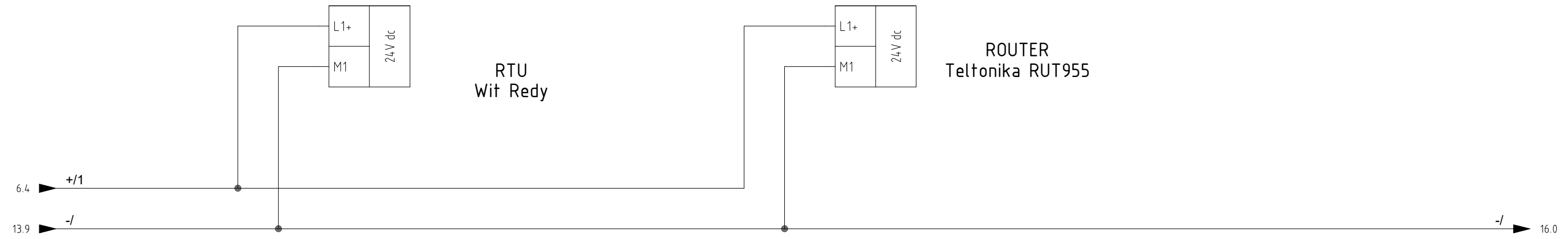

		DATA	03/03/2020		<b>ABBANO</b> POTABILIZZATORE TORPE SERBATOIO TANAUNELLA					SERBATOIO TANAUNELLA SCHEMA QUADRO DI CONTROLLO SCHEMA INDICATIVO COMUNICAZIONE #1			=	
		DISEGN.	ACCIONA AGUA										+	
		VISTO												
REV.	MODIFICA	DATA	FIRMA	APPR.	SOST. IL :	SOST. DA :	FILE :				FG. 15			
0		1			2						F.S. 16			



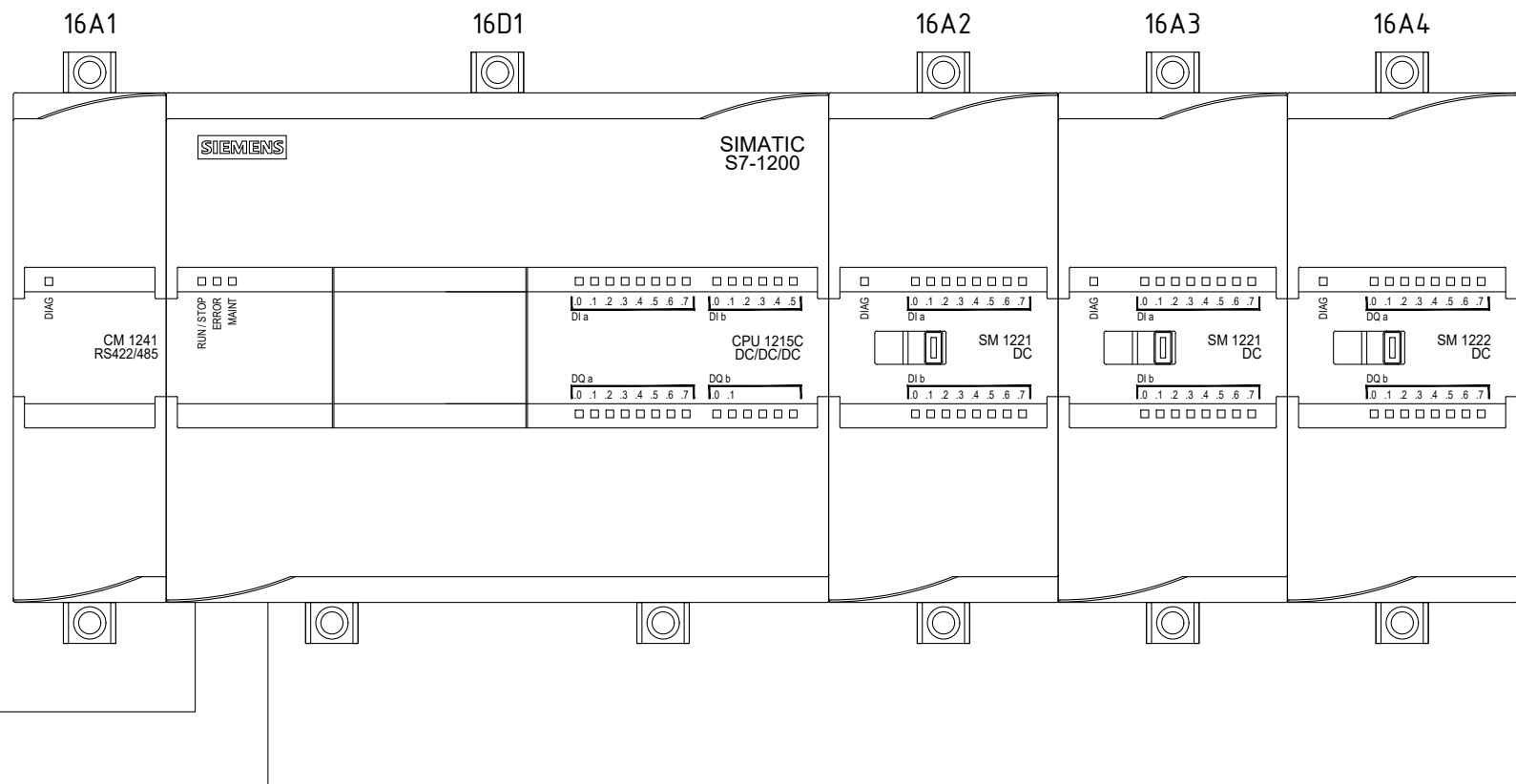

				DATA	03/03/2020	<b>ABBANO</b> POTABILIZZATORE TORPE SERBATOIO TANAUNELLA		SERBATOIO TANAUNELLA		=			
				DISEGN.	ACCIONA AGUA			SCHEMA QUADRO DI CONTROLLO			+		
				VISTO				SCHEMA INDICATIVO					
REV.	MODIFICA	DATA	FIRMA	APPR.	SOST. IL :	SOST. DA :	FILE :	PLC / SCHEDE IO	FG. 16				
	0		1		2	3	4	5	6	7	8	9	F.S. 17

