

Progettazione:

SC **Studio di Ingegneria**
Michele R.G. Curtotti

STUDIO DI INGEGNERIA ING. MICHELE R.G. CURTOTTI
Viale II Giugno, 385 - 71016 San Severo (FG)
Ing.curtotti@pec.it - studlocurtotti@gmail.it

Proponente:

INNOGY ITALIA S.p.A.

Via Francesco Restelli 31/1 - 20124 Milano

c.f e P.Iva 02590640211 - PEC innogy_italia@legalmail.it

PARCO EOLICO SAN SEVERO COMUNE DI SAN SEVERO

Autorizzazione Unica ai sensi della legge 387/03
del parco eolico nel comune di San Severo (FG)

COMMITTENTE: INNOGY ITALIA S.p.A.

Comune di San Severo (FG)

TAVOLA

18

PIANO PARTICELLARE GRAFICO

PROGETTO DEFINITIVO

DATA : Ottobre 2018

AGGIORN. : Novembre 2020

SCALA : _____

DIMENS. : A4

N° FOGLI : _____

COMMITTENTE:
INNOGY ITALIA S.p.A.

RWE
GROUP

PROGETTAZIONE:
ing. Michele R.G. Curtotti



Questo elaborato è di proprietà dei progettisti ed è protetto a termini di legge

Legenda:

Ai

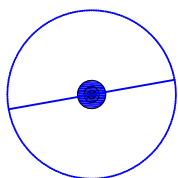

aerogeneratore_area da espropriare

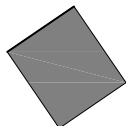

piazzola permanente_area da espropriare

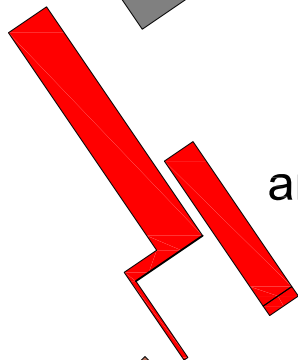

aree di occupazione temporanea

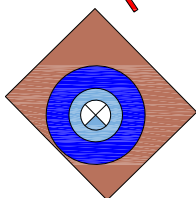

area plinto di fondazione_da espropriare

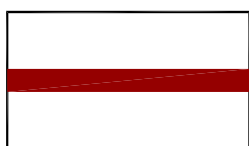

strade nuova formazione_servitù

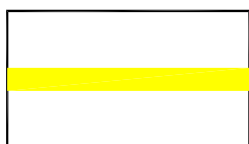

strade da adeguare_aree di occupazione temporanea

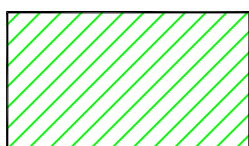

curve da adeguare_aree di occupazione temporanea

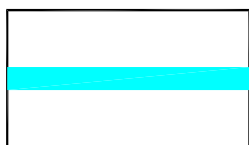

cavidotto MT interno_servitù

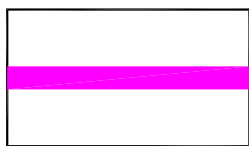

cavidotto MT RTN_servitù

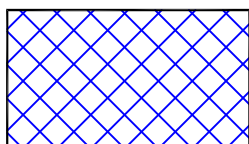

stazione 150/30 kV di Utenza_area da espropriare

COMUNE DI SAN SEVERO - FOGLIO 50

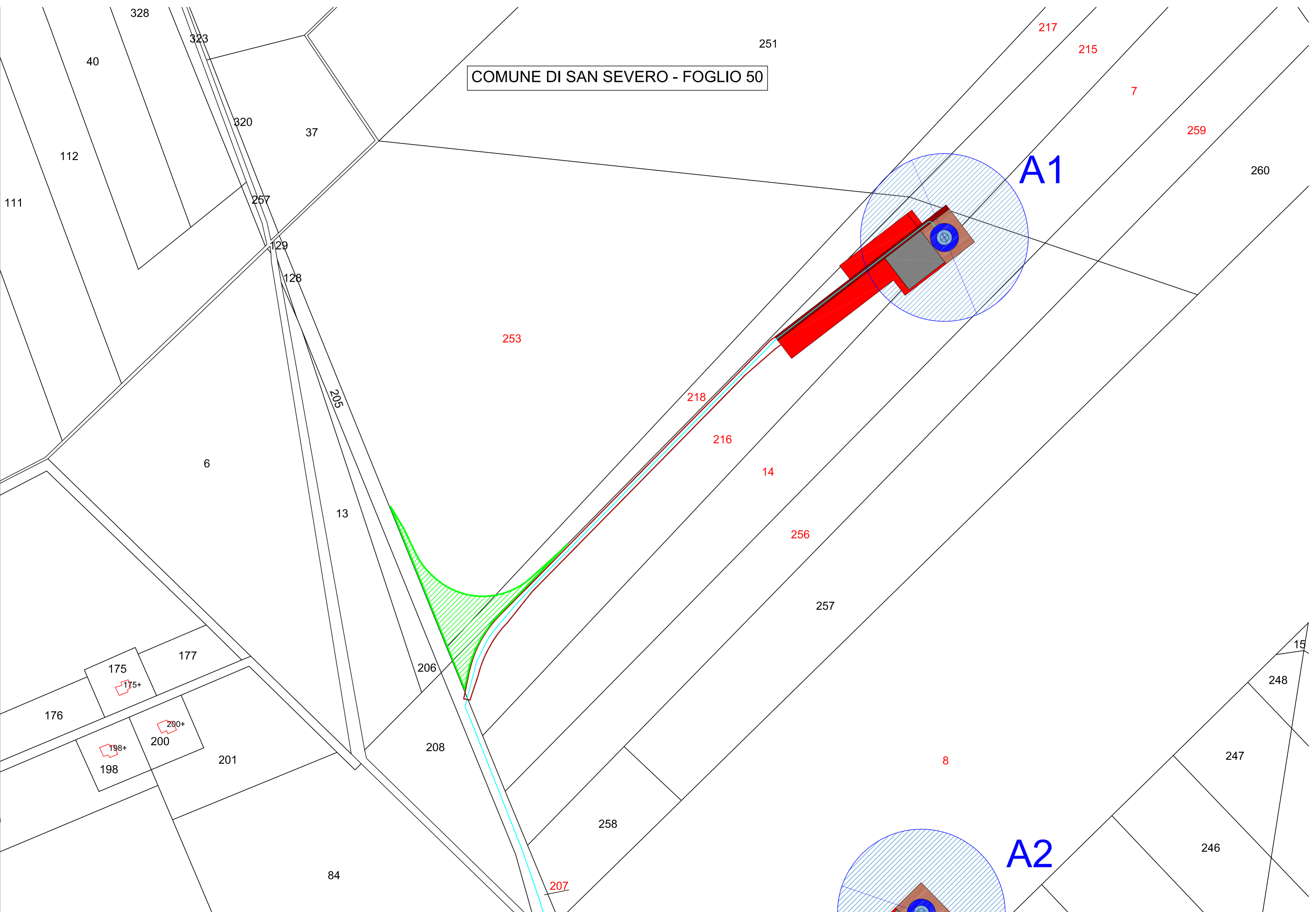

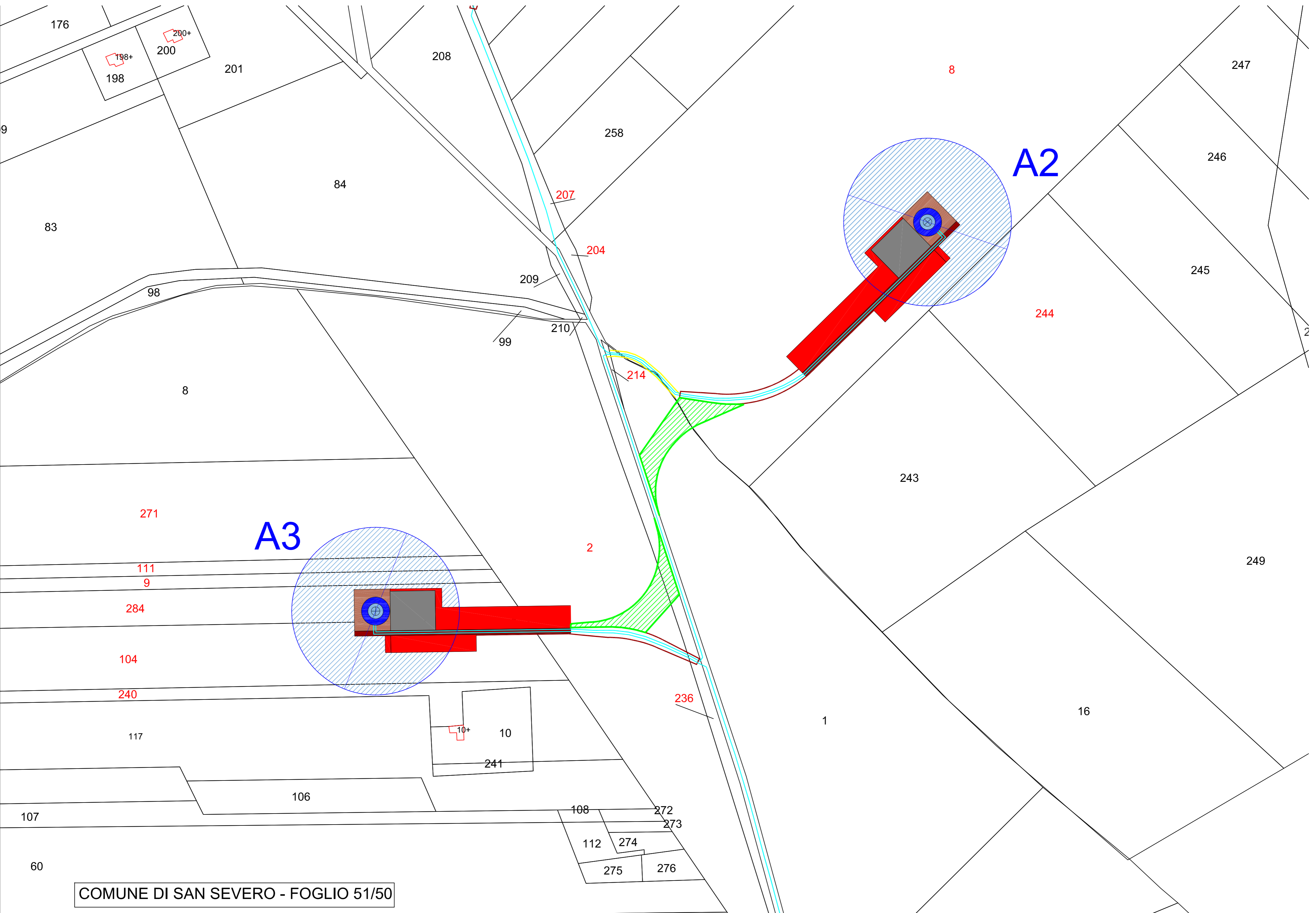

176

198+

200+

200

198

201

208

258

247

84

207

8

246

83

204

A2

209

245

98

210

99

244

8

214

243

271

A3

2

249

111

9

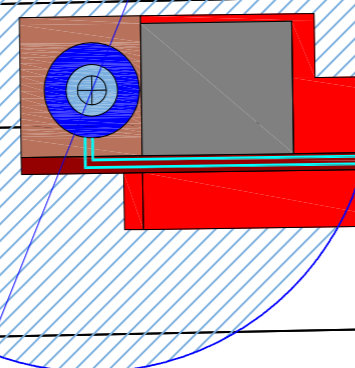

284

104

236

1

16

240

117

10+

10

241

107

106

108

272

273

60

112

274

275

276

COMUNE DI SAN SEVERO - FOGLIO 51/50

A4

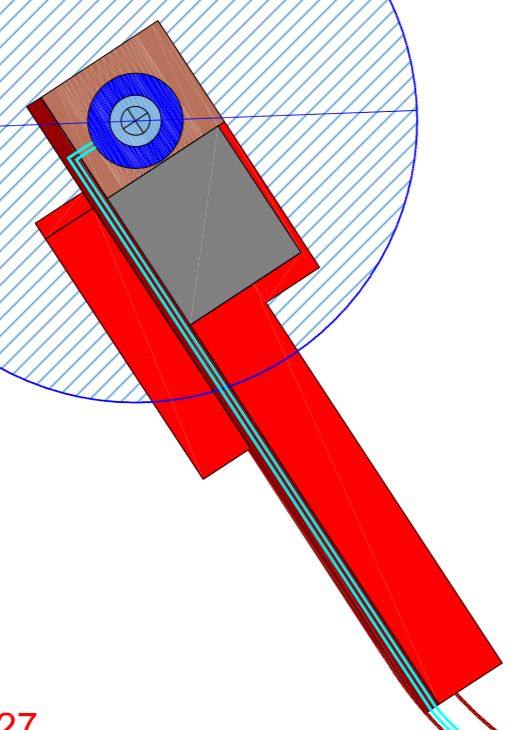
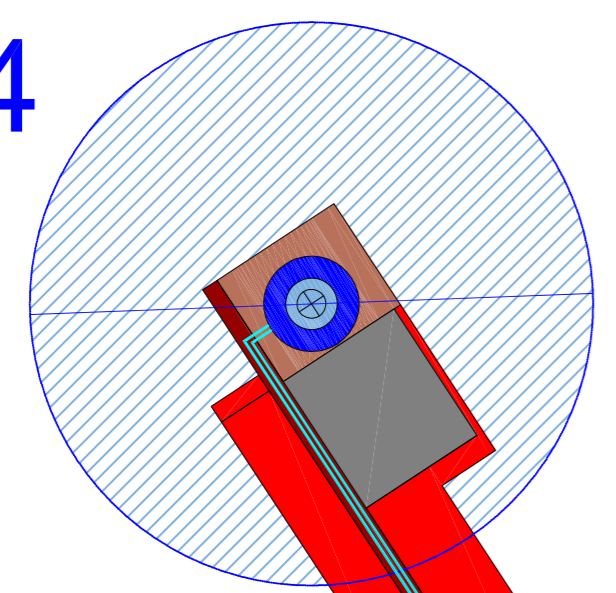

323

324

325

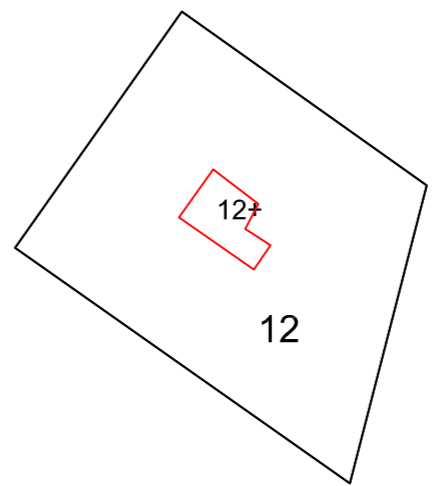

12

12

327

328

329

335

181

115

201

200

113

114

180

185

182

183

290

292

294

296

298

300

291

293

295

14

297

299

301

184

171

176

175

166

287

227

228

285

365

16

229

230

170

167

15

224

223

169

302

COMUNALE SAN MARCO IN LAMIS - FOGGIA

326

327

178

336

335

13

113

288

290

289

291

A5

172

171

286

285

173

170

169

174

375

A6

102

116

99

98

337

338 96

95

339

340 93

15

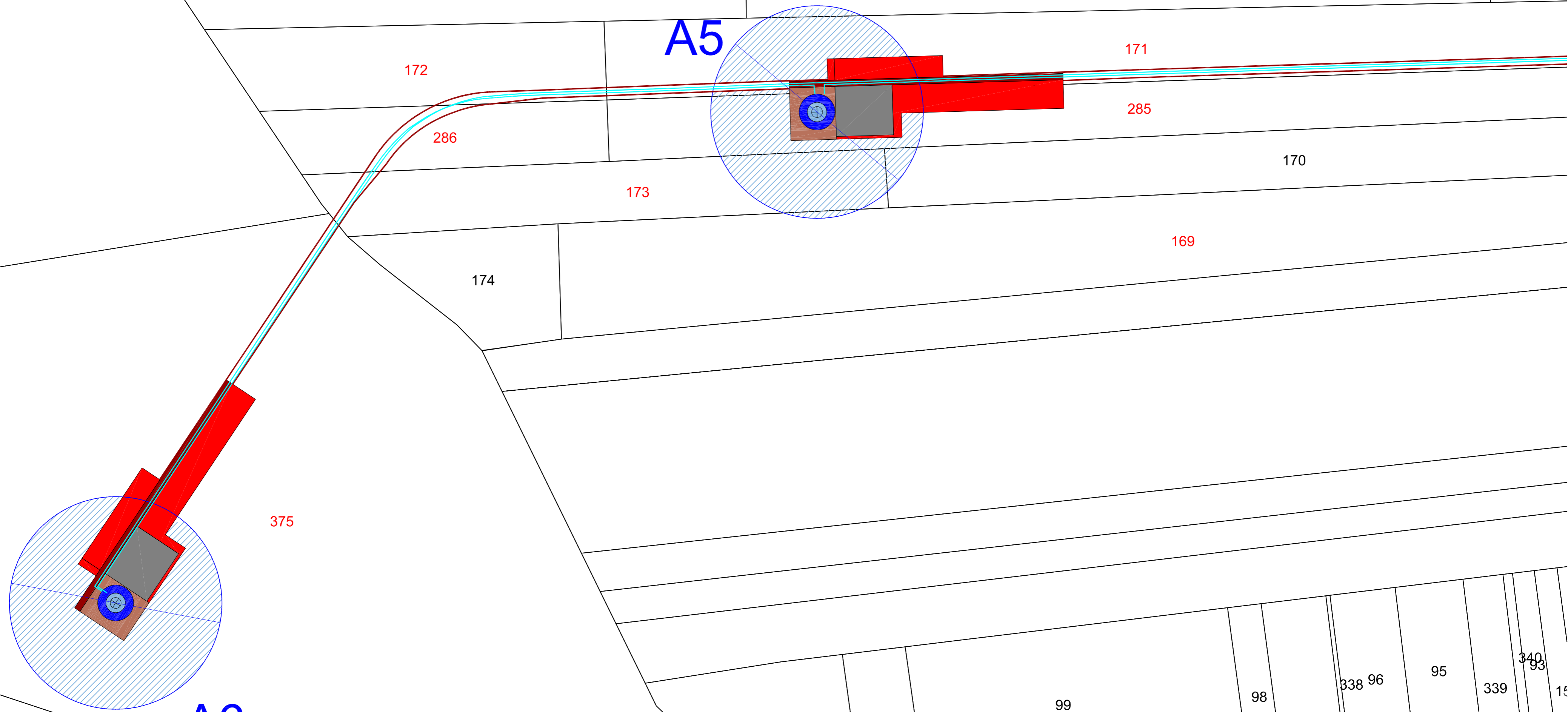



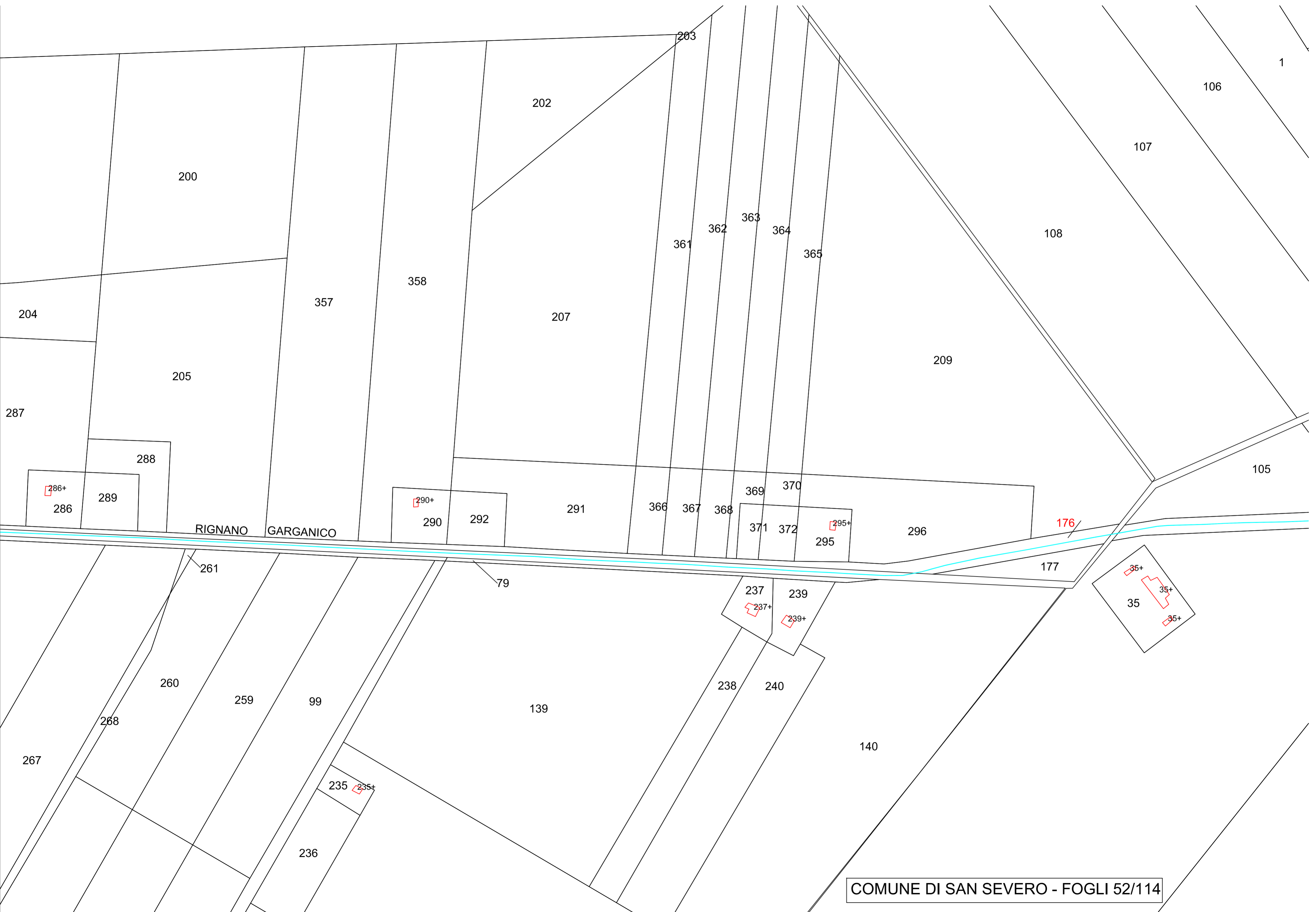

204

287

286+

286

289

288

RIGNANO

GARGANICO

267

268

260

261

259

99

236

235

235+

79

139

238

240

237

237+

239

239+

140

177

35

35+

35+

35+

200

204

287

286+

286

289

288

205

357

358

207

202

361

362

363

364

365

203

369

370

371

372

295+

295

296

176

209

108

107

106

1

105

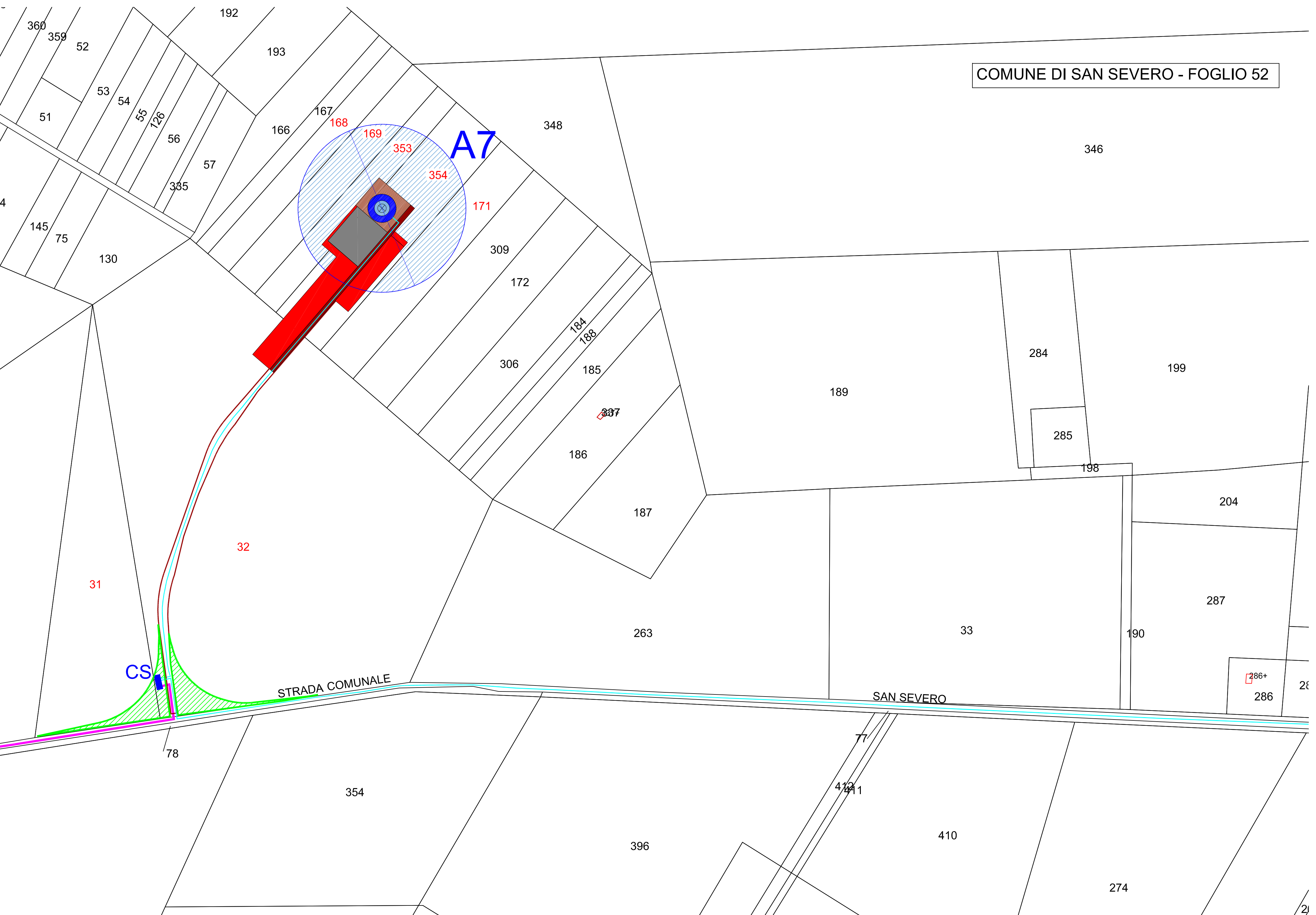

COMUNE DI SAN SEVERO - FOGLI 113/52

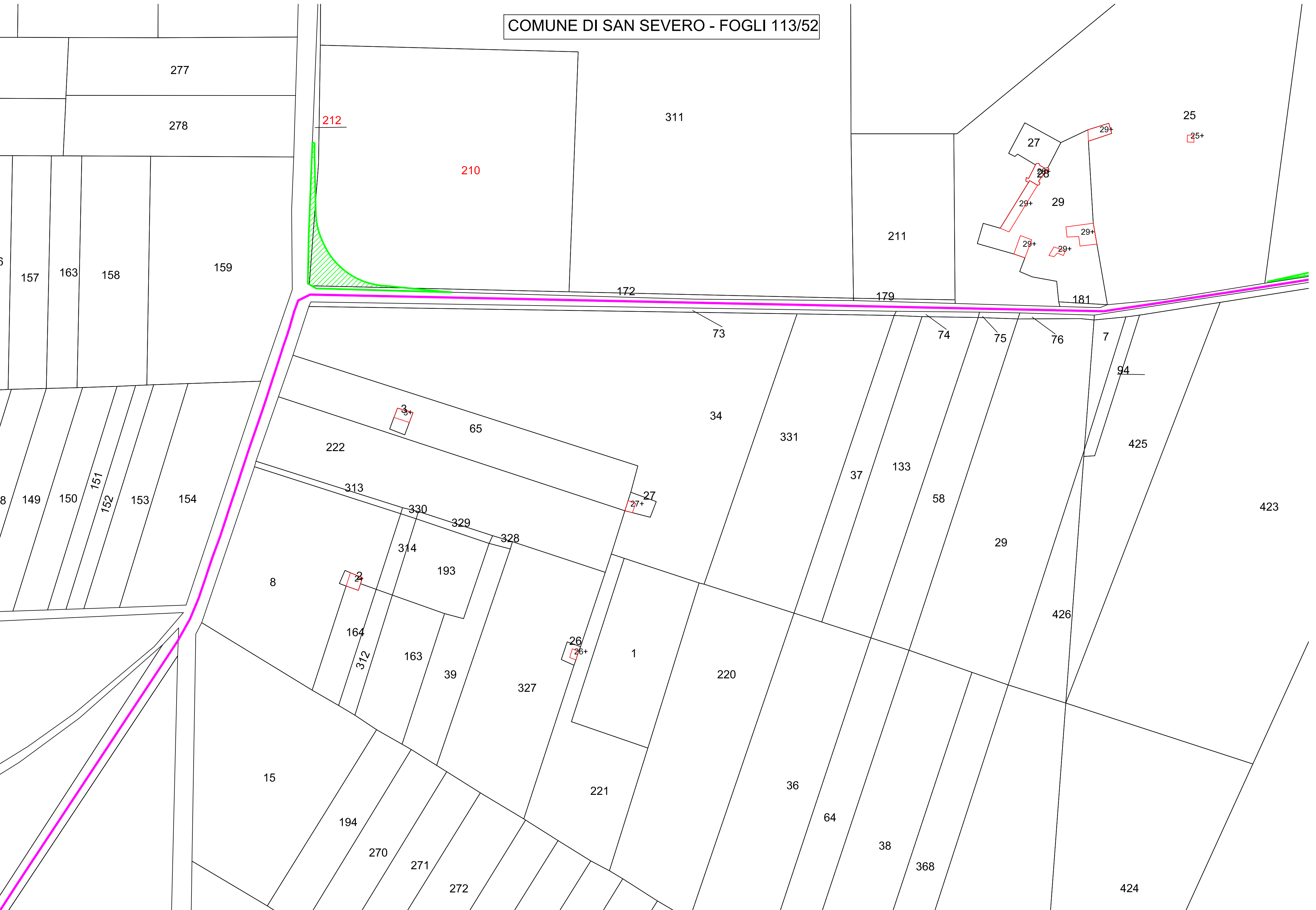

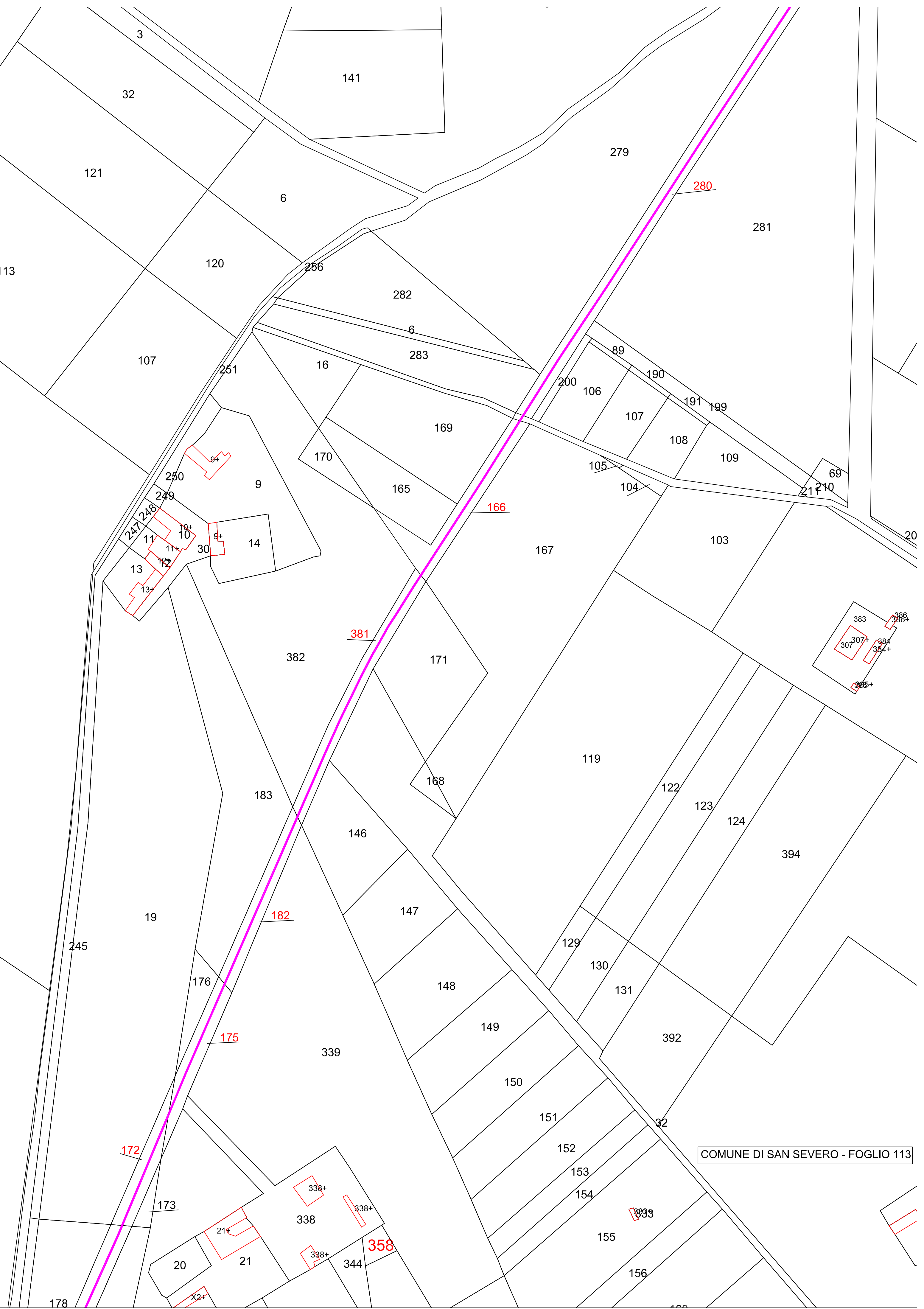

COMUNE DI SAN SEVERO - FOGLIO 113

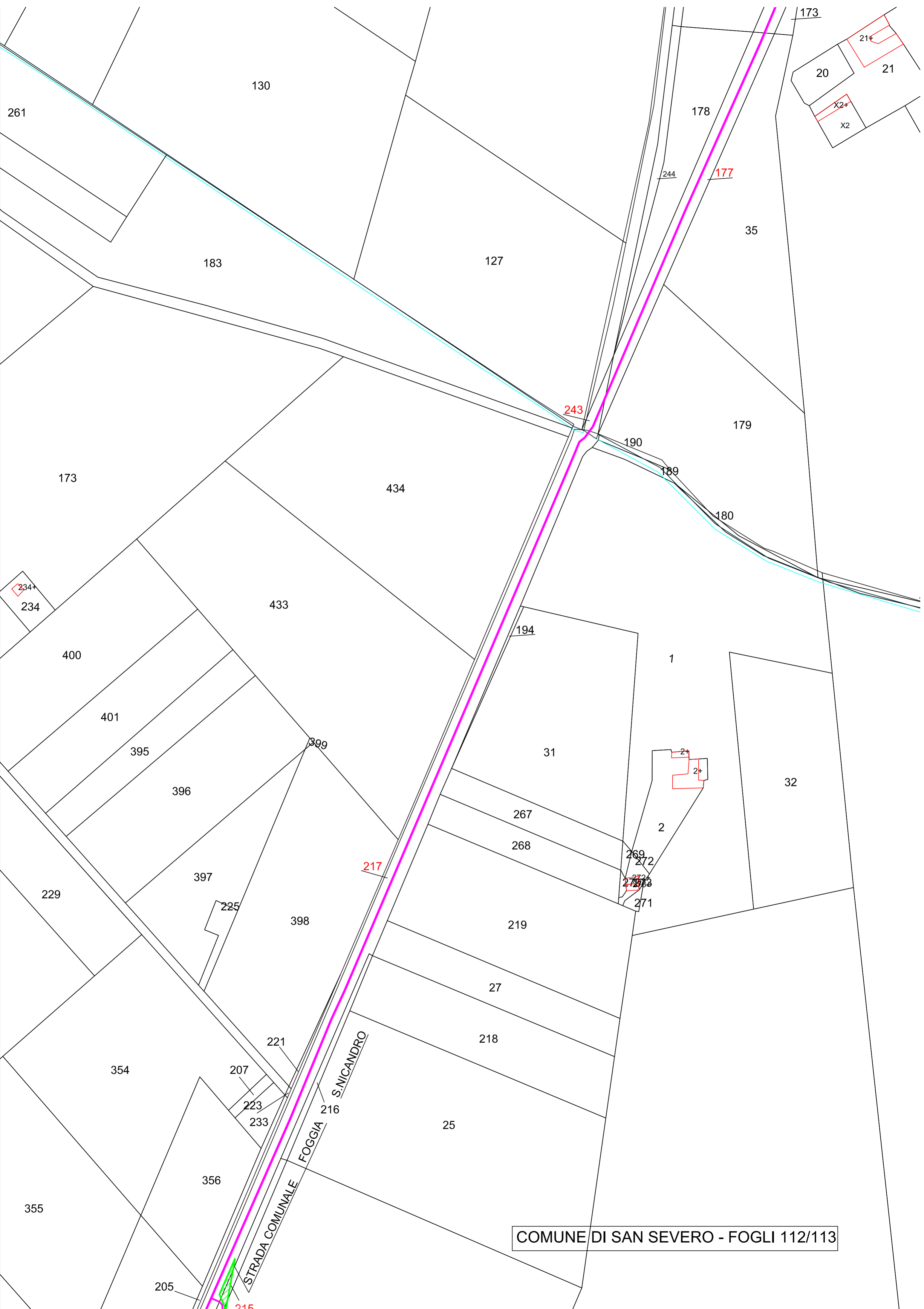

173

21+

20

21

X2+

X2

130

178

35

261

244

177

183

127

179

243

190

189

180

173

434

234+

234

433

194

400

1

401

399

31

395

2+

2+

396

32

397

267

2

229

268

269

272

396

217

273

274

225

398

219

271

S. NICANDRO

27

354

221

218

207

216

25

223

233

356

205

215

STRADA COMUNALE FOGGIA

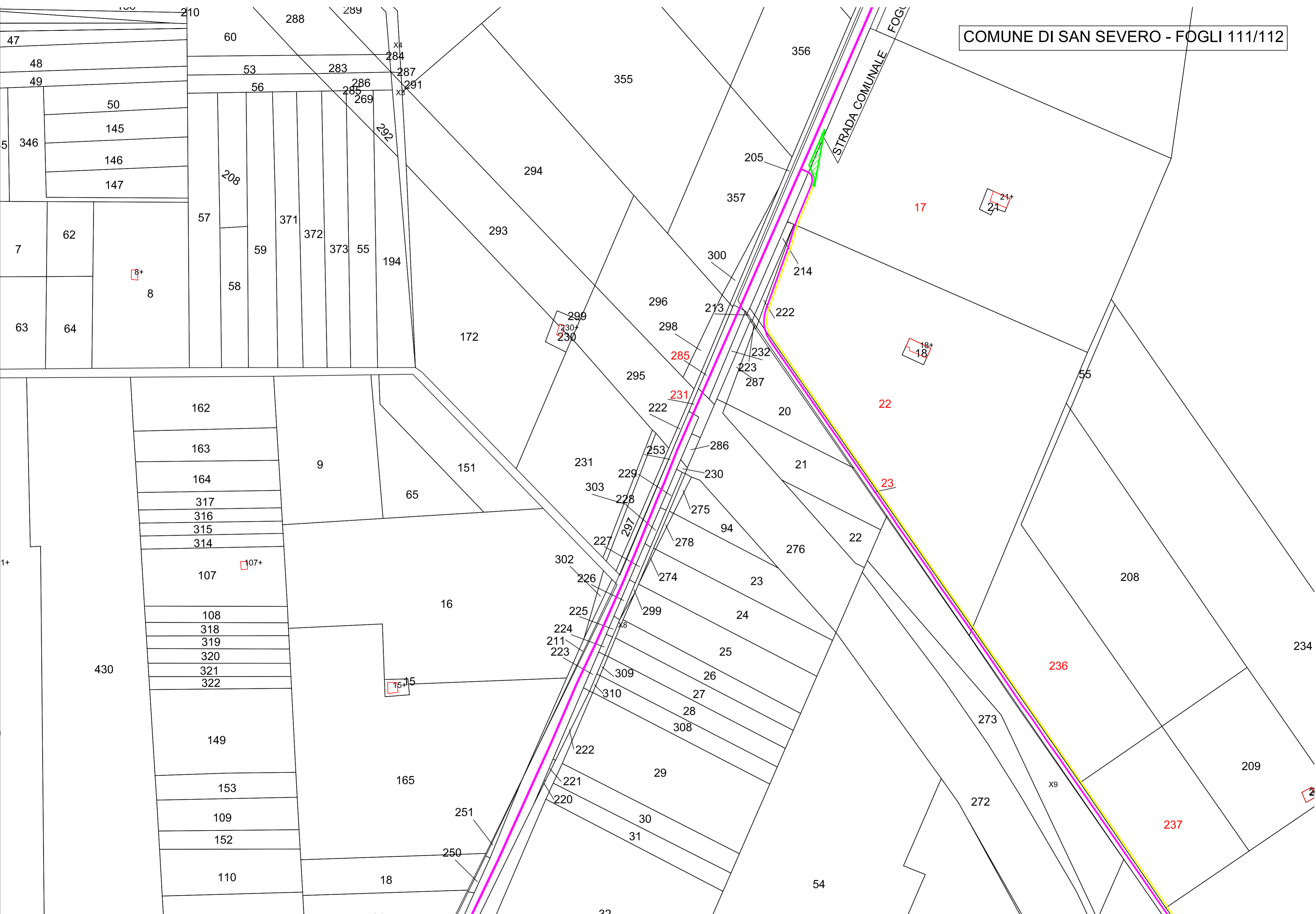

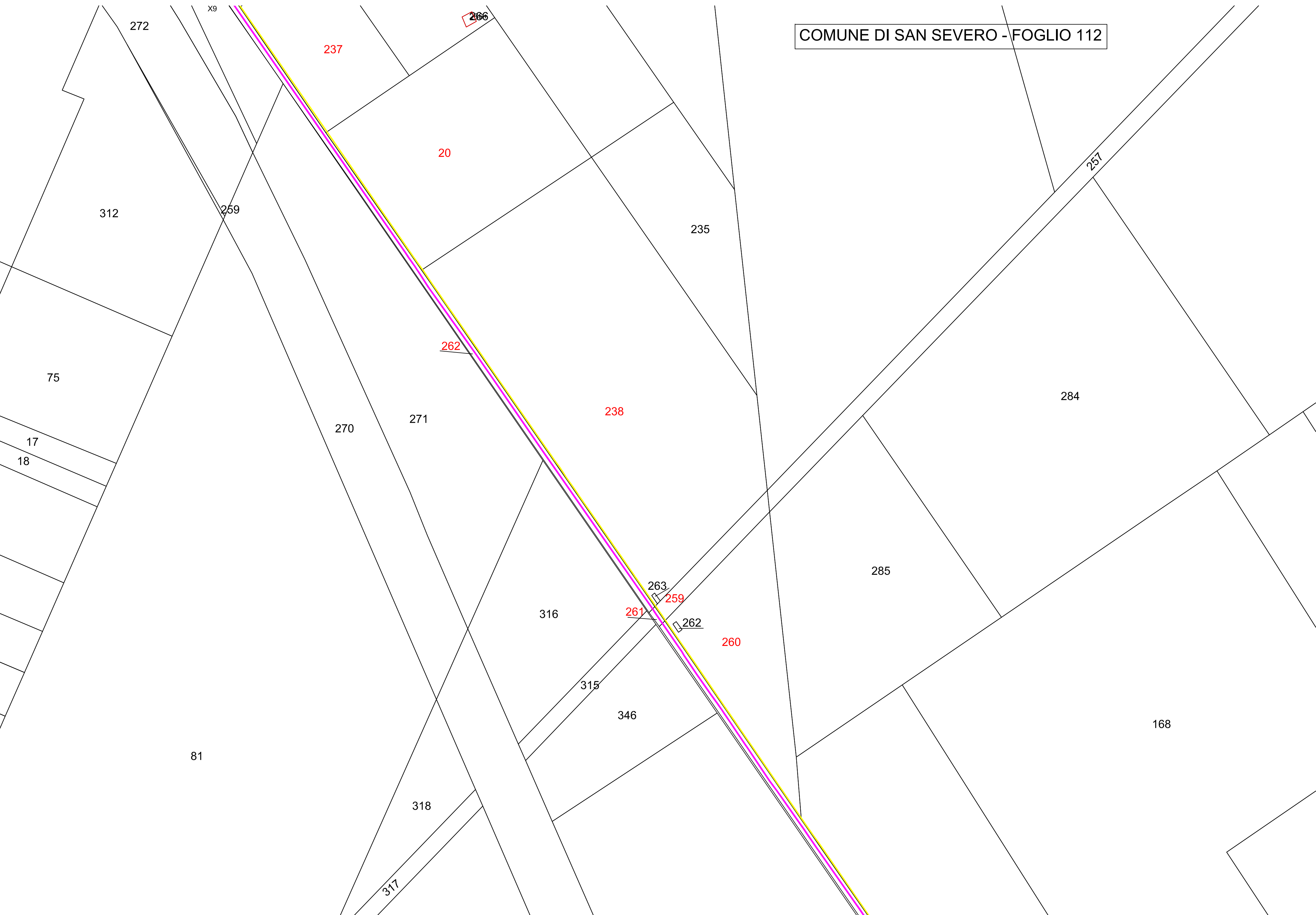



A12

COMUNE DI SAN SEVERO - FOGLI 120/118

A10

A11

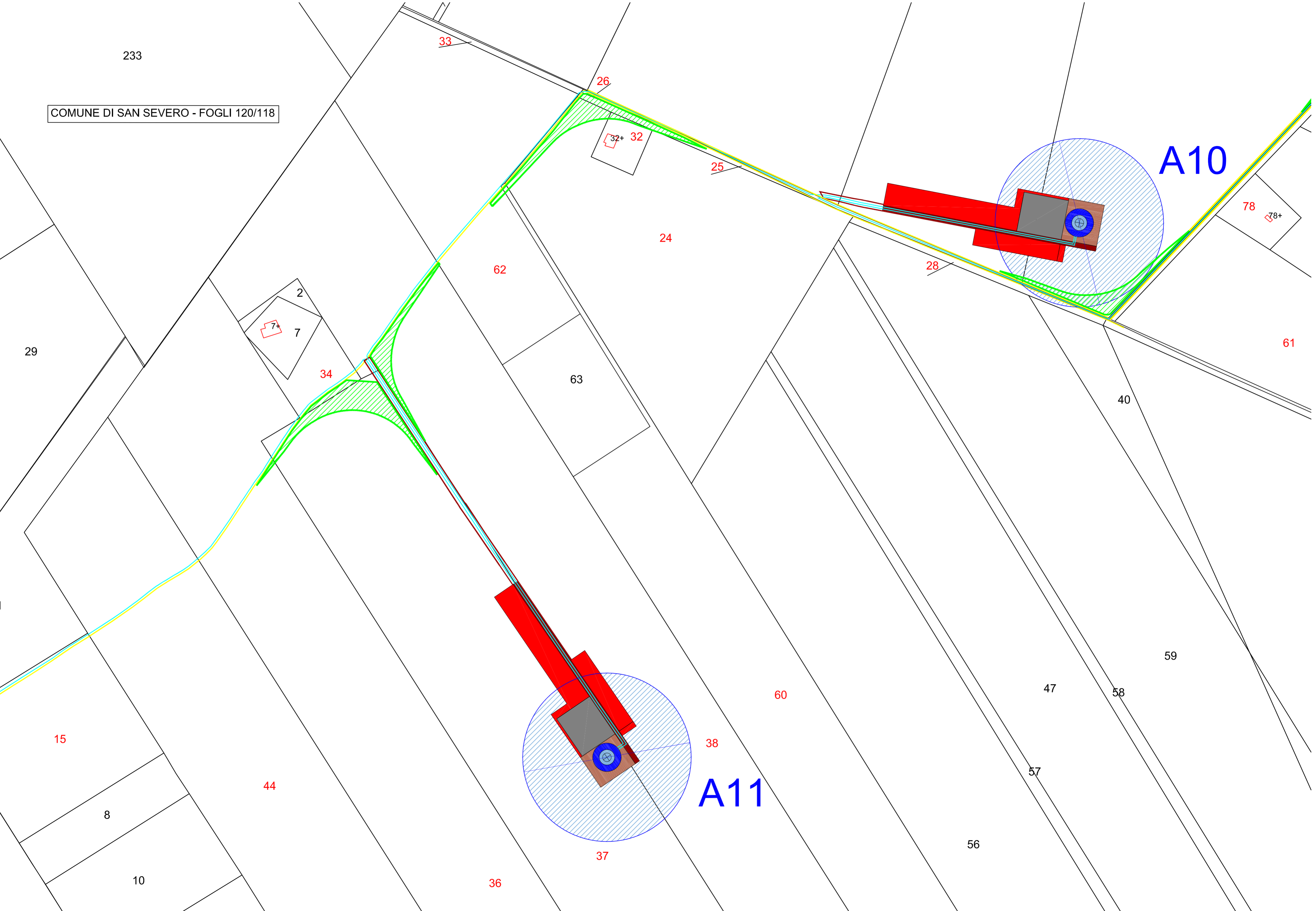

233

29

15

8

10

44

7+

2

7

34

36

37

38

60

63

62

24

40

59

47

58

57

56

33

26

25

28

32+

32

78

78+

61

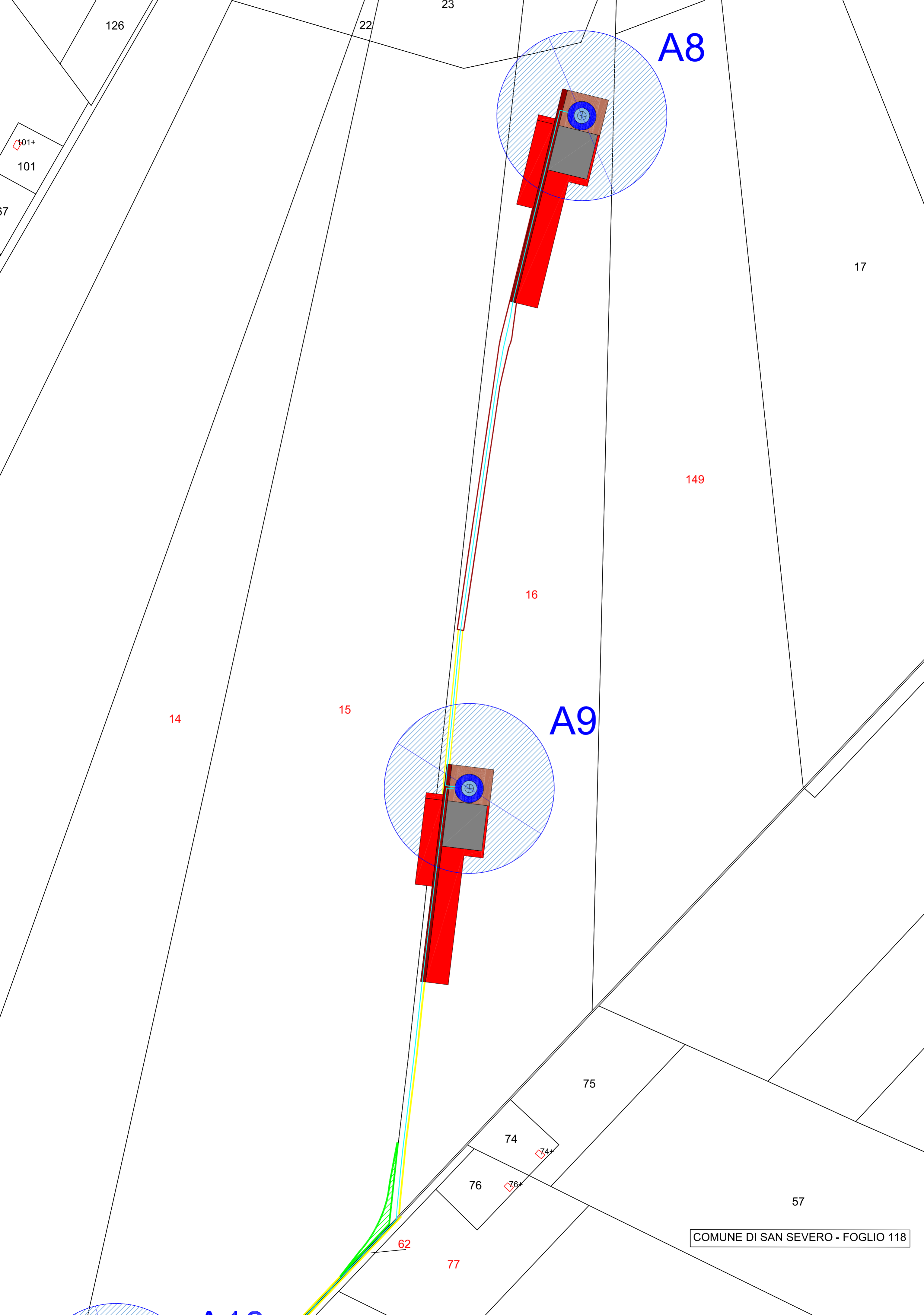

A8

A9

A10

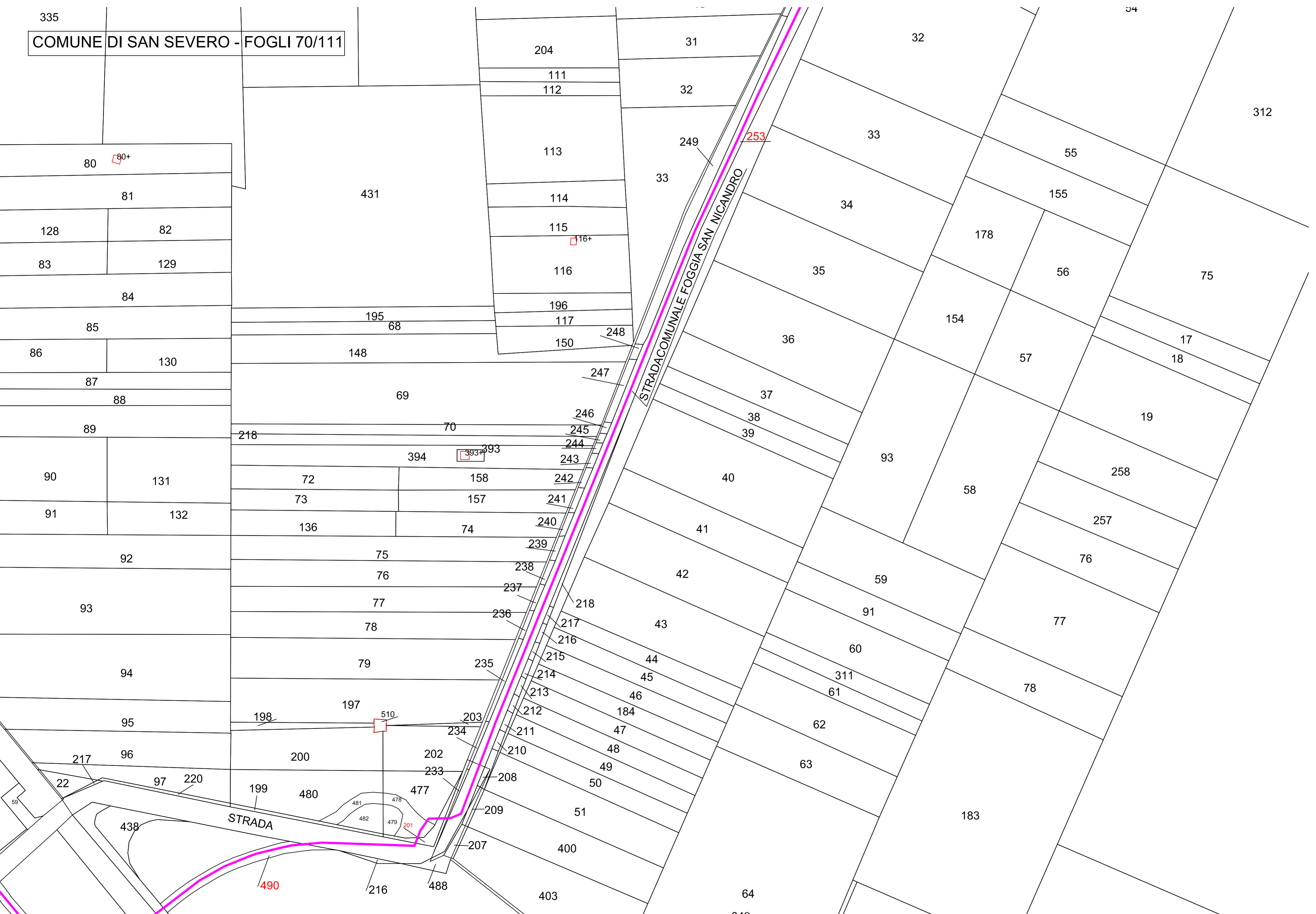

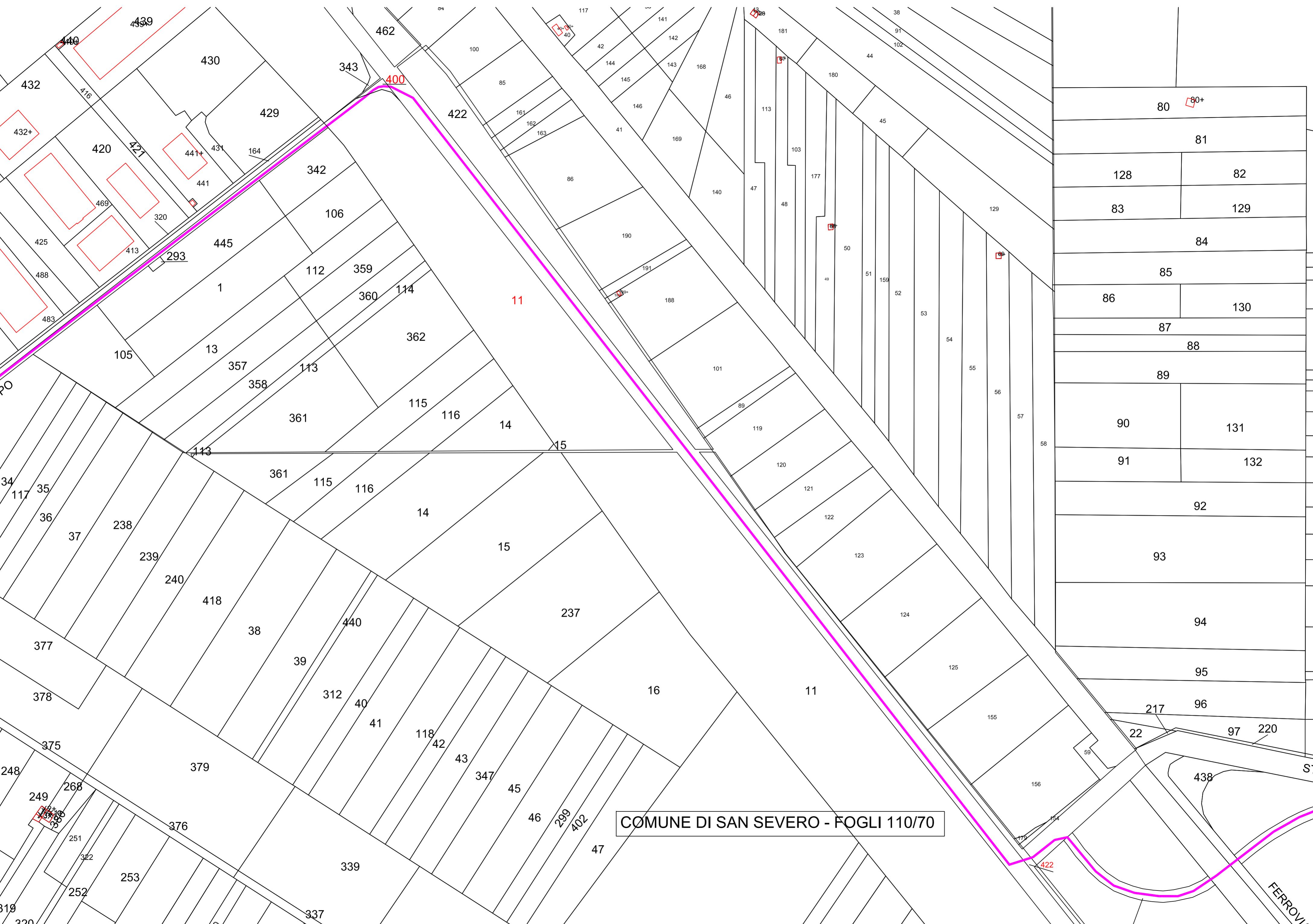

COMUNE DI SAN SEVERO - FOGLI 110/70

FERROVI

COMUNE DI SAN SEVERO - FOGLI 73/110





COMUNE DI SAN SEVERO - FOGLIO 109



COMUNE DI SAN SEVERO - FOGLIO 109

VICINALE

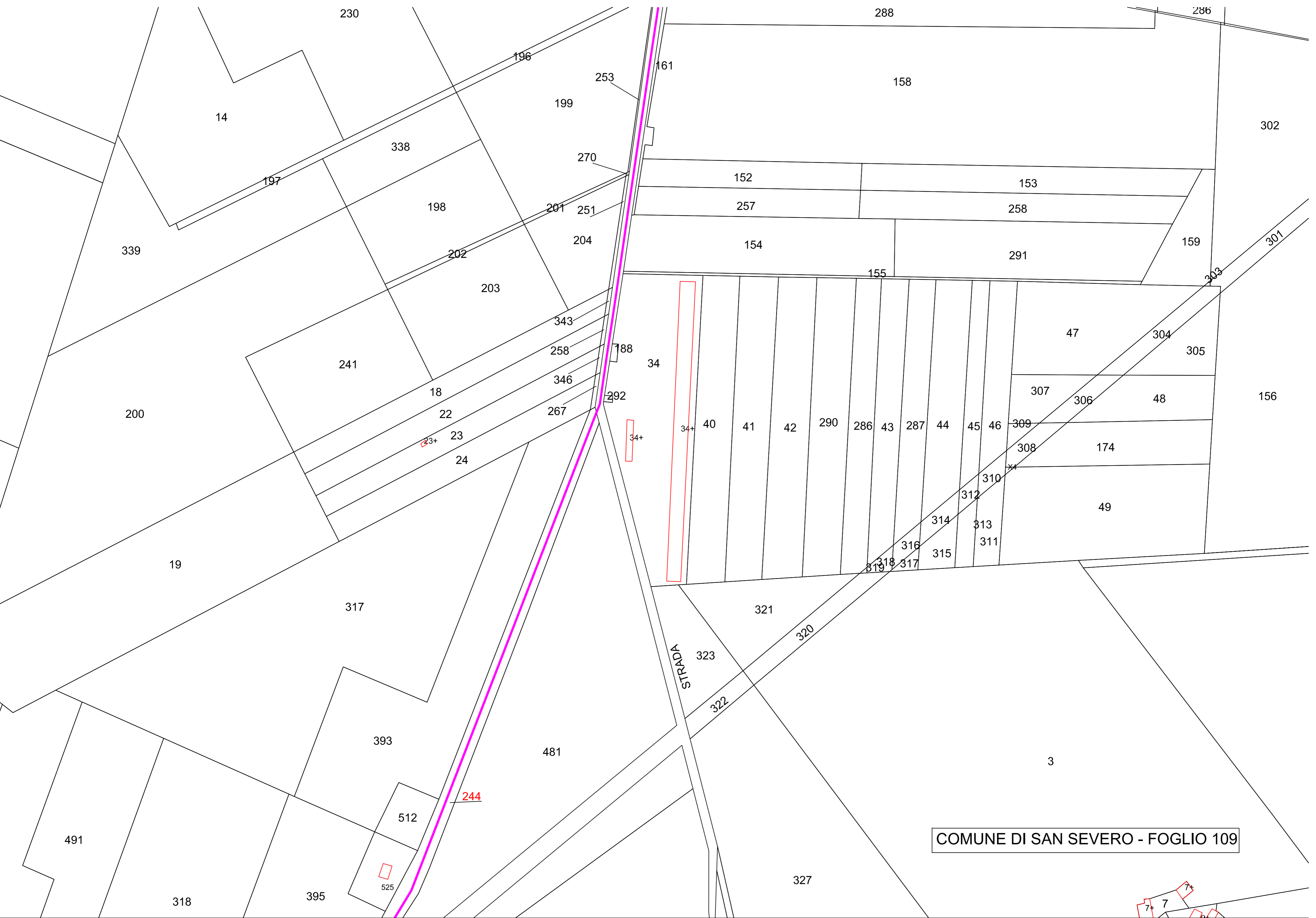

COMUNE DI SAN SEVERO - FOGLIO 109

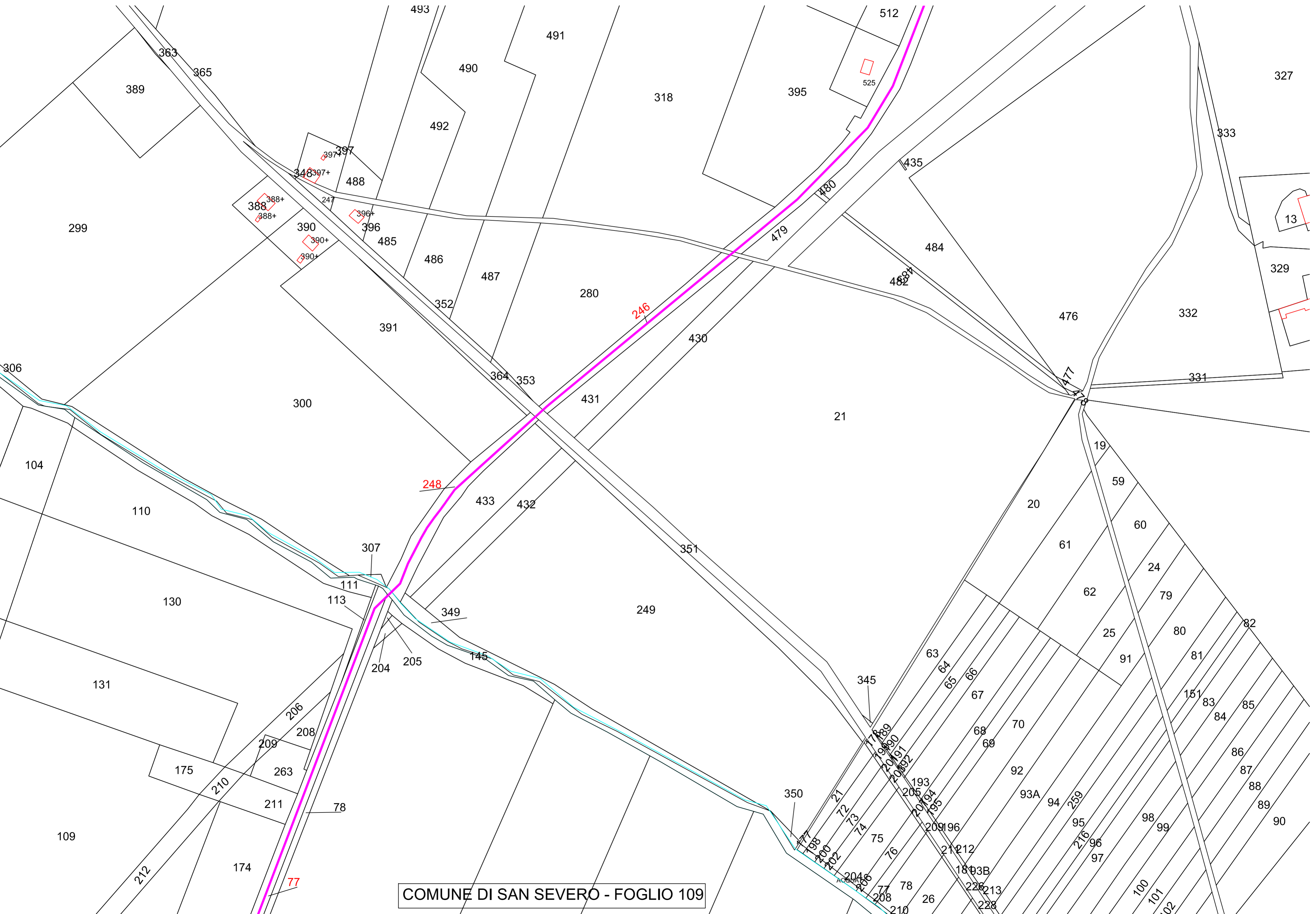

COMUNE DI SAN SEVERO - FOGLIO 109



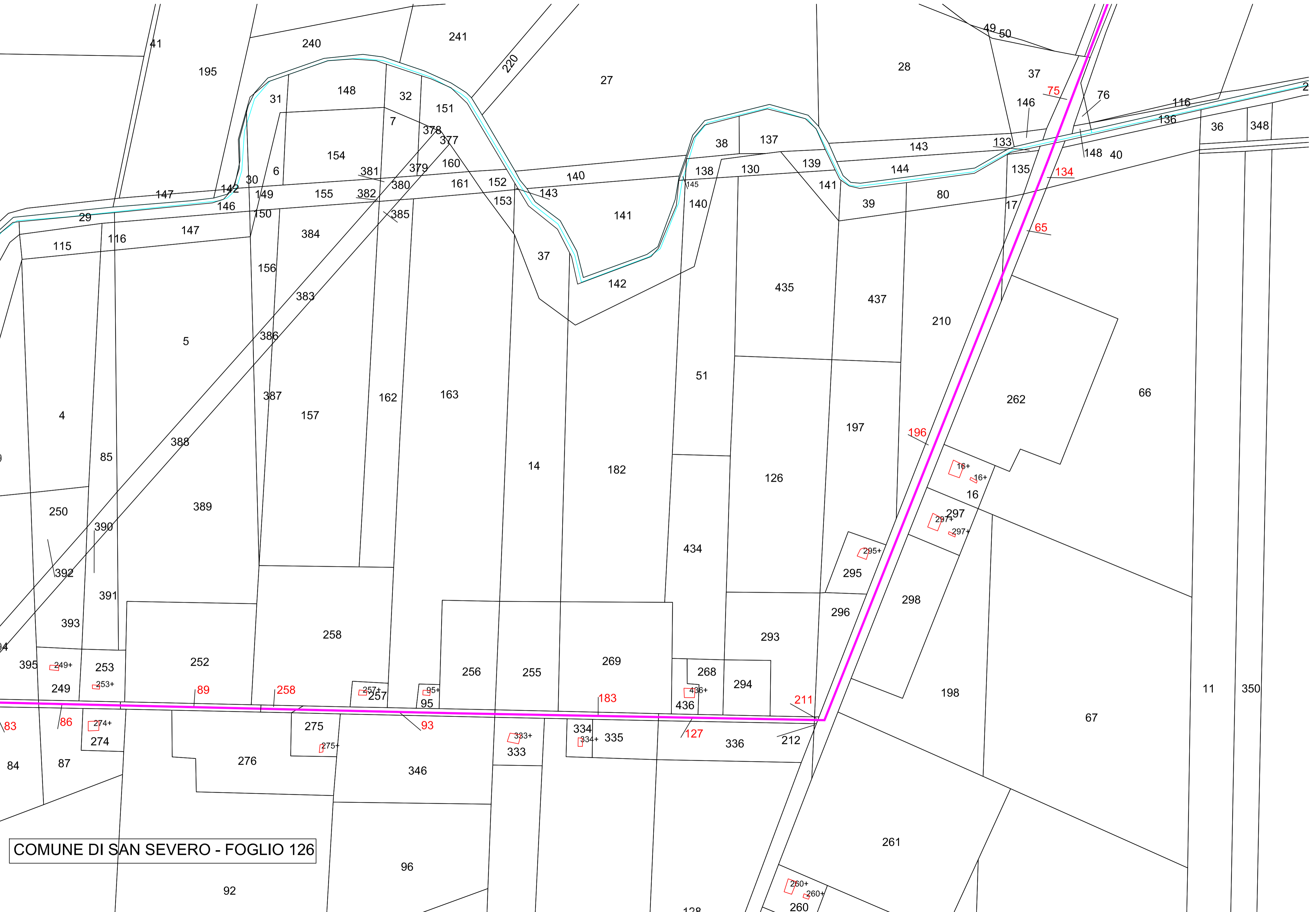

COMUNE DI SAN SEVERO - FOGLIO 126

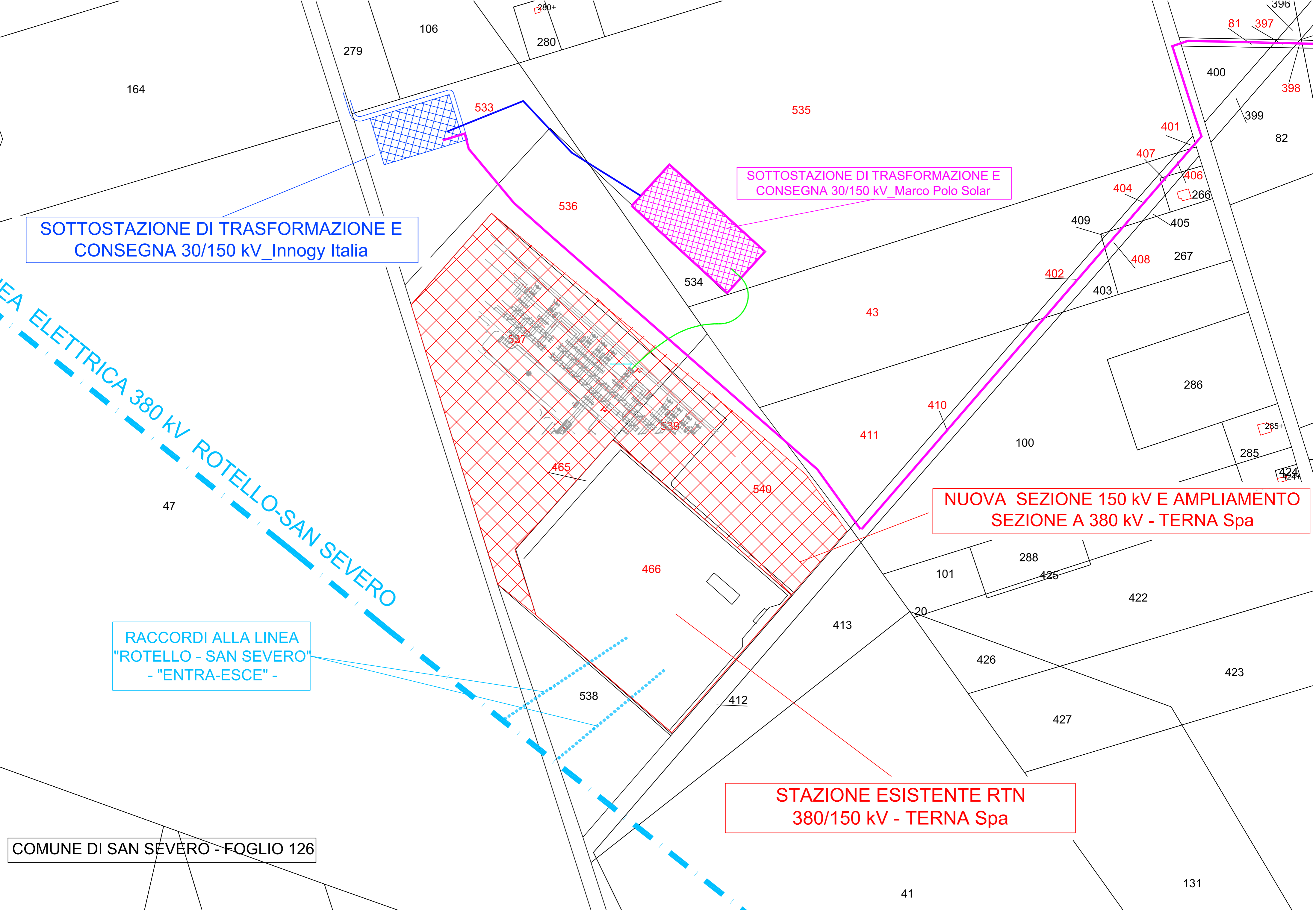

SOTTOSTAZIONE DI TRASFORMAZIONE E
CONSEGNA 30/150 kV_Innogy Italia

SOTTOSTAZIONE DI TRASFORMAZIONE E
CONSEGNA 30/150 kV_Marco Polo Solar

NUOVA SEZIONE 150 kV E AMPLIAMENTO
SEZIONE A 380 kV - TERNA Spa

STAZIONE ESISTENTE RTN
380/150 kV - TERNA Spa

RACCORDI ALLA LINEA
"ROTELLO - SAN SEVERO"
- "ENTRA-ESCE" -