

S.S. 131 di "Carlo Felice"
Adeguamento e messa in sicurezza della S.S.131
Risoluzione dei nodi critici - 2° stralcio
dal km 108+300 al km 158+000

PROGETTO ESECUTIVO

CA284

R.T.I. di PROGETTAZIONE:

Mandataria



**PRO
ITER**
Progetto
Infrastrutture
Territorio s.r.l.

Via G.B. Sammartini n°5
20125 - Milano
Tel. 02 6787911
email: mail@proiter.it

Mandante



Via Artemide n°3
92100 Agrigento
Tel. 0922 421007
email: deltaingegneria@pec.it

PROGETTISTI:

Ing. Riccardo Formichi - Pro Iter srl (Integratore prestazioni specialistiche)
Ordine Ing. di Milano n. 18045

Ing. Riccardo Formichi
Ordine Ing. di Milano n. 18045

IL GEOLOGO

Dott. Geol. Massimo Mezzanatica - Pro Iter srl
Albo Geol. Lombardia n. A762

COORDINATORE PER LA SICUREZZA IN FASE DI PROGETTAZIONE

Ing. Diego Ceccherelli
Ordine Ing. di Milano n. 15813

VISTO: IL RESP. DEL PROCEDIMENTO

Dott. Ing. Salvatore FRASCA



PROTOCOLLO

DATA

GEOTECNICA

USCITA ARCHEOLOGICA "SANTA CRISTINA" AL Km 114+500

Relazione Geotecnica e di Calcolo

CODICE PROGETTO

PROGETTO LIV. PROG. N. PROG.

L O P L S Q E 1 9 0 1

NOME FILE
V03GE00GETRE01B.pdf

CODICE ELAB. **V 0 3 G E 0 0 G E T R E 0 1**

REVISIONE

SCALA:

B

D					
C					
B	Revisione per istruttoria, verifica e controlli D.Lgs. 35/11	Aprile 2021	Parisi	Rivoltini	Formichi
A	Emissione	Marzo 2020	Parisi	Rivoltini	Formichi
REV.	DESCRIZIONE	DATA	REDATTO	VERIFICATO	APPROVATO

INDICE

1	PREMESSA	1
2	DOCUMENTI DI RIFERIMENTO.....	2
2.1	Riferimenti normativi	2
2.2	Documenti di progetto.....	2
3	PROGRAMMI PER L'ANALISI AUTOMATICA.....	3
4	CARATTERISTICHE DEI MATERIALI	4
4.1	Calcestruzzo per elevazioni muri di sostegno.....	4
4.2	Calcestruzzo per fondazioni muri di sostegno e cordoli in c.a.	4
4.3	Calcestruzzo magro per sottofondazioni.....	5
4.4	Malta cementizia per micropali	5
4.5	Acciaio per calcestruzzo armato	5
4.6	Acciaio per micropali	5
5	DESCRIZIONE DELL'OPERA	6
6	INQUADRAMENTO GEOLOGICO E GEOMORFOLOGICO.....	9
7	CARATTERIZZAZIONE GEOTECNICA.....	9
7.1	Descrizione delle indagini.....	9
7.2	Profili stratigrafici dell'area.....	9
7.3	Unità geotecnica C – Coltri eluvio colluviali	9
7.4	Unità geotecnica BA – Basalti alterati	10
7.5	Unità geotecnica B – Basalti non alterati	10
8	AZIONE SISMICA DI RIFERIMENTO	13
9	VERIFICHE DEL MURO DI SOTTOSCARPA.....	14
9.1	Muro di sottoscarpa – configurazione a)	14
9.1.1	Geometria della struttura	14
9.1.2	Analisi dei carichi	16
9.1.3	Verifiche strutturali nell'elevazione del muro.....	17
9.1.4	Verifiche della fondazione su micropali.....	19
9.1.5	Cedimenti	40
9.2	Muro di sottoscarpa – configurazione b)	41
9.2.1	Geometria della struttura	41
9.2.2	Analisi dei carichi	42
9.2.3	Verifiche strutturali dell'elevazione del muro.....	43
9.2.4	Verifiche della fondazione su micropali.....	45
9.2.5	Cedimenti	64
9.3	Verifica di stabilità globale	66
	ALLEGATO 1 - ANALISI NUMERICA GROUP 2019	1
	ALLEGATO 2 - ANALISI NUMERICA PARATIE PLUS.....	1
	ALLEGATO 3 - ANALISI NUMERICA SLIDE.....	1

1 PREMESSA

La presente relazione di calcolo è parte integrante del Progetto Esecutivo denominato *Adeguamento e messa in sicurezza della S.S. 131 "Carlo Felice" – risoluzione dei nodi critici, 2° stralcio, dal km 108+300 al km 158+000*.

Nel seguito si riportano le verifiche geotecniche e strutturali delle opere di sostegno necessarie per l'adeguamento delle corsie di accesso all'area archeologica "Santa Cristina" presenti alla progressiva km 114+500.

Per l'opera in oggetto è prevista l'esecuzione di muri di sottoscarpa con fondazioni su micropali.

Tutte le verifiche sono state condotte in accordo al metodo semiprobabilistico agli stati limite secondo le prescrizioni presenti nelle NTC 2008 e nella relativa circolare applicativa (Circ. 02/02/2009).

Nel seguito si riportano le caratteristiche geotecniche dei terreni interessati dalle opere in esame e i risultati delle verifiche geotecniche e strutturali ad esse inerenti.

Per la descrizione dettagliata della metodologia di calcolo adottata nelle verifiche si rimanda alla Relazione Geotecnica Generale [1].

2 DOCUMENTI DI RIFERIMENTO

2.1 Riferimenti normativi

- **D.M. 14.01.2008** "Norme tecniche per le costruzioni".
- **Circ. 02.02.2009, n.617 C.S.LL.PP.** "Istruzioni per l'applicazione delle norme tecniche per le costruzioni" di cui al D.M. 14.01.2008.
- **UNI EN 1993 1-1** Eurocodice 3 Progettazione delle strutture in acciaio Parte 1-1: Regole generali delle strutture in acciaio.
- **Delibera Regione Autonoma della Sardegna n. 15/31 del 30.03.2004** "Disposizioni preliminari in attuazione dell'Ordinanza P.C.M. 3274 del 20.3.2003".

2.2 Documenti di progetto

- [1] T00GE00GETRE01 Relazione Geotecnica Generale
- [2] T00GE00GETRE02 Relazione Sismica
- [3] V03OS01GETDI01 Muro di sottoscarpa – Carpenteria – Planimetria e prospetto
- [4] V03OS01GETDI02 Muro di sottoscarpa – Carpenteria – Sezioni
- [5] V03OS01GETDI04 Muro di sottoscarpa – Scavo – Sezioni e particolari

3 PROGRAMMI PER L'ANALISI AUTOMATICA

Paratie Plus 19.0

HarpaCeAS – Centro di Analisi Strutturale s.r.l.

Programma di calcolo per l'analisi ad elementi finiti di paratie

Verifiche C.A. S.L.U.

Professore Piero Gelfi

Programma per il calcolo dei domini resistenti M-N per sezioni in calcestruzzo armato

Group 2019 versione 11

Ensoft, Inc.

Programma per il calcolo delle sollecitazioni in pali di fondazione

4 CARATTERISTICHE DEI MATERIALI

4.1 Calcestruzzo per elevazioni muri di sostegno

Classe di resistenza	C32/40		
Classe di esposizione	XC4 – XD1		
Classe di consistenza	S4		
Diametro massimo aggregato	25 mm		
Massimo rapporto acqua/cemento	0.50		
Contenuto minimo di cemento	340 kg/mc		
Copriferro	50 mm		
Resistenza caratteristica a compressione cubica	$R_{ck} =$	40.00	N/mm ²
Resistenza caratteristica a compressione cilindrica	$f_{ck} = 0.83 \times R_{ck}$	= 33.2	N/mm ²
Resistenza media a compressione cilindrica	$f_{cm} = f_{ck} + 8$	= 41.2	N/mm ²
Modulo elastico	$E_c = 22000 \times (f_{cm}/10)^{0.3}$	= 33642.8	N/mm ²
Resistenza a trazione semplice	$f_{ctm} = 0.30 \times f_{ck}^{2/3}$	= 3.1	N/mm ²
Resistenza a trazione caratteristica (frattile 5%)	$f_{ctk} = 0.70 \times f_{ctm}$	= 2.17	N/mm ²
Stato Limite Ultimo			
Coefficiente parziale di sicurezza	$\gamma_C =$	1.50	--
Coefficiente riduttivo per resistenze di lunga durata	$\alpha_{cc} =$	0.85	--
Resistenza a compressione di calcolo	$f_{cd} = \alpha_{cc} \times f_{ck} / \gamma_C$	= 18.81	N/mm ²
Resistenza a trazione di calcolo	$f_{ctd} = f_{ctk} / \gamma_C$	= 1.45	N/mm ²
Stato Limite di Esercizio			
Tensione max di compressione - Comb. rara	$\sigma_c < 0.60 \times f_{ck}$	= 19.92	N/mm ²
Tensione max di compressione - Comb. quasi permanente	$\sigma_c < 0.45 \times f_{ck}$	= 14.94	N/mm ²
Stato Limite di Fessurazione			
Classe di esposizione	XC4 – XD1		
Valore limite di apertura delle fessure - Comb. frequente.	$w \leq w_2$	= 0.3	mm
Valore limite di apertura delle fessure - Comb. quasi perm.	$w \leq w_1$	= 0.2	mm

4.2 Calcestruzzo per fondazioni muri di sostegno e cordoli in c.a.

Classe di resistenza	C25/30		
Classe di esposizione	XC2		
Classe di consistenza	S4		
Diametro massimo aggregato	32 mm		
Massimo rapporto acqua/cemento	0.60		
Contenuto minimo di cemento	300 kg/mc		
Copriferro	50 mm		
Resistenza caratteristica a compressione cubica	$R_{ck} =$	30.00	N/mm ²
Resistenza caratteristica a compressione cilindrica	$f_{ck} = 0.83 \times R_{ck}$	= 24.90	N/mm ²
Resistenza media a compressione cilindrica	$f_{cm} = f_{ck} + 8$	= 32.90	N/mm ²
Modulo elastico	$E_c = 22000 \times (f_{cm}/10)^{0.3}$	= 31447.16	N/mm ²
Resistenza a trazione semplice	$f_{ctm} = 0.30 \times f_{ck}^{2/3}$	= 2.56	N/mm ²
Resistenza a trazione caratteristica (frattile 5%)	$f_{ctk} = 0.70 \times f_{ctm}$	= 1.79	N/mm ²
Stato Limite Ultimo			
Coefficiente parziale di sicurezza	$\gamma_C =$	1.50	--
Coefficiente riduttivo per resistenze di lunga durata	$\alpha_{cc} =$	0.85	--
Resistenza a compressione di calcolo	$f_{cd} = \alpha_{cc} \times f_{ck} / \gamma_C$	= 14.11	N/mm ²
Resistenza a trazione di calcolo	$f_{ctd} = f_{ctk} / \gamma_C$	= 1.19	N/mm ²
Stato Limite di Esercizio			
Tensione max di compressione - Comb. caratteristica/rara	$\sigma_c < 0.60 \times f_{ck}$	= 14.94	N/mm ²
Tensione max di compressione - Comb. quasi permanente	$\sigma_c < 0.45 \times f_{ck}$	= 11.21	N/mm ²
Stato Limite di Fessurazione			
Classe di esposizione	XC2		

Relazione Geotecnica e di Calcolo

RTI di progettazione:



Mandataria

Via G.B. Sammartini n°5
20125 - Milano
Tel. 02 6787911
email: mail@proiter.it



Mandante

Via Artemide n°3
92100 Agrigento
Tel. 0922 421007
email: deltaingegneria@pec.it

Valore limite di apertura delle fessure - Comb. frequente.	$w \leq w_3$	=	0.4 mm
Valore limite di apertura delle fessure - Comb. quasi perm.	$w \leq w_2$	=	0.3 mm

4.3 Calcestruzzo magro per sottofondazioni

Classe di esposizione	X0
Rapporto massimo acqua/cemento	-
Classe di resistenza	C12/15
Contenuto minimo di cemento	150 kg/m ³
Tipo di cemento	CEM I+V
Slump	-
Diametro massimo inerte	32 mm

4.4 Malta cementizia per micropali

Resistenza caratteristica a compressione cubica	$R_{ck} =$	30.00	N/mm ²
Resistenza caratteristica a compressione cilindrica	$f_{ck} = 0.83 \times R_{ck}$	=	24.90 N/mm ²
Resistenza media a compressione cilindrica	$f_{cm} = f_{ck} + 8$	=	32.90 N/mm ²
Modulo elastico	$E_c = 22000 \times (f_{cm}/10)^{0.3}$	=	31447.16 N/mm ²
Resistenza a trazione semplice	$f_{ctm} = 0.30 \times f_{ck}^{2/3}$	=	2.56 N/mm ²
Resistenza a trazione caratteristica (frattile 5%)	$f_{ctk} = 0.70 \times f_{ctm}$	=	1.79 N/mm ²
Stato Limite Ultimo			
Coefficiente parziale di sicurezza	$\gamma_C =$	1.50	--
Coefficiente riduttivo per resistenze di lunga durata	$\alpha_{cc} =$	0.85	--
Resistenza a compressione di calcolo	$f_{cd} = \alpha_{cc} \times f_{ck} / \gamma_C$	=	14.11 N/mm ²
Resistenza a trazione di calcolo	$f_{ctd} = f_{ctk} / \gamma_C$	=	1.19 N/mm ²

4.5 Acciaio per calcestruzzo armato

Si utilizza acciaio per cemento armato tipo **B450C**, con le seguenti caratteristiche:

Tensione caratteristica di rottura (frattile 5%)	$f_{tk} =$	540.00	N/mm ²
Tensione caratteristica di snervamento (frattile 5%)	$f_{yk} =$	450.00	N/mm ²
Stato Limite Ultimo			
Coefficiente parziale di sicurezza	$\gamma_S =$	1.15	--
Resistenza a trazione di calcolo	$f_{yd} = f_{yk} / \gamma_S$	=	391.30 N/mm ²
Stato Limite di Esercizio			
Tensione massima di trazione	$\sigma_s < 0.80 \times f_{yk}$	=	360.00 N/mm ²

4.6 Acciaio per micropali

Si utilizza acciaio tipo **S355**, con le seguenti caratteristiche:

Tensione caratteristica di rottura (frattile 5%)	$f_{tk} =$	510.00	N/mm ²
Tensione caratteristica di snervamento (frattile 5%)	$f_{yk} =$	355.00	N/mm ²
Stato Limite Ultimo			
Coefficiente parziale di sicurezza	$\gamma_S =$	1.05	--
Resistenza a trazione di calcolo	$f_{yd} = f_{yk} / \gamma_S$	=	338.09 N/mm ²

5 DESCRIZIONE DELL'OPERA

Alla progressiva km 114+500 della S.S.131 è presente lo svincolo per l'accesso alla zona archeologica di Santa Cristina.

Al fine di permettere l'esecuzione dell'intervento di adeguamento delle corsie di accesso all'area archeologica risulta necessario realizzare un muro di sottoscarpa oggetto di studio della presente relazione.

Tale muro di sottoscarpa è costituito da 20 conci, di cui 17 di lunghezza 10 m, 2 di 7.5 m e 1 di 2.5 m e presenta altezze variabili da un minimo di circa 1 m ad un massimo di 3.15 m. Per la visualizzazione della planimetria dell'opera si rimanda alla specifica tavola [3].

Le fondazioni dei muri sono costituite da una soletta in calcestruzzo armato vincolata al terreno mediante due file di micropali ϕ 240 (Figura 1 e Figura 2) con lunghezze di perforazione pari a 8, 9.50 e 9.40 m, armati con tubo in acciaio S335, di diametro ϕ 193.7 e spessore 10 mm.

Sia la distanza fra le due file di micropali che il passo longitudinale di quest'ultimi sono stati assunti pari a 1 m.

Nelle Figura 1 e Figura 2 si riportano due differenti sezioni tipo del muro di sottoscarpa. Per maggiori dettagli si rimanda agli specifici elaborati [3], [4] e [5].

Come visibile dalla Figura 1, davanti al muro di sottoscarpa, per un determinato tratto del suo sviluppo, risulta presente una struttura in calcestruzzo adibita alla raccolta delle acque. Pertanto, al fine di massimizzare il contributo stabilizzante dei micropali di fondazione, si è previsto di inclinarne la fila posteriore di un angolo pari a 38° rispetto alla verticale in modo da permettere a tali micropali, in relazione alla configurazione geometrica dell'opera, di lavorare principalmente a trazione, piuttosto che a taglio.

In Figura 3 è riportata la vista in pianta della fondazione del muro di sottoscarpa per uno dei conci di lunghezza 10 m.



Figura 1: Sezione tipologica a) del muro di sottoscarpa – fondazione con micropali verticali – Lunghezza micropali 9.50m [3]



Figura 2: Sezione tipologica b) del muro di sottoscarpa – fondazione con micropalo inclinato – Lunghezza micropali 9.40m e 8m [3]

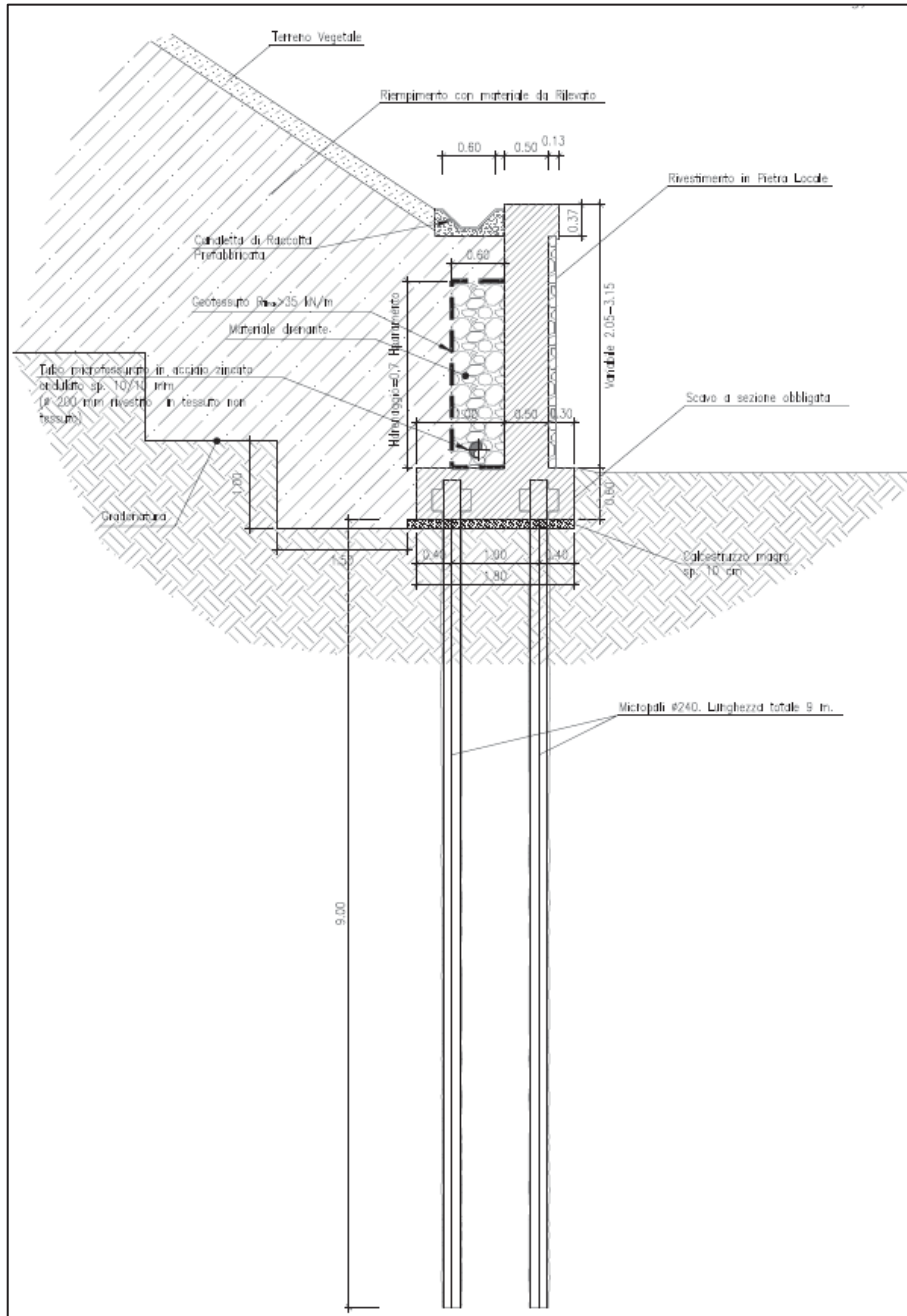

Figura 3: Vista in pianta di un conccio del muro di sottoscarpa di lunghezza 10 m [3]

6 INQUADRAMENTO GEOLOGICO E GEOMORFOLOGICO

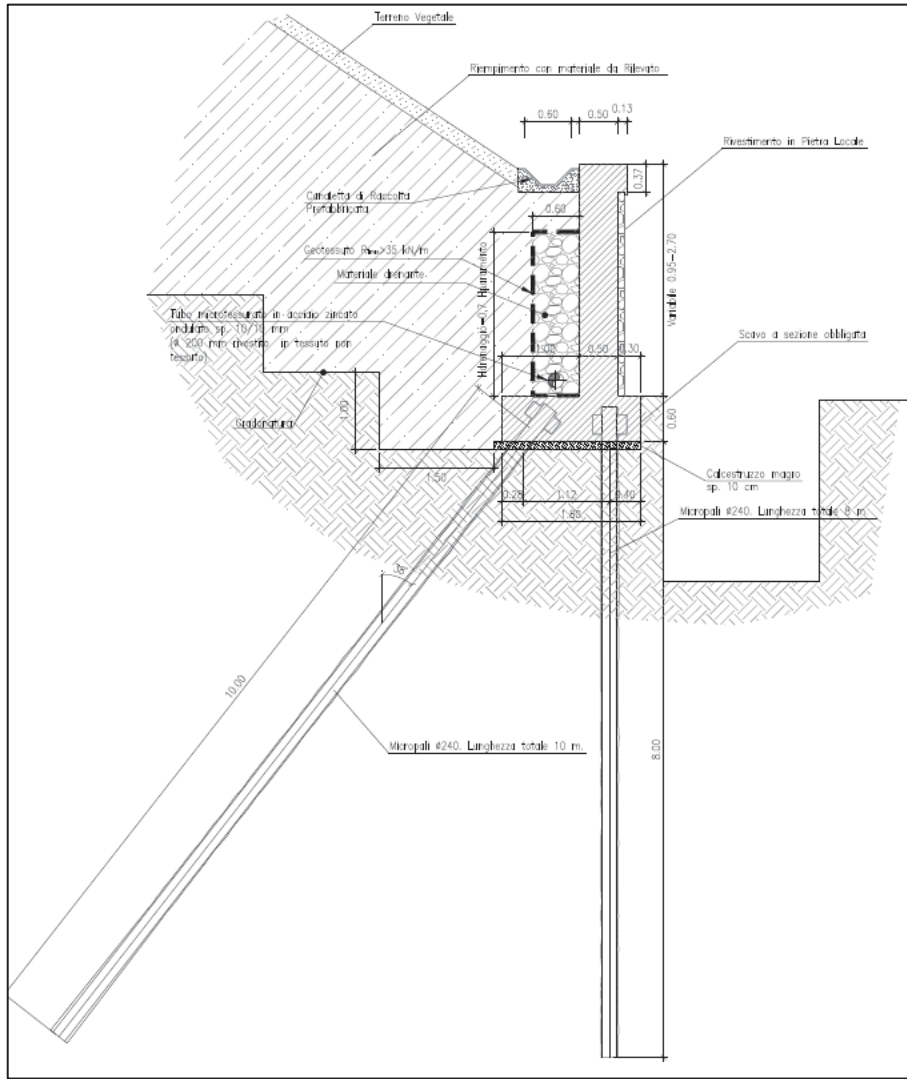
L'intervento si colloca in un'area pressoché pianeggiante, caratterizzata dalla presenza di terreni appartenenti alla Subunità di Dualchi, facente parte del gruppo dei Basalti della Campeda-Planargia, rappresentati da basalti e andesiti basaltiche litoidi, con aspetto vacuolare, di colore grigio, da mediamente a molto fratturati. Al tetto questi si presentano fratturati per uno spessore di circa 5 m. In superficie i basalti sono ricoperti, con uno spessore massimo di 2 m, da una coltre eluvio-colluviale di alterazione e da depositi di copertura quaternari.

7 CARATTERIZZAZIONE GEOTECNICA

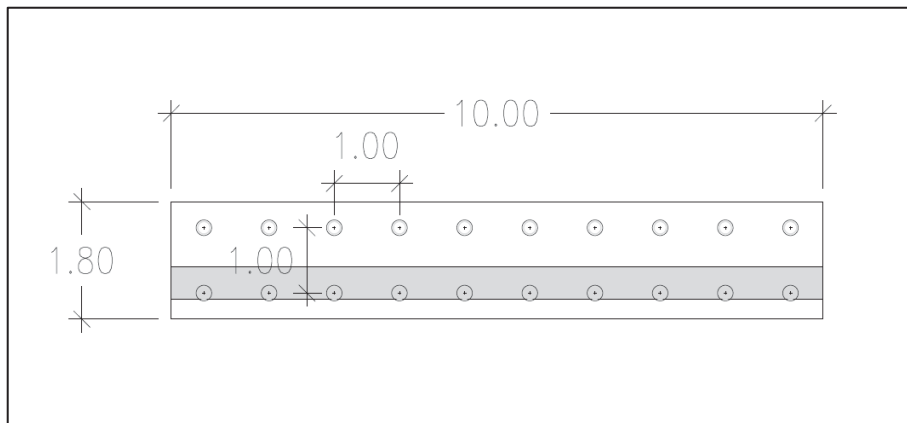
7.1 Descrizione delle indagini

Nel corso della progettazione l'area in oggetto è stata indagata con una serie di sondaggi e prove di laboratorio. Dall'interpretazione delle risultanze delle campagne geotecniche eseguite si sono ricavati i parametri geotecnici dei litotipi incontrati nella tratta in esame. L'ubicazione di tutte le indagini geotecniche è riportata nell'elaborato di progetto **T00GE00GEOPU02A**.

Nello specifico, le campagne di indagine condotte nell'area sono:

- Campagna di indagine geognostica del 1997 eseguita da S.P.G. srl (Sondaggi SE20, SE21, SE29 e SE30).

Complessivamente sono state eseguite le seguenti indagini:

- sondaggi geognostici a carotaggio continuo
- prelievo di campioni indisturbati di terreno, di campioni rimaneggiati e di campioni di roccia sui quali sono state eseguite le prove geotecniche di laboratorio;

7.2 Profili stratigrafici dell'area

Dall'interpretazione dei sondaggi è stata effettuata la ricostruzione stratigrafica dell'area interessata dalle opere in progetto. Dall'esame dei profili stratigrafici, nelle diverse verticali indagate si riconosce la presenza delle unità geotecniche di seguito elencate:

- coltre eluvio – colluviale (**C** – da 0 a -2 m dal p.c.) costituiti prevalentemente da sabbia quarzosa e limi;
- basalti alterati (**BA** – da -2 m a -6.5 m dal p.c.), appartenenti alla formazione di Campeda, derivanti dall'alterazione dei depositi sottostanti (*Basalti compatti*);
- basalti non alterati (**B** – da -6.5 m dal p.c.) appartenenti alla formazione di Campeda.

Il piano di falda si assume coincidente con il piano campagna.

7.3 Unità geotecnica C – Coltri eluvio colluviali

Tenuto conto della natura granulometrica dei terreni interessati (*ghiaiosa-sabbiosa*) e della mancanza di opportune prove geotecniche, per l'unità litologica in esame si è fatto riferimento ai dati di letteratura. Pertanto, le coltri eluvio colluviali sono state caratterizzate considerando i seguenti parametri di resistenza:

- $\gamma = 19 \text{ kN/m}^3$ peso di volume naturale;
- $\phi' = 25^\circ\text{-}28^\circ$ angolo di resistenza al taglio;
- $c' = 0\text{-}10 \text{ kPa}$ coesione in condizioni drenate;
- $E' = 15\text{-}20 \text{ MPa}$ modulo elastico di Young.

7.4 Unità geotecnica BA – Basalti alterati

Per l'unità geotecnica BA (*Basalti alterati*) sono stati considerati i seguenti parametri di resistenza:

- $\gamma = 20 \text{ kN/m}^3$ peso di volume naturale;
- $\phi' = 34^\circ$ angolo di resistenza al taglio;
- $c' = 0 \text{ kPa}$ coesione in condizioni drenate;
- $\tau = 180\text{-}200 \text{ KPa}$ aderenza laterale terreno-calcestruzzo;
- $E' = 200 \text{ MPa}$ modulo elastico di Young.

7.5 Unità geotecnica B – Basalti non alterati

Per tale unità geotecnica si è fatto riferimento ai sondaggi S1 e S2 della campagna di indagine integrativa Anas del 2015-2016 realizzati da Sondedile s.r.l. che interessano gli stessi litotipi.

La caratterizzazione geomeccanica dei Basalti non alterati (*B*) è stata eseguita a partire dai valori della resistenza a compressione uniassiale (σ_{ci}) ottenuta su campioni indisturbati di roccia intatta e dall'indice GSI (*Geological Strength Index*) valutato sulla base delle informazioni desumibili dai rilievi e dalle cassette catalogatrici.

Nelle figure seguenti si riportano l'andamento della resistenza a compressione uniassiale (*stimata da prove di resistenza speditiva tipo Point-Load e da prove di compressione uniassiale UxDC*) e l'indice GSI con la profondità.



Figura 4 - Unita B – Resistenza a compressione uniassiale



Figura 5 – Unità MC - Indice GSI

La stima dei parametri di resistenza al taglio equivalenti dell'ammasso è stata effettuata con il criterio di Hoek & Brown, utilizzando:

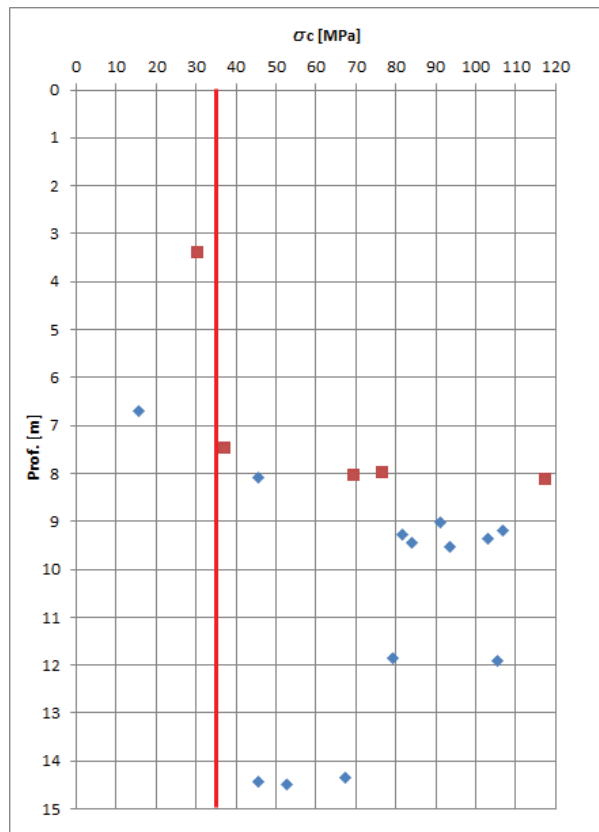
GSI = 60

$m_i = 25$;

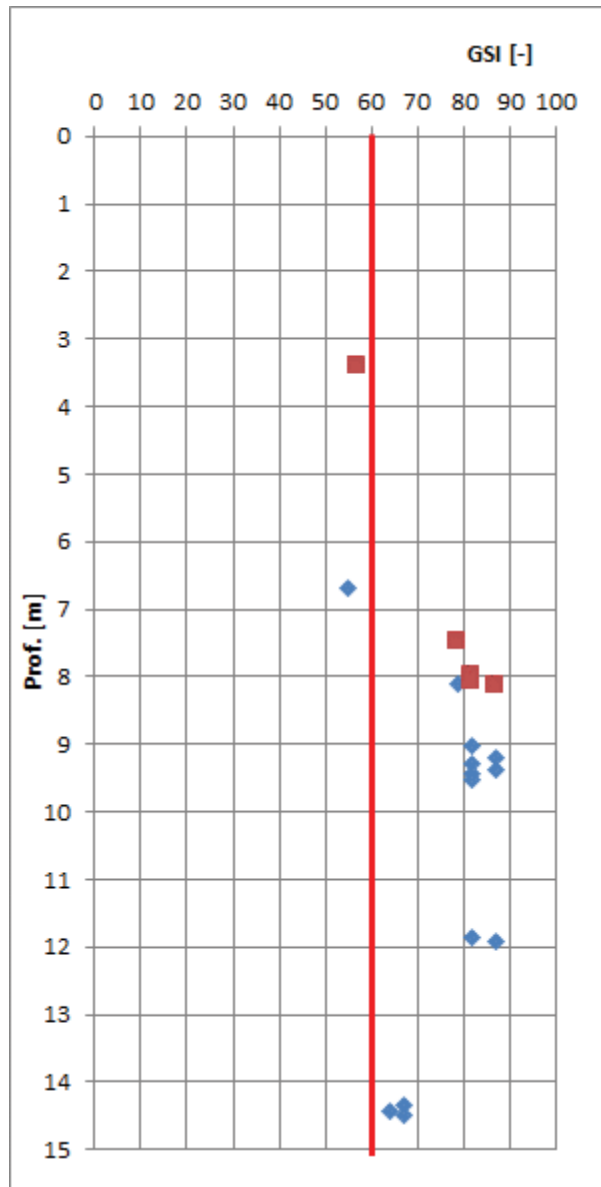
$\sigma_{ci} = 35$ MPa resistenza a compressione uniassiale;

$\gamma = 22$ kN/m³ peso dell'unità di volume;

D = 0 fattore di disturbo.



Figura 6 – Unità B - Criteri di Rottura di H-B e M-C

Per l'unità geotecnica B (*Basalti*) si considerano i seguenti parametri geotecnici:

- $\gamma = 22 \text{ kN/m}^3$ peso di volume naturale;
- $\varphi' = 40^\circ$ angolo di resistenza al taglio;
- $c' = 50 \text{ kPa}$ coesione in condizioni drenate;
- $\tau = 200\text{-}250 \text{ KPa}$ aderenza laterale terreno-calcestruzzo;
- $E' = 4500 \text{ MPa}$ modulo elastico di Young.

8 AZIONE SISMICA DI RIFERIMENTO

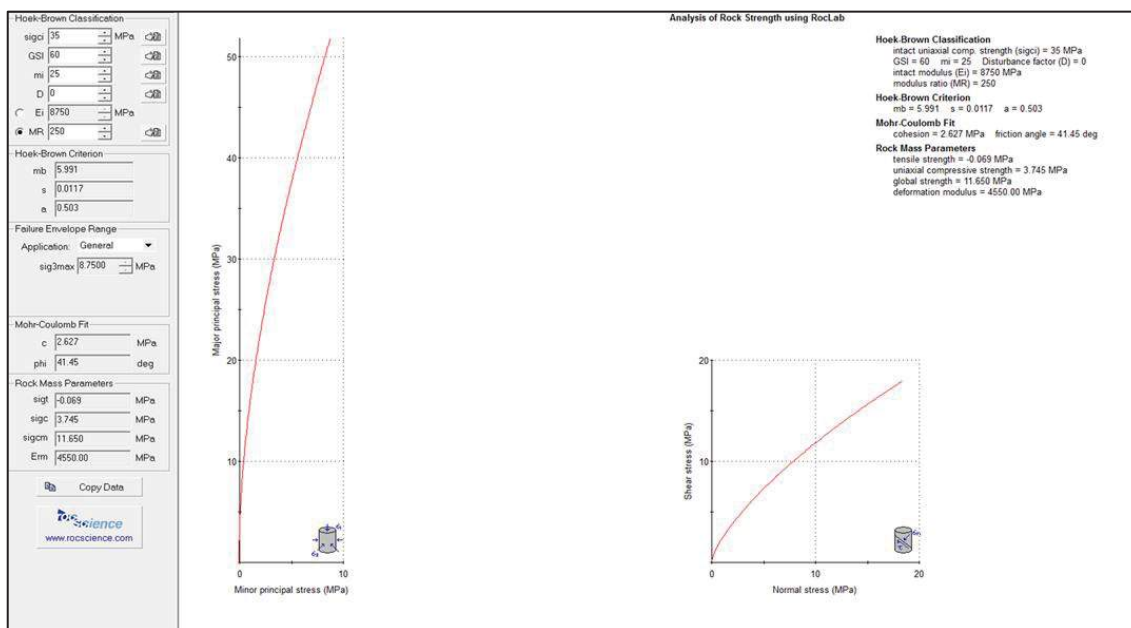
Al km 114+500 della S.S. 131 è previsto l'intervento di adeguamento delle corsie di accesso all'area archeologica di S. Cristina, con la realizzazione di un muro di sottoscarpa in corrispondenza della rampa B. Tale opera prevede una fondazione su micropali.

Per quest'opera non sono disponibili specifiche indagini sismiche, tuttavia l'interpretazione dei risultati dei sondaggi **SE20**, **SE21**, **SE29** e **SE30** (1997) della campagna geognostica di S.P.G. s.r.l. e delle relative fotografie delle cassette catalogatrici, ha consentito di verificare che il substrato roccioso, costituito da basalti e andesiti basaltiche vacuolari e mediamente fratturati, si trova ad una profondità inferiore a 3 m dal piano di appoggio delle fondazioni, sotto una coltre eluvio-colluviale di alterazione dei sottostanti basalti di spessore massimo di 2 m.

Tale stratigrafia, anche in assenza di specifiche indagini sismiche, consente in ogni caso di attribuire all'opera in oggetto una **categoria di sottosuolo di tipo A**, corrispondente ad *ammassi rocciosi affioranti o terreni molto rigidi caratterizzati da valori di velocità delle onde di taglio superiori a 800 m/s, eventualmente comprendenti in superficie terreni di caratteristiche meccaniche più scadenti con spessore massimo pari a 3 m.*

In base alla categoria di sottosuolo determinata con le metodologie di cui sopra (categoria A) il valore del coefficiente di amplificazione stratigrafica S_S (cfr. Tabella 3.2.V del D.M. 14/01/2008) è pari a 1.00.

In base alle condizioni topografiche presenti in sito (T_1 = superficie pianeggiante, pendii e rilievi isolati con inclinazione media $i \leq 15^\circ$) per configurazioni superficiali semplici si può adottare il seguente valore del coefficiente di amplificazione topografica S_T (cfr. Tabella 3.2.VI del D.M. 14/01/2008):

Categoria topografica	S_T
T1	1.0

In assenza di analisi specifiche di risposta sismica locale, l'accelerazione massima può essere valutata mediante la relazione:

$$a_{\max} = S \cdot a_g = S_S \cdot S_T \cdot a_g$$

dove:

- S_S = coefficiente di amplificazione stratigrafica (Tab. 3.2.V);
- S_T = coefficiente di amplificazione topografica (Tab. 3.2.VI);
- a_g = accelerazione orizzontale massima attesa su sito di riferimento rigido.

Nel caso specifico, per i diversi stati limite, il valore di a_{\max} risulta il seguente:

Stato Limite	T_R [anni]	a_g [g]	a_{\max} [g]
SLO	60	0.025	0.025
SLD	101	0.031	0.031
SLV	949	0.060	0.060
SLC	1950	0.071	0.071

9 VERIFICHE DEL MURO DI SOTTOSCARPA

Il muro di sottoscarpa è stato dimensionato con l'ausilio di un foglio elettronico creato "ad hoc", che permette di calcolare le sollecitazioni presenti nella parte in elevazione necessarie per effettuare le verifiche strutturali del muro e di ottenere le azioni sulla fondazione da utilizzare per le verifiche geotecniche e strutturali dei micropali.

Tutte le verifiche sono svolte in accordo con quanto previsto dal D.M. 14/01/2008 e dalla relativa circolare.

Le verifiche delle fondazioni dei muri di sottoscarpa sono state effettuate per due differenti configurazioni riportate nelle precedenti Figura 1 e Figura 2:

- a) fondazione del muro su due file di micropali verticali (L=9.50m);
- b) fondazione del muro su due file di micropali di cui una verticale (L=8m) e una inclinata di 38° rispetto alla verticale (L=9.40m).

Data la presenza di micropali di fondazione, il muro è da considerarsi vincolato al terreno e quindi non libero di traslare. Pertanto, per il calcolo delle spinte del terreno agenti contro il muro è stato considerato il coefficiente di spinta a riposo del terreno $k_0 = 1 - \sin(\phi)$ e, in condizioni sismiche, il coefficiente β , di riduzione dell'accelerazione massima attesa al sito, è stato assunto unitario.

Per la descrizione dettagliata della metodologia di calcolo utilizzata nelle seguenti verifiche si rimanda alla Relazione Geotecnica Generale [1].

Esclusivamente per la configurazione b) le verifiche strutturali dei micropali e la valutazione dei cedimenti verticali e degli spostamenti orizzontali, di cui al paragrafo 9.2.4.4 e al paragrafo 9.2.5, sono state effettuate, cautelativamente, ipotizzando due differenti tipologie di comportamento della struttura:

- fondazione su micropali (analisi con il software Group);
- paratia di micropali vincolata in testa da un ordine di micropali a cavalletto (analisi con il software Paratie Plus).

In particolare, si è ritenuto necessario studiare l'opera anche con un comportamento del tipo paratia in quanto, a valle dell'opera stessa è presente, fino ad una profondità di circa 3 m dalla base del muro, un canale idraulico il cui contributo resistente, a favore di sicurezza, è stato trascurato.

Per la configurazione b), le sollecitazioni massime nei micropali sono state ottenute considerando i risultati più gravosi forniti dalle 3 seguenti tipologie di analisi:

- 1) analisi della struttura come fondazione su micropali, svolta con il software Group 2019;
- 2) analisi della struttura come paratia di micropali, svolta con il software Paratie Plus;
- 3) combinazione dei risultati delle 2 analisi di cui sopra.

Nel seguito si riportano le verifiche per le due configurazioni considerate a) e b).

9.1 Muro di sottoscarpa – configurazione a)

9.1.1 Geometria della struttura

In Tabella 1 sono riassunte le caratteristiche geometriche della parte in elevazione del muro considerate per il relativo dimensionamento, le quali fanno riferimento allo schema di Figura 7.

Sezione Muro di sottoscarpa	H1 [m]	S1 [m]	H2/H3 [m]	S2/S3 [m]	LF [m]	SF [m]	D [m]	LCONCIO [m]
Configurazione a)	3.15	0.5	-	-	1.8	0.6	0.3	10.0

Tabella 1 – Caratteristiche geometriche della sezione di calcolo del muro – configurazione a)



Figura 7: Sezione di calcolo della parte in elevazione del muro

Il dimensionamento è stato effettuato considerando l'altezza massima del paramento del muro $H_1=3.15$ m.

Micropali di fondazione	L [m]	Φ perforazione [m]	Interasse [m]	Inclinazione [deg]
Configurazione a)	9.50	0.240	1	0

Tabella 2 – Caratteristiche geometriche dei micropali di fondazione

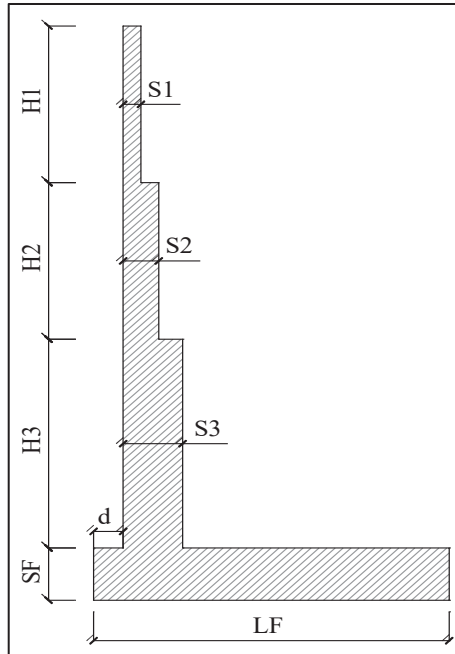
9.1.2 Analisi dei carichi

Per la posizione dei carichi considerati nelle analisi si fa riferimento allo schema di Figura 8.



Figura 8: Disposizione dei carichi considerati nelle analisi del muro di sottoscarpa

In Tabella 3 e Tabella 4 sono riassunti i coefficienti di combinazione delle azioni adottati rispettivamente per le verifiche agli Stati Limite Ultimi e agli Stati Limite di Esercizio.

		Peso proprio	Peso terreno	Peso permanenti	Peso accidentali	Spinta terre	Spinta permanenti	Spinta accidentali	Azioni sismiche
S.L.U.	SLU-F1	1.00	1.00	1.00	0.00	1.30	1.30	1.50	0.00
	SLU-F2	1.30	1.30	1.30	1.50	1.30	1.30	1.50	0.00
	SLV_SISM_↓	1.00	1.00	1.00	0.00	1.00	1.00	0.00	1.00
	SLV_SISM_↑	1.00	1.00	1.00	0.00	1.00	1.00	0.00	1.00

Tabella 3 - Coefficienti di combinazione utilizzati nelle analisi agli Stati Limite Ultimi dell'opera in oggetto; i simboli "↓" e "↑" indicano il verso delle forze d'inerzia dovute al sisma e corrispondono rispettivamente a un'azione sismica verticale verso l'alto (↓) e verso il basso (↑).

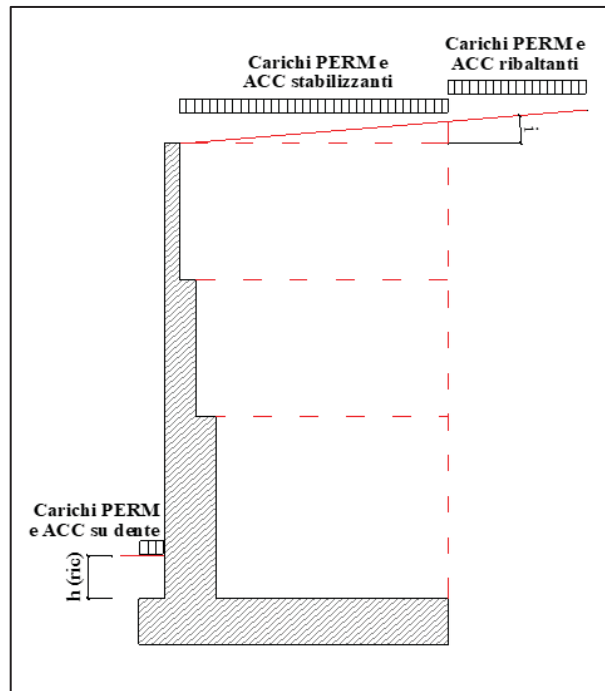
		Peso proprio	Peso terreno	Peso permanenti	Peso accidentali	Spinta terre	Spinta permanenti	Spinta accidentali	Azioni sismiche
S.L.E.	SLE_QP	1.00	1.00	1.00	0.00	1.00	1.00	0.60	0.00
	SLE_FR	1.00	1.00	1.00	0.00	1.00	1.00	0.70	0.00
	SLE_CAR	1.00	1.00	1.00	0.00	1.00	1.00	1.00	0.00
	SLD_SISM ↓	1.00	1.00	1.00	0.00	1.00	1.00	0.00	1.00
	SLD_SISM ↑	1.00	1.00	1.00	0.00	1.00	1.00	0.00	1.00

Tabella 4 - Coefficienti di combinazione utilizzati nelle analisi agli Stati Limite di Esercizio dell'opera in oggetto; i simboli "↓" e "↑" indicano il verso delle forze d'inerzia dovute al sisma e corrispondono rispettivamente a un'azione sismica verticale verso l'alto (↓) e verso il basso (↑).

9.1.2.1 Peso proprio

Il peso proprio degli elementi strutturali in calcestruzzo viene calcolato considerando un peso per unità di volume pari a 25.00 kN/m³.

9.1.2.2 Carichi permanenti

L'unico carico permanente agente sul muro è dovuto al peso del materiale di riempimento a tergo, per il quale è stato considerato un peso specifico di 19.00 kN/m³.

9.1.2.3 Carichi accidentali

L'unico carico accidentale instabilizzante considerato nelle analisi è il sovraccarico stradale pari a 20.00 kPa. Tale sovraccarico è stato cautelativamente considerato infinitamente esteso verso monte.

9.1.3 Verifiche strutturali nell'elevazione del muro

Nei paragrafi seguenti sono riportate le verifiche strutturali dell'elevazione del muro di sottoscampa. Tutte le azioni e le verifiche si riferiscono a un metro lineare di struttura.

A favore di sicurezza le sollecitazioni sono state calcolate considerando nullo l'angolo d'attrito muro-terreno.

Per il dimensionamento del paramento del muro sono state considerate le sollecitazioni calcolate alla base dell'elevazione in quanto più gravose.

9.1.3.1 Sollecitazioni nell'elevazione del muro

In Tabella 5 sono riassunte le sollecitazioni massime utilizzate nelle verifiche strutturali del paramento del muro di sottoscampa.

	N [kN/m]	V [kN/m]	M [kNm/m]
Comb SLU-F1	39.4	171	242
Comb SLU-F2	51.2	171	242
Comb SLV_SISM_↓	38.2	77	107
Comb SLV_SISM_↑	40.6	78	108
Comb SLE_QP	39.4	91	123
Comb SLE_FR	39.4	94	127
Comb SLE_CAR	39.4	102	140
Comb SLE_SISM_↓	38.2	54	70
Comb SLE_SISM_↑	40.6	54	70

Tabella 5 – Sollecitazioni alla base dell'elevazione del muro di sottoscarpa – configurazione a)

9.1.3.2 Verifiche agli Stati Limite Ultimi

9.1.3.2.1 Verifica a pressoflessione (SLU)

L'elevazione del muro ha spessore pari a $S_1=0.5$ m ed armatura principale simmetrica $\varnothing 18/15$ cm.

Si riporta nella seguente figura il risultato delle verifiche a pressoflessione.



Figura 9: Verifica a pressoflessione dell'elevazione del muro di sottoscarpa – configurazione a)

9.1.3.2.2 Verifica a taglio (SLU)

In base a quanto presente al paragrafo 4.1.2.1.3.1 delle NTC 2008, si effettuano le verifiche nei confronti dell'azione tagliante a Stato Limite Ultimo senza armatura trasversale resistente a taglio.

		Comb SLU_F1	Comb SLU_F2	Comb SLV_SISM ↓	Comb SLV_SISM ↑
V_{Ed}	[kN]	171	171	77	78
V_{Rd}	[kN]	210.1	211.9	210.0	210.3

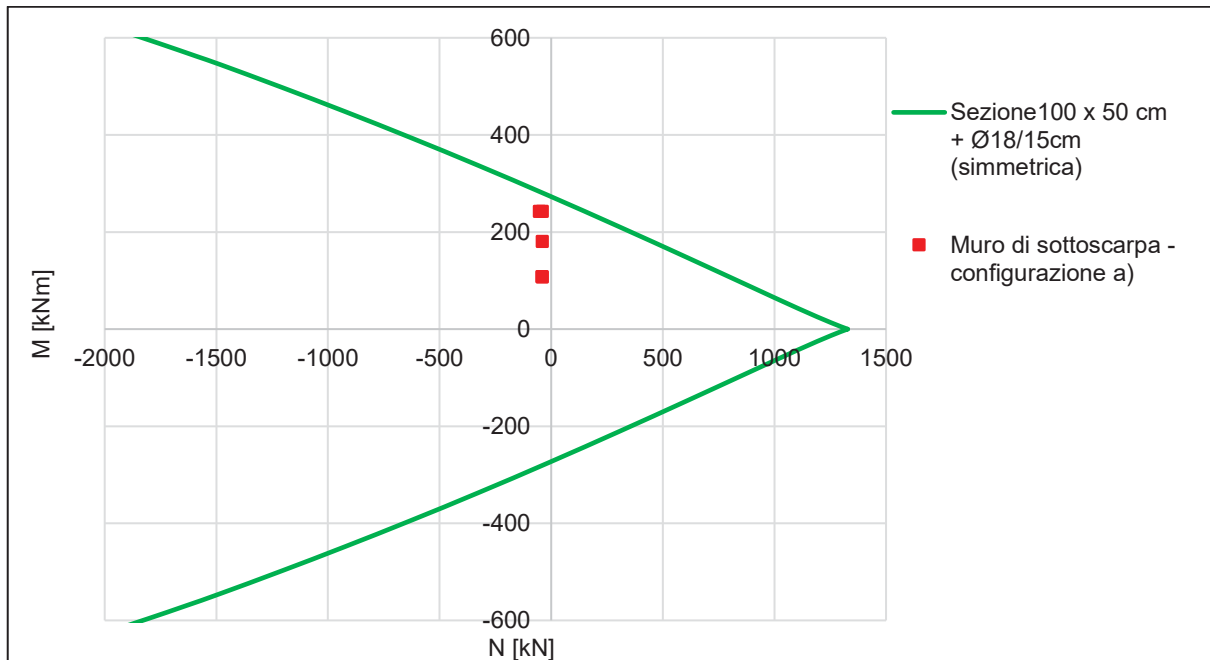
Tabella 6 – Verifica a taglio dell'elevazione del muro di sottoscarpa – configurazione a)

La verifica nei confronti delle azioni taglianti risulta soddisfatta in quanto le massime sollecitazioni di progetto risultano inferiori alle rispettive resistenze per ciascuna delle combinazioni considerate.

9.1.3.3 Verifiche agli Stati Limite di Esercizio

9.1.3.3.1 Verifica di limitazione delle tensioni (SLE)

In base a quanto presente al paragrafo 4.1.2.2.5 delle NTC 2008, si effettuano le verifiche nei confronti dello Stato Limite di Esercizio di limitazione delle tensioni.

	$\sigma_{c,MAX}$	$\sigma_{c,lim}$	$\sigma_{s,MAX}$	$\sigma_{s,lim}$
	[MPa]	[MPa]	[MPa]	[MPa]
SLE_CARATTERISTICA	5.34	19.92	201.86	360
SLE_QUASI PERMANENTE	4.69	14.94	175.98	360
SLD_SISM ↓	2.70	19.92	96.46	360
SLD_SISM ↑	2.71	19.92	96.96	360

Tabella 7 – Verifica SLE di limitazione delle tensioni

Le verifiche di limitazione delle tensioni risultano soddisfatte in quanto le massime tensioni sia lato calcestruzzo che lato acciaio sono sempre inferiori ai limiti imposti dalla normativa.

9.1.3.3.2 Verifica di fessurazione (SLE)

In base a quanto presente al paragrafo 4.1.2.2.4.5 delle NTC 2008, si effettuano le verifiche nei confronti dello Stato Limite di Esercizio di fessurazione:

	w_k	w_{lim}
	[mm]	[mm]
SLE_QUASI PERMANENTE	0.200	0.200
SLE_FREQUENTE	0.207	0.300

Tabella 8 – Verifica a fessurazione dell'elevazione

Le verifiche a fessurazione risultano soddisfatte.

9.1.4 Verifiche della fondazione su micropali

9.1.4.1 Sollecitazioni agenti sulla fondazione

Nella seguente tabella sono riportate le sollecitazioni massime agenti sulla fondazione del muro di sottoscarpa.

	V	N	M
	[kN/m]	[kN/m]	[kNm/m]
Comb SLU-F1	205	176	400
Comb SLU-F2	205	228	392
Comb SLV_SISM ↓	91	186	120
Comb SLV_SISM ↑	92	197	120

Tabella 9 – Sollecitazioni massime agenti sulla fondazione del muro di sottoscarpa

9.1.4.2 Sollecitazioni agenti sui micropali di fondazione

Per il calcolo delle sollecitazioni presenti nei micropali è stato utilizzato il software Group 2019 il quale permette di modellare l'intera fondazione su micropali e di tenere conto dell'interazione fra la platea di fondazione, i micropali e il terreno.

Tramite l'ausilio di tale software è stato possibile ricavare:

- le azioni massime in testa ai micropali (Tabella 10) necessarie per effettuare le verifiche di capacità portante;
- le sollecitazioni interne ai micropali necessarie per effettuare le verifiche strutturali degli stessi.

Nella seguente figura si riporta il modello della fondazione utilizzato nell'analisi.



Figura 10 – Modello della fondazione su micropali – configurazione a) – software Group 2019

In particolare, il software di calcolo Group 2019 schematizza i micropali con modelli del tipo trave su suolo elastico. Per la descrizione della metodologia adottata per definire il legame costitutivo elastico-perfettamente plastico delle molle, utilizzate per la schematizzazione del terreno si rimanda alla Relazione Geotecnica Generale [1].

Nella seguente figura è riportato uno schema del legame costitutivo elastico-perfettamente plastico delle molle utilizzate nelle analisi.

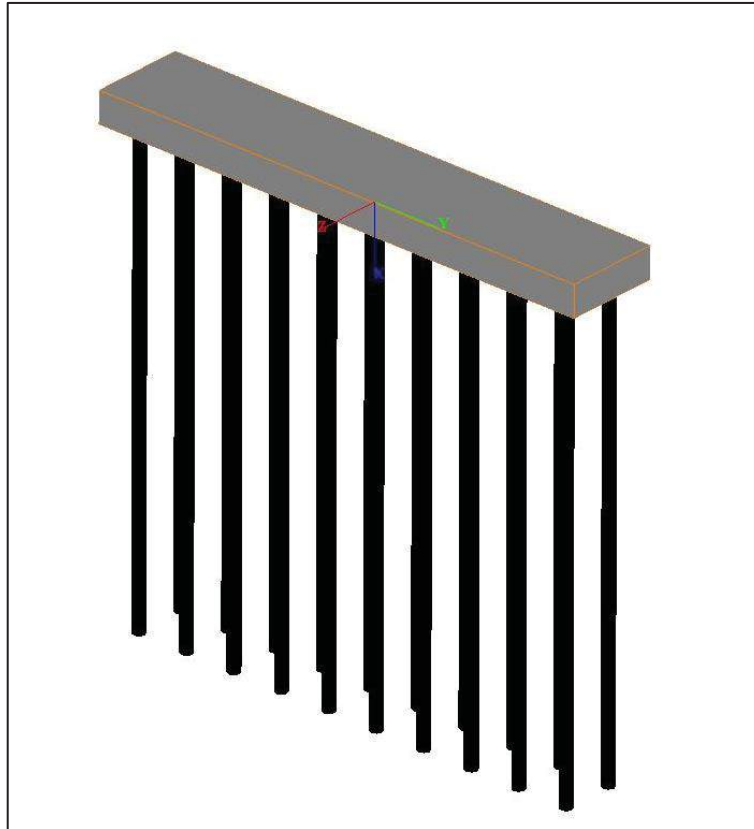

Figura 11 – Legame costitutivo elastico-perfettamente plastico delle molle utilizzate per schematizzare il terreno attorno al micropalo

I parametri mostrati in Figura 11 hanno i seguenti significati:

- coefficiente di reazione k_h [kN/m³] delle molle orizzontali che simulano la reazione del terreno;
- Pressione limite p_u [kPa] delle molle orizzontali che simulano la reazione del terreno.

Si riportano nelle seguenti figure gli andamenti di k_h e di p_u con la profondità considerati nelle analisi.

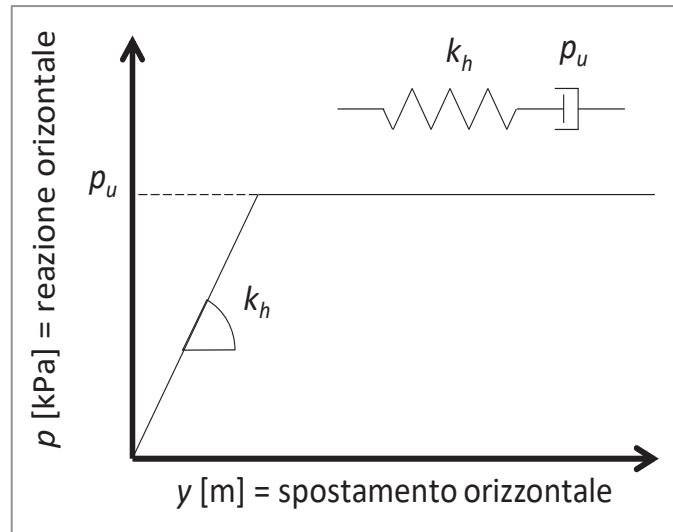

Figura 12 – Andamento del valore del coefficiente k_h con la profondità



Figura 13 – Andamento del valore della pressione limite p_u con la profondità

Si riportano nella seguente tabella le sollecitazioni assiali massime in testa ai micropali necessarie per effettuare le verifiche di capacità portante dei micropali.

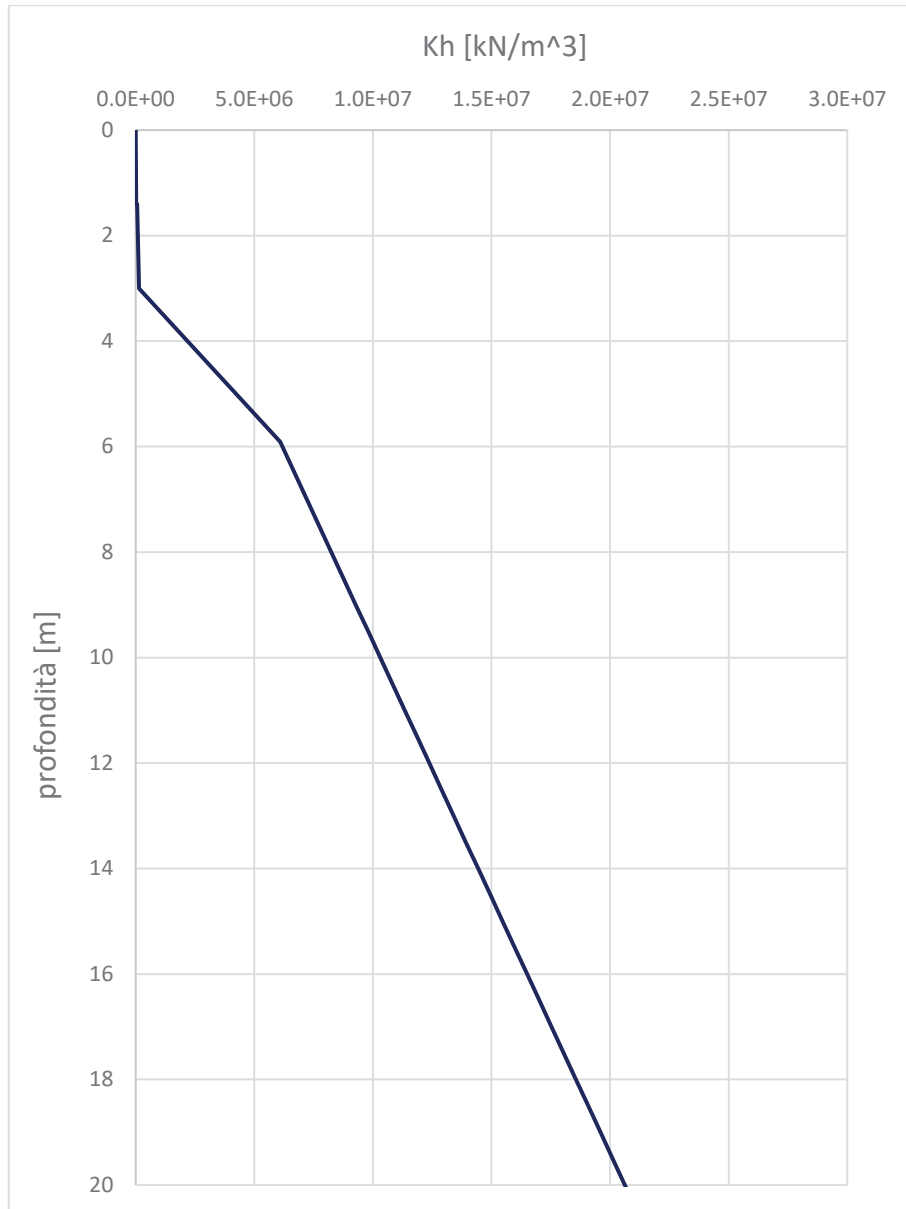
N	Comb.	Comb.	Comb.	Comb.
[kN]	SLU-F1	SLU-F2	SLV_SISM ↓	SLV_SISM ↑
compressione	669.9	688.9	290.3	296.8
trazione	493.9	460.9	104.3	99.8

Tabella 10 – Azione assiale massima di compressione e trazione agente in testa ai micropali

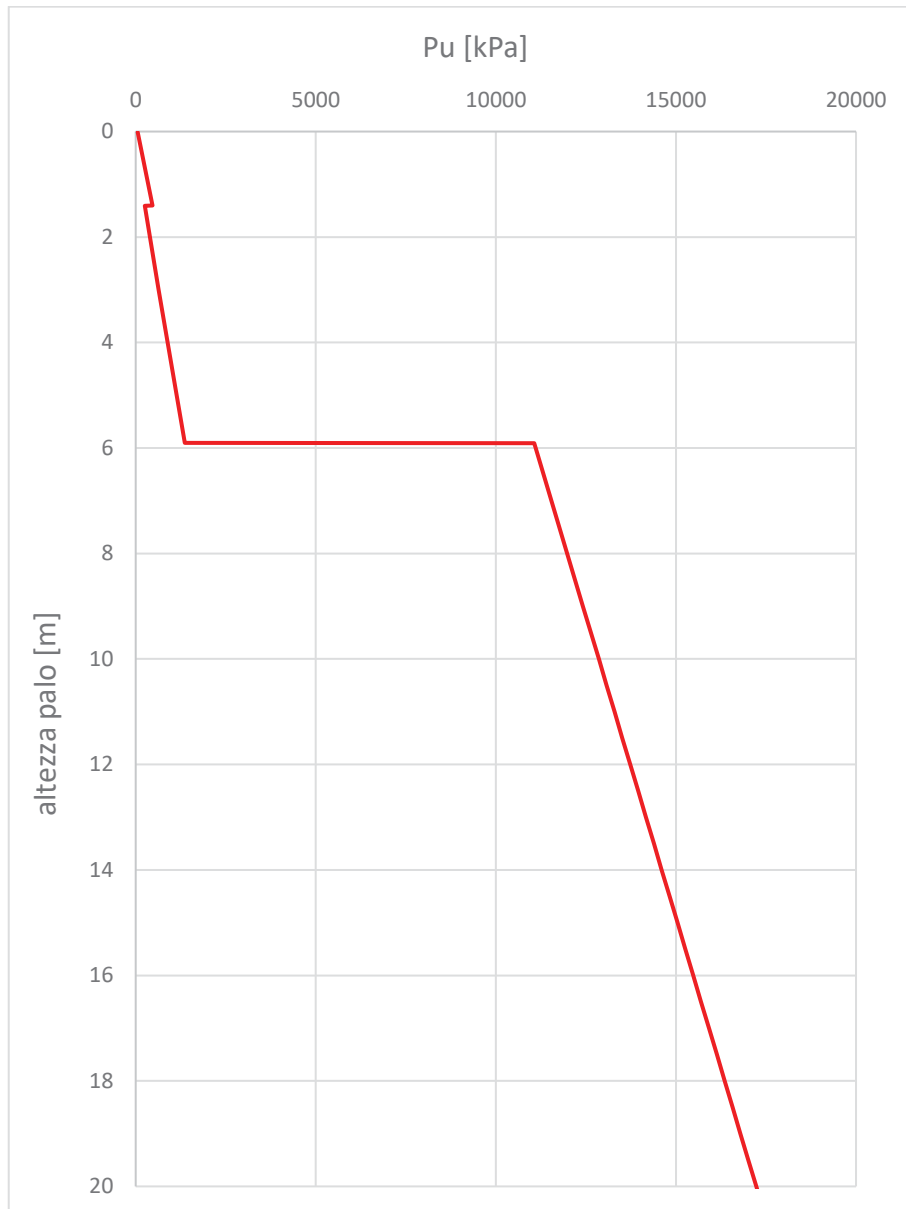
9.1.4.3 Verifica a capacità portante dei micropali di fondazione

Nella seguente tabella si riportano le caratteristiche dei micropali di fondazione.

Caratteristiche dei micropali di fondazione		
Lunghezza perforazione	9.50	[m]
inclinazione	0	[deg]
φ perforazione	0.24	[m]
φ profilato in acciaio	0.1937	[m]
spessore profilato in acciaio	0.01	[m]

Tabella 11 – Caratteristiche dei micropali di fondazione

Le verifiche di capacità portante dei micropali sono state effettuate considerando come contributo resistente solamente l'attrito laterale del palo, trascurando, a favore di sicurezza, il contributo di base.

Per la visualizzazione della procedura metodologica relativa al calcolo della capacità portante verticale di progetto dei micropali si veda quanto specificato nella Relazione Geotecnica Generale [1].

Nella seguente tabella sono riportati i valori dell'aderenza limite caratteristica fra terreno e micropalo τ_{lim} e i valori del coefficiente di sbulbamento α , (parametro empirico funzione del terreno e delle modalità esecutive del micropalo) entrambi definiti al variare della stratigrafia. Il fattore di sbulbamento è stato assunto pari ad 1 in tutti gli strati in quanto la metodologia realizzativa considerata (IGU – iniezione globale unica) nei materiali rocciosi seppur fratturati non garantisce l'espansione della malta cementizia all'esterno dell'area di perforazione.

A favore di sicurezza il contributo alla capacità portante fornito dello strato superficiale di coltri eluvio colluviali è stato considerato nullo.

Stratigrafia		Parametri minimi		Parametri medi	
tipologia dello strato	limite inferiore dello strato i-esimo misurato dalla testa del micropalo [m]	T_{ak} [kPa]	α [-]	T_{ak} [kPa]	α [-]
coltri eluvio colluviali	2	0	0	0	0
basalti alterati	6.5	180	1	200	1
basalti non alterati	-	200	1	250	1

Tabella 12 – Valori dell'aderenza limite caratteristica fra terreno e micropalo e coefficienti di sbulbamento

Si riportano nelle seguenti figure le curve di capacità portante dei micropali di fondazione di compressione e di trazione ottenute considerando i parametri resistenti del terreno (τ_{lim}) minimi e medi.



Figura 14 – Curva di capacità portante verticale in compressione con parametri minimi e medi



Figura 15 – Curva di capacità portante verticale in trazione con parametri minimi e medi

Come visibile dalle figure sopra riportate, considerando la lunghezza dei micropali pari a 9.50 m, le verifiche di capacità portante risultano soddisfatte.

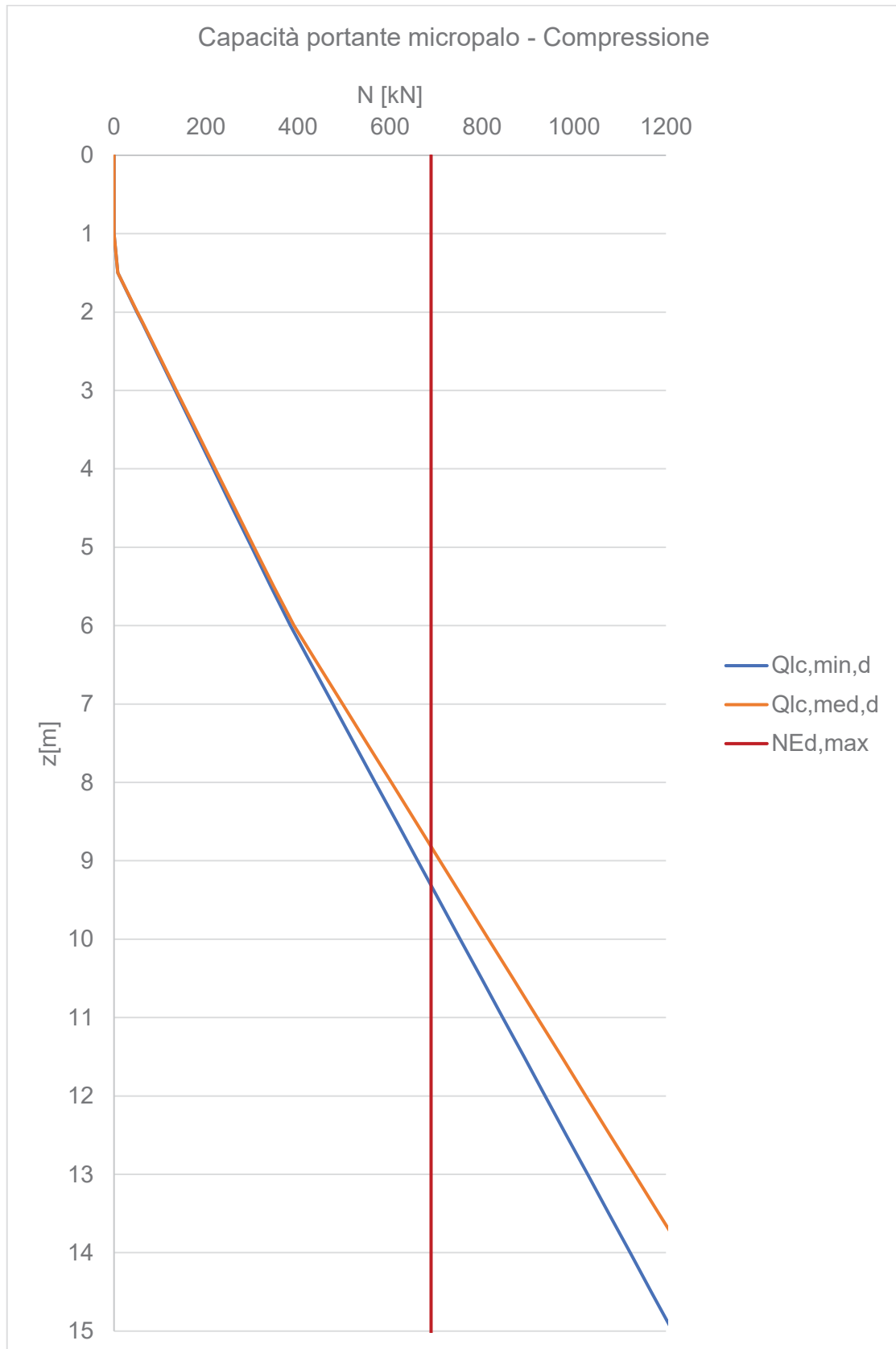
9.1.4.4 Verifiche strutturali dei micropali di fondazione

9.1.4.4.1 Azioni interne ai micropali

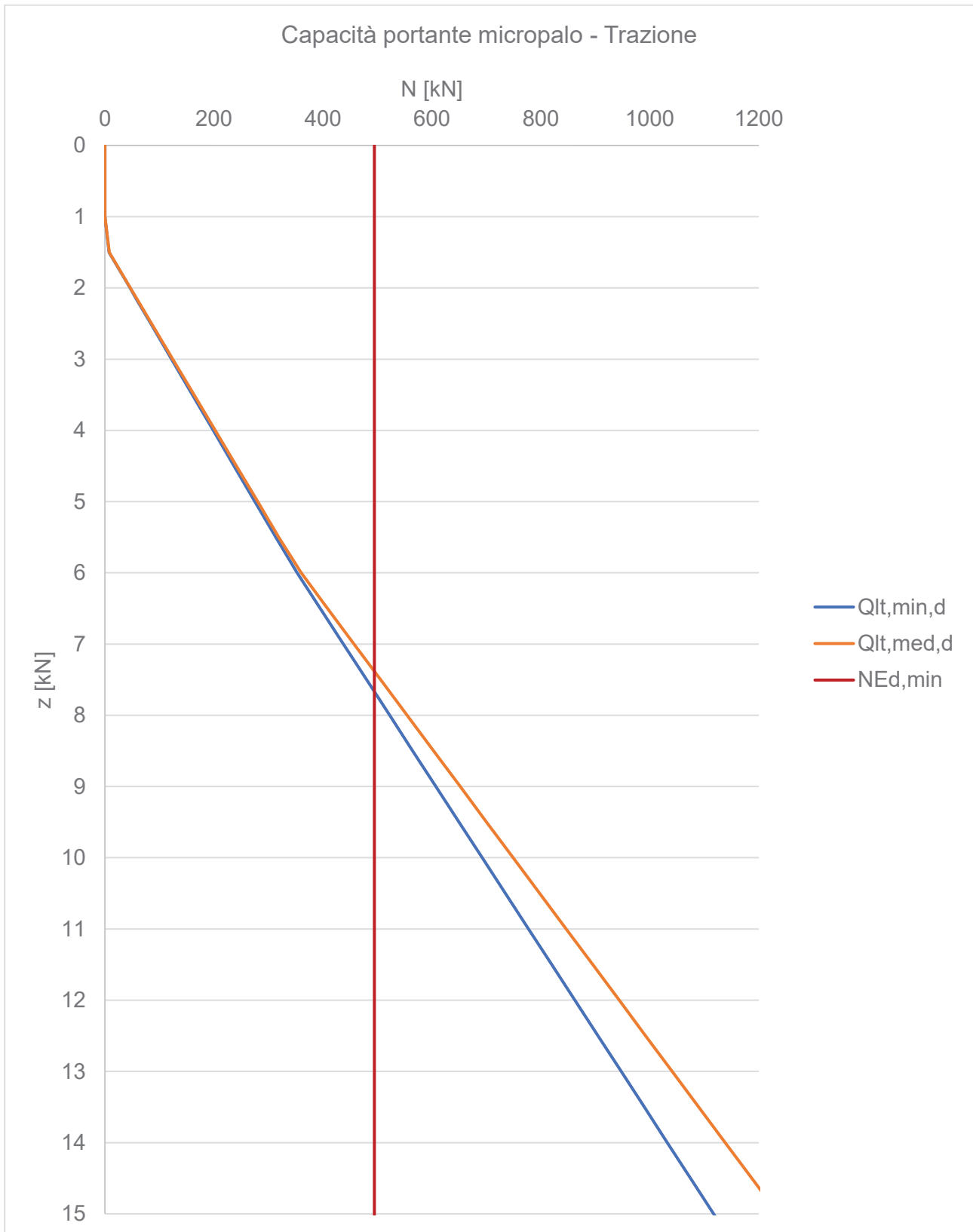
Considerando le sollecitazioni agenti sulla fondazione del muro di sottoscarpa di cui al paragrafo 9.1.4.1, mediante il software di calcolo Group 2019, sono state ottenute le azioni interne di taglio e momento flettente presenti nei micropali per ciascuna combinazione di carico considerata. Tali sollecitazioni sono riportate nelle figure seguenti.

I grafici sottostanti sono limitati ad una lunghezza di 8m e non alla lunghezza totale del palo; si evidenzia che le sollecitazioni di taglio e momento flettente si annullano per profondità maggiori di circa 6m.

SLU F1



Figura 16 – Momento flettente lungo il micropalo – Combinazione SLU F1 – Micropalo compresso – L=9.50m



Figura 17 – Momento flettente lungo il micropalo – Combinazione SLU F1 – Micropalo teso – L=9.50m

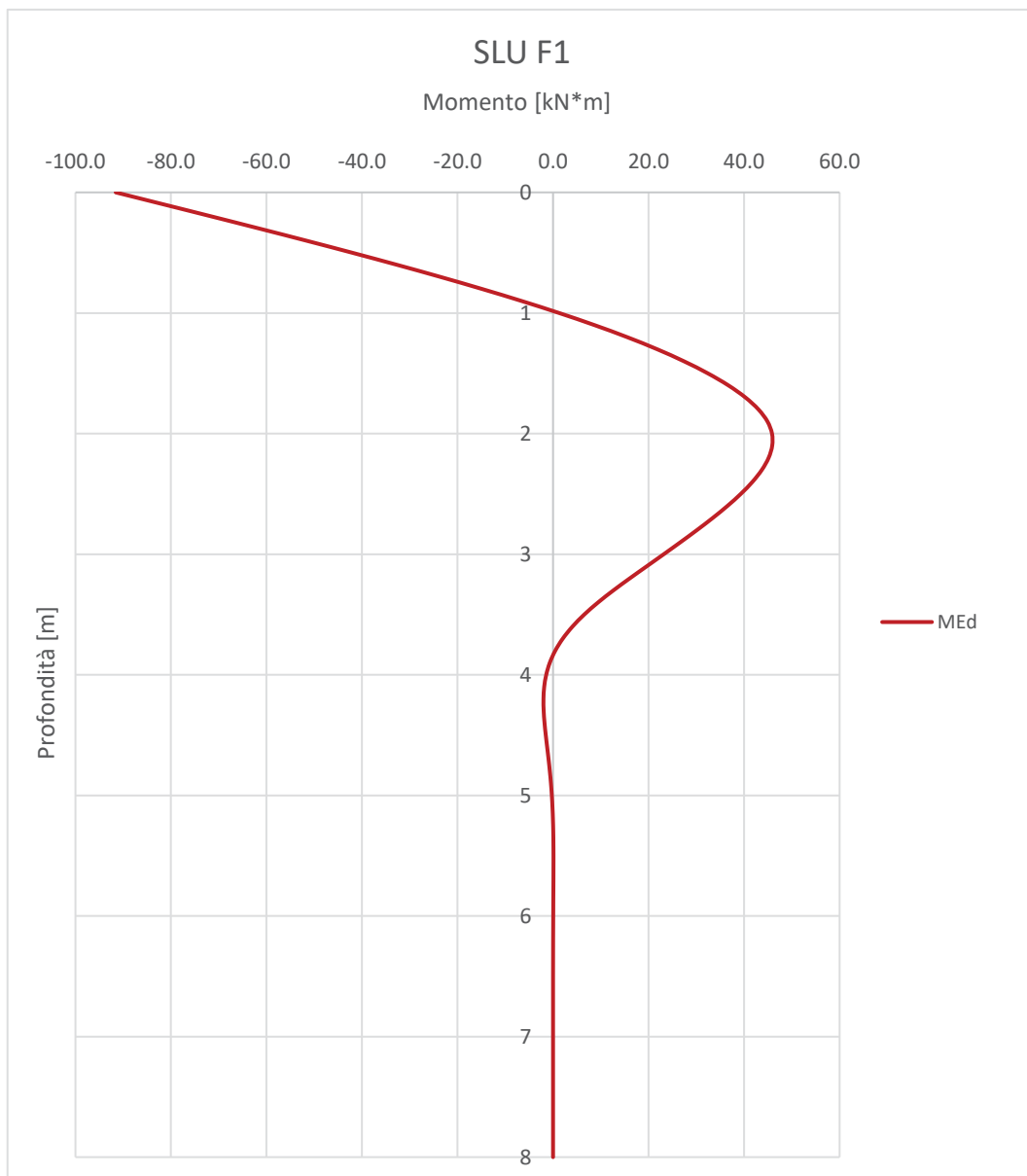

Figura 18 – Taglio lungo il micropalo – Combinazione SLU F1 – In rosso il micropalo teso e in blu quello compresso – L=9.50m

SLU F2

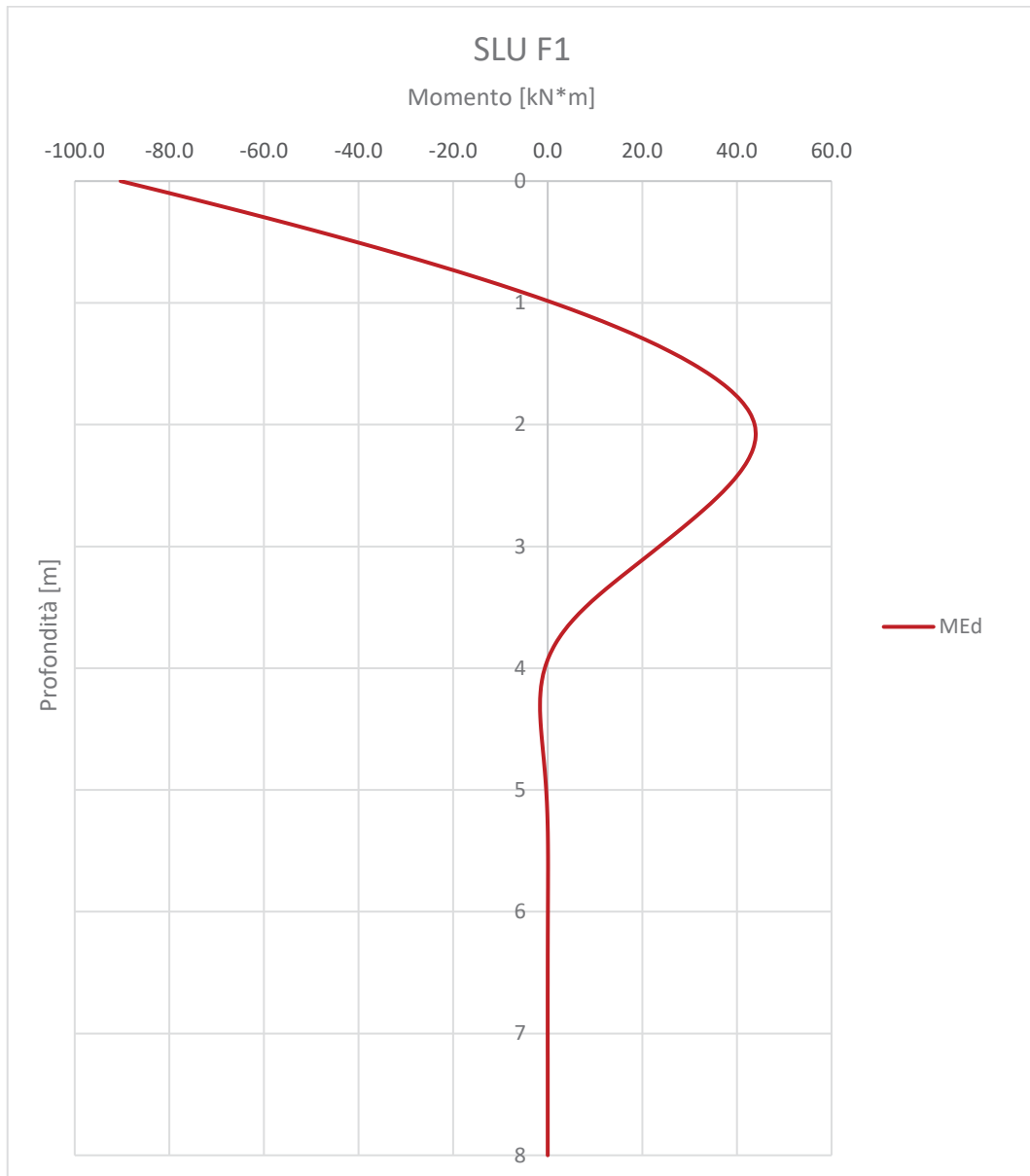

Figura 19 – Momento flettente lungo il micropalo – Combinazione SLU F2 – Micropalo compresso – L=9.50m

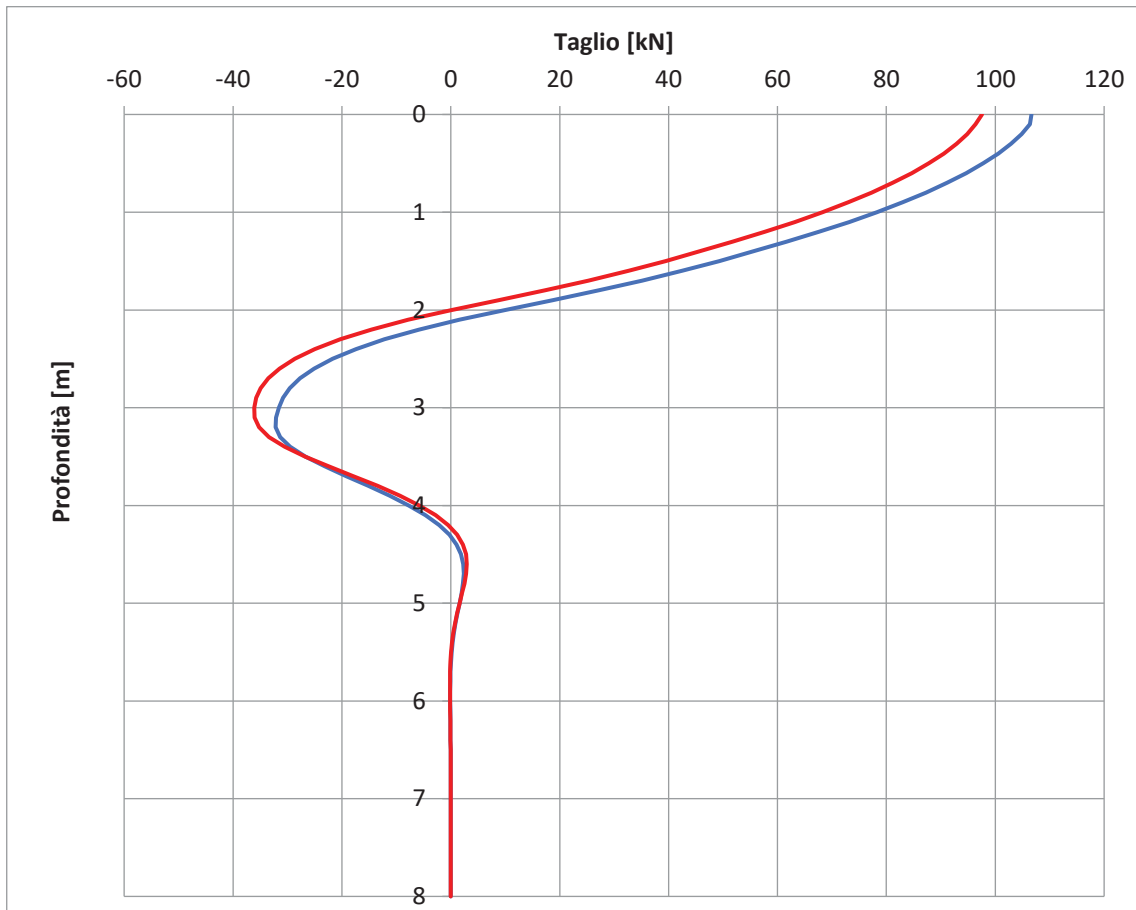

Figura 20 – Momento flettente lungo il micropalo – Combinazione SLU F2 – Micropalo teso – L=9.50m

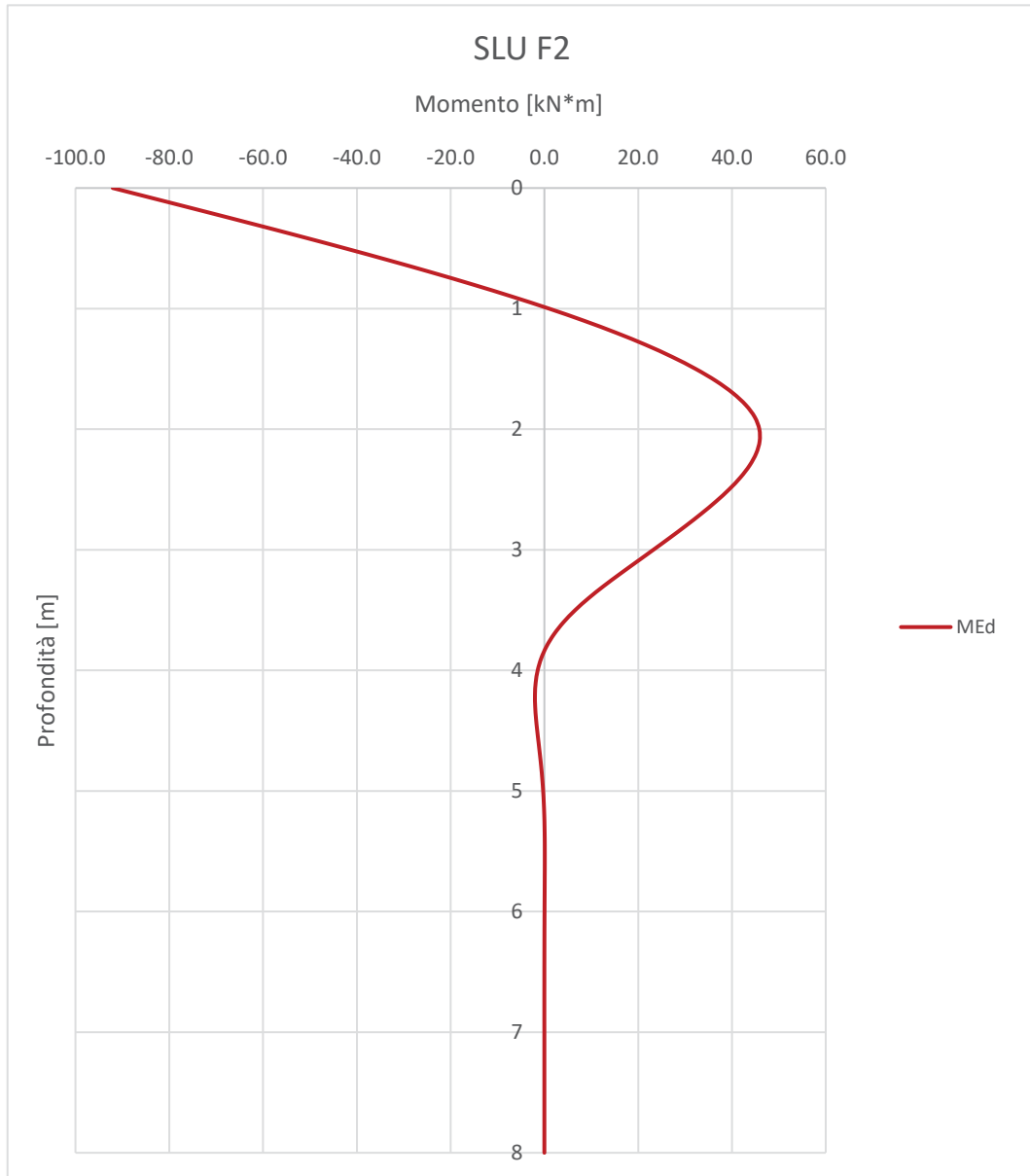

Figura 21 – Taglio lungo il micropalo – Combinazione SLU F2 – In rosso il micropalo teso e in blu quello compresso – L=9.50m

SLV SISM ↓

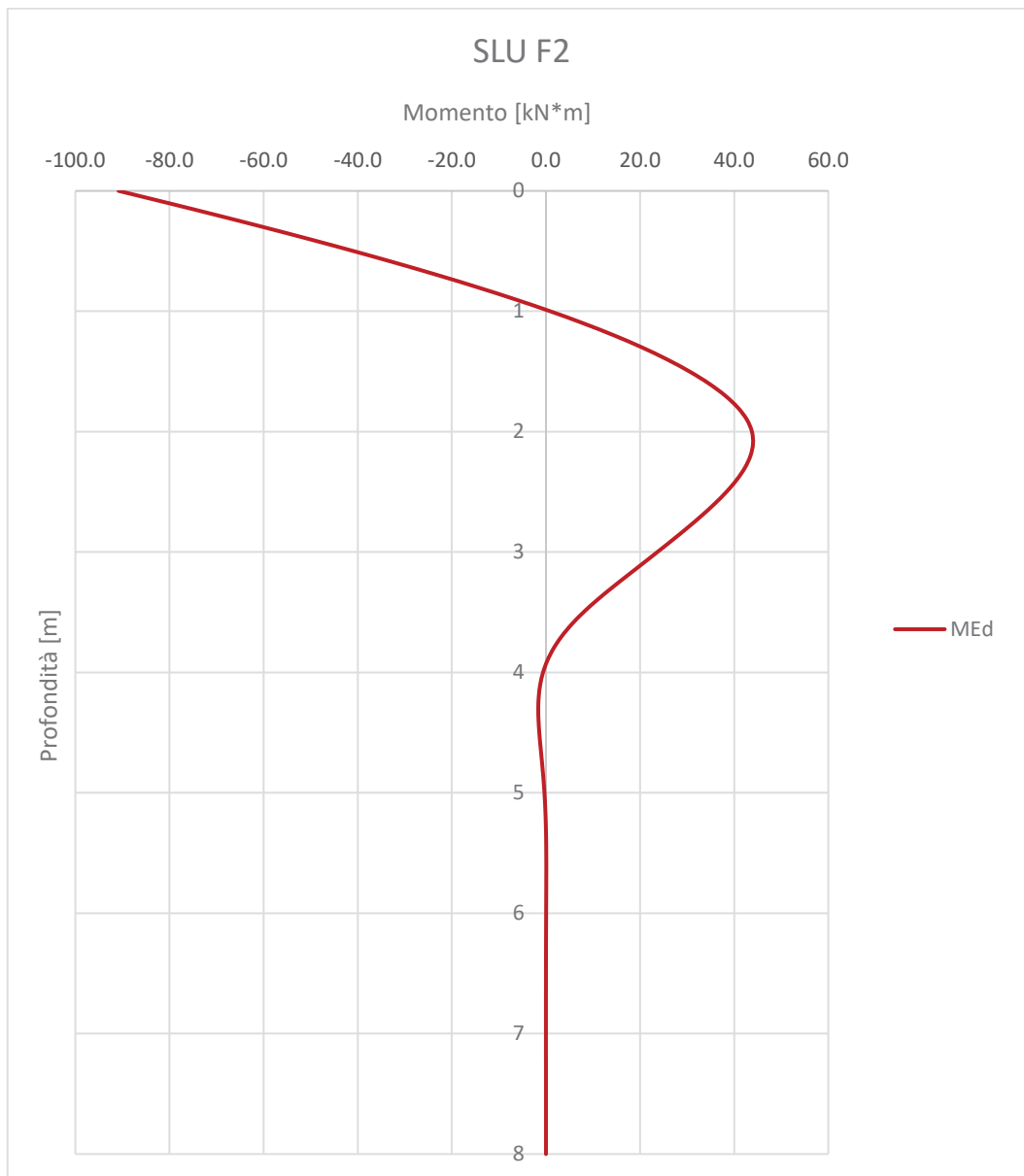

Figura 22 – Momento flettente lungo il micropalo – Combinazione SLV SISM ↓ – Micropalo compresso – L=9.50m

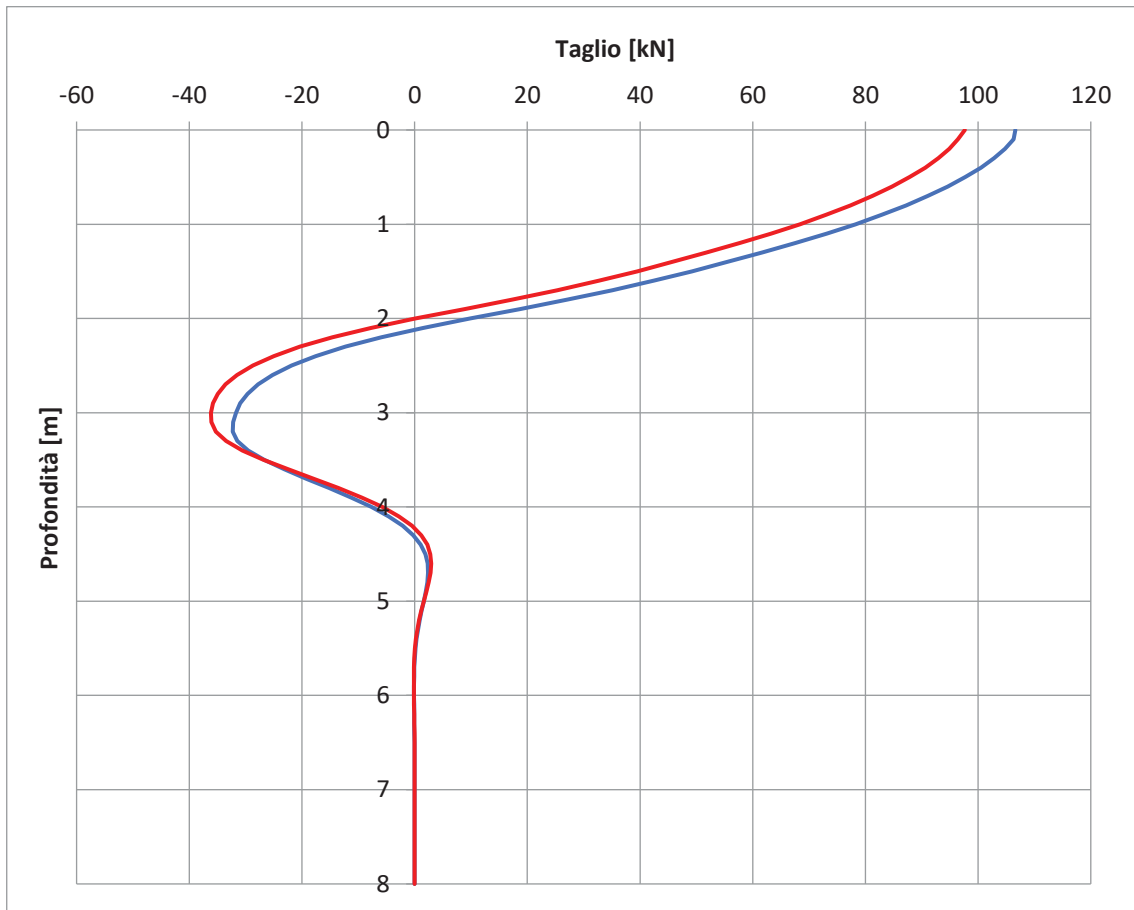

Figura 23 – Momento flettente lungo il micropalo – Combinazione SLV SISM ↓ – Micropalo teso – L=9.50m

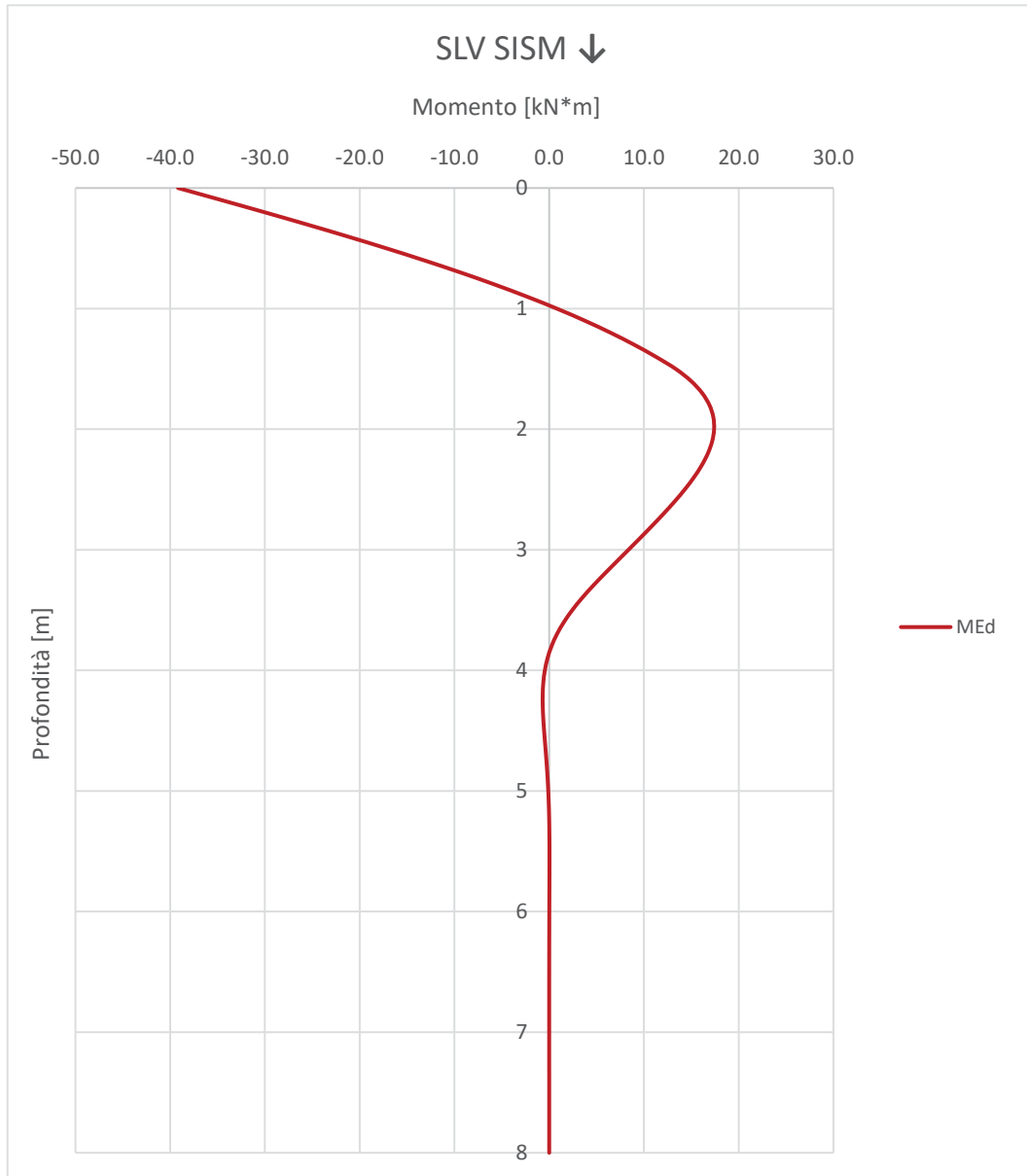

Figura 24 – Taglio lungo il micropalo – Combinazione SLV SISM ↓ – In rosso il micropalo teso e in blu quello compresso – L=9.50m

SLV SISM_↑

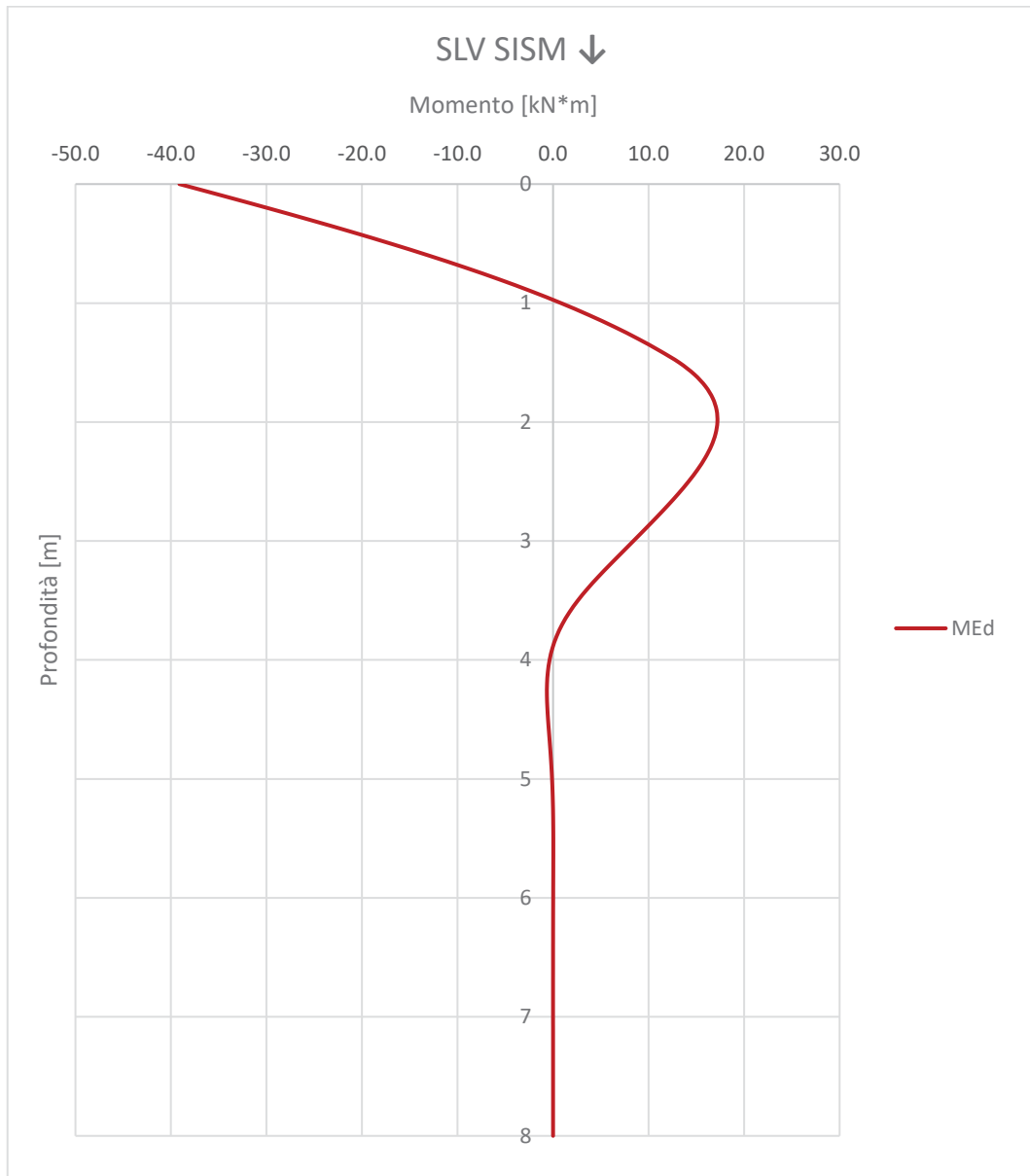

Figura 25 – Momento flettente lungo il micropalo – Combinazione SLV SISM ↑ – Micropalo compresso – L=9.50m

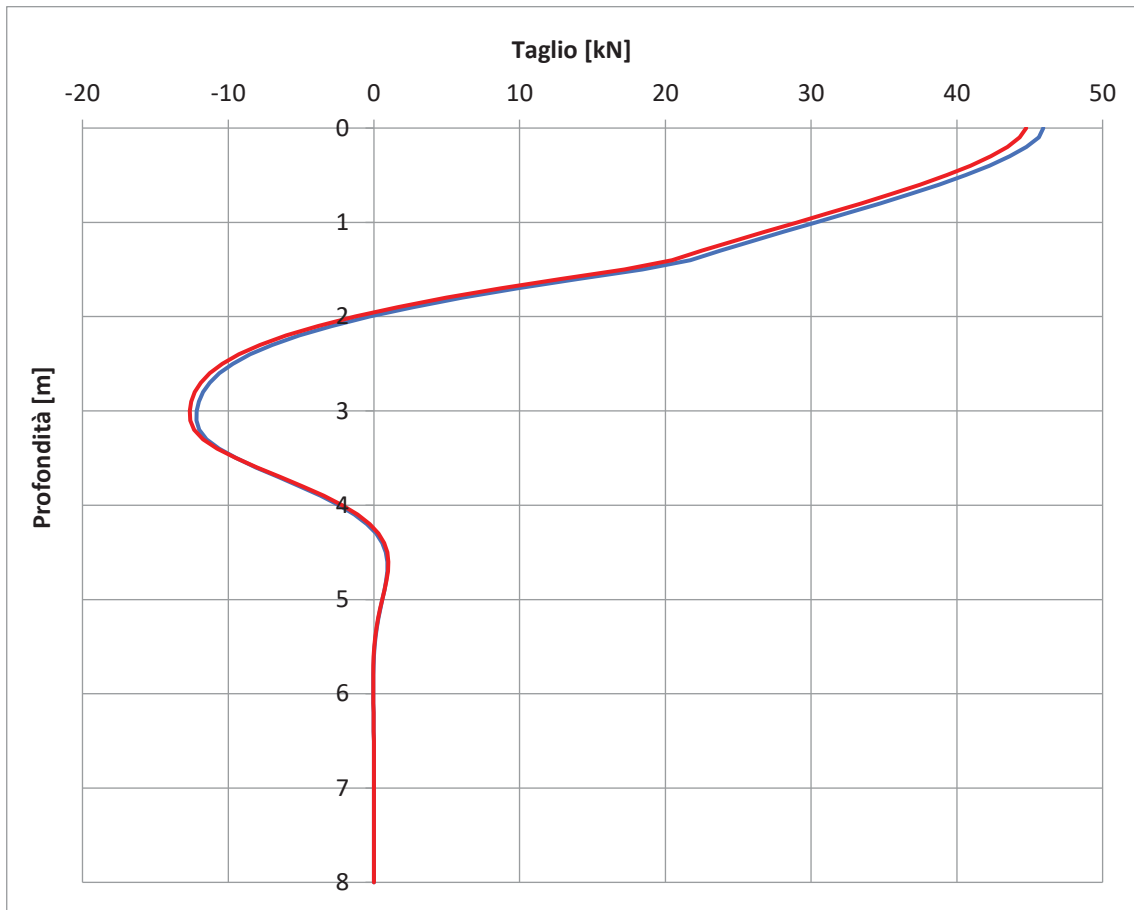

Figura 26 – Momento flettente lungo il micropalo – Combinazione SLV SISM ↑ – Micropalo teso – L=9.50m

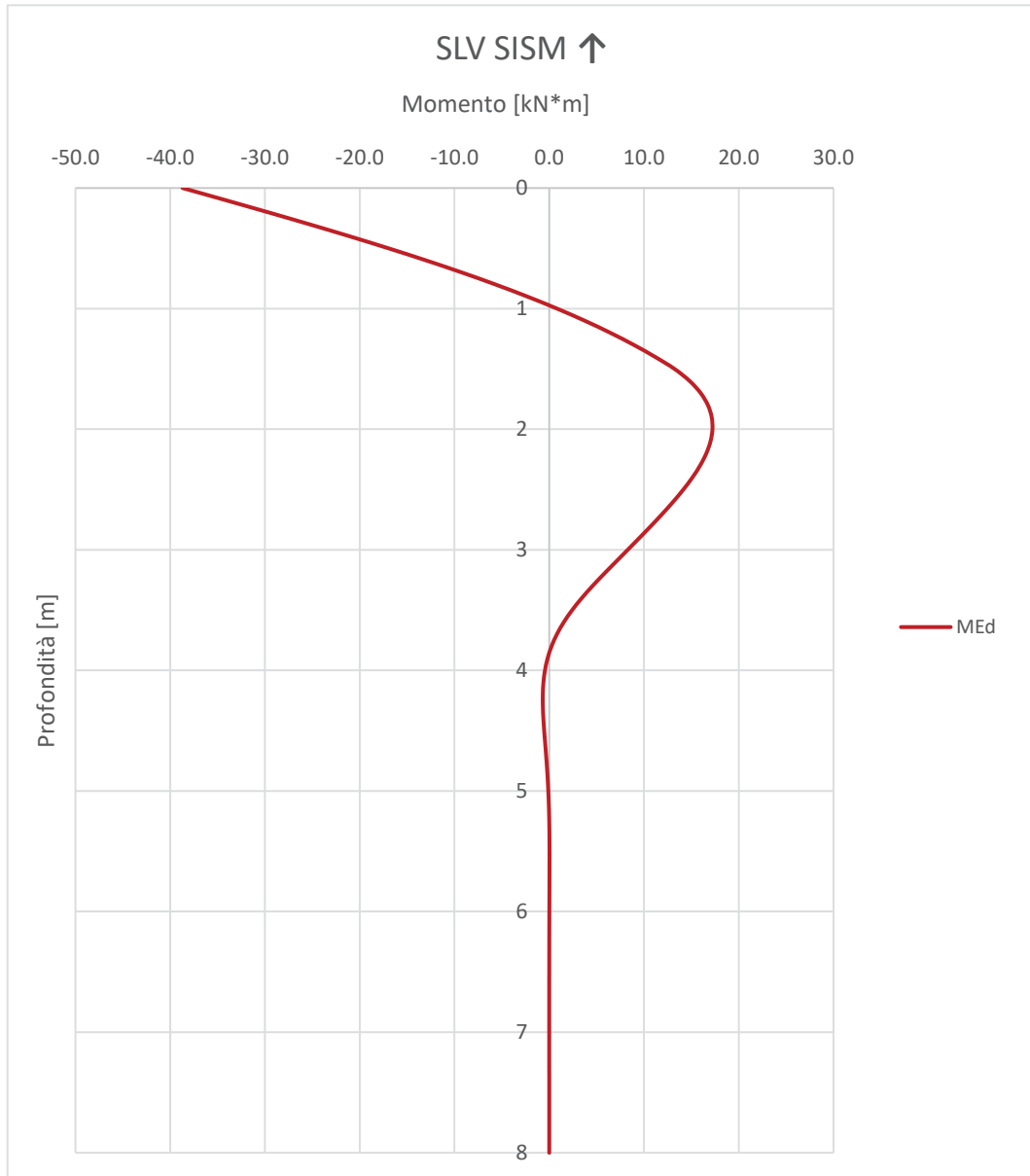

Figura 27 – Taglio lungo il micropalo – Combinazione SLV SISM ↑ – In rosso il micropalo teso e in blu quello compresso – $L=9.50m$

9.1.4.4.2 Verifiche strutturali

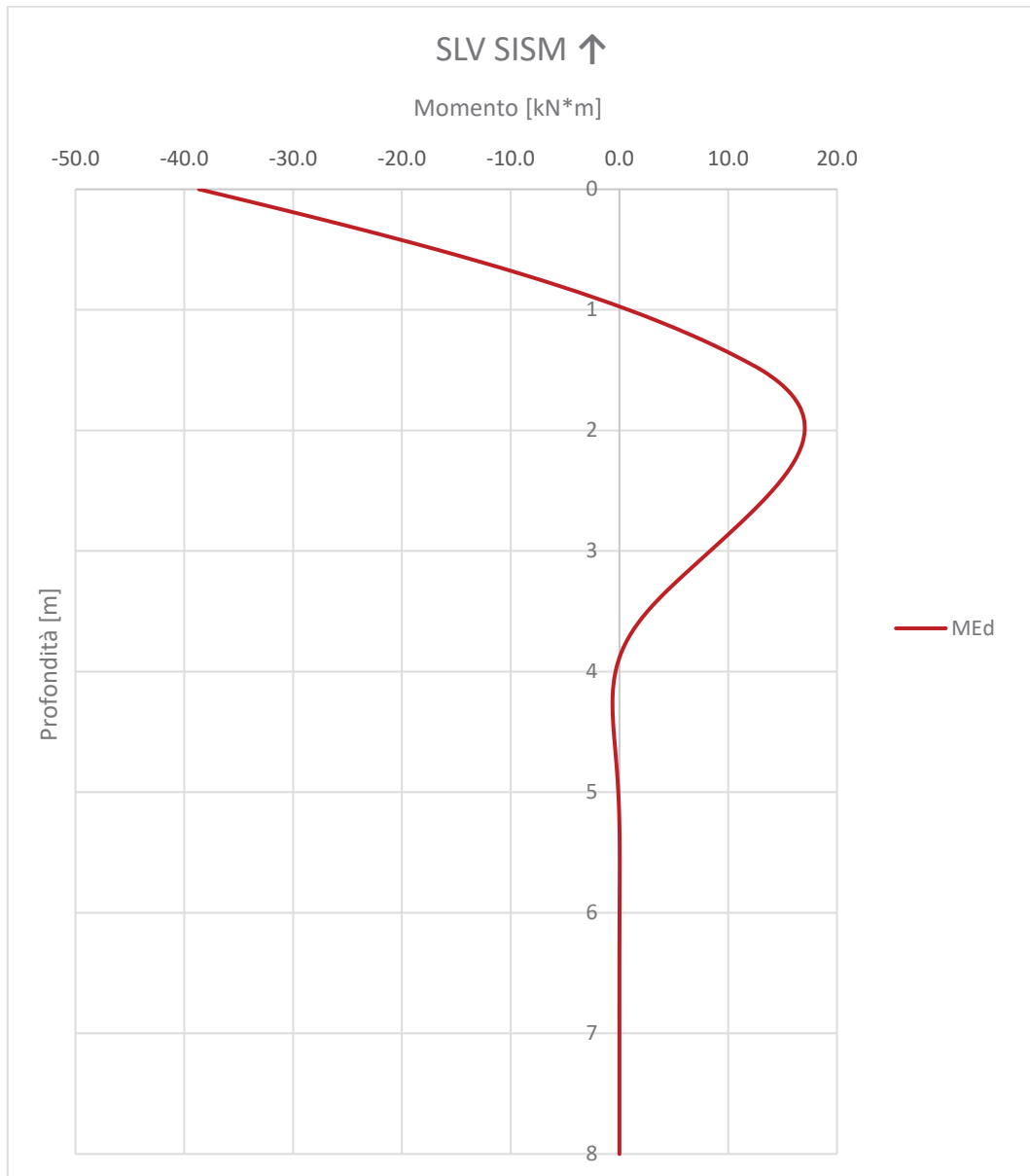
La verifica della resistenza strutturale dei micropali è condotta, cautelativamente, facendo riferimento alla sola resistenza del profilato in acciaio.

In accordo con quanto prescritto al paragrafo 4.2.4.1 delle NTC 2008 e con riferimento alle formule riportate nella UNI EN 1993 1-1, è stata effettuata la verifica a presso o tenso-flessione controllando che il momento flettente sollecitante di progetto M_{Ed} sia minore del momento resistente di progetto, ridotto per effetto dell'azione assiale e di taglio.

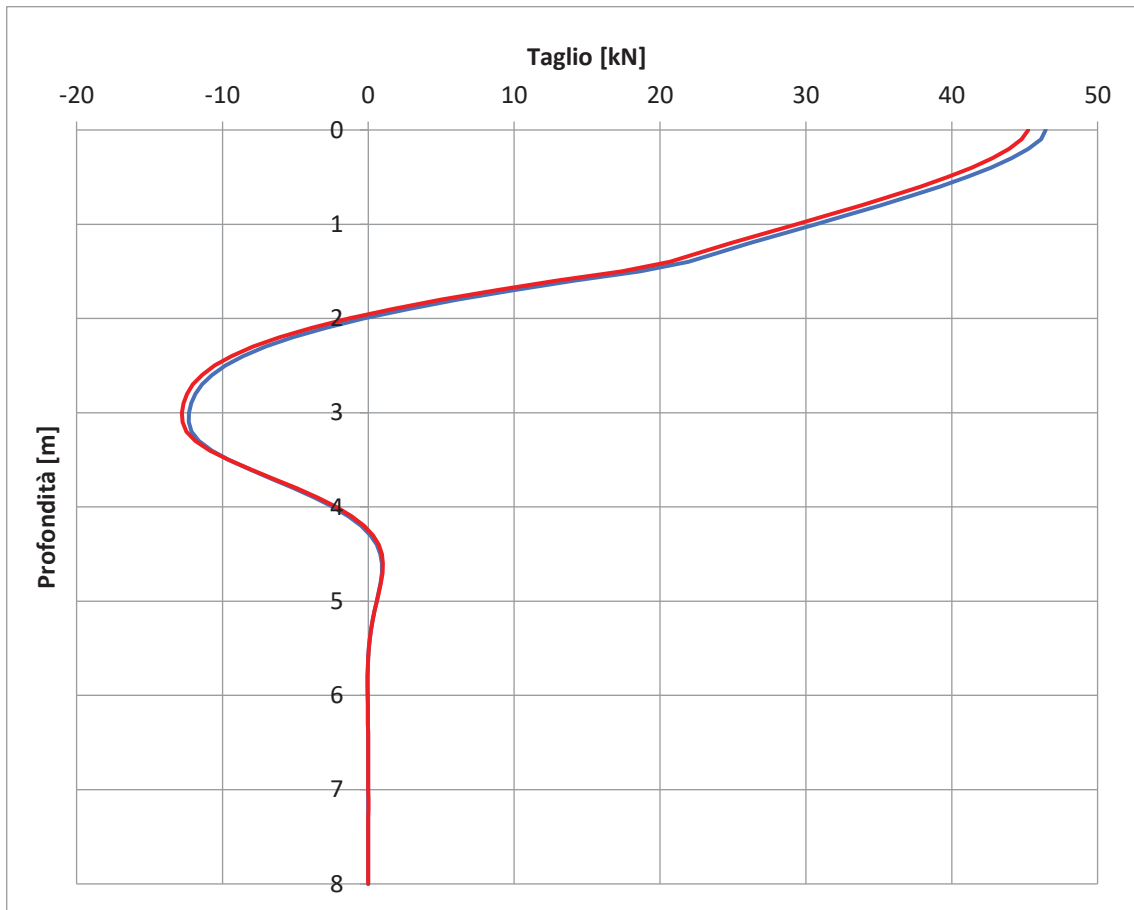
$$M_{Ed} \leq M_{c,Rd} = M_{N,y,Rd}$$

$$M_{N,y,Rd} = 1,04 \cdot M_{V,y,Rd} \cdot (1 - n^{1,7}) \leq M_{V,y,Rd} = \frac{W_{pl} \cdot f_{y,k}}{\gamma_M} \cdot (1 - \rho)$$

$$n = \frac{N_{Ed}}{N_{pl,Rd}}$$

$$\rho = \left(\frac{2V_{Ed}}{V_{c,Rd}} - 1 \right)^2$$

dove:

$M_{N,y,Rd}$	momento plastico di progetto ridotto per effetto dell'azione assiale
$M_{V,y,Rd}$	momento plastico di progetto ridotto per effetto dell'azione di taglio
N_{Ed}	azione assiale di progetto
$N_{pl,Rd}$	resistenza assiale di progetto
V_{Ed}	sollecitazione di taglio di progetto
$V_{c,Rd}$	resistenza a taglio di progetto
ρ	fattore di riduzione del momento resistente da considerarsi solo se la sollecitazione di taglio di progetto è maggiore di metà della resistenza a taglio di progetto

$$V_{c,Rd} = \frac{A_v \cdot f_{yk}}{\sqrt{3} \cdot \gamma_M} = 717.16 \text{ kN}$$

$$A_v = \frac{2 \cdot A}{\pi} = 36.74 \text{ cm}^2$$

dove:

A_v	area di taglio della sezione del profilato in acciaio
A	area della sezione del profilato in acciaio

$$V_{Ed,max} = 97.6 \text{ kN} \leq 0.5 \cdot V_{c,Rd}$$

Dal momento che il taglio massimo di progetto, calcolato tenendo conto di tutte le combinazioni di carico, risulta inferiore alla metà del taglio resistente, è stato possibile trascurare il suo contributo nel calcolo del momento resistente di seguito riportato.

Di seguito si riportano i valori del momento resistente nelle varie combinazioni considerate in funzione della sollecitazione assiale di progetto.

Palo compresso	N_{Ed} (compressione)	M_{Ed}	$M_{N,yRd}(N_{Ed})$	Verifica
	[kN]	[kNm]	[kNm]	
Comb SLU-F1	669.9	91.6	99.5	OK
Comb SLU-F2	688.9	92.1	98.5	OK
Comb SLV_SISM_↓	296.8	39.2	113.9	OK
Comb SLV_SISM_↑	290.3	38.7	114.1	OK

Tabella 13 – Verifica a momento flettente del micropalo compresso

Palo teso	N_{Ed} (trazione)	M_{Ed}	$M_{N,yRd}(N_{Ed})$	Verifica
	[kN]	[kNm]	[kNm]	
Comb SLU-F1	493.9	90.3	107.3	OK
Comb SLU-F2	460.9	90.8	108.6	OK
Comb SLV_SISM_↓	99.8	39.1	114.2	OK
Comb SLV_SISM_↑	104.3	38.6	114.2	OK

Tabella 14 – Verifica a momento flettente del micropalo teso

9.1.5 Cedimenti

La Figura 28 mostra i cedimenti e le rotazioni nel baricentro della fondazione del muro e i cedimenti in corrispondenza dei micropali calcolati automaticamente dal software Group per la combinazione SLE più gravosa, ovvero la SLE_CARATTERISTICA. Il cedimento massimo registrato in corrispondenza dei micropali è pari a 2mm e quindi del tutto trascurabile.



Figura 28 – Cedimenti e rotazioni fondazione

La Figura 29 mostra gli spostamenti orizzontali in corrispondenza dei micropali calcolati dal software Group per la combinazione SLE_CARATTERISTICA. Lo spostamento massimo registrato in direzione Z, pari a 1,5 cm, è ritenuto accettabile, anche in virtù del fatto che l'analisi svolta con il software Group trascura l'attrito tra il piano di fondazione e il terreno.

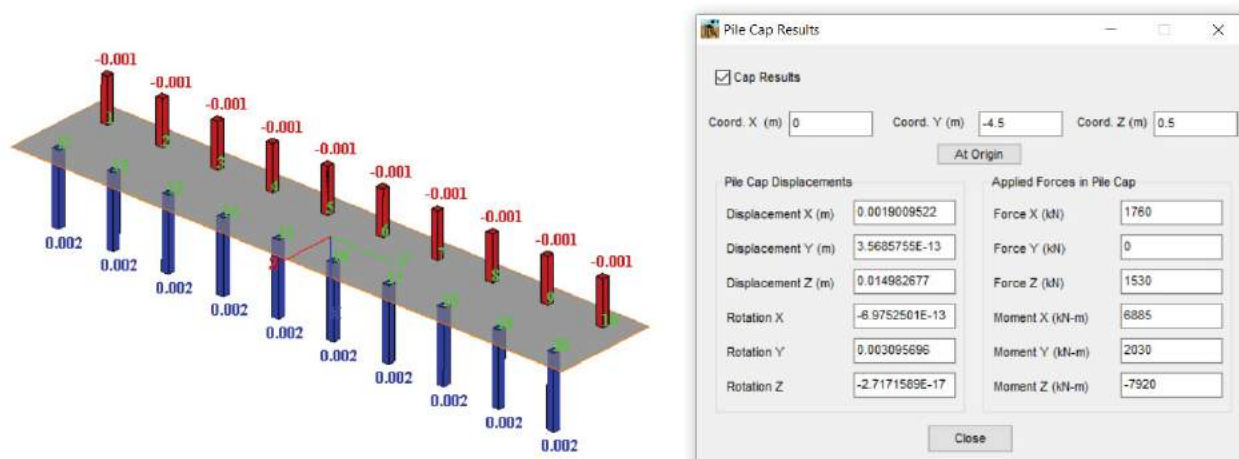

Figura 29 – Spostamenti orizzontali fondazione

In conclusione, la struttura progettata si ritiene adeguata alla sua funzione di sostegno della viabilità.

9.2 Muro di sottoscarpa – configurazione b)

9.2.1 Geometria della struttura

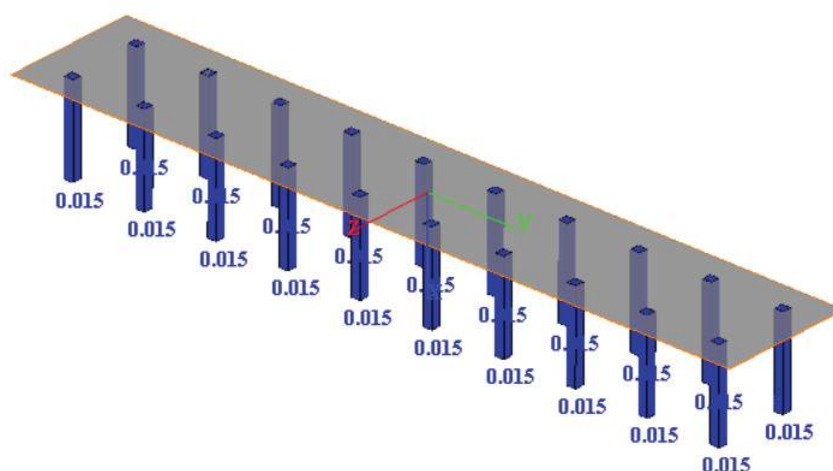
In Tabella 15 sono riassunte le caratteristiche geometriche della parte in elevazione del muro considerate per il relativo dimensionamento, le quali fanno riferimento allo schema di Figura 30.

Sezione Muro di sottoscarpa	H1 [m]	S1 [m]	H2/H3 [m]	S2/S3 [m]	LF [m]	SF [m]	D [m]	LCONCIO [m]
Configurazione b)	2.70	0.5	-	-	1.8	0.6	0.3	10.0

Tabella 15 – Caratteristiche geometriche della sezione di calcolo del muro – configurazione a)



Figura 30: Sezione di calcolo della parte in elevazione del muro

Il dimensionamento è stato effettuato considerando l'altezza massima del paramento del muro $H_1=2.70$ m.

Micropali di fondazione	L [m]	Φ perforazione [m]	Interasse [m]	Inclinazione [deg]
Configurazione b)	8	0.240	1	0
	9.40			38

Tabella 16 – Caratteristiche geometriche dei micropali di fondazione

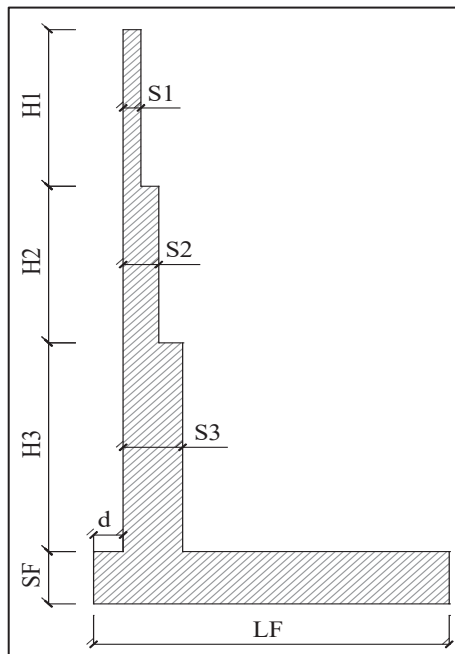
9.2.2 Analisi dei carichi

Per la posizione dei carichi considerati nelle analisi si fa riferimento allo schema di Figura 31.



Figura 31: Disposizione dei carichi considerati nelle analisi del muro di sottoscarpa

In Tabella 17 e Tabella 18 sono riassunti i coefficienti di combinazione delle azioni adottati rispettivamente per le verifiche agli Stati Limite Ultimi e agli Stati Limite di Esercizio.

		Peso proprio	Peso terreno	Peso permanenti	Peso accidentali	Spinta terre	Spinta permanenti	Spinta accidentali	Azioni sismiche
S.L.U.	SLU-F1	1.00	1.00	1.00	0.00	1.30	1.30	1.50	0.00
	SLU-F2	1.30	1.30	1.30	1.50	1.30	1.30	1.50	0.00
	SLV_SISM_↓	1.00	1.00	1.00	0.00	1.00	1.00	0.00	1.00
	SLV_SISM_↑	1.00	1.00	1.00	0.00	1.00	1.00	0.00	1.00

Tabella 17 - Coefficienti di combinazione utilizzati nelle analisi agli Stati Limite Ultimi dell'opera in oggetto; i simboli "↓" e "↑" indicano il verso delle forze d'inerzia dovute al sisma e corrispondono rispettivamente a un'azione sismica verticale verso l'alto (↓) e verso il basso (↑).

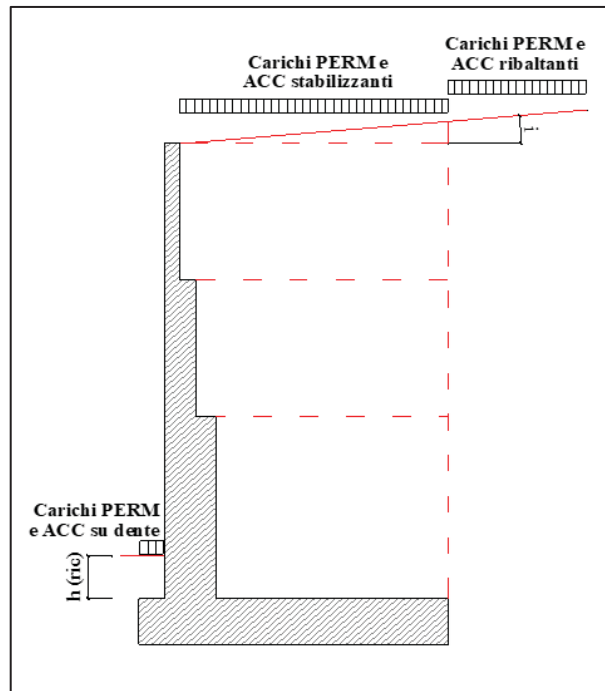
		Peso proprio	Peso terreno	Peso permanenti	Peso accidentali	Spinta terre	Spinta permanenti	Spinta accidentali	Azioni sismiche
S.L.E.	SLE_QP	1.00	1.00	1.00	0.00	1.00	1.00	0.60	0.00
	SLE_FR	1.00	1.00	1.00	0.00	1.00	1.00	0.70	0.00
	SLE_CAR	1.00	1.00	1.00	0.00	1.00	1.00	1.00	0.00
	SLD_SISM ↓	1.00	1.00	1.00	0.00	1.00	1.00	0.00	1.00
	SLD_SISM ↑	1.00	1.00	1.00	0.00	1.00	1.00	0.00	1.00

Tabella 18 - Coefficienti di combinazione utilizzati nelle analisi agli Stati Limite di Esercizio dell'opera in oggetto; i simboli "↓" e "↑" indicano il verso delle forze d'inerzia dovute al sisma e corrispondono rispettivamente a un'azione sismica verticale verso l'alto (↓) e verso il basso (↑).

9.2.2.1 Peso proprio

Il peso proprio degli elementi strutturali in calcestruzzo viene calcolato considerando un peso per unità di volume pari a 25.00 kN/m³.

9.2.2.2 Carichi permanenti

L'unico carico permanente agente sul muro è dovuto al peso del materiale di riempimento a tergo, per il quale è stato considerato un peso specifico di 19.00 kN/m³.

9.2.2.3 Carichi accidentali

L'unico carico accidentale instabilizzante considerato nelle analisi è il sovraccarico stradale pari a 20.00 kPa. Tale sovraccarico è stato cautelativamente considerato infinitamente esteso verso monte.

9.2.3 Verifiche strutturali dell'elevazione del muro

Nei paragrafi seguenti sono riportate le verifiche strutturali dell'elevazione del muro di sottoscampa. Tutte le azioni e le verifiche si riferiscono a un metro lineare di struttura.

A favore di sicurezza le sollecitazioni sono state calcolate considerando nullo l'angolo d'attrito muro-terreno.

Per il dimensionamento del paramento del muro sono state cautelativamente considerate le sollecitazioni calcolate alla base dell'elevazione in quanto più gravose.

9.2.3.1 Sollecitazioni nell'elevazione del muro

In Tabella 19 sono riassunte le sollecitazioni massime utilizzate nelle verifiche strutturali del paramento del muro di sottoscampa.

	N [kN/m]	V [kN/m]	M [kNm/m]
Comb SLU-F1	33.8	139	170
Comb SLU-F2	43.9	139	170
Comb SLV_SISM_↓	32.7	62	74
Comb SLV_SISM_↑	34.8	62	75
Comb SLE_QP	33.8	94	114
Comb SLE_FR	33.8	96	117
Comb SLE_CAR	33.8	103	126
Comb SLE_SISM_↓	32.7	57	68
Comb SLE_SISM_↑	34.8	57	68

Tabella 19 – Sollecitazioni alla base dell'elevazione del muro di sottoscarpa – configurazione b)

9.2.3.2 Verifiche agli Stati Limite Ultimi

9.2.3.2.1 Verifica a pressoflessione (SLU)

L'elevazione del muro ha spessore pari a $S_1=0.5$ m ed armatura principale simmetrica $\varnothing 18/15$ cm.

Si riporta nella seguente figura il risultato delle verifiche a pressoflessione.



Figura 32: Verifica a pressoflessione dell'elevazione del muro di sottoscarpa – configurazione b)

9.2.3.2.2 Verifica a taglio (SLU)

In base a quanto presente al paragrafo 4.1.2.1.3.1 delle NTC 2008, si effettuano le verifiche nei confronti dell'azione tagliante a Stato Limite Ultimo senza armatura trasversale resistente a taglio.

		Comb SLU_F1	Comb SLU_F2	Comb SLV_SISM_↓	Comb SLV_SISM_↑
V_{Ed}	[kN]	139	139	62	62
V_{Rd}	[kN]	209.3	210.8	209.2	209.5

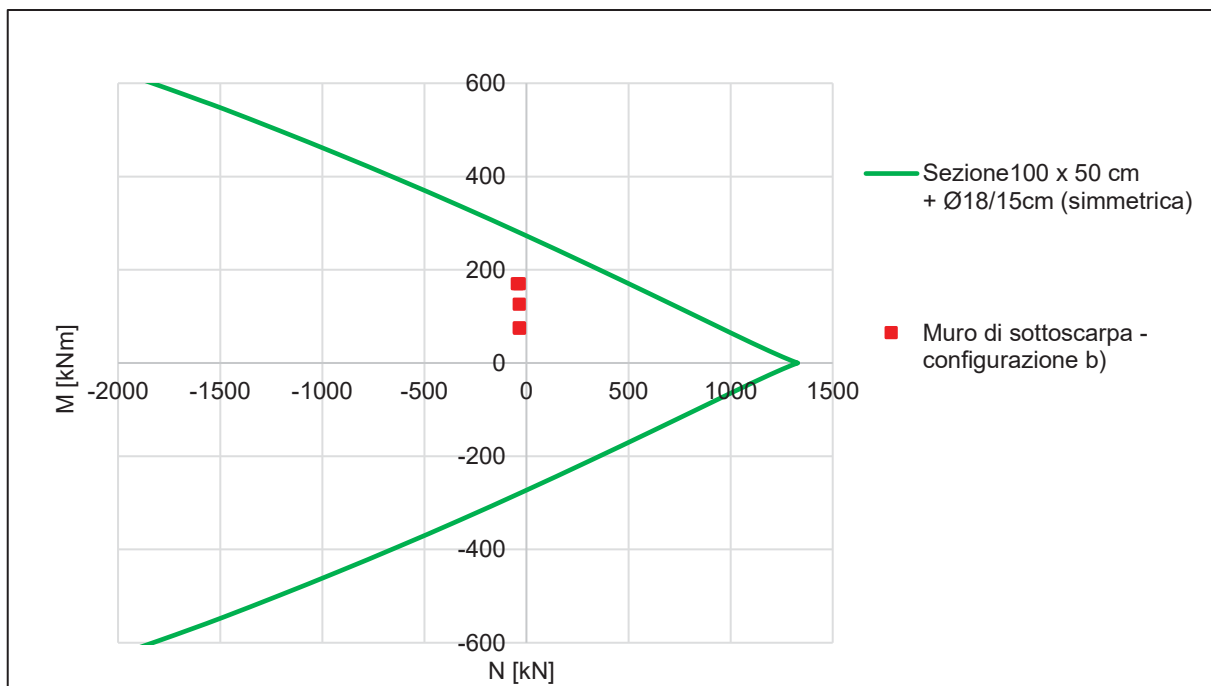
Tabella 20 – Verifica a taglio dell'elevazione del muro di sottoscarpa – configurazione b)

La verifica nei confronti delle azioni taglianti risulta soddisfatta in quanto le massime sollecitazioni di progetto risultano inferiori alle rispettive resistenze per ciascuna delle combinazioni considerate.

9.2.3.3 Verifiche agli Stati Limite di Esercizio

9.2.3.3.1 Verifica di limitazione delle tensioni (SLE)

In base a quanto presente al paragrafo 4.1.2.2.5 delle NTC 2008, si effettuano le verifiche nei confronti dello Stato Limite di Esercizio di limitazione delle tensioni.

	$\sigma_{c,MAX}$	$\sigma_{c,lim}$	$\sigma_{s,MAX}$	$\sigma_{s,lim}$
	[MPa]	[MPa]	[MPa]	[MPa]
SLE_CARATTERISTICA	4.82	19.92	182.9	360
SLE_QUASI PERMANENTE	4.35	14.94	-	-
SLD_SISM ↓	2.59	19.92	93.8	360
SLD_SISM ↑	2.6	19.92	93.4	360

Tabella 21 – Verifica SLE di limitazione delle tensioni

Le verifiche di limitazione delle tensioni risultano soddisfatte in quanto le massime tensioni sia lato calcestruzzo che lato acciaio sono sempre inferiori ai limiti imposti dalla normativa.

9.2.3.3.2 Verifica di fessurazione (SLE)

In base a quanto presente al paragrafo 4.1.2.2.4.5 delle NTC 2008, si effettuano le verifiche nei confronti dello Stato Limite di Esercizio di fessurazione:

	w_k	w_{lim}
	[mm]	[mm]
SLE_QUASI PERMANENTE	0.186	0.200
SLE_FREQUENTE	0.191	0.300

Tabella 22 – Verifica a fessurazione dell'elevazione

Le verifiche a fessurazione risultano soddisfatte.

9.2.4 Verifiche della fondazione su micropali

9.2.4.1 Sollecitazioni agenti sulla fondazione

Nella seguente tabella sono riportate le sollecitazioni massime agenti sulla fondazione del muro di sottoscarpa.

	V	N	M
	[kN/m]	[kN/m]	[kNm/m]
Comb SLU-F1	172	161	301
Comb SLU-F2	172	209	293
Comb SLV_SISM ↓	76	168	84
Comb SLV_SISM ↑	77	177	84

Tabella 23 – Sollecitazioni massime agenti sulla fondazione del muro di sottoscarpa

9.2.4.2 Sollecitazioni agenti sui micropali di fondazione

Per il calcolo delle sollecitazioni presenti nei micropali è stato utilizzato il software Group 2019 il quale permette di modellare l'intera fondazione su micropali e di tenere conto dell'interazione fra la platea di fondazione, i micropali e il terreno.

Tramite l'ausilio di tale software è stato possibile ricavare:

- le azioni massime in testa ai micropali (Tabella 24) necessarie per effettuare le verifiche di capacità portante;
- le sollecitazioni interne ai micropali necessarie per effettuare le verifiche strutturali degli stessi.

Nella seguente figura si riporta il modello della fondazione utilizzato per l'analisi.



Figura 33 – Modello della fondazione su micropali – configurazione b) – software Group 2019

In particolare, il software di calcolo Group 2019 schematizza i micropali con modelli del tipo trave su suolo elastico. Per la descrizione della metodologia adottata per definire il legame costitutivo delle molle del tipo elastico-perfettamente plastico utilizzate per la schematizzazione del terreno si rimanda alla Relazione Geotecnica Generale [1].

Nella seguente figura è riportato uno schema del legame costitutivo elastico-perfettamente plastico delle molle utilizzate nelle analisi.

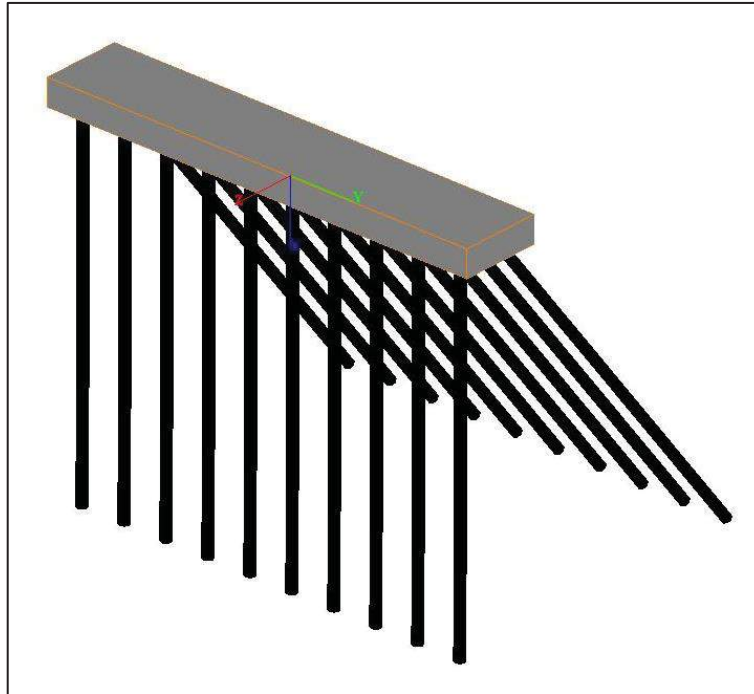

Figura 34 – Legame costitutivo elastico-perfettamente plastico delle molle utilizzate per schematizzare il terreno attorno al micropalo

I parametri mostrati in Figura 34 hanno i seguenti significati:

- coefficiente di reazione k_h [kN/m³] delle molle orizzontali che simulano la reazione del terreno;
- Pressione limite p_u [kPa] delle molle orizzontali che simulano la reazione del terreno.

Si riportano nelle seguenti figure gli andamenti di k_h e di p_u con la profondità considerati nelle analisi.

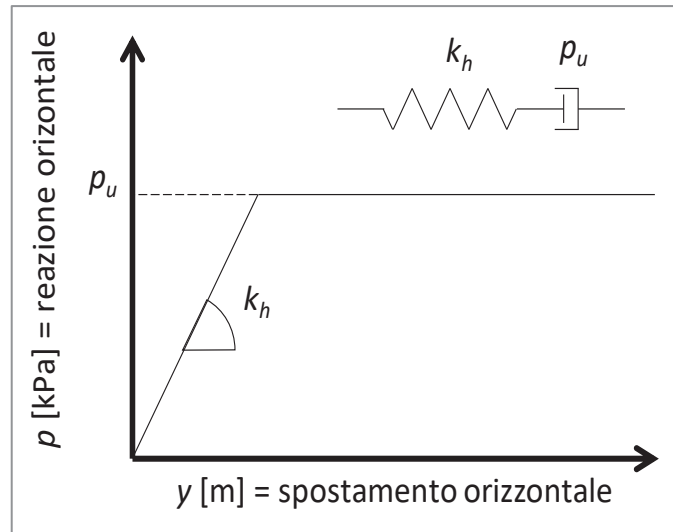

Figura 35 – Andamento del valore del coefficiente k_h con la profondità



Figura 36 – Andamento del valore della pressione limite p_u con la profondità

Si riportano nella seguente tabella le sollecitazioni assiali massime in testa ai micropali necessarie per effettuare le verifiche di capacità portante dei micropali.

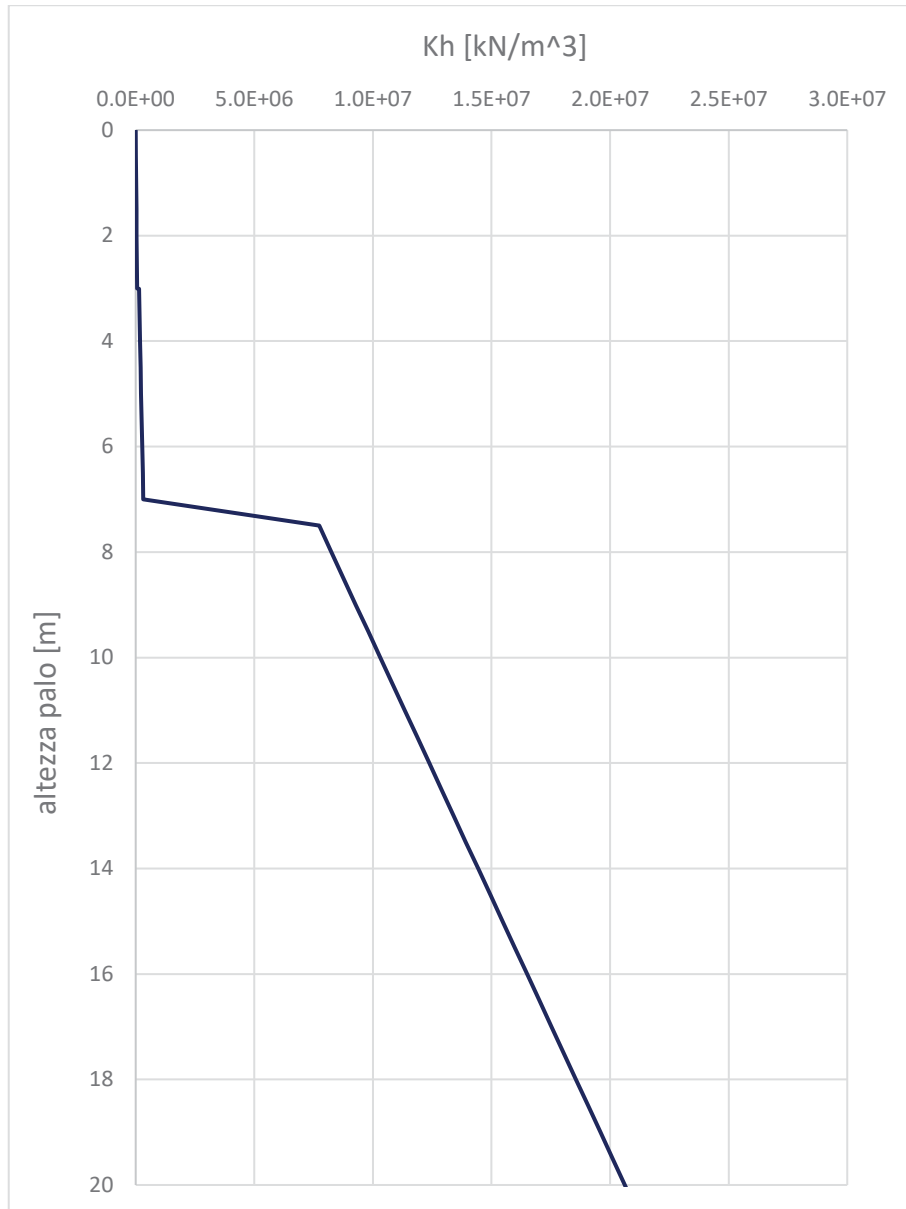
N	Comb.	Comb.	Comb.	Comb.
[kN]	SLU-F1	SLU-F2	SLV_SISM ↓	SLV_SISM ↑
compressione	374.4	406.0	212.7	219.9
trazione	348.7	334.3	145.0	144.0

Tabella 24 – Azione assiale massima di compressione e trazione agente in testa ai micropali

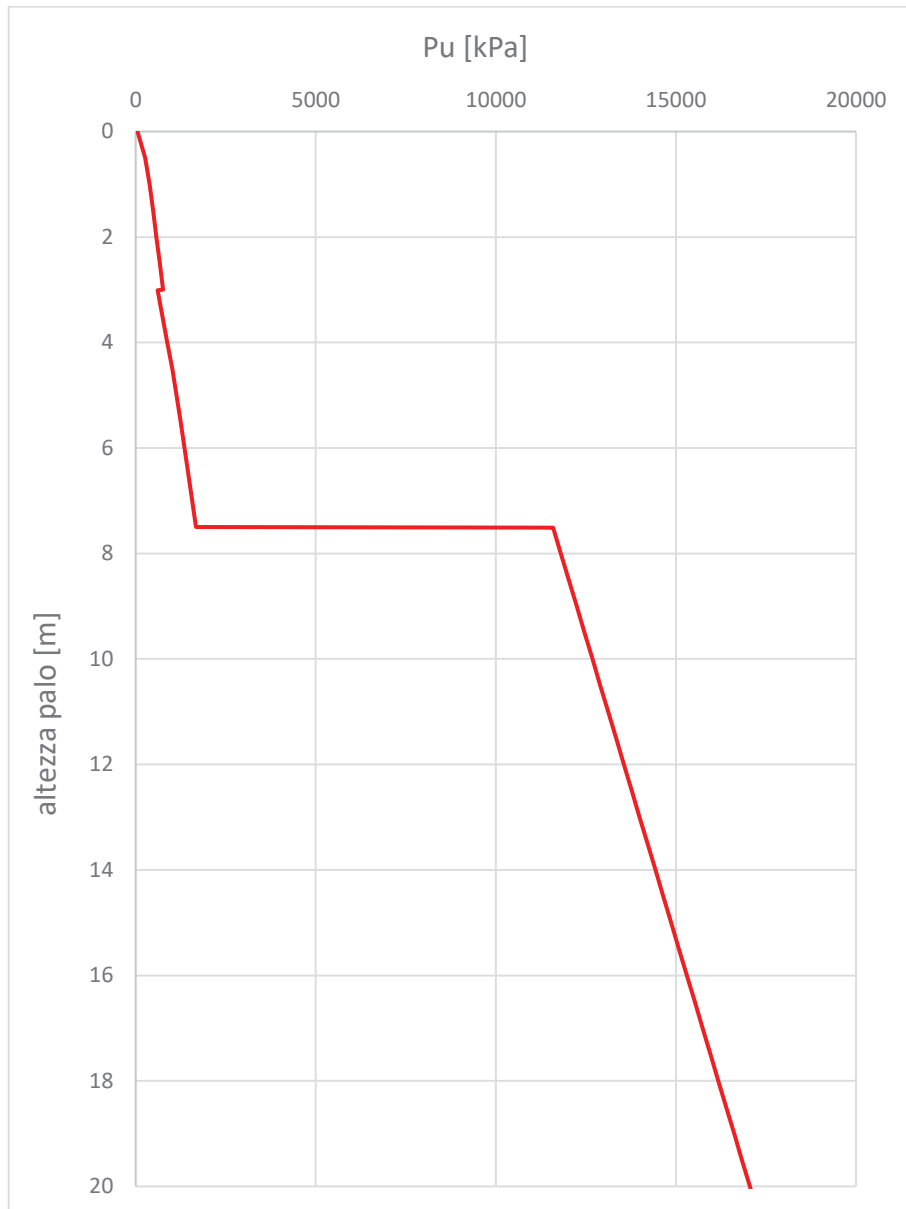
9.2.4.3 Verifica a capacità portante dei micropali di fondazione

Nella seguente tabella si riportano le caratteristiche dei micropali di fondazione.

Caratteristiche dei micropali di fondazione		
lunghezza	8	[m]
	9.4	[m]
inclinazione	0	[deg]
	38	[deg]
φ perforazione	0.24	[m]
φ profilato in acciaio	0.1937	[m]
spessore profilato in acciaio	0.01	[m]

Tabella 25 – Caratteristiche dei micropali di fondazione

Le verifiche di capacità portante dei micropali sono state effettuate considerando come contributo resistente solamente l'attrito laterale del palo, trascurando, a favore di sicurezza, il contributo di base.

Per la visualizzazione della procedura metodologica relativa al calcolo della capacità portante verticale di progetto dei micropali si veda quanto specificato nella Relazione Geotecnica Generale [1].

Nella seguente tabella sono riportati i valori dell'aderenza limite caratteristica fra terreno e micropalo τ_{lim} e i valori del coefficiente di sbulbamento α , (parametro empirico funzione del terreno e delle modalità esecutive del micropalo) entrambi definiti al variare della stratigrafia. Il fattore di sbulbamento è stato assunto pari ad 1 in tutti gli strati in quanto la metodologia realizzativa considerata (IGU – iniezione globale unica) nei materiali rocciosi seppur fratturati non garantisce l'espansione della malta cementizia all'esterno dell'area di perforazione.

A favore di sicurezza il contributo alla capacità portante fornito dello strato superficiale di coltri eluvio colluviali è stato considerato nullo.

Stratigrafia		Parametri minimi		Parametri medi	
tipologia dello strato	limite inferiore dello strato i-esimo misurato dalla testa del micropalo [m]	T_{ak} [kPa]	α [-]	T_{ak} [kPa]	α [-]
coltri eluvio colluviali	3	0	0	0	0
basalti alterati	7.5	180	1	200	1
basalti non alterati	-	200	1	250	1

Tabella 26 – Valori dell'aderenza limite caratteristica fra terreno e micropalo e coefficienti di sbulbamento

Si riportano nelle seguenti figure le curve di capacità portante dei micropali di fondazione di compressione e di trazione ottenute considerando i parametri resistenti del terreno (τ_{lim}) minimi e medi.

Si precisa che il micropalo verticale di lunghezza 8 m è compresso mentre il micropalo inclinato di 38° di lunghezza 9.40 m è teso.



Figura 37 – Curva di capacità portante verticale in compressione con parametri minimi e medi – micropalo verticale L=8m



Figura 38 – Curva di capacità portante verticale in trazione con parametri minimi e medi – micropalo inclinato L=9.40m

Come visibile dalle figure sopra riportate, considerando micropali di lunghezza 8 e 9.40 m, le verifiche di capacità portante risultano soddisfatte.

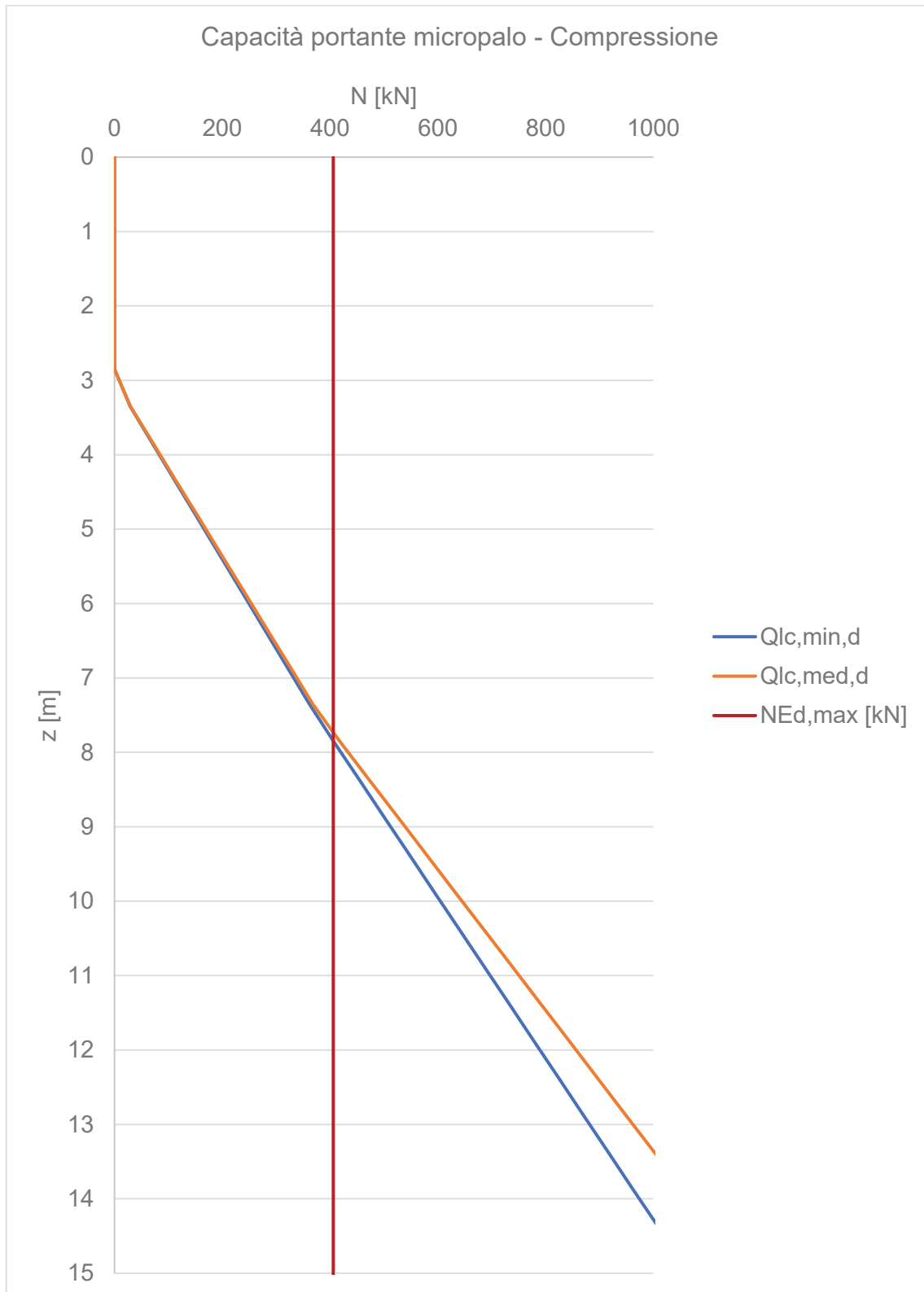
Nel caso limite in cui si attivasse una spinta attiva a tergo del micropalo verticale, trascurando completamente a favore di sicurezza il contrasto fornito dalla struttura in calcestruzzo del canale idraulico, è stata fatta una verifica a sfilamento del micropalo inclinato ipotizzando che il contributo resistente sia fornito dalla sola lunghezza esterna al cuneo di spinta attiva e applicando la metodologia di calcolo riportata al Par. 6.6 delle NTC2008 relativa ai tiranti di ancoraggio definitivi.

La verifica a sfilamento risulta soddisfatta se:

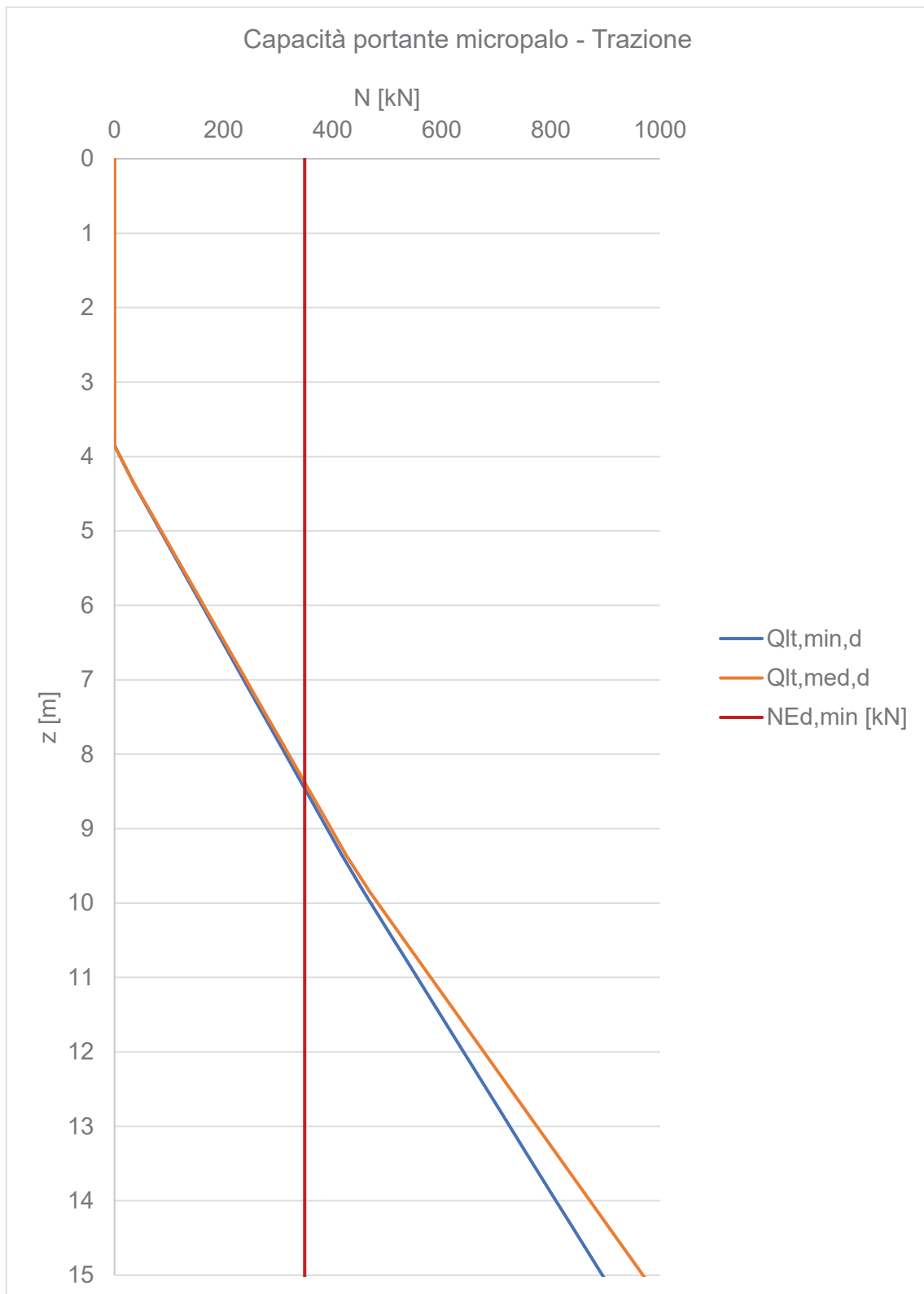
$$T_{Ed} < R_{ad}$$

dove:

- $R_{ad} = \frac{R_{ak}}{\gamma_{Ra}}$;
- $\gamma_{Ra} = 1.2$ per i tiranti definitivi come da tabella 6.6.I delle NTC2008
- $R_{ak} = \min\left(\frac{R_{ac,medio}}{\xi_{a3}}; \frac{R_{ac,minimo}}{\xi_a}\right)$
- $\xi_{a3} = 1.65$ e $\xi_{a4} = 1.6$ da tabella 6.6.III delle NTC2008
- $R_{ac,medio} = \pi \cdot \phi_{perf} \cdot L_B \cdot \tau_{ak,med} \cdot \alpha$;
- $R_{ac,minimo} = \pi \cdot \phi_{perf} \cdot L_B \cdot \tau_{ak,min} \cdot \alpha$;
- L_B lunghezza del micropalo esterna al cuneo di spinta attiva (vedi figura seguente);
- $\phi_{perf} = 0.24m$ come definito in Tabella 25;
- fattore $\alpha = 1$ come definito in Tabella 26;
- aderenza bulbo-terreno τ_{ak} come definita in Tabella 26 per i Basalti alterati.

La lunghezza di ancoraggio L_B viene calcolata in fase statica imponendo che si sviluppi interamente la spinta attiva e considerando la parte di micropalo esterna al cuneo di spinta (linea tratteggiata con origine dal fondo della paratia e inclinata di $45^\circ + \phi/2$ sull'orizzontale).

La lunghezza di ancoraggio L_B è stata prudenzialmente ridotta di 0.2 volte l'altezza di scavo rispetto a quella calcolata geometricamente, come suggeriscono numerose raccomandazioni disponibili in bibliografia.



Figura 39: Schema di calcolo della lunghezza di ancoraggio L_B

Con riferimento alla simbologia rappresentata in figura, la lunghezza di ancoraggio L_B è pari a:

$$L_B = L_{TOT} - L_L$$

con la lunghezza libera L_L è pari a:

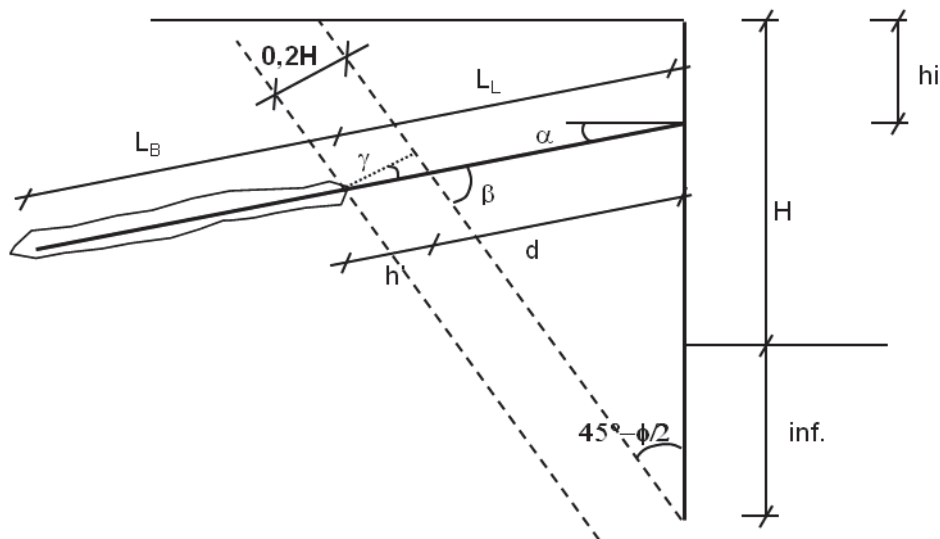
Relazione Geotecnica e di Calcolo

$$L_{L-stat} = d + h' = (H + inf - h_i) \cdot \frac{\sin\left(45 - \frac{\phi}{2}\right)}{\sin\left(45 + \frac{\phi}{2} + \alpha\right)} + \frac{0.2 \cdot H}{\sin\left(45 + \frac{\phi}{2} + \alpha\right)}$$

dove:

α = inclinazione del tirante sull'orizzontale, pari a $90^\circ - 38^\circ = 52^\circ$;

H = altezza dello scavo, pari a 3 m;

h_i = quota del tirante rispetto alla testa della paratia, pari a 0 in quanto si trova in corrispondenza della testa-paratia;

ϕ = angolo d'attrito dei livelli in sito, assunto pari a 34° (unità Basalti alterati).

La lunghezza così calcolata è stata ridotta per tenere conto della distanza pari a 1m tra la testa dei micropali verticali e la testa dei micropali inclinati. Come si evince dalla figura seguente la riduzione della L_L è di 1 m.



Figura 40: Schema di calcolo della lunghezza di ancoraggio L_B tenendo conto dell'interasse dei micropali

La normativa prevede un allungamento della lunghezza libera L_L rispetto alla lunghezza calcolata in fase statica in funzione della sismicità ed in particolare dell'accelerazione sismica di progetto a_{max} , pari nel caso in oggetto a $0.060g$. La seguente relazione è stata adottata per il calcolo della lunghezza libera in fase sismica.

$$L_{L-sism} = L_{L-stat} \cdot \left(1 + 1.5 \cdot \frac{a_{max}}{g}\right)$$

Le seguenti tabelle riportano le grandezze geometriche fondamentali relativamente al caso in oggetto (lunghezza micropali totale, lunghezza libera e lunghezza di ancoraggio), le azioni sollecitanti e le resistenze fornite dalla lunghezza di ancoraggio del micropalo inclinato.

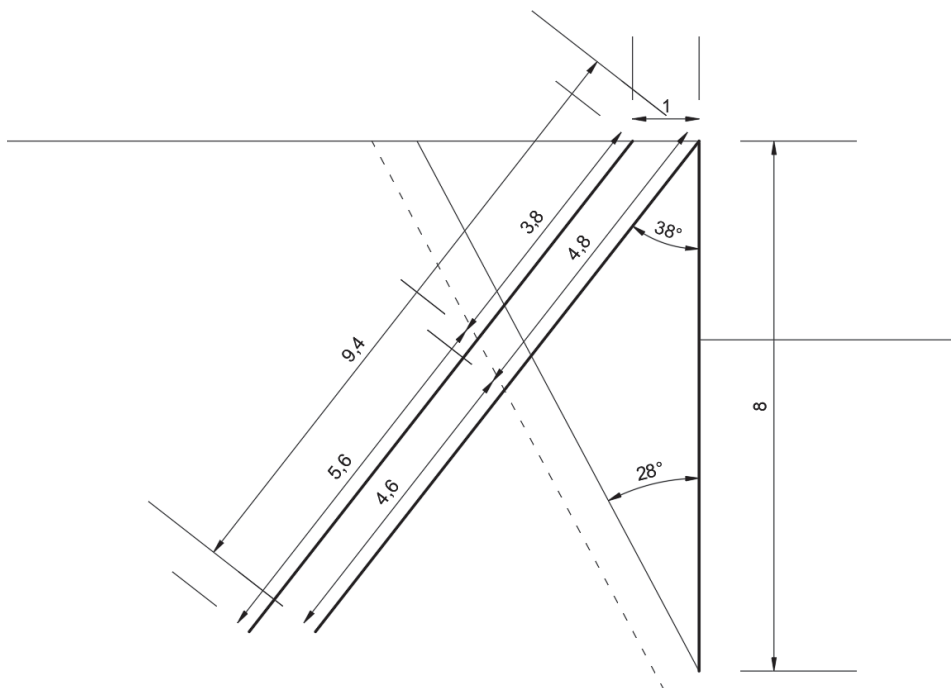
Le verifiche risultano soddisfatte sia in caso statico che in caso sismico.

L_{TOT}	L_{L-stat}	L_{B-stat}	$R_{ad,stat}$	$T_{Ed,stat}$	Verifica a sfilamento
[m]	[m]	[m]	[kN]	[kN]	
9.4	3.8	5.6	393	349	OK

Tabella 27 – Verifica a sfilamento micropalo inclinato – condizione statica

L_{TOT}	L_{L-sism}	L_{B-sism}	$R_{ad,sism}$	$T_{Ed,sism}$	Verifica a sfilamento
[m]	[m]	[m]	[kN]	[kN]	
9.4	4.0	5.4	382	145	OK

Tabella 28 – Verifica a sfilamento micropalo inclinato – condizione sismica

9.2.4.4 Verifiche strutturali dei micropali di fondazione

9.2.4.4.1 Azioni interne ai micropali

Come anticipato nell'introduzione del capitolo 9, le sollecitazioni massime nei micropali sono state ottenute considerando i risultati più gravosi forniti dalle 3 seguenti tipologie di analisi:

- 1) analisi della struttura come fondazione su micropali, svolta con il software Group 2019;
- 2) analisi della struttura come paratia di micropali, svolta con il software Paratie Plus;
- 3) combinazione dei risultati delle 2 analisi di cui sopra.

Nel seguito si riportano i risultati ottenuti.

GROUP 2019 – fondazione su micropali

Considerando le sollecitazioni agenti sulla fondazione del muro di sottoscarpa di cui al paragrafo 9.1.4.1, mediante il software di calcolo Group 2019, sono state ottenute le azioni interne di taglio e momento flettente presenti nei micropali per ciascuna delle combinazioni di carico considerate. Tali sollecitazioni sono riportate nelle figure seguenti.

SLU F1



Figura 41 – Momento flettente lungo il micropalo – Combinazione SLU F1 – In rosso il micropalo teso e in blu quello compresso



Figura 42 – Taglio lungo il micropalo – Combinazione SLU F1 – In rosso il micropalo teso e in blu quello compresso

SLU F2

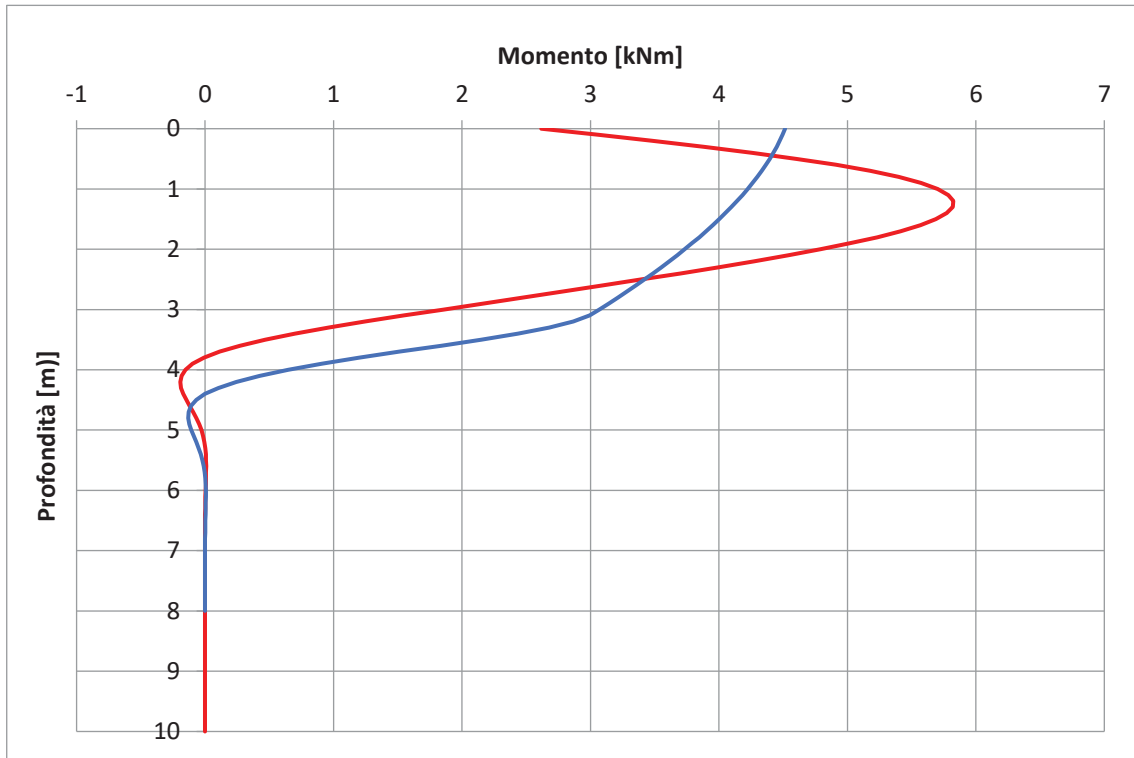

Figura 43 – Momento flettente lungo il micropalo – Combinazione SLU F2 – In rosso il micropalo teso e in blu quello compresso

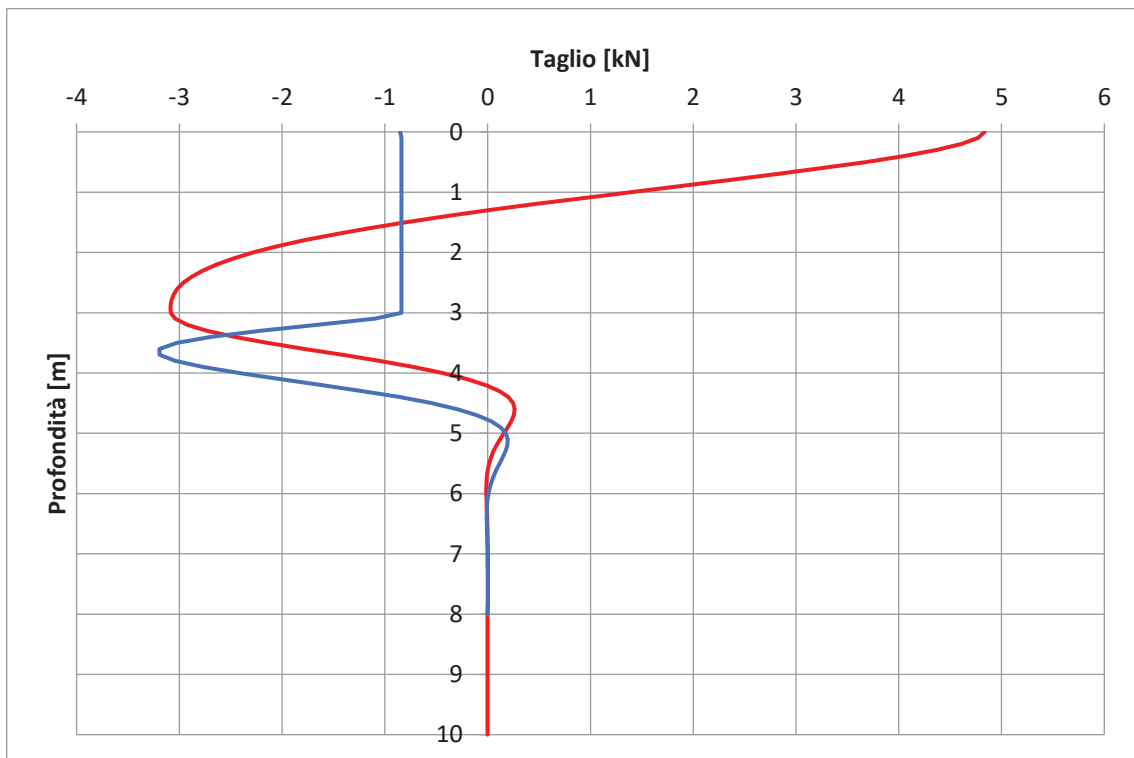

Figura 44 – Taglio lungo il micropalo – Combinazione SLU F2 – In rosso il micropalo teso e in blu quello compresso

SLV SISM ↓

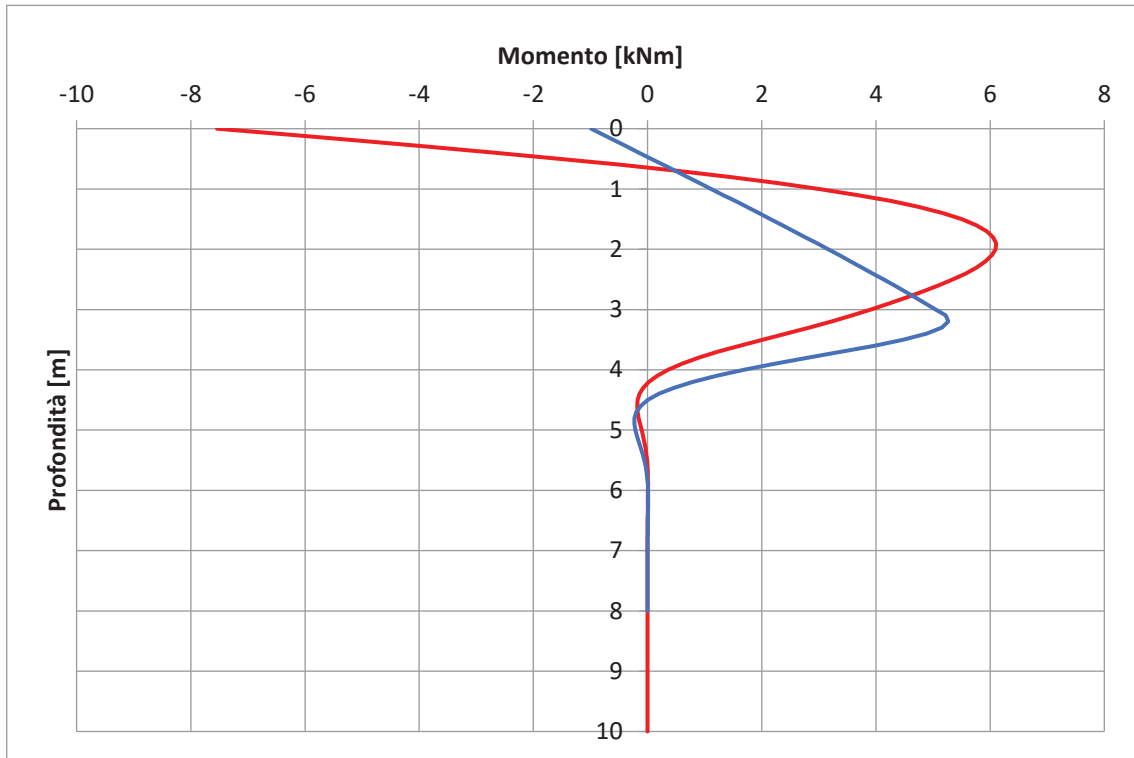

Figura 45 – Momento flettente lungo il micropalo – Combinazione SLV SISM ↓ – In rosso il micropalo teso e in blu quello compresso

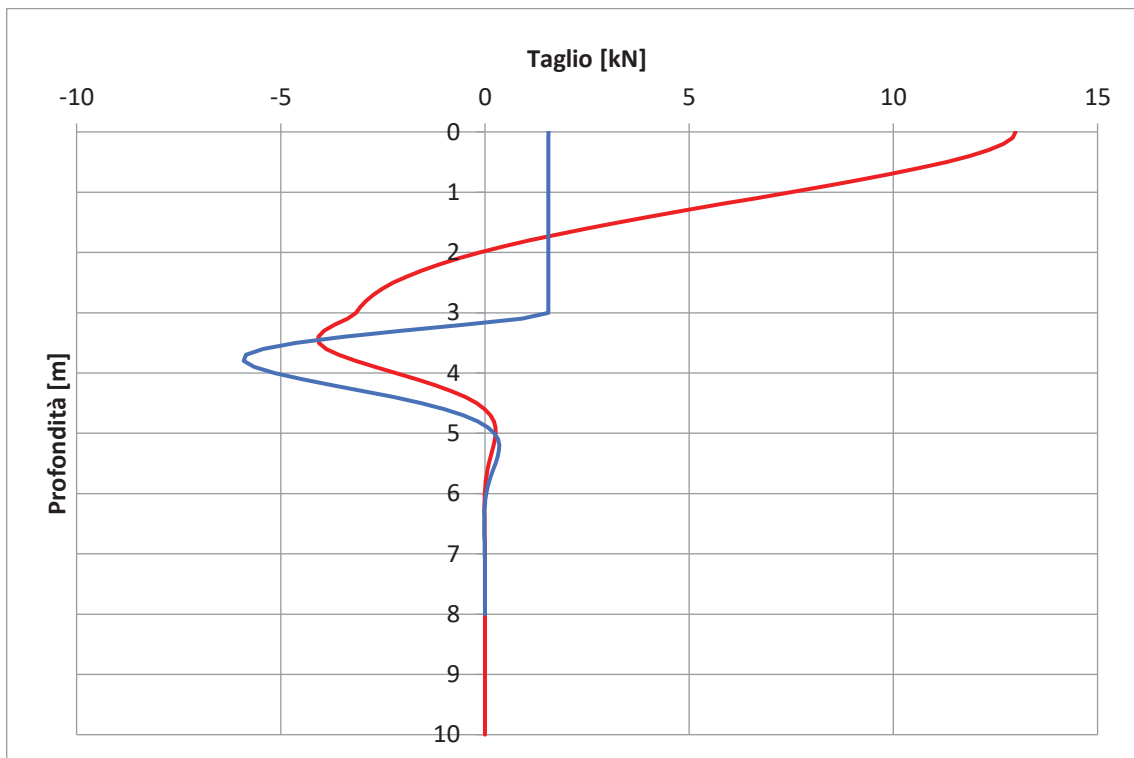

Figura 46 – Taglio lungo il micropalo – Combinazione SLV SISM ↓ – In rosso il micropalo teso e in blu quello compresso

SLV SISM_↑

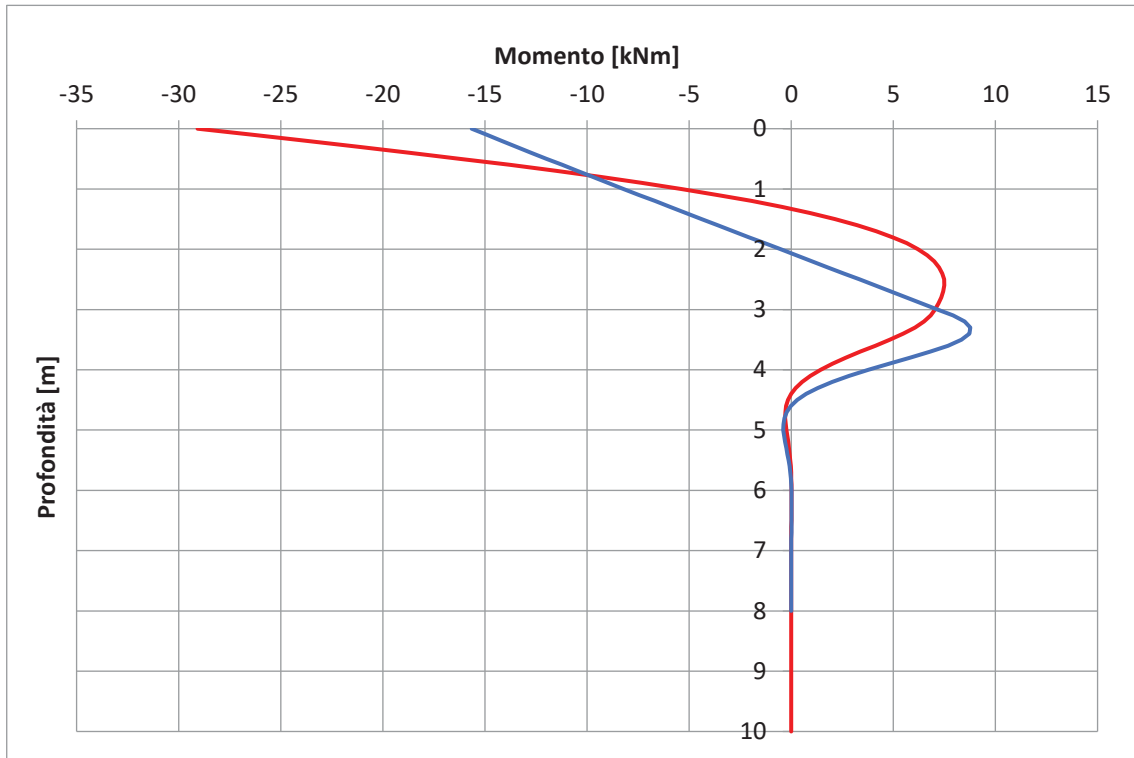

Figura 47 – Momento flettente lungo il micropalo – Combinazione SLV SISM ↑ – In rosso il micropalo teso e in blu quello compresso

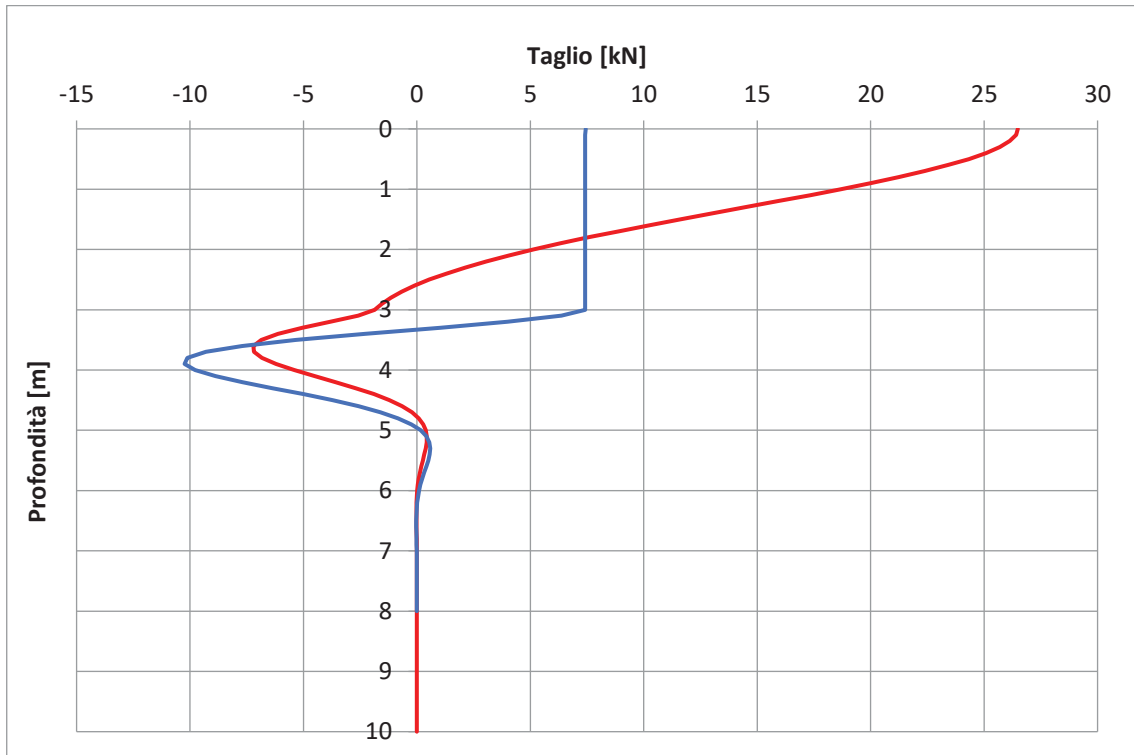

Figura 48 – Taglio lungo il micropalo – Combinazione SLV SISM ↑ – In rosso il micropalo teso e in blu quello compresso

PARATIE PLUS – paratia di micropali

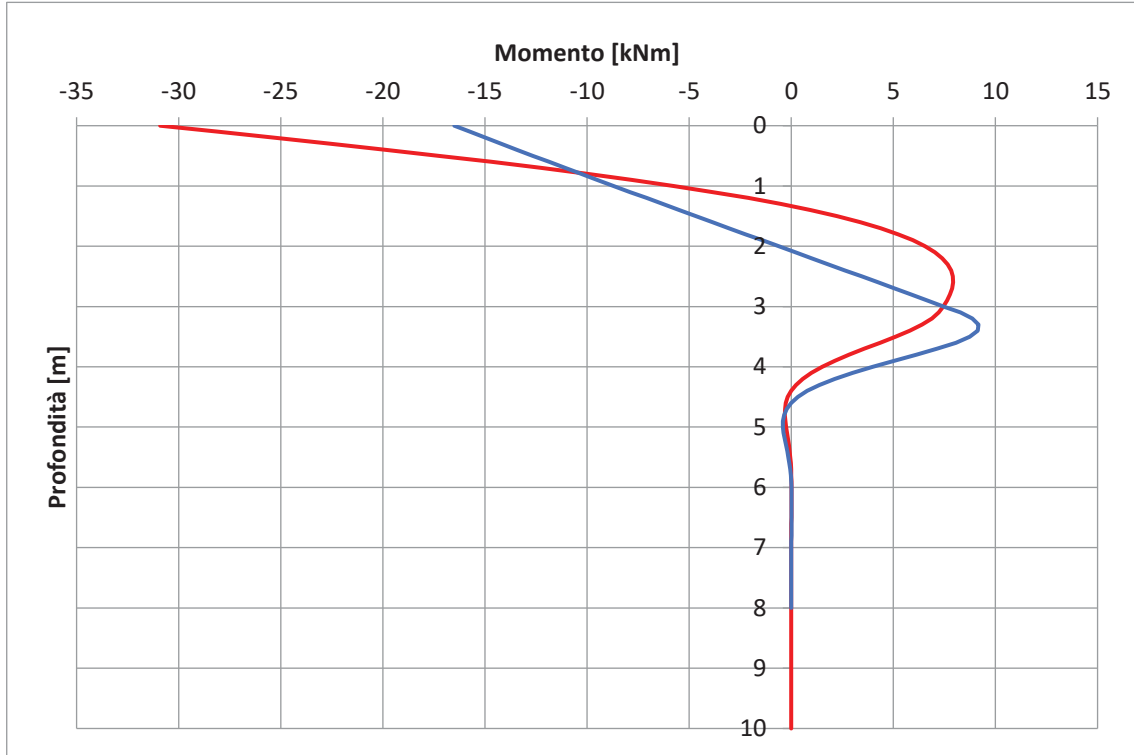
Si riporta in Figura 49 il modello utilizzato per l'analisi svolta con Paratie Plus.

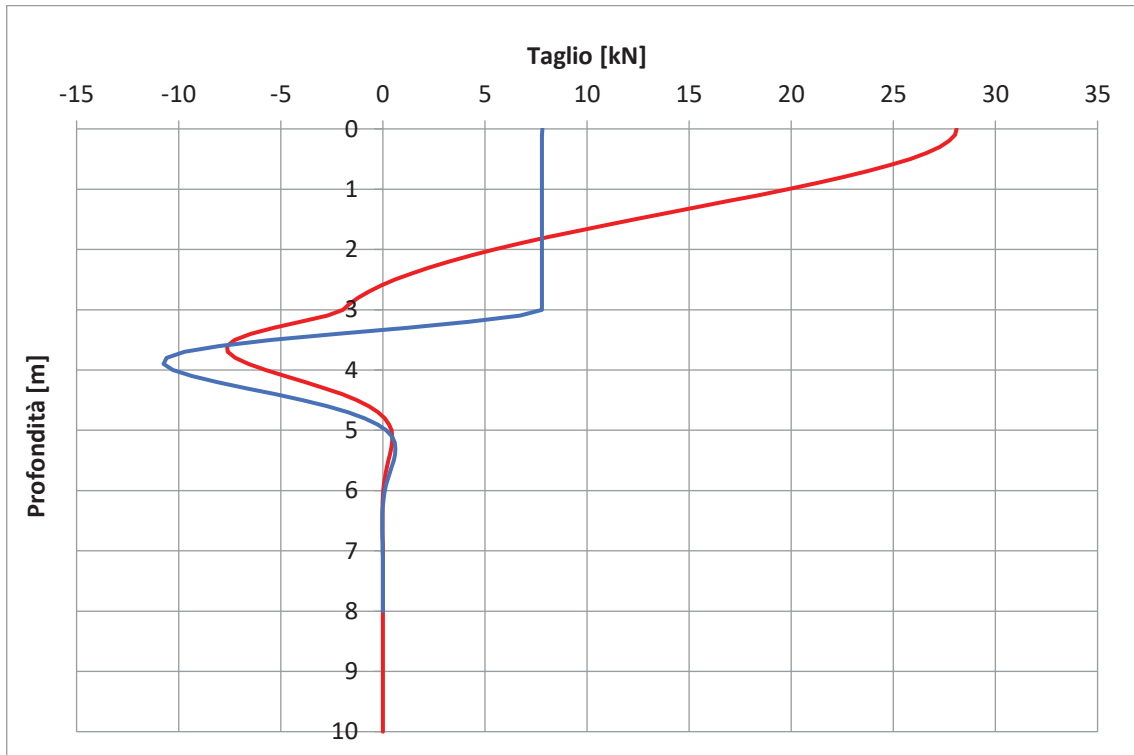

Figura 49 – Modello di calcolo utilizzato – Paratie Plus

Per la definizione dei parametri geotecnici considerati nell'analisi si rimanda al capitolo 7.

SLU – STR

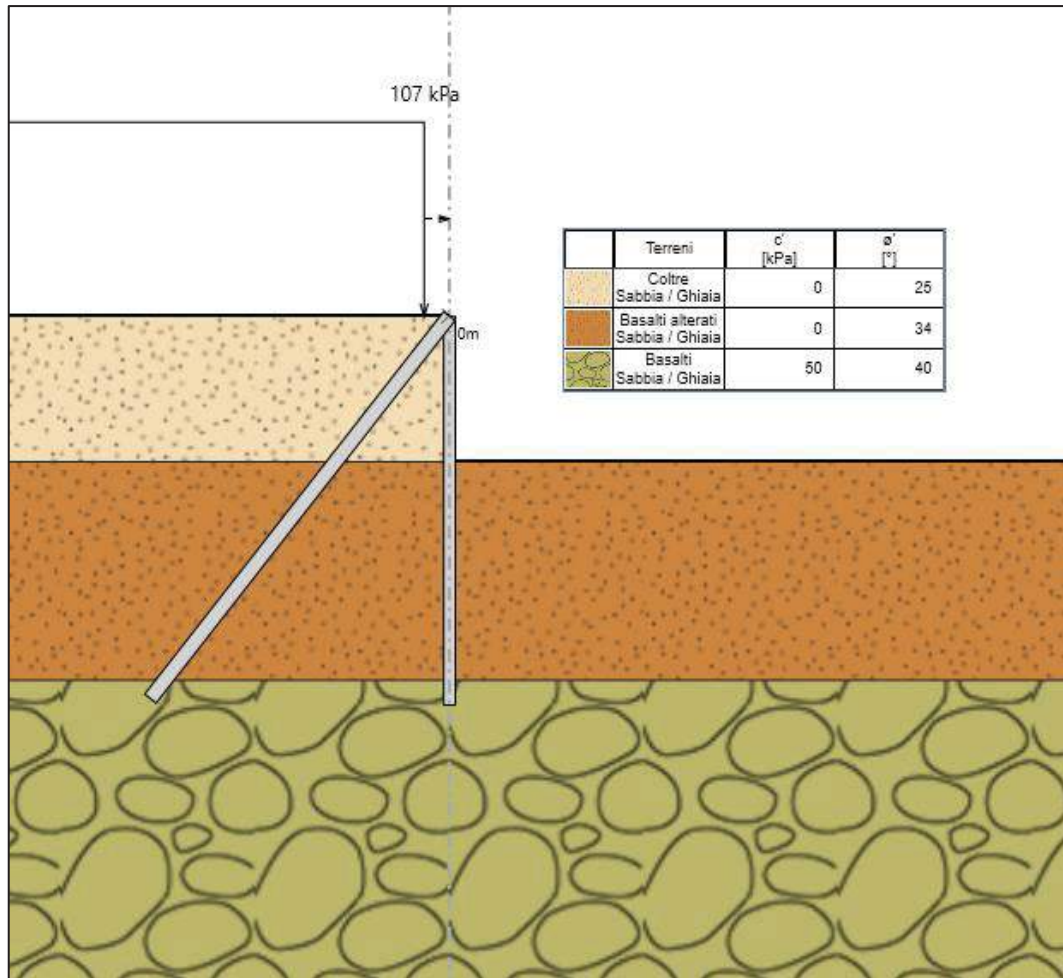

Figura 50 – Momento flettente nel micropalo verticale e azione di trazione nel micropalo inclinato SLU - STR



Figura 51 – Taglio SLU – STR

SLU – SLV

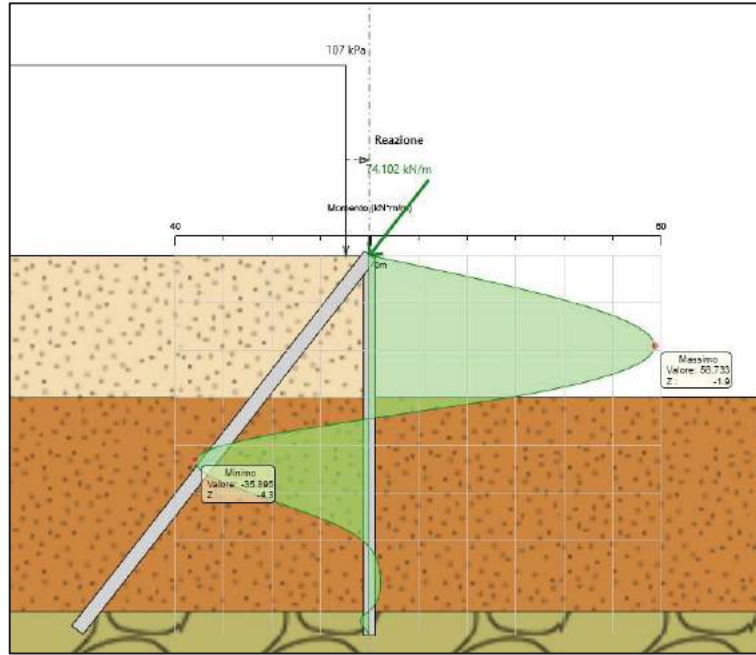

Figura 52 – Momento flettente nel micropalo verticale e azione di trazione nel micropalo inclinato SLU - SLV

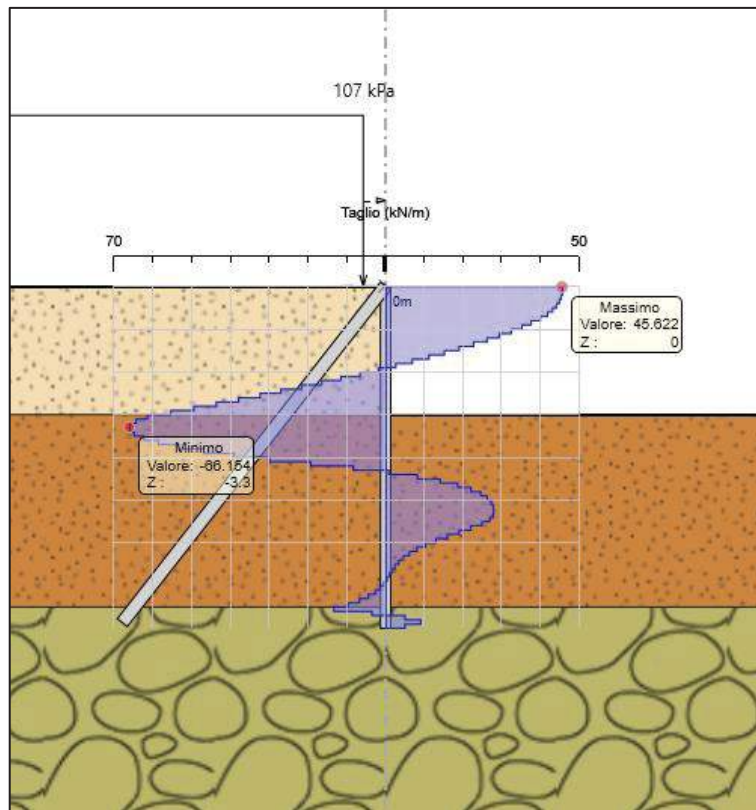

Figura 53 – Taglio SLU – SLV

9.2.4.4.2 Verifiche strutturali

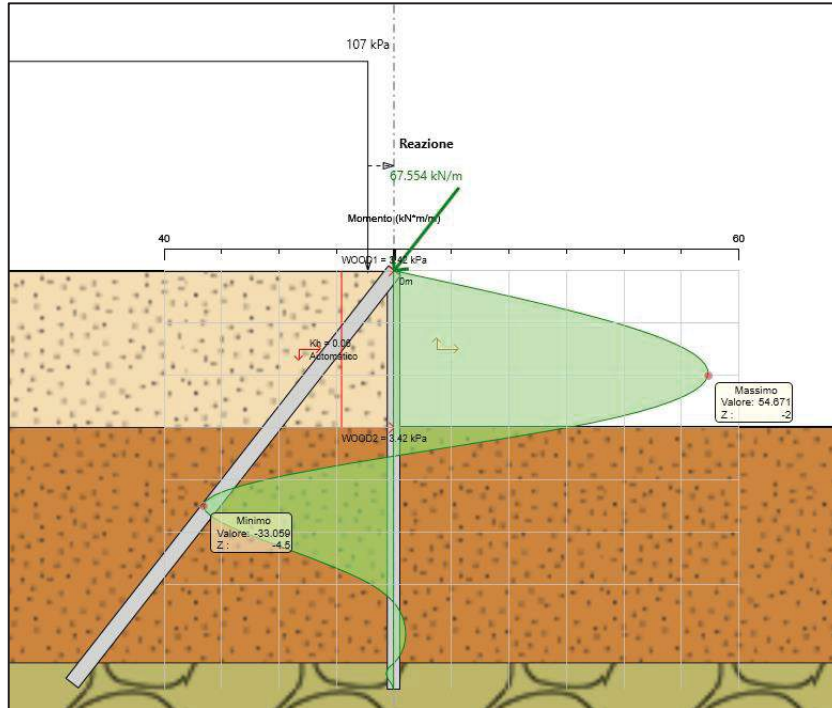
La verifica della resistenza strutturale dei micropali è condotta, cautelativamente, facendo riferimento alla sola resistenza del profilato in acciaio.

In accordo con quanto prescritto dal paragrafo 4.2.4.1 delle NTC 2008 e con riferimento alle formule riportate nelle UNI EN 1993 1-1, è stata effettuata la verifica a presso o tenso-flessione controllando che il momento flettente sollecitante di progetto M_{Ed} sia minore del momento resistente di progetto, ridotto per effetto dell'azione assiale e di taglio.

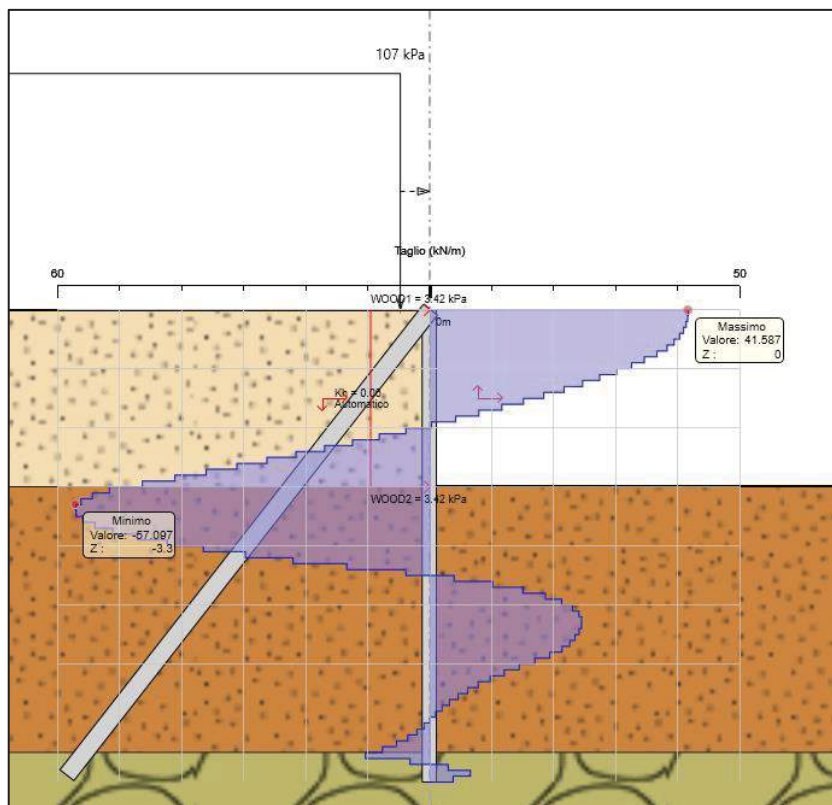
$$M_{Ed} \leq M_{c,Rd} = M_{N,y,Rd}$$

$$M_{N,y,Rd} = 1,04 \cdot M_{V,y,Rd} \cdot (1 - n^{1,7}) \leq M_{V,y,Rd} = \frac{W_{pl} \cdot f_{y,k}}{\gamma_M} \cdot (1 - \rho)$$

$$n = \frac{N_{Ed}}{N_{pl,Rd}}$$

$$\rho = \left(\frac{2V_{Ed}}{V_{c,Rd}} - 1 \right)^2$$

dove:

$M_{N,y,Rd}$	momento plastico di progetto ridotto per effetto dell'azione assiale
$M_{V,y,Rd}$	momento plastico di progetto ridotto per effetto dell'azione di taglio
N_{Ed}	azione assiale di progetto
$N_{pl,Rd}$	resistenza assiale di progetto
V_{Ed}	sollecitazione di taglio di progetto
$V_{c,Rd}$	resistenza a taglio di progetto
ρ	fattore di riduzione del momento resistente da considerarsi solo se la sollecitazione di taglio di progetto è maggiore di metà della resistenza a taglio di progetto

$$V_{c,Rd} = \frac{A_v \cdot f_{yk}}{\sqrt{3} \cdot \gamma_M} = 717.16 \text{ kN}$$

$$A_v = \frac{2 \cdot A}{\pi} = 36.74 \text{ cm}^2$$

dove:

A_v	area di taglio della sezione del profilato in acciaio
A	area della sezione del profilato in acciaio

Per le verifiche sono state considerate le sollecitazioni più gravose fornite dalle due analisi mostrate in precedenza e dalla loro compinazione.

$$V_{Ed,max} = 68.5 \text{ kN} \leq 0.5 \cdot V_{c,Rd}$$

Dal momento che il taglio massimo di progetto, calcolato tenendo conto di tutte le combinazioni di carico, risulta inferiore alla metà del taglio resistente, è stato possibile trascurare il suo contributo nel calcolo del momento resistente di seguito riportato.

Di seguito si riportano i valori del momento resistente nelle varie combinazioni considerate in funzione della sollecitazione assiale di progetto.

Palo compresso	N_{Ed} (compressione)	M_{Ed}	$M_{N,yRd}(N_{Ed})$	Verifica
	[kN]	[kNm]	[kNm]	
Comb SLU-F1	374.4	62.5	111.6	OK
Comb SLU-F2	406.0	61.7	110.5	OK
Comb SLV_SISM_↓	212.7	54.5	114.2	OK
Comb SLV_SISM_↑	219.9	54.5	114.2	OK

Tabella 29 – Verifica a momento flettente del micropalo compresso

Palo teso	N_{Ed} (trazione)	M_{Ed}	$M_{N,yRd}(N_{Ed})$	Verifica
	[kN]	[kNm]	[kNm]	
Comb SLU-F1	348.7	5.8	112.4	OK
Comb SLU-F2	334.3	7.5	112.9	OK
Comb SLV_SISM_↓	145.0	29.1	114.2	OK
Comb SLV_SISM_↑	144.0	28.1	114.2	OK

Tabella 30 – Verifica a momento flettente del micropalo teso

9.2.5 Cedimenti

La Figura 54 mostra i cedimenti e le rotazioni nel baricentro della fondazione del muro e i cedimenti in corrispondenza dei micropali calcolati automaticamente dal software Group per la combinazione SLE più gravosa, ovvero la SLE_CARATTERISTICA. Il cedimento massimo verticale registrato in corrispondenza dei micropali è pari a 2mm e quindi del tutto trascurabile.



Figura 54 – Cedimenti e rotazioni fondazione

La Figura 55 mostra gli spostamenti orizzontali in corrispondenza dei micropali calcolati dal software Group per la combinazione SLE_CARATTERISTICA. Lo spostamento massimo registrato in direzione Z è pari a 3 mm ed è ritenuto trascurabile, anche in virtù del fatto che l'analisi svolta con il software Group trascura l'attrito tra il piano di fondazione e il terreno.

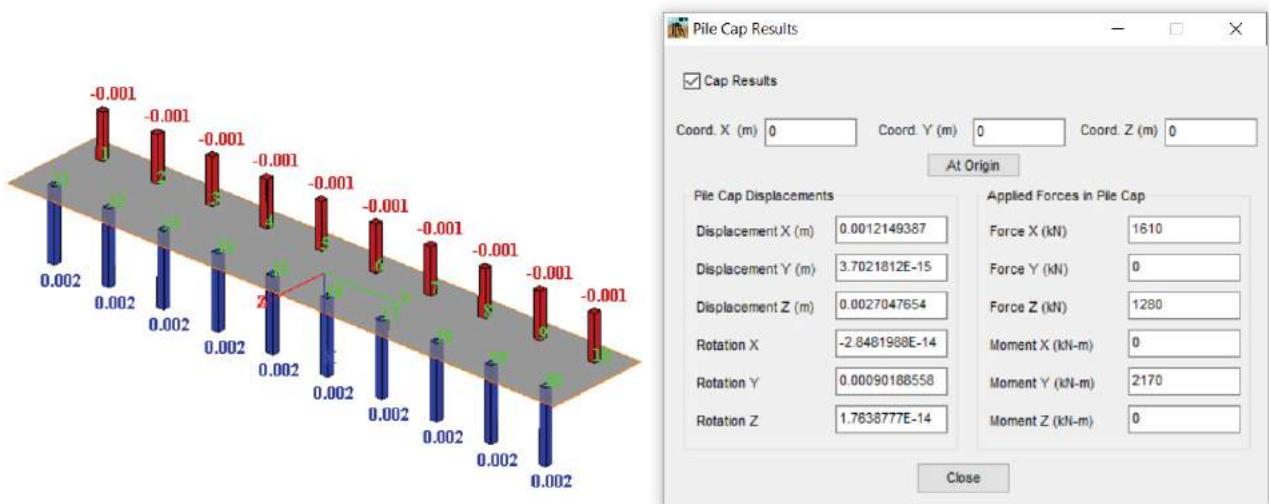

Figura 55 – Spostamenti orizzontali fondazione

La Figura 56 mostra l'andamento degli spostamenti orizzontali ottenuti, per la combinazione SLE_CARATTERISTICA, attraverso l'analisi svolta con il software Paratie Plus. Si ricava uno spostamento in corrispondenza della testa dei micropali pari a 0,5 mm e uno spostamento massimo pari a 8,5 mm. Tali risultati sono ritenuti accettabili, anche in virtù del fatto che, come anticipato al paragrafo 9, il contributo resistente fornito dalla struttura il calcestruzzo del canale idraulico e dal terreno a valle dello stesso è stato trascurato.

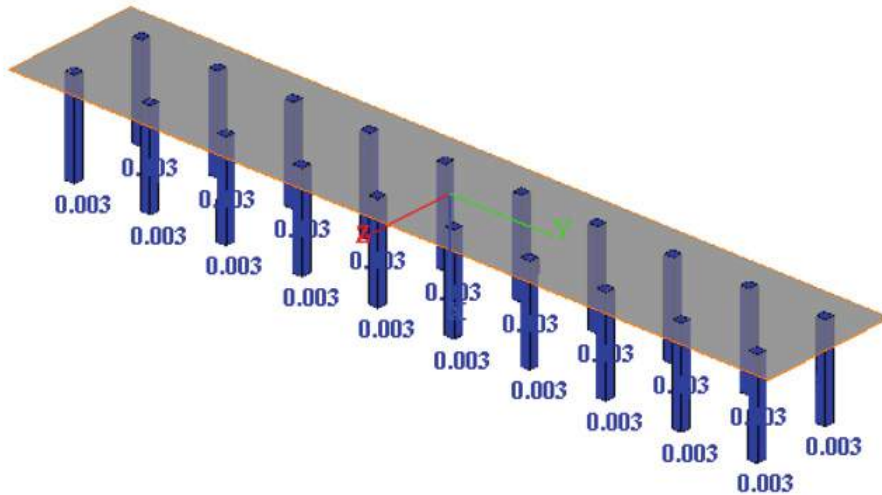

Figura 56 – Spostamenti SLE

In conclusione, gli spostamenti ottenuti attraverso i due modelli sopra descritti sono in entrambi i casi di entità trascurabile e pertanto la struttura progettata si ritiene più che adeguata alla sua funzione di sostegno della viabilità.

9.3 Verifica di stabilità globale

La verifica di stabilità globale si esegue in accordo con le NTC 2008 seguendo la metodologia descritta nel capitolo "Muri di sostegno" della Relazione Geotecnica Generale [1] alla quale si rimanda.

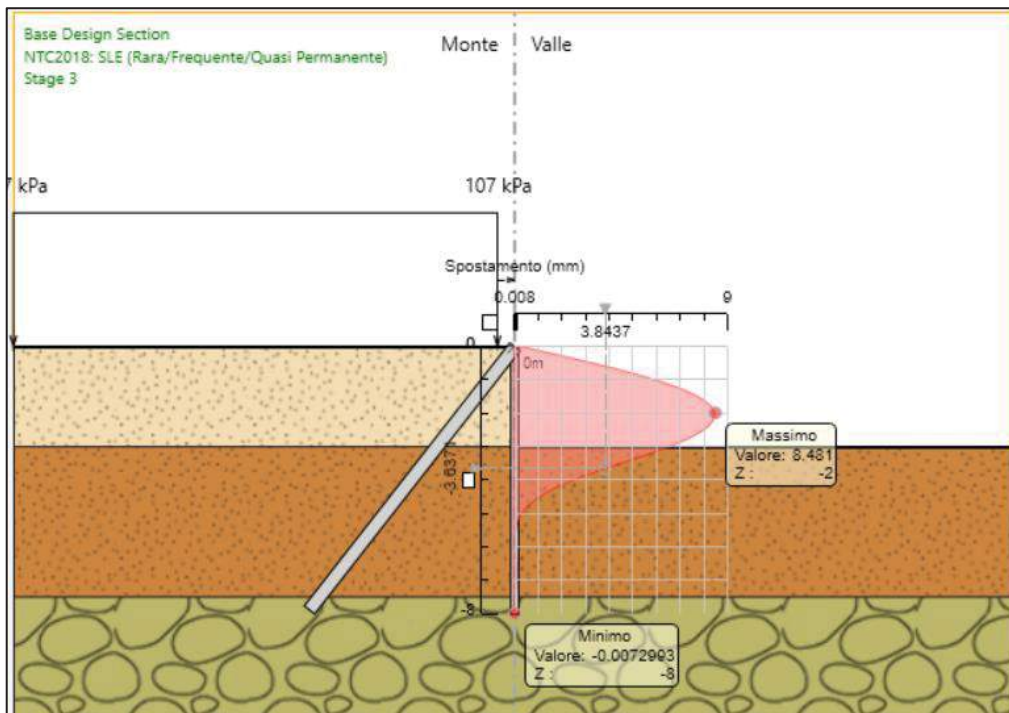
Le analisi sono state eseguite a lungo termine, considerando i parametri del terreno in condizioni drenate. Le verifiche sono state eseguite in condizioni statiche e in condizioni sismiche per le configurazioni definitive e solo in condizioni statiche per le configurazioni provvisorie.

La verifica di stabilità globale in condizioni statiche è stata effettuata secondo l'Approccio 1, Combinazione 2:

A2+M2+R2

Il coefficiente parziale sulla resistenza R2 è pari a 1.1 (come riportato nella Tabella 6.8.I delle NTC2008), mentre i coefficienti A2 e M2 sono riportati rispettivamente nella Tabella 6.2.I e Tabella 6.2.II delle NTC 2008.

Nella verifica di stabilità in condizioni sismiche si pongono pari all'unità i coefficienti parziali sulle azioni e sui parametri geotecnici e si impiegano le resistenze di progetto calcolate con un coefficiente parziale pari a $\gamma_R = 1.2$.

Le verifiche del raggiungimento della condizione di Stato Limite Ultimo (SLU) sono state quindi sviluppate considerando le seguenti condizioni di analisi:

Condizione statica

- Sovraccarico stradale pari al valore caratteristico 20 KPa amplificato per il coefficiente A2 corrispondente ai carichi variabili sfavorevoli (carico totale: $20 \times 1.3 = 26$ KPa).

Condizione sismica: SISMA +

- Accelerazione sismica orizzontale e accelerazione sismica verticale diretta verso il basso (forza inerziale diretta verso l'alto);
- Sovraccarico stradale pari al valore caratteristico di 20 KPa.

Condizione sismica: SISMA -

- Accelerazione sismica orizzontale e accelerazione sismica verticale diretta verso l'alto (forza inerziale diretta verso il basso);
- Sovraccarico stradale pari al valore caratteristico di 20 KPa.

La stabilità in condizioni sismiche è stata eseguita secondo il metodo pseudostatico che consente di rappresentare l'azione sismica mediante un'azione statica equivalente, costante nel tempo, proporzionale al peso W del volume di terreno potenzialmente instabile.

Nelle verifiche allo Stato Limite Ultimo (SLU) le componenti orizzontali e verticali di tale forza possono essere definite come di seguito indicato:

$$F_h = k_h \cdot W$$

$$F_v = k_v \cdot W$$

con k_h e k_v rispettivamente pari ai coefficienti sismici orizzontale e verticale calcolati in base all'azione sismica di progetto definita al Cap. 8 e considerando a favore di sicurezza un fattore di riduzione $\beta_s = 0.38$.

- $k_h = \beta_s a_{\max}/g = 0.023$;
- $k_v = \pm 0.5 k_h = 0.011$

La verifica di stabilità è stata condotta con il programma di calcolo *SLIDE 6.0*, che utilizza, nell'ambito dei metodi all'equilibrio limite per conchi, diversi modelli di calcolo, sulla base dei quali il programma consente di calcolare il coefficiente di sicurezza per una singola superficie di rottura imposta dall'utente, oppure di ricercare in maniera automatica la superficie critica, mediante una tecnica di generazione casuale.

Al fine di valutare le condizioni di stabilità dei rilevati le analisi sono state condotte con il *metodo di Bishop*, basato sull'equilibrio dei momenti e delle forze verticali, con risultante delle forze tra i conchi contigui assunta orizzontale. Le analisi sono state condotte con ricerca automatica della superficie critica.

Le verifiche di stabilità globale sono state svolte in corrispondenza di:

- Sezione 2 in fase provvisoria dove si rileva una scarpata di altezza di circa 6.3m necessaria per la realizzazione del muro di sottoscarpa;
- Sezione 4 in fase definitiva con del muro di sottoscarpa (identificata nella planimetria di progetto [3]). Tale sezione è stata ritenuta la più critica in quanto presenta la massima differenza tra la quota della strada che si trova sopra rilevato e quella che si trova ai piedi del rilevato stesso; in aggiunta nella sezione 4, i micropali raggiungono una profondità inferiore.

Si riportano in Figura 57 e in Figura 60 i modelli utilizzati per effettuare le analisi e in Tabella 31 i parametri geotecnici che caratterizzano la stratigrafia in esame.



Figura 57 – Sezione 2 – Modello Slide



Figura 58 – Sezione 4 – Modello Slide

Parametro	Materiali di riporto		Coltri eluvio colluviali (C)		Basalti alterati (Ba)		Basalti (B)	
	A2-M2-R2	sisma	A2-M2-R2	sisma	A2-M2-R2	sisma	A2-M2-R2	sisma
γ [kN]	20	20	19	19	20	20	22	22
ϕ' [°]	29	35	20	25	28	34	34	40
c' [kPa]	0	0	0	0	0	0	40	50

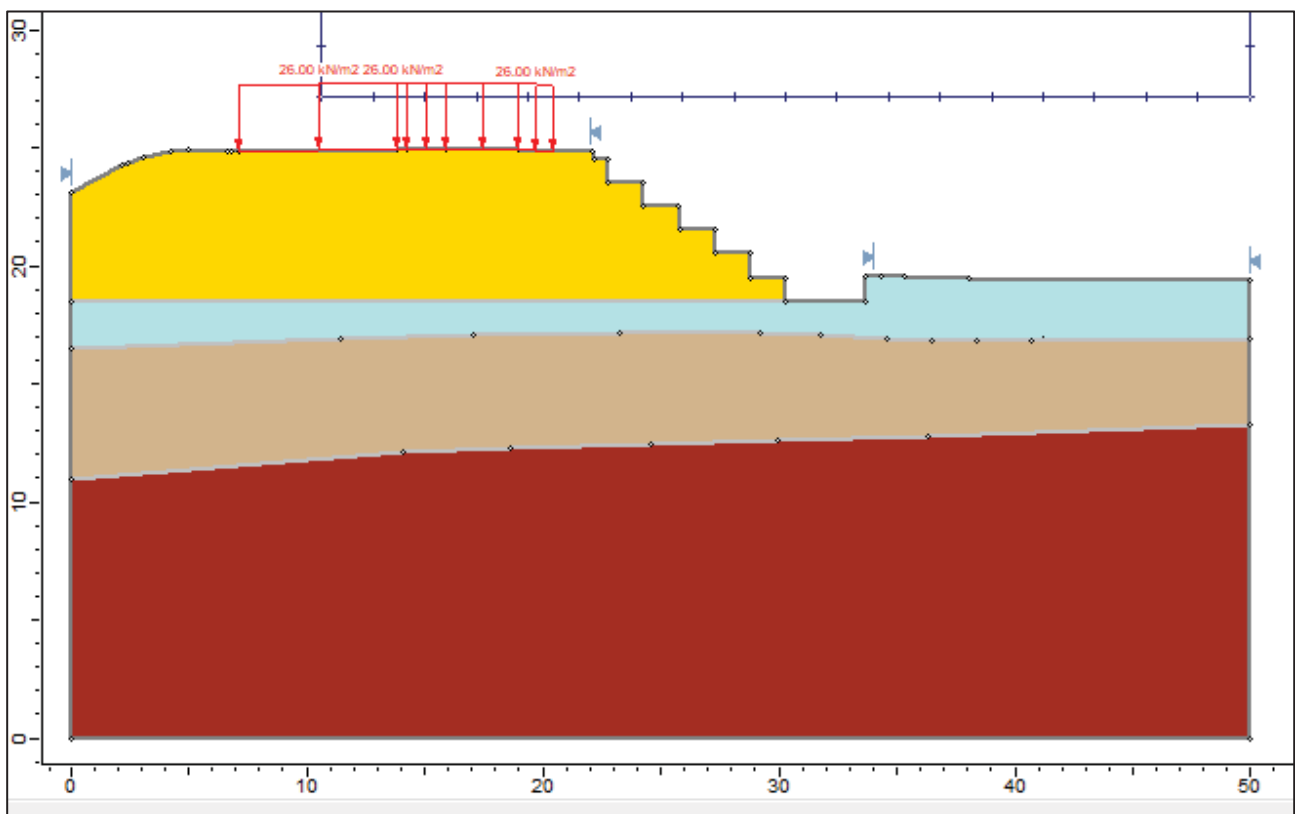
Tabella 31 – Stratigrafia – parametri geotecnici

Si riportano nelle seguenti figure i risultati ottenuti dalle analisi. Tutte le verifiche di stabilità risultano soddisfatte in quanto:

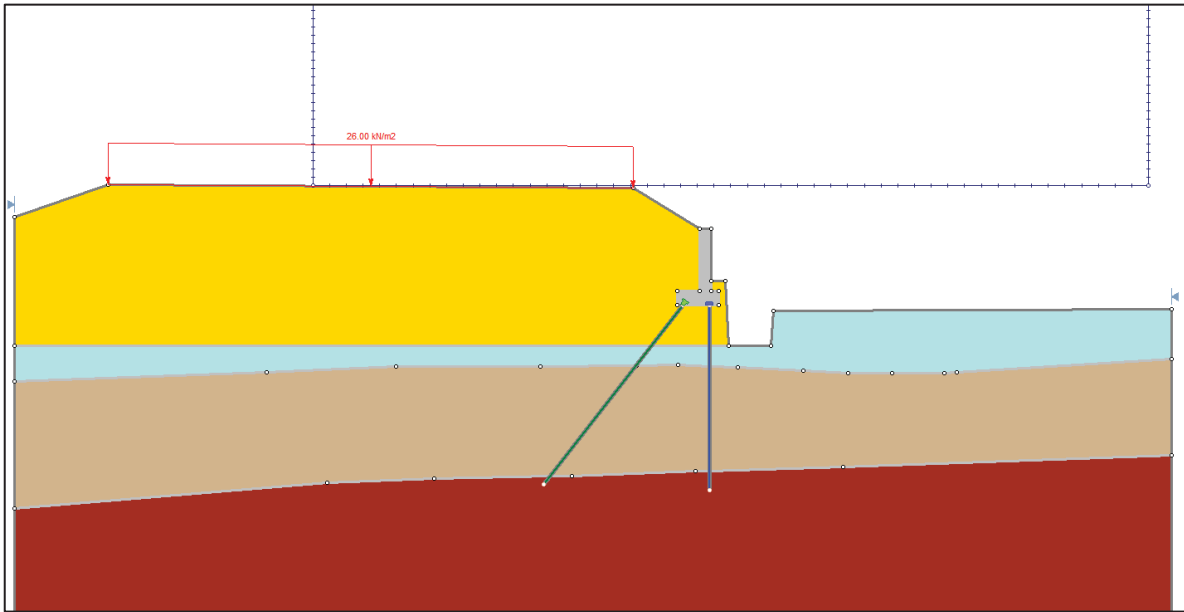
- Sezione 1: in condizioni statiche A2-M2-R2 risulta $F_s = 1.116 > 1.1$;
- Sezione 4: in condizioni statiche A2-M2-R2 risulta $F_s = 3.225 > 1.1$;
- Sezione 4: in condizioni sismiche risulta F_s (sisma +) = $3.654 > 1.2$ e F_s (sisma -) = $3.627 > 1.2$.

Si precisa inoltre che alle superfici di scorrimento che risultano esterne ai i micropali sono associati coefficienti di sicurezza F_s maggiori di quelli sopra riportati.



Figura 59 – Sezione 1 - Verifica in condizioni statiche



Figura 60 – Sezione 4 - Verifica in condizioni statiche

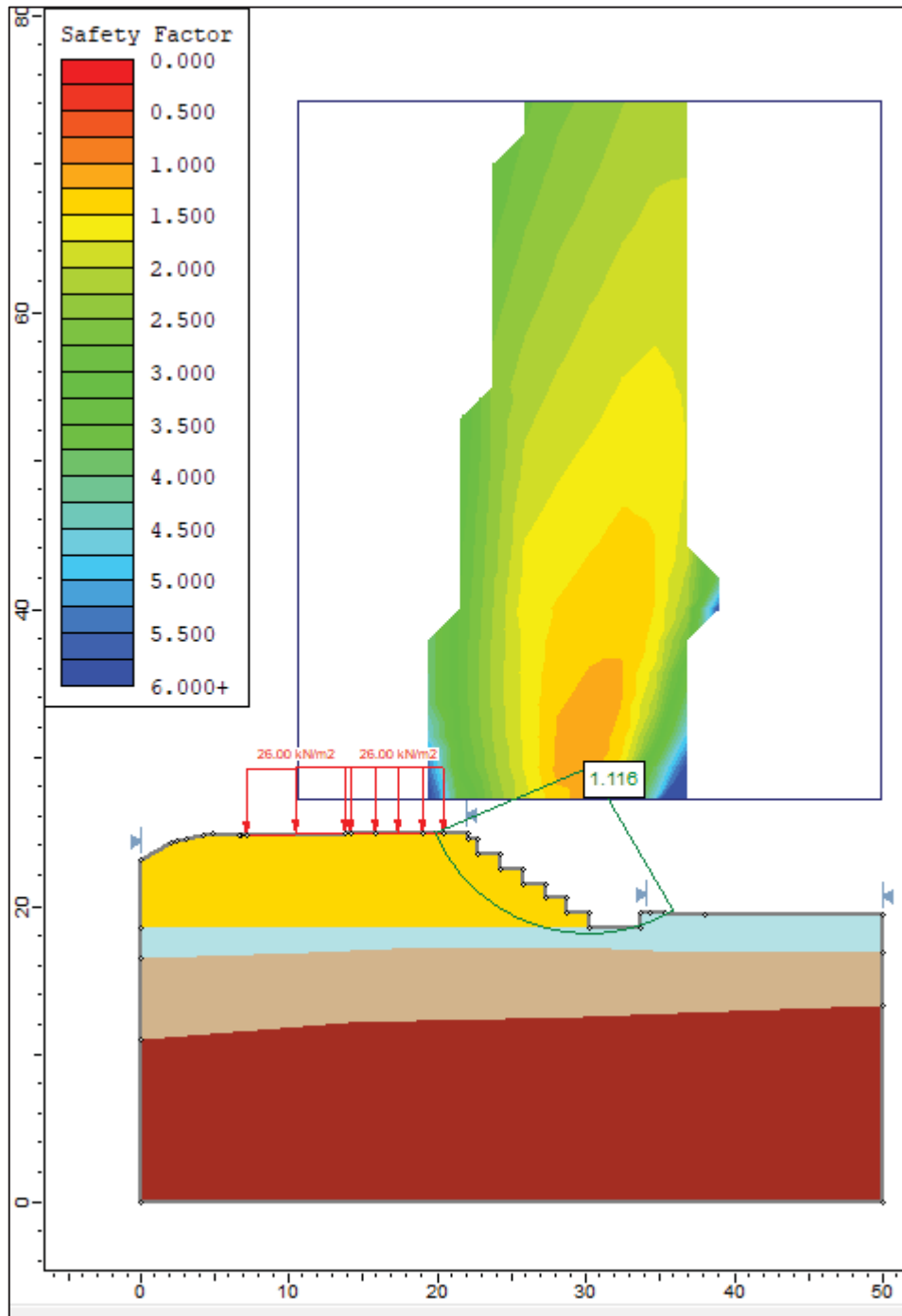

Figura 61 – Sezione 4 - Verifica in condizioni sismiche (Sisma +)

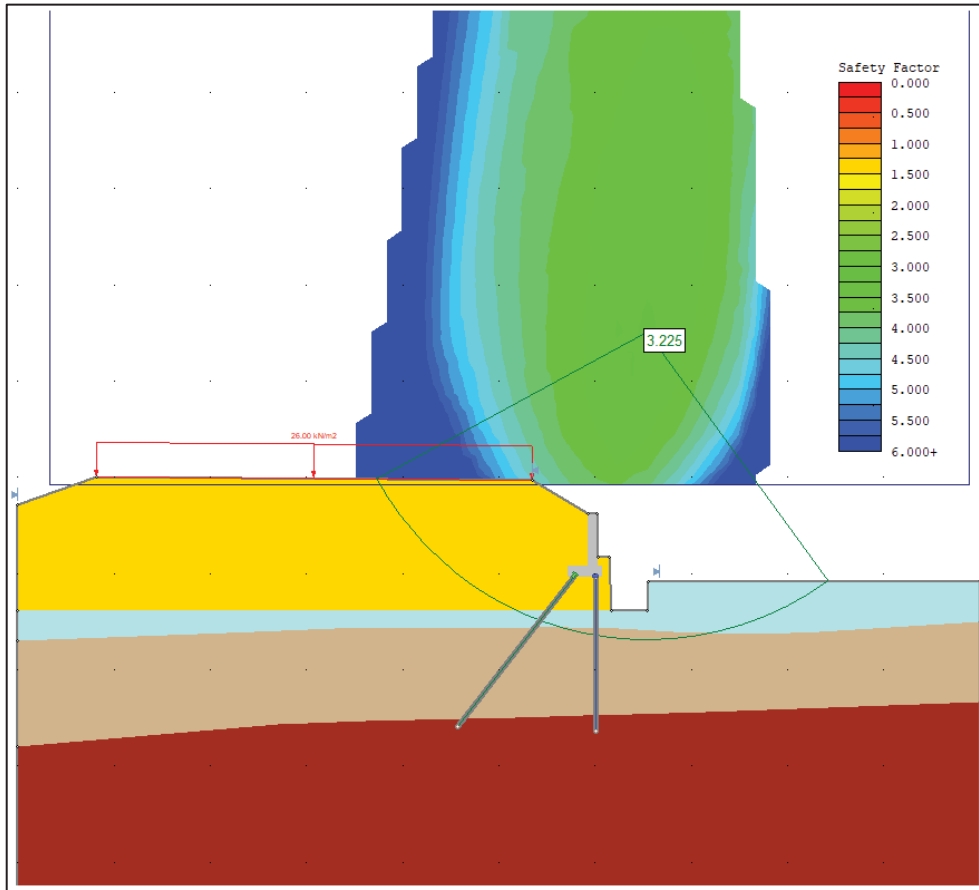

Figura 62 – Sezione 4 - Verifica in condizioni sismiche (Sisma -)

ALLEGATO 1 - ANALISI NUMERICA GROUP 2019

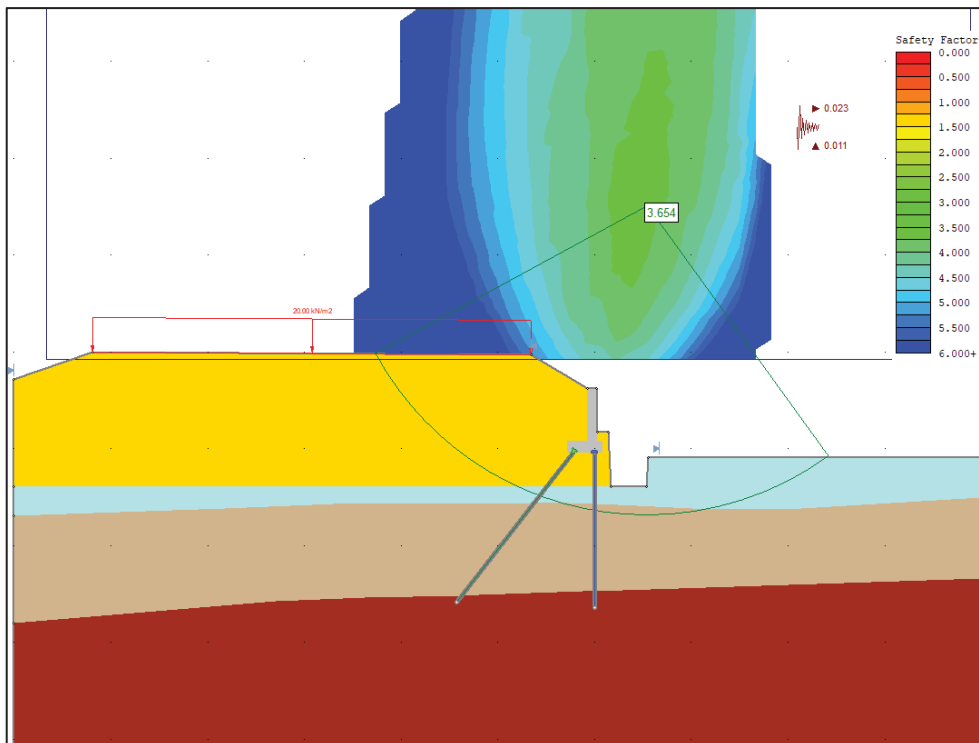
Relazione Geotecnica e di Calcolo

RTI di progettazione:

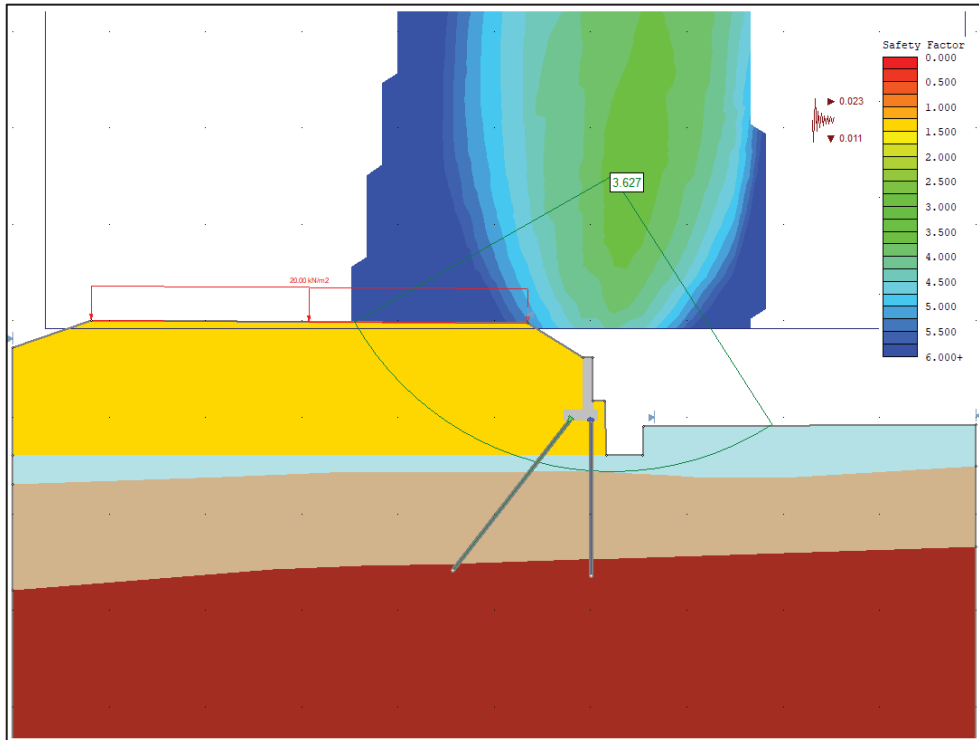

Mandataria

Via G.B. Sammartini n°5
20125 - Milano
Tel. 02 6787911
email: mail@proiter.it



Mandante

Via Artemide n°3
92100 Agrigento
Tel. 0922 421007
email: deltaingegneria@pec.it

=====

GROUP for Windows, Version 2019.11.5

Serial Number : 292797944

Analysis of A Group of Piles
Subjected to Axial and Lateral Loading

(c) Copyright ENSOFT, Inc., 1987-2018
All Rights Reserved

=====

This program is licensed to :

Pro Iter s.r.l.
Milano, Italy

Path to file locations : D:\OneDrive - Pro Iter
s.r.l.\Lavori\P557-05_Carlo Felice_STRALCIO II\5_S.CRISTINA\3_CONFIGURAZIONE
A\2_PALI_TIPO A\Pali_tipo A_sabbia media\1_PARAMETRI MEDI\2.5_GROUP_MP_9\
Name of input data file : Pali A SC_MP_9m.gp11r
Name of output echo file : Pali A SC_MP_9m.gp11e
Name of output results file : Pali A SC_MP_9m.gp11o
Name of output summary file : Pali A SC_MP_9m.gp11t
Name of plot output file : Pali A SC_MP_9m.gp11p
Name of runtime file : Pali A SC_MP_9m.gp11r

Time and Date of Analysis

Date: February 28, 2020 Time: 09:35:06

***** INPUT INFORMATION *****

New Group

ANALYSIS TYPE = 3D ANALYSIS

ADJUST DEPTH FOR BATTER PILES

GENERATE LOAD-DISP (AND T-R) CURVES BASED ON SOIL PROFILE

EXTEND INTERPOLATION FOR L-DP (AND T-R) CURVES

UNITS SYSTEM = METR

* TABLE B * PILE CAP OPTIONS

LENGTH,YY (M) = 10.00
WIDTH, ZZ (M) = 1.800
THICKNESS,XX (M) = 0.6000

* PILE CAP DIMENSIONS ARE NOT CONSIDERED
FOR THE PILE GROUP ANALYSIS

* TABLE C * LOAD AND CONTROL PARAMETERS

** LOAD CASES **

NUMBER OF LOAD CASES : 5

LOAD CASE : 1
CASE NAME : SLU_F1

LOAD TYPE : Dead, DL
SCALE FACTOR : 10.000

* CONCENTRATED LOADS *

NL	VERT.LOAD	HR.LOAD Y	HR.LOAD Z	MOMENT X	MOMENT Y	MOMENT Z	COORD X
COORD Y	COORD Z						
M	M	KN	KN	KN- M	KN- M	KN- M	M
1	1.76E+02	0.00	2.05E+02	0.00	4.00E+02	0.00	0.00
0.00	0.00						

* EQUIVALENT CONCENTRATED LOAD AT ORIGIN *

VER.LOAD X, KN	HOR.LOAD Y, KN	HOR.LOAD Z, KN
1760.00	0.00000	2050.00
MOMENT X, KN- M	MOMENT Y, KN- M	MOMENT Z, KN- M
0.00000	4000.00	0.00000

* THE LOADING IS STATIC *

* CONTROL PARAMETERS *

TOLERANCE ON CONVERGENCE OF PILE CAP MOVEMENT = 1.00000E-04
 TOLERANCE ON DETERMINATION OF PILE DEFLECTIONS = 1.00000E-04 M
 MAX NO OF ITERATIONS ALLOWED FOR FOUNDATION ANALYSIS = 100
 MAXIMUM NO OF ITERATIONS ALLOWED FOR PILE ANALYSIS = 100
 FACTOR TO APPLY THE LOAD IN INCREMENTS = 1.0000
 MINIMUM FACTOR FOR LOAD INCREMENTS = 1.0000
 PRINT RESULTS ONLY AT PILE CAP

LOAD CASE : 2
 CASE NAME : SLU_F2

LOAD TYPE : Dead, DL
 SCALE FACTOR : 10.000

* CONCENTRATED LOADS *

NL	VERT. LOAD	HR. LOAD Y	HR. LOAD Z	MOMENT X	MOMENT Y	MOMENT Z	COORD X
COORD Y	COORD Z						
	KN	KN	KN	KN- M	KN- M	KN- M	M
M	M						
1	2.28E+02	0.00	2.05E+02	0.00	3.92E+02	0.00	0.00
0.00	0.00						

* EQUIVALENT CONCENTRATED LOAD AT ORIGIN *

VER. LOAD X, KN	HOR. LOAD Y, KN	HOR. LOAD Z, KN
2280.00	0.00000	2050.00
MOMENT X, KN- M	MOMENT Y, KN- M	MOMENT Z, KN- M
0.00000	3920.00	0.00000

* THE LOADING IS STATIC *

* CONTROL PARAMETERS *

TOLERANCE ON CONVERGENCE OF PILE CAP MOVEMENT = 1.00000E-04
 TOLERANCE ON DETERMINATION OF PILE DEFLECTIONS = 1.00000E-04 M
 MAX NO OF ITERATIONS ALLOWED FOR FOUNDATION ANALYSIS = 100
 MAXIMUM NO OF ITERATIONS ALLOWED FOR PILE ANALYSIS = 100
 FACTOR TO APPLY THE LOAD IN INCREMENTS = 1.0000
 MINIMUM FACTOR FOR LOAD INCREMENTS = 1.0000
 PRINT RESULTS ONLY AT PILE CAP

LOAD CASE : 3
 CASE NAME : ECC

LOAD TYPE : Dead, DL
 SCALE FACTOR : 10.000

* CONCENTRATED LOADS *

NL	VERT. LOAD	HR. LOAD Y	HR. LOAD Z	MOMENT X	MOMENT Y	MOMENT Z	COORD X
COORD Y	COORD Z						
	KN	KN	KN	KN- M	KN- M	KN- M	M
M	M						
1	1.76E+02	0.00	1.53E+02	0.00	2.91E+02	0.00	0.00
0.00	0.00						

* EQUIVALENT CONCENTRATED LOAD AT ORIGIN *

VER. LOAD X, KN	HOR. LOAD Y, KN	HOR. LOAD Z, KN
1760.00	0.00000	1530.00
MOMENT X, KN- M	MOMENT Y, KN- M	MOMENT Z, KN- M
0.00000	2910.00	0.00000

* THE LOADING IS STATIC *

* CONTROL PARAMETERS *

TOLERANCE ON CONVERGENCE OF PILE CAP MOVEMENT	=	1.00000E-04
TOLERANCE ON DETERMINATION OF PILE DEFLECTIONS	=	1.00000E-04 M
MAX NO OF ITERATIONS ALLOWED FOR FOUNDATION ANALYSIS	=	100
MAXIMUM NO OF ITERATIONS ALLOWED FOR PILE ANALYSIS	=	100
FACTOR TO APPLY THE LOAD IN INCREMENTS	=	1.0000
MINIMUM FACTOR FOR LOAD INCREMENTS	=	1.0000
PRINT RESULTS ONLY AT PILE CAP		

LOAD CASE : 4
CASE NAME : SISM S

LOAD TYPE : Dead, DL
SCALE FACTOR : 10.000

* CONCENTRATED LOADS *

NL	VERT. LOAD	HR. LOAD Y	HR. LOAD Z	MOMENT X	MOMENT Y	MOMENT Z	COORD X
COORD Y	COORD Z						
	KN	KN	KN	KN- M	KN- M	KN- M	M
M	M						
1	1.86E+02	0.00	91.0	0.00	1.20E+02	0.00	0.00
0.00	0.00						

* EQUIVALENT CONCENTRATED LOAD AT ORIGIN *

VER. LOAD X, KN	HOR. LOAD Y, KN	HOR. LOAD Z, KN
1860.00	0.00000	910.000

MOMENT X, KN- M MOMENT Y, KN- M MOMENT Z, KN- M
 0.00000 1200.00 0.00000

* THE LOADING IS STATIC *

* CONTROL PARAMETERS *

TOLERANCE ON CONVERGENCE OF PILE CAP MOVEMENT = 1.00000E-04
 TOLERANCE ON DETERMINATION OF PILE DEFLECTIONS = 1.00000E-04 M
 MAX NO OF ITERATIONS ALLOWED FOR FOUNDATION ANALYSIS = 100
 MAXIMUM NO OF ITERATIONS ALLOWED FOR PILE ANALYSIS = 100
 FACTOR TO APPLY THE LOAD IN INCREMENTS = 1.0000
 MINIMUM FACTOR FOR LOAD INCREMENTS = 1.0000
 PRINT RESULTS ONLY AT PILE CAP

LOAD CASE : 5
 CASE NAME : SISM G

LOAD TYPE : Dead, DL
 SCALE FACTOR : 10.000

* CONCENTRATED LOADS *

NL	VERT. LOAD	HR. LOAD Y	HR. LOAD Z	MOMENT X	MOMENT Y	MOMENT Z	COORD X
COORD Y	COORD Z						
	KN	KN	KN	KN- M	KN- M	KN- M	M
M	M						
1	1.97E+02	0.00	92.0	0.00	1.20E+02	0.00	0.00
0.00	0.00						

* EQUIVALENT CONCENTRATED LOAD AT ORIGIN *

VER. LOAD X, KN HOR. LOAD Y, KN HOR. LOAD Z, KN
 1970.00 0.00000 920.000

MOMENT X, KN- M MOMENT Y, KN- M MOMENT Z, KN- M
 0.00000 1200.00 0.00000

* THE LOADING IS STATIC *

* CONTROL PARAMETERS *

TOLERANCE ON CONVERGENCE OF PILE CAP MOVEMENT = 1.00000E-04
 TOLERANCE ON DETERMINATION OF PILE DEFLECTIONS = 1.00000E-04 M
 MAX NO OF ITERATIONS ALLOWED FOR FOUNDATION ANALYSIS = 100
 MAXIMUM NO OF ITERATIONS ALLOWED FOR PILE ANALYSIS = 100
 FACTOR TO APPLY THE LOAD IN INCREMENTS = 1.0000
 MINIMUM FACTOR FOR LOAD INCREMENTS = 1.0000
 PRINT RESULTS ONLY AT PILE CAP

** LOAD COMBINATIONS **

NUMBER OF LOAD COMB. : 1

LOAD COMB. : 1
COMB. NAME : Load Comb

BENDING RF : 1.0000
SHEAR RF : 1.0000

* THE LOADING IS STATIC *

* CONTROL PARAMETERS *

TOLERANCE ON CONVERGENCE OF PILE CAP MOVEMENT = 1.00000E-04
TOLERANCE ON DETERMINATION OF PILE DEFLECTIONS = 1.00000E-04 M
MAX NO OF ITERATIONS ALLOWED FOR FOUNDATION ANALYSIS = 100
MAXIMUM NO OF ITERATIONS ALLOWED FOR PILE ANALYSIS = 100
FACTOR TO APPLY THE LOAD IN INCREMENTS = 1.0000
MINIMUM FACTOR FOR LOAD INCREMENTS = 1.0000
PRINT RESULTS ONLY AT PILE CAP

* TABLE D * ARRANGEMENT OF PILE GROUPS

	GROUP	CONN.Z-Z	CONN.Y-Y	PILE PROP	P-Y CURVE	L-S CURVE	T-R CURVE
R-F-L SET	1	FIX	FIX	1	1	1 G	1 G
0	2	FIX	FIX	1	1	1 G	1 G
0	3	FIX	FIX	1	1	1 G	1 G
0	4	FIX	FIX	1	1	1 G	1 G
0	5	FIX	FIX	1	1	1 G	1 G
0	6	FIX	FIX	1	1	1 G	1 G
0	7	FIX	FIX	1	1	1 G	1 G
0	8	FIX	FIX	1	1	1 G	1 G
0	9	FIX	FIX	1	1	1 G	1 G
0	10	FIX	FIX	1	1	1 G	1 G
0	11	FIX	FIX	1	1	1 G	1 G

0	12	FIX	FIX	1	1	1 G	1 G
0	13	FIX	FIX	1	1	1 G	1 G
0	14	FIX	FIX	1	1	1 G	1 G
0	15	FIX	FIX	1	1	1 G	1 G
0	16	FIX	FIX	1	1	1 G	1 G
0	17	FIX	FIX	1	1	1 G	1 G
0	18	FIX	FIX	1	1	1 G	1 G
0	19	FIX	FIX	1	1	1 G	1 G
0	20	FIX	FIX	1	1	1 G	1 G

GROUP	CorX, M	CorY, M	CorZ, M	ALPHA,DEG	BETA,DEG	THETA,DEG
GROUND, M	SPz, KN- M	SPy, KN- M				
1	0.000	-4.500	-0.500	0.000	90.00	0.000
0.000	0.000	0.000				
2	0.000	-3.500	-0.500	0.000	90.00	0.000
0.000	0.000	0.000				
3	0.000	-2.500	-0.500	0.000	90.00	0.000
0.000	0.000	0.000				
4	0.000	-1.500	-0.500	0.000	90.00	0.000
0.000	0.000	0.000				
5	0.000	-0.500	-0.500	0.000	90.00	0.000
0.000	0.000	0.000				
6	0.000	0.500	-0.500	0.000	90.00	0.000
0.000	0.000	0.000				
7	0.000	1.500	-0.500	0.000	90.00	0.000
0.000	0.000	0.000				
8	0.000	2.500	-0.500	0.000	90.00	0.000
0.000	0.000	0.000				
9	0.000	3.500	-0.500	0.000	90.00	0.000
0.000	0.000	0.000				
10	0.000	4.500	-0.500	0.000	90.00	0.000
0.000	0.000	0.000				
11	0.000	-4.500	0.500	0.000	90.00	0.000
0.000	0.000	0.000				
12	0.000	-3.500	0.500	0.000	90.00	0.000
0.000	0.000	0.000				
13	0.000	-2.500	0.500	0.000	90.00	0.000
0.000	0.000	0.000				
14	0.000	-1.500	0.500	0.000	90.00	0.000
0.000	0.000	0.000				
15	0.000	-0.500	0.500	0.000	90.00	0.000
0.000	0.000	0.000				
16	0.000	0.500	0.500	0.000	90.00	0.000
0.000	0.000	0.000				

17	0.000	1.500	0.500	0.000	90.00	0.000
0.000	0.000	0.000				
18	0.000	2.500	0.500	0.000	90.00	0.000
0.000	0.000	0.000				
19	0.000	3.500	0.500	0.000	90.00	0.000
0.000	0.000	0.000				
20	0.000	4.500	0.500	0.000	90.00	0.000
0.000	0.000	0.000				

* TABLE E * PILE GEOMETRY AND PROPERTIES
PILE TYPE = 1 - DRIVEN PILE
= 2 - DRILLED SHAFT

PROP	SECTS	INC	PILE TYPE	LENGTH, M
1	1	80	1	9.0000

* PILE SECTIONS *

PROP	SECT	FROM, M	TO, M	CROSS SECT
1	1	0.00000	9.00000	1

* PILE CROSS SECTIONS *

CROSS SECTION : 1
SECTION NAME : MP240
TYPE : NONLINEAR
CROSS SECTION TYPE : ROUND CONC. SHAFT, CASING (AND STEEL SECTION)
CONCRETE DIAMETER : 240.000 MM
CONCRETE FC : 14110.0 KN/ M**2
DIAMETER CASING : NO CASING
EMBEDDED STEEL SECT : PIPE
DIAMETER STEEL : 193.700 MM
THICKNESS STEEL : 10.0000 MM
ES STEEL : 2.10000E+08 KN/ M**2
FY STEEL : 3.55000E+05 KN/ M**2
EQ. YOUNG MODULUS : 3.00000E+07 KN/ M**2

* PILE CROSS SECTIONS PROPERTIES *

NONLINEAR SECTIONS

SECT	DIAM,MM	PERIM,MM	AREA,MM**2	Iz,MM**4	Iy,MM**4	GJ, KN- M**2
EIz IND	EIy IND	Mn, KN- M	Vn, KN			
1	240.00	753.98	4.5239E+04	0.0000	0.0000	4071.5
0	0	0.0000	0.0000			

* TABLE F * SOIL DATA

SOILS INFORMATION

GROUND SURFACE = 0.00000 M

4 LAYER(S) OF SOIL

LAYER 1

THE SOIL-RESISTANCE CURVES SPECIFIED BY THE USER

		TOP OF LAYER	BOTTOM
OF LAYER			
1.40000	X COORDINATE (M)	0.00000	
9.00000	EFFECTIVE UNIT WEIGHT (KN/ M**3)	9.00000	
0.00000	ULTIMATE UNIT SIDE FRICTION (KN/ M**2)	0.00000 (P)	
0.00000	ULTIMATE UNIT TIP RESISTANCE (KN/ M**2)	0.00000	

LAYER 2

THE SOIL-RESISTANCE CURVES SPECIFIED BY THE USER

		TOP OF LAYER	BOTTOM
OF LAYER			
3.00000	X COORDINATE (M)	1.40000	
10.0000	EFFECTIVE UNIT WEIGHT (KN/ M**3)	10.0000	
200.000	ULTIMATE UNIT SIDE FRICTION (KN/ M**2)	200.000	
0.00000	ULTIMATE UNIT TIP RESISTANCE (KN/ M**2)	0.00000	

LAYER 3

THE SOIL-RESISTANCE CURVES SPECIFIED BY THE USER

		TOP OF LAYER	BOTTOM
OF LAYER			
5.90000	X COORDINATE (M)	3.00000	
10.0000	EFFECTIVE UNIT WEIGHT (KN/ M**3)	10.0000	
250.000	ULTIMATE UNIT SIDE FRICTION (KN/ M**2)	250.000	
0.00000	ULTIMATE UNIT TIP RESISTANCE (KN/ M**2)	0.00000	

LAYER 4

THE SOIL-RESISTANCE CURVES SPECIFIED BY THE USER

		TOP OF LAYER	BOTTOM
OF LAYER			
9.00000	X COORDINATE (M)	5.90000	
12.0000	EFFECTIVE UNIT WEIGHT (KN/ M**3)	12.0000	
250.000	ULTIMATE UNIT SIDE FRICTION (KN/ M**2)	250.000	

0.00000 (R) ULTIMATE UNIT TIP RESISTANCE (KN/ M**2) 0.00000 (R)

Notes : Program estimated values for listed parameters
 if zero input values were entered:
 (P) ULTIMATE UNIT SIDE FRICTION for Driven Piles
 (R) ULTIMATE UNIT TIP RESISTANCE for Driven Piles

* TABLE G * INPUT P-Y CURVES

NUM OF SETS : 1

SET 1 NUM OF CURVES 8

CURVE	1	DISTANCE FROM ORIGIN (X-COORD.)	0.00000	M
POINT		P KN	Y M	
1		0.00000	0.00000	
2		9.30000	0.0205600	
3		9.30000	1.00000	
CURVE	2	DISTANCE FROM ORIGIN (X-COORD.)	1.40000	M
POINT		P KN	Y M	
1		0.00000	0.00000	
2		66.0000	0.0105000	
3		66.0000	1.00000	
CURVE	3	DISTANCE FROM ORIGIN (X-COORD.)	1.41000	M
POINT		P KN	Y M	
1		0.00000	0.00000	
2		60.0000	3.90000E-03	
3		60.0000	1.00000	
CURVE	4	DISTANCE FROM ORIGIN (X-COORD.)	3.00000	M
POINT		P KN	Y M	
1		0.00000	0.00000	
2		153.000	4.60000E-03	
3		153.000	1.00000	
CURVE	5	DISTANCE FROM ORIGIN (X-COORD.)	3.01000	M
POINT		P KN	Y M	
1		0.00000	0.00000	
2		153.000	4.60000E-03	
3		153.000	1.00000	
CURVE	6	DISTANCE FROM ORIGIN (X-COORD.)	5.90000	M

POINT	P KN	Y M
1	0.00000	0.00000
2	327.000	2.00000E-04
3	327.000	1.00000

CURVE 7 DISTANCE FROM ORIGIN (X-COORD.) 5.91000 M

POINT	P KN	Y M
1	0.00000	0.00000
2	1656.00	1.80000E-03
3	1656.00	1.00000

CURVE 8 DISTANCE FROM ORIGIN (X-COORD.) 9.00000 M

POINT	P KN	Y M
1	0.00000	0.00000
2	2981.00	1.30000E-03
3	2981.00	1.00000

* TABLE H * AXIAL LOAD VS DISPLACEMENT

AXIAL LOAD-DISPLACEMENT CURVES GENERATED INTERNALLY

NUM OF CURVES 1

CURVE 1 NUM OF POINTS 19

DISPLACEMENT, M	AXIAL LOAD, KN
-0.0551132	-1097.61
-0.0297132	-1097.61
-0.0170132	-1097.61
-7.54986E-03	-1236.68
-5.72591E-03	-1173.39
-1.96476E-03	-522.657
-1.05482E-03	-295.883
-2.14685E-04	-61.5955
-2.14685E-05	-6.15955
0.00000	0.00000
2.14685E-05	6.15955
2.14685E-04	61.5955
1.05482E-03	295.883
1.96476E-03	522.657
5.72591E-03	1173.39
7.54986E-03	1236.68
0.0170132	1097.61
0.0297132	1097.61
0.0551132	1097.61

* TABLE I * TORS. MOM. VS ANGLE ROT.

TORQUE-ROTATION CURVES GENERATED INTERNALLY

NUM OF CURVES 1

CURVE 1 NUM OF POINTS 19

ROT. ANGLE, Rad.	TORS.MOMEN, KN- M
-0.59586	-131.713
-0.38419	-131.713
-0.27836	-131.713
-0.20847	-139.227
-0.18981	-136.184
-0.11996	-104.740
-0.0899626	-87.4165
-0.0346526	-43.4036
-4.14236E-03	-5.69892
0.00000	0.00000
4.14236E-03	5.69892
0.0346526	43.4036
0.0899626	87.4165
0.11996	104.740
0.18981	136.184
0.20847	139.227
0.27836	131.713
0.38419	131.713
0.59586	131.713

* TABLE J * MOMENT CURVATURE SETS

INTERNALLY GENERATED MOMENT CURVATURE

Definitions of Run Messages and Notes:

- C = concrete in section has cracked in tension.
- Y = stress in reinforcing steel has reached yield stress.
- S = stress in steel section has reached yield stress.
- G = stress in casing section has reached yield stress.

Bending Stiffness (EI) = Computed Bending Moment / Curvature.

Position of neutral axis is measured from edge of compression side of pile.

Compressive stresses and strains are positive in sign.

Tensile stresses and strains are negative in sign.

 -
 Computations of Nominal Moment Capacity and Nonlinear Bending
 Stiffness

Section: 1 (MP240), Z Axis,

 -

Input Axial Thrust Forces:

Number of Axial Thrust Force Values = 1

Number	Axial Thrust Force kN
1	0.000

Axial Thrust Force = 0.000 kN ,128

Max Tens Strain m/m	Bending Max Concrete Curvature rad/m Stress kPa	Bending Max Reinf Moment kN-m Stress kPa	Bending Max Casing Stiffness kN-m2 Stress kPa	Depth to Run N Axis Msg m	Max Comp Strain m/m
0.0000000	0.000	0.000	0.000	0.1200000	0.0000000
0.0000059	123.050	0.000	7981.237	0.1200000	0.0000059
-0.0000118	245.561	0.000	7976.844	0.1200000	0.0000118
-0.0000177	367.533	0.000	7972.450	0.1200000	0.0000177
-0.0000236	488.966	0.000	7968.057	0.1200000	0.0000236
-0.0000295	609.861	0.000	7963.664	0.1200000	0.0000295
-0.0000354	730.216	0.000	7959.271	0.1200000	0.0000354
-0.0000413	850.033	0.000	7954.877	0.1200000	0.0000413
-0.0000472	969.311	0.000	7950.484	0.1200000	0.0000472
-0.0000531	1088.049	0.000	7946.091	0.1200000	0.0000531
-0.0000591	1206.249	0.000	7941.698	0.1200000	0.0000591
-0.0000650	1323.910	0.000	7937.304	0.1200000	0.0000650
0.0000709	1441.571	0.000	7932.911	0.1200000	0.0000709

-0.0000709	1441.032	0.000	-11885.811		
	0.000639764	5.072378	7928.518	0.1200000	0.0000768
-0.0000768	1557.616	0.000	-12876.296		
	0.000688976	5.459535	7924.124	0.1200000	0.0000827
-0.0000827	1673.660	0.000	-13866.780		
	0.000738189	5.846258	7919.731	0.1200000	0.0000886
-0.0000886	1789.165	0.000	-14857.264		
	0.000787402	6.232550	7915.338	0.1200000	0.0000945
-0.0000945	1904.132	0.000	-15847.749		
	0.000836614	6.618408	7910.945	0.1200000	0.0001004
-0.0001004	2018.559	0.000	-16838.233		
	0.000885827	7.003835	7906.551	0.1200000	0.0001063
-0.0001063	2132.448	0.000	-17828.717		
	0.000935039	7.388829	7902.158	0.1200000	0.0001122
-0.0001122	2245.798	0.000	-18819.201		
	0.000984252	7.762290	7886.486	0.1199527	0.0001181
-0.0001182	2357.712	0.000	-19819.464	C	
	0.001033465	8.044623	7784.130	0.1195282	0.0001235
-0.0001245	2461.533	0.000	-20902.572	C	
	0.001082677	8.278337	7646.173	0.1189199	0.0001288
-0.0001311	2560.299	0.000	-22036.229	C	
	0.001131890	8.480110	7491.993	0.1182006	0.0001338
-0.0001379	2655.115	0.000	-23208.862	C	
	0.001181102	8.665598	7336.873	0.1174356	0.0001387
-0.0001448	2747.181	0.000	-24407.666	C	
	0.001230315	8.933880	7261.458	0.1170558	0.0001440
-0.0001513	2846.389	0.000	-25522.798	C	
	0.001279528	9.213916	7201.030	0.1167426	0.0001494
-0.0001577	2946.062	0.000	-26627.854	C	
	0.001328740	9.484322	7137.831	0.1163991	0.0001547
-0.0001642	3043.964	0.000	-27747.844	C	
	0.001377953	9.733706	7063.889	0.1159754	0.0001598
-0.0001709	3138.748	0.000	-28898.146	C	
	0.001427165	9.972561	6987.671	0.1155174	0.0001649
-0.0001777	3231.444	0.000	-30067.503	C	
	0.001476378	10.204795	6912.048	0.1150407	0.0001698
-0.0001845	3322.408	0.000	-31252.098	C	
	0.001525591	10.486500	6873.732	0.1148014	0.0001751
-0.0001910	3418.779	0.000	-32370.516	C	
	0.001574803	10.711213	6801.620	0.1143119	0.0001800
-0.0001979	3507.082	0.000	-33576.604	C	
	0.001624016	10.987510	6765.643	0.1140696	0.0001853
-0.0002045	3601.455	0.000	-34708.492	C	
	0.001673228	11.261859	6730.617	0.1138276	0.0001905
-0.0002111	3694.980	0.000	-35845.307	C	
	0.001722441	11.481301	6665.716	0.1133383	0.0001952
-0.0002182	3779.967	0.000	-37076.589	C	
	0.001771654	11.752765	6633.783	0.1130993	0.0002004
-0.0002248	3871.716	0.000	-38224.814	C	
	0.001820866	12.023118	6602.967	0.1128623	0.0002055
-0.0002315	3962.696	0.000	-39377.255	C	
	0.001870079	12.292569	6573.290	0.1126275	0.0002106
-0.0002382	4052.930	0.000	-40533.719	C	
	0.001919291	12.561317	6544.768	0.1123952	0.0002157

-0.0002449	4142.437	0.000	-41694.003	C	
	0.001968504	12.829555	6517.414	0.1121659	0.0002208
-0.0002516	4231.242	0.000	-42857.898	C	
	0.002066929	13.413134	6489.402	0.1119487	0.0002314
-0.0002647	4415.207	0.000	-45095.064	C	
	0.002165354	13.946275	6440.643	0.1115073	0.0002415
-0.0002782	4588.290	0.000	-47443.146	C	
	0.002263780	14.525066	6416.290	0.1113021	0.0002520
-0.0002913	4767.503	0.000	-49697.218	C	
	0.002362205	15.058066	6374.581	0.1108859	0.0002619
-0.0003050	4935.850	0.000	-52064.407	C	
	0.002460630	15.634323	6353.789	0.1106949	0.0002724
-0.0003182	5110.621	0.000	-54332.490	C	
	0.002559055	16.209478	6334.165	0.1105091	0.0002828
-0.0003314	5283.312	0.000	-56605.608	C	
	0.002657480	16.783811	6315.686	0.1103289	0.0002932
-0.0003446	5453.968	0.000	-58883.318	C	
	0.002755906	17.357587	6298.324	0.1101545	0.0003036
-0.0003578	5622.636	0.000	-61165.152	C	
	0.002854331	17.931057	6282.053	0.1099859	0.0003139
-0.0003711	5789.366	0.000	-63450.609	C	
	0.002952756	18.540134	6278.925	0.1100071	0.0003248
-0.0003838	5962.890	0.000	-65625.453	C	
	0.003051181	19.111830	6263.748	0.1098450	0.0003352
-0.0003971	6125.779	0.000	-67916.834	C	
	0.003149606	19.683767	6249.596	0.1096893	0.0003455
-0.0004104	6286.837	0.000	-70210.690	C	
	0.003248031	20.288934	6246.532	0.1097110	0.0003563
-0.0004232	6454.737	0.000	-72389.981	C	
	0.003346457	20.859804	6233.400	0.1095621	0.0003666
-0.0004365	6612.101	0.000	-74688.276	C	
	0.003444882	21.431374	6221.222	0.1094199	0.0003769
-0.0004498	6767.742	0.000	-76987.789	C	
	0.003543307	22.033030	6218.211	0.1094421	0.0003878
-0.0004626	6930.092	0.000	-79170.969	C	
	0.003641732	22.604127	6206.971	0.1093071	0.0003981
-0.0004759	7082.175	0.000	-81473.374	C	
	0.003740157	23.203868	6203.982	0.1093295	0.0004089
-0.0004887	7240.906	0.000	-83657.761	C	
	0.003838583	23.774797	6193.639	0.1092020	0.0004192
-0.0005021	7389.508	0.000	-85962.103	C	
	0.003937008	24.372707	6190.668	0.1092246	0.0004300
-0.0005149	7544.636	0.000	-88147.569	C	
	0.004035433	24.970020	6187.693	0.1092472	0.0004409
-0.0005276	7698.019	0.000	-90332.061	C	
	0.004133858	25.539893	6178.222	0.1091274	0.0004511
-0.0005410	7841.369	0.000	-92639.307	C	
	0.004232283	26.135465	6175.263	0.1091503	0.0004620
-0.0005538	7991.168	0.000	-94824.657	C	
	0.004330709	26.730438	6172.301	0.1091732	0.0004728
-0.0005666	8139.218	0.000	-97009.044	C	
	0.004429134	27.299639	6163.652	0.1090613	0.0004830
-0.0005799	8277.418	0.000	-99317.875	C	
	0.004527559	27.892950	6160.704	0.1090844	0.0004939

-0.0005927	8421.900	0.000	-101502.933	C	
	0.004625984	28.485663	6157.752	0.1091076	0.0005047
-0.0006055	8564.631	0.000	-103687.015	C	
	0.004724409	29.054519	6149.873	0.1090038	0.0005150
-0.0006189	8697.772	0.000	-105996.091	C	
	0.004822835	29.645644	6146.933	0.1090272	0.0005258
-0.0006317	8836.947	0.000	-108180.654	C	
	0.004921260	30.236170	6143.990	0.1090506	0.0005367
-0.0006444	8974.368	0.000	-110364.230	C	
	0.005019685	30.804957	6136.831	0.1089552	0.0005469
-0.0006578	9102.536	0.000	-112672.140	C	
	0.005118110	31.393960	6133.897	0.1089788	0.0005578
-0.0006706	9236.410	0.000	-114856.030	C	
	0.005216535	31.982366	6130.959	0.1090024	0.0005686
-0.0006834	9368.531	0.000	-117038.894	C	
	0.005314961	32.570174	6128.018	0.1090261	0.0005795
-0.0006961	9498.894	0.000	-119220.738	C	
	0.005413386	33.157383	6125.073	0.1090498	0.0005903
-0.0007089	9627.499	0.000	-121401.559	C	
	0.005511811	33.724585	6118.603	0.1089632	0.0006006
-0.0007223	9747.202	0.000	-123709.175	C	
	0.005610236	34.310334	6115.666	0.1089871	0.0006114
-0.0007350	9872.267	0.000	-125890.066	C	
	0.005708661	34.895481	6112.726	0.1090111	0.0006223
-0.0007478	9995.569	0.000	-128069.942	C	
	0.005807087	35.480028	6109.781	0.1090351	0.0006332
-0.0007605	10117.105	0.000	-130248.779	C	
	0.005905512	36.063972	6106.833	0.1090591	0.0006440
-0.0007733	10236.874	0.000	-132426.577	C	
	0.006299213	38.375756	6092.151	0.1090542	0.0006870
-0.0008249	10691.589	0.000	-141261.668	C	
	0.006692913	40.679697	6078.025	0.1090593	0.0007299
-0.0008764	11118.547	0.000	-150083.178	C	
	0.007086614	42.988608	6066.170	0.1091580	0.0007736
-0.0009272	11523.052	0.000	-158764.889	C	
	0.007480315	45.287721	6054.253	0.1092573	0.0008173
-0.0009780	11898.885	0.000	-167429.068	C	
	0.007874016	47.563512	6040.566	0.1092746	0.0008604
-0.0010293	12240.871	0.000	-176212.574	C	
	0.008267717	49.842439	6028.562	0.1093758	0.0009043
-0.0010800	12559.096	0.000	-184847.554	C	
	0.008661417	52.111332	6016.490	0.1094776	0.0009482
-0.0011305	12848.183	0.000	-193464.659	C	
	0.009055118	54.359224	6003.149	0.1095075	0.0009916
-0.0011816	13104.265	0.000	-202201.697	C	
	0.009448819	56.607669	5990.978	0.1096111	0.0010357
-0.0012320	13334.901	0.000	-210787.407	C	
	0.009842520	58.845845	5978.738	0.1097154	0.0010799
-0.0012823	13535.917	0.000	-219354.605	C	
	0.010236220	61.073665	5966.427	0.1098204	0.0011241
-0.0013325	13707.135	0.000	-227903.020	C	
	0.010629921	63.283061	5953.295	0.1098645	0.0011679
-0.0013833	13846.486	0.000	-236569.916	C	
	0.011023622	65.489910	5940.870	0.1099714	0.0012123

-0.0014334	13957.966	0.000	-245084.352	C	
	0.011417323	67.686148	5928.373	0.1100791	0.0012568
-0.0014833	14039.120	0.000	-253579.177	C	
	0.011811024	69.871670	5915.801	0.1101875	0.0013014
-0.0015332	14089.754	0.000	-262054.321	C	
	0.012204724	72.046375	5903.155	0.1102968	0.0013461
-0.0015830	14109.673	0.000	-270509.568	C	
	0.012598425	74.209934	5890.414	0.1104068	0.0013910
-0.0016327	14109.733	0.000	-278944.405	C	
	0.012992126	76.362167	5877.573	0.1105179	0.0014359
-0.0016822	14108.993	0.000	-287358.490	C	
	0.013385827	78.503589	5864.680	0.1106295	0.0014809
-0.0017317	14106.924	0.000	-295752.389	C	
	0.013779528	80.634829	5851.785	0.1107416	0.0015260
-0.0017811	14109.781	0.000	-304126.844	C	
	0.014173228	82.752528	5838.651	0.1108058	0.0015705
-0.0018311	14107.027	0.000	-312624.783	C	
	0.014566929	84.865745	5825.919	0.1109181	0.0016157
-0.0018803	14109.434	0.000	-320965.555	C	
	0.014960630	86.971016	5813.326	0.1110297	0.0016611
-0.0019295	14109.078	0.000	-329289.652	C	
	0.015354331	89.068888	5800.897	0.1111405	0.0017065
-0.0019786	14107.092	0.000	-337597.896	C	
	0.015748031	91.160266	5788.677	0.1112501	0.0017520
-0.0020276	14108.605	0.000	-345891.639	C	
	0.016141732	93.245712	5776.686	0.1113584	0.0017975
-0.0020765	14109.395	0.000	-354171.728	C	
	0.016535433	95.288114	5762.662	0.1114491	0.0018429
-0.0021256	14109.727	0.000	-355000.000	C	
	0.016929134	97.237437	5743.793	0.1115010	0.0018876
-0.0021754	14109.746	0.000	-355000.000	C	
	0.017322835	99.057662	5718.329	0.1114995	0.0019315
-0.0022260	14109.595	0.000	-355000.000	CS	
	0.017716535	100.744938	5686.492	0.1114447	0.0019744
-0.0022776	14109.062	0.000	-355000.000	CS	
	0.018110236	102.290019	5648.188	0.1113340	0.0020163
-0.0023302	14107.633	0.000	-355000.000	CS	
	0.018503937	103.741856	5606.475	0.1111903	0.0020575
-0.0023835	14104.690	0.000	-355000.000	CS	
	0.018897638	105.087520	5560.881	0.1109720	0.0020971
-0.0024383	14109.963	0.000	-355000.000	CS	
	0.019291339	106.378121	5514.294	0.1107747	0.0021370
-0.0024929	14108.385	0.000	-355000.000	CS	
	0.019685039	107.604648	5466.316	0.1105632	0.0021764
-0.0025480	14103.654	0.000	-355000.000	CS	
	0.020078740	108.747565	5416.055	0.1103464	0.0022156
-0.0026033	14109.664	0.000	-355000.000	CS	
	0.020472441	109.812813	5363.934	0.1101357	0.0022547
-0.0026586	14105.780	0.000	-355000.000	CS	
	0.020866142	110.802356	5310.151	0.1099349	0.0022939
-0.0027140	14109.967	0.000	-355000.000	CS	
	0.021259843	111.704128	5254.231	0.1097009	0.0023322
-0.0027701	14106.295	0.000	-355000.000	CS	
	0.021653543	112.548974	5197.716	0.1095242	0.0023716

-0.0028253	14109.989	0.000	-355000.000	CS	
	0.023622047	115.853447	4904.463	0.1088792	0.0025719
-0.0030973	14103.918	0.000	-355000.000	CS	
	0.025590551	118.191551	4618.562	0.1083867	0.0027737
-0.0033681	14104.175	0.000	-355000.000	CS	
	0.027559055	119.954261	4352.626	0.1080511	0.0029778
-0.0036364	14099.093	0.000	-355000.000	CS	
	0.029527559	121.311172	4108.405	0.1077920	0.0031828
-0.0039038	14109.325	0.000	-355000.000	CS	
	0.031496063	122.377407	3885.483	0.1075297	0.0033868
-0.0041723	14099.707	0.000	-355000.000	CS	
	0.033464567	123.236050	3682.583	0.1073593	0.0035927
-0.0044388	14100.402	0.000	-355000.000	CS	
	0.035433071	123.932702	3497.656	0.1072231	0.0037992
-0.0047047	14103.123	0.000	-355000.000	CS	

 -
 Summary of Results for Nominal (Unfactored) Moment Capacity for Section
 Z Axis,

Load No.	Axial Thrust kN	Nominal Mom. Cap. m-kN	Max. Comp. Strain
1	0.000	121.16	0.00300000

 -
 Computations of Nominal Moment Capacity and Nonlinear Bending
 Stiffness
 Section: 1 (MP240), Y Axis,

Input Axial Thrust Forces:

Number of Axial Thrust Force Values = 1

Number	Axial Thrust Force kN
1	0.000

Axial Thrust Force = 0.000 kN ,128

Max Tens Strain	Bending Max Concrete Curvature	Bending Max Reinf Moment	Bending Max Casing Stiffness	Depth to Run N Axis	Max Comp Strain
m/m	rad/m	kN-m	kN-m ²	Msg	m/m
	kPa	kPa	kPa	m	
0.0000000	0.000000000	0.000000			0.0000000
0.0000000	0.000	0.000	0.000		
-0.0000059	0.000049213	0.392777	7981.237	0.1200000	0.0000059
-0.0000118	123.050	0.000	-990.484		
-0.0000118	0.000098425	0.785122	7976.844	0.1200000	0.0000118
-0.0000177	245.561	0.000	-1980.969		
-0.0000177	0.000147638	1.177035	7972.450	0.1200000	0.0000177
-0.0000236	367.533	0.000	-2971.453		
-0.0000236	0.000196850	1.568515	7968.057	0.1200000	0.0000236
-0.0000295	488.966	0.000	-3961.937		
-0.0000295	0.000246063	1.959563	7963.664	0.1200000	0.0000295
-0.0000354	609.861	0.000	-4952.421		
-0.0000354	0.000295276	2.350178	7959.271	0.1200000	0.0000354
-0.0000413	730.216	0.000	-5942.906		
-0.0000413	0.000344488	2.740361	7954.877	0.1200000	0.0000413
-0.0000472	850.033	0.000	-6933.390		
-0.0000472	0.000393701	3.130112	7950.484	0.1200000	0.0000472
-0.0000531	969.311	0.000	-7923.874		
-0.0000531	0.000442913	3.519430	7946.091	0.1200000	0.0000531
-0.0000591	1088.049	0.000	-8914.359		
-0.0000591	0.000492126	3.908316	7941.698	0.1200000	0.0000591
-0.0000650	1206.249	0.000	-9904.843		
-0.0000650	0.000541339	4.296769	7937.304	0.1200000	0.0000650
-0.0000709	1323.910	0.000	-10895.327		
-0.0000709	0.000590551	4.684790	7932.911	0.1200000	0.0000709
-0.0000768	1441.032	0.000	-11885.811		
-0.0000768	0.000639764	5.072378	7928.518	0.1200000	0.0000768
-0.0000827	1557.616	0.000	-12876.296		
-0.0000827	0.000688976	5.459535	7924.124	0.1200000	0.0000827
-0.0000886	1673.660	0.000	-13866.780		
-0.0000886	0.000738189	5.846258	7919.731	0.1200000	0.0000886
-0.0000945	1789.165	0.000	-14857.264		
-0.0000945	0.000787402	6.232550	7915.338	0.1200000	0.0000945
-0.0001004	1904.132	0.000	-15847.749		
-0.0001004	0.000836614	6.618408	7910.945	0.1200000	0.0001004
-0.0001063	2018.559	0.000	-16838.233		
-0.0001063	0.000885827	7.003835	7906.551	0.1200000	0.0001063
-0.0001122	2132.448	0.000	-17828.717		
-0.0001122	0.000935039	7.388829	7902.158	0.1200000	0.0001122
-0.0001182	2245.798	0.000	-18819.201		
-0.0001182	0.000984252	7.762290	7886.486	0.1199527	0.0001181
-0.0001235	2357.712	0.000	-19819.464	C	
-0.0001235	0.001033465	8.044623	7784.130	0.1195282	0.0001235

-0.0001245	2461.533	0.000	-20902.572	C	
	0.001082677	8.278337	7646.173	0.1189199	0.0001288
-0.0001311	2560.299	0.000	-22036.229	C	
	0.001131890	8.480110	7491.993	0.1182006	0.0001338
-0.0001379	2655.115	0.000	-23208.862	C	
	0.001181102	8.665598	7336.873	0.1174356	0.0001387
-0.0001448	2747.181	0.000	-24407.666	C	
	0.001230315	8.933880	7261.458	0.1170558	0.0001440
-0.0001513	2846.389	0.000	-25522.798	C	
	0.001279528	9.213916	7201.030	0.1167426	0.0001494
-0.0001577	2946.062	0.000	-26627.854	C	
	0.001328740	9.484322	7137.831	0.1163991	0.0001547
-0.0001642	3043.964	0.000	-27747.844	C	
	0.001377953	9.733706	7063.889	0.1159754	0.0001598
-0.0001709	3138.748	0.000	-28898.146	C	
	0.001427165	9.972561	6987.671	0.1155174	0.0001649
-0.0001777	3231.444	0.000	-30067.503	C	
	0.001476378	10.204795	6912.048	0.1150407	0.0001698
-0.0001845	3322.408	0.000	-31252.098	C	
	0.001525591	10.486500	6873.732	0.1148014	0.0001751
-0.0001910	3418.779	0.000	-32370.516	C	
	0.001574803	10.711213	6801.620	0.1143119	0.0001800
-0.0001979	3507.082	0.000	-33576.604	C	
	0.001624016	10.987510	6765.643	0.1140696	0.0001853
-0.0002045	3601.455	0.000	-34708.492	C	
	0.001673228	11.261859	6730.617	0.1138276	0.0001905
-0.0002111	3694.980	0.000	-35845.307	C	
	0.001722441	11.481301	6665.716	0.1133383	0.0001952
-0.0002182	3779.967	0.000	-37076.589	C	
	0.001771654	11.752765	6633.783	0.1130993	0.0002004
-0.0002248	3871.716	0.000	-38224.814	C	
	0.001820866	12.023118	6602.967	0.1128623	0.0002055
-0.0002315	3962.696	0.000	-39377.255	C	
	0.001870079	12.292569	6573.290	0.1126275	0.0002106
-0.0002382	4052.930	0.000	-40533.719	C	
	0.001919291	12.561317	6544.768	0.1123952	0.0002157
-0.0002449	4142.437	0.000	-41694.003	C	
	0.001968504	12.829555	6517.414	0.1121659	0.0002208
-0.0002516	4231.242	0.000	-42857.898	C	
	0.002066929	13.413134	6489.402	0.1119487	0.0002314
-0.0002647	4415.207	0.000	-45095.064	C	
	0.002165354	13.946275	6440.643	0.1115073	0.0002415
-0.0002782	4588.290	0.000	-47443.146	C	
	0.002263780	14.525066	6416.290	0.1113021	0.0002520
-0.0002913	4767.503	0.000	-49697.218	C	
	0.002362205	15.058066	6374.581	0.1108859	0.0002619
-0.0003050	4935.850	0.000	-52064.407	C	
	0.002460630	15.634323	6353.789	0.1106949	0.0002724
-0.0003182	5110.621	0.000	-54332.490	C	
	0.002559055	16.209478	6334.165	0.1105091	0.0002828
-0.0003314	5283.312	0.000	-56605.608	C	
	0.002657480	16.783811	6315.686	0.1103289	0.0002932
-0.0003446	5453.968	0.000	-58883.318	C	
	0.002755906	17.357587	6298.324	0.1101545	0.0003036

-0.0003578	5622.636	0.000	-61165.152	C	
	0.002854331	17.931057	6282.053	0.1099859	0.0003139
-0.0003711	5789.366	0.000	-63450.609	C	
	0.002952756	18.540134	6278.925	0.1100071	0.0003248
-0.0003838	5962.890	0.000	-65625.453	C	
	0.003051181	19.111830	6263.748	0.1098450	0.0003352
-0.0003971	6125.779	0.000	-67916.834	C	
	0.003149606	19.683767	6249.596	0.1096893	0.0003455
-0.0004104	6286.837	0.000	-70210.690	C	
	0.003248031	20.288934	6246.532	0.1097110	0.0003563
-0.0004232	6454.737	0.000	-72389.981	C	
	0.003346457	20.859804	6233.400	0.1095621	0.0003666
-0.0004365	6612.101	0.000	-74688.276	C	
	0.003444882	21.431374	6221.222	0.1094199	0.0003769
-0.0004498	6767.742	0.000	-76987.789	C	
	0.003543307	22.033030	6218.211	0.1094421	0.0003878
-0.0004626	6930.092	0.000	-79170.969	C	
	0.003641732	22.604127	6206.971	0.1093071	0.0003981
-0.0004759	7082.175	0.000	-81473.374	C	
	0.003740157	23.203868	6203.982	0.1093295	0.0004089
-0.0004887	7240.906	0.000	-83657.761	C	
	0.003838583	23.774797	6193.639	0.1092020	0.0004192
-0.0005021	7389.508	0.000	-85962.103	C	
	0.003937008	24.372707	6190.668	0.1092246	0.0004300
-0.0005149	7544.636	0.000	-88147.569	C	
	0.004035433	24.970020	6187.693	0.1092472	0.0004409
-0.0005276	7698.019	0.000	-90332.061	C	
	0.004133858	25.539893	6178.222	0.1091274	0.0004511
-0.0005410	7841.369	0.000	-92639.307	C	
	0.004232283	26.135465	6175.263	0.1091503	0.0004620
-0.0005538	7991.168	0.000	-94824.657	C	
	0.004330709	26.730438	6172.301	0.1091732	0.0004728
-0.0005666	8139.218	0.000	-97009.044	C	
	0.004429134	27.299639	6163.652	0.1090613	0.0004830
-0.0005799	8277.418	0.000	-99317.875	C	
	0.004527559	27.892950	6160.704	0.1090844	0.0004939
-0.0005927	8421.900	0.000	-101502.933	C	
	0.004625984	28.485663	6157.752	0.1091076	0.0005047
-0.0006055	8564.631	0.000	-103687.015	C	
	0.004724409	29.054519	6149.873	0.1090038	0.0005150
-0.0006189	8697.772	0.000	-105996.091	C	
	0.004822835	29.645644	6146.933	0.1090272	0.0005258
-0.0006317	8836.947	0.000	-108180.654	C	
	0.004921260	30.236170	6143.990	0.1090506	0.0005367
-0.0006444	8974.368	0.000	-110364.230	C	
	0.005019685	30.804957	6136.831	0.1089552	0.0005469
-0.0006578	9102.536	0.000	-112672.140	C	
	0.005118110	31.393960	6133.897	0.1089788	0.0005578
-0.0006706	9236.410	0.000	-114856.030	C	
	0.005216535	31.982366	6130.959	0.1090024	0.0005686
-0.0006834	9368.531	0.000	-117038.894	C	
	0.005314961	32.570174	6128.018	0.1090261	0.0005795
-0.0006961	9498.894	0.000	-119220.738	C	
	0.005413386	33.157383	6125.073	0.1090498	0.0005903

-0.0007089	9627.499	0.000	-121401.559	C	
	0.005511811	33.724585	6118.603	0.1089632	0.0006006
-0.0007223	9747.202	0.000	-123709.175	C	
	0.005610236	34.310334	6115.666	0.1089871	0.0006114
-0.0007350	9872.267	0.000	-125890.066	C	
	0.005708661	34.895481	6112.726	0.1090111	0.0006223
-0.0007478	9995.569	0.000	-128069.942	C	
	0.005807087	35.480028	6109.781	0.1090351	0.0006332
-0.0007605	10117.105	0.000	-130248.779	C	
	0.005905512	36.063972	6106.833	0.1090591	0.0006440
-0.0007733	10236.874	0.000	-132426.577	C	
	0.006299213	38.375756	6092.151	0.1090542	0.0006870
-0.0008249	10691.589	0.000	-141261.668	C	
	0.006692913	40.679697	6078.025	0.1090593	0.0007299
-0.0008764	11118.547	0.000	-150083.178	C	
	0.007086614	42.988608	6066.170	0.1091580	0.0007736
-0.0009272	11523.052	0.000	-158764.889	C	
	0.007480315	45.287721	6054.253	0.1092573	0.0008173
-0.0009780	11898.885	0.000	-167429.068	C	
	0.007874016	47.563512	6040.566	0.1092746	0.0008604
-0.0010293	12240.871	0.000	-176212.574	C	
	0.008267717	49.842439	6028.562	0.1093758	0.0009043
-0.0010800	12559.096	0.000	-184847.554	C	
	0.008661417	52.111332	6016.490	0.1094776	0.0009482
-0.0011305	12848.183	0.000	-193464.659	C	
	0.009055118	54.359224	6003.149	0.1095075	0.0009916
-0.0011816	13104.265	0.000	-202201.697	C	
	0.009448819	56.607669	5990.978	0.1096111	0.0010357
-0.0012320	13334.901	0.000	-210787.407	C	
	0.009842520	58.845845	5978.738	0.1097154	0.0010799
-0.0012823	13535.917	0.000	-219354.605	C	
	0.010236220	61.073665	5966.427	0.1098204	0.0011241
-0.0013325	13707.135	0.000	-227903.020	C	
	0.010629921	63.283061	5953.295	0.1098645	0.0011679
-0.0013833	13846.486	0.000	-236569.916	C	
	0.011023622	65.489910	5940.870	0.1099714	0.0012123
-0.0014334	13957.966	0.000	-245084.352	C	
	0.011417323	67.686148	5928.373	0.1100791	0.0012568
-0.0014833	14039.120	0.000	-253579.177	C	
	0.011811024	69.871670	5915.801	0.1101875	0.0013014
-0.0015332	14089.754	0.000	-262054.321	C	
	0.012204724	72.046375	5903.155	0.1102968	0.0013461
-0.0015830	14109.673	0.000	-270509.568	C	
	0.012598425	74.209934	5890.414	0.1104068	0.0013910
-0.0016327	14109.733	0.000	-278944.405	C	
	0.012992126	76.362167	5877.573	0.1105179	0.0014359
-0.0016822	14108.993	0.000	-287358.490	C	
	0.013385827	78.503589	5864.680	0.1106295	0.0014809
-0.0017317	14106.924	0.000	-295752.389	C	
	0.013779528	80.634829	5851.785	0.1107416	0.0015260
-0.0017811	14109.781	0.000	-304126.844	C	
	0.014173228	82.752528	5838.651	0.1108058	0.0015705
-0.0018311	14107.027	0.000	-312624.783	C	
	0.014566929	84.865745	5825.919	0.1109181	0.0016157

-0.0018803	14109.434	0.000	-320965.555	C	
	0.014960630	86.971016	5813.326	0.1110297	0.0016611
-0.0019295	14109.078	0.000	-329289.652	C	
	0.015354331	89.068888	5800.897	0.1111405	0.0017065
-0.0019786	14107.092	0.000	-337597.896	C	
	0.015748031	91.160266	5788.677	0.1112501	0.0017520
-0.0020276	14108.605	0.000	-345891.639	C	
	0.016141732	93.245712	5776.686	0.1113584	0.0017975
-0.0020765	14109.395	0.000	-354171.728	C	
	0.016535433	95.288114	5762.662	0.1114491	0.0018429
-0.0021256	14109.727	0.000	-355000.000	C	
	0.016929134	97.237437	5743.793	0.1115010	0.0018876
-0.0021754	14109.746	0.000	-355000.000	C	
	0.017322835	99.057662	5718.329	0.1114995	0.0019315
-0.0022260	14109.595	0.000	-355000.000	CS	
	0.017716535	100.744938	5686.492	0.1114447	0.0019744
-0.0022776	14109.062	0.000	-355000.000	CS	
	0.018110236	102.290019	5648.188	0.1113340	0.0020163
-0.0023302	14107.633	0.000	-355000.000	CS	
	0.018503937	103.741856	5606.475	0.1111903	0.0020575
-0.0023835	14104.690	0.000	-355000.000	CS	
	0.018897638	105.087520	5560.881	0.1109720	0.0020971
-0.0024383	14109.963	0.000	-355000.000	CS	
	0.019291339	106.378121	5514.294	0.1107747	0.0021370
-0.0024929	14108.385	0.000	-355000.000	CS	
	0.019685039	107.604648	5466.316	0.1105632	0.0021764
-0.0025480	14103.654	0.000	-355000.000	CS	
	0.020078740	108.747565	5416.055	0.1103464	0.0022156
-0.0026033	14109.664	0.000	-355000.000	CS	
	0.020472441	109.812813	5363.934	0.1101357	0.0022547
-0.0026586	14105.780	0.000	-355000.000	CS	
	0.020866142	110.802356	5310.151	0.1099349	0.0022939
-0.0027140	14109.967	0.000	-355000.000	CS	
	0.021259843	111.704128	5254.231	0.1097009	0.0023322
-0.0027701	14106.295	0.000	-355000.000	CS	
	0.021653543	112.548974	5197.716	0.1095242	0.0023716
-0.0028253	14109.989	0.000	-355000.000	CS	
	0.023622047	115.853447	4904.463	0.1088792	0.0025719
-0.0030973	14103.918	0.000	-355000.000	CS	
	0.025590551	118.191551	4618.562	0.1083867	0.0027737
-0.0033681	14104.175	0.000	-355000.000	CS	
	0.027559055	119.954261	4352.626	0.1080511	0.0029778
-0.0036364	14099.093	0.000	-355000.000	CS	
	0.029527559	121.311172	4108.405	0.1077920	0.0031828
-0.0039038	14109.325	0.000	-355000.000	CS	
	0.031496063	122.377407	3885.483	0.1075297	0.0033868
-0.0041723	14099.707	0.000	-355000.000	CS	
	0.033464567	123.236050	3682.583	0.1073593	0.0035927
-0.0044388	14100.402	0.000	-355000.000	CS	
	0.035433071	123.932702	3497.656	0.1072231	0.0037992
-0.0047047	14103.123	0.000	-355000.000	CS	

-
Summary of Results for Nominal (Unfactored) Moment Capacity for Section
Y Axis,

-

Load No.	Axial Thrust kN	Nominal Mom. Cap. m-kN	Max. Comp. Strain
----- 1	----- 0.000	----- 121.16	----- 0.00300000

* TABLE K * REDUCTION FACTORS

REDUCTION FACTORS FOR CLOSELY-SPACED PILE GROUPS
ARE NOT CONSIDERED

=====

GROUP for Windows, Version 2019.11.5

Serial Number : 292797944

Analysis of A Group of Piles
Subjected to Axial and Lateral Loading

(c) Copyright ENSOFT, Inc., 1987-2018
All Rights Reserved

=====

Time and Date of Analysis

Date: February 28, 2020 Time: 09:35:06

***** COMPUTATION RESULTS *****

New Group

***** LOAD CASES RESULTS *****

LOAD CASE : 1
CASE NAME : SLU_F1

LOAD TYPE : Dead, DL

* TABLE L * COMPUTATION ON PILE CAP

* EQUIVALENT CONCENTRATED LOAD AT ORIGIN *

VERT. LOAD, KN	HOR. LOAD Y, KN	HOR. LOAD Z, KN
1760.00	0.00000	2050.00

MOMENT X , KN- M	MOMENT Y, KN- M	MOMENT Z, KN- M
0.00000	4000.00	0.00000

* DISPLACEMENT OF GROUPED PILE FOUNDATION AT ORIGIN *

VERTICAL , M	HORIZONTAL Y, M	HORIZONTAL Z, M
4.83724E-04	2.00642E-16	0.0237289
ANGLE ROT. X,RAD	ANGLE ROT. Y,RAD	ANGLE ROT. Z,RAD
-1.25530E-14	4.67079E-03	-7.67552E-19

THE GLOBAL STRUCTURAL COORDINATE SYSTEM

* PILE TOP DISPLACEMENTS *

PILE GROUP	DISP. X, M	DISP. Y, M	DISP. Z, M	ROT. X,RAD	ROT.
Y,RAD	ROT. Z,RAD				
*****	*****	*****	*****	*****	*****
*****	*****				
1	-1.8517E-03	-6.0759E-15	0.023729	-1.2553E-14	
4.6708E-03	-7.6755E-19				
2	-1.8517E-03	-6.0759E-15	0.023729	-1.2553E-14	
4.6708E-03	-7.6755E-19				
3	-1.8517E-03	-6.0759E-15	0.023729	-1.2553E-14	
4.6708E-03	-7.6755E-19				
4	-1.8517E-03	-6.0759E-15	0.023729	-1.2553E-14	
4.6708E-03	-7.6755E-19				
5	-1.8517E-03	-6.0759E-15	0.023729	-1.2553E-14	
4.6708E-03	-7.6755E-19				
6	-1.8517E-03	-6.0759E-15	0.023729	-1.2553E-14	
4.6708E-03	-7.6755E-19				
7	-1.8517E-03	-6.0759E-15	0.023729	-1.2553E-14	
4.6708E-03	-7.6755E-19				
8	-1.8517E-03	-6.0759E-15	0.023729	-1.2553E-14	
4.6708E-03	-7.6755E-19				
9	-1.8517E-03	-6.0759E-15	0.023729	-1.2553E-14	
4.6708E-03	-7.6755E-19				
10	-1.8517E-03	-6.0759E-15	0.023729	-1.2553E-14	
4.6708E-03	-7.6755E-19				
11	2.8191E-03	6.4772E-15	0.023729	-1.2553E-14	
4.6708E-03	-7.6755E-19				
12	2.8191E-03	6.4772E-15	0.023729	-1.2553E-14	
4.6708E-03	-7.6755E-19				
13	2.8191E-03	6.4772E-15	0.023729	-1.2553E-14	
4.6708E-03	-7.6755E-19				
14	2.8191E-03	6.4772E-15	0.023729	-1.2553E-14	
4.6708E-03	-7.6755E-19				
15	2.8191E-03	6.4772E-15	0.023729	-1.2553E-14	
4.6708E-03	-7.6755E-19				
16	2.8191E-03	6.4772E-15	0.023729	-1.2553E-14	

4.6708E-03 -7.6755E-19
 17 2.8191E-03 6.4772E-15 0.023729 -1.2553E-14
 4.6708E-03 -7.6755E-19
 18 2.8191E-03 6.4772E-15 0.023729 -1.2553E-14
 4.6708E-03 -7.6755E-19
 19 2.8191E-03 6.4772E-15 0.023729 -1.2553E-14
 4.6708E-03 -7.6755E-19
 20 2.8191E-03 6.4772E-15 0.023729 -1.2553E-14
 4.6708E-03 -7.6755E-19

MINIMUM -1.8517E-03 -6.0759E-15 0.023729 -1.2553E-14
 4.6708E-03 -7.6755E-19
 Pile N. 1 1 1 1 1
 1
 MAXIMUM 2.8191E-03 6.4772E-15 0.023729 -1.2553E-14
 4.6708E-03 -7.6755E-19
 Pile N. 11 11 1 1 1
 1

* PILE TOP REACTIONS *

PILE GROUP	FOR. X, KN	FOR. Y, KN	FOR. Z, KN	MOM X, KN- M	MOM Y, KN- M
MOM Z, KN- M					
*****	*****	*****	*****	*****	*****
*****	*****	*****	*****	*****	*****
1	-494.47	-3.9244E-11	107.53	-1.7264E-11	
-90.679	-4.1477E-11				
2	-494.47	-3.9244E-11	107.53	-1.7264E-11	
-90.679	-4.1477E-11				
3	-494.47	-3.9244E-11	107.53	-1.7264E-11	
-90.679	-4.1477E-11				
4	-494.47	-3.9244E-11	107.53	-1.7264E-11	
-90.679	-4.1477E-11				
5	-494.47	-3.9244E-11	107.53	-1.7264E-11	
-90.679	-4.1477E-11				
6	-494.47	-3.9244E-11	107.53	-1.7264E-11	
-90.679	-4.1477E-11				
7	-494.47	-3.9244E-11	107.53	-1.7264E-11	
-90.679	-4.1477E-11				
8	-494.47	-3.9244E-11	107.53	-1.7264E-11	
-90.679	-4.1477E-11				
9	-494.47	-3.9244E-11	107.53	-1.7264E-11	
-90.679	-4.1477E-11				
10	-494.47	-3.9244E-11	107.53	-1.7264E-11	
-90.679	-4.1477E-11				
11	670.47	3.9245E-11	97.468	-1.7264E-11	
-91.794	4.4083E-11				
12	670.47	3.9245E-11	97.468	-1.7264E-11	
-91.794	4.4083E-11				
13	670.47	3.9245E-11	97.468	-1.7264E-11	
-91.794	4.4083E-11				
14	670.47	3.9245E-11	97.468	-1.7264E-11	
-91.794	4.4083E-11				
15	670.47	3.9245E-11	97.468	-1.7264E-11	

-91.794	4.4083E-11					
	16	670.47	3.9245E-11	97.468	-1.7264E-11	
-91.794	4.4083E-11					
	17	670.47	3.9245E-11	97.468	-1.7264E-11	
-91.794	4.4083E-11					
	18	670.47	3.9245E-11	97.468	-1.7264E-11	
-91.794	4.4083E-11					
	19	670.47	3.9245E-11	97.468	-1.7264E-11	
-91.794	4.4083E-11					
	20	670.47	3.9245E-11	97.468	-1.7264E-11	
-91.794	4.4083E-11					
	MINIMUM	-494.47	-3.9244E-11	97.468	-1.7264E-11	
-91.794	-4.1477E-11					
	Pile N.	1	1	11	1	11
	1					
	MAXIMUM	670.47	3.9245E-11	107.53	-1.7264E-11	
-90.679	4.4083E-11					
	Pile N.	11	11	1	11	1
	11					

THE PILE COORDINATE SYSTEM (LOCAL AXES)

* PILE TOP DISPLACEMENTS *

PILE GROUP	DISP. x, M	DISP. y, M	DISP. z, M	ROT. x,RAD	ROT.
y,RAD	ROT. z,RAD				
*****	*****	*****	*****	*****	*****
*****	*****				
1	-1.8517E-03	-6.0758E-15	0.023729	-1.2553E-14	
4.6708E-03	-7.6755E-19				
2	-1.8517E-03	-6.0758E-15	0.023729	-1.2553E-14	
4.6708E-03	-7.6755E-19				
3	-1.8517E-03	-6.0758E-15	0.023729	-1.2553E-14	
4.6708E-03	-7.6755E-19				
4	-1.8517E-03	-6.0758E-15	0.023729	-1.2553E-14	
4.6708E-03	-7.6755E-19				
5	-1.8517E-03	-6.0758E-15	0.023729	-1.2553E-14	
4.6708E-03	-7.6755E-19				
6	-1.8517E-03	-6.0758E-15	0.023729	-1.2553E-14	
4.6708E-03	-7.6755E-19				
7	-1.8517E-03	-6.0758E-15	0.023729	-1.2553E-14	
4.6708E-03	-7.6755E-19				
8	-1.8517E-03	-6.0758E-15	0.023729	-1.2553E-14	
4.6708E-03	-7.6755E-19				
9	-1.8517E-03	-6.0758E-15	0.023729	-1.2553E-14	
4.6708E-03	-7.6755E-19				
10	-1.8517E-03	-6.0758E-15	0.023729	-1.2553E-14	
4.6708E-03	-7.6755E-19				
11	2.8191E-03	6.4770E-15	0.023729	-1.2553E-14	
4.6708E-03	-7.6755E-19				
12	2.8191E-03	6.4770E-15	0.023729	-1.2553E-14	

4.6708E-03	-7.6755E-19				
13	2.8191E-03	6.4770E-15	0.023729	-1.2553E-14	
4.6708E-03	-7.6755E-19				
14	2.8191E-03	6.4770E-15	0.023729	-1.2553E-14	
4.6708E-03	-7.6755E-19				
15	2.8191E-03	6.4770E-15	0.023729	-1.2553E-14	
4.6708E-03	-7.6755E-19				
16	2.8191E-03	6.4770E-15	0.023729	-1.2553E-14	
4.6708E-03	-7.6755E-19				
17	2.8191E-03	6.4770E-15	0.023729	-1.2553E-14	
4.6708E-03	-7.6755E-19				
18	2.8191E-03	6.4770E-15	0.023729	-1.2553E-14	
4.6708E-03	-7.6755E-19				
19	2.8191E-03	6.4770E-15	0.023729	-1.2553E-14	
4.6708E-03	-7.6755E-19				
20	2.8191E-03	6.4770E-15	0.023729	-1.2553E-14	

	MINIMUM	-1.8517E-03	-6.0758E-15	0.023729	-1.2553E-14	
4.6708E-03	-7.6755E-19					
	Pile N.	1	1	1	1	1
	1					
	MAXIMUM	2.8191E-03	6.4770E-15	0.023729	-1.2553E-14	
4.6708E-03	-7.6755E-19					
	Pile N.	11	11	1	1	1
	1					

* PILE TOP REACTIONS *

PILE GROUP	AXIAL, KN	LAT. y, KN	LAT. z, KN	MOM x, KN- M	MOM y, KN- M
MOM z, KN- M					
*****	*****	*****	*****	*****	*****
*****	*****	*****	*****	*****	*****
1	-494.47	-3.9213E-11	107.53	-1.7270E-11	
-90.679	-4.1477E-11				
2	-494.47	-3.9213E-11	107.53	-1.7270E-11	
-90.679	-4.1477E-11				
3	-494.47	-3.9213E-11	107.53	-1.7270E-11	
-90.679	-4.1477E-11				
4	-494.47	-3.9213E-11	107.53	-1.7270E-11	
-90.679	-4.1477E-11				
5	-494.47	-3.9213E-11	107.53	-1.7270E-11	
-90.679	-4.1477E-11				
6	-494.47	-3.9213E-11	107.53	-1.7270E-11	
-90.679	-4.1477E-11				
7	-494.47	-3.9213E-11	107.53	-1.7270E-11	
-90.679	-4.1477E-11				
8	-494.47	-3.9213E-11	107.53	-1.7270E-11	
-90.679	-4.1477E-11				
9	-494.47	-3.9213E-11	107.53	-1.7270E-11	
-90.679	-4.1477E-11				
10	-494.47	-3.9213E-11	107.53	-1.7270E-11	
-90.679	-4.1477E-11				
11	670.47	3.9204E-11	97.468	-1.7270E-11	

-91.794	4.4083E-11					
	12	670.47	3.9204E-11	97.468	-1.7270E-11	
-91.794	4.4083E-11					
	13	670.47	3.9204E-11	97.468	-1.7270E-11	
-91.794	4.4083E-11					
	14	670.47	3.9204E-11	97.468	-1.7270E-11	
-91.794	4.4083E-11					
	15	670.47	3.9204E-11	97.468	-1.7270E-11	
-91.794	4.4083E-11					
	16	670.47	3.9204E-11	97.468	-1.7270E-11	
-91.794	4.4083E-11					
	17	670.47	3.9204E-11	97.468	-1.7270E-11	
-91.794	4.4083E-11					
	18	670.47	3.9204E-11	97.468	-1.7270E-11	
-91.794	4.4083E-11					
	19	670.47	3.9204E-11	97.468	-1.7270E-11	
-91.794	4.4083E-11					
	20	670.47	3.9204E-11	97.468	-1.7270E-11	
-91.794	4.4083E-11					
	MINIMUM	-494.47	-3.9213E-11	97.468	-1.7270E-11	
-91.794	-4.1477E-11					
	Pile N.	1	1	11	1	11
	1					
	MAXIMUM	670.47	3.9204E-11	107.53	-1.7270E-11	
-90.679	4.4083E-11					
	Pile N.	11	11	1	1	1
	11					

PILE GROUP STRESS, KN/ M**2
***** *****

1	1.0930E+04
2	1.0930E+04
3	1.0930E+04
4	1.0930E+04
5	1.0930E+04
6	1.0930E+04
7	1.0930E+04
8	1.0930E+04
9	1.0930E+04
10	1.0930E+04
11	1.4821E+04
12	1.4821E+04
13	1.4821E+04
14	1.4821E+04
15	1.4821E+04
16	1.4821E+04
17	1.4821E+04
18	1.4821E+04
19	1.4821E+04
20	1.4821E+04

MINIMUM	1.0930E+04
Pile N.	1

MAXIMUM 1.4821E+04
 Pile N. 11

* EFFECTS FOR Laterally LOADED PILE *

* MINIMUM VALUES AND LOCATIONS *

PILE SHEAR z-DIR	DISPL. SOIL REACT		DISPL. SOIL REACT		MOMENT TOTAL		MOMENT FLEX. RIG.		SHEAR FLEX. RIG.		KN
	y-DIR	z-DIR	y-DIR	z-DIR	z-DIR	z-DIR	y-DIR	y-DIR	y-DIR	y-DIR	
	M	M	M	M	KN- M	KN- M	KN- M	KN- M	KN	KN	
	KN/ M	KN/ M	KN/ M	M**2	KN- M**2	KN- M**2	KN- M**2	KN- M**2	KN	KN	
1	-6.0758E-15	-1.0545E-04	-1.0545E-04	-1.4367E-11	-90.679	-3.8935E-11	-3.8935E-11	-3.8935E-11			
-31.977	-3.1753E-11	-40.424	-40.424	1.0930E+04	7981.2	5796.9	5796.9				
x(M)	0.0000	3.4875	3.4875	2.2500	0.0000	0.0000	0.0000				
3.1500	2.0250	3.7125	3.7125	0.0000	0.1125	0.0000	0.0000				
2	-6.0758E-15	-1.0545E-04	-1.0545E-04	-1.4367E-11	-90.679	-3.8935E-11	-3.8935E-11				
-31.977	-3.1753E-11	-40.424	-40.424	1.0930E+04	7981.2	5796.9	5796.9				
x(M)	0.0000	3.4875	3.4875	2.2500	0.0000	0.0000	0.0000				
3.1500	2.0250	3.7125	3.7125	0.0000	0.1125	0.0000	0.0000				
3	-6.0758E-15	-1.0545E-04	-1.0545E-04	-1.4367E-11	-90.679	-3.8935E-11	-3.8935E-11				
-31.977	-3.1753E-11	-40.424	-40.424	1.0930E+04	7981.2	5796.9	5796.9				
x(M)	0.0000	3.4875	3.4875	2.2500	0.0000	0.0000	0.0000				
3.1500	2.0250	3.7125	3.7125	0.0000	0.1125	0.0000	0.0000				
4	-6.0758E-15	-1.0545E-04	-1.0545E-04	-1.4367E-11	-90.679	-3.8935E-11	-3.8935E-11				
-31.977	-3.1753E-11	-40.424	-40.424	1.0930E+04	7981.2	5796.9	5796.9				
x(M)	0.0000	3.4875	3.4875	2.2500	0.0000	0.0000	0.0000				
3.1500	2.0250	3.7125	3.7125	0.0000	0.1125	0.0000	0.0000				
5	-6.0758E-15	-1.0545E-04	-1.0545E-04	-1.4367E-11	-90.679	-3.8935E-11	-3.8935E-11				
-31.977	-3.1753E-11	-40.424	-40.424	1.0930E+04	7981.2	5796.9	5796.9				
x(M)	0.0000	3.4875	3.4875	2.2500	0.0000	0.0000	0.0000				
3.1500	2.0250	3.7125	3.7125	0.0000	0.1125	0.0000	0.0000				
6	-6.0758E-15	-1.0545E-04	-1.0545E-04	-1.4367E-11	-90.679	-3.8935E-11	-3.8935E-11				
-31.977	-3.1753E-11	-40.424	-40.424	1.0930E+04	7981.2	5796.9	5796.9				
x(M)	0.0000	3.4875	3.4875	2.2500	0.0000	0.0000	0.0000				
3.1500	2.0250	3.7125	3.7125	0.0000	0.1125	0.0000	0.0000				
7	-6.0758E-15	-1.0545E-04	-1.0545E-04	-1.4367E-11	-90.679	-3.8935E-11	-3.8935E-11				
-31.977	-3.1753E-11	-40.424	-40.424	1.0930E+04	7981.2	5796.9	5796.9				
x(M)	0.0000	3.4875	3.4875	2.2500	0.0000	0.0000	0.0000				
3.1500	2.0250	3.7125	3.7125	0.0000	0.1125	0.0000	0.0000				
8	-6.0758E-15	-1.0545E-04	-1.0545E-04	-1.4367E-11	-90.679	-3.8935E-11	-3.8935E-11				
-31.977	-3.1753E-11	-40.424	-40.424	1.0930E+04	7981.2	5796.9	5796.9				
x(M)	0.0000	3.4875	3.4875	2.2500	0.0000	0.0000	0.0000				
3.1500	2.0250	3.7125	3.7125	0.0000	0.1125	0.0000	0.0000				
9	-6.0758E-15	-1.0545E-04	-1.0545E-04	-1.4367E-11	-90.679	-3.8935E-11	-3.8935E-11				
-31.977	-3.1753E-11	-40.424	-40.424	1.0930E+04	7981.2	5796.9	5796.9				
x(M)	0.0000	3.4875	3.4875	2.2500	0.0000	0.0000	0.0000				
3.1500	2.0250	3.7125	3.7125	0.0000	0.1125	0.0000	0.0000				
10	-6.0758E-15	-1.0545E-04	-1.0545E-04	-1.4367E-11	-90.679	-3.8935E-11	-3.8935E-11				
-31.977	-3.1753E-11	-40.424	-40.424	1.0930E+04	7981.2	5796.9	5796.9				
x(M)	0.0000	3.4875	3.4875	2.2500	0.0000	0.0000	0.0000				

3.1500	2.0250	3.7125	0.0000	0.1125	0.0000	
11	-3.5402E-17	-1.3371E-04	-4.4083E-11	-91.794	-1.2562E-11	
-35.794	-1.6135E-11	-45.014	1.4821E+04	7981.2	5786.4	
x(M)	3.7125	3.4875	0.0000	0.0000	3.2625	
3.0375	3.8250	3.7125	0.0000	0.0000	0.0000	
12	-3.5402E-17	-1.3371E-04	-4.4083E-11	-91.794	-1.2562E-11	
-35.794	-1.6135E-11	-45.014	1.4821E+04	7981.2	5786.4	
x(M)	3.7125	3.4875	0.0000	0.0000	3.2625	
3.0375	3.8250	3.7125	0.0000	0.2250	0.0000	
13	-3.5402E-17	-1.3371E-04	-4.4083E-11	-91.794	-1.2562E-11	
-35.794	-1.6135E-11	-45.014	1.4821E+04	7981.2	5786.4	
x(M)	3.7125	3.4875	0.0000	0.0000	3.2625	
3.0375	3.8250	3.7125	0.0000	0.5625	0.0000	
14	-3.5402E-17	-1.3371E-04	-4.4083E-11	-91.794	-1.2562E-11	
-35.794	-1.6135E-11	-45.014	1.4821E+04	7981.2	5786.4	
x(M)	3.7125	3.4875	0.0000	0.0000	3.2625	
3.0375	3.8250	3.7125	0.0000	0.1125	0.0000	
15	-3.5402E-17	-1.3371E-04	-4.4083E-11	-91.794	-1.2562E-11	
-35.794	-1.6135E-11	-45.014	1.4821E+04	7981.2	5786.4	
x(M)	3.7125	3.4875	0.0000	0.0000	3.2625	
3.0375	3.8250	3.7125	0.0000	0.3375	0.0000	
16	-3.5402E-17	-1.3371E-04	-4.4083E-11	-91.794	-1.2562E-11	
-35.794	-1.6135E-11	-45.014	1.4821E+04	7981.2	5786.4	
x(M)	3.7125	3.4875	0.0000	0.0000	3.2625	
3.0375	3.8250	3.7125	0.0000	0.3375	0.0000	
17	-3.5402E-17	-1.3371E-04	-4.4083E-11	-91.794	-1.2562E-11	
-35.794	-1.6135E-11	-45.014	1.4821E+04	7981.2	5786.4	
x(M)	3.7125	3.4875	0.0000	0.0000	3.2625	
3.0375	3.8250	3.7125	0.0000	0.0000	0.0000	
18	-3.5402E-17	-1.3371E-04	-4.4083E-11	-91.794	-1.2562E-11	
-35.794	-1.6135E-11	-45.014	1.4821E+04	7981.2	5786.4	
x(M)	3.7125	3.4875	0.0000	0.0000	3.2625	
3.0375	3.8250	3.7125	0.0000	0.0000	0.0000	
19	-3.5402E-17	-1.3371E-04	-4.4083E-11	-91.794	-1.2562E-11	
-35.794	-1.6135E-11	-45.014	1.4821E+04	7981.2	5786.4	
x(M)	3.7125	3.4875	0.0000	0.0000	3.2625	
3.0375	3.8250	3.7125	0.0000	0.2250	0.0000	
20	-3.5402E-17	-1.3371E-04	-4.4083E-11	-91.794	-1.2562E-11	
-35.794	-1.6135E-11	-45.014	1.4821E+04	7981.2	5786.4	
x(M)	3.7125	3.4875	0.0000	0.0000	3.2625	
3.0375	3.8250	3.7125	0.0000	1.8000	0.0000	
Min.	-6.0758E-15	-1.3371E-04	-4.4083E-11	-91.794	-3.8935E-11	
-35.794	-3.1753E-11	-45.014	1.0930E+04	7981.2	5786.4	
Pile N.	1	11	11	11	1	11
	1	11	1	1	11	

* MAXIMUM VALUES AND LOCATIONS *

PILE SHEAR z-DIR	DISPL. SOIL y-DIR M	DISPL. SOIL z-DIR M	MOMENT TOTAL z-DIR KN- M	MOMENT FLEX. RIG. y-DIR KN- M	SHEAR FLEX. RIG. y-DIR KN	
						KN

	KN/ M	KN/ M	KN/ M**2	KN- M**2	KN- M**2	KN- M**2
*****	*****	*****	*****	*****	*****	*****
*****	*****	*****	*****	*****	*****	*****
1	2.9014E-17	0.023729	4.1477E-11	43.593	1.1062E-11	
106.57	1.4254E-11	88.761	1.0930E+04	7981.2	7981.2	
x(M)	3.7125	0.0000	0.0000	2.0250	3.3750	
0.0000	3.9375	1.9125	0.0000	2.0250	5.8500	
2	2.9014E-17	0.023729	4.1477E-11	43.593	1.1062E-11	
106.57	1.4254E-11	88.761	1.0930E+04	7981.2	7981.2	
x(M)	3.7125	0.0000	0.0000	2.0250	3.3750	
0.0000	3.9375	1.9125	0.0000	2.0250	6.0750	
3	2.9014E-17	0.023729	4.1477E-11	43.593	1.1062E-11	
106.57	1.4254E-11	88.761	1.0930E+04	7981.2	7981.2	
x(M)	3.7125	0.0000	0.0000	2.0250	3.3750	
0.0000	3.9375	1.9125	0.0000	2.0250	5.4000	
4	2.9014E-17	0.023729	4.1477E-11	43.593	1.1062E-11	
106.57	1.4254E-11	88.761	1.0930E+04	7981.2	7981.2	
x(M)	3.7125	0.0000	0.0000	2.0250	3.3750	
0.0000	3.9375	1.9125	0.0000	2.0250	5.0625	
5	2.9014E-17	0.023729	4.1477E-11	43.593	1.1062E-11	
106.57	1.4254E-11	88.761	1.0930E+04	7981.2	7981.2	
x(M)	3.7125	0.0000	0.0000	2.0250	3.3750	
0.0000	3.9375	1.9125	0.0000	2.0250	5.4000	
6	2.9014E-17	0.023729	4.1477E-11	43.593	1.1062E-11	
106.57	1.4254E-11	88.761	1.0930E+04	7981.2	7981.2	
x(M)	3.7125	0.0000	0.0000	2.0250	3.3750	
0.0000	3.9375	1.9125	0.0000	2.0250	5.6250	
7	2.9014E-17	0.023729	4.1477E-11	43.593	1.1062E-11	
106.57	1.4254E-11	88.761	1.0930E+04	7981.2	7981.2	
x(M)	3.7125	0.0000	0.0000	2.0250	3.3750	
0.0000	3.9375	1.9125	0.0000	2.0250	5.8500	
8	2.9014E-17	0.023729	4.1477E-11	43.593	1.1062E-11	
106.57	1.4254E-11	88.761	1.0930E+04	7981.2	7981.2	
x(M)	3.7125	0.0000	0.0000	2.0250	3.3750	
0.0000	3.9375	1.9125	0.0000	2.0250	5.5125	
9	2.9014E-17	0.023729	4.1477E-11	43.593	1.1062E-11	
106.57	1.4254E-11	88.761	1.0930E+04	7981.2	7981.2	
x(M)	3.7125	0.0000	0.0000	2.0250	3.3750	
0.0000	3.9375	1.9125	0.0000	2.0250	5.2875	
10	2.9014E-17	0.023729	4.1477E-11	43.593	1.1062E-11	
106.57	1.4254E-11	88.761	1.0930E+04	7981.2	7981.2	
x(M)	3.7125	0.0000	0.0000	2.0250	3.3750	
0.0000	3.9375	1.9125	0.0000	2.0250	5.2875	
11	6.4770E-15	0.023729	1.5845E-11	45.540	3.9269E-11	
97.543	3.4279E-11	88.149	1.4821E+04	7981.2	7981.2	
x(M)	0.0000	0.0000	2.2500	2.0250	0.0000	
0.0000	1.9125	1.9125	0.0000	0.2250	5.1750	
12	6.4770E-15	0.023729	1.5845E-11	45.540	3.9269E-11	
97.543	3.4279E-11	88.149	1.4821E+04	7981.2	7981.2	
x(M)	0.0000	0.0000	2.2500	2.0250	0.0000	
0.0000	1.9125	1.9125	0.0000	0.6750	4.9500	
13	6.4770E-15	0.023729	1.5845E-11	45.540	3.9269E-11	
97.543	3.4279E-11	88.149	1.4821E+04	7981.2	7981.2	
x(M)	0.0000	0.0000	2.2500	2.0250	0.0000	

0.0000	1.9125	1.9125	0.0000	0.2250	6.4125
14	6.4770E-15	0.023729	1.5845E-11	45.540	3.9269E-11
97.543	3.4279E-11	88.149	1.4821E+04	7981.2	7981.2
x(M)	0.0000	0.0000	2.2500	2.0250	0.0000
0.0000	1.9125	1.9125	0.0000	0.0000	4.9500
15	6.4770E-15	0.023729	1.5845E-11	45.540	3.9269E-11
97.543	3.4279E-11	88.149	1.4821E+04	7981.2	7981.2
x(M)	0.0000	0.0000	2.2500	2.0250	0.0000
0.0000	1.9125	1.9125	0.0000	1.8000	5.9625
16	6.4770E-15	0.023729	1.5845E-11	45.540	3.9269E-11
97.543	3.4279E-11	88.149	1.4821E+04	7981.2	7981.2
x(M)	0.0000	0.0000	2.2500	2.0250	0.0000
0.0000	1.9125	1.9125	0.0000	1.8000	4.9500
17	6.4770E-15	0.023729	1.5845E-11	45.540	3.9269E-11
97.543	3.4279E-11	88.149	1.4821E+04	7981.2	7981.2
x(M)	0.0000	0.0000	2.2500	2.0250	0.0000
0.0000	1.9125	1.9125	0.0000	0.2250	6.5250
18	6.4770E-15	0.023729	1.5845E-11	45.540	3.9269E-11
97.543	3.4279E-11	88.149	1.4821E+04	7981.2	7981.2
x(M)	0.0000	0.0000	2.2500	2.0250	0.0000
0.0000	1.9125	1.9125	0.0000	0.2250	4.9500
19	6.4770E-15	0.023729	1.5845E-11	45.540	3.9269E-11
97.543	3.4279E-11	88.149	1.4821E+04	7981.2	7981.2
x(M)	0.0000	0.0000	2.2500	2.0250	0.0000
0.0000	1.9125	1.9125	0.0000	0.0000	6.1875
20	6.4770E-15	0.023729	1.5845E-11	45.540	3.9269E-11
97.543	3.4279E-11	88.149	1.4821E+04	7981.2	7981.2
x(M)	0.0000	0.0000	2.2500	2.0250	0.0000
0.0000	1.9125	1.9125	0.0000	0.5625	4.9500
Max.	6.4770E-15	0.023729	4.1477E-11	45.540	3.9269E-11
106.57	3.4279E-11	88.761	1.4821E+04	7981.2	7981.2
Pile N.	11	1	1	11	11
11	1	11	1	1	1

1

LOAD CASE : 2
CASE NAME : SLU_F2

LOAD TYPE : Dead, DL

* TABLE L * COMPUTATION ON PILE CAP

* EQUIVALENT CONCENTRATED LOAD AT ORIGIN *

VERT. LOAD, KN	HOR. LOAD Y, KN	HOR. LOAD Z, KN
2280.00	0.00000	2050.00
MOMENT X , KN- M	MOMENT Y, KN- M	MOMENT Z, KN- M

0.00000

3920.00

0.00000

* DISPLACEMENT OF GROUPED PILE FOUNDATION AT ORIGIN *

VERTICAL , M	HORIZONTAL Y, M	HORIZONTAL Z, M
6.04635E-04	-3.60225E-18	0.0237712
ANGLE ROT. X,RAD	ANGLE ROT. Y,RAD	ANGLE ROT. Z,RAD
1.57094E-16	4.64592E-03	4.88789E-20

THE GLOBAL STRUCTURAL COORDINATE SYSTEM

* PILE TOP DISPLACEMENTS *

PILE GROUP	DISP. X, M	DISP. Y, M	DISP. Z, M	ROT. X,RAD	ROT.
Y,RAD	ROT. Z,RAD				
*****	*****	*****	*****	*****	*****
*****	*****				
1	-1.7183E-03	7.4945E-17	0.023771	1.5709E-16	
4.6459E-03	4.8879E-20				
2	-1.7183E-03	7.4945E-17	0.023771	1.5709E-16	
4.6459E-03	4.8879E-20				
3	-1.7183E-03	7.4945E-17	0.023771	1.5709E-16	
4.6459E-03	4.8879E-20				
4	-1.7183E-03	7.4945E-17	0.023771	1.5709E-16	
4.6459E-03	4.8879E-20				
5	-1.7183E-03	7.4945E-17	0.023771	1.5709E-16	
4.6459E-03	4.8879E-20				
6	-1.7183E-03	7.4945E-17	0.023771	1.5709E-16	
4.6459E-03	4.8879E-20				
7	-1.7183E-03	7.4945E-17	0.023771	1.5709E-16	
4.6459E-03	4.8879E-20				
8	-1.7183E-03	7.4945E-17	0.023771	1.5709E-16	
4.6459E-03	4.8879E-20				
9	-1.7183E-03	7.4945E-17	0.023771	1.5709E-16	
4.6459E-03	4.8879E-20				
10	-1.7183E-03	7.4945E-17	0.023771	1.5709E-16	
4.6459E-03	4.8879E-20				
11	2.9276E-03	-8.2149E-17	0.023771	1.5709E-16	
4.6459E-03	4.8879E-20				
12	2.9276E-03	-8.2149E-17	0.023771	1.5709E-16	
4.6459E-03	4.8879E-20				
13	2.9276E-03	-8.2149E-17	0.023771	1.5709E-16	
4.6459E-03	4.8879E-20				
14	2.9276E-03	-8.2149E-17	0.023771	1.5709E-16	
4.6459E-03	4.8879E-20				
15	2.9276E-03	-8.2149E-17	0.023771	1.5709E-16	
4.6459E-03	4.8879E-20				
16	2.9276E-03	-8.2149E-17	0.023771	1.5709E-16	
4.6459E-03	4.8879E-20				

17	2.9276E-03	-8.2149E-17	0.023771	1.5709E-16	
4.6459E-03	4.8879E-20				
18	2.9276E-03	-8.2149E-17	0.023771	1.5709E-16	
4.6459E-03	4.8879E-20				
19	2.9276E-03	-8.2149E-17	0.023771	1.5709E-16	
4.6459E-03	4.8879E-20				
20	2.9276E-03	-8.2149E-17	0.023771	1.5709E-16	
4.6459E-03	4.8879E-20				

MINIMUM	-1.7183E-03	-8.2149E-17	0.023771	1.5709E-16	
4.6459E-03	4.8879E-20				
Pile N.	1	11	1	1	1
1					
MAXIMUM	2.9276E-03	7.4945E-17	0.023771	1.5709E-16	
4.6459E-03	4.8879E-20				
Pile N.	11	1	1	1	1
1					

* PILE TOP REACTIONS *

PILE GROUP	FOR. X, KN	FOR. Y, KN	FOR. Z, KN	MOM X, KN- M	MOM Y, KN- M
MOM Z, KN- M					
*****	*****	*****	*****	*****	*****
*****	*****	*****	*****	*****	*****
1	-461.24	4.5501E-13	107.48	2.2209E-13	
-91.072	5.1239E-13				
2	-461.24	4.5501E-13	107.48	2.2209E-13	
-91.072	5.1239E-13				
3	-461.24	4.5501E-13	107.48	2.2209E-13	
-91.072	5.1239E-13				
4	-461.24	4.5501E-13	107.48	2.2209E-13	
-91.072	5.1239E-13				
5	-461.24	4.5501E-13	107.48	2.2209E-13	
-91.072	5.1239E-13				
6	-461.24	4.5501E-13	107.48	2.2209E-13	
-91.072	5.1239E-13				
7	-461.24	4.5501E-13	107.48	2.2209E-13	
-91.072	5.1239E-13				
8	-461.24	4.5501E-13	107.48	2.2209E-13	
-91.072	5.1239E-13				
9	-461.24	4.5501E-13	107.48	2.2209E-13	
-91.072	5.1239E-13				
10	-461.24	4.5501E-13	107.48	2.2209E-13	
-91.072	5.1239E-13				
11	689.24	-4.5471E-13	97.519	2.2216E-13	
-92.169	-5.5948E-13				
12	689.24	-4.5471E-13	97.519	2.2216E-13	
-92.169	-5.5948E-13				
13	689.24	-4.5471E-13	97.519	2.2216E-13	
-92.169	-5.5948E-13				
14	689.24	-4.5471E-13	97.519	2.2216E-13	
-92.169	-5.5948E-13				
15	689.24	-4.5471E-13	97.519	2.2216E-13	
-92.169	-5.5948E-13				

-92.169	16	689.24	-4.5471E-13	97.519	2.2216E-13		
	-5.5948E-13						
-92.169	17	689.24	-4.5471E-13	97.519	2.2216E-13		
	-5.5948E-13						
-92.169	18	689.24	-4.5471E-13	97.519	2.2216E-13		
	-5.5948E-13						
-92.169	19	689.24	-4.5471E-13	97.519	2.2216E-13		
	-5.5948E-13						
-92.169	20	689.24	-4.5471E-13	97.519	2.2216E-13		
	-5.5948E-13						
-92.169	MINIMUM	-461.24	-4.5471E-13	97.519	2.2209E-13		
	-5.5948E-13						
	Pile N.	1	11	11	1		11
	11						
-91.072	MAXIMUM	689.24	4.5501E-13	107.48	2.2216E-13		
	5.1239E-13						
	Pile N.	11	1	1	11		1
	1						

THE PILE COORDINATE SYSTEM (LOCAL AXES)

* PILE TOP DISPLACEMENTS *

PILE GROUP	DISP. x, M	DISP. y, M	DISP. z, M	ROT. x,RAD	ROT.
y,RAD	ROT. z,RAD				
*****	*****	*****	*****	*****	*****
1	-1.7183E-03	7.5050E-17	0.023771	1.5738E-16	
4.6459E-03	4.8879E-20				
2	-1.7183E-03	7.5050E-17	0.023771	1.5738E-16	
4.6459E-03	4.8879E-20				
3	-1.7183E-03	7.5050E-17	0.023771	1.5738E-16	
4.6459E-03	4.8879E-20				
4	-1.7183E-03	7.5050E-17	0.023771	1.5738E-16	
4.6459E-03	4.8879E-20				
5	-1.7183E-03	7.5050E-17	0.023771	1.5738E-16	
4.6459E-03	4.8879E-20				
6	-1.7183E-03	7.5050E-17	0.023771	1.5738E-16	
4.6459E-03	4.8879E-20				
7	-1.7183E-03	7.5050E-17	0.023771	1.5738E-16	
4.6459E-03	4.8879E-20				
8	-1.7183E-03	7.5050E-17	0.023771	1.5738E-16	
4.6459E-03	4.8879E-20				
9	-1.7183E-03	7.5050E-17	0.023771	1.5738E-16	
4.6459E-03	4.8879E-20				
10	-1.7183E-03	7.5050E-17	0.023771	1.5738E-16	
4.6459E-03	4.8879E-20				
11	2.9276E-03	-8.2328E-17	0.023771	1.5738E-16	
4.6459E-03	4.8879E-20				
12	2.9276E-03	-8.2328E-17	0.023771	1.5738E-16	
4.6459E-03	4.8879E-20				

13	2.9276E-03	-8.2328E-17	0.023771	1.5738E-16
4.6459E-03	4.8879E-20			
14	2.9276E-03	-8.2328E-17	0.023771	1.5738E-16
4.6459E-03	4.8879E-20			
15	2.9276E-03	-8.2328E-17	0.023771	1.5738E-16
4.6459E-03	4.8879E-20			
16	2.9276E-03	-8.2328E-17	0.023771	1.5738E-16
4.6459E-03	4.8879E-20			
17	2.9276E-03	-8.2328E-17	0.023771	1.5738E-16
4.6459E-03	4.8879E-20			
18	2.9276E-03	-8.2328E-17	0.023771	1.5738E-16
4.6459E-03	4.8879E-20			
19	2.9276E-03	-8.2328E-17	0.023771	1.5738E-16
4.6459E-03	4.8879E-20			
20	2.9276E-03	-8.2328E-17	0.023771	1.5738E-16
4.6459E-03	4.8879E-20			

MINIMUM	-1.7183E-03	-8.2328E-17	0.023771	1.5738E-16
4.6459E-03	4.8879E-20			

Pile N.	1	11	1	1	1
1					

MAXIMUM	2.9276E-03	7.5050E-17	0.023771	1.5738E-16
4.6459E-03	4.8879E-20			

Pile N.	11	1	1	1	1
1					

* PILE TOP REACTIONS *

PILE GROUP	AXIAL, KN	LAT. y, KN	LAT. z, KN	MOM x, KN- M	MOM y, KN- M
M MOM z, KN- M	*****	*****	*****	*****	*****
*****	*****	*****	*****	*****	*****
1	-461.24	4.8325E-13	107.48	2.1652E-13	
-91.072	5.1239E-13				
2	-461.24	4.8325E-13	107.48	2.1652E-13	
-91.072	5.1239E-13				
3	-461.24	4.8325E-13	107.48	2.1652E-13	
-91.072	5.1239E-13				
4	-461.24	4.8325E-13	107.48	2.1652E-13	
-91.072	5.1239E-13				
5	-461.24	4.8325E-13	107.48	2.1652E-13	
-91.072	5.1239E-13				
6	-461.24	4.8325E-13	107.48	2.1652E-13	
-91.072	5.1239E-13				
7	-461.24	4.8325E-13	107.48	2.1652E-13	
-91.072	5.1239E-13				
8	-461.24	4.8325E-13	107.48	2.1652E-13	
-91.072	5.1239E-13				
9	-461.24	4.8325E-13	107.48	2.1652E-13	
-91.072	5.1239E-13				
10	-461.24	4.8325E-13	107.48	2.1652E-13	
-91.072	5.1239E-13				
11	689.24	-4.9692E-13	97.519	2.1652E-13	
-92.169	-5.5948E-13				

	12	689.24	-4.9692E-13	97.519	2.1652E-13	
-92.169	-5.5948E-13					
	13	689.24	-4.9692E-13	97.519	2.1652E-13	
-92.169	-5.5948E-13					
	14	689.24	-4.9692E-13	97.519	2.1652E-13	
-92.169	-5.5948E-13					
	15	689.24	-4.9692E-13	97.519	2.1652E-13	
-92.169	-5.5948E-13					
	16	689.24	-4.9692E-13	97.519	2.1652E-13	
-92.169	-5.5948E-13					
	17	689.24	-4.9692E-13	97.519	2.1652E-13	
-92.169	-5.5948E-13					
	18	689.24	-4.9692E-13	97.519	2.1652E-13	
-92.169	-5.5948E-13					
	19	689.24	-4.9692E-13	97.519	2.1652E-13	
-92.169	-5.5948E-13					
	20	689.24	-4.9692E-13	97.519	2.1652E-13	
-92.169	-5.5948E-13					
	MINIMUM	-461.24	-4.9692E-13	97.519	2.1652E-13	
-92.169	-5.5948E-13					
	Pile N.	1	11	11	1	11
	11					
	MAXIMUM	689.24	4.8325E-13	107.48	2.1652E-13	
-91.072	5.1239E-13					
	Pile N.	11	1	1	1	1
	1					

PILE GROUP STRESS, KN/ M**2

1	1.0196E+04
2	1.0196E+04
3	1.0196E+04
4	1.0196E+04
5	1.0196E+04
6	1.0196E+04
7	1.0196E+04
8	1.0196E+04
9	1.0196E+04
10	1.0196E+04
11	1.5236E+04
12	1.5236E+04
13	1.5236E+04
14	1.5236E+04
15	1.5236E+04
16	1.5236E+04
17	1.5236E+04
18	1.5236E+04
19	1.5236E+04
20	1.5236E+04

MINIMUM 1.0196E+04
 Pile N. 1
 MAXIMUM 1.5236E+04

Pile N. 11

* EFFECTS FOR Laterally LOADED PILE *

* MINIMUM VALUES AND LOCATIONS *

PILE SHEAR z-DIR	DISPL. SOIL REACT		DISPL. SOIL REACT		MOMENT TOTAL STRESS		MOMENT FLEX. RIG.		SHEAR FLEX. RIG.		KN
	y-Dir	M	z-Dir	M	z-Dir	M	z-Dir	M	z-Dir	M	
KN/ M	KN/ M	KN/ M	KN/ M	M**2	KN- M	M**2	KN- M	M**2	KN- M	M**2	
1	-3.5968E-19		-1.0626E-04		-5.1239E-13		-91.072		-1.3696E-13		
-32.146	-1.7643E-13		-40.647		1.0196E+04		7981.2		5794.4		
x(M)	3.7125		3.4875		0.0000		0.0000		3.3750		
3.1500	3.9375		3.7125		0.0000		0.0000		0.0000		
2	-3.5968E-19		-1.0626E-04		-5.1239E-13		-91.072		-1.3696E-13		
-32.146	-1.7643E-13		-40.647		1.0196E+04		7981.2		5794.4		
x(M)	3.7125		3.4875		0.0000		0.0000		3.3750		
3.1500	3.9375		3.7125		0.0000		0.0000		0.0000		
3	-3.5968E-19		-1.0626E-04		-5.1239E-13		-91.072		-1.3696E-13		
-32.146	-1.7643E-13		-40.647		1.0196E+04		7981.2		5794.4		
x(M)	3.7125		3.4875		0.0000		0.0000		3.3750		
3.1500	3.9375		3.7125		0.0000		0.0000		0.0000		
4	-3.5968E-19		-1.0626E-04		-5.1239E-13		-91.072		-1.3696E-13		
-32.146	-1.7643E-13		-40.647		1.0196E+04		7981.2		5794.4		
x(M)	3.7125		3.4875		0.0000		0.0000		3.3750		
3.1500	3.9375		3.7125		0.0000		0.0000		0.0000		
5	-3.5968E-19		-1.0626E-04		-5.1239E-13		-91.072		-1.3696E-13		
-32.146	-1.7643E-13		-40.647		1.0196E+04		7981.2		5794.4		
x(M)	3.7125		3.4875		0.0000		0.0000		3.3750		
3.1500	3.9375		3.7125		0.0000		0.0000		0.0000		
6	-3.5968E-19		-1.0626E-04		-5.1239E-13		-91.072		-1.3696E-13		
-32.146	-1.7643E-13		-40.647		1.0196E+04		7981.2		5794.4		
x(M)	3.7125		3.4875		0.0000		0.0000		3.3750		
3.1500	3.9375		3.7125		0.0000		0.0000		0.0000		
7	-3.5968E-19		-1.0626E-04		-5.1239E-13		-91.072		-1.3696E-13		
-32.146	-1.7643E-13		-40.647		1.0196E+04		7981.2		5794.4		
x(M)	3.7125		3.4875		0.0000		0.0000		3.3750		
3.1500	3.9375		3.7125		0.0000		0.0000		0.0000		
8	-3.5968E-19		-1.0626E-04		-5.1239E-13		-91.072		-1.3696E-13		
-32.146	-1.7643E-13		-40.647		1.0196E+04		7981.2		5794.4		
x(M)	3.7125		3.4875		0.0000		0.0000		3.3750		
3.1500	3.9375		3.7125		0.0000		0.0000		0.0000		
9	-3.5968E-19		-1.0626E-04		-5.1239E-13		-91.072		-1.3696E-13		
-32.146	-1.7643E-13		-40.647		1.0196E+04		7981.2		5794.4		
x(M)	3.7125		3.4875		0.0000		0.0000		3.3750		
3.1500	3.9375		3.7125		0.0000		0.0000		0.0000		
10	-3.5968E-19		-1.0626E-04		-5.1239E-13		-91.072		-1.3696E-13		
-32.146	-1.7643E-13		-40.647		1.0196E+04		7981.2		5794.4		
x(M)	3.7125		3.4875		0.0000		0.0000		3.3750		
3.1500	3.9375		3.7125		0.0000		0.0000		0.0000		

11	-8.2329E-17	-1.3425E-04	-2.0142E-13	-92.169	-4.9782E-13
-35.931	-4.3495E-13	-45.190	1.5236E+04	7981.2	5784.2
x(M)	0.0000	3.4875	2.2500	0.0000	0.0000
3.0375	1.9125	3.7125	0.0000	0.0000	0.0000
12	-8.2329E-17	-1.3425E-04	-2.0142E-13	-92.169	-4.9782E-13
-35.931	-4.3495E-13	-45.190	1.5236E+04	7981.2	5784.2
x(M)	0.0000	3.4875	2.2500	0.0000	0.0000
3.0375	1.9125	3.7125	0.0000	0.0000	0.0000
13	-8.2329E-17	-1.3425E-04	-2.0142E-13	-92.169	-4.9782E-13
-35.931	-4.3495E-13	-45.190	1.5236E+04	7981.2	5784.2
x(M)	0.0000	3.4875	2.2500	0.0000	0.0000
3.0375	1.9125	3.7125	0.0000	0.0000	0.0000
14	-8.2329E-17	-1.3425E-04	-2.0142E-13	-92.169	-4.9782E-13
-35.931	-4.3495E-13	-45.190	1.5236E+04	7981.2	5784.2
x(M)	0.0000	3.4875	2.2500	0.0000	0.0000
3.0375	1.9125	3.7125	0.0000	0.0000	0.0000
15	-8.2329E-17	-1.3425E-04	-2.0142E-13	-92.169	-4.9782E-13
-35.931	-4.3495E-13	-45.190	1.5236E+04	7981.2	5784.2
x(M)	0.0000	3.4875	2.2500	0.0000	0.0000
3.0375	1.9125	3.7125	0.0000	0.0000	0.0000
16	-8.2329E-17	-1.3425E-04	-2.0142E-13	-92.169	-4.9782E-13
-35.931	-4.3495E-13	-45.190	1.5236E+04	7981.2	5784.2
x(M)	0.0000	3.4875	2.2500	0.0000	0.0000
3.0375	1.9125	3.7125	0.0000	0.0000	0.0000
17	-8.2329E-17	-1.3425E-04	-2.0142E-13	-92.169	-4.9782E-13
-35.931	-4.3495E-13	-45.190	1.5236E+04	7981.2	5784.2
x(M)	0.0000	3.4875	2.2500	0.0000	0.0000
3.0375	1.9125	3.7125	0.0000	0.0000	0.0000
18	-8.2329E-17	-1.3425E-04	-2.0142E-13	-92.169	-4.9782E-13
-35.931	-4.3495E-13	-45.190	1.5236E+04	7981.2	5784.2
x(M)	0.0000	3.4875	2.2500	0.0000	0.0000
3.0375	1.9125	3.7125	0.0000	0.0000	0.0000
19	-8.2329E-17	-1.3425E-04	-2.0142E-13	-92.169	-4.9782E-13
-35.931	-4.3495E-13	-45.190	1.5236E+04	7981.2	5784.2
x(M)	0.0000	3.4875	2.2500	0.0000	0.0000
3.0375	1.9125	3.7125	0.0000	0.0000	0.0000
20	-8.2329E-17	-1.3425E-04	-2.0142E-13	-92.169	-4.9782E-13
-35.931	-4.3495E-13	-45.190	1.5236E+04	7981.2	5784.2
x(M)	0.0000	3.4875	2.2500	0.0000	0.0000
3.0375	1.9125	3.7125	0.0000	0.0000	0.0000
Min.	-8.2329E-17	-1.3425E-04	-5.1239E-13	-92.169	-4.9782E-13
-35.931	-4.3495E-13	-45.190	1.0196E+04	7981.2	5784.2
Pile N.	11	11	1	11	11
11	11	1	1	11	11

11

* MAXIMUM VALUES AND LOCATIONS *

PILE SHEAR	DISPL. SOIL	DISPL. SOIL	MOMENT TOTAL	MOMENT FLEX.	SHEAR RIG.	SHEAR RIG.
z-DIR	y-Dir	z-Dir	z-Dir	y-Dir	z-Dir	y-Dir
	M	M	KN- M	KN- M	KN- M	KN
KN/ M	KN/ M	KN/ M	M**2	KN- M**2	KN- M**2	KN

KN

14	4.5064E-19	0.023771	5.5948E-13	45.641	1.5984E-13
97.614	2.0530E-13	88.314	1.5236E+04	7981.2	7981.2
x(M)	3.7125	0.0000	0.0000	2.0250	3.2625
0.0000	3.8250	1.9125	0.0000	0.0000	5.2875
15	4.5064E-19	0.023771	5.5948E-13	45.641	1.5984E-13
97.614	2.0530E-13	88.314	1.5236E+04	7981.2	7981.2
x(M)	3.7125	0.0000	0.0000	2.0250	3.2625
0.0000	3.8250	1.9125	0.0000	0.0000	5.1750
16	4.5064E-19	0.023771	5.5948E-13	45.641	1.5984E-13
97.614	2.0530E-13	88.314	1.5236E+04	7981.2	7981.2
x(M)	3.7125	0.0000	0.0000	2.0250	3.2625
0.0000	3.8250	1.9125	0.0000	0.0000	4.9500
17	4.5064E-19	0.023771	5.5948E-13	45.641	1.5984E-13
97.614	2.0530E-13	88.314	1.5236E+04	7981.2	7981.2
x(M)	3.7125	0.0000	0.0000	2.0250	3.2625
0.0000	3.8250	1.9125	0.0000	0.0000	5.4000
18	4.5064E-19	0.023771	5.5948E-13	45.641	1.5984E-13
97.614	2.0530E-13	88.314	1.5236E+04	7981.2	7981.2
x(M)	3.7125	0.0000	0.0000	2.0250	3.2625
0.0000	3.8250	1.9125	0.0000	0.0000	3.8250
19	4.5064E-19	0.023771	5.5948E-13	45.641	1.5984E-13
97.614	2.0530E-13	88.314	1.5236E+04	7981.2	7981.2
x(M)	3.7125	0.0000	0.0000	2.0250	3.2625
0.0000	3.8250	1.9125	0.0000	0.0000	6.1875
20	4.5064E-19	0.023771	5.5948E-13	45.641	1.5984E-13
97.614	2.0530E-13	88.314	1.5236E+04	7981.2	7981.2
x(M)	3.7125	0.0000	0.0000	2.0250	3.2625
0.0000	3.8250	1.9125	0.0000	0.0000	5.6250
Max.	7.5050E-17	0.023771	5.5948E-13	45.641	4.7993E-13
106.55	3.9203E-13	88.795	1.5236E+04	7981.2	7981.2
Pile N.	1	1	11	11	1
1	1	11	1	1	1

1

LOAD CASE : 3
CASE NAME : ECC

LOAD TYPE : Dead, DL

* TABLE L * COMPUTATION ON PILE CAP

* EQUIVALENT CONCENTRATED LOAD AT ORIGIN *

VERT. LOAD, KN	HOR. LOAD Y, KN	HOR. LOAD Z, KN
1760.00	0.00000	1530.00
MOMENT X , KN- M	MOMENT Y, KN- M	MOMENT Z, KN- M
0.00000	2910.00	0.00000

* DISPLACEMENT OF GROUPED PILE FOUNDATION AT ORIGIN *

VERTICAL , M 3.53104E-04	HORIZONTAL Y, M 8.09505E-15	HORIZONTAL Z, M 0.0149827
ANGLE ROT. X,RAD -6.97525E-13	ANGLE ROT. Y,RAD 3.09570E-03	ANGLE ROT. Z,RAD -2.71716E-17

THE GLOBAL STRUCTURAL COORDINATE SYSTEM

* PILE TOP DISPLACEMENTS *

PILE GROUP Y,RAD	DISP. X, M	DISP. Y, M	DISP. Z, M	ROT. X,RAD	ROT. Z,RAD	ROT.
*****	*****	*****	*****	*****	*****	*****
*****	*****	*****	*****	*****	*****	*****
1	-1.1947E-03	-3.4067E-13	0.014983	-6.9752E-13		
3.0957E-03	-2.7172E-17					
2	-1.1947E-03	-3.4067E-13	0.014983	-6.9752E-13		
3.0957E-03	-2.7172E-17					
3	-1.1947E-03	-3.4067E-13	0.014983	-6.9752E-13		
3.0957E-03	-2.7172E-17					
4	-1.1947E-03	-3.4067E-13	0.014983	-6.9752E-13		
3.0957E-03	-2.7172E-17					
5	-1.1947E-03	-3.4067E-13	0.014983	-6.9752E-13		
3.0957E-03	-2.7172E-17					
6	-1.1947E-03	-3.4067E-13	0.014983	-6.9752E-13		
3.0957E-03	-2.7172E-17					
7	-1.1947E-03	-3.4067E-13	0.014983	-6.9752E-13		
3.0957E-03	-2.7172E-17					
8	-1.1947E-03	-3.4067E-13	0.014983	-6.9752E-13		
3.0957E-03	-2.7172E-17					
9	-1.1947E-03	-3.4067E-13	0.014983	-6.9752E-13		
3.0957E-03	-2.7172E-17					
10	-1.1947E-03	-3.4067E-13	0.014983	-6.9752E-13		
3.0957E-03	-2.7172E-17					
11	1.9009E-03	3.5686E-13	0.014983	-6.9752E-13		
3.0957E-03	-2.7172E-17					
12	1.9009E-03	3.5686E-13	0.014983	-6.9752E-13		
3.0957E-03	-2.7172E-17					
13	1.9009E-03	3.5686E-13	0.014983	-6.9752E-13		
3.0957E-03	-2.7172E-17					
14	1.9009E-03	3.5686E-13	0.014983	-6.9752E-13		
3.0957E-03	-2.7172E-17					
15	1.9009E-03	3.5686E-13	0.014983	-6.9752E-13		
3.0957E-03	-2.7172E-17					
16	1.9009E-03	3.5686E-13	0.014983	-6.9752E-13		
3.0957E-03	-2.7172E-17					
17	1.9009E-03	3.5686E-13	0.014983	-6.9752E-13		

3.0957E-03	-2.7172E-17					
18	1.9009E-03	3.5686E-13	0.014983	-6.9752E-13		
3.0957E-03	-2.7172E-17					
19	1.9009E-03	3.5686E-13	0.014983	-6.9752E-13		
3.0957E-03	-2.7172E-17					
20	1.9009E-03	3.5686E-13	0.014983	-6.9752E-13		
3.0957E-03	-2.7172E-17					
	MINIMUM	-1.1947E-03	-3.4067E-13	0.014983	-6.9752E-13	
3.0957E-03	-2.7172E-17					
	Pile N.	1	1	1	1	1
	1					
	MAXIMUM	1.9009E-03	3.5686E-13	0.014983	-6.9752E-13	
3.0957E-03	-2.7172E-17					
	Pile N.	11	11	1	1	1
	1					

* PILE TOP REACTIONS *

PILE GROUP	FOR. X, KN	FOR. Y, KN	FOR. Z, KN	MOM X, KN- M	MOM Y, KN- M
MOM Z, KN- M	*****	*****	*****	*****	*****
*****	*****	*****	*****	*****	*****
1	-330.75	-2.5249E-09	78.956	-9.5963E-10	
-63.668	-2.5339E-09				
2	-330.75	-2.5249E-09	78.956	-9.5963E-10	
-63.668	-2.5339E-09				
3	-330.75	-2.5249E-09	78.956	-9.5963E-10	
-63.668	-2.5339E-09				
4	-330.75	-2.5249E-09	78.956	-9.5963E-10	
-63.668	-2.5339E-09				
5	-330.75	-2.5249E-09	78.956	-9.5963E-10	
-63.668	-2.5339E-09				
6	-330.75	-2.5249E-09	78.956	-9.5963E-10	
-63.668	-2.5339E-09				
7	-330.75	-2.5249E-09	78.956	-9.5963E-10	
-63.668	-2.5339E-09				
8	-330.75	-2.5249E-09	78.956	-9.5963E-10	
-63.668	-2.5339E-09				
9	-330.75	-2.5249E-09	78.956	-9.5963E-10	
-63.668	-2.5339E-09				
10	-330.75	-2.5249E-09	78.956	-9.5963E-10	
-63.668	-2.5339E-09				
11	506.75	2.5321E-09	74.044	-9.5963E-10	
-64.087	2.6449E-09				
12	506.75	2.5321E-09	74.044	-9.5963E-10	
-64.087	2.6449E-09				
13	506.75	2.5321E-09	74.044	-9.5963E-10	
-64.087	2.6449E-09				
14	506.75	2.5321E-09	74.044	-9.5963E-10	
-64.087	2.6449E-09				
15	506.75	2.5321E-09	74.044	-9.5963E-10	
-64.087	2.6449E-09				
16	506.75	2.5321E-09	74.044	-9.5963E-10	

-64.087	2.6449E-09					
	17	506.75	2.5321E-09	74.044	-9.5963E-10	
-64.087	2.6449E-09					
	18	506.75	2.5321E-09	74.044	-9.5963E-10	
-64.087	2.6449E-09					
	19	506.75	2.5321E-09	74.044	-9.5963E-10	
-64.087	2.6449E-09					
	20	506.75	2.5321E-09	74.044	-9.5963E-10	
-64.087	2.6449E-09					
	MINIMUM	-330.75	-2.5249E-09	74.044	-9.5963E-10	
-64.087	-2.5339E-09					
	Pile N.	1	1	11	1	11
	1					
	MAXIMUM	506.75	2.5321E-09	78.956	-9.5963E-10	
-63.668	2.6449E-09					
	Pile N.	11	11	1	1	1
	11					

THE PILE COORDINATE SYSTEM (LOCAL AXES)

* PILE TOP DISPLACEMENTS *

PILE GROUP	DISP. x, M	DISP. y, M	DISP. z, M	ROT. x, RAD	ROT. y, RAD	ROT. z, RAD
*****	*****	*****	*****	*****	*****	*****
*****	*****	*****	*****	*****	*****	*****
1	-1.1947E-03	-3.4067E-13	0.014983	-6.9752E-13		
3.0957E-03	-2.7172E-17					
2	-1.1947E-03	-3.4067E-13	0.014983	-6.9752E-13		
3.0957E-03	-2.7172E-17					
3	-1.1947E-03	-3.4067E-13	0.014983	-6.9752E-13		
3.0957E-03	-2.7172E-17					
4	-1.1947E-03	-3.4067E-13	0.014983	-6.9752E-13		
3.0957E-03	-2.7172E-17					
5	-1.1947E-03	-3.4067E-13	0.014983	-6.9752E-13		
3.0957E-03	-2.7172E-17					
6	-1.1947E-03	-3.4067E-13	0.014983	-6.9752E-13		
3.0957E-03	-2.7172E-17					
7	-1.1947E-03	-3.4067E-13	0.014983	-6.9752E-13		
3.0957E-03	-2.7172E-17					
8	-1.1947E-03	-3.4067E-13	0.014983	-6.9752E-13		
3.0957E-03	-2.7172E-17					
9	-1.1947E-03	-3.4067E-13	0.014983	-6.9752E-13		
3.0957E-03	-2.7172E-17					
10	-1.1947E-03	-3.4067E-13	0.014983	-6.9752E-13		
3.0957E-03	-2.7172E-17					
11	1.9009E-03	3.5686E-13	0.014983	-6.9752E-13		
3.0957E-03	-2.7172E-17					
12	1.9009E-03	3.5686E-13	0.014983	-6.9752E-13		
3.0957E-03	-2.7172E-17					
13	1.9009E-03	3.5686E-13	0.014983	-6.9752E-13		

3.0957E-03	-2.7172E-17				
14	1.9009E-03	3.5686E-13	0.014983	-6.9752E-13	
3.0957E-03	-2.7172E-17				
15	1.9009E-03	3.5686E-13	0.014983	-6.9752E-13	
3.0957E-03	-2.7172E-17				
16	1.9009E-03	3.5686E-13	0.014983	-6.9752E-13	
3.0957E-03	-2.7172E-17				
17	1.9009E-03	3.5686E-13	0.014983	-6.9752E-13	
3.0957E-03	-2.7172E-17				
18	1.9009E-03	3.5686E-13	0.014983	-6.9752E-13	
3.0957E-03	-2.7172E-17				
19	1.9009E-03	3.5686E-13	0.014983	-6.9752E-13	
3.0957E-03	-2.7172E-17				
20	1.9009E-03	3.5686E-13	0.014983	-6.9752E-13	
3.0957E-03	-2.7172E-17				
	MINIMUM	-1.1947E-03	-3.4067E-13	0.014983	-6.9752E-13
3.0957E-03	-2.7172E-17				
	Pile N.	1	1	1	1
	1				
	MAXIMUM	1.9009E-03	3.5686E-13	0.014983	-6.9752E-13
3.0957E-03	-2.7172E-17				
	Pile N.	11	11	1	1
	1				

* PILE TOP REACTIONS *

PILE GROUP	AXIAL, KN	LAT. y, KN	LAT. z, KN	MOM x, KN- M	MOM y, KN- M	MOM z, KN- M
*****	*****	*****	*****	*****	*****	*****
*****	*****	*****	*****	*****	*****	*****
1	-330.75	-2.5249E-09	78.956	-9.5963E-10		
-63.668	-2.5339E-09					
2	-330.75	-2.5249E-09	78.956	-9.5963E-10		
-63.668	-2.5339E-09					
3	-330.75	-2.5249E-09	78.956	-9.5963E-10		
-63.668	-2.5339E-09					
4	-330.75	-2.5249E-09	78.956	-9.5963E-10		
-63.668	-2.5339E-09					
5	-330.75	-2.5249E-09	78.956	-9.5963E-10		
-63.668	-2.5339E-09					
6	-330.75	-2.5249E-09	78.956	-9.5963E-10		
-63.668	-2.5339E-09					
7	-330.75	-2.5249E-09	78.956	-9.5963E-10		
-63.668	-2.5339E-09					
8	-330.75	-2.5249E-09	78.956	-9.5963E-10		
-63.668	-2.5339E-09					
9	-330.75	-2.5249E-09	78.956	-9.5963E-10		
-63.668	-2.5339E-09					
10	-330.75	-2.5249E-09	78.956	-9.5963E-10		
-63.668	-2.5339E-09					
11	506.75	2.5321E-09	74.044	-9.5963E-10		
-64.087	2.6449E-09					
12	506.75	2.5321E-09	74.044	-9.5963E-10		

-64.087	2.6449E-09					
	13	506.75	2.5321E-09	74.044	-9.5963E-10	
-64.087	2.6449E-09					
	14	506.75	2.5321E-09	74.044	-9.5963E-10	
-64.087	2.6449E-09					
	15	506.75	2.5321E-09	74.044	-9.5963E-10	
-64.087	2.6449E-09					
	16	506.75	2.5321E-09	74.044	-9.5963E-10	
-64.087	2.6449E-09					
	17	506.75	2.5321E-09	74.044	-9.5963E-10	
-64.087	2.6449E-09					
	18	506.75	2.5321E-09	74.044	-9.5963E-10	
-64.087	2.6449E-09					
	19	506.75	2.5321E-09	74.044	-9.5963E-10	
-64.087	2.6449E-09					
	20	506.75	2.5321E-09	74.044	-9.5963E-10	
-64.087	2.6449E-09					
	MINIMUM	-330.75	-2.5249E-09	74.044	-9.5963E-10	
-64.087	-2.5339E-09					
	Pile N.	1	1	11	1	11
	1					
	MAXIMUM	506.75	2.5321E-09	78.956	-9.5963E-10	
-63.668	2.6449E-09					
	Pile N.	11	11	1	1	1
	11					

PILE GROUP STRESS, KN/ M**2

1	7311.3
2	7311.3
3	7311.3
4	7311.3
5	7311.3
6	7311.3
7	7311.3
8	7311.3
9	7311.3
10	7311.3
11	1.1202E+04
12	1.1202E+04
13	1.1202E+04
14	1.1202E+04
15	1.1202E+04
16	1.1202E+04
17	1.1202E+04
18	1.1202E+04
19	1.1202E+04
20	1.1202E+04

MINIMUM	7311.3
Pile N.	1
MAXIMUM	1.1202E+04
Pile N.	11

* EFFECTS FOR Laterally LOADED PILE *

* MINIMUM VALUES AND LOCATIONS *

PILE SHEAR z-DIR	DISPL. SOIL REACT		DISPL. SOIL REACT		MOMENT TOTAL STRESS		MOMENT FLEX. RIG.		SHEAR FLEX. RIG.		KN
	y-Dir	M	z-Dir	M	z-Dir	M	z-Dir	M	z-Dir	M	
	KN/ M		KN/ M		KN/ M**2	KN- M**2	KN- M**2	KN- M**2	KN- M**2	KN	
1	-3.4067E-13		-7.7820E-05		-8.3853E-10		-63.668		-2.5103E-09		
-21.204	-2.1705E-09		-26.444		7311.3		7981.2		5955.0		
x(M)	0.0000		3.4875		2.1375		0.0000		0.0000		
3.0375	1.6875		3.7125		0.0000		0.4500		0.0000		
2	-3.4067E-13		-7.7820E-05		-8.3853E-10		-63.668		-2.5103E-09		
-21.204	-2.1705E-09		-26.444		7311.3		7981.2		5955.0		
x(M)	0.0000		3.4875		2.1375		0.0000		0.0000		
3.0375	1.6875		3.7125		0.0000		0.1125		0.0000		
3	-3.4067E-13		-7.7820E-05		-8.3853E-10		-63.668		-2.5103E-09		
-21.204	-2.1705E-09		-26.444		7311.3		7981.2		5955.0		
x(M)	0.0000		3.4875		2.1375		0.0000		0.0000		
3.0375	1.6875		3.7125		0.0000		0.2250		0.0000		
4	-3.4067E-13		-7.7820E-05		-8.3853E-10		-63.668		-2.5103E-09		
-21.204	-2.1705E-09		-26.444		7311.3		7981.2		5955.0		
x(M)	0.0000		3.4875		2.1375		0.0000		0.0000		
3.0375	1.6875		3.7125		0.0000		0.0000		0.0000		
5	-3.4067E-13		-7.7820E-05		-8.3853E-10		-63.668		-2.5103E-09		
-21.204	-2.1705E-09		-26.444		7311.3		7981.2		5955.0		
x(M)	0.0000		3.4875		2.1375		0.0000		0.0000		
3.0375	1.6875		3.7125		0.0000		0.5625		0.0000		
6	-3.4067E-13		-7.7820E-05		-8.3853E-10		-63.668		-2.5103E-09		
-21.204	-2.1705E-09		-26.444		7311.3		7981.2		5955.0		
x(M)	0.0000		3.4875		2.1375		0.0000		0.0000		
3.0375	1.6875		3.7125		0.0000		1.8000		0.0000		
7	-3.4067E-13		-7.7820E-05		-8.3853E-10		-63.668		-2.5103E-09		
-21.204	-2.1705E-09		-26.444		7311.3		7981.2		5955.0		
x(M)	0.0000		3.4875		2.1375		0.0000		0.0000		
3.0375	1.6875		3.7125		0.0000		0.1125		0.0000		
8	-3.4067E-13		-7.7820E-05		-8.3853E-10		-63.668		-2.5103E-09		
-21.204	-2.1705E-09		-26.444		7311.3		7981.2		5955.0		
x(M)	0.0000		3.4875		2.1375		0.0000		0.0000		
3.0375	1.6875		3.7125		0.0000		0.3375		0.0000		
9	-3.4067E-13		-7.7820E-05		-8.3853E-10		-63.668		-2.5103E-09		
-21.204	-2.1705E-09		-26.444		7311.3		7981.2		5955.0		
x(M)	0.0000		3.4875		2.1375		0.0000		0.0000		
3.0375	1.6875		3.7125		0.0000		0.0000		0.0000		
10	-3.4067E-13		-7.7820E-05		-8.3853E-10		-63.668		-2.5103E-09		
-21.204	-2.1705E-09		-26.444		7311.3		7981.2		5955.0		
x(M)	0.0000		3.4875		2.1375		0.0000		0.0000		
3.0375	1.6875		3.7125		0.0000		0.0000		0.0000		
11	-2.0384E-15		-9.4866E-05		-2.6449E-09		-64.087		-6.8539E-10		

-22.993	-8.7100E-10	-28.955	1.1202E+04	7981.2	5952.6
x(M)	3.6000	3.3750	0.0000	0.0000	3.2625
2.9250	3.8250	3.6000	0.0000	4.1625	0.0000
12	-2.0384E-15	-9.4866E-05	-2.6449E-09	-64.087	-6.8539E-10
-22.993	-8.7100E-10	-28.955	1.1202E+04	7981.2	5952.6
x(M)	3.6000	3.3750	0.0000	0.0000	3.2625
2.9250	3.8250	3.6000	0.0000	0.0000	0.0000
13	-2.0384E-15	-9.4866E-05	-2.6449E-09	-64.087	-6.8539E-10
-22.993	-8.7100E-10	-28.955	1.1202E+04	7981.2	5952.6
x(M)	3.6000	3.3750	0.0000	0.0000	3.2625
2.9250	3.8250	3.6000	0.0000	0.1125	0.0000
14	-2.0384E-15	-9.4866E-05	-2.6449E-09	-64.087	-6.8539E-10
-22.993	-8.7100E-10	-28.955	1.1202E+04	7981.2	5952.6
x(M)	3.6000	3.3750	0.0000	0.0000	3.2625
2.9250	3.8250	3.6000	0.0000	0.1125	0.0000
15	-2.0384E-15	-9.4866E-05	-2.6449E-09	-64.087	-6.8539E-10
-22.993	-8.7100E-10	-28.955	1.1202E+04	7981.2	5952.6
x(M)	3.6000	3.3750	0.0000	0.0000	3.2625
2.9250	3.8250	3.6000	0.0000	0.4500	0.0000
16	-2.0384E-15	-9.4866E-05	-2.6449E-09	-64.087	-6.8539E-10
-22.993	-8.7100E-10	-28.955	1.1202E+04	7981.2	5952.6
x(M)	3.6000	3.3750	0.0000	0.0000	3.2625
2.9250	3.8250	3.6000	0.0000	1.1250	0.0000
17	-2.0384E-15	-9.4866E-05	-2.6449E-09	-64.087	-6.8539E-10
-22.993	-8.7100E-10	-28.955	1.1202E+04	7981.2	5952.6
x(M)	3.6000	3.3750	0.0000	0.0000	3.2625
2.9250	3.8250	3.6000	0.0000	0.0000	0.0000
18	-2.0384E-15	-9.4866E-05	-2.6449E-09	-64.087	-6.8539E-10
-22.993	-8.7100E-10	-28.955	1.1202E+04	7981.2	5952.6
x(M)	3.6000	3.3750	0.0000	0.0000	3.2625
2.9250	3.8250	3.6000	0.0000	0.1125	0.0000
19	-2.0384E-15	-9.4866E-05	-2.6449E-09	-64.087	-6.8539E-10
-22.993	-8.7100E-10	-28.955	1.1202E+04	7981.2	5952.6
x(M)	3.6000	3.3750	0.0000	0.0000	3.2625
2.9250	3.8250	3.6000	0.0000	3.6000	0.0000
20	-2.0384E-15	-9.4866E-05	-2.6449E-09	-64.087	-6.8539E-10
-22.993	-8.7100E-10	-28.955	1.1202E+04	7981.2	5952.6
x(M)	3.6000	3.3750	0.0000	0.0000	3.2625
2.9250	3.8250	3.6000	0.0000	0.0000	0.0000
Min.	-3.4067E-13	-9.4866E-05	-2.6449E-09	-64.087	-2.5103E-09
-22.993	-2.1705E-09	-28.955	7311.3	7981.2	5952.6
Pile N.	1	11	11	11	1
1	11	1	1	11	11

11

* MAXIMUM VALUES AND LOCATIONS *

PILE SHEAR	DISPL. SOIL	DISPL. SOIL	MOMENT TOTAL	MOMENT FLEX.	SHEAR FLEX.
	REACT y-DIR	REACT z-DIR	z-DIR	FLEX. RIG. y-DIR	FLEX. RIG. y-DIR
z-DIR	y-DIR	z-DIR	STRESS	z-DIR	y-DIR
	M	M	KN- M	KN- M	KN
	KN/ M	KN/ M	KN- M**2	KN- M**2	KN- M**2
*****	*****	*****	*****	*****	*****

KN

```

*****      *****      *****      *****      *****      *****
      1  1.7527E-15    0.014983  2.5339E-09    29.633  6.1772E-10
78.376  7.8890E-10    70.880   7311.3    7981.2    7981.2
      x( M)    3.7125    0.0000    0.0000    1.9125    3.2625
0.0000    3.8250    1.6875    0.0000    0.3375    4.9500
      2  1.7527E-15    0.014983  2.5339E-09    29.633  6.1772E-10
78.376  7.8890E-10    70.880   7311.3    7981.2    7981.2
      x( M)    3.7125    0.0000    0.0000    1.9125    3.2625
0.0000    3.8250    1.6875    0.0000    0.0000    6.7500
      3  1.7527E-15    0.014983  2.5339E-09    29.633  6.1772E-10
78.376  7.8890E-10    70.880   7311.3    7981.2    7981.2
      x( M)    3.7125    0.0000    0.0000    1.9125    3.2625
0.0000    3.8250    1.6875    0.0000    0.3375    5.1750
      4  1.7527E-15    0.014983  2.5339E-09    29.633  6.1772E-10
78.376  7.8890E-10    70.880   7311.3    7981.2    7981.2
      x( M)    3.7125    0.0000    0.0000    1.9125    3.2625
0.0000    3.8250    1.6875    0.0000    1.5750    4.8375
      5  1.7527E-15    0.014983  2.5339E-09    29.633  6.1772E-10
78.376  7.8890E-10    70.880   7311.3    7981.2    7981.2
      x( M)    3.7125    0.0000    0.0000    1.9125    3.2625
0.0000    3.8250    1.6875    0.0000    0.6750    7.9875
      6  1.7527E-15    0.014983  2.5339E-09    29.633  6.1772E-10
78.376  7.8890E-10    70.880   7311.3    7981.2    7981.2
      x( M)    3.7125    0.0000    0.0000    1.9125    3.2625
0.0000    3.8250    1.6875    0.0000    0.6750    5.4000
      7  1.7527E-15    0.014983  2.5339E-09    29.633  6.1772E-10
78.376  7.8890E-10    70.880   7311.3    7981.2    7981.2
      x( M)    3.7125    0.0000    0.0000    1.9125    3.2625
0.0000    3.8250    1.6875    0.0000    0.6750    3.8250
      8  1.7527E-15    0.014983  2.5339E-09    29.633  6.1772E-10
78.376  7.8890E-10    70.880   7311.3    7981.2    7981.2
      x( M)    3.7125    0.0000    0.0000    1.9125    3.2625
0.0000    3.8250    1.6875    0.0000    0.2250    3.8250
      9  1.7527E-15    0.014983  2.5339E-09    29.633  6.1772E-10
78.376  7.8890E-10    70.880   7311.3    7981.2    7981.2
      x( M)    3.7125    0.0000    0.0000    1.9125    3.2625
0.0000    3.8250    1.6875    0.0000    0.1125    3.8250
      10 1.7527E-15    0.014983  2.5339E-09    29.633  6.1772E-10
78.376  7.8890E-10    70.880   7311.3    7981.2    7981.2
      x( M)    3.7125    0.0000    0.0000    1.9125    3.2625
0.0000    3.8250    1.6875    0.0000    0.2250    4.8375
      11 3.5686E-13    0.014983  8.9833E-10    30.448  2.5324E-09
73.969  2.2440E-09    69.048  1.1202E+04    7981.2    7981.2
      x( M)    0.0000    0.0000    2.1375    1.9125    0.0000
0.0000    1.6875    1.6875    0.0000    0.2250    5.2875
      12 3.5686E-13    0.014983  8.9833E-10    30.448  2.5324E-09
73.969  2.2440E-09    69.048  1.1202E+04    7981.2    7981.2
      x( M)    0.0000    0.0000    2.1375    1.9125    0.0000
0.0000    1.6875    1.6875    0.0000    0.5625    5.1750
      13 3.5686E-13    0.014983  8.9833E-10    30.448  2.5324E-09
73.969  2.2440E-09    69.048  1.1202E+04    7981.2    7981.2
      x( M)    0.0000    0.0000    2.1375    1.9125    0.0000
0.0000    1.6875    1.6875    0.0000    0.0000    4.9500
      14 3.5686E-13    0.014983  8.9833E-10    30.448  2.5324E-09

```

73.969	2.2440E-09	69.048	1.1202E+04	7981.2	7981.2
x(M)	0.0000	0.0000	2.1375	1.9125	0.0000
0.0000	1.6875	1.6875	0.0000	0.0000	5.0625
15	3.5686E-13	0.014983	8.9833E-10	30.448	2.5324E-09
73.969	2.2440E-09	69.048	1.1202E+04	7981.2	7981.2
x(M)	0.0000	0.0000	2.1375	1.9125	0.0000
0.0000	1.6875	1.6875	0.0000	0.1125	3.8250
16	3.5686E-13	0.014983	8.9833E-10	30.448	2.5324E-09
73.969	2.2440E-09	69.048	1.1202E+04	7981.2	7981.2
x(M)	0.0000	0.0000	2.1375	1.9125	0.0000
0.0000	1.6875	1.6875	0.0000	0.3375	5.8500
17	3.5686E-13	0.014983	8.9833E-10	30.448	2.5324E-09
73.969	2.2440E-09	69.048	1.1202E+04	7981.2	7981.2
x(M)	0.0000	0.0000	2.1375	1.9125	0.0000
0.0000	1.6875	1.6875	0.0000	1.5750	3.8250
18	3.5686E-13	0.014983	8.9833E-10	30.448	2.5324E-09
73.969	2.2440E-09	69.048	1.1202E+04	7981.2	7981.2
x(M)	0.0000	0.0000	2.1375	1.9125	0.0000
0.0000	1.6875	1.6875	0.0000	0.5625	3.8250
19	3.5686E-13	0.014983	8.9833E-10	30.448	2.5324E-09
73.969	2.2440E-09	69.048	1.1202E+04	7981.2	7981.2
x(M)	0.0000	0.0000	2.1375	1.9125	0.0000
0.0000	1.6875	1.6875	0.0000	0.1125	3.8250
20	3.5686E-13	0.014983	8.9833E-10	30.448	2.5324E-09
73.969	2.2440E-09	69.048	1.1202E+04	7981.2	7981.2
x(M)	0.0000	0.0000	2.1375	1.9125	0.0000
0.0000	1.6875	1.6875	0.0000	3.2625	5.1750
Max.	3.5686E-13	0.014983	2.5339E-09	30.448	2.5324E-09
78.376	2.2440E-09	70.880	1.1202E+04	7981.2	7981.2
Pile N.	11	1	1	11	11
11	1	11	1	1	1

1

LOAD CASE : 4
CASE NAME : SISM S

LOAD TYPE : Dead, DL

* TABLE L * COMPUTATION ON PILE CAP

* EQUIVALENT CONCENTRATED LOAD AT ORIGIN *

VERT. LOAD, KN	HOR. LOAD Y, KN	HOR. LOAD Z, KN
1860.00	0.00000	910.000
MOMENT X , KN- M	MOMENT Y, KN- M	MOMENT Z, KN- M
0.00000	1200.00	0.00000

* DISPLACEMENT OF GROUPED PILE FOUNDATION AT ORIGIN *

VERTICAL , M 3.33490E-04	HORIZONTAL Y, M -2.06490E-17	HORIZONTAL Z, M 8.10233E-03
ANGLE ROT. X,RAD 3.87942E-15	ANGLE ROT. Y,RAD 1.40175E-03	ANGLE ROT. Z,RAD 6.64586E-20

THE GLOBAL STRUCTURAL COORDINATE SYSTEM

* PILE TOP DISPLACEMENTS *

PILE GROUP Y,RAD	DISP. X, M	DISP. Y, M	DISP. Z, M	ROT. X,RAD	ROT. Z,RAD
*****	*****	*****	*****	*****	*****
*****	*****	*****	*****	*****	*****
1	-3.6739E-04	1.9191E-15	8.1023E-03	3.8794E-15	6.6459E-20
1.4018E-03					
2	-3.6739E-04	1.9191E-15	8.1023E-03	3.8794E-15	6.6459E-20
1.4018E-03					
3	-3.6739E-04	1.9191E-15	8.1023E-03	3.8794E-15	6.6459E-20
1.4018E-03					
4	-3.6739E-04	1.9191E-15	8.1023E-03	3.8794E-15	6.6459E-20
1.4018E-03					
5	-3.6739E-04	1.9191E-15	8.1023E-03	3.8794E-15	6.6459E-20
1.4018E-03					
6	-3.6739E-04	1.9191E-15	8.1023E-03	3.8794E-15	6.6459E-20
1.4018E-03					
7	-3.6739E-04	1.9191E-15	8.1023E-03	3.8794E-15	6.6459E-20
1.4018E-03					
8	-3.6739E-04	1.9191E-15	8.1023E-03	3.8794E-15	6.6459E-20
1.4018E-03					
9	-3.6739E-04	1.9191E-15	8.1023E-03	3.8794E-15	6.6459E-20
1.4018E-03					
10	-3.6739E-04	1.9191E-15	8.1023E-03	3.8794E-15	6.6459E-20
1.4018E-03					
11	1.0344E-03	-1.9604E-15	8.1023E-03	3.8794E-15	6.6459E-20
1.4018E-03					
12	1.0344E-03	-1.9604E-15	8.1023E-03	3.8794E-15	6.6459E-20
1.4018E-03					
13	1.0344E-03	-1.9604E-15	8.1023E-03	3.8794E-15	6.6459E-20
1.4018E-03					
14	1.0344E-03	-1.9604E-15	8.1023E-03	3.8794E-15	6.6459E-20
1.4018E-03					
15	1.0344E-03	-1.9604E-15	8.1023E-03	3.8794E-15	6.6459E-20
1.4018E-03					
16	1.0344E-03	-1.9604E-15	8.1023E-03	3.8794E-15	6.6459E-20
1.4018E-03					
17	1.0344E-03	-1.9604E-15	8.1023E-03	3.8794E-15	6.6459E-20
1.4018E-03					

18	1.0344E-03	-1.9604E-15	8.1023E-03	3.8794E-15
1.4018E-03	6.6459E-20			
19	1.0344E-03	-1.9604E-15	8.1023E-03	3.8794E-15
1.4018E-03	6.6459E-20			
20	1.0344E-03	-1.9604E-15	8.1023E-03	3.8794E-15
1.4018E-03	6.6459E-20			

MINIMUM	-3.6739E-04	-1.9604E-15	8.1023E-03	3.8794E-15
1.4018E-03	6.6459E-20			

Pile N.	1	11	1	1	1
1					

MAXIMUM	1.0344E-03	1.9191E-15	8.1023E-03	3.8794E-15
1.4018E-03	6.6459E-20			

Pile N.	11	1	1	1	1
1					

* PILE TOP REACTIONS *

PILE GROUP	FOR. X, KN	FOR. Y, KN	FOR. Z, KN	MOM X, KN- M	MOM Y, KN- M
MOM Z, KN- M	*****	*****	*****	*****	*****
*****	*****	*****	*****	*****	*****
1	-104.18	1.4572E-11	46.145	5.3397E-12	
-38.564	1.4529E-11				
2	-104.18	1.4572E-11	46.145	5.3397E-12	
-38.564	1.4529E-11				
3	-104.18	1.4572E-11	46.145	5.3397E-12	
-38.564	1.4529E-11				
4	-104.18	1.4572E-11	46.145	5.3397E-12	
-38.564	1.4529E-11				
5	-104.18	1.4572E-11	46.145	5.3397E-12	
-38.564	1.4529E-11				
6	-104.18	1.4572E-11	46.145	5.3397E-12	
-38.564	1.4529E-11				
7	-104.18	1.4572E-11	46.145	5.3397E-12	
-38.564	1.4529E-11				
8	-104.18	1.4572E-11	46.145	5.3397E-12	
-38.564	1.4529E-11				
9	-104.18	1.4572E-11	46.145	5.3397E-12	
-38.564	1.4529E-11				
10	-104.18	1.4572E-11	46.145	5.3397E-12	
-38.564	1.4529E-11				
11	290.18	-1.4572E-11	44.855	5.3397E-12	
-38.616	-1.4812E-11				
12	290.18	-1.4572E-11	44.855	5.3397E-12	
-38.616	-1.4812E-11				
13	290.18	-1.4572E-11	44.855	5.3397E-12	
-38.616	-1.4812E-11				
14	290.18	-1.4572E-11	44.855	5.3397E-12	
-38.616	-1.4812E-11				
15	290.18	-1.4572E-11	44.855	5.3397E-12	
-38.616	-1.4812E-11				
16	290.18	-1.4572E-11	44.855	5.3397E-12	
-38.616	-1.4812E-11				

	17	290.18	-1.4572E-11	44.855	5.3397E-12		
-38.616	-1.4812E-11						
	18	290.18	-1.4572E-11	44.855	5.3397E-12		
-38.616	-1.4812E-11						
	19	290.18	-1.4572E-11	44.855	5.3397E-12		
-38.616	-1.4812E-11						
	20	290.18	-1.4572E-11	44.855	5.3397E-12		
-38.616	-1.4812E-11						
	MINIMUM	-104.18	-1.4572E-11	44.855	5.3397E-12		
-38.616	-1.4812E-11						
	Pile N.	1	11	11	1		11
	11						
	MAXIMUM	290.18	1.4572E-11	46.145	5.3397E-12		
-38.564	1.4529E-11						
	Pile N.	11	1	1	1		1
	1						

THE PILE COORDINATE SYSTEM (LOCAL AXES)

* PILE TOP DISPLACEMENTS *

PILE GROUP	DISP. x, M	DISP. y, M	DISP. z, M	ROT. x, RAD	ROT. y, RAD	ROT. z, RAD
1	-3.6739E-04	1.9191E-15	8.1023E-03	3.8795E-15		
1.4018E-03	6.6459E-20					
2	-3.6739E-04	1.9191E-15	8.1023E-03	3.8795E-15		
1.4018E-03	6.6459E-20					
3	-3.6739E-04	1.9191E-15	8.1023E-03	3.8795E-15		
1.4018E-03	6.6459E-20					
4	-3.6739E-04	1.9191E-15	8.1023E-03	3.8795E-15		
1.4018E-03	6.6459E-20					
5	-3.6739E-04	1.9191E-15	8.1023E-03	3.8795E-15		
1.4018E-03	6.6459E-20					
6	-3.6739E-04	1.9191E-15	8.1023E-03	3.8795E-15		
1.4018E-03	6.6459E-20					
7	-3.6739E-04	1.9191E-15	8.1023E-03	3.8795E-15		
1.4018E-03	6.6459E-20					
8	-3.6739E-04	1.9191E-15	8.1023E-03	3.8795E-15		
1.4018E-03	6.6459E-20					
9	-3.6739E-04	1.9191E-15	8.1023E-03	3.8795E-15		
1.4018E-03	6.6459E-20					
10	-3.6739E-04	1.9191E-15	8.1023E-03	3.8795E-15		
1.4018E-03	6.6459E-20					
11	1.0344E-03	-1.9604E-15	8.1023E-03	3.8795E-15		
1.4018E-03	6.6459E-20					
12	1.0344E-03	-1.9604E-15	8.1023E-03	3.8795E-15		
1.4018E-03	6.6459E-20					
13	1.0344E-03	-1.9604E-15	8.1023E-03	3.8795E-15		
1.4018E-03	6.6459E-20					

14	1.0344E-03	-1.9604E-15	8.1023E-03	3.8795E-15	
1.4018E-03	6.6459E-20				
15	1.0344E-03	-1.9604E-15	8.1023E-03	3.8795E-15	
1.4018E-03	6.6459E-20				
16	1.0344E-03	-1.9604E-15	8.1023E-03	3.8795E-15	
1.4018E-03	6.6459E-20				
17	1.0344E-03	-1.9604E-15	8.1023E-03	3.8795E-15	
1.4018E-03	6.6459E-20				
18	1.0344E-03	-1.9604E-15	8.1023E-03	3.8795E-15	
1.4018E-03	6.6459E-20				
19	1.0344E-03	-1.9604E-15	8.1023E-03	3.8795E-15	
1.4018E-03	6.6459E-20				
20	1.0344E-03	-1.9604E-15	8.1023E-03	3.8795E-15	
1.4018E-03	6.6459E-20				

MINIMUM	-3.6739E-04	-1.9604E-15	8.1023E-03	3.8795E-15	
1.4018E-03	6.6459E-20				
Pile N.	1	11	1	1	1
1					
MAXIMUM	1.0344E-03	1.9191E-15	8.1023E-03	3.8795E-15	
1.4018E-03	6.6459E-20				
Pile N.	11	1	1	1	1
1					

* PILE TOP REACTIONS *

PILE GROUP	AXIAL, KN	LAT. y, KN	LAT. z, KN	MOM x, KN- M	MOM y, KN- M
MOM z, KN- M					
*****	*****	*****	*****	*****	*****
*****	*****				
1	-104.18	1.4578E-11	46.145	5.3373E-12	
-38.564	1.4529E-11				
2	-104.18	1.4578E-11	46.145	5.3373E-12	
-38.564	1.4529E-11				
3	-104.18	1.4578E-11	46.145	5.3373E-12	
-38.564	1.4529E-11				
4	-104.18	1.4578E-11	46.145	5.3373E-12	
-38.564	1.4529E-11				
5	-104.18	1.4578E-11	46.145	5.3373E-12	
-38.564	1.4529E-11				
6	-104.18	1.4578E-11	46.145	5.3373E-12	
-38.564	1.4529E-11				
7	-104.18	1.4578E-11	46.145	5.3373E-12	
-38.564	1.4529E-11				
8	-104.18	1.4578E-11	46.145	5.3373E-12	
-38.564	1.4529E-11				
9	-104.18	1.4578E-11	46.145	5.3373E-12	
-38.564	1.4529E-11				
10	-104.18	1.4578E-11	46.145	5.3373E-12	
-38.564	1.4529E-11				
11	290.18	-1.4590E-11	44.855	5.3373E-12	
-38.616	-1.4812E-11				
12	290.18	-1.4590E-11	44.855	5.3373E-12	
-38.616	-1.4812E-11				

	13	290.18	-1.4590E-11	44.855	5.3373E-12	
-38.616	-1.4812E-11					
	14	290.18	-1.4590E-11	44.855	5.3373E-12	
-38.616	-1.4812E-11					
	15	290.18	-1.4590E-11	44.855	5.3373E-12	
-38.616	-1.4812E-11					
	16	290.18	-1.4590E-11	44.855	5.3373E-12	
-38.616	-1.4812E-11					
	17	290.18	-1.4590E-11	44.855	5.3373E-12	
-38.616	-1.4812E-11					
	18	290.18	-1.4590E-11	44.855	5.3373E-12	
-38.616	-1.4812E-11					
	19	290.18	-1.4590E-11	44.855	5.3373E-12	
-38.616	-1.4812E-11					
	20	290.18	-1.4590E-11	44.855	5.3373E-12	
-38.616	-1.4812E-11					
	MINIMUM	-104.18	-1.4590E-11	44.855	5.3373E-12	
-38.616	-1.4812E-11					
	Pile N.	1	11	11	1	11
	11					
	MAXIMUM	290.18	1.4578E-11	46.145	5.3373E-12	
-38.564	1.4529E-11					
	Pile N.	11	1	1	1	1
	1					

PILE GROUP STRESS, KN/ M**2
 ***** *****

1	2302.9
2	2302.9
3	2302.9
4	2302.9
5	2302.9
6	2302.9
7	2302.9
8	2302.9
9	2302.9
10	2302.9
11	6414.4
12	6414.4
13	6414.4
14	6414.4
15	6414.4
16	6414.4
17	6414.4
18	6414.4
19	6414.4
20	6414.4

MINIMUM	2302.9
Pile N.	1
MAXIMUM	6414.4
Pile N.	11

* EFFECTS FOR Laterally LOADED PILE *

* MINIMUM VALUES AND LOCATIONS *

PILE SHEAR z-DIR	DISPL. SOIL REACT		DISPL. SOIL REACT		MOMENT TOTAL		MOMENT FLEX. RIG.		SHEAR FLEX. RIG.		KN
	y-Dir	M	z-Dir	M	z-Dir	KN- M	z-Dir	KN- M	y-Dir	KN	
	KN/ M		KN/ M		KN/ M**2	KN- M**2	KN- M**2	KN- M**2			
1	-1.0227E-17		-4.2939E-05		-1.4529E-11		-38.564		-3.5361E-12		
-12.105	-4.4981E-12		-15.134		2302.9		7981.2		6091.9		
x(M)	3.6000		3.4875		0.0000		0.0000		3.2625		
3.0375	3.8250		3.7125		0.0000		0.2250		0.0000		
2	-1.0227E-17		-4.2939E-05		-1.4529E-11		-38.564		-3.5361E-12		
-12.105	-4.4981E-12		-15.134		2302.9		7981.2		6091.9		
x(M)	3.6000		3.4875		0.0000		0.0000		3.2625		
3.0375	3.8250		3.7125		0.0000		0.2250		0.0000		
3	-1.0227E-17		-4.2939E-05		-1.4529E-11		-38.564		-3.5361E-12		
-12.105	-4.4981E-12		-15.134		2302.9		7981.2		6091.9		
x(M)	3.6000		3.4875		0.0000		0.0000		3.2625		
3.0375	3.8250		3.7125		0.0000		0.2250		0.0000		
4	-1.0227E-17		-4.2939E-05		-1.4529E-11		-38.564		-3.5361E-12		
-12.105	-4.4981E-12		-15.134		2302.9		7981.2		6091.9		
x(M)	3.6000		3.4875		0.0000		0.0000		3.2625		
3.0375	3.8250		3.7125		0.0000		0.2250		0.0000		
5	-1.0227E-17		-4.2939E-05		-1.4529E-11		-38.564		-3.5361E-12		
-12.105	-4.4981E-12		-15.134		2302.9		7981.2		6091.9		
x(M)	3.6000		3.4875		0.0000		0.0000		3.2625		
3.0375	3.8250		3.7125		0.0000		0.2250		0.0000		
6	-1.0227E-17		-4.2939E-05		-1.4529E-11		-38.564		-3.5361E-12		
-12.105	-4.4981E-12		-15.134		2302.9		7981.2		6091.9		
x(M)	3.6000		3.4875		0.0000		0.0000		3.2625		
3.0375	3.8250		3.7125		0.0000		0.2250		0.0000		
7	-1.0227E-17		-4.2939E-05		-1.4529E-11		-38.564		-3.5361E-12		
-12.105	-4.4981E-12		-15.134		2302.9		7981.2		6091.9		
x(M)	3.6000		3.4875		0.0000		0.0000		3.2625		
3.0375	3.8250		3.7125		0.0000		0.2250		0.0000		
8	-1.0227E-17		-4.2939E-05		-1.4529E-11		-38.564		-3.5361E-12		
-12.105	-4.4981E-12		-15.134		2302.9		7981.2		6091.9		
x(M)	3.6000		3.4875		0.0000		0.0000		3.2625		
3.0375	3.8250		3.7125		0.0000		0.2250		0.0000		
9	-1.0227E-17		-4.2939E-05		-1.4529E-11		-38.564		-3.5361E-12		
-12.105	-4.4981E-12		-15.134		2302.9		7981.2		6091.9		
x(M)	3.6000		3.4875		0.0000		0.0000		3.2625		
3.0375	3.8250		3.7125		0.0000		0.2250		0.0000		
10	-1.0227E-17		-4.2939E-05		-1.4529E-11		-38.564		-3.5361E-12		
-12.105	-4.4981E-12		-15.134		2302.9		7981.2		6091.9		
x(M)	3.6000		3.4875		0.0000		0.0000		3.2625		
3.0375	3.8250		3.7125		0.0000		0.2250		0.0000		
11	-1.9604E-15		-4.6216E-05		-4.9409E-12		-38.616		-1.4570E-11		
-12.558	-1.3789E-11		-15.667		6414.4		7981.2		6091.5		

	1	1.9191E-15	8.1023E-03	4.7872E-12	16.942	1.4519E-11
45.902		1.3547E-11	46.209	2302.9	7981.2	7981.2
	x(M)	0.0000	0.0000	2.1375	1.9125	0.0000
0.0000		1.4625	1.4625	0.0000	0.0000	4.9500
	2	1.9191E-15	8.1023E-03	4.7872E-12	16.942	1.4519E-11
45.902		1.3547E-11	46.209	2302.9	7981.2	7981.2
	x(M)	0.0000	0.0000	2.1375	1.9125	0.0000
0.0000		1.4625	1.4625	0.0000	0.0000	3.8250
	3	1.9191E-15	8.1023E-03	4.7872E-12	16.942	1.4519E-11
45.902		1.3547E-11	46.209	2302.9	7981.2	7981.2
	x(M)	0.0000	0.0000	2.1375	1.9125	0.0000
0.0000		1.4625	1.4625	0.0000	0.0000	3.8250
	4	1.9191E-15	8.1023E-03	4.7872E-12	16.942	1.4519E-11
45.902		1.3547E-11	46.209	2302.9	7981.2	7981.2
	x(M)	0.0000	0.0000	2.1375	1.9125	0.0000
0.0000		1.4625	1.4625	0.0000	0.0000	3.9375
	5	1.9191E-15	8.1023E-03	4.7872E-12	16.942	1.4519E-11
45.902		1.3547E-11	46.209	2302.9	7981.2	7981.2
	x(M)	0.0000	0.0000	2.1375	1.9125	0.0000
0.0000		1.4625	1.4625	0.0000	0.0000	4.7250
	6	1.9191E-15	8.1023E-03	4.7872E-12	16.942	1.4519E-11
45.902		1.3547E-11	46.209	2302.9	7981.2	7981.2
	x(M)	0.0000	0.0000	2.1375	1.9125	0.0000
0.0000		1.4625	1.4625	0.0000	0.0000	4.7250
	7	1.9191E-15	8.1023E-03	4.7872E-12	16.942	1.4519E-11
45.902		1.3547E-11	46.209	2302.9	7981.2	7981.2
	x(M)	0.0000	0.0000	2.1375	1.9125	0.0000
0.0000		1.4625	1.4625	0.0000	0.0000	5.9625
	8	1.9191E-15	8.1023E-03	4.7872E-12	16.942	1.4519E-11
45.902		1.3547E-11	46.209	2302.9	7981.2	7981.2
	x(M)	0.0000	0.0000	2.1375	1.9125	0.0000
0.0000		1.4625	1.4625	0.0000	0.0000	5.7375
	9	1.9191E-15	8.1023E-03	4.7872E-12	16.942	1.4519E-11
45.902		1.3547E-11	46.209	2302.9	7981.2	7981.2
	x(M)	0.0000	0.0000	2.1375	1.9125	0.0000
0.0000		1.4625	1.4625	0.0000	0.0000	5.0625
	10	1.9191E-15	8.1023E-03	4.7872E-12	16.942	1.4519E-11
45.902		1.3547E-11	46.209	2302.9	7981.2	7981.2
	x(M)	0.0000	0.0000	2.1375	1.9125	0.0000
0.0000		1.4625	1.4625	0.0000	0.0000	5.7375
	11	1.1077E-17	8.1023E-03	1.4812E-11	17.138	3.7094E-12
44.752		4.7085E-12	45.883	6414.4	7981.2	7981.2
	x(M)	3.6000	0.0000	0.0000	1.9125	3.2625
0.0000		3.8250	1.4625	0.0000	0.0000	3.9375
	12	1.1077E-17	8.1023E-03	1.4812E-11	17.138	3.7094E-12
44.752		4.7085E-12	45.883	6414.4	7981.2	7981.2
	x(M)	3.6000	0.0000	0.0000	1.9125	3.2625
0.0000		3.8250	1.4625	0.0000	0.4500	3.9375
	13	1.1077E-17	8.1023E-03	1.4812E-11	17.138	3.7094E-12
44.752		4.7085E-12	45.883	6414.4	7981.2	7981.2
	x(M)	3.6000	0.0000	0.0000	1.9125	3.2625
0.0000		3.8250	1.4625	0.0000	0.4500	5.8500
	14	1.1077E-17	8.1023E-03	1.4812E-11	17.138	3.7094E-12
44.752		4.7085E-12	45.883	6414.4	7981.2	7981.2

x(M)	3.6000	0.0000	0.0000	1.9125	3.2625
0.0000	3.8250	1.4625	0.0000	0.0000	4.7250
15	1.1077E-17	8.1023E-03	1.4812E-11	17.138	3.7094E-12
44.752	4.7085E-12	45.883	6414.4	7981.2	7981.2
x(M)	3.6000	0.0000	0.0000	1.9125	3.2625
0.0000	3.8250	1.4625	0.0000	0.0000	3.9375
16	1.1077E-17	8.1023E-03	1.4812E-11	17.138	3.7094E-12
44.752	4.7085E-12	45.883	6414.4	7981.2	7981.2
x(M)	3.6000	0.0000	0.0000	1.9125	3.2625
0.0000	3.8250	1.4625	0.0000	0.0000	5.1750
17	1.1077E-17	8.1023E-03	1.4812E-11	17.138	3.7094E-12
44.752	4.7085E-12	45.883	6414.4	7981.2	7981.2
x(M)	3.6000	0.0000	0.0000	1.9125	3.2625
0.0000	3.8250	1.4625	0.0000	0.4500	4.8375
18	1.1077E-17	8.1023E-03	1.4812E-11	17.138	3.7094E-12
44.752	4.7085E-12	45.883	6414.4	7981.2	7981.2
x(M)	3.6000	0.0000	0.0000	1.9125	3.2625
0.0000	3.8250	1.4625	0.0000	0.4500	6.8625
19	1.1077E-17	8.1023E-03	1.4812E-11	17.138	3.7094E-12
44.752	4.7085E-12	45.883	6414.4	7981.2	7981.2
x(M)	3.6000	0.0000	0.0000	1.9125	3.2625
0.0000	3.8250	1.4625	0.0000	0.4500	4.7250
20	1.1077E-17	8.1023E-03	1.4812E-11	17.138	3.7094E-12
44.752	4.7085E-12	45.883	6414.4	7981.2	7981.2
x(M)	3.6000	0.0000	0.0000	1.9125	3.2625
0.0000	3.8250	1.4625	0.0000	0.0000	4.8375
Max.	1.9191E-15	8.1023E-03	1.4812E-11	17.138	1.4519E-11
45.902	1.3547E-11	46.209	6414.4	7981.2	7981.2
Pile N.	1	1	11	11	1
	1	1	11	1	1

1

LOAD CASE : 5
CASE NAME : SISM G

LOAD TYPE : Dead, DL

* TABLE L * COMPUTATION ON PILE CAP

* EQUIVALENT CONCENTRATED LOAD AT ORIGIN *

VERT. LOAD, KN	HOR. LOAD Y, KN	HOR. LOAD Z, KN
1970.00	0.00000	920.000
MOMENT X , KN- M	MOMENT Y, KN- M	MOMENT Z, KN- M
0.00000	1200.00	0.00000

* DISPLACEMENT OF GROUPED PILE FOUNDATION AT ORIGIN *

VERTICAL , M	HORIZONTAL Y, M	HORIZONTAL Z, M
3.53370E-04	-1.05617E-18	8.18891E-03
ANGLE ROT. X,RAD	ANGLE ROT. Y,RAD	ANGLE ROT. Z,RAD
5.36044E-17	1.40883E-03	-5.99237E-22

THE GLOBAL STRUCTURAL COORDINATE SYSTEM

* PILE TOP DISPLACEMENTS *

PILE GROUP	DISP. X, M	DISP. Y, M	DISP. Z, M	ROT. X,RAD	ROT. Y,RAD	ROT. Z,RAD
1	-3.5104E-04	2.5746E-17	8.1889E-03	5.3604E-17	1.4088E-03	-5.9924E-22
2	-3.5104E-04	2.5746E-17	8.1889E-03	5.3604E-17	1.4088E-03	-5.9924E-22
3	-3.5104E-04	2.5746E-17	8.1889E-03	5.3604E-17	1.4088E-03	-5.9924E-22
4	-3.5104E-04	2.5746E-17	8.1889E-03	5.3604E-17	1.4088E-03	-5.9924E-22
5	-3.5104E-04	2.5746E-17	8.1889E-03	5.3604E-17	1.4088E-03	-5.9924E-22
6	-3.5104E-04	2.5746E-17	8.1889E-03	5.3604E-17	1.4088E-03	-5.9924E-22
7	-3.5104E-04	2.5746E-17	8.1889E-03	5.3604E-17	1.4088E-03	-5.9924E-22
8	-3.5104E-04	2.5746E-17	8.1889E-03	5.3604E-17	1.4088E-03	-5.9924E-22
9	-3.5104E-04	2.5746E-17	8.1889E-03	5.3604E-17	1.4088E-03	-5.9924E-22
10	-3.5104E-04	2.5746E-17	8.1889E-03	5.3604E-17	1.4088E-03	-5.9924E-22
11	1.0578E-03	-2.7858E-17	8.1889E-03	5.3604E-17	1.4088E-03	-5.9924E-22
12	1.0578E-03	-2.7858E-17	8.1889E-03	5.3604E-17	1.4088E-03	-5.9924E-22
13	1.0578E-03	-2.7858E-17	8.1889E-03	5.3604E-17	1.4088E-03	-5.9924E-22
14	1.0578E-03	-2.7858E-17	8.1889E-03	5.3604E-17	1.4088E-03	-5.9924E-22
15	1.0578E-03	-2.7858E-17	8.1889E-03	5.3604E-17	1.4088E-03	-5.9924E-22
16	1.0578E-03	-2.7858E-17	8.1889E-03	5.3604E-17	1.4088E-03	-5.9924E-22
17	1.0578E-03	-2.7858E-17	8.1889E-03	5.3604E-17	1.4088E-03	-5.9924E-22
18	1.0578E-03	-2.7858E-17	8.1889E-03	5.3604E-17	1.4088E-03	-5.9924E-22

1.4088E-03 -5.9924E-22
 19 1.0578E-03 -2.7858E-17 8.1889E-03 5.3604E-17
 1.4088E-03 -5.9924E-22
 20 1.0578E-03 -2.7858E-17 8.1889E-03 5.3604E-17
 1.4088E-03 -5.9924E-22

MINIMUM -3.5104E-04 -2.7858E-17 8.1889E-03 5.3604E-17
 1.4088E-03 -5.9924E-22
 Pile N. 1 11 1 1 1
 1
 MAXIMUM 1.0578E-03 2.5746E-17 8.1889E-03 5.3604E-17
 1.4088E-03 -5.9924E-22
 Pile N. 11 1 1 1 1
 1

* PILE TOP REACTIONS *

PILE GROUP	FOR. X, KN	FOR. Y, KN	FOR. Z, KN	MOM X, KN- M	MOM Y, KN- M
M MOM Z, KN- M	*****	*****	*****	*****	*****
*****	*****	*****	*****	*****	*****
1	-99.621	1.8958E-13	46.655	7.6256E-14	
-39.034 1.9506E-13					
2	-99.621	1.8958E-13	46.655	7.6256E-14	
-39.034 1.9506E-13					
3	-99.621	1.8958E-13	46.655	7.6256E-14	
-39.034 1.9506E-13					
4	-99.621	1.8958E-13	46.655	7.6256E-14	
-39.034 1.9506E-13					
5	-99.621	1.8958E-13	46.655	7.6256E-14	
-39.034 1.9506E-13					
6	-99.621	1.8958E-13	46.655	7.6256E-14	
-39.034 1.9506E-13					
7	-99.621	1.8958E-13	46.655	7.6256E-14	
-39.034 1.9506E-13					
8	-99.621	1.8958E-13	46.655	7.6256E-14	
-39.034 1.9506E-13					
9	-99.621	1.8958E-13	46.655	7.6256E-14	
-39.034 1.9506E-13					
10	-99.621	1.8958E-13	46.655	7.6256E-14	
-39.034 1.9506E-13					
11	296.62	-1.8958E-13	45.345	7.6259E-14	
-39.088 -2.1098E-13					
12	296.62	-1.8958E-13	45.345	7.6259E-14	
-39.088 -2.1098E-13					
13	296.62	-1.8958E-13	45.345	7.6259E-14	
-39.088 -2.1098E-13					
14	296.62	-1.8958E-13	45.345	7.6259E-14	
-39.088 -2.1098E-13					
15	296.62	-1.8958E-13	45.345	7.6259E-14	
-39.088 -2.1098E-13					
16	296.62	-1.8958E-13	45.345	7.6259E-14	
-39.088 -2.1098E-13					
17	296.62	-1.8958E-13	45.345	7.6259E-14	

-39.088	-2.1098E-13	18	296.62	-1.8958E-13	45.345	7.6259E-14		
-39.088	-2.1098E-13	19	296.62	-1.8958E-13	45.345	7.6259E-14		
-39.088	-2.1098E-13	20	296.62	-1.8958E-13	45.345	7.6259E-14		
-39.088	-2.1098E-13							
	MINIMUM		-99.621	-1.8958E-13	45.345	7.6256E-14		
-39.088	-2.1098E-13							
	Pile N.	1		11	11	1		11
	11							
	MAXIMUM		296.62	1.8958E-13	46.655	7.6259E-14		
-39.034	1.9506E-13							
	Pile N.	11		1	1	11		1
	1							

THE PILE COORDINATE SYSTEM (LOCAL AXES)

* PILE TOP DISPLACEMENTS *

PILE GROUP	DISP. x, M	DISP. y, M	DISP. z, M	ROT. x, RAD	ROT. y, RAD	ROT. z, RAD
1	-3.5104E-04	2.5768E-17	8.1889E-03	5.3691E-17		
1.4088E-03	-5.9924E-22					
2	-3.5104E-04	2.5768E-17	8.1889E-03	5.3691E-17		
1.4088E-03	-5.9924E-22					
3	-3.5104E-04	2.5768E-17	8.1889E-03	5.3691E-17		
1.4088E-03	-5.9924E-22					
4	-3.5104E-04	2.5768E-17	8.1889E-03	5.3691E-17		
1.4088E-03	-5.9924E-22					
5	-3.5104E-04	2.5768E-17	8.1889E-03	5.3691E-17		
1.4088E-03	-5.9924E-22					
6	-3.5104E-04	2.5768E-17	8.1889E-03	5.3691E-17		
1.4088E-03	-5.9924E-22					
7	-3.5104E-04	2.5768E-17	8.1889E-03	5.3691E-17		
1.4088E-03	-5.9924E-22					
8	-3.5104E-04	2.5768E-17	8.1889E-03	5.3691E-17		
1.4088E-03	-5.9924E-22					
9	-3.5104E-04	2.5768E-17	8.1889E-03	5.3691E-17		
1.4088E-03	-5.9924E-22					
10	-3.5104E-04	2.5768E-17	8.1889E-03	5.3691E-17		
1.4088E-03	-5.9924E-22					
11	1.0578E-03	-2.7923E-17	8.1889E-03	5.3691E-17		
1.4088E-03	-5.9924E-22					
12	1.0578E-03	-2.7923E-17	8.1889E-03	5.3691E-17		
1.4088E-03	-5.9924E-22					
13	1.0578E-03	-2.7923E-17	8.1889E-03	5.3691E-17		
1.4088E-03	-5.9924E-22					
14	1.0578E-03	-2.7923E-17	8.1889E-03	5.3691E-17		

1.4088E-03 -5.9924E-22
 15 1.0578E-03 -2.7923E-17 8.1889E-03 5.3691E-17
 1.4088E-03 -5.9924E-22
 16 1.0578E-03 -2.7923E-17 8.1889E-03 5.3691E-17
 1.4088E-03 -5.9924E-22
 17 1.0578E-03 -2.7923E-17 8.1889E-03 5.3691E-17
 1.4088E-03 -5.9924E-22
 18 1.0578E-03 -2.7923E-17 8.1889E-03 5.3691E-17
 1.4088E-03 -5.9924E-22
 19 1.0578E-03 -2.7923E-17 8.1889E-03 5.3691E-17
 1.4088E-03 -5.9924E-22
 20 1.0578E-03 -2.7923E-17 8.1889E-03 5.3691E-17
 1.4088E-03 -5.9924E-22

MINIMUM -3.5104E-04 -2.7923E-17 8.1889E-03 5.3691E-17
 1.4088E-03 -5.9924E-22
 Pile N. 1 11 1 1 1
 1
 MAXIMUM 1.0578E-03 2.5768E-17 8.1889E-03 5.3691E-17
 1.4088E-03 -5.9924E-22
 Pile N. 11 1 1 1 1
 1

* PILE TOP REACTIONS *

PILE GROUP	AXIAL, KN	LAT. y, KN	LAT. z, KN	MOM x, KN- M	MOM y, KN- M
1	-99.621	1.9568E-13	46.655	7.3866E-14	
-39.034	1.9506E-13				
2	-99.621	1.9568E-13	46.655	7.3866E-14	
-39.034	1.9506E-13				
3	-99.621	1.9568E-13	46.655	7.3866E-14	
-39.034	1.9506E-13				
4	-99.621	1.9568E-13	46.655	7.3866E-14	
-39.034	1.9506E-13				
5	-99.621	1.9568E-13	46.655	7.3866E-14	
-39.034	1.9506E-13				
6	-99.621	1.9568E-13	46.655	7.3866E-14	
-39.034	1.9506E-13				
7	-99.621	1.9568E-13	46.655	7.3866E-14	
-39.034	1.9506E-13				
8	-99.621	1.9568E-13	46.655	7.3866E-14	
-39.034	1.9506E-13				
9	-99.621	1.9568E-13	46.655	7.3866E-14	
-39.034	1.9506E-13				
10	-99.621	1.9568E-13	46.655	7.3866E-14	
-39.034	1.9506E-13				
11	296.62	-2.0775E-13	45.345	7.3866E-14	
-39.088	-2.1098E-13				
12	296.62	-2.0775E-13	45.345	7.3866E-14	
-39.088	-2.1098E-13				
13	296.62	-2.0775E-13	45.345	7.3866E-14	

-39.088	-2.1098E-13					
	14	296.62	-2.0775E-13	45.345	7.3866E-14	
-39.088	-2.1098E-13					
	15	296.62	-2.0775E-13	45.345	7.3866E-14	
-39.088	-2.1098E-13					
	16	296.62	-2.0775E-13	45.345	7.3866E-14	
-39.088	-2.1098E-13					
	17	296.62	-2.0775E-13	45.345	7.3866E-14	
-39.088	-2.1098E-13					
	18	296.62	-2.0775E-13	45.345	7.3866E-14	
-39.088	-2.1098E-13					
	19	296.62	-2.0775E-13	45.345	7.3866E-14	
-39.088	-2.1098E-13					
	20	296.62	-2.0775E-13	45.345	7.3866E-14	
-39.088	-2.1098E-13					
	MINIMUM	-99.621	-2.0775E-13	45.345	7.3866E-14	
-39.088	-2.1098E-13					
	Pile N.	1	11	11	1	11
	11					
	MAXIMUM	296.62	1.9568E-13	46.655	7.3866E-14	
-39.034	1.9506E-13					
	Pile N.	11	1	1	1	1
	1					

PILE GROUP STRESS, KN/ M**2

1	2202.1
2	2202.1
3	2202.1
4	2202.1
5	2202.1
6	2202.1
7	2202.1
8	2202.1
9	2202.1
10	2202.1
11	6556.8
12	6556.8
13	6556.8
14	6556.8
15	6556.8
16	6556.8
17	6556.8
18	6556.8
19	6556.8
20	6556.8

MINIMUM	2202.1
Pile N.	1
MAXIMUM	6556.8
Pile N.	11

* EFFECTS FOR LATERALLY LOADED PILE *

* MINIMUM VALUES AND LOCATIONS *

PILE SHEAR	DISPL. SOIL	DISPL. SOIL	MOMENT TOTAL	MOMENT FLEX.	MOMENT RIG.	SHEAR FLEX.	SHEAR RIG.	
z-DIR	y-DIR	z-DIR	z-DIR	z-DIR	y-DIR	y-DIR		KN
	M	M	KN- M	KN- M	KN- M	KN- M	KN	
	KN/ M	KN/ M	M**2	M**2	M**2	M**2		
*****	*****	*****	*****	*****	*****	*****	*****	
*****	*****	*****	*****	*****	*****	*****	*****	
1	-1.3741E-19	-4.3454E-05	-1.9506E-13	-39.034	-4.7492E-14			
-12.237	-6.0411E-14	-15.298	2202.1	7981.2	6088.9			
x(M)	3.6000	3.4875	0.0000	0.0000	3.2625			
3.0375	3.8250	3.7125	0.0000	0.0000	0.0000			
2	-1.3741E-19	-4.3454E-05	-1.9506E-13	-39.034	-4.7492E-14			
-12.237	-6.0411E-14	-15.298	2202.1	7981.2	6088.9			
x(M)	3.6000	3.4875	0.0000	0.0000	3.2625			
3.0375	3.8250	3.7125	0.0000	0.0000	0.0000			
3	-1.3741E-19	-4.3454E-05	-1.9506E-13	-39.034	-4.7492E-14			
-12.237	-6.0411E-14	-15.298	2202.1	7981.2	6088.9			
x(M)	3.6000	3.4875	0.0000	0.0000	3.2625			
3.0375	3.8250	3.7125	0.0000	0.0000	0.0000			
4	-1.3741E-19	-4.3454E-05	-1.9506E-13	-39.034	-4.7492E-14			
-12.237	-6.0411E-14	-15.298	2202.1	7981.2	6088.9			
x(M)	3.6000	3.4875	0.0000	0.0000	3.2625			
3.0375	3.8250	3.7125	0.0000	0.0000	0.0000			
5	-1.3741E-19	-4.3454E-05	-1.9506E-13	-39.034	-4.7492E-14			
-12.237	-6.0411E-14	-15.298	2202.1	7981.2	6088.9			
x(M)	3.6000	3.4875	0.0000	0.0000	3.2625			
3.0375	3.8250	3.7125	0.0000	0.0000	0.0000			
6	-1.3741E-19	-4.3454E-05	-1.9506E-13	-39.034	-4.7492E-14			
-12.237	-6.0411E-14	-15.298	2202.1	7981.2	6088.9			
x(M)	3.6000	3.4875	0.0000	0.0000	3.2625			
3.0375	3.8250	3.7125	0.0000	0.0000	0.0000			
7	-1.3741E-19	-4.3454E-05	-1.9506E-13	-39.034	-4.7492E-14			
-12.237	-6.0411E-14	-15.298	2202.1	7981.2	6088.9			
x(M)	3.6000	3.4875	0.0000	0.0000	3.2625			
3.0375	3.8250	3.7125	0.0000	0.0000	0.0000			
8	-1.3741E-19	-4.3454E-05	-1.9506E-13	-39.034	-4.7492E-14			
-12.237	-6.0411E-14	-15.298	2202.1	7981.2	6088.9			
x(M)	3.6000	3.4875	0.0000	0.0000	3.2625			
3.0375	3.8250	3.7125	0.0000	0.0000	0.0000			
9	-1.3741E-19	-4.3454E-05	-1.9506E-13	-39.034	-4.7492E-14			
-12.237	-6.0411E-14	-15.298	2202.1	7981.2	6088.9			
x(M)	3.6000	3.4875	0.0000	0.0000	3.2625			
3.0375	3.8250	3.7125	0.0000	0.0000	0.0000			
10	-1.3741E-19	-4.3454E-05	-1.9506E-13	-39.034	-4.7492E-14			
-12.237	-6.0411E-14	-15.298	2202.1	7981.2	6088.9			
x(M)	3.6000	3.4875	0.0000	0.0000	3.2625			
3.0375	3.8250	3.7125	0.0000	0.0000	0.0000			
11	-2.7923E-17	-4.6781E-05	-7.0388E-14	-39.088	-2.0748E-13			
-12.696	-1.9639E-13	-15.838	6556.8	7981.2	6088.5			
x(M)	0.0000	3.4875	2.1375	0.0000	0.0000			

3.0375	1.4625	3.7125	0.0000	0.0000	0.0000
12	-2.7923E-17	-4.6781E-05	-7.0388E-14	-39.088	-2.0748E-13
-12.696	-1.9639E-13	-15.838	6556.8	7981.2	6088.5
x(M)	0.0000	3.4875	2.1375	0.0000	0.0000
3.0375	1.4625	3.7125	0.0000	0.0000	0.0000
13	-2.7923E-17	-4.6781E-05	-7.0388E-14	-39.088	-2.0748E-13
-12.696	-1.9639E-13	-15.838	6556.8	7981.2	6088.5
x(M)	0.0000	3.4875	2.1375	0.0000	0.0000
3.0375	1.4625	3.7125	0.0000	0.0000	0.0000
14	-2.7923E-17	-4.6781E-05	-7.0388E-14	-39.088	-2.0748E-13
-12.696	-1.9639E-13	-15.838	6556.8	7981.2	6088.5
x(M)	0.0000	3.4875	2.1375	0.0000	0.0000
3.0375	1.4625	3.7125	0.0000	0.0000	0.0000
15	-2.7923E-17	-4.6781E-05	-7.0388E-14	-39.088	-2.0748E-13
-12.696	-1.9639E-13	-15.838	6556.8	7981.2	6088.5
x(M)	0.0000	3.4875	2.1375	0.0000	0.0000
3.0375	1.4625	3.7125	0.0000	0.0000	0.0000
16	-2.7923E-17	-4.6781E-05	-7.0388E-14	-39.088	-2.0748E-13
-12.696	-1.9639E-13	-15.838	6556.8	7981.2	6088.5
x(M)	0.0000	3.4875	2.1375	0.0000	0.0000
3.0375	1.4625	3.7125	0.0000	0.0000	0.0000
17	-2.7923E-17	-4.6781E-05	-7.0388E-14	-39.088	-2.0748E-13
-12.696	-1.9639E-13	-15.838	6556.8	7981.2	6088.5
x(M)	0.0000	3.4875	2.1375	0.0000	0.0000
3.0375	1.4625	3.7125	0.0000	0.0000	0.0000
18	-2.7923E-17	-4.6781E-05	-7.0388E-14	-39.088	-2.0748E-13
-12.696	-1.9639E-13	-15.838	6556.8	7981.2	6088.5
x(M)	0.0000	3.4875	2.1375	0.0000	0.0000
3.0375	1.4625	3.7125	0.0000	0.0000	0.0000
19	-2.7923E-17	-4.6781E-05	-7.0388E-14	-39.088	-2.0748E-13
-12.696	-1.9639E-13	-15.838	6556.8	7981.2	6088.5
x(M)	0.0000	3.4875	2.1375	0.0000	0.0000
3.0375	1.4625	3.7125	0.0000	0.0000	0.0000
20	-2.7923E-17	-4.6781E-05	-7.0388E-14	-39.088	-2.0748E-13
-12.696	-1.9639E-13	-15.838	6556.8	7981.2	6088.5
x(M)	0.0000	3.4875	2.1375	0.0000	0.0000
3.0375	1.4625	3.7125	0.0000	0.0000	0.0000
Min.	-2.7923E-17	-4.6781E-05	-1.9506E-13	-39.088	-2.0748E-13
-12.696	-1.9639E-13	-15.838	2202.1	7981.2	6088.5
Pile N.	11	11	1	11	11
11	11	1	1	11	11

11

* MAXIMUM VALUES AND LOCATIONS *

PILE SHEAR	DISPL. SOIL	DISPL. SOIL	MOMENT TOTAL	MOMENT FLEX.	SHEAR RIG.	SHEAR RIG.
z-DIR	y-Dir	z-Dir	z-Dir	y-Dir	z-Dir	y-Dir
	M	M	KN- M	KN- M	KN	KN
	KN/ M	KN/ M	KN- M**2	KN- M**2	KN- M**2	KN- M**2
*****	*****	*****	*****	*****	*****	*****
*****	*****	*****	*****	*****	*****	*****
1	2.5768E-17	8.1889E-03	6.4284E-14	17.114	1.9489E-13	

KN

46.411	1.8188E-13	46.726	2202.1	7981.2	7981.2
x(M)	0.0000	0.0000	2.1375	1.9125	0.0000
0.0000	1.4625	1.4625	0.0000	0.0000	4.9500
2	2.5768E-17	8.1889E-03	6.4284E-14	17.114	1.9489E-13
46.411	1.8188E-13	46.726	2202.1	7981.2	7981.2
x(M)	0.0000	0.0000	2.1375	1.9125	0.0000
0.0000	1.4625	1.4625	0.0000	0.0000	3.8250
3	2.5768E-17	8.1889E-03	6.4284E-14	17.114	1.9489E-13
46.411	1.8188E-13	46.726	2202.1	7981.2	7981.2
x(M)	0.0000	0.0000	2.1375	1.9125	0.0000
0.0000	1.4625	1.4625	0.0000	0.0000	5.0625
4	2.5768E-17	8.1889E-03	6.4284E-14	17.114	1.9489E-13
46.411	1.8188E-13	46.726	2202.1	7981.2	7981.2
x(M)	0.0000	0.0000	2.1375	1.9125	0.0000
0.0000	1.4625	1.4625	0.0000	0.0000	3.8250
5	2.5768E-17	8.1889E-03	6.4284E-14	17.114	1.9489E-13
46.411	1.8188E-13	46.726	2202.1	7981.2	7981.2
x(M)	0.0000	0.0000	2.1375	1.9125	0.0000
0.0000	1.4625	1.4625	0.0000	0.0000	3.8250
6	2.5768E-17	8.1889E-03	6.4284E-14	17.114	1.9489E-13
46.411	1.8188E-13	46.726	2202.1	7981.2	7981.2
x(M)	0.0000	0.0000	2.1375	1.9125	0.0000
0.0000	1.4625	1.4625	0.0000	0.0000	3.8250
7	2.5768E-17	8.1889E-03	6.4284E-14	17.114	1.9489E-13
46.411	1.8188E-13	46.726	2202.1	7981.2	7981.2
x(M)	0.0000	0.0000	2.1375	1.9125	0.0000
0.0000	1.4625	1.4625	0.0000	0.0000	5.0625
8	2.5768E-17	8.1889E-03	6.4284E-14	17.114	1.9489E-13
46.411	1.8188E-13	46.726	2202.1	7981.2	7981.2
x(M)	0.0000	0.0000	2.1375	1.9125	0.0000
0.0000	1.4625	1.4625	0.0000	0.0000	4.8375
9	2.5768E-17	8.1889E-03	6.4284E-14	17.114	1.9489E-13
46.411	1.8188E-13	46.726	2202.1	7981.2	7981.2
x(M)	0.0000	0.0000	2.1375	1.9125	0.0000
0.0000	1.4625	1.4625	0.0000	0.0000	4.7250
10	2.5768E-17	8.1889E-03	6.4284E-14	17.114	1.9489E-13
46.411	1.8188E-13	46.726	2202.1	7981.2	7981.2
x(M)	0.0000	0.0000	2.1375	1.9125	0.0000
0.0000	1.4625	1.4625	0.0000	0.0000	4.7250
11	1.5793E-19	8.1889E-03	2.1098E-13	17.313	5.2859E-14
45.244	6.7093E-14	46.395	6556.8	7981.2	7981.2
x(M)	3.6000	0.0000	0.0000	1.9125	3.2625
0.0000	3.8250	1.4625	0.0000	0.0000	3.8250
12	1.5793E-19	8.1889E-03	2.1098E-13	17.313	5.2859E-14
45.244	6.7093E-14	46.395	6556.8	7981.2	7981.2
x(M)	3.6000	0.0000	0.0000	1.9125	3.2625
0.0000	3.8250	1.4625	0.0000	0.0000	4.7250
13	1.5793E-19	8.1889E-03	2.1098E-13	17.313	5.2859E-14
45.244	6.7093E-14	46.395	6556.8	7981.2	7981.2
x(M)	3.6000	0.0000	0.0000	1.9125	3.2625
0.0000	3.8250	1.4625	0.0000	0.0000	4.8375
14	1.5793E-19	8.1889E-03	2.1098E-13	17.313	5.2859E-14
45.244	6.7093E-14	46.395	6556.8	7981.2	7981.2
x(M)	3.6000	0.0000	0.0000	1.9125	3.2625

0.0000	3.8250	1.4625	0.0000	0.0000	3.9375
15	1.5793E-19	8.1889E-03	2.1098E-13	17.313	5.2859E-14
45.244	6.7093E-14	46.395	6556.8	7981.2	7981.2
x(M)	3.6000	0.0000	0.0000	1.9125	3.2625
0.0000	3.8250	1.4625	0.0000	0.0000	3.9375
16	1.5793E-19	8.1889E-03	2.1098E-13	17.313	5.2859E-14
45.244	6.7093E-14	46.395	6556.8	7981.2	7981.2
x(M)	3.6000	0.0000	0.0000	1.9125	3.2625
0.0000	3.8250	1.4625	0.0000	0.0000	3.8250
17	1.5793E-19	8.1889E-03	2.1098E-13	17.313	5.2859E-14
45.244	6.7093E-14	46.395	6556.8	7981.2	7981.2
x(M)	3.6000	0.0000	0.0000	1.9125	3.2625
0.0000	3.8250	1.4625	0.0000	0.0000	3.9375
18	1.5793E-19	8.1889E-03	2.1098E-13	17.313	5.2859E-14
45.244	6.7093E-14	46.395	6556.8	7981.2	7981.2
x(M)	3.6000	0.0000	0.0000	1.9125	3.2625
0.0000	3.8250	1.4625	0.0000	0.0000	3.8250
19	1.5793E-19	8.1889E-03	2.1098E-13	17.313	5.2859E-14
45.244	6.7093E-14	46.395	6556.8	7981.2	7981.2
x(M)	3.6000	0.0000	0.0000	1.9125	3.2625
0.0000	3.8250	1.4625	0.0000	0.0000	5.0625
20	1.5793E-19	8.1889E-03	2.1098E-13	17.313	5.2859E-14
45.244	6.7093E-14	46.395	6556.8	7981.2	7981.2
x(M)	3.6000	0.0000	0.0000	1.9125	3.2625
0.0000	3.8250	1.4625	0.0000	0.0000	4.8375
Max.	2.5768E-17	8.1889E-03	2.1098E-13	17.313	1.9489E-13
46.411	1.8188E-13	46.726	6556.8	7981.2	7981.2
Pile N.	1	1	11	11	1
	1	1	11	1	1

1

***** LOAD COMBINATIONS RESULTS *****

LOAD COMB. : 1
 COMB. NAME : Load Comb

* TABLE L * COMPUTATION ON PILE CAP

* EQUIVALENT CONCENTRATED LOAD AT ORIGIN *

VERT. LOAD, KN 0.00000	HOR. LOAD Y, KN 0.00000	HOR. LOAD Z, KN 0.00000
MOMENT X , KN- M	MOMENT Y, KN- M	MOMENT Z, KN- M

0.0000	17	0.0000	0.0000	0.0000	0.0000	
0.0000	0.0000					
0.0000	18	0.0000	0.0000	0.0000	0.0000	
0.0000	0.0000					
0.0000	19	0.0000	0.0000	0.0000	0.0000	
0.0000	0.0000					
0.0000	20	0.0000	0.0000	0.0000	0.0000	
0.0000	0.0000					
0.0000	MINIMUM	0.0000	0.0000	0.0000	0.0000	
0.0000	0.0000					
	Pile N.	1	1	1	1	1
	1					
0.0000	MAXIMUM	0.0000	0.0000	0.0000	0.0000	
0.0000	0.0000					
	Pile N.	1	1	1	1	1
	1					

* PILE TOP REACTIONS *

	PILE GROUP	FOR. X, KN	FOR. Y, KN	FOR. Z, KN	MOM X, KN- M	MOM Y, KN- M
	MOM Z, KN- M					
	*****	*****	*****	*****	*****	*****
	*****	*****	*****	*****	*****	*****
0.0000	1	0.0000	0.0000	0.0000	0.0000	0.0000
0.0000	0.0000					
0.0000	2	0.0000	0.0000	0.0000	0.0000	0.0000
0.0000	0.0000					
0.0000	3	0.0000	0.0000	0.0000	0.0000	0.0000
0.0000	0.0000					
0.0000	4	0.0000	0.0000	0.0000	0.0000	0.0000
0.0000	0.0000					
0.0000	5	0.0000	0.0000	0.0000	0.0000	0.0000
0.0000	0.0000					
0.0000	6	0.0000	0.0000	0.0000	0.0000	0.0000
0.0000	0.0000					
0.0000	7	0.0000	0.0000	0.0000	0.0000	0.0000
0.0000	0.0000					
0.0000	8	0.0000	0.0000	0.0000	0.0000	0.0000
0.0000	0.0000					
0.0000	9	0.0000	0.0000	0.0000	0.0000	0.0000
0.0000	0.0000					
0.0000	10	0.0000	0.0000	0.0000	0.0000	0.0000
0.0000	0.0000					
0.0000	11	0.0000	0.0000	0.0000	0.0000	0.0000
0.0000	0.0000					
0.0000	12	0.0000	0.0000	0.0000	0.0000	0.0000
0.0000	0.0000					
0.0000	13	0.0000	0.0000	0.0000	0.0000	0.0000
0.0000	0.0000					
0.0000	14	0.0000	0.0000	0.0000	0.0000	0.0000
0.0000	0.0000					
0.0000	15	0.0000	0.0000	0.0000	0.0000	0.0000
0.0000	0.0000					

0.0000	13	0.0000	0.0000	0.0000	0.0000	
0.0000	0.0000					
0.0000	14	0.0000	0.0000	0.0000	0.0000	
0.0000	0.0000					
0.0000	15	0.0000	0.0000	0.0000	0.0000	
0.0000	0.0000					
0.0000	16	0.0000	0.0000	0.0000	0.0000	
0.0000	0.0000					
0.0000	17	0.0000	0.0000	0.0000	0.0000	
0.0000	0.0000					
0.0000	18	0.0000	0.0000	0.0000	0.0000	
0.0000	0.0000					
0.0000	19	0.0000	0.0000	0.0000	0.0000	
0.0000	0.0000					
0.0000	20	0.0000	0.0000	0.0000	0.0000	
0.0000	0.0000					
0.0000	MINIMUM	0.0000	0.0000	0.0000	0.0000	
0.0000	0.0000					
	Pile N.	1	1	1	1	1
	1					
0.0000	MAXIMUM	0.0000	0.0000	0.0000	0.0000	
0.0000	0.0000					
	Pile N.	1	1	1	1	1
	1					

* PILE TOP REACTIONS *

M	PILE GROUP	AXIAL, KN	LAT. y, KN	LAT. z, KN	MOM x, KN- M	MOM y, KN- M
MOM z, KN- M	*****	*****	*****	*****	*****	*****
0.0000	1	0.0000	0.0000	0.0000	0.0000	0.0000
0.0000	0.0000					
0.0000	2	0.0000	0.0000	0.0000	0.0000	0.0000
0.0000	0.0000					
0.0000	3	0.0000	0.0000	0.0000	0.0000	0.0000
0.0000	0.0000					
0.0000	4	0.0000	0.0000	0.0000	0.0000	0.0000
0.0000	0.0000					
0.0000	5	0.0000	0.0000	0.0000	0.0000	0.0000
0.0000	0.0000					
0.0000	6	0.0000	0.0000	0.0000	0.0000	0.0000
0.0000	0.0000					
0.0000	7	0.0000	0.0000	0.0000	0.0000	0.0000
0.0000	0.0000					
0.0000	8	0.0000	0.0000	0.0000	0.0000	0.0000
0.0000	0.0000					
0.0000	9	0.0000	0.0000	0.0000	0.0000	0.0000
0.0000	0.0000					
0.0000	10	0.0000	0.0000	0.0000	0.0000	0.0000
0.0000	0.0000					
0.0000	11	0.0000	0.0000	0.0000	0.0000	0.0000
0.0000	0.0000					

0.0000	12	0.0000	0.0000	0.0000	0.0000	
0.0000	0.0000					
0.0000	13	0.0000	0.0000	0.0000	0.0000	
0.0000	0.0000					
0.0000	14	0.0000	0.0000	0.0000	0.0000	
0.0000	0.0000					
0.0000	15	0.0000	0.0000	0.0000	0.0000	
0.0000	0.0000					
0.0000	16	0.0000	0.0000	0.0000	0.0000	
0.0000	0.0000					
0.0000	17	0.0000	0.0000	0.0000	0.0000	
0.0000	0.0000					
0.0000	18	0.0000	0.0000	0.0000	0.0000	
0.0000	0.0000					
0.0000	19	0.0000	0.0000	0.0000	0.0000	
0.0000	0.0000					
0.0000	20	0.0000	0.0000	0.0000	0.0000	
0.0000	0.0000					
0.0000	MINIMUM	0.0000	0.0000	0.0000	0.0000	
0.0000	0.0000					
	Pile N.	1	1	1	1	1
	1					
0.0000	MAXIMUM	0.0000	0.0000	0.0000	0.0000	
0.0000	0.0000					
	Pile N.	1	1	1	1	1
	1					

PILE GROUP STRESS, KN/ M**2
 ***** *****

1	0.0000
2	0.0000
3	0.0000
4	0.0000
5	0.0000
6	0.0000
7	0.0000
8	0.0000
9	0.0000
10	0.0000
11	0.0000
12	0.0000
13	0.0000
14	0.0000
15	0.0000
16	0.0000
17	0.0000
18	0.0000
19	0.0000
20	0.0000

MINIMUM 0.0000
 Pile N. 1
 MAXIMUM 0.0000

Pile N. 1

* EFFECTS FOR Laterally LOADED PILE *

* MINIMUM VALUES AND LOCATIONS *

PILE SHEAR DEM./CAP.	DISPL. SOIL REACT y-Dir	DISPL. SOIL REACT z-Dir	MOMENT TOTAL z-Dir STRESS	MOMENT FLEX. RIG. y-Dir z-Dir	SHEAR DEM./CAP. y-Dir	
z-Dir SHEAR	y-Dir	z-Dir	KN- M	KN- M	KN	KN
KN/ M	M	M	M**2	M**2		
*****	*****	*****	*****	*****	*****	*****
*****	*****	*****	*****	*****	*****	*****
*****	*****	*****	*****	*****	*****	*****
1	0.0000	0.0000	0.0000	0.0000	0.0000	0.0000
0.0000	0.0000	0.0000	0.0000	7981.2	7981.2	0.0000
0.0000						
x(M)	0.0000	0.0000	0.0000	0.0000	0.0000	0.0000
0.0000	0.0000	0.0000	0.0000	0.0000	0.0000	0.0000
0.0000						
2	0.0000	0.0000	0.0000	0.0000	0.0000	0.0000
0.0000	0.0000	0.0000	0.0000	7981.2	7981.2	0.0000
0.0000						
x(M)	0.0000	0.0000	0.0000	0.0000	0.0000	0.0000
0.0000	0.0000	0.0000	0.0000	0.0000	0.0000	0.0000
0.0000						
3	0.0000	0.0000	0.0000	0.0000	0.0000	0.0000
0.0000	0.0000	0.0000	0.0000	7981.2	7981.2	0.0000
0.0000						
x(M)	0.0000	0.0000	0.0000	0.0000	0.0000	0.0000
0.0000	0.0000	0.0000	0.0000	0.0000	0.0000	0.0000
0.0000						
4	0.0000	0.0000	0.0000	0.0000	0.0000	0.0000
0.0000	0.0000	0.0000	0.0000	7981.2	7981.2	0.0000
0.0000						
x(M)	0.0000	0.0000	0.0000	0.0000	0.0000	0.0000
0.0000	0.0000	0.0000	0.0000	0.0000	0.0000	0.0000
0.0000						
5	0.0000	0.0000	0.0000	0.0000	0.0000	0.0000
0.0000	0.0000	0.0000	0.0000	7981.2	7981.2	0.0000
0.0000						
x(M)	0.0000	0.0000	0.0000	0.0000	0.0000	0.0000
0.0000	0.0000	0.0000	0.0000	0.0000	0.0000	0.0000
0.0000						
6	0.0000	0.0000	0.0000	0.0000	0.0000	0.0000
0.0000	0.0000	0.0000	0.0000	7981.2	7981.2	0.0000
0.0000						
x(M)	0.0000	0.0000	0.0000	0.0000	0.0000	0.0000
0.0000	0.0000	0.0000	0.0000	0.0000	0.0000	0.0000
0.0000						

16	0.0000	0.0000	0.0000	0.0000	0.0000	0.0000	0.0000
0.0000	0.0000	0.0000	0.0000	0.0000	7981.2	7981.2	0.0000
0.0000							
x(M)	0.0000	0.0000	0.0000	0.0000	0.0000	0.0000	0.0000
0.0000	0.0000	0.0000	0.0000	0.0000	0.0000	0.0000	0.0000
0.0000							
17	0.0000	0.0000	0.0000	0.0000	0.0000	0.0000	0.0000
0.0000	0.0000	0.0000	0.0000	0.0000	7981.2	7981.2	0.0000
0.0000							
x(M)	0.0000	0.0000	0.0000	0.0000	0.0000	0.0000	0.0000
0.0000	0.0000	0.0000	0.0000	0.0000	0.0000	0.0000	0.0000
0.0000							
18	0.0000	0.0000	0.0000	0.0000	0.0000	0.0000	0.0000
0.0000	0.0000	0.0000	0.0000	0.0000	7981.2	7981.2	0.0000
0.0000							
x(M)	0.0000	0.0000	0.0000	0.0000	0.0000	0.0000	0.0000
0.0000	0.0000	0.0000	0.0000	0.0000	0.0000	0.0000	0.0000
0.0000							
19	0.0000	0.0000	0.0000	0.0000	0.0000	0.0000	0.0000
0.0000	0.0000	0.0000	0.0000	0.0000	7981.2	7981.2	0.0000
0.0000							
x(M)	0.0000	0.0000	0.0000	0.0000	0.0000	0.0000	0.0000
0.0000	0.0000	0.0000	0.0000	0.0000	0.0000	0.0000	0.0000
0.0000							
20	0.0000	0.0000	0.0000	0.0000	0.0000	0.0000	0.0000
0.0000	0.0000	0.0000	0.0000	0.0000	7981.2	7981.2	0.0000
0.0000							
x(M)	0.0000	0.0000	0.0000	0.0000	0.0000	0.0000	0.0000
0.0000	0.0000	0.0000	0.0000	0.0000	0.0000	0.0000	0.0000
0.0000							
Min.	0.0000	0.0000	0.0000	0.0000	0.0000	0.0000	0.0000
0.0000	0.0000	0.0000	0.0000	0.0000	7981.2	7981.2	0.0000
0.0000							
Pile N.	1	1	1	1	1	1	1
1	1	1	1	1	1	1	1

* MAXIMUM VALUES AND LOCATIONS *

PILE SHEAR DEM./CAP.	DISPL.		DISPL.		MOMENT		MOMENT		SHEAR	
	SOIL REACT		SOIL REACT		TOTAL	FLEX. RIG.	FLEX. RIG.	FLEX. RIG.	DEM./CAP.	
	y-DIR		z-DIR		z-DIR	y-DIR		y-DIR		MOMENT
	z-DIR	y-DIR	z-DIR	z-DIR	STRESS	z-DIR	y-DIR	y-DIR		
SHEAR	M		M		KN- M	KN- M		KN		KN
	KN/ M	KN/ M	KN/ M	M**2	KN- M**2	KN- M**2	KN- M**2			
*****	*****	*****	*****	*****	*****	*****	*****	*****	*****	*****
*****	*****	*****	*****	*****	*****	*****	*****	*****	*****	*****
*****	*****	*****	*****	*****	*****	*****	*****	*****	*****	*****
1	0.0000	0.0000	0.0000	0.0000	0.0000	0.0000	0.0000	0.0000	0.0000	0.0000
0.0000	0.0000	0.0000	0.0000	0.0000	0.0000	7981.2	7981.2	7981.2	7981.2	0.0000

0.0000						
x(M)	0.0000	0.0000	0.0000	0.0000	0.0000	0.0000
0.0000	0.0000	0.0000	0.0000	0.0000	0.0000	0.0000
0.0000						
20	0.0000	0.0000	0.0000	0.0000	0.0000	0.0000
0.0000	0.0000	0.0000	0.0000	7981.2	7981.2	0.0000
0.0000						
x(M)	0.0000	0.0000	0.0000	0.0000	0.0000	0.0000
0.0000	0.0000	0.0000	0.0000	0.0000	0.0000	0.0000
0.0000						
Max.	0.0000	0.0000	0.0000	0.0000	0.0000	0.0000
0.0000	0.0000	0.0000	0.0000	7981.2	7981.2	0.0000
0.0000						
Pile N.	1	1	1	1	1	1
1	1	1	1	1	1	1
1						

***** SUMMARY FOR LOAD CASES AND COMBINATIONS *****

***** LOAD CASES RESULTS *****

LOAD CASE : 1

* TABLE L * COMPUTATION ON PILE CAP

* EQUIVALENT CONCENTRATED LOAD AT ORIGIN *

KN- M	MOM Z, KN- M	LOAD X, KN	LOAD Y, KN	LOAD Z, KN	MOM X, KN- M	MOM Y,
		1760.00	0.00000	2050.00	0.00000	
4000.00	0.00000					

* DISPLACEMENT OF GROUPED PILE FOUNDATION AT ORIGIN *

Y,RAD	DISP X, M	DISP Y, M	DISP Z, M	ROT X,RAD	ROT
	4.83724E-04	2.00642E-16	0.0237289	-1.25530E-14	
4.67079E-03	-7.67552E-19				

* PILE TOP DISPLACEMENTS, GLOBAL *

Y,RAD	ROT. Z,RAD	DISP. X, M	DISP. Y, M	DISP. Z, M	ROT. X,RAD	ROT.
		*****	*****	*****	*****	
*****	*****					
MINIMUM	-1.8517E-03	-6.0759E-15	0.023729	-1.2553E-14		
4.6708E-03	-7.6755E-19					
Pile N.	1	1	1	1	1	1
1						
MAXIMUM	2.8191E-03	6.4772E-15	0.023729	-1.2553E-14		
4.6708E-03	-7.6755E-19					
Pile N.	11	11	1	1	1	1

1

* PILE TOP REACTIONS, GLOBAL *

		FOR. X, KN	FOR. Y, KN	FOR. Z, KN	MOM X, KN- M	MOM Y, KN- M	MOM Z, KN- M
*****		*****	*****	*****	*****	*****	*****
*****		*****	*****	*****	*****	*****	*****
MINIMUM		-494.47	-3.9244E-11	97.468	-1.7264E-11		
-91.794	-4.1477E-11						
Pile N.		1	1	11	1	11	
1							
MAXIMUM		670.47	3.9245E-11	107.53	-1.7264E-11		
-90.679	4.4083E-11						
Pile N.		11	11	1	11	1	
11							

* PILE TOP DISPLACEMENTS, LOCAL *

		DISP. x, M	DISP. y, M	DISP. z, M	ROT. x, RAD	ROT. y, RAD	ROT. z, RAD
*****		*****	*****	*****	*****	*****	*****
*****		*****	*****	*****	*****	*****	*****
MINIMUM		-1.8517E-03	-6.0758E-15	0.023729	-1.2553E-14		
4.6708E-03	-7.6755E-19						
Pile N.		1	1	1	1	1	
1							
MAXIMUM		2.8191E-03	6.4770E-15	0.023729	-1.2553E-14		
4.6708E-03	-7.6755E-19						
Pile N.		11	11	1	1	1	
1							

* PILE TOP REACTIONS, LOCAL *

		AXIAL, KN	LAT. y, KN	LAT. z, KN	MOM x, KN- M	MOM y, KN- M	MOM z, KN- M
*****		*****	*****	*****	*****	*****	*****
*****		*****	*****	*****	*****	*****	*****
MINIMUM		-494.47	-3.9213E-11	97.468	-1.7270E-11		
-91.794	-4.1477E-11						
Pile N.		1	1	11	1	11	
1							
MAXIMUM		670.47	3.9204E-11	107.53	-1.7270E-11		
-90.679	4.4083E-11						
Pile N.		11	11	1	1	1	
11							

* EFFECTS FOR Laterally LOADED PILE *

PILE SHEAR	DISPL. SOIL	DISPL. SOIL	MOMENT TOTAL	MOMENT	SHEAR	
	REACT y-DIR	REACT z-DIR	z-DIR	y-DIR	y-DIR	
z-DIR	y-DIR	z-DIR	STRESS			
	M	M	KN- M	KN- M	KN	KN
	KN/ M	KN/ M	KN/ M**2			

Min.	-6.0758E-15	-1.3371E-04	-4.4083E-11	-91.794	-3.8935E-11		
-35.794	-3.1753E-11	-45.014	1.0930E+04				
Pile N.	1	11	11	11	1		11
	1	11	1				
Max.	6.4770E-15	0.023729	4.1477E-11	45.540	3.9269E-11		
106.57	3.4279E-11	88.761	1.4821E+04				
Pile N.	11	1	1	11	11		1
	11	1	11				

LOAD CASE : 2

* TABLE L * COMPUTATION ON PILE CAP

* EQUIVALENT CONCENTRATED LOAD AT ORIGIN *

	LOAD X, KN	LOAD Y, KN	LOAD Z, KN	MOM X, KN- M	MOM Y,
KN- M	MOM Z, KN- M				
	2280.00	0.00000	2050.00	0.00000	
3920.00	0.00000				

* DISPLACEMENT OF GROUPED PILE FOUNDATION AT ORIGIN *

	DISP X, M	DISP Y, M	DISP Z, M	ROT X,RAD	ROT
Y,RAD	ROT Z,RAD				
	6.04635E-04	-3.60225E-18	0.0237712	1.57094E-16	
4.64592E-03	4.88789E-20				

* PILE TOP DISPLACEMENTS, GLOBAL *

	DISP. X, M	DISP. Y, M	DISP. Z, M	ROT. X,RAD	ROT.
Y,RAD	ROT. Z,RAD				
	*****	*****	*****	*****	*****
*****	*****				
MINIMUM	-1.7183E-03	-8.2149E-17	0.023771	1.5709E-16	
4.6459E-03	4.8879E-20				
Pile N.	1	11	1	1	1
	1				
MAXIMUM	2.9276E-03	7.4945E-17	0.023771	1.5709E-16	
4.6459E-03	4.8879E-20				
Pile N.	11	1	1	1	1
	1				

* PILE TOP REACTIONS, GLOBAL *

	FOR. X, KN	FOR. Y, KN	FOR. Z, KN	MOM X, KN- M	MOM Y, KN-
M MOM Z, KN- M					
	*****	*****	*****	*****	*****
*****	*****				
MINIMUM	-461.24	-4.5471E-13	97.519	2.2209E-13	
-92.169	-5.5948E-13				
Pile N.	1	11	11	1	11
	11				
MAXIMUM	689.24	4.5501E-13	107.48	2.2216E-13	
-91.072	5.1239E-13				
Pile N.	11	1	1	11	1
	1				

* PILE TOP DISPLACEMENTS, LOCAL *

DISP. x, M DISP. y, M DISP. z, M ROT. x, RAD ROT. y, RAD ROT. z, RAD

MINIMUM -1.7183E-03 -8.2328E-17 0.023771 1.5738E-16
 4.6459E-03 4.8879E-20

Pile N. 1 11 1 1 1

MAXIMUM 2.9276E-03 7.5050E-17 0.023771 1.5738E-16
 4.6459E-03 4.8879E-20

Pile N. 11 1 1 1 1

* PILE TOP REACTIONS, LOCAL *

AXIAL, KN LAT. y, KN LAT. z, KN MOM x, KN- M MOM y, KN- M MOM z, KN- M

MINIMUM -461.24 -4.9692E-13 97.519 2.1652E-13
 -92.169 -5.5948E-13

Pile N. 1 11 11 1 11

MAXIMUM 689.24 4.8325E-13 107.48 2.1652E-13
 -91.072 5.1239E-13

Pile N. 11 1 1 1 1

* EFFECTS FOR Laterally LOADED PILE *

PILE SHEAR	DISPL. SOIL	DISPL. SOIL	MOMENT TOTAL	MOMENT	SHEAR	
z-DIR	React y-DIR	React z-DIR	z-DIR	y-DIR	y-DIR	
	M	M	KN- M	KN- M	KN	KN
KN/ M	KN/ M	KN/ M**2				

Min. -8.2329E-17 -1.3425E-04 -5.1239E-13 -92.169 -4.9782E-13
 -35.931 -4.3495E-13 -45.190 1.0196E+04

Pile N. 11 11 1 11 11 11

Max. 7.5050E-17 0.023771 5.5948E-13 45.641 4.7993E-13
 106.55 3.9203E-13 88.795 1.5236E+04

Pile N. 1 1 11 11 1 1

LOAD CASE : 3

* TABLE L * COMPUTATION ON PILE CAP

* EQUIVALENT CONCENTRATED LOAD AT ORIGIN *

LOAD X, KN	LOAD Y, KN	LOAD Z, KN	MOM X, KN- M	MOM Y, KN- M	MOM Z, KN- M
1760.00	0.00000	1530.00	0.00000		

2910.00 0.00000

* DISPLACEMENT OF GROUPED PILE FOUNDATION AT ORIGIN *

	DISP X, M	DISP Y, M	DISP Z, M	ROT X,RAD	ROT
Y,RAD	ROT Z,RAD				
	3.53104E-04	8.09505E-15	0.0149827	-6.97525E-13	
3.09570E-03	-2.71716E-17				

* PILE TOP DISPLACEMENTS, GLOBAL *

	DISP. X, M	DISP. Y, M	DISP. Z, M	ROT. X,RAD	ROT.
Y,RAD	ROT. Z,RAD				
	*****	*****	*****	*****	*****
*****	*****	*****	*****	*****	*****
MINIMUM	-1.1947E-03	-3.4067E-13	0.014983	-6.9752E-13	
3.0957E-03	-2.7172E-17				
Pile N.	1	1	1	1	1
1					
MAXIMUM	1.9009E-03	3.5686E-13	0.014983	-6.9752E-13	
3.0957E-03	-2.7172E-17				
Pile N.	11	11	1	1	1
1					

* PILE TOP REACTIONS, GLOBAL *

	FOR. X, KN	FOR. Y, KN	FOR. Z, KN	MOM X, KN- M	MOM Y, KN- M
M MOM Z, KN- M					
	*****	*****	*****	*****	*****
*****	*****	*****	*****	*****	*****
MINIMUM	-330.75	-2.5249E-09	74.044	-9.5963E-10	
-64.087	-2.5339E-09				
Pile N.	1	1	11	1	11
1					
MAXIMUM	506.75	2.5321E-09	78.956	-9.5963E-10	
-63.668	2.6449E-09				
Pile N.	11	11	1	1	1
11					

* PILE TOP DISPLACEMENTS, LOCAL *

	DISP. x, M	DISP. y, M	DISP. z, M	ROT. x,RAD	ROT.
y,RAD	ROT. z,RAD				
	*****	*****	*****	*****	*****
*****	*****	*****	*****	*****	*****
MINIMUM	-1.1947E-03	-3.4067E-13	0.014983	-6.9752E-13	
3.0957E-03	-2.7172E-17				
Pile N.	1	1	1	1	1
1					
MAXIMUM	1.9009E-03	3.5686E-13	0.014983	-6.9752E-13	
3.0957E-03	-2.7172E-17				
Pile N.	11	11	1	1	1
1					

* PILE TOP REACTIONS, LOCAL *

	AXIAL, KN	LAT. y, KN	LAT. z, KN	MOM x, KN- M	MOM y, KN- M
M MOM z, KN- M					
	*****	*****	*****	*****	*****

MINIMUM	-330.75	-2.5249E-09	74.044	-9.5963E-10	
-64.087	-2.5339E-09				
Pile N.	1	1	11	1	11
1					
MAXIMUM	506.75	2.5321E-09	78.956	-9.5963E-10	
-63.668	2.6449E-09				
Pile N.	11	11	1	1	1
11					

* EFFECTS FOR LATERALLY LOADED PILE *

PILE SHEAR	DISPL. SOIL	DISPL. SOIL	MOMENT TOTAL	MOMENT	SHEAR	
z-DIR	y-DIR	z-DIR	z-DIR	y-DIR	y-DIR	
	M	M	KN- M	KN- M	KN	KN
KN/ M	KN/ M	KN/ M**2				
Min.	-3.4067E-13	-9.4866E-05	-2.6449E-09	-64.087	-2.5103E-09	
-22.993	-2.1705E-09	-28.955	7311.3			
Pile N.	1	11	11	11	1	11
1	11	1				
Max.	3.5686E-13	0.014983	2.5339E-09	30.448	2.5324E-09	
78.376	2.2440E-09	70.880	1.1202E+04			
Pile N.	11	1	1	11	11	1
11	1	11				

LOAD CASE : 4

* TABLE L * COMPUTATION ON PILE CAP

* EQUIVALENT CONCENTRATED LOAD AT ORIGIN *

LOAD X, KN	LOAD Y, KN	LOAD Z, KN	MOM X, KN- M	MOM Y, KN- M
1860.00	0.00000	910.000	0.00000	
1200.00	0.00000			

* DISPLACEMENT OF GROUPED PILE FOUNDATION AT ORIGIN *

DISP X, M	DISP Y, M	DISP Z, M	ROT X, RAD	ROT Y, RAD
3.33490E-04	-2.06490E-17	8.10233E-03	3.87942E-15	
1.40175E-03	6.64586E-20			

* PILE TOP DISPLACEMENTS, GLOBAL *

DISP. X, M	DISP. Y, M	DISP. Z, M	ROT. X, RAD	ROT. Y, RAD
MINIMUM	-3.6739E-04	-1.9604E-15	8.1023E-03	3.8794E-15
1.4018E-03	6.6459E-20			
Pile N.	1	11	1	1
1				

	MAXIMUM	1.0344E-03	1.9191E-15	8.1023E-03	3.8794E-15	
1.4018E-03	6.6459E-20					
	Pile N.	11	1	1	1	1
	1					

* PILE TOP REACTIONS, GLOBAL *

		FOR. X, KN	FOR. Y, KN	FOR. Z, KN	MOM X, KN- M	MOM Y, KN- M	MOM Z, KN- M
--	--	------------	------------	------------	--------------	--------------	--------------

	MINIMUM	-104.18	-1.4572E-11	44.855	5.3397E-12	
-38.616	-1.4812E-11					
	Pile N.	1	11	11	1	11
	11					

	MAXIMUM	290.18	1.4572E-11	46.145	5.3397E-12	
-38.564	1.4529E-11					
	Pile N.	11	1	1	1	1
	1					

* PILE TOP DISPLACEMENTS, LOCAL *

		DISP. x, M	DISP. y, M	DISP. z, M	ROT. x, RAD	ROT. y, RAD	ROT. z, RAD
--	--	------------	------------	------------	-------------	-------------	-------------

	MINIMUM	-3.6739E-04	-1.9604E-15	8.1023E-03	3.8795E-15	
1.4018E-03	6.6459E-20					
	Pile N.	1	11	1	1	1
	1					

	MAXIMUM	1.0344E-03	1.9191E-15	8.1023E-03	3.8795E-15	
1.4018E-03	6.6459E-20					
	Pile N.	11	1	1	1	1
	1					

* PILE TOP REACTIONS, LOCAL *

		AXIAL, KN	LAT. y, KN	LAT. z, KN	MOM x, KN- M	MOM y, KN- M	MOM z, KN- M
--	--	-----------	------------	------------	--------------	--------------	--------------

	MINIMUM	-104.18	-1.4590E-11	44.855	5.3373E-12	
-38.616	-1.4812E-11					
	Pile N.	1	11	11	1	11
	11					

	MAXIMUM	290.18	1.4578E-11	46.145	5.3373E-12	
-38.564	1.4529E-11					
	Pile N.	11	1	1	1	1
	1					

* EFFECTS FOR Laterally LOADED PILE *

	PILE SHEAR	DISPL. SOIL REACT y-DIR	DISPL. SOIL REACT z-DIR	MOMENT TOTAL z-DIR	MOMENT y-DIR	SHEAR y-DIR	
	z-DIR	y-DIR	z-DIR	STRESS KN- M	KN- M	KN	KN
		M	M				

	KN/ M	KN/ M	KN/ M**2			
Min.	-1.9604E-15	-4.6216E-05	-1.4529E-11	-38.616	-1.4570E-11	
-12.558	-1.3789E-11	-15.667	2302.9			
Pile N.	11	11	1	11	11	11
	11	11	1			
Max.	1.9191E-15	8.1023E-03	1.4812E-11	17.138	1.4519E-11	
45.902	1.3547E-11	46.209	6414.4			
Pile N.	1	1	11	11	1	1
	1	1	11			

LOAD CASE : 5

* TABLE L * COMPUTATION ON PILE CAP

* EQUIVALENT CONCENTRATED LOAD AT ORIGIN *

KN- M	MOM Z, KN- M	LOAD X, KN	LOAD Y, KN	LOAD Z, KN	MOM X, KN- M	MOM Y,
		1970.00	0.00000	920.000	0.00000	
1200.00	0.00000					

* DISPLACEMENT OF GROUPED PILE FOUNDATION AT ORIGIN *

Y,RAD	DISP X, M	DISP Y, M	DISP Z, M	ROT X,RAD	ROT
	3.53370E-04	-1.05617E-18	8.18891E-03	5.36044E-17	
1.40883E-03	-5.99237E-22				

* PILE TOP DISPLACEMENTS, GLOBAL *

Y,RAD	ROT. Z,RAD	DISP. X, M	DISP. Y, M	DISP. Z, M	ROT. X,RAD	ROT.
		MINIMUM	-3.5104E-04	-2.7858E-17	8.1889E-03	5.3604E-17
1.4088E-03	-5.9924E-22					
		Pile N.	1	11	1	1
			1			
		MAXIMUM	1.0578E-03	2.5746E-17	8.1889E-03	5.3604E-17
1.4088E-03	-5.9924E-22					
		Pile N.	11	1	1	1
			1			

* PILE TOP REACTIONS, GLOBAL *

M MOM Z, KN- M	FOR. X, KN	FOR. Y, KN	FOR. Z, KN	MOM X, KN- M	MOM Y, KN-
	MINIMUM	-99.621	-1.8958E-13	45.345	7.6256E-14
-39.088	-2.1098E-13				
	Pile N.	1	11	11	1
		11			11
	MAXIMUM	296.62	1.8958E-13	46.655	7.6259E-14
-39.034	1.9506E-13				
	Pile N.	11	1	1	11
					1

1

* PILE TOP DISPLACEMENTS, LOCAL *

	DISP. x, M	DISP. y, M	DISP. z, M	ROT. x, RAD	ROT. y, RAD	ROT. z, RAD
MINIMUM	-3.5104E-04	-2.7923E-17	8.1889E-03	5.3691E-17		
1.4088E-03	-5.9924E-22					
Pile N.	1	11	1	1		1
1						
MAXIMUM	1.0578E-03	2.5768E-17	8.1889E-03	5.3691E-17		
1.4088E-03	-5.9924E-22					
Pile N.	11	1	1	1		1
1						

* PILE TOP REACTIONS, LOCAL *

	AXIAL, KN	LAT. y, KN	LAT. z, KN	MOM x, KN- M	MOM y, KN- M	MOM z, KN- M
MINIMUM	-99.621	-2.0775E-13	45.345	7.3866E-14		
-39.088	-2.1098E-13					
Pile N.	1	11	11	1		11
11						
MAXIMUM	296.62	1.9568E-13	46.655	7.3866E-14		
-39.034	1.9506E-13					
Pile N.	11	1	1	1		1
1						

* EFFECTS FOR LATERALLY LOADED PILE *

PILE SHEAR	DISPL. SOIL	DISPL. SOIL	MOMENT TOTAL	MOMENT	SHEAR	
z-DIR	y-DIR	z-DIR	z-DIR	y-DIR	y-DIR	
KN/ M	KN/ M	KN/ M	KN- M	KN- M	KN	KN
Min.	-2.7923E-17	-4.6781E-05	-1.9506E-13	-39.088	-2.0748E-13	
-12.696	-1.9639E-13	-15.838	2202.1			
Pile N.	11	11	1	11	11	11
11	11	1				
Max.	2.5768E-17	8.1889E-03	2.1098E-13	17.313	1.9489E-13	
46.411	1.8188E-13	46.726	6556.8			
Pile N.	1	1	11	11	1	1
1	1	11				

***** LOAD COMBINATIONS RESULTS *****

LOAD COMB : 1

* TABLE L * COMPUTATION ON PILE CAP

* EQUIVALENT CONCENTRATED LOAD AT ORIGIN *

KN- M	MOM Z, KN- M	LOAD X, KN	LOAD Y, KN	LOAD Z, KN	MOM X, KN- M	MOM Y,
0.00000	0.00000	0.00000	0.00000	0.00000	0.00000	

* DISPLACEMENT OF GROUPED PILE FOUNDATION AT ORIGIN *

Y,RAD	ROT Z,RAD	DISP X, M	DISP Y, M	DISP Z, M	ROT X,RAD	ROT
0.00000	0.00000	0.00000	0.00000	0.00000	0.00000	

* PILE TOP DISPLACEMENTS, GLOBAL *

Y,RAD	ROT. Z,RAD	DISP. X, M	DISP. Y, M	DISP. Z, M	ROT. X,RAD	ROT.
0.0000	0.0000	0.0000	0.0000	0.0000	0.0000	
		MINIMUM				
		Pile N.	1	1	1	1
		1				
		MAXIMUM				
		Pile N.	1	1	1	1
		1				

* PILE TOP REACTIONS, GLOBAL *

M MOM Z, KN- M	FOR. X, KN	FOR. Y, KN	FOR. Z, KN	MOM X, KN- M	MOM Y, KN-
0.0000	0.0000	0.0000	0.0000	0.0000	
		MINIMUM			
		Pile N.	1	1	1
		1			
		MAXIMUM			
		Pile N.	1	1	1
		1			

* PILE TOP DISPLACEMENTS, LOCAL *

y,RAD	ROT. z,RAD	DISP. x, M	DISP. y, M	DISP. z, M	ROT. x,RAD	ROT.
0.0000	0.0000	0.0000	0.0000	0.0000	0.0000	
		MINIMUM				
		Pile N.	1	1	1	1
		1				
		MAXIMUM				
		Pile N.	1	1	1	1
		1				

1

* PILE TOP REACTIONS, LOCAL *

M MOM z, KN- M	AXIAL, KN	LAT. y, KN	LAT. z, KN	MOM x, KN- M	MOM y, KN- M
*****	*****	*****	*****	*****	*****
*****	*****	*****	*****	*****	*****
MINIMUM	0.0000	0.0000	0.0000	0.0000	0.0000
0.0000	0.0000				
Pile N.	1	1	1	1	1
1					
MAXIMUM	0.0000	0.0000	0.0000	0.0000	0.0000
0.0000	0.0000				
Pile N.	1	1	1	1	1
1					

* EFFECTS FOR LATERALLY LOADED PILE *

PILE SHEAR	DISPL. SOIL REACT	DISPL. SOIL REACT	MOMENT TOTAL	MOMENT	SHEAR	
z-DIR	y-DIR	z-DIR	z-DIR	y-DIR	y-DIR	
KN/ M	M	M	KN- M	KN- M	KN	KN
*****	*****	*****	*****	*****	*****	*****
*****	*****	*****	*****	*****	*****	*****
Min.	0.0000	0.0000	0.0000	0.0000	0.0000	
0.0000	0.0000	0.0000	0.0000			
Pile N.	1	1	1	1	1	1
1	1	1	1			
Max.	0.0000	0.0000	0.0000	0.0000	0.0000	
0.0000	0.0000	0.0000	0.0000			
Pile N.	1	1	1	1	1	1
1	1	1	1			

=====

GROUP for Windows, Version 2019.11.5

Serial Number : 292797944

Analysis of A Group of Piles
Subjected to Axial and Lateral Loading

(c) Copyright ENSOFT, Inc., 1987-2018
All Rights Reserved

=====

This program is licensed to :

Pro Iter s.r.l.
Milano, Italy

Path to file locations : D:\OneDrive - Pro Iter
s.r.l.\Lavori\P557-05_Carlo Felice_STRALCIO II\5_S.CRISTINA\4_CONFIGURAZIONE
B\2_PALI_TIPO B\2_GROUP_PARAMETRI MEDI\5_Molle 3m NULLE_MP\
Name of input data file : Pali B SC_Mol_3m NULLE_MP.gp11r
Name of output echo file : Pali B SC_Mol_3m NULLE_MP.gp11e
Name of output results file : Pali B SC_Mol_3m NULLE_MP.gp11o
Name of output summary file : Pali B SC_Mol_3m NULLE_MP.gp11t
Name of plot output file : Pali B SC_Mol_3m NULLE_MP.gp11p
Name of runtime file : Pali B SC_Mol_3m NULLE_MP.gp11r

Time and Date of Analysis

Date: February 19, 2020 Time: 16:28:36

***** INPUT INFORMATION *****

New Group

ANALYSIS TYPE = 3D ANALYSIS

ADJUST DEPTH FOR BATTER PILES

GENERATE LOAD-DISP (AND T-R) CURVES BASED ON SOIL PROFILE

EXTEND INTERPOLATION FOR L-DP (AND T-R) CURVES

UNITS SYSTEM = METR

* TABLE B * PILE CAP OPTIONS

LENGTH,YY (M) = 10.00
WIDTH, ZZ (M) = 1.800
THICKNESS,XX (M) = 0.6000

* PILE CAP DIMENSIONS ARE NOT CONSIDERED
FOR THE PILE GROUP ANALYSIS

* TABLE C * LOAD AND CONTROL PARAMETERS

** LOAD CASES **

NUMBER OF LOAD CASES : 5

LOAD CASE : 1
CASE NAME : SLU F1

LOAD TYPE : Dead, DL
SCALE FACTOR : 10.000

* CONCENTRATED LOADS *

NL	VERT.LOAD	HR.LOAD Y	HR.LOAD Z	MOMENT X	MOMENT Y	MOMENT Z	COORD X
COORD Y	COORD Z						
M	M	KN	KN	KN- M	KN- M	KN- M	M
1	1.61E+02	0.00	1.72E+02	0.00	3.01E+02	0.00	0.00
0.00	0.00						

* EQUIVALENT CONCENTRATED LOAD AT ORIGIN *

VER.LOAD X, KN	HOR.LOAD Y, KN	HOR.LOAD Z, KN
1610.00	0.00000	1720.00
MOMENT X, KN- M	MOMENT Y, KN- M	MOMENT Z, KN- M
0.00000	3010.00	0.00000

* THE LOADING IS STATIC *

* CONTROL PARAMETERS *

TOLERANCE ON CONVERGENCE OF PILE CAP MOVEMENT = 1.00000E-04
 TOLERANCE ON DETERMINATION OF PILE DEFLECTIONS = 1.00000E-04 M
 MAX NO OF ITERATIONS ALLOWED FOR FOUNDATION ANALYSIS = 100
 MAXIMUM NO OF ITERATIONS ALLOWED FOR PILE ANALYSIS = 100
 FACTOR TO APPLY THE LOAD IN INCREMENTS = 1.0000
 MINIMUM FACTOR FOR LOAD INCREMENTS = 1.0000
 PRINT RESULTS AT PILE CAP, PILE HEADS AND ALONG PILES
 PRINT RESULTS EVERY 1 NODE(S)

LOAD CASE : 2
 CASE NAME : SLU F2

LOAD TYPE : Dead, DL
 SCALE FACTOR : 10.000

* CONCENTRATED LOADS *

NL	VERT.LOAD	HR.LOAD Y	HR.LOAD Z	MOMENT X	MOMENT Y	MOMENT Z	COORD X
COORD Y	COORD Z						
	KN	KN	KN	KN- M	KN- M	KN- M	M
M	M						
1	2.09E+02	0.00	1.72E+02	0.00	2.93E+02	0.00	0.00
0.00	0.00						

* EQUIVALENT CONCENTRATED LOAD AT ORIGIN *

VER.LOAD X, KN	HOR.LOAD Y, KN	HOR.LOAD Z, KN
2090.00	0.00000	1720.00
MOMENT X, KN- M	MOMENT Y, KN- M	MOMENT Z, KN- M
0.00000	2930.00	0.00000

* THE LOADING IS STATIC *

* CONTROL PARAMETERS *

TOLERANCE ON CONVERGENCE OF PILE CAP MOVEMENT = 1.00000E-04
 TOLERANCE ON DETERMINATION OF PILE DEFLECTIONS = 1.00000E-04 M
 MAX NO OF ITERATIONS ALLOWED FOR FOUNDATION ANALYSIS = 100
 MAXIMUM NO OF ITERATIONS ALLOWED FOR PILE ANALYSIS = 100
 FACTOR TO APPLY THE LOAD IN INCREMENTS = 1.0000
 MINIMUM FACTOR FOR LOAD INCREMENTS = 1.0000
 PRINT RESULTS AT PILE CAP, PILE HEADS AND ALONG PILES
 PRINT RESULTS EVERY 1 NODE(S)

LOAD CASE : 3
 CASE NAME : ECC

LOAD TYPE : Dead, DL
SCALE FACTOR : 10.000

* CONCENTRATED LOADS *

NL	VERT. LOAD	HR. LOAD Y	HR. LOAD Z	MOMENT X	MOMENT Y	MOMENT Z	COORD X
COORD Y	COORD Z						
	KN	KN	KN	KN- M	KN- M	KN- M	M
M	M						
1	1.61E+02	0.00	1.28E+02	0.00	2.17E+02	0.00	0.00
0.00	0.00						

* EQUIVALENT CONCENTRATED LOAD AT ORIGIN *

VER. LOAD X, KN	HOR. LOAD Y, KN	HOR. LOAD Z, KN
1610.00	0.00000	1280.00
MOMENT X, KN- M	MOMENT Y, KN- M	MOMENT Z, KN- M
0.00000	2170.00	0.00000

* THE LOADING IS STATIC *

* CONTROL PARAMETERS *

TOLERANCE ON CONVERGENCE OF PILE CAP MOVEMENT	=	1.00000E-04
TOLERANCE ON DETERMINATION OF PILE DEFLECTIONS	=	1.00000E-04 M
MAX NO OF ITERATIONS ALLOWED FOR FOUNDATION ANALYSIS	=	100
MAXIMUM NO OF ITERATIONS ALLOWED FOR PILE ANALYSIS	=	100
FACTOR TO APPLY THE LOAD IN INCREMENTS	=	1.0000
MINIMUM FACTOR FOR LOAD INCREMENTS	=	1.0000
PRINT RESULTS AT PILE CAP, PILE HEADS AND ALONG PILES		
PRINT RESULTS EVERY	1	NODE(S)

LOAD CASE : 4
CASE NAME : SLV SU

LOAD TYPE : Dead, DL
SCALE FACTOR : 10.000

* CONCENTRATED LOADS *

NL	VERT. LOAD	HR. LOAD Y	HR. LOAD Z	MOMENT X	MOMENT Y	MOMENT Z	COORD X
COORD Y	COORD Z						
	KN	KN	KN	KN- M	KN- M	KN- M	M
M	M						
1	1.68E+02	0.00	76.0	0.00	84.0	0.00	0.00
0.00	0.00						

* EQUIVALENT CONCENTRATED LOAD AT ORIGIN *

VER.LOAD X, KN	HOR.LOAD Y, KN	HOR.LOAD Z, KN
1680.00	0.00000	760.000
MOMENT X, KN- M	MOMENT Y, KN- M	MOMENT Z, KN- M
0.00000	840.000	0.00000

* THE LOADING IS STATIC *

* CONTROL PARAMETERS *

TOLERANCE ON CONVERGENCE OF PILE CAP MOVEMENT	=	1.00000E-04
TOLERANCE ON DETERMINATION OF PILE DEFLECTIONS	=	1.00000E-04 M
MAX NO OF ITERATIONS ALLOWED FOR FOUNDATION ANALYSIS	=	100
MAXIMUM NO OF ITERATIONS ALLOWED FOR PILE ANALYSIS	=	100
FACTOR TO APPLY THE LOAD IN INCREMENTS	=	1.0000
MINIMUM FACTOR FOR LOAD INCREMENTS	=	1.0000
PRINT RESULTS AT PILE CAP, PILE HEADS AND ALONG PILES		
PRINT RESULTS EVERY	1	NODE(S)

LOAD CASE : 5
CASE NAME : SLV GIU

LOAD TYPE : Dead, DL
SCALE FACTOR : 10.000

* CONCENTRATED LOADS *

NL	VERT.LOAD	HR.LOAD Y	HR.LOAD Z	MOMENT X	MOMENT Y	MOMENT Z	COORD X
COORD Y	COORD Z						
	KN	KN	KN	KN- M	KN- M	KN- M	M
M	M						
1	1.77E+02	0.00	77.0	0.00	84.0	0.00	0.00
0.00	0.00						

* EQUIVALENT CONCENTRATED LOAD AT ORIGIN *

VER.LOAD X, KN	HOR.LOAD Y, KN	HOR.LOAD Z, KN
1770.00	0.00000	770.000
MOMENT X, KN- M	MOMENT Y, KN- M	MOMENT Z, KN- M
0.00000	840.000	0.00000

* THE LOADING IS STATIC *

* CONTROL PARAMETERS *

TOLERANCE ON CONVERGENCE OF PILE CAP MOVEMENT	=	1.00000E-04
TOLERANCE ON DETERMINATION OF PILE DEFLECTIONS	=	1.00000E-04 M
MAX NO OF ITERATIONS ALLOWED FOR FOUNDATION ANALYSIS	=	100
MAXIMUM NO OF ITERATIONS ALLOWED FOR PILE ANALYSIS	=	100

FACTOR TO APPLY THE LOAD IN INCREMENTS = 1.0000
 MINIMUM FACTOR FOR LOAD INCREMENTS = 1.0000
 PRINT RESULTS AT PILE CAP, PILE HEADS AND ALONG PILES
 PRINT RESULTS EVERY 1 NODE(S)

** LOAD COMBINATIONS **

NUMBER OF LOAD COMB. : 1

LOAD COMB. : 1
 COMB. NAME : Load Comb

BENDING RF : 1.0000
 SHEAR RF : 1.0000

* THE LOADING IS STATIC *

* CONTROL PARAMETERS *

TOLERANCE ON CONVERGENCE OF PILE CAP MOVEMENT = 1.00000E-04
 TOLERANCE ON DETERMINATION OF PILE DEFLECTIONS = 1.00000E-04 M
 MAX NO OF ITERATIONS ALLOWED FOR FOUNDATION ANALYSIS = 100
 MAXIMUM NO OF ITERATIONS ALLOWED FOR PILE ANALYSIS = 100
 FACTOR TO APPLY THE LOAD IN INCREMENTS = 1.0000
 MINIMUM FACTOR FOR LOAD INCREMENTS = 1.0000
 PRINT RESULTS ONLY AT PILE CAP

* TABLE D * ARRANGEMENT OF PILE GROUPS

R-F-L SET	GROUP	CONN.Z-Z	CONN.Y-Y	PILE PROP	P-Y CURVE	L-S CURVE	T-R CURVE
0	1	FIX	FIX	2	1	1 G	1 G
0	2	FIX	FIX	2	1	1 G	1 G
0	3	FIX	FIX	2	1	1 G	1 G
0	4	FIX	FIX	2	1	1 G	1 G
0	5	FIX	FIX	2	1	1 G	1 G
0	6	FIX	FIX	2	1	1 G	1 G
0	7	FIX	FIX	2	1	1 G	1 G
0	8	FIX	FIX	2	1	1 G	1 G

0	9	FIX	FIX	2	1	1 G	1 G
0	10	FIX	FIX	2	1	1 G	1 G
0	11	FIX	FIX	1	2	2 G	2 G
0	12	FIX	FIX	1	2	2 G	2 G
0	13	FIX	FIX	1	2	2 G	2 G
0	14	FIX	FIX	1	2	2 G	2 G
0	15	FIX	FIX	1	2	2 G	2 G
0	16	FIX	FIX	1	2	2 G	2 G
0	17	FIX	FIX	1	2	2 G	2 G
0	18	FIX	FIX	1	2	2 G	2 G
0	19	FIX	FIX	1	2	2 G	2 G
0	20	FIX	FIX	1	2	2 G	2 G

GROUP	CorX, M	CorY, M	CorZ, M	ALPHA,DEG	BETA,DEG	THETA,DEG	
GROUND, M	SPz, KN- M	SPy, KN- M					
0.000	1	0.000	-4.500	-0.500	90.00	128.0	270.0
0.000	2	0.000	-3.500	-0.500	90.00	128.0	270.0
0.000	3	0.000	-2.500	-0.500	90.00	128.0	270.0
0.000	4	0.000	-1.500	-0.500	90.00	128.0	270.0
0.000	5	0.000	-0.500	-0.500	90.00	128.0	270.0
0.000	6	0.000	0.500	-0.500	90.00	128.0	270.0
0.000	7	0.000	1.500	-0.500	90.00	128.0	270.0
0.000	8	0.000	2.500	-0.500	90.00	128.0	270.0
0.000	9	0.000	3.500	-0.500	90.00	128.0	270.0
0.000	10	0.000	4.500	-0.500	90.00	128.0	270.0
0.000	11	0.000	-4.500	0.500	0.000	90.00	0.000
0.000	12	0.000	-3.500	0.500	0.000	90.00	0.000
0.000	13	0.000	-2.500	0.500	0.000	90.00	0.000
0.000	14	0.000	-1.500	0.500	0.000	90.00	0.000

0.000	0.000	0.000				
15	0.000	-0.500	0.500	0.000	90.00	0.000
0.000	0.000	0.000				
16	0.000	0.500	0.500	0.000	90.00	0.000
0.000	0.000	0.000				
17	0.000	1.500	0.500	0.000	90.00	0.000
0.000	0.000	0.000				
18	0.000	2.500	0.500	0.000	90.00	0.000
0.000	0.000	0.000				
19	0.000	3.500	0.500	0.000	90.00	0.000
0.000	0.000	0.000				
20	0.000	4.500	0.500	0.000	90.00	0.000
0.000	0.000	0.000				

* TABLE E * PILE GEOMETRY AND PROPERTIES
PILE TYPE = 1 - DRIVEN PILE
= 2 - DRILLED SHAFT

PROP	SECTS	INC	PILE TYPE	LENGTH, M
1	1	80	1	8.0000
2	1	100	1	10.000

* PILE SECTIONS *

PROP	SECT	FROM, M	TO, M	CROSS SECT
1	1	0.00000	8.00000	1
2	1	0.00000	10.0000	1

* PILE CROSS SECTIONS *

CROSS SECTION : 1
SECTION NAME : MP240
TYPE : NONLINEAR
CROSS SECTION TYPE : ROUND CONC. SHAFT, CASING (AND STEEL SECTION)
CONCRETE DIAMETER : 240.000 MM
CONCRETE FC : 14110.0 KN/ M**2
DIAMETER CASING : NO CASING
EMBEDDED STEEL SECT : PIPE
DIAMETER STEEL : 193.700 MM
THICKNESS STEEL : 10.0000 MM
ES STEEL : 2.10000E+08 KN/ M**2
FY STEEL : 3.55000E+05 KN/ M**2
EQ. YOUNG MODULUS : 3.00000E+07 KN/ M**2

* PILE CROSS SECTIONS PROPERTIES *

NONLINEAR SECTIONS

SECT	DIAM,MM	PERIM,MM	AREA,MM**2	Iz,MM**4	Iy,MM**4	GJ, KN- M**2
EIz IND	EIy IND	Mn, KN- M	Vn, KN			
1	240.00	753.98	4.5239E+04	0.0000	0.0000	4071.5
0	0	0.0000	0.0000			

* TABLE F * SOIL DATA

SOILS INFORMATION

GROUND SURFACE = 0.00000 M

3 LAYER(S) OF SOIL

LAYER 1

THE SOIL-RESISTANCE CURVES SPECIFIED BY THE USER

OF LAYER		TOP OF LAYER	BOTTOM
	X COORDINATE (M)	0.00000	
3.00000	EFFECTIVE UNIT WEIGHT (KN/ M**3)	9.00000	
9.00000	ULTIMATE UNIT SIDE FRICTION (KN/ M**2)	0.00000 (P)	
0.00000	ULTIMATE UNIT TIP RESISTANCE (KN/ M**2)	0.00000	
0.00000			

LAYER 2

THE SOIL-RESISTANCE CURVES SPECIFIED BY THE USER

OF LAYER		TOP OF LAYER	BOTTOM
	X COORDINATE (M)	3.00000	
7.50000	EFFECTIVE UNIT WEIGHT (KN/ M**3)	10.0000	
10.0000	ULTIMATE UNIT SIDE FRICTION (KN/ M**2)	200.000	
200.000	ULTIMATE UNIT TIP RESISTANCE (KN/ M**2)	0.00000	
0.00000			

LAYER 3

THE SOIL-RESISTANCE CURVES SPECIFIED BY THE USER

OF LAYER		TOP OF LAYER	BOTTOM
	X COORDINATE (M)	7.50000	
10.0000	EFFECTIVE UNIT WEIGHT (KN/ M**3)	12.0000	
12.0000	ULTIMATE UNIT SIDE FRICTION (KN/ M**2)	250.000	
250.000	ULTIMATE UNIT TIP RESISTANCE (KN/ M**2)	0.00000 (R)	
0.00000 (R)			

Notes : Program estimated values for listed parameters
if zero input values were entered:
(P) ULTIMATE UNIT SIDE FRICTION for Driven Piles

(R) ULTIMATE UNIT TIP RESISTANCE for Driven Piles

* TABLE G * INPUT P-Y CURVES

NUM OF SETS : 2

SET 1 NUM OF CURVES 6

CURVE	1	DISTANCE FROM ORIGIN (X-COORD.)		0.00000	M
POINT		P KN	Y M		
1		0.00000	0.00000		
2		9.30000	0.20560		
3		9.30000	1.00000		
CURVE	2	DISTANCE FROM ORIGIN (X-COORD.)		3.00000	M
POINT		P KN	Y M		
1		0.00000	0.00000		
2		115.900	8.60000E-03		
3		115.900	1.00000		
CURVE	3	DISTANCE FROM ORIGIN (X-COORD.)		3.01000	M
POINT		P KN	Y M		
1		0.00000	0.00000		
2		146.200	4.40000E-03		
3		146.200	1.00000		
CURVE	4	DISTANCE FROM ORIGIN (X-COORD.)		7.50000	M
POINT		P KN	Y M		
1		0.00000	0.00000		
2		401.700	2.00000E-04		
3		401.700	1.00000		
CURVE	5	DISTANCE FROM ORIGIN (X-COORD.)		7.51000	M
POINT		P KN	Y M		
1		0.00000	0.00000		
2		2782.30	1.50000E-03		
3		2782.30	1.00000		
CURVE	6	DISTANCE FROM ORIGIN (X-COORD.)		10.0000	M
POINT		P KN	Y M		
1		0.00000	0.00000		
2		3043.60	1.20000E-03		
3		3043.60	1.00000		

SET 2 NUM OF CURVES 6

CURVE	1	DISTANCE FROM ORIGIN (X-COORD.)		0.00000	M
POINT		P KN		Y M	
	1	0.00000		0.00000	
	2	0.00000		0.20000	
	3	0.00000		1.00000	
CURVE	2	DISTANCE FROM ORIGIN (X-COORD.)		3.00000	M
POINT		P KN		Y M	
	1	0.00000		0.00000	
	2	0.00000		0.20000	
	3	0.00000		1.00000	
CURVE	3	DISTANCE FROM ORIGIN (X-COORD.)		3.01000	M
POINT		P KN		Y M	
	1	0.00000		0.00000	
	2	146.200		4.40000E-03	
	3	146.200		1.00000	
CURVE	4	DISTANCE FROM ORIGIN (X-COORD.)		7.50000	M
POINT		P KN		Y M	
	1	0.00000		0.00000	
	2	401.700		2.00000E-04	
	3	401.700		1.00000	
CURVE	5	DISTANCE FROM ORIGIN (X-COORD.)		7.51000	M
POINT		P KN		Y M	
	1	0.00000		0.00000	
	2	2782.30		1.50000E-03	
	3	2782.30		1.00000	
CURVE	6	DISTANCE FROM ORIGIN (X-COORD.)		10.0000	M
POINT		P KN		Y M	
	1	0.00000		0.00000	
	2	3043.60		1.20000E-03	
	3	3043.60		1.00000	

* TABLE H * AXIAL LOAD VS DISPLACEMENT

AXIAL LOAD-DISPLACEMENT CURVES GENERATED INTERNALLY

NUM OF CURVES 2

CURVE 1	NUM OF POINTS 19
DISPLACEMENT, M	AXIAL LOAD, KN
-0.0546833	-755.490
-0.0292833	-755.490
-0.0165833	-755.490
-7.12254E-03	-879.377
-5.23717E-03	-795.864
-1.62813E-03	-290.223
-8.45549E-04	-154.170
-1.69143E-04	-30.8456
-1.69143E-05	-3.08456
0.00000	0.00000
1.69143E-05	3.08456
1.69143E-04	30.8456
8.45549E-04	154.170
1.62813E-03	290.223
5.23717E-03	795.864
7.12254E-03	879.377
0.0165833	755.490
0.0292833	755.490
0.0546833	755.490

CURVE 2	NUM OF POINTS 19
DISPLACEMENT, M	AXIAL LOAD, KN
-0.0533353	-622.789
-0.0279353	-622.789
-0.0152353	-622.789
-5.57817E-03	-739.220
-3.77675E-03	-633.531
-1.06417E-03	-212.476
-5.39716E-04	-109.190
-1.07943E-04	-21.8379
-1.07943E-05	-2.18379
0.00000	0.00000
1.07943E-05	2.18379
1.07943E-04	21.8379
5.39716E-04	109.190
1.06417E-03	212.476
3.77675E-03	633.531
5.57817E-03	739.220
0.0152353	622.789
0.0279353	622.789
0.0533353	622.789

* TABLE I * TORS. MOM. VS ANGLE ROT.

TORQUE-ROTATION CURVES GENERATED INTERNALLY

NUM OF CURVES 2

CURVE 1	NUM OF POINTS 19
ROT. ANGLE, Rad.	TORS.MOMEN, KN- M
-0.55734	-71.6735
-0.34567	-71.6735
-0.23984	-71.6735
-0.17007	-78.4398
-0.15114	-75.5981
-0.0782619	-44.9989
-0.0469218	-27.7554
-0.0105743	-6.40739
-1.05743E-03	-0.64074
0.00000	0.00000
1.05743E-03	0.64074
0.0105743	6.40739
0.0469218	27.7554
0.0782619	44.9989
0.15114	75.5981
0.17007	78.4398
0.23984	71.6735
0.34567	71.6735
0.55734	71.6735

CURVE 2	NUM OF POINTS 19
ROT. ANGLE, Rad.	TORS.MOMEN, KN- M
-0.52474	-74.7347
-0.31308	-74.7347
-0.20724	-74.7347
-0.13421	-81.5199
-0.11662	-78.6464
-0.0590545	-48.6378
-0.0356004	-30.7043
-8.12588E-03	-7.30872
-8.12588E-04	-0.73087
0.00000	0.00000
8.12588E-04	0.73087
8.12588E-03	7.30872
0.0356004	30.7043
0.0590545	48.6378
0.11662	78.6464
0.13421	81.5199
0.20724	74.7347
0.31308	74.7347
0.52474	74.7347

* TABLE J * MOMENT CURVATURE SETS

INTERNALLY GENERATED MOMENT CURVATURE

Definitions of Run Messages and Notes:

- C = concrete in section has cracked in tension.
- Y = stress in reinforcing steel has reached yield stress.
- S = stress in steel section has reached yield stress.
- G = stress in casing section has reached yield stress.

Bending Stiffness (EI) = Computed Bending Moment / Curvature.
 Position of neutral axis is measured from edge of compression side of pile.

Compressive stresses and strains are positive in sign.
 Tensile stresses and strains are negative in sign.

 -

Computations of Nominal Moment Capacity and Nonlinear Bending Stiffness

Section: 1 (MP240), Z Axis,

 -

Input Axial Thrust Forces:

Number of Axial Thrust Force Values = 1

Number	Axial Thrust Force kN
1	0.000

Axial Thrust Force = 0.000 kN ,128

Max Tens Strain	Bending Max Concrete Curvature rad/m	Bending Max Reinf Stress kN-m	Bending Max Casing Stress kPa	Depth to Run N Axis m	Max Comp Strain
0.0000000	0.00000000	0.000000	0.000	0.1200000	0.0000000
0.0000000	0.00049213	0.392777	7981.237	0.1200000	0.0000059
-0.0000059	123.050	0.000	-990.484	0.1200000	0.0000118
-0.0000118	0.000098425	0.785122	7976.844	0.1200000	0.0000118
-0.0000118	245.561	0.000	-1980.969	0.1200000	0.0000177
	0.000147638	1.177035	7972.450	0.1200000	0.0000177

-0.0000177	367.533	0.000	-2971.453		
0.000196850	1.568515	7968.057	0.1200000	0.0000236	
-0.0000236	488.966	0.000	-3961.937		
0.000246063	1.959563	7963.664	0.1200000	0.0000295	
-0.0000295	609.861	0.000	-4952.421		
0.000295276	2.350178	7959.271	0.1200000	0.0000354	
-0.0000354	730.216	0.000	-5942.906		
0.000344488	2.740361	7954.877	0.1200000	0.0000413	
-0.0000413	850.033	0.000	-6933.390		
0.000393701	3.130112	7950.484	0.1200000	0.0000472	
-0.0000472	969.311	0.000	-7923.874		
0.000442913	3.519430	7946.091	0.1200000	0.0000531	
-0.0000531	1088.049	0.000	-8914.359		
0.000492126	3.908316	7941.698	0.1200000	0.0000591	
-0.0000591	1206.249	0.000	-9904.843		
0.000541339	4.296769	7937.304	0.1200000	0.0000650	
-0.0000650	1323.910	0.000	-10895.327		
0.000590551	4.684790	7932.911	0.1200000	0.0000709	
-0.0000709	1441.032	0.000	-11885.811		
0.000639764	5.072378	7928.518	0.1200000	0.0000768	
-0.0000768	1557.616	0.000	-12876.296		
0.000688976	5.459535	7924.124	0.1200000	0.0000827	
-0.0000827	1673.660	0.000	-13866.780		
0.000738189	5.846258	7919.731	0.1200000	0.0000886	
-0.0000886	1789.165	0.000	-14857.264		
0.000787402	6.232550	7915.338	0.1200000	0.0000945	
-0.0000945	1904.132	0.000	-15847.749		
0.000836614	6.618408	7910.945	0.1200000	0.0001004	
-0.0001004	2018.559	0.000	-16838.233		
0.000885827	7.003835	7906.551	0.1200000	0.0001063	
-0.0001063	2132.448	0.000	-17828.717		
0.000935039	7.388829	7902.158	0.1200000	0.0001122	
-0.0001122	2245.798	0.000	-18819.201		
0.000984252	7.762290	7886.486	0.1199527	0.0001181	
-0.0001182	2357.712	0.000	-19819.464 C		
0.001033465	8.044623	7784.130	0.1195282	0.0001235	
-0.0001245	2461.533	0.000	-20902.572 C		
0.001082677	8.278337	7646.173	0.1189199	0.0001288	
-0.0001311	2560.299	0.000	-22036.229 C		
0.001131890	8.480110	7491.993	0.1182006	0.0001338	
-0.0001379	2655.115	0.000	-23208.862 C		
0.001181102	8.665598	7336.873	0.1174356	0.0001387	
-0.0001448	2747.181	0.000	-24407.666 C		
0.001230315	8.933880	7261.458	0.1170558	0.0001440	
-0.0001513	2846.389	0.000	-25522.798 C		
0.001279528	9.213916	7201.030	0.1167426	0.0001494	
-0.0001577	2946.062	0.000	-26627.854 C		
0.001328740	9.484322	7137.831	0.1163991	0.0001547	
-0.0001642	3043.964	0.000	-27747.844 C		
0.001377953	9.733706	7063.889	0.1159754	0.0001598	
-0.0001709	3138.748	0.000	-28898.146 C		
0.001427165	9.972561	6987.671	0.1155174	0.0001649	
-0.0001777	3231.444	0.000	-30067.503 C		
0.001476378	10.204795	6912.048	0.1150407	0.0001698	

-0.0001845	3322.408	0.000	-31252.098	C	
	0.001525591	10.486500	6873.732	0.1148014	0.0001751
-0.0001910	3418.779	0.000	-32370.516	C	
	0.001574803	10.711213	6801.620	0.1143119	0.0001800
-0.0001979	3507.082	0.000	-33576.604	C	
	0.001624016	10.987510	6765.643	0.1140696	0.0001853
-0.0002045	3601.455	0.000	-34708.492	C	
	0.001673228	11.261859	6730.617	0.1138276	0.0001905
-0.0002111	3694.980	0.000	-35845.307	C	
	0.001722441	11.481301	6665.716	0.1133383	0.0001952
-0.0002182	3779.967	0.000	-37076.589	C	
	0.001771654	11.752765	6633.783	0.1130993	0.0002004
-0.0002248	3871.716	0.000	-38224.814	C	
	0.001820866	12.023118	6602.967	0.1128623	0.0002055
-0.0002315	3962.696	0.000	-39377.255	C	
	0.001870079	12.292569	6573.290	0.1126275	0.0002106
-0.0002382	4052.930	0.000	-40533.719	C	
	0.001919291	12.561317	6544.768	0.1123952	0.0002157
-0.0002449	4142.437	0.000	-41694.003	C	
	0.001968504	12.829555	6517.414	0.1121659	0.0002208
-0.0002516	4231.242	0.000	-42857.898	C	
	0.002066929	13.413134	6489.402	0.1119487	0.0002314
-0.0002647	4415.207	0.000	-45095.064	C	
	0.002165354	13.946275	6440.643	0.1115073	0.0002415
-0.0002782	4588.290	0.000	-47443.146	C	
	0.002263780	14.525066	6416.290	0.1113021	0.0002520
-0.0002913	4767.503	0.000	-49697.218	C	
	0.002362205	15.058066	6374.581	0.1108859	0.0002619
-0.0003050	4935.850	0.000	-52064.407	C	
	0.002460630	15.634323	6353.789	0.1106949	0.0002724
-0.0003182	5110.621	0.000	-54332.490	C	
	0.002559055	16.209478	6334.165	0.1105091	0.0002828
-0.0003314	5283.312	0.000	-56605.608	C	
	0.002657480	16.783811	6315.686	0.1103289	0.0002932
-0.0003446	5453.968	0.000	-58883.318	C	
	0.002755906	17.357587	6298.324	0.1101545	0.0003036
-0.0003578	5622.636	0.000	-61165.152	C	
	0.002854331	17.931057	6282.053	0.1099859	0.0003139
-0.0003711	5789.366	0.000	-63450.609	C	
	0.002952756	18.540134	6278.925	0.1100071	0.0003248
-0.0003838	5962.890	0.000	-65625.453	C	
	0.003051181	19.111830	6263.748	0.1098450	0.0003352
-0.0003971	6125.779	0.000	-67916.834	C	
	0.003149606	19.683767	6249.596	0.1096893	0.0003455
-0.0004104	6286.837	0.000	-70210.690	C	
	0.003248031	20.288934	6246.532	0.1097110	0.0003563
-0.0004232	6454.737	0.000	-72389.981	C	
	0.003346457	20.859804	6233.400	0.1095621	0.0003666
-0.0004365	6612.101	0.000	-74688.276	C	
	0.003444882	21.431374	6221.222	0.1094199	0.0003769
-0.0004498	6767.742	0.000	-76987.789	C	
	0.003543307	22.033030	6218.211	0.1094421	0.0003878
-0.0004626	6930.092	0.000	-79170.969	C	
	0.003641732	22.604127	6206.971	0.1093071	0.0003981

-0.0004759	7082.175	0.000	-81473.374	C	
	0.003740157	23.203868	6203.982	0.1093295	0.0004089
-0.0004887	7240.906	0.000	-83657.761	C	
	0.003838583	23.774797	6193.639	0.1092020	0.0004192
-0.0005021	7389.508	0.000	-85962.103	C	
	0.003937008	24.372707	6190.668	0.1092246	0.0004300
-0.0005149	7544.636	0.000	-88147.569	C	
	0.004035433	24.970020	6187.693	0.1092472	0.0004409
-0.0005276	7698.019	0.000	-90332.061	C	
	0.004133858	25.539893	6178.222	0.1091274	0.0004511
-0.0005410	7841.369	0.000	-92639.307	C	
	0.004232283	26.135465	6175.263	0.1091503	0.0004620
-0.0005538	7991.168	0.000	-94824.657	C	
	0.004330709	26.730438	6172.301	0.1091732	0.0004728
-0.0005666	8139.218	0.000	-97009.044	C	
	0.004429134	27.299639	6163.652	0.1090613	0.0004830
-0.0005799	8277.418	0.000	-99317.875	C	
	0.004527559	27.892950	6160.704	0.1090844	0.0004939
-0.0005927	8421.900	0.000	-101502.933	C	
	0.004625984	28.485663	6157.752	0.1091076	0.0005047
-0.0006055	8564.631	0.000	-103687.015	C	
	0.004724409	29.054519	6149.873	0.1090038	0.0005150
-0.0006189	8697.772	0.000	-105996.091	C	
	0.004822835	29.645644	6146.933	0.1090272	0.0005258
-0.0006317	8836.947	0.000	-108180.654	C	
	0.004921260	30.236170	6143.990	0.1090506	0.0005367
-0.0006444	8974.368	0.000	-110364.230	C	
	0.005019685	30.804957	6136.831	0.1089552	0.0005469
-0.0006578	9102.536	0.000	-112672.140	C	
	0.005118110	31.393960	6133.897	0.1089788	0.0005578
-0.0006706	9236.410	0.000	-114856.030	C	
	0.005216535	31.982366	6130.959	0.1090024	0.0005686
-0.0006834	9368.531	0.000	-117038.894	C	
	0.005314961	32.570174	6128.018	0.1090261	0.0005795
-0.0006961	9498.894	0.000	-119220.738	C	
	0.005413386	33.157383	6125.073	0.1090498	0.0005903
-0.0007089	9627.499	0.000	-121401.559	C	
	0.005511811	33.724585	6118.603	0.1089632	0.0006006
-0.0007223	9747.202	0.000	-123709.175	C	
	0.005610236	34.310334	6115.666	0.1089871	0.0006114
-0.0007350	9872.267	0.000	-125890.066	C	
	0.005708661	34.895481	6112.726	0.1090111	0.0006223
-0.0007478	9995.569	0.000	-128069.942	C	
	0.005807087	35.480028	6109.781	0.1090351	0.0006332
-0.0007605	10117.105	0.000	-130248.779	C	
	0.005905512	36.063972	6106.833	0.1090591	0.0006440
-0.0007733	10236.874	0.000	-132426.577	C	
	0.006299213	38.375756	6092.151	0.1090542	0.0006870
-0.0008249	10691.589	0.000	-141261.668	C	
	0.006692913	40.679697	6078.025	0.1090593	0.0007299
-0.0008764	11118.547	0.000	-150083.178	C	
	0.007086614	42.988608	6066.170	0.1091580	0.0007736
-0.0009272	11523.052	0.000	-158764.889	C	
	0.007480315	45.287721	6054.253	0.1092573	0.0008173

-0.0009780	11898.885	0.000	-167429.068	C	
	0.007874016	47.563512	6040.566	0.1092746	0.0008604
-0.0010293	12240.871	0.000	-176212.574	C	
	0.008267717	49.842439	6028.562	0.1093758	0.0009043
-0.0010800	12559.096	0.000	-184847.554	C	
	0.008661417	52.111332	6016.490	0.1094776	0.0009482
-0.0011305	12848.183	0.000	-193464.659	C	
	0.009055118	54.359224	6003.149	0.1095075	0.0009916
-0.0011816	13104.265	0.000	-202201.697	C	
	0.009448819	56.607669	5990.978	0.1096111	0.0010357
-0.0012320	13334.901	0.000	-210787.407	C	
	0.009842520	58.845845	5978.738	0.1097154	0.0010799
-0.0012823	13535.917	0.000	-219354.605	C	
	0.010236220	61.073665	5966.427	0.1098204	0.0011241
-0.0013325	13707.135	0.000	-227903.020	C	
	0.010629921	63.283061	5953.295	0.1098645	0.0011679
-0.0013833	13846.486	0.000	-236569.916	C	
	0.011023622	65.489910	5940.870	0.1099714	0.0012123
-0.0014334	13957.966	0.000	-245084.352	C	
	0.011417323	67.686148	5928.373	0.1100791	0.0012568
-0.0014833	14039.120	0.000	-253579.177	C	
	0.011811024	69.871670	5915.801	0.1101875	0.0013014
-0.0015332	14089.754	0.000	-262054.321	C	
	0.012204724	72.046375	5903.155	0.1102968	0.0013461
-0.0015830	14109.673	0.000	-270509.568	C	
	0.012598425	74.209934	5890.414	0.1104068	0.0013910
-0.0016327	14109.733	0.000	-278944.405	C	
	0.012992126	76.362167	5877.573	0.1105179	0.0014359
-0.0016822	14108.993	0.000	-287358.490	C	
	0.013385827	78.503589	5864.680	0.1106295	0.0014809
-0.0017317	14106.924	0.000	-295752.389	C	
	0.013779528	80.634829	5851.785	0.1107416	0.0015260
-0.0017811	14109.781	0.000	-304126.844	C	
	0.014173228	82.752528	5838.651	0.1108058	0.0015705
-0.0018311	14107.027	0.000	-312624.783	C	
	0.014566929	84.865745	5825.919	0.1109181	0.0016157
-0.0018803	14109.434	0.000	-320965.555	C	
	0.014960630	86.971016	5813.326	0.1110297	0.0016611
-0.0019295	14109.078	0.000	-329289.652	C	
	0.015354331	89.068888	5800.897	0.1111405	0.0017065
-0.0019786	14107.092	0.000	-337597.896	C	
	0.015748031	91.160266	5788.677	0.1112501	0.0017520
-0.0020276	14108.605	0.000	-345891.639	C	
	0.016141732	93.245712	5776.686	0.1113584	0.0017975
-0.0020765	14109.395	0.000	-354171.728	C	
	0.016535433	95.288114	5762.662	0.1114491	0.0018429
-0.0021256	14109.727	0.000	-355000.000	C	
	0.016929134	97.237437	5743.793	0.1115010	0.0018876
-0.0021754	14109.746	0.000	-355000.000	C	
	0.017322835	99.057662	5718.329	0.1114995	0.0019315
-0.0022260	14109.595	0.000	-355000.000	CS	
	0.017716535	100.744938	5686.492	0.1114447	0.0019744
-0.0022776	14109.062	0.000	-355000.000	CS	
	0.018110236	102.290019	5648.188	0.1113340	0.0020163

-0.0023302	14107.633	0.000	-355000.000	CS	
	0.018503937	103.741856	5606.475	0.1111903	0.0020575
-0.0023835	14104.690	0.000	-355000.000	CS	
	0.018897638	105.087520	5560.881	0.1109720	0.0020971
-0.0024383	14109.963	0.000	-355000.000	CS	
	0.019291339	106.378121	5514.294	0.1107747	0.0021370
-0.0024929	14108.385	0.000	-355000.000	CS	
	0.019685039	107.604648	5466.316	0.1105632	0.0021764
-0.0025480	14103.654	0.000	-355000.000	CS	
	0.020078740	108.747565	5416.055	0.1103464	0.0022156
-0.0026033	14109.664	0.000	-355000.000	CS	
	0.020472441	109.812813	5363.934	0.1101357	0.0022547
-0.0026586	14105.780	0.000	-355000.000	CS	
	0.020866142	110.802356	5310.151	0.1099349	0.0022939
-0.0027140	14109.967	0.000	-355000.000	CS	
	0.021259843	111.704128	5254.231	0.1097009	0.0023322
-0.0027701	14106.295	0.000	-355000.000	CS	
	0.021653543	112.548974	5197.716	0.1095242	0.0023716
-0.0028253	14109.989	0.000	-355000.000	CS	
	0.023622047	115.853447	4904.463	0.1088792	0.0025719
-0.0030973	14103.918	0.000	-355000.000	CS	
	0.025590551	118.191551	4618.562	0.1083867	0.0027737
-0.0033681	14104.175	0.000	-355000.000	CS	
	0.027559055	119.954261	4352.626	0.1080511	0.0029778
-0.0036364	14099.093	0.000	-355000.000	CS	
	0.029527559	121.311172	4108.405	0.1077920	0.0031828
-0.0039038	14109.325	0.000	-355000.000	CS	
	0.031496063	122.377407	3885.483	0.1075297	0.0033868
-0.0041723	14099.707	0.000	-355000.000	CS	
	0.033464567	123.236050	3682.583	0.1073593	0.0035927
-0.0044388	14100.402	0.000	-355000.000	CS	
	0.035433071	123.932702	3497.656	0.1072231	0.0037992
-0.0047047	14103.123	0.000	-355000.000	CS	

-
Summary of Results for Nominal (Unfactored) Moment Capacity for Section
Z Axis,

-

Load No.	Axial Thrust kN	Nominal Mom. Cap. m-kN	Max. Comp. Strain
-----	-----	-----	-----
1	0.000	121.16	0.00300000

 -
 Computations of Nominal Moment Capacity and Nonlinear Bending
 Stiffness

Section: 1 (MP240), Y Axis,

 -

Input Axial Thrust Forces:

Number of Axial Thrust Force Values = 1

Number	Axial Thrust Force kN
1	0.000

Axial Thrust Force = 0.000 kN ,128

Max Tens Strain m/m	Bending Max Concrete Curvature rad/m Stress kPa	Bending Max Reinf Moment kN-m Stress kPa	Bending Max Casing Stiffness kN-m2 Stress kPa	Depth to Run N Axis Msg m	Max Comp Strain m/m
0.0000000	0.000	0.000	0.000	0.1200000	0.0000000
-0.0000059	123.050	0.000	7981.237	0.1200000	0.0000059
-0.0000118	245.561	0.000	7976.844	0.1200000	0.0000118
-0.0000177	367.533	0.000	7972.450	0.1200000	0.0000177
-0.0000236	488.966	0.000	7968.057	0.1200000	0.0000236
-0.0000295	609.861	0.000	7963.664	0.1200000	0.0000295
-0.0000354	730.216	0.000	7959.271	0.1200000	0.0000354
-0.0000413	850.033	0.000	7954.877	0.1200000	0.0000413
-0.0000472	969.311	0.000	7950.484	0.1200000	0.0000472
-0.0000531	1088.049	0.000	7946.091	0.1200000	0.0000531
-0.0000591	1206.249	0.000	7941.698	0.1200000	0.0000591
-0.0000650	1323.910	0.000	7937.304	0.1200000	0.0000650
	1441.571	0.000	7932.911	0.1200000	0.0000709

-0.0000709	1441.032	0.000	-11885.811		
	0.000639764	5.072378	7928.518	0.1200000	0.0000768
-0.0000768	1557.616	0.000	-12876.296		
	0.000688976	5.459535	7924.124	0.1200000	0.0000827
-0.0000827	1673.660	0.000	-13866.780		
	0.000738189	5.846258	7919.731	0.1200000	0.0000886
-0.0000886	1789.165	0.000	-14857.264		
	0.000787402	6.232550	7915.338	0.1200000	0.0000945
-0.0000945	1904.132	0.000	-15847.749		
	0.000836614	6.618408	7910.945	0.1200000	0.0001004
-0.0001004	2018.559	0.000	-16838.233		
	0.000885827	7.003835	7906.551	0.1200000	0.0001063
-0.0001063	2132.448	0.000	-17828.717		
	0.000935039	7.388829	7902.158	0.1200000	0.0001122
-0.0001122	2245.798	0.000	-18819.201		
	0.000984252	7.762290	7886.486	0.1199527	0.0001181
-0.0001182	2357.712	0.000	-19819.464	C	
	0.001033465	8.044623	7784.130	0.1195282	0.0001235
-0.0001245	2461.533	0.000	-20902.572	C	
	0.001082677	8.278337	7646.173	0.1189199	0.0001288
-0.0001311	2560.299	0.000	-22036.229	C	
	0.001131890	8.480110	7491.993	0.1182006	0.0001338
-0.0001379	2655.115	0.000	-23208.862	C	
	0.001181102	8.665598	7336.873	0.1174356	0.0001387
-0.0001448	2747.181	0.000	-24407.666	C	
	0.001230315	8.933880	7261.458	0.1170558	0.0001440
-0.0001513	2846.389	0.000	-25522.798	C	
	0.001279528	9.213916	7201.030	0.1167426	0.0001494
-0.0001577	2946.062	0.000	-26627.854	C	
	0.001328740	9.484322	7137.831	0.1163991	0.0001547
-0.0001642	3043.964	0.000	-27747.844	C	
	0.001377953	9.733706	7063.889	0.1159754	0.0001598
-0.0001709	3138.748	0.000	-28898.146	C	
	0.001427165	9.972561	6987.671	0.1155174	0.0001649
-0.0001777	3231.444	0.000	-30067.503	C	
	0.001476378	10.204795	6912.048	0.1150407	0.0001698
-0.0001845	3322.408	0.000	-31252.098	C	
	0.001525591	10.486500	6873.732	0.1148014	0.0001751
-0.0001910	3418.779	0.000	-32370.516	C	
	0.001574803	10.711213	6801.620	0.1143119	0.0001800
-0.0001979	3507.082	0.000	-33576.604	C	
	0.001624016	10.987510	6765.643	0.1140696	0.0001853
-0.0002045	3601.455	0.000	-34708.492	C	
	0.001673228	11.261859	6730.617	0.1138276	0.0001905
-0.0002111	3694.980	0.000	-35845.307	C	
	0.001722441	11.481301	6665.716	0.1133383	0.0001952
-0.0002182	3779.967	0.000	-37076.589	C	
	0.001771654	11.752765	6633.783	0.1130993	0.0002004
-0.0002248	3871.716	0.000	-38224.814	C	
	0.001820866	12.023118	6602.967	0.1128623	0.0002055
-0.0002315	3962.696	0.000	-39377.255	C	
	0.001870079	12.292569	6573.290	0.1126275	0.0002106
-0.0002382	4052.930	0.000	-40533.719	C	
	0.001919291	12.561317	6544.768	0.1123952	0.0002157

-0.0002449	4142.437	0.000	-41694.003	C	
	0.001968504	12.829555	6517.414	0.1121659	0.0002208
-0.0002516	4231.242	0.000	-42857.898	C	
	0.002066929	13.413134	6489.402	0.1119487	0.0002314
-0.0002647	4415.207	0.000	-45095.064	C	
	0.002165354	13.946275	6440.643	0.1115073	0.0002415
-0.0002782	4588.290	0.000	-47443.146	C	
	0.002263780	14.525066	6416.290	0.1113021	0.0002520
-0.0002913	4767.503	0.000	-49697.218	C	
	0.002362205	15.058066	6374.581	0.1108859	0.0002619
-0.0003050	4935.850	0.000	-52064.407	C	
	0.002460630	15.634323	6353.789	0.1106949	0.0002724
-0.0003182	5110.621	0.000	-54332.490	C	
	0.002559055	16.209478	6334.165	0.1105091	0.0002828
-0.0003314	5283.312	0.000	-56605.608	C	
	0.002657480	16.783811	6315.686	0.1103289	0.0002932
-0.0003446	5453.968	0.000	-58883.318	C	
	0.002755906	17.357587	6298.324	0.1101545	0.0003036
-0.0003578	5622.636	0.000	-61165.152	C	
	0.002854331	17.931057	6282.053	0.1099859	0.0003139
-0.0003711	5789.366	0.000	-63450.609	C	
	0.002952756	18.540134	6278.925	0.1100071	0.0003248
-0.0003838	5962.890	0.000	-65625.453	C	
	0.003051181	19.111830	6263.748	0.1098450	0.0003352
-0.0003971	6125.779	0.000	-67916.834	C	
	0.003149606	19.683767	6249.596	0.1096893	0.0003455
-0.0004104	6286.837	0.000	-70210.690	C	
	0.003248031	20.288934	6246.532	0.1097110	0.0003563
-0.0004232	6454.737	0.000	-72389.981	C	
	0.003346457	20.859804	6233.400	0.1095621	0.0003666
-0.0004365	6612.101	0.000	-74688.276	C	
	0.003444882	21.431374	6221.222	0.1094199	0.0003769
-0.0004498	6767.742	0.000	-76987.789	C	
	0.003543307	22.033030	6218.211	0.1094421	0.0003878
-0.0004626	6930.092	0.000	-79170.969	C	
	0.003641732	22.604127	6206.971	0.1093071	0.0003981
-0.0004759	7082.175	0.000	-81473.374	C	
	0.003740157	23.203868	6203.982	0.1093295	0.0004089
-0.0004887	7240.906	0.000	-83657.761	C	
	0.003838583	23.774797	6193.639	0.1092020	0.0004192
-0.0005021	7389.508	0.000	-85962.103	C	
	0.003937008	24.372707	6190.668	0.1092246	0.0004300
-0.0005149	7544.636	0.000	-88147.569	C	
	0.004035433	24.970020	6187.693	0.1092472	0.0004409
-0.0005276	7698.019	0.000	-90332.061	C	
	0.004133858	25.539893	6178.222	0.1091274	0.0004511
-0.0005410	7841.369	0.000	-92639.307	C	
	0.004232283	26.135465	6175.263	0.1091503	0.0004620
-0.0005538	7991.168	0.000	-94824.657	C	
	0.004330709	26.730438	6172.301	0.1091732	0.0004728
-0.0005666	8139.218	0.000	-97009.044	C	
	0.004429134	27.299639	6163.652	0.1090613	0.0004830
-0.0005799	8277.418	0.000	-99317.875	C	
	0.004527559	27.892950	6160.704	0.1090844	0.0004939

-0.0005927	8421.900	0.000	-101502.933	C	
	0.004625984	28.485663	6157.752	0.1091076	0.0005047
-0.0006055	8564.631	0.000	-103687.015	C	
	0.004724409	29.054519	6149.873	0.1090038	0.0005150
-0.0006189	8697.772	0.000	-105996.091	C	
	0.004822835	29.645644	6146.933	0.1090272	0.0005258
-0.0006317	8836.947	0.000	-108180.654	C	
	0.004921260	30.236170	6143.990	0.1090506	0.0005367
-0.0006444	8974.368	0.000	-110364.230	C	
	0.005019685	30.804957	6136.831	0.1089552	0.0005469
-0.0006578	9102.536	0.000	-112672.140	C	
	0.005118110	31.393960	6133.897	0.1089788	0.0005578
-0.0006706	9236.410	0.000	-114856.030	C	
	0.005216535	31.982366	6130.959	0.1090024	0.0005686
-0.0006834	9368.531	0.000	-117038.894	C	
	0.005314961	32.570174	6128.018	0.1090261	0.0005795
-0.0006961	9498.894	0.000	-119220.738	C	
	0.005413386	33.157383	6125.073	0.1090498	0.0005903
-0.0007089	9627.499	0.000	-121401.559	C	
	0.005511811	33.724585	6118.603	0.1089632	0.0006006
-0.0007223	9747.202	0.000	-123709.175	C	
	0.005610236	34.310334	6115.666	0.1089871	0.0006114
-0.0007350	9872.267	0.000	-125890.066	C	
	0.005708661	34.895481	6112.726	0.1090111	0.0006223
-0.0007478	9995.569	0.000	-128069.942	C	
	0.005807087	35.480028	6109.781	0.1090351	0.0006332
-0.0007605	10117.105	0.000	-130248.779	C	
	0.005905512	36.063972	6106.833	0.1090591	0.0006440
-0.0007733	10236.874	0.000	-132426.577	C	
	0.006299213	38.375756	6092.151	0.1090542	0.0006870
-0.0008249	10691.589	0.000	-141261.668	C	
	0.006692913	40.679697	6078.025	0.1090593	0.0007299
-0.0008764	11118.547	0.000	-150083.178	C	
	0.007086614	42.988608	6066.170	0.1091580	0.0007736
-0.0009272	11523.052	0.000	-158764.889	C	
	0.007480315	45.287721	6054.253	0.1092573	0.0008173
-0.0009780	11898.885	0.000	-167429.068	C	
	0.007874016	47.563512	6040.566	0.1092746	0.0008604
-0.0010293	12240.871	0.000	-176212.574	C	
	0.008267717	49.842439	6028.562	0.1093758	0.0009043
-0.0010800	12559.096	0.000	-184847.554	C	
	0.008661417	52.111332	6016.490	0.1094776	0.0009482
-0.0011305	12848.183	0.000	-193464.659	C	
	0.009055118	54.359224	6003.149	0.1095075	0.0009916
-0.0011816	13104.265	0.000	-202201.697	C	
	0.009448819	56.607669	5990.978	0.1096111	0.0010357
-0.0012320	13334.901	0.000	-210787.407	C	
	0.009842520	58.845845	5978.738	0.1097154	0.0010799
-0.0012823	13535.917	0.000	-219354.605	C	
	0.010236220	61.073665	5966.427	0.1098204	0.0011241
-0.0013325	13707.135	0.000	-227903.020	C	
	0.010629921	63.283061	5953.295	0.1098645	0.0011679
-0.0013833	13846.486	0.000	-236569.916	C	
	0.011023622	65.489910	5940.870	0.1099714	0.0012123

-0.0014334	13957.966	0.000	-245084.352	C	
	0.011417323	67.686148	5928.373	0.1100791	0.0012568
-0.0014833	14039.120	0.000	-253579.177	C	
	0.011811024	69.871670	5915.801	0.1101875	0.0013014
-0.0015332	14089.754	0.000	-262054.321	C	
	0.012204724	72.046375	5903.155	0.1102968	0.0013461
-0.0015830	14109.673	0.000	-270509.568	C	
	0.012598425	74.209934	5890.414	0.1104068	0.0013910
-0.0016327	14109.733	0.000	-278944.405	C	
	0.012992126	76.362167	5877.573	0.1105179	0.0014359
-0.0016822	14108.993	0.000	-287358.490	C	
	0.013385827	78.503589	5864.680	0.1106295	0.0014809
-0.0017317	14106.924	0.000	-295752.389	C	
	0.013779528	80.634829	5851.785	0.1107416	0.0015260
-0.0017811	14109.781	0.000	-304126.844	C	
	0.014173228	82.752528	5838.651	0.1108058	0.0015705
-0.0018311	14107.027	0.000	-312624.783	C	
	0.014566929	84.865745	5825.919	0.1109181	0.0016157
-0.0018803	14109.434	0.000	-320965.555	C	
	0.014960630	86.971016	5813.326	0.1110297	0.0016611
-0.0019295	14109.078	0.000	-329289.652	C	
	0.015354331	89.068888	5800.897	0.1111405	0.0017065
-0.0019786	14107.092	0.000	-337597.896	C	
	0.015748031	91.160266	5788.677	0.1112501	0.0017520
-0.0020276	14108.605	0.000	-345891.639	C	
	0.016141732	93.245712	5776.686	0.1113584	0.0017975
-0.0020765	14109.395	0.000	-354171.728	C	
	0.016535433	95.288114	5762.662	0.1114491	0.0018429
-0.0021256	14109.727	0.000	-355000.000	C	
	0.016929134	97.237437	5743.793	0.1115010	0.0018876
-0.0021754	14109.746	0.000	-355000.000	C	
	0.017322835	99.057662	5718.329	0.1114995	0.0019315
-0.0022260	14109.595	0.000	-355000.000	CS	
	0.017716535	100.744938	5686.492	0.1114447	0.0019744
-0.0022776	14109.062	0.000	-355000.000	CS	
	0.018110236	102.290019	5648.188	0.1113340	0.0020163
-0.0023302	14107.633	0.000	-355000.000	CS	
	0.018503937	103.741856	5606.475	0.1111903	0.0020575
-0.0023835	14104.690	0.000	-355000.000	CS	
	0.018897638	105.087520	5560.881	0.1109720	0.0020971
-0.0024383	14109.963	0.000	-355000.000	CS	
	0.019291339	106.378121	5514.294	0.1107747	0.0021370
-0.0024929	14108.385	0.000	-355000.000	CS	
	0.019685039	107.604648	5466.316	0.1105632	0.0021764
-0.0025480	14103.654	0.000	-355000.000	CS	
	0.020078740	108.747565	5416.055	0.1103464	0.0022156
-0.0026033	14109.664	0.000	-355000.000	CS	
	0.020472441	109.812813	5363.934	0.1101357	0.0022547
-0.0026586	14105.780	0.000	-355000.000	CS	
	0.020866142	110.802356	5310.151	0.1099349	0.0022939
-0.0027140	14109.967	0.000	-355000.000	CS	
	0.021259843	111.704128	5254.231	0.1097009	0.0023322
-0.0027701	14106.295	0.000	-355000.000	CS	
	0.021653543	112.548974	5197.716	0.1095242	0.0023716

-0.0028253	14109.989	0.000	-355000.000	CS	
	0.023622047	115.853447	4904.463	0.1088792	0.0025719
-0.0030973	14103.918	0.000	-355000.000	CS	
	0.025590551	118.191551	4618.562	0.1083867	0.0027737
-0.0033681	14104.175	0.000	-355000.000	CS	
	0.027559055	119.954261	4352.626	0.1080511	0.0029778
-0.0036364	14099.093	0.000	-355000.000	CS	
	0.029527559	121.311172	4108.405	0.1077920	0.0031828
-0.0039038	14109.325	0.000	-355000.000	CS	
	0.031496063	122.377407	3885.483	0.1075297	0.0033868
-0.0041723	14099.707	0.000	-355000.000	CS	
	0.033464567	123.236050	3682.583	0.1073593	0.0035927
-0.0044388	14100.402	0.000	-355000.000	CS	
	0.035433071	123.932702	3497.656	0.1072231	0.0037992
-0.0047047	14103.123	0.000	-355000.000	CS	

-
Summary of Results for Nominal (Unfactored) Moment Capacity for Section
Y Axis,

-

Load No.	Axial Thrust kN	Nominal Mom. Cap. m-kN	Max. Comp. Strain
-----	-----	-----	-----
1	0.000	121.16	0.00300000

* TABLE K * REDUCTION FACTORS

REDUCTION FACTORS FOR CLOSELY-SPACED PILE GROUPS
ARE NOT CONSIDERED

=====

GROUP for Windows, Version 2019.11.5

Serial Number : 292797944

Analysis of A Group of Piles
Subjected to Axial and Lateral Loading

(c) Copyright ENSOFT, Inc., 1987-2018
All Rights Reserved

=====

Time and Date of Analysis

Date: February 19, 2020 Time: 16:28:36

***** COMPUTATION RESULTS *****

New Group

***** LOAD CASES RESULTS *****

LOAD CASE : 1
CASE NAME : SLU F1

LOAD TYPE : Dead, DL

* TABLE L * COMPUTATION ON PILE CAP

* EQUIVALENT CONCENTRATED LOAD AT ORIGIN *

VERT. LOAD, KN	HOR. LOAD Y, KN	HOR. LOAD Z, KN
1610.00	0.00000	1720.00

MOMENT X , KN- M MOMENT Y, KN- M MOMENT Z, KN- M
 0.00000 3010.00 0.00000

* DISPLACEMENT OF GROUPED PILE FOUNDATION AT ORIGIN *

VERTICAL , M HORIZONTAL Y, M HORIZONTAL Z, M
 1.23478E-03 -8.97662E-15 2.96195E-03

ANGLE ROT. X,RAD ANGLE ROT. Y,RAD ANGLE ROT. Z,RAD
 1.28580E-14 1.74471E-03 -1.71365E-15

* TABLE M * COMPUTATION ON INDIVIDUAL PILE

THE GLOBAL STRUCTURAL COORDINATE SYSTEM

* PILE TOP DISPLACEMENTS *

PILE GROUP	DISP. X, M	DISP. Y, M	DISP. Z, M	ROT. X,RAD	ROT. Y,RAD	ROT. Z,RAD
1	3.6242E-04	-2.5476E-15	2.9620E-03	1.2858E-14	1.7447E-03	-1.7136E-15
2	3.6242E-04	-2.5476E-15	2.9620E-03	1.2858E-14	1.7447E-03	-1.7136E-15
3	3.6242E-04	-2.5476E-15	2.9620E-03	1.2858E-14	1.7447E-03	-1.7136E-15
4	3.6242E-04	-2.5476E-15	2.9620E-03	1.2858E-14	1.7447E-03	-1.7136E-15
5	3.6242E-04	-2.5476E-15	2.9620E-03	1.2858E-14	1.7447E-03	-1.7136E-15
6	3.6242E-04	-2.5476E-15	2.9620E-03	1.2858E-14	1.7447E-03	-1.7136E-15
7	3.6242E-04	-2.5476E-15	2.9620E-03	1.2858E-14	1.7447E-03	-1.7136E-15
8	3.6242E-04	-2.5476E-15	2.9620E-03	1.2858E-14	1.7447E-03	-1.7136E-15
9	3.6242E-04	-2.5476E-15	2.9620E-03	1.2858E-14	1.7447E-03	-1.7136E-15
10	3.6242E-04	-2.5476E-15	2.9620E-03	1.2858E-14	1.7447E-03	-1.7136E-15
11	2.1071E-03	-1.5406E-14	2.9620E-03	1.2858E-14	1.7447E-03	-1.7136E-15
12	2.1071E-03	-1.5406E-14	2.9620E-03	1.2858E-14	1.7447E-03	-1.7136E-15
13	2.1071E-03	-1.5406E-14	2.9620E-03	1.2858E-14	1.7447E-03	-1.7136E-15
14	2.1071E-03	-1.5406E-14	2.9620E-03	1.2858E-14	1.7447E-03	-1.7136E-15

1.7447E-03	-1.7136E-15				
15	2.1071E-03	-1.5406E-14	2.9620E-03	1.2858E-14	
1.7447E-03	-1.7136E-15				
16	2.1071E-03	-1.5406E-14	2.9620E-03	1.2858E-14	
1.7447E-03	-1.7136E-15				
17	2.1071E-03	-1.5406E-14	2.9620E-03	1.2858E-14	
1.7447E-03	-1.7136E-15				
18	2.1071E-03	-1.5406E-14	2.9620E-03	1.2858E-14	
1.7447E-03	-1.7136E-15				
19	2.1071E-03	-1.5406E-14	2.9620E-03	1.2858E-14	
1.7447E-03	-1.7136E-15				
20	2.1071E-03	-1.5406E-14	2.9620E-03	1.2858E-14	
1.7447E-03	-1.7136E-15				

	MINIMUM	3.6242E-04	-1.5406E-14	2.9620E-03	1.2858E-14	
1.7447E-03	-1.7136E-15					
	Pile N.	1	11	1	1	1
	1					
	MAXIMUM	2.1071E-03	-2.5476E-15	2.9620E-03	1.2858E-14	
1.7447E-03	-1.7136E-15					
	Pile N.	11	1	1	1	1
	1					

* PILE TOP REACTIONS *

	PILE GROUP	FOR. X, KN	FOR. Y, KN	FOR. Z, KN	MOM X, KN- M	MOM Y, KN- M
M MOM Z, KN- M	*****	*****	*****	*****	*****	*****
*****	*****	*****	*****	*****	*****	*****
	1	-213.37	2.6210E-11	172.84	3.9470E-11	
2.6164	3.9509E-11					
	2	-213.37	2.6210E-11	172.84	3.9470E-11	
2.6164	3.9509E-11					
	3	-213.37	2.6210E-11	172.84	3.9470E-11	
2.6164	3.9509E-11					
	4	-213.37	2.6210E-11	172.84	3.9470E-11	
2.6164	3.9509E-11					
	5	-213.37	2.6210E-11	172.84	3.9470E-11	
2.6164	3.9509E-11					
	6	-213.37	2.6210E-11	172.84	3.9470E-11	
2.6164	3.9509E-11					
	7	-213.37	2.6210E-11	172.84	3.9470E-11	
2.6164	3.9509E-11					
	8	-213.37	2.6210E-11	172.84	3.9470E-11	
2.6164	3.9509E-11					
	9	-213.37	2.6210E-11	172.84	3.9470E-11	
2.6164	3.9509E-11					
	10	-213.37	2.6210E-11	172.84	3.9470E-11	
2.6164	3.9509E-11					
	11	374.37	-3.1302E-11	-0.8397	1.1565E-11	
4.5148	-6.5112E-11					
	12	374.37	-3.1302E-11	-0.8397	1.1565E-11	
4.5148	-6.5112E-11					
	13	374.37	-3.1302E-11	-0.8397	1.1565E-11	

4.5148	-6.5112E-11					
	14	374.37	-3.1302E-11	-0.8397	1.1565E-11	
4.5148	-6.5112E-11					
	15	374.37	-3.1302E-11	-0.8397	1.1565E-11	
4.5148	-6.5112E-11					
	16	374.37	-3.1302E-11	-0.8397	1.1565E-11	
4.5148	-6.5112E-11					
	17	374.37	-3.1302E-11	-0.8397	1.1565E-11	
4.5148	-6.5112E-11					
	18	374.37	-3.1302E-11	-0.8397	1.1565E-11	
4.5148	-6.5112E-11					
	19	374.37	-3.1302E-11	-0.8397	1.1565E-11	
4.5148	-6.5112E-11					
	20	374.37	-3.1302E-11	-0.8397	1.1565E-11	
4.5148	-6.5112E-11					
	MINIMUM	-213.37	-3.1302E-11	-0.8397	1.1565E-11	
2.6164	-6.5112E-11					
	Pile N.	1	11	11	11	1
	11					
	MAXIMUM	374.37	2.6210E-11	172.84	3.9470E-11	
4.5148	3.9509E-11					
	Pile N.	11	1	1	1	11
	1					

THE PILE COORDINATE SYSTEM (LOCAL AXES)

* PILE TOP DISPLACEMENTS *

PILE GROUP	DISP. x, M	DISP. y, M	DISP. z, M	ROT. x, RAD	ROT.
y, RAD	ROT. z, RAD				
*****	*****	*****	*****	*****	*****
*****	*****				
1	-1.5380E-03	-2.5482E-15	2.5572E-03	1.1187E-14	
1.7447E-03	6.5662E-15				
2	-1.5380E-03	-2.5482E-15	2.5572E-03	1.1187E-14	
1.7447E-03	6.5662E-15				
3	-1.5380E-03	-2.5482E-15	2.5572E-03	1.1187E-14	
1.7447E-03	6.5662E-15				
4	-1.5380E-03	-2.5482E-15	2.5572E-03	1.1187E-14	
1.7447E-03	6.5662E-15				
5	-1.5380E-03	-2.5482E-15	2.5572E-03	1.1187E-14	
1.7447E-03	6.5662E-15				
6	-1.5380E-03	-2.5482E-15	2.5572E-03	1.1187E-14	
1.7447E-03	6.5662E-15				
7	-1.5380E-03	-2.5482E-15	2.5572E-03	1.1187E-14	
1.7447E-03	6.5662E-15				
8	-1.5380E-03	-2.5482E-15	2.5572E-03	1.1187E-14	
1.7447E-03	6.5662E-15				
9	-1.5380E-03	-2.5482E-15	2.5572E-03	1.1187E-14	
1.7447E-03	6.5662E-15				
10	-1.5380E-03	-2.5482E-15	2.5572E-03	1.1187E-14	

1.7447E-03	6.5662E-15				
11	2.1071E-03	-1.5406E-14	2.9620E-03	1.2858E-14	
1.7447E-03	-1.7136E-15				
12	2.1071E-03	-1.5406E-14	2.9620E-03	1.2858E-14	
1.7447E-03	-1.7136E-15				
13	2.1071E-03	-1.5406E-14	2.9620E-03	1.2858E-14	
1.7447E-03	-1.7136E-15				
14	2.1071E-03	-1.5406E-14	2.9620E-03	1.2858E-14	
1.7447E-03	-1.7136E-15				
15	2.1071E-03	-1.5406E-14	2.9620E-03	1.2858E-14	
1.7447E-03	-1.7136E-15				
16	2.1071E-03	-1.5406E-14	2.9620E-03	1.2858E-14	
1.7447E-03	-1.7136E-15				
17	2.1071E-03	-1.5406E-14	2.9620E-03	1.2858E-14	
1.7447E-03	-1.7136E-15				
18	2.1071E-03	-1.5406E-14	2.9620E-03	1.2858E-14	
1.7447E-03	-1.7136E-15				
19	2.1071E-03	-1.5406E-14	2.9620E-03	1.2858E-14	
1.7447E-03	-1.7136E-15				
20	2.1071E-03	-1.5406E-14	2.9620E-03	1.2858E-14	
1.7447E-03	-1.7136E-15				

	MINIMUM	-1.5380E-03	-1.5406E-14	2.5572E-03	1.1187E-14	
1.7447E-03	-1.7136E-15					
	Pile N.	1	11	1	1	1
	11					
	MAXIMUM	2.1071E-03	-2.5482E-15	2.9620E-03	1.2858E-14	
1.7447E-03	6.5662E-15					
	Pile N.	11	1	11	11	1
	1					

* PILE TOP REACTIONS *

M	MOM z, KN- M	PILE GROUP	AXIAL, KN	LAT. y, KN	LAT. z, KN	MOM x, KN- M	MOM y, KN- M
*****	*****	*****	*****	*****	*****	*****	*****
*****	*****	*****	*****	*****	*****	*****	*****
		1	-274.55	2.6198E-11	4.8365	6.7788E-12	
2.6164	5.5435E-11	2	-274.55	2.6198E-11	4.8365	6.7788E-12	
2.6164	5.5435E-11	3	-274.55	2.6198E-11	4.8365	6.7788E-12	
2.6164	5.5435E-11	4	-274.55	2.6198E-11	4.8365	6.7788E-12	
2.6164	5.5435E-11	5	-274.55	2.6198E-11	4.8365	6.7788E-12	
2.6164	5.5435E-11	6	-274.55	2.6198E-11	4.8365	6.7788E-12	
2.6164	5.5435E-11	7	-274.55	2.6198E-11	4.8365	6.7788E-12	
2.6164	5.5435E-11	8	-274.55	2.6198E-11	4.8365	6.7788E-12	
2.6164	5.5435E-11	9	-274.55	2.6198E-11	4.8365	6.7788E-12	

2.6164	5.5435E-11					
	10	-274.55	2.6198E-11	4.8365	6.7788E-12	
2.6164	5.5435E-11					
	11	374.37	-3.1325E-11	-0.8397	1.1565E-11	
4.5148	-6.5112E-11					
	12	374.37	-3.1325E-11	-0.8397	1.1565E-11	
4.5148	-6.5112E-11					
	13	374.37	-3.1325E-11	-0.8397	1.1565E-11	
4.5148	-6.5112E-11					
	14	374.37	-3.1325E-11	-0.8397	1.1565E-11	
4.5148	-6.5112E-11					
	15	374.37	-3.1325E-11	-0.8397	1.1565E-11	
4.5148	-6.5112E-11					
	16	374.37	-3.1325E-11	-0.8397	1.1565E-11	
4.5148	-6.5112E-11					
	17	374.37	-3.1325E-11	-0.8397	1.1565E-11	
4.5148	-6.5112E-11					
	18	374.37	-3.1325E-11	-0.8397	1.1565E-11	
4.5148	-6.5112E-11					
	19	374.37	-3.1325E-11	-0.8397	1.1565E-11	
4.5148	-6.5112E-11					
	20	374.37	-3.1325E-11	-0.8397	1.1565E-11	
4.5148	-6.5112E-11					
	MINIMUM	-274.55	-3.1325E-11	-0.8397	6.7788E-12	
2.6164	-6.5112E-11					
	Pile N.	1	11	11	1	1
	11					
	MAXIMUM	374.37	2.6198E-11	4.8365	1.1565E-11	
4.5148	5.5435E-11					
	Pile N.	11	1	1	11	11
	1					

PILE GROUP STRESS, KN/ M**2
 ***** *****

1	6068.8
2	6068.8
3	6068.8
4	6068.8
5	6068.8
6	6068.8
7	6068.8
8	6068.8
9	6068.8
10	6068.8
11	8275.4
12	8275.4
13	8275.4
14	8275.4
15	8275.4
16	8275.4
17	8275.4
18	8275.4
19	8275.4

20 8275.4

MINIMUM 6068.8
Pile N. 1
MAXIMUM 8275.4
Pile N. 11

* EFFECTS FOR Laterally LOADED PILE *

* MINIMUM VALUES AND LOCATIONS *

PILE SHEAR z-DIR	DISPL. SOIL REACT y-Dir		DISPL. SOIL REACT z-Dir		MOMENT TOTAL z-Dir		MOMENT FLEX. RIG. y-Dir		SHEAR FLEX. RIG. y-Dir		KN
	KN/ M	M	KN/ M	M	KN- M	M**2	KN- M	M**2	KN	M**2	
1	-2.5482E-15	0.0000	-1.4730E-05	3.4000	-5.5435E-11	0.0000	-0.1927	4.2000	-7.4922E-12	3.9000	
-3.0863	-9.9738E-12		-3.6969		6068.8		7981.2		7920.1		
2.9000	4.3000		3.6000		0.0000		0.2000		1.2000		
2	-2.5482E-15	0.0000	-1.4730E-05	3.4000	-5.5435E-11	0.0000	-0.1927	4.2000	-7.4922E-12	3.9000	
-3.0863	-9.9738E-12		-3.6969		6068.8		7981.2		7920.1		
2.9000	4.3000		3.6000		0.0000		0.6000		1.2000		
3	-2.5482E-15	0.0000	-1.4730E-05	3.4000	-5.5435E-11	0.0000	-0.1927	4.2000	-7.4922E-12	3.9000	
-3.0863	-9.9738E-12		-3.6969		6068.8		7981.2		7920.1		
2.9000	4.3000		3.6000		0.0000		0.2000		1.2000		
4	-2.5482E-15	0.0000	-1.4730E-05	3.4000	-5.5435E-11	0.0000	-0.1927	4.2000	-7.4922E-12	3.9000	
-3.0863	-9.9738E-12		-3.6969		6068.8		7981.2		7920.1		
2.9000	4.3000		3.6000		0.0000		0.9000		1.2000		
5	-2.5482E-15	0.0000	-1.4730E-05	3.4000	-5.5435E-11	0.0000	-0.1927	4.2000	-7.4922E-12	3.9000	
-3.0863	-9.9738E-12		-3.6969		6068.8		7981.2		7920.1		
2.9000	4.3000		3.6000		0.0000		0.2000		1.2000		
6	-2.5482E-15	0.0000	-1.4730E-05	3.4000	-5.5435E-11	0.0000	-0.1927	4.2000	-7.4922E-12	3.9000	
-3.0863	-9.9738E-12		-3.6969		6068.8		7981.2		7920.1		
2.9000	4.3000		3.6000		0.0000		0.0000		1.2000		
7	-2.5482E-15	0.0000	-1.4730E-05	3.4000	-5.5435E-11	0.0000	-0.1927	4.2000	-7.4922E-12	3.9000	
-3.0863	-9.9738E-12		-3.6969		6068.8		7981.2		7920.1		
2.9000	4.3000		3.6000		0.0000		0.4000		1.2000		
8	-2.5482E-15	0.0000	-1.4730E-05	3.4000	-5.5435E-11	0.0000	-0.1927	4.2000	-7.4922E-12	3.9000	
-3.0863	-9.9738E-12		-3.6969		6068.8		7981.2		7920.1		
2.9000	4.3000		3.6000		0.0000		0.3000		1.2000		
9	-2.5482E-15	0.0000	-1.4730E-05	3.4000	-5.5435E-11	0.0000	-0.1927	4.2000	-7.4922E-12	3.9000	
-3.0863	-9.9738E-12		-3.6969		6068.8		7981.2		7920.1		
2.9000	4.3000		3.6000		0.0000		4.2000		3.9000		

2.9000	4.3000	3.6000	0.0000	0.5000	1.2000
10	-2.5482E-15	-1.4730E-05	-5.5435E-11	-0.1927	-7.4922E-12
-3.0863	-9.9738E-12	-3.6969	6068.8	7981.2	7920.1
x(M)	0.0000	3.4000	0.0000	4.2000	3.9000
2.9000	4.3000	3.6000	0.0000	0.2000	1.2000
11	-1.5589E-14	-8.2061E-06	-3.9884E-11	-0.1312	-3.1479E-11
-3.1944	-1.4844E-10	-4.1230	8275.4	7981.2	7934.7
x(M)	0.2000	4.0000	3.3000	4.8000	0.0000
3.6000	3.3000	4.1000	0.0000	0.9000	0.0000
12	-1.5589E-14	-8.2061E-06	-3.9884E-11	-0.1312	-3.1479E-11
-3.1944	-1.4844E-10	-4.1230	8275.4	7981.2	7934.7
x(M)	0.2000	4.0000	3.3000	4.8000	0.0000
3.6000	3.3000	4.1000	0.0000	0.0000	0.0000
13	-1.5589E-14	-8.2061E-06	-3.9884E-11	-0.1312	-3.1479E-11
-3.1944	-1.4844E-10	-4.1230	8275.4	7981.2	7934.7
x(M)	0.2000	4.0000	3.3000	4.8000	0.0000
3.6000	3.3000	4.1000	0.0000	0.2000	0.0000
14	-1.5589E-14	-8.2061E-06	-3.9884E-11	-0.1312	-3.1479E-11
-3.1944	-1.4844E-10	-4.1230	8275.4	7981.2	7934.7
x(M)	0.2000	4.0000	3.3000	4.8000	0.0000
3.6000	3.3000	4.1000	0.0000	0.0000	0.0000
15	-1.5589E-14	-8.2061E-06	-3.9884E-11	-0.1312	-3.1479E-11
-3.1944	-1.4844E-10	-4.1230	8275.4	7981.2	7934.7
x(M)	0.2000	4.0000	3.3000	4.8000	0.0000
3.6000	3.3000	4.1000	0.0000	0.0000	0.0000
16	-1.5589E-14	-8.2061E-06	-3.9884E-11	-0.1312	-3.1479E-11
-3.1944	-1.4844E-10	-4.1230	8275.4	7981.2	7934.7
x(M)	0.2000	4.0000	3.3000	4.8000	0.0000
3.6000	3.3000	4.1000	0.0000	0.4000	0.0000
17	-1.5589E-14	-8.2061E-06	-3.9884E-11	-0.1312	-3.1479E-11
-3.1944	-1.4844E-10	-4.1230	8275.4	7981.2	7934.7
x(M)	0.2000	4.0000	3.3000	4.8000	0.0000
3.6000	3.3000	4.1000	0.0000	0.2000	0.0000
18	-1.5589E-14	-8.2061E-06	-3.9884E-11	-0.1312	-3.1479E-11
-3.1944	-1.4844E-10	-4.1230	8275.4	7981.2	7934.7
x(M)	0.2000	4.0000	3.3000	4.8000	0.0000
3.6000	3.3000	4.1000	0.0000	0.0000	0.0000
19	-1.5589E-14	-8.2061E-06	-3.9884E-11	-0.1312	-3.1479E-11
-3.1944	-1.4844E-10	-4.1230	8275.4	7981.2	7934.7
x(M)	0.2000	4.0000	3.3000	4.8000	0.0000
3.6000	3.3000	4.1000	0.0000	1.0000	0.0000
20	-1.5589E-14	-8.2061E-06	-3.9884E-11	-0.1312	-3.1479E-11
-3.1944	-1.4844E-10	-4.1230	8275.4	7981.2	7934.7
x(M)	0.2000	4.0000	3.3000	4.8000	0.0000
3.6000	3.3000	4.1000	0.0000	0.6000	0.0000
Min.	-1.5589E-14	-1.4730E-05	-5.5435E-11	-0.1927	-3.1479E-11
-3.1944	-1.4844E-10	-4.1230	6068.8	7981.2	7920.1
Pile N.	11	1	1	1	11
11	11	1	1	1	

* MAXIMUM VALUES AND LOCATIONS *

PILE DISPL. DISPL. MOMENT MOMENT SHEAR

SHEAR	SOIL REACT	SOIL REACT	TOTAL	FLEX. RIG.	FLEX. RIG.	
z-DIR	y-DIR	z-DIR	z-DIR	y-DIR	y-DIR	
	y-DIR	z-DIR	STRESS	z-DIR	y-DIR	KN
	M	M	KN- M	KN- M	KN	
	KN/ M	KN/ M	M**2	M**2	M**2	
*****	*****	*****	*****	*****	*****	*****
*****	*****	*****	*****	*****	*****	*****
1	1.4187E-15	2.5572E-03	6.4306E-12	5.8244	2.6638E-11	
4.8353	2.7784E-11	4.8119	6068.8	7981.2	7981.2	
x(M)	1.5000	0.0000	3.4000	1.2000	0.5000	
0.0000	3.3000	0.9000	0.0000	1.1000	9.1000	
2	1.4187E-15	2.5572E-03	6.4306E-12	5.8244	2.6638E-11	
4.8353	2.7784E-11	4.8119	6068.8	7981.2	7981.2	
x(M)	1.5000	0.0000	3.4000	1.2000	0.5000	
0.0000	3.3000	0.9000	0.0000	0.2000	3.6000	
3	1.4187E-15	2.5572E-03	6.4306E-12	5.8244	2.6638E-11	
4.8353	2.7784E-11	4.8119	6068.8	7981.2	7981.2	
x(M)	1.5000	0.0000	3.4000	1.2000	0.5000	
0.0000	3.3000	0.9000	0.0000	0.0000	4.1000	
4	1.4187E-15	2.5572E-03	6.4306E-12	5.8244	2.6638E-11	
4.8353	2.7784E-11	4.8119	6068.8	7981.2	7981.2	
x(M)	1.5000	0.0000	3.4000	1.2000	0.5000	
0.0000	3.3000	0.9000	0.0000	0.7000	4.2000	
5	1.4187E-15	2.5572E-03	6.4306E-12	5.8244	2.6638E-11	
4.8353	2.7784E-11	4.8119	6068.8	7981.2	7981.2	
x(M)	1.5000	0.0000	3.4000	1.2000	0.5000	
0.0000	3.3000	0.9000	0.0000	1.9000	3.9000	
6	1.4187E-15	2.5572E-03	6.4306E-12	5.8244	2.6638E-11	
4.8353	2.7784E-11	4.8119	6068.8	7981.2	7981.2	
x(M)	1.5000	0.0000	3.4000	1.2000	0.5000	
0.0000	3.3000	0.9000	0.0000	0.6000	3.9000	
7	1.4187E-15	2.5572E-03	6.4306E-12	5.8244	2.6638E-11	
4.8353	2.7784E-11	4.8119	6068.8	7981.2	7981.2	
x(M)	1.5000	0.0000	3.4000	1.2000	0.5000	
0.0000	3.3000	0.9000	0.0000	0.0000	3.6000	
8	1.4187E-15	2.5572E-03	6.4306E-12	5.8244	2.6638E-11	
4.8353	2.7784E-11	4.8119	6068.8	7981.2	7981.2	
x(M)	1.5000	0.0000	3.4000	1.2000	0.5000	
0.0000	3.3000	0.9000	0.0000	0.6000	3.9000	
9	1.4187E-15	2.5572E-03	6.4306E-12	5.8244	2.6638E-11	
4.8353	2.7784E-11	4.8119	6068.8	7981.2	7981.2	
x(M)	1.5000	0.0000	3.4000	1.2000	0.5000	
0.0000	3.3000	0.9000	0.0000	1.6000	3.7000	
10	1.4187E-15	2.5572E-03	6.4306E-12	5.8244	2.6638E-11	
4.8353	2.7784E-11	4.8119	6068.8	7981.2	7981.2	
x(M)	1.5000	0.0000	3.4000	1.2000	0.5000	
0.0000	3.3000	0.9000	0.0000	0.0000	4.0000	
11	1.0635E-16	2.9620E-03	6.5112E-11	4.5148	4.5989E-11	
0.1943	6.1315E-11	5.8760	8275.4	7981.2	7981.2	
x(M)	4.2000	0.0000	0.0000	0.0000	3.8000	
5.1000	4.3000	3.2000	0.0000	0.100000	4.9000	
12	1.0635E-16	2.9620E-03	6.5112E-11	4.5148	4.5989E-11	
0.1943	6.1315E-11	5.8760	8275.4	7981.2	7981.2	
x(M)	4.2000	0.0000	0.0000	0.0000	3.8000	

5.1000	4.3000	3.2000	0.0000	0.4000	4.3000
13	1.0635E-16	2.9620E-03	6.5112E-11	4.5148	4.5989E-11
0.1943	6.1315E-11	5.8760	8275.4	7981.2	7981.2
x(M)	4.2000	0.0000	0.0000	0.0000	3.8000
5.1000	4.3000	3.2000	0.0000	0.6000	4.2000
14	1.0635E-16	2.9620E-03	6.5112E-11	4.5148	4.5989E-11
0.1943	6.1315E-11	5.8760	8275.4	7981.2	7981.2
x(M)	4.2000	0.0000	0.0000	0.0000	3.8000
5.1000	4.3000	3.2000	0.0000	0.5000	4.8000
15	1.0635E-16	2.9620E-03	6.5112E-11	4.5148	4.5989E-11
0.1943	6.1315E-11	5.8760	8275.4	7981.2	7981.2
x(M)	4.2000	0.0000	0.0000	0.0000	3.8000
5.1000	4.3000	3.2000	0.0000	1.4000	4.5000
16	1.0635E-16	2.9620E-03	6.5112E-11	4.5148	4.5989E-11
0.1943	6.1315E-11	5.8760	8275.4	7981.2	7981.2
x(M)	4.2000	0.0000	0.0000	0.0000	3.8000
5.1000	4.3000	3.2000	0.0000	0.100000	4.7000
17	1.0635E-16	2.9620E-03	6.5112E-11	4.5148	4.5989E-11
0.1943	6.1315E-11	5.8760	8275.4	7981.2	7981.2
x(M)	4.2000	0.0000	0.0000	0.0000	3.8000
5.1000	4.3000	3.2000	0.0000	0.3000	4.8000
18	1.0635E-16	2.9620E-03	6.5112E-11	4.5148	4.5989E-11
0.1943	6.1315E-11	5.8760	8275.4	7981.2	7981.2
x(M)	4.2000	0.0000	0.0000	0.0000	3.8000
5.1000	4.3000	3.2000	0.0000	0.100000	4.2000
19	1.0635E-16	2.9620E-03	6.5112E-11	4.5148	4.5989E-11
0.1943	6.1315E-11	5.8760	8275.4	7981.2	7981.2
x(M)	4.2000	0.0000	0.0000	0.0000	3.8000
5.1000	4.3000	3.2000	0.0000	0.2000	4.6000
20	1.0635E-16	2.9620E-03	6.5112E-11	4.5148	4.5989E-11
0.1943	6.1315E-11	5.8760	8275.4	7981.2	7981.2
x(M)	4.2000	0.0000	0.0000	0.0000	3.8000
5.1000	4.3000	3.2000	0.0000	0.100000	5.6000
Max.	1.4187E-15	2.9620E-03	6.5112E-11	5.8244	4.5989E-11
4.8353	6.1315E-11	5.8760	8275.4	7981.2	7981.2
Pile N.	1	11	11	1	11
	11	11	11	1	1

1

LOAD CASE : 2
CASE NAME : SLU F2

LOAD TYPE : Dead, DL

* TABLE L * COMPUTATION ON PILE CAP

* EQUIVALENT CONCENTRATED LOAD AT ORIGIN *

VERT. LOAD, KN	HOR. LOAD Y, KN	HOR. LOAD Z, KN
2090.00	0.00000	1720.00
MOMENT X , KN- M	MOMENT Y, KN- M	MOMENT Z, KN- M
0.00000	2930.00	0.00000

* DISPLACEMENT OF GROUPED PILE FOUNDATION AT ORIGIN *

VERTICAL , M	HORIZONTAL Y, M	HORIZONTAL Z, M
1.64348E-03	3.74881E-16	3.61305E-03
ANGLE ROT. X,RAD	ANGLE ROT. Y,RAD	ANGLE ROT. Z,RAD
-9.64481E-16	1.33523E-03	3.62549E-16

* TABLE M * COMPUTATION ON INDIVIDUAL PILE

THE GLOBAL STRUCTURAL COORDINATE SYSTEM

* PILE TOP DISPLACEMENTS *

PILE GROUP	DISP. X, M	DISP. Y, M	DISP. Z, M	ROT. X,RAD	ROT. Y,RAD	ROT. Z,RAD
1	9.7587E-04	-1.0736E-16	3.6131E-03	-9.6448E-16	1.3352E-03	3.6255E-16
2	9.7587E-04	-1.0736E-16	3.6131E-03	-9.6448E-16	1.3352E-03	3.6255E-16
3	9.7587E-04	-1.0736E-16	3.6131E-03	-9.6448E-16	1.3352E-03	3.6255E-16
4	9.7587E-04	-1.0736E-16	3.6131E-03	-9.6448E-16	1.3352E-03	3.6255E-16
5	9.7587E-04	-1.0736E-16	3.6131E-03	-9.6448E-16	1.3352E-03	3.6255E-16
6	9.7587E-04	-1.0736E-16	3.6131E-03	-9.6448E-16	1.3352E-03	3.6255E-16
7	9.7587E-04	-1.0736E-16	3.6131E-03	-9.6448E-16	1.3352E-03	3.6255E-16
8	9.7587E-04	-1.0736E-16	3.6131E-03	-9.6448E-16	1.3352E-03	3.6255E-16
9	9.7587E-04	-1.0736E-16	3.6131E-03	-9.6448E-16	1.3352E-03	3.6255E-16
10	9.7587E-04	-1.0736E-16	3.6131E-03	-9.6448E-16	1.3352E-03	3.6255E-16
11	2.3111E-03	8.5712E-16	3.6131E-03	-9.6448E-16	1.3352E-03	3.6255E-16
12	2.3111E-03	8.5712E-16	3.6131E-03	-9.6448E-16	1.3352E-03	3.6255E-16

13	2.3111E-03	8.5712E-16	3.6131E-03	-9.6448E-16
1.3352E-03	3.6255E-16			
14	2.3111E-03	8.5712E-16	3.6131E-03	-9.6448E-16
1.3352E-03	3.6255E-16			
15	2.3111E-03	8.5712E-16	3.6131E-03	-9.6448E-16
1.3352E-03	3.6255E-16			
16	2.3111E-03	8.5712E-16	3.6131E-03	-9.6448E-16
1.3352E-03	3.6255E-16			
17	2.3111E-03	8.5712E-16	3.6131E-03	-9.6448E-16
1.3352E-03	3.6255E-16			
18	2.3111E-03	8.5712E-16	3.6131E-03	-9.6448E-16
1.3352E-03	3.6255E-16			
19	2.3111E-03	8.5712E-16	3.6131E-03	-9.6448E-16
1.3352E-03	3.6255E-16			
20	2.3111E-03	8.5712E-16	3.6131E-03	-9.6448E-16
1.3352E-03	3.6255E-16			

MINIMUM	9.7587E-04	-1.0736E-16	3.6131E-03	-9.6448E-16
1.3352E-03	3.6255E-16			

Pile N.	1	1	1	1	1
1					

MAXIMUM	2.3111E-03	8.5712E-16	3.6131E-03	-9.6448E-16
1.3352E-03	3.6255E-16			

Pile N.	11	11	1	1	1
1					

* PILE TOP REACTIONS *

PILE GROUP	FOR. X, KN	FOR. Y, KN	FOR. Z, KN	MOM X, KN- M	MOM Y, KN- M
MOM Z, KN- M					
*****	*****	*****	*****	*****	*****
*****	*****	*****	*****	*****	*****
1	-197.03	-2.6427E-12	170.45	-2.9679E-12	
-7.5410	-2.8304E-12				
2	-197.03	-2.6427E-12	170.45	-2.9679E-12	
-7.5410	-2.8304E-12				
3	-197.03	-2.6427E-12	170.45	-2.9679E-12	
-7.5410	-2.8304E-12				
4	-197.03	-2.6427E-12	170.45	-2.9679E-12	
-7.5410	-2.8304E-12				
5	-197.03	-2.6427E-12	170.45	-2.9679E-12	
-7.5410	-2.8304E-12				
6	-197.03	-2.6427E-12	170.45	-2.9679E-12	
-7.5410	-2.8304E-12				
7	-197.03	-2.6427E-12	170.45	-2.9679E-12	
-7.5410	-2.8304E-12				
8	-197.03	-2.6427E-12	170.45	-2.9679E-12	
-7.5410	-2.8304E-12				
9	-197.03	-2.6427E-12	170.45	-2.9679E-12	
-7.5410	-2.8304E-12				
10	-197.03	-2.6427E-12	170.45	-2.9679E-12	
-7.5410	-2.8304E-12				
11	406.03	2.6427E-12	1.5530	-8.6736E-13	
-0.9867	5.8118E-12				

	12	406.03	2.6427E-12	1.5530	-8.6736E-13	
-0.9867	5.8118E-12					
	13	406.03	2.6427E-12	1.5530	-8.6736E-13	
-0.9867	5.8118E-12					
	14	406.03	2.6427E-12	1.5530	-8.6736E-13	
-0.9867	5.8118E-12					
	15	406.03	2.6427E-12	1.5530	-8.6736E-13	
-0.9867	5.8118E-12					
	16	406.03	2.6427E-12	1.5530	-8.6736E-13	
-0.9867	5.8118E-12					
	17	406.03	2.6427E-12	1.5530	-8.6736E-13	
-0.9867	5.8118E-12					
	18	406.03	2.6427E-12	1.5530	-8.6736E-13	
-0.9867	5.8118E-12					
	19	406.03	2.6427E-12	1.5530	-8.6736E-13	
-0.9867	5.8118E-12					
	20	406.03	2.6427E-12	1.5530	-8.6736E-13	
-0.9867	5.8118E-12					
	MINIMUM	-197.03	-2.6427E-12	1.5530	-2.9679E-12	
-7.5410	-2.8304E-12					
	Pile N.	1	1	11	1	1
	1					
	MAXIMUM	406.03	2.6427E-12	170.45	-8.6736E-13	
-0.9867	5.8118E-12					
	Pile N.	11	11	1	11	11
	11					

THE PILE COORDINATE SYSTEM (LOCAL AXES)

* PILE TOP DISPLACEMENTS *

	PILE GROUP	DISP. x, M	DISP. y, M	DISP. z, M	ROT. x, RAD	ROT.
y, RAD	ROT. z, RAD					
*****	*****	*****	*****	*****	*****	*****
*****	*****	*****	*****	*****	*****	*****
	1	-1.4554E-03	-1.0821E-16	3.4479E-03	-9.8328E-16	
1.3352E-03	-3.0779E-16					
	2	-1.4554E-03	-1.0821E-16	3.4479E-03	-9.8328E-16	
1.3352E-03	-3.0779E-16					
	3	-1.4554E-03	-1.0821E-16	3.4479E-03	-9.8328E-16	
1.3352E-03	-3.0779E-16					
	4	-1.4554E-03	-1.0821E-16	3.4479E-03	-9.8328E-16	
1.3352E-03	-3.0779E-16					
	5	-1.4554E-03	-1.0821E-16	3.4479E-03	-9.8328E-16	
1.3352E-03	-3.0779E-16					
	6	-1.4554E-03	-1.0821E-16	3.4479E-03	-9.8328E-16	
1.3352E-03	-3.0779E-16					
	7	-1.4554E-03	-1.0821E-16	3.4479E-03	-9.8328E-16	
1.3352E-03	-3.0779E-16					
	8	-1.4554E-03	-1.0821E-16	3.4479E-03	-9.8328E-16	
1.3352E-03	-3.0779E-16					

9	-1.4554E-03	-1.0821E-16	3.4479E-03	-9.8328E-16
1.3352E-03	-3.0779E-16			
10	-1.4554E-03	-1.0821E-16	3.4479E-03	-9.8328E-16
1.3352E-03	-3.0779E-16			
11	2.3111E-03	8.5698E-16	3.6131E-03	-9.6440E-16
1.3352E-03	3.6255E-16			
12	2.3111E-03	8.5698E-16	3.6131E-03	-9.6440E-16
1.3352E-03	3.6255E-16			
13	2.3111E-03	8.5698E-16	3.6131E-03	-9.6440E-16
1.3352E-03	3.6255E-16			
14	2.3111E-03	8.5698E-16	3.6131E-03	-9.6440E-16
1.3352E-03	3.6255E-16			
15	2.3111E-03	8.5698E-16	3.6131E-03	-9.6440E-16
1.3352E-03	3.6255E-16			
16	2.3111E-03	8.5698E-16	3.6131E-03	-9.6440E-16
1.3352E-03	3.6255E-16			
17	2.3111E-03	8.5698E-16	3.6131E-03	-9.6440E-16
1.3352E-03	3.6255E-16			
18	2.3111E-03	8.5698E-16	3.6131E-03	-9.6440E-16
1.3352E-03	3.6255E-16			
19	2.3111E-03	8.5698E-16	3.6131E-03	-9.6440E-16
1.3352E-03	3.6255E-16			
20	2.3111E-03	8.5698E-16	3.6131E-03	-9.6440E-16
1.3352E-03	3.6255E-16			

MINIMUM	-1.4554E-03	-1.0821E-16	3.4479E-03	-9.8328E-16
1.3352E-03	-3.0779E-16			
Pile N.	1	1	1	1
1				
MAXIMUM	2.3111E-03	8.5698E-16	3.6131E-03	-9.6440E-16
1.3352E-03	3.6255E-16			
Pile N.	11	11	11	11
11				

* PILE TOP REACTIONS *

PILE GROUP	AXIAL, KN	LAT. y, KN	LAT. z, KN	MOM x, KN- M	MOM y, KN- M	MOM z, KN- M
*****	*****	*****	*****	*****	*****	*****
*****	*****	*****	*****	*****	*****	*****
1	-260.20	-2.6555E-12	13.012	-5.9586E-13		
-7.5410	-4.0594E-12					
2	-260.20	-2.6555E-12	13.012	-5.9586E-13		
-7.5410	-4.0594E-12					
3	-260.20	-2.6555E-12	13.012	-5.9586E-13		
-7.5410	-4.0594E-12					
4	-260.20	-2.6555E-12	13.012	-5.9586E-13		
-7.5410	-4.0594E-12					
5	-260.20	-2.6555E-12	13.012	-5.9586E-13		
-7.5410	-4.0594E-12					
6	-260.20	-2.6555E-12	13.012	-5.9586E-13		
-7.5410	-4.0594E-12					
7	-260.20	-2.6555E-12	13.012	-5.9586E-13		
-7.5410	-4.0594E-12					

	8	-260.20	-2.6555E-12	13.012	-5.9586E-13	
-7.5410	-4.0594E-12					
	9	-260.20	-2.6555E-12	13.012	-5.9586E-13	
-7.5410	-4.0594E-12					
	10	-260.20	-2.6555E-12	13.012	-5.9586E-13	
-7.5410	-4.0594E-12					
	11	406.03	2.6179E-12	1.5530	-8.6742E-13	
-0.9867	5.8118E-12					
	12	406.03	2.6179E-12	1.5530	-8.6742E-13	
-0.9867	5.8118E-12					
	13	406.03	2.6179E-12	1.5530	-8.6742E-13	
-0.9867	5.8118E-12					
	14	406.03	2.6179E-12	1.5530	-8.6742E-13	
-0.9867	5.8118E-12					
	15	406.03	2.6179E-12	1.5530	-8.6742E-13	
-0.9867	5.8118E-12					
	16	406.03	2.6179E-12	1.5530	-8.6742E-13	
-0.9867	5.8118E-12					
	17	406.03	2.6179E-12	1.5530	-8.6742E-13	
-0.9867	5.8118E-12					
	18	406.03	2.6179E-12	1.5530	-8.6742E-13	
-0.9867	5.8118E-12					
	19	406.03	2.6179E-12	1.5530	-8.6742E-13	
-0.9867	5.8118E-12					
	20	406.03	2.6179E-12	1.5530	-8.6742E-13	
-0.9867	5.8118E-12					
	MINIMUM	-260.20	-2.6555E-12	1.5530	-8.6742E-13	
-7.5410	-4.0594E-12					
	Pile N.	1	1	11	11	1
	1					
	MAXIMUM	406.03	2.6179E-12	13.012	-5.9586E-13	
-0.9867	5.8118E-12					
	Pile N.	11	11	1	1	11
	11					

PILE GROUP STRESS, KN/ M**2
 ***** *****

1	5751.6
2	5751.6
3	5751.6
4	5751.6
5	5751.6
6	5751.6
7	5751.6
8	5751.6
9	5751.6
10	5751.6
11	8975.2
12	8975.2
13	8975.2
14	8975.2
15	8975.2
16	8975.2

17 8975.2
 18 8975.2
 19 8975.2
 20 8975.2

MINIMUM 5751.6
 Pile N. 1
 MAXIMUM 8975.2
 Pile N. 11

* EFFECTS FOR Laterally LOADED PILE *

* MINIMUM VALUES AND LOCATIONS *

PILE SHEAR z-DIR	DISPL. SOIL y-DIR	DISPL. SOIL z-DIR	MOMENT TOTAL z-DIR		MOMENT FLEX. RIG. y-DIR		SHEAR FLEX. RIG. y-DIR	KN
			KN- M	KN- M**2	KN- M	KN- M**2		
1	-2.1998E-16	-1.1951E-05	-6.3844E-13		-7.5410	-2.6519E-12		
-4.0812	-1.9207E-12	-5.0834	5751.6		7981.2	7898.3		
x(M)	0.8000	3.8000	3.2000		0.0000	0.100000		
3.4000	3.2000	4.0000	0.0000		0.0000	0.0000		
2	-2.1998E-16	-1.1951E-05	-6.3844E-13		-7.5410	-2.6519E-12		
-4.0812	-1.9207E-12	-5.0834	5751.6		7981.2	7898.3		
x(M)	0.8000	3.8000	3.2000		0.0000	0.100000		
3.4000	3.2000	4.0000	0.0000		0.0000	0.0000		
3	-2.1998E-16	-1.1951E-05	-6.3844E-13		-7.5410	-2.6519E-12		
-4.0812	-1.9207E-12	-5.0834	5751.6		7981.2	7898.3		
x(M)	0.8000	3.8000	3.2000		0.0000	0.100000		
3.4000	3.2000	4.0000	0.0000		0.0000	0.0000		
4	-2.1998E-16	-1.1951E-05	-6.3844E-13		-7.5410	-2.6519E-12		
-4.0812	-1.9207E-12	-5.0834	5751.6		7981.2	7898.3		
x(M)	0.8000	3.8000	3.2000		0.0000	0.100000		
3.4000	3.2000	4.0000	0.0000		0.0000	0.0000		
5	-2.1998E-16	-1.1951E-05	-6.3844E-13		-7.5410	-2.6519E-12		
-4.0812	-1.9207E-12	-5.0834	5751.6		7981.2	7898.3		
x(M)	0.8000	3.8000	3.2000		0.0000	0.100000		
3.4000	3.2000	4.0000	0.0000		0.0000	0.0000		
6	-2.1998E-16	-1.1951E-05	-6.3844E-13		-7.5410	-2.6519E-12		
-4.0812	-1.9207E-12	-5.0834	5751.6		7981.2	7898.3		
x(M)	0.8000	3.8000	3.2000		0.0000	0.100000		
3.4000	3.2000	4.0000	0.0000		0.0000	0.0000		
7	-2.1998E-16	-1.1951E-05	-6.3844E-13		-7.5410	-2.6519E-12		
-4.0812	-1.9207E-12	-5.0834	5751.6		7981.2	7898.3		
x(M)	0.8000	3.8000	3.2000		0.0000	0.100000		
3.4000	3.2000	4.0000	0.0000		0.0000	0.0000		
8	-2.1998E-16	-1.1951E-05	-6.3844E-13		-7.5410	-2.6519E-12		
-4.0812	-1.9207E-12	-5.0834	5751.6		7981.2	7898.3		
x(M)	0.8000	3.8000	3.2000		0.0000	0.100000		
3.4000	3.2000	4.0000	0.0000		0.0000	0.0000		

	9	-2.1998E-16	-1.1951E-05	-6.3844E-13	-7.5410	-2.6519E-12
-4.0812	x(M)	-1.9207E-12	-5.0834	5751.6	7981.2	7898.3
3.4000		0.8000	3.8000	3.2000	0.0000	0.100000
	10	-2.1998E-16	-1.1951E-05	-6.3844E-13	-7.5410	-2.6519E-12
-4.0812	x(M)	-1.9207E-12	-5.0834	5751.6	7981.2	7898.3
3.4000		0.8000	3.8000	3.2000	0.0000	0.100000
	11	-7.6135E-18	-1.4114E-05	-5.8118E-12	-0.9867	-3.3142E-12
-5.9085	x(M)	-4.4428E-12	-7.7575	8975.2	7981.2	7926.4
3.8000		4.2000	4.1000	0.0000	0.0000	3.9000
	12	-7.6135E-18	-1.4114E-05	-5.8118E-12	-0.9867	-3.3142E-12
-5.9085	x(M)	-4.4428E-12	-7.7575	8975.2	7981.2	7926.4
3.8000		4.2000	4.1000	0.0000	0.0000	3.9000
	13	-7.6135E-18	-1.4114E-05	-5.8118E-12	-0.9867	-3.3142E-12
-5.9085	x(M)	-4.4428E-12	-7.7575	8975.2	7981.2	7926.4
3.8000		4.2000	4.1000	0.0000	0.0000	3.9000
	14	-7.6135E-18	-1.4114E-05	-5.8118E-12	-0.9867	-3.3142E-12
-5.9085	x(M)	-4.4428E-12	-7.7575	8975.2	7981.2	7926.4
3.8000		4.2000	4.1000	0.0000	0.0000	3.9000
	15	-7.6135E-18	-1.4114E-05	-5.8118E-12	-0.9867	-3.3142E-12
-5.9085	x(M)	-4.4428E-12	-7.7575	8975.2	7981.2	7926.4
3.8000		4.2000	4.1000	0.0000	0.0000	3.9000
	16	-7.6135E-18	-1.4114E-05	-5.8118E-12	-0.9867	-3.3142E-12
-5.9085	x(M)	-4.4428E-12	-7.7575	8975.2	7981.2	7926.4
3.8000		4.2000	4.1000	0.0000	0.0000	3.9000
	17	-7.6135E-18	-1.4114E-05	-5.8118E-12	-0.9867	-3.3142E-12
-5.9085	x(M)	-4.4428E-12	-7.7575	8975.2	7981.2	7926.4
3.8000		4.2000	4.1000	0.0000	0.0000	3.9000
	18	-7.6135E-18	-1.4114E-05	-5.8118E-12	-0.9867	-3.3142E-12
-5.9085	x(M)	-4.4428E-12	-7.7575	8975.2	7981.2	7926.4
3.8000		4.2000	4.1000	0.0000	0.0000	3.9000
	19	-7.6135E-18	-1.4114E-05	-5.8118E-12	-0.9867	-3.3142E-12
-5.9085	x(M)	-4.4428E-12	-7.7575	8975.2	7981.2	7926.4
3.8000		4.2000	4.1000	0.0000	0.0000	3.9000
	20	-7.6135E-18	-1.4114E-05	-5.8118E-12	-0.9867	-3.3142E-12
-5.9085	x(M)	-4.4428E-12	-7.7575	8975.2	7981.2	7926.4
3.8000		4.2000	4.1000	0.0000	0.0000	3.9000

	Min.	-2.1998E-16	-1.4114E-05	-5.8118E-12	-7.5410	-3.3142E-12
-5.9085	Pile N.	-4.4428E-12	-7.7575	5751.6	7981.2	7898.3
		1	11	11	1	11
		11	11	1	1	1

* MAXIMUM VALUES AND LOCATIONS *

PILE SHEAR	DISPL. SOIL	DISPL. SOIL	MOMENT TOTAL	MOMENT FLEX. RIG.	SHEAR FLEX. RIG.	
z-DIR	y-DIR	z-DIR	z-DIR	y-DIR	y-DIR	
	M	M	KN- M	KN- M	KN	KN
KN/ M	KN/ M	KN/ M	M**2	M**2	M**2	
*****	*****	*****	*****	*****	*****	*****
*****	*****	*****	*****	*****	*****	*****
12.991	1.6644E-18	3.4479E-03	4.0594E-12	6.1042	7.0766E-13	
9.2457E-13		8.6062	5751.6	7981.2	7981.2	
x(M)	4.1000	0.0000	0.0000	1.9000	3.8000	
0.0000	4.2000	1.1000	0.0000	0.0000	4.8000	
12.991	1.6644E-18	3.4479E-03	4.0594E-12	6.1042	7.0766E-13	
9.2457E-13		8.6062	5751.6	7981.2	7981.2	
x(M)	4.1000	0.0000	0.0000	1.9000	3.8000	
0.0000	4.2000	1.1000	0.0000	0.0000	4.2000	
12.991	1.6644E-18	3.4479E-03	4.0594E-12	6.1042	7.0766E-13	
9.2457E-13		8.6062	5751.6	7981.2	7981.2	
x(M)	4.1000	0.0000	0.0000	1.9000	3.8000	
0.0000	4.2000	1.1000	0.0000	0.0000	4.1000	
12.991	1.6644E-18	3.4479E-03	4.0594E-12	6.1042	7.0766E-13	
9.2457E-13		8.6062	5751.6	7981.2	7981.2	
x(M)	4.1000	0.0000	0.0000	1.9000	3.8000	
0.0000	4.2000	1.1000	0.0000	0.0000	4.9000	
12.991	1.6644E-18	3.4479E-03	4.0594E-12	6.1042	7.0766E-13	
9.2457E-13		8.6062	5751.6	7981.2	7981.2	
x(M)	4.1000	0.0000	0.0000	1.9000	3.8000	
0.0000	4.2000	1.1000	0.0000	0.0000	4.0000	
12.991	1.6644E-18	3.4479E-03	4.0594E-12	6.1042	7.0766E-13	
9.2457E-13		8.6062	5751.6	7981.2	7981.2	
x(M)	4.1000	0.0000	0.0000	1.9000	3.8000	
0.0000	4.2000	1.1000	0.0000	0.0000	4.5000	
12.991	1.6644E-18	3.4479E-03	4.0594E-12	6.1042	7.0766E-13	
9.2457E-13		8.6062	5751.6	7981.2	7981.2	
x(M)	4.1000	0.0000	0.0000	1.9000	3.8000	
0.0000	4.2000	1.1000	0.0000	0.0000	4.1000	
12.991	1.6644E-18	3.4479E-03	4.0594E-12	6.1042	7.0766E-13	
9.2457E-13		8.6062	5751.6	7981.2	7981.2	
x(M)	4.1000	0.0000	0.0000	1.9000	3.8000	
0.0000	4.2000	1.1000	0.0000	0.0000	4.1000	
1.5556	9.5446E-16	3.6131E-03	2.8621E-12	5.2674	2.6327E-12	
1.1230E-11		15.515	8975.2	7981.2	7981.2	
x(M)	0.6000	0.0000	3.3000	3.2000	0.0000	
0.0000	3.3000	3.2000	0.0000	0.0000	0.3000	

12	9.5446E-16	3.6131E-03	2.8621E-12	5.2674	2.6327E-12
1.5556	1.1230E-11	15.515	8975.2	7981.2	7981.2
x(M)	0.6000	0.0000	3.3000	3.2000	0.0000
0.0000	3.3000	3.2000	0.0000	0.0000	4.9000
13	9.5446E-16	3.6131E-03	2.8621E-12	5.2674	2.6327E-12
1.5556	1.1230E-11	15.515	8975.2	7981.2	7981.2
x(M)	0.6000	0.0000	3.3000	3.2000	0.0000
0.0000	3.3000	3.2000	0.0000	0.0000	0.5000
14	9.5446E-16	3.6131E-03	2.8621E-12	5.2674	2.6327E-12
1.5556	1.1230E-11	15.515	8975.2	7981.2	7981.2
x(M)	0.6000	0.0000	3.3000	3.2000	0.0000
0.0000	3.3000	3.2000	0.0000	0.0000	0.6000
15	9.5446E-16	3.6131E-03	2.8621E-12	5.2674	2.6327E-12
1.5556	1.1230E-11	15.515	8975.2	7981.2	7981.2
x(M)	0.6000	0.0000	3.3000	3.2000	0.0000
0.0000	3.3000	3.2000	0.0000	0.0000	0.5000
16	9.5446E-16	3.6131E-03	2.8621E-12	5.2674	2.6327E-12
1.5556	1.1230E-11	15.515	8975.2	7981.2	7981.2
x(M)	0.6000	0.0000	3.3000	3.2000	0.0000
0.0000	3.3000	3.2000	0.0000	0.0000	4.5000
17	9.5446E-16	3.6131E-03	2.8621E-12	5.2674	2.6327E-12
1.5556	1.1230E-11	15.515	8975.2	7981.2	7981.2
x(M)	0.6000	0.0000	3.3000	3.2000	0.0000
0.0000	3.3000	3.2000	0.0000	0.0000	0.5000
18	9.5446E-16	3.6131E-03	2.8621E-12	5.2674	2.6327E-12
1.5556	1.1230E-11	15.515	8975.2	7981.2	7981.2
x(M)	0.6000	0.0000	3.3000	3.2000	0.0000
0.0000	3.3000	3.2000	0.0000	0.0000	0.4000
19	9.5446E-16	3.6131E-03	2.8621E-12	5.2674	2.6327E-12
1.5556	1.1230E-11	15.515	8975.2	7981.2	7981.2
x(M)	0.6000	0.0000	3.3000	3.2000	0.0000
0.0000	3.3000	3.2000	0.0000	0.0000	0.6000
20	9.5446E-16	3.6131E-03	2.8621E-12	5.2674	2.6327E-12
1.5556	1.1230E-11	15.515	8975.2	7981.2	7981.2
x(M)	0.6000	0.0000	3.3000	3.2000	0.0000
0.0000	3.3000	3.2000	0.0000	0.0000	0.6000
Max.	9.5446E-16	3.6131E-03	4.0594E-12	6.1042	2.6327E-12
12.991	1.1230E-11	15.515	8975.2	7981.2	7981.2
Pile N.	11	11	1	1	11
11	11	11	1	1	

LOAD CASE : 3
CASE NAME : ECC

LOAD TYPE : Dead, DL

* TABLE L * COMPUTATION ON PILE CAP

* EQUIVALENT CONCENTRATED LOAD AT ORIGIN *

VERT. LOAD, KN	HOR. LOAD Y, KN	HOR. LOAD Z, KN
1610.00	0.00000	1280.00
MOMENT X , KN- M	MOMENT Y, KN- M	MOMENT Z, KN- M
0.00000	2170.00	0.00000

* DISPLACEMENT OF GROUPED PILE FOUNDATION AT ORIGIN *

VERTICAL , M	HORIZONTAL Y, M	HORIZONTAL Z, M
1.21494E-03	3.70218E-15	2.70477E-03
ANGLE ROT. X,RAD	ANGLE ROT. Y,RAD	ANGLE ROT. Z,RAD
-2.84820E-14	9.01886E-04	1.76388E-14

* TABLE M * COMPUTATION ON INDIVIDUAL PILE

THE GLOBAL STRUCTURAL COORDINATE SYSTEM

* PILE TOP DISPLACEMENTS *

PILE GROUP	DISP. X, M	DISP. Y, M	DISP. Z, M	ROT. X,RAD	ROT. Y,RAD	ROT. Z,RAD
*****	*****	*****	*****	*****	*****	*****
*****	*****	*****	*****	*****	*****	*****
1	7.6400E-04	-1.0539E-14	2.7048E-03	-2.8482E-14	9.0189E-04	1.7639E-14
2	7.6400E-04	-1.0539E-14	2.7048E-03	-2.8482E-14	9.0189E-04	1.7639E-14
3	7.6400E-04	-1.0539E-14	2.7048E-03	-2.8482E-14	9.0189E-04	1.7639E-14
4	7.6400E-04	-1.0539E-14	2.7048E-03	-2.8482E-14	9.0189E-04	1.7639E-14
5	7.6400E-04	-1.0539E-14	2.7048E-03	-2.8482E-14	9.0189E-04	1.7639E-14
6	7.6400E-04	-1.0539E-14	2.7048E-03	-2.8482E-14	9.0189E-04	1.7639E-14
7	7.6400E-04	-1.0539E-14	2.7048E-03	-2.8482E-14	9.0189E-04	1.7639E-14
8	7.6400E-04	-1.0539E-14	2.7048E-03	-2.8482E-14	9.0189E-04	1.7639E-14
9	7.6400E-04	-1.0539E-14	2.7048E-03	-2.8482E-14	9.0189E-04	1.7639E-14
10	7.6400E-04	-1.0539E-14	2.7048E-03	-2.8482E-14	9.0189E-04	1.7639E-14
11	1.6659E-03	1.7943E-14	2.7048E-03	-2.8482E-14	9.0189E-04	1.7639E-14

9.0189E-04	1.7639E-14				
12	1.6659E-03	1.7943E-14	2.7048E-03	-2.8482E-14	
9.0189E-04	1.7639E-14				
13	1.6659E-03	1.7943E-14	2.7048E-03	-2.8482E-14	
9.0189E-04	1.7639E-14				
14	1.6659E-03	1.7943E-14	2.7048E-03	-2.8482E-14	
9.0189E-04	1.7639E-14				
15	1.6659E-03	1.7943E-14	2.7048E-03	-2.8482E-14	
9.0189E-04	1.7639E-14				
16	1.6659E-03	1.7943E-14	2.7048E-03	-2.8482E-14	
9.0189E-04	1.7639E-14				
17	1.6659E-03	1.7943E-14	2.7048E-03	-2.8482E-14	
9.0189E-04	1.7639E-14				
18	1.6659E-03	1.7943E-14	2.7048E-03	-2.8482E-14	
9.0189E-04	1.7639E-14				
19	1.6659E-03	1.7943E-14	2.7048E-03	-2.8482E-14	
9.0189E-04	1.7639E-14				
20	1.6659E-03	1.7943E-14	2.7048E-03	-2.8482E-14	
9.0189E-04	1.7639E-14				

	MINIMUM	7.6400E-04	-1.0539E-14	2.7048E-03	-2.8482E-14	
9.0189E-04	1.7639E-14					
	Pile N.	1	1	1	1	1
	1					
	MAXIMUM	1.6659E-03	1.7943E-14	2.7048E-03	-2.8482E-14	
9.0189E-04	1.7639E-14					
	Pile N.	11	11	1	1	1
	1					

* PILE TOP REACTIONS *

	PILE GROUP	FOR. X, KN	FOR. Y, KN	FOR. Z, KN	MOM X, KN- M	MOM Y, KN- M
	MOM Z, KN- M					
	*****	*****	*****	*****	*****	*****
	*****	*****	*****	*****	*****	*****
	1	-144.88	-8.9152E-11	126.44	-8.1976E-11	
-6.8564	-7.2147E-11					
	2	-144.88	-8.9152E-11	126.44	-8.1976E-11	
-6.8564	-7.2147E-11					
	3	-144.88	-8.9152E-11	126.44	-8.1976E-11	
-6.8564	-7.2147E-11					
	4	-144.88	-8.9152E-11	126.44	-8.1976E-11	
-6.8564	-7.2147E-11					
	5	-144.88	-8.9152E-11	126.44	-8.1976E-11	
-6.8564	-7.2147E-11					
	6	-144.88	-8.9152E-11	126.44	-8.1976E-11	
-6.8564	-7.2147E-11					
	7	-144.88	-8.9152E-11	126.44	-8.1976E-11	
-6.8564	-7.2147E-11					
	8	-144.88	-8.9152E-11	126.44	-8.1976E-11	
-6.8564	-7.2147E-11					
	9	-144.88	-8.9152E-11	126.44	-8.1976E-11	
-6.8564	-7.2147E-11					
	10	-144.88	-8.9152E-11	126.44	-8.1976E-11	

-6.8564	-7.2147E-11	11	305.88	8.8803E-11	1.5632	-2.5618E-11		
-1.5198	2.0524E-10	12	305.88	8.8803E-11	1.5632	-2.5618E-11		
-1.5198	2.0524E-10	13	305.88	8.8803E-11	1.5632	-2.5618E-11		
-1.5198	2.0524E-10	14	305.88	8.8803E-11	1.5632	-2.5618E-11		
-1.5198	2.0524E-10	15	305.88	8.8803E-11	1.5632	-2.5618E-11		
-1.5198	2.0524E-10	16	305.88	8.8803E-11	1.5632	-2.5618E-11		
-1.5198	2.0524E-10	17	305.88	8.8803E-11	1.5632	-2.5618E-11		
-1.5198	2.0524E-10	18	305.88	8.8803E-11	1.5632	-2.5618E-11		
-1.5198	2.0524E-10	19	305.88	8.8803E-11	1.5632	-2.5618E-11		
-1.5198	2.0524E-10	20	305.88	8.8803E-11	1.5632	-2.5618E-11		
-1.5198	2.0524E-10							
	MINIMUM		-144.88	-8.9152E-11	1.5632	-8.1976E-11		
-6.8564	-7.2147E-11							
	Pile N.	1	1	11	1	1		1
	1							
	MAXIMUM		305.88	8.8803E-11	126.44	-2.5618E-11		
-1.5198	2.0524E-10							
	Pile N.	11	11	1	11	11		11
	11							

THE PILE COORDINATE SYSTEM (LOCAL AXES)

* PILE TOP DISPLACEMENTS *

PILE GROUP	DISP. x, M	DISP. y, M	DISP. z, M	ROT. x, RAD	ROT. y, RAD	ROT. z, RAD
*****	*****	*****	*****	*****	*****	*****
*****	*****	*****	*****	*****	*****	*****
1	-1.0632E-03	-1.0540E-14	2.6017E-03	-3.3304E-14	9.0189E-04	-3.6355E-15
2	-1.0632E-03	-1.0540E-14	2.6017E-03	-3.3304E-14	9.0189E-04	-3.6355E-15
3	-1.0632E-03	-1.0540E-14	2.6017E-03	-3.3304E-14	9.0189E-04	-3.6355E-15
4	-1.0632E-03	-1.0540E-14	2.6017E-03	-3.3304E-14	9.0189E-04	-3.6355E-15
5	-1.0632E-03	-1.0540E-14	2.6017E-03	-3.3304E-14	9.0189E-04	-3.6355E-15
6	-1.0632E-03	-1.0540E-14	2.6017E-03	-3.3304E-14	9.0189E-04	-3.6355E-15
7	-1.0632E-03	-1.0540E-14	2.6017E-03	-3.3304E-14	9.0189E-04	-3.6355E-15

9.0189E-04	-3.6355E-15				
8	-1.0632E-03	-1.0540E-14	2.6017E-03	-3.3304E-14	
9.0189E-04	-3.6355E-15				
9	-1.0632E-03	-1.0540E-14	2.6017E-03	-3.3304E-14	
9.0189E-04	-3.6355E-15				
10	-1.0632E-03	-1.0540E-14	2.6017E-03	-3.3304E-14	
9.0189E-04	-3.6355E-15				
11	1.6659E-03	1.7943E-14	2.7048E-03	-2.8482E-14	
9.0189E-04	1.7639E-14				
12	1.6659E-03	1.7943E-14	2.7048E-03	-2.8482E-14	
9.0189E-04	1.7639E-14				
13	1.6659E-03	1.7943E-14	2.7048E-03	-2.8482E-14	
9.0189E-04	1.7639E-14				
14	1.6659E-03	1.7943E-14	2.7048E-03	-2.8482E-14	
9.0189E-04	1.7639E-14				
15	1.6659E-03	1.7943E-14	2.7048E-03	-2.8482E-14	
9.0189E-04	1.7639E-14				
16	1.6659E-03	1.7943E-14	2.7048E-03	-2.8482E-14	
9.0189E-04	1.7639E-14				
17	1.6659E-03	1.7943E-14	2.7048E-03	-2.8482E-14	
9.0189E-04	1.7639E-14				
18	1.6659E-03	1.7943E-14	2.7048E-03	-2.8482E-14	
9.0189E-04	1.7639E-14				
19	1.6659E-03	1.7943E-14	2.7048E-03	-2.8482E-14	
9.0189E-04	1.7639E-14				
20	1.6659E-03	1.7943E-14	2.7048E-03	-2.8482E-14	
9.0189E-04	1.7639E-14				
	MINIMUM	-1.0632E-03	-1.0540E-14	2.6017E-03	-3.3304E-14
9.0189E-04	-3.6355E-15				
	Pile N.	1	1	1	1
	1				
	MAXIMUM	1.6659E-03	1.7943E-14	2.7048E-03	-2.8482E-14
9.0189E-04	1.7639E-14				
	Pile N.	11	11	11	11
	11				

* PILE TOP REACTIONS *

PILE GROUP	AXIAL, KN	LAT. y, KN	LAT. z, KN	MOM x, KN- M	MOM y, KN- M
MOM z, KN- M					
*****	*****	*****	*****	*****	*****
*****	*****	*****	*****	*****	*****
1	-192.01	-8.9162E-11	10.439	-2.0180E-11	
-6.8564	-1.0732E-10				
2	-192.01	-8.9162E-11	10.439	-2.0180E-11	
-6.8564	-1.0732E-10				
3	-192.01	-8.9162E-11	10.439	-2.0180E-11	
-6.8564	-1.0732E-10				
4	-192.01	-8.9162E-11	10.439	-2.0180E-11	
-6.8564	-1.0732E-10				
5	-192.01	-8.9162E-11	10.439	-2.0180E-11	
-6.8564	-1.0732E-10				
6	-192.01	-8.9162E-11	10.439	-2.0180E-11	

-6.8564	-1.0732E-10	7	-192.01	-8.9162E-11	10.439	-2.0180E-11	
-6.8564	-1.0732E-10	8	-192.01	-8.9162E-11	10.439	-2.0180E-11	
-6.8564	-1.0732E-10	9	-192.01	-8.9162E-11	10.439	-2.0180E-11	
-6.8564	-1.0732E-10	10	-192.01	-8.9162E-11	10.439	-2.0180E-11	
-6.8564	-1.0732E-10	11	305.88	8.8785E-11	1.5632	-2.5618E-11	
-1.5198	2.0524E-10	12	305.88	8.8785E-11	1.5632	-2.5618E-11	
-1.5198	2.0524E-10	13	305.88	8.8785E-11	1.5632	-2.5618E-11	
-1.5198	2.0524E-10	14	305.88	8.8785E-11	1.5632	-2.5618E-11	
-1.5198	2.0524E-10	15	305.88	8.8785E-11	1.5632	-2.5618E-11	
-1.5198	2.0524E-10	16	305.88	8.8785E-11	1.5632	-2.5618E-11	
-1.5198	2.0524E-10	17	305.88	8.8785E-11	1.5632	-2.5618E-11	
-1.5198	2.0524E-10	18	305.88	8.8785E-11	1.5632	-2.5618E-11	
-1.5198	2.0524E-10	19	305.88	8.8785E-11	1.5632	-2.5618E-11	
-1.5198	2.0524E-10	20	305.88	8.8785E-11	1.5632	-2.5618E-11	
-1.5198	2.0524E-10						
	MINIMUM		-192.01	-8.9162E-11	1.5632	-2.5618E-11	
-6.8564	-1.0732E-10	Pile N.	1	1	11	11	1
		1					
	MAXIMUM		305.88	8.8785E-11	10.439	-2.0180E-11	
-1.5198	2.0524E-10	Pile N.	11	11	1	1	11
		11					

PILE GROUP STRESS, KN/ M**2

1	4244.3
2	4244.3
3	4244.3
4	4244.3
5	4244.3
6	4244.3
7	4244.3
8	4244.3
9	4244.3
10	4244.3
11	6761.3
12	6761.3
13	6761.3

14 6761.3
 15 6761.3
 16 6761.3
 17 6761.3
 18 6761.3
 19 6761.3
 20 6761.3

MINIMUM 4244.3
 Pile N. 1
 MAXIMUM 6761.3
 Pile N. 11

* EFFECTS FOR Laterally LOADED PILE *

* MINIMUM VALUES AND LOCATIONS *

SHEAR z-DIR	PILE DISPL. SOIL REACT	DISPL. SOIL REACT	MOMENT TOTAL	MOMENT FLEX. RIG.	SHEAR FLEX. RIG.	KN
	y-Dir	z-Dir	z-Dir	y-Dir	y-Dir	
	M	M	KN- M	KN- M	KN	
	KN/ M	KN/ M	M**2	M**2	M**2	
*****	*****	*****	*****	*****	*****	*****
*****	*****	*****	*****	*****	*****	*****
1	-1.1070E-14	-9.1480E-06	-2.3078E-11	-6.8564	-8.9009E-11	
-3.2025	-4.9671E-11	-4.0132	4244.3	7981.2	7908.7	
x(M)	0.3000	3.9000	2.8000	0.0000	0.0000	
3.5000	3.2000	4.0000	0.0000	0.5000	0.0000	
2	-1.1070E-14	-9.1480E-06	-2.3078E-11	-6.8564	-8.9009E-11	
-3.2025	-4.9671E-11	-4.0132	4244.3	7981.2	7908.7	
x(M)	0.3000	3.9000	2.8000	0.0000	0.0000	
3.5000	3.2000	4.0000	0.0000	0.0000	0.0000	
3	-1.1070E-14	-9.1480E-06	-2.3078E-11	-6.8564	-8.9009E-11	
-3.2025	-4.9671E-11	-4.0132	4244.3	7981.2	7908.7	
x(M)	0.3000	3.9000	2.8000	0.0000	0.0000	
3.5000	3.2000	4.0000	0.0000	0.0000	0.0000	
4	-1.1070E-14	-9.1480E-06	-2.3078E-11	-6.8564	-8.9009E-11	
-3.2025	-4.9671E-11	-4.0132	4244.3	7981.2	7908.7	
x(M)	0.3000	3.9000	2.8000	0.0000	0.0000	
3.5000	3.2000	4.0000	0.0000	0.2000	0.0000	
5	-1.1070E-14	-9.1480E-06	-2.3078E-11	-6.8564	-8.9009E-11	
-3.2025	-4.9671E-11	-4.0132	4244.3	7981.2	7908.7	
x(M)	0.3000	3.9000	2.8000	0.0000	0.0000	
3.5000	3.2000	4.0000	0.0000	3.4000	0.0000	
6	-1.1070E-14	-9.1480E-06	-2.3078E-11	-6.8564	-8.9009E-11	
-3.2025	-4.9671E-11	-4.0132	4244.3	7981.2	7908.7	
x(M)	0.3000	3.9000	2.8000	0.0000	0.0000	
3.5000	3.2000	4.0000	0.0000	1.9000	0.0000	
7	-1.1070E-14	-9.1480E-06	-2.3078E-11	-6.8564	-8.9009E-11	
-3.2025	-4.9671E-11	-4.0132	4244.3	7981.2	7908.7	
x(M)	0.3000	3.9000	2.8000	0.0000	0.0000	
3.5000	3.2000	4.0000	0.0000	1.3000	0.0000	
8	-1.1070E-14	-9.1480E-06	-2.3078E-11	-6.8564	-8.9009E-11	

-3.2025	-4.9671E-11	-4.0132	4244.3	7981.2	7908.7
x(M)	0.3000	3.9000	2.8000	0.0000	0.0000
3.5000	3.2000	4.0000	0.0000	0.100000	0.0000
9	-1.1070E-14	-9.1480E-06	-2.3078E-11	-6.8564	-8.9009E-11
-3.2025	-4.9671E-11	-4.0132	4244.3	7981.2	7908.7
x(M)	0.3000	3.9000	2.8000	0.0000	0.0000
3.5000	3.2000	4.0000	0.0000	0.4000	0.0000
10	-1.1070E-14	-9.1480E-06	-2.3078E-11	-6.8564	-8.9009E-11
-3.2025	-4.9671E-11	-4.0132	4244.3	7981.2	7908.7
x(M)	0.3000	3.9000	2.8000	0.0000	0.0000
3.5000	3.2000	4.0000	0.0000	0.0000	0.0000
11	-2.2161E-16	-1.1066E-05	-2.0524E-10	-1.5198	-9.8065E-11
-4.6997	-1.3108E-10	-6.1491	6761.3	7981.2	7938.7
x(M)	4.2000	4.1000	0.0000	0.0000	3.9000
3.8000	4.3000	4.2000	0.0000	0.9000	3.2000
12	-2.2161E-16	-1.1066E-05	-2.0524E-10	-1.5198	-9.8065E-11
-4.6997	-1.3108E-10	-6.1491	6761.3	7981.2	7938.7
x(M)	4.2000	4.1000	0.0000	0.0000	3.9000
3.8000	4.3000	4.2000	0.0000	4.0000	3.2000
13	-2.2161E-16	-1.1066E-05	-2.0524E-10	-1.5198	-9.8065E-11
-4.6997	-1.3108E-10	-6.1491	6761.3	7981.2	7938.7
x(M)	4.2000	4.1000	0.0000	0.0000	3.9000
3.8000	4.3000	4.2000	0.0000	1.9000	3.2000
14	-2.2161E-16	-1.1066E-05	-2.0524E-10	-1.5198	-9.8065E-11
-4.6997	-1.3108E-10	-6.1491	6761.3	7981.2	7938.7
x(M)	4.2000	4.1000	0.0000	0.0000	3.9000
3.8000	4.3000	4.2000	0.0000	3.4000	3.2000
15	-2.2161E-16	-1.1066E-05	-2.0524E-10	-1.5198	-9.8065E-11
-4.6997	-1.3108E-10	-6.1491	6761.3	7981.2	7938.7
x(M)	4.2000	4.1000	0.0000	0.0000	3.9000
3.8000	4.3000	4.2000	0.0000	0.100000	3.2000
16	-2.2161E-16	-1.1066E-05	-2.0524E-10	-1.5198	-9.8065E-11
-4.6997	-1.3108E-10	-6.1491	6761.3	7981.2	7938.7
x(M)	4.2000	4.1000	0.0000	0.0000	3.9000
3.8000	4.3000	4.2000	0.0000	0.0000	3.2000
17	-2.2161E-16	-1.1066E-05	-2.0524E-10	-1.5198	-9.8065E-11
-4.6997	-1.3108E-10	-6.1491	6761.3	7981.2	7938.7
x(M)	4.2000	4.1000	0.0000	0.0000	3.9000
3.8000	4.3000	4.2000	0.0000	1.5000	3.2000
18	-2.2161E-16	-1.1066E-05	-2.0524E-10	-1.5198	-9.8065E-11
-4.6997	-1.3108E-10	-6.1491	6761.3	7981.2	7938.7
x(M)	4.2000	4.1000	0.0000	0.0000	3.9000
3.8000	4.3000	4.2000	0.0000	0.5000	3.2000
19	-2.2161E-16	-1.1066E-05	-2.0524E-10	-1.5198	-9.8065E-11
-4.6997	-1.3108E-10	-6.1491	6761.3	7981.2	7938.7
x(M)	4.2000	4.1000	0.0000	0.0000	3.9000
3.8000	4.3000	4.2000	0.0000	0.0000	3.2000
20	-2.2161E-16	-1.1066E-05	-2.0524E-10	-1.5198	-9.8065E-11
-4.6997	-1.3108E-10	-6.1491	6761.3	7981.2	7938.7
x(M)	4.2000	4.1000	0.0000	0.0000	3.9000
3.8000	4.3000	4.2000	0.0000	0.0000	3.2000
Min.	-1.1070E-14	-1.1066E-05	-2.0524E-10	-6.8564	-9.8065E-11
-4.6997	-1.3108E-10	-6.1491	4244.3	7981.2	7908.7

Pile N. 1 11 11 11 1 1 11 11
 11 11 1 1 1 1

* MAXIMUM VALUES AND LOCATIONS *

SHEAR z-DIR	PILE SOIL	DISPL.		MOMENT		MOMENT		SHEAR		KN
		SOIL REACT	SOIL REACT	TOTAL	FLEX. RIG.	FLEX. RIG.	FLEX. RIG.	FLEX. RIG.		
		y-DIR	z-DIR	z-DIR	y-DIR	y-DIR	y-DIR	y-DIR		
		M	M	KN- M	KN- M	KN- M	KN- M	KN		
		KN/ M	KN/ M	KN/ M**2	KN- M**2	KN- M**2	KN- M**2	KN		
		*****	*****	*****	*****	*****	*****	*****		
		*****	*****	*****	*****	*****	*****	*****		
	1	5.9437E-17	2.6017E-03	1.0732E-10	4.5792	2.3932E-11				
10.425	3.0904E-11		6.7274	4244.3	7981.2	7981.2				
	x(M)	4.1000	0.0000	0.0000	2.0000	3.7000				
0.0000		4.2000	1.1000	0.0000	0.4000	4.6000				
	2	5.9437E-17	2.6017E-03	1.0732E-10	4.5792	2.3932E-11				
10.425	3.0904E-11		6.7274	4244.3	7981.2	7981.2				
	x(M)	4.1000	0.0000	0.0000	2.0000	3.7000				
0.0000		4.2000	1.1000	0.0000	0.3000	4.0000				
	3	5.9437E-17	2.6017E-03	1.0732E-10	4.5792	2.3932E-11				
10.425	3.0904E-11		6.7274	4244.3	7981.2	7981.2				
	x(M)	4.1000	0.0000	0.0000	2.0000	3.7000				
0.0000		4.2000	1.1000	0.0000	0.6000	4.2000				
	4	5.9437E-17	2.6017E-03	1.0732E-10	4.5792	2.3932E-11				
10.425	3.0904E-11		6.7274	4244.3	7981.2	7981.2				
	x(M)	4.1000	0.0000	0.0000	2.0000	3.7000				
0.0000		4.2000	1.1000	0.0000	0.100000	0.7000				
	5	5.9437E-17	2.6017E-03	1.0732E-10	4.5792	2.3932E-11				
10.425	3.0904E-11		6.7274	4244.3	7981.2	7981.2				
	x(M)	4.1000	0.0000	0.0000	2.0000	3.7000				
0.0000		4.2000	1.1000	0.0000	0.6000	4.5000				
	6	5.9437E-17	2.6017E-03	1.0732E-10	4.5792	2.3932E-11				
10.425	3.0904E-11		6.7274	4244.3	7981.2	7981.2				
	x(M)	4.1000	0.0000	0.0000	2.0000	3.7000				
0.0000		4.2000	1.1000	0.0000	0.3000	4.0000				
	7	5.9437E-17	2.6017E-03	1.0732E-10	4.5792	2.3932E-11				
10.425	3.0904E-11		6.7274	4244.3	7981.2	7981.2				
	x(M)	4.1000	0.0000	0.0000	2.0000	3.7000				
0.0000		4.2000	1.1000	0.0000	0.5000	4.1000				
	8	5.9437E-17	2.6017E-03	1.0732E-10	4.5792	2.3932E-11				
10.425	3.0904E-11		6.7274	4244.3	7981.2	7981.2				
	x(M)	4.1000	0.0000	0.0000	2.0000	3.7000				
0.0000		4.2000	1.1000	0.0000	0.3000	4.0000				
	9	5.9437E-17	2.6017E-03	1.0732E-10	4.5792	2.3932E-11				
10.425	3.0904E-11		6.7274	4244.3	7981.2	7981.2				
	x(M)	4.1000	0.0000	0.0000	2.0000	3.7000				
0.0000		4.2000	1.1000	0.0000	0.2000	4.2000				
	10	5.9437E-17	2.6017E-03	1.0732E-10	4.5792	2.3932E-11				
10.425	3.0904E-11		6.7274	4244.3	7981.2	7981.2				
	x(M)	4.1000	0.0000	0.0000	2.0000	3.7000				
0.0000		4.2000	1.1000	0.0000	2.1000	4.3000				
	11	2.4718E-14	2.7048E-03	8.3859E-11	4.1712	8.9179E-11				

1.5662	3.4723E-10	12.761	6761.3	7981.2	7981.2
x(M)	0.8000	0.0000	3.3000	3.2000	0.0000
0.0000	3.3000	3.2000	0.0000	0.0000	0.8000
12	2.4718E-14	2.7048E-03	8.3859E-11	4.1712	8.9179E-11
1.5662	3.4723E-10	12.761	6761.3	7981.2	7981.2
x(M)	0.8000	0.0000	3.3000	3.2000	0.0000
0.0000	3.3000	3.2000	0.0000	0.0000	4.5000
13	2.4718E-14	2.7048E-03	8.3859E-11	4.1712	8.9179E-11
1.5662	3.4723E-10	12.761	6761.3	7981.2	7981.2
x(M)	0.8000	0.0000	3.3000	3.2000	0.0000
0.0000	3.3000	3.2000	0.0000	1.5000	4.5000
14	2.4718E-14	2.7048E-03	8.3859E-11	4.1712	8.9179E-11
1.5662	3.4723E-10	12.761	6761.3	7981.2	7981.2
x(M)	0.8000	0.0000	3.3000	3.2000	0.0000
0.0000	3.3000	3.2000	0.0000	0.2000	0.8000
15	2.4718E-14	2.7048E-03	8.3859E-11	4.1712	8.9179E-11
1.5662	3.4723E-10	12.761	6761.3	7981.2	7981.2
x(M)	0.8000	0.0000	3.3000	3.2000	0.0000
0.0000	3.3000	3.2000	0.0000	1.3000	0.7000
16	2.4718E-14	2.7048E-03	8.3859E-11	4.1712	8.9179E-11
1.5662	3.4723E-10	12.761	6761.3	7981.2	7981.2
x(M)	0.8000	0.0000	3.3000	3.2000	0.0000
0.0000	3.3000	3.2000	0.0000	0.3000	0.8000
17	2.4718E-14	2.7048E-03	8.3859E-11	4.1712	8.9179E-11
1.5662	3.4723E-10	12.761	6761.3	7981.2	7981.2
x(M)	0.8000	0.0000	3.3000	3.2000	0.0000
0.0000	3.3000	3.2000	0.0000	0.0000	4.3000
18	2.4718E-14	2.7048E-03	8.3859E-11	4.1712	8.9179E-11
1.5662	3.4723E-10	12.761	6761.3	7981.2	7981.2
x(M)	0.8000	0.0000	3.3000	3.2000	0.0000
0.0000	3.3000	3.2000	0.0000	0.3000	0.7000
19	2.4718E-14	2.7048E-03	8.3859E-11	4.1712	8.9179E-11
1.5662	3.4723E-10	12.761	6761.3	7981.2	7981.2
x(M)	0.8000	0.0000	3.3000	3.2000	0.0000
0.0000	3.3000	3.2000	0.0000	1.6000	0.8000
20	2.4718E-14	2.7048E-03	8.3859E-11	4.1712	8.9179E-11
1.5662	3.4723E-10	12.761	6761.3	7981.2	7981.2
x(M)	0.8000	0.0000	3.3000	3.2000	0.0000
0.0000	3.3000	3.2000	0.0000	1.0000	5.3000
Max.	2.4718E-14	2.7048E-03	1.0732E-10	4.5792	8.9179E-11
10.425	3.4723E-10	12.761	6761.3	7981.2	7981.2
Pile N.	11	11	1	1	11
	11	11	11	1	1

LOAD CASE : 4
CASE NAME : SLV SU

LOAD TYPE : Dead, DL

* TABLE L * COMPUTATION ON PILE CAP

* EQUIVALENT CONCENTRATED LOAD AT ORIGIN *

VERT. LOAD, KN	HOR. LOAD Y, KN	HOR. LOAD Z, KN
1680.00	0.00000	760.000
MOMENT X , KN- M	MOMENT Y, KN- M	MOMENT Z, KN- M
0.00000	840.000	0.00000

* DISPLACEMENT OF GROUPED PILE FOUNDATION AT ORIGIN *

VERTICAL , M	HORIZONTAL Y, M	HORIZONTAL Z, M
1.51320E-03	5.50499E-17	3.19959E-03
ANGLE ROT. X,RAD	ANGLE ROT. Y,RAD	ANGLE ROT. Z,RAD
-1.28005E-16	-8.94874E-04	4.15741E-17

* TABLE M * COMPUTATION ON INDIVIDUAL PILE

THE GLOBAL STRUCTURAL COORDINATE SYSTEM

* PILE TOP DISPLACEMENTS *

PILE GROUP	DISP. X, M	DISP. Y, M	DISP. Z, M	ROT. X,RAD	ROT. Y,RAD	ROT. Z,RAD
1	1.9606E-03	-8.9528E-18	3.1996E-03	-1.2800E-16	-8.9487E-04	4.1574E-17
2	1.9606E-03	-8.9528E-18	3.1996E-03	-1.2800E-16	-8.9487E-04	4.1574E-17
3	1.9606E-03	-8.9528E-18	3.1996E-03	-1.2800E-16	-8.9487E-04	4.1574E-17
4	1.9606E-03	-8.9528E-18	3.1996E-03	-1.2800E-16	-8.9487E-04	4.1574E-17
5	1.9606E-03	-8.9528E-18	3.1996E-03	-1.2800E-16	-8.9487E-04	4.1574E-17
6	1.9606E-03	-8.9528E-18	3.1996E-03	-1.2800E-16	-8.9487E-04	4.1574E-17
7	1.9606E-03	-8.9528E-18	3.1996E-03	-1.2800E-16	-8.9487E-04	4.1574E-17
8	1.9606E-03	-8.9528E-18	3.1996E-03	-1.2800E-16	-8.9487E-04	4.1574E-17
9	1.9606E-03	-8.9528E-18	3.1996E-03	-1.2800E-16	-8.9487E-04	4.1574E-17

10	1.9606E-03	-8.9528E-18	3.1996E-03	-1.2800E-16
-8.9487E-04	4.1574E-17			
11	1.0658E-03	1.1905E-16	3.1996E-03	-1.2800E-16
-8.9487E-04	4.1574E-17			
12	1.0658E-03	1.1905E-16	3.1996E-03	-1.2800E-16
-8.9487E-04	4.1574E-17			
13	1.0658E-03	1.1905E-16	3.1996E-03	-1.2800E-16
-8.9487E-04	4.1574E-17			
14	1.0658E-03	1.1905E-16	3.1996E-03	-1.2800E-16
-8.9487E-04	4.1574E-17			
15	1.0658E-03	1.1905E-16	3.1996E-03	-1.2800E-16
-8.9487E-04	4.1574E-17			
16	1.0658E-03	1.1905E-16	3.1996E-03	-1.2800E-16
-8.9487E-04	4.1574E-17			
17	1.0658E-03	1.1905E-16	3.1996E-03	-1.2800E-16
-8.9487E-04	4.1574E-17			
18	1.0658E-03	1.1905E-16	3.1996E-03	-1.2800E-16
-8.9487E-04	4.1574E-17			
19	1.0658E-03	1.1905E-16	3.1996E-03	-1.2800E-16
-8.9487E-04	4.1574E-17			
20	1.0658E-03	1.1905E-16	3.1996E-03	-1.2800E-16
-8.9487E-04	4.1574E-17			

MINIMUM	1.0658E-03	-8.9528E-18	3.1996E-03	-1.2800E-16
-8.9487E-04	4.1574E-17			
Pile N.	11	1	1	1
1				
MAXIMUM	1.9606E-03	1.1905E-16	3.1996E-03	-1.2800E-16
-8.9487E-04	4.1574E-17			
Pile N.	1	11	1	1
1				

* PILE TOP REACTIONS *

PILE GROUP	FOR. X, KN	FOR. Y, KN	FOR. Z, KN	MOM X, KN- M	MOM Y, KN- M
MOM Z, KN- M					
*****	*****	*****	*****	*****	*****
*****	*****	*****	*****	*****	*****
1	-44.724	-3.4878E-13	68.586	-4.0526E-13	
-29.075	-3.9251E-13				
2	-44.724	-3.4878E-13	68.586	-4.0526E-13	
-29.075	-3.9251E-13				
3	-44.724	-3.4878E-13	68.586	-4.0526E-13	
-29.075	-3.9251E-13				
4	-44.724	-3.4878E-13	68.586	-4.0526E-13	
-29.075	-3.9251E-13				
5	-44.724	-3.4878E-13	68.586	-4.0526E-13	
-29.075	-3.9251E-13				
6	-44.724	-3.4878E-13	68.586	-4.0526E-13	
-29.075	-3.9251E-13				
7	-44.724	-3.4878E-13	68.586	-4.0526E-13	
-29.075	-3.9251E-13				
8	-44.724	-3.4878E-13	68.586	-4.0526E-13	
-29.075	-3.9251E-13				

	9	-44.724	-3.4878E-13	68.586	-4.0526E-13	
-29.075	-3.9251E-13					
	10	-44.724	-3.4878E-13	68.586	-4.0526E-13	
-29.075	-3.9251E-13					
	11	212.72	3.4878E-13	7.4144	-1.1417E-13	
-15.649	7.3275E-13					
	12	212.72	3.4878E-13	7.4144	-1.1417E-13	
-15.649	7.3275E-13					
	13	212.72	3.4878E-13	7.4144	-1.1417E-13	
-15.649	7.3275E-13					
	14	212.72	3.4878E-13	7.4144	-1.1417E-13	
-15.649	7.3275E-13					
	15	212.72	3.4878E-13	7.4144	-1.1417E-13	
-15.649	7.3275E-13					
	16	212.72	3.4878E-13	7.4144	-1.1417E-13	
-15.649	7.3275E-13					
	17	212.72	3.4878E-13	7.4144	-1.1417E-13	
-15.649	7.3275E-13					
	18	212.72	3.4878E-13	7.4144	-1.1417E-13	
-15.649	7.3275E-13					
	19	212.72	3.4878E-13	7.4144	-1.1417E-13	
-15.649	7.3275E-13					
	20	212.72	3.4878E-13	7.4144	-1.1417E-13	
-15.649	7.3275E-13					
	MINIMUM	-44.724	-3.4878E-13	7.4144	-4.0526E-13	
-29.075	-3.9251E-13					
	Pile N.	1	1	11	1	1
	1					
	MAXIMUM	212.72	3.4878E-13	68.586	-1.1417E-13	
-15.649	7.3275E-13					
	Pile N.	11	11	1	11	11
	11					

THE PILE COORDINATE SYSTEM (LOCAL AXES)

* PILE TOP DISPLACEMENTS *

PILE GROUP	DISP. x, M	DISP. y, M	DISP. z, M	ROT. x, RAD	ROT.
y, RAD	ROT. z, RAD				
*****	*****	*****	*****	*****	*****
*****	*****	*****	*****	*****	*****
1	-4.2486E-04	-9.8336E-18	3.7284E-03	-1.2643E-16	
-8.9487E-04	-4.6255E-17				
2	-4.2486E-04	-9.8336E-18	3.7284E-03	-1.2643E-16	
-8.9487E-04	-4.6255E-17				
3	-4.2486E-04	-9.8336E-18	3.7284E-03	-1.2643E-16	
-8.9487E-04	-4.6255E-17				
4	-4.2486E-04	-9.8336E-18	3.7284E-03	-1.2643E-16	
-8.9487E-04	-4.6255E-17				
5	-4.2486E-04	-9.8336E-18	3.7284E-03	-1.2643E-16	
-8.9487E-04	-4.6255E-17				

6	-4.2486E-04	-9.8336E-18	3.7284E-03	-1.2643E-16
-8.9487E-04	-4.6255E-17			
7	-4.2486E-04	-9.8336E-18	3.7284E-03	-1.2643E-16
-8.9487E-04	-4.6255E-17			
8	-4.2486E-04	-9.8336E-18	3.7284E-03	-1.2643E-16
-8.9487E-04	-4.6255E-17			
9	-4.2486E-04	-9.8336E-18	3.7284E-03	-1.2643E-16
-8.9487E-04	-4.6255E-17			
10	-4.2486E-04	-9.8336E-18	3.7284E-03	-1.2643E-16
-8.9487E-04	-4.6255E-17			
11	1.0658E-03	1.1899E-16	3.1996E-03	-1.2806E-16
-8.9487E-04	4.1574E-17			
12	1.0658E-03	1.1899E-16	3.1996E-03	-1.2806E-16
-8.9487E-04	4.1574E-17			
13	1.0658E-03	1.1899E-16	3.1996E-03	-1.2806E-16
-8.9487E-04	4.1574E-17			
14	1.0658E-03	1.1899E-16	3.1996E-03	-1.2806E-16
-8.9487E-04	4.1574E-17			
15	1.0658E-03	1.1899E-16	3.1996E-03	-1.2806E-16
-8.9487E-04	4.1574E-17			
16	1.0658E-03	1.1899E-16	3.1996E-03	-1.2806E-16
-8.9487E-04	4.1574E-17			
17	1.0658E-03	1.1899E-16	3.1996E-03	-1.2806E-16
-8.9487E-04	4.1574E-17			
18	1.0658E-03	1.1899E-16	3.1996E-03	-1.2806E-16
-8.9487E-04	4.1574E-17			
19	1.0658E-03	1.1899E-16	3.1996E-03	-1.2806E-16
-8.9487E-04	4.1574E-17			
20	1.0658E-03	1.1899E-16	3.1996E-03	-1.2806E-16
-8.9487E-04	4.1574E-17			

MINIMUM	-4.2486E-04	-9.8336E-18	3.1996E-03	-1.2806E-16	
-8.9487E-04	-4.6255E-17				
Pile N.	1	1	11	11	1
1					
MAXIMUM	1.0658E-03	1.1899E-16	3.7284E-03	-1.2643E-16	
-8.9487E-04	4.1574E-17				
Pile N.	11	11	1	1	1
11					

* PILE TOP REACTIONS *

PILE GROUP	AXIAL, KN	LAT. y, KN	LAT. z, KN	MOM x, KN- M	MOM y, KN- M	MOM z, KN- M
*****	*****	*****	*****	*****	*****	*****
*****	*****	*****	*****	*****	*****	*****
1	-77.469	-3.5785E-13	26.511	-7.6605E-14		
-29.075	-5.6555E-13					
2	-77.469	-3.5785E-13	26.511	-7.6605E-14		
-29.075	-5.6555E-13					
3	-77.469	-3.5785E-13	26.511	-7.6605E-14		
-29.075	-5.6555E-13					
4	-77.469	-3.5785E-13	26.511	-7.6605E-14		
-29.075	-5.6555E-13					

	5	-77.469	-3.5785E-13	26.511	-7.6605E-14	
-29.075	-5.6555E-13					
	6	-77.469	-3.5785E-13	26.511	-7.6605E-14	
-29.075	-5.6555E-13					
	7	-77.469	-3.5785E-13	26.511	-7.6605E-14	
-29.075	-5.6555E-13					
	8	-77.469	-3.5785E-13	26.511	-7.6605E-14	
-29.075	-5.6555E-13					
	9	-77.469	-3.5785E-13	26.511	-7.6605E-14	
-29.075	-5.6555E-13					
	10	-77.469	-3.5785E-13	26.511	-7.6605E-14	
-29.075	-5.6555E-13					
	11	212.72	3.3576E-13	7.4144	-1.1513E-13	
-15.649	7.3275E-13					
	12	212.72	3.3576E-13	7.4144	-1.1513E-13	
-15.649	7.3275E-13					
	13	212.72	3.3576E-13	7.4144	-1.1513E-13	
-15.649	7.3275E-13					
	14	212.72	3.3576E-13	7.4144	-1.1513E-13	
-15.649	7.3275E-13					
	15	212.72	3.3576E-13	7.4144	-1.1513E-13	
-15.649	7.3275E-13					
	16	212.72	3.3576E-13	7.4144	-1.1513E-13	
-15.649	7.3275E-13					
	17	212.72	3.3576E-13	7.4144	-1.1513E-13	
-15.649	7.3275E-13					
	18	212.72	3.3576E-13	7.4144	-1.1513E-13	
-15.649	7.3275E-13					
	19	212.72	3.3576E-13	7.4144	-1.1513E-13	
-15.649	7.3275E-13					
	20	212.72	3.3576E-13	7.4144	-1.1513E-13	
-15.649	7.3275E-13					
	MINIMUM	-77.469	-3.5785E-13	7.4144	-1.1513E-13	
-29.075	-5.6555E-13					
	Pile N.	1	1	11	11	1
	1					
	MAXIMUM	212.72	3.3576E-13	26.511	-7.6605E-14	
-15.649	7.3275E-13					
	Pile N.	11	11	1	1	11
	11					

PILE GROUP STRESS, KN/ M**2

1	1712.4
2	1712.4
3	1712.4
4	1712.4
5	1712.4
6	1712.4
7	1712.4
8	1712.4
9	1712.4
10	1712.4

11 4702.2
 12 4702.2
 13 4702.2
 14 4702.2
 15 4702.2
 16 4702.2
 17 4702.2
 18 4702.2
 19 4702.2
 20 4702.2

MINIMUM 1712.4
 Pile N. 1
 MAXIMUM 4702.2
 Pile N. 11

* EFFECTS FOR Laterally LOADED PILE *

* MINIMUM VALUES AND LOCATIONS *

PILE SHEAR z-DIR	DISPL. SOIL REACT		DISPL. SOIL REACT		MOMENT TOTAL		MOMENT FLEX. RIG.		SHEAR FLEX. RIG.		KN
	y-Dir	M	z-Dir	M	z-Dir	M**2	z-Dir	M**2	z-Dir	M**2	
1	-2.8128E-17	0.9000	-1.8556E-05	4.0000	-8.6513E-14	3.2000	-29.075	0.0000	-3.5755E-13	0.0000	
-7.2067	-2.6927E-13	3.2000	-9.2833	4.1000	1712.4	0.0000	7981.2	0.0000	6151.3	0.0000	
3.6000	3.2000	3.2000	4.1000	4.1000	0.0000	0.0000	0.0000	0.0000	0.0000	0.0000	
2	-2.8128E-17	0.9000	-1.8556E-05	4.0000	-8.6513E-14	3.2000	-29.075	0.0000	-3.5755E-13	0.0000	
-7.2067	-2.6927E-13	3.2000	-9.2833	4.1000	1712.4	0.0000	7981.2	0.0000	6151.3	0.0000	
3.6000	3.2000	3.2000	4.1000	4.1000	0.0000	0.0000	0.0000	0.0000	0.0000	0.0000	
3	-2.8128E-17	0.9000	-1.8556E-05	4.0000	-8.6513E-14	3.2000	-29.075	0.0000	-3.5755E-13	0.0000	
-7.2067	-2.6927E-13	3.2000	-9.2833	4.1000	1712.4	0.0000	7981.2	0.0000	6151.3	0.0000	
3.6000	3.2000	3.2000	4.1000	4.1000	0.0000	0.0000	0.0000	0.0000	0.0000	0.0000	
4	-2.8128E-17	0.9000	-1.8556E-05	4.0000	-8.6513E-14	3.2000	-29.075	0.0000	-3.5755E-13	0.0000	
-7.2067	-2.6927E-13	3.2000	-9.2833	4.1000	1712.4	0.0000	7981.2	0.0000	6151.3	0.0000	
3.6000	3.2000	3.2000	4.1000	4.1000	0.0000	0.0000	0.0000	0.0000	0.0000	0.0000	
5	-2.8128E-17	0.9000	-1.8556E-05	4.0000	-8.6513E-14	3.2000	-29.075	0.0000	-3.5755E-13	0.0000	
-7.2067	-2.6927E-13	3.2000	-9.2833	4.1000	1712.4	0.0000	7981.2	0.0000	6151.3	0.0000	
3.6000	3.2000	3.2000	4.1000	4.1000	0.0000	0.0000	0.0000	0.0000	0.0000	0.0000	
6	-2.8128E-17	0.9000	-1.8556E-05	4.0000	-8.6513E-14	3.2000	-29.075	0.0000	-3.5755E-13	0.0000	
-7.2067	-2.6927E-13	3.2000	-9.2833	4.1000	1712.4	0.0000	7981.2	0.0000	6151.3	0.0000	
3.6000	3.2000	3.2000	4.1000	4.1000	0.0000	0.0000	0.0000	0.0000	0.0000	0.0000	
7	-2.8128E-17	0.9000	-1.8556E-05	4.0000	-8.6513E-14	3.2000	-29.075	0.0000	-3.5755E-13	0.0000	
-7.2067	-2.6927E-13	3.2000	-9.2833	4.1000	1712.4	0.0000	7981.2	0.0000	6151.3	0.0000	

x(M)	0.9000	4.0000	3.2000	0.0000	0.0000
3.6000	3.2000	4.1000	0.0000	0.0000	0.0000
8	-2.8128E-17	-1.8556E-05	-8.6513E-14	-29.075	-3.5755E-13
-7.2067	-2.6927E-13	-9.2833	1712.4	7981.2	6151.3
x(M)	0.9000	4.0000	3.2000	0.0000	0.0000
3.6000	3.2000	4.1000	0.0000	0.0000	0.0000
9	-2.8128E-17	-1.8556E-05	-8.6513E-14	-29.075	-3.5755E-13
-7.2067	-2.6927E-13	-9.2833	1712.4	7981.2	6151.3
x(M)	0.9000	4.0000	3.2000	0.0000	0.0000
3.6000	3.2000	4.1000	0.0000	0.0000	0.0000
10	-2.8128E-17	-1.8556E-05	-8.6513E-14	-29.075	-3.5755E-13
-7.2067	-2.6927E-13	-9.2833	1712.4	7981.2	6151.3
x(M)	0.9000	4.0000	3.2000	0.0000	0.0000
3.6000	3.2000	4.1000	0.0000	0.0000	0.0000
11	-9.7164E-19	-2.3177E-05	-7.3275E-13	-15.649	-4.3441E-13
-10.241	-5.7958E-13	-13.694	4702.2	7981.2	6415.7
x(M)	4.2000	4.2000	0.0000	0.0000	3.9000
3.9000	4.3000	4.3000	0.0000	0.0000	0.0000
12	-9.7164E-19	-2.3177E-05	-7.3275E-13	-15.649	-4.3441E-13
-10.241	-5.7958E-13	-13.694	4702.2	7981.2	6415.7
x(M)	4.2000	4.2000	0.0000	0.0000	3.9000
3.9000	4.3000	4.3000	0.0000	0.0000	0.0000
13	-9.7164E-19	-2.3177E-05	-7.3275E-13	-15.649	-4.3441E-13
-10.241	-5.7958E-13	-13.694	4702.2	7981.2	6415.7
x(M)	4.2000	4.2000	0.0000	0.0000	3.9000
3.9000	4.3000	4.3000	0.0000	0.0000	0.0000
14	-9.7164E-19	-2.3177E-05	-7.3275E-13	-15.649	-4.3441E-13
-10.241	-5.7958E-13	-13.694	4702.2	7981.2	6415.7
x(M)	4.2000	4.2000	0.0000	0.0000	3.9000
3.9000	4.3000	4.3000	0.0000	0.0000	0.0000
15	-9.7164E-19	-2.3177E-05	-7.3275E-13	-15.649	-4.3441E-13
-10.241	-5.7958E-13	-13.694	4702.2	7981.2	6415.7
x(M)	4.2000	4.2000	0.0000	0.0000	3.9000
3.9000	4.3000	4.3000	0.0000	0.0000	0.0000
16	-9.7164E-19	-2.3177E-05	-7.3275E-13	-15.649	-4.3441E-13
-10.241	-5.7958E-13	-13.694	4702.2	7981.2	6415.7
x(M)	4.2000	4.2000	0.0000	0.0000	3.9000
3.9000	4.3000	4.3000	0.0000	0.0000	0.0000
17	-9.7164E-19	-2.3177E-05	-7.3275E-13	-15.649	-4.3441E-13
-10.241	-5.7958E-13	-13.694	4702.2	7981.2	6415.7
x(M)	4.2000	4.2000	0.0000	0.0000	3.9000
3.9000	4.3000	4.3000	0.0000	0.0000	0.0000
18	-9.7164E-19	-2.3177E-05	-7.3275E-13	-15.649	-4.3441E-13
-10.241	-5.7958E-13	-13.694	4702.2	7981.2	6415.7
x(M)	4.2000	4.2000	0.0000	0.0000	3.9000
3.9000	4.3000	4.3000	0.0000	0.0000	0.0000
19	-9.7164E-19	-2.3177E-05	-7.3275E-13	-15.649	-4.3441E-13
-10.241	-5.7958E-13	-13.694	4702.2	7981.2	6415.7
x(M)	4.2000	4.2000	0.0000	0.0000	3.9000
3.9000	4.3000	4.3000	0.0000	0.0000	0.0000
20	-9.7164E-19	-2.3177E-05	-7.3275E-13	-15.649	-4.3441E-13
-10.241	-5.7958E-13	-13.694	4702.2	7981.2	6415.7
x(M)	4.2000	4.2000	0.0000	0.0000	3.9000
3.9000	4.3000	4.3000	0.0000	0.0000	0.0000

Min.	-2.8128E-17	-2.3177E-05	-7.3275E-13	-29.075	-4.3441E-13	
-10.241	-5.7958E-13	-13.694	1712.4	7981.2	6151.3	
Pile N.	1	11	11	1	11	11
	11	11	1	1	1	

* MAXIMUM VALUES AND LOCATIONS *

PILE SHEAR z-DIR	DISPL. SOIL REACT y-DIR M	DISPL. SOIL REACT z-DIR M	MOMENT		MOMENT		SHEAR FLEX. RIG. y-DIR KN
			TOTAL STRESS	FLEX. RIG. z-DIR	FLEX. RIG. z-DIR	FLEX. RIG. y-DIR	
			KN- M	M**2	M**2	M**2	
			KN/ M	KN/ M	KN/ M	KN/ M	
*****	*****	*****	*****	*****	*****	*****	*****
*****	*****	*****	*****	*****	*****	*****	*****
1	2.2690E-19	3.8173E-03	5.6555E-13	7.4937	9.6879E-14		
26.484	1.2655E-13	14.360	1712.4	7981.2	7981.2		
x(M)	4.2000	0.2000	0.0000	2.6000	3.8000		
0.0000	4.3000	1.3000	0.0000	0.0000	5.2000		
2	2.2690E-19	3.8173E-03	5.6555E-13	7.4937	9.6879E-14		
26.484	1.2655E-13	14.360	1712.4	7981.2	7981.2		
x(M)	4.2000	0.2000	0.0000	2.6000	3.8000		
0.0000	4.3000	1.3000	0.0000	0.0000	4.6000		
3	2.2690E-19	3.8173E-03	5.6555E-13	7.4937	9.6879E-14		
26.484	1.2655E-13	14.360	1712.4	7981.2	7981.2		
x(M)	4.2000	0.2000	0.0000	2.6000	3.8000		
0.0000	4.3000	1.3000	0.0000	0.0000	4.9000		
4	2.2690E-19	3.8173E-03	5.6555E-13	7.4937	9.6879E-14		
26.484	1.2655E-13	14.360	1712.4	7981.2	7981.2		
x(M)	4.2000	0.2000	0.0000	2.6000	3.8000		
0.0000	4.3000	1.3000	0.0000	0.0000	4.7000		
5	2.2690E-19	3.8173E-03	5.6555E-13	7.4937	9.6879E-14		
26.484	1.2655E-13	14.360	1712.4	7981.2	7981.2		
x(M)	4.2000	0.2000	0.0000	2.6000	3.8000		
0.0000	4.3000	1.3000	0.0000	0.0000	4.4000		
6	2.2690E-19	3.8173E-03	5.6555E-13	7.4937	9.6879E-14		
26.484	1.2655E-13	14.360	1712.4	7981.2	7981.2		
x(M)	4.2000	0.2000	0.0000	2.6000	3.8000		
0.0000	4.3000	1.3000	0.0000	0.0000	5.4000		
7	2.2690E-19	3.8173E-03	5.6555E-13	7.4937	9.6879E-14		
26.484	1.2655E-13	14.360	1712.4	7981.2	7981.2		
x(M)	4.2000	0.2000	0.0000	2.6000	3.8000		
0.0000	4.3000	1.3000	0.0000	0.0000	4.5000		
8	2.2690E-19	3.8173E-03	5.6555E-13	7.4937	9.6879E-14		
26.484	1.2655E-13	14.360	1712.4	7981.2	7981.2		
x(M)	4.2000	0.2000	0.0000	2.6000	3.8000		
0.0000	4.3000	1.3000	0.0000	0.0000	5.9000		
9	2.2690E-19	3.8173E-03	5.6555E-13	7.4937	9.6879E-14		
26.484	1.2655E-13	14.360	1712.4	7981.2	7981.2		
x(M)	4.2000	0.2000	0.0000	2.6000	3.8000		
0.0000	4.3000	1.3000	0.0000	0.0000	4.6000		
10	2.2690E-19	3.8173E-03	5.6555E-13	7.4937	9.6879E-14		
26.484	1.2655E-13	14.360	1712.4	7981.2	7981.2		

	x(M)	4.2000	0.2000	0.0000	2.6000	3.8000
0.0000		4.3000	1.3000	0.0000	0.0000	4.3000
	11	1.2912E-16	3.3749E-03	3.6959E-13	8.7676	3.3674E-13
7.4404		1.4537E-12	33.497	4702.2	7981.2	7981.2
	x(M)	0.5000	0.4000	3.3000	3.3000	0.0000
0.0000		3.4000	3.4000	0.0000	0.0000	5.3000
	12	1.2912E-16	3.3749E-03	3.6959E-13	8.7676	3.3674E-13
7.4404		1.4537E-12	33.497	4702.2	7981.2	7981.2
	x(M)	0.5000	0.4000	3.3000	3.3000	0.0000
0.0000		3.4000	3.4000	0.0000	0.0000	4.6000
	13	1.2912E-16	3.3749E-03	3.6959E-13	8.7676	3.3674E-13
7.4404		1.4537E-12	33.497	4702.2	7981.2	7981.2
	x(M)	0.5000	0.4000	3.3000	3.3000	0.0000
0.0000		3.4000	3.4000	0.0000	0.0000	5.1000
	14	1.2912E-16	3.3749E-03	3.6959E-13	8.7676	3.3674E-13
7.4404		1.4537E-12	33.497	4702.2	7981.2	7981.2
	x(M)	0.5000	0.4000	3.3000	3.3000	0.0000
0.0000		3.4000	3.4000	0.0000	0.0000	4.7000
	15	1.2912E-16	3.3749E-03	3.6959E-13	8.7676	3.3674E-13
7.4404		1.4537E-12	33.497	4702.2	7981.2	7981.2
	x(M)	0.5000	0.4000	3.3000	3.3000	0.0000
0.0000		3.4000	3.4000	0.0000	0.0000	4.5000
	16	1.2912E-16	3.3749E-03	3.6959E-13	8.7676	3.3674E-13
7.4404		1.4537E-12	33.497	4702.2	7981.2	7981.2
	x(M)	0.5000	0.4000	3.3000	3.3000	0.0000
0.0000		3.4000	3.4000	0.0000	0.0000	5.1000
	17	1.2912E-16	3.3749E-03	3.6959E-13	8.7676	3.3674E-13
7.4404		1.4537E-12	33.497	4702.2	7981.2	7981.2
	x(M)	0.5000	0.4000	3.3000	3.3000	0.0000
0.0000		3.4000	3.4000	0.0000	0.0000	5.2000
	18	1.2912E-16	3.3749E-03	3.6959E-13	8.7676	3.3674E-13
7.4404		1.4537E-12	33.497	4702.2	7981.2	7981.2
	x(M)	0.5000	0.4000	3.3000	3.3000	0.0000
0.0000		3.4000	3.4000	0.0000	0.0000	4.5000
	19	1.2912E-16	3.3749E-03	3.6959E-13	8.7676	3.3674E-13
7.4404		1.4537E-12	33.497	4702.2	7981.2	7981.2
	x(M)	0.5000	0.4000	3.3000	3.3000	0.0000
0.0000		3.4000	3.4000	0.0000	0.0000	5.1000
	20	1.2912E-16	3.3749E-03	3.6959E-13	8.7676	3.3674E-13
7.4404		1.4537E-12	33.497	4702.2	7981.2	7981.2
	x(M)	0.5000	0.4000	3.3000	3.3000	0.0000
0.0000		3.4000	3.4000	0.0000	0.0000	2.1000
	Max.	1.2912E-16	3.8173E-03	5.6555E-13	8.7676	3.3674E-13
26.484		1.4537E-12	33.497	4702.2	7981.2	7981.2
	Pile N.	11	1	1	11	11
		11	11	1	1	

1

LOAD CASE : 5
CASE NAME : SLV GIU

LOAD TYPE : Dead, DL

* TABLE L * COMPUTATION ON PILE CAP

* EQUIVALENT CONCENTRATED LOAD AT ORIGIN *

VERT. LOAD, KN 1770.00	HOR. LOAD Y, KN 0.00000	HOR. LOAD Z, KN 770.000
MOMENT X , KN- M 0.00000	MOMENT Y, KN- M 840.000	MOMENT Z, KN- M 0.00000

* DISPLACEMENT OF GROUPED PILE FOUNDATION AT ORIGIN *

VERTICAL , M 1.60205E-03	HORIZONTAL Y, M -9.81541E-17	HORIZONTAL Z, M 3.35850E-03
ANGLE ROT. X,RAD 2.10913E-16	ANGLE ROT. Y,RAD -9.80024E-04	ANGLE ROT. Z,RAD -6.65595E-17

* TABLE M * COMPUTATION ON INDIVIDUAL PILE

THE GLOBAL STRUCTURAL COORDINATE SYSTEM

* PILE TOP DISPLACEMENTS *

PILE GROUP	DISP. X, M	DISP. Y, M	DISP. Z, M	ROT. X,RAD	ROT. Y, RAD	ROT. Z, RAD
1	2.0921E-03	7.3026E-18	3.3585E-03	2.1091E-16	-9.8002E-04	-6.6559E-17
2	2.0921E-03	7.3026E-18	3.3585E-03	2.1091E-16	-9.8002E-04	-6.6559E-17
3	2.0921E-03	7.3026E-18	3.3585E-03	2.1091E-16	-9.8002E-04	-6.6559E-17
4	2.0921E-03	7.3026E-18	3.3585E-03	2.1091E-16	-9.8002E-04	-6.6559E-17
5	2.0921E-03	7.3026E-18	3.3585E-03	2.1091E-16	-9.8002E-04	-6.6559E-17
6	2.0921E-03	7.3026E-18	3.3585E-03	2.1091E-16	-9.8002E-04	-6.6559E-17
7	2.0921E-03	7.3026E-18	3.3585E-03	2.1091E-16	-9.8002E-04	-6.6559E-17
8	2.0921E-03	7.3026E-18	3.3585E-03	2.1091E-16	-9.8002E-04	-6.6559E-17

-9.8002E-04	-6.6559E-17				
9	2.0921E-03	7.3026E-18	3.3585E-03	2.1091E-16	
-9.8002E-04	-6.6559E-17				
10	2.0921E-03	7.3026E-18	3.3585E-03	2.1091E-16	
-9.8002E-04	-6.6559E-17				
11	1.1120E-03	-2.0361E-16	3.3585E-03	2.1091E-16	
-9.8002E-04	-6.6559E-17				
12	1.1120E-03	-2.0361E-16	3.3585E-03	2.1091E-16	
-9.8002E-04	-6.6559E-17				
13	1.1120E-03	-2.0361E-16	3.3585E-03	2.1091E-16	
-9.8002E-04	-6.6559E-17				
14	1.1120E-03	-2.0361E-16	3.3585E-03	2.1091E-16	
-9.8002E-04	-6.6559E-17				
15	1.1120E-03	-2.0361E-16	3.3585E-03	2.1091E-16	
-9.8002E-04	-6.6559E-17				
16	1.1120E-03	-2.0361E-16	3.3585E-03	2.1091E-16	
-9.8002E-04	-6.6559E-17				
17	1.1120E-03	-2.0361E-16	3.3585E-03	2.1091E-16	
-9.8002E-04	-6.6559E-17				
18	1.1120E-03	-2.0361E-16	3.3585E-03	2.1091E-16	
-9.8002E-04	-6.6559E-17				
19	1.1120E-03	-2.0361E-16	3.3585E-03	2.1091E-16	
-9.8002E-04	-6.6559E-17				
20	1.1120E-03	-2.0361E-16	3.3585E-03	2.1091E-16	
-9.8002E-04	-6.6559E-17				
	MINIMUM	1.1120E-03	-2.0361E-16	3.3585E-03	2.1091E-16
-9.8002E-04	-6.6559E-17				
	Pile N.	11	11	1	1
	1				1
	MAXIMUM	2.0921E-03	7.3026E-18	3.3585E-03	2.1091E-16
-9.8002E-04	-6.6559E-17				
	Pile N.	1	1	1	1
	1				1

* PILE TOP REACTIONS *

	PILE GROUP	FOR. X, KN	FOR. Y, KN	FOR. Z, KN	MOM X, KN- M	MOM Y, KN- M
	MOM Z, KN- M					
	*****	*****	*****	*****	*****	*****
	*****	*****	*****	*****	*****	*****
	1	-42.907	5.4420E-13	69.215	6.4372E-13	
-30.906	6.2187E-13					
	2	-42.907	5.4420E-13	69.215	6.4372E-13	
-30.906	6.2187E-13					
	3	-42.907	5.4420E-13	69.215	6.4372E-13	
-30.906	6.2187E-13					
	4	-42.907	5.4420E-13	69.215	6.4372E-13	
-30.906	6.2187E-13					
	5	-42.907	5.4420E-13	69.215	6.4372E-13	
-30.906	6.2187E-13					
	6	-42.907	5.4420E-13	69.215	6.4372E-13	
-30.906	6.2187E-13					
	7	-42.907	5.4420E-13	69.215	6.4372E-13	

-30.906	6.2187E-13					
	8	-42.907	5.4420E-13	69.215	6.4372E-13	
-30.906	6.2187E-13					
	9	-42.907	5.4420E-13	69.215	6.4372E-13	
-30.906	6.2187E-13					
	10	-42.907	5.4420E-13	69.215	6.4372E-13	
-30.906	6.2187E-13					
	11	219.91	-5.4420E-13	7.7850	1.9066E-13	
-16.501	-1.2141E-12					
	12	219.91	-5.4420E-13	7.7850	1.9066E-13	
-16.501	-1.2141E-12					
	13	219.91	-5.4420E-13	7.7850	1.9066E-13	
-16.501	-1.2141E-12					
	14	219.91	-5.4420E-13	7.7850	1.9066E-13	
-16.501	-1.2141E-12					
	15	219.91	-5.4420E-13	7.7850	1.9066E-13	
-16.501	-1.2141E-12					
	16	219.91	-5.4420E-13	7.7850	1.9066E-13	
-16.501	-1.2141E-12					
	17	219.91	-5.4420E-13	7.7850	1.9066E-13	
-16.501	-1.2141E-12					
	18	219.91	-5.4420E-13	7.7850	1.9066E-13	
-16.501	-1.2141E-12					
	19	219.91	-5.4420E-13	7.7850	1.9066E-13	
-16.501	-1.2141E-12					
	20	219.91	-5.4420E-13	7.7850	1.9066E-13	
-16.501	-1.2141E-12					
	MINIMUM	-42.907	-5.4420E-13	7.7850	1.9066E-13	
-30.906	-1.2141E-12					
	Pile N.	1	11	11	11	1
	11					
	MAXIMUM	219.91	5.4420E-13	69.215	6.4372E-13	
-16.501	6.2187E-13					
	Pile N.	11	1	1	1	11
	1					

THE PILE COORDINATE SYSTEM (LOCAL AXES)

* PILE TOP DISPLACEMENTS *

PILE GROUP	DISP. x, M	DISP. y, M	DISP. z, M	ROT. x, RAD	ROT.
y, RAD					
ROT. z, RAD					
*****	*****	*****	*****	*****	*****
*****	*****	*****	*****	*****	*****
1	-4.1913E-04	6.3742E-18	3.9345E-03	2.0722E-16	
-9.8002E-04	7.7174E-17				
2	-4.1913E-04	6.3742E-18	3.9345E-03	2.0722E-16	
-9.8002E-04	7.7174E-17				
3	-4.1913E-04	6.3742E-18	3.9345E-03	2.0722E-16	
-9.8002E-04	7.7174E-17				
4	-4.1913E-04	6.3742E-18	3.9345E-03	2.0722E-16	

-9.8002E-04	7.7174E-17				
5	-4.1913E-04	6.3742E-18	3.9345E-03	2.0722E-16	
-9.8002E-04	7.7174E-17				
6	-4.1913E-04	6.3742E-18	3.9345E-03	2.0722E-16	
-9.8002E-04	7.7174E-17				
7	-4.1913E-04	6.3742E-18	3.9345E-03	2.0722E-16	
-9.8002E-04	7.7174E-17				
8	-4.1913E-04	6.3742E-18	3.9345E-03	2.0722E-16	
-9.8002E-04	7.7174E-17				
9	-4.1913E-04	6.3742E-18	3.9345E-03	2.0722E-16	
-9.8002E-04	7.7174E-17				
10	-4.1913E-04	6.3742E-18	3.9345E-03	2.0722E-16	
-9.8002E-04	7.7174E-17				
11	1.1120E-03	-2.0368E-16	3.3585E-03	2.1085E-16	
-9.8002E-04	-6.6559E-17				
12	1.1120E-03	-2.0368E-16	3.3585E-03	2.1085E-16	
-9.8002E-04	-6.6559E-17				
13	1.1120E-03	-2.0368E-16	3.3585E-03	2.1085E-16	
-9.8002E-04	-6.6559E-17				
14	1.1120E-03	-2.0368E-16	3.3585E-03	2.1085E-16	
-9.8002E-04	-6.6559E-17				
15	1.1120E-03	-2.0368E-16	3.3585E-03	2.1085E-16	
-9.8002E-04	-6.6559E-17				
16	1.1120E-03	-2.0368E-16	3.3585E-03	2.1085E-16	
-9.8002E-04	-6.6559E-17				
17	1.1120E-03	-2.0368E-16	3.3585E-03	2.1085E-16	
-9.8002E-04	-6.6559E-17				
18	1.1120E-03	-2.0368E-16	3.3585E-03	2.1085E-16	
-9.8002E-04	-6.6559E-17				
19	1.1120E-03	-2.0368E-16	3.3585E-03	2.1085E-16	
-9.8002E-04	-6.6559E-17				
20	1.1120E-03	-2.0368E-16	3.3585E-03	2.1085E-16	
-9.8002E-04	-6.6559E-17				

	MINIMUM	-4.1913E-04	-2.0368E-16	3.3585E-03	2.0722E-16	
-9.8002E-04	-6.6559E-17					
	Pile N.	1	11	11	1	1
	11					
	MAXIMUM	1.1120E-03	6.3742E-18	3.9345E-03	2.1085E-16	
-9.8002E-04	7.7174E-17					
	Pile N.	11	1	1	11	1
	1					

* PILE TOP REACTIONS *

	PILE GROUP	AXIAL, KN	LAT. y, KN	LAT. z, KN	MOM x, KN- M	MOM y, KN- M
	*****	*****	*****	*****	*****	*****
	*****	*****	*****	*****	*****	*****
	1	-76.425	5.3480E-13	28.126	1.2556E-13	
-30.906	8.7919E-13					
	2	-76.425	5.3480E-13	28.126	1.2556E-13	
-30.906	8.7919E-13					
	3	-76.425	5.3480E-13	28.126	1.2556E-13	

-30.906	8.7919E-13					
	4	-76.425	5.3480E-13	28.126	1.2556E-13	
-30.906	8.7919E-13					
	5	-76.425	5.3480E-13	28.126	1.2556E-13	
-30.906	8.7919E-13					
	6	-76.425	5.3480E-13	28.126	1.2556E-13	
-30.906	8.7919E-13					
	7	-76.425	5.3480E-13	28.126	1.2556E-13	
-30.906	8.7919E-13					
	8	-76.425	5.3480E-13	28.126	1.2556E-13	
-30.906	8.7919E-13					
	9	-76.425	5.3480E-13	28.126	1.2556E-13	
-30.906	8.7919E-13					
	10	-76.425	5.3480E-13	28.126	1.2556E-13	
-30.906	8.7919E-13					
	11	219.91	-5.5767E-13	7.7850	1.8965E-13	
-16.501	-1.2141E-12					
	12	219.91	-5.5767E-13	7.7850	1.8965E-13	
-16.501	-1.2141E-12					
	13	219.91	-5.5767E-13	7.7850	1.8965E-13	
-16.501	-1.2141E-12					
	14	219.91	-5.5767E-13	7.7850	1.8965E-13	
-16.501	-1.2141E-12					
	15	219.91	-5.5767E-13	7.7850	1.8965E-13	
-16.501	-1.2141E-12					
	16	219.91	-5.5767E-13	7.7850	1.8965E-13	
-16.501	-1.2141E-12					
	17	219.91	-5.5767E-13	7.7850	1.8965E-13	
-16.501	-1.2141E-12					
	18	219.91	-5.5767E-13	7.7850	1.8965E-13	
-16.501	-1.2141E-12					
	19	219.91	-5.5767E-13	7.7850	1.8965E-13	
-16.501	-1.2141E-12					
	20	219.91	-5.5767E-13	7.7850	1.8965E-13	
-16.501	-1.2141E-12					
	MINIMUM	-76.425	-5.5767E-13	7.7850	1.2556E-13	
-30.906	-1.2141E-12					
	Pile N.	1	11	11	1	1
	11					
	MAXIMUM	219.91	5.3480E-13	28.126	1.8965E-13	
-16.501	8.7919E-13					
	Pile N.	11	1	1	11	11
	1					

PILE GROUP	STRESS, KN/ M**2
*****	*****
1	1689.4
2	1689.4
3	1689.4
4	1689.4
5	1689.4
6	1689.4
7	1689.4

8	1689.4
9	1689.4
10	1689.4
11	4861.0
12	4861.0
13	4861.0
14	4861.0
15	4861.0
16	4861.0
17	4861.0
18	4861.0
19	4861.0
20	4861.0

MINIMUM	1689.4
Pile N.	1
MAXIMUM	4861.0
Pile N.	11

* EFFECTS FOR Laterally LOADED PILE *

* MINIMUM VALUES AND LOCATIONS *

PILE SHEAR z-DIR	DISPL. SOIL REACT		DISPL. SOIL REACT		MOMENT TOTAL		MOMENT FLEX. RIG.		SHEAR FLEX. RIG.		KN
	y-Dir	M	z-Dir	M	z-Dir	KN- M	y-Dir	KN- M	y-Dir	KN	
1	-3.3975E-19	4.2000	-1.9641E-05	4.0000	-8.7919E-13	0.0000	-30.906	7981.2	-1.4561E-13	6137.1	
-7.6295	-1.9124E-13	4.3000	-9.8291	4.1000	1689.4	0.0000	7981.2	7981.2	6137.1	6137.1	
x(M)		4.2000		4.0000	0.0000	0.0000	0.0000	0.0000	3.8000	3.8000	
3.6000		4.3000		4.1000	0.0000	0.0000	0.0000	0.0000	0.0000	0.0000	
2	-3.3975E-19	4.2000	-1.9641E-05	4.0000	-8.7919E-13	0.0000	-30.906	7981.2	-1.4561E-13	6137.1	
-7.6295	-1.9124E-13	4.3000	-9.8291	4.1000	1689.4	0.0000	7981.2	7981.2	6137.1	6137.1	
x(M)		4.2000		4.0000	0.0000	0.0000	0.0000	0.0000	3.8000	3.8000	
3.6000		4.3000		4.1000	0.0000	0.0000	0.0000	0.0000	0.0000	0.0000	
3	-3.3975E-19	4.2000	-1.9641E-05	4.0000	-8.7919E-13	0.0000	-30.906	7981.2	-1.4561E-13	6137.1	
-7.6295	-1.9124E-13	4.3000	-9.8291	4.1000	1689.4	0.0000	7981.2	7981.2	6137.1	6137.1	
x(M)		4.2000		4.0000	0.0000	0.0000	0.0000	0.0000	3.8000	3.8000	
3.6000		4.3000		4.1000	0.0000	0.0000	0.0000	0.0000	0.0000	0.0000	
4	-3.3975E-19	4.2000	-1.9641E-05	4.0000	-8.7919E-13	0.0000	-30.906	7981.2	-1.4561E-13	6137.1	
-7.6295	-1.9124E-13	4.3000	-9.8291	4.1000	1689.4	0.0000	7981.2	7981.2	6137.1	6137.1	
x(M)		4.2000		4.0000	0.0000	0.0000	0.0000	0.0000	3.8000	3.8000	
3.6000		4.3000		4.1000	0.0000	0.0000	0.0000	0.0000	0.0000	0.0000	
5	-3.3975E-19	4.2000	-1.9641E-05	4.0000	-8.7919E-13	0.0000	-30.906	7981.2	-1.4561E-13	6137.1	
-7.6295	-1.9124E-13	4.3000	-9.8291	4.1000	1689.4	0.0000	7981.2	7981.2	6137.1	6137.1	
x(M)		4.2000		4.0000	0.0000	0.0000	0.0000	0.0000	3.8000	3.8000	
3.6000		4.3000		4.1000	0.0000	0.0000	0.0000	0.0000	0.0000	0.0000	
6	-3.3975E-19	4.2000	-1.9641E-05	4.0000	-8.7919E-13	0.0000	-30.906	7981.2	-1.4561E-13	6137.1	
-7.6295	-1.9124E-13	4.3000	-9.8291	4.1000	1689.4	0.0000	7981.2	7981.2	6137.1	6137.1	
x(M)		4.2000		4.0000	0.0000	0.0000	0.0000	0.0000	3.8000	3.8000	

3.6000	4.3000	4.1000	0.0000	0.0000	0.0000
7	-3.3975E-19	-1.9641E-05	-8.7919E-13	-30.906	-1.4561E-13
-7.6295	-1.9124E-13	-9.8291	1689.4	7981.2	6137.1
x(M)	4.2000	4.0000	0.0000	0.0000	3.8000
3.6000	4.3000	4.1000	0.0000	0.0000	0.0000
8	-3.3975E-19	-1.9641E-05	-8.7919E-13	-30.906	-1.4561E-13
-7.6295	-1.9124E-13	-9.8291	1689.4	7981.2	6137.1
x(M)	4.2000	4.0000	0.0000	0.0000	3.8000
3.6000	4.3000	4.1000	0.0000	0.0000	0.0000
9	-3.3975E-19	-1.9641E-05	-8.7919E-13	-30.906	-1.4561E-13
-7.6295	-1.9124E-13	-9.8291	1689.4	7981.2	6137.1
x(M)	4.2000	4.0000	0.0000	0.0000	3.8000
3.6000	4.3000	4.1000	0.0000	0.0000	0.0000
10	-3.3975E-19	-1.9641E-05	-8.7919E-13	-30.906	-1.4561E-13
-7.6295	-1.9124E-13	-9.8291	1689.4	7981.2	6137.1
x(M)	4.2000	4.0000	0.0000	0.0000	3.8000
3.6000	4.3000	4.1000	0.0000	0.0000	0.0000
11	-2.1932E-16	-2.4234E-05	-6.2086E-13	-16.501	-5.5935E-13
-10.742	-2.4663E-12	-14.357	4861.0	7981.2	6362.3
x(M)	0.5000	4.2000	3.4000	0.0000	0.0000
3.9000	3.4000	4.3000	0.0000	0.0000	0.0000
12	-2.1932E-16	-2.4234E-05	-6.2086E-13	-16.501	-5.5935E-13
-10.742	-2.4663E-12	-14.357	4861.0	7981.2	6362.3
x(M)	0.5000	4.2000	3.4000	0.0000	0.0000
3.9000	3.4000	4.3000	0.0000	0.0000	0.0000
13	-2.1932E-16	-2.4234E-05	-6.2086E-13	-16.501	-5.5935E-13
-10.742	-2.4663E-12	-14.357	4861.0	7981.2	6362.3
x(M)	0.5000	4.2000	3.4000	0.0000	0.0000
3.9000	3.4000	4.3000	0.0000	0.0000	0.0000
14	-2.1932E-16	-2.4234E-05	-6.2086E-13	-16.501	-5.5935E-13
-10.742	-2.4663E-12	-14.357	4861.0	7981.2	6362.3
x(M)	0.5000	4.2000	3.4000	0.0000	0.0000
3.9000	3.4000	4.3000	0.0000	0.0000	0.0000
15	-2.1932E-16	-2.4234E-05	-6.2086E-13	-16.501	-5.5935E-13
-10.742	-2.4663E-12	-14.357	4861.0	7981.2	6362.3
x(M)	0.5000	4.2000	3.4000	0.0000	0.0000
3.9000	3.4000	4.3000	0.0000	0.0000	0.0000
16	-2.1932E-16	-2.4234E-05	-6.2086E-13	-16.501	-5.5935E-13
-10.742	-2.4663E-12	-14.357	4861.0	7981.2	6362.3
x(M)	0.5000	4.2000	3.4000	0.0000	0.0000
3.9000	3.4000	4.3000	0.0000	0.0000	0.0000
17	-2.1932E-16	-2.4234E-05	-6.2086E-13	-16.501	-5.5935E-13
-10.742	-2.4663E-12	-14.357	4861.0	7981.2	6362.3
x(M)	0.5000	4.2000	3.4000	0.0000	0.0000
3.9000	3.4000	4.3000	0.0000	0.0000	0.0000
18	-2.1932E-16	-2.4234E-05	-6.2086E-13	-16.501	-5.5935E-13
-10.742	-2.4663E-12	-14.357	4861.0	7981.2	6362.3
x(M)	0.5000	4.2000	3.4000	0.0000	0.0000
3.9000	3.4000	4.3000	0.0000	0.0000	0.0000
19	-2.1932E-16	-2.4234E-05	-6.2086E-13	-16.501	-5.5935E-13
-10.742	-2.4663E-12	-14.357	4861.0	7981.2	6362.3
x(M)	0.5000	4.2000	3.4000	0.0000	0.0000
3.9000	3.4000	4.3000	0.0000	0.0000	0.0000
20	-2.1932E-16	-2.4234E-05	-6.2086E-13	-16.501	-5.5935E-13

-10.742	-2.4663E-12	-14.357	4861.0	7981.2	6362.3
x(M)	0.5000	4.2000	3.4000	0.0000	0.0000
3.9000	3.4000	4.3000	0.0000	0.0000	0.0000

Min.	-2.1932E-16	-2.4234E-05	-8.7919E-13	-30.906	-5.5935E-13
-10.742	-2.4663E-12	-14.357	1689.4	7981.2	6137.1
Pile N.	11	11	1	1	11
	11	11	1	1	1

11

* MAXIMUM VALUES AND LOCATIONS *

PILE SHEAR	DISPL. SOIL	DISPL. SOIL	MOMENT TOTAL	MOMENT FLEX. RIG.	SHEAR FLEX. RIG.	
z-DIR	y-DIR	z-DIR	z-DIR	y-DIR	y-DIR	
	M	M	KN- M	KN- M	KN	KN
	KN/ M	KN/ M	M**2	M**2	M**2	
*****	*****	*****	*****	*****	*****	*****
*****	*****	*****	*****	*****	*****	*****
1	3.9494E-17	4.0346E-03	1.2895E-13	7.9263	5.3445E-13	
28.098	4.2294E-13	15.231	1689.4	7981.2	7981.2	
x(M)	1.0000	0.2000	3.2000	2.6000	0.100000	
0.0000	3.3000	1.3000	0.0000	0.0000	4.4000	
2	3.9494E-17	4.0346E-03	1.2895E-13	7.9263	5.3445E-13	
28.098	4.2294E-13	15.231	1689.4	7981.2	7981.2	
x(M)	1.0000	0.2000	3.2000	2.6000	0.100000	
0.0000	3.3000	1.3000	0.0000	0.0000	4.4000	
3	3.9494E-17	4.0346E-03	1.2895E-13	7.9263	5.3445E-13	
28.098	4.2294E-13	15.231	1689.4	7981.2	7981.2	
x(M)	1.0000	0.2000	3.2000	2.6000	0.100000	
0.0000	3.3000	1.3000	0.0000	0.0000	4.6000	
4	3.9494E-17	4.0346E-03	1.2895E-13	7.9263	5.3445E-13	
28.098	4.2294E-13	15.231	1689.4	7981.2	7981.2	
x(M)	1.0000	0.2000	3.2000	2.6000	0.100000	
0.0000	3.3000	1.3000	0.0000	0.0000	4.7000	
5	3.9494E-17	4.0346E-03	1.2895E-13	7.9263	5.3445E-13	
28.098	4.2294E-13	15.231	1689.4	7981.2	7981.2	
x(M)	1.0000	0.2000	3.2000	2.6000	0.100000	
0.0000	3.3000	1.3000	0.0000	0.0000	5.4000	
6	3.9494E-17	4.0346E-03	1.2895E-13	7.9263	5.3445E-13	
28.098	4.2294E-13	15.231	1689.4	7981.2	7981.2	
x(M)	1.0000	0.2000	3.2000	2.6000	0.100000	
0.0000	3.3000	1.3000	0.0000	0.0000	4.7000	
7	3.9494E-17	4.0346E-03	1.2895E-13	7.9263	5.3445E-13	
28.098	4.2294E-13	15.231	1689.4	7981.2	7981.2	
x(M)	1.0000	0.2000	3.2000	2.6000	0.100000	
0.0000	3.3000	1.3000	0.0000	0.0000	4.8000	
8	3.9494E-17	4.0346E-03	1.2895E-13	7.9263	5.3445E-13	
28.098	4.2294E-13	15.231	1689.4	7981.2	7981.2	
x(M)	1.0000	0.2000	3.2000	2.6000	0.100000	
0.0000	3.3000	1.3000	0.0000	0.0000	4.6000	
9	3.9494E-17	4.0346E-03	1.2895E-13	7.9263	5.3445E-13	
28.098	4.2294E-13	15.231	1689.4	7981.2	7981.2	
x(M)	1.0000	0.2000	3.2000	2.6000	0.100000	

0.0000	3.3000	1.3000	0.0000	0.0000	4.5000
10	3.9494E-17	4.0346E-03	1.2895E-13	7.9263	5.3445E-13
28.098	4.2294E-13	15.231	1689.4	7981.2	7981.2
x(M)	1.0000	0.2000	3.2000	2.6000	0.100000
0.0000	3.3000	1.3000	0.0000	0.0000	4.7000
11	1.6289E-18	3.5563E-03	1.2141E-12	9.1678	7.3045E-13
7.8136	9.7410E-13	35.662	4861.0	7981.2	7981.2
x(M)	4.2000	0.4000	0.0000	3.3000	3.9000
0.0000	4.3000	3.4000	0.0000	0.0000	5.6000
12	1.6289E-18	3.5563E-03	1.2141E-12	9.1678	7.3045E-13
7.8136	9.7410E-13	35.662	4861.0	7981.2	7981.2
x(M)	4.2000	0.4000	0.0000	3.3000	3.9000
0.0000	4.3000	3.4000	0.0000	0.0000	4.5000
13	1.6289E-18	3.5563E-03	1.2141E-12	9.1678	7.3045E-13
7.8136	9.7410E-13	35.662	4861.0	7981.2	7981.2
x(M)	4.2000	0.4000	0.0000	3.3000	3.9000
0.0000	4.3000	3.4000	0.0000	0.0000	5.6000
14	1.6289E-18	3.5563E-03	1.2141E-12	9.1678	7.3045E-13
7.8136	9.7410E-13	35.662	4861.0	7981.2	7981.2
x(M)	4.2000	0.4000	0.0000	3.3000	3.9000
0.0000	4.3000	3.4000	0.0000	0.0000	4.6000
15	1.6289E-18	3.5563E-03	1.2141E-12	9.1678	7.3045E-13
7.8136	9.7410E-13	35.662	4861.0	7981.2	7981.2
x(M)	4.2000	0.4000	0.0000	3.3000	3.9000
0.0000	4.3000	3.4000	0.0000	0.0000	4.7000
16	1.6289E-18	3.5563E-03	1.2141E-12	9.1678	7.3045E-13
7.8136	9.7410E-13	35.662	4861.0	7981.2	7981.2
x(M)	4.2000	0.4000	0.0000	3.3000	3.9000
0.0000	4.3000	3.4000	0.0000	0.0000	5.2000
17	1.6289E-18	3.5563E-03	1.2141E-12	9.1678	7.3045E-13
7.8136	9.7410E-13	35.662	4861.0	7981.2	7981.2
x(M)	4.2000	0.4000	0.0000	3.3000	3.9000
0.0000	4.3000	3.4000	0.0000	0.0000	5.2000
18	1.6289E-18	3.5563E-03	1.2141E-12	9.1678	7.3045E-13
7.8136	9.7410E-13	35.662	4861.0	7981.2	7981.2
x(M)	4.2000	0.4000	0.0000	3.3000	3.9000
0.0000	4.3000	3.4000	0.0000	0.0000	5.3000
19	1.6289E-18	3.5563E-03	1.2141E-12	9.1678	7.3045E-13
7.8136	9.7410E-13	35.662	4861.0	7981.2	7981.2
x(M)	4.2000	0.4000	0.0000	3.3000	3.9000
0.0000	4.3000	3.4000	0.0000	0.0000	5.2000
20	1.6289E-18	3.5563E-03	1.2141E-12	9.1678	7.3045E-13
7.8136	9.7410E-13	35.662	4861.0	7981.2	7981.2
x(M)	4.2000	0.4000	0.0000	3.3000	3.9000
0.0000	4.3000	3.4000	0.0000	0.0000	6.0000
Max.	3.9494E-17	4.0346E-03	1.2141E-12	9.1678	7.3045E-13
28.098	9.7410E-13	35.662	4861.0	7981.2	7981.2
Pile N.	1	1	11	11	11
11	11	11	1	1	

0.0000	7	0.0000	0.0000	0.0000	0.0000	
0.0000	0.0000					
0.0000	8	0.0000	0.0000	0.0000	0.0000	
0.0000	0.0000					
0.0000	9	0.0000	0.0000	0.0000	0.0000	
0.0000	0.0000					
0.0000	10	0.0000	0.0000	0.0000	0.0000	
0.0000	0.0000					
0.0000	11	0.0000	0.0000	0.0000	0.0000	
0.0000	0.0000					
0.0000	12	0.0000	0.0000	0.0000	0.0000	
0.0000	0.0000					
0.0000	13	0.0000	0.0000	0.0000	0.0000	
0.0000	0.0000					
0.0000	14	0.0000	0.0000	0.0000	0.0000	
0.0000	0.0000					
0.0000	15	0.0000	0.0000	0.0000	0.0000	
0.0000	0.0000					
0.0000	16	0.0000	0.0000	0.0000	0.0000	
0.0000	0.0000					
0.0000	17	0.0000	0.0000	0.0000	0.0000	
0.0000	0.0000					
0.0000	18	0.0000	0.0000	0.0000	0.0000	
0.0000	0.0000					
0.0000	19	0.0000	0.0000	0.0000	0.0000	
0.0000	0.0000					
0.0000	20	0.0000	0.0000	0.0000	0.0000	
0.0000	0.0000					
0.0000	MINIMUM	0.0000	0.0000	0.0000	0.0000	
0.0000	0.0000					
	Pile N.	1	1	1	1	1
	1					
0.0000	MAXIMUM	0.0000	0.0000	0.0000	0.0000	
0.0000	0.0000					
	Pile N.	1	1	1	1	1
	1					

* PILE TOP REACTIONS *

M MOM Z, KN- M	PILE GROUP	FOR. X, KN	FOR. Y, KN	FOR. Z, KN	MOM X, KN- M	MOM Y, KN- M
*****	*****	*****	*****	*****	*****	*****
0.0000	1	0.0000	0.0000	0.0000	0.0000	
0.0000	0.0000					
0.0000	2	0.0000	0.0000	0.0000	0.0000	
0.0000	0.0000					
0.0000	3	0.0000	0.0000	0.0000	0.0000	
0.0000	0.0000					
0.0000	4	0.0000	0.0000	0.0000	0.0000	
0.0000	0.0000					
0.0000	5	0.0000	0.0000	0.0000	0.0000	
0.0000	0.0000					

0.0000	6	0.0000	0.0000	0.0000	0.0000	
0.0000	0.0000					
0.0000	7	0.0000	0.0000	0.0000	0.0000	
0.0000	0.0000					
0.0000	8	0.0000	0.0000	0.0000	0.0000	
0.0000	0.0000					
0.0000	9	0.0000	0.0000	0.0000	0.0000	
0.0000	0.0000					
0.0000	10	0.0000	0.0000	0.0000	0.0000	
0.0000	0.0000					
0.0000	11	0.0000	0.0000	0.0000	0.0000	
0.0000	0.0000					
0.0000	12	0.0000	0.0000	0.0000	0.0000	
0.0000	0.0000					
0.0000	13	0.0000	0.0000	0.0000	0.0000	
0.0000	0.0000					
0.0000	14	0.0000	0.0000	0.0000	0.0000	
0.0000	0.0000					
0.0000	15	0.0000	0.0000	0.0000	0.0000	
0.0000	0.0000					
0.0000	16	0.0000	0.0000	0.0000	0.0000	
0.0000	0.0000					
0.0000	17	0.0000	0.0000	0.0000	0.0000	
0.0000	0.0000					
0.0000	18	0.0000	0.0000	0.0000	0.0000	
0.0000	0.0000					
0.0000	19	0.0000	0.0000	0.0000	0.0000	
0.0000	0.0000					
0.0000	20	0.0000	0.0000	0.0000	0.0000	
0.0000	0.0000					
0.0000	MINIMUM	0.0000	0.0000	0.0000	0.0000	
0.0000	0.0000					
	Pile N.	1	1	1	1	1
	1					
0.0000	MAXIMUM	0.0000	0.0000	0.0000	0.0000	
0.0000	0.0000					
	Pile N.	1	1	1	1	1
	1					

THE PILE COORDINATE SYSTEM (LOCAL AXES)

* PILE TOP DISPLACEMENTS *

PILE GROUP	DISP. x, M	DISP. y, M	DISP. z, M	ROT. x, RAD	ROT. y, RAD	ROT. z, RAD
*****	*****	*****	*****	*****	*****	*****
*****	*****	*****	*****	*****	*****	*****
1	0.0000	0.0000	0.0000	0.0000	0.0000	0.0000
0.0000	0.0000					
2	0.0000	0.0000	0.0000	0.0000	0.0000	0.0000
0.0000	0.0000					

0.0000	3	0.0000	0.0000	0.0000	0.0000
0.0000	0.0000				
0.0000	4	0.0000	0.0000	0.0000	0.0000
0.0000	0.0000				
0.0000	5	0.0000	0.0000	0.0000	0.0000
0.0000	0.0000				
0.0000	6	0.0000	0.0000	0.0000	0.0000
0.0000	0.0000				
0.0000	7	0.0000	0.0000	0.0000	0.0000
0.0000	0.0000				
0.0000	8	0.0000	0.0000	0.0000	0.0000
0.0000	0.0000				
0.0000	9	0.0000	0.0000	0.0000	0.0000
0.0000	0.0000				
0.0000	10	0.0000	0.0000	0.0000	0.0000
0.0000	0.0000				
0.0000	11	0.0000	0.0000	0.0000	0.0000
0.0000	0.0000				
0.0000	12	0.0000	0.0000	0.0000	0.0000
0.0000	0.0000				
0.0000	13	0.0000	0.0000	0.0000	0.0000
0.0000	0.0000				
0.0000	14	0.0000	0.0000	0.0000	0.0000
0.0000	0.0000				
0.0000	15	0.0000	0.0000	0.0000	0.0000
0.0000	0.0000				
0.0000	16	0.0000	0.0000	0.0000	0.0000
0.0000	0.0000				
0.0000	17	0.0000	0.0000	0.0000	0.0000
0.0000	0.0000				
0.0000	18	0.0000	0.0000	0.0000	0.0000
0.0000	0.0000				
0.0000	19	0.0000	0.0000	0.0000	0.0000
0.0000	0.0000				
0.0000	20	0.0000	0.0000	0.0000	0.0000
0.0000	0.0000				

0.0000	MINIMUM	0.0000	0.0000	0.0000	0.0000
0.0000	0.0000				
	Pile N.	1	1	1	1
	1				
0.0000	MAXIMUM	0.0000	0.0000	0.0000	0.0000
0.0000	0.0000				
	Pile N.	1	1	1	1
	1				

* PILE TOP REACTIONS *

M MOM z, KN- M	PILE GROUP	AXIAL, KN	LAT. y, KN	LAT. z, KN	MOM x, KN- M	MOM y, KN- M
0.0000	1	0.0000	0.0000	0.0000	0.0000	0.0000

0.0000	2	0.0000	0.0000	0.0000	0.0000
0.0000	0.0000				
0.0000	3	0.0000	0.0000	0.0000	0.0000
0.0000	0.0000				
0.0000	4	0.0000	0.0000	0.0000	0.0000
0.0000	0.0000				
0.0000	5	0.0000	0.0000	0.0000	0.0000
0.0000	0.0000				
0.0000	6	0.0000	0.0000	0.0000	0.0000
0.0000	0.0000				
0.0000	7	0.0000	0.0000	0.0000	0.0000
0.0000	0.0000				
0.0000	8	0.0000	0.0000	0.0000	0.0000
0.0000	0.0000				
0.0000	9	0.0000	0.0000	0.0000	0.0000
0.0000	0.0000				
0.0000	10	0.0000	0.0000	0.0000	0.0000
0.0000	0.0000				
0.0000	11	0.0000	0.0000	0.0000	0.0000
0.0000	0.0000				
0.0000	12	0.0000	0.0000	0.0000	0.0000
0.0000	0.0000				
0.0000	13	0.0000	0.0000	0.0000	0.0000
0.0000	0.0000				
0.0000	14	0.0000	0.0000	0.0000	0.0000
0.0000	0.0000				
0.0000	15	0.0000	0.0000	0.0000	0.0000
0.0000	0.0000				
0.0000	16	0.0000	0.0000	0.0000	0.0000
0.0000	0.0000				
0.0000	17	0.0000	0.0000	0.0000	0.0000
0.0000	0.0000				
0.0000	18	0.0000	0.0000	0.0000	0.0000
0.0000	0.0000				
0.0000	19	0.0000	0.0000	0.0000	0.0000
0.0000	0.0000				
0.0000	20	0.0000	0.0000	0.0000	0.0000
0.0000	0.0000				

0.0000	MINIMUM	0.0000	0.0000	0.0000	0.0000
0.0000	0.0000				
	Pile N.	1	1	1	1
	1				
0.0000	MAXIMUM	0.0000	0.0000	0.0000	0.0000
0.0000	0.0000				
	Pile N.	1	1	1	1
	1				

PILE GROUP	STRESS, KN/ M**2
*****	*****
1	0.0000
2	0.0000
3	0.0000
4	0.0000

1	1	1	1	1	1	1	1	1	1
1	1	1	1	1	1	1	1	1	1

* MAXIMUM VALUES AND LOCATIONS *

PILE SHEAR DEM./CAP.	DISPL. SOIL REACT y-DIR	DISPL. SOIL REACT z-DIR	MOMENT TOTAL z-DIR STRESS	MOMENT FLEX. RIG. y-DIR z-DIR	SHEAR FLEX. RIG. y-DIR	DEM./CAP. MOMENT
z-DIR SHEAR	y-DIR M	z-DIR M	KN- M KN- M**2	KN- M KN- M**2	KN	KN
KN/ M	KN/ M	KN/ M	M**2	M**2		
*****	*****	*****	*****	*****	*****	*****
*****	*****	*****	*****	*****	*****	*****
*****	*****	*****	*****	*****	*****	*****
1	0.0000	0.0000	0.0000	0.0000	0.0000	0.0000
0.0000	0.0000	0.0000	0.0000	7981.2	7981.2	0.0000
0.0000						
x(M)	0.0000	0.0000	0.0000	0.0000	0.0000	0.0000
0.0000	0.0000	0.0000	0.0000	0.0000	0.0000	0.0000
0.0000						
2	0.0000	0.0000	0.0000	0.0000	0.0000	0.0000
0.0000	0.0000	0.0000	0.0000	7981.2	7981.2	0.0000
0.0000						
x(M)	0.0000	0.0000	0.0000	0.0000	0.0000	0.0000
0.0000	0.0000	0.0000	0.0000	0.0000	0.0000	0.0000
0.0000						
3	0.0000	0.0000	0.0000	0.0000	0.0000	0.0000
0.0000	0.0000	0.0000	0.0000	7981.2	7981.2	0.0000
0.0000						
x(M)	0.0000	0.0000	0.0000	0.0000	0.0000	0.0000
0.0000	0.0000	0.0000	0.0000	0.0000	0.0000	0.0000
0.0000						
4	0.0000	0.0000	0.0000	0.0000	0.0000	0.0000
0.0000	0.0000	0.0000	0.0000	7981.2	7981.2	0.0000
0.0000						
x(M)	0.0000	0.0000	0.0000	0.0000	0.0000	0.0000
0.0000	0.0000	0.0000	0.0000	0.0000	0.0000	0.0000
0.0000						
5	0.0000	0.0000	0.0000	0.0000	0.0000	0.0000
0.0000	0.0000	0.0000	0.0000	7981.2	7981.2	0.0000
0.0000						
x(M)	0.0000	0.0000	0.0000	0.0000	0.0000	0.0000
0.0000	0.0000	0.0000	0.0000	0.0000	0.0000	0.0000
0.0000						
6	0.0000	0.0000	0.0000	0.0000	0.0000	0.0000
0.0000	0.0000	0.0000	0.0000	7981.2	7981.2	0.0000
0.0000						
x(M)	0.0000	0.0000	0.0000	0.0000	0.0000	0.0000
0.0000	0.0000	0.0000	0.0000	0.0000	0.0000	0.0000
0.0000						

16	0.0000	0.0000	0.0000	0.0000	0.0000	0.0000
0.0000	0.0000	0.0000	0.0000	7981.2	7981.2	0.0000
0.0000						
x(M)	0.0000	0.0000	0.0000	0.0000	0.0000	0.0000
0.0000	0.0000	0.0000	0.0000	0.0000	0.0000	0.0000
0.0000						
17	0.0000	0.0000	0.0000	0.0000	0.0000	0.0000
0.0000	0.0000	0.0000	0.0000	7981.2	7981.2	0.0000
0.0000						
x(M)	0.0000	0.0000	0.0000	0.0000	0.0000	0.0000
0.0000	0.0000	0.0000	0.0000	0.0000	0.0000	0.0000
0.0000						
18	0.0000	0.0000	0.0000	0.0000	0.0000	0.0000
0.0000	0.0000	0.0000	0.0000	7981.2	7981.2	0.0000
0.0000						
x(M)	0.0000	0.0000	0.0000	0.0000	0.0000	0.0000
0.0000	0.0000	0.0000	0.0000	0.0000	0.0000	0.0000
0.0000						
19	0.0000	0.0000	0.0000	0.0000	0.0000	0.0000
0.0000	0.0000	0.0000	0.0000	7981.2	7981.2	0.0000
0.0000						
x(M)	0.0000	0.0000	0.0000	0.0000	0.0000	0.0000
0.0000	0.0000	0.0000	0.0000	0.0000	0.0000	0.0000
0.0000						
20	0.0000	0.0000	0.0000	0.0000	0.0000	0.0000
0.0000	0.0000	0.0000	0.0000	7981.2	7981.2	0.0000
0.0000						
x(M)	0.0000	0.0000	0.0000	0.0000	0.0000	0.0000
0.0000	0.0000	0.0000	0.0000	0.0000	0.0000	0.0000
0.0000						
Max.	0.0000	0.0000	0.0000	0.0000	0.0000	0.0000
0.0000	0.0000	0.0000	0.0000	7981.2	7981.2	0.0000
0.0000						
Pile N.	1	1	1	1	1	1
1	1	1	1	1	1	1

***** SUMMARY FOR LOAD CASES AND COMBINATIONS *****

***** LOAD CASES RESULTS *****

LOAD CASE : 1

* TABLE L * COMPUTATION ON PILE CAP

* EQUIVALENT CONCENTRATED LOAD AT ORIGIN *

KN- M	LOAD X, KN	LOAD Y, KN	LOAD Z, KN	MOM X, KN- M	MOM Y,
	1610.00	0.00000	1720.00	0.00000	

3010.00 0.00000

* DISPLACEMENT OF GROUPED PILE FOUNDATION AT ORIGIN *

	DISP X, M	DISP Y, M	DISP Z, M	ROT X,RAD	ROT
Y,RAD	ROT Z,RAD				
	1.23478E-03	-8.97662E-15	2.96195E-03	1.28580E-14	
1.74471E-03	-1.71365E-15				

* TABLE M * COMPUTATION ON INDIVIDUAL PILE

* PILE TOP DISPLACEMENTS, GLOBAL *

	DISP. X, M	DISP. Y, M	DISP. Z, M	ROT. X,RAD	ROT.
Y,RAD	ROT. Z,RAD				
	*****	*****	*****	*****	*****
*****	*****				
MINIMUM	3.6242E-04	-1.5406E-14	2.9620E-03	1.2858E-14	
1.7447E-03	-1.7136E-15				
Pile N.	1	11	1	1	1
1					
MAXIMUM	2.1071E-03	-2.5476E-15	2.9620E-03	1.2858E-14	
1.7447E-03	-1.7136E-15				
Pile N.	11	1	1	1	1
1					

* PILE TOP REACTIONS, GLOBAL *

	FOR. X, KN	FOR. Y, KN	FOR. Z, KN	MOM X, KN- M	MOM Y, KN- M
M MOM Z, KN- M					
	*****	*****	*****	*****	*****
*****	*****				
MINIMUM	-213.37	-3.1302E-11	-0.8397	1.1565E-11	
2.6164	-6.5112E-11				
Pile N.	1	11	11	11	1
11					
MAXIMUM	374.37	2.6210E-11	172.84	3.9470E-11	
4.5148	3.9509E-11				
Pile N.	11	1	1	1	11
1					

* PILE TOP DISPLACEMENTS, LOCAL *

	DISP. x, M	DISP. y, M	DISP. z, M	ROT. x,RAD	ROT.
y,RAD	ROT. z,RAD				
	*****	*****	*****	*****	*****
*****	*****				
MINIMUM	-1.5380E-03	-1.5406E-14	2.5572E-03	1.1187E-14	
1.7447E-03	-1.7136E-15				
Pile N.	1	11	1	1	1
11					
MAXIMUM	2.1071E-03	-2.5482E-15	2.9620E-03	1.2858E-14	
1.7447E-03	6.5662E-15				
Pile N.	11	1	11	11	1
1					

* PILE TOP REACTIONS, LOCAL *

AXIAL, KN	LAT. y, KN	LAT. z, KN	MOM x, KN- M	MOM y, KN- M
-----------	------------	------------	--------------	--------------

M MOM z, KN- M

```

*****
*****
MINIMUM          -274.55  -3.1325E-11    -0.8397  6.7788E-12
2.6164  -6.5112E-11
Pile N.          1          11          11          1          1
11
MAXIMUM          374.37  2.6198E-11    4.8365  1.1565E-11
4.5148  5.5435E-11
Pile N.          11          1          1          11          11
1

```

* EFFECTS FOR Laterally LOADED PILE *

PILE SHEAR	DISPL. SOIL	DISPL. SOIL	MOMENT TOTAL	MOMENT	SHEAR	
z-DIR	REACT y-DIR	REACT z-DIR	z-DIR STRESS	y-DIR	y-DIR	
	M	M	KN- M	KN- M	KN	KN
Min.	-1.5589E-14	-1.4730E-05	-5.5435E-11	-0.1927	-3.1479E-11	
-3.1944	-1.4844E-10	-4.1230	6068.8			
Pile N.	11	1	1	1	11	11
11	11	1				
Max.	1.4187E-15	2.9620E-03	6.5112E-11	5.8244	4.5989E-11	
4.8353	6.1315E-11	5.8760	8275.4			
Pile N.	1	11	11	1	11	1
11	11	11				

LOAD CASE : 2

* TABLE L * COMPUTATION ON PILE CAP

* EQUIVALENT CONCENTRATED LOAD AT ORIGIN *

LOAD X, KN	LOAD Y, KN	LOAD Z, KN	MOM X, KN- M	MOM Y,
2090.00	0.00000	1720.00	0.00000	
2930.00	0.00000			

* DISPLACEMENT OF GROUPED PILE FOUNDATION AT ORIGIN *

DISP X, M	DISP Y, M	DISP Z, M	ROT X,RAD	ROT
1.64348E-03	3.74881E-16	3.61305E-03	-9.64481E-16	
1.33523E-03	3.62549E-16			

* TABLE M * COMPUTATION ON INDIVIDUAL PILE

* PILE TOP DISPLACEMENTS, GLOBAL *

DISP. X, M	DISP. Y, M	DISP. Z, M	ROT. X,RAD	ROT.

MINIMUM	9.7587E-04	-1.0736E-16	3.6131E-03	-9.6448E-16	
1.3352E-03	3.6255E-16				
Pile N.	1	1	1	1	1
1					
MAXIMUM	2.3111E-03	8.5712E-16	3.6131E-03	-9.6448E-16	
1.3352E-03	3.6255E-16				
Pile N.	11	11	1	1	1
1					

* PILE TOP REACTIONS, GLOBAL *

	FOR. X, KN	FOR. Y, KN	FOR. Z, KN	MOM X, KN- M	MOM Y, KN- M	MOM Z, KN- M
	*****	*****	*****	*****	*****	*****
MINIMUM	-197.03	-2.6427E-12	1.5530	-2.9679E-12		
-7.5410	-2.8304E-12					
Pile N.	1	1	11	1	1	1
1						
MAXIMUM	406.03	2.6427E-12	170.45	-8.6736E-13		
-0.9867	5.8118E-12					
Pile N.	11	11	1	11	11	11
11						

* PILE TOP DISPLACEMENTS, LOCAL *

	DISP. x, M	DISP. y, M	DISP. z, M	ROT. x, RAD	ROT. y, RAD	ROT. z, RAD
	*****	*****	*****	*****	*****	*****
MINIMUM	-1.4554E-03	-1.0821E-16	3.4479E-03	-9.8328E-16		
1.3352E-03	-3.0779E-16					
Pile N.	1	1	1	1	1	1
1						
MAXIMUM	2.3111E-03	8.5698E-16	3.6131E-03	-9.6440E-16		
1.3352E-03	3.6255E-16					
Pile N.	11	11	11	11	11	11
11						

* PILE TOP REACTIONS, LOCAL *

	AXIAL, KN	LAT. y, KN	LAT. z, KN	MOM x, KN- M	MOM y, KN- M	MOM z, KN- M
	*****	*****	*****	*****	*****	*****
MINIMUM	-260.20	-2.6555E-12	1.5530	-8.6742E-13		
-7.5410	-4.0594E-12					
Pile N.	1	1	11	11	11	11
1						
MAXIMUM	406.03	2.6179E-12	13.012	-5.9586E-13		
-0.9867	5.8118E-12					
Pile N.	11	11	1	1	11	11
11						

* EFFECTS FOR Laterally LOADED PILE *

PILE	DISPL.	DISPL.	MOMENT	MOMENT	SHEAR
------	--------	--------	--------	--------	-------

SHEAR	SOIL REACT	SOIL REACT	TOTAL			
z-DIR	y-DIR	z-DIR	z-DIR	y-DIR	y-DIR	
	y-DIR	z-DIR	STRESS	KN- M	KN	KN
	M	M	KN/ M**2			
*****	*****	*****	*****	*****	*****	*****
*****	*****	*****	*****	*****	*****	*****
Min.	-2.1998E-16	-1.4114E-05	-5.8118E-12	-7.5410	-3.3142E-12	
-5.9085	-4.4428E-12	-7.7575	5751.6			
Pile N.	1	11	11	1	11	11
11	11	11	1			
Max.	9.5446E-16	3.6131E-03	4.0594E-12	6.1042	2.6327E-12	
12.991	1.1230E-11	15.515	8975.2			
Pile N.	11	11	1	1	11	1
11	11	11				

LOAD CASE : 3

* TABLE L * COMPUTATION ON PILE CAP

* EQUIVALENT CONCENTRATED LOAD AT ORIGIN *

KN- M	LOAD X, KN	LOAD Y, KN	LOAD Z, KN	MOM X, KN- M	MOM Y,
	1610.00	0.00000	1280.00	0.00000	
2170.00	0.00000				

* DISPLACEMENT OF GROUPED PILE FOUNDATION AT ORIGIN *

Y,RAD	DISP X, M	DISP Y, M	DISP Z, M	ROT X,RAD	ROT
	1.21494E-03	3.70218E-15	2.70477E-03	-2.84820E-14	
9.01886E-04	1.76388E-14				

* TABLE M * COMPUTATION ON INDIVIDUAL PILE

* PILE TOP DISPLACEMENTS, GLOBAL *

Y,RAD	DISP. X, M	DISP. Y, M	DISP. Z, M	ROT. X,RAD	ROT.
	*****	*****	*****	*****	*****
*****	*****	*****	*****	*****	*****
MINIMUM	7.6400E-04	-1.0539E-14	2.7048E-03	-2.8482E-14	
9.0189E-04	1.7639E-14				
Pile N.	1	1	1	1	1
1					
MAXIMUM	1.6659E-03	1.7943E-14	2.7048E-03	-2.8482E-14	
9.0189E-04	1.7639E-14				
Pile N.	11	11	1	1	1
1					

* PILE TOP REACTIONS, GLOBAL *

M MOM Z, KN- M	FOR. X, KN	FOR. Y, KN	FOR. Z, KN	MOM X, KN- M	MOM Y, KN-
	*****	*****	*****	*****	*****
*****	*****	*****	*****	*****	*****
MINIMUM	-144.88	-8.9152E-11	1.5632	-8.1976E-11	

```

-6.8564  -7.2147E-11
  Pile N.      1      1      11      1      1
    1
  MAXIMUM     305.88  8.8803E-11  126.44  -2.5618E-11
-1.5198  2.0524E-10
  Pile N.     11     11     1     11     11
    11

```

* PILE TOP DISPLACEMENTS, LOCAL *

```

          DISP. x, M  DISP. y, M  DISP. z, M  ROT. x,RAD  ROT.
y,RAD  ROT. z,RAD
          *****  *****  *****  *****  *****
*****  *****

```

```

  MINIMUM     -1.0632E-03  -1.0540E-14  2.6017E-03  -3.3304E-14
9.0189E-04  -3.6355E-15
  Pile N.      1      1      1      1      1
    1
  MAXIMUM      1.6659E-03  1.7943E-14  2.7048E-03  -2.8482E-14
9.0189E-04  1.7639E-14
  Pile N.     11     11     11     11     1
    11

```

* PILE TOP REACTIONS, LOCAL *

```

          AXIAL, KN  LAT. y, KN  LAT. z, KN  MOM x, KN- M  MOM y, KN-
M MOM z, KN- M
          *****  *****  *****  *****  *****
*****  *****

```

```

  MINIMUM     -192.01  -8.9162E-11  1.5632  -2.5618E-11
-6.8564  -1.0732E-10
  Pile N.      1      1      11     11     1
    1
  MAXIMUM     305.88  8.8785E-11  10.439  -2.0180E-11
-1.5198  2.0524E-10
  Pile N.     11     11     1     1     11
    11

```

* EFFECTS FOR LATERALLY LOADED PILE *

```

  PILE DISPL. DISPL. MOMENT MOMENT SHEAR
SHEAR SOIL REACT SOIL REACT TOTAL MOMENT SHEAR
      y-DIR      z-DIR      z-DIR      y-DIR      y-DIR
z-DIR      y-DIR      z-DIR      STRESS      KN      KN
      KN/ M      KN/ M      KN/ M**2      KN- M      KN      KN
*****  *****  *****  *****  *****  *****
*****  *****  *****  *****  *****  *****
  Min. -1.1070E-14  -1.1066E-05  -2.0524E-10  -6.8564  -9.8065E-11
-4.6997  -1.3108E-10  -6.1491  4244.3
  Pile N.      1      11      11      1      11     11
    11     11      1
  Max.  2.4718E-14  2.7048E-03  1.0732E-10  4.5792  8.9179E-11
10.425  3.4723E-10  12.761  6761.3
  Pile N.     11     11     11     1     11     1
    11     11     11

```

LOAD CASE : 4

* TABLE L * COMPUTATION ON PILE CAP

* EQUIVALENT CONCENTRATED LOAD AT ORIGIN *

KN- M	LOAD X, KN	LOAD Y, KN	LOAD Z, KN	MOM X, KN- M	MOM Y,
	MOM Z, KN- M				
	1680.00	0.00000	760.000	0.00000	
840.000	0.00000				

* DISPLACEMENT OF GROUPED PILE FOUNDATION AT ORIGIN *

Y, RAD	DISP X, M	DISP Y, M	DISP Z, M	ROT X, RAD	ROT
	ROT Z, RAD				
	1.51320E-03	5.50499E-17	3.19959E-03	-1.28005E-16	
-8.94874E-04	4.15741E-17				

* TABLE M * COMPUTATION ON INDIVIDUAL PILE

* PILE TOP DISPLACEMENTS, GLOBAL *

Y, RAD	DISP. X, M	DISP. Y, M	DISP. Z, M	ROT. X, RAD	ROT.
	ROT. Z, RAD				
	*****	*****	*****	*****	*****
*****	*****				
MINIMUM	1.0658E-03	-8.9528E-18	3.1996E-03	-1.2800E-16	
-8.9487E-04	4.1574E-17				
Pile N.	11	1	1	1	1
1					
MAXIMUM	1.9606E-03	1.1905E-16	3.1996E-03	-1.2800E-16	
-8.9487E-04	4.1574E-17				
Pile N.	1	11	1	1	1
1					

* PILE TOP REACTIONS, GLOBAL *

M MOM Z, KN- M	FOR. X, KN	FOR. Y, KN	FOR. Z, KN	MOM X, KN- M	MOM Y, KN-
	*****	*****	*****	*****	*****
*****	*****				
MINIMUM	-44.724	-3.4878E-13	7.4144	-4.0526E-13	
-29.075	-3.9251E-13				
Pile N.	1	1	11	1	1
1					
MAXIMUM	212.72	3.4878E-13	68.586	-1.1417E-13	
-15.649	7.3275E-13				
Pile N.	11	11	1	11	11
11					

* PILE TOP DISPLACEMENTS, LOCAL *

y, RAD	DISP. x, M	DISP. y, M	DISP. z, M	ROT. x, RAD	ROT.
	ROT. z, RAD				
	*****	*****	*****	*****	*****
*****	*****				
MINIMUM	-4.2486E-04	-9.8336E-18	3.1996E-03	-1.2806E-16	
-8.9487E-04	-4.6255E-17				

Pile N.	1	1	11	11	1
1					
MAXIMUM	1.0658E-03	1.1899E-16	3.7284E-03	-1.2643E-16	
-8.9487E-04	4.1574E-17				
Pile N.	11	11	1	1	1
11					

* PILE TOP REACTIONS, LOCAL *

	AXIAL, KN	LAT. y, KN	LAT. z, KN	MOM x, KN- M	MOM y, KN- M	MOM z, KN- M
--	-----------	------------	------------	--------------	--------------	--------------

MINIMUM	-77.469	-3.5785E-13	7.4144	-1.1513E-13		
-29.075	-5.6555E-13					

Pile N.	1	1	11	11	1
1					
MAXIMUM	212.72	3.3576E-13	26.511	-7.6605E-14	
-15.649	7.3275E-13				
Pile N.	11	11	1	1	11
11					

* EFFECTS FOR LATERALLY LOADED PILE *

PILE SHEAR	DISPL. SOIL	DISPL. SOIL	MOMENT TOTAL	MOMENT	SHEAR	
	REACT y-DIR	REACT z-DIR	z-DIR	y-DIR	y-DIR	
z-DIR	y-DIR	z-DIR	STRESS	KN- M	KN	KN
	M	M	KN/ M**2			

Min.	-2.8128E-17	-2.3177E-05	-7.3275E-13	-29.075	-4.3441E-13	
-10.241	-5.7958E-13	-13.694	1712.4			

Pile N.	1	11	11	1	11	11
11	11	1				
Max.	1.2912E-16	3.8173E-03	5.6555E-13	8.7676	3.3674E-13	
26.484	1.4537E-12	33.497	4702.2			
Pile N.	11	1	1	11	11	1
11	11	11				

LOAD CASE : 5

* TABLE L * COMPUTATION ON PILE CAP

* EQUIVALENT CONCENTRATED LOAD AT ORIGIN *

	LOAD X, KN	LOAD Y, KN	LOAD Z, KN	MOM X, KN- M	MOM Y,
KN- M	MOM Z, KN- M				
	1770.00	0.00000	770.000	0.00000	
840.000	0.00000				

* DISPLACEMENT OF GROUPED PILE FOUNDATION AT ORIGIN *

	DISP X, M	DISP Y, M	DISP Z, M	ROT X, RAD	ROT
Y, RAD	ROT Z, RAD				
	1.60205E-03	-9.81541E-17	3.35850E-03	2.10913E-16	

-9.80024E-04 -6.65595E-17

* TABLE M * COMPUTATION ON INDIVIDUAL PILE

* PILE TOP DISPLACEMENTS, GLOBAL *

Y,RAD	ROT. Z,RAD	DISP. X, M	DISP. Y, M	DISP. Z, M	ROT. X,RAD	ROT.

MINIMUM		1.1120E-03	-2.0361E-16	3.3585E-03	2.1091E-16	
-9.8002E-04	-6.6559E-17					
Pile N.		11	11	1	1	1
1						
MAXIMUM		2.0921E-03	7.3026E-18	3.3585E-03	2.1091E-16	
-9.8002E-04	-6.6559E-17					
Pile N.		1	1	1	1	1
1						

* PILE TOP REACTIONS, GLOBAL *

M MOM Z, KN- M		FOR. X, KN	FOR. Y, KN	FOR. Z, KN	MOM X, KN- M	MOM Y, KN- M

MINIMUM		-42.907	-5.4420E-13	7.7850	1.9066E-13	
-30.906	-1.2141E-12					
Pile N.		1	11	11	11	1
11						
MAXIMUM		219.91	5.4420E-13	69.215	6.4372E-13	
-16.501	6.2187E-13					
Pile N.		11	1	1	1	11
1						

* PILE TOP DISPLACEMENTS, LOCAL *

y,RAD	ROT. z,RAD	DISP. x, M	DISP. y, M	DISP. z, M	ROT. x,RAD	ROT.

MINIMUM		-4.1913E-04	-2.0368E-16	3.3585E-03	2.0722E-16	
-9.8002E-04	-6.6559E-17					
Pile N.		1	11	11	1	1
11						
MAXIMUM		1.1120E-03	6.3742E-18	3.9345E-03	2.1085E-16	
-9.8002E-04	7.7174E-17					
Pile N.		11	1	1	11	1
1						

* PILE TOP REACTIONS, LOCAL *

M MOM z, KN- M		AXIAL, KN	LAT. y, KN	LAT. z, KN	MOM x, KN- M	MOM y, KN- M

MINIMUM		-76.425	-5.5767E-13	7.7850	1.2556E-13	
-30.906	-1.2141E-12					
Pile N.		1	11	11	1	1

11
 MAXIMUM 219.91 5.3480E-13 28.126 1.8965E-13
 -16.501 8.7919E-13
 Pile N. 11 1 1 11 11
 1

* EFFECTS FOR Laterally LOADED PILE *

PILE SHEAR	DISPL. SOIL REACT y-DIR	DISPL. SOIL REACT z-DIR	MOMENT TOTAL z-DIR	MOMENT y-DIR	SHEAR y-DIR	
z-DIR	y-DIR	z-DIR	STRESS KN- M	KN- M	KN	KN
KN/ M	KN/ M	KN/ M**2				
*****	*****	*****	*****	*****	*****	*****
*****	*****	*****	*****	*****	*****	*****
Min. -10.742	-2.1932E-16	-2.4234E-05	-8.7919E-13	-30.906	-5.5935E-13	
	-2.4663E-12	-14.357	1689.4			
Pile N. 11	11	11	1	1	11	11
11	11	1				
Max. 28.098	3.9494E-17	4.0346E-03	1.2141E-12	9.1678	7.3045E-13	
	9.7410E-13	35.662	4861.0			
Pile N. 11	1	1	11	11	11	1
11	11	11				

***** LOAD COMBINATIONS RESULTS *****

LOAD COMB : 1

* TABLE L * COMPUTATION ON PILE CAP

* EQUIVALENT CONCENTRATED LOAD AT ORIGIN *

LOAD X, KN	LOAD Y, KN	LOAD Z, KN	MOM X, KN- M	MOM Y,
KN- M	MOM Z, KN- M			
0.00000	0.00000	0.00000	0.00000	0.00000
0.00000	0.00000			

* DISPLACEMENT OF GROUPED PILE FOUNDATION AT ORIGIN *

DISP X, M	DISP Y, M	DISP Z, M	ROT X,RAD	ROT
Y,RAD	ROT Z,RAD			
0.00000	0.00000	0.00000	0.00000	
0.00000	0.00000			

* PILE TOP DISPLACEMENTS, GLOBAL *

DISP. X, M	DISP. Y, M	DISP. Z, M	ROT. X,RAD	ROT.
Y,RAD	ROT. Z,RAD			
*****	*****	*****	*****	*****
*****	*****	*****	*****	*****
MINIMUM	0.0000	0.0000	0.0000	0.0000
0.0000	0.0000			
Pile N. 1	1	1	1	1
1				
MAXIMUM	0.0000	0.0000	0.0000	0.0000

0.0000 0.0000
 Pile N. 1 1 1 1 1
 1

* PILE TOP REACTIONS, GLOBAL *

FOR. X, KN FOR. Y, KN FOR. Z, KN MOM X, KN- M MOM Y, KN-
 M MOM Z, KN- M
 ***** ***** ***** *****
 ***** *****

MINIMUM 0.0000 0.0000 0.0000 0.0000
 0.0000 0.0000
 Pile N. 1 1 1 1 1
 1

MAXIMUM 0.0000 0.0000 0.0000 0.0000
 0.0000 0.0000
 Pile N. 1 1 1 1 1
 1

* PILE TOP DISPLACEMENTS, LOCAL *

DISP. x, M DISP. y, M DISP. z, M ROT. x,RAD ROT.
 y,RAD ROT. z,RAD
 ***** ***** ***** *****
 ***** *****

MINIMUM 0.0000 0.0000 0.0000 0.0000
 0.0000 0.0000
 Pile N. 1 1 1 1 1
 1

MAXIMUM 0.0000 0.0000 0.0000 0.0000
 0.0000 0.0000
 Pile N. 1 1 1 1 1
 1

* PILE TOP REACTIONS, LOCAL *

AXIAL, KN LAT. y, KN LAT. z, KN MOM x, KN- M MOM y, KN-
 M MOM z, KN- M
 ***** ***** ***** *****
 ***** *****

MINIMUM 0.0000 0.0000 0.0000 0.0000
 0.0000 0.0000
 Pile N. 1 1 1 1 1
 1

MAXIMUM 0.0000 0.0000 0.0000 0.0000
 0.0000 0.0000
 Pile N. 1 1 1 1 1
 1

* EFFECTS FOR Laterally LOADED PILE *

PILE DISPL. DISPL. MOMENT MOMENT SHEAR
 SHEAR SOIL REACT SOIL REACT TOTAL
 z-DIR y-DIR z-DIR z-DIR y-DIR y-DIR
 y-DIR z-DIR STRESS
 M M KN- M KN- M KN KN
 KN/ M KN/ M KN/ M**2

```

*****  *****  *****  *****  *****  *****
*****  *****  *****  *****
Min.      0.0000    0.0000    0.0000    0.0000    0.0000
0.0000    0.0000    0.0000    0.0000
Pile N.   1        1        1        1        1        1
1         1        1
Max.      0.0000    0.0000    0.0000    0.0000    0.0000
0.0000    0.0000    0.0000    0.0000
Pile N.   1        1        1        1        1        1
1         1        1

```

ALLEGATO 2 - ANALISI NUMERICA PARATIE PLUS

Relazione Geotecnica e di Calcolo

RTI di progettazione:



Mandataria

Via G.B. Sammartini n°5
20125 - Milano
Tel. 02 6787911
email: mail@proiter.it



Mandante

Via Artemide n°3
92100 Agrigento
Tel. 0922 421007
email: deltaingegneria@pec.it



Report di Calcolo

Sommario

1. Descrizione del Software	3
2. Descrizione della Stratigrafia e degli Strati di Terreno	4
3. Descrizione Pareti	5
4. Fasi di Calcolo	6
4.1. Stage 1	6
Stage 1	6
4.2. Stage 2	8
Stage 2	8
4.3. Stage 3	10
Stage 3	10
4.4. Stage 4	12
Stage 4	12
5. Descrizione Coefficienti Design Assumption	14
5.1. Risultati SLE (Rara/Frequente/Quasi Permanente)	15
5.1.1. Tabella Grafici dei Risultati	15
5.1.2. Risultati Elementi strutturali - SLE (Rara/Frequente/Quasi Permanente)	17
5.2. Risultati A1+M1+R1 (R3 per tiranti)	18
5.2.1. Tabella Grafici dei Risultati	18
5.2.2. Risultati Elementi strutturali - A1+M1+R1 (R3 per tiranti)	20
5.3. Risultati SISMICA STR.....	21
5.3.1. Tabella Grafici dei Risultati	21
5.3.2. Risultati Elementi strutturali - SISMICA STR	23

1. Descrizione del Software

ParatiePlus analizza il comportamento meccanico di una struttura di sostegno flessibile di uno scavo in terreno o roccia, ponendo l'accento sull'aspetto dell'interazione "locale" fra parete e terreno.

ParatiePlus non permette lo studio di problematiche che coinvolgano un movimento esteso del versante di scavo, in quanto ParatiePlus non consente lo sviluppo di movimenti rigidi della parete o parti di ammasso rispetto ad altre parti di terreno.

Scopo precipuo di ParatiePlus è quindi il calcolo delle azioni flettenti e taglianti e delle deformazioni laterali della parete di sostegno, e la valutazione di tutte quelle grandezze a queste connesse.

Lo studio di una parete flessibile è condotto attraverso una simulazione numerica del reale: il programma stabilisce e risolve un sistema di equazioni algebriche la cui soluzione permette di riprodurre abbastanza realisticamente l'effettivo comportamento dell'opera di sostegno.

La simulazione numerica è quella offerta dal metodo degli elementi finiti.

La schematizzazione in elementi finiti avviene in questo modo:

- si analizza un problema piano (nel piano Y-Z): i gradi di libertà nodali attivi sono lo spostamento laterale e la rotazione fuori piano: gli spostamenti verticali sono automaticamente vincolati (di conseguenza le azioni assiali nelle pareti verticali non sono calcolate);
- la parete flessibile di sostegno vera e propria è schematizzata da una serie di elementi finiti BEAM verticali;
- il terreno, che spinge contro la parete (da monte e da valle) e che reagisce in modo complesso alle deformazioni della parete, è simulato attraverso un doppio letto di molle elasto-plastiche connesse agli stessi nodi della parete;
- i tiranti, i puntoni, le solette, gli appoggi cedevoli o fissi, sono schematizzati tramite molle puntuali convergenti in alcuni punti (nodi) della parete ove convergono parimenti elementi BEAM ed elementi terreno.

2. Descrizione della Stratigrafia e degli Strati di Terreno

Tipo : HORIZONTAL

Quota : 0 m

OCR : 1

Tipo : HORIZONTAL

Quota : -3 m

OCR : 1

Tipo : HORIZONTAL

Quota : -7.5 m

OCR : 1

Strato di Terreno	Terreno	γ dry	γ sat	ϕ'	ϕ	c_v	ϕ_p	c'	Su	Modulo Elastico	Eu	Evc	Eur	Ah	Avexp	Pa	Rur/Rvc	Rvc	Ku	Kvc	Kur		
		kN/m ³	kN/m ³	°	°	°	kPa	kPa			kPa	kPa	kPa	kPa	kPa	kPa			kPa	kN/m ³	kN/m ³	kN/m ³	
1	Coltre	19	19	25				0		Constant	15000		45000										
2	Basalti alterati	20	20	34				0		Constant	200000		600000										
3	Basalti	22	22	40				50		Constant	4500000		13500000										

3. Descrizione Pareti

X : 0 m

Quota in alto : 0 m

Quota di fondo : -8 m

Muro di sinistra

Sezione : micropali

Area equivalente : 0.0116867317833214 m

Inerzia equivalente : 0 m⁴/m

Materiale calcestruzzo : C25/30

Tipo sezione : Tangent

Spaziatura : 1 m

Diametro : 0.24 m

Efficacia : 1

Materiale acciaio : S355

Sezione : CHS193.7*10

Tipo sezione : O

Spaziatura : 1 m

Spessore : 0.01 m

Diametro : 0.1937 m

4. Fasi di Calcolo

4.1. Stage 1

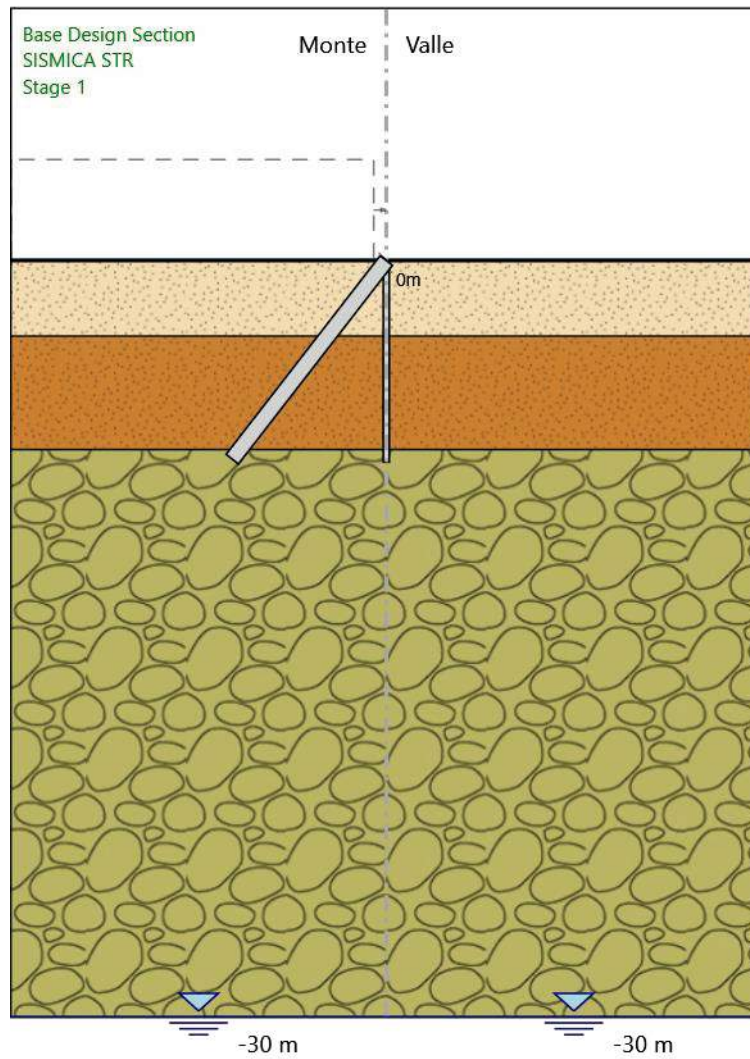

Stage 1

Elementi strutturali

Paratia : WallElement

X : 0 m

Quota in alto : 0 m

Quota di fondo : -8 m

Sezione : micropali

Tirante : Tieback

X : 0 m

Z : 0 m

Lunghezza bulbo : 10 m

ParatiePlus 2019 [v: 19.0.1]

Diametro bulbo : 0.24 m
Lunghezza libera : 0 m
Spaziatura orizzontale : 1 m
Precarico : 0 kN
Angolo : 52 °
Sezione : micropalo
Area : 0.00577 m²

4.2. Stage 2

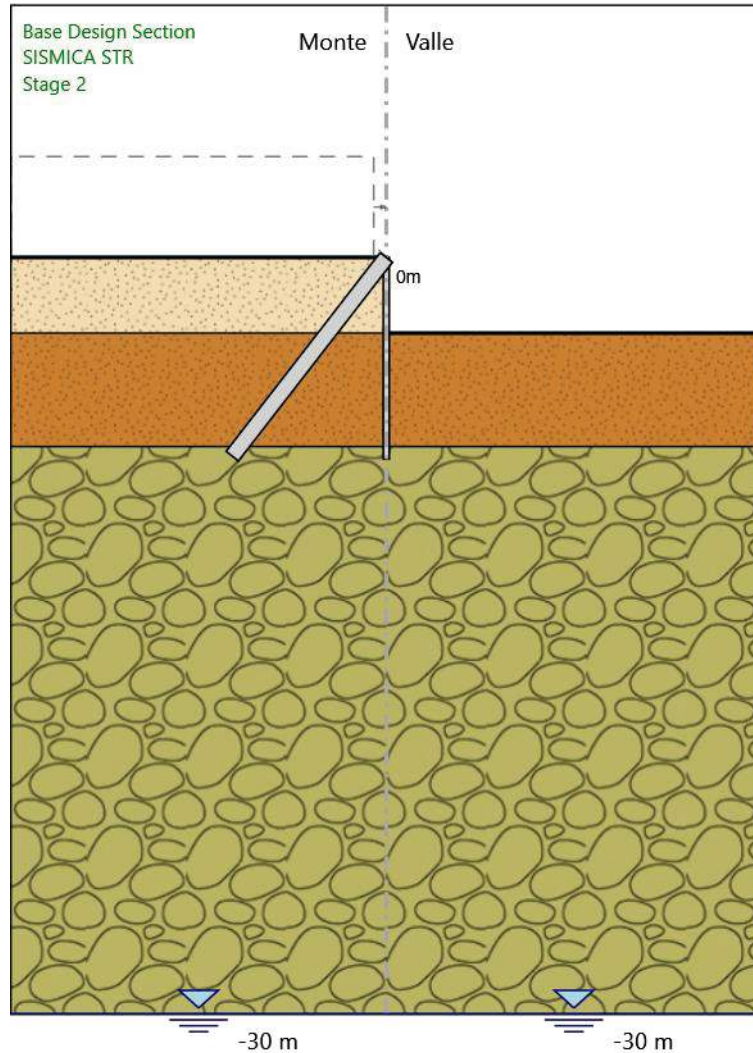

Stage 2

Elementi strutturali

Paratia : WallElement

X : 0 m

Quota in alto : 0 m

Quota di fondo : -8 m

Sezione : micropali

Tirante : Tieback

X : 0 m

Z : 0 m

Lunghezza bulbo : 10 m

Diametro bulbo : 0.24 m

Lunghezza libera : 0 m

Spaziatura orizzontale : 1 m

Precarico : 0 kN

Angolo : 52 °

Sezione : micropalo

Area : 0.00577 m²

4.3. Stage 3

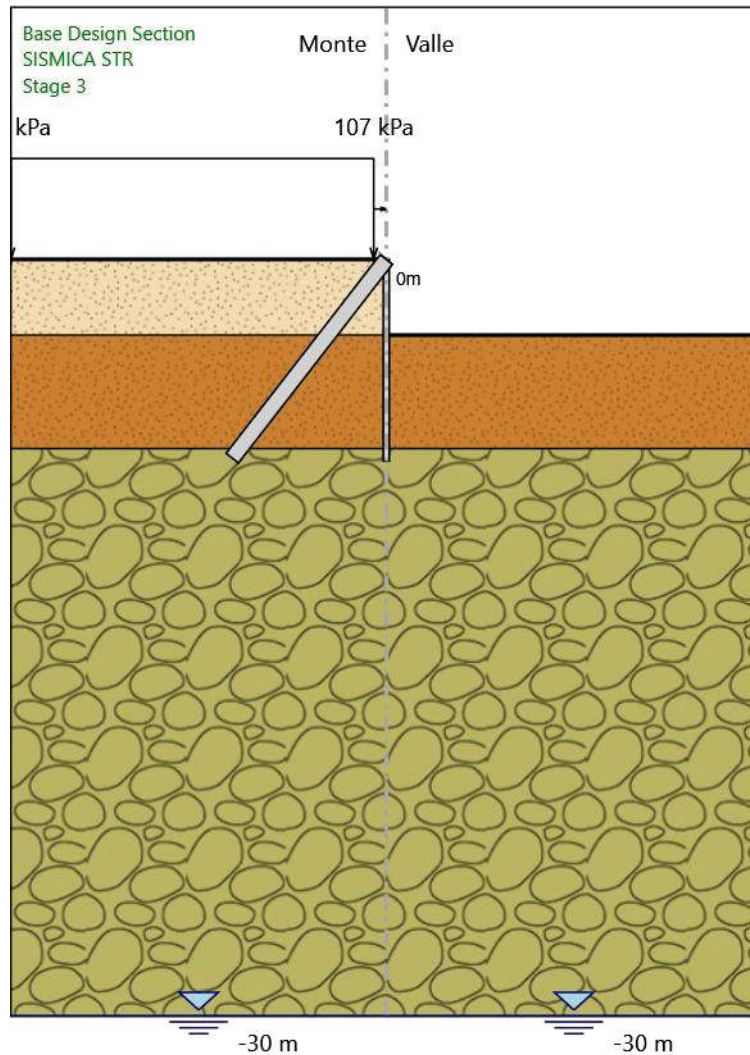

Stage 3

Elementi strutturali

Paratia : WallElement

X : 0 m

Quota in alto : 0 m

Quota di fondo : -8 m

Sezione : micropali

Tirante : Tieback

X : 0 m

Z : 0 m

Lunghezza bulbo : 10 m

Diametro bulbo : 0.24 m

Lunghezza libera : 0 m

Spaziatura orizzontale : 1 m

Precarico : 0 kN

Angolo : 52 °

Sezione : micropalo

Area : 0.00577 m²

4.4. Stage 4

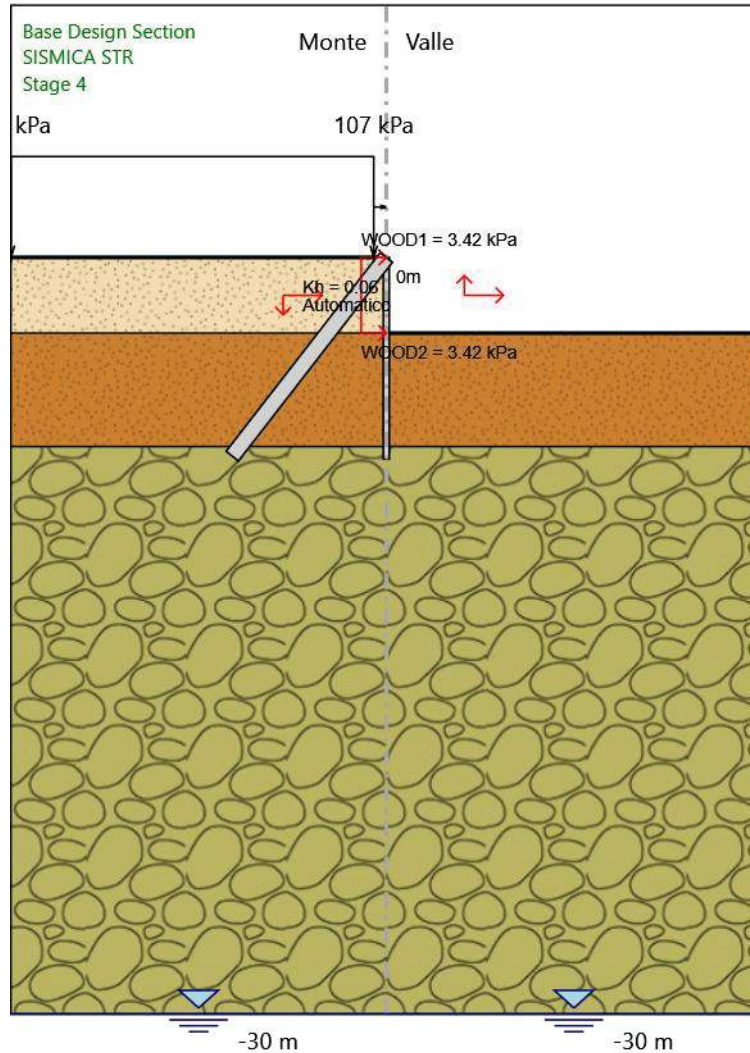

Stage 4

Elementi strutturali

Paratia : WallElement

X : 0 m

Quota in alto : 0 m

Quota di fondo : -8 m

Sezione : micropali

Tirante : Tieback

X : 0 m

Z : 0 m

Lunghezza bulbo : 10 m

Diametro bulbo : 0.24 m

Lunghezza libera : 0 m

Spaziatura orizzontale : 1 m

Precarico : 0 kN

Angolo : 52 °

Sezione : micropalo

Area : 0.00577 m²

5. Descrizione Coefficienti Design Assumption

Coefficienti A

Nome	Carichi Per- manenti Sfavorevoli (F_dead_lo ad_unfa- vour)	Carichi Per- manenti Favorevoli (F_dead_lo ad_favour)	Carichi Va- riabili Sfa- vorevoli (F_live_loa d_unfa- vour)	Carichi Va- riabili Fa- vorevoli (F_live_loa d_favour)	Carico Si- smico (F_seism_ load)	Pres sioni Lato Mon te (F_ Wa- terD R)	Pres sioni Lato Vall e (F_ Wa- ter Res)	Carichi Perma- nenti De- stabiliz- zanti (F_UPL_G DStab)	Carichi Perma- nenti Sta- bilizzanti (F_UPL_G Stab)	Carichi Va- riabili De- stabiliz- zanti (F_UPL_Q DStab)	Carichi Perma- nenti De- stabiliz- zanti (F_HYD_G DStab)	Carichi Perma- nenti Sta- bilizzanti (F_HYD_G Stab)	Carichi Va- riabili De- stabiliz- zanti (F_HYD_Q DStab)
Simbolo	γ_G	γ_G	γ_Q	γ_Q	γ_{QE}	γ_G	γ_G	γ_{Gdst}	γ_{Gstb}	γ_{Qdst}	γ_{Gdst}	γ_{Gstb}	γ_{Qdst}
Nominal	1	1	1	1	1	1	1	1	1	1	1	1	1
SLE (Rara/Fre- quente/ Quasi Perma- nente)	1	1	1	1	0	1	1	1	1	1	1	1	1
A1+M1+ R1 (R3 per tiranti)	1.3	1	1.5	1	0	1.3	1	1	1	1	1.3	0.9	1
SISMICA STR	1	1	1	1	1	1	1	1	1	1	1	1	1

Coefficienti M

Nome	Parziale su $\tan(\phi')$ (F_Fr)	Parziale su c' (F_eff_cohe)	Parziale su Su (F_Su)	Parziale su qu (F_qu)	Parziale su peso specifico (F_gamma)
Simbolo	γ_ϕ	γ_c	γ_{cu}	γ_{qu}	γ_γ
Nominal	1	1	1	1	1
SLE (Rara/Fre- quente/Quasi Per- manente)	1	1	1	1	1
A1+M1+R1 (R3 per tiranti)	1	1	1	1	1
SISMICA STR	1	1	1	1	1

Coefficienti R

Nome	Parziale resistenza terreno (es. Kp) (F_Soil_Res_walls)	Parziale resistenza Tiranti permanenti (F_Anch_P)	Parziale resistenza Tiranti temporanei (F_Anch_T)	Parziale elementi strutturali (F_wall)
Simbolo	γ_{Re}	γ_{ap}	γ_{at}	
Nominal	1	1	1	1
SLE (Rara/Fre- quente/Quasi Perma- nente)	1	1	1	1
A1+M1+R1 (R3 per tiranti)	1	1.2	1.1	1
SISMICA STR	1	1.2	1.1	1

5.1. Risultati SLE (Rara/Frequente/Quasi Permanente)

5.1.1. Tabella Grafici dei Risultati

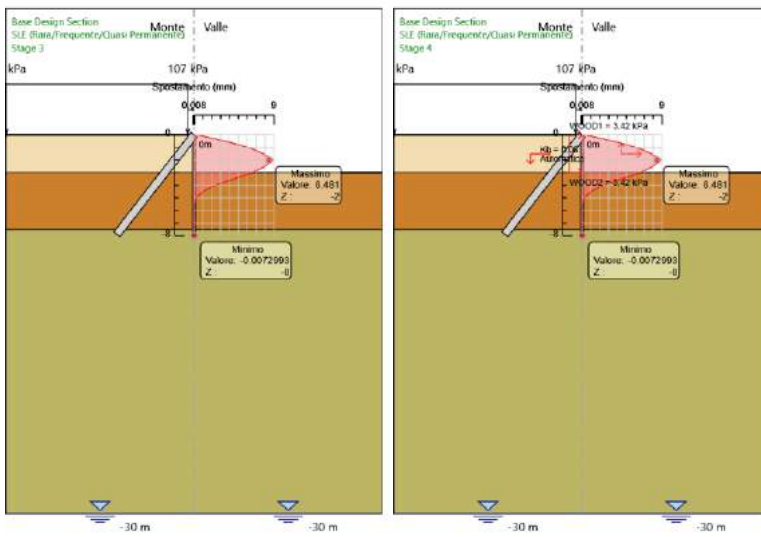
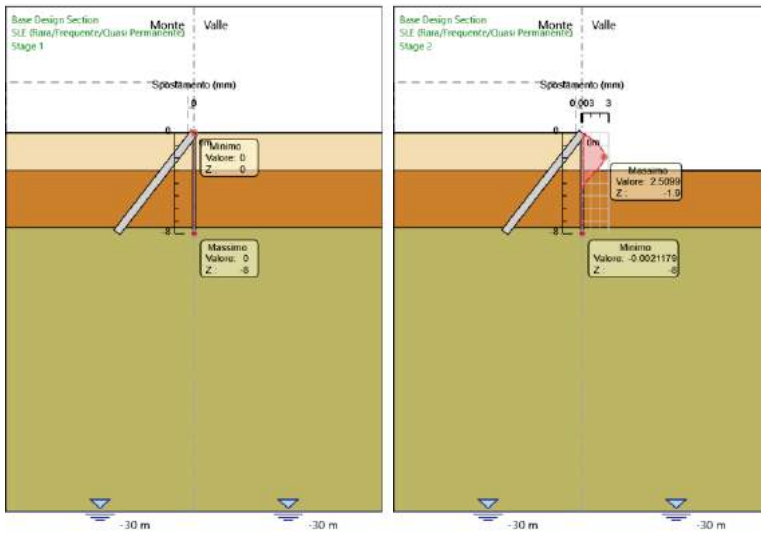

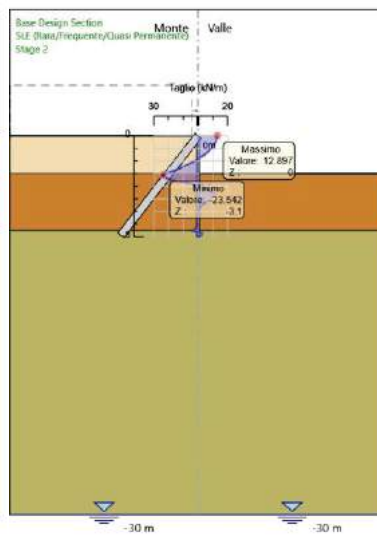
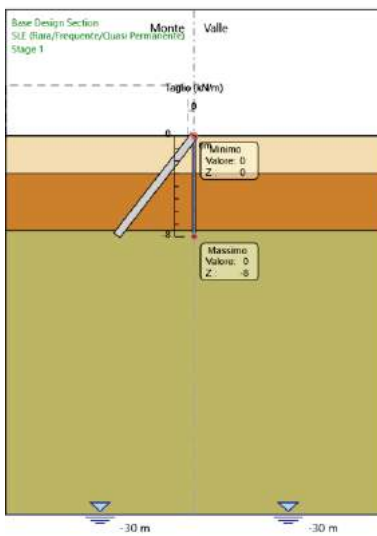
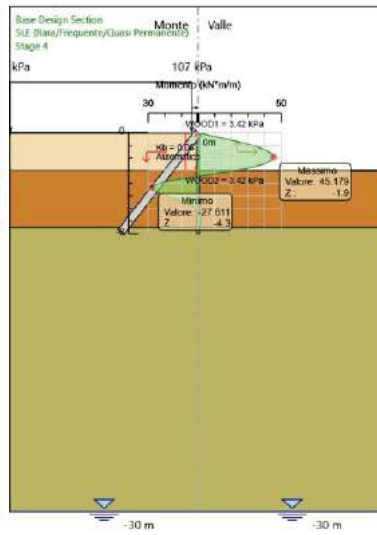
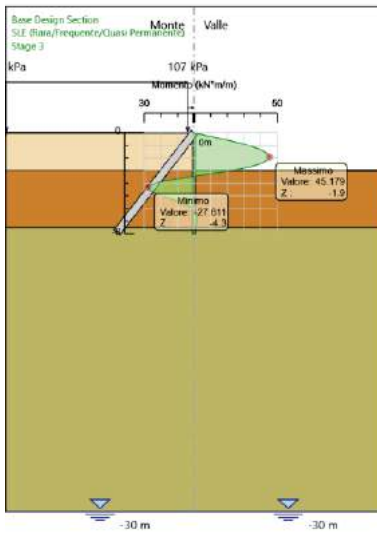
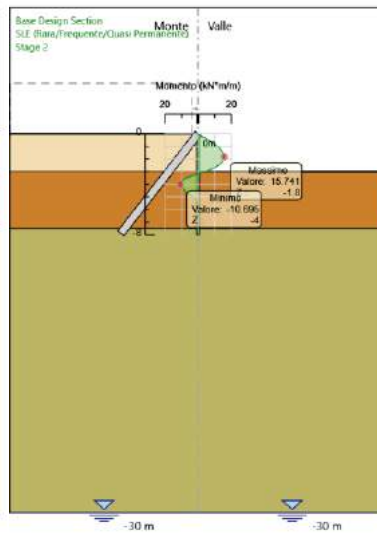
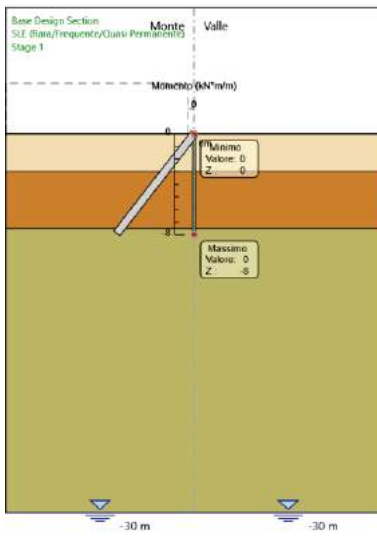

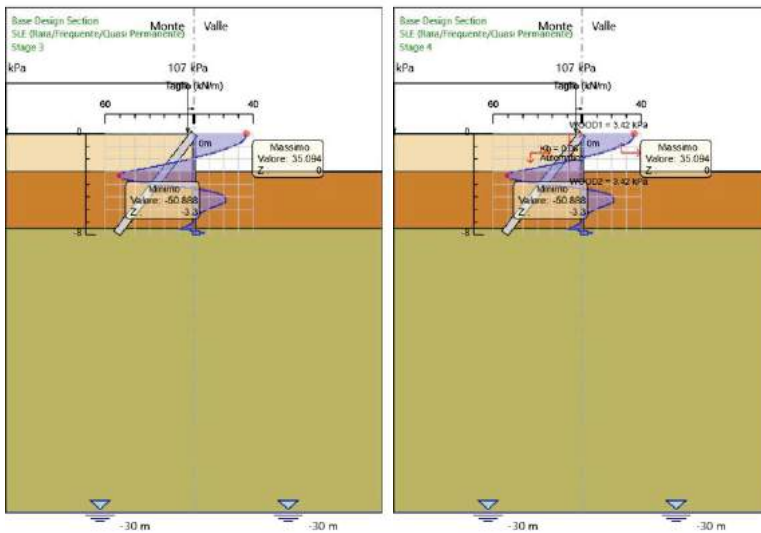

5.1.2. Risultati Elementi strutturali - SLE (Rara/Frequente/Quasi Permanente)

Design Assumption: SLE (Rara/Frequente/Quasi Permanente) Sollecitazione Tieback

Stage	Forza (kN/m)
Stage 1	0
Stage 2	20.94892
Stage 3	57.00177
Stage 4	57.00177

5.2. Risultati A1+M1+R1 (R3 per tiranti)

5.2.1. Tabella Grafici dei Risultati

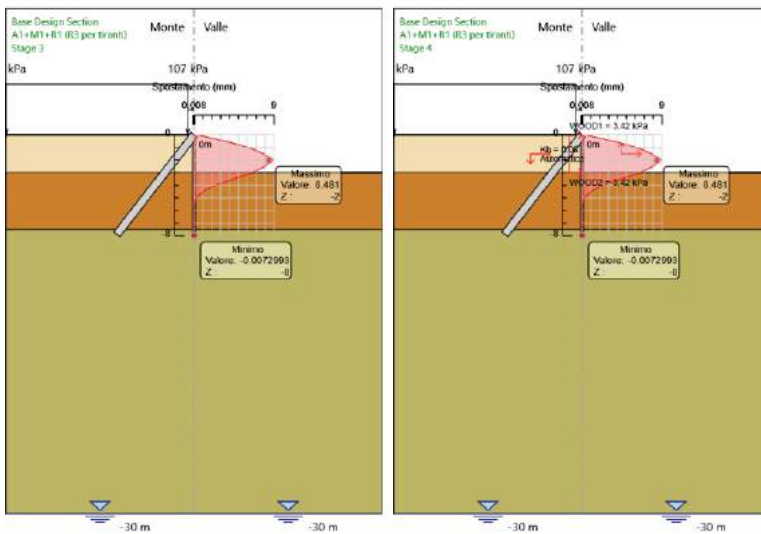
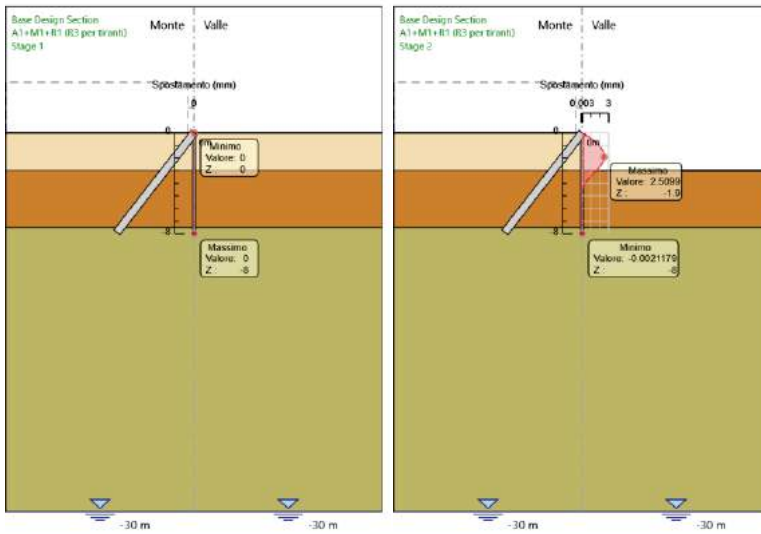

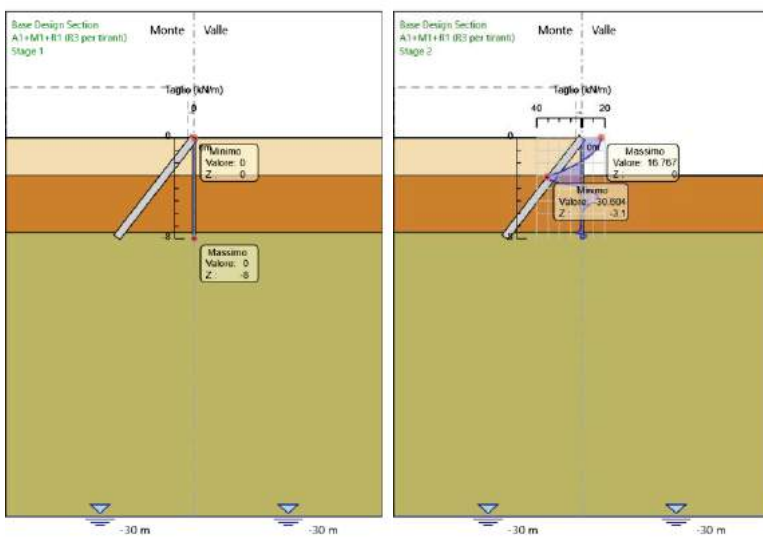
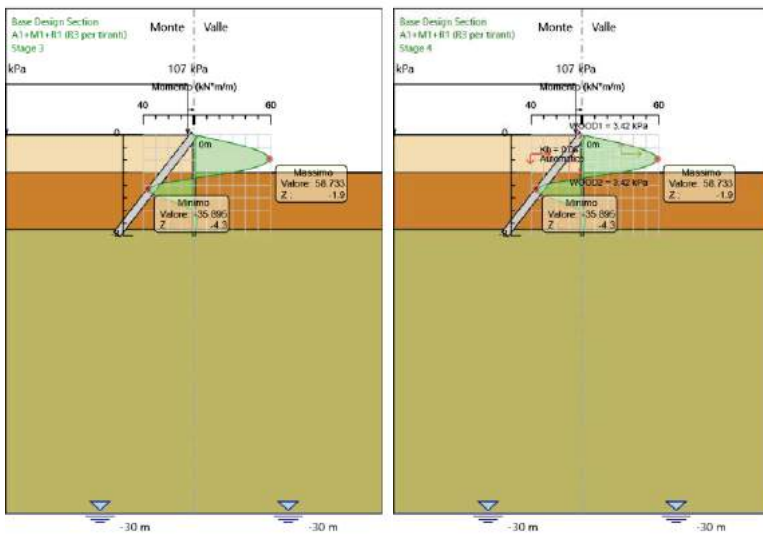
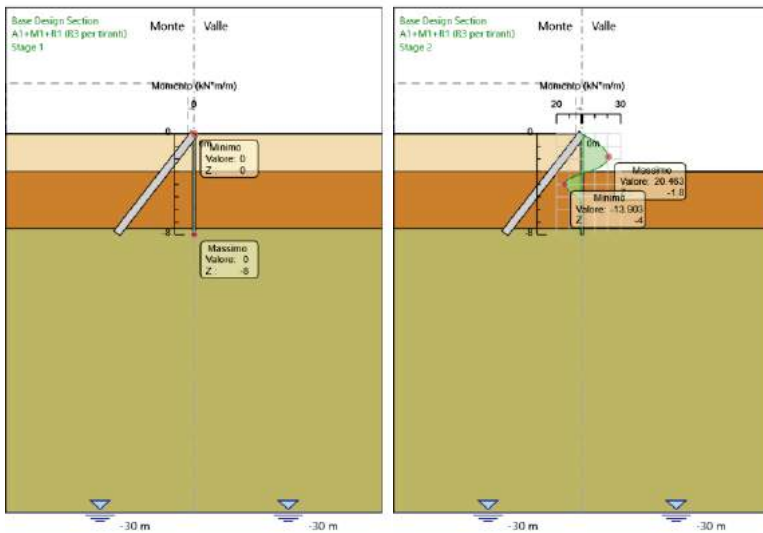

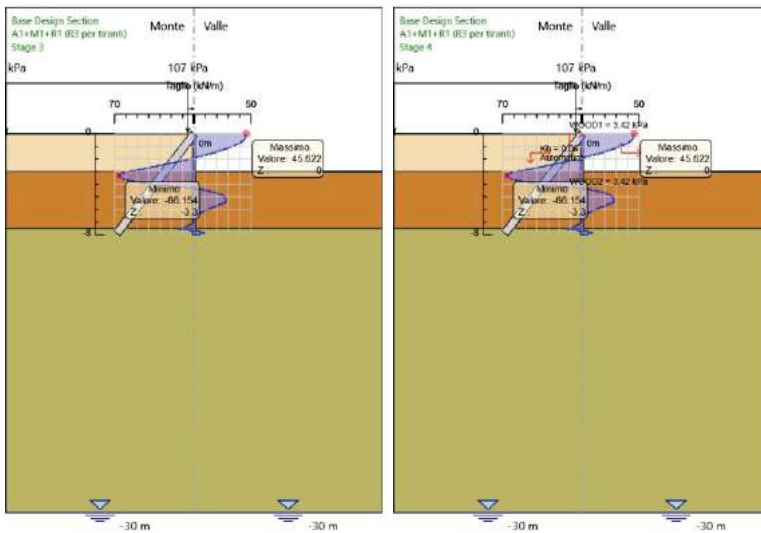

5.2.2. Risultati Elementi strutturali - A1+M1+R1 (R3 per tiranti)

Design Assumption: A1+M1+R1 (R3 per tiranti) Sollecitazione Tieback

Stage	Forza (kN/m)
Stage 1	0
Stage 2	27.233596
Stage 3	74.102301
Stage 4	74.102301

5.3. Risultati SISMICA STR

5.3.1. Tabella Grafici dei Risultati

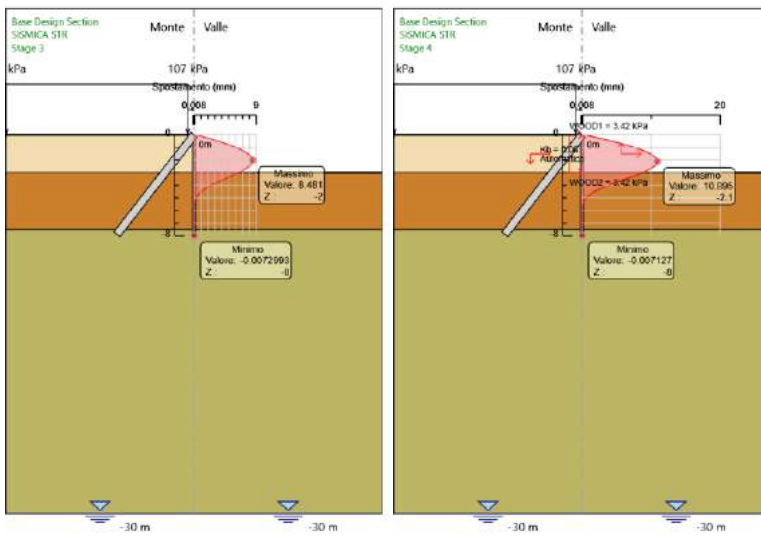
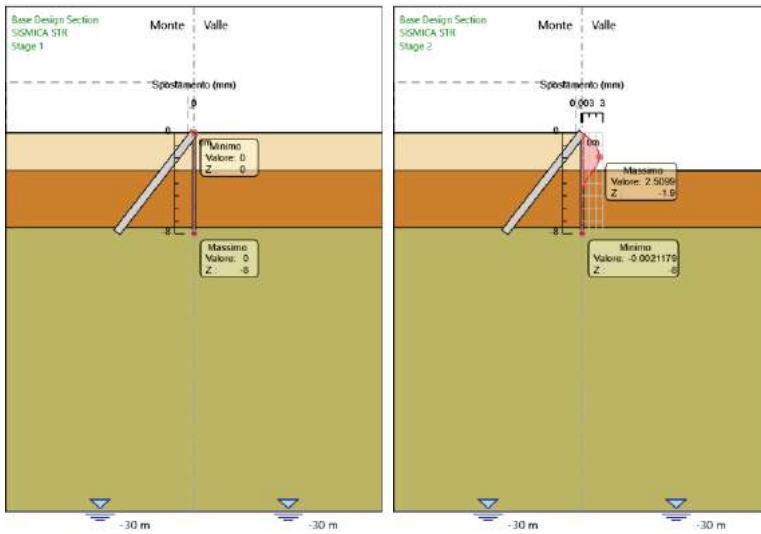

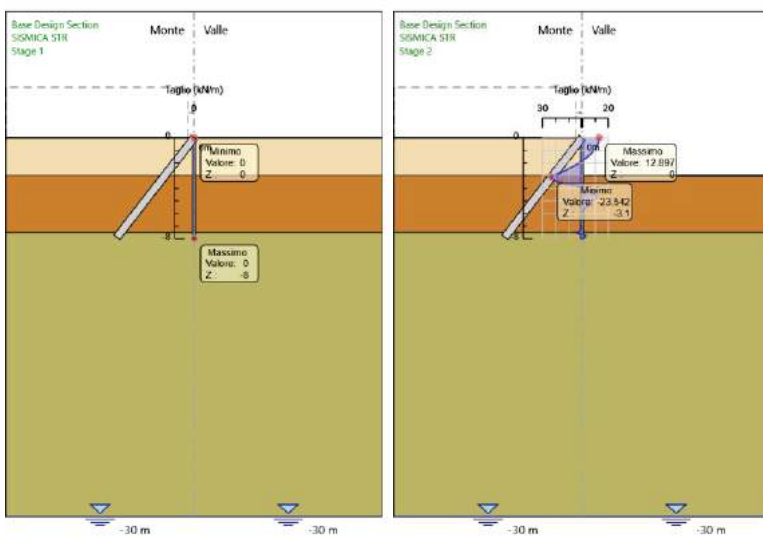
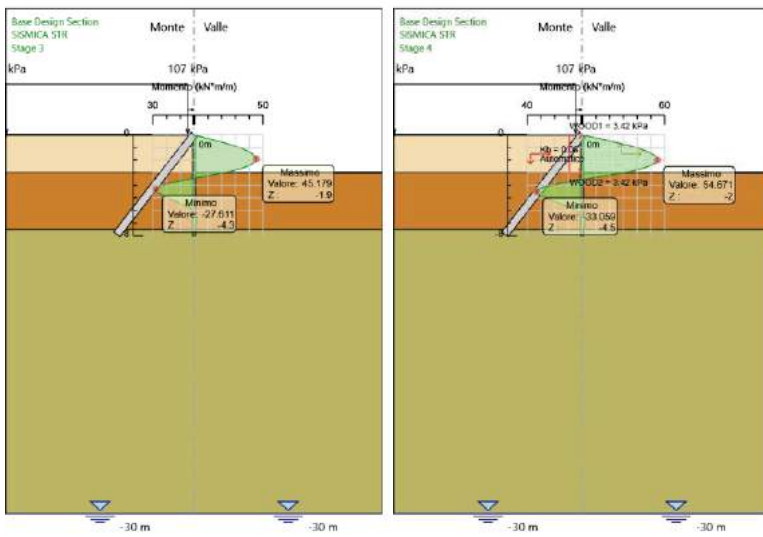
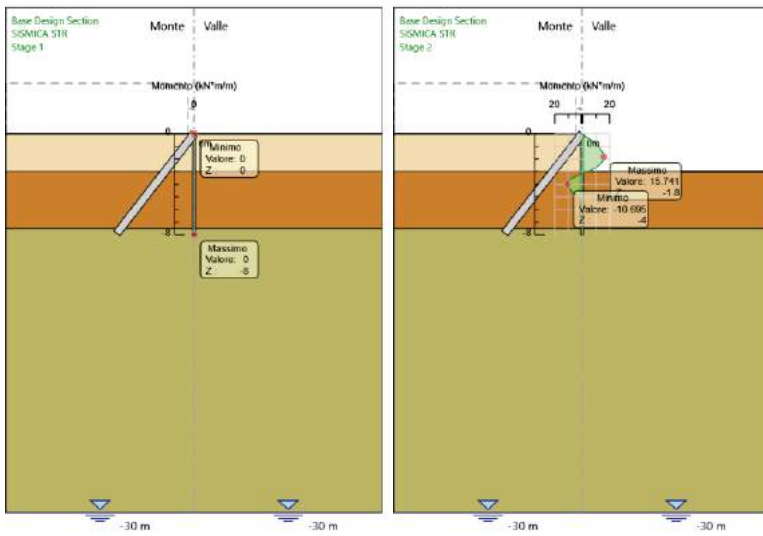

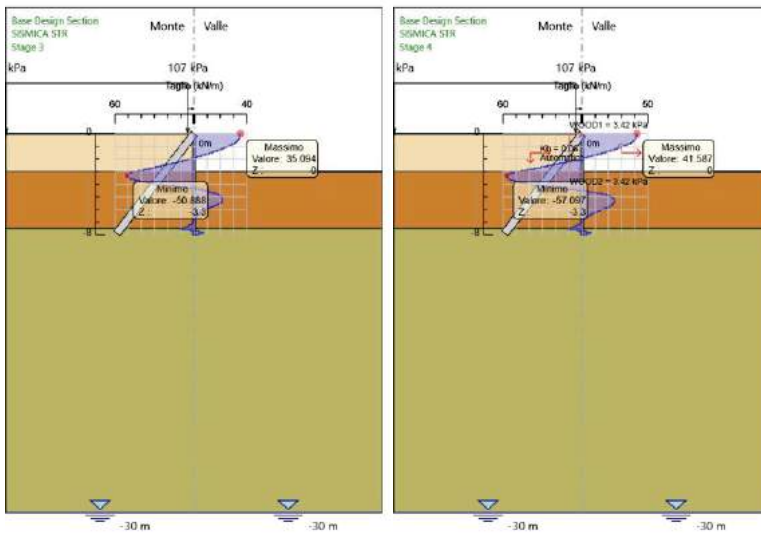

5.3.2. Risultati Elementi strutturali - SISMICA STR

Design Assumption: SISMICA STR Sollecitazione Tieback

Stage	Forza (kN/m)
Stage 1	0
Stage 2	20.94892
Stage 3	57.00177
Stage 4	67.55363

ALLEGATO 3 - ANALISI NUMERICA SLIDE

Relazione Geotecnica e di Calcolo

RTI di progettazione:



Mandataria

Via G.B. Sammartini n°5
20125 - Milano
Tel. 02 6787911
email: mail@proiter.it



Mandante

Via Artemide n°3
92100 Agrigento
Tel. 0922 421007
email: deltaingegneria@pec.it

Slide Analysis Information

SLIDE - An Interactive Slope Stability Program

Project Summary

File Name: opera V03-Sez 2- A2 M2 R2.slim
Slide Modeler Version: 6.039
Project Title: SLIDE - An Interactive Slope Stability Program
Date Created: 06/05/2020, 15:16:12

General Settings

Units of Measurement: Metric Units
Time Units: days
Permeability Units: meters/second
Failure Direction: Left to Right
Data Output: Standard
Maximum Material Properties: 20
Maximum Support Properties: 20

Analysis Options

Analysis Methods Used

Bishop simplified

Number of slices: 25
Tolerance: 0.005
Maximum number of iterations: 50
Check malpha < 0.2: Yes
Initial trial value of FS: 1
Steffensen Iteration: Yes

Groundwater Analysis

Groundwater Method: Water Surfaces
Pore Fluid Unit Weight: 9.81 kN/m³
Advanced Groundwater Method: None

Random Numbers

Pseudo-random Seed: 10116
Random Number Generation Method: Park and Miller v.3

	<i>Project</i>		
	SLIDE - An Interactive Slope Stability Program		
	<i>Analysis Description</i>		
	<i>Drawn By</i>	<i>Scale</i>	<i>Company</i>
<i>Date</i>	06/05/2020, 15:16:12	<i>File Name</i> opera V03-Sez 2- A2 M2 R2.slim	

Surface Options

Surface Type: Circular
Search Method: Grid Search
Radius Increment: 10
Composite Surfaces: Disabled
Reverse Curvature: Create Tension Crack
Minimum Elevation: 1
Minimum Depth: Not Defined





Loading

1 Distributed Load present

Distributed Load 1

Distribution: Constant
Magnitude [kPa]: 26
Orientation: Vertical

Material Properties

Property	riporto	detriti eluvio-colluviali	basalti alterati	Basalti
Color				
Strength Type	Mohr-Coulomb	Mohr-Coulomb	Mohr-Coulomb	Mohr-Coulomb
Unit Weight [kN/m3]	20	19	20	22
Cohesion [kPa]	0.001	0.001	0.001	40
Friction Angle [deg]	29	20	28	34
Water Surface	None	None	None	None
Ru Value	0	0	0	0

Global Minimums

Method: bishop simplified

FS: 1.116380
Center: 30.259, 29.352
Radius: 11.341
Left Slip Surface Endpoint: 19.823, 24.914
Right Slip Surface Endpoint: 35.942, 19.537
Resisting Moment=3143.54 kN-m
Driving Moment=2815.84 kN-m
Total Slice Area=28.7282 m2

	Project		
	SLIDE - An Interactive Slope Stability Program		
	Analysis Description		
	Drawn By	Scale	Company
Date	06/05/2020, 15:16:12	File Name	opera V03-Sez 2- A2 M2 R2.slim

Valid / Invalid Surfaces

Method: bishop simplified

Number of Valid Surfaces: 1966
 Number of Invalid Surfaces: 2841

Error Codes:

Error Code -101 reported for 14 surfaces
 Error Code -1000 reported for 2827 surfaces

Error Codes

The following errors were encountered during the computation:

- 101 = Only one (or zero) surface / slope intersections.
- 1000 = No valid slip surfaces are generated at a grid center. Unable to draw a surface.

Slice Data

Global Minimum Query (bishop simplified) - Safety Factor: 1.11638

Slice Number	Width [m]	Weight [kN]	Base Material	Base Cohesion [kPa]	Base Friction Angle [degrees]	Shear Stress [kPa]	Shear Strength [kPa]	Base Normal Stress [kPa]	Pore Pressure [kPa]	Effective Normal Stress [kPa]
1	0.639013	8.06813	riporto	0.001	29	9.39725	10.4909	18.9243	0	18.9243
2	0.639013	22.3061	riporto	0.001	29	9.85569	11.0027	19.8476	0	19.8476
3	0.639013	33.4965	riporto	0.001	29	16.0768	17.9478	32.3768	0	32.3768
4	0.639013	40.8842	riporto	0.001	29	20.895	23.3268	42.0808	0	42.0808
5	0.639013	40.85	riporto	0.001	29	21.974	24.5313	44.2539	0	44.2539
6	0.639013	40.354	riporto	0.001	29	22.6761	25.3151	45.6678	0	45.6678
7	0.639013	45.1851	riporto	0.001	29	26.3879	29.4589	53.1434	0	53.1434
8	0.639013	38.5069	riporto	0.001	29	23.2857	25.9957	46.8958	0	46.8958
9	0.639013	42.8608	riporto	0.001	29	26.767	29.8821	53.9069	0	53.9069
10	0.639013	37.1956	riporto	0.001	29	23.943	26.7295	48.2195	0	48.2195
11	0.639013	36.9198	riporto	0.001	29	24.4617	27.3086	49.2642	0	49.2642
12	0.649252	34.9433	detriti eluvio-colluviali	0.001	20	16.0681	17.9381	49.2819	0	49.2819
13	0.649252	29.1141	detriti eluvio-colluviali	0.001	20	13.6436	15.2314	41.8451	0	41.8451
14	0.649252	29.5184	detriti eluvio-colluviali	0.001	20	14.0918	15.7318	43.2202	0	43.2202
15	0.649252	18.6887	detriti eluvio-colluviali	0.001	20	9.08759	10.1452	27.8709	0	27.8709
16	0.649252	19.2634	detriti eluvio-colluviali detriti	0.001	20	9.54084	10.6512	29.2611	0	29.2611

	Project			SLIDE - An Interactive Slope Stability Program		
	Analysis Description					
	Drawn By		Scale		Company	
	Date			File Name		
06/05/2020, 15:16:12			opera V03-Sez 2- A2 M2 R2.slim			

			eluvio-colluviali							
18	0.649252	6.04681	detriti	0.001	20	3.1102	3.47217	9.53697	0	9.53697
			eluvio-colluviali							
19	0.649252	5.23818	detriti	0.001	20	2.74775	3.06753	8.42522	0	8.42522
			eluvio-colluviali							
20	0.649252	3.9583	detriti	0.001	20	2.11952	2.36619	6.49831	0	6.49831
			eluvio-colluviali							
21	0.649252	2.1938	detriti	0.001	20	1.20078	1.34053	3.68032	0	3.68032
			eluvio-colluviali							
22	0.649252	7.21582	detriti	0.001	20	4.03959	4.50972	12.3876	0	12.3876
			eluvio-colluviali							
23	0.649252	10.0229	detriti	0.001	20	5.75297	6.4225	17.643	0	17.643
			eluvio-colluviali							
24	0.649252	6.44473	detriti	0.001	20	3.8031	4.2457	11.6622	0	11.6622
			eluvio-colluviali							
25	0.649252	2.25931	detriti	0.001	20	1.37593	1.53606	4.21752	0	4.21752
			eluvio-colluviali							

Interslice Data

Global Minimum Query (bishop simplified) - Safety Factor: 1.11638

Slice Number	X coordinate [m]	Y coordinate - Bottom [m]	Interslice Normal Force [kN]	Interslice Shear Force [kN]	Interslice Force Angle [degrees]
1	19.8229	24.9142	0	0	0
2	20.462	23.6403	18.1048	0	0
3	21.101	22.6635	31.1969	0	0
4	21.74	21.8666	46.7309	0	0
5	22.379	21.1966	61.5785	0	0
6	23.018	20.6242	72.8706	0	0
7	23.657	20.1314	80.8944	0	0
8	24.296	19.7058	86.6565	0	0
9	24.9351	19.3389	88.9885	0	0
10	25.5741	19.0244	88.8425	0	0
11	26.2131	18.7577	86.4085	0	0
12	26.8521	18.5353	81.7426	0	0
13	27.5013	18.3518	80.3567	0	0
14	28.1506	18.2091	77.4736	0	0
15	28.7999	18.1056	72.8006	0	0
16	29.4491	18.0403	68.7238	0	0
17	30.0984	18.0124	63.3468	0	0
18	30.7476	18.0218	60.1635	0	0
19	31.3969	18.0685	57.7	0	0
20	32.0461	18.1529	55.2054	0	0
21	32.6954	18.276	53.0301	0	0
22	33.3446	18.439	51.6509	0	0

	Project		
	SLIDE - An Interactive Slope Stability Program		
	Analysis Description		
	Drawn By	Scale	Company
Date	06/05/2020, 15:16:12		File Name
			opera V03-Sez 2- A2 M2 R2.slim

23	33.9939	18.6437	46.4926	0	0
24	34.6431	18.8927	38.3661	0	0
25	35.2924	19.1892	32.4406	0	0
26	35.9416	19.5374	0	0	0

List Of Coordinates

Distributed Load

X	Y
7.07881	24.8495
13.8235	24.9948
14.2054	24.9928
15.8632	24.9845
18.9453	24.9297
20.4379	24.9033

External Boundary

X	Y
2.1	24.3011
-1.42e-014	23.1584
-1.42109e-014	18.5349
-1.24345e-014	16.4895
-1.59872e-014	10.9731
-1.42e-014	0
50	0
50	13.2831
50	16.9498
50	19.4058
38.0549	19.4786
35.2825	19.5558
34.2981	19.5797
33.6393	19.6103
33.6291	18.5353
30.2491	18.5353
30.2391	19.5353
28.7491	19.5353
28.7391	20.5353
27.2491	20.5353
27.2391	21.5353
25.7491	21.5353
25.7391	22.5353
24.2491	22.5353



<i>Project</i>			SLIDE - An Interactive Slope Stability Program		
<i>Analysis Description</i>					
<i>Drawn By</i>		<i>Scale</i>		<i>Company</i>	
<i>Date</i>			<i>File Name</i>		
06/05/2020, 15:16:12			opera V03-Sez 2- A2 M2 R2.slim		

24.2391	23.5353
22.7491	23.5353
22.7391	24.5353
22.11	24.5353
22.1	24.874
18.9453	24.9297
15.8632	24.9845
14.2054	24.9928
13.8235	24.9948
7.07881	24.8495
6.79068	24.8434
6.56681	24.8569
4.88831	24.9583
4.16396	24.8493
3.00045	24.5993
2.37774	24.3936

Material Boundary

X	Y
-1.42109e-014	18.5349
30.2491	18.5353

Material Boundary

X	Y
-1.59872e-014	10.9731
14.009	12.1289
18.6241	12.2907
24.5615	12.4255
29.9052	12.6143
36.2744	12.8031
50	13.2831

Material Boundary

X	Y
-1.24345e-014	16.4895
11.387	16.8927
16.98	17.1246
23.2229	17.1478
29.1638	17.1941
31.728	17.1109
34.567	16.9681
36.487	16.866



<i>Project</i>		
SLIDE - An Interactive Slope Stability Program		
<i>Analysis Description</i>		
<i>Drawn By</i>	<i>Scale</i>	<i>Company</i>
<i>Date</i>	06/05/2020, 15:16:12	<i>File Name</i> opera V03-Sez 2- A2 M2 R2.slim

38.3867	16.8457
---------	---------

Material Boundary

X	Y
40.6537	16.866
41.198	16.8986

Material Boundary

X	Y
38.3867	16.8457
40.6537	16.866
50	16.9498



<i>Project</i>		
SLIDE - An Interactive Slope Stability Program		
<i>Analysis Description</i>		
<i>Drawn By</i>	<i>Scale</i>	<i>Company</i>
<i>Date</i>	06/05/2020, 15:16:12	<i>File Name</i> opera V03-Sez 2- A2 M2 R2.slim

Slide Analysis Information

SLIDE - An Interactive Slope Stability Program

Project Summary

File Name: opera V03 - Sez 4 - A2 M2 R2.slim
Slide Modeler Version: 6.008
Project Title: SLIDE - An Interactive Slope Stability Program
Date Created: 06/05/2020, 15:16:12

General Settings

Units of Measurement: Metric Units
Time Units: days
Permeability Units: meters/second
Failure Direction: Left to Right
Data Output: Standard
Maximum Material Properties: 20
Maximum Support Properties: 20

Analysis Options

Analysis Methods Used

Bishop simplified

Number of slices: 25
Tolerance: 0.005
Maximum number of iterations: 50
Check malpha < 0.2: Yes
Initial trial value of FS: 1
Steffensen Iteration: Yes

Groundwater Analysis

Groundwater Method: Water Surfaces
Pore Fluid Unit Weight: 9.81 kN/m3
Advanced Groundwater Method: None

Random Numbers

Pseudo-random Seed: 10116
Random Number Generation Method: Park and Miller v.3

	<i>Project</i>		
	SLIDE - An Interactive Slope Stability Program		
	<i>Analysis Description</i>		
	<i>Drawn By</i>	<i>Scale</i>	<i>Company</i>
<i>Date</i>	06/05/2020, 15:16:12	<i>File Name</i> opera V03 - Sez 4 - A2 M2 R2.slim	

Surface Options

Surface Type: Circular
Search Method: Grid Search
Radius Increment: 10
Composite Surfaces: Disabled
Reverse Curvature: Create Tension Crack
Minimum Elevation: Not Defined
Minimum Depth: Not Defined





Loading

1 Distributed Load present

Distributed Load 1

Distribution: Constant
Magnitude [kPa]: 26
Orientation: Vertical

Material Properties

Property	cls	riporto	detriti eluvio-colluviali	basalti alterati	Basalti
Color					
Strength Type	Mohr-Coulomb	Mohr-Coulomb	Mohr-Coulomb	Mohr-Coulomb	Mohr-Coulomb
Unit Weight [kN/m3]	25	20	19	20	22
Cohesion [kPa]	7000	0.001	0.001	0.001	40
Friction Angle [deg]	1	29	20	28	34
Water Surface	None	None	None	None	None
Ru Value	0	0	0	0	0

Support Properties

micropali verticali

Support Type: Micro-Pile
Force Application: Passive
Out-of-Plane Spacing: 1 m
Pile Shear Strength: 700 kN
Force Direction: Parallel to Surface

micropali inclinati

Support Type: Soil Nail

	Project		
	SLIDE - An Interactive Slope Stability Program		
	Analysis Description		
Drawn By	Scale	Company	
Date	06/05/2020, 15:16:12	File Name opera V03 - Sez 4 - A2 M2 R2.slim	

Force Application: Passive
 Out-of-Plane Spacing: 1 m
 Tensile Capacity: 450 kN
 Plate Capacity: 450 kN
 Bond Strength: 70 kN/m

Global Minimums

Method: bishop simplified

FS: 3.224820
 Center: 32.728, 32.542
 Radius: 16.017
 Left Slip Surface Endpoint: 18.644, 24.916
 Right Slip Surface Endpoint: 42.135, 19.579
 Resisting Moment=30364 kN-m
 Driving Moment=9415.71 kN-m

Valid / Invalid Surfaces

Method: bishop simplified

Number of Valid Surfaces: 15534
 Number of Invalid Surfaces: 25397

Error Codes:

Error Code -101 reported for 357 surfaces
 Error Code -103 reported for 2 surfaces
 Error Code -112 reported for 2 surfaces
 Error Code -1000 reported for 25036 surfaces

Error Codes

The following errors were encountered during the computation:

- 101 = Only one (or zero) surface / slope intersections.
- 103 = Two surface / slope intersections, but one or more surface / nonslope external polygon intersections lie between them. This usually occurs when the slip surface extends past the bottom of the soil region, but may also occur on a benched slope model with two sets of Slope Limits.
- 112 = The coefficient $M\text{-Alpha} = \cos(\alpha)(1 + \tan(\alpha)\tan(\phi))/F < 0.2$ for the final iteration of the safety factor calculation. This screens out some slip surfaces which may not be valid in the context of the analysis, in particular, deep seated slip surfaces with many high negative base angle slices in the passive zone.
- 1000 = No valid slip surfaces are generated at a grid center. Unable to draw a surface.

Slice Data

Global Minimum Query (bishop simplified) - Safety Factor: 3.22482

		Base		Base	Effective
	Project	SLIDE - An Interactive Slope Stability Program			
	Analysis Description				
	Drawn By	Scale	Company		
	Date	06/05/2020, 15:16:12	File Name	opera V03 - Sez 4 - A2 M2 R2.slim	

Slice Number	Width [m]	Weight [kN]	Base Material	Cohesion [kPa]	Friction Angle [degrees]	Stress [kPa]	Strength [kPa]	Normal Stress [kPa]	Pressure [kPa]	Normal Stress [kPa]
1	0.907213	13.3624	riporto	0.001	29	5.46964	17.6386	31.819	0	31.819
2	0.907213	37.4731	riporto	0.001	29	9.44112	30.4459	54.9241	0	54.9241
3	0.907213	57.1857	riporto	0.001	29	12.8805	41.5374	74.9335	0	74.9335
4	0.907213	73.7693	riporto	0.001	29	15.9008	51.2772	92.5044	0	92.5044
5	0.907213	87.9285	riporto	0.001	29	18.5742	59.8985	108.058	0	108.058
6	0.907213	100.103	riporto	0.001	29	20.95	67.5601	121.879	0	121.879
7	0.907213	110.589	riporto	0.001	29	23.0634	74.3754	134.175	0	134.175
8	0.907213	119.595	riporto	0.001	29	24.9403	80.4281	145.094	0	145.094
9	1.10898	155.707	detriti eluvio-colluviali	0.001	20	17.2181	55.5254	152.552	0	152.552
10	1.10898	153.75	detriti eluvio-colluviali	0.001	20	49.8208	160.663	441.416	0	441.416
11	0.993975	132.65	basalti alterati	0.001	28	21.0806	67.9812	127.852	0	127.852
12	0.993975	134.699	basalti alterati	0.001	28	0	0	-1.63777	0	-1.63777
13	0.993975	66.109	basalti alterati	0.001	28	10.7297	34.6014	65.0739	0	65.0739
14	0.993975	28.4815	basalti alterati	0.001	28	4.67034	15.061	28.3238	0	28.3238
15	0.993975	39.4076	basalti alterati	0.001	28	6.52812	21.052	39.5911	0	39.5911
16	0.993975	56.901	basalti alterati	0.001	28	9.52332	30.711	57.757	0	57.757
17	0.993975	55.2425	basalti alterati	0.001	28	9.34331	30.1305	56.6654	0	56.6654
18	0.993975	52.3281	basalti alterati	0.001	28	8.94695	28.8523	54.2614	0	54.2614
19	0.866289	42.36	detriti eluvio-colluviali	0.001	20	5.67464	18.2997	50.2753	0	50.2753
20	0.866289	38.5256	detriti eluvio-colluviali	0.001	20	5.19738	16.7606	46.0465	0	46.0465
21	0.866289	33.809	detriti eluvio-colluviali	0.001	20	4.59517	14.8186	40.711	0	40.711
22	0.866289	28.1575	detriti eluvio-colluviali	0.001	20	3.85783	12.4408	34.1781	0	34.1781
23	0.866289	21.5029	detriti eluvio-colluviali	0.001	20	2.97193	9.58394	26.3289	0	26.3289
24	0.866289	13.7558	detriti eluvio-colluviali	0.001	20	1.91974	6.19082	17.0064	0	17.0064
25	0.866289	4.79823	detriti eluvio-colluviali	0.001	20	0.677185	2.1838	5.99718	0	5.99718

Interslice Data

Global Minimum Query (bishop simplified) - Safety Factor: 3.22482

Slice Number	X coordinate [m]	Y coordinate - Bottom [m]	Interslice Normal Force [kN]	Interslice Shear Force [kN]	Interslice Force Angle [degrees]
1	18.6436	24.9157	0	0	0
2	19.5509	23.4376	42.0721	0	0

	Project		SLIDE - An Interactive Slope Stability Program		
	Analysis Description				
	Drawn By		Scale	Company	
	Date		06/05/2020, 15:16:12		File Name

3	20.4581	22.2476	98.8684	0	0
4	21.3653	21.2542	161.621	0	0
5	22.2725	20.4091	225.374	0	0
6	23.1797	19.683	286.988	0	0
7	24.0869	19.0566	344.326	0	0
8	24.9941	18.5167	395.856	0	0
9	25.9013	18.0534	440.449	0	0
10	27.0103	17.5811	493.417	0	0
11	28.1193	17.2031	327.945	0	0
12	29.1133	16.939	340.768	0	0
13	30.1072	16.7416	-346.152	0	0
14	31.1012	16.6086	-348.158	0	0
15	32.0952	16.5382	-350.807	0	0
16	33.0892	16.5298	-356.961	0	0
17	34.0831	16.5832	-369.508	0	0
18	35.0771	16.6989	-385.353	0	0
19	36.0711	16.8785	-403.989	0	0
20	36.9374	17.0888	-419.475	0	0
21	37.8037	17.3512	-436.063	0	0
22	38.67	17.6687	-452.967	0	0
23	39.5363	18.0448	-469.161	0	0
24	40.4025	18.4841	-483.303	0	0
25	41.2688	18.9929	-493.619	0	0
26	42.1351	19.5794	0	0	0

List Of Coordinates

Distributed Load

X	Y
4.0706	25
26.7322	24.869

External Boundary

X	Y
0	23.5939
0	18.0531
0	16.5201
0	11.0268
0	9e-016
50	0
50	13.3136
50	17.469

	Project			SLIDE - An Interactive Slope Stability Program
	Analysis Description			
	Drawn By		Scale	Company
	Date		File Name	
SLIDEINTERPRET 6.039		06/05/2020, 15:16:12		opera V03 - Sez 4 - A2 M2 R2.slim

50	19.6103
32.7709	19.5426
32.6872	18.0535
30.8353	18.0535
30.7147	20.8535
30.143	20.8535
30.1144	23.0975
29.6144	23.0975
26.7322	24.869
4.0706	25

Material Boundary

X	Y
30.0144	11.7975
30.0144	12.6454
30.0144	17.164
30.0144	18.0535
30.0144	19.7975

Material Boundary

X	Y
22.8581	12.0668
23.1321	12.4175
26.8636	17.1933
27.5356	18.0534
28.8983	19.7975

Material Boundary

X	Y
29.6144	23.0975
29.6144	20.3975
28.6144	20.3975
28.6144	19.7975
28.8983	19.7975
30.0144	19.7975
30.4144	19.7975
30.4144	20.3975
30.151	20.3975
30.143	20.8535

Material Boundary

--



<i>Project</i>		
SLIDE - An Interactive Slope Stability Program		
<i>Analysis Description</i>		
<i>Drawn By</i>	<i>Scale</i>	<i>Company</i>
<i>Date</i>	06/05/2020, 15:16:12	<i>File Name</i> opera V03 - Sez 4 - A2 M2 R2.slim

X	Y
0	18.0531
27.5356	18.0534
30.0144	18.0535
30.8353	18.0535

Material Boundary

X	Y
0	11.0268
13.5194	12.1422
18.1344	12.304
23.1321	12.4175
24.0718	12.4388
29.4155	12.6276
30.0144	12.6454
35.7847	12.8164
50	13.3136

Material Boundary

X	Y
0	16.5201
10.8973	16.906
16.4903	17.138
22.7333	17.1611
26.8636	17.1933
28.6742	17.2075
30.0144	17.164
31.2383	17.1242
34.0773	16.9814
35.9973	16.8793
37.897	16.859

Material Boundary

X	Y
37.897	16.859
40.164	16.8793
40.7083	16.9119
50	17.469



<i>Project</i>			SLIDE - An Interactive Slope Stability Program		
<i>Analysis Description</i>					
<i>Drawn By</i>		<i>Scale</i>		<i>Company</i>	
<i>Date</i>			06/05/2020, 15:16:12		<i>File Name</i>
			opera V03 - Sez 4 - A2 M2 R2.slim		

Slide Analysis Information

SLIDE - An Interactive Slope Stability Program

Project Summary

File Name: opera V03 - Sez4 - sisma -.slim
Slide Modeler Version: 6.008
Project Title: SLIDE - An Interactive Slope Stability Program
Date Created: 06/05/2020, 15:16:12

General Settings

Units of Measurement: Metric Units
Time Units: days
Permeability Units: meters/second
Failure Direction: Left to Right
Data Output: Standard
Maximum Material Properties: 20
Maximum Support Properties: 20

Analysis Options

Analysis Methods Used

Bishop simplified

Number of slices: 25
Tolerance: 0.005
Maximum number of iterations: 50
Check malpha < 0.2: Yes
Initial trial value of FS: 1
Steffensen Iteration: Yes

Groundwater Analysis

Groundwater Method: Water Surfaces
Pore Fluid Unit Weight: 9.81 kN/m³
Advanced Groundwater Method: None

Random Numbers

Pseudo-random Seed: 10116
Random Number Generation Method: Park and Miller v.3

	<i>Project</i>		
	SLIDE - An Interactive Slope Stability Program		
	<i>Analysis Description</i>		
	<i>Drawn By</i>	<i>Scale</i>	<i>Company</i>
<i>Date</i>	06/05/2020, 15:16:12	<i>File Name</i> opera V03 - Sez4 - sisma -.slim	

Surface Options

Surface Type: Circular
Search Method: Grid Search
Radius Increment: 10
Composite Surfaces: Disabled
Reverse Curvature: Create Tension Crack
Minimum Elevation: Not Defined
Minimum Depth: Not Defined





Loading

Seismic Load Coefficient (Horizontal): 0.023
Seismic Load Coefficient (Vertical): 0.011
1 Distributed Load present

Distributed Load 1

Distribution: Constant
Magnitude [kPa]: 20
Orientation: Vertical

Material Properties

Property	cls	riporto	detriti eluvio-colluviali	basalti alterati	Basalti
Color					
Strength Type	Mohr-Coulomb	Mohr-Coulomb	Mohr-Coulomb	Mohr-Coulomb	Mohr-Coulomb
Unit Weight [kN/m3]	25	20	19	20	22
Cohesion [kPa]	7000	0.001	0.001	0.001	50
Friction Angle [deg]	1	35	25	34	40
Water Surface	None	None	None	None	None
Ru Value	0	0	0	0	0

Support Properties

micropali verticali

Support Type: Micro-Pile
Force Application: Passive
Out-of-Plane Spacing: 1 m
Pile Shear Strength: 700 kN
Force Direction: Parallel to Surface

micropali inclinati

	Project		
	SLIDE - An Interactive Slope Stability Program		
	Analysis Description		
	Drawn By	Scale	Company
Date	06/05/2020, 15:16:12	File Name	opera V03 - Sez4 - sisma -.slim

Support Type: Soil Nail
 Force Application: Passive
 Out-of-Plane Spacing: 1 m
 Tensile Capacity: 450 kN
 Plate Capacity: 450 kN
 Bond Strength: 70 kN/m

Global Minimums

Method: bishop simplified

FS: 3.627270
 Center: 31.135, 32.542
 Radius: 15.415
 Left Slip Surface Endpoint: 17.736, 24.921
 Right Slip Surface Endpoint: 39.460, 19.569
 Resisting Moment=32037.3 kN-m
 Driving Moment=8832.34 kN-m

Valid / Invalid Surfaces

Method: bishop simplified

Number of Valid Surfaces: 15536
 Number of Invalid Surfaces: 25395

Error Codes:

Error Code -101 reported for 357 surfaces
 Error Code -103 reported for 2 surfaces
 Error Code -1000 reported for 25036 surfaces

Error Codes

The following errors were encountered during the computation:

- 101 = Only one (or zero) surface / slope intersections.
- 103 = Two surface / slope intersections, but one or more surface / nonslope external polygon intersections lie between them. This usually occurs when the slip surface extends past the bottom of the soil region, but may also occur on a benched slope model with two sets of Slope Limits.
- 1000 = No valid slip surfaces are generated at a grid center. Unable to draw a surface.

Slice Data

Global Minimum Query (bishop simplified) - Safety Factor: 3.62727

Slice Number	Width [m]	Weight [kN]	Base Material	Base Cohesion [kPa]	Base Friction Angle [degrees]	Shear Stress [kPa]	Shear Strength [kPa]	Base Normal Stress [kPa]	Pore Pressure [kPa]	Effective Normal Stress [kPa]
			<i>Project</i> SLIDE - An Interactive Slope Stability Program							
			<i>Analysis Description</i>							
			<i>Drawn By</i>				<i>Scale</i>		<i>Company</i>	
			<i>Date</i>				06/05/2020, 15:16:12		<i>File Name</i>	

1	0.904118	12.666	riporto	0.001	35	5.07271	18.4001	26.2767	0	26.2767
2	0.904118	35.5444	riporto	0.001	35	9.28486	33.6787	48.0968	0	48.0968
3	0.904118	54.2703	riporto	0.001	35	12.9572	46.9994	67.1207	0	67.1207
4	0.904118	70.0044	riporto	0.001	35	16.1938	58.7393	83.8868	0	83.8868
5	0.904118	83.4001	riporto	0.001	35	19.0635	69.1484	98.7525	0	98.7525
6	0.904118	94.8689	riporto	0.001	35	21.6143	78.4008	111.966	0	111.966
7	0.904118	104.689	riporto	0.001	35	23.8809	86.6224	123.708	0	123.708
8	0.904118	113.056	riporto	0.001	35	25.8889	93.906	134.111	0	134.111
9	0.904118	120.114	riporto	0.001	35	27.6574	100.321	143.272	0	143.272
10	0.852082	118.471	detriti eluvio-colluviali	0.001	25	19.8009	71.8233	154.024	0	154.024
11	0.852082	118.162	detriti eluvio-colluviali	0.001	25	69.1641	250.877	538.006	0	538.006
12	0.852082	112.515	detriti eluvio-colluviali	0.001	25	16.7166	60.6355	130.031	0	130.031
13	0.852082	108.056	detriti eluvio-colluviali	0.001	25	16.1714	58.6581	125.79	0	125.79
14	0.852082	109.66	detriti eluvio-colluviali	0.001	25	6.86037	24.8844	53.3627	0	53.3627
15	1.0037	54.2149	detriti eluvio-colluviali	0.001	25	6.99148	25.36	54.3825	0	54.3825
16	0.832292	14.4642	detriti eluvio-colluviali	0.001	25	2.26691	8.2227	17.6315	0	17.6315
17	0.832292	15.8152	detriti eluvio-colluviali	0.001	25	2.49609	9.05399	19.4142	0	19.4142
18	0.832292	35.8915	detriti eluvio-colluviali	0.001	25	5.70509	20.6939	44.376	0	44.376
19	0.832292	33.7776	detriti eluvio-colluviali	0.001	25	5.40889	19.6195	42.0719	0	42.0719
20	0.832292	30.9115	detriti eluvio-colluviali	0.001	25	4.98813	18.0933	38.799	0	38.799
21	0.832292	27.2648	detriti eluvio-colluviali	0.001	25	4.43537	16.0883	34.4992	0	34.4992
22	0.832292	22.7994	detriti eluvio-colluviali	0.001	25	3.74097	13.5695	29.0977	0	29.0977
23	0.832292	17.4653	detriti eluvio-colluviali	0.001	25	2.89242	10.4916	22.4972	0	22.4972
24	0.832292	11.1973	detriti eluvio-colluviali	0.001	25	1.87332	6.79504	14.5699	0	14.5699
25	0.832292	3.91032	detriti eluvio-colluviali	0.001	25	0.661779	2.40045	5.14565	0	5.14565

Interslice Data

Global Minimum Query (bishop simplified) - Safety Factor: 3.62727

Slice	X coordinate	Y coordinate - Bottom	Interslice Normal Force	Interslice Shear Force	Interslice Force Angle
-------	--------------	-----------------------	-------------------------	------------------------	------------------------

	Project				
	SLIDE - An Interactive Slope Stability Program				
	Analysis Description				
	Drawn By		Scale	Company	
Date			06/05/2020, 15:16:12		File Name
					opera V03 - Sez4 - sisma -.slim

	[m]	[m]	[kN]	[kN]	[degrees]
1	17.7363	24.921	0	0	0
2	18.6404	23.5148	32.6554	0	0
3	19.5445	22.3801	79.6597	0	0
4	20.4486	21.4332	132.751	0	0
5	21.3528	20.6293	187.157	0	0
6	22.2569	19.9411	239.811	0	0
7	23.161	19.3504	288.599	0	0
8	24.0651	18.8445	331.998	0	0
9	24.9692	18.4145	368.877	0	0
10	25.8734	18.0534	398.371	0	0
11	26.7254	17.7718	427.611	0	0
12	27.5775	17.5437	217.052	0	0
13	28.4296	17.3668	228.4	0	0
14	29.2817	17.2394	233.144	0	0
15	30.1338	17.1601	-462.936	0	0
16	31.1375	17.1275	-466.933	0	0
17	31.9698	17.1501	-468.885	0	0
18	32.802	17.2179	-471.914	0	0
19	33.6343	17.3314	-480.874	0	0
20	34.4666	17.4918	-491.343	0	0
21	35.2989	17.7005	-502.879	0	0
22	36.1312	17.9595	-514.88	0	0
23	36.9635	18.2718	-526.554	0	0
24	37.7958	18.6407	-536.859	0	0
25	38.6281	19.071	-544.43	0	0
26	39.4604	19.5689	0	0	0

List Of Coordinates

Distributed Load

X	Y
4.0706	25
26.7322	24.869

External Boundary

X	Y
0	23.5939
0	18.0531
0	16.5201
0	11.0268
0	9e-016

	Project		
	SLIDE - An Interactive Slope Stability Program		
	Analysis Description		
	Drawn By	Scale	Company
Date	06/05/2020, 15:16:12	File Name	opera V03 - Sez4 - sisma -.slim

50	0
50	13.3136
50	17.469
50	19.6103
32.7709	19.5426
32.6872	18.0535
30.8353	18.0535
30.7147	20.8535
30.143	20.8535
30.1144	23.0975
29.6144	23.0975
26.7322	24.869
4.0706	25

Material Boundary

X	Y
30.0144	11.7975
30.0144	12.6454
30.0144	17.164
30.0144	18.0535
30.0144	19.7975

Material Boundary

X	Y
22.8581	12.0668
23.1321	12.4175
26.8636	17.1933
27.5356	18.0534
28.8983	19.7975

Material Boundary

X	Y
29.6144	23.0975
29.6144	20.3975
28.6144	20.3975
28.6144	19.7975
28.8983	19.7975
30.0144	19.7975
30.4144	19.7975
30.4144	20.3975
30.151	20.3975
30.143	20.8535

	<i>Project</i>		
	SLIDE - An Interactive Slope Stability Program		
	<i>Analysis Description</i>		
	<i>Drawn By</i>	<i>Scale</i>	<i>Company</i>
<i>Date</i>	06/05/2020, 15:16:12	<i>File Name</i>	opera V03 - Sez4 - sisma -.slim

Material Boundary

X	Y
0	18.0531
27.5356	18.0534
30.0144	18.0535
30.8353	18.0535

Material Boundary

X	Y
0	11.0268
13.5194	12.1422
18.1344	12.304
23.1321	12.4175
24.0718	12.4388
29.4155	12.6276
30.0144	12.6454
35.7847	12.8164
50	13.3136

Material Boundary

X	Y
0	16.5201
10.8973	16.906
16.4903	17.138
22.7333	17.1611
26.8636	17.1933
28.6742	17.2075
30.0144	17.164
31.2383	17.1242
34.0773	16.9814
35.9973	16.8793
37.897	16.859

Material Boundary

X	Y
37.897	16.859
40.164	16.8793
40.7083	16.9119
50	17.469



Project

SLIDE - An Interactive Slope Stability Program

Analysis Description

Drawn By

Scale

Company

Date

06/05/2020, 15:16:12

File Name

opera V03 - Sez4 - sisma -.slim

Slide Analysis Information

SLIDE - An Interactive Slope Stability Program

Project Summary

File Name: opera V03 - Sez 4 - sisma +.slim
Slide Modeler Version: 6.008
Project Title: SLIDE - An Interactive Slope Stability Program
Date Created: 06/05/2020, 15:16:12

General Settings

Units of Measurement: Metric Units
Time Units: days
Permeability Units: meters/second
Failure Direction: Left to Right
Data Output: Standard
Maximum Material Properties: 20
Maximum Support Properties: 20

Analysis Options

Analysis Methods Used

Bishop simplified

Number of slices: 25
Tolerance: 0.005
Maximum number of iterations: 50
Check malpha < 0.2: Yes
Initial trial value of FS: 1
Steffensen Iteration: Yes

Groundwater Analysis

Groundwater Method: Water Surfaces
Pore Fluid Unit Weight: 9.81 kN/m³
Advanced Groundwater Method: None

Random Numbers

Pseudo-random Seed: 10116
Random Number Generation Method: Park and Miller v.3

	<i>Project</i>		
	SLIDE - An Interactive Slope Stability Program		
	<i>Analysis Description</i>		
	<i>Drawn By</i>	<i>Scale</i>	<i>Company</i>
<i>Date</i>	06/05/2020, 15:16:12	<i>File Name</i> opera V03 - Sez 4 - sisma +.slim	

Surface Options

Surface Type: Circular
Search Method: Grid Search
Radius Increment: 10
Composite Surfaces: Disabled
Reverse Curvature: Create Tension Crack
Minimum Elevation: Not Defined
Minimum Depth: Not Defined





Loading

Seismic Load Coefficient (Horizontal): 0.023
Seismic Load Coefficient (Vertical): -0.011
1 Distributed Load present

Distributed Load 1

Distribution: Constant
Magnitude [kPa]: 20
Orientation: Vertical

Material Properties

Property	cls	riporto	detriti eluvio-colluviali	basalti alterati	Basalti
Color					
Strength Type	Mohr-Coulomb	Mohr-Coulomb	Mohr-Coulomb	Mohr-Coulomb	Mohr-Coulomb
Unit Weight [kN/m3]	25	20	19	20	22
Cohesion [kPa]	7000	0.001	0.001	0.001	50
Friction Angle [deg]	1	35	25	34	40
Water Surface	None	None	None	None	None
Ru Value	0	0	0	0	0

Support Properties

micropali verticali

Support Type: Micro-Pile
Force Application: Passive
Out-of-Plane Spacing: 1 m
Pile Shear Strength: 700 kN
Force Direction: Parallel to Surface

micropali inclinati

	Project		
	SLIDE - An Interactive Slope Stability Program		
	Analysis Description		
	Drawn By	Scale	Company
Date	06/05/2020, 15:16:12	File Name	opera V03 - Sez 4 - sisma +.slim

Support Type: Soil Nail
 Force Application: Passive
 Out-of-Plane Spacing: 1 m
 Tensile Capacity: 450 kN
 Plate Capacity: 450 kN
 Bond Strength: 70 kN/m

Global Minimums

Method: bishop simplified

FS: 3.653860
 Center: 32.728, 32.542
 Radius: 16.017
 Left Slip Surface Endpoint: 18.644, 24.916
 Right Slip Surface Endpoint: 42.135, 19.579
 Resisting Moment=33992.9 kN-m
 Driving Moment=9303.3 kN-m

Valid / Invalid Surfaces

Method: bishop simplified

Number of Valid Surfaces: 15536
 Number of Invalid Surfaces: 25395

Error Codes:

Error Code -101 reported for 357 surfaces
 Error Code -103 reported for 2 surfaces
 Error Code -1000 reported for 25036 surfaces

Error Codes

The following errors were encountered during the computation:

- 101 = Only one (or zero) surface / slope intersections.
- 103 = Two surface / slope intersections, but one or more surface / nonslope external polygon intersections lie between them. This usually occurs when the slip surface extends past the bottom of the soil region, but may also occur on a benched slope model with two sets of Slope Limits.
- 1000 = No valid slip surfaces are generated at a grid center. Unable to draw a surface.

Slice Data

Global Minimum Query (bishop simplified) - Safety Factor: 3.65386

Slice Number	Width [m]	Weight [kN]	Base Material	Base Cohesion [kPa]	Base Friction Angle [degrees]	Shear Stress [kPa]	Shear Strength [kPa]	Base Normal Stress [kPa]	Pore Pressure [kPa]	Effective Normal Stress [kPa]
			<i>Project</i> SLIDE - An Interactive Slope Stability Program							
			<i>Analysis Description</i>							
			<i>Drawn By</i>				<i>Scale</i>		<i>Company</i>	
			<i>Date</i> 06/05/2020, 15:16:12				<i>File Name</i> opera V03 - Sez 4 - sisma +.slim			

1	0.907213	13.3624	riporto	0.001	35	5.04869	18.4472	26.3439	0	26.3439
2	0.907213	37.4731	riporto	0.001	35	9.31962	34.0526	48.6307	0	48.6307
3	0.907213	57.1857	riporto	0.001	35	13.0436	47.6596	68.0635	0	68.0635
4	0.907213	73.7693	riporto	0.001	35	16.33	59.6675	85.2124	0	85.2124
5	0.907213	87.9285	riporto	0.001	35	19.2505	70.3387	100.452	0	100.452
6	0.907213	100.103	riporto	0.001	35	21.855	79.855	114.043	0	114.043
7	0.907213	110.589	riporto	0.001	35	24.1793	88.3476	126.172	0	126.172
8	0.907213	119.595	riporto	0.001	35	26.2499	95.9136	136.977	0	136.977
9	1.10898	155.707	detriti eluvio-colluviali	0.001	25	18.6221	68.0425	145.915	0	145.915
10	1.10898	153.75	detriti eluvio-colluviali	0.001	25	55.8765	204.165	437.83	0	437.83
11	0.993975	132.65	basalti alterati	0.001	34	23.2259	84.8643	125.815	0	125.815
12	0.993975	134.699	basalti alterati	0.001	34	0	0	-3.12843	0	-3.12843
13	0.993975	66.109	basalti alterati	0.001	34	11.8503	43.2994	64.1925	0	64.1925
14	0.993975	28.4815	basalti alterati	0.001	34	5.16426	18.8695	27.9736	0	27.9736
15	0.993975	39.4076	basalti alterati	0.001	34	7.22726	26.4074	39.1491	0	39.1491
16	0.993975	56.901	basalti alterati	0.001	34	10.5563	38.5712	57.1827	0	57.1827
17	0.993975	55.2425	basalti alterati	0.001	34	10.37	37.8905	56.1735	0	56.1735
18	0.993975	52.3281	basalti alterati	0.001	34	9.94329	36.3314	53.862	0	53.862
19	0.866289	42.36	detriti eluvio-colluviali	0.001	25	6.36926	23.2724	49.9058	0	49.9058
20	0.866289	38.5256	detriti eluvio-colluviali	0.001	25	5.83911	21.3353	45.7515	0	45.7515
21	0.866289	33.809	detriti eluvio-colluviali	0.001	25	5.1678	18.8824	40.4913	0	40.4913
22	0.866289	28.1575	detriti eluvio-colluviali	0.001	25	4.34332	15.8699	34.031	0	34.031
23	0.866289	21.5029	detriti eluvio-colluviali	0.001	25	3.34996	12.2403	26.2473	0	26.2473
24	0.866289	13.7558	detriti eluvio-colluviali	0.001	25	2.16684	7.91734	16.9767	0	16.9767
25	0.866289	4.79823	detriti eluvio-colluviali	0.001	25	0.765481	2.79696	5.99595	0	5.99595

Interslice Data

Global Minimum Query (bishop simplified) - Safety Factor: 3.65386

Slice Number	X coordinate [m]	Y coordinate - Bottom [m]	Interslice Normal Force [kN]	Interslice Shear Force [kN]	Interslice Force Angle [degrees]
1	18.6436	24.9157	0	0	0
2	19.5509	23.4376	34.6688	0	0
3	20.4581	22.2476	84.9491	0	0
4	21.3653	21.2542	142.046	0	0
5	22.2725	20.4091	200.946	0	0

	Project		
	SLIDE - An Interactive Slope Stability Program		
	Analysis Description		
	Drawn By	Scale	Company
Date	06/05/2020, 15:16:12		File Name
			opera V03 - Sez 4 - sisma +.slim

6	23.1797	19.683	258.449	0	0
7	24.0869	19.0566	312.363	0	0
8	24.9941	18.5167	361.106	0	0
9	25.9013	18.0534	403.505	0	0
10	27.0103	17.5811	455.366	0	0
11	28.1193	17.2031	285.369	0	0
12	29.1133	16.939	298.576	0	0
13	30.1072	16.7416	-385.54	0	0
14	31.1012	16.6086	-387.255	0	0
15	32.0952	16.5382	-389.764	0	0
16	33.0892	16.5298	-395.709	0	0
17	34.0831	16.5832	-407.941	0	0
18	35.0771	16.6989	-423.479	0	0
19	36.0711	16.8785	-441.828	0	0
20	36.9374	17.0888	-456.862	0	0
21	37.8037	17.3512	-473.042	0	0
22	38.67	17.6687	-489.594	0	0
23	39.5363	18.0448	-505.505	0	0
24	40.4025	18.4841	-519.444	0	0
25	41.2688	18.9929	-529.642	0	0
26	42.1351	19.5794	0	0	0

List Of Coordinates

Distributed Load

X	Y
4.0706	25
26.7322	24.869

External Boundary

X	Y
0	23.5939
0	18.0531
0	16.5201
0	11.0268
0	9e-016
50	0
50	13.3136
50	17.469
50	19.6103
32.7709	19.5426
32.6872	18.0535

	<i>Project</i>		
	SLIDE - An Interactive Slope Stability Program		
	<i>Analysis Description</i>		
	<i>Drawn By</i>	<i>Scale</i>	<i>Company</i>
<i>Date</i>	06/05/2020, 15:16:12	<i>File Name</i>	opera V03 - Sez 4 - sisma +.slim

30.8353	18.0535
30.7147	20.8535
30.143	20.8535
30.1144	23.0975
29.6144	23.0975
26.7322	24.869
4.0706	25

Material Boundary

X	Y
30.0144	11.7975
30.0144	12.6454
30.0144	17.164
30.0144	18.0535
30.0144	19.7975

Material Boundary

X	Y
22.8581	12.0668
23.1321	12.4175
26.8636	17.1933
27.5356	18.0534
28.8983	19.7975

Material Boundary

X	Y
29.6144	23.0975
29.6144	20.3975
28.6144	20.3975
28.6144	19.7975
28.8983	19.7975
30.0144	19.7975
30.4144	19.7975
30.4144	20.3975
30.151	20.3975
30.143	20.8535

Material Boundary

X	Y
0	18.0531
27.5356	18.0534

	<i>Project</i>		
	SLIDE - An Interactive Slope Stability Program		
	<i>Analysis Description</i>		
	<i>Drawn By</i>	<i>Scale</i>	<i>Company</i>
<i>Date</i>		<i>File Name</i>	
06/05/2020, 15:16:12		opera V03 - Sez 4 - sisma +.slim	

30.0144	18.0535
30.8353	18.0535

Material Boundary

X	Y
0	11.0268
13.5194	12.1422
18.1344	12.304
23.1321	12.4175
24.0718	12.4388
29.4155	12.6276
30.0144	12.6454
35.7847	12.8164
50	13.3136

Material Boundary

X	Y
0	16.5201
10.8973	16.906
16.4903	17.138
22.7333	17.1611
26.8636	17.1933
28.6742	17.2075
30.0144	17.164
31.2383	17.1242
34.0773	16.9814
35.9973	16.8793
37.897	16.859

Material Boundary

X	Y
37.897	16.859
40.164	16.8793
40.7083	16.9119
50	17.469



<i>Project</i>			SLIDE - An Interactive Slope Stability Program		
<i>Analysis Description</i>					
<i>Drawn By</i>		<i>Scale</i>		<i>Company</i>	
<i>Date</i>			<i>File Name</i>		
06/05/2020, 15:16:12			opera V03 - Sez 4 - sisma +.slim		