

PIANTA SPICCATO - Scala 1:50

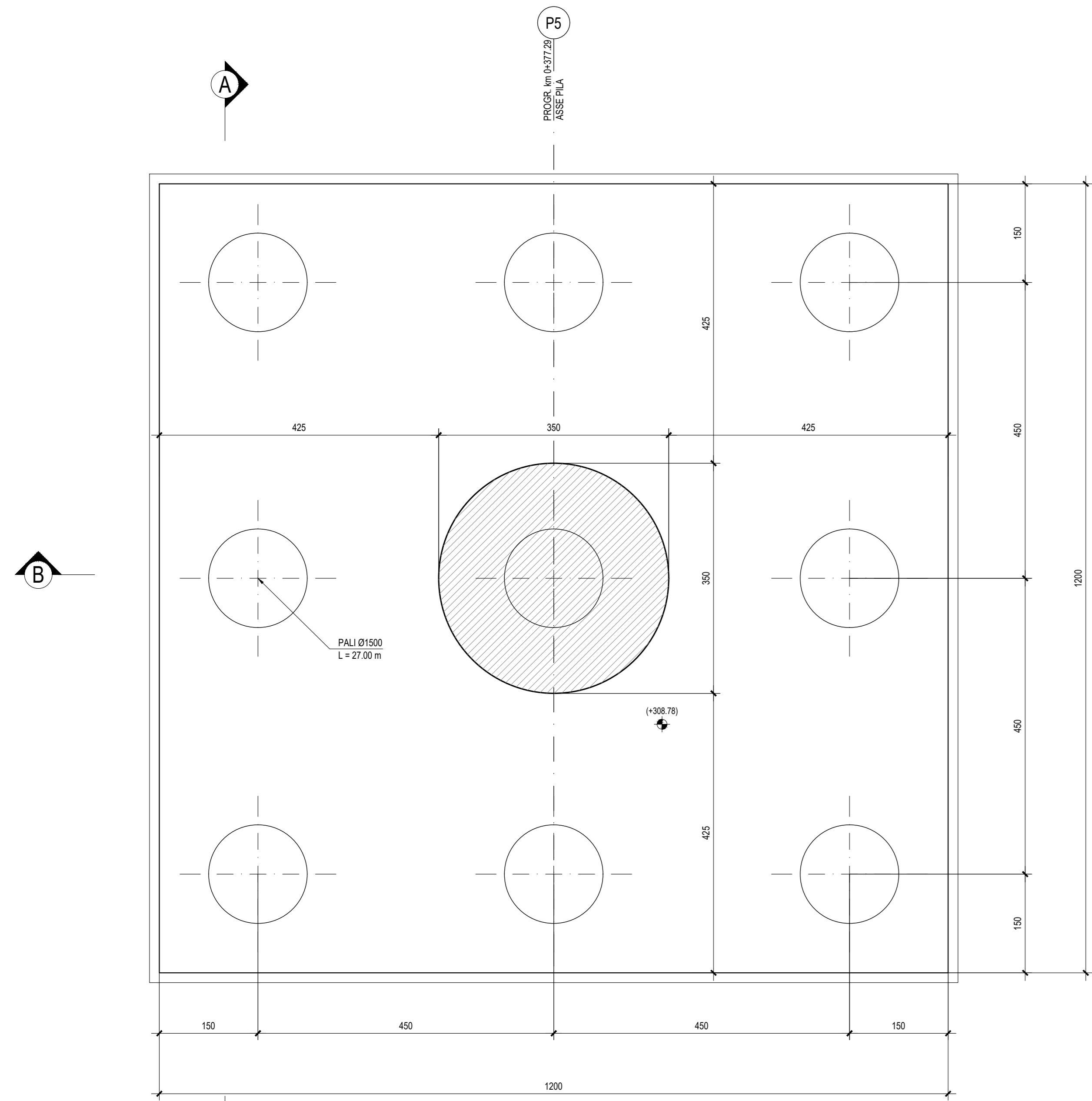

PIANTA PULVINO - Scala 1:50

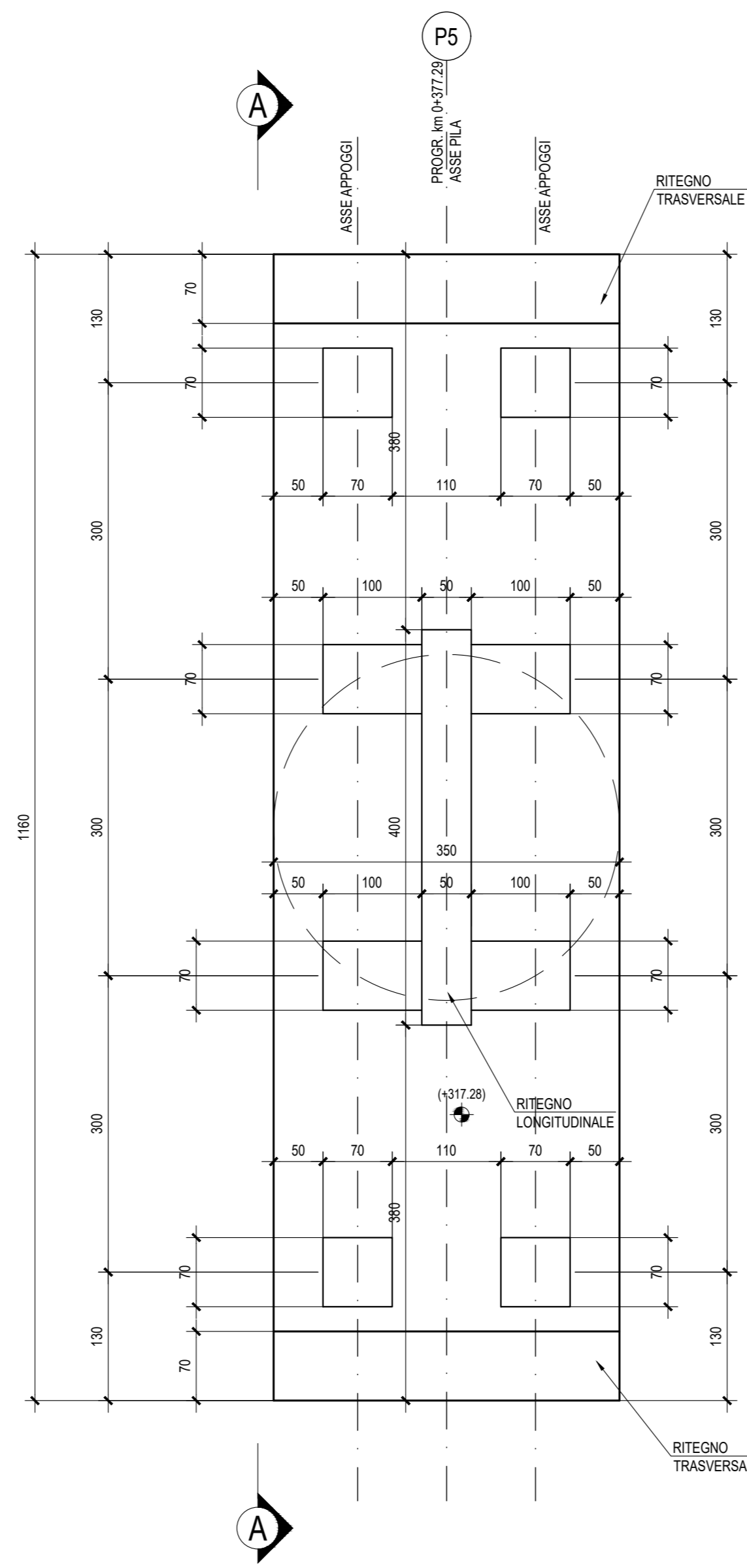

SEZIONE B-B - Scala 1:50

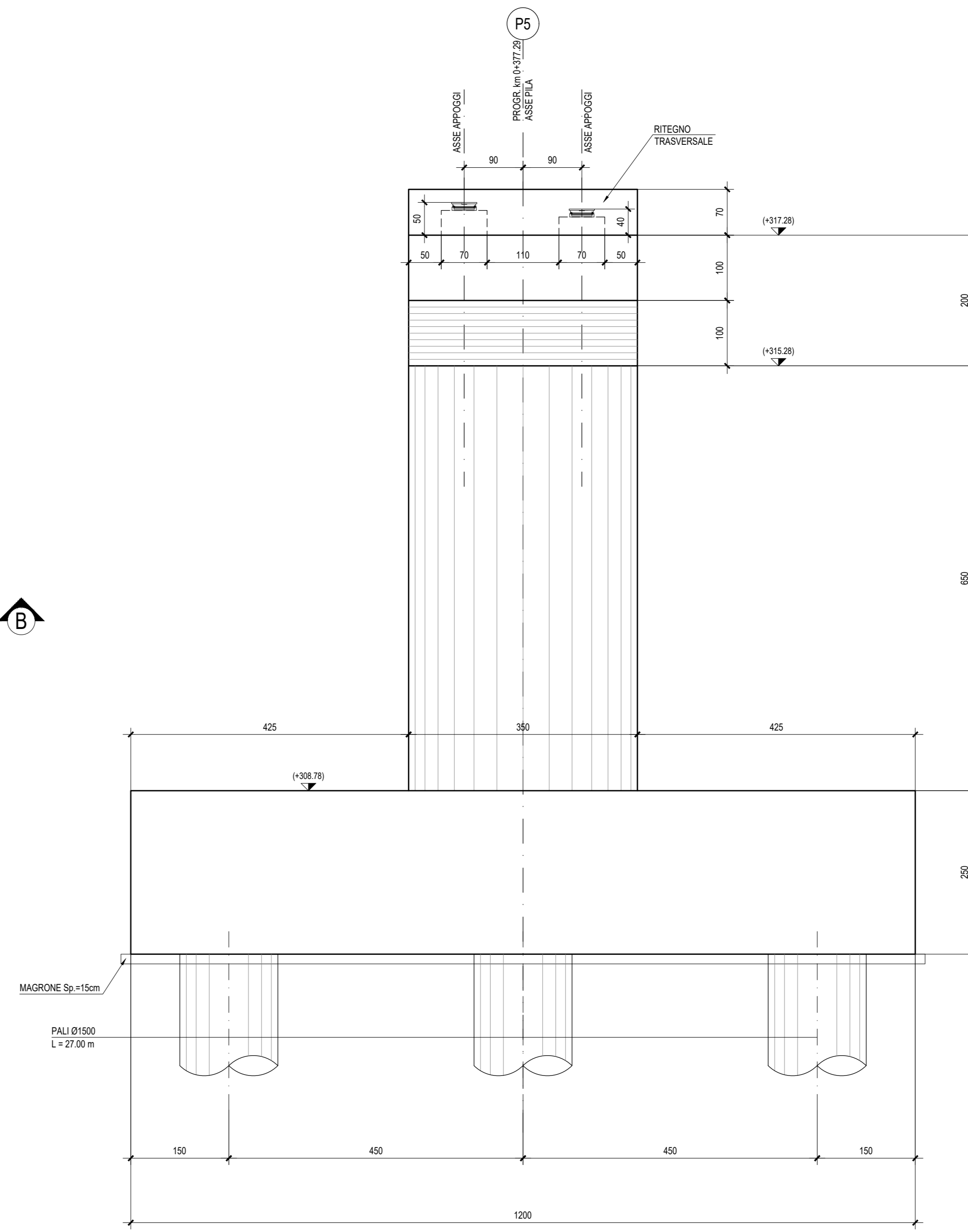

VISTA A-A - Scala 1:50

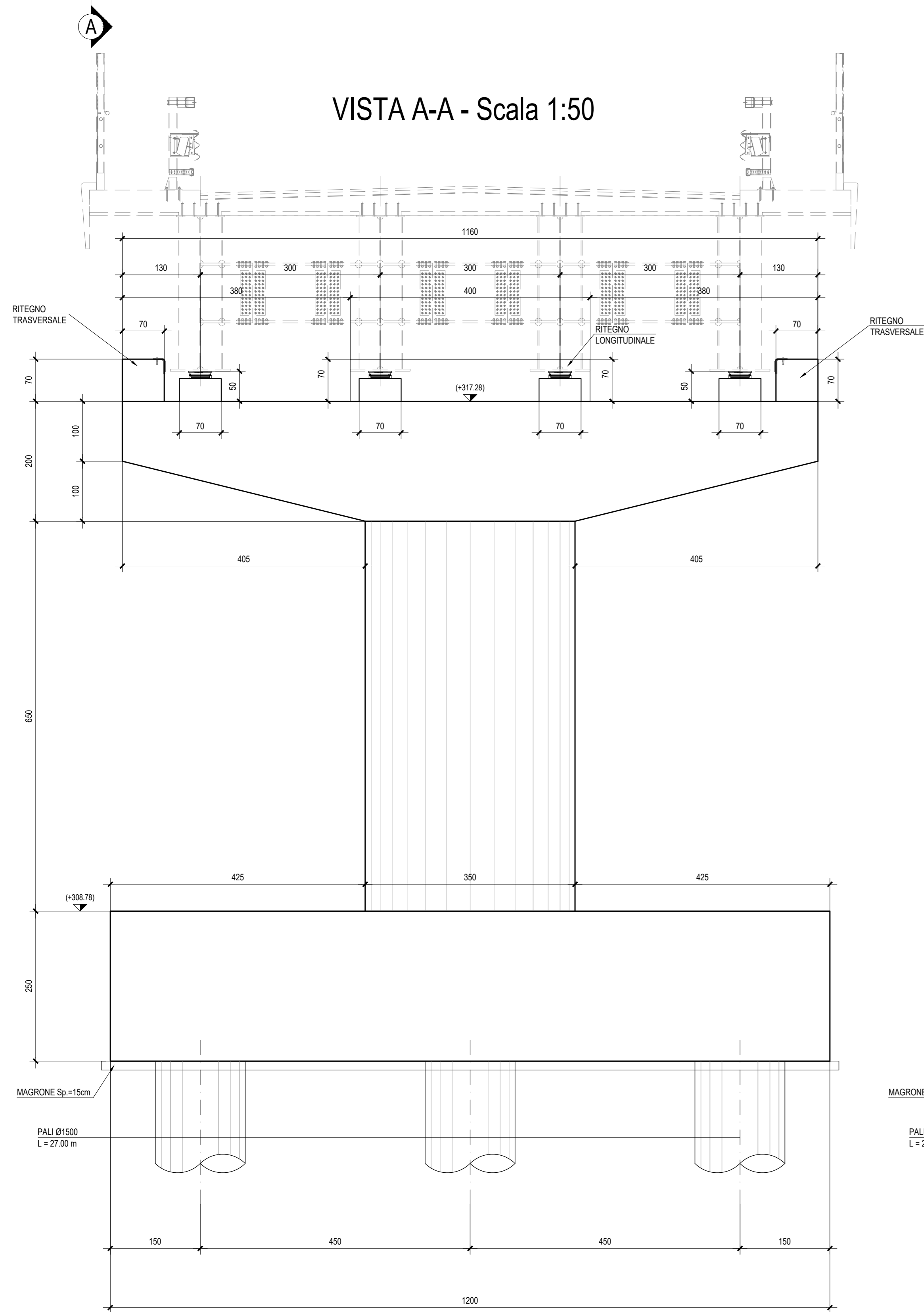

SEZIONE B-B - Scala 1:50

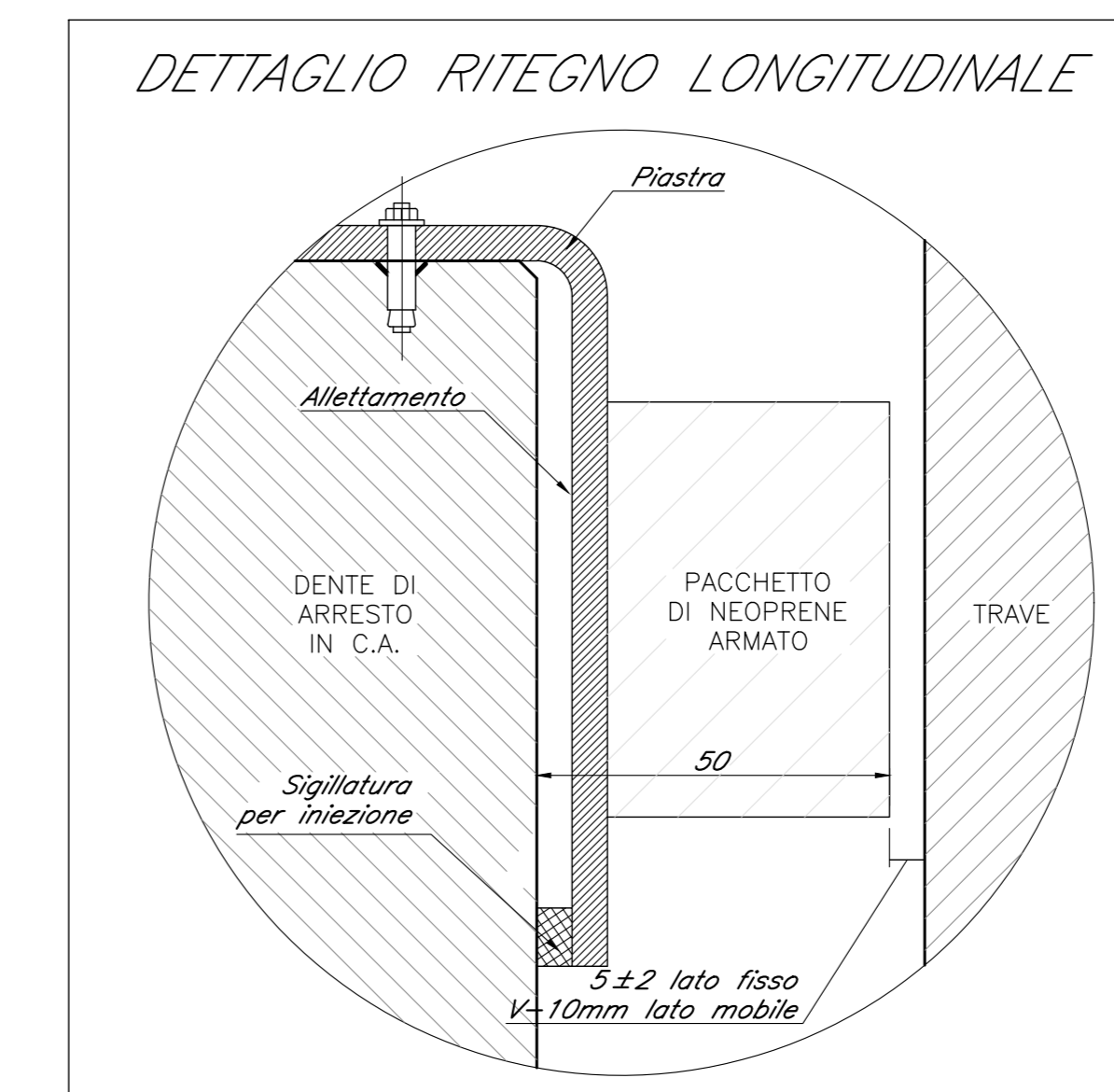
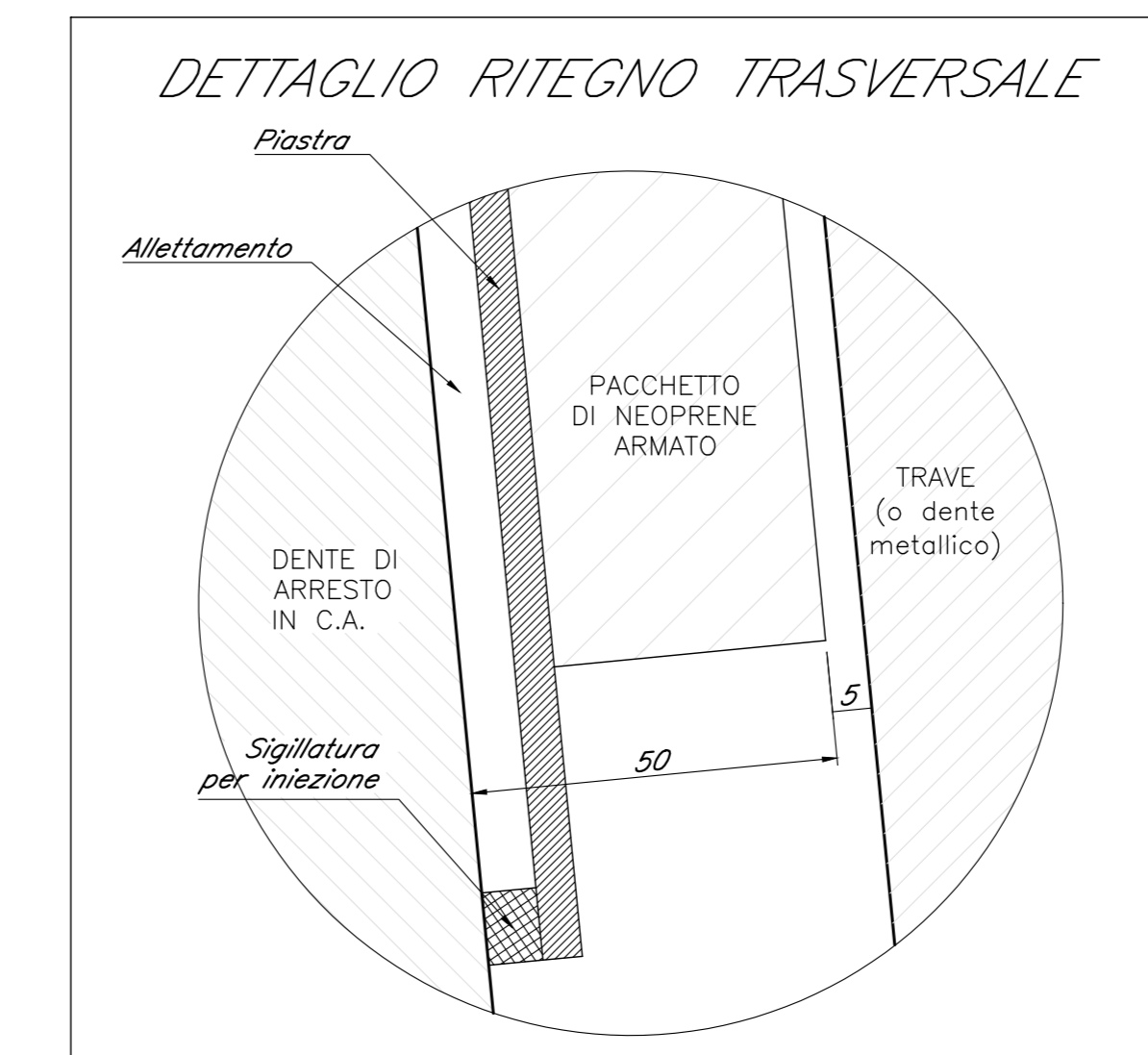
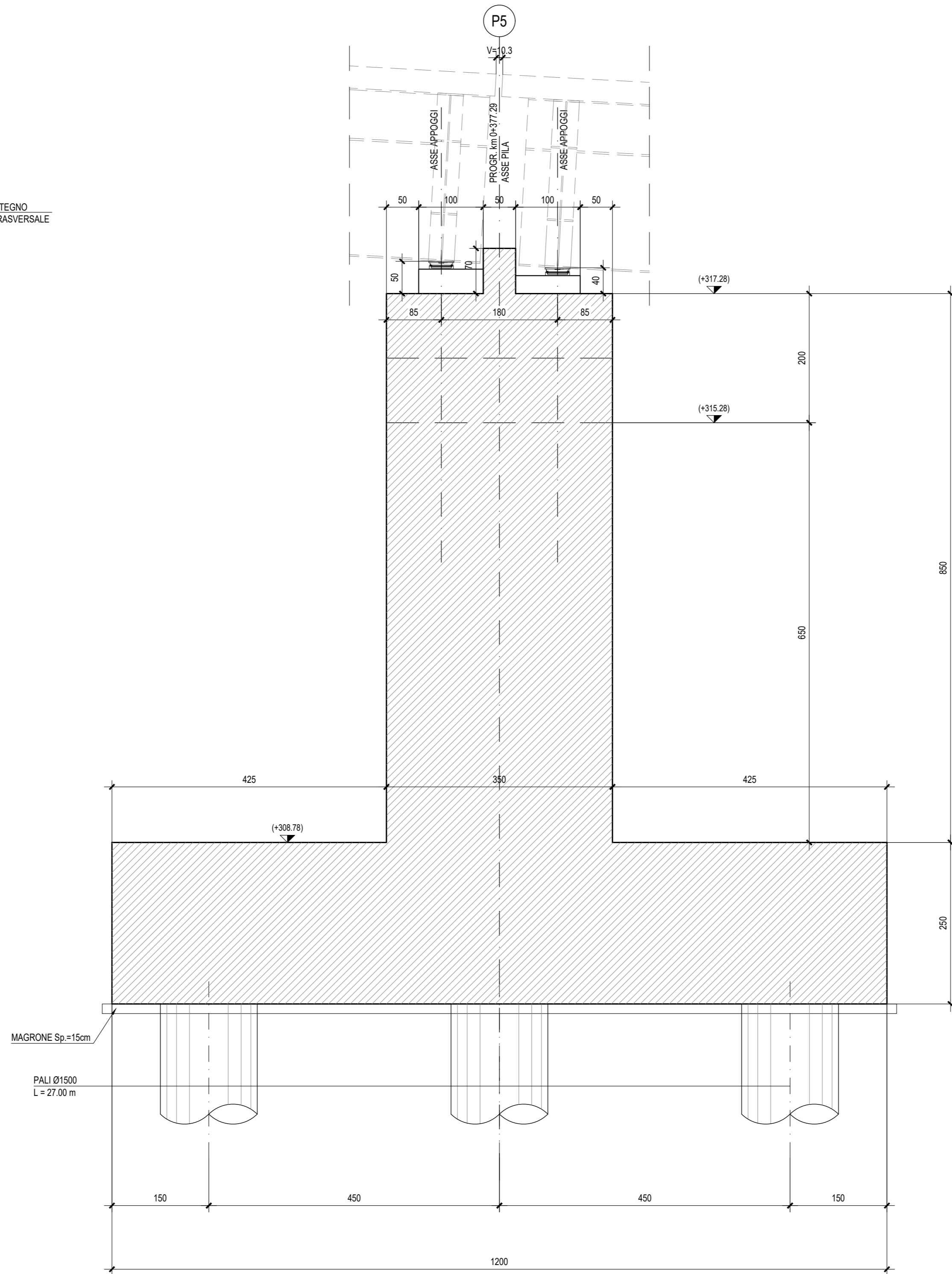

NB: Per la tabella materiali rimanda all'elaborato "RS3T.3.0.D.09.TT.VI.00.0.0.001.A"

COMMITTENTE: **RFI** RETE FERROVIARIA ITALIANA GRUPPO FERROVIE DELLO STATO ITALIANE

PROGETTAZIONE: **ITALFER** GRUPPO FERROVIE DELLO STATO ITALIANE

DIRETTRICE FERROVIARIA MESSINA - CATANIA - PALERMO
NUOVO COLLEGAMENTO PALERMO - CATANIA

U.O. OPERE CIVILI E GESTIONE DELLE VARIANTI

PROGETTO DEFINITIVO

TRATTA LERCARA DIR. - CALTANISSETTA XIRBI (LOTTO 3)

VIADOTTI IN INTERFERENZA
 IV03 - CAVALCAFERROVIA SU NV62C
 Carpentaria Pila 5

SCALA: 1:50

COMMESSA	LOTTO	FASE	ENTE	TIPO DOC.	OPERA/DISCIPLINA	PROGR.	REV.
RS3T	30	D	09	BB	IV0300	006	B

Rev.	Descrizione	Redatto	Data	Verificato	Data	Approvato	Data	Autorizzato Data
A	Emissione Esecutiva	AVI	Gen-2020	AVI	Gen-2020	AVI	Gen-2020	
B	Emissione Esecutiva	AVI	Mag-2020	AVI	Mag-2020	AVI	Mag-2020	

File: RS3T.3.0.D.09.BB.IV.03.0.0.006.B n. Elab.: 09_631