

NUOVA S.S. 341 "GALLARATESE" - TRATTO DA SAMARATE A CONFINE
CON LA PROVINCIA DI NOVARA - TRATTO NORD

STRALCIO FUNZIONALE DAL KM 6+500 (SVINCOLO S.S. 336 NORD)
AL KM 8+844 (SVINCOLO AUTOSTRADA A8)
"BRETELLA DI GALLARATE"

PROGETTO ESECUTIVO

 Ing. Renato Vaira (Ordine degli Ingg. di Torino e Provincia n° 4663 W)	 Ing. Valerio Bajetti Ordine degli Ingg. di Roma e provincia n° A-26211	ING. RENATO DEL PRETE Ing. Renato Del Prete Ordine degli Ingg. di Bari e provincia n° 5073	 Arch. Nicoletta Frattini Ordine degli Arch. di Torino e provincia n° A-8433	 Ing. Gabriele Incecchi Ordine degli Ingg. di Roma e provincia n° A-12102
	 Società designata: GA&M Prof. Ing. Matteo Ranieri Ordine degli Ingg. di Bari e provincia n° 1137	 Servizi & Engineering Trasporti Ambiente Costruzioni Prof. Ing. Luigi Monterisi Ordine degli Ingg. di Bari e provincia n° 1771	 Via Imperatore Traiano n.4 - 20126 Bari Ing. Gioacchino Angarano Ordine degli Ingg. di Bari e provincia n° 5970	DOTT. GEOL. DANILLO GALLO Dott. Geol. Danilo Gallo Ordine dei Geologi della Regione Puglia n° 588

VISTO: IL RESPONSABILE DEL PROCEDIMENTO Dott. Ing. Giancarlo LUONGO	RESPONSABILE INTEGRAZIONE DELLE PRESTAZIONI SPECIALISTICHE  Ing. Renato DEL PRETE	IL PROGETTISTA FIRMATARIO DELLA PRESTAZIONE  Ing. Valerio BAJETTI	GEOLOGO  Prof. Ing. Geol. Luigi MONTERISI	COORDINATORE DELLA SICUREZZA IN FASE DI PROGETTAZIONE  Ing. Gaetano RANIERI
--	--	--	--	--

<h1>LA101</h1>	<h2>LA - OPERE D'ARTE MINORI- VASCHE DI PRIMA PIOGGIA</h2> <h3>LA-01-VASCA DI PRIMA PIOGGIA TIPO 1</h3> <p>RELAZIONE TECNICA E DI CALCOLO VASCA DI PRIMA PIOGGIA TIPO 1</p>
----------------	---

CODICE PROGETTO PROGETTO LIV. PROG. N. PROG. M 1533 E 1801	NOME FILE LA101 - P00OI01STRRE01_A.dwg	REVISIONE A	SCALA: -
CODICE ELAB. P00OI01STRRE01			

C					
B					
A	EMISSIONE	Maggio 2021	ING. FRANCO NACCI	ING. VALERIO BAJETTI	ING. RENATO DEL PRETE
REV.	DESCRIZIONE	DATA	REDATTO	VERIFICATO	APPROVATO

SOMMARIO

1	PREMESSA	3
2	DESCRIZIONE DELL'OPERA.....	3
3	NORMATIVA DI RIFERIMENTO	5
4	UNITA' DI MISURA	5
5	MATERIALI	6
5.1	Calcestruzzo	6
5.1.1	Calcestruzzo per opere di sottofondazione	6
5.1.2	Calcestruzzo per FONDAZIONI ED ELEVAZIONI	6
5.1.3	Caratteristiche del calcestruzzo ai fini della durabilità	6
5.1.4	Copriferro.....	7
5.2	Acciaio.....	7
5.2.1	Acciaio per barre di armatura lenta	8
6	PROGRAMMA PER L'ANALISI AUTOMATICA.....	8
6.1	Affidabilità sul codice di calcolo utilizzato	8
7	CARATTERIZZAZIONE GEOTECNICA DEI TERRENI.....	10
8	ZONIZZAZIONE E CARATTERIZZAZIONE SIMSICA.....	11
8.1	Vita nominale	11
8.2	Classe d'uso	12
8.3	Periodo di riferimento per l'azione sismica	12
8.4	Pericolosità sismica di base	12
8.5	Fattore di struttura	13
8.6	Definizione dei coefficienti sismici di calcolo	21
9	CRITERI DI VERIFICA.....	22
9.1	Verifica agli stati limite ultimi	22
9.2	Verifica agli stati limite di esercizio.....	23
10	MODELLAZIONE STRUTTURALE	23
10.1	Schematizzazione della sovrastruttura e dei vincoli	23
10.2	Modellazione dei materiali	24
10.3	Modellazione dei vincoli esterni e degli svincoli interni	24
10.4	Modello di calcolo.....	24
11	ANALISI DEI CARICHI.....	26
11.1	Carichi Permanenti strutturali	26
11.1.1	Peso proprio delle strutture in cemento armato.....	26
11.2	Carichi Permanenti non strutturali	26
11.2.1	Peso del magrone in fondazione.....	26
11.2.2	Peso CHIISINI IN GHISA.....	26
11.2.3	Peso in copertura.....	26
11.2.4	Spinta sulle pareti dovuta al terreno.....	26
11.3	Azioni Variabili Q.....	26
11.3.1	Azioni variabili sulla soletta di copertura	26

11.3.2	Spinta laterale dovuta ai sovraccarichi accidentali	26
11.3.3	Carichi accidentali in platea	26
11.3.4	Peso dell'acqua	27
11.3.5	Azioni indotte dalle variazioni termiche	27
11.4	Azione sismica	27
12	COMBINAZIONI DI CARICO.....	28
13	VERIFICHE STRUTTURALI.....	28
14	VERIFICHE GEOTECNICHE	192

1 PREMESSA

La presente relazione di calcolo riporta la descrizione, il dimensionamento, le verifiche strutturali e geotecniche della vasca di prima pioggia di tipo "V1" realizzata in cemento armato gettato in opera, nell'ambito del progetto esecutivo dei lavori inerenti la Nuova S.S. 341 "Gallaratese" nel tratto da Samarate a confine con la provincia di Novara.

La relazione definisce le norme adottate e i materiali impiegati, identifica i carichi agenti e infine riporta le verifiche delle sezioni maggiormente sollecitate.

2 DESCRIZIONE DELL'OPERA

La vasca di prima pioggia di tipo "V1" viene completamente realizzata in cls armato gettato in opera.

La platea di fondazione si sviluppa su tre livelli.

La platea di base a quota intradosso pari a -2,50 m presenta le seguenti caratteristiche geometriche:

- Spessore di 50 cm
- Superficie totale in pianta pari a 13,80 m x 7,70 m

La platea intermedia a quota intradosso pari a -0.50 m presenta le seguenti caratteristiche geometriche:

- Spessore di 50 cm
- Forma planimetrica a L con superficie totale in pianta pari a 4,0 m x 3,80 m + 1,80 m x 3,40 m

La platea superiore a quota intradosso pari a 0.00 m presenta le seguenti caratteristiche geometriche:

- Spessore di 50 cm
- Superficie totale in pianta pari a 3,00 m x 3,80 m

I setti perimetrali controterra hanno spessore pari a 40 cm; il setto centrale che divide la vasca ha anch'esso uno spessore pari a 40 cm.

La vasca presenta al livello + 2,20 m di copertura una soletta con spessore 40 cm e di dimensioni planimetriche pari a 17,30 m x 7,20 m sulla quale poggieranno i chiusini carrabili per l'accesso del personale addetto alla manutenzione dell'opera.

L'altezza massima della vasca è pari a 5,20 m comprensiva dello spessore della platea e della soletta di copertura. L'altezza minima è pari a 2,60 m comprensiva dello spessore della platea e della soletta di copertura.

Si riportano di seguito alcune immagini che descrivono tale opera.

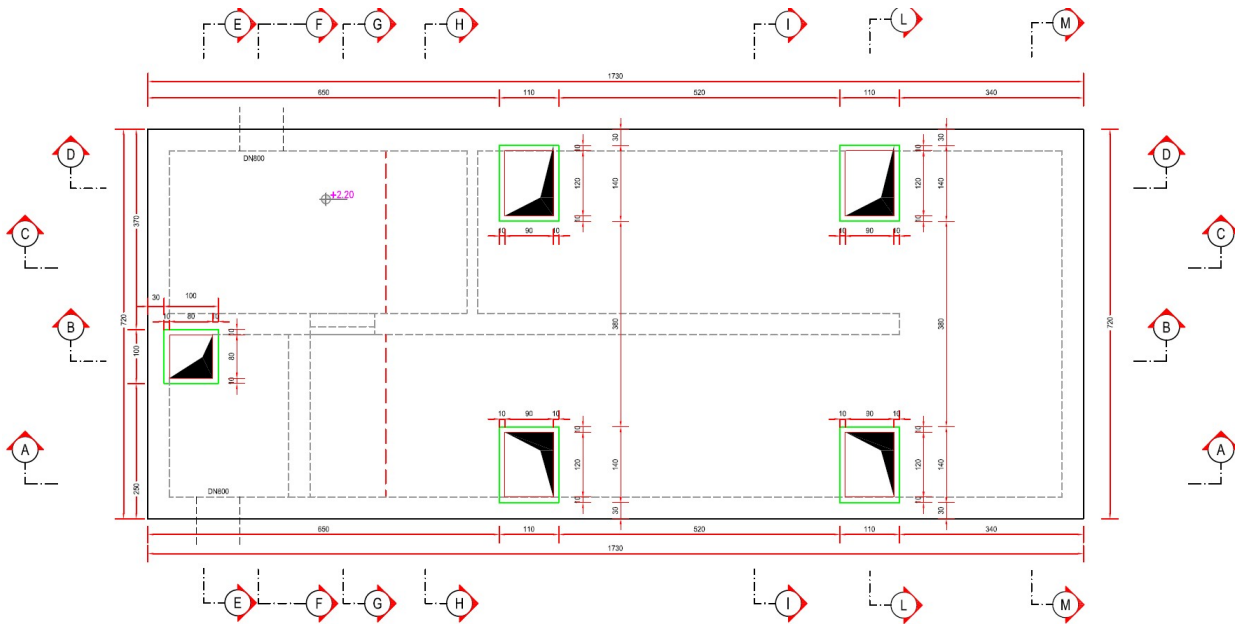

I.1 PIANA DELLA COPERTURA

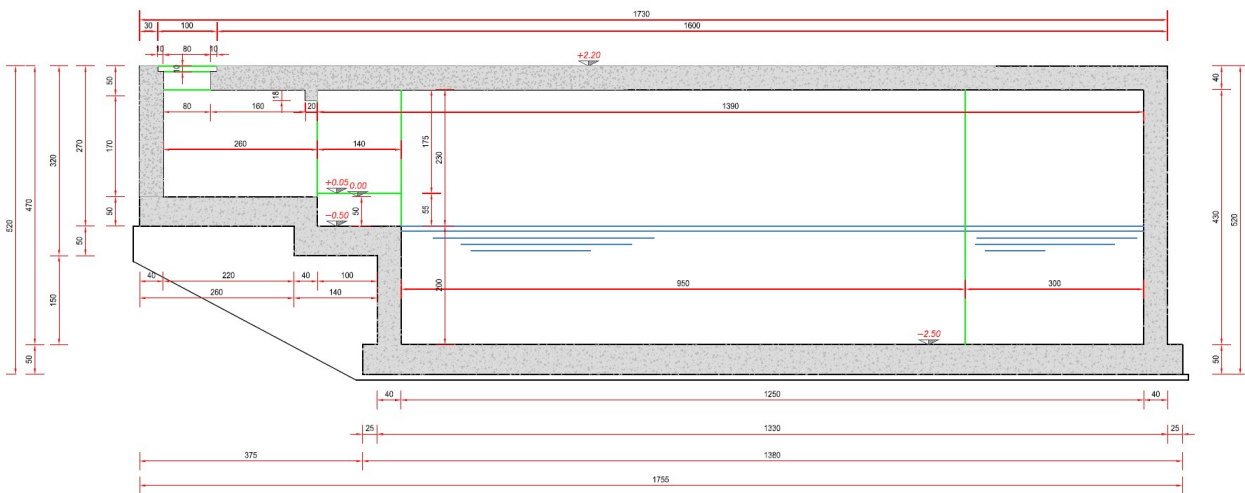

I.2 SEZIONE LONGITUDINALE B-B

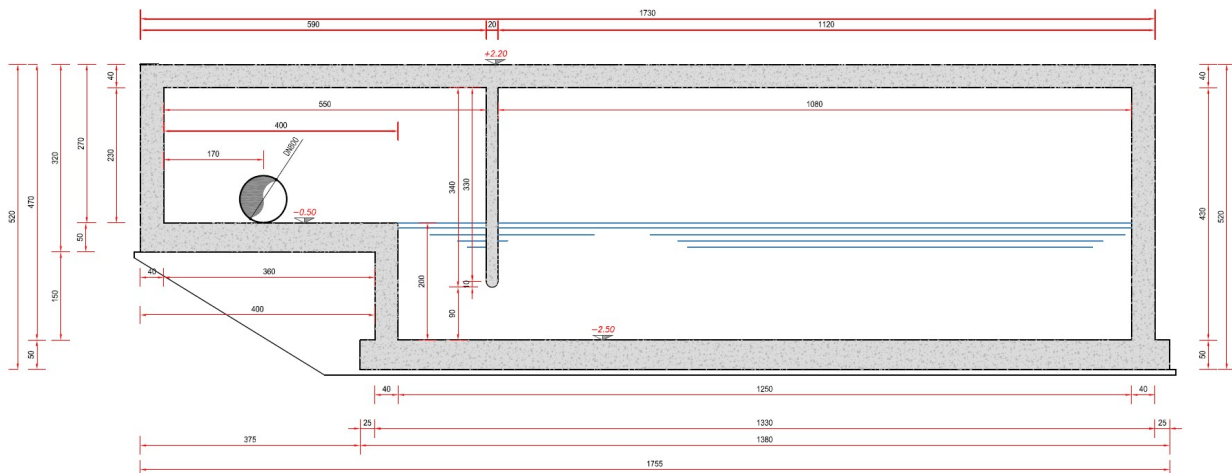

I.3 SEZIONE LONGITUDINALE C-C

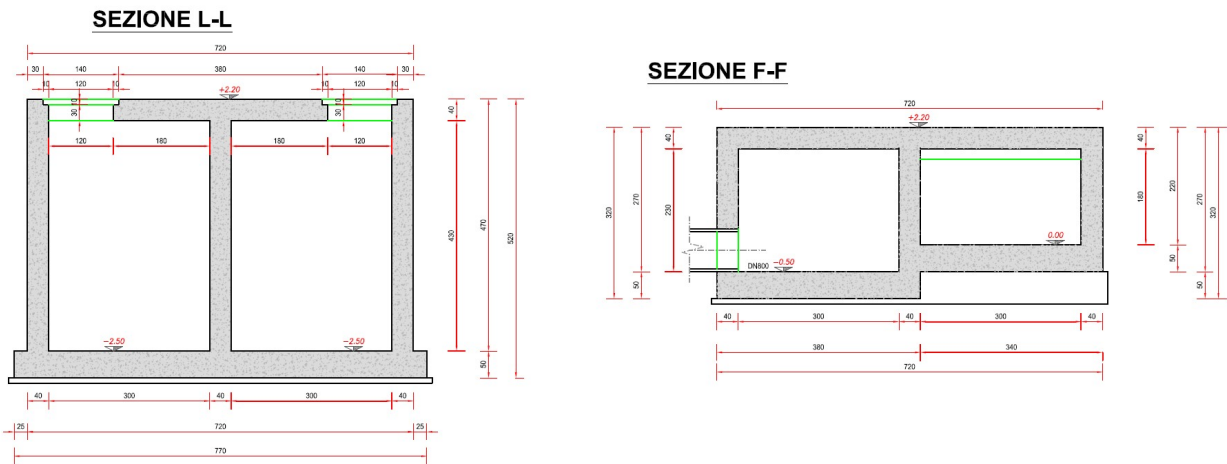

I.4 SEZIONI TRASVERSALI L-L/F-F

3 NORMATIVA DI RIFERIMENTO

Le verifiche sono state eseguite secondo i metodi classici della scienza delle costruzioni e nel rispetto della seguente normativa:

- **Legge 05/01/1971 n.1086** → Norme per la disciplina delle opere in conglomerato cementizio armato, normale e precompresso ed a struttura metallica
- **Legge 02/02/1974 n. 64** → Provvedimenti per le costruzioni con particolari prescrizioni per le zone sismiche
- **DM 17/01/2018** → Aggiornamento delle Norme Tecniche per le Costruzioni
- **Circolare n. 7 del 21/01/2019 /C.S.LL.PP.** → Istruzioni per l'applicazione dell' "Aggiornamento delle Norme Tecniche per le Costruzioni" di cui al DM 17/01/2018
- **UNI EN 1992-1 (Eurocodice 2 – Parte 1)** → Progettazione delle strutture in calcestruzzo – Regole generali
- **UNI EN 1992-2 (Eurocodice 2 – Parte 2)** → Progettazione delle strutture in calcestruzzo – Ponti
- **UNI EN 1998-5 (Eurocodice 8) – Gennaio 2015** → Progettazione delle strutture per la resistenza sismica – Parte 5: Fondazioni, strutture di contenimento ed aspetti geotecnici
- **UNI EN 206-1:2016** → Calcestruzzo – Specificazione, prestazione e conformità
- **UNI 11104:2016** → Calcestruzzo – Specificazione, prestazione, produzione e conformità – Istruzioni complementari per l'applicazione della EN 206-1
- **Servizio Tecnico Centrale della Presidenza del Consiglio Superiore dei LL.PP.** Linee guida sul calcestruzzo strutturale

4 UNITA' DI MISURA

Nei calcoli è stato fatto uso delle seguenti unità di misura:

- Per i carichi kN/m^2 , kN/m , Kn
- Per i momenti kNm

- Per i tagli e gli sforzi normali kN
- Per le tensioni N/mm²
- Per le accelerazioni m/sec²

5 MATERIALI

5.1 CALCESTRUZZO

5.1.1 CALCESTRUZZO PER OPERE DI SOTTOFONDAZIONE

Per le opere di sottofondazione è stato previsto un calcestruzzo con classe di resistenza **C12/15** e classe di esposizione **X0**.

Tale calcestruzzo non ha valenza strutturale e quindi non se ne riportano le caratteristiche meccaniche.

5.1.2 CALCESTRUZZO PER FONDAZIONI ED ELEVAZIONI

Per tutte le strutture in c.a. è stato previsto un calcestruzzo con classe di resistenza **C35/45** con le seguenti caratteristiche meccaniche:

Fase finale	R_{ck}	=	45.00	MPa
Resistenza a compressione cilindrica	f_{ck}	=	$0.83 \times R_{ck}$	= 37.35 MPa
Resistenza cilindrica media	f_{cm}	=	$f_{ck} + 8$	= 45.35 MPa
Modulo elastico	E_c	=	$22000 \times (f_{cm}/10)^{0.3}$	= 34625 MPa
Coefficiente parziale di sicurezza calcestruzzo	γ_c	=	1.5	
Coefficiente per le resistenze di lunga durata	α_{cc}	=	0.85	
Resistenza a compressione di calcolo	f_{cd}	=	$\alpha_{cc} \times f_{ck} / \gamma_c$	= 21.16 MPa
Resistenza a trazione media	f_{ctm}	=	$0.30 \times f_{ck}^{2/3}$	= 3.35 MPa
Resistenza a trazione	f_{ctk}	=	$0.7 \times f_{ctm}$	= 2.35 MPa
Resistenza a trazione di calcolo	f_{ctd}	=	f_{ctk} / γ_c	= 1.56 MPa
S.L.E.				
Tensione limite di esercizio (comb. Rare)	σ_{cR}	=	$f_{ck} \times 0.60$	= 22.41 MPa
Tensione limite di esercizio (comb. Quasi Perm.)	σ_{cP}	=	$f_{ck} \times 0.45$	= 16.81 MPa
Classe di esposizione fondazioni			XD3/XF4	
Classe di esposizione elevazioni			XD3/XF4	

5.1.3 CARATTERISTICHE DEL CALCESTRUZZO AI FINI DELLA DURABILITÀ

Al fine di valutare le caratteristiche vincolanti delle miscele di calcestruzzo nei confronti della durabilità viene fatto riferimento alla norma EN 206-1 ed alla norma UNI 11104.

Di seguito viene riportata la classe di esposizione che risulta vincolante ai fini delle caratteristiche della miscela. Inoltre, sono riportati la classe di resistenza, la dimensione

massima degli aggregati, la classe di consistenza ed il copriferro minimo delle armature, tenuto anche conto della Vita Nominale dell'opera $V_N = 100$ anni:

Calcestruzzo fondazioni:

Classe di esposizione XD3/XF4
 Classe di resistenza caratteristica a compressione: C35/45
 Dimensione max aggregati: 25 mm
 Classe minima di consistenza: S4
 Copriferro minimo: 50 mm

Calcestruzzo elevazioni:

Classe di esposizione XD3/XF4
 Classe di resistenza caratteristica a compressione: C35/45
 Dimensione max aggregati: 25 mm
 Classe minima di consistenza: S4
 Copriferro minimo: 50 mm

5.1.4 COPRIFERRO

Ai fini di preservare le armature dai fenomeni di aggressione ambientale, dovrà essere previsto un idoneo copriferro; il suo valore, misurato tra la parete interna del cassero e la generatrice dell'armatura metallica più vicina, individua il cosiddetto "copriferro nominale".

Il copriferro nominale è somma di due contributi, il copriferro minimo e la tolleranza di posizionamento.

Nel caso in oggetto si hanno i seguenti parametri:

- Classe di esposizione XD3/XF4 fondazioni ed elevazioni
- Classe di resistenza caratteristica a compressione: C35/45
- Dimensione max aggregati: 25 mm
- Classe minima di consistenza: S4

Il valore del copriferro minimo è valutato secondo quanto riportato al punto C4.1.6.1.3 della Circolare n. 7. Nel caso in esame la classe di esposizione ambientale è molto aggressiva e si pone, come da tabella C4.1.IV un copriferro minimo pari a 40 mm. Inoltre, data la vita nominale della struttura pari a 100 anni, come da normativa, deve aggiungersi un copriferro aggiuntivo pari a 10 mm. Si ottiene pertanto un copriferro nominale pari a 50 mm.

Tabella C4.1.IV - Copriferri minimi in mm

			barre da c.a. elementi a piastra		barre da c.a. altri elementi		cavi da c.a.p. elementi a piastra		cavi da c.a.p. altri elementi	
C_{min}	C_o	ambiente	$C \geq C_o$	$C_{min} < C < C_o$	$C \geq C_o$	$C_{min} < C < C_o$	$C \geq C_o$	$C_{min} < C < C_o$	$C \geq C_o$	$C_{min} < C < C_o$
C25/30	C35/45	ordinario	15	20	20	25	25	30	30	35
C30/37	C40/50	aggressivo	25	30	30	35	35	40	40	45
C35/45	C45/55	molto ag.	35	40	40	45	45	50	50	50

5.2 ACCIAIO

5.2.1 ACCIAIO PER BARRE DI ARMATURA LENTA

Per le barre di armatura lenta è stato previsto un acciaio del tipo **B450C**, con le seguenti caratteristiche meccaniche:

- $f_{t,k}$ = 540,00 MPa (resistenza caratteristica a rottura)
- $f_{y,k}$ = 450,00 MPa (tensione caratteristica di snervamento)
- γ_s = 1,15 (Coefficiente parziale di sicurezza acciaio)
- $f_{y,d} = f_{y,k}/\gamma_s$ = 391,30 MPa (tensione di snervamento di calcolo)
- E_s = 200.000 MPa (modulo elastico istantaneo)
- $\sigma_{sR} = f_{y,k}/0.75$ = 337,50 MPa (Tensione limite di esercizio per comb. Rare)

6 PROGRAMMA PER L'ANALISI AUTOMATICA

Informazioni sul codice di calcolo

Titolo: IPERSPACE BIM

Versione: 4.0.0

Produttore-Distributore: SOFT.LAB s.r.l., Ponte (BN)

Codice Licenza: Licenza C04936

6.1 AFFIDABILITÀ SUL CODICE DI CALCOLO UTILIZZATO



ATTESTATO DI AFFIDABILITA'

(Ai sensi del par. 10.2 del D.M. 17.01.2018 "Norme Tecniche per le Costruzioni" e successive modificazioni)

In base a quanto richiesto al par. 10.2 delle Norme Tecniche per le Costruzioni il produttore e distributore Soft. Lab Srl espone la seguente relazione riguardante il solutore numerico e, più in generale, la procedura di analisi e dimensionamento di **IperSpace BIM** e **inSide**. Il manuale teorico del solutore nonché il documento comprendente i numerosi esempi di confronto vengono distribuiti insieme al software.

Il motore di calcolo adottato da **IperSpace BIM** e **inSide** denominato SpaceSolver è un programma ad elementi finiti che permette l'analisi statica e dinamica in ambito lineare, con estensioni per il calcolo degli effetti del secondo ordine.

SpaceSolver è interamente sviluppato e testato nell'ambiente di sviluppo MatLab® che è programma di analisi numerica riconosciuto a livello mondiale per gli usi nella ricerca universitaria e la cui affidabilità è ampiamente documentata. Il solutore quindi fa uso delle librerie di soluzione di MatLab® avvalendosi principalmente della tecnologia delle matrici sparse (nello specifico il pacchetto UMFPACK di Timothy A. Davis), sfruttando nei modelli con pochi gradi di libertà la ben nota libreria numerica LAPACK anche essa a disposizione all'interno di MatLab® e per quanto concerne la soluzione del problema agli autovalori (analisi modale) per matrici sparse al pacchetto ARPACK.

Il solutore dispone di diversi elementi finiti tra cui particolare rilevanza assumono gli elementi monodimensionali BEAM, bidimensionali SHELL (PIASTRA o MEMBRANA) e USER (PALO, PLINTO SU PALI e ISOLATORI).

- l'elemento BEAM oltre a supportare le classiche funzionalità di disassamento e della deformabilità a taglio (vedi elementi tozzi), porta in conto la posizione effettiva del centro di taglio ottenendo l'effetto torcente di una sollecitazione tagliante eccentrica rispetto ad esso; quando è su suolo alla Winkler tiene in conto la spazialità dell'effetto del terreno in direzione ortogonale all'asse dell'elemento
- l'elemento SHELL tiene conto anche del disassamento e per azioni nel proprio piano si avvale della teoria descritta nell'articolo di A.Ibrahimbegovic, E.Wilson e R.Taylor "A robust quadrilateral membrane finite element with drilling degrees of freedom" che porta in conto la rigidità intorno all'asse ortogonale al piano dell'elemento, caratteristica peraltro assente nella maggioranza dei solutori in commercio
- l'elemento USER dal punto di vista del solutore è fondamentalmente una matrice delle rigidità, una matrice delle masse e una matrice di forze nodali equivalenti; questo elemento offre la possibilità di modellare elementi complessi non contemplati dal solutore vero e proprio, con tale elemento, ad esempio, sono stati modellati i PALI ed i PLINTI SU PALI, basati sulle equazioni di MINDLIN per un elemento immerso in un semispazio elastico con estensione rispetto alla stratigrafia e gli ISOLATORI

Via Borgo, 29 – 82030 Ponte (BN)
Tel/Fax: +39.0824.874.392 Mail: info@soft.lab.it P.IVA 00893670620





www.soft.lab.it



L'analisi con i contributi del secondo ordine viene realizzata aggiornando la matrice di rigidezza elastica del sistema con i contributi della matrice di rigidezza geometrica.

L'analisi statica non lineare (PushOver) si basa sul solutore Non lineare, riconosciuto a livello internazionale, Seismstruct del prof. Pinho.

Alcuni esempi di validazione si trovano nella Relazione Tecnica e nel manuale.

In fase di input, su ogni dato, viene eseguito un controllo di compatibilità. Un ulteriore procedura di controllo può essere lanciata dall'utente in modo da individuare tutti gli errori gravi e i principali difetti della modellazione. Analoghi controlli vengono eseguiti da IperSpace BIM e inSide in fase di calcolo prima della preparazione dei dati per il solutore. Apposite procedure di controllo sono predisposte per il dimensionamento e verifica degli elementi in c.a., acciaio, legno, etc. Tali controlli riguardano l'esito della verifica: vengono segnalati, per via numerica e grafica, i casi in contrasto con le comuni tecniche costruttive e gli errori di dimensionamento che bloccano lo sviluppo delle fasi successive della progettazione, (ad esempio il disegno esecutivo).

Ulteriori funzioni, a disposizione dell'utente, agevolano il controllo dei dati e dei risultati. E' possibile eseguire una funzione di ricerca su tutte le proprietà (geometriche, fisiche, di carico, ecc.) del modello individuando gli elementi interessati. Si possono rappresentare ed interrogare graficamente, in ogni sezione desiderata, tutti i risultati dell'analisi e del dimensionamento strutturale. Nel caso sismico viene evidenziata la posizione del centro di massa e delle rigidezze del sistema con disegno della ellisse delle rigidezze, per dare la possibilità all'utente di valutare eventuali irregolarità strutturali. Per gli edifici è possibile, per ogni piano, a partire dalle fondazioni, conoscere la risultante delle azioni verticali e orizzontali. Analisi particolari come la ricerca di labilità interne o la ricerca di cinematismi consentono all'utente di ricercare eventuali anomalie nella struttura.

ing. Dario Nicola Pica
 Amministratore Unico



7 CARATTERIZZAZIONE GEOTECNICA DEI TERRENI

I **parametri geotecnici di calcolo** utilizzati nelle verifiche geotecniche sono i seguenti valori indicati tra parentesi, corrispondenti ai valori medi del range di variabilità indicati per ogni unità geotecnica d'interesse:

Unità geotecnica	Descrizione	γ_n (kN/m ³)	c' (kPa)	ϕ (°)	E (MPa)
Ug1a	Ghiaia in matrice sabbiosa e sabbia con ghiaia	18-20 (19)	0-5 (3)	27-34 (30)	10-40 (25)
Ug1	Ghiaia in matrice sabbiosa	19-21 (20)	0	35-40 (37)	70-130 <25m 150-200 >25m (100)

Ug2	Sabbia e sabbia limosa con ghiaia	18-20 (19)	0-10 (5)	30-35 (32)	80-130 <25m 150-200 >25m (100)
-----	--------------------------------------	---------------	-------------	---------------	--------------------------------------

T.1 Parametri geotecnici

Le unità geotecniche Ug3 ed Ug4 sono presenti oltre i 45m, dunque non sono interessate direttamente dalle opere in progetto.

Il livello della falda risulta essere sempre profondo lungo l'intero intervento, tra i 20÷35 m di profondità rispetto al piano campagna. Pertanto, le verifiche sono state condotte trascurando la presenza della falda, in quanto non interessata direttamente o indirettamente dalla costruzione dell'opera.

Il terreno spingente è costituito da materiale idoneo per la costruzione del rilevato, caratterizzato dai seguenti parametri geotecnici:

- Peso per unità di volume: $\gamma = 20,00 \text{ kN/m}^3$
- Angolo di attrito interno: $\phi = 37,00^\circ$
- Coesione efficace: $c' = 0,00 \text{ kN/m}^2$

A favore di sicurezza i calcoli e le verifiche sono stati effettuati considerando il terreno di fondazione di tipo **UG1a** con i seguenti valori:

- Peso per unità di volume: $\gamma = 19,00 \text{ kN/m}^3$
- Angolo di attrito interno: $\phi = 30,00^\circ$
- Coesione efficace: $c' = 0,00 \text{ kN/m}^2$
- Modulo di elasticità: $E = 25 \text{ MPa}$

8 ZONIZZAZIONE E CARATTERIZZAZIONE SIMSICA

8.1 VITA NOMINALE

La vita nominale di progetto V_N di un'opera è convenzionalmente definita come il numero di anni nel quale è previsto che l'opera, purché soggetta alla necessaria manutenzione, mantenga specifici livelli prestazionali.

I valori minimi di V_N da adottare per i diversi tipi di costruzione sono riportati nella Tab. 2.4.I delle NTC2018. Tali valori possono saranno impiegati anche per definire le azioni dipendenti dal tempo.

Tab. 2.4.I – Valori minimi della Vita nominale V_N di progetto per i diversi tipi di costruzioni

TIPI DI COSTRUZIONI		Valori minimi di V_N (anni)
1	Costruzioni temporanee e provvisorie	10
2	Costruzioni con livelli di prestazioni ordinari	50
3	Costruzioni con livelli di prestazioni elevati	100

Nel caso in oggetto, l'opera ricade nella definizione di "**Costruzioni con livelli di prestazioni elevati**".

La vita nominale viene pertanto assunta: $V_N = 100$ anni.

8.2 CLASSE D'USO

Il DM 17/01/2018 al punto 2.4.2 attribuisce alle costruzioni, in funzione della loro destinazione d'uso e quindi delle conseguenze di una interruzione di operatività o di un'eventuale collasso in conseguenza di un evento sismico, diverse classi d'uso. Nel caso in oggetto si fa riferimento alla Classe IV: "*Costruzioni con funzioni pubbliche o strategiche importanti, anche con riferimento alla gestione della protezione civile in caso di calamità. Industrie con attività particolarmente pericolose per l'ambiente. Reti viarie di tipo A o B, di cui al DM 5/11/2001, n. 6792, "Norme funzionali e geometriche per la costruzione delle strade", e di tipo C quando appartenenti ad itinerari di collegamento tra capoluoghi di provincia non altresì serviti da strade di tipo A o B. Ponti e reti ferroviarie di importanza critica per il mantenimento delle vie di comunicazione, particolarmente dopo un evento sismico. Dighe connesse al funzionamento di acquedotti e a impianti di produzione di energia elettrica.*"

Il coefficiente d'uso risulta pertanto: $C_U = 2$.

8.3 PERIODO DI RIFERIMENTO PER L'AZIONE SISMICA

Le azioni sismiche su ciascuna costruzione vengono valutate in relazione ad un periodo di riferimento V_R che si ricava, per ciascun tipo di costruzione, moltiplicandone la vita nominale V_N per il coefficiente d'uso C_U .

Per l'opera in progetto si ottiene pertanto il periodo di riferimento: $V_R = V_N \times C_U = 100 \times 2 = 200$ anni.

8.4 PERICOLOSITÀ SISMICA DI BASE

Il progetto in esame ricade nel Comune di Gallarate. La pericolosità sismica, in accordo alle NTC 2018, è definita in termini di accelerazione orizzontale massima attesa a_g in condizioni di campo libero su sito di riferimento rigido con superficie topografica orizzontale, con riferimento a prefissate probabilità di eccedenza PVR, come definite al § 3.2.1 NTC 2018, nel periodo di riferimento V_R come definito al § 2.4 NTC 2018.

Considerando un periodo di riferimento $V_R = 200$ anni, uno stato limite di salvaguardia della vita (SLV) corrisponde a una probabilità di superamento PVR nel periodo di riferimento V_R pari al 10%.

I terreni presenti nell'area in esame appartengono alla categoria di sottosuolo C.

Per quanto riguarda il coefficiente topografico, per configurazioni topografiche semplici, si può adottare la classificazione come da Tabella 3.2.III delle NTC 2018; nel caso in esame (Superficie pianeggiante, pendii e rilievi isolati con inclinazione media $i \leq 15^\circ$) si considera la categoria T1.

Il coefficiente S che tiene conto della categoria di sottosuolo e delle condizioni topografiche viene definito mediante la relazione seguente:

$$S = S_S \times S_T$$

con

S_S = coefficiente di amplificazione stratigrafica

S_T = coefficiente di amplificazione topografica

Tab. 3.2.V – Valori massimi del coefficiente di amplificazione topografica S_T

Categoria topografica	Ubicazione dell'opera o dell'intervento	S_T
T1	-	1,0
T2	In corrispondenza della sommità del pendio	1,2
T3	In corrispondenza della cresta di un rilievo con pendenza media minore o uguale a 30°	1,2
T4	In corrispondenza della cresta di un rilievo con pendenza media maggiore di 30°	1,4

Tab. 3.2.IV – Espressioni di S_S e di C_C

Categoria sottosuolo	S_S	C_C
A	1,00	1,00
B	$1,00 \leq 1,40 - 0,40 \cdot F_o \cdot \frac{a_g}{g} \leq 1,20$	$1,10 \cdot (T_C^*)^{-0,20}$
C	$1,00 \leq 1,70 - 0,60 \cdot F_o \cdot \frac{a_g}{g} \leq 1,50$	$1,05 \cdot (T_C^*)^{-0,33}$
D	$0,90 \leq 2,40 - 1,50 \cdot F_o \cdot \frac{a_g}{g} \leq 1,80$	$1,25 \cdot (T_C^*)^{-0,50}$
E	$1,00 \leq 2,00 - 1,10 \cdot F_o \cdot \frac{a_g}{g} \leq 1,60$	$1,15 \cdot (T_C^*)^{-0,40}$

Nel caso specifico, riassumendo, si ha:

Categoria di suolo C
Categoria topografica T1
Coeff. di amplificazione stratigrafica S_S 1.50
Coefficiente di amplificazione topografica S_T 1.000
Coefficiente $S = S_S \times S_T$ 1.50

TABELLA 1 – PARAMETRI PER LA VALUTAZIONE DELL'AZIONE SISMICA

8.5 FATTORE DI STRUTTURA

A favore di sicurezza e visto il fatto che le opere in esame sono opere interrato, il calcolo e le verifiche sono state effettuate in campo elastico. Il fattore di struttura è stato pertanto posto pari a $q = 1,00$. Lo spettro di progetto adottato sarà pertanto identico allo spettro elastico.

Qui di seguito si riporta la sintesi delle scelte progettuali adottati con i tempi di ritorno dell'azione sismica identificati in funzione del singolo stato limite.

FASE 1. INDIVIDUAZIONE DELLA PERICOLOSITÀ DEL SITO

Ricerca per coordinate

LONGITUDINE

LATITUDINE

Ricerca per comune

REGIONE

PROVINCIA

COMUNE

Elaborazioni grafiche

Grafici spettri di risposta ▶▶▶

Variabilità dei parametri ▶▶▶

Elaborazioni numeriche

Tabella parametri ▶▶▶

Reticolo di riferimento



Controllo sul reticolo

- Sito esterno al reticolo
- Interpolazione su 3 nodi
- Interpolazione corretta

Interpolazione

superficie rigata ▼

La "Ricerca per comune" utilizza le ... coordinate ISTAT del comune per identificare il sito. Si sottolinea che ... all'interno del territorio comunale le azioni sismiche possono essere significativamente diverse da quelle così individuate e si consiglia, quindi, la "Ricerca per coordinate".

Nodi del reticolo intorno al sito

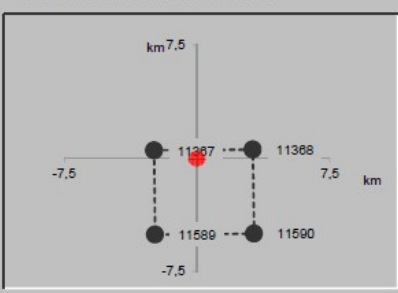

INTRO
FASE 1
FASE 2
FASE 3

Spettri di risposta elastici per i periodi di ritorno T_R di riferimento

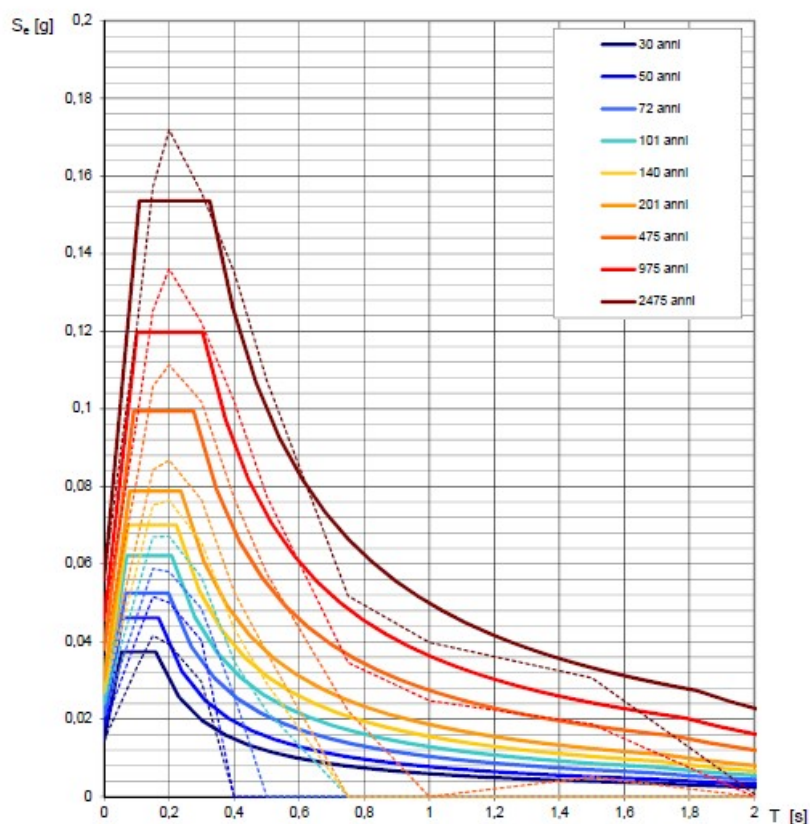

Valori dei parametri a_g , F_o , T_C^* per i periodi di ritorno T_R di riferimento

T_R [anni]	a_g [g]	F_o [-]	T_C^* [s]
30	0,015	2,564	0,159
50	0,018	2,534	0,167
72	0,021	2,502	0,198
101	0,024	2,587	0,207
140	0,027	2,596	0,222
201	0,030	2,603	0,236
475	0,038	2,619	0,276
975	0,046	2,632	0,303
2475	0,056	2,750	0,325

Valori dei parametri a_g , F_o , T_c^* : variabilità col periodo di ritorno T_R

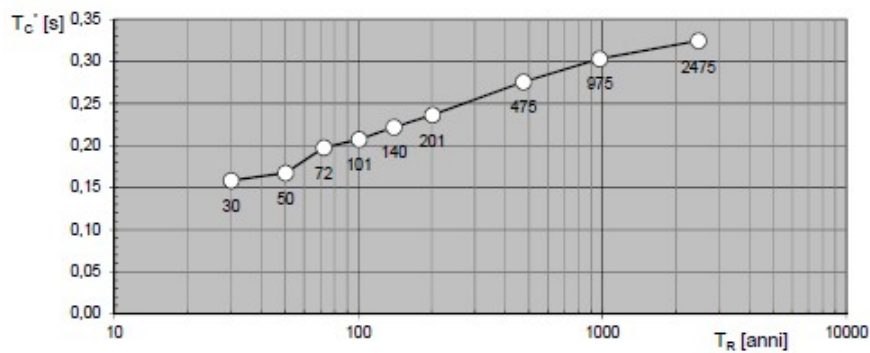
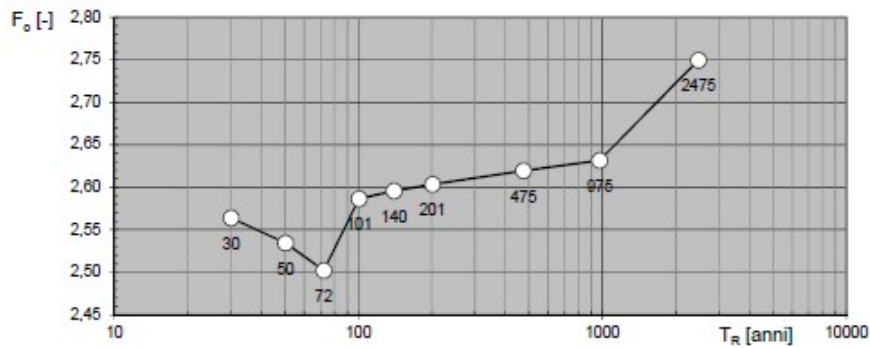
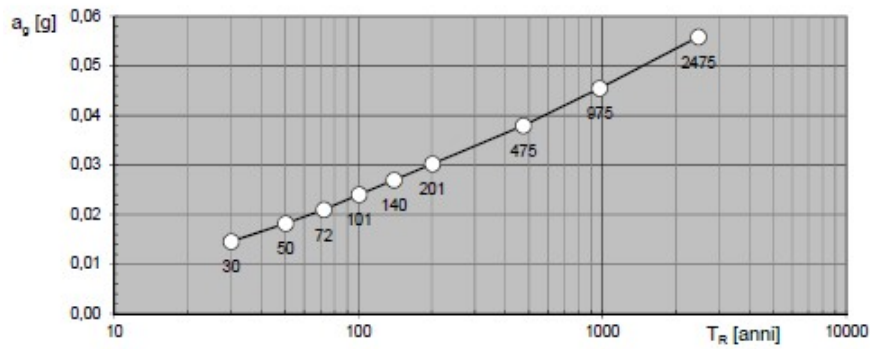

FASE 2. SCELTA DELLA STRATEGIA DI PROGETTAZIONE

Vita nominale della costruzione (in anni) - V_N info

Coefficiente d'uso della costruzione - c_U info

Valori di progetto

Periodo di riferimento per la costruzione (in anni) - V_R info

Periodi di ritorno per la definizione dell'azione sismica (in anni) - T_R info

Stati limite di esercizio - SLE	SLO - $P_{VR} = 81\%$	<input type="text" value="120"/>
	SLD - $P_{VR} = 63\%$	<input type="text" value="201"/>
Stati limite ultimi - SLU	SLV - $P_{VR} = 10\%$	<input type="text" value="1898"/>
	SLC - $P_{VR} = 5\%$	<input type="text" value="2475"/>

Elaborazioni

- Grafici parametri azione
- Grafici spettri di risposta
- Tabella parametri azione

Strategia di progettazione

Stato	Strategia per costruzioni ordinarie (TR [anni])	Strategia scelta (TR [anni])
SLO	~40	120
SLD	~60	201
SLV	~100	1898
SLC	~150	2475

LEGENDA GRAFICO

---□--- Strategia per costruzioni ordinarie

---□--- Strategia scelta

INTRO
FASE 1
FASE 2
FASE 3

Valori di progetto dei parametri a_g , F_o , T_C^* in funzione del periodo di ritorno T_R

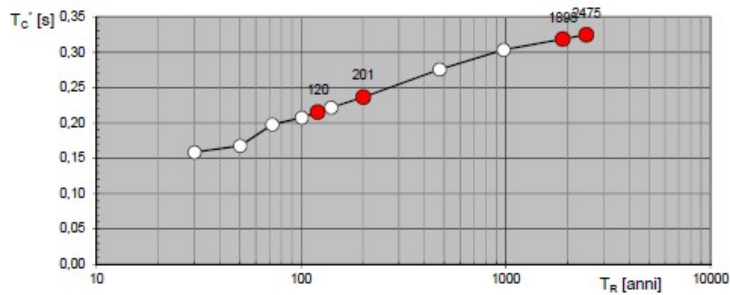
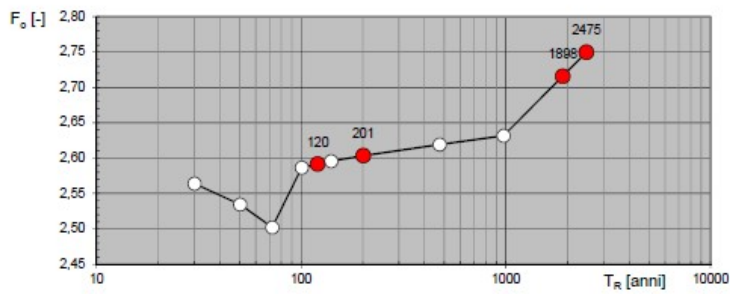
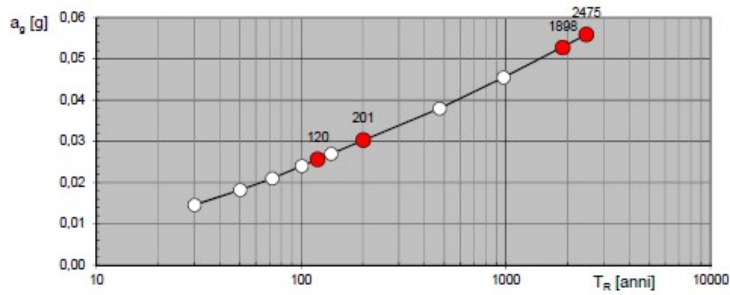

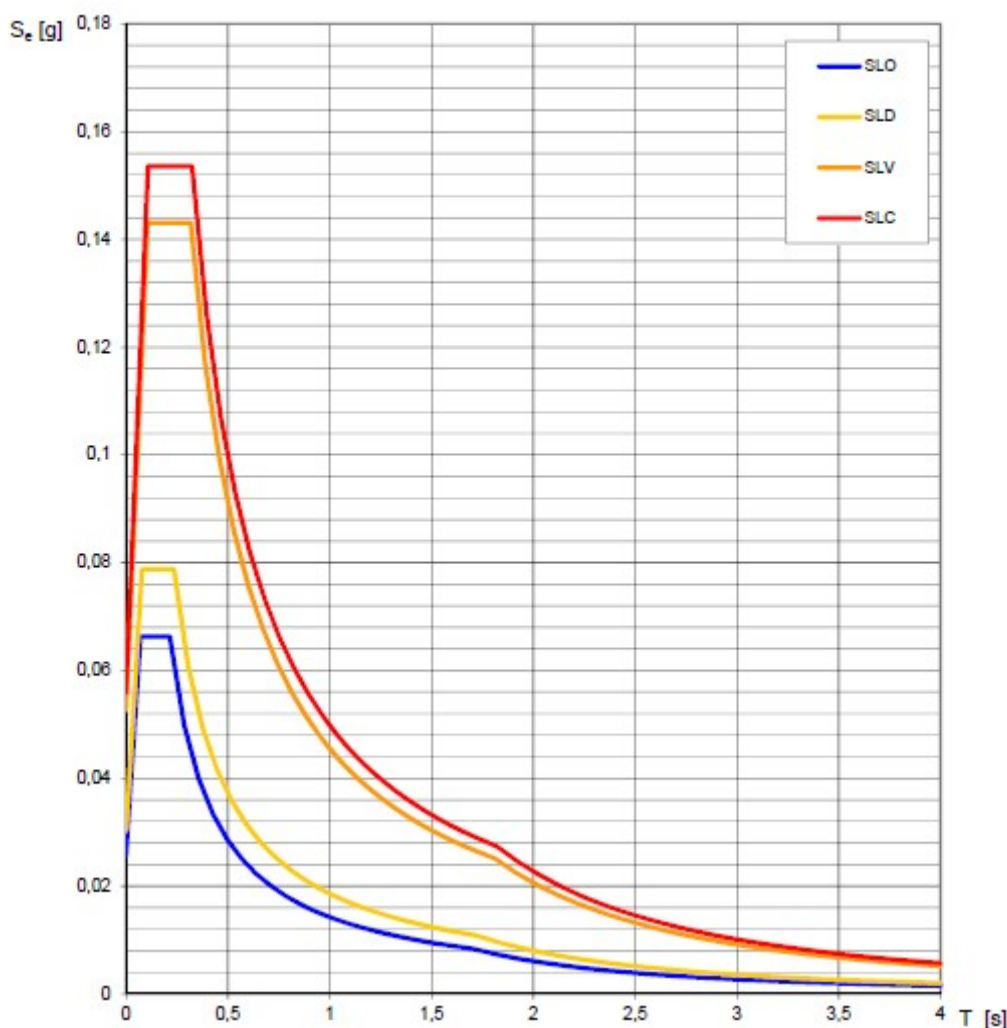
Spettri di risposta elastici per i diversi Stati Limite

Valori dei parametri a_g , F_o , T_C^* per i periodi di ritorno T_R associati a ciascuno SL

SLATO LIMITE	T_R [anni]	a_g [g]	F_o [-]	T_C^* [s]
SLO	120	0,026	2,592	0,215
SLD	201	0,030	2,603	0,236
SLV	1898	0,053	2,716	0,318
SLC	2475	0,056	2,750	0,325

Nell'immagine successiva è riportata la determinazione dei parametri dello spettro di risposta valutato per lo Stato Limite di Salvaguardia della Vita (SLV):

FASE 3. DETERMINAZIONE DELL'AZIONE DI PROGETTO

Stato Limite
Stato Limite considerato: **SLV** info

Risposta sismica locale
 Categoria di sottosuolo: **C** info $S_s = 1,500$ $C_c = 1,532$ info
 Categoria topografica: **T1** info $h/H = 0,000$ $S_T = 1,000$ info
(h=quota sito, H=altezza rilievo topografico)

Compon. orizzontale
 Spettro di progetto elastico (SLE) Smorzamento ξ (%): **5** $\eta = 1,000$ info
 Spettro di progetto inelastico (SLU) Fattore q_0 : **1** Regol. in altezza: **si** info

Compon. verticale
 Spettro di progetto Fattore q : **1** $\eta = 1/q = 1,000$ info

Elaborazioni
 Grafici spettri di risposta ▶▶▶
 Parametri e punti spettri di risposta ▶▶▶

$S_{d,o}$ [g]

$S_{d,v}$ [g]

S_e [g]

Spettri di risposta

— Spettro di progetto - componente orizzontale
— Spettro di progetto - componente verticale
— Spettro elastico di riferimento (Cat. A-T1, $\xi = 5\%$)

INTRO
FASE 1
FASE 2
FASE 3

Spettri di risposta (componenti orizz. e vert.) per lo stato limite: **SLV**

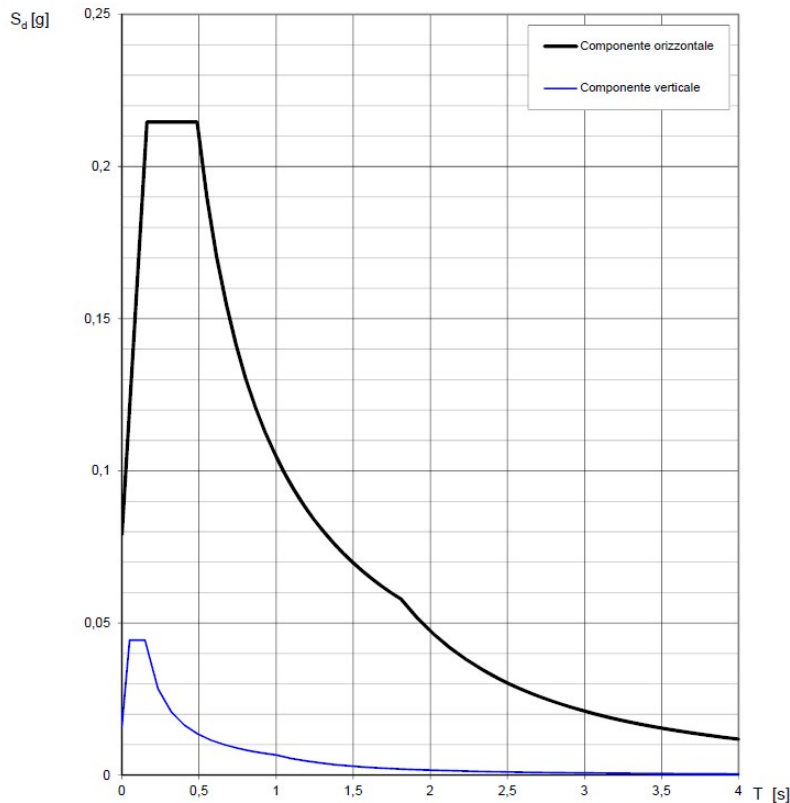

Parametri e punti dello spettro di risposta orizzontale per lo stato limite: SLV

Parametri indipendenti

STATO LIMITE	SLV
a_g	0,053 g
F_0	2,716
T_c	0,318 s
S_0	1,500
C_c	1,532
S_T	1,000
q	1,000

Parametri dipendenti

S	1,500
η	1,000
T_B	0,163 s
T_C	0,488 s
T_D	1,811 s

Espressioni dei parametri dipendenti

$$S = S_0 \cdot S_T \quad (\text{NTC-08 Eq. 3.2.5})$$

$$\eta = \sqrt{10 / (5 + \xi)} \geq 0,55; \quad \eta = 1/q \quad (\text{NTC-08 Eq. 3.2.6; §. 3.2.3.5})$$

$$T_B = T_C / 3 \quad (\text{NTC-07 Eq. 3.2.8})$$

$$T_C = C_c \cdot T_c^* \quad (\text{NTC-07 Eq. 3.2.7})$$

$$T_D = 4,0 \cdot a_g / g + 1,6 \quad (\text{NTC-07 Eq. 3.2.9})$$

Espressioni dello spettro di risposta (NTC-08 Eq. 3.2.4)

$$0 \leq T < T_B \quad S_e(T) = a_g \cdot S \cdot \eta \cdot F_0 \cdot \left[\frac{T}{T_B} + \frac{1}{\eta \cdot F_0} \left(1 - \frac{T}{T_B} \right) \right]$$

$$T_B \leq T < T_C \quad S_e(T) = a_g \cdot S \cdot \eta \cdot F_0$$

$$T_C \leq T < T_D \quad S_e(T) = a_g \cdot S \cdot \eta \cdot F_0 \cdot \left(\frac{T_C}{T} \right)$$

$$T_D \leq T \quad S_e(T) = a_g \cdot S \cdot \eta \cdot F_0 \cdot \left(\frac{T_C \cdot T_D}{T^2} \right)$$

Lo spettro di progetto $S_d(T)$ per le verifiche agli Stati Limite Ultimi è ottenuto dalle espressioni dello spettro elastico $S_e(T)$ sostituendo η con $1/q$, dove q è il fattore di struttura. (NTC-08 § 3.2.3.5)

Punti dello spettro di risposta

T [s]	Se [g]
0,000	0,079
0,163	0,215
0,488	0,215
0,551	0,190
0,614	0,171
0,677	0,155
0,740	0,142
0,803	0,130
0,866	0,121
0,929	0,113
0,992	0,106
1,055	0,099
1,118	0,094
1,181	0,089
1,244	0,084
1,307	0,080
1,370	0,076
1,433	0,073
1,496	0,070
1,559	0,067
1,622	0,065
1,685	0,062
1,748	0,060
1,811	0,058
1,915	0,052
2,019	0,046
2,124	0,042
2,228	0,038
2,332	0,035
2,436	0,032
2,541	0,029
2,645	0,027
2,749	0,025
2,853	0,023
2,958	0,022
3,062	0,020
3,166	0,019
3,270	0,018
3,375	0,017
3,479	0,016
3,583	0,015
3,687	0,014
3,792	0,013
3,896	0,012
4,000	0,012

8.6 DEFINIZIONE DEI COEFFICIENTI SISMICI DI CALCOLO

Nell'analisi pseudo-statica, l'azione sismica è rappresentata da una forza statica equivalente pari al prodotto delle forze di gravità per un opportuno coefficiente sismico.

Nelle verifiche, i valori dei coefficienti sismici orizzontale k_h e verticale k_v sono stati valutati mediante le espressioni

$$k_h = \beta_m \cdot \frac{a_{max}}{g} \quad [7.11.6]$$

$$k_v = \pm 0,5 \cdot k_h \quad [7.11.7]$$

dove

β_m = coefficiente di riduzione dell'accelerazione massima attesa al sito;

a_{max} = accelerazione orizzontale massima attesa al sito;

γ = accelerazione di gravità.

L'accelerazione massima è stata valutata con la relazione

$$a_{max} = S \cdot a_g = (S_S \cdot S_T) \cdot a_g \quad [7.11.8]$$

dove

S = coefficiente che comprende l'effetto dell'amplificazione stratigrafica (S_S) e dell'amplificazione topografica (S_T), di cui al § 3.2.3.2 delle NTC 2018;

a_g = accelerazione orizzontale massima attesa su sito di riferimento rigido.

Nella precedente espressione, il coefficiente di riduzione dell'accelerazione massima attesa al sito è pari a 1 in quanto trattasi di muri non liberi di subire spostamenti relativi rispetto al terreno.

L'accelerazione massima al suolo è pari a:

$$a_{max} = S \times a_g = 1.5 \times 0.053 = 0.079 \text{ g}$$

da cui il coefficiente sismico orizzontale k_h :

$$k_h = \beta_m \times a_{max}/g = 1 \times 0.079 = 0.079$$

$$k_v = k_h / 2 = 0.040$$

9 CRITERI DI VERIFICA

9.1 VERIFICA AGLI STATI LIMITE ULTIMI

La verifica di resistenza delle sezioni nei vari elementi strutturali, viene condotta tenendo conto delle sollecitazioni più gravose che si individuano nelle diverse combinazioni di carico.

Le verifiche si basano sul concetto dei coefficienti di sicurezza parziali e considerano due famiglie di combinazioni (indicate come A1-M1 e A2-M2) generate con le seguenti modalità:

Caso A1-M1: in questo tipo di combinazioni vengono incrementati le azioni permanenti e variabili con i coefficienti (γ_G , γ_Q) e vengono lasciate inalterate le caratteristiche di resistenza del terreno. Le combinazioni ottenute sono rilevanti per stabilire la capacità strutturale delle opere che interagiscono con il terreno.

Caso A2-M2: in questo tipo di combinazioni vengono incrementati i carichi variabili e vengono ridotte le caratteristiche di resistenza del terreno ($\text{tg}(\Phi)$, c' o c_u) secondo i coefficienti parziali ($\gamma_{\tan\Phi}$, $\gamma_{c'}$, γ_{c_u} , q_u) definiti da normativa. Le combinazioni ottenute sono rilevanti per il dimensionamento geotecnico.

Le combinazioni e i coefficienti moltiplicativi delle singole azioni vengono definiti in base a quanto indicato al paragrafo 5.1.3.14. del D.M.17/01/18.

Nei successivi paragrafi saranno condotte le verifiche per le condizioni di carico più gravose (considerando le combinazioni di carico che portano rispettivamente ai valori massimi di azione assiale, momento flettente e taglio), nelle sezioni significative.

9.2 VERIFICA AGLI STATI LIMITE DI ESERCIZIO

Definizione degli stati limite di fessurazione

Ai fini delle verifiche degli stati limite di esercizio si definiscono le seguenti combinazioni (D.M. del 17.01.2018 par.2.5.3):

$$\text{Rara)} \Rightarrow G1+G2 +Qk1+\sum i\psi 0i \cdot Qki$$

$$\text{Frequente)} \Rightarrow G1+G2 +\psi 11 \cdot Qk1+\sum i\psi 2i \cdot Qki$$

$$\text{Quasi permanente)} \Rightarrow G1+G2 +\psi 21 \cdot Qk1+\sum i\psi 2i \cdot Qki +\sum i\psi 2i \cdot Qki$$

Le condizioni ambientali, ai fini della protezione contro la corrosione delle armature, sono suddivise in ordinarie, aggressive e molto aggressive in relazione a quanto indicato dalla Tab. 4.1.III delle NTC2018.

Tab. 4.1.III – Descrizione delle condizioni ambientali

Condizioni ambientali	Classe di esposizione
Ordinarie	X0, XC1, XC2, XC3, XF1
Aggressive	XC4, XD1, XS1, XA1, XA2, XF2, XF3
Molto aggressive	XD2, XD3, XS2, XS3, XA3, XF4

Per le opere della presente relazione con condizioni ambientali molto aggressive si ha:

Elevazione/Fondazione

Verifiche a fessurazione – condizioni ambientali molto aggressive – armatura poco sensibile:

Combinazione di azioni frequente: $wk \leq w1 = 0.2 \text{ mm}$

Combinazione di azioni quasi permanente: $wk \leq w1 = 0.2 \text{ mm}$

10 MODELLAZIONE STRUTTURALE

10.1 SCHEMATIZZAZIONE DELLA SOVRASTRUTTURA E DEI VINCOLI

Le analisi di sollecitazione e le verifiche sono state condotte utilizzando il software IPERSPACE BIM 4.0.0 prodotto e distribuito dalla Soft.Lab S.r.l con sede in Ponte (BN).

I modelli matematici delle strutture analizzate, i dettagli dei quali sono riportati nei rispettivi allegati, sono stati realizzati utilizzando elementi bidimensionali secondo i criteri che seguono:

- elementi bidimensionali tipo guscio a 3 o 4 nodi;
- elementi bidimensionali tipo guscio su suolo elastico alla Winkler a 3 o 4 nodi;

L' interazione terreno - struttura è schematizzata mediante apposite molle di opportuna rigidità. In particolare, in funzione delle caratteristiche geotecniche del terreno, è stata considerata una schematizzazione alla Winkler considerando un coefficiente di sottofondo verticale $ks,v = 7.500,00 \text{ kN/m}^3$.

10.2 MODELLAZIONE DEI MATERIALI

I materiali considerati hanno comportamento elastico lineare in fase di calcolo delle sollecitazioni.

10.3 MODELLAZIONE DEI VINCOLI ESTERNI E DEGLI SVINCOLI INTERNI

I vincoli esterni sono considerati puntuali e sono costituiti da vincoli rigidi o da molle a comportamento elastico lineare a simulare il suolo elastico alla Winkler.

10.4 MODELLO DI CALCOLO

È stato assemblato un modello tridimensionale agli elementi finiti secondo le modalità descritte in precedenza. Si riportano qui di seguito alcune viste del modello nella rappresentazione con ingombri:

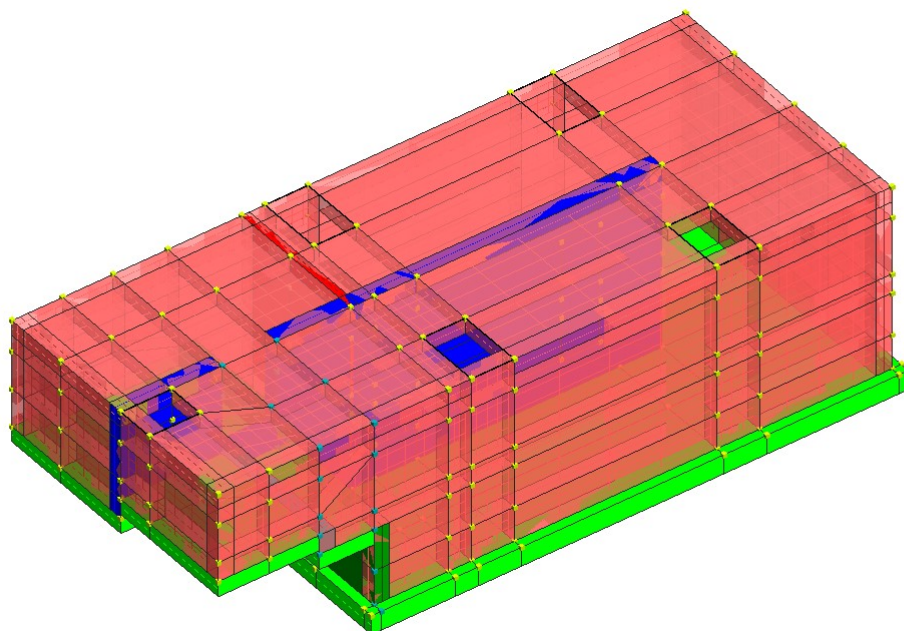

vista completa del modello

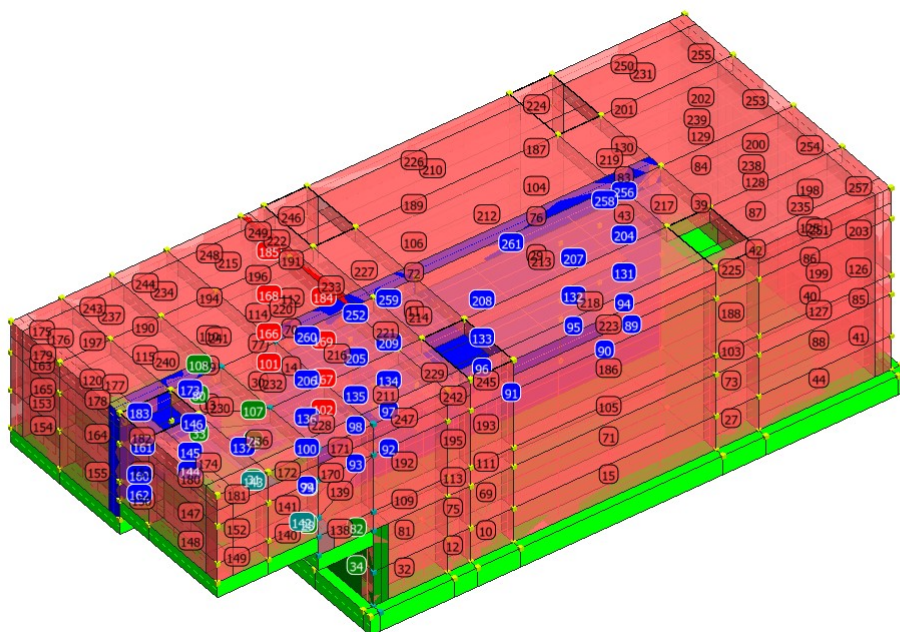

vista del modello con numerazione degli shell muri verticali e soletta di copertura

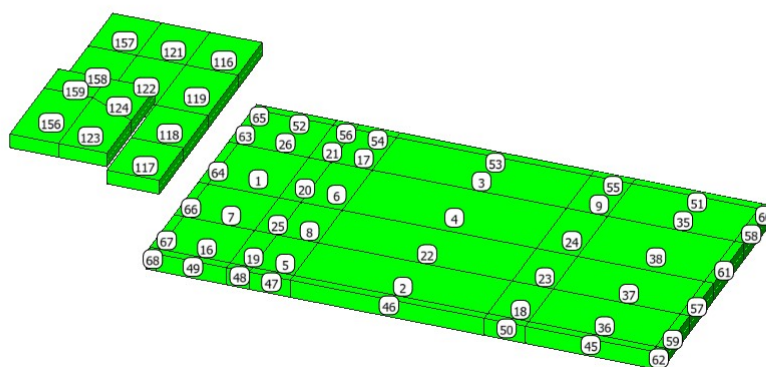

vista fem del modello con numerazione degli shell platea

11 ANALISI DEI CARICHI

11.1 CARICHI PERMANENTI STRUTTURALI

11.1.1 PESO PROPRIO DELLE STRUTTURE IN CEMENTO ARMATO

Il peso per unità di volume delle strutture in cemento armato è assunto pari a $\gamma_{ca} = 25,00 \text{ kN/m}^3$. Il peso proprio degli elementi strutturali è assegnato automaticamente dal software di calcolo agli elementi finiti sulla base delle caratteristiche geometriche e delle caratteristiche dei materiali assegnate ai singoli elementi (beam e/o shell).

Tale carico nel modello è definitivo come "g1"

11.2 CARICHI PERMANENTI NON STRUTTURALI

11.2.1 PESO DEL MAGRONE IN FONDAZIONE

Il peso per unità di volume del magrone in calcestruzzo è assunto pari a $\gamma_{csi} = 22,00 \text{ kN/m}^3$. Il magrone in calcestruzzo, nella vasca di prima pioggia, è presente nella zona a quota -2.50 m.

Lo spessore medio complessivo di tale ringrosso è assunto pari a **40 cm**. In ogni caso il valore considerato nei calcoli è stato opportunamente, a favore di sicurezza, incrementato per tenere conto di possibili minime differenze tra il progettato e l'as-built.

Tale carico nel modello è definitivo come "g2".

$$g2 = 22 \text{ kN/m}^3 \times 0,40 \text{ m} = 0,88 \text{ kN/m}^2.$$

11.2.2 PESO CHIUSINI IN GHISA

Per il chiusino in ghisa è stato considerato un peso $P_{chiusino} = 0,40 \text{ kN}$ come da valori di catalogo dei principali fornitori (il valore considerato nei calcoli è stato opportunamente incrementato a favore di sicurezza), con distribuzione lineare sulle aste del modello pari a 0,20 kN/m

11.2.3 PESO IN COPERTURA

Sulla soletta di copertura è stato applicato un carico uniformemente distribuito pari a:

$$\text{Peso} = 2,00 \text{ kN/m}^2.$$

11.2.4 SPINTA SULLE PARETI DOVUTA AL TERRENO

Si prevede l'ipotesi di un terreno avente angolo di attrito $\phi = 37^\circ$, coesione nulla ed un peso di volume $\gamma = 19 \text{ kN/m}^3$; il coefficiente di spinta viene calcolato, considerando l'elevata rigidità della struttura, utilizzando la formula $Ko=1-\sin\phi'$, per cui si ottiene un valore di $Ko= 0,40$.

11.3 AZIONI VARIABILI Q

11.3.1 AZIONI VARIABILI SULLA SOLETTA DI COPERTURA

E' stato assunto un carico accidentale agente sulla soletta di copertura della vasca pari a **30,00 kN/m²** (soletta carrabile).

11.3.2 SPINTA LATERALE DOVUTA AI SOVRACCARICHI ACCIDENTALI

La spinta agente sui piedritti è stata assunta pari a pari a:

$$p1 = 5 \text{ kN/m}^2.$$

11.3.3 CARICHI ACCIDENTALI IN PLATEA

E' stata assunta pari a pari a = 6 kN/m².

11.3.4 PESO DELL'ACQUA

E' stata assunta pari a $a = 20 \text{ kN/m}^2$ con spinta idrostatica sulle pareti.

11.3.5 AZIONI INDOTTE DALLE VARIAZIONI TERMICHE

Si considera una variazione termica uniforme pari a $15 \text{ }^\circ\text{C}$

11.4 AZIONE SISMICA

L'inerzia della struttura dovuta all'azione sismica è computata automaticamente dal software di calcolo utilizzato.

La sovraspinta sismica del terreno è calcolata con la teoria di Mononobe-Okabe.

Nell'analisi pseudo-statica, l'azione sismica è rappresentata da una forza statica equivalente pari al prodotto delle forze di gravità per un opportuno coefficiente sismico.

Nelle verifiche, i valori dei coefficienti sismici orizzontale k_h e verticale k_v sono stati valutati mediante le espressioni

$$k_h = \beta_m \cdot \frac{a_{\max}}{g} \quad [7.11.6]$$

$$k_v = \pm 0,5 \cdot k_h \quad [7.11.7]$$

dove

β_m = coefficiente di riduzione dell'accelerazione massima attesa al sito;

a_{\max} = accelerazione orizzontale massima attesa al sito;

γ = accelerazione di gravità.

L'accelerazione massima è stata valutata con la relazione

$$a_{\max} = S \cdot a_g = (S_S \cdot S_T) \cdot a_g \quad [7.11.8]$$

dove

S = coefficiente che comprende l'effetto dell'amplificazione stratigrafica (S_S) e dell'amplificazione topografica (S_T), di cui al § 3.2.3.2 delle NTC 2018;

a_g = accelerazione orizzontale massima attesa su sito di riferimento rigido.

Nella precedente espressione, il coefficiente di riduzione dell'accelerazione massima attesa al sito è pari a 1 in quanto trattasi di muri non liberi di subire spostamenti relativi rispetto al terreno.

L'accelerazione massima al suolo è pari a:

$$a_{\max} = S \times a_g = 1,5 \times 0,053 = 0,079 \text{ g}$$

da cui il coefficiente sismico orizzontale k_h :

$$k_h = \beta_m \times a_{\max}/g = 1 \times 0,079 = 0,079$$

12 COMBINAZIONI DI CARICO

Le combinazioni di carico considerate ai fini delle verifiche sono stabilite in modo da garantire la sicurezza in conformità a quanto prescritto al Cap. 2 delle NTC 2018.

L' approccio seguito per il calcolo e verifica dell' opera è l' **Approccio 2** con la combinazione dei coefficienti parziali **A1+M1+R3** (D.M. 17/01/2018 cap.6.4.3.1).

13 VERIFICHE STRUTTURALI

Si riportano di seguito i diagrammi delle deformate e gli involuipi delle sollecitazioni SLU/SLV massimi e minimi. A seguire sono riportati i tabulati di verifica.

Tipo diagramma: Deformata
 Combinazione corrente: Scenario Copia di Set_NT_2018 A2_SLV_SLD_STR_GEO - C.3

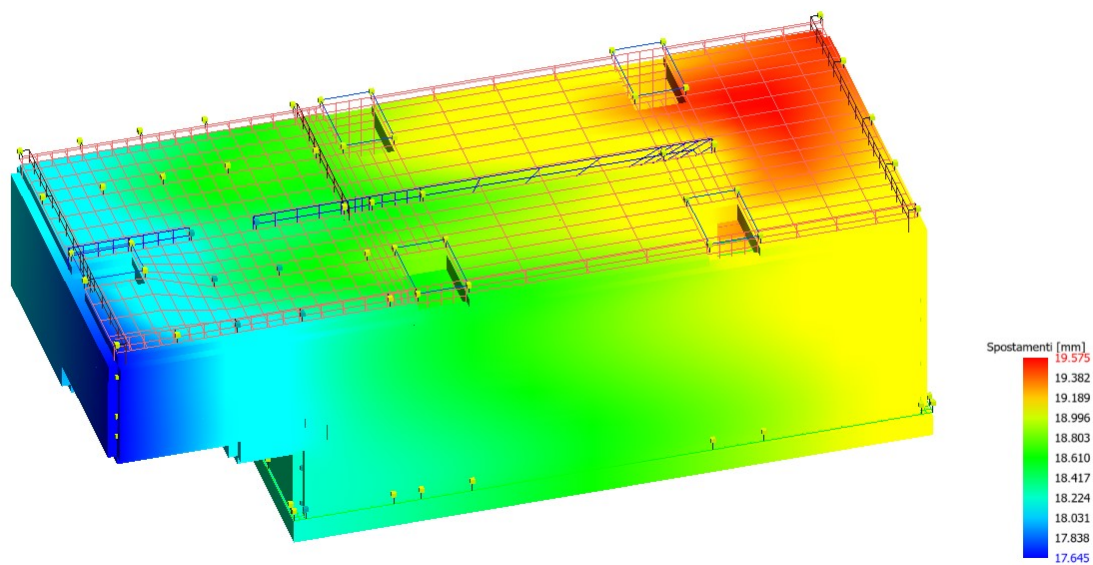

deformate allo SLU/SLV

Tipo diagramma: Deformata
 Combinazione corrente : Scenario Copia di Set_NT_2018 A2_SLV_SLD_STR_GEO - C 7

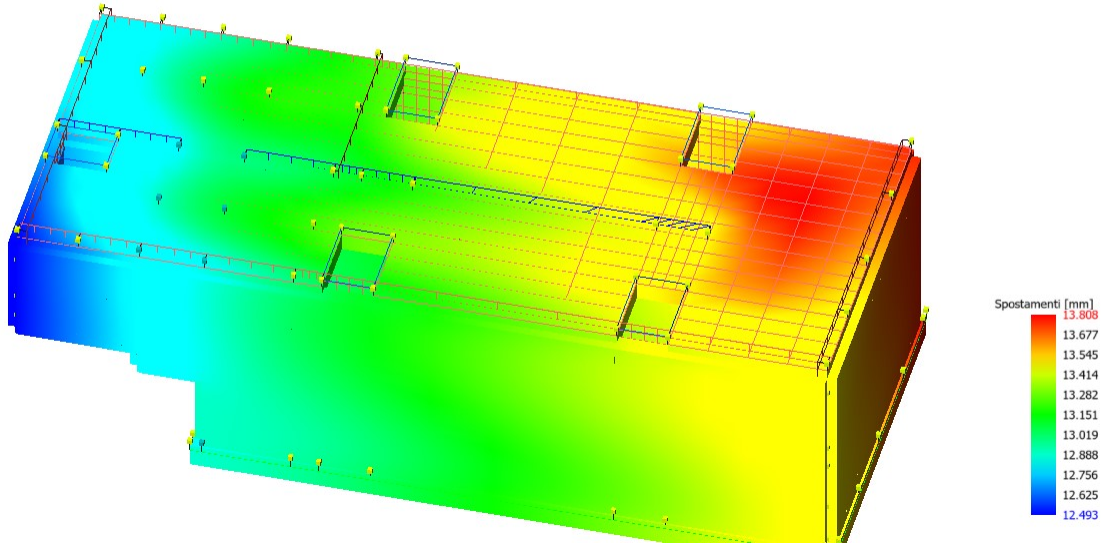

deformate allo SLE combinazione rara

Tipo diagramma: Sollecitazioni
 Combinazione corrente : Scenario Copia di Set_NT_2018 A2_SLV_SLD_STR_GEO - C 3
 Sollecitazione aste: Momento fl.Y - pilastri/pali: Momento fl.Y
 Sollecitazione Muri: M1
 Sollecitazione Setti: Momento fl.Z



Diagramma del momento flettente M1 allo SLU

Tipo diagramma: Sollecitazioni
 Combinazione corrente: Scenario Copia di Set_NT_2018 A2_SLV_SLD_STR_GEO - C.3
 Sollecitazione aste: Momento fl.Y - pilastri/pali: Momento fl.Y
 Sollecitazioni Muri: M II
 Sollecitazione Setti: Momento fl.Z

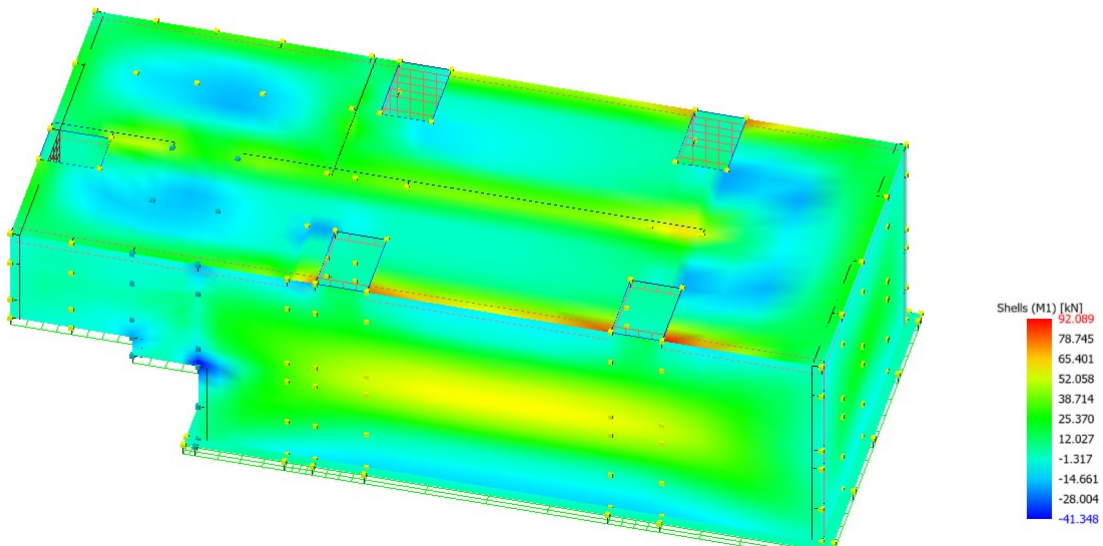

Diagramma del momento flettente M2 allo SLU

Criteria di verifica

Criterio di verifica: CLS Muri ND		
Generici		
Resistenza caratteristica Rck	daN/cm ²	450
Tensione caratteristica snervamento acciaio fyk	daN/cm ²	4500
Deformazione unitaria ε _{c0}		0.002
Deformazione ultima ε _{cu}		0.0035
ε _{fu} (solo incrudimento)		0.01
Modulo elastico E acciaio	daN/cm ²	2E06
Copriferro di calcolo	cm	5.0
Copriferro di disegno	cm	3.5
Coefficiente di sicurezza γ _{ClS}		1.5
Coefficiente di sicurezza γ _{Acc}		1.15
Riduzione f _{cd} calcestruzzo		0.85
Usa staffe minime di normativa in assenza di sisma		Si
Usa staffe minime di normativa in presenza di sisma		Si
Generici N.T.		
Inclinazione bielle compresse cotg(θ)		1.00
Modello acciaio		Elasto-plastico
Elemento esistente		No
Generici D.M. 96 T.A.		
Tensione ammissibile σ _c	daN/cm ²	122.5
Tensione ammissibile σ _c in trazione	daN/cm ²	26.4
Tensione ammissibile σ _c acciaio	daN/cm ²	2600.0
Tensione tangenziale ammissibile τ _{c0}	daN/cm ²	7.3
Tensione tangenziale massima τ _{c1}	daN/cm ²	21.1
Coefficiente di omogeneizzazione n		15
Coefficiente di omogeneizzazione n in trazione		0.5
Sezione interamente reagente		No
Fessurazioni		
Verifica a decompressione		No
Verifica formazione fessure		No
Verifica aperture fessure		Si

Classe di esposizione		XD3
Tipo armatura		Poco sensibile
Combinazione Rara		No
W ammissibile Combinazione Rara	mm	
Combinazione QP		Si
W ammissibile Combinazione QP	mm	0.200
Combinazione Freq.		Si
W ammissibile Combinazione Freq.	mm	0.200
Valore caratteristico apertura fessure $w_k(*w_m)$		1
f_c efficace	daN/cm ²	30.99
Coefficiente di breve o lunga durata k_t		0.40
Coefficiente di aderenza k_1		0.80
Tensioni ammissibili di esercizio		
Verifica Combinazione Rara		Si
Tensione ammissibile σ_{Cl}	daN/cm ²	199
Tensione ammissibile $\sigma_{Acciaio}$	daN/cm ²	3600
Verifica Combinazione QP		Si
Tensione ammissibile σ_{Cl}	daN/cm ²	149
Tensione ammissibile $\sigma_{Acciaio}$	daN/cm ²	3600
Verifica Combinazione Freq.		Si
Tensione ammissibile σ_{Cl}	daN/cm ²	149
Tensione ammissibile $\sigma_{Acciaio}$	daN/cm ²	3600
Coefficienti di omogeneizzazione		
Acciaio - Cls compresso		15
Cls teso - Cls compresso		0.5
Armatura muri		
Minima percentuale armatura rispetto al Cls in direzione X	%	0.1
Minima percentuale armatura rispetto al Cls in direzione Y	%	0.1
Massima percentuale armatura rispetto al Cls in direzione X	%	2
Massima percentuale armatura rispetto al Cls in direzione Y	%	2
Verifica muri		
Step incremento armatura	cmq	0.01
Verifica muri come pareti		No

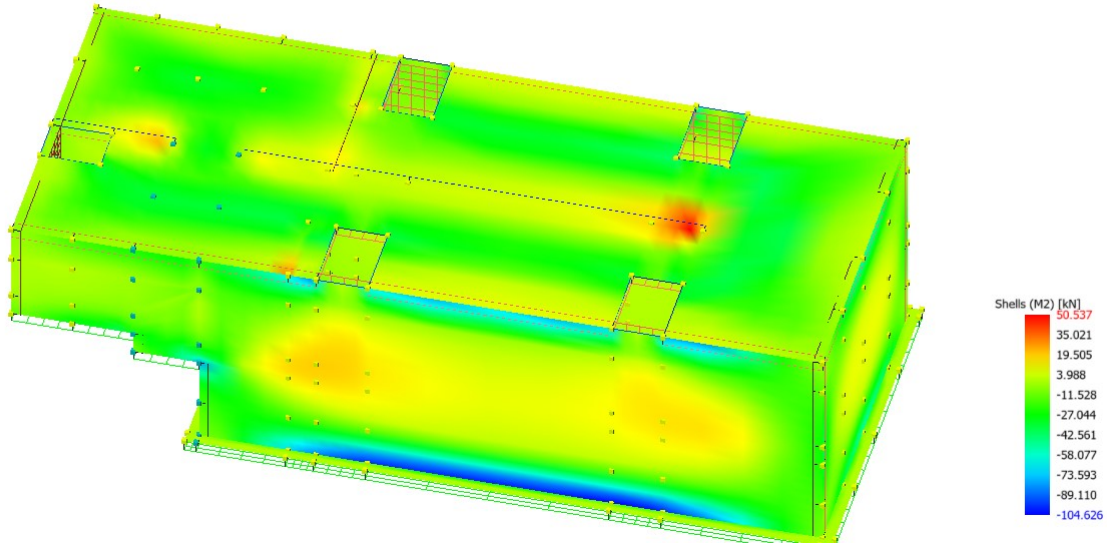
Criterio di verifica: CLS Platee ND		
Generici		
Resistenza caratteristica R_{ck}	daN/cm ²	450
Tensione caratteristica snervamento acciaio f_{yk}	daN/cm ²	4500
Deformazione unitaria ϵ_{c0}		0.002
Deformazione ultima ϵ_{cu}		0.0035
ϵ_{fu} (solo incrudimento)		0.00214
Modulo elastico E acciaio	daN/cm ²	2E06
Copriferro di calcolo	cm	5.0
Copriferro di disegno	cm	3.5
Coefficiente di sicurezza γ_{Cl}		1.5
Coefficiente di sicurezza γ_{Acc}		1.15
Riduzione f_{cd} calcestruzzo		0.85
Usa staffe minime di normativa in assenza di sisma		Si
Usa staffe minime di normativa in presenza di sisma		Si
Generici N.T.		
Inclinazione bielle compresse $\cotg(\theta)$		1.00
Modello acciaio		Incrudente
Incrudimento E_y/E_0		0.000
Elemento esistente		No
Generici D.M. 96 T.A.		
Tensione ammissibile σ_c	daN/cm ²	122.5
Tensione ammissibile σ_c in trazione	daN/cm ²	26.4
Tensione ammissibile σ_c acciaio	daN/cm ²	2600.0
Tensione tangenziale ammissibile τ_{c0}	daN/cm ²	7.3
Tensione tangenziale massima τ_{c1}	daN/cm ²	21.1
Coefficiente di omogeneizzazione n		15
Coefficiente di omogeneizzazione n in trazione		0.5
Sezione interamente reagente		No
Fessurazioni		
Verifica a decompressione		No

Verifica formazione fessure		No
Verifica aperture fessure		Si
Classe di esposizione		XD3
Tipo armatura		Poco sensibile
Combinazione Rara		No
Combinazione QP		Si
W ammissibile Combinazione QP	mm	0.200
Combinazione Freq.		Si
W ammissibile Combinazione Freq.	mm	0.200
Valore caratteristico apertura fessure $w_k(*w_m)$		1
f_c efficace	daN/cm ²	30.99
Coefficiente di breve o lunga durata k_t		0.40
Coefficiente di aderenza k_1		0.80
Tensioni ammissibili di esercizio		
Verifica Combinazione Rara		Si
Tensione ammissibile σ_{Cl}	daN/cm ²	199
Tensione ammissibile $\sigma_{Acciaio}$	daN/cm ²	3600
Verifica Combinazione QP		Si
Tensione ammissibile σ_{Cl}	daN/cm ²	149
Tensione ammissibile $\sigma_{Acciaio}$	daN/cm ²	3600
Verifica Combinazione Freq.		No
Coefficienti di omogeneizzazione		
Acciaio - Cls compresso		15
Cls teso - Cls compresso		0.5
Armatura muri		
Minima percentuale armatura rispetto al Cls in direzione X	%	0.1
Minima percentuale armatura rispetto al Cls in direzione Y	%	0.1
Massima percentuale armatura rispetto al Cls in direzione X	%	2
Massima percentuale armatura rispetto al Cls in direzione Y	%	2
Verifica muri		
Step incremento armatura	cm ²	0.01
Verifica muri come pareti		No

PRESENTAZIONE DEI RISULTATI

Il sistema di riferimento globale rispetto al quale è stata riferita l'intera struttura è una terna di assi cartesiani sinistrorsa OXYZ (X,Y, e Z sono disposti e orientati rispettivamente secondo il pollice, l'indice ed il medio della mano destra, una volta posizionati questi ultimi a 90° tra loro).

La terna di riferimento locale per un'asta è pure una terna sinistrorsa O'xyz che ha l'asse x orientato dal nodo iniziale I dell'asta verso il nodo finale J e gli assi y e z diretti secondo gli assi geometrici della sezione con l'asse y orizzontale e orientato in modo da portarsi a coincidere con l'asse x a mezzo di una rotazione oraria di 90° e l'asse z di conseguenza.

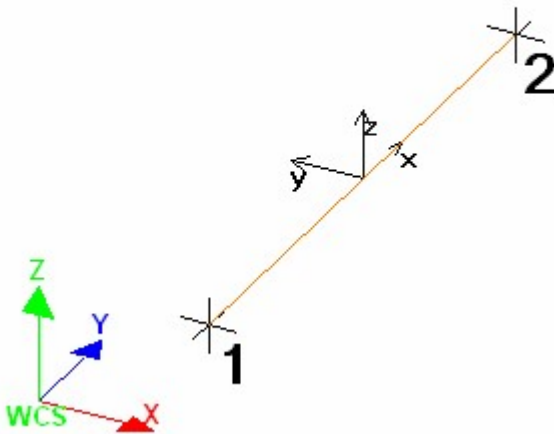

Per un'asta comunque disposta nello spazio la sua terna locale è orientata in modo tale da portarsi a coincidere con la terna globale a mezzo di rotazioni orarie degli assi locali inferiori a 180°.

- Le forze, sia sulle aste che sulle pareti o lastre, sono positive se opposte agli assi locali;
- Le forze nodali sono positive se opposte agli assi globali;
- Le coppie sono positive se sinistrorse.

Le caratteristiche di sollecitazione sono positive se sulla faccia di normale positiva sono rappresentate da vettori equiversi agli assi di riferimento locali; in particolare il vettore momento positivo rappresenta una coppia che ruota come le dita della mano destra che si chiudono quando il pollice è equi verso all'asse locale.

- Le traslazioni sono positive se concorde con gli assi globali;

- Le rotazioni sono positive se sinistrorse.
- Il sistema di riferimento locale per gli elementi bidimensionali è quello riportato in figura

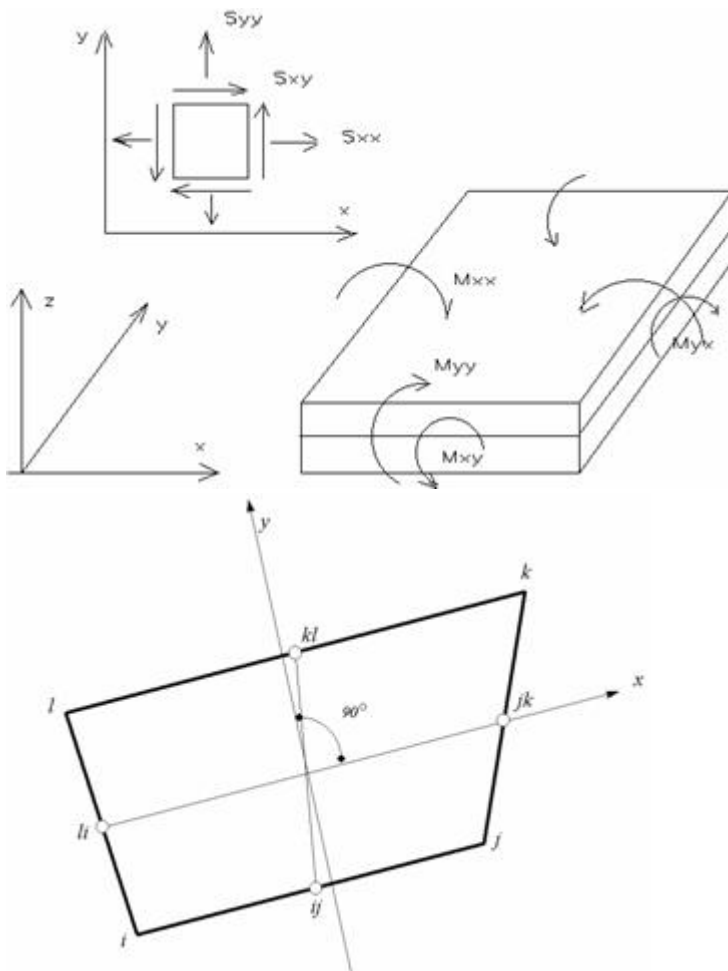

La terna locale per l'elemento shell è costituita dall'asse x locale che va dal nodo li al nodo jk, l'asse y è diretto secondo il piano dell'elemento e orientato verso il nodo l e l'asse z di conseguenza in modo da formare la solita terna sinistrorsa. L'asse z locale rappresenta la normale positiva all'elemento.

Le sollecitazioni dell'elemento sono:

a) sforzi membranali.

$$S_{xx} = s_x$$

$$S_{yy} = s_y$$

$$S_{xy} = t_{xy}$$

b) sforzi flessionali:

M_{xx} momento flettente che genera s_x , cioè intorno ad y.

M_{yy} momento flettente che genera s_y , cioè intorno ad x

M_{xy} momento torcente che genera t_{xy} .

Le sollecitazioni principali dell'elemento sono:

$$M_{1,2} = \frac{M_{xx} + M_{yy}}{2} \pm \sqrt{\left(\frac{M_{xx} - M_{yy}}{2}\right)^2 + M_{xy}^2}$$

$$S_{1,2} = \frac{S_{xx} + S_{yy}}{2} \pm \sqrt{\left(\frac{S_{xx} - S_{yy}}{2}\right)^2 + S_{xy}^2}$$

$$\tan 2\theta = \frac{M_{xy}}{M_{xx} - M_{yy}}$$

dove θ è l'angolo formato dagli assi principali di M1 e M2 con quelli di riferimento e

$$\tan 2\psi = \frac{S_{xy}}{S_{xx} - S_{yy}}$$

dove ψ è l'angolo formato dagli assi principali di S1 e S2 con quelli di riferimento

L'elemento shell usato come piastra dà i momenti flettenti e non i tagli in direzione ortogonale all'elemento che possono ottenersi come derivazione dei momenti flettenti;

$$T_{zx} = M_{xx,x} + M_{xy,y}$$

$$T_{zy} = M_{xy,y} + M_{yy,y}$$

quando invece viene usato come lastra ci restituisce una 's' costante ed una 't' costante non adatti a rappresentare momenti flettenti, ma solo sforzi normali e tagli nel piano della lastra.

Nodi - Geometria e vincoli

Nodo	X	Y	Z	Tx	Ty	Tz	Rx	Ry	Rz	Impalcato
	Coordinate [m]			Vincoli						
0	5.500	11.400	4.000	0	0	0	0	0	0	2
0	5.500	11.400	2.500	0	0	0	0	0	0	2
0	5.500	11.400	0.900	0	0	0	0	0	0	0
0	5.500	17.300	3.000	0	0	0	0	0	0	2
0	7.200	17.300	3.000	0	0	0	0	0	0	2
0	3.400	17.300	3.000	0	0	0	0	0	0	2
0	3.400	17.300	2.500	1	1	0	0	0	1	1
0	2.400	17.300	2.500	1	1	0	0	0	1	1
0	0.000	17.300	2.500	1	1	0	0	0	1	1
0	0.000	17.300	4.000	0	0	0	0	0	0	2
0	2.400	17.300	4.000	0	0	0	0	0	0	2
0	2.400	17.300	3.000	0	0	0	0	0	0	2
0	0.000	17.300	3.000	0	0	0	0	0	0	2
0	3.400	17.300	4.000	0	0	0	0	0	0	2
0	5.500	17.300	4.000	0	0	0	0	0	0	2
0	7.200	17.300	4.000	0	0	0	0	0	0	2
0	1.700	14.700	2.500	1	1	0	0	0	1	1
0	3.400	14.700	2.500	1	1	0	0	0	1	1
0	2.400	16.000	2.500	1	1	0	0	0	1	1
0	3.400	16.000	2.500	1	1	0	0	0	1	1
0	0.000	16.000	2.500	1	1	0	0	0	1	1
0	3.400	16.000	3.000	0	0	0	0	0	0	2
0	5.500	0.000	0.900	0	0	0	0	0	0	0
0	0.000	0.000	0.900	0	0	0	0	0	0	0
0	3.400	14.700	4.000	0	0	0	0	0	0	1
0	1.700	0.000	2.500	0	0	0	0	0	0	2
0	3.400	0.000	2.500	0	0	0	0	0	0	2
0	0.000	0.000	2.500	0	0	0	0	0	0	2

Nodo	X	Y	Z	Tx	Ty	Tz	Rx	Ry	Rz	Impalcato
0	5.500	0.000	2.500	0	0	0	0	0	0	2
0	7.200	0.000	2.500	0	0	0	0	0	0	2
0	0.000	9.700	4.000	0	0	0	0	0	0	2
0	0.000	4.500	4.000	0	0	0	0	0	0	2
0	7.200	3.400	4.000	0	0	0	0	0	0	2
0	7.200	4.500	4.000	0	0	0	0	0	0	2
0	0.000	0.000	4.000	0	0	0	0	0	0	2
0	1.700	0.000	4.000	0	0	0	0	0	0	2
0	3.400	0.000	4.000	0	0	0	0	0	0	2
0	7.200	16.000	4.000	0	0	0	0	0	0	2
0	0.000	16.000	4.000	0	0	0	0	0	0	2
0	0.000	10.800	4.000	0	0	0	0	0	0	2
0	5.500	0.000	4.000	0	0	0	0	0	0	2
0	7.200	0.000	4.000	0	0	0	0	0	0	2
0	3.400	16.000	4.000	0	0	0	0	0	0	2
0	7.200	14.700	4.000	0	0	0	0	0	0	2
0	0.000	14.700	4.000	0	0	0	0	0	0	2
0	3.400	3.400	4.000	0	0	0	0	0	0	2
0	7.200	10.800	4.000	0	0	0	0	0	0	2
0	3.400	10.800	4.000	0	0	0	0	0	0	2
0	3.400	11.400	4.000	0	0	0	0	0	0	2
0	3.400	5.000	4.000	0	0	0	0	0	0	2
0	7.200	11.400	4.000	0	0	0	0	0	0	2
0	0.000	11.400	4.000	0	0	0	0	0	0	2
0	0.000	13.300	4.000	0	0	0	0	0	0	2
0	3.400	6.000	4.000	0	0	0	0	0	0	2
0	3.400	9.700	4.000	0	0	0	0	0	0	2
0	7.200	13.300	4.000	0	0	0	0	0	0	2
0	3.400	13.300	4.000	0	0	0	0	0	0	2
0	7.200	9.700	4.000	0	0	0	0	0	0	2
0	0.000	3.400	4.000	0	0	0	0	0	0	2
0	0.000	14.700	2.500	1	1	0	0	0	1	1
1	-0.250	-0.250	0.000	1	1	0	0	0	1	0
1	0.000	9.700	4.800	0	0	0	0	0	0	2
2	0.000	4.500	4.800	0	0	0	0	0	0	2
2	0.000	-0.250	0.000	1	1	0	0	0	1	0
3	3.400	13.300	4.800	0	0	0	0	0	0	2
3	1.700	-0.250	0.000	1	1	0	0	0	1	0
4	7.200	3.400	4.800	0	0	0	0	0	0	2
4	3.400	-0.250	0.000	1	1	0	0	0	1	0
5	0.000	3.400	4.800	0	0	0	0	0	0	2
5	5.500	-0.250	0.000	1	1	0	0	0	1	0
6	7.200	4.500	4.800	0	0	0	0	0	0	2
6	7.200	-0.250	0.000	1	1	0	0	0	1	0
7	5.500	13.300	4.800	0	0	0	0	0	0	2
7	7.450	-0.250	0.000	1	1	0	0	0	1	0
8	7.200	9.700	4.800	0	0	0	0	0	0	2
8	-0.250	0.000	0.000	1	1	0	0	0	1	0
9	1.700	4.500	4.800	0	0	0	0	0	0	2
9	0.000	0.000	0.000	1	1	0	0	0	1	0
10	1.700	0.000	0.000	1	1	0	0	0	1	0
10	3.400	4.500	4.800	0	0	0	0	0	0	2
11	1.700	11.400	4.800	0	0	0	0	0	0	2
11	3.400	0.000	0.000	1	1	0	0	0	1	0
12	5.500	0.000	0.000	1	1	0	0	0	1	0
12	1.700	13.300	4.800	0	0	0	0	0	0	2
13	7.200	0.000	0.000	1	1	0	0	0	1	0
13	7.200	13.300	4.800	0	0	0	0	0	0	2
14	7.450	0.000	0.000	1	1	0	0	0	1	0
14	1.700	3.400	4.800	0	0	0	0	0	0	2
15	3.400	9.700	4.800	0	0	0	0	0	0	2

Nodo	X	Y	Z	Tx	Ty	Tz	Rx	Ry	Rz	Impalcato
15	-0.250	3.400	0.000	1	1	0	0	0	1	0
16	1.700	9.700	4.800	0	0	0	0	0	0	2
16	0.000	3.400	0.000	1	1	0	0	0	1	0
17	0.000	13.300	4.800	0	0	0	0	0	0	2
17	1.700	3.400	0.000	1	1	0	0	0	1	0
18	0.000	11.400	4.800	0	0	0	0	0	0	2
18	3.400	3.400	0.000	1	1	0	0	0	1	0
19	5.500	3.400	0.000	1	1	0	0	0	1	0
19	5.500	11.400	4.800	0	0	0	0	0	0	2
20	7.200	3.400	0.000	1	1	0	0	0	1	0
20	7.200	11.400	4.800	0	0	0	0	0	0	2
21	7.450	3.400	0.000	1	1	0	0	0	1	0
21	3.400	11.400	4.800	0	0	0	0	0	0	2
22	1.700	10.800	4.800	0	0	0	0	0	0	2
22	-0.250	4.500	0.000	1	1	0	0	0	1	0
23	5.500	9.700	4.800	0	0	0	0	0	0	2
23	0.000	4.500	0.000	1	1	0	0	0	1	0
24	1.700	4.500	0.000	1	1	0	0	0	1	0
24	5.500	4.500	4.800	0	0	0	0	0	0	2
25	3.400	4.500	0.000	1	1	0	0	0	1	0
25	5.500	3.400	4.800	0	0	0	0	0	0	2
26	5.500	4.500	0.000	1	1	0	0	0	1	0
26	3.400	10.800	4.800	0	0	0	0	0	0	2
27	7.200	4.500	0.000	1	1	0	0	0	1	0
27	3.400	3.400	4.800	0	0	0	0	0	0	2
28	7.450	4.500	0.000	1	1	0	0	0	1	0
28	7.200	10.800	4.800	0	0	0	0	0	0	2
29	5.500	10.800	4.800	0	0	0	0	0	0	2
30	0.000	14.700	4.800	0	0	0	0	0	0	2
31	-0.250	9.700	0.000	1	1	0	0	0	1	0
31	2.400	16.000	4.800	0	0	0	0	0	0	2
32	0.000	9.700	0.000	1	1	0	0	0	1	0
32	1.700	14.700	4.800	0	0	0	0	0	0	2
33	1.700	9.700	0.000	1	1	0	0	0	1	0
33	7.200	14.700	4.800	0	0	0	0	0	0	2
34	3.400	9.700	0.000	1	1	0	0	0	1	0
34	3.400	16.000	4.800	0	0	0	0	0	0	2
35	5.500	14.700	4.800	0	0	0	0	0	0	2
35	5.500	9.700	0.000	1	1	0	0	0	1	0
36	7.200	16.000	4.800	0	0	0	0	0	0	2
36	7.200	9.700	0.000	1	1	0	0	0	1	0
37	3.400	14.700	4.800	0	0	0	0	0	0	2
37	7.450	9.700	0.000	1	1	0	0	0	1	0
38	-0.250	10.800	0.000	1	1	0	0	0	1	0
38	7.200	0.000	4.800	0	0	0	0	0	0	2
39	0.000	10.800	4.800	0	0	0	0	0	0	2
39	0.000	10.800	0.000	1	1	0	0	0	1	0
40	0.000	16.000	4.800	0	0	0	0	0	0	2
40	1.700	10.800	0.000	1	1	0	0	0	1	0
41	3.400	10.800	0.000	1	1	0	0	0	1	0
41	5.500	16.000	4.800	0	0	0	0	0	0	2
42	5.500	0.000	4.800	0	0	0	0	0	0	2
42	5.500	10.800	0.000	1	1	0	0	0	1	0
43	7.200	10.800	0.000	1	1	0	0	0	1	0
43	3.400	0.000	4.800	0	0	0	0	0	0	2
44	0.000	0.000	4.800	0	0	0	0	0	0	2
44	7.450	10.800	0.000	1	1	0	0	0	1	0
45	-0.250	11.400	0.000	1	1	0	0	0	1	0
45	1.700	0.000	4.800	0	0	0	0	0	0	2
46	0.000	11.400	0.000	1	1	0	0	0	1	0
46	2.400	17.300	4.800	0	0	0	0	0	0	2

Nodo	X	Y	Z	Tx	Ty	Tz	Rx	Ry	Rz	Impalcato
47	0.000	17.300	4.800	0	0	0	0	0	0	2
47	1.700	11.400	0.000	1	1	0	0	0	1	0
48	7.200	17.300	4.800	0	0	0	0	0	0	2
48	3.400	11.400	0.000	1	1	0	0	0	1	0
49	5.500	11.400	0.000	1	1	0	0	0	1	0
49	5.500	17.300	4.800	0	0	0	0	0	0	2
50	3.400	17.300	4.800	0	0	0	0	0	0	2
50	7.200	11.400	0.000	1	1	0	0	0	1	0
51	7.450	11.400	0.000	1	1	0	0	0	1	0
52	-0.250	13.300	0.000	1	1	0	0	0	1	0
53	0.000	13.300	0.000	1	1	0	0	0	1	0
54	1.700	13.300	0.000	1	1	0	0	0	1	0
55	3.400	13.300	0.000	1	1	0	0	0	1	0
56	5.500	13.300	0.000	1	1	0	0	0	1	0
57	7.200	13.300	0.000	1	1	0	0	0	1	0
58	7.450	13.300	0.000	1	1	0	0	0	1	0
59	-0.250	13.550	0.000	1	1	0	0	0	1	0
60	0.000	13.550	0.000	1	1	0	0	0	1	0
61	1.700	13.550	0.000	1	1	0	0	0	1	0
62	3.400	13.550	0.000	1	1	0	0	0	1	0
63	5.500	13.550	0.000	1	1	0	0	0	1	0
64	7.200	13.550	0.000	1	1	0	0	0	1	0
65	7.450	13.550	0.000	1	1	0	0	0	1	0
77	0.000	3.400	0.900	0	0	0	0	0	0	0
78	3.400	5.000	0.900	0	0	0	0	0	0	0
79	3.400	3.400	0.900	0	0	0	0	0	0	0
80	3.400	10.800	0.900	0	0	0	0	0	0	0
81	3.400	9.700	0.900	0	0	0	0	0	0	0
82	5.500	13.300	0.900	0	0	0	0	0	0	0
83	3.400	13.300	0.900	0	0	0	0	0	0	0
84	3.400	11.400	0.900	0	0	0	0	0	0	0
85	1.700	13.300	0.900	0	0	0	0	0	0	0
86	7.200	13.300	0.900	0	0	0	0	0	0	0
87	7.200	11.400	0.900	0	0	0	0	0	0	0
88	0.000	13.300	0.900	0	0	0	0	0	0	0
89	0.000	11.400	0.900	0	0	0	0	0	0	0
90	7.200	9.700	0.900	0	0	0	0	0	0	0
91	7.200	10.800	0.900	0	0	0	0	0	0	0
92	0.000	10.800	0.900	0	0	0	0	0	0	0
93	0.000	9.700	0.900	0	0	0	0	0	0	0
94	0.000	4.500	0.900	0	0	0	0	0	0	0
95	7.200	3.400	0.900	0	0	0	0	0	0	0
96	7.200	4.500	0.900	0	0	0	0	0	0	0
97	3.400	6.000	0.900	0	0	0	0	0	0	0
98	7.200	0.000	0.900	0	0	0	0	0	0	0
99	1.700	0.000	0.900	0	0	0	0	0	0	0
100	3.400	0.000	0.900	0	0	0	0	0	0	0
109	0.000	0.000	2.000	0	0	0	0	0	0	1
110	1.700	0.000	2.000	0	0	0	0	0	0	1
111	3.400	0.000	2.000	0	0	0	0	0	0	1
112	5.500	0.000	2.000	0	0	0	0	0	0	1
113	7.200	0.000	2.000	0	0	0	0	0	0	1
116	0.000	3.400	2.000	0	0	0	0	0	0	1
118	3.400	3.400	2.000	0	0	0	0	0	0	1
120	7.200	3.400	2.000	0	0	0	0	0	0	1
123	0.000	4.500	2.000	0	0	0	0	0	0	1
127	7.200	4.500	2.000	0	0	0	0	0	0	1
129	3.400	5.000	2.000	0	0	0	0	0	0	0
130	3.400	6.000	2.000	0	0	0	0	0	0	0
132	0.000	9.700	2.000	0	0	0	0	0	0	1
134	3.400	9.700	2.000	0	0	0	0	0	0	0

Nodo	X	Y	Z	Tx	Ty	Tz	Rx	Ry	Rz	Impalcato
136	7.200	9.700	2.000	0	0	0	0	0	0	1
139	0.000	10.800	2.000	0	0	0	0	0	0	1
141	3.400	10.800	2.000	0	0	0	0	0	0	0
143	7.200	10.800	2.000	0	0	0	0	0	0	1
146	0.000	11.400	2.000	0	0	0	0	0	0	1
148	3.400	11.400	2.000	0	0	0	0	0	0	0
149	5.500	11.400	2.000	0	0	0	0	0	0	1
150	7.200	11.400	2.000	0	0	0	0	0	0	1
153	0.000	13.300	2.000	1	1	0	0	0	1	1
154	1.700	13.300	2.000	1	1	0	0	0	1	1
155	3.400	13.300	2.000	1	1	0	0	0	1	1
156	5.500	13.300	2.000	1	1	0	0	0	1	1
157	7.200	13.300	2.000	1	1	0	0	0	1	1
166	0.000	14.700	2.000	1	1	0	0	0	1	1
167	1.700	14.700	2.000	1	1	0	0	0	1	1
168	3.400	14.700	2.000	1	1	0	0	0	1	1
169	5.500	14.700	2.000	1	1	0	0	0	1	1
170	7.200	14.700	2.000	1	1	0	0	0	1	1
171	3.400	16.000	2.000	1	1	0	0	0	1	1
172	5.500	16.000	2.000	1	1	0	0	0	1	1
173	7.200	16.000	2.000	1	1	0	0	0	1	1
174	3.400	17.300	2.000	1	1	0	0	0	1	1
175	5.500	17.300	2.000	1	1	0	0	0	1	1
176	7.200	17.300	2.000	1	1	0	0	0	1	1
177	0.000	3.400	2.500	0	0	0	0	0	0	2
178	7.200	3.400	2.500	0	0	0	0	0	0	2
179	0.000	4.500	2.500	0	0	0	0	0	0	2
180	7.200	4.500	2.500	0	0	0	0	0	0	2
181	0.000	9.700	2.500	0	0	0	0	0	0	2
182	7.200	9.700	2.500	0	0	0	0	0	0	2
183	3.400	5.000	2.500	0	0	0	0	0	0	2
184	3.400	9.700	2.500	0	0	0	0	0	0	2
185	3.400	6.000	2.500	0	0	0	0	0	0	2
186	3.400	3.400	2.500	0	0	0	0	0	0	2
187	7.200	13.300	2.500	0	0	0	0	0	0	2
188	0.000	13.300	2.500	0	0	0	0	0	0	2
189	3.400	13.300	2.500	0	0	0	0	0	0	2
190	5.500	13.300	2.500	0	0	0	0	0	0	2
191	7.200	10.800	2.500	0	0	0	0	0	0	2
192	0.000	10.800	2.500	0	0	0	0	0	0	2
193	3.400	10.800	2.500	0	0	0	0	0	0	2
194	7.200	11.400	2.500	0	0	0	0	0	0	2
195	0.000	11.400	2.500	0	0	0	0	0	0	2
196	3.400	11.400	2.500	0	0	0	0	0	0	2
197	7.200	14.700	3.000	0	0	0	0	0	0	2
198	0.000	14.700	3.000	0	0	0	0	0	0	2
199	0.000	16.000	3.000	0	0	0	0	0	0	2
200	7.200	16.000	3.000	0	0	0	0	0	0	2

Aste - Carichi

Descrizione carichi aste

- UnifG Uniforme globale
- UnifL Uniforme locale
- VarG Variabile lineare globale
- VarL Variabile lineare locale
- PolG Poligonale globale
- Termico Distorsione termica
- Torcente Carico torcente
- Precomp. Carico da precompressione
- PolL Poligonale locale

Sezione	Ni	Nf	Cond.	Tipo c.	Xi	QXi	QYi	QZi	Xf	QXf	QYf	QZf
---------	----	----	-------	---------	----	-----	-----	-----	----	-----	-----	-----

Sezione	Ni	Nf	Cond.	Tipo c.	Xi	QXi	QYi	QZi	Xf	QXf	QYf	QZf
					m	car. dist. kN/m coppie torc. kN			m	car. dist. kN/m coppie torc. kN		
Trave 0												
Sezione Nulla	1	39	NEVE	UnifL	0.00	0.00	0.00	0.50	1.10	0.00	0.00	0.50
Sezione Nulla	1	39	botola	UnifG	0.00	0.00	0.00	0.50	1.10	0.00	0.00	0.50
Sezione Nulla	1	39	variabili copertura	UnifL	0.00	0.00	0.00	10.00	1.10	0.00	0.00	10.00
Sezione Nulla	2	9	NEVE	UnifL	0.00	0.00	0.00	0.50	1.70	0.00	0.00	0.50
Sezione Nulla	2	9	botola	UnifG	0.00	0.00	0.00	0.50	1.70	0.00	0.00	0.50
Sezione Nulla	2	9	variabili copertura	UnifL	0.00	0.00	0.00	10.00	1.70	0.00	0.00	10.00
Sezione Nulla	4	25	NEVE	UnifL	0.00	0.00	0.00	0.50	1.70	0.00	0.00	0.50
Sezione Nulla	4	25	botola	UnifG	0.00	0.00	0.00	0.50	1.70	0.00	0.00	0.50
Sezione Nulla	4	25	variabili copertura	UnifL	0.00	0.00	0.00	10.00	1.70	0.00	0.00	10.00
Sezione Nulla	5	2	NEVE	UnifL	0.00	0.00	0.00	0.50	1.10	0.00	0.00	0.50
Sezione Nulla	5	2	botola	UnifG	0.00	0.00	0.00	0.50	1.10	0.00	0.00	0.50
Sezione Nulla	5	2	variabili copertura	UnifL	0.00	0.00	0.00	10.00	1.10	0.00	0.00	10.00
Sezione Nulla	6	4	NEVE	UnifL	0.00	0.00	0.00	0.50	1.10	0.00	0.00	0.50
Sezione Nulla	6	4	botola	UnifG	0.00	0.00	0.00	0.50	1.10	0.00	0.00	0.50
Sezione Nulla	6	4	variabili copertura	UnifL	0.00	0.00	0.00	10.00	1.10	0.00	0.00	10.00
Sezione Nulla	8	23	NEVE	UnifL	0.00	0.00	0.00	0.50	1.70	0.00	0.00	0.50
Sezione Nulla	8	23	botola	UnifG	0.00	0.00	0.00	0.50	1.70	0.00	0.00	0.50
Sezione Nulla	8	23	variabili copertura	UnifL	0.00	0.00	0.00	10.00	1.70	0.00	0.00	10.00
Sezione Nulla	9	14	NEVE	UnifL	0.00	0.00	0.00	0.50	1.10	0.00	0.00	0.50
Sezione Nulla	9	14	botola	UnifG	0.00	0.00	0.00	0.50	1.10	0.00	0.00	0.50
Sezione Nulla	9	14	variabili copertura	UnifL	0.00	0.00	0.00	10.00	1.10	0.00	0.00	10.00
Sezione Nulla	14	5	NEVE	UnifL	0.00	0.00	0.00	0.50	1.70	0.00	0.00	0.50
Sezione Nulla	14	5	botola	UnifG	0.00	0.00	0.00	0.50	1.70	0.00	0.00	0.50
Sezione Nulla	14	5	variabili copertura	UnifL	0.00	0.00	0.00	10.00	1.70	0.00	0.00	10.00
Sezione Nulla	16	1	NEVE	UnifL	0.00	0.00	0.00	0.50	1.70	0.00	0.00	0.50
Sezione Nulla	16	1	botola	UnifG	0.00	0.00	0.00	0.50	1.70	0.00	0.00	0.50
Sezione Nulla	16	1	variabili copertura	UnifL	0.00	0.00	0.00	10.00	1.70	0.00	0.00	10.00
Sezione Nulla	22	16	NEVE	UnifL	0.00	0.00	0.00	0.50	1.10	0.00	0.00	0.50
Sezione Nulla	22	16	botola	UnifG	0.00	0.00	0.00	0.50	1.10	0.00	0.00	0.50
Sezione Nulla	22	16	variabili copertura	UnifL	0.00	0.00	0.00	10.00	1.10	0.00	0.00	10.00
Sezione Nulla	23	29	NEVE	UnifL	0.00	0.00	0.00	0.50	1.10	0.00	0.00	0.50
Sezione Nulla	23	29	botola	UnifG	0.00	0.00	0.00	0.50	1.10	0.00	0.00	0.50
Sezione Nulla	23	29	variabili copertura	UnifL	0.00	0.00	0.00	10.00	1.10	0.00	0.00	10.00
Sezione Nulla	24	6	NEVE	UnifL	0.00	0.00	0.00	0.50	1.70	0.00	0.00	0.50
Sezione Nulla	24	6	botola	UnifG	0.00	0.00	0.00	0.50	1.70	0.00	0.00	0.50
Sezione Nulla	24	6	variabili copertura	UnifL	0.00	0.00	0.00	10.00	1.70	0.00	0.00	10.00
Sezione Nulla	25	24	NEVE	UnifL	0.00	0.00	0.00	0.50	1.10	0.00	0.00	0.50
Sezione Nulla	25	24	botola	UnifG	0.00	0.00	0.00	0.50	1.10	0.00	0.00	0.50
Sezione Nulla	25	24	variabili copertura	UnifL	0.00	0.00	0.00	10.00	1.10	0.00	0.00	10.00
Sezione Nulla	28	8	NEVE	UnifL	0.00	0.00	0.00	0.50	1.10	0.00	0.00	0.50
Sezione Nulla	28	8	botola	UnifG	0.00	0.00	0.00	0.50	1.10	0.00	0.00	0.50
Sezione Nulla	28	8	variabili copertura	UnifL	0.00	0.00	0.00	10.00	1.10	0.00	0.00	10.00
Sezione Nulla	29	28	NEVE	UnifL	0.00	0.00	0.00	0.50	1.70	0.00	0.00	0.50
Sezione Nulla	29	28	botola	UnifG	0.00	0.00	0.00	0.50	1.70	0.00	0.00	0.50
Sezione Nulla	29	28	variabili copertura	UnifL	0.00	0.00	0.00	10.00	1.70	0.00	0.00	10.00
Sezione Nulla	31	34	NEVE	UnifL	0.00	0.00	0.00	0.50	1.00	0.00	0.00	0.50
Sezione Nulla	31	34	botola	UnifL	0.00	0.00	0.00	0.50	1.00	0.00	0.00	0.50
Sezione Nulla	31	34	variabili copertura	UnifL	0.00	0.00	0.00	10.00	1.00	0.00	0.00	10.00
Sezione Nulla	34	50	NEVE	UnifL	0.00	0.00	0.00	0.50	1.30	0.00	0.00	0.50
Sezione Nulla	34	50	botola	UnifL	0.00	0.00	0.00	0.50	1.30	0.00	0.00	0.50
Sezione Nulla	34	50	variabili copertura	UnifL	0.00	0.00	0.00	10.00	1.30	0.00	0.00	10.00
Sezione Nulla	39	22	NEVE	UnifL	0.00	0.00	0.00	0.50	1.70	0.00	0.00	0.50
Sezione Nulla	39	22	botola	UnifG	0.00	0.00	0.00	0.50	1.70	0.00	0.00	0.50
Sezione Nulla	39	22	variabili copertura	UnifL	0.00	0.00	0.00	10.00	1.70	0.00	0.00	10.00
Sezione Nulla	46	31	NEVE	UnifL	0.00	0.00	0.00	0.50	1.30	0.00	0.00	0.50
Sezione Nulla	46	31	botola	UnifL	0.00	0.00	0.00	0.50	1.30	0.00	0.00	0.50
Sezione Nulla	46	31	variabili copertura	UnifL	0.00	0.00	0.00	10.00	1.30	0.00	0.00	10.00
Sezione Nulla	50	46	NEVE	UnifL	0.00	0.00	0.00	0.50	1.00	0.00	0.00	0.50

Sezione	Ni	Nf	Cond.	Tipo c.	Xi	QXi	QYi	QZi	Xf	QXf	QYf	QZf
Sezione Nulla	50	46	botola	UnifL	0.00	0.00	0.00	0.50	1.00	0.00	0.00	0.50
Sezione Nulla	50	46	variabili copertura	UnifL	0.00	0.00	0.00	10.00	1.00	0.00	0.00	10.00

Pareti - geometria e vincoli

Parete	Nodi	Tipo	Materiale	Criterio	N.P.	N.P.X	N.P.Y	Spess.
								m
1	56-55-48-49	Platea	C35/45	CLS_Platee_ND	9			0.50
2	24-33-32-23	Platea	C35/45	CLS_Platee_ND	8			0.50
3	36-35-26-27	Platea	C35/45	CLS_Platee_ND	8			0.50
4	35-34-25-26	Platea	C35/45	CLS_Platee_ND	8			0.50
5	33-40-39-32	Platea	C35/45	CLS_Platee_ND	8			0.50
6	42-41-34-35	Platea	C35/45	CLS_Platee_ND	8			0.50
7	55-54-47-48	Platea	C35/45	CLS_Platee_ND	16			0.50
8	41-40-33-34	Platea	C35/45	CLS_Platee_ND	8			0.50
9	20-27-26-19	Platea	C35/45	CLS_Platee_ND	12			0.50
10	32-39-92-93	Discreto	C35/45	CLS_Muri_ND	16	4	4	0.40
11	27-96-90-36	Discreto	C35/45	CLS_Muri_ND	16	4	4	0.40
12	39-46-89-92	Discreto	C35/45	CLS_Muri_ND	16	4	4	0.40
13	50-87-86-57	Discreto	C35/45	CLS_Muri_ND	16	4	4	0.40
14	36-90-91-43	Discreto	C35/45	CLS_Muri_ND	16	4	4	0.40
15	23-32-93-94	Discreto	C35/45	CLS_Muri_ND	16	4	4	0.40
16	47-54-53-46	Platea	C35/45	CLS_Platee_ND	13			0.50
17	36-43-42-35	Platea	C35/45	CLS_Platee_ND	8			0.50
18	17-24-23-16	Platea	C35/45	CLS_Platee_ND	8			0.50
19	40-47-46-39	Platea	C35/45	CLS_Platee_ND	8			0.50
20	49-48-41-42	Platea	C35/45	CLS_Platee_ND	8			0.50
21	43-50-49-42	Platea	C35/45	CLS_Platee_ND	8			0.50
22	34-33-24-25	Platea	C35/45	CLS_Platee_ND	8			0.50
23	25-24-17-18	Platea	C35/45	CLS_Platee_ND	8			0.50
24	26-25-18-19	Platea	C35/45	CLS_Platee_ND	8			0.50
25	48-47-40-41	Platea	C35/45	CLS_Platee_ND	12			0.50
26	57-56-49-50	Platea	C35/45	CLS_Platee_ND	9			0.50
27	16-23-94-77	Discreto	C35/45	CLS_Muri_ND	16	4	4	0.40
28	54-55-83-85	Discreto	C35/45	CLS_Muri_ND	16	4	4	0.40
29	20-95-96-27	Discreto	C35/45	CLS_Muri_ND	16	4	4	0.40
30	43-91-87-50	Discreto	C35/45	CLS_Muri_ND	16	4	4	0.40
31	56-82-83-55	Discreto	C35/45	CLS_Muri_ND	16	4	4	0.40
32	46-53-88-89	Discreto	C35/45	CLS_Muri_ND	16	4	4	0.40
33	57-86-82-56	Discreto	C35/45	CLS_Muri_ND	16	4	4	0.40
34	53-54-85-88	Discreto	C35/45	CLS_Muri_ND	16	4	4	0.40
35	13-20-19-12	Platea	C35/45	CLS_Platee_ND	16			0.50
36	10-17-16-9	Platea	C35/45	CLS_Platee_ND	11			0.50
37	18-17-10-11	Platea	C35/45	CLS_Platee_ND	11			0.50
38	19-18-11-12	Platea	C35/45	CLS_Platee_ND	13			0.50
39	12-0-98-13	Discreto	C35/45	CLS_Muri_ND	16	4	4	0.40
40	10-99-100-11	Discreto	C35/45	CLS_Muri_ND	16	4	4	0.40
41	9-0-99-10	Discreto	C35/45	CLS_Muri_ND	16	4	4	0.40
42	11-100-0-12	Discreto	C35/45	CLS_Muri_ND	16	4	4	0.40
43	13-98-95-20	Discreto	C35/45	CLS_Muri_ND	16	4	4	0.40
44	9-16-77-0	Discreto	C35/45	CLS_Muri_ND	16	4	4	0.40
45	9-16-15-8	Platea	C35/45	CLS_Platee_ND	8			0.50
46	23-32-31-22	Platea	C35/45	CLS_Platee_ND	8			0.50
47	32-39-38-31	Platea	C35/45	CLS_Platee_ND	8			0.50
48	39-46-45-38	Platea	C35/45	CLS_Platee_ND	8			0.50
49	46-53-52-45	Platea	C35/45	CLS_Platee_ND	8			0.50
50	16-23-22-15	Platea	C35/45	CLS_Platee_ND	8			0.50
51	14-21-20-13	Platea	C35/45	CLS_Platee_ND	8			0.50
52	58-57-50-51	Platea	C35/45	CLS_Platee_ND	8			0.50
53	37-36-27-28	Platea	C35/45	CLS_Platee_ND	8			0.50
54	37-44-43-36	Platea	C35/45	CLS_Platee_ND	8			0.50

Parete	Nodi	Tipo	Materiale	Criterio	N.P.	N.P.X	N.P.Y	Spess.
55	21-28-27-20	Platea	C35/45	CLS_Platee_ND	8			0.50
56	44-51-50-43	Platea	C35/45	CLS_Platee_ND	8			0.50
57	11-10-3-4	Platea	C35/45	CLS_Platee_ND	8			0.50
58	6-13-12-5	Platea	C35/45	CLS_Platee_ND	8			0.50
59	3-10-9-2	Platea	C35/45	CLS_Platee_ND	8			0.50
60	7-14-13-6	Platea	C35/45	CLS_Platee_ND	4			0.50
61	12-11-4-5	Platea	C35/45	CLS_Platee_ND	8			0.50
62	2-9-8-1	Platea	C35/45	CLS_Platee_ND	4			0.50
63	64-63-56-57	Platea	C35/45	CLS_Platee_ND	8			0.50
64	63-62-55-56	Platea	C35/45	CLS_Platee_ND	8			0.50
65	65-64-57-58	Platea	C35/45	CLS_Platee_ND	4			0.50
66	62-61-54-55	Platea	C35/45	CLS_Platee_ND	8			0.50
67	54-61-60-53	Platea	C35/45	CLS_Platee_ND	8			0.50
68	53-60-59-52	Platea	C35/45	CLS_Platee_ND	4			0.50
69	93-92-139-132	Discreto	C35/45	CLS_Muri_ND	16	4	4	0.40
70	90-136-143-91	Discreto	C35/45	CLS_Muri_ND	16	4	4	0.40
71	94-93-132-123	Discreto	C35/45	CLS_Muri_ND	16	4	4	0.40
72	96-127-136-90	Discreto	C35/45	CLS_Muri_ND	16	4	4	0.40
73	77-94-123-116	Discreto	C35/45	CLS_Muri_ND	16	4	4	0.40
74	85-83-155-154	Discreto	C35/45	CLS_Muri_ND	16	4	4	0.40
75	92-89-146-139	Discreto	C35/45	CLS_Muri_ND	16	4	4	0.40
76	95-120-127-96	Discreto	C35/45	CLS_Muri_ND	16	4	4	0.40
77	91-143-150-87	Discreto	C35/45	CLS_Muri_ND	16	4	4	0.40
78	82-156-155-83	Discreto	C35/45	CLS_Muri_ND	16	4	4	0.40
79	87-150-157-86	Discreto	C35/45	CLS_Muri_ND	16	4	4	0.40
80	86-157-156-82	Discreto	C35/45	CLS_Muri_ND	16	4	4	0.40
81	89-88-153-146	Discreto	C35/45	CLS_Muri_ND	16	4	4	0.40
82	88-85-154-153	Discreto	C35/45	CLS_Muri_ND	16	4	4	0.40
83	98-113-120-95	Discreto	C35/45	CLS_Muri_ND	16	4	4	0.40
84	0-112-113-98	Discreto	C35/45	CLS_Muri_ND	16	4	4	0.40
85	0-109-110-99	Discreto	C35/45	CLS_Muri_ND	16	4	4	0.40
86	99-110-111-100	Discreto	C35/45	CLS_Muri_ND	16	4	4	0.40
87	100-111-112-0	Discreto	C35/45	CLS_Muri_ND	16	4	4	0.40
88	0-77-116-109	Discreto	C35/45	CLS_Muri_ND	16	4	4	0.40
89	18-78-79	Discreto	C35/45	CLS_Muri_ND	16	4	4	0.40
90	18-25-97-78	Discreto	C35/45	CLS_Muri_ND	16	4	4	0.40
91	25-34-81-97	Discreto	C35/45	CLS_Muri_ND	16	4	4	0.40
92	34-41-80-81	Discreto	C35/45	CLS_Muri_ND	16	4	4	0.40
93	41-48-84-80	Discreto	C35/45	CLS_Muri_ND	16	4	4	0.40
94	79-78-129-118	Discreto	C35/45	CLS_Muri_ND	16	4	4	0.40
95	78-97-130-129	Discreto	C35/45	CLS_Muri_ND	16	4	4	0.40
96	97-81-134-130	Discreto	C35/45	CLS_Muri_ND	16	4	4	0.40
97	81-80-141-134	Discreto	C35/45	CLS_Muri_ND	16	4	4	0.40
98	80-84-148-141	Discreto	C35/45	CLS_Muri_ND	16	4	4	0.40
99	48-55-83-84	Discreto	C35/45	CLS_Muri_ND	16	4	4	0.40
100	84-83-155-148	Discreto	C35/45	CLS_Muri_ND	16	4	4	0.40
101	0-149-150-87	Discreto	C35/45	CLS_Muri_ND	16	4	4	0.20
102	84-148-149-0	Discreto	C35/45	CLS_Muri_ND	16	4	4	0.20
103	116-123-179-177	Discreto	C35/45	CLS_Muri_ND	16	4	4	0.40
104	120-178-180-127	Discreto	C35/45	CLS_Muri_ND	16	4	4	0.40
105	123-132-181-179	Discreto	C35/45	CLS_Muri_ND	16	4	4	0.40
106	127-180-182-136	Discreto	C35/45	CLS_Muri_ND	16	4	4	0.40
107	156-190-189-155	Discreto	C35/45	CLS_Muri_ND	16	4	4	0.40
108	157-187-190-156	Discreto	C35/45	CLS_Muri_ND	16	4	4	0.40
109	146-153-188-195	Discreto	C35/45	CLS_Muri_ND	16	4	4	0.40
110	150-194-187-157	Discreto	C35/45	CLS_Muri_ND	16	4	4	0.40
111	132-139-192-181	Discreto	C35/45	CLS_Muri_ND	16	4	4	0.40
112	136-182-191-143	Discreto	C35/45	CLS_Muri_ND	16	4	4	0.40
113	139-146-195-192	Discreto	C35/45	CLS_Muri_ND	16	4	4	0.40
114	143-191-194-150	Discreto	C35/45	CLS_Muri_ND	16	4	4	0.40
115	157-187-197-170	Discreto	C35/45	CLS_Muri_ND	16	4	4	0.40

Parete	Nodi	Tipo	Materiale	Criterio	N.P.	N.P.X	N.P.Y	Spess.
116	170-169-156-157	Platea	C35/45	CLS_Platee_ND	8			0.40
117	154-167-166-153	Platea	C35/45	CLS_Platee_ND	16			0.40
118	168-167-154-155	Platea	C35/45	CLS_Platee_ND	16			0.40
119	169-168-155-156	Platea	C35/45	CLS_Platee_ND	9			0.40
120	170-197-200-173	Discreto	C35/45	CLS_Muri_ND	16	4	4	0.40
121	173-172-169-170	Platea	C35/45	CLS_Platee_ND	8			0.40
122	172-171-168-169	Platea	C35/45	CLS_Platee_ND	8			0.40
123	0-0-0-0	Platea	C35/45	CLS_Platee_ND	16			0.40
124	0-0-0-0	Platea	C35/45	CLS_Platee_ND	16			0.40
125	110-0-0-111	Discreto	C35/45	CLS_Muri_ND	16	4	4	0.40
126	109-0-0-110	Discreto	C35/45	CLS_Muri_ND	16	4	4	0.40
127	109-116-177-0	Discreto	C35/45	CLS_Muri_ND	16	4	4	0.40
128	111-0-0-112	Discreto	C35/45	CLS_Muri_ND	16	4	4	0.40
129	112-0-0-113	Discreto	C35/45	CLS_Muri_ND	16	4	4	0.40
130	113-0-178-120	Discreto	C35/45	CLS_Muri_ND	16	4	4	0.40
131	118-129-183-186	Discreto	C35/45	CLS_Muri_ND	16	4	4	0.40
132	129-130-185-183	Discreto	C35/45	CLS_Muri_ND	16	4	4	0.40
133	130-134-184-185	Discreto	C35/45	CLS_Muri_ND	16	4	4	0.40
134	134-141-193-184	Discreto	C35/45	CLS_Muri_ND	16	4	4	0.40
135	141-148-196-193	Discreto	C35/45	CLS_Muri_ND	16	4	4	0.40
136	148-155-189-196	Discreto	C35/45	CLS_Muri_ND	16	4	4	0.40
137	155-168-0-189	Discreto	C35/45	CLS_Muri_ND	16	4	4	0.40
138	188-153-166-0	Discreto	C35/45	CLS_Muri_ND	16	4	4	0.40
139	0-188-0-198	Discreto	C35/45	CLS_Muri_ND	16	4	4	0.40
140	0-0-199-198	Discreto	C35/45	CLS_Muri_ND	16	4	4	0.40
141	198-199-0-0	Discreto	C35/45	CLS_Muri_ND	16	4	4	0.40
142	166-167-0-0	Discreto	C35/45	CLS_Muri_ND	16	4	4	0.40
143	167-168-0-0	Discreto	C35/45	CLS_Muri_ND	16	4	4	0.40
144	168-171-0-0	Discreto	C35/45	CLS_Muri_ND	16	4	4	0.40
145	0-0-0	Discreto	C35/45	CLS_Muri_ND	16	4	4	0.40
146	0-0-0-0	Discreto	C35/45	CLS_Muri_ND	16	4	4	0.40
147	0-0-0-0	Discreto	C35/45	CLS_Muri_ND	16	4	4	0.40
148	0-0-0-0	Discreto	C35/45	CLS_Muri_ND	16	4	4	0.40
149	0-0-0-199	Discreto	C35/45	CLS_Muri_ND	16	4	4	0.40
150	0-0-0-0	Discreto	C35/45	CLS_Muri_ND	16	4	4	0.40
151	0-0-0-0	Discreto	C35/45	CLS_Muri_ND	16	4	4	0.40
152	199-0-0-0	Discreto	C35/45	CLS_Muri_ND	16	4	4	0.40
153	173-200-0-176	Discreto	C35/45	CLS_Muri_ND	16	4	4	0.40
154	176-0-0-175	Discreto	C35/45	CLS_Muri_ND	16	4	4	0.40
155	175-0-0-174	Discreto	C35/45	CLS_Muri_ND	16	4	4	0.40
156	0-0-0-0	Platea	C35/45	CLS_Platee_ND	16			0.40
157	176-175-172-173	Platea	C35/45	CLS_Platee_ND	9			0.40
158	175-174-171-172	Platea	C35/45	CLS_Platee_ND	8			0.40
159	0-0-0-0	Platea	C35/45	CLS_Platee_ND	16			0.40
160	0-0-0	Discreto	C35/45	CLS_Muri_ND	16	4	4	0.40
161	0-0-0-0	Discreto	C35/45	CLS_Muri_ND	16	4	4	0.40
162	171-174-0-0	Discreto	C35/45	CLS_Muri_ND	16	4	4	0.40
163	200-0-0-0	Discreto	C35/45	CLS_Muri_ND	16	4	4	0.40
164	0-0-0-0	Discreto	C35/45	CLS_Muri_ND	16	4	4	0.40
165	0-0-0-0	Discreto	C35/45	CLS_Muri_ND	16	4	4	0.40
166	149-0-194-150	Discreto	C35/45	CLS_Muri_ND	16	4	4	0.20
167	148-196-0-149	Discreto	C35/45	CLS_Muri_ND	16	4	4	0.20
168	0-0-0-194	Discreto	C35/45	CLS_Muri_ND	16	4	4	0.20
169	196-0-0-0	Discreto	C35/45	CLS_Muri_ND	16	4	4	0.20
170	0-198-0	Discreto	C35/45	CLS_Muri_ND	16	4	4	0.40
171	17-0-0-30	Discreto	C35/45	CLS_Muri_ND	16	4	4	0.40
172	30-0-0-40	Discreto	C35/45	CLS_Muri_ND	16	4	4	0.40
173	0-0-34-37	Discreto	C35/45	CLS_Muri_ND	16	4	4	0.40
174	46-47-40-31	Discreto	C35/45	CLS_Muri_ND	16	4	4	0.40
175	0-36-48-0	Discreto	C35/45	CLS_Muri_ND	16	4	4	0.40
176	48-49-41-36	Discreto	C35/45	CLS_Muri_ND	16	4	4	0.40

Parete	Nodi	Tipo	Materiale	Criterio	N.P.	N.P.X	N.P.Y	Spess.
177	49-50-34-41	Discreto	C35/45	CLS_Muri_ND	16	4	4	0.40
178	0-49-50-0	Discreto	C35/45	CLS_Muri_ND	16	4	4	0.40
179	0-48-49-0	Discreto	C35/45	CLS_Muri_ND	16	4	4	0.40
180	0-0-46-47	Discreto	C35/45	CLS_Muri_ND	16	4	4	0.40
181	40-0-0-47	Discreto	C35/45	CLS_Muri_ND	16	4	4	0.40
182	46-0-0-50	Discreto	C35/45	CLS_Muri_ND	16	4	4	0.40
183	0-0-50-34	Discreto	C35/45	CLS_Muri_ND	16	4	4	0.40
184	0-21-19-0	Discreto	C35/45	CLS_Muri_ND	16	4	4	0.20
185	0-19-20-0	Discreto	C35/45	CLS_Muri_ND	16	4	4	0.20
186	179-181-0-0	Discreto	C35/45	CLS_Muri_ND	16	4	4	0.40
187	178-0-0-180	Discreto	C35/45	CLS_Muri_ND	16	4	4	0.40
188	177-179-0-0	Discreto	C35/45	CLS_Muri_ND	16	4	4	0.40
189	180-0-0-182	Discreto	C35/45	CLS_Muri_ND	16	4	4	0.40
190	187-0-0-197	Discreto	C35/45	CLS_Muri_ND	16	4	4	0.40
191	182-0-0-191	Discreto	C35/45	CLS_Muri_ND	16	4	4	0.40
192	195-188-0-0	Discreto	C35/45	CLS_Muri_ND	16	4	4	0.40
193	181-192-0-0	Discreto	C35/45	CLS_Muri_ND	16	4	4	0.40
194	194-0-0-187	Discreto	C35/45	CLS_Muri_ND	16	4	4	0.40
195	192-195-0-0	Discreto	C35/45	CLS_Muri_ND	16	4	4	0.40
196	191-0-0-194	Discreto	C35/45	CLS_Muri_ND	16	4	4	0.40
197	197-0-0-200	Discreto	C35/45	CLS_Muri_ND	16	4	4	0.40
198	0-0-0-0	Discreto	C35/45	CLS_Muri_ND	16	4	4	0.40
199	0-177-0-0	Discreto	C35/45	CLS_Muri_ND	16	4	4	0.40
200	0-0-0-0	Discreto	C35/45	CLS_Muri_ND	16	4	4	0.40
201	0-0-0-178	Discreto	C35/45	CLS_Muri_ND	16	4	4	0.40
202	0-0-0-0	Discreto	C35/45	CLS_Muri_ND	16	4	4	0.40
203	0-0-0-0	Discreto	C35/45	CLS_Muri_ND	16	4	4	0.40
204	186-183-0-0	Discreto	C35/45	CLS_Muri_ND	16	4	4	0.40
205	193-196-0-0	Discreto	C35/45	CLS_Muri_ND	16	4	4	0.40
206	196-189-0-0	Discreto	C35/45	CLS_Muri_ND	16	4	4	0.40
207	183-185-0-0	Discreto	C35/45	CLS_Muri_ND	16	4	4	0.40
208	185-184-0-0	Discreto	C35/45	CLS_Muri_ND	16	4	4	0.40
209	184-193-0-0	Discreto	C35/45	CLS_Muri_ND	16	4	4	0.40
210	8-23-24-6	Discreto	C35/45	CLS_Muri_ND	16	4	4	0.40
211	12-17-18-11	Discreto	C35/45	CLS_Muri_ND	16	4	4	0.40
212	23-15-10-24	Discreto	C35/45	CLS_Muri_ND	16	4	4	0.40
213	15-16-9-10	Discreto	C35/45	CLS_Muri_ND	16	4	4	0.40
214	26-22-16-15	Discreto	C35/45	CLS_Muri_ND	16	4	4	0.40
215	13-7-19-20	Discreto	C35/45	CLS_Muri_ND	16	4	4	0.40
216	3-12-11-21	Discreto	C35/45	CLS_Muri_ND	16	4	4	0.40
217	10-9-14-27	Discreto	C35/45	CLS_Muri_ND	16	4	4	0.40
218	16-1-2-9	Discreto	C35/45	CLS_Muri_ND	16	4	4	0.40
219	24-10-27-25	Discreto	C35/45	CLS_Muri_ND	16	4	4	0.40
220	7-3-21-19	Discreto	C35/45	CLS_Muri_ND	16	4	4	0.40
221	21-11-22-26	Discreto	C35/45	CLS_Muri_ND	16	4	4	0.40
222	28-20-19-29	Discreto	C35/45	CLS_Muri_ND	16	4	4	0.40
223	0-0-1-2	Discreto	C35/45	CLS_Muri_ND	16	4	4	0.40
224	0-4-6-0	Discreto	C35/45	CLS_Muri_ND	16	4	4	0.40
225	0-0-2-5	Discreto	C35/45	CLS_Muri_ND	16	4	4	0.40
226	0-6-8-0	Discreto	C35/45	CLS_Muri_ND	16	4	4	0.40
227	29-26-15-23	Discreto	C35/45	CLS_Muri_ND	16	4	4	0.40
228	32-30-17-12	Discreto	C35/45	CLS_Muri_ND	16	4	4	0.40
229	22-11-18-39	Discreto	C35/45	CLS_Muri_ND	16	4	4	0.40
230	34-31-32-37	Discreto	C35/45	CLS_Muri_ND	16	4	4	0.40
231	38-4-25-42	Discreto	C35/45	CLS_Muri_ND	16	4	4	0.40
232	37-32-12-3	Discreto	C35/45	CLS_Muri_ND	16	4	4	0.40
233	19-21-26-29	Discreto	C35/45	CLS_Muri_ND	16	4	4	0.40
234	33-35-7-13	Discreto	C35/45	CLS_Muri_ND	16	4	4	0.40
235	45-14-5-44	Discreto	C35/45	CLS_Muri_ND	16	4	4	0.40
236	31-40-30-32	Discreto	C35/45	CLS_Muri_ND	16	4	4	0.40
237	36-41-35-33	Discreto	C35/45	CLS_Muri_ND	16	4	4	0.40

Parete	Nodi	Tipo	Materiale	Criterio	N.P.	N.P.X	N.P.Y	Spess.
238	43-27-14-45	Discreto	C35/45	CLS_Muri_ND	16	4	4	0.40
239	42-25-27-43	Discreto	C35/45	CLS_Muri_ND	16	4	4	0.40
240	41-34-37-35	Discreto	C35/45	CLS_Muri_ND	16	4	4	0.40
241	35-37-3-7	Discreto	C35/45	CLS_Muri_ND	16	4	4	0.40
242	0-0-18-39	Discreto	C35/45	CLS_Muri_ND	16	4	4	0.40
243	0-33-36-0	Discreto	C35/45	CLS_Muri_ND	16	4	4	0.40
244	0-13-33-0	Discreto	C35/45	CLS_Muri_ND	16	4	4	0.40
245	0-0-39-1	Discreto	C35/45	CLS_Muri_ND	16	4	4	0.40
246	0-8-28-0	Discreto	C35/45	CLS_Muri_ND	16	4	4	0.40
247	0-0-17-18	Discreto	C35/45	CLS_Muri_ND	16	4	4	0.40
248	0-20-13-0	Discreto	C35/45	CLS_Muri_ND	16	4	4	0.40
249	0-28-20-0	Discreto	C35/45	CLS_Muri_ND	16	4	4	0.40
250	0-38-4-0	Discreto	C35/45	CLS_Muri_ND	16	4	4	0.40
251	0-0-5-44	Discreto	C35/45	CLS_Muri_ND	16	4	4	0.40
252	0-0-21-26	Discreto	C35/45	CLS_Muri_ND	16	4	4	0.40
253	0-43-42-0	Discreto	C35/45	CLS_Muri_ND	16	4	4	0.40
254	0-45-43-0	Discreto	C35/45	CLS_Muri_ND	16	4	4	0.40
255	0-42-38-0	Discreto	C35/45	CLS_Muri_ND	16	4	4	0.40
256	0-0-27	Discreto	C35/45	CLS_Muri_ND	16	4	4	0.40
257	0-44-45-0	Discreto	C35/45	CLS_Muri_ND	16	4	4	0.40
258	0-0-10-27	Discreto	C35/45	CLS_Muri_ND	16	4	4	0.40
259	0-0-26-15	Discreto	C35/45	CLS_Muri_ND	16	4	4	0.40
260	0-0-3-21	Discreto	C35/45	CLS_Muri_ND	16	4	4	0.40
261	0-0-15-10	Discreto	C35/45	CLS_Muri_ND	16	4	4	0.40

Muri - Carichi

- Shell Indice dello shell
- Cond. Condizione di carico
- Tipo Tipologia di spinta
- g Peso specifico: terreno o acqua
- Ht Quota del piano di campagna
- Ø Angolo di attrito interno
- c Coesione
- d Angolo di attrito terreno paramento shell
- b Angolo di inclinazione del piano di campagna
- k0 Coefficiente di spinta a riposo (quando richiesto)
- bm Coefficiente di riduzione dell'accelerazione massima attesa al sito (quando richiesto)
- Ag Accelerazione del sito a meno di 'g': quando richiesto, rappresenta il valore della accelerazione dello spettro per T=0, quindi comprensiva dei coefficienti di amplificazione topografica (S_T) e stratigrafica (S_S)
- Q Valore del carico uniforme
- Vert.1 Valore del carico nel primo vertice⁽¹⁾
- Vert.2 Valore del carico nel secondo vertice⁽¹⁾
- Vert.3 Valore del carico nel terzo vertice⁽¹⁾
- Vert.4 Valore del carico nel quarto vertice⁽¹⁾
- Hw Altezza del pelo libero dell'acqua

⁽¹⁾: Per shell con numero di vertici maggiori 4, per carichi trapezoidali, il valore del carico nei vertici e' stampato a gruppi di 4 secondo l'ordine con cui i vertici sono stati definiti

Shell	Cond.	Tipo	Ht	g	Ø	c	d	b	k0	bm	Ag
			m	kN/m ³	°	kPa	°	°			
10	Spinta terreno	Terreno - Riposo - Dir.Neg.	6.80	19.00	--	--	--	--	0.40	--	--
10	Sovraspinta sismica terreno	Sisma terreno - Riposo - Dir.Pos.	4.80	19.00	--	--	--	--	0.40	1.00	0.07
10	Sovraspinta sismica terreno	Sisma terreno - Riposo - Dir.Neg.	0.00	19.00	--	--	--	--	0.40	1.00	0.07
11	Spinta terreno	Terreno - Riposo - Dir.Neg.	4.80	19.00	--	--	--	--	0.40	--	--
11	Sovraspinta sismica terreno	Sisma terreno - Riposo - Dir.Neg.	0.00	19.00	--	--	--	--	0.40	1.00	0.07
11	Sovraspinta sismica terreno	Sisma terreno - Riposo - Dir.Pos.	5.27	23.00	--	--	--	--	0.50	1.00	0.07
11	Sovraspinta sismica terreno	Sisma terreno - Riposo - Dir.Pos.	5.27	23.00	--	--	--	--	0.43	1.00	0.04
11	Sovraspinta sismica terreno	Sisma terreno - Riposo - Dir.Pos.	4.80	19.00	--	--	--	--	0.50	1.00	0.07
12	Spinta terreno	Terreno - Riposo - Dir.Neg.	6.80	19.00	--	--	--	--	0.40	--	--
12	Sovraspinta sismica terreno	Sisma terreno - Riposo - Dir.Neg.	0.00	19.00	--	--	--	--	0.40	1.00	0.07

Shell	Cond.	Tipo	Ht	g	Ø	c	d	b	k0	bm	Ag
12	Sovraspinta sismica terreno	Sisma terreno - Riposo - Dir.Pos.	4.80	19.00	--	--	--	--	0.40	1.00	0.07
13	Spinta terreno	Terreno - Riposo - Dir.Neg.	4.80	19.00	--	--	--	--	0.40	--	--
13	Sovraspinta sismica terreno	Sisma terreno - Riposo - Dir.Neg.	0.00	19.00	--	--	--	--	0.40	1.00	0.07
13	Sovraspinta sismica terreno	Sisma terreno - Riposo - Dir.Pos.	4.80	19.00	--	--	--	--	0.50	1.00	0.07
14	Spinta terreno	Terreno - Riposo - Dir.Neg.	4.80	19.00	--	--	--	--	0.40	--	--
14	Sovraspinta sismica terreno	Sisma terreno - Riposo - Dir.Neg.	0.00	19.00	--	--	--	--	0.40	1.00	0.07
14	Sovraspinta sismica terreno	Sisma terreno - Riposo - Dir.Pos.	4.80	19.00	--	--	--	--	0.50	1.00	0.07
15	Spinta terreno	Terreno - Riposo - Dir.Neg.	6.80	19.00	--	--	--	--	0.40	--	--
15	permanenti platea	Sisma terreno - Riposo - Dir.Pos.	5.50	23.00	--	--	--	--	0.50	1.00	0.07
15	Sovraspinta sismica terreno	Sisma terreno - Riposo - Dir.Pos.	5.27	23.00	--	--	--	--	0.50	1.00	0.07
15	Sovraspinta sismica terreno	Sisma terreno - Riposo - Dir.Pos.	5.27	23.00	--	--	--	--	0.43	1.00	0.04
15	Sovraspinta sismica terreno	Sisma terreno - Riposo - Dir.Neg.	0.00	19.00	--	--	--	--	0.40	1.00	0.07
27	Spinta terreno	Terreno - Riposo - Dir.Neg.	6.80	19.00	--	--	--	--	0.40	--	--
27	Sovraspinta sismica terreno	Sisma terreno - Riposo - Dir.Neg.	0.00	19.00	--	--	--	--	0.40	1.00	0.07
27	Sovraspinta sismica terreno	Sisma terreno - Riposo - Dir.Pos.	5.27	23.00	--	--	--	--	0.43	1.00	0.04
27	Sovraspinta sismica terreno	Sisma terreno - Riposo - Dir.Pos.	5.27	23.00	--	--	--	--	0.50	1.00	0.07
28	Spinta terreno	Terreno - Riposo - Dir.Neg.	4.80	19.00	--	--	--	--	0.40	--	--
28	Sovraspinta sismica terreno	Sisma terreno - Riposo - Dir.Neg.	0.00	19.00	--	--	--	--	0.40	1.00	0.07
29	Spinta terreno	Terreno - Riposo - Dir.Neg.	4.80	19.00	--	--	--	--	0.40	--	--
29	Sovraspinta sismica terreno	Sisma terreno - Riposo - Dir.Pos.	4.80	19.00	--	--	--	--	0.50	1.00	0.07
29	Sovraspinta sismica terreno	Sisma terreno - Riposo - Dir.Neg.	0.00	19.00	--	--	--	--	0.40	1.00	0.07
29	Sovraspinta sismica terreno	Sisma terreno - Riposo - Dir.Pos.	5.27	23.00	--	--	--	--	0.50	1.00	0.07
29	Sovraspinta sismica terreno	Sisma terreno - Riposo - Dir.Pos.	5.27	23.00	--	--	--	--	0.43	1.00	0.04
30	Spinta terreno	Terreno - Riposo - Dir.Neg.	4.80	19.00	--	--	--	--	0.40	--	--
30	Sovraspinta sismica terreno	Sisma terreno - Riposo - Dir.Neg.	0.00	19.00	--	--	--	--	0.40	1.00	0.07
30	Sovraspinta sismica terreno	Sisma terreno - Riposo - Dir.Pos.	4.80	19.00	--	--	--	--	0.50	1.00	0.07
31	Spinta terreno	Terreno - Riposo - Dir.Neg.	4.80	19.00	--	--	--	--	0.40	--	--
31	Sovraspinta sismica terreno	Sisma terreno - Riposo - Dir.Neg.	0.00	19.00	--	--	--	--	0.40	1.00	0.07
32	Spinta terreno	Terreno - Riposo - Dir.Neg.	6.80	19.00	--	--	--	--	0.40	--	--
32	Sovraspinta sismica terreno	Sisma terreno - Riposo - Dir.Neg.	0.00	19.00	--	--	--	--	0.40	1.00	0.07
32	Sovraspinta sismica terreno	Sisma terreno - Riposo - Dir.Pos.	4.80	19.00	--	--	--	--	0.40	1.00	0.07
33	Spinta terreno	Terreno - Riposo - Dir.Neg.	4.80	19.00	--	--	--	--	0.40	--	--
33	Sovraspinta sismica terreno	Sisma terreno - Riposo - Dir.Neg.	0.00	19.00	--	--	--	--	0.40	1.00	0.07
34	Spinta terreno	Terreno - Riposo - Dir.Neg.	4.80	19.00	--	--	--	--	0.40	--	--
34	Sovraspinta sismica terreno	Sisma terreno - Riposo - Dir.Neg.	0.00	19.00	--	--	--	--	0.40	1.00	0.07
39	Spinta terreno	Terreno - Riposo - Dir.Neg.	4.80	19.00	--	--	--	--	0.40	--	--
39	Sovraspinta sismica terreno	Sisma terreno - Riposo - Dir.Neg.	0.00	19.00	--	--	--	--	0.40	1.00	0.07
40	Spinta terreno	Terreno - Riposo - Dir.Neg.	4.80	19.00	--	--	--	--	0.40	--	--
40	Sovraspinta sismica terreno	Sisma terreno - Riposo - Dir.Neg.	0.00	19.00	--	--	--	--	0.40	1.00	0.07
41	Spinta terreno	Terreno - Riposo - Dir.Neg.	4.80	19.00	--	--	--	--	0.40	--	--
41	Sovraspinta sismica terreno	Sisma terreno - Riposo - Dir.Neg.	0.00	19.00	--	--	--	--	0.40	1.00	0.07
42	Spinta terreno	Terreno - Riposo - Dir.Neg.	4.80	19.00	--	--	--	--	0.40	--	--
42	Sovraspinta sismica terreno	Sisma terreno - Riposo - Dir.Neg.	0.00	19.00	--	--	--	--	0.40	1.00	0.07
43	Spinta terreno	Terreno - Riposo - Dir.Neg.	4.80	19.00	--	--	--	--	0.40	--	--
43	Sovraspinta sismica terreno	Sisma terreno - Riposo - Dir.Pos.	4.80	19.00	--	--	--	--	0.50	1.00	0.07
43	Sovraspinta sismica terreno	Sisma terreno - Riposo - Dir.Neg.	0.00	19.00	--	--	--	--	0.40	1.00	0.07
44	Spinta terreno	Terreno - Riposo - Dir.Neg.	6.80	19.00	--	--	--	--	0.40	--	--
44	Sovraspinta sismica terreno	Sisma terreno - Riposo - Dir.Neg.	0.00	19.00	--	--	--	--	0.40	1.00	0.07
44	Sovraspinta sismica terreno	Sisma terreno - Riposo - Dir.Pos.	4.80	19.00	--	--	--	--	0.40	1.00	0.07
69	Spinta terreno	Terreno - Riposo - Dir.Neg.	6.80	19.00	--	--	--	--	0.40	--	--
69	Sovraspinta sismica terreno	Sisma terreno - Riposo - Dir.Pos.	4.80	19.00	--	--	--	--	0.40	1.00	0.07
69	Sovraspinta sismica terreno	Sisma terreno - Riposo - Dir.Neg.	0.00	19.00	--	--	--	--	0.40	1.00	0.07
70	Spinta terreno	Terreno - Riposo - Dir.Neg.	4.80	19.00	--	--	--	--	0.40	--	--
70	Sovraspinta sismica terreno	Sisma terreno - Riposo - Dir.Pos.	4.80	19.00	--	--	--	--	0.50	1.00	0.07
70	Sovraspinta sismica terreno	Sisma terreno - Riposo - Dir.Neg.	0.00	19.00	--	--	--	--	0.40	1.00	0.07
71	Spinta terreno	Terreno - Riposo - Dir.Neg.	6.80	19.00	--	--	--	--	0.40	--	--
71	permanenti platea	Sisma terreno - Riposo - Dir.Pos.	5.50	23.00	--	--	--	--	0.50	1.00	0.07
71	Sovraspinta sismica terreno	Sisma terreno - Riposo - Dir.Pos.	5.27	23.00	--	--	--	--	0.43	1.00	0.04
71	Sovraspinta sismica terreno	Sisma terreno - Riposo - Dir.Pos.	5.27	23.00	--	--	--	--	0.50	1.00	0.07
71	Sovraspinta sismica terreno	Sisma terreno - Riposo - Dir.Neg.	0.00	19.00	--	--	--	--	0.40	1.00	0.07
72	Spinta terreno	Terreno - Riposo - Dir.Neg.	4.80	19.00	--	--	--	--	0.40	--	--

Shell	Cond.	Tipo	Ht	g	Ø	c	d	b	k0	bm	Ag
72	Sovraspinta sismica terreno	Sisma terreno - Riposo - Dir.Pos.	5.27	23.00	--	--	--	--	0.50	1.00	0.07
72	Sovraspinta sismica terreno	Sisma terreno - Riposo - Dir.Neg.	0.00	19.00	--	--	--	--	0.40	1.00	0.07
72	Sovraspinta sismica terreno	Sisma terreno - Riposo - Dir.Pos.	4.80	19.00	--	--	--	--	0.50	1.00	0.07
72	Sovraspinta sismica terreno	Sisma terreno - Riposo - Dir.Pos.	5.27	23.00	--	--	--	--	0.43	1.00	0.04
73	Spinta terreno	Terreno - Riposo - Dir.Neg.	6.80	19.00	--	--	--	--	0.40	--	--
73	Sovraspinta sismica terreno	Sisma terreno - Riposo - Dir.Pos.	5.27	23.00	--	--	--	--	0.50	1.00	0.07
73	Sovraspinta sismica terreno	Sisma terreno - Riposo - Dir.Neg.	0.00	19.00	--	--	--	--	0.40	1.00	0.07
73	Sovraspinta sismica terreno	Sisma terreno - Riposo - Dir.Pos.	5.27	23.00	--	--	--	--	0.43	1.00	0.04
74	Spinta terreno	Terreno - Riposo - Dir.Neg.	4.80	19.00	--	--	--	--	0.40	--	--
74	Sovraspinta sismica terreno	Sisma terreno - Riposo - Dir.Neg.	0.00	19.00	--	--	--	--	0.40	1.00	0.07
75	Spinta terreno	Terreno - Riposo - Dir.Neg.	6.80	19.00	--	--	--	--	0.40	--	--
75	Sovraspinta sismica terreno	Sisma terreno - Riposo - Dir.Neg.	0.00	19.00	--	--	--	--	0.40	1.00	0.07
75	Sovraspinta sismica terreno	Sisma terreno - Riposo - Dir.Pos.	4.80	19.00	--	--	--	--	0.40	1.00	0.07
76	Spinta terreno	Terreno - Riposo - Dir.Neg.	4.80	19.00	--	--	--	--	0.40	--	--
76	Sovraspinta sismica terreno	Sisma terreno - Riposo - Dir.Pos.	5.27	23.00	--	--	--	--	0.43	1.00	0.04
76	Sovraspinta sismica terreno	Sisma terreno - Riposo - Dir.Neg.	0.00	19.00	--	--	--	--	0.40	1.00	0.07
76	Sovraspinta sismica terreno	Sisma terreno - Riposo - Dir.Pos.	5.27	23.00	--	--	--	--	0.50	1.00	0.07
76	Sovraspinta sismica terreno	Sisma terreno - Riposo - Dir.Pos.	4.80	19.00	--	--	--	--	0.50	1.00	0.07
77	Spinta terreno	Terreno - Riposo - Dir.Neg.	4.80	19.00	--	--	--	--	0.40	--	--
77	Sovraspinta sismica terreno	Sisma terreno - Riposo - Dir.Pos.	4.80	19.00	--	--	--	--	0.50	1.00	0.07
77	Sovraspinta sismica terreno	Sisma terreno - Riposo - Dir.Neg.	0.00	19.00	--	--	--	--	0.40	1.00	0.07
78	Spinta terreno	Terreno - Riposo - Dir.Neg.	4.80	19.00	--	--	--	--	0.40	--	--
78	Sovraspinta sismica terreno	Sisma terreno - Riposo - Dir.Neg.	0.00	19.00	--	--	--	--	0.40	1.00	0.07
79	Spinta terreno	Terreno - Riposo - Dir.Neg.	4.80	19.00	--	--	--	--	0.40	--	--
79	Sovraspinta sismica terreno	Sisma terreno - Riposo - Dir.Neg.	0.00	19.00	--	--	--	--	0.40	1.00	0.07
79	Sovraspinta sismica terreno	Sisma terreno - Riposo - Dir.Pos.	4.80	19.00	--	--	--	--	0.50	1.00	0.07
80	Spinta terreno	Terreno - Riposo - Dir.Neg.	4.80	19.00	--	--	--	--	0.40	--	--
80	Sovraspinta sismica terreno	Sisma terreno - Riposo - Dir.Neg.	0.00	19.00	--	--	--	--	0.40	1.00	0.07
81	Spinta terreno	Terreno - Riposo - Dir.Neg.	6.80	19.00	--	--	--	--	0.40	--	--
81	Sovraspinta sismica terreno	Sisma terreno - Riposo - Dir.Pos.	4.80	19.00	--	--	--	--	0.40	1.00	0.07
81	Sovraspinta sismica terreno	Sisma terreno - Riposo - Dir.Neg.	0.00	19.00	--	--	--	--	0.40	1.00	0.07
82	Spinta terreno	Terreno - Riposo - Dir.Neg.	4.80	19.00	--	--	--	--	0.40	--	--
82	Sovraspinta sismica terreno	Sisma terreno - Riposo - Dir.Neg.	0.00	19.00	--	--	--	--	0.40	1.00	0.07
83	Spinta terreno	Terreno - Riposo - Dir.Neg.	4.80	19.00	--	--	--	--	0.40	--	--
83	Sovraspinta sismica terreno	Sisma terreno - Riposo - Dir.Pos.	4.80	19.00	--	--	--	--	0.50	1.00	0.07
83	Sovraspinta sismica terreno	Sisma terreno - Riposo - Dir.Neg.	0.00	19.00	--	--	--	--	0.40	1.00	0.07
84	Spinta terreno	Terreno - Riposo - Dir.Neg.	4.80	19.00	--	--	--	--	0.40	--	--
84	Sovraspinta sismica terreno	Sisma terreno - Riposo - Dir.Neg.	0.00	19.00	--	--	--	--	0.40	1.00	0.07
85	Spinta terreno	Terreno - Riposo - Dir.Neg.	4.80	19.00	--	--	--	--	0.40	--	--
85	Sovraspinta sismica terreno	Sisma terreno - Riposo - Dir.Neg.	0.00	19.00	--	--	--	--	0.40	1.00	0.07
86	Spinta terreno	Terreno - Riposo - Dir.Neg.	4.80	19.00	--	--	--	--	0.40	--	--
86	Sovraspinta sismica terreno	Sisma terreno - Riposo - Dir.Neg.	0.00	19.00	--	--	--	--	0.40	1.00	0.07
87	Spinta terreno	Terreno - Riposo - Dir.Neg.	4.80	19.00	--	--	--	--	0.40	--	--
87	Sovraspinta sismica terreno	Sisma terreno - Riposo - Dir.Neg.	0.00	19.00	--	--	--	--	0.40	1.00	0.07
88	Spinta terreno	Terreno - Riposo - Dir.Neg.	6.80	19.00	--	--	--	--	0.40	--	--
88	Sovraspinta sismica terreno	Sisma terreno - Riposo - Dir.Neg.	0.00	19.00	--	--	--	--	0.40	1.00	0.07
88	Sovraspinta sismica terreno	Sisma terreno - Riposo - Dir.Pos.	4.80	19.00	--	--	--	--	0.40	1.00	0.07
103	Spinta terreno	Terreno - Riposo - Dir.Neg.	6.80	19.00	--	--	--	--	0.40	--	--
103	Sovraspinta sismica terreno	Sisma terreno - Riposo - Dir.Pos.	5.27	23.00	--	--	--	--	0.43	1.00	0.04
103	Sovraspinta sismica terreno	Sisma terreno - Riposo - Dir.Pos.	4.80	19.00	--	--	--	--	0.40	1.00	0.07
103	Sovraspinta sismica terreno	Sisma terreno - Riposo - Dir.Neg.	0.00	19.00	--	--	--	--	0.40	1.00	0.07
103	Sovraspinta sismica terreno	Sisma terreno - Riposo - Dir.Pos.	5.27	23.00	--	--	--	--	0.50	1.00	0.07
104	Spinta terreno	Terreno - Riposo - Dir.Neg.	4.80	19.00	--	--	--	--	0.40	--	--
104	Sovraspinta sismica terreno	Sisma terreno - Riposo - Dir.Pos.	5.27	23.00	--	--	--	--	0.50	1.00	0.07
104	Sovraspinta sismica terreno	Sisma terreno - Riposo - Dir.Pos.	5.27	23.00	--	--	--	--	0.43	1.00	0.04
104	Sovraspinta sismica terreno	Sisma terreno - Riposo - Dir.Neg.	0.00	19.00	--	--	--	--	0.40	1.00	0.07
104	Sovraspinta sismica terreno	Sisma terreno - Riposo - Dir.Pos.	4.80	19.00	--	--	--	--	0.50	1.00	0.07
105	Spinta terreno	Terreno - Riposo - Dir.Neg.	6.80	19.00	--	--	--	--	0.40	--	--
105	permanenti platea	Sisma terreno - Riposo - Dir.Pos.	5.50	23.00	--	--	--	--	0.50	1.00	0.07
105	Sovraspinta sismica terreno	Sisma terreno - Riposo - Dir.Pos.	5.27	23.00	--	--	--	--	0.43	1.00	0.04
105	Sovraspinta sismica terreno	Sisma terreno - Riposo - Dir.Pos.	5.27	23.00	--	--	--	--	0.50	1.00	0.07

Shell	Cond.	Tipo	Ht	g	Ø	c	d	b	k0	bm	Ag
105	Sovraspinta sismica terreno	Sisma terreno - Riposo - Dir.Pos.	4.80	19.00	--	--	--	--	0.40	1.00	0.07
105	Sovraspinta sismica terreno	Sisma terreno - Riposo - Dir.Neg.	0.00	19.00	--	--	--	--	0.40	1.00	0.07
106	Spinta terreno	Terreno - Riposo - Dir.Neg.	4.80	19.00	--	--	--	--	0.40	--	--
106	Sovraspinta sismica terreno	Sisma terreno - Riposo - Dir.Pos.	4.80	19.00	--	--	--	--	0.50	1.00	0.07
106	Sovraspinta sismica terreno	Sisma terreno - Riposo - Dir.Neg.	0.00	19.00	--	--	--	--	0.40	1.00	0.07
106	Sovraspinta sismica terreno	Sisma terreno - Riposo - Dir.Pos.	5.27	23.00	--	--	--	--	0.43	1.00	0.04
106	Sovraspinta sismica terreno	Sisma terreno - Riposo - Dir.Pos.	5.27	23.00	--	--	--	--	0.50	1.00	0.07
107	Sovraspinta sismica terreno	Sisma terreno - Riposo - Dir.Neg.	0.00	19.00	--	--	--	--	0.40	1.00	0.07
108	Sovraspinta sismica terreno	Sisma terreno - Riposo - Dir.Neg.	0.00	19.00	--	--	--	--	0.40	1.00	0.07
109	Spinta terreno	Terreno - Riposo - Dir.Neg.	6.80	19.00	--	--	--	--	0.40	--	--
109	Sovraspinta sismica terreno	Sisma terreno - Riposo - Dir.Neg.	0.00	19.00	--	--	--	--	0.40	1.00	0.07
109	Sovraspinta sismica terreno	Sisma terreno - Riposo - Dir.Pos.	4.80	19.00	--	--	--	--	0.40	1.00	0.07
110	Spinta terreno	Terreno - Riposo - Dir.Neg.	4.80	19.00	--	--	--	--	0.40	--	--
110	Sovraspinta sismica terreno	Sisma terreno - Riposo - Dir.Pos.	4.80	19.00	--	--	--	--	0.50	1.00	0.07
110	Sovraspinta sismica terreno	Sisma terreno - Riposo - Dir.Neg.	0.00	19.00	--	--	--	--	0.40	1.00	0.07
111	Spinta terreno	Terreno - Riposo - Dir.Neg.	6.80	19.00	--	--	--	--	0.40	--	--
111	Sovraspinta sismica terreno	Sisma terreno - Riposo - Dir.Neg.	0.00	19.00	--	--	--	--	0.40	1.00	0.07
111	Sovraspinta sismica terreno	Sisma terreno - Riposo - Dir.Pos.	4.80	19.00	--	--	--	--	0.40	1.00	0.07
112	Spinta terreno	Terreno - Riposo - Dir.Neg.	4.80	19.00	--	--	--	--	0.40	--	--
112	Sovraspinta sismica terreno	Sisma terreno - Riposo - Dir.Neg.	0.00	19.00	--	--	--	--	0.40	1.00	0.07
112	Sovraspinta sismica terreno	Sisma terreno - Riposo - Dir.Pos.	4.80	19.00	--	--	--	--	0.50	1.00	0.07
113	Spinta terreno	Terreno - Riposo - Dir.Neg.	6.80	19.00	--	--	--	--	0.40	--	--
113	Sovraspinta sismica terreno	Sisma terreno - Riposo - Dir.Pos.	4.80	19.00	--	--	--	--	0.40	1.00	0.07
113	Sovraspinta sismica terreno	Sisma terreno - Riposo - Dir.Neg.	0.00	19.00	--	--	--	--	0.40	1.00	0.07
114	Spinta terreno	Terreno - Riposo - Dir.Neg.	4.80	19.00	--	--	--	--	0.40	--	--
114	Sovraspinta sismica terreno	Sisma terreno - Riposo - Dir.Neg.	0.00	19.00	--	--	--	--	0.40	1.00	0.07
114	Sovraspinta sismica terreno	Sisma terreno - Riposo - Dir.Pos.	4.80	19.00	--	--	--	--	0.50	1.00	0.07
115	Spinta terreno	Terreno - Riposo - Dir.Neg.	4.80	19.00	--	--	--	--	0.40	--	--
115	Sovraspinta sismica terreno	Sisma terreno - Riposo - Dir.Neg.	0.00	19.00	--	--	--	--	0.40	1.00	0.07
115	Sovraspinta sismica terreno	Sisma terreno - Riposo - Dir.Pos.	4.80	19.00	--	--	--	--	0.50	1.00	0.07
120	Spinta terreno	Terreno - Riposo - Dir.Neg.	4.80	19.00	--	--	--	--	0.40	--	--
120	Sovraspinta sismica terreno	Sisma terreno - Riposo - Dir.Pos.	4.80	19.00	--	--	--	--	0.50	1.00	0.07
120	Sovraspinta sismica terreno	Sisma terreno - Riposo - Dir.Neg.	0.00	19.00	--	--	--	--	0.40	1.00	0.07
125	Spinta terreno	Terreno - Riposo - Dir.Neg.	4.80	19.00	--	--	--	--	0.40	--	--
125	Sovraspinta sismica terreno	Sisma terreno - Riposo - Dir.Neg.	0.00	19.00	--	--	--	--	0.40	1.00	0.07
126	Spinta terreno	Terreno - Riposo - Dir.Neg.	4.80	19.00	--	--	--	--	0.40	--	--
126	Sovraspinta sismica terreno	Sisma terreno - Riposo - Dir.Neg.	0.00	19.00	--	--	--	--	0.40	1.00	0.07
127	Spinta terreno	Terreno - Riposo - Dir.Neg.	6.80	19.00	--	--	--	--	0.40	--	--
127	Sovraspinta sismica terreno	Sisma terreno - Riposo - Dir.Neg.	0.00	19.00	--	--	--	--	0.40	1.00	0.07
127	Sovraspinta sismica terreno	Sisma terreno - Riposo - Dir.Pos.	4.80	19.00	--	--	--	--	0.40	1.00	0.07
128	Spinta terreno	Terreno - Riposo - Dir.Neg.	4.80	19.00	--	--	--	--	0.40	--	--
128	Sovraspinta sismica terreno	Sisma terreno - Riposo - Dir.Neg.	0.00	19.00	--	--	--	--	0.40	1.00	0.07
129	Spinta terreno	Terreno - Riposo - Dir.Neg.	4.80	19.00	--	--	--	--	0.40	--	--
129	Sovraspinta sismica terreno	Sisma terreno - Riposo - Dir.Neg.	0.00	19.00	--	--	--	--	0.40	1.00	0.07
130	Spinta terreno	Terreno - Riposo - Dir.Neg.	4.80	19.00	--	--	--	--	0.40	--	--
130	Sovraspinta sismica terreno	Sisma terreno - Riposo - Dir.Neg.	0.00	19.00	--	--	--	--	0.40	1.00	0.07
130	Sovraspinta sismica terreno	Sisma terreno - Riposo - Dir.Pos.	4.80	19.00	--	--	--	--	0.50	1.00	0.07
138	Spinta terreno	Terreno - Riposo - Dir.Neg.	6.80	19.00	--	--	--	--	0.40	--	--
138	Sovraspinta sismica terreno	Sisma terreno - Riposo - Dir.Pos.	4.80	19.00	--	--	--	--	0.40	1.00	0.07
138	Sovraspinta sismica terreno	Sisma terreno - Riposo - Dir.Neg.	0.00	19.00	--	--	--	--	0.40	1.00	0.07
139	Spinta terreno	Terreno - Riposo - Dir.Neg.	6.80	19.00	--	--	--	--	0.40	--	--
139	Sovraspinta sismica terreno	Sisma terreno - Riposo - Dir.Pos.	4.80	19.00	--	--	--	--	0.40	1.00	0.07
139	Sovraspinta sismica terreno	Sisma terreno - Riposo - Dir.Neg.	0.00	19.00	--	--	--	--	0.40	1.00	0.07
140	Spinta terreno	Terreno - Riposo - Dir.Neg.	6.80	19.00	--	--	--	--	0.40	--	--
140	Sovraspinta sismica terreno	Sisma terreno - Riposo - Dir.Neg.	0.00	19.00	--	--	--	--	0.40	1.00	0.07
140	Sovraspinta sismica terreno	Sisma terreno - Riposo - Dir.Pos.	4.80	19.00	--	--	--	--	0.40	1.00	0.07
141	Spinta terreno	Terreno - Riposo - Dir.Neg.	6.80	19.00	--	--	--	--	0.40	--	--
141	Sovraspinta sismica terreno	Sisma terreno - Riposo - Dir.Pos.	4.80	19.00	--	--	--	--	0.40	1.00	0.07
141	Sovraspinta sismica terreno	Sisma terreno - Riposo - Dir.Neg.	0.00	19.00	--	--	--	--	0.40	1.00	0.07
142	Spinta terreno	Terreno - Riposo - Dir.Neg.	4.80	19.00	--	--	--	--	0.40	--	--
142	Sovraspinta sismica terreno	Sisma terreno - Riposo - Dir.Neg.	0.00	19.00	--	--	--	--	0.40	1.00	0.07

Shell	Cond.	Tipo	Ht	g	Ø	c	d	b	k0	bm	Ag
143	Spinta terreno	Terreno - Riposo - Dir.Neg.	4.80	19.00	--	--	--	--	0.40	--	--
143	Sovraspinta sismica terreno	Sisma terreno - Riposo - Dir.Neg.	0.00	19.00	--	--	--	--	0.40	1.00	0.07
147	Spinta terreno	Terreno - Riposo - Dir.Neg.	4.80	19.00	--	--	--	--	0.40	--	--
147	Sovraspinta sismica terreno	Sisma terreno - Riposo - Dir.Neg.	0.00	19.00	--	--	--	--	0.40	1.00	0.07
148	Spinta terreno	Terreno - Riposo - Dir.Neg.	4.80	19.00	--	--	--	--	0.40	--	--
148	Sovraspinta sismica terreno	Sisma terreno - Riposo - Dir.Neg.	0.00	19.00	--	--	--	--	0.40	1.00	0.07
149	Spinta terreno	Terreno - Riposo - Dir.Neg.	6.80	19.00	--	--	--	--	0.40	--	--
149	Sovraspinta sismica terreno	Sisma terreno - Riposo - Dir.Pos.	4.80	19.00	--	--	--	--	0.40	1.00	0.07
149	Sovraspinta sismica terreno	Sisma terreno - Riposo - Dir.Neg.	0.00	19.00	--	--	--	--	0.40	1.00	0.07
150	Spinta terreno	Terreno - Riposo - Dir.Neg.	4.80	19.00	--	--	--	--	0.40	--	--
150	Sovraspinta sismica terreno	Sisma terreno - Riposo - Dir.Neg.	0.00	19.00	--	--	--	--	0.40	1.00	0.07
151	Spinta terreno	Terreno - Riposo - Dir.Neg.	4.80	19.00	--	--	--	--	0.40	--	--
151	Sovraspinta sismica terreno	Sisma terreno - Riposo - Dir.Neg.	0.00	19.00	--	--	--	--	0.40	1.00	0.07
152	Spinta terreno	Terreno - Riposo - Dir.Neg.	6.80	19.00	--	--	--	--	0.40	--	--
152	Sovraspinta sismica terreno	Sisma terreno - Riposo - Dir.Pos.	4.80	19.00	--	--	--	--	0.40	1.00	0.07
152	Sovraspinta sismica terreno	Sisma terreno - Riposo - Dir.Neg.	0.00	19.00	--	--	--	--	0.40	1.00	0.07
153	Spinta terreno	Terreno - Riposo - Dir.Neg.	4.80	19.00	--	--	--	--	0.40	--	--
153	Sovraspinta sismica terreno	Sisma terreno - Riposo - Dir.Neg.	0.00	19.00	--	--	--	--	0.40	1.00	0.07
153	Sovraspinta sismica terreno	Sisma terreno - Riposo - Dir.Pos.	4.80	19.00	--	--	--	--	0.50	1.00	0.07
154	Spinta terreno	Terreno - Riposo - Dir.Neg.	4.80	19.00	--	--	--	--	0.40	--	--
154	Sovraspinta sismica terreno	Sisma terreno - Riposo - Dir.Neg.	0.00	19.00	--	--	--	--	0.40	1.00	0.07
155	Spinta terreno	Terreno - Riposo - Dir.Neg.	4.80	19.00	--	--	--	--	0.40	--	--
155	Sovraspinta sismica terreno	Sisma terreno - Riposo - Dir.Neg.	0.00	19.00	--	--	--	--	0.40	1.00	0.07
163	Spinta terreno	Terreno - Riposo - Dir.Neg.	4.80	19.00	--	--	--	--	0.40	--	--
163	Sovraspinta sismica terreno	Sisma terreno - Riposo - Dir.Neg.	0.00	19.00	--	--	--	--	0.40	1.00	0.07
163	Sovraspinta sismica terreno	Sisma terreno - Riposo - Dir.Pos.	4.80	19.00	--	--	--	--	0.50	1.00	0.07
164	Spinta terreno	Terreno - Riposo - Dir.Neg.	4.80	19.00	--	--	--	--	0.40	--	--
164	Sovraspinta sismica terreno	Sisma terreno - Riposo - Dir.Neg.	0.00	19.00	--	--	--	--	0.40	1.00	0.07
165	Spinta terreno	Terreno - Riposo - Dir.Neg.	4.80	19.00	--	--	--	--	0.40	--	--
165	Sovraspinta sismica terreno	Sisma terreno - Riposo - Dir.Neg.	0.00	19.00	--	--	--	--	0.40	1.00	0.07
170	Spinta terreno	Terreno - Riposo - Dir.Neg.	6.80	19.00	--	--	--	--	0.40	--	--
170	Sovraspinta sismica terreno	Sisma terreno - Riposo - Dir.Pos.	4.80	19.00	--	--	--	--	0.40	1.00	0.07
170	Sovraspinta sismica terreno	Sisma terreno - Riposo - Dir.Neg.	0.00	19.00	--	--	--	--	0.40	1.00	0.07
171	Spinta terreno	Terreno - Riposo - Dir.Neg.	6.80	19.00	--	--	--	--	0.40	--	--
171	Sovraspinta sismica terreno	Sisma terreno - Riposo - Dir.Neg.	0.00	19.00	--	--	--	--	0.40	1.00	0.07
172	Spinta terreno	Terreno - Riposo - Dir.Neg.	6.80	19.00	--	--	--	--	0.40	--	--
172	Sovraspinta sismica terreno	Sisma terreno - Riposo - Dir.Neg.	0.00	19.00	--	--	--	--	0.40	1.00	0.07
175	Spinta terreno	Terreno - Riposo - Dir.Neg.	4.80	19.00	--	--	--	--	0.40	--	--
175	Sovraspinta sismica terreno	Sisma terreno - Riposo - Dir.Neg.	0.00	19.00	--	--	--	--	0.40	1.00	0.07
178	Spinta terreno	Terreno - Riposo - Dir.Neg.	4.80	19.00	--	--	--	--	0.40	--	--
178	Sovraspinta sismica terreno	Sisma terreno - Riposo - Dir.Neg.	0.00	19.00	--	--	--	--	0.40	1.00	0.07
179	Spinta terreno	Terreno - Riposo - Dir.Neg.	4.80	19.00	--	--	--	--	0.40	--	--
179	Sovraspinta sismica terreno	Sisma terreno - Riposo - Dir.Neg.	0.00	19.00	--	--	--	--	0.40	1.00	0.07
180	Spinta terreno	Terreno - Riposo - Dir.Neg.	4.80	19.00	--	--	--	--	0.40	--	--
180	Sovraspinta sismica terreno	Sisma terreno - Riposo - Dir.Neg.	0.00	19.00	--	--	--	--	0.40	1.00	0.07
181	Spinta terreno	Terreno - Riposo - Dir.Neg.	6.80	19.00	--	--	--	--	0.40	--	--
181	Sovraspinta sismica terreno	Sisma terreno - Riposo - Dir.Neg.	0.00	19.00	--	--	--	--	0.40	1.00	0.07
182	Spinta terreno	Terreno - Riposo - Dir.Neg.	4.80	19.00	--	--	--	--	0.40	--	--
182	Sovraspinta sismica terreno	Sisma terreno - Riposo - Dir.Neg.	0.00	19.00	--	--	--	--	0.40	1.00	0.07
186	Spinta terreno	Terreno - Riposo - Dir.Neg.	6.80	19.00	--	--	--	--	0.40	--	--
186	permanenti platea	Sisma terreno - Riposo - Dir.Pos.	5.50	23.00	--	--	--	--	0.50	1.00	0.07
186	Sovraspinta sismica terreno	Sisma terreno - Riposo - Dir.Neg.	0.00	19.00	--	--	--	--	0.40	1.00	0.07
186	Sovraspinta sismica terreno	Sisma terreno - Riposo - Dir.Pos.	4.80	19.00	--	--	--	--	0.40	1.00	0.07
186	Sovraspinta sismica terreno	Sisma terreno - Riposo - Dir.Pos.	5.27	23.00	--	--	--	--	0.50	1.00	0.07
186	Sovraspinta sismica terreno	Sisma terreno - Riposo - Dir.Pos.	5.27	23.00	--	--	--	--	0.43	1.00	0.04
187	Spinta terreno	Terreno - Riposo - Dir.Neg.	4.80	19.00	--	--	--	--	0.40	--	--
187	Sovraspinta sismica terreno	Sisma terreno - Riposo - Dir.Pos.	4.80	19.00	--	--	--	--	0.50	1.00	0.07
187	Sovraspinta sismica terreno	Sisma terreno - Riposo - Dir.Neg.	0.00	19.00	--	--	--	--	0.40	1.00	0.07
187	Sovraspinta sismica terreno	Sisma terreno - Riposo - Dir.Pos.	5.27	23.00	--	--	--	--	0.50	1.00	0.07
187	Sovraspinta sismica terreno	Sisma terreno - Riposo - Dir.Pos.	5.27	23.00	--	--	--	--	0.43	1.00	0.04
188	Spinta terreno	Terreno - Riposo - Dir.Neg.	6.80	19.00	--	--	--	--	0.40	--	--

Shell	Cond.	Tipo	Ht	g	Ø	c	d	b	k0	bm	Ag
188	Sovraspinta sismica terreno	Sisma terreno - Riposo - Dir.Pos.	5.27	23.00	--	--	--	--	0.43	1.00	0.04
188	Sovraspinta sismica terreno	Sisma terreno - Riposo - Dir.Neg.	0.00	19.00	--	--	--	--	0.40	1.00	0.07
188	Sovraspinta sismica terreno	Sisma terreno - Riposo - Dir.Pos.	5.27	23.00	--	--	--	--	0.50	1.00	0.07
188	Sovraspinta sismica terreno	Sisma terreno - Riposo - Dir.Pos.	4.80	19.00	--	--	--	--	0.40	1.00	0.07
189	Spinta terreno	Terreno - Riposo - Dir.Neg.	4.80	19.00	--	--	--	--	0.40	--	--
189	Sovraspinta sismica terreno	Sisma terreno - Riposo - Dir.Pos.	5.27	23.00	--	--	--	--	0.43	1.00	0.04
189	Sovraspinta sismica terreno	Sisma terreno - Riposo - Dir.Neg.	0.00	19.00	--	--	--	--	0.40	1.00	0.07
189	Sovraspinta sismica terreno	Sisma terreno - Riposo - Dir.Pos.	5.27	23.00	--	--	--	--	0.50	1.00	0.07
189	Sovraspinta sismica terreno	Sisma terreno - Riposo - Dir.Pos.	4.80	19.00	--	--	--	--	0.50	1.00	0.07
190	Spinta terreno	Terreno - Riposo - Dir.Neg.	4.80	19.00	--	--	--	--	0.40	--	--
190	Sovraspinta sismica terreno	Sisma terreno - Riposo - Dir.Neg.	0.00	19.00	--	--	--	--	0.40	1.00	0.07
190	Sovraspinta sismica terreno	Sisma terreno - Riposo - Dir.Pos.	4.80	19.00	--	--	--	--	0.50	1.00	0.07
191	Spinta terreno	Terreno - Riposo - Dir.Neg.	4.80	19.00	--	--	--	--	0.40	--	--
191	Sovraspinta sismica terreno	Sisma terreno - Riposo - Dir.Neg.	0.00	19.00	--	--	--	--	0.40	1.00	0.07
191	Sovraspinta sismica terreno	Sisma terreno - Riposo - Dir.Pos.	4.80	19.00	--	--	--	--	0.50	1.00	0.07
192	Spinta terreno	Terreno - Riposo - Dir.Neg.	6.80	19.00	--	--	--	--	0.40	--	--
192	Sovraspinta sismica terreno	Sisma terreno - Riposo - Dir.Pos.	4.80	19.00	--	--	--	--	0.40	1.00	0.07
192	Sovraspinta sismica terreno	Sisma terreno - Riposo - Dir.Neg.	0.00	19.00	--	--	--	--	0.40	1.00	0.07
193	Spinta terreno	Terreno - Riposo - Dir.Neg.	6.80	19.00	--	--	--	--	0.40	--	--
193	Sovraspinta sismica terreno	Sisma terreno - Riposo - Dir.Pos.	4.80	19.00	--	--	--	--	0.40	1.00	0.07
193	Sovraspinta sismica terreno	Sisma terreno - Riposo - Dir.Neg.	0.00	19.00	--	--	--	--	0.40	1.00	0.07
194	Spinta terreno	Terreno - Riposo - Dir.Neg.	4.80	19.00	--	--	--	--	0.40	--	--
194	Sovraspinta sismica terreno	Sisma terreno - Riposo - Dir.Pos.	4.80	19.00	--	--	--	--	0.50	1.00	0.07
194	Sovraspinta sismica terreno	Sisma terreno - Riposo - Dir.Neg.	0.00	19.00	--	--	--	--	0.40	1.00	0.07
195	Spinta terreno	Terreno - Riposo - Dir.Neg.	6.80	19.00	--	--	--	--	0.40	--	--
195	Sovraspinta sismica terreno	Sisma terreno - Riposo - Dir.Neg.	0.00	19.00	--	--	--	--	0.40	1.00	0.07
195	Sovraspinta sismica terreno	Sisma terreno - Riposo - Dir.Pos.	4.80	19.00	--	--	--	--	0.40	1.00	0.07
196	Spinta terreno	Terreno - Riposo - Dir.Neg.	4.80	19.00	--	--	--	--	0.40	--	--
196	Sovraspinta sismica terreno	Sisma terreno - Riposo - Dir.Neg.	0.00	19.00	--	--	--	--	0.40	1.00	0.07
196	Sovraspinta sismica terreno	Sisma terreno - Riposo - Dir.Pos.	4.80	19.00	--	--	--	--	0.50	1.00	0.07
197	Spinta terreno	Terreno - Riposo - Dir.Neg.	4.80	19.00	--	--	--	--	0.40	--	--
197	Sovraspinta sismica terreno	Sisma terreno - Riposo - Dir.Neg.	0.00	19.00	--	--	--	--	0.40	1.00	0.07
197	Sovraspinta sismica terreno	Sisma terreno - Riposo - Dir.Pos.	4.80	19.00	--	--	--	--	0.50	1.00	0.07
198	Spinta terreno	Terreno - Riposo - Dir.Neg.	4.80	19.00	--	--	--	--	0.40	--	--
198	Sovraspinta sismica terreno	Sisma terreno - Riposo - Dir.Neg.	0.00	19.00	--	--	--	--	0.40	1.00	0.07
199	Spinta terreno	Terreno - Riposo - Dir.Neg.	6.80	19.00	--	--	--	--	0.40	--	--
199	Sovraspinta sismica terreno	Sisma terreno - Riposo - Dir.Neg.	0.00	19.00	--	--	--	--	0.40	1.00	0.07
199	Sovraspinta sismica terreno	Sisma terreno - Riposo - Dir.Pos.	4.80	19.00	--	--	--	--	0.40	1.00	0.07
200	Spinta terreno	Terreno - Riposo - Dir.Neg.	4.80	19.00	--	--	--	--	0.40	--	--
200	Sovraspinta sismica terreno	Sisma terreno - Riposo - Dir.Neg.	0.00	19.00	--	--	--	--	0.40	1.00	0.07
201	Spinta terreno	Terreno - Riposo - Dir.Neg.	4.80	19.00	--	--	--	--	0.40	--	--
201	Sovraspinta sismica terreno	Sisma terreno - Riposo - Dir.Neg.	0.00	19.00	--	--	--	--	0.40	1.00	0.07
201	Sovraspinta sismica terreno	Sisma terreno - Riposo - Dir.Pos.	4.80	19.00	--	--	--	--	0.50	1.00	0.07
202	Spinta terreno	Terreno - Riposo - Dir.Neg.	4.80	19.00	--	--	--	--	0.40	--	--
202	Sovraspinta sismica terreno	Sisma terreno - Riposo - Dir.Neg.	0.00	19.00	--	--	--	--	0.40	1.00	0.07
203	Spinta terreno	Terreno - Riposo - Dir.Neg.	4.80	19.00	--	--	--	--	0.40	--	--
203	Sovraspinta sismica terreno	Sisma terreno - Riposo - Dir.Neg.	0.00	19.00	--	--	--	--	0.40	1.00	0.07
210	Sovraspinta sismica terreno	Sisma terreno - Riposo - Dir.Pos.	0.00	23.00	--	--	--	--	0.50	1.00	0.07
210	Sovraspinta sismica terreno	Sisma terreno - Riposo - Dir.Pos.	5.27	23.00	--	--	--	--	0.50	1.00	0.07
212	Sovraspinta sismica terreno	Sisma terreno - Riposo - Dir.Pos.	0.00	23.00	--	--	--	--	0.50	1.00	0.07
212	Sovraspinta sismica terreno	Sisma terreno - Riposo - Dir.Pos.	5.27	23.00	--	--	--	--	0.50	1.00	0.07
213	Sovraspinta sismica terreno	Sisma terreno - Riposo - Dir.Pos.	0.00	23.00	--	--	--	--	0.50	1.00	0.07
213	Sovraspinta sismica terreno	Sisma terreno - Riposo - Dir.Pos.	5.27	23.00	--	--	--	--	0.50	1.00	0.07
217	Sovraspinta sismica terreno	Sisma terreno - Riposo - Dir.Pos.	5.27	23.00	--	--	--	--	0.50	1.00	0.07
217	Sovraspinta sismica terreno	Sisma terreno - Riposo - Dir.Pos.	0.00	23.00	--	--	--	--	0.50	1.00	0.07
218	Sovraspinta sismica terreno	Sisma terreno - Riposo - Dir.Pos.	0.00	23.00	--	--	--	--	0.50	1.00	0.07
218	Sovraspinta sismica terreno	Sisma terreno - Riposo - Dir.Pos.	5.27	23.00	--	--	--	--	0.50	1.00	0.07
219	Sovraspinta sismica terreno	Sisma terreno - Riposo - Dir.Pos.	0.00	23.00	--	--	--	--	0.50	1.00	0.07
219	Sovraspinta sismica terreno	Sisma terreno - Riposo - Dir.Pos.	5.27	23.00	--	--	--	--	0.50	1.00	0.07
223	Spinta terreno	Terreno - Riposo - Dir.Neg.	6.80	19.00	--	--	--	--	0.40	--	--
223	permanenti platea	Sisma terreno - Riposo - Dir.Pos.	5.50	23.00	--	--	--	--	0.50	1.00	0.07

Shell	Cond.	Tipo	Ht	g	Ø	c	d	b	k0	bm	Ag
223	Sovraspinta sismica terreno	Sisma terreno - Riposo - Dir.Neg.	0.00	19.00	--	--	--	--	0.40	1.00	0.07
223	Sovraspinta sismica terreno	Sisma terreno - Riposo - Dir.Pos.	5.27	23.00	--	--	--	--	0.50	1.00	0.07
223	Sovraspinta sismica terreno	Sisma terreno - Riposo - Dir.Pos.	5.27	23.00	--	--	--	--	0.43	1.00	0.04
224	Spinta terreno	Terreno - Riposo - Dir.Neg.	4.80	19.00	--	--	--	--	0.40	--	--
224	Sovraspinta sismica terreno	Sisma terreno - Riposo - Dir.Pos.	5.27	23.00	--	--	--	--	0.50	1.00	0.07
224	Sovraspinta sismica terreno	Sisma terreno - Riposo - Dir.Neg.	0.00	19.00	--	--	--	--	0.40	1.00	0.07
224	Sovraspinta sismica terreno	Sisma terreno - Riposo - Dir.Pos.	5.27	23.00	--	--	--	--	0.43	1.00	0.04
225	Spinta terreno	Terreno - Riposo - Dir.Neg.	6.80	19.00	--	--	--	--	0.40	--	--
225	Sovraspinta sismica terreno	Sisma terreno - Riposo - Dir.Pos.	5.27	23.00	--	--	--	--	0.50	1.00	0.07
225	Sovraspinta sismica terreno	Sisma terreno - Riposo - Dir.Pos.	5.27	23.00	--	--	--	--	0.43	1.00	0.04
225	Sovraspinta sismica terreno	Sisma terreno - Riposo - Dir.Neg.	0.00	19.00	--	--	--	--	0.40	1.00	0.07
226	Spinta terreno	Terreno - Riposo - Dir.Neg.	4.80	19.00	--	--	--	--	0.40	--	--
226	Sovraspinta sismica terreno	Sisma terreno - Riposo - Dir.Pos.	5.27	23.00	--	--	--	--	0.50	1.00	0.07
226	Sovraspinta sismica terreno	Sisma terreno - Riposo - Dir.Neg.	0.00	19.00	--	--	--	--	0.40	1.00	0.07
226	Sovraspinta sismica terreno	Sisma terreno - Riposo - Dir.Pos.	5.27	23.00	--	--	--	--	0.43	1.00	0.04
242	Spinta terreno	Terreno - Riposo - Dir.Neg.	6.80	19.00	--	--	--	--	0.40	--	--
242	Sovraspinta sismica terreno	Sisma terreno - Riposo - Dir.Neg.	0.00	19.00	--	--	--	--	0.40	1.00	0.07
243	Spinta terreno	Terreno - Riposo - Dir.Neg.	4.80	19.00	--	--	--	--	0.40	--	--
243	Sovraspinta sismica terreno	Sisma terreno - Riposo - Dir.Neg.	0.00	19.00	--	--	--	--	0.40	1.00	0.07
244	Spinta terreno	Terreno - Riposo - Dir.Neg.	4.80	19.00	--	--	--	--	0.40	--	--
244	Sovraspinta sismica terreno	Sisma terreno - Riposo - Dir.Neg.	0.00	19.00	--	--	--	--	0.40	1.00	0.07
245	Spinta terreno	Terreno - Riposo - Dir.Neg.	6.80	19.00	--	--	--	--	0.40	--	--
245	Sovraspinta sismica terreno	Sisma terreno - Riposo - Dir.Neg.	0.00	19.00	--	--	--	--	0.40	1.00	0.07
246	Spinta terreno	Terreno - Riposo - Dir.Neg.	4.80	19.00	--	--	--	--	0.40	--	--
246	Sovraspinta sismica terreno	Sisma terreno - Riposo - Dir.Neg.	0.00	19.00	--	--	--	--	0.40	1.00	0.07
247	Spinta terreno	Terreno - Riposo - Dir.Neg.	6.80	19.00	--	--	--	--	0.40	--	--
247	Sovraspinta sismica terreno	Sisma terreno - Riposo - Dir.Neg.	0.00	19.00	--	--	--	--	0.40	1.00	0.07
248	Spinta terreno	Terreno - Riposo - Dir.Neg.	4.80	19.00	--	--	--	--	0.40	--	--
248	Sovraspinta sismica terreno	Sisma terreno - Riposo - Dir.Neg.	0.00	19.00	--	--	--	--	0.40	1.00	0.07
249	Spinta terreno	Terreno - Riposo - Dir.Neg.	4.80	19.00	--	--	--	--	0.40	--	--
249	Sovraspinta sismica terreno	Sisma terreno - Riposo - Dir.Neg.	0.00	19.00	--	--	--	--	0.40	1.00	0.07
250	Spinta terreno	Terreno - Riposo - Dir.Neg.	4.80	19.00	--	--	--	--	0.40	--	--
250	Sovraspinta sismica terreno	Sisma terreno - Riposo - Dir.Neg.	0.00	19.00	--	--	--	--	0.40	1.00	0.07
251	Spinta terreno	Terreno - Riposo - Dir.Neg.	6.80	19.00	--	--	--	--	0.40	--	--
251	Sovraspinta sismica terreno	Sisma terreno - Riposo - Dir.Neg.	0.00	19.00	--	--	--	--	0.40	1.00	0.07
253	Spinta terreno	Terreno - Riposo - Dir.Neg.	4.80	19.00	--	--	--	--	0.40	--	--
253	Sovraspinta sismica terreno	Sisma terreno - Riposo - Dir.Neg.	0.00	19.00	--	--	--	--	0.40	1.00	0.07
254	Spinta terreno	Terreno - Riposo - Dir.Neg.	4.80	19.00	--	--	--	--	0.40	--	--
254	Sovraspinta sismica terreno	Sisma terreno - Riposo - Dir.Neg.	0.00	19.00	--	--	--	--	0.40	1.00	0.07
255	Spinta terreno	Terreno - Riposo - Dir.Neg.	4.80	19.00	--	--	--	--	0.40	--	--
255	Sovraspinta sismica terreno	Sisma terreno - Riposo - Dir.Neg.	0.00	19.00	--	--	--	--	0.40	1.00	0.07
257	Spinta terreno	Terreno - Riposo - Dir.Neg.	4.80	19.00	--	--	--	--	0.40	--	--
257	Sovraspinta sismica terreno	Sisma terreno - Riposo - Dir.Neg.	0.00	19.00	--	--	--	--	0.40	1.00	0.07

Shell	Cond.	Tipo	Q	Vert.1	Vert.2	Vert.3	Vert.4	Hw	g
			kN/m^2	kN/m^2	kN/m^2	kN/m^2	kN/m^2	m	kN/m^3
1	Peso Proprio	Peso Proprio kN	49.88						
1	accidentali platea	Uniforme_GLOBZ	6.00						
1	Spinta acqua	Uniforme_GLOBZ	22.00						
1	permanenti platea	Uniforme_GLOBZ	6.00						
2	Peso Proprio	Peso Proprio kN	110.50						
2	accidentali platea	Uniforme_GLOBZ	6.00						
2	Spinta acqua	Uniforme_GLOBZ	22.00						
2	permanenti platea	Uniforme_GLOBZ	6.00						
3	Peso Proprio	Peso Proprio kN	110.50						
3	accidentali platea	Uniforme_GLOBZ	6.00						
3	Spinta acqua	Uniforme_GLOBZ	22.00						
3	permanenti platea	Uniforme_GLOBZ	6.00						
4	Peso Proprio	Peso Proprio kN	136.50						
4	accidentali platea	Uniforme_GLOBZ	6.00						
4	Spinta acqua	Uniforme_GLOBZ	22.00						

Shell	Cond.	Tipo	Q	Vert.1	Vert.2	Vert.3	Vert.4	Hw	g
4	permanenti platea	Uniforme_GLOBZ	6.00						
5	Peso Proprio	Peso Proprio kN	23.38						
5	accidentali platea	Uniforme_GLOBZ	6.00						
5	Spinta acqua	Uniforme_GLOBZ	22.00						
5	permanenti platea	Uniforme_GLOBZ	6.00						
6	Peso Proprio	Peso Proprio kN	28.88						
6	accidentali platea	Uniforme_GLOBZ	6.00						
6	Spinta acqua	Uniforme_GLOBZ	22.00						
6	permanenti platea	Uniforme_GLOBZ	6.00						
6	Peso Proprio	Peso Proprio kN	40.38						
7	accidentali platea	Uniforme_GLOBZ	6.00						
7	Spinta acqua	Uniforme_GLOBZ	22.00						
7	permanenti platea	Uniforme_GLOBZ	6.00						
8	Peso Proprio	Peso Proprio kN	23.38						
8	accidentali platea	Uniforme_GLOBZ	6.00						
8	Spinta acqua	Uniforme_GLOBZ	22.00						
8	permanenti platea	Uniforme_GLOBZ	6.00						
9	Peso Proprio	Peso Proprio kN	23.38						
9	accidentali platea	Uniforme_GLOBZ	6.00						
9	Spinta acqua	Uniforme_GLOBZ	22.00						
9	permanenti platea	Uniforme_GLOBZ	6.00						
10	Peso Proprio	Peso Proprio kN	9.90						
10	Spinta acqua	Idrostatico - Positivo						2.00	11.00
10	Spinta sovraccarico	Uniforme_GLOBX	-5.00						
11	Peso Proprio	Peso Proprio kN	46.80						
11	Spinta acqua	Idrostatico - Positivo						2.00	11.00
11	Spinta sovraccarico	Uniforme_GLOBX	5.00						
11	Sovraspinta sismica falda	Idrostatico - Negativo						2.40	1.10
12	Peso Proprio	Peso Proprio kN	5.40						
12	Spinta acqua	Idrostatico - Positivo						2.00	11.00
12	Spinta sovraccarico	Uniforme_GLOBX	-5.00						
13	Peso Proprio	Peso Proprio kN	17.10						
13	Spinta acqua	Idrostatico - Positivo						2.00	11.00
13	Spinta sovraccarico	Uniforme_GLOBX	5.00						
14	Peso Proprio	Peso Proprio kN	9.90						
14	Spinta acqua	Idrostatico - Positivo						2.00	11.00
14	Spinta sovraccarico	Uniforme_GLOBX	5.00						
15	Peso Proprio	Peso Proprio kN	46.80						
15	Spinta acqua	Idrostatico - Positivo						2.00	11.00
15	Spinta sovraccarico	Uniforme_GLOBX	-5.00						
15	Sovraspinta sismica falda	Trapez.GlobX							
15	Sovraspinta sismica falda	Idrostatico - Negativo						2.40	1.10
16	Peso Proprio	Peso Proprio kN	40.38						
16	accidentali platea	Uniforme_GLOBZ	6.00						
16	Spinta acqua	Uniforme_GLOBZ	22.00						
16	permanenti platea	Uniforme_GLOBZ	6.00						
17	Peso Proprio	Peso Proprio kN	23.38						
17	accidentali platea	Uniforme_GLOBZ	6.00						
17	Spinta acqua	Uniforme_GLOBZ	22.00						
17	permanenti platea	Uniforme_GLOBZ	6.00						
18	Peso Proprio	Peso Proprio kN	23.38						
18	accidentali platea	Uniforme_GLOBZ	6.00						
18	Spinta acqua	Uniforme_GLOBZ	22.00						
18	permanenti platea	Uniforme_GLOBZ	6.00						
19	Peso Proprio	Peso Proprio kN	12.75						
19	accidentali platea	Uniforme_GLOBZ	6.00						
19	Spinta acqua	Uniforme_GLOBZ	22.00						
19	permanenti platea	Uniforme_GLOBZ	6.00						

Shell	Cond.	Tipo	Q	Vert.1	Vert.2	Vert.3	Vert.4	Hw	g
20	Peso Proprio	Peso Proprio kN	15.75						
20	accidentali platea	Uniforme_GLOBZ	6.00						
20	Spinta acqua	Uniforme_GLOBZ	22.00						
20	permanenti platea	Uniforme_GLOBZ	6.00						
21	Peso Proprio	Peso Proprio kN	12.75						
21	accidentali platea	Uniforme_GLOBZ	6.00						
21	Spinta acqua	Uniforme_GLOBZ	22.00						
21	permanenti platea	Uniforme_GLOBZ	6.00						
22	Peso Proprio	Peso Proprio kN	110.50						
22	accidentali platea	Uniforme_GLOBZ	6.00						
22	Spinta acqua	Uniforme_GLOBZ	22.00						
22	permanenti platea	Uniforme_GLOBZ	6.00						
23	Peso Proprio	Peso Proprio kN	23.38						
23	accidentali platea	Uniforme_GLOBZ	6.00						
23	Spinta acqua	Uniforme_GLOBZ	22.00						
23	permanenti platea	Uniforme_GLOBZ	6.00						
24	Peso Proprio	Peso Proprio kN	28.88						
24	accidentali platea	Uniforme_GLOBZ	6.00						
24	Spinta acqua	Uniforme_GLOBZ	22.00						
24	permanenti platea	Uniforme_GLOBZ	6.00						
25	Peso Proprio	Peso Proprio kN	12.75						
25	accidentali platea	Uniforme_GLOBZ	6.00						
25	Spinta acqua	Uniforme_GLOBZ	22.00						
25	permanenti platea	Uniforme_GLOBZ	6.00						
26	Peso Proprio	Peso Proprio kN	40.38						
26	accidentali platea	Uniforme_GLOBZ	6.00						
26	Spinta acqua	Uniforme_GLOBZ	22.00						
26	permanenti platea	Uniforme_GLOBZ	6.00						
27	Peso Proprio	Peso Proprio kN	9.90						
27	Spinta acqua	Idrostatico - Positivo						2.00	11.00
27	Spinta sovraccarico	Uniforme_GLOBX	-5.00						
27	Sovraspinta sismica falda	Idrostatico - Negativo						2.40	1.10
27	Sovraspinta sismica falda	Trapez.GlobX							
28	Peso Proprio	Peso Proprio kN	15.30						
28	Spinta acqua	Idrostatico - Positivo						2.00	11.00
29	Peso Proprio	Peso Proprio kN	9.90						
29	Spinta acqua	Idrostatico - Positivo						2.00	11.00
29	Spinta sovraccarico	Uniforme_GLOBX	5.00						
29	Sovraspinta sismica falda	Idrostatico - Negativo						2.40	1.10
30	Peso Proprio	Peso Proprio kN	5.40						
30	Spinta acqua	Idrostatico - Positivo						2.00	11.00
30	Spinta sovraccarico	Uniforme_GLOBX	5.00						
31	Peso Proprio	Peso Proprio kN	18.90						
31	Spinta acqua	Idrostatico - Positivo						2.00	11.00
32	Peso Proprio	Peso Proprio kN	17.10						
32	Spinta acqua	Idrostatico - Positivo						2.00	11.00
32	Spinta sovraccarico	Uniforme_GLOBX	-5.00						
33	Peso Proprio	Peso Proprio kN	15.30						
33	Spinta acqua	Idrostatico - Positivo						2.00	11.00
34	Peso Proprio	Peso Proprio kN	15.30						
34	Spinta acqua	Idrostatico - Positivo						2.00	11.00
35	Peso Proprio	Peso Proprio kN	72.25						
35	accidentali platea	Uniforme_GLOBZ	6.00						
35	Spinta acqua	Uniforme_GLOBZ	22.00						
35	permanenti platea	Uniforme_GLOBZ	6.00						
36	Peso Proprio	Peso Proprio kN	72.25						
36	accidentali platea	Uniforme_GLOBZ	6.00						
36	Spinta acqua	Uniforme_GLOBZ	22.00						

Shell	Cond.	Tipo	Q	Vert.1	Vert.2	Vert.3	Vert.4	Hw	g
36	permanenti platea	Uniforme_GLOBZ	6.00						
37	Peso Proprio	Peso Proprio kN	72.25						
37	accidentali platea	Uniforme_GLOBZ	6.00						
37	Spinta acqua	Uniforme_GLOBZ	22.00						
37	permanenti platea	Uniforme_GLOBZ	6.00						
38	Peso Proprio	Peso Proprio kN	89.25						
38	accidentali platea	Uniforme_GLOBZ	6.00						
38	Spinta acqua	Uniforme_GLOBZ	22.00						
38	permanenti platea	Uniforme_GLOBZ	6.00						
39	Peso Proprio	Peso Proprio kN	15.30						
39	Spinta acqua	Idrostatico - Positivo						2.00	11.00
39	Spinta sovraccarico	Uniforme_GLOBY	-5.00						
40	Peso Proprio	Peso Proprio kN	15.30						
40	Spinta acqua	Idrostatico - Positivo						2.00	11.00
40	Spinta sovraccarico	Uniforme_GLOBY	-5.00						
41	Peso Proprio	Peso Proprio kN	15.30						
41	Spinta acqua	Idrostatico - Positivo						2.00	11.00
41	Spinta sovraccarico	Uniforme_GLOBY	-5.00						
42	Peso Proprio	Peso Proprio kN	18.90						
42	Spinta acqua	Idrostatico - Positivo						2.00	11.00
42	Spinta sovraccarico	Uniforme_GLOBY	-5.00						
43	Peso Proprio	Peso Proprio kN	30.60						
43	Spinta acqua	Idrostatico - Positivo						2.00	11.00
43	Spinta sovraccarico	Uniforme_GLOBX	5.00						
44	Peso Proprio	Peso Proprio kN	30.60						
44	Spinta acqua	Idrostatico - Positivo						2.00	11.00
44	Spinta sovraccarico	Uniforme_GLOBX	-5.00						
45	Peso Proprio	Peso Proprio kN	10.63						
45	peso terreno	Uniforme_GLOBZ	90.00						
45	accidentali platea	Uniforme_GLOBZ	6.00						
46	Peso Proprio	Peso Proprio kN	16.25						
46	peso terreno	Uniforme_GLOBZ	90.00						
46	accidentali platea	Uniforme_GLOBZ	6.00						
47	Peso Proprio	Peso Proprio kN	3.44						
47	peso terreno	Uniforme_GLOBZ	90.00						
47	accidentali platea	Uniforme_GLOBZ	6.00						
48	Peso Proprio	Peso Proprio kN	1.87						
48	peso terreno	Uniforme_GLOBZ	90.00						
48	accidentali platea	Uniforme_GLOBZ	6.00						
49	Peso Proprio	Peso Proprio kN	5.94						
49	peso terreno	Uniforme_GLOBZ	90.00						
49	accidentali platea	Uniforme_GLOBZ	6.00						
50	Peso Proprio	Peso Proprio kN	3.44						
50	peso terreno	Uniforme_GLOBZ	90.00						
50	accidentali platea	Uniforme_GLOBZ	6.00						
51	Peso Proprio	Peso Proprio kN	10.63						
51	peso terreno	Uniforme_GLOBZ	90.00						
51	accidentali platea	Uniforme_GLOBZ	6.00						
52	Peso Proprio	Peso Proprio kN	5.94						
52	peso terreno	Uniforme_GLOBZ	90.00						
52	accidentali platea	Uniforme_GLOBZ	6.00						
53	Peso Proprio	Peso Proprio kN	16.25						
53	peso terreno	Uniforme_GLOBZ	90.00						
53	accidentali platea	Uniforme_GLOBZ	6.00						
54	Peso Proprio	Peso Proprio kN	3.44						
54	peso terreno	Uniforme_GLOBZ	90.00						
54	accidentali platea	Uniforme_GLOBZ	6.00						
55	Peso Proprio	Peso Proprio kN	3.44						
55	peso terreno	Uniforme_GLOBZ	90.00						
55	accidentali platea	Uniforme_GLOBZ	6.00						
56	Peso Proprio	Peso Proprio kN	1.87						

Shell	Cond.	Tipo	Q	Vert.1	Vert.2	Vert.3	Vert.4	Hw	g
56	peso terreno	Uniforme_GLOBZ	90.00						
56	accidentali platea	Uniforme_GLOBZ	6.00						
57	Peso Proprio	Peso Proprio kN	5.31						
57	peso terreno	Uniforme_GLOBZ	90.00						
57	accidentali platea	Uniforme_GLOBZ	6.00						
58	Peso Proprio	Peso Proprio kN	5.31						
58	peso terreno	Uniforme_GLOBZ	90.00						
58	accidentali platea	Uniforme_GLOBZ	6.00						
59	Peso Proprio	Peso Proprio kN	5.31						
59	peso terreno	Uniforme_GLOBZ	90.00						
59	accidentali platea	Uniforme_GLOBZ	6.00						
60	Peso Proprio	Peso Proprio kN	0.78						
60	peso terreno	Uniforme_GLOBZ	90.00						
60	accidentali platea	Uniforme_GLOBZ	6.00						
61	Peso Proprio	Peso Proprio kN	6.56						
61	peso terreno	Uniforme_GLOBZ	90.00						
61	accidentali platea	Uniforme_GLOBZ	6.00						
62	Peso Proprio	Peso Proprio kN	0.78						
62	peso terreno	Uniforme_GLOBZ	90.00						
62	accidentali platea	Uniforme_GLOBZ	6.00						
63	Peso Proprio	Peso Proprio kN	5.31						
63	peso terreno	Uniforme_GLOBZ	90.00						
63	accidentali platea	Uniforme_GLOBZ	6.00						
64	Peso Proprio	Peso Proprio kN	6.56						
64	peso terreno	Uniforme_GLOBZ	90.00						
64	accidentali platea	Uniforme_GLOBZ	6.00						
65	Peso Proprio	Peso Proprio kN	0.78						
65	peso terreno	Uniforme_GLOBZ	90.00						
65	accidentali platea	Uniforme_GLOBZ	6.00						
66	Peso Proprio	Peso Proprio kN	5.31						
66	peso terreno	Uniforme_GLOBZ	90.00						
66	accidentali platea	Uniforme_GLOBZ	6.00						
67	Peso Proprio	Peso Proprio kN	5.31						
67	peso terreno	Uniforme_GLOBZ	90.00						
67	accidentali platea	Uniforme_GLOBZ	6.00						
68	Peso Proprio	Peso Proprio kN	0.78						
68	peso terreno	Uniforme_GLOBZ	90.00						
68	accidentali platea	Uniforme_GLOBZ	6.00						
69	Peso Proprio	Peso Proprio kN	12.10						
69	Spinta acqua	Idrostatico - Positivo						2.00	11.00
69	Spinta sovraccarico	Uniforme_GLOBX	-5.00						
70	Peso Proprio	Peso Proprio kN	12.10						
70	Spinta acqua	Idrostatico - Positivo						2.00	11.00
70	Spinta sovraccarico	Uniforme_GLOBX	5.00						
71	Peso Proprio	Peso Proprio kN	57.20						
71	Spinta acqua	Idrostatico - Positivo						2.00	11.00
71	Spinta sovraccarico	Uniforme_GLOBX	-5.00						
71	Sovraspinta sismica falda	Trapez.GlobX							
71	Sovraspinta sismica falda	Idrostatico - Negativo						2.40	1.10
72	Peso Proprio	Peso Proprio kN	57.20						
72	Spinta acqua	Idrostatico - Positivo						2.00	11.00
72	Spinta sovraccarico	Uniforme_GLOBX	5.00						
72	Sovraspinta sismica falda	Idrostatico - Negativo						2.40	1.10
73	Peso Proprio	Peso Proprio kN	12.10						
73	Spinta acqua	Idrostatico - Positivo						2.00	11.00
73	Spinta sovraccarico	Uniforme_GLOBX	-5.00						
73	Sovraspinta sismica falda	Trapez.GlobX							

Shell	Cond.	Tipo	Q	Vert.1	Vert.2	Vert.3	Vert.4	Hw	g
73	Sovraspinta sismica falda	Idrostatico - Negativo						2.40	1.10
74	Peso Proprio	Peso Proprio kN	18.70						
74	Spinta acqua	Idrostatico - Positivo						2.00	11.00
75	Peso Proprio	Peso Proprio kN	6.60						
75	Spinta acqua	Idrostatico - Positivo						2.00	11.00
75	Spinta sovraccarico	Uniforme_GLOBX	-5.00						
76	Peso Proprio	Peso Proprio kN	12.10						
76	Spinta acqua	Idrostatico - Positivo						2.00	11.00
76	Spinta sovraccarico	Uniforme_GLOBX	5.00						
76	Sovraspinta sismica falda	Idrostatico - Negativo						2.40	1.10
77	Peso Proprio	Peso Proprio kN	6.60						
77	Spinta acqua	Idrostatico - Positivo						2.00	11.00
77	Spinta sovraccarico	Uniforme_GLOBX	5.00						
78	Peso Proprio	Peso Proprio kN	23.10						
78	Spinta acqua	Idrostatico - Positivo						2.00	11.00
79	Peso Proprio	Peso Proprio kN	20.90						
79	Spinta acqua	Idrostatico - Positivo						2.00	11.00
79	Spinta sovraccarico	Uniforme_GLOBX	5.00						
80	Peso Proprio	Peso Proprio kN	18.70						
80	Spinta acqua	Idrostatico - Positivo						2.00	11.00
81	Peso Proprio	Peso Proprio kN	20.90						
81	Spinta acqua	Idrostatico - Positivo						2.00	11.00
81	Spinta sovraccarico	Uniforme_GLOBX	-5.00						
82	Peso Proprio	Peso Proprio kN	18.70						
82	Spinta acqua	Idrostatico - Positivo						2.00	11.00
83	Peso Proprio	Peso Proprio kN	37.40						
83	Spinta acqua	Idrostatico - Positivo						2.00	11.00
83	Spinta sovraccarico	Uniforme_GLOBX	5.00						
84	Peso Proprio	Peso Proprio kN	18.70						
84	Spinta acqua	Idrostatico - Positivo						2.00	11.00
84	Spinta sovraccarico	Uniforme_GLOBY	-5.00						
85	Peso Proprio	Peso Proprio kN	18.70						
85	Spinta acqua	Idrostatico - Positivo						2.00	11.00
85	Spinta sovraccarico	Uniforme_GLOBY	-5.00						
86	Peso Proprio	Peso Proprio kN	18.70						
86	Spinta acqua	Idrostatico - Positivo						2.00	11.00
86	Spinta sovraccarico	Uniforme_GLOBY	-5.00						
87	Peso Proprio	Peso Proprio kN	23.10						
87	Spinta acqua	Idrostatico - Positivo						2.00	11.00
87	Spinta sovraccarico	Uniforme_GLOBY	-5.00						
88	Peso Proprio	Peso Proprio kN	37.40						
88	Spinta acqua	Idrostatico - Positivo						2.00	11.00
88	Spinta sovraccarico	Uniforme_GLOBX	-5.00						
89	Peso Proprio	Peso Proprio kN	7.20						
90	Peso Proprio	Peso Proprio kN	9.45						
91	Peso Proprio	Peso Proprio kN	40.05						
92	Peso Proprio	Peso Proprio kN	9.90						
93	Peso Proprio	Peso Proprio kN	5.40						
94	Peso Proprio	Peso Proprio kN	17.60						
95	Peso Proprio	Peso Proprio kN	11.00						
96	Peso Proprio	Peso Proprio kN	40.70						
97	Peso Proprio	Peso Proprio kN	12.10						
98	Peso Proprio	Peso Proprio kN	6.60						
99	Peso Proprio	Peso Proprio kN	17.10						
100	Peso Proprio	Peso Proprio kN	20.90						
101	Peso Proprio	Peso Proprio kN	9.35						
102	Peso Proprio	Peso Proprio kN	11.55						
103	Peso Proprio	Peso Proprio kN	5.50						
103	Spinta acqua	Idrostatico - Positivo						2.00	11.00

Shell	Cond.	Tipo	Q	Vert.1	Vert.2	Vert.3	Vert.4	Hw	g
103	permanenti platea	Idrostatico - Negativo						2.00	11.00
103	Spinta sovraccarico	Uniforme_GLOBX	-5.00						
103	Sovraspinta sismica falda	Trapez.GlobX							
103	Sovraspinta sismica falda	Idrostatico - Negativo						2.40	1.10
104	Peso Proprio	Peso Proprio kN	5.50						
104	Spinta acqua	Idrostatico - Positivo						2.00	11.00
104	permanenti platea	Idrostatico - Negativo						2.00	11.00
104	Spinta sovraccarico	Uniforme_GLOBX	5.00						
104	Sovraspinta sismica falda	Idrostatico - Negativo						2.40	1.10
105	Peso Proprio	Peso Proprio kN	26.00						
105	Spinta acqua	Idrostatico - Positivo						2.00	11.00
105	permanenti platea	Idrostatico - Negativo						2.00	11.00
105	Spinta sovraccarico	Uniforme_GLOBX	-5.00						
105	Sovraspinta sismica falda	Trapez.GlobX							
105	Sovraspinta sismica falda	Idrostatico - Negativo						2.40	1.10
106	Peso Proprio	Peso Proprio kN	26.00						
106	Spinta acqua	Idrostatico - Positivo						2.00	11.00
106	permanenti platea	Idrostatico - Negativo						2.00	11.00
106	Spinta sovraccarico	Uniforme_GLOBX	5.00						
106	Sovraspinta sismica falda	Idrostatico - Negativo						2.40	1.10
107	Peso Proprio	Peso Proprio kN	10.50						
107	Spinta acqua	Idrostatico - Positivo						2.00	11.00
108	Peso Proprio	Peso Proprio kN	8.50						
108	Spinta acqua	Idrostatico - Positivo						2.00	11.00
109	Peso Proprio	Peso Proprio kN	9.50						
109	Spinta acqua	Idrostatico - Positivo						2.00	11.00
109	Spinta sovraccarico	Uniforme_GLOBX	-5.00						
110	Peso Proprio	Peso Proprio kN	9.50						
110	Spinta acqua	Idrostatico - Positivo						2.00	11.00
110	Spinta sovraccarico	Uniforme_GLOBX	5.00						
111	Peso Proprio	Peso Proprio kN	5.50						
111	Spinta acqua	Idrostatico - Positivo						2.00	11.00
111	Spinta sovraccarico	Uniforme_GLOBX	-5.00						
112	Peso Proprio	Peso Proprio kN	5.50						
112	Spinta acqua	Idrostatico - Positivo						2.00	11.00
112	Spinta sovraccarico	Uniforme_GLOBX	5.00						
113	Peso Proprio	Peso Proprio kN	3.00						
113	Spinta acqua	Idrostatico - Positivo						2.00	11.00
113	Spinta sovraccarico	Uniforme_GLOBX	-5.00						
114	Peso Proprio	Peso Proprio kN	3.00						
114	Spinta acqua	Idrostatico - Positivo						2.00	11.00
114	Spinta sovraccarico	Uniforme_GLOBX	5.00						
115	Peso Proprio	Peso Proprio kN	10.50						
115	Spinta sovraccarico	Uniforme_GLOBX	5.00						
116	Peso Proprio	Peso Proprio kN	23.80						
116	accidentali platea	Uniforme_GLOBZ	6.00						
117	Peso Proprio	Peso Proprio kN	23.80						
117	accidentali platea	Uniforme_GLOBZ	6.00						
118	Peso Proprio	Peso Proprio kN	23.80						
118	accidentali platea	Uniforme_GLOBZ	6.00						
119	Peso Proprio	Peso Proprio kN	29.40						
119	accidentali platea	Uniforme_GLOBZ	6.00						
120	Peso Proprio	Peso Proprio kN	13.00						
120	Spinta sovraccarico	Uniforme_GLOBX	5.00						
121	Peso Proprio	Peso Proprio kN	22.10						

Shell	Cond.	Tipo	Q	Vert.1	Vert.2	Vert.3	Vert.4	Hw	g
121	accidentali platea	Uniforme_GLOBZ	6.00						
122	Peso Proprio	Peso Proprio kN	27.30						
122	accidentali platea	Uniforme_GLOBZ	6.00						
123	Peso Proprio	Peso Proprio kN	26.65						
123	accidentali platea	Uniforme_GLOBZ	6.00						
124	Peso Proprio	Peso Proprio kN	17.55						
124	accidentali platea	Uniforme_GLOBZ	6.00						
125	Peso Proprio	Peso Proprio kN	8.50						
125	Spinta acqua	Idrostatico - Positivo						2.00	11.00
125	Spinta sovraccarico	Uniforme_GLOBY	-5.00						
126	Peso Proprio	Peso Proprio kN	8.50						
126	Spinta acqua	Idrostatico - Positivo						2.00	11.00
126	Spinta sovraccarico	Uniforme_GLOBY	-5.00						
127	Peso Proprio	Peso Proprio kN	17.00						
127	Spinta acqua	Idrostatico - Positivo						2.00	11.00
127	Spinta sovraccarico	Uniforme_GLOBX	-5.00						
128	Peso Proprio	Peso Proprio kN	10.50						
128	Spinta acqua	Idrostatico - Positivo						2.00	11.00
128	Spinta sovraccarico	Uniforme_GLOBY	-5.00						
129	Peso Proprio	Peso Proprio kN	8.50						
129	Spinta acqua	Idrostatico - Positivo						2.00	11.00
129	Spinta sovraccarico	Uniforme_GLOBY	-5.00						
130	Peso Proprio	Peso Proprio kN	17.00						
130	Spinta acqua	Idrostatico - Positivo						2.00	11.00
130	Spinta sovraccarico	Uniforme_GLOBX	5.00						
131	Peso Proprio	Peso Proprio kN	8.00						
132	Peso Proprio	Peso Proprio kN	5.00						
133	Peso Proprio	Peso Proprio kN	18.50						
134	Peso Proprio	Peso Proprio kN	5.50						
135	Peso Proprio	Peso Proprio kN	3.00						
136	Peso Proprio	Peso Proprio kN	9.50						
137	Peso Proprio	Peso Proprio kN	7.00						
138	Peso Proprio	Peso Proprio kN	7.00						
138	Spinta sovraccarico	Uniforme_GLOBX	-5.00						
139	Peso Proprio	Peso Proprio kN	14.00						
139	Spinta sovraccarico	Uniforme_GLOBX	-5.00						
140	Peso Proprio	Peso Proprio kN	6.50						
140	Spinta sovraccarico	Uniforme_GLOBX	-5.00						
141	Peso Proprio	Peso Proprio kN	13.00						
141	Spinta sovraccarico	Uniforme_GLOBX	-5.00						
142	Peso Proprio	Peso Proprio kN	8.50						
143	Peso Proprio	Peso Proprio kN	8.50						
144	Peso Proprio	Peso Proprio kN	6.50						
145	Peso Proprio	Peso Proprio kN	3.25						
146	Peso Proprio	Peso Proprio kN	16.25						
147	Peso Proprio	Peso Proprio kN	24.00						
148	Peso Proprio	Peso Proprio kN	12.00						
149	Peso Proprio	Peso Proprio kN	6.50						
149	Spinta sovraccarico	Uniforme_GLOBX	-5.00						
150	Peso Proprio	Peso Proprio kN	5.00						
151	Peso Proprio	Peso Proprio kN	10.00						
152	Peso Proprio	Peso Proprio kN	13.00						
152	Spinta sovraccarico	Uniforme_GLOBX	-5.00						
153	Peso Proprio	Peso Proprio kN	13.00						
153	Spinta sovraccarico	Uniforme_GLOBX	5.00						
154	Peso Proprio	Peso Proprio kN	17.00						
155	Peso Proprio	Peso Proprio kN	21.00						
156	Peso Proprio	Peso Proprio kN	31.20						
156	accidentali platea	Uniforme_GLOBZ	6.00						
157	Peso Proprio	Peso Proprio kN	22.10						
157	accidentali platea	Uniforme_GLOBZ	6.00						

Shell	Cond.	Tipo	Q	Vert.1	Vert.2	Vert.3	Vert.4	Hw	g
158	Peso Proprio	Peso Proprio kN	27.30						
158	accidentali platea	Uniforme_GLOBZ	6.00						
159	Peso Proprio	Peso Proprio kN	13.00						
159	accidentali platea	Uniforme_GLOBZ	6.00						
160	Peso Proprio	Peso Proprio kN	3.25						
161	Peso Proprio	Peso Proprio kN	16.25						
162	Peso Proprio	Peso Proprio kN	6.50						
163	Peso Proprio	Peso Proprio kN	13.00						
163	Spinta sovraccarico	Uniforme_GLOBX	5.00						
164	Peso Proprio	Peso Proprio kN	21.00						
165	Peso Proprio	Peso Proprio kN	17.00						
166	Peso Proprio	Peso Proprio kN	4.25						
167	Peso Proprio	Peso Proprio kN	5.25						
168	Peso Proprio	Peso Proprio kN	12.75						
169	Peso Proprio	Peso Proprio kN	15.75						
170	Peso Proprio	Peso Proprio kN	7.00						
170	Spinta sovraccarico	Uniforme_GLOBX	-5.00						
171	Peso Proprio	Peso Proprio kN	11.20						
171	Spinta sovraccarico	Uniforme_GLOBX	-5.00						
172	Peso Proprio	Peso Proprio kN	10.40						
172	Spinta sovraccarico	Uniforme_GLOBX	-5.00						
173	Peso Proprio	Peso Proprio kN	10.40						
174	Peso Proprio	Peso Proprio kN	31.20						
174	NEVE	Uniforme_GLOBZ	1.55						
174	Permanenti copertura	Uniforme_GLOBZ	2.00						
174	variabili copertura	Uniforme_GLOBZ	30.00						
175	Peso Proprio	Peso Proprio kN	10.40						
175	Spinta sovraccarico	Uniforme_GLOBX	5.00						
176	Peso Proprio	Peso Proprio kN	22.10						
176	NEVE	Uniforme_GLOBZ	1.55						
176	Permanenti copertura	Uniforme_GLOBZ	2.00						
176	variabili copertura	Uniforme_GLOBZ	30.00						
177	Peso Proprio	Peso Proprio kN	27.30						
177	NEVE	Uniforme_GLOBZ	1.55						
177	Permanenti copertura	Uniforme_GLOBZ	2.00						
177	variabili copertura	Uniforme_GLOBZ	30.00						
178	Peso Proprio	Peso Proprio kN	16.80						
179	Peso Proprio	Peso Proprio kN	13.60						
180	Peso Proprio	Peso Proprio kN	19.20						
181	Peso Proprio	Peso Proprio kN	10.40						
181	Spinta sovraccarico	Uniforme_GLOBX	-5.00						
182	Peso Proprio	Peso Proprio kN	8.00						
183	Peso Proprio	Peso Proprio kN	10.40						
184	Peso Proprio	Peso Proprio kN	8.40						
185	Peso Proprio	Peso Proprio kN	6.80						
186	Peso Proprio	Peso Proprio kN	78.00						
186	Spinta acqua	Idrostatico - Positivo						2.00	11.00
186	permanent platea	Idrostatico - Negativo						2.00	11.00
186	Spinta sovraccarico	Uniforme_GLOBX	-5.00						
186	Sovraspinta sismica falda	Trapez.GlobX							
186	Sovraspinta sismica falda	Idrostatico - Negativo						2.40	1.10
187	Peso Proprio	Peso Proprio kN	16.50						
187	Spinta acqua	Idrostatico - Positivo						2.00	11.00
187	permanent platea	Idrostatico - Negativo						2.00	11.00
187	Spinta sovraccarico	Uniforme_GLOBX	5.00						
187	Sovraspinta	Idrostatico - Negativo						2.40	1.10

Shell	Cond.	Tipo	Q	Vert.1	Vert.2	Vert.3	Vert.4	Hw	g
		sismica falda							
188	Peso Proprio	Peso Proprio kN	16.50						
188	Spinta acqua	Idrostatico - Positivo						2.00	11.00
188	permanenti platea	Idrostatico - Negativo						2.00	11.00
188	Spinta sovraccarico	Uniforme_GLOBX	-5.00						
188	Sovrappinta sismica falda	Idrostatico - Negativo						2.40	1.10
188	Sovrappinta sismica falda	Trapez.GlobX							
189	Peso Proprio	Peso Proprio kN	78.00						
189	Spinta acqua	Idrostatico - Positivo						2.00	11.00
189	permanenti platea	Idrostatico - Negativo						2.00	11.00
189	Spinta sovraccarico	Uniforme_GLOBX	5.00						
189	Sovrappinta sismica falda	Idrostatico - Negativo						2.40	1.10
190	Peso Proprio	Peso Proprio kN	17.50						
190	Spinta sovraccarico	Uniforme_GLOBX	5.00						
191	Peso Proprio	Peso Proprio kN	16.50						
191	Spinta acqua	Idrostatico - Positivo						2.00	11.00
191	Spinta sovraccarico	Uniforme_GLOBX	5.00						
192	Peso Proprio	Peso Proprio kN	28.50						
192	Spinta acqua	Idrostatico - Positivo						2.00	11.00
192	Spinta sovraccarico	Uniforme_GLOBX	-5.00						
193	Peso Proprio	Peso Proprio kN	16.50						
193	Spinta acqua	Idrostatico - Positivo						2.00	11.00
193	Spinta sovraccarico	Uniforme_GLOBX	-5.00						
194	Peso Proprio	Peso Proprio kN	28.50						
194	Spinta acqua	Idrostatico - Positivo						2.00	11.00
194	Spinta sovraccarico	Uniforme_GLOBX	5.00						
195	Peso Proprio	Peso Proprio kN	9.00						
195	Spinta acqua	Idrostatico - Positivo						2.00	11.00
195	Spinta sovraccarico	Uniforme_GLOBX	-5.00						
196	Peso Proprio	Peso Proprio kN	9.00						
196	Spinta acqua	Idrostatico - Positivo						2.00	11.00
196	Spinta sovraccarico	Uniforme_GLOBX	5.00						
197	Peso Proprio	Peso Proprio kN	13.00						
197	Spinta sovraccarico	Uniforme_GLOBX	5.00						
198	Peso Proprio	Peso Proprio kN	25.50						
198	Spinta acqua	Idrostatico - Positivo						2.00	11.00
198	Spinta sovraccarico	Uniforme_GLOBY	-5.00						
199	Peso Proprio	Peso Proprio kN	51.00						
199	Spinta acqua	Idrostatico - Positivo						2.00	11.00
199	Spinta sovraccarico	Uniforme_GLOBX	-5.00						
200	Peso Proprio	Peso Proprio kN	31.50						
200	Spinta acqua	Idrostatico - Positivo						2.00	11.00
200	Spinta sovraccarico	Uniforme_GLOBY	-5.00						
201	Peso Proprio	Peso Proprio kN	51.00						
201	Spinta acqua	Idrostatico - Positivo						2.00	11.00
201	Spinta sovraccarico	Uniforme_GLOBX	5.00						
202	Peso Proprio	Peso Proprio kN	25.50						
202	Spinta acqua	Idrostatico - Positivo						2.00	11.00
202	Spinta sovraccarico	Uniforme_GLOBY	-5.00						
203	Peso Proprio	Peso Proprio kN	25.50						
203	Spinta acqua	Idrostatico - Positivo						2.00	11.00
203	Spinta sovraccarico	Uniforme_GLOBY	-5.00						
204	Peso Proprio	Peso Proprio kN	24.00						
205	Peso Proprio	Peso Proprio kN	9.00						
206	Peso Proprio	Peso Proprio kN	28.50						
207	Peso Proprio	Peso Proprio kN	15.00						
208	Peso Proprio	Peso Proprio kN	55.50						
209	Peso Proprio	Peso Proprio kN	16.50						

Shell	Cond.	Tipo	Q	Vert.1	Vert.2	Vert.3	Vert.4	Hw	g
210	Peso Proprio	Peso Proprio kN	88.40						
210	NEVE	Uniforme_GLOBZ	1.55						
210	Permanenti copertura	Uniforme_GLOBZ	2.00						
210	variabili copertura	Uniforme_GLOBZ	30.00						
210	permanenti platea	Idrostatico - Positivo						2.00	11.00
211	Peso Proprio	Peso Proprio kN	32.30						
211	NEVE	Uniforme_GLOBZ	1.55						
211	Permanenti copertura	Uniforme_GLOBZ	2.00						
211	variabili copertura	Uniforme_GLOBZ	30.00						
212	Peso Proprio	Peso Proprio kN	109.20						
212	NEVE	Uniforme_GLOBZ	1.55						
212	Permanenti copertura	Uniforme_GLOBZ	2.00						
212	variabili copertura	Uniforme_GLOBZ	30.00						
212	permanenti platea	Idrostatico - Positivo						2.00	11.00
213	Peso Proprio	Peso Proprio kN	88.40						
213	NEVE	Uniforme_GLOBZ	1.55						
213	Permanenti copertura	Uniforme_GLOBZ	2.00						
213	variabili copertura	Uniforme_GLOBZ	30.00						
213	permanenti platea	Idrostatico - Positivo						2.00	11.00
214	Peso Proprio	Peso Proprio kN	18.70						
214	NEVE	Uniforme_GLOBZ	1.55						
214	Permanenti copertura	Uniforme_GLOBZ	2.00						
214	variabili copertura	Uniforme_GLOBZ	30.00						
215	Peso Proprio	Peso Proprio kN	32.30						
215	NEVE	Uniforme_GLOBZ	1.55						
215	Permanenti copertura	Uniforme_GLOBZ	2.00						
215	variabili copertura	Uniforme_GLOBZ	30.00						
216	Peso Proprio	Peso Proprio kN	32.30						
216	NEVE	Uniforme_GLOBZ	1.55						
216	Permanenti copertura	Uniforme_GLOBZ	2.00						
216	variabili copertura	Uniforme_GLOBZ	30.00						
217	Peso Proprio	Peso Proprio kN	18.70						
217	NEVE	Uniforme_GLOBZ	1.55						
217	Permanenti copertura	Uniforme_GLOBZ	2.00						
217	variabili copertura	Uniforme_GLOBZ	30.00						
217	permanenti platea	Idrostatico - Positivo						2.00	11.00
218	Peso Proprio	Peso Proprio kN	88.40						
218	NEVE	Uniforme_GLOBZ	1.55						
218	Permanenti copertura	Uniforme_GLOBZ	2.00						
218	variabili copertura	Uniforme_GLOBZ	30.00						
219	Peso Proprio	Peso Proprio kN	23.10						
219	NEVE	Uniforme_GLOBZ	1.55						
219	Permanenti copertura	Uniforme_GLOBZ	2.00						
219	variabili copertura	Uniforme_GLOBZ	30.00						
219	permanenti platea	Idrostatico - Positivo						2.00	11.00
220	Peso Proprio	Peso Proprio kN	39.90						
220	NEVE	Uniforme_GLOBZ	1.55						
220	Permanenti copertura	Uniforme_GLOBZ	2.00						
220	variabili copertura	Uniforme_GLOBZ	30.00						
221	Peso Proprio	Peso Proprio kN	10.20						
221	NEVE	Uniforme_GLOBZ	1.55						

Shell	Cond.	Tipo	Q	Vert.1	Vert.2	Vert.3	Vert.4	Hw	g
221	Permanenti copertura	Uniforme_GLOBZ	2.00						
221	variabili copertura	Uniforme_GLOBZ	30.00						
222	Peso Proprio	Peso Proprio kN	10.20						
222	NEVE	Uniforme_GLOBZ	1.55						
222	Permanenti copertura	Uniforme_GLOBZ	2.00						
222	variabili copertura	Uniforme_GLOBZ	30.00						
223	Peso Proprio	Peso Proprio kN	41.60						
223	Spinta acqua	Idrostatico - Positivo						2.00	11.00
223	permanent platea	Idrostatico - Negativo						2.00	11.00
223	Spinta sovraccarico	Uniforme_GLOBX	-5.00						
223	Sovrappinta sismica falda	Idrostatico - Negativo						2.40	1.10
223	Sovrappinta sismica falda	Trapez.GlobX							
224	Peso Proprio	Peso Proprio kN	8.80						
224	Spinta acqua	Idrostatico - Positivo						2.00	11.00
224	permanent platea	Idrostatico - Negativo						2.00	11.00
224	Spinta sovraccarico	Uniforme_GLOBX	5.00						
224	Sovrappinta sismica falda	Idrostatico - Negativo						2.40	1.10
225	Peso Proprio	Peso Proprio kN	8.80						
225	Spinta acqua	Idrostatico - Positivo						2.00	11.00
225	permanent platea	Idrostatico - Negativo						2.00	11.00
225	Spinta sovraccarico	Uniforme_GLOBX	-5.00						
225	Sovrappinta sismica falda	Idrostatico - Negativo						2.40	1.10
225	Sovrappinta sismica falda	Trapez.GlobX							
226	Peso Proprio	Peso Proprio kN	41.60						
226	Spinta acqua	Idrostatico - Positivo						2.00	11.00
226	permanent platea	Idrostatico - Negativo						2.00	11.00
226	Spinta sovraccarico	Uniforme_GLOBX	5.00						
226	Sovrappinta sismica falda	Idrostatico - Negativo						2.40	1.10
227	Peso Proprio	Peso Proprio kN	23.10						
227	NEVE	Uniforme_GLOBZ	1.55						
227	Permanenti copertura	Uniforme_GLOBZ	2.00						
227	variabili copertura	Uniforme_GLOBZ	30.00						
228	Peso Proprio	Peso Proprio kN	23.80						
228	NEVE	Uniforme_GLOBZ	1.55						
228	Permanenti copertura	Uniforme_GLOBZ	2.00						
228	variabili copertura	Uniforme_GLOBZ	30.00						
229	Peso Proprio	Peso Proprio kN	10.20						
229	NEVE	Uniforme_GLOBZ	1.55						
229	Permanenti copertura	Uniforme_GLOBZ	2.00						
229	variabili copertura	Uniforme_GLOBZ	30.00						
230	Peso Proprio	Peso Proprio kN	17.55						
230	NEVE	Uniforme_GLOBZ	1.55						
230	Permanenti copertura	Uniforme_GLOBZ	2.00						
230	variabili copertura	Uniforme_GLOBZ	30.00						
231	Peso Proprio	Peso Proprio kN	57.80						
231	NEVE	Uniforme_GLOBZ	1.55						
231	Permanenti copertura	Uniforme_GLOBZ	2.00						
231	variabili copertura	Uniforme_GLOBZ	30.00						
232	Peso Proprio	Peso Proprio kN	23.80						

Shell	Cond.	Tipo	Q	Vert.1	Vert.2	Vert.3	Vert.4	Hw	g
232	NEVE	Uniforme_GLOBZ	1.55						
232	Permanenti copertura	Uniforme_GLOBZ	2.00						
232	variabili copertura	Uniforme_GLOBZ	30.00						
233	Peso Proprio	Peso Proprio kN	12.60						
233	NEVE	Uniforme_GLOBZ	1.55						
233	Permanenti copertura	Uniforme_GLOBZ	2.00						
233	variabili copertura	Uniforme_GLOBZ	30.00						
234	Peso Proprio	Peso Proprio kN	23.80						
234	NEVE	Uniforme_GLOBZ	1.55						
234	Permanenti copertura	Uniforme_GLOBZ	2.00						
234	variabili copertura	Uniforme_GLOBZ	30.00						
235	Peso Proprio	Peso Proprio kN	57.80						
235	NEVE	Uniforme_GLOBZ	1.55						
235	Permanenti copertura	Uniforme_GLOBZ	2.00						
235	variabili copertura	Uniforme_GLOBZ	30.00						
236	Peso Proprio	Peso Proprio kN	26.65						
236	NEVE	Uniforme_GLOBZ	1.55						
236	Permanenti copertura	Uniforme_GLOBZ	2.00						
236	variabili copertura	Uniforme_GLOBZ	30.00						
237	Peso Proprio	Peso Proprio kN	22.10						
237	NEVE	Uniforme_GLOBZ	1.55						
237	Permanenti copertura	Uniforme_GLOBZ	2.00						
237	variabili copertura	Uniforme_GLOBZ	30.00						
238	Peso Proprio	Peso Proprio kN	57.80						
238	NEVE	Uniforme_GLOBZ	1.55						
238	Permanenti copertura	Uniforme_GLOBZ	2.00						
238	variabili copertura	Uniforme_GLOBZ	30.00						
239	Peso Proprio	Peso Proprio kN	71.40						
239	NEVE	Uniforme_GLOBZ	1.55						
239	Permanenti copertura	Uniforme_GLOBZ	2.00						
239	variabili copertura	Uniforme_GLOBZ	30.00						
240	Peso Proprio	Peso Proprio kN	27.30						
240	NEVE	Uniforme_GLOBZ	1.55						
240	Permanenti copertura	Uniforme_GLOBZ	2.00						
240	variabili copertura	Uniforme_GLOBZ	30.00						
241	Peso Proprio	Peso Proprio kN	29.40						
241	NEVE	Uniforme_GLOBZ	1.55						
241	Permanenti copertura	Uniforme_GLOBZ	2.00						
241	variabili copertura	Uniforme_GLOBZ	30.00						
242	Peso Proprio	Peso Proprio kN	4.80						
242	Spinta acqua	Idrostatico - Positivo						2.00	11.00
242	Spinta sovraccarico	Uniforme_GLOBX	-5.00						
243	Peso Proprio	Peso Proprio kN	10.40						
243	Spinta sovraccarico	Uniforme_GLOBX	5.00						
244	Peso Proprio	Peso Proprio kN	11.20						
244	Spinta sovraccarico	Uniforme_GLOBX	5.00						
245	Peso Proprio	Peso Proprio kN	8.80						
245	Spinta acqua	Idrostatico - Positivo						2.00	11.00
245	Spinta sovraccarico	Uniforme_GLOBX	-5.00						
246	Peso Proprio	Peso Proprio kN	8.80						
246	Spinta acqua	Idrostatico - Positivo						2.00	11.00
246	Spinta sovraccarico	Uniforme_GLOBX	5.00						

Shell	Cond.	Tipo	Q	Vert.1	Vert.2	Vert.3	Vert.4	Hw	g
247	Peso Proprio	Peso Proprio kN	15.20						
247	Spinta acqua	Idrostatico - Positivo						2.00	11.00
247	Spinta sovraccarico	Uniforme_GLOBX	-5.00						
248	Peso Proprio	Peso Proprio kN	15.20						
248	Spinta acqua	Idrostatico - Positivo						2.00	11.00
248	Spinta sovraccarico	Uniforme_GLOBX	5.00						
249	Peso Proprio	Peso Proprio kN	4.80						
249	Spinta acqua	Idrostatico - Positivo						2.00	11.00
249	Spinta sovraccarico	Uniforme_GLOBX	5.00						
250	Peso Proprio	Peso Proprio kN	27.20						
250	Spinta acqua	Idrostatico - Positivo						2.00	11.00
250	Spinta sovraccarico	Uniforme_GLOBX	5.00						
251	Peso Proprio	Peso Proprio kN	27.20						
251	Spinta acqua	Idrostatico - Positivo						2.00	11.00
251	Spinta sovraccarico	Uniforme_GLOBX	-5.00						
252	Peso Proprio	Peso Proprio kN	4.80						
253	Peso Proprio	Peso Proprio kN	16.80						
253	Spinta acqua	Idrostatico - Positivo						2.00	11.00
253	Spinta sovraccarico	Uniforme_GLOBY	-5.00						
254	Peso Proprio	Peso Proprio kN	13.60						
254	Spinta acqua	Idrostatico - Positivo						2.00	11.00
254	Spinta sovraccarico	Uniforme_GLOBY	-5.00						
255	Peso Proprio	Peso Proprio kN	13.60						
255	Spinta acqua	Idrostatico - Positivo						2.00	11.00
255	Spinta sovraccarico	Uniforme_GLOBY	-5.00						
256	Peso Proprio	Peso Proprio kN	6.40						
257	Peso Proprio	Peso Proprio kN	13.60						
257	Spinta acqua	Idrostatico - Positivo						2.00	11.00
257	Spinta sovraccarico	Uniforme_GLOBY	-5.00						
258	Peso Proprio	Peso Proprio kN	8.40						
259	Peso Proprio	Peso Proprio kN	8.80						
260	Peso Proprio	Peso Proprio kN	15.20						
261	Peso Proprio	Peso Proprio kN	35.60						

Risultati Analisi Statica - Spostamenti massimi - Nodi

Scenario di calcolo: **Copia di Set_NT_2018 A2_SLV_SLD_STR_GEO**

la tripletta (Cb [-SubC-Cbm]) indica la Combinazione - SottoCombinazione sismica - Posizione Masse, nel caso non sismico mancano SubC-Cbm

Nodo	Trasl. X	Trasl. Y	Trasl. Z	Rotaz. X	Rotaz. Y	Rotaz. Z
	mm	mm	mm	°	°	°
0	0.0(3)	-0.1(2)	-18.0(3)	0.01(2)	0.01(3)	0.00(4)
0	0.2(2)	-0.2(6)	-18.6(3)	0.00(2)	0.00(5)	0.00(4)
0	0.1(3)	-0.1(6)	-18.6(3)	0.00(2)	0.00(1)	-0.00(1)
0	0.0(3)	-0.0(6)	-18.6(3)	0.00(2)	0.00(5)	-0.00(3)
0	0.1(2)	-0.1(2)	-18.0(3)	0.01(2)	0.00(2)	-0.00(6)
0	0.1(2)	-0.1(6)	-18.1(3)	0.01(6)	0.00(2)	0.00(1)
0	0.1(2)	-0.1(2)	-17.9(3)	0.01(2)	0.00(3)	-0.00(6)
0	0.0(1)	0.0(1)	-17.9(3)	0.01(2)	0.00(2)	0.00(1)
0	0.0(1)	0.0(1)	-17.8(3)	0.01(2)	0.00(3)	0.00(1)
0	0.0(1)	0.0(1)	-17.6(3)	0.01(2)	0.00(2)	0.00(1)
0	0.1(2)	-0.3(2)	-17.6(3)	0.01(2)	0.00(3)	0.00(2)
0	0.1(2)	-0.2(2)	-17.8(3)	0.01(2)	0.00(2)	0.00(2)
0	0.0(2)	-0.1(2)	-17.8(3)	0.01(2)	0.00(2)	0.00(2)
0	0.0(2)	-0.1(2)	-17.6(3)	0.01(2)	0.01(2)	0.00(2)
0	0.1(2)	-0.2(2)	-17.9(3)	0.01(2)	0.00(2)	0.00(5)
0	0.1(2)	-0.2(2)	-18.0(3)	0.01(6)	0.00(2)	-0.00(6)
0	0.1(2)	-0.2(6)	-18.1(3)	0.01(6)	0.00(2)	0.00(1)
0	0.2(3)	-0.2(2)	-18.2(3)	0.01(2)	0.01(2)	0.00(3)
0	0.3(2)	-0.3(6)	-19.1(3)	0.00(2)	0.00(3)	-0.00(4)
0	0.3(2)	-0.3(6)	-19.2(3)	0.01(2)	0.00(3)	0.00(5)

Nodo	Trasl. X	Trasl. Y	Trasl. Z	Rotaz. X	Rotaz. Y	Rotaz. Z
0	0.3(2)	-0.3(6)	-19.3(3)	0.01(2)	0.00(2)	-0.00(6)
0	0.1(2)	-0.2(6)	-18.3(3)	0.01(6)	0.00(5)	0.00(4)
0	0.2(2)	-0.3(2)	-17.9(3)	0.01(2)	0.01(3)	0.00(5)
0	0.5(5)	-0.3(2)	-18.5(3)	0.00(2)	-0.01(5)	0.01(5)
0	0.2(2)	-0.3(6)	-19.4(3)	0.01(2)	0.00(1)	-0.00(5)
0	0.3(2)	-0.3(2)	-19.5(3)	0.00(2)	0.00(5)	-0.00(2)
0	0.1(3)	-0.2(2)	-18.0(3)	0.01(3)	0.01(2)	0.00(4)
0	0.2(3)	-0.2(6)	-18.4(3)	0.01(6)	0.01(5)	0.00(4)
0	0.2(2)	-0.3(2)	-18.1(3)	0.01(2)	0.01(3)	0.00(5)
0	0.3(3)	-0.3(2)	-19.1(3)	0.00(6)	0.00(1)	0.00(3)
0	0.2(2)	-0.3(2)	-18.7(3)	0.00(2)	0.01(5)	-0.00(5)
0	0.2(3)	-0.3(2)	-18.6(3)	0.00(2)	0.00(5)	0.00(4)
0	0.2(2)	-0.3(2)	-18.5(3)	0.00(6)	0.01(5)	0.00(1)
0	0.3(4)	-0.3(2)	-18.9(3)	0.00(3)	0.00(1)	0.00(3)
0	0.2(2)	-0.2(2)	-18.7(3)	0.01(3)	0.01(5)	0.00(2)
0	0.4(5)	-0.3(2)	-18.5(3)	0.00(2)	-0.01(5)	0.01(5)
0	0.3(5)	-0.3(2)	-18.3(3)	0.01(2)	0.00(3)	0.00(5)
0	0.3(4)	-0.3(2)	-18.9(3)	0.00(2)	0.00(1)	0.00(3)
0	0.3(3)	-0.3(2)	-18.6(3)	0.00(2)	0.00(5)	0.00(4)
0	0.2(3)	-0.2(6)	-18.5(3)	0.01(6)	0.01(5)	0.00(5)
0	0.2(3)	-0.3(2)	-18.4(3)	0.01(6)	0.01(2)	0.00(1)
0	0.2(2)	-0.3(2)	-18.8(3)	0.00(2)	0.01(5)	-0.00(5)
0	0.5(5)	-0.3(6)	-19.0(3)	0.00(6)	-0.02(5)	-0.00(5)
0	0.2(2)	-0.3(2)	-19.2(3)	0.00(2)	0.02(5)	-0.00(4)
0	0.2(2)	-0.3(2)	-19.3(3)	0.00(2)	0.01(5)	0.00(5)
0	0.6(5)	-0.3(6)	-18.9(3)	0.00(2)	-0.02(5)	0.00(3)
0	0.5(5)	-0.3(2)	-18.6(3)	0.00(2)	-0.02(5)	0.00(1)
0	0.2(3)	-0.2(6)	-19.5(3)	0.00(2)	0.00(2)	0.00(4)
0	0.1(2)	-0.2(6)	-19.4(3)	0.00(3)	0.00(2)	-0.01(5)
0	0.2(5)	-0.2(6)	-19.1(3)	0.00(2)	0.00(2)	-0.00(4)
0	0.2(2)	-0.3(6)	-19.3(3)	0.00(3)	0.00(2)	0.00(5)
0	0.2(5)	-0.2(6)	-19.2(3)	0.00(3)	0.00(3)	0.01(5)
0	0.1(5)	-0.1(6)	-19.1(3)	0.00(6)	0.00(5)	-0.00(4)
0	0.1(3)	-0.1(6)	-19.4(3)	0.01(6)	0.00(2)	-0.00(5)
0	0.0(1)	0.0(1)	-17.9(3)	0.01(2)	0.00(5)	0.00(1)
0	0.0(1)	0.0(1)	-18.0(3)	0.01(2)	0.00(3)	0.00(1)
0	0.0(1)	0.0(1)	-17.9(3)	0.01(2)	0.00(3)	0.00(1)
0	0.0(1)	0.0(1)	-18.1(3)	0.01(2)	0.00(2)	0.00(1)
0	0.0(1)	0.0(1)	-18.0(3)	0.01(2)	0.00(5)	0.00(1)
0	0.0(1)	0.0(1)	-18.1(3)	0.00(6)	0.00(4)	0.00(1)
1	0.0(1)	0.0(1)	-19.1(3)	0.01(6)	0.00(2)	0.00(1)
1	0.3(3)	-0.3(2)	-18.6(3)	0.00(2)	-0.01(5)	-0.00(5)
2	0.0(1)	0.0(1)	-19.1(3)	0.01(6)	0.00(2)	0.00(1)
2	0.3(3)	-0.3(6)	-18.9(3)	0.00(6)	-0.01(5)	0.00(5)
3	0.0(1)	0.0(1)	-19.2(3)	0.01(6)	0.00(2)	0.00(1)
3	0.3(2)	-0.3(2)	-18.4(3)	0.01(2)	-0.00(4)	0.00(4)
4	0.0(1)	0.0(1)	-19.3(3)	0.01(6)	0.00(2)	0.00(1)
4	0.3(1)	-0.4(2)	-19.3(3)	0.01(2)	0.01(5)	0.00(5)
5	0.0(1)	0.0(1)	-19.4(3)	0.01(6)	0.00(4)	0.00(1)
5	0.4(3)	-0.3(6)	-18.9(3)	0.00(3)	-0.01(5)	-0.00(5)
6	0.0(1)	0.0(1)	-19.5(3)	0.01(6)	0.00(4)	0.00(1)
6	0.3(1)	-0.4(2)	-19.2(3)	0.01(2)	0.01(5)	-0.00(5)
7	0.0(1)	0.0(1)	-19.6(3)	0.01(6)	0.00(4)	0.00(1)
7	0.2(2)	-0.3(2)	-18.6(3)	0.01(2)	0.00(1)	0.00(1)
8	0.0(1)	0.0(1)	-19.1(3)	0.01(6)	0.00(2)	0.00(1)
8	0.3(1)	-0.3(2)	-18.8(3)	0.00(2)	0.01(5)	0.00(5)
9	0.3(2)	-0.3(2)	-19.1(3)	0.01(3)	-0.00(6)	-0.00(3)
9	0.0(1)	0.0(1)	-19.1(3)	0.01(6)	0.00(2)	0.00(1)
10	0.3(1)	-0.3(2)	-19.0(3)	0.01(3)	0.00(1)	-0.00(3)
10	0.0(1)	0.0(1)	-19.2(3)	0.01(6)	0.00(2)	0.00(1)
11	0.3(2)	-0.3(2)	-18.7(3)	0.00(3)	0.00(3)	0.00(2)

Nodo	Trasl. X	Trasl. Y	Trasl. Z	Rotaz. X	Rotaz. Y	Rotaz. Z
11	0.0(1)	0.0(1)	-19.3(3)	0.01(6)	0.00(2)	0.00(1)
12	0.3(2)	-0.4(2)	-18.5(3)	0.01(2)	0.00(3)	0.00(2)
12	0.0(1)	0.0(1)	-19.4(3)	0.01(6)	0.00(4)	0.00(1)
13	0.3(2)	-0.3(6)	-18.5(3)	0.01(2)	0.00(1)	0.00(2)
13	0.0(1)	0.0(1)	-19.5(3)	0.01(6)	0.00(4)	0.00(1)
14	0.0(1)	0.0(1)	-19.5(3)	0.01(6)	0.00(4)	0.00(1)
14	0.3(3)	-0.3(6)	-19.3(3)	0.01(6)	0.00(3)	-0.00(5)
15	0.0(1)	0.0(1)	-18.9(3)	0.00(6)	-0.01(6)	0.00(1)
15	0.3(1)	-0.3(2)	-18.7(3)	0.00(2)	0.00(5)	0.00(1)
16	0.3(2)	-0.3(2)	-18.8(3)	0.00(6)	-0.00(6)	0.00(4)
16	0.0(1)	0.0(1)	-18.9(3)	0.00(6)	-0.01(6)	0.00(1)
17	0.3(3)	-0.4(2)	-18.3(3)	0.01(2)	0.01(3)	0.00(5)
17	0.0(1)	0.0(1)	-18.8(3)	0.00(6)	-0.00(6)	0.00(1)
18	0.3(3)	-0.4(2)	-18.4(3)	0.00(6)	-0.01(5)	0.00(5)
18	0.0(1)	0.0(1)	-18.9(3)	0.00(2)	0.00(3)	0.00(1)
19	0.3(1)	-0.3(2)	-18.7(3)	0.00(2)	0.00(1)	0.00(6)
19	0.0(1)	0.0(1)	-19.0(3)	0.01(2)	0.01(4)	0.00(1)
20	0.3(1)	-0.3(2)	-18.7(3)	0.01(2)	0.00(5)	0.00(1)
20	0.0(1)	0.0(1)	-19.2(3)	0.01(2)	0.01(6)	0.00(1)
21	0.0(1)	0.0(1)	-19.3(3)	0.01(2)	0.01(6)	0.00(1)
21	0.3(1)	-0.3(2)	-18.5(3)	0.00(2)	0.00(1)	0.00(4)
22	0.0(1)	0.0(1)	-18.8(3)	0.00(6)	-0.01(6)	0.00(1)
22	0.3(1)	-0.3(2)	-18.7(3)	0.00(3)	-0.00(6)	0.00(1)
23	0.3(1)	-0.3(2)	-18.9(3)	0.01(3)	0.00(4)	-0.00(6)
23	0.0(1)	0.0(1)	-18.8(3)	0.00(6)	-0.01(6)	0.00(1)
24	0.3(1)	-0.3(2)	-19.4(3)	0.01(3)	0.00(1)	0.00(3)
24	0.0(1)	0.0(1)	-18.8(3)	0.00(6)	-0.00(6)	0.00(1)
25	0.3(1)	-0.4(2)	-19.5(3)	0.01(6)	0.00(1)	-0.00(1)
25	0.0(1)	0.0(1)	-18.9(3)	0.00(2)	0.00(3)	0.00(1)
26	0.3(1)	-0.3(2)	-18.6(3)	0.00(2)	0.00(5)	0.00(1)
26	0.0(1)	0.0(1)	-18.9(3)	0.00(2)	0.01(4)	0.00(1)
27	0.3(1)	-0.3(2)	-19.2(3)	0.02(3)	0.00(1)	0.00(6)
27	0.0(1)	0.0(1)	-19.2(3)	0.00(2)	0.01(6)	0.00(1)
28	0.0(1)	0.0(1)	-19.2(3)	0.00(2)	0.01(6)	0.00(1)
28	0.3(1)	-0.3(6)	-18.7(3)	0.01(2)	0.01(5)	0.00(1)
29	0.3(1)	-0.3(6)	-18.7(3)	0.01(3)	0.00(1)	0.00(4)
30	0.3(3)	-0.4(2)	-18.1(3)	0.01(2)	0.01(3)	0.00(4)
31	0.0(1)	0.0(1)	-18.5(3)	0.00(6)	0.00(5)	0.00(1)
31	0.2(2)	-0.4(2)	-18.1(3)	0.01(3)	0.00(1)	0.00(2)
32	0.2(3)	-0.4(2)	-18.4(3)	0.01(3)	0.00(4)	0.00(1)
32	0.0(1)	0.0(1)	-18.5(3)	0.00(6)	0.00(5)	0.00(1)
33	0.2(2)	-0.3(6)	-18.4(3)	0.01(2)	0.00(5)	0.00(2)
33	0.0(1)	0.0(1)	-18.5(3)	0.00(2)	-0.00(6)	0.00(1)
34	0.2(2)	-0.3(2)	-18.1(3)	0.01(3)	0.00(1)	0.00(2)
34	0.0(1)	0.0(1)	-18.5(3)	0.00(2)	0.00(3)	0.00(1)
35	0.2(2)	-0.3(2)	-18.5(3)	0.01(3)	0.00(2)	0.00(2)
35	0.0(1)	0.0(1)	-18.6(3)	0.00(2)	0.00(4)	0.00(1)
36	0.2(2)	-0.3(6)	-18.3(3)	0.01(6)	0.00(2)	0.00(2)
36	0.0(1)	0.0(1)	-18.8(3)	0.00(2)	0.00(3)	0.00(1)
37	0.0(1)	0.0(1)	-18.8(3)	0.00(2)	0.00(3)	0.00(1)
37	0.2(2)	-0.3(2)	-18.3(3)	0.01(3)	0.00(1)	0.00(2)
38	0.0(1)	0.0(1)	-18.4(3)	0.00(6)	-0.00(6)	0.00(1)
38	0.3(2)	-0.4(2)	-19.5(3)	0.01(2)	0.00(5)	-0.00(1)
39	0.3(3)	-0.3(2)	-18.5(3)	0.00(6)	-0.01(5)	0.00(5)
39	0.0(1)	0.0(1)	-18.4(3)	0.00(6)	-0.00(6)	0.00(1)
40	0.2(3)	-0.4(2)	-17.9(3)	0.01(2)	0.01(3)	0.00(4)
40	0.0(1)	0.0(1)	-18.4(3)	0.00(2)	-0.00(6)	0.00(1)
41	0.2(2)	-0.3(2)	-18.3(3)	0.01(3)	0.00(2)	0.00(1)
41	0.0(1)	0.0(1)	-18.5(3)	0.00(2)	0.00(3)	0.00(1)
42	0.3(2)	-0.4(2)	-19.4(3)	0.01(2)	0.00(2)	-0.00(5)
42	0.0(1)	0.0(1)	-18.5(3)	0.00(2)	0.00(1)	0.00(1)

Nodo	Trasl. X	Trasl. Y	Trasl. Z	Rotaz. X	Rotaz. Y	Rotaz. Z
43	0.3(2)	-0.3(2)	-19.3(3)	0.01(2)	0.00(2)	-0.00(2)
43	0.0(1)	0.0(1)	-18.7(3)	0.00(2)	0.00(4)	0.00(1)
44	0.0(1)	0.0(1)	-18.7(3)	0.00(2)	0.00(4)	0.00(1)
44	0.3(2)	-0.3(6)	-19.1(3)	0.00(2)	0.00(3)	-0.00(5)
45	0.0(1)	0.0(1)	-18.4(3)	0.00(6)	-0.00(6)	0.00(1)
45	0.3(2)	-0.3(2)	-19.2(3)	0.01(2)	0.00(3)	0.00(6)
46	0.2(2)	-0.4(2)	-17.8(3)	0.01(3)	0.00(2)	0.00(2)
46	0.0(1)	0.0(1)	-18.4(3)	0.00(6)	-0.00(6)	0.00(1)
47	0.2(3)	-0.4(2)	-17.6(3)	0.01(2)	0.01(3)	0.00(2)
47	0.0(1)	0.0(1)	-18.4(3)	0.00(2)	-0.00(6)	0.00(1)
48	0.2(2)	-0.3(6)	-18.1(3)	0.01(6)	0.00(2)	0.00(1)
48	0.0(1)	0.0(1)	-18.4(3)	0.00(2)	0.00(3)	0.00(1)
49	0.2(2)	-0.3(6)	-18.0(3)	0.01(3)	0.00(2)	-0.00(6)
49	0.0(1)	0.0(1)	-18.5(3)	0.00(2)	0.00(1)	0.00(1)
50	0.2(2)	-0.3(2)	-17.9(3)	0.01(2)	0.00(4)	0.00(4)
50	0.0(1)	0.0(1)	-18.6(3)	0.00(2)	0.00(4)	0.00(1)
51	0.0(1)	0.0(1)	-18.7(3)	0.00(2)	0.00(4)	0.00(1)
52	0.0(1)	0.0(1)	-18.3(3)	0.00(2)	-0.00(6)	0.00(1)
53	0.0(1)	0.0(1)	-18.3(3)	0.00(2)	-0.00(6)	0.00(1)
54	0.0(1)	0.0(1)	-18.3(3)	0.00(2)	0.00(3)	0.00(1)
55	0.0(1)	0.0(1)	-18.4(3)	0.00(2)	0.00(3)	0.00(1)
56	0.0(1)	0.0(1)	-18.4(3)	0.00(2)	0.00(3)	0.00(1)
57	0.0(1)	0.0(1)	-18.5(3)	0.00(2)	0.00(3)	0.00(1)
58	0.0(1)	0.0(1)	-18.5(3)	0.00(2)	0.00(3)	0.00(1)
59	0.0(1)	0.0(1)	-18.3(3)	0.00(2)	-0.00(6)	0.00(1)
60	0.0(1)	0.0(1)	-18.3(3)	0.00(2)	-0.00(6)	0.00(1)
61	0.0(1)	0.0(1)	-18.3(3)	0.00(2)	0.00(3)	0.00(1)
62	0.0(1)	0.0(1)	-18.3(3)	0.00(2)	0.00(3)	0.00(1)
63	0.0(1)	0.0(1)	-18.4(3)	0.00(2)	0.00(2)	0.00(1)
64	0.0(1)	0.0(1)	-18.5(3)	0.00(2)	0.00(3)	0.00(1)
65	0.0(1)	0.0(1)	-18.5(3)	0.00(2)	0.00(3)	0.00(1)
77	0.3(5)	-0.1(6)	-18.8(3)	0.00(6)	0.02(5)	-0.00(5)
78	0.1(3)	-0.1(2)	-18.9(3)	0.00(2)	0.00(3)	-0.00(6)
79	0.1(3)	-0.1(2)	-18.9(3)	0.00(2)	0.00(3)	-0.00(1)
80	0.0(3)	-0.0(2)	-18.5(3)	0.00(2)	0.00(3)	0.00(4)
81	0.1(3)	-0.1(2)	-18.6(3)	0.00(2)	0.00(3)	0.00(4)
82	0.0(6)	0.0(6)	-18.4(3)	-0.00(6)	0.00(3)	-0.00(3)
83	0.0(6)	-0.0(2)	-18.4(3)	-0.00(3)	0.00(3)	-0.00(6)
84	0.0(3)	-0.0(2)	-18.5(3)	0.00(3)	0.00(2)	0.00(2)
85	-0.0(6)	0.0(6)	-18.3(3)	-0.00(2)	0.00(3)	0.00(6)
86	0.0(6)	-0.0(2)	-18.5(3)	-0.00(3)	-0.00(3)	-0.00(6)
87	0.0(3)	-0.0(2)	-18.6(3)	0.00(3)	0.00(3)	0.00(3)
88	-0.0(2)	-0.0(2)	-18.3(3)	-0.00(6)	0.00(6)	0.00(3)
89	0.2(5)	-0.1(2)	-18.4(3)	0.00(2)	0.02(5)	0.00(5)
90	0.1(6)	-0.1(2)	-18.8(3)	0.00(2)	-0.00(5)	-0.00(5)
91	0.0(6)	-0.0(2)	-18.7(3)	0.00(2)	-0.00(5)	-0.00(5)
92	0.2(5)	-0.1(2)	-18.4(3)	0.00(2)	0.02(5)	0.00(5)
93	0.3(5)	-0.1(2)	-18.4(3)	0.00(2)	0.02(5)	0.00(5)
94	0.3(5)	-0.1(6)	-18.8(3)	0.00(6)	0.02(5)	-0.00(5)
95	0.1(6)	-0.1(6)	-19.2(3)	0.00(6)	-0.01(5)	0.00(5)
96	0.1(6)	-0.1(2)	-19.1(3)	0.00(2)	-0.01(5)	0.00(5)
97	0.1(3)	-0.1(2)	-18.8(3)	0.00(2)	0.00(3)	-0.00(6)
98	0.1(3)	-0.1(6)	-19.5(3)	0.00(6)	0.00(2)	0.00(4)
99	0.1(5)	-0.1(6)	-19.2(3)	0.01(6)	0.00(2)	0.00(5)
100	0.1(2)	-0.1(6)	-19.3(3)	-0.01(5)	0.00(2)	0.00(5)
109	0.1(5)	-0.1(6)	-19.1(3)	0.00(6)	0.00(2)	-0.00(4)
110	0.2(5)	-0.2(6)	-19.2(3)	0.00(6)	0.00(2)	0.01(5)
111	0.1(2)	-0.2(6)	-19.3(3)	0.00(6)	0.00(2)	0.00(5)
112	0.1(2)	-0.2(6)	-19.4(3)	0.00(6)	0.00(1)	-0.01(5)
113	0.1(3)	-0.2(6)	-19.5(3)	0.00(6)	0.00(1)	0.00(4)
116	0.7(5)	-0.1(6)	-18.9(3)	0.00(2)	0.01(5)	-0.00(5)

Nodo	Trasl. X	Trasl. Y	Trasl. Z	Rotaz. X	Rotaz. Y	Rotaz. Z
118	0.2(3)	-0.1(2)	-19.0(3)	0.00(2)	0.01(4)	0.00(3)
120	-0.2(5)	-0.1(6)	-19.2(3)	0.00(2)	0.00(2)	0.00(5)
123	0.7(5)	-0.1(6)	-18.8(3)	0.00(2)	0.01(5)	-0.00(5)
127	-0.2(5)	-0.1(2)	-19.2(3)	0.00(2)	-0.00(5)	0.00(5)
129	0.2(3)	-0.1(2)	-18.9(3)	0.00(2)	0.01(4)	0.00(3)
130	0.2(3)	-0.1(2)	-18.8(3)	0.00(2)	0.01(4)	0.00(4)
132	0.7(5)	-0.1(2)	-18.5(3)	0.00(2)	0.01(5)	0.00(5)
134	0.1(3)	-0.1(2)	-18.6(3)	0.00(2)	0.00(3)	0.00(4)
136	-0.1(5)	-0.1(2)	-18.8(3)	0.00(2)	0.00(1)	-0.00(5)
139	0.6(5)	-0.1(2)	-18.4(3)	0.00(2)	0.01(5)	0.01(5)
141	0.1(3)	-0.1(2)	-18.5(3)	0.00(2)	0.00(3)	0.00(4)
143	0.0(2)	-0.1(2)	-18.7(3)	0.00(2)	0.00(1)	-0.00(5)
146	0.5(5)	-0.1(2)	-18.4(3)	0.00(2)	0.01(5)	0.01(5)
148	0.1(3)	-0.1(2)	-18.5(3)	0.00(6)	0.00(1)	0.00(3)
149	0.1(3)	-0.1(6)	-18.6(3)	0.00(2)	0.00(1)	-0.00(1)
150	0.1(3)	-0.1(2)	-18.7(3)	0.00(3)	0.00(1)	0.00(6)
153	0.0(1)	0.0(1)	-18.3(3)	0.01(2)	0.00(5)	0.00(1)
154	0.0(1)	0.0(1)	-18.3(3)	0.01(2)	0.00(5)	0.00(1)
155	0.0(1)	0.0(1)	-18.3(3)	0.01(2)	0.00(3)	0.00(1)
156	0.0(1)	0.0(1)	-18.4(3)	0.01(3)	0.00(3)	0.00(1)
157	0.0(1)	0.0(1)	-18.5(3)	0.01(6)	0.00(4)	0.00(1)
166	0.0(1)	0.0(1)	-18.1(3)	0.00(2)	0.00(2)	0.00(1)
167	0.0(1)	0.0(1)	-18.1(3)	0.00(2)	-0.00(6)	0.00(1)
168	0.0(1)	0.0(1)	-18.1(3)	0.01(2)	0.00(5)	0.00(1)
169	0.0(1)	0.0(1)	-18.1(3)	0.01(2)	0.00(3)	0.00(1)
170	0.0(1)	0.0(1)	-18.4(3)	0.01(6)	0.01(3)	0.00(1)
171	0.0(1)	0.0(1)	-18.0(3)	0.01(2)	-0.00(6)	0.00(1)
172	0.0(1)	0.0(1)	-18.0(3)	0.00(6)	0.00(3)	0.00(1)
173	0.0(1)	0.0(1)	-18.2(3)	0.01(6)	0.01(3)	0.00(1)
174	0.0(1)	0.0(1)	-17.9(3)	0.00(2)	0.00(2)	0.00(1)
175	0.0(1)	0.0(1)	-18.0(3)	0.00(2)	0.00(2)	0.00(1)
176	0.0(1)	0.0(1)	-18.1(3)	0.01(6)	0.00(3)	0.00(1)
177	0.7(5)	-0.2(6)	-18.9(3)	0.00(6)	0.00(2)	-0.00(5)
178	-0.1(5)	-0.2(6)	-19.3(3)	0.00(6)	0.01(4)	0.00(5)
179	0.8(5)	-0.2(6)	-18.8(3)	0.00(6)	0.00(2)	-0.00(5)
180	-0.2(5)	-0.2(2)	-19.2(3)	0.00(2)	0.01(4)	0.00(5)
181	0.7(5)	-0.2(2)	-18.5(3)	0.00(2)	0.00(2)	0.00(5)
182	0.1(6)	-0.2(2)	-18.8(3)	0.00(2)	0.00(4)	-0.00(5)
183	0.2(3)	-0.2(2)	-18.9(3)	0.00(2)	0.00(4)	0.00(3)
184	0.2(3)	-0.2(2)	-18.6(3)	0.00(2)	0.00(4)	0.00(4)
185	0.2(3)	-0.2(2)	-18.8(3)	0.00(2)	0.00(4)	0.00(4)
186	0.2(3)	-0.2(2)	-19.0(3)	0.00(2)	0.00(4)	0.00(3)
187	0.0(3)	-0.1(6)	-18.5(3)	0.01(6)	0.00(3)	0.00(4)
188	0.1(5)	-0.1(2)	-18.2(3)	0.01(2)	0.01(5)	0.01(5)
189	0.0(4)	-0.1(2)	-18.3(3)	0.01(2)	0.00(3)	0.00(1)
190	0.0(2)	-0.1(3)	-18.4(3)	0.01(3)	0.00(3)	0.00(3)
191	0.1(2)	-0.1(2)	-18.7(3)	0.00(2)	0.00(1)	-0.00(5)
192	0.6(5)	-0.2(2)	-18.4(3)	0.00(2)	0.00(2)	0.01(5)
193	0.1(3)	-0.1(2)	-18.5(3)	0.00(2)	0.00(1)	0.00(4)
194	0.1(2)	-0.1(2)	-18.7(3)	0.01(3)	0.00(4)	0.00(6)
195	0.5(5)	-0.2(2)	-18.4(3)	0.00(2)	0.00(2)	0.01(5)
196	0.1(3)	-0.1(2)	-18.5(3)	0.00(6)	0.00(1)	0.00(3)
197	0.1(3)	-0.1(6)	-18.4(3)	0.01(6)	0.00(3)	-0.00(6)
198	0.1(5)	-0.1(2)	-18.1(3)	0.01(2)	0.01(5)	0.00(5)
199	0.0(5)	-0.1(2)	-17.9(3)	0.01(2)	0.01(5)	0.00(5)
200	0.1(3)	-0.1(6)	-18.2(3)	0.01(6)	0.00(2)	0.00(3)

Verifica dei Muri in calcestruzzo

Scenario di calcolo: **Copia di Set_NT_2018 A2_SLV_SLD_STR_GEO**

Simbologia:

Muro	Indice del muro in verifica
Nodi	[n1-n2-n3-n4...] Indici dei nodi di attacco del muro
Pann.X	Numero di pannelli in direzione locale X del muro(per muri a pannelli)
Pann.Y	Numero di pannelli in direzione locale Y del muro(per muri a pannelli)
Pann	Numero totale di pannelli (per muri a mesh)
Spess [cm]	Spessore del muro
Criterio	Criterio di verifica adottato per la verifica
Pannello	Indice del pannello
Nx [kN]	Sforzo in direzione x locale per metro lineare ($N_x = s_{xx} * spessore$)
Ny [kN]	Sforzo in direzione y locale per metro lineare ($N_y = s_{yy} * spessore$)
Nxy [kN]	Sforzo tagliante locale per metro lineare ($N_{xy} = s_{xy} * spessore$)
Mx [kN*m]	Momento in direzione x locale per metro lineare
My [kN*m]	Momento in direzione y locale per metro lineare
Mxy [kN*m]	Momento torcente locale per metro lineare
Ax [m ²]	Armatura totale pannello in direzione x locale ⁽¹⁾
Ay [m ²]	Armatura totale pannello in direzione y locale ⁽¹⁾
ec	Deformazione nel cls ⁽²⁾
ef	Deformazione nell'acciaio ⁽²⁾
Massimi	Armature massime riscontrate nel muro
Massimo	massima sigma ideale riscontrata nel muro
sid+,sid- [MPa]	$(s_x^2 + s_y^2 - s_x * s_y + 3 * t_{xy}^2)^{1/2}$ Tensioni ideali ai lembi della lastra (Acciaio)
sid+,sid- [MPa]	$(s_x^2 + s_y^2 - s_x * s_y + 3 * t_{xy}^2)^{1/2}$ Tensioni ideali ai lembi della lastra (Legno)
Fatt.Ampl.Sisma	Fattore moltiplicativo di gruppo per le azioni sismiche (solo se diverso da 1.0)
Cs	Coefficiente di sicurezza definito dal rapporto $ M_r(N) / M_d $ ($M_r(N)$ =Momento resistente corrispondente allo sforzo normale N, M_d =momento agente), quando richiesto dal criterio di verifica
z _E	Livello di sicurezza sismico definito come rapporto tra l'accelerazione sopportabile e l'accelerazione di progetto, quando richiesto dal criterio di verifica

Note Verifica muri:

⁽¹⁾: Le armature Ax ed Ay vanno intese come a metro lineare di pannello.

⁽²⁾:Le deformazioni sono stampate a meno del fattore 10⁻³; esse si riferiscono alla verifica considerando quali sollecitazioni di progetto $M_{x,d} = M_x +/- |M_{xy}|$, $M_{y,d} = M_y +/- |M_{xy}|$ scegliendo il segno in modo tale da rendere massimo in valore assoluto il relativo momento flettente,le sollecitazioni stampate si riferiscono alle sollecitazioni in una data combinazione riferite al sistema locale del pannello

Muro [Platea]: 1 - Nodi: [56-55-48-49]Pann=9Spess.=50 cm, Terreno=Terreno1, ,Criterio=CLS_Platee_ND, Materiale=C35/45: **Verificato**

Armatura a maglia doppia

Pannello	Nx	Ny	Nxy	Mx	My	Mxy	Ax	Ay	C	Cs	ZE
	kN	kN	kN	kN*m	kN*m	kN*m	mmq	mmq			
1	-26.92	-17.38	21.24	0.42	-8.32	5.43	3142	3142	4	18	--
2	-2.96	-51.17	15.32	-7.92	2.88	3.07	3142	3142	3	23	--
3	-25.49	-52.51	10.82	-16.24	2.34	0.42	3142	3142	3	15	--
4	-35.65	-58.21	0.16	-10.73	1.49	-0.88	3142	3142	3	22	--
5	22.17	-14.65	-25.97	-2.02	6.25	1.66	3142	3142	4	32	--
6	-106.38	-48.58	-17.15	15.51	7.98	0.18	3142	3142	4	17	--
7	-52.57	-76.94	18.47	12.54	8.79	0.84	3142	3142	3	20	--
8	-43.16	-64.13	5.84	6.34	3.38	4.24	3142	3142	3	24	--
9	-31.75	-64.48	7.48	0.32	5.86	5.88	3142	3142	3	22	--
Massimi/minimi											
1							3142				
1								3142			
3										15	

Muro [Platea]: 2 - Nodi: [24-33-32-23]Pann=8Spess.=50 cm, Terreno=Terreno1, ,Criterio=CLS_Platee_ND, Materiale=C35/45: **Verificato**

Armatura a maglia doppia

Pannello	Nx	Ny	Nxy	Mx	My	Mxy	Ax	Ay	C	Cs	ZE
	kN	kN	kN	kN*m	kN*m	kN*m	mmq	mmq			
1	2.51	74.28	50.60	1.46	22.50	1.06	3142	3142	4	10.0	--
2	36.46	234.46	39.38	-4.75	-42.70	1.00	3142	3142	5	4.6	--
3	17.31	120.21	-2.05	6.18	37.18	0.78	3142	3142	4	6.0	--
4	2.77	154.44	2.92	-7.48	-60.02	0.50	3142	3142	4	3.6	--
5	11.19	122.84	2.42	6.60	36.64	-1.17	3142	3142	4	6.0	--
6	-0.42	153.95	3.52	-7.15	-59.66	-1.00	3142	3142	4	3.6	--
7	-10.11	77.89	-38.20	2.86	21.45	-2.59	3142	3142	4	9.8	--
8	29.27	178.25	-42.27	-4.55	-42.81	-2.13	3142	3142	4	4.8	--
Massimi/minimi											
1							3142				
1								3142			
6										3.6	

Muro [Platea]: 3 - Nodi: [36-35-26-27]Pann=8Spess.=50 cm, Terreno=Terreno1, ,Criterio=CLS_Platee_ND, Materiale=C35/45: **Verificato**

Armatura a maglia doppia

Pannello	Nx	Ny	Nxy	Mx	My	Mxy	Ax	Ay	C	Cs	ZE
	kN	kN	kN	kN*m	kN*m	kN*m	mmq	mmq			
1	26.27	6.35	-13.67	-25.48	-2.07	-3.91	3142	3142	4	8.3	--
2	21.41	-24.68	17.80	-41.42	-3.98	-2.27	3142	3142	4	5.6	--
3	28.54	-21.21	10.24	-42.81	-4.48	-0.03	3142	3142	4	5.7	--
4	52.60	13.30	47.90	-29.15	-3.30	0.67	3142	3142	4	8.0	--
5	-50.15	-25.34	-1.41	27.52	4.03	-4.92	3142	3142	4	8.0	--
6	1.66	-22.83	20.56	39.55	8.33	-2.98	3142	3142	4	5.9	--
7	4.64	-16.80	1.54	40.07	7.90	0.17	3142	3142	4	6.2	--
8	-38.31	-14.52	40.02	27.83	2.37	0.98	3142	3142	4	9.0	--
Massimi/minimi											
1							3142				
1								3142			
2										5.6	

Muro [Platea]: 4 - Nodi: [35-34-25-26]Pann=8Spess.=50 cm, Terreno=Terreno1, ,Criterio=CLS_Platee_ND, Materiale=C35/45: **Verificato**

Armatura a maglia doppia

Pannello	Nx	Ny	Nxy	Mx	My	Mxy	Ax	Ay	C	Cs	Z _E
	kN	kN	kN	kN*m	kN*m	kN*m	mmq	mmq			
1	-103.81	-36.93	30.69	27.77	3.94	1.57	3142	3142	4	9.2	--
2	-56.33	-26.33	4.31	38.97	8.27	0.57	3142	3142	4	6.6	--
3	-58.46	-17.42	24.34	39.57	7.47	-2.55	3142	3142	4	6.2	--
4	-117.59	-13.07	2.56	29.46	1.59	-4.10	3142	3142	4	8.2	--
5	-1.67	-1.50	33.14	-19.04	-1.29	2.73	3142	3142	4	12	--
6	-47.87	-24.27	3.32	-30.14	-2.88	0.67	3142	3142	4	8.4	--
7	-52.10	-15.00	10.41	-30.26	-4.00	-1.82	3142	3142	4	8.1	--
8	-3.36	36.73	-15.07	-18.90	-4.87	-3.41	3142	3142	3	11	--
Massimi/minimi											
1							3142				
1								3142			
3										6.2	

Muro [Platea]: 5 - Nodi: [33-40-39-32]Pann=8Spess.=50 cm, Terreno=Terreno1, ,Criterio=CLS_Platee_ND, Materiale=C35/45: **Verificato**

Armatura a maglia doppia

Pannello	Nx	Ny	Nxy	Mx	My	Mxy	Ax	Ay	C	Cs	Z _E
	kN	kN	kN	kN*m	kN*m	kN*m	mmq	mmq			
1	12.58	-28.01	63.19	-0.08	12.94	7.39	3142	3142	4	13	--
2	7.88	280.10	40.47	-4.18	-32.04	6.89	3142	3142	5	5.0	--
3	-14.78	34.04	15.71	2.38	20.03	0.10	3142	3142	4	12	--
4	30.22	217.73	4.58	-4.97	-36.36	1.63	3142	3142	5	5.4	--
5	-16.86	31.13	-18.50	3.63	19.50	-2.28	3142	3142	4	11	--
6	28.94	167.21	-20.83	-4.22	-35.97	-0.90	3142	3142	4	5.9	--
7	2.64	-27.83	-58.32	3.64	12.41	-7.46	3142	3142	4	13	--
8	8.21	208.82	-65.77	-0.67	-27.00	-6.38	3142	3142	4	6.2	--
Massimi/minimi											
1							3142				
1								3142			
2										5.0	

Muro [Platea]: 6 - Nodi: [42-41-34-35]Pann=8Spess.=50 cm, Terreno=Terreno1, ,Criterio=CLS_Platee_ND, Materiale=C35/45: **Verificato**

Armatura a maglia doppia

Pannello	Nx	Ny	Nxy	Mx	My	Mxy	Ax	Ay	C	Cs	Z _E
	kN	kN	kN	kN*m	kN*m	kN*m	mmq	mmq			
1	-168.84	-17.18	53.66	20.57	3.06	5.14	3142	3142	4	11	--
2	-132.68	-31.94	18.75	25.53	3.70	1.12	3142	3142	4	10	--
3	-136.21	-28.62	-11.12	26.40	3.30	-0.87	3142	3142	4	10	--
4	-180.65	-5.93	-51.75	22.16	2.30	-6.01	3142	3142	4	10	--
5	57.03	-13.03	47.83	-11.20	-0.18	5.84	3142	3142	4	14	--
6	20.71	5.83	12.01	-16.28	-2.14	1.80	3142	3142	4	14	--
7	23.65	7.01	-18.98	-17.11	-2.22	0.19	3142	3142	4	14	--
8	73.80	-12.22	-52.72	-12.97	-0.54	-5.20	3142	3142	3	13	--
Massimi/minimi											
1							3142				
1								3142			
4										10	

Muro [Platea]: 7 - Nodi: [55-54-47-48]Pann=16Spess.=50 cm, Terreno=Terreno1, ,Criterio=CLS_Platee_ND, Materiale=C35/45: **Verificato**

Armatura a maglia doppia

Pannello	Nx	Ny	Nxy	Mx	My	Mxy	Ax	Ay	C	Cs	Z _E
----------	----	----	-----	----	----	-----	----	----	---	----	----------------

Pannello	Nx	Ny	Nxy	Mx	My	Mxy	Ax	Ay	C	Cs	ZE
	kN	kN	kN	kN*m	kN*m	kN*m	mmq	mmq			
1	-11.59	-8.53	7.42	-4.52	-3.61	-5.15	3142	3142	4	26	--
2	-43.63	-18.10	12.15	-8.61	0.85	-5.65	3142	3142	4	18	--
3	-37.57	-23.83	-0.78	-13.97	1.50	-2.52	3142	3142	4	16	--
4	8.93	-51.58	35.09	-11.24	2.46	0.55	3142	3142	3	21	--
5	-27.30	-22.30	6.78	1.50	-7.87	-5.72	3142	3142	4	19	--
6	-45.86	-58.65	12.35	5.21	7.53	-4.98	3142	3142	3	21	--
7	-45.60	-23.52	9.41	6.33	7.05	-3.66	3142	3142	4	24	--
8	-70.13	-69.68	20.32	6.06	5.02	1.93	3142	3142	6	33	--
9	-37.09	-23.87	9.72	3.73	-10.47	-3.92	3142	3142	4	18	--
10	-46.30	-71.96	10.77	10.79	10.09	-3.43	3142	3142	3	18	--
11	-54.22	-37.84	16.19	13.41	9.84	-2.00	3142	3142	4	17	--
12	-83.09	-34.72	33.09	12.20	7.32	1.27	3142	3142	4	20	--
13	-60.69	-89.30	-10.69	6.93	5.31	1.15	3142	3142	6	32	--
14	-63.75	-94.28	-10.16	10.44	9.64	2.10	3142	3142	6	21	--
15	-79.80	-89.52	-13.65	13.01	9.38	1.88	3142	3142	6	18	--
16	-110.59	-71.89	-8.02	12.80	6.55	1.81	3142	3142	6	19	--
Massimi/minimi											
1							3142				
1								3142			
3										16	

Muro [Platea]: 8 - Nodi: [41-40-33-34]Pann=8Spess.=50 cm, Terreno=Terreno1, ,Criterio=CLS_Platee_ND, Materiale=C35/45: **Verificato**

Armatura a maglia doppia

Pannello	Nx	Ny	Nxy	Mx	My	Mxy	Ax	Ay	C	Cs	ZE
	kN	kN	kN	kN*m	kN*m	kN*m	mmq	mmq			
1	-8.14	-20.96	-9.48	-3.18	2.33	-3.83	3142	3142	3	36	--
2	-29.68	-11.60	10.82	-6.29	-0.14	-1.55	3142	3142	3	33	--
3	-28.18	-10.20	25.42	-6.59	-0.85	-1.07	3142	3142	3	33	--
4	-51.84	-14.07	14.60	3.77	1.15	-0.70	3142	3142	1	58	--
5	-119.68	-20.01	-15.45	14.19	2.93	-3.68	3142	3142	4	15	--
6	-99.68	-24.84	4.87	17.35	3.18	-1.52	3142	3142	4	14	--
7	-127.07	-36.82	-2.60	17.83	3.60	0.91	3142	3142	6	15	--
8	-150.76	-26.36	14.38	15.96	2.76	2.89	3142	3142	6	15	--
Massimi/minimi											
1							3142				
1								3142			
6										14	

Muro [Platea]: 9 - Nodi: [20-27-26-19]Pann=12Spess.=50 cm, Terreno=Terreno1, ,Criterio=CLS_Platee_ND, Materiale=C35/45: **Verificato**

Armatura a maglia doppia

Pannello	Nx	Ny	Nxy	Mx	My	Mxy	Ax	Ay	C	Cs	ZE
	kN	kN	kN	kN*m	kN*m	kN*m	mmq	mmq			
1	7.25	78.65	5.36	-4.10	-33.44	9.33	3142	3142	4	5.5	--
2	4.79	129.03	48.21	-2.30	-18.33	6.89	3142	3142	4	8.9	--
3	-2.28	-138.97	40.99	0.15	20.44	6.98	3142	3142	4	10	--
4	-29.62	-72.12	-27.48	2.65	30.67	3.84	3142	3142	4	7.7	--
5	-30.63	-100.96	-44.47	6.10	34.01	1.14	3142	3142	4	7.7	--
6	-25.82	-161.66	-58.70	5.89	25.73	-2.72	3142	3142	4	9.9	--
7	-6.72	-75.49	-110.18	5.45	12.48	-9.28	3142	3142	4	12	--
8	-14.22	104.59	-80.17	2.28	-7.91	-9.88	3142	3142	5	13	--
9	-11.03	221.80	-56.63	-0.43	-37.19	-6.54	3142	3142	4	4.7	--
10	3.18	126.62	-22.24	-4.26	-49.23	1.94	3142	3142	4	4.4	--
11	2.05	99.04	-13.55	0.03	-11.64	-1.46	3142	3142	5	18	--
12	-24.96	-51.95	-36.38	3.10	20.75	-0.13	3142	3142	4	12	--
Massimi/minimi											

Pannello	Nx	Ny	Nxy	Mx	My	Mxy	Ax	Ay	C	Cs	Z _E
1							3142				
1								3142			
10										4.4	

Muro : 10 - Nodi: [32-39-92-93], Pann.X=4, Pann.Y=4Spess.=40 cm, Terreno=--,Criterio=CLS_Muri_ND, Materiale=C35/45: **Verificato**

Armatura a maglia doppia

Pannello	Nx	Ny	Nxy	Mx	My	Mxy	Ax	Ay	C	Cs	Z _E
	kN	kN	kN	kN*m	kN*m	kN*m	mmq	mmq			
1	-12.44	-125.09	22.45	-13.59	-111.40	4.06	3142	3142	5	1.8	--
2	-3.97	-123.13	13.02	-8.46	-76.37	5.26	3142	3142	5	2.6	--
3	1.80	-119.94	9.08	-3.68	-46.26	6.41	3142	3142	5	4.0	--
4	6.59	-117.49	5.62	0.86	-20.71	7.15	3142	3142	5	7.5	--
5	-12.16	-129.91	6.40	-13.10	-108.09	4.28	3142	3142	5	1.9	--
6	-0.58	-124.54	10.46	-7.89	-73.88	5.95	3142	3142	5	2.6	--
7	5.63	-120.46	8.59	-2.99	-44.53	7.46	3142	3142	5	4.0	--
8	10.69	-117.15	5.77	1.65	-19.78	8.41	3142	3142	5	7.4	--
9	-10.88	-121.24	13.39	-12.48	-103.95	5.15	3142	3142	5	1.9	--
10	-0.09	-118.98	8.91	-7.19	-70.76	7.15	3142	3142	5	2.7	--
11	7.70	-116.65	8.50	-2.20	-42.43	9.10	3142	3142	5	4.1	--
12	14.38	-114.24	6.14	2.52	-18.66	10.31	3142	3142	5	7.2	--
13	-8.08	-107.91	6.20	-11.78	-98.90	5.99	3142	3142	5	2.0	--
14	-0.86	-111.05	11.95	-6.47	-66.90	8.56	3142	3142	5	2.8	--
15	9.87	-110.86	10.09	-1.42	-39.80	10.95	3142	3142	5	4.1	--
16	18.15	-109.35	7.19	3.40	-17.30	12.45	3142	3142	5	7.0	--
Massimi/minimi											
1							3142				
1								3142			
1										1.8	

Muro : 11 - Nodi: [27-96-90-36], Pann.X=4, Pann.Y=4Spess.=40 cm, Terreno=--,Criterio=CLS_Muri_ND, Materiale=C35/45: **Verificato**

Armatura a maglia doppia

Pannello	Nx	Ny	Nxy	Mx	My	Mxy	Ax	Ay	C	Cs	Z _E
	kN	kN	kN	kN*m	kN*m	kN*m	mmq	mmq			
1	-115.17	-12.77	55.46	-71.56	-8.89	-1.17	3142	3142	5	2.9	--
2	-96.01	-10.79	56.90	-68.78	-8.50	-0.24	3142	3142	5	3.0	--
3	-94.15	-10.06	56.61	-65.13	-7.98	0.87	3142	3142	5	3.1	--
4	-102.55	-10.27	61.79	-57.41	-6.97	2.63	3142	3142	5	3.4	--
5	-104.53	-9.55	54.83	-48.53	-5.89	-0.90	3142	3142	5	4.2	--
6	-91.88	-8.07	55.91	-46.38	-5.49	0.00	3142	3142	5	4.4	--
7	-90.83	-6.44	57.16	-43.30	-4.91	1.39	3142	3142	5	4.6	--
8	-95.31	-5.46	61.97	-37.32	-3.99	3.64	3142	3142	5	5.0	--
9	-100.51	-6.34	55.13	-28.55	-3.22	-0.69	3142	3142	5	7.1	--
10	-90.39	-5.07	55.14	-26.95	-2.86	0.31	3142	3142	5	7.5	--
11	-89.32	-2.70	57.25	-24.55	-2.18	1.89	3142	3142	5	7.8	--
12	-92.29	-0.67	61.57	-20.43	-1.33	4.60	3142	3142	5	8.2	--
13	-96.35	-3.28	55.37	-11.55	-0.88	-0.56	3142	3142	5	17	--
14	-65.11	11.46	56.51	-10.87	-1.61	-0.47	3142	3142	6	18	--
15	-68.22	22.47	76.32	-10.34	-1.76	-1.11	3142	3142	6	18	--
16	-77.92	44.05	104.94	-9.99	-2.28	-2.43	3142	3142	6	16	--
Massimi/minimi											
1							3142				
1								3142			
1										2.9	

Muro : 12 - Nodi: [39-46-89-92], Pann.X=4, Pann.Y=4Spess.=40 cm, Terreno=--,Criterio=CLS_Muri_ND, Materiale=C35/45: **Verificato**

Armatura a maglia doppia

Pannello	Nx	Ny	Nxy	Mx	My	Mxy	Ax	Ay	C	Cs	ZE
	kN	kN	kN	kN*m	kN*m	kN*m	mmq	mmq			
1	-8.16	-105.84	32.39	-11.15	-94.54	7.00	3142	3142	5	2.0	--
2	3.05	-109.00	16.03	-5.82	-63.40	9.72	3142	3142	5	2.8	--
3	12.74	-106.94	11.31	-0.76	-37.42	12.52	3142	3142	5	4.2	--
4	21.34	-104.48	8.00	4.04	-16.12	14.23	3142	3142	5	6.8	--
5	-5.08	-125.47	17.36	-10.66	-91.01	7.44	3142	3142	5	2.1	--
6	7.53	-109.09	15.91	-5.33	-60.52	10.72	3142	3142	5	2.9	--
7	15.74	-103.41	11.04	-0.33	-35.51	13.81	3142	3142	5	4.2	--
8	23.68	-100.29	8.43	4.48	-15.20	15.65	3142	3142	5	6.7	--
9	-4.08	-120.42	9.82	-10.07	-86.60	7.99	3142	3142	5	2.2	--
10	8.58	-104.50	9.10	-4.81	-57.28	11.66	3142	3142	5	3.0	--
11	16.96	-97.73	10.41	0.13	-33.43	15.11	3142	3142	5	4.2	--
12	25.30	-94.58	8.85	4.87	-14.25	17.09	3142	3142	5	6.6	--
13	-4.77	-95.85	-4.02	-9.38	-81.37	8.47	3142	3142	5	2.3	--
14	6.59	-94.06	7.46	-4.23	-53.67	12.67	3142	3142	5	3.1	--
15	16.29	-89.83	9.52	0.59	-31.20	16.41	3142	3142	5	4.3	--
16	25.92	-86.71	9.51	5.18	-13.26	18.52	3142	3142	5	6.4	--
Massimi/minimi											
1							3142				
1								3142			
1										2.0	

Muro : 13 - Nodi: [50-87-86-57], Pann.X=4, Pann.Y=4Spess.=40 cm, Terreno=--,Criterio=CLS_Muri_ND, Materiale=C35/45: **Verificato**

Armatura a maglia doppia

Pannello	Nx	Ny	Nxy	Mx	My	Mxy	Ax	Ay	C	Cs	ZE
	kN	kN	kN	kN*m	kN*m	kN*m	mmq	mmq			
1	-93.15	-10.04	89.56	-28.69	-4.03	-1.35	3142	3142	5	6.8	--
2	-128.79	-18.85	108.33	-25.91	-3.15	-4.39	3142	3142	4	7.0	--
3	-107.13	-23.14	128.58	-22.71	-2.37	-2.43	3142	3142	4	8.3	--
4	-181.46	-37.01	150.76	-30.25	-2.19	-1.27	3142	3142	4	6.9	--
5	-169.52	-4.89	107.29	-15.79	-3.95	-2.59	3142	3142	4	12	--
6	-134.48	-15.95	116.36	-14.42	-1.48	-3.87	3142	3142	4	12	--
7	-88.69	-31.13	227.81	-12.89	0.03	-2.69	3142	3142	3	13	--
8	-198.28	-46.38	203.36	-15.91	4.02	-4.99	3142	3142	3	11	--
9	-56.88	83.35	192.89	-9.20	0.14	-1.60	3142	3142	6	19	--
10	-111.15	28.64	242.47	-6.79	-0.41	-4.65	3142	3142	3	18	--
11	-85.22	-8.10	243.94	-6.27	1.96	-2.63	3142	3142	3	23	--
12	-158.57	-29.52	209.80	-7.41	6.31	-6.42	3142	3142	3	15	--
13	-154.57	79.60	244.06	-0.15	-4.02	-5.29	3142	3142	3	19	--
14	-13.49	113.45	205.22	-5.44	-1.51	-0.75	3142	3142	6	31	--
15	-80.90	31.68	260.67	-0.88	3.69	-2.58	3142	3142	3	30	--
16	-122.82	-0.06	220.97	-1.92	7.29	-7.32	3142	3142	3	13	--
Massimi/minimi											
1							3142				
1								3142			
1										6.8	

Muro : 14 - Nodi: [36-90-91-43], Pann.X=4, Pann.Y=4Spess.=40 cm, Terreno=--,Criterio=CLS_Muri_ND, Materiale=C35/45: **Verificato**

Armatura a maglia doppia

Pannello	Nx	Ny	Nxy	Mx	My	Mxy	Ax	Ay	C	Cs	ZE
	kN	kN	kN	kN*m	kN*m	kN*m	mmq	mmq			
1	-103.06	-10.59	70.51	-50.51	-6.24	3.54	3142	3142	5	3.8	--
2	-106.33	-10.92	58.34	-46.34	-5.85	3.20	3142	3142	5	4.2	--

Pannello	Nx	Ny	Nxy	Mx	My	Mxy	Ax	Ay	C	Cs	z _E
3	-101.20	-10.76	64.45	-42.03	-5.46	3.00	3142	3142	5	4.6	--
4	-94.48	-9.57	60.66	-37.99	-5.16	2.39	3142	3142	5	5.1	--
5	-100.38	-3.51	64.45	-32.02	-3.78	5.18	3142	3142	5	5.6	--
6	-101.87	-2.67	62.29	-29.13	-3.77	5.05	3142	3142	5	6.1	--
7	-99.85	-3.72	61.88	-26.11	-3.86	4.85	3142	3142	5	6.7	--
8	-98.43	-5.65	66.04	-23.12	-4.13	4.18	3142	3142	5	7.6	--
9	-96.75	1.66	62.81	-16.88	-1.59	6.67	3142	3142	5	8.8	--
10	-98.31	2.62	62.31	-15.03	-1.94	6.71	3142	3142	5	9.5	--
11	-98.35	2.32	62.82	-13.06	-2.54	6.64	3142	3142	5	10	--
12	-172.89	1.09	71.99	-12.27	-3.71	5.74	3142	3142	4	12	--
13	-86.12	65.42	125.38	-9.68	-2.69	-3.67	3142	3142	6	15	--
14	-87.72	74.16	133.10	-9.36	-2.54	-3.89	3142	3142	6	15	--
15	-88.63	83.87	141.37	-8.91	-2.09	-4.21	3142	3142	6	16	--
16	-88.67	94.70	150.15	-8.31	-1.15	-4.39	3142	3142	6	16	--
Massimi/minimi											
1							3142				
1								3142			
1										3.8	

Muro : 15 - Nodi: [23-32-93-94], Pann.X=4, Pann.Y=4Spess.=40 cm, Terreno=--,Criterio=CLS_Muri_ND, Materiale=C35/45: **Verificato**

Armatura a maglia doppia

Pannello	Nx	Ny	Nxy	Mx	My	Mxy	Ax	Ay	C	Cs	z _E
	kN	kN	kN	kN*m	kN*m	kN*m	mmq	mmq			
1	-16.74	-131.65	-7.17	-14.68	-118.29	-1.46	3142	3142	5	1.8	--
2	-17.67	-120.66	-7.85	-9.98	-82.53	-1.36	3142	3142	5	2.5	--
3	-18.70	-115.95	-7.62	-5.75	-51.04	-1.33	3142	3142	5	4.0	--
4	-19.85	-111.61	-7.10	-1.98	-23.69	-1.34	3142	3142	5	8.3	--
5	-14.70	-107.19	-4.58	-14.55	-117.12	-0.30	3142	3142	5	1.8	--
6	-16.83	-104.51	-5.80	-9.96	-81.81	-0.23	3142	3142	5	2.5	--
7	-18.58	-103.53	-6.58	-5.89	-50.59	-0.12	3142	3142	5	4.1	--
8	-20.03	-101.28	-7.19	-2.33	-23.32	-0.01	3142	3142	5	8.9	--
9	-13.87	-107.29	-3.18	-14.42	-116.35	0.67	3142	3142	5	1.8	--
10	-14.54	-104.87	-2.46	-9.76	-81.07	0.78	3142	3142	5	2.5	--
11	-15.03	-104.26	-2.70	-5.61	-49.94	0.88	3142	3142	5	4.1	--
12	-15.43	-102.47	-3.52	-1.95	-22.81	0.95	3142	3142	5	8.7	--
13	-13.46	-126.04	7.54	-14.02	-114.21	2.60	3142	3142	5	1.8	--
14	-9.88	-117.20	7.22	-9.06	-79.06	3.00	3142	3142	5	2.5	--
15	-6.88	-114.51	5.56	-4.56	-48.35	3.45	3142	3142	5	4.0	--
16	-4.48	-112.29	3.12	-0.48	-21.90	3.76	3142	3142	5	8.1	--
Massimi/minimi											
1							3142				
1								3142			
1										1.8	

Muro [Platea]: 16 - Nodi: [47-54-53-46]Pann=13Spess.=50 cm, Terreno=Terreno1, ,Criterio=CLS_Platee_ND, Materiale=C35/45: **Verificato**

Armatura a maglia doppia

Pannello	Nx	Ny	Nxy	Mx	My	Mxy	Ax	Ay	C	Cs	z _E
	kN	kN	kN	kN*m	kN*m	kN*m	mmq	mmq			
1	-75.75	-10.43	1.08	11.05	15.16	-0.68	3142	3142	3	16	--
2	-53.96	-37.29	-2.87	2.40	8.90	-1.07	3142	3142	3	26	--
3	-10.45	-18.29	-11.03	-8.36	3.20	-6.02	3142	3142	4	18	--
4	-82.95	-41.23	24.01	9.46	4.89	-7.45	3142	3142	6	16	--
5	-27.48	5.10	-16.16	0.99	-9.68	-2.45	3142	3142	3	21	--
6	-7.96	15.33	-19.92	-0.51	-19.90	-0.96	3142	3142	4	12	--
7	-14.99	44.38	-6.27	0.21	-22.56	1.01	3142	3142	4	10	--
8	-14.52	146.08	12.21	-1.02	-17.16	2.75	3142	3142	5	11	--

Pannello	Nx	Ny	Nxy	Mx	My	Mxy	Ax	Ay	C	Cs	ZE
9	-73.26	-102.13	48.75	5.47	11.87	-2.26	3142	3142	6	19	--
10	-43.35	16.37	10.65	10.52	16.74	-1.79	3142	3142	4	13	--
11	-79.48	-45.09	40.38	7.04	5.26	-7.37	3142	3142	6	18	--
12	-76.92	-56.41	44.42	7.65	8.39	-6.15	3142	3142	6	18	--
13	-88.47	-52.65	34.77	8.90	9.76	-6.78	3142	3142	6	16	--
Massimi/minimi											
1							3142				
1								3142			
7										10	

Muro [Platea]: 17 - Nodi: [36-43-42-35]Pann=8Spess.=50 cm, Terreno=Terreno1, ,Criterio=CLS_Platee_ND, Materiale=C35/45: **Verificato**

Armatura a maglia doppia

Pannello	Nx	Ny	Nxy	Mx	My	Mxy	Ax	Ay	C	Cs	ZE
	kN	kN	kN	kN*m	kN*m	kN*m	mmq	mmq			
1	-5.11	79.11	-72.63	-1.81	-15.47	-4.32	3142	3142	4	12	--
2	0.90	-150.35	-83.99	1.11	21.27	-3.24	3142	3142	4	11	--
3	17.37	15.11	-38.88	-3.63	-20.10	1.67	3142	3142	4	11	--
4	-20.40	-100.34	-40.87	2.93	27.09	2.09	3142	3142	4	9.3	--
5	18.86	5.34	-11.84	-3.20	-18.50	3.36	3142	3142	4	11	--
6	-22.04	-98.61	-15.29	3.65	26.29	4.08	3142	3142	4	8.9	--
7	3.84	41.73	19.37	-0.99	-11.45	8.31	3142	3142	4	12	--
8	-6.48	-139.50	18.21	3.03	19.83	8.31	3142	3142	4	9.9	--
Massimi/minimi											
1							3142				
1								3142			
6										8.9	

Muro [Platea]: 18 - Nodi: [17-24-23-16]Pann=8Spess.=50 cm, Terreno=Terreno1, ,Criterio=CLS_Platee_ND, Materiale=C35/45: **Verificato**

Armatura a maglia doppia

Pannello	Nx	Ny	Nxy	Mx	My	Mxy	Ax	Ay	C	Cs	ZE
	kN	kN	kN	kN*m	kN*m	kN*m	mmq	mmq			
1	1.18	-19.61	82.39	5.13	14.29	8.24	3142	3142	4	11	--
2	-0.45	266.37	71.74	-0.44	-34.26	8.41	3142	3142	4	4.6	--
3	-19.47	47.89	39.48	4.17	22.97	0.27	3142	3142	4	10	--
4	33.64	238.07	9.88	-4.47	-40.91	1.04	3142	3142	5	4.8	--
5	-10.70	43.36	1.74	2.04	23.22	-2.67	3142	3142	4	9.3	--
6	37.06	200.11	-12.50	-6.45	-43.79	-2.39	3142	3142	4	4.5	--
7	24.61	-32.53	-52.06	-1.14	14.92	-10.42	3142	3142	4	10	--
8	11.50	276.80	-59.86	-4.52	-35.61	-9.96	3142	3142	4	4.3	--
Massimi/minimi											
1							3142				
1								3142			
8										4.3	

Muro [Platea]: 19 - Nodi: [40-47-46-39]Pann=8Spess.=50 cm, Terreno=Terreno1, ,Criterio=CLS_Platee_ND, Materiale=C35/45: **Verificato**

Armatura a maglia doppia

Pannello	Nx	Ny	Nxy	Mx	My	Mxy	Ax	Ay	C	Cs	ZE
	kN	kN	kN	kN*m	kN*m	kN*m	mmq	mmq			
1	-6.40	-53.76	46.07	0.43	9.34	7.74	3142	3142	4	15	--
2	-16.61	216.20	36.47	-2.86	-23.42	8.96	3142	3142	4	6.4	--
3	-49.94	-124.13	35.59	3.89	14.30	-2.08	3142	3142	6	17	--
4	8.81	203.09	-3.11	-2.10	-25.53	2.93	3142	3142	5	7.4	--
5	-52.77	-119.65	26.81	4.87	13.99	-3.58	3142	3142	6	16	--

Pannello	Nx	Ny	Nxy	Mx	My	Mxy	Ax	Ay	C	Cs	Z _E
6	8.32	168.93	-16.91	-0.44	-24.97	-1.54	3142	3142	4	8.2	--
7	-15.43	-51.34	-33.68	4.71	9.45	-8.86	3142	3142	4	14	--
8	-5.66	182.59	-43.22	1.83	-19.79	-7.70	3142	3142	4	7.8	--
Massimi/minimi											
1							3142				
1								3142			
2										6.4	

Muro [Platea]: 20 - Nodi: [49-48-41-42]Pann=8Spess.=50 cm, Terreno=Terreno1, ,Criterio=CLS_Platee_ND, Materiale=C35/45: **Verificato**

Armatura a maglia doppia

Pannello	Nx	Ny	Nxy	Mx	My	Mxy	Ax	Ay	C	Cs	Z _E
	kN	kN	kN	kN*m	kN*m	kN*m	mmq	mmq			
1	-166.09	-30.85	38.50	17.04	4.09	5.79	3142	3142	4	12	--
2	-157.70	-37.35	15.30	20.07	3.24	1.48	3142	3142	4	13	--
3	-163.48	-32.53	-8.90	20.61	2.57	-1.36	3142	3142	4	13	--
4	-183.44	-13.93	-32.23	18.50	2.20	-6.39	3142	3142	4	12	--
5	51.42	-20.78	26.95	-7.23	2.24	6.67	3142	3142	4	17	--
6	41.01	-9.76	7.03	-10.29	1.11	1.89	3142	3142	4	20	--
7	51.11	-23.85	-9.00	-11.12	1.03	-1.70	3142	3142	3	19	--
8	72.74	-38.53	-35.96	-9.46	-0.27	-5.97	3142	3142	3	15	--
Massimi/minimi											
1							3142				
1								3142			
4										12	

Muro [Platea]: 21 - Nodi: [43-50-49-42]Pann=8Spess.=50 cm, Terreno=Terreno1, ,Criterio=CLS_Platee_ND, Materiale=C35/45: **Verificato**

Armatura a maglia doppia

Pannello	Nx	Ny	Nxy	Mx	My	Mxy	Ax	Ay	C	Cs	Z _E
	kN	kN	kN	kN*m	kN*m	kN*m	mmq	mmq			
1	-6.10	52.97	-68.48	-1.72	-8.89	-4.50	3142	3142	4	18	--
2	-9.42	-155.96	-77.82	1.51	17.29	-3.50	3142	3142	4	14	--
3	11.32	28.62	-49.85	-1.70	-12.00	1.53	3142	3142	4	18	--
4	-24.03	-134.49	-50.84	2.12	20.75	1.91	3142	3142	4	12	--
5	12.03	26.11	-32.31	-1.19	-11.63	5.36	3142	3142	4	14	--
6	-25.96	-130.37	-27.08	2.76	20.37	5.15	3142	3142	4	11	--
7	-2.40	44.63	-14.49	-0.08	-7.87	11.19	3142	3142	4	13	--
8	-16.16	-143.26	-2.64	3.36	16.31	10.17	3142	3142	4	11	--
Massimi/minimi											
1							3142				
1								3142			
8										11	

Muro [Platea]: 22 - Nodi: [34-33-24-25]Pann=8Spess.=50 cm, Terreno=Terreno1, ,Criterio=CLS_Platee_ND, Materiale=C35/45: **Verificato**

Armatura a maglia doppia

Pannello	Nx	Ny	Nxy	Mx	My	Mxy	Ax	Ay	C	Cs	Z _E
	kN	kN	kN	kN*m	kN*m	kN*m	mmq	mmq			
1	-46.82	-7.28	12.44	-4.69	0.06	-2.87	3142	3142	3	34	--
2	-60.13	-10.44	14.37	-8.82	-1.18	-1.43	3142	3142	3	26	--
3	-65.18	-1.10	-0.40	-8.91	-2.18	0.12	3142	3142	3	29	--
4	-77.32	-10.60	-8.57	7.06	1.28	0.69	3142	3142	1	34	--
5	-84.76	-21.12	14.12	15.90	2.12	-2.58	3142	3142	4	14	--
6	-132.78	-25.62	-3.28	23.59	4.24	0.45	3142	3142	6	12	--
7	-143.59	-25.58	-11.79	24.39	4.05	1.59	3142	3142	6	11	--

Pannello	Nx	Ny	Nxy	Mx	My	Mxy	Ax	Ay	C	Cs	z _E
8	-163.73	-28.99	-10.02	21.13	3.36	2.64	3142	3142	6	12	--
Massimi/minimi											
1							3142				
1								3142			
7										11	

Muro [Platea]: 23 - Nodi: [25-24-17-18]Pann=8Spess.=50 cm, Terreno=Terreno1, ,Criterio=CLS_Platee_ND, Materiale=C35/45: **Verificato**

Armatura a maglia doppia

Pannello	Nx	Ny	Nxy	Mx	My	Mxy	Ax	Ay	C	Cs	z _E
	kN	kN	kN	kN*m	kN*m	kN*m	mmq	mmq			
1	-88.74	-20.58	-6.85	7.46	-0.21	0.88	3142	3142	1	32	--
2	-88.89	-27.27	-8.64	8.21	0.84	0.39	3142	3142	1	31	--
3	-148.82	-48.56	-26.37	7.39	3.92	2.20	3142	3142	6	29	--
4	-138.86	-60.67	-20.72	9.92	9.31	4.25	3142	3142	6	19	--
5	-199.49	-43.99	-36.12	19.00	1.03	0.21	3142	3142	6	15	--
6	-142.95	-10.49	-31.96	20.89	-0.42	3.59	3142	3142	4	11	--
7	-140.51	-16.65	-21.80	20.35	3.49	5.38	3142	3142	4	11	--
8	-151.83	-26.70	-2.46	17.15	8.73	5.68	3142	3142	4	12	--
Massimi/minimi											
1							3142				
1								3142			
7										11	

Muro [Platea]: 24 - Nodi: [26-25-18-19]Pann=8Spess.=50 cm, Terreno=Terreno1, ,Criterio=CLS_Platee_ND, Materiale=C35/45: **Verificato**

Armatura a maglia doppia

Pannello	Nx	Ny	Nxy	Mx	My	Mxy	Ax	Ay	C	Cs	z _E
	kN	kN	kN	kN*m	kN*m	kN*m	mmq	mmq			
1	-209.60	-0.02	100.11	24.68	-3.29	2.49	3142	3142	4	11	--
2	-162.29	-23.03	51.61	29.68	0.36	-4.05	3142	3142	4	8.4	--
3	-157.53	-28.09	25.43	28.63	4.70	-7.61	3142	3142	4	7.8	--
4	-193.35	-24.26	-3.91	23.68	10.32	-10.77	3142	3142	4	8.4	--
5	60.16	27.41	88.21	-13.12	-7.73	4.06	3142	3142	3	14	--
6	6.03	45.39	58.05	-17.07	-8.90	-1.82	3142	3142	3	13	--
7	-4.84	42.91	31.93	-14.67	-5.42	-4.35	3142	3142	3	13	--
8	14.72	28.13	-5.31	-6.76	4.41	-9.31	3142	3142	3	15	--
Massimi/minimi											
1							3142				
1								3142			
3										7.8	

Muro [Platea]: 25 - Nodi: [48-47-40-41]Pann=12Spess.=50 cm, Terreno=Terreno1, ,Criterio=CLS_Platee_ND, Materiale=C35/45: **Verificato**

Armatura a maglia doppia

Pannello	Nx	Ny	Nxy	Mx	My	Mxy	Ax	Ay	C	Cs	z _E
	kN	kN	kN	kN*m	kN*m	kN*m	mmq	mmq			
1	-105.35	-27.70	-12.89	11.42	4.19	-4.40	3142	3142	4	17	--
2	-125.86	-41.14	-1.10	11.75	5.41	-1.22	3142	3142	3	21	--
3	-137.66	-44.69	-18.38	15.01	4.44	0.71	3142	3142	6	18	--
4	-136.29	-49.19	-9.52	14.52	3.92	1.59	3142	3142	6	17	--
5	-140.28	-40.89	5.56	13.60	3.67	3.96	3142	3142	6	16	--
6	1.24	-41.42	38.21	-3.17	0.83	2.89	3142	3142	3	41	--
7	-1.41	-25.96	22.83	-7.43	1.09	6.43	3142	3142	4	18	--
8	33.18	-33.74	13.20	-19.40	3.08	-5.92	3142	3142	4	9.6	--
9	47.81	-34.24	-6.34	-8.96	2.49	-5.70	3142	3142	4	16	--

Pannello	Nx	Ny	Nxy	Mx	My	Mxy	Ax	Ay	C	Cs	ZE
10	-33.25	-41.10	-23.29	4.60	5.55	-6.69	3142	3142	3	21	--
11	-112.70	-35.90	12.48	14.21	2.30	-0.88	3142	3142	4	18	--
12	-44.62	-29.37	4.14	4.05	2.09	0.66	3142	3142	1	55	--
Massimi/minimi											
1							3142				
1								3142			
8										9.6	

Muro [Platea]: 26 - Nodi: [57-56-49-50]Pann=9Spess.=50 cm, Terreno=Terreno1, ,Criterio=CLS_Platee_ND, Materiale=C35/45: **Verificato**

Armatura a maglia doppia

Pannello	Nx	Ny	Nxy	Mx	My	Mxy	Ax	Ay	C	Cs	ZE
	kN	kN	kN	kN*m	kN*m	kN*m	mmq	mmq			
1	-15.73	-58.76	41.00	5.57	5.85	-10.67	3142	3142	3	16	--
2	-36.91	-68.00	34.21	14.32	8.77	-6.96	3142	3142	3	12	--
3	-75.57	-46.88	79.05	15.91	5.63	-5.51	3142	3142	4	12	--
4	21.07	2.06	90.98	-4.77	1.74	-6.14	3142	3142	4	23	--
5	-8.05	-19.09	68.41	-19.65	-5.47	-5.23	3142	3142	4	10	--
6	31.07	-20.37	58.86	-29.15	-3.66	-4.40	3142	3142	4	7.3	--
7	46.76	-77.53	21.93	-16.39	10.12	-5.44	3142	3142	3	11	--
8	11.93	-71.25	8.99	1.47	13.87	-8.50	3142	3142	2	12	--
9	6.82	-38.22	41.43	-2.94	-0.17	-12.93	3142	3142	4	16	--
Massimi/minimi											
1							3142				
1								3142			
6										7.3	

Muro : 27 - Nodi: [16-23-94-77], Pann.X=4, Pann.Y=4Spess.=40 cm, Terreno=--,Criterio=CLS_Muri_ND, Materiale=C35/45: **Verificato**

Armatura a maglia doppia

Pannello	Nx	Ny	Nxy	Mx	My	Mxy	Ax	Ay	C	Cs	ZE
	kN	kN	kN	kN*m	kN*m	kN*m	mmq	mmq			
1	-18.16	-134.81	29.85	-13.93	-113.29	-1.61	3142	3142	5	1.8	--
2	-16.02	-129.29	20.88	-8.94	-77.64	-3.17	3142	3142	5	2.6	--
3	-16.55	-122.33	18.06	-4.34	-46.98	-4.70	3142	3142	5	4.1	--
4	-17.98	-115.49	16.22	-0.03	-20.95	-5.77	3142	3142	5	7.8	--
5	-18.84	-148.19	7.48	-14.38	-116.00	-1.69	3142	3142	5	1.8	--
6	-14.08	-137.93	12.81	-9.52	-79.91	-2.74	3142	3142	5	2.6	--
7	-14.44	-128.70	11.78	-4.99	-48.65	-3.90	3142	3142	5	4.0	--
8	-16.47	-120.34	10.79	-0.74	-22.03	-4.74	3142	3142	5	7.8	--
9	-19.01	-149.70	8.67	-14.69	-117.99	-1.53	3142	3142	5	1.8	--
10	-14.05	-139.48	3.37	-9.91	-81.53	-2.36	3142	3142	5	2.5	--
11	-14.34	-130.29	4.16	-5.46	-49.90	-3.13	3142	3142	5	4.0	--
12	-16.15	-122.06	4.68	-1.30	-22.86	-3.70	3142	3142	5	7.9	--
13	-18.58	-139.41	-13.65	-14.86	-119.18	-1.84	3142	3142	5	1.8	--
14	-16.05	-133.90	-4.58	-10.15	-82.57	-2.15	3142	3142	5	2.5	--
15	-16.14	-126.92	-1.92	-5.79	-50.77	-2.59	3142	3142	5	3.9	--
16	-17.25	-120.47	-0.59	-1.72	-23.46	-2.95	3142	3142	5	7.9	--
Massimi/minimi											
1							3142				
1								3142			
13										1.8	

Muro : 28 - Nodi: [54-55-83-85], Pann.X=4, Pann.Y=4Spess.=40 cm, Terreno=--,Criterio=CLS_Muri_ND, Materiale=C35/45: **Verificato**

Armatura a maglia doppia

Pannello	Nx	Ny	Nxy	Mx	My	Mxy	Ax	Ay	C	Cs	ZE
	kN	kN	kN	kN*m	kN*m	kN*m	mmq	mmq			
1	2.83	-28.13	41.25	2.18	23.19	0.27	3142	3142	6	8.3	--
2	6.07	18.63	-96.32	0.50	15.59	-0.73	3142	3142	2	12	--
3	8.77	36.22	-96.49	-1.17	10.15	-0.59	3142	3142	2	17	--
4	22.29	25.20	48.30	-5.04	-3.58	0.10	3142	3142	6	37	--
5	1.62	-17.93	14.71	1.99	21.62	-1.71	3142	3142	6	8.3	--
6	6.19	21.11	-123.19	0.51	15.17	-2.37	3142	3142	2	11	--
7	8.58	38.77	-123.02	-1.11	10.74	-2.37	3142	3142	2	14	--
8	16.31	31.99	21.47	-5.27	-2.58	-1.60	3142	3142	6	27	--
9	1.56	0.69	-9.23	1.83	17.50	-3.25	3142	3142	6	9.2	--
10	5.96	27.52	-149.36	1.55	13.67	-3.70	3142	3142	2	11	--
11	7.95	45.21	-149.93	0.58	10.97	-4.36	3142	3142	2	12	--
12	8.88	62.96	-149.44	-1.19	6.85	-4.16	3142	3142	2	16	--
13	2.65	24.20	-29.71	2.57	12.78	-2.33	3142	3142	6	12	--
14	10.51	33.09	-176.58	4.52	11.73	-1.82	3142	3142	2	14	--
15	8.62	52.35	-179.23	5.71	10.17	-3.25	3142	3142	2	14	--
16	6.40	71.98	-179.01	6.29	8.12	-4.21	3142	3142	2	15	--
Massimi/minimi											
1							3142				
1								3142			
5										8.3	

Muro : 29 - Nodi: [20-95-96-27], Pann.X=4, Pann.Y=4Spess.=40 cm, Terreno=--,Criterio=CLS_Muri_ND, Materiale=C35/45: **Verificato**

Armatura a maglia doppia

Pannello	Nx	Ny	Nxy	Mx	My	Mxy	Ax	Ay	C	Cs	ZE
	kN	kN	kN	kN*m	kN*m	kN*m	mmq	mmq			
1	-122.16	-12.78	76.63	-69.38	-8.54	-0.88	3142	3142	5	3.0	--
2	-114.30	-13.16	70.60	-70.37	-8.77	-0.89	3142	3142	5	2.9	--
3	-128.75	-14.68	82.45	-72.42	-9.06	-0.30	3142	3142	5	2.9	--
4	-130.41	-14.19	51.13	-73.82	-9.27	-1.24	3142	3142	5	2.8	--
5	-114.77	-7.93	77.17	-46.31	-5.39	-1.68	3142	3142	5	4.4	--
6	-112.97	-11.69	74.71	-47.60	-5.77	-1.43	3142	3142	5	4.3	--
7	-119.62	-7.09	72.02	-48.74	-6.06	-1.23	3142	3142	5	4.2	--
8	-120.31	-6.34	61.54	-49.47	-6.27	-1.23	3142	3142	5	4.1	--
9	-107.46	-6.95	77.97	-26.81	-2.56	-2.56	3142	3142	5	7.1	--
10	-108.31	-6.69	73.95	-27.79	-2.95	-2.13	3142	3142	5	6.9	--
11	-111.50	-4.91	69.29	-28.54	-3.30	-1.73	3142	3142	5	6.9	--
12	-111.18	-4.18	63.07	-29.02	-3.56	-1.43	3142	3142	5	6.8	--
13	-100.45	-5.14	77.38	-10.51	0.07	-3.20	3142	3142	5	15	--
14	-102.20	-4.31	72.91	-11.13	-0.37	-2.61	3142	3142	5	15	--
15	-103.97	-3.02	68.22	-11.57	-0.75	-2.02	3142	3142	5	15	--
16	-103.75	-2.53	63.16	-11.87	-1.02	-1.58	3142	3142	5	15	--
Massimi/minimi											
1							3142				
1								3142			
4										2.8	

Muro : 30 - Nodi: [43-91-87-50], Pann.X=4, Pann.Y=4Spess.=40 cm, Terreno=--,Criterio=CLS_Muri_ND, Materiale=C35/45: **Verificato**

Armatura a maglia doppia

Pannello	Nx	Ny	Nxy	Mx	My	Mxy	Ax	Ay	C	Cs	ZE
	kN	kN	kN	kN*m	kN*m	kN*m	mmq	mmq			
1	-97.50	-10.95	83.21	-35.34	-4.99	1.87	3142	3142	5	5.5	--
2	-116.33	-10.05	74.45	-33.86	-4.86	1.16	3142	3142	5	6.0	--
3	-116.48	-11.58	72.64	-32.30	-4.70	0.46	3142	3142	5	6.4	--
4	-100.43	-16.15	66.80	-30.70	-4.50	-0.24	3142	3142	5	6.7	--
5	-102.70	-3.53	71.49	-20.91	-4.36	3.32	3142	3142	5	8.5	--

Pannello	Nx	Ny	Nxy	Mx	My	Mxy	Ax	Ay	C	Cs	Ze
6	-108.37	-0.43	73.83	-19.48	-4.44	2.60	3142	3142	5	9.4	--
7	-110.91	0.15	72.23	-18.17	-4.40	1.73	3142	3142	5	10	--
8	-106.10	-3.41	75.56	-17.02	-4.22	0.95	3142	3142	5	12	--
9	-180.07	5.11	75.66	-10.77	-4.93	4.84	3142	3142	4	14	--
10	-82.86	77.11	170.27	-9.98	0.10	-4.13	3142	3142	6	14	--
11	-81.52	81.12	175.11	-9.93	0.72	-3.60	3142	3142	6	15	--
12	-77.92	83.82	181.23	-9.82	0.98	-2.92	3142	3142	6	16	--
13	-179.79	16.83	69.82	-3.37	-5.44	6.04	3142	3142	4	16	--
14	-187.44	22.79	70.51	-2.89	-7.20	5.23	3142	3142	4	15	--
15	-207.95	104.37	171.02	-4.54	-9.58	3.32	3142	3142	3	14	--
16	-253.04	139.67	178.24	-0.99	-13.38	2.20	3142	3142	3	11	--
Massimi/minimi											
1							3142				
1								3142			
1										5.5	

Muro : 31 - Nodi: [56-82-83-55], Pann.X=4, Pann.Y=4Spess.=40 cm, Terreno=--,Criterio=CLS_Muri_ND, Materiale=C35/45: **Verificato**

Armatura a maglia doppia

Pannello	Nx	Ny	Nxy	Mx	My	Mxy	Ax	Ay	C	Cs	Ze
	kN	kN	kN	kN*m	kN*m	kN*m	mmq	mmq			
1	-28.35	0.43	88.34	24.47	2.31	0.14	3142	3142	6	7.9	--
2	-21.74	0.79	58.41	21.99	2.05	-2.36	3142	3142	6	8.0	--
3	4.53	0.60	31.86	15.97	1.98	-3.77	3142	3142	6	9.7	--
4	16.55	-6.47	111.72	13.41	1.88	-0.65	3142	3142	3	13	--
5	-3.51	4.58	244.34	16.95	0.44	0.40	3142	3142	2	11	--
6	4.12	2.32	210.62	16.13	0.44	-1.95	3142	3142	2	11	--
7	19.73	-1.78	177.09	13.79	1.91	-3.49	3142	3142	2	11	--
8	32.50	-10.80	147.36	11.30	3.30	-0.53	3142	3142	2	16	--
9	14.10	6.01	245.79	11.51	-1.35	0.33	3142	3142	2	16	--
10	21.80	3.82	211.77	11.62	-1.32	-2.11	3142	3142	2	14	--
11	36.32	-1.42	180.43	11.38	1.30	-4.41	3142	3142	2	12	--
12	48.53	-9.17	150.25	10.14	6.00	-1.00	3142	3142	2	16	--
13	3.45	-3.17	240.52	5.71	-0.54	0.34	3142	3142	1	32	--
14	27.54	10.67	64.12	-3.14	-5.28	-2.21	3142	3142	6	25	--
15	52.54	0.71	183.56	7.65	-0.06	-4.47	3142	3142	2	15	--
16	59.31	-3.53	17.06	4.43	14.43	-1.74	3142	3142	6	12	--
Massimi/minimi											
1							3142				
1								3142			
1										7.9	

Muro : 32 - Nodi: [46-53-88-89], Pann.X=4, Pann.Y=4Spess.=40 cm, Terreno=--,Criterio=CLS_Muri_ND, Materiale=C35/45: **Verificato**

Armatura a maglia doppia

Pannello	Nx	Ny	Nxy	Mx	My	Mxy	Ax	Ay	C	Cs	Ze
	kN	kN	kN	kN*m	kN*m	kN*m	mmq	mmq			
1	-3.99	-78.32	11.42	-7.85	-68.72	10.04	3142	3142	5	2.6	--
2	4.11	-72.94	8.43	-3.23	-44.84	14.96	3142	3142	5	3.4	--
3	14.54	-70.24	9.54	1.12	-25.83	19.31	3142	3142	5	4.5	--
4	25.60	-68.47	11.17	5.25	-11.04	21.73	3142	3142	5	6.2	--
5	-4.79	-45.85	-0.24	-5.32	-46.82	11.80	3142	3142	5	3.4	--
6	1.15	-41.56	2.95	-2.11	-29.76	17.64	3142	3142	5	4.2	--
7	7.78	-35.32	7.08	0.63	-16.89	22.60	3142	3142	5	5.0	--
8	18.07	-31.65	12.84	3.03	-7.52	25.37	3142	3142	5	6.0	--
9	-4.00	-18.03	-5.30	-2.85	-22.22	12.94	3142	3142	5	5.5	--
10	-4.47	-10.54	-7.11	-2.19	-14.17	18.50	3142	3142	5	5.9	--
11	-5.72	0.11	-2.54	-2.40	-8.23	22.86	3142	3142	5	6.2	--

Pannello	Nx	Ny	Nxy	Mx	My	Mxy	Ax	Ay	C	Cs	ZE
12	-1.79	9.59	6.97	-3.51	-4.28	25.25	3142	3142	5	6.4	--
13	-6.51	-31.72	-0.06	-1.82	-5.10	9.44	3142	3142	4	13	--
14	-11.67	19.92	-16.70	-5.16	-3.41	12.88	3142	3142	5	11	--
15	-22.37	19.94	-11.64	-9.30	-2.97	14.94	3142	3142	5	8.0	--
16	-25.71	25.00	-5.15	-14.63	-2.94	15.91	3142	3142	5	6.4	--
Massimi/minimi											
1							3142				
1								3142			
1										2.6	

Muro : 33 - Nodi: [57-86-82-56], Pann.X=4, Pann.Y=4Spess.=40 cm, Terreno=--,Criterio=CLS_Muri_ND, Materiale=C35/45: **Verificato**

Armatura a maglia doppia

Pannello	Nx	Ny	Nxy	Mx	My	Mxy	Ax	Ay	C	Cs	ZE
	kN	kN	kN	kN*m	kN*m	kN*m	mmq	mmq			
1	242.91	72.48	244.21	19.02	1.24	1.54	3142	3142	2	7.4	--
2	34.98	21.88	131.38	14.50	1.73	5.71	3142	3142	6	9.2	--
3	-12.59	11.06	132.35	21.20	1.97	4.50	3142	3142	6	7.5	--
4	-27.85	3.69	114.26	24.03	2.23	2.62	3142	3142	6	7.3	--
5	188.85	54.72	237.16	14.83	0.40	-1.86	3142	3142	2	9.7	--
6	40.89	47.70	292.50	13.91	2.25	5.05	3142	3142	2	9.8	--
7	6.86	21.56	291.15	15.93	0.95	3.97	3142	3142	2	9.6	--
8	-5.09	10.69	273.36	16.90	0.57	2.46	3142	3142	2	9.9	--
9	119.38	32.42	236.60	12.30	2.61	-2.60	3142	3142	2	12	--
10	41.77	32.81	302.00	12.15	2.06	5.88	3142	3142	2	10	--
11	18.21	19.40	298.88	12.46	-0.41	4.24	3142	3142	2	11	--
12	11.95	10.34	276.80	11.94	-1.14	2.40	3142	3142	2	13	--
13	56.41	10.38	238.94	10.91	6.46	-2.77	3142	3142	2	13	--
14	37.10	11.59	303.90	9.59	1.36	6.09	3142	3142	2	12	--
15	31.04	8.12	303.06	7.65	-2.16	3.66	3142	3142	2	16	--
16	30.81	5.25	278.79	5.54	-2.96	1.86	3142	3142	2	25	--
Massimi/minimi											
1							3142				
1								3142			
4										7.3	

Muro : 34 - Nodi: [53-54-85-88], Pann.X=4, Pann.Y=4Spess.=40 cm, Terreno=--,Criterio=CLS_Muri_ND, Materiale=C35/45: **Verificato**

Armatura a maglia doppia

Pannello	Nx	Ny	Nxy	Mx	My	Mxy	Ax	Ay	C	Cs	ZE
	kN	kN	kN	kN*m	kN*m	kN*m	mmq	mmq			
1	41.00	160.99	114.44	2.01	14.22	2.78	3142	3142	6	9.8	--
2	-5.15	53.03	16.45	-3.81	7.73	6.10	3142	3142	2	13	--
3	-25.61	13.79	-17.88	-10.71	-0.33	5.46	3142	3142	5	12	--
4	-35.98	33.32	-19.62	-15.04	0.39	5.80	3142	3142	5	9.4	--
5	19.89	37.69	101.37	1.80	14.09	4.89	3142	3142	6	9.8	--
6	-2.89	46.33	-11.21	-1.32	10.79	6.29	3142	3142	2	11	--
7	-4.93	63.99	-14.36	-3.70	8.82	7.34	3142	3142	2	11	--
8	-6.72	82.03	-18.65	-6.55	6.21	7.22	3142	3142	2	13	--
9	10.36	-5.07	89.39	1.92	19.99	3.99	3142	3142	6	8.0	--
10	2.21	31.22	-39.04	-0.42	13.78	3.10	3142	3142	2	11	--
11	2.50	48.68	-41.92	-2.58	9.61	3.53	3142	3142	2	14	--
12	33.78	39.63	101.63	-4.45	0.14	3.68	3142	3142	6	23	--
13	5.52	-24.85	67.31	2.13	22.64	2.29	3142	3142	6	7.8	--
14	5.30	20.93	-68.13	0.28	15.20	0.97	3142	3142	2	12	--
15	7.24	38.84	-69.29	-1.52	9.82	1.16	3142	3142	2	17	--
16	28.15	26.85	76.20	-5.00	-2.61	1.69	3142	3142	6	28	--
Massimi/minimi											

Pannello	Nx	Ny	Nxy	Mx	My	Mxy	Ax	Ay	C	Cs	Z _E
1							3142				
1								3142			
13										7.8	

Muro [Platea]: 35 - Nodi: [13-20-19-12]Pann=16Spess.=50 cm, Terreno=Terreno1, ,Criterio=CLS_Platee_ND, Materiale=C35/45: **Verificato**

Armatura a maglia doppia

Pannello	Nx	Ny	Nxy	Mx	My	Mxy	Ax	Ay	C	Cs	Z _E
	kN	kN	kN	kN*m	kN*m	kN*m	mmq	mmq			
1	-0.67	1.13	22.29	-4.27	-10.38	-9.17	3142	3142	4	13	--
2	12.01	0.11	40.05	-10.70	-2.76	-14.00	3142	3142	4	10	--
3	29.51	-3.68	56.28	-17.58	2.29	-12.59	3142	3142	4	8.1	--
4	97.07	-14.84	85.60	-16.09	7.65	-3.73	3142	3142	4	12	--
5	-18.96	13.69	28.42	-1.09	-36.65	-9.52	3142	3142	4	5.4	--
6	-19.48	10.92	34.87	7.19	-4.98	-16.07	3142	3142	4	11	--
7	-27.91	10.92	55.50	13.28	14.43	-14.51	3142	3142	4	8.6	--
8	-65.96	18.81	108.34	14.00	25.47	-3.49	3142	3142	4	8.5	--
9	-19.84	27.76	30.41	-4.43	-57.19	-4.00	3142	3142	4	4.0	--
10	-34.70	15.00	27.80	6.40	-8.29	-6.69	3142	3142	4	17	--
11	-73.23	18.50	37.03	16.20	20.86	-6.40	3142	3142	4	9.1	--
12	-125.76	28.35	42.06	20.25	39.31	-1.50	3142	3142	4	6.0	--
13	-13.14	101.04	56.19	-2.93	-44.64	1.33	3142	3142	4	5.0	--
14	-23.43	82.79	62.30	0.86	-10.03	3.04	3142	3142	5	18	--
15	-64.08	-21.08	69.65	6.07	15.39	5.05	3142	3142	4	12	--
16	-76.57	-54.48	29.51	8.76	30.68	1.68	3142	3142	4	8.1	--
Massimi/minimi											
1							3142				
1								3142			
9										4.0	

Muro [Platea]: 36 - Nodi: [10-17-16-9]Pann=11Spess.=50 cm, Terreno=Terreno1, ,Criterio=CLS_Platee_ND, Materiale=C35/45: **Verificato**

Armatura a maglia doppia

Pannello	Nx	Ny	Nxy	Mx	My	Mxy	Ax	Ay	C	Cs	Z _E
	kN	kN	kN	kN*m	kN*m	kN*m	mmq	mmq			
1	-74.10	105.04	-34.65	14.97	26.62	5.86	3142	3142	4	7.1	--
2	-74.91	44.92	-51.45	5.68	17.29	-1.40	3142	3142	4	13	--
3	-6.70	193.15	-64.70	-2.10	-37.06	-1.32	3142	3142	4	5.5	--
4	-29.57	97.52	-27.17	0.18	-41.33	5.03	3142	3142	4	5.0	--
5	-13.12	58.46	-31.84	-0.95	-33.49	9.26	3142	3142	4	5.6	--
6	0.49	30.02	-20.01	-2.90	-14.27	8.07	3142	3142	4	11	--
7	25.21	19.99	-35.75	-9.95	-3.61	13.36	3142	3142	4	11	--
8	34.91	11.90	-50.78	-20.08	-0.44	10.93	3142	3142	4	7.9	--
9	82.73	22.56	-87.03	-11.86	7.23	5.51	3142	3142	4	13	--
10	-39.19	62.89	-85.59	14.95	23.28	10.39	3142	3142	4	7.1	--
11	0.27	49.99	-50.30	4.96	1.52	18.68	3142	3142	4	11	--
Massimi/minimi											
1							3142				
1								3142			
4										5.0	

Muro [Platea]: 37 - Nodi: [18-17-10-11]Pann=11Spess.=50 cm, Terreno=Terreno1, ,Criterio=CLS_Platee_ND, Materiale=C35/45: **Verificato**

Armatura a maglia doppia

Pannello	Nx	Ny	Nxy	Mx	My	Mxy	Ax	Ay	C	Cs	Z _E
	kN	kN	kN	kN*m	kN*m	kN*m	mmq	mmq			

Pannello	Nx	Ny	Nxy	Mx	My	Mxy	Ax	Ay	C	Cs	ZE
1	-73.63	-164.82	42.51	11.13	26.34	0.06	3142	3142	4	11	--
2	-85.77	-155.54	-43.61	7.86	11.71	9.28	3142	3142	4	13	--
3	-170.47	-112.34	4.64	14.01	9.47	0.40	3142	3142	6	20	--
4	-105.61	-135.14	3.91	7.48	22.88	-3.30	3142	3142	4	11	--
5	-67.49	-58.26	-15.66	3.74	15.37	-10.73	3142	3142	4	10	--
6	-12.33	79.32	-11.96	0.27	-19.24	-10.02	3142	3142	4	8.0	--
7	-9.95	22.44	21.04	-3.73	-43.07	-6.28	3142	3142	4	5.0	--
8	-15.10	28.39	43.08	-4.31	-46.79	-1.66	3142	3142	4	5.1	--
9	-20.42	114.29	90.18	2.97	-23.73	3.26	3142	3142	4	8.4	--
10	-65.87	-77.55	104.67	12.36	20.18	0.59	3142	3142	4	13	--
11	-53.64	-92.89	43.54	5.12	9.11	-5.42	3142	3142	6	19	--
Massimi/minimi											
1							3142				
1								3142			
7										5.0	

Muro [Platea]: 38 - Nodi: [19-18-11-12]Pann=13Spess.=50 cm, Terreno=Terreno1, ,Criterio=CLS_Platee_ND, Materiale=C35/45: **Verificato**

Armatura a maglia doppia

Pannello	Nx	Ny	Nxy	Mx	My	Mxy	Ax	Ay	C	Cs	ZE
	kN	kN	kN	kN*m	kN*m	kN*m	mmq	mmq			
1	-130.82	-115.54	24.38	13.72	26.20	0.98	3142	3142	4	10	--
2	-181.99	-115.27	39.40	17.70	10.34	-4.79	3142	3142	4	13	--
3	-67.12	-136.40	38.66	3.80	12.80	-10.19	3142	3142	4	12	--
4	-111.90	-168.88	-20.15	8.74	29.18	-3.68	3142	3142	4	8.6	--
5	-71.58	-96.15	-85.12	8.03	17.98	-8.43	3142	3142	4	10	--
6	-24.40	95.02	-67.16	1.54	-27.25	-5.29	3142	3142	4	7.1	--
7	-24.12	4.10	-19.84	-4.90	-45.68	0.22	3142	3142	4	5.4	--
8	-25.28	1.44	2.54	-4.16	-43.92	2.39	3142	3142	4	5.4	--
9	-31.30	78.10	38.71	1.86	-24.45	7.90	3142	3142	4	7.3	--
10	-84.42	-67.22	58.08	7.51	14.17	10.94	3142	3142	4	11	--
11	-119.57	-69.77	3.52	17.09	31.88	-1.08	3142	3142	4	8.0	--
12	-49.68	-51.96	-11.98	6.60	13.98	-1.10	3142	3142	3	17	--
13	-69.13	-97.79	-29.24	7.05	12.20	5.44	3142	3142	6	15	--
Massimi/minimi											
1							3142				
1								3142			
8										5.4	

Muro : 39 - Nodi: [12-0-98-13], Pann.X=4, Pann.Y=4Spess.=40 cm, Terreno=--,Criterio=CLS_Muri_ND, Materiale=C35/45: **Verificato**

Armatura a maglia doppia

Pannello	Nx	Ny	Nxy	Mx	My	Mxy	Ax	Ay	C	Cs	ZE
	kN	kN	kN	kN*m	kN*m	kN*m	mmq	mmq			
1	-94.39	-12.52	11.64	-43.33	-5.21	4.22	3142	3142	5	4.3	--
2	-72.06	-11.72	-1.24	-32.82	-4.13	4.19	3142	3142	5	5.5	--
3	-43.12	-7.64	4.73	-21.83	-3.34	3.56	3142	3142	5	7.8	--
4	-26.58	0.58	10.38	-17.47	-3.00	0.36	3142	3142	4	11	--
5	-86.37	-14.49	9.07	-27.15	-2.72	6.74	3142	3142	5	6.0	--
6	-69.64	-14.85	0.34	-20.45	-2.63	7.15	3142	3142	5	7.3	--
7	-43.75	-15.91	3.53	-13.77	-3.60	6.21	3142	3142	5	9.9	--
8	-27.20	-8.15	6.50	-10.56	-4.33	1.25	3142	3142	4	17	--
9	-78.56	-19.94	8.65	-14.46	-0.51	8.85	3142	3142	5	8.7	--
10	-64.78	-21.88	1.88	-10.81	-1.47	9.49	3142	3142	5	9.9	--
11	-44.71	-24.45	3.26	-7.36	-4.22	8.36	3142	3142	5	13	--
12	-23.12	-25.34	13.72	-5.62	-8.73	2.71	3142	3142	5	17	--
13	-71.44	-26.78	9.28	-4.70	1.48	9.99	3142	3142	5	14	--
14	-60.07	-30.13	3.86	-3.50	-0.62	10.67	3142	3142	5	14	--

Pannello	Nx	Ny	Nxy	Mx	My	Mxy	Ax	Ay	C	Cs	ZE
15	-44.92	-34.77	4.85	-2.68	-5.23	9.44	3142	3142	5	13	--
16	-29.50	-40.04	16.28	-3.19	-13.30	3.07	3142	3142	5	12	--
Massimi/minimi											
1							3142				
1								3142			
1										4.3	

Muro : 40 - Nodi: [10-99-100-11], Pann.X=4, Pann.Y=4Spess.=40 cm, Terreno=--,Criterio=CLS_Muri_ND, Materiale=C35/45: **Verificato**

Armatura a maglia doppia

Pannello	Nx	Ny	Nxy	Mx	My	Mxy	Ax	Ay	C	Cs	ZE
	kN	kN	kN	kN*m	kN*m	kN*m	mmq	mmq			
1	-81.42	-12.92	55.79	-47.38	-5.61	-3.42	3142	3142	5	4.0	--
2	-76.14	-14.30	48.94	-52.96	-6.22	-2.53	3142	3142	5	3.7	--
3	-90.69	-14.92	61.20	-58.46	-6.94	-0.93	3142	3142	5	3.5	--
4	-117.18	-13.94	43.18	-63.42	-7.64	-0.32	3142	3142	5	3.3	--
5	-75.47	-18.41	55.73	-29.95	-2.76	-5.39	3142	3142	5	5.7	--
6	-74.56	-22.03	52.64	-34.46	-3.05	-4.02	3142	3142	5	5.3	--
7	-87.34	-19.87	56.09	-38.33	-3.61	-2.49	3142	3142	5	5.0	--
8	-105.77	-14.99	45.06	-41.30	-4.23	-1.18	3142	3142	5	4.9	--
9	-69.36	-26.02	56.80	-16.07	-0.18	-7.23	3142	3142	5	8.7	--
10	-72.28	-27.34	53.60	-19.02	-0.14	-5.51	3142	3142	5	8.2	--
11	-82.81	-24.31	52.63	-21.45	-0.52	-3.70	3142	3142	5	8.1	--
12	-95.68	-19.44	44.09	-23.16	-1.03	-1.87	3142	3142	5	8.2	--
13	-63.44	-34.34	56.82	-5.19	2.16	-8.31	3142	3142	5	15	--
14	-88.48	14.97	-2.61	-11.18	-3.16	2.34	3142	3142	6	15	--
15	-93.94	12.49	-0.68	-11.68	-3.25	1.52	3142	3142	6	16	--
16	-99.31	12.39	-0.65	-11.95	-3.39	0.76	3142	3142	6	16	--
Massimi/minimi											
1							3142				
1								3142			
4										3.3	

Muro : 41 - Nodi: [9-0-99-10], Pann.X=4, Pann.Y=4Spess.=40 cm, Terreno=--,Criterio=CLS_Muri_ND, Materiale=C35/45: **Verificato**

Armatura a maglia doppia

Pannello	Nx	Ny	Nxy	Mx	My	Mxy	Ax	Ay	C	Cs	ZE
	kN	kN	kN	kN*m	kN*m	kN*m	mmq	mmq			
1	22.92	11.38	36.14	-13.40	-3.50	1.57	3142	3142	4	13	--
2	-13.95	-2.63	52.75	-18.33	-3.26	-2.15	3142	3142	5	9.4	--
3	-47.84	-9.23	67.86	-27.82	-3.67	-3.38	3142	3142	5	6.4	--
4	-75.69	-11.32	60.50	-38.90	-4.71	-3.58	3142	3142	5	4.8	--
5	56.56	30.53	-4.16	-6.26	3.91	2.90	3142	3142	6	20	--
6	-19.24	-11.39	58.38	-11.36	-4.41	-4.25	3142	3142	5	12	--
7	-47.93	-15.58	67.43	-17.34	-2.75	-6.31	3142	3142	5	8.4	--
8	-68.86	-16.26	62.80	-24.11	-2.53	-6.28	3142	3142	5	6.6	--
9	8.04	-23.48	39.51	-4.52	-12.42	-1.53	3142	3142	5	14	--
10	-22.74	-25.98	61.39	-6.13	-5.98	-6.12	3142	3142	5	16	--
11	-45.42	-26.48	67.22	-9.08	-2.20	-8.56	3142	3142	5	11	--
12	-62.08	-25.39	63.30	-12.64	-0.67	-8.49	3142	3142	5	9.5	--
13	-8.04	-48.34	38.95	-3.03	-18.22	-1.90	3142	3142	5	9.9	--
14	-25.65	-44.00	60.94	-2.41	-7.97	-7.01	3142	3142	5	13	--
15	-42.43	-39.91	65.87	-2.83	-1.99	-9.67	3142	3142	5	16	--
16	-55.80	-36.24	62.53	-3.87	0.92	-9.65	3142	3142	5	15	--
Massimi/minimi											
1							3142				
1								3142			
4										4.8	

Muro : 42 - Nodi: [11-100-0-12], Pann.X=4, Pann.Y=4Spess.=40 cm, Terreno=--,Criterio=CLS_Muri_ND, Materiale=C35/45: **Verificato**

Armatura a maglia doppia

Pannello	Nx	Ny	Nxy	Mx	My	Mxy	Ax	Ay	C	Cs	ZE
	kN	kN	kN	kN*m	kN*m	kN*m	mmq	mmq			
1	-116.31	-14.10	31.60	-64.27	-7.76	-0.12	3142	3142	5	3.2	--
2	-92.16	-14.96	18.28	-61.22	-7.27	0.92	3142	3142	5	3.3	--
3	-86.10	-14.41	26.88	-57.00	-6.71	2.63	3142	3142	5	3.4	--
4	-98.33	-12.97	17.90	-51.50	-6.11	3.83	3142	3142	5	3.7	--
5	-105.95	-15.52	30.68	-42.06	-4.33	0.12	3142	3142	5	4.9	--
6	-89.85	-19.36	21.01	-40.40	-3.83	1.79	3142	3142	5	4.9	--
7	-83.92	-19.72	24.30	-37.32	-3.36	3.71	3142	3142	5	5.0	--
8	-90.13	-16.21	18.35	-32.93	-3.06	5.52	3142	3142	5	5.3	--
9	-96.97	-19.06	31.39	-23.71	-1.11	0.21	3142	3142	5	8.6	--
10	-86.26	-22.70	23.04	-22.86	-0.65	2.48	3142	3142	5	8.1	--
11	-81.01	-23.52	22.78	-20.88	-0.28	4.77	3142	3142	5	7.9	--
12	-83.22	-20.79	17.51	-17.96	-0.24	7.08	3142	3142	5	8.1	--
13	-99.13	11.57	-1.97	-11.98	-3.35	-0.04	3142	3142	6	17	--
14	-92.60	10.36	-0.68	-11.72	-3.14	-0.99	3142	3142	6	16	--
15	-87.64	12.90	3.51	-11.21	-3.05	-2.00	3142	3142	6	15	--
16	-76.74	-26.07	16.96	-6.12	2.37	8.02	3142	3142	5	14	--
Massimi/minimi											
1							3142				
1								3142			
1										3.2	

Muro : 43 - Nodi: [13-98-95-20], Pann.X=4, Pann.Y=4Spess.=40 cm, Terreno=--,Criterio=CLS_Muri_ND, Materiale=C35/45: **Verificato**

Armatura a maglia doppia

Pannello	Nx	Ny	Nxy	Mx	My	Mxy	Ax	Ay	C	Cs	ZE
	kN	kN	kN	kN*m	kN*m	kN*m	mmq	mmq			
1	-11.87	10.43	67.81	-13.43	-2.57	-2.39	3142	3142	4	12	--
2	-56.27	-5.25	90.01	-31.33	-3.63	-4.82	3142	3142	5	5.5	--
3	-81.75	-10.55	92.23	-50.26	-5.89	-2.96	3142	3142	5	3.8	--
4	-112.54	-12.42	90.52	-63.30	-7.69	-1.23	3142	3142	5	3.2	--
5	-7.96	10.02	73.20	-8.17	-3.74	-4.62	3142	3142	4	15	--
6	-53.58	-5.62	92.24	-19.02	-1.54	-7.77	3142	3142	5	7.4	--
7	-78.42	-11.61	93.71	-32.01	-2.77	-5.22	3142	3142	5	5.5	--
8	-105.10	-10.29	89.35	-41.72	-4.47	-2.76	3142	3142	5	4.7	--
9	8.46	-6.02	74.69	-3.71	-6.51	-6.90	3142	3142	5	14	--
10	-51.58	-9.53	95.09	-9.39	0.17	-10.10	3142	3142	5	10	--
11	-74.41	-12.76	94.17	-17.06	0.06	-7.28	3142	3142	5	8.3	--
12	-97.58	-9.31	88.05	-23.57	-1.53	-4.18	3142	3142	5	7.4	--
13	-2.90	-22.71	73.32	-1.47	-9.23	-7.43	3142	3142	5	12	--
14	-48.50	-16.45	96.00	-1.98	1.53	-11.25	3142	3142	5	15	--
15	-70.45	-14.46	93.75	-5.03	2.62	-8.53	3142	3142	5	15	--
16	-91.05	-8.95	86.63	-8.56	1.17	-5.13	3142	3142	5	15	--
Massimi/minimi											
1							3142				
1								3142			
4										3.2	

Muro : 44 - Nodi: [9-16-77-0], Pann.X=4, Pann.Y=4Spess.=40 cm, Terreno=--,Criterio=CLS_Muri_ND, Materiale=C35/45: **Verificato**

Armatura a maglia doppia

Pannello	Nx	Ny	Nxy	Mx	My	Mxy	Ax	Ay	C	Cs	ZE
----------	----	----	-----	----	----	-----	----	----	---	----	----

Pannello	Nx	Ny	Nxy	Mx	My	Mxy	Ax	Ay	C	Cs	z _E
	kN	kN	kN	kN*m	kN*m	kN*m	mmq	mmq			
1	2.32	-40.59	15.55	-3.66	-21.86	-6.62	3142	3142	4	6.9	--
2	-2.76	-9.35	18.01	-5.41	-12.87	-10.50	3142	3142	5	8.2	--
3	-16.90	-12.29	18.16	-8.17	-7.23	-12.95	3142	3142	5	9.2	--
4	-32.61	-18.73	16.26	-11.86	-3.20	-14.05	3142	3142	5	7.6	--
5	-8.87	-66.94	28.49	-5.99	-51.93	-8.83	3142	3142	5	3.3	--
6	-12.56	-63.92	29.26	-2.59	-32.85	-13.88	3142	3142	5	4.3	--
7	-18.82	-60.58	31.04	0.31	-17.55	-17.94	3142	3142	5	5.7	--
8	-27.12	-57.10	31.63	2.73	-5.46	-20.12	3142	3142	5	7.8	--
9	-13.25	-85.65	27.68	-9.76	-83.02	-5.74	3142	3142	5	2.3	--
10	-17.43	-85.56	28.83	-4.85	-54.57	-9.36	3142	3142	5	3.2	--
11	-21.52	-82.79	29.16	-0.29	-30.93	-12.74	3142	3142	5	4.7	--
12	-25.87	-79.25	28.89	3.96	-11.55	-14.89	3142	3142	5	7.7	--
13	-15.31	-124.34	23.30	-12.48	-103.27	-2.81	3142	3142	5	2.0	--
14	-17.48	-113.07	24.84	-7.39	-70.09	-5.23	3142	3142	5	2.8	--
15	-19.52	-107.03	24.47	-2.67	-41.64	-7.53	3142	3142	5	4.2	--
16	-21.89	-101.85	23.34	1.74	-17.65	-9.11	3142	3142	5	7.7	--
Massimi/minimi											
1							3142				
1								3142			
13										2.0	

Muro [Platea]: 45 - Nodi: [9-16-15-8]Pann=8Spess.=50 cm, Terreno=Terreno1, ,Criterio=CLS_Platee_ND, Materiale=C35/45: **Verificato**

Armatura a maglia doppia

Pannello	Nx	Ny	Nxy	Mx	My	Mxy	Ax	Ay	C	Cs	z _E
	kN	kN	kN	kN*m	kN*m	kN*m	mmq	mmq			
1	-43.49	0.63	-26.31	4.63	1.64	4.59	3142	3142	6	28	--
2	-40.94	-12.69	-19.23	4.09	-0.43	-0.74	3142	3142	6	53	--
3	-36.38	0.25	-32.16	3.01	0.60	7.50	3142	3142	6	25	--
4	-32.68	-4.23	-36.23	2.57	-0.29	-1.36	3142	3142	6	65	--
5	-14.43	-4.89	-24.91	1.03	0.15	6.14	3142	3142	6	35	--
6	-17.82	6.00	-26.73	1.32	-0.28	-1.45	3142	3142	6	92	--
7	-24.55	-3.83	-22.46	1.43	-0.13	3.61	3142	3142	6	51	--
8	-24.83	-2.02	-9.49	1.79	-0.13	0.07	3142	3142	4	>100	--
Massimi/minimi											
1							3142				
1								3142			
3										25	

Muro [Platea]: 46 - Nodi: [23-32-31-22]Pann=8Spess.=50 cm, Terreno=Terreno1, ,Criterio=CLS_Platee_ND, Materiale=C35/45: **Verificato**

Armatura a maglia doppia

Pannello	Nx	Ny	Nxy	Mx	My	Mxy	Ax	Ay	C	Cs	z _E
	kN	kN	kN	kN*m	kN*m	kN*m	mmq	mmq			
1	-8.60	-1.64	18.04	0.59	0.32	-2.24	3142	3142	4	89	--
2	-6.53	-2.21	8.96	0.38	-0.28	-0.34	3142	3142	5	>100	--
3	2.27	-2.19	5.40	-0.14	0.62	-1.26	3142	3142	6	>100	--
4	12.22	-0.67	3.17	-0.92	-0.14	0.43	3142	3142	3	>100	--
5	1.77	-1.95	5.20	-0.10	0.61	-1.32	3142	3142	6	>100	--
6	10.43	-1.00	-0.98	-0.77	-0.14	-0.27	3142	3142	3	>100	--
7	-9.37	-2.41	-15.53	0.75	0.87	1.87	3142	3142	5	91	--
8	-7.33	-2.45	-10.41	0.46	-0.16	0.49	3142	3142	4	>100	--
Massimi/minimi											
1							3142				
1								3142			
1										89	

Muro [Platea]: 47 - Nodi: [32-39-38-31]Pann=8Spess.=50 cm, Terreno=Terreno1, ,Criterio=CLS_Platee_ND, Materiale=C35/45: **Verificato**

Armatura a maglia doppia

Pannello	Nx	Ny	Nxy	Mx	My	Mxy	Ax	Ay	C	Cs	Z _E
	kN	kN	kN	kN*m	kN*m	kN*m	mmq	mmq			
1	-14.51	0.12	-11.84	1.71	0.48	1.75	3142	3142	5	73	--
2	-16.14	1.73	-7.08	1.52	-0.12	0.57	3142	3142	3	>100	--
3	-8.22	-1.44	13.34	0.70	0.48	-2.93	3142	3142	6	69	--
4	-13.63	-0.93	12.75	1.03	-0.29	0.59	3142	3142	6	>100	--
5	-4.50	-5.65	-14.12	0.65	1.31	2.65	3142	3142	5	64	--
6	-14.95	-1.68	12.57	1.11	-0.24	0.74	3142	3142	6	>100	--
7	-18.35	-0.76	13.24	2.58	0.44	-2.24	3142	3142	6	53	--
8	-17.41	-1.06	9.72	2.47	-0.03	0.04	3142	3142	6	>100	--
Massimi/minimi											
1							3142				
1								3142			
7										53	

Muro [Platea]: 48 - Nodi: [39-46-45-38]Pann=8Spess.=50 cm, Terreno=Terreno1, ,Criterio=CLS_Platee_ND, Materiale=C35/45: **Verificato**

Armatura a maglia doppia

Pannello	Nx	Ny	Nxy	Mx	My	Mxy	Ax	Ay	C	Cs	Z _E
	kN	kN	kN	kN*m	kN*m	kN*m	mmq	mmq			
1	-34.34	-2.21	-20.72	3.37	0.52	2.30	3142	3142	2	45	--
2	-31.63	-1.49	-10.58	3.10	-0.09	0.82	3142	3142	2	65	--
3	-34.22	1.52	12.49	2.61	0.21	-3.32	3142	3142	6	43	--
4	-45.40	0.90	-9.83	4.08	-0.27	0.58	3142	3142	3	56	--
5	-36.65	1.82	15.20	3.41	0.29	-3.54	3142	3142	6	37	--
6	-50.71	0.75	-6.27	4.36	-0.33	-0.12	3142	3142	3	58	--
7	-34.87	2.13	23.34	4.91	0.21	-3.18	3142	3142	6	32	--
8	-37.85	-1.06	13.96	5.09	0.19	-0.27	3142	3142	6	48	--
Massimi/minimi											
1							3142				
1								3142			
7										32	

Muro [Platea]: 49 - Nodi: [46-53-52-45]Pann=8Spess.=50 cm, Terreno=Terreno1, ,Criterio=CLS_Platee_ND, Materiale=C35/45: **Verificato**

Armatura a maglia doppia

Pannello	Nx	Ny	Nxy	Mx	My	Mxy	Ax	Ay	C	Cs	Z _E
	kN	kN	kN	kN*m	kN*m	kN*m	mmq	mmq			
1	-52.54	-5.30	23.03	3.30	0.12	-3.71	3142	3142	6	37	--
2	-47.93	-4.51	-9.24	4.32	-0.24	0.35	3142	3142	2	56	--
3	-52.14	-7.79	22.59	4.69	0.79	-5.22	3142	3142	6	26	--
4	-54.55	3.53	23.75	4.70	-0.37	1.06	3142	3142	6	45	--
5	-63.32	-2.26	18.08	5.16	0.57	-4.84	3142	3142	6	26	--
6	-55.85	0.20	23.27	4.42	-0.44	0.94	3142	3142	6	49	--
7	-71.11	-0.41	34.86	7.09	2.31	-4.35	3142	3142	6	23	--
8	-43.00	-18.83	17.22	4.51	-0.44	0.30	3142	3142	6	54	--
Massimi/minimi											
1							3142				
1								3142			
7										23	

Muro [Platea]: 50 - Nodi: [16-23-22-15]Pann=8Spess.=50 cm, Terreno=Terreno1, ,Criterio=CLS_Platee_ND, Materiale=C35/45: **Verificato**

Armatura a maglia doppia

Pannello	Nx	Ny	Nxy	Mx	My	Mxy	Ax	Ay	C	Cs	Z _E
	kN	kN	kN	kN*m	kN*m	kN*m	mmq	mmq			
1	-16.68	3.31	-10.81	1.97	-0.29	1.63	3142	3142	6	70	--
2	-28.72	2.57	-1.60	2.24	-0.20	0.34	3142	3142	4	99	--
3	-8.68	-0.77	10.49	0.75	0.28	-1.22	3142	3142	4	>100	--
4	-22.43	-1.43	4.13	1.90	-0.09	-0.17	3142	3142	4	>100	--
5	-8.56	-0.17	-6.53	0.60	0.29	1.28	3142	3142	6	>100	--
6	-20.38	-1.05	1.14	1.71	-0.12	0.05	3142	3142	4	>100	--
7	-20.10	4.60	9.56	1.78	-0.35	-1.17	3142	3142	4	86	--
8	-20.45	1.36	5.71	1.77	-0.12	-0.55	3142	3142	4	>100	--
Massimi/minimi											
1							3142				
1								3142			
1										70	

Muro [Platea]: 51 - Nodi: [14-21-20-13]Pann=8Spess.=50 cm, Terreno=Terreno1, ,Criterio=CLS_Platee_ND, Materiale=C35/45: **Verificato**

Armatura a maglia doppia

Pannello	Nx	Ny	Nxy	Mx	My	Mxy	Ax	Ay	C	Cs	Z _E
	kN	kN	kN	kN*m	kN*m	kN*m	mmq	mmq			
1	-38.31	-12.75	20.51	3.92	-0.41	0.78	3142	3142	6	55	--
2	-40.00	-0.00	27.09	4.39	1.70	-4.81	3142	3142	6	28	--
3	-28.96	-3.79	37.64	2.26	-0.31	1.57	3142	3142	6	67	--
4	-31.58	0.28	34.48	2.62	0.59	-7.97	3142	3142	6	24	--
5	-21.08	4.44	28.73	1.56	-0.25	1.55	3142	3142	6	82	--
6	-19.98	-4.22	27.05	1.48	0.18	-6.57	3142	3142	6	32	--
7	-30.01	2.30	11.64	2.22	-0.04	-0.18	3142	3142	4	>100	--
8	-24.41	-3.94	24.90	1.37	-0.28	-3.95	3142	3142	6	48	--
Massimi/minimi											
1							3142				
1								3142			
4										24	

Muro [Platea]: 52 - Nodi: [58-57-50-51]Pann=8Spess.=50 cm, Terreno=Terreno1, ,Criterio=CLS_Platee_ND, Materiale=C35/45: **Verificato**

Armatura a maglia doppia

Pannello	Nx	Ny	Nxy	Mx	My	Mxy	Ax	Ay	C	Cs	Z _E
	kN	kN	kN	kN*m	kN*m	kN*m	mmq	mmq			
1	-28.58	-30.49	24.09	-0.27	4.28	1.25	3142	3142	3	46	--
2	-0.63	-54.73	21.62	-0.43	4.28	1.10	3142	3142	6	49	--
3	3.07	-55.36	25.55	-0.39	4.82	0.92	3142	3142	6	46	--
4	3.16	-55.23	16.91	-0.18	3.41	0.40	3142	3142	6	69	--
5	2.94	-77.44	46.96	2.87	8.39	-6.24	3142	3142	3	18	--
6	-2.32	-63.81	15.82	0.62	5.15	-4.65	3142	3142	6	27	--
7	-8.01	-54.04	25.37	0.88	4.91	-5.47	3142	3142	6	25	--
8	-5.66	-54.85	22.33	0.10	3.46	-3.69	3142	3142	6	37	--
Massimi/minimi											
1							3142				
1								3142			
5										18	

Muro [Platea]: 53 - Nodi: [37-36-27-28]Pann=8Spess.=50 cm, Terreno=Terreno1, ,Criterio=CLS_Platee_ND, Materiale=C35/45: **Verificato**

Armatura a maglia doppia

Pannello	Nx	Ny	Nxy	Mx	My	Mxy	Ax	Ay	C	Cs	Z _E
----------	----	----	-----	----	----	-----	----	----	---	----	----------------

Pannello	Nx	Ny	Nxy	Mx	My	Mxy	Ax	Ay	C	Cs	ZE
	kN	kN	kN	kN*m	kN*m	kN*m	mmq	mmq			
1	-1.65	-8.70	-4.19	-0.14	0.68	0.37	3142	3142	4	>100	--
2	-1.14	0.22	9.03	-0.30	-0.11	0.39	3142	3142	6	>100	--
3	-2.16	-0.47	4.42	-0.50	0.03	0.42	3142	3142	5	>100	--
4	-2.79	-11.20	9.83	-0.27	0.74	-0.29	3142	3142	5	>100	--
5	-0.70	-4.16	12.62	0.39	0.54	-1.81	3142	3142	6	>100	--
6	-1.76	0.58	7.37	0.54	-0.04	-1.86	3142	3142	6	>100	--
7	-3.94	-1.51	4.04	1.03	0.29	-1.17	3142	3142	5	>100	--
8	-1.62	-11.53	17.67	0.34	0.82	-2.26	3142	3142	4	82	--
Massimi/minimi											
1							3142				
1								3142			
8										82	

Muro [Platea]: 54 - Nodi: [37-44-43-36]Pann=8Spess.=50 cm, Terreno=Terreno1, ,Criterio=CLS_Platee_ND, Materiale=C35/45: **Verificato**

Armatura a maglia doppia

Pannello	Nx	Ny	Nxy	Mx	My	Mxy	Ax	Ay	C	Cs	ZE
	kN	kN	kN	kN*m	kN*m	kN*m	mmq	mmq			
1	-12.07	0.99	0.63	0.76	-0.21	-0.40	3142	3142	4	>100	--
2	-16.33	-0.61	-18.28	0.19	0.14	2.63	3142	3142	6	90	--
3	-15.07	-0.93	-17.41	1.17	-0.31	-0.73	3142	3142	6	>100	--
4	-9.43	-1.66	-18.15	0.83	0.52	3.93	3142	3142	6	53	--
5	-15.59	-1.95	-16.82	1.20	-0.25	-0.87	3142	3142	6	>100	--
6	-12.82	-2.44	-13.67	1.06	0.61	3.57	3142	3142	6	55	--
7	-16.85	-1.32	-12.66	2.68	-0.02	-0.00	3142	3142	6	95	--
8	-18.73	-1.19	-17.48	2.87	0.56	2.87	3142	3142	6	44	--
Massimi/minimi											
1							3142				
1								3142			
8										44	

Muro [Platea]: 55 - Nodi: [21-28-27-20]Pann=8Spess.=50 cm, Terreno=Terreno1, ,Criterio=CLS_Platee_ND, Materiale=C35/45: **Verificato**

Armatura a maglia doppia

Pannello	Nx	Ny	Nxy	Mx	My	Mxy	Ax	Ay	C	Cs	ZE
	kN	kN	kN	kN*m	kN*m	kN*m	mmq	mmq			
1	-38.11	4.34	-4.54	3.30	0.03	0.52	3142	3142	4	68	--
2	-22.51	3.07	8.82	2.64	-0.39	-1.55	3142	3142	6	61	--
3	-13.35	-5.22	6.16	0.91	-0.13	0.57	3142	3142	6	>100	--
4	-18.38	-6.57	-16.49	1.25	1.25	1.25	3142	3142	4	>100	--
5	-21.77	-0.17	10.94	1.82	-0.09	-1.06	3142	3142	4	89	--
6	-7.78	-0.09	15.63	0.53	0.25	-2.23	3142	3142	6	91	--
7	-33.76	8.45	-6.39	2.77	-0.18	0.59	3142	3142	4	76	--
8	-21.00	10.48	-12.48	1.86	-1.39	1.30	3142	3142	4	81	--
Massimi/minimi											
1							3142				
1								3142			
2										61	

Muro [Platea]: 56 - Nodi: [44-51-50-43]Pann=8Spess.=50 cm, Terreno=Terreno1, ,Criterio=CLS_Platee_ND, Materiale=C35/45: **Verificato**

Armatura a maglia doppia

Pannello	Nx	Ny	Nxy	Mx	My	Mxy	Ax	Ay	C	Cs	ZE
	kN	kN	kN	kN*m	kN*m	kN*m	mmq	mmq			
1	-6.65	0.16	-2.51	-0.78	-0.14	-0.47	3142	3142	4	>100	--

Pannello	Nx	Ny	Nxy	Mx	My	Mxy	Ax	Ay	C	Cs	Z _E
2	-36.34	-1.94	-16.75	0.78	0.12	2.44	3142	3142	6	80	--
3	-37.50	-1.10	-16.63	2.78	-0.41	-1.03	3142	3142	6	68	--
4	-35.37	0.69	-15.38	2.74	0.37	3.83	3142	3142	6	39	--
5	-39.60	-1.01	-18.25	3.67	-0.35	-0.77	3142	3142	6	58	--
6	-37.90	0.57	-17.38	3.62	0.49	3.94	3142	3142	6	34	--
7	-36.48	-1.78	-14.74	5.13	0.22	0.28	3142	3142	6	48	--
8	-35.73	0.47	-24.52	5.15	0.42	3.40	3142	3142	6	30	--
Massimi/minimi											
1							3142				
1								3142			
8										30	

Muro [Platea]: 57 - Nodi: [11-10-3-4]Pann=8Spess.=50 cm, Terreno=Terreno1, ,Criterio=CLS_Platee_ND, Materiale=C35/45: **Verificato**

Armatura a maglia doppia

Pannello	Nx	Ny	Nxy	Mx	My	Mxy	Ax	Ay	C	Cs	Z _E
	kN	kN	kN	kN*m	kN*m	kN*m	mmq	mmq			
1	-45.70	3.22	22.22	3.27	-1.17	-2.50	3142	3142	4	45	--
2	-46.59	8.96	12.69	3.36	0.02	-0.29	3142	3142	4	71	--
3	-0.74	-2.89	32.52	0.21	1.07	-4.20	3142	3142	4	48	--
4	-13.57	-3.89	19.35	0.92	-0.15	0.19	3142	3142	6	>100	--
5	-10.34	0.50	8.62	0.54	0.47	-3.46	3142	3142	6	63	--
6	-11.54	-5.02	14.66	0.60	-0.17	1.42	3142	3142	6	>100	--
7	-24.68	2.77	20.37	3.16	-0.50	-3.48	3142	3142	6	39	--
8	-29.16	4.42	14.74	3.55	0.18	0.24	3142	3142	6	68	--
Massimi/minimi											
1							3142				
1								3142			
7										39	

Muro [Platea]: 58 - Nodi: [6-13-12-5]Pann=8Spess.=50 cm, Terreno=Terreno1, ,Criterio=CLS_Platee_ND, Materiale=C35/45: **Verificato**

Armatura a maglia doppia

Pannello	Nx	Ny	Nxy	Mx	My	Mxy	Ax	Ay	C	Cs	Z _E
	kN	kN	kN	kN*m	kN*m	kN*m	mmq	mmq			
1	-12.44	-31.73	17.53	-0.42	4.02	0.57	3142	3142	6	56	--
2	-5.49	-33.00	32.06	-0.50	2.73	1.50	3142	3142	6	61	--
3	2.44	-36.63	35.94	-0.26	3.10	1.33	3142	3142	6	58	--
4	6.59	-45.03	11.11	0.01	3.03	0.16	3142	3142	4	81	--
5	-4.00	-47.97	25.47	2.16	5.55	-4.12	3142	3142	6	27	--
6	-4.14	-40.06	28.93	1.32	3.49	-6.87	3142	3142	6	25	--
7	-4.94	-32.44	36.37	0.49	2.89	-7.82	3142	3142	6	24	--
8	-2.27	-45.48	36.38	-0.44	2.18	-5.43	3142	3142	6	34	--
Massimi/minimi											
1							3142				
1								3142			
7										24	

Muro [Platea]: 59 - Nodi: [3-10-9-2]Pann=8Spess.=50 cm, Terreno=Terreno1, ,Criterio=CLS_Platee_ND, Materiale=C35/45: **Verificato**

Armatura a maglia doppia

Pannello	Nx	Ny	Nxy	Mx	My	Mxy	Ax	Ay	C	Cs	Z _E
	kN	kN	kN	kN*m	kN*m	kN*m	mmq	mmq			
1	6.28	-50.16	-27.82	-0.17	2.35	-0.20	3142	3142	6	>100	--
2	0.40	-35.36	-39.78	-0.28	3.05	-1.37	3142	3142	6	58	--
3	-6.46	-28.56	-32.35	-0.53	2.39	-1.73	3142	3142	6	62	--

Pannello	Nx	Ny	Nxy	Mx	My	Mxy	Ax	Ay	C	Cs	z _E
4	-11.13	-29.97	-17.48	-0.41	3.94	-0.67	3142	3142	6	56	--
5	-2.16	-47.42	-39.52	-0.62	2.17	5.94	3142	3142	6	32	--
6	-4.74	-35.48	-41.51	0.69	3.22	8.63	3142	3142	6	22	--
7	-4.98	-35.72	-29.77	1.51	3.17	7.15	3142	3142	6	25	--
8	-4.60	-44.41	-24.57	2.10	5.32	4.13	3142	3142	6	27	--
Massimi/minimi											
1							3142				
1								3142			
6										22	

Muro [Platea]: 60 - Nodi: [7-14-13-6]Pann=4Spess.=50 cm, Terreno=Terreno1, ,Criterio=CLS_Platee_ND, Materiale=C35/45: **Verificato**

Armatura a maglia doppia

Pannello	Nx	Ny	Nxy	Mx	My	Mxy	Ax	Ay	C	Cs	z _E
	kN	kN	kN	kN*m	kN*m	kN*m	mmq	mmq			
1	-3.60	-4.63	2.21	-0.07	0.06	-0.48	3142	3142	5	>100	--
2	-0.51	-11.65	5.21	-0.29	1.27	-0.45	3142	3142	6	>100	--
3	-12.07	-3.33	8.51	1.32	0.12	-0.82	3142	3142	5	>100	--
4	-21.07	-20.83	26.90	2.17	2.14	-2.40	3142	3142	6	56	--
Massimi/minimi											
1							3142				
1								3142			
4										56	

Muro [Platea]: 61 - Nodi: [12-11-4-5]Pann=8Spess.=50 cm, Terreno=Terreno1, ,Criterio=CLS_Platee_ND, Materiale=C35/45: **Verificato**

Armatura a maglia doppia

Pannello	Nx	Ny	Nxy	Mx	My	Mxy	Ax	Ay	C	Cs	z _E
	kN	kN	kN	kN*m	kN*m	kN*m	mmq	mmq			
1	-26.53	2.34	-18.43	3.00	-0.27	3.10	3142	3142	6	42	--
2	-27.86	2.24	-13.40	3.13	0.09	-0.18	3142	3142	6	78	--
3	-6.36	1.04	-6.74	0.26	0.35	2.92	3142	3142	6	77	--
4	-8.25	-3.68	-12.85	0.35	-0.20	-1.17	3142	3142	6	>100	--
5	-3.89	0.31	-18.10	0.16	0.35	3.03	3142	3142	6	74	--
6	6.05	-6.04	-5.25	-0.48	-0.50	0.42	3142	3142	5	>100	--
7	-39.36	1.13	-17.53	3.04	-0.78	1.71	3142	3142	4	54	--
8	-38.51	6.71	-9.41	3.03	0.07	0.40	3142	3142	4	75	--
Massimi/minimi											
1							3142				
1								3142			
1										42	

Muro [Platea]: 62 - Nodi: [2-9-8-1]Pann=4Spess.=50 cm, Terreno=Terreno1, ,Criterio=CLS_Platee_ND, Materiale=C35/45: **Verificato**

Armatura a maglia doppia

Pannello	Nx	Ny	Nxy	Mx	My	Mxy	Ax	Ay	C	Cs	z _E
	kN	kN	kN	kN*m	kN*m	kN*m	mmq	mmq			
1	-0.91	-12.45	-5.92	-0.28	1.30	0.49	3142	3142	6	>100	--
2	-5.15	-2.99	-2.41	-0.08	0.08	0.49	3142	3142	5	>100	--
3	-20.57	-20.05	-27.58	2.15	2.06	2.46	3142	3142	6	55	--
4	-15.10	-2.22	-6.47	1.74	0.14	0.72	3142	3142	5	>100	--
Massimi/minimi											
1							3142				
1								3142			
3										55	

Muro [Platea]: 63 - Nodi: [64-63-56-57]Pann=8Spess.=50 cm, Terreno=Terreno1, ,Criterio=CLS_Platee_ND, Materiale=C35/45: **Verificato**

Armatura a maglia doppia

Pannello	Nx	Ny	Nxy	Mx	My	Mxy	Ax	Ay	C	Cs	Z _E
	kN	kN	kN	kN*m	kN*m	kN*m	mmq	mmq			
1	15.95	17.54	-9.38	-2.12	-0.07	-0.69	3142	3142	3	88	--
2	61.02	-6.18	-27.58	-5.87	-1.07	2.85	3142	3142	3	27	--
3	-23.88	-8.90	8.61	2.45	-0.51	-0.10	3142	3142	6	>100	--
4	-22.52	-4.45	20.71	2.55	1.76	-2.21	3142	3142	6	54	--
5	-43.86	-8.58	14.35	3.85	-0.22	-0.71	3142	3142	3	57	--
6	-57.14	5.55	20.25	4.97	0.52	-2.58	3142	3142	3	35	--
7	-62.68	4.33	9.94	4.89	0.02	-0.44	3142	3142	3	49	--
8	-48.75	-1.46	12.68	3.71	-0.35	-1.63	3142	3142	3	49	--
Massimi/minimi											
1							3142				
1								3142			
2										27	

Muro [Platea]: 64 - Nodi: [63-62-55-56]Pann=8Spess.=50 cm, Terreno=Terreno1, ,Criterio=CLS_Platee_ND, Materiale=C35/45: **Verificato**

Armatura a maglia doppia

Pannello	Nx	Ny	Nxy	Mx	My	Mxy	Ax	Ay	C	Cs	Z _E
	kN	kN	kN	kN*m	kN*m	kN*m	mmq	mmq			
1	-63.37	6.65	4.30	5.59	0.17	0.11	3142	3142	3	46	--
2	-51.71	-2.64	10.02	4.55	-0.44	-1.34	3142	3142	3	44	--
3	-60.38	-0.57	0.74	5.02	-0.13	1.06	3142	3142	3	43	--
4	-62.95	1.07	-3.91	5.29	0.09	-0.60	3142	3142	3	45	--
5	-33.16	-3.29	0.44	2.87	-0.32	0.66	3142	3142	2	73	--
6	-33.67	-1.36	-4.86	3.05	0.75	-0.28	3142	3142	2	77	--
7	28.49	-1.65	4.79	-3.04	-0.26	0.82	3142	3142	3	63	--
8	-49.55	0.52	-5.94	4.36	0.81	0.70	3142	3142	5	51	--
Massimi/minimi											
1							3142				
1								3142			
3										43	

Muro [Platea]: 65 - Nodi: [65-64-57-58]Pann=4Spess.=50 cm, Terreno=Terreno1, ,Criterio=CLS_Platee_ND, Materiale=C35/45: **Verificato**

Armatura a maglia doppia

Pannello	Nx	Ny	Nxy	Mx	My	Mxy	Ax	Ay	C	Cs	Z _E
	kN	kN	kN	kN*m	kN*m	kN*m	mmq	mmq			
1	0.03	-6.37	0.55	-0.34	0.07	-0.39	3142	3142	5	>100	--
2	3.23	-6.37	-7.91	-0.92	0.71	0.98	3142	3142	3	>100	--
3	5.58	-2.56	8.66	-0.42	0.64	-1.06	3142	3142	3	>100	--
4	-16.72	-0.64	8.84	2.17	0.04	-0.77	3142	3142	1	86	--
Massimi/minimi											
1							3142				
1								3142			
4										86	

Muro [Platea]: 66 - Nodi: [62-61-54-55]Pann=8Spess.=50 cm, Terreno=Terreno1, ,Criterio=CLS_Platee_ND, Materiale=C35/45: **Verificato**

Armatura a maglia doppia

Pannello	Nx	Ny	Nxy	Mx	My	Mxy	Ax	Ay	C	Cs	Z _E
	kN	kN	kN	kN*m	kN*m	kN*m	mmq	mmq			

Pannello	Nx	Ny	Nxy	Mx	My	Mxy	Ax	Ay	C	Cs	ZE
1	18.85	-2.55	3.46	-1.92	-0.22	-0.85	3142	3142	3	89	--
2	-26.24	1.03	9.15	2.12	0.75	-0.70	3142	3142	6	91	--
3	-38.23	-2.21	3.24	3.22	-0.33	-0.53	3142	3142	6	69	--
4	-38.66	-1.14	7.27	3.37	0.63	-0.42	3142	3142	6	68	--
5	-51.30	0.53	6.87	4.37	-0.17	-0.33	3142	3142	3	56	--
6	-48.60	-1.15	12.26	4.22	0.26	-1.39	3142	3142	3	46	--
7	-66.62	2.39	4.78	5.37	0.00	-0.15	3142	3142	3	48	--
8	-61.82	-0.72	8.44	4.98	-0.19	-0.95	3142	3142	3	44	--
Massimi/minimi											
1							3142				
1								3142			
8										44	

Muro [Platea]: 67 - Nodi: [54-61-60-53]Pann=8Spess.=50 cm, Terreno=Terreno1, ,Criterio=CLS_Platee_ND, Materiale=C35/45: **Verificato**

Armatura a maglia doppia

Pannello	Nx	Ny	Nxy	Mx	My	Mxy	Ax	Ay	C	Cs	ZE
	kN	kN	kN	kN*m	kN*m	kN*m	mmq	mmq			
1	-0.43	-58.68	13.78	-0.01	4.36	-1.96	3142	3142	6	41	--
2	-0.34	-51.24	17.30	0.70	4.38	-3.04	3142	3142	6	35	--
3	-4.80	-33.05	17.50	1.91	3.58	-1.78	3142	3142	6	48	--
4	-0.47	17.97	-1.26	-0.09	-2.03	0.59	3142	3142	3	94	--
5	1.77	-64.11	-0.52	0.04	5.55	-0.27	3142	3142	3	45	--
6	0.15	-45.56	1.25	-0.13	3.82	-0.88	3142	3142	3	55	--
7	-9.61	-33.27	6.97	-0.54	3.36	-0.15	3142	3142	6	73	--
8	0.77	9.92	-1.51	-0.07	-1.35	-0.78	3142	3142	3	>100	--
Massimi/minimi											
1							3142				
1								3142			
2										35	

Muro [Platea]: 68 - Nodi: [53-60-59-52]Pann=4Spess.=50 cm, Terreno=Terreno1, ,Criterio=CLS_Platee_ND, Materiale=C35/45: **Verificato**

Armatura a maglia doppia

Pannello	Nx	Ny	Nxy	Mx	My	Mxy	Ax	Ay	C	Cs	ZE
	kN	kN	kN	kN*m	kN*m	kN*m	mmq	mmq			
1	-6.44	-15.80	12.96	0.57	1.81	-1.04	3142	3142	6	89	--
2	-7.59	-1.20	1.66	1.05	0.31	-0.38	3142	3142	5	>100	--
3	-0.91	8.26	0.45	-0.09	-1.02	0.11	3142	3142	3	>100	--
4	-4.60	0.46	-0.16	0.05	-0.23	-0.21	3142	3142	6	>100	--
Massimi/minimi											
1							3142				
1								3142			
1										89	

Muro : 69 - Nodi: [93-92-139-132], Pann.X=4, Pann.Y=4Spess.=40 cm, Terreno=--,Criterio=CLS_Muri_ND, Materiale=C35/45: **Verificato**

Armatura a maglia doppia

Pannello	Nx	Ny	Nxy	Mx	My	Mxy	Ax	Ay	C	Cs	ZE
	kN	kN	kN	kN*m	kN*m	kN*m	mmq	mmq			
1	9.78	-113.97	1.35	5.45	2.73	7.39	3142	3142	5	15	--
2	12.40	-110.67	-4.05	9.85	23.24	6.98	3142	3142	5	6.9	--
3	12.85	-106.76	-9.98	13.43	38.67	5.93	3142	3142	5	4.7	--
4	10.39	-101.82	-16.24	16.13	49.51	4.33	3142	3142	5	3.8	--
5	15.03	-113.90	1.57	6.37	2.80	8.72	3142	3142	5	13	--
6	18.24	-110.48	-4.01	10.90	22.43	8.24	3142	3142	5	6.8	--

Pannello	Nx	Ny	Nxy	Mx	My	Mxy	Ax	Ay	C	Cs	ZE
7	19.19	-106.81	-10.34	14.59	37.12	6.98	3142	3142	5	4.7	--
8	17.61	-102.69	-17.11	17.36	47.43	5.11	3142	3142	5	3.9	--
9	20.13	-111.60	2.06	7.34	2.85	10.70	3142	3142	5	10	--
10	24.39	-108.67	-3.66	11.95	21.42	10.09	3142	3142	5	6.6	--
11	26.13	-105.48	-10.42	15.68	35.27	8.52	3142	3142	5	4.7	--
12	25.16	-101.70	-17.92	18.43	44.99	6.23	3142	3142	5	4.0	--
13	25.24	-107.22	3.05	8.29	2.85	12.90	3142	3142	5	8.8	--
14	30.83	-104.89	-2.76	12.93	20.12	12.09	3142	3142	5	6.4	--
15	33.70	-102.36	-9.99	16.65	32.94	10.13	3142	3142	5	4.8	--
16	33.20	-99.20	-18.29	19.30	41.98	7.32	3142	3142	5	4.2	--
Massimi/minimi											
1							3142				
1								3142			
4										3.8	

Muro : 70 - Nodi: [90-136-143-91], Pann.X=4, Pann.Y=4Spess.=40 cm, Terreno=--,Criterio=CLS_Muri_ND, Materiale=C35/45: **Verificato**

Armatura a maglia doppia

Pannello	Nx	Ny	Nxy	Mx	My	Mxy	Ax	Ay	C	Cs	ZE
	kN	kN	kN	kN*m	kN*m	kN*m	mmq	mmq			
1	-90.33	12.56	60.76	5.56	2.39	7.94	3142	3142	5	15	--
2	-91.98	13.99	60.85	5.48	1.28	8.22	3142	3142	5	15	--
3	-93.83	15.48	61.18	5.45	-0.47	8.50	3142	3142	5	15	--
4	-96.56	17.49	61.80	5.54	-2.95	8.22	3142	3142	5	15	--
5	-86.71	19.08	59.33	13.67	4.24	7.51	3142	3142	5	9.7	--
6	-88.37	20.77	59.21	12.53	2.75	7.86	3142	3142	5	10	--
7	-90.47	22.81	59.16	11.35	0.40	8.24	3142	3142	5	10	--
8	-93.27	25.40	59.16	10.14	-3.03	8.13	3142	3142	5	11	--
9	-82.77	25.31	57.62	18.87	5.68	6.29	3142	3142	5	8.1	--
10	-84.45	27.31	57.19	16.81	3.90	6.63	3142	3142	5	8.7	--
11	-86.60	29.85	56.60	14.60	1.02	7.01	3142	3142	5	9.5	--
12	-89.38	33.01	55.97	12.20	-3.28	6.94	3142	3142	5	11	--
13	-78.40	30.88	55.77	21.73	6.70	4.40	3142	3142	5	7.8	--
14	-80.09	33.57	54.81	18.92	4.70	4.67	3142	3142	5	8.6	--
15	-82.11	36.50	53.60	15.92	1.39	4.97	3142	3142	5	9.8	--
16	-84.88	39.98	52.24	12.69	-3.65	4.92	3142	3142	5	12	--
Massimi/minimi											
1							3142				
1								3142			
13										7.8	

Muro : 71 - Nodi: [94-93-132-123], Pann.X=4, Pann.Y=4Spess.=40 cm, Terreno=--,Criterio=CLS_Muri_ND, Materiale=C35/45: **Verificato**

Armatura a maglia doppia

Pannello	Nx	Ny	Nxy	Mx	My	Mxy	Ax	Ay	C	Cs	ZE
	kN	kN	kN	kN*m	kN*m	kN*m	mmq	mmq			
1	12.41	-69.96	41.98	-2.11	-12.55	0.18	3142	3142	6	16	--
2	-23.42	-102.47	-5.94	5.08	24.80	-1.20	3142	3142	5	8.0	--
3	-25.73	-97.41	-5.65	7.80	42.31	-0.93	3142	3142	5	4.8	--
4	-28.31	-92.95	-5.55	9.83	54.79	-0.51	3142	3142	5	3.7	--
5	16.83	-65.16	53.42	-1.58	-12.05	-0.15	3142	3142	6	16	--
6	-23.18	-95.98	-8.44	4.05	25.48	0.20	3142	3142	5	8.0	--
7	-24.91	-92.51	-9.13	6.37	43.28	0.30	3142	3142	5	4.7	--
8	-26.81	-89.49	-9.87	8.00	56.03	0.39	3142	3142	5	3.6	--
9	30.57	-69.80	71.91	-1.52	-11.45	-0.29	3142	3142	6	17	--
10	-16.86	-97.95	-6.91	4.68	25.56	0.90	3142	3142	5	7.8	--
11	-18.11	-94.79	-9.11	7.11	43.14	0.74	3142	3142	5	4.7	--
12	-19.82	-91.75	-11.46	8.82	55.69	0.49	3142	3142	5	3.7	--

Pannello	Nx	Ny	Nxy	Mx	My	Mxy	Ax	Ay	C	Cs	ZE
13	58.53	-81.78	98.92	-1.82	-10.88	-0.65	3142	3142	6	18	--
14	-1.78	-106.83	-4.43	7.27	24.48	3.60	3142	3142	5	7.4	--
15	-2.14	-103.26	-8.98	10.27	41.06	3.00	3142	3142	5	4.7	--
16	-3.82	-99.26	-13.65	12.50	52.81	2.08	3142	3142	5	3.8	--
Massimi/minimi											
1							3142				
1								3142			
8										3.6	

Muro : 72 - Nodi: [96-127-136-90], Pann.X=4, Pann.Y=4Spess.=40 cm, Terreno=--,Criterio=CLS_Muri_ND, Materiale=C35/45: **Verificato**

Armatura a maglia doppia

Pannello	Nx	Ny	Nxy	Mx	My	Mxy	Ax	Ay	C	Cs	ZE
	kN	kN	kN	kN*m	kN*m	kN*m	mmq	mmq			
1	-71.27	13.06	43.19	-12.49	-2.26	0.22	3142	3142	6	16	--
2	-66.46	17.64	54.85	-12.00	-1.87	-0.36	3142	3142	6	16	--
3	-70.47	31.36	73.06	-11.33	-2.08	-1.02	3142	3142	6	16	--
4	-80.62	58.60	98.43	-10.23	-2.65	-2.23	3142	3142	6	16	--
5	-86.49	3.37	55.02	17.39	3.41	-0.30	3142	3142	5	12	--
6	-82.38	6.62	52.93	18.04	3.43	0.90	3142	3142	5	11	--
7	-81.96	10.72	55.78	17.88	4.56	2.31	3142	3142	5	10	--
8	-83.60	15.29	58.99	15.89	5.47	5.11	3142	3142	5	9.7	--
9	-81.29	6.77	54.23	27.18	4.99	-0.12	3142	3142	5	7.5	--
10	-79.21	11.17	52.01	27.66	4.82	0.93	3142	3142	5	7.1	--
11	-79.15	15.85	54.86	26.69	6.09	1.99	3142	3142	5	7.1	--
12	-80.29	21.09	57.72	22.86	7.08	4.26	3142	3142	5	7.5	--
13	-76.39	10.19	53.08	33.65	6.11	0.11	3142	3142	5	6.0	--
14	-76.12	15.79	50.94	34.01	5.72	0.86	3142	3142	5	5.8	--
15	-76.24	21.01	53.78	32.38	7.10	1.46	3142	3142	5	6.0	--
16	-76.64	26.82	56.36	27.09	8.17	2.97	3142	3142	5	6.8	--
Massimi/minimi											
1							3142				
1								3142			
14										5.8	

Muro : 73 - Nodi: [77-94-123-116], Pann.X=4, Pann.Y=4Spess.=40 cm, Terreno=--,Criterio=CLS_Muri_ND, Materiale=C35/45: **Verificato**

Armatura a maglia doppia

Pannello	Nx	Ny	Nxy	Mx	My	Mxy	Ax	Ay	C	Cs	ZE
	kN	kN	kN	kN*m	kN*m	kN*m	mmq	mmq			
1	16.85	-80.61	43.08	-3.12	-12.23	1.00	3142	3142	6	15	--
2	-24.32	-100.09	12.88	8.57	23.83	-6.41	3142	3142	5	6.8	--
3	-28.12	-92.79	11.13	12.06	39.48	-5.84	3142	3142	5	4.5	--
4	-32.76	-85.94	9.59	14.77	50.39	-4.77	3142	3142	5	3.7	--
5	15.95	-80.27	41.78	-3.06	-12.44	0.83	3142	3142	6	15	--
6	-22.85	-103.68	8.84	7.73	24.02	-5.23	3142	3142	5	7.1	--
7	-26.64	-96.19	7.81	11.19	40.21	-4.75	3142	3142	5	4.6	--
8	-30.60	-89.29	6.56	13.90	51.54	-3.84	3142	3142	5	3.7	--
9	14.98	-78.89	40.46	-2.94	-12.59	0.64	3142	3142	6	15	--
10	-22.08	-105.69	4.64	6.96	24.18	-4.01	3142	3142	5	7.4	--
11	-25.54	-98.25	4.28	10.34	40.83	-3.59	3142	3142	5	4.6	--
12	-29.25	-91.35	3.49	13.00	52.53	-2.82	3142	3142	5	3.7	--
13	14.22	-76.55	39.49	-2.76	-12.69	0.54	3142	3142	6	15	--
14	-22.00	-106.16	0.74	6.31	24.33	-3.12	3142	3142	5	7.6	--
15	-25.10	-99.31	0.79	9.55	41.35	-2.75	3142	3142	5	4.7	--
16	-28.00	-92.57	0.77	12.09	53.38	-2.09	3142	3142	5	3.7	--
Massimi/minimi											
1							3142				

Pannello	Nx	Ny	Nxy	Mx	My	Mxy	Ax	Ay	C	Cs	ZE
1								3142			
8										3.7	

Muro : 74 - Nodi: [85-83-155-154], Pann.X=4, Pann.Y=4Spess.=40 cm, Terreno=--,Criterio=CLS_Muri_ND, Materiale=C35/45: **Verificato**

Armatura a maglia doppia

Pannello	Nx	Ny	Nxy	Mx	My	Mxy	Ax	Ay	C	Cs	ZE
	kN	kN	kN	kN*m	kN*m	kN*m	mmq	mmq			
1	22.89	45.40	51.42	-6.63	-12.20	0.11	3142	3142	6	15	--
2	21.19	67.40	53.90	-7.45	-22.19	0.01	3142	3142	6	8.1	--
3	14.21	112.03	-99.00	-7.06	-36.63	0.66	3142	3142	2	4.7	--
4	10.20	137.43	-99.55	-7.96	-56.56	0.88	3142	3142	2	3.0	--
5	17.63	50.46	25.06	-7.10	-10.78	-0.21	3142	3142	6	17	--
6	17.98	69.85	28.69	-8.02	-21.10	1.56	3142	3142	6	8.0	--
7	16.18	109.67	-119.73	-7.60	-36.30	2.76	3142	3142	2	4.5	--
8	19.00	119.23	-120.13	-8.15	-56.22	2.91	3142	3142	2	2.9	--
9	11.31	62.06	1.26	-6.31	-6.43	-1.94	3142	3142	6	22	--
10	11.36	80.94	5.28	-8.99	-16.26	1.95	3142	3142	6	9.8	--
11	12.07	123.03	-137.36	-9.82	-34.34	5.52	3142	3142	2	4.3	--
12	18.00	134.04	-131.70	-9.94	-62.70	5.33	3142	3142	2	2.5	--
13	5.47	93.13	-177.09	5.44	3.96	-4.40	3142	3142	2	19	--
14	7.56	92.84	-18.70	-0.24	-8.28	-1.47	3142	3142	6	18	--
15	-1.05	144.29	-172.28	-7.52	-26.79	3.09	3142	3142	2	5.6	--
16	-4.14	194.33	-161.10	-13.83	-77.25	12.57	3142	3142	2	1.8	--
Massimi/minimi											
1							3142				
1								3142			
16										1.8	

Muro : 75 - Nodi: [92-89-146-139], Pann.X=4, Pann.Y=4Spess.=40 cm, Terreno=--,Criterio=CLS_Muri_ND, Materiale=C35/45: **Verificato**

Armatura a maglia doppia

Pannello	Nx	Ny	Nxy	Mx	My	Mxy	Ax	Ay	C	Cs	ZE
	kN	kN	kN	kN*m	kN*m	kN*m	mmq	mmq			
1	29.19	-102.34	4.07	8.95	2.80	14.68	3142	3142	5	7.9	--
2	35.97	-100.42	-1.62	13.62	18.89	13.70	3142	3142	5	6.3	--
3	39.99	-98.56	-9.11	17.27	30.80	11.38	3142	3142	5	4.9	--
4	39.98	-96.04	-18.01	19.81	39.25	8.09	3142	3142	5	4.4	--
5	31.95	-97.96	4.92	9.36	2.68	16.10	3142	3142	5	7.3	--
6	39.69	-96.30	-0.49	13.96	17.81	14.93	3142	3142	5	6.3	--
7	44.77	-95.00	-8.04	17.55	28.98	12.30	3142	3142	5	5.0	--
8	45.46	-93.13	-17.57	19.97	36.96	8.61	3142	3142	5	4.5	--
9	34.39	-92.57	5.90	9.68	2.49	17.52	3142	3142	5	6.8	--
10	43.52	-91.45	0.83	14.19	16.55	16.16	3142	3142	5	6.1	--
11	49.81	-90.34	-6.57	17.67	26.90	13.19	3142	3142	5	5.1	--
12	51.40	-89.58	-16.60	19.96	34.38	9.08	3142	3142	5	4.7	--
13	35.70	-85.82	7.22	9.85	2.23	18.93	3142	3142	5	6.5	--
14	47.24	-85.83	2.23	14.26	15.10	17.37	3142	3142	5	5.8	--
15	56.74	-86.10	-5.35	17.55	24.54	14.02	3142	3142	5	5.3	--
16	59.48	-84.29	-14.08	19.73	31.54	9.50	3142	3142	5	5.0	--
Massimi/minimi											
1							3142				
1								3142			
4										4.4	

Muro : 76 - Nodi: [95-120-127-96], Pann.X=4, Pann.Y=4Spess.=40 cm, Terreno=--,Criterio=CLS_Muri_ND, Materiale=C35/45: **Verificato**

Armatura a maglia doppia

Pannello	Nx	Ny	Nxy	Mx	My	Mxy	Ax	Ay	C	Cs	ZE
	kN	kN	kN	kN*m	kN*m	kN*m	mmq	mmq			
1	-80.85	17.02	43.48	-12.08	-3.07	1.14	3142	3142	6	15	--
2	-80.19	15.90	42.53	-12.31	-3.03	0.95	3142	3142	6	15	--
3	-79.12	15.09	41.67	-12.48	-2.95	0.76	3142	3142	6	15	--
4	-77.40	14.64	40.89	-12.59	-2.82	0.66	3142	3142	6	15	--
5	-84.51	-3.36	74.16	16.49	5.17	-3.52	3142	3142	5	10	--
6	-86.82	-1.36	70.05	16.65	4.66	-2.82	3142	3142	5	11	--
7	-88.33	0.30	65.99	16.80	4.22	-2.10	3142	3142	5	11	--
8	-88.85	1.56	62.11	16.94	3.86	-1.56	3142	3142	5	11	--
9	-76.86	-2.61	71.69	25.32	7.15	-3.14	3142	3142	5	7.1	--
10	-79.27	-0.23	68.18	25.80	6.65	-2.50	3142	3142	5	7.2	--
11	-80.85	1.95	64.46	26.21	6.17	-1.81	3142	3142	5	7.3	--
12	-81.77	3.65	60.87	26.55	5.75	-1.32	3142	3142	5	7.3	--
13	-69.55	-2.74	69.08	31.02	8.63	-2.47	3142	3142	5	6.0	--
14	-72.17	1.02	65.76	31.73	8.15	-1.93	3142	3142	5	6.0	--
15	-73.76	3.84	62.39	32.34	7.65	-1.34	3142	3142	5	6.0	--
16	-75.16	6.41	59.25	32.85	7.17	-0.91	3142	3142	5	6.0	--
Massimi/minimi											
1							3142				
1								3142			
16										6.0	

Muro : 77 - Nodi: [91-143-150-87], Pann.X=4, Pann.Y=4Spess.=40 cm, Terreno=--,Criterio=CLS_Muri_ND, Materiale=C35/45: **Verificato**

Armatura a maglia doppia

Pannello	Nx	Ny	Nxy	Mx	My	Mxy	Ax	Ay	C	Cs	ZE
	kN	kN	kN	kN*m	kN*m	kN*m	mmq	mmq			
1	-176.14	26.42	63.34	2.10	-6.28	6.41	3142	3142	4	15	--
2	-196.93	116.79	149.50	-1.27	-9.10	4.59	3142	3142	3	13	--
3	-204.35	126.31	149.77	-1.57	-12.69	4.15	3142	3142	3	10	--
4	-199.69	125.67	141.30	-2.02	-18.69	6.53	3142	3142	3	6.8	--
5	-96.12	27.92	59.04	9.17	-6.47	7.48	3142	3142	5	12	--
6	-194.40	145.44	130.65	2.44	-10.84	4.29	3142	3142	3	11	--
7	-195.54	156.04	129.69	1.81	-14.88	4.16	3142	3142	3	8.8	--
8	-194.08	165.56	128.20	1.35	-19.13	6.27	3142	3142	3	6.5	--
9	-91.96	35.93	55.45	10.24	-7.82	6.39	3142	3142	5	12	--
10	-190.42	169.88	108.98	4.96	-12.35	3.72	3142	3142	3	10	--
11	-189.74	181.99	108.59	3.99	-17.01	3.82	3142	3142	3	7.8	--
12	-189.02	195.62	106.58	2.92	-22.29	5.98	3142	3142	3	5.7	--
13	-87.42	43.24	51.23	10.05	-9.08	4.48	3142	3142	5	14	--
14	-185.31	187.31	84.31	6.07	-13.48	2.81	3142	3142	3	9.9	--
15	-185.55	201.96	82.80	4.76	-18.85	3.16	3142	3142	3	7.2	--
16	-181.05	219.10	83.36	3.39	-25.19	5.44	3142	3142	3	5.1	--
Massimi/minimi											
1							3142				
1								3142			
16										5.1	

Muro : 78 - Nodi: [82-156-155-83], Pann.X=4, Pann.Y=4Spess.=40 cm, Terreno=--,Criterio=CLS_Muri_ND, Materiale=C35/45: **Verificato**

Armatura a maglia doppia

Pannello	Nx	Ny	Nxy	Mx	My	Mxy	Ax	Ay	C	Cs	ZE
	kN	kN	kN	kN*m	kN*m	kN*m	mmq	mmq			
1	38.44	15.06	96.27	-14.40	-7.11	-0.01	3142	3142	6	13	--
2	44.88	11.90	66.55	-11.96	-7.17	-0.43	3142	3142	6	15	--
3	58.66	6.07	42.52	-5.20	-3.35	-2.52	3142	3142	6	24	--

Pannello	Nx	Ny	Nxy	Mx	My	Mxy	Ax	Ay	C	Cs	ZE
4	74.39	-1.69	20.09	2.02	19.28	-1.40	3142	3142	6	9.3	--
5	59.66	13.24	96.76	-25.58	-8.09	0.01	3142	3142	6	7.1	--
6	62.98	12.51	68.13	-23.33	-8.19	1.96	3142	3142	6	7.2	--
7	74.20	9.20	45.90	-15.26	-6.20	1.97	3142	3142	6	10	--
8	91.13	1.73	25.13	-4.16	22.45	0.08	3142	3142	6	8.5	--
9	120.55	-5.00	217.92	-39.80	-8.35	-0.45	3142	3142	3	4.3	--
10	103.94	3.65	166.37	-38.62	-8.02	2.59	3142	3142	3	4.2	--
11	101.61	13.00	187.83	-34.93	-9.02	5.68	3142	3142	2	4.3	--
12	131.64	12.26	169.32	-23.49	17.65	3.10	3142	3142	2	6.4	--
13	163.14	2.47	213.14	-62.69	-9.09	-0.66	3142	3142	3	2.6	--
14	134.34	9.67	166.28	-60.27	-8.72	4.01	3142	3142	3	2.6	--
15	103.67	20.34	186.99	-67.31	-10.31	5.72	3142	3142	2	2.4	--
16	140.06	21.78	163.66	-78.95	0.03	2.82	3142	3142	2	2.1	--
Massimi/minimi											
1							3142				
1								3142			
16										2.1	

Muro : 79 - Nodi : [87-150-157-86], Pann.X=4, Pann.Y=4Spess.=40 cm, Terreno=--,Criterio=CLS_Muri_ND, Materiale=C35/45: **Verificato**

Armatura a maglia doppia

Pannello	Nx	Ny	Nxy	Mx	My	Mxy	Ax	Ay	C	Cs	ZE
	kN	kN	kN	kN*m	kN*m	kN*m	mmq	mmq			
1	-185.81	137.13	245.54	0.37	-5.56	-3.14	3142	3142	3	20	--
2	-74.29	45.66	153.50	5.31	0.93	-3.34	3142	3142	1	23	--
3	-75.07	97.49	283.57	3.34	5.06	-2.72	3142	3142	3	23	--
4	-82.04	48.99	235.57	2.68	7.63	-7.86	3142	3142	3	12	--
5	-184.81	187.04	236.42	3.23	-8.66	-3.06	3142	3142	3	14	--
6	-92.37	33.73	119.54	8.59	1.33	-2.90	3142	3142	5	18	--
7	-81.72	208.85	312.46	7.27	5.84	-2.85	3142	3142	3	18	--
8	-20.37	137.49	259.04	7.72	6.90	-9.30	3142	3142	3	10	--
9	-190.56	230.20	212.33	4.93	-10.11	-2.69	3142	3142	3	12	--
10	-99.11	55.43	115.56	9.24	1.32	-2.90	3142	3142	5	17	--
11	-51.17	463.88	352.03	10.11	5.52	-2.59	3142	3142	2	14	--
12	176.82	337.29	315.76	13.08	2.99	-9.41	3142	3142	2	7.3	--
13	-198.71	261.10	175.48	5.58	-11.04	-2.09	3142	3142	3	11	--
14	-104.59	72.32	105.69	9.11	1.15	-2.46	3142	3142	5	18	--
15	-55.06	558.08	208.54	11.01	5.43	-2.06	3142	3142	2	13	--
16	174.38	1047.86	500.45	20.53	7.66	-0.17	3142	3142	2	3.3	--
Massimi/minimi											
1							3142				
1								3142			
16										3.3	

Muro : 80 - Nodi : [86-157-156-82], Pann.X=4, Pann.Y=4Spess.=40 cm, Terreno=--,Criterio=CLS_Muri_ND, Materiale=C35/45: **Verificato**

Armatura a maglia doppia

Pannello	Nx	Ny	Nxy	Mx	My	Mxy	Ax	Ay	C	Cs	ZE
	kN	kN	kN	kN*m	kN*m	kN*m	mmq	mmq			
1	-54.53	-15.45	270.02	7.82	11.34	-3.78	3142	3142	3	13	--
2	29.29	-11.73	303.17	5.28	-0.34	4.65	3142	3142	2	19	--
3	41.15	19.12	148.79	-8.13	-7.59	1.35	3142	3142	6	20	--
4	37.91	17.08	125.88	-12.89	-7.51	0.36	3142	3142	6	14	--
5	-134.63	-37.37	272.94	3.88	16.55	-5.91	3142	3142	3	8.8	--
6	49.99	7.33	156.45	-8.54	-5.99	-1.79	3142	3142	6	18	--
7	57.41	9.09	148.38	-18.88	-9.10	-2.84	3142	3142	6	8.4	--
8	59.27	11.99	125.65	-24.05	-8.60	-1.54	3142	3142	6	7.1	--
9	-148.93	-34.34	238.38	-9.94	20.04	-9.86	3142	3142	2	6.6	--

Pannello	Nx	Ny	Nxy	Mx	My	Mxy	Ax	Ay	C	Cs	ZE
10	55.17	-8.30	156.05	-25.75	-8.45	-9.45	3142	3142	6	5.2	--
11	73.00	3.21	143.96	-33.29	-9.23	-6.48	3142	3142	6	4.5	--
12	119.13	-19.19	269.76	-37.55	-8.25	-3.20	3142	3142	3	4.2	--
13	-67.14	-7.90	148.34	-62.22	2.82	-10.48	3142	3142	6	2.8	--
14	57.57	0.53	142.96	-52.92	-8.90	-12.42	3142	3142	6	2.8	--
15	121.60	-18.41	299.11	-54.41	-8.15	-9.62	3142	3142	3	2.7	--
16	155.32	-6.10	259.83	-60.86	-8.94	-5.07	3142	3142	3	2.5	--
Massimi/minimi											
1							3142				
1								3142			
16										2.5	

Muro : 81 - Nodi: [89-88-153-146], Pann.X=4, Pann.Y=4Spess.=40 cm, Terreno=--,Criterio=CLS_Muri_ND, Materiale=C35/45: **Verificato**

Armatura a maglia doppia

Pannello	Nx	Ny	Nxy	Mx	My	Mxy	Ax	Ay	C	Cs	ZE
	kN	kN	kN	kN*m	kN*m	kN*m	mmq	mmq			
1	38.44	-67.31	11.46	9.44	1.25	22.16	3142	3142	5	5.9	--
2	53.08	-69.34	8.09	13.33	11.10	20.09	3142	3142	5	5.5	--
3	244.10	-166.41	93.82	14.05	16.23	14.17	3142	3142	3	5.4	--
4	273.87	-182.51	55.01	15.60	21.64	9.16	3142	3142	3	6.0	--
5	34.99	-29.72	19.52	5.42	-0.69	26.03	3142	3142	5	5.9	--
6	234.69	-89.75	165.05	6.85	2.83	20.88	3142	3142	3	5.6	--
7	363.68	-44.67	158.61	7.79	2.71	15.60	3142	3142	2	5.7	--
8	424.44	-74.43	99.09	9.13	5.71	9.63	3142	3142	2	6.6	--
9	14.49	16.76	21.79	-5.48	-2.72	26.15	3142	3142	5	6.0	--
10	259.38	97.47	233.93	-6.46	-5.83	21.31	3142	3142	2	5.4	--
11	477.92	55.53	255.50	-7.05	-10.91	18.08	3142	3142	2	4.6	--
12	574.23	51.98	117.10	-6.84	-13.80	8.69	3142	3142	2	6.3	--
13	-17.13	36.17	4.13	-21.76	-4.31	16.20	3142	3142	5	5.1	--
14	15.06	64.28	17.89	-31.84	-9.01	15.30	3142	3142	5	4.0	--
15	357.86	361.72	203.55	-40.79	-16.09	8.66	3142	3142	2	2.7	--
16	1056.12	381.77	359.46	-67.72	-35.30	5.64	4600	3928	2	1.5	--
Massimi/minimi											
16							4600				
16								3928			
16										1.5	

Muro : 82 - Nodi: [88-85-154-153], Pann.X=4, Pann.Y=4Spess.=40 cm, Terreno=--,Criterio=CLS_Muri_ND, Materiale=C35/45: **Verificato**

Armatura a maglia doppia

Pannello	Nx	Ny	Nxy	Mx	My	Mxy	Ax	Ay	C	Cs	ZE
	kN	kN	kN	kN*m	kN*m	kN*m	mmq	mmq			
1	-46.23	54.91	-25.05	-19.86	0.25	5.59	3142	3142	5	7.8	--
2	-60.14	85.04	-35.13	-24.81	-1.75	3.43	3142	3142	5	7.1	--
3	-92.09	120.66	-59.03	-28.28	-8.65	-2.32	3142	3142	5	6.7	--
4	16.78	212.76	-113.11	-14.01	-76.07	-20.18	3142	3142	2	1.6	--
5	-8.61	102.49	-26.50	-10.23	1.77	4.91	3142	3142	2	13	--
6	-9.08	121.67	-40.73	-14.22	-7.56	-0.99	3142	3142	2	13	--
7	6.63	129.76	-64.88	-15.14	-26.92	-9.61	3142	3142	2	4.7	--
8	24.37	123.83	-76.59	-11.88	-58.31	-11.77	3142	3142	2	2.5	--
9	5.05	82.27	-51.23	-7.33	-3.55	1.34	3142	3142	2	22	--
10	24.89	73.12	103.43	-7.76	-15.91	-2.52	3142	3142	6	9.8	--
11	16.71	106.27	-62.22	-9.22	-33.52	-4.24	3142	3142	2	4.6	--
12	17.64	109.56	-61.08	-8.43	-52.46	-5.77	3142	3142	2	3.0	--
13	27.33	46.86	79.09	-6.68	-10.78	0.39	3142	3142	6	16	--
14	23.85	68.34	80.99	-7.60	-20.62	-1.32	3142	3142	6	8.2	--
15	13.86	111.14	-75.30	-7.41	-35.72	-1.39	3142	3142	2	4.7	--

Pannello	Nx	Ny	Nxy	Mx	My	Mxy	Ax	Ay	C	Cs	ZE
16	9.09	136.09	-75.51	-8.00	-55.47	-2.59	3142	3142	2	2.9	--
Massimi/minimi											
1							3142				
1								3142			
4										1.6	

Muro : 83 - Nodi: [98-113-120-95], Pann.X=4, Pann.Y=4Spess.=40 cm, Terreno=--,Criterio=CLS_Muri_ND, Materiale=C35/45: **Verificato**

Armatura a maglia doppia

Pannello	Nx	Ny	Nxy	Mx	My	Mxy	Ax	Ay	C	Cs	ZE
	kN	kN	kN	kN*m	kN*m	kN*m	mmq	mmq			
1	-18.36	-39.73	70.03	0.16	-12.56	-7.19	3142	3142	5	10.0	--
2	-46.35	-25.36	94.22	4.04	2.60	-11.32	3142	3142	5	13	--
3	-66.14	-17.02	92.08	5.32	5.09	-8.99	3142	3142	5	14	--
4	-78.91	19.41	45.41	-11.29	-3.05	1.77	3142	3142	6	16	--
5	-31.49	-54.59	65.48	1.08	-16.17	-6.22	3142	3142	5	8.9	--
6	-43.32	-34.99	89.44	8.66	3.36	-10.18	3142	3142	5	11	--
7	-61.10	-20.20	88.76	13.70	7.28	-8.49	3142	3142	5	9.0	--
8	-77.13	-9.11	81.73	15.84	6.31	-5.49	3142	3142	5	9.5	--
9	-42.85	-64.84	60.41	1.44	-19.33	-4.77	3142	3142	5	8.3	--
10	-41.56	-42.65	82.70	11.53	3.70	-8.12	3142	3142	5	10	--
11	-56.35	-23.05	84.05	19.38	8.89	-7.16	3142	3142	5	7.5	--
12	-70.49	-9.28	78.25	23.66	8.25	-4.83	3142	3142	5	7.1	--
13	-52.19	-70.92	55.54	1.44	-21.77	-3.13	3142	3142	5	8.1	--
14	-41.23	-47.53	74.57	13.02	3.78	-5.47	3142	3142	5	11	--
15	-51.92	-24.97	78.12	22.80	9.89	-5.22	3142	3142	5	7.1	--
16	-63.60	-9.18	74.31	28.61	9.62	-3.73	3142	3142	5	6.2	--
Massimi/minimi											
1							3142				
1								3142			
16										6.2	

Muro : 84 - Nodi: [0-112-113-98], Pann.X=4, Pann.Y=4Spess.=40 cm, Terreno=--,Criterio=CLS_Muri_ND, Materiale=C35/45: **Verificato**

Armatura a maglia doppia

Pannello	Nx	Ny	Nxy	Mx	My	Mxy	Ax	Ay	C	Cs	ZE
	kN	kN	kN	kN*m	kN*m	kN*m	mmq	mmq			
1	-64.31	-34.79	11.01	3.32	3.36	10.21	3142	3142	5	14	--
2	-55.24	-39.82	6.97	2.31	0.01	10.83	3142	3142	5	15	--
3	-44.68	-46.69	8.48	0.75	-6.68	9.56	3142	3142	5	12	--
4	-37.12	-54.23	20.30	-1.70	-18.66	3.10	3142	3142	5	9.2	--
5	-57.72	-43.01	14.01	9.46	4.99	9.41	3142	3142	5	11	--
6	-50.80	-49.60	11.48	6.54	0.39	9.88	3142	3142	5	12	--
7	-44.93	-57.91	13.79	3.00	-8.43	8.62	3142	3142	5	12	--
8	-45.51	-66.39	25.06	-1.00	-24.17	2.53	3142	3142	5	7.5	--
9	-52.14	-49.98	17.96	13.33	6.15	7.78	3142	3142	5	9.4	--
10	-47.10	-57.63	16.82	9.04	0.49	8.05	3142	3142	5	12	--
11	-45.15	-66.60	19.57	4.13	-10.12	6.92	3142	3142	5	12	--
12	-52.18	-74.38	29.47	-0.84	-28.70	1.68	3142	3142	5	6.7	--
13	-47.53	-55.21	22.51	15.43	6.88	5.57	3142	3142	5	9.5	--
14	-43.91	-63.33	22.59	10.25	0.42	5.67	3142	3142	5	12	--
15	-44.78	-72.49	25.36	4.49	-11.51	4.85	3142	3142	5	12	--
16	-56.80	-79.35	32.62	-0.96	-32.00	0.72	3142	3142	5	6.2	--
Massimi/minimi											
1							3142				
1								3142			
16										6.2	

Muro : 85 - Nodi: [0-109-110-99], Pann.X=4, Pann.Y=4Spess.=40 cm, Terreno=--,Criterio=CLS_Muri_ND, Materiale=C35/45: **Verificato**

Armatura a maglia doppia

Pannello	Nx	Ny	Nxy	Mx	My	Mxy	Ax	Ay	C	Cs	ZE
	kN	kN	kN	kN*m	kN*m	kN*m	mmq	mmq			
1	-25.41	-73.14	35.66	-2.27	-24.99	-1.79	3142	3142	5	7.6	--
2	-28.92	-64.41	56.98	0.22	-10.51	-7.05	3142	3142	5	11	--
3	-39.18	-55.86	62.28	2.07	-2.10	-9.78	3142	3142	5	17	--
4	-49.45	-48.85	59.93	3.27	2.33	-9.87	3142	3142	5	15	--
5	-41.26	-95.32	30.96	-2.16	-32.08	-1.42	3142	3142	5	6.1	--
6	-32.70	-84.29	49.89	1.87	-13.41	-6.16	3142	3142	5	10	--
7	-36.30	-72.35	55.96	5.55	-2.49	-8.81	3142	3142	5	14	--
8	-43.51	-62.04	54.98	8.67	3.47	-9.03	3142	3142	5	11	--
9	-53.62	-111.14	25.56	-2.42	-38.06	-0.90	3142	3142	5	5.3	--
10	-36.16	-100.01	41.60	2.56	-16.14	-4.66	3142	3142	5	9.9	--
11	-34.10	-86.21	47.75	7.50	-3.07	-7.02	3142	3142	5	14	--
12	-38.50	-73.48	48.12	11.99	4.20	-7.34	3142	3142	5	10	--
13	-62.37	-122.12	21.12	-2.82	-42.70	-0.38	3142	3142	5	4.9	--
14	-38.63	-111.31	32.72	2.62	-18.35	-2.93	3142	3142	5	9.8	--
15	-32.32	-96.49	38.38	8.32	-3.68	-4.73	3142	3142	5	15	--
16	-34.36	-82.43	39.96	13.69	4.57	-5.08	3142	3142	5	10	--
Massimi/minimi											
1							3142				
1								3142			
13										4.9	

Muro : 86 - Nodi: [99-110-111-100], Pann.X=4, Pann.Y=4Spess.=40 cm, Terreno=--,Criterio=CLS_Muri_ND, Materiale=C35/45: **Verificato**

Armatura a maglia doppia

Pannello	Nx	Ny	Nxy	Mx	My	Mxy	Ax	Ay	C	Cs	ZE
	kN	kN	kN	kN*m	kN*m	kN*m	mmq	mmq			
1	-57.16	-43.83	55.14	3.93	4.41	-8.60	3142	3142	5	15	--
2	-85.68	20.43	-0.24	-10.97	-3.60	1.95	3142	3142	6	16	--
3	-91.25	17.92	0.01	-11.64	-3.73	1.30	3142	3142	6	16	--
4	-95.31	17.10	-0.39	-11.99	-3.83	0.67	3142	3142	6	16	--
5	-50.71	-53.94	51.38	11.06	6.43	-7.99	3142	3142	5	10	--
6	-57.56	-47.34	47.55	12.77	7.67	-6.31	3142	3142	5	10	--
7	-64.70	-41.34	43.48	13.90	8.00	-4.35	3142	3142	5	11	--
8	-70.68	-36.50	38.29	14.56	7.99	-2.26	3142	3142	5	12	--
9	-44.90	-62.98	45.91	15.68	7.93	-6.59	3142	3142	5	8.9	--
10	-51.73	-54.42	42.96	18.49	9.60	-5.26	3142	3142	5	8.4	--
11	-58.43	-47.36	39.63	20.46	10.19	-3.64	3142	3142	5	8.3	--
12	-63.78	-42.04	35.72	21.65	10.31	-1.88	3142	3142	5	8.5	--
13	-39.88	-70.37	39.22	18.26	8.91	-4.65	3142	3142	5	8.6	--
14	-46.47	-60.45	37.52	21.83	10.95	-3.75	3142	3142	5	7.8	--
15	-52.89	-52.54	35.36	24.39	11.75	-2.60	3142	3142	5	7.4	--
16	-57.95	-46.76	32.83	25.97	11.99	-1.33	3142	3142	5	7.3	--
Massimi/minimi											
1							3142				
1								3142			
16										7.3	

Muro : 87 - Nodi: [100-111-112-0], Pann.X=4, Pann.Y=4Spess.=40 cm, Terreno=--,Criterio=CLS_Muri_ND, Materiale=C35/45: **Verificato**

Armatura a maglia doppia

Pannello	Nx	Ny	Nxy	Mx	My	Mxy	Ax	Ay	C	Cs	ZE
	kN	kN	kN	kN*m	kN*m	kN*m	mmq	mmq			

Pannello	Nx	Ny	Nxy	Mx	My	Mxy	Ax	Ay	C	Cs	ZE
1	-95.42	16.29	-1.42	-12.07	-3.80	-0.01	3142	3142	6	17	--
2	-90.83	15.84	-0.84	-11.81	-3.64	-0.83	3142	3142	6	16	--
3	-85.62	18.39	1.17	-11.14	-3.52	-1.67	3142	3142	6	16	--
4	-70.00	-32.13	17.24	3.89	4.93	8.29	3142	3142	5	15	--
5	-73.11	-33.98	31.92	14.78	7.99	0.17	3142	3142	5	14	--
6	-70.84	-34.35	26.47	14.47	8.14	2.82	3142	3142	5	12	--
7	-67.22	-36.00	22.84	13.53	8.12	5.36	3142	3142	5	11	--
8	-63.38	-38.51	18.61	11.82	7.28	7.74	3142	3142	5	10	--
9	-66.41	-38.89	31.13	22.07	10.35	0.16	3142	3142	5	9.1	--
10	-65.22	-38.54	27.04	21.55	10.43	2.41	3142	3142	5	8.4	--
11	-61.92	-40.36	24.07	19.91	10.25	4.55	3142	3142	5	8.2	--
12	-57.53	-44.11	20.92	17.04	9.09	6.49	3142	3142	5	8.5	--
13	-60.66	-43.09	29.96	26.54	12.06	0.17	3142	3142	5	7.5	--
14	-60.09	-42.28	27.44	25.86	12.09	1.82	3142	3142	5	7.2	--
15	-57.04	-44.15	25.62	23.73	11.77	3.37	3142	3142	5	7.4	--
16	-52.48	-48.56	23.89	20.06	10.33	4.73	3142	3142	5	8.0	--
Massimi/minimi											
1							3142				
1								3142			
14										7.2	

Muro : 88 - Nodi: [0-77-116-109], Pann.X=4, Pann.Y=4Spess.=40 cm, Terreno=--,Criterio=CLS_Muri_ND, Materiale=C35/45: **Verificato**

Armatura a maglia doppia

Pannello	Nx	Ny	Nxy	Mx	My	Mxy	Ax	Ay	C	Cs	ZE
	kN	kN	kN	kN*m	kN*m	kN*m	mmq	mmq			
1	-48.48	-28.28	13.03	-16.46	-0.15	-14.15	3142	3142	5	6.5	--
2	-62.55	-37.61	9.03	-21.48	1.86	-12.78	3142	3142	5	5.9	--
3	-72.59	-45.76	5.14	-25.94	2.92	-10.46	3142	3142	5	5.6	--
4	-78.94	-52.23	1.86	-29.45	3.34	-7.64	3142	3142	5	5.5	--
5	-37.13	-53.74	30.30	4.81	4.72	-20.59	3142	3142	5	7.8	--
6	-47.65	-50.40	26.79	6.49	12.89	-19.13	3142	3142	5	6.2	--
7	-56.38	-47.86	21.85	7.56	18.44	-16.06	3142	3142	5	5.8	--
8	-62.60	-46.29	16.01	8.19	21.83	-11.91	3142	3142	5	5.9	--
9	-31.08	-74.85	27.71	8.15	5.59	-15.81	3142	3142	5	8.2	--
10	-36.91	-70.01	25.33	12.03	20.00	-15.21	3142	3142	5	5.7	--
11	-42.39	-65.33	21.97	15.06	30.38	-13.24	3142	3142	5	4.6	--
12	-47.08	-60.79	17.87	17.17	37.32	-10.22	3142	3142	5	4.2	--
13	-25.02	-95.81	21.63	6.18	4.15	-9.97	3142	3142	5	12	--
14	-28.79	-89.60	19.39	10.43	22.97	-9.88	3142	3142	5	6.2	--
15	-32.75	-83.47	16.86	13.89	36.92	-8.89	3142	3142	5	4.5	--
16	-36.67	-77.10	14.24	16.49	46.53	-7.16	3142	3142	5	3.8	--
Massimi/minimi											
1							3142				
1								3142			
16										3.8	

Muro : 89 - Nodi: [18-78-79], Pann.X=4, Pann.Y=4Spess.=40 cm, Terreno=--,Criterio=CLS_Muri_ND, Materiale=C35/45: **Verificato**

Armatura a maglia doppia

Pannello	Nx	Ny	Nxy	Mx	My	Mxy	Ax	Ay	C	Cs	ZE
	kN	kN	kN	kN*m	kN*m	kN*m	mmq	mmq			
1	-331.04	-423.97	-340.74	-2.92	-5.42	-3.31	3142	3142	4	29	--
2	-342.90	-489.56	-360.62	-2.89	-5.42	-3.41	3142	3142	4	30	--
3	-341.94	-567.61	-383.93	-2.77	-5.51	-3.55	3142	3142	4	30	--
4	-305.00	-649.09	-409.51	-2.45	-5.82	-3.65	3142	3142	4	30	--
5	-49.77	-105.89	-67.22	-1.73	-3.85	-2.05	3142	3142	1	35	--
6	-248.23	-326.39	-248.18	-1.95	-4.42	-2.46	3142	3142	4	35	--

Pannello	Nx	Ny	Nxy	Mx	My	Mxy	Ax	Ay	C	Cs	ZE
7	-251.08	-393.54	-295.21	-1.91	-4.59	-2.66	3142	3142	4	34	--
8	-43.71	-128.34	-75.03	-1.38	-3.81	-2.25	3142	3142	1	35	--
9	-42.74	-106.71	-58.69	-1.55	-3.52	-1.80	3142	3142	1	39	--
10	-44.35	-110.72	-62.13	-1.52	-3.48	-1.86	3142	3142	1	39	--
11	-44.69	-114.65	-66.81	-1.44	-3.45	-1.96	3142	3142	1	39	--
12	-41.50	-120.32	-69.78	-1.25	-3.48	-2.03	3142	3142	1	38	--
13	-37.97	-103.14	-51.99	-1.32	-3.11	-1.55	3142	3142	1	44	--
14	-39.93	-107.86	-56.80	-1.33	-3.10	-1.60	3142	3142	1	44	--
15	-40.62	-112.26	-62.57	-1.26	-3.09	-1.69	3142	3142	1	44	--
16	-38.94	-116.79	-66.42	-1.10	-3.12	-1.78	3142	3142	1	43	--
Massimi/minimi											
1							3142				
1								3142			
1										29	

Muro : 90 - Nodi: [18-25-97-78], Pann.X=4, Pann.Y=4Spess.=40 cm, Terreno=--,Criterio=CLS_Muri_ND, Materiale=C35/45: **Verificato**

Armatura a maglia doppia

Pannello	Nx	Ny	Nxy	Mx	My	Mxy	Ax	Ay	C	Cs	ZE
	kN	kN	kN	kN*m	kN*m	kN*m	mmq	mmq			
1	-12.89	-152.86	-18.30	-0.62	-5.52	-0.31	3142	3142	1	37	--
2	-11.53	-144.62	-5.80	-0.55	-5.17	-0.11	3142	3142	1	40	--
3	-10.44	-132.93	-1.81	-0.51	-4.58	-0.06	3142	3142	1	46	--
4	-12.53	-123.86	4.74	-0.43	-3.97	-0.02	3142	3142	1	53	--
5	-15.44	-147.43	-8.33	-0.68	-5.68	-0.15	3142	3142	1	37	--
6	-11.74	-137.78	-5.17	-0.60	-5.22	-0.09	3142	3142	1	40	--
7	-14.62	-128.83	4.69	-0.51	-4.51	-0.05	3142	3142	1	46	--
8	-13.61	-121.45	7.25	-0.42	-3.97	-0.00	3142	3142	1	53	--
9	-52.12	-400.52	-52.11	-0.89	-7.26	-0.03	3142	3142	4	34	--
10	-17.36	-131.60	4.51	-0.59	-5.06	-0.10	3142	3142	1	41	--
11	-13.04	-124.11	4.57	-0.51	-4.49	-0.02	3142	3142	1	47	--
12	-12.83	-116.12	6.13	-0.41	-3.96	0.02	3142	3142	1	53	--
13	-58.79	-329.88	-23.34	-0.83	-6.66	-0.19	3142	3142	4	35	--
14	-12.07	-126.52	1.15	-0.60	-5.01	-0.06	3142	3142	1	42	--
15	-13.62	-119.63	4.78	-0.50	-4.46	-0.00	3142	3142	1	47	--
16	-13.05	-113.16	7.63	-0.40	-3.95	0.03	3142	3142	1	52	--
Massimi/minimi											
1							3142				
1								3142			
9										34	

Muro : 91 - Nodi: [25-34-81-97], Pann.X=4, Pann.Y=4Spess.=40 cm, Terreno=--,Criterio=CLS_Muri_ND, Materiale=C35/45: **Verificato**

Armatura a maglia doppia

Pannello	Nx	Ny	Nxy	Mx	My	Mxy	Ax	Ay	C	Cs	ZE
	kN	kN	kN	kN*m	kN*m	kN*m	mmq	mmq			
1	-42.28	-300.80	2.93	-0.76	-6.18	-0.08	3142	3142	4	38	--
2	-14.89	-118.45	8.11	-0.57	-4.93	0.01	3142	3142	1	42	--
3	-13.54	-112.67	9.75	-0.47	-4.44	0.05	3142	3142	1	46	--
4	-11.60	-108.59	10.06	-0.37	-3.96	0.09	3142	3142	1	51	--
5	-11.04	-98.39	41.72	-0.65	-5.38	0.17	3142	3142	2	37	--
6	-7.72	-98.34	43.65	-0.56	-4.92	0.18	3142	3142	2	40	--
7	-10.51	-111.03	11.52	-0.44	-4.49	0.22	3142	3142	1	44	--
8	-7.57	-107.49	10.83	-0.31	-4.01	0.25	3142	3142	1	49	--
9	-9.16	-99.56	58.82	-0.67	-5.60	0.38	3142	3142	2	35	--
10	-2.03	-98.98	60.97	-0.54	-5.07	0.39	3142	3142	2	38	--
11	-6.01	-112.10	13.75	-0.37	-4.52	0.50	3142	3142	1	42	--
12	-1.35	-110.13	12.66	-0.19	-4.04	0.55	3142	3142	1	45	--

Pannello	Nx	Ny	Nxy	Mx	My	Mxy	Ax	Ay	C	Cs	ZE
13	-6.19	-109.62	88.30	-0.64	-5.53	0.74	3142	3142	2	33	--
14	8.54	-109.37	87.94	-0.46	-4.97	0.81	3142	3142	2	36	--
15	1.70	-118.69	18.29	-0.20	-4.37	1.04	3142	3142	1	39	--
16	8.67	-117.03	15.91	0.03	-4.03	1.11	3142	3142	1	41	--
Massimi/minimi											
1							3142				
1								3142			
13										33	

Muro : 92 - Nodi: [34-41-80-81], Pann.X=4, Pann.Y=4Spess.=40 cm, Terreno=--,Criterio=CLS_Muri_ND, Materiale=C35/45: **Verificato**

Armatura a maglia doppia

Pannello	Nx	Ny	Nxy	Mx	My	Mxy	Ax	Ay	C	Cs	ZE
	kN	kN	kN	kN*m	kN*m	kN*m	mmq	mmq			
1	-3.32	-113.91	117.57	-0.54	-5.09	1.06	3142	3142	2	34	--
2	19.11	-118.83	110.79	-0.28	-4.52	1.26	3142	3142	2	36	--
3	9.43	-125.46	21.89	0.03	-3.99	1.63	3142	3142	1	37	--
4	4.32	-126.25	-0.48	0.47	-3.59	2.08	3142	3142	5	37	--
5	-1.98	-121.34	118.53	-0.43	-4.35	1.05	3142	3142	2	39	--
6	25.24	-123.87	117.91	-0.15	-4.05	1.44	3142	3142	2	38	--
7	13.78	-128.41	21.64	0.17	-3.77	1.88	3142	3142	1	37	--
8	7.70	-127.73	-2.86	0.58	-3.68	2.35	3142	3142	5	35	--
9	0.03	-120.02	129.65	-0.26	-3.17	1.26	3142	3142	2	47	--
10	30.01	-124.44	125.29	0.00	-3.36	1.74	3142	3142	2	41	--
11	57.34	-128.53	119.80	0.32	-3.69	2.07	3142	3142	2	37	--
12	10.81	-127.87	-5.61	0.57	-3.85	2.69	3142	3142	5	32	--
13	-2.48	-168.94	89.91	0.39	2.99	1.01	3142	3142	6	54	--
14	34.72	-122.88	135.54	0.06	-2.48	2.10	3142	3142	2	46	--
15	66.97	-128.48	128.75	0.33	-3.38	2.54	3142	3142	2	36	--
16	14.39	-127.07	-8.50	0.22	-4.21	3.05	3142	3142	5	29	--
Massimi/minimi											
1							3142				
1								3142			
16										29	

Muro : 93 - Nodi: [41-48-84-80], Pann.X=4, Pann.Y=4Spess.=40 cm, Terreno=--,Criterio=CLS_Muri_ND, Materiale=C35/45: **Verificato**

Armatura a maglia doppia

Pannello	Nx	Ny	Nxy	Mx	My	Mxy	Ax	Ay	C	Cs	ZE
	kN	kN	kN	kN*m	kN*m	kN*m	mmq	mmq			
1	-11.77	-137.64	6.73	0.31	3.16	1.88	3142	3142	5	42	--
2	40.66	-122.97	144.70	-0.02	-1.68	2.34	3142	3142	2	52	--
3	75.58	-128.40	136.05	0.12	-3.09	2.92	3142	3142	2	35	--
4	18.16	-126.60	-11.14	-0.53	-4.62	3.32	3142	3142	5	27	--
5	-9.70	-149.39	-1.93	0.32	3.93	1.81	3142	3142	5	37	--
6	2.99	-138.67	-3.90	-0.37	1.19	2.54	3142	3142	5	57	--
7	82.61	-128.06	141.20	-0.22	-2.74	3.16	3142	3142	2	36	--
8	21.72	-126.56	-13.45	-1.55	-4.96	3.48	3142	3142	5	25	--
9	-8.65	-148.26	-5.83	0.34	4.74	1.46	3142	3142	5	34	--
10	5.00	-138.47	-7.93	-0.58	1.92	2.25	3142	3142	5	51	--
11	71.81	-311.05	135.60	-1.10	-0.91	4.06	3142	3142	3	35	--
12	114.98	-316.18	116.15	-2.58	-4.65	4.68	3142	3142	3	24	--
13	-8.44	-137.50	-13.11	0.41	5.69	1.16	3142	3142	5	31	--
14	-0.67	-301.47	22.54	-0.56	2.64	2.36	3142	3142	4	47	--
15	79.44	-311.04	147.40	-1.13	0.47	3.59	3142	3142	3	38	--
16	154.06	-356.25	119.84	-6.99	-1.82	4.99	3142	3142	3	14	--
Massimi/minimi											
1							3142				

Pannello	Nx	Ny	Nxy	Mx	My	Mxy	Ax	Ay	C	Cs	ZE
1								3142			
16										14	

Muro : 94 - Nodi: [79-78-129-118], Pann.X=4, Pann.Y=4Spess.=40 cm, Terreno=--,Criterio=CLS_Muri_ND, Materiale=C35/45: **Verificato**

Armatura a maglia doppia

Pannello	Nx	Ny	Nxy	Mx	My	Mxy	Ax	Ay	C	Cs	ZE
	kN	kN	kN	kN*m	kN*m	kN*m	mmq	mmq			
1	-0.48	-151.20	0.23	-0.06	-3.55	-0.01	3142	3142	1	60	--
2	-0.36	-148.64	1.31	-0.04	-2.89	0.03	3142	3142	1	73	--
3	-0.31	-147.24	2.17	-0.03	-2.23	0.06	3142	3142	1	93	--
4	-0.38	-146.76	2.93	-0.02	-1.57	0.08	3142	3142	1	>100	--
5	-3.57	-144.57	1.06	-0.22	-3.50	-0.05	3142	3142	1	60	--
6	-2.79	-142.06	3.43	-0.15	-2.85	-0.01	3142	3142	1	74	--
7	-2.45	-139.98	5.44	-0.10	-2.21	0.02	3142	3142	1	95	--
8	-2.47	-138.32	7.36	-0.05	-1.56	0.04	3142	3142	1	>100	--
9	-7.03	-135.40	3.01	-0.32	-3.45	-0.04	3142	3142	1	61	--
10	-6.16	-132.75	5.27	-0.23	-2.81	-0.01	3142	3142	1	75	--
11	-5.53	-130.23	7.39	-0.14	-2.18	0.00	3142	3142	1	97	--
12	-5.42	-127.55	9.46	-0.07	-1.55	0.01	3142	3142	1	>100	--
13	-10.27	-125.39	5.64	-0.34	-3.43	-0.01	3142	3142	1	61	--
14	-8.83	-123.24	6.82	-0.25	-2.80	-0.00	3142	3142	1	75	--
15	-8.17	-120.28	8.27	-0.16	-2.17	0.00	3142	3142	1	96	--
16	-7.96	-116.87	9.74	-0.08	-1.55	0.01	3142	3142	1	>100	--
Massimi/minimi											
1							3142				
1								3142			
5										60	

Muro : 95 - Nodi: [78-97-130-129], Pann.X=4, Pann.Y=4Spess.=40 cm, Terreno=--,Criterio=CLS_Muri_ND, Materiale=C35/45: **Verificato**

Armatura a maglia doppia

Pannello	Nx	Ny	Nxy	Mx	My	Mxy	Ax	Ay	C	Cs	ZE
	kN	kN	kN	kN*m	kN*m	kN*m	mmq	mmq			
1	-12.64	-118.41	6.12	-0.34	-3.41	0.00	3142	3142	1	61	--
2	-10.27	-116.19	7.43	-0.25	-2.79	0.01	3142	3142	1	75	--
3	-9.55	-113.23	8.48	-0.16	-2.17	0.01	3142	3142	1	96	--
4	-9.14	-109.28	9.16	-0.08	-1.55	0.01	3142	3142	1	>100	--
5	-10.47	-115.88	7.16	-0.33	-3.40	0.02	3142	3142	1	61	--
6	-10.91	-112.57	7.88	-0.24	-2.79	0.02	3142	3142	1	74	--
7	-9.97	-108.78	8.36	-0.15	-2.17	0.02	3142	3142	1	95	--
8	-9.41	-104.58	8.41	-0.07	-1.55	0.01	3142	3142	1	>100	--
9	-11.71	-112.36	8.35	-0.31	-3.40	0.03	3142	3142	1	61	--
10	-10.97	-108.96	8.31	-0.22	-2.79	0.03	3142	3142	1	74	--
11	-9.77	-105.09	8.01	-0.13	-2.17	0.02	3142	3142	1	94	--
12	-9.00	-100.75	7.57	-0.05	-1.56	0.02	3142	3142	1	>100	--
13	-13.22	-108.93	9.00	-0.30	-3.39	0.04	3142	3142	1	60	--
14	-10.51	-105.89	8.19	-0.21	-2.79	0.04	3142	3142	1	73	--
15	-9.17	-102.32	7.46	-0.12	-2.18	0.03	3142	3142	1	94	--
16	-7.58	-97.87	6.83	-0.03	-1.56	0.02	3142	3142	1	>100	--
Massimi/minimi											
1							3142				
1								3142			
13										60	

Muro : 96 - Nodi: [97-81-134-130], Pann.X=4, Pann.Y=4Spess.=40 cm, Terreno=--,Criterio=CLS_Muri_ND, Materiale=C35/45: **Verificato**

Armatura a maglia doppia

Pannello	Nx	Ny	Nxy	Mx	My	Mxy	Ax	Ay	C	Cs	ZE
	kN	kN	kN	kN*m	kN*m	kN*m	mmq	mmq			
1	-9.78	-105.06	9.25	-0.26	-3.42	0.10	3142	3142	1	59	--
2	-8.20	-102.05	7.84	-0.15	-2.81	0.09	3142	3142	1	71	--
3	-6.52	-98.25	6.29	-0.05	-2.20	0.07	3142	3142	1	91	--
4	-10.86	-98.98	0.70	0.11	-1.57	0.09	3142	3142	5	>100	--
5	-4.44	-105.26	9.25	-0.16	-3.48	0.26	3142	3142	1	55	--
6	-1.70	-101.82	7.22	-0.01	-2.88	0.24	3142	3142	1	66	--
7	-6.99	-101.87	-0.98	0.24	-2.26	0.29	3142	3142	5	81	--
8	-5.22	-97.69	-2.90	0.38	-1.71	0.22	3142	3142	5	>100	--
9	-5.17	-113.14	0.51	0.14	-3.39	0.76	3142	3142	5	50	--
10	-2.51	-108.64	-1.45	0.37	-2.95	0.71	3142	3142	5	57	--
11	-0.02	-104.30	-3.72	0.58	-2.50	0.62	3142	3142	5	66	--
12	2.20	-99.83	-6.20	0.77	-2.02	0.50	3142	3142	5	82	--
13	2.46	-118.11	-1.31	0.46	-3.55	1.41	3142	3142	5	42	--
14	6.23	-112.99	-4.31	0.71	-3.34	1.28	3142	3142	5	45	--
15	9.25	-107.99	-7.50	0.93	-3.02	1.09	3142	3142	5	51	--
16	11.51	-102.57	-10.68	1.12	-2.61	0.88	3142	3142	5	59	--
Massimi/minimi											
1							3142				
1								3142			
13										42	

Muro : 97 - Nodi: [81-80-141-134], Pann.X=4, Pann.Y=4Spess.=40 cm, Terreno=--,Criterio=CLS_Muri_ND, Materiale=C35/45: **Verificato**

Armatura a maglia doppia

Pannello	Nx	Ny	Nxy	Mx	My	Mxy	Ax	Ay	C	Cs	ZE
	kN	kN	kN	kN*m	kN*m	kN*m	mmq	mmq			
1	9.47	-120.85	-3.80	0.72	-3.80	1.95	3142	3142	5	36	--
2	13.72	-115.34	-7.73	0.94	-3.80	1.68	3142	3142	5	38	--
3	16.83	-109.31	-11.57	1.07	-3.55	1.37	3142	3142	5	42	--
4	18.25	-102.92	-15.19	1.16	-3.13	1.10	3142	3142	5	49	--
5	13.06	-121.98	-6.14	0.80	-4.11	2.13	3142	3142	5	34	--
6	17.72	-115.66	-10.12	0.95	-4.21	1.74	3142	3142	5	35	--
7	20.72	-109.14	-14.23	1.01	-3.92	1.36	3142	3142	5	39	--
8	22.30	-102.41	-18.14	1.04	-3.42	1.08	3142	3142	5	46	--
9	16.93	-121.89	-9.01	0.73	-4.60	2.32	3142	3142	5	30	--
10	21.87	-114.99	-13.22	0.80	-4.76	1.76	3142	3142	5	32	--
11	24.93	-107.83	-17.58	0.80	-4.34	1.29	3142	3142	5	37	--
12	26.22	-100.47	-21.71	0.80	-3.67	1.02	3142	3142	5	44	--
13	21.11	-120.63	-12.49	0.31	-5.38	2.49	3142	3142	5	27	--
14	26.33	-112.97	-17.06	0.35	-5.51	1.71	3142	3142	5	29	--
15	29.34	-105.03	-21.64	0.37	-4.80	1.19	3142	3142	5	35	--
16	30.11	-97.02	-25.88	0.45	-3.88	0.98	3142	3142	5	42	--
Massimi/minimi											
1							3142				
1								3142			
13										27	

Muro : 98 - Nodi: [80-84-148-141], Pann.X=4, Pann.Y=4Spess.=40 cm, Terreno=--,Criterio=CLS_Muri_ND, Materiale=C35/45: **Verificato**

Armatura a maglia doppia

Pannello	Nx	Ny	Nxy	Mx	My	Mxy	Ax	Ay	C	Cs	ZE
	kN	kN	kN	kN*m	kN*m	kN*m	mmq	mmq			
1	24.84	-119.12	-15.82	-0.53	-6.24	2.62	3142	3142	5	24	--
2	29.89	-110.27	-20.65	-0.40	-6.23	1.70	3142	3142	5	26	--
3	32.65	-101.38	-25.30	-0.14	-5.13	1.21	3142	3142	5	33	--

Pannello	Nx	Ny	Nxy	Mx	My	Mxy	Ax	Ay	C	Cs	ZE
4	32.84	-92.68	-29.43	0.21	-3.99	1.06	3142	3142	5	41	--
5	27.56	-117.67	-18.89	-1.73	-7.05	2.76	3142	3142	5	21	--
6	32.34	-107.42	-23.78	-1.32	-6.79	1.83	3142	3142	5	24	--
7	34.89	-97.66	-28.29	-0.57	-5.32	1.41	3142	3142	5	31	--
8	208.47	-124.77	29.53	2.65	-2.43	1.53	3142	3142	2	38	--
9	29.91	-116.01	-23.01	-3.96	-8.02	3.14	3142	3142	5	19	--
10	34.33	-102.93	-27.78	-2.65	-7.33	2.37	3142	3142	5	21	--
11	36.59	-92.31	-31.47	-0.88	-5.51	1.99	3142	3142	5	27	--
12	224.93	-119.90	27.23	3.53	-2.64	1.96	3142	3142	2	28	--
13	133.18	-290.07	74.94	-7.80	-8.26	9.00	3142	3142	3	10	--
14	41.01	-256.69	-32.27	-2.08	-6.44	6.69	3142	3142	4	18	--
15	183.24	-269.12	31.30	3.04	-3.96	6.14	3142	3142	3	18	--
16	186.83	-254.79	7.22	4.31	-3.15	4.50	3142	3142	3	18	--
Massimi/minimi											
1							3142				
1								3142			
13										10	

Muro : 99 - Nodi : [48-55-83-84], Pann.X=4, Pann.Y=4Spess.=40 cm, Terreno=--,Criterio=CLS_Muri_ND, Materiale=C35/45: **Verificato**

Armatura a maglia doppia

Pannello	Nx	Ny	Nxy	Mx	My	Mxy	Ax	Ay	C	Cs	ZE
	kN	kN	kN	kN*m	kN*m	kN*m	mmq	mmq			
1	-8.21	-123.52	-7.83	0.68	6.73	0.80	3142	3142	5	28	--
2	34.87	-255.75	172.43	0.26	3.40	2.19	3142	3142	3	41	--
3	79.61	-262.43	173.16	-0.28	1.13	2.57	3142	3142	3	62	--
4	48.52	-93.07	30.10	0.35	-2.74	1.53	3142	3142	1	48	--
5	-10.20	-184.19	167.41	1.29	9.34	1.21	3142	3142	3	21	--
6	25.99	-181.08	175.90	1.06	5.67	2.28	3142	3142	3	27	--
7	65.48	-177.23	186.43	0.95	1.96	2.98	3142	3142	3	44	--
8	138.60	-38.40	187.05	-0.08	-2.19	3.97	3142	3142	2	32	--
9	-17.44	-117.82	155.52	1.90	14.39	2.40	3142	3142	3	12	--
10	-0.67	-104.22	164.16	1.02	7.31	2.82	3142	3142	3	20	--
11	33.19	-91.23	182.00	-0.24	2.57	2.70	3142	3142	3	39	--
12	103.07	36.83	178.88	-2.40	-0.95	2.41	3142	3142	2	36	--
13	2.98	42.66	-41.29	0.93	10.34	1.30	3142	3142	5	16	--
14	-15.25	34.72	-29.43	-0.29	5.00	0.74	3142	3142	5	32	--
15	-8.11	-63.16	141.64	-2.87	0.64	-4.08	3142	3142	3	28	--
16	39.93	-25.90	158.28	-5.28	-1.23	-4.99	3142	3142	3	18	--
Massimi/minimi											
1							3142				
1								3142			
9										12	

Muro : 100 - Nodi : [84-83-155-148], Pann.X=4, Pann.Y=4Spess.=40 cm, Terreno=--,Criterio=CLS_Muri_ND, Materiale=C35/45: **Verificato**

Armatura a maglia doppia

Pannello	Nx	Ny	Nxy	Mx	My	Mxy	Ax	Ay	C	Cs	ZE
	kN	kN	kN	kN*m	kN*m	kN*m	mmq	mmq			
1	36.57	-101.46	-8.72	-0.36	-7.27	3.38	3142	3142	5	19	--
2	45.41	-91.37	-13.08	-1.20	-7.18	4.20	3142	3142	5	18	--
3	51.49	-85.23	-21.01	-0.85	-6.53	3.76	3142	3142	5	20	--
4	52.91	-79.52	-31.60	-0.14	-5.99	2.84	3142	3142	5	23	--
5	217.94	-46.06	191.45	-0.60	-4.23	4.51	3142	3142	2	23	--
6	315.58	-68.69	175.41	-0.94	-5.89	5.11	3142	3142	2	18	--
7	69.15	-69.71	-19.51	-0.68	-7.29	4.40	3142	3142	5	17	--
8	73.91	-71.23	-33.42	-0.70	-7.96	3.68	3142	3142	5	17	--
9	196.47	49.26	206.49	-4.46	-3.23	3.01	3142	3142	2	21	--

Pannello	Nx	Ny	Nxy	Mx	My	Mxy	Ax	Ay	C	Cs	ZE
10	342.62	39.34	229.79	-6.39	-5.34	4.10	3142	3142	2	13	--
11	551.91	-12.39	218.98	-6.57	-7.53	5.56	3142	3142	2	8.4	--
12	605.66	-19.77	46.31	-6.58	-10.61	4.70	3142	3142	2	8.2	--
13	118.27	24.68	179.54	-8.68	-2.37	-4.95	3142	3142	3	13	--
14	247.79	101.72	210.55	-13.53	-3.76	-4.17	3142	3142	3	8.6	--
15	499.43	337.09	211.61	-21.38	-5.89	0.70	3142	3142	2	5.0	--
16	1142.59	313.45	341.89	-19.54	-12.42	9.02	4513	3142	2	3.1	--
Massimi/minimi											
16							4513				
1								3142			
16										3.1	

Muro : 101 - Nodi: [0-149-150-87], Pann.X=4, Pann.Y=4Spess.=20 cm, Terreno=--,Criterio=CLS_Muri_ND, Materiale=C35/45: **Verificato**

Armatura a maglia doppia

Pannello	Nx	Ny	Nxy	Mx	My	Mxy	Ax	Ay	C	Cs	ZE
	kN	kN	kN	kN*m	kN*m	kN*m	mmq	mmq			
1	1.11	77.17	-3.66	0.03	-0.08	-0.05	3142	3142	6	>100	--
2	1.53	87.00	-3.37	0.04	-0.15	-0.12	3142	3142	6	>100	--
3	-1.80	14.40	9.36	-0.03	-0.45	-0.07	3142	3142	3	>100	--
4	-64.59	-74.04	75.60	-0.30	-0.69	0.19	3142	3142	3	91	--
5	3.02	-1.65	-0.17	0.11	0.02	-0.07	3142	3142	2	>100	--
6	1.11	61.20	-6.96	0.12	-0.19	-0.11	3142	3142	6	>100	--
7	-5.50	60.20	1.64	0.16	-0.26	-0.18	3142	3142	6	>100	--
8	-91.44	-63.57	86.64	-0.01	-0.51	0.13	3142	3142	3	>100	--
9	-5.16	-18.08	21.85	0.17	-0.01	-0.08	3142	3142	3	>100	--
10	-1.10	40.25	-7.48	0.21	-0.22	-0.09	3142	3142	6	>100	--
11	-11.76	40.26	2.06	0.28	-0.29	-0.15	3142	3142	6	>100	--
12	-111.49	-78.73	87.75	0.22	-0.35	0.16	3142	3142	3	>100	--
13	-13.14	-41.48	34.37	0.23	-0.04	-0.08	3142	3142	3	>100	--
14	-7.46	-56.01	24.16	0.27	-0.17	-0.08	3142	3142	2	>100	--
15	-33.78	-71.88	36.91	0.31	-0.30	-0.12	3142	3142	2	>100	--
16	-122.15	-92.84	88.78	0.35	-0.25	0.18	3142	3142	3	>100	--
Massimi/minimi											
1							3142				
1								3142			
4										91	

Muro : 102 - Nodi: [84-148-149-0], Pann.X=4, Pann.Y=4Spess.=20 cm, Terreno=--,Criterio=CLS_Muri_ND, Materiale=C35/45: **Verificato**

Armatura a maglia doppia

Pannello	Nx	Ny	Nxy	Mx	My	Mxy	Ax	Ay	C	Cs	ZE
	kN	kN	kN	kN*m	kN*m	kN*m	mmq	mmq			
1	-53.62	-81.31	-67.44	-0.31	0.01	-0.42	3142	3142	4	>100	--
2	-0.25	-0.77	-5.37	0.03	0.42	0.12	3142	3142	2	>100	--
3	4.09	56.26	-2.25	0.04	0.43	0.09	3142	3142	3	>100	--
4	2.73	59.18	0.85	0.03	0.21	-0.02	3142	3142	3	>100	--
5	-73.18	-1.63	-75.84	0.08	0.55	-0.30	3142	3142	3	89	--
6	-8.90	-7.79	-21.33	0.20	0.49	0.17	3142	3142	2	>100	--
7	-1.57	2.52	-5.70	0.14	0.36	0.10	3142	3142	2	>100	--
8	1.81	-19.69	-4.62	0.03	0.20	0.01	3142	3142	5	>100	--
9	-80.57	17.12	-63.02	0.38	0.98	-0.28	3142	3142	3	59	--
10	-34.79	0.90	-40.38	0.39	0.56	0.10	3142	3142	3	>100	--
11	-4.01	-7.40	-6.72	0.25	0.33	0.08	3142	3142	2	>100	--
12	0.14	30.03	-18.28	0.19	-0.05	0.03	3142	3142	6	>100	--
13	-83.31	20.47	-48.20	0.54	1.23	-0.23	3142	3142	3	51	--
14	-47.17	-1.24	-33.94	0.48	0.61	0.04	3142	3142	3	>100	--
15	-7.33	-13.02	-2.51	0.35	0.30	0.05	3142	3142	2	>100	--

Pannello	Nx	Ny	Nxy	Mx	My	Mxy	Ax	Ay	C	Cs	ZE
16	-13.93	-24.46	14.45	0.26	0.11	-0.02	3142	3142	3	>100	--
Massimi/minimi											
1							3142				
1								3142			
13										51	

Muro : 103 - Nodi: [116-123-179-177], Pann.X=4, Pann.Y=4Spess.=40 cm, Terreno=--,Criterio=CLS_Muri_ND, Materiale=C35/45: **Verificato**

Armatura a maglia doppia

Pannello	Nx	Ny	Nxy	Mx	My	Mxy	Ax	Ay	C	Cs	ZE
	kN	kN	kN	kN*m	kN*m	kN*m	mmq	mmq			
1	-33.89	-83.42	8.43	16.27	55.72	-3.76	3142	3142	5	3.4	--
2	-36.31	-79.01	7.51	16.97	57.88	-3.11	3142	3142	5	3.3	--
3	-37.97	-76.31	6.67	17.50	59.24	-2.41	3142	3142	5	3.3	--
4	-39.10	-74.52	5.74	17.87	59.82	-1.72	3142	3142	5	3.3	--
5	-32.90	-85.11	5.56	15.44	57.11	-2.99	3142	3142	5	3.4	--
6	-34.88	-81.76	4.95	16.17	59.37	-2.42	3142	3142	5	3.3	--
7	-36.58	-78.95	4.41	16.74	60.80	-1.82	3142	3142	5	3.2	--
8	-38.32	-76.07	3.88	17.17	61.43	-1.21	3142	3142	5	3.2	--
9	-32.12	-86.80	2.79	14.51	58.30	-2.09	3142	3142	5	3.4	--
10	-33.87	-83.73	2.35	15.24	60.65	-1.61	3142	3142	5	3.3	--
11	-35.61	-80.87	1.90	15.82	62.16	-1.10	3142	3142	5	3.2	--
12	-37.40	-78.02	1.51	16.25	62.83	-0.58	3142	3142	5	3.2	--
13	-31.91	-87.08	0.39	13.52	59.35	-1.47	3142	3142	5	3.4	--
14	-32.97	-85.19	-0.22	14.20	61.80	-1.04	3142	3142	5	3.3	--
15	-34.68	-82.40	-0.65	14.74	63.38	-0.57	3142	3142	5	3.2	--
16	-36.91	-79.03	-1.22	15.13	64.12	-0.10	3142	3142	5	3.2	--
Massimi/minimi											
1							3142				
1								3142			
16										3.2	

Muro : 104 - Nodi: [120-178-180-127], Pann.X=4, Pann.Y=4Spess.=40 cm, Terreno=--,Criterio=CLS_Muri_ND, Materiale=C35/45: **Verificato**

Armatura a maglia doppia

Pannello	Nx	Ny	Nxy	Mx	My	Mxy	Ax	Ay	C	Cs	ZE
	kN	kN	kN	kN*m	kN*m	kN*m	mmq	mmq			
1	-67.10	0.49	66.97	33.48	9.40	-1.86	3142	3142	5	5.7	--
2	-67.55	2.82	63.69	34.32	8.95	-1.42	3142	3142	5	5.6	--
3	-68.70	5.11	60.62	35.02	8.45	-0.91	3142	3142	5	5.6	--
4	-69.25	7.13	57.77	35.64	7.93	-0.55	3142	3142	5	5.6	--
5	-62.26	0.32	65.26	34.28	9.73	-1.46	3142	3142	5	5.6	--
6	-64.24	3.48	62.40	35.16	9.31	-1.08	3142	3142	5	5.5	--
7	-65.89	6.20	59.45	35.91	8.81	-0.63	3142	3142	5	5.5	--
8	-67.25	8.65	56.64	36.57	8.27	-0.31	3142	3142	5	5.5	--
9	-59.64	1.22	63.56	34.57	9.95	-1.05	3142	3142	5	5.6	--
10	-61.33	4.45	61.11	35.49	9.56	-0.73	3142	3142	5	5.5	--
11	-62.90	7.26	58.28	36.27	9.08	-0.34	3142	3142	5	5.5	--
12	-64.27	9.81	55.43	36.96	8.52	-0.05	3142	3142	5	5.4	--
13	-59.24	3.23	61.64	34.40	10.07	-0.65	3142	3142	5	5.7	--
14	-58.55	5.61	59.68	35.33	9.73	-0.39	3142	3142	5	5.6	--
15	-59.43	8.17	56.99	36.13	9.26	-0.05	3142	3142	5	5.5	--
16	-59.93	10.43	54.17	36.83	8.68	0.21	3142	3142	5	5.4	--
Massimi/minimi											
1							3142				
1								3142			
16										5.4	

Muro : 105 - Nodi: [123-132-181-179], Pann.X=4, Pann.Y=4Spess.=40 cm, Terreno=--,Criterio=CLS_Muri_ND, Materiale=C35/45: **Verificato**

Armatura a maglia doppia

Pannello	Nx	Ny	Nxy	Mx	My	Mxy	Ax	Ay	C	Cs	Z _E
	kN	kN	kN	kN*m	kN*m	kN*m	mmq	mmq			
1	-30.17	-86.16	-5.66	10.90	61.03	-0.13	3142	3142	5	3.3	--
2	-31.65	-85.49	-5.87	11.35	63.62	0.11	3142	3142	5	3.2	--
3	-32.99	-83.20	-6.09	11.67	65.29	0.36	3142	3142	5	3.1	--
4	-34.25	-79.90	-6.38	11.84	66.09	0.60	3142	3142	5	3.1	--
5	-28.05	-83.30	-10.43	8.79	62.41	0.46	3142	3142	5	3.2	--
6	-29.20	-83.03	-10.79	9.09	65.05	0.50	3142	3142	5	3.1	--
7	-30.24	-81.14	-11.17	9.26	66.76	0.52	3142	3142	5	3.0	--
8	-31.22	-78.29	-11.54	9.31	67.54	0.54	3142	3142	5	3.0	--
9	-21.12	-86.34	-13.14	9.65	61.96	0.26	3142	3142	5	3.3	--
10	-22.33	-85.60	-14.11	9.96	64.55	0.13	3142	3142	5	3.2	--
11	-23.52	-83.67	-15.08	10.14	66.21	-0.00	3142	3142	5	3.1	--
12	-24.73	-81.13	-15.99	10.18	66.96	-0.13	3142	3142	5	3.0	--
13	-5.70	-95.38	-16.95	13.66	58.66	1.27	3142	3142	5	3.4	--
14	-7.37	-93.55	-18.88	14.14	61.07	0.77	3142	3142	5	3.3	--
15	-9.28	-91.23	-20.75	14.46	62.63	0.24	3142	3142	5	3.3	--
16	-11.46	-88.86	-22.50	14.62	63.36	-0.26	3142	3142	5	3.2	--
Massimi/minimi											
1							3142				
1								3142			
8										3.0	

Muro : 106 - Nodi: [127-180-182-136], Pann.X=4, Pann.Y=4Spess.=40 cm, Terreno=--,Criterio=CLS_Muri_ND, Materiale=C35/45: **Verificato**

Armatura a maglia doppia

Pannello	Nx	Ny	Nxy	Mx	My	Mxy	Ax	Ay	C	Cs	Z _E
	kN	kN	kN	kN*m	kN*m	kN*m	mmq	mmq			
1	-71.88	12.76	52.00	36.53	6.66	0.30	3142	3142	5	5.5	--
2	-73.63	19.17	50.12	36.80	6.11	0.76	3142	3142	5	5.4	--
3	-74.60	24.72	52.92	34.80	7.55	0.97	3142	3142	5	5.7	--
4	-75.14	30.90	55.33	28.74	8.67	1.82	3142	3142	5	6.6	--
5	-70.07	14.38	51.23	37.50	6.87	0.42	3142	3142	5	5.3	--
6	-72.36	21.27	49.58	37.71	6.22	0.69	3142	3142	5	5.3	--
7	-73.14	27.05	52.38	35.54	7.67	0.66	3142	3142	5	5.6	--
8	-73.07	33.48	54.65	29.15	8.82	1.06	3142	3142	5	6.7	--
9	-67.78	16.10	50.40	37.92	6.99	0.54	3142	3142	5	5.2	--
10	-70.93	23.38	49.02	38.06	6.23	0.61	3142	3142	5	5.2	--
11	-71.85	29.35	51.79	35.76	7.70	0.32	3142	3142	5	5.6	--
12	-71.44	35.98	53.97	29.16	8.85	0.26	3142	3142	5	6.9	--
13	-65.11	17.93	49.50	37.79	7.02	0.65	3142	3142	5	5.2	--
14	-69.58	25.49	48.48	37.86	6.17	0.52	3142	3142	5	5.3	--
15	-71.12	31.56	51.20	35.47	7.63	-0.01	3142	3142	5	5.7	--
16	-70.73	38.35	53.28	28.78	8.78	-0.53	3142	3142	5	6.9	--
Massimi/minimi											
1							3142				
1								3142			
10										5.2	

Muro : 107 - Nodi: [156-190-189-155], Pann.X=4, Pann.Y=4Spess.=40 cm, Terreno=--,Criterio=CLS_Muri_ND, Materiale=C35/45: **Verificato**

Armatura a maglia doppia

Pannello	Nx	Ny	Nxy	Mx	My	Mxy	Ax	Ay	C	Cs	Z _E
	kN	kN	kN	kN*m	kN*m	kN*m	mmq	mmq			

Pannello	Nx	Ny	Nxy	Mx	My	Mxy	Ax	Ay	C	Cs	ZE
1	-56.16	16.26	-16.79	6.90	1.40	-1.16	3142	3142	3	25	--
2	-37.65	7.29	-27.92	2.03	0.39	2.48	3142	3142	4	44	--
3	-11.40	-3.79	-29.51	-9.24	-1.85	-3.60	3142	3142	2	15	--
4	-11.34	3.55	-39.17	-23.73	-2.38	-4.73	3142	3142	2	6.8	--
5	-12.94	48.07	-14.99	4.21	2.12	-1.15	3142	3142	3	36	--
6	-19.05	26.34	-24.92	1.17	0.63	2.13	3142	3142	4	59	--
7	-9.63	-7.34	-28.18	-6.03	-3.39	-4.51	3142	3142	2	18	--
8	-15.88	-7.58	-37.07	-9.78	0.20	-6.67	3142	3142	2	12	--
9	-5.06	81.62	-10.52	1.94	2.70	-1.00	3142	3142	3	48	--
10	-11.66	48.41	-16.69	0.47	0.86	1.61	3142	3142	4	74	--
11	-0.90	-10.72	-21.46	-2.52	-5.01	-4.08	3142	3142	2	21	--
12	-26.02	-44.03	-31.69	-4.07	1.07	-5.77	3142	3142	2	20	--
13	-4.45	117.83	-2.59	0.39	2.75	-0.46	3142	3142	3	54	--
14	-13.85	70.49	-8.00	0.09	0.84	0.88	3142	3142	4	>100	--
15	-8.39	-1.70	1.44	-0.08	-5.63	-2.08	3142	3142	2	25	--
16	-50.12	-124.27	-32.74	-2.61	0.35	-4.42	3142	3142	2	28	--
Massimi/minimi											
1							3142				
1								3142			
4										6.8	

Muro : 108 - Nodi : [157-187-190-156], Pann.X=4, Pann.Y=4Spess.=40 cm, Terreno=--,Criterio=CLS_Muri_ND, Materiale=C35/45: **Verificato**

Armatura a maglia doppia

Pannello	Nx	Ny	Nxy	Mx	My	Mxy	Ax	Ay	C	Cs	ZE
	kN	kN	kN	kN*m	kN*m	kN*m	mmq	mmq			
1	-49.89	-15.81	67.92	-30.57	-0.46	-3.39	3142	3142	2	5.9	--
2	-38.84	1.21	25.03	-16.77	-3.32	-4.05	3142	3142	3	9.5	--
3	-45.10	20.16	2.92	0.40	-0.36	-8.41	3142	3142	3	21	--
4	-50.04	22.75	-10.68	7.11	1.33	-5.51	3142	3142	3	16	--
5	-125.07	4.52	118.41	-10.11	4.91	-4.87	3142	3142	3	14	--
6	-19.50	32.62	23.81	-9.53	-5.19	-2.31	3142	3142	3	16	--
7	-2.90	55.83	0.68	-0.34	-0.91	-7.46	3142	3142	3	22	--
8	-5.56	56.23	-7.64	4.19	1.87	-5.24	3142	3142	3	20	--
9	-86.70	8.63	112.01	-1.73	7.65	-5.75	3142	3142	3	14	--
10	-7.06	79.29	11.36	-3.51	-6.91	-1.52	3142	3142	3	21	--
11	-1.51	99.89	-1.82	-0.49	-1.09	-5.75	3142	3142	3	26	--
12	-2.29	95.95	-4.52	1.86	2.35	-4.45	3142	3142	3	26	--
13	-10.35	14.26	85.26	1.15	10.15	-6.59	3142	3142	3	11	--
14	-3.36	113.16	-4.83	-0.63	-7.92	1.05	3142	3142	2	19	--
15	-9.79	144.94	-0.08	-0.15	-1.20	-2.96	3142	3142	3	41	--
16	-3.27	137.92	-2.47	0.35	2.35	-2.44	3142	3142	3	35	--
Massimi/minimi											
1							3142				
1								3142			
1										5.9	

Muro : 109 - Nodi : [146-153-188-195], Pann.X=4, Pann.Y=4Spess.=40 cm, Terreno=--,Criterio=CLS_Muri_ND, Materiale=C35/45: **Verificato**

Armatura a maglia doppia

Pannello	Nx	Ny	Nxy	Mx	My	Mxy	Ax	Ay	C	Cs	ZE
	kN	kN	kN	kN*m	kN*m	kN*m	mmq	mmq			
1	68.84	-64.16	-21.53	18.62	27.48	5.56	3142	3142	5	6.1	--
2	67.37	-73.35	-29.40	18.61	29.35	2.48	3142	3142	5	6.4	--
3	62.93	-70.30	-35.47	18.13	31.17	-0.24	3142	3142	5	6.4	--
4	57.16	-68.34	-41.33	17.48	32.80	-2.76	3142	3142	5	5.7	--
5	438.68	-53.32	30.43	9.22	7.72	3.51	3142	3142	2	9.5	--
6	429.99	-71.62	6.07	8.71	10.36	0.87	3142	3142	2	13	--

Pannello	Nx	Ny	Nxy	Mx	My	Mxy	Ax	Ay	C	Cs	ZE
7	90.89	-45.65	-37.44	10.11	16.87	-3.22	3142	3142	5	9.9	--
8	81.40	-44.12	-44.95	9.34	19.79	-6.64	3142	3142	5	7.5	--
9	623.08	29.23	67.94	-6.29	-8.53	1.59	3142	3142	2	11	--
10	618.89	7.98	-40.95	-6.87	-7.77	-2.61	3142	3142	2	9.5	--
11	545.69	39.63	-86.49	-7.90	-2.72	-6.43	3142	3142	2	7.2	--
12	466.67	59.58	-103.00	-8.41	3.00	-9.06	3142	3142	2	6.7	--
13	1089.03	280.60	-246.18	-70.69	-47.47	23.34	4600	3928	2	1.1	--
14	687.68	420.47	-125.15	-50.26	-29.70	5.83	4600	3928	2	3.0	--
15	509.63	386.07	-61.72	-39.51	-16.28	0.02	4600	3928	2	5.0	--
16	420.09	325.47	-28.46	-32.08	-6.41	-2.37	4600	3928	2	6.1	--
Massimi/minimi											
13							4600				
13								3928			
13										1.1	

Muro : 110 - Nodi: [150-194-187-157], Pann.X=4, Pann.Y=4Spess.=40 cm, Terreno=--,Criterio=CLS_Muri_ND, Materiale=C35/45: **Verificato**

Armatura a maglia doppia

Pannello	Nx	Ny	Nxy	Mx	My	Mxy	Ax	Ay	C	Cs	ZE
	kN	kN	kN	kN*m	kN*m	kN*m	mmq	mmq			
1	-180.49	265.93	146.25	5.70	-11.56	-1.87	3142	3142	3	11	--
2	-112.39	83.07	93.12	8.28	0.90	-1.89	3142	3142	5	21	--
3	-183.69	524.17	153.82	13.03	6.35	0.58	3142	3142	3	15	--
4	41.02	1143.18	-133.16	14.00	11.29	-4.21	3142	3262	2	1.2	--
5	-182.49	268.42	125.74	5.36	-11.82	-1.50	3142	3142	3	11	--
6	-101.74	84.53	88.63	7.93	0.74	-1.54	3142	3142	5	22	--
7	-176.83	523.68	58.48	12.02	6.80	1.06	3142	3142	3	14	--
8	155.25	767.44	-81.64	12.73	8.57	-2.04	3142	3142	2	6.3	--
9	-175.46	264.83	107.51	4.93	-11.90	-1.14	3142	3142	3	11	--
10	-172.13	346.18	80.64	8.25	0.65	0.96	3142	3142	3	24	--
11	-144.23	465.57	12.88	10.66	6.98	1.51	3142	3142	3	14	--
12	152.32	575.69	-53.10	11.60	7.86	-1.74	3142	3142	2	10	--
13	-172.49	259.62	89.81	4.43	-11.91	-0.70	3142	3142	3	12	--
14	-167.45	329.08	57.21	7.68	0.59	1.61	3142	3142	3	23	--
15	-112.91	398.12	-8.95	9.60	6.92	1.69	3142	3142	3	15	--
16	135.39	456.83	-40.21	10.65	6.84	-2.49	3142	3142	2	13	--
Massimi/minimi											
1							3142				
4								3262			
4										1.2	

Muro : 111 - Nodi: [132-139-192-181], Pann.X=4, Pann.Y=4Spess.=40 cm, Terreno=--,Criterio=CLS_Muri_ND, Materiale=C35/45: **Verificato**

Armatura a maglia doppia

Pannello	Nx	Ny	Nxy	Mx	My	Mxy	Ax	Ay	C	Cs	ZE
	kN	kN	kN	kN*m	kN*m	kN*m	mmq	mmq			
1	9.44	-100.71	-20.72	17.59	54.89	2.96	3142	3142	5	3.6	--
2	6.88	-96.81	-23.48	18.23	57.10	2.06	3142	3142	5	3.5	--
3	4.27	-94.22	-26.30	18.69	58.54	1.13	3142	3142	5	3.4	--
4	1.70	-92.91	-28.95	18.98	59.23	0.23	3142	3142	5	3.5	--
5	15.63	-99.60	-22.19	18.84	52.55	3.50	3142	3142	5	3.7	--
6	13.10	-96.81	-25.37	19.49	54.67	2.49	3142	3142	5	3.6	--
7	10.27	-94.24	-28.34	19.95	56.06	1.45	3142	3142	5	3.6	--
8	6.97	-91.55	-31.31	20.23	56.74	0.46	3142	3142	5	3.6	--
9	22.67	-98.35	-23.50	19.86	49.85	4.29	3142	3142	5	3.8	--
10	20.24	-96.13	-26.97	20.45	51.90	3.08	3142	3142	5	3.7	--
11	17.19	-93.62	-30.37	20.84	53.27	1.85	3142	3142	5	3.7	--
12	13.41	-90.61	-33.67	21.05	53.97	0.68	3142	3142	5	3.8	--

Pannello	Nx	Ny	Nxy	Mx	My	Mxy	Ax	Ay	C	Cs	ZE
13	30.73	-96.25	-24.45	20.62	46.56	4.98	3142	3142	5	4.0	--
14	28.16	-94.10	-28.28	21.11	48.54	3.51	3142	3142	5	4.0	--
15	24.94	-91.76	-32.06	21.38	49.91	2.05	3142	3142	5	4.0	--
16	21.03	-89.12	-35.71	21.46	50.68	0.66	3142	3142	5	4.0	--
Massimi/minimi											
1							3142				
1								3142			
3										3.4	

Muro : 112 - Nodi : [136-182-191-143], Pann.X=4, Pann.Y=4Spess.=40 cm, Terreno=--,Criterio=CLS_Muri_ND, Materiale=C35/45: **Verificato**

Armatura a maglia doppia

Pannello	Nx	Ny	Nxy	Mx	My	Mxy	Ax	Ay	C	Cs	ZE
	kN	kN	kN	kN*m	kN*m	kN*m	mmq	mmq			
1	-76.37	36.17	54.31	22.65	7.18	2.71	3142	3142	5	8.0	--
2	-76.80	38.19	52.91	19.47	5.09	2.90	3142	3142	5	9.1	--
3	-78.51	40.99	51.28	16.09	1.54	3.13	3142	3142	5	11	--
4	-81.28	44.61	49.39	12.43	-3.93	3.11	3142	3142	5	13	--
5	-73.39	38.34	53.26	22.76	7.33	1.57	3142	3142	5	8.3	--
6	-74.39	40.69	51.72	19.41	5.22	1.73	3142	3142	5	9.6	--
7	-76.10	43.60	49.83	15.88	1.58	1.91	3142	3142	5	11	--
8	-78.62	47.21	47.56	12.10	-4.07	1.92	3142	3142	5	15	--
9	-71.11	40.77	52.24	22.58	7.41	0.38	3142	3142	5	8.8	--
10	-71.84	43.11	50.56	19.14	5.29	0.52	3142	3142	5	10	--
11	-73.40	46.06	48.36	15.51	1.59	0.65	3142	3142	5	13	--
12	-75.75	49.61	45.77	11.66	-4.17	0.70	3142	3142	5	16	--
13	-69.94	43.63	51.11	22.13	7.42	-0.80	3142	3142	5	8.8	--
14	-69.02	45.41	49.33	18.66	5.29	-0.69	3142	3142	5	10	--
15	-69.97	48.11	46.84	15.01	1.57	-0.60	3142	3142	5	13	--
16	-72.30	51.88	44.13	11.13	-4.22	-0.50	3142	3142	5	17	--
Massimi/minimi											
1							3142				
1								3142			
1										8.0	

Muro : 113 - Nodi : [139-146-195-192], Pann.X=4, Pann.Y=4Spess.=40 cm, Terreno=--,Criterio=CLS_Muri_ND, Materiale=C35/45: **Verificato**

Armatura a maglia doppia

Pannello	Nx	Ny	Nxy	Mx	My	Mxy	Ax	Ay	C	Cs	ZE
	kN	kN	kN	kN*m	kN*m	kN*m	mmq	mmq			
1	37.47	-93.33	-24.67	21.00	43.59	5.38	3142	3142	5	4.2	--
2	34.66	-91.37	-28.90	21.35	45.53	3.70	3142	3142	5	4.2	--
3	31.31	-89.27	-33.07	21.51	46.91	2.02	3142	3142	5	4.2	--
4	27.36	-87.06	-37.18	21.46	47.76	0.44	3142	3142	5	4.2	--
5	42.46	-90.70	-24.67	21.06	41.13	5.58	3142	3142	5	4.4	--
6	39.60	-88.95	-29.08	21.34	43.04	3.72	3142	3142	5	4.4	--
7	36.36	-87.00	-33.60	21.40	44.46	1.86	3142	3142	5	4.4	--
8	32.28	-84.80	-38.07	21.24	45.39	0.13	3142	3142	5	4.5	--
9	47.80	-87.71	-24.27	20.94	38.38	5.71	3142	3142	5	4.6	--
10	44.52	-85.67	-29.00	21.13	40.27	3.65	3142	3142	5	4.7	--
11	42.11	-83.98	-34.43	21.10	41.73	1.60	3142	3142	5	4.7	--
12	37.50	-81.92	-38.98	20.82	42.77	-0.32	3142	3142	5	4.7	--
13	50.55	-83.97	-23.31	20.56	35.29	5.72	3142	3142	5	5.0	--
14	51.45	-80.71	-29.93	20.62	37.20	3.51	3142	3142	5	5.0	--
15	48.26	-80.42	-34.98	20.55	38.76	1.25	3142	3142	5	5.1	--
16	42.27	-77.89	-40.23	20.14	39.96	-0.84	3142	3142	5	5.0	--
Massimi/minimi											
1							3142				

Pannello	Nx	Ny	Nxy	Mx	My	Mxy	Ax	Ay	C	Cs	ZE
1								3142			
2										4.2	

Muro : 114 - Nodi : [143-191-194-150], Pann.X=4, Pann.Y=4Spess.=40 cm, Terreno=--,Criterio=CLS_Muri_ND, Materiale=C35/45: **Verificato**

Armatura a maglia doppia

Pannello	Nx	Ny	Nxy	Mx	My	Mxy	Ax	Ay	C	Cs	ZE
	kN	kN	kN	kN*m	kN*m	kN*m	mmq	mmq			
1	-83.83	48.12	47.87	9.51	-9.86	2.82	3142	3142	5	14	--
2	-179.86	193.59	65.31	6.24	-14.03	1.95	3142	3142	3	10	--
3	-180.82	208.50	61.93	4.80	-19.81	2.56	3142	3142	3	7.1	--
4	-184.36	222.57	59.70	3.33	-26.71	5.24	3142	3142	3	4.9	--
5	-81.34	50.66	45.71	9.09	-10.19	1.76	3142	3142	5	15	--
6	-175.43	194.70	53.95	6.08	-14.16	1.37	3142	3142	3	10	--
7	-176.27	208.31	49.94	4.58	-20.07	2.16	3142	3142	3	7.1	--
8	-177.77	225.00	44.88	3.04	-27.05	4.96	3142	3142	3	4.9	--
9	-78.67	53.05	43.64	8.61	-10.41	0.68	3142	3142	5	17	--
10	-170.28	194.19	43.15	5.78	-14.12	0.76	3142	3142	3	11	--
11	-171.03	207.89	37.47	4.27	-20.07	1.74	3142	3142	3	7.3	--
12	-170.94	222.97	30.79	2.67	-27.18	4.69	3142	3142	3	4.9	--
13	-76.26	55.33	41.73	8.09	-10.48	-0.36	3142	3142	5	17	--
14	-77.95	58.03	39.88	6.05	-16.23	-0.18	3142	3142	5	11	--
15	-163.96	205.02	26.50	3.86	-19.83	1.29	3142	3142	3	7.5	--
16	-163.59	217.72	17.72	2.21	-26.82	4.46	3142	3142	3	5.0	--
Massimi/minimi											
1							3142				
1								3142			
8										4.9	

Muro : 115 - Nodi : [157-187-197-170], Pann.X=4, Pann.Y=4Spess.=40 cm, Terreno=--,Criterio=CLS_Muri_ND, Materiale=C35/45: **Verificato**

Armatura a maglia doppia

Pannello	Nx	Ny	Nxy	Mx	My	Mxy	Ax	Ay	C	Cs	ZE
	kN	kN	kN	kN*m	kN*m	kN*m	mmq	mmq			
1	54.10	89.37	-206.27	0.93	3.06	5.74	3142	3142	3	20	--
2	-98.15	22.67	-96.99	-7.80	-0.42	3.58	3142	3142	3	18	--
3	-164.16	10.48	-18.62	-14.67	-1.99	5.26	3142	3142	3	11	--
4	-194.45	3.62	-34.28	-19.66	-2.97	2.30	3142	3142	3	10	--
5	-36.32	188.10	-119.82	4.53	6.83	5.22	3142	3142	3	13	--
6	-33.50	120.56	-44.57	-4.18	-0.08	2.03	3142	3142	6	32	--
7	-168.55	55.48	-18.88	-6.41	-1.33	2.69	3142	3142	3	24	--
8	-192.29	42.16	-14.06	-8.66	-2.51	1.37	3142	3142	3	22	--
9	-72.20	190.85	-67.80	6.49	8.41	3.66	3142	3142	3	13	--
10	-80.43	51.57	-31.54	4.75	2.76	-0.29	3142	3142	1	40	--
11	-82.71	108.24	2.06	-4.97	-1.34	1.00	3142	3142	6	34	--
12	-105.23	80.88	6.25	-5.85	-1.98	0.51	3142	3142	6	33	--
13	-99.21	180.10	-36.45	7.64	10.95	2.14	3142	3142	3	12	--
14	-96.67	31.08	-19.13	6.90	3.20	-0.98	3142	3142	5	26	--
15	-85.25	25.47	-10.18	6.60	1.18	-0.99	3142	3142	5	27	--
16	-80.99	23.37	-7.48	6.62	0.46	-0.99	3142	3142	5	27	--
Massimi/minimi											
1							3142				
1								3142			
4										10	

Muro [Platea]: 116 - Nodi : [170-169-156-157]Pann=8Spess.=40 cm, Terreno=Terreno1, ,Criterio=CLS_Platee_ND, Materiale=C35/45: **Verificato**

Armatura a maglia doppia

Pannello	Nx	Ny	Nxy	Mx	My	Mxy	Ax	Ay	C	Cs	Z _E
	kN	kN	kN	kN*m	kN*m	kN*m	mmq	mmq			
1	-38.31	64.47	-64.93	-10.86	-3.30	9.30	3142	3142	3	9.8	--
2	-0.29	6.77	-85.55	-0.62	9.91	5.90	3142	3142	3	12	--
3	-117.55	-72.57	-123.49	16.00	13.92	5.88	3142	3142	3	9.6	--
4	-67.68	-2.20	-79.31	13.55	-1.86	7.36	3142	3142	3	9.6	--
5	-23.67	-7.52	-60.97	2.18	-15.98	12.39	3142	3142	3	6.8	--
6	71.08	51.28	-38.75	-5.65	-21.75	12.37	3142	3142	3	5.4	--
7	170.82	207.64	-92.98	-21.34	-24.08	11.67	3142	3142	3	4.4	--
8	-33.70	157.42	-37.90	-15.05	-11.04	7.73	3142	3142	3	8.6	--
Massimi/minimi											
1							3142				
1								3142			
7										4.4	

Muro [Platea]: 117 - Nodi: [154-167-166-153]Pann=16Spess.=40 cm, Terreno=Terreno1, ,Criterio=CLS_Platee_ND, Materiale=C35/45: **Verificato**

Armatura a maglia doppia

Pannello	Nx	Ny	Nxy	Mx	My	Mxy	Ax	Ay	C	Cs	Z _E
	kN	kN	kN	kN*m	kN*m	kN*m	mmq	mmq			
1	-3.81	-9.20	-46.67	-17.82	2.20	-0.47	3142	3142	2	10	--
2	-63.52	50.42	-7.86	-31.83	-6.31	4.10	3142	3142	2	5.6	--
3	-32.48	119.70	8.91	-37.02	-14.09	3.57	3142	3142	2	4.8	--
4	50.53	191.75	35.62	-22.82	-22.59	4.43	3142	3142	3	6.0	--
5	-101.89	-2.32	-91.55	6.94	9.27	-3.88	3142	3142	3	15	--
6	-93.96	29.39	-43.48	3.43	4.32	2.62	3142	3142	3	27	--
7	-59.91	64.93	-21.71	0.54	-7.19	3.12	3142	3142	2	18	--
8	-27.09	70.19	36.64	-0.64	-20.41	11.49	3142	3142	3	5.7	--
9	-165.04	2.60	-91.38	19.45	11.00	-3.22	3142	3142	3	9.5	--
10	-111.78	1.00	-57.42	22.06	8.16	0.99	3142	3142	3	9.0	--
11	-88.13	20.47	-27.80	20.07	-0.93	4.42	3142	3142	2	8.4	--
12	-118.69	23.88	15.30	11.79	-17.80	9.75	3142	3142	3	6.8	--
13	-205.55	-0.25	-60.56	28.61	5.52	-1.70	3142	3142	2	7.3	--
14	-125.44	-14.90	-54.35	37.29	6.58	-1.18	3142	3142	2	5.5	--
15	-111.89	3.56	-38.96	35.34	3.79	-1.84	3142	3142	2	5.6	--
16	-207.00	51.01	0.12	27.01	-7.90	3.47	3142	3142	2	7.3	--
Massimi/minimi											
1							3142				
1								3142			
3										4.8	

Muro [Platea]: 118 - Nodi: [168-167-154-155]Pann=16Spess.=40 cm, Terreno=Terreno1, ,Criterio=CLS_Platee_ND, Materiale=C35/45: **Verificato**

Armatura a maglia doppia

Pannello	Nx	Ny	Nxy	Mx	My	Mxy	Ax	Ay	C	Cs	Z _E
	kN	kN	kN	kN*m	kN*m	kN*m	mmq	mmq			
1	-23.37	-213.25	47.11	2.93	26.68	1.58	3142	3142	2	7.9	--
2	-16.88	-159.86	91.13	2.35	19.10	4.73	3142	3142	2	9.0	--
3	-20.85	-60.04	104.96	1.67	3.98	5.62	3142	3142	2	21	--
4	-46.34	45.44	76.74	1.39	-23.77	-0.69	3142	3142	2	7.5	--
5	-47.55	-154.03	12.86	6.53	36.23	-0.10	3142	3142	2	5.9	--
6	-33.31	-128.32	13.15	4.89	23.59	0.99	3142	3142	3	8.6	--
7	-21.43	-49.24	-0.52	2.31	5.13	1.85	3142	3142	4	28	--
8	-3.23	-48.10	17.63	-5.81	-34.75	-1.17	3142	3142	2	5.5	--
9	-51.19	-149.09	-6.52	7.34	37.04	0.41	3142	3142	2	5.7	--
10	-44.57	-132.82	-13.75	7.89	23.29	-0.69	3142	3142	3	8.8	--
11	-27.31	-56.69	-9.05	4.46	5.69	1.18	3142	3142	4	29	--

Pannello	Nx	Ny	Nxy	Mx	My	Mxy	Ax	Ay	C	Cs	ZE
12	-5.22	-64.50	-5.55	-4.75	-31.80	0.01	3142	3142	2	6.3	--
13	-26.45	-217.46	-28.38	3.02	28.31	-2.06	3142	3142	2	7.4	--
14	-40.65	-173.79	-54.75	5.97	19.06	-5.37	3142	3142	3	8.9	--
15	-41.72	-104.06	-65.13	5.34	6.91	-6.42	3142	3142	3	16	--
16	-32.27	-2.76	-40.06	0.83	-18.19	-2.73	3142	3142	2	9.2	--
Massimi/minimi											
1							3142				
1								3142			
8										5.5	

Muro [Platea]: 119 - Nodi: [169-168-155-156]Pann=9Spess.=40 cm, Terreno=Terreno1, ,Criterio=CLS_Platee_ND, Materiale=C35/45: **Verificato**

Armatura a maglia doppia

Pannello	Nx	Ny	Nxy	Mx	My	Mxy	Ax	Ay	C	Cs	ZE
	kN	kN	kN	kN*m	kN*m	kN*m	mmq	mmq			
1	-40.04	-42.72	-0.61	-1.66	-22.60	2.35	3142	3142	2	7.9	--
2	-61.51	10.96	11.39	3.78	-7.44	1.98	3142	3142	2	20	--
3	-154.24	-92.64	52.33	14.62	19.98	-1.04	3142	3142	3	9.8	--
4	-4.18	-125.83	49.27	1.55	25.30	-6.65	3142	3142	3	6.6	--
5	-56.98	-62.17	-13.88	6.16	18.52	-6.27	3142	3142	2	8.1	--
6	-69.18	-29.76	-54.97	8.37	3.92	-6.95	3142	3142	2	13	--
7	41.73	24.67	3.55	-8.14	-26.23	-5.10	3142	3142	3	6.0	--
8	-19.51	-23.56	-1.97	-4.92	-37.22	1.96	3142	3142	2	5.0	--
9	-32.01	-55.26	20.05	-2.12	-3.80	-4.38	3142	3142	3	24	--
Massimi/minimi											
1							3142				
1								3142			
8										5.0	

Muro : 120 - Nodi: [170-197-200-173], Pann.X=4, Pann.Y=4Spess.=40 cm, Terreno=--,Criterio=CLS_Muri_ND, Materiale=C35/45: **Verificato**

Armatura a maglia doppia

Pannello	Nx	Ny	Nxy	Mx	My	Mxy	Ax	Ay	C	Cs	ZE
	kN	kN	kN	kN*m	kN*m	kN*m	mmq	mmq			
1	-195.75	-1.49	-6.64	-19.08	-2.92	0.42	3142	3142	3	11	--
2	-189.99	-10.65	-18.05	-17.85	-2.62	-0.60	3142	3142	3	12	--
3	-184.72	-12.48	-2.67	-17.81	-2.53	-0.87	3142	3142	3	12	--
4	-183.83	-7.81	-17.53	-19.24	-2.68	-1.41	3142	3142	3	11	--
5	-193.49	28.10	-8.22	-9.22	-2.60	0.26	3142	3142	3	23	--
6	-190.23	19.50	-7.50	-9.54	-2.28	-0.53	3142	3142	3	22	--
7	-183.59	13.62	-6.89	-9.74	-2.06	-1.13	3142	3142	3	20	--
8	-175.54	11.17	-10.85	-9.91	-1.95	-1.59	3142	3142	3	19	--
9	-110.72	59.93	6.42	-6.24	-2.13	0.17	3142	3142	6	32	--
10	-110.68	44.36	4.50	-6.42	-2.05	-0.19	3142	3142	6	31	--
11	-106.68	34.19	2.45	-6.29	-1.97	-0.59	3142	3142	6	30	--
12	-99.88	28.23	-1.42	-5.86	-1.87	-0.92	3142	3142	6	30	--
13	-77.15	20.24	-8.06	6.27	0.33	-0.89	3142	3142	5	28	--
14	-74.20	16.41	-10.27	5.55	0.45	-0.73	3142	3142	5	32	--
15	-70.28	12.92	-13.01	4.96	0.70	-0.60	3142	3142	5	36	--
16	-92.25	35.81	2.97	-4.42	-1.83	-0.51	3142	3142	6	42	--
Massimi/minimi											
1							3142				
1								3142			
4										11	

Muro [Platea]: 121 - Nodi: [173-172-169-170]Pann=8Spess.=40 cm, Terreno=Terreno1, ,Criterio=CLS_Platee_ND, Materiale=C35/45: **Verificato**

Armatura a maglia doppia

Pannello	Nx	Ny	Nxy	Mx	My	Mxy	Ax	Ay	C	Cs	Z _E
	kN	kN	kN	kN*m	kN*m	kN*m	mmq	mmq			
1	-6.58	-65.18	-14.85	-7.57	3.18	-7.12	3142	3142	3	13	--
2	-51.53	-57.42	6.16	-13.93	2.15	-2.58	3142	3142	3	12	--
3	-52.00	-56.47	17.53	-14.23	1.91	0.41	3142	3142	3	14	--
4	-3.08	-63.47	38.24	-8.15	2.50	5.46	3142	3142	3	14	--
5	-140.04	-151.98	-7.71	17.15	9.80	-6.97	3142	3142	3	8.8	--
6	-93.53	-168.10	10.27	23.81	14.60	-2.64	3142	3142	3	7.8	--
7	-95.05	-169.05	10.38	24.24	14.78	0.59	3142	3142	3	8.3	--
8	-148.28	-151.80	27.75	18.01	9.98	5.64	3142	3142	3	9.0	--
Massimi/minimi											
1							3142				
1								3142			
6										7.8	

Muro [Platea]: 122 - Nodi: [172-171-168-169]Pann=8Spess.=40 cm, Terreno=Terreno1, ,Criterio=CLS_Platee_ND, Materiale=C35/45: **Verificato**

Armatura a maglia doppia

Pannello	Nx	Ny	Nxy	Mx	My	Mxy	Ax	Ay	C	Cs	Z _E
	kN	kN	kN	kN*m	kN*m	kN*m	mmq	mmq			
1	-192.00	-171.74	31.12	17.82	8.91	3.97	3142	3142	3	10	--
2	-155.43	-181.47	10.51	22.10	13.97	0.22	3142	3142	3	9.6	--
3	-153.82	-184.52	-0.44	21.88	15.58	-2.41	3142	3142	3	8.8	--
4	-191.11	-187.95	-31.80	18.00	14.13	-4.01	3142	3142	3	10	--
5	-71.24	-64.83	29.53	-0.84	2.28	5.07	3142	3142	3	27	--
6	-107.74	-57.94	23.12	-4.62	1.49	0.81	3142	3142	3	38	--
7	-99.99	-64.31	28.00	-4.75	2.70	-3.45	3142	3142	3	25	--
8	-32.48	-91.47	32.16	-2.67	7.90	-10.18	3142	3142	3	11	--
Massimi/minimi											
1							3142				
1								3142			
3										8.8	

Muro [Platea]: 123 - Nodi: [0-0-0-0]Pann=16Spess.=40 cm, Terreno=Terreno1, ,Criterio=CLS_Platee_ND, Materiale=C35/45: **Verificato**

Armatura a maglia doppia

Pannello	Nx	Ny	Nxy	Mx	My	Mxy	Ax	Ay	C	Cs	Z _E
	kN	kN	kN	kN*m	kN*m	kN*m	mmq	mmq			
1	72.51	66.80	49.71	-17.10	-4.61	-11.50	3142	3142	2	6.3	--
2	46.41	109.25	61.54	-28.45	-8.28	-10.14	3142	3142	2	4.8	--
3	65.19	164.10	52.75	-32.17	-13.23	-9.26	3142	3142	2	4.4	--
4	129.28	213.95	18.80	-28.85	-22.80	1.47	3142	3142	3	5.6	--
5	-18.95	-4.19	16.45	4.41	2.55	-10.67	3142	3142	3	13	--
6	50.79	82.44	45.06	-4.02	-3.92	-6.72	3142	3142	2	17	--
7	78.45	109.50	46.18	-7.33	-8.65	-4.79	3142	3142	2	13	--
8	56.90	120.45	66.55	-17.13	-19.44	7.81	3142	3142	3	6.3	--
9	-58.13	-23.64	17.67	11.50	3.34	-6.50	3142	3142	3	11	--
10	6.34	-5.45	35.22	13.62	7.50	-3.81	3142	3142	3	11	--
11	51.01	34.85	39.41	7.87	2.38	-1.22	3142	3142	3	20	--
12	41.25	91.02	42.58	-8.56	-15.63	9.44	3142	3142	3	7.1	--
13	-78.92	-37.09	35.68	12.74	3.37	-3.32	3142	3142	3	13	--
14	4.52	-52.53	47.89	20.02	6.44	-2.30	3142	3142	3	8.5	--
15	67.37	-21.79	30.87	21.15	1.31	-1.20	3142	3142	3	8.1	--
16	60.57	81.65	-7.76	5.74	-12.20	5.88	3142	3142	3	9.9	--
Massimi/minimi											
1							3142				
1								3142			

Pannello	Nx	Ny	Nxy	Mx	My	Mxy	Ax	Ay	C	Cs	ZE
3										4.4	

Muro [Platea]: 124 - Nodi: [0-0-0-0]Pann=16Spess.=40 cm, Terreno=Terreno1, ,Criterio=CLS_Platee_ND, Materiale=C35/45: **Verificato**

Armatura a maglia doppia

Pannello	Nx	Ny	Nxy	Mx	My	Mxy	Ax	Ay	C	Cs	ZE
	kN	kN	kN	kN*m	kN*m	kN*m	mmq	mmq			
1	24.74	-3.82	-25.84	-11.10	0.17	-0.57	3142	3142	4	16	--
2	-21.53	53.11	-3.68	-13.43	-3.07	4.16	3142	3142	3	11	--
3	-30.63	107.46	-6.12	-8.85	-9.24	6.03	3142	3142	3	11	--
4	-0.42	173.91	-26.43	-4.13	-18.58	7.10	3142	3142	3	6.4	--
5	-13.52	19.59	-61.15	1.47	4.66	-1.09	3142	3142	3	33	--
6	-28.06	44.97	-43.39	3.47	2.24	5.08	3142	3142	3	23	--
7	-22.09	64.25	-46.44	4.74	-5.13	8.01	3142	3142	3	14	--
8	-6.80	105.84	-28.61	-0.26	-20.27	3.28	3142	3142	2	7.4	--
9	-16.58	48.80	-66.83	4.07	5.17	2.81	3142	3142	2	23	--
10	-37.00	24.47	-68.13	10.69	5.69	5.12	3142	3142	3	12	--
11	-44.87	44.45	-57.26	9.51	-1.68	6.77	3142	3142	3	12	--
12	-20.85	111.84	-45.99	0.45	-22.91	2.00	3142	3142	2	7.0	--
13	-52.42	-14.14	-84.97	10.11	8.08	0.45	3142	3142	3	19	--
14	-44.76	-38.18	-68.46	11.42	8.12	1.63	3142	3142	4	15	--
15	-69.51	-14.00	-60.16	7.52	5.17	2.03	3142	3142	4	21	--
16	-41.88	166.20	-45.41	0.11	-17.39	0.22	3142	3142	2	9.4	--
Massimi/minimi											
1							3142				
1								3142			
4										6.4	

Muro : 125 - Nodi: [110-0-0-111], Pann.X=4, Pann.Y=4Spess.=40 cm, Terreno=--,Criterio=CLS_Muri_ND, Materiale=C35/45: **Verificato**

Armatura a maglia doppia

Pannello	Nx	Ny	Nxy	Mx	My	Mxy	Ax	Ay	C	Cs	ZE
	kN	kN	kN	kN*m	kN*m	kN*m	mmq	mmq			
1	-37.79	-74.20	33.86	19.15	9.36	-3.00	3142	3142	5	8.9	--
2	-44.17	-63.65	33.19	23.08	11.60	-2.45	3142	3142	5	7.8	--
3	-50.43	-55.33	32.05	25.91	12.52	-1.70	3142	3142	5	7.2	--
4	-55.45	-49.31	30.61	27.68	12.83	-0.84	3142	3142	5	7.0	--
5	-35.62	-76.09	30.44	19.29	9.48	-1.92	3142	3142	5	9.3	--
6	-42.01	-65.38	30.40	23.35	11.82	-1.60	3142	3142	5	7.9	--
7	-48.28	-56.92	29.93	26.29	12.80	-1.11	3142	3142	5	7.2	--
8	-53.22	-50.79	29.19	28.13	13.13	-0.52	3142	3142	5	7.0	--
9	-34.22	-77.40	27.00	19.17	9.49	-0.82	3142	3142	5	9.8	--
10	-40.41	-66.67	27.60	23.30	11.91	-0.74	3142	3142	5	8.2	--
11	-46.56	-58.18	27.80	26.31	12.94	-0.51	3142	3142	5	7.4	--
12	-51.40	-52.01	27.73	28.18	13.30	-0.20	3142	3142	5	7.0	--
13	-33.40	-78.16	23.58	18.82	9.41	0.27	3142	3142	5	10	--
14	-39.36	-67.53	24.80	22.95	11.88	0.12	3142	3142	5	8.6	--
15	-45.26	-59.11	25.64	25.97	12.95	0.09	3142	3142	5	7.6	--
16	-49.97	-52.96	26.27	27.86	13.34	0.13	3142	3142	5	7.1	--
Massimi/minimi											
1							3142				
1								3142			
8										7.0	

Muro : 126 - Nodi: [109-0-0-110], Pann.X=4, Pann.Y=4Spess.=40 cm, Terreno=--,Criterio=CLS_Muri_ND, Materiale=C35/45: **Verificato**

Armatura a maglia doppia

Pannello	Nx kN	Ny kN	Nxy kN	Mx kN*m	My kN*m	Mxy kN*m	Ax mmq	Ay mmq	C	Cs	ZE
1	-62.85	-129.68	18.21	-3.40	-45.37	-0.28	3142	3142	5	4.6	--
2	-37.94	-116.82	25.81	2.62	-19.51	-1.56	3142	3142	5	9.9	--
3	-31.03	-101.60	31.29	8.45	-4.08	-2.86	3142	3142	5	17	--
4	-32.61	-86.97	33.58	14.20	4.69	-3.19	3142	3142	5	11	--
5	-65.35	-132.82	14.36	-3.52	-46.31	0.00	3142	3142	5	4.6	--
6	-39.35	-118.38	21.73	2.42	-19.99	-0.58	3142	3142	5	10	--
7	-30.48	-103.43	26.96	8.33	-4.30	-1.58	3142	3142	5	20	--
8	-30.83	-88.95	29.59	14.20	4.66	-1.95	3142	3142	5	12	--
9	-66.02	-133.14	10.67	-3.64	-46.66	0.23	3142	3142	5	4.5	--
10	-39.90	-118.82	17.40	2.25	-20.32	0.35	3142	3142	5	10	--
11	-30.17	-104.42	22.68	8.13	-4.52	-0.31	3142	3142	5	23	--
12	-29.83	-90.18	25.58	14.03	4.57	-0.69	3142	3142	5	13	--
13	-66.33	-129.89	6.10	-3.77	-46.34	0.50	3142	3142	5	4.5	--
14	-39.44	-118.30	13.68	2.12	-20.55	1.37	3142	3142	5	9.6	--
15	-29.58	-104.61	18.51	7.88	-4.74	0.97	3142	3142	5	22	--
16	-29.16	-90.74	21.67	13.71	4.42	0.56	3142	3142	5	14	--
Massimi/minimi											
1							3142				
1								3142			
13										4.5	

 Muro : 127 - Nodi: [109-116-177-0], Pann.X=4, Pann.Y=4Spess.=40 cm, Terreno=--,Criterio=CLS_Muri_ND, Materiale=C35/45: **Verificato**
Armatura a maglia doppia

Pannello	Nx kN	Ny kN	Nxy kN	Mx kN*m	My kN*m	Mxy kN*m	Ax mmq	Ay mmq	C	Cs	ZE
1	-80.99	-49.80	-0.40	-31.45	3.13	-5.21	3142	3142	5	5.6	--
2	-81.67	-53.00	-1.91	-32.22	3.15	-3.41	3142	3142	5	5.7	--
3	-81.18	-53.70	-3.15	-32.65	3.13	-1.63	3142	3142	5	5.9	--
4	-79.69	-53.22	-4.28	-32.71	3.07	0.35	3142	3142	5	6.2	--
5	-65.51	-42.37	11.70	8.50	23.49	-8.38	3142	3142	5	6.2	--
6	-66.68	-43.44	9.34	8.52	23.95	-5.84	3142	3142	5	6.6	--
7	-67.26	-42.99	6.96	8.39	24.23	-3.26	3142	3142	5	7.2	--
8	-67.32	-42.04	4.77	8.08	24.38	-0.56	3142	3142	5	7.9	--
9	-49.91	-58.09	14.78	18.19	40.57	-7.52	3142	3142	5	4.2	--
10	-51.29	-56.76	12.94	18.54	41.81	-5.73	3142	3142	5	4.2	--
11	-52.38	-55.41	11.06	18.68	42.53	-3.87	3142	3142	5	4.3	--
12	-53.22	-54.55	9.29	18.60	42.74	-1.98	3142	3142	5	4.5	--
13	-39.32	-75.16	12.32	17.86	51.18	-5.54	3142	3142	5	3.6	--
14	-40.77	-71.95	11.15	18.43	53.03	-4.49	3142	3142	5	3.5	--
15	-42.22	-69.77	9.99	18.80	54.18	-3.38	3142	3142	5	3.5	--
16	-43.68	-68.62	8.87	18.98	54.65	-2.28	3142	3142	5	3.5	--
Massimi/minimi											
1							3142				
1								3142			
15										3.5	

 Muro : 128 - Nodi: [111-0-0-112], Pann.X=4, Pann.Y=4Spess.=40 cm, Terreno=--,Criterio=CLS_Muri_ND, Materiale=C35/45: **Verificato**
Armatura a maglia doppia

Pannello	Nx kN	Ny kN	Nxy kN	Mx kN*m	My kN*m	Mxy kN*m	Ax mmq	Ay mmq	C	Cs	ZE
1	-58.49	-45.46	28.99	28.32	12.92	0.18	3142	3142	5	7.0	--
2	-58.39	-44.33	27.65	27.58	12.92	1.31	3142	3142	5	6.9	--
3	-55.44	-46.15	26.83	25.21	12.53	2.36	3142	3142	5	7.2	--
4	-50.60	-50.83	26.21	21.17	10.92	3.23	3142	3142	5	8.2	--

Pannello	Nx	Ny	Nxy	Mx	My	Mxy	Ax	Ay	C	Cs	ZE
5	-56.20	-46.80	28.33	28.81	13.23	0.19	3142	3142	5	6.9	--
6	-56.11	-45.53	27.73	28.04	13.22	0.98	3142	3142	5	6.9	--
7	-53.18	-47.26	27.58	25.58	12.80	1.70	3142	3142	5	7.3	--
8	-48.37	-51.91	27.65	21.40	11.10	2.25	3142	3142	5	8.4	--
9	-54.42	-47.95	27.62	28.88	13.41	0.21	3142	3142	5	6.9	--
10	-54.44	-46.53	27.77	28.10	13.39	0.65	3142	3142	5	6.9	--
11	-51.58	-48.13	28.31	25.59	12.93	1.02	3142	3142	5	7.5	--
12	-46.79	-52.65	29.07	21.35	11.18	1.25	3142	3142	5	8.8	--
13	-53.19	-48.91	26.92	28.57	13.45	0.22	3142	3142	5	6.9	--
14	-53.51	-47.34	27.77	27.79	13.42	0.32	3142	3142	5	7.1	--
15	-50.78	-48.76	28.99	25.27	12.93	0.35	3142	3142	5	7.8	--
16	-45.87	-53.06	30.41	21.03	11.13	0.27	3142	3142	5	9.3	--
Massimi/minimi											
1							3142				
1								3142			
9										6.9	

Muro : 129 - Nodi : [112-0-0-113], Pann.X=4, Pann.Y=4Spess.=40 cm, Terreno=--,Criterio=CLS_Muri_ND, Materiale=C35/45: **Verificato**

Armatura a maglia doppia

Pannello	Nx	Ny	Nxy	Mx	My	Mxy	Ax	Ay	C	Cs	ZE
	kN	kN	kN	kN*m	kN*m	kN*m	mmq	mmq			
1	-45.59	-57.65	25.94	16.14	7.19	3.72	3142	3142	5	10.0	--
2	-42.38	-65.76	26.79	10.58	0.33	3.70	3142	3142	5	14	--
3	-43.90	-74.75	29.58	4.60	-12.20	3.23	3142	3142	5	13	--
4	-56.94	-82.62	34.78	-1.29	-33.84	-0.30	3142	3142	5	6.0	--
5	-43.53	-58.66	28.03	16.23	7.26	2.51	3142	3142	5	11	--
6	-40.88	-66.49	29.25	10.56	0.24	2.39	3142	3142	5	15	--
7	-43.55	-75.03	32.01	4.50	-12.46	2.05	3142	3142	5	14	--
8	-58.30	-82.94	36.64	-1.40	-34.53	-0.82	3142	3142	5	5.8	--
9	-42.07	-59.18	30.06	16.12	7.25	1.29	3142	3142	5	11	--
10	-39.73	-66.65	31.59	10.43	0.12	1.09	3142	3142	5	17	--
11	-42.88	-74.49	34.45	4.39	-12.64	0.93	3142	3142	5	15	--
12	-57.88	-81.62	38.28	-1.49	-34.73	-1.30	3142	3142	5	5.7	--
13	-40.96	-59.23	31.94	15.83	7.15	0.07	3142	3142	5	12	--
14	-38.51	-66.29	33.79	10.21	-0.02	-0.21	3142	3142	5	19	--
15	-41.52	-73.37	36.27	4.29	-12.75	-0.23	3142	3142	5	16	--
16	-56.56	-77.98	40.27	-1.55	-34.47	-1.81	3142	3142	5	5.6	--
Massimi/minimi											
1							3142				
1								3142			
16										5.6	

Muro : 130 - Nodi : [113-0-178-120], Pann.X=4, Pann.Y=4Spess.=40 cm, Terreno=--,Criterio=CLS_Muri_ND, Materiale=C35/45: **Verificato**

Armatura a maglia doppia

Pannello	Nx	Ny	Nxy	Mx	My	Mxy	Ax	Ay	C	Cs	ZE
	kN	kN	kN	kN*m	kN*m	kN*m	mmq	mmq			
1	-48.86	-72.69	52.10	1.06	-23.10	-2.13	3142	3142	5	8.0	--
2	-36.23	-49.29	68.33	13.63	3.75	-3.26	3142	3142	5	12	--
3	-48.68	-25.67	73.43	24.12	10.30	-3.55	3142	3142	5	7.2	--
4	-61.64	-8.63	71.26	30.70	10.28	-2.73	3142	3142	5	6.0	--
5	-53.94	-73.54	49.30	1.02	-23.51	-1.11	3142	3142	5	8.2	--
6	-38.73	-49.74	64.76	13.61	3.63	-1.72	3142	3142	5	13	--
7	-47.89	-25.66	70.51	24.46	10.36	-2.45	3142	3142	5	7.4	--
8	-58.33	-7.95	69.22	31.33	10.52	-2.09	3142	3142	5	6.0	--
9	-55.33	-73.08	46.74	0.93	-23.67	-0.15	3142	3142	5	8.5	--
10	-38.78	-49.54	61.02	13.50	3.42	-0.18	3142	3142	5	14	--

Pannello	Nx	Ny	Nxy	Mx	My	Mxy	Ax	Ay	C	Cs	z _E
11	-46.80	-25.28	67.41	24.47	10.30	-1.32	3142	3142	5	7.7	--
12	-56.30	-7.21	67.11	31.53	10.63	-1.42	3142	3142	5	6.1	--
13	-53.64	-71.45	44.01	0.80	-23.56	0.91	3142	3142	5	8.3	--
14	-36.82	-48.70	57.46	13.31	3.11	1.43	3142	3142	5	13	--
15	-45.73	-24.56	64.38	24.18	10.12	-0.18	3142	3142	5	8.1	--
16	-55.80	-6.39	64.98	31.32	10.62	-0.76	3142	3142	5	6.2	--
Massimi/minimi											
1							3142				
1								3142			
8										6.0	

Muro : 131 - Nodi: [118-129-183-186], Pann.X=4, Pann.Y=4Spess.=40 cm, Terreno=--,Criterio=CLS_Muri_ND, Materiale=C35/45: **Verificato**

Armatura a maglia doppia

Pannello	Nx	Ny	Nxy	Mx	My	Mxy	Ax	Ay	C	Cs	z _E
	kN	kN	kN	kN*m	kN*m	kN*m	mmq	mmq			
1	-0.38	-147.34	3.58	-0.01	-1.09	0.07	3142	3142	1	>100	--
2	-2.27	-485.18	7.95	0.02	1.49	0.28	3142	3142	3	>100	--
3	-2.46	-488.87	9.94	0.04	1.99	0.27	3142	3142	3	>100	--
4	-2.90	-498.24	12.66	0.07	2.49	0.25	3142	3142	3	97	--
5	-2.62	-137.47	8.74	-0.01	-1.09	0.05	3142	3142	1	>100	--
6	-13.65	-448.58	20.05	0.07	1.46	0.30	3142	3142	3	>100	--
7	-14.33	-449.78	24.74	0.11	1.95	0.28	3142	3142	3	>100	--
8	-14.88	-453.55	28.93	0.14	2.44	0.27	3142	3142	3	96	--
9	-5.66	-125.21	10.92	-0.02	-1.09	0.01	3142	3142	1	>100	--
10	-29.52	-399.72	26.11	0.10	1.43	0.24	3142	3142	3	>100	--
11	-30.35	-398.79	30.99	0.14	1.90	0.23	3142	3142	3	>100	--
12	-31.59	-396.20	35.66	0.19	2.38	0.21	3142	3142	3	97	--
13	-8.18	-113.47	10.75	-0.03	-1.09	0.00	3142	3142	1	>100	--
14	-43.48	-352.04	27.57	0.10	1.40	0.20	3142	3142	3	>100	--
15	-44.28	-349.94	31.13	0.15	1.86	0.20	3142	3142	3	>100	--
16	-45.63	-344.76	34.76	0.19	2.32	0.19	3142	3142	3	97	--
Massimi/minimi											
1							3142				
1								3142			
8										96	

Muro : 132 - Nodi: [129-130-185-183], Pann.X=4, Pann.Y=4Spess.=40 cm, Terreno=--,Criterio=CLS_Muri_ND, Materiale=C35/45: **Verificato**

Armatura a maglia doppia

Pannello	Nx	Ny	Nxy	Mx	My	Mxy	Ax	Ay	C	Cs	z _E
	kN	kN	kN	kN*m	kN*m	kN*m	mmq	mmq			
1	-9.37	-105.53	9.59	-0.02	-1.10	0.00	3142	3142	1	>100	--
2	-51.22	-319.11	26.97	0.10	1.38	0.18	3142	3142	3	>100	--
3	-51.80	-316.73	28.97	0.14	1.83	0.17	3142	3142	3	>100	--
4	-53.37	-312.80	31.24	0.19	2.28	0.16	3142	3142	3	97	--
5	-9.44	-100.85	8.37	-0.01	-1.10	0.01	3142	3142	1	>100	--
6	-54.27	-298.37	26.03	0.11	1.37	0.16	3142	3142	3	>100	--
7	-54.59	-295.98	26.84	0.15	1.82	0.15	3142	3142	3	>100	--
8	-54.67	-293.88	27.49	0.19	2.26	0.14	3142	3142	3	98	--
9	-9.09	-96.90	7.03	0.01	-1.11	0.01	3142	3142	1	>100	--
10	-54.85	-281.70	25.03	0.13	1.36	0.13	3142	3142	3	>100	--
11	-54.76	-279.55	24.67	0.17	1.80	0.13	3142	3142	3	>100	--
12	-54.26	-277.76	24.16	0.21	2.23	0.12	3142	3142	3	99	--
13	-8.66	-92.89	5.96	0.03	-1.12	0.01	3142	3142	1	>100	--
14	-52.93	-269.18	24.33	0.16	1.35	0.12	3142	3142	3	>100	--
15	-52.49	-267.37	22.85	0.19	1.78	0.11	3142	3142	3	>100	--
16	-53.42	-263.16	20.78	0.23	2.22	0.10	3142	3142	3	100	--

Pannello	Nx	Ny	Nxy	Mx	My	Mxy	Ax	Ay	C	Cs	ZE
Massimi/minimi											
1							3142				
1								3142			
4										97	

Muro : 133 - Nodi: [130-134-184-185], Pann.X=4, Pann.Y=4Spess.=40 cm, Terreno=--,Criterio=CLS_Muri_ND, Materiale=C35/45: **Verificato**

Armatura a maglia doppia

Pannello	Nx	Ny	Nxy	Mx	My	Mxy	Ax	Ay	C	Cs	ZE
	kN	kN	kN	kN*m	kN*m	kN*m	mmq	mmq			
1	-9.94	-93.70	-0.32	0.18	-1.14	0.07	3142	3142	5	>100	--
2	-42.72	-250.57	24.38	0.31	1.30	0.05	3142	3142	3	>100	--
3	-41.70	-249.32	21.79	0.35	1.74	0.04	3142	3142	3	>100	--
4	-40.24	-245.44	19.06	0.39	2.17	0.03	3142	3142	3	>100	--
5	-3.88	-93.03	-4.36	0.47	-1.29	0.17	3142	3142	5	>100	--
6	-3.10	-91.56	-5.27	0.53	-1.03	0.14	3142	3142	5	>100	--
7	-18.61	-244.79	24.54	0.82	1.60	-0.00	3142	3142	3	>100	--
8	-17.16	-242.51	21.19	0.88	2.05	-0.03	3142	3142	3	>100	--
9	3.67	-95.99	-8.01	0.90	-1.64	0.40	3142	3142	5	>100	--
10	-22.70	-245.28	4.90	1.54	0.58	0.25	3142	3142	4	>100	--
11	-21.62	-243.90	2.78	1.65	1.03	0.16	3142	3142	4	>100	--
12	-20.58	-243.56	0.78	1.74	1.49	0.08	3142	3142	4	>100	--
13	42.40	-267.41	37.36	1.94	-0.37	0.88	3142	3142	3	66	--
14	42.99	-264.05	32.16	2.10	0.02	0.77	3142	3142	3	64	--
15	42.98	-261.86	27.11	2.26	0.44	0.65	3142	3142	3	63	--
16	42.38	-261.35	22.33	2.41	0.87	0.54	3142	3142	3	63	--
Massimi/minimi											
1							3142				
1								3142			
16										63	

Muro : 134 - Nodi: [134-141-193-184], Pann.X=4, Pann.Y=4Spess.=40 cm, Terreno=--,Criterio=CLS_Muri_ND, Materiale=C35/45: **Verificato**

Armatura a maglia doppia

Pannello	Nx	Ny	Nxy	Mx	My	Mxy	Ax	Ay	C	Cs	ZE
	kN	kN	kN	kN*m	kN*m	kN*m	mmq	mmq			
1	72.02	-275.33	32.58	2.01	-0.94	1.39	3142	3142	3	53	--
2	69.90	-268.23	25.97	2.17	-0.60	1.29	3142	3142	3	52	--
3	68.43	-264.38	19.80	2.34	-0.25	1.18	3142	3142	3	51	--
4	67.80	-263.71	13.90	2.52	0.12	1.05	3142	3142	3	51	--
5	86.05	-273.77	27.12	1.87	-1.17	1.54	3142	3142	3	52	--
6	84.03	-268.84	20.03	2.01	-0.86	1.46	3142	3142	3	51	--
7	81.43	-264.05	13.68	2.16	-0.55	1.38	3142	3142	3	51	--
8	78.18	-259.15	7.79	2.33	-0.24	1.27	3142	3142	3	50	--
9	26.19	-95.14	-24.38	0.82	-3.17	0.93	3142	3142	5	50	--
10	99.51	-267.90	12.35	1.73	-1.06	1.64	3142	3142	3	52	--
11	95.49	-262.14	5.31	1.85	-0.81	1.58	3142	3142	3	51	--
12	90.17	-255.44	-1.06	1.97	-0.57	1.50	3142	3142	3	51	--
13	29.44	-91.29	-28.45	0.54	-3.29	0.94	3142	3142	5	49	--
14	28.55	-87.57	-29.86	0.61	-2.98	0.92	3142	3142	5	53	--
15	165.78	-116.11	-3.13	2.02	-1.43	1.08	3142	3142	2	53	--
16	159.88	-110.56	-11.76	2.04	-1.28	1.04	3142	3142	2	54	--
Massimi/minimi											
1							3142				
1								3142			
13										49	

Muro : 135 - Nodi: [141-148-196-193], Pann.X=4, Pann.Y=4Spess.=40 cm, Terreno=--,Criterio=CLS_Muri_ND, Materiale=C35/45: **Verificato**

Armatura a maglia doppia

Pannello	Nx	Ny	Nxy	Mx	My	Mxy	Ax	Ay	C	Cs	ZE
	kN	kN	kN	kN*m	kN*m	kN*m	mmq	mmq			
1	191.96	-122.19	12.54	2.39	-1.87	1.22	3142	3142	2	45	--
2	187.75	-117.48	1.31	2.45	-1.66	1.15	3142	3142	2	45	--
3	181.92	-112.48	-9.02	2.46	-1.50	1.06	3142	3142	2	46	--
4	174.54	-107.39	-18.39	2.42	-1.39	0.97	3142	3142	2	48	--
5	205.81	-118.34	8.96	3.00	-1.97	1.33	3142	3142	2	37	--
6	200.97	-113.80	-2.59	3.06	-1.78	1.17	3142	3142	2	38	--
7	194.05	-108.53	-13.36	3.03	-1.65	0.99	3142	3142	2	40	--
8	185.17	-102.38	-23.49	2.91	-1.56	0.82	3142	3142	2	44	--
9	221.40	-114.29	5.09	4.01	-2.24	1.49	3142	3142	2	28	--
10	214.15	-109.11	-6.14	4.07	-2.06	1.16	3142	3142	2	30	--
11	207.50	-103.24	-18.70	3.95	-1.94	0.82	3142	3142	2	33	--
12	196.75	-96.54	-29.14	3.69	-1.87	0.50	3142	3142	2	38	--
13	233.45	-116.47	2.45	5.74	-2.80	1.76	3142	3142	2	21	--
14	231.98	-104.21	-13.62	5.74	-2.68	1.08	3142	3142	2	23	--
15	222.08	-96.80	-24.27	5.45	-2.58	0.45	3142	3142	2	26	--
16	209.19	-91.95	-34.55	4.97	-2.44	-0.15	3142	3142	2	31	--
Massimi/minimi											
1							3142				
1								3142			
13										21	

Muro : 136 - Nodi: [148-155-189-196], Pann.X=4, Pann.Y=4Spess.=40 cm, Terreno=--,Criterio=CLS_Muri_ND, Materiale=C35/45: **Verificato**

Armatura a maglia doppia

Pannello	Nx	Ny	Nxy	Mx	My	Mxy	Ax	Ay	C	Cs	ZE
	kN	kN	kN	kN*m	kN*m	kN*m	mmq	mmq			
1	48.29	-66.24	-39.23	0.32	-5.65	2.01	3142	3142	5	26	--
2	46.13	-68.76	-43.84	0.53	-5.46	1.44	3142	3142	5	29	--
3	42.08	-65.17	-47.28	0.65	-5.27	0.89	3142	3142	5	33	--
4	36.95	-59.63	-49.63	0.71	-5.04	0.34	3142	3142	5	37	--
5	68.79	-61.81	-46.51	-0.55	-8.18	2.54	3142	3142	5	19	--
6	62.52	-64.55	-50.51	-0.49	-8.23	1.89	3142	3142	5	20	--
7	55.46	-61.55	-54.97	-0.34	-8.14	1.10	3142	3142	5	22	--
8	227.88	-240.66	-88.35	-0.49	-8.43	-0.98	3142	3142	3	24	--
9	608.46	-65.01	-28.75	-6.10	-13.08	5.28	3142	3142	2	8.1	--
10	563.12	-63.78	-135.69	-4.60	-13.42	3.25	3142	3142	2	12	--
11	454.46	-25.36	-179.51	-3.95	-13.16	1.84	3142	3142	2	13	--
12	344.87	4.06	-183.65	-3.37	-12.35	0.70	3142	3142	2	15	--
13	1132.14	136.73	-259.84	-14.59	-14.00	3.88	4513	3142	2	4.9	--
14	706.63	231.34	-208.30	-15.15	-14.15	4.71	4513	3142	2	8.0	--
15	450.47	189.46	-184.31	-14.25	-15.55	4.78	4513	3142	2	7.9	--
16	253.19	127.46	-168.69	-13.26	-17.27	4.27	4513	3142	2	8.0	--
Massimi/minimi											
13							4513				
1								3142			
13										4.9	

Muro : 137 - Nodi: [155-168-0-189], Pann.X=4, Pann.Y=4Spess.=40 cm, Terreno=--,Criterio=CLS_Muri_ND, Materiale=C35/45: **Verificato**

Armatura a maglia doppia

Pannello	Nx	Ny	Nxy	Mx	My	Mxy	Ax	Ay	C	Cs	ZE
	kN	kN	kN	kN*m	kN*m	kN*m	mmq	mmq			
1	140.67	243.91	100.41	-0.66	-7.98	5.02	4513	3142	2	12	--

Pannello	Nx	Ny	Nxy	Mx	My	Mxy	Ax	Ay	C	Cs	ZE
2	249.93	122.30	139.25	-0.84	-6.76	6.36	4513	3142	2	13	--
3	205.19	-96.05	204.50	-0.81	-8.59	7.55	4513	3142	3	13	--
4	79.71	-127.91	171.59	-1.44	-9.71	7.99	4513	3142	3	12	--
5	101.73	77.96	298.87	-0.66	-3.72	2.99	4513	3142	2	27	--
6	285.69	21.80	278.13	-1.05	-2.66	3.53	4513	3142	2	30	--
7	423.34	-1.75	211.53	-1.49	-1.08	3.44	4513	3142	2	42	--
8	581.14	-114.67	67.35	1.17	0.91	0.48	4513	3142	3	>100	--
9	26.23	-12.55	100.27	0.78	5.16	2.98	4513	3142	5	24	--
10	100.26	-14.12	88.60	0.91	2.58	3.17	4513	3142	5	34	--
11	270.31	-22.62	66.59	1.26	0.96	3.39	4513	3142	4	45	--
12	1002.02	-46.50	72.02	1.23	3.15	3.00	4513	3142	3	26	--
13	192.45	95.29	450.10	0.25	7.77	0.75	4513	3142	2	21	--
14	199.65	-148.50	8.49	-3.32	-4.75	-0.96	4513	3142	4	37	--
15	970.11	-45.41	190.86	-4.89	-10.11	-2.45	4513	3142	3	16	--
16	1660.93	152.74	175.14	-5.24	-13.84	-4.80	4513	3142	2	1.5	--
Massimi/minimi											
1							4513				
1								3142			
16										1.5	

Muro : 138 - Nodi : [188-153-166-0], Pann.X=4, Pann.Y=4Spess.=40 cm, Terreno=--,Criterio=CLS_Muri_ND, Materiale=C35/45: **Verificato**

Armatura a maglia doppia

Pannello	Nx	Ny	Nxy	Mx	My	Mxy	Ax	Ay	C	Cs	ZE
	kN	kN	kN	kN*m	kN*m	kN*m	mmq	mmq			
1	175.50	394.84	-184.00	-12.31	-27.88	-11.78	4600	3928	2	4.4	--
2	-49.48	466.65	-213.69	-17.27	-10.90	-13.96	4600	3928	2	6.6	--
3	-54.78	195.64	-72.77	-22.02	-4.68	-11.91	4600	3928	5	8.3	--
4	-41.61	1307.89	-381.87	-31.74	-23.10	-5.45	4600	3928	2	1.2	--
5	196.02	398.03	-197.70	-21.43	-31.42	-15.89	4600	3928	2	3.7	--
6	-105.52	414.73	-236.58	-22.66	-9.98	-15.29	4600	3928	2	6.8	--
7	-79.14	173.41	-118.90	-22.92	-3.35	-14.53	4600	3928	5	7.7	--
8	123.00	767.98	-344.51	-23.60	-17.85	-6.57	4600	3928	2	4.7	--
9	253.40	357.49	-177.66	-34.46	-32.15	-21.94	4600	3928	2	3.4	--
10	-52.09	85.05	-110.36	-28.36	-8.38	-17.90	4600	3928	5	6.1	--
11	-67.38	106.69	-140.37	-21.23	-3.25	-14.78	4600	3928	5	7.9	--
12	37.74	414.25	-334.43	-15.82	-11.15	-5.33	4600	3928	2	10	--
13	338.34	194.75	-109.84	-55.01	-19.88	-33.68	4600	3928	2	2.5	--
14	-35.82	28.14	-102.29	-34.42	-5.65	-16.35	4600	3928	5	5.5	--
15	-59.40	30.70	-147.88	-18.82	-2.68	-14.12	4600	3928	5	8.6	--
16	-65.03	87.66	-329.50	-10.12	-1.12	4.75	4600	3928	6	19	--
Massimi/minimi											
1							4600				
1								3928			
4										1.2	

Muro : 139 - Nodi : [0-188-0-198], Pann.X=4, Pann.Y=4Spess.=40 cm, Terreno=--,Criterio=CLS_Muri_ND, Materiale=C35/45: **Verificato**

Armatura a maglia doppia

Pannello	Nx	Ny	Nxy	Mx	My	Mxy	Ax	Ay	C	Cs	ZE
	kN	kN	kN	kN*m	kN*m	kN*m	mmq	mmq			
1	-6.75	-37.44	10.32	16.74	-6.33	9.76	3142	3142	5	7.3	--
2	-2.30	-1.87	-5.68	14.81	-7.25	5.49	3142	3142	5	9.4	--
3	-50.54	192.83	-3.72	3.16	-7.06	1.91	3142	3142	3	18	--
4	96.40	277.45	2.08	-3.15	-8.79	-0.04	3142	3142	2	17	--
5	2.58	4.62	-0.01	17.93	-10.08	7.09	3142	3142	5	7.6	--
6	-65.81	222.38	-14.82	6.06	-8.86	1.94	3142	3142	3	14	--
7	27.18	347.82	25.39	-0.88	-6.91	0.09	3142	3142	2	19	--

Pannello	Nx	Ny	Nxy	Mx	My	Mxy	Ax	Ay	C	Cs	ZE
8	132.00	375.80	43.78	-9.99	-10.39	-0.64	3142	3142	2	12	--
9	-27.27	238.95	-41.60	9.23	-14.33	1.89	3142	3142	3	9.5	--
10	-19.19	395.25	-57.20	0.60	-9.44	-2.99	3142	3142	2	10	--
11	-25.24	526.54	36.56	-9.92	-6.11	-2.90	3142	3142	2	12	--
12	175.21	545.57	121.26	-19.10	-12.63	-1.82	3142	3142	2	7.1	--
13	101.37	380.58	-129.01	-0.57	-20.69	-5.70	3142	3142	2	4.9	--
14	-77.50	505.53	-135.31	-9.26	-10.49	-9.24	3142	3142	2	5.6	--
15	-154.09	659.65	-78.30	-18.56	-5.13	-8.41	4600	3928	2	9.7	--
16	149.55	1074.88	242.61	-30.20	-18.15	-7.60	4600	3928	2	2.6	--
Massimi/minimi											
15							4600				
15								3928			
16										2.6	

Muro : 140 - Nodi : [0-0-199-198], Pann.X=4, Pann.Y=4Spess.=40 cm, Terreno=--,Criterio=CLS_Muri_ND, Materiale=C35/45: **Verificato**

Armatura a maglia doppia

Pannello	Nx	Ny	Nxy	Mx	My	Mxy	Ax	Ay	C	Cs	ZE
	kN	kN	kN	kN*m	kN*m	kN*m	mmq	mmq			
1	163.13	121.88	-233.24	-9.85	-37.16	13.64	3142	3142	2	3.4	--
2	325.89	42.96	-63.24	-13.56	-24.84	7.14	3142	3142	2	5.8	--
3	299.63	48.92	-0.35	-12.05	-16.52	4.43	3142	3142	2	8.7	--
4	259.82	39.98	32.07	-10.25	-9.96	3.13	3142	3142	2	11	--
5	33.26	-39.59	-111.70	-5.10	-35.08	3.72	3142	3142	2	5.1	--
6	117.86	-62.77	-77.33	-5.78	-25.48	4.69	3142	3142	2	6.7	--
7	168.62	-70.64	-22.09	-6.49	-17.62	4.29	3142	3142	2	9.2	--
8	177.94	-65.62	19.28	-6.34	-11.14	3.73	3142	3142	2	14	--
9	13.71	-63.40	-33.31	-4.14	-29.88	2.00	3142	3142	2	6.3	--
10	49.75	-70.50	-26.26	-3.93	-23.10	2.21	3142	3142	2	8.0	--
11	81.25	-80.63	-10.87	-3.60	-16.69	2.71	3142	3142	2	10	--
12	101.75	-84.14	10.74	-3.33	-11.02	3.01	3142	3142	2	15	--
13	-2.63	-153.76	-3.35	-3.90	-30.29	0.54	3142	3142	3	7.0	--
14	20.84	-149.47	3.51	-3.25	-22.76	0.79	3142	3142	3	9.1	--
15	39.74	-149.57	11.30	-2.73	-16.44	1.21	3142	3142	3	12	--
16	58.90	-88.12	13.72	-1.78	-9.75	2.53	3142	3142	2	17	--
Massimi/minimi											
1							3142				
1								3142			
1										3.4	

Muro : 141 - Nodi : [198-199-0-0], Pann.X=4, Pann.Y=4Spess.=40 cm, Terreno=--,Criterio=CLS_Muri_ND, Materiale=C35/45: **Verificato**

Armatura a maglia doppia

Pannello	Nx	Ny	Nxy	Mx	My	Mxy	Ax	Ay	C	Cs	ZE
	kN	kN	kN	kN*m	kN*m	kN*m	mmq	mmq			
1	194.93	34.96	59.43	-7.89	-2.15	1.78	3142	3142	2	17	--
2	10.33	-10.22	51.86	-5.77	7.06	0.59	3142	3142	5	25	--
3	-13.50	-16.38	48.24	-3.77	10.49	-0.44	3142	3142	5	18	--
4	-36.54	-21.48	42.73	-2.19	10.89	-1.26	3142	3142	5	16	--
5	158.24	-51.02	56.40	-5.34	-3.74	2.95	3142	3142	2	20	--
6	13.45	-35.82	57.46	-3.56	5.73	2.08	3142	3142	5	25	--
7	-7.17	-32.94	54.75	-2.08	9.33	1.08	3142	3142	5	19	--
8	-27.87	-31.75	49.24	-0.94	9.99	0.22	3142	3142	5	19	--
9	94.70	-148.32	39.92	-3.14	-5.63	2.15	3142	3142	3	27	--
10	11.88	-50.79	53.50	-1.12	4.80	2.81	3142	3142	5	26	--
11	-3.18	-44.17	53.73	-0.20	8.28	2.03	3142	3142	5	19	--
12	-20.10	-39.20	50.06	0.50	9.03	1.19	3142	3142	5	19	--
13	64.22	-147.74	34.98	-1.52	-5.22	2.07	3142	3142	3	29	--

Pannello	Nx	Ny	Nxy	Mx	My	Mxy	Ax	Ay	C	Cs	ZE
14	7.54	-54.53	47.51	0.71	4.26	3.17	3142	3142	5	27	--
15	-2.18	-47.17	49.46	1.40	7.31	2.54	3142	3142	5	20	--
16	-14.39	-40.93	47.65	1.80	7.99	1.70	3142	3142	5	20	--
Massimi/minimi											
1							3142				
1								3142			
4										16	

Muro : 142 - Nodi: [166-167-0-0], Pann.X=4, Pann.Y=4Spess.=40 cm, Terreno=--,Criterio=CLS_Muri_ND, Materiale=C35/45: **Verificato**

Armatura a maglia doppia

Pannello	Nx	Ny	Nxy	Mx	My	Mxy	Ax	Ay	C	Cs	ZE
	kN	kN	kN	kN*m	kN*m	kN*m	mmq	mmq			
1	8.52	147.06	82.69	5.05	38.00	-1.43	3142	3142	2	4.3	--
2	8.55	77.22	220.30	0.91	4.61	-3.18	3142	3142	6	23	--
3	6.48	109.11	73.54	-4.52	-36.80	-0.93	3142	3142	2	4.6	--
4	16.80	60.04	67.99	-10.90	-86.55	1.08	3142	3142	2	2.1	--
5	8.60	47.94	61.72	4.78	41.00	0.39	3142	3142	2	4.4	--
6	6.03	55.45	258.08	0.47	6.64	-0.09	3142	3142	6	27	--
7	15.68	56.58	65.81	-4.20	-32.23	0.54	3142	3142	2	5.6	--
8	15.22	54.98	62.56	-8.39	-67.60	1.65	3142	3142	2	2.6	--
9	6.81	30.44	35.75	5.34	44.45	-1.45	3142	3142	2	4.1	--
10	9.10	36.94	219.87	0.82	8.55	-0.24	3142	3142	6	21	--
11	13.49	51.56	36.87	-3.39	-28.48	0.48	3142	3142	2	6.3	--
12	11.93	67.38	37.11	-8.02	-65.65	0.01	3142	3142	2	2.8	--
13	5.51	65.84	-1.90	6.24	47.86	-1.28	3142	3142	2	3.7	--
14	5.52	72.73	-0.71	1.71	10.92	-0.96	3142	3142	2	15	--
15	7.48	79.87	0.64	-3.13	-24.42	-0.32	3142	3142	2	7.2	--
16	9.68	100.34	0.23	-8.14	-63.87	0.28	3142	3142	2	2.7	--
Massimi/minimi											
1							3142				
1								3142			
4										2.1	

Muro : 143 - Nodi: [167-168-0-0], Pann.X=4, Pann.Y=4Spess.=40 cm, Terreno=--,Criterio=CLS_Muri_ND, Materiale=C35/45: **Verificato**

Armatura a maglia doppia

Pannello	Nx	Ny	Nxy	Mx	My	Mxy	Ax	Ay	C	Cs	ZE
	kN	kN	kN	kN*m	kN*m	kN*m	mmq	mmq			
1	5.26	71.28	-31.58	6.47	50.11	0.34	3142	3142	2	3.6	--
2	5.06	75.02	-31.62	1.89	13.36	0.69	3142	3142	2	13	--
3	6.32	89.80	-32.46	-2.91	-21.85	0.83	3142	3142	2	7.8	--
4	9.27	112.75	-33.10	-7.88	-61.49	0.89	3142	3142	2	2.8	--
5	4.05	32.79	-71.79	6.09	50.94	0.35	3142	3142	2	3.6	--
6	7.15	42.58	-70.21	1.66	16.34	-0.12	3142	3142	2	11	--
7	8.63	64.55	-69.93	-2.32	-19.32	0.57	3142	3142	2	9.1	--
8	9.91	76.37	-68.16	-6.68	-55.05	2.12	3142	3142	2	3.1	--
9	7.01	20.43	-105.58	6.52	52.86	-0.75	3142	3142	2	3.5	--
10	11.58	23.37	-114.06	2.58	20.04	0.60	3142	3142	2	9.1	--
11	7.66	41.16	-115.61	-1.32	-13.96	1.39	3142	3142	2	12	--
12	5.98	46.47	-112.16	-5.81	-48.61	1.09	3142	3142	2	3.7	--
13	19.02	57.20	-143.34	7.15	55.96	-2.10	3142	3142	2	3.1	--
14	5.99	64.87	-114.07	2.93	22.75	-2.04	3142	3142	2	7.3	--
15	3.14	17.83	16.27	-0.90	-4.93	-3.82	3142	3142	6	22	--
16	-8.74	46.06	-130.90	-4.33	-32.47	0.91	3142	3142	2	5.5	--
Massimi/minimi											
1							3142				
1								3142			

Pannello	Nx	Ny	Nxy	Mx	My	Mxy	Ax	Ay	C	Cs	ZE
4										2.8	

Muro : 144 - Nodi: [168-171-0-0], Pann.X=4, Pann.Y=4Spess.=40 cm, Terreno=--,Criterio=CLS_Muri_ND, Materiale=C35/45: **Verificato**

Armatura a maglia doppia

Pannello	Nx	Ny	Nxy	Mx	My	Mxy	Ax	Ay	C	Cs	ZE
	kN	kN	kN	kN*m	kN*m	kN*m	mmq	mmq			
1	-20.70	-316.79	-57.45	-0.27	-5.55	5.81	3142	3142	4	21	--
2	-19.98	-337.41	-67.50	-0.72	-13.39	5.05	3142	3142	4	13	--
3	-24.48	-389.36	-76.06	-2.18	-23.67	2.84	3142	3142	4	9.4	--
4	-69.01	-565.56	279.69	-5.06	-43.07	-0.60	3142	3142	3	6.3	--
5	-15.73	-189.39	562.24	-1.18	-9.11	0.79	3142	3142	6	22	--
6	-34.87	-335.54	429.92	-3.34	-19.83	0.89	3142	3142	3	12	--
7	-34.91	-293.25	38.88	-4.66	-31.67	-0.77	3142	3142	4	7.3	--
8	-39.85	-329.63	40.05	-5.89	-45.39	-1.06	3142	3142	4	5.2	--
9	-32.63	-232.04	504.06	-2.13	-12.35	-0.15	3142	3142	3	18	--
10	-40.90	-244.52	498.90	-4.32	-23.25	-0.11	3142	3142	3	9.8	--
11	-46.38	-245.22	498.29	-5.74	-35.30	0.09	3142	3142	3	6.5	--
12	-36.59	-268.06	497.30	-6.54	-48.33	-0.19	3142	3142	3	4.8	--
13	-29.79	-199.52	490.59	-1.45	-16.21	-1.66	3142	3142	3	12	--
14	-40.60	-192.35	497.48	-1.48	-22.56	-1.10	3142	3142	3	9.3	--
15	-42.15	-186.20	498.55	-3.03	-34.25	0.30	3142	3142	3	6.4	--
16	-31.91	-182.14	494.20	-6.18	-53.38	1.05	3142	3142	3	4.0	--
Massimi/minimi											
1							3142				
1								3142			
16										4.0	

Muro : 145 - Nodi: [0-0-0], Pann.X=4, Pann.Y=4Spess.=40 cm, Terreno=--,Criterio=CLS_Muri_ND, Materiale=C35/45: **Verificato**

Armatura a maglia doppia

Pannello	Nx	Ny	Nxy	Mx	My	Mxy	Ax	Ay	C	Cs	ZE
	kN	kN	kN	kN*m	kN*m	kN*m	mmq	mmq			
1	-44.49	-323.29	-39.18	-3.10	-24.76	0.39	3142	3142	1	9.5	--
2	-52.31	-317.70	-43.54	-2.98	-23.98	0.27	3142	3142	1	9.9	--
3	-60.58	-314.92	-48.09	-2.85	-23.20	0.13	3142	3142	1	10	--
4	-68.89	-313.92	-52.86	-2.73	-22.45	-0.00	3142	3142	1	11	--
5	-43.78	-277.76	-20.21	-2.94	-24.09	-0.63	3142	3142	2	9.4	--
6	-58.08	-278.79	-41.53	-2.64	-22.90	-0.54	3142	3142	2	10.0	--
7	-66.63	-283.04	-55.77	-2.37	-21.75	-0.35	3142	3142	2	11	--
8	-70.31	-287.78	-67.06	-2.10	-20.62	-0.11	3142	3142	2	11	--
9	-23.62	-178.72	-27.03	-2.35	-19.42	-0.14	3142	3142	2	11	--
10	-14.60	-136.29	-25.11	-1.93	-17.43	0.44	3142	3142	1	12	--
11	-11.80	-135.69	-31.38	-1.63	-16.22	0.73	3142	3142	1	13	--
12	-10.32	-135.55	-36.51	-1.35	-15.01	1.01	3142	3142	1	13	--
13	2.16	-14.13	-37.78	-1.38	-14.55	0.67	3142	3142	1	13	--
14	11.36	14.78	-48.26	-0.61	-14.04	0.29	3142	3142	2	13	--
15	6.76	-5.48	-44.34	-0.33	-13.37	0.55	3142	3142	2	14	--
16	-0.33	-28.03	-45.91	-0.20	-12.28	0.79	3142	3142	2	15	--
Massimi/minimi											
1							3142				
1								3142			
5										9.4	

Muro : 146 - Nodi: [0-0-0-0], Pann.X=4, Pann.Y=4Spess.=40 cm, Terreno=--,Criterio=CLS_Muri_ND, Materiale=C35/45: **Verificato**

Armatura a maglia doppia

Pannello	Nx kN	Ny kN	Nxy kN	Mx kN*m	My kN*m	Mxy kN*m	Ax mmq	Ay mmq	C	Cs	ZE
1	-151.80	-283.09	-161.53	-3.43	-16.55	-5.64	3142	3142	1	11	--
2	-59.71	-242.27	-118.62	-0.65	-10.17	-2.35	3142	3142	1	18	--
3	-46.01	-201.20	-96.94	0.61	-4.27	0.16	3142	3142	1	50	--
4	-90.52	-561.16	-218.45	2.61	7.59	4.42	3142	3142	3	23	--
5	-142.81	-212.96	-156.56	-3.00	-14.92	-4.20	3142	3142	2	12	--
6	-131.95	-201.80	-173.28	-0.60	-9.24	-1.34	3142	3142	2	21	--
7	-128.25	-433.58	-212.81	2.30	0.32	2.55	3142	3142	3	43	--
8	-114.33	-421.64	-177.03	3.38	7.19	4.15	3142	3142	3	22	--
9	-88.06	-107.64	-118.64	-1.59	-11.76	-2.77	3142	3142	2	14	--
10	-107.59	-111.39	-136.85	-0.06	-7.39	-0.80	3142	3142	2	25	--
11	-91.04	-288.46	-135.48	2.59	0.85	2.57	3142	3142	4	40	--
12	-142.66	-299.07	-157.16	3.46	6.24	3.64	3142	3142	3	24	--
13	-37.43	-30.53	-54.14	-0.72	-9.12	-2.43	3142	3142	2	17	--
14	-34.08	-67.29	-53.59	0.04	-5.45	-0.88	3142	3142	1	32	--
15	-50.66	-212.10	-100.10	1.75	1.74	2.40	3142	3142	4	48	--
16	-207.61	-250.33	-158.67	3.23	5.41	3.67	3142	3142	3	25	--
Massimi/minimi											
1							3142				
1								3142			
1										11	

Muro : 147 - Nodi: [0-0-0-0], Pann.X=4, Pann.Y=4Spess.=40 cm, Terreno=--,Criterio=CLS_Muri_ND, Materiale=C35/45: **Verificato**

Armatura a maglia doppia

Pannello	Nx kN	Ny kN	Nxy kN	Mx kN*m	My kN*m	Mxy kN*m	Ax mmq	Ay mmq	C	Cs	ZE
1	15.07	-16.53	17.77	1.68	-0.82	0.94	3142	3142	6	72	--
2	-23.02	-18.69	46.07	-1.60	0.21	1.16	3142	3142	5	71	--
3	-28.98	-25.05	40.21	-1.78	-0.07	1.27	3142	3142	5	64	--
4	-19.85	-28.91	25.81	-0.29	-2.26	1.02	3142	3142	4	60	--
5	12.74	-84.36	62.88	-0.42	-2.06	2.89	3142	3142	3	41	--
6	11.37	-81.24	55.37	-0.48	-1.49	2.53	3142	3142	3	51	--
7	8.11	-79.43	46.14	-0.69	-1.95	2.16	3142	3142	3	49	--
8	-3.45	-72.13	36.61	-0.94	-3.36	1.71	3142	3142	4	40	--
9	24.77	-116.33	62.69	-1.15	-3.27	2.25	3142	3142	3	38	--
10	29.52	-112.45	56.47	-1.35	-2.54	1.87	3142	3142	3	47	--
11	28.69	-108.67	49.08	-1.66	-3.01	1.58	3142	3142	3	45	--
12	23.14	-105.82	41.32	-1.98	-4.69	1.34	3142	3142	3	34	--
13	27.37	-56.46	10.52	-1.31	-4.93	1.06	3142	3142	6	33	--
14	33.32	-47.29	8.39	-1.28	-4.14	0.85	3142	3142	6	40	--
15	42.98	-102.07	46.47	-1.77	-3.43	1.22	3142	3142	3	45	--
16	36.59	-97.10	43.34	-2.00	-4.63	1.31	3142	3142	3	35	--
Massimi/minimi											
1							3142				
1								3142			
13										33	

Muro : 148 - Nodi: [0-0-0-0], Pann.X=4, Pann.Y=4Spess.=40 cm, Terreno=--,Criterio=CLS_Muri_ND, Materiale=C35/45: **Verificato**

Armatura a maglia doppia

Pannello	Nx kN	Ny kN	Nxy kN	Mx kN*m	My kN*m	Mxy kN*m	Ax mmq	Ay mmq	C	Cs	ZE
1	4.13	13.70	49.39	-0.81	-6.43	2.39	3142	3142	3	21	--
2	6.52	0.64	51.28	-0.47	-4.34	2.21	3142	3142	3	29	--
3	5.68	-5.12	52.06	-0.11	-2.90	1.99	3142	3142	3	39	--
4	2.89	-7.33	51.27	0.23	-1.93	1.80	3142	3142	3	52	--

Pannello	Nx	Ny	Nxy	Mx	My	Mxy	Ax	Ay	C	Cs	ZE
5	-6.02	-87.75	64.42	-0.92	-7.48	3.81	3142	3142	3	18	--
6	2.04	-88.54	66.32	-0.71	-5.73	3.68	3142	3142	3	22	--
7	7.27	-86.32	66.64	-0.56	-4.28	3.46	3142	3142	3	26	--
8	10.32	-82.39	66.11	-0.47	-3.13	3.23	3142	3142	3	32	--
9	-9.71	-129.04	65.99	-1.29	-9.71	3.40	3142	3142	3	16	--
10	0.57	-121.35	67.32	-1.18	-7.65	3.18	3142	3142	3	19	--
11	9.53	-118.83	67.04	-1.11	-5.97	2.90	3142	3142	3	24	--
12	16.84	-117.36	65.94	-1.09	-4.63	2.62	3142	3142	3	29	--
13	-7.97	-143.61	74.46	-1.67	-12.40	2.63	3142	3142	3	14	--
14	7.68	-130.78	71.47	-1.59	-9.84	2.41	3142	3142	3	17	--
15	20.46	-125.95	67.88	-1.54	-7.75	2.15	3142	3142	3	21	--
16	30.39	-123.69	64.00	-1.52	-6.09	1.93	3142	3142	3	26	--
Massimi/minimi											
1							3142				
1								3142			
13										14	

Muro : 149 - Nodi : [0-0-0-199], Pann.X=4, Pann.Y=4Spess.=40 cm, Terreno=--,Criterio=CLS_Muri_ND, Materiale=C35/45: **Verificato**

Armatura a maglia doppia

Pannello	Nx	Ny	Nxy	Mx	My	Mxy	Ax	Ay	C	Cs	ZE
	kN	kN	kN	kN*m	kN*m	kN*m	mmq	mmq			
1	-6.43	-143.39	10.50	-3.29	-26.58	-0.75	3142	3142	3	7.8	--
2	9.95	-138.13	10.06	-2.44	-19.79	0.03	3142	3142	3	11	--
3	23.38	-135.42	13.70	-1.73	-14.09	0.90	3142	3142	3	14	--
4	33.23	-132.94	19.51	-1.08	-9.43	1.60	3142	3142	3	19	--
5	-7.46	-106.66	6.99	-2.44	-20.47	-0.58	3142	3142	3	9.9	--
6	3.63	-107.45	8.82	-1.55	-15.25	0.21	3142	3142	3	13	--
7	12.11	-105.28	12.27	-0.75	-10.83	1.19	3142	3142	3	17	--
8	18.76	-103.33	16.86	-0.07	-7.16	1.98	3142	3142	3	23	--
9	-5.15	-67.74	13.54	-1.70	-14.48	0.32	3142	3142	3	14	--
10	-0.36	-66.70	13.94	-0.96	-10.86	1.08	3142	3142	3	17	--
11	4.67	-66.66	14.72	-0.23	-7.70	1.92	3142	3142	3	21	--
12	8.42	-66.34	16.91	0.40	-5.04	2.61	3142	3142	3	26	--
13	0.36	-39.32	24.01	-1.22	-12.16	0.58	3142	3142	3	15	--
14	4.30	-35.12	19.31	-0.33	-8.82	0.40	3142	3142	3	21	--
15	3.95	-32.65	18.35	0.18	-6.19	0.49	3142	3142	3	29	--
16	2.90	-31.42	19.14	0.31	-4.11	0.61	3142	3142	3	42	--
Massimi/minimi											
1							3142				
1								3142			
1										7.8	

Muro : 150 - Nodi : [0-0-0-0], Pann.X=4, Pann.Y=4Spess.=40 cm, Terreno=--,Criterio=CLS_Muri_ND, Materiale=C35/45: **Verificato**

Armatura a maglia doppia

Pannello	Nx	Ny	Nxy	Mx	My	Mxy	Ax	Ay	C	Cs	ZE
	kN	kN	kN	kN*m	kN*m	kN*m	mmq	mmq			
1	0.22	-120.86	67.34	-1.85	-13.80	1.42	3142	3142	3	14	--
2	19.45	-112.47	62.14	-1.77	-10.94	1.45	3142	3142	3	17	--
3	34.84	-106.10	57.74	-1.75	-8.59	1.44	3142	3142	3	21	--
4	46.17	-101.89	52.83	-1.72	-6.83	1.40	3142	3142	3	25	--
5	2.88	-81.12	55.97	-1.88	-13.47	0.83	3142	3142	3	14	--
6	27.08	-76.39	54.66	-1.90	-10.78	0.93	3142	3142	3	17	--
7	45.19	-72.10	49.97	-1.93	-8.60	1.01	3142	3142	3	21	--
8	54.71	-65.91	44.45	-1.88	-6.50	1.17	3142	3142	3	26	--
9	5.58	-22.71	51.32	-2.03	-13.53	0.68	3142	3142	3	14	--
10	32.19	-18.95	46.50	-2.09	-10.94	0.81	3142	3142	3	17	--

Pannello	Nx	Ny	Nxy	Mx	My	Mxy	Ax	Ay	C	Cs	z _E
11	56.03	-16.42	49.56	-1.78	-8.26	0.92	3142	3142	3	21	--
12	68.01	-7.15	41.19	-1.89	-7.42	0.72	3142	3142	3	24	--
13	13.83	115.59	-3.86	-2.26	-19.82	1.02	3142	3142	2	8.3	--
14	6.39	87.40	26.19	-1.35	-13.49	-1.26	3142	3142	3	12	--
15	25.66	90.96	48.88	-1.33	-7.02	-1.62	3142	3142	3	21	--
16	116.79	114.90	92.12	-1.72	5.32	1.13	3142	3142	2	27	--
Massimi/minimi											
1							3142				
1								3142			
13										8.3	

Muro : 151 - Nodi: [0-0-0-0], Pann.X=4, Pann.Y=4Spess.=40 cm, Terreno=--,Criterio=CLS_Muri_ND, Materiale=C35/45: **Verificato**

Armatura a maglia doppia

Pannello	Nx	Ny	Nxy	Mx	My	Mxy	Ax	Ay	C	Cs	z _E
	kN	kN	kN	kN*m	kN*m	kN*m	mmq	mmq			
1	31.19	-38.55	-2.60	-1.84	-5.29	0.78	3142	3142	6	32	--
2	34.07	-27.32	-2.16	-1.86	-4.39	0.85	3142	3142	6	37	--
3	35.90	-19.19	0.48	-1.70	-3.62	0.98	3142	3142	6	42	--
4	37.34	-60.48	41.33	-1.42	-3.90	1.31	3142	3142	3	39	--
5	62.49	-58.66	36.57	-1.76	-5.03	1.33	3142	3142	3	32	--
6	30.64	-7.31	-7.64	-2.42	-4.24	0.81	3142	3142	6	38	--
7	43.78	-36.58	34.14	-1.32	-3.42	1.24	3142	3142	3	42	--
8	34.00	-31.59	39.54	-1.15	-3.41	1.36	3142	3142	3	41	--
9	71.64	-12.17	30.11	-1.99	-4.13	1.09	3142	3142	3	37	--
10	53.75	-0.78	25.43	-2.04	-4.04	1.61	3142	3142	3	34	--
11	37.10	-2.55	34.69	-1.61	-3.54	1.38	3142	3142	3	39	--
12	28.83	-3.57	41.37	-1.27	-3.08	1.46	3142	3142	3	42	--
13	85.95	75.29	25.84	-2.36	-6.26	2.24	3142	3142	3	21	--
14	60.96	74.60	45.69	-5.39	-3.60	1.29	3142	3142	2	27	--
15	51.03	55.21	50.12	-4.88	-2.04	0.88	3142	3142	2	32	--
16	48.76	41.35	52.35	-3.95	-0.89	0.79	3142	3142	2	39	--
Massimi/minimi											
1							3142				
1								3142			
13										21	

Muro : 152 - Nodi: [199-0-0-0], Pann.X=4, Pann.Y=4Spess.=40 cm, Terreno=--,Criterio=CLS_Muri_ND, Materiale=C35/45: **Verificato**

Armatura a maglia doppia

Pannello	Nx	Ny	Nxy	Mx	My	Mxy	Ax	Ay	C	Cs	z _E
	kN	kN	kN	kN*m	kN*m	kN*m	mmq	mmq			
1	42.48	-130.34	29.96	-0.22	-4.22	2.30	3142	3142	3	32	--
2	2.62	-49.77	42.19	1.79	3.81	3.54	3142	3142	5	27	--
3	-3.08	-42.89	44.84	2.39	6.25	2.87	3142	3142	5	22	--
4	-10.63	-36.72	44.36	2.62	6.75	1.90	3142	3142	5	23	--
5	25.45	-100.64	25.19	0.77	-3.05	2.74	3142	3142	3	36	--
6	-2.43	-39.63	37.94	1.94	3.12	3.92	3142	3142	5	28	--
7	-5.04	-33.43	40.83	2.36	4.88	3.09	3142	3142	5	25	--
8	-8.45	-27.56	41.28	2.47	5.16	1.95	3142	3142	5	28	--
9	12.01	-65.00	22.47	1.03	-2.09	3.20	3142	3142	3	38	--
10	-6.99	-27.89	34.31	0.50	2.02	4.07	3142	3142	5	32	--
11	-7.57	-21.77	37.03	0.53	3.09	3.14	3142	3142	5	31	--
12	2.37	-25.99	49.72	0.86	2.86	2.37	3142	3142	2	37	--
13	-9.66	-23.81	28.23	-2.60	-0.85	1.49	3142	3142	5	47	--
14	-10.72	-18.49	30.83	-3.78	0.67	1.14	3142	3142	5	39	--
15	-9.68	-11.93	32.41	-4.69	1.32	0.58	3142	3142	5	37	--
16	-6.92	-3.80	32.36	-5.06	1.40	-0.06	3142	3142	5	38	--

Pannello	Nx	Ny	Nxy	Mx	My	Mxy	Ax	Ay	C	Cs	ZE
Massimi/minimi											
1							3142				
1								3142			
3										22	

Muro : 153 - Nodi: [173-200-0-176], Pann.X=4, Pann.Y=4Spess.=40 cm, Terreno=--,Criterio=CLS_Muri_ND, Materiale=C35/45: **Verificato**

Armatura a maglia doppia

Pannello	Nx	Ny	Nxy	Mx	My	Mxy	Ax	Ay	C	Cs	ZE
	kN	kN	kN	kN*m	kN*m	kN*m	mmq	mmq			
1	-178.12	-6.79	-6.46	-19.26	-2.54	-2.72	3142	3142	3	9.9	--
2	-145.18	-0.72	-51.50	-13.92	-1.63	-4.14	3142	3142	3	12	--
3	-48.94	-2.40	-33.61	-8.51	-0.75	-2.30	3142	3142	3	18	--
4	5.07	6.03	-12.70	-7.20	-0.45	-0.79	3142	3142	3	24	--
5	-162.36	14.83	-19.91	-9.17	-1.49	-1.94	3142	3142	3	19	--
6	-126.12	13.33	-38.97	-7.05	-0.53	-1.91	3142	3142	3	24	--
7	-61.22	2.31	-37.28	-4.73	0.35	-1.32	3142	3142	3	33	--
8	-8.47	4.63	-17.30	-3.43	0.72	-0.25	3142	3142	3	52	--
9	-88.84	24.77	-7.77	-5.08	-1.47	-1.10	3142	3142	6	33	--
10	-68.23	20.12	-14.43	-3.95	-0.56	-1.11	3142	3142	6	40	--
11	-38.41	14.16	-14.62	-2.65	0.89	-0.87	3142	3142	6	56	--
12	-9.89	11.13	-5.36	-1.57	3.36	-0.42	3142	3142	6	50	--
13	-79.96	29.56	-3.89	-3.65	-1.31	-0.52	3142	3142	6	49	--
14	-47.72	-0.30	-23.07	2.97	1.18	0.18	3142	3142	5	63	--
15	-67.21	7.76	-24.58	0.29	1.76	-0.50	3142	3142	3	84	--
16	-16.38	11.41	-3.50	-0.74	4.00	-0.13	3142	3142	6	46	--
Massimi/minimi											
1							3142				
1								3142			
1										9.9	

Muro : 154 - Nodi: [176-0-0-175], Pann.X=4, Pann.Y=4Spess.=40 cm, Terreno=--,Criterio=CLS_Muri_ND, Materiale=C35/45: **Verificato**

Armatura a maglia doppia

Pannello	Nx	Ny	Nxy	Mx	My	Mxy	Ax	Ay	C	Cs	ZE
	kN	kN	kN	kN*m	kN*m	kN*m	mmq	mmq			
1	-9.72	3.57	10.44	-7.55	-0.43	0.73	3142	3142	3	23	--
2	-66.51	-4.43	27.03	-8.84	-0.78	2.04	3142	3142	3	19	--
3	-152.86	-5.72	47.88	-15.08	-1.87	3.85	3142	3142	3	11	--
4	-207.94	-6.10	9.13	-20.61	-2.85	1.97	3142	3142	3	9.9	--
5	-20.15	2.61	12.82	-3.91	0.87	0.30	3142	3142	3	46	--
6	-73.41	0.19	31.82	-5.53	0.21	1.11	3142	3142	3	31	--
7	-141.91	11.15	37.43	-8.69	-1.01	1.64	3142	3142	3	21	--
8	-188.22	20.67	13.90	-11.43	-2.09	1.44	3142	3142	3	17	--
9	-6.22	14.12	12.87	-1.34	2.71	0.72	3142	3142	6	55	--
10	-39.61	15.00	23.55	-2.53	0.53	1.66	3142	3142	6	47	--
11	-72.50	19.94	23.23	-3.89	-0.65	1.80	3142	3142	6	36	--
12	-93.21	24.72	11.27	-5.01	-1.26	1.81	3142	3142	6	30	--
13	-12.26	13.88	12.22	-0.60	3.39	0.44	3142	3142	6	49	--
14	-38.95	17.87	21.10	-1.70	0.85	1.09	3142	3142	6	71	--
15	-65.03	24.38	19.41	-2.89	-0.50	1.23	3142	3142	6	49	--
16	-81.39	30.08	9.12	-3.98	-1.07	1.35	3142	3142	6	38	--
Massimi/minimi											
1							3142				
1								3142			
4										9.9	

Muro : 155 - Nodi: [175-0-0-174], Pann.X=4, Pann.Y=4Spess.=40 cm, Terreno=--,Criterio=CLS_Muri_ND, Materiale=C35/45: **Verificato**

Armatura a maglia doppia

Pannello	Nx	Ny	Nxy	Mx	My	Mxy	Ax	Ay	C	Cs	ZE
	kN	kN	kN	kN*m	kN*m	kN*m	mmq	mmq			
1	-210.59	-4.71	-3.78	-19.98	-2.73	0.59	3142	3142	3	11	--
2	-142.02	-0.88	-19.16	-14.01	-1.73	-2.03	3142	3142	4	13	--
3	-76.32	5.20	-15.19	-7.21	-0.61	-0.81	3142	3142	4	25	--
4	108.53	20.53	-61.41	-4.99	-0.39	4.80	3142	3142	3	18	--
5	-192.14	25.00	-9.97	-11.58	-1.98	1.04	3142	3142	3	17	--
6	-150.29	31.19	-34.22	-8.69	-0.35	1.28	3142	3142	3	21	--
7	-65.35	37.24	-44.71	-5.50	0.93	2.81	3142	3142	3	24	--
8	116.29	18.45	-42.38	-4.39	-0.13	4.84	3142	3142	2	19	--
9	-93.17	26.49	-6.05	-5.59	-1.00	1.96	3142	3142	6	27	--
10	-66.70	26.47	-24.41	-5.76	0.18	2.30	3142	3142	6	25	--
11	-13.87	23.79	-36.57	-7.01	0.96	2.94	3142	3142	6	19	--
12	110.80	23.97	-19.98	-9.04	-0.98	3.43	3142	3142	2	14	--
13	-80.84	32.68	-6.64	-4.94	-0.77	1.60	3142	3142	6	31	--
14	-56.10	31.03	-23.07	-6.32	0.27	1.85	3142	3142	6	24	--
15	-7.29	23.52	-31.96	-8.06	0.79	1.65	3142	3142	6	20	--
16	75.69	112.83	21.01	-19.14	-6.82	-2.96	3142	3142	2	8.1	--
Massimi/minimi											
1							3142				
1								3142			
16										8.1	

Muro [Platea]: 156 - Nodi: [0-0-0-0]Pann=16Spess.=40 cm, Terreno=Terreno1, ,Criterio=CLS_Platee_ND, Materiale=C35/45: **Verificato**

Armatura a maglia doppia

Pannello	Nx	Ny	Nxy	Mx	My	Mxy	Ax	Ay	C	Cs	ZE
	kN	kN	kN	kN*m	kN*m	kN*m	mmq	mmq			
1	-28.34	-87.29	51.45	9.26	6.80	-1.86	3142	3142	3	18	--
2	-3.61	-78.73	56.50	13.43	9.75	-2.20	3142	3142	4	12	--
3	-6.98	-31.39	86.54	7.67	5.65	-1.82	3142	3142	4	20	--
4	-8.57	77.02	78.45	0.20	-11.14	-2.24	3142	3142	3	13	--
5	-25.63	-63.90	44.15	6.99	4.74	1.04	3142	3142	4	24	--
6	-7.49	-56.75	53.65	11.01	10.26	-5.37	3142	3142	3	12	--
7	-2.09	-13.87	59.67	7.67	7.27	-9.03	3142	3142	3	11	--
8	0.99	32.30	51.88	0.57	-12.50	-6.21	3142	3142	3	10.0	--
9	-2.39	-60.66	53.75	0.60	3.06	1.30	3142	3142	3	46	--
10	-11.70	-35.12	36.57	1.32	5.77	-5.48	3142	3142	3	17	--
11	-0.21	-8.81	39.73	1.54	4.86	-10.49	3142	3142	3	13	--
12	4.90	22.11	35.05	-0.41	-7.89	-7.36	3142	3142	3	12	--
13	22.87	-43.29	33.64	-15.56	0.74	0.60	3142	3142	3	12	--
14	-6.27	-30.41	27.04	-21.67	0.05	-2.71	3142	3142	3	7.9	--
15	2.56	-8.75	26.41	-13.59	0.41	-6.47	3142	3142	3	9.5	--
16	4.97	28.38	16.85	-3.64	-4.20	-5.28	3142	3142	3	20	--
Massimi/minimi											
1							3142				
1								3142			
14										7.9	

Muro [Platea]: 157 - Nodi: [176-175-172-173]Pann=9Spess.=40 cm, Terreno=Terreno1, ,Criterio=CLS_Platee_ND, Materiale=C35/45: **Verificato**

Armatura a maglia doppia

Pannello	Nx	Ny	Nxy	Mx	My	Mxy	Ax	Ay	C	Cs	ZE
	kN	kN	kN	kN*m	kN*m	kN*m	mmq	mmq			
1	-41.47	-12.91	41.79	-2.00	-16.92	-7.52	3142	3142	3	7.9	--

Pannello	Nx	Ny	Nxy	Mx	My	Mxy	Ax	Ay	C	Cs	ZE
2	-47.96	38.33	67.29	8.56	-4.26	-5.63	3142	3142	3	14	--
3	-121.74	-58.53	106.57	12.40	12.60	-6.75	3142	3142	3	10	--
4	16.55	-24.36	80.49	0.59	11.09	-7.65	3142	3142	3	10	--
5	-6.61	-14.62	65.50	-7.48	-2.36	-7.79	3142	3142	3	13	--
6	15.67	6.28	21.64	-9.40	-2.96	-6.96	3142	3142	3	12	--
7	14.56	14.91	8.52	-3.69	-5.46	-4.54	3142	3142	3	19	--
8	-1.13	5.48	16.95	-2.45	-17.00	-6.54	3142	3142	3	8.1	--
9	-29.71	0.33	38.56	-1.23	-4.00	-13.89	3142	3142	3	11	--
Massimi/minimi											
1							3142				
1								3142			
1										7.9	

Muro [Platea]: 158 - Nodi: [175-174-171-172]Pann=8Spess.=40 cm, Terreno=Terreno1, ,Criterio=CLS_Platee_ND, Materiale=C35/45: **Verificato**

Armatura a maglia doppia

Pannello	Nx	Ny	Nxy	Mx	My	Mxy	Ax	Ay	C	Cs	ZE
	kN	kN	kN	kN*m	kN*m	kN*m	mmq	mmq			
1	-45.77	-12.93	-23.98	0.86	-12.42	6.04	3142	3142	3	10	--
2	28.46	-87.86	0.14	-6.28	6.60	2.32	3142	3142	6	22	--
3	-49.31	-12.98	-26.14	1.63	-2.57	5.69	3142	3142	4	23	--
4	-64.01	-9.30	-50.95	1.73	0.29	8.09	3142	3142	4	20	--
5	-52.11	-43.37	-53.25	5.98	12.94	6.35	3142	3142	3	10	--
6	-167.61	-45.92	-59.73	13.99	14.65	3.53	3142	3142	3	11	--
7	-73.72	15.52	-41.56	8.18	-4.66	2.62	3142	3142	3	19	--
8	-78.80	-31.29	-25.45	2.06	-17.51	7.82	3142	3142	3	7.7	--
Massimi/minimi											
1							3142				
1								3142			
8										7.7	

Muro [Platea]: 159 - Nodi: [0-0-0-0]Pann=16Spess.=40 cm, Terreno=Terreno1, ,Criterio=CLS_Platee_ND, Materiale=C35/45: **Verificato**

Armatura a maglia doppia

Pannello	Nx	Ny	Nxy	Mx	My	Mxy	Ax	Ay	C	Cs	ZE
	kN	kN	kN	kN*m	kN*m	kN*m	mmq	mmq			
1	49.77	32.32	-9.79	-9.31	-5.84	-2.71	3142	3142	4	15	--
2	18.69	3.86	-17.29	-16.16	-1.91	-2.81	3142	3142	3	9.9	--
3	8.91	-4.18	-1.73	-17.63	-0.48	-2.86	3142	3142	3	9.3	--
4	38.92	6.25	9.92	-12.33	-0.06	1.42	3142	3142	3	13	--
5	5.03	25.53	-25.65	-1.49	-9.57	-3.99	3142	3142	3	14	--
6	16.33	11.07	5.45	-2.52	-0.42	-4.02	3142	3142	4	29	--
7	6.05	2.10	7.81	-1.97	3.05	-3.10	3142	3142	4	31	--
8	0.19	-3.00	22.70	-0.23	3.88	3.91	3142	3142	3	25	--
9	-10.99	33.04	-11.41	1.97	-12.19	-3.68	3142	3142	3	12	--
10	0.32	10.62	-0.52	6.03	1.04	-2.55	3142	3142	3	22	--
11	-6.63	-10.60	2.92	7.47	5.74	-0.99	3142	3142	3	23	--
12	-30.64	-10.02	15.92	6.26	6.19	4.04	3142	3142	3	19	--
13	-25.43	69.64	12.83	5.42	-10.04	0.51	3142	3142	3	17	--
14	-4.63	7.29	29.54	10.53	1.69	2.57	3142	3142	3	15	--
15	-2.46	-32.02	19.18	13.23	6.10	2.33	3142	3142	3	12	--
16	-38.47	-39.60	-2.68	9.93	6.19	3.62	3142	3142	3	15	--
Massimi/minimi											
1							3142				
1								3142			
3										9.3	

Muro : 160 - Nodi: [0-0-0], Pann.X=4, Pann.Y=4Spess.=40 cm, Terreno=--,Criterio=CLS_Muri_ND, Materiale=C35/45: **Verificato**

Armatura a maglia doppia

Pannello	Nx	Ny	Nxy	Mx	My	Mxy	Ax	Ay	C	Cs	ZE
	kN	kN	kN	kN*m	kN*m	kN*m	mmq	mmq			
1	-20.39	-158.93	-73.51	-1.85	-14.78	-1.38	3142	3142	1	13	--
2	-22.14	-164.19	-75.25	-1.80	-14.36	-1.37	3142	3142	1	14	--
3	-24.11	-170.42	-76.70	-1.76	-13.98	-1.39	3142	3142	1	14	--
4	-26.39	-177.32	-77.84	-1.71	-13.60	-1.44	3142	3142	1	15	--
5	-14.23	-89.72	-69.82	-1.98	-15.19	-1.23	3142	3142	1	12	--
6	-18.54	-84.89	-72.21	-2.01	-14.18	-1.14	3142	3142	1	13	--
7	-20.95	-81.06	-75.71	-1.99	-13.11	-1.13	3142	3142	1	14	--
8	-20.72	-78.98	-80.27	-1.93	-12.06	-1.15	3142	3142	1	15	--
9	3.53	39.03	-153.64	-2.01	-15.74	-2.81	3142	3142	2	10.0	--
10	3.36	46.83	-159.90	-1.75	-12.23	-3.09	3142	3142	2	12	--
11	-10.89	-6.75	-99.09	-1.80	-10.48	-2.20	3142	3142	1	15	--
12	-12.73	62.41	-165.41	-1.68	-6.60	-2.33	3142	3142	2	20	--
13	46.09	349.50	-166.10	-0.33	-8.09	-2.41	3142	3142	2	13	--
14	4.68	18.65	-65.98	1.11	-7.83	1.97	3142	3142	5	19	--
15	-10.72	15.25	-71.56	2.59	-4.37	3.06	3142	3142	5	25	--
16	-70.16	183.70	-154.06	3.43	4.56	2.61	3142	3142	2	23	--
Massimi/minimi											
1							3142				
1								3142			
9										10.0	

Muro : 161 - Nodi: [0-0-0-0], Pann.X=4, Pann.Y=4Spess.=40 cm, Terreno=--,Criterio=CLS_Muri_ND, Materiale=C35/45: **Verificato**

Armatura a maglia doppia

Pannello	Nx	Ny	Nxy	Mx	My	Mxy	Ax	Ay	C	Cs	ZE
	kN	kN	kN	kN*m	kN*m	kN*m	mmq	mmq			
1	-101.27	-125.78	-101.72	-2.91	-9.64	-4.00	3142	3142	1	15	--
2	-40.35	-60.62	-58.53	-0.55	-5.25	-0.84	3142	3142	1	33	--
3	-27.92	4.03	-33.02	0.77	-2.86	1.15	3142	3142	1	47	--
4	15.40	162.18	-65.48	1.58	-1.81	2.30	3142	3142	2	40	--
5	-82.73	-2.25	-77.49	-2.99	-7.00	-2.32	3142	3142	1	21	--
6	-70.33	14.99	-73.51	-0.74	-3.80	0.74	3142	3142	1	42	--
7	-65.66	92.91	-102.44	1.09	-2.72	2.57	3142	3142	2	33	--
8	-37.22	34.35	-45.93	2.39	-1.76	3.09	3142	3142	1	36	--
9	-66.63	28.13	-56.43	-1.58	-2.75	-0.51	3142	3142	5	57	--
10	-100.89	135.22	-75.66	0.43	-1.79	2.72	3142	3142	2	38	--
11	-75.68	109.30	-73.51	1.86	-2.34	3.36	3142	3142	2	31	--
12	-59.94	80.70	-64.94	2.16	-2.42	3.28	3142	3142	2	31	--
13	-70.36	67.90	-22.97	6.86	-2.45	1.74	3142	3142	5	23	--
14	-59.85	75.28	-19.07	5.70	-1.82	2.86	3142	3142	1	23	--
15	-54.35	109.97	-22.84	3.21	-2.68	3.93	3142	3142	2	26	--
16	-48.46	72.47	-30.76	1.82	-3.45	4.13	3142	3142	2	24	--
Massimi/minimi											
1							3142				
1								3142			
1										15	

Muro : 162 - Nodi: [171-174-0-0], Pann.X=4, Pann.Y=4Spess.=40 cm, Terreno=--,Criterio=CLS_Muri_ND, Materiale=C35/45: **Verificato**

Armatura a maglia doppia

Pannello	Nx	Ny	Nxy	Mx	My	Mxy	Ax	Ay	C	Cs	ZE
	kN	kN	kN	kN*m	kN*m	kN*m	mmq	mmq			
1	-15.10	-179.01	520.10	-1.43	-16.43	1.44	3142	3142	3	12	--

Pannello	Nx	Ny	Nxy	Mx	My	Mxy	Ax	Ay	C	Cs	ZE
2	-6.18	-176.20	509.01	-1.45	-22.63	0.73	3142	3142	3	9.3	--
3	-2.42	-179.94	503.02	-3.14	-34.75	-0.72	3142	3142	3	6.2	--
4	-14.80	-165.12	499.65	-6.39	-54.69	-1.70	3142	3142	3	3.8	--
5	-2.22	-114.23	542.91	-1.40	-9.39	-1.30	3142	3142	6	20	--
6	2.39	-135.84	475.95	-4.04	-21.18	-0.96	3142	3142	3	9.6	--
7	4.25	-127.10	477.98	-5.77	-35.58	-0.60	3142	3142	3	5.8	--
8	-6.12	-98.47	478.90	-6.88	-51.01	-0.05	3142	3142	3	4.0	--
9	-2.82	-10.72	56.07	0.81	8.66	-1.22	3142	3142	5	20	--
10	-9.04	-16.85	434.89	-2.72	-15.09	-1.58	3142	3142	3	12	--
11	8.82	3.75	435.59	-4.69	-31.71	-0.04	3142	3142	3	6.0	--
12	17.86	25.53	418.61	-6.32	-48.33	0.60	3142	3142	3	3.8	--
13	-52.09	3.68	367.82	2.26	16.23	-4.75	3142	3142	2	9.1	--
14	-18.01	47.91	263.51	-0.11	-7.69	-2.47	3142	3142	3	18	--
15	-18.12	301.99	346.48	-2.37	-24.54	-1.28	3142	3142	2	5.6	--
16	77.07	313.64	427.11	-5.94	-49.83	-1.00	3142	3142	2	2.8	--
Massimi/minimi											
1							3142				
1								3142			
16										2.8	

Muro : 163 - Nodi: [200-0-0-0], Pann.X=4, Pann.Y=4Spess.=40 cm, Terreno=--,Criterio=CLS_Muri_ND, Materiale=C35/45: **Verificato**

Armatura a maglia doppia

Pannello	Nx	Ny	Nxy	Mx	My	Mxy	Ax	Ay	C	Cs	ZE
	kN	kN	kN	kN*m	kN*m	kN*m	mmq	mmq			
1	-52.28	6.69	-16.00	5.00	1.58	-0.69	3142	3142	5	35	--
2	-43.84	-0.40	-17.66	3.92	1.42	-0.56	3142	3142	5	44	--
3	-36.51	-7.92	-16.04	2.56	0.25	-0.53	3142	3142	5	64	--
4	-20.60	11.00	-1.06	-0.19	4.25	0.07	3142	3142	6	44	--
5	-47.24	8.57	-10.59	5.00	1.65	-1.36	3142	3142	5	31	--
6	-40.30	0.72	-11.66	3.95	1.45	-1.38	3142	3142	5	37	--
7	-35.58	-7.13	-10.66	2.63	0.25	-1.39	3142	3142	5	49	--
8	-22.01	10.39	1.39	0.12	4.20	0.20	3142	3142	6	43	--
9	-42.79	11.28	-4.66	3.98	1.47	-1.91	3142	3142	5	34	--
10	-36.81	3.18	-5.41	3.23	1.29	-2.06	3142	3142	5	37	--
11	-33.39	-4.61	-5.26	2.24	0.26	-2.13	3142	3142	5	45	--
12	-20.48	9.95	3.64	0.24	3.92	0.31	3142	3142	6	45	--
13	-38.71	14.73	1.41	2.05	1.07	-2.20	3142	3142	5	46	--
14	-33.19	6.81	0.75	1.83	0.95	-2.45	3142	3142	5	46	--
15	-29.88	-0.61	-0.05	1.43	0.25	-2.57	3142	3142	5	49	--
16	-16.18	10.06	5.58	0.17	3.42	0.42	3142	3142	6	49	--
Massimi/minimi											
1							3142				
1								3142			
5										31	

Muro : 164 - Nodi: [0-0-0-0], Pann.X=4, Pann.Y=4Spess.=40 cm, Terreno=--,Criterio=CLS_Muri_ND, Materiale=C35/45: **Verificato**

Armatura a maglia doppia

Pannello	Nx	Ny	Nxy	Mx	My	Mxy	Ax	Ay	C	Cs	ZE
	kN	kN	kN	kN*m	kN*m	kN*m	mmq	mmq			
1	-69.73	35.23	-7.02	-4.53	-0.58	1.03	3142	3142	6	36	--
2	-47.18	32.52	-20.56	-5.99	0.26	0.94	3142	3142	6	29	--
3	-3.85	22.42	-25.73	-9.18	0.13	0.40	3142	3142	6	20	--
4	70.84	137.18	-51.84	-10.83	-9.44	-4.19	3142	3142	2	12	--
5	-59.94	35.30	-7.30	-4.04	-0.44	0.36	3142	3142	6	46	--
6	-39.56	32.33	-17.41	-5.61	0.07	0.21	3142	3142	6	34	--
7	-2.33	22.13	-19.36	-7.42	-0.50	-0.99	3142	3142	6	23	--

Pannello	Nx	Ny	Nxy	Mx	My	Mxy	Ax	Ay	C	Cs	ZE
8	63.73	82.64	-48.94	-6.36	-8.01	-4.61	3142	3142	2	14	--
9	-51.73	33.86	-7.62	-3.59	-0.37	-0.23	3142	3142	6	52	--
10	-97.54	56.81	-44.29	-4.23	0.46	-1.38	3142	3142	3	37	--
11	-42.89	50.35	-52.43	-5.36	-0.59	-2.35	3142	3142	3	26	--
12	49.02	57.56	-41.44	-3.60	-6.99	-4.04	3142	3142	2	17	--
13	-116.15	45.87	-35.58	-4.57	-0.36	-1.47	3142	3142	3	35	--
14	-90.56	46.36	-42.81	-5.17	0.03	-1.80	3142	3142	3	29	--
15	-39.37	36.36	-44.90	-5.07	-0.99	-2.22	3142	3142	3	27	--
16	36.06	45.46	-36.57	-2.02	-6.28	-3.48	3142	3142	2	19	--
Massimi/minimi											
1							3142				
1								3142			
4										12	

Muro : 165 - Nodi : [0-0-0-0], Pann.X=4, Pann.Y=4Spess.=40 cm, Terreno=--,Criterio=CLS_Muri_ND, Materiale=C35/45: **Verificato**

Armatura a maglia doppia

Pannello	Nx	Ny	Nxy	Mx	My	Mxy	Ax	Ay	C	Cs	ZE
	kN	kN	kN	kN*m	kN*m	kN*m	mmq	mmq			
1	-16.87	12.95	10.60	-0.11	3.70	0.22	3142	3142	6	48	--
2	-41.36	-1.53	6.50	1.72	1.08	-1.11	3142	3142	1	70	--
3	-51.56	5.88	7.51	2.21	1.15	-1.06	3142	3142	5	61	--
4	-70.89	32.32	6.43	-3.26	-0.87	0.82	3142	3142	6	50	--
5	-19.47	11.83	8.50	0.17	3.74	0.05	3142	3142	6	50	--
6	-38.62	-0.00	-1.41	1.93	1.08	-0.73	3142	3142	1	74	--
7	-48.06	14.72	-3.62	2.56	1.52	-0.78	3142	3142	1	60	--
8	-56.64	22.40	-6.38	2.77	1.28	-0.77	3142	3142	5	57	--
9	-19.84	10.76	6.23	0.25	3.55	-0.09	3142	3142	6	52	--
10	-34.56	2.76	-9.06	1.72	0.97	-0.38	3142	3142	1	94	--
11	-42.32	16.29	-12.28	2.20	1.40	-0.59	3142	3142	1	71	--
12	-50.76	29.87	-17.53	2.32	1.49	-0.77	3142	3142	1	64	--
13	-18.18	9.80	3.97	0.14	3.17	-0.22	3142	3142	6	56	--
14	-56.38	10.90	-23.18	-1.44	0.55	-0.99	3142	3142	4	82	--
15	-93.82	27.98	-25.03	-2.59	-0.08	-1.27	3142	3142	3	53	--
16	-114.02	38.73	-28.98	-3.67	-0.50	-1.41	3142	3142	3	41	--
Massimi/minimi											
1							3142				
1								3142			
16										41	

Muro : 166 - Nodi : [149-0-194-150], Pann.X=4, Pann.Y=4Spess.=20 cm, Terreno=--,Criterio=CLS_Muri_ND, Materiale=C35/45: **Verificato**

Armatura a maglia doppia

Pannello	Nx	Ny	Nxy	Mx	My	Mxy	Ax	Ay	C	Cs	ZE
	kN	kN	kN	kN*m	kN*m	kN*m	mmq	mmq			
1	-23.28	-53.20	42.99	0.26	-0.06	-0.07	3142	3142	3	>100	--
2	-11.43	-64.54	32.01	0.29	-0.18	-0.06	3142	3142	2	>100	--
3	-36.36	-79.17	42.85	0.38	-0.28	-0.10	3142	3142	2	>100	--
4	-122.60	-99.22	90.24	0.19	-0.23	0.52	3142	3142	3	>100	--
5	-25.96	-57.90	48.11	0.27	-0.06	-0.07	3142	3142	3	>100	--
6	-13.11	-67.59	36.47	0.30	-0.18	-0.04	3142	3142	2	>100	--
7	-63.87	-92.36	84.31	0.33	-0.21	-0.11	3142	3142	3	>100	--
8	-124.12	-101.49	91.68	0.34	-0.19	0.49	3142	3142	3	>100	--
9	-31.35	-61.03	53.06	0.27	-0.06	-0.07	3142	3142	3	>100	--
10	-15.10	-69.40	40.91	0.29	-0.18	-0.03	3142	3142	2	>100	--
11	-66.53	-93.63	88.16	0.33	-0.18	-0.10	3142	3142	3	>100	--
12	-122.85	-102.05	92.46	0.44	-0.15	0.50	3142	3142	3	88	--
13	-38.78	-62.76	57.71	0.27	-0.06	-0.07	3142	3142	3	>100	--

Pannello	Nx	Ny	Nxy	Mx	My	Mxy	Ax	Ay	C	Cs	ZE
14	-45.61	-78.90	77.92	0.27	-0.15	-0.05	3142	3142	3	>100	--
15	-23.29	9.34	-3.18	0.37	-0.25	0.02	3142	3142	6	>100	--
16	-117.59	-101.03	92.89	0.62	-0.11	0.58	3142	3142	3	69	--
Massimi/minimi											
1							3142				
1								3142			
16										69	

Muro : 167 - Nodi: [148-196-0-149], Pann.X=4, Pann.Y=4Spess.=20 cm, Terreno=--,Criterio=CLS_Muri_ND, Materiale=C35/45: **Verificato**

Armatura a maglia doppia

Pannello	Nx	Ny	Nxy	Mx	My	Mxy	Ax	Ay	C	Cs	ZE
	kN	kN	kN	kN*m	kN*m	kN*m	mmq	mmq			
1	-82.86	19.03	-37.93	0.13	1.28	-0.28	3142	3142	3	48	--
2	-51.69	-4.19	-26.84	0.61	0.67	0.02	3142	3142	3	>100	--
3	-9.99	-16.34	2.73	0.38	0.28	0.02	3142	3142	2	>100	--
4	-23.49	-35.70	20.40	0.30	0.09	-0.03	3142	3142	3	>100	--
5	-83.96	16.49	-32.16	0.34	1.33	-0.14	3142	3142	3	51	--
6	-57.09	-6.78	-21.90	0.55	0.68	-0.00	3142	3142	3	>100	--
7	-11.45	-18.08	6.72	0.40	0.28	0.00	3142	3142	2	>100	--
8	-4.52	-34.92	16.86	0.32	0.09	-0.02	3142	3142	2	>100	--
9	-83.74	13.09	-26.24	0.39	1.34	-0.06	3142	3142	3	53	--
10	-60.77	-9.77	-16.95	0.52	0.68	-0.02	3142	3142	3	>100	--
11	-13.23	-19.70	10.80	0.41	0.28	-0.02	3142	3142	2	>100	--
12	-6.38	-37.14	21.05	0.32	0.09	-0.03	3142	3142	2	>100	--
13	-83.68	8.92	-20.51	0.38	1.32	-0.01	3142	3142	3	57	--
14	-63.27	-13.09	-12.06	0.48	0.67	-0.04	3142	3142	3	>100	--
15	-14.92	-21.20	14.94	0.40	0.28	-0.04	3142	3142	2	>100	--
16	-8.34	-38.80	25.26	0.32	0.08	-0.05	3142	3142	2	>100	--
Massimi/minimi											
1							3142				
1								3142			
1										48	

Muro : 168 - Nodi: [0-0-0-194], Pann.X=4, Pann.Y=4Spess.=20 cm, Terreno=--,Criterio=CLS_Muri_ND, Materiale=C35/45: **Verificato**

Armatura a maglia doppia

Pannello	Nx	Ny	Nxy	Mx	My	Mxy	Ax	Ay	C	Cs	ZE
	kN	kN	kN	kN*m	kN*m	kN*m	mmq	mmq			
1	-48.16	-62.89	66.09	0.23	-0.06	-0.07	3142	3142	3	>100	--
2	-15.30	3.69	-11.55	0.25	-0.23	0.01	3142	3142	6	>100	--
3	-24.51	6.28	-4.84	0.29	-0.24	0.05	3142	3142	6	>100	--
4	-112.35	-96.40	93.44	0.38	-0.09	0.12	3142	3142	3	>100	--
5	-17.72	-51.56	54.30	0.16	-0.01	-0.06	3142	3142	2	>100	--
6	-20.23	0.99	-13.43	0.16	-0.21	0.03	3142	3142	6	>100	--
7	-25.16	3.31	-7.33	0.18	-0.21	0.07	3142	3142	6	>100	--
8	-67.00	-70.62	52.13	0.14	-0.34	0.09	3142	3142	2	>100	--
9	-20.05	-57.21	70.09	-0.06	0.15	-0.10	3142	3142	5	>100	--
10	-24.93	-0.54	-15.26	0.04	-0.17	0.03	3142	3142	6	>100	--
11	-31.44	-51.81	66.49	0.00	-0.19	0.10	3142	3142	2	>100	--
12	-45.52	-52.18	52.37	-0.02	-0.43	0.12	3142	3142	2	>100	--
13	-107.30	-44.75	81.23	-0.24	0.09	-0.13	3142	3142	4	>100	--
14	-87.87	-41.73	106.41	-0.25	0.13	-0.03	3142	3142	4	>100	--
15	-17.67	-34.08	68.51	-0.21	-0.09	0.12	3142	3142	1	>100	--
16	-18.31	-30.43	55.35	-0.24	-0.61	0.16	3142	3142	1	>100	--
Massimi/minimi											
1							3142				
1								3142			

Pannello	Nx	Ny	Nxy	Mx	My	Mxy	Ax	Ay	C	Cs	ZE
16										>100	

Muro : 169 - Nodi: [196-0-0-0], Pann.X=4, Pann.Y=4Spess.=20 cm, Terreno=--,Criterio=CLS_Muri_ND, Materiale=C35/45: **Verificato**

Armatura a maglia doppia

Pannello	Nx	Ny	Nxy	Mx	My	Mxy	Ax	Ay	C	Cs	ZE
	kN	kN	kN	kN*m	kN*m	kN*m	mmq	mmq			
1	-82.41	-1.52	-10.40	0.33	1.22	0.10	3142	3142	3	58	--
2	-23.17	-7.27	16.06	0.43	0.62	-0.04	3142	3142	2	>100	--
3	-16.45	-24.18	23.01	0.37	0.27	-0.06	3142	3142	2	>100	--
4	-11.51	-40.43	33.39	0.29	0.08	-0.06	3142	3142	2	>100	--
5	-82.12	-21.37	1.76	0.13	0.99	0.21	3142	3142	3	64	--
6	-23.75	-15.61	27.13	0.32	0.56	-0.01	3142	3142	2	>100	--
7	-20.09	-28.76	33.60	0.28	0.24	-0.08	3142	3142	2	>100	--
8	-17.31	-40.88	43.67	0.22	0.08	-0.10	3142	3142	2	>100	--
9	-85.59	-46.92	10.08	0.05	0.76	0.28	3142	3142	3	76	--
10	-24.25	-26.42	35.34	0.20	0.43	0.04	3142	3142	2	>100	--
11	-23.22	-33.82	40.58	0.17	0.17	-0.10	3142	3142	2	>100	--
12	-19.59	-39.38	51.95	0.03	0.11	-0.15	3142	3142	1	>100	--
13	-30.31	-35.68	32.96	0.12	0.66	0.27	3142	3142	2	85	--
14	-23.75	-39.46	39.28	0.09	0.23	0.07	3142	3142	2	>100	--
15	-84.80	-61.69	17.59	-0.14	0.02	-0.12	3142	3142	4	>100	--
16	-107.47	-50.48	46.41	-0.21	0.03	-0.17	3142	3142	4	>100	--
Massimi/minimi											
1							3142				
1								3142			
1										58	

Muro : 170 - Nodi: [0-198-0], Pann.X=4, Pann.Y=4Spess.=40 cm, Terreno=--,Criterio=CLS_Muri_ND, Materiale=C35/45: **Verificato**

Armatura a maglia doppia

Pannello	Nx	Ny	Nxy	Mx	My	Mxy	Ax	Ay	C	Cs	ZE
	kN	kN	kN	kN*m	kN*m	kN*m	mmq	mmq			
1	-29.96	-36.87	-23.66	12.10	-0.18	-12.27	3142	3142	5	8.0	--
2	-33.20	-39.49	-25.70	11.95	-0.83	-11.99	3142	3142	5	8.2	--
3	-36.23	-41.51	-27.85	11.71	-1.53	-11.67	3142	3142	5	8.4	--
4	-38.96	-43.04	-30.19	11.40	-2.29	-11.32	3142	3142	5	8.7	--
5	-22.45	-11.02	-9.51	7.77	1.17	-12.11	3142	3142	5	9.8	--
6	-30.23	-17.08	-13.46	8.54	0.99	-11.68	3142	3142	5	9.7	--
7	-37.90	-23.23	-17.98	9.04	0.53	-11.09	3142	3142	5	9.8	--
8	-45.94	-29.16	-22.56	9.30	-0.20	-10.36	3142	3142	5	10	--
9	-11.35	17.37	5.35	2.88	2.09	-9.76	3142	3142	5	15	--
10	-26.85	8.26	-1.08	4.87	2.71	-10.19	3142	3142	5	13	--
11	-40.86	-1.90	-8.09	6.24	2.60	-9.99	3142	3142	5	12	--
12	-53.80	-12.39	-14.97	7.00	1.86	-9.21	3142	3142	5	12	--
13	-5.34	47.33	16.46	-3.17	-0.12	-6.43	3142	3142	5	20	--
14	-30.51	33.28	10.51	0.66	2.82	-8.05	3142	3142	5	17	--
15	-48.70	18.77	3.33	3.35	4.01	-8.55	3142	3142	5	15	--
16	-63.66	3.82	-5.03	4.88	3.69	-7.99	3142	3142	5	16	--
Massimi/minimi											
1							3142				
1								3142			
1										8.0	

Muro : 171 - Nodi: [17-0-0-30], Pann.X=4, Pann.Y=4Spess.=40 cm, Terreno=--,Criterio=CLS_Muri_ND, Materiale=C35/45: **Verificato**

Armatura a maglia doppia

Pannello	Nx	Ny	Nxy	Mx	My	Mxy	Ax	Ay	C	Cs	ZE
	kN	kN	kN	kN*m	kN*m	kN*m	mmq	mmq			
1	-106.25	-170.07	25.53	-30.41	-5.20	1.86	3142	3142	4	6.4	--
2	-107.67	-167.28	15.77	-27.86	-4.71	1.46	3142	3142	4	7.1	--
3	-108.73	-226.88	-3.15	-25.42	-4.29	1.51	3142	3142	3	7.7	--
4	-108.40	-205.26	-15.31	-23.81	-3.68	1.20	3142	3142	3	8.3	--
5	-103.28	-138.61	24.75	-21.09	-4.10	7.18	3142	3142	4	7.3	--
6	-104.18	-135.13	13.03	-19.23	-3.73	5.26	3142	3142	4	8.5	--
7	-104.51	-128.41	1.71	-17.77	-3.28	3.38	3142	3142	4	9.8	--
8	-105.06	-117.94	-8.25	-16.53	-2.81	1.61	3142	3142	4	11	--
9	-98.70	-109.49	23.50	-12.11	-4.27	8.81	3142	3142	4	9.9	--
10	-99.50	-105.54	10.16	-10.94	-3.94	6.43	3142	3142	4	12	--
11	-100.37	-99.26	-2.88	-10.09	-3.46	4.21	3142	3142	4	14	--
12	-102.00	-90.24	-14.81	-9.33	-2.95	2.20	3142	3142	4	18	--
13	-18.13	-83.44	16.88	10.12	-3.32	10.77	3142	3142	5	9.3	--
14	-18.23	-78.77	2.38	10.18	-2.89	8.03	3142	3142	5	11	--
15	-17.86	-73.94	-11.59	9.87	-2.46	5.70	3142	3142	5	12	--
16	-20.04	-67.06	-25.59	9.47	-1.94	3.54	3142	3142	5	15	--
Massimi/minimi											
1							3142				
1								3142			
1										6.4	

Muro : 172 - Nodi: [30-0-0-40], Pann.X=4, Pann.Y=4Spess.=40 cm, Terreno=--,Criterio=CLS_Muri_ND, Materiale=C35/45: **Verificato**

Armatura a maglia doppia

Pannello	Nx	Ny	Nxy	Mx	My	Mxy	Ax	Ay	C	Cs	ZE
	kN	kN	kN	kN*m	kN*m	kN*m	mmq	mmq			
1	-107.45	-177.19	-23.52	-22.57	-3.07	0.91	3142	3142	3	8.8	--
2	-104.96	-114.80	-9.47	-22.00	-2.44	-0.83	3142	3142	4	9.1	--
3	-100.98	-96.72	-11.30	-20.43	-1.77	-1.40	3142	3142	4	9.5	--
4	-93.08	-78.97	-12.02	-18.27	-1.11	-1.82	3142	3142	4	10	--
5	-105.85	-104.48	-15.38	-15.46	-2.27	0.10	3142	3142	4	13	--
6	-105.90	-89.30	-19.81	-14.39	-1.64	-1.19	3142	3142	4	13	--
7	-103.10	-73.43	-21.83	-13.07	-0.96	-2.23	3142	3142	4	14	--
8	-95.82	-57.60	-22.25	-11.35	-0.23	-2.93	3142	3142	4	14	--
9	-104.56	-78.65	-23.62	-8.60	-2.32	0.50	3142	3142	4	23	--
10	-106.41	-65.57	-28.86	-7.82	-1.57	-0.87	3142	3142	4	24	--
11	-105.16	-51.84	-31.00	-6.89	-0.71	-1.90	3142	3142	4	24	--
12	-98.42	-38.46	-31.17	-5.76	0.19	-2.53	3142	3142	4	25	--
13	-25.01	-57.83	-36.21	8.99	-1.15	1.74	3142	3142	5	18	--
14	-31.46	-46.90	-42.42	8.40	-0.21	0.38	3142	3142	5	22	--
15	-36.00	-36.12	-44.11	7.66	0.87	-0.52	3142	3142	5	24	--
16	-36.42	-26.57	-42.94	6.80	1.87	-0.96	3142	3142	5	25	--
Massimi/minimi											
1							3142				
1								3142			
1										8.8	

Muro : 173 - Nodi: [0-0-34-37], Pann.X=4, Pann.Y=4Spess.=40 cm, Terreno=--,Criterio=CLS_Muri_ND, Materiale=C35/45: **Verificato**

Armatura a maglia doppia

Pannello	Nx	Ny	Nxy	Mx	My	Mxy	Ax	Ay	C	Cs	ZE
	kN	kN	kN	kN*m	kN*m	kN*m	mmq	mmq			
1	-9.33	-643.40	13.79	0.49	17.38	0.72	3142	3142	3	16	--
2	-12.48	-652.94	31.37	0.64	23.66	-0.05	3142	3142	3	12	--
3	-12.36	-668.94	49.94	0.51	30.85	-0.83	3142	3142	3	9.1	--
4	20.79	-603.08	58.70	1.94	36.71	-2.26	3142	3142	4	7.2	--

Pannello	Nx	Ny	Nxy	Mx	My	Mxy	Ax	Ay	C	Cs	ZE
5	-40.18	-464.52	-5.71	1.61	15.91	0.59	3142	3142	3	16	--
6	-33.80	-430.38	1.84	1.93	21.51	-0.77	3142	3142	3	11	--
7	0.66	-383.54	-11.82	2.38	27.79	-2.16	3142	3142	3	8.3	--
8	72.63	-322.67	-10.54	4.27	32.59	-2.80	3142	3142	4	6.8	--
9	-56.57	-341.63	-47.19	2.08	13.31	0.37	3142	3142	3	18	--
10	-20.18	-321.30	-53.39	2.51	18.11	-1.37	3142	3142	3	12	--
11	27.53	-291.71	-65.20	2.84	23.82	-2.70	3142	3142	3	8.9	--
12	51.08	-259.17	-24.04	3.82	28.26	-2.01	3142	3142	4	7.6	--
13	-37.77	-307.46	-99.75	1.87	10.04	0.11	3142	3142	3	23	--
14	-7.68	-252.07	-99.35	2.00	13.49	-2.05	3142	3142	3	15	--
15	27.69	-226.19	-95.55	1.99	18.06	-4.30	3142	3142	3	10	--
16	33.32	-203.00	-44.76	4.33	22.55	-2.92	3142	3142	4	8.7	--
Massimi/minimi											
1							3142				
1								3142			
8										6.8	

Muro : 174 - Nodi: [46-47-40-31], Pann.X=4, Pann.Y=4Spess.=40 cm, Terreno=--,Criterio=CLS_Muri_ND, Materiale=C35/45: **Verificato**

Armatura a maglia doppia

Pannello	Nx	Ny	Nxy	Mx	My	Mxy	Ax	Ay	C	Cs	ZE
	kN	kN	kN	kN*m	kN*m	kN*m	mmq	mmq			
1	-16.28	-23.12	-29.72	1.17	29.45	-0.82	3142	3142	4	6.4	--
2	-2.43	-4.48	-21.04	-1.14	4.75	1.52	3142	3142	3	31	--
3	1.70	8.08	-19.84	-5.81	-10.47	5.31	3142	3142	3	12	--
4	9.20	13.47	-19.86	-17.34	-17.42	12.34	3142	3142	3	6.4	--
5	-19.23	-9.69	-28.24	0.14	23.63	-3.68	3142	3142	4	7.1	--
6	-10.40	-17.70	-37.47	-5.58	4.95	-3.92	3142	3142	4	20	--
7	-5.78	-15.59	-34.63	-11.97	-6.31	-3.51	3142	3142	4	12	--
8	-5.93	-18.06	-25.36	-18.26	-11.52	-2.00	3142	3142	4	9.5	--
9	3.15	-13.06	-20.54	-0.78	16.74	-7.32	3142	3142	3	8.0	--
10	-7.48	-22.82	-19.86	-4.54	3.10	-10.54	3142	3142	3	13	--
11	-16.53	-28.67	-15.85	-8.59	-4.36	-10.95	3142	3142	3	9.9	--
12	-22.55	-36.00	-9.66	-12.24	-8.13	-9.70	3142	3142	3	8.9	--
13	0.90	-20.89	-9.01	-0.86	7.10	-6.46	3142	3142	3	14	--
14	-15.25	-18.00	-12.55	2.22	0.90	-9.77	3142	3142	4	16	--
15	-26.19	-33.76	-8.50	5.79	-1.30	-10.19	3142	3142	4	12	--
16	-32.55	-46.87	-4.39	9.02	-1.88	-9.16	3142	3142	4	11	--
Massimi/minimi											
1							3142				
1								3142			
4										6.4	

Muro : 175 - Nodi: [0-36-48-0], Pann.X=4, Pann.Y=4Spess.=40 cm, Terreno=--,Criterio=CLS_Muri_ND, Materiale=C35/45: **Verificato**

Armatura a maglia doppia

Pannello	Nx	Ny	Nxy	Mx	My	Mxy	Ax	Ay	C	Cs	ZE
	kN	kN	kN	kN*m	kN*m	kN*m	mmq	mmq			
1	-95.88	29.92	21.23	-6.42	-0.57	0.39	3142	3142	3	30	--
2	-67.97	16.55	4.33	-4.57	0.08	-0.36	3142	3142	4	41	--
3	-43.56	11.10	3.98	-2.84	0.72	-0.83	3142	3142	4	54	--
4	-9.57	10.41	6.97	-0.07	2.76	0.49	3142	3142	6	58	--
5	-91.14	26.64	24.58	-10.18	-1.06	1.48	3142	3142	3	18	--
6	-68.77	21.88	21.53	-7.41	-0.43	1.24	3142	3142	3	23	--
7	-40.92	17.60	16.89	-4.82	0.39	0.56	3142	3142	3	37	--
8	-9.33	8.88	0.50	-3.23	1.60	-0.01	3142	3142	4	60	--
9	-86.50	21.13	26.87	-14.61	-1.52	2.38	3142	3142	3	12	--
10	-64.39	18.64	23.91	-10.93	-1.08	2.27	3142	3142	3	15	--

Pannello	Nx	Ny	Nxy	Mx	My	Mxy	Ax	Ay	C	Cs	z _E
11	-34.38	16.12	18.24	-7.54	-0.43	1.53	3142	3142	3	22	--
12	2.33	15.93	6.97	-5.34	1.67	0.49	3142	3142	3	33	--
13	-81.01	5.85	13.67	-19.74	-2.06	0.98	3142	3142	4	9.8	--
14	-59.45	1.76	11.97	-15.06	-1.54	1.20	3142	3142	4	12	--
15	-25.54	12.45	19.37	-11.39	-0.41	0.47	3142	3142	3	16	--
16	8.46	12.78	6.78	-9.52	1.87	0.11	3142	3142	3	20	--
Massimi/minimi											
1							3142				
1								3142			
13										9.8	

Muro : 176 - Nodi: [48-49-41-36], Pann.X=4, Pann.Y=4Spess.=40 cm, Terreno=--,Criterio=CLS_Muri_ND, Materiale=C35/45: **Verificato**

Armatura a maglia doppia

Pannello	Nx	Ny	Nxy	Mx	My	Mxy	Ax	Ay	C	Cs	z _E
	kN	kN	kN	kN*m	kN*m	kN*m	mmq	mmq			
1	-29.80	-20.19	-11.25	2.29	1.19	4.76	3142	3142	4	28	--
2	-24.99	-13.03	-15.67	6.91	0.83	8.56	3142	3142	4	13	--
3	-24.33	-3.74	-18.30	13.29	0.43	8.97	3142	3142	4	8.8	--
4	-25.82	4.73	-20.67	18.73	0.71	8.13	3142	3142	4	7.3	--
5	-20.43	-20.21	-26.66	0.66	9.92	7.55	3142	3142	3	11	--
6	-21.02	-16.89	-34.62	-1.14	1.89	13.80	3142	3142	3	12	--
7	-20.59	-12.27	-39.22	-1.64	-2.15	14.39	3142	3142	3	12	--
8	-21.39	-7.06	-42.55	-1.77	-3.80	13.28	3142	3142	3	11	--
9	-9.22	-16.87	-32.21	-0.06	18.00	5.79	3142	3142	3	8.1	--
10	-12.90	-13.71	-38.94	-4.86	4.01	11.33	3142	3142	3	12	--
11	-15.26	-10.35	-44.35	-9.45	-3.55	11.87	3142	3142	3	9.1	--
12	-17.43	-6.57	-48.26	-13.35	-7.22	11.14	3142	3142	3	7.9	--
13	-0.81	-16.80	-37.47	-0.25	22.46	2.22	3142	3142	3	7.9	--
14	-4.99	-13.02	-43.11	-6.43	5.36	6.02	3142	3142	3	15	--
15	-9.24	-8.96	-48.68	-13.06	-4.12	6.37	3142	3142	3	9.9	--
16	-13.22	-5.18	-52.96	-18.96	-8.94	6.22	3142	3142	3	7.7	--
Massimi/minimi											
1							3142				
1								3142			
4										7.3	

Muro : 177 - Nodi: [49-50-34-41], Pann.X=4, Pann.Y=4Spess.=40 cm, Terreno=--,Criterio=CLS_Muri_ND, Materiale=C35/45: **Verificato**

Armatura a maglia doppia

Pannello	Nx	Ny	Nxy	Mx	My	Mxy	Ax	Ay	C	Cs	z _E
	kN	kN	kN	kN*m	kN*m	kN*m	mmq	mmq			
1	8.38	-17.17	-42.24	-0.45	22.60	-2.41	3142	3142	3	7.8	--
2	3.60	-11.34	-48.83	-6.69	5.43	-1.24	3142	3142	3	24	--
3	-2.45	-6.14	-54.66	-13.53	-3.96	-1.29	3142	3142	3	13	--
4	-8.87	-1.91	-58.52	-19.73	-8.60	-0.82	3142	3142	3	9.4	--
5	22.42	-12.26	-46.24	-0.70	17.38	-6.88	3142	3142	3	8.0	--
6	14.56	-3.93	-55.73	-5.08	3.79	-8.21	3142	3142	3	14	--
7	4.25	1.39	-62.62	-9.74	-3.17	-8.68	3142	3142	3	10	--
8	-6.50	5.39	-64.89	-13.84	-5.81	-7.76	3142	3142	3	8.9	--
9	36.42	-8.30	-37.93	0.06	9.49	-8.28	3142	3142	4	11	--
10	21.00	-1.45	-54.11	-0.54	2.31	-10.55	3142	3142	4	15	--
11	6.61	16.26	-68.98	-0.22	-0.69	-10.89	3142	3142	3	16	--
12	-7.94	16.53	-69.52	1.17	-0.86	-9.30	3142	3142	3	18	--
13	74.01	47.80	-57.96	4.10	0.09	-6.64	3142	3142	3	17	--
14	25.29	29.37	-54.43	6.62	0.25	-8.33	3142	3142	3	13	--
15	20.46	6.92	-51.47	12.52	2.73	-6.40	3142	3142	3	9.9	--
16	-0.82	3.75	-75.55	27.26	7.60	0.45	3142	3142	3	6.9	--

Pannello	Nx	Ny	Nxy	Mx	My	Mxy	Ax	Ay	C	Cs	ZE
Massimi/minimi											
1							3142				
1								3142			
16										6.9	

Muro : 178 - Nodi : [0-49-50-0], Pann.X=4, Pann.Y=4Spess.=40 cm, Terreno=--,Criterio=CLS_Muri_ND, Materiale=C35/45: **Verificato**

Armatura a maglia doppia

Pannello	Nx	Ny	Nxy	Mx	My	Mxy	Ax	Ay	C	Cs	ZE
	kN	kN	kN	kN*m	kN*m	kN*m	mmq	mmq			
1	-111.58	36.00	-37.15	-6.85	-0.66	-1.68	3142	3142	3	24	--
2	-87.32	35.42	-40.79	-6.54	-0.33	-1.73	3142	3142	3	25	--
3	-39.01	26.73	-38.44	-5.29	-1.07	-1.70	3142	3142	3	28	--
4	28.17	39.42	-34.62	-1.15	-5.90	-3.04	3142	3142	2	21	--
5	-107.40	24.38	-37.87	-9.57	-0.84	-1.56	3142	3142	3	19	--
6	-84.37	24.09	-39.45	-8.24	-0.56	-1.18	3142	3142	3	22	--
7	-39.96	19.86	-34.60	-5.63	-0.99	-0.87	3142	3142	3	30	--
8	24.84	36.18	-35.64	-0.33	-5.70	-2.57	3142	3142	2	22	--
9	-105.03	10.24	-38.23	-13.00	-0.93	-0.78	3142	3142	3	15	--
10	-84.93	5.36	-29.81	-10.45	-0.99	0.73	3142	3142	4	18	--
11	-45.32	7.32	-27.48	-6.38	-0.91	0.98	3142	3142	4	27	--
12	33.32	33.91	-40.96	1.36	-5.61	-1.78	3142	3142	2	25	--
13	-100.05	-8.60	-38.53	-16.98	-1.21	2.52	3142	3142	3	11	--
14	-79.07	-11.16	-32.72	-13.48	-1.36	3.54	3142	3142	4	12	--
15	-36.94	-1.40	-28.64	-6.92	-1.65	3.38	3142	3142	4	19	--
16	11.64	48.33	-29.40	6.96	-5.40	1.32	3142	3142	2	23	--
Massimi/minimi											
1							3142				
1								3142			
13										11	

Muro : 179 - Nodi : [0-48-49-0], Pann.X=4, Pann.Y=4Spess.=40 cm, Terreno=--,Criterio=CLS_Muri_ND, Materiale=C35/45: **Verificato**

Armatura a maglia doppia

Pannello	Nx	Ny	Nxy	Mx	My	Mxy	Ax	Ay	C	Cs	ZE
	kN	kN	kN	kN*m	kN*m	kN*m	mmq	mmq			
1	-14.58	8.55	2.07	-0.16	2.70	-0.38	3142	3142	6	62	--
2	-57.29	16.59	-27.26	-3.10	0.30	-1.46	3142	3142	3	44	--
3	-89.74	24.52	-30.37	-4.84	-0.48	-1.87	3142	3142	3	31	--
4	-109.53	31.50	-32.93	-6.21	-0.78	-1.85	3142	3142	3	26	--
5	-8.79	15.41	-16.73	-2.96	1.70	-0.86	3142	3142	3	50	--
6	-52.38	16.27	-29.32	-5.08	-0.32	-2.20	3142	3142	3	27	--
7	-86.50	18.98	-32.77	-7.45	-0.81	-2.52	3142	3142	3	21	--
8	-105.86	22.01	-34.84	-9.18	-0.97	-2.17	3142	3142	3	18	--
9	3.60	18.25	-15.44	-5.05	0.72	-1.16	3142	3142	3	31	--
10	-46.61	12.67	-28.53	-7.52	-0.90	-2.77	3142	3142	3	19	--
11	-83.09	9.86	-32.90	-10.64	-1.04	-2.88	3142	3142	3	15	--
12	-102.02	9.01	-35.31	-12.89	-1.03	-2.03	3142	3142	3	14	--
13	11.77	17.22	-11.85	-8.89	0.63	-0.26	3142	3142	3	21	--
14	-39.62	5.64	-25.04	-10.63	-0.79	-0.92	3142	3142	3	17	--
15	-79.00	-4.90	-30.29	-14.44	-1.10	-0.32	3142	3142	3	14	--
16	-98.10	-8.44	-34.88	-17.20	-1.19	1.00	3142	3142	3	11	--
Massimi/minimi											
1							3142				
1								3142			
16										11	

Muro : 180 - Nodi: [0-0-46-47], Pann.X=4, Pann.Y=4Spess.=40 cm, Terreno=--,Criterio=CLS_Muri_ND, Materiale=C35/45: **Verificato**

Armatura a maglia doppia

Pannello	Nx	Ny	Nxy	Mx	My	Mxy	Ax	Ay	C	Cs	ZE
	kN	kN	kN	kN*m	kN*m	kN*m	mmq	mmq			
1	-21.71	-28.43	21.33	-0.50	-3.41	0.48	3142	3142	4	50	--
2	-21.14	-36.01	19.42	-0.08	-4.44	-0.27	3142	3142	3	42	--
3	-28.05	-36.07	17.81	-0.51	-5.93	-1.21	3142	3142	3	28	--
4	-42.48	-40.56	18.38	-1.12	-7.27	-2.27	3142	3142	3	21	--
5	-10.55	-72.41	30.90	-1.22	-5.32	1.14	3142	3142	4	31	--
6	-19.42	-72.96	27.32	-1.47	-7.51	0.25	3142	3142	4	26	--
7	-23.05	-75.94	20.86	-2.06	-10.34	-1.29	3142	3142	3	17	--
8	-35.48	-78.54	16.98	-2.58	-13.54	-3.02	3142	3142	3	12	--
9	3.72	-100.15	39.00	-2.18	-7.02	1.35	3142	3142	4	25	--
10	-7.81	-99.96	34.33	-2.19	-10.43	1.03	3142	3142	4	18	--
11	-10.41	-104.09	24.26	-2.01	-14.75	-0.14	3142	3142	3	14	--
12	-39.34	-101.15	25.32	-1.97	-19.19	-2.14	3142	3142	4	9.7	--
13	27.91	-96.45	40.88	-2.19	-6.69	1.73	3142	3142	3	24	--
14	16.91	-97.21	38.19	-2.20	-9.53	2.48	3142	3142	3	17	--
15	-14.75	-101.72	43.32	-2.70	-14.20	3.22	3142	3142	4	12	--
16	-50.03	-98.64	30.33	-3.17	-21.41	0.99	3142	3142	4	9.2	--
Massimi/minimi											
1							3142				
1								3142			
16										9.2	

Muro : 181 - Nodi: [40-0-0-47], Pann.X=4, Pann.Y=4Spess.=40 cm, Terreno=--,Criterio=CLS_Muri_ND, Materiale=C35/45: **Verificato**

Armatura a maglia doppia

Pannello	Nx	Ny	Nxy	Mx	My	Mxy	Ax	Ay	C	Cs	ZE
	kN	kN	kN	kN*m	kN*m	kN*m	mmq	mmq			
1	-79.20	-62.17	-12.68	-15.04	-0.48	-2.20	3142	3142	4	12	--
2	-55.13	-44.01	-11.88	-10.81	-0.23	-2.07	3142	3142	4	16	--
3	-18.38	-25.07	-10.33	-6.63	-0.94	-1.48	3142	3142	4	24	--
4	38.92	-6.62	-7.12	-3.00	-4.96	-0.39	3142	3142	4	36	--
5	-81.41	-42.29	-22.47	-9.11	0.35	-3.23	3142	3142	4	17	--
6	-56.94	-27.38	-22.49	-6.59	0.47	-2.96	3142	3142	4	21	--
7	-21.21	-3.58	-35.12	-4.53	-0.26	-2.28	3142	3142	3	29	--
8	21.44	6.99	-21.99	0.48	-4.59	1.10	3142	3142	5	33	--
9	-83.87	-25.95	-30.94	-4.49	0.95	-2.73	3142	3142	4	28	--
10	-59.64	-14.28	-30.91	-3.31	1.18	-2.51	3142	3142	4	34	--
11	-24.63	-3.25	-30.18	-2.62	0.12	-2.04	3142	3142	4	42	--
12	12.93	1.66	-27.39	0.75	-4.79	0.98	3142	3142	5	33	--
13	-32.03	-18.48	-40.84	5.73	2.52	-1.03	3142	3142	5	29	--
14	-29.73	0.99	-60.10	3.96	2.00	-1.54	3142	3142	2	36	--
15	-16.27	1.86	-51.83	2.48	0.75	-1.48	3142	3142	2	49	--
16	4.75	-3.14	-30.71	1.13	-5.01	0.66	3142	3142	5	34	--
Massimi/minimi											
1							3142				
1								3142			
1										12	

Muro : 182 - Nodi: [46-0-0-50], Pann.X=4, Pann.Y=4Spess.=40 cm, Terreno=--,Criterio=CLS_Muri_ND, Materiale=C35/45: **Verificato**

Armatura a maglia doppia

Pannello	Nx	Ny	Nxy	Mx	My	Mxy	Ax	Ay	C	Cs	ZE
	kN	kN	kN	kN*m	kN*m	kN*m	mmq	mmq			
1	-22.21	-20.46	-25.33	-8.91	-2.12	-7.94	3142	3142	4	12	--

Pannello	Nx	Ny	Nxy	Mx	My	Mxy	Ax	Ay	C	Cs	ZE
2	-19.35	36.60	-9.46	2.71	-0.88	-2.49	3142	3142	3	37	--
3	-0.01	84.89	-4.80	-0.17	-3.04	-1.38	3142	3142	6	40	--
4	-6.66	104.28	-16.44	2.85	-4.85	-1.27	3142	3142	6	29	--
5	-43.87	8.81	-37.09	-7.04	-1.64	-5.91	3142	3142	3	15	--
6	-20.85	26.70	-29.45	-1.33	-1.96	-4.16	3142	3142	3	31	--
7	5.16	68.72	-10.96	-0.27	-2.77	-2.40	3142	3142	6	35	--
8	7.90	75.64	-26.70	0.56	-4.02	-1.37	3142	3142	6	33	--
9	-51.83	21.05	-42.42	-5.85	-1.68	-3.28	3142	3142	3	22	--
10	-25.04	26.13	-40.32	-3.09	-1.24	-2.88	3142	3142	3	33	--
11	10.02	52.83	-13.23	-0.85	-2.71	-2.19	3142	3142	6	37	--
12	16.68	49.48	-22.48	-0.29	-3.52	-1.11	3142	3142	6	40	--
13	-56.09	29.69	-43.12	-4.78	-1.51	-1.96	3142	3142	3	30	--
14	-28.11	28.60	-42.50	-3.45	-1.11	-1.89	3142	3142	3	37	--
15	12.58	40.26	-11.04	-1.48	-2.69	-1.83	3142	3142	6	41	--
16	31.83	52.92	-53.74	-0.18	-3.19	-0.82	3142	3142	2	46	--
Massimi/minimi											
1							3142				
1								3142			
1										12	

Muro : 183 - Nodi: [0-0-50-34], Pann.X=4, Pann.Y=4Spess.=40 cm, Terreno=--,Criterio=CLS_Muri_ND, Materiale=C35/45: **Verificato**

Armatura a maglia doppia

Pannello	Nx	Ny	Nxy	Mx	My	Mxy	Ax	Ay	C	Cs	ZE
	kN	kN	kN	kN*m	kN*m	kN*m	mmq	mmq			
1	-68.05	-97.94	-122.12	0.35	6.24	0.48	3142	3142	3	31	--
2	-24.65	-126.35	-118.01	1.29	7.58	-1.84	3142	3142	3	22	--
3	10.77	-128.78	-106.67	2.14	8.19	-5.02	3142	3142	3	16	--
4	38.30	-122.13	-49.62	3.38	8.14	-4.63	3142	3142	4	16	--
5	-7.39	-6.26	-51.72	0.39	1.85	3.13	3142	3142	1	39	--
6	-21.61	-5.29	-61.98	1.04	2.76	2.24	3142	3142	1	38	--
7	-15.19	-10.19	-59.75	1.87	3.39	1.41	3142	3142	1	40	--
8	1.31	-25.71	-70.35	2.29	4.07	3.13	3142	3142	2	27	--
9	-10.81	-5.87	-50.78	-0.38	0.69	3.61	3142	3142	1	45	--
10	-17.52	-9.72	-49.86	-0.14	1.10	3.05	3142	3142	1	46	--
11	-37.99	-11.14	-76.19	0.90	2.40	2.58	3142	3142	2	39	--
12	-50.26	-17.65	-53.89	0.47	5.86	3.74	3142	3142	2	20	--
13	-16.51	13.47	-56.32	-2.84	-0.52	4.66	3142	3142	2	26	--
14	-23.57	-7.44	-51.70	-3.68	-0.36	4.35	3142	3142	2	24	--
15	-41.01	-29.11	-51.51	-4.53	1.16	3.89	3142	3142	2	23	--
16	-92.31	-34.67	-51.63	-6.46	7.86	3.05	3142	3142	2	18	--
Massimi/minimi											
1							3142				
1								3142			
3										16	

Muro : 184 - Nodi: [0-21-19-0], Pann.X=4, Pann.Y=4Spess.=20 cm, Terreno=--,Criterio=CLS_Muri_ND, Materiale=C35/45: **Verificato**

Armatura a maglia doppia

Pannello	Nx	Ny	Nxy	Mx	My	Mxy	Ax	Ay	C	Cs	ZE
	kN	kN	kN	kN*m	kN*m	kN*m	mmq	mmq			
1	-39.72	-49.21	34.36	0.17	0.61	0.37	3142	3142	2	80	--
2	-57.73	-82.30	4.91	-0.17	0.02	0.02	3142	3142	3	>100	--
3	-97.31	-66.81	7.47	-0.34	-0.07	-0.16	3142	3142	3	>100	--
4	-126.67	-56.26	41.38	-0.37	0.02	-0.19	3142	3142	4	>100	--
5	-43.13	-56.74	34.74	0.09	0.60	0.32	3142	3142	2	86	--
6	-50.71	-76.53	-1.97	-0.33	-0.12	-0.07	3142	3142	3	>100	--
7	-104.66	-69.59	4.22	-0.55	-0.12	-0.19	3142	3142	3	>100	--

Pannello	Nx	Ny	Nxy	Mx	My	Mxy	Ax	Ay	C	Cs	ZE
8	-144.18	-67.51	36.21	-0.55	0.01	-0.17	3142	3142	3	>100	--
9	-43.99	-57.70	34.35	-0.17	0.58	0.21	3142	3142	2	100	--
10	-47.24	-53.55	-4.65	-0.64	-0.25	-0.20	3142	3142	3	94	--
11	-112.21	-75.54	7.91	-0.82	-0.14	-0.20	3142	3142	3	81	--
12	-157.01	-88.65	35.39	-0.73	0.02	-0.16	3142	3142	3	97	--
13	23.13	71.84	-22.68	-1.56	0.27	-0.46	3142	3142	6	37	--
14	10.35	31.79	-31.69	-1.17	-0.29	-0.64	3142	3142	6	42	--
15	-21.42	-3.07	-34.13	-0.75	-0.16	-0.49	3142	3142	6	62	--
16	-172.81	-123.98	37.81	-0.95	0.05	0.31	3142	3142	3	69	--
Massimi/minimi											
1							3142				
1								3142			
13										37	

Muro : 185 - Nodi : [0-19-20-0], Pann.X=4, Pann.Y=4Spess.=20 cm, Terreno=--,Criterio=CLS_Muri_ND, Materiale=C35/45: **Verificato**

Armatura a maglia doppia

Pannello	Nx	Ny	Nxy	Mx	My	Mxy	Ax	Ay	C	Cs	ZE
	kN	kN	kN	kN*m	kN*m	kN*m	mmq	mmq			
1	-125.63	-47.58	77.14	-0.34	0.14	-0.13	3142	3142	4	>100	--
2	-22.00	-36.46	79.11	-0.12	0.31	-0.09	3142	3142	5	>100	--
3	-52.70	-25.24	110.17	-0.31	0.14	0.11	3142	3142	4	>100	--
4	-2.64	-10.79	51.53	-0.38	-0.82	0.40	3142	3142	1	63	--
5	-142.51	-58.02	69.99	-0.47	0.13	-0.07	3142	3142	3	>100	--
6	-22.41	-29.50	74.26	-0.00	0.33	-0.11	3142	3142	5	>100	--
7	-26.29	-9.22	-12.55	-0.29	-0.09	0.13	3142	3142	6	>100	--
8	8.03	4.64	46.86	-0.39	-0.99	0.44	3142	3142	1	53	--
9	-154.25	-79.28	62.61	-0.60	0.19	-0.02	3142	3142	3	>100	--
10	-115.74	-51.48	78.96	-0.38	0.18	0.11	3142	3142	3	>100	--
11	-1.13	-0.27	62.77	0.27	0.51	-0.17	3142	3142	5	>100	--
12	17.41	23.41	40.11	-0.10	-1.08	0.41	3142	3142	1	50	--
13	-165.78	-114.41	51.71	-0.69	0.25	0.45	3142	3142	3	76	--
14	-121.71	-73.14	57.69	-0.46	0.08	0.57	3142	3142	3	81	--
15	1.73	10.83	37.09	1.34	0.25	-0.09	3142	3142	1	53	--
16	30.83	59.41	35.19	1.71	-0.87	0.10	3142	3142	5	41	--
Massimi/minimi											
1							3142				
1								3142			
16										41	

Muro : 186 - Nodi : [179-181-0-0], Pann.X=4, Pann.Y=4Spess.=40 cm, Terreno=--,Criterio=CLS_Muri_ND, Materiale=C35/45: **Verificato**

Armatura a maglia doppia

Pannello	Nx	Ny	Nxy	Mx	My	Mxy	Ax	Ay	C	Cs	ZE
	kN	kN	kN	kN*m	kN*m	kN*m	mmq	mmq			
1	-37.04	-77.41	-7.03	11.67	64.88	1.24	3142	3142	5	3.1	--
2	-41.54	-70.33	-8.44	10.43	57.52	2.11	3142	3142	5	3.4	--
3	-46.21	-64.14	-10.78	7.83	43.52	2.72	3142	3142	5	4.3	--
4	-51.01	-58.70	-14.59	3.87	23.33	2.74	3142	3142	5	7.7	--
5	-33.48	-76.49	-12.27	8.97	66.18	0.58	3142	3142	5	3.0	--
6	-36.82	-69.39	-13.38	7.65	58.20	0.53	3142	3142	5	3.4	--
7	-39.84	-62.42	-14.51	5.40	42.97	0.30	3142	3142	5	4.6	--
8	-42.19	-53.85	-15.77	2.45	20.89	-0.15	3142	3142	5	9.5	--
9	-27.55	-78.75	-17.70	9.79	65.57	-0.45	3142	3142	5	3.1	--
10	-31.87	-71.48	-19.82	8.35	57.63	-0.80	3142	3142	5	3.5	--
11	-36.03	-64.32	-21.15	5.89	42.56	-0.87	3142	3142	5	4.6	--
12	-39.74	-55.80	-21.62	2.64	20.72	-0.62	3142	3142	5	9.4	--
13	-16.69	-83.87	-25.56	14.37	62.19	-1.49	3142	3142	5	3.2	--

Pannello	Nx	Ny	Nxy	Mx	My	Mxy	Ax	Ay	C	Cs	ZE
14	-25.62	-75.66	-28.78	12.94	55.18	-3.13	3142	3142	5	3.5	--
15	-35.49	-67.26	-29.50	10.09	41.83	-4.34	3142	3142	5	4.4	--
16	-45.05	-59.22	-26.88	5.88	22.48	-4.79	3142	3142	5	7.3	--
Massimi/minimi											
1							3142				
1								3142			
5										3.0	

Muro : 187 - Nodi: [178-0-0-180], Pann.X=4, Pann.Y=4Spess.=40 cm, Terreno=--,Criterio=CLS_Muri_ND, Materiale=C35/45: **Verificato**

Armatura a maglia doppia

Pannello	Nx	Ny	Nxy	Mx	My	Mxy	Ax	Ay	C	Cs	ZE
	kN	kN	kN	kN*m	kN*m	kN*m	mmq	mmq			
1	-51.96	3.02	58.62	32.63	9.96	0.21	3142	3142	5	6.1	--
2	-52.93	7.39	56.65	33.52	9.75	0.36	3142	3142	5	5.9	--
3	-54.27	11.03	54.16	34.29	9.34	0.61	3142	3142	5	5.7	--
4	-56.37	14.91	51.60	34.99	8.71	0.84	3142	3142	5	5.6	--
5	-44.45	8.85	54.54	27.31	9.21	1.31	3142	3142	5	6.9	--
6	-44.72	12.04	52.23	28.02	9.29	1.33	3142	3142	5	6.8	--
7	-45.75	15.60	49.58	28.65	9.00	1.51	3142	3142	5	6.6	--
8	-48.23	19.46	47.06	29.27	8.32	1.73	3142	3142	5	6.4	--
9	-37.62	15.30	50.63	19.11	7.76	2.01	3142	3142	5	9.3	--
10	-35.95	18.06	48.28	19.53	8.35	1.96	3142	3142	5	9.2	--
11	-36.58	21.68	44.69	19.92	8.28	2.18	3142	3142	5	8.9	--
12	-40.00	26.23	41.53	20.36	7.47	2.49	3142	3142	5	8.6	--
13	-30.73	22.90	47.46	8.78	5.64	2.29	3142	3142	5	18	--
14	-25.86	26.44	44.02	9.05	7.17	2.17	3142	3142	5	17	--
15	-25.76	30.51	38.97	9.13	7.45	2.51	3142	3142	5	17	--
16	-31.21	35.59	34.76	9.12	6.26	2.98	3142	3142	5	16	--
Massimi/minimi											
1							3142				
1								3142			
4										5.6	

Muro : 188 - Nodi: [177-179-0-0], Pann.X=4, Pann.Y=4Spess.=40 cm, Terreno=--,Criterio=CLS_Muri_ND, Materiale=C35/45: **Verificato**

Armatura a maglia doppia

Pannello	Nx	Ny	Nxy	Mx	My	Mxy	Ax	Ay	C	Cs	ZE
	kN	kN	kN	kN*m	kN*m	kN*m	mmq	mmq			
1	-44.08	-68.69	4.66	18.03	58.58	-0.21	3142	3142	5	3.4	--
2	-48.93	-61.08	3.91	17.31	51.99	1.83	3142	3142	5	3.7	--
3	-55.37	-53.26	4.31	15.47	39.88	3.26	3142	3142	5	4.6	--
4	-63.89	-43.60	6.98	12.67	23.04	3.94	3142	3142	5	7.3	--
5	-42.28	-70.89	2.78	17.51	60.18	0.14	3142	3142	5	3.4	--
6	-48.29	-62.88	1.50	17.22	53.37	1.99	3142	3142	5	3.6	--
7	-55.76	-53.85	1.03	16.13	40.84	3.41	3142	3142	5	4.5	--
8	-66.00	-42.69	1.26	14.75	23.73	4.27	3142	3142	5	7.1	--
9	-40.94	-72.69	0.49	16.66	61.60	0.63	3142	3142	5	3.3	--
10	-47.15	-64.42	-1.10	16.50	54.65	2.38	3142	3142	5	3.5	--
11	-54.94	-55.44	-2.65	15.61	41.83	3.92	3142	3142	5	4.4	--
12	-65.17	-44.28	-4.70	14.42	24.35	5.15	3142	3142	5	6.7	--
13	-39.24	-74.16	-2.04	15.44	62.92	1.07	3142	3142	5	3.2	--
14	-45.53	-66.27	-3.49	15.13	55.93	2.82	3142	3142	5	3.4	--
15	-53.22	-57.54	-5.96	13.90	42.94	4.49	3142	3142	5	4.2	--
16	-61.91	-47.96	-10.16	11.72	24.97	5.93	3142	3142	5	6.4	--
Massimi/minimi											
1							3142				
1								3142			

Pannello	Nx	Ny	Nxy	Mx	My	Mxy	Ax	Ay	C	Cs	ZE
13										3.2	

Muro : 189 - Nodi : [180-0-0-182], Pann.X=4, Pann.Y=4Spess.=40 cm, Terreno=--,Criterio=CLS_Muri_ND, Materiale=C35/45: **Verificato**

Armatura a maglia doppia

Pannello	Nx	Ny	Nxy	Mx	My	Mxy	Ax	Ay	C	Cs	ZE
	kN	kN	kN	kN*m	kN*m	kN*m	mmq	mmq			
1	-61.84	21.78	47.51	35.89	6.77	0.94	3142	3142	5	5.5	--
2	-66.51	29.73	47.29	35.78	5.73	0.29	3142	3142	5	5.6	--
3	-67.51	35.99	49.90	33.34	7.16	-0.73	3142	3142	5	5.9	--
4	-65.93	43.19	51.91	26.90	8.23	-2.21	3142	3142	5	6.9	--
5	-56.10	28.11	44.15	29.89	5.80	1.30	3142	3142	5	6.4	--
6	-62.34	35.93	45.61	29.37	4.54	-0.11	3142	3142	5	6.8	--
7	-63.44	42.18	47.71	27.12	5.91	-1.70	3142	3142	5	7.0	--
8	-61.48	50.25	49.94	21.92	6.75	-4.48	3142	3142	5	7.6	--
9	-51.70	35.63	40.62	20.31	4.06	1.50	3142	3142	5	9.1	--
10	-58.17	41.71	44.29	19.13	2.73	-0.59	3142	3142	5	10	--
11	-58.74	47.57	45.28	17.39	4.06	-2.37	3142	3142	5	10	--
12	-57.27	57.01	47.83	14.48	4.42	-6.09	3142	3142	5	9.7	--
13	-49.41	44.58	37.65	7.63	1.63	1.34	3142	3142	5	22	--
14	-127.34	54.61	49.19	-7.04	-1.77	-0.78	3142	3142	3	27	--
15	-129.70	69.68	41.47	-6.99	-0.55	-1.46	3142	3142	3	25	--
16	-53.93	62.71	45.29	4.74	1.40	-6.62	3142	3142	5	18	--
Massimi/minimi											
1							3142				
1								3142			
1										5.5	

Muro : 190 - Nodi : [187-0-0-197], Pann.X=4, Pann.Y=4Spess.=40 cm, Terreno=--,Criterio=CLS_Muri_ND, Materiale=C35/45: **Verificato**

Armatura a maglia doppia

Pannello	Nx	Ny	Nxy	Mx	My	Mxy	Ax	Ay	C	Cs	ZE
	kN	kN	kN	kN*m	kN*m	kN*m	mmq	mmq			
1	-124.84	51.37	-18.76	12.07	6.64	0.52	3142	3142	5	17	--
2	-96.30	40.97	-10.28	8.79	3.49	-1.64	3142	3142	5	20	--
3	-84.26	34.65	-4.61	8.67	1.71	-1.60	3142	3142	5	20	--
4	-77.34	31.20	-3.19	8.18	0.90	-1.50	3142	3142	5	21	--
5	-94.97	68.05	17.70	9.57	4.51	-1.52	3142	3142	5	19	--
6	-88.54	52.75	5.10	9.11	3.34	-1.81	3142	3142	5	19	--
7	-79.01	44.31	3.09	8.48	1.87	-1.92	3142	3142	5	20	--
8	-72.05	38.38	1.93	7.81	1.06	-1.81	3142	3142	5	21	--
9	-78.76	68.48	28.14	6.64	3.60	-1.08	3142	3142	5	26	--
10	-75.04	59.95	18.09	6.47	2.57	-1.64	3142	3142	5	25	--
11	-70.74	51.39	11.26	6.12	1.56	-1.89	3142	3142	5	25	--
12	-65.78	44.51	7.55	5.62	0.88	-1.91	3142	3142	5	27	--
13	-108.13	77.08	58.60	-6.77	0.82	-1.04	3142	3142	3	27	--
14	-124.57	73.30	63.03	-7.24	-0.21	-1.77	3142	3142	3	23	--
15	-137.55	68.81	60.69	-7.48	-1.26	-2.02	3142	3142	3	22	--
16	-144.41	63.28	53.91	-7.49	-2.00	-1.87	3142	3142	3	23	--
Massimi/minimi											
1							3142				
1								3142			
1										17	

Muro : 191 - Nodi : [182-0-0-191], Pann.X=4, Pann.Y=4Spess.=40 cm, Terreno=--,Criterio=CLS_Muri_ND, Materiale=C35/45: **Verificato**

Armatura a maglia doppia

Pannello	Nx	Ny	Nxy	Mx	My	Mxy	Ax	Ay	C	Cs	ZE
	kN	kN	kN	kN*m	kN*m	kN*m	mmq	mmq			
1	-63.60	46.77	49.41	20.48	7.13	-3.32	3142	3142	5	8.4	--
2	-63.47	49.37	47.07	17.09	5.08	-3.27	3142	3142	5	9.9	--
3	-64.34	52.22	44.00	13.55	1.51	-3.21	3142	3142	5	12	--
4	-66.26	55.52	40.42	9.87	-4.08	-2.95	3142	3142	5	16	--
5	-55.32	53.77	47.45	16.65	6.17	-6.77	3142	3142	5	8.5	--
6	-54.06	55.49	44.14	13.73	4.51	-6.81	3142	3142	5	9.7	--
7	-54.06	57.95	40.03	10.71	1.44	-6.76	3142	3142	5	11	--
8	-55.69	61.16	35.43	7.57	-3.48	-6.24	3142	3142	5	14	--
9	-46.38	60.51	45.87	11.38	4.55	-9.47	3142	3142	5	9.5	--
10	-43.23	61.96	41.75	9.31	3.59	-9.60	3142	3142	5	10	--
11	-42.34	64.28	36.42	7.11	1.47	-9.56	3142	3142	5	12	--
12	-44.03	67.42	30.93	4.83	-2.29	-8.76	3142	3142	5	15	--
13	-36.58	67.82	44.17	4.91	2.08	-10.98	3142	3142	5	12	--
14	-30.88	70.25	39.12	4.11	2.29	-11.38	3142	3142	5	13	--
15	-29.11	73.07	32.56	3.03	1.62	-11.39	3142	3142	5	14	--
16	-32.06	76.60	26.57	1.77	-0.56	-10.36	3142	3142	5	16	--
Massimi/minimi											
1							3142				
1								3142			
1										8.4	

Muro : 192 - Nodi: [195-188-0-0], Pann.X=4, Pann.Y=4Spess.=40 cm, Terreno=--,Criterio=CLS_Muri_ND, Materiale=C35/45: **Verificato**

Armatura a maglia doppia

Pannello	Nx	Ny	Nxy	Mx	My	Mxy	Ax	Ay	C	Cs	ZE
	kN	kN	kN	kN*m	kN*m	kN*m	mmq	mmq			
1	41.32	-63.65	-51.02	15.57	34.91	-7.41	3142	3142	5	4.7	--
2	11.11	-55.92	-60.88	12.03	35.10	-12.45	3142	3142	5	4.2	--
3	-22.26	-50.76	-65.42	7.79	30.04	-15.39	3142	3142	5	4.4	--
4	-57.34	-47.42	-66.56	3.13	18.69	-17.01	3142	3142	5	5.6	--
5	56.05	-35.66	-54.62	7.30	24.99	-11.75	3142	3142	5	5.4	--
6	17.77	-32.59	-60.43	4.65	29.27	-16.16	3142	3142	5	4.3	--
7	-20.70	-32.97	-61.17	2.61	26.86	-18.20	3142	3142	5	4.4	--
8	-58.21	-34.49	-60.67	0.74	17.53	-18.92	3142	3142	5	5.4	--
9	62.36	11.55	-51.19	-9.14	16.27	-14.42	3142	3142	5	6.2	--
10	17.36	-0.54	-47.42	-6.40	24.71	-16.31	3142	3142	5	4.7	--
11	-21.15	-11.55	-47.35	-3.84	24.52	-17.48	3142	3142	5	4.6	--
12	-58.77	-20.59	-48.25	-2.35	17.31	-17.77	3142	3142	5	5.5	--
13	318.04	203.87	-11.45	-22.33	6.22	-5.34	3142	3142	2	5.1	--
14	19.25	24.24	-14.16	-15.15	20.14	-10.10	3142	3142	5	6.2	--
15	-16.89	2.30	-23.69	-8.58	21.88	-12.89	3142	3142	5	5.5	--
16	-55.69	-12.11	-29.63	-4.72	16.94	-14.16	3142	3142	5	6.2	--
Massimi/minimi											
1							3142				
1								3142			
2										4.2	

Muro : 193 - Nodi: [181-192-0-0], Pann.X=4, Pann.Y=4Spess.=40 cm, Terreno=--,Criterio=CLS_Muri_ND, Materiale=C35/45: **Verificato**

Armatura a maglia doppia

Pannello	Nx	Ny	Nxy	Mx	My	Mxy	Ax	Ay	C	Cs	ZE
	kN	kN	kN	kN*m	kN*m	kN*m	mmq	mmq			
1	-7.62	-85.11	-33.42	19.00	58.21	-1.80	3142	3142	5	3.4	--
2	-20.60	-75.48	-38.31	18.21	51.96	-4.58	3142	3142	5	3.6	--
3	-37.91	-64.22	-39.86	16.59	40.12	-6.87	3142	3142	5	4.3	--
4	-57.16	-51.80	-35.98	14.41	23.51	-8.52	3142	3142	5	6.2	--

Pannello	Nx	Ny	Nxy	Mx	My	Mxy	Ax	Ay	C	Cs	ZE
5	-1.81	-85.84	-36.64	20.23	55.84	-1.70	3142	3142	5	3.6	--
6	-17.75	-75.74	-42.70	19.43	49.97	-4.51	3142	3142	5	3.7	--
7	-37.81	-63.87	-45.45	17.96	38.72	-6.56	3142	3142	5	4.4	--
8	-61.41	-49.50	-43.93	16.50	22.99	-7.70	3142	3142	5	6.5	--
9	4.23	-85.47	-39.72	20.86	53.28	-1.74	3142	3142	5	3.7	--
10	-13.84	-75.51	-47.08	19.71	47.98	-4.75	3142	3142	5	3.8	--
11	-36.49	-63.70	-51.48	17.80	37.51	-6.61	3142	3142	5	4.6	--
12	-63.63	-49.51	-52.18	15.79	22.67	-7.17	3142	3142	5	6.7	--
13	10.90	-84.11	-42.65	20.92	50.32	-2.12	3142	3142	5	3.9	--
14	-8.98	-74.47	-51.24	19.12	45.81	-5.44	3142	3142	5	4.0	--
15	-33.93	-63.49	-56.93	16.24	36.35	-7.31	3142	3142	5	4.6	--
16	-63.66	-50.73	-59.89	12.55	22.31	-7.68	3142	3142	5	6.6	--
Massimi/minimi											
1							3142				
1								3142			
1										3.4	

Muro : 194 - Nodi: [194-0-0-187], Pann.X=4, Pann.Y=4Spess.=40 cm, Terreno=--,Criterio=CLS_Muri_ND, Materiale=C35/45: **Verificato**

Armatura a maglia doppia

Pannello	Nx	Ny	Nxy	Mx	My	Mxy	Ax	Ay	C	Cs	ZE
	kN	kN	kN	kN*m	kN*m	kN*m	mmq	mmq			
1	-81.24	73.25	78.25	3.59	-13.32	-0.83	3142	3142	5	13	--
2	-131.04	278.58	27.55	6.18	0.35	2.25	3142	3142	3	25	--
3	-82.50	302.75	-11.87	7.33	6.04	1.66	3142	3142	3	19	--
4	-134.25	107.78	40.13	11.12	4.18	-2.23	3142	3142	5	16	--
5	-70.13	74.86	71.95	2.39	-12.22	-0.48	3142	3142	5	14	--
6	-36.56	245.11	-6.04	4.15	-0.30	2.35	3142	3142	2	30	--
7	-72.57	195.65	4.89	4.96	4.58	1.88	3142	3142	3	25	--
8	-102.35	80.96	40.35	9.11	5.32	-0.96	3142	3142	5	21	--
9	-59.07	76.57	69.02	1.02	-10.14	-0.06	3142	3142	5	18	--
10	-64.30	77.36	62.11	2.95	-1.59	2.27	3142	3142	5	39	--
11	-70.25	76.51	54.38	4.75	2.56	1.26	3142	3142	5	34	--
12	-79.42	75.30	41.85	6.12	3.91	-0.07	3142	3142	5	33	--
13	-50.59	79.85	68.48	-0.76	-7.42	0.23	3142	3142	5	23	--
14	-81.55	100.26	22.62	-4.30	-1.79	3.08	3142	3142	3	28	--
15	-81.90	90.00	29.39	-5.27	0.66	1.87	3142	3142	3	29	--
16	-91.67	81.91	45.55	-6.13	1.37	0.28	3142	3142	3	32	--
Massimi/minimi											
1							3142				
1								3142			
1										13	

Muro : 195 - Nodi: [192-195-0-0], Pann.X=4, Pann.Y=4Spess.=40 cm, Terreno=--,Criterio=CLS_Muri_ND, Materiale=C35/45: **Verificato**

Armatura a maglia doppia

Pannello	Nx	Ny	Nxy	Mx	My	Mxy	Ax	Ay	C	Cs	ZE
	kN	kN	kN	kN*m	kN*m	kN*m	mmq	mmq			
1	16.55	-82.13	-44.85	20.60	47.74	-2.68	3142	3142	5	4.0	--
2	-4.91	-72.95	-54.12	18.22	43.98	-6.37	3142	3142	5	4.0	--
3	-31.41	-62.96	-60.41	14.51	35.38	-8.46	3142	3142	5	4.6	--
4	-62.49	-52.10	-64.54	9.34	21.87	-9.18	3142	3142	5	6.4	--
5	21.24	-80.02	-46.23	20.13	45.67	-3.29	3142	3142	5	4.2	--
6	-1.63	-71.22	-55.95	17.34	42.52	-7.31	3142	3142	5	4.1	--
7	-29.27	-62.06	-62.35	13.14	34.55	-9.67	3142	3142	5	4.5	--
8	-60.69	-53.05	-66.59	7.36	21.36	-10.78	3142	3142	5	6.2	--
9	26.18	-77.26	-47.56	19.46	43.40	-4.04	3142	3142	5	4.3	--
10	1.69	-68.81	-57.53	16.34	40.91	-8.38	3142	3142	5	4.1	--

Pannello	Nx	Ny	Nxy	Mx	My	Mxy	Ax	Ay	C	Cs	z _E
11	-27.02	-60.56	-63.84	11.82	33.60	-11.02	3142	3142	5	4.5	--
12	-59.07	-53.21	-67.68	5.79	20.72	-12.52	3142	3142	5	6.0	--
13	32.10	-73.61	-48.87	18.56	40.91	-4.83	3142	3142	5	4.4	--
14	5.17	-65.89	-58.74	15.21	39.15	-9.52	3142	3142	5	4.1	--
15	-25.20	-58.17	-64.92	10.59	32.49	-12.45	3142	3142	5	4.5	--
16	-57.84	-52.36	-67.96	4.65	20.00	-14.23	3142	3142	5	5.8	--
Massimi/minimi											
1							3142				
1								3142			
2										4.0	

Muro : 196 - Nodi: [191-0-0-194], Pann.X=4, Pann.Y=4Spess.=40 cm, Terreno=--,Criterio=CLS_Muri_ND, Materiale=C35/45: **Verificato**

Armatura a maglia doppia

Pannello	Nx	Ny	Nxy	Mx	My	Mxy	Ax	Ay	C	Cs	z _E
	kN	kN	kN	kN*m	kN*m	kN*m	mmq	mmq			
1	-69.00	59.29	37.45	6.99	-10.12	-2.50	3142	3142	5	14	--
2	-71.00	61.68	35.29	5.03	-15.66	-2.00	3142	3142	5	10	--
3	-73.36	64.69	33.19	3.18	-22.34	-1.00	3142	3142	5	7.8	--
4	-148.23	208.92	0.25	1.48	-25.26	3.57	3142	3142	3	5.5	--
5	-58.05	64.35	31.77	5.14	-8.85	-5.35	3142	3142	5	13	--
6	-60.04	66.44	29.15	3.50	-13.73	-4.37	3142	3142	5	10.0	--
7	-62.46	68.79	26.49	1.97	-19.62	-2.75	3142	3142	5	8.1	--
8	-65.28	71.56	23.67	0.57	-26.66	0.35	3142	3142	5	6.7	--
9	-46.45	70.03	27.01	3.06	-6.53	-7.47	3142	3142	5	13	--
10	-48.50	71.63	24.47	1.87	-10.42	-6.11	3142	3142	5	11	--
11	-50.56	72.95	21.91	0.73	-15.09	-4.00	3142	3142	5	9.4	--
12	-52.33	73.53	19.37	-0.36	-20.57	-0.32	3142	3142	5	8.6	--
13	-35.86	78.64	23.32	0.75	-3.40	-8.77	3142	3142	5	15	--
14	-38.53	79.59	21.89	0.05	-6.08	-7.16	3142	3142	5	14	--
15	-40.35	79.29	20.79	-0.65	-9.26	-4.78	3142	3142	5	13	--
16	-40.83	76.34	19.44	-1.46	-12.89	-0.88	3142	3142	5	13	--
Massimi/minimi											
1							3142				
1								3142			
4										5.5	

Muro : 197 - Nodi: [197-0-0-200], Pann.X=4, Pann.Y=4Spess.=40 cm, Terreno=--,Criterio=CLS_Muri_ND, Materiale=C35/45: **Verificato**

Armatura a maglia doppia

Pannello	Nx	Ny	Nxy	Mx	My	Mxy	Ax	Ay	C	Cs	z _E
	kN	kN	kN	kN*m	kN*m	kN*m	mmq	mmq			
1	-72.30	27.03	-4.32	7.67	0.68	-1.37	3142	3142	5	22	--
2	-68.87	22.13	-6.96	7.08	0.76	-1.18	3142	3142	5	24	--
3	-64.64	17.45	-9.85	6.48	1.03	-1.03	3142	3142	5	27	--
4	-59.27	12.51	-12.98	5.83	1.35	-0.87	3142	3142	5	30	--
5	-67.21	32.90	-0.17	7.24	0.78	-1.69	3142	3142	5	23	--
6	-63.50	27.26	-2.95	6.85	0.85	-1.56	3142	3142	5	24	--
7	-59.16	21.60	-5.74	6.37	1.11	-1.46	3142	3142	5	26	--
8	-53.78	15.51	-8.39	5.79	1.44	-1.39	3142	3142	5	28	--
9	-61.78	38.16	4.49	5.26	0.62	-1.86	3142	3142	5	28	--
10	-58.12	31.90	1.58	5.10	0.71	-1.80	3142	3142	5	29	--
11	-53.93	25.57	-0.97	4.86	0.96	-1.77	3142	3142	5	30	--
12	-48.81	18.78	-3.10	4.51	1.27	-1.80	3142	3142	5	32	--
13	-145.64	57.87	45.11	-7.11	-2.26	-1.50	3142	3142	3	25	--
14	-128.10	40.71	3.23	-6.15	-1.93	-1.29	3142	3142	4	28	--
15	-119.84	35.49	0.89	-5.22	-1.45	-1.03	3142	3142	4	34	--
16	-107.84	29.92	-0.48	-4.14	-0.79	-0.90	3142	3142	4	41	--

Pannello	Nx	Ny	Nxy	Mx	My	Mxy	Ax	Ay	C	Cs	ZE
Massimi/minimi											
1							3142				
1								3142			
1										22	

Muro : 198 - Nodi : [0-0-0-0], Pann.X=4, Pann.Y=4Spess.=40 cm, Terreno=--,Criterio=CLS_Muri_ND, Materiale=C35/45: **Verificato**

Armatura a maglia doppia

Pannello	Nx	Ny	Nxy	Mx	My	Mxy	Ax	Ay	C	Cs	ZE
	kN	kN	kN	kN*m	kN*m	kN*m	mmq	mmq			
1	-30.54	-78.32	16.96	17.41	8.91	2.47	3142	3142	5	9.9	--
2	-36.16	-68.37	19.35	21.37	11.38	1.90	3142	3142	5	8.5	--
3	-41.92	-60.43	21.48	24.28	12.48	1.34	3142	3142	5	7.7	--
4	-46.55	-54.60	23.39	26.10	12.88	0.81	3142	3142	5	7.4	--
5	-28.65	-74.83	8.10	14.04	7.71	5.42	3142	3142	5	10	--
6	-34.12	-66.62	12.02	17.36	10.00	4.29	3142	3142	5	9.1	--
7	-39.66	-60.07	15.85	19.81	11.01	3.03	3142	3142	5	8.6	--
8	-44.05	-55.20	19.41	21.35	11.40	1.74	3142	3142	5	8.6	--
9	-27.74	-67.86	1.35	9.21	5.95	7.66	3142	3142	5	12	--
10	-33.36	-62.37	6.49	11.48	7.81	6.11	3142	3142	5	11	--
11	-38.71	-58.06	11.60	13.13	8.62	4.31	3142	3142	5	11	--
12	-42.80	-54.79	16.31	14.15	8.92	2.44	3142	3142	5	12	--
13	-106.71	-49.60	-4.67	-7.48	1.03	6.32	3142	3142	4	15	--
14	-118.27	-49.93	3.12	-8.28	1.66	5.01	3142	3142	4	16	--
15	-126.06	-50.27	9.56	-8.88	1.81	3.54	3142	3142	4	17	--
16	-130.74	-50.23	14.36	-9.25	1.80	2.05	3142	3142	4	19	--
Massimi/minimi											
1							3142				
1								3142			
4										7.4	

Muro : 199 - Nodi : [0-177-0-0], Pann.X=4, Pann.Y=4Spess.=40 cm, Terreno=--,Criterio=CLS_Muri_ND, Materiale=C35/45: **Verificato**

Armatura a maglia doppia

Pannello	Nx	Ny	Nxy	Mx	My	Mxy	Ax	Ay	C	Cs	ZE
	kN	kN	kN	kN*m	kN*m	kN*m	mmq	mmq			
1	-75.78	-53.99	-5.51	-31.59	3.31	3.13	3142	3142	5	5.8	--
2	-66.21	-48.23	-6.42	-28.50	2.85	7.56	3142	3142	5	5.6	--
3	-53.89	-40.52	-6.25	-23.39	1.93	11.32	3142	3142	5	5.7	--
4	-39.95	-31.72	-4.52	-16.82	0.56	13.67	3142	3142	5	6.5	--
5	-65.88	-41.87	0.54	7.24	23.39	4.18	3142	3142	5	7.2	--
6	-61.02	-39.73	-4.23	6.01	20.57	10.90	3142	3142	5	6.3	--
7	-53.48	-37.35	-6.46	4.63	15.35	16.48	3142	3142	5	6.2	--
8	-44.24	-34.45	-6.27	3.00	7.53	19.96	3142	3142	5	7.2	--
9	-53.84	-51.16	6.01	17.76	41.59	1.95	3142	3142	5	4.6	--
10	-53.22	-48.81	2.13	15.40	36.68	7.53	3142	3142	5	4.5	--
11	-50.98	-46.90	0.29	11.64	27.62	12.29	3142	3142	5	5.0	--
12	-47.67	-45.18	0.82	6.86	13.90	15.70	3142	3142	5	6.7	--
13	-46.19	-62.74	7.12	18.61	53.42	0.12	3142	3142	5	3.8	--
14	-49.25	-58.18	5.53	16.82	47.38	3.46	3142	3142	5	3.9	--
15	-52.25	-53.82	5.95	13.28	36.17	6.18	3142	3142	5	4.7	--
16	-55.60	-50.34	9.58	7.99	19.76	8.27	3142	3142	5	7.1	--
Massimi/minimi											
1							3142				
1								3142			
13										3.8	

Muro : 200 - Nodi: [0-0-0-0], Pann.X=4, Pann.Y=4Spess.=40 cm, Terreno=--,Criterio=CLS_Muri_ND, Materiale=C35/45: **Verificato**

Armatura a maglia doppia

Pannello	Nx	Ny	Nxy	Mx	My	Mxy	Ax	Ay	C	Cs	ZE
	kN	kN	kN	kN*m	kN*m	kN*m	mmq	mmq			
1	-49.48	-50.49	25.40	26.79	13.01	0.25	3142	3142	5	7.4	--
2	-49.71	-48.75	27.66	26.04	12.96	-0.38	3142	3142	5	7.5	--
3	-47.19	-49.63	30.18	23.63	12.45	-1.04	3142	3142	5	8.0	--
4	-42.78	-53.02	32.88	19.58	10.66	-1.73	3142	3142	5	9.3	--
5	-46.94	-51.54	23.13	21.93	11.52	0.29	3142	3142	5	8.9	--
6	-47.30	-49.49	27.14	21.31	11.48	-1.31	3142	3142	5	8.8	--
7	-44.94	-49.34	31.30	19.31	11.01	-2.90	3142	3142	5	8.9	--
8	-40.54	-51.04	35.60	15.94	9.38	-4.39	3142	3142	5	9.7	--
9	-45.45	-52.04	21.08	14.53	9.03	0.33	3142	3142	5	13	--
10	-45.83	-49.83	26.11	14.13	9.02	-2.01	3142	3142	5	12	--
11	-43.62	-48.38	31.26	12.80	8.68	-4.29	3142	3142	5	12	--
12	-39.14	-47.72	36.52	10.57	7.41	-6.39	3142	3142	5	12	--
13	-135.30	-50.82	16.93	-9.55	1.31	0.43	3142	3142	3	21	--
14	-133.09	-46.45	22.15	-9.05	1.98	-1.40	3142	3142	4	20	--
15	-128.91	-41.97	27.50	-8.34	2.18	-3.22	3142	3142	4	18	--
16	-38.13	-44.31	35.11	3.54	4.92	-7.42	3142	3142	5	16	--
Massimi/minimi											
1							3142				
1								3142			
1										7.4	

Muro : 201 - Nodi: [0-0-0-178], Pann.X=4, Pann.Y=4Spess.=40 cm, Terreno=--,Criterio=CLS_Muri_ND, Materiale=C35/45: **Verificato**

Armatura a maglia doppia

Pannello	Nx	Ny	Nxy	Mx	My	Mxy	Ax	Ay	C	Cs	ZE
	kN	kN	kN	kN*m	kN*m	kN*m	mmq	mmq			
1	-59.42	-67.00	39.35	0.85	-22.58	2.71	3142	3142	5	8.0	--
2	-39.78	-45.77	49.97	12.18	2.39	4.04	3142	3142	5	12	--
3	-43.36	-21.95	57.97	22.67	9.35	2.14	3142	3142	5	8.0	--
4	-49.23	-3.97	60.77	29.62	10.15	0.66	3142	3142	5	6.6	--
5	-55.47	-57.02	33.54	0.30	-20.17	4.68	3142	3142	5	8.0	--
6	-38.67	-38.68	39.32	9.79	1.43	7.66	3142	3142	5	11	--
7	-42.18	-16.02	48.25	18.61	7.63	5.34	3142	3142	5	8.3	--
8	-45.94	1.65	54.64	24.70	8.72	2.58	3142	3142	5	7.3	--
9	-49.83	-44.31	28.04	-0.46	-16.38	6.25	3142	3142	5	8.8	--
10	-37.13	-29.00	30.22	6.13	0.56	10.43	3142	3142	5	12	--
11	-41.49	-8.35	38.93	12.34	5.20	7.94	3142	3142	5	9.7	--
12	-43.42	8.86	48.79	17.04	6.28	4.11	3142	3142	5	9.4	--
13	-43.05	-29.95	23.59	-1.44	-11.74	7.03	3142	3142	5	10	--
14	-93.49	-8.11	15.67	-5.66	-1.36	9.29	3142	3142	4	14	--
15	-123.39	4.16	29.43	-6.78	-0.71	7.50	3142	3142	4	15	--
16	-42.67	17.08	43.27	6.83	2.88	5.31	3142	3142	5	16	--
Massimi/minimi											
1							3142				
1								3142			
4										6.6	

Muro : 202 - Nodi: [0-0-0-0], Pann.X=4, Pann.Y=4Spess.=40 cm, Terreno=--,Criterio=CLS_Muri_ND, Materiale=C35/45: **Verificato**

Armatura a maglia doppia

Pannello	Nx	Ny	Nxy	Mx	My	Mxy	Ax	Ay	C	Cs	ZE
	kN	kN	kN	kN*m	kN*m	kN*m	mmq	mmq			
1	-38.56	-58.12	35.40	14.65	6.73	-2.30	3142	3142	5	12	--

Pannello	Nx	Ny	Nxy	Mx	My	Mxy	Ax	Ay	C	Cs	ZE
2	-36.87	-63.74	37.60	9.37	-0.26	-2.61	3142	3142	5	16	--
3	-40.64	-69.12	39.50	3.73	-12.49	-2.18	3142	3142	5	14	--
4	-53.84	-71.10	39.08	-1.32	-32.57	-2.02	3142	3142	5	5.8	--
5	-36.09	-53.98	39.24	11.85	5.81	-5.44	3142	3142	5	11	--
6	-33.76	-57.27	41.68	7.50	-0.48	-5.77	3142	3142	5	15	--
7	-35.72	-59.94	42.10	2.88	-11.28	-4.74	3142	3142	5	13	--
8	-45.42	-60.64	38.61	-1.23	-28.57	-3.12	3142	3142	5	6.3	--
9	-34.05	-47.79	40.84	7.83	4.55	-7.79	3142	3142	5	13	--
10	-30.19	-48.12	43.29	4.87	-0.53	-8.11	3142	3142	5	15	--
11	-29.33	-48.10	42.80	1.69	-9.19	-6.68	3142	3142	5	13	--
12	-34.35	-46.83	37.71	-1.16	-23.00	-3.83	3142	3142	5	7.4	--
13	-32.21	-40.73	39.57	2.61	3.02	-8.99	3142	3142	5	16	--
14	-79.42	-24.09	48.46	-4.70	-0.82	-6.59	3142	3142	4	18	--
15	-21.82	-33.76	41.10	0.15	-6.65	-7.63	3142	3142	5	14	--
16	-21.56	-29.58	34.46	-1.09	-16.25	-4.07	3142	3142	5	9.6	--
Massimi/minimi											
1							3142				
1								3142			
4										5.8	

Muro : 203 - Nodi: [0-0-0-0], Pann.X=4, Pann.Y=4Spess.=40 cm, Terreno=--,Criterio=CLS_Muri_ND, Materiale=C35/45: **Verificato**

Armatura a maglia doppia

Pannello	Nx	Ny	Nxy	Mx	My	Mxy	Ax	Ay	C	Cs	ZE
	kN	kN	kN	kN*m	kN*m	kN*m	mmq	mmq			
1	-66.13	-121.44	3.63	-3.51	-44.25	0.83	3142	3142	5	4.7	--
2	-40.36	-113.91	6.70	1.53	-20.24	2.82	3142	3142	5	9.1	--
3	-28.92	-102.25	10.82	7.05	-4.98	3.25	3142	3142	5	19	--
4	-27.10	-89.91	14.20	12.54	3.97	2.98	3142	3142	5	13	--
5	-60.20	-108.53	0.06	-3.48	-39.66	1.14	3142	3142	5	5.1	--
6	-37.59	-102.69	-1.06	0.83	-18.57	4.80	3142	3142	5	8.9	--
7	-27.04	-94.14	1.04	5.38	-4.97	6.26	3142	3142	5	17	--
8	-25.27	-84.32	4.34	9.96	3.18	6.21	3142	3142	5	12	--
9	-51.82	-90.09	-3.98	-3.32	-32.64	1.30	3142	3142	5	6.0	--
10	-32.69	-86.38	-6.39	-0.07	-15.58	6.31	3142	3142	5	9.3	--
11	-24.14	-80.95	-5.90	3.18	-4.48	8.53	3142	3142	5	16	--
12	-23.68	-74.33	-3.08	6.39	2.23	8.65	3142	3142	5	13	--
13	-42.34	-65.22	-5.28	-3.02	-23.76	1.36	3142	3142	5	8.0	--
14	-26.41	-64.71	-8.88	-1.11	-11.76	7.08	3142	3142	5	11	--
15	-20.38	-63.04	-9.68	0.51	-3.71	9.73	3142	3142	5	15	--
16	-91.28	-49.58	-12.54	-6.56	-0.62	7.15	3142	3142	4	15	--
Massimi/minimi											
1							3142				
1								3142			
1										4.7	

Muro : 204 - Nodi: [186-183-0-0], Pann.X=4, Pann.Y=4Spess.=40 cm, Terreno=--,Criterio=CLS_Muri_ND, Materiale=C35/45: **Verificato**

Armatura a maglia doppia

Pannello	Nx	Ny	Nxy	Mx	My	Mxy	Ax	Ay	C	Cs	ZE
	kN	kN	kN	kN*m	kN*m	kN*m	mmq	mmq			
1	-2.08	-508.76	17.28	0.09	3.52	0.23	3142	3142	3	71	--
2	-2.64	-542.87	27.15	0.12	5.12	0.09	3142	3142	3	52	--
3	-3.99	-589.05	41.46	0.21	6.88	-0.17	3142	3142	4	39	--
4	-14.78	-664.36	69.01	0.31	9.05	-0.63	3142	3142	4	30	--
5	-17.72	-456.40	40.05	0.23	3.43	0.20	3142	3142	3	71	--
6	-24.76	-465.03	59.50	0.38	4.97	0.05	3142	3142	3	52	--
7	-38.62	-464.92	81.09	0.60	6.60	-0.23	3142	3142	4	38	--

Pannello	Nx	Ny	Nxy	Mx	My	Mxy	Ax	Ay	C	Cs	ZE
8	-59.25	-458.57	110.05	0.93	8.44	-0.76	3142	3142	4	28	--
9	-36.12	-395.24	46.06	0.30	3.32	0.17	3142	3142	3	72	--
10	-46.03	-385.53	61.72	0.47	4.76	0.05	3142	3142	3	52	--
11	-58.74	-362.80	70.11	0.71	6.21	-0.17	3142	3142	4	38	--
12	-61.09	-326.16	70.96	1.03	7.68	-0.57	3142	3142	4	29	--
13	-48.85	-341.22	41.08	0.29	3.24	0.15	3142	3142	3	72	--
14	-55.68	-324.34	47.78	0.45	4.59	0.06	3142	3142	3	52	--
15	-60.02	-297.10	41.46	0.66	5.90	-0.12	3142	3142	4	39	--
16	-48.29	-264.15	33.46	0.90	7.11	-0.43	3142	3142	4	31	--
Massimi/minimi											
1							3142				
1								3142			
8										28	

Muro : 205 - Nodi: [193-196-0-0], Pann.X=4, Pann.Y=4Spess.=40 cm, Terreno=--,Criterio=CLS_Muri_ND, Materiale=C35/45: **Verificato**

Armatura a maglia doppia

Pannello	Nx	Ny	Nxy	Mx	My	Mxy	Ax	Ay	C	Cs	ZE
	kN	kN	kN	kN*m	kN*m	kN*m	mmq	mmq			
1	154.61	-95.03	-33.40	2.13	-1.24	0.70	3142	3142	2	59	--
2	15.01	-60.25	-34.37	0.17	-1.85	0.33	3142	3142	5	92	--
3	84.00	-93.46	-99.03	0.39	1.69	-0.59	3142	3142	6	90	--
4	12.86	-170.52	-25.38	0.08	5.50	-1.89	3142	3142	3	29	--
5	162.51	-89.89	-38.83	2.37	-1.44	0.42	3142	3142	2	60	--
6	14.11	-56.79	-35.69	-0.29	-2.10	0.04	3142	3142	5	93	--
7	-23.90	-172.57	-28.79	-2.49	0.33	-0.75	3142	3142	4	60	--
8	8.71	-162.81	-29.77	-2.39	4.64	-1.89	3142	3142	3	33	--
9	170.08	-83.47	-44.50	2.79	-1.76	-0.12	3142	3142	2	57	--
10	-18.22	-183.22	-41.57	-2.85	-1.86	-0.48	3142	3142	4	58	--
11	26.04	-174.37	-45.89	-4.75	-0.17	-1.41	3142	3142	3	30	--
12	4.14	-156.49	-34.70	-5.91	3.80	-2.03	3142	3142	3	24	--
13	175.41	-73.82	-50.43	3.52	-2.35	-1.16	3142	3142	2	35	--
14	56.35	-188.15	-58.69	-3.76	-2.26	-1.70	3142	3142	3	33	--
15	21.84	-168.99	-51.65	-7.96	-0.80	-2.39	3142	3142	3	18	--
16	1.59	-153.49	-40.01	-10.72	3.07	-2.41	3142	3142	3	15	--
Massimi/minimi											
1							3142				
1								3142			
16										15	

Muro : 206 - Nodi: [196-189-0-0], Pann.X=4, Pann.Y=4Spess.=40 cm, Terreno=--,Criterio=CLS_Muri_ND, Materiale=C35/45: **Verificato**

Armatura a maglia doppia

Pannello	Nx	Ny	Nxy	Mx	My	Mxy	Ax	Ay	C	Cs	ZE
	kN	kN	kN	kN*m	kN*m	kN*m	mmq	mmq			
1	126.73	-210.07	-63.64	0.36	-4.22	-2.63	3142	3142	3	33	--
2	59.58	-183.80	-71.81	-0.69	-2.58	-3.98	3142	3142	3	33	--
3	13.83	-168.44	-61.91	-1.47	0.27	-4.18	3142	3142	3	33	--
4	-10.74	-156.11	-48.28	-1.21	5.47	-3.03	3142	3142	3	25	--
5	140.60	-199.70	-98.90	-0.06	-6.88	-2.99	3142	3142	3	22	--
6	114.38	-6.89	-104.56	0.52	-3.94	-3.56	3142	3142	2	26	--
7	-6.18	-190.51	-60.86	1.40	1.68	-4.46	3142	3142	3	33	--
8	-23.43	-191.48	-49.03	2.58	8.61	-2.82	3142	3142	3	19	--
9	112.28	-190.16	-112.77	-2.31	-11.35	-2.36	3142	3142	3	16	--
10	56.52	-19.44	-78.31	-1.09	-5.69	-3.16	3142	3142	2	21	--
11	-20.17	-256.53	-34.99	0.97	2.98	-3.87	3142	3142	3	34	--
12	-27.81	-272.83	-39.91	2.34	11.11	-2.60	3142	3142	3	17	--
13	16.35	45.43	-60.47	-7.09	-16.26	2.63	3142	3142	2	9.8	--

Pannello	Nx	Ny	Nxy	Mx	My	Mxy	Ax	Ay	C	Cs	ZE
14	6.93	-54.08	-13.70	-0.64	-6.74	-2.11	3142	3142	2	23	--
15	-6.44	-398.36	-3.92	0.15	3.68	-3.01	3142	3142	3	37	--
16	-6.48	-412.06	-18.40	0.69	12.42	-2.37	3142	3142	3	17	--
Massimi/minimi											
1							3142				
1								3142			
13										9.8	

Muro : 207 - Nodi: [183-185-0-0], Pann.X=4, Pann.Y=4Spess.=40 cm, Terreno=--,Criterio=CLS_Muri_ND, Materiale=C35/45: **Verificato**

Armatura a maglia doppia

Pannello	Nx	Ny	Nxy	Mx	My	Mxy	Ax	Ay	C	Cs	ZE
	kN	kN	kN	kN*m	kN*m	kN*m	mmq	mmq			
1	-53.01	-306.70	33.69	0.28	3.17	0.13	3142	3142	3	72	--
2	-54.77	-289.70	33.62	0.42	4.47	0.05	3142	3142	3	52	--
3	-54.19	-264.86	20.46	0.61	5.69	-0.10	3142	3142	4	40	--
4	-39.42	-238.98	9.40	0.84	6.75	-0.34	3142	3142	4	32	--
5	-53.87	-286.13	27.25	0.27	3.13	0.11	3142	3142	3	72	--
6	-52.64	-270.06	23.85	0.40	4.40	0.05	3142	3142	3	52	--
7	-50.18	-248.52	8.46	0.59	5.56	-0.08	3142	3142	4	41	--
8	-35.20	-227.43	-0.70	0.79	6.57	-0.24	3142	3142	4	33	--
9	-51.99	-270.52	21.65	0.28	3.10	0.09	3142	3142	3	73	--
10	-48.63	-256.89	16.07	0.40	4.34	0.03	3142	3142	3	53	--
11	-44.93	-239.72	-0.36	0.59	5.47	-0.06	3142	3142	4	41	--
12	-25.89	-223.88	-8.61	0.78	6.46	-0.17	3142	3142	4	34	--
13	-46.92	-259.43	17.23	0.31	3.07	0.08	3142	3142	3	73	--
14	-43.05	-249.08	10.90	0.42	4.29	0.03	3142	3142	3	53	--
15	-39.89	-234.18	-6.88	0.61	5.40	-0.04	3142	3142	4	42	--
16	-21.49	-221.91	-13.78	0.79	6.39	-0.10	3142	3142	4	35	--
Massimi/minimi											
1							3142				
1								3142			
4										32	

Muro : 208 - Nodi: [185-184-0-0], Pann.X=4, Pann.Y=4Spess.=40 cm, Terreno=--,Criterio=CLS_Muri_ND, Materiale=C35/45: **Verificato**

Armatura a maglia doppia

Pannello	Nx	Ny	Nxy	Mx	My	Mxy	Ax	Ay	C	Cs	ZE
	kN	kN	kN	kN*m	kN*m	kN*m	mmq	mmq			
1	-37.07	-246.18	13.64	0.47	3.03	-0.00	3142	3142	3	75	--
2	-30.85	-238.62	5.16	0.58	4.27	-0.03	3142	3142	3	53	--
3	-30.14	-228.34	-13.59	0.76	5.40	-0.06	3142	3142	4	41	--
4	-15.51	-222.13	-18.07	0.90	6.43	-0.03	3142	3142	4	35	--
5	-14.09	-243.05	14.35	0.97	2.95	-0.10	3142	3142	3	75	--
6	-9.42	-238.24	4.74	1.10	4.31	-0.15	3142	3142	3	51	--
7	-18.89	-228.15	-14.63	1.26	5.58	-0.16	3142	3142	4	39	--
8	-10.59	-224.39	-17.45	1.36	6.84	-0.02	3142	3142	4	33	--
9	11.78	-248.71	16.93	1.83	2.66	-0.09	3142	3142	3	83	--
10	12.97	-243.71	6.55	2.02	4.24	-0.29	3142	3142	3	50	--
11	-10.06	-229.86	-12.09	2.20	5.85	-0.42	3142	3142	4	36	--
12	-6.38	-226.42	-14.62	2.25	7.66	-0.28	3142	3142	4	28	--
13	40.10	-252.66	13.71	2.70	1.83	0.23	3142	3142	3	63	--
14	35.55	-245.10	3.26	3.10	3.56	-0.24	3142	3142	3	56	--
15	29.56	-237.33	-4.08	3.37	5.78	-0.65	3142	3142	3	35	--
16	-3.20	-220.64	-11.29	3.49	8.42	-0.89	3142	3142	4	24	--
Massimi/minimi											
1							3142				
1								3142			

Pannello	Nx	Ny	Nxy	Mx	My	Mxy	Ax	Ay	C	Cs	ZE
16										24	

Muro : 209 - Nodi: [184-193-0-0], Pann.X=4, Pann.Y=4Spess.=40 cm, Terreno=--,Criterio=CLS_Muri_ND, Materiale=C35/45: **Verificato**

Armatura a maglia doppia

Pannello	Nx	Ny	Nxy	Mx	My	Mxy	Ax	Ay	C	Cs	ZE
	kN	kN	kN	kN*m	kN*m	kN*m	mmq	mmq			
1	57.42	-251.04	4.88	2.90	0.97	0.69	3142	3142	3	51	--
2	48.14	-238.28	-4.37	3.48	2.64	0.00	3142	3142	3	53	--
3	36.83	-227.32	-9.41	3.96	5.12	-0.77	3142	3142	3	38	--
4	-3.99	-208.91	-9.40	4.14	8.57	-1.41	3142	3142	4	22	--
5	68.31	-248.30	-1.72	2.70	0.46	0.95	3142	3142	3	50	--
6	53.22	-233.00	-10.82	3.28	1.93	0.23	3142	3142	3	52	--
7	38.50	-219.54	-13.79	3.83	4.38	-0.70	3142	3142	3	41	--
8	26.07	-209.48	-13.15	4.19	8.36	-1.51	3142	3142	3	23	--
9	77.79	-243.39	-10.58	2.23	-0.05	1.20	3142	3142	3	52	--
10	57.27	-225.18	-18.89	2.68	1.13	0.47	3142	3142	3	58	--
11	38.41	-209.23	-19.87	3.20	3.43	-0.60	3142	3142	3	49	--
12	23.75	-197.17	-16.14	3.68	7.67	-1.73	3142	3142	3	24	--
13	143.82	-99.99	-26.13	1.97	-1.05	0.88	3142	3142	2	59	--
14	115.64	-83.30	-40.41	1.79	-0.67	0.53	3142	3142	2	75	--
15	36.19	-197.16	-27.62	1.75	2.25	-0.53	3142	3142	3	80	--
16	19.01	-182.63	-20.59	2.24	6.58	-1.85	3142	3142	3	26	--
Massimi/minimi											
1							3142				
1								3142			
4										22	

Muro : 210 - Nodi: [8-23-24-6], Pann.X=4, Pann.Y=4Spess.=40 cm, Terreno=--,Criterio=CLS_Muri_ND, Materiale=C35/45: **Verificato**

Armatura a maglia doppia

Pannello	Nx	Ny	Nxy	Mx	My	Mxy	Ax	Ay	C	Cs	ZE
	kN	kN	kN	kN*m	kN*m	kN*m	mmq	mmq			
1	-64.71	32.97	-25.54	47.45	5.52	-1.10	3142	3142	4	4.1	--
2	-68.07	42.25	-36.29	45.52	6.26	-1.37	3142	3142	4	4.3	--
3	-48.00	67.99	-35.30	47.11	6.59	0.17	3142	3142	4	4.2	--
4	-80.24	64.13	-37.53	57.78	6.76	1.48	3142	3142	4	3.4	--
5	-27.02	10.41	-45.63	14.26	1.25	-1.48	3142	3142	5	12	--
6	-59.53	41.86	-50.44	15.97	2.29	-1.23	3142	3142	5	12	--
7	-57.75	48.81	-44.23	16.86	2.68	-0.77	3142	3142	5	11	--
8	-76.40	22.50	-29.17	18.22	2.23	0.44	3142	3142	5	11	--
9	-39.84	29.98	-52.51	-21.19	-2.37	1.39	3142	3142	3	8.7	--
10	-61.39	50.43	-46.99	-17.72	-2.16	-0.02	3142	3142	3	11	--
11	-59.82	37.95	-35.88	-18.23	-0.20	0.48	3142	3142	3	11	--
12	-83.18	3.85	-19.42	-22.99	2.61	4.75	3142	3142	3	7.4	--
13	-43.31	69.70	-70.28	-35.50	-6.39	4.38	3142	3142	3	5.0	--
14	-62.28	49.58	-44.04	-32.09	-4.15	0.12	3142	3142	3	6.2	--
15	-63.49	29.58	-27.86	-33.26	-1.80	-0.23	3142	3142	3	6.0	--
16	-94.27	0.22	-13.01	-42.76	2.12	0.55	3142	3142	3	4.7	--
Massimi/minimi											
1							3142				
1								3142			
4										3.4	

Muro : 211 - Nodi: [12-17-18-11], Pann.X=4, Pann.Y=4Spess.=40 cm, Terreno=--,Criterio=CLS_Muri_ND, Materiale=C35/45: **Verificato**

Armatura a maglia doppia

Pannello	Nx	Ny	Nxy	Mx	My	Mxy	Ax	Ay	C	Cs	ZE
	kN	kN	kN	kN*m	kN*m	kN*m	mmq	mmq			
1	-80.70	-34.90	-27.47	-35.35	-10.21	2.15	3142	3142	3	5,4	--
2	-88.28	-28.80	-33.35	-35.59	-6.83	1.89	3142	3142	3	5,5	--
3	-94.67	-18.85	-37.12	-36.07	-3.76	1.27	3142	3142	3	5,5	--
4	-96.90	-4.62	-35.62	-37.80	-1.44	1.03	3142	3142	3	5,3	--
5	-73.67	-56.34	-31.27	-23.86	-8.63	2.08	3142	3142	3	7,8	--
6	-81.87	-50.44	-40.29	-22.89	-5.88	1.75	3142	3142	3	8,3	--
7	-90.94	-40.90	-48.10	-22.11	-2.92	0.75	3142	3142	3	9,0	--
8	-100.72	-25.88	-50.47	-22.39	-0.32	-0.92	3142	3142	3	8,9	--
9	-43.59	-89.01	-33.16	0.12	-5.95	3.58	3142	3142	2	21	--
10	-60.72	-64.31	-38.90	6.08	-1.31	4.82	3142	3142	5	18	--
11	-73.01	-60.18	-47.70	10.03	-0.07	4.66	3142	3142	5	14	--
12	-91.92	-53.44	-57.57	14.06	0.69	3.98	3142	3142	5	11	--
13	-50.91	-85.05	-34.70	30.87	0.59	3.69	3142	3142	4	5,8	--
14	-61.40	-83.99	-45.20	35.57	1.98	3.75	3142	3142	4	5,1	--
15	-73.49	-81.92	-55.14	41.75	3.64	3.09	3142	3142	4	4,5	--
16	-89.32	-79.92	-64.07	50.50	5.26	1.63	3142	3142	4	3,9	--
Massimi/minimi											
1							3142				
1								3142			
16										3,9	

Muro : 212 - Nodi: [23-15-10-24], Pann.X=4, Pann.Y=4Spess.=40 cm, Terreno=--,Criterio=CLS_Muri_ND, Materiale=C35/45: **Verificato**

Armatura a maglia doppia

Pannello	Nx	Ny	Nxy	Mx	My	Mxy	Ax	Ay	C	Cs	ZE
	kN	kN	kN	kN*m	kN*m	kN*m	mmq	mmq			
1	-47.17	84.30	-40.39	-30.33	-8.48	2.67	3142	3142	3	6,0	--
2	-69.53	47.42	-36.76	-34.88	-4.94	-0.12	3142	3142	3	5,8	--
3	-73.10	26.35	-19.52	-36.08	-2.41	-1.23	3142	3142	3	5,4	--
4	-97.35	16.20	-6.55	-38.46	2.58	-3.61	3142	3142	3	4,9	--
5	-43.18	55.19	-36.27	-16.49	-7.14	-1.63	3142	3142	3	11	--
6	-75.11	41.25	-27.60	-22.00	-3.62	-0.65	3142	3142	3	9,0	--
7	-80.28	25.28	-12.57	-22.02	-1.40	-1.62	3142	3142	3	8,6	--
8	-92.02	23.03	-9.57	-20.51	3.77	-3.87	3142	3142	3	8,4	--
9	-53.68	28.06	-43.17	9.57	-2.13	-4.26	3142	3142	3	14	--
10	6.80	41.06	-17.17	9.40	1.08	-0.90	3142	3142	6	18	--
11	0.06	41.48	-11.78	10.46	1.48	-0.42	3142	3142	6	18	--
12	-87.02	18.51	-5.03	12.17	6.95	-3.21	3142	3142	3	13	--
13	-70.23	10.50	-47.31	52.09	5.19	-4.00	3142	3142	3	3,6	--
14	-84.87	15.05	-19.66	54.48	6.72	-1.31	3142	3142	3	3,7	--
15	-93.18	18.43	-10.58	54.43	7.52	-0.36	3142	3142	3	3,8	--
16	-97.33	21.84	2.37	60.25	12.44	-0.49	3142	3142	3	3,4	--
Massimi/minimi											
1							3142				
1								3142			
16										3,4	

Muro : 213 - Nodi: [15-16-9-10], Pann.X=4, Pann.Y=4Spess.=40 cm, Terreno=--,Criterio=CLS_Muri_ND, Materiale=C35/45: **Verificato**

Armatura a maglia doppia

Pannello	Nx	Ny	Nxy	Mx	My	Mxy	Ax	Ay	C	Cs	ZE
	kN	kN	kN	kN*m	kN*m	kN*m	mmq	mmq			
1	-96.03	-3.72	-38.00	31.16	3.60	-2.44	3142	3142	3	6,1	--
2	-87.24	-2.15	-11.76	29.91	4.20	-1.45	3142	3142	3	6,5	--
3	-84.76	5.05	-10.56	30.29	4.87	-0.30	3142	3142	3	6,7	--
4	-75.25	9.46	-18.57	35.24	9.81	2.23	3142	3142	3	5,4	--

Pannello	Nx	Ny	Nxy	Mx	My	Mxy	Ax	Ay	C	Cs	ZE
5	17.78	36.26	23.54	4.70	0.74	0.41	3142	3142	6	37	--
6	9.99	40.35	20.26	5.26	0.84	0.34	3142	3142	6	34	--
7	2.72	40.57	13.09	6.43	1.16	0.29	3142	3142	6	28	--
8	-85.58	-8.03	-11.14	2.59	6.75	3.46	3142	3142	3	19	--
9	-127.05	-39.64	-34.04	-19.75	-1.41	-4.29	3142	3142	3	8.8	--
10	-88.23	-33.65	-18.14	-20.16	-0.88	-1.26	3142	3142	3	9.6	--
11	-88.32	-20.45	-18.83	-18.95	0.06	0.68	3142	3142	3	10	--
12	-93.23	-18.52	-5.81	-18.87	5.11	3.39	3142	3142	3	9.2	--
13	-136.97	-69.62	-33.24	-32.00	-1.10	-4.11	3142	3142	3	5.9	--
14	-89.35	-43.86	-25.11	-27.97	-1.31	-0.59	3142	3142	3	7.2	--
15	-89.47	-30.16	-20.45	-27.23	-0.37	0.41	3142	3142	3	7.4	--
16	-104.23	-28.30	-3.72	-30.76	4.48	2.20	3142	3142	3	6.3	--
Massimi/minimi											
1							3142				
1								3142			
4										5.4	

Muro : 214 - Nodi : [26-22-16-15], Pann.X=4, Pann.Y=4Spess.=40 cm, Terreno=--,Criterio=CLS_Muri_ND, Materiale=C35/45: **Verificato**

Armatura a maglia doppia

Pannello	Nx	Ny	Nxy	Mx	My	Mxy	Ax	Ay	C	Cs	ZE
	kN	kN	kN	kN*m	kN*m	kN*m	mmq	mmq			
1	-81.81	-6.92	-71.69	32.60	3.40	-1.52	3142	3142	3	6.0	--
2	-78.64	-9.46	-77.05	32.45	2.87	-1.93	3142	3142	3	5.9	--
3	-81.32	-7.67	-76.30	32.52	2.67	-2.36	3142	3142	3	5.8	--
4	-87.18	-2.31	-69.90	32.25	2.87	-2.81	3142	3142	3	5.8	--
5	-49.38	-26.69	-60.48	4.06	0.26	-1.53	3142	3142	1	36	--
6	-54.55	-29.86	-69.80	3.92	0.14	-1.52	3142	3142	1	37	--
7	-84.69	-31.10	-77.93	3.07	-1.40	-2.41	3142	3142	4	37	--
8	-101.74	-25.57	-70.81	2.52	-1.48	-3.48	3142	3142	4	34	--
9	-38.01	-31.12	-46.64	-16.00	-5.55	1.80	3142	3142	3	11	--
10	-43.17	-42.78	-70.92	-13.48	-7.34	-0.76	3142	3142	3	14	--
11	-80.84	-44.30	-92.77	-13.59	-7.28	-3.92	3142	3142	3	12	--
12	-126.93	-34.35	-86.58	-16.42	-5.40	-6.55	3142	3142	3	9.2	--
13	-3.07	-4.28	-22.01	-20.81	-11.58	12.86	3142	3142	3	5.7	--
14	-4.20	-34.29	-33.19	-7.20	-12.59	1.97	3142	3142	3	13	--
15	-24.74	-87.24	-58.78	-7.40	-11.79	-6.06	3142	3142	3	11	--
16	-174.64	-113.82	-124.76	-22.25	-9.36	-17.21	3142	3142	3	5.5	--
Massimi/minimi											
1							3142				
1								3142			
16										5.5	

Muro : 215 - Nodi : [13-7-19-20], Pann.X=4, Pann.Y=4Spess.=40 cm, Terreno=--,Criterio=CLS_Muri_ND, Materiale=C35/45: **Verificato**

Armatura a maglia doppia

Pannello	Nx	Ny	Nxy	Mx	My	Mxy	Ax	Ay	C	Cs	ZE
	kN	kN	kN	kN*m	kN*m	kN*m	mmq	mmq			
1	-38.32	27.30	-54.10	29.95	0.38	-6.94	3142	3142	3	5.3	--
2	-33.50	73.14	-51.69	25.38	2.74	-8.27	3142	3142	4	5.8	--
3	-28.24	80.08	-52.07	19.21	3.26	-9.02	3142	3142	4	6.9	--
4	-41.87	75.51	-39.96	14.48	5.30	-7.46	3142	3142	4	9.0	--
5	-37.38	16.65	-57.21	0.93	-5.12	-7.48	3142	3142	3	15	--
6	-34.93	16.32	-56.05	0.55	-4.12	-9.70	3142	3142	3	14	--
7	-33.20	32.52	-48.66	0.48	0.90	-10.64	3142	3142	4	16	--
8	-42.72	27.56	-39.96	1.56	6.70	-7.84	3142	3142	4	13	--
9	-37.71	5.94	-55.05	-17.05	-9.93	-6.81	3142	3142	3	8.3	--
10	-37.80	0.09	-51.68	-14.38	-7.52	-8.74	3142	3142	3	8.5	--

Pannello	Nx	Ny	Nxy	Mx	My	Mxy	Ax	Ay	C	Cs	z _E
11	-37.25	2.78	-41.83	-10.49	-0.05	-9.39	3142	3142	4	9.9	--
12	-55.49	-9.82	-32.61	-5.59	10.76	-5.75	3142	3142	4	12	--
13	-33.24	5.01	-43.43	-25.78	-10.65	-4.77	3142	3142	4	6.4	--
14	-35.61	-2.72	-38.81	-21.53	-7.11	-5.73	3142	3142	4	7.2	--
15	-43.83	-13.98	-30.92	-15.53	0.06	-5.64	3142	3142	4	9.4	--
16	-65.11	-29.23	-19.56	-8.96	15.36	-2.45	3142	3142	4	11	--
Massimi/minimi											
1							3142				
1								3142			
1										5.3	

Muro : 216 - Nodi: [3-12-11-21], Pann.X=4, Pann.Y=4Spess.=40 cm, Terreno=--,Criterio=CLS_Muri_ND, Materiale=C35/45: **Verificato**

Armatura a maglia doppia

Pannello	Nx	Ny	Nxy	Mx	My	Mxy	Ax	Ay	C	Cs	z _E
	kN	kN	kN	kN*m	kN*m	kN*m	mmq	mmq			
1	-89.27	-6.82	-13.75	26.41	7.07	5.49	3142	3142	3	6.4	--
2	-80.86	-11.28	-12.23	33.28	10.27	-0.26	3142	3142	4	6.1	--
3	-93.82	-3.03	-14.19	33.70	7.48	0.39	3142	3142	4	6.0	--
4	-100.24	6.08	-27.01	33.72	6.65	1.40	3142	3142	4	5.9	--
5	-87.76	-5.25	-17.86	-5.41	-4.22	6.41	3142	3142	3	17	--
6	-92.77	-2.09	-17.48	-4.42	1.48	2.37	3142	3142	3	30	--
7	-67.06	-7.62	-20.36	4.02	0.40	-0.74	3142	3142	1	42	--
8	-68.87	-5.21	-25.81	4.17	0.87	-0.90	3142	3142	1	40	--
9	-86.98	-9.58	-20.46	-25.86	-8.81	4.65	3142	3142	3	6.7	--
10	-92.54	-5.53	-21.61	-26.39	-3.80	3.19	3142	3142	3	6.9	--
11	-94.44	-0.50	-21.85	-25.81	-1.71	1.99	3142	3142	3	7.4	--
12	-89.25	2.26	-21.77	-24.68	-1.59	2.17	3142	3142	3	7.6	--
13	-84.95	-19.32	-23.74	-35.97	-10.40	3.09	3142	3142	3	5.2	--
14	-91.48	-13.95	-26.74	-36.72	-6.31	2.64	3142	3142	3	5.2	--
15	-95.14	-5.95	-27.67	-37.13	-3.51	2.05	3142	3142	3	5.3	--
16	-92.09	3.35	-24.52	-37.67	-2.22	2.64	3142	3142	3	5.1	--
Massimi/minimi											
1							3142				
1								3142			
16										5.1	

Muro : 217 - Nodi: [10-9-14-27], Pann.X=4, Pann.Y=4Spess.=40 cm, Terreno=--,Criterio=CLS_Muri_ND, Materiale=C35/45: **Verificato**

Armatura a maglia doppia

Pannello	Nx	Ny	Nxy	Mx	My	Mxy	Ax	Ay	C	Cs	z _E
	kN	kN	kN	kN*m	kN*m	kN*m	mmq	mmq			
1	-76.41	-13.58	-24.88	40.78	20.72	4.54	3142	3142	3	4.5	--
2	-64.65	-29.91	-23.85	41.05	26.79	4.46	3142	3142	3	4.4	--
3	-60.17	-45.66	-23.95	36.54	34.65	2.30	3142	3142	3	5.2	--
4	-67.77	-46.79	-16.95	27.54	38.61	-9.13	3142	3142	3	4.2	--
5	-69.03	-28.36	-3.71	2.82	14.38	4.40	3142	3142	3	10	--
6	-64.12	-37.10	-7.26	0.18	17.27	1.15	3142	3142	3	11	--
7	-62.75	-41.76	-10.82	-3.37	17.67	-4.99	3142	3142	3	8.7	--
8	-67.55	-41.56	-12.72	-6.34	11.00	-13.43	3142	3142	3	8.1	--
9	-69.31	-36.74	14.58	-18.12	7.79	3.60	3142	3142	3	9.3	--
10	-50.95	-46.46	6.92	-17.36	5.72	-1.45	3142	3142	3	11	--
11	-50.06	-48.83	-11.76	-18.54	2.11	-8.52	3142	3142	3	7.4	--
12	-67.73	-42.22	-19.42	-21.48	-2.28	-15.38	3142	3142	3	5.5	--
13	-78.91	-49.81	42.49	-21.85	3.27	12.37	3142	3142	3	5.9	--
14	-11.53	-52.21	9.95	-8.65	-2.42	0.81	3142	3142	3	20	--
15	-11.10	-51.78	-10.12	-9.27	-8.33	-9.45	3142	3142	3	10	--
16	-73.81	-51.30	-40.84	-25.16	-15.88	-24.56	3142	3142	3	4.1	--

Pannello	Nx	Ny	Nxy	Mx	My	Mxy	Ax	Ay	C	Cs	Ze
Massimi/minimi											
1							3142				
1								3142			
16										4.1	

Muro : 218 - Nodi : [16-1-2-9], Pann.X=4, Pann.Y=4Spess.=40 cm, Terreno=--,Criterio=CLS_Muri_ND, Materiale=C35/45: **Verificato**

Armatura a maglia doppia

Pannello	Nx	Ny	Nxy	Mx	My	Mxy	Ax	Ay	C	Cs	Ze
	kN	kN	kN	kN*m	kN*m	kN*m	mmq	mmq			
1	-150.26	-76.84	-60.95	-33.28	-0.15	-0.28	3142	3142	3	6.4	--
2	-92.18	-47.25	-31.44	-23.73	-0.61	0.32	3142	3142	3	8.5	--
3	-92.80	-35.36	-22.82	-23.24	0.17	-0.23	3142	3142	3	8.8	--
4	-118.71	-34.39	2.67	-31.47	3.80	-2.11	3142	3142	3	6.2	--
5	-158.14	-46.87	-35.90	15.41	1.76	1.68	3142	3142	5	13	--
6	-98.07	-58.53	-27.73	16.15	2.56	0.34	3142	3142	5	13	--
7	-100.73	-51.99	-17.08	16.52	2.76	-0.08	3142	3142	5	12	--
8	-140.43	-33.04	-5.01	16.71	2.48	-2.05	3142	3142	5	11	--
9	-148.69	-30.52	-15.89	28.43	2.50	1.41	3142	3142	5	7.2	--
10	-101.60	-51.39	-29.59	28.15	3.95	0.57	3142	3142	5	7.2	--
11	-103.46	-55.17	-16.50	28.50	4.12	-0.11	3142	3142	5	7.2	--
12	-128.43	-38.24	-23.80	30.07	2.93	-1.34	3142	3142	5	6.7	--
13	-131.15	-12.98	-10.06	67.65	6.98	2.28	3142	3142	4	3.0	--
14	-97.99	-35.73	-24.94	59.01	7.96	1.28	3142	3142	4	3.4	--
15	-110.59	-53.27	-18.76	59.01	8.58	-1.53	3142	3142	4	3.4	--
16	-124.68	-36.82	-31.59	69.50	7.62	-3.39	3142	3142	4	2.9	--
Massimi/minimi											
1							3142				
1								3142			
16										2.9	

Muro : 219 - Nodi : [24-10-27-25], Pann.X=4, Pann.Y=4Spess.=40 cm, Terreno=--,Criterio=CLS_Muri_ND, Materiale=C35/45: **Verificato**

Armatura a maglia doppia

Pannello	Nx	Ny	Nxy	Mx	My	Mxy	Ax	Ay	C	Cs	Ze
	kN	kN	kN	kN*m	kN*m	kN*m	mmq	mmq			
1	-68.60	33.78	-39.88	-28.05	-0.27	-14.16	3142	3142	3	4.8	--
2	-12.40	29.07	-19.64	-13.63	-4.77	-1.43	3142	3142	3	13	--
3	-2.79	41.96	-9.43	-13.92	-9.53	9.90	3142	3142	3	8.0	--
4	-4.39	40.16	-0.88	-29.25	-15.13	24.74	3142	3142	3	3.6	--
5	-60.74	12.60	-22.37	-19.28	7.40	-2.98	3142	3142	3	9.0	--
6	-38.32	1.82	-19.96	-19.70	6.60	1.95	3142	3142	3	9.1	--
7	-27.58	-0.07	-8.52	-20.52	4.03	7.78	3142	3142	3	6.9	--
8	-24.14	-10.42	4.49	-21.77	-0.19	14.02	3142	3142	3	5.4	--
9	-60.50	3.93	-4.96	14.38	16.45	-4.40	3142	3142	3	9.1	--
10	-49.60	-7.69	-3.37	12.71	20.96	-1.43	3142	3142	3	8.6	--
11	-45.12	-15.24	0.30	9.76	22.85	4.25	3142	3142	3	7.1	--
12	-36.20	-29.89	5.98	6.81	16.83	12.43	3142	3142	3	6.7	--
13	-61.27	-8.98	14.08	70.25	24.57	-0.63	3142	3142	3	2.8	--
14	-53.97	-18.12	19.91	77.71	32.64	-0.17	3142	3142	3	2.6	--
15	-45.69	-33.49	20.70	84.53	42.94	1.48	3142	3142	3	2.3	--
16	-43.06	-57.69	15.36	84.76	48.39	6.77	3142	3142	3	2.2	--
Massimi/minimi											
1							3142				
1								3142			
16										2.2	

Muro : 220 - Nodi: [7-3-21-19], Pann.X=4, Pann.Y=4Spess.=40 cm, Terreno=--,Criterio=CLS_Muri_ND, Materiale=C35/45: **Verificato**

Armatura a maglia doppia

Pannello	Nx	Ny	Nxy	Mx	My	Mxy	Ax	Ay	C	Cs	ZE
	kN	kN	kN	kN*m	kN*m	kN*m	mmq	mmq			
1	-37.51	-3.25	-38.21	-26.47	-11.47	-1.99	3142	3142	4	6.9	--
2	-42.84	-7.97	-31.68	-22.01	-6.79	-1.39	3142	3142	4	8.5	--
3	-60.68	-13.20	-28.41	-15.65	-0.46	-0.37	3142	3142	3	13	--
4	-81.27	-15.18	-10.01	-8.90	17.63	1.03	3142	3142	4	10	--
5	-51.96	-1.00	-40.48	-16.76	-11.96	0.36	3142	3142	3	12	--
6	-50.75	-6.80	-29.66	-13.49	-3.31	2.96	3142	3142	4	12	--
7	-64.40	-2.50	-23.96	-8.56	3.26	5.05	3142	3142	4	15	--
8	-86.82	8.55	-23.43	-3.49	16.17	4.51	3142	3142	4	9.2	--
9	-43.57	6.01	-44.34	0.46	-5.59	-0.25	3142	3142	2	33	--
10	-55.25	-6.57	-34.21	7.35	3.85	6.22	3142	3142	4	15	--
11	-64.41	1.48	-34.33	9.18	5.57	8.08	3142	3142	4	12	--
12	-79.13	16.10	-38.17	9.81	12.29	5.47	3142	3142	4	11	--
13	-42.51	-25.58	-42.47	53.96	14.85	0.10	3142	3142	4	3.7	--
14	-55.32	-4.68	-45.41	48.15	11.80	4.83	3142	3142	4	3.8	--
15	-66.95	4.61	-42.98	39.96	7.15	5.17	3142	3142	3	4.5	--
16	-68.37	5.15	-48.26	33.82	8.04	2.51	3142	3142	3	5.6	--
Massimi/minimi											
1							3142				
1								3142			
13										3.7	

Muro : 221 - Nodi: [21-11-22-26], Pann.X=4, Pann.Y=4Spess.=40 cm, Terreno=--,Criterio=CLS_Muri_ND, Materiale=C35/45: **Verificato**

Armatura a maglia doppia

Pannello	Nx	Ny	Nxy	Mx	My	Mxy	Ax	Ay	C	Cs	ZE
	kN	kN	kN	kN*m	kN*m	kN*m	mmq	mmq			
1	-107.81	11.68	-40.03	34.65	9.53	1.30	3142	3142	3	5.8	--
2	-102.97	8.15	-48.18	34.08	6.84	-0.13	3142	3142	3	6.1	--
3	-96.67	5.82	-56.83	33.48	5.24	-0.73	3142	3142	3	6.0	--
4	-89.99	2.67	-64.28	33.01	4.30	-1.19	3142	3142	3	6.0	--
5	-65.39	-8.46	-33.74	4.02	0.55	-1.00	3142	3142	1	40	--
6	-61.95	-8.37	-39.77	4.01	0.77	-1.22	3142	3142	1	38	--
7	-57.45	-10.90	-46.09	4.07	0.66	-1.38	3142	3142	1	37	--
8	-52.06	-19.38	-52.03	4.10	0.46	-1.49	3142	3142	1	36	--
9	-76.89	-2.82	-22.60	-23.54	-2.15	2.75	3142	3142	3	7.7	--
10	-68.94	-1.76	-23.91	-22.46	-2.71	2.74	3142	3142	3	8.0	--
11	-59.57	-2.94	-27.24	-21.04	-3.29	2.72	3142	3142	3	8.4	--
12	-46.84	-22.73	-33.26	-19.05	-3.97	2.81	3142	3142	3	9.1	--
13	-80.31	6.83	-19.79	-38.25	-2.38	3.95	3142	3142	3	4.8	--
14	-71.49	12.99	-16.21	-38.34	-2.75	4.93	3142	3142	3	4.7	--
15	-58.20	19.23	-11.82	-37.49	-3.66	6.59	3142	3142	3	4.5	--
16	-33.25	8.47	-9.02	-34.45	-5.21	9.34	3142	3142	3	4.5	--
Massimi/minimi											
1							3142				
1								3142			
16										4.5	

Muro : 222 - Nodi: [28-20-19-29], Pann.X=4, Pann.Y=4Spess.=40 cm, Terreno=--,Criterio=CLS_Muri_ND, Materiale=C35/45: **Verificato**

Armatura a maglia doppia

Pannello	Nx	Ny	Nxy	Mx	My	Mxy	Ax	Ay	C	Cs	ZE
	kN	kN	kN	kN*m	kN*m	kN*m	mmq	mmq			
1	66.40	42.06	57.02	2.80	22.89	4.36	3142	3142	4	6.8	--

Pannello	Nx	Ny	Nxy	Mx	My	Mxy	Ax	Ay	C	Cs	ZE
2	2.60	-73.96	6.43	0.14	3.27	0.14	3142	3142	5	59	--
3	-7.56	-135.72	8.65	1.30	-2.82	-1.54	3142	3142	3	49	--
4	-67.12	-265.90	72.19	8.86	-11.65	-4.97	3142	3142	3	14	--
5	89.66	-24.10	46.90	4.24	17.78	3.61	3142	3142	4	9.1	--
6	-4.99	-62.70	36.37	4.83	2.15	-1.46	3142	3142	3	31	--
7	-6.22	-128.05	38.97	7.38	-1.94	-3.57	3142	3142	3	18	--
8	-77.14	-168.58	61.10	16.70	-9.15	-6.23	3142	3142	3	8.9	--
9	45.02	-35.84	58.84	3.04	14.22	3.71	3142	3142	4	11	--
10	7.31	-63.71	59.53	8.57	2.53	0.50	3142	3142	4	21	--
11	-9.12	-107.29	57.92	15.62	-1.96	-2.12	3142	3142	3	11	--
12	-58.22	-123.65	59.67	25.78	-6.76	-3.44	3142	3142	3	6.9	--
13	22.15	-45.09	68.95	0.14	12.55	5.70	3142	3142	4	11	--
14	9.48	-56.53	67.01	12.27	2.86	3.93	3142	3142	4	12	--
15	-11.38	-85.58	66.60	24.70	-1.63	2.31	3142	3142	4	7.1	--
16	-46.34	-99.53	61.76	36.77	-4.71	0.73	3142	3142	3	5.3	--
Massimi/minimi											
1							3142				
1								3142			
16										5.3	

Muro : 223 - Nodi: [0-0-1-2], Pann.X=4, Pann.Y=4Spess.=40 cm, Terreno=--,Criterio=CLS_Muri_ND, Materiale=C35/45: **Verificato**

Armatura a maglia doppia

Pannello	Nx	Ny	Nxy	Mx	My	Mxy	Ax	Ay	C	Cs	ZE
	kN	kN	kN	kN*m	kN*m	kN*m	mmq	mmq			
1	-36.82	-142.41	-14.86	-1.96	-9.26	1.26	3142	3142	3	20	--
2	-41.31	-146.06	-18.89	-4.91	-26.63	-0.13	3142	3142	3	8.0	--
3	-63.59	-149.17	-29.56	-7.98	-48.28	-1.34	3142	3142	4	4.3	--
4	-76.27	-147.20	-16.54	-11.41	-75.14	-0.47	3142	3142	4	2.8	--
5	-21.14	-119.83	-10.62	-2.15	-13.96	-0.57	3142	3142	3	14	--
6	-41.91	-110.38	-17.62	-4.07	-31.67	-0.62	3142	3142	4	6.4	--
7	-38.49	-103.71	-20.02	-6.21	-50.80	0.00	3142	3142	4	4.1	--
8	-34.31	-101.51	-19.99	-8.43	-70.83	1.42	3142	3142	4	2.9	--
9	-9.77	-126.59	-25.10	-2.41	-13.95	0.07	3142	3142	3	15	--
10	-42.08	-115.76	-25.85	-4.46	-31.68	0.21	3142	3142	4	6.6	--
11	-43.11	-110.66	-23.19	-6.80	-51.02	0.14	3142	3142	4	4.1	--
12	-42.05	-118.86	-16.26	-9.42	-71.18	0.63	3142	3142	4	2.9	--
13	-1.73	-148.78	-29.94	0.02	-9.22	-3.13	3142	3142	3	17	--
14	-47.96	-145.57	-20.00	-3.16	-26.14	-1.86	3142	3142	4	7.6	--
15	-53.20	-154.37	-17.61	-6.56	-47.02	-0.24	3142	3142	4	4.5	--
16	-63.06	-153.90	-16.55	-10.63	-72.57	0.17	3142	3142	4	3.0	--
Massimi/minimi											
1							3142				
1								3142			
4										2.8	

Muro : 224 - Nodi: [0-4-6-0], Pann.X=4, Pann.Y=4Spess.=40 cm, Terreno=--,Criterio=CLS_Muri_ND, Materiale=C35/45: **Verificato**

Armatura a maglia doppia

Pannello	Nx	Ny	Nxy	Mx	My	Mxy	Ax	Ay	C	Cs	ZE
	kN	kN	kN	kN*m	kN*m	kN*m	mmq	mmq			
1	-90.81	23.03	63.49	-11.70	2.12	2.36	3142	3142	4	15	--
2	-67.51	22.80	49.42	-9.43	5.34	1.76	3142	3142	4	18	--
3	-66.41	29.02	30.22	-9.38	6.08	1.67	3142	3142	4	18	--
4	-87.24	39.73	17.08	-11.52	3.91	1.76	3142	3142	4	15	--
5	-80.51	27.10	63.47	-18.38	0.14	4.87	3142	3142	4	8.8	--
6	-50.04	33.02	45.31	-12.07	4.13	2.73	3142	3142	4	13	--
7	-49.26	44.05	22.59	-11.96	5.21	0.58	3142	3142	4	16	--

Pannello	Nx	Ny	Nxy	Mx	My	Mxy	Ax	Ay	C	Cs	ZE
8	-82.31	61.75	12.94	-18.09	2.92	-1.00	3142	3142	3	11	--
9	-65.18	33.70	56.86	-24.66	-1.32	11.50	3142	3142	4	5.6	--
10	-30.46	57.12	35.21	-8.48	1.47	4.96	3142	3142	4	15	--
11	-30.14	76.55	14.65	-8.25	2.79	-2.28	3142	3142	3	19	--
12	-78.23	90.66	1.67	-23.53	2.99	-7.35	3142	3142	4	6.6	--
13	-56.76	61.18	35.45	-29.63	-4.70	20.81	3142	3142	4	4.0	--
14	-4.53	88.38	8.12	0.18	5.34	1.31	3142	3142	5	27	--
15	1.48	111.31	10.78	-0.01	6.56	0.66	3142	3142	5	24	--
16	-98.75	134.15	-17.18	-26.41	0.58	-17.65	3142	3142	4	4.7	--
Massimi/minimi											
1							3142				
1								3142			
13										4.0	

Muro : 225 - Nodi : [0-0-2-5], Pann.X=4, Pann.Y=4Spess.=40 cm, Terreno=---,Criterio=CLS_Muri_ND, Materiale=C35/45: **Verificato**

Armatura a maglia doppia

Pannello	Nx	Ny	Nxy	Mx	My	Mxy	Ax	Ay	C	Cs	ZE
	kN	kN	kN	kN*m	kN*m	kN*m	mmq	mmq			
1	-75.34	-31.87	11.27	9.93	7.75	4.49	3142	3142	5	14	--
2	-88.50	-80.78	39.19	6.16	-15.68	7.21	3142	3142	4	8.9	--
3	-102.74	-56.08	44.87	4.74	-27.63	14.89	3142	3142	4	4.7	--
4	-98.72	-22.38	27.80	1.75	-38.02	25.94	3142	3142	4	3.0	--
5	-77.95	-30.97	1.98	13.78	9.31	4.75	3142	3142	5	11	--
6	-87.12	-21.51	2.44	13.13	0.75	5.37	3142	3142	5	11	--
7	-92.71	-12.29	0.64	11.82	-2.74	6.74	3142	3142	5	11	--
8	-100.74	-5.20	1.97	14.52	0.83	2.90	3142	3142	5	12	--
9	-77.14	-32.92	-6.94	13.51	9.66	5.66	3142	3142	5	11	--
10	-86.60	-23.80	-8.81	12.78	1.00	5.32	3142	3142	5	11	--
11	-95.65	-13.96	-6.98	11.34	-2.58	3.53	3142	3142	5	14	--
12	-102.61	-5.47	-4.08	13.85	0.75	3.35	3142	3142	5	12	--
13	-73.50	-36.02	-14.93	9.26	8.77	6.27	3142	3142	5	13	--
14	-81.51	-87.10	-35.42	5.49	-14.34	3.00	3142	3142	4	12	--
15	-77.20	-74.40	-41.38	3.65	-26.03	-5.18	3142	3142	3	6.5	--
16	-107.66	-55.34	-40.33	-0.79	-35.77	-20.20	3142	3142	4	3.6	--
Massimi/minimi											
1							3142				
1								3142			
4										3.0	

Muro : 226 - Nodi : [0-6-8-0], Pann.X=4, Pann.Y=4Spess.=40 cm, Terreno=---,Criterio=CLS_Muri_ND, Materiale=C35/45: **Verificato**

Armatura a maglia doppia

Pannello	Nx	Ny	Nxy	Mx	My	Mxy	Ax	Ay	C	Cs	ZE
	kN	kN	kN	kN*m	kN*m	kN*m	mmq	mmq			
1	-136.12	55.52	38.85	-17.30	-2.67	0.12	3142	3142	3	12	--
2	-118.81	43.22	42.70	-20.64	-3.53	-1.11	3142	3142	4	9.6	--
3	-119.30	51.40	35.69	-19.92	-2.15	-1.40	3142	3142	4	9.8	--
4	-126.83	65.08	42.84	-14.52	-2.99	-3.75	3142	3142	4	12	--
5	-140.81	50.60	35.00	-28.01	-4.37	-0.94	3142	3142	4	7.3	--
6	-114.81	43.68	41.49	-31.48	-4.89	-1.12	3142	3142	4	6.4	--
7	-114.86	53.35	34.58	-30.09	-3.44	-1.27	3142	3142	4	6.7	--
8	-126.14	62.39	39.58	-23.56	-4.75	-2.18	3142	3142	4	8.2	--
9	-146.38	48.09	41.61	-41.12	-6.12	-2.11	3142	3142	4	4.9	--
10	-112.79	44.16	37.97	-42.83	-6.31	-1.06	3142	3142	4	4.8	--
11	-111.20	57.00	35.00	-40.69	-4.75	-1.59	3142	3142	4	4.9	--
12	-121.31	53.34	34.35	-34.78	-6.25	-0.48	3142	3142	4	5.9	--
13	-138.67	37.60	37.19	-56.83	-8.49	-2.26	3142	3142	4	3.6	--

Pannello	Nx	Ny	Nxy	Mx	My	Mxy	Ax	Ay	C	Cs	ZE
14	-117.94	49.13	28.48	-54.37	-7.94	-2.00	3142	3142	4	3.7	--
15	-100.04	59.84	31.07	-51.31	-5.85	-2.79	3142	3142	4	3.8	--
16	-108.88	36.39	15.89	-49.16	-7.57	-0.12	3142	3142	4	4.2	--
Massimi/minimi											
1							3142				
1								3142			
13										3.6	

Muro : 227 - Nodi: [29-26-15-23], Pann.X=4, Pann.Y=4Spess.=40 cm, Terreno=--,Criterio=CLS_Muri_ND, Materiale=C35/45: **Verificato**

Armatura a maglia doppia

Pannello	Nx	Ny	Nxy	Mx	My	Mxy	Ax	Ay	C	Cs	ZE
	kN	kN	kN	kN*m	kN*m	kN*m	mmq	mmq			
1	-105.60	25.85	-102.46	-7.98	9.10	-9.76	3142	3142	4	9.9	--
2	-18.49	56.67	-68.60	-4.25	-4.54	-7.60	3142	3142	3	15	--
3	14.24	108.35	-63.52	-6.44	-13.03	-2.30	3142	3142	3	11	--
4	64.40	129.47	-77.66	-17.95	-18.84	7.35	3142	3142	3	6.5	--
5	-76.88	36.77	-103.14	-3.65	6.00	-8.32	3142	3142	4	13	--
6	-43.25	35.43	-109.24	-5.41	-1.75	-8.66	3142	3142	3	14	--
7	-7.48	32.15	-95.42	-7.31	-6.85	-7.22	3142	3142	3	13	--
8	5.33	30.54	-69.08	-9.75	-9.14	-4.77	3142	3142	3	13	--
9	-65.10	25.65	-99.92	11.15	5.05	-8.30	3142	3142	3	10	--
10	-51.28	21.16	-99.65	11.24	1.35	-9.11	3142	3142	3	9.8	--
11	-40.19	18.19	-91.08	11.10	-1.01	-8.63	3142	3142	3	10	--
12	-33.92	17.84	-76.78	10.94	-2.31	-7.36	3142	3142	3	11	--
13	-60.98	15.99	-92.87	38.27	5.71	-5.50	3142	3142	3	4.6	--
14	-58.32	11.17	-92.32	41.76	4.72	-6.22	3142	3142	3	4.2	--
15	-57.32	7.15	-87.18	45.35	4.37	-6.27	3142	3142	3	3.9	--
16	-59.26	5.31	-78.37	48.32	4.47	-5.91	3142	3142	3	3.7	--
Massimi/minimi											
1							3142				
1								3142			
16										3.7	

Muro : 228 - Nodi: [32-30-17-12], Pann.X=4, Pann.Y=4Spess.=40 cm, Terreno=--,Criterio=CLS_Muri_ND, Materiale=C35/45: **Verificato**

Armatura a maglia doppia

Pannello	Nx	Ny	Nxy	Mx	My	Mxy	Ax	Ay	C	Cs	ZE
	kN	kN	kN	kN*m	kN*m	kN*m	mmq	mmq			
1	-56.75	-32.89	-11.09	-35.16	-14.23	-1.12	3142	3142	3	5.5	--
2	-62.40	-36.24	-14.23	-35.21	-14.60	-0.37	3142	3142	3	5.6	--
3	-68.08	-37.87	-17.93	-35.15	-14.18	0.71	3142	3142	3	5.6	--
4	-73.82	-37.71	-22.13	-35.19	-12.80	1.68	3142	3142	3	5.5	--
5	-52.49	-53.76	-6.78	-25.73	-11.97	-1.26	3142	3142	3	7.4	--
6	-57.19	-57.04	-11.46	-25.62	-12.01	-0.19	3142	3142	3	7.8	--
7	-62.07	-58.83	-17.11	-25.21	-11.56	0.84	3142	3142	3	7.7	--
8	-67.16	-58.92	-23.38	-24.65	-10.54	1.69	3142	3142	3	7.7	--
9	-46.61	-78.24	-1.92	-6.72	-7.76	-1.04	3142	3142	3	23	--
10	-29.58	-88.89	-5.07	-4.46	-6.75	2.52	3142	3142	2	22	--
11	-33.38	-91.40	-13.20	-3.44	-6.93	2.92	3142	3142	2	21	--
12	-38.00	-91.81	-22.18	-2.04	-6.71	3.30	3142	3142	2	21	--
13	-39.11	-80.50	-4.85	23.22	-0.83	-0.30	3142	3142	4	8.4	--
14	-40.17	-82.51	-10.70	24.54	-0.77	0.98	3142	3142	4	7.7	--
15	-42.43	-83.64	-17.67	26.11	-0.56	2.02	3142	3142	4	7.0	--
16	-46.51	-83.73	-25.39	27.92	-0.16	2.82	3142	3142	4	6.5	--
Massimi/minimi											
1							3142				
1								3142			

Pannello	Nx	Ny	Nxy	Mx	My	Mxy	Ax	Ay	C	Cs	ZE
4										5.5	

Muro : 229 - Nodi : [22-11-18-39], Pann.X=4, Pann.Y=4Spess.=40 cm, Terreno=--,Criterio=CLS_Muri_ND, Materiale=C35/45: **Verificato**

Armatura a maglia doppia

Pannello	Nx	Ny	Nxy	Mx	My	Mxy	Ax	Ay	C	Cs	ZE
	kN	kN	kN	kN*m	kN*m	kN*m	mmq	mmq			
1	15.39	-52.49	15.37	-3.47	-51.64	-6.27	3142	3142	3	3.4	--
2	16.15	-95.32	9.60	1.22	-25.17	2.05	3142	3142	3	7.6	--
3	5.67	-153.45	4.35	0.17	18.94	-1.26	3142	3142	5	11	--
4	-84.60	-363.71	114.26	1.48	74.08	-0.33	3142	3142	4	3.3	--
5	18.70	-72.28	19.43	-1.63	-45.65	-3.10	3142	3142	3	4.2	--
6	11.82	-102.33	20.97	1.10	-25.31	2.59	3142	3142	3	7.4	--
7	16.34	-160.35	47.47	1.04	18.62	-2.02	3142	3142	5	10	--
8	-181.66	-170.47	73.55	0.88	65.46	4.00	3142	3142	3	3.1	--
9	8.67	-82.46	24.69	-0.84	-42.34	-1.87	3142	3142	3	4.6	--
10	-10.89	-104.81	33.66	1.12	-24.49	2.45	3142	3142	3	7.7	--
11	-24.01	-137.86	62.80	0.68	17.74	-2.72	3142	3142	5	10	--
12	-104.66	-130.51	76.64	4.06	61.12	3.27	3142	3142	3	3.3	--
13	3.15	-90.20	29.67	-0.75	-40.19	-1.28	3142	3142	3	4.9	--
14	-15.36	-106.37	43.60	0.81	-23.49	2.27	3142	3142	3	8.1	--
15	-39.95	-117.62	62.76	0.59	16.57	-3.19	3142	3142	5	11	--
16	-85.46	-115.59	78.40	5.41	57.66	2.93	3142	3142	3	3.4	--
Massimi/minimi											
1							3142				
1								3142			
8										3.1	

Muro : 230 - Nodi : [34-31-32-37], Pann.X=4, Pann.Y=4Spess.=40 cm, Terreno=--,Criterio=CLS_Muri_ND, Materiale=C35/45: **Verificato**

Armatura a maglia doppia

Pannello	Nx	Ny	Nxy	Mx	My	Mxy	Ax	Ay	C	Cs	ZE
	kN	kN	kN	kN*m	kN*m	kN*m	mmq	mmq			
1	-56.49	-4.01	-11.02	53.15	8.48	9.99	3142	3142	3	3.2	--
2	-43.09	8.66	-11.84	43.89	12.42	6.99	3142	3142	3	3.9	--
3	-52.02	13.69	-27.12	38.69	15.71	4.64	3142	3142	3	4.6	--
4	-58.77	18.31	-35.35	29.95	14.48	-3.47	3142	3142	3	6.0	--
5	-44.18	-1.25	-14.47	16.66	2.80	3.72	3142	3142	3	9.7	--
6	-42.35	5.95	-25.56	8.97	5.78	4.36	3142	3142	3	15	--
7	-46.80	11.08	-28.93	1.72	5.88	0.55	3142	3142	3	30	--
8	-54.29	6.93	-29.31	-3.21	-0.91	-4.67	3142	3142	3	25	--
9	-25.42	3.54	-18.21	-10.99	-0.10	4.53	3142	3142	3	13	--
10	-38.19	15.55	-28.25	-16.57	-0.39	4.67	3142	3142	3	9.3	--
11	-47.95	9.49	-25.21	-20.61	-2.76	0.80	3142	3142	3	9.3	--
12	-54.06	1.72	-22.89	-24.13	-8.02	-2.14	3142	3142	3	7.6	--
13	-13.44	34.01	-20.51	-32.27	-8.45	11.58	3142	3142	3	4.4	--
14	-36.64	16.53	-17.65	-28.49	-6.62	5.76	3142	3142	3	5.7	--
15	-46.22	2.99	-16.86	-31.82	-9.05	1.65	3142	3142	3	5.9	--
16	-53.18	-8.85	-15.56	-34.30	-12.17	-0.81	3142	3142	3	5.7	--
Massimi/minimi											
1							3142				
1								3142			
1										3.2	

Muro : 231 - Nodi : [38-4-25-42], Pann.X=4, Pann.Y=4Spess.=40 cm, Terreno=--,Criterio=CLS_Muri_ND, Materiale=C35/45: **Verificato**

Armatura a maglia doppia

Pannello	Nx	Ny	Nxy	Mx	My	Mxy	Ax	Ay	C	Cs	ZE
	kN	kN	kN	kN*m	kN*m	kN*m	mmq	mmq			
1	10.20	-7.89	8.24	2.02	9.92	9.27	3142	3142	3	10	--
2	-7.00	-20.19	3.88	6.48	2.29	14.12	3142	3142	3	9.3	--
3	-21.42	-35.09	1.46	12.55	-1.01	14.02	3142	3142	3	7.3	--
4	-34.01	-48.52	-1.77	18.26	-1.98	11.42	3142	3142	3	6.6	--
5	8.27	-28.75	19.65	1.30	29.10	10.34	3142	3142	3	5.0	--
6	-3.02	-37.21	22.05	-4.07	5.93	16.01	3142	3142	3	9.0	--
7	-14.26	-41.21	20.19	-9.25	-7.72	16.03	3142	3142	3	7.7	--
8	-22.52	-46.71	14.60	-13.79	-14.51	12.49	3142	3142	3	7.4	--
9	-5.63	-50.69	18.83	4.34	46.26	5.82	3142	3142	3	3.8	--
10	-6.04	-55.21	26.73	-3.15	10.19	8.81	3142	3142	3	11	--
11	-7.10	-52.31	27.59	-10.63	-13.58	7.74	3142	3142	3	9.3	--
12	-6.54	-54.72	21.14	-17.62	-26.33	2.86	3142	3142	3	6.8	--
13	6.58	-85.98	22.81	5.27	64.37	2.00	3142	3142	3	3.1	--
14	-7.66	-82.81	22.54	0.96	13.93	4.88	3142	3142	4	11	--
15	-2.70	-71.11	19.88	-3.53	-22.18	2.02	3142	3142	3	8.4	--
16	10.62	-59.37	19.43	-9.93	-44.81	-7.75	3142	3142	3	3.8	--
Massimi/minimi											
1							3142				
1								3142			
13										3.1	

Muro : 232 - Nodi: [37-32-12-3], Pann.X=4, Pann.Y=4Spess.=40 cm, Terreno=--,Criterio=CLS_Muri_ND, Materiale=C35/45: **Verificato**

Armatura a maglia doppia

Pannello	Nx	Ny	Nxy	Mx	My	Mxy	Ax	Ay	C	Cs	ZE
	kN	kN	kN	kN*m	kN*m	kN*m	mmq	mmq			
1	-51.08	5.77	-33.46	26.15	-10.02	-11.67	3142	3142	3	5.3	--
2	-59.20	1.43	-31.79	25.44	-25.27	-2.58	3142	3142	3	6.9	--
3	-63.52	-4.95	-27.68	23.94	-26.93	3.92	3142	3142	3	6.2	--
4	-62.44	-28.35	-20.11	22.66	-12.05	14.00	3142	3142	4	5.5	--
5	-56.50	1.08	-27.71	-3.85	-10.98	-6.25	3142	3142	3	11	--
6	-62.56	-3.24	-24.89	-2.29	-20.37	-3.31	3142	3142	3	8.1	--
7	-70.38	-6.68	-21.36	-2.49	-21.56	3.32	3142	3142	3	7.7	--
8	-78.09	-7.88	-18.51	-4.28	-14.22	7.18	3142	3142	3	9.0	--
9	-59.23	-5.39	-21.59	-24.73	-13.51	-2.98	3142	3142	3	7.2	--
10	-65.50	-9.57	-20.46	-23.55	-17.32	-1.44	3142	3142	3	8.1	--
11	-65.38	-19.07	-25.59	-23.08	-15.53	2.49	3142	3142	4	7.9	--
12	-71.58	-19.22	-24.31	-24.11	-11.84	4.77	3142	3142	4	7.0	--
13	-59.26	-16.52	-15.69	-35.02	-14.59	-1.37	3142	3142	3	5.5	--
14	-65.32	-20.27	-17.10	-34.62	-16.09	-0.62	3142	3142	3	5.7	--
15	-65.67	-23.65	-23.93	-33.89	-13.82	1.69	3142	3142	4	5.7	--
16	-71.16	-24.24	-25.23	-34.42	-11.50	3.05	3142	3142	4	5.4	--
Massimi/minimi											
1							3142				
1								3142			
1										5.3	

Muro : 233 - Nodi: [19-21-26-29], Pann.X=4, Pann.Y=4Spess.=40 cm, Terreno=--,Criterio=CLS_Muri_ND, Materiale=C35/45: **Verificato**

Armatura a maglia doppia

Pannello	Nx	Ny	Nxy	Mx	My	Mxy	Ax	Ay	C	Cs	ZE
	kN	kN	kN	kN*m	kN*m	kN*m	mmq	mmq			
1	-110.76	-8.09	-49.25	-4.92	40.84	-2.45	3142	3142	3	4.4	--
2	-126.68	-2.53	-48.76	-7.44	30.75	-1.74	3142	3142	3	5.9	--
3	-142.79	7.80	-54.52	-10.19	23.22	-2.54	3142	3142	3	7.4	--
4	-147.14	14.00	-72.46	-11.96	16.62	-5.14	3142	3142	3	8.7	--

Pannello	Nx	Ny	Nxy	Mx	My	Mxy	Ax	Ay	C	Cs	ZE
5	-102.22	23.55	-68.24	-0.21	32.53	-3.20	3142	3142	3	5.3	--
6	-104.76	29.33	-74.87	-1.16	24.82	-4.40	3142	3142	3	6.4	--
7	-103.02	32.28	-83.70	-2.02	18.36	-6.04	3142	3142	3	7.6	--
8	-96.61	36.56	-92.52	-2.66	13.08	-7.53	3142	3142	3	9.0	--
9	-82.33	23.29	-80.74	10.49	20.10	-2.21	3142	3142	4	8.4	--
10	-82.92	25.63	-86.42	10.82	16.04	-3.57	3142	3142	3	9.6	--
11	-79.64	25.59	-90.92	10.94	12.26	-5.32	3142	3142	3	11	--
12	-74.79	27.03	-95.47	11.02	8.74	-6.66	3142	3142	3	11	--
13	-82.79	54.57	-72.99	32.91	15.06	-1.24	3142	3142	3	6.0	--
14	-71.78	30.88	-79.70	33.82	11.13	-1.95	3142	3142	3	5.7	--
15	-66.27	21.83	-85.49	34.78	8.77	-3.21	3142	3142	3	5.3	--
16	-63.40	19.07	-90.02	36.00	7.27	-4.26	3142	3142	3	5.0	--
Massimi/minimi											
1							3142				
1								3142			
1										4.4	

Muro : 234 - Nodi: [33-35-7-13], Pann.X=4, Pann.Y=4Spess.=40 cm, Terreno=--,Criterio=CLS_Muri_ND, Materiale=C35/45: **Verificato**

Armatura a maglia doppia

Pannello	Nx	Ny	Nxy	Mx	My	Mxy	Ax	Ay	C	Cs	ZE
	kN	kN	kN	kN*m	kN*m	kN*m	mmq	mmq			
1	-36.12	17.27	-51.07	33.23	2.78	-0.71	3142	3142	3	5.8	--
2	-38.15	18.89	-52.87	33.94	2.38	-2.48	3142	3142	3	5.4	--
3	-39.64	20.42	-54.01	33.81	1.79	-4.10	3142	3142	3	5.2	--
4	-40.14	23.07	-54.50	32.72	1.12	-5.57	3142	3142	3	5.2	--
5	-33.98	12.07	-53.57	0.33	-4.08	2.26	3142	3142	3	30	--
6	-36.47	14.00	-54.69	0.80	-4.39	-0.18	3142	3142	3	41	--
7	-38.19	15.41	-55.65	1.06	-4.76	-2.61	3142	3142	3	26	--
8	-38.82	16.34	-56.45	1.12	-5.10	-4.97	3142	3142	3	19	--
9	-32.88	8.35	-55.83	-20.65	-9.92	2.53	3142	3142	3	8.5	--
10	-35.55	9.48	-56.05	-20.31	-10.32	0.23	3142	3142	3	9.6	--
11	-37.33	9.65	-56.08	-19.65	-10.61	-2.14	3142	3142	3	9.0	--
12	-37.98	8.71	-55.89	-18.69	-10.62	-4.44	3142	3142	3	8.5	--
13	-33.02	6.27	-57.16	-31.43	-13.86	2.71	3142	3142	3	5.8	--
14	-35.99	6.43	-56.26	-31.05	-14.57	0.96	3142	3142	3	6.1	--
15	-38.00	5.49	-54.99	-30.10	-14.88	-1.03	3142	3142	3	6.3	--
16	-32.78	9.11	-45.48	-28.27	-12.30	-3.16	3142	3142	4	6.2	--
Massimi/minimi											
1							3142				
1								3142			
4										5.2	

Muro : 235 - Nodi: [45-14-5-44], Pann.X=4, Pann.Y=4Spess.=40 cm, Terreno=--,Criterio=CLS_Muri_ND, Materiale=C35/45: **Verificato**

Armatura a maglia doppia

Pannello	Nx	Ny	Nxy	Mx	My	Mxy	Ax	Ay	C	Cs	ZE
	kN	kN	kN	kN*m	kN*m	kN*m	mmq	mmq			
1	-30.30	-31.35	-23.67	16.29	-1.26	-10.41	3142	3142	3	7.3	--
2	-16.68	-19.06	-21.44	11.07	0.37	-12.23	3142	3142	3	8.3	--
3	-5.23	-7.40	-16.24	6.11	4.43	-11.57	3142	3142	3	11	--
4	-3.40	4.57	-9.08	2.83	11.30	-6.41	3142	3142	3	11	--
5	-31.89	-61.56	-33.82	-13.93	-11.55	-11.01	3142	3142	3	7.9	--
6	-24.93	-62.84	-31.11	-9.17	-3.91	-13.54	3142	3142	3	8.6	--
7	-20.20	-64.42	-24.65	-3.81	10.77	-12.41	3142	3142	3	8.7	--
8	-24.75	-60.51	-14.74	1.84	34.78	-5.94	3142	3142	3	4.9	--
9	-33.77	-90.28	-24.69	-17.27	-21.29	-1.23	3142	3142	3	9.1	--
10	-31.03	-96.89	-24.50	-10.03	-7.39	-5.20	3142	3142	3	13	--

Pannello	Nx	Ny	Nxy	Mx	My	Mxy	Ax	Ay	C	Cs	z _E
11	-33.07	-103.13	-22.07	-2.37	17.79	-5.20	3142	3142	3	9.0	--
12	-43.34	-98.33	-14.31	5.21	55.92	-1.64	3142	3142	3	3.6	--
13	-37.18	-128.95	7.57	-9.68	-37.43	9.25	3142	3142	3	4.5	--
14	6.09	24.04	-19.05	-1.91	-11.66	2.82	3142	3142	6	13	--
15	-22.24	-149.82	-27.29	1.40	24.83	3.65	3142	3142	5	7.5	--
16	-31.81	-148.18	-35.36	5.56	76.47	1.05	3142	3142	4	2.8	--
Massimi/minimi											
1							3142				
1								3142			
16										2.8	

Muro : 236 - Nodi: [31-40-30-32], Pann.X=4, Pann.Y=4Spess.=40 cm, Terreno=--,Criterio=CLS_Muri_ND, Materiale=C35/45: **Verificato**

Armatura a maglia doppia

Pannello	Nx	Ny	Nxy	Mx	My	Mxy	Ax	Ay	C	Cs	z _E
	kN	kN	kN	kN*m	kN*m	kN*m	mmq	mmq			
1	-11.36	10.52	-9.16	-27.77	-12.98	8.27	3142	3142	3	5.4	--
2	-31.40	-1.87	-9.68	-32.18	-12.04	3.63	3142	3142	3	5.5	--
3	-42.95	-14.17	-9.80	-34.67	-12.63	0.40	3142	3142	3	5.6	--
4	-50.50	-25.49	-9.64	-35.27	-13.48	-1.12	3142	3142	3	5.5	--
5	-19.19	-23.26	-9.83	-24.49	-13.09	-1.17	3142	3142	3	7.6	--
6	-31.61	-29.86	-6.04	-27.90	-13.23	-2.17	3142	3142	3	6.5	--
7	-40.93	-37.80	-4.14	-28.53	-12.65	-2.48	3142	3142	3	6.4	--
8	-47.09	-47.26	-4.30	-27.02	-12.11	-2.20	3142	3142	3	6.8	--
9	-28.55	-44.55	-3.43	-14.06	-9.05	-7.99	3142	3142	3	8.9	--
10	-35.17	-53.20	1.26	-13.70	-8.86	-6.22	3142	3142	3	9.9	--
11	-40.17	-62.43	2.97	-11.89	-8.39	-4.47	3142	3142	3	12	--
12	-43.30	-71.74	2.02	-8.86	-7.89	-2.76	3142	3142	3	17	--
13	-36.02	-58.15	-1.03	12.15	-1.90	-7.59	3142	3142	4	10.0	--
14	-37.98	-66.50	1.16	15.46	-1.53	-5.58	3142	3142	4	9.4	--
15	-38.52	-72.80	1.18	18.43	-1.19	-3.66	3142	3142	4	8.9	--
16	-38.70	-77.46	-0.93	21.19	-0.97	-1.93	3142	3142	4	8.5	--
Massimi/minimi											
1							3142				
1								3142			
1										5.4	

Muro : 237 - Nodi: [36-41-35-33], Pann.X=4, Pann.Y=4Spess.=40 cm, Terreno=--,Criterio=CLS_Muri_ND, Materiale=C35/45: **Verificato**

Armatura a maglia doppia

Pannello	Nx	Ny	Nxy	Mx	My	Mxy	Ax	Ay	C	Cs	z _E
	kN	kN	kN	kN*m	kN*m	kN*m	mmq	mmq			
1	-28.17	12.56	-23.17	23.22	1.34	6.72	3142	3142	4	6.5	--
2	-30.51	20.01	-25.70	26.82	2.05	5.08	3142	3142	4	6.1	--
3	-32.66	27.12	-28.23	29.62	2.68	3.38	3142	3142	4	5.9	--
4	-34.67	33.78	-30.78	31.72	3.18	1.68	3142	3142	4	5.9	--
5	-23.26	-1.95	-45.51	-1.62	-4.24	11.39	3142	3142	3	12	--
6	-25.70	2.61	-48.18	-1.28	-4.17	9.20	3142	3142	3	14	--
7	-28.39	6.46	-50.43	-0.80	-4.00	6.93	3142	3142	3	17	--
8	-31.15	9.58	-52.19	-0.24	-3.95	4.63	3142	3142	3	22	--
9	-20.01	-2.72	-51.09	-16.40	-8.74	9.79	3142	3142	3	7.4	--
10	-23.03	0.85	-53.13	-18.57	-9.24	8.18	3142	3142	3	7.3	--
11	-26.34	3.96	-54.52	-19.93	-9.40	6.45	3142	3142	3	7.4	--
12	-29.67	6.46	-55.37	-20.57	-9.60	4.60	3142	3142	3	7.8	--
13	-17.14	-1.82	-55.70	-23.81	-11.08	5.87	3142	3142	3	6.5	--
14	-21.23	1.07	-57.18	-27.43	-11.96	5.42	3142	3142	3	5.9	--
15	-25.33	3.41	-57.75	-29.82	-12.49	4.84	3142	3142	3	5.6	--
16	-29.39	5.17	-57.67	-31.09	-13.09	3.99	3142	3142	3	5.6	--

Pannello	Nx	Ny	Nxy	Mx	My	Mxy	Ax	Ay	C	Cs	ZE
Massimi/minimi											
1							3142				
1								3142			
16										5.6	

Muro : 238 - Nodi: [43-27-14-45], Pann.X=4, Pann.Y=4Spess.=40 cm, Terreno=--,Criterio=CLS_Muri_ND, Materiale=C35/45: **Verificato**

Armatura a maglia doppia

Pannello	Nx	Ny	Nxy	Mx	My	Mxy	Ax	Ay	C	Cs	ZE
	kN	kN	kN	kN*m	kN*m	kN*m	mmq	mmq			
1	-57.91	-61.28	-23.07	27.40	1.74	-1.21	3142	3142	4	7.0	--
2	-55.26	-56.33	-24.42	26.24	0.87	-2.56	3142	3142	4	6.9	--
3	-49.00	-52.81	-23.90	23.80	-0.46	-4.92	3142	3142	3	6.9	--
4	-41.46	-42.91	-24.19	20.67	-1.30	-7.63	3142	3142	3	7.0	--
5	-49.81	-57.65	-25.80	-28.58	-7.24	-0.06	3142	3142	3	6.9	--
6	-48.42	-58.75	-29.22	-26.07	-9.41	-0.67	3142	3142	3	7.4	--
7	-45.20	-59.22	-31.86	-22.43	-12.45	-3.04	3142	3142	3	7.8	--
8	-39.31	-60.08	-33.71	-18.29	-13.78	-6.91	3142	3142	3	7.8	--
9	-43.43	-60.15	-20.06	-42.80	-0.38	5.24	3142	3142	3	4.1	--
10	-42.78	-66.99	-20.84	-38.61	-11.35	9.92	3142	3142	3	4.1	--
11	-41.14	-73.64	-23.45	-31.83	-20.79	8.58	3142	3142	3	4.9	--
12	-37.87	-82.27	-24.62	-24.70	-25.35	4.24	3142	3142	3	6.8	--
13	-48.53	-59.31	-0.94	-16.22	13.89	20.72	3142	3142	3	5.4	--
14	-41.67	-71.83	1.12	-14.58	-8.46	19.20	3142	3142	3	5.9	--
15	-35.72	-84.29	1.73	-15.76	-23.52	17.97	3142	3142	3	4.9	--
16	-35.40	-103.07	1.44	-14.30	-34.21	15.26	3142	3142	3	4.2	--
Massimi/minimi											
1							3142				
1								3142			
10										4.1	

Muro : 239 - Nodi: [42-25-27-43], Pann.X=4, Pann.Y=4Spess.=40 cm, Terreno=--,Criterio=CLS_Muri_ND, Materiale=C35/45: **Verificato**

Armatura a maglia doppia

Pannello	Nx	Ny	Nxy	Mx	My	Mxy	Ax	Ay	C	Cs	ZE
	kN	kN	kN	kN*m	kN*m	kN*m	mmq	mmq			
1	-44.22	-60.37	-6.24	22.94	-1.68	7.88	3142	3142	3	6.4	--
2	-51.30	-67.71	-11.30	26.04	-0.46	3.96	3142	3142	3	6.6	--
3	-57.12	-66.34	-17.03	27.71	1.15	1.14	3142	3142	4	6.9	--
4	-58.63	-65.27	-20.65	27.83	1.79	-0.23	3142	3142	4	7.1	--
5	-30.20	-52.13	5.67	-18.38	-15.95	6.97	3142	3142	3	7.7	--
6	-38.08	-55.23	-4.96	-23.24	-13.11	1.75	3142	3142	3	7.9	--
7	-44.65	-56.36	-14.16	-26.96	-8.93	-0.73	3142	3142	3	7.2	--
8	-49.06	-57.03	-21.21	-28.78	-6.07	-0.74	3142	3142	3	6.7	--
9	-10.62	-56.29	9.05	-25.61	-29.19	-4.15	3142	3142	3	6.0	--
10	-19.70	-55.38	-4.37	-33.85	-21.09	-9.73	3142	3142	3	4.5	--
11	-31.35	-53.72	-13.82	-41.74	-7.92	-9.74	3142	3142	3	3.8	--
12	-41.72	-53.42	-17.93	-45.09	-1.29	-1.64	3142	3142	3	4.2	--
13	19.09	-52.84	1.62	-14.53	-38.08	-14.89	3142	3142	3	3.8	--
14	-3.27	-43.26	-9.36	-15.36	-23.01	-17.97	3142	3142	3	4.8	--
15	-25.42	-45.89	-12.95	-11.96	1.37	-18.94	3142	3142	3	6.3	--
16	-44.85	-45.80	-11.82	-11.80	41.69	-9.49	3142	3142	3	3.9	--
Massimi/minimi											
1							3142				
1								3142			
13										3.8	

Muro : 240 - Nodi: [41-34-37-35], Pann.X=4, Pann.Y=4Spess.=40 cm, Terreno=--,Criterio=CLS_Muri_ND, Materiale=C35/45: **Verificato**

Armatura a maglia doppia

Pannello	Nx	Ny	Nxy	Mx	My	Mxy	Ax	Ay	C	Cs	ZE
	kN	kN	kN	kN*m	kN*m	kN*m	mmq	mmq			
1	-14.84	1.09	-60.31	-24.89	-10.53	0.12	3142	3142	3	7.7	--
2	-20.42	3.32	-60.69	-28.76	-11.39	1.35	3142	3142	3	6.5	--
3	-25.64	4.66	-60.12	-31.23	-12.27	2.57	3142	3142	3	5.8	--
4	-30.61	5.79	-59.01	-32.34	-13.70	3.34	3142	3142	3	5.5	--
5	-14.76	7.30	-64.60	-17.31	-6.15	-5.67	3142	3142	3	8.4	--
6	-21.35	7.80	-62.93	-19.92	-5.98	-2.57	3142	3142	3	8.6	--
7	-28.17	8.25	-60.75	-21.34	-7.09	0.95	3142	3142	3	8.8	--
8	-33.14	8.36	-58.88	-21.47	-10.04	3.83	3142	3142	3	7.8	--
9	-18.49	14.76	-66.86	3.26	0.96	-7.03	3142	3142	3	19	--
10	-24.59	11.36	-62.10	4.44	3.41	-4.23	3142	3142	3	23	--
11	-32.90	14.50	-59.57	4.41	4.48	0.59	3142	3142	3	37	--
12	-35.37	11.17	-57.28	4.50	-0.77	6.27	3142	3142	3	18	--
13	-36.10	30.67	-67.20	44.07	9.08	-0.06	3142	3142	3	4.5	--
14	-38.33	36.90	-51.94	54.65	14.27	-0.98	3142	3142	3	3.5	--
15	-34.10	28.43	-53.55	61.28	18.97	0.63	3142	3142	3	3.2	--
16	-40.06	13.71	-54.08	62.26	19.01	5.18	3142	3142	3	2.9	--
Massimi/minimi											
1							3142				
1								3142			
16										2.9	

Muro : 241 - Nodi: [35-37-3-7], Pann.X=4, Pann.Y=4Spess.=40 cm, Terreno=--,Criterio=CLS_Muri_ND, Materiale=C35/45: **Verificato**

Armatura a maglia doppia

Pannello	Nx	Ny	Nxy	Mx	My	Mxy	Ax	Ay	C	Cs	ZE
	kN	kN	kN	kN*m	kN*m	kN*m	mmq	mmq			
1	-34.76	5.92	-57.49	-32.35	-15.56	3.22	3142	3142	3	5.5	--
2	-38.39	5.33	-55.38	-31.66	-17.20	2.11	3142	3142	3	5.8	--
3	-40.95	3.63	-52.70	-30.59	-17.70	0.43	3142	3142	3	6.4	--
4	-35.36	-0.14	-42.12	-28.91	-14.30	-1.47	3142	3142	4	6.5	--
5	-38.45	7.54	-56.59	-20.50	-14.62	5.08	3142	3142	3	7.7	--
6	-42.88	6.26	-53.43	-19.16	-18.42	3.90	3142	3142	3	8.5	--
7	-46.22	4.02	-49.71	-18.29	-19.38	1.61	3142	3142	3	9.1	--
8	-39.66	-6.42	-39.35	-17.75	-14.21	-0.79	3142	3142	4	11	--
9	-44.35	11.50	-54.01	5.79	-10.58	9.03	3142	3142	3	9.7	--
10	-48.50	7.67	-50.24	7.08	-21.26	6.70	3142	3142	3	6.8	--
11	-52.45	4.38	-45.97	7.00	-22.78	0.52	3142	3142	3	8.2	--
12	-54.38	0.27	-42.00	5.84	-14.83	-2.24	3142	3142	3	11	--
13	-51.99	17.96	-47.75	47.57	-7.40	6.42	3142	3142	3	3.7	--
14	-54.86	7.58	-42.63	32.84	-25.67	4.29	3142	3142	3	5.4	--
15	-45.74	-21.17	-38.11	31.35	-24.77	0.42	3142	3142	4	6.2	--
16	-46.68	-25.73	-36.22	43.40	-9.73	-1.80	3142	3142	4	4.4	--
Massimi/minimi											
1							3142				
1								3142			
13										3.7	

Muro : 242 - Nodi: [0-0-18-39], Pann.X=4, Pann.Y=4Spess.=40 cm, Terreno=--,Criterio=CLS_Muri_ND, Materiale=C35/45: **Verificato**

Armatura a maglia doppia

Pannello	Nx	Ny	Nxy	Mx	My	Mxy	Ax	Ay	C	Cs	ZE
	kN	kN	kN	kN*m	kN*m	kN*m	mmq	mmq			
1	-90.45	-42.34	-67.50	4.26	8.02	-9.45	3142	3142	5	11	--

Pannello	Nx	Ny	Nxy	Mx	My	Mxy	Ax	Ay	C	Cs	ZE
2	-100.74	-114.64	-94.70	-1.70	-17.24	-11.30	3142	3142	4	7.3	--
3	-123.37	-112.21	-115.65	-5.25	-38.73	-14.81	3142	3142	4	3.9	--
4	-191.28	-136.38	-130.49	-16.13	-76.55	-4.09	3142	3142	4	2.6	--
5	-87.20	-46.57	-69.77	1.67	7.18	-11.41	3142	3142	5	11	--
6	-94.06	-131.02	-90.40	-4.85	-20.65	-12.87	3142	3142	4	6.3	--
7	-124.97	-147.25	-92.64	-9.30	-43.96	-13.57	3142	3142	4	3.7	--
8	-145.62	-201.71	-75.67	-17.88	-78.46	-2.78	3142	3142	4	2.7	--
9	-85.19	-48.91	-70.16	0.09	6.38	-13.44	3142	3142	5	10	--
10	-94.14	-140.92	-79.16	-6.40	-22.78	-14.29	3142	3142	4	5.7	--
11	-120.84	-155.11	-72.96	-10.66	-44.96	-13.62	3142	3142	4	3.7	--
12	-159.79	-163.52	-69.96	-14.90	-73.73	-2.35	3142	3142	4	2.8	--
13	-73.91	-134.75	-75.51	-2.95	-7.90	-14.60	3142	3142	4	9.4	--
14	-96.64	-139.44	-71.18	-6.63	-23.92	-15.42	3142	3142	4	5.4	--
15	-123.13	-143.03	-66.49	-9.93	-44.31	-13.87	3142	3142	4	3.7	--
16	-158.61	-140.94	-68.29	-12.81	-67.80	-1.85	3142	3142	4	3.1	--
Massimi/minimi											
1							3142				
1								3142			
4										2.6	

Muro : 243 - Nodi: [0-33-36-0], Pann.X=4, Pann.Y=4Spess.=40 cm, Terreno=--,Criterio=CLS_Muri_ND, Materiale=C35/45: **Verificato**

Armatura a maglia doppia

Pannello	Nx	Ny	Nxy	Mx	My	Mxy	Ax	Ay	C	Cs	ZE
	kN	kN	kN	kN*m	kN*m	kN*m	mmq	mmq			
1	-127.86	45.66	10.34	-12.58	-2.54	-1.12	3142	3142	4	15	--
2	-123.09	39.90	7.03	-11.45	-2.31	-0.68	3142	3142	4	17	--
3	-115.56	34.24	4.70	-10.01	-1.86	-0.31	3142	3142	4	20	--
4	-113.20	35.85	25.65	-8.34	-1.31	0.32	3142	3142	3	24	--
5	-122.97	44.74	14.37	-18.66	-2.93	-0.59	3142	3142	4	11	--
6	-125.48	37.56	41.48	-17.14	-2.67	0.19	3142	3142	3	12	--
7	-118.49	34.70	34.31	-15.18	-2.24	0.84	3142	3142	3	13	--
8	-107.41	30.95	28.56	-12.83	-1.67	1.31	3142	3142	3	15	--
9	-122.17	30.00	49.18	-25.53	-3.24	-0.46	3142	3142	3	8.1	--
10	-114.25	35.34	15.25	-23.64	-3.03	0.55	3142	3142	4	8.6	--
11	-108.02	27.71	12.58	-21.15	-2.61	1.30	3142	3142	4	9.3	--
12	-101.85	24.50	30.81	-18.08	-2.02	2.01	3142	3142	3	10	--
13	-115.86	21.44	47.96	-32.99	-3.72	-3.50	3142	3142	3	5.7	--
14	-112.06	22.44	43.10	-30.69	-3.32	-2.53	3142	3142	3	6.3	--
15	-105.91	20.36	38.01	-27.70	-2.84	-1.56	3142	3142	3	7.1	--
16	-96.44	16.37	33.16	-24.07	-2.30	-0.66	3142	3142	3	8.3	--
Massimi/minimi											
1							3142				
1								3142			
13										5.7	

Muro : 244 - Nodi: [0-13-33-0], Pann.X=4, Pann.Y=4Spess.=40 cm, Terreno=--,Criterio=CLS_Muri_ND, Materiale=C35/45: **Verificato**

Armatura a maglia doppia

Pannello	Nx	Ny	Nxy	Mx	My	Mxy	Ax	Ay	C	Cs	ZE
	kN	kN	kN	kN*m	kN*m	kN*m	mmq	mmq			
1	-110.89	52.37	59.61	-13.98	-0.85	-1.30	3142	3142	3	14	--
2	-122.07	52.33	63.95	-14.28	-1.45	-1.76	3142	3142	3	13	--
3	-130.90	52.08	62.41	-14.14	-2.07	-1.83	3142	3142	3	13	--
4	-135.73	50.74	56.27	-13.58	-2.49	-1.54	3142	3142	3	14	--
5	-112.93	33.93	59.24	-20.13	-1.95	-1.71	3142	3142	3	9.5	--
6	-120.81	35.66	63.13	-20.66	-2.34	-1.90	3142	3142	3	9.3	--
7	-126.64	37.93	61.95	-20.54	-2.72	-1.73	3142	3142	3	9.5	--

Pannello	Nx	Ny	Nxy	Mx	My	Mxy	Ax	Ay	C	Cs	ZE
8	-129.50	39.34	56.64	-19.84	-2.94	-1.22	3142	3142	3	10	--
9	-113.60	13.11	57.85	-27.13	-2.99	-2.67	3142	3142	3	7.0	--
10	-119.20	17.71	60.82	-27.90	-3.20	-2.54	3142	3142	3	6.9	--
11	-122.41	23.13	59.79	-27.81	-3.36	-2.09	3142	3142	3	7.0	--
12	-123.47	27.70	55.35	-26.96	-3.39	-1.35	3142	3142	3	7.4	--
13	-113.10	-10.24	54.82	-34.78	-4.21	-5.76	3142	3142	3	5.1	--
14	-117.01	-1.89	56.48	-35.80	-4.26	-5.57	3142	3142	3	5.1	--
15	-118.29	8.15	55.41	-35.72	-4.19	-5.11	3142	3142	3	5.1	--
16	-117.88	16.55	52.21	-34.70	-4.01	-4.36	3142	3142	3	5.4	--
Massimi/minimi											
1							3142				
1								3142			
14										5.1	

Muro : 245 - Nodi : [0-0-39-1], Pann.X=4, Pann.Y=4Spess.=40 cm, Terreno=--,Criterio=CLS_Muri_ND, Materiale=C35/45: **Verificato**

Armatura a maglia doppia

Pannello	Nx	Ny	Nxy	Mx	My	Mxy	Ax	Ay	C	Cs	ZE
	kN	kN	kN	kN*m	kN*m	kN*m	mmq	mmq			
1	-74.03	-38.63	-28.55	12.39	8.49	-8.80	3142	3142	5	9.6	--
2	-74.92	-85.60	-7.16	9.86	-13.33	-4.90	3142	3142	4	11	--
3	-27.64	-76.88	-5.30	9.93	-23.77	3.34	3142	3142	3	7.5	--
4	-76.57	-67.99	21.84	7.09	-32.39	17.15	3142	3142	4	4.1	--
5	-82.63	-36.24	-38.93	15.68	9.61	-7.79	3142	3142	5	8.7	--
6	-97.10	-25.98	-32.34	15.29	1.69	-7.01	3142	3142	5	9.2	--
7	-111.99	-14.93	-24.28	14.39	-1.77	-4.88	3142	3142	5	11	--
8	-122.50	-2.27	-8.83	16.72	0.81	-3.95	3142	3142	5	10	--
9	-88.56	-36.12	-49.66	14.49	9.86	-6.97	3142	3142	5	9.5	--
10	-108.08	-25.91	-44.70	13.73	2.11	-6.89	3142	3142	5	10	--
11	-125.75	-14.96	-32.65	12.93	-1.01	-7.07	3142	3142	5	11	--
12	-152.86	-11.10	-17.42	16.22	1.76	-2.56	3142	3142	5	11	--
13	-91.36	-37.73	-60.70	9.15	9.07	-7.53	3142	3142	5	12	--
14	-108.80	-79.86	-84.35	4.98	-11.04	-8.96	3142	3142	4	10	--
15	-141.74	-54.74	-83.77	1.46	-20.82	-14.71	3142	3142	4	5.6	--
16	-181.28	37.00	-44.88	4.26	-32.37	-18.80	3142	3142	4	3.6	--
Massimi/minimi											
1							3142				
1								3142			
16										3.6	

Muro : 246 - Nodi : [0-8-28-0], Pann.X=4, Pann.Y=4Spess.=40 cm, Terreno=--,Criterio=CLS_Muri_ND, Materiale=C35/45: **Verificato**

Armatura a maglia doppia

Pannello	Nx	Ny	Nxy	Mx	My	Mxy	Ax	Ay	C	Cs	ZE
	kN	kN	kN	kN*m	kN*m	kN*m	mmq	mmq			
1	-77.94	74.83	47.01	-7.55	-1.05	-7.89	3142	3142	4	13	--
2	-20.21	80.19	36.12	0.03	0.99	-11.81	3142	3142	5	14	--
3	-18.11	84.37	29.01	0.01	1.78	-12.03	3142	3142	5	13	--
4	-23.85	88.31	23.44	-0.60	1.00	-10.96	3142	3142	5	15	--
5	-70.36	82.60	45.24	-12.60	-3.50	-5.15	3142	3142	4	11	--
6	-12.76	90.25	32.17	-2.19	-0.21	-11.30	3142	3142	5	14	--
7	-10.25	97.64	25.51	-1.43	1.72	-12.09	3142	3142	5	13	--
8	-19.71	102.04	21.69	-2.06	2.17	-11.30	3142	3142	5	13	--
9	-69.68	112.67	29.56	-17.56	-5.36	1.96	3142	3142	3	10	--
10	-6.23	107.64	24.31	-2.45	-1.85	-9.65	3142	3142	5	15	--
11	-3.26	118.13	19.35	-1.49	1.27	-11.66	3142	3142	5	13	--
12	-17.06	125.49	21.88	-3.11	3.17	-11.74	3142	3142	5	12	--
13	-63.19	130.93	25.15	-21.97	-9.58	12.72	3142	3142	3	5.8	--

Pannello	Nx	Ny	Nxy	Mx	My	Mxy	Ax	Ay	C	Cs	ZE
14	-1.85	156.31	5.73	0.18	-2.44	-4.95	3142	3142	1	23	--
15	3.50	157.11	11.48	-0.36	1.05	-7.14	3142	3142	5	20	--
16	-60.03	187.34	16.80	-2.46	0.85	-9.29	3142	3142	5	16	--
Massimi/minimi											
1							3142				
1								3142			
13										5.8	

Muro : 247 - Nodi: [0-0-17-18], Pann.X=4, Pann.Y=4Spess.=40 cm, Terreno=--,Criterio=CLS_Muri_ND, Materiale=C35/45: **Verificato**

Armatura a maglia doppia

Pannello	Nx	Ny	Nxy	Mx	My	Mxy	Ax	Ay	C	Cs	ZE
	kN	kN	kN	kN*m	kN*m	kN*m	mmq	mmq			
1	-79.33	-126.50	-69.40	-3.07	-8.89	-16.51	3142	3142	4	8.3	--
2	-102.76	-125.93	-66.25	-5.50	-23.52	-16.31	3142	3142	4	5.3	--
3	-126.53	-125.12	-63.99	-7.56	-40.68	-13.69	3142	3142	4	3.9	--
4	-145.88	-125.09	-65.10	-9.63	-58.97	-2.74	3142	3142	4	3.4	--
5	-87.04	-35.82	-59.69	-0.71	6.05	-18.42	3142	3142	5	8.0	--
6	-107.60	-110.71	-62.08	-4.11	-20.83	-15.89	3142	3142	4	5.7	--
7	-129.07	-111.07	-60.72	-5.37	-34.46	-12.69	3142	3142	4	4.4	--
8	-148.03	-111.33	-58.69	-7.36	-48.74	-2.55	3142	3142	4	4.1	--
9	-88.65	-25.34	-48.42	-1.86	7.90	-17.00	3142	3142	5	7.8	--
10	-110.53	-102.55	-52.92	-4.11	-17.15	-14.22	3142	3142	4	6.6	--
11	-134.07	-105.59	-51.37	-4.74	-28.65	-11.37	3142	3142	4	5.2	--
12	-157.68	-108.15	-47.95	-6.30	-40.55	-2.70	3142	3142	4	4.8	--
13	-87.70	-18.62	-32.13	-2.92	9.42	-13.97	3142	3142	5	8.3	--
14	-111.55	-98.86	-38.13	-4.34	-14.08	-11.57	3142	3142	4	8.0	--
15	-138.27	-103.55	-37.83	-4.45	-24.07	-9.37	3142	3142	4	6.2	--
16	-165.97	-108.35	-36.00	-5.65	-34.42	-2.47	3142	3142	4	5.6	--
Massimi/minimi											
1							3142				
1								3142			
4										3.4	

Muro : 248 - Nodi: [0-20-13-0], Pann.X=4, Pann.Y=4Spess.=40 cm, Terreno=--,Criterio=CLS_Muri_ND, Materiale=C35/45: **Verificato**

Armatura a maglia doppia

Pannello	Nx	Ny	Nxy	Mx	My	Mxy	Ax	Ay	C	Cs	ZE
	kN	kN	kN	kN*m	kN*m	kN*m	mmq	mmq			
1	-80.85	74.02	67.50	-6.99	-4.70	-0.70	3142	3142	4	26	--
2	-80.98	68.68	28.71	-8.64	-2.66	1.96	3142	3142	3	19	--
3	-87.76	60.27	34.31	-11.04	-0.96	0.90	3142	3142	3	17	--
4	-98.39	54.44	48.32	-12.93	-0.49	-0.31	3142	3142	3	16	--
5	-72.85	72.20	70.58	-9.68	-4.22	-1.44	3142	3142	4	18	--
6	-75.47	46.73	32.13	-12.32	-3.35	0.68	3142	3142	3	16	--
7	-89.13	39.38	36.70	-15.85	-2.02	-0.17	3142	3142	3	13	--
8	-102.25	34.39	49.30	-18.58	-1.71	-1.05	3142	3142	3	11	--
9	-62.63	64.48	72.36	-13.14	-4.36	-2.61	3142	3142	4	13	--
10	-74.86	71.81	52.74	-16.64	-4.27	-1.44	3142	3142	4	11	--
11	-94.56	74.43	45.53	-21.33	-3.22	-1.89	3142	3142	4	8.9	--
12	-104.32	11.82	50.08	-24.97	-2.86	-2.39	3142	3142	3	7.6	--
13	-37.93	55.62	65.74	-18.30	-5.90	-4.55	3142	3142	4	8.6	--
14	-63.91	74.77	49.80	-21.01	-4.81	-4.93	3142	3142	4	7.7	--
15	-89.08	73.99	46.59	-27.42	-4.11	-5.13	3142	3142	4	6.3	--
16	-106.75	-13.86	50.30	-31.97	-4.13	-5.56	3142	3142	3	5.5	--
Massimi/minimi											
1							3142				
1								3142			

Pannello	Nx	Ny	Nxy	Mx	My	Mxy	Ax	Ay	C	Cs	ZE
16										5.5	

Muro : 249 - Nodi: [0-28-20-0], Pann.X=4, Pann.Y=4Spess.=40 cm, Terreno=--,Criterio=CLS_Muri_ND, Materiale=C35/45: **Verificato**

Armatura a maglia doppia

Pannello	Nx	Ny	Nxy	Mx	My	Mxy	Ax	Ay	C	Cs	ZE
	kN	kN	kN	kN*m	kN*m	kN*m	mmq	mmq			
1	-64.13	86.22	4.71	-3.85	0.29	-7.51	3142	3142	4	18	--
2	-34.01	89.26	21.89	-1.60	-2.36	-7.50	3142	3142	5	18	--
3	-35.71	87.35	22.63	-1.99	-4.34	-5.03	3142	3142	5	19	--
4	-33.73	84.01	21.88	-2.55	-6.35	-1.15	3142	3142	5	24	--
5	-61.41	97.99	6.18	-5.20	1.84	-7.94	3142	3142	4	15	--
6	-69.03	93.85	8.77	-5.95	0.98	-6.43	3142	3142	4	16	--
7	-66.46	87.32	10.44	-6.67	0.16	-4.24	3142	3142	4	18	--
8	-60.73	78.89	11.83	-7.73	-0.01	-0.42	3142	3142	4	25	--
9	-65.44	110.20	18.75	-6.85	3.50	-8.72	3142	3142	4	13	--
10	-71.21	105.92	18.78	-8.22	3.12	-6.87	3142	3142	4	13	--
11	-68.57	89.25	19.75	-9.27	2.53	-4.75	3142	3142	4	14	--
12	-59.78	78.69	24.97	-10.46	3.28	-1.57	3142	3142	4	17	--
13	-13.12	132.61	45.13	-1.19	7.07	-7.57	3142	3142	1	12	--
14	-54.13	65.98	27.04	-10.68	4.02	-6.56	3142	3142	4	12	--
15	-64.37	71.90	30.33	-13.10	2.66	-5.06	3142	3142	4	11	--
16	-74.44	73.75	24.93	-15.63	4.99	-3.70	3142	3142	4	10	--
Massimi/minimi											
1							3142				
1								3142			
16										10	

Muro : 250 - Nodi: [0-38-4-0], Pann.X=4, Pann.Y=4Spess.=40 cm, Terreno=--,Criterio=CLS_Muri_ND, Materiale=C35/45: **Verificato**

Armatura a maglia doppia

Pannello	Nx	Ny	Nxy	Mx	My	Mxy	Ax	Ay	C	Cs	ZE
	kN	kN	kN	kN*m	kN*m	kN*m	mmq	mmq			
1	-36.33	-19.36	20.77	-2.36	-7.97	6.46	3142	3142	5	13	--
2	-91.89	-6.57	13.84	-12.47	-2.28	7.72	3142	3142	4	10	--
3	-124.43	1.93	23.72	-18.42	-2.90	7.19	3142	3142	4	8.2	--
4	-140.20	19.90	50.45	-16.91	-3.01	5.05	3142	3142	4	9.7	--
5	-32.85	-12.11	18.62	-3.00	-5.41	5.97	3142	3142	5	17	--
6	-92.21	-7.70	13.24	-17.92	-2.92	5.69	3142	3142	4	8.7	--
7	-123.49	-2.57	20.61	-28.26	-4.04	6.17	3142	3142	4	6.1	--
8	-148.50	16.73	46.46	-27.82	-5.11	6.45	3142	3142	4	6.2	--
9	-33.13	-9.37	15.21	-9.60	-3.25	1.08	3142	3142	4	18	--
10	-92.82	-10.76	12.63	-23.80	-3.62	2.80	3142	3142	4	7.7	--
11	-125.40	-7.56	19.68	-39.29	-4.96	3.92	3142	3142	4	4.9	--
12	-161.57	3.45	39.04	-42.34	-6.89	7.55	3142	3142	4	4.3	--
13	-34.16	-20.16	17.33	-10.96	-2.95	-1.51	3142	3142	3	16	--
14	-98.64	-20.14	13.70	-30.30	-4.54	-1.59	3142	3142	3	6.5	--
15	-121.75	-11.09	18.97	-50.84	-5.96	0.23	3142	3142	4	4.1	--
16	-154.59	-32.27	19.49	-61.66	-9.32	4.25	3142	3142	4	3.3	--
Massimi/minimi											
1							3142				
1								3142			
16										3.3	

Muro : 251 - Nodi: [0-0-5-44], Pann.X=4, Pann.Y=4Spess.=40 cm, Terreno=--,Criterio=CLS_Muri_ND, Materiale=C35/45: **Verificato**

Armatura a maglia doppia

Pannello	Nx	Ny	Nxy	Mx	My	Mxy	Ax	Ay	C	Cs	ZE
	kN	kN	kN	kN*m	kN*m	kN*m	mmq	mmq			
1	-29.00	-25.14	-2.26	-11.29	-0.85	13.52	3142	3142	5	7.9	--
2	-21.50	-18.73	-0.51	-7.39	-1.97	12.96	3142	3142	5	9.6	--
3	-16.85	-14.31	-0.62	-3.90	-9.17	7.46	3142	3142	4	12	--
4	-21.76	-16.71	4.43	-2.72	-11.13	2.85	3142	3142	3	14	--
5	-32.03	-94.46	-8.38	0.22	-9.38	16.81	3142	3142	4	7.9	--
6	-33.73	-94.30	-4.39	-1.09	-17.91	14.77	3142	3142	4	6.3	--
7	-38.11	-91.75	0.37	-2.58	-27.56	11.06	3142	3142	4	5.3	--
8	-47.33	-102.55	6.52	-4.50	-38.49	4.51	3142	3142	4	4.8	--
9	-45.35	-128.27	2.90	-0.31	-13.87	14.15	3142	3142	4	7.5	--
10	-50.60	-126.51	5.50	-2.82	-29.03	13.24	3142	3142	4	5.0	--
11	-55.69	-126.76	9.99	-5.11	-46.48	10.43	3142	3142	4	3.7	--
12	-58.27	-136.19	13.87	-7.36	-65.58	4.37	3142	3142	4	3.0	--
13	-57.20	-142.75	26.72	0.16	-10.51	8.74	3142	3142	4	11	--
14	-64.52	-150.42	32.34	-3.64	-27.58	10.46	3142	3142	4	5.6	--
15	-77.66	-167.96	38.31	-7.39	-50.01	11.48	3142	3142	4	3.5	--
16	-110.49	-171.12	27.23	-12.26	-79.68	5.83	3142	3142	4	2.5	--
Massimi/minimi											
1							3142				
1								3142			
16										2.5	

Muro : 252 - Nodi: [0-0-21-26], Pann.X=4, Pann.Y=4Spess.=40 cm, Terreno=--,Criterio=CLS_Muri_ND, Materiale=C35/45: **Verificato**

Armatura a maglia doppia

Pannello	Nx	Ny	Nxy	Mx	My	Mxy	Ax	Ay	C	Cs	ZE
	kN	kN	kN	kN*m	kN*m	kN*m	mmq	mmq			
1	5.75	-160.05	-16.59	0.82	11.46	-2.80	3142	3142	3	15	--
2	4.44	-154.98	-11.34	1.55	17.64	-3.00	3142	3142	3	10	--
3	6.32	-152.00	-9.00	2.40	25.38	-2.36	3142	3142	3	7.7	--
4	12.07	-146.17	-9.60	3.84	33.82	-0.41	3142	3142	4	6.2	--
5	1.11	-150.64	-20.15	-1.61	10.76	-2.70	3142	3142	3	16	--
6	0.54	-142.91	-13.13	-0.43	17.40	-2.95	3142	3142	3	10	--
7	5.01	-138.50	-8.71	1.05	26.10	-2.45	3142	3142	3	7.4	--
8	14.78	-138.14	-12.51	3.09	36.12	-0.19	3142	3142	3	5.8	--
9	-3.86	-142.82	-25.09	-5.33	9.93	-2.46	3142	3142	3	17	--
10	-4.49	-132.77	-17.63	-3.55	16.90	-2.59	3142	3142	3	11	--
11	1.39	-121.71	-8.51	-0.92	26.48	-2.18	3142	3142	3	7.3	--
12	21.75	-123.31	-10.26	2.04	37.85	-0.03	3142	3142	3	5.5	--
13	-8.20	-137.57	-30.76	-10.84	8.98	-2.18	3142	3142	3	15	--
14	-9.90	-127.07	-23.97	-8.47	16.00	-1.88	3142	3142	3	12	--
15	-4.77	-112.83	-17.23	-3.54	26.22	-1.42	3142	3142	3	7.5	--
16	25.82	-88.80	-1.09	1.13	39.46	-0.02	3142	3142	3	5.2	--
Massimi/minimi											
1							3142				
1								3142			
16										5.2	

Muro : 253 - Nodi: [0-43-42-0], Pann.X=4, Pann.Y=4Spess.=40 cm, Terreno=--,Criterio=CLS_Muri_ND, Materiale=C35/45: **Verificato**

Armatura a maglia doppia

Pannello	Nx	Ny	Nxy	Mx	My	Mxy	Ax	Ay	C	Cs	ZE
	kN	kN	kN	kN*m	kN*m	kN*m	mmq	mmq			
1	-131.11	-57.22	17.41	-21.42	-0.71	0.43	3142	3142	4	9.7	--
2	-131.36	-54.84	20.09	-20.88	-0.53	-1.05	3142	3142	4	9.6	--
3	-128.25	-49.71	24.31	-19.27	-0.21	-2.50	3142	3142	4	9.7	--
4	-118.99	-41.80	30.59	-16.52	0.02	-3.88	3142	3142	4	10	--

Pannello	Nx	Ny	Nxy	Mx	My	Mxy	Ax	Ay	C	Cs	ZE
5	-129.30	-63.99	17.17	-30.97	-2.45	0.38	3142	3142	4	6.7	--
6	-129.88	-62.09	18.66	-30.27	-2.24	-0.70	3142	3142	4	6.8	--
7	-127.50	-57.03	21.76	-28.03	-1.82	-1.70	3142	3142	4	7.1	--
8	-118.98	-48.35	26.73	-24.04	-1.37	-2.60	3142	3142	4	7.9	--
9	-127.04	-71.68	17.24	-41.42	-4.14	0.14	3142	3142	4	5.1	--
10	-127.95	-70.61	17.41	-40.59	-3.87	-0.44	3142	3142	4	5.1	--
11	-126.22	-66.27	19.27	-37.75	-3.34	-0.85	3142	3142	4	5.5	--
12	-118.39	-57.57	22.42	-32.45	-2.67	-1.11	3142	3142	4	6.2	--
13	-124.76	-79.79	17.65	-52.72	-5.78	-1.09	3142	3142	4	3.9	--
14	-125.70	-80.42	16.55	-51.79	-5.45	-1.20	3142	3142	4	4.0	--
15	-124.26	-77.64	17.17	-48.39	-4.85	-1.06	3142	3142	4	4.3	--
16	-116.79	-69.93	17.98	-41.72	-4.02	-0.79	3142	3142	4	4.9	--
Massimi/minimi											
1							3142				
1								3142			
13										3.9	

Muro : 254 - Nodi : [0-45-43-0], Pann.X=4, Pann.Y=4Spess.=40 cm, Terreno=--,Criterio=CLS_Muri_ND, Materiale=C35/45: **Verificato**

Armatura a maglia doppia

Pannello	Nx	Ny	Nxy	Mx	My	Mxy	Ax	Ay	C	Cs	ZE
	kN	kN	kN	kN*m	kN*m	kN*m	mmq	mmq			
1	-108.64	-48.39	-3.38	-15.88	-0.80	5.22	3142	3142	4	9.9	--
2	-119.50	-52.28	4.29	-18.27	-0.59	4.18	3142	3142	4	9.3	--
3	-126.12	-55.22	10.34	-20.02	-0.64	2.98	3142	3142	4	9.2	--
4	-129.61	-57.01	14.57	-21.07	-0.72	1.77	3142	3142	4	9.2	--
5	-109.72	-49.20	-0.67	-22.61	-2.04	3.83	3142	3142	4	7.9	--
6	-119.95	-55.59	6.43	-26.28	-2.11	3.11	3142	3142	4	7.1	--
7	-125.75	-60.11	11.78	-28.89	-2.30	2.25	3142	3142	4	6.8	--
8	-128.40	-62.92	15.31	-30.44	-2.45	1.37	3142	3142	4	6.6	--
9	-110.51	-52.11	3.43	-30.10	-3.24	1.84	3142	3142	4	6.5	--
10	-120.05	-60.72	9.46	-35.15	-3.57	1.55	3142	3142	4	5.7	--
11	-125.06	-66.40	13.69	-38.67	-3.91	1.14	3142	3142	4	5.3	--
12	-126.88	-69.90	16.46	-40.72	-4.11	0.69	3142	3142	4	5.1	--
13	-113.30	-63.12	7.47	-38.05	-4.57	-0.89	3142	3142	3	5.4	--
14	-119.71	-68.02	13.11	-44.80	-5.16	-0.63	3142	3142	4	4.6	--
15	-123.68	-74.40	15.80	-49.27	-5.59	-0.79	3142	3142	4	4.2	--
16	-124.77	-78.16	17.89	-51.83	-5.80	-0.93	3142	3142	4	4.0	--
Massimi/minimi											
1							3142				
1								3142			
16										4.0	

Muro : 255 - Nodi : [0-42-38-0], Pann.X=4, Pann.Y=4Spess.=40 cm, Terreno=--,Criterio=CLS_Muri_ND, Materiale=C35/45: **Verificato**

Armatura a maglia doppia

Pannello	Nx	Ny	Nxy	Mx	My	Mxy	Ax	Ay	C	Cs	ZE
	kN	kN	kN	kN*m	kN*m	kN*m	mmq	mmq			
1	-102.45	-32.39	37.66	-13.18	-0.22	-4.83	3142	3142	4	11	--
2	-78.37	-22.45	42.99	-9.75	-1.27	-5.04	3142	3142	4	14	--
3	-15.86	-21.18	37.58	-1.20	-4.57	-7.47	3142	3142	5	16	--
4	-10.52	-14.64	31.24	-1.00	-10.96	-4.05	3142	3142	5	13	--
5	-102.67	-37.08	32.75	-19.03	-1.19	-3.20	3142	3142	4	9.3	--
6	-77.39	-24.60	37.30	-13.72	-1.63	-3.27	3142	3142	4	12	--
7	-39.94	-10.05	37.18	-8.61	-3.00	-2.43	3142	3142	4	18	--
8	-2.92	-1.11	27.50	-0.76	-7.57	-3.70	3142	3142	5	17	--
9	-102.41	-45.07	26.93	-25.58	-2.12	-1.20	3142	3142	4	7.7	--
10	-75.87	-30.38	30.22	-17.99	-2.03	-1.04	3142	3142	4	11	--

Pannello	Nx	Ny	Nxy	Mx	My	Mxy	Ax	Ay	C	Cs	z _E
11	-35.25	-12.66	29.01	-10.53	-2.62	-0.49	3142	3142	4	18	--
12	5.21	14.40	21.81	-0.22	-4.67	-3.10	3142	3142	5	24	--
13	-101.27	-57.28	20.54	-32.80	-3.18	-0.54	3142	3142	4	6.2	--
14	-76.39	-45.43	21.32	-22.66	-2.48	0.34	3142	3142	3	8.8	--
15	-32.04	-23.61	18.99	-12.29	-2.27	0.41	3142	3142	3	15	--
16	17.21	30.61	12.34	0.75	-2.61	-2.23	3142	3142	5	39	--
Massimi/minimi											
1							3142				
1								3142			
13										6.2	

Muro : 256 - Nodi: [0-0-27], Pann.X=4, Pann.Y=4Spess.=40 cm, Terreno=--,Criterio=CLS_Muri_ND, Materiale=C35/45: **Verificato**

Armatura a maglia doppia

Pannello	Nx	Ny	Nxy	Mx	My	Mxy	Ax	Ay	C	Cs	z _E
	kN	kN	kN	kN*m	kN*m	kN*m	mmq	mmq			
1	-19.04	-696.95	134.30	0.42	10.94	-1.26	3142	3142	4	24	--
2	-40.23	-786.42	108.44	0.40	11.33	-1.10	3142	3142	4	25	--
3	-41.46	-866.34	78.39	0.24	11.34	-0.96	3142	3142	4	26	--
4	-10.22	-903.93	39.80	0.16	10.79	-0.60	3142	3142	4	28	--
5	-56.42	-479.18	119.06	1.03	9.76	-1.26	3142	3142	4	24	--
6	-52.64	-572.55	142.72	0.84	10.92	-1.43	3142	3142	4	22	--
7	-47.57	-745.65	137.80	0.46	12.14	-1.43	3142	3142	4	22	--
8	-8.61	-1007.39	83.08	0.15	12.94	-0.99	3142	3142	4	24	--
9	-57.29	-325.82	77.24	1.29	8.90	-1.18	3142	3142	4	24	--
10	-57.69	-393.60	112.17	1.36	10.53	-1.82	3142	3142	4	20	--
11	-63.42	-562.34	151.28	0.97	12.95	-2.26	3142	3142	4	18	--
12	-41.22	-1096.90	162.45	0.08	15.30	-1.73	3142	3142	4	20	--
13	-37.47	-255.38	36.12	1.22	8.09	-0.89	3142	3142	4	26	--
14	-28.71	-283.35	63.69	1.62	9.42	-1.90	3142	3142	4	21	--
15	-29.05	-399.75	96.38	1.58	13.98	-3.71	3142	3142	3	14	--
16	-13.50	-1120.22	157.34	-0.81	18.61	-2.60	3142	3142	3	16	--
Massimi/minimi											
1							3142				
1								3142			
15										14	

Muro : 257 - Nodi: [0-44-45-0], Pann.X=4, Pann.Y=4Spess.=40 cm, Terreno=--,Criterio=CLS_Muri_ND, Materiale=C35/45: **Verificato**

Armatura a maglia doppia

Pannello	Nx	Ny	Nxy	Mx	My	Mxy	Ax	Ay	C	Cs	z _E
	kN	kN	kN	kN*m	kN*m	kN*m	mmq	mmq			
1	-36.92	-41.00	-5.60	-2.67	-16.55	1.49	3142	3142	5	11	--
2	-20.84	-43.65	-8.35	-1.87	-8.58	6.95	3142	3142	5	13	--
3	-71.57	-39.51	-16.54	-9.88	-3.80	5.50	3142	3142	4	13	--
4	-92.49	-44.07	-11.29	-12.98	-1.69	5.82	3142	3142	4	11	--
5	-33.56	-19.85	-4.57	-2.14	-11.72	1.50	3142	3142	5	15	--
6	-16.32	-26.87	-6.11	-2.36	-6.45	6.62	3142	3142	5	15	--
7	-70.40	-33.42	-13.48	-13.13	-3.70	3.83	3142	3142	4	12	--
8	-93.34	-41.43	-8.38	-18.07	-2.41	4.19	3142	3142	4	9.2	--
9	-31.49	4.54	-0.20	-1.16	-7.46	1.39	3142	3142	5	22	--
10	-10.72	-8.03	-2.08	-2.61	-4.63	5.70	3142	3142	5	19	--
11	-69.09	-27.82	-8.95	-16.46	-3.72	1.53	3142	3142	4	11	--
12	-93.95	-40.68	-3.54	-23.66	-3.15	1.90	3142	3142	4	8.0	--
13	-5.88	-5.17	10.67	-5.14	-5.68	-1.40	3142	3142	3	27	--
14	-32.92	-8.64	-4.28	-10.82	-4.60	-1.21	3142	3142	3	16	--
15	-69.41	-27.79	-2.56	-19.74	-3.98	-1.02	3142	3142	3	9.7	--
16	-96.57	-47.74	2.19	-29.59	-4.08	-0.93	3142	3142	3	6.8	--

Pannello	Nx	Ny	Nxy	Mx	My	Mxy	Ax	Ay	C	Cs	ZE
Massimi/minimi											
1							3142				
1								3142			
16										6.8	

Muro : 258 - Nodi: [0-0-10-27], Pann.X=4, Pann.Y=4Spess.=40 cm, Terreno=--,Criterio=CLS_Muri_ND, Materiale=C35/45: **Verificato**

Armatura a maglia doppia

Pannello	Nx	Ny	Nxy	Mx	My	Mxy	Ax	Ay	C	Cs	ZE
	kN	kN	kN	kN*m	kN*m	kN*m	mmq	mmq			
1	-20.63	-232.53	16.62	1.13	7.59	-0.67	3142	3142	4	27	--
2	-4.66	-251.16	31.54	1.69	8.67	-1.49	3142	3142	4	23	--
3	46.42	-297.11	67.91	2.30	11.05	-3.99	3142	3142	3	16	--
4	150.69	-614.71	28.81	-1.93	21.00	-7.28	3142	3142	3	10.0	--
5	-16.29	-219.49	-2.26	1.05	7.35	-0.50	3142	3142	4	29	--
6	7.48	-229.20	19.60	1.52	8.08	-1.08	3142	3142	4	25	--
7	56.93	-259.18	29.31	2.35	9.37	-2.88	3142	3142	3	19	--
8	225.51	-363.92	19.82	2.48	13.35	-7.91	3142	3142	3	12	--
9	-8.31	-216.31	-12.05	0.98	7.19	-0.37	3142	3142	4	30	--
10	3.31	-212.95	-5.06	1.33	7.80	-0.77	3142	3142	4	26	--
11	58.61	-233.46	24.81	2.20	8.24	-1.86	3142	3142	4	22	--
12	192.18	-273.46	29.01	3.26	10.22	-6.19	3142	3142	3	14	--
13	-3.43	-214.25	-15.34	0.98	7.08	-0.24	3142	3142	4	31	--
14	13.93	-207.16	-10.17	1.19	7.57	-0.56	3142	3142	4	27	--
15	35.82	-202.25	-0.96	1.82	8.07	-1.19	3142	3142	4	24	--
16	147.73	-256.03	49.09	3.36	7.58	-4.22	3142	3142	3	19	--
Massimi/minimi											
1							3142				
1								3142			
4										10.0	

Muro : 259 - Nodi: [0-0-26-15], Pann.X=4, Pann.Y=4Spess.=40 cm, Terreno=--,Criterio=CLS_Muri_ND, Materiale=C35/45: **Verificato**

Armatura a maglia doppia

Pannello	Nx	Ny	Nxy	Mx	My	Mxy	Ax	Ay	C	Cs	ZE
	kN	kN	kN	kN*m	kN*m	kN*m	mmq	mmq			
1	-3.16	-205.60	-8.24	4.21	12.16	-1.41	3142	3142	4	16	--
2	-3.37	-204.76	-8.08	4.19	14.95	-0.95	3142	3142	4	14	--
3	-5.70	-203.58	-8.45	4.19	17.79	-0.05	3142	3142	4	12	--
4	-7.63	-204.76	-10.08	4.14	20.54	1.07	3142	3142	4	10	--
5	-4.31	-196.60	-6.70	4.26	12.46	-1.79	3142	3142	4	16	--
6	-3.46	-195.88	-5.80	4.24	16.01	-1.42	3142	3142	4	13	--
7	-3.93	-195.75	-5.95	4.17	19.84	-0.50	3142	3142	4	11	--
8	-2.32	-200.64	-9.05	4.29	23.60	0.81	3142	3142	3	9.1	--
9	15.80	-190.94	-12.12	3.96	12.60	-2.24	3142	3142	3	15	--
10	-4.31	-182.40	-3.82	3.99	16.91	-2.09	3142	3142	4	12	--
11	-3.01	-181.24	-4.08	4.05	21.90	-1.26	3142	3142	4	9.4	--
12	-1.63	-183.88	-9.63	4.28	26.99	0.36	3142	3142	3	8.0	--
13	11.11	-174.63	-13.87	2.77	12.15	-2.66	3142	3142	3	15	--
14	8.12	-170.62	-10.25	3.13	17.56	-2.71	3142	3142	3	11	--
15	5.90	-167.85	-9.00	3.48	24.00	-1.95	3142	3142	3	8.4	--
16	2.05	-161.17	-8.14	4.15	30.74	-0.29	3142	3142	4	7.0	--
Massimi/minimi											
1							3142				
1								3142			
16										7.0	

Muro : 260 - Nodi: [0-0-3-21], Pann.X=4, Pann.Y=4Spess.=40 cm, Terreno=--,Criterio=CLS_Muri_ND, Materiale=C35/45: **Verificato**

Armatura a maglia doppia

Pannello	Nx	Ny	Nxy	Mx	My	Mxy	Ax	Ay	C	Cs	ZE
	kN	kN	kN	kN*m	kN*m	kN*m	mmq	mmq			
1	-12.18	-148.93	-40.82	-0.12	12.00	-1.26	3142	3142	3	16	--
2	-5.57	-140.10	-39.14	1.10	18.78	0.29	3142	3142	3	11	--
3	8.28	-135.00	-39.75	2.23	27.75	1.81	3142	3142	3	7.2	--
4	24.74	-139.68	-38.44	4.13	38.86	2.68	3142	3142	3	5.1	--
5	-22.64	-188.93	-42.21	3.56	15.78	-1.11	3142	3142	3	13	--
6	-12.42	-188.38	-37.19	4.06	22.00	-0.03	3142	3142	3	10.0	--
7	3.46	-187.14	-32.10	4.57	29.03	0.78	3142	3142	3	7.4	--
8	20.85	-188.34	-31.94	5.19	36.00	2.46	3142	3142	3	5.7	--
9	-30.15	-268.28	-44.48	3.25	18.32	-1.42	3142	3142	3	12	--
10	-27.93	-261.24	-43.02	3.84	23.93	-0.65	3142	3142	3	9.4	--
11	-5.31	-245.64	-43.50	4.60	29.43	0.78	3142	3142	4	7.6	--
12	49.07	-236.94	-31.19	5.57	35.01	3.59	3142	3142	4	5.9	--
13	-11.61	-431.35	-31.93	1.04	19.61	-1.35	3142	3142	3	12	--
14	-14.53	-450.62	-43.72	1.46	24.94	-0.70	3142	3142	3	10	--
15	-19.36	-491.31	-74.58	2.20	30.66	0.84	3142	3142	4	8.4	--
16	20.49	-454.51	-74.33	3.22	37.96	4.01	3142	3142	4	6.2	--
Massimi/minimi											
1							3142				
1								3142			
4										5.1	

Muro : 261 - Nodi: [0-0-15-10], Pann.X=4, Pann.Y=4Spess.=40 cm, Terreno=--,Criterio=CLS_Muri_ND, Materiale=C35/45: **Verificato**

Armatura a maglia doppia

Pannello	Nx	Ny	Nxy	Mx	My	Mxy	Ax	Ay	C	Cs	ZE
	kN	kN	kN	kN*m	kN*m	kN*m	mmq	mmq			
1	-1.08	-213.41	-19.38	1.01	7.07	-0.06	3142	3142	4	31	--
2	14.99	-202.69	-17.46	1.12	7.38	-0.23	3142	3142	4	29	--
3	41.02	-186.51	-12.36	1.34	7.66	-0.63	3142	3142	4	26	--
4	83.55	-134.24	4.29	1.89	7.71	-2.42	3142	3142	3	21	--
5	5.48	-225.91	-10.81	1.34	7.60	0.23	3142	3142	3	29	--
6	2.27	-216.41	-17.54	1.38	7.90	0.30	3142	3142	4	27	--
7	10.36	-211.79	-15.10	1.47	8.07	0.36	3142	3142	4	26	--
8	21.13	-195.14	-10.75	1.77	8.10	0.39	3142	3142	4	26	--
9	10.42	-231.18	-10.33	2.16	8.91	0.16	3142	3142	3	25	--
10	8.58	-226.96	-11.46	2.07	9.41	0.51	3142	3142	3	23	--
11	-1.25	-216.99	-16.09	2.06	9.74	0.81	3142	3142	4	21	--
12	0.73	-211.60	-14.19	2.04	9.80	1.32	3142	3142	4	20	--
13	-2.86	-219.23	-11.72	3.48	10.77	-0.56	3142	3142	4	20	--
14	-3.28	-218.02	-11.95	3.43	12.36	-0.05	3142	3142	4	18	--
15	7.40	-222.73	-11.33	3.40	13.79	0.77	3142	3142	3	15	--
16	-6.11	-219.41	-10.91	3.35	15.12	1.49	3142	3142	4	14	--
Massimi/minimi											
1							3142				
1								3142			
16										14	

Coefficienti di sicurezza filtrati per minimo Globale (Aste CIs/Peda-> coeff. glob. flessione,altro-> coeff. globale)

Nome	Combinazione	Cs
Muro 168: Nodi[0,0,0,194] Tipo:Calcestruzzo	1	100.4
Muro 132: Nodi[129,130,185,183] Tipo:Calcestruzzo	3	97.41
Muro 131: Nodi[118,129,183,186] Tipo:Calcestruzzo	3	95.5

Nome	Combinazione	Cs
Muro 101: Nodi[0,149,150,87] Tipo:Calcestruzzo	3	91.27
Muro 46: Nodi[23,32,31,22] Tipo:Calcestruzzo	4	89.18
Muro 68: Nodi[53,60,59,52] Tipo:Calcestruzzo	6	88.86
Muro 65: Nodi[65,64,57,58] Tipo:Calcestruzzo	1	86.49
Muro 53: Nodi[37,36,27,28] Tipo:Calcestruzzo	4	82.09
Muro 50: Nodi[16,23,22,15] Tipo:Calcestruzzo	6	70.4
Muro 166: Nodi[149,0,194,150] Tipo:Calcestruzzo	3	69.5
Muro 133: Nodi[130,134,184,185] Tipo:Calcestruzzo	3	62.63
Muro 55: Nodi[21,28,27,20] Tipo:Calcestruzzo	6	60.9
Muro 95: Nodi[78,97,130,129] Tipo:Calcestruzzo	1	60.5
Muro 94: Nodi[79,78,129,118] Tipo:Calcestruzzo	1	60.07
Muro 169: Nodi[196,0,0,0] Tipo:Calcestruzzo	3	57.76
Muro 60: Nodi[7,14,13,6] Tipo:Calcestruzzo	6	55.61
Muro 62: Nodi[2,9,8,1] Tipo:Calcestruzzo	6	55.2
Muro 47: Nodi[32,39,38,31] Tipo:Calcestruzzo	6	52.71
Muro 102: Nodi[84,148,149,0] Tipo:Calcestruzzo	3	50.84
Muro 134: Nodi[134,141,193,184] Tipo:Calcestruzzo	5	48.6
Muro 167: Nodi[148,196,0,149] Tipo:Calcestruzzo	3	47.81
Muro 54: Nodi[37,44,43,36] Tipo:Calcestruzzo	6	44.29
Muro 66: Nodi[62,61,54,55] Tipo:Calcestruzzo	3	44.27
Muro 64: Nodi[63,62,55,56] Tipo:Calcestruzzo	3	43.16
Muro 96: Nodi[97,81,134,130] Tipo:Calcestruzzo	5	42.22
Muro 61: Nodi[12,11,4,5] Tipo:Calcestruzzo	6	41.89
Muro 165: Nodi[0,0,0,0] Tipo:Calcestruzzo	3	41.05
Muro 185: Nodi[0,19,20,0] Tipo:Calcestruzzo	5	40.73
Muro 57: Nodi[11,10,3,4] Tipo:Calcestruzzo	6	38.5
Muro 184: Nodi[0,21,19,0] Tipo:Calcestruzzo	6	36.9
Muro 67: Nodi[54,61,60,53] Tipo:Calcestruzzo	6	35.11
Muro 90: Nodi[18,25,97,78] Tipo:Calcestruzzo	4	34.41
Muro 147: Nodi[0,0,0,0] Tipo:Calcestruzzo	6	33.38
Muro 91: Nodi[25,34,81,97] Tipo:Calcestruzzo	2	33.17
Muro 207: Nodi[183,185,0,0] Tipo:Calcestruzzo	4	32.06
Muro 48: Nodi[39,46,45,38] Tipo:Calcestruzzo	6	31.79
Muro 163: Nodi[200,0,0,0] Tipo:Calcestruzzo	5	31.21
Muro 56: Nodi[44,51,50,43] Tipo:Calcestruzzo	6	30.14
Muro 89: Nodi[18,78,79] Tipo:Calcestruzzo	4	29.15
Muro 92: Nodi[34,41,80,81] Tipo:Calcestruzzo	5	29.01
Muro 204: Nodi[186,183,0,0] Tipo:Calcestruzzo	4	28.18
Muro 63: Nodi[64,63,56,57] Tipo:Calcestruzzo	3	27.3
Muro 97: Nodi[81,80,141,134] Tipo:Calcestruzzo	5	26.62
Muro 45: Nodi[9,16,15,8] Tipo:Calcestruzzo	6	24.52
Muro 51: Nodi[14,21,20,13] Tipo:Calcestruzzo	6	24.24
Muro 208: Nodi[185,184,0,0] Tipo:Calcestruzzo	4	24.14
Muro 58: Nodi[6,13,12,5] Tipo:Calcestruzzo	6	23.99
Muro 49: Nodi[46,53,52,45] Tipo:Calcestruzzo	6	23.14
Muro 197: Nodi[197,0,0,200] Tipo:Calcestruzzo	5	22.39
Muro 209: Nodi[184,193,0,0] Tipo:Calcestruzzo	4	22.32
Muro 59: Nodi[3,10,9,2] Tipo:Calcestruzzo	6	21.74
Muro 152: Nodi[199,0,0,0] Tipo:Calcestruzzo	5	21.7
Muro 151: Nodi[0,0,0,0] Tipo:Calcestruzzo	3	21.14
Muro 135: Nodi[141,148,196,193] Tipo:Calcestruzzo	2	20.59
Muro 52: Nodi[58,57,50,51] Tipo:Calcestruzzo	3	18.16
Muro 190: Nodi[187,0,0,197] Tipo:Calcestruzzo	5	16.7
Muro 141: Nodi[198,199,0,0] Tipo:Calcestruzzo	5	16.01
Muro 183: Nodi[0,0,50,34] Tipo:Calcestruzzo	3	15.97
Muro 7: Nodi[55,54,47,48] Tipo:Calcestruzzo	4	15.64
Muro 161: Nodi[0,0,0,0] Tipo:Calcestruzzo	1	15.43
Muro 1: Nodi[56,55,48,49] Tipo:Calcestruzzo	3	15.34
Muro 205: Nodi[193,196,0,0] Tipo:Calcestruzzo	3	14.54
Muro 8: Nodi[41,40,33,34] Tipo:Calcestruzzo	4	14.32
Muro 148: Nodi[0,0,0,0] Tipo:Calcestruzzo	3	14.18

Nome	Combinazione	Cs
Muro 256: Nodi[0,0,27] Tipo:Calcestruzzo	3	14.18
Muro 93: Nodi[41,48,84,80] Tipo:Calcestruzzo	3	13.95
Muro 261: Nodi[0,0,15,10] Tipo:Calcestruzzo	4	13.52
Muro 194: Nodi[194,0,0,187] Tipo:Calcestruzzo	5	12.71
Muro 99: Nodi[48,55,83,84] Tipo:Calcestruzzo	3	12.46
Muro 164: Nodi[0,0,0,0] Tipo:Calcestruzzo	2	12
Muro 181: Nodi[40,0,0,47] Tipo:Calcestruzzo	4	11.79
Muro 182: Nodi[46,0,0,50] Tipo:Calcestruzzo	4	11.56
Muro 20: Nodi[49,48,41,42] Tipo:Calcestruzzo	4	11.51
Muro 179: Nodi[0,48,49,0] Tipo:Calcestruzzo	3	11.33
Muro 23: Nodi[25,24,17,18] Tipo:Calcestruzzo	4	10.81
Muro 22: Nodi[34,33,24,25] Tipo:Calcestruzzo	6	10.73
Muro 120: Nodi[170,197,200,173] Tipo:Calcestruzzo	3	10.61
Muro 178: Nodi[0,49,50,0] Tipo:Calcestruzzo	3	10.59
Muro 146: Nodi[0,0,0,0] Tipo:Calcestruzzo	1	10.54
Muro 21: Nodi[43,50,49,42] Tipo:Calcestruzzo	4	10.52
Muro 249: Nodi[0,28,20,0] Tipo:Calcestruzzo	4	10.48
Muro 16: Nodi[47,54,53,46] Tipo:Calcestruzzo	4	10.25
Muro 98: Nodi[80,84,148,141] Tipo:Calcestruzzo	3	10.15
Muro 6: Nodi[42,41,34,35] Tipo:Calcestruzzo	4	10.15
Muro 115: Nodi[157,187,197,170] Tipo:Calcestruzzo	3	10.05
Muro 160: Nodi[0,0,0] Tipo:Calcestruzzo	2	9.981
Muro 258: Nodi[0,0,10,27] Tipo:Calcestruzzo	3	9.951
Muro 153: Nodi[173,200,0,176] Tipo:Calcestruzzo	3	9.932
Muro 154: Nodi[176,0,0,175] Tipo:Calcestruzzo	3	9.866
Muro 175: Nodi[0,36,48,0] Tipo:Calcestruzzo	4	9.828
Muro 206: Nodi[196,189,0,0] Tipo:Calcestruzzo	2	9.755
Muro 25: Nodi[48,47,40,41] Tipo:Calcestruzzo	4	9.631
Muro 145: Nodi[0,0,0] Tipo:Calcestruzzo	2	9.427
Muro 159: Nodi[0,0,0,0] Tipo:Calcestruzzo	3	9.266
Muro 180: Nodi[0,0,46,47] Tipo:Calcestruzzo	4	9.214
Muro 17: Nodi[36,43,42,35] Tipo:Calcestruzzo	4	8.887
Muro 172: Nodi[30,0,0,40] Tipo:Calcestruzzo	3	8.846
Muro 122: Nodi[172,171,168,169] Tipo:Calcestruzzo	3	8.837
Muro 191: Nodi[182,0,0,191] Tipo:Calcestruzzo	5	8.446
Muro 28: Nodi[54,55,83,85] Tipo:Calcestruzzo	6	8.314
Muro 150: Nodi[0,0,0,0] Tipo:Calcestruzzo	2	8.312
Muro 155: Nodi[175,0,0,174] Tipo:Calcestruzzo	2	8.123
Muro 170: Nodi[0,198,0] Tipo:Calcestruzzo	5	8.038
Muro 112: Nodi[136,182,191,143] Tipo:Calcestruzzo	5	8.002
Muro 31: Nodi[56,82,83,55] Tipo:Calcestruzzo	6	7.948
Muro 157: Nodi[176,175,172,173] Tipo:Calcestruzzo	3	7.908
Muro 156: Nodi[0,0,0,0] Tipo:Calcestruzzo	3	7.887
Muro 34: Nodi[53,54,85,88] Tipo:Calcestruzzo	6	7.826
Muro 149: Nodi[0,0,0,199] Tipo:Calcestruzzo	3	7.797
Muro 70: Nodi[90,136,143,91] Tipo:Calcestruzzo	5	7.781
Muro 121: Nodi[173,172,169,170] Tipo:Calcestruzzo	3	7.771
Muro 24: Nodi[26,25,18,19] Tipo:Calcestruzzo	4	7.766
Muro 158: Nodi[175,174,171,172] Tipo:Calcestruzzo	3	7.741
Muro 198: Nodi[0,0,0,0] Tipo:Calcestruzzo	5	7.372
Muro 200: Nodi[0,0,0,0] Tipo:Calcestruzzo	5	7.355
Muro 33: Nodi[57,86,82,56] Tipo:Calcestruzzo	6	7.338
Muro 86: Nodi[99,110,111,100] Tipo:Calcestruzzo	5	7.334
Muro 26: Nodi[57,56,49,50] Tipo:Calcestruzzo	4	7.28
Muro 176: Nodi[48,49,41,36] Tipo:Calcestruzzo	4	7.27
Muro 87: Nodi[100,111,112,0] Tipo:Calcestruzzo	5	7.242
Muro 125: Nodi[110,0,0,111] Tipo:Calcestruzzo	5	6.96
Muro 259: Nodi[0,0,26,15] Tipo:Calcestruzzo	4	6.955
Muro 177: Nodi[49,50,34,41] Tipo:Calcestruzzo	3	6.906
Muro 128: Nodi[111,0,0,112] Tipo:Calcestruzzo	5	6.862
Muro 13: Nodi[50,87,86,57] Tipo:Calcestruzzo	5	6.843

Nome	Combinazione	Cs
Muro 107: Nodi[156,190,189,155] Tipo:Calcestruzzo	2	6.782
Muro 173: Nodi[0,0,34,37] Tipo:Calcestruzzo	4	6.773
Muro 257: Nodi[0,44,45,0] Tipo:Calcestruzzo	3	6.751
Muro 201: Nodi[0,0,0,178] Tipo:Calcestruzzo	5	6.567
Muro 171: Nodi[17,0,0,30] Tipo:Calcestruzzo	4	6.43
Muro 124: Nodi[0,0,0,0] Tipo:Calcestruzzo	3	6.389
Muro 19: Nodi[40,47,46,39] Tipo:Calcestruzzo	4	6.38
Muro 174: Nodi[46,47,40,31] Tipo:Calcestruzzo	3	6.357
Muro 4: Nodi[35,34,25,26] Tipo:Calcestruzzo	4	6.221
Muro 84: Nodi[0,112,113,98] Tipo:Calcestruzzo	5	6.217
Muro 83: Nodi[98,113,120,95] Tipo:Calcestruzzo	5	6.216
Muro 255: Nodi[0,42,38,0] Tipo:Calcestruzzo	4	6.2
Muro 76: Nodi[95,120,127,96] Tipo:Calcestruzzo	5	6.005
Muro 130: Nodi[113,0,178,120] Tipo:Calcestruzzo	5	5.99
Muro 108: Nodi[157,187,190,156] Tipo:Calcestruzzo	2	5.858
Muro 202: Nodi[0,0,0,0] Tipo:Calcestruzzo	5	5.844
Muro 72: Nodi[96,127,136,90] Tipo:Calcestruzzo	5	5.82
Muro 246: Nodi[0,8,28,0] Tipo:Calcestruzzo	3	5.792
Muro 243: Nodi[0,33,36,0] Tipo:Calcestruzzo	3	5.726
Muro 3: Nodi[36,35,26,27] Tipo:Calcestruzzo	4	5.634
Muro 129: Nodi[112,0,0,113] Tipo:Calcestruzzo	5	5.6
Muro 237: Nodi[36,41,35,33] Tipo:Calcestruzzo	3	5.58
Muro 187: Nodi[178,0,0,180] Tipo:Calcestruzzo	5	5.579
Muro 30: Nodi[43,91,87,50] Tipo:Calcestruzzo	5	5.542
Muro 248: Nodi[0,20,13,0] Tipo:Calcestruzzo	3	5.531
Muro 118: Nodi[168,167,154,155] Tipo:Calcestruzzo	2	5.53
Muro 214: Nodi[26,22,16,15] Tipo:Calcestruzzo	3	5.519
Muro 196: Nodi[191,0,0,194] Tipo:Calcestruzzo	3	5.498
Muro 228: Nodi[32,30,17,12] Tipo:Calcestruzzo	3	5.495
Muro 189: Nodi[180,0,0,182] Tipo:Calcestruzzo	5	5.45
Muro 213: Nodi[15,16,9,10] Tipo:Calcestruzzo	3	5.412
Muro 104: Nodi[120,178,180,127] Tipo:Calcestruzzo	5	5.411
Muro 38: Nodi[19,18,11,12] Tipo:Calcestruzzo	4	5.401
Muro 236: Nodi[31,40,30,32] Tipo:Calcestruzzo	3	5.355
Muro 215: Nodi[13,7,19,20] Tipo:Calcestruzzo	3	5.343
Muro 222: Nodi[28,20,19,29] Tipo:Calcestruzzo	3	5.29
Muro 232: Nodi[37,32,12,3] Tipo:Calcestruzzo	3	5.264
Muro 106: Nodi[127,180,182,136] Tipo:Calcestruzzo	5	5.227
Muro 252: Nodi[0,0,21,26] Tipo:Calcestruzzo	3	5.188
Muro 234: Nodi[33,35,7,13] Tipo:Calcestruzzo	3	5.155
Muro 77: Nodi[91,143,150,87] Tipo:Calcestruzzo	3	5.121
Muro 260: Nodi[0,0,3,21] Tipo:Calcestruzzo	3	5.116
Muro 216: Nodi[3,12,11,21] Tipo:Calcestruzzo	3	5.094
Muro 244: Nodi[0,13,33,0] Tipo:Calcestruzzo	3	5.054
Muro 37: Nodi[18,17,10,11] Tipo:Calcestruzzo	4	4.984
Muro 36: Nodi[10,17,16,9] Tipo:Calcestruzzo	4	4.98
Muro 119: Nodi[169,168,155,156] Tipo:Calcestruzzo	2	4.975
Muro 5: Nodi[33,40,39,32] Tipo:Calcestruzzo	5	4.967
Muro 85: Nodi[0,109,110,99] Tipo:Calcestruzzo	5	4.872
Muro 114: Nodi[143,191,194,150] Tipo:Calcestruzzo	3	4.871
Muro 117: Nodi[154,167,166,153] Tipo:Calcestruzzo	2	4.835
Muro 41: Nodi[9,0,99,10] Tipo:Calcestruzzo	5	4.775
Muro 203: Nodi[0,0,0,0] Tipo:Calcestruzzo	5	4.654
Muro 126: Nodi[109,0,0,110] Tipo:Calcestruzzo	5	4.507
Muro 221: Nodi[21,11,22,26] Tipo:Calcestruzzo	3	4.485
Muro 233: Nodi[19,21,26,29] Tipo:Calcestruzzo	3	4.447
Muro 116: Nodi[170,169,156,157] Tipo:Calcestruzzo	3	4.439
Muro 9: Nodi[20,27,26,19] Tipo:Calcestruzzo	4	4.397
Muro 123: Nodi[0,0,0,0] Tipo:Calcestruzzo	2	4.373
Muro 75: Nodi[92,89,146,139] Tipo:Calcestruzzo	5	4.351
Muro 39: Nodi[12,0,98,13] Tipo:Calcestruzzo	5	4.325

Nome	Combinazione	Cs
Muro 18: Nodi[17,24,23,16] Tipo:Calcestruzzo	4	4.258
Muro 192: Nodi[195,188,0,0] Tipo:Calcestruzzo	5	4.203
Muro 113: Nodi[139,146,195,192] Tipo:Calcestruzzo	5	4.17
Muro 238: Nodi[43,27,14,45] Tipo:Calcestruzzo	3	4.077
Muro 217: Nodi[10,9,14,27] Tipo:Calcestruzzo	3	4.074
Muro 144: Nodi[168,171,0,0] Tipo:Calcestruzzo	3	4.022
Muro 195: Nodi[192,195,0,0] Tipo:Calcestruzzo	5	4.02
Muro 35: Nodi[13,20,19,12] Tipo:Calcestruzzo	4	4.003
Muro 254: Nodi[0,45,43,0] Tipo:Calcestruzzo	4	3.986
Muro 224: Nodi[0,4,6,0] Tipo:Calcestruzzo	4	3.965
Muro 211: Nodi[12,17,18,11] Tipo:Calcestruzzo	4	3.931
Muro 253: Nodi[0,43,42,0] Tipo:Calcestruzzo	4	3.909
Muro 69: Nodi[93,92,139,132] Tipo:Calcestruzzo	5	3.841
Muro 14: Nodi[36,90,91,43] Tipo:Calcestruzzo	5	3.83
Muro 88: Nodi[0,77,116,109] Tipo:Calcestruzzo	5	3.782
Muro 239: Nodi[42,25,27,43] Tipo:Calcestruzzo	3	3.764
Muro 199: Nodi[0,177,0,0] Tipo:Calcestruzzo	5	3.751
Muro 73: Nodi[77,94,123,116] Tipo:Calcestruzzo	5	3.7
Muro 227: Nodi[29,26,15,23] Tipo:Calcestruzzo	3	3.694
Muro 241: Nodi[35,37,3,7] Tipo:Calcestruzzo	3	3.69
Muro 220: Nodi[7,3,21,19] Tipo:Calcestruzzo	4	3.659
Muro 71: Nodi[94,93,132,123] Tipo:Calcestruzzo	5	3.633
Muro 245: Nodi[0,0,39,1] Tipo:Calcestruzzo	4	3.627
Muro 2: Nodi[24,33,32,23] Tipo:Calcestruzzo	4	3.616
Muro 226: Nodi[0,6,8,0] Tipo:Calcestruzzo	4	3.594
Muro 127: Nodi[109,116,177,0] Tipo:Calcestruzzo	5	3.509
Muro 111: Nodi[132,139,192,181] Tipo:Calcestruzzo	5	3.446
Muro 210: Nodi[8,23,24,6] Tipo:Calcestruzzo	4	3.434
Muro 247: Nodi[0,0,17,18] Tipo:Calcestruzzo	4	3.408
Muro 193: Nodi[181,192,0,0] Tipo:Calcestruzzo	5	3.404
Muro 212: Nodi[23,15,10,24] Tipo:Calcestruzzo	3	3.394
Muro 140: Nodi[0,0,199,198] Tipo:Calcestruzzo	2	3.391
Muro 79: Nodi[87,150,157,86] Tipo:Calcestruzzo	2	3.334
Muro 40: Nodi[10,99,100,11] Tipo:Calcestruzzo	5	3.281
Muro 250: Nodi[0,38,4,0] Tipo:Calcestruzzo	4	3.258
Muro 42: Nodi[11,100,0,12] Tipo:Calcestruzzo	5	3.246
Muro 43: Nodi[13,98,95,20] Tipo:Calcestruzzo	5	3.23
Muro 103: Nodi[116,123,179,177] Tipo:Calcestruzzo	5	3.167
Muro 188: Nodi[177,179,0,0] Tipo:Calcestruzzo	5	3.167
Muro 230: Nodi[34,31,32,37] Tipo:Calcestruzzo	3	3.166
Muro 229: Nodi[22,11,18,39] Tipo:Calcestruzzo	3	3.126
Muro 231: Nodi[38,4,25,42] Tipo:Calcestruzzo	3	3.08
Muro 225: Nodi[0,0,2,5] Tipo:Calcestruzzo	4	3.044
Muro 186: Nodi[179,181,0,0] Tipo:Calcestruzzo	5	3.041
Muro 105: Nodi[123,132,181,179] Tipo:Calcestruzzo	5	2.985
Muro 240: Nodi[41,34,37,35] Tipo:Calcestruzzo	3	2.927
Muro 218: Nodi[16,1,2,9] Tipo:Calcestruzzo	4	2.885
Muro 11: Nodi[27,96,90,36] Tipo:Calcestruzzo	5	2.871
Muro 223: Nodi[0,0,1,2] Tipo:Calcestruzzo	4	2.826
Muro 29: Nodi[20,95,96,27] Tipo:Calcestruzzo	5	2.813
Muro 162: Nodi[171,174,0,0] Tipo:Calcestruzzo	2	2.785
Muro 143: Nodi[167,168,0,0] Tipo:Calcestruzzo	2	2.785
Muro 235: Nodi[45,14,5,44] Tipo:Calcestruzzo	4	2.758
Muro 242: Nodi[0,0,18,39] Tipo:Calcestruzzo	4	2.63
Muro 32: Nodi[46,53,88,89] Tipo:Calcestruzzo	5	2.581
Muro 251: Nodi[0,0,5,44] Tipo:Calcestruzzo	4	2.541
Muro 80: Nodi[86,157,156,82] Tipo:Calcestruzzo	3	2.533
Muro 219: Nodi[24,10,27,25] Tipo:Calcestruzzo	3	2.162
Muro 142: Nodi[166,167,0,0] Tipo:Calcestruzzo	2	2.076
Muro 78: Nodi[82,156,155,83] Tipo:Calcestruzzo	2	2.072
Muro 12: Nodi[39,46,89,92] Tipo:Calcestruzzo	5	2.043

Nome	Combinazione	Cs
Muro 44: Nodi[9,16,77,0] Tipo:Calcestruzzo	5	1.982
Muro 10: Nodi[32,39,92,93] Tipo:Calcestruzzo	5	1.822
Muro 74: Nodi[85,83,155,154] Tipo:Calcestruzzo	2	1.79
Muro 15: Nodi[23,32,93,94] Tipo:Calcestruzzo	5	1.765
Muro 27: Nodi[16,23,94,77] Tipo:Calcestruzzo	5	1.756
Muro 82: Nodi[88,85,154,153] Tipo:Calcestruzzo	2	1.64
Minimi		1.64

Coefficienti di sicurezza filtrati per minimo Tensioni SLE

Nome	Combinazione	Cs
Muro 60: Nodi[7,14,13,6] Tipo:Calcestruzzo	13	687.9
Muro 53: Nodi[37,36,27,28] Tipo:Calcestruzzo	10	614.6
Muro 62: Nodi[2,9,8,1] Tipo:Calcestruzzo	13	481.3
Muro 54: Nodi[37,44,43,36] Tipo:Calcestruzzo	8	438.4
Muro 50: Nodi[16,23,22,15] Tipo:Calcestruzzo	14	397.4
Muro 51: Nodi[14,21,20,13] Tipo:Calcestruzzo	10	349.4
Muro 47: Nodi[32,39,38,31] Tipo:Calcestruzzo	13	255.9
Muro 65: Nodi[65,64,57,58] Tipo:Calcestruzzo	14	228
Muro 58: Nodi[6,13,12,5] Tipo:Calcestruzzo	14	218
Muro 56: Nodi[44,51,50,43] Tipo:Calcestruzzo	14	215
Muro 45: Nodi[9,16,15,8] Tipo:Calcestruzzo	10	178.6
Muro 55: Nodi[21,28,27,20] Tipo:Calcestruzzo	10	174.1
Muro 68: Nodi[53,60,59,52] Tipo:Calcestruzzo	10	166.2
Muro 48: Nodi[39,46,45,38] Tipo:Calcestruzzo	14	146.8
Muro 61: Nodi[12,11,4,5] Tipo:Calcestruzzo	10	130.5
Muro 49: Nodi[46,53,52,45] Tipo:Calcestruzzo	13	129.4
Muro 46: Nodi[23,32,31,22] Tipo:Calcestruzzo	10	122.9
Muro 8: Nodi[41,40,33,34] Tipo:Calcestruzzo	14	108.7
Muro 132: Nodi[129,130,185,183] Tipo:Calcestruzzo	14	91.5
Muro 207: Nodi[183,185,0,0] Tipo:Calcestruzzo	14	89.5
Muro 23: Nodi[25,24,17,18] Tipo:Calcestruzzo	13	84.31
Muro 57: Nodi[11,10,3,4] Tipo:Calcestruzzo	10	82.2
Muro 67: Nodi[54,61,60,53] Tipo:Calcestruzzo	10	79.53
Muro 52: Nodi[58,57,50,51] Tipo:Calcestruzzo	14	77.28
Muro 59: Nodi[3,10,9,2] Tipo:Calcestruzzo	10	75.42
Muro 66: Nodi[62,61,54,55] Tipo:Calcestruzzo	9	70.11
Muro 95: Nodi[78,97,130,129] Tipo:Calcestruzzo	14	68.95
Muro 131: Nodi[118,129,183,186] Tipo:Calcestruzzo	14	67.46
Muro 169: Nodi[196,0,0,0] Tipo:Calcestruzzo	14	63.79
Muro 89: Nodi[18,78,79] Tipo:Calcestruzzo	14	61.75
Muro 168: Nodi[0,0,0,194] Tipo:Calcestruzzo	14	59.7
Muro 94: Nodi[79,78,129,118] Tipo:Calcestruzzo	14	57.35
Muro 166: Nodi[149,0,194,150] Tipo:Calcestruzzo	14	53.75
Muro 90: Nodi[18,25,97,78] Tipo:Calcestruzzo	14	51.38
Muro 1: Nodi[56,55,48,49] Tipo:Calcestruzzo	9	48.21
Muro 163: Nodi[200,0,0,0] Tipo:Calcestruzzo	9	48.19
Muro 91: Nodi[25,34,81,97] Tipo:Calcestruzzo	14	46.32
Muro 101: Nodi[0,149,150,87] Tipo:Calcestruzzo	14	44.77
Muro 204: Nodi[186,183,0,0] Tipo:Calcestruzzo	14	44.15
Muro 7: Nodi[55,54,47,48] Tipo:Calcestruzzo	8	43.84
Muro 167: Nodi[148,196,0,149] Tipo:Calcestruzzo	14	43.47
Muro 64: Nodi[63,62,55,56] Tipo:Calcestruzzo	9	42.04
Muro 22: Nodi[34,33,24,25] Tipo:Calcestruzzo	9	37.97
Muro 180: Nodi[0,0,46,47] Tipo:Calcestruzzo	14	36.76
Muro 172: Nodi[30,0,0,40] Tipo:Calcestruzzo	10	36.36
Muro 179: Nodi[0,48,49,0] Tipo:Calcestruzzo	14	35.03
Muro 152: Nodi[199,0,0,0] Tipo:Calcestruzzo	10	34.97
Muro 165: Nodi[0,0,0,0] Tipo:Calcestruzzo	14	34.76
Muro 147: Nodi[0,0,0,0] Tipo:Calcestruzzo	14	33.79
Muro 122: Nodi[172,171,168,169] Tipo:Calcestruzzo	14	32.24
Muro 148: Nodi[0,0,0,0] Tipo:Calcestruzzo	14	30.95

Nome	Combinazione	Cs
Muro 175: Nodi[0,36,48,0] Tipo:Calcestruzzo	14	30.66
Muro 181: Nodi[40,0,0,47] Tipo:Calcestruzzo	10	30.36
Muro 153: Nodi[173,200,0,176] Tipo:Calcestruzzo	14	30.32
Muro 154: Nodi[176,0,0,175] Tipo:Calcestruzzo	14	28.87
Muro 158: Nodi[175,174,171,172] Tipo:Calcestruzzo	10	28.67
Muro 261: Nodi[0,0,15,10] Tipo:Calcestruzzo	14	28.31
Muro 183: Nodi[0,0,50,34] Tipo:Calcestruzzo	14	28.07
Muro 121: Nodi[173,172,169,170] Tipo:Calcestruzzo	14	27.84
Muro 102: Nodi[84,148,149,0] Tipo:Calcestruzzo	9	27.29
Muro 259: Nodi[0,0,26,15] Tipo:Calcestruzzo	14	26.62
Muro 256: Nodi[0,0,27] Tipo:Calcestruzzo	14	26.35
Muro 257: Nodi[0,44,45,0] Tipo:Calcestruzzo	10	25.61
Muro 255: Nodi[0,42,38,0] Tipo:Calcestruzzo	10	25.14
Muro 243: Nodi[0,33,36,0] Tipo:Calcestruzzo	10	24.68
Muro 185: Nodi[0,19,20,0] Tipo:Calcestruzzo	10	23.2
Muro 120: Nodi[170,197,200,173] Tipo:Calcestruzzo	14	22.55
Muro 197: Nodi[197,0,0,200] Tipo:Calcestruzzo	14	21.8
Muro 171: Nodi[17,0,0,30] Tipo:Calcestruzzo	9	21.5
Muro 63: Nodi[64,63,56,57] Tipo:Calcestruzzo	10	20.29
Muro 184: Nodi[0,21,19,0] Tipo:Calcestruzzo	9	20.16
Muro 96: Nodi[97,81,134,130] Tipo:Calcestruzzo	14	19.77
Muro 25: Nodi[48,47,40,41] Tipo:Calcestruzzo	9	19.5
Muro 157: Nodi[176,175,172,173] Tipo:Calcestruzzo	14	19.15
Muro 178: Nodi[0,49,50,0] Tipo:Calcestruzzo	14	18.96
Muro 208: Nodi[185,184,0,0] Tipo:Calcestruzzo	14	18.87
Muro 258: Nodi[0,0,10,27] Tipo:Calcestruzzo	14	18.77
Muro 86: Nodi[99,110,111,100] Tipo:Calcestruzzo	10	18.68
Muro 87: Nodi[100,111,112,0] Tipo:Calcestruzzo	10	18.48
Muro 133: Nodi[130,134,184,185] Tipo:Calcestruzzo	14	18.48
Muro 244: Nodi[0,13,33,0] Tipo:Calcestruzzo	8	18.35
Muro 21: Nodi[43,50,49,42] Tipo:Calcestruzzo	10	18.1
Muro 173: Nodi[0,0,34,37] Tipo:Calcestruzzo	14	18.04
Muro 149: Nodi[0,0,0,199] Tipo:Calcestruzzo	14	18
Muro 260: Nodi[0,0,3,21] Tipo:Calcestruzzo	10	17.59
Muro 92: Nodi[34,41,80,81] Tipo:Calcestruzzo	14	17.29
Muro 146: Nodi[0,0,0,0] Tipo:Calcestruzzo	14	16.87
Muro 83: Nodi[98,113,120,95] Tipo:Calcestruzzo	10	16.26
Muro 4: Nodi[35,34,25,26] Tipo:Calcestruzzo	9	15.8
Muro 198: Nodi[0,0,0,0] Tipo:Calcestruzzo	10	14.78
Muro 20: Nodi[49,48,41,42] Tipo:Calcestruzzo	9	14.7
Muro 200: Nodi[0,0,0,0] Tipo:Calcestruzzo	10	14.59
Muro 159: Nodi[0,0,0,0] Tipo:Calcestruzzo	8	14.57
Muro 84: Nodi[0,112,113,98] Tipo:Calcestruzzo	10	14.56
Muro 76: Nodi[95,120,127,96] Tipo:Calcestruzzo	10	14.28
Muro 125: Nodi[110,0,0,111] Tipo:Calcestruzzo	10	14.19
Muro 176: Nodi[48,49,41,36] Tipo:Calcestruzzo	9	14.05
Muro 128: Nodi[111,0,0,112] Tipo:Calcestruzzo	10	14.03
Muro 24: Nodi[26,25,18,19] Tipo:Calcestruzzo	9	13.79
Muro 13: Nodi[50,87,86,57] Tipo:Calcestruzzo	14	13.77
Muro 31: Nodi[56,82,83,55] Tipo:Calcestruzzo	14	13.67
Muro 28: Nodi[54,55,83,85] Tipo:Calcestruzzo	14	13.63
Muro 248: Nodi[0,20,13,0] Tipo:Calcestruzzo	14	13.4
Muro 252: Nodi[0,0,21,26] Tipo:Calcestruzzo	10	13.35
Muro 174: Nodi[46,47,40,31] Tipo:Calcestruzzo	9	13
Muro 202: Nodi[0,0,0,0] Tipo:Calcestruzzo	10	12.98
Muro 254: Nodi[0,45,43,0] Tipo:Calcestruzzo	10	12.93
Muro 201: Nodi[0,0,0,178] Tipo:Calcestruzzo	10	12.57
Muro 145: Nodi[0,0,0] Tipo:Calcestruzzo	14	12.57
Muro 129: Nodi[112,0,0,113] Tipo:Calcestruzzo	10	12.57
Muro 253: Nodi[0,43,42,0] Tipo:Calcestruzzo	10	12.52
Muro 130: Nodi[113,0,178,120] Tipo:Calcestruzzo	10	12.41

Nome	Combinazione	Cs
Muro 41: Nodi[9,0,99,10] Tipo:Calcestruzzo	10	12.3
Muro 99: Nodi[48,55,83,84] Tipo:Calcestruzzo	14	12.27
Muro 107: Nodi[156,190,189,155] Tipo:Calcestruzzo	14	12.24
Muro 72: Nodi[96,127,136,90] Tipo:Calcestruzzo	10	11.99
Muro 34: Nodi[53,54,85,88] Tipo:Calcestruzzo	14	11.9
Muro 151: Nodi[0,0,0,0] Tipo:Calcestruzzo	14	11.86
Muro 17: Nodi[36,43,42,35] Tipo:Calcestruzzo	10	11.85
Muro 215: Nodi[13,7,19,20] Tipo:Calcestruzzo	9	11.76
Muro 170: Nodi[0,198,0] Tipo:Calcestruzzo	14	11.72
Muro 85: Nodi[0,109,110,99] Tipo:Calcestruzzo	10	11.56
Muro 26: Nodi[57,56,49,50] Tipo:Calcestruzzo	10	11.51
Muro 6: Nodi[42,41,34,35] Tipo:Calcestruzzo	9	11.48
Muro 249: Nodi[0,28,20,0] Tipo:Calcestruzzo	10	11.48
Muro 156: Nodi[0,0,0,0] Tipo:Calcestruzzo	10	11.46
Muro 39: Nodi[12,0,98,13] Tipo:Calcestruzzo	10	11.37
Muro 209: Nodi[184,193,0,0] Tipo:Calcestruzzo	14	11.29
Muro 108: Nodi[157,187,190,156] Tipo:Calcestruzzo	14	10.92
Muro 182: Nodi[46,0,0,50] Tipo:Calcestruzzo	14	10.76
Muro 189: Nodi[180,0,0,182] Tipo:Calcestruzzo	10	10.61
Muro 187: Nodi[178,0,0,180] Tipo:Calcestruzzo	10	10.59
Muro 203: Nodi[0,0,0,0] Tipo:Calcestruzzo	10	10.58
Muro 214: Nodi[26,22,16,15] Tipo:Calcestruzzo	9	10.32
Muro 126: Nodi[109,0,0,110] Tipo:Calcestruzzo	10	10.31
Muro 235: Nodi[45,14,5,44] Tipo:Calcestruzzo	9	10.3
Muro 104: Nodi[120,178,180,127] Tipo:Calcestruzzo	10	10.15
Muro 106: Nodi[127,180,182,136] Tipo:Calcestruzzo	10	10
Muro 144: Nodi[168,171,0,0] Tipo:Calcestruzzo	14	9.835
Muro 14: Nodi[36,90,91,43] Tipo:Calcestruzzo	10	9.632
Muro 97: Nodi[81,80,141,134] Tipo:Calcestruzzo	14	9.517
Muro 134: Nodi[134,141,193,184] Tipo:Calcestruzzo	14	9.483
Muro 216: Nodi[3,12,11,21] Tipo:Calcestruzzo	9	9.199
Muro 224: Nodi[0,4,6,0] Tipo:Calcestruzzo	14	9.185
Muro 232: Nodi[37,32,12,3] Tipo:Calcestruzzo	9	9.176
Muro 218: Nodi[16,1,2,9] Tipo:Calcestruzzo	10	9.168
Muro 211: Nodi[12,17,18,11] Tipo:Calcestruzzo	9	9.073
Muro 234: Nodi[33,35,7,13] Tipo:Calcestruzzo	9	9.061
Muro 177: Nodi[49,50,34,41] Tipo:Calcestruzzo	9	9.058
Muro 247: Nodi[0,0,17,18] Tipo:Calcestruzzo	10	9.052
Muro 205: Nodi[193,196,0,0] Tipo:Calcestruzzo	14	9.008
Muro 237: Nodi[36,41,35,33] Tipo:Calcestruzzo	9	9.003
Muro 228: Nodi[32,30,17,12] Tipo:Calcestruzzo	9	8.915
Muro 250: Nodi[0,38,4,0] Tipo:Calcestruzzo	10	8.91
Muro 30: Nodi[43,91,87,50] Tipo:Calcestruzzo	14	8.787
Muro 226: Nodi[0,6,8,0] Tipo:Calcestruzzo	10	8.732
Muro 93: Nodi[41,48,84,80] Tipo:Calcestruzzo	10	8.706
Muro 213: Nodi[15,16,9,10] Tipo:Calcestruzzo	9	8.655
Muro 236: Nodi[31,40,30,32] Tipo:Calcestruzzo	9	8.571
Muro 155: Nodi[175,0,0,174] Tipo:Calcestruzzo	14	8.552
Muro 118: Nodi[168,167,154,155] Tipo:Calcestruzzo	14	8.545
Muro 164: Nodi[0,0,0,0] Tipo:Calcestruzzo	14	8.467
Muro 233: Nodi[19,21,26,29] Tipo:Calcestruzzo	9	8.337
Muro 88: Nodi[0,77,116,109] Tipo:Calcestruzzo	10	8.16
Muro 16: Nodi[47,54,53,46] Tipo:Calcestruzzo	10	8.152
Muro 222: Nodi[28,20,19,29] Tipo:Calcestruzzo	9	8.097
Muro 225: Nodi[0,0,2,5] Tipo:Calcestruzzo	10	8.091
Muro 206: Nodi[196,189,0,0] Tipo:Calcestruzzo	14	8.069
Muro 246: Nodi[0,8,28,0] Tipo:Calcestruzzo	14	8.058
Muro 38: Nodi[19,18,11,12] Tipo:Calcestruzzo	10	8.034
Muro 161: Nodi[0,0,0,0] Tipo:Calcestruzzo	14	7.998
Muro 70: Nodi[90,136,143,91] Tipo:Calcestruzzo	14	7.976
Muro 230: Nodi[34,31,32,37] Tipo:Calcestruzzo	9	7.825

Nome	Combinazione	Cs
Muro 37: Nodi[18,17,10,11] Tipo:Calcestruzzo	10	7.819
Muro 191: Nodi[182,0,0,191] Tipo:Calcestruzzo	14	7.804
Muro 119: Nodi[169,168,155,156] Tipo:Calcestruzzo	14	7.789
Muro 221: Nodi[21,11,22,26] Tipo:Calcestruzzo	9	7.755
Muro 3: Nodi[36,35,26,27] Tipo:Calcestruzzo	10	7.704
Muro 112: Nodi[136,182,191,143] Tipo:Calcestruzzo	14	7.507
Muro 210: Nodi[8,23,24,6] Tipo:Calcestruzzo	9	7.387
Muro 73: Nodi[77,94,123,116] Tipo:Calcestruzzo	10	7.207
Muro 238: Nodi[43,27,14,45] Tipo:Calcestruzzo	9	7.155
Muro 150: Nodi[0,0,0,0] Tipo:Calcestruzzo	14	6.999
Muro 40: Nodi[10,99,100,11] Tipo:Calcestruzzo	10	6.96
Muro 43: Nodi[13,98,95,20] Tipo:Calcestruzzo	10	6.954
Muro 217: Nodi[10,9,14,27] Tipo:Calcestruzzo	9	6.935
Muro 71: Nodi[94,93,132,123] Tipo:Calcestruzzo	10	6.831
Muro 141: Nodi[198,199,0,0] Tipo:Calcestruzzo	14	6.776
Muro 190: Nodi[187,0,0,197] Tipo:Calcestruzzo	14	6.772
Muro 42: Nodi[11,100,0,12] Tipo:Calcestruzzo	10	6.735
Muro 245: Nodi[0,0,39,1] Tipo:Calcestruzzo	10	6.642
Muro 35: Nodi[13,20,19,12] Tipo:Calcestruzzo	10	6.567
Muro 135: Nodi[141,148,196,193] Tipo:Calcestruzzo	14	6.522
Muro 239: Nodi[42,25,27,43] Tipo:Calcestruzzo	9	6.461
Muro 98: Nodi[80,84,148,141] Tipo:Calcestruzzo	14	6.371
Muro 241: Nodi[35,37,3,7] Tipo:Calcestruzzo	9	6.225
Muro 127: Nodi[109,116,177,0] Tipo:Calcestruzzo	10	6.15
Muro 231: Nodi[38,4,25,42] Tipo:Calcestruzzo	9	6.142
Muro 199: Nodi[0,177,0,0] Tipo:Calcestruzzo	10	6.133
Muro 115: Nodi[157,187,197,170] Tipo:Calcestruzzo	14	6.087
Muro 11: Nodi[27,96,90,36] Tipo:Calcestruzzo	10	5.815
Muro 29: Nodi[20,95,96,27] Tipo:Calcestruzzo	10	5.812
Muro 227: Nodi[29,26,15,23] Tipo:Calcestruzzo	9	5.805
Muro 251: Nodi[0,0,5,44] Tipo:Calcestruzzo	10	5.802
Muro 193: Nodi[181,192,0,0] Tipo:Calcestruzzo	10	5.788
Muro 124: Nodi[0,0,0,0] Tipo:Calcestruzzo	14	5.663
Muro 69: Nodi[93,92,139,132] Tipo:Calcestruzzo	10	5.542
Muro 223: Nodi[0,0,1,2] Tipo:Calcestruzzo	10	5.476
Muro 220: Nodi[7,3,21,19] Tipo:Calcestruzzo	9	5.441
Muro 111: Nodi[132,139,192,181] Tipo:Calcestruzzo	10	5.297
Muro 19: Nodi[40,47,46,39] Tipo:Calcestruzzo	10	5.272
Muro 188: Nodi[177,179,0,0] Tipo:Calcestruzzo	10	5.23
Muro 9: Nodi[20,27,26,19] Tipo:Calcestruzzo	10	5.203
Muro 103: Nodi[116,123,179,177] Tipo:Calcestruzzo	10	5.192
Muro 32: Nodi[46,53,88,89] Tipo:Calcestruzzo	10	5.125
Muro 186: Nodi[179,181,0,0] Tipo:Calcestruzzo	10	5.066
Muro 229: Nodi[22,11,18,39] Tipo:Calcestruzzo	9	5.019
Muro 242: Nodi[0,0,18,39] Tipo:Calcestruzzo	10	4.972
Muro 212: Nodi[23,15,10,24] Tipo:Calcestruzzo	9	4.97
Muro 105: Nodi[123,132,181,179] Tipo:Calcestruzzo	10	4.914
Muro 117: Nodi[154,167,166,153] Tipo:Calcestruzzo	10	4.903
Muro 195: Nodi[192,195,0,0] Tipo:Calcestruzzo	10	4.856
Muro 36: Nodi[10,17,16,9] Tipo:Calcestruzzo	10	4.643
Muro 116: Nodi[170,169,156,157] Tipo:Calcestruzzo	14	4.636
Muro 33: Nodi[57,86,82,56] Tipo:Calcestruzzo	14	4.493
Muro 240: Nodi[41,34,37,35] Tipo:Calcestruzzo	9	4.458
Muro 123: Nodi[0,0,0,0] Tipo:Calcestruzzo	10	4.429
Muro 194: Nodi[194,0,0,187] Tipo:Calcestruzzo	14	4.415
Muro 75: Nodi[92,89,146,139] Tipo:Calcestruzzo	10	4.276
Muro 113: Nodi[139,146,195,192] Tipo:Calcestruzzo	10	4.272
Muro 160: Nodi[0,0,0] Tipo:Calcestruzzo	14	4.267
Muro 5: Nodi[33,40,39,32] Tipo:Calcestruzzo	10	4.188
Muro 140: Nodi[0,0,199,198] Tipo:Calcestruzzo	14	4.026
Muro 77: Nodi[91,143,150,87] Tipo:Calcestruzzo	10	3.971

Nome	Combinazione	Cs
Muro 196: Nodi[191,0,0,194] Tipo:Calcestruzzo	10	3.882
Muro 2: Nodi[24,33,32,23] Tipo:Calcestruzzo	10	3.82
Muro 18: Nodi[17,24,23,16] Tipo:Calcestruzzo	10	3.801
Muro 12: Nodi[39,46,89,92] Tipo:Calcestruzzo	10	3.743
Muro 114: Nodi[143,191,194,150] Tipo:Calcestruzzo	10	3.687
Muro 192: Nodi[195,188,0,0] Tipo:Calcestruzzo	14	3.54
Muro 44: Nodi[9,16,77,0] Tipo:Calcestruzzo	10	3.464
Muro 80: Nodi[86,157,156,82] Tipo:Calcestruzzo	14	3.328
Muro 143: Nodi[167,168,0,0] Tipo:Calcestruzzo	14	3.283
Muro 10: Nodi[32,39,92,93] Tipo:Calcestruzzo	10	3.155
Muro 219: Nodi[24,10,27,25] Tipo:Calcestruzzo	9	3.023
Muro 27: Nodi[16,23,94,77] Tipo:Calcestruzzo	10	2.952
Muro 15: Nodi[23,32,93,94] Tipo:Calcestruzzo	10	2.867
Muro 142: Nodi[166,167,0,0] Tipo:Calcestruzzo	14	2.78
Muro 162: Nodi[171,174,0,0] Tipo:Calcestruzzo	14	2.643
Muro 78: Nodi[82,156,155,83] Tipo:Calcestruzzo	14	2.599
Muro 74: Nodi[85,83,155,154] Tipo:Calcestruzzo	14	2.429
Muro 82: Nodi[88,85,154,153] Tipo:Calcestruzzo	14	2.402
Muro 136: Nodi[148,155,189,196] Tipo:Calcestruzzo	14	2.026
Muro 100: Nodi[84,83,155,148] Tipo:Calcestruzzo	14	1.945
Muro 139: Nodi[0,188,0,198] Tipo:Calcestruzzo	14	1.772
Muro 81: Nodi[89,88,153,146] Tipo:Calcestruzzo	10	1.6
Muro 79: Nodi[87,150,157,86] Tipo:Calcestruzzo	14	1.577
Muro 109: Nodi[146,153,188,195] Tipo:Calcestruzzo	10	1.548
Muro 110: Nodi[150,194,187,157] Tipo:Calcestruzzo	14	1.481
Muro 138: Nodi[188,153,166,0] Tipo:Calcestruzzo	14	1.449
Muro 137: Nodi[155,168,0,189] Tipo:Calcestruzzo	14	1.439
Minimi		1.439

Coefficienti di sicurezza filtrati per minimo Fessure

Nome	Combinazione	Cs
Muro 132: Nodi[129,130,185,183] Tipo:Calcestruzzo	13	1e+10
Muro 204: Nodi[186,183,0,0] Tipo:Calcestruzzo	13	1e+10
Muro 184: Nodi[0,21,19,0] Tipo:Calcestruzzo	13	1e+10
Muro 146: Nodi[0,0,0,0] Tipo:Calcestruzzo	13	1e+10
Muro 131: Nodi[118,129,183,186] Tipo:Calcestruzzo	13	1e+10
Muro 94: Nodi[79,78,129,118] Tipo:Calcestruzzo	13	1e+10
Muro 90: Nodi[18,25,97,78] Tipo:Calcestruzzo	13	1e+10
Muro 168: Nodi[0,0,0,194] Tipo:Calcestruzzo	13	1e+10
Muro 95: Nodi[78,97,130,129] Tipo:Calcestruzzo	13	1e+10
Muro 166: Nodi[149,0,194,150] Tipo:Calcestruzzo	13	1e+10
Muro 89: Nodi[18,78,79] Tipo:Calcestruzzo	13	1e+10
Muro 20: Nodi[49,48,41,42] Tipo:Calcestruzzo	14	6339
Muro 62: Nodi[2,9,8,1] Tipo:Calcestruzzo	13	2576
Muro 22: Nodi[34,33,24,25] Tipo:Calcestruzzo	14	2229
Muro 172: Nodi[30,0,0,40] Tipo:Calcestruzzo	11	1407
Muro 8: Nodi[41,40,33,34] Tipo:Calcestruzzo	14	1136
Muro 25: Nodi[48,47,40,41] Tipo:Calcestruzzo	14	819.9
Muro 256: Nodi[0,0,27] Tipo:Calcestruzzo	13	669
Muro 1: Nodi[56,55,48,49] Tipo:Calcestruzzo	11	556.3
Muro 48: Nodi[39,46,45,38] Tipo:Calcestruzzo	14	500.8
Muro 60: Nodi[7,14,13,6] Tipo:Calcestruzzo	14	485.5
Muro 51: Nodi[14,21,20,13] Tipo:Calcestruzzo	11	419.1
Muro 54: Nodi[37,44,43,36] Tipo:Calcestruzzo	14	393
Muro 47: Nodi[32,39,38,31] Tipo:Calcestruzzo	14	387.9
Muro 66: Nodi[62,61,54,55] Tipo:Calcestruzzo	11	347.2
Muro 207: Nodi[183,185,0,0] Tipo:Calcestruzzo	13	337.1
Muro 6: Nodi[42,41,34,35] Tipo:Calcestruzzo	11	276.2
Muro 53: Nodi[37,36,27,28] Tipo:Calcestruzzo	14	271
Muro 49: Nodi[46,53,52,45] Tipo:Calcestruzzo	13	247.3
Muro 7: Nodi[55,54,47,48] Tipo:Calcestruzzo	14	235.9

Nome	Combinazione	Cs
Muro 23: Nodi[25,24,17,18] Tipo:Calcestruzzo	11	171.1
Muro 122: Nodi[172,171,168,169] Tipo:Calcestruzzo	14	166.3
Muro 64: Nodi[63,62,55,56] Tipo:Calcestruzzo	14	158.4
Muro 50: Nodi[16,23,22,15] Tipo:Calcestruzzo	14	143.6
Muro 45: Nodi[9,16,15,8] Tipo:Calcestruzzo	11	129.7
Muro 24: Nodi[26,25,18,19] Tipo:Calcestruzzo	11	128.5
Muro 58: Nodi[6,13,12,5] Tipo:Calcestruzzo	14	128.5
Muro 169: Nodi[196,0,0,0] Tipo:Calcestruzzo	11	104
Muro 56: Nodi[44,51,50,43] Tipo:Calcestruzzo	14	99.65
Muro 65: Nodi[65,64,57,58] Tipo:Calcestruzzo	14	97.04
Muro 61: Nodi[12,11,4,5] Tipo:Calcestruzzo	11	72.92
Muro 167: Nodi[148,196,0,149] Tipo:Calcestruzzo	14	71.5
Muro 68: Nodi[53,60,59,52] Tipo:Calcestruzzo	14	70.93
Muro 55: Nodi[21,28,27,20] Tipo:Calcestruzzo	14	69.88
Muro 171: Nodi[17,0,0,30] Tipo:Calcestruzzo	14	62.67
Muro 145: Nodi[0,0,0] Tipo:Calcestruzzo	12	51.82
Muro 52: Nodi[58,57,50,51] Tipo:Calcestruzzo	14	44.75
Muro 46: Nodi[23,32,31,22] Tipo:Calcestruzzo	14	44.38
Muro 57: Nodi[11,10,3,4] Tipo:Calcestruzzo	11	38.47
Muro 59: Nodi[3,10,9,2] Tipo:Calcestruzzo	13	36.67
Muro 214: Nodi[26,22,16,15] Tipo:Calcestruzzo	11	34.88
Muro 102: Nodi[84,148,149,0] Tipo:Calcestruzzo	14	34.77
Muro 67: Nodi[54,61,60,53] Tipo:Calcestruzzo	14	33.1
Muro 228: Nodi[32,30,17,12] Tipo:Calcestruzzo	11	31.71
Muro 213: Nodi[15,16,9,10] Tipo:Calcestruzzo	12	30.34
Muro 216: Nodi[3,12,11,21] Tipo:Calcestruzzo	14	27.08
Muro 176: Nodi[48,49,41,36] Tipo:Calcestruzzo	11	26.07
Muro 4: Nodi[35,34,25,26] Tipo:Calcestruzzo	11	25.19
Muro 221: Nodi[21,11,22,26] Tipo:Calcestruzzo	11	21.73
Muro 86: Nodi[99,110,111,100] Tipo:Calcestruzzo	11	20.78
Muro 87: Nodi[100,111,112,0] Tipo:Calcestruzzo	11	20.66
Muro 153: Nodi[173,200,0,176] Tipo:Calcestruzzo	14	20.26
Muro 220: Nodi[7,3,21,19] Tipo:Calcestruzzo	14	19.42
Muro 238: Nodi[43,27,14,45] Tipo:Calcestruzzo	11	19.22
Muro 101: Nodi[0,149,150,87] Tipo:Calcestruzzo	14	18.69
Muro 257: Nodi[0,44,45,0] Tipo:Calcestruzzo	13	18.55
Muro 259: Nodi[0,0,26,15] Tipo:Calcestruzzo	13	17.81
Muro 91: Nodi[25,34,81,97] Tipo:Calcestruzzo	12	17.55
Muro 121: Nodi[173,172,169,170] Tipo:Calcestruzzo	14	17.43
Muro 21: Nodi[43,50,49,42] Tipo:Calcestruzzo	12	16.89
Muro 255: Nodi[0,42,38,0] Tipo:Calcestruzzo	14	16.43
Muro 158: Nodi[175,174,171,172] Tipo:Calcestruzzo	14	16.19
Muro 163: Nodi[200,0,0,0] Tipo:Calcestruzzo	14	16.08
Muro 83: Nodi[98,113,120,95] Tipo:Calcestruzzo	11	15.91
Muro 174: Nodi[46,47,40,31] Tipo:Calcestruzzo	11	15.55
Muro 236: Nodi[31,40,30,32] Tipo:Calcestruzzo	11	15.04
Muro 175: Nodi[0,36,48,0] Tipo:Calcestruzzo	13	14.75
Muro 198: Nodi[0,0,0,0] Tipo:Calcestruzzo	11	14.71
Muro 200: Nodi[0,0,0,0] Tipo:Calcestruzzo	11	14.58
Muro 237: Nodi[36,41,35,33] Tipo:Calcestruzzo	11	14.16
Muro 76: Nodi[95,120,127,96] Tipo:Calcestruzzo	11	13.9
Muro 125: Nodi[110,0,0,111] Tipo:Calcestruzzo	11	13.84
Muro 128: Nodi[111,0,0,112] Tipo:Calcestruzzo	11	13.75
Muro 148: Nodi[0,0,0,0] Tipo:Calcestruzzo	14	13.46
Muro 217: Nodi[10,9,14,27] Tipo:Calcestruzzo	14	13.29
Muro 234: Nodi[33,35,7,13] Tipo:Calcestruzzo	11	13.22
Muro 149: Nodi[0,0,0,199] Tipo:Calcestruzzo	14	13.17
Muro 154: Nodi[176,0,0,175] Tipo:Calcestruzzo	14	12.8
Muro 179: Nodi[0,48,49,0] Tipo:Calcestruzzo	13	12.12
Muro 180: Nodi[0,0,46,47] Tipo:Calcestruzzo	13	11.94
Muro 185: Nodi[0,19,20,0] Tipo:Calcestruzzo	14	11.84

Nome	Combinazione	Cs
Muro 239: Nodi[42,25,27,43] Tipo:Calcestruzzo	12	11.64
Muro 84: Nodi[0,112,113,98] Tipo:Calcestruzzo	13	11.54
Muro 165: Nodi[0,0,0,0] Tipo:Calcestruzzo	14	11.43
Muro 201: Nodi[0,0,0,178] Tipo:Calcestruzzo	11	11.39
Muro 130: Nodi[113,0,178,120] Tipo:Calcestruzzo	11	11.18
Muro 181: Nodi[40,0,0,47] Tipo:Calcestruzzo	14	10.44
Muro 152: Nodi[199,0,0,0] Tipo:Calcestruzzo	14	10.43
Muro 202: Nodi[0,0,0,0] Tipo:Calcestruzzo	13	10.39
Muro 232: Nodi[37,32,12,3] Tipo:Calcestruzzo	11	10.36
Muro 260: Nodi[0,0,3,21] Tipo:Calcestruzzo	14	10.24
Muro 157: Nodi[176,175,172,173] Tipo:Calcestruzzo	14	10.01
Muro 129: Nodi[112,0,0,113] Tipo:Calcestruzzo	13	9.943
Muro 178: Nodi[0,49,50,0] Tipo:Calcestruzzo	13	9.914
Muro 156: Nodi[0,0,0,0] Tipo:Calcestruzzo	14	9.735
Muro 41: Nodi[9,0,99,10] Tipo:Calcestruzzo	11	9.666
Muro 241: Nodi[35,37,3,7] Tipo:Calcestruzzo	11	9.584
Muro 261: Nodi[0,0,15,10] Tipo:Calcestruzzo	14	9.53
Muro 211: Nodi[12,17,18,11] Tipo:Calcestruzzo	14	9.339
Muro 17: Nodi[36,43,42,35] Tipo:Calcestruzzo	13	9.242
Muro 147: Nodi[0,0,0,0] Tipo:Calcestruzzo	14	9.148
Muro 229: Nodi[22,11,18,39] Tipo:Calcestruzzo	14	9.095
Muro 187: Nodi[178,0,0,180] Tipo:Calcestruzzo	13	8.913
Muro 240: Nodi[41,34,37,35] Tipo:Calcestruzzo	11	8.896
Muro 183: Nodi[0,0,50,34] Tipo:Calcestruzzo	14	8.826
Muro 104: Nodi[120,178,180,127] Tipo:Calcestruzzo	11	8.776
Muro 39: Nodi[12,0,98,13] Tipo:Calcestruzzo	11	8.755
Muro 85: Nodi[0,109,110,99] Tipo:Calcestruzzo	13	8.63
Muro 159: Nodi[0,0,0,0] Tipo:Calcestruzzo	14	8.476
Muro 243: Nodi[0,33,36,0] Tipo:Calcestruzzo	13	8.232
Muro 254: Nodi[0,45,43,0] Tipo:Calcestruzzo	14	8.209
Muro 231: Nodi[38,4,25,42] Tipo:Calcestruzzo	14	8.07
Muro 203: Nodi[0,0,0,0] Tipo:Calcestruzzo	13	8.06
Muro 215: Nodi[13,7,19,20] Tipo:Calcestruzzo	13	7.964
Muro 253: Nodi[0,43,42,0] Tipo:Calcestruzzo	14	7.922
Muro 31: Nodi[56,82,83,55] Tipo:Calcestruzzo	11	7.818
Muro 126: Nodi[109,0,0,110] Tipo:Calcestruzzo	13	7.795
Muro 244: Nodi[0,13,33,0] Tipo:Calcestruzzo	13	7.592
Muro 63: Nodi[64,63,56,57] Tipo:Calcestruzzo	14	7.522
Muro 96: Nodi[97,81,134,130] Tipo:Calcestruzzo	13	7.469
Muro 233: Nodi[19,21,26,29] Tipo:Calcestruzzo	11	7.44
Muro 208: Nodi[185,184,0,0] Tipo:Calcestruzzo	13	7.428
Muro 252: Nodi[0,0,21,26] Tipo:Calcestruzzo	14	7.412
Muro 28: Nodi[54,55,83,85] Tipo:Calcestruzzo	11	7.287
Muro 133: Nodi[130,134,184,185] Tipo:Calcestruzzo	13	7.055
Muro 107: Nodi[156,190,189,155] Tipo:Calcestruzzo	14	6.836
Muro 235: Nodi[45,14,5,44] Tipo:Calcestruzzo	14	6.796
Muro 219: Nodi[24,10,27,25] Tipo:Calcestruzzo	11	6.777
Muro 230: Nodi[34,31,32,37] Tipo:Calcestruzzo	11	6.615
Muro 120: Nodi[170,197,200,173] Tipo:Calcestruzzo	13	6.091
Muro 88: Nodi[0,77,116,109] Tipo:Calcestruzzo	11	5.78
Muro 197: Nodi[197,0,0,200] Tipo:Calcestruzzo	13	5.596
Muro 34: Nodi[53,54,85,88] Tipo:Calcestruzzo	13	5.582
Muro 144: Nodi[168,171,0,0] Tipo:Calcestruzzo	14	5.578
Muro 218: Nodi[16,1,2,9] Tipo:Calcestruzzo	14	5.565
Muro 222: Nodi[28,20,19,29] Tipo:Calcestruzzo	13	5.556
Muro 14: Nodi[36,90,91,43] Tipo:Calcestruzzo	13	5.489
Muro 43: Nodi[13,98,95,20] Tipo:Calcestruzzo	11	5.488
Muro 247: Nodi[0,0,17,18] Tipo:Calcestruzzo	14	5.437
Muro 173: Nodi[0,0,34,37] Tipo:Calcestruzzo	14	5.403
Muro 40: Nodi[10,99,100,11] Tipo:Calcestruzzo	11	5.384
Muro 250: Nodi[0,38,4,0] Tipo:Calcestruzzo	14	5.377

Nome	Combinazione	Cs
Muro 92: Nodi[34,41,80,81] Tipo:Calcestruzzo	13	5.262
Muro 258: Nodi[0,0,10,27] Tipo:Calcestruzzo	14	5.135
Muro 73: Nodi[77,94,123,116] Tipo:Calcestruzzo	11	5.107
Muro 42: Nodi[11,100,0,12] Tipo:Calcestruzzo	11	5.064
Muro 26: Nodi[57,56,49,50] Tipo:Calcestruzzo	14	5.058
Muro 177: Nodi[49,50,34,41] Tipo:Calcestruzzo	13	4.983
Muro 72: Nodi[96,127,136,90] Tipo:Calcestruzzo	13	4.906
Muro 71: Nodi[94,93,132,123] Tipo:Calcestruzzo	11	4.832
Muro 193: Nodi[181,192,0,0] Tipo:Calcestruzzo	11	4.811
Muro 13: Nodi[50,87,86,57] Tipo:Calcestruzzo	13	4.764
Muro 117: Nodi[154,167,166,153] Tipo:Calcestruzzo	13	4.742
Muro 212: Nodi[23,15,10,24] Tipo:Calcestruzzo	14	4.684
Muro 210: Nodi[8,23,24,6] Tipo:Calcestruzzo	11	4.67
Muro 248: Nodi[0,20,13,0] Tipo:Calcestruzzo	13	4.666
Muro 119: Nodi[169,168,155,156] Tipo:Calcestruzzo	14	4.549
Muro 29: Nodi[20,95,96,27] Tipo:Calcestruzzo	11	4.488
Muro 11: Nodi[27,96,90,36] Tipo:Calcestruzzo	11	4.445
Muro 151: Nodi[0,0,0,0] Tipo:Calcestruzzo	12	4.444
Muro 225: Nodi[0,0,2,5] Tipo:Calcestruzzo	14	4.431
Muro 118: Nodi[168,167,154,155] Tipo:Calcestruzzo	13	4.394
Muro 226: Nodi[0,6,8,0] Tipo:Calcestruzzo	13	4.258
Muro 108: Nodi[157,187,190,156] Tipo:Calcestruzzo	14	4.231
Muro 106: Nodi[127,180,182,136] Tipo:Calcestruzzo	13	4.182
Muro 127: Nodi[109,116,177,0] Tipo:Calcestruzzo	11	4.165
Muro 38: Nodi[19,18,11,12] Tipo:Calcestruzzo	13	4.165
Muro 199: Nodi[0,177,0,0] Tipo:Calcestruzzo	11	4.137
Muro 3: Nodi[36,35,26,27] Tipo:Calcestruzzo	13	4.096
Muro 36: Nodi[10,17,16,9] Tipo:Calcestruzzo	14	4.041
Muro 170: Nodi[0,198,0] Tipo:Calcestruzzo	12	4.008
Muro 124: Nodi[0,0,0,0] Tipo:Calcestruzzo	14	3.998
Muro 189: Nodi[180,0,0,182] Tipo:Calcestruzzo	13	3.984
Muro 2: Nodi[24,33,32,23] Tipo:Calcestruzzo	11	3.945
Muro 209: Nodi[184,193,0,0] Tipo:Calcestruzzo	13	3.836
Muro 16: Nodi[47,54,53,46] Tipo:Calcestruzzo	13	3.835
Muro 37: Nodi[18,17,10,11] Tipo:Calcestruzzo	13	3.64
Muro 249: Nodi[0,28,20,0] Tipo:Calcestruzzo	13	3.595
Muro 245: Nodi[0,0,39,1] Tipo:Calcestruzzo	13	3.566
Muro 188: Nodi[177,179,0,0] Tipo:Calcestruzzo	11	3.506
Muro 150: Nodi[0,0,0,0] Tipo:Calcestruzzo	12	3.493
Muro 103: Nodi[116,123,179,177] Tipo:Calcestruzzo	11	3.487
Muro 164: Nodi[0,0,0,0] Tipo:Calcestruzzo	13	3.472
Muro 182: Nodi[46,0,0,50] Tipo:Calcestruzzo	13	3.471
Muro 155: Nodi[175,0,0,174] Tipo:Calcestruzzo	11	3.467
Muro 186: Nodi[179,181,0,0] Tipo:Calcestruzzo	11	3.423
Muro 251: Nodi[0,0,5,44] Tipo:Calcestruzzo	14	3.379
Muro 99: Nodi[48,55,83,84] Tipo:Calcestruzzo	13	3.338
Muro 105: Nodi[123,132,181,179] Tipo:Calcestruzzo	11	3.287
Muro 32: Nodi[46,53,88,89] Tipo:Calcestruzzo	11	3.251
Muro 223: Nodi[0,0,1,2] Tipo:Calcestruzzo	14	3.177
Muro 205: Nodi[193,196,0,0] Tipo:Calcestruzzo	13	3.155
Muro 227: Nodi[29,26,15,23] Tipo:Calcestruzzo	14	3.077
Muro 30: Nodi[43,91,87,50] Tipo:Calcestruzzo	14	3.072
Muro 35: Nodi[13,20,19,12] Tipo:Calcestruzzo	14	3.026
Muro 134: Nodi[134,141,193,184] Tipo:Calcestruzzo	13	2.956
Muro 97: Nodi[81,80,141,134] Tipo:Calcestruzzo	13	2.911
Muro 242: Nodi[0,0,18,39] Tipo:Calcestruzzo	14	2.857
Muro 93: Nodi[41,48,84,80] Tipo:Calcestruzzo	14	2.841
Muro 116: Nodi[170,169,156,157] Tipo:Calcestruzzo	14	2.797
Muro 224: Nodi[0,4,6,0] Tipo:Calcestruzzo	13	2.61
Muro 9: Nodi[20,27,26,19] Tipo:Calcestruzzo	14	2.574
Muro 246: Nodi[0,8,28,0] Tipo:Calcestruzzo	14	2.531

Nome	Combinazione	Cs
Muro 70: Nodi[90,136,143,91] Tipo:Calcestruzzo	13	2.478
Muro 69: Nodi[93,92,139,132] Tipo:Calcestruzzo	13	2.449
Muro 206: Nodi[196,189,0,0] Tipo:Calcestruzzo	13	2.446
Muro 191: Nodi[182,0,0,191] Tipo:Calcestruzzo	13	2.418
Muro 111: Nodi[132,139,192,181] Tipo:Calcestruzzo	13	2.401
Muro 12: Nodi[39,46,89,92] Tipo:Calcestruzzo	11	2.388
Muro 112: Nodi[136,182,191,143] Tipo:Calcestruzzo	13	2.33
Muro 141: Nodi[198,199,0,0] Tipo:Calcestruzzo	13	2.327
Muro 190: Nodi[187,0,0,197] Tipo:Calcestruzzo	13	2.319
Muro 123: Nodi[0,0,0,0] Tipo:Calcestruzzo	12	2.31
Muro 161: Nodi[0,0,0,0] Tipo:Calcestruzzo	13	2.277
Muro 19: Nodi[40,47,46,39] Tipo:Calcestruzzo	13	2.225
Muro 44: Nodi[9,16,77,0] Tipo:Calcestruzzo	11	2.215
Muro 135: Nodi[141,148,196,193] Tipo:Calcestruzzo	13	2.146
Muro 115: Nodi[157,187,197,170] Tipo:Calcestruzzo	13	2.065
Muro 98: Nodi[80,84,148,141] Tipo:Calcestruzzo	13	2.009
Muro 10: Nodi[32,39,92,93] Tipo:Calcestruzzo	11	2.009
Muro 195: Nodi[192,195,0,0] Tipo:Calcestruzzo	13	1.966
Muro 196: Nodi[191,0,0,194] Tipo:Calcestruzzo	13	1.964
Muro 27: Nodi[16,23,94,77] Tipo:Calcestruzzo	11	1.873
Muro 5: Nodi[33,40,39,32] Tipo:Calcestruzzo	13	1.842
Muro 15: Nodi[23,32,93,94] Tipo:Calcestruzzo	11	1.8
Muro 77: Nodi[91,143,150,87] Tipo:Calcestruzzo	13	1.749
Muro 33: Nodi[57,86,82,56] Tipo:Calcestruzzo	13	1.741
Muro 113: Nodi[139,146,195,192] Tipo:Calcestruzzo	13	1.701
Muro 114: Nodi[143,191,194,150] Tipo:Calcestruzzo	13	1.692
Muro 80: Nodi[86,157,156,82] Tipo:Calcestruzzo	14	1.684
Muro 18: Nodi[17,24,23,16] Tipo:Calcestruzzo	13	1.677
Muro 143: Nodi[167,168,0,0] Tipo:Calcestruzzo	14	1.668
Muro 75: Nodi[92,89,146,139] Tipo:Calcestruzzo	13	1.661
Muro 142: Nodi[166,167,0,0] Tipo:Calcestruzzo	13	1.651
Muro 162: Nodi[171,174,0,0] Tipo:Calcestruzzo	13	1.591
Muro 78: Nodi[82,156,155,83] Tipo:Calcestruzzo	13	1.511
Muro 140: Nodi[0,0,199,198] Tipo:Calcestruzzo	13	1.407
Muro 160: Nodi[0,0,0] Tipo:Calcestruzzo	13	1.386
Muro 82: Nodi[88,85,154,153] Tipo:Calcestruzzo	13	1.367
Muro 192: Nodi[195,188,0,0] Tipo:Calcestruzzo	13	1.328
Muro 74: Nodi[85,83,155,154] Tipo:Calcestruzzo	13	1.315
Muro 194: Nodi[194,0,0,187] Tipo:Calcestruzzo	13	1.303
Minimi		1.303

14 VERIFICHE GEOTECNICHE

Il calcolo del carico limite è valutato secondo la formula di Terzaghi-Meyerof

$$Q_{lim} = q \cdot N_q \cdot C_q \cdot E_q \cdot \alpha_q \cdot \beta_q \cdot \psi_q + c \cdot N_c \cdot C_c \cdot E_c \cdot \alpha_c \cdot \beta_c \cdot \psi_c + \gamma \cdot N_\gamma \cdot \frac{B}{2} \cdot C_\gamma \cdot E_\gamma \cdot \alpha_\gamma \cdot \beta_\gamma \cdot \psi_\gamma$$

dove :

N_q, N_c, N_γ = Coefficienti di Terzaghi - Meyerof per la striscia indefinita

Z_q, Z_c, Z_γ = coefficienti correttivi di forma funzione del rapporto B/L

X_q, X_c, X_γ = coefficienti correttivi di inclinazione del carico dipendente da H/V

a_q, a_c, a_g = coefficienti correttivi di inclinazione del piano di posa

b_q, b_c, b_g = coefficienti correttivi di inclinazione del piano campagna

z_q, z_c, z_g = coefficienti sismimici per considerare l'effetto cinematico, considerati solo in presenza di sisma

y_q, y_c, y_g = coefficienti correttivi di punzonamento dipendenti da un indice di rigidezza del terreno, in particolare detto I_r l'indice di rigidezza del terreno (secondo la teoria di Vesic dipendente dal modulo tangenziale $G < 1.5 E / (1+n)$ del terreno, dalla coesione c , dalla tensione effettiva alla profondità $B/2$ sotto il piano di posa, dall'angolo di attrito del terreno di fondazione) ed I_{rcrit} l'indice di rigidezza critico (dipendente dall'angolo di attrito del terreno e dal rapporto B/L) risulta che i coefficienti di punzonamento sono uguali alla unità quando $I_r \geq I_{rcrit}$, mentre sono minori dell'unità quando $I_r < I_{rcrit}$.

Oltre a queste correzioni un'altra deriva dalla eccentricità del carico riducendo le dimensioni della fondazione in modo che il carico risulti centrato rispetto alla fondazione ridotta, dette e_b ed e_l le eccentricità del carico nella direzione di B ed L il carico limite si calcola per una fondazione di dimensioni ridotte $B' = B - 2e_b$ e $L' = L - 2e_l$

Altra correzione deriva dalla presenza della falda inserendo i pesi del terreno immerso nel primo e terzo termine, in particolare, detta H_f la profondità della falda e D la profondità del piano di posa, si ha:

per $H_f < D$ si valuta la pressione effettiva sul piano di posa considerando che parte del terreno superiore è immerso, mentre nel terzo termine si userà il peso immerso

per $H_f > D$ ed $H_f < D + B$ il peso del terreno del terzo termine si interpola tra i valori immerso e secco secondo la formula:

$$g = g' + (g - g') * D / B$$

per $H_f > D + B$ la falda è trascurata.

I coefficienti di Terzaghi - Meyerof per la striscia ed i coefficienti correttivi sono dati dalle relazioni:

$$N_q = \frac{1 + \sin(\phi)}{1 - \sin(\phi)} e^{\pi \tan(\phi)}$$

$$N_c = (N_q - 1) \cot(\phi)$$

Il coefficiente N_g non è suscettibile di una espressione in forma analitica chiusa, ed è stato calcolato per via numerica da diversi Autori. I valori del coefficiente sono riportati nella seguente tabella in funzione dell'angolo f :

f°	0	1	2	3	4	5	6	7	8
N_g	0	0.07	0.15	0.24	0.34	0.45	0.57	0.71	0.86
f°	9	10	11	12	13	14	15	16	17
N_g	1.03	1.22	1.44	1.69	1.97	2.29	2.65	3.06	3.53
f°	18	19	20	21	22	23	24	25	26
N_g	4.07	4.68	5.39	6.2	7.13	8.2	9.44	10.88	12.54
f°	27	28	29	30	31	32	33	34	35
N_g	14.47	16.72	19.34	22.4	25.99	30.22	35.19	41.06	48.03

f^o	36	37	38	39	40	41	42	43	44
N_g	56.31	66.19	78.03	92.25	109.41	130.22	155.55	186.54	224.64
f^o	45	46	47	48	49	50			
N_g	271.76	330.75	403.67	496.01	613.16	762.89			

$$\zeta_q = 1 + \frac{B}{L} \tan(\varphi)$$

$$\zeta_c = 1 + \frac{B}{L} \frac{N_q}{N_c}$$

$$\zeta_r = 1 - 0.4 \frac{B}{L}$$

$$m = \frac{2 + \frac{B}{L}}{1 + \frac{B}{L}}$$

$$\xi_q = \left[1 - \frac{H \tan(\phi)}{V \tan(\phi) + BLc} \right]^m$$

$$\xi_c = \xi_q - \frac{1 - \xi_q}{N_c \cdot \tan(\phi)}$$

$$\xi_r = \left[1 - \frac{H \tan(\phi)}{V \tan(\phi) + BLc} \right]^{m+1}$$

$$\psi_q = \exp \left(0.6 \frac{B}{L} - 4.4 \right) \tan(\phi) + \frac{3.07 \sin(\phi) \log_{10}(2I_r)}{1 + \sin(\phi)}$$

$$\psi_c = \psi_q - \frac{1 - \psi_q}{N_q \tan(\phi)} \text{ se } \varphi \neq 0; \quad \psi_c = 0.32 + 0.12 \frac{B}{L} + 0.6 \log_{10}(I_r) \text{ se } \varphi = 0$$

$$\psi_r = \psi_q$$

$$\alpha_q = \alpha_r = (1 - \varepsilon \tan(\phi))^2$$

$$\alpha_c = \alpha_q - \frac{1 - \alpha_q}{N_c \tan(\phi)}$$

$$\beta_q = (1 - \tan(\omega))^2 \cos(\omega)$$

$$\beta_c = \beta_q - \frac{q - \beta_q}{N_c \tan(\phi)}$$

$$\beta_c = \beta_q - \frac{q - \beta_q}{N_c \tan(\phi)}$$

$$\varepsilon < \pi/4; \quad \omega < \pi/4; \quad \omega < \varphi$$

$$zq = zc = 1$$

$$zg = (1 - kh / \tan(\phi))^{0.45}$$

$$kh = \beta \frac{\alpha_{\max}}{g} \cdot (\text{vedi } NT - 7.11.3)$$

Per la fondazione composta si adotta una fondazione rettangolare equivalente ottenuta mediando le basi dei tratti pesati rispetto alla loro lunghezza; il numero di tratti che si prendono in considerazione sono quelli che si ottengono considerando la parte di fondazione sulla quale le tensioni del terreno non sono nulle considerando le sole condizioni di equilibrio (metodo del trapezio). La fondazione equivalente è poi ridotta in base alle eccentricità della risultante dei carichi verticali.

Simbologia carico limite fondazione rettangolare:

B	Base
L	Lunghezza
eb	Eccentricità secondo B
el	Eccentricità secondo L
D	Profondità del piano di posa
e	Inclinazione del piano di posa
w	Inclinazione del piano campagna
f	Angolo di attrito del terreno di fondazione
c	Coesione del terreno di fondazione
G	Modulo tangenziale del terreno di fondazione
g_1	Peso specifico terreno superiore
g	Peso specifico terreno di fondazione
g_{1Sat}	Peso specifico terreno saturo superiore
g_{Sat}	Peso specifico terreno saturo di fondazione
Hf	Profondità della falda
W0	Peso specifico acqua
Fv	Componente ortogonale dell'azione sulla fondazione
Fh	Componente tangenziale dell'azione sulla fondazione

Platea 1-3

Dati della fondazione rettangolare

La falda è assente.

Base B	7.70 m
Lunghezza L	13.80 m
Eccentricità eb	0.15 m
Eccentricità el	0.11 m
Forza Fv	1561776 kg
Forza Fh	115254 kg

Parametri geotecnici

D	e	w	f	c	G	g ₁	g
m	°	°	°	kg/cmq	kg/cmq	t/mc	t/mc
2.50	0.00	0.00	30.00	0.00	93.77	1.90	1.90

Carico limite

La fondazione data è equivalente a una fondazione rettangolare di dimensioni B=7.40 m ed L=13.59 m. Si riportano di seguito i coefficienti correttivi.

N _q	N _c	N _g
18.401	30.140	22.400
a _q	a _c	a _g
1.000	1.000	1.000
b _q	b _c	b _g
1.000	1.000	1.000
x _q	x _c	x _g
0.881	0.875	0.816
y _q	y _c	y _g
1.000	1.000	1.000
z _q	z _c	z _g
1.314	1.332	0.782
z _q	z _c	z _g
1.000	1.000	1.000
N' _q	N' _c	N' _g
21.315	35.119	14.303

Di seguito si riporta una sintesi dei valori utilizzati per effettuare la verifica della fondazione.

Indice di rigidezza critico I_{crit} 99.314
 Indice di rigidezza I_r 137.918
 Azione verticale sollecitante V 1561776 kg
 Azione orizzontale sollecitante H 115254 kg
 Eccentricità lungo B e_b 0.15 m
 Eccentricità lungo L e_l 0.11 m
 Carico limite verticale di calcolo Q_{lim} 20.18 kg/cmq
 Carico limite verticale di progetto Q_d 8.77 kg/cmq
 Coefficiente di sicurezza g_v 2.300

Carico limite orizzontale di calcolo H_{lim} 901692 kg
 Carico limite orizzontale di progetto H_d 819720 kg
 Coefficiente di sicurezza g_h 1.100
 V=1561776 kg £ V_d=8814399 kg **VERIFICATO**
 H=115254 kg £ H_d=819720 kg **VERIFICATO**

La fondazione è considerata infinitamente rigida rispetto al terreno. Gli strati poggiano su un substrato rigido individuato alla profondità corrispondente all'ultimo strato.

N°	H	Eed	g	Imp.
	m	kg/cmq	t/mc	
1	10.00	375.00	1.90	No

Si riportano di seguito i risultati ottenuti.

Profondità fondazione D_f 2.50 m
 Carico netto q_{eff} 0.00 kg/cmq
 Cedimento Immediato (fine) W_{of} 0 mm

Cedimento Immediato (grossa) W_0g 16 mm
 Cedimento di consolidazione(fine) W_c 0 mm
 Cedimento totale W_t 16 mm

Platea 1-5

Dati della fondazione rettangolare

La falda è assente.
 Base B 7.70 m
 Lunghezza L 13.80 m
 Eccentricità eb 0.32 m
 Eccentricità el 0.11 m
 Forza Fv 743871 kg
 Forza Fh 118048 kg

Parametri geotecnici

D	e	w	f	c	G	g_1	g
m	°	°	°	kg/cmq	kg/cmq	t/mc	t/mc
2.50	0.00	0.00	30.00	0.00	93.77	1.90	1.90

Carico limite

La fondazione data è equivalente a una fondazione rettangolare di dimensioni B=7.07 m ed L=13.59 m. Si riportano di seguito i coefficienti correttivi.

N_q	N_c	N_g
18.401	30.140	22.400
a_q	a_c	a_g
1.000	1.000	1.000
b_q	b_c	b_g
1.000	1.000	1.000
x_q	x_c	x_g
0.751	0.737	0.632
y_q	y_c	y_g
1.000	1.000	1.000
z_q	z_c	z_g
1.300	1.318	0.792
z_q	z_c	z_g
1.000	1.000	1.000
N'_q	N'_c	N'_g
17.967	29.251	11.207

Di seguito si riporta una sintesi dei valori utilizzati per effettuare la verifica della fondazione.

Indice di rigidezza critico $I_{r_{crit}}$ 101.211
 Indice di rigidezza I_r 141.672
 Azione verticale sollecitante V 743871 kg
 Azione orizzontale sollecitante H 118048 kg
 Eccentricità lungo B eb 0.32 m
 Eccentricità lungo L el 0.11 m
 Carico limite verticale di calcolo Q_{lim} 16.06 kg/cmq
 Carico limite verticale di progetto Q_d 6.98 kg/cmq
 Coefficiente di sicurezza g_v 2.300

Carico limite orizzontale di calcolo H_{lim} 429474 kg
 Carico limite orizzontale di progetto H_d 390431 kg
 Coefficiente di sicurezza g_h 1.100
 V=743871 kg £ Vd=6705796 kg **VERIFICATO**
 H=118048 kg £ Hd=390431 kg **VERIFICATO**

La fondazione è considerata infinitamente rigida rispetto al terreno. Gli strati poggiano su un substrato rigido individuato alla profondità corrispondente all'ultimo strato.

N°	H	Eed	g	Imp.
	m	kg/cmq	t/mc	
1	10.00	375.00	1.90	No

Si riportano di seguito i risultati ottenuti.

Profondità fondazione Df 2.50 m
 Carico netto q_{eff} 0.00 kg/cmq
 Cedimento Immediato (fine) W0f 0 mm
 Cedimento Immediato (grossa) W0g 4 mm
 Cedimento di consolidazione(fine) Wc 0 mm
 Cedimento totale Wt 4 mm

Riepilogo risultati del calcolo

Elm.	Combinazione	V	Vd	CsV (>2.30)	H	Hd	CsH (>1.10)	Qd	qe	W
		kg	kg		kg	kg		kg/cmq	kg/cmq	mm
1	1	797465	7089229	20.45	109056	418560	4.22	7.40	0.28	4
	2	1127889	8098410	16.51	107678	591988	6.05	8.28	0.59	9
	3	1561776	8814399	12.98	115254	819720	7.82	8.77	0.99	16
	4	1338062	8492161	14.60	117162	702300	6.59	8.46	0.78	12
	5	743871	6705796	20.73	118048	390431	3.64	6.98	0.23	4
	6	1063784	10639391	23.00	5079	558342	>100	10.42	0.53	8
	(7+8)-I-1	1214633	7810863	14.79	121461	637517	5.77	8.03	0.67	10
	(7+8)-I-2	1219489	7829051	14.77	115666	640066	6.09	8.13	0.67	11
	(7+8)-I-3	1217465	9774070	18.46	59669	639003	11.78	9.36	0.67	11
	(7+8)-I-4	1222321	9950629	18.72	44969	641552	15.69	9.62	0.68	11
	(7+8)-II-1	1209957	8441968	16.05	107536	635063	6.50	8.39	0.66	10
	(7+8)-II-2	1226147	8688163	16.30	82415	643560	8.59	8.82	0.68	11
	(7+8)-II-3	1210807	9100773	17.29	90905	635509	7.69	8.79	0.66	10
	(7+8)-II-4	1226997	9491375	17.79	57687	644006	12.28	9.37	0.68	11
	(7+8)-III-1	1215624	8648921	16.36	95751	638037	7.33	8.59	0.67	10
	(7+8)-III-2	1220481	8695054	16.39	87959	640586	8.01	8.72	0.67	11
	(7+8)-III-3	1216473	9371004	17.72	76227	638483	9.21	9.04	0.67	10
	(7+8)-III-4	1221330	9460905	17.82	65802	641032	10.72	9.22	0.67	11
	(7+8)-IV-1	1214266	7803984	14.78	121352	637325	5.78	8.03	0.67	10
	(7+8)-IV-2	1219856	7835211	14.77	115822	640258	6.08	8.13	0.67	11
	(7+8)-IV-3	1217098	9778090	18.48	59814	638811	11.75	9.36	0.67	11
	(7+8)-IV-4	1222688	9945433	18.71	44883	641745	15.73	9.62	0.68	11
	(7+8)-V-1	1208737	8418119	16.02	107535	634422	6.49	8.38	0.66	10
	(7+8)-V-2	1227368	8707238	16.32	83056	644201	8.53	8.82	0.68	11
	(7+8)-V-3	1209586	9072434	17.25	91144	634868	7.66	8.78	0.66	10
	(7+8)-V-4	1228217	9512591	17.81	58225	644647	12.18	9.37	0.68	11
	(7+8)-VI-1	1215258	8640978	16.35	95693	637845	7.33	8.59	0.67	10
	(7+8)-VI-2	1220847	8702021	16.39	88077	640778	8.00	8.73	0.67	11
	(7+8)-VI-3	1216107	9361599	17.71	76240	638291	9.21	9.04	0.67	10
	(7+8)-VI-4	1221696	9469093	17.83	65859	641224	10.71	9.23	0.67	11
	(7+8)-VII-1	1214804	7975133	15.10	115960	637607	6.05	8.15	0.67	10
	(7+8)-VII-2	1219661	7998772	15.08	109751	640156	6.42	8.25	0.67	11
	(7+8)-VII-3	1217293	9821302	18.56	62008	638913	11.33	9.35	0.67	11

Elm.	Combinazione	V	Vd	CsV (>2.30)	H	Hd	CsH (>1.10)	Qd	qe	W
	(7+8)-VII-4	1222150	9980519	18.78	48312	641463	14.61	9.59	0.68	11
	(7+8)-VIII-1	1210009	8487697	16.13	106249	635090	6.58	8.42	0.66	10
	(7+8)-VIII-2	1226198	8743493	16.40	80560	643587	8.79	8.86	0.68	11
	(7+8)-VIII-3	1210756	9057783	17.21	91906	635482	7.61	8.76	0.66	10
	(7+8)-VIII-4	1226945	9433781	17.68	59482	643979	11.91	9.33	0.68	11
	(7+8)-IX-1	1215675	8699041	16.46	94254	638064	7.45	8.62	0.67	10
	(7+8)-IX-2	1220532	8748026	16.48	86279	640613	8.17	8.76	0.67	11
	(7+8)-IX-3	1216422	9322532	17.63	77481	638456	9.06	9.01	0.67	10
	(7+8)-IX-4	1221279	9407950	17.72	67310	641005	10.48	9.19	0.67	11
	(7+8)-X-1	1214438	7968048	15.09	115861	637414	6.05	8.14	0.67	10
	(7+8)-X-2	1220027	8005092	15.09	109899	640348	6.41	8.25	0.67	11
	(7+8)-X-3	1216927	9825922	18.57	62119	638721	11.31	9.35	0.67	11
	(7+8)-X-4	1222516	9974575	18.77	48269	641655	14.62	9.59	0.68	11
	(7+8)-XI-1	1208788	8463548	16.10	106265	634449	6.57	8.41	0.66	10
	(7+8)-XI-2	1227419	8762714	16.42	81194	644228	8.73	8.86	0.68	11
	(7+8)-XI-3	1209535	9029853	17.17	92124	634841	7.58	8.75	0.66	10
	(7+8)-XI-4	1228166	9454734	17.71	60034	644620	11.81	9.33	0.68	11
	(7+8)-XII-1	1215309	8691004	16.45	94200	637872	7.45	8.62	0.67	10
	(7+8)-XII-2	1220898	8755070	16.49	86393	640805	8.16	8.76	0.67	11
	(7+8)-XII-3	1216056	9313269	17.61	77487	638264	9.06	9.01	0.67	10
	(7+8)-XII-4	1221645	9416008	17.73	67374	641197	10.47	9.19	0.67	11
	(9+10)-I-1	1172616	9378418	18.40	45824	615464	14.77	9.39	0.63	10
	(9+10)-I-2	1177473	9375774	18.31	40493	618013	16.79	9.49	0.63	10
	(9+10)-I-3	1175448	9327940	18.25	52678	616950	12.88	9.29	0.63	10
	(9+10)-I-4	1180305	9353725	18.23	46377	619499	14.69	9.41	0.64	10
	(9+10)-II-1	1167941	9997765	19.69	44702	613010	15.08	9.57	0.62	10
	(9+10)-II-2	1184131	10193579	19.80	16529	621507	41.36	10.09	0.64	10
	(9+10)-II-3	1168790	9996592	19.67	47522	613456	14.20	9.54	0.62	10
	(9+10)-II-4	1184980	10234983	19.87	19211	621953	35.61	10.07	0.64	10
	(9+10)-III-1	1173607	10258228	20.10	25865	615984	26.20	9.92	0.63	10
	(9+10)-III-2	1178464	10406145	20.31	12308	618533	55.28	10.17	0.63	10
	(9+10)-III-3	1174457	10257222	20.09	29523	616430	22.97	9.88	0.63	10
	(9+10)-III-4	1179314	10388060	20.26	17459	618979	39.00	10.10	0.63	10
	(9+10)-IV-1	1172250	9370035	18.38	45746	615272	14.79	9.39	0.63	10
	(9+10)-IV-2	1177839	9381865	18.32	40699	618205	16.71	9.49	0.63	10
	(9+10)-IV-3	1175082	9328437	18.26	53025	616758	12.79	9.29	0.63	10
	(9+10)-IV-4	1180671	9352251	18.22	46084	619692	14.79	9.41	0.64	10
	(9+10)-V-1	1166720	9957778	19.63	45417	612369	14.83	9.55	0.62	10
	(9+10)-V-2	1185351	10203946	19.80	17741	622148	38.58	10.08	0.64	10
	(9+10)-V-3	1167570	10005685	19.71	48646	612815	13.86	9.53	0.62	10
	(9+10)-V-4	1186201	10212094	19.80	19154	622594	35.76	10.06	0.64	10
	(9+10)-VI-1	1173241	10245114	20.08	26023	615792	26.03	9.92	0.63	10
	(9+10)-VI-2	1178830	10415228	20.32	12363	618725	55.05	10.18	0.63	10
	(9+10)-VI-3	1174091	10257641	20.09	29881	616238	22.69	9.87	0.63	10
	(9+10)-VI-4	1179680	10387200	20.25	17118	619171	39.79	10.11	0.64	10
	(9+10)-VII-1	1172787	9564740	18.76	40760	615554	16.61	9.52	0.63	10
	(9+10)-VII-2	1177644	9581638	18.71	34263	618103	19.84	9.63	0.63	10
	(9+10)-VII-3	1175277	9526151	18.64	46817	616860	14.49	9.43	0.63	10
	(9+10)-VII-4	1180134	9561183	18.63	39937	619410	17.06	9.56	0.64	10
	(9+10)-VIII-1	1167992	10029904	19.75	44537	613037	15.14	9.59	0.62	10
	(9+10)-VIII-2	1184182	10247757	19.90	15205	621534	44.97	10.13	0.64	10
	(9+10)-VIII-3	1168739	10041374	19.76	46702	613429	14.45	9.56	0.62	10
	(9+10)-VIII-4	1184929	10289312	19.97	17865	621926	38.29	10.11	0.64	10
	(9+10)-IX-1	1173659	10297139	20.18	25392	616011	26.69	9.94	0.63	10
	(9+10)-IX-2	1178515	10463129	20.42	10910	618560	62.36	10.21	0.63	10

Elm.	Combinazione	V	Vd	CsV (>2.30)	H	Hd	CsH (>1.10)	Qd	qe	W
	(9+10)-IX-3	1174405	10309154	20.19	28353	616403	23.91	9.91	0.63	10
	(9+10)-IX-4	1179262	10452236	20.39	15663	618952	43.47	10.15	0.63	10
	(9+10)-X-1	1172421	9555691	18.75	40716	615361	16.62	9.51	0.63	10
	(9+10)-X-2	1178010	9588012	18.72	34454	618295	19.74	9.63	0.63	10
	(9+10)-X-3	1174911	9526591	18.65	47170	616668	14.38	9.43	0.63	10
	(9+10)-X-4	1180500	9559699	18.63	39641	619602	17.19	9.56	0.64	10
	(9+10)-XI-1	1166772	9989088	19.69	45293	612396	14.87	9.56	0.62	10
	(9+10)-XI-2	1185402	10258272	19.90	16407	622175	41.71	10.11	0.64	10
	(9+10)-XI-3	1167519	10050857	19.80	47809	612788	14.10	9.55	0.62	10
	(9+10)-XI-4	1186149	10264521	19.90	17902	622567	38.25	10.10	0.64	10
	(9+10)-XII-1	1173292	10283550	20.16	25573	615819	26.49	9.94	0.63	10
	(9+10)-XII-2	1178882	10473028	20.43	10923	618752	62.31	10.21	0.63	10
	(9+10)-XII-3	1174039	10309654	20.20	28708	616211	23.61	9.90	0.63	10
	(9+10)-XII-4	1179629	10451465	20.38	15317	619144	44.46	10.15	0.64	10
Minimi coeff. sic.										
1	3			12.98						
1	5						3.64			

Wmax=16 mm

Wmin=4 mm

Verifica a scorrimento globale delle fondazione

Combinazione Combinazione di verifica

N Sforzo normale

Hd Azione orizzontale depurata dalle azioni assorbite da pali e plinti su pali

R Resistenza allo scorrimento $R=A*c+N*tg(f)$

CS R/Hd

CSd Coefficiente di sicurezza di progetto

Area delle strutture di fondazione a contatto con il terreno **A=135.0600 m²**

Combinazione	N	Hd	R	CS.	CSd	ver
	kg	kg	kg			
1	975558	168757	563238	3.34	1.10	Si
2	1319383	168894	761746	4.51	1.10	Si
3	1883356	176147	1087356	6.17	1.10	Si
4	1672537	175745	965640	5.49	1.10	Si
5	927650	170055	535579	3.15	1.10	Si
6	1249390	6266	721336	115.12	1.10	Si
(7+8)-I-1	1421655	201076	820793	4.08	1.10	Si
(7+8)-I-2	1418018	201822	818693	4.06	1.10	Si
(7+8)-I-3	1421433	34821	820665	23.57	1.10	Si
(7+8)-I-4	1417797	29800	818565	27.47	1.10	Si
(7+8)-II-1	1425820	147966	823198	5.56	1.10	Si
(7+8)-II-2	1413698	148884	816199	5.48	1.10	Si
(7+8)-II-3	1425754	101720	823159	8.09	1.10	Si
(7+8)-II-4	1413632	99973	816161	8.16	1.10	Si
(7+8)-III-1	1421577	141138	820748	5.82	1.10	Si
(7+8)-III-2	1417941	141428	818648	5.79	1.10	Si
(7+8)-III-3	1421511	90301	820710	9.09	1.10	Si
(7+8)-III-4	1417874	89713	818610	9.12	1.10	Si
(7+8)-IV-1	1421123	201496	820486	4.07	1.10	Si
(7+8)-IV-2	1418550	201448	819000	4.07	1.10	Si
(7+8)-IV-3	1420902	35327	820358	23.22	1.10	Si
(7+8)-IV-4	1418328	29502	818872	27.76	1.10	Si
(7+8)-V-1	1424048	149568	822175	5.50	1.10	Si
(7+8)-V-2	1415470	147947	817222	5.52	1.10	Si

Combinazione	N	Hd	R	CS.	CSd	ver
(7+8)-V-3	1423982	103394	822136	7.95	1.10	Si
(7+8)-V-4	1415403	99245	817183	8.23	1.10	Si
(7+8)-VI-1	1421046	141570	820441	5.80	1.10	Si
(7+8)-VI-2	1418472	141058	818955	5.81	1.10	Si
(7+8)-VI-3	1420979	90755	820403	9.04	1.10	Si
(7+8)-VI-4	1418406	89354	818917	9.16	1.10	Si
(7+8)-VII-1	1421907	198407	820938	4.14	1.10	Si
(7+8)-VII-2	1418270	199081	818839	4.11	1.10	Si
(7+8)-VII-3	1421181	36759	820519	22.32	1.10	Si
(7+8)-VII-4	1417545	32550	818420	25.14	1.10	Si
(7+8)-VIII-1	1425896	147252	823241	5.59	1.10	Si
(7+8)-VIII-2	1413774	148063	816243	5.51	1.10	Si
(7+8)-VIII-3	1425678	102345	823116	8.04	1.10	Si
(7+8)-VIII-4	1413556	100771	816117	8.10	1.10	Si
(7+8)-IX-1	1421653	140348	820792	5.85	1.10	Si
(7+8)-IX-2	1418016	140604	818692	5.82	1.10	Si
(7+8)-IX-3	1421435	91067	820666	9.01	1.10	Si
(7+8)-IX-4	1417799	90539	818566	9.04	1.10	Si
(7+8)-X-1	1421376	198828	820632	4.13	1.10	Si
(7+8)-X-2	1418802	198706	819146	4.12	1.10	Si
(7+8)-X-3	1420650	37263	820212	22.01	1.10	Si
(7+8)-X-4	1418076	32249	818727	25.39	1.10	Si
(7+8)-XI-1	1424124	148855	822218	5.52	1.10	Si
(7+8)-XI-2	1415545	147127	817265	5.55	1.10	Si
(7+8)-XI-3	1423906	104017	822093	7.90	1.10	Si
(7+8)-XI-4	1415328	100040	817140	8.17	1.10	Si
(7+8)-XII-1	1421121	140780	820485	5.83	1.10	Si
(7+8)-XII-2	1418548	140234	818999	5.84	1.10	Si
(7+8)-XII-3	1420904	91520	820359	8.96	1.10	Si
(7+8)-XII-4	1418330	90180	818873	9.08	1.10	Si
(9+10)-I-1	1375527	92060	794161	8.63	1.10	Si
(9+10)-I-2	1371890	92541	792061	8.56	1.10	Si
(9+10)-I-3	1375305	84561	794033	9.39	1.10	Si
(9+10)-I-4	1371669	81329	791933	9.74	1.10	Si
(9+10)-II-1	1379692	58714	796565	13.57	1.10	Si
(9+10)-II-2	1367570	54903	789567	14.38	1.10	Si
(9+10)-II-3	1379625	57173	796527	13.93	1.10	Si
(9+10)-II-4	1367503	47019	789528	16.79	1.10	Si
(9+10)-III-1	1375449	35021	794116	22.68	1.10	Si
(9+10)-III-2	1371813	33114	792016	23.92	1.10	Si
(9+10)-III-3	1375383	28794	794078	27.58	1.10	Si
(9+10)-III-4	1371746	22621	791978	35.01	1.10	Si
(9+10)-IV-1	1374995	92504	793854	8.58	1.10	Si
(9+10)-IV-2	1372422	92194	792368	8.59	1.10	Si
(9+10)-IV-3	1374774	84257	793726	9.42	1.10	Si
(9+10)-IV-4	1372200	81753	792240	9.69	1.10	Si
(9+10)-V-1	1377920	60288	795543	13.20	1.10	Si
(9+10)-V-2	1369341	55004	790590	14.37	1.10	Si
(9+10)-V-3	1377854	57643	795504	13.80	1.10	Si
(9+10)-V-4	1369275	48530	790551	16.29	1.10	Si
(9+10)-VI-1	1374918	35522	793809	22.35	1.10	Si
(9+10)-VI-2	1372344	32849	792323	24.12	1.10	Si
(9+10)-VI-3	1374851	28713	793771	27.64	1.10	Si
(9+10)-VI-4	1372278	23113	792285	34.28	1.10	Si
(9+10)-VII-1	1375779	89471	794306	8.88	1.10	Si
(9+10)-VII-2	1372142	89784	792207	8.82	1.10	Si

Combinazione	N	Hd	R	CS.	CSd	ver
(9+10)-VII-3	1375053	81810	793887	9.70	1.10	Si
(9+10)-VII-4	1371416	78673	791788	10.06	1.10	Si
(9+10)-VIII-1	1379767	58440	796609	13.63	1.10	Si
(9+10)-VIII-2	1367645	54309	789610	14.54	1.10	Si
(9+10)-VIII-3	1379550	56722	796483	14.04	1.10	Si
(9+10)-VIII-4	1367428	46821	789485	16.86	1.10	Si
(9+10)-IX-1	1375525	34393	794160	23.09	1.10	Si
(9+10)-IX-2	1371888	32297	792060	24.52	1.10	Si
(9+10)-IX-3	1375307	28093	794034	28.26	1.10	Si
(9+10)-IX-4	1371670	21946	791934	36.09	1.10	Si
(9+10)-X-1	1375247	89918	793999	8.83	1.10	Si
(9+10)-X-2	1372674	89436	792514	8.86	1.10	Si
(9+10)-X-3	1374521	81507	793580	9.74	1.10	Si
(9+10)-X-4	1371948	79100	792094	10.01	1.10	Si
(9+10)-XI-1	1377996	60005	795586	13.26	1.10	Si
(9+10)-XI-2	1369417	54428	790633	14.53	1.10	Si
(9+10)-XI-3	1377778	57212	795461	13.90	1.10	Si
(9+10)-XI-4	1369199	48319	790508	16.36	1.10	Si
(9+10)-XII-1	1374993	34895	793853	22.75	1.10	Si
(9+10)-XII-2	1372420	32034	792367	24.73	1.10	Si
(9+10)-XII-3	1374775	28020	793727	28.33	1.10	Si
(9+10)-XII-4	1372202	22440	792241	35.30	1.10	Si