

Concessione Mineraria per l'Estrazione e Valorizzazione di Minerali di Ferro

“ GIACCURU “

finalizzata allo sfruttamento del Giacimento Residuo ed al Ripristino Ambientale e
Riconversione Turistico-Sociale della Miniera.

Comuni di Aritzo e Gadoni - Provincia di Nuoro

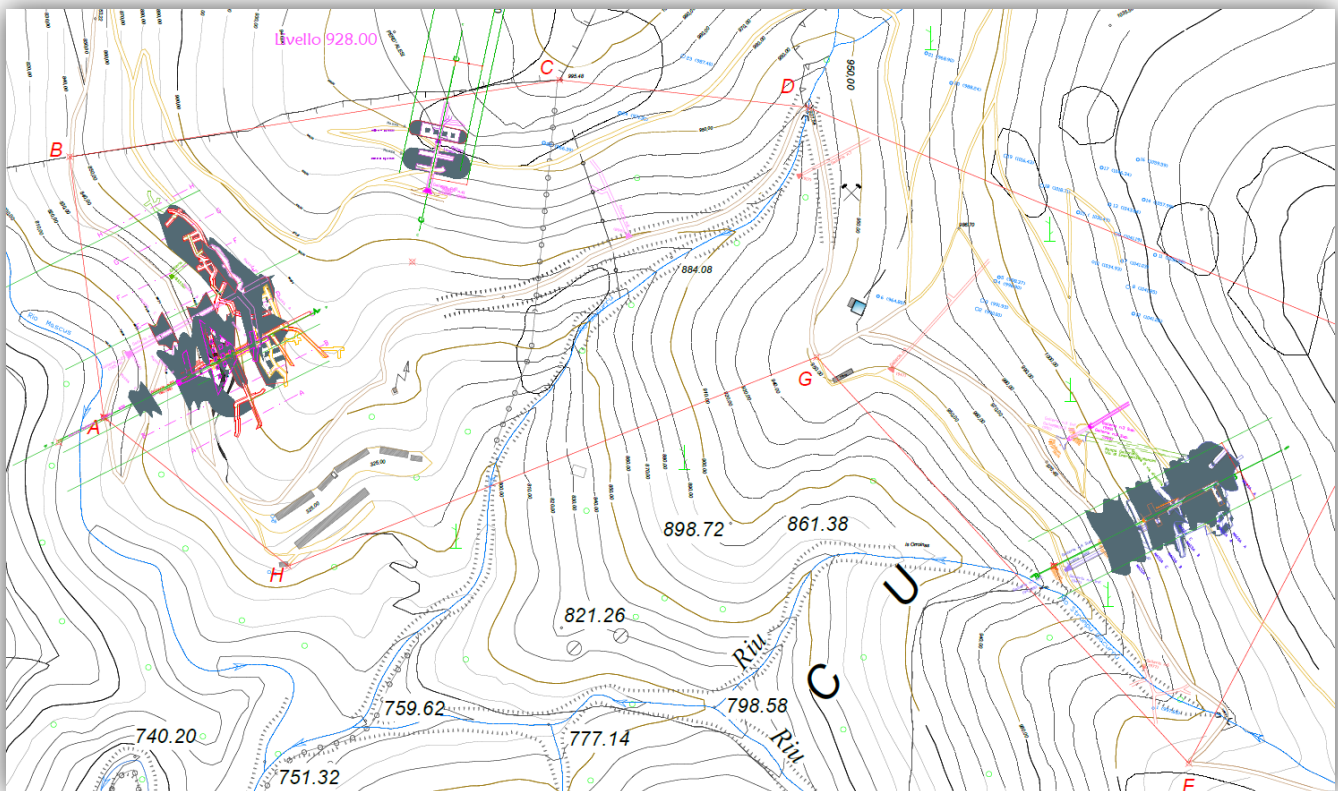

Tav. 4.0- Planimetria e Sezioni VALUTAZIONE GIACIMENTO

L'Esercente

Timbro e Firma

SABBIE di PARMA srl
Strada Argine Maestro del Po, 6
43016 POLESINE ZIBELLO (PR)
C.F. e P.I.: 02235870348

Il Tecnico

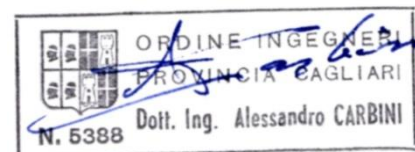

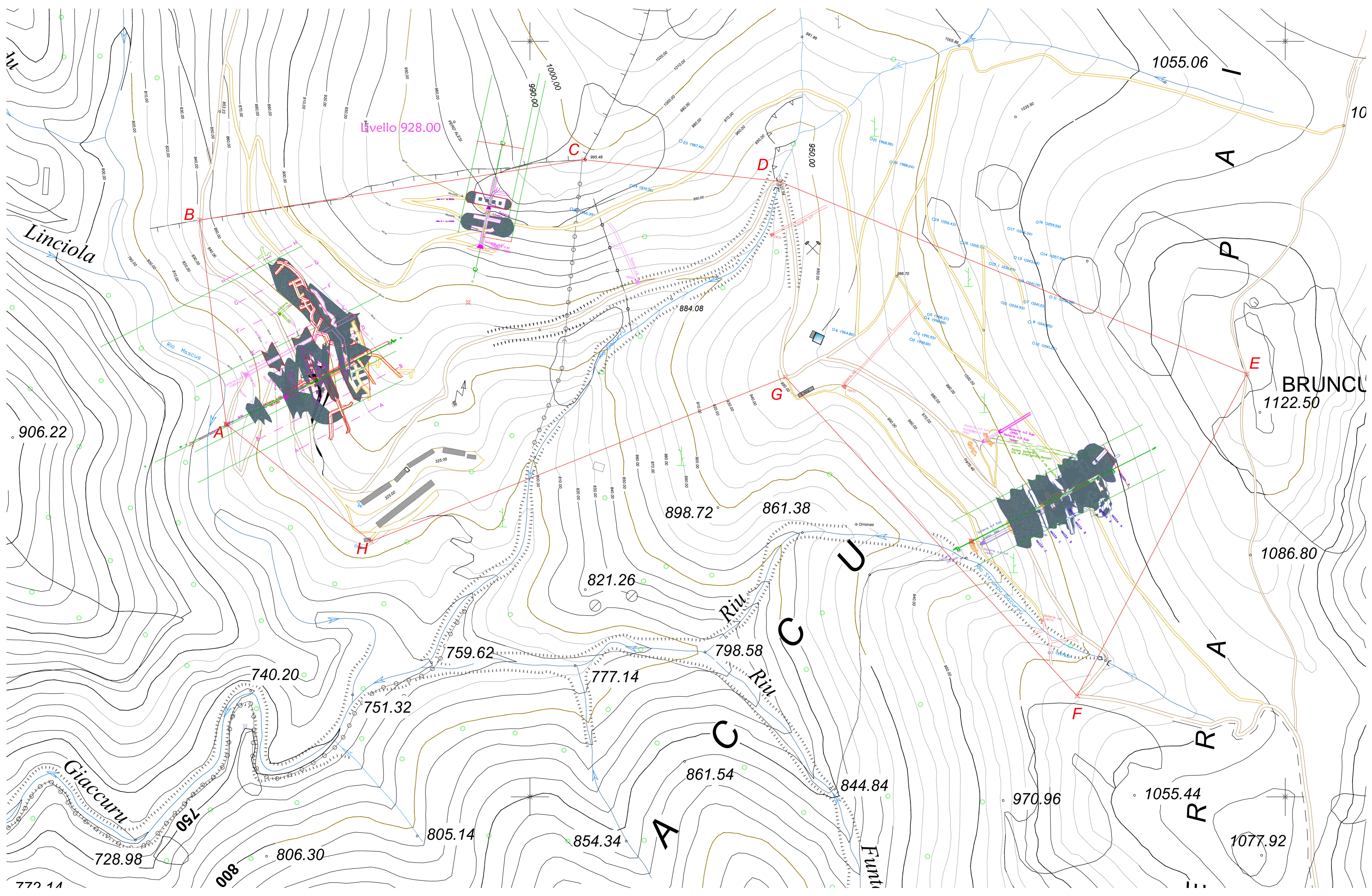

Stato Attuale

Sezione A - A
PERDABILA

Scala Lunghezze 1:500
Scala Altezze 1:500

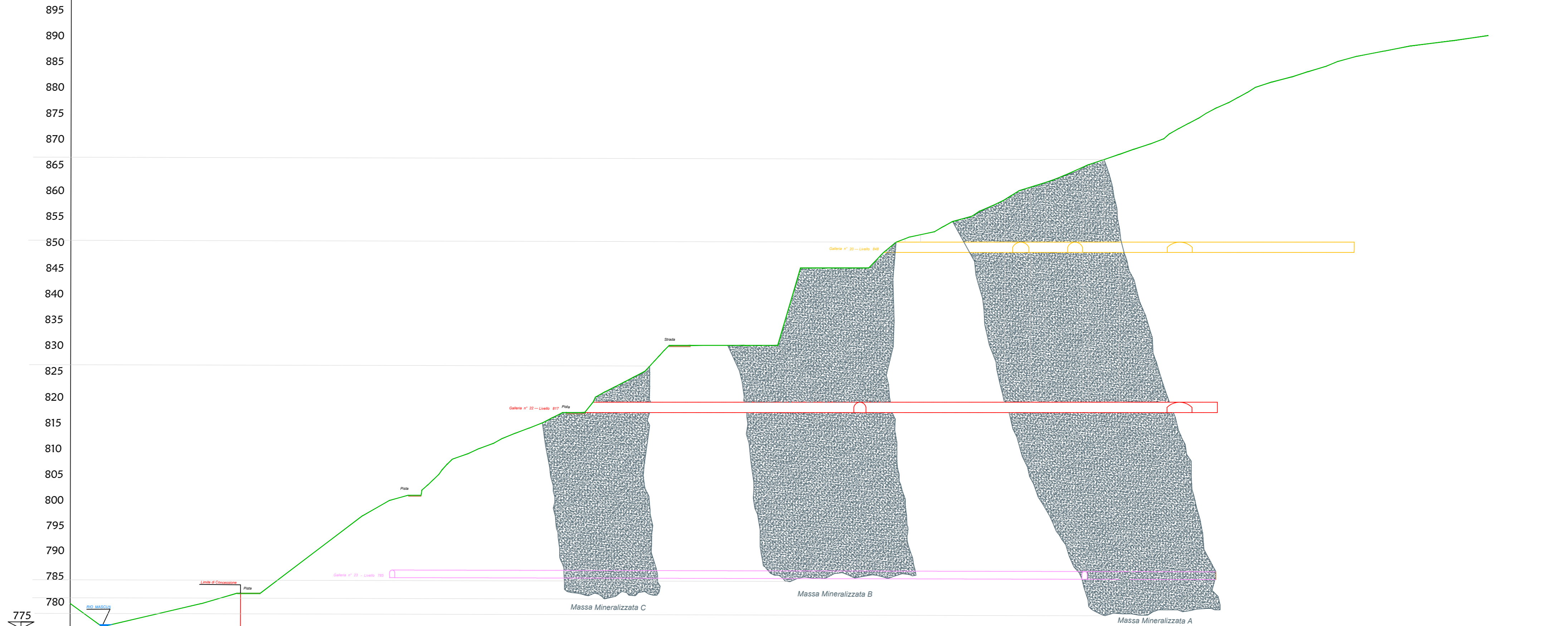

Punti Battuti	0	1	2	3	4	5	6	7	9	11	12	13	14	15	17	18	19	20	21	22	23	24	25	27	28	30	31	32	33	34	35	36						
Quote	775.50	780.00	782.00	782.00	785.00	790.00	795.00	800.00	801.00	801.00	805.00	810.00	815.00	817.00	817.00	820.00	825.00	830.00	830.00	830.00	845.00	845.00	850.00	855.00	860.00	865.00	870.00	875.00	880.00	885.00	886.00	887.00	888.00	889.00	890.00			
Distanze Parziali		19.24	6.92	4.43	4.05	6.53	6.58	7.89	3.62	2.46	3.37	2.67	5.10	12.29	4.67	3.51	2.08	9.57	4.69	4.11	10.43	6.44	4.41	13.19	5.28	14.64	9.22	13.35	14.54	8.30	9.49	15.93	3.69	5.23	5.19	8.02	6.93	
Distanze Progressive	0.00	19.24	26.16	30.59	34.64	41.17	47.75	55.64	59.26	61.72	65.09	67.76	72.86	85.15	89.82	93.33	95.41	104.98	109.67	113.78	124.21	130.65	135.06	148.25	161.44	176.08	185.30	199.84	208.14	217.63	223.07	226.76	232.00	237.23	242.46	247.65	255.67	262.60

Planimetrie livelli Mineralizzati Perdàbila

Livello 848.07

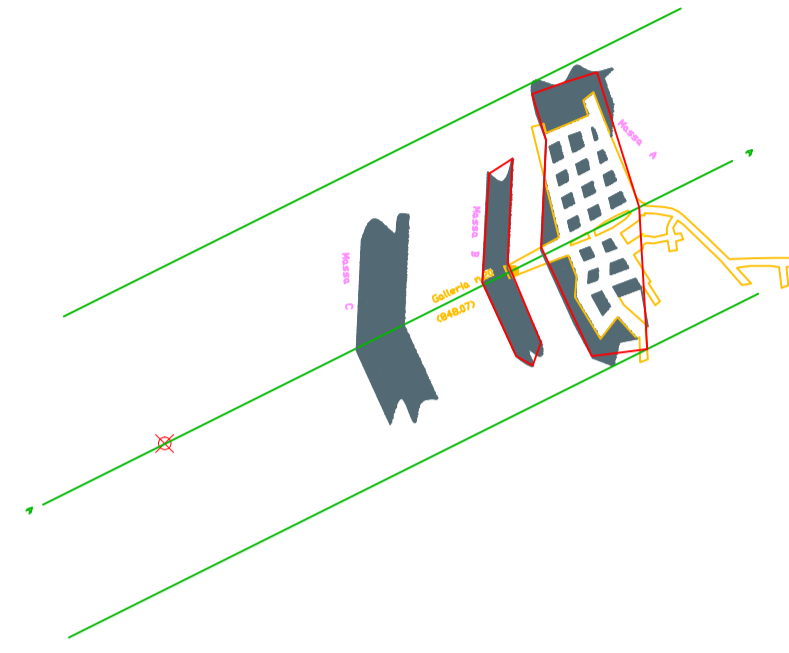

Livello 830.00

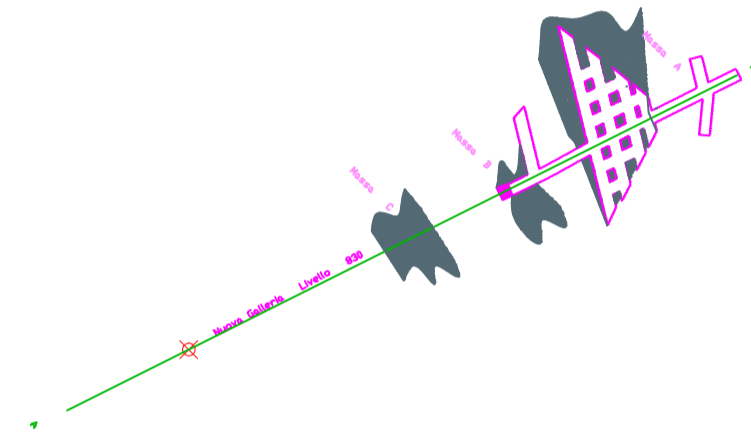

Livello 817.00

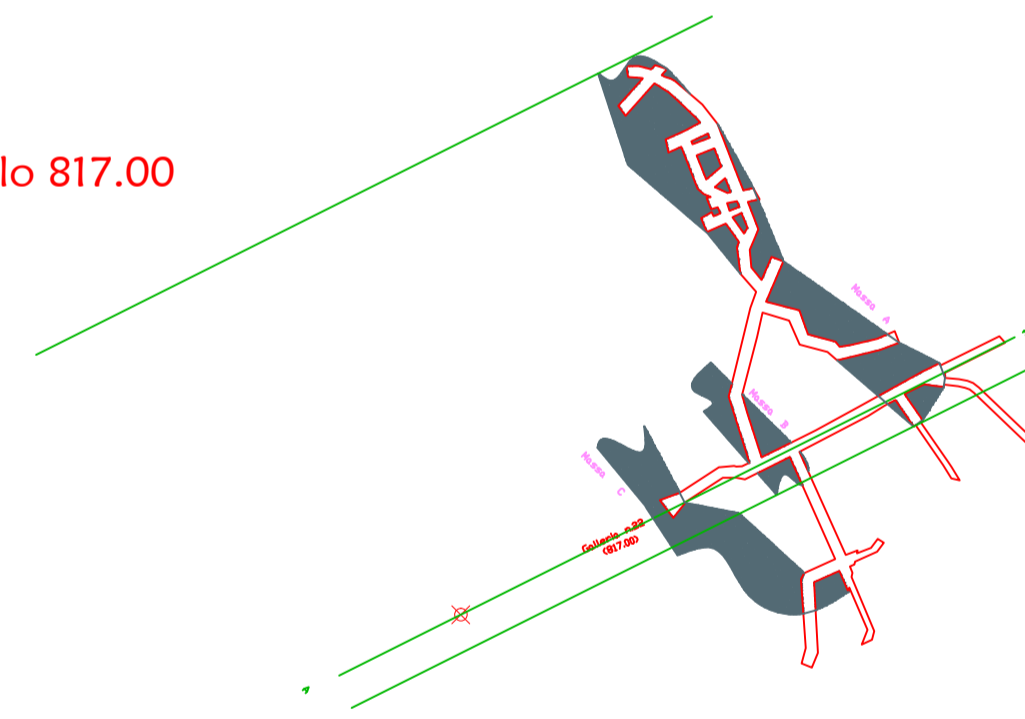

Livello 785.44

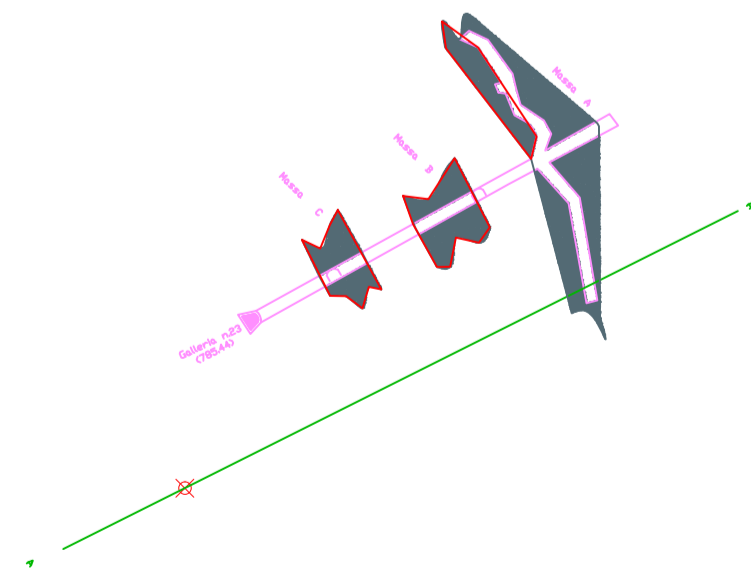

Sezioni STATO ATTUALE

Ottenimento Masse Mineralizzate da Materiale Esplorativo e Disegni d'Epoca

PERDABILA

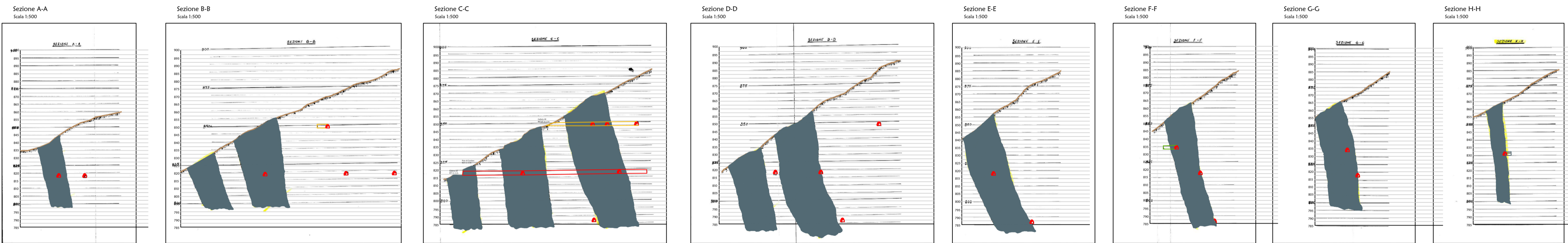
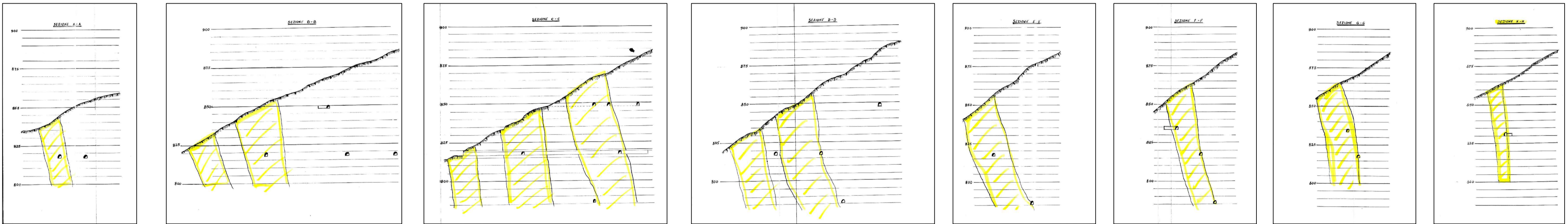

Stato ATTUALE

Sezione B - B
MAMOINI

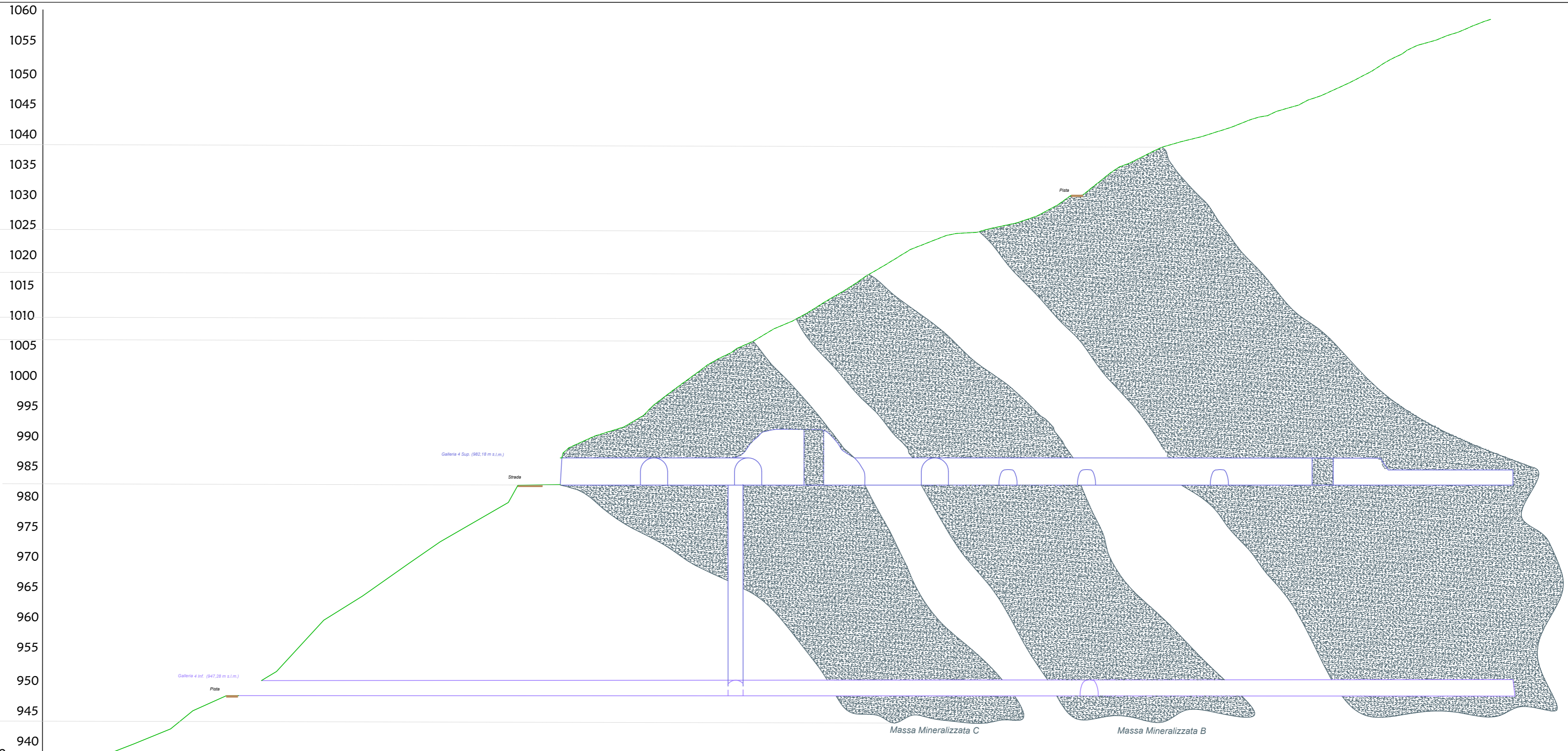

Scala Lunghezze 1:500
Scala Altezze 1:500

934.50

Punti Battuti	1	2	3 4 5	6		7	8 9 10	11		12
Quote	936.00	943.50	947.00 947.28 949.78	959.50		982.00	982.10 986.50	1023.50	1030.10	1059.30
Distanze Parziali		12.50	9.25 4.40 11.89		32.16	6.98	65.57		88.44	
Distanze Progressive	0	12.50	21.75 33.00	38.04		70.02	77.18	142.75		231.19

Planimetrie livelli Mineralizzati Mamoià

Livello 998.00

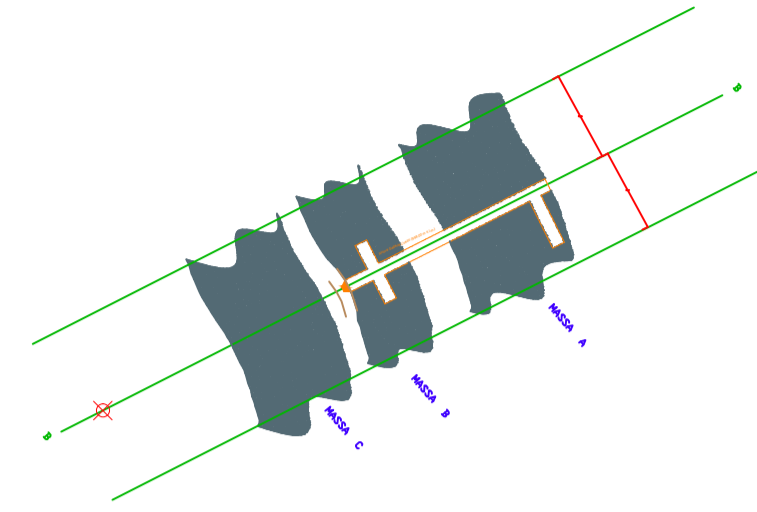

Livello 982.00

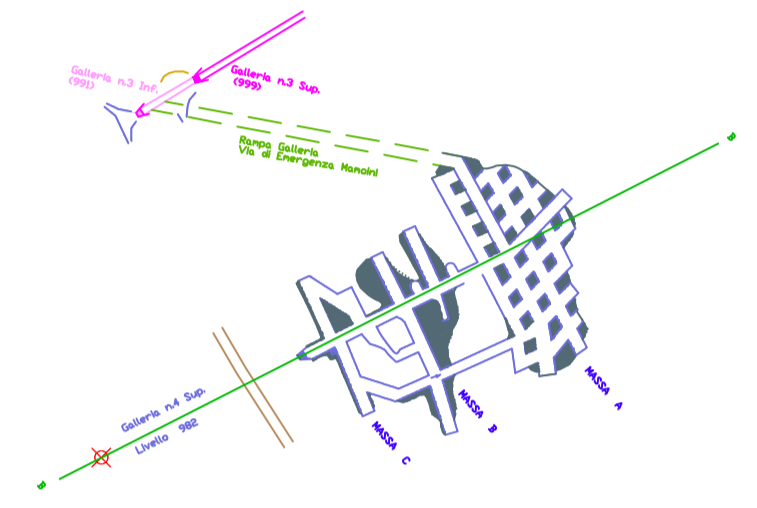

Livello 947.28

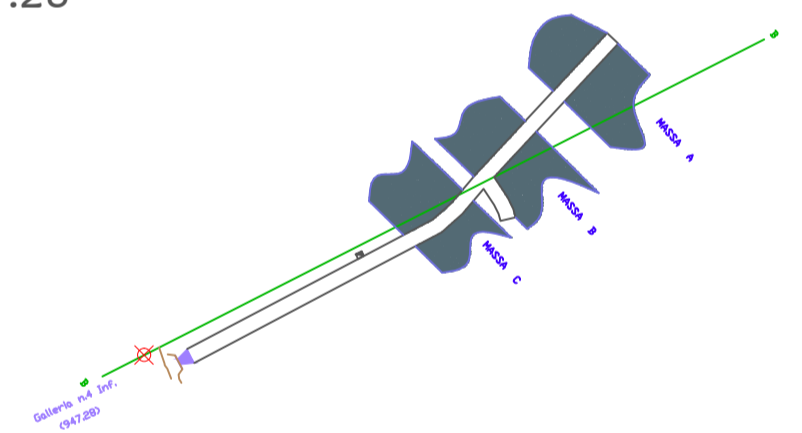

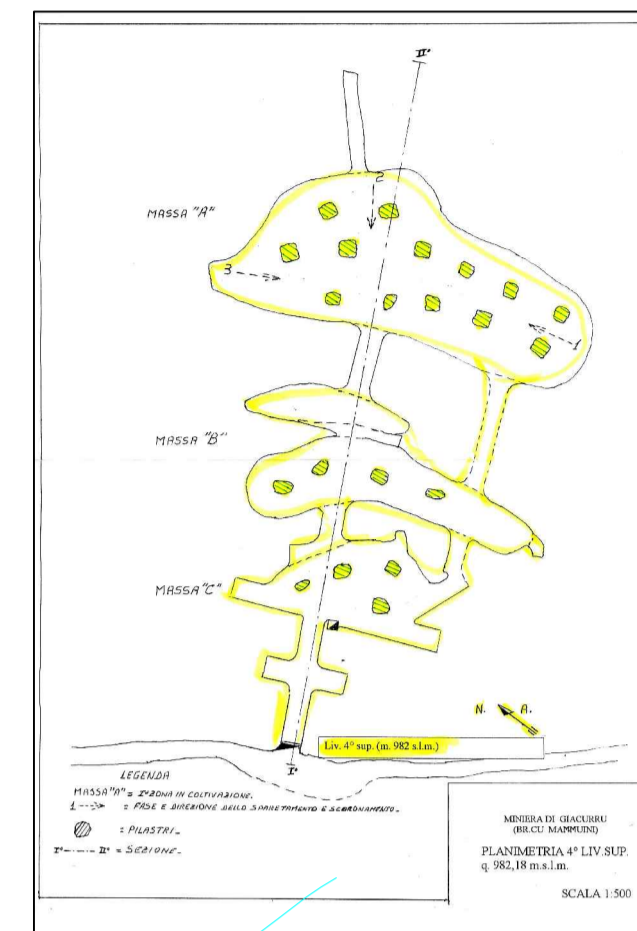
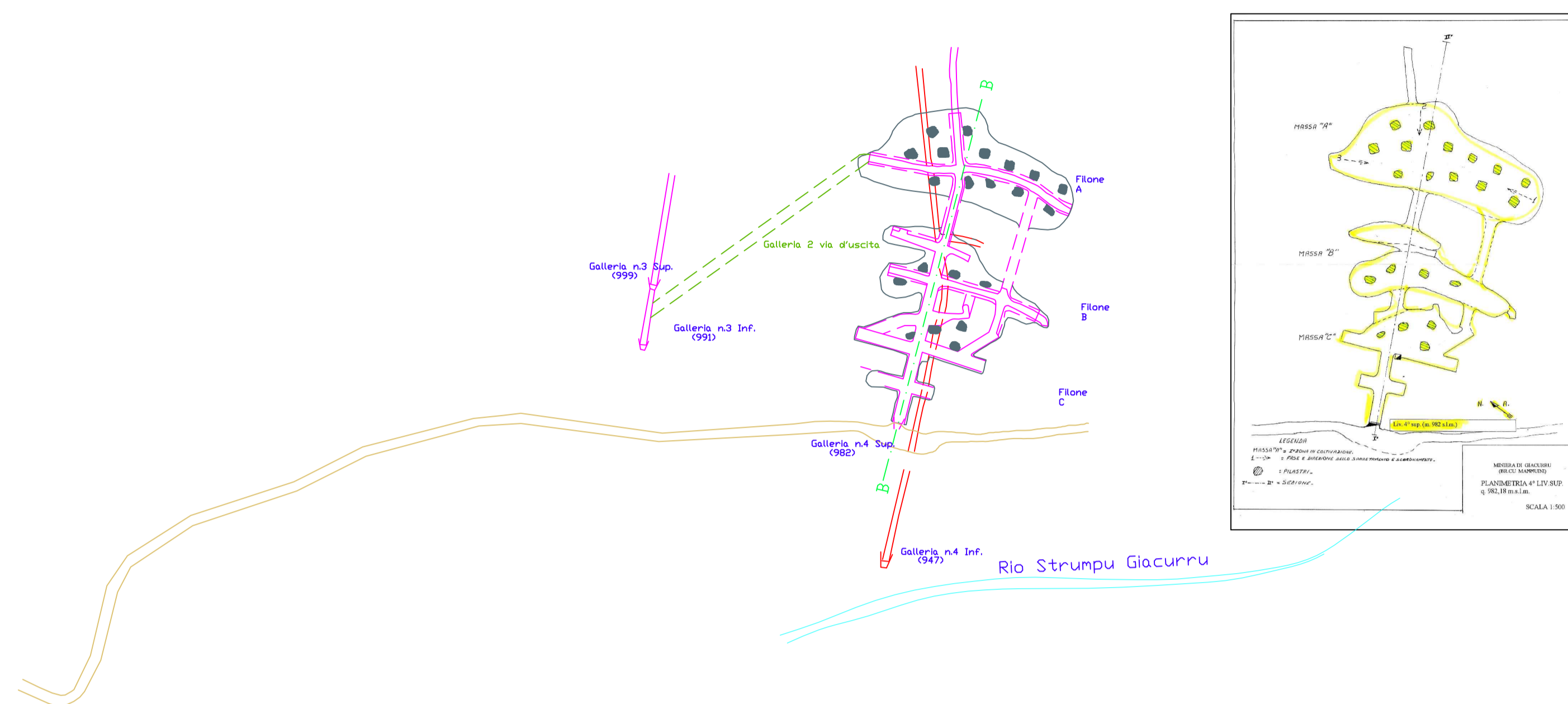

Vecchia Sezione
MAMOINI

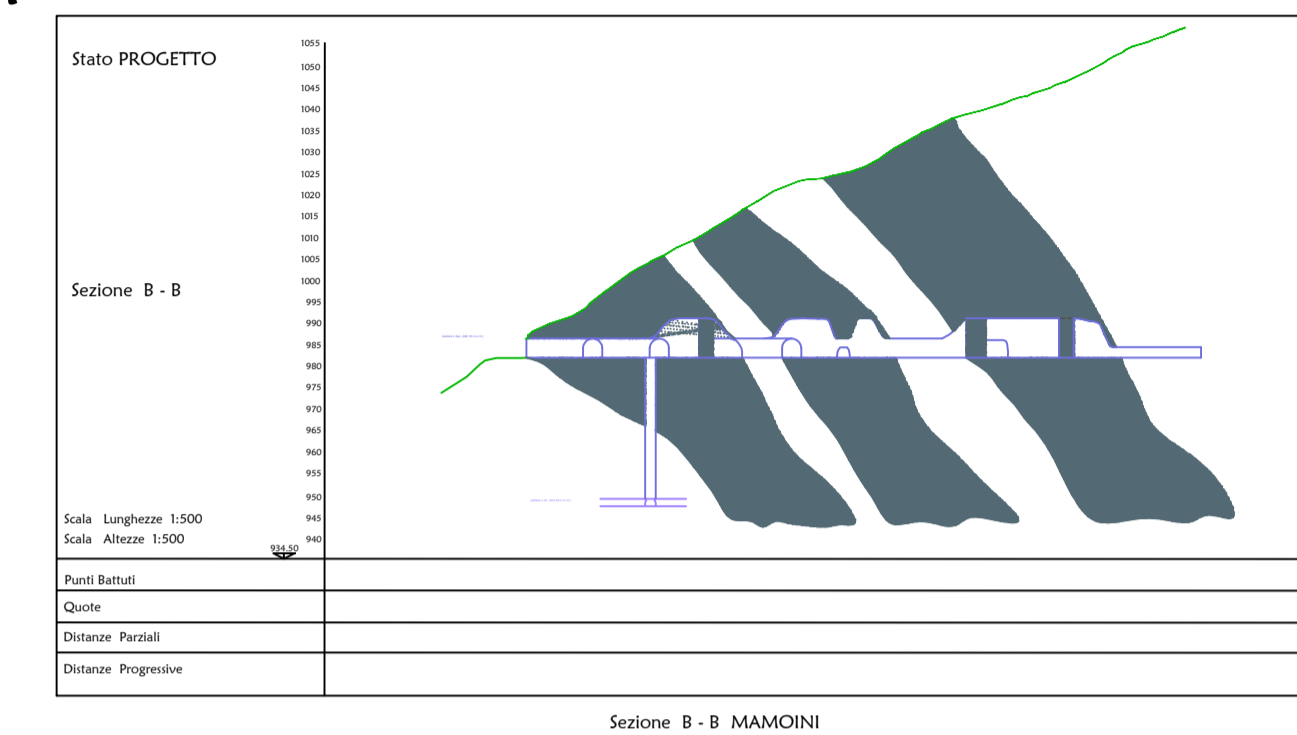

Sezioni STATO ATTUALE

Ottenimento Masse
Mineralizzate da Materiale
Esplorativo e Disegni d'Epoca

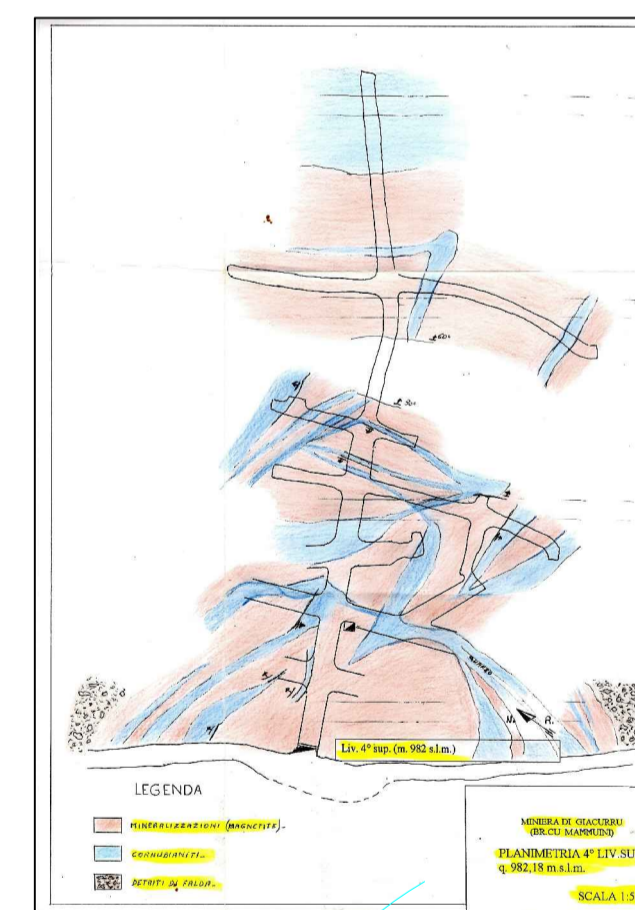
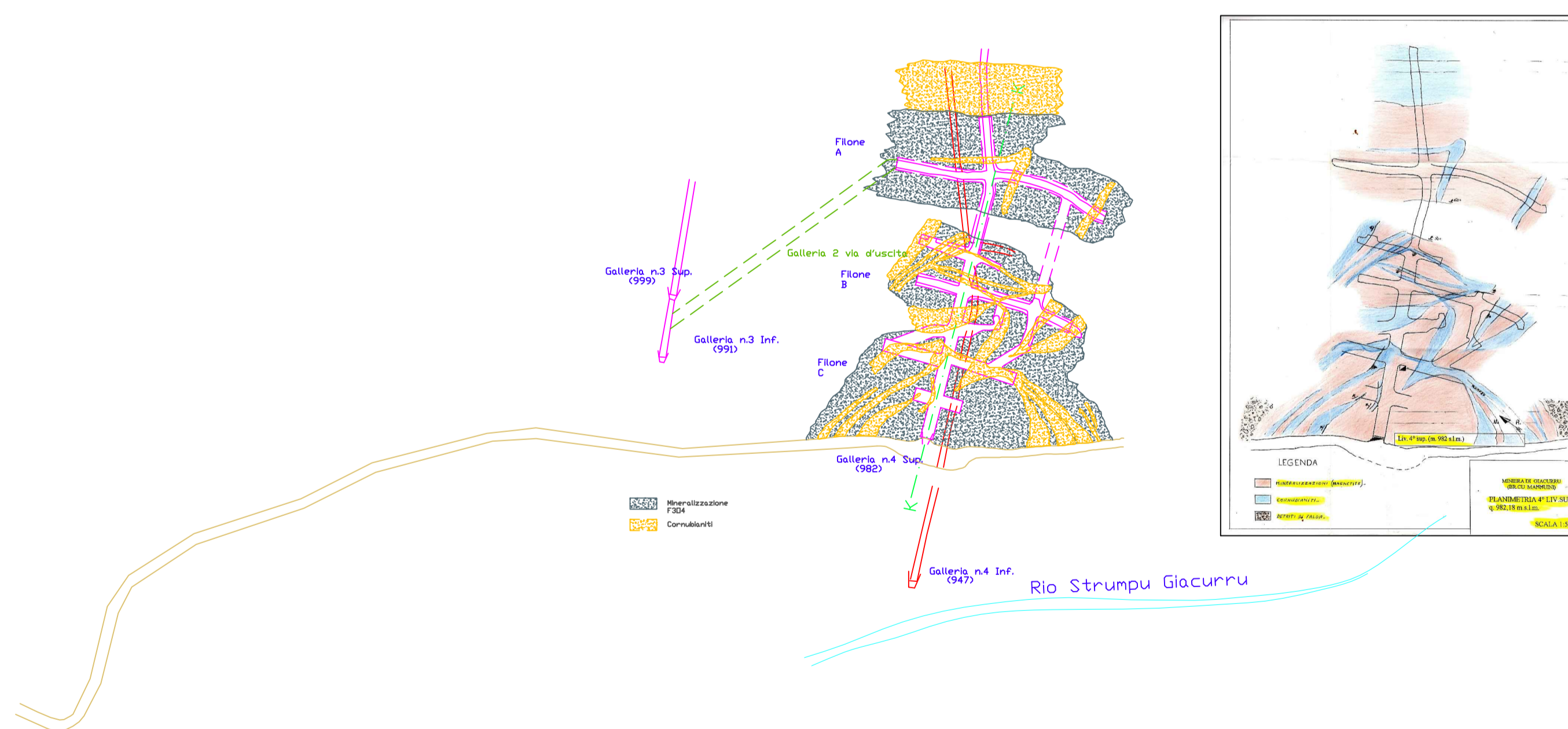

Fori Sonda zona W Mamoini

Fori 2 - 3 - 4 - 5 - 7 - 8 - 9

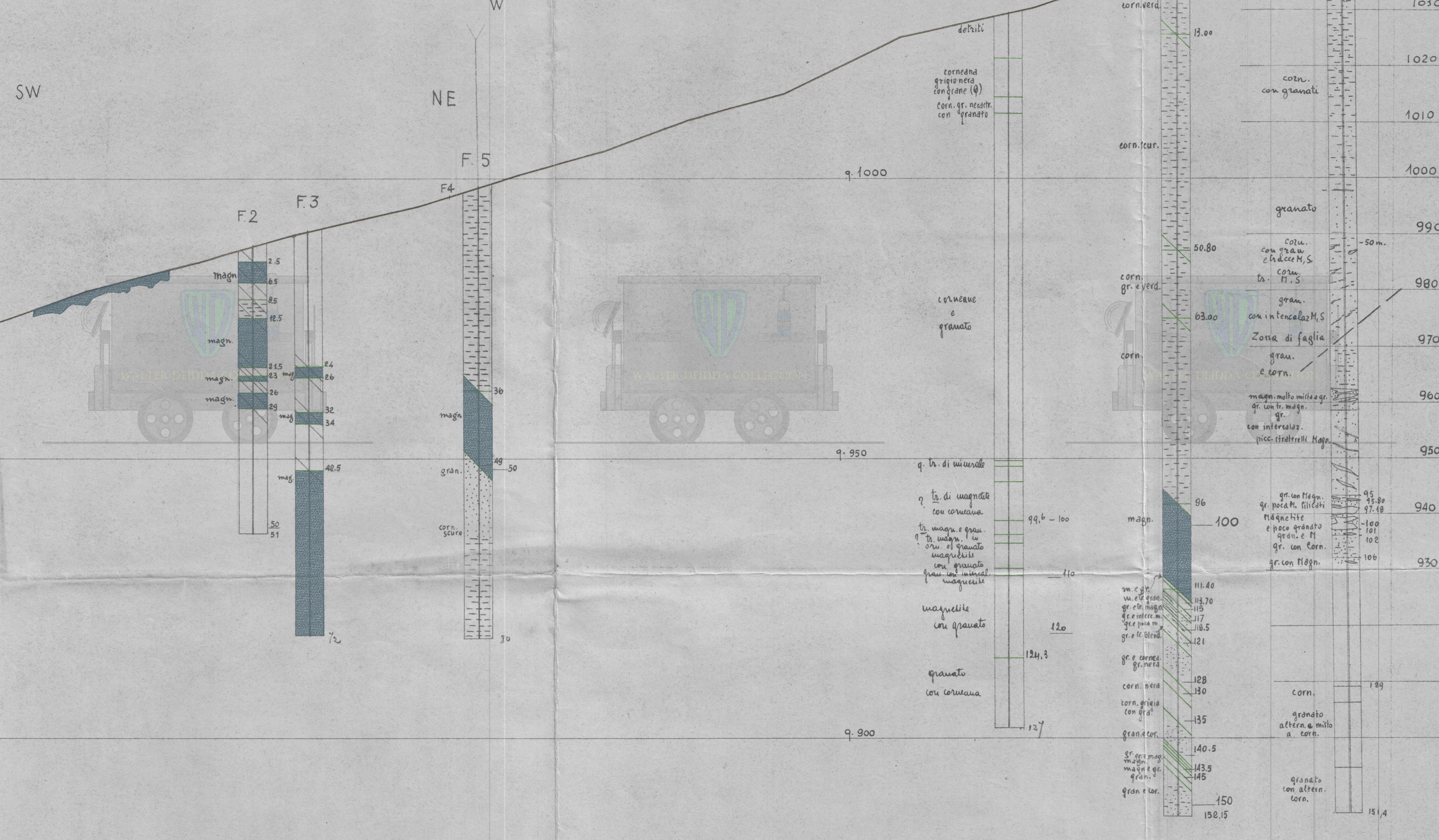

Planimetrie livelli Mineralizzati Perdàbila Alta

Livello 950.00



Livello 928.00

