

RIP. 2,82  
SCA. 0,01

PROGR. 24,000  
PARZ. 0,000

SEZ.NUM. 4-1  
PARZ. 0,000

PROGR. 11,50  
SCA. 0,00

SEZ.NUM. 4-4  
PARZ. 25,000

PROGR. 100,000  
PARZ. 25,000

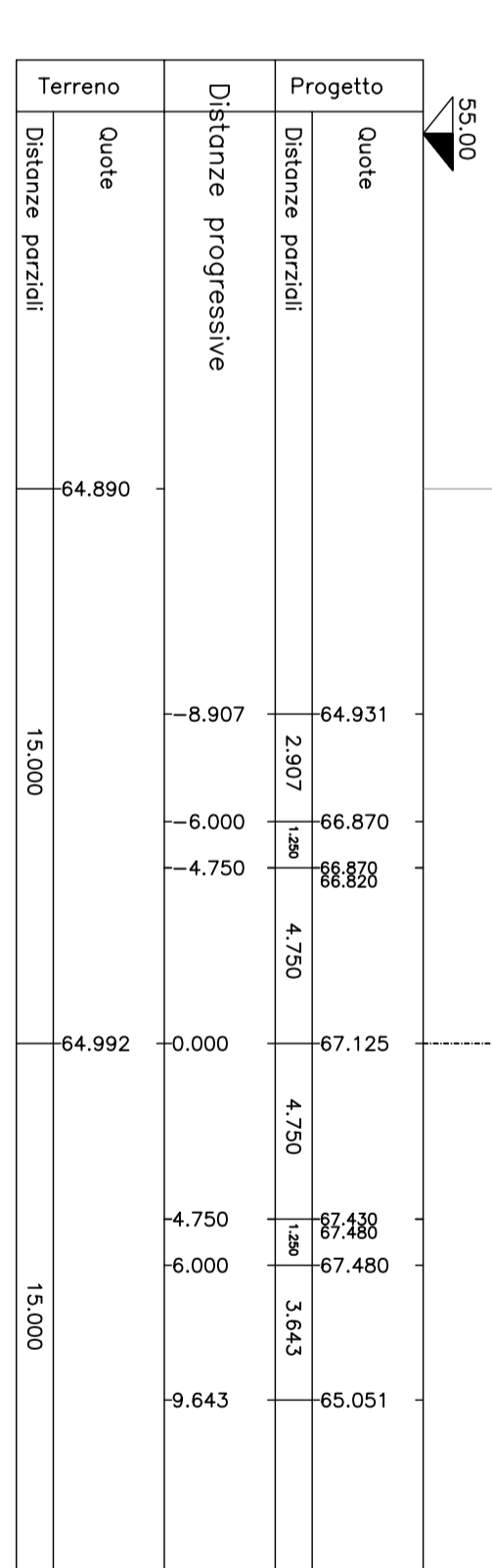
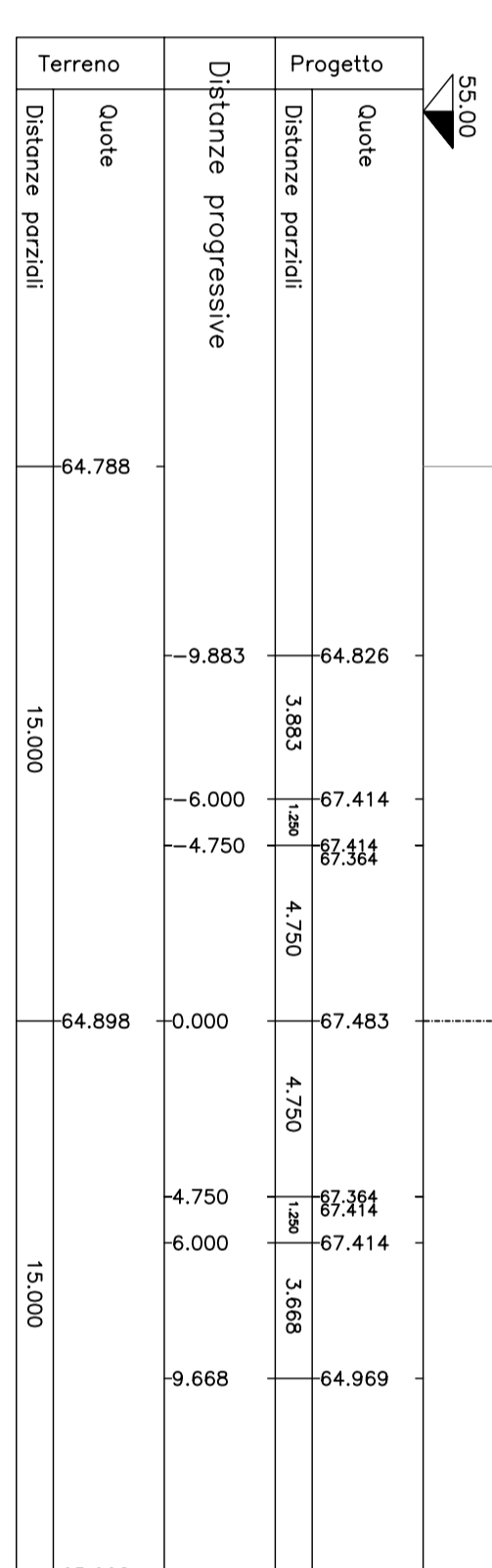
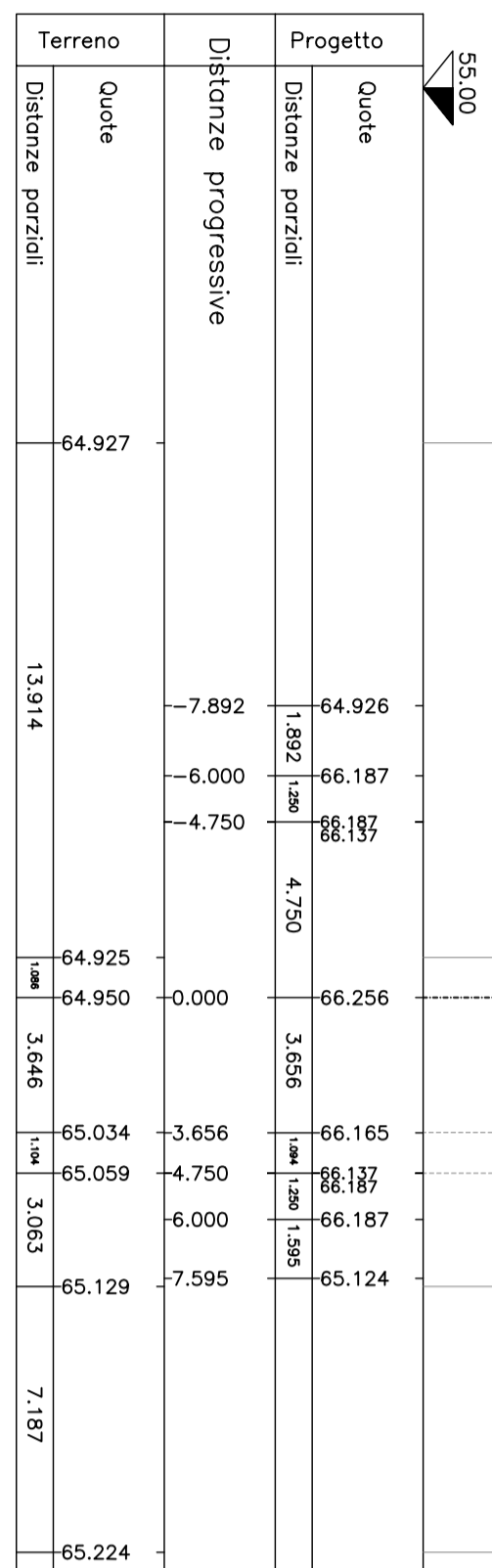
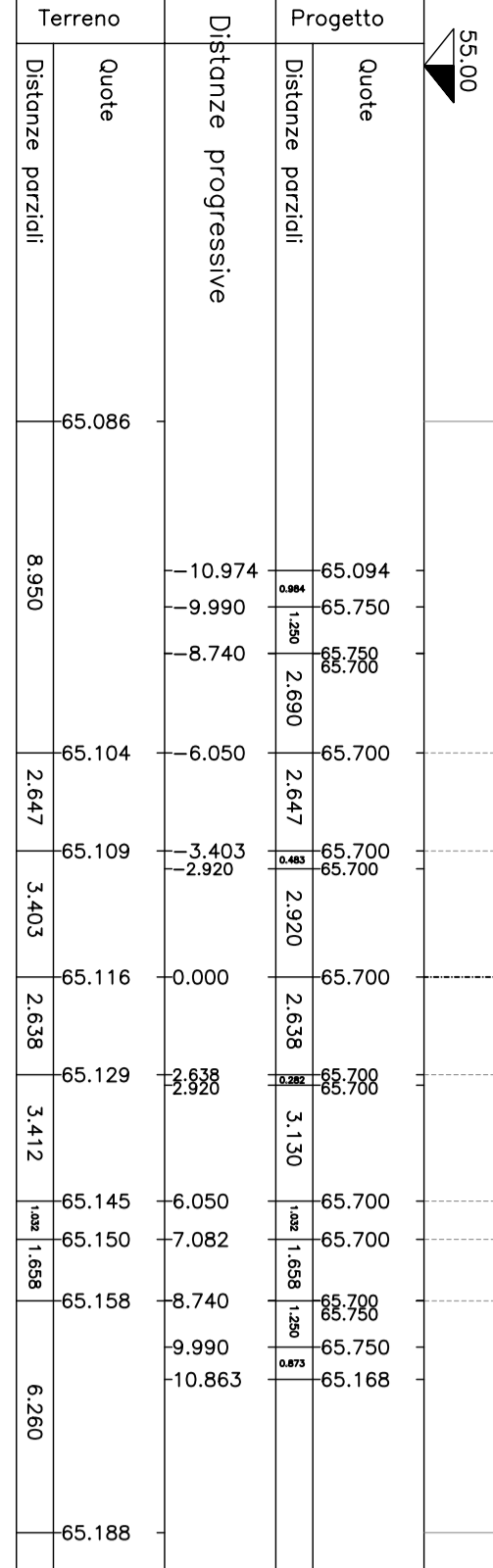
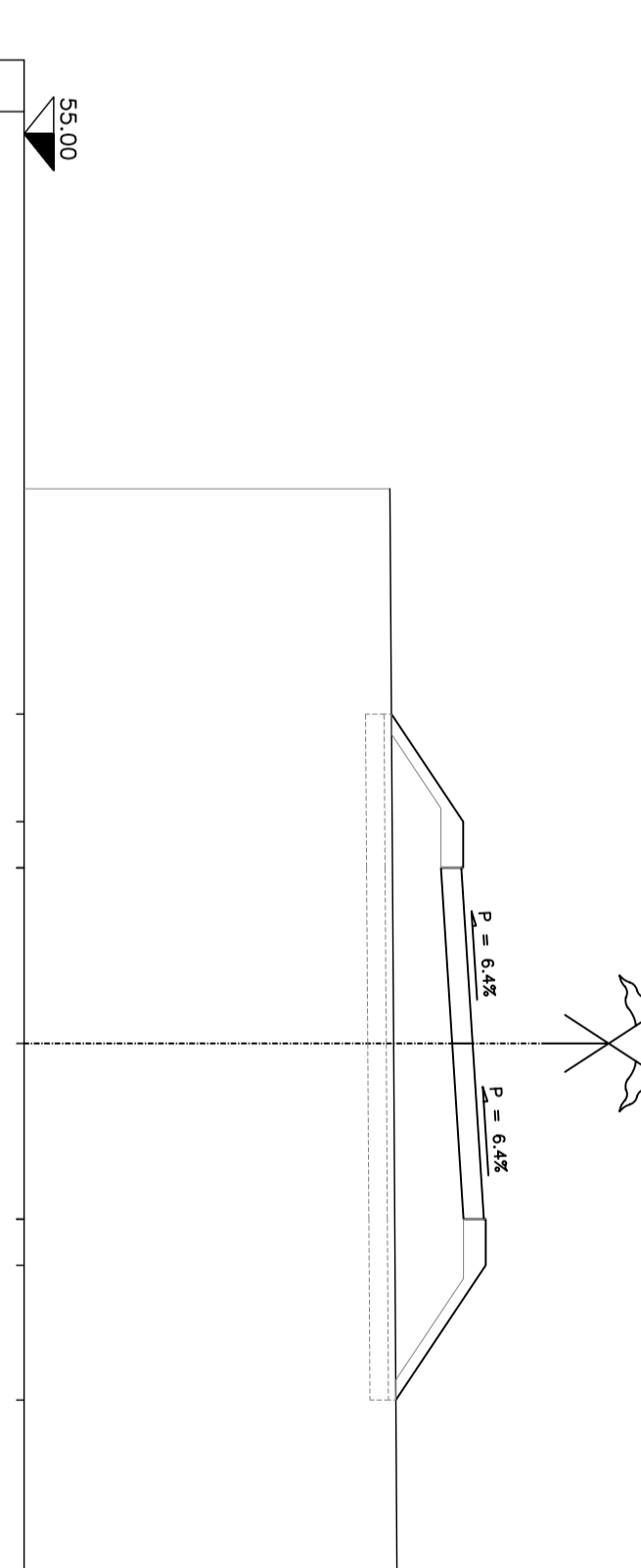
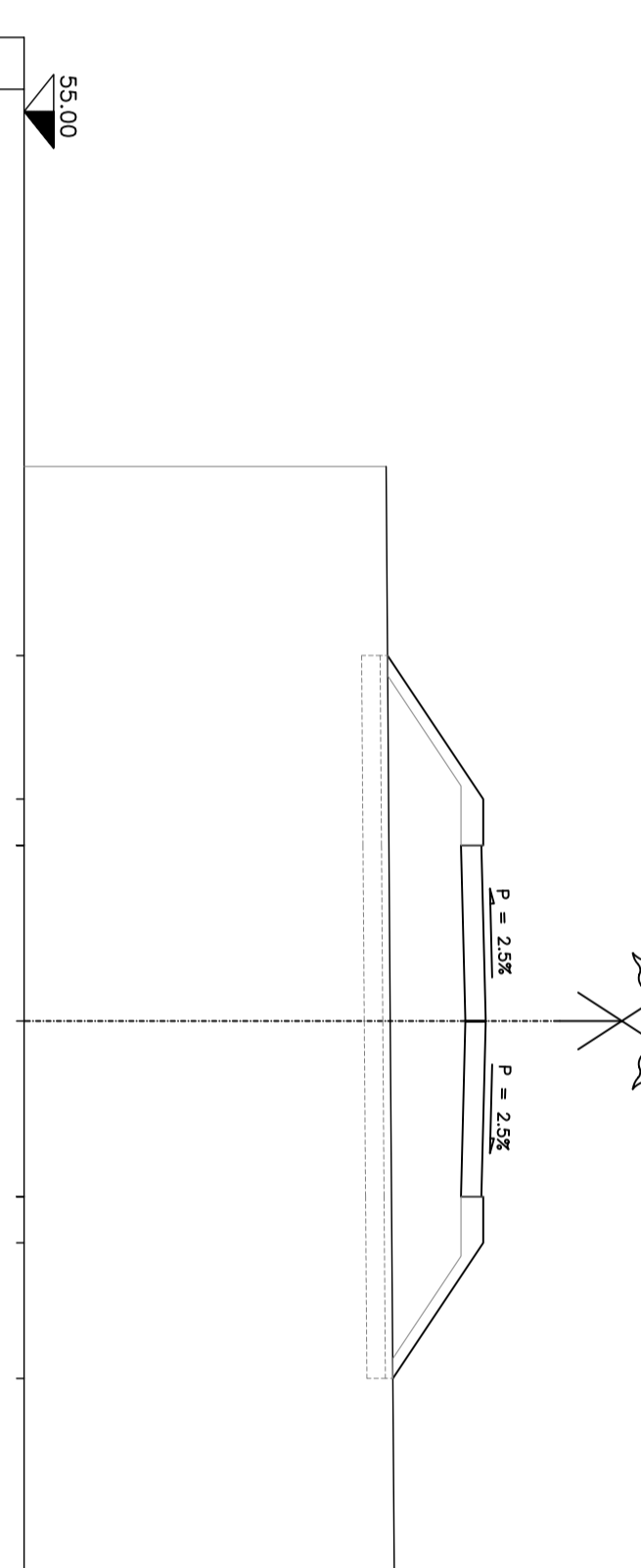
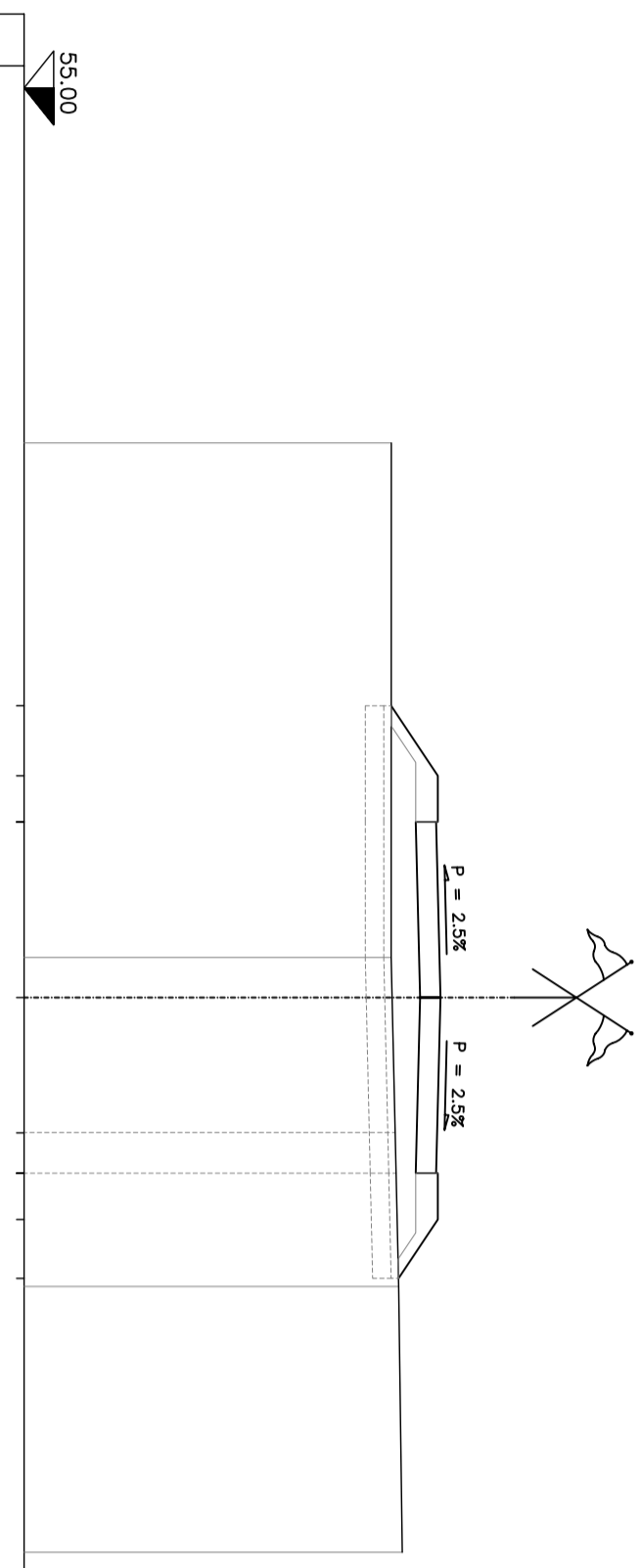
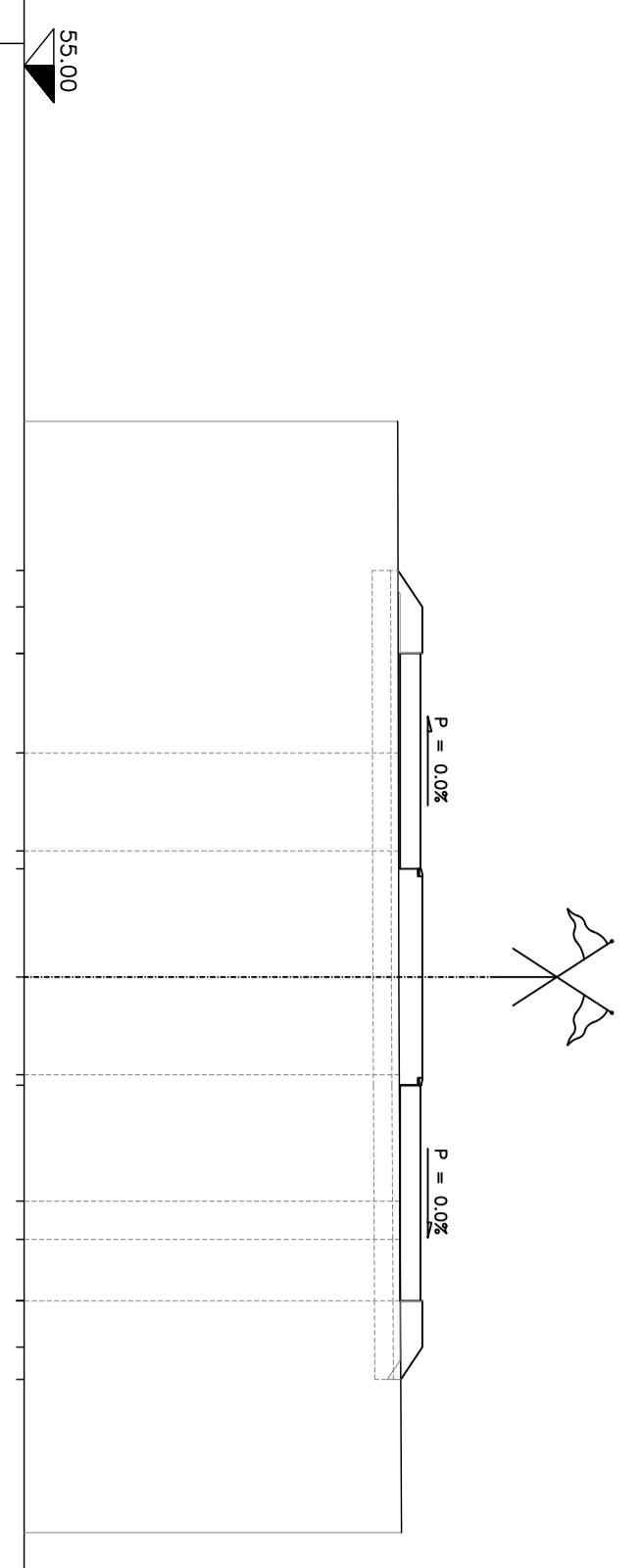

RIP. 1,96  
SCA. 0,14

PROGR. 31,220  
PARZ. 7,220

RIP. 19,74  
SCA. 0,00

PROGR. 125,000  
PARZ. 25,000

RIP. 36,97  
SCA. 0,00

PROGR. 225,000  
PARZ. 12,942

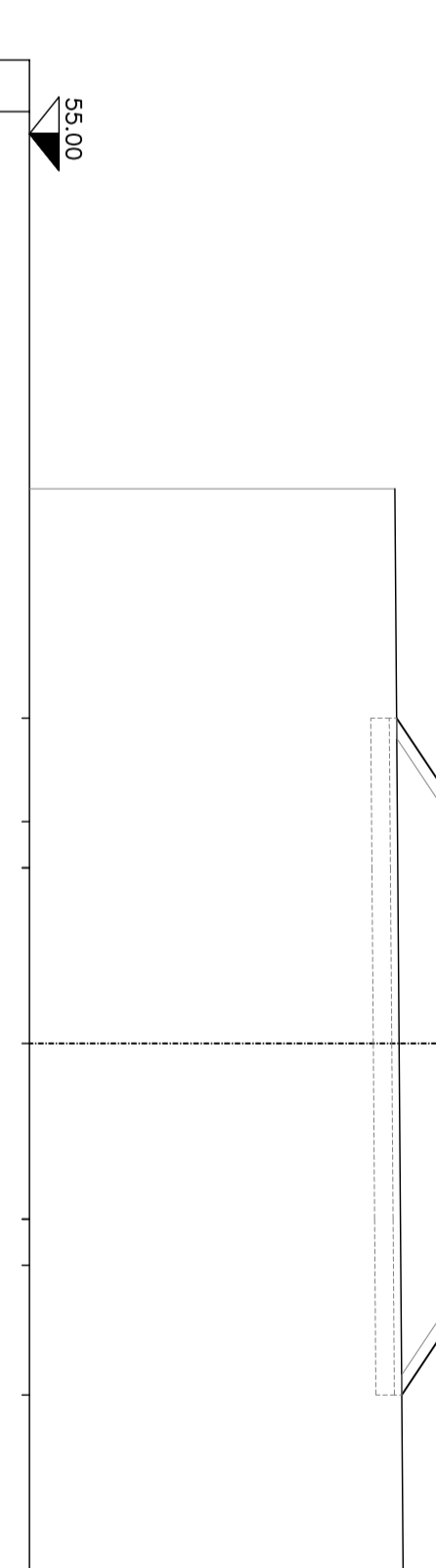
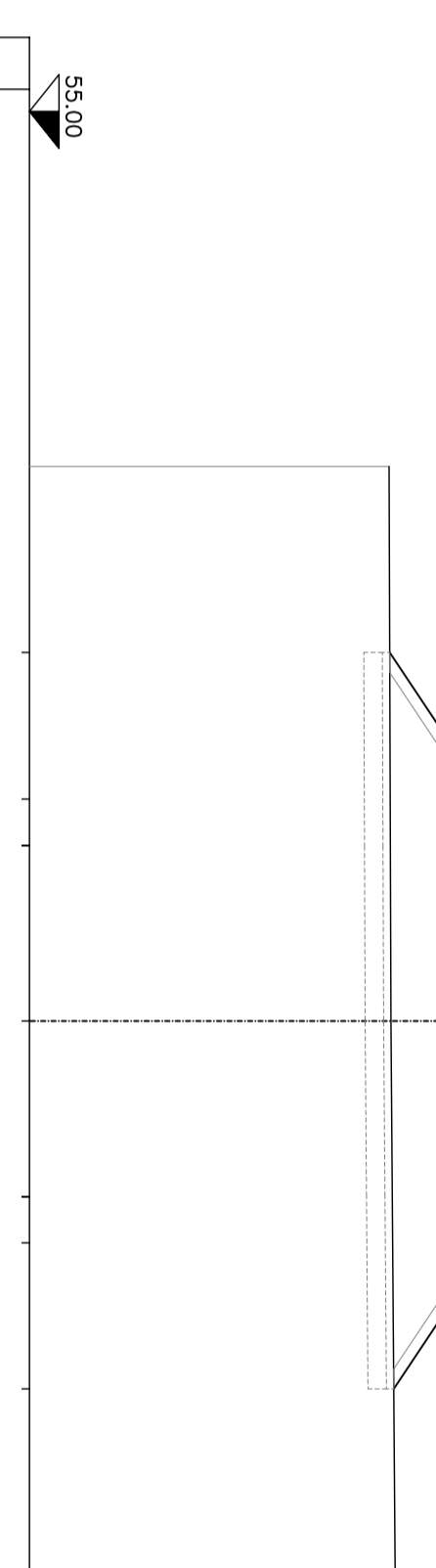
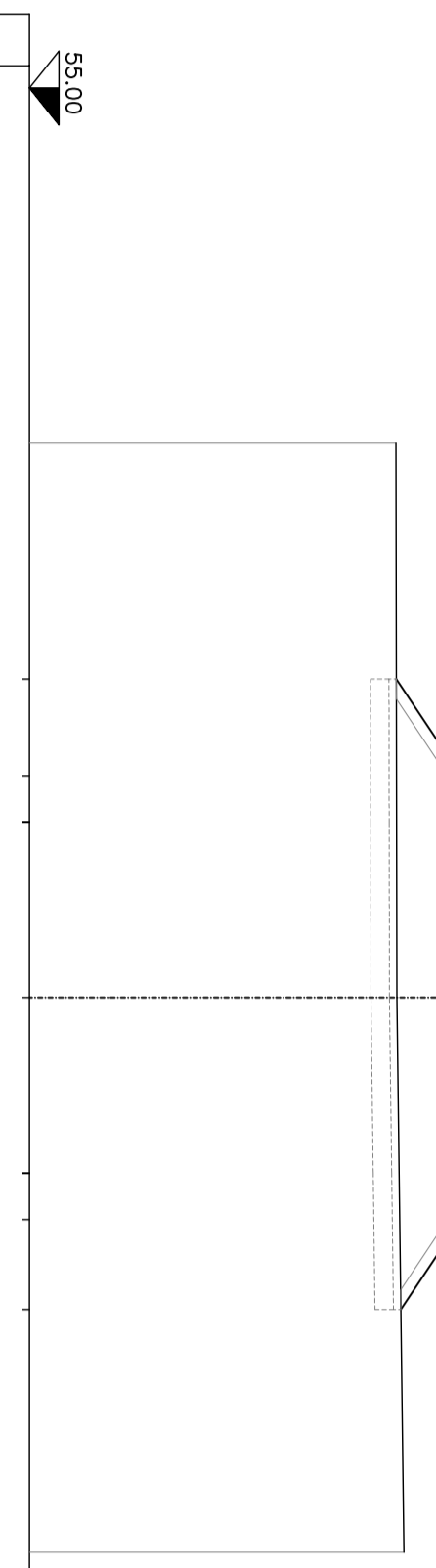
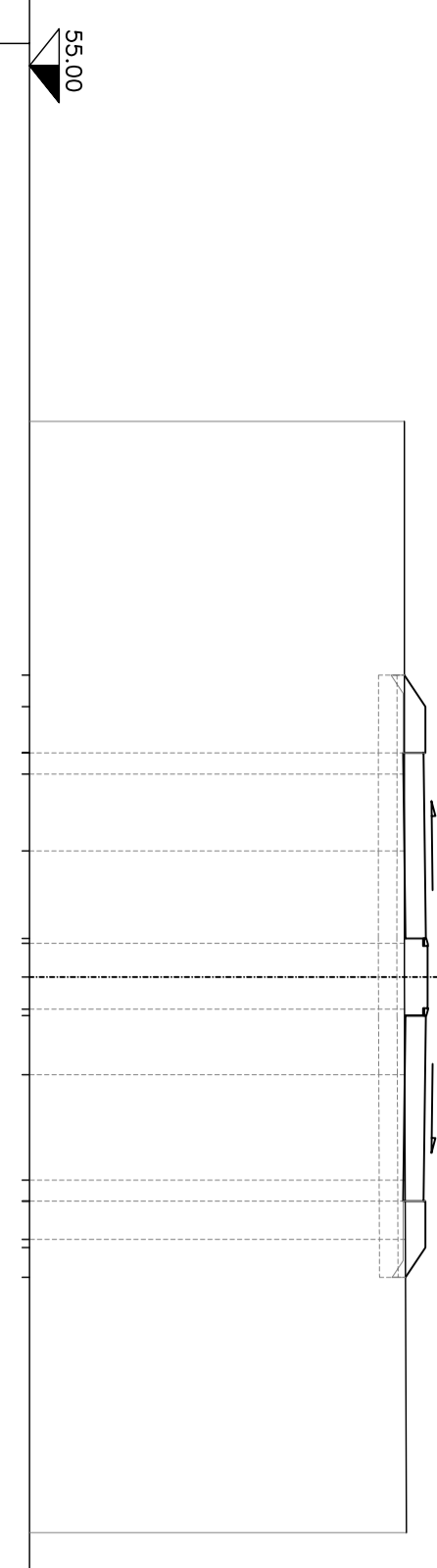
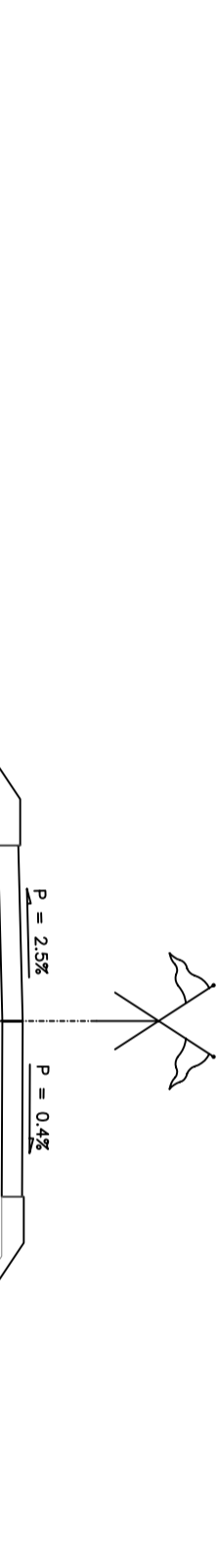

RIP. 1,57  
SCA. 0,54

PROGR. 41,480  
PARZ. 10,280

RIP. 26,14  
SCA. 0,00

PROGR. 150,000  
PARZ. 25,000

RIP. 34,77  
SCA. 0,00

PROGR. 250,000  
PARZ. 25,000

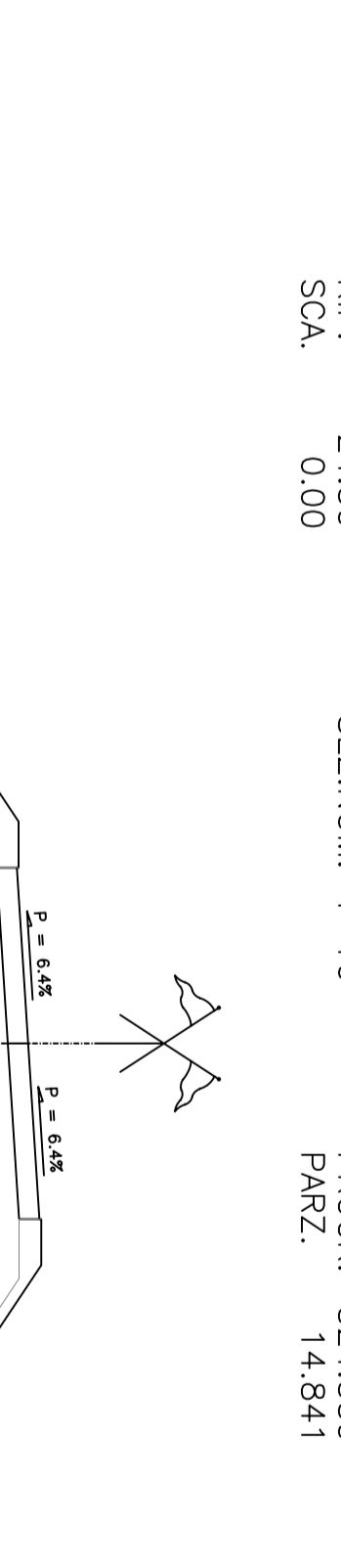
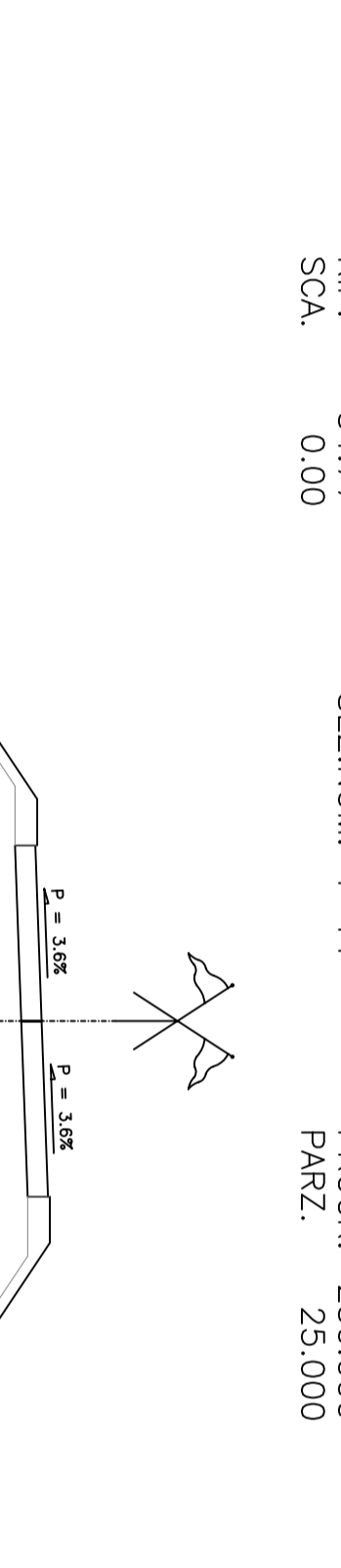
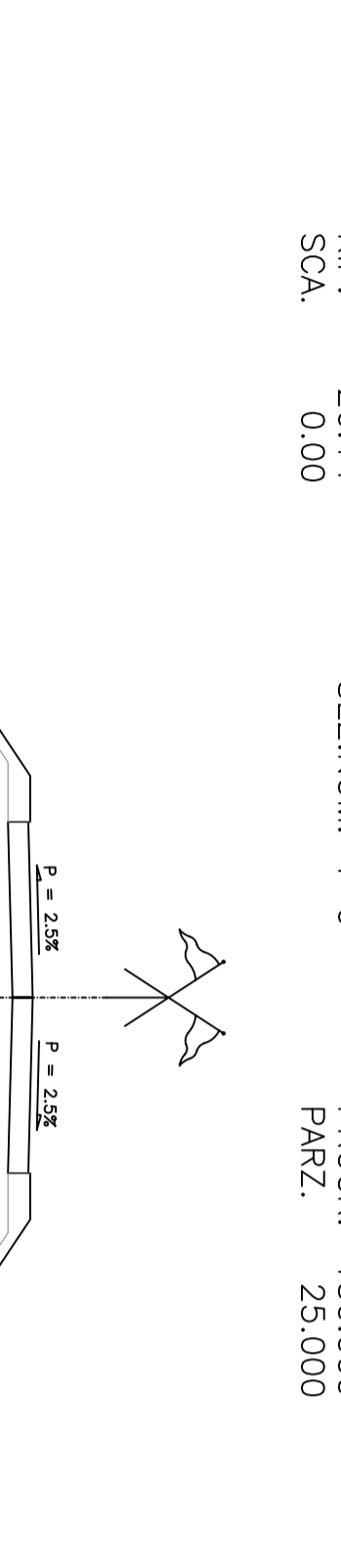
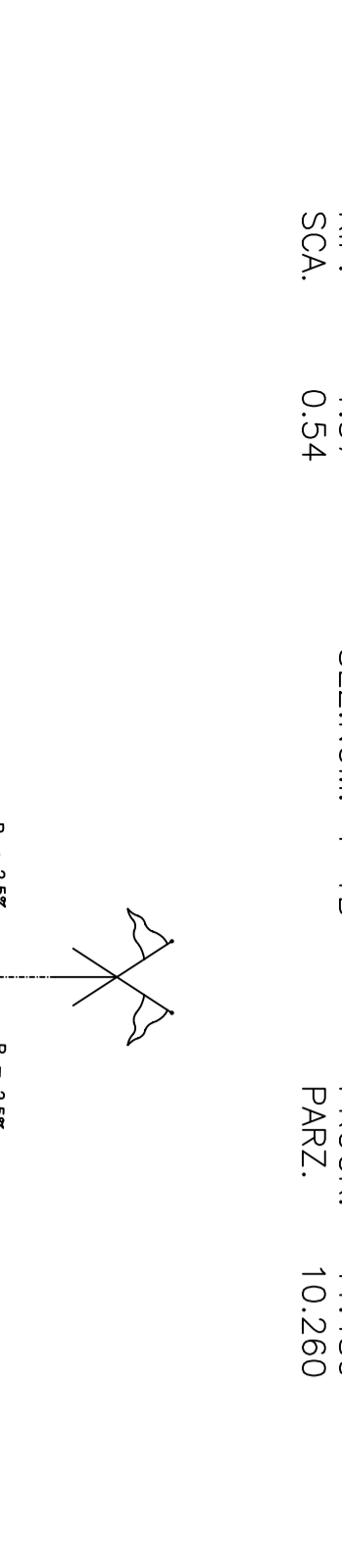

RIP. 3,62  
SCA. 0,53

PROGR. 78,000  
PARZ. 23,000

RIP. 30,33  
SCA. 0,00

PROGR. 291,304  
PARZ. 13,890

RIP. 9,60  
SCA. 0,00

PROGR. 375,000  
PARZ. 23,000

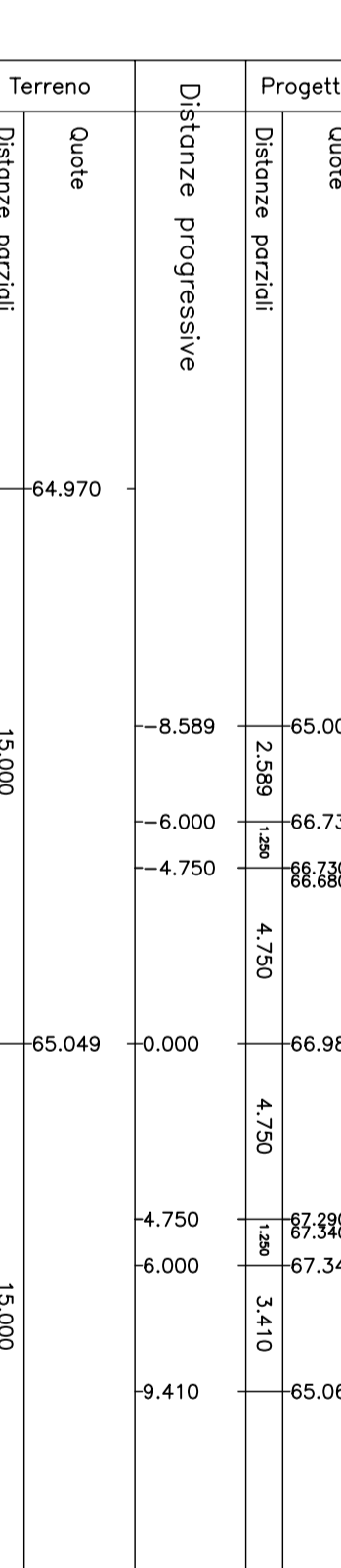
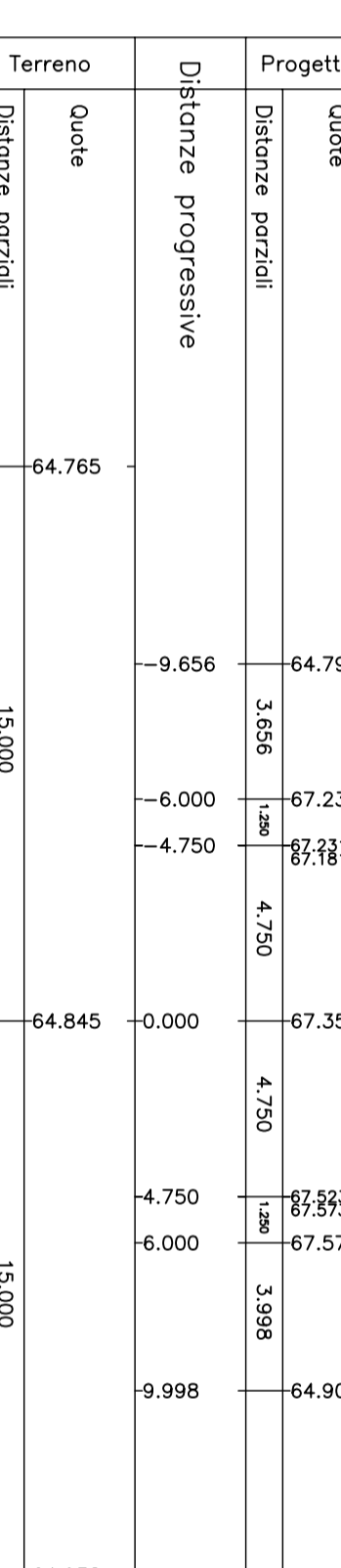
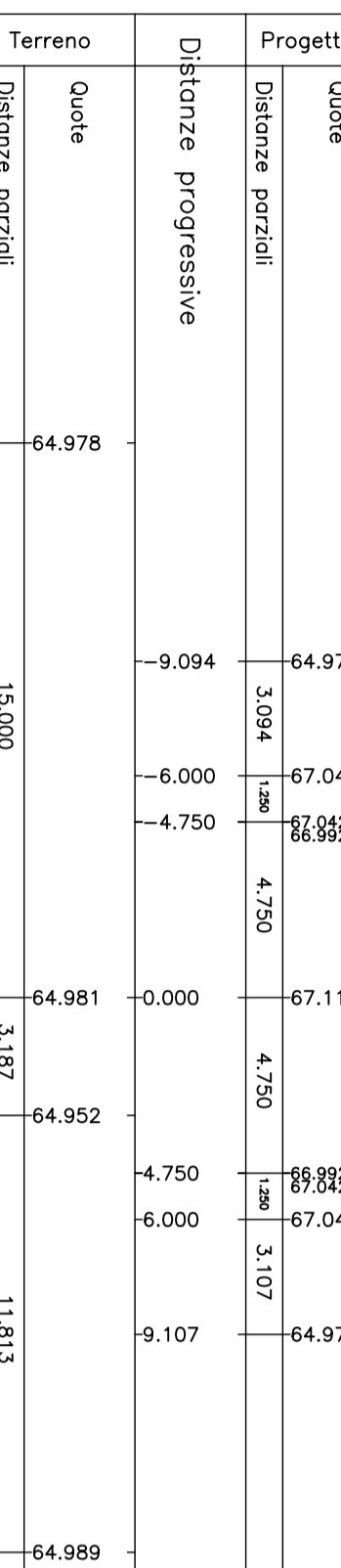
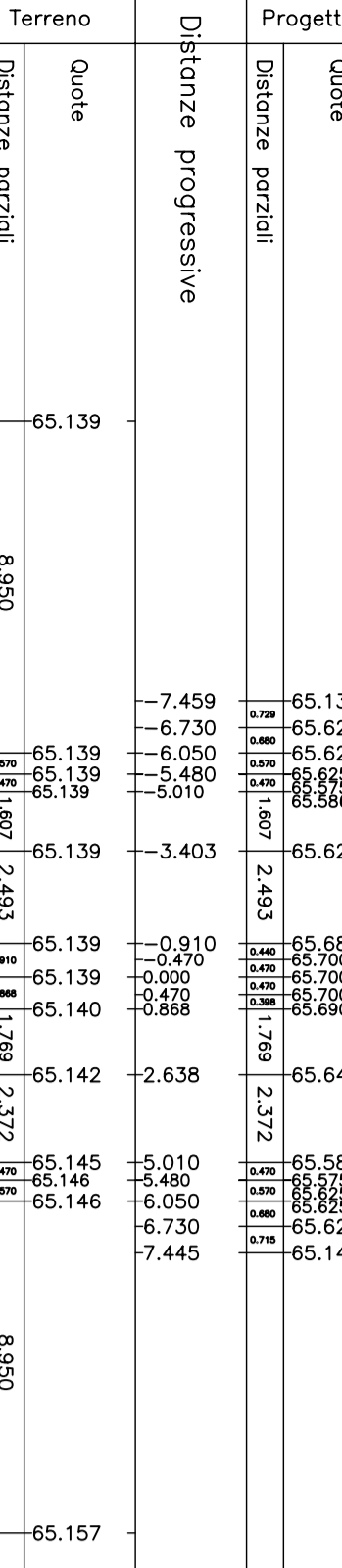

RIP. 1,50  
SCA. 0,55

PROGR. 50,000  
PARZ. 8,520

RIP. 32,30  
SCA. 0,00

PROGR. 267,614  
PARZ. 17,814

RIP. 23,23  
SCA. 0,00

PROGR. 350,000  
PARZ. 23,481



RIP. 3,62  
SCA. 0,53

PROGR. 78,000  
PARZ. 23,000

RIP. 30,33  
SCA. 0,00

PROGR. 291,304  
PARZ. 13,890

RIP. 9,60  
SCA. 0,00

PROGR. 375,000  
PARZ. 23,000

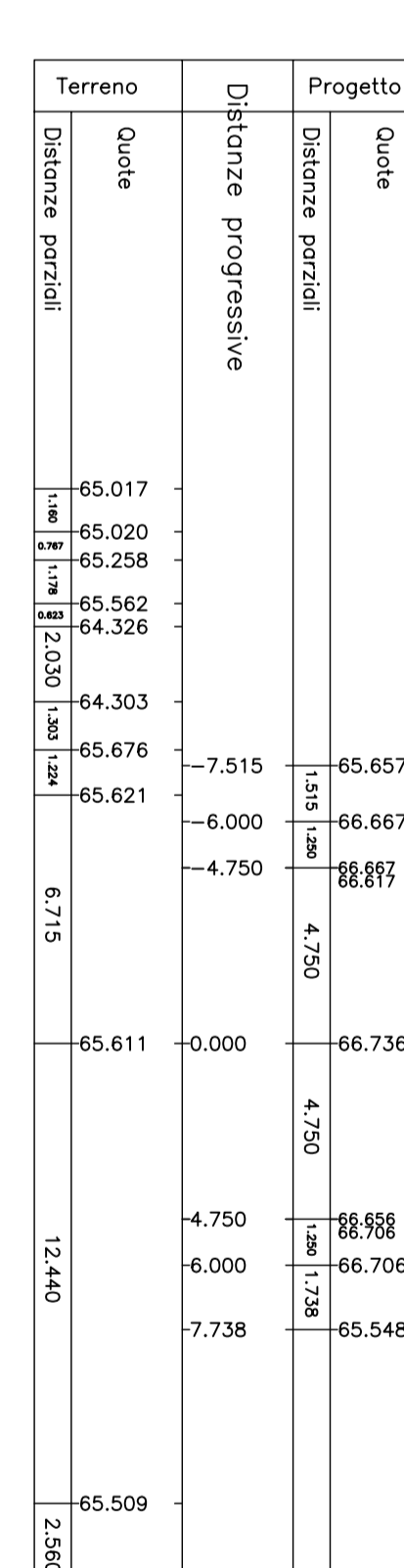
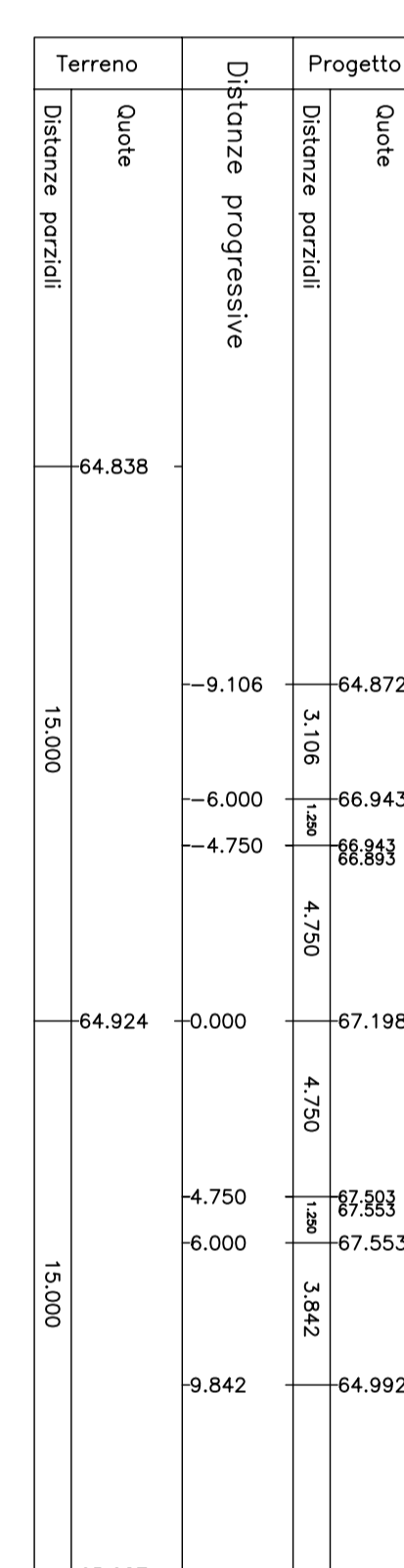
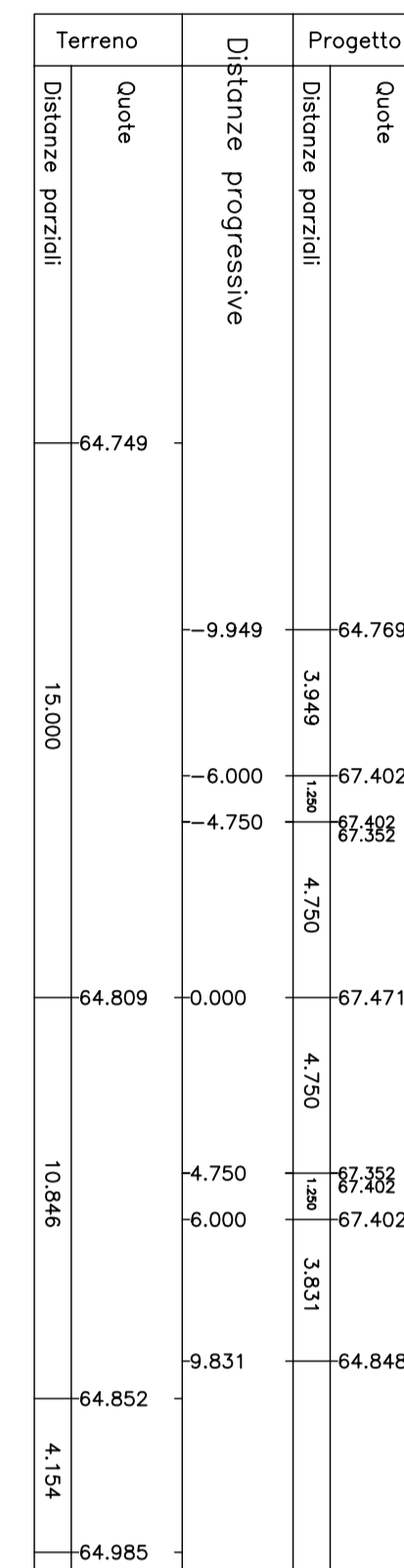
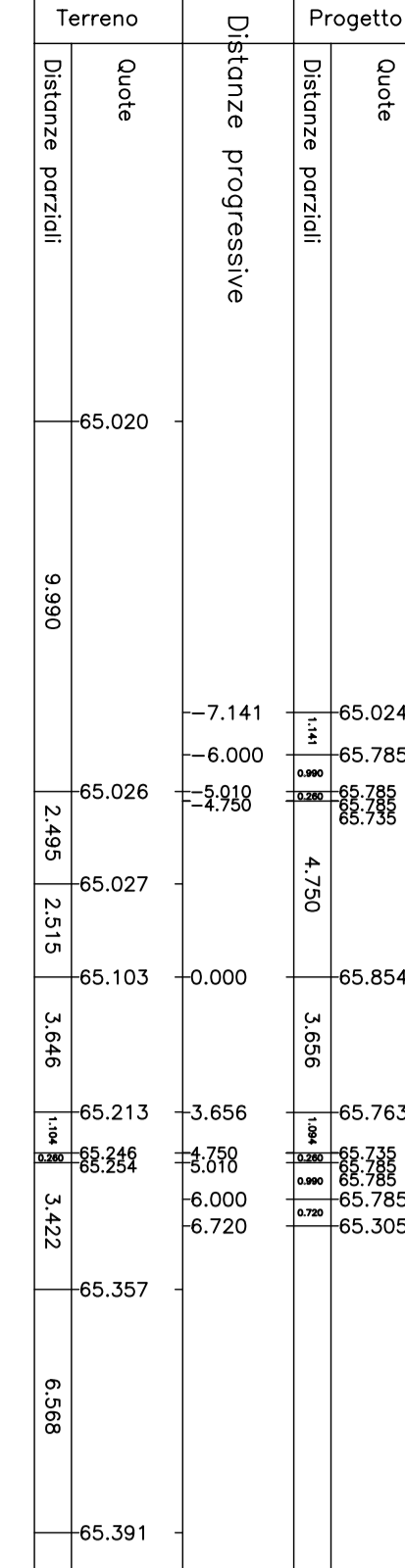
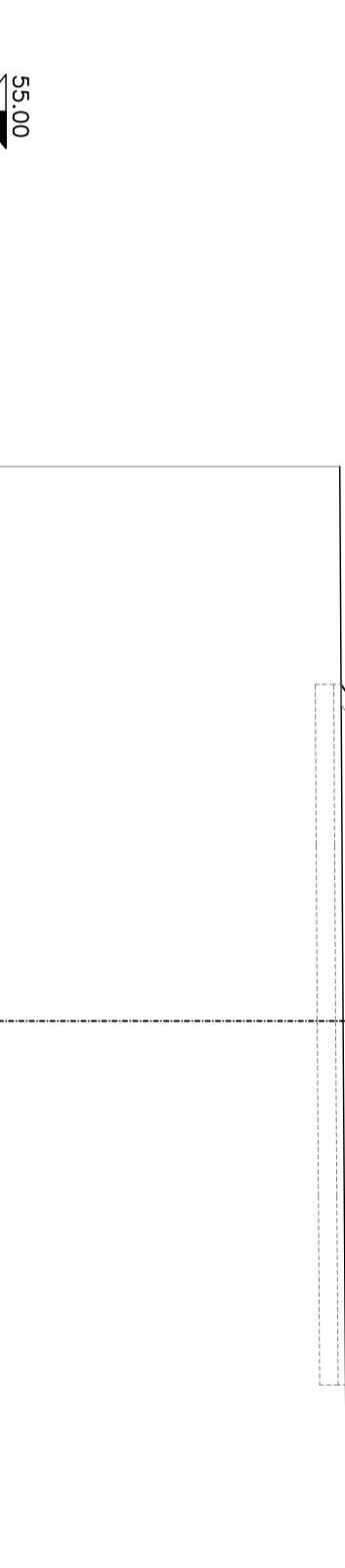
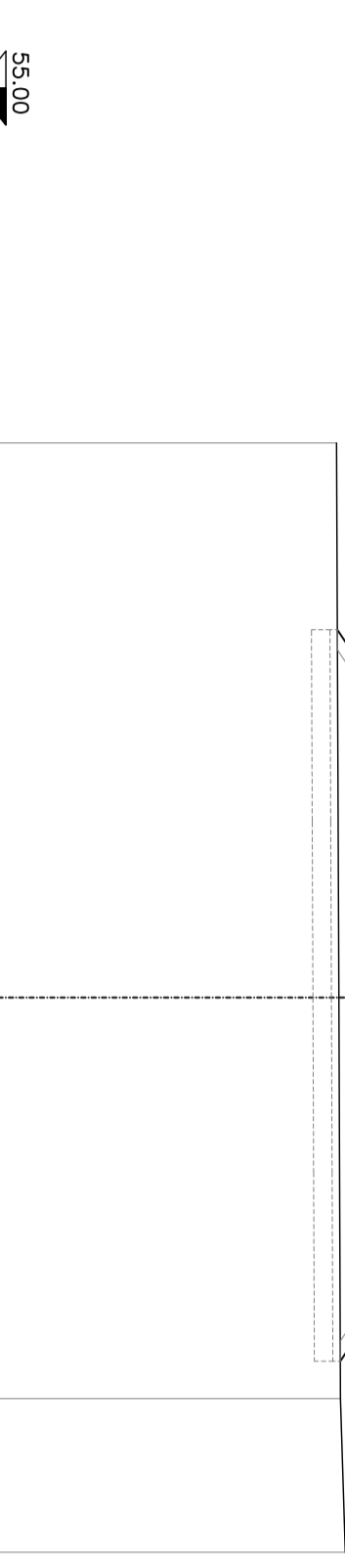
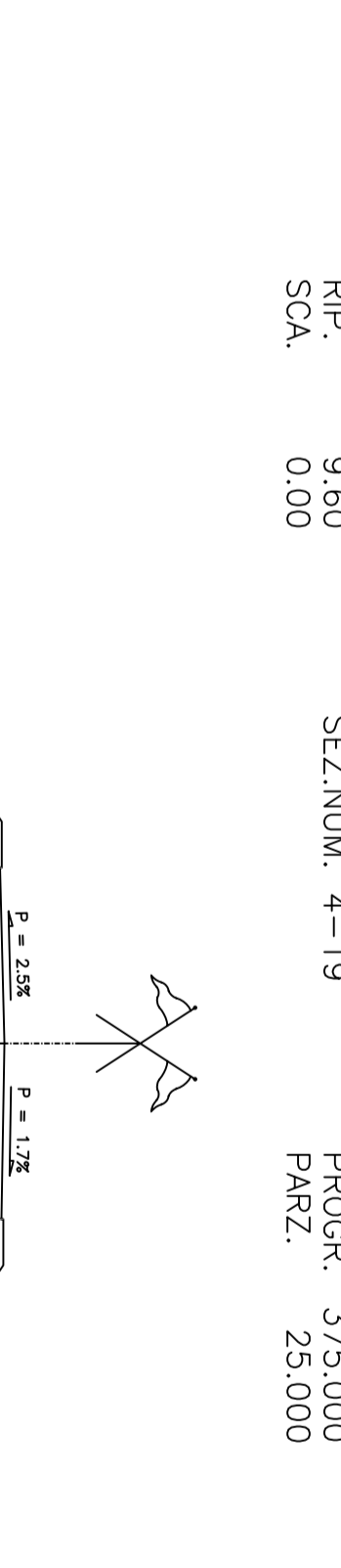
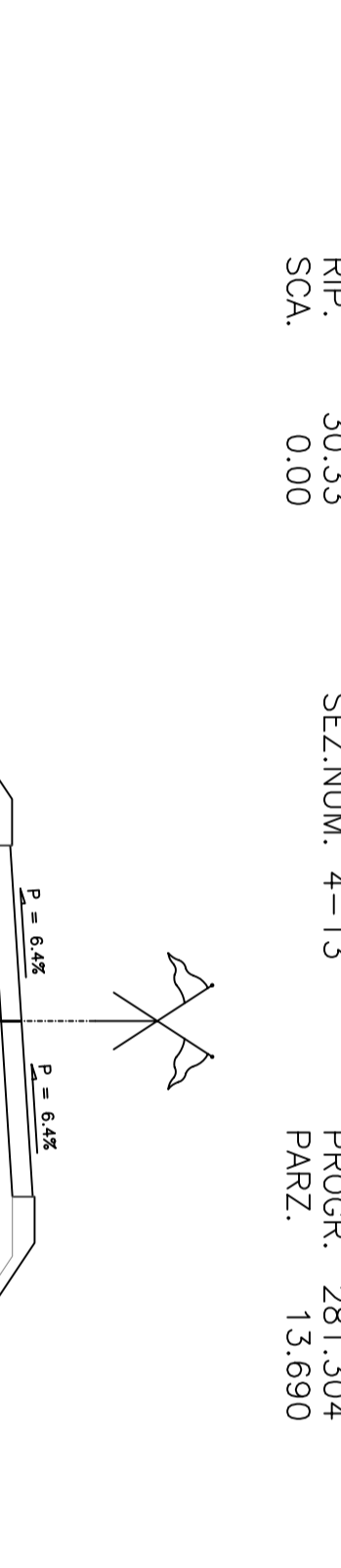
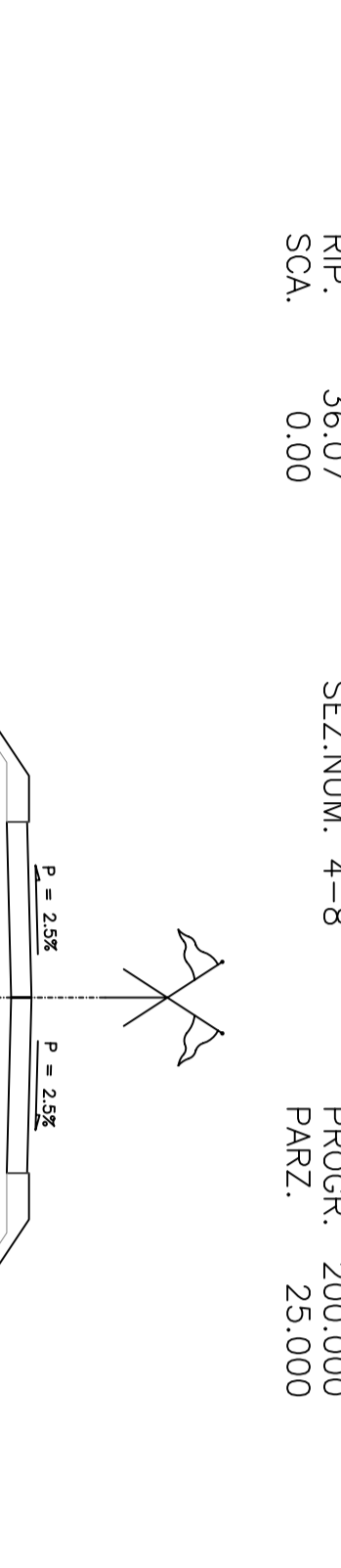
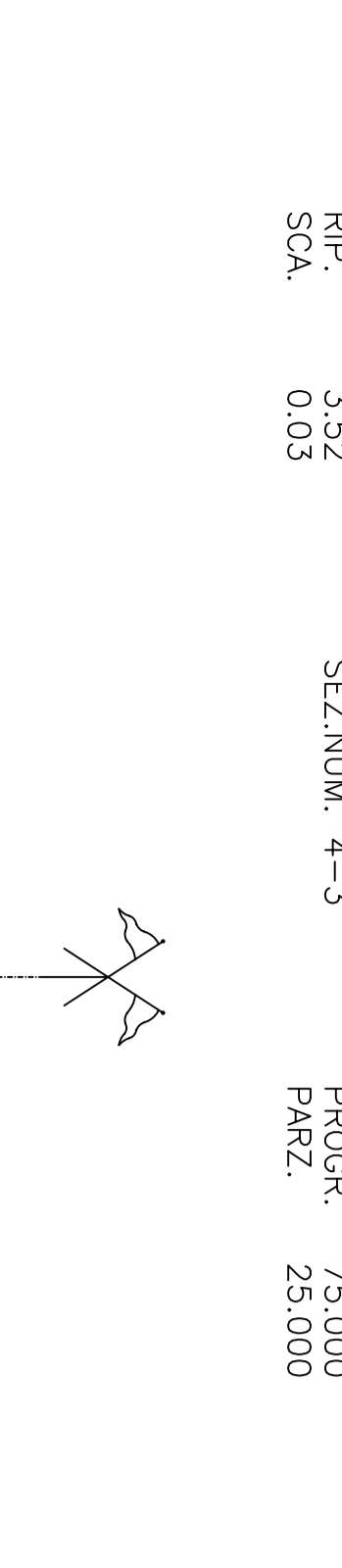

Anas SPA

DIREZIONE CENTRALE PROGETTAZIONE

S.S. N. 9 "Via Emilia"  
Variante di Casalpusterrengo ed eliminazione  
passaggio a livello sulla SP ex S.S. N. 234

PROGETTO DEFINITIVO

CONTRIBUTI SPECIALISTICI	
INGEGNERIA	ING. ...
ARCHITETTURA	ARCH. ...
PAESAGGIO	PAES. ...
...	...

VERBA RESPONSABILI	
PROGETTO	...
VERIFICA	...
...	...
DATA	FEBBRAIO 2011
REV.	01/01

NOTE FILE: 00651581\_01\_SEZ\_4-19\_12-04