

RIP. 0,00 SEZ.NUM. 5-22 PROG. 251,866 PARZ. 1,866  
 RIP. 0,00 SEZ.NUM. 5-27 PROG. 350,000 PARZ. 25,000  
 RIP. 1,54 SEZ.NUM. 5-32 PROG. 415,632 PARZ. 1,139  
 RIP. 5,56 SEZ.NUM. 5-37 PROG. 503,514 PARZ. 3,514

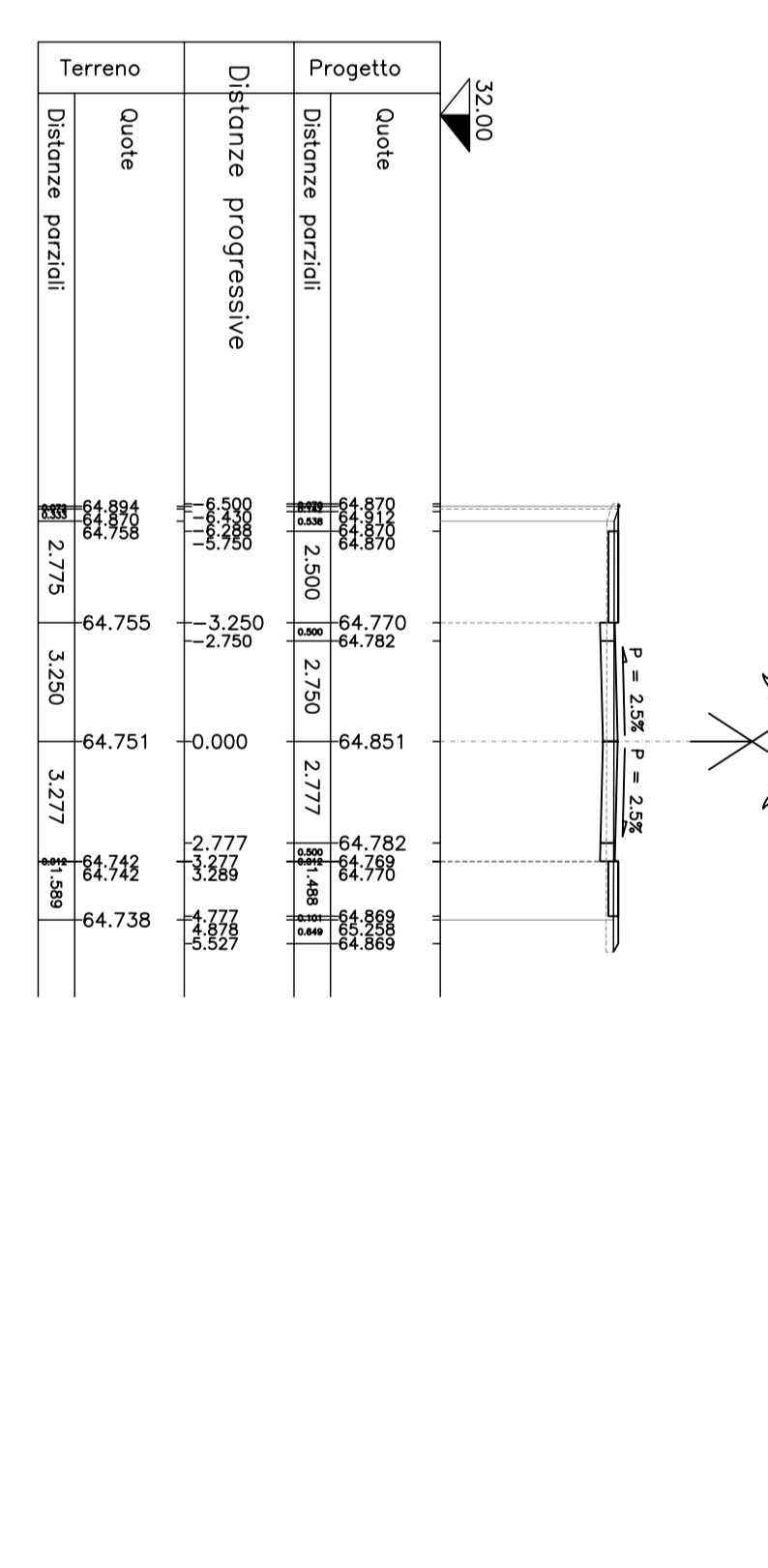
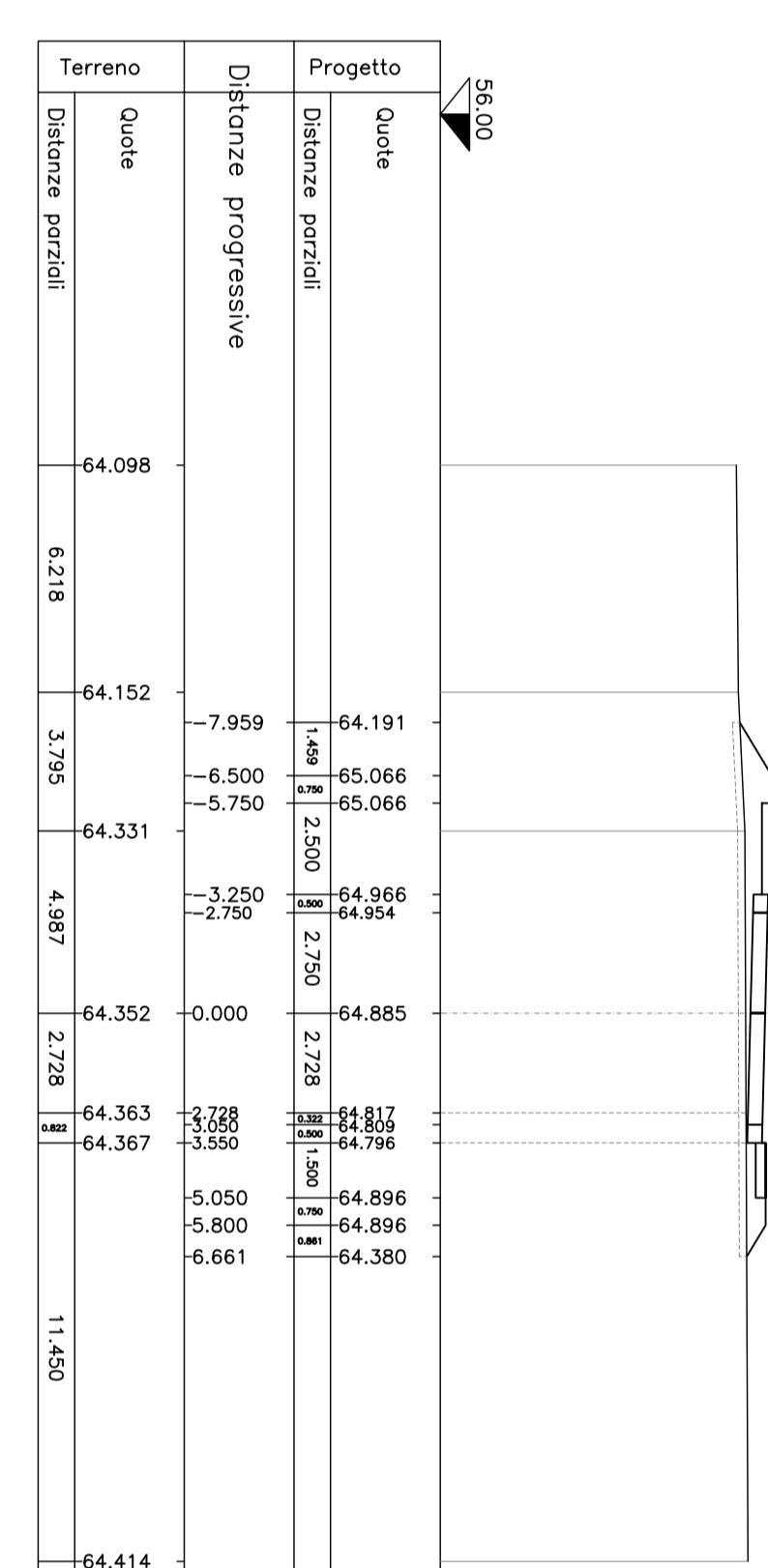
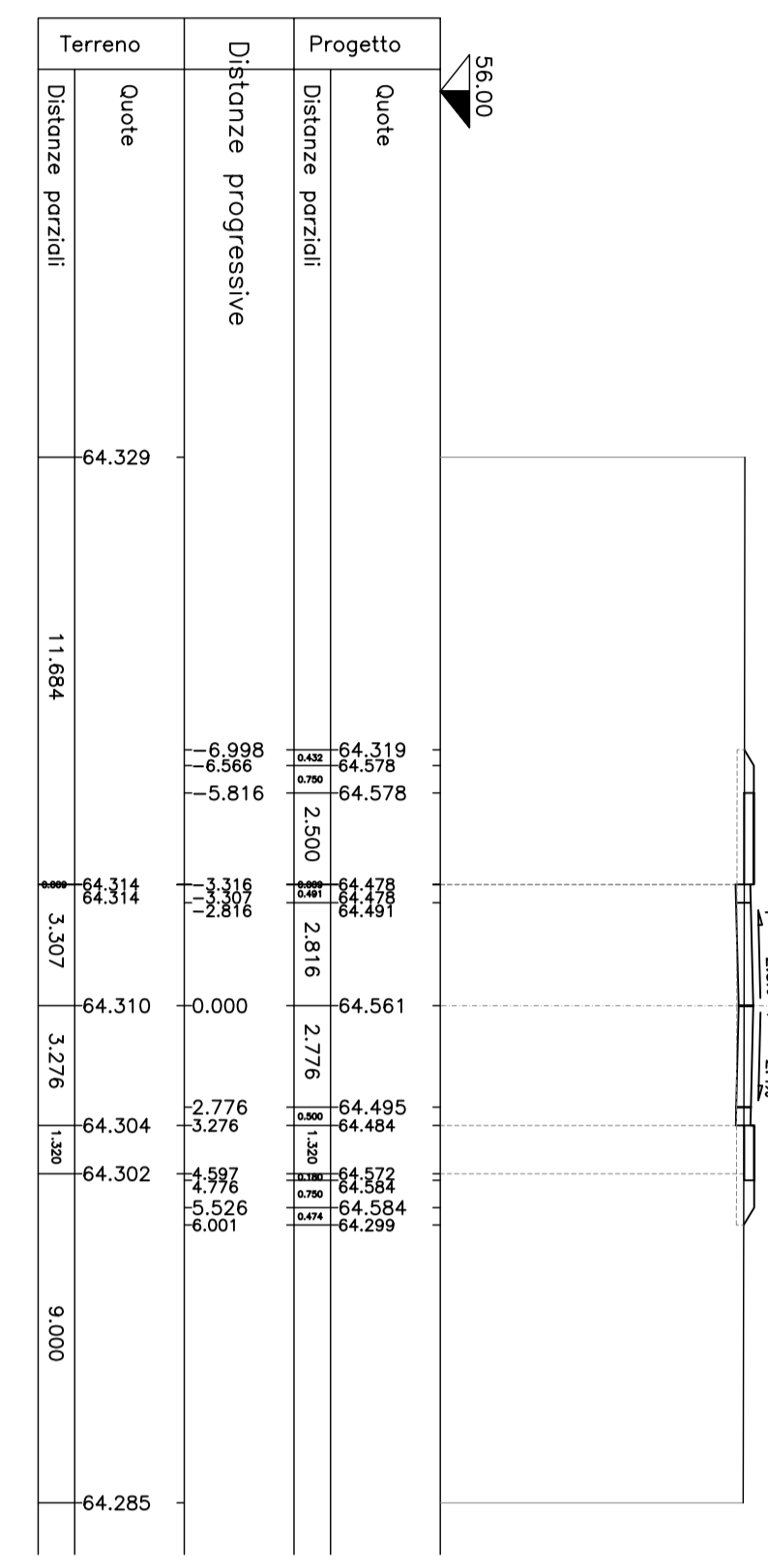
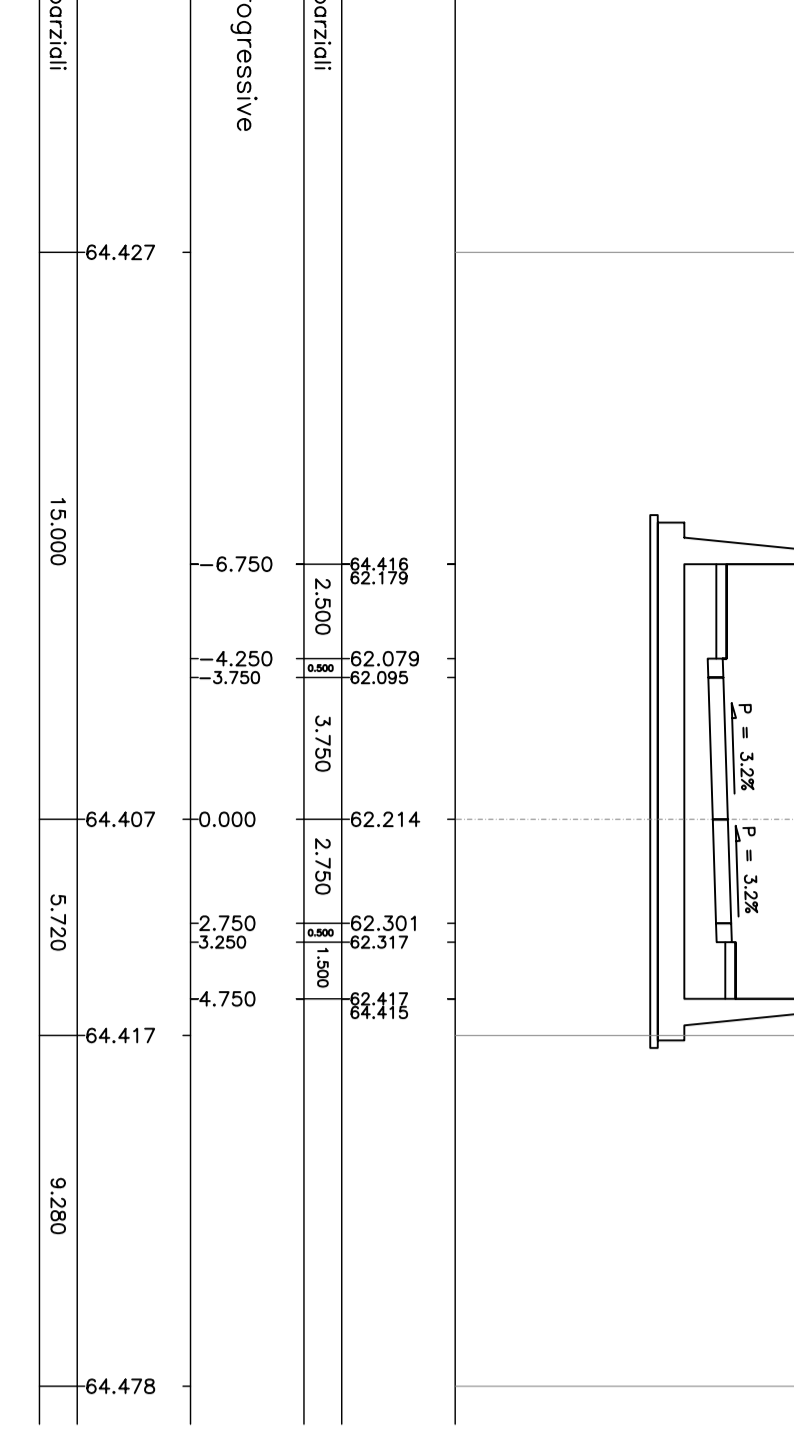
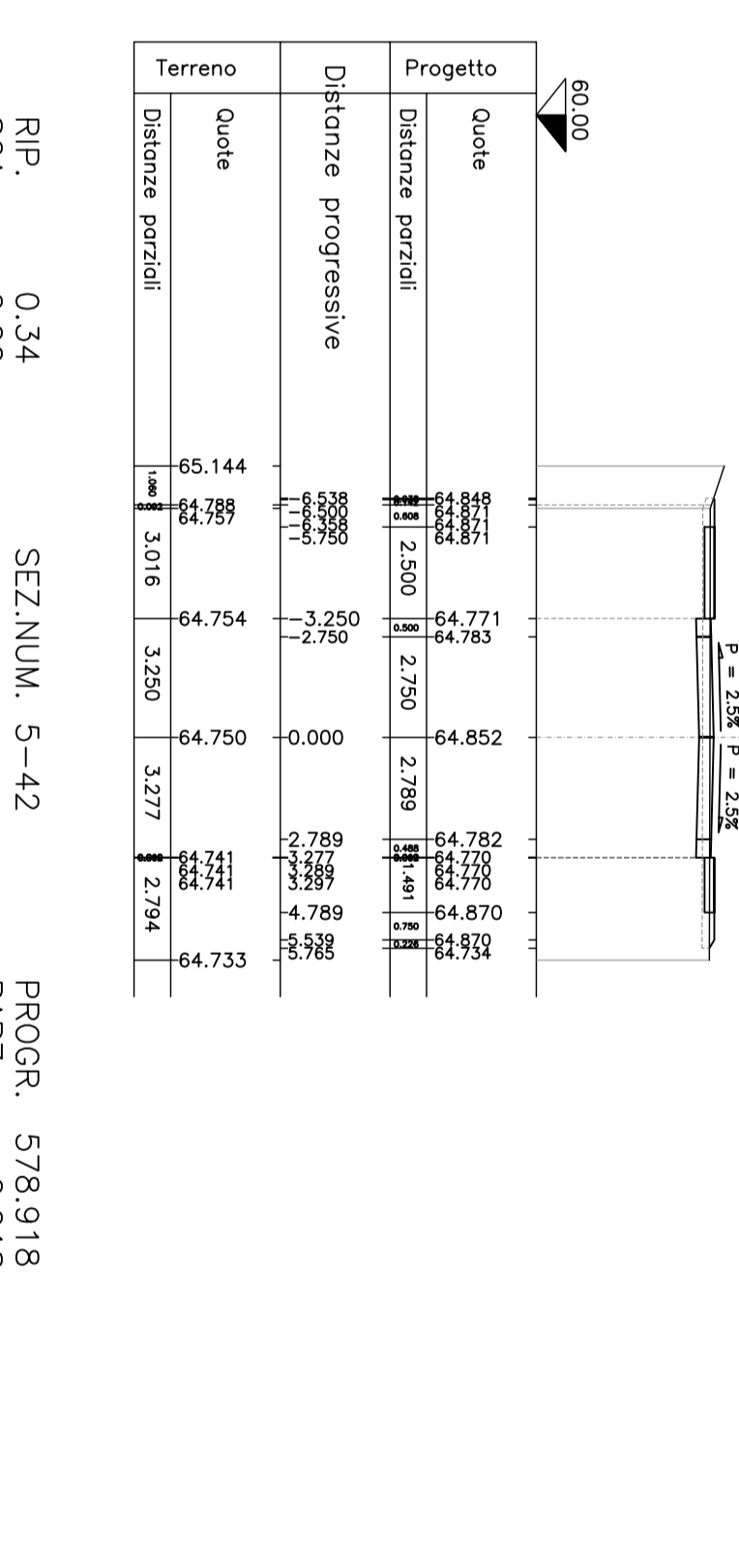
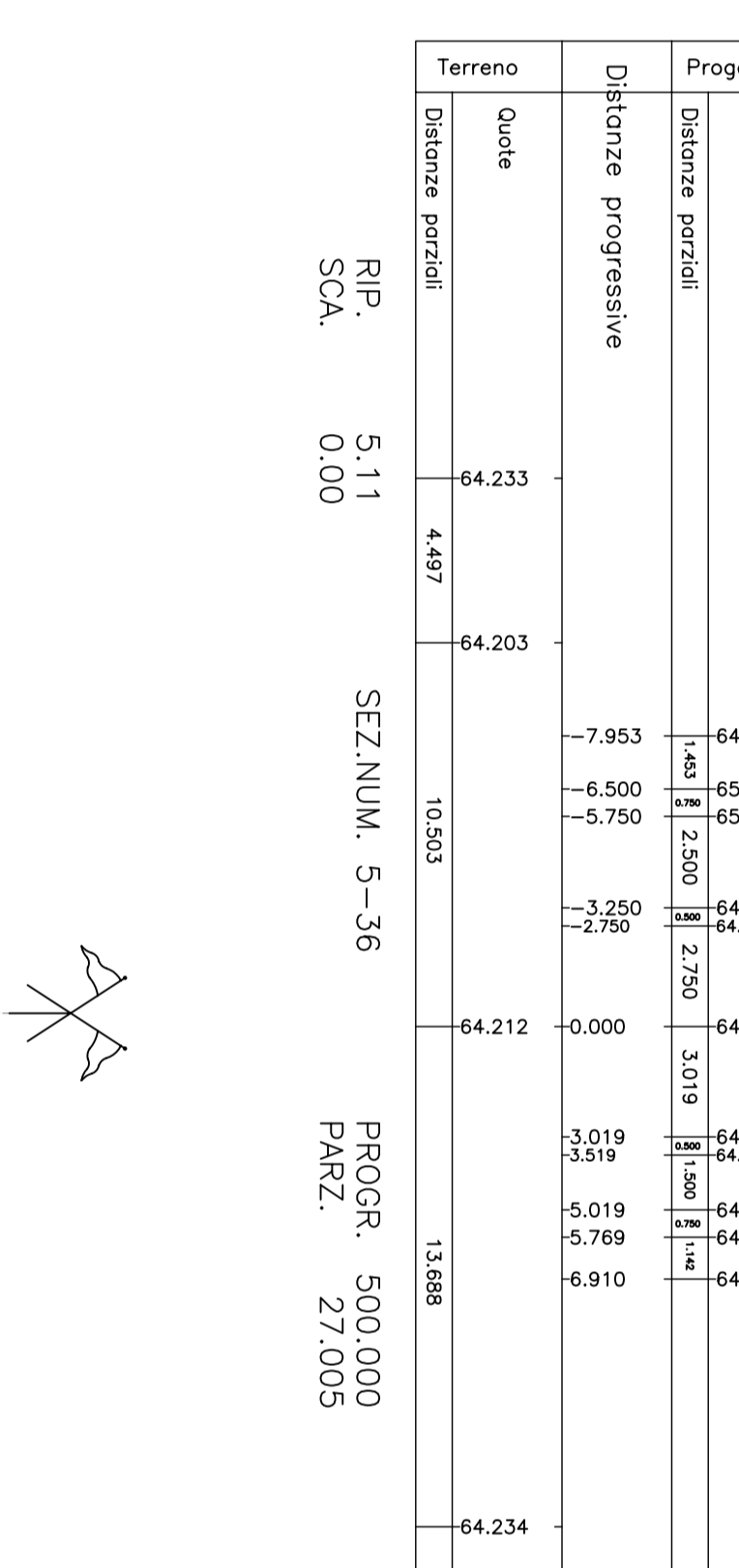
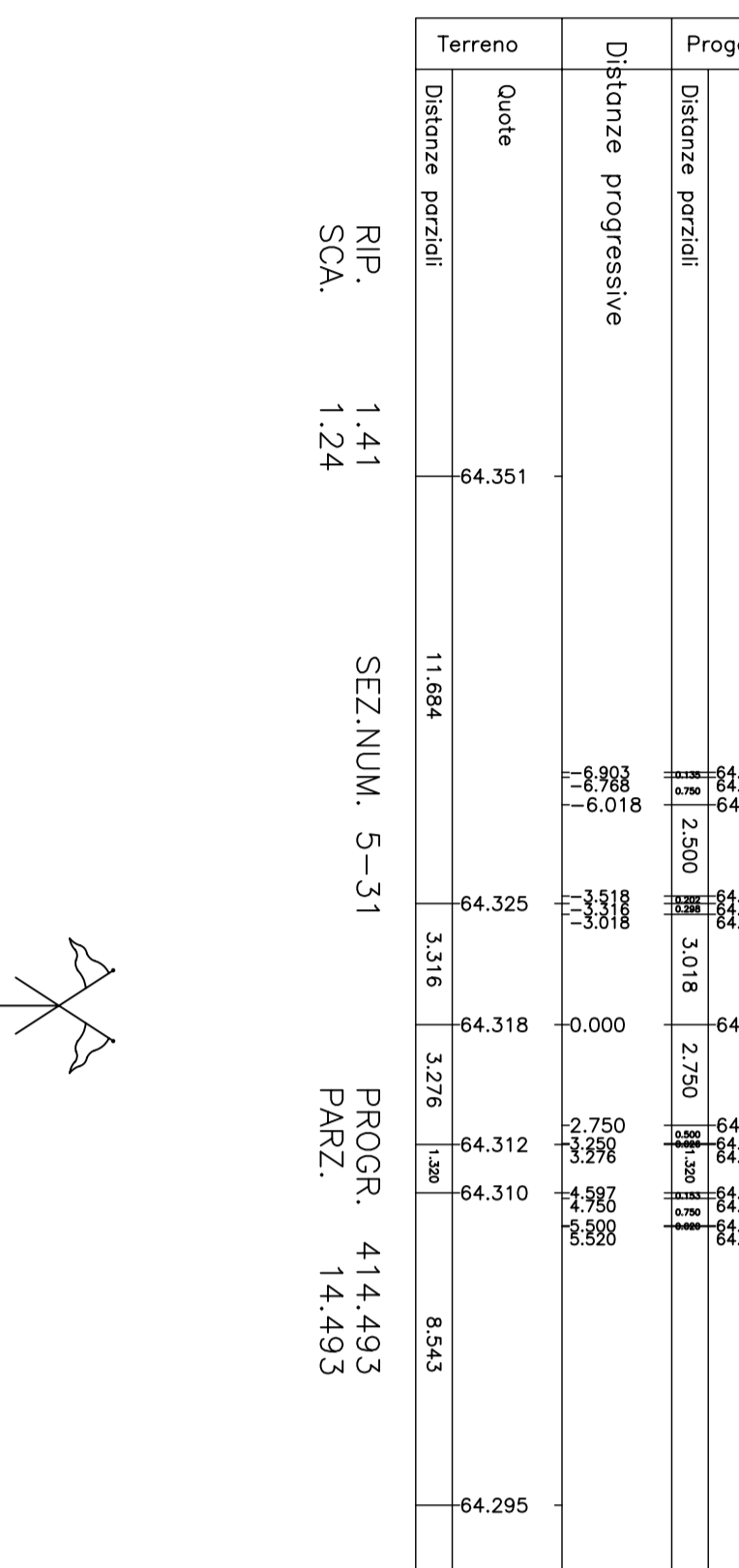
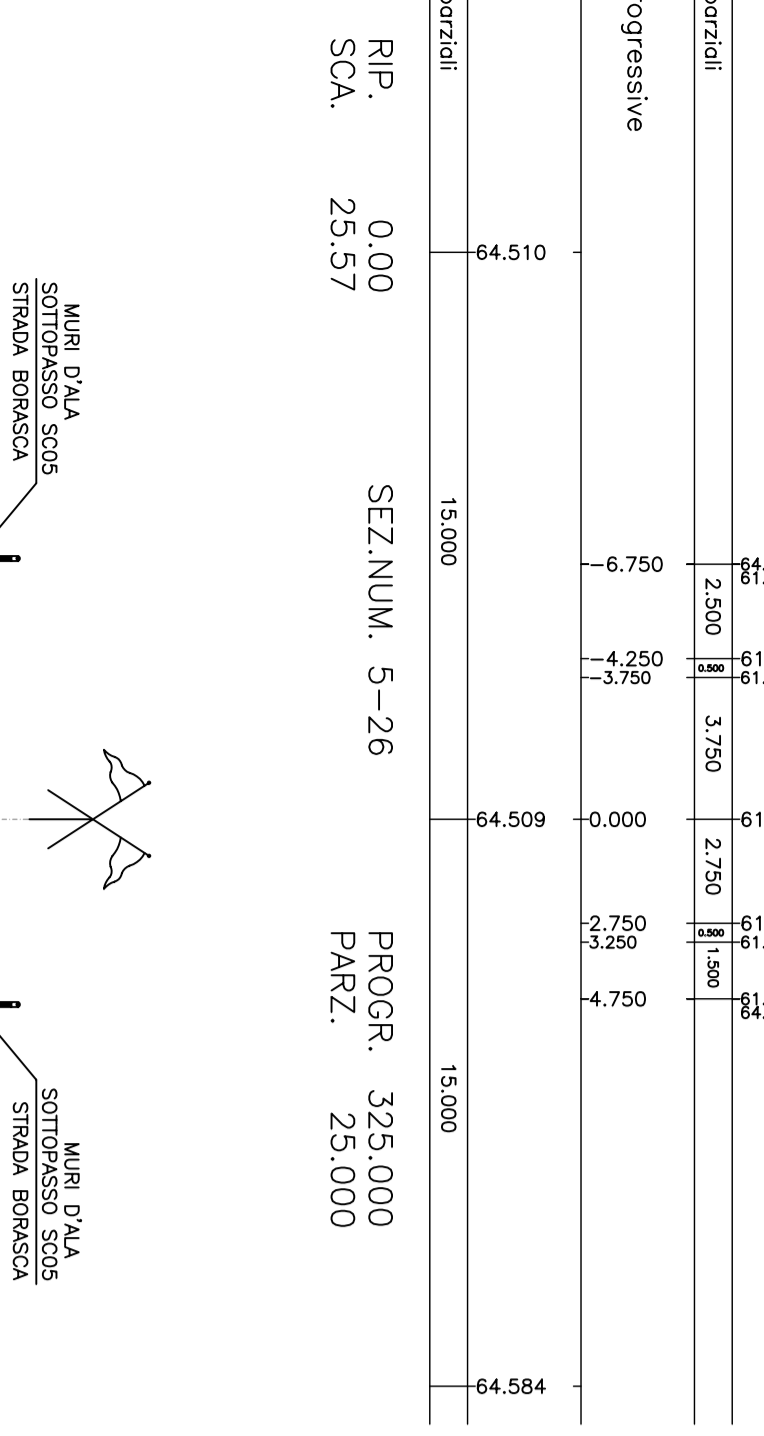
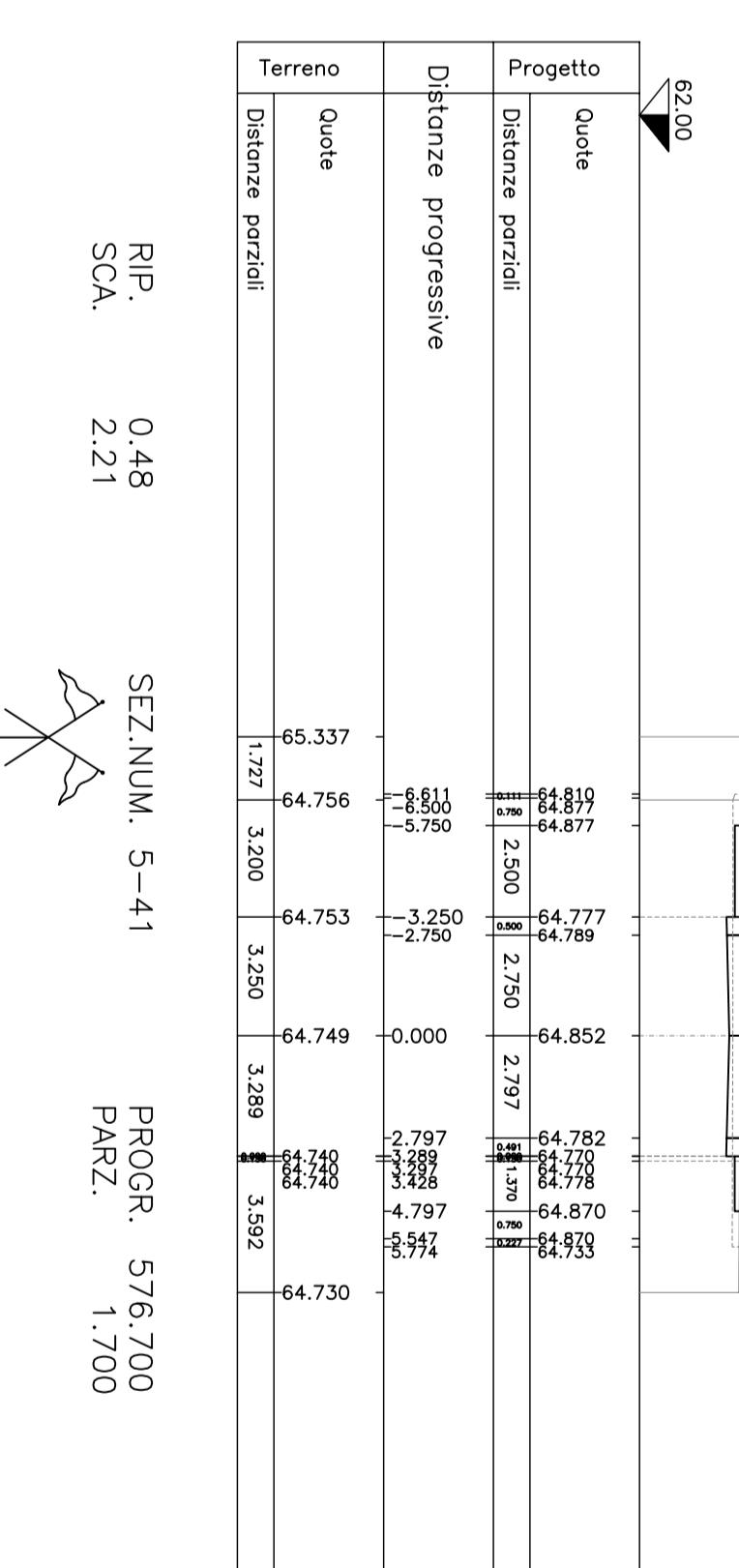
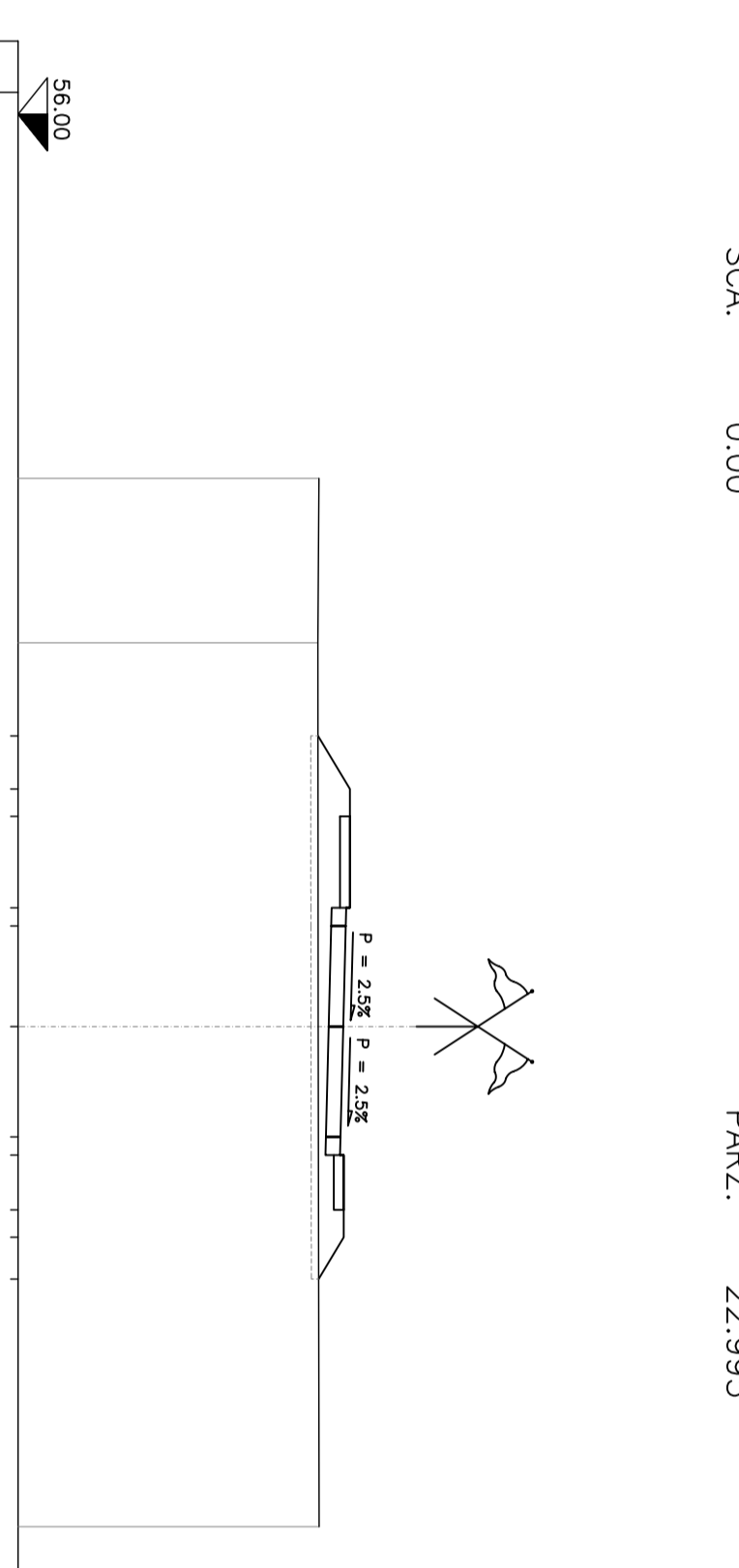
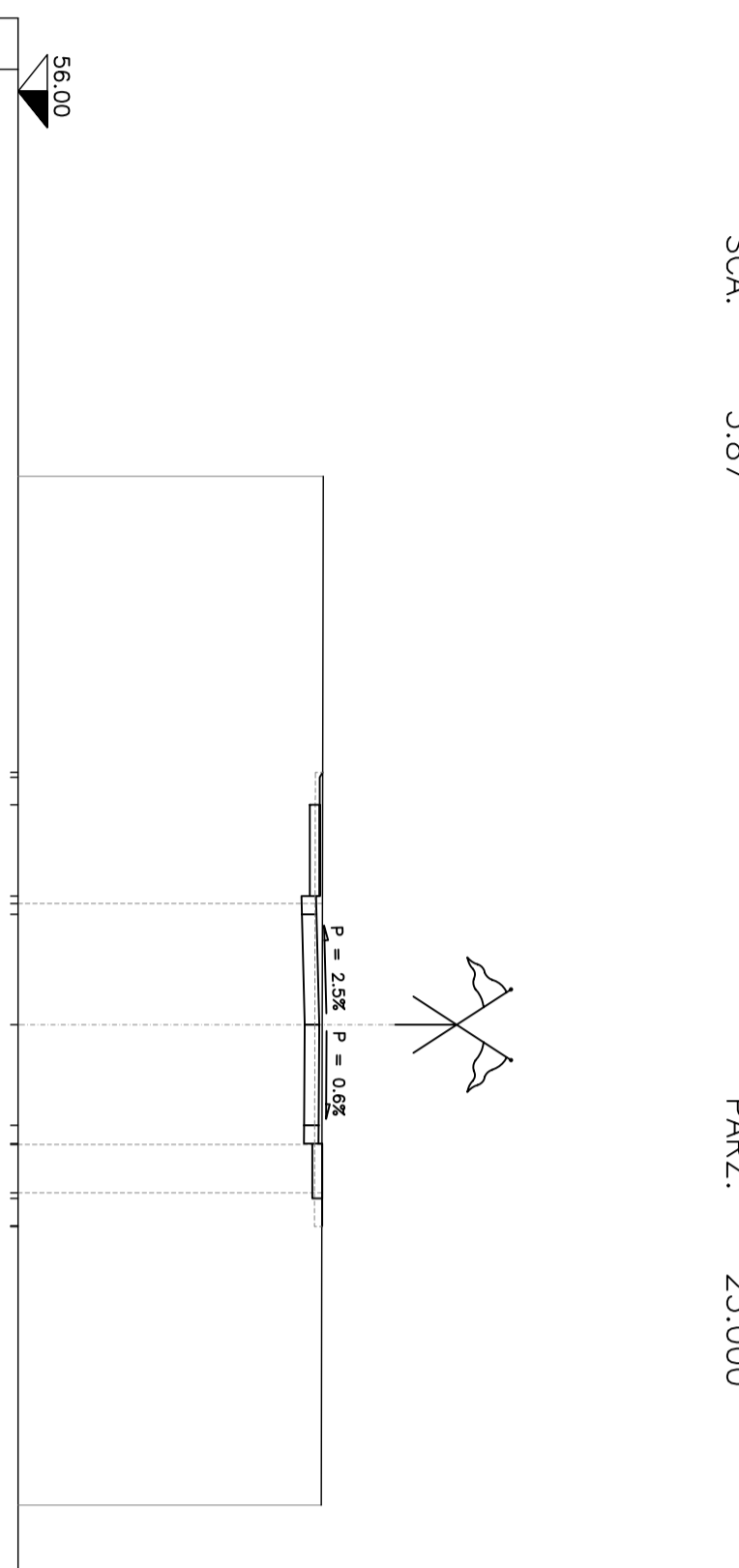
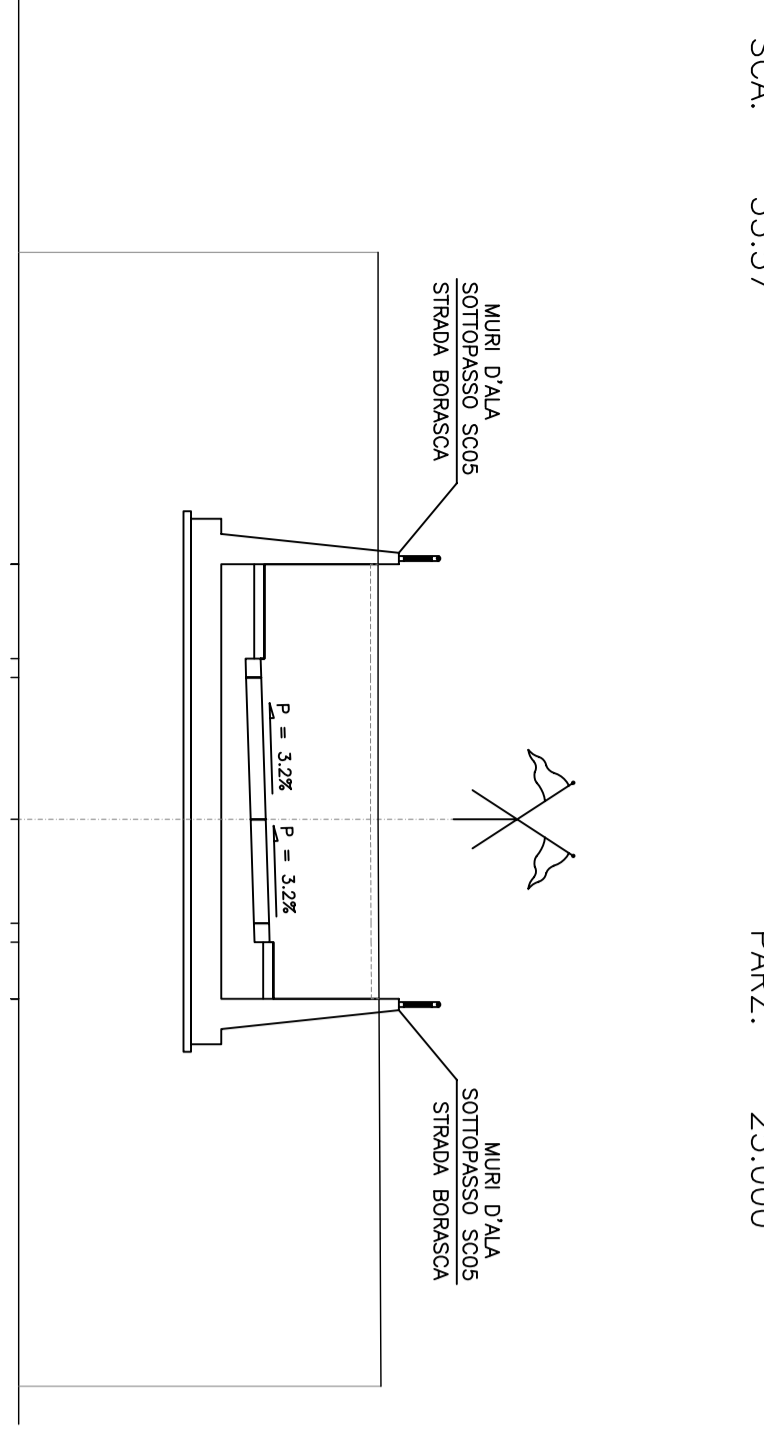
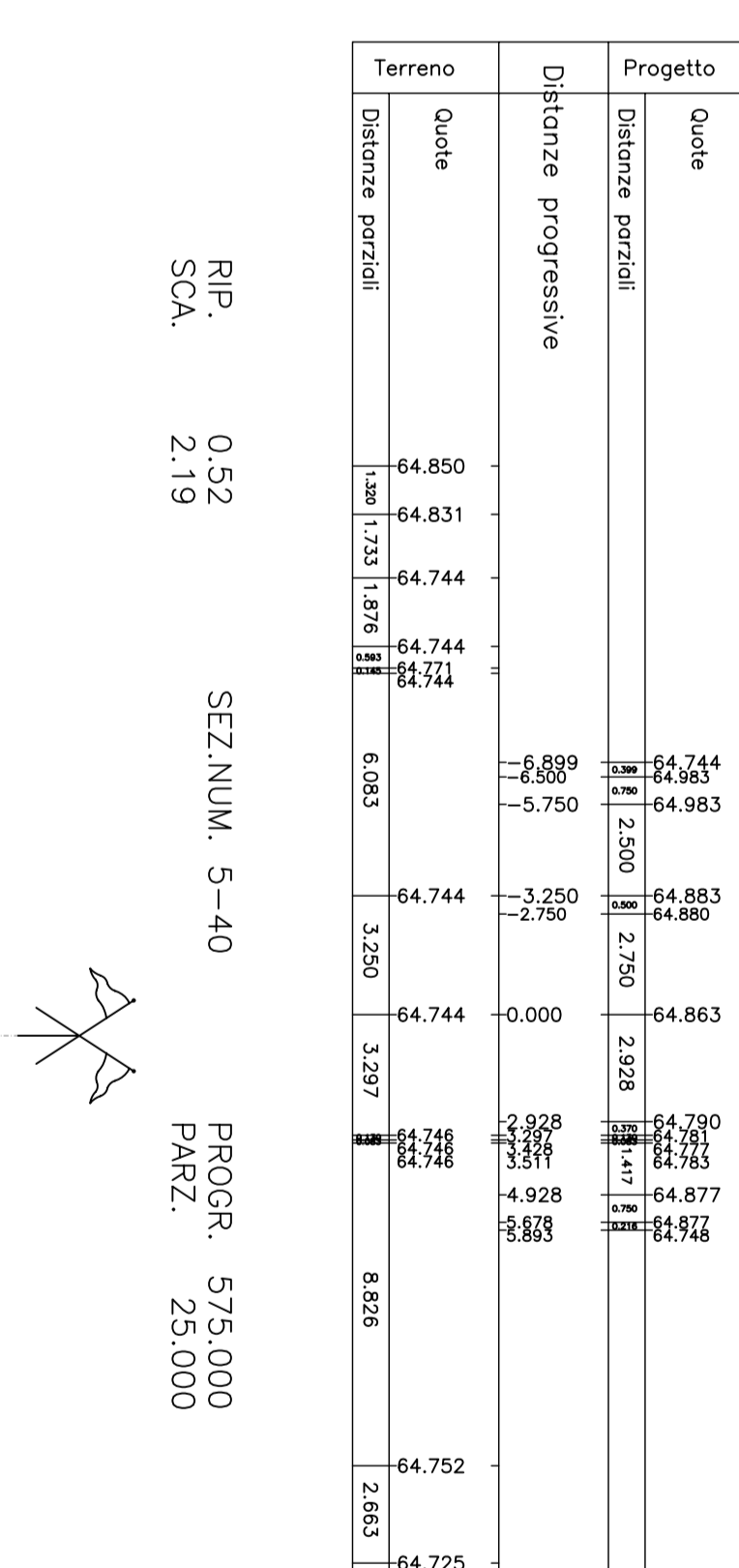
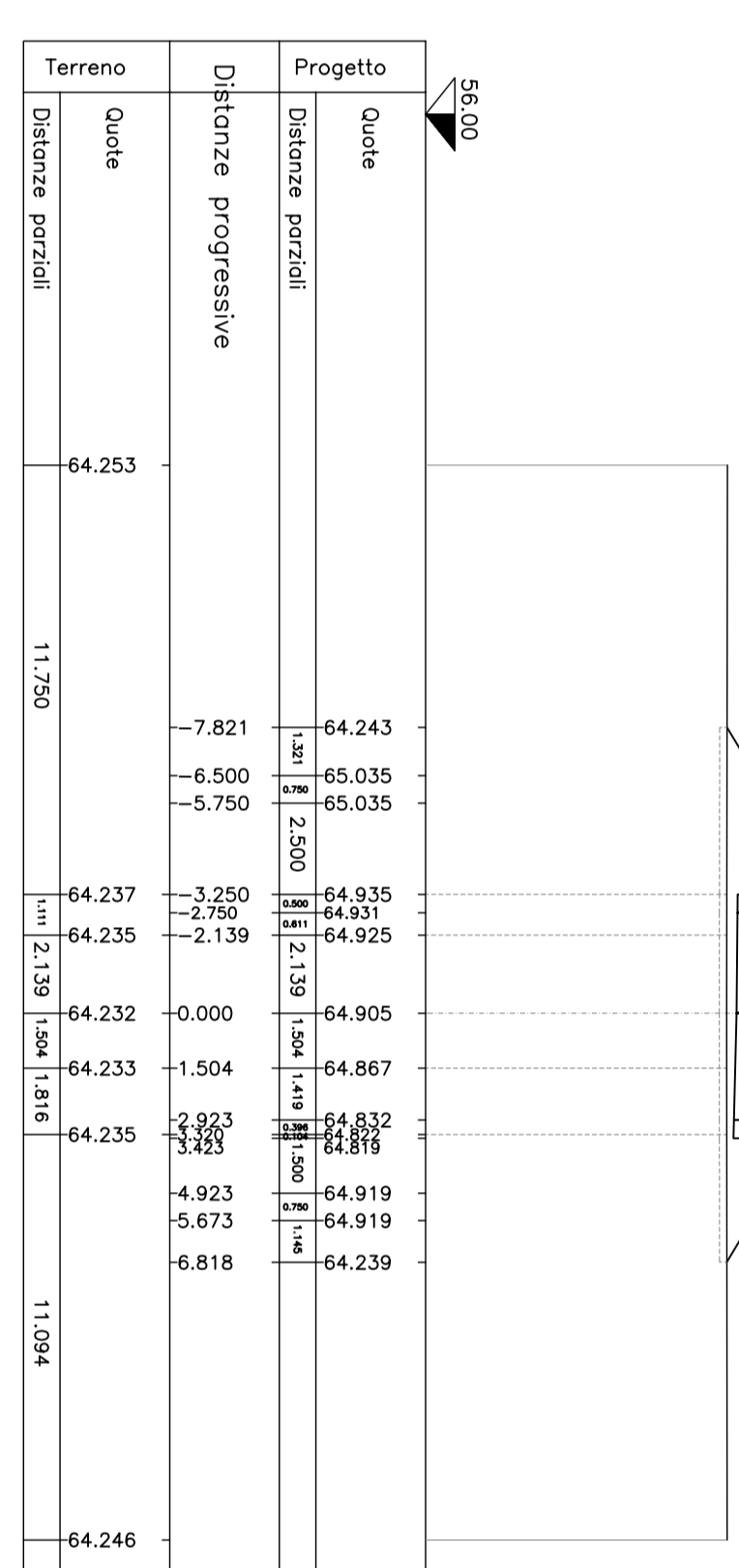
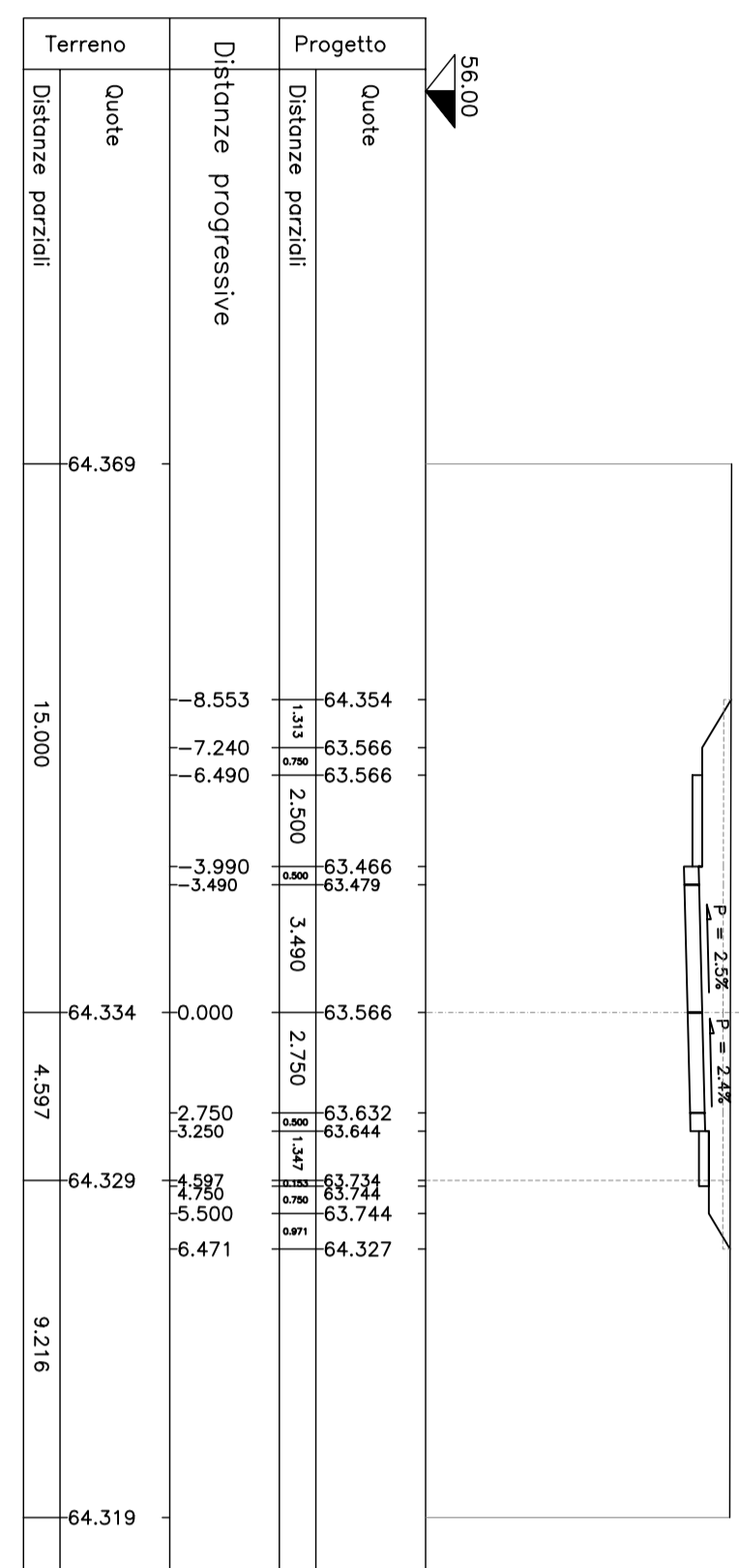
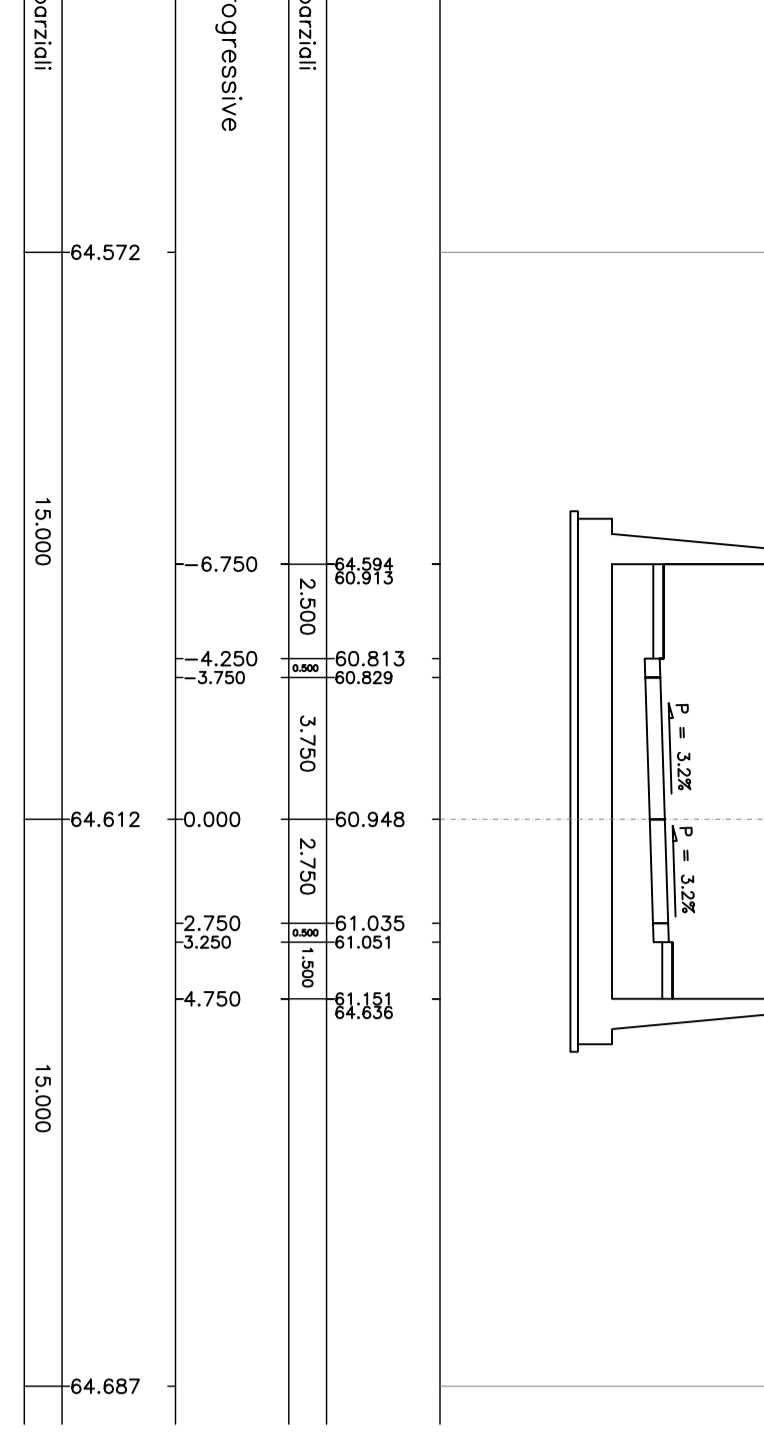
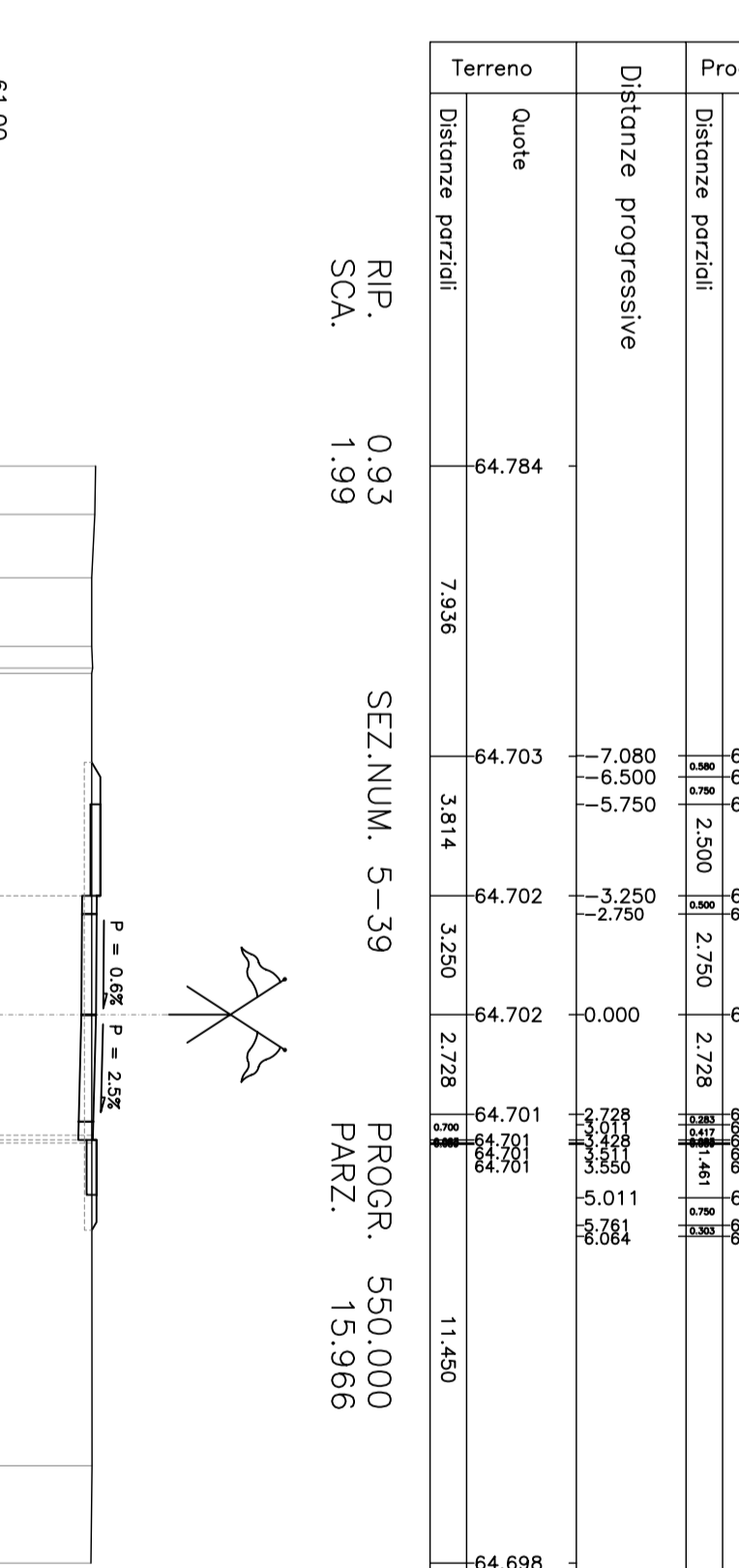
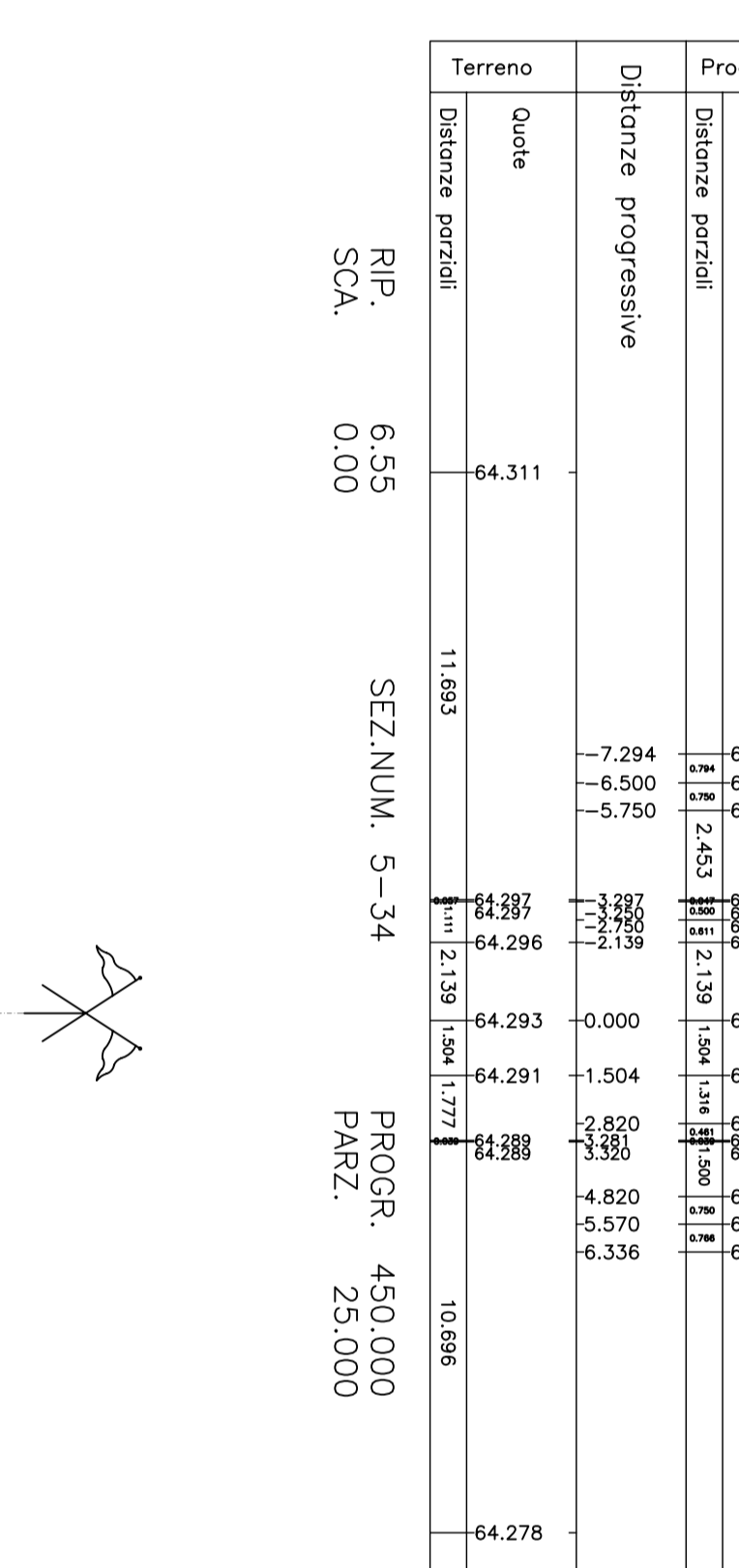
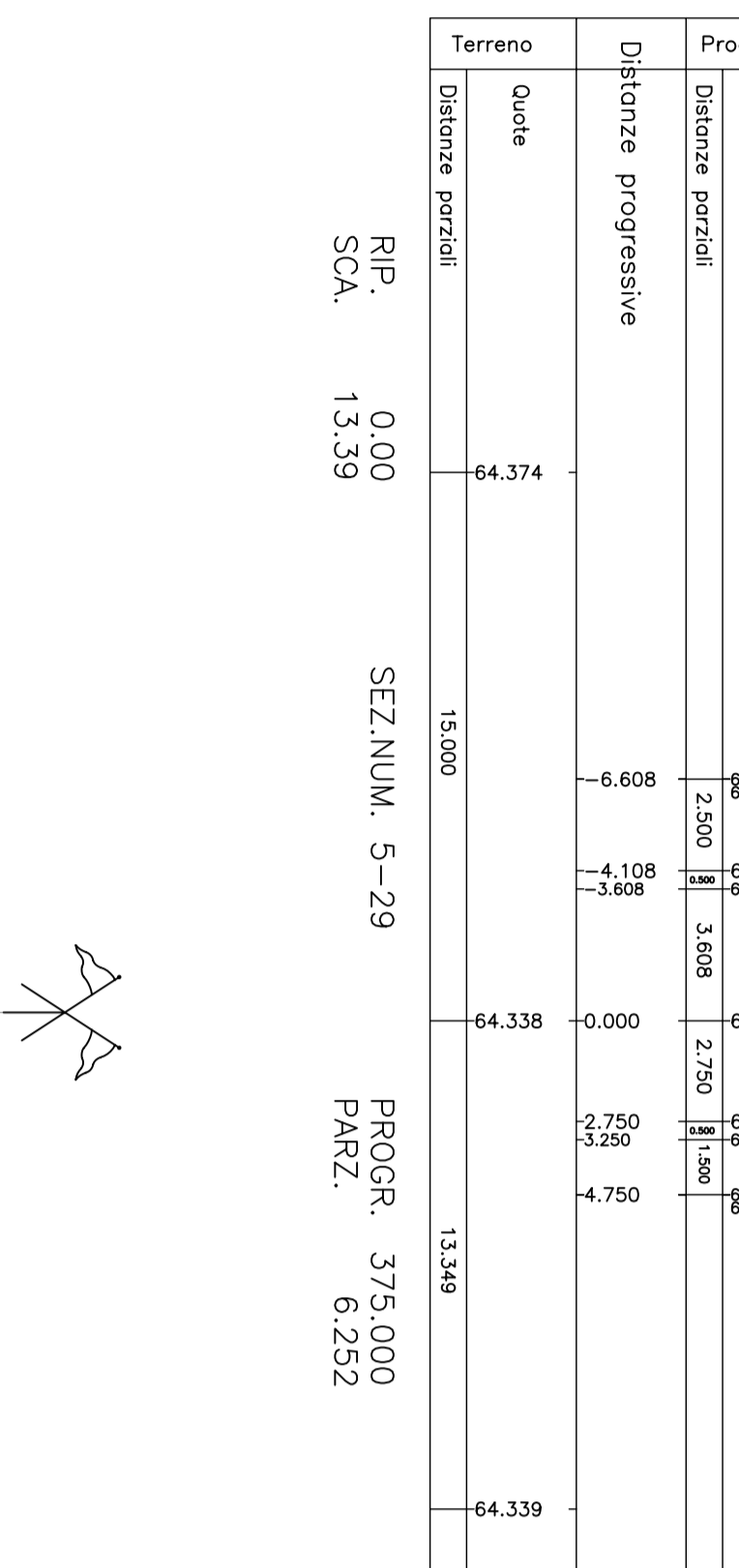
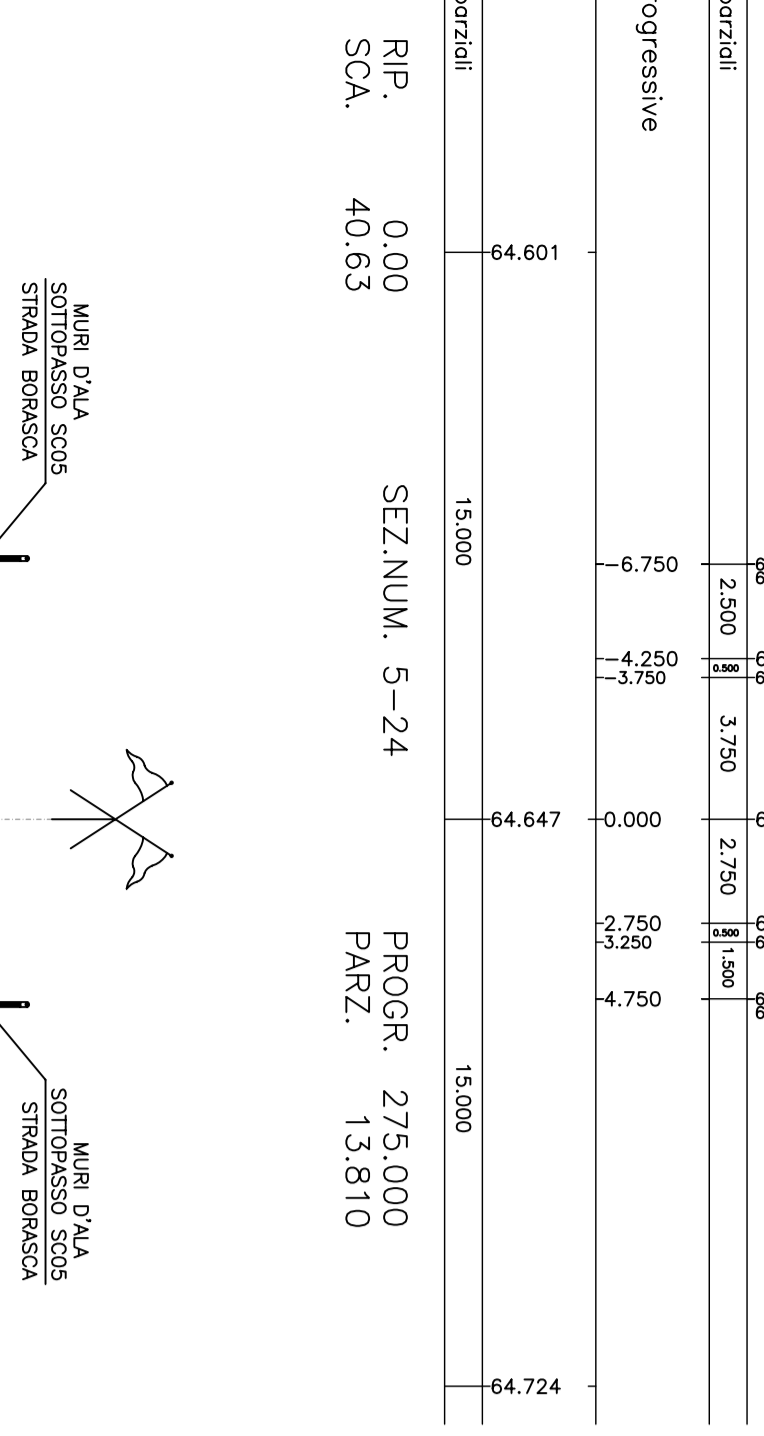
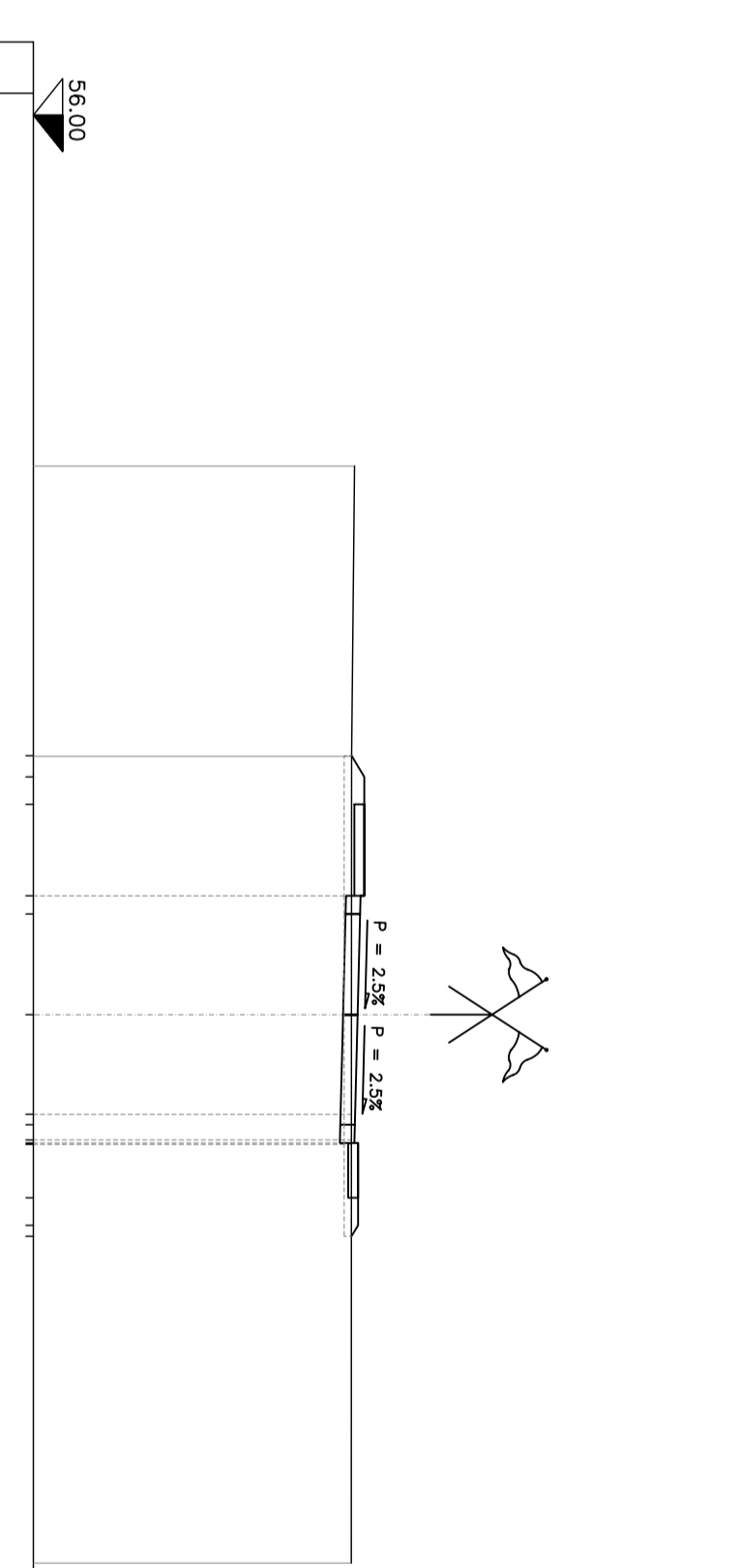
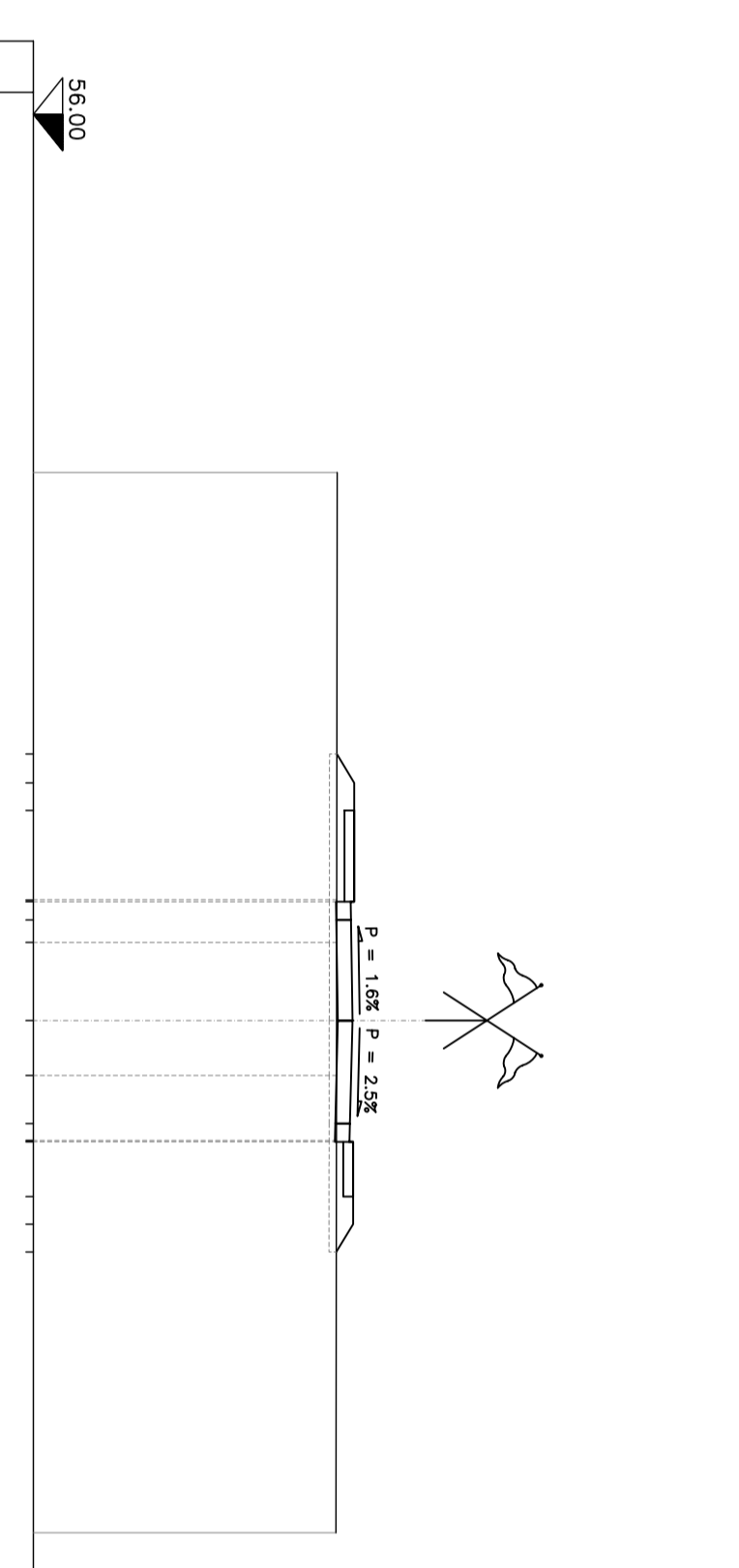
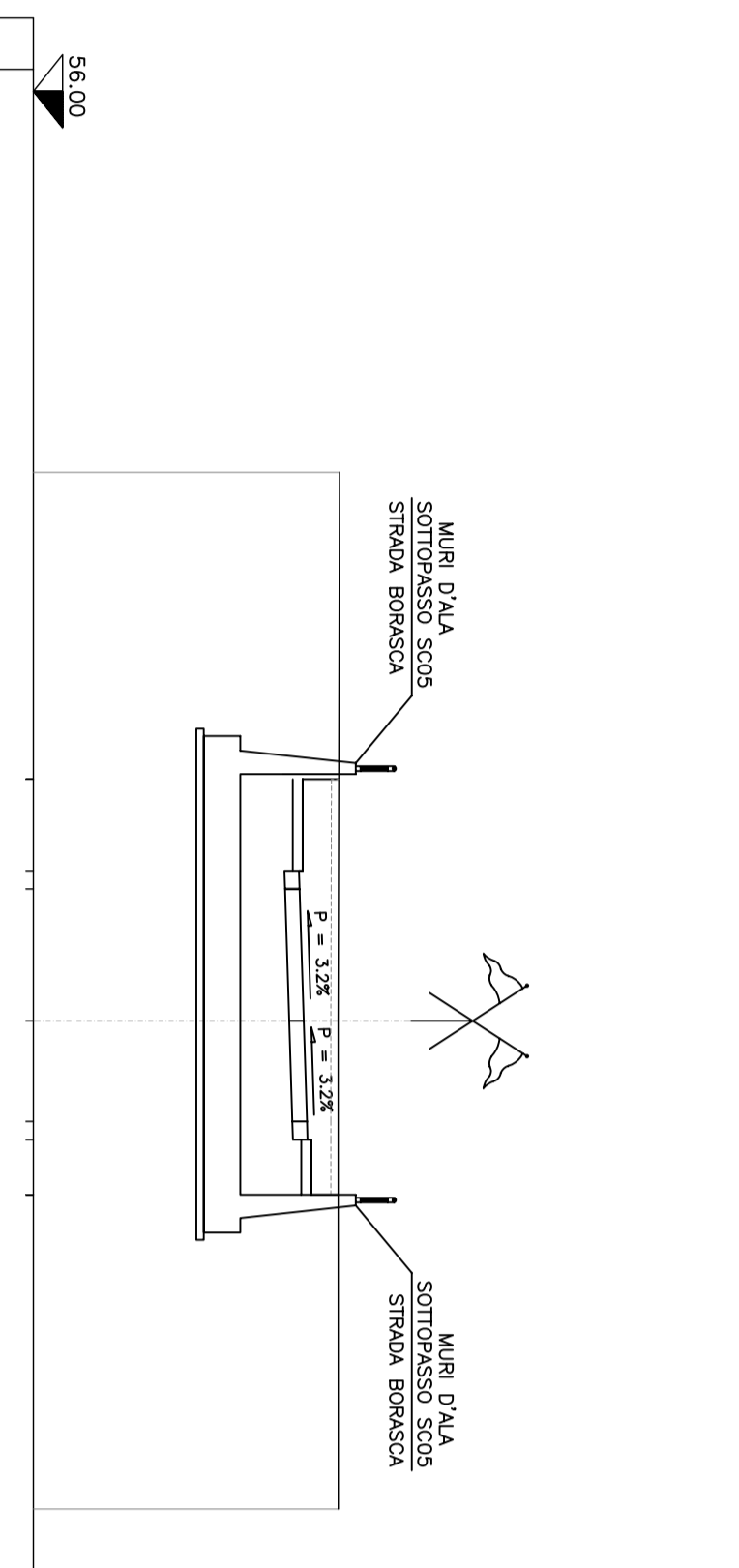
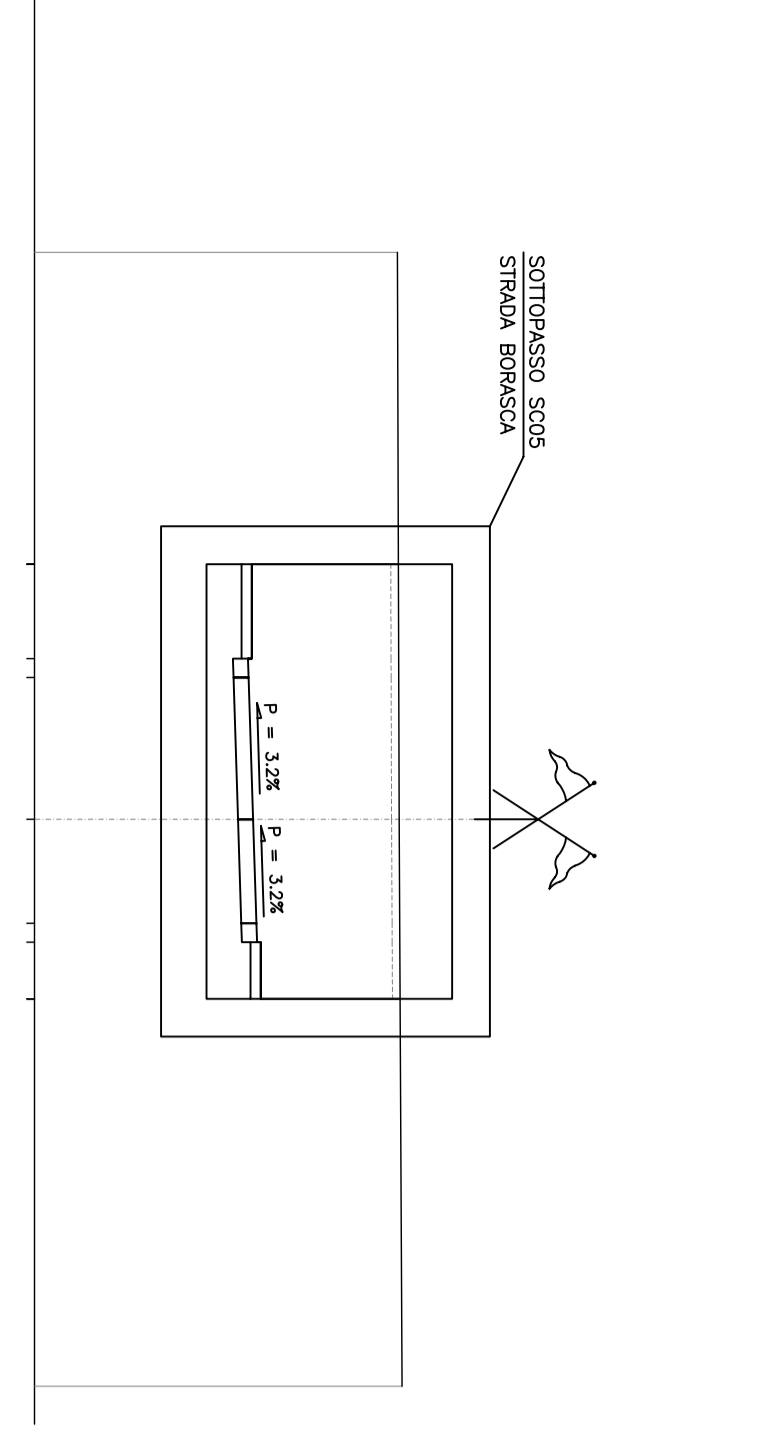
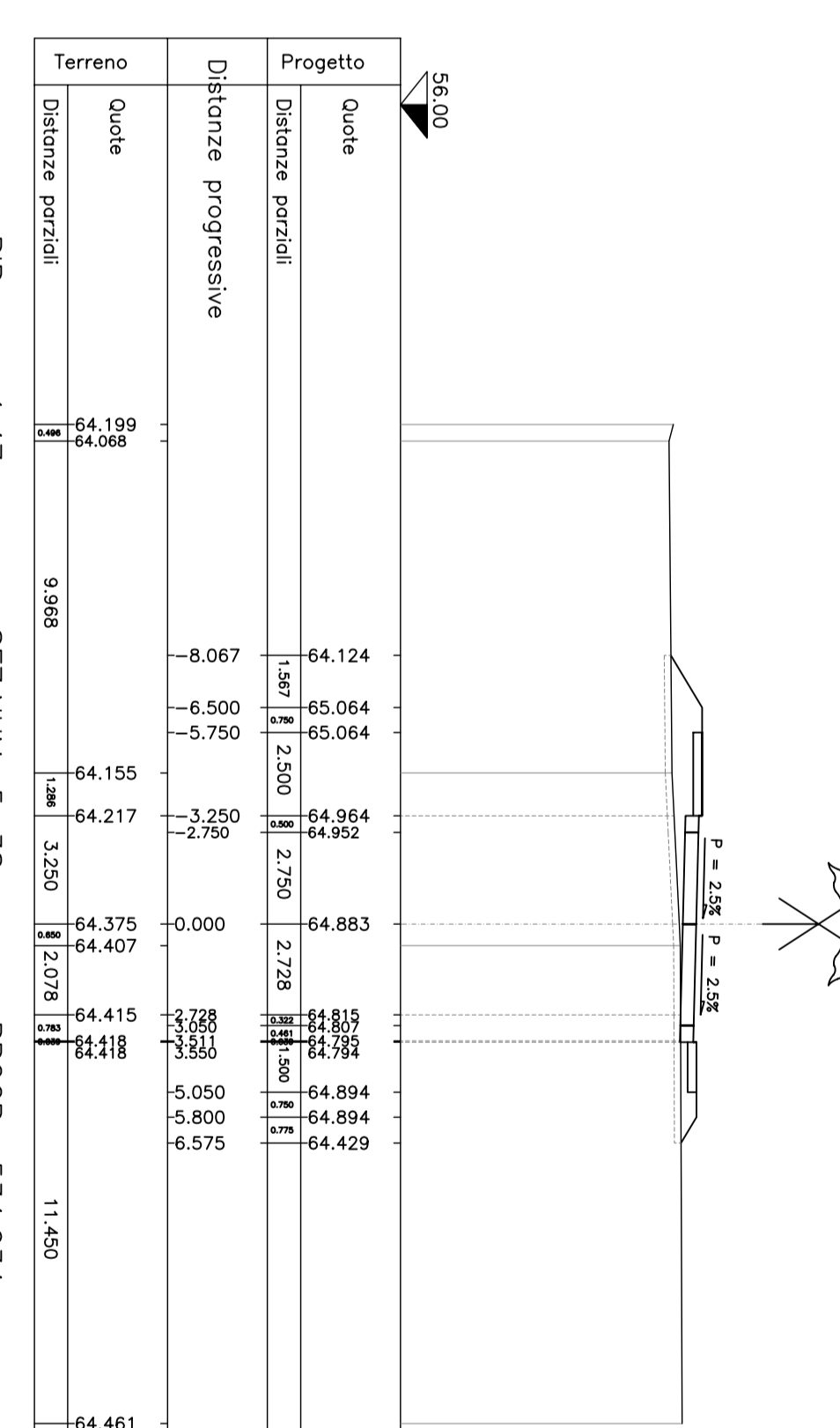
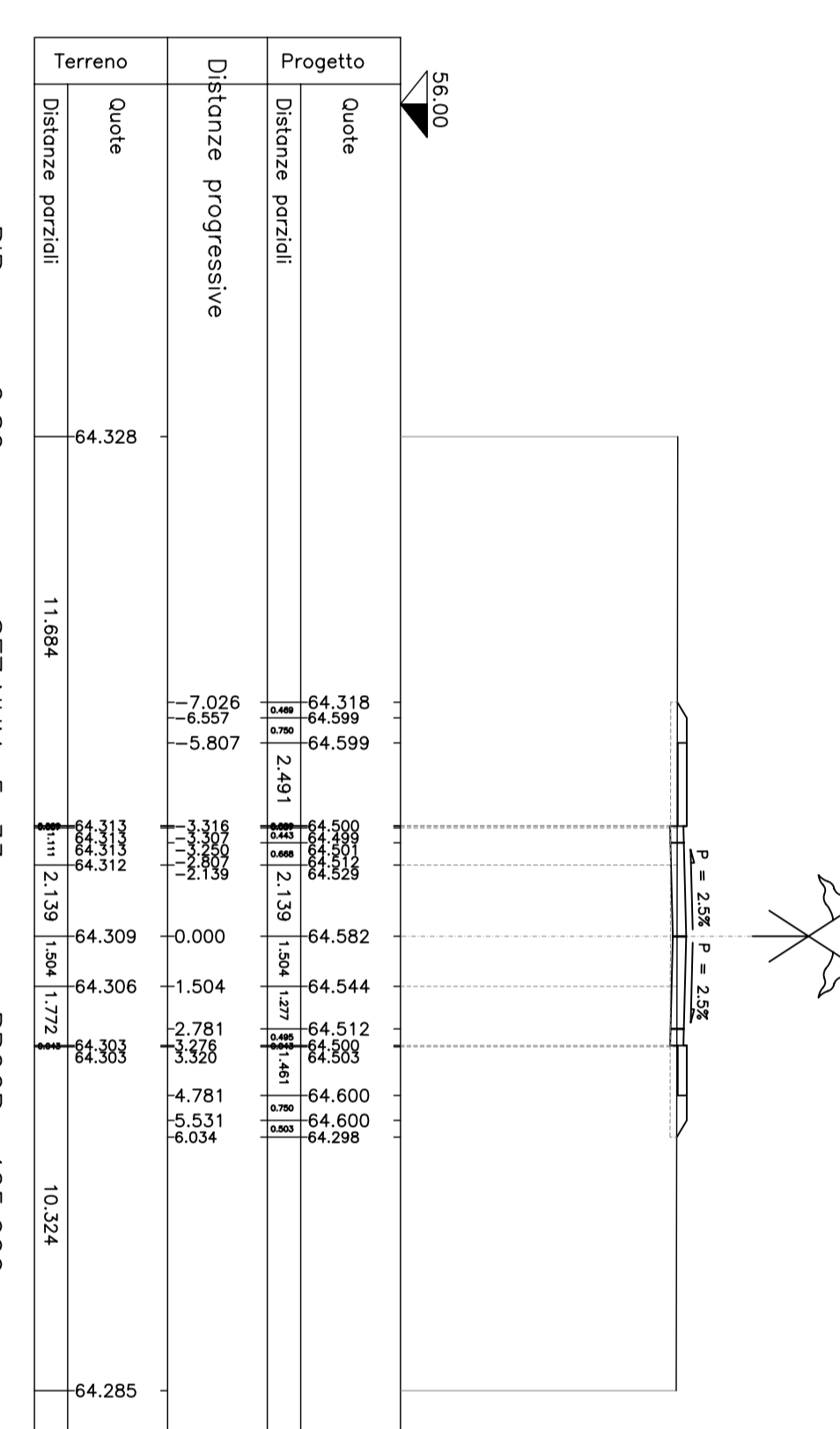
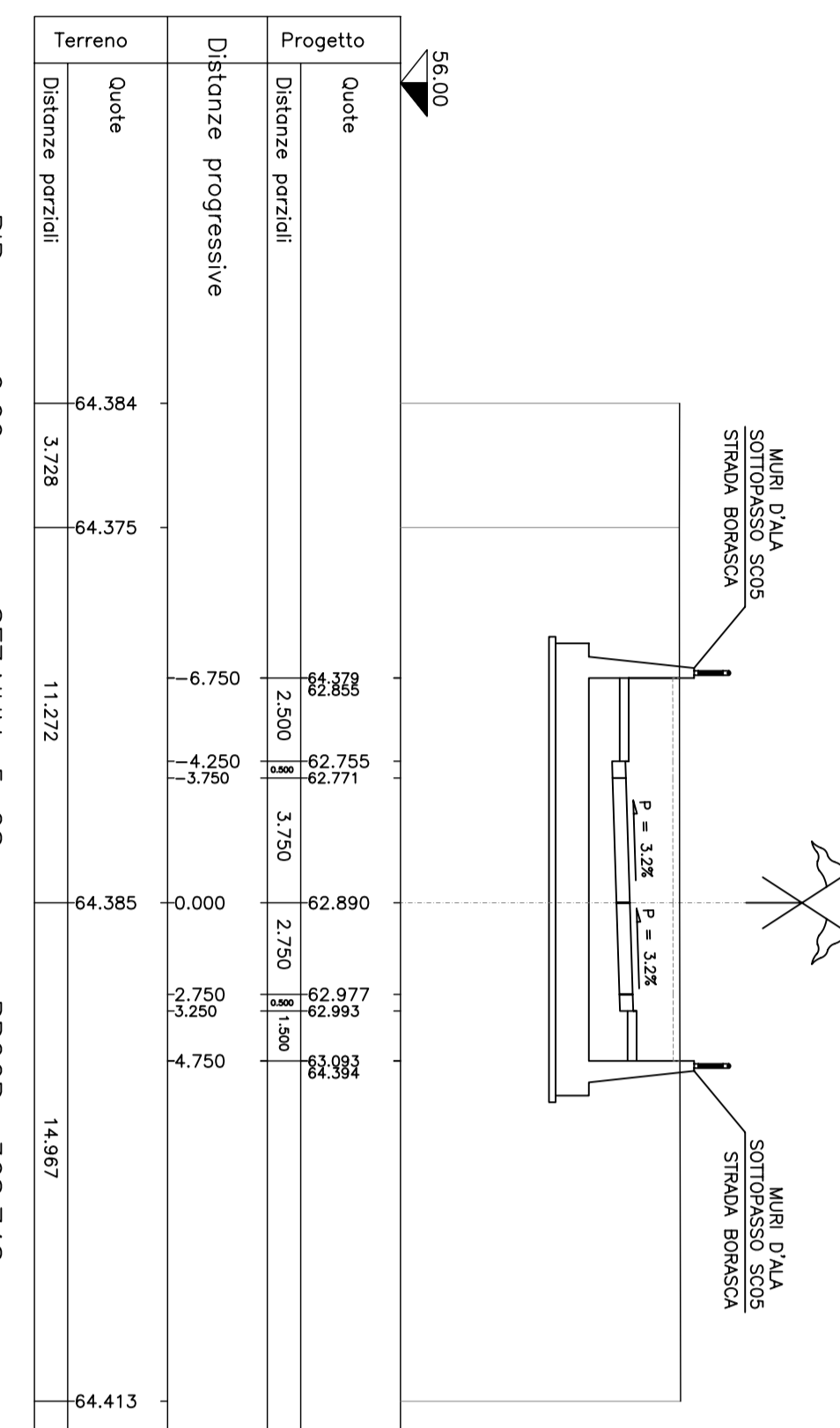
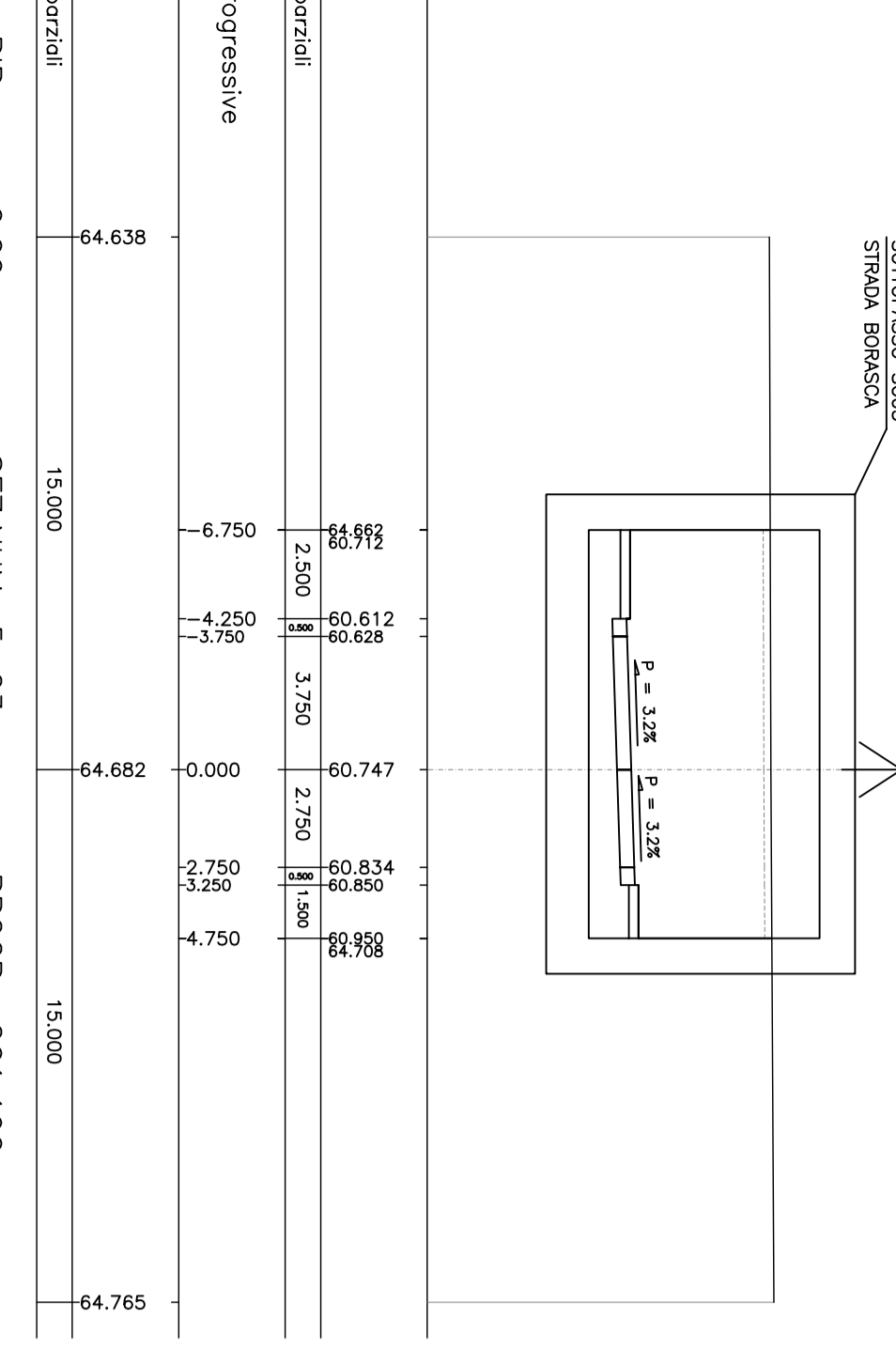

**Anas SPA** DIREZIONE CENTRALE PROGETTAZIONE

**S.S. N. 9 "Via Emilia"**  
 Variante di Castelpiserverigo ad eliminazione  
 passaggio a livello sulla SP ex S.S. N. 234

**PROGETTO DEFINITIVO**

**CONTRIBUTI SPECIALISTICI**

**PROGETTO** SA05 1541 FEBBRAIO 2011

NOTE: FILE: 006-1541\_01\_SEZ. 5-22 A SEZ. 5-42