

NUMERO SEZIONE	1	2	3	4	5	6	7	8	9	10	11	12	13	14	15	16	17	18	19	20	21	22	23
QUOTE PROGETTO	47.00	47.10	47.15	47.14	47.12	47.10	47.05	47.00	46.95	46.90	46.85	46.80	46.75	46.70	46.65	46.60	46.55	46.50	46.45	46.40	46.35	46.30	46.25
QUOTE TERRENO	47.00	47.00	47.00	47.00	47.00	47.00	47.00	47.00	47.00	47.00	47.00	47.00	47.00	47.00	47.00	47.00	47.00	47.00	47.00	47.00	47.00	47.00	47.00
DISTANZE PARZIALI	0.00	25.00	50.00	75.00	100.00	125.00	150.00	175.00	200.00	225.00	250.00	275.00	300.00	325.00	350.00	375.00	400.00	425.00	450.00	475.00	500.00	525.00	550.00
ETOMETRICHE	0.00	25.00	50.00	75.00	100.00	125.00	150.00	175.00	200.00	225.00	250.00	275.00	300.00	325.00	350.00	375.00	400.00	425.00	450.00	475.00	500.00	525.00	550.00
DISTANZE PROGRESSIVE	25.00	50.00	75.00	100.00	125.00	150.00	175.00	200.00	225.00	250.00	275.00	300.00	325.00	350.00	375.00	400.00	425.00	450.00	475.00	500.00	525.00	550.00	575.00
ANDAMENTO PLANIMETRICO	[Diagram showing horizontal alignment with curves and elevations]																						
ANDAMENTO SOPRAELEVAZIONE	[Diagram showing vertical alignment with curves and elevations]																						

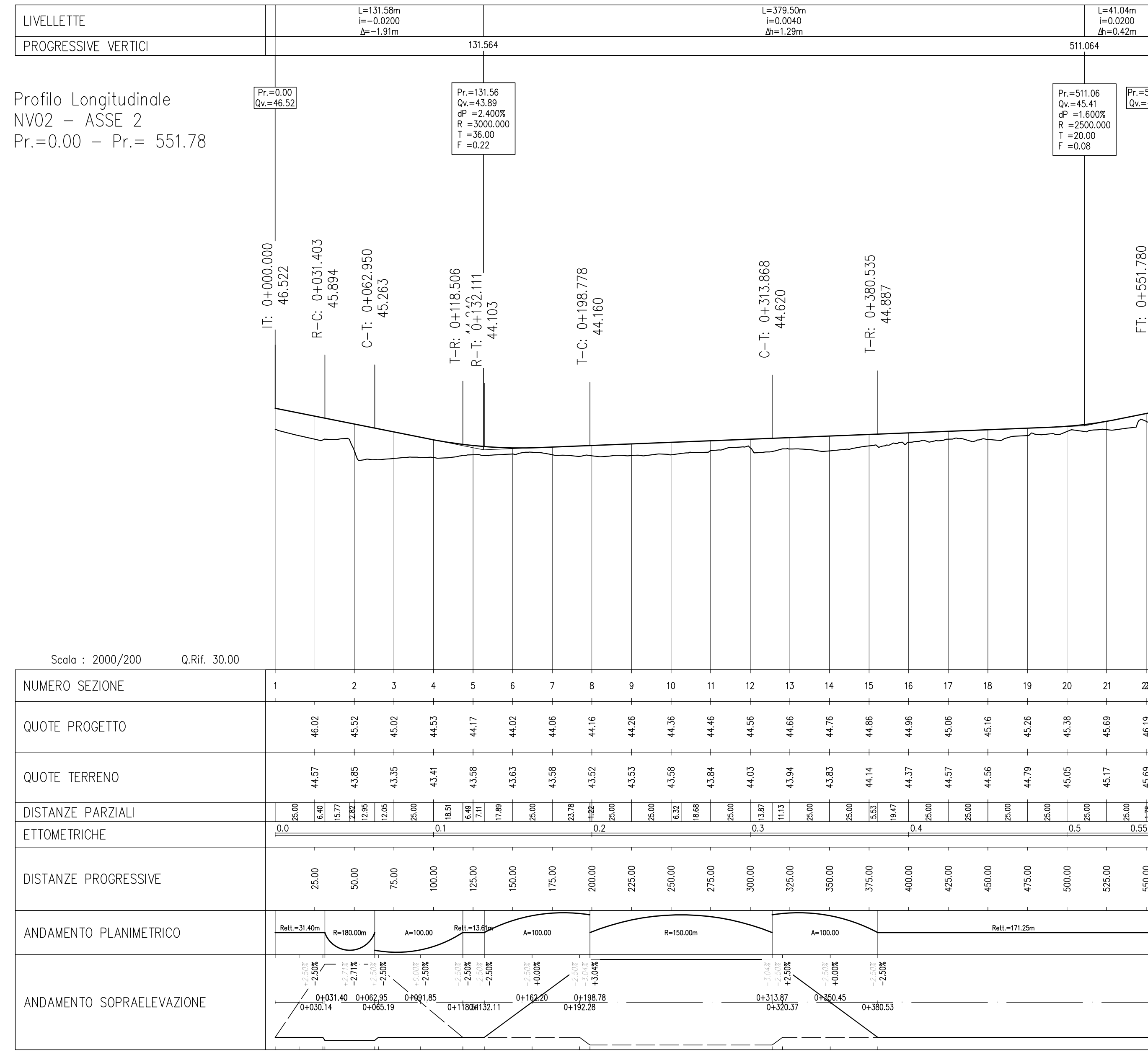

NUMERO SEZIONE	1	2	3	4	5	6	7	8	9	10	11	12	13	14	15	16	17	18	19	20	21	22	23
QUOTE PROGETTO	46.00	46.05	46.10	46.15	46.20	46.25	46.30	46.35	46.40	46.45	46.50	46.55	46.60	46.65	46.70	46.75	46.80	46.85	46.90	46.95	47.00	47.05	47.10
QUOTE TERRENO	46.00	46.00	46.00	46.00	46.00	46.00	46.00	46.00	46.00	46.00	46.00	46.00	46.00	46.00	46.00	46.00	46.00	46.00	46.00	46.00	46.00	46.00	46.00
DISTANZE PARZIALI	0.00	25.00	50.00	75.00	100.00	125.00	150.00	175.00	200.00	225.00	250.00	275.00	300.00	325.00	350.00	375.00	400.00	425.00	450.00	475.00	500.00	525.00	550.00
ETOMETRICHE	0.00	25.00	50.00	75.00	100.00	125.00	150.00	175.00	200.00	225.00	250.00	275.00	300.00	325.00	350.00	375.00	400.00	425.00	450.00	475.00	500.00	525.00	550.00
DISTANZE PROGRESSIVE	25.00	50.00	75.00	100.00	125.00	150.00	175.00	200.00	225.00	250.00	275.00	300.00	325.00	350.00	375.00	400.00	425.00	450.00	475.00	500.00	525.00	550.00	575.00
ANDAMENTO PLANIMETRICO	[Diagram showing horizontal alignment with curves and elevations]																						
ANDAMENTO SOPRAELEVAZIONE	[Diagram showing vertical alignment with curves and elevations]																						

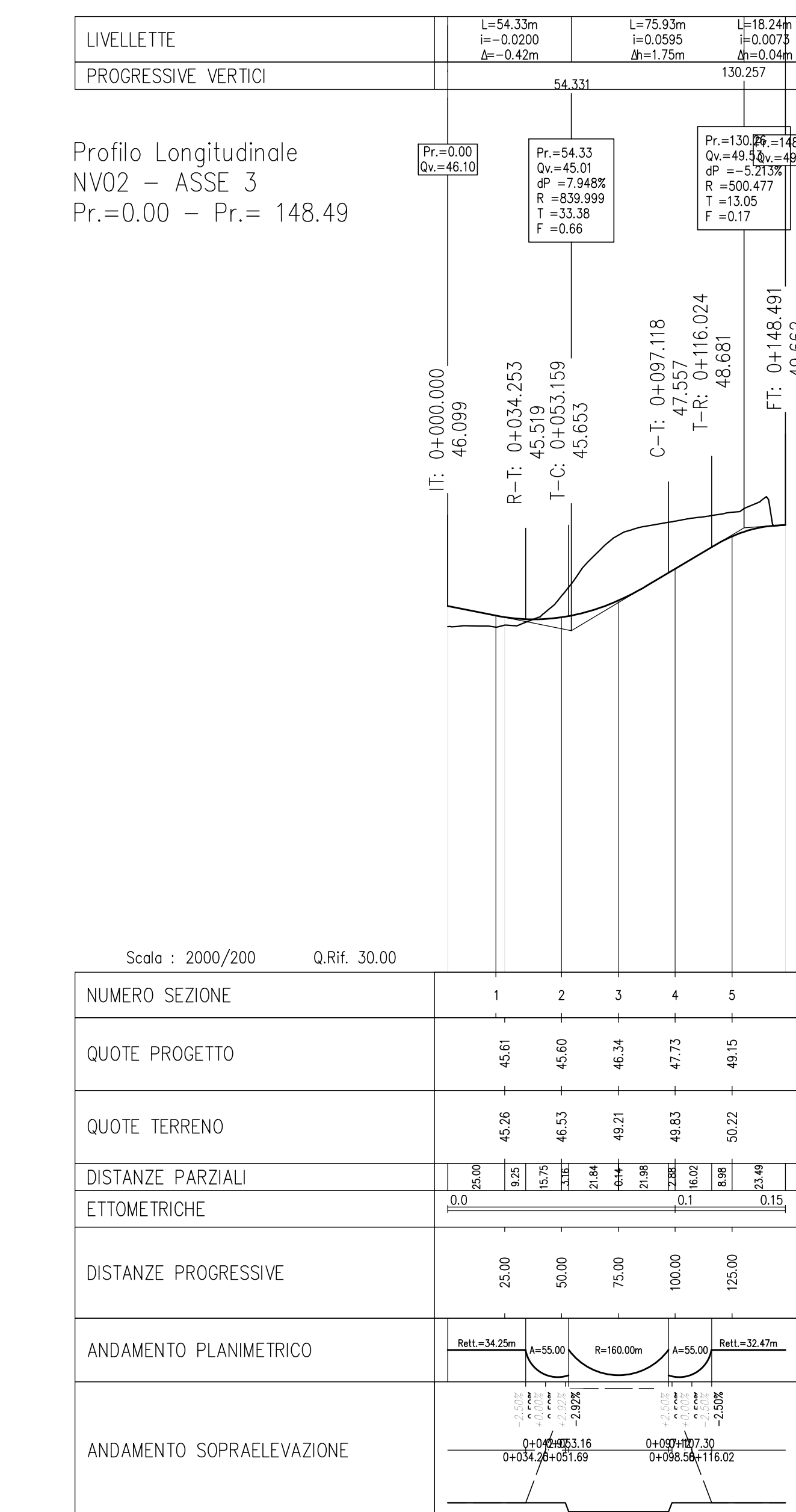

NUMERO SEZIONE	1	2	3	4	5
QUOTE PROGETTO	45.81	45.80	45.79	45.78	45.77
QUOTE TERRENO	45.81	45.81	45.81	45.81	45.81
DISTANZE PARZIALI	0.00	25.00	50.00	75.00	100.00
ETOMETRICHE	0.00	25.00	50.00	75.00	100.00
DISTANZE PROGRESSIVE	25.00	50.00	75.00	100.00	125.00
ANDAMENTO PLANIMETRICO	[Diagram showing horizontal alignment with curves and elevations]				
ANDAMENTO SOPRAELEVAZIONE	[Diagram showing vertical alignment with curves and elevations]				

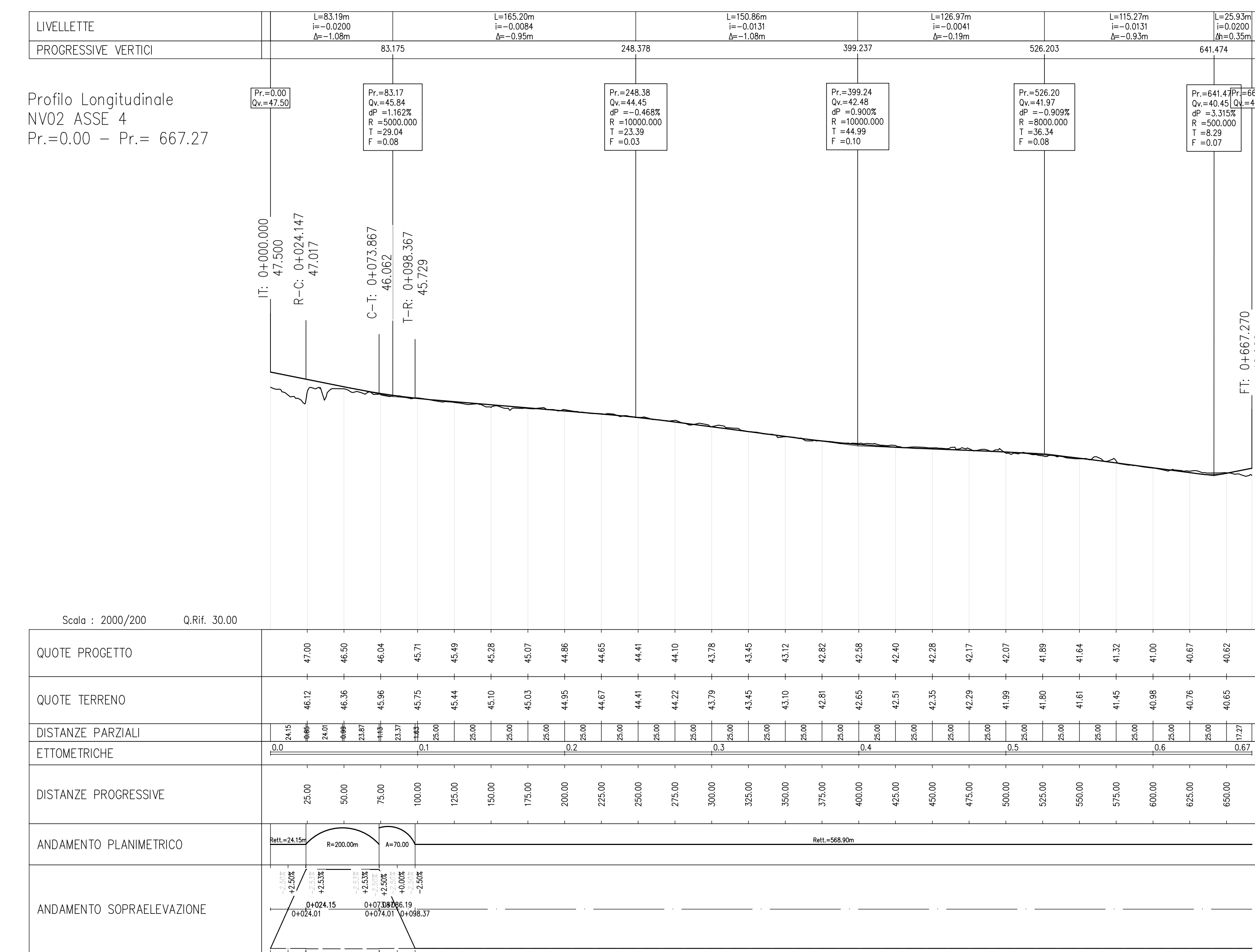
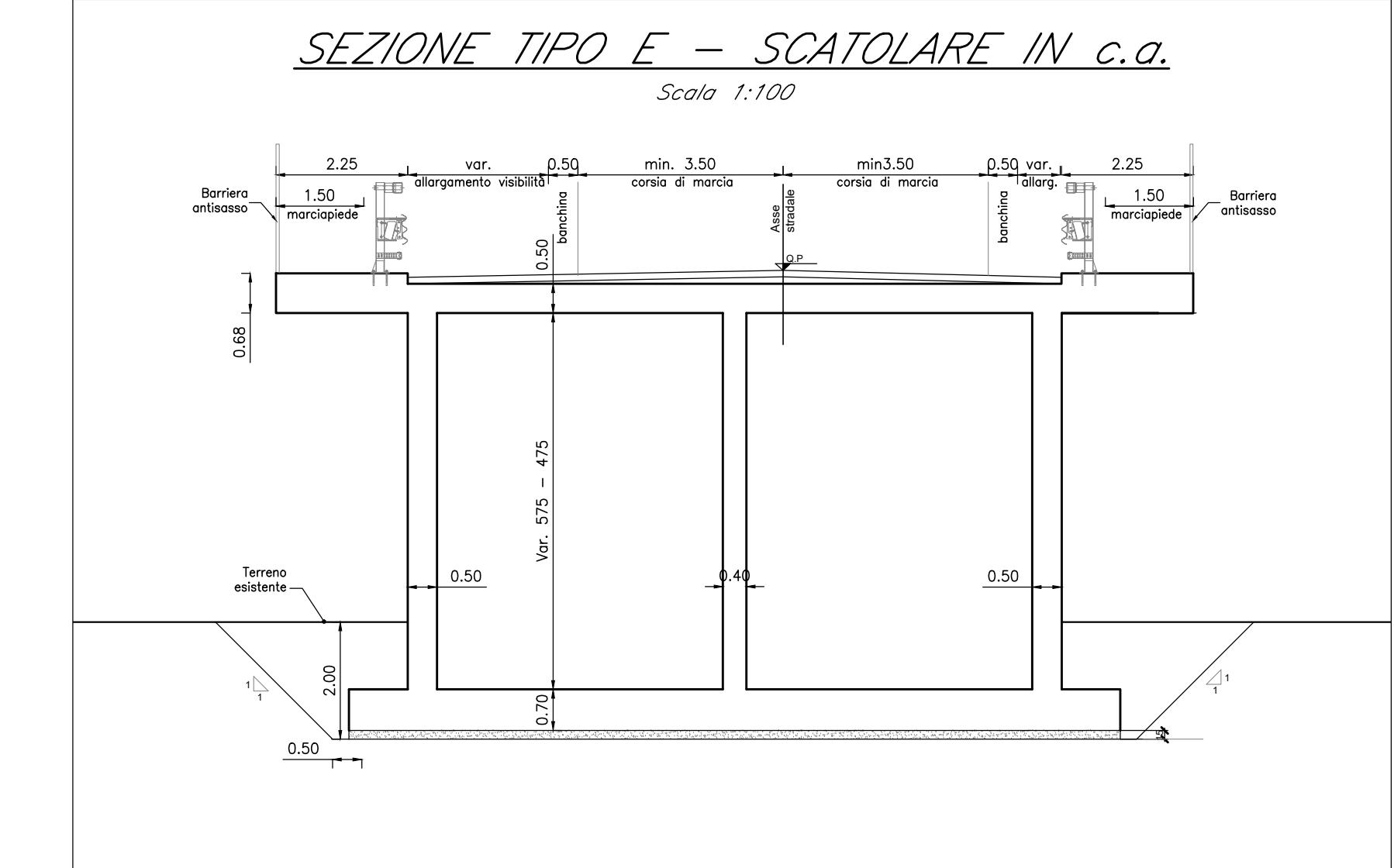

NUMERO SEZIONE	1	2	3	4	5	6	7	8	9	10	11	12	13	14	15	16	17	18	19	20	21	22	23
QUOTE PROGETTO	47.00	47.05	47.10	47.15	47.20	47.25	47.30	47.35	47.40	47.45	47.50	47.55	47.60	47.65	47.70	47.75	47.80	47.85	47.90	47.95	48.00	48.05	48.10
QUOTE TERRENO	47.00	47.00	47.00	47.00	47.00	47.00	47.00	47.00	47.00	47.00	47.00	47.00	47.00	47.00	47.00	47.00	47.00	47.00	47.00	47.00	47.00	47.00	47.00
DISTANZE PARZIALI	0.00	25.00	50.00	75.00	100.00	125.00	150.00	175.00	200.00	225.00	250.00	275.00	300.00	325.00	350.00	375.00	400.00	425.00	450.00	475.00	500.00	525.00	550.00
ETOMETRICHE	0.00	25.00	50.00	75.00	100.00	125.00	150.00	175.00	200.00	225.00	250.00	275.00	300.00	325.00	350.00	375.00	400.00	425.00	450.00	475.00	500.00	525.00	550.00
DISTANZE PROGRESSIVE	25.00	50.00	75.00	100.00	125.00	150.00	175.00	200.00	225.00	250.00	275.00	300.00	325.00	350.00	375.00	400.00	425.00	450.00	475.00	500.00	525.00	550.00	575.00
ANDAMENTO PLANIMETRICO	[Diagram showing horizontal alignment with curves and elevations]																						
ANDAMENTO SOPRAELEVAZIONE	[Diagram showing vertical alignment with curves and elevations]																						

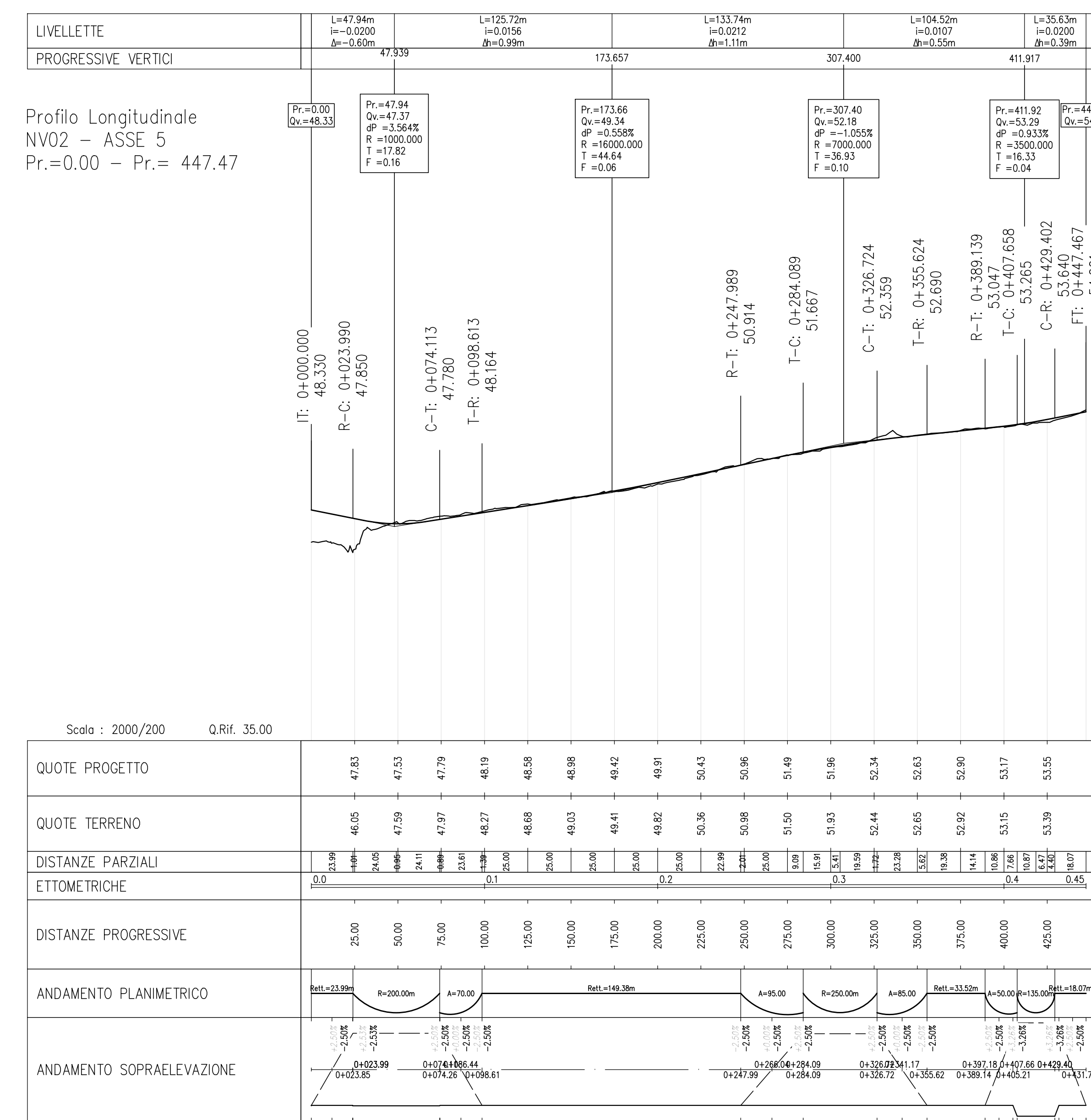

NUMERO SEZIONE	1	2	3	4	5	6	7	8	9	10	11	12	13	14	15	16	17	18	19	20	21	22	23
QUOTE PROGETTO	47.85	47.90	47.95	48.00	48.05	48.10	48.15	48.20	48.25	48.30	48.35	48.40	48.45	48.50	48.55	48.60	48.65	48.70	48.75	48.80	48.85	48.90	48.95
QUOTE TERRENO	47.85	47.85	47.85	47.85	47.85	47.85	47.85	47.85	47.85	47.85	47.85	47.85	47.85	47.85	47.85	47.85	47.85	47.85	47.85	47.85	47.85	47.85	47.85
DISTANZE PARZIALI	0.00	25.00	50.00	75.00	100.00	125.00	150.00	175.00	200.00	225.00	250.00	275.00	300.00	325.00	350.00	375.00	400.00	425.00	450.00	475.00	500.00	525.00	550.00
ETOMETRICHE	0.00	25.00	50.00	75.00	100.00	125.00	150.00	175.00	200.00	225.00	250.00	275.00	300.00	325.00	350.00	375.00	400.00	425.00	450.00	475.00	500.00	525.00	550.00
DISTANZE PROGRESSIVE	25.00	50.00	75.00	100.00	125.00	150.00	175.00	200.00	225.00	250.00	275.00	300.00	325.00	350.00	375.00	400.00	425.00	450.00	475.00	500.00	525.00	550.00	575.00
ANDAMENTO PLANIMETRICO	[Diagram showing horizontal alignment with curves and elevations]																						
ANDAMENTO SOPRAELEVAZIONE	[Diagram showing vertical alignment with curves and elevations]																						

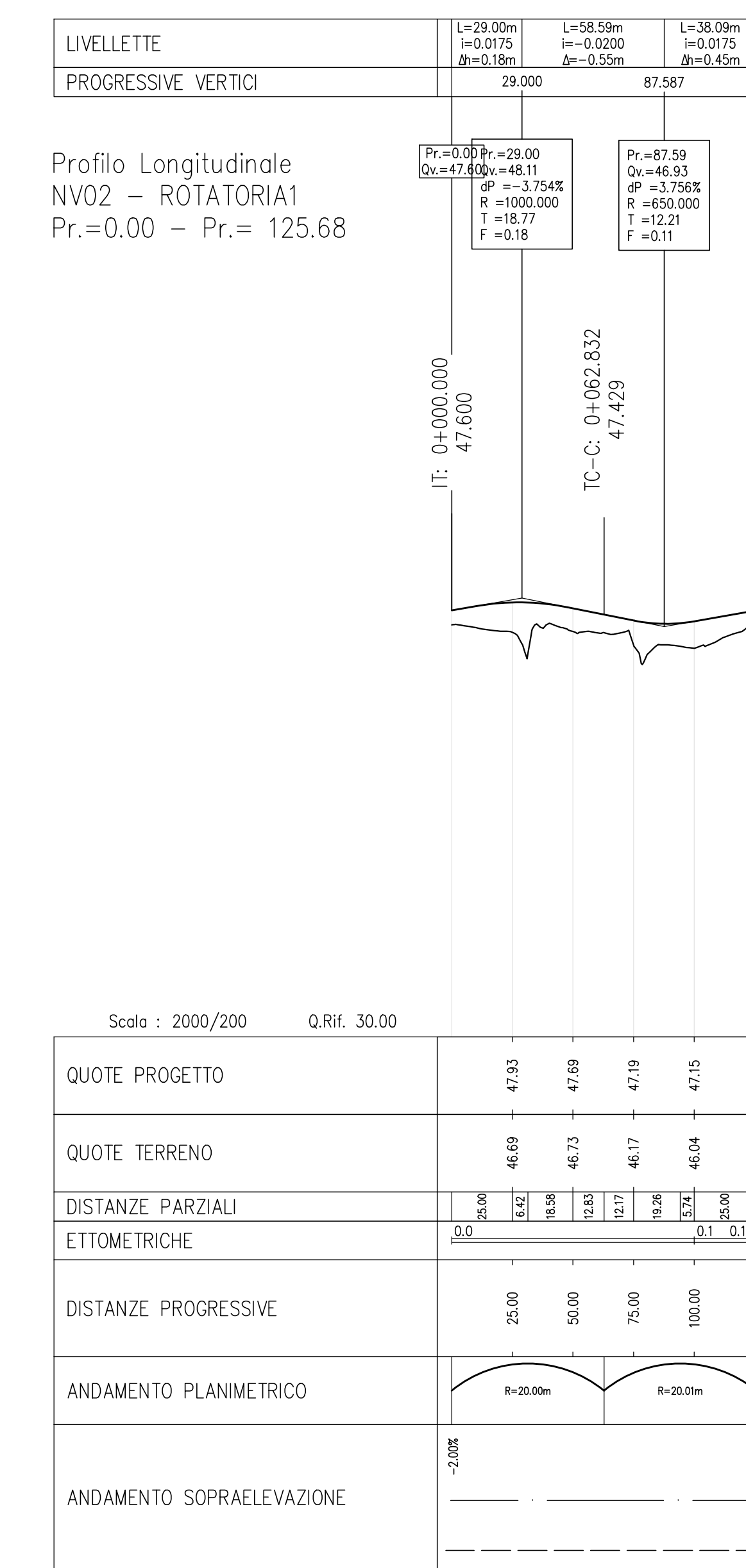

NUMERO SEZIONE	1	2	3	4	5
QUOTE PROGETTO	47.95	47.95	47.95	47.95	47.95
QUOTE TERRENO	47.95	47.95	47.95	47.95	47.95
DISTANZE PARZIALI	0.00	25.00	50.00	75.00	100.00
ETOMETRICHE	0.00	25.00	50.00	75.00	100.00
DISTANZE PROGRESSIVE	25.00	50.00	75.00	100.00	125.00
ANDAMENTO PLANIMETRICO	[Diagram showing horizontal alignment with curves and elevations]				
ANDAMENTO SOPRAELEVAZIONE	[Diagram showing vertical alignment with curves and elevations]				

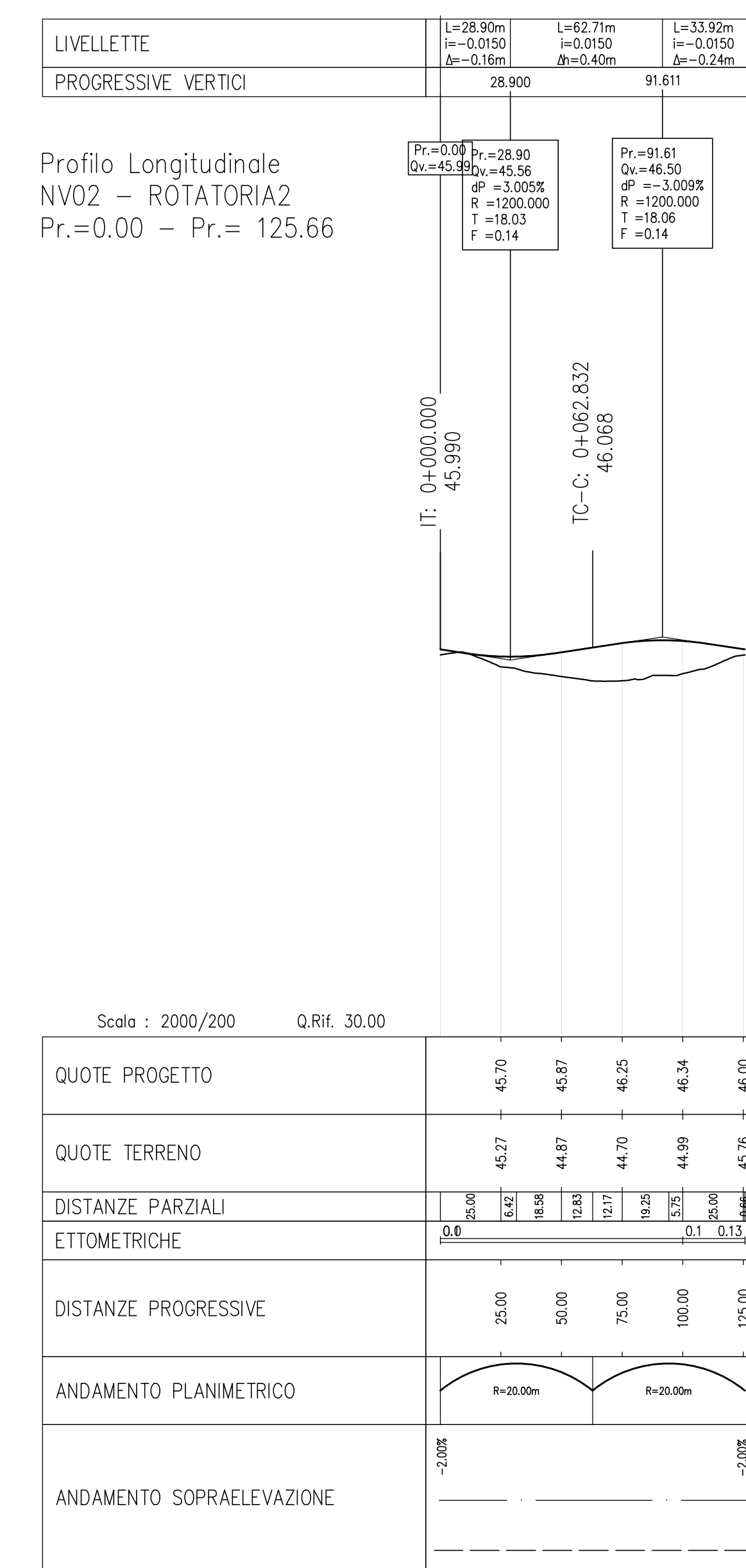

NUMERO SEZIONE	1	2	3	4	5
QUOTE PROGETTO	45.70	45.70	45.70	45.70	45.70
QUOTE TERRENO	45.70	45.70	45.70	45.70	45.70
DISTANZE PARZIALI	0.00	25.00	50.00	75.00	100.00
ETOMETRICHE	0.00	25.00	50.00	75.00	100.00
DISTANZE PROGRESSIVE	25.00	50.00	75.00	100.00	125.00
ANDAMENTO PLANIMETRICO	[Diagram showing horizontal alignment with curves and elevations]				
ANDAMENTO SOPRAELEVAZIONE	[Diagram showing vertical alignment with curves and elevations]				

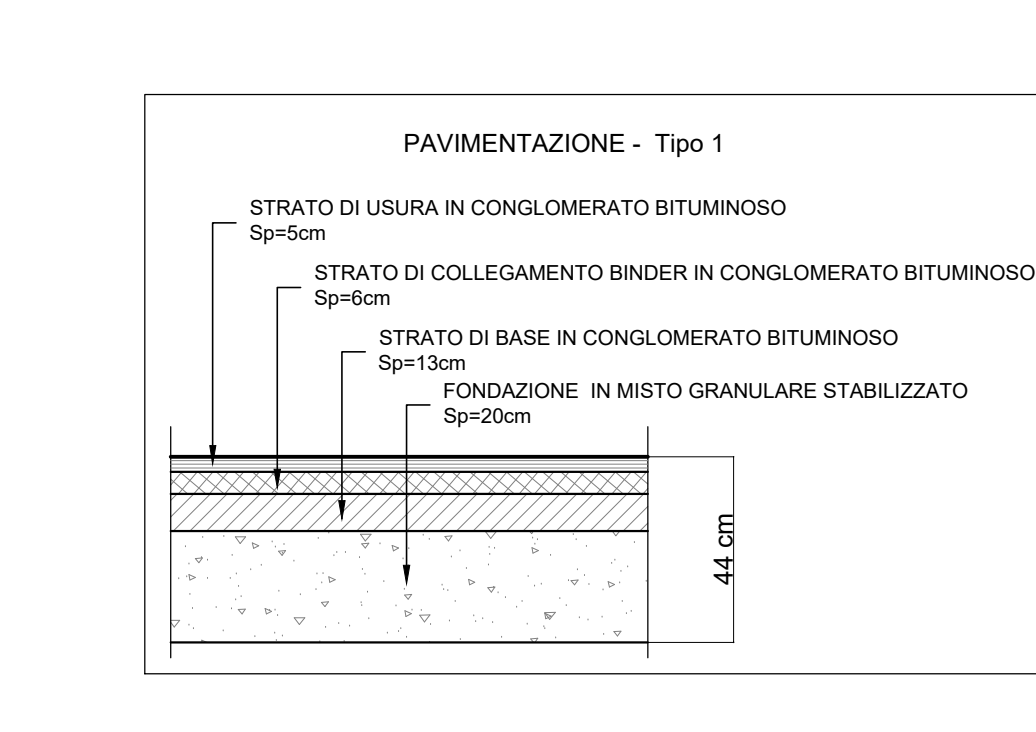
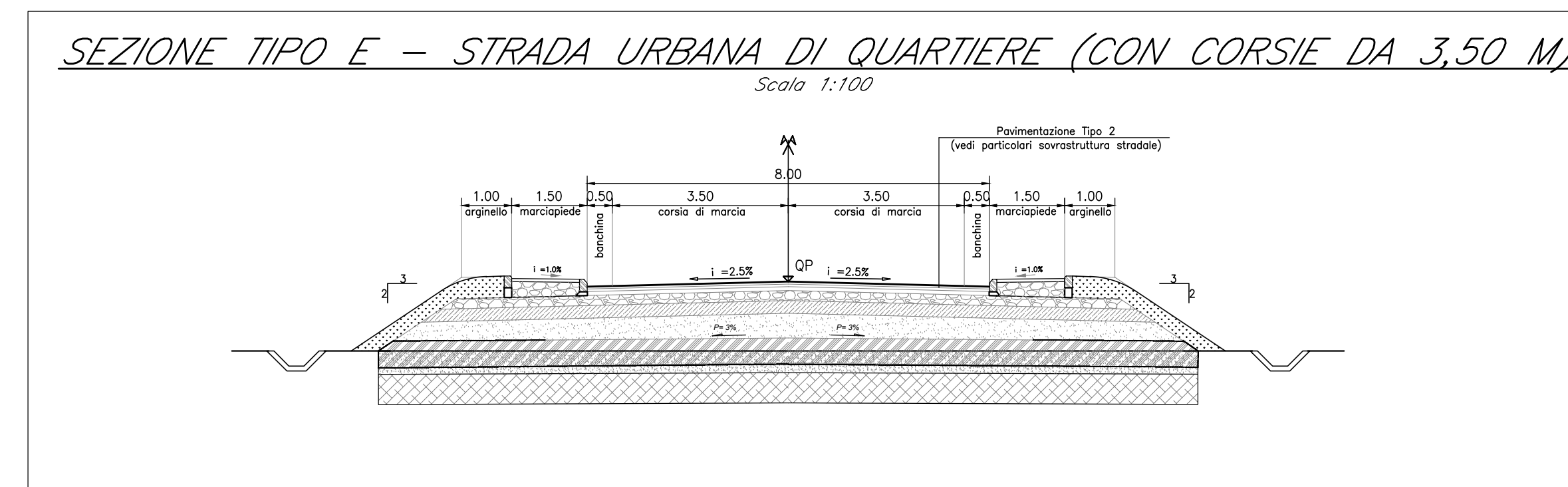
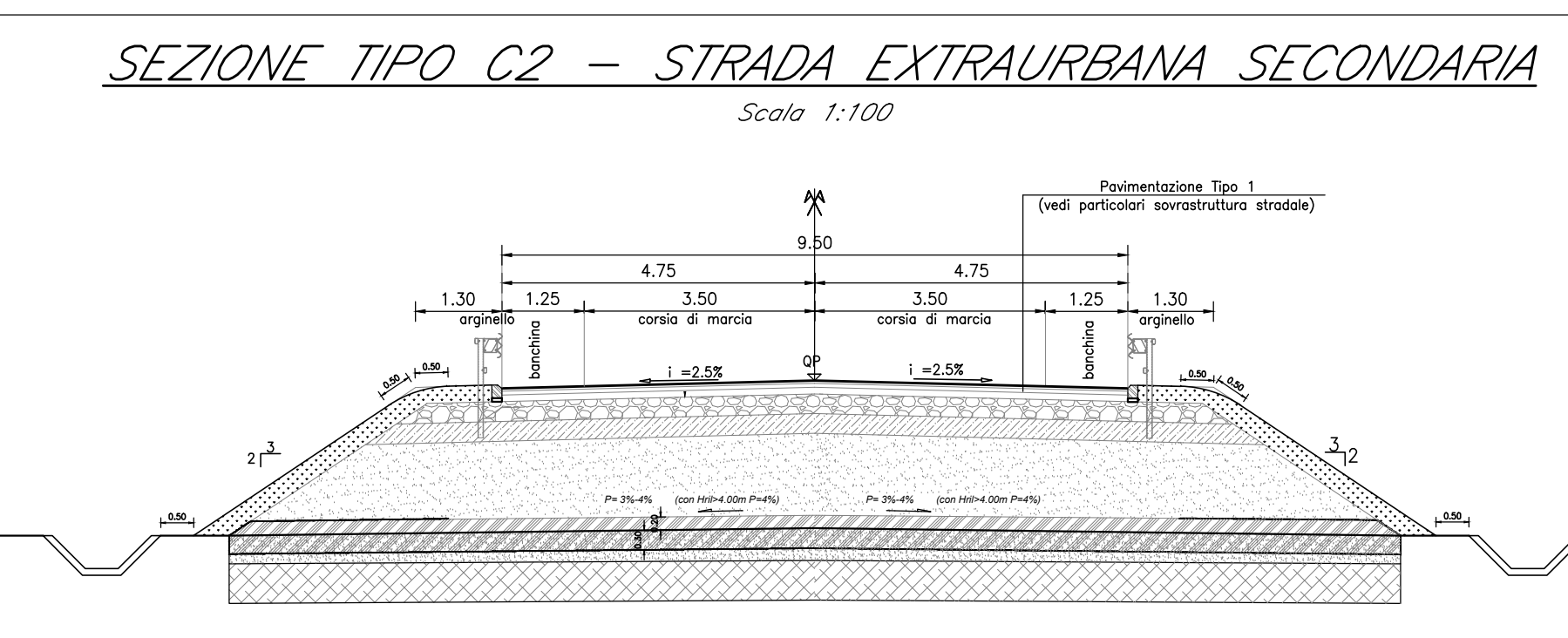
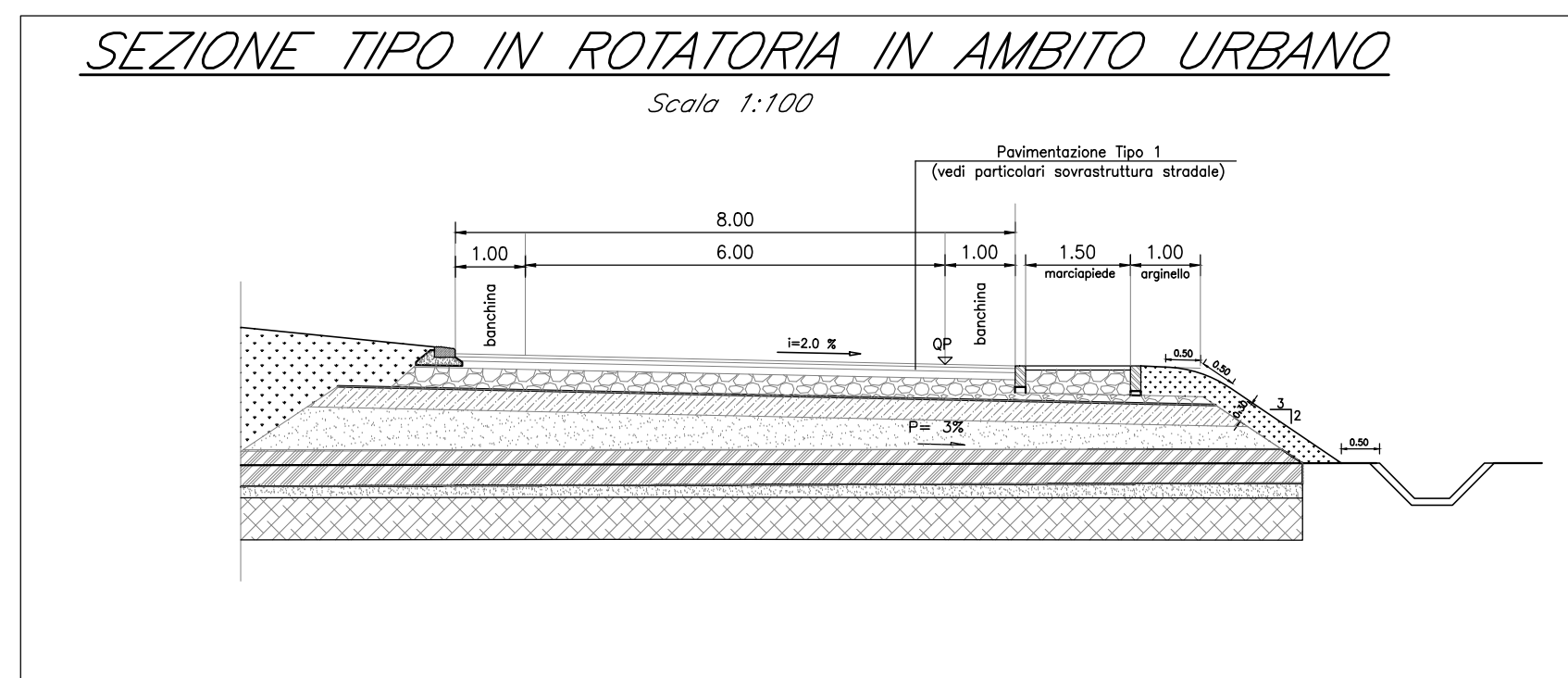

COMMITTENTE: **RFI** RETTE FERROVIARIE ITALIANE GRUPPO FERROVIE DELLO STATO ITALIANE

PROGETTAZIONE: **ITALFERR** GRUPPO FERROVIE DELLO STATO ITALIANE

DIREZIONE TECNICA
S.O. PROGETTAZIONE INTEGRATA CENTRO
PROGETTO DI FATIBILITA' TECNICO ECONOMICA

VELOCIZZAZIONE DELLA LINEA ROMA - PESCARA
RADDOPPIO FERROVIARIO TRATTA INTERPORTO D'ABRUZZO - MANOPPELLO (LOTTO 1)

VIABILITA' STRADALI - NV02 - Nuova viabilità di accesso a Brecciarola

Profili di progetto e sezioni tipo

SCALA: Varie

COMMESSA LOTTO FASE ENTE TIPO DOC. OPERA/DISCIPLINA PROGR. REV.

IA96 00 R 29 LZ NV0200 001 B

Rev.	Descrizione	Redatto	Data	Verificato	Data	Approvato	Data	Autografo	Data
A	Emissione definitiva	[Signature]	Agosto 2021	[Signature]	Agosto 2021	[Signature]	Agosto 2021	[Signature]	Agosto 2021
B	Rev. richieste RFI	[Signature]	Nov 2021	[Signature]	Nov 2021	[Signature]	Nov 2021	[Signature]	Nov 2021

File: IA9600R29LZNV020001B.dwg n. Etab.: 21.9