







LEGENDA

-  Cavo nudo in rame Ø35mm
-  Pozzetto di messa a terra 60x60cm
compreso di dispersore a croce
lunghezza 1,50 m
-  Cabine Trasformatori
-  Cabine Impianto
-  Cabina di Raccolta
-  Cabina Ausiliaria
-  Cabina di Consegna



Scala 1:2000

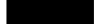
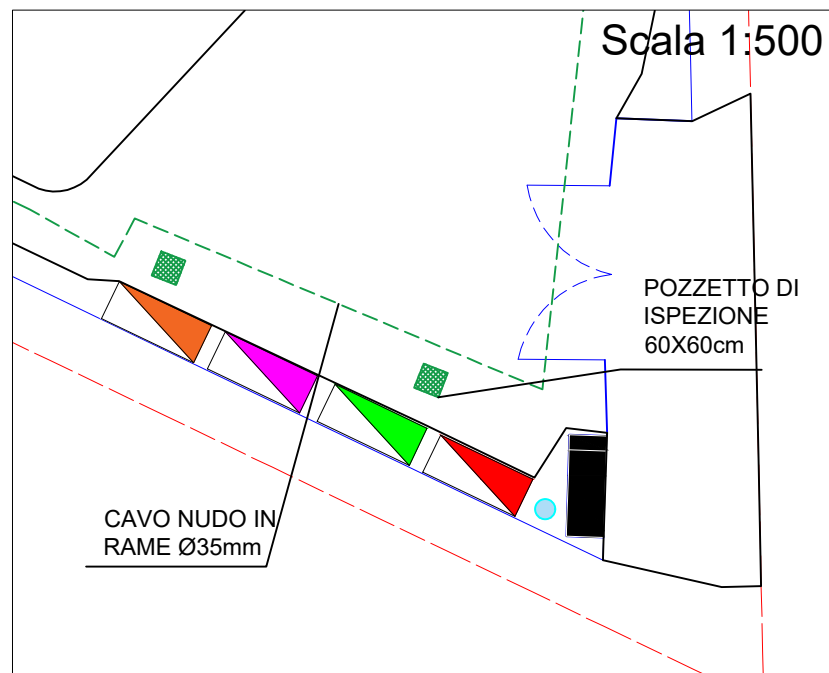
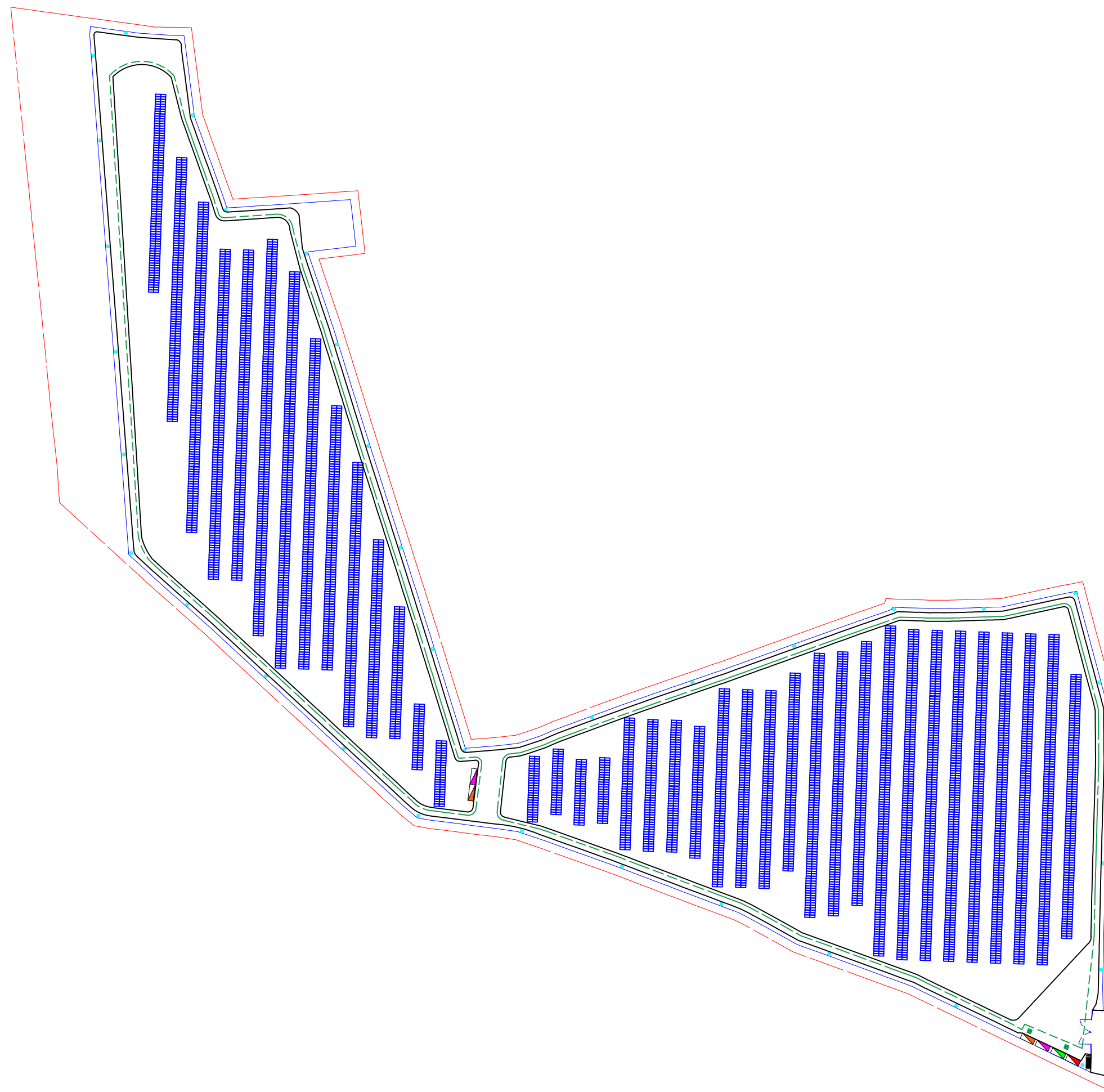

Particolare Collegamento Tracker

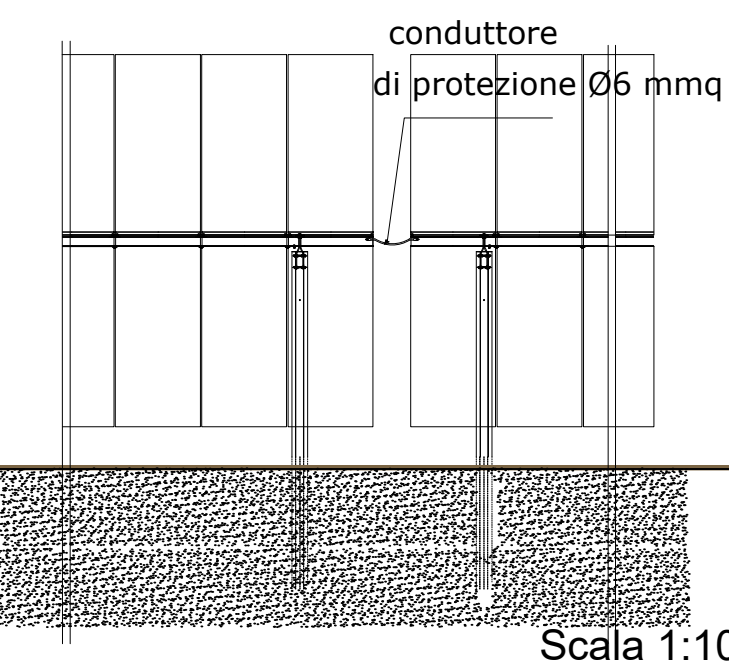

Particolare Testa Tracker

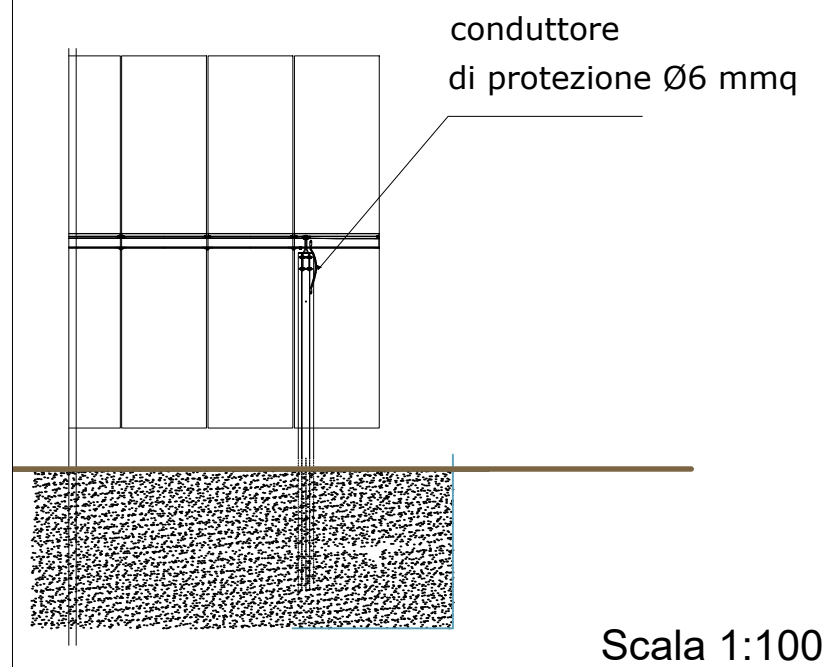

Particolare Picchetto

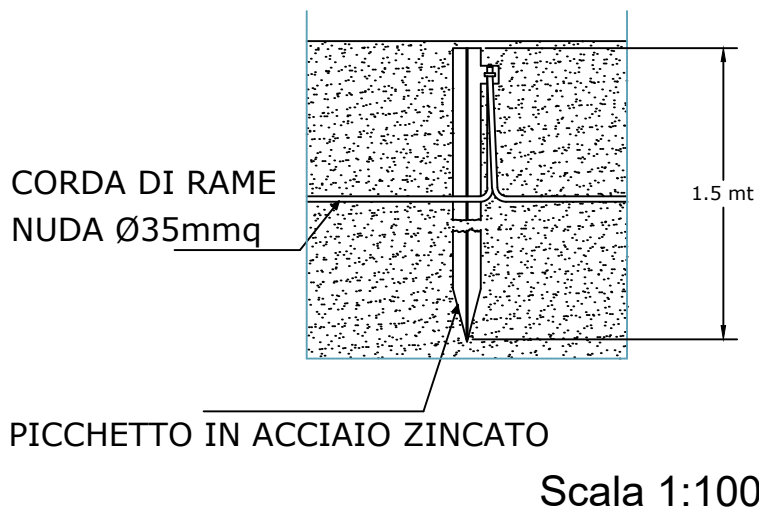

Particolare Pozzetto

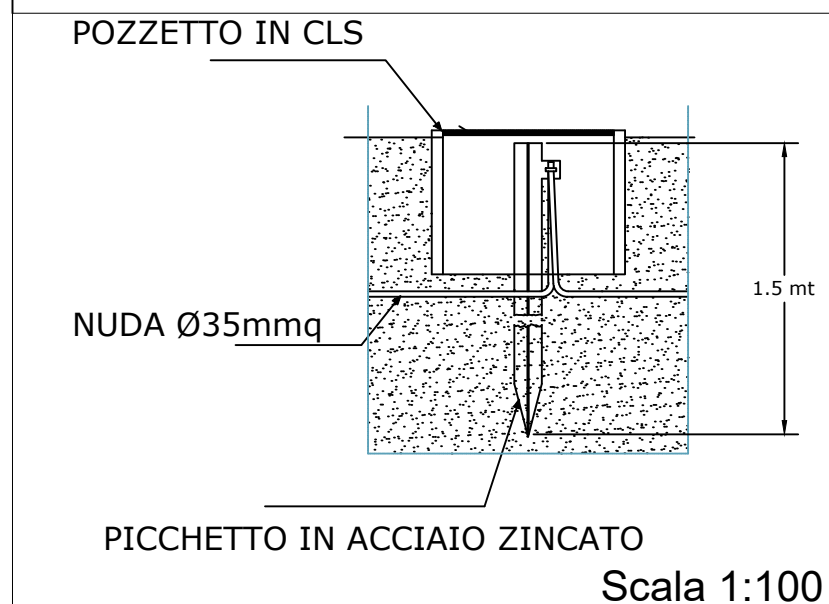

COMUNI DI TORRE SANTA SUSANNA-MESAGNE-ERCHIE

Provincia di Brindisi



PROGETTO
Ingveprogetti s.r.l.s.
via Geofilo n.7-72023, Mesagne (BR)
email: info@ingveprogetti.it

RESPONSABILE DEL PROGETTO
Ing. Giorgio Vece

COSTRUZIONE ED ESERCIZIO DI UN IMPIANTO AGROVOLTAICO DENOMINATO "SPARPAGLIATA", DELLE OPERE ED INFRASTRUTTURE CONNESSE, SITO NEI COMUNI DI TORRE SANTA SUSANNA, MESAGNE ED ERCHIE (BR), CON POTENZA NOMINALE PARI A 30.000,000 KWn E POTENZA DI PICCO PARI A 33.888,78 KWp.

OGGETTO: Tavola impianto messa a terra Lotto SP_3

ELABORATO:
C9DVVB4_Elaborato
Grafico_17b

PROGETTISTA
Ing. Giorgio Vece

NOME FILE:
SP_Messaaterra

SCALA: 1:2.000
1:500
1:100

TIMBRO E FIRMA

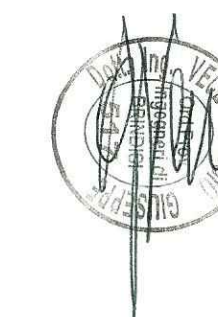

STATO DEL PROGETTO PROGETTO DEFINITIVO PER V.I.A.

N°	DATA	DESCRIZIONE	VERIFICATO	APPROVATO
00	AGOSTO 2020			
01	DICEMBRE 2020	Revisione	Ing. Giorgio Vece	
02				

Powertis
Luminora Sparpagliata S.r.l
Via Venti Settembre 1, 00187 Roma
C.F. e P.IVA 15954411003