

NOTE GENERALI

LEGENDA

P.L. TR. 200 ANN. (m s.m.)

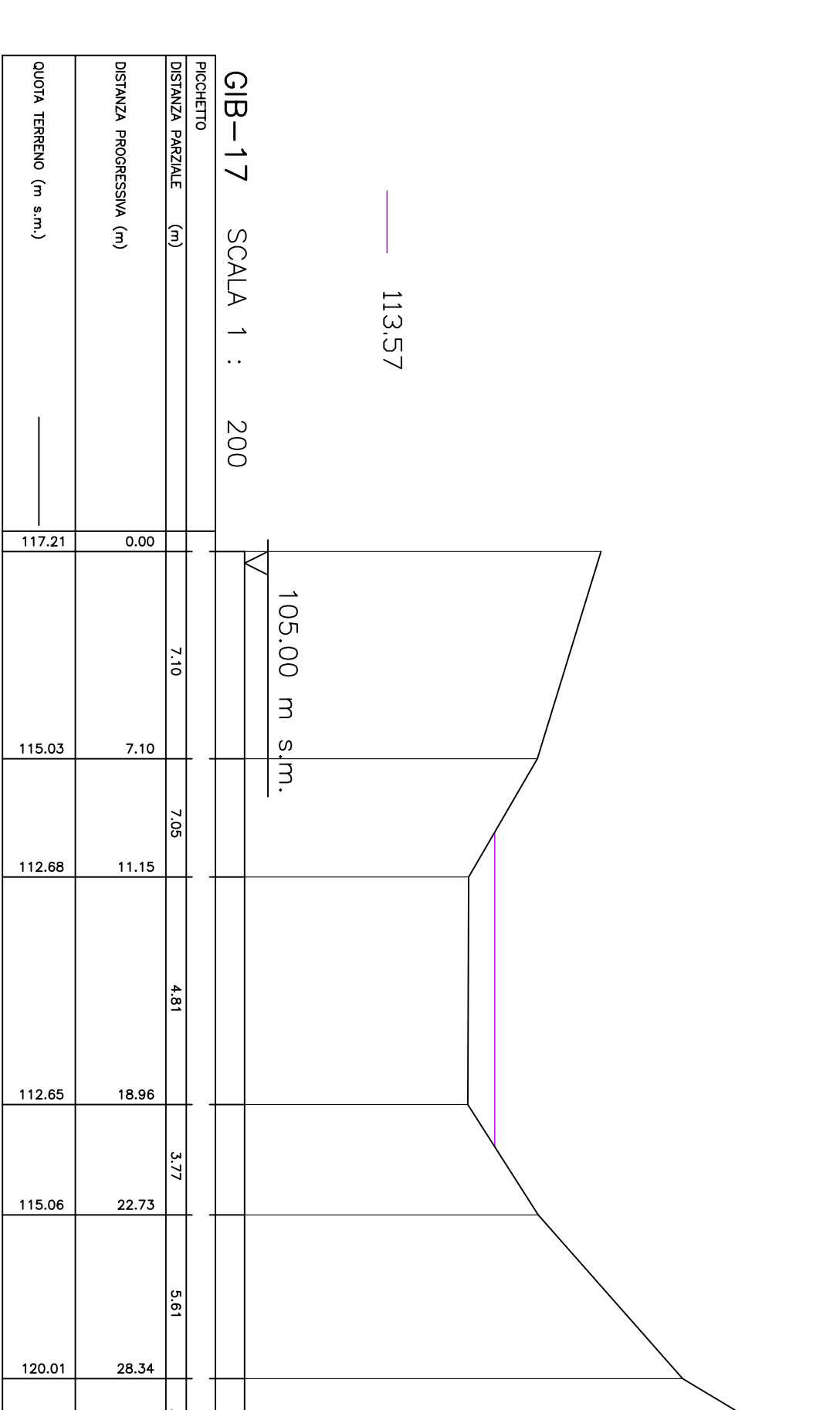
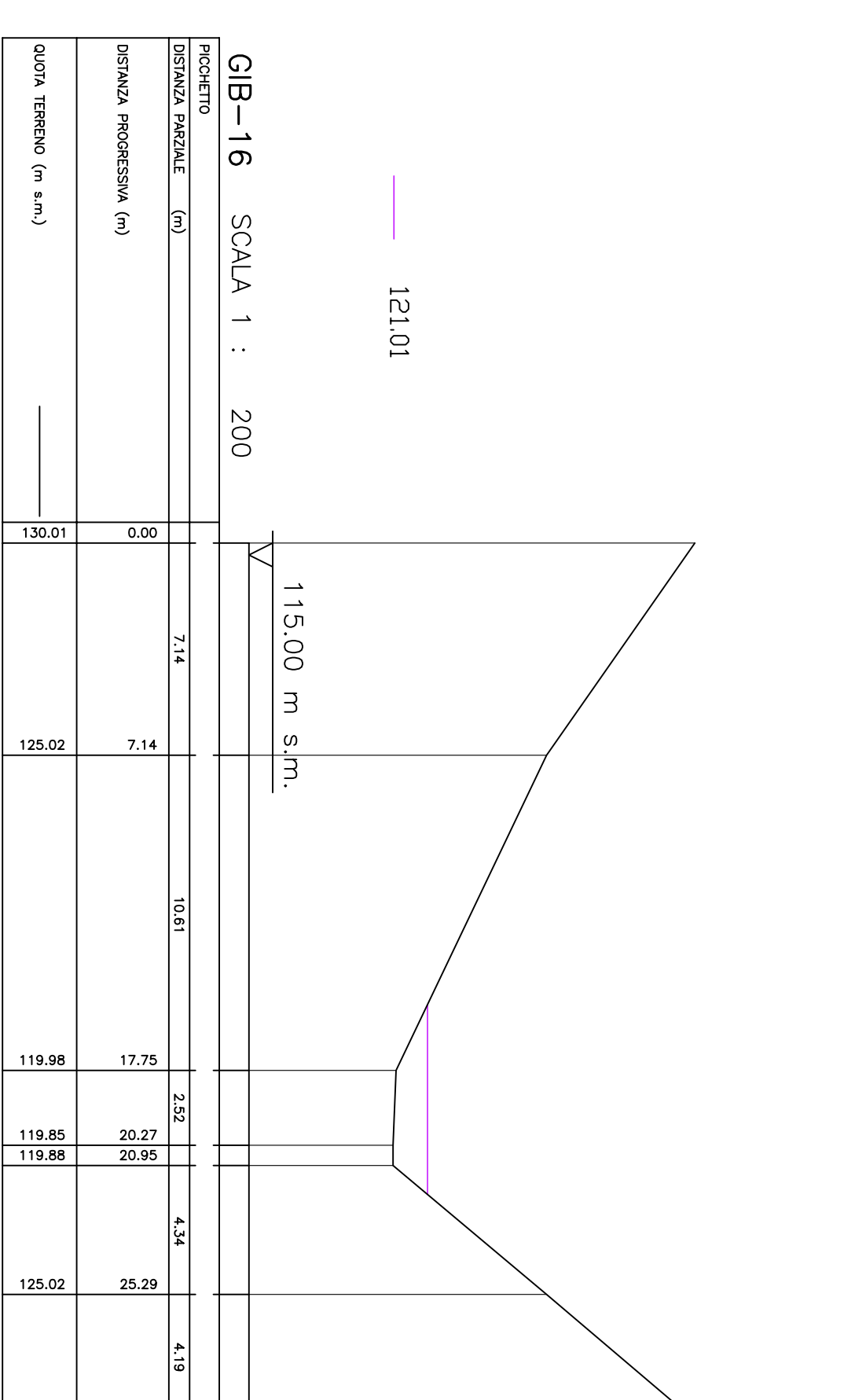
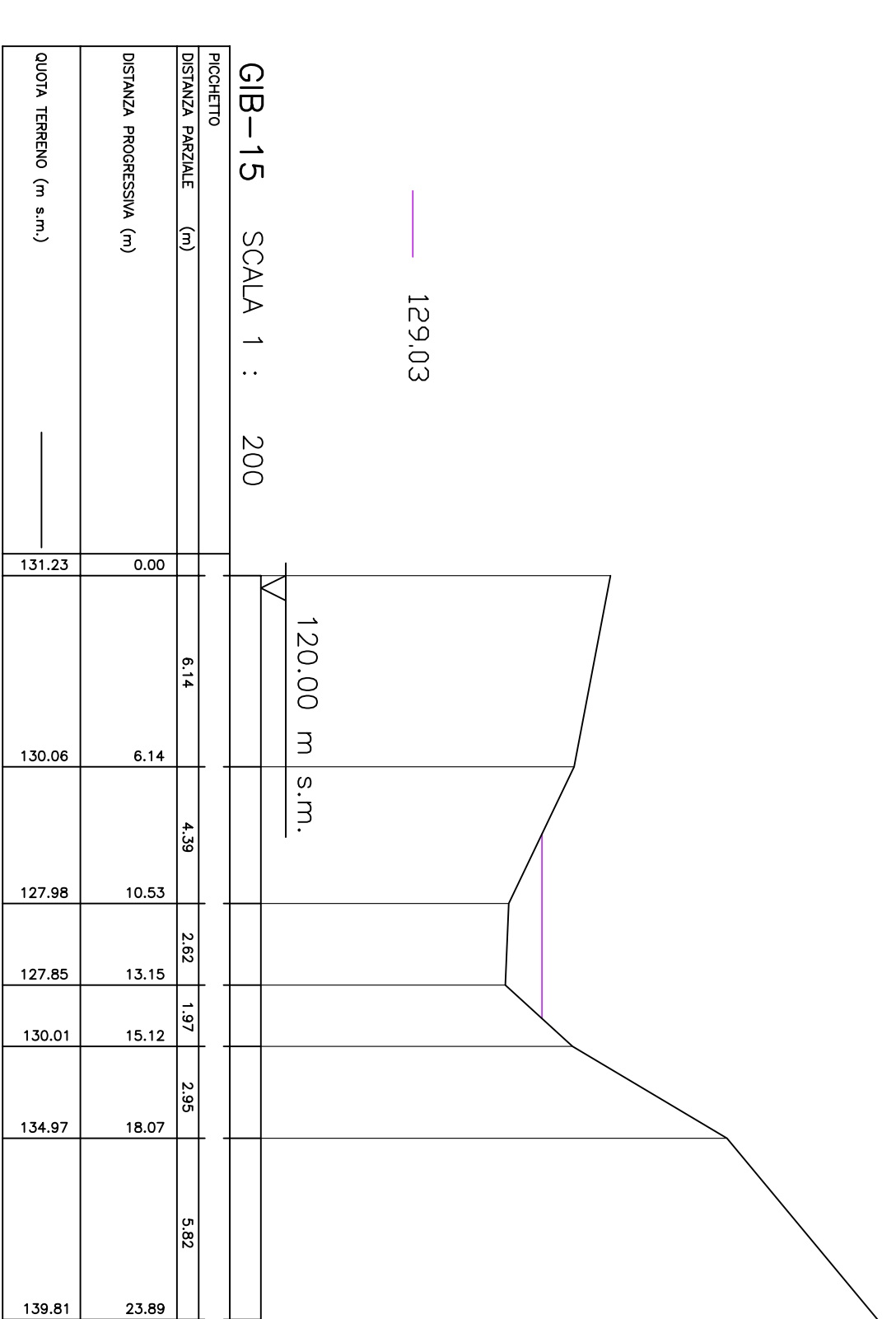
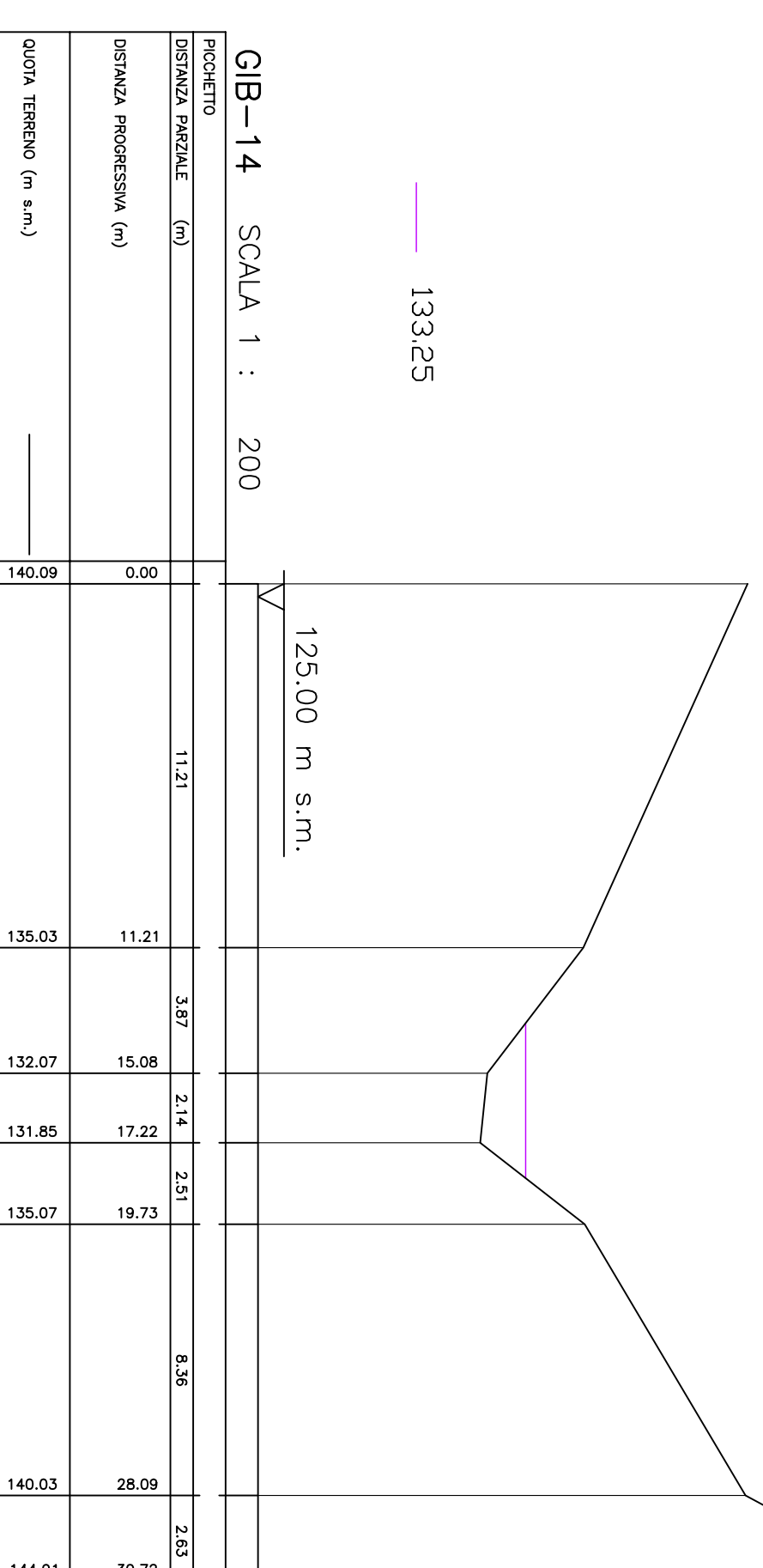
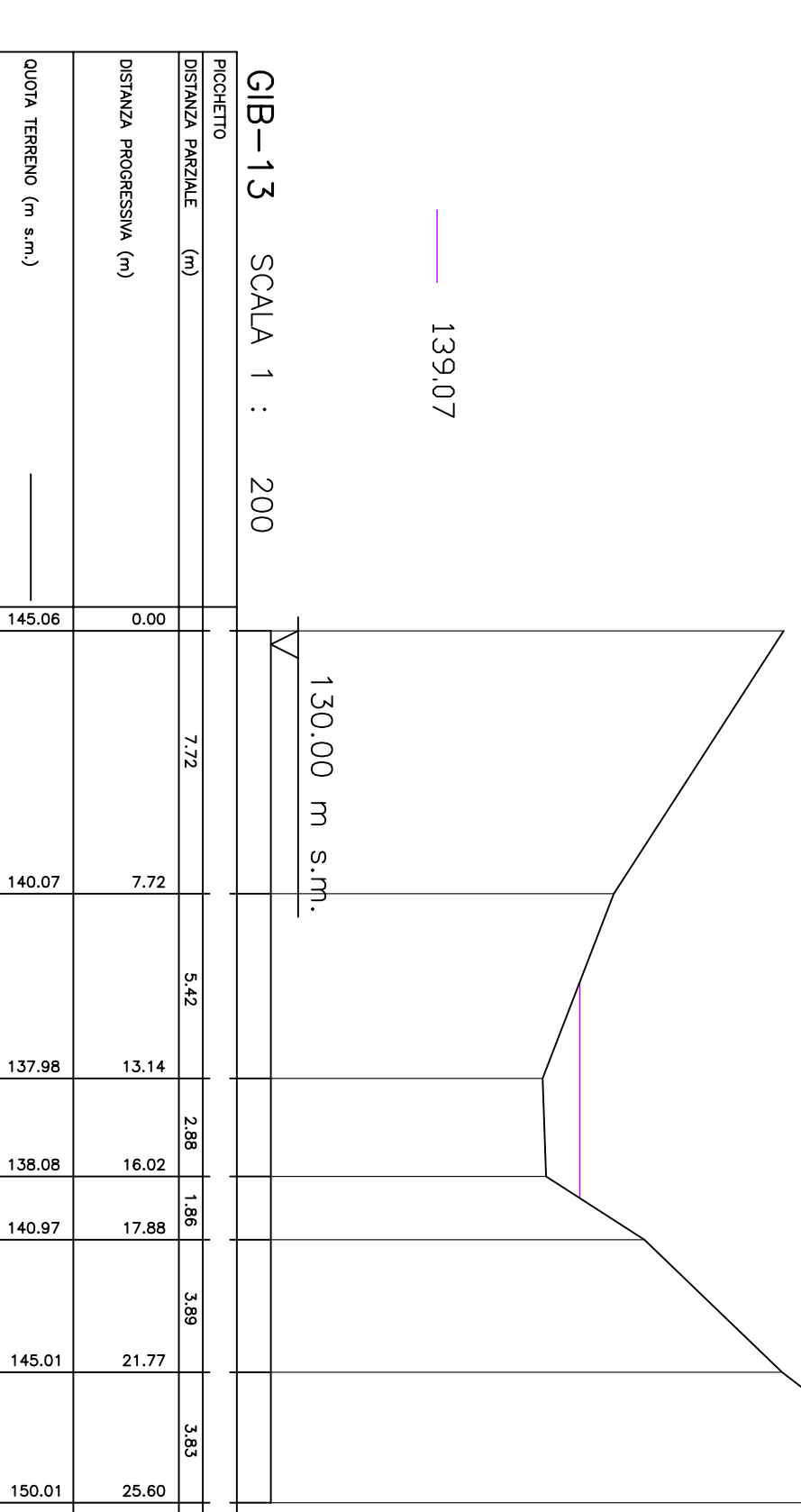
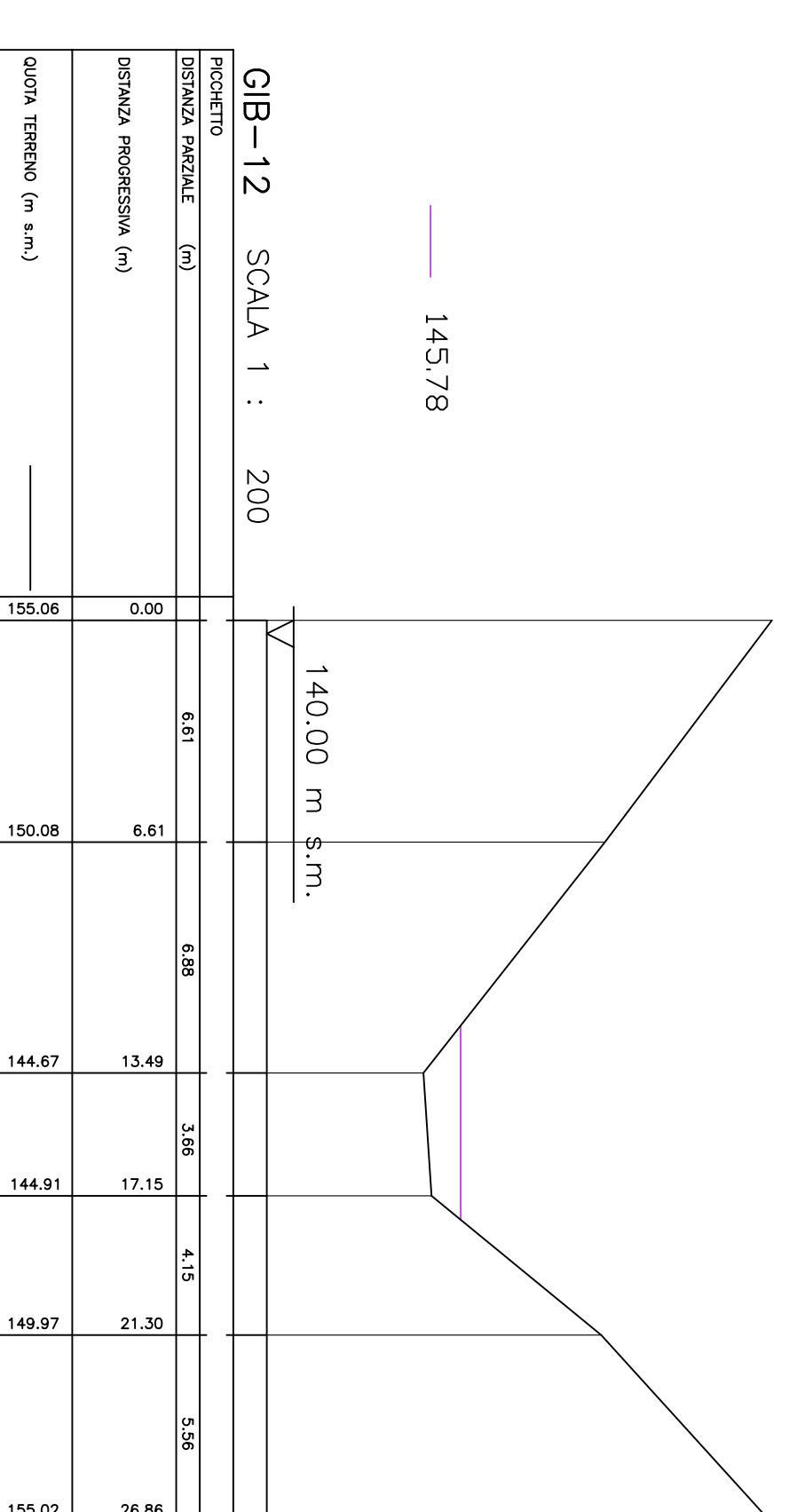
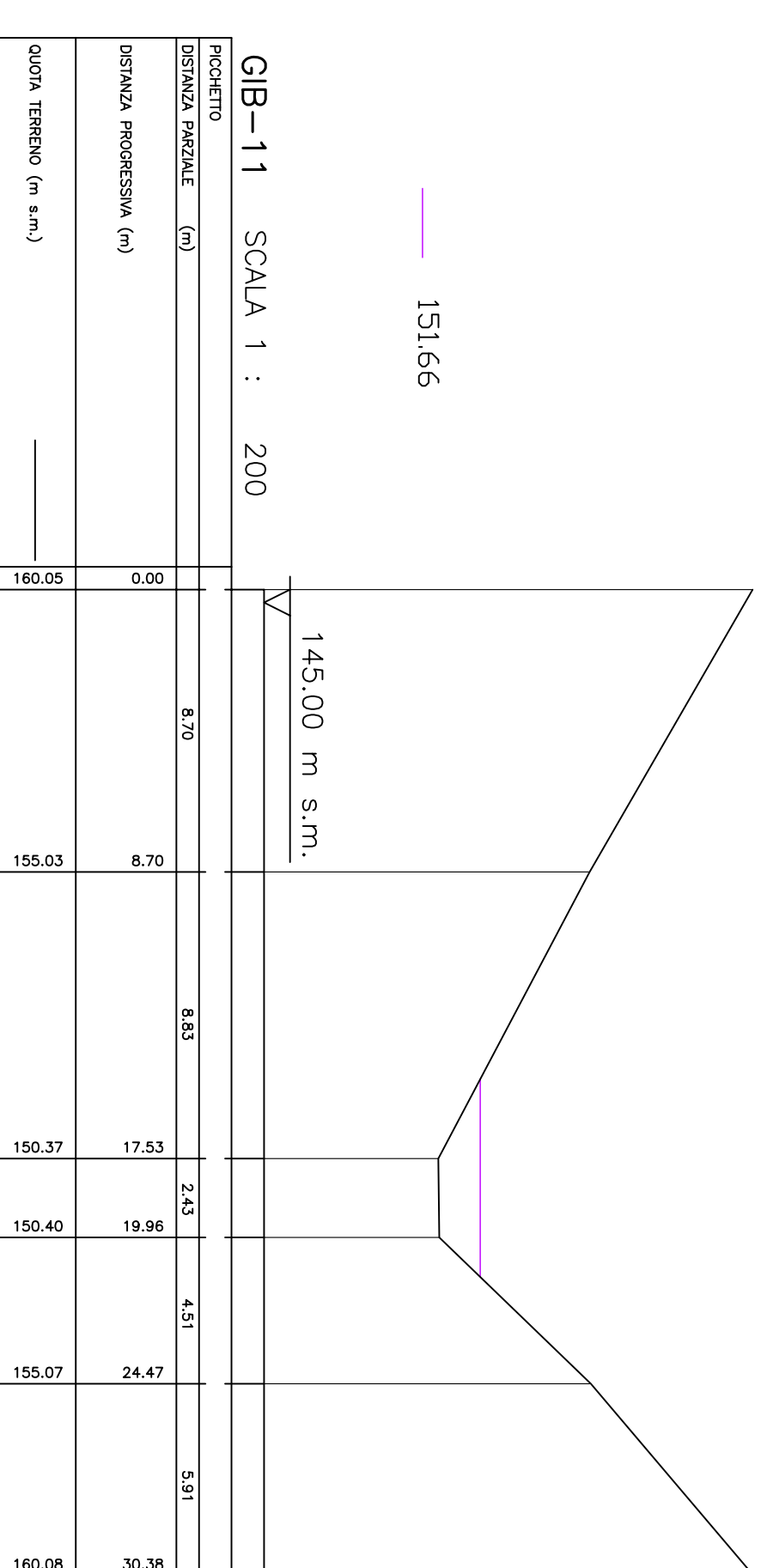
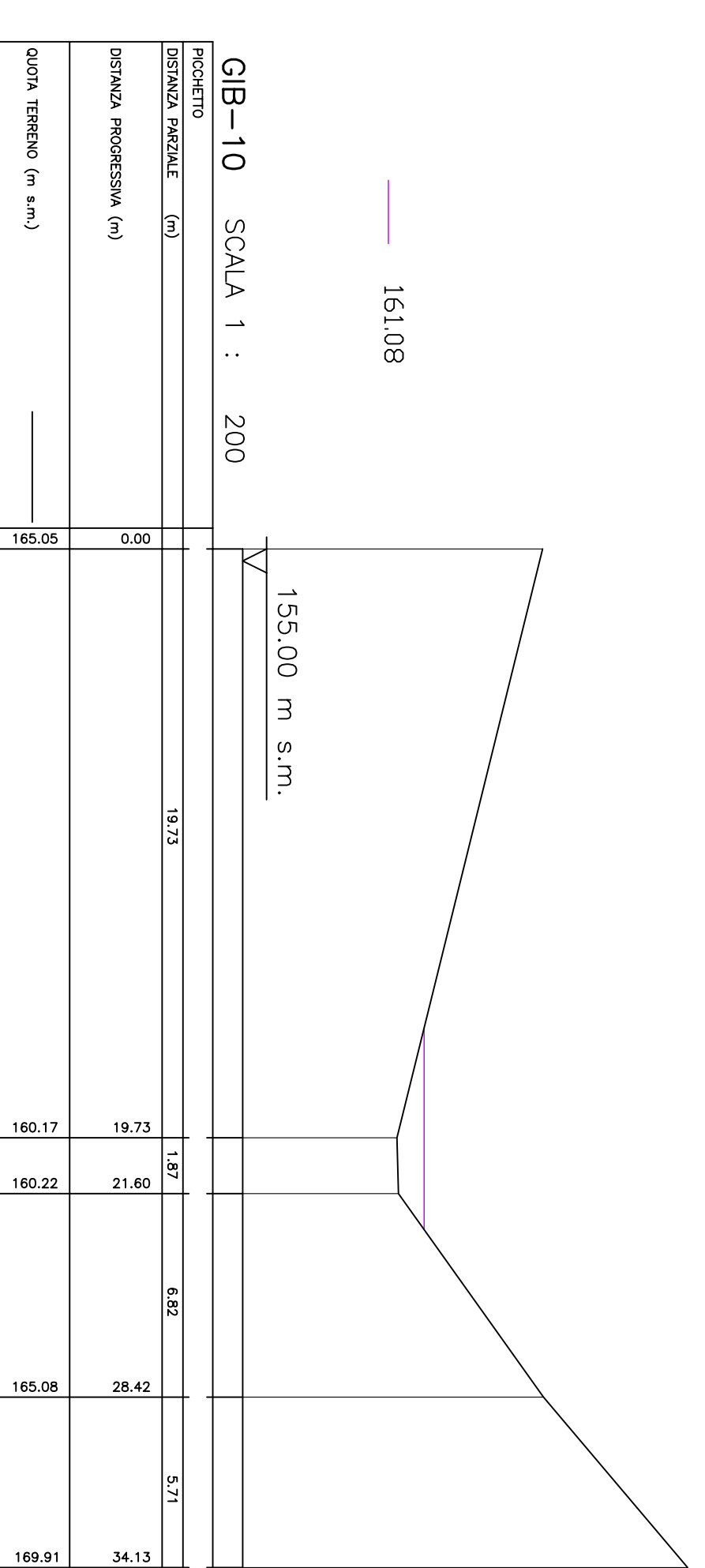
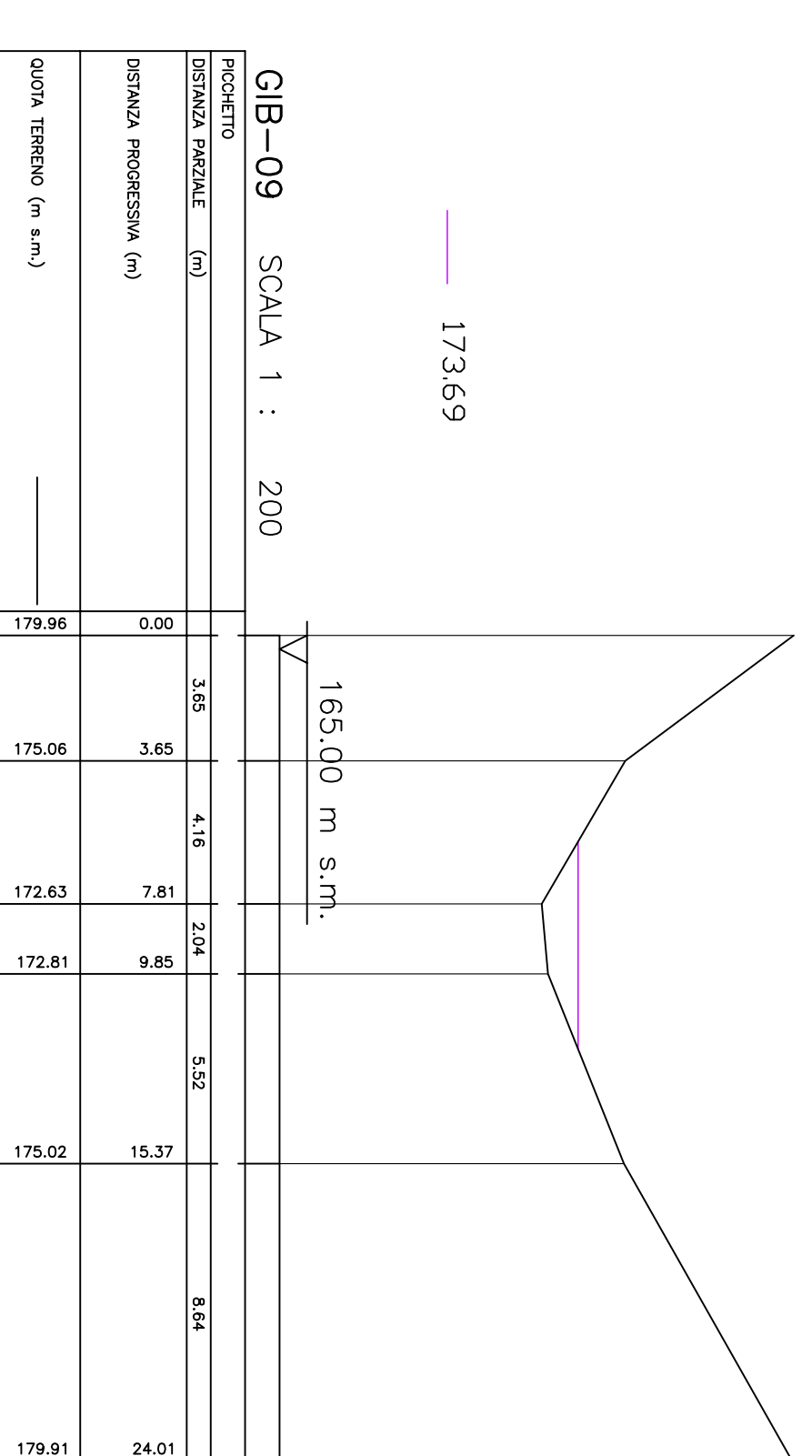
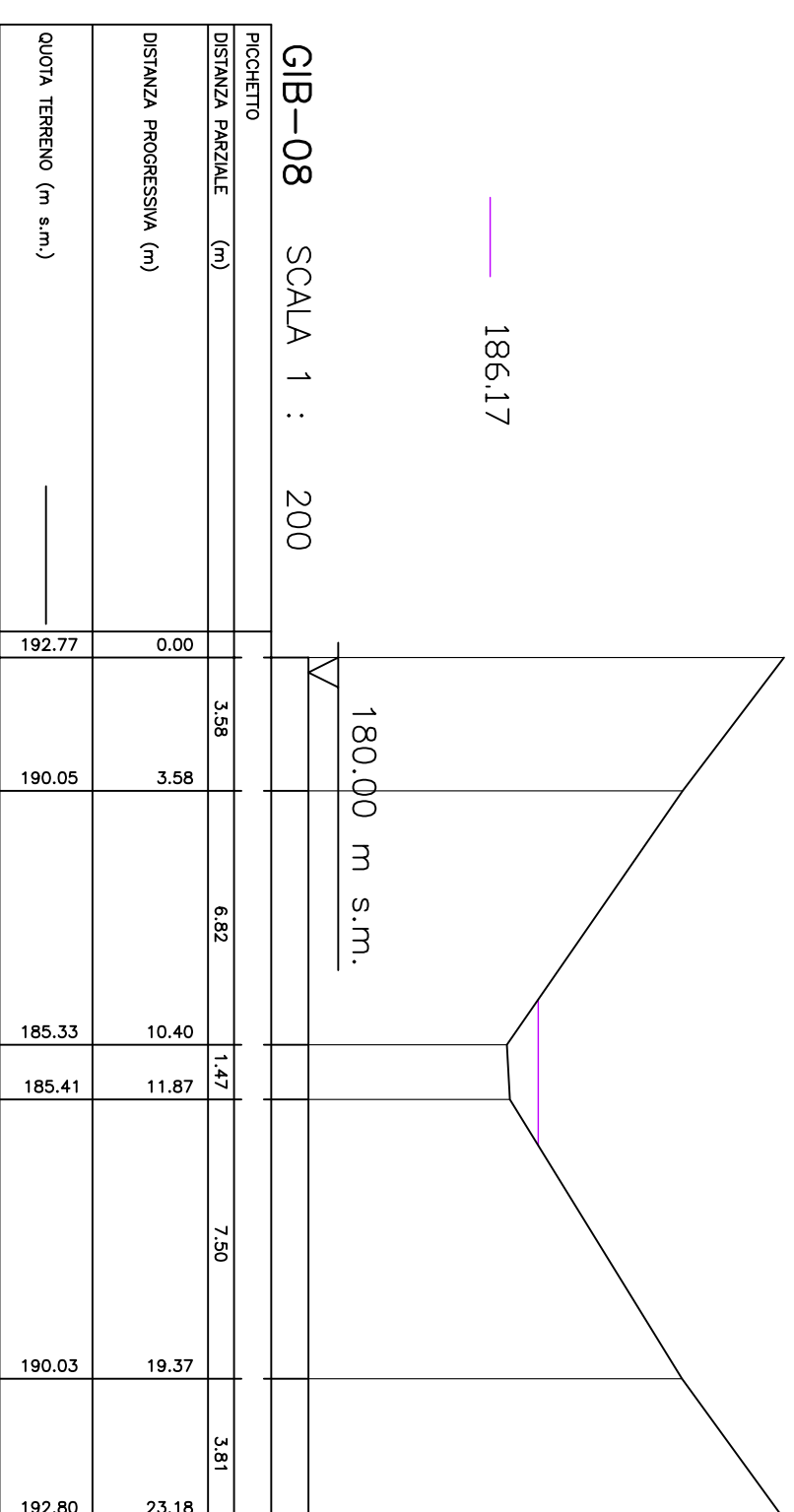
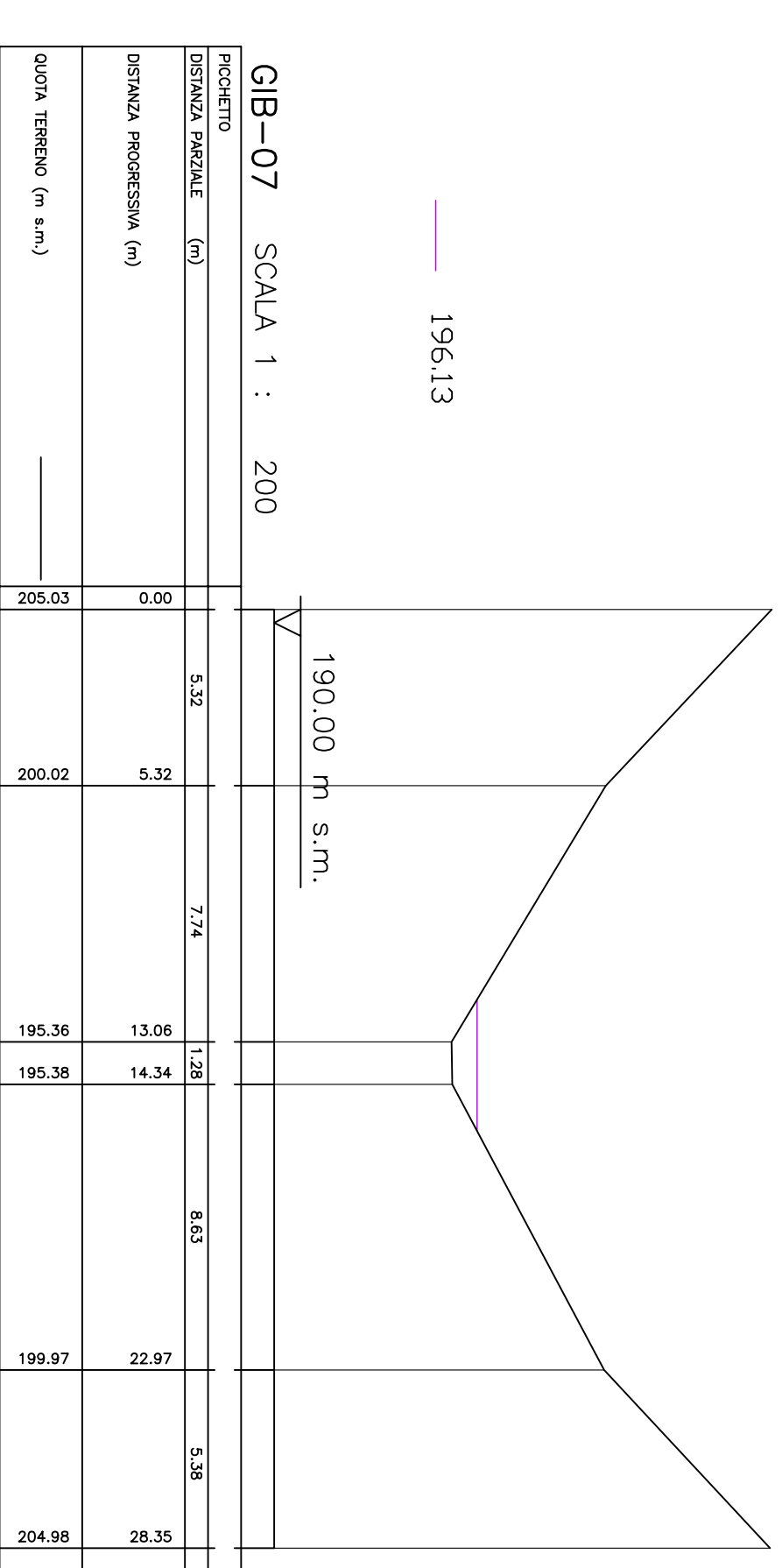
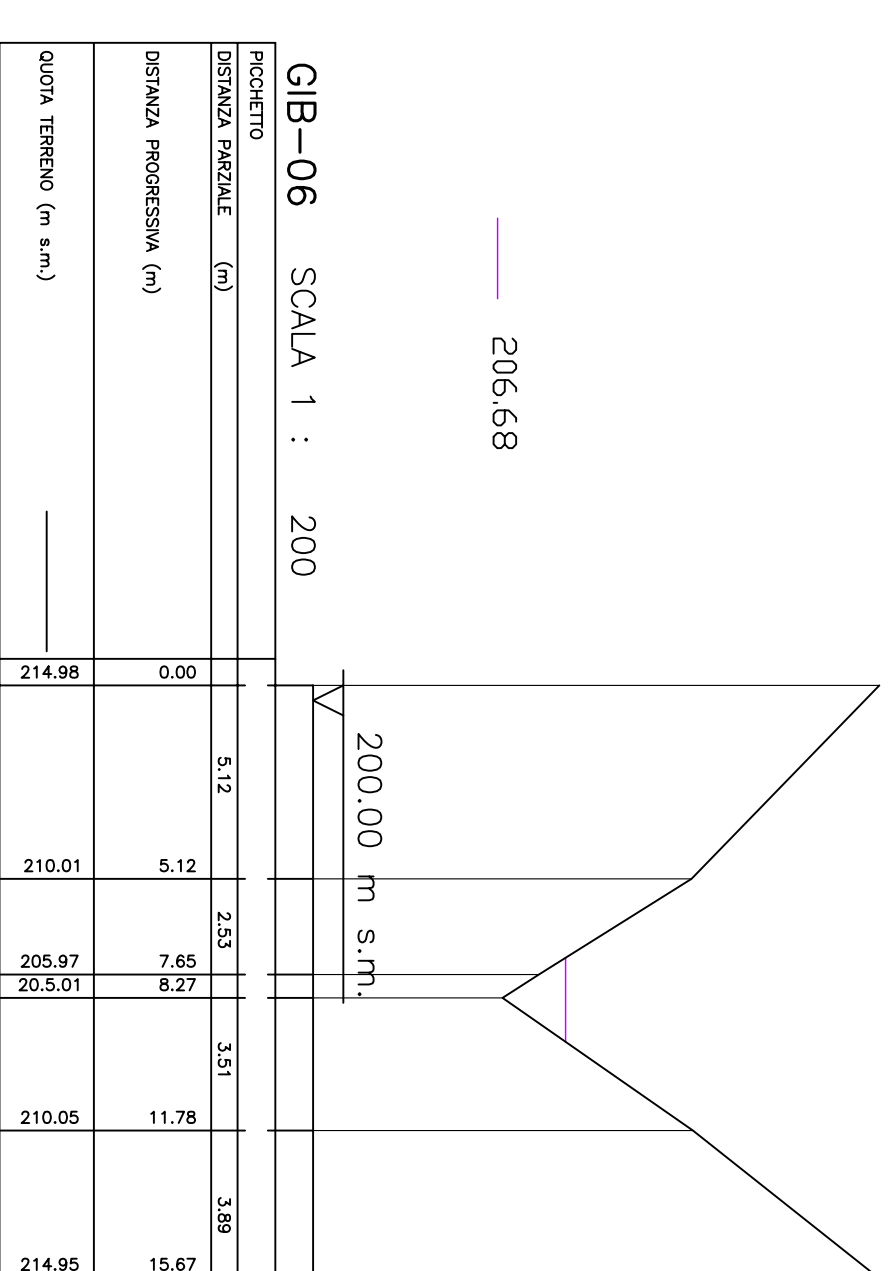
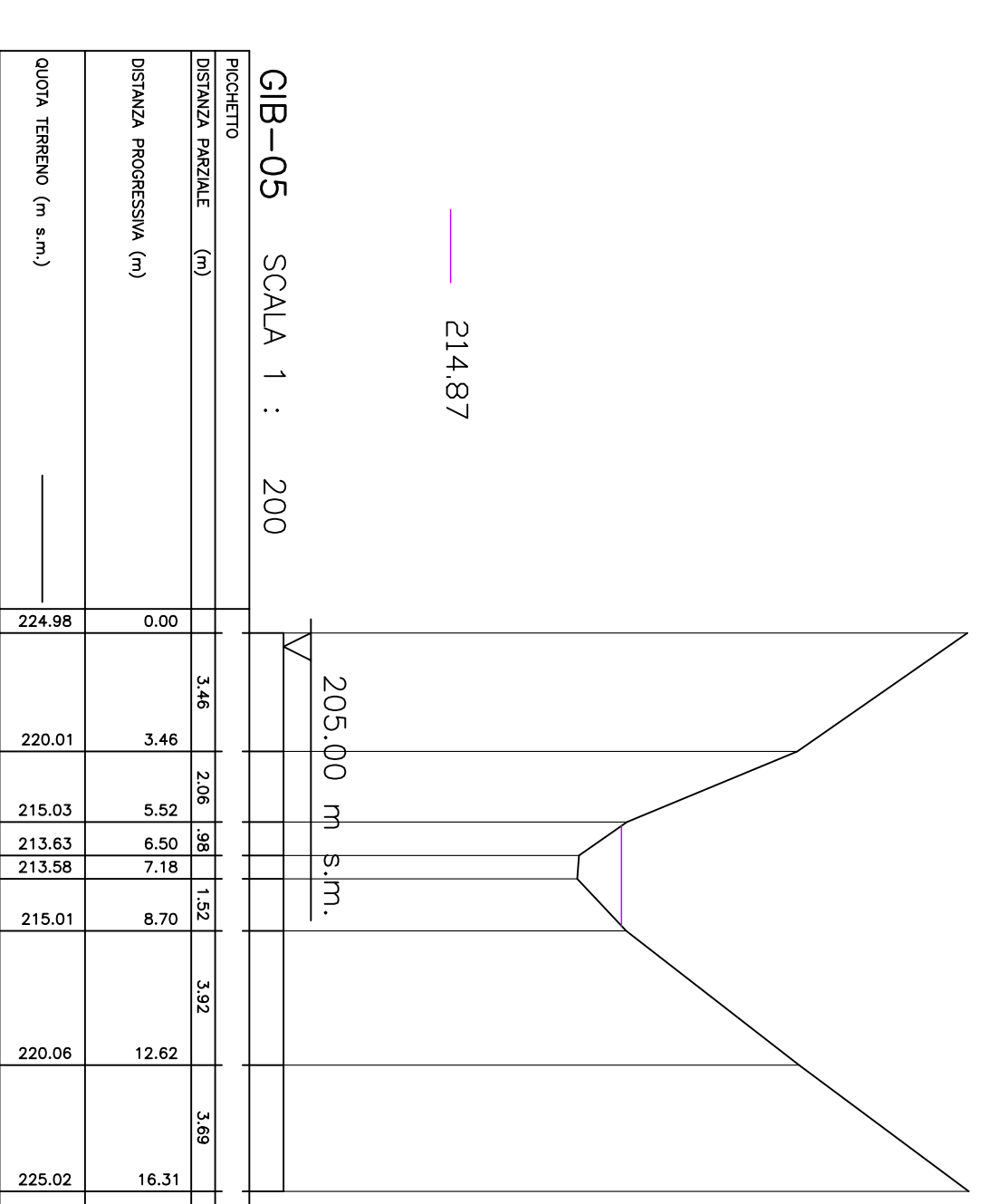
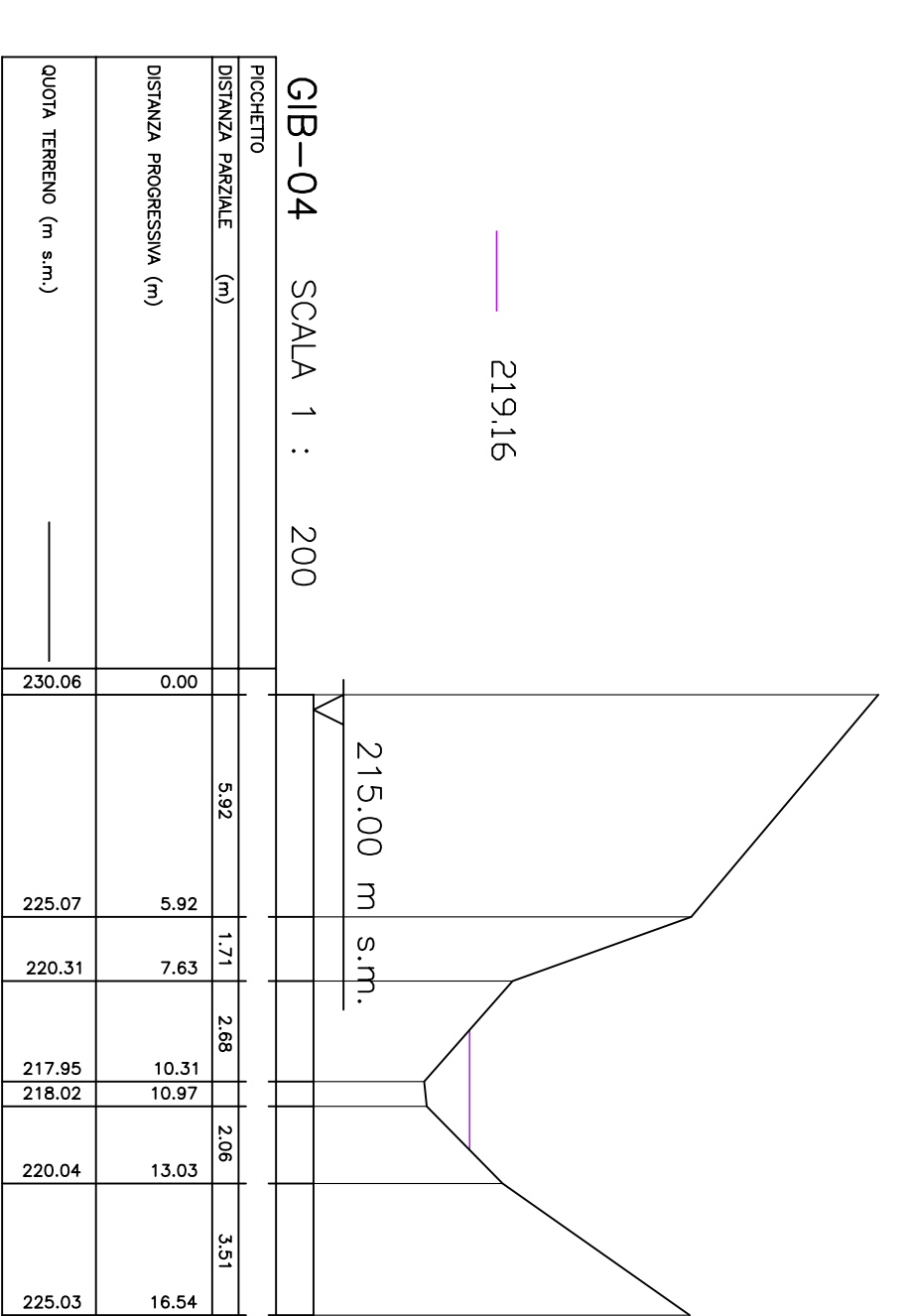
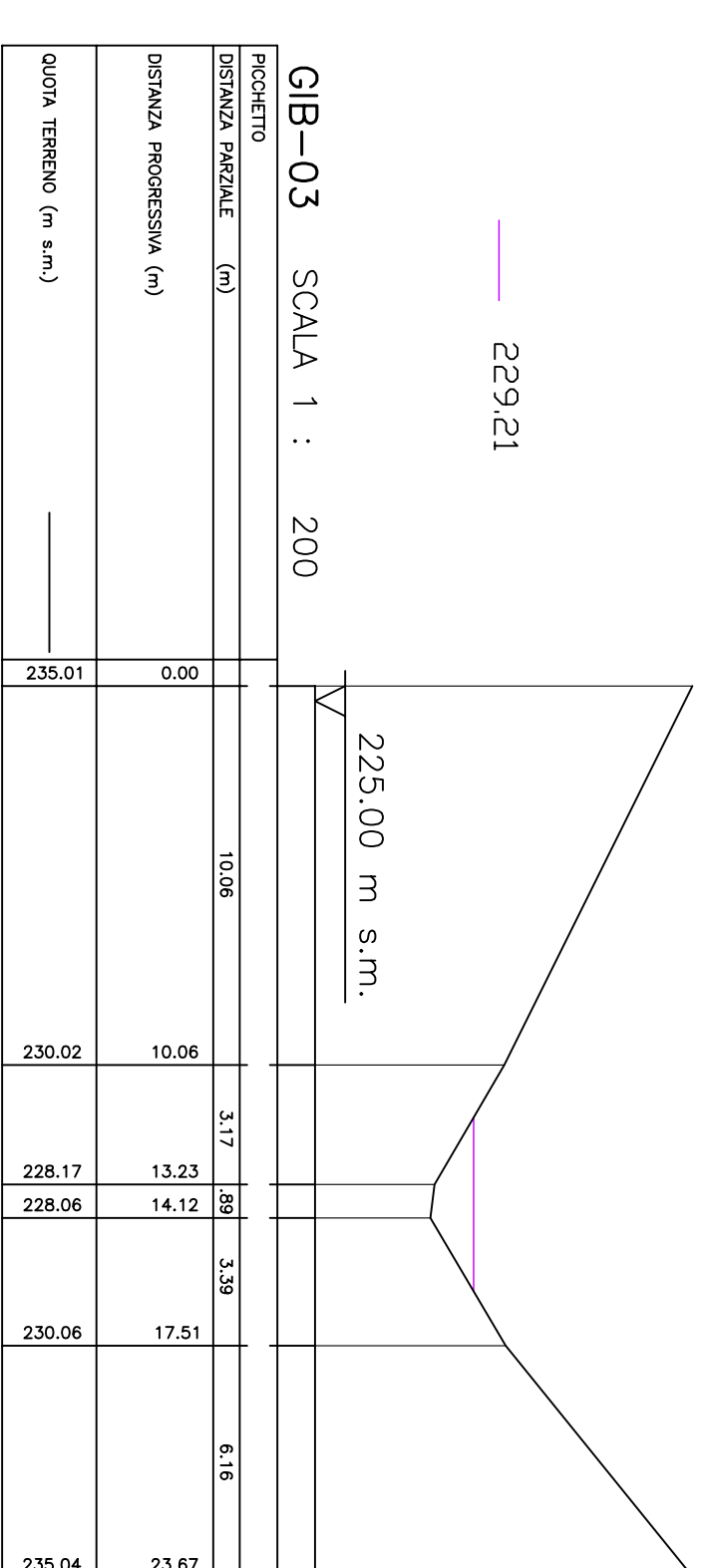
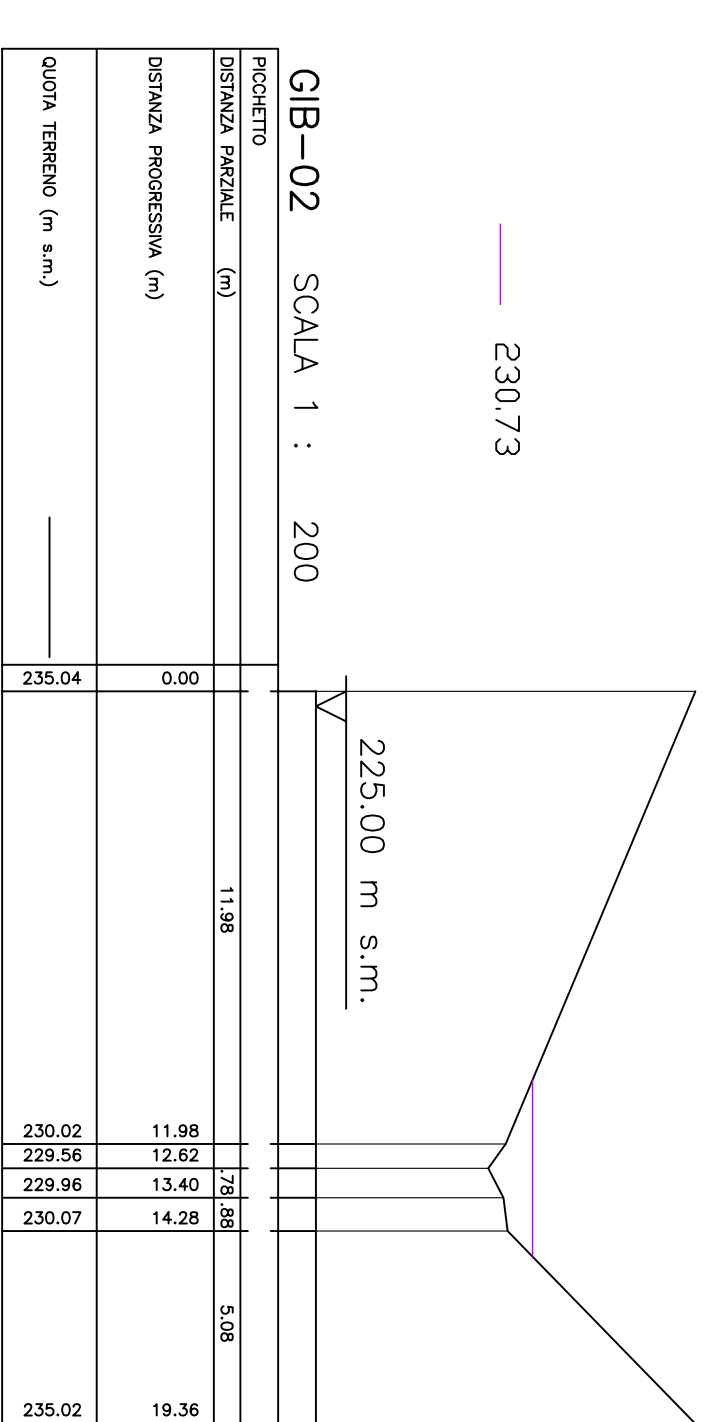
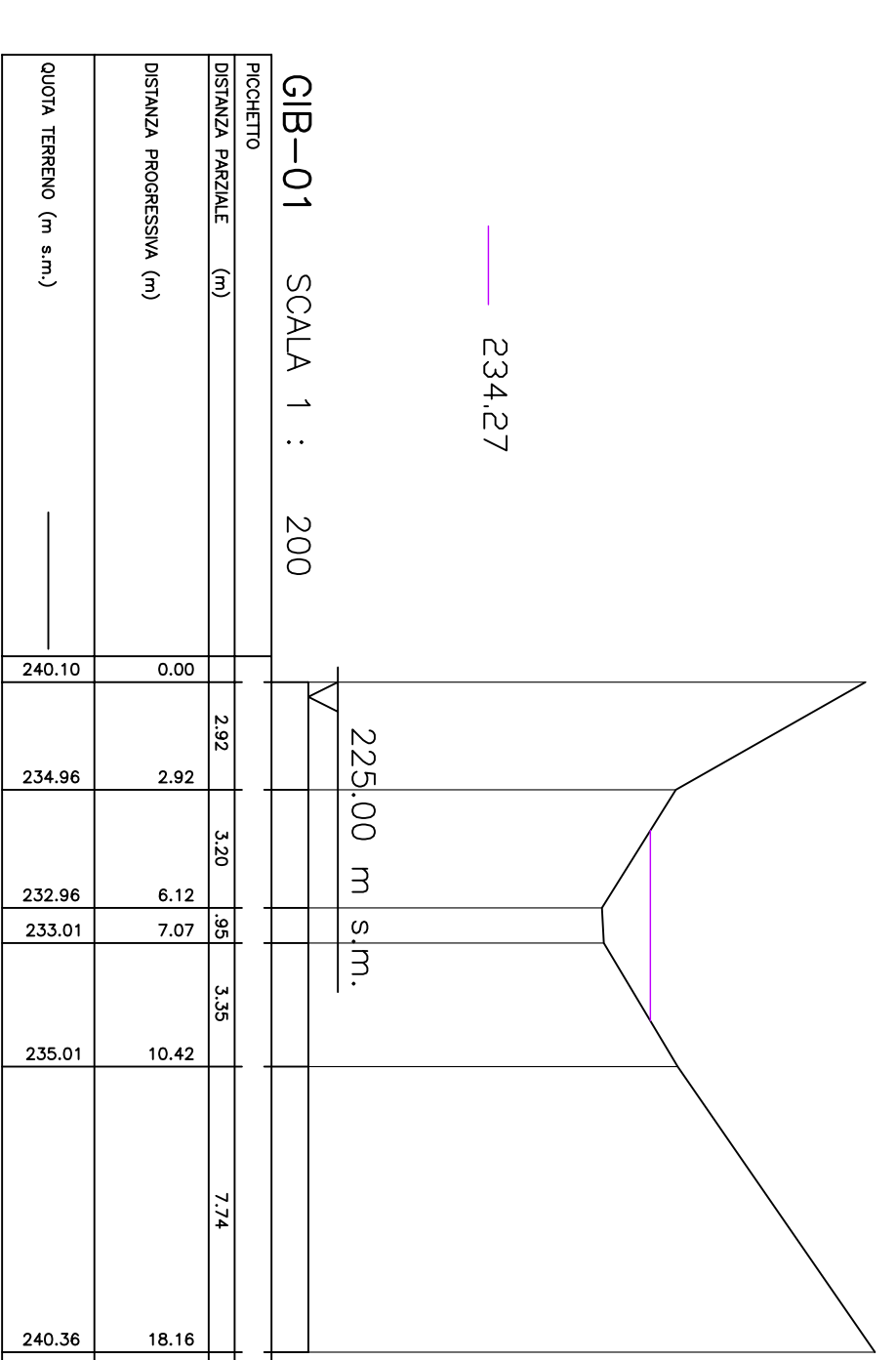

Stretto
di Messina



PONTE SULLO STRETTO DI MESSINA

PROGETTO DEFINITIVO

ALTERNATIVE AI SITI DI DEPOSITO

REVISIONE: 01/01/2011 DATA: 01/01/2011 AUTORE: ING. RICCARDO BIANCHI

EUROLINK S.p.A.

SOCIETÀ ITALIANA PER CONDOTTE D'ACQUA S.p.A.
CORPORATIVA MARITTIMI - C.A.C. di Brera snc. Cap. s.r.l.
ISIRIKAWAMA - HARIMA HEAVY INDUSTRIES CO. LTD.
ACI S.C.P.A. - CONSORZIO STABILE

PROGETTISTA Ing. Riccardo Bianchi P. 220243 Via S. Maria 10100	CONTORE Ing. Riccardo Bianchi P. 220243 Via S. Maria 10100	REDAZIONE Ing. Riccardo Bianchi P. 220243 Via S. Maria 10100	VERIFICA Ing. Riccardo Bianchi P. 220243 Via S. Maria 10100
--	--	--	---

AMV0654_F0

STUDIO DI IMPATTO AMBIENTALE

QUADRO DI RIFERIMENTO PROGETTUALE

SISTEMAZIONE TRATTI DI CORSI D'ACQUA - SEZIONI 1, GIB-15/17

DATA	15/01/2011
REVISIONE	01
PROGETTO	AMV0654_F0
REDAZIONE	ING. RICCARDO BIANCHI
VERIFICA	ING. RICCARDO BIANCHI

NUMERO DEL FILE: AMV0654_F0_01M