



Città metropolitana
di Roma Capitale



PROVINCIA
DI FROSINONE



Comune di Gavignano



Comune di Paliano



Comune di Anagni

Committente:

GRUPOTEC SOLAR ITALIA 15 SRL



Via Statuto, 10 - 20121 Milano - Italy
pec: grupotecsolaritalia15srl@legalmail.it

PROCEDIMENTO VIA NAZIONALE

ai sensi dell'art. 23 bis del D.Lgs. 152/06 e s.m.i.

Denominazione progetto:

**REALIZZAZIONE IMPIANTO AGRIVOLTAICO
"GAVIGNANO"**

Potenza nominale complessiva = 17.263,8 kWp

Sito in:

COMUNI DI GAVIGNANO (RM), PALIANO (FR) E ANAGNI (FR)

Titolo elaborato:

**Schede Tecniche dei Principali Componenti
di Impianto**



Elaborato n.

EL03

Scala -

Responsabile Coordinamento e revisione progetto : Ing. Nicodemo Agostino

TIMBRI E FIRME:

Progettisti : Grupotec Solar Italia 15 S.r.l.



Collaboratori : -

REV.:	REDAZIONE:	CONTROLLO:	APPROVAZIONE :	DATA:
01	Maria Dolores Torregrosa	Ing. Nicodemo Agostino	Ing. Nicodemo Agostino	02/11/2021
02	Maria Dolores Torregrosa	Ing. Nicodemo Agostino	Ing. Nicodemo Agostino	13/12/2021
03				

FIRMA/TIMBRO
COMMITTENTE:



FLYREN
THE CULTURE OF CLEAN ENERGY

Flyren Development S.r.l.
Lungo Po Antonelli, 21 - 10153 Torino (TO)
tel: 011/ 8123575 - fax: 011/ 8127528
email: info@flyren.eu
web: www.flyren.eu
C.F. / P. IVA n. 12062400010

MODULI FOTOVOLTAICI

TR 78M 560-580 Watt Mono-facial

Tiling Ribbon (TR) Technology

Positive power tolerance of 0~+3%

(Draft)

TIGER Pro

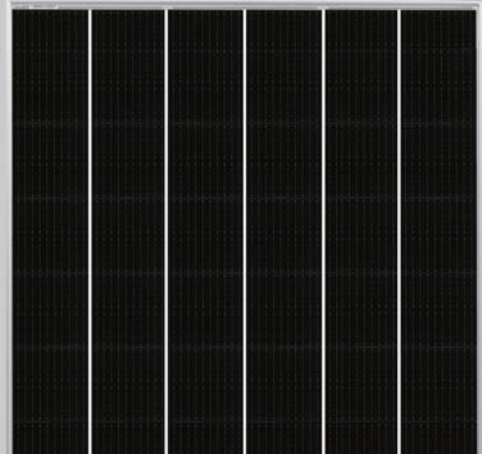

KEY FEATURES



TR technology + Half Cell

TR technology with Half cell aims to eliminate the cell gap to increase module efficiency (mono-facial up to 21.21%)



MBB instead of 5BB

MBB technology decreases the distance between bus bars and finger grid line which is benefit to power increase.



Higher lifetime Power Yield

2% first year degradation,
0.55% linear degradation



Best Warranty

12 year product warranty,
25 year linear power warranty



Strengthened Mechanical Support

5400 Pa snow load, 2400 Pa wind load



LINEAR PERFORMANCE WARRANTY

12 Year Product Warranty • 25 Year Linear Power Warranty
0.55% Annual Degradation Over 25 years

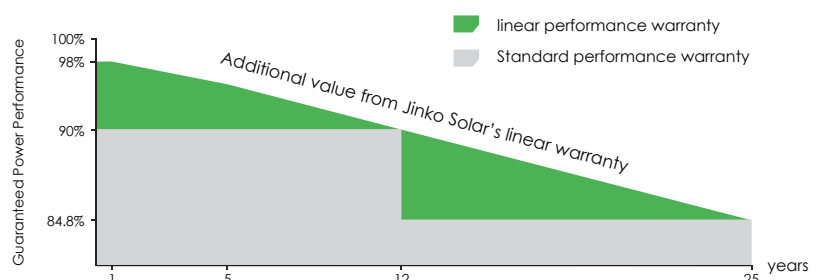

ISO9001:2015, ISO14001:2015, ISO45001:2018 certified factory

IEC61215, IEC61730 certified product

Engineering Drawings

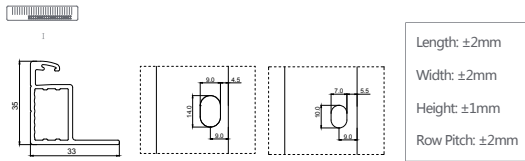
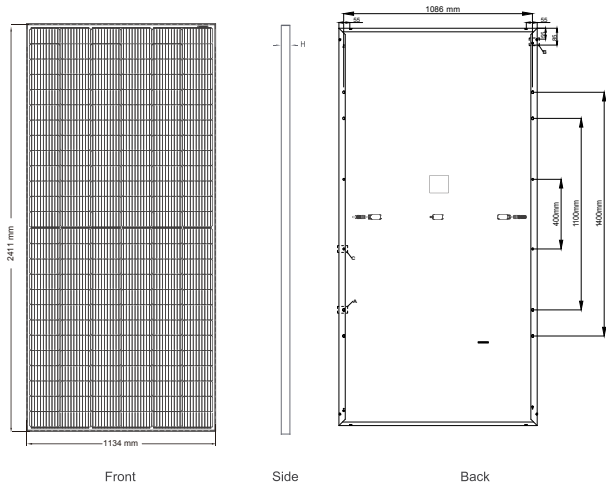

Packaging Configuration

(Two pallets = One stack)

31pcs/pallets, 62pcs/stack, 496pcs/ 40'HQ Container

Electrical Performance & Temperature Dependence

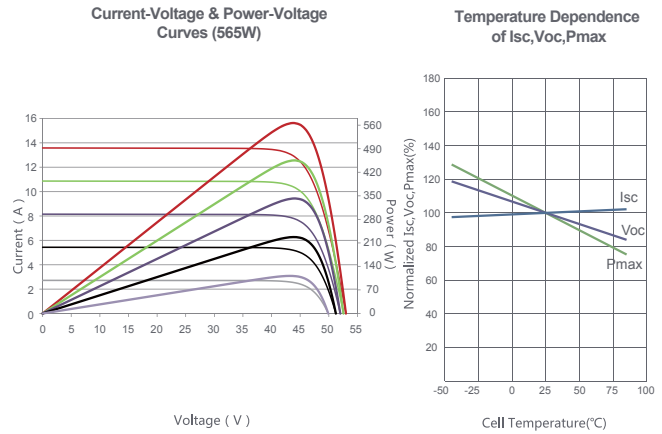

Mechanical Characteristics

Cell Type	P type Mono-crystalline
No. of cells	156 (2×78)
Dimensions	2411×1134×35mm (94.92×44.65×1.38 inch)
Weight	30.93 kg (68.2 lbs)
Front Glass	3.2mm, Anti-Reflection Coating, High Transmission, Low Iron, Tempered Glass
Frame	Anodized Aluminium Alloy
Junction Box	IP68 Rated
Output Cables	TUV 1×4.0mm ² (+): 290mm, (-): 145 mm or Customized Length

SPECIFICATIONS

Module Type	JKM560M-7RL4-V		JKM565M-7RL4-V		JKM570M-7RL4-V		JKM575M-7RL4-V		JKM580M-7RL4-V	
	STC	NOCT	STC	NOCT	STC	NOCT	STC	NOCT	STC	NOCT
Maximum Power (Pmax)	560Wp	417Wp	565Wp	420Wp	570Wp	424Wp	575Wp	428Wp	580Wp	432Wp
Maximum Power Voltage (Vmp)	44.31V	40.63V	44.43V	40.72V	44.55V	40.80V	44.67V	40.89V	44.78V	40.97V
Maximum Power Current (Imp)	12.64A	10.25A	12.72A	10.32A	12.80A	10.39A	12.88A	10.46A	12.96A	10.53A
Open-circuit Voltage (Voc)	52.90V	49.93V	53.00V	50.03V	53.10V	50.12V	53.20V	50.21V	53.30V	50.31V
Short-circuit Current (Isc)	13.50A	10.90A	13.58A	10.97A	13.66A	11.03A	13.74A	11.10A	13.82A	11.16A
Module Efficiency STC (%)	20.48%		20.67%		20.85%		21.03%		21.21%	
Operating Temperature(°C)	-40°C~+85°C									
Maximum system voltage	1500VDC (IEC)									
Maximum series fuse rating	25A									
Power tolerance	0~+3%									
Temperature coefficients of Pmax	-0.35%/°C									
Temperature coefficients of Voc	-0.28%/°C									
Temperature coefficients of Isc	0.048%/°C									
Nominal operating cell temperature (NOCT)	45±2°C									

* STC: ☀ Irradiance 1000W/m² 📏 Cell Temperature 25°C

☁ AM=1.5

NOCT: ☀ Irradiance 800W/m² 📏 Ambient Temperature 20°C

☁ AM=1.5

🌀 Wind Speed 1m/s

* Power measurement tolerance: ± 3%

STRUTTURE DI SUPPORTO AD INSEGUIMENTO
(TRACKER)

STI-H250™

Horizontal Single Axis Tracker

Technical data

Dual Row - Decentralized



Land adaptability



Wind load



Snow load



Earthquake load



Grease free & minimum maintenance



Wind Tunnel test



Dynamic Test



10 years

Warranty



Patented

Design

- Irreversible electromechanical rotative drive, powered by a high performance geared motor with only 100W.
- Self-power from external PV panel, powered from the grid.
- Wide range of motion: 110° (± 55°).
- High slope adaptability.
- High adaptability to non regular layouts.
- Over 99,9% Availability.
- Compatible with different foundation solutions: ramming, micropiles, concrete pads, predrilling, screw pile.
- Compatible with all PV modules (framed, glass-glass, thin-film, bifacial).

Operation and Maintenance

- Free access for panel cleaning.
- Minimum O&M work due to the reduced amount of component, simplicity and robustness.
- Minimum maintenance.
- Rotative bushing lubrication free.

Control System

- High operation reliability.
- Alarm management fully configurable by customer.
- Increased production thanks to a Backtracking Algorithm customized for every STI-H250™ (no shadows).
- Easy integration into the plant's communications system and SCADA thanks to Modbus TCP / IP standard.
- Wireless communication system with Zigbee®.
- Remote monitoring and predictive maintenance (avoid stops and increases availability).
- Quick commissioning & backtracking tools.

Installation

- Minimum installation time, fast & simple.
- High tolerances to foundation positioning error, in the three axes (X, Y, Z) and to rotation in Y and Z axes.
- Low panel height for easy assembly.
- 100% bolted connections. No drilling, cutting or welding on-site.

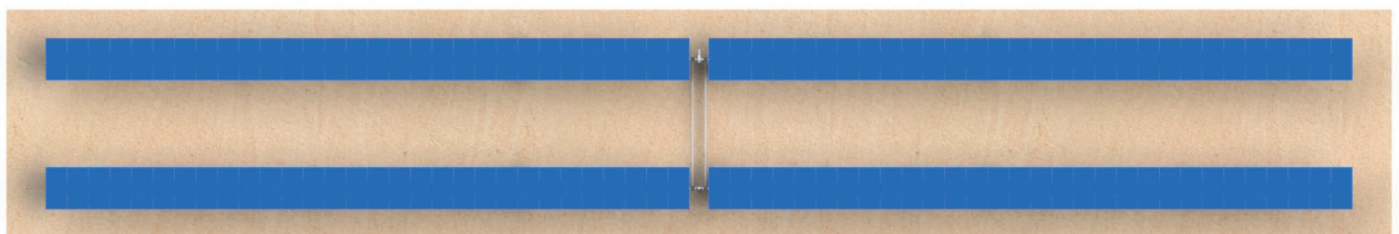

SYSTEM DESCRIPTION

Tracker type	Horizontal Single Axis tracker (HSAT). Decentralized. DUAL-ROW
Ground Coverage Ratio	Configurable by project, standard 33%
Tracker area	Aprox. 250 m ² /2,691 ft ² .

DIMENSIONS (For a 72 cel. PV and 1/GCR=3 Tracker)*

PV Modules per torsion row	60 (Configurable by project)
Number of rows	2
Peak Power (350Wp PV Module)	42 Kwp
Number of piles per tracker	19
PV module height. Tracker in 0° horizontal position	Aprox. 1.35m/4.43ft.
PV module height. Tracker in 55° horizontal position	Aprox. 2.25m/7.38ft.

ROTATION DRIVE

Drive transmission	Rotative electromechanical actuator
Power Back-up	Self-power (LiFe P04 Backup battery) / Powered from the grid
Drive set power consumption	< 0.45Kwh/day
Motor power	100W / 24VDC

MECHANICAL SPECIFICATIONS

Range of motion	110° (+/-55°)
Max. wind speed (in horizontal position)	140km/h (*)
Structure Materials	HDG Steel S235, S275, S355, S350GD, ZM310 or equivalent
Compliance	Grounding bonding UL2703/Structural Design ASCE7-10 or EUROCODE
Site topography flexibility	15% N-S / 10% E-W in same tracker No limits E-W in diferents trackers (Higher values to be validated)

CONTROL SYSTEM

Tracking control system	NREL SOLPOS astronomical algorithm running at PLC (Accuracy ±0.01°)
Shadow management	Customized Backtracking algorithm
Wind management	Stow criteria configurable by user
Communications protocol	Modbus RS485 or Modbus Wireless option (Zigbee®)

MAINTENANCE

Maintenance	Minimum (annual review)
-------------	-------------------------

WARRANTY

Structural / For Drive Gear & Control System	10 years structural / 5 years Drive & Control System
--	--

(*) Configurable depending on Project. Other options available.

CONVERTITORI CC/CA
(INVERTER)

SUN2000-185KTL-H1

Smart String Inverter



9
MPP Trackers



>99.0%
Max. Efficiency



String-level
Management



Smart I-V Curve
Diagnosis Supported



MBUS
Supported



Fuse Free
Design



Surge Arresters for
DC & AC



IP66
Protection

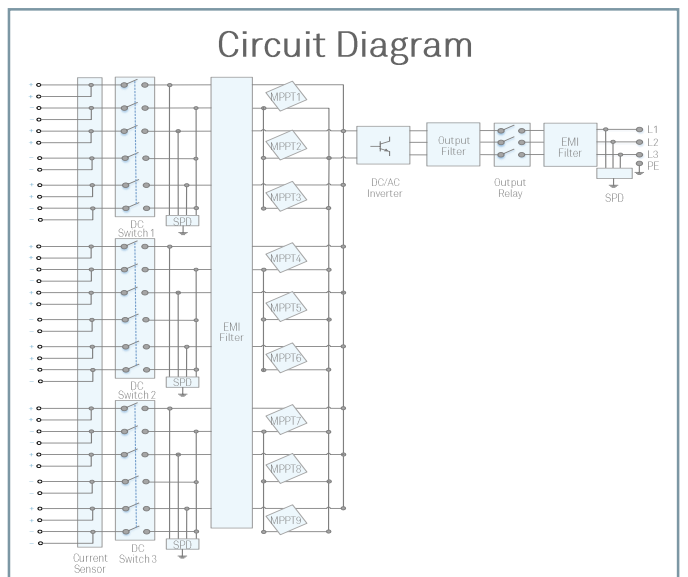
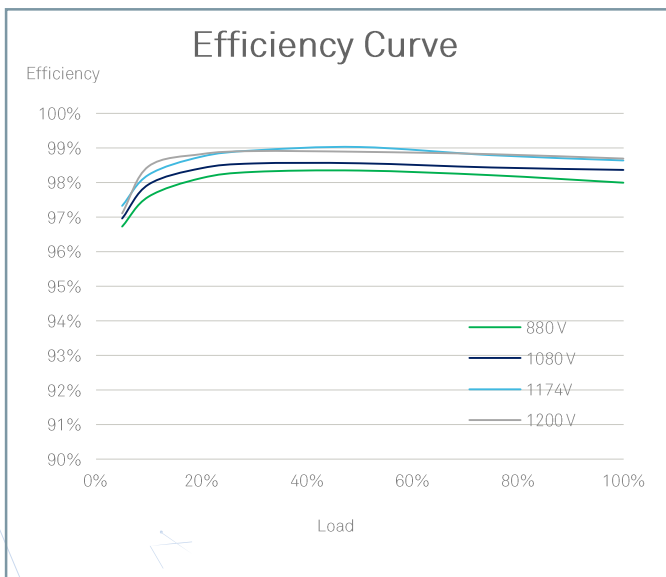

Technical Specifications

Efficiency	
Max. Efficiency	99.03%
European Efficiency	98.69%
Input	
Max. Input Voltage	1,500 V
Max. Current per MPPT	26 A
Max. Short Circuit Current per MPPT	40 A
Start Voltage	550 V
MPPT Operating Voltage Range	500 V ~ 1,500 V
Nominal Input Voltage	1,080 V
Number of Inputs	18
Number of MPP Trackers	9
Output	
Nominal AC Active Power	175,000 W @40°C, 168,000 W @45°C, 150,000 W @50°C
Max. AC Apparent Power	185,000 VA
Max. AC Active Power (cosφ=1)	185,000 W
Nominal Output Voltage	800 V, 3W + PE
Rated AC Grid Frequency	50 Hz / 60 Hz
Nominal Output Current	126.3 A @40°C, 121.3 A @45°C, 108.3 A @50°C
Max. Output Current	134.9 A
Adjustable Power Factor Range	0.8 LG ... 0.8 LD
Max. Total Harmonic Distortion	< 3%
Protection	
Input-side Disconnection Device	Yes
Anti-islanding Protection	Yes
AC Overcurrent Protection	Yes
DC Reverse-polarity Protection	Yes
PV-array String Fault Monitoring	Yes
DC Surge Arrester	Type II
AC Surge Arrester	Type II
DC Insulation Resistance Detection	Yes
Residual Current Monitoring Unit	Yes
Communication	
Display	LED Indicators, Bluetooth/WLAN + APP
USB	Yes
MBUS	Yes
RS485	Yes
General	
Dimensions (W x H x D)	1,035 x 700 x 365 mm (40.7 x 27.6 x 14.4 inch)
Weight (with mounting plate)	84 kg (185.2lb.)
Operating Temperature Range	-25°C ~ 60°C (-13°F ~ 140°F)
Cooling Method	Smart Air Cooling
Max. Operating Altitude without Derating	4,000 m (13,123 ft.)
Relative Humidity	0 ~ 100%
DC Connector	Staubli MC4 EVO2
AC Connector	Waterproof Connector + OT/DT Terminal
Protection Degree	IP66
Topology	Transformerless
Standard Compliance (more available upon request)	
Certificate	EN 62109-1/-2, IEC 62109-1/-2, EN 50530, IEC 62116, IEC 60068, IEC 61683
Grid Code	IEC 61727, P.O. 12.3, RD 1699, RD 661, RD 413, RD 1565, RD 1663, UNE 206007-1, UNE 206006

CAVI ELETTRICI PER STRINGHE FOTOVOLTAICHE

H1Z2Z2-K



Marcatura: CE 0987 SPECIALCAVI BALDASSARI H1Z2Z2-K <formazione> IEMMEQU HAR <lotta> <anno> ECA



CARATTERISTICHE COSTRUTTIVE

Anima:

Conduttore in rame stagnato flessibile, classe 5

Isolamento:

Mescola LSZH a base di gomma reticolata

Guaina esterna:

Mescola LSZH a base di gomma reticolata speciale, resistente ai raggi UV

Colori:

Colore anima:

Bianco

Colore guaina esterna:

Nero o Rosso (basato su RAL 9005 o 3000)

CARATTERISTICHE ELETTRICHE

Tensione di esercizio anime:

Tensione nominale di esercizio:

1.0kV C.A. - 1.5kV C.C. (anche verso terra)

Massima tensione di esercizio:

1.2kV C.A. - 1.8kV C.C. (anche verso terra)

Tensione di esercizio guaina:

Tensione nominale di esercizio:

1.0kV C.A. - 1.5kV C.C. (anche verso terra)

Massima tensione di esercizio:

1.2kV C.A. - 1.8kV C.C. (anche verso terra)

Tensione di prova: 15 kV C.C.

RIFERIMENTI NORMATIVI

EN 50618
 EN 60228 EN 50395
 EN 50618
 EN 50618 EN 50395 EN 62230
 EN 50618 EN 50396 EN 60228
 EN 60811-401 EN 50618
 EN 60811-504 EN 60811-505 EN 60811-506 EN 50618
 EN 60811-403 EN 50396 EN 50618
 EN 50618 EN 50289-4-17 metodo A
 EN 50618
 EN 60068-2-78
 EN 60811-503
 EN 60332-1-2
 EN 61034-2 (LT≥60%)
 EN 50525-1
 EN 50618 EN 60216-1 EN 60216-2

CLASSE DI REAZIONE AL FUOCO

EN 50575:2016 E_{ca}

TEMPERATURE

Temperatura minima di esercizio: -40°C

Temperatura massima di esercizio: +90°C

Temperatura massima di cortocircuito: +250°C

CONDIZIONI DI POSA



Temperatura minima di posa -25°C



Raggio minimo di posa d4



Max sforzo di tiro: 15N/mm² sezione torrame posa fissa, 50N/mm² installazione



Posa fissa



In aria libera



In tubo o canalina in aria



In canale interrato



Interrato con protezione

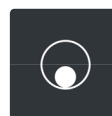

In tubo interrato



Direttamente interrato

APPLICAZIONI

Cavo conforme ai requisiti previsti dal Regolamento Prodotti da Costruzione (CPR UE 305/11), con l'obiettivo di limitare la produzione e la diffusione di fuoco e di fumo.

Cavo unipolare halogen free adatto al collegamento dei vari elementi degli impianti fotovoltaici e solari.

Il cavo H1Z2Z2-K ha un'ottima resistenza ai raggi UV ed alle condizioni atmosferiche.

Il funzionamento del cavo è stimato in circa 25 anni (EN 50618) ed il periodo previsto per un suo utilizzo ad una temperatura massima del conduttore di 120°C e ad una temperatura massima ambientale di 90°C è limitato a 20.000 ore.

Per posa fissa all'esterno ed all'interno di fabbricati, senza protezione o entro tubazioni in vista o incassate.**

CODICE ARTICOLO	FORMAZIONE	DIAMETRO ESTERNO ¹	PESO CAVO ¹	RESISTENZA MAX CONDUTTORE A 20°C
[n°]	[n° x mm ²]	[mm]	[kg/km]	[Ohm/km]
*SO25001NE	1 X 2.50	4.8	42	8.21
*SO25001RO	1 X 2.50	4.8	42	8.21
SO40001NE	1 X 4.00	5.3	55	5.09
SO40001RO	1 X 4.00	5.3	55	5.09
SO60001NE	1 X 6.00	6.0	76	3.39
SO60001RO	1 X 6.00	6.0	76	3.39
SO100001NE	1 X 10.00	7.3	121	1.95
SO100001RO	1 X 10.00	7.3	121	1.95
SO160001NE	1 X 16.00	8.3	177	1.24
*SO160001RO	1 X 16.00	8.3	177	1.24
*SO250001NE	1 X 25.00	10.2	271	0.795
*SO250001RO	1 X 25.00	10.2	271	0.795
*SO350001NE	1 X 35.00	11.2	360	0.565
*SO350001RO	1 X 35.00	11.2	360	0.565
*SO500001NE	1 X 50.00	13.0	500	0.393
*SO500001RO	1 X 50.00	13.0	500	0.393
*SO700001NE	1 X 70.00	14.9	690	0.277
*SO700001RO	1 X 70.00	14.9	690	0.277
*SO950001NE	1 X 95.00	16.7	905	0.210
*SO950001RO	1 X 95.00	16.7	905	0.210
*SO1200001NE	1 X 120.00	18.4	1135	0.164
**SO1200001RO	1 X 120.00	18.4	1135	0.164

¹ Salvo disponibilità, prodotto da allestire su richiesta e quantità minima
² Se non diversamente specificato, i valori relativi a peso e diametro sono da ritenersi indicativi.
 Nota: altri valori, se disponibili e rilasciati per la pubblicazione, vengono forniti su richiesta.

SU RICHIESTA

- Armatura a treccia di acciaio zincato
- Armatura a fili di acciaio zincato
- Conduttore in alluminio

**APPLICAZIONI

Idoneo per applicazioni non rientranti nell'ambito del regolamento CPR e per installazioni all'interno di un ambiente chiuso, ad esclusione di casi con rischi specifici di innesco/propagazione incendio dove viene consigliato l'utilizzo di cavi con prestazioni di reazione al fuoco superiori (almeno Cca-s3,d1,a3).
 Ammessa la posa interrata, diretta o indiretta.

CAVI ELETTRICI PER INTERRAMENTO DIRETTO

HARMOHNY ALL GROUND XZ1 (S) AI

VOLTAGE: 0,6/1 kV



STANDARDS

UNE-HD 603-5X - Design and testing standards

UNE-EN 60332-1-2, IEC 60332-1-2 - Flame retardant

UNE-EN 60754-1, IEC 60754-1 - Fire retardant

UNE-EN 60754-2, IEC 60754-2 - Low acidity and corrosivity of evolved gases

UNE-EN 61034, IEC 61034 - Low opacity of evolved fumes

CONSTRUCTION

CONDUCTOR:

Aluminium, semi-rigid class 2

INSULATION:

Cross-linked polyethylene (XLPE)

OUTER SHEATH:

Halogen-free Polyolefine

APPLICATIONS AND MAIN CHARACTERISTICS

Low voltage power distribution cable for directly buried installations with no special preparation of the ground.

High weathering, tear, abrasion and impact resistance, making it a very resilient cable for directly buried installation while generating savings in installation costs.

Maximum conductor rating temperature 90 °C.

safety cable with flame retardant properties, halogen-free, low acidity and



HARMOHNY ALL GROUND XZ1 (S) AI

VOLTAGE: 0,6/1 kV



								
	mm ²	mm	kg/km	mm	A	A	V/A.km	V/A.km
0399402	70	20.7	455	85	187	162	0.875	0.984
0399401	95	22.3	555	90	230	193	0.653	0.711
0399403	120	24.0	660	120	269	219	0.534	0.562
16901A4	150	25.8	765	130	312	247	0.449	0.457
0399404	185	27.7	920	140	359	278	0.373	0.364
16901A5	240	30.5	1115	155	428	320	0.303	0.278
0399405	300	32.8	1335	165	497	363	0.257	0.222
0399406	400	35.9	1660	180	603	422	0.217	0.173

Riferimento Normativo/Standard Reference

ENEL - ENDESA DC 4147	Costruzione e requisiti/Construction and specifications
ENEL GLOBAL STANDARD GSC 002	
CENELEC HD 603	
2014/35/UE	Direttiva Bassa Tensione/Low Voltage Directive
2011/65/CE	Direttiva RoHS/RoHS Directive
ENEL-DIS-25/07/2014-0663040	Certificazione ENEL DC 4147/ENEL Certification DC 4147
ENEL-DIS-04/03/2016-0151789	Certificazione ENEL GSC 002/ENEL Certification GSC 002



DESCRIZIONE

Cavo per linee di distribuzione di energia unipolare o quadri-polare ad elica visibile con conduttori in alluminio, isolati con polietilene reticolato, sotto guaina termoplastica di poliolefina.

Denominazione unipolare ENEL: ARE4*E
Denominazione unipolare ENDESA: XZ1
Denominazione quadri-polare ENEL: ARE4*EX

Conduttore

Corda di alluminio, rigida compatta, classe 2

Isolante

Miscela di polietilene reticolato XLPE

Guaina esterna

Miscela termoplastica di poliolefina

Colore isolante

Naturale o bianco

Colore guaina

Nero

CARATTERISTICHE TECNICHE

Tensione nominale U_0/U : 0,6/1 kV

Temperatura massima di esercizio: 90°C

Temperatura minima di posa: 0°C

Temperatura massima di corto circuito: 250°C

Sforzo massimo di trazione: 50 N/mm²

Raggio minimo di curvatura: 6 volte il diametro esterno massimo

Condizioni di impiego

Adatto per impiego all'interno in locali anche bagnati o all'esterno; posa fissa su murature e strutture metalliche. Ammessa anche la posa interrata.

DESCRIPTION

Power single-core or four-core visible helix assembled cable for distribution line with aluminium conductor, insulated with cross-linked polyethylene, with thermoplastic polyolefin sheath.

ENEL single-core designation: ARE4*E
ENDESA single-core designation: XZ1
ENEL four-core designation: ARE4*EX

Conductor

Aluminium stranded wire, class 2

Insulation

Cross-linked polyethylene XLPE

Outer sheath

Thermoplastic polyolefin compound

Insulation colour

Neutral or white

Sheath colour

Black

TECHNICAL CHARACTERISTICS

Nominal voltage U_0/U : 0,6/1 kV

Maximum operating temperature: 90°C

Minimum installation temperature: 0°C

Maximum short circuit temperature: 250°C

Maximum tensile stress: 50 N/mm²

Minimum bending radius: 6 x maximum external diameter

Use and installation

Suitable to be used indoor or outdoor, even in wet environments; it can be fixed on walls and/or metal structures. Suitable also for laying underground.



Matricola ENEL	Formazione	Ø indicativo conduttore	Spessore medio isolante	Spessore medio guaina	Ø indicativo produzione	Peso indicativo cavo	Resistenza elettrica max a 20°C	Portata di corrente Current rating			
								In aria libera Free in air 30°C	In tubo in aria In pipe in air 30°C	Interrato Underground 20°C	In tubo interrato Underground in pipe 20°C
ENEL Code	Formation	Approx. conductor Ø	Average insulation thickness	Average sheath thickness	Approx. production Ø	Approx. cable weight	Max. electrical resistance at 20°C	A	A	A	A
	n° x mm²	mm	mm	mm	mm	kg/km	ohm/km				
ARE4*E-XZ1											
330300	1 x 10	3,5	0,7	1,3	7,7	70	3,08	45	39	75	56
330301	1 x 25	6,1	0,9	1,3	10,7	130	1,20	110	88	119	95
330302	1 x 50	8,2	1,0	1,3	13,0	200	0,641	164	131	167	134
330303	1 x 95	11,4	1,1	1,4	17,0	350	0,320	261	209	245	196
330304	1 x 150	14,4	1,4	1,4	20,0	540	0,206	350	280	313	250
330305	1 x 240	18,4	1,7	1,5	25,0	850	0,125	490	392	413	331
ARE4*EX											
330655	3x95+50N	11,4/8,2	1,1/1,0	1,4/1,3	38,0	1250	0,320/0,641	239	210	245	195
330656	3x150+95N	14,4/11,4	1,4/1,1	1,4/1,4	46,0	1970	0,206/0,320	318	280	305	245
330657	3x240+150N	18,4/14,4	1,7/1,4	1,5/1,4	58,0	3070	0,125/0,206	425	375	405	325

N.B. Il coefficiente di resistività termica del terreno preso a riferimento per il calcolo della portata dei cavi interrati è di 1°C.m/W, profondità di posa 0,8 m. Calcolo della portata di corrente eseguito considerando quattro cavi unipolari a contatto o cavo quadripolare posato singolarmente con temperatura dei conduttori di 90°C.
N.B. The thermal resistivity coefficient used as a reference for the calculation of the buried cables current rating is 1°C.m/W, 0,8 m installation depth. Calculation of current rating performed considering four single-core cables in contact or four-core cable laid singly with conductor temperature of 90°C.

CAVI ELETTRICI DI MEDIA TENSIONE
(RAME e ALLUMINIO)

Norme di riferimento

Standards

HD 620 CEI 20-13pqa, IEC 60502pqa
EN 50575:2014 + EN 50575/A1:2016



Conduttore rigido di rame rosso ricotto. Classe 2.
Semiconduttore interno elastomerico estruso
Isolamento in HEPR di qualità G16
Semiconduttore esterno elastomerico estruso pelabile a freddo per il grado 1,8/3kV solo su richiesta
Schermo costituito a fili di rame rosso
Guaina in mescola termoplastica tipo R12 per cavi MT

Rigid class 2 red copper conductor.
Inner semi-conducting layer
Elastomeric mixture insulation (G16 quality).
Outer semi-conducting layer special high module hepr for 1.8 / 3 kV only on request
Red copper wire shield.
Sheath of PVC R12 type. For MT

<i>Tensione nominale U₀</i>	da 1,8kV a 18kV	<i>Nominal voltage U₀</i>
<i>Tensione nominale U</i>	da 3kV a 30kV	<i>Nominal voltage U</i>
<i>Temperatura massima di esercizio</i>	+90°C	<i>Maximun operating temperature</i>
<i>Temperatura massima di corto circuito</i>	+250°C	<i>Maximun short circuit temperature</i>
<i>Temperatura minima di esercizio (senza shock meccanico)</i>	-15°C	<i>Min. operating temperature (without mechanical shocks)</i>
<i>Temperatura minima di installazione e maneggio</i>	0°C	<i>Minimum installation and use temperature</i>

Condizioni di impiego piu comuni

Adatti per il trasporto di energia tra le cabine di trasformazione e le grandi utenze. Adatti per l'alimentazione elettrica in costruzioni ed altre opere di Ingegneria civile con l'obiettivo di limitare la produzione e la diffusione di fuoco e fumo, conformi al Regolamento CPR. Per posa in aria libera, in tubo o canale. Ammessa la posa interrata anche non protetta.

Condizioni di posa

Raggio minimo di curvatura per diametro D (in mm):

12 D

Sforzo massimo di tiro:

60 N/mm

Imballo

Imballo e quantitativi minimi da definire in sede d'ordine

Colori anime

Unipolare: rosa

Tripolare: rosa

Colori guaina

Rosso

Note

Nei cavi con tensione nominale di isolamento U₀ verso terra inferiore o uguale a 3,6 kV è ammessa l'omissione degli strati semiconduttori.

Common features

Suitable for the transport of energy between the substations and large users. For electrical power system in constructions and other civil engineering bulginngs, in order to limit fire and smoke production and spread, in accordance with the CPR. For free-hanging, pipe or channel. Laying underground also not protected.

Employment

Minimum bending radius per D cable diameter (in mm):

12 D

Maximum pulling stress:

60 N/mm

Packing

Packaging and minimal quantity to agree

Core colours

Single core: pink

Three cores: pink

Sheath colour

Red

Note

In cables with a rated voltage of U₀ insulation to lower ground or equal to 3.6 kV is allowed the omission of the semiconductor layers.

U_o/U : 1,8/3 kV - U max : 3,6 kV(EX GRADO 8)

Numero conduttori	Sezione nominale	Diametro indicativo conduttore	Diametro isolante	Diametro indicativo esterno	Peso indicativo cavo (Cu)	Raggio minimo curvatura
Conductor number	Nominal cross section	Approx cond. diameter	Insulation diameter	Approx overall diameter	Approx cable weight	Minimum radius bending
(N.)	(mm ²)	(mm)	(mm)	(mm)	(kg/km)	(mm)
Unipolare / Single core						
1x	10	4.0	8.0	14.5	289	180
1x	16	4.8	8.8	15.2	348	190
1x	25	6.0	10.0	16.5	448	200
1x	35	7.0	11.0	17.5	547	220
1x	50	8.1	12.1	18.5	677	240
1x	70	9.9	13.9	20.1	905	260
1x	95	11.5	15.5	22.1	1174	290
1x	120	12.9	16.9	23.3	1423	310
1x	150	14.2	18.2	24.7	1692	330
1x	185	15.9	19.9	26.5	2040	350
1x	240	18.3	22.3	29.0	2587	390
1x	300	20.7	24.7	31.6	3184	420
1x	400	23.5	27.5	34.6	4010	460
1x	500	26.5	31.0	38.3	5055	510
1x	630	31.2	36.2	43.1	6388	570

Formazione	Resistenza elettrica a 20°C	Capacità a 50 Hz	Resistenza apparente a 90°C e 50 Hz		Reattanza di fase		Portate di corrente			
			A trifoglio	In piano	A trifoglio	In piano	In aria a trifoglio	In aria in Piano	Interrato a trifoglio	Interrato in piano
Formation	Electric Resistance 20°C	Capacities 50 Hz	Apparent resistance at 90°C and 50 Hz		Phase Reactance		Current carrying capacities			
			Trefoil formation	Flat	Trefoil formation	Flat	Trefoil formation in air	Flat in air	Trefoil formation in ground	Flat in ground
(N° x mmq)	(Ohm/km)	(microF/km)	(Ohm/km)	(Ohm/km)	(Ohm/km)	(Ohm/km)	(A)	(A)	(A)	(A)
Unipolare / Single core										
1x10	1,83	0,19	2,34	2,34	0,13	0,19	87	111	99	104
1x16	1,15	0,23	1,47	1,47	1,12	0,18	114	145	126	133
1x25	0,727	0,27	0,927	0,927	0,12	0,18	149	190	162	171
1x35	0,524	0,30	0,669	0,668	0,11	0,17	181	230	193	204
1x50	0,387	0,34	0,494	0,494	0,11	0,16	219	276	227	241
1x70	0,268	0,40	0,342	0,342	0,10	0,16	275	345	278	294
1x95	0,193	0,45	0,246	0,246	0,098	0,16	339	422	332	351
1x120	0,153	0,50	0,196	0,196	0,095	0,15	393	487	377	399
1x150	0,124	0,55	0,159	0,158	0,092	0,15	466	550	421	445
1x185	0,0991	0,60	0,128	0,127	0,089	0,15	516	635	477	500
1x240	0,0754	0,68	0,0985	0,0974	0,086	0,14	617	745	550	580
1x300	0,0601	0,75	0,0797	0,0781	0,084	0,14	709	855	621	650
1x400	0,0470	0,83	0,0638	0,0628	0,083	0,14	824	990	702	735
1x500	0,0366	0,88	0,0517	0,0492	0,081	0,14	954	1140	790	830
1x630	0,0283	0,92	0,0425	0,0392	0,079	0,14	1102	1300	885	930

Uo/U : 3,6/6 kV - U max : 7,2 kV(EX GRADO 11)

Numero conduttori	Sezione nominale	Diametro indicativo conduttore	Diametro isolante	Diametro indicativo esterno	Peso indicativo cavo (Cu)	Raggio minimo curvatura
Conductor number	Nominal cross section	Approx cond. diameter	Insulation diameter	Approx overall diameter	Approx cable weight	Minimum radius bending
(N.)	(mm ²)	(mm)	(mm)	(mm)	(kg/km)	(mm)
Unipolare / Single core						
1x	10	4.0	11.6	17.5	347	210
1x	16	4.8	12.4	17.0	416	204
1x	25	6.0	13.6	18.8	549	225
1x	35	7.0	14.6	19.8	653	238
1x	50	8.1	15.7	21.4	792	257
1x	70	9.9	17.5	23.3	1035	280
1x	95	11.5	19.1	24.8	1317	298
1x	120	12.9	20.5	26.3	1564	316
1x	150	14.2	21.8	27.8	1841	334
1x	185	15.9	23.6	29.5	2203	354
1x	240	18.3	26.0	32.1	2822	386
1x	300	20.7	28.4	34.8	3366	418
1x	400	23.5	32.4	37.8	4158	454
1x	500	26.5	35.9	41.8	5247	502
1x	630	31.2	39.9	45.8	6534	550

Formazione	Resistenza elettrica a 20°C	Capacità a 50 Hz	Resistenza apparente a 90°C e 50 Hz		Reattanza di fase		Portata di corrente			
			A trifoglio	In piano	A trifoglio	In piano	In aria a trifoglio	In aria in Piano	Interrato a trifoglio	Interrato in piano
Formation	Electric resistance at 20°C	Capacities 50 Hz	Apparent resistance at 90°C and 50 Hz		Phase Reactance		Current carrying capacities			
			Trefoil formation	Flat	Trefoil formation	Flat	Trefoil formation in air	Flat in air	Trefoil formation in ground	Flat in ground
(N° x mmq)	(Ohm/km)	(microF/km)	(Ohm/km)	(Ohm/km)	(Ohm/km)	(Ohm/km)	(A)	(A)	(A)	(A)
Unipolare / Single core										
1x10	1.83	0.16	2.34	2.34	0.16	0.21	91	105	93	98
1x16	1.15	0.18	1.47	1.47	0.15	0.20	117	136	120	128
1x25	0.727	0.21	0.927	0.927	0.14	0.19	154	178	155	163
1x35	0.524	0.23	0.669	0.669	0.13	0.19	186	219	185	195
1x50	0.387	0.26	0.494	0.494	0.12	0.18	223	260	218	231
1x70	0.268	0.29	0.342	0.342	0.12	0.17	279	325	270	285
1x95	0.193	0.32	0.246	0.246	0.11	0.17	340	398	320	340
1x120	0.153	0.36	0.196	0.196	0.11	0.16	395	460	365	385
1x150	0.124	0.38	0.159	0.158	0.10	0.16	448	520	410	432
1x185	0.0991	0.42	0.128	0.127	0.10	0.16	516	600	464	490
1x240	0.0754	0.47	0.0985	0.0973	0.097	0.16	610	705	540	565
1x300	0.0601	0.52	0.0797	0.0780	0.095	0.15	703	810	605	635
1x400	0.0470	0.57	0.0638	0.0617	0.092	0.15	815	935	690	720
1x500	0.0366	0.64	0.0517	0.0490	0.089	0.15	945	1080	780	810
1x630	0.0283	0.73	0.0425	0.0390	0.087	0.15	1085	1230	875	900

U_o/U : 12/20 kV - U max : 24 kV (EX GRADO 32)

Numero conduttori	Sezione nominale	Diametro indicativo conduttore	Diametro indicativo isolante	Diametro indicativo esterno	Peso indicativo del cavo	Raggio minimo curvatura
Conductor Number (N°)	Nominal Section (mmq)	Approx conductor diameter (mm)	Insulation diameter (mm)	Approx external diameter (mm)	Approx cable weight (kg/km)	Minimum radius bending (mm)
Unipolare / Single core						
1x	25	6.0	20.4	26.9	846	360
1x	35	7.0	20.4	27.3	945	360
1x	50	8.1	21.5	28.5	1095	380
1x	70	9.9	23.3	30.4	1343	400
1x	95	11.5	24.9	32.4	1652	430
1x	120	12.9	26.3	33.9	1920	450
1x	150	14.2	27.6	35.2	2209	470
1x	185	15.9	29.4	37.0	2587	490
1x	240	18.3	31.8	39.5	3174	530
1x	300	20.7	34.2	42.0	3821	560
1x	400	23.5	37.0	45.3	4696	610
1x	500	26.5	40.0	49.0	5771	650
1x	630	31.3	44.7	53.7	7323	730

Formazione	Resistenza elettrica a 20°C	Capacità a 50 Hz	Resistenza apparente a 90°C e 50 Hz		Reattanza di fase		Portata di corrente			
			A trifoglio	Interrato in piano	A trifoglio	In piano	In aria a trifoglio	In aria in Piano	Interrato a trifoglio	Interrato in piano
Trefoil formation	Electric resistance at 20°C	Capacities 50 Hz	Apparent resistance at 90°C and 50 Hz		Phase Reactance		Current carrying capacities			
			Trefoil	Flat	Trefoil	Flat	Trefoil formation in air	Flat in air	Trefoil formation in ground	Flat in ground
(N° x mmq)	(Ohm/km)	(microF/km)	(Ohm/km)	(Ohm/km)	(Ohm/km)	(Ohm/km)	(A)	(A)	(A)	(A)
Unipolare / Single core										
1x25	0.727	0.16	0.927	0.927	0.14	0.20	158	176	153	158
1x35	0.524	0.17	0.669	0.669	0.14	0.20	190	213	182	189
1x50	0.387	0.18	0.494	0.494	0.13	0.19	230	255	216	225
1x70	0.268	0.21	0.342	0.342	0.13	0.19	285	320	265	275
1x95	0.193	0.23	0.246	0.246	0.12	0.18	348	390	315	329
1x120	0.153	0.25	0.196	0.196	0.12	0.18	400	450	360	374
1x150	0.124	0.27	0.159	0.158	0.11	0.17	450	510	402	416
1x185	0.0991	0.29	0.128	0.127	0.11	0.17	520	585	455	472
1x240	0.0754	0.32	0.0985	0.0972	0.11	0.16	615	690	528	545
1x300	0.0601	0.35	0.0797	0.0779	0.10	0.16	705	790	595	611
1x400	0.0470	0.39	0.0638	0.0616	0.099	0.16	815	910	674	690
1x500	0.0366	0.43	0.0517	0.0489	0.096	0.15	945	1050	762	776
1x630	0.0283	0.49	0.0425	0.0389	0.093	0.15	1087	1190	858	875

U_o/U : 18/30 kV - U max : 36 kV (EX GRADO 47)

Numero conduttori	Sezione nominale	Diametro indicativo conduttore	Diametro indicativo isolante	Diametro est. indicativo di produzione	Peso indicativo del cavo	Raggio minimo curvatura
Conductor Number	Nominal Section	Approx cond. diameter	Approx insulation diameter	Approx external diameter	Approx cable weight	Minimum radius bending
(N°)	(mmq)	(mm)	(mm)	(mm)	(kg/km)	(mm)
Unipolare / Single core						
1x	35	7.0	28.0	33.8	1290	450
1x	50	8.1	27.1	35.9	1420	460
1x	70	9.9	28.9	36.1	1660	470
1x	95	11.5	30.5	37.8	1980	510
1x	120	12.9	31.9	39.1	2260	520
1x	150	14.2	33.2	40.7	2560	540
1x	185	15.9	35.0	42.6	2960	570
1x	240	18.3	37.4	45.3	3610	610
1x	300	20.7	39.8	47.8	4280	640
1x	400	23.5	42.6	51.2	5200	680
1x	500	26.5	45.6	55.0	6310	730
1x	630	31.2	50.3	61.9	7930	800

Formazione	Resistenza elettrica a 20°C	Capacità a 50 Hz	Resistenza apparente a 90°C e 50 Hz		Reattanza di fase		Portata di corrente			
			A trifoglio	In piano	A trifoglio	In piano	In aria a trifoglio	In aria in Piano	Interrato a trifoglio	Interrato in piano
Formation	Electric Resistance 20°C	Capacities 50 Hz	Apparent resistance at 90°C and 50 Hz		Phase Reactance		Current carrying capacities			
			Trefoil	Flat	Trefoil	Flat	Flat in air		Trefoil formation in ground	Flat in ground
(N° x mmq)	(Ohm/km)	(microF/km)	(Ohm/km)	(Ohm/km)	(Ohm/km)	(Ohm/km)	(A)	(A)	(A)	(A)
Unipolare / Single core										
1x35	0.524	0.14	0.699	0.699	0.15	0.20	191	212	182	188
1x50	0.387	0.15	0.494	0.494	0.15	0.20	229	254	214	222
1x70	0.268	0.16	0.342	0.342	0.14	0.20	285	316	263	272
1x95	0.193	0.18	0.246	0.266	0.13	0.19	347	387	314	325
1x120	0.153	0.19	0.196	0.196	0.13	0.18	401	445	358	370
1x150	0.124	0.20	0.159	0.158	0.12	0.18	452	505	400	415
1x185	0.0991	0.22	0.128	0.127	0.12	0.18	520	580	453	469
1x240	0.0754	0.24	0.0985	0.0972	0.11	0.17	615	680	525	540
1x300	0.0601	0.27	0.0797	0.0779	0.11	0.17	705	775	593	606
1x400	0.0470	0.29	0.0638	0.0616	0.11	0.16	815	895	671	685
1x500	0.0366	0.32	0.0617	0.0489	0.10	0.16	943	1030	761	775
1x630	0.0283	0.36	0.0425	0.0389	0.099	0.16	1085	1170	860	875

Note
Le portate dei cavi interrati sono stati calcolati con resistività termica del Terreno 100°C cm/W

Note
The current carrying capacities of underground cables have been calculated with thermal resistivity of the Land 100 ° C cm / W

TRI-MVP ARE4H1R-12/20 kV

TRI-MVP ARE4H1R-18/30 kV

Costruzione, requisiti elettrici, fisici e meccanici:	CEI 20-13 IEC 60502-2
Misura delle scariche parziali:	CEI 20-16 IEC 60885-3
Prove a impulso:	IEC 60230
Non propagazione della fiamma:	EN 60332-1-2
Gas corrosivi o alogenidrici:	EN 50267-2-1



Descrizione

- Conduttore: alluminio, formazione rigida compatta, classe 2
- Strato semiconduttore: estruso
- Isolamento: polietilene reticolato XLPE senza piombo
- Strato semiconduttore: estruso, pelabile a freddo
- Schermo: fili di rame rosso con nastro di rame in controspirale
- Guaina: miscela a base di PVC, qualità ST2
- Colore: rosso

N.B. Il cavo può essere fornito nella versione tripolare riunito ad elica visibile. In tal caso la sigla di designazione diventa ARE4H1RX seguita dalla tensione nominale di esercizio.

Caratteristiche funzionali

- Tensione nominale di esercizio
ARE4H1R -12/20 kV U_o/U: 12/20 kV
ARE4H1R -18/30 kV U_o/U: 18/30 kV
- Tensione U max
ARE4H1R -12/20 kV U_o/U: 24 kV
ARE4H1R -18/30 kV U_o/U: 36 kV
- Temperatura massima di esercizio: 90°C
- Temperatura minima di esercizio: -15°C
(in assenza di sollecitazioni meccaniche)
- Temperatura massima di corto circuito: 250°C
- Resistenza elettrica massima dello schermo: 3 Ω/km

Marcatura

Pb free LA TRIVENETA CAVI TRI-MVP ARE4H1R [tens. nominale] [form.] [anno] [ordine] [metrica]

Condizioni di posa

- Temperatura minima di posa: 0°C
- Raggio minimo di curvatura consigliato: 12 volte il diametro del cavo
- Massimo sforzo di trazione consigliato: 60 N/mm² di sezione del conduttore

Impiego e tipo di posa

Adatto per il trasporto di energia tra le cabine di trasformazione e le grandi utenze. Per posa in aria libera, in tubo o canale.

Ammessa la posa interrata, in conformità all'art. 4.3.11 della norma CEI 11-17.

ARE4H1R - 12/20 kV

U_o/U: 12/20 kV

U max: 24 kV

Caratteristiche tecniche

Formazione	Ø indicativo conduttore	Ø indicativo isolante	Ø esterno max	Peso indicativo cavo	Portata di corrente A			
					in aria		interrato*	
n° x mm ²	mm	mm	mm	kg/km	a trifoglio	in piano	a trifoglio	in piano
1 x 35	7,1	18,70	26,2	595	154	185	129	134
1 x 50	8,2	19,80	27,4	655	184	222	152	157
1 x 70	9,9	21,50	29,2	760	230	278	186	192
1 x 95	11,4	23,00	31,0	890	280	338	221	229
1 x 120	13,1	24,70	32,8	1020	324	391	252	260
1 x 150	14,4	26,00	34,5	1145	368	440	281	288
1 x 185	16,2	27,80	36,4	1300	424	504	317	324
1 x 240	18,4	30,00	38,9	1535	502	593	367	373
1 x 300	20,7	32,25	41,6	1780	577	677	414	419
1 x 400	23,6	35,20	44,9	2280	673	769	470	466
1 x 500	26,5	38,10	48,3	2595	781	890	550	540
1 x 630	30,2	41,80	52,4	3135	909	1030	710	700

(*) I valori di portata si riferiscono alle seguenti condizioni:

- Resistività termica del terreno: 1 K·m/W
- Temperatura ambiente 20°C
- profondità di posa: 0,8 m

Caratteristiche elettriche

Formazione	Resistenza elettrica a 20°C	Resistenza apparente a 90°C 50Hz		Reattanza di fase		Capacità a 50Hz
		Ω/km		Ω/Km		
n° x mm ²	Ω/Km	a trifoglio	in piano	a trifoglio	in piano	μF/km
1 x 35	0,868	1,113	1,113	0,14	0,15	170
1 x 50	0,641	0,822	0,822	0,13	0,14	186
1 x 70	0,443	0,568	0,568	0,13	0,13	211
1 x 95	0,320	0,411	0,411	0,12	0,13	232
1 x 120	0,253	0,325	0,325	0,12	0,12	257
1 x 150	0,206	0,265	0,265	0,11	0,12	275
1 x 185	0,164	0,211	0,211	0,11	0,12	301
1 x 240	0,125	0,161	0,161	0,11	0,11	332
1 x 300	0,100	0,130	0,129	0,10	0,11	364
1 x 400	0,0778	0,102	0,101	0,099	0,11	405
1 x 500	0,0605	0,0801	0,0794	0,096	0,11	446
1 x 630	0,0469	0,0635	0,0625	0,093	0,10	498

ARE4H1R - 18/30 kV

U_o/U: 18/30 kV

U max: 36 kV

Caratteristiche tecniche

Formazione	Ø indicativo conduttore	Ø indicativo isolante	Ø esterno max	Peso indicativo cavo	Portata di corrente A			
					in aria		interrato*	
n° x mm ²	mm	mm	mm	kg/km	a trifoglio	in piano	a trifoglio	in piano
1 x 50	8,2	24,60	32,7	885	184	222	152	157
1 x 70	9,9	26,30	34,8	1025	230	278	186	192
1 x 95	11,4	27,80	36,4	1150	280	338	221	229
1 x 120	13,1	29,50	38,4	1310	324	391	252	260
1 x 150	14,4	30,80	39,8	1430	368	440	281	288
1 x 185	16,2	32,60	41,9	1620	424	504	317	324
1 x 240	18,4	34,80	44,5	1875	502	593	367	373
1 x 300	20,7	37,05	47,1	2135	577	677	414	419
1 x 400	23,6	40,00	50,5	2645	673	769	470	466
1 x 500	26,5	42,90	53,8	2710	781	890	550	540
1 x 630	30,2	46,60	58,0	3260	909	1030	710	700

(*) I valori di portata si riferiscono alle seguenti condizioni:

- Resistività termica del terreno: 1 K·m/W
- Temperatura ambiente 20°C
- profondità di posa: 0,8 m

Caratteristiche elettriche

Formazione	Resistenza elettrica a 20°C	Resistenza apparente a 90°C 50Hz		Reattanza di fase		Capacità a 50Hz
		Ω/km		Ω/Km		
n° x mm ²	Ω/Km	a trifoglio	in piano	a trifoglio	in piano	μF/km
1 x 50	0,641	0,822	0,822	0,14	0,15	143
1 x 70	0,443	0,568	0,568	0,13	0,15	160
1 x 95	0,320	0,411	0,411	0,12	0,14	175
1 x 120	0,253	0,325	0,325	0,12	0,13	192
1 x 150	0,206	0,265	0,265	0,11	0,13	205
1 x 185	0,164	0,211	0,211	0,11	0,12	222
1 x 240	0,125	0,161	0,161	0,11	0,12	244
1 x 300	0,100	0,130	0,129	0,10	0,11	265
1 x 400	0,0778	0,102	0,101	0,101	0,11	294
1 x 500	0,0605	0,0801	0,0794	0,097	0,11	321
1 x 630	0,0469	0,0635	0,0625	0,094	0,11	357