

# PLANIMETRIA GENERALE PAVIMENTAZIONI ESTERNE

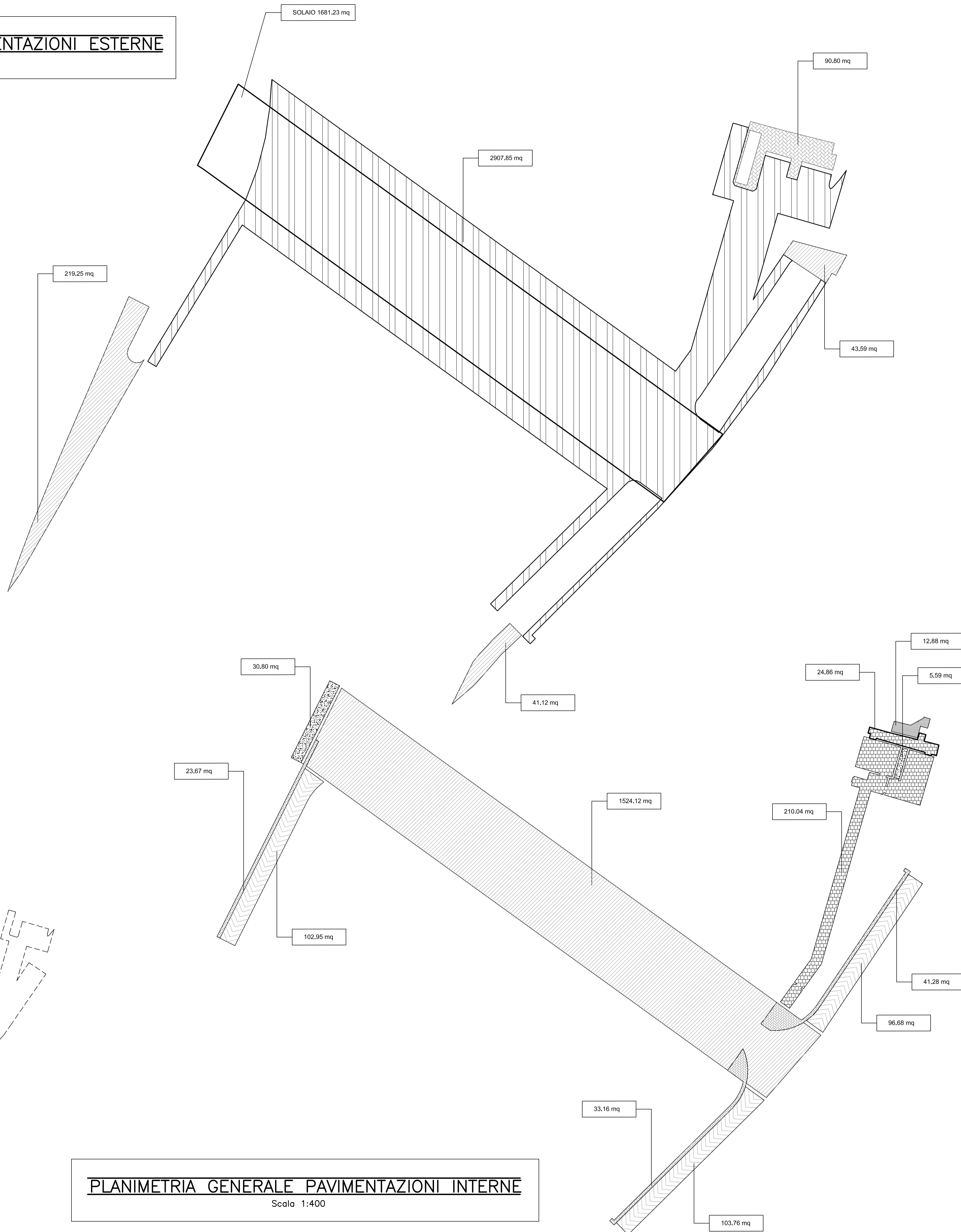





Scala 1:400



# PLANIMETRIA GENERALE PAVIMENTAZIONI INTERNE

Scala 1:400

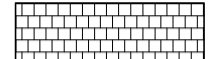
## LEGENDA

-  NUOVA PAVIMENTAZIONE BITUMINOSA
-  RIPRISTINO PAVIMENTAZIONE BITUMINOSA PIAZZALE
-  PAVIMENTAZIONE IN AUTOBLOCCANTI IN CLS
-  PAVIMENTAZIONE IN MASSETTO DI CLS
-  PAVIMENTAZIONE IN CLS BOCCIARDATO
-  PAVIMENTAZIONE IN PIASTRELLE IN MONOCOTTURA
-  RIFACIMENTO PAVIMENTAZIONI IN PIASTRELLE DI MONOCOTTURA

 SOCIETA' ITALIANA TRAFORO AUTOSTRADALE DEL FREJUS SOCIETE FRANCAISE DU TUNNEL ROUTIER DU FREJUS					
<b>Traforo Autostradale del Fréjus / Tunnel Routier du Fréjus</b> <b>CONSTRUZIONE GALLERIA DI SICUREZZA / CONSTRUCTION GALERIE DE SECURITE</b>					
PROGETTO DEFINITIVO 2006 / PROJET 2006					
<b>OPERE ESTERNE LATO ITALIA</b> <b>PARCHEGGIO SOTTOPASSO INTERRATO</b> <b>PLANIMETRIA SCHEMATICA INTERVENTI DI PAVIMENTAZIONE</b> <b>COMPUTO DELLE QUANTITA'</b>					
24.11.2006	DZ	CT	MO	Assiomentopage Mise à jour	B A
15.09.2006	DZ	CT	MO	6145.2-P-350A.dwg	6145.2-P-350 A
Formato : 840X594	Scala : 1:400	No.	No.	No. Com.	
		Architetti & Designers Bellinzona - Svizzera			
Progettisti: Ing. Andrea Mordasini, Dott. Ing. Marco Russo - Lombardi SA Collaborazione specialistica: Arch. Renzo Molina, Dott. Ing. Corrado Trasino					