

VISTO per ATIVA S.p.A.



Amministratore Delegato  
Dott. Ing. LUIGI CRESTA



TORINO - IVREA - QUINCINETTO

IVREA - SANTHIA'

SISTEMA AUTOSTRADALE  
TANGENZIALE DI TORINO

# AUTOSTRADA A4/A5 - A5 TORINO QUINCINETTO IVREA SANTHIA'

## NODO IDRAULICO DI IVREA 2° FASE DI COMPLETAMENTO

### PROGETTO DEFINITIVO

### LOTTO 1 - INTERCONNESSIONE DI PAVONE SEZIONI TRASVERSALI RAMPA D

IL PROGETTISTA	REDATTO	CONTROLLATO	APPROVATO													
  Il Direttore Tecnico  Dott. Ing. ROBERTO PETRALI ordine degli Ingegneri di Milano n° 14638	ATIVA ENGINEERING D. Traversa	ATIVA ENGINEERING F. Racca	ATIVA ENGINEERING V. Palmisano													
	DATA GIUGNO 2012	REVISIONE	DATA													
	SCALA 1 : 250															
	<table border="1"> <thead> <tr> <th>UFFICIO</th> <th>COMMESSA</th> <th>N° PROGETTO</th> <th>FASE</th> <th>ARGOMENTO</th> <th>N° ELABORATO</th> <th>REV</th> </tr> </thead> <tbody> <tr> <td>SSP0101A05</td> <td>0000</td> <td>0000</td> <td>PD</td> <td>STD</td> <td>106</td> <td>--</td> </tr> </tbody> </table>	UFFICIO	COMMESSA	N° PROGETTO	FASE	ARGOMENTO	N° ELABORATO	REV	SSP0101A05	0000	0000	PD	STD	106	--	
UFFICIO	COMMESSA	N° PROGETTO	FASE	ARGOMENTO	N° ELABORATO	REV										
SSP0101A05	0000	0000	PD	STD	106	--										

Rampa D\_Ciglio Sx San-To  
 Sez. D1  
 Progr : 0+999.00  
 Scala : 1:250  
 Q.Rif. : 220.00

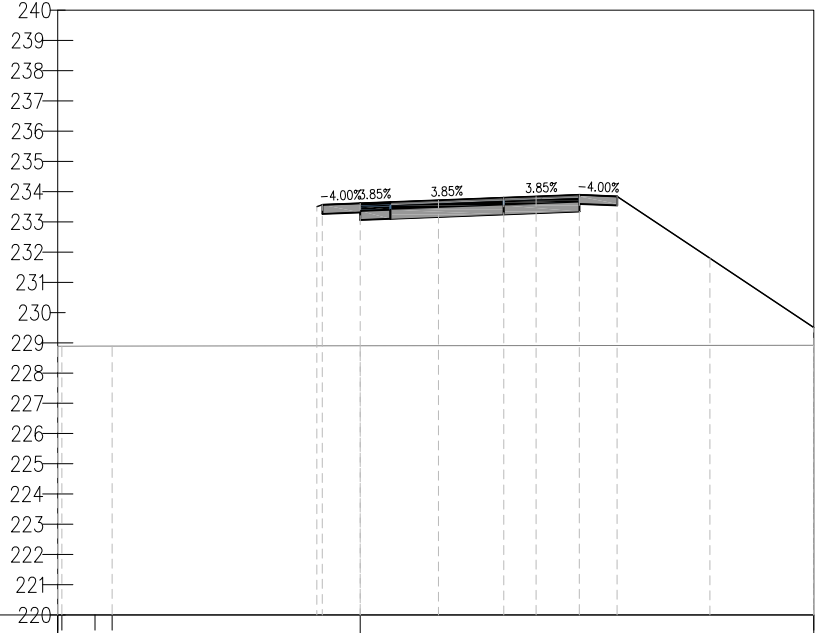

PROGRESSIVE TERRENO	-10.80	-8.77	-8.20	-	-	-	15.00							
QUOTE TERRENO	228.89	228.89	228.89	228.90	-	-	228.92							
DISTANZE PARZIALI TERRENO	1.09	0.57	8.20	-	-	15.00	-							
PROGRESSIVE PROGETTO	-	-	-	1.53	-0.72	1.00	2.59	4.75	5.81	7.25	7.78	8.50	11.56	15.00
QUOTE PROGETTO	-	-	-	233.58	233.58	233.61	233.65	233.71	233.79	233.83	233.89	233.84	231.80	229.50
DISTANZE PARZIALI PROGETTO	-	-	-	0.54	0.71	0.57	1.59	2.16	1.07	1.43	0.54	0.71	3.07	3.44

Rampa D\_Ciglio Sx San-To  
 Sez. D2  
 Progr : 1+000.00  
 Scala : 1:250  
 Q.Rif. : 220.00

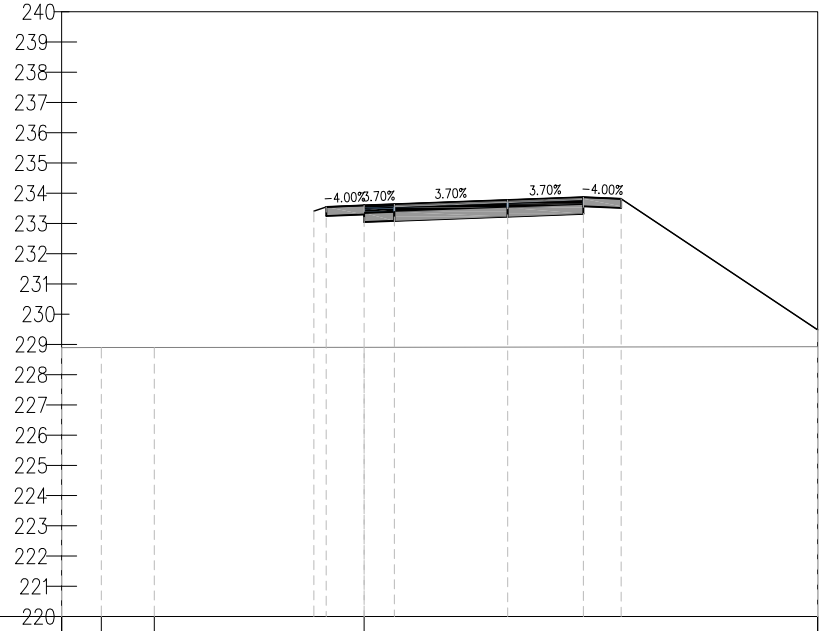

PROGRESSIVE TERRENO	10.00	-8.69	-6.94	0.00	15.00			
QUOTE TERRENO	228.89	228.90	228.90	228.90	228.92			
DISTANZE PARZIALI TERRENO	1.31	1.75	6.94	15.00				
PROGRESSIVE PROGETTO		-1.66	0.00	1.00	4.75	7.25	8.50	15.00
QUOTE PROGETTO		233.40	233.60	233.63	233.77	233.87	233.82	229.48
DISTANZE PARZIALI PROGETTO		1.25	1.00	3.75	2.50	1.25	6.50	

Rampa D\_Ciglio Sx San-To  
 Sez. D3  
 Progr : 1+008.23  
 Scala : 1:250  
 Q.Rif. : 220.00

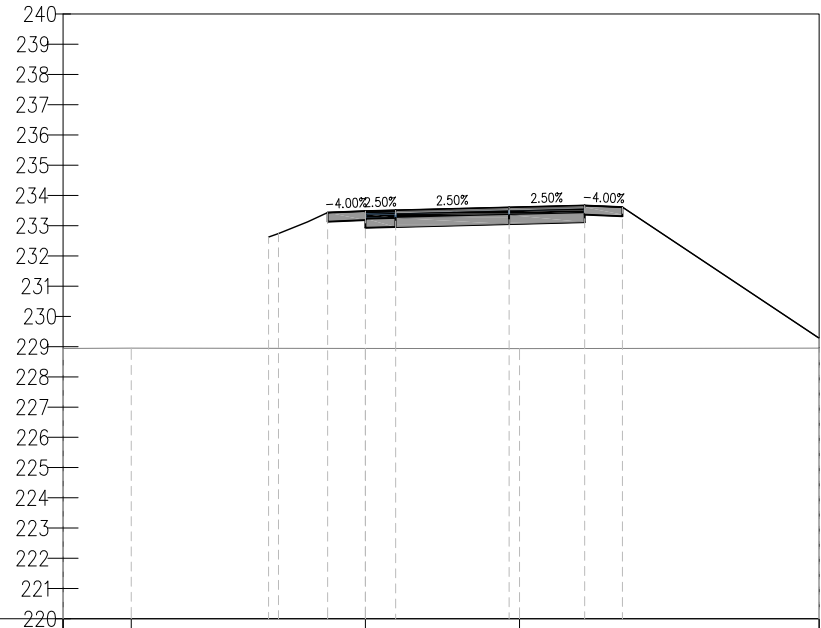

PROGRESSIVE TERRENO	10.00	-7.74	0.00	5.10	15.00					
QUOTE TERRENO	228.94	228.95	228.94	228.94	228.95					
DISTANZE PARZIALI TERRENO	2.26	7.74	5.10	9.90						
PROGRESSIVE PROGETTO		-2.89	-1.91	-1.25	0.00	1.00	4.75	7.25	8.50	15.00
QUOTE PROGETTO		232.64	233.12	233.43	233.48	233.51	233.60	233.66	233.61	229.28
DISTANZE PARZIALI PROGETTO		0.96	0.66	1.25	1.00	3.75	2.50	1.25	6.50	

Rampa D\_Ciglio Sx San-To  
 Sez. D4  
 Progr : 1+018.51  
 Scala : 1:250  
 Q.Rif. : 220.00

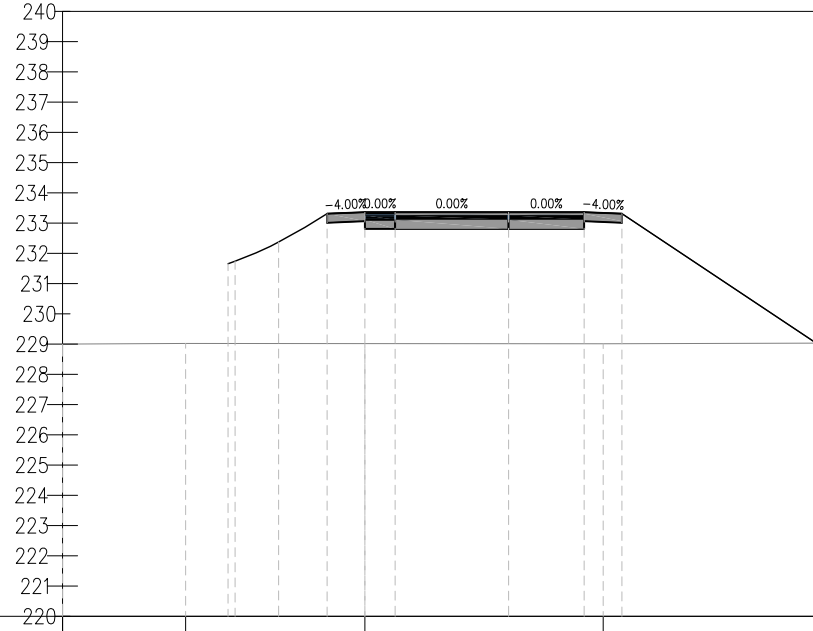

PROGRESSIVE TERRENO	10.00	5.93	0.00	7.88	15.00
QUOTE TERRENO	229.00	229.02	229.02	229.01	229.03
DISTANZE PARZIALI TERRENO	4.07	5.93	7.88	7.12	
PROGRESSIVE PROGETTO		4.59	0.00	4.75	8.50
QUOTE PROGETTO		231.66	233.36	233.36	233.31
DISTANZE PARZIALI PROGETTO		0.69	1.25	3.75	6.42

Rampa D\_Ciglio Sx San-To  
 Sez. D5  
 Progr : 1+025.00  
 Scala : 1:250  
 Q.Rif. : 220.00

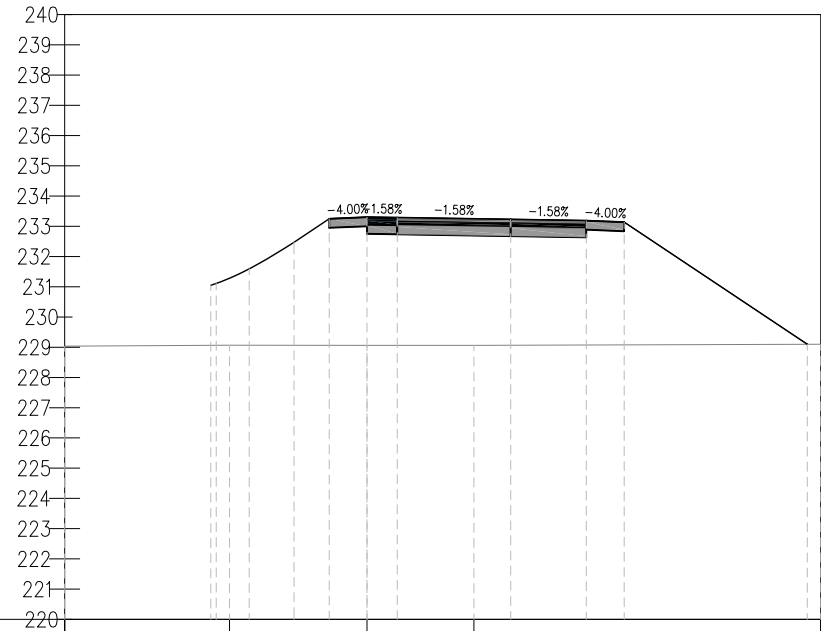

PROGRESSIVE TERRENO	10.00	4.55	3.53	15.00
QUOTE TERRENO	229.04	229.07	229.06	229.10
DISTANZE PARZIALI TERRENO	5.45	4.55	3.53	11.47
PROGRESSIVE PROGETTO	5.00	4.75	7.25	14.56
QUOTE PROGETTO	231.95	231.59	233.22	229.10
DISTANZE PARZIALI PROGETTO	0.52	0.65	1.17	6.06

Rampa D\_Ciglio Sx San-To  
 Sez. D6  
 Progr : 1+028.80  
 Scala : 1:250  
 Q.Rif. : 220.00

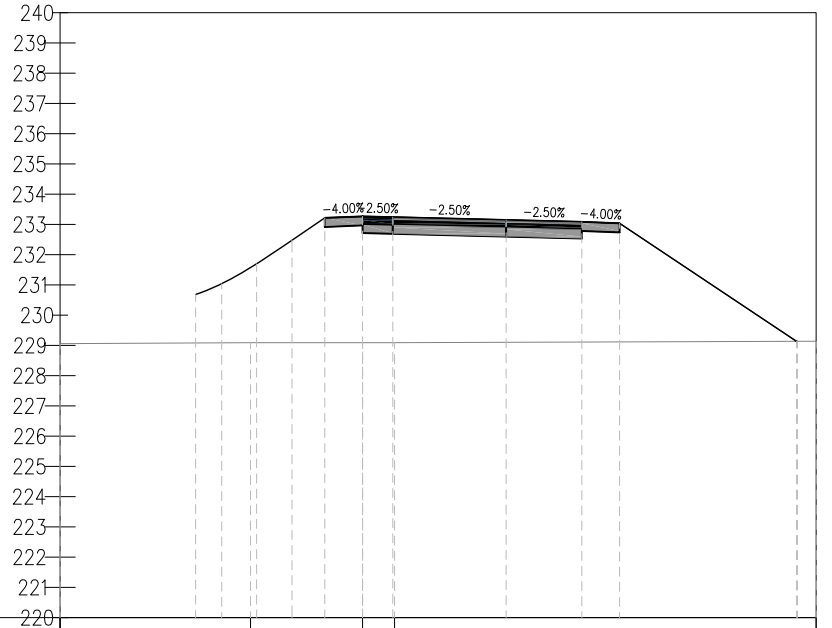

PROGRESSIVE TERRENO	10.00					15.00
QUOTE TERRENO	229.06		229.09	229.09	229.09	229.14
DISTANZE PARZIALI TERRENO		6.29		3.71	1.06	13.94
PROGRESSIVE PROGETTO		5.57		1.25	1.00	14.38
QUOTE PROGETTO	230.09	231.13	231.42	232.48	233.22	233.27
DISTANZE PARZIALI PROGETTO		0.53	0.95	1.08	1.25	1.00
						3.75
						2.50
						1.25
						5.85
						229.13

Rampa D\_Ciglio Sx San-To  
 Sez. D7  
 Progr : 1+038.90  
 Scala : 1:250  
 Q.Rif. : 220.00

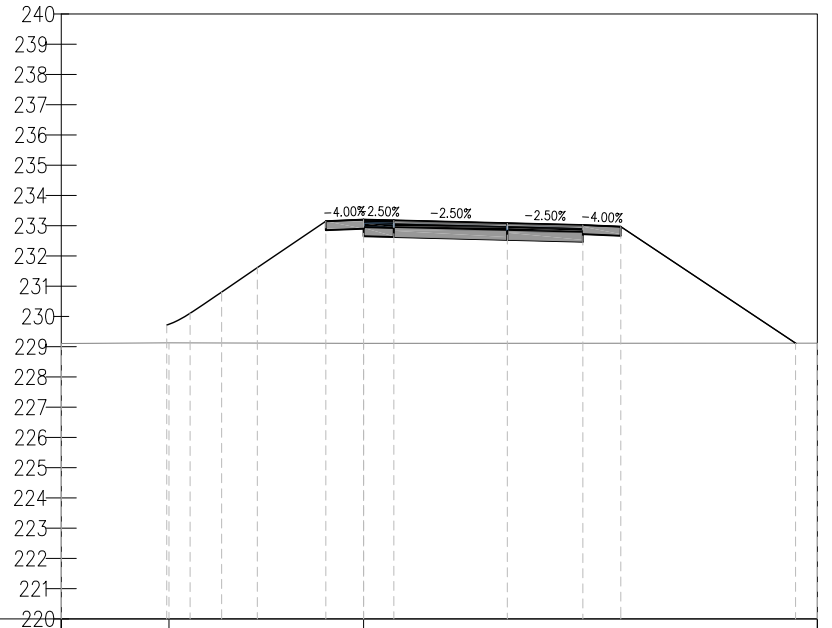

PROGRESSIVE TERRENO	10.00	6.44		15.00
QUOTE TERRENO	229.11	229.13	229.11	229.12
DISTANZE PARZIALI TERRENO	3.56	6.22	15.00	
PROGRESSIVE PROGETTO	6.44	5.91	4.75	7.25
QUOTE PROGETTO	229.73	230.00	233.08	235.02
DISTANZE PARZIALI PROGETTO	0.42	1.18	3.75	5.78



Rampa D\_Ciglio Sx San-To  
 Sez. D8  
 Progr : 1+049.00  
 Scala : 1:250  
 Q.Rif. : 220.00

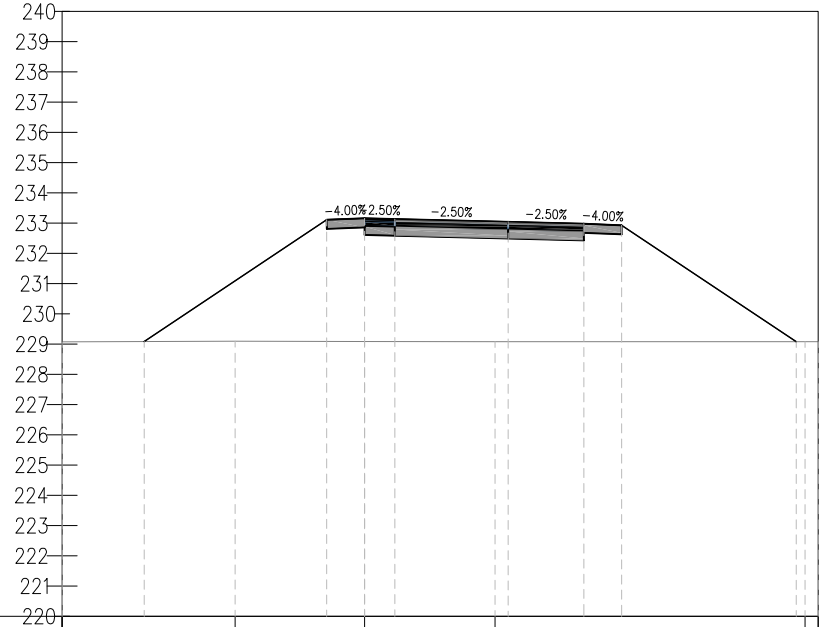

PROGRESSIVE TERRENO	10.00	-4.28	4.31	14.56
QUOTE TERRENO	229.07	229.10	229.09	229.08
DISTANZE PARZIALI TERRENO	5.72	4.28	4.31	10.25
PROGRESSIVE PROGETTO	-7.29	-1.25	1.00	4.75
QUOTE PROGETTO	229.08	233.11	233.16	233.04
DISTANZE PARZIALI PROGETTO	6.04	1.25	1.00	2.50
			3.75	1.25
				5.77
				8.50
				7.25
				14.27

Rampa D\_Ciglio Sx San-To  
 Sez. D9  
 Progr : 1+050.00  
 Scala : 1:250  
 Q.Rif. : 220.00

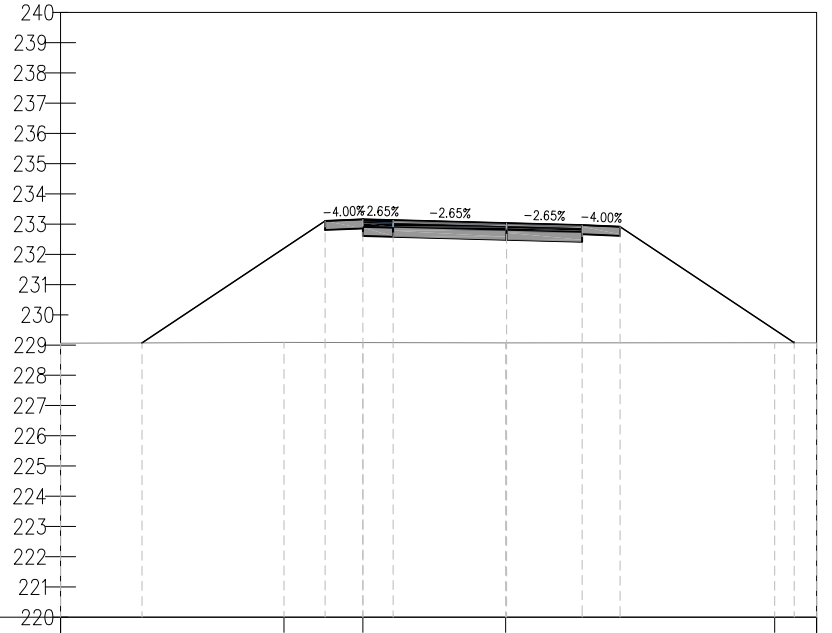

PROGRESSIVE TERRENO	10.00		-2.61	0.00	4.72		13.62	15.00
QUOTE TERRENO	229.06		229.09	229.08	229.07		229.08	229.07
DISTANZE PARZIALI TERRENO		7.39	2.61		4.72		8.90	1.38
PROGRESSIVE PROGETTO		-7.30	-1.25	0.00	4.75	7.25	8.50	14.26
QUOTE PROGETTO		229.07	233.11	233.16	233.03	232.96	232.91	229.07
DISTANZE PARZIALI PROGETTO		6.05	1.25	1.00	3.75	2.50	1.25	5.76

Rampa D\_Ciglio Sx San-To  
 Sez. D10  
 Progr : 1+059.10  
 Scala : 1:250  
 Q.Rif. : 220.00

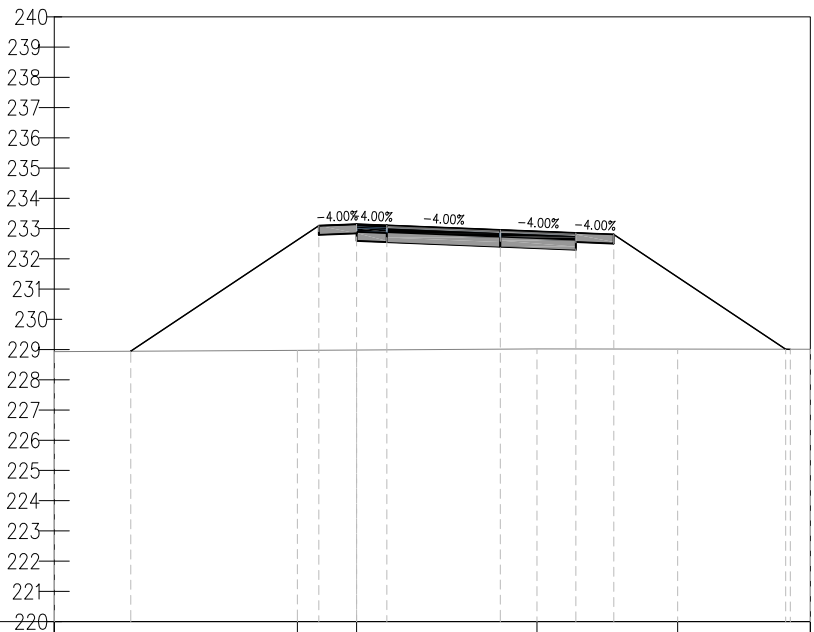

PROGRESSIVE TERRENO	10.00			-1.96	0.00		5.96		10.61	15.00	
QUOTE TERRENO	228.93			228.97	228.98		229.02		229.02	229.01	
DISTANZE PARZIALI TERRENO		8.04		1.96			5.96		4.65	4.39	
PROGRESSIVE PROGETTO		-7.47		-1.25	0.00	1.00		4.75	7.25	8.50	14.39
QUOTE PROGETTO		228.94		233.09	233.14	233.10		232.95	232.85	232.80	229.00
DISTANZE PARZIALI PROGETTO		6.22		1.25	1.00		3.75		2.50	1.25	5.69

Rampa D\_Ciglio Sx San-To  
 Sez. D11  
 Progr : 1+075.00  
 Scala : 1:250  
 Q.Rif. : 220.00

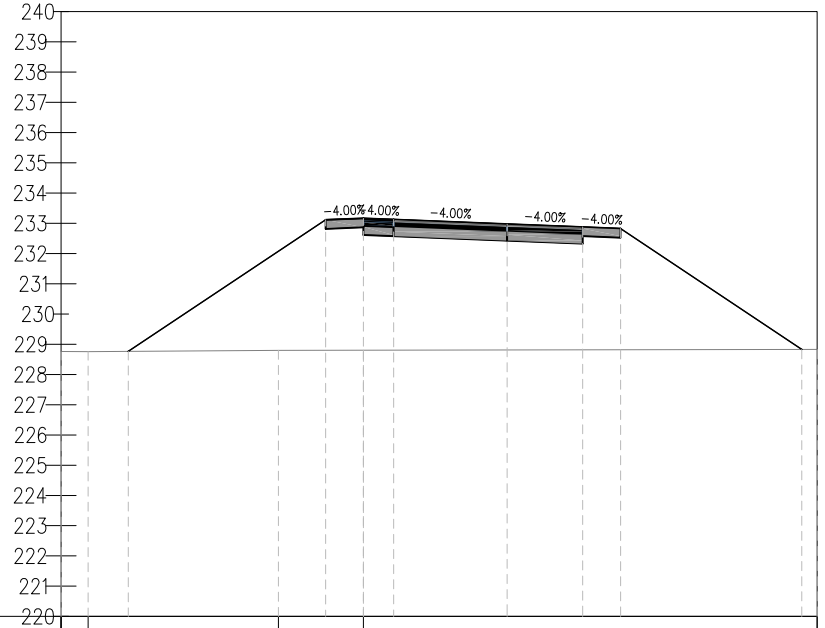

PROGRESSIVE TERRENO	10.00	9.10	2.81	0.00	15.00			
QUOTE TERRENO	228.76	228.75	228.80	228.80	228.83			
DISTANZE PARZIALI TERRENO	0.90	6.29	2.81	15.00				
PROGRESSIVE PROGETTO	-7.78	-1.25	0.00	1.00	4.75	7.25	8.50	14.50
QUOTE PROGETTO	228.76	233.12	233.17	233.13	232.98	232.88	232.83	228.83
DISTANZE PARZIALI PROGETTO	6.53	1.25	1.00	3.75	2.50	1.25	6.00	

Rampa D\_Ciglio Sx San-To  
 Sez. D12  
 Progr : 1+100.00  
 Scala : 1:250  
 Q.Rif. : 220.00

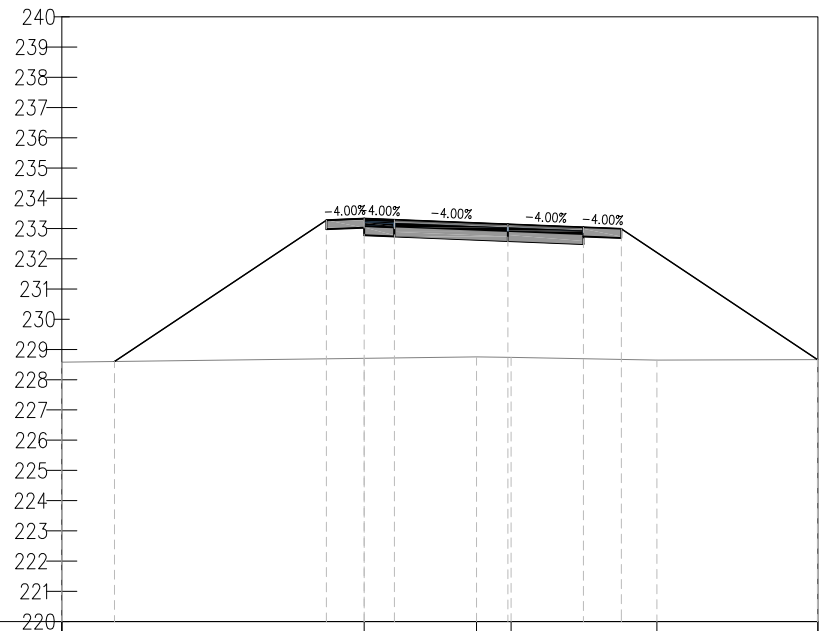

PROGRESSIVE TERRENO	10.00	0.00	3.71	4.85	9.68	15.00		
QUOTE TERRENO	228.56	228.71	228.75	228.74	228.65	228.66		
DISTANZE PARZIALI TERRENO	10.00	3.71	1.14	4.82	5.31			
PROGRESSIVE PROGETTO	-8.26	-1.25	0.00	1.00	4.75	7.25	8.50	14.98
QUOTE PROGETTO	228.60	233.28	233.33	233.29	233.14	233.04	232.99	228.66
DISTANZE PARZIALI PROGETTO	7.01	1.25	1.00	3.75	2.50	1.25	6.48	

Rampa D\_Ciglio Sx San-To  
 Sez. D13  
 Progr : 1+125.00  
 Scala : 1:250  
 Q.Rif. : 220.00

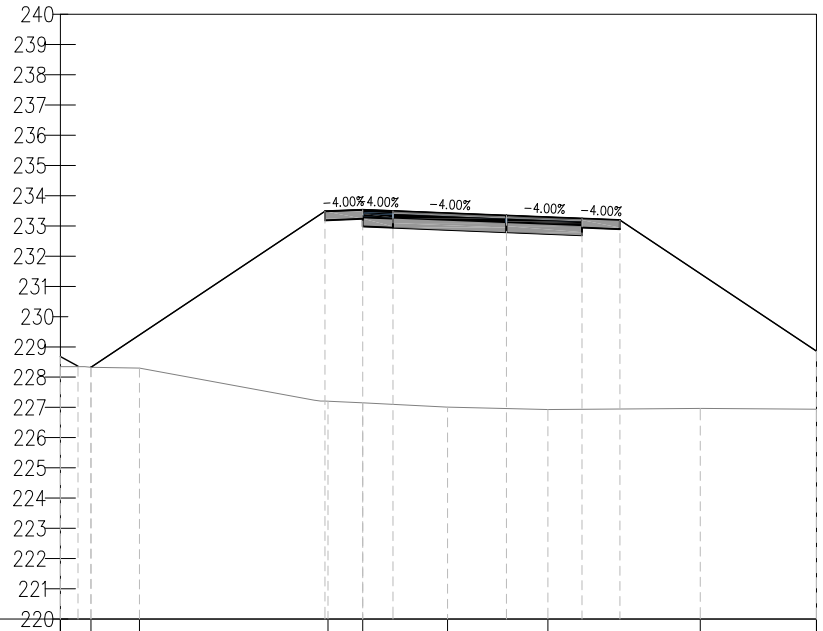

PROGRESSIVE TERRENO	10.00	-8.99	-7.39	-1.15	2.80	6.12	11.16	15.00
QUOTE TERRENO	228.35	228.32	228.30	227.21	227.15	227.01	226.93	226.94
DISTANZE PARZIALI TERRENO	0.71	1.60	5.79	1.15	2.80	3.29	5.04	3.75
PROGRESSIVE PROGETTO	-8.99	-1.25	1.00	4.75	7.25	8.50	15.00	
QUOTE PROGETTO	228.32	233.48	233.53	233.49	233.34	233.24	233.19	228.86
DISTANZE PARZIALI PROGETTO		7.74	1.25	1.00	3.75	2.50	1.25	6.50

Rampa D\_Ciglio Sx San-To  
 Sez. D14  
 Progr : 1+146.03  
 Scala : 1:250  
 Q.Rif. : 220.00

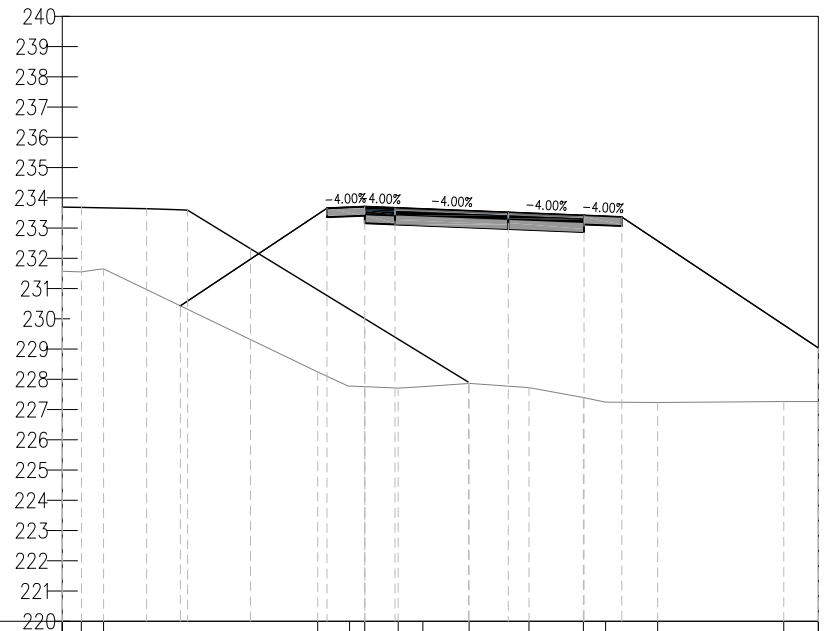

PROGRESSIVE TERRENO	10.00	-9.37	-8.64		-1.56	-0.50	0.00	1.10	1.92	3.45	5.43	7.23	7.96	9.68	13.85	15.00
QUOTE TERRENO	231.57	231.55	231.65		228.24	227.78	227.76	227.71	227.76	227.86	227.73	227.40	227.25	227.24	227.27	227.27
DISTANZE PARZIALI TERRENO	0.63	0.54		7.08	1.02	0.50	1.10	0.80	1.53	1.79	1.80	0.73	1.61		4.17	1.10
PROGRESSIVE PROGETTO				-6.10	-1.25	0.00	1.00			4.75	7.25	8.50				15.00
QUOTE PROGETTO				230.43	233.66	233.71	233.67			233.52	233.42	233.37				229.04
DISTANZE PARZIALI PROGETTO				4.85	1.25	1.00		3.75		2.50	1.25		6.50			

Rampa D\_Ciglio Sx San-To  
 Sez. D15  
 Progr : 1+150.00  
 Scala : 1:250  
 Q.Rif. : 220.00

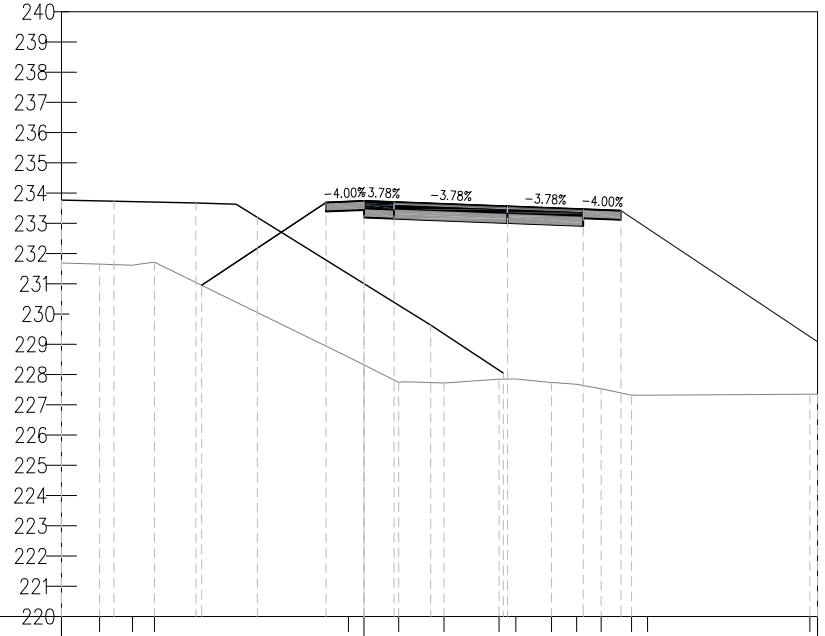

PROGRESSIVE TERRENO	10.00	-8.74	-7.65	-6.92		-0.51	1.15	2.65	4.47	5.03	6.20	7.04	7.85	8.85	14.75	
QUOTE TERRENO	231.69	231.65	231.61	231.71		228.58	228.32	227.74	227.72	227.85	227.85	227.74	227.68	227.53	227.32	227.35
DISTANZE PARZIALI TERRENO	1.26	1.09			6.41	0.51	1.15	1.32	1.82	0.56	1.18	0.78	0.81	1.00		5.37
PROGRESSIVE PROGETTO				-5.36		-1.25	1.00		4.75	7.25	8.50					
QUOTE PROGETTO				230.95		233.69	233.74	233.70	233.56	233.47	233.42					
DISTANZE PARZIALI PROGETTO				4.11		1.25	1.00	3.75	2.50	1.25						



Rampa D\_Ciglio Sx San-To  
 Sez. D16  
 Progr : 1+173.37  
 Scala : 1:250  
 Q.Rif. : 220.00

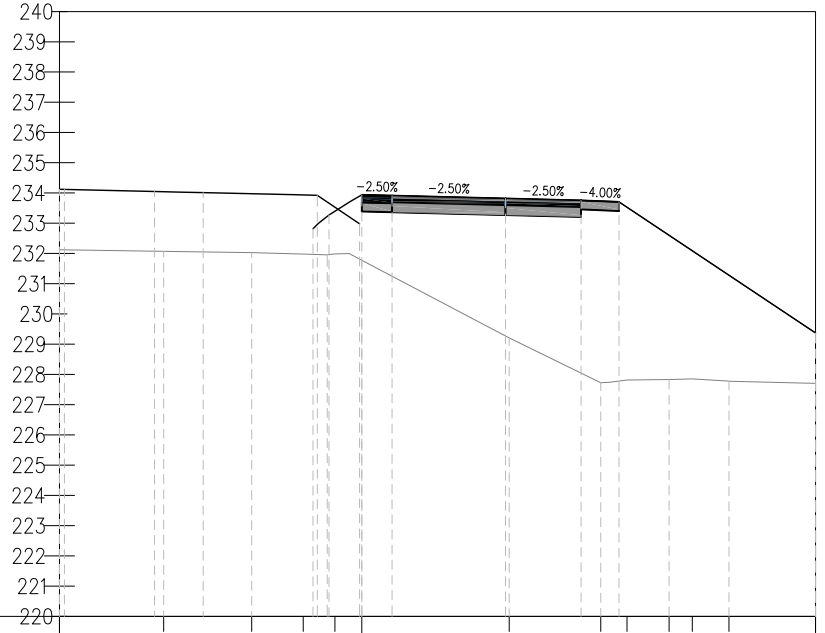

PROGRESSIVE TERRENO	10.00	6.56	3.64	1.94	0.89		4.87	7.90	8.77	10.16	10.93	12.14	15.00
QUOTE TERRENO	232.12	232.07	232.03	231.98	231.98	231.77	229.20	227.73	227.82	227.83	227.85	227.78	227.70
DISTANZE PARZIALI TERRENO	3.44	2.91	1.70	0.79		4.87	3.03	0.57	1.39	0.77	1.21	2.81	
PROGRESSIVE PROGETTO				1.82	1.08	0.00	1.00	4.75	7.25	8.50			15.00
QUOTE PROGETTO				232.82	233.27	233.94	233.91	233.82	233.76	233.71			229.37
DISTANZE PARZIALI PROGETTO				0.71	1.00	3.75	2.50	1.25	6.50				

Rampa D\_Ciglio Sx San-To  
 Sez. D17  
 Progr : 1+175.00  
 Scala : 1:250  
 Q.Rif. : 220.00

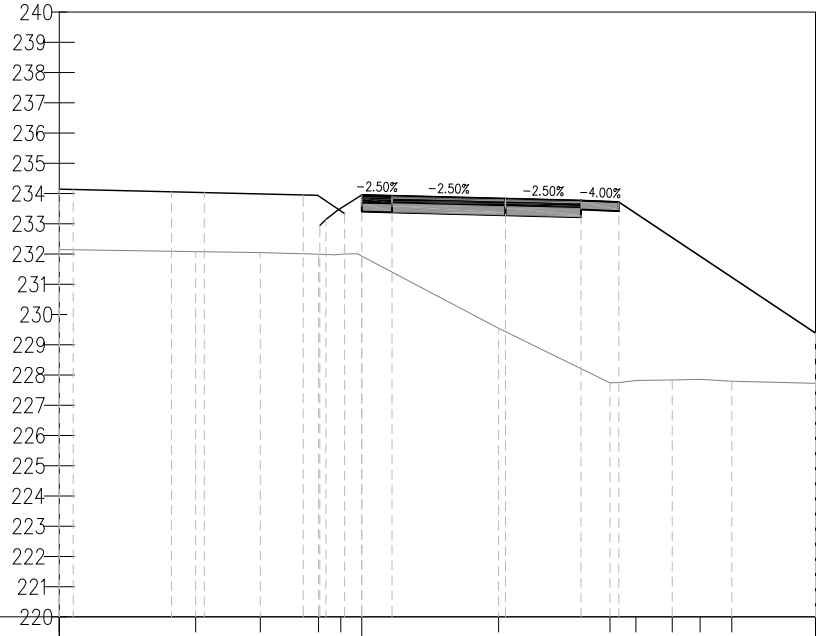

PROGRESSIVE TERRENO	0.00	4.51	5.49	6.36	6.83	7.20	7.57	8.21	9.07	10.27	11.18	12.24	15.00
QUOTE TERRENO	232.15	232.08	232.05	231.99	232.00	231.93	229.54	227.74	227.82	227.83	227.86	227.79	227.72
DISTANZE PARZIALI TERRENO		4.51	2.14	1.92	0.56	0.55	4.52	3.69	1.20	0.92	1.05	2.72	
PROGRESSIVE PROGETTO				1.39	0.79	1.00	4.75	7.25	8.50				15.00
QUOTE PROGETTO				232.94	233.45	233.95	233.93	233.83	233.77	233.72			229.39
DISTANZE PARZIALI PROGETTO				0.79	1.00	3.75	2.50	1.25	6.50				

Rampa D\_Ciglio Sx San-To  
 Sez. D18  
 Progr : 1+200.00  
 Scala : 1:250  
 Q.Rif. : 220.00

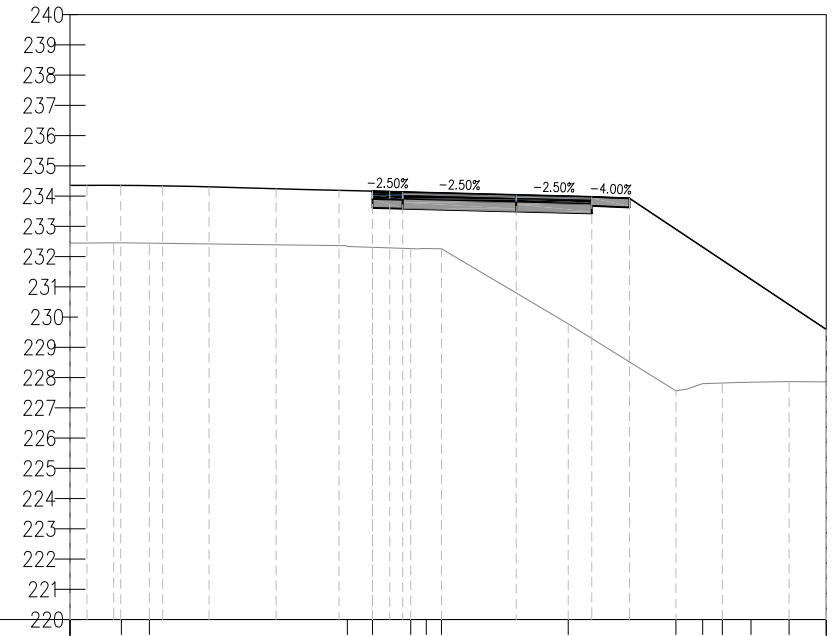

PROGRESSIVE TERRENO	10.00	-8.30	-7.38	-0.83	0.00	1.27	1.78	2.28	6.47	10.03	10.92	11.57	12.52	13.77	15.00
QUOTE TERRENO	232.44	232.46	232.44	232.34	232.31	232.26	232.26	232.26	229.78	227.56	227.80	227.82	227.85	227.87	227.86
DISTANZE PARZIALI TERRENO	1.44	0.93	6.52	0.83	1.27	0.50	4.19	3.56	0.55	0.65	0.67	1.26	1.23		
PROGRESSIVE PROGETTO					1.00		4.75	7.25	8.50						15.00
QUOTE PROGETTO				234.16	234.13		234.04	233.98	233.93					229.59	
DISTANZE PARZIALI PROGETTO				1.00	3.75	2.50	1.25	6.50							

Rampa D\_Ciglio Sx San-To  
 Sez. D19  
 Progr : 1+200.70  
 Scala : 1:250  
 Q.Rif. : 220.00

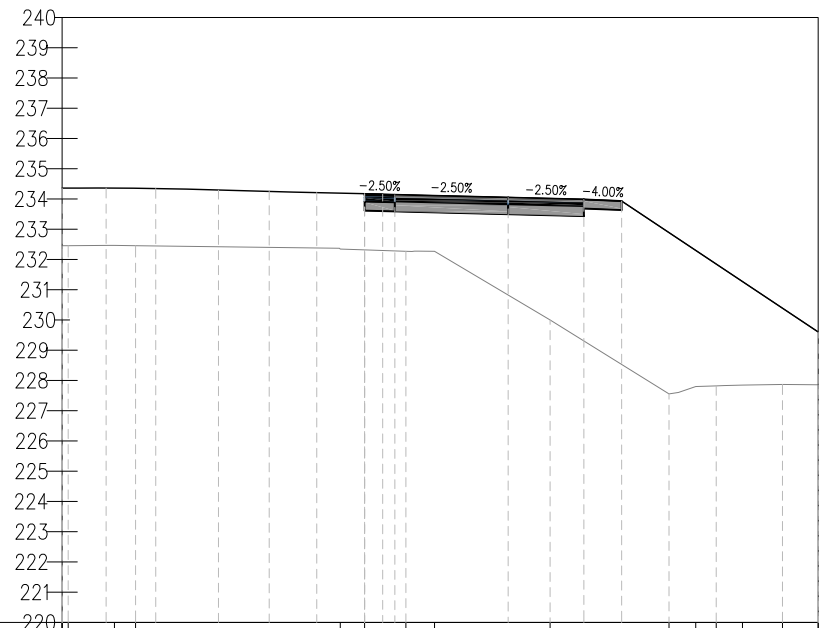

PROGRESSIVE TERRENO	0.000	1.33	0.70	6.74	0.80	1.37	0.53	3.82	3.93	0.57	0.68	0.61	1.32	1.18	15.00	
QUOTE TERRENO	234.45	232.47	232.45		232.34	232.32	232.27	232.27	230.00		227.56	227.80	227.82	227.84	227.87	227.86
DISTANZE PARZIALI TERRENO																
PROGRESSIVE PROGETTO						1.00		4.75	7.25	8.50					15.00	
QUOTE PROGETTO					234.16	234.14		234.05	233.98	233.93					229.60	
DISTANZE PARZIALI PROGETTO					1.00	3.75	2.50	1.25	6.50							

Rampa D\_Ciglio Sx San-To  
 Sez. D20  
 Progr : 1+225.00  
 Scala : 1:250  
 Q.Rif. : 220.00

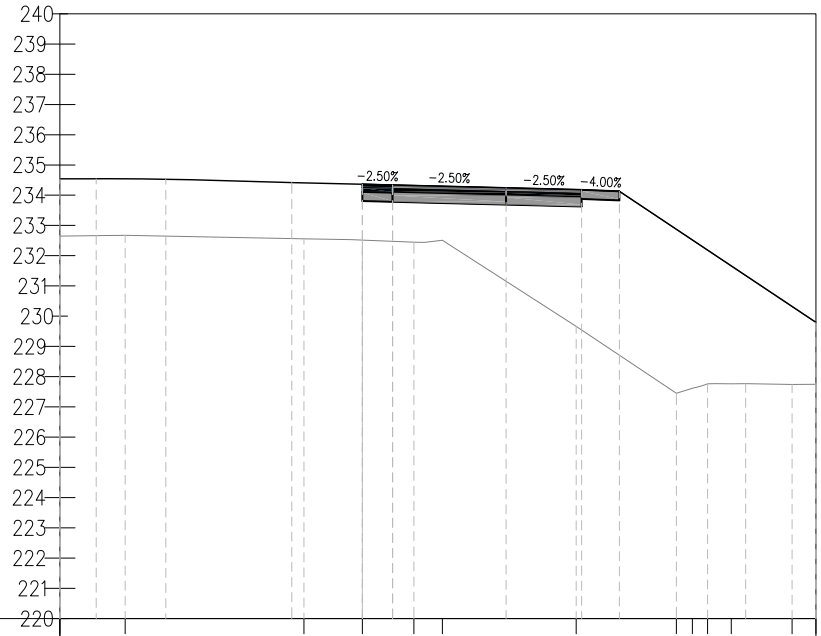

PROGRESSIVE TERRENO	0.00	2.16	5.91	1.51	1.71	0.58	4.43	7.07	3.31	0.53	0.53	1.54	0.79	15.00
QUOTE TERRENO	232.65	232.68		232.56	232.52	232.45	232.51		229.66	227.45	227.61	227.76	227.76	227.75
DISTANZE PARZIALI TERRENO		2.16	5.91	1.51	1.71	0.58	4.43	7.07	3.31	0.53	0.53	1.54	0.79	15.00
PROGRESSIVE PROGETTO					1.00		4.75	7.25	8.50					15.00
QUOTE PROGETTO					234.36	234.33	234.24	234.18	234.13					229.79
DISTANZE PARZIALI PROGETTO					1.00	3.75	2.50	1.25	6.50					

Rampa D\_Ciglio Sx San-To  
 Sez. D21  
 Progr : 1+228.03  
 Scala : 1:250  
 Q.Rif. : 220.00

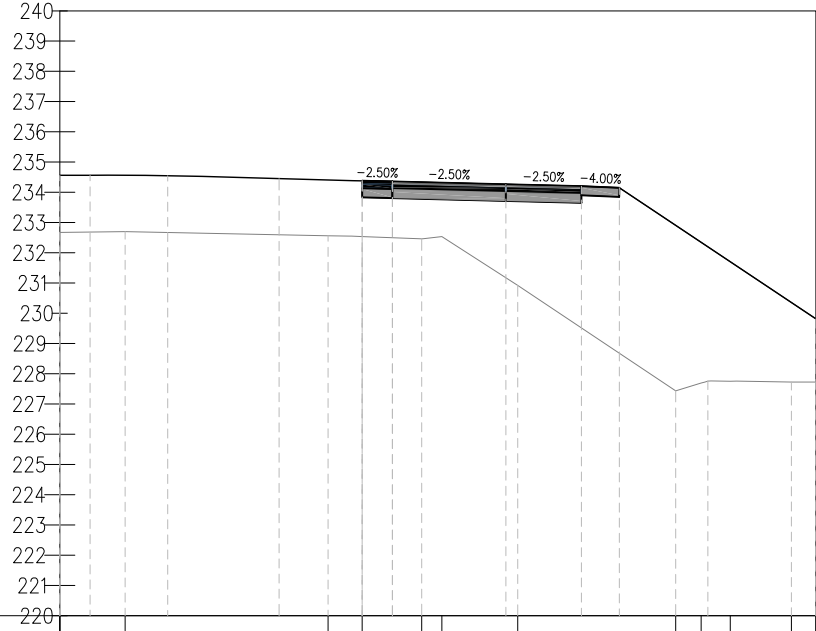

PROGRESSIVE TERRENO	10.00	7.84	1.13	1.97	2.63	5.14	10.37	11.21	12.17	14.19	15.00
QUOTE TERRENO	232.67	232.70	232.56	232.54	232.46	232.54	230.92	227.43	227.69	227.75	227.73
DISTANZE PARZIALI TERRENO	2.16	6.71	0.71	1.97	0.60	2.51	5.22	0.84	0.63	1.81	0.81
PROGRESSIVE PROGETTO				1.00		4.75	7.25	8.50			15.00
QUOTE PROGETTO			234.38	234.36		234.26	234.20	234.15			229.82
DISTANZE PARZIALI PROGETTO			1.00	3.75	2.50	1.25	6.50				

Rampa D\_Ciglio Sx San-To  
 Sez. D22  
 Progr : 1+244.00  
 Scala : 1:250  
 Q.Rif. : 220.00

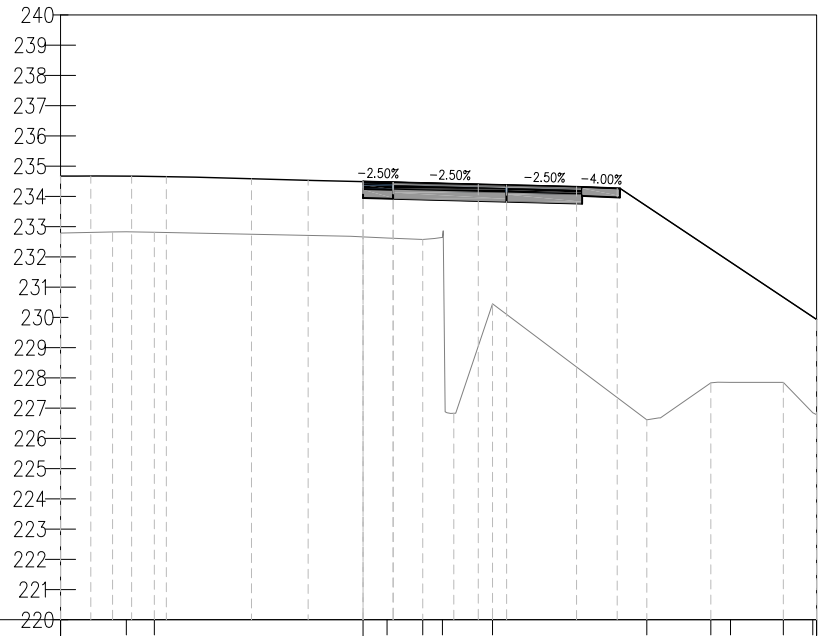

PROGRESSIVE TERRENO	10.00	7.82	6.90	0.79	1.18	0.07	1.22	5.10	1.67	1.75	0.98	14.88	
QUOTE TERRENO	232.79	232.83	232.81	232.66	232.62	232.58	232.65	230.45	226.61	227.83	227.85	227.85	226.95
DISTANZE PARZIALI TERRENO	1.72	0.92	6.47	0.79	1.18	0.07	1.22	5.10	1.67	1.75	0.98		
PROGRESSIVE PROGETTO				0.93				4.75	7.06	8.41	9.29	15.00	
QUOTE PROGETTO				234.49	234.47			234.38	234.32	234.27	233.73	229.93	
DISTANZE PARZIALI PROGETTO				0.93		3.47		2.31	1.16	0.79	5.71		