

COMMITTENTE



DIREZIONE STAZIONI

SOGGETTO TECNICO

DIREZIONE STAZIONI - INGEGNERIA E INVESTIMENTI

PROGETTAZIONE

MANDATARIA

CODING
GENERAL ENGINEERING & PLANNING

CODING S.R.L.

MANDANTE

POLITECNICA
BUILDING FOR HUMANS

POLITECNICA SOC. COOP.

SWS

SWS ENGINEERING S.P.A.

HUB DI MESSINA

PROGETTO DI FATTIBILITÀ TECNICO ED ECONOMICA

RIQUALIFICAZIONE, RIFUNZIONALIZZAZIONE, MIGLIORAMENTO SISMICO DEL COMPLESSO DI STAZIONE E MIGLIORAMENTO DELL'ACCESSIBILITÀ TRA IL SERVIZIO FERROVIARIO E IL SERVIZIO MARITTIMO

DOCUMENTI GENERALI

Documentazione Fotografica

SCALA

-

PROGETTO	ANNO	SOTTOPR.	LIVELLO	NOME DOC.	TIPO DOC.	SCALA	NUM.	REV.
3 2 6 2	2 1	S 0 1	P F	M S 0 0	D F	S X	E 0 1 A	

Rev	Descrizione	Redatto	Verificato	Approvato	Data	Autorizzato Il progettista	Data
A	Emissione	M. Mitsch	S. Martella	L. Nardoni	ott.2021	G. Coppa	ott.2021

Controllo Qualità

QA & QC	Verificato	Approvato	Autorizzato
	G. Soriero	F. Bordini	R. Vangeli

Soggetto Tecnico	Data	Referente di Progetto	Data
	00/00/00		00/00/00

POSIZIONE ARCHIVIO

LINEA

= = = =

SEDE TECNICA

□ □ □ □ □ □

NOME DOC.

□ □ □ □ □ □

NUMERAZIONE

□ □ □ □ □ □

Verificato e Trasmesso	Data	Convalidato	Data	Archiviato	Data

INDICE

1	FOTO COMPLESSO DI STAZIONE	3
1.1	MESSINA CENTRALE	3
1.2	Corte degli Ulivi	3
1.3	Sala Mazzoni.....	4
1.4	Atrio.....	5
1.5	Atrio commerciale	6
1.6	Collegamento tra Atrio primo binario e sottopasso.....	7
1.7	Collegamento primo e secondo marciapiede con Me Marittima	8
1.8	Secondo e terzo marciapiede.....	9
1.9	Quinto marciapiede.....	20
1.10	Sottopasso	21
2	MESSINA MARITTIMA.....	22
2.1	Accesso Interporto	22
2.2	Atrio.....	23
2.3	Sala del Mosaico.....	24
2.4	Fingers imbarco navi Blu Ferries	25
2.5	Balconata.....	26
2.6	Terrazza	27
2.7	Esterno lato Cittadella.....	28

1 FOTO COMPLESSO DI STAZIONE

1.1 MESSINA CENTRALE

1.2 Corte degli Ulivi

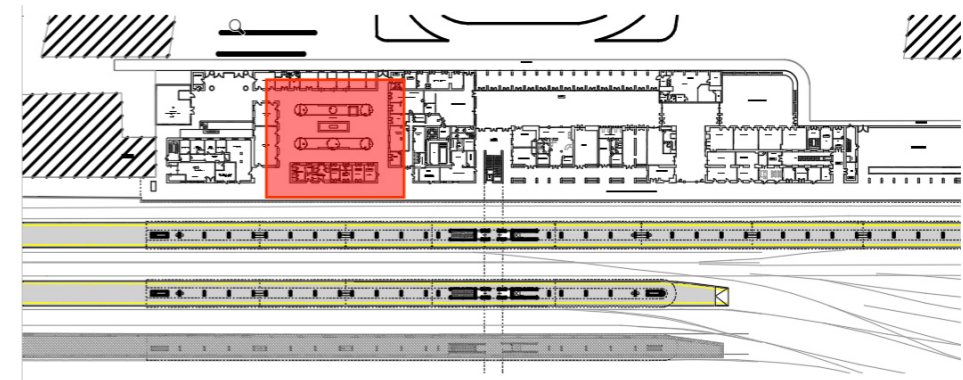
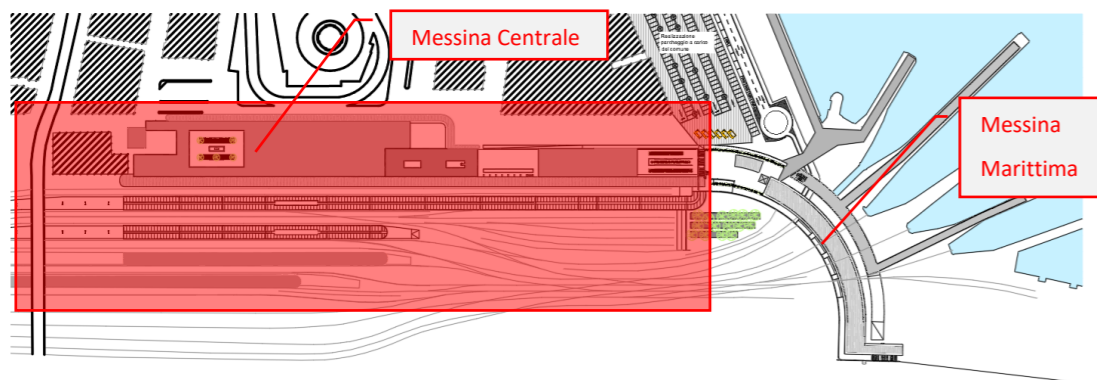

1.3 Sala Mazzoni

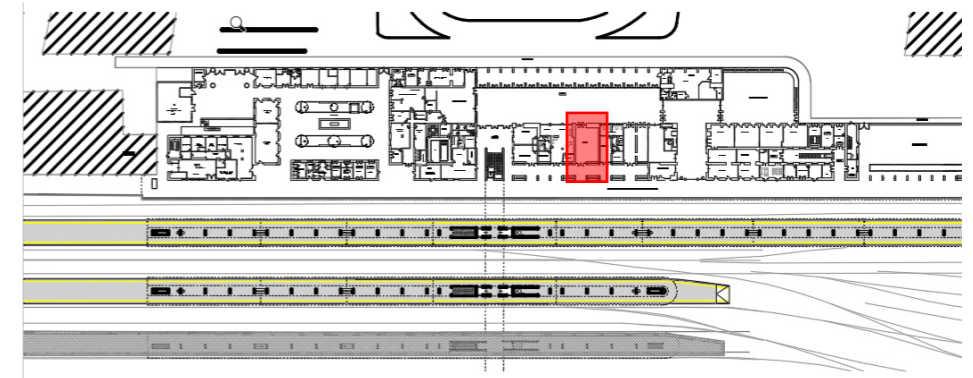
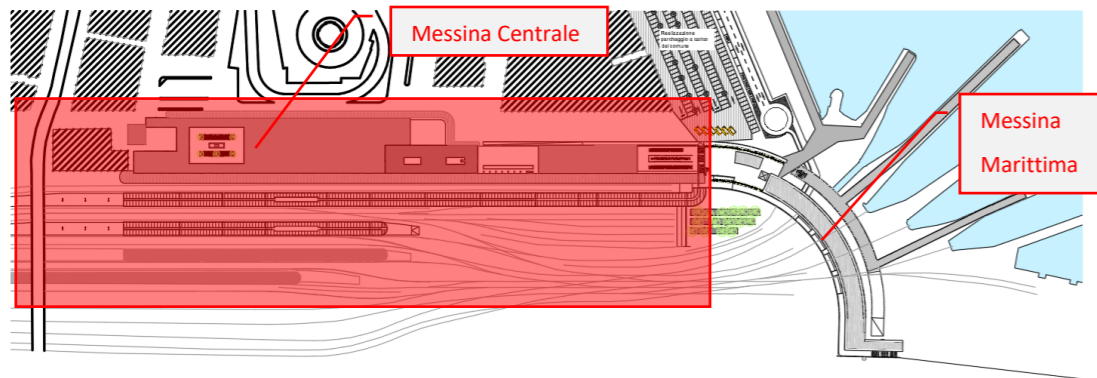
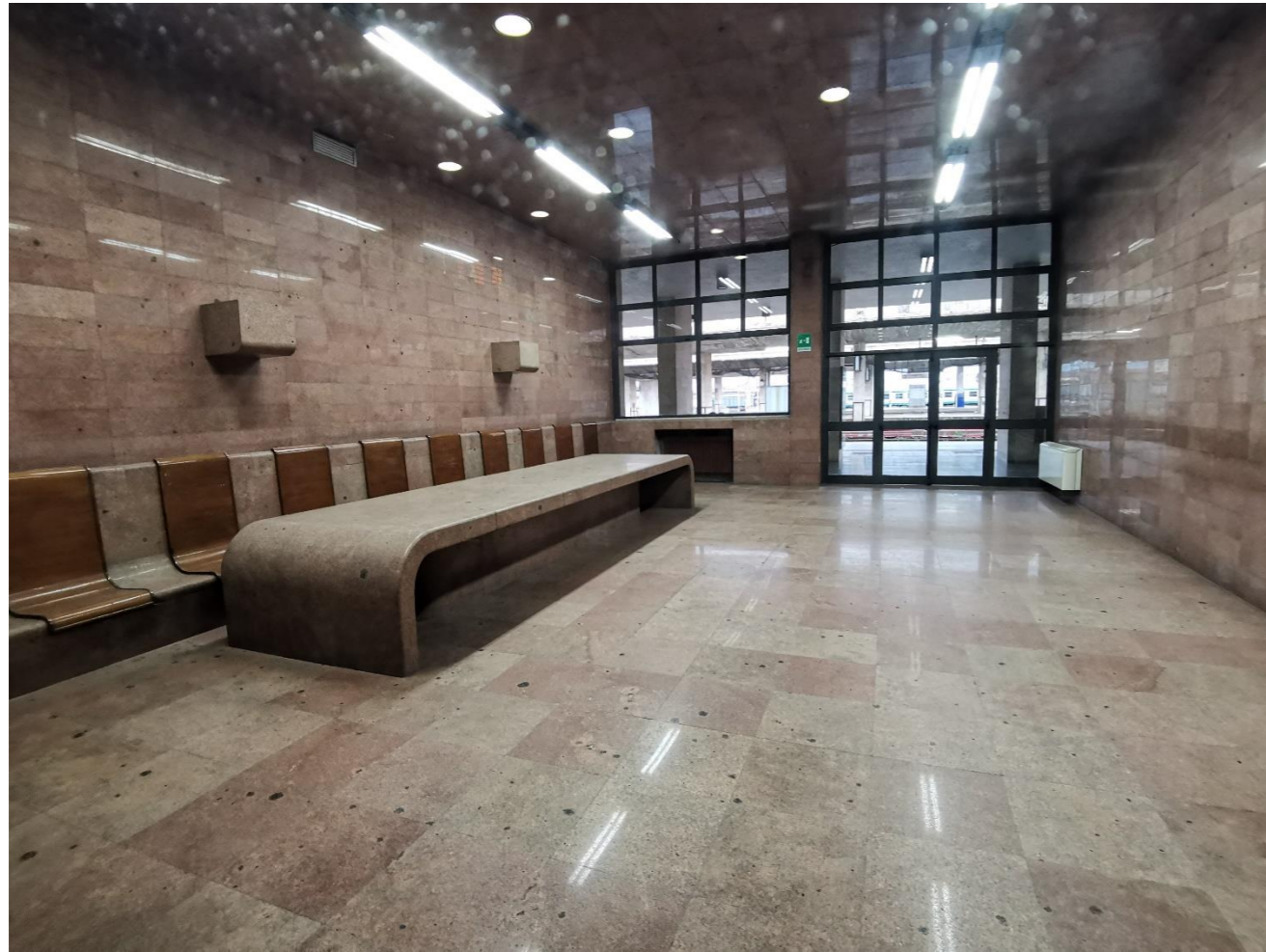

1.4 Atrio

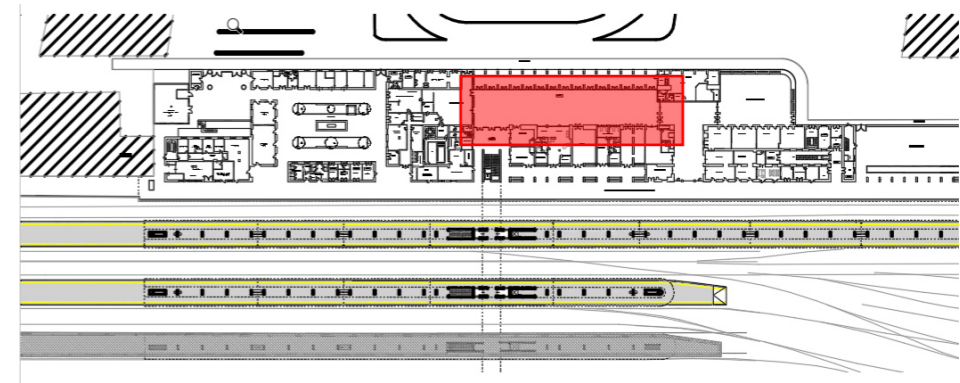
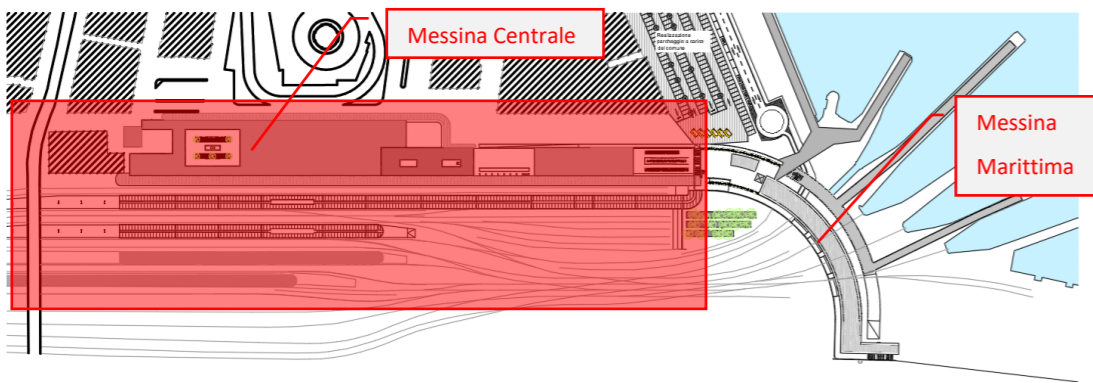

1.5 Atrio commerciale

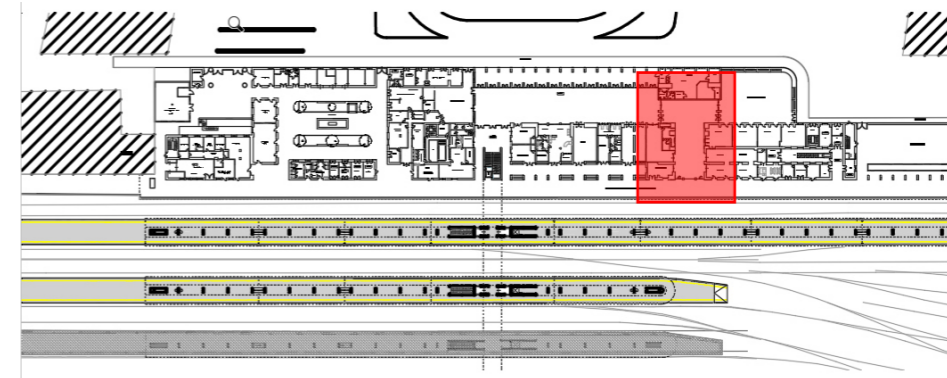
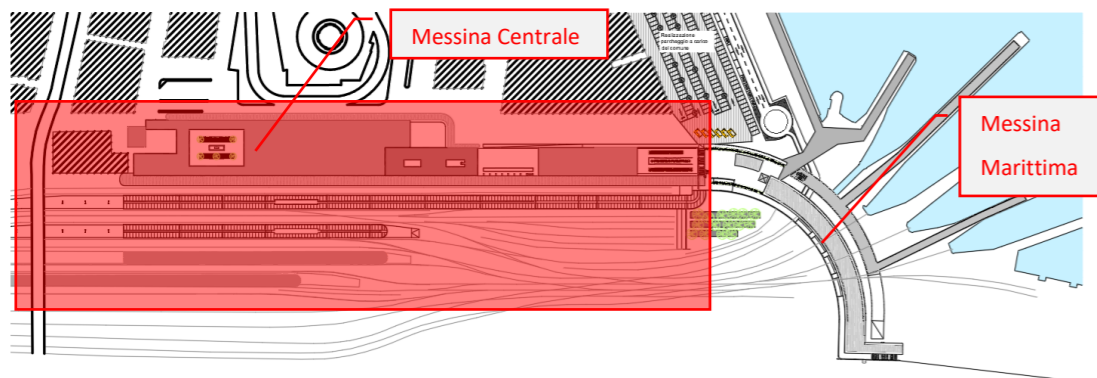

1.6 Collegamento tra Atrio primo binario e sottopasso

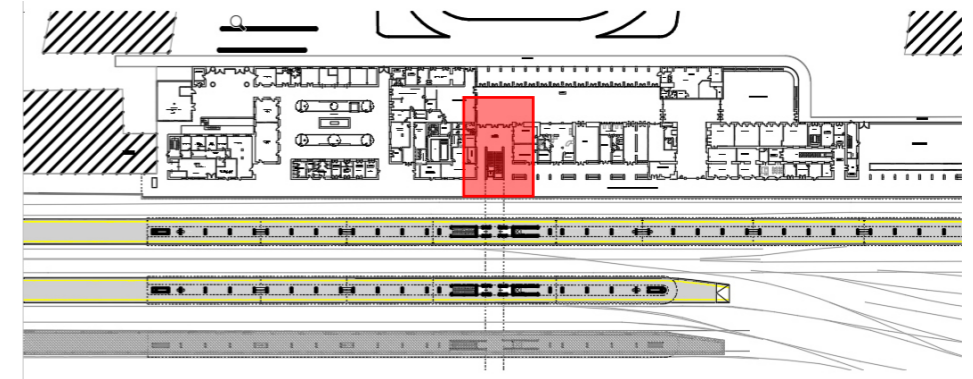
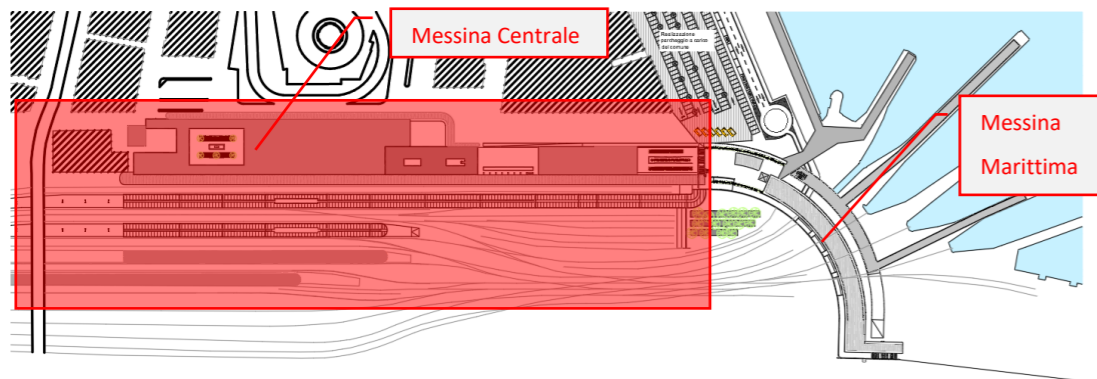

1.7 Collegamento primo e secondo marciapiede con Me Marittima

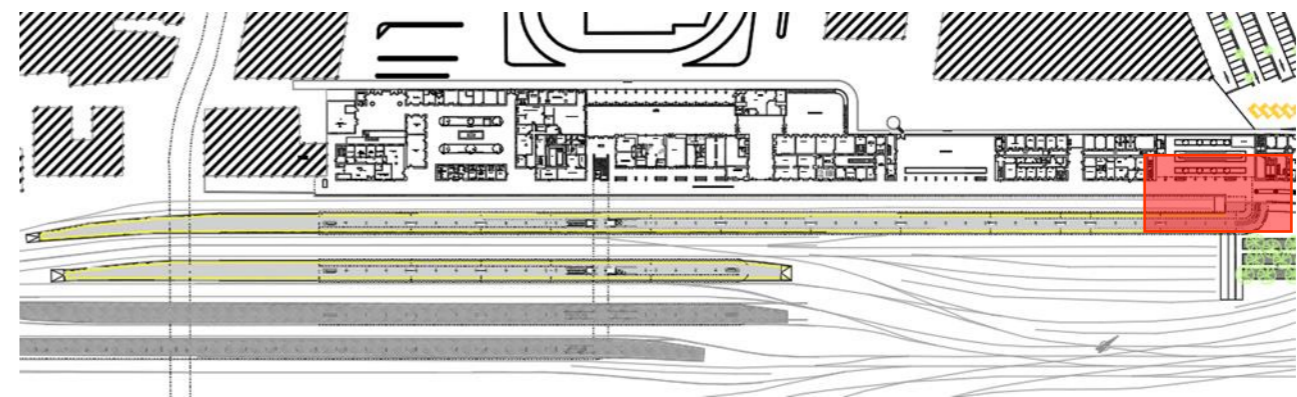
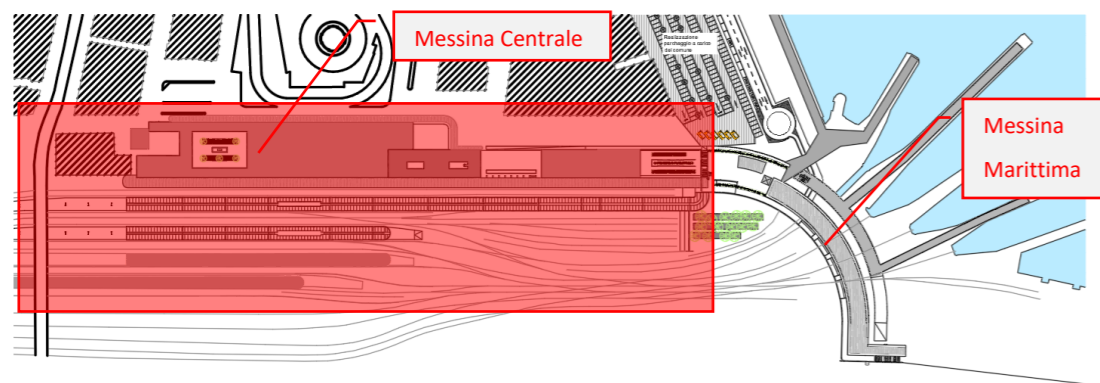
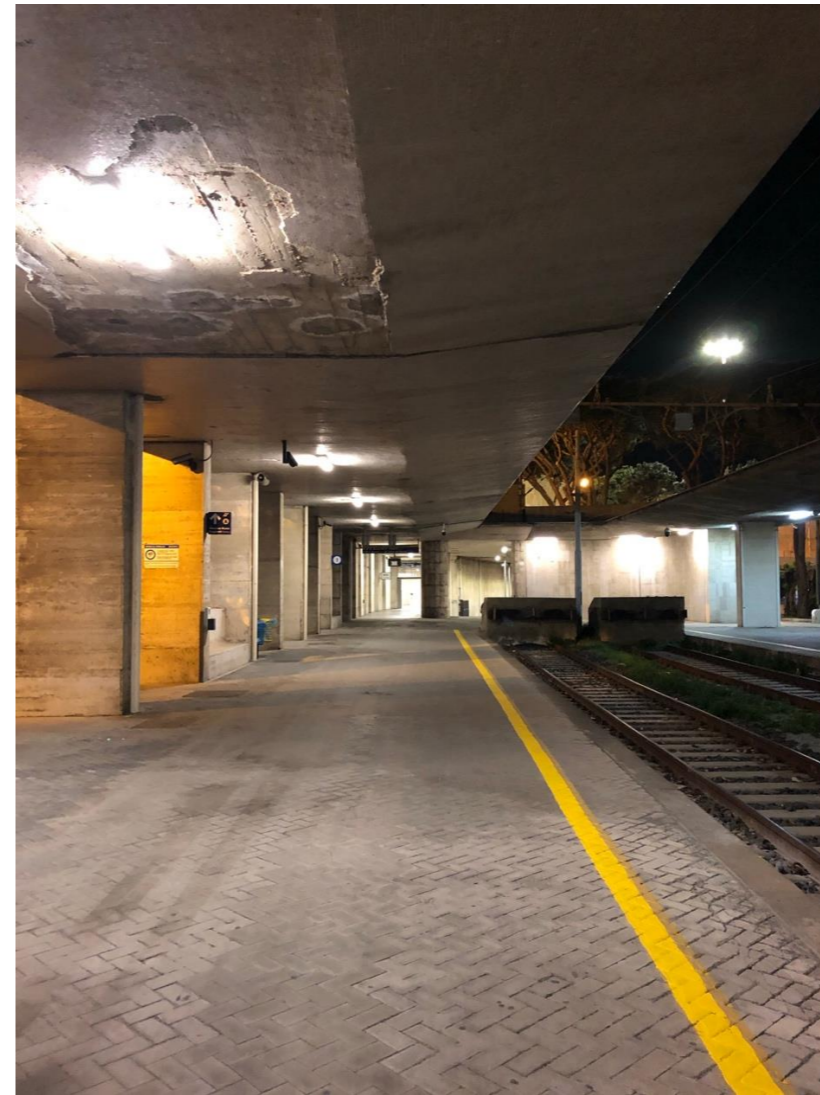
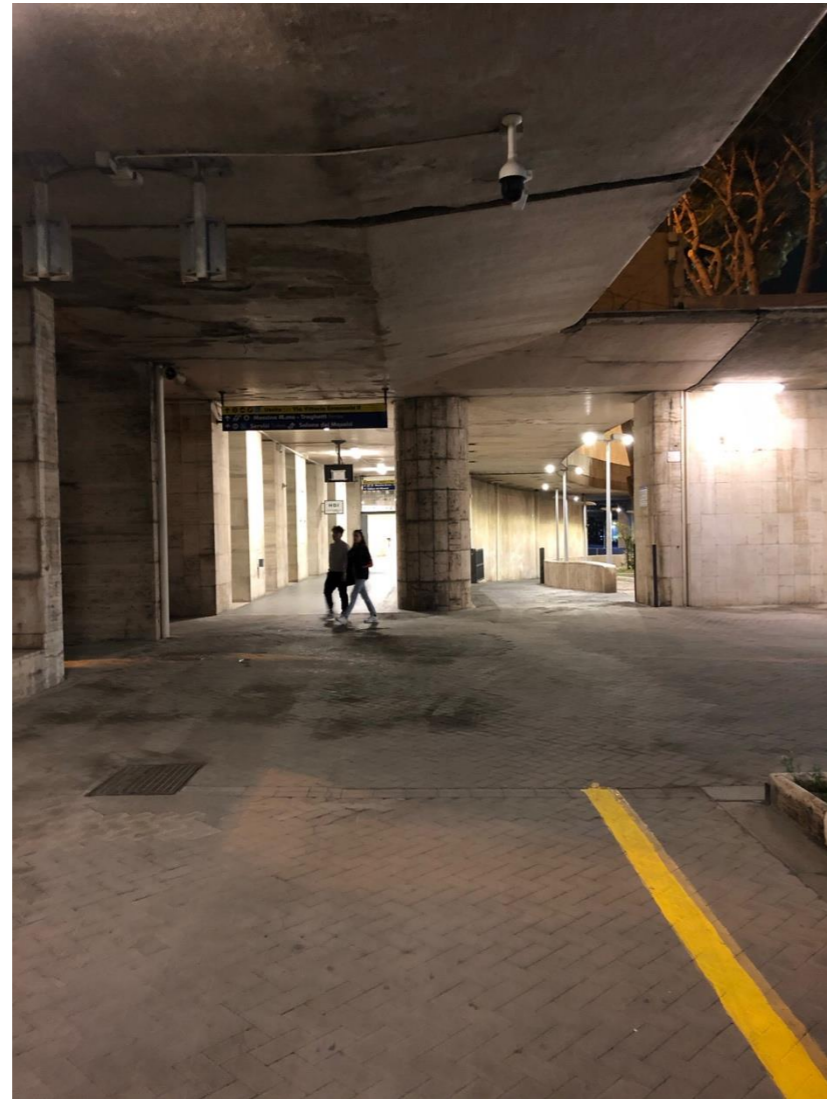

1.8 Secondo e terzo marciapiede

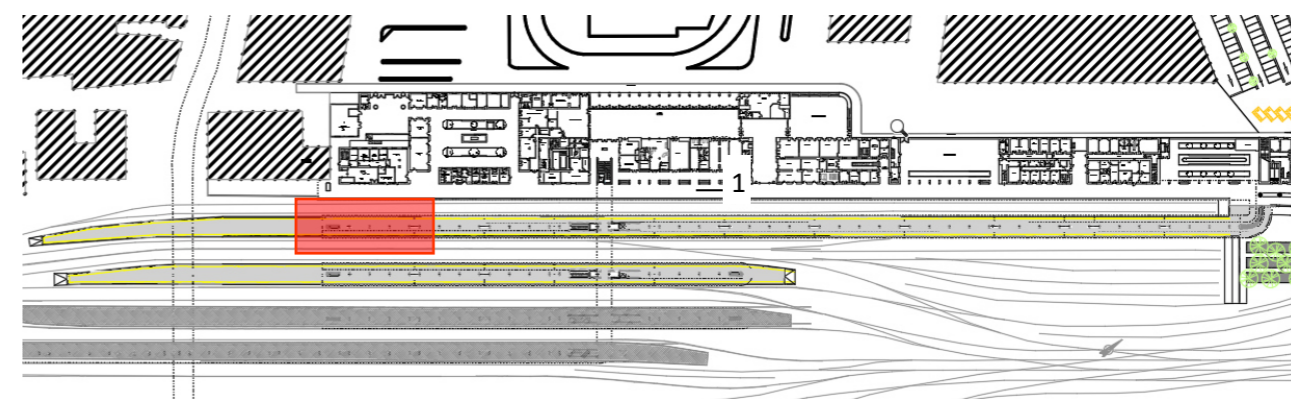
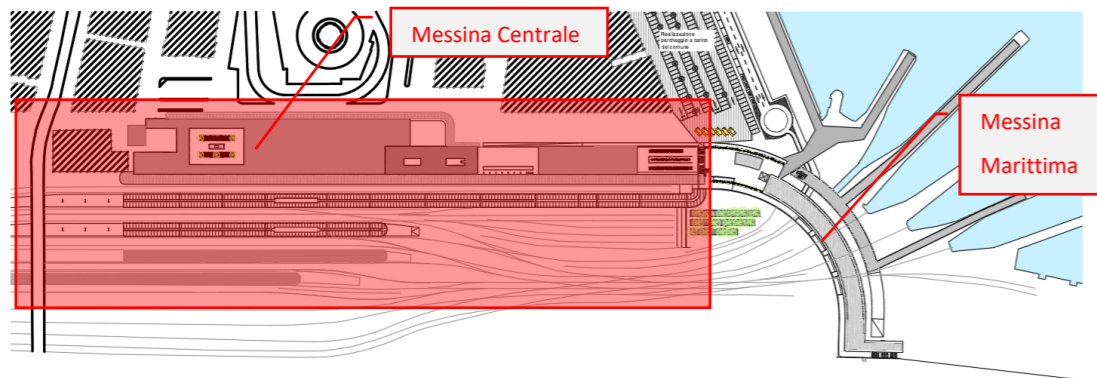

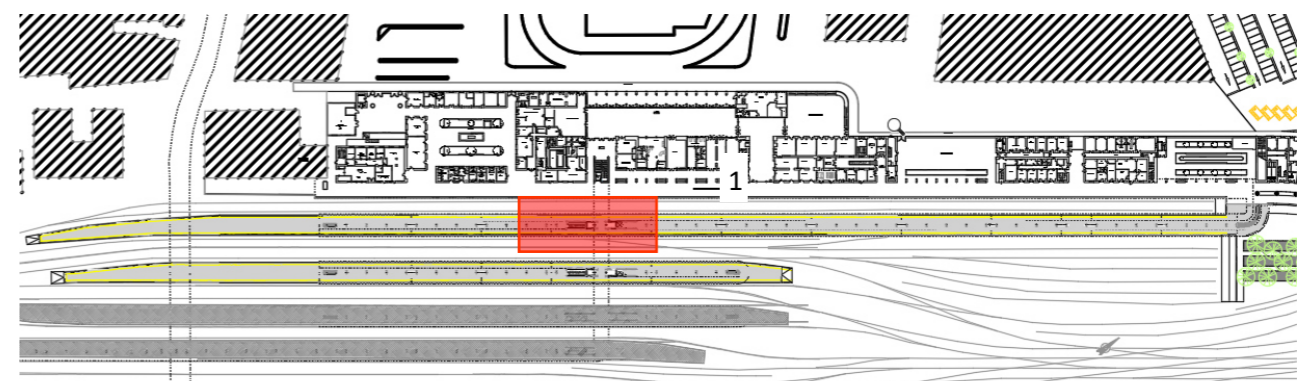
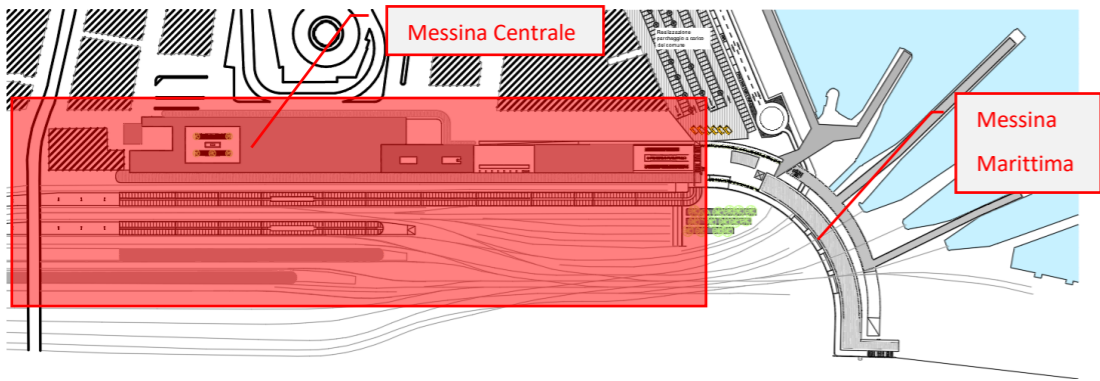

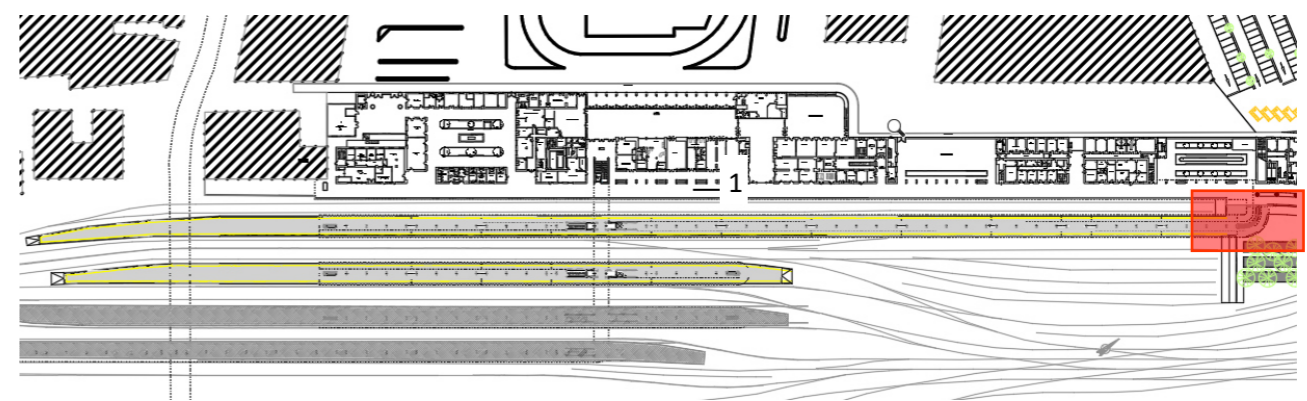
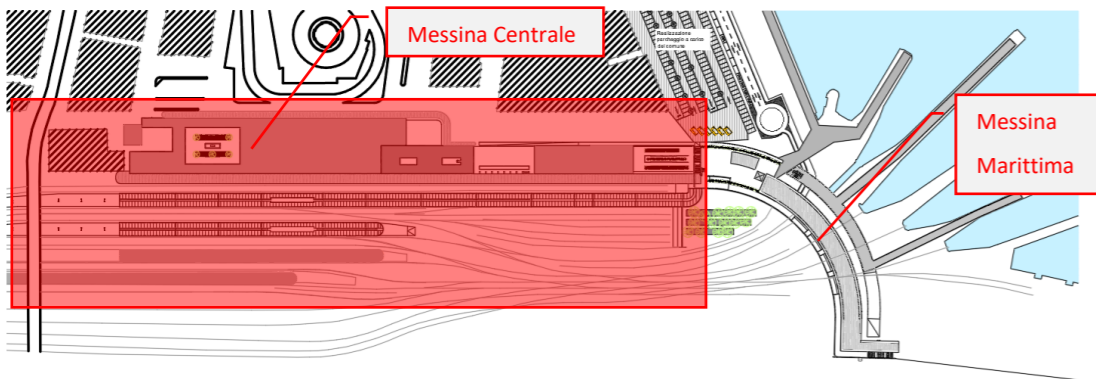

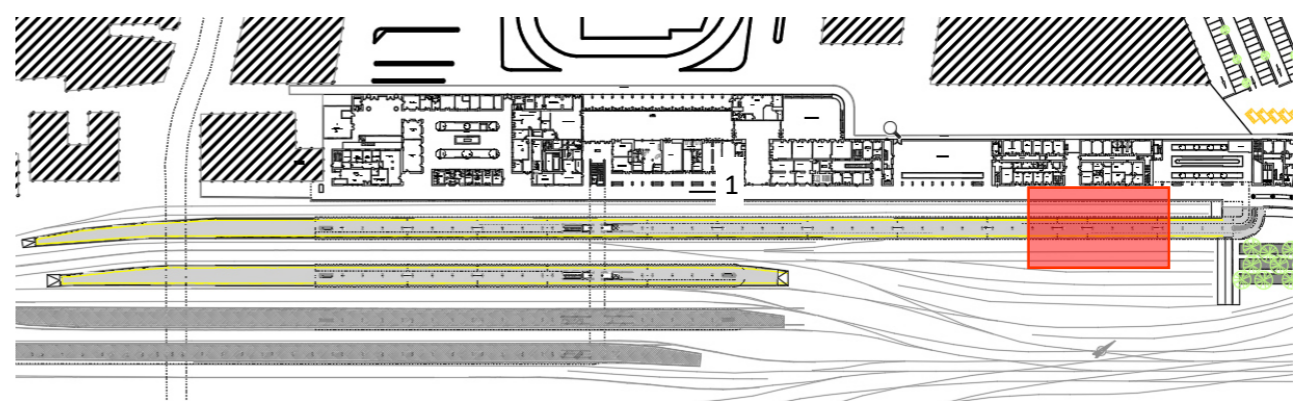
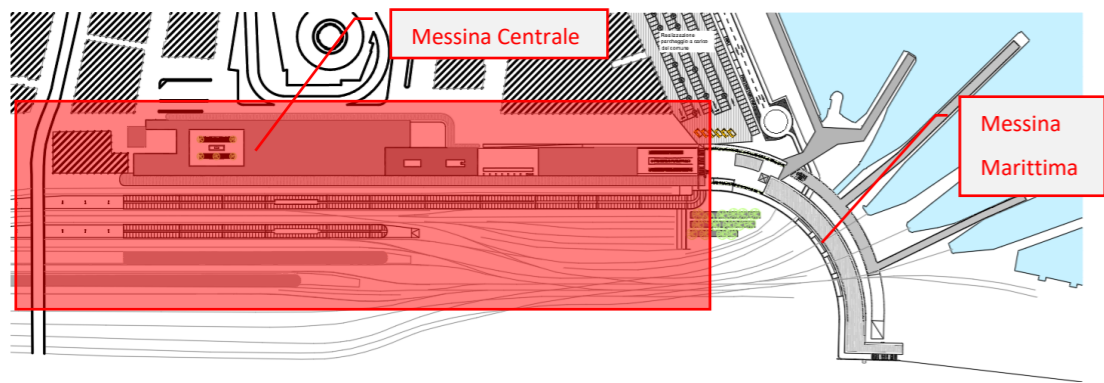

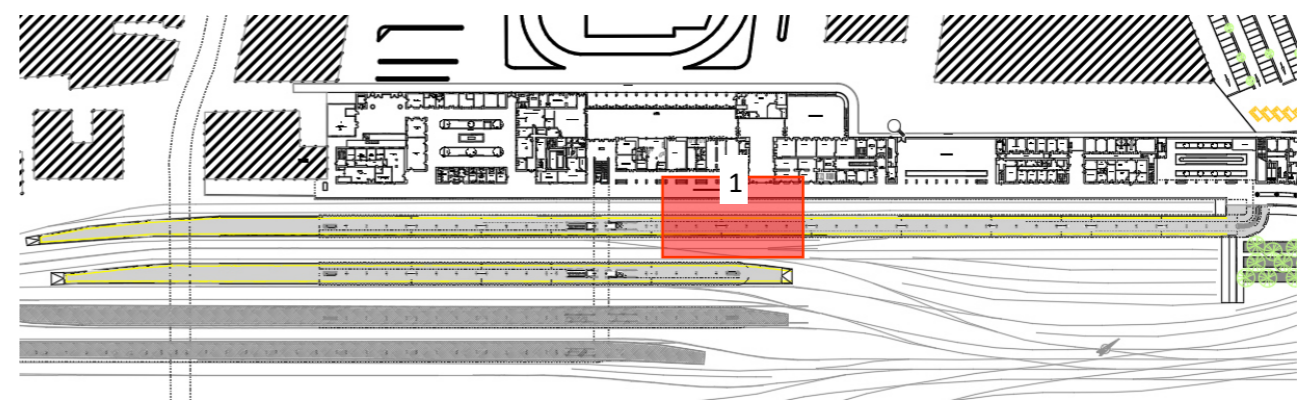
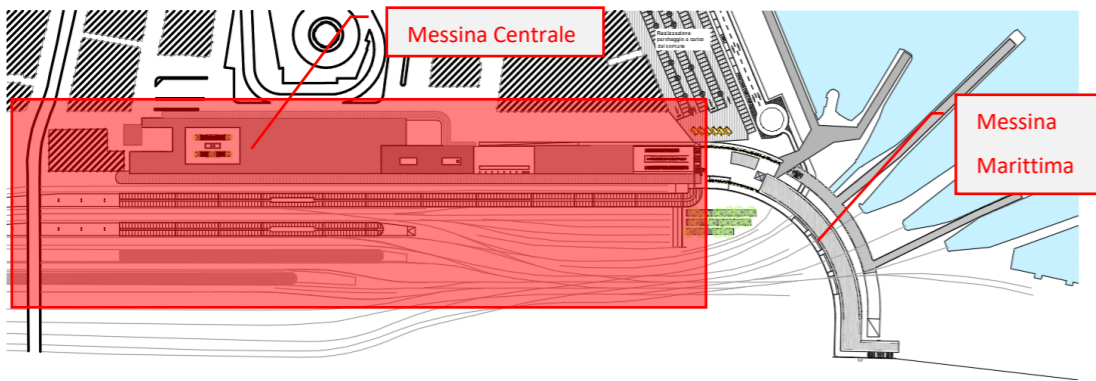

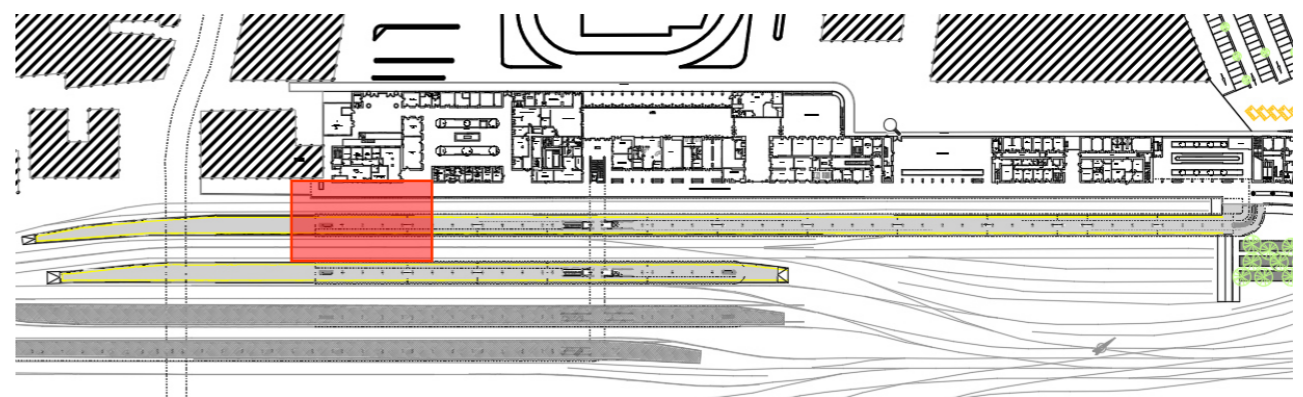
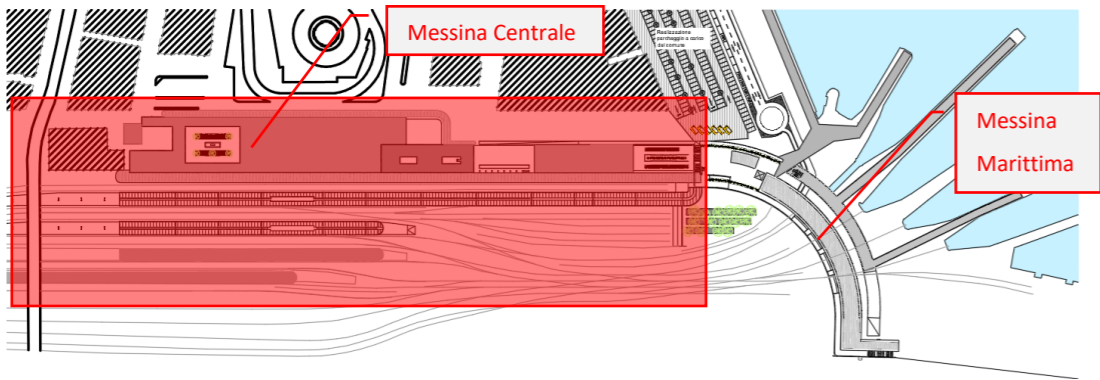

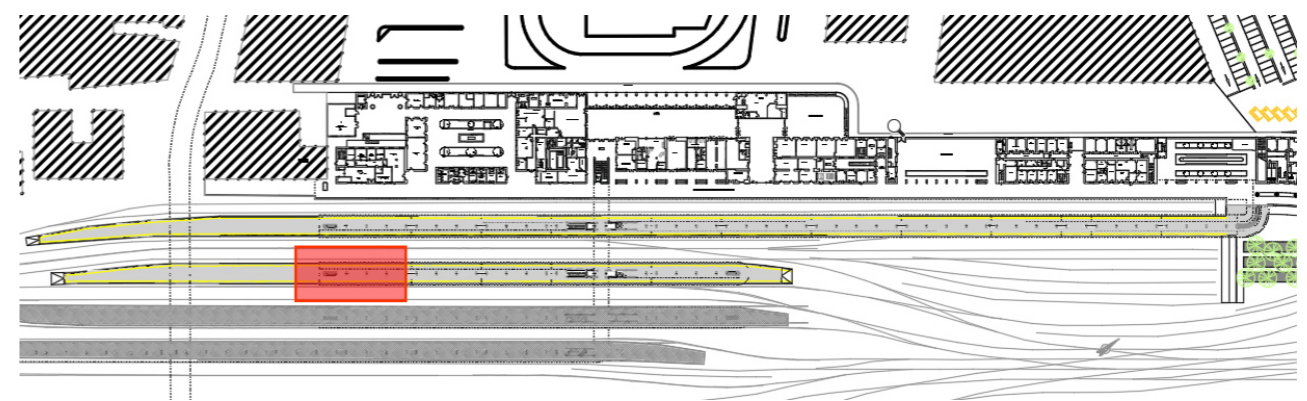
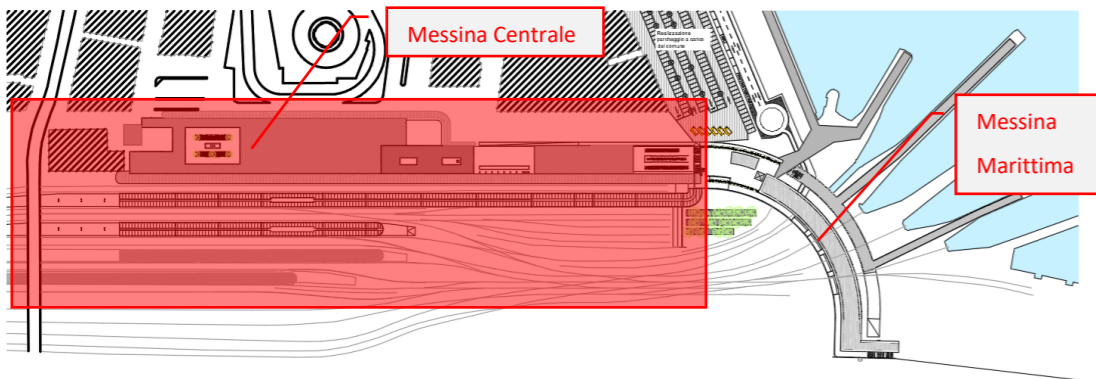

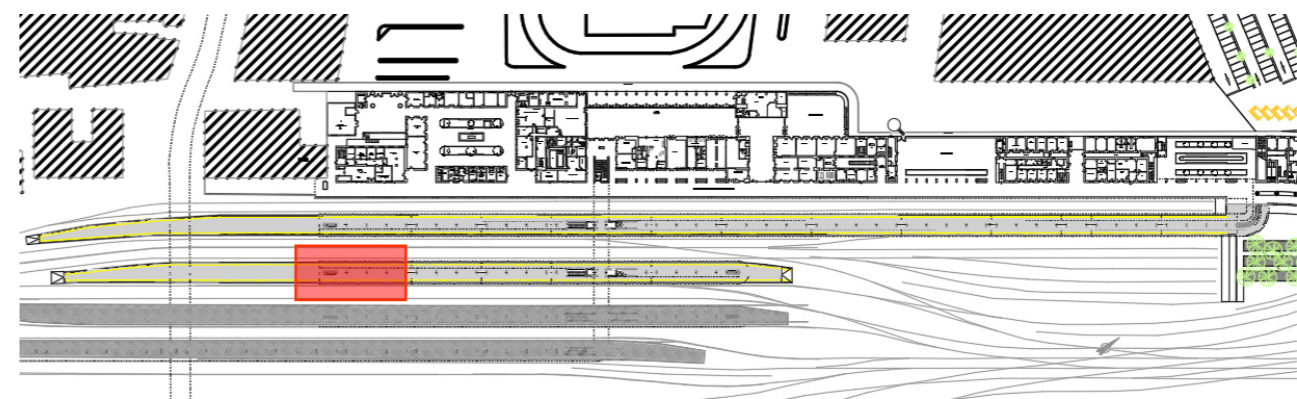
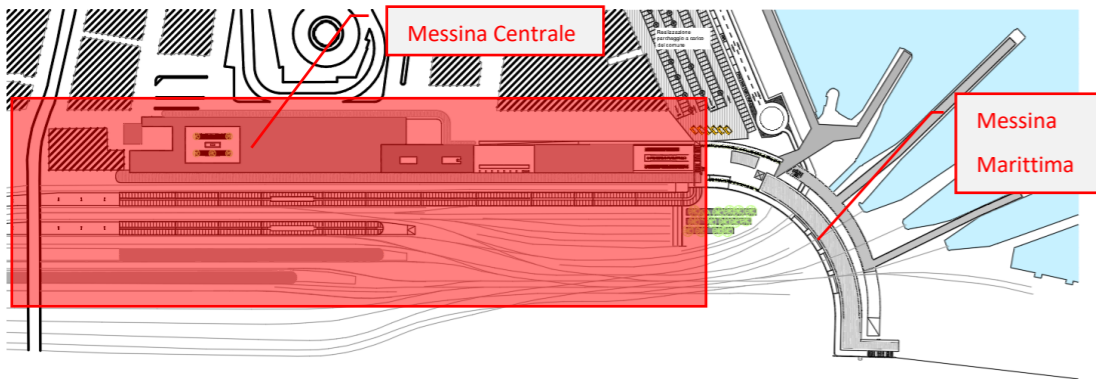

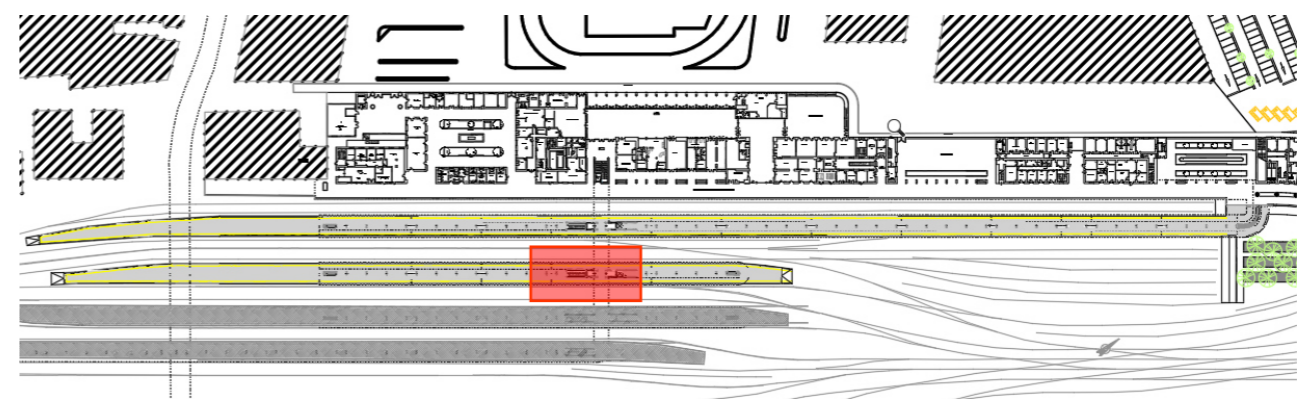
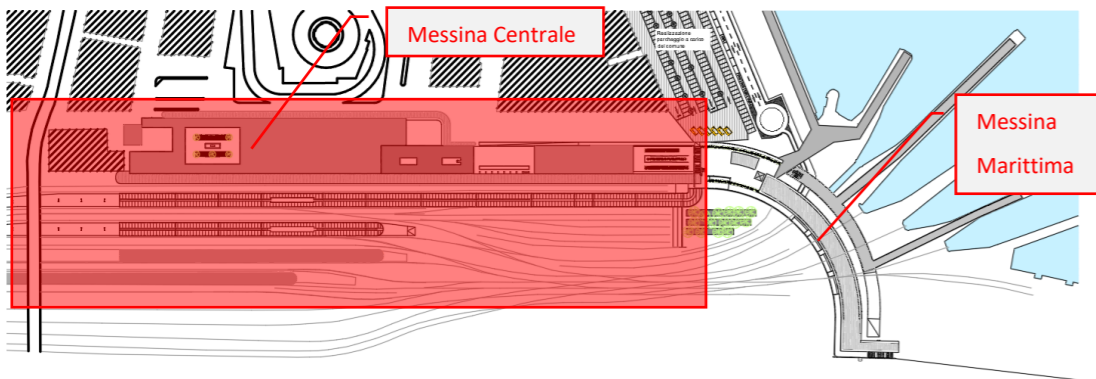

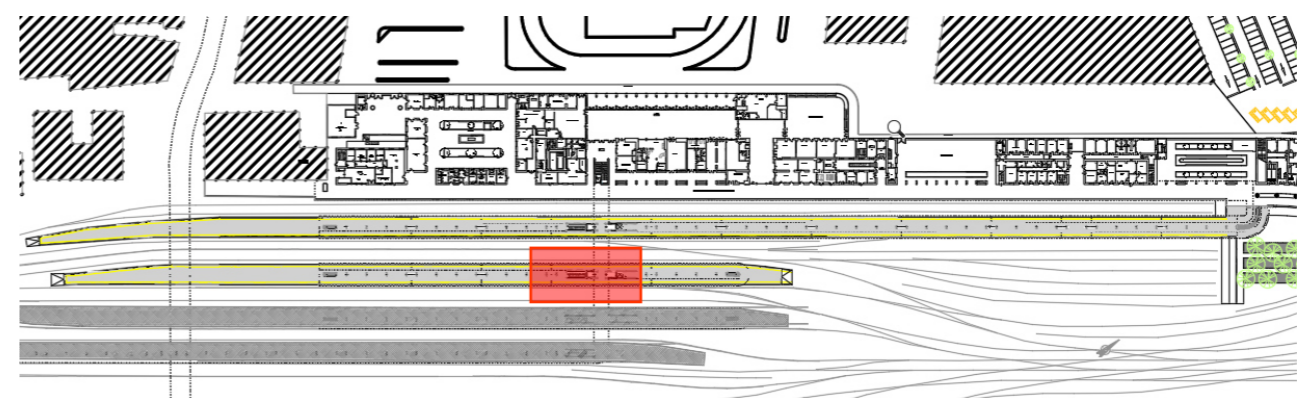
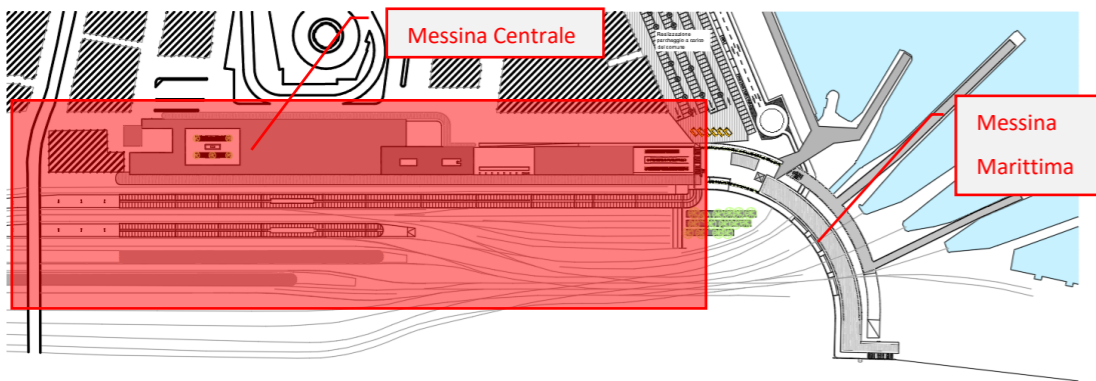

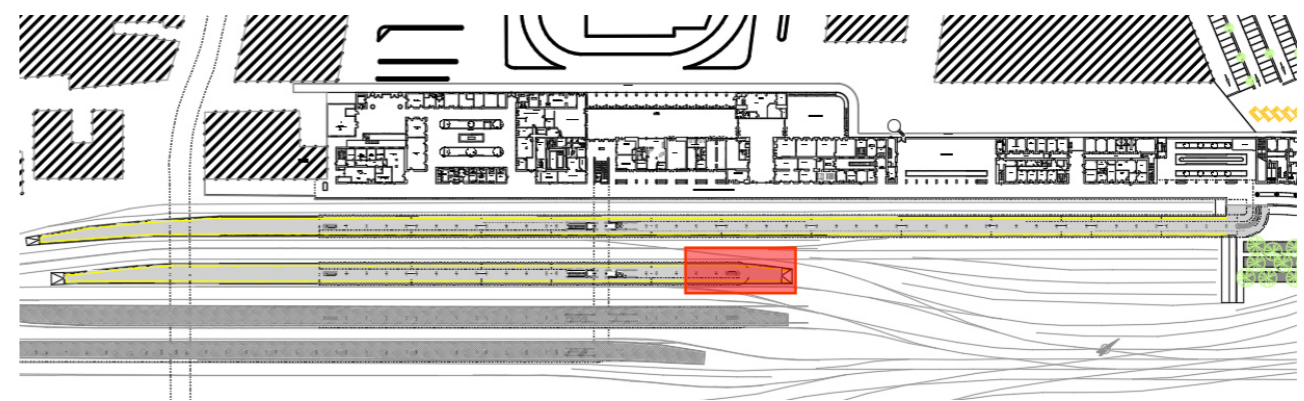
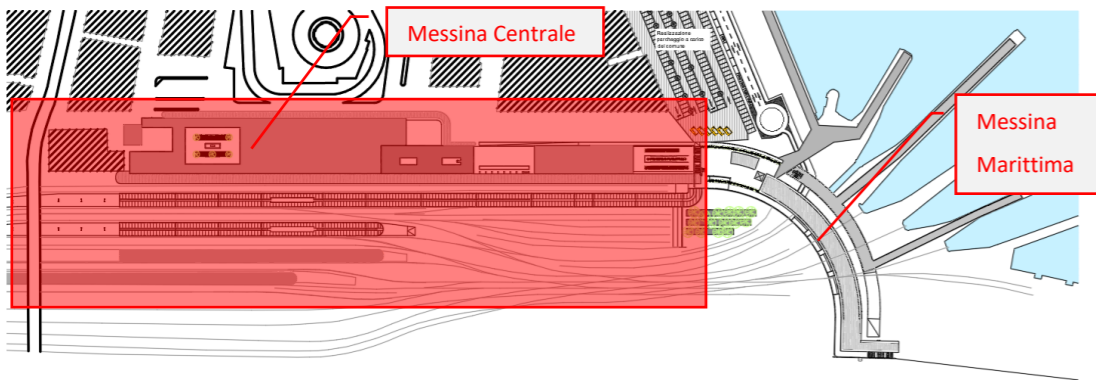

1.9 Quinto marciapiede

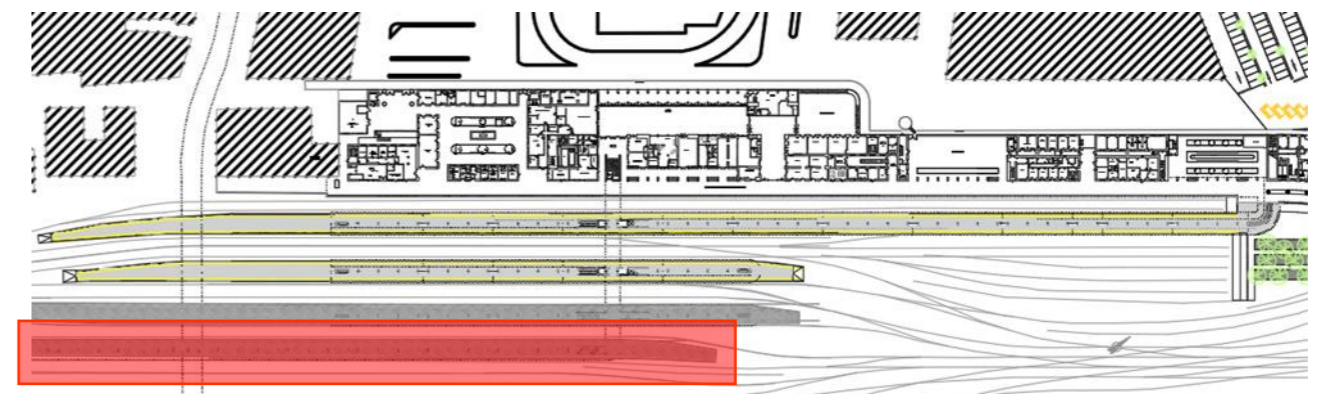
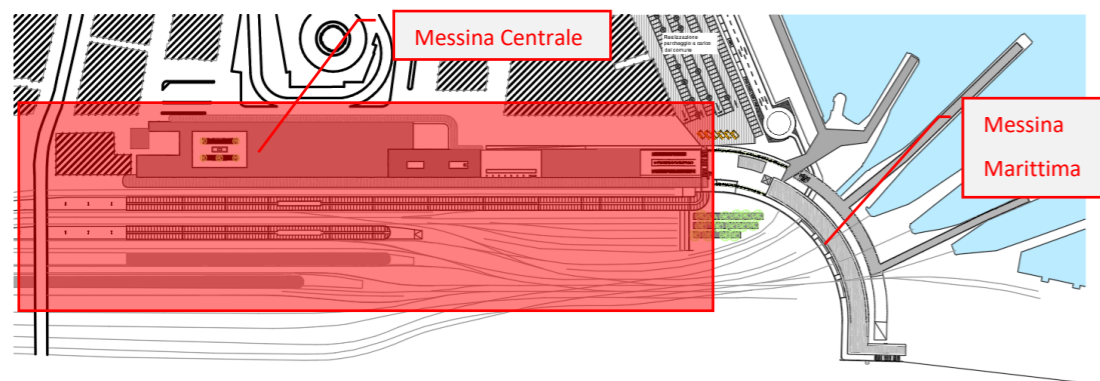

1.10 Sottopasso

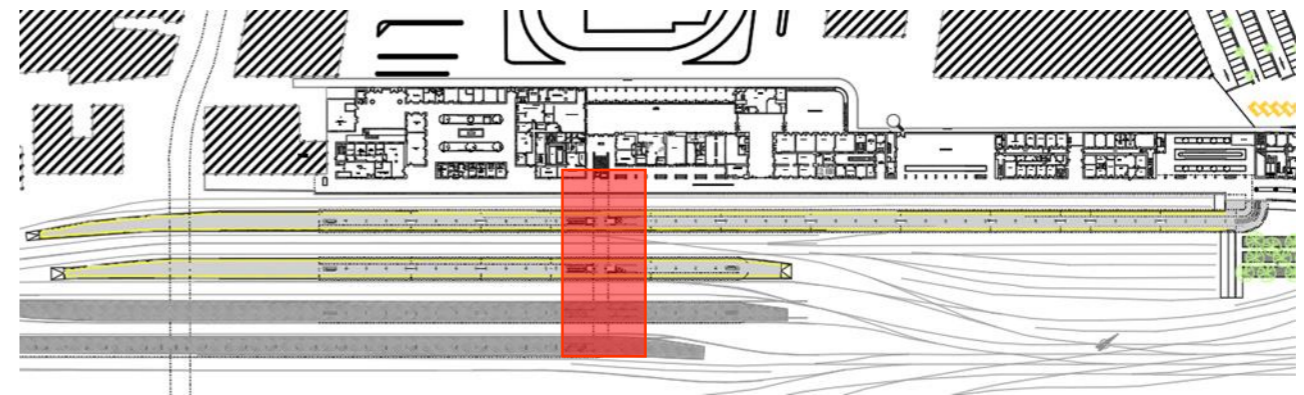
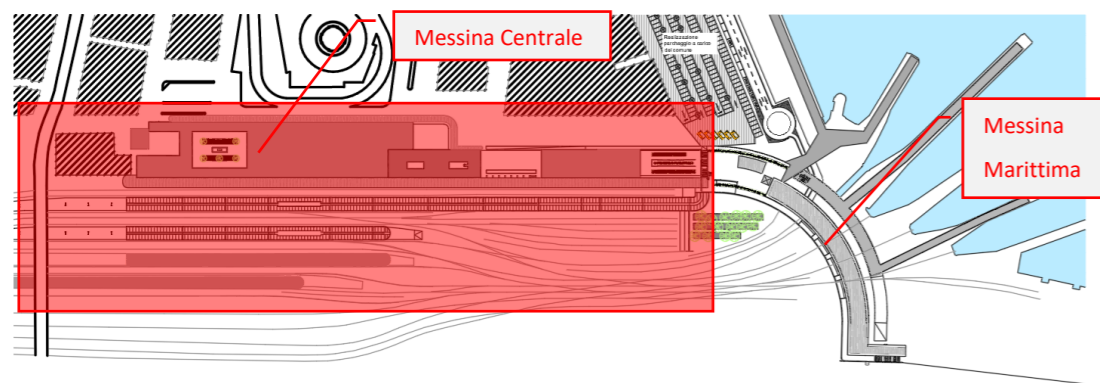
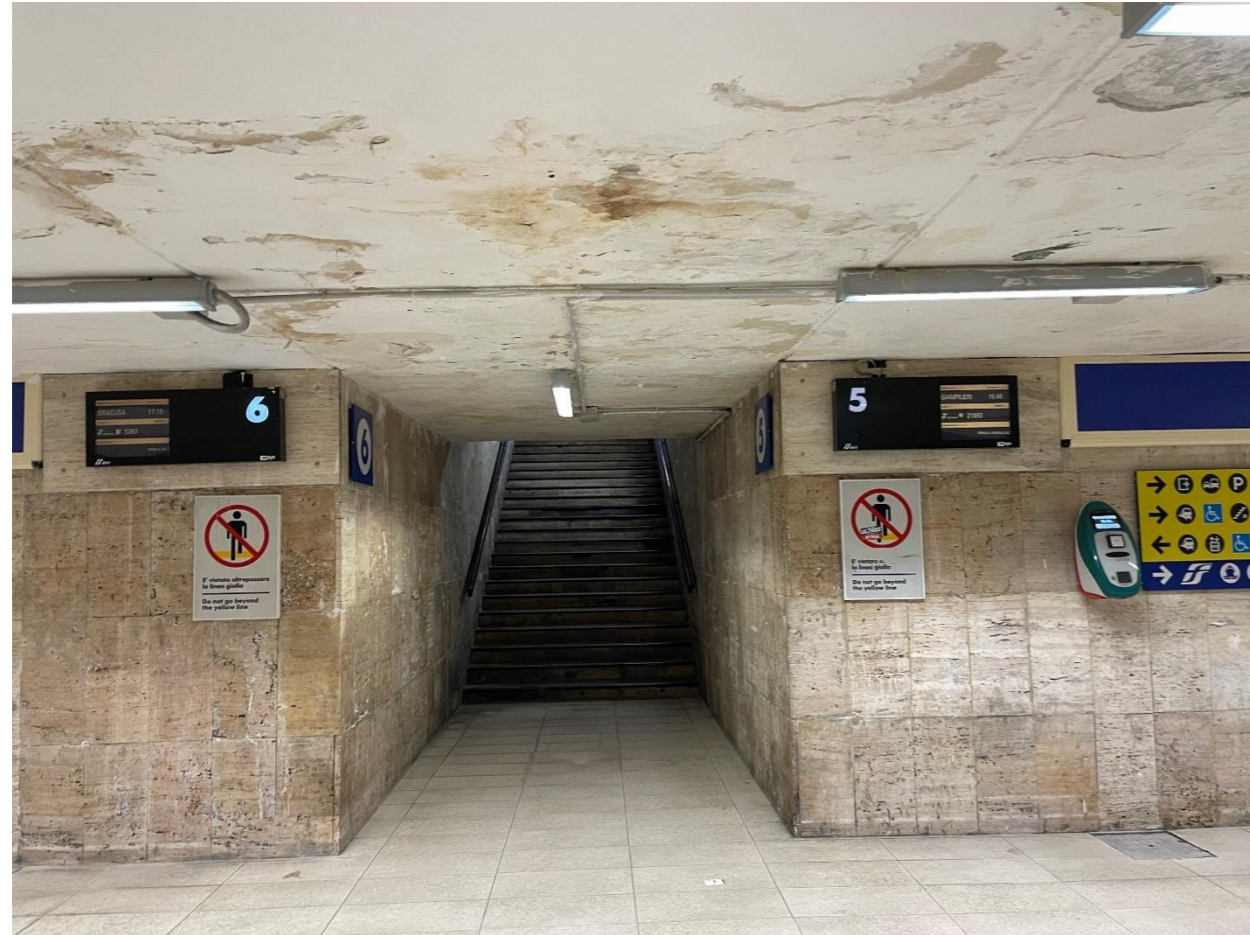

2 MESSINA MARITTIMA

2.1 Accesso Interporto

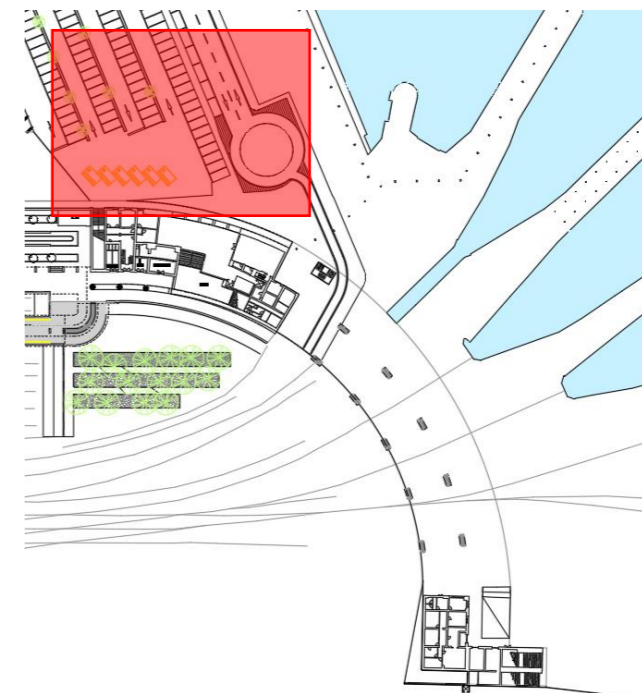
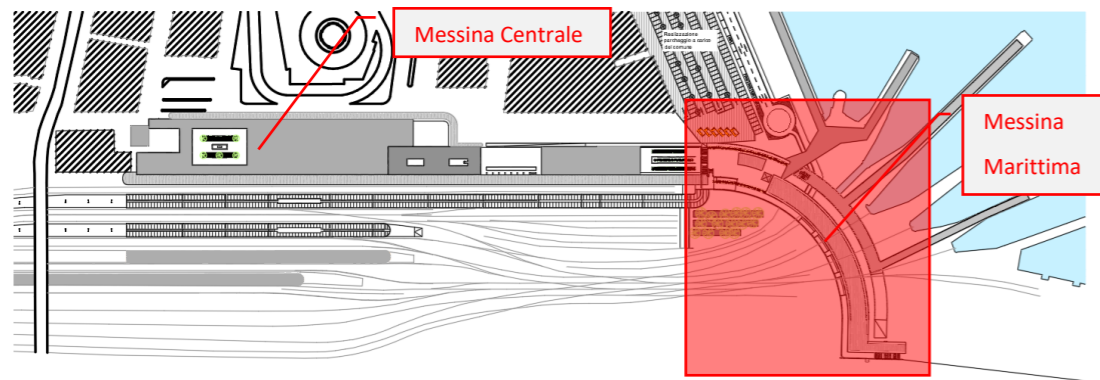
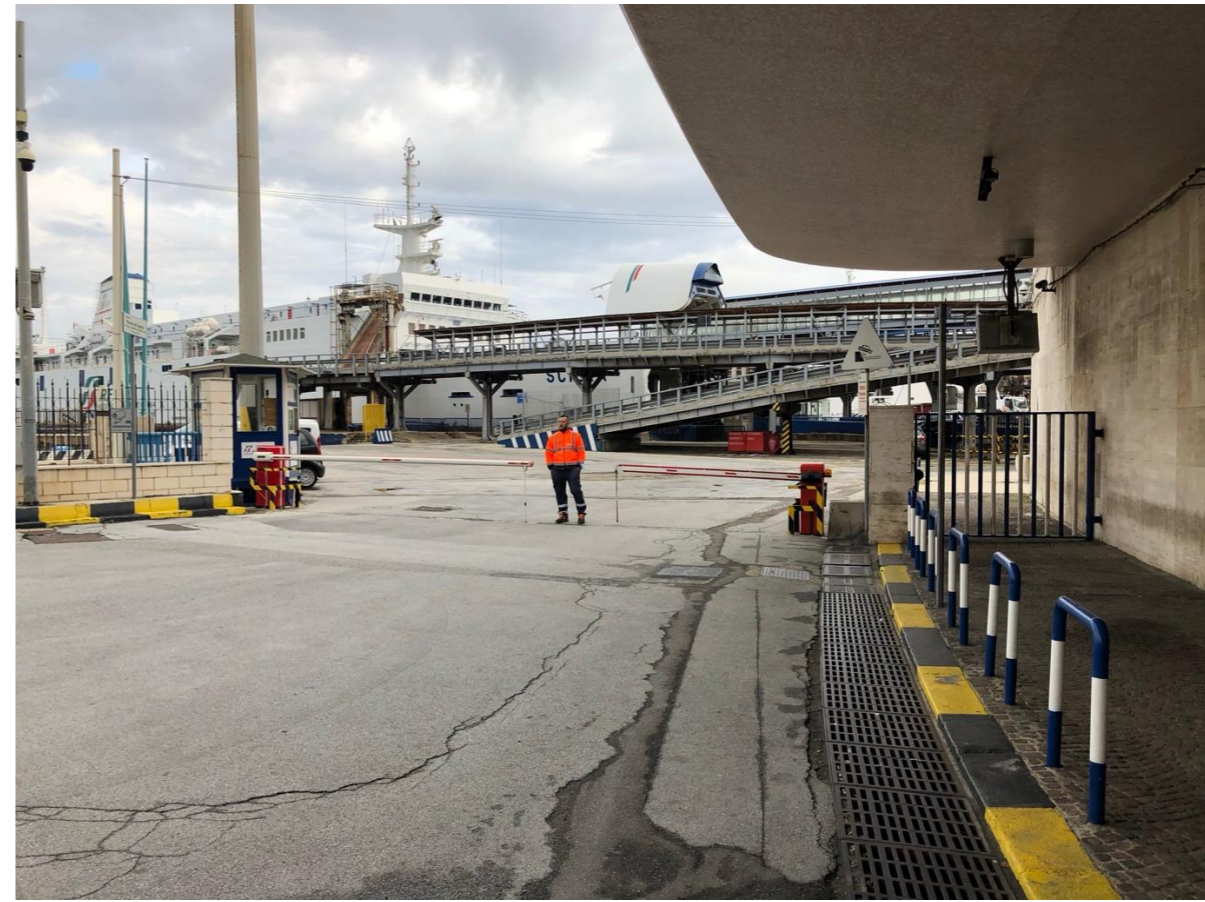

2.2 Atrio

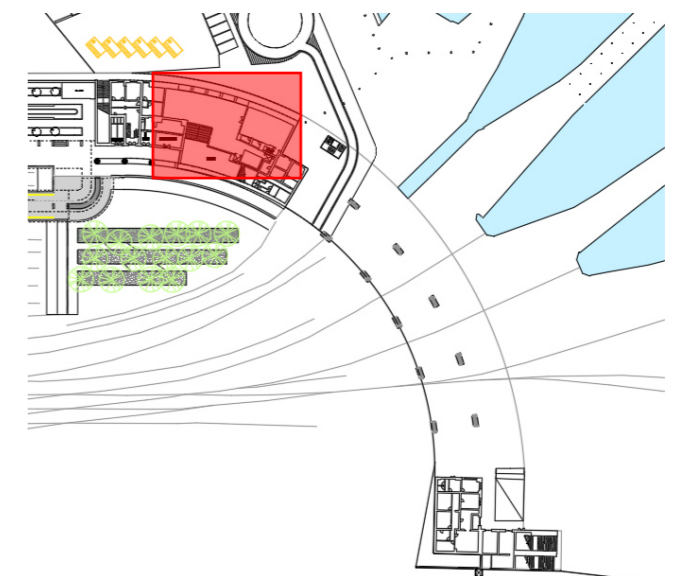
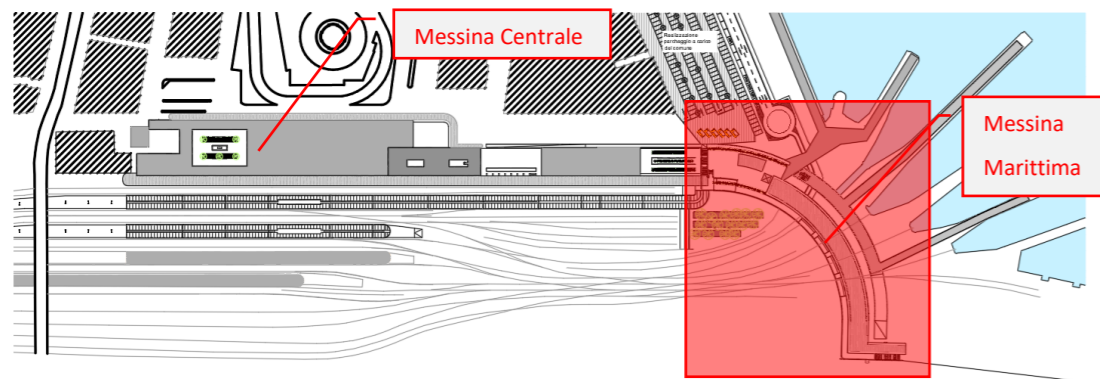
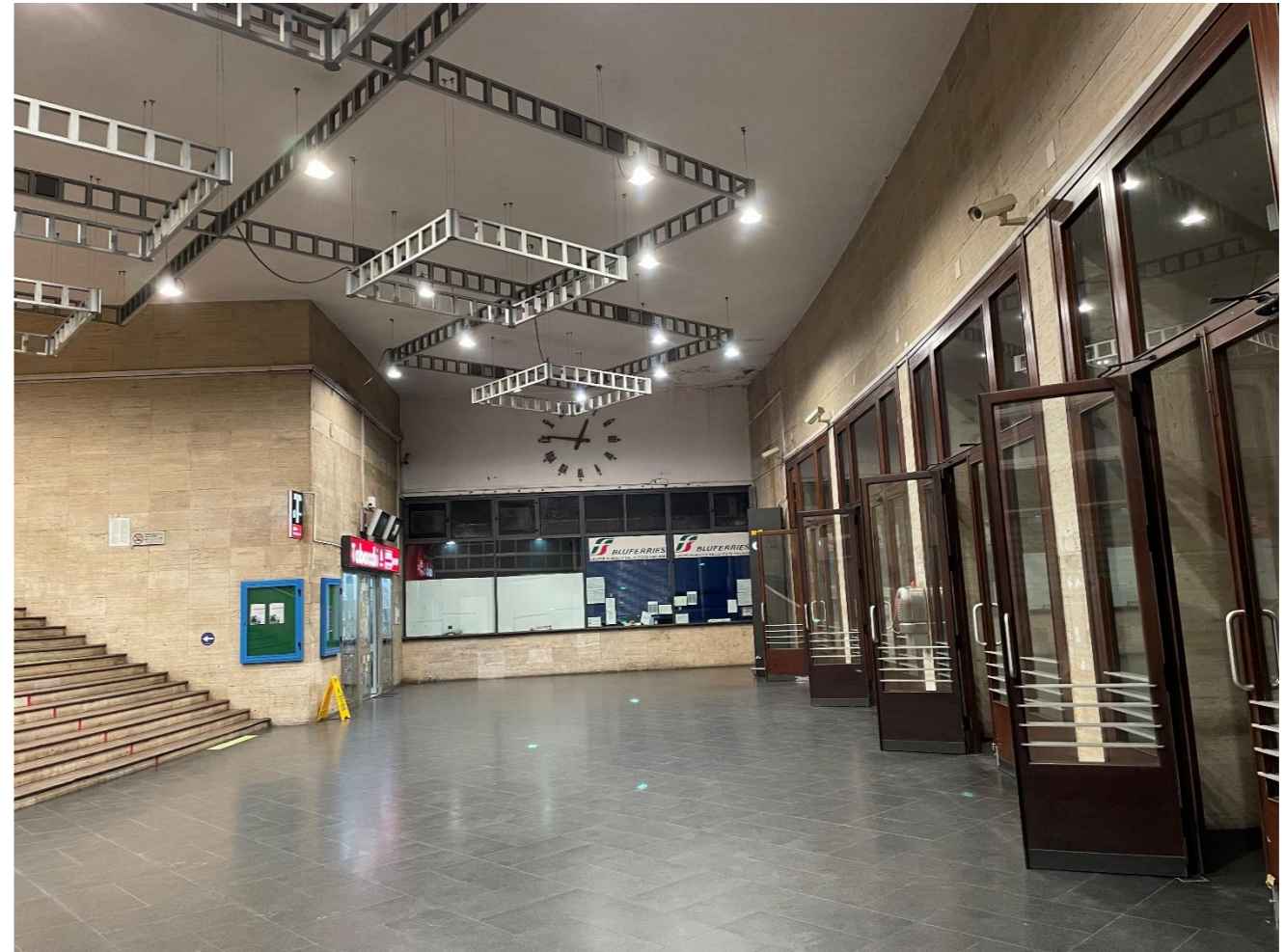

2.3 Sala del Mosaico

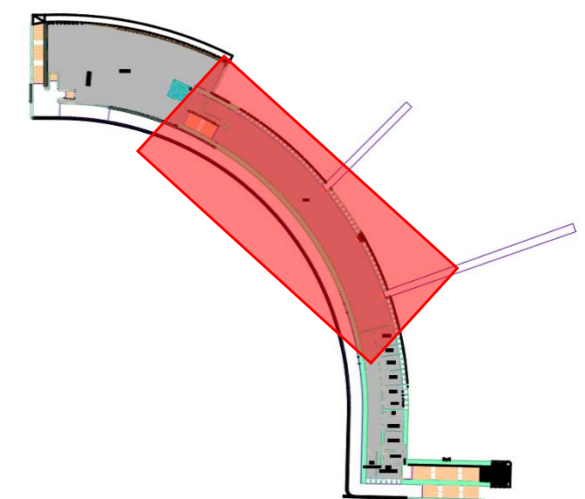
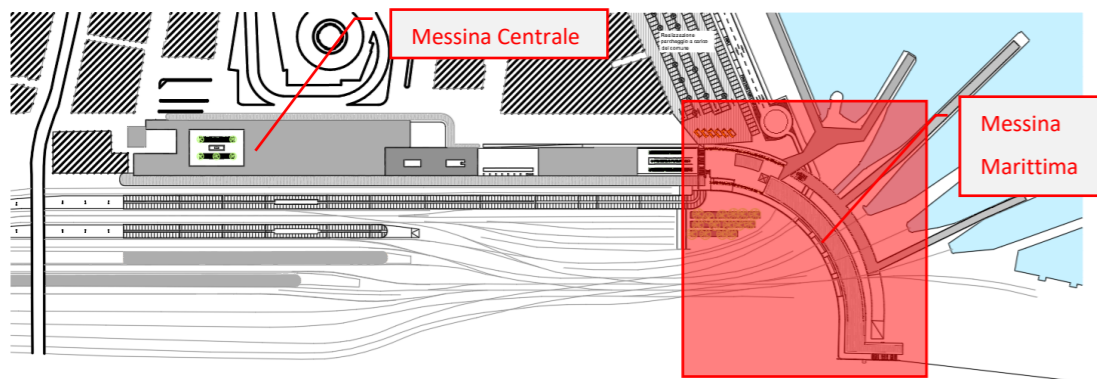
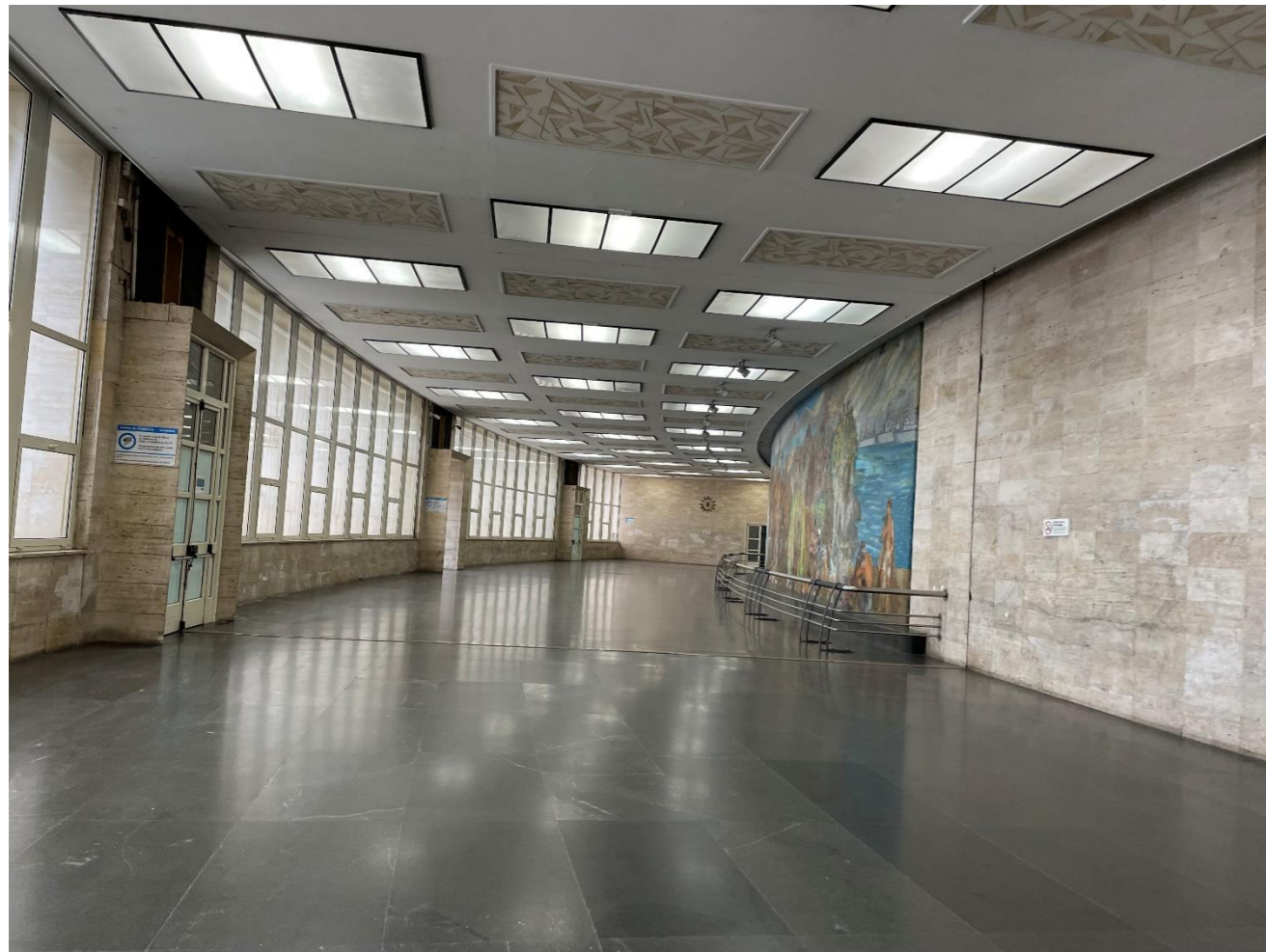

2.4 Fingers imbarco navi Blu Ferries

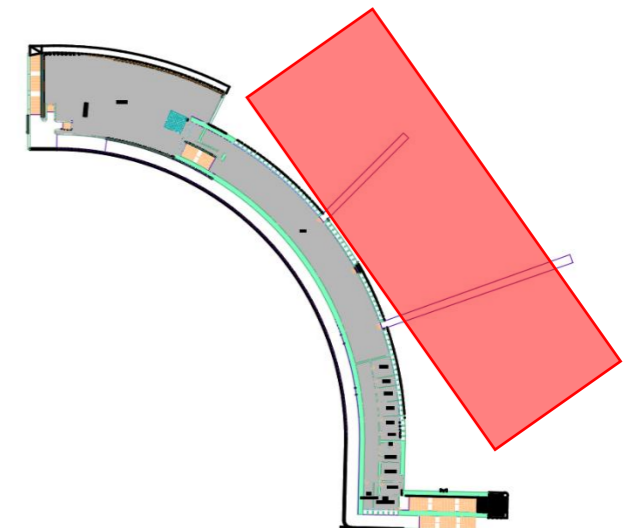
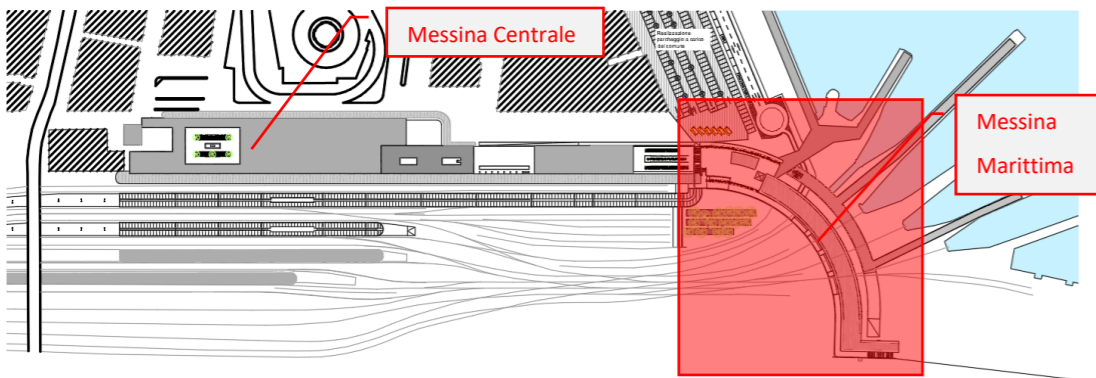

2.5 Balconata

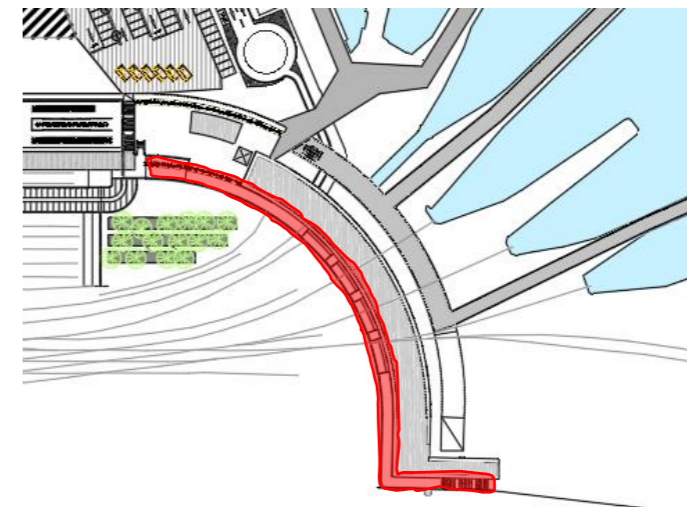
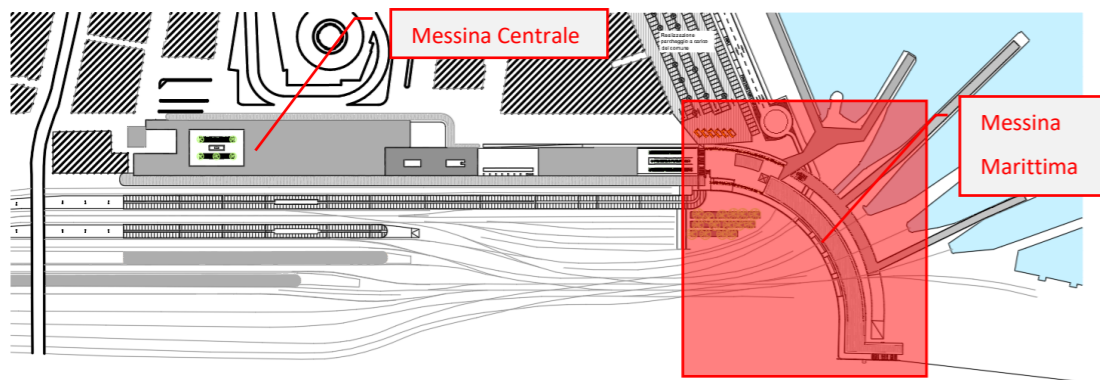

2.6 Terrazza

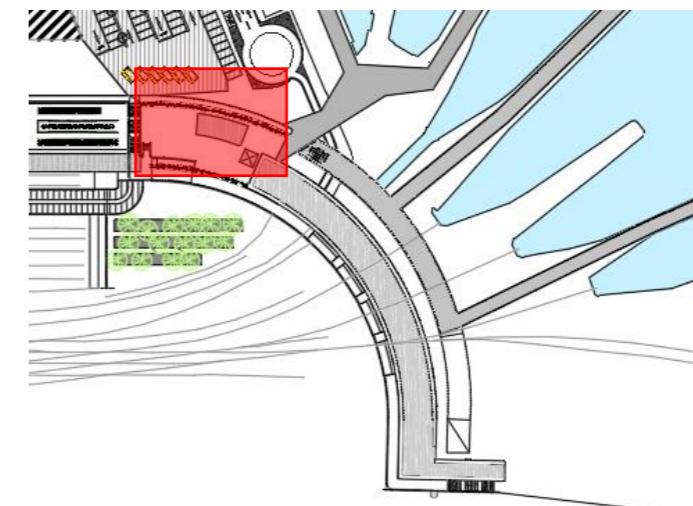
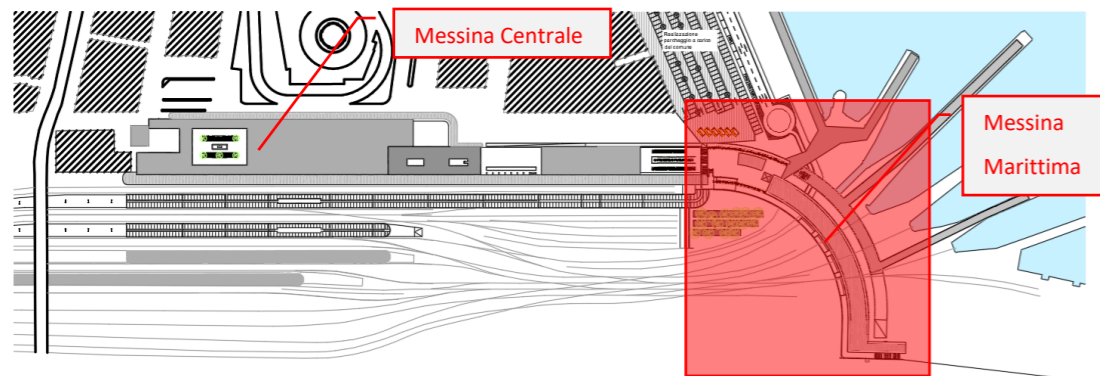

2.7 Esterno lato Cittadella

