

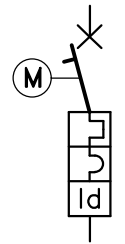

SELETTORE 2 POSIZIONI
(LOCALE DISTANTE)



SELETTORE 2 POSIZIONI
(LOCALE DISTANTE)



INTERRUTTORE AUTOMATICO
MAGNETOTERMICO
DIFFERENZIALE
MOTORIZZATO

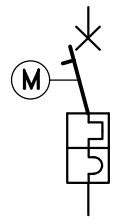

INTERRUTTORE AUTOMATICO
MAGNETOTERMICO MOTORIZZATO

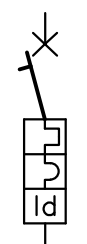

INTERRUTTORE AUTOMATICO
MAGNETOTERMICO
DIFFERENZIALE

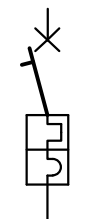

INTERRUTTORE AUTOMATICO
MAGNETOTERMICO



SEZIONATORE SOTTO CARICO
CON FUSIBILI

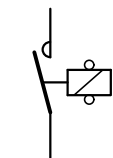

CONTATTORE



RELE PASSO PASSO



PULSANTE NORMALMENTE APERTO



CONTATTO DI FINE CORSA



CONTATTO CHIUSO
RITARDATO ALL' APERTURA

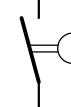

CONTATTO APERTO
RITARDATO ALLA CHIUSURA

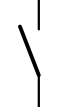

CONTATTO APERTO

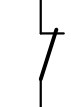

CONTATTO CHIUSO



CONTATTO RELE' TERMICO APERTO

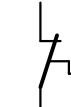

CONTATTO RELE' TERMICO CHIUSO

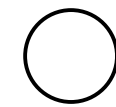

TRASFORMATORE DI POTENZA
(AUSILIARI)

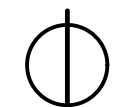

TRASFORMATORE DI CORRENTE



INDICA ESTRAIBILITA'

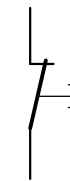

PULSANTE NORMALMENTE CHIUSO



AMPEROMETRO



COMMUTATORE AMPEROMETRICO



VOLMETRO



COMMUTATORE VOLMETRICO



FUSIBILE



OROLOGIO
GIORNALIERO SETTIMANALE



LAMPADA DI SEGNALAZIONE



MORSETTI APPARECCHIATURE INSTALLATE
IN CAMPO



MORSETTI QUADRO



MORSETTI ALTRI QUADRI



RELE' DI POTENZA



RELE' AUSILIARIO



RELE' TEMPORIZZATO

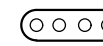

LINCK
RIMOVIBILE SOLO CON ATTREZZO

Preparato CECCARANI		Data		Committente Ginevra Energia S.r.l. VIA PIETRO BORSIERI 2A, 00195 - ROMA			Progettato  GL ASSOCIATES S.r.l. VIA ALBERTO MARIO 1 00152 ROMA - ITALIA TEL./FAX: 06/58303719		OGGETTO LEGENDA QUADRO QESA-CC-2 LOCALE QUADRI BT						ATT. D		COMMESSA 2021-001		ORIGINE FIN. DISC. GHAD E		PROG. TIPO DOC. 015 SCH	
------------------------	--	------	--	--	--	--	--	--	---	--	--	--	--	--	------------------	--	-----------------------------	--	-------------------------------------	--	-----------------------------------	--

SEZIONE NORMALE

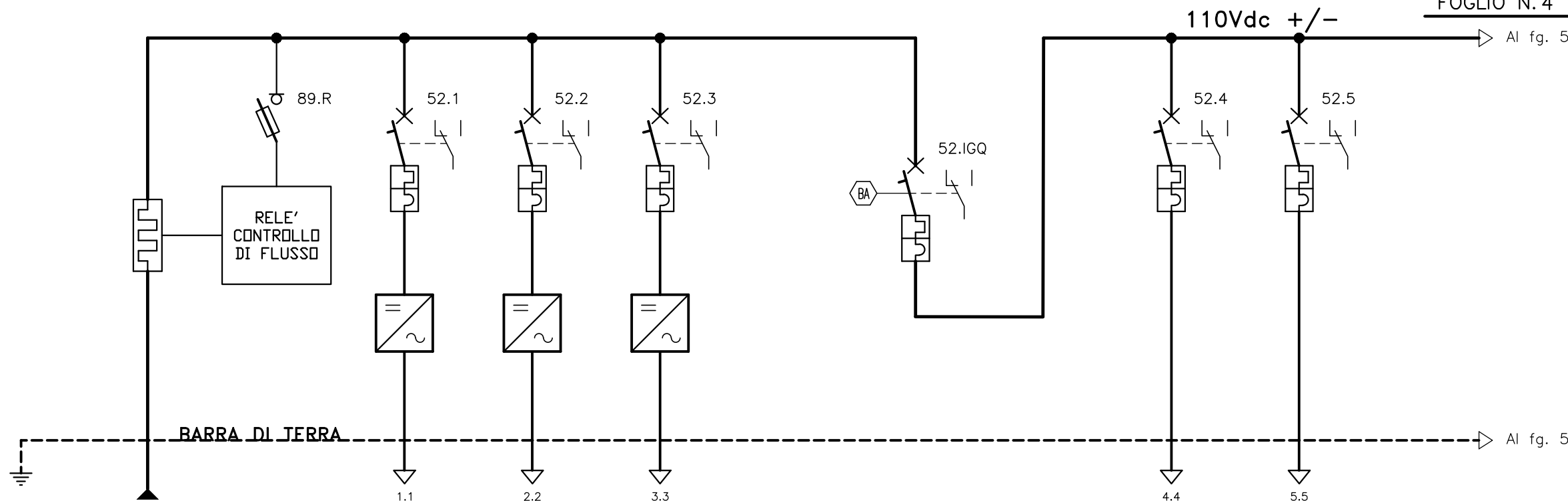

N° PROGRES.CIRCUITO		TERRA	IG	EIC-1	EIC-2	EIC-3	IGQ	EIC-4	EIC-5	
U T E N Z A	DENOMINAZIONE	DALLA PRESA DI TERRA	INGRESSO DA QE-RAD-1	ALIMENTAZIONE QUADRO RTU	ALIMENTAZIONE PC HM OSCILLO PERTURBOGRAFO	ALIMENTAZIONE CMD MOTORIZZAZIONE IG	INTERRUTTORE GENERALE QUADRO	ALIMENTAZIONE AUX-1 QMT-B	ALIMENTAZIONE AUX-2 QMT-B	
	POTENZA	kW								
	CORRENTE ASSORB.	A								
	CADUTA TENSIONE	P/t								
Q U A D R O	INTER.	TIPO/CURVA		S202	S202	S202	S202	S202	S202	
		ESECUZIONE		FISSO	FISSO	FISSO	FISSO	FISSO	FISSO	
		N° POLI		2	2	2	2	2	2	
		CORREN. NOM.	A	10	16	6	63	16	16	
	RELE'	corr.nom.	A	10	16	6	63	16	16	
		corr.mag.	Im	100	160	60	630	160	160	
		taratura	A	10	16	6	63	16	16	
	POTERE INTERRUZIONE	kA		6	6	6	6	6	6	
	SEZI.	TIPO								
		ESECUZIONE								
N° POLI										
CORREN. NOM.		A								
A V V I.	ESECUZIONE									
	N° POLI									
	CONTATTORE									
	TERMICO	A								
L I N E A	TIPO									
	FORM. x SEZ.	mmq								
	LUNG. CALCOLO / MAX CIRCUITO	mt								
	PORTATA CAVO	A								

Preparato CECCARANI	Data	Committente Ginevra Energia S.r.l. VIA PIETRO BORSIERI 2A, 00195 - ROMA	Progettato  GL ASSOCIATES S.p.A. VIA ALBERTO MARIO 1 00152 ROMA - ITALIA TEL./FAX: 06/58303719	OGGETTO SCHEMA ELETTRICO UNIFILARE QUADRO QESA-CC-2 LOCALE QUADRI BT	ATT. D	COMMESSA 2021-001	ORIGINE FIN. DISC. PROG. TIPO DOC. GHAD E 015 SCH
------------------------	------	--	--	--	------------------	-----------------------------	---

110Vdc +/-

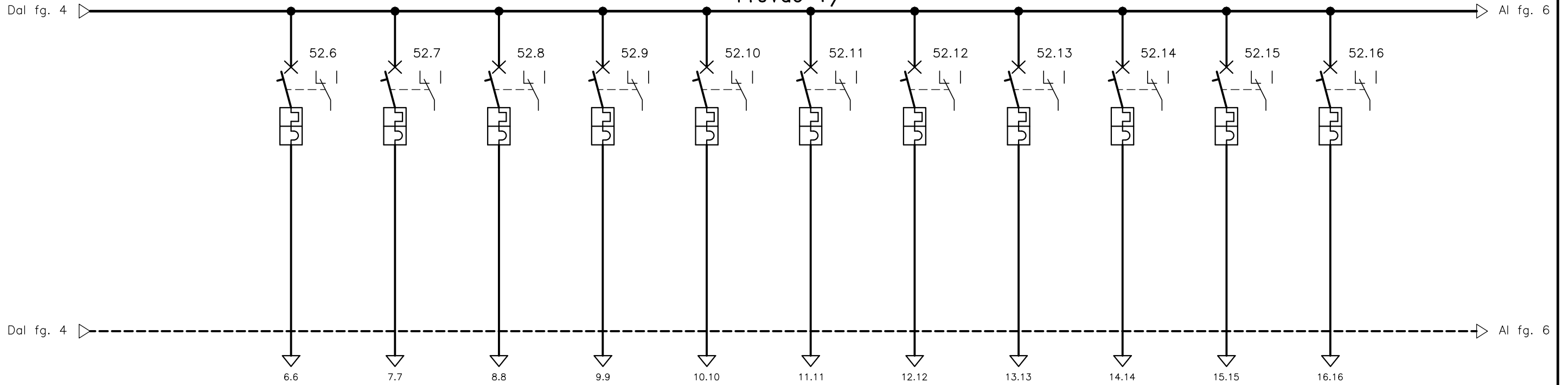

N° PROGRES.CIRCUITO		EIC-6	EIC-7	EIC-8	EIC-9	EIC-10	RIS	RIS	EIC-11	EIC-12	EIC-11	EIC-12		
UTENZA	DENOMINAZIONE	ALIMENTAZIONE QUADRO MISURE AT	ALIMENTAZIONE QUADRO-1 RTU	ALIMENTAZIONE QUADRO-2 RTU	ALIMENTAZIONE PANNELLO 1 P&C	ALIMENTAZIONE PANNELLO 2 P&C	RISERVA	RISERVA	ALIMENTAZIONE AUX SEZIONATORE 289T-G2	ALIMENTAZIONE MOTORE SEZIONATORE 289T-G2	ALIMENTAZIONE AUX SEZIONATORE 289T-G3	ALIMENTAZIONE MOTORE SEZIONATORE 289T-G3		
	POTENZA	kW												
	CORRENTE ASSORB.	A												
	CADUTA TENSIONE	V												
QUADRO	INTER.	TIPO/CURVA	S202	S202	S202	S202	S202	S202	S202	S202	S202	S202		
		ESECUZIONE	FISSO	FISSO	FISSO	FISSO	FISSO	FISSO	FISSO	FISSO	FISSO	FISSO		
		N° POLI	2	2	2	2	2	2	2	2	2	2		
		CORREN. NOM.	A	10	10	10	10	10	10	16	10	16	10	
		RELE'	corr.nom.	A	10	10	10	10	10	10	16	10	16	10
			corr.mag. taratura	Im	100	100	100	100	100	100	160	100	160	100
	POTERE INTERRUZIONE	kA	6	6	6	6	6	6	6	6	6	6		
	SEZI.	TIPO												
		ESECUZIONE												
		N° POLI												
		CORREN. NOM.	A											
	AVV. I.	ESECUZIONE												
N° POLI														
CONTATTORE														
TERMICO		A												
LINEA	TIPO													
	FORM. x SEZ.	mmq												
	LUNG. CALCOLO / MAX CIRCUITO	mt												
	PORTATA CAVO	A												

Preparato CECCARANI	Data	Committente Ginevra Energia S.r.l. VIA PIETRO BORSIERI 2A, 00195 - ROMA	Progettato  GL ASSOCIATES S.p.A. VIA ALBERTO MARIO 1 00152 ROMA - ITALIA TEL./FAX: 06/58303719	OGGETTO SCHEMA ELETTRICO UNIFILARE QUADRO QESA-CC-2 LOCALE QUADRI BT	ATT. D	COMMESSA 2021-001	ORIGINE FIN. GHAD	DISC. E	PROG. 015	TIPO DOC. SCH
------------------------	------	--	--	--	------------------	-----------------------------	-----------------------------	-------------------	---------------------	-------------------------

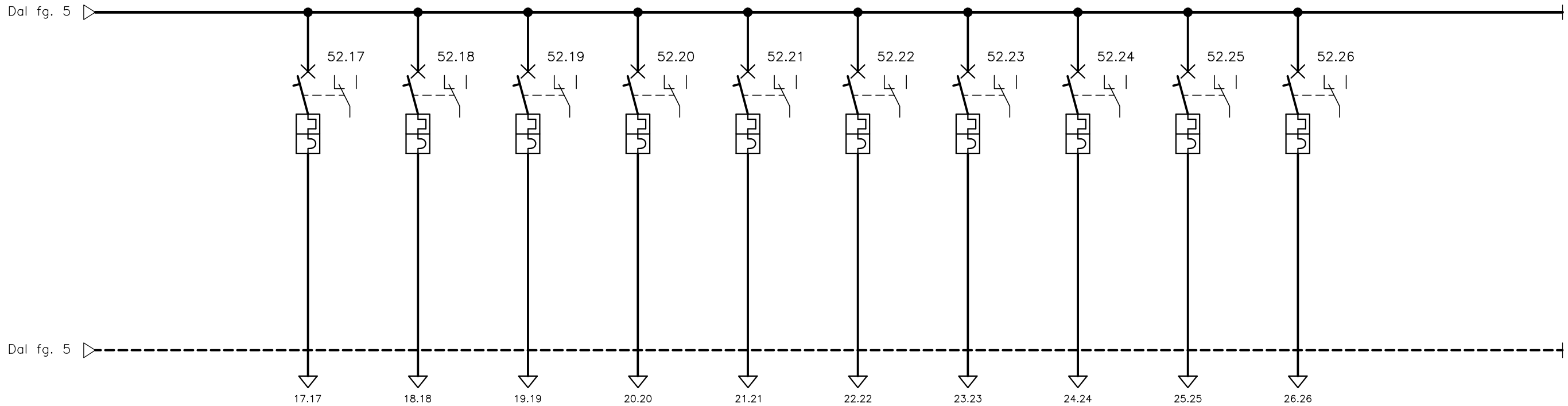

N° PROGRES.CIRCUITO		EIC-17	EIC-18	EIC-19	EIC-20	EIC-21	EIC-22	EIC-23	EIC-24	EIC-25	EIC-26			
U T E N Z A	DENOMINAZIONE	ALIMENTAZIONE AUX INTERRUPTORE 252-G2	ALIMENTAZIONE MOTORE INTERRUPTORE 252-G2	ALIMENTAZIONE AUX INTERRUPTORE 252-G3	ALIMENTAZIONE MOTORE INTERRUPTORE 252-G3	ALIMENTAZIONE AUX SEZIONATORE 289T-IG	ALIMENTAZIONE MOTORE SEZIONATORE 289T-IG	ALIMENTAZIONE AUX INTERRUPTORE 252-IG	ALIMENTAZIONE MOTORE INTERRUPTORE 252-IG	ALIMENTAZIONE AUX REATTORE SHUNT-1	ALIMENTAZIONE AUX REATTORE SHUNT-2			
	POTENZA	kW												
	CORRENTE ASSORB.	A												
	CADUTA TENSIONE	P/t												
Q U A D R O	INTER.	TIPO/CURVA	S202	S202	S202	S202	S202	S202	S202	S202	S202	S202		
		ESECUZIONE	FISSO	FISSO	FISSO	FISSO	FISSO	FISSO	FISSO	FISSO	FISSO	FISSO		
		N° POLI	2	2	2	2	2	2	2	2	2	2		
		CORREN. NOM.	A	10	16	10	16	10	16	10	16	16	16	
		RELE'	corr.nom. A	10	16	10	16	10	16	10	16	16	16	
		corr.mag. Im	100	160	100	160	100	160	100	160	160	160		
		taratura A	10	16	10	16	10	16	10	16	16	16		
	POTERE INTERRUZIONE	kA	6	6	6	6	6	6	6	6	6	6		
	S E Z I.	TIPO												
		ESECUZIONE												
N° POLI														
CORREN. NOM.		A												
A V V I.	ESECUZIONE													
	N° POLI													
	CONTATTORE													
	TERMICO	A												
L I N E A	TIPO													
	FORM. x SEZ.	mmq												
	LUNG. CALCOLO / MAX CIRCUITO	mt												
	PORTATA CAVO	A												

Preparato CECCARANI	Data	Committente Ginevra Energia S.r.l. VIA PIETRO BORSIERI 2A, 00195 - ROMA	Progettato  GL ASSOCIATES S.r.l. VIA ALBERTO MARIO 1 00152 ROMA - ITALIA TEL./FAX: 06/58303719	OGGETTO SCHEMA ELETTRICO UNIFILARE QUADRO QESA-CC-2 LOCALE QUADRI BT	ATT. D	COMMESSA 2021-001	ORIGINE FIN. GHAD	DISC. E	PROG. 015	TIPO DOC. SCH
------------------------	------	--	---	--	------------------	-----------------------------	-----------------------------	-------------------	---------------------	-------------------------

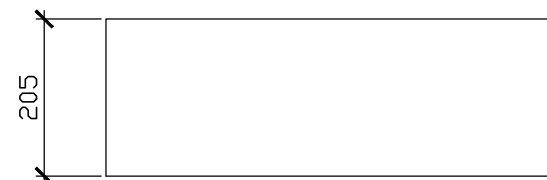
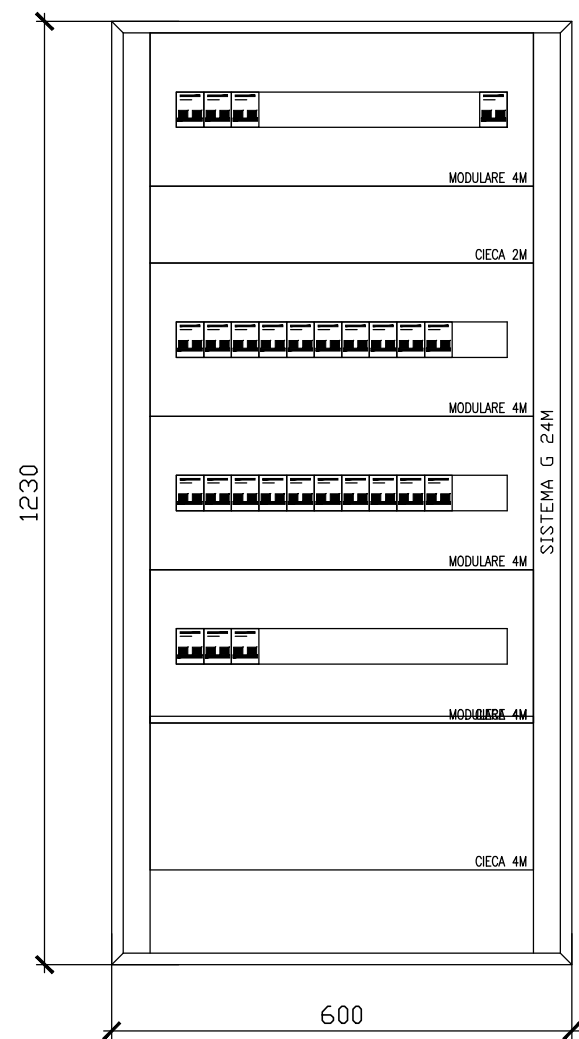

Preparato CECCARANI		Committente Ginevra Energia S.r.l. VIA PIETRO BORSIERI 2A, 00195 - ROMA	 Progettato GL ASSOCIATES S.r.l. VIA ALBERTO MARIO 1 00152 ROMA - ITALIA TEL./FAX: 06/58303719	OGGETTO FRONTE QUADRO QUADRO QESA-CC-2 LOCALE QUADRI BT											ATT. D	COMMESSA 2021-001	ORIGINE GHAD	FIN. D	DISC. E	PROG. 015	TIPO DOC. SCH
Vagliato GENTILI																					
Approvato ARANEO																					