

- Note:
1. The Skysmart system drive 90 panels with one motor
  2. Every row has 1 motor pier and 6 regular piers
  3. Tracking range:  $\pm 60^\circ$

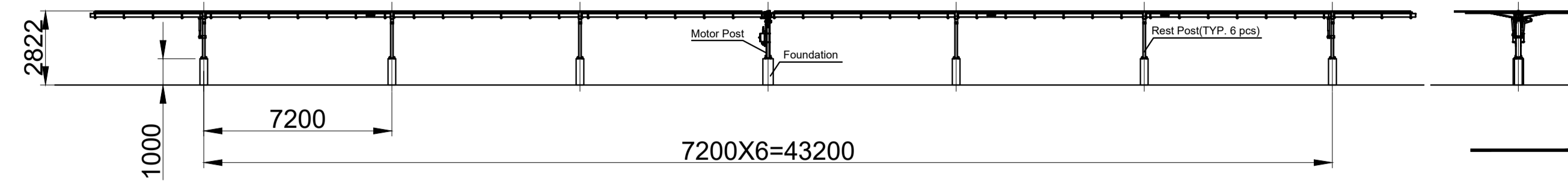

1 row, each row has 90 modules

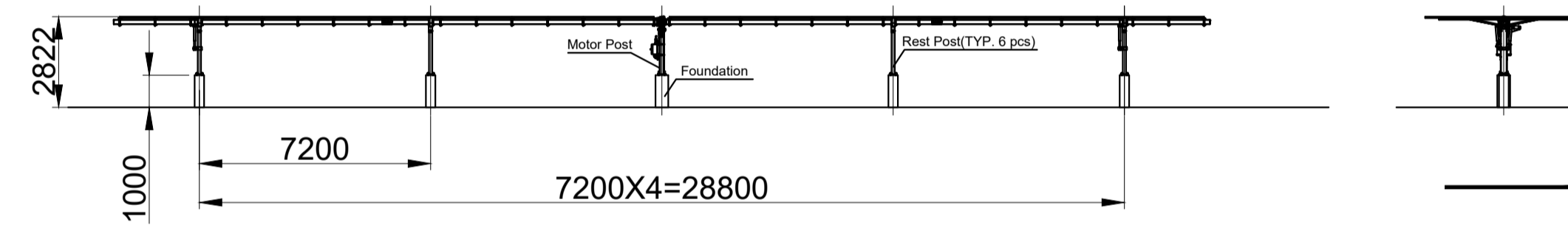
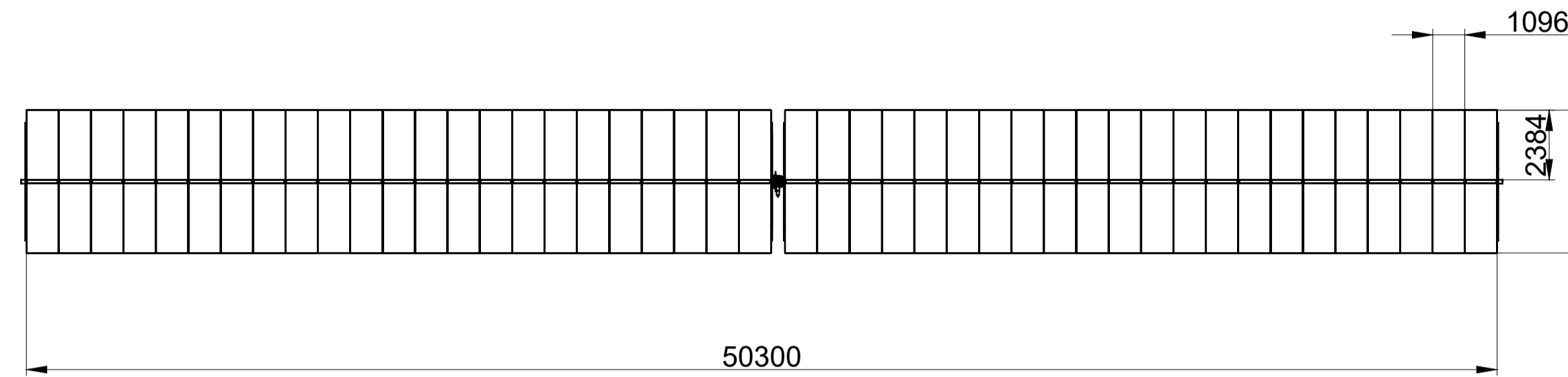

1 row, each row has 60 modules

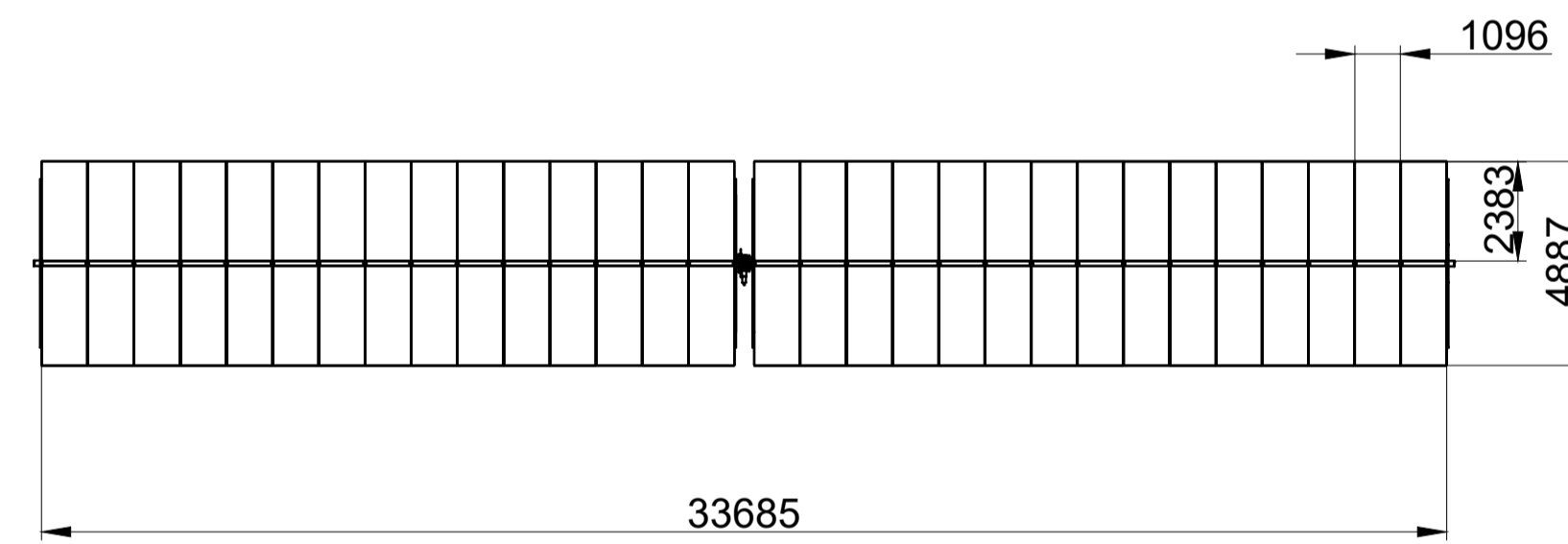

- Note:
1. The Skysmart system drive 60 panels with one motor
  2. Every row has 1 motor pier and 6 regular piers
  3. Tracking range:  $\pm 60^\circ$

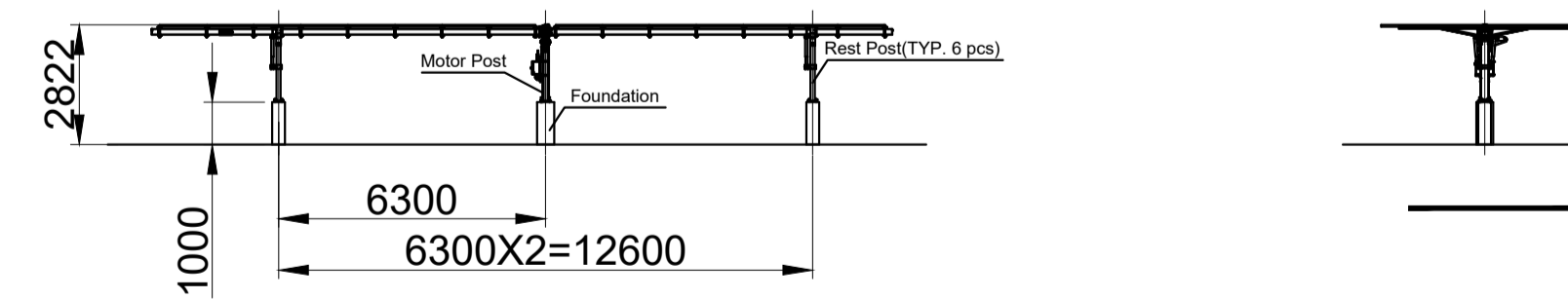

1 row, each row has 30 modules

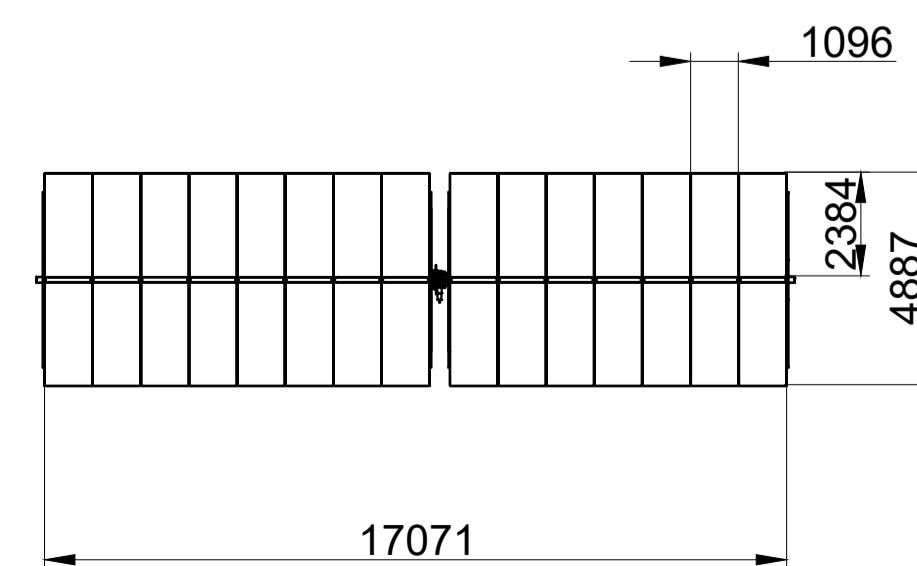

- Note:
1. The Skysmart system drive 30 panels with one motor
  2. Every row has 1 motor pier and 6 regular piers
  3. Tracking range:  $\pm 60^\circ$

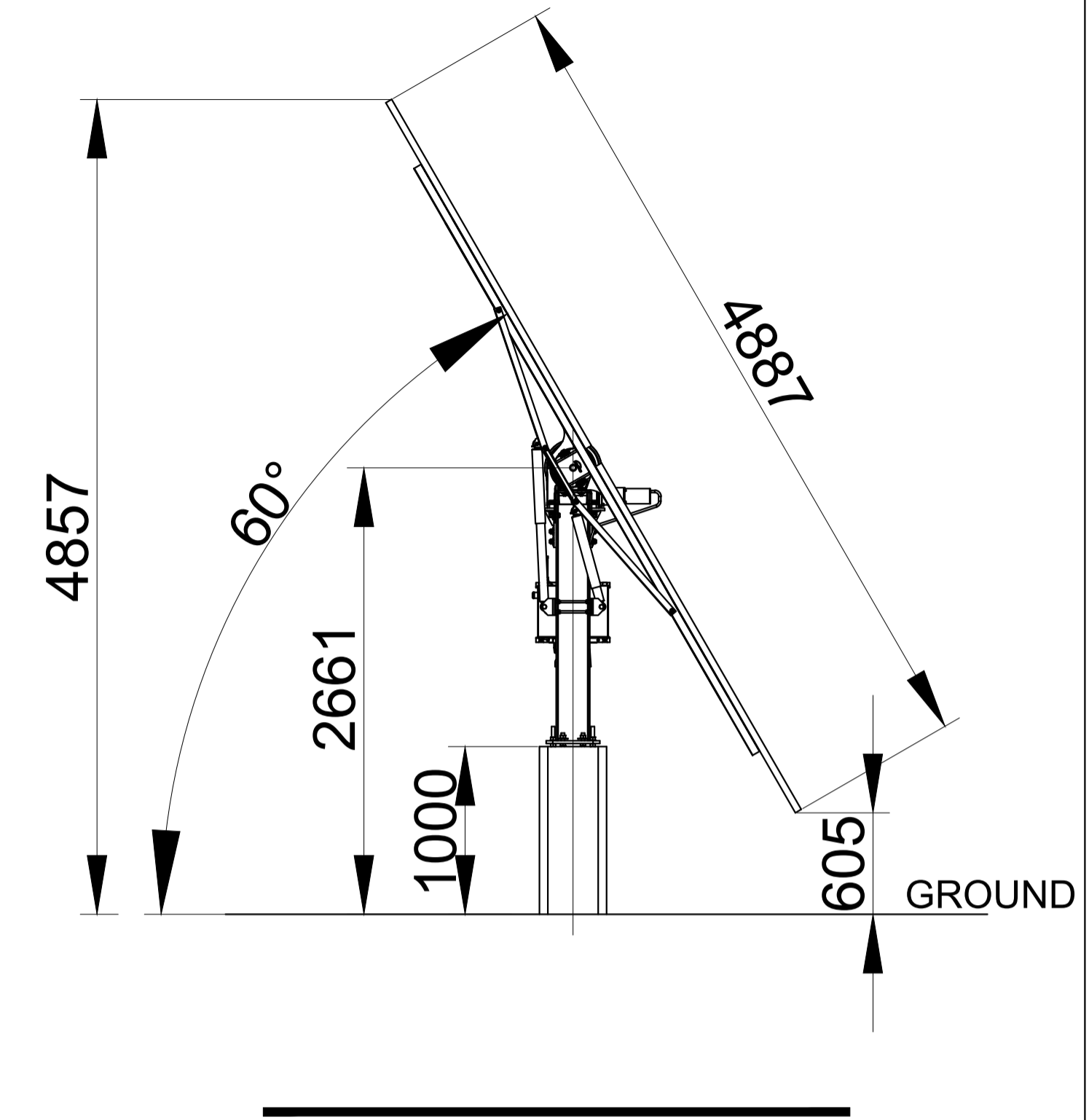

		<b>REGIONE PUGLIA</b> <b>COMUNE di MANFREDONIA</b>	
Progettazione e Coordinamento Progettazione Elettronica	<b>Ing. Giovanni Cis</b> Tel. 349 0737323 E-Mail: giovanni.cis@ingpec.eu		
Studio Architettonico Progettazione Strutturale	<b>Ing. Leo Baldo Petitti</b> Tel. 329 1145542 E-Mail: leobaldo.petitti@ingpec.eu		
Studio Naturalistico	<b>Dott. Forestale Lupo</b> Corso Roma, 110 71121 Foggia E-Mail: lugliupo@libero.it		
Studio Geologico	<b>Dott. Pasquale G. Longo</b> Via Pescasseroli 13 66100 Chieti	Studio Agronomico <b>Dott. N. D'Erico</b> Via Golo 8 71017 Torremaggiore (FG)	Studio Edilizio <b>Ing. A.L. Giordano</b> Tel. +39 346 6330966 E-Mail: lauragordano.ing@gmail.com
Studio Architettonico	<b>Arch. Marianna Denora</b> Via Sirena 3 70022 Altamura (BA)		
Progettante	<b>IPC PUGLIA</b> <small>Via Aarno, 108 66020 San Giovanni Teatino (CH) - P.IVA 0421120718</small>		<b>IPC PUGLIA</b> <small>Via Aarno, 108 66020 San Giovanni Teatino (CH) - P.IVA 0421120718</small>
Opere	<b>PROGETTO PER UN IMPIANTO DI PRODUZIONE AGROVOLTAICO INTEGRATO DA REALIZZARSI NEL COMUNE DI MANFREDONIA (FG) IN LOCALITA' "BORGHO FONTE ROSA - MACCHIA ROTONDA"</b>		
Folder	ODPYOW1_Progetto definitivo.zip		
Oggetto	Nome file ODPYOW1_PD_T14_Rev0_Strutture_di_supporto_dei_moduli		
Descrizione elaborato	Strutture di supporto dei moduli		ELABORATO <b>T 14</b>
Rev.	Data	Oggetto della revisione:	Elaborazione Verifica Approvazione
Scala:	<b>ODPYOW1</b>		
Formato:	Codice Pratica		