



AUTOSTRADA REGIONALE CISPADANA DAL CASELLO DI REGGIOLO-ROLO SULLA A22 AL CASELLO DI FERRARA SUD SULLA A13

CODICE C.U.P. E81B0800060009

PROGETTO DEFINITIVO

ASSE AUTOSTRADALE (COMPRESIVO DEGLI INTERVENTI LOCALI DI COLLEGAMENTO VIARIO AL SISTEMA AUTOSTRADALE)

OPERE STRUTTURALI

OPERE D'ARTE MAGGIORI : SOTTOVIA

SST01- SVINCOLO AUTOSTAZIONE REGGIOLO ROLO - SOTTOPASSO RAMPA B

SOTTOVIA - RELAZIONE DI CALCOLO

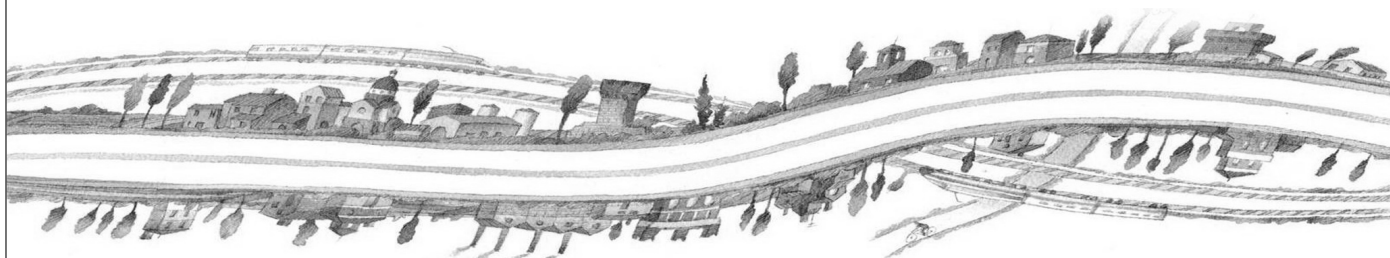

IL PROGETTISTA

PIACENTINI INGEGNERI S.r.l.
Ing. Luca Piacentini
Albo Ing. Bologna n° 4152



RESPONSABILE INTEGRAZIONE
PRESTAZIONI SPECIALISTICHE

Ing. Emilio Salsi
Albo Ing. Reggio Emilia n° 945



IL CONCESSIONARIO

Autostrada Regionale
Cispadana S.p.A.
IL PRESIDENTE
Graziano Pattuzzi

G					
F					
E					
D					
C					
B					
A	17.04.2012	Emissione	Di Leo	Piacentini	Salsi
REV.	DATA	DESCRIZIONE	REDAZIONE	CONTROLLO	APPROVAZIONE

IDENTIFICAZIONE ELABORATO

NUM. PROGR.	FASE	LOTTO	GRUPPO	CODICE OPERA WBS	TRATTO OPERA	AMBITO	TIPO ELABORATO	PROGRESSIVO	REV.
3088	PD	0	S01	SST01	0	OM	RC	01	A

DATA: MAGGIO 2012

SCALA: 1:100

INDICE

1. DESCRIZIONE DELL'OPERA	4
2. DOCUMENTI DI RIFERIMENTO.....	5
3. DURABILITÀ E PRESCRIZIONI SUI MATERIALI	6
4. INCIDENZE.....	8
5. CRITERI DI CALCOLO	9
5.1. CALCOLO DELLE SPINTE SUI PARAMENTI VERTICALI	9
5.1.1. Spinte attive in condizioni statiche.....	10
5.1.2. Spinte a riposo	11
5.1.3. Spinte attive in condizioni sismiche	12
5.1.3.1 Rilevato asciutto.....	13
5.1.3.2 Rilevato saturo a grana fine (dinamicamente impervio: $k < 5 \cdot 10^{-4}$ m/s).....	13
5.1.3.3 Rilevato saturo a grana grossa (dinamicamente permeabile: $k \geq 5 \cdot 10^{-4}$ m/s).....	13
5.1.3.4 Punto di applicazione delle spinte attive sismiche.....	14
5.1.4. Sovraspinte sismiche su muri non in grado di spostarsi.....	15
5.1.4.1 Rilevato parzialmente immerso.....	17
5.1.4.2 Punto di applicazione delle spinte attive sismiche.....	17
5.1.5. Sovraspinte sismiche su muri non in grado di spostarsi.....	18
5.2. CRITERI E DEFINIZIONE DELL'AZIONE SISMICA.....	19
5.3. COMBINAZIONI DI CARICO	24
5.3.1. Combinazioni per la verifica allo SLU.....	24
5.3.2. Combinazioni per la verifica allo SLE.....	26
5.3.3. Combinazioni per la condizione sismica.....	27
6. PARAMETRI GEOTECNICI	28
7. SOTTOPASSO SCATOLARE	29
7.1. PROGRAMMI DI CALCOLO UTILIZZATI	31
7.1.1. Pro_Sap	31
7.1.2. Modellazione adottata	31
7.2. ANALISI DEI CARICHI	34
7.2.1. Peso proprio e carichi permanenti portati.....	35
7.2.2. Spinta delle terre	36
7.2.3. Spinta della falda interna allo scatolare.....	38
7.2.4. Carichi veicolari sulla soletta superiore	38
7.2.5. Spinte sui piedritti indotte dai sovraccarichi accidentali	46

7.2.6.	Sovraccarichi accidentali sulla soletta di fondazione.....	51
7.2.7.	Frenatura.....	51
7.2.8.	Azioni sismiche.....	53
7.2.8.1	<i>Stato limite di salvaguardia della vita (SLV)</i>	53
7.2.9.	Azioni termiche.....	54
7.2.10.	Ritiro.....	55
7.3.	COMBINAZIONI DI CARICO ADOTTATE	57
7.3.1.	Combinazioni per lo stato limite ultimo	57
7.3.2.	Combinazioni per gli stati limite di esercizio: combinazione rara.....	58
7.3.3.	Combinazioni per gli stati limite di esercizio: combinazione frequente	60
7.3.4.	Combinazioni per gli stati limite di esercizio: combinazione quasi permanente.....	61
7.3.5.	Combinazioni per lo stato limite ultimo di Salvaguardia della vita	61
7.4.	DIAGRAMMI DELLE CARATTERISTICHE DELLA SOLLECITAZIONE	63
7.4.1.	Inviluppo SLU/SLV momento flettente soletta superiore e soletta di fondazione.....	63
7.4.2.	Inviluppo SLU/SLV momento flettente piedritti	64
7.4.3.	Inviluppo taglio SLU/SLV soletta superiore e soletta di fondazione.....	64
7.4.4.	Inviluppo taglio SLU/SLV piedritti	65
7.5.	VERIFICHE DI RESISTENZA ED A FESSURAZIONE	66
7.5.1.	Soletta superiore: attacco piedritto (Asta 9).....	68
7.5.2.	Soletta superiore: mezzeria (Asta 12)	77
7.5.3.	Soletta di fondazione: attacco piedritto (Asta 11)	86
7.5.4.	Soletta di fondazione: mezzeria (Asta 15).....	95
7.5.5.	Piedritto: attacco soletta di fondazione (Asta 2)	104
7.5.6.	Piedritto: attacco soletta superiore (Asta 6).....	113
7.5.7.	Piedritto: mezzeria (Asta 4)	122
7.5.8.	Verifiche allo stato limite ultimo per taglio.....	131
7.5.8.1	<i>Soletta superiore attacco piedritto (Asta 9)</i>	131
7.5.8.2	<i>Soletta inferiore attacco piedritto (Asta 11)</i>	132
7.5.8.3	<i>Piedritto attacco soletta inferiore (Asta 2)</i>	133
7.5.8.4	<i>Piedritto attacco soletta superiore (Asta 6)</i>	134
7.5.9.	Armatura di ripartizione dello scatolare	135
8.	VERIFICHE GEOTECNICHE	142
8.1.	VERIFICA DELLA CAPACITÀ PORTANTE DEL TERRENO DI FONDAZIONE	142
8.2.	VERIFICA A GALLEGGIAMENTO	145
9.	ALLEGATO A. –SCATOLARE-CALCOLO AGLI ELEMENTI FINITI.....	148
10.	ALLEGATO C. –TABELLE PER IL CALCOLO DELLE SOLLECITAZIONI TRASVERSALI NELLA SOLETTA SUPERIORE	311

1. DESCRIZIONE DELL'OPERA

La presente relazione di calcolo riguarda il sottopasso scatolare previsto nell'ambito della realizzazione del Sottovia denominato "Svincolo autostazione di Reggiolo Rolo – Sottopasso Rampa B" dell'Autostrada Cispadana.

L'opera la cui sezione in retto misura 11.50x6.90m si sviluppa complessivamente per 36.36m . L'altezza di ricoprimento assunta ai fini del calcolo della struttura è pari a 1.00m.

Le azioni considerate nel calcolo sono quelle tipiche di una struttura interrata con le aggiunte delle azioni di tipo stradale, con applicazione della Normativa sui ponti ferroviari D. M. Min. II. TT. del 14 gennaio 2008 – Norme tecniche per le costruzioni.

L'opera ricade in zona sismica, pertanto, saranno applicate le azioni di rito previste dalla norma, così come riportato nei capitoli successivi.

2. DOCUMENTI DI RIFERIMENTO

[1] Elenco delle normative di riferimento “PD_0_0000_0000_0_GE_KT_01”

[2] Tabella materiali e classi di esposizione calcestruzzo “PD_0_0000_0000_0_GE_TB_01”

[3] Relazione geotecnica Sottopasso rampa B “PD_0_S01_SST01_0_GT_RB_01”

3. DURABILITÀ E PRESCRIZIONI SUI MATERIALI

Per garantire la durabilità delle strutture in calcestruzzo armato ordinario, esposte all'azione dell'ambiente, si devono adottare i provvedimenti atti a limitare gli effetti di degrado indotti dall'attacco chimico, fisico e derivante dalla corrosione delle armature e dai cicli di gelo e disgelo.

Al fine di ottenere la prestazione richiesta in funzione delle condizioni ambientali, nonché per la definizione della relativa classe, si fa riferimento alle indicazioni contenute nelle Linee Guida sul calcestruzzo strutturale edite dal Servizio Tecnico Centrale del Consiglio Superiore dei Lavori Pubblici ovvero alle norme UNI EN 206-1:2006 ed UNI 11104:2004.

Ai fini di preservare le armature dai fenomeni di aggressione ambientale, dovrà essere previsto un idoneo copriferro; il suo valore, misurato tra la parete interna del cassero e la generatrice dell'armatura metallica più vicina, individua il cosiddetto "copriferro nominale".

Il copriferro nominale c_{nom} è somma di due contributi, il copriferro minimo c_{min} e la tolleranza di posizionamento h . Vale pertanto: $c_{nom} = c_{min} + h$.

La tolleranza di posizionamento delle armature "h", per le strutture gettate in opera, può essere assunta pari a 5 mm, nell'ipotesi in cui sia previsto controllo di qualità con misura dei copriferri.

In accordo con le specifiche dei materiali da utilizzarsi per l'opera in oggetto, si utilizzano i seguenti tipi di calcestruzzo e copri ferri minimi. Il copriferro è valutato in accordo a quanto prescritto nella Norma UNI EN 1992-1-1, mentre la classe di resistenza minima è definita in accordo al Prospetto 4 della Norma UNI 11104:2004.

In base a quanto definito nel riferimento [2] e in accordo con quanto previsto nelle tabelle 4.2.III e 4.1.IV del D.M. 14 Gennaio 2008 si definiscono le condizioni ambientali ed i relativi limiti di apertura delle fessure accettabili per ciascun elemento strutturale.

Condizioni ambientali	Classe di esposizione
Ordinarie	X0, XC1, XC2, XC3, XF1
Aggressive	XC4, XD1, XS1, XA1, XA2, XF2, XF3
Molto aggressive	XD2, XD3, XS2, XS3, XA3, XF4

TABELLA 3.1 – DESCRIZIONE DELLE CONDIZIONI AMBIENTALI (TABELLA 4.2.III NTC 2008)

Nella tabella 4.1.IV del D.M. 14 Gennaio 2008, riportata di seguito per comodità, sono indicati i criteri di scelta dello stato limite di fessurazione con riferimento alle condizioni ambientale e al tipo di armatura. Nel caso specifico si evidenziano i limiti di apertura delle fessure da utilizzare per le verifiche agli stati limite di esercizio.

Gruppi di esigenze	Condizioni ambientali	Combinazione di azioni	Armatura			
			Sensibile		Poco sensibile	
			Stato limite	w_d	Stato limite	w_d
a	Ordinarie	frequente	ap. fessure	$\leq w_2$	ap. fessure	$\leq w_3$
		quasi permanente	ap. fessure	$\leq w_1$	ap. fessure	$\leq w_2$
b	Aggressive	frequente	ap. fessure	$\leq w_1$	ap. fessure	$\leq w_2$
		quasi permanente	decompressione	-	ap. fessure	$\leq w_1$
c	Molto aggressive	frequente	formazione fessure	-	ap. fessure	$\leq w_1$
		quasi permanente	decompressione	-	ap. fessure	$\leq w_1$

TABELLA 3.2 - CRITERI DI SCELTA DELLO STATO LIMITE DI FESSURAZIONE (TABELLA 4.1.IV NTC 2008)

4. INCIDENZE

Si forniscono qui di seguito le incidenze di armatura relative ai seguenti elementi costituenti l'Opera.

Cod Wbs	Descrizione Opera	Parte d'opera	Incidenza kg/mc		
			Fondazio ne	Elevazio ne	Solet ta
SST01	SVINCOLO REGGIOLO-ROLO - SOTTOPASSO RAMPA B	SCATOLARE	135	125	110
		MURO AD U (compresa vasca)	90	105	

5. CRITERI DI CALCOLO

In ottemperanza con la normativa vigente, i calcoli sono condotti con il metodo semiprobabilistico agli stati limite.

5.1. Calcolo delle spinte sui paramenti verticali

In generale occorre considerare, di volta in volta, le spinte più appropriate a seconda della deformabilità della parete.

Nel caso di muri per i quali si possano accettare significative deformazioni, è possibile assumere, sia in condizioni statiche sia in condizioni sismiche, un regime di spinte attive. Altrimenti è in genere necessario assumere condizioni di spinta a riposo.

In presenza di sisma, è consentito l'approccio pseudo-statico, secondo il quale il complesso muro + terreno mobilitato è pensato soggetto ad un'accelerazione sismica uniforme avente le seguenti componenti

$$\text{Orizzontale} = k_h g \qquad \text{Verticale} = k_v g = \pm 0.5 k_h g$$

Come nel caso statico, anche in condizioni sismiche è necessario distinguere tra:

- muri indeformabili;
- muri deformabili;
- muri molto deformabili;

Nella prima classe di muri (**muri indeformabili**) possono essere inclusi i manufatti aventi pareti adeguatamente contrastate, quali, ad esempio, gli scatolari. In questo caso è opportuno adottare spinte sismiche secondo la teoria di Wood (1973), come meglio indicato nel §5.1.4.

Nella categoria dei **muri deformabili** si possono includere le pareti sufficientemente deformabili grazie alla loro snellezza ma tuttavia sostanzialmente vincolate, in qualche modo, ad altre strutture, come ad esempio le pareti di manufatti a U. In questo caso potranno essere considerate spinte comprese tra valori a riposo e attive, in ragione della deformabilità. Queste ultime (sismiche attive) saranno valutate assumendo

(SLV) $k_h = \beta_m \cdot a_{max}/g$, con $\beta_m=1$

Nella categoria dei **muri molto deformabili** per i quali possono essere ipotizzati significativi spostamenti relativi tra muro e terreno, si possono includere, ad esempio, i muri di sostegno fondati su fondazioni dirette. In questo caso si assumeranno certamente spinte attive, da valutarsi, introducendo nel caso sismico un coefficiente β_m in accordo con la Tabella 7.11.II di NTC2008.

(SLV) $k_h = \beta_m \cdot a_{max}/g$ (β_m da Tab 7.11.II)

in questo caso $\beta_m = 0.31$,

Seguono ora i criteri generali di valutazione delle spinte, applicabili a geometrie ordinarie.

5.1.1. Spinte attive in condizioni statiche

Ad una generica profondità z , nel caso di terreno puramente granulare, lo sforzo orizzontale totale $\sigma_A(z)$ sulla parete è dato da:

$$\sigma_A(z) = K_A \cdot [\sigma_v(z) - u(z)] + u(z) \quad (5-1)$$

In cui

$\sigma_v(z)$ = sforzo verticale totale alla generica profondità, ossia il peso della colonna di terreno e di acqua soprastante la quota z .

$u(z)$ = pressione dell'acqua alla generica profondità

Il coefficiente di spinta attiva K_A può, in genere, essere assunto pari a

$$K_A = \tan^2\left(\frac{\pi}{4} - \frac{\phi}{2}\right) \quad (5-2)$$

È possibile, tuttavia, mettere in conto l'angolo d'attrito δ tra terra e muro, assumendo quindi che la spinta sia inclinata, rispetto alla normale alla superficie di contatto tra muro e terreno, di un angolo δ .

In questo caso il coefficiente di spinta attiva può essere valutato con le note formule derivate dalla teoria di Coulomb e sviluppate da Muller-Breslau.

CONDIZIONI DI SPINTA ATTIVA – Teoria di Coulomb

$$K_A = \frac{\text{sen}^2(\psi + \phi)}{\text{sen}^2 \psi \text{sen}(\psi - \delta) \left[1 + \sqrt{\frac{\text{sen}(\phi + \delta) \text{sen}(\phi - \beta)}{\text{sen}(\psi - \delta) \text{sen}(\psi + \beta)}} \right]^2} \quad (5-3)$$

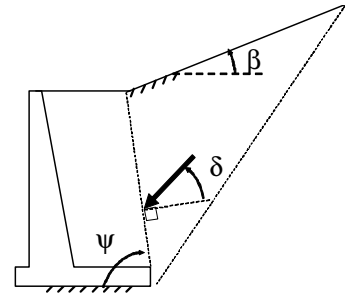

Operando nell'ambito del metodo agli stati limite, nelle formule precedenti, va introdotto l'angolo d'attrito di calcolo, cioè $\tan(\phi_d) = \tan(\phi_k) / \gamma_\phi$ se si opera nell'ambito di una combinazione GEO (ad esempio A2+M2+R2).

5.1.2. Spinte a riposo

Ad una generica profondità z , nel caso di terreno puramente granulare, lo sforzo orizzontale totale $\sigma_0(z)$ sulla parete è dato da:

$$\sigma_0(z) = K_0 \cdot [\sigma_v(z) - u(z)] + u(z) \quad (5-4)$$

In cui, nel caso di piano campagna orizzontale, il coefficiente di spinta a riposo K_0 se non diversamente definito, può essere assunto pari a

$$K_0 = (1 - \sin(\phi)) \cdot \sqrt{OCR} \quad (5-5)$$

Con $OCR = GSC =$ grado di sovraconsolidazione.

5.1.3. Spinte attive in condizioni sismiche

Nell'ambito dell'approccio pseudo-statico, il complesso muro + terreno mobilitato è pensato soggetto ad un'accelerazione sismica uniforme avente le seguenti componenti

Orizzontale = $k_h \cdot g$ Verticale = $k_v \cdot g$

La spinta totale attiva su un paramento di altezza pari ad H è data da:

$$E_d = \frac{1}{2} \gamma^* (1 \pm k_v) K_{A,E} H^2 + E_{ws} + E_{wd} \quad (5-6)$$

Il primo termine è la spinta attiva dovuta allo scheletro solido, il secondo termine E_{ws} è la risultante delle pressioni idrostatiche ed il terzo E_{wd} è la risultante delle sovrappressioni interstiziali.

I coefficienti di spinta attiva sono dati dalle seguenti espressioni (Mononobe & Okabe, nel seguito M-O):

CONDIZIONI DI SPINTA ATTIVA – Teoria di M-O

$$\beta \leq \phi - \theta: K_{A,E} = \frac{\text{sen}^2(\psi + \phi - \theta)}{\cos \theta \text{sen}^2 \psi \text{sen}(\psi - \theta - \delta) \left[1 + \sqrt{\frac{\text{sen}(\phi + \delta) \text{sen}(\phi - \beta - \theta)}{\text{sen}(\psi - \theta - \delta) \text{sen}(\psi + \beta)}} \right]^2}$$

$$\beta > \phi - \theta: K_{A,E} = \frac{\text{sen}^2(\psi + \phi - \theta)}{\cos \theta \text{sen}^2 \psi \text{sen}(\psi - \theta - \delta)}$$

(5-7)

Operando nell'ambito del metodo agli stati limite, nelle formule precedenti, va introdotto l'angolo d'attrito di calcolo, cioè $\tan(\phi_d) = \tan(\phi_k) / \gamma_\phi$ se si opera nell'ambito di una combinazione GEO (ad esempio A2+M2+R2).

A seconda della definizione del peso specifico γ^* del cuneo e dell'angolo θ definito come l'angolo, rispetto alla verticale, fra le azioni esterne orizzontali e quelle verticali agenti sul cuneo di spinta di volume V, l'espressione generale può essere utilizzata per tre diverse condizioni nelle quali può trovarsi il rilevato.

5.1.3.1 Rilevato asciutto

Non c'è alcuna azione dovuta all'acqua: corrisponde alla configurazione originale ipotizzata da M-O. Come peso specifico γ^* si deve assumere il peso secco γ_d ; la forza orizzontale F_h è pari alla massa del terreno moltiplicata per l'accelerazione orizzontale mentre la forza verticale F_v è il peso del cuneo incrementato o decrementato dall'accelerazione sismica verticale; quindi:

$$\gamma^* = \gamma_d$$

$$\tan \theta = \frac{k_h}{1 \pm k_v}$$

$$E_{ws} = E_{wd} = 0$$

5.1.3.2 Rilevato saturo a grana fine (dinamicamente impervio: $k < 5 \cdot 10^{-4}$ m/s)

In sostanza si assume che l'acqua, imprigionata negli interstizi, si muova insieme con il terreno: l'accelerazione sismica agirà quindi sulla massa complessiva (terreno+acqua) del cuneo, pari a $V \cdot \gamma_{sat}$. Si ammette che le pressioni interstiziali non subiscano variazioni ai fini del calcolo delle azioni sulla parete. In questo caso l'equilibrio limite del cuneo è fatto al netto della risultante delle azioni idrostatiche e quindi, nelle formule generali, si assumerà:

$$\gamma^* = \gamma'$$

$$\tan \theta = \frac{\gamma_{sat}}{\gamma'} \frac{k_h}{1 \pm k_v}$$

Alla spinta efficace dovrà essere aggiunta la spinta idrostatica dell'acqua, mentre, per ipotesi, la componente idrodinamica non può svilupparsi. Quindi:

$$E_{ws} = \frac{1}{2} \gamma_w H^2$$

$$E_{wd} = 0$$

5.1.3.3 Rilevato saturo a grana grossa (dinamicamente permeabile: $k \geq 5 \cdot 10^{-4}$ m/s)

Si ammette che l'acqua negli interstizi possa muoversi liberamente, indipendentemente dalle deformazioni subite dal terreno: l'accelerazione sismica agirà quindi sulla massa della sola parte solida del cuneo, pari a

$V \cdot \gamma_d$. L'equilibrio limite del cuneo è fatto al netto della risultante delle pressioni interstiziali e quindi, nelle formule generali, si assumerà:

$$\gamma^* = \gamma'$$

$$\tan \theta = \frac{\gamma_d}{\gamma'} \frac{k_h}{1 \pm k_v}$$

In questo caso dovranno essere aggiunte sia la spinta idrostatica sia la sovrappinta idrodinamica della stessa acqua di falda.

$$E_{ws} = \frac{1}{2} \gamma_w H^2$$

$$E_{wd} = \frac{7}{12} k_h \gamma_w H'^2 \quad \text{con } H' = \text{altezza della freatica dal piede del muro.}$$

5.1.3.4 Punto di applicazione delle spinte attive sismiche

Considerato che la spinta attiva complessiva è in generale composta da tre termini, occorre calcolare il punto di applicazione di ognuno di essi

1. **Componente associata allo scheletro solido:** è possibile operare come segue

- a) si calcola la spinta attiva in condizioni statiche ($S_{A,S}$)
- b) si calcola la quota parte efficace di spinta sismica E_d dovuta alla terra:

$$S_{A,E} = \frac{1}{2} \gamma^* (1 \pm k_v) K_{A,E} H^2$$

Nel caso di terreno eterogeneo, la spinta attiva è calcolata considerando la variabilità di $K_{A,sismico}$. Nel caso di terreno omogeneo ma parzialmente in falda, si suggerisce di adottare l'approccio sopra indicato, piuttosto che introdurre diversi valori dei coefficienti di spinta.

- c) si calcola l'incremento di spinta dovuto alla terra in caso di sisma (componente efficace):

$$\Delta S_A = S_{A,E} - S_{A,S}$$

- d) Nel caso di muri che possano ruotare alla base, si può considerare che tale incremento abbia una risultante nello stesso punto della risultante delle spinte statiche
- e) Negli altri casi si può assumere che tale azione si distribuisca uniformemente sulla parete, il che equivale ad applicare un carico uniformemente distribuito pari a:

$$q = \Delta S_A / H$$

2. **Componente idrostatica:** è applicata come nel caso statico

3. **Componente idrodinamica (E_{wd}):** se esiste, è applicata considerando la seguente distribuzione di pressioni:

$$q_{wd}(z) = \pm \frac{7}{8} k_h \gamma_w \sqrt{H' \cdot z} \quad \text{con } z \text{ quota del generico punto rispetto la base della parete.}$$

5.1.4. Sovrappinte sismiche su muri non in grado di spostarsi

In questo caso l'utilizzo delle equazioni di M-O non è raccomandato. Le spinte delle terre, sono calcolate in regime di spinta a riposo che comporta il calcolo delle spinte sismiche in tali condizioni; l'incremento dinamico di spinta del terreno può essere quindi calcolato attraverso la nota formulazione di Wood (1973) come:

$$\Delta P_d = S \cdot a_g / g \cdot \gamma \cdot h_{tot}^2 = a_{max} / g \cdot \gamma \cdot h_{tot}^2$$

Con h_{tot} = altezza del muro.

Questa spinta è applicata come una distribuzione uniforme lungo l'altezza h_{tot} .

Il punto di applicazione della spinta che interessa lo scatolare è posto $h_{scat}/2$, con "h_{tot}" altezza dalla fondazione dello scatolare al piano stradale e h_{scat} l'altezza dello scatolare.

Essendo "ΔP_d" la risultante globale, ed il diagramma di spinta di tipo rettangolare, è immediato ricavare la quota parte della spinta che agisce sul piedritto dello scatolare.

L'azione sismica è rappresentata da un insieme di forze statiche orizzontali e verticali, date dal prodotto delle forze di gravità per i coefficienti sismici in precedenza definiti, di cui la componente verticale è considerata agente verso l'alto o verso il basso, in modo da produrre gli effetti più sfavorevoli.



FIGURA 5-1 ALTEZZE DI RIFERIMENTO PER IL CALCOLO DELL'AZIONE SISMICA

5.1.4.1 Rilevato parzialmente immerso

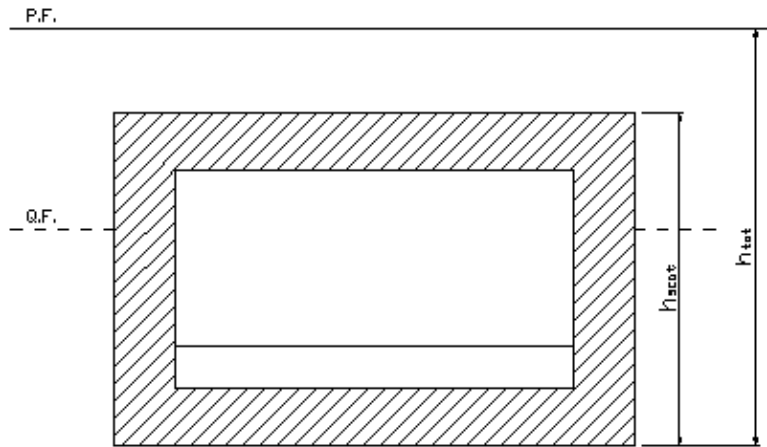

FIGURA 5-2: TERRAPIENO PARZIALMENTE IMMERSO.

Ebeling e Morrison (1992) indicano il modo per utilizzare, anche in questo caso, le equazioni di M-O: sostanzialmente questo caso può essere assimilato a quello di un terrapieno completamente immerso omogeneo, avente un peso specifico equivalente. Per calcolare la risultante delle spinte, si potrà operare come segue. Si definiscono i pesi specifici medi da associare rispettivamente alla componente efficace verticale ed alla componente laterale

$$\gamma_v^* = \left(\frac{h_w}{h}\right)^2 \cdot \gamma' + \left[1 - \left(\frac{h_w}{h}\right)^2\right] \cdot \gamma_d$$

$$\gamma_H^* = \begin{cases} \gamma_d & \text{se terreno din. permeabile} \\ \left(\frac{h_w}{h}\right)^2 \cdot \gamma_{sat} + \left[1 - \left(\frac{h_w}{h}\right)^2\right] \cdot \gamma_d & \text{se terreno din. impervio} \end{cases}$$

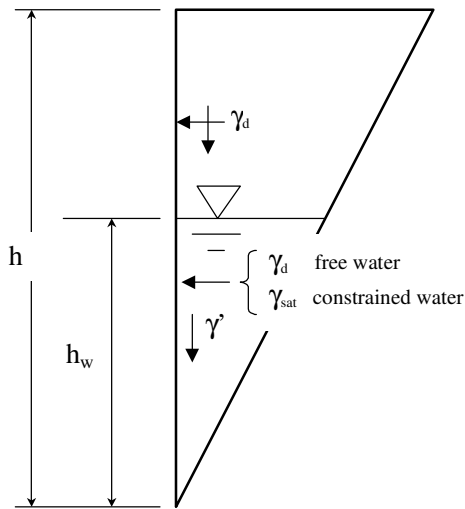
Definendo

$$\tan \theta = \frac{\gamma_H^* \cdot k_h}{\gamma_v^* \cdot 1 - k_v}$$

si applicherà poi la (5-6) calcolando i coefficienti di spinta tramite le (5-7) e ponendo $\gamma^* = \gamma_v^*$.

5.1.4.2 Punto di applicazione delle spinte attive sismiche

Considerato che la spinta attiva complessiva è in generale composta da tre termini, occorre calcolare il punto di applicazione di ognuno di essi

4. **Componente associata allo scheletro solido:** è possibile operare come segue

f) si calcola la spinta attiva in condizioni statiche ($S_{A,S}$)

g) si calcola la quota parte efficace di spinta sismica E_d dovuta alla terra:

$$S_{A,E} = \frac{1}{2} \gamma^* (1 \pm k_v) K_{A,E} H^2$$

Nel caso di terreno eterogeneo, la spinta attiva è calcolata considerando la variabilità di $K_{A,sismico}$. Nel caso di terreno omogeneo ma parzialmente in falda, si suggerisce di adottare l'approccio sopra indicato, piuttosto che introdurre diversi valori dei coefficienti di spinta.

h) si calcola l'incremento di spinta dovuto alla terra in caso di sisma (componente efficace):

$$\Delta S_A = S_{A,E} - S_{A,S}$$

i) Nel caso di muri che possano ruotare alla base, si può considerare che tale incremento abbia una risultante nello stesso punto della risultante delle spinte statiche

j) Negli altri casi si può assumere che tale azione si distribuisca uniformemente sulla parete, il che equivale ad applicare un carico uniformemente distribuito pari a:

$$q = \Delta S_A / H$$

5. **Componente idrostatica:** è applicata come nel caso statico

6. **Componente idrodinamica (E_{wd}):** se esiste, è applicata considerando la seguente distribuzione di pressioni:

$$q_{wd}(z) = \pm \frac{7}{8} k_h \gamma_w \sqrt{H \cdot z} \quad \text{con } z \text{ quota del generico punto rispetto la base della parete.}$$

5.1.5. Sovraspinte sismiche su muri non in grado di spostarsi

In questo caso l'utilizzo delle equazioni di M-O non è raccomandato. Le spinte delle terre, sono calcolate in regime di spinta a riposo che comporta il calcolo delle spinte sismiche in tali condizioni; l'incremento dinamico di spinta del terreno può essere quindi calcolato attraverso la nota formulazione di Wood (1973) come:

$$\Delta P_d = S \cdot a_g / g \cdot \gamma \cdot h_{tot}^2 = a_{max} / g \cdot \gamma \cdot h_{tot}^2$$

Con h_{tot} = altezza del muro.

Questa spinta è applicata come una distribuzione uniforme lungo l'altezza h_{tot} .

Nel caso di scatolare, si assumerà $\gamma = 19.5 \text{ kN/m}^3$ = peso di volume del materiale compattato del rilevato.

Il punto di applicazione della spinta che interessa lo scatolare è posto $h_{scat}/2$, con “ h_{tot} ” altezza dalla fondazione dello scatolare al piano stradale e h_{scat} l'altezza dello scatolare.

Essendo “ ΔP_d ” la risultante globale, ed il diagramma di spinta di tipo rettangolare, è immediato ricavare la quota parte della spinta che agisce sul piedritto dello scatolare.

L'azione sismica è rappresentata da un insieme di forze statiche orizzontali e verticali, date dal prodotto delle forze di gravità per i coefficienti sismici in precedenza definiti, di cui la componente verticale è considerata agente verso l'alto o verso il basso, in modo da produrre gli effetti più sfavorevoli.



FIGURA 5-3 ALTEZZE DI RIFERIMENTO PER IL CALCOLO DELL'AZIONE SISMICA

5.2. Criteri e definizione dell'azione sismica

L'effetto dell'azione sismica di progetto sull'opera nel suo complesso, includendo il volume significativo di terreno, la struttura di fondazione, gli elementi strutturali e non strutturali, nonché gli impianti, deve rispettare gli stati limite ultimi e di esercizio definiti al § 3.2.1, i cui requisiti di sicurezza sono indicati nel § 7.1 della norma.

Il rispetto degli stati limite si considera conseguito quando:

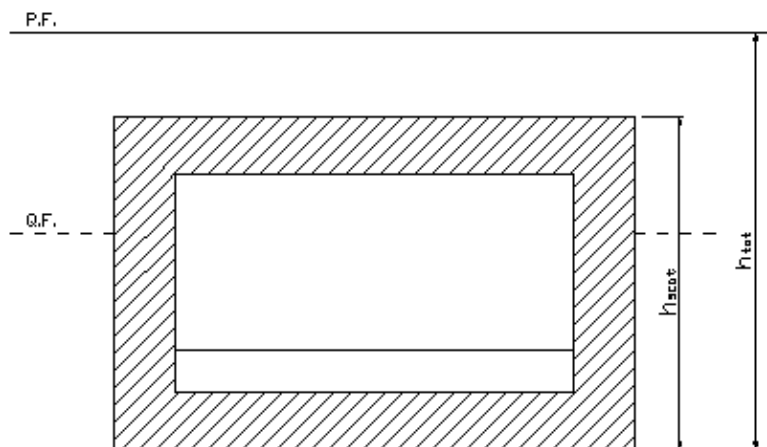
nei confronti degli stati limite di esercizio siano rispettate le verifiche relative al solo Stato Limite di Danno;

nei confronti degli stati limite ultimi siano rispettate le indicazioni progettuali e costruttive riportate nel § 7 e siano soddisfatte le verifiche relative al solo Stato Limite di salvaguardia della Vita.

Per Stato Limite di Danno (SLD) s'intende che l'opera, nel suo complesso, a seguito del terremoto, includendo gli elementi strutturali, quelli non strutturali, le apparecchiature rilevanti alla sua funzione, subisce danni tali da non provocare rischi agli utenti e non compromette significativamente la capacità di resistenza e di rigidezza nei confronti delle azioni verticali e orizzontali. Lo stato limite di esercizio comporta la verifica delle tensioni di lavoro, in conformità al § 4.1.2.2.5 (NT).

Per Stato Limite di salvaguardia della Vita (SLV) si intende che l'opera a seguito del terremoto subisce rotture e crolli dei componenti non strutturali e impiantistici e significativi danni di componenti strutturali, cui si associa una perdita significativa di rigidezza nei confronti delle azioni orizzontali (creazione di cerniere plastiche secondo il criterio della gerarchia delle resistenze), mantenendo ancora un margine di sicurezza (resistenza e rigidezza) nei confronti delle azioni verticali.

Gli stati limite, sia di esercizio sia ultimi, sono individuati riferendosi alle prestazioni che l'opera a realizzarsi deve assolvere durante un evento sismico; per la funzione che l'opera deve espletare nella sua vita utile, è significativo calcolare lo Stato Limite di Danno (SLD) per l'esercizio e lo Stato Limite di Salvaguardia della Vita (SLV) per lo stato limite ultimo.

In merito alle opere scatolari di cui trattasi, nel rispetto del punto § 7.9.2., assimilando l'opera scatolare alla categoria delle spalle da ponte, rientrando tra le opere che si muovono con il terreno (§ 7.9.2.1), si può ritenere che la struttura debba mantenere sotto l'azione sismica un comportamento elastico; queste categorie di opere che si muovono con il terreno non subiscono le amplificazioni dell'accelerazione del suolo.

Le azioni sismiche sono valutate in relazione al periodo di riferimento della struttura, che si ricava moltiplicandone la vita nominale V_N per il coefficiente d'uso C_U

$$V_R = V_N \cdot C_U$$

Il valore del coefficiente d'uso C_U è definito, al variare della classe d'uso, come mostrato nella tabella seguente:

CLASSE D'USO	I	II	III	IV
COEFFICIENTE C_U	0,7	1,0	1,5	2,0

TABELLA 5.1 VALORI DEL COEFFICIENTE D'USO C_U

Il valore di probabilità di superamento del periodo di riferimento P_{VR} , cui riferirsi per individuare l'azione sismica agente, è:

$$P_{VR}(SLV) = 10\%$$

Il **periodo di ritorno** dell'azione sismica T_R espresso in anni vale:

$$T_R(SLV) = - \frac{V_r}{\ln(1 - P_{vr})}$$

ASSE AUTOSTRADALE						
OPERA	Vita Nominale [anni]	Classe d'uso	Coefficiente d'uso	Periodo di Riferimento [anni]	Periodo di ritorno [anni]	di SLV
Rilevati	100	IV	2	200		1898
Viadotti	100	IV	2	200		1898
Sovrappassi di svincolo	100	IV	2	200		1898
Ponti	100	IV	2	200		1898
Gallerie e trincee confinate	100	IV	2	200		1898
Sovrappassi	100	IV	2	200		1898
Sottovia						
Manufatto scatolare per sottovia la cui proiezione cade sull'asse autostradale	100	IV	2	200		1898
Muri ad U per sottovia statali	50	IV	2	100		949
Muri ad U per sottovia ex statali e provinciali	50	III	1.5	75		712
Muri ad U per sottovia comunali e poderali	50	II	1	50		475
Edifici di stazione e caserma di polizia	50	IV	2	100		949
Caselli autostradali	50	IV	2	100		949
Opere minori: attraversamenti idraulici	100	IV	2	200		1898

Opere minori: muri di sostegno per rilevato autostradale (sottoscarpa)	100	IV	2	200	1898
Opere minori: muri di sostegno per trincea autostradale (controripa)	100	IV	2	200	1898
Opere provvisionali (1)	10	II	1	10	95
VIABILITA' DI ADDUZIONE E DI COLLEGAMENTO (tipologia C1 e C2)					
OPERA	<i>Vita Nominale [anni]</i>	<i>Classe d'uso</i>	<i>Coefficiente d'uso</i>	<i>Periodo di Riferimento [anni]</i>	<i>Periodo di ritorno SLV [anni]</i>
Opere provvisionali (1)	10	II	1	10	
Riquilificazione della S.P. 72 "Parma-Mezzani (1PR) - Tipologia F2					
Rilevati	50	III	1.5	75	712
Opere minori: attraversamenti idraulici	50	III	1.5	75	712
Variante alla S.P. n 41 in corrispondenza del tracciato Cispadano – tratto tra S.P. n 60 e Brescello (1RE) – tipologia C1					
Rilevati	50	III	1.5	75	712
Ponti	50	III	1.5	75	712
Viadotti	50	III	1.5	75	712
Sottovia	50	III	1.5	75	712
Opere minori: attraversamenti idraulici	50	III	1.5	75	712
Cispadana tra la S.P. n 2 "Reggiolo-Gonzaga" e la ex S.S. n 62 "della Cisa" (2RE) – tipologia C1					
Rilevati	50	III	1.5	75	712
Ponti	50	III	1.5	75	712
Opere minori: attraversamenti idraulici	50	III	1.5	75	712
Raccordo Bondeno-Cento-Autostrada Cispadana (1FE)					

Rilevati tipologia C2	50	III	1.5	75	712
Rilevati tipologia F2	50	III	1.5	75	712
Ponti	50	III	1.5	75	712
Opere minori: attraversamenti idraulici	50	III	1.5	75	712

(1) Le verifiche sismiche di opere provvisorie o strutture in fase costruttiva possono omettersi quando le relative durate previste in progetto siano inferiori a 2 anni. (Rif. NTC 2008 par. 2.4.1)

TABELLA 5.2 PERIODO DI RITORNO PER L'AZIONE SISMICA

Dato il valore del periodo di ritorno suddetto, tramite le tabelle riportate nell'Allegato B della norma o tramite la mappatura messa a disposizione in rete dall'Istituto Nazionale di Geofisica e Vulcanologia (INGV), è possibile definire i valori di a_g , F_0 , T_c^* .

a_g → accelerazione massima al sito;

F_0 → valore massimo del fattore di amplificazione dello spettro in accelerazione orizzontale;

T_c^* → periodo di inizio del tratto a velocità costante dello spettro in accelerazione orizzontale;

S → coefficiente che comprende l'effetto dell'amplificazione stratigrafica (S_s) e dell'amplificazione topografica (S_t).

L'opera in oggetto ricade nelle vicinanze del comune di Reggiolo di cui si riportano le caratteristiche sismiche in funzione del periodo di ritorno del sisma definito nella tabella precedente :

Periodo di ritorno SLV [anni]	a_g/g	F_0	T_c^* (s)	Categoria sottosuolo	S_s	a_{max}/g
1898	0.221	2.489	0.285	C	1.37	0.303

Il calcolo viene eseguito con il metodo pseudostatico (§ 7.11.6 NT). In queste condizioni l'azione sismica è rappresentata da una forza statica equivalente pari al prodotto delle forze di gravità per un opportuno coefficiente sismico.

5.3. Combinazioni di carico

Le combinazioni di carico, utilizzate per condurre le verifiche agli stati limite ultimi e agli stati limite di esercizio, sono state originate in ottemperanza con quanto prescritto dalla vigente normativa.

5.3.1. Combinazioni per la verifica allo SLU

Gli stati limite ultimi delle opere interrato si riferiscono allo sviluppo di meccanismi di collasso, determinati dalla mobilitazione della resistenza del terreno, e al raggiungimento della resistenza degli elementi strutturali che compongono l'opera.

Le verifiche agli stati limite ultimi sono eseguiti in riferimento ai seguenti stati limite:

-SLU di tipo geotecnico (GEO) e di equilibrio di corpo rigido (EQU)

collasso per carico limite dell'insieme fondazione-terreno;

-SLU di tipo strutturale (STR)

raggiungimento della resistenza negli elementi strutturali.

Trattandosi di opere interrato, le verifiche saranno condotte secondo l'approccio progettuale "Approccio 1", utilizzando i coefficienti parziali riportati nelle Tabelle 6.2.I e 5.1.V per i parametri geotecnici e le azioni.

combinazione 1 → (A1+M1+R1) ⇒ STR (verifiche degli elementi strutturali)

combinazione 2 → (A2+M2+R2) ⇒ GEO (carico limite)

PARAMETRO	GRANDEZZA ALLA QUALE APPLICARE IL COEFF. PARZIALE	COEFFICIENTE PARZIALE γ_M	M ₁	M ₂
Tangente dell'angolo di resistenza al taglio	$\tan \varphi'_k$	$\gamma_{\varphi'}$	1	1,25
Coesione efficace	c'_k	$\gamma_{c'}$	1	1,25
Resistenza non drenata	c'_{uk}	γ_{cu}	1	1,4

Peso dell'unità di volume	γ	γ_{γ}	1	1
---------------------------	----------	-------------------	---	---

TABELLA 5.3 - COEFFICIENTI PARZIALI PER I PARAMETRI DEL TERRENO (TABELLA 6.2.II NTC 2008)

VERIFICA	COEFF. PARZIALE (R1)	COEFF. PARZIALE (R2)
Capacità portante della fondazione	$\gamma_{R=1}$	$\gamma_{R=1}$
Scorrimento	$\gamma_{R=1}$	$\gamma_{R=1}$
Resistenza del terreno a valle	$\gamma_{R=1}$	$\gamma_{R=1}$

TABELLA 5.4- COEFFICIENTI PARZIALI γ_R PER LA RESISTENZA DEL SISTEMA

Ai fini delle verifiche degli stati limite ultimi si definiscono le seguenti combinazioni:

$$\text{STR}) \Rightarrow \gamma_{G1} \cdot G_1 + \gamma_{G2} \cdot G_2 + \gamma_{Q1} \cdot Q_{k1} + \gamma_{0i} \sum_i \psi_{0i} \cdot Q_{ki} \Rightarrow (\Phi_d' = \Phi_k')$$

$$\text{GEO}) \Rightarrow \gamma_{G1} \cdot G_1 + \gamma_{G2} \cdot G_2 + \gamma_{Q1} \cdot Q_{k1} + \gamma_{0i} \sum_i \psi_{0i} \cdot Q_{ki} \Rightarrow (\Phi_d' = \tan^{-1}(\tan \Phi_k' / \gamma_{\phi}))$$

I valori dei coefficienti parziali delle azioni sono dedotti dalla tabella 5.1.V del D.M. 14 Gennaio 2008

Tabella 5.1.V – Coefficienti parziali di sicurezza per le combinazioni di carico agli SLU

		Coefficiente	EQU ⁽¹⁾	A1 STR	A2 GEO
Carichi permanenti	favorevoli	γ_{G1}	0,90	1,00	1,00
	sfavorevoli		1,10	1,35	1,00
Carichi permanenti non strutturali ⁽²⁾	favorevoli	γ_{G2}	0,00	0,00	0,00
	sfavorevoli		1,50	1,50	1,30
Carichi variabili da traffico	favorevoli	γ_Q	0,00	0,00	0,00
	sfavorevoli		1,35	1,35	1,15
Carichi variabili	favorevoli	γ_{Qi}	0,00	0,00	0,00
	sfavorevoli		1,50	1,50	1,30
Distorsioni e presollecitazioni di progetto	favorevoli	$\gamma_{\epsilon 1}$	0,90	1,00	1,00
	sfavorevoli		1,00 ⁽³⁾	1,00 ⁽⁴⁾	1,00
Ritiro e viscosità, Variazioni termiche, Cedimenti vincolari	favorevoli	$\gamma_{\epsilon 2}, \gamma_{\epsilon 3}, \gamma_{\epsilon 4}$	0,00	0,00	0,00
	sfavorevoli		1,20	1,20	1,00

⁽¹⁾ Equilibrio che non coinvolga i parametri di deformabilità e resistenza del terreno; altrimenti si applicano i valori di GEO.
⁽²⁾ Nel caso in cui i carichi permanenti non strutturali (ad es. carichi permanenti portati) siano compiutamente definiti si potranno adottare gli stessi coefficienti validi per le azioni permanenti.
⁽³⁾ 1,30 per instabilità in strutture con precompressione esterna
⁽⁴⁾ 1,20 per effetti locali

5.3.2. Combinazioni per la verifica allo SLE

Ai fini delle verifiche degli stati limite di esercizio (fessurazione/ stato tensionale) si definiscono le seguenti combinazioni:

$$\text{Frequente)} \quad \Rightarrow \quad G_1 + G_2 + \psi_{11} \cdot Q_{k1} + \sum_i \psi_{2i} \cdot Q_{ki} \quad \Rightarrow (\Phi_d' = \Phi_k')$$

$$\text{Quasi permanente)} \quad \Rightarrow \quad G_1 + G_2 + \psi_{21} \cdot Q_{k1} + \sum_i \psi_{2i} \cdot Q_{ki} \quad \Rightarrow (\Phi_d' = \Phi_k')$$

$$\text{Rara)} \quad \Rightarrow \quad G_1 + G_2 + Q_{k1} + \sum_i \psi_{0i} \cdot Q_{ki} \quad \Rightarrow (\Phi_d' = \Phi_k')$$

I valori dei coefficienti di combinazione sono dedotti dalla tabella 5.1.Vi del D.M. 14 Gennaio 2008.

Tabella 5.1.VI - Coefficienti ψ per le azioni variabili per ponti stradali e pedonali

<i>Azioni</i>	<i>Gruppo di azioni (Tabella 5.1.IV)</i>	<i>Coefficiente Ψ_0 di combinazione</i>	<i>Coefficiente Ψ_1 (valori frequenti)</i>	<i>Coefficiente Ψ_2 (valori quasi permanenti)</i>
<i>Azioni da traffico (Tabella 5.1.IV)</i>	Schema 1 (Carichi tandem)	0,75	0,75	0,0
	Schemi 1, 5 e 6 (Carichi distribuiti)	0,40	0,40	0,0
	Schemi 3 e 4 (carichi concentrati)	0,40	0,40	0,0
	Schema 2	0,0	0,75	0,0
	2	0,0	0,0	0,0
	3	0,0	0,0	0,0
	4 (folla)	----	0,75	0,0
	5	0,0	0,0	0,0
<i>Vento q_5</i>	Vento a ponte scarico SLU e SLE	0,6	0,2	0,0
	Esecuzione	0,8	----	0,0
	Vento a ponte carico	0,6		
<i>Neve q_5</i>	SLU e SLE	0,0	0,0	0,0
	esecuzione	0,8	0,6	0,5
<i>Temperatura</i>	T_k	0,6	0,6	0,5

5.3.3. Combinazioni per la condizione sismica

Per la condizione sismica, le combinazioni per gli stati limite ultimi da prendere in considerazione sono le seguenti (approccio 1):

$$\text{STR}) \Rightarrow E+G_1+G_2+\sum_i \Psi_{2i} \cdot Q_{ki} \Rightarrow (\Phi_d' = \Phi_k')$$

$$\text{GEO}) \Rightarrow E+G_1+G_2+\sum_i \Psi_{2i} \cdot Q_{ki} \Rightarrow (\text{spinte } \Phi_d' = \tan^{-1}(\tan \Phi_k' / \gamma_\phi))$$

Gli effetti dell'azione sismica saranno valutati tenendo conto delle masse associate ai seguenti carichi gravitazionali:

$$G_1+G_2+\sum_i \Psi_{2i} \cdot Q_{ki}$$

6. PARAMETRI GEOTECNICI

Ai fini del calcolo della spinta esercitata dalle terre sui piedritti e del carico da ricoprimento sulla soletta superiore del **manufatto scatolare** si utilizzano i parametri seguenti, in accordo con quanto riportato nella Relazione Geotecnica di cui al rif. [3]:

- angolo di attrito interno del terreno $\Phi = 23^\circ$
- coefficiente di spinta a riposo $k_0 = 0.609$ (stato limite STR)
- coefficiente di spinta attiva $k_a = 0.438$ (stato limite STR)
- coefficiente di spinta a riposo, combinazione M2 $k_{0,M2} = 0.67$ (stato limite GEO)
- coefficiente di spinta attiva, combinazione M2 $k_{a,M2} = 0.51$ (stato limite GEO)
- peso specifico del terreno asciutto $\gamma_{dry} = 18.5$ [kN/m³]
- coefficiente di sottofondazione $k_s = 5000$ [kN/m³]

Si assume inoltre, ai fini del calcolo dei carichi permanenti, un peso specifico per la piattaforma stradale pari a $\gamma_{pav} = 22$ kN/m³.

7. SOTTOPASSO SCATOLARE

Si riportano di seguito le dimensioni geometriche della struttura:

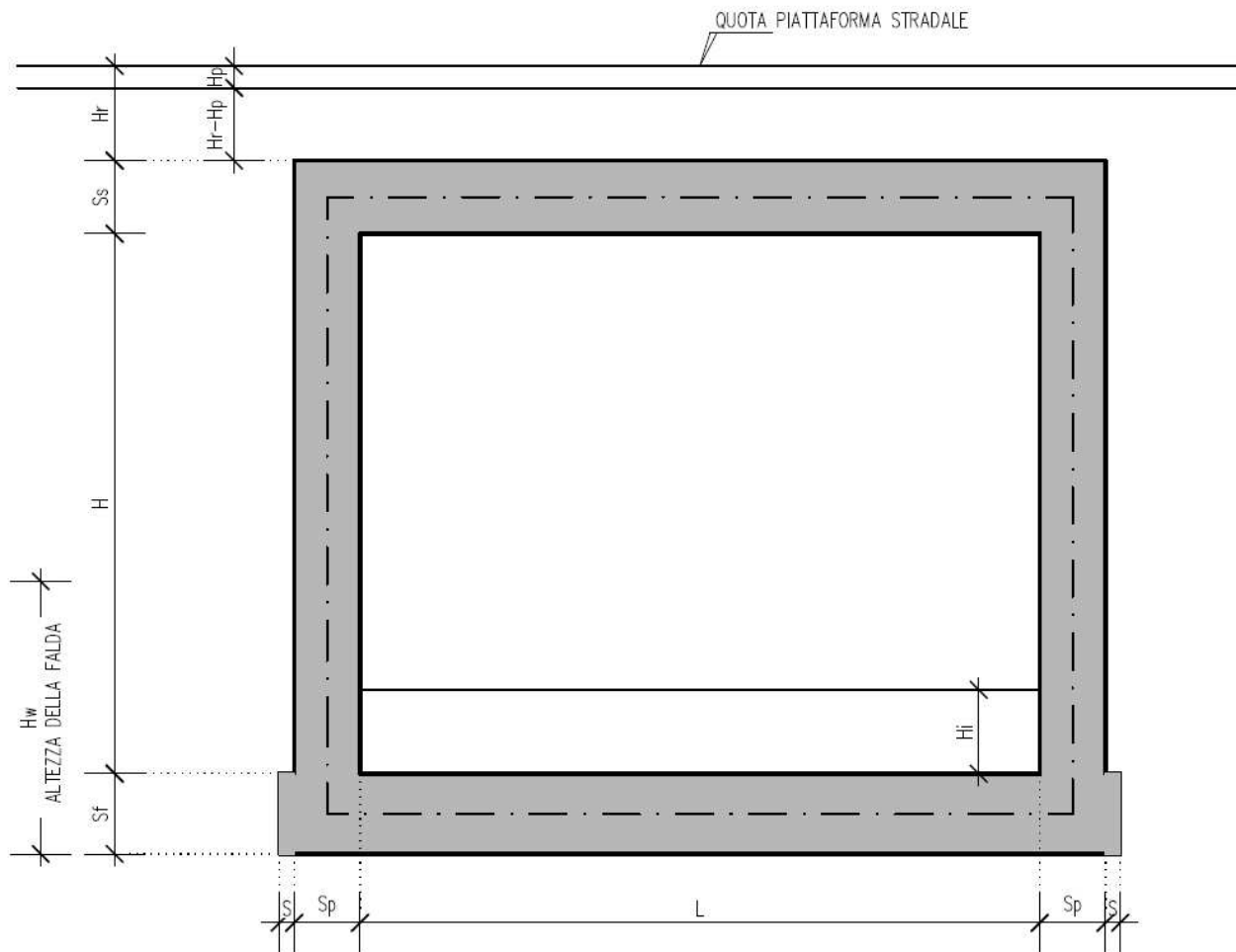

Dimensioni geometriche (sezione in retto):

L	=	11.50	m
H	=	6.90	m
H _r	=	1.00	m
H _p	=	0.40	m
S _p	=	1.10	m



$S_s = 1.10 \text{ m}$

$S = 0.20 \text{ m}$

$S_f = 1.20 \text{ m}$

$H_i = 1.00 \text{ m}$

Falda? si

$H_f = 4.50 \text{ m}$

rispetto ad asse soletta inferiore

7.1. PROGRAMMI DI CALCOLO UTILIZZATI

7.1.1. Pro Sap

Il calcolo della struttura viene condotto con il programma PRO_SAP (prodotto dalla 2S.I. Software e Servizi per l'Ingegneria S.r.l. P.tta Schiatti 8/b 44100 Ferrara)

Gli elementi utilizzati per la modellazione dello schema statico della struttura sono i seguenti:

- Elemento tipo BEAM (trave)
- Elemento tipo BOUNDARY (molla)
- Elemento tipo STIFFNESS (matrice di rigidezza)

Il codice di calcolo adottato e' ALGOR SUPERSAP prodotto dalla ALGOR INTERACTIVE SYSTEMS, Inc. Pittsburgh, PA, USA.

Il programma SUPERSAP applica il metodo degli elementi finiti a strutture di forma qualunque, diversamente caricate e vincolate, nell' ambito del comportamento lineare delle stesse.

Si sottolinea che il solutore ALGOR SUPERSAP e' stato sottoposto, con esito positivo e relativa certificazione, ai test NAFEMS (test di confronto della National Agency for Finite Element Methods and Standards in Inghilterra).

Inoltre, il solutore ALGOR SUPERSAP e' soggetto ad attivita' di controllo ai sensi della QA (quality assurance), condizione essenziale per l' utilizzo dei codici di calcolo nell' ambito della progettazione nucleare ed off-shore.

7.1.2. Modellazione adottata

La struttura viene schematizzata attraverso un modello analitico agli elementi finiti. Si è assunto lo schema statico di telaio chiuso. La mesh è composta da 16 beam elements e da 16 nodi (figure 2a e 2b); l'output di calcolo viene raccolto nell'allegato.

L'analisi strutturale e' condotta con il metodo degli spostamenti per la valutazione dello stato tenso-deformativo indotto da carichi statici.

Il suolo viene modellato facendo ricorso all'usuale artificio delle molle elastiche alla Winkler.

Nel caso in esame il valore della costante di sottofondo si assume pari a:

$$K_s = 5000 \text{ kN/m}^3$$

Agli effetti delle caratteristiche geometriche delle varie aste si è quindi assunto:

- una sezione rettangolare $b \times h = 100 \times S_s$ cm per la soletta superiore
- una sezione rettangolare $b \times h = 100 \times S_f$ cm per la soletta di fondazione
- una sezione rettangolare $b \times h = 100 \times S_p$ cm per i piedritti

Per le aste del reticolo si è assunto:

$E_c = 31477 / 32308 \text{ N/mm}^2$; modulo elastico del calcestruzzo rispettivamente per classe di resistenza C25/30 e C28/35.

Lo schema statico della struttura e la relativa numerazione dei nodi e delle aste sono riportati nelle figure seguenti:

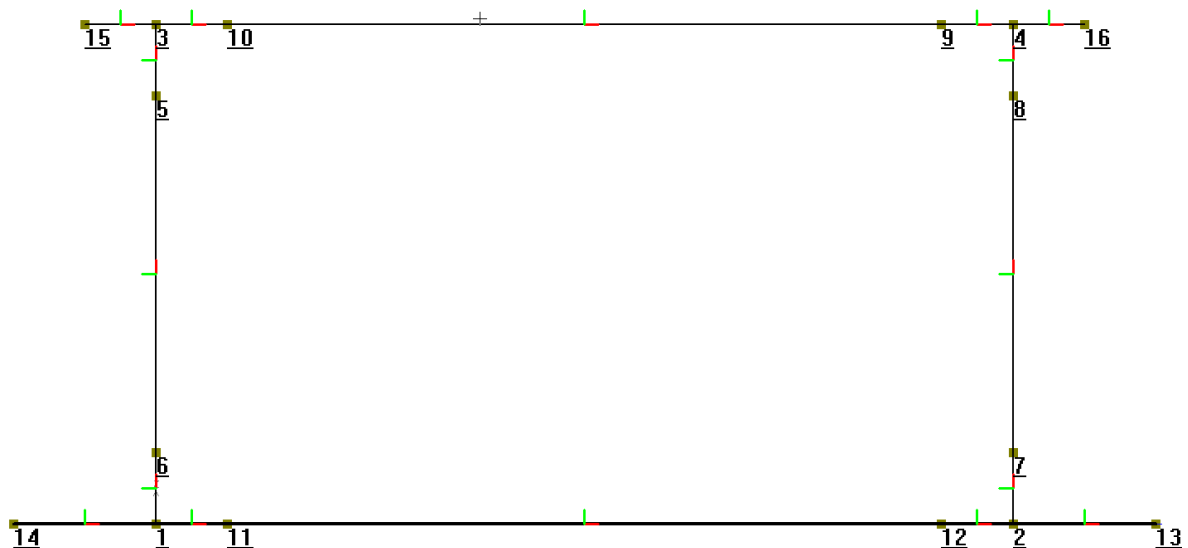

FIG. 2A - NUMERAZIONE DEI NODI

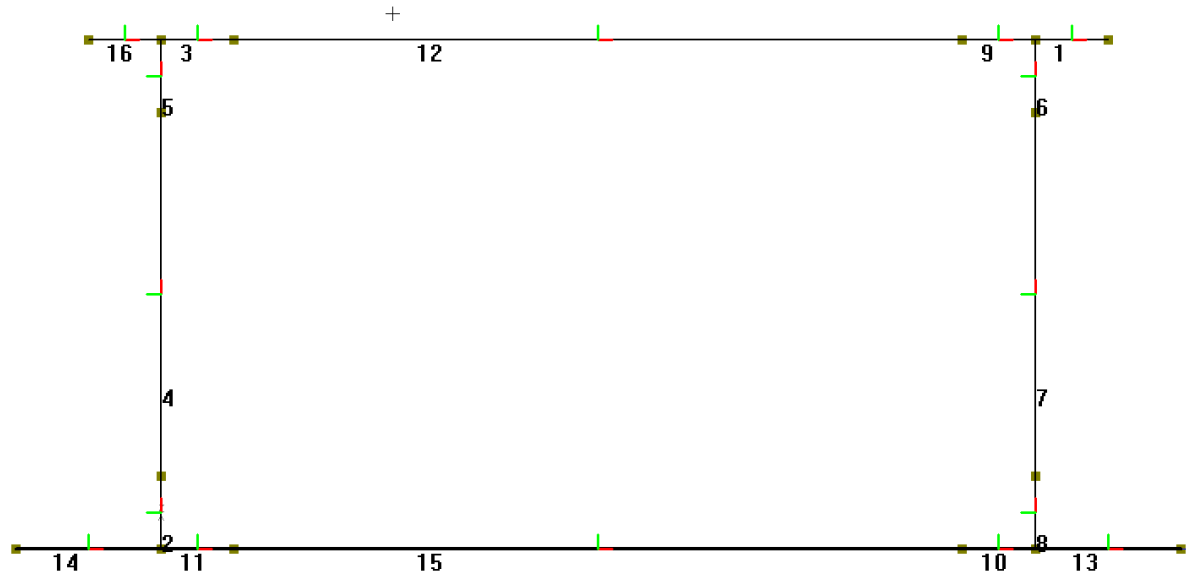

FIG. 2B - NUMERAZIONE DELLE ASTE

7.2. Analisi dei carichi

Nel seguente paragrafo si descrivono i carichi elementari da assumere per le verifiche di resistenza in esercizio ed in presenza dell'evento sismico.

Vengono prese in considerazione n°24 Condizioni Elementari di carico (CDC1÷ CDC 24), di seguito determinate.

Si considerano nel calcolo delle sollecitazioni agenti nel tombino i seguenti carichi. I dettagli relativi a ciascuna condizione di carico sono riportati nel paragrafo di analisi dei carichi.

CDC	Tipo	Sigla Id
1	Ggk	CDC=Ggk (peso proprio della struttura)
2	Gk	CDC=Gk (permanenti portati)
3	Gk	CDC=Gk (spinta a riposo piedritto sx)
4	Gk	CDC=Gk (spinta a riposo piedritto dx)
5	Gk	CDC=Gk (spinta attiva piedritto sx)
6	Gk	CDC=Gk (spinta attiva piedritto dx)
7	Qk	CDC=Qk (spinta idraulica interna)
8	Qk	CDC=Qk (Q1k centrato)
9	Qk	CDC=Qk (Q1k filo piedritto dx)
10	Qk	CDC=Qk (Q1k filo piedritto sx)
11	Qk	CDC=Qk (Accidentale 20kN/m ²)
12	Qk	CDC=Qk (Accidentale su piedritto sx)
13	Qk	CDC=Qk (Accidentale su piedritto dx)
14	Qk	CDC=Qk (Accidentale 9kPa su piedritto sx)
15	Qk	CDC=Qk (Accidentale 9kPa su piedritto dx)
16	Qk	CDC=Qk (Accidentale 20kPa su piedritto sx)

CDC	Tipo	Sigla Id
17	Qk	CDC=Qk (Accidentale 20kPa su piedritto dx)
18	Qk	CDC=Qk (frenatura)
19	Qk	CDC=Qk (Sisma orizzontale)
20	Qk	CDC=Qk (Sisma verticale)
21	Qk	CDC=Qk (Spinta idrodinamica)
22	Qk	CDC=Qk (Variazione termica uniforme)
23	Qk	CDC=Qk (Variazione termica lineare su soletta e piedritti)
24	Qk	CDC=Qk (Ritiro differenziale soletta)

Tali Combinazioni Elementari saranno opportunamente combinate secondo quanto previsto dalla normativa vigente.

Per i materiali si assumono i seguenti pesi specifici:

- calcestruzzo armato:	25 kN/m ³
- rilevato	20 kN/m ³
- pavimentazione (spessore 0.40m)	22 kN/m ³

7.2.1. Peso proprio e carichi permanenti portati

Soletta superiore

peso proprio	1.10	*	25	=	30.00	kN/m ²
peso pavimentazione	0.40	*	22	=	8.80	kN/m ²
peso sovrastruttura stradale	0.60	*	20	=	12.00	kN/m ²
totale					20.80	kN/m²

Soletta inferiore

peso proprio	1.20	*	25,00	=	30.00	kN/m ²
peso sovrastruttura stradale	1.00	*	22.00	=	22.00	kN/m ²
totale					52.00	kN/m²

Piedritti

peso proprio	1.10	*	25,00	=	27.50	kN/m ²
--------------	------	---	-------	---	--------------	-------------------

Tali carichi vengono considerati nelle condizioni di carico elementari CDC 1-2, in particolare nella CDC1 sono presenti i pesi propri della struttura, nella condizione di carico CDC2 i carichi permanenti portati.

7.2.2. Spinta delle terre

Il reinterro a ridosso dello scatolare verrà realizzato tramite materiale di buone caratteristiche meccaniche, in accordo a quanto riportato al paragrafo 5 del presente documento.

La spinta del terreno assume un andamento lineare con la profondità secondo la legge:

$$p_h = \lambda \gamma_t z$$

dove si considera come coefficiente di spinta λ il coefficiente di spinta attiva o a riposo a seconda dell'elemento strutturale di cui si vogliono massimizzare le sollecitazioni

1) In presenza di falda esterna allo scatolare

Le pressioni del terreno relative alla spinta a riposo, in corrispondenza dei nodi caratteristici dei piedritti, risultano essere le seguenti:

$$\begin{aligned}
 p_2 &= (22 * 0.40 + 20 * 0.60) * 0.609 = 18.86 \quad \text{kN/m}^2 \\
 p_{12} &= p_2 + (18.50 * 0.55) * 0.609 = 25.06 \quad \text{kN/m}^2 \\
 p_w &= p_{12} + (18.50 * 3) * 0.609 = 58.86 \quad \text{kN/m}^2 \\
 p_{11} &= p_w + (8.50 * 3.90) * 0.609 + (10.000 * 3.90) = 118.05 \quad \text{kN/m}^2 \\
 p_1 &= p_{11} + (8.50 * 0.6) * 0.609 + (10.000 * 0.6) = 127.15 \quad \text{kN/m}^2
 \end{aligned}$$

Tali spinte vengono considerate nella Condizione Elementare (CDC 3) sul piedritto sx e nella Condizione Elementare (CDC 4) sul piedritto dx.

Le pressioni del terreno relative alla spinta attiva, in corrispondenza dei nodi caratteristici dei piedritti, risultano essere le seguenti:

$$\begin{aligned}
 p_2 &= (22 * 0.40 + 20 * 0.60) * 0.438 &&= 10.05 && \text{kN/m}^2 \\
 p_{12} &= p_2 + (18.50 * 0.55) * 0.438 &&= 13.35 && \text{kN/m}^2 \\
 p_w &= p_{12} + (18.50 * 3) * 0.438 &&= 31.36 && \text{kN/m}^2 \\
 p_{11} &= p_w + (8.50 * 3.90) * 0.438 + (10.000 * 3.90) &&= 81.11 && \text{kN/m}^2 \\
 p_1 &= p_{11} + (8.50 * 0.6) * 0.438 + (10.000 * 0.6) &&= 88.77 && \text{kN/m}^2
 \end{aligned}$$

Tali spinte vengono considerate nella Condizione Elementare (CDC 5) sul piedritto sx e nella Condizione Elementare (CDC 6) sul piedritto dx.

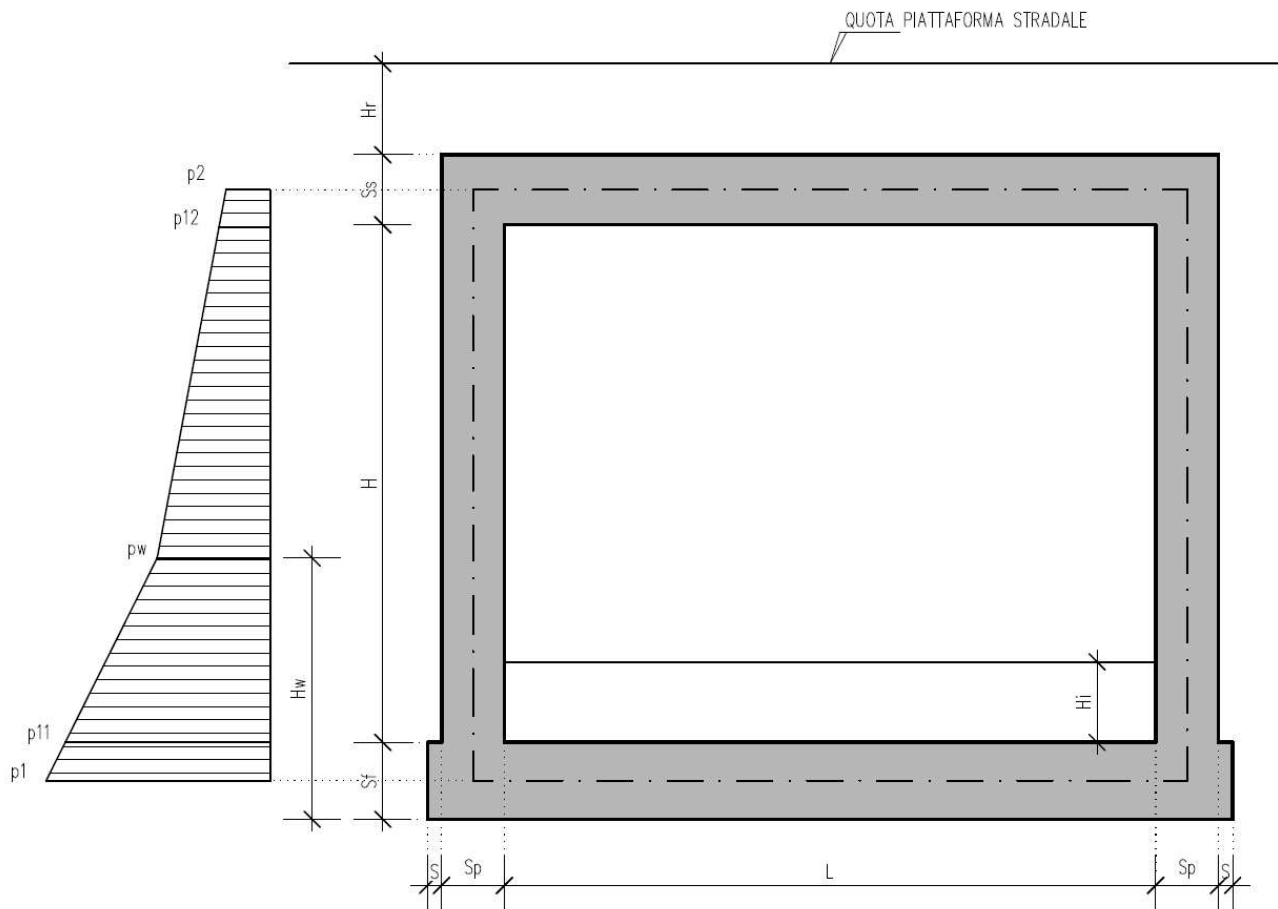

Nelle combinazioni di carico verranno considerate:

- 1) Spinta a riposo su entrambi i piedritti;
- 2) Spinta attiva su ambo i piedritti;
- 3) Spinta a riposo su piedritto sx e spinta attiva su piedritto dx;

La condizione di spinta 3) serve a mettere in conto possibili situazioni (anche temporanee) di disomogeneità nei costipamenti o altre condizioni che possano generare situazioni di spinte asimmetriche sull'opera. La condizione di spinta attiva, sebbene poco realistica considerando le caratteristiche dell'opera, viene comunque considerata a favore di sicurezza per massimizzare i valori delle sollecitazioni flessionali in corrispondenza delle mezzerie delle solette.

Naturalmente queste spinte saranno opportunamente combinate, utilizzando i valori dei coefficienti parziali delle azioni da assumere nell'analisi per la determinazione degli effetti delle azioni nelle verifiche agli stati limite ultimi.

7.2.3. Spinta della falda interna allo scatolare

Assente

(Condizione Elementare CDC 7)

7.2.4. Carichi veicolari sulla soletta superiore

I casi di carico CDC8, CDC9, CDC10 e CDC11 sono relativi agli effetti indotti sulla soletta superiore dai carichi veicolari agenti in corrispondenza della sovrastruttura stradale. I carichi di riferimento sono descritti nel paragrafo 5.1.3.3 del D.M. 14/01/2008.

In particolare lo schema di carico 1 è costituito da carichi concentrati su due assi in tandem e da carichi uniformemente distribuiti ; i carichi concentrati sono pari a:

$Q_{1k} = 300 \text{ kN}$ ad asse ($300 + 300 = 600 \text{ kN}$) su corsia n.1 di larghezza convenzionale pari a 3 m ;

$Q_{2k} = 200 \text{ kN}$ ad asse ($200 + 200 = 400 \text{ kN}$) su corsia n.2 di larghezza convenzionale pari a 3 m ;

$Q_{3k} = 100 \text{ kN}$ ad asse ($100 + 100 = 200 \text{ kN}$) su corsia n.3 di larghezza convenzionale pari a 3 m ;

Si ipotizza che tali carichi siano applicati su un'impronta rettangolare pari a $2.4 \times 1.60 \text{ m}$ (1.6 m sviluppo parallelo alla corsia di traffico, 2.4 m sviluppo perpendicolare), ovvero pari all'ingombro complessivo esterno del tandem. Per quanto riguarda i carichi uniformemente distribuiti (associati ai carichi tandem) si considera prudenzialmente il carico $q_{1k} = 9 \text{ kN/m}^2$ applicato a tutte le colonne di carico (la norma prevede l'applicazione dalla seconda alla n-esima corsia di un carico ridotto da 2.5 kN/m^2).

I carichi tandem vengono posizionati ortogonalmente all'asse del sottovia e vengono ripartiti sia in direzione longitudinale che trasversale dal piano stradale al piano medio della soletta superiore. Si assume che la diffusione avvenga con un angolo di 30° attraverso il rilevato stradale (in accordo al punto C5.1.3.3.7.1 della circolare ministeriale del 02/02/2009) e con un angolo di 45° nella soletta superiore del tombino. L'effetto dei carichi tandem sulla soletta superiore viene pertanto messo in conto attraverso la determinazione di un carico equivalente distribuito q_{eq} a cui si somma il carico uniforme $q_{1k} = 9 \text{ kN/m}^2$.

Ai fini del calcolo della ripartizione dei carichi accidentali si assume cautelativamente un'altezza di ricoprimento $H_r = 0.90 \text{ m}$.

Diffusione del carico tandem in direzione longitudinale (parallela all'asse stradale)

La larghezza di diffusione del carico tandem in direzione longitudinale è pari a:

$$L_{dl} = 1.6 \text{ m} + 2x [\tan 30^\circ \times H_r + \tan 45^\circ \times S_s/2]$$

Nel caso in esame risulta:

$$L_{dl} = 1.60 + 2 * (0.90 * \text{tg}30^\circ + 0.55) = \mathbf{3.74} \text{ m}$$

Diffusione del carico tandem in direzione trasversale (ortogonale all'asse stradale)

In direzione trasversale alla strada detta L_{dt} la larghezza di diffusione del carico trasversale dal piano stradale alla quota del piano medio della soletta superiore, assumendo che detta diffusione avvenga con angolo di diffusione di 30° attraverso il rilevato stradale e di 45° sino al piano medio della soletta superiore

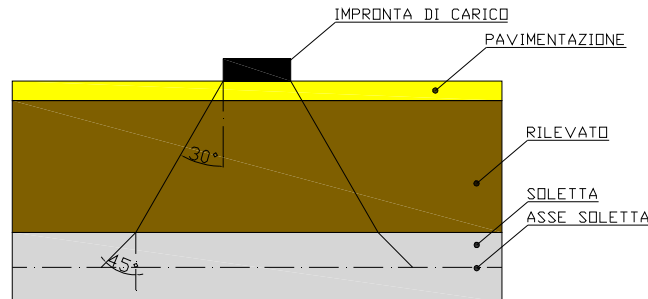

risulta:

$$L_{dt} = 2.40 + 2 \cdot (0.90 \cdot \text{tg}30^\circ + 0.55) = 5.30 \quad \text{m}$$

Il valore di L_{dt} viene poi limitato in base alle seguenti circostanze:

presenza della seconda colonna di carico: il carico della 1° colonna, in corrispondenza dell'adiacenza alla 2° colonna, può essere diffuso al massimo fino a 0.30m all'esterno dell'impronta del carico;

posizionando il carico in adiacenza al cordolo, ne consegue che la massima diffusione lato cordolo è pari a:

$$L_{d, \text{cordolo}} = \text{tan}30 \times H_r + \text{tan}45 \times S_s/2$$

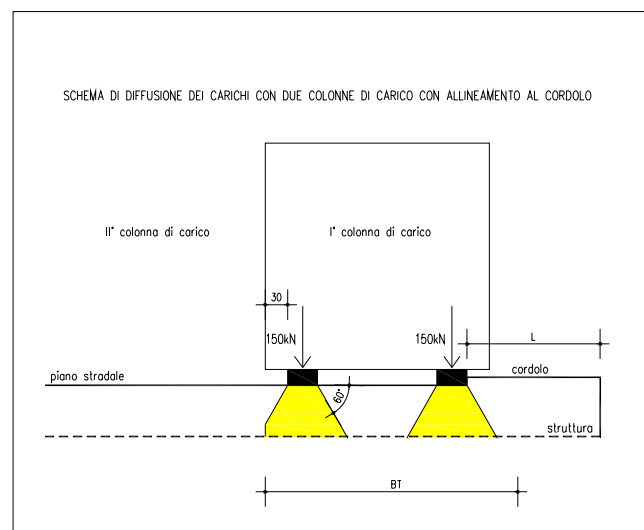
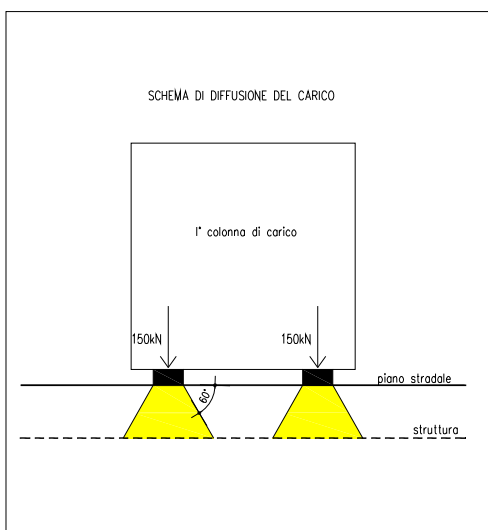

pertanto la larghezza di diffusione trasversale non può risultare superiore al valore di:

$$L_{dt,max} = 2.40 + 0.30 + (0.90 * \operatorname{tg}30^\circ + 0.55) = \mathbf{3.77} \quad \text{m}$$

Calcolo del carico distribuito equivalente al tandem

Avendo definito L_{dl} e L_{dt} si può valutare l'intensità del carico q_{eq} equivalente all'effetto indotto dai carichi tandem sulla soletta superiore:

Considerando il carico tandem dovuto alla prima colonna di carico

$$q_{eq} = 2 \times Q_{1k} / (L_{dl} \times L_{dt,max}) = \mathbf{42.57} \text{ kN/m}$$

cui si sovrappone il carico $q = 9 \text{ kN/m}$ uniforme su tutta la soletta (corrispondente al carico q_{1k}).

La posizione del carico q_{eq} equivalente al tandem viene variata su tutta la soletta nei casi di carico CDC8-10 per massimizzare:

CDC 8: il momento in mezzera soletta;

CDC 9: il taglio nella soletta a filo piedritto destro;

CDC 10: il taglio nella soletta a filo piedritto sinistro.

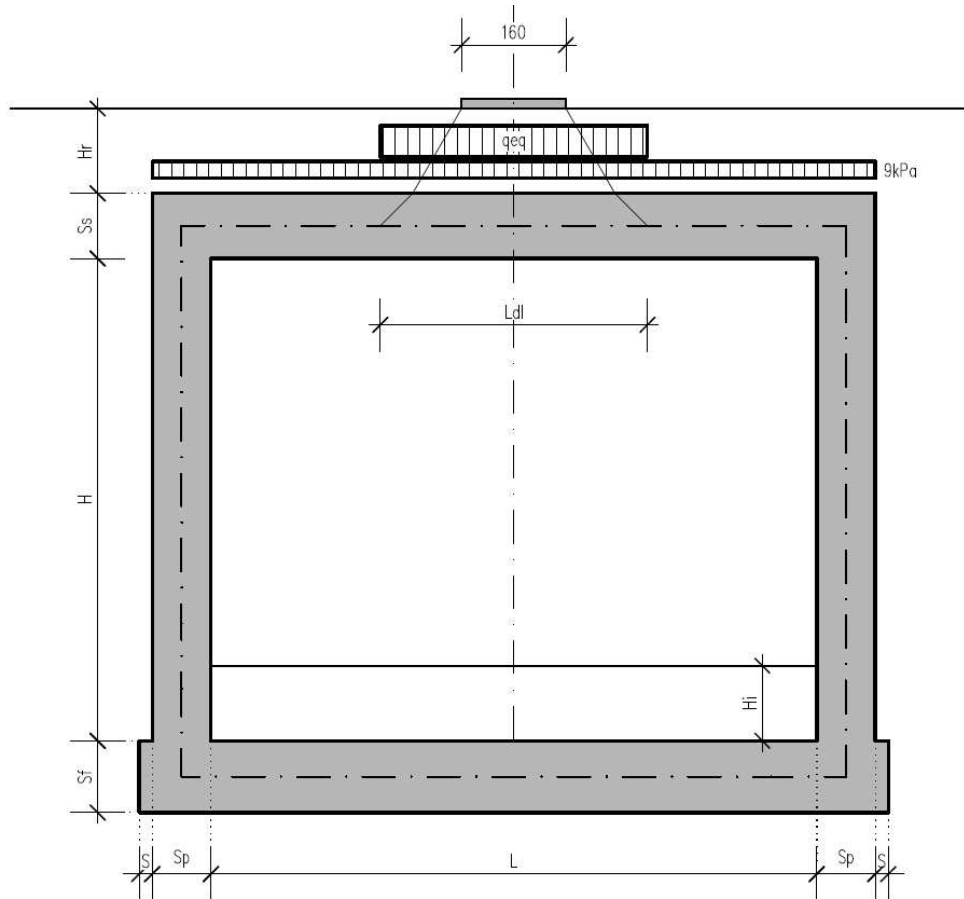

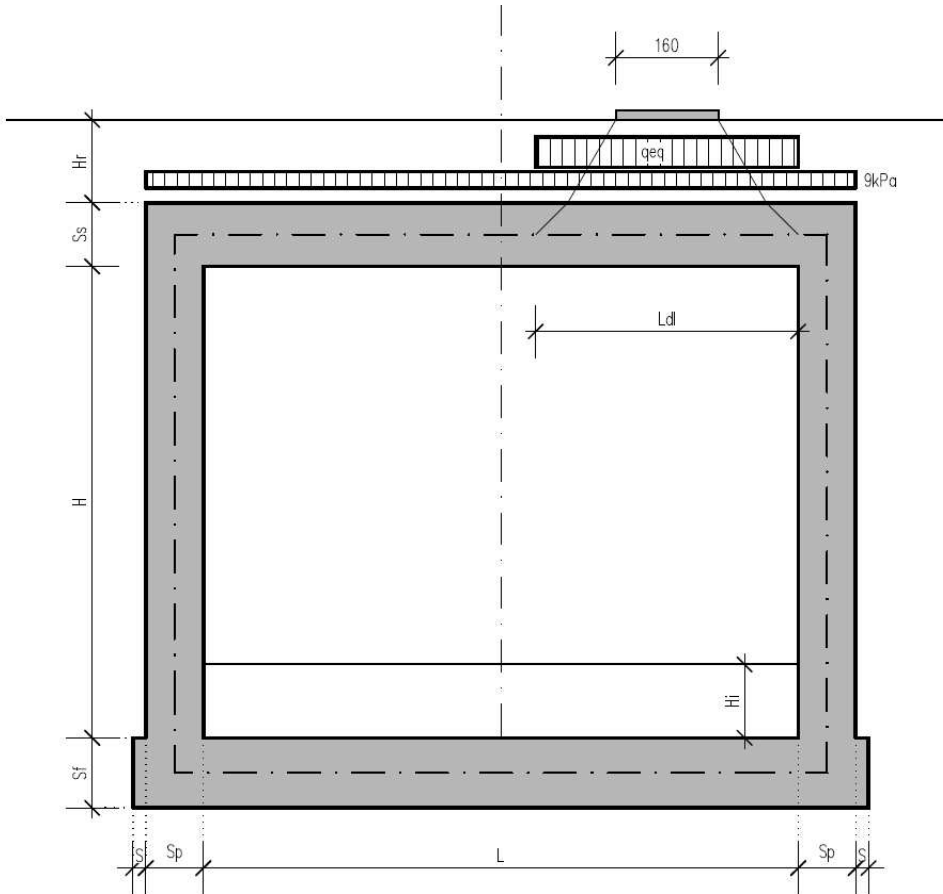

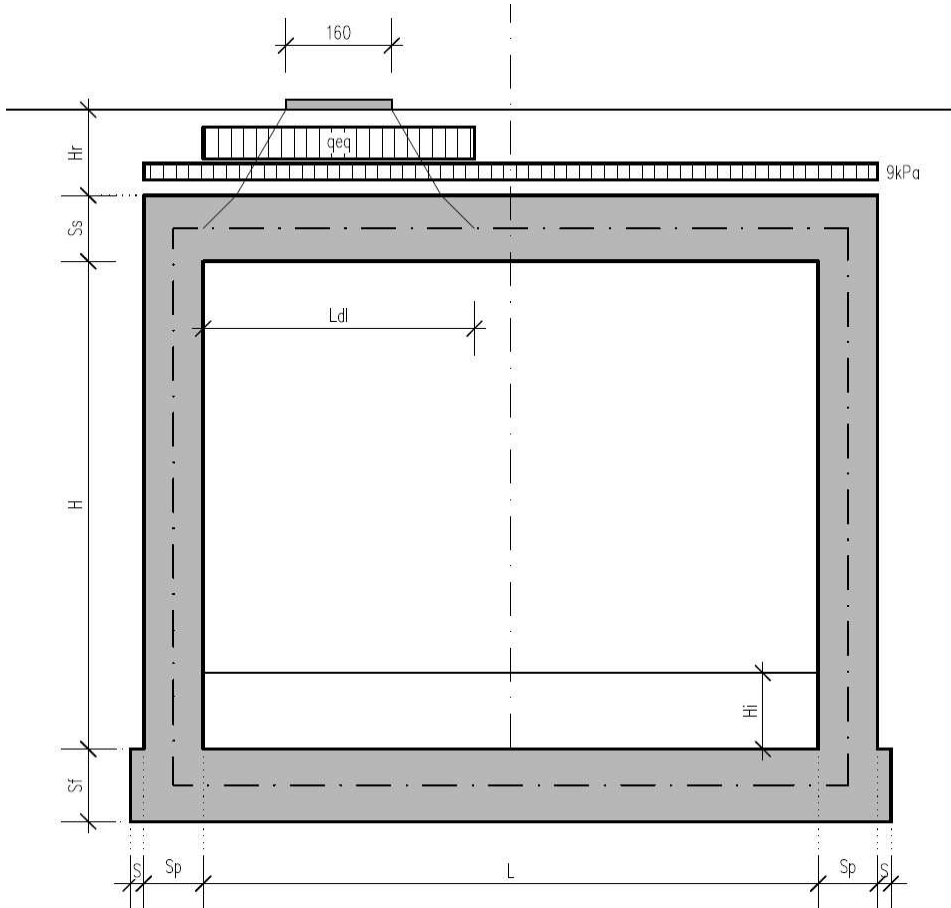

Si noti che se $L_{dl} > L + 2 \times S_p$ (larghezza netta interna + spessore dei piedritti) allora il carico equivalente è applicato a tutte le aste della soletta superiore nei tre casi di carico CDC 8-10 che vengono a coincidere tra di loro.

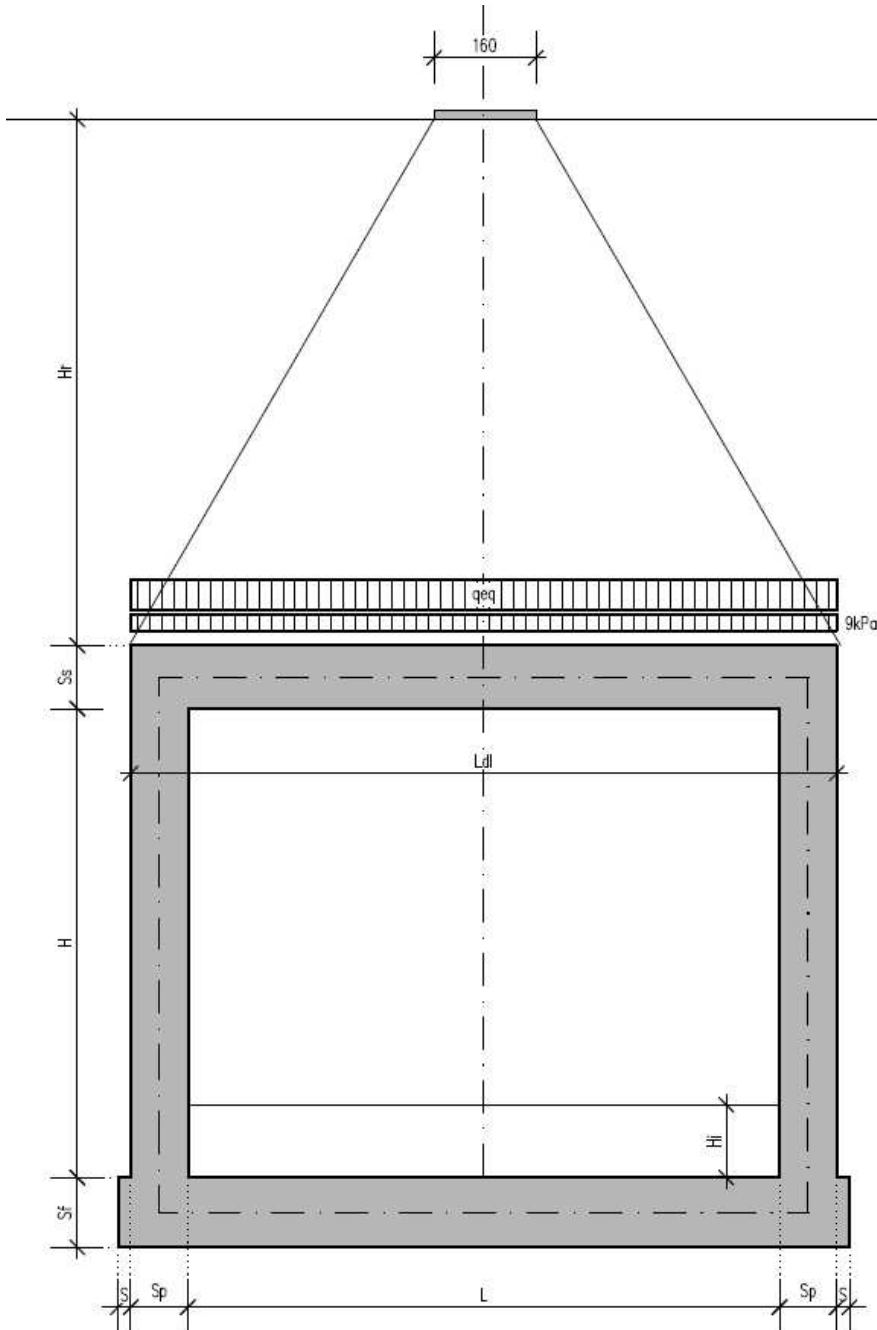

CDC11: sovraccarico uniforme da 20kN/m^2

Si ipotizza che la soletta superiore sia gravata da un carico accidentale uniformemente distribuito di intensità pari a 20 kN/m^2 (scenario da traffico da utilizzarsi in alternativa ai casi di carico 8, 9 e 10).

7.2.5. Spinte sui piedritti indotte dai sovraccarichi accidentali

In accordo con il punto C5.1.3.3.7.1 della circolare ministeriale 02/02/2009 per il calcolo delle spinte generate dal sovraccarico sul rilevato si può considerare applicato lo schema di carico 1, in cui per semplicità i carichi tandem possono essere sostituiti da carichi uniformemente distribuiti equivalenti, applicati su una superficie rettangolare larga 3.0 m e lunga 2.20 m. Anche in questo caso si tiene in conto la diffusione del carico attraverso il rilevato sia in direzione longitudinale che trasversale. Al tandem si somma il carico uniformemente distribuito agente sulla i-esima corsia di carico $q_{ik} = 9 \text{ kN/m}^2$.

Diffusione del carico tandem in direzione longitudinale (parallela all'asse stradale)

Il carico tandem trasformato in carico uniformemente distribuito assume il valore:

$$600/(3.00 \times 2.20) = 90.91 \text{ kN/m}^2$$

La larghezza di diffusione del carico tandem in direzione longitudinale è pari a:

$$L_{dl,sup} = 2.2 \text{ m} + [\tan 30^\circ \times (2 \times H_r + S_s/2)] = 3.56 \text{ m} \quad (\text{piano medio sol. sup.})$$

$$L_{dl,inf} = 2.2 \text{ m} + [\tan 30^\circ \times (2 \times H_r + S_s/2 + H + S_t/2)] = 8.20 \text{ m} \quad (\text{piano medio sol. inf.})$$

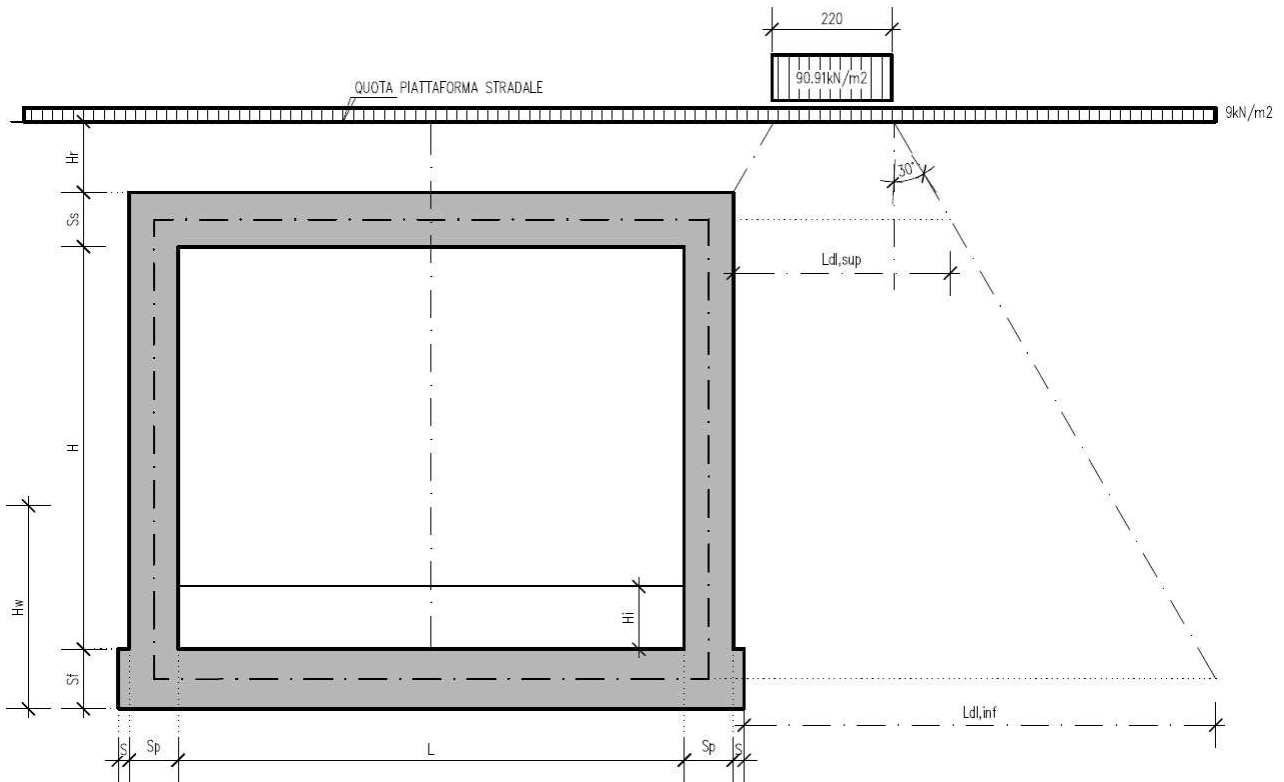

Diffusione del carico tandem in direzione trasversale (ortogonale all'asse stradale)

In direzione trasversale, considerando due colonne di carico e la ripartizione trasversale del carico distribuito, si ottiene quanto riportato nella figura seguente:

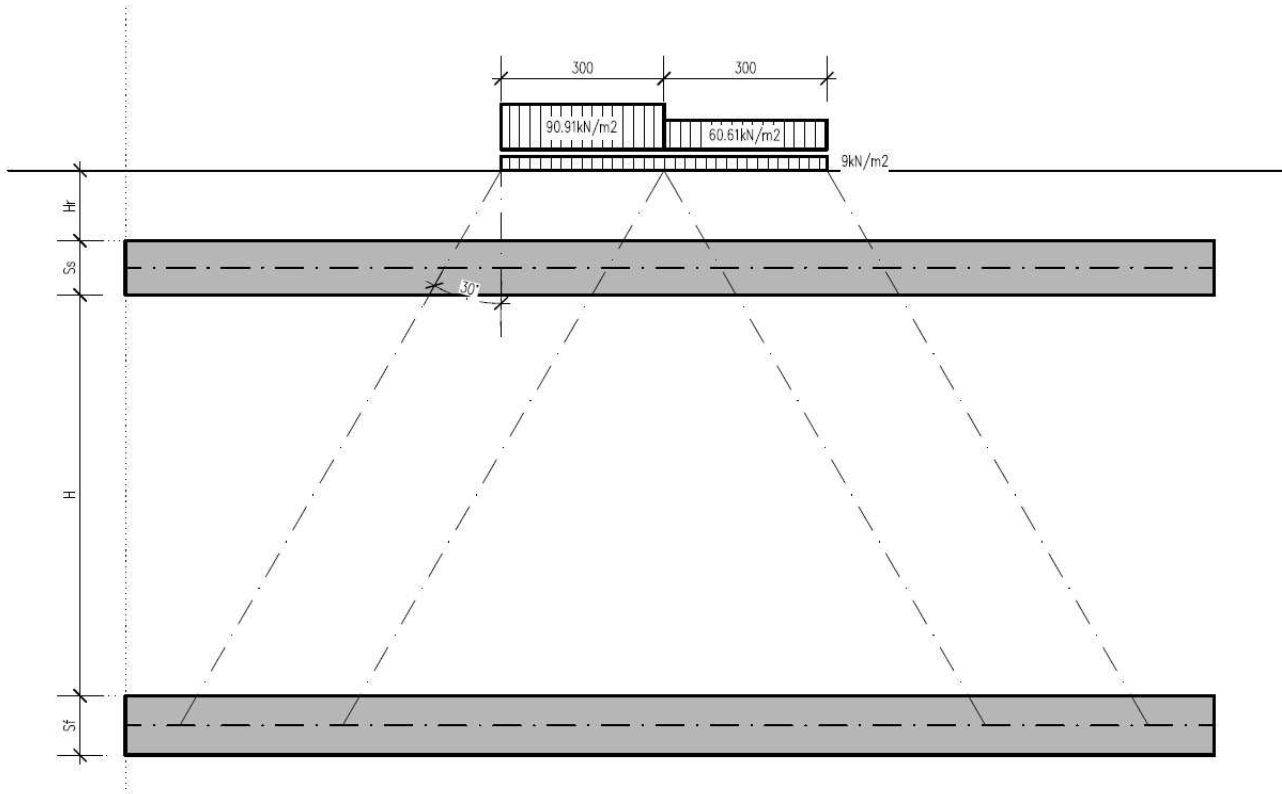

Per il calcolo delle azioni agenti sulle pareti dello scatolare, si considera il carico distribuito dovuto alla colonna di carico 1, limitando la diffusione del carico sul lato della seconda colonna di carico come schema seguente:

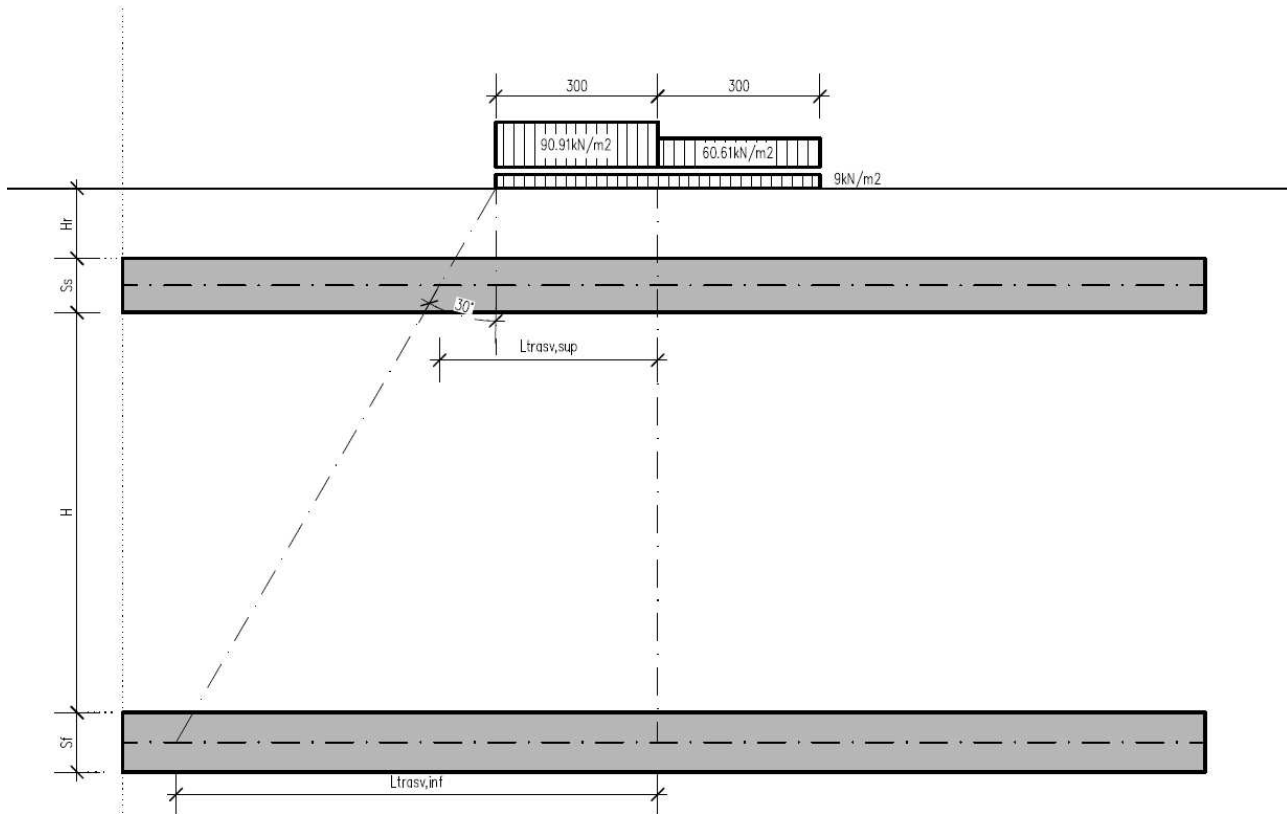

La larghezza di diffusione del carico tandem in direzione longitudinale è pari a:

$$L_{dt,sup} = 3 \text{ m} + [\tan 30^\circ \times (H_r + S_s/2)] = 3.84 \text{ m} \quad (\text{piano medio sol. sup.})$$

$$L_{dt,inf} = 3 \text{ m} + 2 \times [\tan 30^\circ \times (H_r + S_s + H + S_s/2)] = 8.48 \text{ m} \quad (\text{piano medio sol. inf.})$$

Definizione dei carichi di progetto

Il diagramma di spinta applicato ai piedritti varia linearmente fra i valori $q_{acc,sup2}$ e $q_{acc,sup1}$ come esemplificato nella immagine seguente.

$$q_{acc,sup} = 2 \times Q_{1,k} \times (L_{dt,sup} \times L_{dl,sup}) \times k_0 = 31.06 \text{ kN/m}$$

$$q_{acc,inf} = 2 \times Q_{1,k} \times (L_{dt,inf} \times L_{dl,inf}) \times k_0 = 7.19 \text{ kN/m}$$

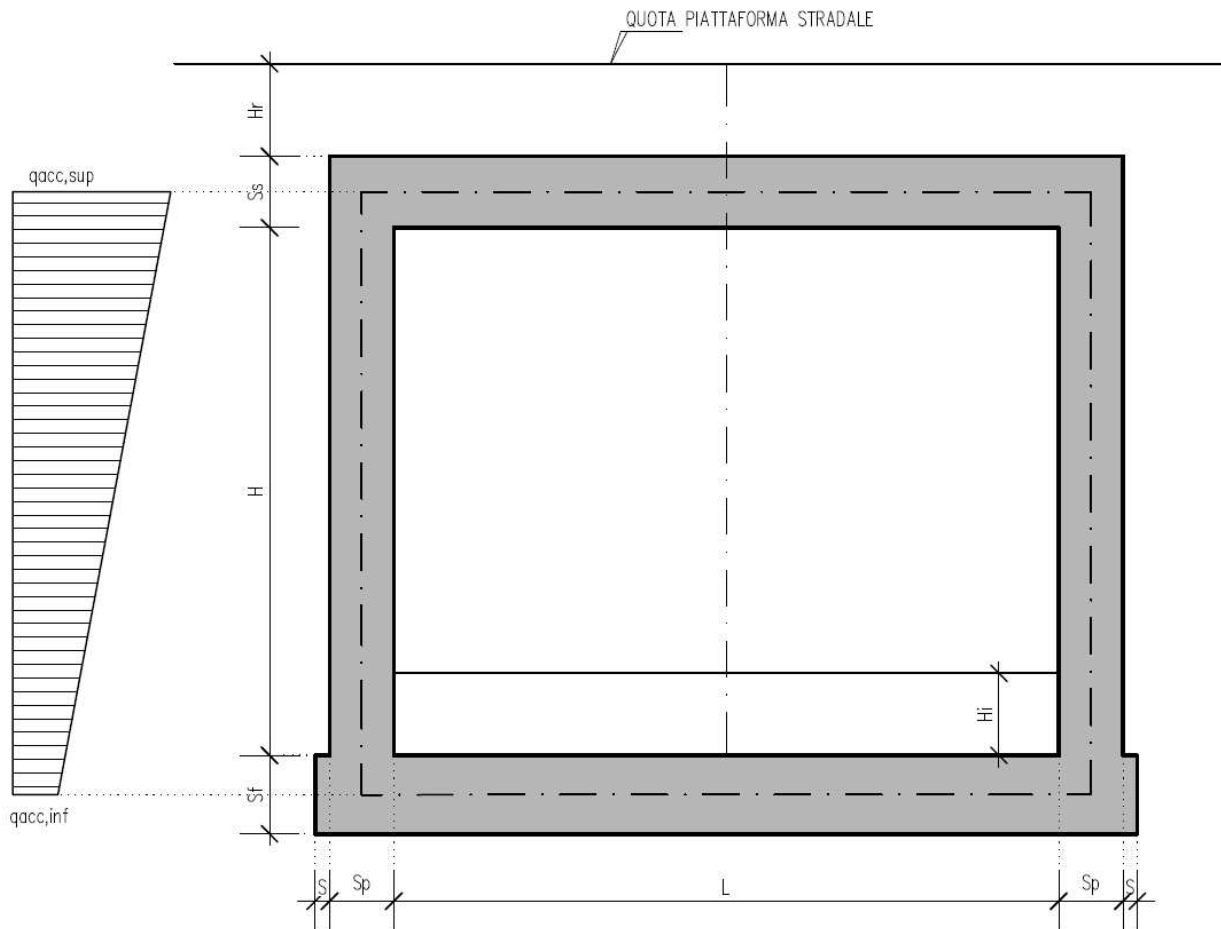

Loadings 20-23: spinta sul piedritto generata dal carico accidentale $q1k = 9 \text{ kN/m}^2$ sul rilevato

Nelle condizioni di carico in oggetto si considera l'assenza del carico tandem:

$$p = k_0 \times q1k = 0.609 \times 9 = 5.48 \text{ kN/m (spinta a riposo, CDC 14 e 15, piedritto sinistro/destro)}$$

CDC 16-17: spinta sul piedritto generata dal sovraccarico da 20 kN/m^2 sul rilevato

Nello scenario di carico da traffico alternativo allo Schema di Carico 1 si considera, ai fini del calcolo della spinta sui piedritti, un carico q_{acc} sul terrapieno pari a 20 kN/m^2 .

Tale carico genera spinte pari a:

$$p = k_0 \times q_{acc} = 0.609 \times 20 = 12.18 \text{ kN/m (spinta a riposo, CDC 16 e 17, piedritto sinistro/destro)}$$

7.2.6. Sovraccarichi accidentali sulla soletta di fondazione

Sulla soletta di fondazione si applica il carico tandem corrispondente a ciascuna colonna di carico $Q_{i,k}$, ripartito su una larghezza pari all'ingombro della colonna di carico convenzionale (3m), e una lunghezza ottenuta dalla ripartizione del carico fino al piano medio della soletta attraverso il ricoprimento, assumendo che detta diffusione avvenga con angolo di diffusione di 30° attraverso il rilevato stradale e di 45° sino al piano medio della soletta.

Base collaborante trasversale: $B_T = 3.00 \text{ m}$

Ingombro longitudinale: $L_L = 1.60 + 2 * (1.00 * \tan 30^\circ + 1.20/2) = 3.95 \text{ m}$

$q'_{acc,1} = 600/3.00/3.95 + 9 = 59.63 \text{ kN/m}^2$ (carico distribuito equivalente alla prima colonna di carico)

$q'_{acc,2} = 400/3.00/3.95 + 2.5 = 36.50 \text{ kN/m}^2$ (carico distribuito equivalente alla seconda colonna di carico)

(Condizioni Elementari CDC 15÷17)

7.2.7. Frenatura

La forza di frenatura q_3 è funzione del carico totale agente sulla corsia convenzionale n.1 e risulta pari a (si veda il paragrafo 5.1.3.5 del D.M. 14/01/2008):

$$180 \text{ kN} \leq q_3 = 0.6 \times 2 \times Q_{1k} + 0.10 \times q_{1k} \times w_1 \times L \leq 900 \text{ kN}$$

dove:

$Q_{1k} = 300 \text{ kN}$

$q_{1k} = 9 \text{ kN/m}^2$

$w_1 = 3.00 \text{ m}$ (larghezza della corsia)

$L = 2 \times S_p + B_i$ (larghezza della soletta compresi i piedritti)

Nel caso in esame risulta:

$$q_3 = 396.99 \text{ kN}$$

L'azione di cui sopra, viene distribuita sulla soletta superiore dello scatolare; il valore della frenatura equivalente da applicare alla soletta, si ottiene distribuendo il valore del carico frenante, alla lunghezza della soletta e alla larghezza di diffusione del carico (L_{dt}), con la seguente relazione:

$$q_{3,dis} = 396.99 / (3.77 * 13.70) = 8.36 \text{ kN/m}^2$$

(applicata nel CDC 18)

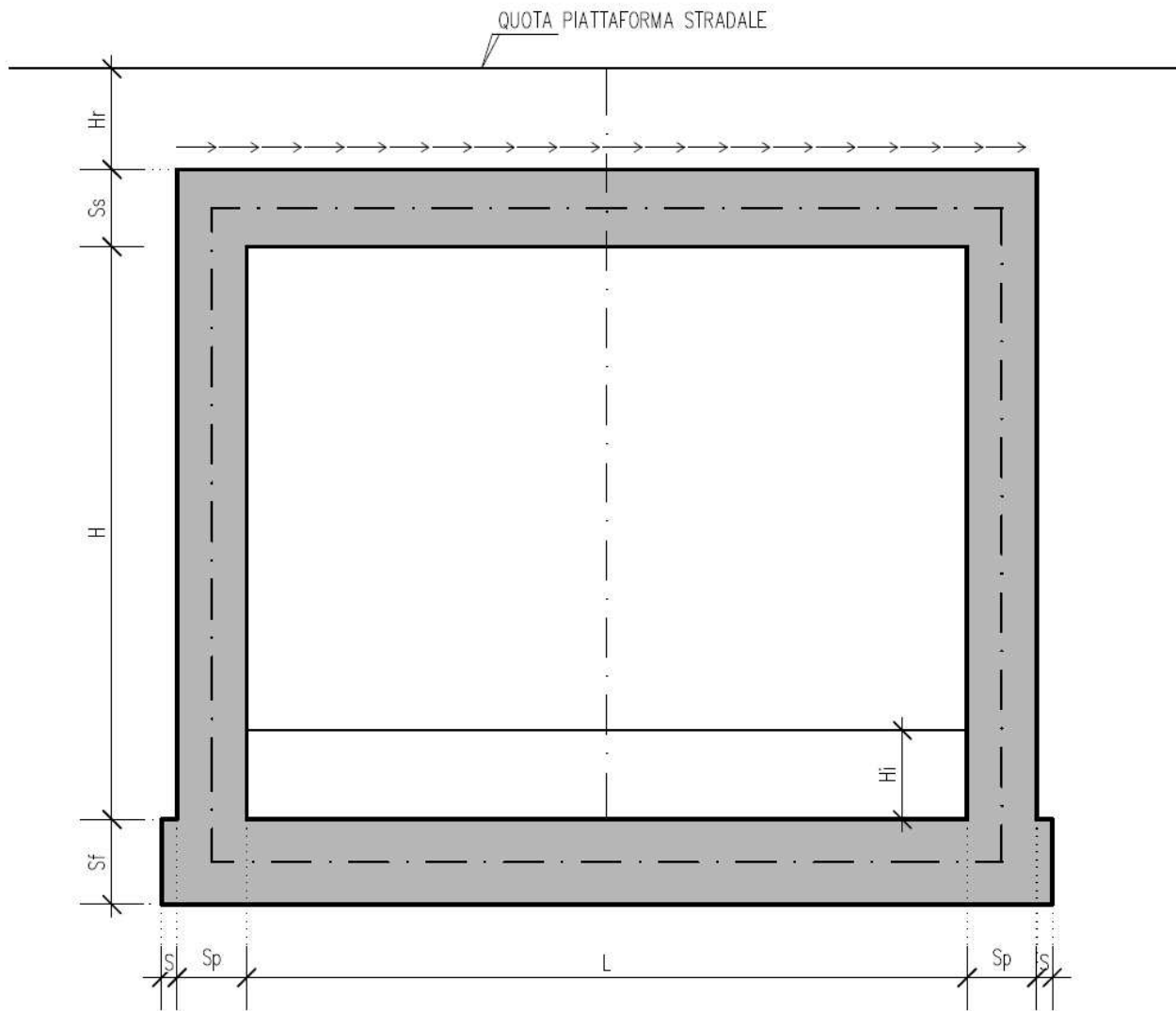

7.2.8. Azioni sismiche

(CDC elementari 18-20)

7.2.8.1 Stato limite di salvaguardia della vita (SLV)

La risultante delle forze inerziali orizzontali indotte dal sisma viene valutata con la seguente espressione:

$$F_h = P \cdot k_h$$

$$k_h = \beta_m \cdot \frac{a_{max}}{g}$$

$$(SLV) \quad k_h = \beta_m \cdot \frac{a_{max}}{g} = 0.303 \quad k_v = \pm 0.5 \cdot k_h = 0.151$$

P = peso proprio;

k = coefficienti sismici;

Nel caso di sisma orizzontale si considera la spinta derivante dall'oscillazione del cuneo di terreno spingente con l'applicazione del diagramma triangolare di pressioni, tipico dei muri di sostegno, avente la risultante a 1/3 dell'altezza. Per tener conto dell'incremento di spinta del terreno dovuta al sisma si fa riferimento all'EC8, in cui l'incremento di spinta sismica ΔP per la condizione a riposo viene valutato:

$$\Delta P_d = S \cdot a_g / g \cdot \gamma \cdot h_{tot}^2$$

La risultante di tale incremento di spinta viene applicata ad h/2 del piedritto.

1 - Ai fini delle azioni verticali sulla soletta superiore, non considerando i carichi accidentali si ha:

Peso proprio soletta	27.50	kN/m ²
Carichi permanenti	20.80	kN/m ²
Inerzia soletta+perm.	7.31	kN/m ²

2 - Ai fini delle azioni orizzontali, sui piedritti si considera il contributo della sovraspinta sismica dovuto al sisma oscillatorio e le spinte inerziali agenti sui piedritti, mentre sulla soletta superiore si considera l'inerzia della stessa nonché i permanenti portati.

Spinta inerziale sulla soletta superiore:

$$P \cdot k_h = 14.62 \text{ kN/m}$$

Spinta inerziale sui piedritti:

$$P \cdot k_h = 8.33 \text{ kN/m}$$

$$P \cdot k_v = 4.16 \text{ kN/m}$$

Sovraspinta sismica:

$$k_h \times \gamma \times h_{tot} = 53.77 \text{ kN/m}$$

dove si indica con h_{tot} l'altezza totale del tombino compresi gli spessori delle solette superiore e inferiore più l'altezza di ricoprimento totale del tombino. Si fa osservare che tale metodologia porta ad azioni eccessivamente prudenziali, soprattutto per tombini con altezza di ricoprimento elevata.

7.2.9. Azioni termiche

Sono stati considerati gli effetti dovuti alle variazioni termiche. In particolare, è stata considerata una variazione termica uniforme di $\pm 10^\circ\text{C}$ sulla soletta superiore (CDC 22) ed un salto termico di 5°C sulla soletta superiore e sui piedritti, analizzando nelle combinazioni di carico i due casi di intradosso più caldo dell'estradosso e viceversa agendo sul segno della sollecitazione, con andamento lineare nello spessore della soletta superiore e sui piedritti (CDC 21).

Per il coefficiente di dilatazione termica si assume:

$$\alpha = 10 \cdot 10^{-6} = 0.00001 \text{ } ^\circ\text{C}^{-1}$$

7.2.10. Ritiro

Si considera soggetta a fenomeni di ritiro la sola soletta superiore.

La deformazione totale da ritiro si può esprimere come:

$$\varepsilon_{cs} = \varepsilon_{cd} + \varepsilon_{ca}$$

dove:

ε_{cs} è la deformazione totale per ritiro

ε_{cd} è la deformazione per ritiro da essiccamento

ε_{ca} è la deformazione per ritiro autogeno.

Il valore medio a tempo infinito della deformazione per ritiro da essiccamento:

$$\varepsilon_{cd,\infty} = k_h \cdot \varepsilon_{c0}$$

può essere valutato mediante i valori delle seguenti Tab. 11.2.Va-b (NTC) in funzione della resistenza caratteristica a compressione, dell'umidità relativa e del parametro h_0 :

Tabella 11.2.Va – Valori di ε_{c0}

f_{ck}	Deformazione da ritiro per essiccamento (in ‰)					
	Umidità relativa (in ‰)					
	20,00	40,00	60,00	80,00	90,00	100,00
20,00	-0,62	-0,58	-0,49	-0,30	-0,17	0,00
25,00	-0,59	-0,55	-0,46	-0,29	-0,16	0,00
28,00	-0,56	-0,53	-0,45	-0,28	-0,15	0,00
32,00	-0,54	-0,51	-0,42	-0,26	-0,15	0,00
40,00	-0,48	-0,46	-0,38	-0,24	-0,13	0,00
60,00	-0,38	-0,36	-0,30	-0,19	0,10	0,00
80,00	-0,30	-0,28	-0,24	-0,15	-0,07	0,00

Tabella 11.2.Vb – Valori di k_h

h_0 (mm)	k_h
100	1
200	0,85

300	0,75
400	0,725
500	0,7

I valori intermedi dei parametri indicati in tabella si ottengono per l'interpolazione lineare.

Il valore medio a tempo infinito della deformazione per ritiro autogeno $\epsilon_{ca,\infty}$ può essere valutato

mediante l'espressione:

$$\epsilon_{ca,\infty} = -2.5 \cdot (f_{ck} - 10) \cdot 10^{-6} \quad (\text{con } f_{ck} \text{ in N/mm}^2)$$

Assumendo come umidità relativa

$$U_r = 70\%$$

Si ha il seguente valore del ritiro:

$$\epsilon_{cs} = -0.000298$$

Il modulo viscoso a tempo infinito, in considerazione del valore di h_0 , della resistenza del calcestruzzo e della U.R., può cautelativamente essere assunto pari a $\Phi (t = \infty) = 1.6$. Il modulo elastico ridotto del calcestruzzo risulta quindi pari a:

$$E_c^* = E_c / (1 + \Phi) = 12426.25 \text{ N/mm}^2. \text{ (CDC 22)}$$

7.3. Combinazioni di carico adottate

I carichi caratteristici sopra elencati (CDC), al fine di ottenere le sollecitazioni di progetto per effettuare le successive verifiche, sono opportunamente combinati fra loro.

7.3.1. Combinazioni per lo stato limite ultimo

$\gamma_{G1} G_1 + \gamma_{e2} R + \gamma_{Q1} Q_{k1} + \gamma_{e3} \psi_{0\ e3} T$ (carico da traffico veicolare Q_{k1} principale)

$\gamma_{G1} G_1 + \gamma_{e2} R + \gamma_{e3} T + \gamma_{Q1} \psi_{01} Q_{k1}$ (azioni termiche T principali)

	Peso proprio	Permanenti portati	Spinta a riposo piedritto sx	Spinta riposo piedritto dx	Spinta attiva piedritto sx	Spinta attiva piedritto dx	Spinta acqua interna	Q1k centrato	Q1k filo piedritto dx	Q1k filo piedritto sx	Accidentale 9kPa su soletta	Accidentale 20 kPa	Accidentale su piedritto sx	Accidentale su piedritto dx	Accidentale 9kPa piedritto sx	Accidentale 9kPa piedritto dx	Accidentale 20kPa piedritto sx	Accidentale 20kPa piedritto dx	Frenatura	Sisma orizzontale	Sisma verticale	Spinta idrodinamica	Termica Uniforme	Termica tarfalla +	Ritiro	
SLU	1.35	1.35	0	0	1	1	1.35	1.35	0	0	0	0	0	0	0	0	0	0	0	0	0	0	0.72	0.72	1.2	
	1.35	1.35	0	0	1	1	1.35	0	0	0	0	1.35	0	0	0	0	0	0	0	0	0	0	0.72	0.72	1.2	
	1.35	1.35	0	0	1	1	1.35	1.01	0	0	0	0	0	0	0	0	0	0	0	0	0	0	1.2	1.2	1.2	
	1.35	1.35	0	0	1	1	1.35	0	0	0	0	1.01	0	0	0	0	0	0	0	0	0	0	0	1.2	1.2	1.2
	1.35	1.35	1.35	0	0	1	0	1.01	0	0	0	0	0	0	1.01	0	0	0	0	1.35	0	0	0	0.72	0.72	0
	1.35	1.35	1.35	0	0	1	0	0	0	0	0	1.01	0	1.01	0	0	0	1.01	0	1.35	0	0	0	0.72	0.72	0
	1.35	1.35	1.35	0	0	1	0	0	0	0	1.01	0	0	0	0	0	0	0	0	1.35	0	0	0	0.72	0.72	0
	1.35	1.35	1.35	0	0	1	0	1.01	0	0	0	0	0	0	0	1.01	0	0	0	0	0	0	0	-1.2	-1.2	0
	1.35	1.35	1.35	0	0	1	0	0	0	0	0	1.01	0	1.01	0	0	0	0	0	0	0	0	0	-1.2	-1.2	0
	1.35	1.35	0	0	1	1	0	1.35	0	0	0	0	0	0	0	0	0	0	0	0	0	0	0	0.72	0.72	0
	1.35	1.35	0	0	1	1	0	0	0	0	0	0	1.35	0	0	0	0	0	0	0	0	0	0	0.72	0.72	0
	1.35	1.35	0	0	1	1	0	1.01	0	0	0	0	0	0	0	0	0	0	0	0	0	0	0	-1.2	1.2	0
	1.35	1.35	0	0	1	1	0	0	0	0	0	0	1.01	0	0	0	0	0	0	0	0	0	0	-1.2	1.2	0
	1.35	1.35	1.35	0	0	1	0	1.01	0	0	0	0	0	0	1.01	0	0	0	0	1.35	0	0	0	0.72	0.72	1.2

1.35	1.35	1.35	0	0	1	0	0	0	0	0	1.01	0	0	0	0	1.01	0	1.35	0	0	0	0.72	0.72	1.2
1.35	1.35	1.35	0	0	1	0	0	0	0	1.01	0	1.01	0	0	0	0	0	1.35	0	0	0	0.72	0.72	1.2
1.35	1.35	1.35	0	0	1	0	1.01	0	0	0	0	0	0	1.01	0	0	0	0	0	0	0	1.2	-1.2	1.2
1.35	1.35	1.35	0	0	1	0	0	0	0	0	1.01	0	0	0	0	1.01	0	0	0	0	0	1.2	-1.2	1.2
1.35	1.35	1.35	0	0	1	0	0	0	0	1.01	0	1.01	0	0	0	0	0	0	0	0	0	1.2	-1.2	1.2
1.35	1.35	1.35	0	0	1	0	0	0	1.01	0	0	0	0	1.01	0	0	0	1.35	0	0	0	0.72	0.72	1.2
1.35	1.35	1.35	0	0	1	0	0	0	1.01	0	0	0	0	1.01	0	0	0	0	0	0	0	1.2	-1.2	1.2
1	1	1.35	0	0	1	0	0	0	0	0	0	1.01	0	0	0	0	0	1.35	0	0	0	0.72	0.72	1.2
1	1	1.35	0	0	1	0	0	0	0	0	0	1.01	0	0	0	0	0	0	0	0	0	1.2	1.2	1.2
1.35	1.35	1.35	0	0	1	0	0	1.01	0	0	0	0	0	1.01	0	0	0	1.35	0	0	0	0	0	0
1.35	1.35	1.35	0	0	1	0	0	0	0	0	1.01	0	0	0	0	1.01	0	1.35	0	0	0	0	0	0
1.35	1.35	1.35	0	0	1	0	0	0	1.35	0	0	0	0	1.01	0	0	0	0	0	0	0	0.72	0.72	1.2
1.35	1.35	1.35	0	0	1	0	0	0	0	0	1.35	0	0	0	0	1.01	0	0	0	0	0	0.72	0.72	1.2
1.35	1.35	1.35	0	0	1	0	0	0	0	0	0	1.01	0	0	0	0	0	1.35	0	0	0	0.72	0.72	1.2
1	1	1.35	1.35	0	0	0	1.01	0	0	0	0	0	0	1.01	1.01	0	0	1.35	0	0	0	0.72	0.72	0
1	1	1.35	1.35	0	0	0	0	0	0	0	1.01	0	0	0	0	1.01	1.01	1.35	0	0	0	0.72	0.72	0
1	1	1.35	1.35	0	0	0	0	0	0	1.01	0	1.01	1.01	0	0	0	0	1.35	0	0	0	0.72	0.72	0
1.35	1.35	1.35	0	0	1	0	0	0	0	0	0	1.01	0	0	0	0	0	1.35	0	0	0	0.72	0.72	1.2

7.3.2. Combinazioni per gli stati limite di esercizio: combinazione rara

$G_1 + R + Q_{k1} + \psi_{0e3} T$ (carico da traffico veicolare Q_{k1} principale)

$G_1 + R + T + \psi_{01} Q_{k1}$ (azioni termiche T principali)

	Peso proprio	Permanenti portati	Spinta a riposo piedritto sx	Spinta a riposo piedritto dx	Spinta attiva piedritto sx	Spinta attiva piedritto dx	Spinta acqua interna	Q1k centrato	Q1k filo piedritto dx	Q1k filo piedritto sx	Accidentale 9kPa su soletta	Accidentale 20 kPa	Accidentale su piedritto sx	Accidentale su piedritto dx	Accidentale 9kPa piedritto sx	Accidentale 9kPa piedritto dx	Accidentale 20kPa piedritto sx	Accidentale 20kPa piedritto dx	Frenatura	Sisma orizzontale	Sisma verticale	Spinta idrodinamica	Termica Uniforme	Termica farfalla +	Ritiro
SLE RAR	1	1	0	0	1	1	1	1	0	0	0	0	0	0	0	0	0	0	0	0	0	0	0.6	0.6	1



1	1	0	0	1	1	1	0	0	0	0	1	0	0	0	0	0	0	0	0	0	0.6	0.6	1	
1	1	0	0	1	1	1	0.75	0	0	0	0	0	0	0	0	0	0	0	0	0	1	1	1	
1	1	0	0	1	1	1	0	0	0	0	0.75	0	0	0	0	0	0	0	0	0	1	1	1	
1	1	1	0	0	1	0	0.75	0	0	0	0	0	0	0.75	0	0	0	1	0	0	0	-0.6	-0.6	0
1	1	1	0	0	1	0	0	0	0	0	0.75	0	0	0	0	0.75	0	1	0	0	0	-0.6	-0.6	0
1	1	1	0	0	1	0	0.75	0	0	0	0	0	0	0.75	0	0	0	0	0	0	0	-1	-1	0
1	1	1	0	0	1	0	0	0	0	0	0.75	0	0	0	0	0.75	0	0	0	0	0	-1	-1	0
1	1	1	0	0	1	0	0	0	0	0.75	0	0.75	0	0	0	0	0	0	0	0	0	-1	-1	0
1	1	0	0	1	1	1	1	0	0	0	0	0	0	0	0	0	0	0	0	0	0	-0.6	0.6	1
1	1	0	0	1	1	1	0	0	0	0	1	0	0	0	0	0	0	0	0	0	0	-0.6	0.6	1
1	1	0	0	1	1	1	0.75	0	0	0	0	0	0	0	0	0	0	0	0	0	0	-1	1	1
1	1	0	0	1	1	1	0	0	0	0	0.75	0	0	0	0	0	0	0	0	0	0	-1	1	1
1	1	1	0	0	1	0	0.75	0	0	0	0	0	0	0.75	0	0	0	1	0	0	0	0.6	-0.6	1
1	1	1	0	0	1	0	0	0	0	0	0.75	0	0	0	0	0.75	0	1	0	0	0	0.6	-0.6	1
1	1	1	0	0	1	0	0	0	0	0.75	0	0.75	0	0	0	0	0	1	0	0	0	0.6	-0.6	1
1	1	1	0	0	1	0	0.75	0	0	0	0	0	0	0.75	0	0	0	0	0	0	0	1	-1	1
1	1	1	0	0	1	0	0	0	0	0	0.75	0	0	0	0	0.75	0	0	0	0	0	1	-1	1
1	1	1	0	0	1	0	0	0	0	0.75	0	0.75	0	0	0	0	0	0	0	0	0	1	-1	1
1	1	1	0	0	1	0	0	0	0.75	0	0	0	0	0.75	0	0	0	1	0	0	0	0.6	-0.6	1
1	1	1	0	0	1	0	0	0	0.75	0	0	0	0	0.75	0	0	0	0	0	0	0	1	-1	1
1	1	1	0	0	1	0	0	0	0	0	0	0.75	0	0	0	0	0	1	0	0	0	0.6	0.6	1
1	1	1	0	0	1	0	0	0	0	0	0	0.75	0	0	0	0	0	0	0	0	0	1	1	1

7.3.3. Combinazioni per gli stati limite di esercizio: combinazione frequente

$$G_1 + R + \psi_{11} Q_{k1} + \psi_{2e3} T \quad (\text{carico da traffico veicolare } Q_{k1} \text{ principale})$$

	Peso proprio	Permanenti portati	Spinta a riposo piedritto sx	Spinta a riposo piedritto dx	Spinta attiva piedritto sx	Spinta attiva piedritto dx	Spinta acqua interna	Q1k centrato	Q1k filo piedritto dx	Q1k filo piedritto sx	Accidentale 9kPa su soletta	Accidentale 20 kPa	Accidentale su piedritto sx	Accidentale su piedritto dx	Accidentale 9kPa piedritto sx	Accidentale 9kPa piedritto dx	Accidentale 20kPa piedritto sx	Accidentale 20kPa piedritto dx	Frenatura	Sisma orizzontale	Sisma verticale	Spinta idrodinamica	Termica Uniforme	Termica farfalla +	Ritiro	
SLE FR	1	1	0	0	1	1	0	0.75	0	0	0	0	0	0	0	0	0	0	0	0	0	0	0.6	0.6	1	
	1	1	0	0	1	1	0	0	0	0	0	0.75	0	0	0	0	0.75	0	0	0	0	0	0	0.6	0.6	1
	1	1	1	0	0	1	0	0.75	0	0	0	0	0	0	0.75	0	0	0	0	0	0	0	0	-0.6	-0.6	0
	1	1	1	0	0	1	0	0	0	0	0	0.75	0	0	0	0	0.75	0	0	0	0	0	0	-0.6	-0.6	0
	1	1	1	0	0	1	0	0	0	0	0.75	0	0.75	0	0	0	0	0	0	0	0	0	0	-0.6	-0.6	0
	1	1	0	0	1	1	0	0.75	0	0	0	0	0	0	0	0	0	0	0	0	0	0	0	-0.6	0.6	0
	1	1	0	0	1	1	0	0	0	0	0	0	0.75	0	0	0	0	0	0	0	0	0	0	-0.6	0.6	0
	1	1	1	0	0	1	0	0.75	0	0	0	0	0	0	0	0.75	0	0	0	0	0	0	0	0.6	-0.6	1
	1	1	1	0	0	1	0	0	0	0	0	0	0.75	0	0	0	0	0.75	0	0	0	0	0	0.6	-0.6	1
	1	1	1	0	0	1	0	0	0	0	0	0.75	0	0.75	0	0	0	0	0	0	0	0	0	0.6	-0.6	1
	1	1	1	0	0	1	0	0	0	0	0.75	0	0	0.75	0	0.75	0	0	0	0	0	0	0	0.6	-0.6	1
	1	1	1	0	0	1	0	0	0	0	0	0	0	0.75	0	0	0	0	0	0	0	0	0	0.6	0.6	1

7.3.4. Combinazioni per gli stati limite di esercizio: combinazione quasi permanente

$$G_1 + R + \psi_{21} Q_{k1} + \psi_{2e3} T$$

	Peso proprio	Permanenti portati	Spinta a riposo piedritto sx	Spinta riposo piedritto dx	Spinta attiva piedritto sx	Spinta attiva piedritto dx	Spinta acqua interna	Q1k centrato	Q1k filo piedritto dx	Q1k filo piedritto sx	Accidentale 9kPa su soletta	Accidentale 20 kPa	Accidentale su piedritto sx	Accidentale su piedritto dx	Accidentale 9kPa piedritto sx	Accidentale 9kPa piedritto dx	Accidentale 20kPa piedritto sx	Accidentale 20kPa piedritto dx	Frenatura	Sisma orizzontale	Sisma verticale	Spinta idrodinamica	Termica Uniforme	Termica farfalla +	Ritiro	
SLE QP	1	1	0	0	1	1	0	0	0	0	0	0	0	0	0	0	0	0	0	0	0	0	0.5	0.5	1	
	1	1	1	0	0	1	0	0	0	0	0	0	0	0	0	0	0	0	0	0	0	0	-0.5	-0.5	0	
	1	1	0	0	1	1	0	0	0	0	0	0	0	0	0	0	0	0	0	0	0	0	-0.5	0.5	0	
	1	1	1	0	0	1	0	0	0	0	0	0	0	0	0	0	0	0	0	0	0	0	0	0.5	-0.5	1
	1	1	1	0	0	1	0	0	0	0	0	0	0	0	0	0	0	0	0	0	0	0	0	0.5	0.5	1

7.3.5. Combinazioni per lo stato limite ultimo di Salvaguardia della vita

Si considera il sisma agente nella direzione trasversale dello scatolare (gli effetti del sisma agente nella direzione longitudinale del manufatto sono poco rilevanti), associato al sisma in direzione verticale (considerando in alternativa entrambi i versi d'azione). La non contemporaneità della massima azione verticale e orizzontale viene tenuta in conto, come prescritto dalle NTC 2008 (Par. 7.3.5), considerando i 4 seguenti scenari:

$$E_1 = 1.00 E_H + 0.30 E_V + (\text{sisma orizzontale al 100\%, sisma verticale verso l'alto al 30\%})$$

$$E_2 = 1.00 E_H + 0.30 E_V - (\text{sisma orizzontale al 100\%, sisma verticale verso il basso al 30\%})$$

$$E_3 = 0.30 E_H + 1.00 E_V + (\text{sisma orizzontale al 30\%, sisma verticale verso l'alto al 100\%})$$

$$E_4 = 0.30 E_H + 1.00 E_V - (\text{sisma orizzontale al 30\%, sisma verticale verso il basso al 100\%})$$

$$G_1 + E + \psi_{21} Q_{k1} + \psi_{2e3} T$$



	Peso proprio	Permanenti portati	Spinta a riposo piedritto sx	Spinta a riposo piedritto dx	Spinta attiva piedritto sx	Spinta attiva piedritto dx	Spinta acqua interna	Q1k centrato	Q1k filo piedritto dx	Q1k filo piedritto sx	Accidentale 9kPa su soletta	Accidentale 20 kPa	Accidentale su piedritto sx	Accidentale su piedritto dx	Accidentale 9kPa piedritto sx	Accidentale 9kPa piedritto dx	Accidentale 20kPa piedritto sx	Accidentale 20kPa piedritto dx	Frenatura	Sisma orizzontale	Sisma verticale	Spinta idrodinamica	Termica Uniforme	Termica farfalla +	Ritiro
SISMA	1	1	1	1	0	0	0	0	0	0	0	0	0	0	0	0	0	0	0	0.3	1	0	0.5	0.5	1
	1	1	1	1	0	0	1	0	0	0	0	0	0	0	0	0	0	0	0	1	0.3	1	-0.5	-0.5	0
	1	1	1	1	0	0	0	0	0	0	0	0	0	0	0	0	0	0	0	0.3	1	0	-0.5	0.5	0
	1	1	1	1	0	0	1	0	0	0	0	0	0	0	0	0	0	0	0	1	0.3	1	0.5	-0.5	1
	1	1	1	1	0	0	1	0	0	0	0	0	0	0	0	0	0	0	0	1	-0.3	1	0.5	0.5	1

7.4. Diagrammi delle caratteristiche della sollecitazione

7.4.1. Inviluppo SLU/SLV momento flettente soletta superiore e soletta di fondazione

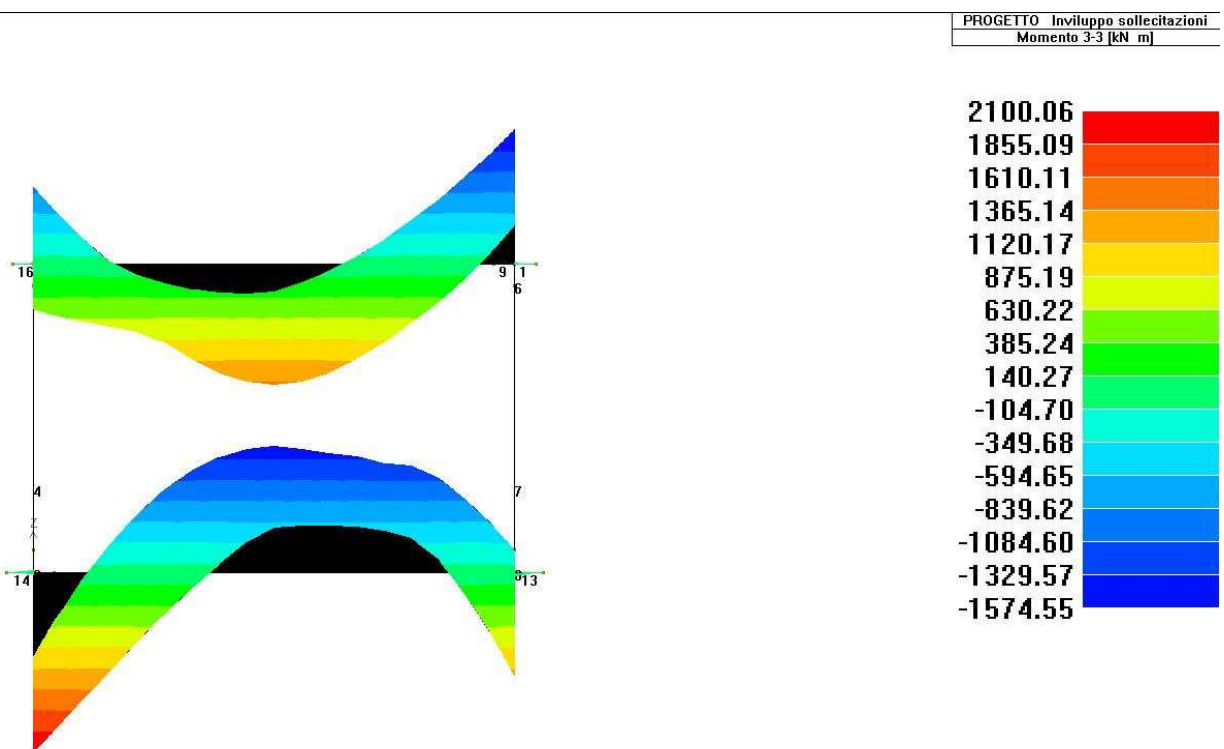

7.4.2. Inviluppo SLU/SLV momento flettente piedritti

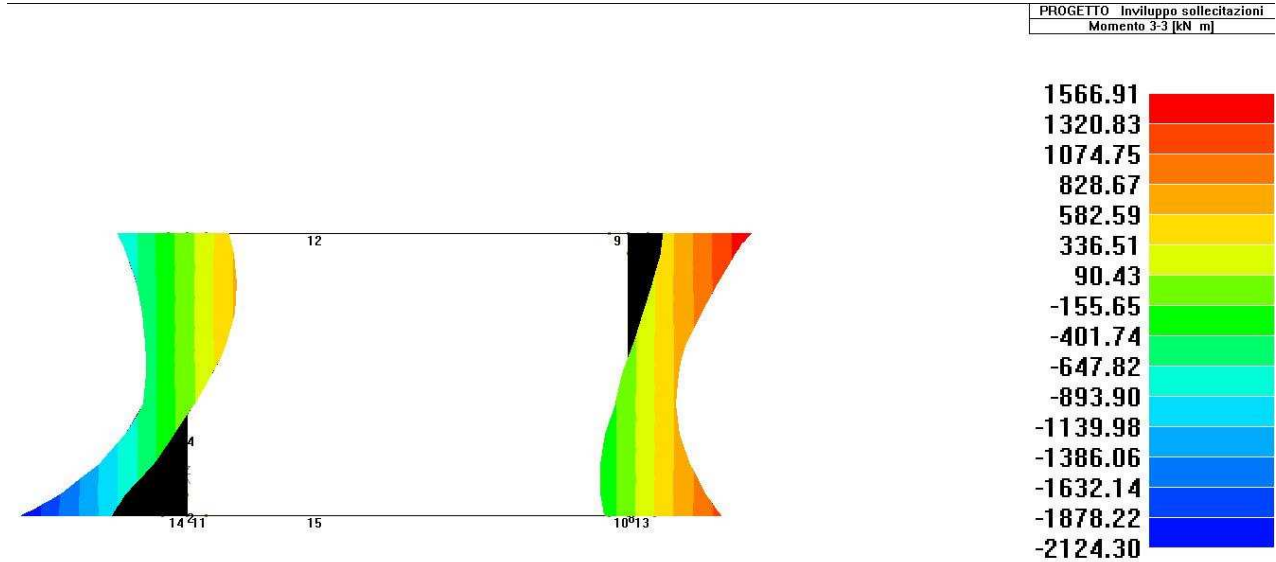

7.4.3. Inviluppo taglio SLU/SLV soletta superiore e soletta di fondazione

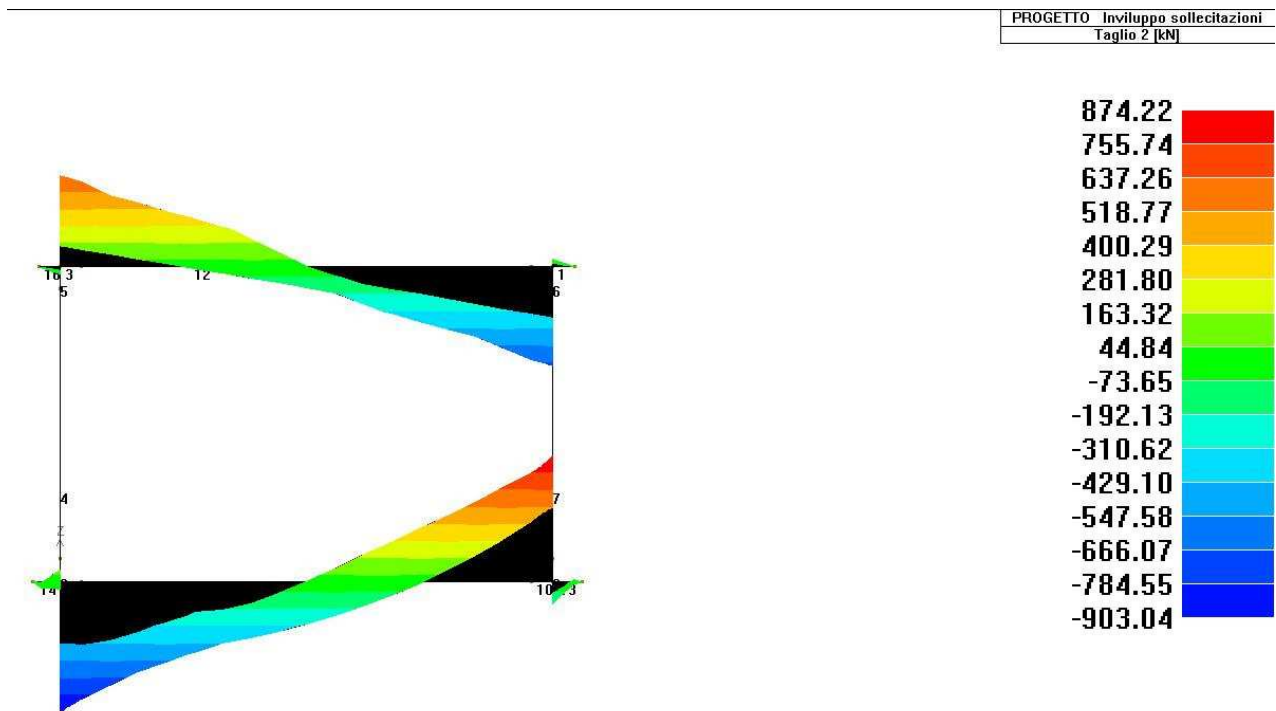

7.4.4. Inviluppo taglio SLU/SLV piedritti

PROGETTO Inviluppo sollecitazioni
Taglio 2 [kN]

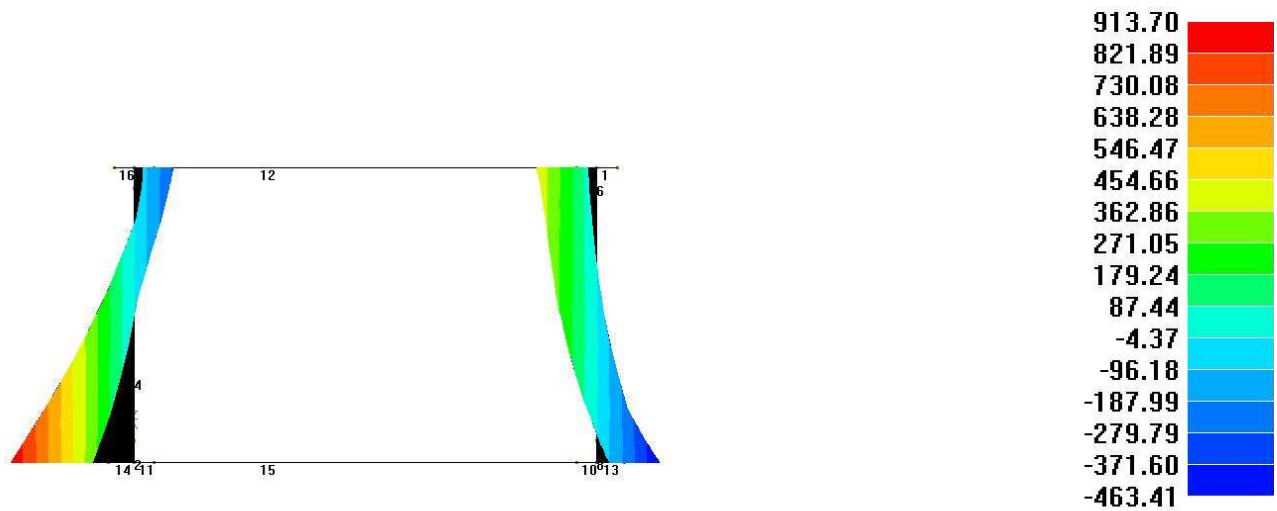

7.5. Verifiche di resistenza ed a fessurazione

Di seguito si riportano le verifiche delle sezioni per le aste più significative e per le Combinazioni di carico risultate più critiche.

Le verifiche a flessione sono effettuate rispettivamente:

- nella sezione ubicata a metà fra asse piedritto e sezione d'attacco piedritto-soletta nel caso delle verifiche della soletta;
- nella sezione ubicata a metà fra asse soletta e sezione d'attacco del piedritto nel caso delle verifiche del piedritto.

Le verifiche a taglio sono eseguite nelle sezioni di attacco soletta-piedritto.

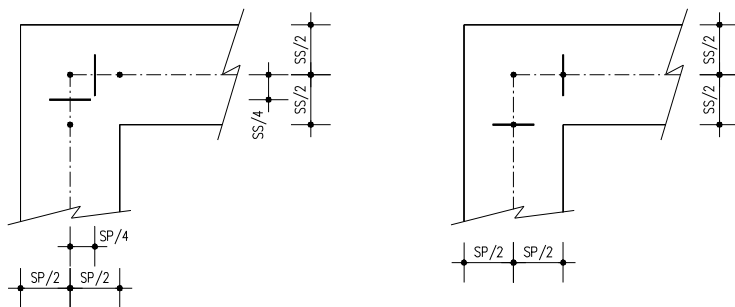

I calcoli di verifica sono effettuati con il metodo degli Stati Limite, applicando il combinato D. M.14.01.2008 con l'UNI EN 1992 (Eurocodice 2).

Le verifiche a fessurazione sono state condotte considerando:

Verifica di formazione delle fessure: la verifica si esegue per la sezione interamente reagente e per le sollecitazioni di esercizio si determina la massima trazione nel calcestruzzo σ_{ct} , confrontandola con la resistenza caratteristica a trazione per flessione f_{ctk} : se risulta $\sigma_{ct} < f_{ctk}$ la verifica è soddisfatta, altrimenti si procede alla verifica di apertura delle fessure.

Verifica di apertura delle fessure: l'apertura convenzionale delle fessure è calcolata con le modalità indicate nell'EC2, come richiesto dal D. M. Min. II. TT. del 14 gennaio 2008, e valutata con le sollecitazioni relative

alle Combinazioni FR o QP della normativa vigente sui ponti stradali". La massima apertura ammissibile risulta rispettivamente per le strutture in ambiente ordinario ed armature poco sensibili:

1) combinazione di carico Frequente:

$$w_k \leq w_3 = 0.40 \text{ mm}$$

2) combinazione di carico quasi permanente:

$$w_k \leq w_2 = 0.30 \text{ mm}$$

Nel caso di strutture in ambiente molto aggressivo ed armature poco sensibili:

1) combinazione di carico Frequente:

$$w_k \leq w_1 = 0.20 \text{ mm}$$

2) combinazione di carico quasi permanente:

$$w_k \leq w_1 = 0.20 \text{ mm}$$

Verifica delle tensioni di esercizio: si eseguono per la condizione di carico Quasi Permanente e Rara, verificando rispettivamente che le tensioni di lavoro siano inferiori ai seguenti limiti:

per la condizione QP si verifica che le massime tensioni presenti nel calcestruzzo siano inferiori a $\sigma_c < 0.45 f_{ck}$;

per la condizione rara si verifica che le massime tensioni presenti nel calcestruzzo siano inferiori a $\sigma_c < 0.60 f_{ck}$, mentre quelle dell'acciaio $\sigma_s < 0.80 f_{yk}$

7.5.1. Soletta superiore: attacco piedritto (Asta 9)

2SI s.r.l - ProVLIM - Verifica sezioni

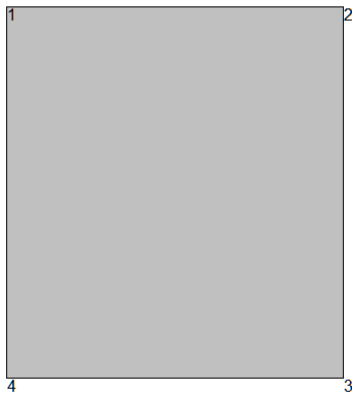

Geometria della sezione:

Vert.	X	Y
n.	cm	cm
1	0,0	110,0
2	100,0	110,0
3	100,0	0,0
4	0,0	0,0

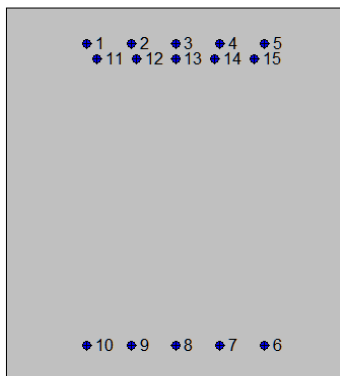

Armature:

Pos.	X	Y	Area	Pretens.
n.	cm	cm	cmq	(s/n)
1	23,7	99,5	4,5	no
2	36,8	99,5	4,5	no
3	50,0	99,5	4,5	no
4	63,2	99,5	4,5	no
5	76,3	99,5	4,5	no
6	76,3	10,5	4,5	no
7	63,2	10,5	4,5	no
8	50,0	10,5	4,5	no
9	36,8	10,5	4,5	no
10	23,7	10,5	4,5	no
11	26,6	95,1	4,5	no
12	38,3	95,1	4,5	no
13	50,0	95,1	4,5	no
14	61,7	95,1	4,5	no
15	73,4	95,1	4,5	no

Normativa di riferimento:

D.M. 14/01/2008 - 'Norme tecniche per le costruzioni'

Note:

Verifiche SLE per ambiente molto aggressivo

Materiali:

Calcestruzzo classe: C28/35

Rck (resistenza caratteristica cubica a compressione) = 350 daN/cm²

fck (resistenza caratteristica cilindrica a compressione) = 290 daN/cm²

fctm (resistenza a trazione media) = 28 daN/cm²

G (modulo di elasticità tangenziale) = 145424 daN/cm²

E (modulo elastico istantaneo iniziale) = 325750 daN/cm²

C. Poisson (coefficiente di contrazione trasversale) = 0.12

Coefficiente di dilatazione termica = 0.000050

Peso specifico del calcestruzzo armato = 2500 daN/mc

Barre d'acciaio ad aderenza migliorata tipo: B450C

f_{yk} (tensione caratteristica di snervamento) = 4500 daN/cm²

f_{kt} (tensione caratteristica di rottura) = 5400 daN/cm²

ϵ_{uk} (deformazione di rottura) = 0.075

G (modulo di elasticità tangenziale) = 793100 daN/cm²

E (modulo elastico) = 2060000 daN/cm²

C. Poisson (coefficiente di contrazione trasversale) = 0.30

Coefficiente di dilatazione termica = 0.000012

Peso specifico = 7850 daN/mc

Dominio SLU:

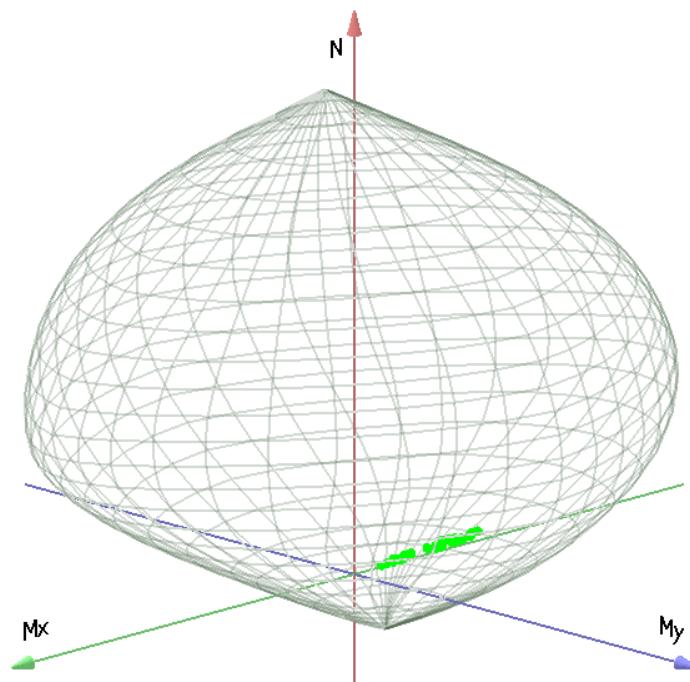

Caratteristiche limite della sezione:

Nu	Mxu	Myu	Stato Sez.
kN	kN m	kN m	
-2655,3	-354,9	0,0	Completamente tesa
20732,0	354,9	0,0	Completamente compressa
0,0	900,4	0,0	Fibre inferiori tese
0,0	-1624,4	0,0	Fibre superiori tese

0,0	0,0	1070,6	Fibre di sinistra tese
0,0	0,0	-1070,6	Fibre di destra tese

Verifiche stato limite ultimo:

Per ogni combinazione di carico saranno svolte le verifiche:

Verifica per Mxu, Myu e Nu proporzionali (sigla verifica: P)

e in caso di verifica proporzionale positiva:

Verifica con rapporto Mxu, Myu assegnato (sigla verifica: M)

Verifica con Nu costante (sigla verifica: N)

Cmb.	N	Mx	My	Tipo	Nu	Mxu	Myu	Sd/Su	Verif.
	kN	kN m	kN m		kN	kN m	kN m		
1	93,6	-548,4	0,0	P	300,1	-1758,1	0,0	0,310	OK
				M	18503,7	-547,5	0,0	0,000	
				N	93,6	-1666,3	0,0	0,330	
2	80,7	-460,0	0,0	P	309,0	-1762,0	0,0	0,260	OK
				M	18724,4	-459,1	0,0	0,000	
				N	80,7	-1660,5	0,0	0,280	
3	77,4	-384,1	0,0	P	359,7	-1784,4	0,0	0,210	OK
				M	18913,6	-383,1	0,0	0,000	
				N	77,4	-1659,1	0,0	0,230	
4	67,7	-318,0	0,0	P	382,2	-1794,3	0,0	0,180	OK
				M	19077,9	-317,2	0,0	0,000	
				N	67,7	-1654,7	0,0	0,190	
5	276,7	-1366,0	0,0	P	361,6	-1785,3	0,0	0,760	OK
				M	16457,1	-1365,0	0,0	0,020	
				N	276,7	-1747,7	0,0	0,780	
6	280,4	-1348,0	0,0	P	372,3	-1790,0	0,0	0,750	OK
				M	16502,4	-1347,0	0,0	0,020	
				N	280,4	-1749,4	0,0	0,770	
7	300,6	-1356,0	0,0	P	399,5	-1801,9	0,0	0,750	OK
				M	16482,6	-1354,9	0,0	0,020	
				N	300,6	-1758,3	0,0	0,770	
8	220,0	-1165,0	0,0	P	334,9	-1773,5	0,0	0,660	OK
				M	16961,3	-1164,0	0,0	0,010	
				N	220,0	-1722,6	0,0	0,680	
9	223,8	-1146,0	0,0	P	347,4	-1779,0	0,0	0,640	OK
				M	17009,0	-1145,0	0,0	0,010	



				N	223,8	-1724,3	0,0	0,660	
10	244,0	-1155,0	0,0	P	378,7	-1792,8	0,0	0,640	OK
				M	16986,4	-1154,0	0,0	0,010	
				N	244,0	-1733,2	0,0	0,670	
11	120,3	-648,1	0,0	P	328,7	-1770,7	0,0	0,370	OK
				M	18254,8	-647,2	0,0	0,010	
				N	120,3	-1678,2	0,0	0,390	
12	107,4	-559,8	0,0	P	340,7	-1776,0	0,0	0,310	OK
				M	18475,4	-558,9	0,0	0,010	
				N	107,4	-1672,4	0,0	0,330	
13	113,2	-517,8	0,0	P	393,3	-1799,2	0,0	0,290	OK
				M	18580,0	-517,0	0,0	0,010	
				N	113,2	-1675,0	0,0	0,310	
14	103,5	-451,7	0,0	P	414,4	-1808,5	0,0	0,250	OK
				M	18744,9	-450,8	0,0	0,000	
				N	103,5	-1670,7	0,0	0,270	
15	249,9	-1266,0	0,0	P	351,5	-1780,8	0,0	0,710	OK
				M	16708,3	-1264,9	0,0	0,010	
				N	249,9	-1735,8	0,0	0,730	
16	253,7	-1248,0	0,0	P	363,0	-1785,9	0,0	0,700	OK
				M	16753,2	-1247,0	0,0	0,010	
				N	253,7	-1737,5	0,0	0,720	
17	273,9	-1256,0	0,0	P	392,3	-1798,8	0,0	0,700	OK
				M	16733,0	-1255,0	0,0	0,020	
				N	273,9	-1746,5	0,0	0,720	
18	184,2	-1031,0	0,0	P	315,3	-1764,8	0,0	0,580	OK
				M	17297,0	-1030,0	0,0	0,010	
				N	184,2	-1706,7	0,0	0,600	
19	188,0	-1013,0	0,0	P	328,6	-1770,7	0,0	0,570	OK
				M	17342,0	-1012,0	0,0	0,010	
				N	188,0	-1708,4	0,0	0,590	
20	208,2	-1021,0	0,0	P	364,3	-1786,4	0,0	0,570	OK
				M	17322,0	-1020,0	0,0	0,010	
				N	208,2	-1717,3	0,0	0,590	
21	239,9	-1192,0	0,0	P	359,1	-1784,1	0,0	0,670	OK
				M	16893,5	-1191,0	0,0	0,010	
				N	239,9	-1731,4	0,0	0,690	
22	174,2	-956,8	0,0	P	321,8	-1767,7	0,0	0,540	OK
				M	17482,7	-955,9	0,0	0,010	
				N	174,2	-1702,2	0,0	0,560	

23	261,8	-858,1	0,0	P	572,9	-1877,9	0,0	0,460	OK
				M	17729,9	-857,1	0,0	0,010	
				N	261,8	-1741,1	0,0	0,490	
24	182,0	-462,9	0,0	P	772,3	-1964,2	0,0	0,240	OK
				M	18717,0	-462,0	0,0	0,010	
				N	182,0	-1705,7	0,0	0,270	
25	259,2	-1174,0	0,0	P	397,7	-1801,1	0,0	0,650	OK
				M	16938,7	-1173,0	0,0	0,010	
				N	259,2	-1740,0	0,0	0,670	
26	272,9	-1219,0	0,0	P	403,8	-1803,9	0,0	0,680	OK
				M	16825,7	-1218,1	0,0	0,020	
				N	272,9	-1746,0	0,0	0,700	
27	172,8	-936,1	0,0	P	326,7	-1769,8	0,0	0,530	OK
				M	17534,6	-935,2	0,0	0,010	
				N	172,8	-1701,6	0,0	0,550	
28	186,8	-994,8	0,0	P	332,8	-1772,6	0,0	0,560	OK
				M	17387,5	-993,9	0,0	0,010	
				N	186,8	-1707,8	0,0	0,580	
29	251,0	-955,9	0,0	P	482,8	-1838,5	0,0	0,520	OK
				M	17485,0	-955,0	0,0	0,010	
				N	251,0	-1736,3	0,0	0,550	
30	374,5	-1124,0	0,0	P	634,6	-1904,8	0,0	0,590	OK
				M	17064,2	-1122,9	0,0	0,020	
				N	374,5	-1790,9	0,0	0,630	
31	391,6	-1071,0	0,0	P	708,1	-1936,6	0,0	0,550	OK
				M	17197,0	-1070,0	0,0	0,020	
				N	391,6	-1798,5	0,0	0,590	
32	434,1	-1014,0	0,0	P	856,3	-2000,3	0,0	0,510	OK
				M	17339,5	-1013,0	0,0	0,020	
				N	434,1	-1817,2	0,0	0,560	
33	260,8	-972,3	0,0	P	494,5	-1843,7	0,0	0,530	OK
				M	17444,2	-971,3	0,0	0,010	
				N	260,8	-1740,7	0,0	0,560	
75	205,9	-589,1	0,0	P	671,3	-1920,7	0,0	0,310	OK
				M	18402,5	-588,1	0,0	0,010	
				N	205,9	-1716,3	0,0	0,340	
76	394,3	-1449,0	0,0	P	502,7	-1847,2	0,0	0,780	OK
				M	16249,1	-1447,9	0,0	0,020	
				N	394,3	-1799,7	0,0	0,800	
77	226,3	-665,2	0,0	P	650,3	-1911,6	0,0	0,350	OK

				M	18212,1	-664,3	0,0	0,010	
				N	226,3	-1725,4	0,0	0,380	
78	374,0	-1373,0	0,0	P	503,2	-1847,5	0,0	0,740	OK
				M	16439,6	-1372,0	0,0	0,020	
				N	374,0	-1790,7	0,0	0,770	
79	361,3	-1180,0	0,0	P	575,3	-1879,0	0,0	0,630	OK
				M	16923,7	-1179,0	0,0	0,020	
				N	361,3	-1785,1	0,0	0,660	

Riepilogo combinazioni maggiormente gravose:

Cmb.	N	Mx	My	Tipo	Nu	Mxu	Myu	Sd/Su	Verif.
	kN	kN m	kN m		kN	kN m	kN m		
76	394,3	-1449,0	0,0	P	502,7	-1847,2	0,0	0,780	OK
5	276,7	-1366,0	0,0	M	16457,1	-1365,0	0,0	0,020	OK
76	394,3	-1449,0	0,0	N	394,3	-1799,7	0,0	0,800	OK

Verifiche stato limite di esercizio per c. c. rare:

Valori limite (tensioni: segno (-) = compressione, (+) = trazione):

CLS: $\sigma_{cL} = 17400,0$ kN/mq (verifica Ok per $\sigma_c/\sigma_{cL} < 1$)

Acciaio: $\sigma_{aL} = 360000,0$ kN/mq (verifica Ok per $\sigma_a/\sigma_{aL} < 1$)

Cmb	Mx	My	N	σ_c	σ_c/σ_{cL}	σ_a	σ_a/σ_{aL}
n. e stato	kN m	kN m	kN	kN/mq		kN/mq	
46 OK	-413,7	0,0	104,8	-2945,7	0,17	96417,6	0,27
47 OK	-348,3	0,0	95,2	-2484,0	0,14	80443,9	0,22
48 OK	-283,4	0,0	91,8	-2028,8	0,12	63965,1	0,18
49 OK	-234,3	0,0	84,6	-1681,8	0,10	51981,2	0,14
50 OK	-985,7	0,0	225,7	-7004,7	0,40	232246,9	0,65
51 OK	-972,0	0,0	228,5	-6910,8	0,40	228395,4	0,63
52 OK	-978,0	0,0	243,5	-6961,3	0,40	228379,6	0,63
53 OK	-845,5	0,0	184,8	-6003,2	0,35	200138,5	0,56
54 OK	-831,9	0,0	187,6	-5910,0	0,34	196312,2	0,55
55 OK	-837,9	0,0	202,6	-5960,6	0,34	196295,0	0,55
56 OK	-456,2	0,0	116,2	-3248,7	0,19	106256,3	0,30
57 OK	-390,7	0,0	106,6	-2786,2	0,16	90259,1	0,25
58 OK	-354,2	0,0	110,7	-2533,6	0,15	80361,2	0,22
59 OK	-305,1	0,0	103,5	-2186,6	0,13	68375,6	0,19

60	OK	-902,5	0,0	203,4	-6411,5	0,37	212985,1	0,59
61	OK	-888,8	0,0	206,2	-6317,6	0,36	209133,4	0,58
62	OK	-894,8	0,0	221,2	-6368,2	0,37	209117,2	0,58
63	OK	-734,1	0,0	155,0	-5209,0	0,30	174342,7	0,48
64	OK	-720,4	0,0	157,8	-5115,1	0,29	170490,0	0,47
65	OK	-726,4	0,0	172,8	-5165,8	0,30	170471,9	0,47
66	OK	-847,3	0,0	195,9	-6022,3	0,35	199439,1	0,55
67	OK	-678,9	0,0	147,5	-4819,8	0,28	160795,8	0,45
68	OK	-650,2	0,0	202,3	-4650,4	0,27	147612,5	0,41
69	OK	-348,4	0,0	142,0	-2508,7	0,14	75622,8	0,21

Verifiche stato limite di esercizio per c. c. frequenti:

Valori limite:

Fessure: $WkL = 0,30$ mm (verifica Ok per $Wk/WkL < 1$)

	Cmb	Mx	My	N	Wk	Wk/WkL
n. e stato	kN m	kN m	kN	mm		
34	OK	-364,2	0,0	101,5	0.13	0,44
35	OK	-379,5	0,0	112,4	0.14	0,46
36	OK	-764,7	0,0	175,1	0.29	0,95
37	OK	-751,1	0,0	177,9	0.28	0,93
38	OK	-757,1	0,0	192,9	0.28	0,93
39	OK	-447,4	0,0	123,7	0.16	0,54
40	OK	-398,3	0,0	116,5	0.14	0,48
41	OK	-681,6	0,0	152,9	0.25	0,85
42	OK	-667,9	0,0	155,7	0.25	0,83
43	OK	-673,9	0,0	170,7	0.25	0,83
44	OK	-751,4	0,0	180,2	0.28	0,93
45	OK	-429,2	0,0	151,7	0.15	0,50

Verifiche stato limite di esercizio per c. c. quasi permanenti:

Valori limite:

CLS: $\sigma cL = 13050,0$ kN/mq (verifica Ok per $\sigma c/\sigma cL < 1$)

Fessure: $WkL = 0,20$ mm (verifica Ok per $Wk/WkL < 1$)



Cmb	Mx	My	N	σ_c	σ_c/σ_{cL}	Wk	Wk/WkL
n. e stato	kN m	kN m	kN	kN/mq		mm	
70 OK	-236,0	0,0	93,8	-1698,2	0,13	0,08	0,40
71 OK	-567,1	0,0	154,4	-4044,0	0,31	0,20	1,00
72 OK	-312,0	0,0	114,1	-2240,3	0,17	0,11	0,54
73 OK	-491,0	0,0	134,1	-3501,6	0,27	0,18	0,89
74 OK	-324,4	0,0	119,3	-2329,6	0,18	0,11	0,56

7.5.2. Soletta superiore: mezzeria (Asta 12)

2SI s.r.l - ProVLIM - Verifica sezioni

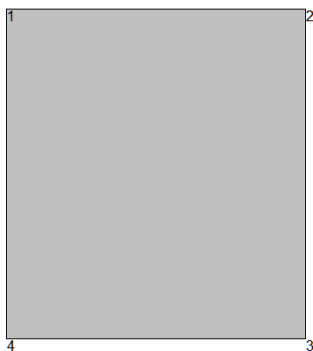

Geometria della sezione:

Vert.	X	Y
n.	cm	cm
1	0,0	110,0
2	100,0	110,0
3	100,0	0,0
4	0,0	0,0

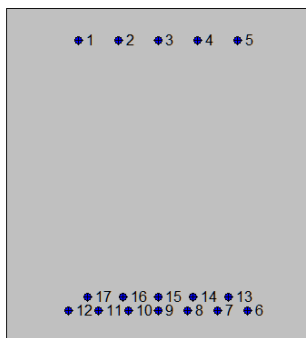

Armature:

Pos.	X	Y	Area	Pretens.
------	---	---	------	----------

n.	cm	cm	cmq	(s/n)
1	23,7	99,5	4,5	no
2	36,8	99,5	4,5	no
3	50,0	99,5	4,5	no
4	63,2	99,5	4,5	no
5	76,3	99,5	4,5	no
6	79,6	10,5	4,5	no
7	69,8	10,5	4,5	no
8	59,9	10,5	4,5	no
9	50,0	10,5	4,5	no
10	40,1	10,5	4,5	no
11	30,3	10,5	4,5	no
12	20,4	10,5	4,5	no
13	73,4	14,9	4,5	no
14	61,7	14,9	4,5	no
15	50,0	14,9	4,5	no
16	38,3	14,9	4,5	no
17	26,6	14,9	4,5	no

Normativa di riferimento:

D.M. 14/01/2008 - 'Norme tecniche per le costruzioni'

Note:

Verifiche SLE per ambiente molto aggressivo

Materiali:

Calcestruzzo classe: C28/35

Rck (resistenza caratteristica cubica a compressione) = 350 daN/cm²

fck (resistenza caratteristica cilindrica a compressione) = 290 daN/cm²

fctm (resistenza a trazione media) = 28 daN/cm²

G (modulo di elasticità tangenziale) = 145424 daN/cm²

E (modulo elastico istantaneo iniziale) = 325750 daN/cm²

C. Poisson (coefficiente di contrazione trasversale) = 0.12

Coefficiente di dilatazione termica = 0.000050

Peso specifico del calcestruzzo armato = 2500 daN/m³

Barre d'acciaio ad aderenza migliorata tipo: B450C

f_{yk} (tensione caratteristica di snervamento) = 4500 daN/cm²

f_{kt} (tensione caratteristica di rottura) = 5400 daN/cm²

ϵ_{uk} (deformazione di rottura) = 0.075

G (modulo di elasticità tangenziale) = 793100 daN/cm²

E (modulo elastico) = 2060000 daN/cm²

C. Poisson (coefficiente di contrazione trasversale) = 0.30

Coefficiente di dilatazione termica = 0.000012

Peso specifico = 7850 daN/mc

Dominio SLU:

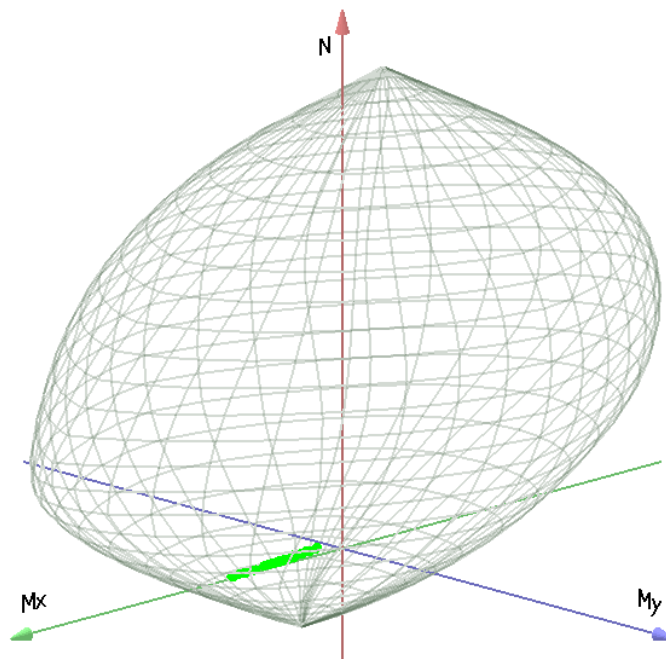

Caratteristiche limite della sezione:

Nu	Mxu	Myu	Stato Sez.
kN	kN m	kN m	
-3009,4	512,5	0,0	Completamente tesa
21086,0	-512,5	0,0	Completamente compressa
0,0	1939,5	0,0	Fibre inferiori tese

0,0	-900,7	0,0	Fibre superiori tese
0,0	0,0	1158,1	Fibre di sinistra tese
0,0	0,0	-1158,1	Fibre di destra tese

Verifiche stato limite ultimo:

Per ogni combinazione di carico saranno svolte le verifiche:

Verifica per Mxu, Myu e Nu proporzionali (sigla verifica: P)

e in caso di verifica proporzionale positiva:

Verifica con rapporto Mxu, Myu assegnato (sigla verifica: M)

Verifica con Nu costante (sigla verifica: N)

Cmb.	N	Mx	My	Tipo	Nu	Mxu	Myu	Sd/Su	Verif.
	kN	kN m	kN m		kN	kN m	kN m		
1	93,6	1402,0	0,0	P	133,4	1998,1	0,0	0,700	OK
				M	16358,0	1401,0	0,0	0,010	
				N	93,6	1980,7	0,0	0,710	
2	80,7	1213,0	0,0	P	132,8	1997,9	0,0	0,610	OK
				M	16830,2	1212,0	0,0	0,000	
				N	80,7	1975,0	0,0	0,610	
3	77,4	1373,0	0,0	P	112,1	1988,8	0,0	0,690	OK
				M	16431,0	1371,8	0,0	0,000	
				N	77,4	1973,6	0,0	0,700	
4	67,7	1231,0	0,0	P	109,4	1987,6	0,0	0,620	OK
				M	16785,2	1230,0	0,0	0,000	
				N	67,7	1969,3	0,0	0,620	
5	208,7	891,2	0,0	P	505,7	2159,3	0,0	0,410	OK
				M	17632,8	890,2	0,0	0,010	
				N	208,7	2031,0	0,0	0,440	
6	212,4	742,8	0,0	P	632,9	2213,4	0,0	0,340	OK
				M	18002,6	741,8	0,0	0,010	
				N	212,4	2032,6	0,0	0,360	
7	232,6	606,5	0,0	P	890,2	2321,2	0,0	0,260	OK
				M	18341,4	605,6	0,0	0,010	
				N	232,6	2041,4	0,0	0,300	
8	220,0	794,5	0,0	P	610,2	2203,8	0,0	0,360	OK
				M	17873,8	793,5	0,0	0,010	
				N	220,0	2035,9	0,0	0,390	
9	223,8	646,0	0,0	P	789,7	2279,4	0,0	0,280	OK

				M	18243,6	644,9	0,0	0,010	
				N	223,8	2037,6	0,0	0,320	
10	244,0	509,8	0,0	P	1164,7	2433,4	0,0	0,210	OK
				M	18581,6	508,9	0,0	0,010	
				N	244,0	2046,4	0,0	0,250	
11	120,3	1302,0	0,0	P	186,8	2021,5	0,0	0,640	OK
				M	16607,9	1301,0	0,0	0,010	
				N	120,3	1992,4	0,0	0,650	
12	107,4	1113,0	0,0	P	195,4	2025,2	0,0	0,550	OK
				M	17080,1	1111,9	0,0	0,010	
				N	107,4	1986,7	0,0	0,560	
13	113,2	1239,0	0,0	P	184,6	2020,5	0,0	0,610	OK
				M	16765,5	1237,9	0,0	0,010	
				N	113,2	1989,3	0,0	0,620	
14	103,5	1098,0	0,0	P	190,7	2023,2	0,0	0,540	OK
				M	17117,1	1097,1	0,0	0,010	
				N	103,5	1985,0	0,0	0,550	
15	181,9	991,0	0,0	P	387,0	2108,3	0,0	0,470	OK
				M	17384,3	989,9	0,0	0,010	
				N	181,9	2019,3	0,0	0,490	
16	185,7	842,5	0,0	P	472,8	2145,2	0,0	0,390	OK
				M	17754,3	841,5	0,0	0,010	
				N	185,7	2021,0	0,0	0,420	
17	205,9	706,3	0,0	P	647,0	2219,4	0,0	0,320	OK
				M	18093,1	705,4	0,0	0,010	
				N	205,9	2029,8	0,0	0,350	
18	184,2	928,2	0,0	P	421,3	2123,1	0,0	0,440	OK
				M	17540,8	927,2	0,0	0,010	
				N	184,2	2020,3	0,0	0,460	
19	188,0	779,8	0,0	P	522,3	2166,4	0,0	0,360	OK
				M	17908,7	779,4	0,0	0,010	
				N	188,0	2022,0	0,0	0,390	
20	208,2	643,5	0,0	P	729,3	2254,1	0,0	0,280	OK
				M	18249,3	642,6	0,0	0,010	
				N	208,2	2030,8	0,0	0,320	
21	171,9	822,9	0,0	P	445,7	2133,6	0,0	0,390	OK
				M	17803,3	821,8	0,0	0,010	
				N	171,9	2015,0	0,0	0,410	
22	174,2	760,2	0,0	P	493,6	2154,1	0,0	0,350	OK
				M	17959,0	759,3	0,0	0,010	



				N	174,2	2016,0	0,0	0,380	
23	193,8	632,6	0,0	P	684,8	2235,3	0,0	0,280	OK
				M	18276,4	631,7	0,0	0,010	
				N	193,8	2024,5	0,0	0,310	
24	182,0	729,8	0,0	P	542,4	2175,0	0,0	0,330	OK
				M	18034,8	728,8	0,0	0,010	
				N	182,0	2019,4	0,0	0,360	
25	191,2	858,5	0,0	P	478,3	2147,6	0,0	0,400	OK
				M	17714,6	857,4	0,0	0,010	
				N	191,2	2023,4	0,0	0,420	
26	204,9	878,3	0,0	P	503,5	2158,4	0,0	0,410	OK
				M	17664,9	877,3	0,0	0,010	
				N	204,9	2029,4	0,0	0,430	
27	172,8	892,6	0,0	P	410,1	2118,3	0,0	0,420	OK
				M	17629,4	891,6	0,0	0,010	
				N	172,8	2015,4	0,0	0,440	
28	186,8	921,1	0,0	P	431,5	2127,5	0,0	0,430	OK
				M	17558,5	920,1	0,0	0,010	
				N	186,8	2021,5	0,0	0,460	
29	183,0	841,5	0,0	P	465,9	2142,2	0,0	0,390	OK
				M	17756,7	840,5	0,0	0,010	
				N	183,0	2019,8	0,0	0,420	
30	306,5	622,1	0,0	P	1207,4	2450,6	0,0	0,250	OK
				M	18302,5	621,2	0,0	0,020	
				N	306,5	2073,5	0,0	0,300	
31	323,6	466,7	0,0	P	1879,4	2710,5	0,0	0,170	OK
				M	18689,0	465,6	0,0	0,020	
				N	323,6	2080,9	0,0	0,220	
32	366,1	322,3	0,0	P	3694,7	3252,7	0,0	0,100	OK
				M	19046,8	321,3	0,0	0,020	
				N	366,1	2099,3	0,0	0,150	
33	192,8	831,6	0,0	P	500,1	2156,9	0,0	0,390	OK
				M	17781,2	830,6	0,0	0,010	
				N	192,8	2024,1	0,0	0,410	
75	179,5	680,6	0,0	P	577,6	2189,9	0,0	0,310	OK
				M	18157,3	679,6	0,0	0,010	
				N	179,5	2018,3	0,0	0,340	
76	306,2	336,6	0,0	P	2717,0	2986,7	0,0	0,110	OK
				M	19011,5	335,6	0,0	0,020	
				N	306,2	2073,4	0,0	0,160	

77	199,9	604,6	0,0	P	747,8	2261,8	0,0	0,270	OK
				M	18346,1	603,6	0,0	0,010	
				N	199,9	2027,2	0,0	0,300	
78	285,9	412,7	0,0	P	1877,2	2709,7	0,0	0,150	OK
				M	18822,5	411,8	0,0	0,010	
				N	285,9	2064,6	0,0	0,200	
79	273,2	525,8	0,0	P	1290,6	2483,9	0,0	0,210	OK
				M	18541,9	524,9	0,0	0,010	
				N	273,2	2059,1	0,0	0,250	

Riepilogo combinazioni maggiormente gravose:

Cmb.	N	Mx	My	Tipo	Nu	Mxu	Myu	Sd/Su	Verif.
	kN	kN m	kN m		kN	kN m	kN m		
1	93,6	1402,0	0,0	P	133,4	1998,1	0,0	0,700	OK
30	306,5	622,1	0,0	M	18302,5	621,2	0,0	0,020	OK
1	93,6	1402,0	0,0	N	93,6	1980,7	0,0	0,710	OK

Verifiche stato limite di esercizio per c. c. rare:

Valori limite (tensioni: segno (-) = compressione, (+) = trazione):

CLS: $\sigma_{cL} = 17400,0$ kN/mq (verifica Ok per $\sigma_c/\sigma_{cL} < 1$)

Acciaio: $\sigma_{aL} = 360000,0$ kN/mq (verifica Ok per $\sigma_a/\sigma_{aL} < 1$)

Cmb	Mx	My	N	σ_c	σ_c/σ_{cL}	σ_a	σ_a/σ_{aL}
n. e stato	kN m	kN m	kN	kN/mq		kN/mq	
46 OK	1031,0	0,0	104,8	-6760,0	0,39	214033,6	0,59
47 OK	890,8	0,0	95,2	-5844,1	0,34	184523,1	0,51
48 OK	1019,0	0,0	91,8	-6672,6	0,38	212567,0	0,59
49 OK	914,0	0,0	84,6	-5986,7	0,34	190467,4	0,53
50 OK	634,7	0,0	175,3	-4236,9	0,24	122253,6	0,34
51 OK	524,4	0,0	178,1	-3521,0	0,20	98196,0	0,27
52 OK	423,2	0,0	193,1	-2869,4	0,16	75124,5	0,21
53 OK	554,0	0,0	184,8	-3717,8	0,21	104021,0	0,29
54 OK	443,8	0,0	187,6	-3001,0	0,17	80017,6	0,22
55 OK	342,6	0,0	202,6	-2346,0	0,13	57026,7	0,16
56 OK	988,4	0,0	116,2	-6492,1	0,37	203826,8	0,57
57 OK	848,3	0,0	106,6	-5576,8	0,32	174340,9	0,48
58 OK	948,3	0,0	110,7	-6228,1	0,36	195625,4	0,54

59	OK	843,2	0,0	103,5	-5541,5	0,32	173505,6	0,48
60	OK	717,8	0,0	153,0	-4762,3	0,27	142117,3	0,39
61	OK	607,6	0,0	155,9	-4048,5	0,23	118046,5	0,33
62	OK	506,4	0,0	170,9	-3399,5	0,20	94916,9	0,26
63	OK	665,5	0,0	155,0	-4424,0	0,25	130638,6	0,36
64	OK	555,3	0,0	157,8	-3709,7	0,21	106584,0	0,30
65	OK	454,1	0,0	172,8	-3059,9	0,18	83472,9	0,23
66	OK	593,0	0,0	145,6	-3947,0	0,23	115768,2	0,32
67	OK	540,7	0,0	147,5	-3608,3	0,21	104303,7	0,29
68	OK	628,6	0,0	151,9	-4182,3	0,24	122926,3	0,34
69	OK	709,6	0,0	142,0	-4701,7	0,27	141286,3	0,39

Verifiche stato limite di esercizio per c. c. frequenti:

Valori limite:

Fessure: $WkL = 0,30$ mm (verifica Ok per $Wk/WkL < 1$)

	Cmb	Mx	My	N	Wk	Wk/WkL
n. e stato	kN m	kN m	kN	mm		
34	OK	938,3	0,0	101,5	0.28	0,95
35	OK	823,8	0,0	112,4	0.25	0,82
36	OK	634,9	0,0	175,1	0.18	0,59
37	OK	524,6	0,0	177,9	0.14	0,47
38	OK	423,4	0,0	192,9	0.11	0,36
39	OK	855,1	0,0	123,7	0.25	0,85
40	OK	750,0	0,0	116,5	0.22	0,74
41	OK	718,0	0,0	152,9	0.21	0,69
42	OK	607,8	0,0	155,7	0.17	0,57
43	OK	506,6	0,0	170,7	0.14	0,46
44	OK	577,7	0,0	180,2	0.16	0,53
45	OK	628,8	0,0	151,7	0.18	0,59

Verifiche stato limite di esercizio per c. c. quasi permanenti:

Valori limite:

CLS: $\sigma_{cL} = 13050,0$ kN/mq (verifica Ok per $\sigma_c/\sigma_{cL} < 1$)

Fessure: $WkL = 0,20$ mm (verifica Ok per $Wk/WkL < 1$)

	Cmb	Mx	My	N	σ_c	σ_c/σ_{cL}	Wk	Wk/WkL
n. e stato		kN m	kN m	kN	kN/mq		mm	
70	OK	640,2	0,0	93,8	-4218,2	0,32	0.19	0,95
71	OK	381,4	0,0	154,4	-2575,2	0,20	0.10	0,50
72	OK	564,1	0,0	114,1	-3738,5	0,29	0.16	0,82
73	OK	457,5	0,0	134,1	-3058,9	0,23	0.13	0,63
74	OK	624,1	0,0	119,3	-4131,4	0,32	0.18	0,91

7.5.3. Soletta di fondazione: attacco piedritto (Asta 11)

2SI s.r.l - ProVLIM - Verifica sezioni

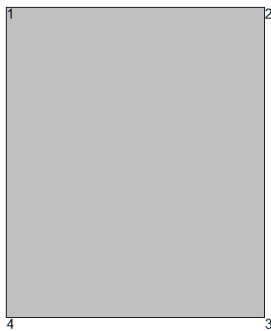

Geometria della sezione:

Vert.	X	Y
n.	cm	cm
1	0,0	120,0
2	100,0	120,0
3	100,0	0,0
4	0,0	0,0

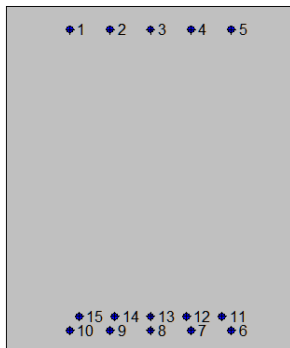

Armature:

Pos.	X	Y	Area	Pretens.
------	---	---	------	----------

n.	cm	cm	cmq	(s/n)
1	22,0	112,0	4,5	no
2	36,0	112,0	4,5	no
3	50,0	112,0	4,5	no
4	64,0	112,0	4,5	no
5	78,0	112,0	4,5	no
6	78,0	8,0	4,5	no
7	64,0	8,0	4,5	no
8	50,0	8,0	4,5	no
9	36,0	8,0	4,5	no
10	22,0	8,0	4,5	no
11	74,8	12,8	4,5	no
12	62,4	12,8	4,5	no
13	50,0	12,8	4,5	no
14	37,6	12,8	4,5	no
15	25,2	12,8	4,5	no

Normativa di riferimento:

D.M. 14/01/2008 - 'Norme tecniche per le costruzioni'

Note:

Verifiche SLE per ambiente ordinario

Materiali:

Calcestruzzo classe: C25/30

Rck (resistenza caratteristica cubica a compressione) = 300 daN/cm²

fck (resistenza caratteristica cilindrica a compressione) = 249 daN/cm²

fctm (resistenza a trazione media) = 26 daN/cm²

G (modulo di elasticità tangenziale) = 140388 daN/cm²

E (modulo elastico istantaneo iniziale) = 314470 daN/cm²

C. Poisson (coefficiente di contrazione trasversale) = 0.12

Coefficiente di dilatazione termica = 0.000050

Peso specifico del calcestruzzo armato = 2500 daN/m³

Barre d'acciaio ad aderenza migliorata tipo: B450C

f_{yk} (tensione caratteristica di snervamento) = 4500 daN/cm²

f_{kt} (tensione caratteristica di rottura) = 5400 daN/cm²

ϵ_{uk} (deformazione di rottura) = 0.075

G (modulo di elasticità tangenziale) = 793100 daN/cm²

E (modulo elastico) = 2060000 daN/cm²

C. Poisson (coefficiente di contrazione trasversale) = 0.30

Coefficiente di dilatazione termica = 0.000012

Peso specifico = 7850 daN/mc

Dominio SLU:

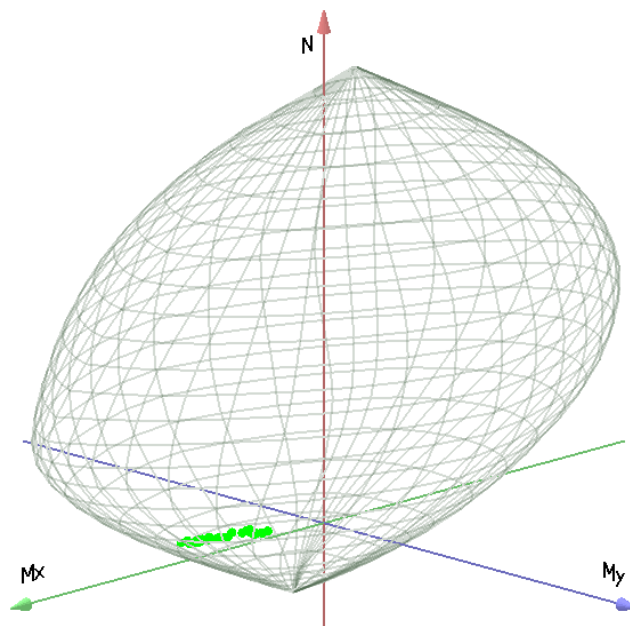

Caratteristiche limite della sezione:

Nu	Mxu	Myu	Stato Sez.
kN	kN m	kN m	
-2655,3	417,8	0,0	Completamente tesa
19587,3	-417,8	0,0	Completamente compressa
0,0	1841,0	0,0	Fibre inferiori tese
0,0	-988,6	0,0	Fibre superiori tese
0,0	0,0	1052,5	Fibre di sinistra tese
0,0	0,0	-1052,5	Fibre di destra tese

Verifiche stato limite ultimo:

Per ogni combinazione di carico saranno svolte le verifiche:

Verifica per Mxu, Myu e Nu proporzionali (sigla verifica: P)

e in caso di verifica proporzionale positiva:

Verifica con rapporto Mxu, Myu assegnato (sigla verifica: M)

Verifica con Nu costante (sigla verifica: N)

Cmb.	N kN	Mx kN m	My kN m	Tipo	Nu kN	Mxu kN m	Myu kN m	Sd/Su	Verif.
1	333,9	962,3	0,0	P	773,0	2227,8	0,0	0,430	OK
				M	16551,5	961,2	0,0	0,020	
				N	333,9	2010,5	0,0	0,480	
2	346,9	972,6	0,0	P	799,1	2240,4	0,0	0,430	OK
				M	16528,0	971,7	0,0	0,020	
				N	346,9	2017,0	0,0	0,480	
3	350,1	925,6	0,0	P	858,3	2269,1	0,0	0,410	OK
				M	16632,6	925,2	0,0	0,020	
				N	350,1	2018,6	0,0	0,460	
4	359,7	933,4	0,0	P	878,1	2278,6	0,0	0,410	OK
				M	16615,8	932,6	0,0	0,020	
				N	359,7	2023,4	0,0	0,460	
5	626,7	1616,0	0,0	P	885,0	2281,9	0,0	0,710	OK
				M	15076,9	1614,9	0,0	0,040	
				N	626,7	2156,2	0,0	0,750	
6	673,6	1697,0	0,0	P	910,7	2294,3	0,0	0,740	OK
				M	14893,2	1696,0	0,0	0,040	
				N	673,6	2179,2	0,0	0,780	
7	705,8	1746,0	0,0	P	931,5	2304,3	0,0	0,760	OK
				M	14778,5	1744,2	0,0	0,050	
				N	705,8	2195,0	0,0	0,790	
8	548,9	1314,0	0,0	P	970,3	2322,9	0,0	0,570	OK
				M	15759,0	1313,0	0,0	0,030	
				N	548,9	2117,8	0,0	0,620	
9	595,7	1396,0	0,0	P	996,5	2335,4	0,0	0,600	OK
				M	15573,8	1395,0	0,0	0,040	
				N	595,7	2140,9	0,0	0,650	
10	628,0	1445,0	0,0	P	1019,8	2346,4	0,0	0,620	OK
				M	15463,3	1444,0	0,0	0,040	

				N	628,0	2156,8	0,0	0,670	
11	307,3	847,9	0,0	P	814,7	2248,0	0,0	0,380	OK
				M	16808,2	846,9	0,0	0,020	
				N	307,3	1997,1	0,0	0,420	
12	320,2	858,2	0,0	P	844,0	2262,2	0,0	0,380	OK
				M	16785,5	857,1	0,0	0,020	
				N	320,2	2003,6	0,0	0,430	
13	314,4	772,3	0,0	P	939,7	2308,2	0,0	0,330	OK
				M	16977,8	771,4	0,0	0,020	
				N	314,4	2000,7	0,0	0,390	
14	324,1	780,0	0,0	P	963,9	2319,8	0,0	0,340	OK
				M	16960,5	779,1	0,0	0,020	
				N	324,1	2005,6	0,0	0,390	
15	653,4	1730,0	0,0	P	856,7	2268,3	0,0	0,760	OK
				M	14817,9	1728,0	0,0	0,040	
				N	653,4	2169,3	0,0	0,800	
16	700,2	1812,0	0,0	P	881,1	2280,1	0,0	0,790	OK
				M	14609,7	1813,0	0,0	0,050	
				N	700,2	2192,3	0,0	0,830	
17	732,5	1860,0	0,0	P	901,9	2290,1	0,0	0,810	OK
				M	n.d.	n.d.	n.d.	n.d.	
				N	732,5	2208,0	0,0	0,840	
18	584,6	1468,0	0,0	P	914,4	2296,1	0,0	0,640	OK
				M	15411,5	1466,9	0,0	0,040	
				N	584,6	2135,4	0,0	0,690	
19	631,4	1549,0	0,0	P	941,2	2308,9	0,0	0,670	OK
				M	15228,2	1547,9	0,0	0,040	
				N	631,4	2158,5	0,0	0,720	
20	663,7	1598,0	0,0	P	963,4	2319,5	0,0	0,690	OK
				M	15117,5	1596,9	0,0	0,040	
				N	663,7	2174,4	0,0	0,730	
21	663,4	1757,0	0,0	P	856,4	2268,2	0,0	0,770	OK
				M	14752,1	1755,0	0,0	0,040	
				N	663,4	2174,2	0,0	0,810	
22	594,6	1494,0	0,0	P	913,7	2295,7	0,0	0,650	OK
				M	15352,4	1493,0	0,0	0,040	
				N	594,6	2140,4	0,0	0,700	
23	744,6	1577,0	0,0	P	1133,2	2400,0	0,0	0,660	OK
				M	15165,0	1575,9	0,0	0,050	
				N	744,6	2213,9	0,0	0,710	



24	689,9	1269,0	0,0	P	1360,2	2501,9	0,0	0,510	OK
				M	15860,8	1267,9	0,0	0,040	
				N	689,9	2187,2	0,0	0,580	
25	644,1	1542,0	0,0	P	970,3	2322,8	0,0	0,660	OK
				M	15244,0	1541,0	0,0	0,040	
				N	644,1	2164,7	0,0	0,710	
26	681,1	1627,0	0,0	P	972,9	2324,1	0,0	0,700	OK
				M	15052,0	1625,9	0,0	0,040	
				N	681,1	2182,9	0,0	0,740	
27	595,9	1494,0	0,0	P	916,2	2296,9	0,0	0,650	OK
				M	15352,4	1493,0	0,0	0,040	
				N	595,9	2141,0	0,0	0,700	
28	632,6	1542,0	0,0	P	948,7	2312,5	0,0	0,670	OK
				M	15244,0	1541,0	0,0	0,040	
				N	632,6	2159,1	0,0	0,710	
29	755,4	1744,0	0,0	P	1015,4	2344,4	0,0	0,740	OK
				M	14784,4	1741,8	0,0	0,050	
				N	755,4	2219,2	0,0	0,790	
30	554,3	1040,0	0,0	P	1325,3	2486,6	0,0	0,420	OK
				M	16376,5	1039,0	0,0	0,030	
				N	554,3	2120,5	0,0	0,490	
31	591,5	1064,0	0,0	P	1400,6	2519,5	0,0	0,420	OK
				M	16322,6	1062,9	0,0	0,040	
				N	591,5	2138,8	0,0	0,500	
32	605,5	1021,0	0,0	P	1526,1	2573,3	0,0	0,400	OK
				M	16419,2	1020,0	0,0	0,040	
				N	605,5	2145,7	0,0	0,480	
33	745,5	1678,0	0,0	P	1048,5	2360,1	0,0	0,710	OK
				M	14936,2	1677,0	0,0	0,050	
				N	745,5	2214,4	0,0	0,760	
75	548,1	1126,0	0,0	P	1178,6	2421,3	0,0	0,460	OK
				M	16183,1	1124,9	0,0	0,030	
				N	548,1	2117,4	0,0	0,530	
76	824,1	1882,0	0,0	P	1029,5	2351,0	0,0	0,800	OK
				M	n.d.	n.d.	n.d.	n.d.	
				N	824,1	2252,5	0,0	0,830	
77	527,8	1039,0	0,0	P	1245,2	2451,2	0,0	0,420	OK
				M	16378,8	1038,0	0,0	0,030	
				N	527,8	2107,3	0,0	0,490	
78	844,4	1969,0	0,0	P	1002,8	2338,3	0,0	0,840	OK

				M	n.d.	n.d.	n.d.	n.d.	
				N	844,4	2262,4	0,0	0,870	
79	857,0	1881,0	0,0	P	1082,6	2376,2	0,0	0,790	OK
				M	n.d.	n.d.	n.d.	n.d.	
				N	857,0	2268,4	0,0	0,830	

Riepilogo combinazioni maggiormente gravose:

Cmb.	N	Mx	My	Tipo	Nu	Mxu	Myu	Sd/Su	Verif.
	kN	kN m	kN m		kN	kN m	kN m		
78	844,4	1969,0	0,0	P	1002,8	2338,3	0,0	0,840	OK
7	705,8	1746,0	0,0	M	14778,5	1744,2	0,0	0,050	OK
78	844,4	1969,0	0,0	N	844,4	2262,4	0,0	0,870	OK

Verifiche stato limite di esercizio per c. c. rare:

Valori limite (tensioni: segno (-) = compressione, (+) = trazione):

CLS: $\sigma_{cL} = 14940,0$ kN/mq (verifica Ok per $\sigma_c/\sigma_{cL} < 1$)

Acciaio: $\sigma_{aL} = 360000,0$ kN/mq (verifica Ok per $\sigma_a/\sigma_{aL} < 1$)

Cmb	Mx	My	N	σ_c	σ_c/σ_{cL}	σ_a	σ_a/σ_{aL}
n. e stato	kN m	kN m	kN	kN/mq		kN/mq	
46 OK	753,2	0,0	322,8	-4466,0	0,30	138990,5	0,39
47 OK	760,8	0,0	332,3	-4514,0	0,30	139778,8	0,39
48 OK	725,9	0,0	335,8	-4315,5	0,29	131528,2	0,37
49 OK	731,6	0,0	343,0	-4351,4	0,29	132114,7	0,37
50 OK	1114,0	0,0	451,2	-6592,7	0,44	208157,3	0,58
51 OK	1175,0	0,0	486,0	-6958,6	0,47	218558,7	0,61
52 OK	1211,0	0,0	510,0	-7176,1	0,48	224356,5	0,62
53 OK	890,9	0,0	392,5	-5287,4	0,35	163349,9	0,45
54 OK	951,5	0,0	427,2	-5650,8	0,38	173675,6	0,48
55 OK	987,7	0,0	451,2	-5869,3	0,39	179523,6	0,50
56 OK	704,5	0,0	311,5	-4181,7	0,28	129062,6	0,36
57 OK	712,2	0,0	321,0	-4230,2	0,28	129875,0	0,36
58 OK	644,8	0,0	316,9	-3841,5	0,26	115016,0	0,32
59 OK	650,5	0,0	324,1	-3877,4	0,26	115604,7	0,32
60 OK	1209,0	0,0	473,4	-7146,9	0,48	227519,2	0,63
61 OK	1270,0	0,0	508,2	-7512,9	0,50	237918,3	0,66
62 OK	1306,0	0,0	532,2	-7730,5	0,52	243714,0	0,68

63	OK	1019,0	0,0	422,2	-6035,1	0,40	189470,1	0,53
64	OK	1079,0	0,0	457,0	-6395,2	0,43	199646,2	0,55
65	OK	1116,0	0,0	481,0	-6618,4	0,44	205672,1	0,57
66	OK	1229,0	0,0	480,9	-7264,9	0,49	231315,8	0,64
67	OK	1038,0	0,0	429,7	-6147,4	0,41	193039,6	0,54
68	OK	1213,0	0,0	551,1	-7206,7	0,48	220770,0	0,61
69	OK	984,4	0,0	511,6	-5876,5	0,39	172892,4	0,48

Verifiche stato limite di esercizio per c. c. frequenti:

Valori limite:

Fessure: $WkL = 0,40$ mm (verifica Ok per $Wk/WkL < 1$)

	Cmb	Mx	My	N	Wk	Wk/WkL
n. e stato		kN m	kN m	kN	mm	
34	OK	728,8	0,0	326,1	0.18	0,44
35	OK	834,2	0,0	383,5	0.20	0,50
36	OK	888,1	0,0	402,1	0.22	0,54
37	OK	948,6	0,0	436,9	0.23	0,57
38	OK	984,9	0,0	460,9	0.24	0,59
39	OK	633,5	0,0	304,0	0.15	0,38
40	OK	639,2	0,0	311,1	0.15	0,38
41	OK	983,4	0,0	424,3	0.24	0,60
42	OK	1044,0	0,0	459,1	0.25	0,64
43	OK	1080,0	0,0	483,1	0.26	0,66
44	OK	1182,0	0,0	504,3	0.29	0,73
45	OK	987,3	0,0	502,0	0.23	0,58

Verifiche stato limite di esercizio per c. c. quasi permanenti:

Valori limite:

CLS: $\sigma cL = 11205,0$ kN/mq (verifica Ok per $\sigma c/\sigma cL < 1$)

Fessure: $WkL = 0,30$ mm (verifica Ok per $Wk/WkL < 1$)

	Cmb	Mx	My	N	σc	$\sigma c/\sigma cL$	Wk	Wk/WkL
n. e stato		kN m	kN m	kN	kN/mq		mm	



70	OK	656,2	0,0	333,8	-3914,2	0,35	0,15	0,51
71	OK	769,2	0,0	392,0	-4588,6	0,41	0,18	0,60
72	OK	569,0	0,0	313,5	-3403,8	0,30	0,13	0,44
73	OK	856,4	0,0	412,3	-5098,4	0,46	0,20	0,68
74	OK	808,7	0,0	427,0	-4830,4	0,43	0,19	0,63

7.5.4. Soletta di fondazione: mezzeria (Asta 15)

2SI s.r.l - ProVLIM - Verifica sezioni

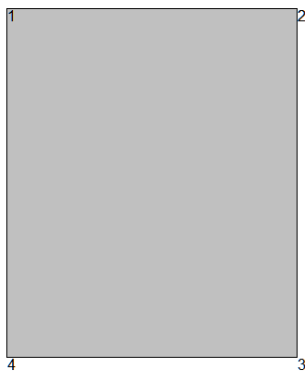

Geometria della sezione:

Vert.	X	Y
n.	cm	cm
1	0,0	120,0
2	100,0	120,0
3	100,0	0,0
4	0,0	0,0

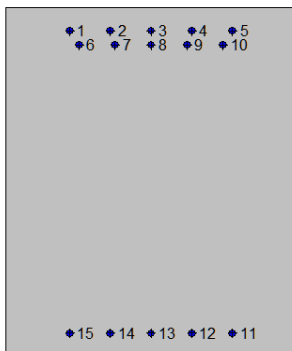

Armature:

Pos.	X	Y	Area	Pretens.
n.	cm	cm	cmq	(s/n)
1	22,0	112,0	4,5	no
2	36,0	112,0	4,5	no
3	50,0	112,0	4,5	no
4	64,0	112,0	4,5	no
5	78,0	112,0	4,5	no
6	25,2	107,2	4,5	no
7	37,6	107,2	4,5	no
8	50,0	107,2	4,5	no
9	62,4	107,2	4,5	no
10	74,8	107,2	4,5	no
11	78,0	8,0	4,5	no
12	64,0	8,0	4,5	no
13	50,0	8,0	4,5	no
14	36,0	8,0	4,5	no
15	22,0	8,0	4,5	no

Normativa di riferimento:

D.M. 14/01/2008 - 'Norme tecniche per le costruzioni'

Note:

Verifiche SLE per ambiente ordinario

Materiali:

Calcestruzzo classe: C25/30

Rck (resistenza caratteristica cubica a compressione) = 300 daN/cm²

fck (resistenza caratteristica cilindrica a compressione) = 249 daN/cm²

fctm (resistenza a trazione media) = 26 daN/cm²

G (modulo di elasticità tangenziale) = 140388 daN/cm²

E (modulo elastico istantaneo iniziale) = 314470 daN/cm²

C. Poisson (coefficiente di contrazione trasversale) = 0.12

Coefficiente di dilatazione termica = 0.000050

Peso specifico del calcestruzzo armato = 2500 daN/mc

Barre d'acciaio ad aderenza migliorata tipo: B450C

f_{yk} (tensione caratteristica di snervamento) = 4500 daN/cm²

f_{kt} (tensione caratteristica di rottura) = 5400 daN/cm²

ϵ_{uk} (deformazione di rottura) = 0.075

G (modulo di elasticità tangenziale) = 793100 daN/cm²

E (modulo elastico) = 2060000 daN/cm²

C. Poisson (coefficiente di contrazione trasversale) = 0.30

Coefficiente di dilatazione termica = 0.000012

Peso specifico = 7850 daN/mc

Dominio SLU:

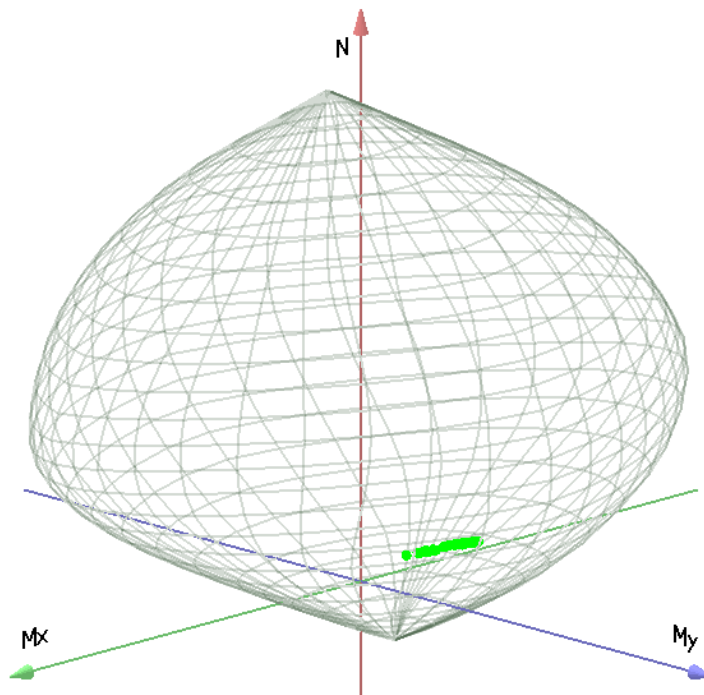

Caratteristiche limite della sezione:

Nu	Mxu	Myu	Stato Sez.
kN	kN m	kN m	
-2655,3	-417,8	0,0	Completamente tesa
19587,3	417,8	0,0	Completamente compressa
0,0	988,6	0,0	Fibre inferiori tese
0,0	-1841,0	0,0	Fibre superiori tese

0,0	0,0	1052,5	Fibre di sinistra tese
0,0	0,0	-1052,5	Fibre di destra tese

Verifiche stato limite ultimo:

Per ogni combinazione di carico saranno svolte le verifiche:

Verifica per Mxu, Myu e Nu proporzionali (sigla verifica: P)

e in caso di verifica proporzionale positiva:

Verifica con rapporto Mxu, Myu assegnato (sigla verifica: M)

Verifica con Nu costante (sigla verifica: N)

Cmb.	N	Mx	My	Tipo	Nu	Mxu	Myu	Sd/Su	Verif.
	kN	kN m	kN m		kN	kN m	kN m		
1	331,7	-1341,0	0,0	P	520,3	-2103,6	0,0	0,640	OK
				M	15697,2	-1340,4	0,0	0,020	
				N	331,7	-2009,4	0,0	0,670	
2	344,5	-1318,0	0,0	P	554,2	-2120,4	0,0	0,620	OK
				M	15750,3	-1316,8	0,0	0,020	
				N	344,5	-2015,8	0,0	0,650	
3	347,7	-1261,0	0,0	P	589,5	-2137,8	0,0	0,590	OK
				M	15878,9	-1259,8	0,0	0,020	
				N	347,7	-2017,4	0,0	0,620	
4	357,3	-1244,0	0,0	P	618,1	-2151,9	0,0	0,580	OK
				M	15916,9	-1243,0	0,0	0,020	
				N	357,3	-2022,2	0,0	0,610	
5	400,5	-1366,0	0,0	P	633,1	-2159,3	0,0	0,630	OK
				M	15641,6	-1365,0	0,0	0,030	
				N	400,5	-2043,9	0,0	0,670	
6	423,8	-1353,0	0,0	P	684,2	-2184,4	0,0	0,620	OK
				M	15668,8	-1352,9	0,0	0,030	
				N	423,8	-2055,5	0,0	0,660	
7	431,8	-1238,0	0,0	P	777,8	-2230,1	0,0	0,550	OK
				M	15930,4	-1237,0	0,0	0,030	
				N	431,8	-2059,5	0,0	0,600	
8	388,9	-1306,0	0,0	P	644,7	-2165,0	0,0	0,600	OK
				M	15777,3	-1304,9	0,0	0,020	
				N	388,9	-2038,1	0,0	0,640	
9	412,3	-1293,0	0,0	P	698,8	-2191,6	0,0	0,590	OK
				M	15806,3	-1292,0	0,0	0,030	

				N	412,3	-2049,8	0,0	0,630	
10	420,3	-1178,0	0,0	P	799,4	-2240,6	0,0	0,530	OK
				M	16065,9	-1176,9	0,0	0,030	
				N	420,3	-2053,8	0,0	0,570	
11	305,3	-1444,0	0,0	P	435,9	-2061,6	0,0	0,700	OK
				M	15465,5	-1443,0	0,0	0,020	
				N	305,3	-1996,1	0,0	0,720	
12	318,1	-1421,0	0,0	P	464,7	-2076,0	0,0	0,680	OK
				M	15517,8	-1419,8	0,0	0,020	
				N	318,1	-2002,5	0,0	0,710	
13	312,3	-1400,0	0,0	P	462,9	-2075,1	0,0	0,670	OK
				M	15564,9	-1399,0	0,0	0,020	
				N	312,3	-1999,6	0,0	0,700	
14	321,9	-1383,0	0,0	P	485,6	-2086,4	0,0	0,660	OK
				M	15603,3	-1382,0	0,0	0,020	
				N	321,9	-2004,5	0,0	0,690	
15	426,9	-1262,0	0,0	P	749,8	-2216,5	0,0	0,570	OK
				M	15876,7	-1260,8	0,0	0,030	
				N	426,9	-2057,1	0,0	0,610	
16	450,2	-1249,0	0,0	P	809,4	-2245,4	0,0	0,560	OK
				M	15905,6	-1248,0	0,0	0,030	
				N	450,2	-2068,7	0,0	0,600	
17	458,3	-1135,0	0,0	P	930,2	-2303,7	0,0	0,490	OK
				M	16162,9	-1133,9	0,0	0,030	
				N	458,3	-2072,8	0,0	0,550	
18	424,4	-1167,0	0,0	P	818,1	-2249,7	0,0	0,520	OK
				M	16090,7	-1165,9	0,0	0,030	
				N	424,4	-2055,8	0,0	0,570	
19	447,7	-1154,0	0,0	P	885,4	-2282,1	0,0	0,510	OK
				M	16120,0	-1152,9	0,0	0,030	
				N	447,7	-2067,5	0,0	0,560	
20	455,7	-1039,0	0,0	P	1031,6	-2352,0	0,0	0,440	OK
				M	16378,8	-1038,0	0,0	0,030	
				N	455,7	-2071,5	0,0	0,500	
21	436,9	-1243,0	0,0	P	785,1	-2233,6	0,0	0,560	OK
				M	15919,1	-1242,0	0,0	0,030	
				N	436,9	-2062,1	0,0	0,600	
22	434,4	-1148,0	0,0	P	858,7	-2269,3	0,0	0,510	OK
				M	16133,6	-1146,9	0,0	0,030	
				N	434,4	-2060,8	0,0	0,560	



23	470,3	-787,6	0,0	P	1540,1	-2579,2	0,0	0,300	OK
				M	16944,0	-786,4	0,0	0,030	
				N	470,3	-2078,7	0,0	0,380	
24	481,7	-733,8	0,0	P	1750,5	-2666,7	0,0	0,270	OK
				M	17064,2	-732,8	0,0	0,030	
				N	481,7	-2084,4	0,0	0,350	
25	417,7	-1288,0	0,0	P	713,0	-2198,5	0,0	0,590	OK
				M	15817,7	-1287,0	0,0	0,030	
				N	417,7	-2052,5	0,0	0,630	
26	431,3	-1276,0	0,0	P	749,1	-2216,1	0,0	0,580	OK
				M	15844,9	-1274,9	0,0	0,030	
				N	431,3	-2059,3	0,0	0,620	
27	435,7	-1262,0	0,0	P	768,3	-2225,5	0,0	0,570	OK
				M	15876,7	-1260,8	0,0	0,030	
				N	435,7	-2061,5	0,0	0,610	
28	448,9	-1269,0	0,0	P	791,2	-2236,6	0,0	0,570	OK
				M	15860,8	-1267,9	0,0	0,030	
				N	448,9	-2068,1	0,0	0,610	
29	481,0	-1095,0	0,0	P	1033,6	-2353,0	0,0	0,460	OK
				M	16252,9	-1093,9	0,0	0,030	
				N	481,0	-2084,1	0,0	0,520	
30	484,7	-730,3	0,0	P	1777,1	-2677,5	0,0	0,270	OK
				M	17072,0	-729,3	0,0	0,030	
				N	484,7	-2085,9	0,0	0,350	
31	521,7	-698,1	0,0	P	2094,5	-2802,8	0,0	0,250	OK
				M	17144,2	-697,1	0,0	0,030	
				N	521,7	-2104,3	0,0	0,330	
32	535,6	-559,3	0,0	P	2982,0	-3114,0	0,0	0,180	OK
				M	17454,7	-558,3	0,0	0,030	
				N	535,6	-2111,2	0,0	0,260	
33	471,3	-1013,0	0,0	P	1112,0	-2390,0	0,0	0,420	OK
				M	16437,7	-1011,8	0,0	0,030	
				N	471,3	-2079,2	0,0	0,490	
75	443,8	-842,1	0,0	P	1306,0	-2478,1	0,0	0,340	OK
				M	16821,3	-841,1	0,0	0,030	
				N	443,8	-2065,5	0,0	0,410	
76	483,2	-891,3	0,0	P	1355,1	-2499,7	0,0	0,360	OK
				M	16710,8	-890,3	0,0	0,030	
				N	483,2	-2085,2	0,0	0,430	
77	423,7	-921,0	0,0	P	1096,1	-2382,5	0,0	0,390	OK

				M	16642,3	-920,8	0,0	0,020	
				N	423,7	-2055,5	0,0	0,450	
78	503,4	-812,3	0,0	P	1618,9	-2612,4	0,0	0,310	OK
				M	16888,4	-811,2	0,0	0,030	
				N	503,4	-2095,2	0,0	0,390	
79	515,9	-781,3	0,0	P	1764,6	-2672,4	0,0	0,290	OK
				M	16957,6	-780,4	0,0	0,030	
				N	515,9	-2101,4	0,0	0,370	

Riepilogo combinazioni maggiormente gravose:

Cmb.	N	Mx	My	Tipo	Nu	Mxu	Myu	Sd/Su	Verif.
	kN	kN m	kN m		kN	kN m	kN m		
11	305,3	-1444,0	0,0	P	435,9	-2061,6	0,0	0,700	OK
5	400,5	-1366,0	0,0	M	15641,6	-1365,0	0,0	0,030	OK
11	305,3	-1444,0	0,0	N	305,3	-1996,1	0,0	0,720	OK

Verifiche stato limite di esercizio per c. c. rare:

Valori limite (tensioni: segno (-) = compressione, (+) = trazione):

CLS: $\sigma_{cL} = 14940,0$ kN/mq (verifica Ok per $\sigma_c/\sigma_{cL} < 1$)

Acciaio: $\sigma_{aL} = 360000,0$ kN/mq (verifica Ok per $\sigma_a/\sigma_{aL} < 1$)

Cmb	Mx	My	N	σ_c	σ_c/σ_{cL}	σ_a	σ_a/σ_{aL}
n. e stato	kN m	kN m	kN	kN/mq		kN/mq	
46 OK	-956,5	0,0	320,6	-5626,4	0,38	185367,9	0,51
47 OK	-939,6	0,0	330,1	-5535,0	0,37	180579,0	0,50
48 OK	-898,5	0,0	333,5	-5302,1	0,35	170904,4	0,47
49 OK	-885,8	0,0	340,6	-5233,2	0,35	167316,0	0,46
50 OK	-978,3	0,0	331,0	-5756,3	0,39	189283,6	0,53
51 OK	-968,4	0,0	348,3	-5708,9	0,38	185308,8	0,51
52 OK	-883,6	0,0	354,3	-5227,4	0,35	165459,9	0,46
53 OK	-933,5	0,0	321,4	-5495,6	0,37	180060,7	0,50
54 OK	-923,7	0,0	338,7	-5448,7	0,36	176110,7	0,49
55 OK	-838,8	0,0	344,6	-4966,4	0,33	156254,2	0,43
56 OK	-1001,0	0,0	309,3	-5873,8	0,39	196617,3	0,55
57 OK	-983,6	0,0	318,8	-5779,9	0,39	191708,5	0,53
58 OK	-971,9	0,0	314,8	-5711,0	0,38	189448,9	0,53
59 OK	-959,2	0,0	321,9	-5642,5	0,38	185851,6	0,52

60	OK	-892,0	0,0	353,0	-5274,8	0,35	167494,7	0,47
61	OK	-882,2	0,0	370,3	-5227,1	0,35	163562,4	0,45
62	OK	-797,3	0,0	376,3	-4743,3	0,32	143734,9	0,40
63	OK	-817,9	0,0	350,9	-4849,8	0,32	150893,3	0,42
64	OK	-808,1	0,0	368,2	-4801,6	0,32	146973,2	0,41
65	OK	-723,2	0,0	374,2	-4316,5	0,29	127177,3	0,35
66	OK	-877,7	0,0	360,4	-5196,6	0,35	163518,5	0,45
67	OK	-803,6	0,0	358,3	-4771,3	0,32	146924,6	0,41
68	OK	-773,1	0,0	395,1	-4612,3	0,31	136429,5	0,38
69	OK	-733,6	0,0	404,6	-4388,7	0,29	126589,1	0,35

Verifiche stato limite di esercizio per c. c. frequenti:

Valori limite:

Fessure: $WkL = 0,40$ mm (verifica Ok per $Wk/WkL < 1$)

	Cmb	Mx	My	N	Wk	Wk/WkL
n. e stato		kN m	kN m	kN	mm	
34	OK	-895,9	0,0	323,9	0.23	0,57
35	OK	-888,4	0,0	349,6	0.22	0,56
36	OK	-936,1	0,0	330,9	0.24	0,60
37	OK	-926,3	0,0	348,3	0.23	0,58
38	OK	-841,4	0,0	354,2	0.21	0,52
39	OK	-982,1	0,0	301,9	0.26	0,64
40	OK	-969,5	0,0	309,0	0.25	0,63
41	OK	-849,9	0,0	353,0	0.21	0,53
42	OK	-840,0	0,0	370,3	0.20	0,51
43	OK	-755,2	0,0	376,3	0.18	0,45
44	OK	-848,8	0,0	383,3	0.21	0,51
45	OK	-730,9	0,0	395,0	0.17	0,42

Verifiche stato limite di esercizio per c. c. quasi permanenti:

Valori limite:

CLS: $\sigma cL = 11205,0$ kN/mq (verifica Ok per $\sigma c/\sigma cL < 1$)

Fessure: $WkL = 0,30$ mm (verifica Ok per $Wk/WkL < 1$)



Cmb	Mx	My	N	σ_c	σ_c/σ_{cL}	Wk	Wk/WkL
n. e stato	kN m	kN m	kN	kN/mq		mm	
70 OK	-713,5	0,0	331,5	-4242,4	0,38	0.17	0,57
71 OK	-752,7	0,0	335,0	-4468,8	0,40	0.18	0,61
72 OK	-792,4	0,0	311,4	-4684,7	0,42	0.20	0,66
73 OK	-673,8	0,0	355,1	-4024,3	0,36	0.16	0,52
74 OK	-717,0	0,0	369,7	-4279,0	0,38	0.17	0,56

7.5.5. Piedritto: attacco soletta di fondazione (Asta 2)

2SI s.r.l - ProVLIM - Verifica sezioni

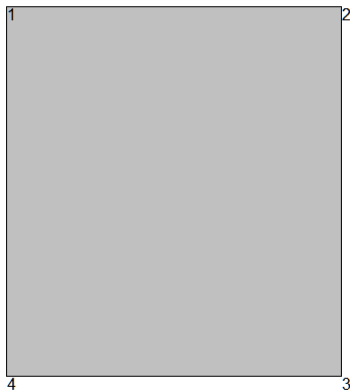

Geometria della sezione:

Vert.	X	Y
n.	cm	cm
1	0,0	110,0
2	100,0	110,0
3	100,0	0,0
4	0,0	0,0

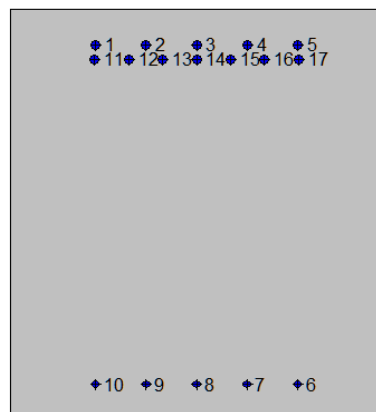

Armature:

Pos.	X	Y	Area	Pretens.
n.	cm	cm	cmq	(s/n)
1	22,9	100,6	4,5	no
2	36,5	100,6	4,5	no
3	50,0	100,6	4,5	no
4	63,5	100,6	4,5	no
5	77,1	100,6	4,5	no
6	77,2	9,2	3,1	no
7	63,6	9,2	3,1	no
8	50,0	9,2	3,1	no
9	36,4	9,2	3,1	no
10	22,8	9,2	3,1	no
11	22,5	96,6	4,5	no
12	31,7	96,6	4,5	no
13	40,8	96,6	4,5	no
14	50,0	96,6	4,5	no
15	59,2	96,6	4,5	no
16	68,3	96,6	4,5	no
17	77,4	96,6	4,5	no

Normativa di riferimento:

D.M. 14/01/2008 - 'Norme tecniche per le costruzioni'

Note:

Verifiche SLE per ambiente ordinario

Materiali:

Calcestruzzo classe: C28/35

Rck (resistenza caratteristica cubica a compressione) = 350 daN/cm²

fck (resistenza caratteristica cilindrica a compressione) = 290 daN/cm²

fctm (resistenza a trazione media) = 28 daN/cm²

G (modulo di elasticità tangenziale) = 145424 daN/cm²

E (modulo elastico istantaneo iniziale) = 325750 daN/cm²

C. Poisson (coefficiente di contrazione trasversale) = 0.12

Coefficiente di dilatazione termica = 0.000050

Peso specifico del calcestruzzo armato = 2500 daN/mc

Barre d'acciaio ad aderenza migliorata tipo: B450C

f_{yk} (tensione caratteristica di snervamento) = 4500 daN/cm²

f_{kt} (tensione caratteristica di rottura) = 5400 daN/cm²

ϵ_{uk} (deformazione di rottura) = 0.075

G (modulo di elasticità tangenziale) = 793100 daN/cm²

E (modulo elastico) = 2060000 daN/cm²

C. Poisson (coefficiente di contrazione trasversale) = 0.30

Coefficiente di dilatazione termica = 0.000012

Peso specifico = 7850 daN/mc

Dominio SLU:

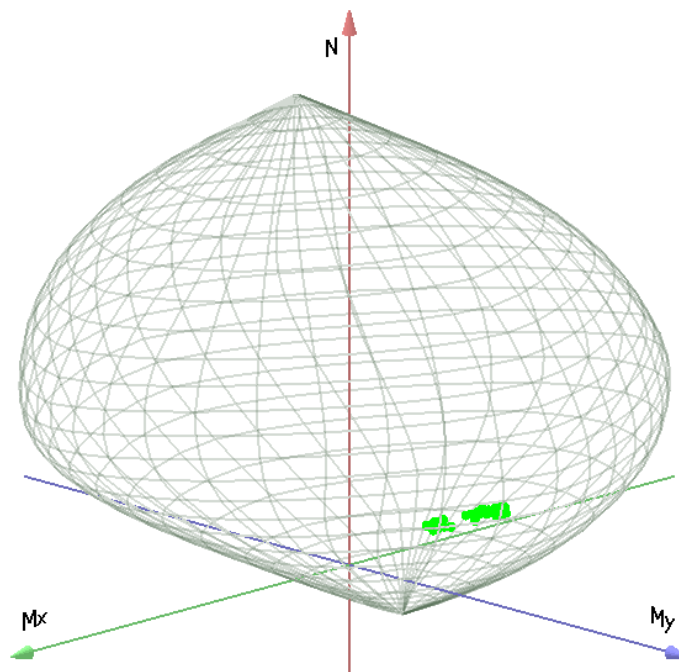

Caratteristiche limite della sezione:

Nu	Mxu	Myu	Stato Sez.
kN	kN m	kN m	
-2738,9	-637,6	0,0	Completamente tesa

20815,6	637,6	0,0	Completamente compressa
0,0	662,7	0,0	Fibre inferiori tese
0,0	-1956,7	0,0	Fibre superiori tese
0,0	0,0	1033,5	Fibre di sinistra tese
0,0	0,0	-1033,5	Fibre di destra tese

Verifiche stato limite ultimo:

Per ogni combinazione di carico saranno svolte le verifiche:

Verifica per Mxu, Myu e Nu proporzionali (sigla verifica: P)

e in caso di verifica proporzionale positiva:

Verifica con rapporto Mxu, Myu assegnato (sigla verifica: M)

Verifica con Nu costante (sigla verifica: N)

Cmb.	N	Mx	My	Tipo	Nu	Mxu	Myu	Sd/Su	Verif.
	kN	kN m	kN m		kN	kN m	kN m		
1	925,2	-1079,0	46,3	P	2472,6	-2883,6	123,6	0,370	OK
				M	16598,6	-1078,3	46,2	0,060	
				N	925,2	-2342,2	100,4	0,460	
2	919,5	-1084,0	46,0	P	2437,1	-2873,1	121,8	0,380	OK
				M	16586,3	-1083,2	45,9	0,050	
				N	919,5	-2340,0	99,2	0,460	
3	877,2	-1028,0	43,9	P	2456,6	-2878,9	122,8	0,360	OK
				M	16725,7	-1027,3	43,8	0,050	
				N	877,2	-2323,0	99,1	0,440	
4	872,9	-1032,0	43,6	P	2427,9	-2870,4	121,4	0,360	OK
				M	16715,8	-1031,3	43,6	0,050	
				N	872,9	-2321,4	98,2	0,440	
5	794,1	-1639,0	39,7	P	1187,1	-2450,1	59,4	0,670	OK
				M	15152,8	-1638,2	39,7	0,050	
				N	794,1	-2293,6	55,6	0,710	
6	783,1	-1706,0	39,2	P	1111,3	-2420,9	55,6	0,700	OK
				M	14964,1	-1705,1	39,1	0,050	
				N	783,1	-2289,3	52,5	0,740	
7	694,8	-1731,0	34,7	P	945,6	-2355,7	47,3	0,730	OK
				M	14894,3	-1730,3	34,7	0,050	
				N	694,8	-2253,5	45,2	0,770	
8	843,6	-1360,0	42,2	P	1617,8	-2608,1	80,9	0,520	OK
				M	15900,5	-1358,9	42,1	0,050	

				N	843,6	-2312,3	71,7	0,590	
9	832,5	-1427,0	41,6	P	1496,3	-2564,8	74,8	0,560	OK
				M	15727,8	-1425,8	41,6	0,050	
				N	832,5	-2308,2	67,3	0,620	
10	744,2	-1452,0	37,2	P	1272,3	-2482,4	63,6	0,580	OK
				M	15663,0	-1451,0	37,2	0,050	
				N	744,2	-2272,9	58,2	0,640	
11	925,2	-971,7	46,3	P	2845,6	-2988,6	142,3	0,320	OK
				M	16865,0	-971,1	46,2	0,050	
				N	925,2	-2340,8	111,4	0,410	
12	919,5	-977,1	46,0	P	2801,1	-2976,6	140,0	0,330	OK
				M	16851,9	-976,4	45,9	0,050	
				N	919,5	-2338,7	110,0	0,420	
13	877,2	-884,2	43,9	P	3007,1	-3031,1	150,4	0,290	OK
				M	17082,7	-883,6	43,8	0,050	
				N	877,2	-2321,1	115,1	0,380	
14	872,9	-888,2	43,6	P	2969,3	-3021,3	148,4	0,290	OK
				M	17072,8	-887,6	43,6	0,050	
				N	872,9	-2319,5	114,0	0,380	
15	794,1	-1746,0	39,7	P	1098,9	-2416,1	54,9	0,720	OK
				M	14850,1	-1744,8	39,7	0,050	
				N	794,1	-2293,8	52,2	0,760	
16	783,1	-1813,0	39,2	P	1032,3	-2390,1	51,6	0,760	OK
				M	14653,8	-1812,1	39,1	0,050	
				N	783,1	-2289,6	49,4	0,790	
17	694,8	-1838,0	34,7	P	880,7	-2329,8	44,0	0,790	OK
				M	14582,1	-1837,1	34,7	0,050	
				N	694,8	-2253,7	42,6	0,810	
18	843,6	-1504,0	42,2	P	1423,9	-2538,6	71,2	0,590	OK
				M	15521,4	-1503,1	42,2	0,050	
				N	843,6	-2312,9	64,9	0,650	
19	832,5	-1571,0	41,6	P	1326,2	-2502,6	66,3	0,630	OK
				M	15339,7	-1570,2	41,6	0,050	
				N	832,5	-2308,8	61,2	0,680	
20	744,2	-1595,0	37,2	P	1133,6	-2429,6	56,7	0,660	OK
				M	15276,0	-1594,2	37,2	0,050	
				N	744,2	-2273,3	53,0	0,700	
21	846,8	-1776,0	42,3	P	1164,0	-2441,3	58,2	0,730	OK
				M	14760,5	-1775,2	42,3	0,060	
				N	846,8	-2315,1	55,2	0,770	

22	896,3	-1533,0	44,8	P	1500,4	-2566,3	75,0	0,600	OK
				M	15441,6	-1532,2	44,8	0,060	
				N	896,3	-2334,0	68,2	0,660	
23	442,1	-1493,0	22,1	P	663,7	-2241,4	33,2	0,670	OK
				M	15560,2	-1491,9	22,1	0,030	
				N	442,1	-2148,1	31,8	0,690	
24	491,5	-1200,0	24,6	P	968,6	-2364,9	48,4	0,510	OK
				M	16301,5	-1198,9	24,6	0,030	
				N	491,5	-2168,4	44,4	0,550	
25	740,3	-1543,0	37,0	P	1172,9	-2444,7	58,7	0,630	OK
				M	15418,4	-1542,1	37,0	0,050	
				N	740,3	-2271,6	54,5	0,680	
26	782,0	-1623,0	39,1	P	1179,1	-2447,1	59,0	0,660	OK
				M	15197,5	-1622,2	39,1	0,050	
				N	782,0	-2288,6	55,1	0,710	
27	962,1	-1544,0	48,1	P	1627,2	-2611,4	81,4	0,590	OK
				M	15410,2	-1543,2	48,1	0,060	
				N	962,1	-2359,9	73,5	0,650	
28	879,1	-1573,0	44,0	P	1417,4	-2536,2	70,9	0,620	OK
				M	15333,1	-1572,2	43,9	0,060	
				N	879,1	-2327,3	65,0	0,680	
29	632,5	-1702,0	31,6	P	863,2	-2322,8	43,2	0,730	OK
				M	14978,2	-1701,4	31,6	0,040	
				N	632,5	-2227,9	41,4	0,760	
30	637,7	-1032,0	31,9	P	1609,9	-2605,3	80,5	0,400	OK
				M	16717,7	-1031,2	31,9	0,040	
				N	637,7	-2227,9	68,8	0,460	
31	633,4	-1045,0	31,7	P	1570,7	-2591,4	78,5	0,400	OK
				M	16685,6	-1044,1	31,6	0,040	
				N	633,4	-2226,3	67,5	0,470	
32	557,3	-981,7	27,9	P	1445,6	-2546,5	72,3	0,380	OK
				M	16843,4	-980,9	27,8	0,030	
				N	557,3	-2194,9	62,3	0,450	
33	631,4	-1628,0	31,6	P	907,8	-2340,7	45,4	0,690	OK
				M	15187,6	-1627,1	31,6	0,040	
				N	631,4	-2227,3	43,2	0,730	
75	579,5	-1115,0	29,0	P	1294,5	-2490,8	64,7	0,450	OK
				M	16512,4	-1113,9	29,0	0,030	
				N	579,5	-2204,6	57,3	0,510	

76	423,3	-1780,0	21,2	P	518,7	-2181,0	25,9	0,820	OK	
					M	14756,7	-1780,1	21,2		0,030
					N	423,3	-2140,4	25,5		0,830
77	579,5	-1033,0	29,0	P	1424,2	-2538,7	71,2	0,410	OK	
					M	16716,0	-1032,1	29,0		0,030
					N	579,5	-2204,2	61,8		0,470
78	423,3	-1862,0	21,2	P	493,4	-2170,3	24,7	0,860	OK	
					M	14517,9	-1860,9	21,2		0,030
					N	423,3	-2140,5	24,3		0,870
79	376,0	-1760,0	18,8	P	460,7	-2156,5	23,0	0,820	OK	
					M	14814,6	-1760,5	18,8		0,020
					N	376,0	-2120,3	22,6		0,830

Riepilogo combinazioni maggiormente gravose:

Cmb.	N	Mx	My	Tipo	Nu	Mxu	Myu	Sd/Su	Verif.
	kN	kN m	kN m		kN	kN m	kN m		
78	423,3	-1862,0	21,2	P	493,4	-2170,3	24,7	0,860	OK
1	925,2	-1079,0	46,3	M	16598,6	-1078,3	46,2	0,060	OK
78	423,3	-1862,0	21,2	N	423,3	-2140,5	24,3	0,870	OK

Verifiche stato limite di esercizio per c. c. rare:

Valori limite (tensioni: segno (-) = compressione, (+) = trazione):

CLS: $\sigma_{cL} = 17400,0$ kN/mq (verifica Ok per $\sigma_c/\sigma_{cL} < 1$)

Acciaio: $\sigma_{aL} = 360000,0$ kN/mq (verifica Ok per $\sigma_a/\sigma_{aL} < 1$)

Cmb	Mx	My	N	σ_c	σ_c/σ_{cL}	σ_a	σ_a/σ_{aL}
n. e stato	kN m	kN m	kN	kN/mq		kN/mq	
46 OK	-818,4	0,0	685,3	-5770,1	0,33	121038,1	0,34
47 OK	-822,4	0,0	681,1	-5795,4	0,33	122206,9	0,34
48 OK	-780,1	0,0	650,0	-5498,8	0,32	115620,4	0,32
49 OK	-783,1	0,0	646,8	-5517,7	0,32	116501,2	0,32
50 OK	-1136,0	0,0	597,3	-7846,4	0,45	195880,1	0,54
51 OK	-1185,0	0,0	589,1	-8166,4	0,47	207085,3	0,58
52 OK	-1204,0	0,0	523,5	-8254,9	0,47	216539,9	0,60
53 OK	-929,5	0,0	633,9	-6492,2	0,37	148676,7	0,41
54 OK	-979,4	0,0	625,7	-6820,9	0,39	159998,2	0,44
55 OK	-997,5	0,0	560,1	-6908,5	0,40	169123,3	0,47

56	OK	-772,8	0,0	685,3	-5463,1	0,31	111392,5	0,31
57	OK	-776,7	0,0	681,1	-5487,9	0,32	112534,1	0,31
58	OK	-704,1	0,0	650,0	-4986,8	0,29	99561,1	0,28
59	OK	-707,1	0,0	646,8	-5005,9	0,29	100433,3	0,28
60	OK	-1225,0	0,0	597,3	-8435,6	0,48	215026,7	0,60
61	OK	-1275,0	0,0	589,1	-8761,7	0,50	226462,6	0,63
62	OK	-1293,0	0,0	523,5	-8842,2	0,51	235732,5	0,65
63	OK	-1049,0	0,0	633,9	-7288,0	0,42	174256,3	0,48
64	OK	-1099,0	0,0	625,7	-7615,9	0,44	185640,2	0,52
65	OK	-1117,0	0,0	560,1	-7700,5	0,44	194811,2	0,54
66	OK	-1247,0	0,0	636,4	-8602,7	0,49	216581,3	0,60
67	OK	-1071,0	0,0	673,0	-7453,4	0,43	175853,9	0,49
68	OK	-1185,0	0,0	477,2	-8102,1	0,47	216254,9	0,60
69	OK	-967,1	0,0	513,9	-6682,7	0,38	166319,3	0,46

Verifiche stato limite di esercizio per c. c. frequenti:

Valori limite:

Fessure: $WkL = 0,40$ mm (verifica Ok per $Wk/WkL < 1$)

	Cmb	Mx	My	N	Wk	Wk/WkL
n. e stato		kN m	kN m	kN	mm	
34	OK	-785,9	0,0	650,0	0.15	0,38
35	OK	-874,3	0,0	637,7	0.18	0,44
36	OK	-923,7	0,0	633,9	0.19	0,48
37	OK	-973,6	0,0	625,7	0.21	0,52
38	OK	-991,7	0,0	560,1	0.22	0,55
39	OK	-696,6	0,0	650,0	0.12	0,31
40	OK	-699,6	0,0	646,8	0.13	0,32
41	OK	-1013,0	0,0	633,9	0.22	0,54
42	OK	-1063,0	0,0	625,7	0.23	0,58
43	OK	-1081,0	0,0	560,1	0.25	0,61
44	OK	-1193,0	0,0	654,9	0.27	0,67
45	OK	-972,9	0,0	513,9	0.22	0,55

Verifiche stato limite di esercizio per c. c. quasi permanenti:

Valori limite:

CLS: $\sigma_{cL} = 13050,0$ kN/mq (verifica Ok per $\sigma_c/\sigma_{cL} < 1$)

Fessure: $W_{kL} = 0,30$ mm (verifica Ok per $W_k/W_{kL} < 1$)

	Cmb	Mx	My	N	σ_c	σ_c/σ_{cL}	Wk	Wk/WkL
n. e stato		kN m	kN m	kN	kN/mq		mm	
70 OK		-690,1	0,0	544,1	-4852,0	0,37	0.13	0,45
71 OK		-786,6	0,0	532,0	-5492,0	0,42	0.16	0,55
72 OK		-608,4	0,0	544,1	-4302,6	0,33	0.11	0,37
73 OK		-868,3	0,0	532,0	-6036,1	0,46	0.19	0,63
74 OK		-815,8	0,0	532,0	-5686,7	0,44	0.17	0,57

7.5.6. Piedritto: attacco soletta superiore (Asta 6)

2SI s.r.l - ProVLIM - Verifica sezioni

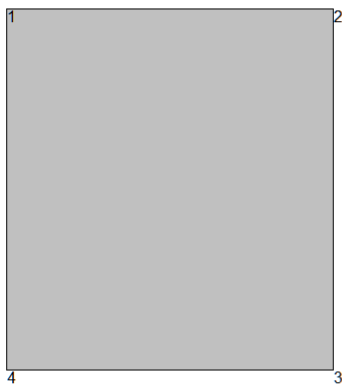

Geometria della sezione:

Vert.	X	Y
n.	cm	cm
1	0,0	110,0
2	100,0	110,0
3	100,0	0,0
4	0,0	0,0

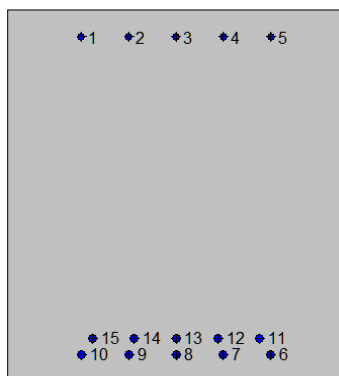

Armature:

Pos.	X	Y	Area	Pretens.
n.	cm	cm	cmq	(s/n)
1	21,9	102,2	3,1	no
2	35,9	102,2	3,1	no
3	50,0	102,2	3,1	no
4	64,1	102,2	3,1	no
5	78,1	102,2	3,1	no
6	78,0	8,0	4,5	no
7	64,0	8,0	4,5	no
8	50,0	8,0	4,5	no
9	36,0	8,0	4,5	no
10	22,0	8,0	4,5	no
11	74,8	12,8	4,5	no
12	62,4	12,8	4,5	no
13	50,0	12,8	4,5	no
14	37,6	12,8	4,5	no
15	25,2	12,8	4,5	no

Normativa di riferimento:

D.M. 14/01/2008 - 'Norme tecniche per le costruzioni'

Note:

Verifiche SLE per ambiente ordinario

Materiali:

Calcestruzzo classe: C28/35

Rck (resistenza caratteristica cubica a compressione) = 350 daN/cm²

fck (resistenza caratteristica cilindrica a compressione) = 290 daN/cm²

fctm (resistenza a trazione media) = 28 daN/cm²

G (modulo di elasticità tangenziale) = 145424 daN/cm²

E (modulo elastico istantaneo iniziale) = 325750 daN/cm²

C. Poisson (coefficiente di contrazione trasversale) = 0.12

Coefficiente di dilatazione termica = 0.000050

Peso specifico del calcestruzzo armato = 2500 daN/mc

Barre d'acciaio ad aderenza migliorata tipo: B450C

f_{yk} (tensione caratteristica di snervamento) = 4500 daN/cm²

f_{kt} (tensione caratteristica di rottura) = 5400 daN/cm²

ϵ_{uk} (deformazione di rottura) = 0.075

G (modulo di elasticità tangenziale) = 793100 daN/cm²

E (modulo elastico) = 2060000 daN/cm²

C. Poisson (coefficiente di contrazione trasversale) = 0.30

Coefficiente di dilatazione termica = 0.000012

Peso specifico = 7850 daN/mc

Dominio SLU:

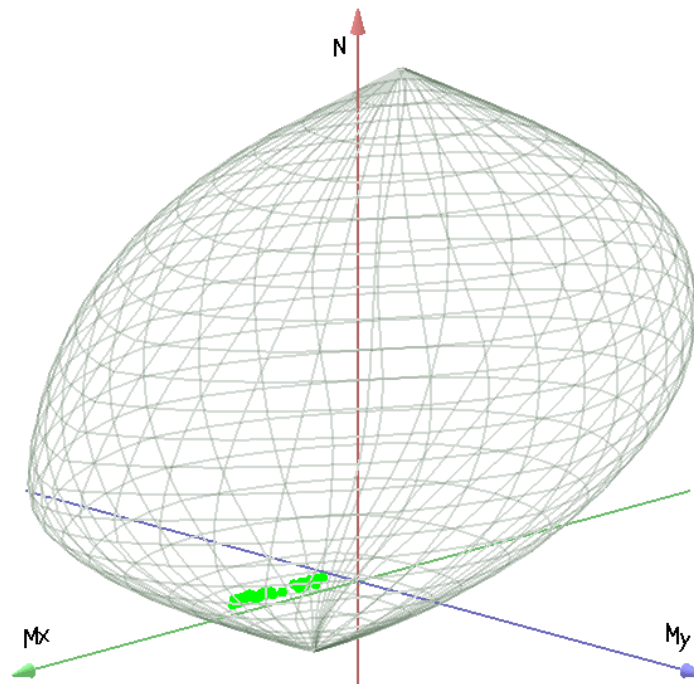

Caratteristiche limite della sezione:

Nu	Mxu	Myu	Stato Sez.
kN	kN m	kN m	
-2384,9	499,4	0,0	Completamente tesa
20461,5	-499,4	0,0	Completamente compressa
0,0	1672,4	0,0	Fibre inferiori tese

0,0	-663,9	0,0	Fibre superiori tese
0,0	0,0	947,7	Fibre di sinistra tese
0,0	0,0	-947,7	Fibre di destra tese

Verifiche stato limite ultimo:

Per ogni combinazione di carico saranno svolte le verifiche:

Verifica per Mxu, Myu e Nu proporzionali (sigla verifica: P)

e in caso di verifica proporzionale positiva:

Verifica con rapporto Mxu, Myu assegnato (sigla verifica: M)

Verifica con Nu costante (sigla verifica: N)

Cmb.	N	Mx	My	Tipo	Nu	Mxu	Myu	Sd/Su	Verif.
	kN	kN m	kN m		kN	kN m	kN m		
1	647,4	672,1	32,4	P	2590,7	2689,6	129,5	0,250	OK
				M	17621,5	671,6	32,3	0,040	
				N	647,4	1959,2	94,4	0,340	
2	641,7	580,6	32,1	P	3152,1	2852,0	157,6	0,200	OK
				M	17846,8	580,2	32,1	0,040	
				N	641,7	1955,4	108,0	0,300	
3	599,4	500,1	30,0	P	3537,4	2951,4	176,9	0,170	OK
				M	18045,1	499,7	29,9	0,030	
				N	599,4	1936,1	116,0	0,260	
4	595,1	431,7	29,8	P	4300,2	3119,4	215,0	0,140	OK
				M	18213,1	431,4	29,7	0,030	
				N	595,1	1932,4	133,2	0,220	
5	682,5	1448,0	34,1	P	995,7	2112,5	49,8	0,680	OK
				M	15702,0	1447,0	34,1	0,040	
				N	682,5	1978,3	46,6	0,730	
6	684,9	1425,0	34,3	P	1020,2	2122,7	51,0	0,670	OK
				M	15759,0	1424,1	34,2	0,040	
				N	684,9	1979,3	47,6	0,720	
7	621,0	1414,0	31,1	P	912,4	2077,5	45,6	0,680	OK
				M	15786,7	1413,1	31,0	0,040	
				N	621,0	1951,6	42,9	0,720	
8	633,0	1251,0	31,7	P	1088,4	2150,9	54,4	0,580	OK
				M	16191,3	1250,0	31,6	0,040	
				N	633,0	1956,5	49,5	0,640	
9	635,5	1228,0	31,8	P	1119,8	2163,7	56,0	0,570	OK



				M	16248,0	1227,1	31,7	0,040	
				N	635,5	1957,5	50,6	0,630	
10	571,6	1217,0	28,6	P	991,3	2110,6	49,6	0,580	OK
				M	16276,1	1215,9	28,6	0,030	
				N	571,6	1929,7	45,3	0,630	
11	647,4	764,5	32,4	P	2160,0	2550,7	108,0	0,300	OK
				M	17393,7	763,9	32,3	0,040	
				N	647,4	1960,2	83,0	0,390	
12	641,7	673,1	32,1	P	2553,0	2677,9	127,6	0,250	OK
				M	17619,1	672,6	32,1	0,040	
				N	641,7	1956,8	93,3	0,340	
13	599,4	624,0	30,0	P	2580,5	2686,4	129,0	0,230	OK
				M	17740,4	623,5	29,9	0,030	
				N	599,4	1938,4	93,1	0,320	
14	595,1	555,6	29,8	P	3014,0	2814,0	150,7	0,200	OK
				M	17908,7	555,2	29,7	0,030	
				N	595,1	1935,5	103,6	0,290	
15	682,5	1355,0	34,1	P	1082,1	2148,3	54,1	0,630	OK
				M	15933,1	1353,9	34,1	0,040	
				N	682,5	1978,1	49,8	0,680	
16	684,9	1333,0	34,3	P	1109,6	2159,6	55,5	0,620	OK
				M	15987,6	1332,0	34,2	0,040	
				N	684,9	1979,1	50,8	0,670	
17	621,0	1321,0	31,1	P	992,4	2111,1	49,6	0,630	OK
				M	16017,7	1320,0	31,0	0,040	
				N	621,0	1951,4	45,9	0,680	
18	633,0	1127,0	31,7	P	1243,4	2213,7	62,2	0,510	OK
				M	16498,2	1126,1	31,6	0,040	
				N	633,0	1956,1	54,9	0,580	
19	635,5	1104,0	31,8	P	1283,5	2229,7	64,2	0,490	OK
				M	16555,4	1103,0	31,7	0,040	
				N	635,5	1957,1	56,3	0,560	
20	571,6	1093,0	28,6	P	1134,8	2169,9	56,7	0,500	OK
				M	16583,2	1092,0	28,6	0,030	
				N	571,6	1929,4	50,5	0,570	
21	629,8	1269,0	31,5	P	1062,1	2140,1	53,1	0,590	OK
				M	16146,3	1268,1	31,5	0,040	
				N	629,8	1955,1	48,5	0,650	
22	580,3	1041,0	29,0	P	1231,3	2208,9	61,6	0,470	OK
				M	16712,0	1039,9	29,0	0,030	



				N	580,3	1933,0	53,9	0,540	
23	440,3	886,7	22,0	P	1062,8	2140,4	53,2	0,410	OK
				M	17094,2	885,8	22,0	0,030	
				N	440,3	1871,4	46,5	0,470	
24	390,9	502,4	19,5	P	1920,4	2468,1	96,0	0,200	OK
				M	18041,2	501,9	19,5	0,020	
				N	390,9	1847,7	71,9	0,270	
25	736,3	1275,0	36,8	P	1288,8	2231,8	64,4	0,570	OK
				M	16130,7	1274,1	36,8	0,050	
				N	736,3	2000,9	57,8	0,640	
26	686,0	1298,0	34,3	P	1150,1	2176,1	57,5	0,600	OK
				M	16074,2	1297,0	34,3	0,040	
				N	686,0	1979,4	52,3	0,660	
27	610,6	1028,0	30,5	P	1336,8	2250,7	66,8	0,460	OK
				M	16743,4	1027,1	30,5	0,040	
				N	610,6	1946,1	57,8	0,530	
28	682,0	1097,0	34,1	P	1419,2	2282,8	71,0	0,480	OK
				M	16572,5	1096,0	34,1	0,040	
				N	682,0	1977,0	61,5	0,550	
29	558,8	1014,0	27,9	P	1213,3	2201,6	60,7	0,460	OK
				M	16778,4	1013,1	27,9	0,030	
				N	558,8	1923,6	53,0	0,530	
30	530,0	1143,0	26,5	P	975,6	2104,1	48,8	0,540	OK
				M	16459,4	1142,0	26,5	0,030	
				N	530,0	1911,4	44,3	0,600	
31	525,7	1082,0	26,3	P	1034,1	2128,5	51,7	0,510	OK
				M	16610,8	1081,0	26,3	0,030	
				N	525,7	1909,4	46,4	0,570	
32	449,6	996,4	22,5	P	943,3	2090,5	47,2	0,480	OK
				M	16823,1	995,4	22,5	0,030	
				N	449,6	1875,7	42,3	0,530	
33	559,8	1028,0	28,0	P	1194,9	2194,2	59,7	0,470	OK
				M	16744,3	1026,9	28,0	0,030	
				N	559,8	1924,1	52,4	0,530	
75	431,7	630,0	21,6	P	1615,4	2357,4	80,8	0,270	OK
				M	17727,0	629,5	21,6	0,020	
				N	431,7	1866,5	64,0	0,340	
76	497,7	1456,0	24,9	P	675,5	1976,0	33,8	0,740	OK
				M	15683,4	1455,0	24,9	0,030	
				N	497,7	1897,7	32,4	0,770	

77	431,7	700,4	21,6	P	1403,2	2276,6	70,2	0,310	OK	
					M	17553,7	699,7	21,6		0,020
					N	431,7	1866,9	57,5		0,370
78	497,7	1385,0	24,9	P	716,5	1993,8	35,8	0,690	OK	
					M	15859,4	1384,1	24,9		0,030
					N	497,7	1897,6	34,1		0,730
79	467,7	1189,0	23,4	P	798,1	2028,9	39,9	0,590	OK	
					M	16345,7	1188,1	23,4		0,030
					N	467,7	1884,1	37,1		0,630

Riepilogo combinazioni maggiormente gravose:

Cmb.	N	Mx	My	Tipo	Nu	Mxu	Myu	Sd/Su	Verif.
	kN	kN m	kN m		kN	kN m	kN m		
76	497,7	1456,0	24,9	P	675,5	1976,0	33,8	0,740	OK
25	736,3	1275,0	36,8	M	16130,7	1274,1	36,8	0,050	OK
76	497,7	1456,0	24,9	N	497,7	1897,7	32,4	0,770	OK

Verifiche stato limite di esercizio per c. c. rare:

Valori limite (tensioni: segno (-) = compressione, (+) = trazione):

CLS: $\sigma_{cL} = 17400,0$ kN/mq (verifica Ok per $\sigma_c/\sigma_{cL} < 1$)

Acciaio: $\sigma_{aL} = 360000,0$ kN/mq (verifica Ok per $\sigma_a/\sigma_{aL} < 1$)

Cmb	Mx	My	N	σ_c	σ_c/σ_{cL}	σ_a	σ_a/σ_{aL}
n. e stato	kN m	kN m	kN	kN/mq		kN/mq	
46 OK	495,7	0,0	479,6	-3621,2	0,21	78899,4	0,22
47 OK	428,0	0,0	475,3	-3140,6	0,18	62765,2	0,17
48 OK	360,1	0,0	444,3	-2650,2	0,15	49056,1	0,14
49 OK	309,3	0,0	441,1	-2283,7	0,13	37344,9	0,10
50 OK	1038,0	0,0	497,0	-7387,5	0,42	212808,1	0,59
51 OK	1021,0	0,0	498,8	-7271,7	0,42	208349,0	0,58
52 OK	1013,0	0,0	451,4	-7191,5	0,41	210988,8	0,59
53 OK	901,1	0,0	460,4	-6428,1	0,37	181910,1	0,51
54 OK	884,3	0,0	462,2	-6313,4	0,36	177506,6	0,49
55 OK	875,9	0,0	414,7	-6231,3	0,36	180034,4	0,50
56 OK	535,1	0,0	479,6	-3898,6	0,22	88596,2	0,25
57 OK	467,3	0,0	475,3	-3419,5	0,20	72325,8	0,20
58 OK	425,6	0,0	444,3	-3117,0	0,18	64870,1	0,18

59	OK	374,8	0,0	441,1	-2754,9	0,16	52844,5	0,15
60	OK	961,1	0,0	497,0	-6859,1	0,39	193443,1	0,54
61	OK	944,3	0,0	498,8	-6744,4	0,39	189040,6	0,53
62	OK	936,0	0,0	451,4	-6663,2	0,38	191578,9	0,53
63	OK	797,8	0,0	460,4	-5716,8	0,33	155936,0	0,43
64	OK	781,1	0,0	462,2	-5602,4	0,32	151569,9	0,42
65	OK	772,7	0,0	414,8	-5522,1	0,32	154042,1	0,43
66	OK	897,2	0,0	457,9	-6400,0	0,37	181172,3	0,50
67	OK	733,9	0,0	421,2	-5257,8	0,30	143670,6	0,40
68	OK	686,1	0,0	405,2	-4920,6	0,28	133211,0	0,37
69	OK	392,7	0,0	368,5	-2865,7	0,16	63528,6	0,18

Verifiche stato limite di esercizio per c. c. frequenti:

Valori limite:

Fessure: $WkL = 0,40$ mm (verifica Ok per $Wk/WkL < 1$)

	Cmb	Mx	My	N	Wk	Wk/WkL
n. e stato	kN m	kN m	kN	mm		
34	OK	438,2	0,0	444,3	0.08	0,21
35	OK	449,3	0,0	450,2	0.09	0,22
36	OK	822,9	0,0	460,4	0.21	0,53
37	OK	806,2	0,0	462,2	0.20	0,51
38	OK	797,8	0,0	414,7	0.21	0,52
39	OK	515,2	0,0	444,3	0.11	0,27
40	OK	464,5	0,0	441,1	0.09	0,23
41	OK	745,9	0,0	460,4	0.18	0,46
42	OK	729,1	0,0	462,2	0.18	0,45
43	OK	720,8	0,0	414,7	0.18	0,46
44	OK	802,4	0,0	439,4	0.21	0,52
45	OK	470,9	0,0	368,5	0.11	0,26

Verifiche stato limite di esercizio per c. c. quasi permanenti:

Valori limite:

CLS: $\sigma_{cL} = 13050,0$ kN/mq (verifica Ok per $\sigma_c/\sigma_{cL} < 1$)

Fessure: $WkL = 0,30$ mm (verifica Ok per $Wk/WkL < 1$)

Cmb	Mx	My	N	σ_c	σ_c/σ_{cL}	Wk	Wk/WkL
n. e stato	kN m	kN m	kN	kN/mq		mm	
70 OK	285,2	0,0	338,3	-2096,7	0,16	0.05	0,16
71 OK	603,0	0,0	350,3	-4322,0	0,33	0.15	0,51
72 OK	355,7	0,0	338,3	-2597,0	0,20	0.07	0,24
73 OK	532,5	0,0	350,4	-3834,7	0,29	0.13	0,43
74 OK	370,0	0,0	350,3	-2700,9	0,21	0.07	0,25

7.5.7. Piedritto: mezzeria (Asta 4)

2SI s.r.l - ProVLIM - Verifica sezioni

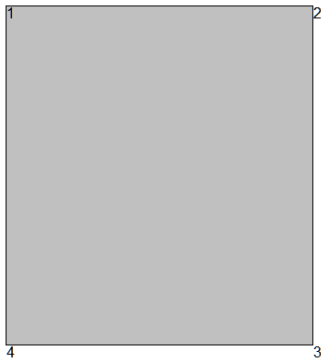

Geometria della sezione:

Vert.	X	Y
n.	cm	cm
1	0,0	110,0
2	100,0	110,0
3	100,0	0,0
4	0,0	0,0

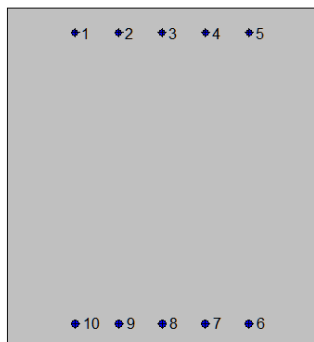

Armature:

Pos.	X	Y	Area	Pretens.
n.	cm	cm	cmq	(s/n)
1	21,9	102,2	3,1	no
2	35,9	102,2	3,1	no
3	50,0	102,2	3,1	no
4	64,1	102,2	3,1	no
5	78,1	102,2	3,1	no
6	78,0	8,0	4,5	no
7	64,0	8,0	4,5	no
8	50,0	8,0	4,5	no
9	36,0	8,0	4,5	no
10	22,0	8,0	4,5	no

Normativa di riferimento:

D.M. 14/01/2008 - 'Norme tecniche per le costruzioni'

Note:

Verifiche SLE per ambiente ordinario

Materiali:

Calcestruzzo classe: C28/35

Rck (resistenza caratteristica cubica a compressione) = 350 daN/cm²

fck (resistenza caratteristica cilindrica a compressione) = 290 daN/cm²

fctm (resistenza a trazione media) = 28 daN/cm²

G (modulo di elasticità tangenziale) = 145424 daN/cm²

E (modulo elastico istantaneo iniziale) = 325750 daN/cm²

ν (coefficiente di contrazione trasversale) = 0.12

Coefficiente di dilatazione termica = 0.000050

Peso specifico del calcestruzzo armato = 2500 daN/mc

Barre d'acciaio ad aderenza migliorata tipo: B450C

f_{yk} (tensione caratteristica di snervamento) = 4500 daN/cm²

f_{kt} (tensione caratteristica di rottura) = 5400 daN/cm²

ϵ_{uk} (deformazione di rottura) = 0.075

G (modulo di elasticità tangenziale) = 793100 daN/cm²

E (modulo elastico) = 2060000 daN/cm²

ν (coefficiente di contrazione trasversale) = 0.30

Coefficiente di dilatazione termica = 0.000012

Peso specifico = 7850 daN/mc

Dominio SLU:

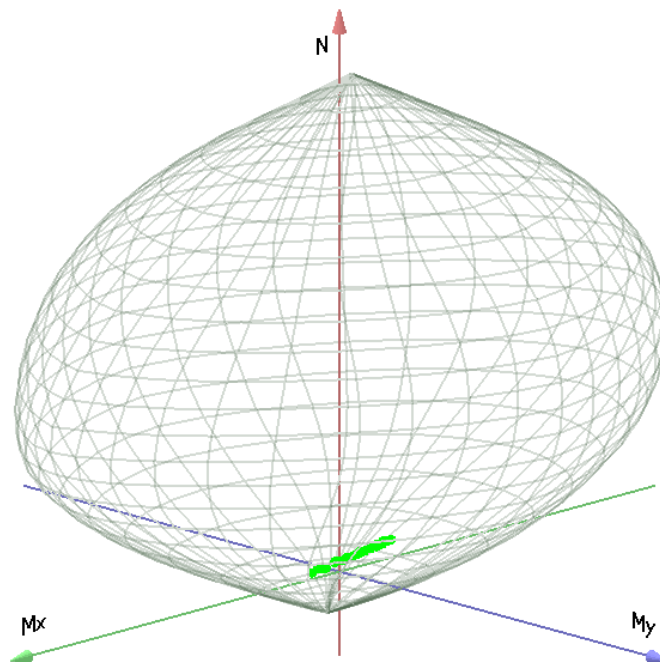

Caratteristiche limite della sezione:

Nu	Mxu	Myu	Stato Sez.
----	-----	-----	------------

kN	kN m	kN m	
-1499,8	125,9	0,0	Completamente tesa
19576,4	-125,9	0,0	Completamente compressa
0,0	879,9	0,0	Fibre inferiori tese
0,0	-625,7	0,0	Fibre superiori tese
0,0	0,0	678,8	Fibre di sinistra tese
0,0	0,0	-678,8	Fibre di destra tese

Verifiche stato limite ultimo:

Per ogni combinazione di carico saranno svolte le verifiche:

Verifica per M_{xu} , M_{yu} e N_u proporzionali (sigla verifica: P)

e in caso di verifica proporzionale positiva:

Verifica con rapporto M_{xu} , M_{yu} assegnato (sigla verifica: M)

Verifica con N_u costante (sigla verifica: N)

Cmb.	N	Mx	My	Tipo	Nu	Mxu	Myu	Sd/Su	Verif.
	kN	kN m	kN m		kN	kN m	kN m		
1	786,0	-519,6	39,3	P	2904,8	-1920,3	145,2	0,270	OK
				M	18614,7	-519,5	39,3	0,040	
				N	786,0	-997,6	75,5	0,520	
2	780,2	-476,4	39,0	P	3489,8	-2130,9	174,5	0,220	OK
				M	18721,0	-476,3	39,0	0,040	
				N	780,2	-994,6	81,4	0,480	
3	738,0	-407,9	36,9	P	4332,3	-2394,5	216,6	0,170	OK
				M	18889,4	-407,8	36,9	0,040	
				N	738,0	-974,3	88,1	0,420	
4	733,7	-375,5	36,7	P	5039,9	-2579,4	252,0	0,150	OK
				M	18968,4	-375,4	36,7	0,040	
				N	733,7	-971,9	94,9	0,390	
5	654,9	-365,8	32,7	P	4238,3	-2367,4	211,9	0,150	OK
				M	18993,5	-365,7	32,7	0,030	
				N	654,9	-935,2	83,7	0,390	
6	643,8	-298,1	32,2	P	5998,7	-2777,6	299,9	0,110	OK
				M	19157,4	-298,0	32,2	0,030	
				N	643,8	-929,1	100,3	0,320	
7	555,5	-178,5	27,8	P	9099,9	-2924,1	455,1	0,060	OK
				M	19434,2	-178,4	27,8	0,030	
				N	555,5	-884,7	137,7	0,200	

8	704,4	-419,3	35,2	P	3694,3	-2199,1	184,7	0,190	OK
				M	18862,1	-419,2	35,2	0,040	
				N	704,4	-958,8	80,5	0,440	
9	693,3	-351,7	34,7	P	5123,4	-2599,0	256,1	0,130	OK
				M	19027,0	-351,6	34,7	0,040	
				N	693,3	-952,9	93,9	0,370	
10	605,0	-232,1	30,3	P	7744,1	-2970,9	387,2	0,080	OK
				M	19314,4	-232,0	30,2	0,030	
				N	605,0	-909,6	118,5	0,250	
11	786,0	-512,6	39,3	P	2998,3	-1955,3	149,9	0,260	OK
				M	18631,9	-512,5	39,3	0,040	
				N	786,0	-997,5	76,5	0,510	
12	780,2	-469,4	39,0	P	3607,7	-2170,5	180,4	0,220	OK
				M	18738,2	-469,3	39,0	0,040	
				N	780,2	-994,5	82,7	0,470	
13	738,0	-398,4	36,9	P	4545,1	-2453,6	227,3	0,160	OK
				M	18912,6	-398,3	36,9	0,040	
				N	738,0	-974,2	90,2	0,410	
14	733,7	-366,1	36,7	P	5280,1	-2634,6	264,0	0,140	OK
				M	18991,3	-366,0	36,7	0,040	
				N	733,7	-971,8	97,4	0,380	
15	654,9	-372,8	32,7	P	4071,8	-2317,8	203,6	0,160	OK
				M	18976,4	-372,7	32,7	0,030	
				N	654,9	-935,3	82,1	0,400	
16	643,8	-305,1	32,2	P	5774,6	-2736,6	288,7	0,110	OK
				M	19140,6	-305,0	32,2	0,030	
				N	643,8	-929,2	98,0	0,330	
17	555,5	-185,6	27,8	P	8816,1	-2945,6	440,9	0,060	OK
				M	19419,8	-185,5	27,8	0,030	
				N	555,5	-885,1	132,5	0,210	
18	704,4	-428,8	35,2	P	3514,0	-2139,1	175,7	0,200	OK
				M	18838,9	-428,7	35,2	0,040	
				N	704,4	-958,9	78,8	0,450	
19	693,3	-361,1	34,7	P	4875,5	-2539,3	243,7	0,140	OK
				M	19004,2	-361,0	34,7	0,040	
				N	693,3	-953,0	91,5	0,380	
20	605,0	-241,5	30,3	P	7404,0	-2955,5	370,2	0,080	OK
				M	19292,6	-241,4	30,2	0,030	
				N	605,0	-909,9	114,0	0,260	
21	707,6	-364,5	35,4	P	4978,8	-2564,7	248,9	0,140	OK



				M	18995,7	-364,4	35,4	0,040	
				N	707,6	-959,7	93,2	0,380	
22	757,1	-420,5	37,9	P	4288,7	-2382,0	214,4	0,180	OK
				M	18858,3	-420,4	37,8	0,040	
				N	757,1	-983,3	88,5	0,430	
23	338,9	204,4	17,0	P	4139,7	2496,8	207,0	0,080	OK
				M	18788,8	204,3	16,9	0,020	
				N	338,9	1039,3	86,2	0,200	
24	388,4	251,9	19,4	P	3630,6	2354,6	181,5	0,110	OK
				M	18672,6	251,8	19,4	0,020	
				N	388,4	1063,0	82,0	0,240	
25	601,1	-204,4	30,1	P	8688,3	-2954,4	434,3	0,070	OK
				M	19377,1	-204,3	30,0	0,030	
				N	601,1	-906,7	133,3	0,220	
26	642,7	-186,0	32,1	P	9853,6	-2851,7	492,8	0,060	OK
				M	19413,0	-185,9	32,1	0,030	
				N	642,7	-924,3	159,7	0,200	
27	822,8	-426,0	41,1	P	4931,2	-2553,1	246,6	0,170	OK
				M	18843,7	-425,9	41,1	0,040	
				N	822,8	-1013,9	97,9	0,420	
28	739,9	-358,6	37,0	P	5558,7	-2694,1	277,9	0,130	OK
				M	19009,3	-358,5	37,0	0,040	
				N	739,9	-974,6	100,5	0,370	
29	493,3	36,9	24,7	P	15608,6	1167,6	780,3	0,030	OK
				M	19189,9	36,8	24,6	0,030	
				N	493,3	941,1	628,9	0,040	
30	534,6	-125,1	26,7	P	11297,5	-2643,7	564,9	0,050	OK
				M	19492,9	-125,1	26,7	0,030	
				N	534,6	-870,6	186,0	0,140	
31	530,3	-53,4	26,5	P	15265,7	-1535,8	763,4	0,030	OK
				M	19395,7	-53,4	26,6	0,030	
				N	530,3	-829,9	412,5	0,060	
32	454,2	70,2	22,7	P	13167,5	2035,1	658,4	0,030	OK
				M	19111,4	70,1	22,7	0,020	
				N	454,2	1059,5	342,8	0,070	
33	492,2	73,3	24,6	P	13336,7	1985,1	666,8	0,040	OK
				M	19103,4	73,2	24,6	0,030	
				N	492,2	1073,1	360,5	0,070	
75	462,1	-25,4	23,1	P	16543,0	-909,7	827,0	0,030	OK
				M	19336,0	-25,3	23,0	0,020	

				N	462,1	-687,4	624,9	0,040	
76	315,9	165,0	15,8	P	5266,2	2750,6	263,2	0,060	OK
				M	18884,7	164,9	15,8	0,020	
				N	315,9	1027,6	98,3	0,160	
77	462,1	-25,4	23,1	P	16543,0	-909,7	827,0	0,030	OK
				M	19336,0	-25,3	23,0	0,020	
				N	462,1	-687,4	624,9	0,040	
78	315,9	159,6	15,8	P	5542,1	2800,0	277,0	0,060	OK
				M	18897,8	159,5	15,8	0,020	
				N	315,9	1027,4	101,6	0,150	
79	277,2	308,6	13,9	P	1356,8	1510,5	67,8	0,200	OK
				M	18535,7	308,2	13,8	0,010	
				N	277,2	1011,6	45,4	0,300	

Riepilogo combinazioni maggiormente gravose:

Cmb.	N	Mx	My	Tipo	Nu	Mxu	Myu	Sd/Su	Verif.
	kN	kN m	kN m		kN	kN m	kN m		
1	786,0	-519,6	39,3	P	2904,8	-1920,3	145,2	0,270	OK
1	786,0	-519,6	39,3	M	18614,7	-519,5	39,3	0,040	OK
1	786,0	-519,6	39,3	N	786,0	-997,6	75,5	0,520	OK

Verifiche stato limite di esercizio per c. c. rare:

Valori limite (tensioni: segno (-) = compressione, (+) = trazione):

CLS: $\sigma_{cL} = 17400,0$ kN/mq (verifica Ok per $\sigma_c/\sigma_{cL} < 1$)

Acciaio: $\sigma_{aL} = 360000,0$ kN/mq (verifica Ok per $\sigma_a/\sigma_{aL} < 1$)

Cmb	Mx	My	N	σ_c	σ_c/σ_{cL}	σ_a	σ_a/σ_{aL}
n. e stato	kN m	kN m	kN	kN/mq		kN/mq	
46 OK	-301,1	0,0	582,2	-2555,4	0,15	47250,9	0,13
47 OK	-269,1	0,0	578,0	-2211,9	0,13	33016,3	0,09
48 OK	-213,9	0,0	546,9	-1675,1	0,10	-21904,4	0,06
49 OK	-190,0	0,0	543,7	-1459,3	0,08	-19409,8	0,05
50 OK	-269,9	0,0	494,1	-2327,1	0,13	47419,4	0,13
51 OK	-219,6	0,0	485,9	-1788,8	0,10	24956,4	0,07
52 OK	-130,9	0,0	420,4	-1000,6	0,06	-13495,1	0,04
53 OK	-314,3	0,0	530,8	-2768,5	0,16	64088,5	0,18
54 OK	-264,0	0,0	522,6	-2224,9	0,13	39343,3	0,11

55	OK	-175,2	0,0	457,0	-1366,0	0,08	-17921,7	0,05
56	OK	-298,1	0,0	582,2	-2522,5	0,14	45772,2	0,13
57	OK	-266,1	0,0	578,0	-2179,8	0,13	31729,5	0,09
58	OK	-209,0	0,0	546,9	-1628,5	0,09	-21375,9	0,06
59	OK	-185,0	0,0	543,7	-1417,3	0,08	-18917,2	0,05
60	OK	-275,8	0,0	494,1	-2392,2	0,14	50531,4	0,14
61	OK	-225,5	0,0	485,9	-1851,7	0,11	27444,2	0,08
62	OK	-136,7	0,0	420,4	-1044,8	0,06	-14023,1	0,04
63	OK	-322,1	0,0	530,8	-2854,2	0,16	68453,3	0,19
64	OK	-271,9	0,0	522,6	-2311,7	0,13	43221,1	0,12
65	OK	-183,1	0,0	457,0	-1442,1	0,08	-18780,7	0,05
66	OK	-269,6	0,0	533,3	-2272,6	0,13	40242,8	0,11
67	OK	-315,9	0,0	569,9	-2734,8	0,16	57110,4	0,16
68	OK	42,6	0,0	374,1	-520,9	0,03	-7396,1	0,02
69	OK	82,4	0,0	410,8	-732,1	0,04	-10185,3	0,03

Verifiche stato limite di esercizio per c. c. frequenti:

Valori limite:

Fessure: $WkL = 0,40$ mm (verifica Ok per $Wk/WkL < 1$)

	Cmb	Mx	My	N	Wk	Wk/WkL
n. e stato		kN m	kN m	kN	mm	
34	OK	-256,0	0,0	546,9	0.06	0,15
35	OK	-184,3	0,0	534,6	0.01	0,03
36	OK	-272,2	0,0	530,8	0.08	0,20
37	OK	-221,9	0,0	522,6	0.04	0,09
38	OK	-133,1	0,0	457,0	0.00	0,01
39	OK	-250,2	0,0	546,9	0.05	0,14
40	OK	-226,2	0,0	543,7	0.04	0,09
41	OK	-278,0	0,0	530,8	0.08	0,21
42	OK	-227,8	0,0	522,6	0.04	0,11
43	OK	-139,0	0,0	457,0	0.01	0,01
44	OK	-196,5	0,0	551,7	0.02	0,04
45	OK	40,3	0,0	410,8	0.00	0,00

Verifiche stato limite di esercizio per c. c. quasi permanenti:

Valori limite:

CLS: $\sigma_{cL} = 13050,0$ kN/mq (verifica Ok per $\sigma_c/\sigma_{cL} < 1$)

Fessure: $W_{kL} = 0,30$ mm (verifica Ok per $W_k/W_{kL} < 1$)

	Cmb	Mx	My	N	σ_c	σ_c/σ_{cL}	Wk	Wk/WkL
n. e stato		kN m	kN m	kN	kN/mq		mm	
70	OK	-131,4	0,0	440,9	-1007,0	0,08	0.00	0,01
71	OK	-148,0	0,0	428,9	-1135,3	0,09	0.01	0,04
72	OK	-126,1	0,0	440,9	-970,8	0,07	0.00	0,01
73	OK	-153,4	0,0	428,9	-1181,6	0,09	0.01	0,04
74	OK	-45,6	0,0	428,9	-564,1	0,04	0.00	0,00

7.5.8. Verifiche allo stato limite ultimo per taglio

7.5.8.1 Soletta superiore attacco piedritto (Asta 9)

V_{sdu}	644.33	kN
M_{sdu}	-	kNm
N_{sdu}	0	kN
R_{ck}	35	N/mm ²
f_{ck}	28	N/mm ²
γ_c	1.5	
f_{yk}	450	N/mm ²
bw	100	cm
d	98.50	cm
A_{sl}	45.2	cm ²
c	11.50	cm
α	90	gradi
α	1.57	rad
θ	21.80	gradi
$ctg\theta$	2.50	
θ imposto	21.80	gradi
A_{sw}	3.76	cm ²
passo staffe	50	cm
f_{cd}	15.867	N/mm ²
$f_{ctd,0,05}$	1.240	N/mm ²
f_{yd}	391.304	N/mm ²
σ_{cp}	0.0000	N/mm ²
<i>verifica senza armatura resistente a taglio</i>		
V_{Rd}	401.594	kN
$V_{Rd,min}$	318.719	kN
$\rho_{sw,min}$	0.000941	
$s_{l,max}$	60.00	cm
$A_{sw,min}$	5.644	cm ² / $s_{l,max}$
<i>verifica con armatura resistente a taglio (staffe)</i>		
V_{Rcd}	2425.013	kN
V_{Rsd}	652.202	kN
V_{Rd}	652.202	kN

La verifica a taglio risulta soddisfatta considerando staffe a due bracci $\phi 12/ (60 \times 50)$

7.5.8.2 Soletta inferiore attacco piedritto (Asta 11)

V_{sdu}	812.35	kN
M_{sdu}	-	kNm
N_{sdu}	0	kN
R_{ck}	35	N/mm ²
f_{ck}	28	N/mm ²
γ_c	1.5	
f_{yk}	450	N/mm ²
b_w	100	cm
d	110.80	cm
A_{sl}	45.2	cm ²
c	9.20	cm
α	90	gradi
α	1.57	rad
θ	21.80	gradi
$ctg\theta$	2.50	
$\theta_{imposto}$	21.80	gradi
A_{sw}	3.76	cm ²
passo staffe	25	cm
f_{cd}	15.867	N/mm ²
$f_{ctd_{0,05}}$	1.240	N/mm ²
f_{yd}	391.304	N/mm ²
σ_{cp}	0.0000	N/mm ²
verifica senza armatura resistente a taglio		
V_{Rd}	426.657	kN
$V_{Rd,min}$	349.016	kN
$\rho_{sw,min}$	0.000941	
$s_{l,max}$	60.00	cm
$A_{sw,min}$	5.644	cm ² / $s_{l,max}$
verifica con armatura resistente a taglio (staffe)		
V_{Rcd}	2727.831	kN
V_{Rsd}	1467.289	kN
V_{Rd}	1467.289	kN

La verifica a taglio risulta soddisfatta considerando staffe a due bracci $\phi 12/ (60 \times 25)$

7.5.8.3 Piedritto attacco soletta inferiore (Asta 2)

V_{sdu}	807.88	kN
M_{sdu}	-	kNm
N_{sdu}	367.79	kN
R_{ck}	35	N/mm ²
f_{ck}	28	N/mm ²
γ_c	1.5	
f_{yk}	450	N/mm ²
b_w	100	cm
d	99.80	cm
A_{sl}	54.24	cm ²
c	10.20	cm
α	90	gradi
α	1.57	rad
θ	21.80	gradi
$ctg\theta$	2.50	
$\theta_{imposto}$	21.80	gradi
A_{sw}	3.76	cm ²
passo staffe	40	cm
f_{cd}	15.867	N/mm ²
$f_{ctd_{0,05}}$	1.240	N/mm ²
f_{yd}	391.304	N/mm ²
σ_{cp}	0.3360	N/mm ²
verifica senza armatura resistente a taglio		
V_{Rd}	479.931	kN
$V_{Rd,min}$	372.243	kN
$\rho_{sw,min}$	0.000941	
$s_{l,max}$	60.00	cm
$A_{sw,min}$	5.644	cm ² / $s_{l,max}$
verifica con armatura resistente a taglio (staffe)		
V_{Rcd}	2509.051	kN
V_{Rsd}	826.012	kN
V_{Rd}	826.012	kN

La verifica a taglio risulta soddisfatta considerando staffe a due bracci $\phi 12/ (60 \times 40)$

7.5.8.4 Piedritto attacco soletta superiore (Asta 6)

V_{sdu}	410.25	kN
M_{sdu}	-	kNm
N_{sdu}	457.17	kN
R_{ck}	35	N/mm ²
f_{ck}	28	N/mm ²
γ_c	1.5	
f_{yk}	450	N/mm ²
b_w	100	cm
d	99.80	cm
A_{sl}	54.24	cm ²
c	10.20	cm
α	90	gradi
α	1.57	rad
θ	43.89	gradi
$ctg\theta$	1.04	
$\theta_{imposto}$	-	gradi
A_{sw}	0.00	cm ²
passo staffe	0.00	cm
f_{cd}	15.867	N/mm ²
$f_{ctd_{0,05}}$	1.240	N/mm ²
f_{yd}	391.304	N/mm ²
σ_{cp}	0.4177	N/mm ²
<i>verifica senza armatura resistente a taglio</i>		
V_{Rd}	492.155	kN

La verifica a taglio risulta soddisfatta senza necessità di prevedere armatura per il taglio.

7.5.9. Armatura di ripartizione dello scatolare

L'armatura di ripartizione nelle solette e nelle pareti dello scatolare (direzione y) viene posta in misura non inferiore al 20% dell'armatura principale (direzione x) (EC2 § 9.3).

L'armatura di ripartizione viene disposta non uniformemente, ma leggermente maggiorata nei punti in cui è maggiore anche l'armatura principale, punti in cui, peraltro, risultano maggiori le sollecitazioni trasversali alla luce di calcolo dello scatolare. Ad esempio, l'armatura di ripartizione viene posta in quantità maggiore all'intradosso della sezione di mezzera della soletta superiore che è il punto dove si hanno i maggiori momenti secondari dovuti ai carichi mobili stradali ed alla sovrastruttura stradale (gli unici carichi non uniformemente distribuiti sulla larghezza dello scatolare e quindi gli unici carichi che danno azioni flessionali trasversali). Essendo tali carichi ubicati al centro dello scatolare, essi generano azioni flessionali che tendono le fibre poste all'intradosso, dove viene appunto incrementata l'armatura di ripartizione.

Semplici valutazioni consentono di provare che l'armatura di ripartizione pari al 20% della principale è sicuramente sufficiente per assorbire le azioni flessionali trasversali secondarie, ovvero nella direzione ortogonale a quella di massima inflessione della soletta.

Come già osservato la massima azione flessionale secondaria si ha nella soletta superiore, perché solo qui sono applicate azioni non uniformemente distribuite su un intero elemento strutturale; tali azioni localizzate sono i carichi mobili stradali ed il peso della sovrastruttura.

Schematizzando, la soletta superiore come una lastra infinitamente lunga in direzione y, appoggiata sui bordi distanti $l_x = (1.10/2 + 11.50 + 1.10/2)m = 12.60m$, si valuta con l'ausilio di risultati tabellati (formule di BITTNER, vedi Allegato C) il massimo momento flettente in direzione y sotto l'effetto di una fascia caricata di larghezza $t_y = 10.5$ m (larghezza caricata) per i carichi permanenti e variabili, e di lunghezza $t_{x-var} = 3.74m$ (lunghezza di diffusione longitudinale dei carichi da traffico) per i carichi variabili, mentre per i carichi permanenti $t_{x-perm} = 12.60m$.

Contributo dei carichi permanenti:

$$p_{perm} = 22 \cdot 0.40 + 20 \cdot 0.60 = 20.80 \text{ kN/m}^2$$

$$p_{perm-SLU} = 22 \cdot 0.40 \cdot 1.35 + 20 \cdot 0.60 \cdot 1.35 = 28.08 \text{ kN/m}^2$$

$$P = p \cdot t_y \cdot t_x = 20.80 \cdot 10.5 \cdot 12.60 = 2,762.12 \text{ kN}$$

$$P_{SLU} = p_{SLU} \cdot t_y \cdot t_x = 3,728.86 \text{ kN}$$

$$l_y = \infty \quad t_y/l_x = 0.84 \Rightarrow 1 \quad t_x/l_x = 1.00 \quad \alpha_{ym} = 0.0270$$

Il massimo momento trasversale risulta:

$$M_{ym;SLE} = \alpha_{ym} * P = 74.47 \text{ kNm/m}$$

$$M_{ym,SLU} = \alpha_{ym} * P_{SLU} = 100.53 \text{ kNm/m}$$

Contributo dei carichi variabili:

$$p_{var} = (600+400+200)/(10.5 * 3.74) + 9 = 39.44 \text{ kN/m}^2$$

$$p_{var,SLU} = 39.44 * 1.35 = 53.25 \text{ kN/m}^2$$

$$P = p * t_y * t_x = 39.44 * 10.5 * 3.74 = 1,858.76 \text{ kN}$$

$$P_{SLU} = p_{SLU} * t_y * t_x = 53.25 * 10.5 * 3.74 = 2,509.32 \text{ kN}$$

$$l_y = \infty \quad t_y/l_x = 0.84 \Rightarrow 1 \quad t_x/l_x = 0.30 \quad \alpha_{ym} = 0.0418$$

Il massimo momento trasversale risulta:

$$M_{ym;SLE} = \alpha_{ym} * P = 77.73 \text{ kNm/m}$$

$$M_{ym,SLU} = \alpha_{ym} * P_{SLU} = 104.94 \text{ kNm/m}$$

Sollecitazioni totali:

$$M_{ym;SLE} = 152.20 \text{ kNm/m}$$

$$M_{ym,SLU} = 205.47 \text{ kNm/m}$$

Verifiche allo stato limite ultimo per flessione

2SI s.r.l - ProVLIM - Verifica sezioni

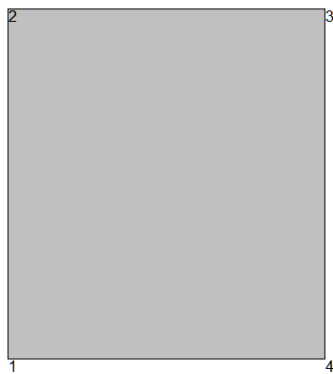

Geometria della sezione:

Vert.	X	Y
n.	cm	cm
1	0,0	0,0
2	0,0	110,0
3	100,0	110,0
4	100,0	0,0

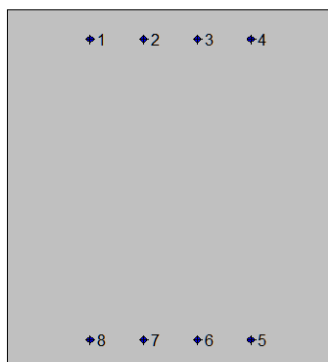

Armature:

Pos.	X	Y	Area	Pretens.
n.	cm	cm	cmq	(s/n)
1	25,3	101,1	3,1	no
2	41,8	101,1	3,1	no
3	58,2	101,1	3,1	no
4	74,7	101,1	3,1	no
5	74,7	8,9	3,1	no
6	58,2	8,9	3,1	no
7	41,8	8,9	3,1	no
8	25,3	8,9	3,1	no

Normativa di riferimento:

D.M. 14/01/2008 - 'Norme tecniche per le costruzioni'

Note:

Verifiche SLE per ambiente molto aggressivo

Materiali:

Calcestruzzo classe: C28/35

Rck (resistenza caratteristica cubica a compressione) = 350 daN/cm²
 fck (resistenza caratteristica cilindrica a compressione) = 290 daN/cm²
 fctm (resistenza a trazione media) = 28 daN/cm²
 G (modulo di elasticità tangenziale) = 145424 daN/cm²
 E (modulo elastico istantaneo iniziale) = 325750 daN/cm²
 C. Poisson (coefficiente di contrazione trasversale) = 0.12
 Coefficiente di dilatazione termica = 0.000050
 Peso specifico del calcestruzzo armato = 2500 daN/mc

Barre d'acciaio ad aderenza migliorata tipo: B450C

fyk (tensione caratteristica di snervamento) = 4500 daN/cm²
 fkt (tensione caratteristica di rottura) = 5400 daN/cm²
 εuk (deformazione di rottura) = 0.075
 G (modulo di elasticità tangenziale) = 793100 daN/cm²
 E (modulo elastico) = 2060000 daN/cm²
 C. Poisson (coefficiente di contrazione trasversale) = 0.30

Coefficiente di dilatazione termica = 0.000012

Peso specifico = 7850 daN/mc

Dominio SLU:

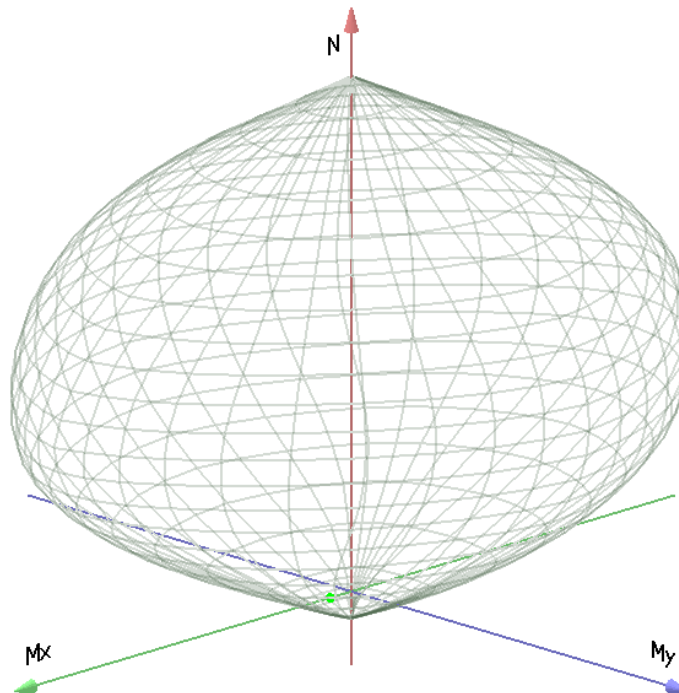

Caratteristiche limite della sezione:

Nu	Mxu	Myu	Stato Sez.
kN	kN m	kN m	
-983,5	0,0	0,0	Completamente tesa
19060,1	0,0	0,0	Completamente compressa
0,0	506,2	0,0	Fibre inferiori tese
0,0	-506,2	0,0	Fibre superiori tese
0,0	0,0	464,2	Fibre di sinistra tese
0,0	0,0	-464,2	Fibre di destra tese

Verifiche stato limite ultimo:

Per ogni combinazione di carico saranno svolte le verifiche:

Verifica per Mxu, Myu e Nu proporzionali (sigla verifica: P)

e in caso di verifica proporzionale positiva:

Verifica con rapporto M_{xu} , M_{yu} assegnato (sigla verifica: M)

Verifica con N_u costante (sigla verifica: N)

Cmb.	N	Mx	My	Tipo	Nu	Mxu	Myu	Sd/Su	Verif.
	kN	kN m	kN m		kN	kN m	kN m		
1	0,0	205,5	0,0	P	0,0	506,2	0,0	0,410	OK
				M	n.d.	n.d.	n.d.	n.d.	
				N	0,0	506,2	0,0	0,410	

Riepilogo combinazioni maggiormente gravose:

Cmb.	N	Mx	My	Tipo	Nu	Mxu	Myu	Sd/Su	Verif.
	kN	kN m	kN m		kN	kN m	kN m		
1	0,0	205,5	0,0	P	0,0	506,2	0,0	0,410	OK
1	0,0	205,5	0,0	M	n.d.	n.d.	n.d.	n.d.	OK
1	0,0	205,5	0,0	N	0,0	506,2	0,0	0,410	OK

Verifiche stato limite di esercizio per c. c. rare:

Valori limite (tensioni: segno (-) = compressione, (+) = trazione):

CLS: $\sigma_{cL} = 17400,0$ kN/mq (verifica Ok per $\sigma_c/\sigma_{cL} < 1$)

Acciaio: $\sigma_{aL} = 360000,0$ kN/mq (verifica Ok per $\sigma_a/\sigma_{aL} < 1$)

Cmb	Mx	My	N	σ_c	σ_c/σ_{cL}	σ_a	σ_a/σ_{aL}
n. e stato	kN m	kN m	kN	kN/mq		kN/mq	
2 OK	152,2	0,0	0,0	-1708,2	0,10	127300,5	0,35

Verifiche stato limite di esercizio per c. c. frequenti:

Valori limite:

Fessure: $W_{kL} = 0,30$ mm (verifica Ok per $W_k/W_{kL} < 1$)

Cmb	Mx	My	N	Wk	Wk/WkL
n. e stato	kN m	kN m	kN	mm	
3 OK	152,2	0,0	0,0	0,00	0,00

Si noti, inoltre, che l'ipotesi di lastra di lunghezza indefinita porta sicuramente a sovrastimare i momenti trasversali e che nel punto di massimo momento trasversale l'armatura di ripartizione è molto maggiore, essendo presenti anche le barre distanziatrici (non messe in conto nella verifica precedente).

Pertanto si può affermare che l'armatura di ripartizione assunta pari al 20% della principale è largamente sufficiente in relazione alle modeste sollecitazioni trasversali secondarie che possono nascere nella struttura dello scatolare.

In Allegato B si riporta un prospetto illustrativo con i risultati tabellati per la determinazione delle sollecitazioni trasversali nelle piastre rettangolari appoggiate sui quattro lati caricate uniformemente su una zona rettangolare centrale (formule di BITTNER).

8. Verifiche geotecniche

8.1. Verifica della capacità portante del terreno di fondazione

Considerando il tipo di struttura, ai fini della verifica della portanza del terreno stesso, non si ritengono significativi gli squilibri dovuti a spinte orizzontali non simmetriche o ad azioni orizzontali applicate alla sommità dello scatolare quali frenatura o sisma.

Al proposito si fa notare che dette spinte (o azioni) sono state applicate sul telaio piano schematizzante la canna scatolare senza considerare in alcun modo l'effetto di contenimento laterale esercitato dal terreno di rinfiacco al fine di massimizzare gli effetti flessionali agenti sui piedritti (e sulle solette) del tombino.

Pertanto nel seguito le pressioni agenti sul terreno di fondazione vengono calcolate in presenza dei soli carichi verticali:

- peso proprio sezione scatolare
- peso terreno di ricoprimento e pavimentazione stradale
- carichi accidentali da traffico
- peso ricoprimento interno allo scatolare senza tenere in conto la presenza di azioni orizzontali.
- Carichi accidentali da traffico sulla soletta inferiore

Ai fini della combinazione dei carichi verranno utilizzati i seguenti coefficienti di norma:

A1-STR: $1.35 (G_1 + G_2 + G_3) + 1.35 Q$

A2-GEO: $G_1 + G_2 + G_3 + 1.15 Q$

Fra i carichi accidentali elencati:

- Carico mobile veicolare sulla soletta superiore, posizione per massimo momento in mezzeria soletta superiore
- Carico mobile veicolare sulla soletta superiore, posizione per massimo taglio all'attacco del piedritto dx

- Sovraccarico uniforme da 20kPa sulle soletta superiore

verrà considerato di volta in volta il carico più sfavorevole ai fini della determinazione:

- del massimo carico verticale agente ad intradosso fondazione ;
- della massima pressione di contatto terreno/fondazione.

Nelle tabelle seguenti, si fornisce per entrambi gli scenari di norma elencati e per ognuna delle due "condizioni di verifica" sopra descritte:

- nella prima colonna il carico considerato ;
- nella seconda colonna la reazione verticale (agente su un metro di fondazione) indotta dal carico in esame (N, [kN]);
- nella terza colonna il momento (agente su un metro di fondazione) indotto dal carico in esame (M, [kN.m]);
- nella quarta colonna l'eccentricità della reazione verticale ($e=M/N$, [m]);
- nella quinta colonna il coefficiente di combinazione del carico in esame.

Si riportano quindi nell'ultima riga:

- il carico N_{tot} agente ad intradosso fondazione (ogni metro di canna) nella combinazione in esame ;
- il momento M_{tot} agente ad intradosso fondazione (ogni metro di canna) nella combinazione in esame ;
- l'eccentricità della reazione verticale $e = M_{tot} / N_{tot}$;
- la pressione di contatto terreno/fondazione valutate con la teoria di *Mayerhof* :

$$\sigma_{terr} = N_{tot} / (B_i + 2 \times S_p + 2 \times S_b - 2 \times e) \text{ [kPa]}$$

Combinazione A1-STR

Carico	N (kN)	M (kN)	e (m)	coeff.
peso proprio	1179.25	0	0	1.35
pesi portati	604.20	0	0	1.35
veicolari max soletta	628.28	0	0	1.35
veicolari max taglio dx	628.28	2437.95	3.88	1.35
veicolari 20kPa	619.80	0.00	0	1.35
	N _{tot} (kN)	M _{tot} (kNm)	e (m)	sigma (kPa)
Risultante	3255.83	0	0	230.910
Risultante	3255.83	2437.95	0.749	258.350
Risultante	3244.38	0.00	0	230.098

Combinazione A2-GEO

Carico	N (kN)	M (kN)	e (m)	coeff.
peso proprio	1179.25	0	0	1
pesi portati	604.20	0	0	1
veicolari max soletta	628.28	0	0	1.15
veicolari max taglio dx	628.28	2437.95	3.88	1.15
veicolari 20kPa	619.80	0.00	0	1.15
	Ntot (kN)	Mtot (kNm)	e (m)	sigma (kPa)
Risultante	2505.97	0	0	177.728
Risultante	2505.97	2437.955	0.973	206.180
Risultante	2496.22	0.00	0	177.037

8.2. Verifica a galleggiamento

La verifica viene eseguita in condizione di esercizio (ovviamente in assenza di sovraccarichi accidentali), considerando il battente alla sua altezza massima.

Per la stabilità al sollevamento deve risultare che il valore di progetto dell'azione instabilizzante $V_{inst,d}$, combinazione di azioni permanenti ($G_{inst,d}$), sia non maggiore della combinazione dei valori di progetto delle azioni stabilizzanti ($G_{stb,d}$) e delle resistenze (R_d):

$$V_{inst,d} \leq G_{stb,d} + R_d \quad \text{dove } V_{inst,d} = G_{inst,d}$$

Le verifiche agli stati limite ultimi sono eseguite in riferimento alla seguente combinazione:

1. combinazione 2 → (A2+M2) → GEO (galleggiamento)

Tabella 6.2.III - Coefficienti parziali per le azioni o per l'effetto delle azioni

CARICHI	EFFETTO	SIMBOLO γ_F	(A2) STR
Permanente	favorevole	γ_{G1}	0.9
	sfavorevole		1.1
Permanente non strutturali	favorevole	γ_{G2}	0.0
	sfavorevole		1.1

Tabella 6.2.II - Coefficienti parziali per i parametri del terreno

PARAMETRO	GRANDEZZA ALLA QUALE APPLICARE IL COEFF. PARZIALE	COEFFICIENTE PARZIALE γ_M	M_2
Tangente dell'angolo di	$\tan \phi'_k$	$\gamma_{\phi'}$	1.25

resistenza al taglio			
Coesione efficace	c'_k	γ_c	1.25
Resistenza non drenata	c'_{uk}	γ_{cu}	1.4
Peso dell'unità di volume	γ	γ_γ	1

Dato il livello di falda di progetto, la spinta di galleggiamento risulta:

pareti		SX	
	spessore pareti elevazione	1.1	m
	altezza pareti elevazione	6.9	m
	peso pareti	379.50	kN/m
soletta sup.	spessore soletta	1.1	m
	luce netta	13.7	m
	peso soletta	376.75	kN/m
fondazione	spessore fondazione	1.2	m
	luce netta	13.7	m
	peso fondazione	411.00	kN/m
sovrastuttura stradale interna	spessore sovrastruttura	1	m
	luce netta	11.5	m
	peso specifico	22	kN/m ³
	peso fondazione	253.00	kN/m
sbalzi	spessore sbalzi	1.2	m
	lunghezza sbalzi	0.2	m
	peso sbalzi	12.00	kN/m
terreno su sbalzi	altezza terreno sbalzi	8	kN/m
	peso specifico terreno	8.5	kN/m ³

	peso terreno	27.20	kN/m
	peso totale struttura	1206.45	kN
	area spinta idrica	13.7	m ²
	altezza falda in costruzione	4.1	m
	altezza falda in esercizio	5.1	m
	pressione manufatto (strutture)	88.06	kN/m ²
	pressione sovrastruttura stradale	18.47	kN/m ²
	spinta falda in esercizio	41	kN/m ²
	costruzione ($V_{inst,d}/G_{stb,d} \leq 1$)	0.57	ok
	esercizio ($V_{inst,d}/G_{stb,d} \leq 1$)	0.47	ok

La verifica pertanto è soddisfatta.

9. ALLEGATO A. –SCATOLARE-CALCOLO AGLI ELEMENTI FINITI



Software e Servizi
per l'Ingegneria s.r.l.

PRO_SAP
PROfessional **S**tructural **A**nalysis **P**rogram

Relazione di calcolo strutturale impostata e redatta secondo le modalità previste nel D.M. 14 Gennaio 2008 cap. 10 “Redazione dei progetti strutturali esecutivi e delle relazioni di calcolo”.

2S.I. Software e Servizi per l'Ingegneria S.r.l.

Via Garibaldi, 90

44121 Ferrara FE (Italy)

Tel. +39 0532 200091

3088-PD-0-S01-SST01-0-OM-RC-01-A

Pagina 148 di 312

Fax +39 0532 200086

www.2si.it

info@2si.it

D.M. 14/01/08 cap. 10.2 Affidabilità dei codici utilizzati

<http://www.2si.it/software/Affidabilità.htm>

CARATTERISTICHE MATERIALI UTILIZZATI

LEGENDA TABELLA DATI MATERIALI

Il programma consente l'uso di materiali diversi. Sono previsti i seguenti tipi di materiale:

1	materiale tipo cemento armato
2	materiale tipo acciaio
3	materiale tipo muratura
4	materiale tipo legno
5	materiale tipo generico

I materiali utilizzati nella modellazione sono individuati da una sigla identificativa ed un codice numerico (gli elementi strutturali richiamano quest'ultimo nella propria descrizione). Per ogni materiale vengono riportati in tabella i seguenti dati:

<i>Young</i>	modulo di elasticità normale
<i>Poisson</i>	coefficiente di contrazione trasversale
<i>G</i>	modulo di elasticità tangenziale
<i>Gamma</i>	peso specifico
<i>Alfa</i>	coefficiente di dilatazione termica

I dati soprariportati vengono utilizzati per la modellazione dello schema statico e per la determinazione dei carichi inerziali e termici. In relazione al tipo di materiale vengono riportati inoltre:

1	cemento armato	Rck	resistenza caratteristica cubica
		Fctm	resistenza media a trazione semplice
2	acciaio	Ft	tensione di rottura a trazione
		Fy	tensione di snervamento
		Fd	resistenza di calcolo
		Fdt	resistenza di calcolo per spess. t>40 mm

	Sadm	tensione ammissibile
	Sadmt	tensione ammissibile per spess. $t > 40$ mm
3	muratura	
	Resist. Fk	resistenza caratteristica a compressione
	Resist. Fvko	resistenza caratteristica a taglio
4	legno	
	Resist. fc0k	Resistenza caratteristica (tensione amm. per REGLES) per compressione
	Resist. ff0k	Resistenza caratteristica (tensione amm. per REGLES) per trazione
	Resist. fmk	Resistenza caratteristica (tensione amm. per REGLES) per flessione
	Resist. fvk	Resistenza caratteristica (tensione amm. per REGLES) per taglio
	Modulo E0,05	Modulo elastico parallelo caratteristico
	Lamellare	lamellare o massiccio

Con riferimento al **Documento di Affidabilità** "Test di validazione del software di calcolo PRO_SAP e dei moduli aggiuntivi PRO_SAP Modulo Geotecnico, PRO_CAD nodi acciaio e PRO_MST" - versione Maggio 2011, disponibile per il download sul sito www.2si.it, si segnalano i seguenti esempi applicativi:

Modellazione di strutture in c.a.

Test N°	Titolo
41	GERARCHIA DELLE RESISTENZE PER TRAVI IN C.A.
42	GERARCHIA DELLE RESISTENZE PER PILASTRI IN C.A.
43	VERIFICA ALLE TA DI STRUTTURE IN C.A.
44	VERIFICA AGLI SLU DI STRUTTURE IN C.A.
45	VERIFICA A PUNZONAMENTO ALLO SLU DI PIASTRE IN C.A.
46	VERIFICA A PUNZONAMENTO ALLO SLU DI TRAVI IN C.A.
47	PROGETTAZIONE A TAGLIO DI STRUTTURE IN C.A. SECONDO IL D.M. 9/1/96
48	PROGETTAZIONE A TAGLIO DI STRUTTURE IN C.A. SECONDO IL D.M. 14/1/2008
49	VERIFICA ALLO SLE (TENSIONI E FESSURAZIONE) DI STRUTTURE IN C.A.
50	VERIFICA ALLO SLE (DEFORMAZIONE) DI STRUTTURE IN C.A.
51	FATTORE DI STRUTTURA
52	SOVRARESISTENZE

53	DETTAGLI COSTRUTTIVI C.A.: LIMITI D'ARMATURA PILASTRI E NODI TRAVE-PILASTRO
54	PARETI IN C.A. SNELLE IN ZONA SISMICA
80	ANALISI PUSHOVER DI UN EDIFICIO IN C.A.
120	PROGETTO E VERIFICA DI TRAVI PREM

Id	Tipo / Note	Young	Poisson	G	Gamma	Alfa
		kg/cm ²	kg/cm ²	kg/cm ²	kg/cm ³	
3	c.a. classe 30	3.122e+05	0.12	1.394e+05	2.50e-03	1.00e-05
	Rck	300.0				
	fctm	26.1				
4	c.a. classe 35	3.372e+05	0.12	1.505e+05	2.50e-03	1.00e-05
	Rck	350.0				
	fctm	28.9				

MODELLAZIONE DELLE SEZIONI

LEGENDA TABELLA DATI SEZIONI

Il programma consente l'uso di sezioni diverse. Sono previsti i seguenti tipi di sezione:

- 1 sezione di tipo generico
- 2 profilati semplici
- 3 profilati accoppiati e speciali

Le sezioni utilizzate nella modellazione sono individuate da una sigla identificativa ed un codice numerico (gli elementi strutturali richiamano quest'ultimo nella propria descrizione). Per ogni sezione vengono riportati in tabella i seguenti dati:

Area	area della sezione
A V2	area della sezione/fattore di taglio (per il taglio in direzione 2)
A V3	area della sezione/fattore di taglio (per il taglio in direzione 3)
Jt	fattore torsionale di rigidezza
J2-2	momento d'inerzia della sezione riferito all'asse 2
J3-3	momento d'inerzia della sezione riferito all'asse 3
W2-2	modulo di resistenza della sezione riferito all'asse 2
W3-3	modulo di resistenza della sezione riferito all'asse 3
Wp2-2	modulo di resistenza plastico della sezione riferito all'asse 2
Wp3-3	modulo di resistenza plastico della sezione riferito all'asse 3

I dati soprariportati vengono utilizzati per la determinazione dei carichi inerziali e per la definizione delle rigidità degli elementi strutturali; qualora il valore di Area V2 (e/o Area V3) sia nullo la deformabilità per taglio V2 (e/o V3) è trascurata. La valutazione delle caratteristiche inerziali delle sezioni è condotta nel riferimento 2-3 dell'elemento.

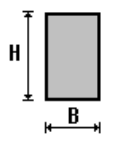
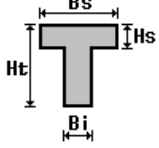
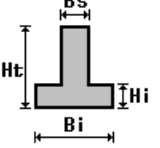
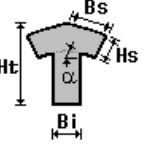
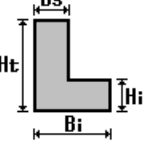
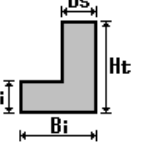
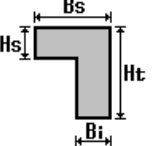
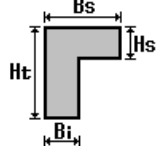
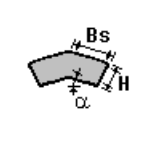
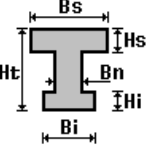
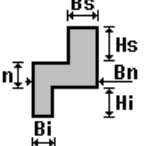
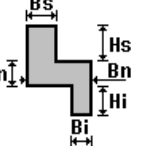
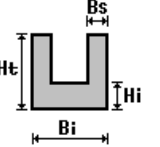
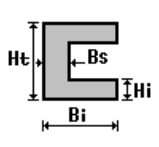
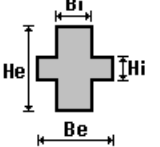
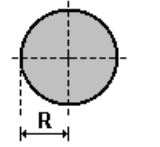
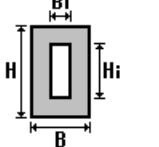
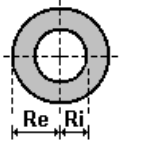
 rettangolare	 a T	 a T rovescia	 a T di colmo	 a L	 a L specchiata
 a L specchiata rovescia	 a L rovescia	 a L di colmo	 a doppio T	 a quattro specchiata	 a quattro
 a U	 a C	 a croce	 circolare	 rettangolare cava	 circolare cava

Per quanto concerne i profilati semplici ed accoppiati l'asse 2 del riferimento coincide con l'asse x riportato nei più diffusi profilati.

Per quanto concerne le sezioni di tipo generico (tipo 1.):

i valori dimensionali con prefisso B sono riferiti all'asse 2

i valori dimensionali con prefisso H sono riferiti all'asse 3

Con riferimento al **Documento di Affidabilità** "Test di validazione del software di calcolo PRO_SAP e dei moduli aggiuntivi PRO_SAP Modulo Geotecnico, PRO_CAD nodi acciaio e PRO_MST" - versione Maggio 2011, disponibile per il download sul sito www.2si.it, si segnalano i seguenti esempi applicativi:

Test N°	Titolo
1	CARATTERISTICHE GEOMETRICHE E INERZIALI
44	VERIFICA AGLI SLU DI STRUTTURE IN C.A.
47	PROGETTAZIONE A TAGLIO DI STRUTTURE IN C.A. SECONDO IL D.M. 9/1/96

48	PROGETTAZIONE A TAGLIO DI STRUTTURE IN C.A. SECONDO IL D.M. 14/1/2008
49	VERIFICA ALLO SLE (TENSIONI E FESSURAZIONE) DI STRUTTURE IN C.A.
50	VERIFICA ALLO SLE (DEFORMAZIONE) DI STRUTTURE IN C.A.
95	ANALISI DI RESISTENZA AL FUOCO

Id	Tipo	Area	A V2	A V3	Jt	J 2-2	J 3-3	W 2-2	W 3-3	Wp 2-2	Wp 3-3
		cm2	cm2	cm2	cm4	cm4	cm4	cm3	cm3	cm3	cm3
1	Rettangolare: b=100.00 =110.00 h	1.100e+04	9166.67	9166.67	1.695e+07	9.167e+06	1.109e+07	1.833e+05	2.017e+05	2.750e+05	3.025e+05
2	Rettangolare: b=100.00 =110.00 h	1.100e+04	9166.67	9166.67	1.695e+07	9.167e+06	1.109e+07	1.833e+05	2.017e+05	2.750e+05	3.025e+05
3	Rettangolare: b=100.00 =120.00 h	1.200e+04	1.000e+04	1.000e+04	1.993e+07	1.000e+07	1.440e+07	2.000e+05	2.400e+05	3.000e+05	3.600e+05

MODELLAZIONE STRUTTURA: NODI

LEGENDA TABELLA DATI NODI

Il programma utilizza per la modellazione nodi strutturali.

Ogni nodo è individuato dalle coordinate cartesiane nel sistema di riferimento globale (X Y Z).

Ad ogni nodo è eventualmente associato un codice di vincolamento rigido, un codice di fondazione speciale, ed un set di sei molle (tre per le traslazioni, tre per le rotazioni). Le tabelle sottoriportate riflettono le succitate possibilità. In particolare per ogni nodo viene indicato in tabella:

Nodo	numero del nodo.
X	valore della coordinata X
Y	valore della coordinata Y
Z	valore della coordinata Z

Per i nodi ai quali sia associato un codice di vincolamento rigido, un codice di fondazione speciale o un set di molle viene indicato in tabella:

Nodo	numero del nodo.
X	valore della coordinata X
Y	valore della coordinata Y
Z	valore della coordinata Z

Note	eventuale codice di vincolo (es. v=110010 sei valori relativi ai sei gradi di libertà previsti per il nodo TxTyTzRxRyRz, il valore 1 indica che lo spostamento o rotazione relativo è impedito, il valore 0 indica che lo spostamento o rotazione relativo è libero).
Note	(FS = 1, 2,...) eventuale codice del tipo di fondazione speciale (1, 2,... fanno riferimento alle tipologie: plinto, palo, plinto su pali,...) che è collegato al nodo. (ISO = "id SIGLA") indice e sigla identificativa dell' eventuale isolatore sismico assegnato al nodo
Rig. TX	valore della rigidità dei vincoli elastici eventualmente applicati al nodo, nello specifico TX (idem per TY, TZ, RX, RY, RZ).

Per strutture sismicamente isolate viene inoltre inserita la tabella delle caratteristiche per gli isolatori utilizzati; le caratteristiche sono indicate in conformità al cap. 7.10 del D.M. 14/01/08

TABELLA DATI NODI

Nodo	X	Y	Z	Nodo	X	Y	Z	Nodo	X	Y	Z
	cm	cm	cm		cm	cm	cm		cm	cm	cm
1	0.0	0.0	0.0	2	1260.0	0.0	0.0	3	0.0	0.0	805.0
4	1260.0	0.0	805.0	5	0.0	0.0	750.0	6	0.0	0.0	60.0
7	1260.0	0.0	60.0	8	1260.0	0.0	750.0	9	1205.0	0.0	805.0
10	55.0	0.0	805.0	11	55.0	0.0	0.0	12	1205.0	0.0	0.0
13	1335.0	0.0	0.0	14	-70.0	0.0	0.0	15	-55.0	0.0	805.0
16	1315.0	0.0	805.0								

MODELLAZIONE STRUTTURA: ELEMENTI TRAVE

TABELLA DATI TRAVI

Il programma utilizza per la modellazione elementi a due nodi denominati in generale travi.

Ogni elemento trave è individuato dal nodo iniziale e dal nodo finale.

Ogni elemento è caratterizzato da un insieme di proprietà riportate in tabella che ne completano la modellazione.

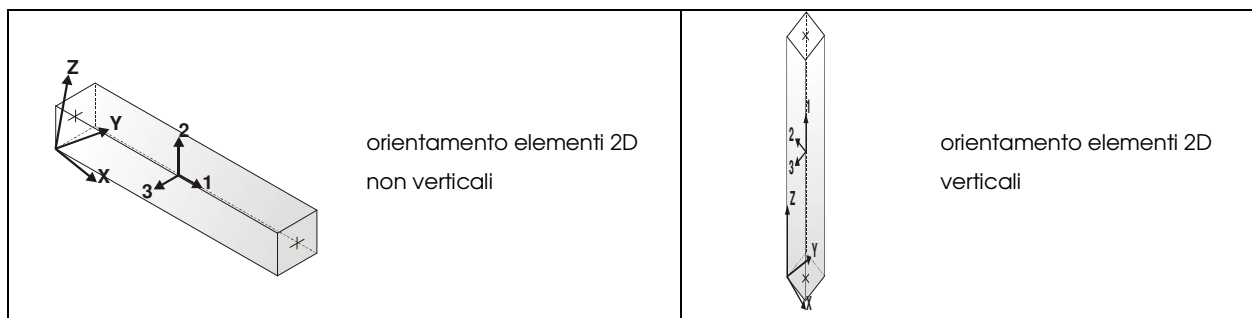

In particolare per ogni elemento viene indicato in tabella:

Elem.	numero dell'elemento
Note	codice di comportamento: trave, trave di fondazione, pilastro, asta, asta tesa, asta compressa
Nodo I (J)	numero del nodo iniziale (finale)
Mat.	codice del materiale assegnato all'elemento
Sez.	codice della sezione assegnata all'elemento
Rotaz.	valore della rotazione dell'elemento, attorno al proprio asse, nel caso in cui l'orientamento di default non sia adottabile; l'orientamento di default prevede per gli elementi non verticali l'asse 2 contenuto nel piano verticale e l'asse 3 orizzontale, per gli elementi verticali l'asse 2 diretto secondo X negativo e l'asse 3 diretto secondo Y negativo
Svincolo I (J)	codici di svincolo per le azioni interne; i primi sei codici si riferiscono al nodo iniziale, i restanti sei al nodo finale (il valore 1 indica che la relativa azione interna non è attiva)
Wink V	costante di sottofondo (coefficiente di Winkler) per la modellazione della trave su suolo elastico
Wink O	costante di sottofondo (coefficiente di Winkler) per la modellazione del suolo elastico orizzontale

Con riferimento al **Documento di Affidabilità** "Test di validazione del software di calcolo PRO_SAP e dei moduli aggiuntivi PRO_SAP Modulo Geotecnico, PRO_CAD nodi acciaio e PRO_MST" - versione Maggio 2011, disponibile per il download sul sito www.2si.it, si segnalano i seguenti esempi applicativi:

Test N°	Titolo
2	TRAVI A UNA CAMPATA
3	TRAVE A PIU' CAMPATE
4	TRAVE A UNA CAMPATA SU TERRENO ALLA WINKLER
5	TRAVI SU TERRENO ALLA WINKLER CON CARICO TRASVERSALE
6	TELAI PIANI CON CERNIERE ALLA BASE
7	TELAI PIANI CON INCASTRI ALLA BASE
11	STRUTTURE SOGGETTE A VARIAZIONI TERMICHE
12	STRUTTURE SU TERRENO ALLA WINKLER SOTTOPOSTE A CARICHI DISTRIBUITI TRIANGOLARI
21	DRILLING
24	TENSIONI E ROTAZIONI RISPETTO ALLA CORDA DI ELEMENTI TRAVE

27	FRECCIA DI ELEMENTI TRAVE
41	GERARCHIA DELLE RESISTENZE PER TRAVI IN C.A.
42	GERARCHIA DELLE RESISTENZE PER PILASTRI IN C.A.
43	VERIFICA ALLE TA DI STRUTTURE IN C.A.
44	VERIFICA AGLI SLU DI STRUTTURE IN C.A.
46	VERIFICA A PUNZONAMENTO ALLO SLU DI TRAVI IN C.A.
47	PROGETTAZIONE A TAGLIO DI STRUTTURE IN C.A. SECONDO IL D.M. 9/1/96
48	PROGETTAZIONE A TAGLIO DI STRUTTURE IN C.A. SECONDO IL D.M. 14/1/2008
49	VERIFICA ALLO SLE (TENSIONI E FESSURAZIONE) DI STRUTTURE IN C.A.
50	VERIFICA ALLO SLE (DEFORMAZIONE) DI STRUTTURE IN C.A.
51	FATTORE DI STRUTTURA
52	SOVRARESISTENZE
53	DETTAGLI COSTRUTTIVI C.A.: LIMITI D'ARMATURA PILASTRI E NODI TRAVE-PILASTRO
55	VERIFICA DI STABILITA' DI ASTE COMPRESSE IN ACCIAIO – METODO OMEGA
56	LUCE LIBERA DI TRAVI E ASTE IN ACCIAIO
57	LUCE LIBERA DI COLONNE IN ACCIAIO
58	SVERGOLAMENTO DI TRAVI IN ACCIAIO
63	STABILITA' DI ASTE COMPOSTE IN ACCIAIO
68	VALUTAZIONE EFFETTO P- δ SU PILASTRATA
69	VALUTAZIONE EFFETTO P- δ SU TELAIO 3D
80	ANALISI PUSHOVER DI UN EDIFICIO IN C.A.
82	ANALISI ELASTO PLASTICA INCREMENTALE
83	ANALISI ELASTO PLASTICA INCREMENTALE
89	VERIFICA ALLO SLU DI STRUTTURE IN LEGNO SECONDO EC5
90	VERIFICA ALLO SLE DI STRUTTURE IN LEGNO SECONDO EC5
93	SNELLEZZE EC5
120	PROGETTO E VERIFICA DI TRAVI PREM

Elem. Note Nodo I Nodo J Mat. Sez. Rotaz. Svincolo I Svincolo J Wink V Wink O

						gradi	daN/cm3	daN/cm3
1	Trave	4	16	4	1			
2	Pilas.	1	6	4	2			
3	Trave	3	10	4	1			
4	Pilas.	6	5	4	2			
5	Pilas.	5	3	4	2			
6	Pilas.	8	4	4	2			
7	Pilas.	7	8	4	2			
8	Pilas.	2	7	4	2			
9	Trave	9	4	4	1			
10	Trave f.	12	2	3	3		0.50	2.00
11	Trave f.	1	11	3	3		0.50	2.00
12	Trave	10	9	4	1			
13	Trave f.	2	13	3	3		0.50	2.00
14	Trave f.	14	1	3	3		0.50	2.00
15	Trave f.	11	12	3	3		0.50	2.00
16	Trave	15	3	4	1			

MODELLAZIONE DELLE AZIONI

LEGENDA TABELLA DATI AZIONI

Il programma consente l'uso di diverse tipologie di carico (azioni). Le azioni utilizzate nella modellazione sono individuate da una sigla identificativa ed un codice numerico (gli elementi strutturali richiamano quest'ultimo nella propria descrizione). Per ogni azione applicata alla struttura viene di riportato il codice, il tipo e la sigla identificativa. Le tabelle successive dettagliano i valori caratteristici di ogni azione in relazione al tipo. Le tabelle riportano infatti i seguenti dati in relazione al tipo:

1	carico concentrato nodale 6 dati (forza Fx, Fy, Fz, momento Mx, My, Mz)
2	spostamento nodale impresso 6 dati (spostamento Tx, Ty, Tz, rotazione Rx, Ry, Rz)
3	carico distribuito globale su elemento tipo trave 7 dati (fx, fy, fz, mx, my, mz, ascissa di inizio carico) 7 dati (fx, fy, fz, mx, my, mz, ascissa di fine carico)
4	carico distribuito locale su elemento tipo trave 7 dati (f1, f2, f3, m1, m2, m3, ascissa di inizio carico)

	7 dati ($f_1, f_2, f_3, m_1, m_2, m_3$, ascissa di fine carico)
5	carico concentrato globale su elemento tipo trave 7 dati ($F_x, F_y, F_z, M_x, M_y, M_z$, ascissa di carico)
6	carico concentrato locale su elemento tipo trave 7 dati ($F_1, F_2, F_3, M_1, M_2, M_3$, ascissa di carico)
7	variazione termica applicata ad elemento tipo trave 7 dati (variazioni termiche: uniforme, media e differenza in altezza e larghezza al nodo iniziale e finale)
8	carico di pressione uniforme su elemento tipo piastra 1 dato (pressione)
9	carico di pressione variabile su elemento tipo piastra 4 dati (pressione, quota, pressione, quota)
10	variazione termica applicata ad elemento tipo piastra 2 dati (variazioni termiche: media e differenza nello spessore)
11	carico variabile generale su elementi tipo trave e piastra 1 dato descrizione della tipologia 4 dati per segmento (posizione, valore, posizione, valore) la tipologia precisa l'ascissa di definizione, la direzione del carico, la modalità di carico e la larghezza d'influenza per gli elementi tipo trave
12	gruppo di carichi con impronta su piastra 9 dati (numero di ripetizioni in direzione X e Y, valore di ciascun carico, posizione centrale del primo, dimensioni dell'impronta, interasse tra i carichi)

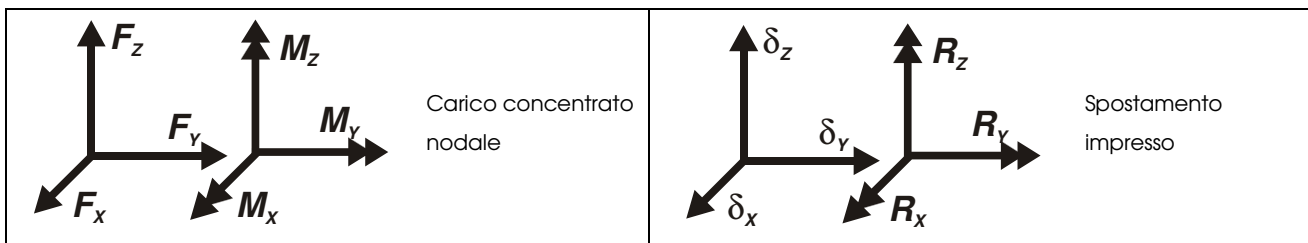

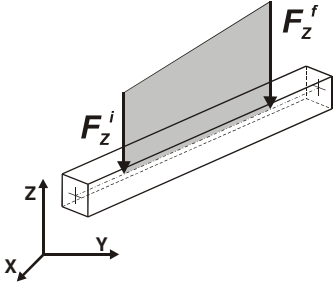
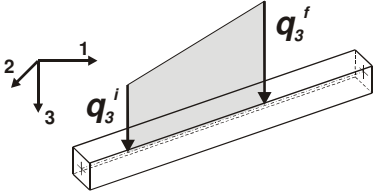
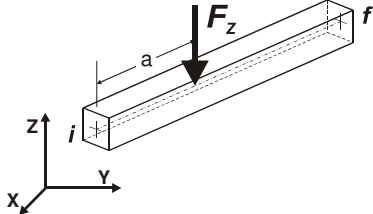
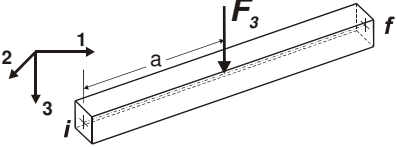
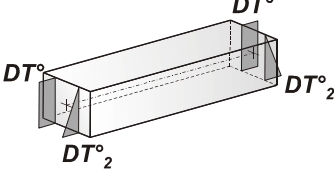
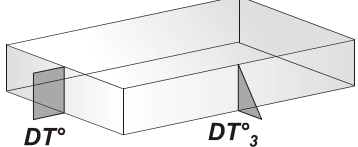
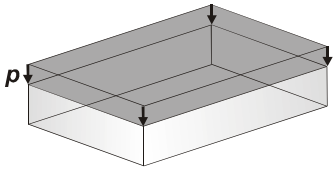
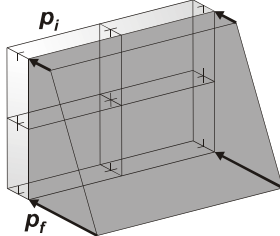
 <p>Carico distribuito globale</p>	 <p>Carico distribuito locale</p>
 <p>Carico concentrato globale</p>	 <p>Carico concentrato locale</p>
 <p>Carico termico 2D</p>	 <p>Carico termico 3D</p>
 <p>Carico pressione uniforme</p>	 <p>Carico pressione variabile</p>

Tipo carico concentrato nodale

Id	Tipo	Fx	Fy	Fz	Mx	My	Mz
		kN	kN	kN	kN m	kN m	kN m
52	CN:Fx=3995.00	39.95	0.0	0.0	0.0	0.0	0.0

Tipo carico distribuito globale su trave

Id	Tipo	Pos.	fx	fy	fz	mx	my	mz
		m	kN/ m	kN/ m	kN/ m	kN	kN	kN
4	DG:Fzi=-20.80 Fzf=-20.80	0.0	0.0	0.0	-20.80	0.0	0.0	0.0
		0.0	0.0	0.0	-20.80	0.0	0.0	0.0
5	DG:Fzi=-22.00 Fzf=-22.00	0.0	0.0	0.0	-22.00	0.0	0.0	0.0
		0.0	0.0	0.0	-22.00	0.0	0.0	0.0
10	DG:Fxi=25.06 Fxf=18.86	0.0	25.06	0.0	0.0	0.0	0.0	0.0
		0.0	18.86	0.0	0.0	0.0	0.0	0.0
11	DG:xi=390.00 xf=690.00 Fxf=25.06	3.90	58.86	0.0	0.0	0.0	0.0	0.0
		6.90	25.06	0.0	0.0	0.0	0.0	0.0
12	DG:xi=0.0 xf=390.00 Fxf=58.86	0.0	118.05	0.0	0.0	0.0	0.0	0.0
		3.90	58.86	0.0	0.0	0.0	0.0	0.0
13	DG:Fxi=127.15 Fxf=118.05	0.0	127.15	0.0	0.0	0.0	0.0	0.0
		0.0	118.05	0.0	0.0	0.0	0.0	0.0
14	DG:Fxi=-25.06 Fxf=-18.86	0.0	-25.06	0.0	0.0	0.0	0.0	0.0
		0.0	-18.86	0.0	0.0	0.0	0.0	0.0
15	DG:xi=390.00 xf=690.00 Fxf=-25.06	3.90	-58.86	0.0	0.0	0.0	0.0	0.0
		6.90	-25.06	0.0	0.0	0.0	0.0	0.0
16	DG:xi=0.0 xf=390.00 Fxf=-58.86	0.0	-118.05	0.0	0.0	0.0	0.0	0.0
		3.90	-58.86	0.0	0.0	0.0	0.0	0.0
17	DG:Fxi=-127.15 Fxf=-118.05	0.0	-127.15	0.0	0.0	0.0	0.0	0.0
		0.0	-118.05	0.0	0.0	0.0	0.0	0.0
20	DG:Fxi=18.02 Fxf=13.57	0.0	18.02	0.0	0.0	0.0	0.0	0.0
		0.0	13.57	0.0	0.0	0.0	0.0	0.0
21	DG:xi=390.00 xf=690.00 Fxf=18.02	3.90	42.33	0.0	0.0	0.0	0.0	0.0
		6.90	18.02	0.0	0.0	0.0	0.0	0.0
22	DG:xi=0.0 xf=390.00 Fxf=42.33	0.0	95.85	0.0	0.0	0.0	0.0	0.0
		3.90	42.33	0.0	0.0	0.0	0.0	0.0
23	DG:Fxi=104.09 Fxf=95.85	0.0	104.09	0.0	0.0	0.0	0.0	0.0
		0.0	95.85	0.0	0.0	0.0	0.0	0.0
24	DG:Fxi=-18.05 Fxf=-13.57	0.0	-18.05	0.0	0.0	0.0	0.0	0.0
		0.0	-13.57	0.0	0.0	0.0	0.0	0.0
25	DG:xi=390.00 xf=690.00 Fxf=-18.02	3.90	-42.33	0.0	0.0	0.0	0.0	0.0
		6.90	-18.02	0.0	0.0	0.0	0.0	0.0
26	DG:xi=0.0 xf=390.00 Fxf=-42.33	0.0	-95.85	0.0	0.0	0.0	0.0	0.0
		3.90	-42.33	0.0	0.0	0.0	0.0	0.0
27	DG:Fxi=-104.09 Fxf=-95.85	0.0	-104.09	0.0	0.0	0.0	0.0	0.0
		0.0	-95.85	0.0	0.0	0.0	0.0	0.0



Id	Tipo	Pos.	fx	fy	fz	mx	my	mz
30	DG:Fzi=-9.00 Fzf=-9.00	0.0	0.0	0.0	-9.00	0.0	0.0	0.0
		0.0	0.0	0.0	-9.00	0.0	0.0	0.0
31	DG:xi=388.00 xf=762.00 Fzi=-42.57 Fzf=-42.57	3.88	0.0	0.0	-42.57	0.0	0.0	0.0
		7.62	0.0	0.0	-42.57	0.0	0.0	0.0
32	DG:xi=776.00 xf=1150.00 Fzi=-42.57 Fzf=-42.57	7.76	0.0	0.0	-42.57	0.0	0.0	0.0
		11.50	0.0	0.0	-42.57	0.0	0.0	0.0
33	DG:xi=0.0 xf=374.00 Fzi=-42.57 Fzf=-42.57	0.0	0.0	0.0	-42.57	0.0	0.0	0.0
		3.74	0.0	0.0	-42.57	0.0	0.0	0.0
34	DG:Fzi=-20.00 Fzf=-20.00	0.0	0.0	0.0	-20.00	0.0	0.0	0.0
		0.0	0.0	0.0	-20.00	0.0	0.0	0.0
36	DG:Fxi=29.43 Fxf=31.06	0.0	29.43	0.0	0.0	0.0	0.0	0.0
		0.0	31.06	0.0	0.0	0.0	0.0	0.0
37	DG:Fxi=8.97 Fxf=29.43	0.0	8.97	0.0	0.0	0.0	0.0	0.0
		0.0	29.43	0.0	0.0	0.0	0.0	0.0
38	DG:Fxi=7.19 Fxf=8.97	0.0	7.19	0.0	0.0	0.0	0.0	0.0
		0.0	8.97	0.0	0.0	0.0	0.0	0.0
39	DG:Fxi=-29.43 Fxf=-31.06	0.0	-29.43	0.0	0.0	0.0	0.0	0.0
		0.0	-31.06	0.0	0.0	0.0	0.0	0.0
40	DG:Fxi=-8.97 Fxf=-29.43	0.0	-8.97	0.0	0.0	0.0	0.0	0.0
		0.0	-29.43	0.0	0.0	0.0	0.0	0.0
41	DG:Fxi=-7.19 Fxf=-8.97	0.0	-7.19	0.0	0.0	0.0	0.0	0.0
		0.0	-8.97	0.0	0.0	0.0	0.0	0.0
42	DG:Fxi=5.48 Fxf=5.48	0.0	5.48	0.0	0.0	0.0	0.0	0.0
		0.0	5.48	0.0	0.0	0.0	0.0	0.0
43	DG:Fxi=-5.48 Fxf=-5.48	0.0	-5.48	0.0	0.0	0.0	0.0	0.0
		0.0	-5.48	0.0	0.0	0.0	0.0	0.0
44	DG:Fxi=12.18 Fxf=12.18	0.0	12.18	0.0	0.0	0.0	0.0	0.0
		0.0	12.18	0.0	0.0	0.0	0.0	0.0
45	DG:Fxi=-12.18 Fxf=-12.18	0.0	-12.18	0.0	0.0	0.0	0.0	0.0
		0.0	-12.18	0.0	0.0	0.0	0.0	0.0
46	DG:Fxi=8.36 Fxf=8.36	0.0	8.36	0.0	0.0	0.0	0.0	0.0
		0.0	8.36	0.0	0.0	0.0	0.0	0.0
47	DG:xi=575.00 xf=875.00 Fzi=-60.00 Fzf=-60.00	5.75	0.0	0.0	-60.00	0.0	0.0	0.0
		8.75	0.0	0.0	-60.00	0.0	0.0	0.0
48	DG:xi=275.00 xf=575.00 Fzi=-60.00 Fzf=-60.00	2.75	0.0	0.0	-60.00	0.0	0.0	0.0
		5.75	0.0	0.0	-60.00	0.0	0.0	0.0
49	DG:xi=275.00 xf=575.00 Fzi=-36.50 Fzf=-36.50	2.75	0.0	0.0	-36.50	0.0	0.0	0.0
		5.75	0.0	0.0	-36.50	0.0	0.0	0.0

Id	Tipo	Pos.	fx	fy	fz	mx	my	mz
50	DG:Fxi=8.33 Fxf=8.33	0.0	8.33	0.0	0.0	0.0	0.0	0.0
		0.0	8.33	0.0	0.0	0.0	0.0	0.0
51	DG:Fxi=53.77 Fxf=53.77	0.0	53.77	0.0	0.0	0.0	0.0	0.0
		0.0	53.77	0.0	0.0	0.0	0.0	0.0
53	DG:Fxi=14.62 Fxf=14.62	0.0	14.62	0.0	0.0	0.0	0.0	0.0
		0.0	14.62	0.0	0.0	0.0	0.0	0.0
56	DG:Fzi=-7.31 Fzf=-7.31	0.0	0.0	0.0	-7.31	0.0	0.0	0.0
		0.0	0.0	0.0	-7.31	0.0	0.0	0.0
57	DG:Fzi=-4.16 Fzf=-4.16	0.0	0.0	0.0	-4.16	0.0	0.0	0.0
		0.0	0.0	0.0	-4.16	0.0	0.0	0.0
80	DG:xi=0.0 xf=20.00 Fzi=-168.80 Fzf=-168.80	0.0	0.0	0.0	-168.80	0.0	0.0	0.0
		0.20	0.0	0.0	-168.80	0.0	0.0	0.0
81	DG:xi=55.00 xf=75.00 Fzi=-168.80 Fzf=-168.80	0.55	0.0	0.0	-168.80	0.0	0.0	0.0
		0.75	0.0	0.0	-168.80	0.0	0.0	0.0

Tipo variazione termica applicata a trave

Id	Tipo	DT uniforme	DT iniziale	DT finale	DT 2-2 ini	DT 2-2 fin	DT 3-3 ini	DT 3-3 fin
		C	C	C	C	C	C	C
1	T2:DT=-10.00	-10.00	0.0	0.0	0.0	0.0	0.0	0.0
2	T2:DT2i=5.00 DT2f=5.00	0.0	0.0	0.0	5.00	5.00	0.0	0.0
3	T2:DT=-11.50	-11.50	0.0	0.0	0.0	0.0	0.0	0.0
9	T2:DT2i=-5.00 DT2f=-5.00	0.0	0.0	0.0	-5.00	-5.00	0.0	0.0

SCHEMATIZZAZIONE DEI CASI DI CARICO

LEGENDA TABELLA CASI DI CARICO

Il programma consente l'applicazione di diverse tipologie di casi di carico.

Sono previsti i seguenti 11 tipi di casi di carico:

	Sigla	Tipo	Descrizione
1	Ggk	A	caso di carico comprensivo del peso proprio struttura
2	Gk	NA	caso di carico con azioni permanenti
3	Qk	NA	caso di carico con azioni variabili
4	Gsk	A	caso di carico comprensivo dei carichi permanenti sui solai e sulle coperture
5	Qsk	A	caso di carico comprensivo dei carichi variabili sui solai

6	Qnk	A	caso di carico comprensivo dei carichi di neve sulle coperture
7	Qtk	SA	caso di carico comprensivo di una variazione termica agente sulla struttura
8	Qvk	NA	caso di carico comprensivo di azioni da vento sulla struttura
9	Esk	SA	caso di carico sismico con analisi statica equivalente
10	Edk	SA	caso di carico sismico con analisi dinamica
11	Pk	NA	caso di carico comprensivo di azioni derivanti da coazioni, cedimenti e precompressioni

Sono di tipo automatico A (ossia non prevedono introduzione dati da parte dell'utente) i seguenti casi di carico: 1-Ggk; 4-Gsk; 5-Qsk; 6-Qnk.

Sono di tipo semi-automatico SA (ossia prevedono una minima introduzione dati da parte dell'utente) i seguenti casi di carico:

7-Qtk, in quanto richiede solo il valore della variazione termica;

9-Esk e 10-Edk, in quanto richiedono il valore dell'angolo di ingresso del sisma e l'individuazione dei casi di carico partecipanti alla definizione delle masse.

Sono di tipo non automatico NA ossia prevedono la diretta applicazione di carichi generici agli elementi strutturali (si veda il precedente punto Modellazione delle Azioni) i restanti casi di carico.

Nella tabella successiva vengono riportati i casi di carico agenti sulla struttura, con l'indicazione dei dati relativi al caso di carico stesso:

Numero Tipo e Sigla identificativa, Valore di riferimento del caso di carico (se previsto).

In successione, per i casi di carico non automatici, viene riportato l'elenco di nodi ed elementi direttamente caricati con la sigla identificativa del carico.

Per i casi di carico di tipo sismico (9-Esk e 10-Edk), viene riportata la tabella di definizione delle masse: per ogni caso di carico partecipante alla definizione delle masse viene indicata la relativa aliquota (partecipazione) considerata. Si precisa che per i caso di carico 5-Qsk e 6-Qnk la partecipazione è prevista localmente per ogni elemento solaio o copertura presente nel modello (si confronti il valore Sksol nel capitolo relativo agli elementi solaio) e pertanto la loro partecipazione è di norma pari a uno.

CDC	Tipo	Sigla Id	Note
1	Ggk	CDC=Ggk (peso proprio della struttura)	
2	Gk	CDC=Gk (permanente)	D2 : 1 Azione : DG:Fzi=-20.80 Fzf=-20.80
			D2 : 3 Azione : DG:Fzi=-20.80 Fzf=-20.80
			D2 : 9 Azione : DG:Fzi=-20.80 Fzf=-20.80
			D2 : 12 Azione : DG:Fzi=-20.80 Fzf=-20.80
			D2 : 13 Azione : DG:xi=55.00 xf=75.00 Fzi=-168.80 Fzf=-168.80
			D2 : 14 Azione : DG:xi=0.0 xf=20.00 Fzi=-168.80 Fzf=-168.80

CDC	Tipo	Sigla Id	Note
			D2 : 15 Azione : DG:Fzi=-22.00 Fzf=-22.00
			D2 : 16 Azione : DG:Fzi=-20.80 Fzf=-20.80
3	Gk	CDC=Gk (Spinta a riposo piedritto sx)	D2 : 2 Azione : DG:Fxi=127.15 Fxf=118.05
			D2 : 4 Azione : DG:xi=390.00 xf=690.00 Fxf=25.06
			D2 : 4 Azione : DG:xi=0.0 xf=390.00 Fxf=58.86
			D2 : 5 Azione : DG:Fxi=25.06 Fxf=18.86
4	Gk	CDC=Gk (Spinta riposo piedritto dx)	D2 : 6 Azione : DG:Fxi=-25.06 Fxf=-18.86
			D2 : 7 Azione : DG:xi=390.00 xf=690.00 Fxf=-25.06
			D2 : 7 Azione : DG:xi=0.0 xf=390.00 Fxf=-58.86
			D2 : 8 Azione : DG:Fxi=-127.15 Fxf=-118.05
5	Gk	CDC=Gk (Spinta attiva piedritto sx)	D2 : 2 Azione : DG:Fxi=104.09 Fxf=95.85
			D2 : 4 Azione : DG:xi=390.00 xf=690.00 Fxf=18.02
			D2 : 4 Azione : DG:xi=0.0 xf=390.00 Fxf=42.33
			D2 : 5 Azione : DG:Fxi=18.02 Fxf=13.57
6	Gk	CDC=G1k (Spinta attiva piedritto dx)	D2 : 6 Azione : DG:Fxi=-18.05 Fxf=-13.57
			D2 : 7 Azione : DG:xi=390.00 xf=690.00 Fxf=-18.02
			D2 : 7 Azione : DG:xi=0.0 xf=390.00 Fxf=-42.33
			D2 : 8 Azione : DG:Fxi=-104.09 Fxf=-95.85
8	Qk	CDC=Qk (Q1k centrato)	D2 : 1 Azione : DG:Fzi=-9.00 Fzf=-9.00
			D2 : 3 Azione : DG:Fzi=-9.00 Fzf=-9.00
			D2 : 9 Azione : DG:Fzi=-9.00 Fzf=-9.00
			D2 : 12 Azione : DG:Fzi=-9.00 Fzf=-9.00
			D2 : 12 Azione : DG:xi=388.00 xf=762.00 Fzi=-42.57 Fzf=-42.57
			D2 : 16 Azione : DG:Fzi=-9.00 Fzf=-9.00
9	Qk	CDC=Qk (Q1k a filo piedritto dx)	D2 : 1 Azione : DG:Fzi=-9.00 Fzf=-9.00
			D2 : 3 Azione : DG:Fzi=-9.00 Fzf=-9.00
			D2 : 9 Azione : DG:Fzi=-9.00 Fzf=-9.00
			D2 : 12 Azione : DG:Fzi=-9.00 Fzf=-9.00
			D2 : 12 Azione : DG:xi=776.00 xf=1150.00 Fzi=-42.57 Fzf=-42.57
			D2 : 16 Azione : DG:Fzi=-9.00 Fzf=-9.00
10	Qk	CDC=Qk (Q1k a filo piedritto sx)	D2 : 1 Azione : DG:Fzi=-9.00 Fzf=-9.00
			D2 : 3 Azione : DG:Fzi=-9.00 Fzf=-9.00
			D2 : 9 Azione : DG:Fzi=-9.00 Fzf=-9.00
			D2 : 12 Azione : DG:Fzi=-9.00 Fzf=-9.00
			D2 : 12 Azione : DG:xi=0.0 xf=374.00 Fzi=-42.57 Fzf=-42.57
			D2 : 16 Azione : DG:Fzi=-9.00 Fzf=-9.00
11	Qk	CDC=Qk (Accidentale 9kPa su soletta)	D2 : 1 Azione : DG:Fzi=-9.00 Fzf=-9.00
			D2 : 3 Azione : DG:Fzi=-9.00 Fzf=-9.00

CDC	Tipo	Sigla Id	Note
			D2 : 9 Azione : DG:Fzi=-9.00 Fzf=-9.00
			D2 : 12 Azione : DG:Fzi=-9.00 Fzf=-9.00
			D2 : 16 Azione : DG:Fzi=-9.00 Fzf=-9.00
12	Qk	CDC=Qk (Accidentale 20kN/mq)	D2 : 1 Azione : DG:Fzi=-20.00 Fzf=-20.00
			D2 : 3 Azione : DG:Fzi=-20.00 Fzf=-20.00
			D2 : 9 Azione : DG:Fzi=-20.00 Fzf=-20.00
			D2 : 12 Azione : DG:Fzi=-20.00 Fzf=-20.00
			D2 : 16 Azione : DG:Fzi=-20.00 Fzf=-20.00
13	Qk	CDC=Qk (Accidentale su piedritto sx)	D2 : 2 Azione : DG:Fxi=7.19 Fxf=8.97
			D2 : 4 Azione : DG:Fxi=8.97 Fxf=29.43
			D2 : 5 Azione : DG:Fxi=29.43 Fxf=31.06
14	Qk	CDC=Qk (Accidentale su piedritto dx)	D2 : 6 Azione : DG:Fxi=-29.43 Fxf=-31.06
			D2 : 7 Azione : DG:Fxi=-8.97 Fxf=-29.43
			D2 : 8 Azione : DG:Fxi=-7.19 Fxf=-8.97
15	Qk	CDC=Qk (Accidentale 9kPa su piedritto sx)	D2 : 2 Azione : DG:Fxi=5.48 Fxf=5.48
			D2 : 4 Azione : DG:Fxi=5.48 Fxf=5.48
			D2 : 5 Azione : DG:Fxi=5.48 Fxf=5.48
16	Qk	CDC=Qk (Accidentale 9kPa su piedritto dx)	D2 : 6 Azione : DG:Fxi=-5.48 Fxf=-5.48
			D2 : 7 Azione : DG:Fxi=-5.48 Fxf=-5.48
			D2 : 8 Azione : DG:Fxi=-5.48 Fxf=-5.48
17	Qk	CDC=Qk (Accidentale 20kPa su piedritto sx)	D2 : 2 Azione : DG:Fxi=12.18 Fxf=12.18
			D2 : 4 Azione : DG:Fxi=12.18 Fxf=12.18
			D2 : 5 Azione : DG:Fxi=12.18 Fxf=12.18
18	Qk	CDC=Qk (Accidentale 20kPa su piedritto dx)	D2 : 6 Azione : DG:Fxi=-12.18 Fxf=-12.18
			D2 : 7 Azione : DG:Fxi=-12.18 Fxf=-12.18
			D2 : 8 Azione : DG:Fxi=-12.18 Fxf=-12.18
19	Qk	CDC=Qk (frenatura)	D2 : 1 Azione : DG:Fxi=8.36 Fxf=8.36
			D2 : 3 Azione : DG:Fxi=8.36 Fxf=8.36
			D2 : 9 Azione : DG:Fxi=8.36 Fxf=8.36
			D2 : 12 Azione : DG:Fxi=8.36 Fxf=8.36
			D2 : 16 Azione : DG:Fxi=8.36 Fxf=8.36
20	Qk	CDC=Qk (acc sol inf campata dx)	D2 : 15 Azione : DG:xi=575.00 xf=875.00 Fzi=-60.00 Fzf=-60.00
21	Qk	CDC=Qk (acc sol inf campata sx)	D2 : 15 Azione : DG:xi=275.00 xf=575.00 Fzi=-60.00 Fzf=-60.00
22	Qk	CDC=Qk (acc sol inf campata dx-sx)	D2 : 15 Azione : DG:xi=575.00 xf=875.00 Fzi=-60.00 Fzf=-60.00
			D2 : 15 Azione : DG:xi=275.00 xf=575.00 Fzi=-36.50 Fzf=-36.50
23	Qk	CDC=Qk (sisma orizzontale)	Nodo: 3 Azione : CN:Fx=3995.00
			D2 : 1 Azione : DG:Fxi=14.62 Fxf=14.62
			D2 : 2 Azione : DG:Fxi=53.77 Fxf=53.77

CDC	Tipo	Sigla Id	Note
			D2 : 3 Azione : DG:Fxi=14.62 Fxf=14.62
			D2 : 4 Azione : DG:Fxi=8.33 Fxf=8.33
			D2 : 4 Azione : DG:Fxi=53.77 Fxf=53.77
			D2 : 5 Azione : DG:Fxi=53.77 Fxf=53.77
			D2 : 7 Azione : DG:Fxi=8.33 Fxf=8.33
			D2 : 9 Azione : DG:Fxi=14.62 Fxf=14.62
			D2 : 12 Azione : DG:Fxi=14.62 Fxf=14.62
			D2 : 16 Azione : DG:Fxi=14.62 Fxf=14.62
24	Qk	CDC=Qk (sisma verticale)	D2 : 1 Azione : DG:Fzi=-7.31 Fzf=-7.31
			D2 : 3 Azione : DG:Fzi=-7.31 Fzf=-7.31
			D2 : 4 Azione : DG:Fzi=-4.16 Fzf=-4.16
			D2 : 7 Azione : DG:Fzi=-4.16 Fzf=-4.16
			D2 : 9 Azione : DG:Fzi=-7.31 Fzf=-7.31
			D2 : 12 Azione : DG:Fzi=-7.31 Fzf=-7.31
			D2 : 16 Azione : DG:Fzi=-7.31 Fzf=-7.31
26	Qk	CDC=Qk (Termica uniforme)	D2 : 12 Azione : T2:DT=-10.00
27	Qk	CDC=Qk (At farfalla)	D2 : 4 Azione : T2:DT2i=5.00 DT2f=5.00
			D2 : 7 Azione : T2:DT2i=-5.00 DT2f=-5.00
			D2 : 12 Azione : T2:DT2i=5.00 DT2f=5.00
28	Qk	CDC=Qk (Ritiro soletta)	D2 : 12 Azione : T2:DT=-11.50

DEFINIZIONE DELLE COMBINAZIONI

LEGENDA TABELLA COMBINAZIONI DI CARICO

Il programma combina i diversi tipi di casi di carico (CDC) secondo le regole previste dalla normativa vigente.

Le combinazioni previste sono destinate al controllo di sicurezza della struttura ed alla verifica degli spostamenti e delle sollecitazioni.

La prima tabella delle combinazioni riportata di seguito comprende le seguenti informazioni: *Numero, Tipo, Sigla identificativa*. Una seconda tabella riporta il *peso nella combinazione*, assunto per ogni caso di carico.

Ai fini delle verifiche degli stati limite si definiscono le seguenti combinazioni delle azioni:

Combinazione fondamentale SLU

$$\gamma G_1 \cdot G_1 + \gamma G_2 \cdot G_2 + \gamma P \cdot P + \gamma Q_1 \cdot Q_{k1} + \gamma Q_2 \cdot \psi_{02} \cdot Q_{k2} + \gamma Q_3 \cdot \psi_{03} \cdot Q_{k3} + \dots$$

Combinazione caratteristica (rara) SLE

$$G_1 + G_2 + P + Q_{k1} + \psi_{02} \cdot Q_{k2} + \psi_{03} \cdot Q_{k3} + \dots$$

Combinazione frequente SLE

$$G_1 + G_2 + P + \psi_{11} \cdot Q_{k1} + \psi_{22} \cdot Q_{k2} + \psi_{23} \cdot Q_{k3} + \dots$$

Combinazione quasi permanente SLE

$$G_1 + G_2 + P + \psi_{21} \cdot Q_{k1} + \psi_{22} \cdot Q_{k2} + \psi_{23} \cdot Q_{k3} + \dots$$

Combinazione sismica, impiegata per gli stati limite ultimi e di esercizio connessi all'azione sismica E

$$E + G_1 + G_2 + P + \psi_{21} \cdot Q_{k1} + \psi_{22} \cdot Q_{k2} + \dots$$

Combinazione eccezionale, impiegata per gli stati limite connessi alle azioni eccezionali

$$G_1 + G_2 + P + \psi_{21} \cdot Q_{k1} + \psi_{22} \cdot Q_{k2} + \dots$$

Dove:

NTC 2008 Tabella 2.5.1

Destinazione d'uso/azione	ψ_0	ψ_1	ψ_2
Categoria A residenziali	0,70	0,50	0,30
Categoria B uffici	0,70	0,50	0,30
Categoria C ambienti suscettibili di affollamento	0,70	0,70	0,60
Categoria D ambienti ad uso commerciale	0,70	0,70	0,60
Categoria E biblioteche, archivi, magazzini,...	1,00	0,90	0,80
Categoria F Rimesse e parcheggi (autoveicoli ≤ 30 kN)	0,70	0,70	0,60
Categoria G Rimesse e parcheggi (autoveicoli > 30 kN)	0,70	0,50	0,30
Categoria H Coperture	0,00	0,00	0,00
Vento	0,60	0,20	0,00
Neve a quota ≤ 1000 m	0,50	0,20	0,00
Neve a quota > 1000 m	0,70	0,50	0,20
Variazioni Termiche	0,60	0,50	0,00

Nelle verifiche possono essere adottati in alternativa, due diversi approcci progettuali:

- per l'approccio 1 si considerano due diverse combinazioni di gruppi di coefficienti di sicurezza parziali per le azioni, per i materiali e per la resistenza globale (combinazione 1 con coefficienti A1 e combinazione 2 con coefficienti A2),
- per l'approccio 2 si definisce un'unica combinazione per le azioni, per la resistenza dei materiali e per la resistenza globale (con coefficienti A1).

NTC 2008 Tabella 2.6.1

Coefficiente	EQU	A1	A2
γ_f			



Carichi permanenti	Favorevoli	γ_{G1}	0,9	1,0	1,0
	Sfavorevoli		1,1	1,3	1,0
Carichi permanenti non strutturali (Non compiutamente definiti)	Favorevoli	γ_{G2}	0,0	0,0	0,0
	Sfavorevoli		1,5	1,5	1,3
Carichi variabili	Favorevoli	γ_{Qi}	0,0	0,0	0,0
	Sfavorevoli		1,5	1,5	1,3

Cmb	Tipo	Sigla Id	effetto P-delta
1	SLU	CMB1	
2	SLU	CMB2	
3	SLU	CMB3	
4	SLU	CMB4	
5	SLU	CMB5	
6	SLU	CMB6	
7	SLU	CMB7	
8	SLU	CMB8	
9	SLU	CMB9	
10	SLU	CMB10	
11	SLU	CMB11	
12	SLU	CMB12	
13	SLU	CMB13	
14	SLU	CMB14	
15	SLU	CMB15	
16	SLU	CMB16	
17	SLU	CMB17	
18	SLU	CMB18	
19	SLU	CMB19	
20	SLU	CMB20	
21	SLU	CMB21	
22	SLU	CMB22	
23	SLU	CMB23	
24	SLU	CMB24	
25	SLU	CMB25	
26	SLU	CMB26	
27	SLU	CMB27	
28	SLU	CMB28	
29	SLU	CMB29	
30	SLU	CMB30	



Cmb	Tipo	Sigla Id	effetto P-delta
31	SLU	CMB31	
32	SLU	CMB32	
33	SLU	CMB33	
34	SLE(f)	CMB34	
35	SLE(f)	CMB35	
36	SLE(f)	CMB36	
37	SLE(f)	CMB37	
38	SLE(f)	CMB38	
39	SLE(f)	CMB39	
40	SLE(f)	CMB40	
41	SLE(f)	CMB41	
42	SLE(f)	CMB42	
43	SLE(f)	CMB43	
44	SLE(f)	CMB44	
45	SLE(f)	CMB45	
46	SLE(r)	CMB46	
47	SLE(r)	CMB47	
48	SLE(r)	CMB48	
49	SLE(r)	CMB49	
50	SLE(r)	CMB50	
51	SLE(r)	CMB51	
52	SLE(r)	CMB52	
53	SLE(r)	CMB53	
54	SLE(r)	CMB54	
55	SLE(r)	CMB55	
56	SLE(r)	CMB56	
57	SLE(r)	CMB57	
58	SLE(r)	CMB58	
59	SLE(r)	CMB59	
60	SLE(r)	CMB60	
61	SLE(r)	CMB61	
62	SLE(r)	CMB62	
63	SLE(r)	CMB63	
64	SLE(r)	CMB64	
65	SLE(r)	CMB65	
66	SLE(r)	CMB66	
67	SLE(r)	CMB67	
68	SLE(r)	CMB68	



Cmb	Tipo	Sigla Id	effetto P-delta
69	SLE(r)	CMB69	
70	SLE(p)	CMB70	
71	SLE(p)	CMB71	
72	SLE(p)	CMB72	
73	SLE(p)	CMB73	
74	SLE(p)	CMB74	
75	SLU	CMB75	
76	SLU	CMB76	
77	SLU	CMB77	
78	SLU	CMB78	
79	SLU	CMB79	

Cmb	CDC 1/15...	CDC 2/16...	CDC 3/17...	CDC 4/18...	CDC 5/19...	CDC 6/20...	CDC 7/21...	CDC 8/22...	CDC 9/23...	CDC 10/24...	CDC 11/25...	CDC 12/26...	CDC 13/27...	CDC 14/28...
1	1.35	1.35	0.0	0.0	1.00	1.00	1.35	1.35	0.0	0.0	0.0	0.0	0.0	0.0
	0.0	0.0	0.0	0.0	0.0	0.0	0.0	0.0	0.0	0.0	0.0	0.72	0.72	1.20
2	1.35	1.35	0.0	0.0	1.00	1.00	1.35	0.0	0.0	0.0	0.0	1.35	0.0	0.0
	0.0	0.0	0.0	0.0	0.0	0.0	0.0	0.0	0.0	0.0	0.0	0.72	0.72	1.20
3	1.35	1.35	0.0	0.0	1.00	1.00	1.35	1.01	0.0	0.0	0.0	0.0	0.0	0.0
	0.0	0.0	0.0	0.0	0.0	0.0	0.0	0.0	0.0	0.0	0.0	1.20	1.20	1.20
4	1.35	1.35	0.0	0.0	1.00	1.00	1.35	0.0	0.0	0.0	0.0	1.01	0.0	0.0
	0.0	0.0	0.0	0.0	0.0	0.0	0.0	0.0	0.0	0.0	0.0	1.20	1.20	1.20
5	1.35	1.35	1.35	0.0	0.0	1.00	0.0	1.01	0.0	0.0	0.0	0.0	0.0	0.0
	1.01	0.0	0.0	0.0	1.35	0.0	0.0	0.0	0.0	0.0	0.0	-0.72	-0.72	0.0
6	1.35	1.35	1.35	0.0	0.0	1.00	0.0	0.0	0.0	0.0	0.0	1.01	0.0	0.0
	0.0	0.0	1.01	0.0	1.35	0.0	0.0	0.0	0.0	0.0	0.0	-0.72	-0.72	0.0
7	1.35	1.35	1.35	0.0	0.0	1.00	0.0	0.0	0.0	0.0	1.01	0.0	1.01	0.0
	0.0	0.0	0.0	0.0	1.35	0.0	0.0	0.0	0.0	0.0	0.0	-0.72	-0.72	0.0
8	1.35	1.35	1.35	0.0	0.0	1.00	0.0	1.01	0.0	0.0	0.0	0.0	0.0	0.0
	1.01	0.0	0.0	0.0	0.0	0.0	0.0	0.0	0.0	0.0	0.0	-1.20	-1.20	0.0
9	1.35	1.35	1.35	0.0	0.0	1.00	0.0	0.0	0.0	0.0	0.0	1.01	0.0	0.0
	0.0	0.0	1.01	0.0	0.0	0.0	0.0	0.0	0.0	0.0	0.0	-1.20	-1.20	0.0
10	1.35	1.35	1.35	0.0	0.0	1.00	0.0	0.0	0.0	0.0	1.01	0.0	1.01	0.0
	0.0	0.0	0.0	0.0	0.0	0.0	0.0	0.0	0.0	0.0	0.0	-1.20	-1.20	0.0
11	1.35	1.35	0.0	0.0	1.00	1.00	0.0	1.35	0.0	0.0	0.0	0.0	0.0	0.0
	0.0	0.0	0.0	0.0	0.0	0.0	0.0	0.0	0.0	0.0	0.0	-0.72	0.72	0.0
12	1.35	1.35	0.0	0.0	1.00	1.00	0.0	0.0	0.0	0.0	0.0	1.35	0.0	0.0



Cmb	CDC 1/15...	CDC 2/16...	CDC 3/17...	CDC 4/18...	CDC 5/19...	CDC 6/20...	CDC 7/21...	CDC 8/22...	CDC 9/23...	CDC 10/24...	CDC 11/25...	CDC 12/26...	CDC 13/27...	CDC 14/28...
	0.0	0.0	0.0	0.0	0.0	0.0	0.0	0.0	0.0	0.0	0.0	-0.72	0.72	0.0
13	1.35	1.35	0.0	0.0	1.00	1.00	0.0	1.01	0.0	0.0	0.0	0.0	0.0	0.0
	0.0	0.0	0.0	0.0	0.0	0.0	0.0	0.0	0.0	0.0	0.0	-1.20	1.20	0.0
14	1.35	1.35	0.0	0.0	1.00	1.00	0.0	0.0	0.0	0.0	0.0	1.01	0.0	0.0
	0.0	0.0	0.0	0.0	0.0	0.0	0.0	0.0	0.0	0.0	0.0	-1.20	1.20	0.0
15	1.35	1.35	1.35	0.0	0.0	1.00	0.0	1.01	0.0	0.0	0.0	0.0	0.0	0.0
	1.01	0.0	0.0	0.0	1.35	0.0	0.0	0.0	0.0	0.0	0.0	0.72	-0.72	1.20
16	1.35	1.35	1.35	0.0	0.0	1.00	0.0	0.0	0.0	0.0	0.0	1.01	0.0	0.0
	0.0	0.0	1.01	0.0	1.35	0.0	0.0	0.0	0.0	0.0	0.0	0.72	-0.72	1.20
17	1.35	1.35	1.35	0.0	0.0	1.00	0.0	0.0	0.0	0.0	1.01	0.0	1.01	0.0
	0.0	0.0	0.0	0.0	1.35	0.0	0.0	0.0	0.0	0.0	0.0	0.72	-0.72	1.20
18	1.35	1.35	1.35	0.0	0.0	1.00	0.0	1.01	0.0	0.0	0.0	0.0	0.0	0.0
	1.01	0.0	0.0	0.0	0.0	0.0	0.0	0.0	0.0	0.0	0.0	1.20	-1.20	1.20
19	1.35	1.35	1.35	0.0	0.0	1.00	0.0	0.0	0.0	0.0	0.0	1.01	0.0	0.0
	0.0	0.0	1.01	0.0	0.0	0.0	0.0	0.0	0.0	0.0	0.0	1.20	-1.20	1.20
20	1.35	1.35	1.35	0.0	0.0	1.00	0.0	0.0	0.0	0.0	1.01	0.0	1.01	0.0
	0.0	0.0	0.0	0.0	0.0	0.0	0.0	0.0	0.0	0.0	0.0	1.20	-1.20	1.20
21	1.35	1.35	1.35	0.0	0.0	1.00	0.0	0.0	0.0	1.01	0.0	0.0	0.0	0.0
	1.01	0.0	0.0	0.0	1.35	0.0	0.0	0.0	0.0	0.0	0.0	0.72	-0.72	1.20
22	1.35	1.35	1.35	0.0	0.0	1.00	0.0	0.0	0.0	1.01	0.0	0.0	0.0	0.0
	1.01	0.0	0.0	0.0	0.0	0.0	0.0	0.0	0.0	0.0	0.0	1.20	-1.20	1.20
23	1.00	1.00	1.35	0.0	0.0	1.00	0.0	0.0	0.0	0.0	0.0	0.0	1.01	0.0
	0.0	0.0	0.0	0.0	1.35	0.0	0.0	0.0	0.0	0.0	0.0	0.72	0.72	1.20
24	1.00	1.00	1.35	0.0	0.0	1.00	0.0	0.0	0.0	0.0	0.0	0.0	1.01	0.0
	0.0	0.0	0.0	0.0	0.0	0.0	0.0	0.0	0.0	0.0	0.0	1.20	1.20	1.20
25	1.35	1.35	1.35	0.0	0.0	1.00	0.0	0.0	1.01	0.0	0.0	0.0	0.0	0.0
	1.01	0.0	0.0	0.0	1.35	0.0	1.13	0.0	0.0	0.0	0.0	0.0	0.0	0.0
26	1.35	1.35	1.35	0.0	0.0	1.00	0.0	0.0	0.0	0.0	0.0	1.01	0.0	0.0
	0.0	0.0	1.01	0.0	1.35	0.0	1.13	0.0	0.0	0.0	0.0	0.0	0.0	0.0
27	1.35	1.35	1.35	0.0	0.0	1.00	0.0	0.0	0.0	1.35	0.0	0.0	0.0	0.0
	1.01	0.0	0.0	0.0	0.0	0.0	0.0	0.0	0.0	0.0	0.0	0.72	-0.72	1.20
28	1.35	1.35	1.35	0.0	0.0	1.00	0.0	0.0	0.0	0.0	0.0	1.35	0.0	0.0
	0.0	0.0	1.01	0.0	0.0	0.0	0.0	0.0	0.0	0.0	0.0	0.72	-0.72	1.20
29	1.35	1.35	1.35	0.0	0.0	1.00	0.0	0.0	0.0	0.0	0.0	0.0	1.01	0.0
	0.0	0.0	0.0	0.0	1.35	0.0	0.0	0.0	0.0	0.0	0.0	0.72	0.72	1.20
30	1.00	1.00	1.35	1.35	0.0	0.0	0.0	1.01	0.0	0.0	0.0	0.0	0.0	0.0
	1.01	1.01	0.0	0.0	1.35	0.0	0.0	1.13	0.0	0.0	0.0	-0.72	-0.72	0.0



Cmb	CDC 1/15...	CDC 2/16...	CDC 3/17...	CDC 4/18...	CDC 5/19...	CDC 6/20...	CDC 7/21...	CDC 8/22...	CDC 9/23...	CDC 10/24...	CDC 11/25...	CDC 12/26...	CDC 13/27...	CDC 14/28...
31	1.00	1.00	1.35	1.35	0.0	0.0	0.0	0.0	0.0	0.0	0.0	1.01	0.0	0.0
	0.0	0.0	1.01	1.01	1.35	0.0	0.0	1.13	0.0	0.0	0.0	-0.72	-0.72	0.0
32	1.00	1.00	1.35	1.35	0.0	0.0	0.0	0.0	0.0	0.0	1.01	0.0	1.01	1.01
	0.0	0.0	0.0	0.0	1.35	0.0	0.0	1.13	0.0	0.0	0.0	-0.72	-0.72	0.0
33	1.35	1.35	1.35	0.0	0.0	1.00	0.0	0.0	0.0	0.0	0.0	0.0	1.01	0.0
	0.0	0.0	0.0	0.0	1.35	0.0	1.13	0.0	0.0	0.0	0.0	0.72	0.72	1.20
34	1.00	1.00	0.0	0.0	1.00	1.00	0.0	0.75	0.0	0.0	0.0	0.0	0.0	0.0
	0.0	0.0	0.0	0.0	0.0	0.0	0.0	0.0	0.0	0.0	0.0	0.60	0.60	1.00
35	1.00	1.00	0.0	0.0	1.00	1.00	0.0	0.0	0.0	0.0	0.0	0.75	0.0	0.0
	0.0	0.0	0.75	0.0	0.0	0.0	0.0	0.0	0.0	0.0	0.0	0.60	0.60	1.00
36	1.00	1.00	1.00	0.0	0.0	1.00	0.0	0.75	0.0	0.0	0.0	0.0	0.0	0.0
	0.75	0.0	0.0	0.0	0.0	0.0	0.0	0.0	0.0	0.0	0.0	-0.60	-0.60	0.0
37	1.00	1.00	1.00	0.0	0.0	1.00	0.0	0.0	0.0	0.0	0.0	0.75	0.0	0.0
	0.0	0.0	0.75	0.0	0.0	0.0	0.0	0.0	0.0	0.0	0.0	-0.60	-0.60	0.0
38	1.00	1.00	1.00	0.0	0.0	1.00	0.0	0.0	0.0	0.0	0.75	0.0	0.75	0.0
	0.0	0.0	0.0	0.0	0.0	0.0	0.0	0.0	0.0	0.0	0.0	-0.60	-0.60	0.0
39	1.00	1.00	0.0	0.0	1.00	1.00	0.0	0.75	0.0	0.0	0.0	0.0	0.0	0.0
	0.0	0.0	0.0	0.0	0.0	0.0	0.0	0.0	0.0	0.0	0.0	-0.60	0.60	0.0
40	1.00	1.00	0.0	0.0	1.00	1.00	0.0	0.0	0.0	0.0	0.0	0.75	0.0	0.0
	0.0	0.0	0.0	0.0	0.0	0.0	0.0	0.0	0.0	0.0	0.0	-0.60	0.60	0.0
41	1.00	1.00	1.00	0.0	0.0	1.00	0.0	0.75	0.0	0.0	0.0	0.0	0.0	0.0
	0.75	0.0	0.0	0.0	0.0	0.0	0.0	0.0	0.0	0.0	0.0	0.60	-0.60	1.00
42	1.00	1.00	1.00	0.0	0.0	1.00	0.0	0.0	0.0	0.0	0.0	0.75	0.0	0.0
	0.0	0.0	0.75	0.0	0.0	0.0	0.0	0.0	0.0	0.0	0.0	0.60	-0.60	1.00
43	1.00	1.00	1.00	0.0	0.0	1.00	0.0	0.0	0.0	0.0	0.75	0.0	0.75	0.0
	0.0	0.0	0.0	0.0	0.0	0.0	0.0	0.0	0.0	0.0	0.0	0.60	-0.60	1.00
44	1.00	1.00	1.00	0.0	0.0	1.00	0.0	0.0	0.0	0.75	0.0	0.0	0.75	0.0
	0.75	0.0	0.0	0.0	0.0	0.0	0.0	0.0	0.0	0.0	0.0	0.60	-0.60	1.00
45	1.00	1.00	1.00	0.0	0.0	1.00	0.0	0.0	0.0	0.0	0.0	0.0	0.75	0.0
	0.0	0.0	0.0	0.0	0.0	0.0	0.0	0.0	0.0	0.0	0.0	0.60	0.60	1.00
46	1.00	1.00	0.0	0.0	1.00	1.00	1.00	1.00	0.0	0.0	0.0	0.0	0.0	0.0
	0.0	0.0	0.0	0.0	0.0	0.0	0.0	0.0	0.0	0.0	0.0	0.60	0.60	1.00
47	1.00	1.00	0.0	0.0	1.00	1.00	1.00	0.0	0.0	0.0	0.0	1.00	0.0	0.0
	0.0	0.0	0.0	0.0	0.0	0.0	0.0	0.0	0.0	0.0	0.0	0.60	0.60	1.00
48	1.00	1.00	0.0	0.0	1.00	1.00	1.00	0.75	0.0	0.0	0.0	0.0	0.0	0.0
	0.0	0.0	0.0	0.0	0.0	0.0	0.0	0.0	0.0	0.0	0.0	1.00	1.00	1.00
49	1.00	1.00	0.0	0.0	1.00	1.00	1.00	0.0	0.0	0.0	0.0	0.75	0.0	0.0



Cmb	CDC 1/15...	CDC 2/16...	CDC 3/17...	CDC 4/18...	CDC 5/19...	CDC 6/20...	CDC 7/21...	CDC 8/22...	CDC 9/23...	CDC 10/24...	CDC 11/25...	CDC 12/26...	CDC 13/27...	CDC 14/28...
	0.0	0.0	0.0	0.0	0.0	0.0	0.0	0.0	0.0	0.0	0.0	1.00	1.00	1.00
50	1.00	1.00	1.00	0.0	0.0	1.00	0.0	0.75	0.0	0.0	0.0	0.0	0.0	0.0
	0.75	0.0	0.0	0.0	1.00	0.0	0.0	0.0	0.0	0.0	0.0	-0.60	-0.60	0.0
51	1.00	1.00	1.00	0.0	0.0	1.00	0.0	0.0	0.0	0.0	0.0	0.75	0.0	0.0
	0.0	0.0	0.75	0.0	1.00	0.0	0.0	0.0	0.0	0.0	0.0	-0.60	-0.60	0.0
52	1.00	1.00	1.00	0.0	0.0	1.00	0.0	0.0	0.0	0.0	0.75	0.0	0.75	0.0
	0.0	0.0	0.0	0.0	1.00	0.0	0.0	0.0	0.0	0.0	0.0	-0.60	-0.60	0.0
53	1.00	1.00	1.00	0.0	0.0	1.00	0.0	0.75	0.0	0.0	0.0	0.0	0.0	0.0
	0.75	0.0	0.0	0.0	0.0	0.0	0.0	0.0	0.0	0.0	0.0	-1.00	-1.00	0.0
54	1.00	1.00	1.00	0.0	0.0	1.00	0.0	0.0	0.0	0.0	0.0	0.75	0.0	0.0
	0.0	0.0	0.75	0.0	0.0	0.0	0.0	0.0	0.0	0.0	0.0	-1.00	-1.00	0.0
55	1.00	1.00	1.00	0.0	0.0	1.00	0.0	0.0	0.0	0.0	0.75	0.0	0.75	0.0
	0.0	0.0	0.0	0.0	0.0	0.0	0.0	0.0	0.0	0.0	0.0	-1.00	-1.00	0.0
56	1.00	1.00	0.0	0.0	1.00	1.00	1.00	1.00	0.0	0.0	0.0	0.0	0.0	0.0
	0.0	0.0	0.0	0.0	0.0	0.0	0.0	0.0	0.0	0.0	0.0	-0.60	0.60	1.00
57	1.00	1.00	0.0	0.0	1.00	1.00	1.00	0.0	0.0	0.0	0.0	1.00	0.0	0.0
	0.0	0.0	0.0	0.0	0.0	0.0	0.0	0.0	0.0	0.0	0.0	-0.60	0.60	1.00
58	1.00	1.00	0.0	0.0	1.00	1.00	1.00	0.75	0.0	0.0	0.0	0.0	0.0	0.0
	0.0	0.0	0.0	0.0	0.0	0.0	0.0	0.0	0.0	0.0	0.0	-1.00	1.00	1.00
59	1.00	1.00	0.0	0.0	1.00	1.00	1.00	0.0	0.0	0.0	0.0	0.75	0.0	0.0
	0.0	0.0	0.0	0.0	0.0	0.0	0.0	0.0	0.0	0.0	0.0	-1.00	1.00	1.00
60	1.00	1.00	1.00	0.0	0.0	1.00	0.0	0.75	0.0	0.0	0.0	0.0	0.0	0.0
	0.75	0.0	0.0	0.0	1.00	0.0	0.0	0.0	0.0	0.0	0.0	0.60	-0.60	1.00
61	1.00	1.00	1.00	0.0	0.0	1.00	0.0	0.0	0.0	0.0	0.0	0.75	0.0	0.0
	0.0	0.0	0.75	0.0	1.00	0.0	0.0	0.0	0.0	0.0	0.0	0.60	-0.60	1.00
62	1.00	1.00	1.00	0.0	0.0	1.00	0.0	0.0	0.0	0.0	0.75	0.0	0.75	0.0
	0.0	0.0	0.0	0.0	1.00	0.0	0.0	0.0	0.0	0.0	0.0	0.60	-0.60	1.00
63	1.00	1.00	1.00	0.0	0.0	1.00	0.0	0.75	0.0	0.0	0.0	0.0	0.0	0.0
	0.75	0.0	0.0	0.0	0.0	0.0	0.0	0.0	0.0	0.0	0.0	1.00	-1.00	1.00
64	1.00	1.00	1.00	0.0	0.0	1.00	0.0	0.0	0.0	0.0	0.0	0.75	0.0	0.0
	0.0	0.0	0.75	0.0	0.0	0.0	0.0	0.0	0.0	0.0	0.0	1.00	-1.00	1.00
65	1.00	1.00	1.00	0.0	0.0	1.00	0.0	0.0	0.0	0.0	0.75	0.0	0.75	0.0
	0.0	0.0	0.0	0.0	0.0	0.0	0.0	0.0	0.0	0.0	0.0	1.00	-1.00	1.00
66	1.00	1.00	1.00	0.0	0.0	1.00	0.0	0.0	0.0	0.75	0.0	0.0	0.0	0.0
	0.75	0.0	0.0	0.0	1.00	0.0	0.0	0.0	0.0	0.0	0.0	0.60	-0.60	1.00
67	1.00	1.00	1.00	0.0	0.0	1.00	0.0	0.0	0.0	0.75	0.0	0.0	0.0	0.0
	0.75	0.0	0.0	0.0	0.0	0.0	0.0	0.0	0.0	0.0	0.0	1.00	-1.00	1.00

Cmb	CDC 1/15...	CDC 2/16...	CDC 3/17...	CDC 4/18...	CDC 5/19...	CDC 6/20...	CDC 7/21...	CDC 8/22...	CDC 9/23...	CDC 10/24...	CDC 11/25...	CDC 12/26...	CDC 13/27...	CDC 14/28...
68	1.00	1.00	1.00	0.0	0.0	1.00	0.0	0.0	0.0	0.0	0.0	0.0	0.75	0.0
	0.0	0.0	0.0	0.0	1.00	0.0	0.0	0.0	0.0	0.0	0.0	0.60	0.60	1.00
69	1.00	1.00	1.00	0.0	0.0	1.00	0.0	0.0	0.0	0.0	0.0	0.0	0.75	0.0
	0.0	0.0	0.0	0.0	0.0	0.0	0.0	0.0	0.0	0.0	0.0	1.00	1.00	1.00
70	1.00	1.00	0.0	0.0	1.00	1.00	0.0	0.0	0.0	0.0	0.0	0.0	0.0	0.0
	0.0	0.0	0.0	0.0	0.0	0.0	0.0	0.0	0.0	0.0	0.0	0.50	0.50	1.00
71	1.00	1.00	1.00	0.0	0.0	1.00	0.0	0.0	0.0	0.0	0.0	0.0	0.0	0.0
	0.0	0.0	0.0	0.0	0.0	0.0	0.0	0.0	0.0	0.0	0.0	-0.50	-0.50	0.0
72	1.00	1.00	0.0	0.0	1.00	1.00	0.0	0.0	0.0	0.0	0.0	0.0	0.0	0.0
	0.0	0.0	0.0	0.0	0.0	0.0	0.0	0.0	0.0	0.0	0.0	-0.50	0.50	0.0
73	1.00	1.00	1.00	0.0	0.0	1.00	0.0	0.0	0.0	0.0	0.0	0.0	0.0	0.0
	0.0	0.0	0.0	0.0	0.0	0.0	0.0	0.0	0.0	0.0	0.0	0.50	-0.50	1.00
74	1.00	1.00	1.00	0.0	0.0	1.00	0.0	0.0	0.0	0.0	0.0	0.0	0.0	0.0
	0.0	0.0	0.0	0.0	0.0	0.0	0.0	0.0	0.0	0.0	0.0	0.50	0.50	1.00
75	1.00	1.00	1.00	1.00	0.0	0.0	0.0	0.0	0.0	0.0	0.0	0.0	0.0	0.0
	0.0	0.0	0.0	0.0	0.0	0.0	0.0	0.0	0.30	1.00	0.0	0.50	0.50	1.00
76	1.00	1.00	1.00	1.00	0.0	0.0	1.00	0.0	0.0	0.0	0.0	0.0	0.0	0.0
	0.0	0.0	0.0	0.0	0.0	0.0	0.0	0.0	1.00	0.30	1.00	-0.50	-0.50	0.0
77	1.00	1.00	1.00	1.00	0.0	0.0	0.0	0.0	0.0	0.0	0.0	0.0	0.0	0.0
	0.0	0.0	0.0	0.0	0.0	0.0	0.0	0.0	0.30	1.00	0.0	-0.50	0.50	0.0
78	1.00	1.00	1.00	1.00	0.0	0.0	1.00	0.0	0.0	0.0	0.0	0.0	0.0	0.0
	0.0	0.0	0.0	0.0	0.0	0.0	0.0	0.0	1.00	0.30	1.00	0.50	-0.50	1.00
79	1.00	1.00	1.00	1.00	0.0	0.0	1.00	0.0	0.0	0.0	0.0	0.0	0.0	0.0
	0.0	0.0	0.0	0.0	0.0	0.0	0.0	0.0	1.00	-0.30	1.00	0.50	0.50	1.00

RISULTATI NODALI

LEGENDA RISULTATI NODALI

Il controllo dei risultati delle analisi condotte, per quanto concerne i nodi strutturali, è possibile in relazione alle tabelle sottoriportate.

Una prima tabella riporta infatti per ogni nodo e per ogni combinazione (o caso di carico) gli spostamenti nodali.

Una seconda tabella riporta per ogni nodo a cui sia associato un vincolo rigido e/o elastico o una fondazione speciale e per ogni combinazione (o caso di carico) i valori delle azioni esercitate dalla struttura sui vincoli (reazioni vincolari cambiate di segno).

Una terza tabella, infine riassume per ogni nodo le sei combinazioni in cui si attingono i valori minimi e massimi della reazione Fz, della reazione Mx e della reazione My.

Nodo	Cmb	Traslazione X	Traslazione Y	Traslazione Z	Rotazione X	Rotazione Y	Rotazione Z
		cm	cm	cm			
1	1	5.60e-03	0.0	-4.35	0.0	-7.99e-04	0.0
1	2	5.81e-03	0.0	-4.33	0.0	-7.73e-04	0.0
1	3	5.87e-03	0.0	-4.20	0.0	-7.43e-04	0.0
1	4	6.03e-03	0.0	-4.18	0.0	-7.23e-04	0.0
1	5	0.19	0.0	-2.83	0.0	1.82e-03	0.0
1	6	0.21	0.0	-2.69	0.0	2.09e-03	0.0
1	7	0.23	0.0	-2.25	0.0	2.56e-03	0.0
1	8	0.14	0.0	-3.53	0.0	5.44e-04	0.0
1	9	0.16	0.0	-3.39	0.0	8.08e-04	0.0
1	10	0.18	0.0	-2.94	0.0	1.28e-03	0.0
1	11	5.15e-03	0.0	-4.38	0.0	-9.51e-04	0.0
1	12	5.37e-03	0.0	-4.36	0.0	-9.25e-04	0.0
1	13	5.27e-03	0.0	-4.24	0.0	-9.47e-04	0.0
1	14	5.43e-03	0.0	-4.22	0.0	-9.27e-04	0.0
1	15	0.19	0.0	-2.81	0.0	1.98e-03	0.0
1	16	0.21	0.0	-2.66	0.0	2.24e-03	0.0
1	17	0.23	0.0	-2.22	0.0	2.72e-03	0.0
1	18	0.14	0.0	-3.49	0.0	7.48e-04	0.0
1	19	0.16	0.0	-3.35	0.0	1.01e-03	0.0
1	20	0.18	0.0	-2.91	0.0	1.49e-03	0.0
1	21	0.19	0.0	-3.15	0.0	1.44e-03	0.0
1	22	0.14	0.0	-3.83	0.0	2.11e-04	0.0
1	23	0.23	0.0	-1.06	0.0	2.91e-03	0.0
1	24	0.18	0.0	-1.75	0.0	1.62e-03	0.0
1	25	0.19	0.0	-2.93	0.0	2.19e-03	0.0
1	26	0.21	0.0	-3.13	0.0	1.88e-03	0.0
1	27	0.14	0.0	-4.11	0.0	-8.70e-05	0.0
1	28	0.16	0.0	-3.51	0.0	9.01e-04	0.0
1	29	0.23	0.0	-2.04	0.0	2.70e-03	0.0
1	30	0.06	0.0	-2.88	0.0	1.02e-03	0.0
1	31	0.06	0.0	-2.86	0.0	1.06e-03	0.0
1	32	0.06	0.0	-2.61	0.0	1.17e-03	0.0
1	33	0.23	0.0	-2.48	0.0	2.50e-03	0.0

1	34	5.47e-03	0.0	-3.10	0.0	-4.93e-04	0.0
1	35	0.03	0.0	-2.92	0.0	-1.49e-04	0.0
1	36	0.06	0.0	-2.79	0.0	8.22e-05	0.0
1	37	0.08	0.0	-2.69	0.0	2.78e-04	0.0
1	38	0.09	0.0	-2.36	0.0	6.31e-04	0.0
1	39	5.09e-03	0.0	-3.12	0.0	-6.20e-04	0.0
1	40	5.22e-03	0.0	-3.11	0.0	-6.06e-04	0.0
1	41	0.06	0.0	-2.77	0.0	2.09e-04	0.0
1	42	0.08	0.0	-2.66	0.0	4.05e-04	0.0
1	43	0.09	0.0	-2.33	0.0	7.57e-04	0.0
1	44	0.11	0.0	-2.70	0.0	4.26e-04	0.0
1	45	0.09	0.0	-2.20	0.0	7.35e-04	0.0
1	46	5.41e-03	0.0	-3.21	0.0	-5.38e-04	0.0
1	47	5.57e-03	0.0	-3.20	0.0	-5.19e-04	0.0
1	48	5.63e-03	0.0	-3.10	0.0	-4.97e-04	0.0
1	49	5.75e-03	0.0	-3.09	0.0	-4.83e-04	0.0
1	50	0.10	0.0	-2.27	0.0	1.03e-03	0.0
1	51	0.12	0.0	-2.17	0.0	1.23e-03	0.0
1	52	0.13	0.0	-1.84	0.0	1.58e-03	0.0
1	53	0.06	0.0	-2.79	0.0	8.60e-05	0.0
1	54	0.08	0.0	-2.69	0.0	2.82e-04	0.0
1	55	0.09	0.0	-2.36	0.0	6.34e-04	0.0
1	56	5.22e-03	0.0	-3.23	0.0	-6.03e-04	0.0
1	57	5.38e-03	0.0	-3.21	0.0	-5.84e-04	0.0
1	58	5.31e-03	0.0	-3.12	0.0	-6.05e-04	0.0
1	59	5.43e-03	0.0	-3.11	0.0	-5.91e-04	0.0
1	60	0.10	0.0	-2.25	0.0	1.16e-03	0.0
1	61	0.12	0.0	-2.15	0.0	1.36e-03	0.0
1	62	0.13	0.0	-1.82	0.0	1.71e-03	0.0
1	63	0.06	0.0	-2.76	0.0	2.56e-04	0.0
1	64	0.08	0.0	-2.65	0.0	4.52e-04	0.0
1	65	0.09	0.0	-2.32	0.0	8.04e-04	0.0
1	66	0.10	0.0	-2.50	0.0	7.62e-04	0.0
1	67	0.06	0.0	-3.01	0.0	-1.43e-04	0.0
1	68	0.13	0.0	-1.68	0.0	1.69e-03	0.0
1	69	0.09	0.0	-2.20	0.0	7.31e-04	0.0
1	70	5.60e-03	0.0	-2.76	0.0	-3.58e-04	0.0
1	71	0.05	0.0	-2.53	0.0	6.79e-05	0.0
1	72	5.25e-03	0.0	-2.78	0.0	-4.74e-04	0.0
1	73	0.05	0.0	-2.51	0.0	1.84e-04	0.0

1	74	0.05	0.0	-2.52	0.0	1.20e-04	0.0
1	75	0.09	0.0	-2.30	0.0	9.45e-04	0.0
1	76	0.29	0.0	-0.49	0.0	4.05e-03	0.0
1	77	0.09	0.0	-2.32	0.0	8.29e-04	0.0
1	78	0.29	0.0	-0.47	0.0	4.17e-03	0.0
1	79	0.29	0.0	-0.33	0.0	4.16e-03	0.0
2	1	-5.56e-03	0.0	-4.29	0.0	6.89e-04	0.0
2	2	-5.78e-03	0.0	-4.26	0.0	6.64e-04	0.0
2	3	-5.83e-03	0.0	-4.14	0.0	6.38e-04	0.0
2	4	-5.99e-03	0.0	-4.12	0.0	6.19e-04	0.0
2	5	0.18	0.0	-5.48	0.0	3.16e-03	0.0
2	6	0.20	0.0	-5.59	0.0	3.36e-03	0.0
2	7	0.22	0.0	-5.55	0.0	3.64e-03	0.0
2	8	0.12	0.0	-4.79	0.0	1.87e-03	0.0
2	9	0.14	0.0	-4.89	0.0	2.07e-03	0.0
2	10	0.16	0.0	-4.85	0.0	2.35e-03	0.0
2	11	-5.12e-03	0.0	-4.31	0.0	8.40e-04	0.0
2	12	-5.34e-03	0.0	-4.29	0.0	8.15e-04	0.0
2	13	-5.24e-03	0.0	-4.17	0.0	8.40e-04	0.0
2	14	-5.40e-03	0.0	-4.16	0.0	8.21e-04	0.0
2	15	0.18	0.0	-5.45	0.0	3.00e-03	0.0
2	16	0.20	0.0	-5.56	0.0	3.21e-03	0.0
2	17	0.22	0.0	-5.52	0.0	3.49e-03	0.0
2	18	0.12	0.0	-4.75	0.0	1.67e-03	0.0
2	19	0.14	0.0	-4.86	0.0	1.87e-03	0.0
2	20	0.16	0.0	-4.82	0.0	2.15e-03	0.0
2	21	0.18	0.0	-5.11	0.0	2.44e-03	0.0
2	22	0.12	0.0	-4.41	0.0	1.10e-03	0.0
2	23	0.22	0.0	-4.37	0.0	3.33e-03	0.0
2	24	0.16	0.0	-3.68	0.0	2.05e-03	0.0
2	25	0.18	0.0	-5.93	0.0	3.41e-03	0.0
2	26	0.20	0.0	-5.69	0.0	3.07e-03	0.0
2	27	0.12	0.0	-4.45	0.0	1.02e-03	0.0
2	28	0.14	0.0	-5.01	0.0	1.97e-03	0.0
2	29	0.22	0.0	-5.34	0.0	3.52e-03	0.0
2	30	0.05	0.0	-4.34	0.0	1.64e-03	0.0
2	31	0.05	0.0	-4.32	0.0	1.60e-03	0.0
2	32	0.05	0.0	-4.08	0.0	1.50e-03	0.0
2	33	0.22	0.0	-5.45	0.0	3.22e-03	0.0
2	34	-5.43e-03	0.0	-3.05	0.0	4.16e-04	0.0

2	35	0.02	0.0	-3.20	0.0	7.01e-04	0.0
2	36	0.05	0.0	-3.37	0.0	1.02e-03	0.0
2	37	0.07	0.0	-3.44	0.0	1.17e-03	0.0
2	38	0.08	0.0	-3.41	0.0	1.38e-03	0.0
2	39	-5.06e-03	0.0	-3.08	0.0	5.42e-04	0.0
2	40	-5.18e-03	0.0	-3.06	0.0	5.28e-04	0.0
2	41	0.05	0.0	-3.34	0.0	8.96e-04	0.0
2	42	0.07	0.0	-3.42	0.0	1.05e-03	0.0
2	43	0.08	0.0	-3.39	0.0	1.26e-03	0.0
2	44	0.09	0.0	-3.40	0.0	1.05e-03	0.0
2	45	0.08	0.0	-3.26	0.0	1.28e-03	0.0
2	46	-5.38e-03	0.0	-3.16	0.0	4.57e-04	0.0
2	47	-5.54e-03	0.0	-3.15	0.0	4.38e-04	0.0
2	48	-5.59e-03	0.0	-3.05	0.0	4.20e-04	0.0
2	49	-5.71e-03	0.0	-3.04	0.0	4.06e-04	0.0
2	50	0.09	0.0	-3.88	0.0	1.97e-03	0.0
2	51	0.11	0.0	-3.96	0.0	2.12e-03	0.0
2	52	0.12	0.0	-3.93	0.0	2.33e-03	0.0
2	53	0.05	0.0	-3.37	0.0	1.02e-03	0.0
2	54	0.07	0.0	-3.44	0.0	1.17e-03	0.0
2	55	0.08	0.0	-3.41	0.0	1.38e-03	0.0
2	56	-5.19e-03	0.0	-3.18	0.0	5.21e-04	0.0
2	57	-5.35e-03	0.0	-3.16	0.0	5.03e-04	0.0
2	58	-5.28e-03	0.0	-3.07	0.0	5.27e-04	0.0
2	59	-5.40e-03	0.0	-3.06	0.0	5.13e-04	0.0
2	60	0.09	0.0	-3.86	0.0	1.85e-03	0.0
2	61	0.11	0.0	-3.93	0.0	2.00e-03	0.0
2	62	0.12	0.0	-3.90	0.0	2.21e-03	0.0
2	63	0.05	0.0	-3.34	0.0	8.50e-04	0.0
2	64	0.07	0.0	-3.41	0.0	1.00e-03	0.0
2	65	0.08	0.0	-3.38	0.0	1.21e-03	0.0
2	66	0.09	0.0	-3.60	0.0	1.43e-03	0.0
2	67	0.05	0.0	-3.08	0.0	4.29e-04	0.0
2	68	0.12	0.0	-3.77	0.0	2.23e-03	0.0
2	69	0.08	0.0	-3.26	0.0	1.29e-03	0.0
2	70	-5.56e-03	0.0	-2.72	0.0	2.91e-04	0.0
2	71	0.04	0.0	-2.96	0.0	7.65e-04	0.0
2	72	-5.22e-03	0.0	-2.74	0.0	4.06e-04	0.0
2	73	0.04	0.0	-2.94	0.0	6.50e-04	0.0
2	74	0.04	0.0	-2.95	0.0	7.13e-04	0.0

2	75	0.08	0.0	-3.64	0.0	1.59e-03	0.0
2	76	0.27	0.0	-5.09	0.0	4.56e-03	0.0
2	77	0.08	0.0	-3.66	0.0	1.70e-03	0.0
2	78	0.27	0.0	-5.06	0.0	4.44e-03	0.0
2	79	0.27	0.0	-4.93	0.0	4.46e-03	0.0
3	1	0.08	0.0	-4.37	0.0	8.40e-04	0.0
3	2	0.08	0.0	-4.35	0.0	7.74e-04	0.0
3	3	0.11	0.0	-4.22	0.0	8.08e-04	0.0
3	4	0.11	0.0	-4.20	0.0	7.58e-04	0.0
3	5	2.30	0.0	-2.85	0.0	2.95e-03	0.0
3	6	2.52	0.0	-2.71	0.0	3.11e-03	0.0
3	7	2.87	0.0	-2.26	0.0	3.37e-03	0.0
3	8	1.09	0.0	-3.55	0.0	1.63e-03	0.0
3	9	1.31	0.0	-3.40	0.0	1.79e-03	0.0
3	10	1.66	0.0	-2.96	0.0	2.05e-03	0.0
3	11	-0.08	0.0	-4.40	0.0	6.72e-04	0.0
3	12	-0.08	0.0	-4.37	0.0	6.06e-04	0.0
3	13	-0.11	0.0	-4.25	0.0	5.82e-04	0.0
3	14	-0.11	0.0	-4.24	0.0	5.32e-04	0.0
3	15	2.46	0.0	-2.82	0.0	3.12e-03	0.0
3	16	2.68	0.0	-2.68	0.0	3.28e-03	0.0
3	17	3.03	0.0	-2.23	0.0	3.54e-03	0.0
3	18	1.30	0.0	-3.51	0.0	1.86e-03	0.0
3	19	1.52	0.0	-3.37	0.0	2.02e-03	0.0
3	20	1.87	0.0	-2.92	0.0	2.28e-03	0.0
3	21	2.03	0.0	-3.16	0.0	2.57e-03	0.0
3	22	0.88	0.0	-3.85	0.0	1.30e-03	0.0
3	23	3.04	0.0	-1.06	0.0	3.34e-03	0.0
3	24	1.88	0.0	-1.76	0.0	2.10e-03	0.0
3	25	2.56	0.0	-2.94	0.0	3.20e-03	0.0
3	26	2.35	0.0	-3.15	0.0	2.89e-03	0.0
3	27	0.70	0.0	-4.13	0.0	1.17e-03	0.0
3	28	1.49	0.0	-3.53	0.0	2.05e-03	0.0
3	29	3.03	0.0	-2.05	0.0	3.50e-03	0.0
3	30	1.19	0.0	-2.89	0.0	1.62e-03	0.0
3	31	1.19	0.0	-2.87	0.0	1.55e-03	0.0
3	32	1.19	0.0	-2.62	0.0	1.43e-03	0.0
3	33	2.83	0.0	-2.49	0.0	3.22e-03	0.0
3	34	0.07	0.0	-3.11	0.0	5.41e-04	0.0
3	35	0.37	0.0	-2.93	0.0	7.85e-04	0.0

3	36	0.50	0.0	-2.80	0.0	8.95e-04	0.0
3	37	0.66	0.0	-2.70	0.0	1.01e-03	0.0
3	38	0.92	0.0	-2.37	0.0	1.21e-03	0.0
3	39	-0.06	0.0	-3.14	0.0	4.00e-04	0.0
3	40	-0.06	0.0	-3.12	0.0	3.64e-04	0.0
3	41	0.63	0.0	-2.78	0.0	1.04e-03	0.0
3	42	0.79	0.0	-2.67	0.0	1.15e-03	0.0
3	43	1.05	0.0	-2.34	0.0	1.35e-03	0.0
3	44	0.87	0.0	-2.71	0.0	1.16e-03	0.0
3	45	1.05	0.0	-2.21	0.0	1.32e-03	0.0
3	46	0.07	0.0	-3.23	0.0	5.93e-04	0.0
3	47	0.07	0.0	-3.21	0.0	5.44e-04	0.0
3	48	0.09	0.0	-3.11	0.0	5.72e-04	0.0
3	49	0.09	0.0	-3.10	0.0	5.36e-04	0.0
3	50	1.37	0.0	-2.29	0.0	1.85e-03	0.0
3	51	1.53	0.0	-2.18	0.0	1.96e-03	0.0
3	52	1.79	0.0	-1.85	0.0	2.16e-03	0.0
3	53	0.47	0.0	-2.80	0.0	8.64e-04	0.0
3	54	0.64	0.0	-2.70	0.0	9.81e-04	0.0
3	55	0.90	0.0	-2.37	0.0	1.17e-03	0.0
3	56	1.31e-03	0.0	-3.24	0.0	5.21e-04	0.0
3	57	1.36e-03	0.0	-3.22	0.0	4.72e-04	0.0
3	58	-0.02	0.0	-3.13	0.0	4.53e-04	0.0
3	59	-0.02	0.0	-3.12	0.0	4.16e-04	0.0
3	60	1.51	0.0	-2.26	0.0	1.99e-03	0.0
3	61	1.67	0.0	-2.16	0.0	2.10e-03	0.0
3	62	1.93	0.0	-1.83	0.0	2.30e-03	0.0
3	63	0.65	0.0	-2.77	0.0	1.05e-03	0.0
3	64	0.82	0.0	-2.67	0.0	1.17e-03	0.0
3	65	1.08	0.0	-2.33	0.0	1.36e-03	0.0
3	66	1.19	0.0	-2.52	0.0	1.57e-03	0.0
3	67	0.34	0.0	-3.02	0.0	6.40e-04	0.0
3	68	1.93	0.0	-1.69	0.0	2.27e-03	0.0
3	69	1.08	0.0	-2.21	0.0	1.35e-03	0.0
3	70	0.07	0.0	-2.77	0.0	3.78e-04	0.0
3	71	0.37	0.0	-2.54	0.0	6.21e-04	0.0
3	72	-0.05	0.0	-2.79	0.0	2.49e-04	0.0
3	73	0.50	0.0	-2.52	0.0	7.50e-04	0.0
3	74	0.50	0.0	-2.53	0.0	7.69e-04	0.0
3	75	1.28	0.0	-2.31	0.0	1.62e-03	0.0

3	76	3.98	0.0	-0.50	0.0	4.31e-03	0.0
3	77	1.16	0.0	-2.33	0.0	1.49e-03	0.0
3	78	4.11	0.0	-0.48	0.0	4.43e-03	0.0
3	79	4.11	0.0	-0.34	0.0	4.41e-03	0.0
4	1	-0.17	0.0	-4.30	0.0	-9.47e-04	0.0
4	2	-0.17	0.0	-4.28	0.0	-8.80e-04	0.0
4	3	-0.19	0.0	-4.15	0.0	-9.09e-04	0.0
4	4	-0.19	0.0	-4.14	0.0	-8.59e-04	0.0
4	5	2.37	0.0	-5.50	0.0	1.85e-03	0.0
4	6	2.59	0.0	-5.60	0.0	2.14e-03	0.0
4	7	2.94	0.0	-5.56	0.0	2.61e-03	0.0
4	8	1.22	0.0	-4.81	0.0	6.09e-04	0.0
4	9	1.44	0.0	-4.91	0.0	8.90e-04	0.0
4	10	1.79	0.0	-4.87	0.0	1.36e-03	0.0
4	11	-4.67e-03	0.0	-4.33	0.0	-7.79e-04	0.0
4	12	-4.15e-03	0.0	-4.31	0.0	-7.13e-04	0.0
4	13	0.02	0.0	-4.19	0.0	-6.85e-04	0.0
4	14	0.03	0.0	-4.17	0.0	-6.35e-04	0.0
4	15	2.21	0.0	-5.47	0.0	1.69e-03	0.0
4	16	2.43	0.0	-5.58	0.0	1.97e-03	0.0
4	17	2.78	0.0	-5.53	0.0	2.44e-03	0.0
4	18	1.00	0.0	-4.77	0.0	3.84e-04	0.0
4	19	1.22	0.0	-4.87	0.0	6.65e-04	0.0
4	20	1.57	0.0	-4.83	0.0	1.14e-03	0.0
4	21	1.79	0.0	-5.13	0.0	1.22e-03	0.0
4	22	0.58	0.0	-4.42	0.0	-7.81e-05	0.0
4	23	2.79	0.0	-4.38	0.0	2.66e-03	0.0
4	24	1.58	0.0	-3.69	0.0	1.34e-03	0.0
4	25	2.56	0.0	-5.95	0.0	2.11e-03	0.0
4	26	2.35	0.0	-5.71	0.0	1.84e-03	0.0
4	27	0.46	0.0	-4.47	0.0	-2.90e-04	0.0
4	28	1.25	0.0	-5.03	0.0	6.26e-04	0.0
4	29	2.78	0.0	-5.36	0.0	2.49e-03	0.0
4	30	1.26	0.0	-4.35	0.0	1.05e-03	0.0
4	31	1.26	0.0	-4.33	0.0	1.13e-03	0.0
4	32	1.26	0.0	-4.09	0.0	1.25e-03	0.0
4	33	2.58	0.0	-5.46	0.0	2.25e-03	0.0
4	34	-0.13	0.0	-3.07	0.0	-6.16e-04	0.0
4	35	0.16	0.0	-3.22	0.0	-2.66e-04	0.0
4	36	0.56	0.0	-3.38	0.0	1.34e-04	0.0



4	37	0.72	0.0	-3.46	0.0	3.42e-04	0.0
4	38	0.98	0.0	-3.43	0.0	6.93e-04	0.0
4	39	1.37e-03	0.0	-3.09	0.0	-4.76e-04	0.0
4	40	1.66e-03	0.0	-3.08	0.0	-4.39e-04	0.0
4	41	0.42	0.0	-3.36	0.0	-6.04e-06	0.0
4	42	0.59	0.0	-3.43	0.0	2.03e-04	0.0
4	43	0.85	0.0	-3.40	0.0	5.53e-04	0.0
4	44	0.66	0.0	-3.41	0.0	2.42e-04	0.0
4	45	0.85	0.0	-3.27	0.0	5.88e-04	0.0
4	46	-0.13	0.0	-3.18	0.0	-6.71e-04	0.0
4	47	-0.13	0.0	-3.16	0.0	-6.22e-04	0.0
4	48	-0.16	0.0	-3.07	0.0	-6.47e-04	0.0
4	49	-0.16	0.0	-3.05	0.0	-6.10e-04	0.0
4	50	1.44	0.0	-3.89	0.0	1.08e-03	0.0
4	51	1.60	0.0	-3.97	0.0	1.29e-03	0.0
4	52	1.86	0.0	-3.94	0.0	1.64e-03	0.0
4	53	0.58	0.0	-3.38	0.0	1.65e-04	0.0
4	54	0.74	0.0	-3.46	0.0	3.74e-04	0.0
4	55	1.00	0.0	-3.42	0.0	7.24e-04	0.0
4	56	-0.07	0.0	-3.19	0.0	-6.00e-04	0.0
4	57	-0.07	0.0	-3.17	0.0	-5.50e-04	0.0
4	58	-0.04	0.0	-3.09	0.0	-5.28e-04	0.0
4	59	-0.04	0.0	-3.07	0.0	-4.91e-04	0.0
4	60	1.30	0.0	-3.87	0.0	9.45e-04	0.0
4	61	1.46	0.0	-3.95	0.0	1.15e-03	0.0
4	62	1.72	0.0	-3.92	0.0	1.50e-03	0.0
4	63	0.40	0.0	-3.35	0.0	-2.20e-05	0.0
4	64	0.56	0.0	-3.42	0.0	1.87e-04	0.0
4	65	0.82	0.0	-3.39	0.0	5.37e-04	0.0
4	66	0.98	0.0	-3.61	0.0	6.02e-04	0.0
4	67	0.09	0.0	-3.09	0.0	-3.65e-04	0.0
4	68	1.72	0.0	-3.78	0.0	1.54e-03	0.0
4	69	0.83	0.0	-3.27	0.0	5.56e-04	0.0
4	70	-0.12	0.0	-2.73	0.0	-4.42e-04	0.0
4	71	0.43	0.0	-2.97	0.0	1.51e-04	0.0
4	72	2.13e-04	0.0	-2.75	0.0	-3.14e-04	0.0
4	73	0.30	0.0	-2.95	0.0	2.35e-05	0.0
4	74	0.30	0.0	-2.96	0.0	3.94e-06	0.0
4	75	1.08	0.0	-3.65	0.0	8.29e-04	0.0
4	76	4.03	0.0	-5.10	0.0	4.04e-03	0.0

4	77	1.21	0.0	-3.68	0.0	9.57e-04	0.0
4	78	3.91	0.0	-5.08	0.0	3.91e-03	0.0
4	79	3.91	0.0	-4.94	0.0	3.93e-03	0.0
5	1	0.04	0.0	-4.37	0.0	7.41e-04	0.0
5	2	0.04	0.0	-4.35	0.0	6.89e-04	0.0
5	3	0.07	0.0	-4.21	0.0	7.34e-04	0.0
5	4	0.07	0.0	-4.20	0.0	6.95e-04	0.0
5	5	2.14	0.0	-2.85	0.0	2.89e-03	0.0
5	6	2.35	0.0	-2.70	0.0	3.06e-03	0.0
5	7	2.68	0.0	-2.26	0.0	3.35e-03	0.0
5	8	1.00	0.0	-3.54	0.0	1.51e-03	0.0
5	9	1.21	0.0	-3.40	0.0	1.68e-03	0.0
5	10	1.55	0.0	-2.96	0.0	1.97e-03	0.0
5	11	-0.12	0.0	-4.40	0.0	5.59e-04	0.0
5	12	-0.11	0.0	-4.37	0.0	5.06e-04	0.0
5	13	-0.14	0.0	-4.25	0.0	4.90e-04	0.0
5	14	-0.14	0.0	-4.24	0.0	4.50e-04	0.0
5	15	2.29	0.0	-2.82	0.0	3.07e-03	0.0
5	16	2.50	0.0	-2.68	0.0	3.24e-03	0.0
5	17	2.83	0.0	-2.23	0.0	3.53e-03	0.0
5	18	1.21	0.0	-3.51	0.0	1.75e-03	0.0
5	19	1.42	0.0	-3.37	0.0	1.93e-03	0.0
5	20	1.75	0.0	-2.92	0.0	2.21e-03	0.0
5	21	1.89	0.0	-3.16	0.0	2.52e-03	0.0
5	22	0.81	0.0	-3.85	0.0	1.21e-03	0.0
5	23	2.85	0.0	-1.06	0.0	3.40e-03	0.0
5	24	1.77	0.0	-1.76	0.0	2.12e-03	0.0
5	25	2.39	0.0	-2.94	0.0	3.16e-03	0.0
5	26	2.20	0.0	-3.15	0.0	2.86e-03	0.0
5	27	0.64	0.0	-4.13	0.0	1.07e-03	0.0
5	28	1.38	0.0	-3.52	0.0	1.96e-03	0.0
5	29	2.84	0.0	-2.05	0.0	3.53e-03	0.0
5	30	1.10	0.0	-2.89	0.0	1.54e-03	0.0
5	31	1.11	0.0	-2.87	0.0	1.47e-03	0.0
5	32	1.12	0.0	-2.62	0.0	1.37e-03	0.0
5	33	2.65	0.0	-2.49	0.0	3.25e-03	0.0
5	34	0.04	0.0	-3.11	0.0	4.76e-04	0.0
5	35	0.33	0.0	-2.93	0.0	7.35e-04	0.0
5	36	0.45	0.0	-2.80	0.0	8.04e-04	0.0
5	37	0.61	0.0	-2.70	0.0	9.33e-04	0.0

5	38	0.85	0.0	-2.37	0.0	1.14e-03	0.0
5	39	-0.08	0.0	-3.14	0.0	3.24e-04	0.0
5	40	-0.08	0.0	-3.12	0.0	2.95e-04	0.0
5	41	0.58	0.0	-2.78	0.0	9.56e-04	0.0
5	42	0.73	0.0	-2.67	0.0	1.09e-03	0.0
5	43	0.98	0.0	-2.34	0.0	1.30e-03	0.0
5	44	0.80	0.0	-2.71	0.0	1.10e-03	0.0
5	45	0.98	0.0	-2.21	0.0	1.30e-03	0.0
5	46	0.04	0.0	-3.23	0.0	5.20e-04	0.0
5	47	0.04	0.0	-3.21	0.0	4.81e-04	0.0
5	48	0.06	0.0	-3.11	0.0	5.19e-04	0.0
5	49	0.07	0.0	-3.10	0.0	4.90e-04	0.0
5	50	1.27	0.0	-2.28	0.0	1.79e-03	0.0
5	51	1.43	0.0	-2.18	0.0	1.92e-03	0.0
5	52	1.68	0.0	-1.85	0.0	2.13e-03	0.0
5	53	0.43	0.0	-2.80	0.0	7.61e-04	0.0
5	54	0.58	0.0	-2.70	0.0	8.90e-04	0.0
5	55	0.83	0.0	-2.36	0.0	1.10e-03	0.0
5	56	-0.02	0.0	-3.24	0.0	4.42e-04	0.0
5	57	-0.02	0.0	-3.22	0.0	4.03e-04	0.0
5	58	-0.04	0.0	-3.13	0.0	3.90e-04	0.0
5	59	-0.04	0.0	-3.12	0.0	3.61e-04	0.0
5	60	1.40	0.0	-2.26	0.0	1.94e-03	0.0
5	61	1.56	0.0	-2.16	0.0	2.07e-03	0.0
5	62	1.80	0.0	-1.82	0.0	2.28e-03	0.0
5	63	0.60	0.0	-2.77	0.0	9.64e-04	0.0
5	64	0.76	0.0	-2.67	0.0	1.09e-03	0.0
5	65	1.00	0.0	-2.33	0.0	1.30e-03	0.0
5	66	1.11	0.0	-2.52	0.0	1.53e-03	0.0
5	67	0.31	0.0	-3.02	0.0	5.58e-04	0.0
5	68	1.81	0.0	-1.69	0.0	2.28e-03	0.0
5	69	1.00	0.0	-2.21	0.0	1.35e-03	0.0
5	70	0.05	0.0	-2.77	0.0	3.35e-04	0.0
5	71	0.34	0.0	-2.54	0.0	5.55e-04	0.0
5	72	-0.07	0.0	-2.79	0.0	1.96e-04	0.0
5	73	0.46	0.0	-2.52	0.0	6.94e-04	0.0
5	74	0.46	0.0	-2.53	0.0	7.37e-04	0.0
5	75	1.19	0.0	-2.31	0.0	1.61e-03	0.0
5	76	3.75	0.0	-0.50	0.0	4.35e-03	0.0
5	77	1.07	0.0	-2.33	0.0	1.47e-03	0.0

5	78	3.86	0.0	-0.48	0.0	4.49e-03	0.0
5	79	3.87	0.0	-0.34	0.0	4.50e-03	0.0
6	1	-0.04	0.0	-4.35	0.0	-6.26e-04	0.0
6	2	-0.03	0.0	-4.33	0.0	-5.99e-04	0.0
6	3	-0.03	0.0	-4.20	0.0	-5.78e-04	0.0
6	4	-0.03	0.0	-4.18	0.0	-5.57e-04	0.0
6	5	0.31	0.0	-2.83	0.0	2.09e-03	0.0
6	6	0.35	0.0	-2.69	0.0	2.36e-03	0.0
6	7	0.40	0.0	-2.25	0.0	2.84e-03	0.0
6	8	0.18	0.0	-3.53	0.0	7.63e-04	0.0
6	9	0.22	0.0	-3.39	0.0	1.04e-03	0.0
6	10	0.27	0.0	-2.95	0.0	1.52e-03	0.0
6	11	-0.05	0.0	-4.38	0.0	-7.95e-04	0.0
6	12	-0.04	0.0	-4.36	0.0	-7.68e-04	0.0
6	13	-0.05	0.0	-4.24	0.0	-8.05e-04	0.0
6	14	-0.04	0.0	-4.22	0.0	-7.84e-04	0.0
6	15	0.32	0.0	-2.81	0.0	2.26e-03	0.0
6	16	0.36	0.0	-2.66	0.0	2.53e-03	0.0
6	17	0.41	0.0	-2.22	0.0	3.01e-03	0.0
6	18	0.19	0.0	-3.49	0.0	9.90e-04	0.0
6	19	0.23	0.0	-3.35	0.0	1.26e-03	0.0
6	20	0.28	0.0	-2.91	0.0	1.74e-03	0.0
6	21	0.29	0.0	-3.15	0.0	1.73e-03	0.0
6	22	0.16	0.0	-3.83	0.0	4.58e-04	0.0
6	23	0.42	0.0	-1.06	0.0	3.15e-03	0.0
6	24	0.29	0.0	-1.76	0.0	1.81e-03	0.0
6	25	0.34	0.0	-2.93	0.0	2.44e-03	0.0
6	26	0.34	0.0	-3.13	0.0	2.15e-03	0.0
6	27	0.14	0.0	-4.11	0.0	1.61e-04	0.0
6	28	0.22	0.0	-3.51	0.0	1.15e-03	0.0
6	29	0.41	0.0	-2.04	0.0	2.97e-03	0.0
6	30	0.13	0.0	-2.88	0.0	1.18e-03	0.0
6	31	0.14	0.0	-2.86	0.0	1.23e-03	0.0
6	32	0.14	0.0	-2.61	0.0	1.33e-03	0.0
6	33	0.40	0.0	-2.48	0.0	2.76e-03	0.0
6	34	-0.02	0.0	-3.10	0.0	-3.67e-04	0.0
6	35	0.03	0.0	-2.92	0.0	-8.88e-06	0.0
6	36	0.07	0.0	-2.79	0.0	2.31e-04	0.0
6	37	0.10	0.0	-2.69	0.0	4.35e-04	0.0
6	38	0.14	0.0	-2.36	0.0	7.90e-04	0.0



6	39	-0.03	0.0	-3.13	0.0	-5.08e-04	0.0
6	40	-0.03	0.0	-3.11	0.0	-4.93e-04	0.0
6	41	0.08	0.0	-2.77	0.0	3.72e-04	0.0
6	42	0.11	0.0	-2.66	0.0	5.76e-04	0.0
6	43	0.15	0.0	-2.33	0.0	9.31e-04	0.0
6	44	0.14	0.0	-2.70	0.0	6.18e-04	0.0
6	45	0.14	0.0	-2.20	0.0	8.92e-04	0.0
6	46	-0.02	0.0	-3.21	0.0	-4.07e-04	0.0
6	47	-0.02	0.0	-3.20	0.0	-3.87e-04	0.0
6	48	-0.02	0.0	-3.10	0.0	-3.72e-04	0.0
6	49	-0.02	0.0	-3.09	0.0	-3.57e-04	0.0
6	50	0.17	0.0	-2.28	0.0	1.22e-03	0.0
6	51	0.20	0.0	-2.17	0.0	1.42e-03	0.0
6	52	0.24	0.0	-1.84	0.0	1.78e-03	0.0
6	53	0.07	0.0	-2.79	0.0	2.35e-04	0.0
6	54	0.10	0.0	-2.69	0.0	4.39e-04	0.0
6	55	0.14	0.0	-2.36	0.0	7.95e-04	0.0
6	56	-0.03	0.0	-3.23	0.0	-4.79e-04	0.0
6	57	-0.02	0.0	-3.21	0.0	-4.59e-04	0.0
6	58	-0.03	0.0	-3.12	0.0	-4.92e-04	0.0
6	59	-0.03	0.0	-3.11	0.0	-4.77e-04	0.0
6	60	0.18	0.0	-2.25	0.0	1.36e-03	0.0
6	61	0.21	0.0	-2.15	0.0	1.56e-03	0.0
6	62	0.25	0.0	-1.82	0.0	1.92e-03	0.0
6	63	0.09	0.0	-2.76	0.0	4.25e-04	0.0
6	64	0.11	0.0	-2.66	0.0	6.28e-04	0.0
6	65	0.15	0.0	-2.33	0.0	9.84e-04	0.0
6	66	0.16	0.0	-2.51	0.0	9.63e-04	0.0
6	67	0.06	0.0	-3.01	0.0	2.94e-05	0.0
6	68	0.24	0.0	-1.68	0.0	1.88e-03	0.0
6	69	0.14	0.0	-2.20	0.0	8.87e-04	0.0
6	70	-0.01	0.0	-2.76	0.0	-2.47e-04	0.0
6	71	0.06	0.0	-2.53	0.0	1.94e-04	0.0
6	72	-0.02	0.0	-2.78	0.0	-3.76e-04	0.0
6	73	0.07	0.0	-2.51	0.0	3.24e-04	0.0
6	74	0.07	0.0	-2.52	0.0	2.52e-04	0.0
6	75	0.16	0.0	-2.30	0.0	1.12e-03	0.0
6	76	0.55	0.0	-0.49	0.0	4.34e-03	0.0
6	77	0.15	0.0	-2.32	0.0	9.95e-04	0.0
6	78	0.55	0.0	-0.47	0.0	4.47e-03	0.0

6	79	0.55	0.0	-0.33	0.0	4.44e-03	0.0
7	1	0.03	0.0	-4.29	0.0	5.16e-04	0.0
7	2	0.03	0.0	-4.27	0.0	4.90e-04	0.0
7	3	0.03	0.0	-4.14	0.0	4.73e-04	0.0
7	4	0.02	0.0	-4.12	0.0	4.53e-04	0.0
7	5	0.37	0.0	-5.48	0.0	3.09e-03	0.0
7	6	0.40	0.0	-5.59	0.0	3.30e-03	0.0
7	7	0.44	0.0	-5.55	0.0	3.61e-03	0.0
7	8	0.23	0.0	-4.79	0.0	1.75e-03	0.0
7	9	0.26	0.0	-4.89	0.0	1.96e-03	0.0
7	10	0.30	0.0	-4.85	0.0	2.27e-03	0.0
7	11	0.04	0.0	-4.31	0.0	6.84e-04	0.0
7	12	0.04	0.0	-4.29	0.0	6.58e-04	0.0
7	13	0.04	0.0	-4.17	0.0	6.98e-04	0.0
7	14	0.04	0.0	-4.16	0.0	6.78e-04	0.0
7	15	0.36	0.0	-5.46	0.0	2.92e-03	0.0
7	16	0.39	0.0	-5.56	0.0	3.13e-03	0.0
7	17	0.43	0.0	-5.52	0.0	3.44e-03	0.0
7	18	0.22	0.0	-4.75	0.0	1.53e-03	0.0
7	19	0.25	0.0	-4.86	0.0	1.74e-03	0.0
7	20	0.29	0.0	-4.82	0.0	2.05e-03	0.0
7	21	0.32	0.0	-5.11	0.0	2.36e-03	0.0
7	22	0.19	0.0	-4.41	0.0	9.64e-04	0.0
7	23	0.42	0.0	-4.37	0.0	3.34e-03	0.0
7	24	0.28	0.0	-3.68	0.0	2.01e-03	0.0
7	25	0.38	0.0	-5.93	0.0	3.35e-03	0.0
7	26	0.38	0.0	-5.70	0.0	3.03e-03	0.0
7	27	0.18	0.0	-4.46	0.0	8.86e-04	0.0
7	28	0.26	0.0	-5.01	0.0	1.84e-03	0.0
7	29	0.43	0.0	-5.34	0.0	3.49e-03	0.0
7	30	0.14	0.0	-4.34	0.0	1.57e-03	0.0
7	31	0.14	0.0	-4.32	0.0	1.53e-03	0.0
7	32	0.13	0.0	-4.08	0.0	1.44e-03	0.0
7	33	0.41	0.0	-5.45	0.0	3.20e-03	0.0
7	34	0.01	0.0	-3.06	0.0	2.90e-04	0.0
7	35	0.06	0.0	-3.21	0.0	5.86e-04	0.0
7	36	0.11	0.0	-3.37	0.0	9.23e-04	0.0
7	37	0.13	0.0	-3.44	0.0	1.08e-03	0.0
7	38	0.16	0.0	-3.42	0.0	1.31e-03	0.0
7	39	0.02	0.0	-3.08	0.0	4.30e-04	0.0



7	40	0.02	0.0	-3.07	0.0	4.15e-04	0.0
7	41	0.10	0.0	-3.34	0.0	7.83e-04	0.0
7	42	0.12	0.0	-3.42	0.0	9.39e-04	0.0
7	43	0.15	0.0	-3.39	0.0	1.17e-03	0.0
7	44	0.15	0.0	-3.40	0.0	9.56e-04	0.0
7	45	0.15	0.0	-3.26	0.0	1.21e-03	0.0
7	46	0.02	0.0	-3.17	0.0	3.26e-04	0.0
7	47	0.02	0.0	-3.15	0.0	3.06e-04	0.0
7	48	0.01	0.0	-3.06	0.0	2.95e-04	0.0
7	49	0.01	0.0	-3.04	0.0	2.80e-04	0.0
7	50	0.21	0.0	-3.88	0.0	1.91e-03	0.0
7	51	0.23	0.0	-3.96	0.0	2.06e-03	0.0
7	52	0.26	0.0	-3.93	0.0	2.29e-03	0.0
7	53	0.11	0.0	-3.37	0.0	9.18e-04	0.0
7	54	0.13	0.0	-3.44	0.0	1.07e-03	0.0
7	55	0.16	0.0	-3.41	0.0	1.30e-03	0.0
7	56	0.02	0.0	-3.18	0.0	3.97e-04	0.0
7	57	0.02	0.0	-3.16	0.0	3.78e-04	0.0
7	58	0.02	0.0	-3.08	0.0	4.14e-04	0.0
7	59	0.02	0.0	-3.06	0.0	3.99e-04	0.0
7	60	0.20	0.0	-3.86	0.0	1.77e-03	0.0
7	61	0.22	0.0	-3.93	0.0	1.92e-03	0.0
7	62	0.25	0.0	-3.90	0.0	2.15e-03	0.0
7	63	0.10	0.0	-3.34	0.0	7.30e-04	0.0
7	64	0.12	0.0	-3.41	0.0	8.86e-04	0.0
7	65	0.15	0.0	-3.38	0.0	1.12e-03	0.0
7	66	0.17	0.0	-3.60	0.0	1.35e-03	0.0
7	67	0.07	0.0	-3.08	0.0	3.11e-04	0.0
7	68	0.25	0.0	-3.77	0.0	2.20e-03	0.0
7	69	0.15	0.0	-3.26	0.0	1.22e-03	0.0
7	70	7.12e-03	0.0	-2.72	0.0	1.81e-04	0.0
7	71	0.08	0.0	-2.96	0.0	6.76e-04	0.0
7	72	0.01	0.0	-2.74	0.0	3.09e-04	0.0
7	73	0.07	0.0	-2.94	0.0	5.48e-04	0.0
7	74	0.08	0.0	-2.95	0.0	6.19e-04	0.0
7	75	0.17	0.0	-3.64	0.0	1.51e-03	0.0
7	76	0.55	0.0	-5.09	0.0	4.61e-03	0.0
7	77	0.18	0.0	-3.66	0.0	1.64e-03	0.0
7	78	0.54	0.0	-5.07	0.0	4.48e-03	0.0
7	79	0.54	0.0	-4.93	0.0	4.51e-03	0.0

8	1	-0.12	0.0	-4.30	0.0	-8.48e-04	0.0
8	2	-0.12	0.0	-4.28	0.0	-7.95e-04	0.0
8	3	-0.14	0.0	-4.15	0.0	-8.36e-04	0.0
8	4	-0.15	0.0	-4.13	0.0	-7.96e-04	0.0
8	5	2.26	0.0	-5.50	0.0	2.07e-03	0.0
8	6	2.47	0.0	-5.60	0.0	2.35e-03	0.0
8	7	2.79	0.0	-5.56	0.0	2.82e-03	0.0
8	8	1.18	0.0	-4.80	0.0	7.93e-04	0.0
8	9	1.38	0.0	-4.91	0.0	1.07e-03	0.0
8	10	1.70	0.0	-4.87	0.0	1.54e-03	0.0
8	11	0.03	0.0	-4.33	0.0	-6.67e-04	0.0
8	12	0.03	0.0	-4.31	0.0	-6.14e-04	0.0
8	13	0.06	0.0	-4.19	0.0	-5.93e-04	0.0
8	14	0.06	0.0	-4.17	0.0	-5.53e-04	0.0
8	15	2.11	0.0	-5.47	0.0	1.89e-03	0.0
8	16	2.32	0.0	-5.57	0.0	2.16e-03	0.0
8	17	2.64	0.0	-5.53	0.0	2.63e-03	0.0
8	18	0.98	0.0	-4.77	0.0	5.50e-04	0.0
8	19	1.18	0.0	-4.87	0.0	8.28e-04	0.0
8	20	1.50	0.0	-4.83	0.0	1.30e-03	0.0
8	21	1.71	0.0	-5.13	0.0	1.41e-03	0.0
8	22	0.57	0.0	-4.42	0.0	7.51e-05	0.0
8	23	2.64	0.0	-4.38	0.0	2.80e-03	0.0
8	24	1.50	0.0	-3.69	0.0	1.42e-03	0.0
8	25	2.43	0.0	-5.95	0.0	2.30e-03	0.0
8	26	2.24	0.0	-5.71	0.0	2.03e-03	0.0
8	27	0.47	0.0	-4.47	0.0	-1.39e-04	0.0
8	28	1.21	0.0	-5.03	0.0	7.87e-04	0.0
8	29	2.64	0.0	-5.35	0.0	2.64e-03	0.0
8	30	1.20	0.0	-4.35	0.0	1.22e-03	0.0
8	31	1.19	0.0	-4.33	0.0	1.29e-03	0.0
8	32	1.19	0.0	-4.09	0.0	1.40e-03	0.0
8	33	2.45	0.0	-5.46	0.0	2.40e-03	0.0
8	34	-0.10	0.0	-3.07	0.0	-5.51e-04	0.0
8	35	0.17	0.0	-3.22	0.0	-2.00e-04	0.0
8	36	0.55	0.0	-3.38	0.0	2.55e-04	0.0
8	37	0.70	0.0	-3.46	0.0	4.61e-04	0.0
8	38	0.94	0.0	-3.42	0.0	8.10e-04	0.0
8	39	0.02	0.0	-3.09	0.0	-4.00e-04	0.0
8	40	0.02	0.0	-3.08	0.0	-3.71e-04	0.0

8	41	0.42	0.0	-3.36	0.0	1.04e-04	0.0
8	42	0.57	0.0	-3.43	0.0	3.10e-04	0.0
8	43	0.81	0.0	-3.40	0.0	6.59e-04	0.0
8	44	0.64	0.0	-3.41	0.0	3.60e-04	0.0
8	45	0.81	0.0	-3.27	0.0	6.57e-04	0.0
8	46	-0.10	0.0	-3.18	0.0	-5.98e-04	0.0
8	47	-0.10	0.0	-3.16	0.0	-5.59e-04	0.0
8	48	-0.12	0.0	-3.07	0.0	-5.94e-04	0.0
8	49	-0.12	0.0	-3.05	0.0	-5.65e-04	0.0
8	50	1.37	0.0	-3.89	0.0	1.24e-03	0.0
8	51	1.52	0.0	-3.97	0.0	1.44e-03	0.0
8	52	1.76	0.0	-3.94	0.0	1.79e-03	0.0
8	53	0.57	0.0	-3.38	0.0	2.98e-04	0.0
8	54	0.72	0.0	-3.45	0.0	5.04e-04	0.0
8	55	0.96	0.0	-3.42	0.0	8.53e-04	0.0
8	56	-0.04	0.0	-3.19	0.0	-5.21e-04	0.0
8	57	-0.04	0.0	-3.17	0.0	-4.82e-04	0.0
8	58	-0.01	0.0	-3.09	0.0	-4.66e-04	0.0
8	59	-0.02	0.0	-3.07	0.0	-4.36e-04	0.0
8	60	1.24	0.0	-3.87	0.0	1.09e-03	0.0
8	61	1.40	0.0	-3.95	0.0	1.29e-03	0.0
8	62	1.63	0.0	-3.92	0.0	1.64e-03	0.0
8	63	0.40	0.0	-3.35	0.0	9.54e-05	0.0
8	64	0.55	0.0	-3.42	0.0	3.02e-04	0.0
8	65	0.79	0.0	-3.39	0.0	6.51e-04	0.0
8	66	0.95	0.0	-3.61	0.0	7.34e-04	0.0
8	67	0.10	0.0	-3.09	0.0	-2.57e-04	0.0
8	68	1.64	0.0	-3.78	0.0	1.64e-03	0.0
8	69	0.79	0.0	-3.27	0.0	6.14e-04	0.0
8	70	-0.10	0.0	-2.73	0.0	-4.00e-04	0.0
8	71	0.41	0.0	-2.97	0.0	2.40e-04	0.0
8	72	0.02	0.0	-2.75	0.0	-2.62e-04	0.0
8	73	0.30	0.0	-2.95	0.0	1.02e-04	0.0
8	74	0.30	0.0	-2.96	0.0	5.84e-05	0.0
8	75	1.03	0.0	-3.65	0.0	9.22e-04	0.0
8	76	3.80	0.0	-5.10	0.0	4.25e-03	0.0
8	77	1.15	0.0	-3.67	0.0	1.06e-03	0.0
8	78	3.69	0.0	-5.08	0.0	4.11e-03	0.0
8	79	3.69	0.0	-4.94	0.0	4.11e-03	0.0
9	1	-0.17	0.0	-4.36	0.0	-1.03e-03	0.0

9	2	-0.17	0.0	-4.33	0.0	-9.48e-04	0.0
9	3	-0.19	0.0	-4.21	0.0	-9.66e-04	0.0
9	4	-0.19	0.0	-4.19	0.0	-9.06e-04	0.0
9	5	2.37	0.0	-5.40	0.0	1.65e-03	0.0
9	6	2.59	0.0	-5.49	0.0	1.94e-03	0.0
9	7	2.94	0.0	-5.43	0.0	2.41e-03	0.0
9	8	1.22	0.0	-4.78	0.0	4.37e-04	0.0
9	9	1.44	0.0	-4.87	0.0	7.21e-04	0.0
9	10	1.79	0.0	-4.80	0.0	1.19e-03	0.0
9	11	-4.49e-03	0.0	-4.38	0.0	-8.75e-04	0.0
9	12	-3.99e-03	0.0	-4.35	0.0	-7.95e-04	0.0
9	13	0.03	0.0	-4.23	0.0	-7.61e-04	0.0
9	14	0.03	0.0	-4.21	0.0	-7.02e-04	0.0
9	15	2.21	0.0	-5.39	0.0	1.50e-03	0.0
9	16	2.43	0.0	-5.48	0.0	1.78e-03	0.0
9	17	2.78	0.0	-5.41	0.0	2.25e-03	0.0
9	18	1.00	0.0	-4.75	0.0	2.32e-04	0.0
9	19	1.22	0.0	-4.84	0.0	5.16e-04	0.0
9	20	1.57	0.0	-4.78	0.0	9.87e-04	0.0
9	21	1.79	0.0	-5.07	0.0	1.05e-03	0.0
9	22	0.58	0.0	-4.44	0.0	-2.19e-04	0.0
9	23	2.79	0.0	-4.24	0.0	2.54e-03	0.0
9	24	1.58	0.0	-3.62	0.0	1.28e-03	0.0
9	25	2.56	0.0	-5.84	0.0	1.94e-03	0.0
9	26	2.35	0.0	-5.62	0.0	1.66e-03	0.0
9	27	0.46	0.0	-4.49	0.0	-4.28e-04	0.0
9	28	1.25	0.0	-5.00	0.0	4.80e-04	0.0
9	29	2.78	0.0	-5.22	0.0	2.35e-03	0.0
9	30	1.26	0.0	-4.30	0.0	8.88e-04	0.0
9	31	1.26	0.0	-4.28	0.0	9.69e-04	0.0
9	32	1.26	0.0	-4.03	0.0	1.10e-03	0.0
9	33	2.58	0.0	-5.35	0.0	2.10e-03	0.0
9	34	-0.13	0.0	-3.10	0.0	-6.69e-04	0.0
9	35	0.16	0.0	-3.23	0.0	-3.22e-04	0.0
9	36	0.56	0.0	-3.38	0.0	2.10e-05	0.0
9	37	0.72	0.0	-3.44	0.0	2.32e-04	0.0
9	38	0.98	0.0	-3.39	0.0	5.81e-04	0.0
9	39	1.55e-03	0.0	-3.12	0.0	-5.42e-04	0.0
9	40	1.83e-03	0.0	-3.10	0.0	-4.98e-04	0.0
9	41	0.42	0.0	-3.36	0.0	-1.06e-04	0.0

9	42	0.59	0.0	-3.43	0.0	1.05e-04	0.0
9	43	0.85	0.0	-3.38	0.0	4.54e-04	0.0
9	44	0.66	0.0	-3.40	0.0	1.32e-04	0.0
9	45	0.85	0.0	-3.24	0.0	5.24e-04	0.0
9	46	-0.13	0.0	-3.22	0.0	-7.32e-04	0.0
9	47	-0.13	0.0	-3.20	0.0	-6.73e-04	0.0
9	48	-0.16	0.0	-3.11	0.0	-6.89e-04	0.0
9	49	-0.16	0.0	-3.09	0.0	-6.45e-04	0.0
9	50	1.44	0.0	-3.84	0.0	9.39e-04	0.0
9	51	1.60	0.0	-3.90	0.0	1.15e-03	0.0
9	52	1.86	0.0	-3.85	0.0	1.50e-03	0.0
9	53	0.58	0.0	-3.37	0.0	4.07e-05	0.0
9	54	0.74	0.0	-3.44	0.0	2.52e-04	0.0
9	55	1.00	0.0	-3.39	0.0	6.01e-04	0.0
9	56	-0.07	0.0	-3.23	0.0	-6.67e-04	0.0
9	57	-0.07	0.0	-3.21	0.0	-6.08e-04	0.0
9	58	-0.04	0.0	-3.12	0.0	-5.81e-04	0.0
9	59	-0.04	0.0	-3.10	0.0	-5.36e-04	0.0
9	60	1.30	0.0	-3.82	0.0	8.12e-04	0.0
9	61	1.46	0.0	-3.89	0.0	1.02e-03	0.0
9	62	1.72	0.0	-3.84	0.0	1.37e-03	0.0
9	63	0.40	0.0	-3.35	0.0	-1.30e-04	0.0
9	64	0.56	0.0	-3.42	0.0	8.09e-05	0.0
9	65	0.82	0.0	-3.37	0.0	4.30e-04	0.0
9	66	0.98	0.0	-3.59	0.0	4.77e-04	0.0
9	67	0.09	0.0	-3.12	0.0	-4.65e-04	0.0
9	68	1.72	0.0	-3.70	0.0	1.44e-03	0.0
9	69	0.83	0.0	-3.24	0.0	5.05e-04	0.0
9	70	-0.12	0.0	-2.76	0.0	-4.76e-04	0.0
9	71	0.43	0.0	-2.97	0.0	6.77e-05	0.0
9	72	3.82e-04	0.0	-2.77	0.0	-3.60e-04	0.0
9	73	0.30	0.0	-2.95	0.0	-4.88e-05	0.0
9	74	0.30	0.0	-2.96	0.0	-4.39e-05	0.0
9	75	1.08	0.0	-3.61	0.0	7.43e-04	0.0
9	76	4.03	0.0	-4.88	0.0	3.82e-03	0.0
9	77	1.21	0.0	-3.63	0.0	8.59e-04	0.0
9	78	3.91	0.0	-4.87	0.0	3.71e-03	0.0
9	79	3.91	0.0	-4.73	0.0	3.76e-03	0.0
10	1	0.08	0.0	-4.42	0.0	9.21e-04	0.0
10	2	0.08	0.0	-4.39	0.0	8.43e-04	0.0

10	3	0.11	0.0	-4.26	0.0	8.65e-04	0.0
10	4	0.11	0.0	-4.24	0.0	8.06e-04	0.0
10	5	2.30	0.0	-3.01	0.0	3.01e-03	0.0
10	6	2.52	0.0	-2.88	0.0	3.15e-03	0.0
10	7	2.87	0.0	-2.45	0.0	3.39e-03	0.0
10	8	1.09	0.0	-3.64	0.0	1.74e-03	0.0
10	9	1.31	0.0	-3.51	0.0	1.89e-03	0.0
10	10	1.66	0.0	-3.07	0.0	2.13e-03	0.0
10	11	-0.08	0.0	-4.44	0.0	7.67e-04	0.0
10	12	-0.08	0.0	-4.41	0.0	6.89e-04	0.0
10	13	-0.11	0.0	-4.29	0.0	6.58e-04	0.0
10	14	-0.11	0.0	-4.27	0.0	5.99e-04	0.0
10	15	2.46	0.0	-2.99	0.0	3.16e-03	0.0
10	16	2.68	0.0	-2.86	0.0	3.30e-03	0.0
10	17	3.03	0.0	-2.43	0.0	3.54e-03	0.0
10	18	1.30	0.0	-3.62	0.0	1.95e-03	0.0
10	19	1.52	0.0	-3.48	0.0	2.09e-03	0.0
10	20	1.87	0.0	-3.05	0.0	2.33e-03	0.0
10	21	2.03	0.0	-3.31	0.0	2.60e-03	0.0
10	22	0.88	0.0	-3.93	0.0	1.39e-03	0.0
10	23	3.04	0.0	-1.25	0.0	3.29e-03	0.0
10	24	1.88	0.0	-1.88	0.0	2.07e-03	0.0
10	25	2.56	0.0	-3.12	0.0	3.22e-03	0.0
10	26	2.35	0.0	-3.31	0.0	2.91e-03	0.0
10	27	0.70	0.0	-4.20	0.0	1.25e-03	0.0
10	28	1.49	0.0	-3.64	0.0	2.13e-03	0.0
10	29	3.03	0.0	-2.24	0.0	3.46e-03	0.0
10	30	1.19	0.0	-2.98	0.0	1.70e-03	0.0
10	31	1.19	0.0	-2.96	0.0	1.62e-03	0.0
10	32	1.19	0.0	-2.71	0.0	1.50e-03	0.0
10	33	2.83	0.0	-2.67	0.0	3.18e-03	0.0
10	34	0.07	0.0	-3.15	0.0	5.95e-04	0.0
10	35	0.37	0.0	-2.98	0.0	8.25e-04	0.0
10	36	0.50	0.0	-2.86	0.0	9.79e-04	0.0
10	37	0.66	0.0	-2.76	0.0	1.09e-03	0.0
10	38	0.92	0.0	-2.44	0.0	1.26e-03	0.0
10	39	-0.06	0.0	-3.16	0.0	4.66e-04	0.0
10	40	-0.06	0.0	-3.15	0.0	4.22e-04	0.0
10	41	0.63	0.0	-2.84	0.0	1.11e-03	0.0
10	42	0.79	0.0	-2.74	0.0	1.21e-03	0.0

10	43	1.05	0.0	-2.42	0.0	1.39e-03	0.0
10	44	0.87	0.0	-2.78	0.0	1.21e-03	0.0
10	45	1.05	0.0	-2.28	0.0	1.33e-03	0.0
10	46	0.07	0.0	-3.26	0.0	6.54e-04	0.0
10	47	0.07	0.0	-3.24	0.0	5.95e-04	0.0
10	48	0.09	0.0	-3.15	0.0	6.14e-04	0.0
10	49	0.09	0.0	-3.13	0.0	5.71e-04	0.0
10	50	1.37	0.0	-2.39	0.0	1.90e-03	0.0
10	51	1.53	0.0	-2.29	0.0	2.00e-03	0.0
10	52	1.79	0.0	-1.97	0.0	2.18e-03	0.0
10	53	0.47	0.0	-2.85	0.0	9.60e-04	0.0
10	54	0.64	0.0	-2.75	0.0	1.07e-03	0.0
10	55	0.89	0.0	-2.43	0.0	1.24e-03	0.0
10	56	1.13e-03	0.0	-3.27	0.0	5.88e-04	0.0
10	57	1.21e-03	0.0	-3.25	0.0	5.30e-04	0.0
10	58	-0.02	0.0	-3.16	0.0	5.05e-04	0.0
10	59	-0.02	0.0	-3.15	0.0	4.61e-04	0.0
10	60	1.51	0.0	-2.37	0.0	2.03e-03	0.0
10	61	1.67	0.0	-2.27	0.0	2.13e-03	0.0
10	62	1.93	0.0	-1.95	0.0	2.31e-03	0.0
10	63	0.65	0.0	-2.83	0.0	1.13e-03	0.0
10	64	0.82	0.0	-2.73	0.0	1.24e-03	0.0
10	65	1.08	0.0	-2.41	0.0	1.42e-03	0.0
10	66	1.19	0.0	-2.60	0.0	1.61e-03	0.0
10	67	0.34	0.0	-3.06	0.0	7.13e-04	0.0
10	68	1.93	0.0	-1.82	0.0	2.24e-03	0.0
10	69	1.08	0.0	-2.28	0.0	1.35e-03	0.0
10	70	0.07	0.0	-2.79	0.0	4.12e-04	0.0
10	71	0.37	0.0	-2.58	0.0	6.84e-04	0.0
10	72	-0.05	0.0	-2.81	0.0	2.95e-04	0.0
10	73	0.50	0.0	-2.56	0.0	8.01e-04	0.0
10	74	0.50	0.0	-2.57	0.0	7.96e-04	0.0
10	75	1.28	0.0	-2.40	0.0	1.63e-03	0.0
10	76	3.98	0.0	-0.74	0.0	4.26e-03	0.0
10	77	1.16	0.0	-2.41	0.0	1.51e-03	0.0
10	78	4.11	0.0	-0.72	0.0	4.38e-03	0.0
10	79	4.11	0.0	-0.58	0.0	4.33e-03	0.0
11	1	5.11e-03	0.0	-4.30	0.0	-9.17e-04	0.0
11	2	5.31e-03	0.0	-4.28	0.0	-8.92e-04	0.0
11	3	5.35e-03	0.0	-4.15	0.0	-8.56e-04	0.0

11	4	5.50e-03	0.0	-4.14	0.0	-8.37e-04	0.0
11	5	0.19	0.0	-2.93	0.0	1.63e-03	0.0
11	6	0.21	0.0	-2.80	0.0	1.88e-03	0.0
11	7	0.23	0.0	-2.38	0.0	2.35e-03	0.0
11	8	0.14	0.0	-3.56	0.0	3.83e-04	0.0
11	9	0.16	0.0	-3.43	0.0	6.37e-04	0.0
11	10	0.18	0.0	-3.01	0.0	1.11e-03	0.0
11	11	4.70e-03	0.0	-4.32	0.0	-1.06e-03	0.0
11	12	4.90e-03	0.0	-4.30	0.0	-1.03e-03	0.0
11	13	4.81e-03	0.0	-4.18	0.0	-1.04e-03	0.0
11	14	4.96e-03	0.0	-4.17	0.0	-1.02e-03	0.0
11	15	0.19	0.0	-2.91	0.0	1.77e-03	0.0
11	16	0.21	0.0	-2.78	0.0	2.02e-03	0.0
11	17	0.23	0.0	-2.36	0.0	2.49e-03	0.0
11	18	0.14	0.0	-3.53	0.0	5.68e-04	0.0
11	19	0.16	0.0	-3.40	0.0	8.22e-04	0.0
11	20	0.18	0.0	-2.98	0.0	1.29e-03	0.0
11	21	0.19	0.0	-3.22	0.0	1.22e-03	0.0
11	22	0.14	0.0	-3.84	0.0	2.82e-05	0.0
11	23	0.23	0.0	-1.21	0.0	2.71e-03	0.0
11	24	0.18	0.0	-1.84	0.0	1.46e-03	0.0
11	25	0.19	0.0	-3.04	0.0	2.00e-03	0.0
11	26	0.21	0.0	-3.23	0.0	1.69e-03	0.0
11	27	0.14	0.0	-4.10	0.0	-2.70e-04	0.0
11	28	0.16	0.0	-3.55	0.0	7.12e-04	0.0
11	29	0.23	0.0	-2.18	0.0	2.48e-03	0.0
11	30	0.06	0.0	-2.93	0.0	8.90e-04	0.0
11	31	0.06	0.0	-2.91	0.0	9.29e-04	0.0
11	32	0.06	0.0	-2.67	0.0	1.04e-03	0.0
11	33	0.23	0.0	-2.61	0.0	2.29e-03	0.0
11	34	4.99e-03	0.0	-3.07	0.0	-5.83e-04	0.0
11	35	0.03	0.0	-2.91	0.0	-2.52e-04	0.0
11	36	0.06	0.0	-2.79	0.0	-2.66e-05	0.0
11	37	0.08	0.0	-2.70	0.0	1.62e-04	0.0
11	38	0.09	0.0	-2.39	0.0	5.10e-04	0.0
11	39	4.65e-03	0.0	-3.09	0.0	-6.98e-04	0.0
11	40	4.76e-03	0.0	-3.08	0.0	-6.84e-04	0.0
11	41	0.06	0.0	-2.78	0.0	8.85e-05	0.0
11	42	0.08	0.0	-2.68	0.0	2.77e-04	0.0
11	43	0.09	0.0	-2.37	0.0	6.25e-04	0.0

11	44	0.10	0.0	-2.72	0.0	2.81e-04	0.0
11	45	0.09	0.0	-2.24	0.0	6.14e-04	0.0
11	46	4.94e-03	0.0	-3.18	0.0	-6.31e-04	0.0
11	47	5.08e-03	0.0	-3.17	0.0	-6.12e-04	0.0
11	48	5.14e-03	0.0	-3.07	0.0	-5.86e-04	0.0
11	49	5.25e-03	0.0	-3.06	0.0	-5.72e-04	0.0
11	50	0.10	0.0	-2.33	0.0	8.98e-04	0.0
11	51	0.12	0.0	-2.23	0.0	1.09e-03	0.0
11	52	0.13	0.0	-1.92	0.0	1.43e-03	0.0
11	53	0.06	0.0	-2.79	0.0	-2.32e-05	0.0
11	54	0.08	0.0	-2.70	0.0	1.65e-04	0.0
11	55	0.09	0.0	-2.39	0.0	5.13e-04	0.0
11	56	4.76e-03	0.0	-3.19	0.0	-6.90e-04	0.0
11	57	4.91e-03	0.0	-3.17	0.0	-6.71e-04	0.0
11	58	4.85e-03	0.0	-3.09	0.0	-6.84e-04	0.0
11	59	4.96e-03	0.0	-3.07	0.0	-6.70e-04	0.0
11	60	0.10	0.0	-2.31	0.0	1.01e-03	0.0
11	61	0.12	0.0	-2.22	0.0	1.20e-03	0.0
11	62	0.13	0.0	-1.91	0.0	1.55e-03	0.0
11	63	0.06	0.0	-2.77	0.0	1.31e-04	0.0
11	64	0.08	0.0	-2.68	0.0	3.20e-04	0.0
11	65	0.09	0.0	-2.36	0.0	6.68e-04	0.0
11	66	0.10	0.0	-2.54	0.0	6.12e-04	0.0
11	67	0.06	0.0	-3.00	0.0	-2.70e-04	0.0
11	68	0.13	0.0	-1.77	0.0	1.54e-03	0.0
11	69	0.09	0.0	-2.24	0.0	6.11e-04	0.0
11	70	5.11e-03	0.0	-2.74	0.0	-4.38e-04	0.0
11	71	0.05	0.0	-2.53	0.0	-2.63e-05	0.0
11	72	4.79e-03	0.0	-2.75	0.0	-5.43e-04	0.0
11	73	0.05	0.0	-2.52	0.0	7.90e-05	0.0
11	74	0.05	0.0	-2.52	0.0	2.13e-05	0.0
11	75	0.09	0.0	-2.35	0.0	8.07e-04	0.0
11	76	0.29	0.0	-0.71	0.0	3.82e-03	0.0
11	77	0.09	0.0	-2.36	0.0	7.01e-04	0.0
11	78	0.29	0.0	-0.69	0.0	3.93e-03	0.0
11	79	0.29	0.0	-0.56	0.0	3.93e-03	0.0
12	1	-5.07e-03	0.0	-4.24	0.0	8.08e-04	0.0
12	2	-5.27e-03	0.0	-4.22	0.0	7.83e-04	0.0
12	3	-5.32e-03	0.0	-4.10	0.0	7.52e-04	0.0
12	4	-5.47e-03	0.0	-4.08	0.0	7.33e-04	0.0

12	5	0.18	0.0	-5.31	0.0	3.19e-03	0.0
12	6	0.20	0.0	-5.40	0.0	3.39e-03	0.0
12	7	0.22	0.0	-5.34	0.0	3.65e-03	0.0
12	8	0.13	0.0	-4.68	0.0	1.94e-03	0.0
12	9	0.14	0.0	-4.78	0.0	2.14e-03	0.0
12	10	0.16	0.0	-4.72	0.0	2.40e-03	0.0
12	11	-4.67e-03	0.0	-4.26	0.0	9.45e-04	0.0
12	12	-4.87e-03	0.0	-4.24	0.0	9.20e-04	0.0
12	13	-4.78e-03	0.0	-4.12	0.0	9.35e-04	0.0
12	14	-4.92e-03	0.0	-4.11	0.0	9.17e-04	0.0
12	15	0.18	0.0	-5.29	0.0	3.05e-03	0.0
12	16	0.20	0.0	-5.38	0.0	3.25e-03	0.0
12	17	0.22	0.0	-5.33	0.0	3.51e-03	0.0
12	18	0.12	0.0	-4.66	0.0	1.76e-03	0.0
12	19	0.14	0.0	-4.75	0.0	1.95e-03	0.0
12	20	0.16	0.0	-4.70	0.0	2.22e-03	0.0
12	21	0.18	0.0	-4.98	0.0	2.49e-03	0.0
12	22	0.12	0.0	-4.35	0.0	1.19e-03	0.0
12	23	0.22	0.0	-4.19	0.0	3.32e-03	0.0
12	24	0.16	0.0	-3.57	0.0	2.08e-03	0.0
12	25	0.18	0.0	-5.74	0.0	3.43e-03	0.0
12	26	0.20	0.0	-5.52	0.0	3.09e-03	0.0
12	27	0.12	0.0	-4.40	0.0	1.11e-03	0.0
12	28	0.14	0.0	-4.90	0.0	2.06e-03	0.0
12	29	0.22	0.0	-5.15	0.0	3.52e-03	0.0
12	30	0.05	0.0	-4.25	0.0	1.70e-03	0.0
12	31	0.05	0.0	-4.23	0.0	1.66e-03	0.0
12	32	0.05	0.0	-4.00	0.0	1.55e-03	0.0
12	33	0.22	0.0	-5.27	0.0	3.22e-03	0.0
12	34	-4.96e-03	0.0	-3.03	0.0	5.06e-04	0.0
12	35	0.02	0.0	-3.16	0.0	7.82e-04	0.0
12	36	0.05	0.0	-3.31	0.0	1.09e-03	0.0
12	37	0.07	0.0	-3.38	0.0	1.23e-03	0.0
12	38	0.08	0.0	-3.34	0.0	1.43e-03	0.0
12	39	-4.62e-03	0.0	-3.04	0.0	6.20e-04	0.0
12	40	-4.73e-03	0.0	-3.03	0.0	6.06e-04	0.0
12	41	0.05	0.0	-3.29	0.0	9.75e-04	0.0
12	42	0.07	0.0	-3.36	0.0	1.12e-03	0.0
12	43	0.08	0.0	-3.32	0.0	1.32e-03	0.0
12	44	0.09	0.0	-3.34	0.0	1.11e-03	0.0

12	45	0.08	0.0	-3.19	0.0	1.33e-03	0.0
12	46	-4.90e-03	0.0	-3.14	0.0	5.50e-04	0.0
12	47	-5.05e-03	0.0	-3.12	0.0	5.32e-04	0.0
12	48	-5.10e-03	0.0	-3.03	0.0	5.09e-04	0.0
12	49	-5.21e-03	0.0	-3.02	0.0	4.96e-04	0.0
12	50	0.09	0.0	-3.77	0.0	2.01e-03	0.0
12	51	0.11	0.0	-3.84	0.0	2.16e-03	0.0
12	52	0.12	0.0	-3.80	0.0	2.35e-03	0.0
12	53	0.05	0.0	-3.31	0.0	1.09e-03	0.0
12	54	0.07	0.0	-3.38	0.0	1.23e-03	0.0
12	55	0.08	0.0	-3.34	0.0	1.43e-03	0.0
12	56	-4.73e-03	0.0	-3.15	0.0	6.08e-04	0.0
12	57	-4.88e-03	0.0	-3.13	0.0	5.90e-04	0.0
12	58	-4.81e-03	0.0	-3.04	0.0	6.06e-04	0.0
12	59	-4.92e-03	0.0	-3.03	0.0	5.93e-04	0.0
12	60	0.09	0.0	-3.75	0.0	1.90e-03	0.0
12	61	0.11	0.0	-3.82	0.0	2.04e-03	0.0
12	62	0.12	0.0	-3.78	0.0	2.24e-03	0.0
12	63	0.05	0.0	-3.29	0.0	9.33e-04	0.0
12	64	0.07	0.0	-3.36	0.0	1.08e-03	0.0
12	65	0.08	0.0	-3.31	0.0	1.28e-03	0.0
12	66	0.09	0.0	-3.52	0.0	1.48e-03	0.0
12	67	0.05	0.0	-3.05	0.0	5.12e-04	0.0
12	68	0.12	0.0	-3.65	0.0	2.26e-03	0.0
12	69	0.08	0.0	-3.19	0.0	1.34e-03	0.0
12	70	-5.07e-03	0.0	-2.70	0.0	3.72e-04	0.0
12	71	0.04	0.0	-2.92	0.0	8.27e-04	0.0
12	72	-4.76e-03	0.0	-2.72	0.0	4.76e-04	0.0
12	73	0.04	0.0	-2.90	0.0	7.23e-04	0.0
12	74	0.04	0.0	-2.91	0.0	7.80e-04	0.0
12	75	0.08	0.0	-3.55	0.0	1.64e-03	0.0
12	76	0.27	0.0	-4.84	0.0	4.51e-03	0.0
12	77	0.08	0.0	-3.57	0.0	1.74e-03	0.0
12	78	0.27	0.0	-4.82	0.0	4.41e-03	0.0
12	79	0.27	0.0	-4.69	0.0	4.41e-03	0.0
13	1	-5.56e-03	0.0	-4.34	0.0	6.89e-04	0.0
13	2	-5.78e-03	0.0	-4.31	0.0	6.63e-04	0.0
13	3	-5.83e-03	0.0	-4.18	0.0	6.37e-04	0.0
13	4	-5.99e-03	0.0	-4.17	0.0	6.18e-04	0.0
13	5	0.18	0.0	-5.72	0.0	3.15e-03	0.0

13	6	0.20	0.0	-5.84	0.0	3.36e-03	0.0
13	7	0.22	0.0	-5.82	0.0	3.64e-03	0.0
13	8	0.12	0.0	-4.93	0.0	1.87e-03	0.0
13	9	0.14	0.0	-5.05	0.0	2.07e-03	0.0
13	10	0.16	0.0	-5.03	0.0	2.35e-03	0.0
13	11	-5.12e-03	0.0	-4.38	0.0	8.40e-04	0.0
13	12	-5.33e-03	0.0	-4.35	0.0	8.14e-04	0.0
13	13	-5.24e-03	0.0	-4.24	0.0	8.39e-04	0.0
13	14	-5.40e-03	0.0	-4.22	0.0	8.20e-04	0.0
13	15	0.18	0.0	-5.68	0.0	3.00e-03	0.0
13	16	0.20	0.0	-5.80	0.0	3.21e-03	0.0
13	17	0.22	0.0	-5.78	0.0	3.49e-03	0.0
13	18	0.12	0.0	-4.88	0.0	1.66e-03	0.0
13	19	0.14	0.0	-5.00	0.0	1.87e-03	0.0
13	20	0.16	0.0	-4.98	0.0	2.15e-03	0.0
13	21	0.18	0.0	-5.29	0.0	2.44e-03	0.0
13	22	0.12	0.0	-4.49	0.0	1.10e-03	0.0
13	23	0.22	0.0	-4.62	0.0	3.33e-03	0.0
13	24	0.16	0.0	-3.84	0.0	2.05e-03	0.0
13	25	0.18	0.0	-6.18	0.0	3.40e-03	0.0
13	26	0.20	0.0	-5.92	0.0	3.07e-03	0.0
13	27	0.12	0.0	-4.53	0.0	1.02e-03	0.0
13	28	0.14	0.0	-5.16	0.0	1.97e-03	0.0
13	29	0.22	0.0	-5.60	0.0	3.51e-03	0.0
13	30	0.05	0.0	-4.46	0.0	1.64e-03	0.0
13	31	0.05	0.0	-4.44	0.0	1.60e-03	0.0
13	32	0.05	0.0	-4.19	0.0	1.50e-03	0.0
13	33	0.22	0.0	-5.69	0.0	3.22e-03	0.0
13	34	-5.43e-03	0.0	-3.09	0.0	4.16e-04	0.0
13	35	0.02	0.0	-3.26	0.0	7.00e-04	0.0
13	36	0.05	0.0	-3.44	0.0	1.02e-03	0.0
13	37	0.07	0.0	-3.53	0.0	1.17e-03	0.0
13	38	0.08	0.0	-3.52	0.0	1.38e-03	0.0
13	39	-5.06e-03	0.0	-3.12	0.0	5.41e-04	0.0
13	40	-5.18e-03	0.0	-3.10	0.0	5.27e-04	0.0
13	41	0.05	0.0	-3.41	0.0	8.96e-04	0.0
13	42	0.07	0.0	-3.50	0.0	1.05e-03	0.0
13	43	0.08	0.0	-3.49	0.0	1.26e-03	0.0
13	44	0.09	0.0	-3.48	0.0	1.05e-03	0.0
13	45	0.08	0.0	-3.36	0.0	1.28e-03	0.0

13	46	-5.38e-03	0.0	-3.20	0.0	4.57e-04	0.0
13	47	-5.54e-03	0.0	-3.18	0.0	4.38e-04	0.0
13	48	-5.59e-03	0.0	-3.09	0.0	4.19e-04	0.0
13	49	-5.71e-03	0.0	-3.07	0.0	4.05e-04	0.0
13	50	0.09	0.0	-4.03	0.0	1.97e-03	0.0
13	51	0.11	0.0	-4.12	0.0	2.12e-03	0.0
13	52	0.12	0.0	-4.10	0.0	2.33e-03	0.0
13	53	0.05	0.0	-3.44	0.0	1.02e-03	0.0
13	54	0.07	0.0	-3.53	0.0	1.17e-03	0.0
13	55	0.08	0.0	-3.52	0.0	1.38e-03	0.0
13	56	-5.19e-03	0.0	-3.22	0.0	5.21e-04	0.0
13	57	-5.35e-03	0.0	-3.20	0.0	5.02e-04	0.0
13	58	-5.28e-03	0.0	-3.11	0.0	5.26e-04	0.0
13	59	-5.40e-03	0.0	-3.10	0.0	5.12e-04	0.0
13	60	0.09	0.0	-3.99	0.0	1.85e-03	0.0
13	61	0.11	0.0	-4.08	0.0	2.00e-03	0.0
13	62	0.12	0.0	-4.07	0.0	2.21e-03	0.0
13	63	0.05	0.0	-3.40	0.0	8.49e-04	0.0
13	64	0.07	0.0	-3.49	0.0	9.99e-04	0.0
13	65	0.08	0.0	-3.47	0.0	1.21e-03	0.0
13	66	0.09	0.0	-3.71	0.0	1.43e-03	0.0
13	67	0.05	0.0	-3.11	0.0	4.29e-04	0.0
13	68	0.12	0.0	-3.94	0.0	2.23e-03	0.0
13	69	0.08	0.0	-3.36	0.0	1.29e-03	0.0
13	70	-5.56e-03	0.0	-2.74	0.0	2.91e-04	0.0
13	71	0.04	0.0	-3.02	0.0	7.65e-04	0.0
13	72	-5.22e-03	0.0	-2.77	0.0	4.06e-04	0.0
13	73	0.04	0.0	-2.99	0.0	6.50e-04	0.0
13	74	0.04	0.0	-3.01	0.0	7.13e-04	0.0
13	75	0.08	0.0	-3.76	0.0	1.58e-03	0.0
13	76	0.27	0.0	-5.43	0.0	4.56e-03	0.0
13	77	0.08	0.0	-3.79	0.0	1.70e-03	0.0
13	78	0.27	0.0	-5.40	0.0	4.44e-03	0.0
13	79	0.27	0.0	-5.26	0.0	4.46e-03	0.0
14	1	5.60e-03	0.0	-4.41	0.0	-7.99e-04	0.0
14	2	5.81e-03	0.0	-4.38	0.0	-7.73e-04	0.0
14	3	5.87e-03	0.0	-4.25	0.0	-7.42e-04	0.0
14	4	6.03e-03	0.0	-4.23	0.0	-7.23e-04	0.0
14	5	0.19	0.0	-2.71	0.0	1.82e-03	0.0
14	6	0.21	0.0	-2.55	0.0	2.09e-03	0.0

14	7	0.23	0.0	-2.07	0.0	2.56e-03	0.0
14	8	0.14	0.0	-3.49	0.0	5.44e-04	0.0
14	9	0.16	0.0	-3.33	0.0	8.08e-04	0.0
14	10	0.18	0.0	-2.85	0.0	1.28e-03	0.0
14	11	5.15e-03	0.0	-4.45	0.0	-9.51e-04	0.0
14	12	5.37e-03	0.0	-4.42	0.0	-9.25e-04	0.0
14	13	5.27e-03	0.0	-4.30	0.0	-9.46e-04	0.0
14	14	5.43e-03	0.0	-4.28	0.0	-9.27e-04	0.0
14	15	0.19	0.0	-2.67	0.0	1.98e-03	0.0
14	16	0.21	0.0	-2.51	0.0	2.24e-03	0.0
14	17	0.23	0.0	-2.03	0.0	2.71e-03	0.0
14	18	0.14	0.0	-3.44	0.0	7.48e-04	0.0
14	19	0.16	0.0	-3.28	0.0	1.01e-03	0.0
14	20	0.18	0.0	-2.80	0.0	1.49e-03	0.0
14	21	0.19	0.0	-3.05	0.0	1.44e-03	0.0
14	22	0.14	0.0	-3.82	0.0	2.11e-04	0.0
14	23	0.23	0.0	-0.85	0.0	2.91e-03	0.0
14	24	0.18	0.0	-1.64	0.0	1.62e-03	0.0
14	25	0.19	0.0	-2.78	0.0	2.19e-03	0.0
14	26	0.21	0.0	-3.00	0.0	1.88e-03	0.0
14	27	0.14	0.0	-4.12	0.0	-8.68e-05	0.0
14	28	0.16	0.0	-3.45	0.0	9.01e-04	0.0
14	29	0.23	0.0	-1.85	0.0	2.70e-03	0.0
14	30	0.06	0.0	-2.81	0.0	1.02e-03	0.0
14	31	0.06	0.0	-2.78	0.0	1.06e-03	0.0
14	32	0.06	0.0	-2.53	0.0	1.17e-03	0.0
14	33	0.23	0.0	-2.30	0.0	2.50e-03	0.0
14	34	5.47e-03	0.0	-3.14	0.0	-4.93e-04	0.0
14	35	0.03	0.0	-2.93	0.0	-1.49e-04	0.0
14	36	0.06	0.0	-2.79	0.0	8.22e-05	0.0
14	37	0.08	0.0	-2.67	0.0	2.78e-04	0.0
14	38	0.09	0.0	-2.31	0.0	6.30e-04	0.0
14	39	5.09e-03	0.0	-3.17	0.0	-6.20e-04	0.0
14	40	5.21e-03	0.0	-3.15	0.0	-6.05e-04	0.0
14	41	0.06	0.0	-2.75	0.0	2.09e-04	0.0
14	42	0.08	0.0	-2.63	0.0	4.05e-04	0.0
14	43	0.09	0.0	-2.28	0.0	7.57e-04	0.0
14	44	0.11	0.0	-2.67	0.0	4.26e-04	0.0
14	45	0.09	0.0	-2.15	0.0	7.35e-04	0.0
14	46	5.41e-03	0.0	-3.25	0.0	-5.38e-04	0.0

14	47	5.57e-03	0.0	-3.23	0.0	-5.19e-04	0.0
14	48	5.63e-03	0.0	-3.14	0.0	-4.97e-04	0.0
14	49	5.75e-03	0.0	-3.12	0.0	-4.82e-04	0.0
14	50	0.10	0.0	-2.20	0.0	1.03e-03	0.0
14	51	0.12	0.0	-2.08	0.0	1.23e-03	0.0
14	52	0.13	0.0	-1.73	0.0	1.58e-03	0.0
14	53	0.06	0.0	-2.78	0.0	8.60e-05	0.0
14	54	0.08	0.0	-2.67	0.0	2.82e-04	0.0
14	55	0.09	0.0	-2.31	0.0	6.34e-04	0.0
14	56	5.22e-03	0.0	-3.27	0.0	-6.03e-04	0.0
14	57	5.38e-03	0.0	-3.25	0.0	-5.83e-04	0.0
14	58	5.31e-03	0.0	-3.16	0.0	-6.05e-04	0.0
14	59	5.43e-03	0.0	-3.15	0.0	-5.90e-04	0.0
14	60	0.10	0.0	-2.17	0.0	1.16e-03	0.0
14	61	0.12	0.0	-2.05	0.0	1.36e-03	0.0
14	62	0.13	0.0	-1.70	0.0	1.71e-03	0.0
14	63	0.06	0.0	-2.74	0.0	2.56e-04	0.0
14	64	0.08	0.0	-2.62	0.0	4.52e-04	0.0
14	65	0.09	0.0	-2.27	0.0	8.04e-04	0.0
14	66	0.10	0.0	-2.45	0.0	7.62e-04	0.0
14	67	0.06	0.0	-3.02	0.0	-1.43e-04	0.0
14	68	0.13	0.0	-1.56	0.0	1.69e-03	0.0
14	69	0.09	0.0	-2.15	0.0	7.31e-04	0.0
14	70	5.59e-03	0.0	-2.79	0.0	-3.58e-04	0.0
14	71	0.05	0.0	-2.52	0.0	6.78e-05	0.0
14	72	5.25e-03	0.0	-2.82	0.0	-4.74e-04	0.0
14	73	0.05	0.0	-2.50	0.0	1.84e-04	0.0
14	74	0.05	0.0	-2.51	0.0	1.20e-04	0.0
14	75	0.09	0.0	-2.23	0.0	9.44e-04	0.0
14	76	0.29	0.0	-0.21	0.0	4.05e-03	0.0
14	77	0.09	0.0	-2.26	0.0	8.28e-04	0.0
14	78	0.29	0.0	-0.18	0.0	4.17e-03	0.0
14	79	0.29	0.0	-0.04	0.0	4.15e-03	0.0
15	1	0.08	0.0	-4.32	0.0	8.40e-04	0.0
15	2	0.08	0.0	-4.30	0.0	7.74e-04	0.0
15	3	0.11	0.0	-4.17	0.0	8.07e-04	0.0
15	4	0.11	0.0	-4.16	0.0	7.58e-04	0.0
15	5	2.30	0.0	-2.69	0.0	2.95e-03	0.0
15	6	2.52	0.0	-2.53	0.0	3.11e-03	0.0
15	7	2.87	0.0	-2.07	0.0	3.37e-03	0.0

15	8	1.09	0.0	-3.46	0.0	1.63e-03	0.0
15	9	1.31	0.0	-3.31	0.0	1.79e-03	0.0
15	10	1.66	0.0	-2.84	0.0	2.05e-03	0.0
15	11	-0.08	0.0	-4.36	0.0	6.71e-04	0.0
15	12	-0.08	0.0	-4.34	0.0	6.05e-04	0.0
15	13	-0.11	0.0	-4.22	0.0	5.81e-04	0.0
15	14	-0.11	0.0	-4.21	0.0	5.32e-04	0.0
15	15	2.46	0.0	-2.65	0.0	3.12e-03	0.0
15	16	2.68	0.0	-2.50	0.0	3.28e-03	0.0
15	17	3.03	0.0	-2.04	0.0	3.54e-03	0.0
15	18	1.30	0.0	-3.41	0.0	1.86e-03	0.0
15	19	1.52	0.0	-3.26	0.0	2.02e-03	0.0
15	20	1.87	0.0	-2.79	0.0	2.28e-03	0.0
15	21	2.03	0.0	-3.02	0.0	2.57e-03	0.0
15	22	0.88	0.0	-3.78	0.0	1.30e-03	0.0
15	23	3.04	0.0	-0.88	0.0	3.34e-03	0.0
15	24	1.88	0.0	-1.65	0.0	2.10e-03	0.0
15	25	2.56	0.0	-2.77	0.0	3.19e-03	0.0
15	26	2.35	0.0	-2.99	0.0	2.89e-03	0.0
15	27	0.70	0.0	-4.07	0.0	1.17e-03	0.0
15	28	1.49	0.0	-3.41	0.0	2.05e-03	0.0
15	29	3.03	0.0	-1.86	0.0	3.49e-03	0.0
15	30	1.19	0.0	-2.80	0.0	1.62e-03	0.0
15	31	1.19	0.0	-2.79	0.0	1.55e-03	0.0
15	32	1.19	0.0	-2.54	0.0	1.43e-03	0.0
15	33	2.83	0.0	-2.31	0.0	3.22e-03	0.0
15	34	0.07	0.0	-3.08	0.0	5.40e-04	0.0
15	35	0.37	0.0	-2.89	0.0	7.84e-04	0.0
15	36	0.50	0.0	-2.75	0.0	8.95e-04	0.0
15	37	0.66	0.0	-2.64	0.0	1.01e-03	0.0
15	38	0.92	0.0	-2.30	0.0	1.21e-03	0.0
15	39	-0.06	0.0	-3.11	0.0	4.00e-04	0.0
15	40	-0.06	0.0	-3.10	0.0	3.63e-04	0.0
15	41	0.63	0.0	-2.72	0.0	1.04e-03	0.0
15	42	0.79	0.0	-2.61	0.0	1.15e-03	0.0
15	43	1.05	0.0	-2.27	0.0	1.35e-03	0.0
15	44	0.87	0.0	-2.65	0.0	1.16e-03	0.0
15	45	1.05	0.0	-2.14	0.0	1.32e-03	0.0
15	46	0.07	0.0	-3.19	0.0	5.92e-04	0.0
15	47	0.07	0.0	-3.18	0.0	5.43e-04	0.0

15	48	0.09	0.0	-3.08	0.0	5.72e-04	0.0
15	49	0.09	0.0	-3.07	0.0	5.35e-04	0.0
15	50	1.37	0.0	-2.18	0.0	1.84e-03	0.0
15	51	1.53	0.0	-2.07	0.0	1.96e-03	0.0
15	52	1.79	0.0	-1.73	0.0	2.16e-03	0.0
15	53	0.47	0.0	-2.76	0.0	8.63e-04	0.0
15	54	0.64	0.0	-2.64	0.0	9.81e-04	0.0
15	55	0.90	0.0	-2.30	0.0	1.17e-03	0.0
15	56	1.31e-03	0.0	-3.21	0.0	5.20e-04	0.0
15	57	1.36e-03	0.0	-3.20	0.0	4.72e-04	0.0
15	58	-0.02	0.0	-3.11	0.0	4.52e-04	0.0
15	59	-0.02	0.0	-3.10	0.0	4.16e-04	0.0
15	60	1.51	0.0	-2.15	0.0	1.99e-03	0.0
15	61	1.67	0.0	-2.04	0.0	2.10e-03	0.0
15	62	1.93	0.0	-1.70	0.0	2.30e-03	0.0
15	63	0.65	0.0	-2.71	0.0	1.05e-03	0.0
15	64	0.82	0.0	-2.60	0.0	1.17e-03	0.0
15	65	1.08	0.0	-2.26	0.0	1.36e-03	0.0
15	66	1.19	0.0	-2.43	0.0	1.57e-03	0.0
15	67	0.34	0.0	-2.99	0.0	6.40e-04	0.0
15	68	1.93	0.0	-1.57	0.0	2.27e-03	0.0
15	69	1.08	0.0	-2.14	0.0	1.35e-03	0.0
15	70	0.07	0.0	-2.75	0.0	3.77e-04	0.0
15	71	0.37	0.0	-2.50	0.0	6.21e-04	0.0
15	72	-0.05	0.0	-2.78	0.0	2.49e-04	0.0
15	73	0.50	0.0	-2.48	0.0	7.50e-04	0.0
15	74	0.50	0.0	-2.49	0.0	7.69e-04	0.0
15	75	1.28	0.0	-2.22	0.0	1.62e-03	0.0
15	76	3.98	0.0	-0.26	0.0	4.31e-03	0.0
15	77	1.16	0.0	-2.25	0.0	1.49e-03	0.0
15	78	4.11	0.0	-0.23	0.0	4.43e-03	0.0
15	79	4.11	0.0	-0.10	0.0	4.41e-03	0.0
16	1	-0.17	0.0	-4.25	0.0	-9.46e-04	0.0
16	2	-0.17	0.0	-4.23	0.0	-8.79e-04	0.0
16	3	-0.19	0.0	-4.10	0.0	-9.09e-04	0.0
16	4	-0.19	0.0	-4.09	0.0	-8.59e-04	0.0
16	5	2.37	0.0	-5.60	0.0	1.85e-03	0.0
16	6	2.59	0.0	-5.72	0.0	2.14e-03	0.0
16	7	2.94	0.0	-5.71	0.0	2.61e-03	0.0
16	8	1.22	0.0	-4.84	0.0	6.09e-04	0.0

16	9	1.44	0.0	-4.96	0.0	8.91e-04	0.0
16	10	1.79	0.0	-4.94	0.0	1.36e-03	0.0
16	11	-4.67e-03	0.0	-4.29	0.0	-7.79e-04	0.0
16	12	-4.15e-03	0.0	-4.27	0.0	-7.12e-04	0.0
16	13	0.02	0.0	-4.15	0.0	-6.84e-04	0.0
16	14	0.03	0.0	-4.14	0.0	-6.34e-04	0.0
16	15	2.21	0.0	-5.56	0.0	1.69e-03	0.0
16	16	2.43	0.0	-5.68	0.0	1.97e-03	0.0
16	17	2.78	0.0	-5.67	0.0	2.44e-03	0.0
16	18	1.00	0.0	-4.79	0.0	3.85e-04	0.0
16	19	1.22	0.0	-4.91	0.0	6.66e-04	0.0
16	20	1.57	0.0	-4.89	0.0	1.14e-03	0.0
16	21	1.79	0.0	-5.19	0.0	1.23e-03	0.0
16	22	0.58	0.0	-4.42	0.0	-7.75e-05	0.0
16	23	2.79	0.0	-4.53	0.0	2.67e-03	0.0
16	24	1.58	0.0	-3.77	0.0	1.34e-03	0.0
16	25	2.56	0.0	-6.06	0.0	2.11e-03	0.0
16	26	2.35	0.0	-5.81	0.0	1.84e-03	0.0
16	27	0.46	0.0	-4.45	0.0	-2.89e-04	0.0
16	28	1.25	0.0	-5.06	0.0	6.27e-04	0.0
16	29	2.78	0.0	-5.49	0.0	2.49e-03	0.0
16	30	1.26	0.0	-4.41	0.0	1.05e-03	0.0
16	31	1.26	0.0	-4.40	0.0	1.13e-03	0.0
16	32	1.26	0.0	-4.16	0.0	1.25e-03	0.0
16	33	2.58	0.0	-5.59	0.0	2.25e-03	0.0
16	34	-0.13	0.0	-3.03	0.0	-6.15e-04	0.0
16	35	0.16	0.0	-3.20	0.0	-2.66e-04	0.0
16	36	0.56	0.0	-3.39	0.0	1.34e-04	0.0
16	37	0.72	0.0	-3.47	0.0	3.43e-04	0.0
16	38	0.98	0.0	-3.46	0.0	6.93e-04	0.0
16	39	1.37e-03	0.0	-3.06	0.0	-4.76e-04	0.0
16	40	1.66e-03	0.0	-3.05	0.0	-4.39e-04	0.0
16	41	0.42	0.0	-3.36	0.0	-5.63e-06	0.0
16	42	0.59	0.0	-3.44	0.0	2.03e-04	0.0
16	43	0.85	0.0	-3.43	0.0	5.53e-04	0.0
16	44	0.66	0.0	-3.42	0.0	2.43e-04	0.0
16	45	0.85	0.0	-3.30	0.0	5.88e-04	0.0
16	46	-0.13	0.0	-3.14	0.0	-6.71e-04	0.0
16	47	-0.13	0.0	-3.13	0.0	-6.21e-04	0.0
16	48	-0.16	0.0	-3.03	0.0	-6.47e-04	0.0

16	49	-0.16	0.0	-3.02	0.0	-6.10e-04	0.0
16	50	1.44	0.0	-3.95	0.0	1.08e-03	0.0
16	51	1.60	0.0	-4.04	0.0	1.29e-03	0.0
16	52	1.86	0.0	-4.03	0.0	1.64e-03	0.0
16	53	0.58	0.0	-3.39	0.0	1.66e-04	0.0
16	54	0.74	0.0	-3.48	0.0	3.75e-04	0.0
16	55	1.00	0.0	-3.46	0.0	7.25e-04	0.0
16	56	-0.07	0.0	-3.16	0.0	-5.99e-04	0.0
16	57	-0.07	0.0	-3.14	0.0	-5.50e-04	0.0
16	58	-0.04	0.0	-3.06	0.0	-5.28e-04	0.0
16	59	-0.04	0.0	-3.05	0.0	-4.91e-04	0.0
16	60	1.30	0.0	-3.92	0.0	9.45e-04	0.0
16	61	1.46	0.0	-4.01	0.0	1.15e-03	0.0
16	62	1.72	0.0	-4.00	0.0	1.50e-03	0.0
16	63	0.40	0.0	-3.35	0.0	-2.16e-05	0.0
16	64	0.56	0.0	-3.44	0.0	1.87e-04	0.0
16	65	0.82	0.0	-3.42	0.0	5.37e-04	0.0
16	66	0.98	0.0	-3.65	0.0	6.02e-04	0.0
16	67	0.09	0.0	-3.07	0.0	-3.65e-04	0.0
16	68	1.72	0.0	-3.87	0.0	1.54e-03	0.0
16	69	0.83	0.0	-3.30	0.0	5.56e-04	0.0
16	70	-0.12	0.0	-2.71	0.0	-4.41e-04	0.0
16	71	0.43	0.0	-2.98	0.0	1.52e-04	0.0
16	72	2.13e-04	0.0	-2.73	0.0	-3.14e-04	0.0
16	73	0.30	0.0	-2.95	0.0	2.39e-05	0.0
16	74	0.30	0.0	-2.96	0.0	4.30e-06	0.0
16	75	1.08	0.0	-3.70	0.0	8.30e-04	0.0
16	76	4.03	0.0	-5.32	0.0	4.04e-03	0.0
16	77	1.21	0.0	-3.73	0.0	9.57e-04	0.0
16	78	3.91	0.0	-5.29	0.0	3.91e-03	0.0
16	79	3.91	0.0	-5.16	0.0	3.93e-03	0.0

Nodo	Traslazione X	Traslazione Y	Traslazione Z	Rotazione X	Rotazione Y	Rotazione Z
	-0.19	0.0	-6.18	0.0	-1.06e-03	0.0
	4.11	0.0	-0.04	0.0	4.61e-03	0.0

Nodo	Cmb	Azione X	Azione Y	Azione Z	Azione RX	Azione RY	Azione RZ
		kN	kN	kN	kN m	kN m	kN m

Nodo	Azione X	Azione Y	Azione Z	Azione RX	Azione RY	Azione RZ
------	----------	----------	----------	-----------	-----------	-----------



Nodo	Cmb	Azione X	Azione Y	Azione Z	Azione RX	Azione RY	Azione RZ
		kN	kN	kN	kN m	kN m	kN m

RISULTATI OPERE DI FONDAZIONE

LEGENDA RISULTATI OPERE DI FONDAZIONE

Il controllo dei risultati delle analisi condotte, per quanto concerne le opere di fondazione, è possibile in relazione alle tabelle sottoriportate.

La prima tabella è riferita alle fondazioni tipo palo e plinto su pali.

Per questo tipo di fondazione vengono riportate le sei componenti di sollecitazione (esprese nel riferimento globale della struttura) per ogni palo componente l'opera.

In particolare viene riportato:

Nodo	numero del nodo a cui è applicato il plinto
Tipo	codice corrispondente al nome assegnato al tipo di plinto di fondazione: 3) palo singolo (<i>PALO</i>) 4) plinto su palo 5) plinto su due pali (<i>PL.2P</i>) 6) plinto su tre pali (<i>PL.3P</i>) 7) plinto su quattro pali (<i>PL.4P</i>) 8) plinto rettangolare su cinque pali (<i>PL.5P.R</i>) 9) plinto pentagonale su cinque pali (<i>PL.5P</i>) 10) plinto su sei pali (<i>PL.6P</i>)
Palo	numero del palo
Comb.	combinazione di carico in cui si verificano le sei componenti di sollecitazione.
Quota	quota assoluta della sezione del palo per cui si riportano le sei componenti di sollecitazione.

L'azione F_z (corrispondente allo sforzo normale nel palo) è costante poiché il peso del palo stesso non è considerato nella modellazione.

La seconda tabella è riferita alle fondazioni tipo plinto su suolo elastico.

Per questo tipo di fondazione vengono riportate le pressioni nei quattro vertici dell'impronta sul terreno.

In particolare viene riportato:

Nodo	numero del nodo a cui è applicato il plinto
Tipo	Codice identificativo del nome assegnato al plinto
area	area dell'impronta del plinto
Wink O Wink V	coefficienti di Winkler (orizzontale e verticale) adottati
Comb	Combinazione di carico in cui si verificano i valori riportati
Pi (P1 P2 P3 P4)	valori di pressione nei vertici

La terza tabella è riferita alle fondazioni tipo platea su suolo elastico.

Per questo tipo di fondazione vengono riportate le pressioni in ogni vertice (nodo) degli elementi costituenti la platea.

La quarta tabella è riferita alle fondazioni tipo trave su suolo elastico.

Per questo tipo di fondazione vengono riportate le pressioni alle estremità dell'elemento e la massima (in valore assoluto) pressione lungo lo sviluppo dell'elemento.

Vengono inoltre riportati, con funzione statistica, i valori massimo e minimo delle pressioni che compaiono nella tabella.

Con riferimento al **Documento di Affidabilità** "Test di validazione del software di calcolo PRO_SAP e dei moduli aggiuntivi PRO_SAP Modulo Geotecnico, PRO_CAD nodi acciaio e PRO_MST" - versione Maggio 2011, disponibile per il download sul sito www.2si.it, si segnalano i seguenti esempi applicativi:

Test N°	Titolo
96	PLINTO SUPERFICIALE
97	PLINTO SUPERFICIALE
98	PLINTO SUPERFICIALE
99	PLINTO SUPERFICIALE
100	PLINTO SUPERFICIALE
101	PLINTO SUPERFICIALE
102	PLINTO SUPERFICIALE
103	PLINTO SUPERFICIALE
104	PLINTO SUPERFICIALE
105	PLINTO SUPERFICIALE
106	PLINTO SUPERFICIALE
107	PLINTO SUPERFICIALE
108	PLINTO SUPERFICIALE
109	PLINTO SUPERFICIALE
110	PLINTO SUPERFICIALE
111	PLINTO SUPERFICIALE
112	PLINTO SUPERFICIALE
113	PLINTO SUPERFICIALE
114	PLINTO SUPERFICIALE
115	FONDAZIONE NASTRIFORME
116	CALCOLO DEI K DI WINKLER

Elem.	Cmb	Pt ini	Pt fin	Pt max	Cmb	Pt ini	Pt fin	Pt max	Cmb	Pt ini	Pt fin	Pt max	
		kN/ m2	kN/ m2	kN/ m2		kN/ m2	kN/ m2	kN/ m2		kN/ m2	kN/ m2	kN/ m2	kN/ m2
10	1	-212.20	-214.27	-214.27	2	-211.20	-213.20	-213.20	3	-204.86	-206.78	-206.78	
	4	-204.11	-205.98	-205.98	5	-265.31	-274.05	-274.05	6	-269.98	-279.26	-279.26	
	7	-267.23	-277.27	-277.27	8	-234.17	-239.42	-239.42	9	-238.84	-244.63	-244.63	
	10	-236.09	-242.64	-242.64	11	-213.16	-215.63	-215.63	12	-212.16	-214.56	-214.56	
	13	-206.15	-208.60	-208.60	14	-205.40	-207.80	-207.80	15	-264.35	-272.69	-272.69	
	16	-269.02	-277.90	-277.90	17	-266.27	-275.91	-275.91	18	-232.88	-237.60	-237.60	
	19	-237.55	-242.81	-242.81	20	-234.81	-240.82	-240.82	21	-248.76	-255.54	-255.54	
	22	-217.30	-220.45	-220.45	23	-209.50	-218.64	-218.64	24	-178.42	-184.10	-184.10	
	25	-286.95	-296.37	-296.37	26	-276.23	-284.71	-284.71	27	-219.77	-222.71	-222.71	
	28	-245.02	-250.58	-250.58	29	-257.34	-267.03	-267.03	30	-212.41	-217.01	-217.01	
	31	-211.52	-216.01	-216.01	32	-199.76	-203.97	-203.97	33	-263.54	-272.42	-272.42	
	34	-151.43	-152.70	-152.70	35	-158.18	-160.23	-160.23	36	-165.40	-168.31	-168.31	
	37	-168.86	-172.18	-172.18	38	-166.82	-170.70	-170.70	39	-152.23	-153.84	-153.84	
	40	-151.67	-153.24	-153.24	41	-164.59	-167.18	-167.18	42	-168.06	-171.05	-171.05	
	43	-166.02	-169.57	-169.57	44	-166.93	-169.89	-169.89	45	-159.44	-163.05	-163.05	
	46	-156.85	-158.24	-158.24	47	-156.10	-157.45	-157.45	48	-151.45	-152.74	-152.74	
	49	-150.90	-152.14	-152.14	50	-188.44	-193.93	-193.93	51	-191.91	-197.80	-197.80	
	52	-189.87	-196.32	-196.32	53	-165.37	-168.27	-168.27	54	-168.84	-172.15	-172.15	
	55	-166.80	-170.67	-170.67	56	-157.26	-158.82	-158.82	57	-156.51	-158.03	-158.03	
	58	-152.14	-153.70	-153.70	59	-151.58	-153.11	-153.11	60	-187.64	-192.80	-192.80	
	61	-191.10	-196.67	-196.67	62	-189.07	-195.19	-195.19	63	-164.30	-166.76	-166.76	
	64	-167.76	-170.63	-170.63	65	-165.72	-169.15	-169.15	66	-176.06	-180.06	-180.06	
	67	-152.72	-154.03	-154.03	68	-182.48	-188.67	-188.67	69	-159.47	-163.08	-163.08	
	70	-135.17	-136.09	-136.09	71	-145.86	-148.06	-148.06	72	-135.91	-137.13	-137.13	
	73	-145.13	-147.02	-147.02	74	-145.53	-147.59	-147.59	75	-177.71	-182.15	-182.15	
	76	-241.78	-254.25	-254.25	77	-178.44	-183.19	-183.19	78	-241.04	-253.22	-253.22	
	79	-234.26	-246.47	-246.47									
	11	1	-217.59	-215.22	-217.45	2	-216.50	-214.19	-216.36	3	-209.95	-207.74	-209.82
		4	-209.13	-206.98	-209.01	5	-141.67	-146.41	-146.41	6	-134.58	-140.03	-140.03
7		-112.35	-119.09	-119.09	8	-176.53	-177.79	-177.79	9	-169.44	-171.41	-171.41	
10		-147.20	-150.47	-150.47	11	-218.98	-216.21	-218.82	12	-217.89	-215.19	-217.73	
13		-211.82	-209.08	-211.66	14	-211.00	-208.31	-210.84	15	-140.28	-145.41	-145.41	
16		-133.19	-139.03	-139.03	17	-110.95	-118.10	-118.10	18	-174.66	-176.45	-176.45	
19		-167.57	-170.08	-170.08	20	-145.33	-149.14	-149.14	21	-157.30	-160.95	-160.95	
22		-191.68	-191.99	-191.99	23	-52.79	-60.51	-60.51	24	-87.73	-91.95	-91.95	
25		-146.42	-152.16	-152.16	26	-156.63	-161.52	-161.52	27	-205.60	-205.10	-205.59	
28		-175.49	-177.69	-177.69	29	-101.89	-109.01	-109.01	30	-143.97	-146.58	-146.58	



	31	-142.95	-145.67	-145.67	32	-130.67	-133.70	-133.70	33	-123.87	-130.46	-130.46
	34	-155.04	-153.55	-154.95	35	-145.96	-145.40	-145.94	36	-139.58	-139.65	-139.66
	37	-134.32	-134.91	-134.91	38	-117.81	-119.37	-119.37	39	-156.20	-154.38	-156.09
	40	-155.59	-153.81	-155.49	41	-138.42	-138.82	-138.82	42	-133.16	-134.08	-134.08
	43	-116.64	-118.54	-118.54	44	-135.06	-136.03	-136.03	45	-109.99	-111.84	-111.84
	46	-160.68	-159.07	-160.59	47	-159.88	-158.31	-159.79	48	-155.07	-153.58	-154.99
	49	-154.47	-153.01	-154.38	50	-113.73	-116.38	-116.38	51	-108.47	-111.64	-111.64
	52	-91.96	-96.10	-96.10	53	-139.55	-139.63	-139.63	54	-134.28	-134.89	-134.89
	55	-117.77	-119.34	-119.34	56	-161.28	-159.49	-161.17	57	-160.47	-158.73	-160.37
	58	-156.06	-154.28	-155.96	59	-155.46	-153.71	-155.35	60	-112.57	-115.55	-115.55
	61	-107.31	-110.81	-110.81	62	-90.80	-95.27	-95.27	63	-137.99	-138.51	-138.51
	64	-132.72	-133.78	-133.78	65	-116.21	-118.23	-118.23	66	-125.21	-127.09	-127.09
	67	-150.63	-150.05	-150.60	68	-84.14	-88.57	-88.57	69	-110.03	-111.87	-111.87
	70	-138.09	-136.99	-138.03	71	-126.46	-126.51	-126.52	72	-139.15	-137.75	-139.07
	73	-125.40	-125.75	-125.75	74	-125.98	-126.17	-126.17	75	-114.87	-117.26	-117.26
	76	-24.61	-35.44	-35.44	77	-115.93	-118.02	-118.02	78	-23.55	-34.68	-34.68
	79	-16.67	-27.77	-27.77								
13	1	-214.27	-216.85	-216.85	2	-213.20	-215.69	-215.69	3	-206.78	-209.17	-209.17
	4	-205.98	-208.30	-208.30	5	-274.05	-285.87	-285.87	6	-279.26	-291.85	-291.85
	7	-277.27	-290.92	-290.92	8	-239.42	-246.42	-246.42	9	-244.63	-252.39	-252.39
	10	-242.64	-251.47	-251.47	11	-215.63	-218.78	-218.78	12	-214.56	-217.61	-217.61
	13	-208.60	-211.75	-211.75	14	-207.80	-210.88	-210.88	15	-272.69	-283.95	-283.95
	16	-277.90	-289.92	-289.92	17	-275.91	-289.00	-289.00	18	-237.60	-243.84	-243.84
	19	-242.81	-249.82	-249.82	20	-240.82	-248.89	-248.89	21	-255.54	-264.68	-264.68
	22	-220.45	-224.57	-224.57	23	-218.64	-231.13	-231.13	24	-184.10	-191.79	-191.79
	25	-296.37	-309.14	-309.14	26	-284.71	-296.23	-296.23	27	-222.71	-226.54	-226.54
	28	-250.58	-257.97	-257.97	29	-267.03	-280.20	-280.20	30	-217.01	-223.17	-223.17
	31	-216.01	-222.02	-222.02	32	-203.97	-209.61	-209.61	33	-272.42	-284.50	-284.50
	34	-152.70	-154.26	-154.26	35	-160.23	-162.86	-162.86	36	-168.31	-172.14	-172.14
	37	-172.18	-176.57	-176.57	38	-170.70	-175.89	-175.89	39	-153.84	-155.87	-155.87
	40	-153.24	-155.22	-155.22	41	-167.18	-170.54	-170.54	42	-171.05	-174.97	-174.97
	43	-169.57	-174.29	-174.29	44	-169.89	-173.81	-173.81	45	-163.05	-167.86	-167.86
	46	-158.24	-159.95	-159.95	47	-157.45	-159.09	-159.09	48	-152.74	-154.31	-154.31
	49	-152.14	-153.66	-153.66	50	-193.93	-201.32	-201.32	51	-197.80	-205.76	-205.76
	52	-196.32	-205.07	-205.07	53	-168.27	-172.09	-172.09	54	-172.15	-176.53	-176.53
	55	-170.67	-175.84	-175.84	56	-158.82	-160.77	-160.77	57	-158.03	-159.91	-159.91
	58	-153.70	-155.68	-155.68	59	-153.11	-155.03	-155.03	60	-192.80	-199.72	-199.72
	61	-196.67	-204.15	-204.15	62	-195.19	-203.47	-203.47	63	-166.76	-169.94	-169.94
	64	-170.63	-174.38	-174.38	65	-169.15	-173.69	-173.69	66	-180.06	-185.41	-185.41
	67	-154.03	-155.63	-155.63	68	-188.67	-197.04	-197.04	69	-163.08	-167.91	-167.91

	70	-136.09	-137.18	-137.18	71	-148.06	-150.92	-150.92	72	-137.13	-138.65	-138.65
	73	-147.02	-149.46	-149.46	74	-147.59	-150.26	-150.26	75	-182.15	-188.09	-188.09
	76	-254.25	-271.34	-271.34	77	-183.19	-189.56	-189.56	78	-253.22	-269.87	-269.87
	79	-246.47	-263.19	-263.19								
14	1	-220.38	-217.59	-220.21	2	-219.20	-216.50	-219.03	3	-212.55	-209.95	-212.39
	4	-211.66	-209.13	-211.51	5	-135.29	-141.67	-141.67	6	-127.27	-134.58	-134.58
	7	-103.38	-112.35	-112.35	8	-174.62	-176.53	-176.53	9	-166.61	-169.44	-169.44
	10	-142.71	-147.20	-147.20	11	-222.31	-218.98	-222.10	12	-221.13	-217.89	-220.92
	13	-215.13	-211.82	-214.93	14	-214.25	-211.00	-214.04	15	-133.36	-140.28	-140.28
	16	-125.35	-133.19	-133.19	17	-101.45	-110.95	-110.95	18	-172.04	-174.66	-174.66
	19	-164.02	-167.57	-167.57	20	-140.13	-145.33	-145.33	21	-152.26	-157.30	-157.30
	22	-190.94	-191.68	-191.68	23	-42.62	-52.79	-52.79	24	-82.07	-87.73	-87.73
	25	-138.76	-146.42	-146.42	26	-150.03	-156.63	-156.63	27	-205.91	-205.60	-205.89
	28	-172.33	-175.49	-175.49	29	-92.46	-101.89	-101.89	30	-140.41	-143.97	-143.97
	31	-139.24	-142.95	-142.95	32	-126.58	-130.67	-130.67	33	-115.13	-123.87	-123.87
	34	-156.76	-155.04	-156.66	35	-146.49	-145.96	-146.45	36	-139.29	-139.58	-139.58
	37	-133.34	-134.32	-134.32	38	-115.60	-117.81	-117.81	39	-158.37	-156.20	-158.24
	40	-157.71	-155.59	-157.58	41	-137.69	-138.42	-138.42	42	-131.74	-133.16	-133.16
	43	-113.99	-116.64	-116.64	44	-133.57	-135.06	-135.06	45	-107.42	-109.99	-109.99
	46	-162.57	-160.68	-162.45	47	-161.69	-159.88	-161.58	48	-156.81	-155.07	-156.70
	49	-156.15	-154.47	-156.05	50	-110.11	-113.73	-113.73	51	-104.16	-108.47	-108.47
	52	-86.42	-91.96	-91.96	53	-139.25	-139.55	-139.55	54	-133.30	-134.28	-134.28
	55	-115.55	-117.77	-117.77	56	-163.39	-161.28	-163.26	57	-162.51	-160.47	-162.38
	58	-158.18	-156.06	-158.05	59	-157.52	-155.46	-157.39	60	-108.51	-112.57	-112.57
	61	-102.56	-107.31	-107.31	62	-84.81	-90.80	-90.80	63	-137.09	-137.99	-137.99
	64	-131.14	-132.72	-132.72	65	-113.40	-116.21	-116.21	66	-122.54	-125.21	-125.21
	67	-151.13	-150.63	-151.10	68	-78.24	-84.14	-84.14	69	-107.47	-110.03	-110.03
	70	-139.34	-138.09	-139.26	71	-126.23	-126.46	-126.46	72	-140.81	-139.15	-140.71
	73	-124.76	-125.40	-125.40	74	-125.56	-125.98	-125.98	75	-111.56	-114.87	-114.87
	76	-10.43	-24.61	-24.61	77	-113.03	-115.93	-115.93	78	-8.96	-23.55	-23.55
	79	-2.13	-16.67	-16.67								
15	1	-215.22	-212.20	-212.20	2	-214.19	-211.20	-211.20	3	-207.74	-204.86	-204.86
	4	-206.98	-204.11	-204.11	5	-146.41	-265.31	-265.31	6	-140.03	-269.98	-269.98
	7	-119.09	-267.23	-267.23	8	-177.79	-234.17	-234.17	9	-171.41	-238.84	-238.84
	10	-150.47	-236.09	-236.09	11	-216.21	-213.16	-213.16	12	-215.19	-212.16	-212.16
	13	-209.08	-206.15	-206.15	14	-208.31	-205.40	-205.40	15	-145.41	-264.35	-264.35
	16	-139.03	-269.02	-269.02	17	-118.10	-266.27	-266.27	18	-176.45	-232.88	-232.88
	19	-170.08	-237.55	-237.55	20	-149.14	-234.81	-234.81	21	-160.95	-248.76	-248.76
	22	-191.99	-217.30	-217.30	23	-60.51	-209.50	-209.50	24	-91.95	-178.42	-178.42
	25	-152.16	-274.65	-274.65	26	-161.52	-265.17	-265.17	27	-205.10	-219.77	-219.77



28	-177.69	-245.02	-245.02	29	-109.01	-257.34	-257.34	30	-146.58	-212.41	-212.41
31	-145.67	-211.52	-211.52	32	-133.70	-199.76	-199.76	33	-130.46	-252.04	-252.04
34	-153.55	-151.43	-151.43	35	-145.40	-158.18	-158.18	36	-139.65	-165.40	-165.40
37	-134.91	-168.86	-168.86	38	-119.37	-166.82	-166.82	39	-154.38	-152.23	-152.23
40	-153.81	-151.67	-151.67	41	-138.82	-164.59	-164.59	42	-134.08	-168.06	-168.06
43	-118.54	-166.02	-166.02	44	-136.03	-166.93	-166.93	45	-111.84	-159.44	-159.44
46	-159.07	-156.85	-156.85	47	-158.31	-156.10	-156.10	48	-153.58	-151.45	-151.45
49	-153.01	-150.90	-150.90	50	-116.38	-188.44	-188.44	51	-111.64	-191.91	-191.91
52	-96.10	-189.87	-189.87	53	-139.63	-165.37	-165.37	54	-134.89	-168.84	-168.84
55	-119.34	-166.80	-166.80	56	-159.49	-157.26	-157.26	57	-158.73	-156.51	-156.51
58	-154.28	-152.14	-152.14	59	-153.71	-151.58	-151.58	60	-115.55	-187.64	-187.64
61	-110.81	-191.10	-191.10	62	-95.27	-189.07	-189.07	63	-138.51	-164.30	-164.30
64	-133.78	-167.76	-167.76	65	-118.23	-165.72	-165.72	66	-127.09	-176.06	-176.06
67	-150.05	-152.72	-152.72	68	-88.57	-182.48	-182.48	69	-111.87	-159.47	-159.47
70	-136.99	-135.17	-135.29	71	-126.51	-145.86	-145.86	72	-137.75	-135.91	-135.91
73	-125.75	-145.13	-145.13	74	-126.17	-145.53	-145.53	75	-117.26	-177.71	-177.71
76	-35.44	-241.78	-241.78	77	-118.02	-178.44	-178.44	78	-34.68	-241.04	-241.04
79	-27.77	-234.26	-234.26								

Elem.	Pt ini	Pt fin	Pt max	Pt ini	Pt fin	Pt max	Pt ini	Pt fin	Pt max
	-309.14								
	-2.13								

RISULTATI ELEMENTI TIPO TRAVE

LEGENDA RISULTATI ELEMENTI TIPO TRAVE

Il controllo dei risultati delle analisi condotte, per quanto concerne gli elementi tipo trave, è possibile in relazione alle tabelle sottoriportate.

Gli elementi vengono suddivisi, in relazione alle proprietà in elementi:

- tipo **pilastro**
- tipo **trave in elevazione**
- tipo **trave in fondazione**

Per ogni elemento, e per ogni combinazione (o caso di carico) vengono riportati i risultati più significativi.

Per gli elementi tipo *pilastro* sono riportati in tabella i seguenti valori:

Pilas.	numero dell'elemento pilastro
Cmb	combinazione in cui si verificano i valori riportati
M3 mx/mn	momento flettente in campata M3 max (prima riga) / min (seconda riga)
M2 mx/mn	momento flettente in campata M2 max (prima riga) / min (seconda riga)
D2/D3	freccia massima in direzione 2 (prima riga) / direzione 3 (seconda riga)
Q2/Q3	carico totale in direzione 2 (prima riga) / direzione 3 (seconda riga)
Pos.	ascissa del punto iniziale e finale dell'elemento
N, V2, ecc..	sei componenti di sollecitazione al piede ed in sommità dell'elemento

Per gli elementi tipo *trave in elevazione* sono riportati, oltre al numero dell'elemento, i medesimi risultati visti per i pilastri.

Per gli elementi tipo *trave in fondazione* (trave f.) sono riportati, oltre al numero dell'elemento, i medesimi risultati visti per i pilastri e la massima pressione sul terreno.

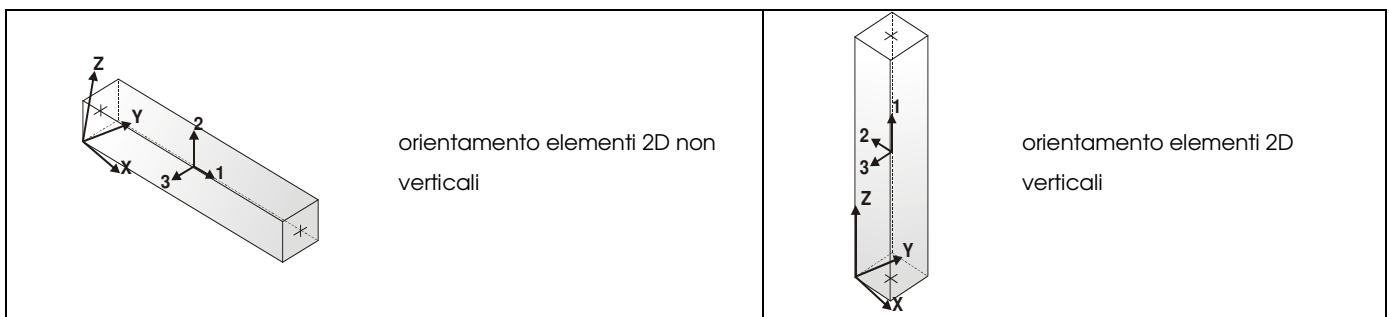

Pilas.	Cmb	M3 mx/mn	M2 mx/mn	D 2 / D 3	Q 2 / Q 3	Pos.	N	V 2	V 3	T	M 2	M 3
		kN m	kN m	m	kN	cm	kN	kN	kN	kN m	kN m	kN m
2	1	-992.03	0.0	4.13e-04	-59.98	0.0	-936.35	335.03	0.0	0.0	0.0	-1174.81
		-1174.81	0.0	0.0	0.0	30.0	-925.21	304.42	0.0	0.0	0.0	-1078.92
						60.0	-914.07	275.05	0.0	0.0	0.0	-992.03
2	2	-993.54	0.0	3.96e-04	-59.98	0.0	-930.60	347.99	0.0	0.0	0.0	-1184.09
		-1184.09	0.0	0.0	0.0	30.0	-919.46	317.38	0.0	0.0	0.0	-1084.31
						60.0	-908.32	288.00	0.0	0.0	0.0	-993.54
2	3	-936.12	0.0	3.81e-04	-59.98	0.0	-888.31	351.22	0.0	0.0	0.0	-1128.61
		-1128.61	0.0	0.0	0.0	30.0	-877.17	320.61	0.0	0.0	0.0	-1027.87
						60.0	-866.04	291.24	0.0	0.0	0.0	-936.12
2	4	-937.25	0.0	3.68e-04	-59.98	0.0	-884.01	360.91	0.0	0.0	0.0	-1135.55
		-1135.55	0.0	0.0	0.0	30.0	-872.87	330.30	0.0	0.0	0.0	-1031.90
						60.0	-861.74	300.93	0.0	0.0	0.0	-937.25
2	5	-1463.00	0.0	-1.20e-03	-102.63	0.0	-805.25	664.48	0.0	0.0	0.0	-1830.53
		-1830.53	0.0	0.0	0.0	30.0	-794.11	612.24	0.0	0.0	0.0	-1639.07
						60.0	-782.97	561.85	0.0	0.0	0.0	-1463.00
2	6	-1515.94	0.0	-1.37e-03	-106.69	0.0	-794.19	715.17	0.0	0.0	0.0	-1912.67
		-1912.67	0.0	0.0	0.0	30.0	-783.05	660.90	0.0	0.0	0.0	-1706.30
						60.0	-771.92	608.48	0.0	0.0	0.0	-1515.94
2	7	-1528.87	0.0	-1.66e-03	-104.20	0.0	-705.89	751.44	0.0	0.0	0.0	-1948.16
		-1948.16	0.0	0.0	0.0	30.0	-694.76	698.55	0.0	0.0	0.0	-1730.70
						60.0	-683.62	647.23	0.0	0.0	0.0	-1528.87
2	8	-1210.60	0.0	-4.17e-04	-102.63	0.0	-854.71	575.79	0.0	0.0	0.0	-1524.92
		-1524.92	0.0	0.0	0.0	30.0	-843.57	523.55	0.0	0.0	0.0	-1360.06
						60.0	-832.43	473.16	0.0	0.0	0.0	-1210.60
2	9	-1263.55	0.0	-5.81e-04	-106.69	0.0	-843.65	626.48	0.0	0.0	0.0	-1607.06
		-1607.06	0.0	0.0	0.0	30.0	-832.51	572.22	0.0	0.0	0.0	-1427.30
						60.0	-821.38	519.79	0.0	0.0	0.0	-1263.55
2	10	-1276.47	0.0	-8.69e-04	-104.20	0.0	-755.36	662.75	0.0	0.0	0.0	-1642.55
		-1642.55	0.0	0.0	0.0	30.0	-744.22	609.86	0.0	0.0	0.0	-1451.69
						60.0	-733.08	558.55	0.0	0.0	0.0	-1276.47
2	11	-892.86	0.0	5.11e-04	-59.98	0.0	-936.35	308.33	0.0	0.0	0.0	-1059.62
		-1059.62	0.0	0.0	0.0	30.0	-925.21	277.72	0.0	0.0	0.0	-971.74
						60.0	-914.07	248.34	0.0	0.0	0.0	-892.86
2	12	-894.37	0.0	4.94e-04	-59.98	0.0	-930.60	321.28	0.0	0.0	0.0	-1068.89
		-1068.89	0.0	0.0	0.0	30.0	-919.46	290.67	0.0	0.0	0.0	-977.13



						60.0	-908.33	261.30	0.0	0.0	0.0	-894.37
2	13	-803.19	0.0	5.12e-04	-59.98	0.0	-888.31	315.42	0.0	0.0	0.0	-974.20
		-974.20	0.0	0.0	0.0	30.0	-877.18	284.81	0.0	0.0	0.0	-884.20
						60.0	-866.04	255.44	0.0	0.0	0.0	-803.19
2	14	-804.32	0.0	4.99e-04	-59.98	0.0	-884.01	325.11	0.0	0.0	0.0	-981.14
		-981.14	0.0	0.0	0.0	30.0	-872.88	294.51	0.0	0.0	0.0	-888.23
						60.0	-861.74	265.13	0.0	0.0	0.0	-804.32
2	15	-1562.17	0.0	-1.30e-03	-102.63	0.0	-805.25	691.18	0.0	0.0	0.0	-1945.72
		-1945.72	0.0	0.0	0.0	30.0	-794.11	638.95	0.0	0.0	0.0	-1746.25
						60.0	-782.97	588.56	0.0	0.0	0.0	-1562.17
2	16	-1615.11	0.0	-1.47e-03	-106.69	0.0	-794.19	741.88	0.0	0.0	0.0	-2027.86
		-2027.86	0.0	0.0	0.0	30.0	-783.05	687.61	0.0	0.0	0.0	-1813.48
						60.0	-771.91	635.19	0.0	0.0	0.0	-1615.11
2	17	-1628.04	0.0	-1.75e-03	-104.20	0.0	-705.89	778.14	0.0	0.0	0.0	-2063.35
		-2063.35	0.0	0.0	0.0	30.0	-694.76	725.25	0.0	0.0	0.0	-1837.88
						60.0	-683.62	673.94	0.0	0.0	0.0	-1628.04
2	18	-1343.53	0.0	-5.48e-04	-102.63	0.0	-854.71	611.59	0.0	0.0	0.0	-1679.33
		-1679.33	0.0	0.0	0.0	30.0	-843.57	559.35	0.0	0.0	0.0	-1503.73
						60.0	-832.43	508.96	0.0	0.0	0.0	-1343.53
2	19	-1396.47	0.0	-7.12e-04	-106.69	0.0	-843.65	662.28	0.0	0.0	0.0	-1761.47
		-1761.47	0.0	0.0	0.0	30.0	-832.51	608.02	0.0	0.0	0.0	-1570.97
						60.0	-821.37	555.59	0.0	0.0	0.0	-1396.47
2	20	-1409.40	0.0	-1.00e-03	-104.20	0.0	-755.35	698.55	0.0	0.0	0.0	-1796.95
		-1796.95	0.0	0.0	0.0	30.0	-744.22	645.66	0.0	0.0	0.0	-1595.36
						60.0	-733.08	594.34	0.0	0.0	0.0	-1409.40
2	21	-1588.60	0.0	-9.81e-04	-102.63	0.0	-857.96	701.26	0.0	0.0	0.0	-1978.20
		-1978.20	0.0	0.0	0.0	30.0	-846.82	649.02	0.0	0.0	0.0	-1775.70
						60.0	-835.68	598.63	0.0	0.0	0.0	-1588.60
2	22	-1369.96	0.0	-2.28e-04	-102.63	0.0	-907.42	621.66	0.0	0.0	0.0	-1711.80
		-1711.80	0.0	0.0	0.0	30.0	-896.28	569.42	0.0	0.0	0.0	-1533.18
						60.0	-885.14	519.03	0.0	0.0	0.0	-1369.96
2	23	-1279.86	0.0	-1.85e-03	-104.20	0.0	-450.31	790.27	0.0	0.0	0.0	-1722.45
		-1722.45	0.0	0.0	0.0	30.0	-442.06	737.38	0.0	0.0	0.0	-1493.34
						60.0	-433.81	686.06	0.0	0.0	0.0	-1279.86
2	24	-1006.57	0.0	-1.06e-03	-104.20	0.0	-499.77	724.81	0.0	0.0	0.0	-1409.88
		-1409.88	0.0	0.0	0.0	30.0	-491.52	671.92	0.0	0.0	0.0	-1200.41
						60.0	-483.27	620.60	0.0	0.0	0.0	-1006.57
2	25	-1361.70	0.0	-1.42e-03	-102.63	0.0	-751.45	681.89	0.0	0.0	0.0	-1739.68
		-1739.68	0.0	0.0	0.0	30.0	-740.31	629.65	0.0	0.0	0.0	-1542.99
						60.0	-729.17	579.26	0.0	0.0	0.0	-1361.70



2	26	-1429.92	0.0	-1.24e-03	-106.69	0.0	-793.10	722.74	0.0	0.0	0.0	-1831.19
		-1831.19	0.0	0.0	0.0	30.0	-781.97	668.47	0.0	0.0	0.0	-1622.55
						60.0	-770.83	616.05	0.0	0.0	0.0	-1429.92
2	27	-1380.12	0.0	-4.98e-05	-102.63	0.0	-973.20	623.00	0.0	0.0	0.0	-1722.76
		-1722.76	0.0	0.0	0.0	30.0	-962.06	570.76	0.0	0.0	0.0	-1543.74
						60.0	-950.92	520.37	0.0	0.0	0.0	-1380.12
2	28	-1398.11	0.0	-6.46e-04	-106.69	0.0	-890.24	663.49	0.0	0.0	0.0	-1763.83
		-1763.83	0.0	0.0	0.0	30.0	-879.10	609.22	0.0	0.0	0.0	-1572.97
						60.0	-867.96	556.80	0.0	0.0	0.0	-1398.11
2	29	-1484.78	0.0	-1.74e-03	-104.20	0.0	-643.62	801.10	0.0	0.0	0.0	-1933.86
		-1933.86	0.0	0.0	0.0	30.0	-632.48	748.21	0.0	0.0	0.0	-1701.50
						60.0	-621.34	696.90	0.0	0.0	0.0	-1484.78
2	30	-884.91	0.0	-6.85e-04	-102.63	0.0	-645.99	566.67	0.0	0.0	0.0	-1193.75
		-1193.75	0.0	0.0	0.0	30.0	-637.74	514.44	0.0	0.0	0.0	-1031.63
						60.0	-629.49	464.04	0.0	0.0	0.0	-884.91
2	31	-887.57	0.0	-7.13e-04	-106.69	0.0	-641.69	603.98	0.0	0.0	0.0	-1217.58
		-1217.58	0.0	0.0	0.0	30.0	-633.44	549.71	0.0	0.0	0.0	-1044.57
						60.0	-625.19	497.29	0.0	0.0	0.0	-887.57
2	32	-819.86	0.0	-7.76e-04	-104.20	0.0	-565.57	618.02	0.0	0.0	0.0	-1159.10
		-1159.10	0.0	0.0	0.0	30.0	-557.32	565.14	0.0	0.0	0.0	-981.66
						60.0	-549.07	513.82	0.0	0.0	0.0	-819.86
2	33	-1414.42	0.0	-1.61e-03	-104.20	0.0	-642.53	791.25	0.0	0.0	0.0	-1857.60
		-1857.60	0.0	0.0	0.0	30.0	-631.39	738.36	0.0	0.0	0.0	-1628.20
						60.0	-620.26	687.05	0.0	0.0	0.0	-1414.42
2	34	-701.40	0.0	2.44e-04	-59.98	0.0	-658.27	327.19	0.0	0.0	0.0	-879.47
		-879.47	0.0	0.0	0.0	30.0	-650.02	296.58	0.0	0.0	0.0	-785.94
						60.0	-641.77	267.21	0.0	0.0	0.0	-701.40
2	35	-772.19	0.0	-3.03e-05	-65.46	0.0	-645.95	389.74	0.0	0.0	0.0	-986.14
		-986.14	0.0	0.0	0.0	30.0	-637.70	356.39	0.0	0.0	0.0	-874.25
						60.0	-629.45	324.27	0.0	0.0	0.0	-772.19
2	36	-816.59	0.0	-1.12e-04	-76.03	0.0	-642.15	414.45	0.0	0.0	0.0	-1042.17
		-1042.17	0.0	0.0	0.0	30.0	-633.90	375.75	0.0	0.0	0.0	-923.68
						60.0	-625.65	338.42	0.0	0.0	0.0	-816.59
2	37	-855.90	0.0	-2.34e-04	-79.04	0.0	-633.94	452.09	0.0	0.0	0.0	-1103.17
		-1103.17	0.0	0.0	0.0	30.0	-625.69	411.89	0.0	0.0	0.0	-973.61
						60.0	-617.44	373.05	0.0	0.0	0.0	-855.90
2	38	-865.50	0.0	-4.47e-04	-77.20	0.0	-568.37	479.02	0.0	0.0	0.0	-1129.52
		-1129.52	0.0	0.0	0.0	30.0	-560.12	439.84	0.0	0.0	0.0	-991.72
						60.0	-551.87	401.83	0.0	0.0	0.0	-865.50
2	39	-618.76	0.0	3.25e-04	-59.98	0.0	-658.27	304.94	0.0	0.0	0.0	-783.48



		-783.48	0.0	0.0	0.0	30.0	-650.02	274.33	0.0	0.0	0.0	-696.62
						60.0	-641.77	244.95	0.0	0.0	0.0	-618.76
2	40	-619.60	0.0	3.16e-04	-59.98	0.0	-655.08	312.13	0.0	0.0	0.0	-788.64
		-788.64	0.0	0.0	0.0	30.0	-646.83	281.52	0.0	0.0	0.0	-699.62
						60.0	-638.58	252.15	0.0	0.0	0.0	-619.60
2	41	-899.23	0.0	-1.93e-04	-76.03	0.0	-642.15	436.70	0.0	0.0	0.0	-1138.17
		-1138.17	0.0	0.0	0.0	30.0	-633.90	398.01	0.0	0.0	0.0	-1013.00
						60.0	-625.65	360.68	0.0	0.0	0.0	-899.23
2	42	-938.54	0.0	-3.15e-04	-79.04	0.0	-633.94	474.35	0.0	0.0	0.0	-1199.16
		-1199.16	0.0	0.0	0.0	30.0	-625.69	434.14	0.0	0.0	0.0	-1062.92
						60.0	-617.44	395.31	0.0	0.0	0.0	-938.54
2	43	-948.14	0.0	-5.29e-04	-77.20	0.0	-568.37	501.28	0.0	0.0	0.0	-1225.51
		-1225.51	0.0	0.0	0.0	30.0	-560.12	462.10	0.0	0.0	0.0	-1081.04
						60.0	-551.87	424.08	0.0	0.0	0.0	-948.14
2	44	-1054.02	0.0	-3.37e-04	-79.66	0.0	-663.12	524.87	0.0	0.0	0.0	-1344.81
		-1344.81	0.0	0.0	0.0	30.0	-654.87	484.46	0.0	0.0	0.0	-1193.44
						60.0	-646.62	445.21	0.0	0.0	0.0	-1054.02
2	45	-834.32	0.0	-5.11e-04	-77.20	0.0	-522.13	520.25	0.0	0.0	0.0	-1123.08
		-1123.08	0.0	0.0	0.0	30.0	-513.88	481.07	0.0	0.0	0.0	-972.91
						60.0	-505.63	443.05	0.0	0.0	0.0	-834.32
2	46	-734.83	0.0	2.69e-04	-59.98	0.0	-693.59	323.83	0.0	0.0	0.0	-910.89
		-910.89	0.0	0.0	0.0	30.0	-685.34	293.22	0.0	0.0	0.0	-818.36
						60.0	-677.09	263.84	0.0	0.0	0.0	-734.83
2	47	-735.95	0.0	2.57e-04	-59.98	0.0	-689.33	333.42	0.0	0.0	0.0	-917.76
		-917.76	0.0	0.0	0.0	30.0	-681.08	302.81	0.0	0.0	0.0	-822.36
						60.0	-672.83	273.44	0.0	0.0	0.0	-735.95
2	48	-692.70	0.0	2.46e-04	-59.98	0.0	-658.27	336.87	0.0	0.0	0.0	-876.58
		-876.58	0.0	0.0	0.0	30.0	-650.02	306.26	0.0	0.0	0.0	-780.14
						60.0	-641.77	276.89	0.0	0.0	0.0	-692.70
2	49	-693.53	0.0	2.37e-04	-59.98	0.0	-655.08	344.07	0.0	0.0	0.0	-881.73
		-881.73	0.0	0.0	0.0	30.0	-646.83	313.46	0.0	0.0	0.0	-783.13
						60.0	-638.58	284.08	0.0	0.0	0.0	-693.53
2	50	-1011.29	0.0	-6.96e-04	-76.03	0.0	-605.51	471.54	0.0	0.0	0.0	-1271.13
		-1271.13	0.0	0.0	0.0	30.0	-597.26	432.84	0.0	0.0	0.0	-1135.50
						60.0	-589.01	395.51	0.0	0.0	0.0	-1011.29
2	51	-1050.60	0.0	-8.18e-04	-79.04	0.0	-597.30	509.18	0.0	0.0	0.0	-1332.12
		-1332.12	0.0	0.0	0.0	30.0	-589.05	468.98	0.0	0.0	0.0	-1185.43
						60.0	-580.80	430.14	0.0	0.0	0.0	-1050.60
2	52	-1060.20	0.0	-1.03e-03	-77.20	0.0	-531.74	536.11	0.0	0.0	0.0	-1358.47
		-1358.47	0.0	0.0	0.0	30.0	-523.49	496.93	0.0	0.0	0.0	-1203.55



						60.0	-515.24	458.92	0.0	0.0	0.0	-1060.20
2	53	-825.29	0.0	-1.14e-04	-76.03	0.0	-642.15	404.77	0.0	0.0	0.0	-1045.07
		-1045.07	0.0	0.0	0.0	30.0	-633.90	366.07	0.0	0.0	0.0	-929.48
						60.0	-625.65	328.74	0.0	0.0	0.0	-825.29
2	54	-864.60	0.0	-2.36e-04	-79.04	0.0	-633.94	442.41	0.0	0.0	0.0	-1106.07
		-1106.07	0.0	0.0	0.0	30.0	-625.69	402.21	0.0	0.0	0.0	-979.41
						60.0	-617.44	363.37	0.0	0.0	0.0	-864.60
2	55	-874.20	0.0	-4.50e-04	-77.20	0.0	-568.37	469.34	0.0	0.0	0.0	-1132.42
		-1132.42	0.0	0.0	0.0	30.0	-560.12	430.16	0.0	0.0	0.0	-997.52
						60.0	-551.87	392.15	0.0	0.0	0.0	-874.20
2	56	-692.63	0.0	3.11e-04	-59.98	0.0	-693.59	312.46	0.0	0.0	0.0	-861.87
		-861.87	0.0	0.0	0.0	30.0	-685.34	281.85	0.0	0.0	0.0	-772.75
						60.0	-677.09	252.48	0.0	0.0	0.0	-692.63
2	57	-693.75	0.0	2.99e-04	-59.98	0.0	-689.33	322.06	0.0	0.0	0.0	-868.74
		-868.74	0.0	0.0	0.0	30.0	-681.08	291.45	0.0	0.0	0.0	-776.75
						60.0	-672.83	262.08	0.0	0.0	0.0	-693.75
2	58	-622.37	0.0	3.15e-04	-59.98	0.0	-658.27	317.93	0.0	0.0	0.0	-794.88
		-794.88	0.0	0.0	0.0	30.0	-650.02	287.32	0.0	0.0	0.0	-704.12
						60.0	-641.77	257.95	0.0	0.0	0.0	-622.37
2	59	-623.20	0.0	3.06e-04	-59.98	0.0	-655.08	325.13	0.0	0.0	0.0	-800.04
		-800.04	0.0	0.0	0.0	30.0	-646.83	294.52	0.0	0.0	0.0	-707.12
						60.0	-638.58	265.14	0.0	0.0	0.0	-623.20
2	60	-1093.93	0.0	-7.78e-04	-76.03	0.0	-605.51	493.79	0.0	0.0	0.0	-1367.12
		-1367.12	0.0	0.0	0.0	30.0	-597.26	455.10	0.0	0.0	0.0	-1224.82
						60.0	-589.01	417.77	0.0	0.0	0.0	-1093.93
2	61	-1133.24	0.0	-8.99e-04	-79.04	0.0	-597.30	531.44	0.0	0.0	0.0	-1428.12
		-1428.12	0.0	0.0	0.0	30.0	-589.05	491.24	0.0	0.0	0.0	-1274.75
						60.0	-580.80	452.40	0.0	0.0	0.0	-1133.24
2	62	-1142.84	0.0	-1.11e-03	-77.20	0.0	-531.74	558.37	0.0	0.0	0.0	-1454.47
		-1454.47	0.0	0.0	0.0	30.0	-523.49	519.19	0.0	0.0	0.0	-1292.86
						60.0	-515.24	481.17	0.0	0.0	0.0	-1142.84
2	63	-936.06	0.0	-2.23e-04	-76.03	0.0	-642.15	434.60	0.0	0.0	0.0	-1173.74
		-1173.74	0.0	0.0	0.0	30.0	-633.90	395.91	0.0	0.0	0.0	-1049.20
						60.0	-625.65	358.58	0.0	0.0	0.0	-936.06
2	64	-975.38	0.0	-3.45e-04	-79.04	0.0	-633.94	472.25	0.0	0.0	0.0	-1234.74
		-1234.74	0.0	0.0	0.0	30.0	-625.69	432.04	0.0	0.0	0.0	-1099.13
						60.0	-617.44	393.20	0.0	0.0	0.0	-975.38
2	65	-984.98	0.0	-5.59e-04	-77.20	0.0	-568.37	499.18	0.0	0.0	0.0	-1261.09
		-1261.09	0.0	0.0	0.0	30.0	-560.12	459.99	0.0	0.0	0.0	-1117.24
						60.0	-551.87	421.98	0.0	0.0	0.0	-984.98

2	66	-1113.55	0.0	-5.40e-04	-76.03	0.0	-644.66	501.27	0.0	0.0	0.0	-1391.24
		-1391.24	0.0	0.0	0.0	30.0	-636.41	462.58	0.0	0.0	0.0	-1246.69
						60.0	-628.16	425.25	0.0	0.0	0.0	-1113.55
2	67	-955.69	0.0	-1.45e-05	-76.03	0.0	-681.29	442.08	0.0	0.0	0.0	-1197.86
		-1197.86	0.0	0.0	0.0	30.0	-673.04	403.39	0.0	0.0	0.0	-1071.07
						60.0	-664.79	366.05	0.0	0.0	0.0	-955.69
2	68	-1029.02	0.0	-1.10e-03	-77.20	0.0	-485.49	577.34	0.0	0.0	0.0	-1352.03
		-1352.03	0.0	0.0	0.0	30.0	-477.24	538.16	0.0	0.0	0.0	-1184.73
						60.0	-468.99	500.15	0.0	0.0	0.0	-1029.02
2	69	-825.61	0.0	-5.09e-04	-77.20	0.0	-522.13	529.93	0.0	0.0	0.0	-1120.18
		-1120.18	0.0	0.0	0.0	30.0	-513.88	490.75	0.0	0.0	0.0	-967.11
						60.0	-505.63	452.73	0.0	0.0	0.0	-825.61
2	70	-603.28	0.0	1.67e-04	-59.98	0.0	-552.31	334.87	0.0	0.0	0.0	-785.96
		-785.96	0.0	0.0	0.0	30.0	-544.06	304.26	0.0	0.0	0.0	-690.12
						60.0	-535.81	274.88	0.0	0.0	0.0	-603.28
2	71	-682.65	0.0	-9.63e-05	-73.56	0.0	-540.30	402.06	0.0	0.0	0.0	-901.54
		-901.54	0.0	0.0	0.0	30.0	-532.05	364.60	0.0	0.0	0.0	-786.58
						60.0	-523.80	328.50	0.0	0.0	0.0	-682.65
2	72	-527.68	0.0	2.41e-04	-59.98	0.0	-552.31	314.50	0.0	0.0	0.0	-698.14
		-698.14	0.0	0.0	0.0	30.0	-544.06	283.90	0.0	0.0	0.0	-608.41
						60.0	-535.81	254.52	0.0	0.0	0.0	-527.68
2	73	-758.25	0.0	-1.71e-04	-73.56	0.0	-540.30	422.42	0.0	0.0	0.0	-989.36
		-989.36	0.0	0.0	0.0	30.0	-532.05	384.96	0.0	0.0	0.0	-868.29
						60.0	-523.80	348.86	0.0	0.0	0.0	-758.25
2	74	-701.33	0.0	-1.31e-04	-73.56	0.0	-540.30	437.14	0.0	0.0	0.0	-941.27
		-941.27	0.0	0.0	0.0	30.0	-532.05	399.68	0.0	0.0	0.0	-815.78
						60.0	-523.80	363.58	0.0	0.0	0.0	-701.33
2	75	-963.62	0.0	-6.46e-04	-83.24	0.0	-587.78	566.10	0.0	0.0	0.0	-1278.03
		-1278.03	0.0	0.0	0.0	30.0	-579.53	523.80	0.0	0.0	0.0	-1114.58
						60.0	-571.28	482.86	0.0	0.0	0.0	-963.62
2	76	-1540.08	0.0	-2.56e-03	-105.82	0.0	-431.56	880.69	0.0	0.0	0.0	-2036.48
		-2036.48	0.0	0.0	0.0	30.0	-423.31	827.10	0.0	0.0	0.0	-1780.34
						60.0	-415.06	774.87	0.0	0.0	0.0	-1540.08
2	77	-888.01	0.0	-5.71e-04	-83.24	0.0	-587.78	545.74	0.0	0.0	0.0	-1190.21
		-1190.21	0.0	0.0	0.0	30.0	-579.53	503.44	0.0	0.0	0.0	-1032.86
						60.0	-571.28	462.50	0.0	0.0	0.0	-888.01
2	78	-1615.69	0.0	-2.63e-03	-105.82	0.0	-431.56	901.05	0.0	0.0	0.0	-2124.30
		-2124.30	0.0	0.0	0.0	30.0	-423.31	847.46	0.0	0.0	0.0	-1862.06
						60.0	-415.06	795.23	0.0	0.0	0.0	-1615.69
2	79	-1510.33	0.0	-2.62e-03	-105.82	0.0	-384.29	913.70	0.0	0.0	0.0	-2026.53



		-2026.53	0.0	0.0	0.0	30.0	-376.04	860.10	0.0	0.0	0.0	-1760.49
						60.0	-367.79	807.88	0.0	0.0	0.0	-1510.33
4	1	-512.60	0.0	7.92e-04	-359.98	0.0	-914.07	275.05	0.0	0.0	0.0	-992.03
		-992.03	0.0	0.0	0.0	345.0	-785.99	26.04	0.0	0.0	0.0	-519.62
						690.0	-657.91	-84.93	0.0	0.0	0.0	-649.83
4	2	-459.44	0.0	-7.28e-04	-359.98	0.0	-908.32	288.00	0.0	0.0	0.0	-993.54
		-993.54	0.0	0.0	0.0	345.0	-780.24	38.99	0.0	0.0	0.0	-476.43
						690.0	-652.16	-71.97	0.0	0.0	0.0	-561.95
4	3	-388.07	0.0	-9.82e-04	-359.98	0.0	-866.04	291.24	0.0	0.0	0.0	-936.12
		-936.12	0.0	0.0	0.0	345.0	-737.96	42.23	0.0	0.0	0.0	-407.85
						690.0	-609.87	-68.74	0.0	0.0	0.0	-482.21
4	4	-347.40	0.0	-9.93e-04	-359.98	0.0	-861.74	300.93	0.0	0.0	0.0	-937.25
		-937.25	0.0	0.0	0.0	345.0	-733.66	51.92	0.0	0.0	0.0	-375.54
						690.0	-605.57	-59.04	0.0	0.0	0.0	-416.46
4	5	-292.09	0.0	-0.02	-673.84	0.0	-782.97	561.85	0.0	0.0	0.0	-1463.00
		-1463.00	0.0	0.0	0.0	345.0	-654.89	114.87	0.0	0.0	0.0	-365.77
						690.0	-526.81	-111.99	0.0	0.0	0.0	-413.70
4	6	-194.32	0.0	-0.02	-720.54	0.0	-771.92	608.48	0.0	0.0	0.0	-1515.94
		-1515.94	0.0	0.0	0.0	345.0	-643.83	138.16	0.0	0.0	0.0	-298.10
						690.0	-515.75	-112.05	0.0	0.0	0.0	-305.96
4	7	-32.47	0.0	-0.02	-769.46	0.0	-683.62	647.23	0.0	0.0	0.0	-1528.87
		-1528.87	0.0	0.0	0.0	345.0	-555.54	170.27	0.0	0.0	0.0	-178.54
						690.0	-427.46	-122.23	0.0	0.0	0.0	-138.30
4	8	-416.79	0.0	-8.22e-03	-673.84	0.0	-832.43	473.16	0.0	0.0	0.0	-1210.60
		-1210.60	0.0	0.0	0.0	345.0	-704.35	26.18	0.0	0.0	0.0	-419.35
						690.0	-576.27	-200.68	0.0	0.0	0.0	-773.25
4	9	-339.33	0.0	-9.95e-03	-720.54	0.0	-821.38	519.79	0.0	0.0	0.0	-1263.55
		-1263.55	0.0	0.0	0.0	345.0	-693.29	49.47	0.0	0.0	0.0	-351.68
						690.0	-565.21	-200.74	0.0	0.0	0.0	-665.51
4	10	-200.14	0.0	-0.01	-769.46	0.0	-733.08	558.55	0.0	0.0	0.0	-1276.47
		-1276.47	0.0	0.0	0.0	345.0	-605.00	81.58	0.0	0.0	0.0	-232.12
						690.0	-476.92	-210.91	0.0	0.0	0.0	-497.85
4	11	-512.59	0.0	1.48e-03	-359.98	0.0	-914.07	248.34	0.0	0.0	0.0	-892.86
		-892.86	0.0	0.0	0.0	345.0	-785.99	-0.67	0.0	0.0	0.0	-512.59
						690.0	-657.91	-111.63	0.0	0.0	0.0	-734.93
4	12	-468.57	0.0	1.40e-03	-359.98	0.0	-908.33	261.30	0.0	0.0	0.0	-894.37
		-894.37	0.0	0.0	0.0	345.0	-780.24	12.28	0.0	0.0	0.0	-469.40
						690.0	-652.16	-98.68	0.0	0.0	0.0	-647.05
4	13	-398.43	0.0	1.56e-03	-359.98	0.0	-866.04	255.44	0.0	0.0	0.0	-803.19
		-803.19	0.0	0.0	0.0	345.0	-737.96	6.43	0.0	0.0	0.0	-398.43



						690.0	-609.88	-104.54	0.0	0.0	0.0	-596.29
4	14	-363.57	0.0	1.50e-03	-359.98	0.0	-861.74	265.13	0.0	0.0	0.0	-804.32
		-804.32	0.0	0.0	0.0	345.0	-733.66	16.12	0.0	0.0	0.0	-366.12
						690.0	-605.58	-94.84	0.0	0.0	0.0	-530.54
4	15	-253.05	0.0	-0.02	-673.84	0.0	-782.97	588.56	0.0	0.0	0.0	-1562.17
		-1562.17	0.0	0.0	0.0	345.0	-654.89	141.58	0.0	0.0	0.0	-372.80
						690.0	-526.81	-85.29	0.0	0.0	0.0	-328.59
4	16	-155.28	0.0	-0.02	-720.54	0.0	-771.91	635.19	0.0	0.0	0.0	-1615.11
		-1615.11	0.0	0.0	0.0	345.0	-643.83	164.86	0.0	0.0	0.0	-305.13
						690.0	-515.75	-85.35	0.0	0.0	0.0	-220.85
4	17	6.57	0.0	-0.02	-769.46	0.0	-683.62	673.94	0.0	0.0	0.0	-1628.04
		-1628.04	0.0	0.0	0.0	345.0	-555.54	196.98	0.0	0.0	0.0	-185.57
						690.0	-427.46	-95.52	0.0	0.0	0.0	-53.20
4	18	-408.23	0.0	-0.01	-673.84	0.0	-832.43	508.96	0.0	0.0	0.0	-1343.53
		-1343.53	0.0	0.0	0.0	345.0	-704.35	61.98	0.0	0.0	0.0	-428.77
						690.0	-576.27	-164.88	0.0	0.0	0.0	-659.17
4	19	-322.99	0.0	-0.01	-720.54	0.0	-821.37	555.59	0.0	0.0	0.0	-1396.47
		-1396.47	0.0	0.0	0.0	345.0	-693.29	85.27	0.0	0.0	0.0	-361.10
						690.0	-565.21	-164.94	0.0	0.0	0.0	-551.43
4	20	-178.69	0.0	-0.01	-769.46	0.0	-733.08	594.34	0.0	0.0	0.0	-1409.40
		-1409.40	0.0	0.0	0.0	345.0	-605.00	117.38	0.0	0.0	0.0	-241.54
						690.0	-476.92	-175.11	0.0	0.0	0.0	-383.77
4	21	-227.36	0.0	-0.02	-673.84	0.0	-835.68	598.63	0.0	0.0	0.0	-1588.60
		-1588.60	0.0	0.0	0.0	345.0	-707.60	151.65	0.0	0.0	0.0	-364.48
						690.0	-579.52	-75.22	0.0	0.0	0.0	-285.52
4	22	-391.22	0.0	-6.48e-03	-673.84	0.0	-885.14	519.03	0.0	0.0	0.0	-1369.96
		-1369.96	0.0	0.0	0.0	345.0	-757.06	72.05	0.0	0.0	0.0	-420.45
						690.0	-628.98	-154.81	0.0	0.0	0.0	-616.10
4	23	425.62	0.0	-0.02	-769.46	0.0	-433.81	686.06	0.0	0.0	0.0	-1279.86
		-1279.86	0.0	0.0	0.0	345.0	-338.93	209.10	0.0	0.0	0.0	204.44
						690.0	-244.06	-83.39	0.0	0.0	0.0	378.64
4	24	352.01	0.0	-0.01	-769.46	0.0	-483.27	620.60	0.0	0.0	0.0	-1006.57
		-1006.57	0.0	0.0	0.0	345.0	-388.39	143.64	0.0	0.0	0.0	251.88
						690.0	-293.52	-148.86	0.0	0.0	0.0	200.25
4	25	-100.67	0.0	-0.02	-673.84	0.0	-729.17	579.26	0.0	0.0	0.0	-1361.70
		-1361.70	0.0	0.0	0.0	345.0	-601.09	132.28	0.0	0.0	0.0	-204.39
						690.0	-473.01	-94.58	0.0	0.0	0.0	-192.25
4	26	-69.13	0.0	-0.02	-720.54	0.0	-770.83	616.05	0.0	0.0	0.0	-1429.92
		-1429.92	0.0	0.0	0.0	345.0	-642.75	145.73	0.0	0.0	0.0	-185.97
						690.0	-514.67	-104.49	0.0	0.0	0.0	-167.72



4	27	-395.61	0.0	-5.00e-03	-673.84	0.0	-950.92	520.37	0.0	0.0	0.0	-1380.12
		-1380.12	0.0	0.0	0.0	345.0	-822.84	73.39	0.0	0.0	0.0	-426.00
						690.0	-694.76	-153.47	0.0	0.0	0.0	-617.03
4	28	-319.42	0.0	-0.01	-720.54	0.0	-867.96	556.80	0.0	0.0	0.0	-1398.11
		-1398.11	0.0	0.0	0.0	345.0	-739.88	86.48	0.0	0.0	0.0	-358.57
						690.0	-611.80	-163.73	0.0	0.0	0.0	-544.73
4	29	286.11	0.0	-0.02	-769.46	0.0	-621.34	696.90	0.0	0.0	0.0	-1484.78
		-1484.78	0.0	0.0	0.0	345.0	-493.26	219.94	0.0	0.0	0.0	36.90
						690.0	-365.18	-72.56	0.0	0.0	0.0	248.48
4	30	-125.11	0.0	-9.70e-03	-673.84	0.0	-629.49	464.04	0.0	0.0	0.0	-884.91
		-884.91	0.0	0.0	0.0	345.0	-534.61	17.07	0.0	0.0	0.0	-125.11
						690.0	-439.74	-209.80	0.0	0.0	0.0	-510.46
4	31	-51.13	0.0	-9.71e-03	-720.54	0.0	-625.19	497.29	0.0	0.0	0.0	-887.57
		-887.57	0.0	0.0	0.0	345.0	-530.31	26.96	0.0	0.0	0.0	-53.35
						690.0	-435.44	-223.25	0.0	0.0	0.0	-444.83
4	32	76.11	0.0	-9.74e-03	-769.46	0.0	-549.07	513.82	0.0	0.0	0.0	-819.86
		-819.86	0.0	0.0	0.0	345.0	-454.20	36.86	0.0	0.0	0.0	70.20
						690.0	-359.32	-255.64	0.0	0.0	0.0	-349.83
4	33	296.98	0.0	-0.02	-769.46	0.0	-620.26	687.05	0.0	0.0	0.0	-1414.42
		-1414.42	0.0	0.0	0.0	345.0	-492.17	210.08	0.0	0.0	0.0	73.26
						690.0	-364.09	-82.41	0.0	0.0	0.0	250.85
4	34	-252.55	0.0	-6.31e-04	-359.98	0.0	-641.77	267.21	0.0	0.0	0.0	-701.40
		-701.40	0.0	0.0	0.0	345.0	-546.90	18.20	0.0	0.0	0.0	-256.04
						690.0	-452.02	-92.77	0.0	0.0	0.0	-413.30
4	35	-166.62	0.0	-2.96e-03	-423.01	0.0	-629.45	324.27	0.0	0.0	0.0	-772.19
		-772.19	0.0	0.0	0.0	345.0	-534.58	43.75	0.0	0.0	0.0	-184.31
						690.0	-439.70	-98.73	0.0	0.0	0.0	-307.79
4	36	-272.17	0.0	-3.76e-03	-499.21	0.0	-625.65	338.42	0.0	0.0	0.0	-816.59
		-816.59	0.0	0.0	0.0	345.0	-530.78	7.29	0.0	0.0	0.0	-272.17
						690.0	-435.90	-160.79	0.0	0.0	0.0	-576.14
4	37	-218.20	0.0	-5.04e-03	-533.89	0.0	-617.44	373.05	0.0	0.0	0.0	-855.90
		-855.90	0.0	0.0	0.0	345.0	-522.56	24.58	0.0	0.0	0.0	-221.92
						690.0	-427.69	-160.84	0.0	0.0	0.0	-496.13
4	38	-119.25	0.0	-7.16e-03	-570.21	0.0	-551.87	401.83	0.0	0.0	0.0	-865.50
		-865.50	0.0	0.0	0.0	345.0	-457.00	48.43	0.0	0.0	0.0	-133.14
						690.0	-362.12	-168.39	0.0	0.0	0.0	-371.63
4	39	-250.18	0.0	9.56e-04	-359.98	0.0	-641.77	244.95	0.0	0.0	0.0	-618.76
		-618.76	0.0	0.0	0.0	345.0	-546.90	-4.06	0.0	0.0	0.0	-250.18
						690.0	-452.02	-115.02	0.0	0.0	0.0	-484.22
4	40	-226.19	0.0	9.12e-04	-359.98	0.0	-638.58	252.15	0.0	0.0	0.0	-619.60



		-619.60	0.0	0.0	0.0	345.0	-543.70	3.14	0.0	0.0	0.0	-226.19
						690.0	-448.83	-107.83	0.0	0.0	0.0	-435.40
4	41	-271.57	0.0	-4.94e-03	-499.21	0.0	-625.65	360.68	0.0	0.0	0.0	-899.23
		-899.23	0.0	0.0	0.0	345.0	-530.77	29.55	0.0	0.0	0.0	-278.03
						690.0	-435.90	-138.54	0.0	0.0	0.0	-505.21
4	42	-213.63	0.0	-6.23e-03	-533.89	0.0	-617.44	395.31	0.0	0.0	0.0	-938.54
		-938.54	0.0	0.0	0.0	345.0	-522.56	46.84	0.0	0.0	0.0	-227.78
						690.0	-427.69	-138.58	0.0	0.0	0.0	-425.21
4	43	-106.48	0.0	-8.35e-03	-570.21	0.0	-551.87	424.08	0.0	0.0	0.0	-948.14
		-948.14	0.0	0.0	0.0	345.0	-457.00	70.68	0.0	0.0	0.0	-138.99
						690.0	-362.12	-146.13	0.0	0.0	0.0	-300.71
4	44	-159.47	0.0	-6.66e-03	-598.57	0.0	-646.62	445.21	0.0	0.0	0.0	-1054.02
		-1054.02	0.0	0.0	0.0	345.0	-551.75	77.63	0.0	0.0	0.0	-196.45
						690.0	-456.87	-153.37	0.0	0.0	0.0	-358.66
4	45	89.16	0.0	-8.38e-03	-570.21	0.0	-505.63	443.05	0.0	0.0	0.0	-834.32
		-834.32	0.0	0.0	0.0	345.0	-410.75	89.66	0.0	0.0	0.0	40.28
						690.0	-315.88	-127.16	0.0	0.0	0.0	-55.98
4	46	-299.10	0.0	-6.17e-04	-359.98	0.0	-677.09	263.84	0.0	0.0	0.0	-734.83
		-734.83	0.0	0.0	0.0	345.0	-582.21	14.83	0.0	0.0	0.0	-301.08
						690.0	-487.34	-96.13	0.0	0.0	0.0	-469.94
4	47	-262.80	0.0	-6.27e-04	-359.98	0.0	-672.83	273.44	0.0	0.0	0.0	-735.95
		-735.95	0.0	0.0	0.0	345.0	-577.96	24.43	0.0	0.0	0.0	-269.09
						690.0	-483.08	-86.54	0.0	0.0	0.0	-404.85
4	48	-206.10	0.0	-8.39e-04	-359.98	0.0	-641.77	276.89	0.0	0.0	0.0	-692.70
		-692.70	0.0	0.0	0.0	345.0	-546.90	27.87	0.0	0.0	0.0	-213.94
						690.0	-452.02	-83.09	0.0	0.0	0.0	-337.82
4	49	-176.34	0.0	-8.47e-04	-359.98	0.0	-638.58	284.08	0.0	0.0	0.0	-693.53
		-693.53	0.0	0.0	0.0	345.0	-543.70	35.07	0.0	0.0	0.0	-189.95
						690.0	-448.83	-75.89	0.0	0.0	0.0	-288.99
4	50	-238.75	0.0	-0.01	-499.21	0.0	-589.01	395.51	0.0	0.0	0.0	-1011.29
		-1011.29	0.0	0.0	0.0	345.0	-494.14	64.38	0.0	0.0	0.0	-269.90
						690.0	-399.26	-103.70	0.0	0.0	0.0	-376.90
4	51	-175.46	0.0	-0.01	-533.89	0.0	-580.80	430.14	0.0	0.0	0.0	-1050.60
		-1050.60	0.0	0.0	0.0	345.0	-485.93	81.68	0.0	0.0	0.0	-219.65
						690.0	-391.05	-103.74	0.0	0.0	0.0	-296.89
4	52	-58.27	0.0	-0.01	-570.21	0.0	-515.24	458.92	0.0	0.0	0.0	-1060.20
		-1060.20	0.0	0.0	0.0	345.0	-420.36	105.52	0.0	0.0	0.0	-130.87
						690.0	-325.49	-111.30	0.0	0.0	0.0	-172.40
4	53	-314.26	0.0	-3.55e-03	-499.21	0.0	-625.65	328.74	0.0	0.0	0.0	-825.29
		-825.29	0.0	0.0	0.0	345.0	-530.78	-2.39	0.0	0.0	0.0	-314.26



						690.0	-435.90	-170.47	0.0	0.0	0.0	-651.62
4	54	-264.01	0.0	-4.83e-03	-533.89	0.0	-617.44	363.37	0.0	0.0	0.0	-864.60
		-864.60	0.0	0.0	0.0	345.0	-522.56	14.91	0.0	0.0	0.0	-264.01
						690.0	-427.69	-170.51	0.0	0.0	0.0	-571.61
4	55	-165.70	0.0	-6.95e-03	-570.21	0.0	-551.87	392.15	0.0	0.0	0.0	-874.20
		-874.20	0.0	0.0	0.0	345.0	-457.00	38.75	0.0	0.0	0.0	-175.23
						690.0	-362.12	-178.07	0.0	0.0	0.0	-447.12
4	56	-298.08	0.0	7.30e-04	-359.98	0.0	-677.09	252.48	0.0	0.0	0.0	-692.63
		-692.63	0.0	0.0	0.0	345.0	-582.22	3.47	0.0	0.0	0.0	-298.08
						690.0	-487.34	-107.50	0.0	0.0	0.0	-506.16
4	57	-264.92	0.0	6.84e-04	-359.98	0.0	-672.83	262.08	0.0	0.0	0.0	-693.75
		-693.75	0.0	0.0	0.0	345.0	-577.96	13.06	0.0	0.0	0.0	-266.09
						690.0	-483.08	-97.90	0.0	0.0	0.0	-441.06
4	58	-208.96	0.0	7.75e-04	-359.98	0.0	-641.77	257.95	0.0	0.0	0.0	-622.37
		-622.37	0.0	0.0	0.0	345.0	-546.90	8.93	0.0	0.0	0.0	-208.96
						690.0	-452.02	-102.03	0.0	0.0	0.0	-398.18
4	59	-182.41	0.0	7.33e-04	-359.98	0.0	-638.58	265.14	0.0	0.0	0.0	-623.20
		-623.20	0.0	0.0	0.0	345.0	-543.70	16.13	0.0	0.0	0.0	-184.97
						690.0	-448.83	-94.83	0.0	0.0	0.0	-349.35
4	60	-218.52	0.0	-0.01	-499.21	0.0	-589.01	417.77	0.0	0.0	0.0	-1093.93
		-1093.93	0.0	0.0	0.0	345.0	-494.14	86.64	0.0	0.0	0.0	-275.76
						690.0	-399.26	-81.44	0.0	0.0	0.0	-305.98
4	61	-145.92	0.0	-0.01	-533.89	0.0	-580.80	452.40	0.0	0.0	0.0	-1133.24
		-1133.24	0.0	0.0	0.0	345.0	-485.93	103.93	0.0	0.0	0.0	-225.51
						690.0	-391.05	-81.49	0.0	0.0	0.0	-225.97
4	62	-25.74	0.0	-0.02	-570.21	0.0	-515.24	481.17	0.0	0.0	0.0	-1142.84
		-1142.84	0.0	0.0	0.0	345.0	-420.36	127.78	0.0	0.0	0.0	-136.72
						690.0	-325.49	-89.04	0.0	0.0	0.0	-101.47
4	63	-316.60	0.0	-5.14e-03	-499.21	0.0	-625.65	358.58	0.0	0.0	0.0	-936.06
		-936.06	0.0	0.0	0.0	345.0	-530.77	27.44	0.0	0.0	0.0	-322.11
						690.0	-435.90	-140.64	0.0	0.0	0.0	-556.55
4	64	-259.08	0.0	-6.42e-03	-533.89	0.0	-617.44	393.20	0.0	0.0	0.0	-975.38
		-975.38	0.0	0.0	0.0	345.0	-522.56	44.74	0.0	0.0	0.0	-271.86
						690.0	-427.69	-140.68	0.0	0.0	0.0	-476.55
4	65	-152.38	0.0	-8.54e-03	-570.21	0.0	-551.87	421.98	0.0	0.0	0.0	-984.98
		-984.98	0.0	0.0	0.0	345.0	-457.00	68.58	0.0	0.0	0.0	-183.08
						690.0	-362.12	-148.24	0.0	0.0	0.0	-352.05
4	66	-199.44	0.0	-9.47e-03	-499.21	0.0	-628.16	425.25	0.0	0.0	0.0	-1113.55
		-1113.55	0.0	0.0	0.0	345.0	-533.28	94.12	0.0	0.0	0.0	-269.58
						690.0	-438.41	-73.96	0.0	0.0	0.0	-273.99



4	67	-307.06	0.0	-2.43e-03	-499.21	0.0	-664.79	366.05	0.0	0.0	0.0	-955.69
		-955.69	0.0	0.0	0.0	345.0	-569.92	34.92	0.0	0.0	0.0	-315.94
						690.0	-475.04	-133.16	0.0	0.0	0.0	-524.57
4	68	186.27	0.0	-0.02	-570.21	0.0	-468.99	500.15	0.0	0.0	0.0	-1029.02
		-1029.02	0.0	0.0	0.0	345.0	-374.12	146.75	0.0	0.0	0.0	42.55
						690.0	-279.24	-70.07	0.0	0.0	0.0	143.26
4	69	144.30	0.0	-8.59e-03	-570.21	0.0	-505.63	452.73	0.0	0.0	0.0	-825.61
		-825.61	0.0	0.0	0.0	345.0	-410.75	99.34	0.0	0.0	0.0	82.38
						690.0	-315.88	-117.48	0.0	0.0	0.0	19.50
4	70	-124.50	0.0	-6.21e-04	-359.98	0.0	-535.81	274.88	0.0	0.0	0.0	-603.28
		-603.28	0.0	0.0	0.0	345.0	-440.94	25.87	0.0	0.0	0.0	-131.44
						690.0	-346.06	-85.09	0.0	0.0	0.0	-262.23
4	71	-148.00	0.0	-2.81e-03	-470.85	0.0	-523.80	328.50	0.0	0.0	0.0	-682.65
		-682.65	0.0	0.0	0.0	345.0	-428.92	11.55	0.0	0.0	0.0	-148.00
						690.0	-334.05	-142.36	0.0	0.0	0.0	-412.83
4	72	-126.08	0.0	6.85e-04	-359.98	0.0	-535.81	254.52	0.0	0.0	0.0	-527.68
		-527.68	0.0	0.0	0.0	345.0	-440.94	5.51	0.0	0.0	0.0	-126.08
						690.0	-346.06	-105.45	0.0	0.0	0.0	-327.11
4	73	-145.43	0.0	-3.89e-03	-470.85	0.0	-523.80	348.86	0.0	0.0	0.0	-758.25
		-758.25	0.0	0.0	0.0	345.0	-428.92	31.91	0.0	0.0	0.0	-153.36
						690.0	-334.05	-122.00	0.0	0.0	0.0	-347.94
4	74	-28.27	0.0	-3.90e-03	-470.85	0.0	-523.80	363.58	0.0	0.0	0.0	-701.33
		-701.33	0.0	0.0	0.0	345.0	-428.92	46.63	0.0	0.0	0.0	-45.64
						690.0	-334.05	-107.27	0.0	0.0	0.0	-189.42
4	75	54.21	0.0	-0.01	-599.40	0.0	-571.28	482.86	0.0	0.0	0.0	-963.62
		-963.62	0.0	0.0	0.0	345.0	-462.06	101.64	0.0	0.0	0.0	-7.29
						690.0	-352.83	-116.54	0.0	0.0	0.0	-72.18
4	76	406.80	0.0	-0.03	-899.34	0.0	-415.06	774.87	0.0	0.0	0.0	-1540.08
		-1540.08	0.0	0.0	0.0	345.0	-315.88	243.67	0.0	0.0	0.0	164.96
						690.0	-216.70	-124.48	0.0	0.0	0.0	331.39
4	77	38.38	0.0	-9.26e-03	-599.40	0.0	-571.28	462.50	0.0	0.0	0.0	-888.01
		-888.01	0.0	0.0	0.0	345.0	-462.06	81.27	0.0	0.0	0.0	-1.93
						690.0	-352.83	-136.90	0.0	0.0	0.0	-137.07
4	78	452.46	0.0	-0.03	-899.34	0.0	-415.06	795.23	0.0	0.0	0.0	-1615.69
		-1615.69	0.0	0.0	0.0	345.0	-315.88	264.03	0.0	0.0	0.0	159.60
						690.0	-216.70	-104.12	0.0	0.0	0.0	396.28
4	79	634.17	0.0	-0.03	-899.34	0.0	-367.79	807.88	0.0	0.0	0.0	-1510.33
		-1510.33	0.0	0.0	0.0	345.0	-277.22	276.68	0.0	0.0	0.0	308.59
						690.0	-186.65	-91.47	0.0	0.0	0.0	588.91
5	1	-649.83	0.0	-4.31e-04	-8.69	0.0	-657.91	-84.93	0.0	0.0	0.0	-649.83



		-699.04	0.0	0.0	0.0	27.5	-647.70	-89.58	0.0	0.0	0.0	-673.83
						55.0	-637.49	-93.61	0.0	0.0	0.0	-699.04
5	2	-561.95	0.0	-3.99e-04	-8.69	0.0	-652.16	-71.97	0.0	0.0	0.0	-561.95
		-604.03	0.0	0.0	0.0	27.5	-641.95	-76.62	0.0	0.0	0.0	-582.39
						55.0	-631.74	-80.66	0.0	0.0	0.0	-604.03
5	3	-482.21	0.0	-4.21e-04	-8.69	0.0	-609.87	-68.74	0.0	0.0	0.0	-482.21
		-522.51	0.0	0.0	0.0	27.5	-599.66	-73.39	0.0	0.0	0.0	-501.76
						55.0	-589.46	-77.42	0.0	0.0	0.0	-522.51
5	4	-416.46	0.0	-3.97e-04	-8.69	0.0	-605.57	-59.04	0.0	0.0	0.0	-416.46
		-451.44	0.0	0.0	0.0	27.5	-595.37	-63.69	0.0	0.0	0.0	-433.35
						55.0	-585.16	-67.73	0.0	0.0	0.0	-451.44
5	5	-413.70	0.0	-1.60e-03	-19.35	0.0	-526.81	-111.99	0.0	0.0	0.0	-413.70
		-480.83	0.0	0.0	0.0	27.5	-516.60	-122.24	0.0	0.0	0.0	-445.93
						55.0	-506.39	-131.34	0.0	0.0	0.0	-480.83
5	6	-305.96	0.0	-1.69e-03	-23.07	0.0	-515.75	-112.05	0.0	0.0	0.0	-305.96
		-374.14	0.0	0.0	0.0	27.5	-505.54	-124.16	0.0	0.0	0.0	-338.47
						55.0	-495.33	-135.12	0.0	0.0	0.0	-374.14
5	7	-138.30	0.0	-1.84e-03	-33.11	0.0	-427.46	-122.23	0.0	0.0	0.0	-138.30
		-214.80	0.0	0.0	0.0	27.5	-417.25	-139.24	0.0	0.0	0.0	-174.28
						55.0	-407.04	-155.33	0.0	0.0	0.0	-214.80
5	8	-773.25	0.0	-8.55e-04	-19.35	0.0	-576.27	-200.68	0.0	0.0	0.0	-773.25
		-889.16	0.0	0.0	0.0	27.5	-566.06	-210.93	0.0	0.0	0.0	-829.87
						55.0	-555.85	-220.03	0.0	0.0	0.0	-889.16
5	9	-665.51	0.0	-9.46e-04	-23.07	0.0	-565.21	-200.74	0.0	0.0	0.0	-665.51
		-782.47	0.0	0.0	0.0	27.5	-555.00	-212.85	0.0	0.0	0.0	-722.40
						55.0	-544.79	-223.81	0.0	0.0	0.0	-782.47
5	10	-497.85	0.0	-1.10e-03	-33.11	0.0	-476.92	-210.91	0.0	0.0	0.0	-497.85
		-623.13	0.0	0.0	0.0	27.5	-466.71	-227.93	0.0	0.0	0.0	-558.21
						55.0	-456.50	-244.02	0.0	0.0	0.0	-623.13
5	11	-734.93	0.0	3.33e-04	-8.69	0.0	-657.91	-111.63	0.0	0.0	0.0	-734.93
		-798.83	0.0	0.0	0.0	27.5	-647.70	-116.28	0.0	0.0	0.0	-766.29
						55.0	-637.49	-120.32	0.0	0.0	0.0	-798.83
5	12	-647.05	0.0	3.01e-04	-8.69	0.0	-652.16	-98.68	0.0	0.0	0.0	-647.05
		-703.83	0.0	0.0	0.0	27.5	-641.95	-103.33	0.0	0.0	0.0	-674.84
						55.0	-631.74	-107.37	0.0	0.0	0.0	-703.83
5	13	-596.29	0.0	2.90e-04	-8.69	0.0	-609.88	-104.54	0.0	0.0	0.0	-596.29
		-656.28	0.0	0.0	0.0	27.5	-599.67	-109.18	0.0	0.0	0.0	-625.69
						55.0	-589.46	-113.22	0.0	0.0	0.0	-656.28
5	14	-530.54	0.0	2.66e-04	-8.69	0.0	-605.58	-94.84	0.0	0.0	0.0	-530.54
		-585.21	0.0	0.0	0.0	27.5	-595.37	-99.49	0.0	0.0	0.0	-557.28



						55.0	-585.16	-103.53	0.0	0.0	0.0	-585.21
5	15	-328.59	0.0	-1.70e-03	-19.35	0.0	-526.81	-85.29	0.0	0.0	0.0	-328.59
		-381.03	0.0	0.0	0.0	27.5	-516.60	-95.54	0.0	0.0	0.0	-353.48
						55.0	-506.39	-104.64	0.0	0.0	0.0	-381.03
5	16	-220.85	0.0	-1.79e-03	-23.07	0.0	-515.75	-85.35	0.0	0.0	0.0	-220.85
		-274.35	0.0	0.0	0.0	27.5	-505.54	-97.46	0.0	0.0	0.0	-246.01
						55.0	-495.33	-108.42	0.0	0.0	0.0	-274.35
5	17	-53.20	0.0	-1.94e-03	-33.11	0.0	-427.46	-95.52	0.0	0.0	0.0	-53.20
		-115.00	0.0	0.0	0.0	27.5	-417.25	-112.53	0.0	0.0	0.0	-81.82
						55.0	-407.04	-128.62	0.0	0.0	0.0	-115.00
5	18	-659.17	0.0	-9.86e-04	-19.35	0.0	-576.27	-164.88	0.0	0.0	0.0	-659.17
		-755.39	0.0	0.0	0.0	27.5	-566.06	-175.13	0.0	0.0	0.0	-705.95
						55.0	-555.85	-184.23	0.0	0.0	0.0	-755.39
5	19	-551.43	0.0	-1.08e-03	-23.07	0.0	-565.21	-164.94	0.0	0.0	0.0	-551.43
		-648.70	0.0	0.0	0.0	27.5	-555.00	-177.05	0.0	0.0	0.0	-598.48
						55.0	-544.79	-188.01	0.0	0.0	0.0	-648.70
5	20	-383.77	0.0	-1.23e-03	-33.11	0.0	-476.92	-175.11	0.0	0.0	0.0	-383.77
		-489.36	0.0	0.0	0.0	27.5	-466.71	-192.13	0.0	0.0	0.0	-434.29
						55.0	-456.50	-208.22	0.0	0.0	0.0	-489.36
5	21	-285.52	0.0	-1.40e-03	-19.35	0.0	-579.52	-75.22	0.0	0.0	0.0	-285.52
		-332.42	0.0	0.0	0.0	27.5	-569.31	-85.47	0.0	0.0	0.0	-307.64
						55.0	-559.10	-94.56	0.0	0.0	0.0	-332.42
5	22	-616.10	0.0	-6.83e-04	-19.35	0.0	-628.98	-154.81	0.0	0.0	0.0	-616.10
		-706.78	0.0	0.0	0.0	27.5	-618.77	-165.06	0.0	0.0	0.0	-660.11
						55.0	-608.56	-174.16	0.0	0.0	0.0	-706.78
5	23	378.64	0.0	-1.85e-03	-33.11	0.0	-244.06	-83.39	0.0	0.0	0.0	378.64
		323.50	0.0	0.0	0.0	27.5	-236.50	-100.41	0.0	0.0	0.0	353.34
						55.0	-228.93	-116.50	0.0	0.0	0.0	323.50
5	24	200.25	0.0	-1.15e-03	-33.11	0.0	-293.52	-148.86	0.0	0.0	0.0	200.25
		109.10	0.0	0.0	0.0	27.5	-285.96	-165.87	0.0	0.0	0.0	156.95
						55.0	-278.39	-181.96	0.0	0.0	0.0	109.10
5	25	-192.25	0.0	-1.74e-03	-19.35	0.0	-473.01	-94.58	0.0	0.0	0.0	-192.25
		-249.80	0.0	0.0	0.0	27.5	-462.80	-104.83	0.0	0.0	0.0	-219.69
						55.0	-452.59	-113.93	0.0	0.0	0.0	-249.80
5	26	-167.72	0.0	-1.58e-03	-23.07	0.0	-514.67	-104.49	0.0	0.0	0.0	-167.72
		-231.75	0.0	0.0	0.0	27.5	-504.46	-116.60	0.0	0.0	0.0	-198.15
						55.0	-494.25	-127.56	0.0	0.0	0.0	-231.75
5	27	-617.03	0.0	-6.09e-04	-19.35	0.0	-694.76	-153.47	0.0	0.0	0.0	-617.03
		-706.98	0.0	0.0	0.0	27.5	-684.55	-163.72	0.0	0.0	0.0	-660.68
						55.0	-674.34	-172.82	0.0	0.0	0.0	-706.98



5	28	-544.73	0.0	-1.10e-03	-23.07	0.0	-611.80	-163.73	0.0	0.0	0.0	-544.73
		-641.34	0.0	0.0	0.0	27.5	-601.59	-175.85	0.0	0.0	0.0	-591.45
						55.0	-591.38	-186.81	0.0	0.0	0.0	-641.34
5	29	248.48	0.0	-1.93e-03	-33.11	0.0	-365.18	-72.56	0.0	0.0	0.0	248.48
		199.29	0.0	0.0	0.0	27.5	-354.97	-89.58	0.0	0.0	0.0	226.16
						55.0	-344.76	-105.67	0.0	0.0	0.0	199.29
5	30	-510.46	0.0	-8.59e-04	-19.35	0.0	-439.74	-209.80	0.0	0.0	0.0	-510.46
		-631.39	0.0	0.0	0.0	27.5	-432.18	-220.05	0.0	0.0	0.0	-569.59
						55.0	-424.61	-229.15	0.0	0.0	0.0	-631.39
5	31	-444.83	0.0	-8.21e-04	-23.07	0.0	-435.44	-223.25	0.0	0.0	0.0	-444.83
		-574.17	0.0	0.0	0.0	27.5	-427.88	-235.36	0.0	0.0	0.0	-507.91
						55.0	-420.31	-246.32	0.0	0.0	0.0	-574.17
5	32	-349.83	0.0	-7.59e-04	-33.11	0.0	-359.32	-255.64	0.0	0.0	0.0	-349.83
		-499.71	0.0	0.0	0.0	27.5	-351.76	-272.65	0.0	0.0	0.0	-422.49
						55.0	-344.20	-288.74	0.0	0.0	0.0	-499.71
5	33	250.85	0.0	-1.78e-03	-33.11	0.0	-364.09	-82.41	0.0	0.0	0.0	250.85
		196.24	0.0	0.0	0.0	27.5	-353.88	-99.43	0.0	0.0	0.0	225.82
						55.0	-343.68	-115.52	0.0	0.0	0.0	196.24
5	34	-413.30	0.0	-2.75e-04	-8.69	0.0	-452.02	-92.77	0.0	0.0	0.0	-413.30
		-466.82	0.0	0.0	0.0	27.5	-444.46	-97.42	0.0	0.0	0.0	-439.46
						55.0	-436.90	-101.45	0.0	0.0	0.0	-466.82
5	35	-307.79	0.0	-4.13e-04	-13.71	0.0	-439.70	-98.73	0.0	0.0	0.0	-307.79
		-365.97	0.0	0.0	0.0	27.5	-432.14	-105.89	0.0	0.0	0.0	-335.94
						55.0	-424.58	-112.44	0.0	0.0	0.0	-365.97
5	36	-576.14	0.0	-4.60e-04	-14.34	0.0	-435.90	-160.79	0.0	0.0	0.0	-576.14
		-668.67	0.0	0.0	0.0	27.5	-428.34	-168.39	0.0	0.0	0.0	-621.42
						55.0	-420.78	-175.13	0.0	0.0	0.0	-668.67
5	37	-496.13	0.0	-5.28e-04	-17.10	0.0	-427.69	-160.84	0.0	0.0	0.0	-496.13
		-589.45	0.0	0.0	0.0	27.5	-420.13	-169.81	0.0	0.0	0.0	-541.62
						55.0	-412.56	-177.94	0.0	0.0	0.0	-589.45
5	38	-371.63	0.0	-6.38e-04	-24.55	0.0	-362.12	-168.39	0.0	0.0	0.0	-371.63
		-471.13	0.0	0.0	0.0	27.5	-354.56	-181.01	0.0	0.0	0.0	-419.69
						55.0	-347.00	-192.94	0.0	0.0	0.0	-471.13
5	39	-484.22	0.0	1.94e-04	-8.69	0.0	-452.02	-115.02	0.0	0.0	0.0	-484.22
		-549.98	0.0	0.0	0.0	27.5	-444.46	-119.67	0.0	0.0	0.0	-516.50
						55.0	-436.90	-123.71	0.0	0.0	0.0	-549.98
5	40	-435.40	0.0	1.76e-04	-8.69	0.0	-448.83	-107.83	0.0	0.0	0.0	-435.40
		-497.20	0.0	0.0	0.0	27.5	-441.27	-112.47	0.0	0.0	0.0	-465.70
						55.0	-433.70	-116.51	0.0	0.0	0.0	-497.20
5	41	-505.21	0.0	-5.41e-04	-14.34	0.0	-435.90	-138.54	0.0	0.0	0.0	-505.21



		-585.51	0.0	0.0	0.0	27.5	-428.34	-146.13	0.0	0.0	0.0	-544.38
						55.0	-420.77	-152.88	0.0	0.0	0.0	-585.51
5	42	-425.21	0.0	-6.09e-04	-17.10	0.0	-427.69	-138.58	0.0	0.0	0.0	-425.21
		-506.29	0.0	0.0	0.0	27.5	-420.13	-147.56	0.0	0.0	0.0	-464.57
						55.0	-412.56	-155.68	0.0	0.0	0.0	-506.29
5	43	-300.71	0.0	-7.20e-04	-24.55	0.0	-362.12	-146.13	0.0	0.0	0.0	-300.71
		-387.96	0.0	0.0	0.0	27.5	-354.56	-158.75	0.0	0.0	0.0	-342.65
						55.0	-347.00	-170.69	0.0	0.0	0.0	-387.96
5	44	-358.66	0.0	-6.16e-04	-26.81	0.0	-456.87	-153.37	0.0	0.0	0.0	-358.66
		-450.51	0.0	0.0	0.0	27.5	-449.31	-167.12	0.0	0.0	0.0	-402.74
						55.0	-441.75	-180.18	0.0	0.0	0.0	-450.51
5	45	-55.98	0.0	-7.14e-04	-24.55	0.0	-315.88	-127.16	0.0	0.0	0.0	-55.98
		-132.80	0.0	0.0	0.0	27.5	-308.32	-139.78	0.0	0.0	0.0	-92.70
						55.0	-300.75	-151.72	0.0	0.0	0.0	-132.80
5	46	-469.94	0.0	-3.01e-04	-8.69	0.0	-487.34	-96.13	0.0	0.0	0.0	-469.94
		-525.32	0.0	0.0	0.0	27.5	-479.78	-100.78	0.0	0.0	0.0	-497.03
						55.0	-472.21	-104.82	0.0	0.0	0.0	-525.32
5	47	-404.85	0.0	-2.78e-04	-8.69	0.0	-483.08	-86.54	0.0	0.0	0.0	-404.85
		-454.94	0.0	0.0	0.0	27.5	-475.52	-91.18	0.0	0.0	0.0	-429.30
						55.0	-467.96	-95.22	0.0	0.0	0.0	-454.94
5	48	-337.82	0.0	-2.96e-04	-8.69	0.0	-452.02	-83.09	0.0	0.0	0.0	-337.82
		-386.02	0.0	0.0	0.0	27.5	-444.46	-87.74	0.0	0.0	0.0	-361.32
						55.0	-436.90	-91.78	0.0	0.0	0.0	-386.02
5	49	-288.99	0.0	-2.79e-04	-8.69	0.0	-448.83	-75.89	0.0	0.0	0.0	-288.99
		-333.23	0.0	0.0	0.0	27.5	-441.27	-80.54	0.0	0.0	0.0	-310.52
						55.0	-433.70	-84.58	0.0	0.0	0.0	-333.23
5	50	-376.90	0.0	-9.94e-04	-14.34	0.0	-399.26	-103.70	0.0	0.0	0.0	-376.90
		-438.03	0.0	0.0	0.0	27.5	-391.70	-111.30	0.0	0.0	0.0	-406.48
						55.0	-384.14	-118.04	0.0	0.0	0.0	-438.03
5	51	-296.89	0.0	-1.06e-03	-17.10	0.0	-391.05	-103.74	0.0	0.0	0.0	-296.89
		-358.81	0.0	0.0	0.0	27.5	-383.49	-112.72	0.0	0.0	0.0	-326.68
						55.0	-375.93	-120.85	0.0	0.0	0.0	-358.81
5	52	-172.40	0.0	-1.17e-03	-24.55	0.0	-325.49	-111.30	0.0	0.0	0.0	-172.40
		-240.49	0.0	0.0	0.0	27.5	-317.92	-123.92	0.0	0.0	0.0	-204.75
						55.0	-310.36	-135.85	0.0	0.0	0.0	-240.49
5	53	-651.62	0.0	-4.39e-04	-14.34	0.0	-435.90	-170.47	0.0	0.0	0.0	-651.62
		-749.48	0.0	0.0	0.0	27.5	-428.34	-178.07	0.0	0.0	0.0	-699.56
						55.0	-420.78	-184.81	0.0	0.0	0.0	-749.48
5	54	-571.61	0.0	-5.07e-04	-17.10	0.0	-427.69	-170.51	0.0	0.0	0.0	-571.61
		-670.26	0.0	0.0	0.0	27.5	-420.13	-179.49	0.0	0.0	0.0	-619.76



						55.0	-412.56	-187.62	0.0	0.0	0.0	-670.26
5	55	-447.12	0.0	-6.17e-04	-24.55	0.0	-362.12	-178.07	0.0	0.0	0.0	-447.12
		-551.93	0.0	0.0	0.0	27.5	-354.56	-190.69	0.0	0.0	0.0	-497.84
						55.0	-347.00	-202.62	0.0	0.0	0.0	-551.93
5	56	-506.16	0.0	2.60e-04	-8.69	0.0	-487.34	-107.50	0.0	0.0	0.0	-506.16
		-567.78	0.0	0.0	0.0	27.5	-479.78	-112.15	0.0	0.0	0.0	-536.37
						55.0	-472.22	-116.18	0.0	0.0	0.0	-567.78
5	57	-441.06	0.0	2.36e-04	-8.69	0.0	-483.08	-97.90	0.0	0.0	0.0	-441.06
		-497.41	0.0	0.0	0.0	27.5	-475.52	-102.55	0.0	0.0	0.0	-468.64
						55.0	-467.96	-106.59	0.0	0.0	0.0	-497.41
5	58	-398.18	0.0	2.27e-04	-8.69	0.0	-452.02	-102.03	0.0	0.0	0.0	-398.18
		-456.79	0.0	0.0	0.0	27.5	-444.46	-106.68	0.0	0.0	0.0	-426.89
						55.0	-436.90	-110.72	0.0	0.0	0.0	-456.79
5	59	-349.35	0.0	2.09e-04	-8.69	0.0	-448.83	-94.83	0.0	0.0	0.0	-349.35
		-404.01	0.0	0.0	0.0	27.5	-441.27	-99.48	0.0	0.0	0.0	-376.08
						55.0	-433.70	-103.52	0.0	0.0	0.0	-404.01
5	60	-305.98	0.0	-1.08e-03	-14.34	0.0	-399.26	-81.44	0.0	0.0	0.0	-305.98
		-354.87	0.0	0.0	0.0	27.5	-391.70	-89.04	0.0	0.0	0.0	-329.44
						55.0	-384.14	-95.78	0.0	0.0	0.0	-354.87
5	61	-225.97	0.0	-1.14e-03	-17.10	0.0	-391.05	-81.49	0.0	0.0	0.0	-225.97
		-275.65	0.0	0.0	0.0	27.5	-383.49	-90.47	0.0	0.0	0.0	-249.63
						55.0	-375.93	-98.59	0.0	0.0	0.0	-275.65
5	62	-101.47	0.0	-1.25e-03	-24.55	0.0	-325.49	-89.04	0.0	0.0	0.0	-101.47
		-157.32	0.0	0.0	0.0	27.5	-317.92	-101.66	0.0	0.0	0.0	-127.71
						55.0	-310.36	-113.60	0.0	0.0	0.0	-157.32
5	63	-556.55	0.0	-5.48e-04	-14.34	0.0	-435.90	-140.64	0.0	0.0	0.0	-556.55
		-638.00	0.0	0.0	0.0	27.5	-428.34	-148.23	0.0	0.0	0.0	-596.29
						55.0	-420.77	-154.98	0.0	0.0	0.0	-638.00
5	64	-476.55	0.0	-6.16e-04	-17.10	0.0	-427.69	-140.68	0.0	0.0	0.0	-476.55
		-558.78	0.0	0.0	0.0	27.5	-420.13	-149.66	0.0	0.0	0.0	-516.49
						55.0	-412.56	-157.78	0.0	0.0	0.0	-558.78
5	65	-352.05	0.0	-7.27e-04	-24.55	0.0	-362.12	-148.24	0.0	0.0	0.0	-352.05
		-440.46	0.0	0.0	0.0	27.5	-354.56	-160.85	0.0	0.0	0.0	-394.56
						55.0	-347.00	-172.79	0.0	0.0	0.0	-440.46
5	66	-273.99	0.0	-8.50e-04	-14.34	0.0	-438.41	-73.96	0.0	0.0	0.0	-273.99
		-318.77	0.0	0.0	0.0	27.5	-430.84	-81.56	0.0	0.0	0.0	-295.40
						55.0	-423.28	-88.30	0.0	0.0	0.0	-318.77
5	67	-524.57	0.0	-3.23e-04	-14.34	0.0	-475.04	-133.16	0.0	0.0	0.0	-524.57
		-601.90	0.0	0.0	0.0	27.5	-467.48	-140.75	0.0	0.0	0.0	-562.25
						55.0	-459.92	-147.50	0.0	0.0	0.0	-601.90



5	68	143.26	0.0	-1.25e-03	-24.55	0.0	-279.24	-70.07	0.0	0.0	0.0	143.26
		97.84	0.0	0.0	0.0	27.5	-271.68	-82.69	0.0	0.0	0.0	122.24
						55.0	-264.12	-94.62	0.0	0.0	0.0	97.84
5	69	19.50	0.0	-7.35e-04	-24.55	0.0	-315.88	-117.48	0.0	0.0	0.0	19.50
		-51.99	0.0	0.0	0.0	27.5	-308.32	-130.10	0.0	0.0	0.0	-14.56
						55.0	-300.75	-142.04	0.0	0.0	0.0	-51.99
5	70	-262.23	0.0	-1.92e-04	-8.69	0.0	-346.06	-85.09	0.0	0.0	0.0	-262.23
		-311.53	0.0	0.0	0.0	27.5	-338.50	-89.74	0.0	0.0	0.0	-286.28
						55.0	-330.94	-93.78	0.0	0.0	0.0	-311.53
5	71	-412.83	0.0	-3.17e-04	-12.08	0.0	-334.05	-142.36	0.0	0.0	0.0	-412.83
		-494.60	0.0	0.0	0.0	27.5	-326.49	-148.82	0.0	0.0	0.0	-452.89
						55.0	-318.92	-154.43	0.0	0.0	0.0	-494.60
5	72	-327.11	0.0	1.18e-04	-8.69	0.0	-346.06	-105.45	0.0	0.0	0.0	-327.11
		-387.61	0.0	0.0	0.0	27.5	-338.50	-110.10	0.0	0.0	0.0	-356.77
						55.0	-330.94	-114.14	0.0	0.0	0.0	-387.61
5	73	-347.94	0.0	-3.91e-04	-12.08	0.0	-334.05	-122.00	0.0	0.0	0.0	-347.94
		-418.52	0.0	0.0	0.0	27.5	-326.48	-128.46	0.0	0.0	0.0	-382.40
						55.0	-318.92	-134.07	0.0	0.0	0.0	-418.52
5	74	-189.42	0.0	-4.09e-04	-12.08	0.0	-334.05	-107.27	0.0	0.0	0.0	-189.42
		-251.90	0.0	0.0	0.0	27.5	-326.49	-113.74	0.0	0.0	0.0	-219.83
						55.0	-318.92	-119.35	0.0	0.0	0.0	-251.90
5	75	-72.18	0.0	-8.82e-04	-20.95	0.0	-352.83	-116.54	0.0	0.0	0.0	-72.18
		-142.20	0.0	0.0	0.0	27.5	-345.27	-127.44	0.0	0.0	0.0	-105.75
						55.0	-337.70	-137.49	0.0	0.0	0.0	-142.20
5	76	331.39	0.0	-2.37e-03	-41.65	0.0	-216.70	-124.48	0.0	0.0	0.0	331.39
		251.32	0.0	0.0	0.0	27.5	-209.14	-145.73	0.0	0.0	0.0	294.22
						55.0	-201.57	-166.13	0.0	0.0	0.0	251.32
5	77	-137.07	0.0	-8.08e-04	-20.95	0.0	-352.83	-136.90	0.0	0.0	0.0	-137.07
		-218.29	0.0	0.0	0.0	27.5	-345.27	-147.80	0.0	0.0	0.0	-176.24
						55.0	-337.70	-157.85	0.0	0.0	0.0	-218.29
5	78	396.28	0.0	-2.45e-03	-41.65	0.0	-216.70	-104.12	0.0	0.0	0.0	396.28
		327.41	0.0	0.0	0.0	27.5	-209.13	-125.37	0.0	0.0	0.0	364.71
						55.0	-201.57	-145.77	0.0	0.0	0.0	327.41
5	79	588.91	0.0	-2.45e-03	-41.65	0.0	-186.65	-91.47	0.0	0.0	0.0	588.91
		526.99	0.0	0.0	0.0	27.5	-179.08	-112.72	0.0	0.0	0.0	560.81
						55.0	-171.52	-133.12	0.0	0.0	0.0	526.99
6	1	697.28	0.0	4.90e-04	8.70	0.0	-657.63	84.92	0.0	0.0	0.0	648.07
		648.07	0.0	0.0	0.0	27.5	-647.42	89.57	0.0	0.0	0.0	672.07
						55.0	-637.21	93.61	0.0	0.0	0.0	697.28
6	2	602.28	0.0	4.57e-04	8.70	0.0	-651.88	71.96	0.0	0.0	0.0	560.20



		560.20	0.0	0.0	0.0	27.5	-641.67	76.62	0.0	0.0	0.0	580.64
						55.0	-631.47	80.66	0.0	0.0	0.0	602.28
6	3	520.85	0.0	4.77e-04	8.70	0.0	-609.61	68.73	0.0	0.0	0.0	480.54
		480.54	0.0	0.0	0.0	27.5	-599.40	73.38	0.0	0.0	0.0	500.10
						55.0	-589.19	77.42	0.0	0.0	0.0	520.85
6	4	449.78	0.0	4.52e-04	8.70	0.0	-605.31	59.04	0.0	0.0	0.0	414.80
		414.80	0.0	0.0	0.0	27.5	-595.10	63.69	0.0	0.0	0.0	431.69
						55.0	-584.89	67.73	0.0	0.0	0.0	449.78
6	5	1525.75	0.0	-1.09e-03	8.70	0.0	-692.67	277.27	0.0	0.0	0.0	1370.75
		1370.75	0.0	0.0	0.0	27.5	-682.46	281.92	0.0	0.0	0.0	1447.65
						55.0	-672.25	285.96	0.0	0.0	0.0	1525.75
6	6	1504.24	0.0	-1.24e-03	8.70	0.0	-695.13	281.05	0.0	0.0	0.0	1347.16
		1347.16	0.0	0.0	0.0	27.5	-684.92	285.70	0.0	0.0	0.0	1425.10
						55.0	-674.71	289.74	0.0	0.0	0.0	1504.24
6	7	1498.51	0.0	-1.50e-03	8.70	0.0	-631.22	301.25	0.0	0.0	0.0	1330.32
		1330.32	0.0	0.0	0.0	27.5	-621.01	305.91	0.0	0.0	0.0	1413.82
						55.0	-610.80	309.95	0.0	0.0	0.0	1498.51
6	8	1310.88	0.0	-3.95e-04	8.70	0.0	-643.21	211.34	0.0	0.0	0.0	1192.14
		1192.14	0.0	0.0	0.0	27.5	-633.00	215.99	0.0	0.0	0.0	1250.91
						55.0	-622.79	220.03	0.0	0.0	0.0	1310.88
6	9	1289.37	0.0	-5.49e-04	8.70	0.0	-645.67	215.12	0.0	0.0	0.0	1168.55
		1168.55	0.0	0.0	0.0	27.5	-635.46	219.77	0.0	0.0	0.0	1228.36
						55.0	-625.25	223.81	0.0	0.0	0.0	1289.37
6	10	1283.64	0.0	-8.09e-04	8.70	0.0	-581.76	235.32	0.0	0.0	0.0	1151.71
		1151.71	0.0	0.0	0.0	27.5	-571.55	239.98	0.0	0.0	0.0	1217.08
						55.0	-561.34	244.02	0.0	0.0	0.0	1283.64
6	11	797.05	0.0	-3.93e-04	8.70	0.0	-657.63	111.62	0.0	0.0	0.0	733.15
		733.15	0.0	0.0	0.0	27.5	-647.42	116.28	0.0	0.0	0.0	764.50
						55.0	-637.21	120.32	0.0	0.0	0.0	797.05
6	12	702.06	0.0	-3.60e-04	8.70	0.0	-651.88	98.67	0.0	0.0	0.0	645.29
		645.29	0.0	0.0	0.0	27.5	-641.67	103.33	0.0	0.0	0.0	673.07
						55.0	-631.46	107.37	0.0	0.0	0.0	702.06
6	13	654.58	0.0	-3.47e-04	8.70	0.0	-609.61	104.53	0.0	0.0	0.0	594.59
		594.59	0.0	0.0	0.0	27.5	-599.40	109.18	0.0	0.0	0.0	623.99
						55.0	-589.19	113.22	0.0	0.0	0.0	654.58
6	14	583.52	0.0	-3.22e-04	8.70	0.0	-605.31	94.83	0.0	0.0	0.0	528.85
		528.85	0.0	0.0	0.0	27.5	-595.10	99.49	0.0	0.0	0.0	555.59
						55.0	-584.89	103.53	0.0	0.0	0.0	583.52
6	15	1425.98	0.0	-9.94e-04	8.70	0.0	-692.67	250.56	0.0	0.0	0.0	1285.67
		1285.67	0.0	0.0	0.0	27.5	-682.46	255.22	0.0	0.0	0.0	1355.22



						55.0	-672.25	259.26	0.0	0.0	0.0	1425.98
6	16	1404.47	0.0	-1.15e-03	8.70	0.0	-695.13	254.34	0.0	0.0	0.0	1262.07
		1262.07	0.0	0.0	0.0	27.5	-684.93	259.00	0.0	0.0	0.0	1332.67
						55.0	-674.72	263.04	0.0	0.0	0.0	1404.47
6	17	1398.74	0.0	-1.41e-03	8.70	0.0	-631.22	274.55	0.0	0.0	0.0	1245.24
		1245.24	0.0	0.0	0.0	27.5	-621.01	279.20	0.0	0.0	0.0	1321.39
						55.0	-610.80	283.24	0.0	0.0	0.0	1398.74
6	18	1177.14	0.0	-2.65e-04	8.70	0.0	-643.21	175.54	0.0	0.0	0.0	1078.09
		1078.09	0.0	0.0	0.0	27.5	-633.00	180.19	0.0	0.0	0.0	1127.02
						55.0	-622.80	184.23	0.0	0.0	0.0	1177.14
6	19	1155.63	0.0	-4.19e-04	8.70	0.0	-645.68	179.32	0.0	0.0	0.0	1054.50
		1054.50	0.0	0.0	0.0	27.5	-635.47	183.97	0.0	0.0	0.0	1104.47
						55.0	-625.26	188.01	0.0	0.0	0.0	1155.63
6	20	1149.90	0.0	-6.78e-04	8.70	0.0	-581.76	199.53	0.0	0.0	0.0	1037.66
		1037.66	0.0	0.0	0.0	27.5	-571.55	204.18	0.0	0.0	0.0	1093.18
						55.0	-561.34	208.22	0.0	0.0	0.0	1149.90
6	21	1337.12	0.0	-7.36e-04	8.70	0.0	-639.96	240.49	0.0	0.0	0.0	1202.35
		1202.35	0.0	0.0	0.0	27.5	-629.75	245.14	0.0	0.0	0.0	1269.14
						55.0	-619.54	249.18	0.0	0.0	0.0	1337.12
6	22	1088.28	0.0	-1.40e-05	8.70	0.0	-590.50	165.47	0.0	0.0	0.0	994.77
		994.77	0.0	0.0	0.0	27.5	-580.29	170.12	0.0	0.0	0.0	1040.93
						55.0	-570.08	174.16	0.0	0.0	0.0	1088.28
6	23	960.71	0.0	-1.51e-03	8.70	0.0	-447.90	262.42	0.0	0.0	0.0	813.87
		813.87	0.0	0.0	0.0	27.5	-440.34	267.08	0.0	0.0	0.0	886.69
						55.0	-432.78	271.12	0.0	0.0	0.0	960.71
6	24	551.90	0.0	-7.67e-04	8.70	0.0	-398.44	173.27	0.0	0.0	0.0	454.10
		454.10	0.0	0.0	0.0	27.5	-390.88	177.92	0.0	0.0	0.0	502.40
						55.0	-383.32	181.96	0.0	0.0	0.0	551.90
6	25	1348.67	0.0	-1.22e-03	8.70	0.0	-746.47	259.85	0.0	0.0	0.0	1203.25
		1203.25	0.0	0.0	0.0	27.5	-736.26	264.51	0.0	0.0	0.0	1275.36
						55.0	-726.05	268.55	0.0	0.0	0.0	1348.67
6	26	1375.54	0.0	-1.07e-03	8.70	0.0	-696.22	273.48	0.0	0.0	0.0	1222.62
		1222.62	0.0	0.0	0.0	27.5	-686.01	278.14	0.0	0.0	0.0	1298.48
						55.0	-675.80	282.18	0.0	0.0	0.0	1375.54
6	27	1074.83	0.0	-1.10e-04	8.70	0.0	-620.78	164.13	0.0	0.0	0.0	982.06
		982.06	0.0	0.0	0.0	27.5	-610.57	168.78	0.0	0.0	0.0	1027.85
						55.0	-600.36	172.82	0.0	0.0	0.0	1074.83
6	28	1148.17	0.0	-3.97e-04	8.70	0.0	-692.25	178.11	0.0	0.0	0.0	1047.70
		1047.70	0.0	0.0	0.0	27.5	-682.04	182.77	0.0	0.0	0.0	1097.34
						55.0	-671.83	186.81	0.0	0.0	0.0	1148.17



6	29	1084.55	0.0	-1.42e-03	8.70	0.0	-568.97	251.59	0.0	0.0	0.0	943.67
		943.67	0.0	0.0	0.0	27.5	-558.76	256.25	0.0	0.0	0.0	1013.51
						55.0	-548.55	260.28	0.0	0.0	0.0	1084.55
6	30	1247.64	0.0	-6.42e-04	19.35	0.0	-537.56	364.42	0.0	0.0	0.0	1041.68
		1041.68	0.0	0.0	0.0	27.5	-530.00	374.67	0.0	0.0	0.0	1143.33
						55.0	-522.43	383.77	0.0	0.0	0.0	1247.64
6	31	1190.44	0.0	-6.81e-04	23.07	0.0	-533.26	377.87	0.0	0.0	0.0	976.06
		976.06	0.0	0.0	0.0	27.5	-525.70	389.98	0.0	0.0	0.0	1081.66
						55.0	-518.14	400.94	0.0	0.0	0.0	1190.44
6	32	1116.12	0.0	-7.47e-04	33.11	0.0	-457.17	410.25	0.0	0.0	0.0	881.21
		881.21	0.0	0.0	0.0	27.5	-449.61	427.27	0.0	0.0	0.0	996.39
						55.0	-442.04	443.36	0.0	0.0	0.0	1116.12
6	33	1101.29	0.0	-1.29e-03	8.70	0.0	-570.05	261.44	0.0	0.0	0.0	955.00
		955.00	0.0	0.0	0.0	27.5	-559.84	266.10	0.0	0.0	0.0	1027.55
						55.0	-549.63	270.14	0.0	0.0	0.0	1101.29
6	34	465.58	0.0	3.17e-04	8.70	0.0	-451.82	92.76	0.0	0.0	0.0	412.06
		412.06	0.0	0.0	0.0	27.5	-444.26	97.41	0.0	0.0	0.0	438.22
						55.0	-436.70	101.45	0.0	0.0	0.0	465.58
6	35	479.71	0.0	-1.23e-04	8.70	0.0	-457.76	103.75	0.0	0.0	0.0	420.14
		420.14	0.0	0.0	0.0	27.5	-450.19	108.40	0.0	0.0	0.0	449.33
						55.0	-442.63	112.44	0.0	0.0	0.0	479.71
6	36	870.53	0.0	-1.14e-04	8.70	0.0	-467.94	166.44	0.0	0.0	0.0	776.49
		776.49	0.0	0.0	0.0	27.5	-460.38	171.09	0.0	0.0	0.0	822.91
						55.0	-452.82	175.13	0.0	0.0	0.0	870.53
6	37	854.56	0.0	-2.29e-04	8.70	0.0	-469.77	169.24	0.0	0.0	0.0	758.97
		758.97	0.0	0.0	0.0	27.5	-462.21	173.90	0.0	0.0	0.0	806.16
						55.0	-454.65	177.94	0.0	0.0	0.0	854.56
6	38	850.30	0.0	-4.21e-04	8.70	0.0	-422.31	184.25	0.0	0.0	0.0	746.46
		746.46	0.0	0.0	0.0	27.5	-414.75	188.90	0.0	0.0	0.0	797.79
						55.0	-407.19	192.94	0.0	0.0	0.0	850.30
6	39	548.73	0.0	-2.36e-04	8.70	0.0	-451.82	115.01	0.0	0.0	0.0	482.97
		482.97	0.0	0.0	0.0	27.5	-444.26	119.67	0.0	0.0	0.0	515.25
						55.0	-436.70	123.71	0.0	0.0	0.0	548.73
6	40	495.95	0.0	-2.18e-04	8.70	0.0	-448.63	107.82	0.0	0.0	0.0	434.15
		434.15	0.0	0.0	0.0	27.5	-441.07	112.47	0.0	0.0	0.0	464.46
						55.0	-433.51	116.51	0.0	0.0	0.0	495.95
6	41	787.39	0.0	-3.33e-05	8.70	0.0	-467.94	144.18	0.0	0.0	0.0	705.58
		705.58	0.0	0.0	0.0	27.5	-460.38	148.84	0.0	0.0	0.0	745.89
						55.0	-452.82	152.88	0.0	0.0	0.0	787.39
6	42	771.41	0.0	-1.48e-04	8.70	0.0	-469.77	146.99	0.0	0.0	0.0	688.06



		688.06	0.0	0.0	0.0	27.5	-462.21	151.64	0.0	0.0	0.0	729.14
						55.0	-454.65	155.68	0.0	0.0	0.0	771.41
6	43	767.16	0.0	-3.41e-04	8.70	0.0	-422.31	161.99	0.0	0.0	0.0	675.56
		675.56	0.0	0.0	0.0	27.5	-414.75	166.65	0.0	0.0	0.0	720.76
						55.0	-407.19	170.69	0.0	0.0	0.0	767.16
6	44	851.43	0.0	-1.73e-04	8.70	0.0	-446.97	171.49	0.0	0.0	0.0	754.61
		754.61	0.0	0.0	0.0	27.5	-439.41	176.14	0.0	0.0	0.0	802.42
						55.0	-431.85	180.18	0.0	0.0	0.0	851.43
6	45	512.07	0.0	-3.49e-04	8.70	0.0	-376.08	143.02	0.0	0.0	0.0	430.90
		430.90	0.0	0.0	0.0	27.5	-368.52	147.68	0.0	0.0	0.0	470.89
						55.0	-360.96	151.72	0.0	0.0	0.0	512.07
6	46	524.01	0.0	3.45e-04	8.70	0.0	-487.13	96.12	0.0	0.0	0.0	468.64
		468.64	0.0	0.0	0.0	27.5	-479.57	100.78	0.0	0.0	0.0	495.73
						55.0	-472.01	104.82	0.0	0.0	0.0	524.01
6	47	453.65	0.0	3.21e-04	8.70	0.0	-482.88	86.53	0.0	0.0	0.0	403.55
		403.55	0.0	0.0	0.0	27.5	-475.31	91.18	0.0	0.0	0.0	428.00
						55.0	-467.75	95.22	0.0	0.0	0.0	453.65
6	48	384.78	0.0	3.38e-04	8.70	0.0	-451.82	83.08	0.0	0.0	0.0	336.58
		336.58	0.0	0.0	0.0	27.5	-444.26	87.74	0.0	0.0	0.0	360.08
						55.0	-436.70	91.78	0.0	0.0	0.0	384.78
6	49	332.00	0.0	3.20e-04	8.70	0.0	-448.63	75.88	0.0	0.0	0.0	287.76
		287.76	0.0	0.0	0.0	27.5	-441.07	80.54	0.0	0.0	0.0	309.29
						55.0	-433.51	84.58	0.0	0.0	0.0	332.00
6	50	1101.52	0.0	-6.48e-04	8.70	0.0	-504.58	223.88	0.0	0.0	0.0	975.89
		975.89	0.0	0.0	0.0	27.5	-497.02	228.53	0.0	0.0	0.0	1038.11
						55.0	-489.45	232.57	0.0	0.0	0.0	1101.52
6	51	1085.55	0.0	-7.63e-04	8.70	0.0	-506.41	226.68	0.0	0.0	0.0	958.37
		958.37	0.0	0.0	0.0	27.5	-498.84	231.34	0.0	0.0	0.0	1021.36
						55.0	-491.28	235.38	0.0	0.0	0.0	1085.55
6	52	1081.30	0.0	-9.56e-04	8.70	0.0	-458.95	241.69	0.0	0.0	0.0	945.86
		945.86	0.0	0.0	0.0	27.5	-451.39	246.34	0.0	0.0	0.0	1012.98
						55.0	-443.82	250.38	0.0	0.0	0.0	1081.30
6	53	951.34	0.0	-1.35e-04	8.70	0.0	-467.94	176.11	0.0	0.0	0.0	851.97
		851.97	0.0	0.0	0.0	27.5	-460.38	180.77	0.0	0.0	0.0	901.05
						55.0	-452.82	184.81	0.0	0.0	0.0	951.34
6	54	935.36	0.0	-2.49e-04	8.70	0.0	-469.77	178.92	0.0	0.0	0.0	834.45
		834.45	0.0	0.0	0.0	27.5	-462.21	183.58	0.0	0.0	0.0	884.31
						55.0	-454.65	187.62	0.0	0.0	0.0	935.36
6	55	931.11	0.0	-4.42e-04	8.70	0.0	-422.31	193.93	0.0	0.0	0.0	821.95
		821.95	0.0	0.0	0.0	27.5	-414.75	198.58	0.0	0.0	0.0	875.93



							55.0	-407.19	202.62	0.0	0.0	0.0	931.11
6	56	566.47	0.0	3.03e-04	8.70	0.0	-487.13	107.49	0.0	0.0	0.0	0.0	504.85
		504.85	0.0	0.0	0.0	27.5	-479.57	112.14	0.0	0.0	0.0	0.0	535.06
							55.0	-472.01	116.18	0.0	0.0	0.0	566.47
6	57	496.11	0.0	2.79e-04	8.70	0.0	-482.88	97.89	0.0	0.0	0.0	0.0	439.76
		439.76	0.0	0.0	0.0	27.5	-475.31	102.55	0.0	0.0	0.0	0.0	467.34
							55.0	-467.75	106.59	0.0	0.0	0.0	496.11
6	58	455.54	0.0	2.69e-04	8.70	0.0	-451.82	102.02	0.0	0.0	0.0	0.0	396.92
		396.92	0.0	0.0	0.0	27.5	-444.26	106.68	0.0	0.0	0.0	0.0	425.63
							55.0	-436.70	110.72	0.0	0.0	0.0	455.54
6	59	402.77	0.0	2.51e-04	8.70	0.0	-448.63	94.82	0.0	0.0	0.0	0.0	348.11
		348.11	0.0	0.0	0.0	27.5	-441.07	99.48	0.0	0.0	0.0	0.0	374.84
							55.0	-433.51	103.52	0.0	0.0	0.0	402.77
6	60	1018.38	0.0	-5.67e-04	8.70	0.0	-504.58	201.62	0.0	0.0	0.0	0.0	904.98
		904.98	0.0	0.0	0.0	27.5	-497.02	206.28	0.0	0.0	0.0	0.0	961.08
							55.0	-489.46	210.32	0.0	0.0	0.0	1018.38
6	61	1002.40	0.0	-6.82e-04	8.70	0.0	-506.41	204.43	0.0	0.0	0.0	0.0	887.46
		887.46	0.0	0.0	0.0	27.5	-498.85	209.08	0.0	0.0	0.0	0.0	944.33
							55.0	-491.28	213.12	0.0	0.0	0.0	1002.40
6	62	998.15	0.0	-8.75e-04	8.70	0.0	-458.95	219.43	0.0	0.0	0.0	0.0	874.96
		874.96	0.0	0.0	0.0	27.5	-451.39	224.09	0.0	0.0	0.0	0.0	935.96
							55.0	-443.82	228.13	0.0	0.0	0.0	998.15
6	63	839.89	0.0	-2.70e-05	8.70	0.0	-467.94	146.28	0.0	0.0	0.0	0.0	756.93
		756.93	0.0	0.0	0.0	27.5	-460.38	150.94	0.0	0.0	0.0	0.0	797.81
							55.0	-452.82	154.98	0.0	0.0	0.0	839.89
6	64	823.91	0.0	-1.41e-04	8.70	0.0	-469.77	149.09	0.0	0.0	0.0	0.0	739.41
		739.41	0.0	0.0	0.0	27.5	-462.21	153.74	0.0	0.0	0.0	0.0	781.06
							55.0	-454.65	157.78	0.0	0.0	0.0	823.91
6	65	819.66	0.0	-3.34e-04	8.70	0.0	-422.31	164.09	0.0	0.0	0.0	0.0	726.90
		726.90	0.0	0.0	0.0	27.5	-414.75	168.75	0.0	0.0	0.0	0.0	772.68
							55.0	-407.19	172.79	0.0	0.0	0.0	819.66
6	66	952.39	0.0	-3.76e-04	8.70	0.0	-465.44	194.14	0.0	0.0	0.0	0.0	843.11
		843.11	0.0	0.0	0.0	27.5	-457.88	198.80	0.0	0.0	0.0	0.0	897.15
							55.0	-450.31	202.84	0.0	0.0	0.0	952.39
6	67	773.90	0.0	-1.65e-04	8.70	0.0	-428.80	138.80	0.0	0.0	0.0	0.0	695.06
		695.06	0.0	0.0	0.0	27.5	-421.24	143.46	0.0	0.0	0.0	0.0	733.88
							55.0	-413.68	147.50	0.0	0.0	0.0	773.90
6	68	743.06	0.0	-8.83e-04	8.70	0.0	-412.72	200.46	0.0	0.0	0.0	0.0	630.30
		630.30	0.0	0.0	0.0	27.5	-405.16	205.12	0.0	0.0	0.0	0.0	686.08
							55.0	-397.59	209.16	0.0	0.0	0.0	743.06



6	69	431.26	0.0	-3.28e-04	8.70	0.0	-376.08	133.34	0.0	0.0	0.0	355.42
		355.42	0.0	0.0	0.0	27.5	-368.52	138.00	0.0	0.0	0.0	392.74
						55.0	-360.96	142.04	0.0	0.0	0.0	431.26
6	70	310.50	0.0	2.27e-04	8.70	0.0	-345.90	85.08	0.0	0.0	0.0	261.19
		261.19	0.0	0.0	0.0	27.5	-338.34	89.74	0.0	0.0	0.0	285.25
						55.0	-330.77	93.78	0.0	0.0	0.0	310.50
6	71	644.94	0.0	-1.14e-04	8.70	0.0	-357.91	145.74	0.0	0.0	0.0	562.28
		562.28	0.0	0.0	0.0	27.5	-350.35	150.40	0.0	0.0	0.0	603.01
						55.0	-342.79	154.43	0.0	0.0	0.0	644.94
6	72	386.56	0.0	-1.53e-04	8.70	0.0	-345.90	105.45	0.0	0.0	0.0	326.06
		326.06	0.0	0.0	0.0	27.5	-338.33	110.10	0.0	0.0	0.0	355.72
						55.0	-330.77	114.14	0.0	0.0	0.0	386.56
6	73	568.87	0.0	-4.01e-05	8.70	0.0	-357.91	125.38	0.0	0.0	0.0	497.41
		497.41	0.0	0.0	0.0	27.5	-350.35	130.03	0.0	0.0	0.0	532.54
						55.0	-342.79	134.07	0.0	0.0	0.0	568.87
6	74	402.24	0.0	-2.22e-05	8.70	0.0	-357.91	110.65	0.0	0.0	0.0	338.88
		338.88	0.0	0.0	0.0	27.5	-350.35	115.31	0.0	0.0	0.0	369.96
						55.0	-342.79	119.35	0.0	0.0	0.0	402.24
6	75	686.84	0.0	-4.90e-04	12.08	0.0	-439.28	197.49	0.0	0.0	0.0	574.74
		574.74	0.0	0.0	0.0	27.5	-431.72	203.95	0.0	0.0	0.0	629.96
						55.0	-424.15	209.56	0.0	0.0	0.0	686.84
6	76	1566.91	0.0	-2.30e-03	12.08	0.0	-505.31	394.30	0.0	0.0	0.0	1346.57
		1346.57	0.0	0.0	0.0	27.5	-497.74	400.76	0.0	0.0	0.0	1455.91
						55.0	-490.18	406.37	0.0	0.0	0.0	1566.91
6	77	762.91	0.0	-5.64e-04	12.08	0.0	-439.28	217.85	0.0	0.0	0.0	639.61
		639.61	0.0	0.0	0.0	27.5	-431.72	224.31	0.0	0.0	0.0	700.43
						55.0	-424.15	229.93	0.0	0.0	0.0	762.91
6	78	1490.84	0.0	-2.22e-03	12.08	0.0	-505.31	373.93	0.0	0.0	0.0	1281.70
		1281.70	0.0	0.0	0.0	27.5	-497.74	380.40	0.0	0.0	0.0	1385.44
						55.0	-490.18	386.01	0.0	0.0	0.0	1490.84
6	79	1291.34	0.0	-2.23e-03	12.08	0.0	-475.27	361.29	0.0	0.0	0.0	1089.15
		1089.15	0.0	0.0	0.0	27.5	-467.71	367.75	0.0	0.0	0.0	1189.42
						55.0	-460.14	373.36	0.0	0.0	0.0	1291.34
7	1	990.33	0.0	1.46e-03	359.98	0.0	-913.79	-275.06	0.0	0.0	0.0	990.33
		510.87	0.0	0.0	0.0	345.0	-785.71	-26.05	0.0	0.0	0.0	517.89
						690.0	-657.63	84.92	0.0	0.0	0.0	648.07
7	2	991.85	0.0	1.47e-03	359.98	0.0	-908.05	-288.01	0.0	0.0	0.0	991.85
		457.71	0.0	0.0	0.0	345.0	-779.97	-39.00	0.0	0.0	0.0	474.71
						690.0	-651.88	71.96	0.0	0.0	0.0	560.20
7	3	934.51	0.0	1.69e-03	359.98	0.0	-865.77	-291.25	0.0	0.0	0.0	934.51



		386.43	0.0	0.0	0.0	345.0	-737.69	-42.23	0.0	0.0	0.0	406.21
						690.0	-609.61	68.73	0.0	0.0	0.0	480.54
7	4	935.65	0.0	1.70e-03	359.98	0.0	-861.47	-300.94	0.0	0.0	0.0	935.65
		345.77	0.0	0.0	0.0	345.0	-733.39	-51.93	0.0	0.0	0.0	373.91
						690.0	-605.31	59.04	0.0	0.0	0.0	414.80
7	5	1370.75	0.0	-0.02	359.98	0.0	-948.83	-82.71	0.0	0.0	0.0	385.81
		348.65	0.0	0.0	0.0	345.0	-820.75	166.30	0.0	0.0	0.0	576.97
						690.0	-692.67	277.27	0.0	0.0	0.0	1370.75
7	6	1347.16	0.0	-0.02	359.98	0.0	-951.30	-78.93	0.0	0.0	0.0	336.13
		302.24	0.0	0.0	0.0	345.0	-823.21	170.08	0.0	0.0	0.0	540.33
						690.0	-695.13	281.05	0.0	0.0	0.0	1347.16
7	7	1330.32	0.0	-0.02	359.98	0.0	-887.38	-58.72	0.0	0.0	0.0	179.86
		163.40	0.0	0.0	0.0	345.0	-759.30	190.29	0.0	0.0	0.0	453.78
						690.0	-631.22	301.25	0.0	0.0	0.0	1330.32
7	8	1192.14	0.0	-9.46e-03	359.98	0.0	-899.37	-148.64	0.0	0.0	0.0	662.12
		536.58	0.0	0.0	0.0	345.0	-771.29	100.37	0.0	0.0	0.0	625.82
						690.0	-643.21	211.34	0.0	0.0	0.0	1192.14
7	9	1168.55	0.0	-0.01	359.98	0.0	-901.84	-144.86	0.0	0.0	0.0	612.44
		493.42	0.0	0.0	0.0	345.0	-773.75	104.15	0.0	0.0	0.0	589.18
						690.0	-645.67	215.12	0.0	0.0	0.0	1168.55
7	10	1151.71	0.0	-0.01	359.98	0.0	-837.92	-124.65	0.0	0.0	0.0	456.17
		372.01	0.0	0.0	0.0	345.0	-709.84	124.36	0.0	0.0	0.0	502.63
						690.0	-581.76	235.32	0.0	0.0	0.0	1151.71
7	11	891.14	0.0	-1.12e-03	359.98	0.0	-913.79	-248.35	0.0	0.0	0.0	891.14
		510.83	0.0	0.0	0.0	345.0	-785.71	0.66	0.0	0.0	0.0	510.83
						690.0	-657.63	111.62	0.0	0.0	0.0	733.15
7	12	892.66	0.0	-1.05e-03	359.98	0.0	-908.05	-261.31	0.0	0.0	0.0	892.66
		466.83	0.0	0.0	0.0	345.0	-779.96	-12.29	0.0	0.0	0.0	467.66
						690.0	-651.88	98.67	0.0	0.0	0.0	645.29
7	13	801.55	0.0	-1.14e-03	359.98	0.0	-865.77	-255.45	0.0	0.0	0.0	801.55
		396.76	0.0	0.0	0.0	345.0	-737.69	-6.44	0.0	0.0	0.0	396.76
						690.0	-609.61	104.53	0.0	0.0	0.0	594.59
7	14	802.69	0.0	-1.09e-03	359.98	0.0	-861.47	-265.14	0.0	0.0	0.0	802.69
		361.90	0.0	0.0	0.0	345.0	-733.39	-16.13	0.0	0.0	0.0	364.46
						690.0	-605.31	94.83	0.0	0.0	0.0	528.85
7	15	1285.67	0.0	-0.02	359.98	0.0	-948.84	-109.42	0.0	0.0	0.0	485.00
		424.81	0.0	0.0	0.0	345.0	-820.75	139.60	0.0	0.0	0.0	584.02
						690.0	-692.67	250.56	0.0	0.0	0.0	1285.67
7	16	1262.07	0.0	-0.02	359.98	0.0	-951.30	-105.64	0.0	0.0	0.0	435.32
		378.39	0.0	0.0	0.0	345.0	-823.22	143.38	0.0	0.0	0.0	547.39



						690.0	-695.13	254.34	0.0	0.0	0.0	1262.07
7	17	1245.24	0.0	-0.02	359.98	0.0	-887.39	-85.43	0.0	0.0	0.0	279.05
		239.55	0.0	0.0	0.0	345.0	-759.30	163.58	0.0	0.0	0.0	460.83
						690.0	-631.22	274.55	0.0	0.0	0.0	1245.24
7	18	1078.09	0.0	-7.56e-03	359.98	0.0	-899.38	-184.44	0.0	0.0	0.0	795.07
		599.08	0.0	0.0	0.0	345.0	-771.30	64.58	0.0	0.0	0.0	635.27
						690.0	-643.21	175.54	0.0	0.0	0.0	1078.09
7	19	1054.50	0.0	-9.28e-03	359.98	0.0	-901.84	-180.66	0.0	0.0	0.0	745.40
		559.19	0.0	0.0	0.0	345.0	-773.76	68.36	0.0	0.0	0.0	598.64
						690.0	-645.68	179.32	0.0	0.0	0.0	1054.50
7	20	1037.66	0.0	-0.01	359.98	0.0	-837.93	-160.45	0.0	0.0	0.0	589.13
		443.22	0.0	0.0	0.0	345.0	-709.84	88.56	0.0	0.0	0.0	512.08
						690.0	-581.76	199.53	0.0	0.0	0.0	1037.66
7	21	1202.35	0.0	-0.01	359.98	0.0	-896.12	-119.49	0.0	0.0	0.0	471.18
		395.93	0.0	0.0	0.0	345.0	-768.04	129.52	0.0	0.0	0.0	535.45
						690.0	-639.96	240.49	0.0	0.0	0.0	1202.35
7	22	994.77	0.0	-3.90e-03	359.98	0.0	-846.66	-194.51	0.0	0.0	0.0	781.26
		559.20	0.0	0.0	0.0	345.0	-718.58	54.50	0.0	0.0	0.0	586.70
						690.0	-590.50	165.47	0.0	0.0	0.0	994.77
7	23	813.87	0.0	-0.02	359.98	0.0	-637.65	-97.55	0.0	0.0	0.0	-68.66
		-118.61	0.0	0.0	0.0	345.0	-542.78	151.46	0.0	0.0	0.0	71.29
						690.0	-447.90	262.42	0.0	0.0	0.0	813.87
7	24	454.10	0.0	-0.01	359.98	0.0	-588.19	-186.71	0.0	0.0	0.0	186.76
		-15.11	0.0	0.0	0.0	345.0	-493.32	62.30	0.0	0.0	0.0	19.12
						690.0	-398.44	173.27	0.0	0.0	0.0	454.10
7	25	1203.25	0.0	-0.02	359.98	0.0	-1002.63	-100.12	0.0	0.0	0.0	338.45
		286.28	0.0	0.0	0.0	345.0	-874.55	148.89	0.0	0.0	0.0	469.54
						690.0	-746.47	259.85	0.0	0.0	0.0	1203.25
7	26	1222.62	0.0	-0.02	359.98	0.0	-952.38	-86.50	0.0	0.0	0.0	263.80
		223.39	0.0	0.0	0.0	345.0	-824.30	162.52	0.0	0.0	0.0	441.90
						690.0	-696.22	273.48	0.0	0.0	0.0	1222.62
7	27	982.06	0.0	-2.92e-03	359.98	0.0	-876.94	-195.85	0.0	0.0	0.0	777.77
		552.25	0.0	0.0	0.0	345.0	-748.86	53.17	0.0	0.0	0.0	578.60
						690.0	-620.78	164.13	0.0	0.0	0.0	982.06
7	28	1047.70	0.0	-9.49e-03	359.98	0.0	-948.41	-181.87	0.0	0.0	0.0	746.94
		557.61	0.0	0.0	0.0	345.0	-820.33	67.15	0.0	0.0	0.0	596.01
						690.0	-692.25	178.11	0.0	0.0	0.0	1047.70
7	29	943.67	0.0	-0.02	359.98	0.0	-825.13	-108.39	0.0	0.0	0.0	135.90
		76.60	0.0	0.0	0.0	345.0	-697.05	140.63	0.0	0.0	0.0	238.47
						690.0	-568.97	251.59	0.0	0.0	0.0	943.67



7	30	1041.68	0.0	-0.01	673.84	0.0	-727.31	-309.43	0.0	0.0	0.0	349.26
		41.49	0.0	0.0	0.0	345.0	-632.43	137.55	0.0	0.0	0.0	122.89
						690.0	-537.56	364.42	0.0	0.0	0.0	1041.68
7	31	976.06	0.0	-0.01	720.54	0.0	-723.01	-342.67	0.0	0.0	0.0	351.94
		-19.20	0.0	0.0	0.0	345.0	-628.14	127.65	0.0	0.0	0.0	51.15
						690.0	-533.26	377.87	0.0	0.0	0.0	976.06
7	32	881.21	0.0	-0.01	769.46	0.0	-646.92	-359.20	0.0	0.0	0.0	284.37
		-131.75	0.0	0.0	0.0	345.0	-552.04	117.76	0.0	0.0	0.0	-72.25
						690.0	-457.17	410.25	0.0	0.0	0.0	881.21
7	33	955.00	0.0	-0.02	359.98	0.0	-826.21	-98.53	0.0	0.0	0.0	79.24
		28.44	0.0	0.0	0.0	345.0	-698.13	150.48	0.0	0.0	0.0	215.81
						690.0	-570.05	261.44	0.0	0.0	0.0	955.00
7	34	700.22	0.0	1.16e-03	359.98	0.0	-641.57	-267.22	0.0	0.0	0.0	700.22
		251.34	0.0	0.0	0.0	345.0	-546.70	-18.20	0.0	0.0	0.0	254.83
						690.0	-451.82	92.76	0.0	0.0	0.0	412.06
7	35	632.47	0.0	-1.33e-03	359.98	0.0	-647.51	-256.23	0.0	0.0	0.0	632.47
		224.99	0.0	0.0	0.0	345.0	-552.63	-7.21	0.0	0.0	0.0	224.99
						690.0	-457.76	103.75	0.0	0.0	0.0	420.14
7	36	776.49	0.0	-4.38e-03	359.98	0.0	-657.69	-193.54	0.0	0.0	0.0	556.28
		336.73	0.0	0.0	0.0	345.0	-562.82	55.47	0.0	0.0	0.0	365.07
						690.0	-467.94	166.44	0.0	0.0	0.0	776.49
7	37	758.97	0.0	-5.66e-03	359.98	0.0	-659.52	-190.73	0.0	0.0	0.0	519.39
		307.11	0.0	0.0	0.0	345.0	-564.65	58.28	0.0	0.0	0.0	337.87
						690.0	-469.77	169.24	0.0	0.0	0.0	758.97
7	38	746.46	0.0	-7.77e-03	359.98	0.0	-612.06	-175.73	0.0	0.0	0.0	403.35
		229.89	0.0	0.0	0.0	345.0	-517.19	73.28	0.0	0.0	0.0	273.59
						690.0	-422.31	184.25	0.0	0.0	0.0	746.46
7	39	617.56	0.0	-6.57e-04	359.98	0.0	-641.57	-244.96	0.0	0.0	0.0	617.56
		248.95	0.0	0.0	0.0	345.0	-546.70	4.05	0.0	0.0	0.0	248.95
						690.0	-451.82	115.01	0.0	0.0	0.0	482.97
7	40	618.41	0.0	-6.16e-04	359.98	0.0	-638.38	-252.16	0.0	0.0	0.0	618.41
		224.97	0.0	0.0	0.0	345.0	-543.51	-3.15	0.0	0.0	0.0	224.97
						690.0	-448.63	107.82	0.0	0.0	0.0	434.15
7	41	705.58	0.0	-3.21e-03	359.98	0.0	-657.69	-215.80	0.0	0.0	0.0	638.94
		361.81	0.0	0.0	0.0	345.0	-562.82	33.22	0.0	0.0	0.0	370.95
						690.0	-467.94	144.18	0.0	0.0	0.0	705.58
7	42	688.06	0.0	-4.48e-03	359.98	0.0	-659.52	-212.99	0.0	0.0	0.0	602.05
		332.18	0.0	0.0	0.0	345.0	-564.65	36.02	0.0	0.0	0.0	343.74
						690.0	-469.77	146.99	0.0	0.0	0.0	688.06
7	43	675.56	0.0	-6.59e-03	359.98	0.0	-612.06	-197.98	0.0	0.0	0.0	486.01



		254.97	0.0	0.0	0.0	345.0	-517.19	51.03	0.0	0.0	0.0	279.47
						690.0	-422.31	161.99	0.0	0.0	0.0	675.56
7	44	754.61	0.0	-4.90e-03	359.98	0.0	-636.72	-188.49	0.0	0.0	0.0	499.55
		293.08	0.0	0.0	0.0	345.0	-541.85	60.52	0.0	0.0	0.0	325.77
						690.0	-446.97	171.49	0.0	0.0	0.0	754.61
7	45	430.90	0.0	-6.59e-03	359.98	0.0	-565.83	-216.96	0.0	0.0	0.0	372.26
		92.13	0.0	0.0	0.0	345.0	-470.96	32.06	0.0	0.0	0.0	100.27
						690.0	-376.08	143.02	0.0	0.0	0.0	430.90
7	46	733.59	0.0	1.17e-03	359.98	0.0	-676.88	-263.85	0.0	0.0	0.0	733.59
		297.83	0.0	0.0	0.0	345.0	-582.01	-14.84	0.0	0.0	0.0	299.80
						690.0	-487.13	96.12	0.0	0.0	0.0	468.64
7	47	734.71	0.0	1.17e-03	359.98	0.0	-672.63	-273.45	0.0	0.0	0.0	734.71
		261.53	0.0	0.0	0.0	345.0	-577.75	-24.44	0.0	0.0	0.0	267.82
						690.0	-482.88	86.53	0.0	0.0	0.0	403.55
7	48	691.52	0.0	1.36e-03	359.98	0.0	-641.57	-276.90	0.0	0.0	0.0	691.52
		204.89	0.0	0.0	0.0	345.0	-546.70	-27.88	0.0	0.0	0.0	212.74
						690.0	-451.82	83.08	0.0	0.0	0.0	336.58
7	49	692.36	0.0	1.37e-03	359.98	0.0	-638.38	-284.09	0.0	0.0	0.0	692.36
		175.14	0.0	0.0	0.0	345.0	-543.51	-35.08	0.0	0.0	0.0	188.75
						690.0	-448.63	75.88	0.0	0.0	0.0	287.76
7	50	975.89	0.0	-0.01	359.98	0.0	-694.33	-136.10	0.0	0.0	0.0	359.34
		255.44	0.0	0.0	0.0	345.0	-599.45	112.91	0.0	0.0	0.0	366.30
						690.0	-504.58	223.88	0.0	0.0	0.0	975.89
7	51	958.37	0.0	-0.01	359.98	0.0	-696.16	-133.29	0.0	0.0	0.0	322.45
		223.39	0.0	0.0	0.0	345.0	-601.28	115.72	0.0	0.0	0.0	339.10
						690.0	-506.41	226.68	0.0	0.0	0.0	958.37
7	52	945.86	0.0	-0.02	359.98	0.0	-648.70	-118.29	0.0	0.0	0.0	206.41
		133.23	0.0	0.0	0.0	345.0	-553.82	130.72	0.0	0.0	0.0	274.83
						690.0	-458.95	241.69	0.0	0.0	0.0	945.86
7	53	851.97	0.0	-4.59e-03	359.98	0.0	-657.69	-183.86	0.0	0.0	0.0	564.98
		370.48	0.0	0.0	0.0	345.0	-562.82	65.15	0.0	0.0	0.0	407.16
						690.0	-467.94	176.11	0.0	0.0	0.0	851.97
7	54	834.45	0.0	-5.86e-03	359.98	0.0	-659.52	-181.06	0.0	0.0	0.0	528.09
		340.86	0.0	0.0	0.0	345.0	-564.65	67.96	0.0	0.0	0.0	379.96
						690.0	-469.77	178.92	0.0	0.0	0.0	834.45
7	55	821.95	0.0	-7.98e-03	359.98	0.0	-612.06	-166.05	0.0	0.0	0.0	412.05
		256.48	0.0	0.0	0.0	345.0	-517.19	82.96	0.0	0.0	0.0	315.69
						690.0	-422.31	193.93	0.0	0.0	0.0	821.95
7	56	691.38	0.0	5.66e-04	359.98	0.0	-676.88	-252.49	0.0	0.0	0.0	691.38
		296.80	0.0	0.0	0.0	345.0	-582.01	-3.48	0.0	0.0	0.0	296.80



						690.0	-487.13	107.49	0.0	0.0	0.0	504.85
7	57	692.50	0.0	5.72e-04	359.98	0.0	-672.63	-262.08	0.0	0.0	0.0	692.50
		263.64	0.0	0.0	0.0	345.0	-577.75	-13.07	0.0	0.0	0.0	264.82
						690.0	-482.88	97.89	0.0	0.0	0.0	439.76
7	58	621.17	0.0	-8.84e-04	359.98	0.0	-641.57	-257.95	0.0	0.0	0.0	621.17
		207.74	0.0	0.0	0.0	345.0	-546.70	-8.94	0.0	0.0	0.0	207.74
						690.0	-451.82	102.02	0.0	0.0	0.0	396.92
7	59	622.02	0.0	-8.54e-04	359.98	0.0	-638.38	-265.15	0.0	0.0	0.0	622.02
		181.19	0.0	0.0	0.0	345.0	-543.51	-16.14	0.0	0.0	0.0	183.75
						690.0	-448.63	94.82	0.0	0.0	0.0	348.11
7	60	904.98	0.0	-0.01	359.98	0.0	-694.33	-158.36	0.0	0.0	0.0	442.00
		299.70	0.0	0.0	0.0	345.0	-599.46	90.66	0.0	0.0	0.0	372.18
						690.0	-504.58	201.62	0.0	0.0	0.0	904.98
7	61	887.46	0.0	-0.01	359.98	0.0	-696.16	-155.55	0.0	0.0	0.0	405.11
		267.66	0.0	0.0	0.0	345.0	-601.28	93.46	0.0	0.0	0.0	344.98
						690.0	-506.41	204.43	0.0	0.0	0.0	887.46
7	62	874.96	0.0	-0.01	359.98	0.0	-648.70	-140.54	0.0	0.0	0.0	289.07
		177.50	0.0	0.0	0.0	345.0	-553.82	108.47	0.0	0.0	0.0	280.70
						690.0	-458.95	219.43	0.0	0.0	0.0	874.96
7	63	756.93	0.0	-3.01e-03	359.98	0.0	-657.69	-213.69	0.0	0.0	0.0	675.78
		404.09	0.0	0.0	0.0	345.0	-562.82	35.32	0.0	0.0	0.0	415.04
						690.0	-467.94	146.28	0.0	0.0	0.0	756.93
7	64	739.41	0.0	-4.29e-03	359.98	0.0	-659.52	-210.89	0.0	0.0	0.0	638.89
		374.46	0.0	0.0	0.0	345.0	-564.65	38.13	0.0	0.0	0.0	387.84
						690.0	-469.77	149.09	0.0	0.0	0.0	739.41
7	65	726.90	0.0	-6.40e-03	359.98	0.0	-612.06	-195.88	0.0	0.0	0.0	522.85
		297.25	0.0	0.0	0.0	345.0	-517.19	53.13	0.0	0.0	0.0	323.57
						690.0	-422.31	164.09	0.0	0.0	0.0	726.90
7	66	843.11	0.0	-7.72e-03	359.98	0.0	-655.19	-165.84	0.0	0.0	0.0	431.74
		276.54	0.0	0.0	0.0	345.0	-560.31	83.18	0.0	0.0	0.0	336.11
						690.0	-465.44	194.14	0.0	0.0	0.0	843.11
7	67	695.06	0.0	-5.88e-04	359.98	0.0	-618.55	-221.17	0.0	0.0	0.0	665.52
		374.47	0.0	0.0	0.0	345.0	-523.68	27.84	0.0	0.0	0.0	378.98
						690.0	-428.80	138.80	0.0	0.0	0.0	695.06
7	68	630.30	0.0	-0.01	359.98	0.0	-602.47	-159.52	0.0	0.0	0.0	175.33
		31.03	0.0	0.0	0.0	345.0	-507.59	89.50	0.0	0.0	0.0	101.50
						690.0	-412.72	200.46	0.0	0.0	0.0	630.30
7	69	363.56	0.0	-6.38e-03	359.98	0.0	-565.83	-226.63	0.0	0.0	0.0	363.56
		58.18	0.0	0.0	0.0	345.0	-470.96	22.38	0.0	0.0	0.0	58.18
						690.0	-376.08	133.34	0.0	0.0	0.0	355.42



7	70	602.31	0.0	1.07e-03	359.98	0.0	-535.65	-274.89	0.0	0.0	0.0	602.31
		123.50	0.0	0.0	0.0	345.0	-440.77	-25.88	0.0	0.0	0.0	130.44
						690.0	-345.90	85.08	0.0	0.0	0.0	261.19
7	71	562.28	0.0	-3.32e-03	359.98	0.0	-547.66	-214.24	0.0	0.0	0.0	484.87
		211.78	0.0	0.0	0.0	345.0	-452.79	34.78	0.0	0.0	0.0	222.26
						690.0	-357.91	145.74	0.0	0.0	0.0	562.28
7	72	526.68	0.0	-4.25e-04	359.98	0.0	-535.65	-254.53	0.0	0.0	0.0	526.68
		125.06	0.0	0.0	0.0	345.0	-440.77	-5.52	0.0	0.0	0.0	125.06
						690.0	-345.90	105.45	0.0	0.0	0.0	326.06
7	73	560.50	0.0	-2.24e-03	359.98	0.0	-547.66	-234.60	0.0	0.0	0.0	560.50
		227.64	0.0	0.0	0.0	345.0	-452.79	14.42	0.0	0.0	0.0	227.64
						690.0	-357.91	125.38	0.0	0.0	0.0	497.41
7	74	503.56	0.0	-2.22e-03	359.98	0.0	-547.66	-249.32	0.0	0.0	0.0	503.56
		119.91	0.0	0.0	0.0	345.0	-452.79	-0.31	0.0	0.0	0.0	119.91
						690.0	-357.91	110.65	0.0	0.0	0.0	338.88
7	75	574.74	0.0	-8.66e-03	453.61	0.0	-657.73	-256.12	0.0	0.0	0.0	404.68
		84.95	0.0	0.0	0.0	345.0	-548.51	52.20	0.0	0.0	0.0	104.85
						690.0	-439.28	197.49	0.0	0.0	0.0	574.74
7	76	1346.57	0.0	-0.03	413.38	0.0	-703.67	-19.08	0.0	0.0	0.0	-320.28
		-320.28	0.0	0.0	0.0	345.0	-604.49	269.13	0.0	0.0	0.0	162.98
						690.0	-505.31	394.30	0.0	0.0	0.0	1346.57
7	77	639.61	0.0	-9.74e-03	453.61	0.0	-657.73	-235.76	0.0	0.0	0.0	329.05
		62.01	0.0	0.0	0.0	345.0	-548.50	72.57	0.0	0.0	0.0	99.47
						690.0	-439.28	217.85	0.0	0.0	0.0	639.61
7	78	1281.70	0.0	-0.03	413.38	0.0	-703.67	-39.44	0.0	0.0	0.0	-244.66
		-244.66	0.0	0.0	0.0	345.0	-604.49	248.77	0.0	0.0	0.0	168.36
						690.0	-505.31	373.93	0.0	0.0	0.0	1281.70
7	79	1089.15	0.0	-0.03	413.38	0.0	-656.41	-52.09	0.0	0.0	0.0	-349.94
		-355.68	0.0	0.0	0.0	345.0	-565.84	236.12	0.0	0.0	0.0	19.45
						690.0	-475.27	361.29	0.0	0.0	0.0	1089.15
8	1	1173.11	0.0	-3.47e-04	59.98	0.0	-936.07	-335.04	0.0	0.0	0.0	1173.11
		990.33	0.0	0.0	0.0	30.0	-924.93	-304.43	0.0	0.0	0.0	1077.22
						60.0	-913.79	-275.06	0.0	0.0	0.0	990.33
8	2	1182.40	0.0	-3.31e-04	59.98	0.0	-930.32	-347.99	0.0	0.0	0.0	1182.40
		991.85	0.0	0.0	0.0	30.0	-919.18	-317.39	0.0	0.0	0.0	1082.63
						60.0	-908.05	-288.01	0.0	0.0	0.0	991.85
8	3	1127.00	0.0	-3.18e-04	59.98	0.0	-888.05	-351.23	0.0	0.0	0.0	1127.00
		934.51	0.0	0.0	0.0	30.0	-876.91	-320.62	0.0	0.0	0.0	1026.26
						60.0	-865.77	-291.25	0.0	0.0	0.0	934.51
8	4	1133.96	0.0	-3.06e-04	59.98	0.0	-883.75	-360.92	0.0	0.0	0.0	1133.96



		935.65	0.0	0.0	0.0	30.0	-872.61	-330.31	0.0	0.0	0.0	1030.30
						60.0	-861.47	-300.94	0.0	0.0	0.0	935.65
8	5	453.18	0.0	-1.87e-03	59.98	0.0	-971.11	-142.69	0.0	0.0	0.0	453.18
		385.81	0.0	0.0	0.0	30.0	-959.97	-112.08	0.0	0.0	0.0	414.99
						60.0	-948.83	-82.71	0.0	0.0	0.0	385.81
8	6	401.23	0.0	-1.99e-03	59.98	0.0	-973.57	-138.91	0.0	0.0	0.0	401.23
		336.13	0.0	0.0	0.0	30.0	-962.43	-108.30	0.0	0.0	0.0	364.18
						60.0	-951.30	-78.93	0.0	0.0	0.0	336.13
8	7	232.84	0.0	-2.17e-03	59.98	0.0	-909.66	-118.70	0.0	0.0	0.0	232.84
		179.86	0.0	0.0	0.0	30.0	-898.52	-88.09	0.0	0.0	0.0	201.85
						60.0	-887.38	-58.72	0.0	0.0	0.0	179.86
8	8	769.05	0.0	-1.08e-03	59.98	0.0	-921.65	-208.62	0.0	0.0	0.0	769.05
		662.12	0.0	0.0	0.0	30.0	-910.51	-178.01	0.0	0.0	0.0	711.08
						60.0	-899.37	-148.64	0.0	0.0	0.0	662.12
8	9	717.10	0.0	-1.20e-03	59.98	0.0	-924.11	-204.84	0.0	0.0	0.0	717.10
		612.44	0.0	0.0	0.0	30.0	-912.97	-174.23	0.0	0.0	0.0	660.27
						60.0	-901.84	-144.86	0.0	0.0	0.0	612.44
8	10	548.71	0.0	-1.38e-03	59.98	0.0	-860.20	-184.63	0.0	0.0	0.0	548.71
		456.17	0.0	0.0	0.0	30.0	-849.06	-154.03	0.0	0.0	0.0	497.94
						60.0	-837.92	-124.65	0.0	0.0	0.0	456.17
8	11	1057.90	0.0	-4.44e-04	59.98	0.0	-936.06	-308.33	0.0	0.0	0.0	1057.90
		891.14	0.0	0.0	0.0	30.0	-924.93	-277.72	0.0	0.0	0.0	970.02
						60.0	-913.79	-248.35	0.0	0.0	0.0	891.14
8	12	1067.19	0.0	-4.28e-04	59.98	0.0	-930.32	-321.29	0.0	0.0	0.0	1067.19
		892.66	0.0	0.0	0.0	30.0	-919.18	-290.68	0.0	0.0	0.0	975.42
						60.0	-908.05	-261.31	0.0	0.0	0.0	892.66
8	13	972.57	0.0	-4.48e-04	59.98	0.0	-888.04	-315.43	0.0	0.0	0.0	972.57
		801.55	0.0	0.0	0.0	30.0	-876.91	-284.82	0.0	0.0	0.0	882.56
						60.0	-865.77	-255.45	0.0	0.0	0.0	801.55
8	14	979.52	0.0	-4.36e-04	59.98	0.0	-883.75	-325.12	0.0	0.0	0.0	979.52
		802.69	0.0	0.0	0.0	30.0	-872.61	-294.51	0.0	0.0	0.0	886.60
						60.0	-861.47	-265.14	0.0	0.0	0.0	802.69
8	15	568.39	0.0	-1.77e-03	59.98	0.0	-971.11	-169.40	0.0	0.0	0.0	568.39
		485.00	0.0	0.0	0.0	30.0	-959.97	-138.79	0.0	0.0	0.0	522.20
						60.0	-948.84	-109.42	0.0	0.0	0.0	485.00
8	16	516.45	0.0	-1.89e-03	59.98	0.0	-973.57	-165.62	0.0	0.0	0.0	516.45
		435.32	0.0	0.0	0.0	30.0	-962.43	-135.01	0.0	0.0	0.0	471.39
						60.0	-951.30	-105.64	0.0	0.0	0.0	435.32
8	17	348.06	0.0	-2.07e-03	59.98	0.0	-909.66	-145.41	0.0	0.0	0.0	348.06
		279.05	0.0	0.0	0.0	30.0	-898.52	-114.80	0.0	0.0	0.0	309.06



						60.0	-887.39	-85.43	0.0	0.0	0.0	279.05
8	18	923.48	0.0	-9.48e-04	59.98	0.0	-921.65	-244.42	0.0	0.0	0.0	923.48
		795.07	0.0	0.0	0.0	30.0	-910.51	-213.81	0.0	0.0	0.0	854.78
						60.0	-899.38	-184.44	0.0	0.0	0.0	795.07
8	19	871.54	0.0	-1.07e-03	59.98	0.0	-924.11	-240.64	0.0	0.0	0.0	871.54
		745.40	0.0	0.0	0.0	30.0	-912.98	-210.03	0.0	0.0	0.0	803.97
						60.0	-901.84	-180.66	0.0	0.0	0.0	745.40
8	20	703.15	0.0	-1.25e-03	59.98	0.0	-860.20	-220.43	0.0	0.0	0.0	703.15
		589.13	0.0	0.0	0.0	30.0	-849.06	-189.82	0.0	0.0	0.0	641.64
						60.0	-837.93	-160.45	0.0	0.0	0.0	589.13
8	21	560.62	0.0	-1.43e-03	59.98	0.0	-918.40	-179.47	0.0	0.0	0.0	560.62
		471.18	0.0	0.0	0.0	30.0	-907.26	-148.86	0.0	0.0	0.0	511.40
						60.0	-896.12	-119.49	0.0	0.0	0.0	471.18
8	22	915.71	0.0	-6.08e-04	59.98	0.0	-868.94	-254.49	0.0	0.0	0.0	915.71
		781.26	0.0	0.0	0.0	30.0	-857.80	-223.88	0.0	0.0	0.0	843.98
						60.0	-846.66	-194.51	0.0	0.0	0.0	781.26
8	23	7.62	0.0	-1.99e-03	59.98	0.0	-654.15	-157.53	0.0	0.0	0.0	7.62
		-68.66	0.0	0.0	0.0	30.0	-645.90	-126.93	0.0	0.0	0.0	-35.02
						60.0	-637.65	-97.55	0.0	0.0	0.0	-68.66
8	24	316.53	0.0	-1.21e-03	59.98	0.0	-604.69	-246.69	0.0	0.0	0.0	316.53
		186.76	0.0	0.0	0.0	30.0	-596.44	-216.08	0.0	0.0	0.0	247.15
						60.0	-588.19	-186.71	0.0	0.0	0.0	186.76
8	25	416.28	0.0	-2.02e-03	59.98	0.0	-1024.91	-160.10	0.0	0.0	0.0	416.28
		338.45	0.0	0.0	0.0	30.0	-1013.77	-129.50	0.0	0.0	0.0	372.87
						60.0	-1002.63	-100.12	0.0	0.0	0.0	338.45
8	26	333.45	0.0	-1.82e-03	59.98	0.0	-974.66	-146.48	0.0	0.0	0.0	333.45
		263.80	0.0	0.0	0.0	30.0	-963.52	-115.87	0.0	0.0	0.0	294.13
						60.0	-952.38	-86.50	0.0	0.0	0.0	263.80
8	27	913.02	0.0	-5.61e-04	59.98	0.0	-899.21	-255.83	0.0	0.0	0.0	913.02
		777.77	0.0	0.0	0.0	30.0	-888.08	-225.22	0.0	0.0	0.0	840.89
						60.0	-876.94	-195.85	0.0	0.0	0.0	777.77
8	28	873.81	0.0	-1.14e-03	59.98	0.0	-970.69	-241.85	0.0	0.0	0.0	873.81
		746.94	0.0	0.0	0.0	30.0	-959.55	-211.24	0.0	0.0	0.0	805.88
						60.0	-948.41	-181.87	0.0	0.0	0.0	746.94
8	29	218.68	0.0	-2.09e-03	59.98	0.0	-847.40	-168.37	0.0	0.0	0.0	218.68
		135.90	0.0	0.0	0.0	30.0	-836.27	-137.76	0.0	0.0	0.0	172.79
						60.0	-825.13	-108.39	0.0	0.0	0.0	135.90
8	30	565.33	0.0	-9.48e-04	102.63	0.0	-743.81	-412.05	0.0	0.0	0.0	565.33
		349.26	0.0	0.0	0.0	30.0	-735.56	-359.82	0.0	0.0	0.0	449.60
						60.0	-727.31	-309.43	0.0	0.0	0.0	349.26



8	31	589.18	0.0	-9.21e-04	106.69	0.0	-739.51	-449.36	0.0	0.0	0.0	589.18
		351.94	0.0	0.0	0.0	30.0	-731.26	-395.09	0.0	0.0	0.0	462.55
						60.0	-723.01	-342.67	0.0	0.0	0.0	351.94
8	32	530.84	0.0	-8.62e-04	104.20	0.0	-663.42	-463.41	0.0	0.0	0.0	530.84
		284.37	0.0	0.0	0.0	30.0	-655.17	-410.52	0.0	0.0	0.0	399.79
						60.0	-646.92	-359.20	0.0	0.0	0.0	284.37
8	33	156.11	0.0	-1.92e-03	59.98	0.0	-848.49	-158.52	0.0	0.0	0.0	156.11
		79.24	0.0	0.0	0.0	30.0	-837.35	-127.91	0.0	0.0	0.0	113.18
						60.0	-826.21	-98.53	0.0	0.0	0.0	79.24
8	34	878.30	0.0	-1.97e-04	59.98	0.0	-658.07	-327.20	0.0	0.0	0.0	878.30
		700.22	0.0	0.0	0.0	30.0	-649.82	-296.59	0.0	0.0	0.0	784.76
						60.0	-641.57	-267.22	0.0	0.0	0.0	700.22
8	35	803.96	0.0	-3.72e-04	59.98	0.0	-664.01	-316.21	0.0	0.0	0.0	803.96
		632.47	0.0	0.0	0.0	30.0	-655.76	-285.60	0.0	0.0	0.0	713.71
						60.0	-647.51	-256.23	0.0	0.0	0.0	632.47
8	36	690.15	0.0	-5.73e-04	59.98	0.0	-674.19	-253.52	0.0	0.0	0.0	690.15
		556.28	0.0	0.0	0.0	30.0	-665.94	-222.91	0.0	0.0	0.0	618.72
						60.0	-657.69	-193.54	0.0	0.0	0.0	556.28
8	37	651.58	0.0	-6.65e-04	59.98	0.0	-676.02	-250.72	0.0	0.0	0.0	651.58
		519.39	0.0	0.0	0.0	30.0	-667.77	-220.11	0.0	0.0	0.0	580.98
						60.0	-659.52	-190.73	0.0	0.0	0.0	519.39
8	38	526.53	0.0	-7.98e-04	59.98	0.0	-628.56	-235.71	0.0	0.0	0.0	526.53
		403.35	0.0	0.0	0.0	30.0	-620.31	-205.10	0.0	0.0	0.0	460.44
						60.0	-612.06	-175.73	0.0	0.0	0.0	403.35
8	39	782.29	0.0	-2.78e-04	59.98	0.0	-658.07	-304.94	0.0	0.0	0.0	782.29
		617.56	0.0	0.0	0.0	30.0	-649.82	-274.33	0.0	0.0	0.0	695.43
						60.0	-641.57	-244.96	0.0	0.0	0.0	617.56
8	40	787.45	0.0	-2.69e-04	59.98	0.0	-654.88	-312.14	0.0	0.0	0.0	787.45
		618.41	0.0	0.0	0.0	30.0	-646.63	-281.53	0.0	0.0	0.0	698.43
						60.0	-638.38	-252.16	0.0	0.0	0.0	618.41
8	41	786.16	0.0	-4.92e-04	59.98	0.0	-674.19	-275.78	0.0	0.0	0.0	786.16
		638.94	0.0	0.0	0.0	30.0	-665.94	-245.17	0.0	0.0	0.0	708.05
						60.0	-657.69	-215.80	0.0	0.0	0.0	638.94
8	42	747.59	0.0	-5.84e-04	59.98	0.0	-676.02	-272.97	0.0	0.0	0.0	747.59
		602.05	0.0	0.0	0.0	30.0	-667.77	-242.36	0.0	0.0	0.0	670.32
						60.0	-659.52	-212.99	0.0	0.0	0.0	602.05
8	43	622.55	0.0	-7.17e-04	59.98	0.0	-628.56	-257.97	0.0	0.0	0.0	622.55
		486.01	0.0	0.0	0.0	30.0	-620.31	-227.36	0.0	0.0	0.0	549.78
						60.0	-612.06	-197.98	0.0	0.0	0.0	486.01
8	44	630.40	0.0	-5.90e-04	59.98	0.0	-653.22	-248.47	0.0	0.0	0.0	630.40



		499.55	0.0	0.0	0.0	30.0	-644.97	-217.86	0.0	0.0	0.0	560.48
						60.0	-636.72	-188.49	0.0	0.0	0.0	499.55
8	45	520.18	0.0	-7.37e-04	59.98	0.0	-582.33	-276.94	0.0	0.0	0.0	520.18
		372.26	0.0	0.0	0.0	30.0	-574.08	-246.33	0.0	0.0	0.0	441.72
						60.0	-565.83	-216.96	0.0	0.0	0.0	372.26
8	46	909.65	0.0	-2.21e-04	59.98	0.0	-693.38	-323.83	0.0	0.0	0.0	909.65
		733.59	0.0	0.0	0.0	30.0	-685.13	-293.23	0.0	0.0	0.0	817.12
						60.0	-676.88	-263.85	0.0	0.0	0.0	733.59
8	47	916.53	0.0	-2.09e-04	59.98	0.0	-689.13	-333.43	0.0	0.0	0.0	916.53
		734.71	0.0	0.0	0.0	30.0	-680.88	-302.82	0.0	0.0	0.0	821.12
						60.0	-672.63	-273.45	0.0	0.0	0.0	734.71
8	48	875.40	0.0	-2.00e-04	59.98	0.0	-658.07	-336.88	0.0	0.0	0.0	875.40
		691.52	0.0	0.0	0.0	30.0	-649.82	-306.27	0.0	0.0	0.0	778.96
						60.0	-641.57	-276.90	0.0	0.0	0.0	691.52
8	49	880.57	0.0	-1.91e-04	59.98	0.0	-654.88	-344.07	0.0	0.0	0.0	880.57
		692.36	0.0	0.0	0.0	30.0	-646.63	-313.47	0.0	0.0	0.0	781.97
						60.0	-638.38	-284.09	0.0	0.0	0.0	692.36
8	50	458.75	0.0	-1.16e-03	59.98	0.0	-710.83	-196.08	0.0	0.0	0.0	458.75
		359.34	0.0	0.0	0.0	30.0	-702.58	-165.47	0.0	0.0	0.0	404.55
						60.0	-694.33	-136.10	0.0	0.0	0.0	359.34
8	51	420.18	0.0	-1.25e-03	59.98	0.0	-712.66	-193.28	0.0	0.0	0.0	420.18
		322.45	0.0	0.0	0.0	30.0	-704.41	-162.67	0.0	0.0	0.0	366.82
						60.0	-696.16	-133.29	0.0	0.0	0.0	322.45
8	52	295.13	0.0	-1.38e-03	59.98	0.0	-665.20	-178.27	0.0	0.0	0.0	295.13
		206.41	0.0	0.0	0.0	30.0	-656.95	-147.66	0.0	0.0	0.0	246.27
						60.0	-648.70	-118.29	0.0	0.0	0.0	206.41
8	53	693.05	0.0	-5.71e-04	59.98	0.0	-674.19	-243.84	0.0	0.0	0.0	693.05
		564.98	0.0	0.0	0.0	30.0	-665.94	-213.24	0.0	0.0	0.0	624.52
						60.0	-657.69	-183.86	0.0	0.0	0.0	564.98
8	54	654.47	0.0	-6.63e-04	59.98	0.0	-676.02	-241.04	0.0	0.0	0.0	654.47
		528.09	0.0	0.0	0.0	30.0	-667.77	-210.43	0.0	0.0	0.0	586.79
						60.0	-659.52	-181.06	0.0	0.0	0.0	528.09
8	55	529.43	0.0	-7.96e-04	59.98	0.0	-628.56	-226.03	0.0	0.0	0.0	529.43
		412.05	0.0	0.0	0.0	30.0	-620.31	-195.42	0.0	0.0	0.0	466.24
						60.0	-612.06	-166.05	0.0	0.0	0.0	412.05
8	56	860.62	0.0	-2.62e-04	59.98	0.0	-693.38	-312.47	0.0	0.0	0.0	860.62
		691.38	0.0	0.0	0.0	30.0	-685.13	-281.86	0.0	0.0	0.0	771.50
						60.0	-676.88	-252.49	0.0	0.0	0.0	691.38
8	57	867.50	0.0	-2.50e-04	59.98	0.0	-689.13	-322.07	0.0	0.0	0.0	867.50
		692.50	0.0	0.0	0.0	30.0	-680.88	-291.46	0.0	0.0	0.0	775.50

						60.0	-672.63	-262.08	0.0	0.0	0.0	692.50
8	58	793.69	0.0	-2.68e-04	59.98	0.0	-658.07	-317.94	0.0	0.0	0.0	793.69
		621.17	0.0	0.0	0.0	30.0	-649.82	-287.33	0.0	0.0	0.0	702.93
						60.0	-641.57	-257.95	0.0	0.0	0.0	621.17
8	59	798.85	0.0	-2.59e-04	59.98	0.0	-654.88	-325.13	0.0	0.0	0.0	798.85
		622.02	0.0	0.0	0.0	30.0	-646.63	-294.52	0.0	0.0	0.0	705.94
						60.0	-638.38	-265.15	0.0	0.0	0.0	622.02
8	60	554.76	0.0	-1.08e-03	59.98	0.0	-710.83	-218.34	0.0	0.0	0.0	554.76
		442.00	0.0	0.0	0.0	30.0	-702.58	-187.73	0.0	0.0	0.0	493.88
						60.0	-694.33	-158.36	0.0	0.0	0.0	442.00
8	61	516.19	0.0	-1.17e-03	59.98	0.0	-712.66	-215.53	0.0	0.0	0.0	516.19
		405.11	0.0	0.0	0.0	30.0	-704.41	-184.92	0.0	0.0	0.0	456.15
						60.0	-696.16	-155.55	0.0	0.0	0.0	405.11
8	62	391.15	0.0	-1.30e-03	59.98	0.0	-665.20	-200.53	0.0	0.0	0.0	391.15
		289.07	0.0	0.0	0.0	30.0	-656.95	-169.92	0.0	0.0	0.0	335.61
						60.0	-648.70	-140.54	0.0	0.0	0.0	289.07
8	63	821.75	0.0	-4.62e-04	59.98	0.0	-674.19	-273.68	0.0	0.0	0.0	821.75
		675.78	0.0	0.0	0.0	30.0	-665.94	-243.07	0.0	0.0	0.0	744.26
						60.0	-657.69	-213.69	0.0	0.0	0.0	675.78
8	64	783.17	0.0	-5.54e-04	59.98	0.0	-676.02	-270.87	0.0	0.0	0.0	783.17
		638.89	0.0	0.0	0.0	30.0	-667.77	-240.26	0.0	0.0	0.0	706.53
						60.0	-659.52	-210.89	0.0	0.0	0.0	638.89
8	65	658.13	0.0	-6.87e-04	59.98	0.0	-628.56	-255.86	0.0	0.0	0.0	658.13
		522.85	0.0	0.0	0.0	30.0	-620.31	-225.26	0.0	0.0	0.0	585.99
						60.0	-612.06	-195.88	0.0	0.0	0.0	522.85
8	66	548.99	0.0	-8.23e-04	59.98	0.0	-671.69	-225.82	0.0	0.0	0.0	548.99
		431.74	0.0	0.0	0.0	30.0	-663.44	-195.21	0.0	0.0	0.0	485.87
						60.0	-655.19	-165.84	0.0	0.0	0.0	431.74
8	67	815.97	0.0	-2.10e-04	59.98	0.0	-635.05	-281.16	0.0	0.0	0.0	815.97
		665.52	0.0	0.0	0.0	30.0	-626.80	-250.55	0.0	0.0	0.0	736.25
						60.0	-618.55	-221.17	0.0	0.0	0.0	665.52
8	68	288.78	0.0	-1.32e-03	59.98	0.0	-618.97	-219.50	0.0	0.0	0.0	288.78
		175.33	0.0	0.0	0.0	30.0	-610.72	-188.89	0.0	0.0	0.0	227.56
						60.0	-602.47	-159.52	0.0	0.0	0.0	175.33
8	69	517.29	0.0	-7.39e-04	59.98	0.0	-582.33	-286.62	0.0	0.0	0.0	517.29
		363.56	0.0	0.0	0.0	30.0	-574.08	-256.01	0.0	0.0	0.0	435.92
						60.0	-565.83	-226.63	0.0	0.0	0.0	363.56
8	70	784.99	0.0	-1.27e-04	59.98	0.0	-552.15	-334.87	0.0	0.0	0.0	784.99
		602.31	0.0	0.0	0.0	30.0	-543.90	-304.26	0.0	0.0	0.0	689.15
						60.0	-535.65	-274.89	0.0	0.0	0.0	602.31



8	71	631.16	0.0	-4.20e-04	59.98	0.0	-564.16	-274.22	0.0	0.0	0.0	631.16
		484.87	0.0	0.0	0.0	30.0	-555.91	-243.61	0.0	0.0	0.0	553.52
						60.0	-547.66	-214.24	0.0	0.0	0.0	484.87
8	72	697.15	0.0	-2.01e-04	59.98	0.0	-552.15	-314.51	0.0	0.0	0.0	697.15
		526.68	0.0	0.0	0.0	30.0	-543.90	-283.90	0.0	0.0	0.0	607.42
						60.0	-535.65	-254.53	0.0	0.0	0.0	526.68
8	73	719.00	0.0	-3.46e-04	59.98	0.0	-564.16	-294.58	0.0	0.0	0.0	719.00
		560.50	0.0	0.0	0.0	30.0	-555.91	-263.97	0.0	0.0	0.0	635.25
						60.0	-547.66	-234.60	0.0	0.0	0.0	560.50
8	74	670.90	0.0	-3.86e-04	59.98	0.0	-564.16	-309.30	0.0	0.0	0.0	670.90
		503.56	0.0	0.0	0.0	30.0	-555.91	-278.70	0.0	0.0	0.0	582.73
						60.0	-547.66	-249.32	0.0	0.0	0.0	503.56
8	75	580.15	0.0	-9.14e-04	73.56	0.0	-674.23	-329.68	0.0	0.0	0.0	580.15
		404.68	0.0	0.0	0.0	30.0	-665.98	-292.22	0.0	0.0	0.0	486.90
						60.0	-657.73	-256.12	0.0	0.0	0.0	404.68
8	76	-287.04	0.0	-2.75e-03	73.56	0.0	-720.17	-92.64	0.0	0.0	0.0	-287.04
		-320.28	0.0	0.0	0.0	30.0	-711.92	-55.18	0.0	0.0	0.0	-309.18
						60.0	-703.67	-19.08	0.0	0.0	0.0	-320.28
8	77	492.31	0.0	-9.88e-04	73.56	0.0	-674.23	-309.32	0.0	0.0	0.0	492.31
		329.05	0.0	0.0	0.0	30.0	-665.98	-271.86	0.0	0.0	0.0	405.16
						60.0	-657.73	-235.76	0.0	0.0	0.0	329.05
8	78	-199.20	0.0	-2.67e-03	73.56	0.0	-720.17	-113.00	0.0	0.0	0.0	-199.20
		-244.66	0.0	0.0	0.0	30.0	-711.92	-75.54	0.0	0.0	0.0	-227.45
						60.0	-703.67	-39.44	0.0	0.0	0.0	-244.66
8	79	-296.89	0.0	-2.69e-03	73.56	0.0	-672.91	-125.65	0.0	0.0	0.0	-296.89
		-349.94	0.0	0.0	0.0	30.0	-664.66	-88.19	0.0	0.0	0.0	-328.93
						60.0	-656.41	-52.09	0.0	0.0	0.0	-349.94

Pilas.	M3 mx/mn	M2 mx/mn	D 2 / D 3	Q 2 / Q 3	N	V 2	V 3	T
	-2124.30	0.0	-0.03	-899.34	-1024.91	-463.41	0.0	0.0
	1566.91	0.0	1.70e-03	769.46	-171.52	913.70	0.0	0.0

Trave	Cmb	M3 mx/mn	M2 mx/mn	D 2 / D 3	Q 2 / Q 3	Pos.	N	V 2	V 3	T	M 2	M 3
		kN m	kN m	m	kN	cm	kN	kN	kN	kN m	kN m	kN m
1	1	0.0	0.0	-5.20e-04	-42.55	0.0	0.0	42.55	0.0	0.0	0.0	-11.70
		-11.70	0.0	0.0	0.0	27.5	0.0	21.27	0.0	0.0	0.0	-2.92
						55.0	0.0	0.0	0.0	0.0	0.0	0.0
1	2	0.0	0.0	-4.83e-04	-50.71	0.0	0.0	50.71	0.0	0.0	0.0	-13.95
		-13.95	0.0	0.0	0.0	27.5	0.0	25.36	0.0	0.0	0.0	-3.49
						55.0	0.0	0.0	0.0	0.0	0.0	0.0



1	3	0.0	0.0	-4.99e-04	-40.86	0.0	0.0	40.86	0.0	0.0	0.0	-11.24
		-11.24	0.0	0.0	0.0	27.5	0.0	20.43	0.0	0.0	0.0	-2.81
						55.0	0.0	0.0	0.0	0.0	0.0	0.0
1	4	0.0	0.0	-4.72e-04	-46.97	0.0	0.0	46.97	0.0	0.0	0.0	-12.92
		-12.92	0.0	0.0	0.0	27.5	0.0	23.49	0.0	0.0	0.0	-3.23
						55.0	0.0	0.0	0.0	0.0	0.0	0.0
1	5	0.0	0.0	-1.02e-03	-40.86	0.0	6.21	40.86	0.0	0.0	0.0	-11.24
		-11.24	0.0	0.0	0.0	27.5	3.10	20.43	0.0	0.0	0.0	-2.81
						55.0	0.0	0.0	0.0	0.0	0.0	0.0
1	6	0.0	0.0	-1.18e-03	-46.97	0.0	6.21	46.97	0.0	0.0	0.0	-12.92
		-12.92	0.0	0.0	0.0	27.5	3.10	23.49	0.0	0.0	0.0	-3.23
						55.0	0.0	0.0	0.0	0.0	0.0	0.0
1	7	0.0	0.0	-1.43e-03	-40.86	0.0	6.21	40.86	0.0	0.0	0.0	-11.24
		-11.24	0.0	0.0	0.0	27.5	3.10	20.43	0.0	0.0	0.0	-2.81
						55.0	0.0	0.0	0.0	0.0	0.0	0.0
1	8	0.0	0.0	-3.36e-04	-40.86	0.0	0.0	40.86	0.0	0.0	0.0	-11.24
		-11.24	0.0	0.0	0.0	27.5	0.0	20.43	0.0	0.0	0.0	-2.81
						55.0	0.0	0.0	0.0	0.0	0.0	0.0
1	9	0.0	0.0	-4.91e-04	-46.97	0.0	0.0	46.97	0.0	0.0	0.0	-12.92
		-12.92	0.0	0.0	0.0	27.5	0.0	23.49	0.0	0.0	0.0	-3.23
						55.0	0.0	0.0	0.0	0.0	0.0	0.0
1	10	0.0	0.0	-7.50e-04	-40.86	0.0	0.0	40.86	0.0	0.0	0.0	-11.24
		-11.24	0.0	0.0	0.0	27.5	0.0	20.43	0.0	0.0	0.0	-2.81
						55.0	0.0	0.0	0.0	0.0	0.0	0.0
1	11	0.0	0.0	-4.27e-04	-42.55	0.0	0.0	42.55	0.0	0.0	0.0	-11.70
		-11.70	0.0	0.0	0.0	27.5	0.0	21.27	0.0	0.0	0.0	-2.92
						55.0	0.0	0.0	0.0	0.0	0.0	0.0
1	12	0.0	0.0	-3.91e-04	-50.71	0.0	0.0	50.71	0.0	0.0	0.0	-13.95
		-13.95	0.0	0.0	0.0	27.5	0.0	25.36	0.0	0.0	0.0	-3.49
						55.0	0.0	0.0	0.0	0.0	0.0	0.0
1	13	0.0	0.0	-3.76e-04	-40.86	0.0	0.0	40.86	0.0	0.0	0.0	-11.24
		-11.24	0.0	0.0	0.0	27.5	0.0	20.43	0.0	0.0	0.0	-2.81
						55.0	0.0	0.0	0.0	0.0	0.0	0.0
1	14	0.0	0.0	-3.48e-04	-46.97	0.0	0.0	46.97	0.0	0.0	0.0	-12.92
		-12.92	0.0	0.0	0.0	27.5	0.0	23.49	0.0	0.0	0.0	-3.23
						55.0	0.0	0.0	0.0	0.0	0.0	0.0
1	15	0.0	0.0	-9.29e-04	-40.86	0.0	6.21	40.86	0.0	0.0	0.0	-11.24
		-11.24	0.0	0.0	0.0	27.5	3.10	20.43	0.0	0.0	0.0	-2.81
						55.0	0.0	0.0	0.0	0.0	0.0	0.0
1	16	0.0	0.0	-1.08e-03	-46.97	0.0	6.21	46.97	0.0	0.0	0.0	-12.92



		-12.92	0.0	0.0	0.0	27.5	3.10	23.49	0.0	0.0	0.0	-3.23
						55.0	0.0	0.0	0.0	0.0	0.0	0.0
1	17	0.0	0.0	-1.34e-03	-40.86	0.0	6.21	40.86	0.0	0.0	0.0	-11.24
		-11.24	0.0	0.0	0.0	27.5	3.10	20.43	0.0	0.0	0.0	-2.81
						55.0	0.0	0.0	0.0	0.0	0.0	0.0
1	18	0.0	0.0	-2.12e-04	-40.86	0.0	0.0	40.86	0.0	0.0	0.0	-11.24
		-11.24	0.0	0.0	0.0	27.5	0.0	20.43	0.0	0.0	0.0	-2.81
						55.0	0.0	0.0	0.0	0.0	0.0	0.0
1	19	0.0	0.0	-3.67e-04	-46.97	0.0	0.0	46.97	0.0	0.0	0.0	-12.92
		-12.92	0.0	0.0	0.0	27.5	0.0	23.49	0.0	0.0	0.0	-3.23
						55.0	0.0	0.0	0.0	0.0	0.0	0.0
1	20	0.0	0.0	-6.26e-04	-40.86	0.0	0.0	40.86	0.0	0.0	0.0	-11.24
		-11.24	0.0	0.0	0.0	27.5	0.0	20.43	0.0	0.0	0.0	-2.81
						55.0	0.0	0.0	0.0	0.0	0.0	0.0
1	21	0.0	0.0	-6.75e-04	-40.86	0.0	6.21	40.86	0.0	0.0	0.0	-11.24
		-11.24	0.0	0.0	0.0	27.5	3.10	20.43	0.0	0.0	0.0	-2.81
						55.0	0.0	0.0	0.0	0.0	0.0	0.0
1	22	0.0	0.0	-4.19e-05	-40.86	0.0	0.0	40.86	0.0	0.0	0.0	-11.24
		-11.24	0.0	0.0	0.0	27.5	0.0	20.43	0.0	0.0	0.0	-2.81
						55.0	0.0	0.0	0.0	0.0	0.0	0.0
1	23	0.0	0.0	-1.47e-03	-26.57	0.0	6.21	26.57	0.0	0.0	0.0	-7.31
		-7.31	0.0	0.0	0.0	27.5	3.10	13.28	0.0	0.0	0.0	-1.83
						55.0	0.0	0.0	0.0	0.0	0.0	0.0
1	24	0.0	0.0	-7.40e-04	-26.57	0.0	0.0	26.57	0.0	0.0	0.0	-7.31
		-7.31	0.0	0.0	0.0	27.5	0.0	13.28	0.0	0.0	0.0	-1.83
						55.0	0.0	0.0	0.0	0.0	0.0	0.0
1	25	0.0	0.0	-1.16e-03	-40.86	0.0	6.21	40.86	0.0	0.0	0.0	-11.24
		-11.24	0.0	0.0	0.0	27.5	3.10	20.43	0.0	0.0	0.0	-2.81
						55.0	0.0	0.0	0.0	0.0	0.0	0.0
1	26	0.0	0.0	-1.01e-03	-46.97	0.0	6.21	46.97	0.0	0.0	0.0	-12.92
		-12.92	0.0	0.0	0.0	27.5	3.10	23.49	0.0	0.0	0.0	-3.23
						55.0	0.0	0.0	0.0	0.0	0.0	0.0
1	27	0.0	0.0	-1.58e-04	-42.55	0.0	0.0	42.55	0.0	0.0	0.0	-11.70
		-11.70	0.0	0.0	0.0	27.5	0.0	21.27	0.0	0.0	0.0	-2.92
						55.0	0.0	0.0	0.0	0.0	0.0	0.0
1	28	0.0	0.0	-3.46e-04	-50.71	0.0	0.0	50.71	0.0	0.0	0.0	-13.95
		-13.95	0.0	0.0	0.0	27.5	0.0	25.36	0.0	0.0	0.0	-3.49
						55.0	0.0	0.0	0.0	0.0	0.0	0.0
1	29	0.0	0.0	-1.37e-03	-35.86	0.0	6.21	35.86	0.0	0.0	0.0	-9.86
		-9.86	0.0	0.0	0.0	27.5	3.10	17.93	0.0	0.0	0.0	-2.47



						55.0	0.0	0.0	0.0	0.0	0.0	0.0
1	30	0.0	0.0	-5.80e-04	-31.56	0.0	6.21	31.56	0.0	0.0	0.0	-8.68
		-8.68	0.0	0.0	0.0	27.5	3.10	15.78	0.0	0.0	0.0	-2.17
						55.0	0.0	0.0	0.0	0.0	0.0	0.0
1	31	0.0	0.0	-6.21e-04	-37.68	0.0	6.21	37.68	0.0	0.0	0.0	-10.36
		-10.36	0.0	0.0	0.0	27.5	3.10	18.84	0.0	0.0	0.0	-2.59
						55.0	0.0	0.0	0.0	0.0	0.0	0.0
1	32	0.0	0.0	-6.88e-04	-31.56	0.0	6.21	31.56	0.0	0.0	0.0	-8.68
		-8.68	0.0	0.0	0.0	27.5	3.10	15.78	0.0	0.0	0.0	-2.17
						55.0	0.0	0.0	0.0	0.0	0.0	0.0
1	33	0.0	0.0	-1.24e-03	-35.86	0.0	6.21	35.86	0.0	0.0	0.0	-9.86
		-9.86	0.0	0.0	0.0	27.5	3.10	17.93	0.0	0.0	0.0	-2.47
						55.0	0.0	0.0	0.0	0.0	0.0	0.0
1	34	0.0	0.0	-3.38e-04	-30.28	0.0	0.0	30.28	0.0	0.0	0.0	-8.33
		-8.33	0.0	0.0	0.0	27.5	0.0	15.14	0.0	0.0	0.0	-2.08
						55.0	0.0	0.0	0.0	0.0	0.0	0.0
1	35	0.0	0.0	-1.46e-04	-34.81	0.0	0.0	34.82	0.0	0.0	0.0	-9.57
		-9.57	0.0	0.0	0.0	27.5	0.0	17.41	0.0	0.0	0.0	-2.39
						55.0	0.0	0.0	0.0	0.0	0.0	0.0
1	36	0.0	0.0	-7.42e-05	-30.28	0.0	0.0	30.28	0.0	0.0	0.0	-8.33
		-8.33	0.0	0.0	0.0	27.5	0.0	15.14	0.0	0.0	0.0	-2.08
						55.0	0.0	0.0	0.0	0.0	0.0	0.0
1	37	0.0	0.0	-1.89e-04	-34.81	0.0	0.0	34.82	0.0	0.0	0.0	-9.57
		-9.57	0.0	0.0	0.0	27.5	0.0	17.41	0.0	0.0	0.0	-2.39
						55.0	0.0	0.0	0.0	0.0	0.0	0.0
1	38	0.0	0.0	-3.82e-04	-30.28	0.0	0.0	30.28	0.0	0.0	0.0	-8.33
		-8.33	0.0	0.0	0.0	27.5	0.0	15.14	0.0	0.0	0.0	-2.08
						55.0	0.0	0.0	0.0	0.0	0.0	0.0
1	39	0.0	0.0	-2.61e-04	-30.28	0.0	0.0	30.28	0.0	0.0	0.0	-8.33
		-8.33	0.0	0.0	0.0	27.5	0.0	15.14	0.0	0.0	0.0	-2.08
						55.0	0.0	0.0	0.0	0.0	0.0	0.0
1	40	0.0	0.0	-2.41e-04	-34.81	0.0	0.0	34.82	0.0	0.0	0.0	-9.57
		-9.57	0.0	0.0	0.0	27.5	0.0	17.41	0.0	0.0	0.0	-2.39
						55.0	0.0	0.0	0.0	0.0	0.0	0.0
1	41	0.0	0.0	-2.55e-06	-30.28	0.0	0.0	30.28	0.0	0.0	0.0	-8.33
		-8.33	0.0	0.0	0.0	27.5	0.0	15.14	0.0	0.0	0.0	-2.08
						55.0	0.0	0.0	0.0	0.0	0.0	0.0
1	42	0.0	0.0	-1.12e-04	-34.81	0.0	0.0	34.82	0.0	0.0	0.0	-9.57
		-9.57	0.0	0.0	0.0	27.5	0.0	17.41	0.0	0.0	0.0	-2.39
						55.0	0.0	0.0	0.0	0.0	0.0	0.0



1	43	0.0	0.0	-3.05e-04	-30.28	0.0	0.0	30.28	0.0	0.0	0.0	-8.33
		-8.33	0.0	0.0	0.0	27.5	0.0	15.14	0.0	0.0	0.0	-2.08
						55.0	0.0	0.0	0.0	0.0	0.0	0.0
1	44	0.0	0.0	-1.34e-04	-30.28	0.0	0.0	30.28	0.0	0.0	0.0	-8.33
		-8.33	0.0	0.0	0.0	27.5	0.0	15.14	0.0	0.0	0.0	-2.08
						55.0	0.0	0.0	0.0	0.0	0.0	0.0
1	45	0.0	0.0	-3.24e-04	-26.57	0.0	0.0	26.57	0.0	0.0	0.0	-7.31
		-7.31	0.0	0.0	0.0	27.5	0.0	13.28	0.0	0.0	0.0	-1.83
						55.0	0.0	0.0	0.0	0.0	0.0	0.0
1	46	0.0	0.0	-3.68e-04	-31.52	0.0	0.0	31.52	0.0	0.0	0.0	-8.67
		-8.67	0.0	0.0	0.0	27.5	0.0	15.76	0.0	0.0	0.0	-2.17
						55.0	0.0	0.0	0.0	0.0	0.0	0.0
1	47	0.0	0.0	-3.41e-04	-37.56	0.0	0.0	37.57	0.0	0.0	0.0	-10.33
		-10.33	0.0	0.0	0.0	27.5	0.0	18.78	0.0	0.0	0.0	-2.58
						55.0	0.0	0.0	0.0	0.0	0.0	0.0
1	48	0.0	0.0	-3.55e-04	-30.28	0.0	0.0	30.28	0.0	0.0	0.0	-8.33
		-8.33	0.0	0.0	0.0	27.5	0.0	15.14	0.0	0.0	0.0	-2.08
						55.0	0.0	0.0	0.0	0.0	0.0	0.0
1	49	0.0	0.0	-3.35e-04	-34.81	0.0	0.0	34.82	0.0	0.0	0.0	-9.57
		-9.57	0.0	0.0	0.0	27.5	0.0	17.41	0.0	0.0	0.0	-2.39
						55.0	0.0	0.0	0.0	0.0	0.0	0.0
1	50	0.0	0.0	-5.97e-04	-30.28	0.0	4.60	30.28	0.0	0.0	0.0	-8.33
		-8.33	0.0	0.0	0.0	27.5	2.30	15.14	0.0	0.0	0.0	-2.08
						55.0	0.0	0.0	0.0	0.0	0.0	0.0
1	51	0.0	0.0	-7.12e-04	-34.81	0.0	4.60	34.82	0.0	0.0	0.0	-9.57
		-9.57	0.0	0.0	0.0	27.5	2.30	17.41	0.0	0.0	0.0	-2.39
						55.0	0.0	0.0	0.0	0.0	0.0	0.0
1	52	0.0	0.0	-9.05e-04	-30.28	0.0	4.60	30.28	0.0	0.0	0.0	-8.33
		-8.33	0.0	0.0	0.0	27.5	2.30	15.14	0.0	0.0	0.0	-2.08
						55.0	0.0	0.0	0.0	0.0	0.0	0.0
1	53	0.0	0.0	-9.16e-05	-30.28	0.0	0.0	30.28	0.0	0.0	0.0	-8.33
		-8.33	0.0	0.0	0.0	27.5	0.0	15.14	0.0	0.0	0.0	-2.08
						55.0	0.0	0.0	0.0	0.0	0.0	0.0
1	54	0.0	0.0	-2.07e-04	-34.81	0.0	0.0	34.82	0.0	0.0	0.0	-9.57
		-9.57	0.0	0.0	0.0	27.5	0.0	17.41	0.0	0.0	0.0	-2.39
						55.0	0.0	0.0	0.0	0.0	0.0	0.0
1	55	0.0	0.0	-3.99e-04	-30.28	0.0	0.0	30.28	0.0	0.0	0.0	-8.33
		-8.33	0.0	0.0	0.0	27.5	0.0	15.14	0.0	0.0	0.0	-2.08
						55.0	0.0	0.0	0.0	0.0	0.0	0.0
1	56	0.0	0.0	-3.29e-04	-31.52	0.0	0.0	31.52	0.0	0.0	0.0	-8.67



		-8.67	0.0	0.0	0.0	27.5	0.0	15.76	0.0	0.0	0.0	-2.17
						55.0	0.0	0.0	0.0	0.0	0.0	0.0
1	57	0.0	0.0	-3.02e-04	-37.56	0.0	0.0	37.57	0.0	0.0	0.0	-10.33
		-10.33	0.0	0.0	0.0	27.5	0.0	18.78	0.0	0.0	0.0	-2.58
						55.0	0.0	0.0	0.0	0.0	0.0	0.0
1	58	0.0	0.0	-2.90e-04	-30.28	0.0	0.0	30.28	0.0	0.0	0.0	-8.33
		-8.33	0.0	0.0	0.0	27.5	0.0	15.14	0.0	0.0	0.0	-2.08
						55.0	0.0	0.0	0.0	0.0	0.0	0.0
1	59	0.0	0.0	-2.69e-04	-34.81	0.0	0.0	34.82	0.0	0.0	0.0	-9.57
		-9.57	0.0	0.0	0.0	27.5	0.0	17.41	0.0	0.0	0.0	-2.39
						55.0	0.0	0.0	0.0	0.0	0.0	0.0
1	60	0.0	0.0	-5.20e-04	-30.28	0.0	4.60	30.28	0.0	0.0	0.0	-8.33
		-8.33	0.0	0.0	0.0	27.5	2.30	15.14	0.0	0.0	0.0	-2.08
						55.0	0.0	0.0	0.0	0.0	0.0	0.0
1	61	0.0	0.0	-6.35e-04	-34.81	0.0	4.60	34.82	0.0	0.0	0.0	-9.57
		-9.57	0.0	0.0	0.0	27.5	2.30	17.41	0.0	0.0	0.0	-2.39
						55.0	0.0	0.0	0.0	0.0	0.0	0.0
1	62	0.0	0.0	-8.28e-04	-30.28	0.0	4.60	30.28	0.0	0.0	0.0	-8.33
		-8.33	0.0	0.0	0.0	27.5	2.30	15.14	0.0	0.0	0.0	-2.08
						55.0	0.0	0.0	0.0	0.0	0.0	0.0
1	63	0.0	0.0	-1.13e-05	-30.28	0.0	0.0	30.28	0.0	0.0	0.0	-8.33
		-8.33	0.0	0.0	0.0	27.5	0.0	15.14	0.0	0.0	0.0	-2.08
						55.0	0.0	0.0	0.0	0.0	0.0	0.0
1	64	0.0	0.0	-1.04e-04	-34.81	0.0	0.0	34.82	0.0	0.0	0.0	-9.57
		-9.57	0.0	0.0	0.0	27.5	0.0	17.41	0.0	0.0	0.0	-2.39
						55.0	0.0	0.0	0.0	0.0	0.0	0.0
1	65	0.0	0.0	-2.96e-04	-30.28	0.0	0.0	30.28	0.0	0.0	0.0	-8.33
		-8.33	0.0	0.0	0.0	27.5	0.0	15.14	0.0	0.0	0.0	-2.08
						55.0	0.0	0.0	0.0	0.0	0.0	0.0
1	66	0.0	0.0	-3.32e-04	-30.28	0.0	4.60	30.28	0.0	0.0	0.0	-8.33
		-8.33	0.0	0.0	0.0	27.5	2.30	15.14	0.0	0.0	0.0	-2.08
						55.0	0.0	0.0	0.0	0.0	0.0	0.0
1	67	0.0	0.0	-2.00e-04	-30.28	0.0	0.0	30.28	0.0	0.0	0.0	-8.33
		-8.33	0.0	0.0	0.0	27.5	0.0	15.14	0.0	0.0	0.0	-2.08
						55.0	0.0	0.0	0.0	0.0	0.0	0.0
1	68	0.0	0.0	-8.47e-04	-26.57	0.0	4.60	26.57	0.0	0.0	0.0	-7.31
		-7.31	0.0	0.0	0.0	27.5	2.30	13.28	0.0	0.0	0.0	-1.83
						55.0	0.0	0.0	0.0	0.0	0.0	0.0
1	69	0.0	0.0	-3.07e-04	-26.57	0.0	0.0	26.57	0.0	0.0	0.0	-7.31
		-7.31	0.0	0.0	0.0	27.5	0.0	13.28	0.0	0.0	0.0	-1.83



						55.0	0.0	0.0	0.0	0.0	0.0	0.0
1	70	0.0	0.0	-2.42e-04	-26.57	0.0	0.0	26.57	0.0	0.0	0.0	-7.31
		-7.31	0.0	0.0	0.0	27.5	0.0	13.28	0.0	0.0	0.0	-1.83
						55.0	0.0	0.0	0.0	0.0	0.0	0.0
1	71	0.0	0.0	-8.38e-05	-26.57	0.0	0.0	26.57	0.0	0.0	0.0	-7.31
		-7.31	0.0	0.0	0.0	27.5	0.0	13.28	0.0	0.0	0.0	-1.83
						55.0	0.0	0.0	0.0	0.0	0.0	0.0
1	72	0.0	0.0	-1.72e-04	-26.57	0.0	0.0	26.57	0.0	0.0	0.0	-7.31
		-7.31	0.0	0.0	0.0	27.5	0.0	13.28	0.0	0.0	0.0	-1.83
						55.0	0.0	0.0	0.0	0.0	0.0	0.0
1	73	0.0	0.0	-1.36e-05	-26.57	0.0	0.0	26.57	0.0	0.0	0.0	-7.31
		-7.31	0.0	0.0	0.0	27.5	0.0	13.28	0.0	0.0	0.0	-1.83
						55.0	0.0	0.0	0.0	0.0	0.0	0.0
1	74	0.0	0.0	-2.85e-06	-26.57	0.0	0.0	26.57	0.0	0.0	0.0	-7.31
		-7.31	0.0	0.0	0.0	27.5	0.0	13.28	0.0	0.0	0.0	-1.83
						55.0	0.0	0.0	0.0	0.0	0.0	0.0
1	75	0.0	0.0	-4.57e-04	-30.59	0.0	2.41	30.59	0.0	0.0	0.0	-8.41
		-8.41	0.0	0.0	0.0	27.5	1.21	15.29	0.0	0.0	0.0	-2.10
						55.0	0.0	0.0	0.0	0.0	0.0	0.0
1	76	0.0	0.0	-2.22e-03	-27.77	0.0	8.04	27.77	0.0	0.0	0.0	-7.64
		-7.64	0.0	0.0	0.0	27.5	4.02	13.89	0.0	0.0	0.0	-1.91
						55.0	0.0	0.0	0.0	0.0	0.0	0.0
1	77	0.0	0.0	-5.27e-04	-30.59	0.0	2.41	30.59	0.0	0.0	0.0	-8.41
		-8.41	0.0	0.0	0.0	27.5	1.21	15.29	0.0	0.0	0.0	-2.10
						55.0	0.0	0.0	0.0	0.0	0.0	0.0
1	78	0.0	0.0	-2.15e-03	-27.77	0.0	8.04	27.77	0.0	0.0	0.0	-7.64
		-7.64	0.0	0.0	0.0	27.5	4.02	13.89	0.0	0.0	0.0	-1.91
						55.0	0.0	0.0	0.0	0.0	0.0	0.0
1	79	0.0	0.0	-2.16e-03	-25.36	0.0	8.04	25.36	0.0	0.0	0.0	-6.97
		-6.97	0.0	0.0	0.0	27.5	4.02	12.68	0.0	0.0	0.0	-1.74
						55.0	0.0	0.0	0.0	0.0	0.0	0.0
3	1	-395.22	0.0	-5.10e-04	-42.55	0.0	-93.61	594.94	0.0	0.0	0.0	-710.74
		-710.74	0.0	0.0	0.0	27.5	-93.61	573.67	0.0	0.0	0.0	-550.05
						55.0	-93.61	552.40	0.0	0.0	0.0	-395.22
3	2	-312.36	0.0	-4.69e-04	-50.71	0.0	-80.66	581.03	0.0	0.0	0.0	-617.98
		-617.98	0.0	0.0	0.0	27.5	-80.66	555.67	0.0	0.0	0.0	-461.68
						55.0	-80.66	530.32	0.0	0.0	0.0	-312.36
3	3	-243.26	0.0	-4.83e-04	-40.86	0.0	-77.42	548.59	0.0	0.0	0.0	-533.75
		-533.75	0.0	0.0	0.0	27.5	-77.42	528.16	0.0	0.0	0.0	-385.70
						55.0	-77.42	507.73	0.0	0.0	0.0	-243.26



3	4	-181.27	0.0	-4.53e-04	-46.97	0.0	-67.73	538.18	0.0	0.0	0.0	-464.35
		-464.35	0.0	0.0	0.0	27.5	-67.73	514.70	0.0	0.0	0.0	-319.58
						55.0	-67.73	491.21	0.0	0.0	0.0	-181.27
3	5	-247.26	0.0	-1.66e-03	-40.86	0.0	-137.55	465.53	0.0	0.0	0.0	-492.07
		-492.07	0.0	0.0	0.0	27.5	-140.65	445.10	0.0	0.0	0.0	-366.86
						55.0	-143.76	424.67	0.0	0.0	0.0	-247.26
3	6	-153.38	0.0	-1.74e-03	-46.97	0.0	-141.33	448.36	0.0	0.0	0.0	-387.06
		-387.06	0.0	0.0	0.0	27.5	-144.44	424.88	0.0	0.0	0.0	-266.99
						55.0	-147.54	401.39	0.0	0.0	0.0	-153.38
3	7	-35.88	0.0	-1.87e-03	-40.86	0.0	-161.54	366.18	0.0	0.0	0.0	-226.04
		-226.04	0.0	0.0	0.0	27.5	-164.64	345.75	0.0	0.0	0.0	-128.15
						55.0	-167.75	325.31	0.0	0.0	0.0	-35.88
3	8	-628.39	0.0	-9.50e-04	-40.86	0.0	-220.03	514.99	0.0	0.0	0.0	-900.39
		-900.39	0.0	0.0	0.0	27.5	-220.03	494.56	0.0	0.0	0.0	-761.58
						55.0	-220.03	474.13	0.0	0.0	0.0	-628.39
3	9	-534.51	0.0	-1.03e-03	-46.97	0.0	-223.81	497.82	0.0	0.0	0.0	-795.39
		-795.39	0.0	0.0	0.0	27.5	-223.81	474.34	0.0	0.0	0.0	-661.72
						55.0	-223.81	450.85	0.0	0.0	0.0	-534.51
3	10	-417.00	0.0	-1.17e-03	-40.86	0.0	-244.02	415.64	0.0	0.0	0.0	-634.37
		-634.37	0.0	0.0	0.0	27.5	-244.02	395.21	0.0	0.0	0.0	-522.88
						55.0	-244.02	374.77	0.0	0.0	0.0	-417.00
3	11	-495.01	0.0	-4.21e-04	-42.55	0.0	-120.32	594.95	0.0	0.0	0.0	-810.53
		-810.53	0.0	0.0	0.0	27.5	-120.32	573.67	0.0	0.0	0.0	-649.85
						55.0	-120.32	552.40	0.0	0.0	0.0	-495.01
3	12	-412.15	0.0	-3.80e-04	-50.71	0.0	-107.37	581.03	0.0	0.0	0.0	-717.77
		-717.77	0.0	0.0	0.0	27.5	-107.37	555.68	0.0	0.0	0.0	-561.48
						55.0	-107.37	530.32	0.0	0.0	0.0	-412.15
3	13	-377.03	0.0	-3.64e-04	-40.86	0.0	-113.22	548.60	0.0	0.0	0.0	-667.52
		-667.52	0.0	0.0	0.0	27.5	-113.22	528.16	0.0	0.0	0.0	-519.47
						55.0	-113.22	507.73	0.0	0.0	0.0	-377.03
3	14	-315.04	0.0	-3.34e-04	-46.97	0.0	-103.53	538.19	0.0	0.0	0.0	-598.12
		-598.12	0.0	0.0	0.0	27.5	-103.53	514.70	0.0	0.0	0.0	-453.35
						55.0	-103.53	491.21	0.0	0.0	0.0	-315.04
3	15	-147.47	0.0	-1.75e-03	-40.86	0.0	-110.84	465.53	0.0	0.0	0.0	-392.27
		-392.27	0.0	0.0	0.0	27.5	-113.95	445.10	0.0	0.0	0.0	-267.06
						55.0	-117.05	424.67	0.0	0.0	0.0	-147.47
3	16	-53.59	0.0	-1.83e-03	-46.97	0.0	-114.63	448.36	0.0	0.0	0.0	-287.27
		-287.27	0.0	0.0	0.0	27.5	-117.73	424.87	0.0	0.0	0.0	-167.20
						55.0	-120.83	401.39	0.0	0.0	0.0	-53.59
3	17	63.92	0.0	-1.96e-03	-40.86	0.0	-134.83	366.17	0.0	0.0	0.0	-126.24



		-126.24	0.0	0.0	0.0	27.5	-137.94	345.74	0.0	0.0	0.0	-28.35
						55.0	-141.04	325.31	0.0	0.0	0.0	63.92
3	18	-494.62	0.0	-1.07e-03	-40.86	0.0	-184.23	514.99	0.0	0.0	0.0	-766.62
		-766.62	0.0	0.0	0.0	27.5	-184.23	494.56	0.0	0.0	0.0	-627.81
						55.0	-184.23	474.13	0.0	0.0	0.0	-494.62
3	19	-400.74	0.0	-1.15e-03	-46.97	0.0	-188.01	497.82	0.0	0.0	0.0	-661.62
		-661.62	0.0	0.0	0.0	27.5	-188.01	474.33	0.0	0.0	0.0	-527.95
						55.0	-188.01	450.85	0.0	0.0	0.0	-400.74
3	20	-283.23	0.0	-1.29e-03	-40.86	0.0	-208.22	415.63	0.0	0.0	0.0	-500.60
		-500.60	0.0	0.0	0.0	27.5	-208.22	395.20	0.0	0.0	0.0	-389.11
						55.0	-208.22	374.77	0.0	0.0	0.0	-283.23
3	21	-69.86	0.0	-1.44e-03	-40.86	0.0	-100.77	518.24	0.0	0.0	0.0	-343.66
		-343.66	0.0	0.0	0.0	27.5	-103.88	497.81	0.0	0.0	0.0	-203.95
						55.0	-106.98	477.38	0.0	0.0	0.0	-69.86
3	22	-417.02	0.0	-7.64e-04	-40.86	0.0	-174.16	567.70	0.0	0.0	0.0	-718.01
		-718.01	0.0	0.0	0.0	27.5	-174.16	547.27	0.0	0.0	0.0	-564.71
						55.0	-174.16	526.84	0.0	0.0	0.0	-417.02
3	23	420.19	0.0	-1.83e-03	-26.57	0.0	-122.71	202.37	0.0	0.0	0.0	316.19
		316.19	0.0	0.0	0.0	27.5	-125.81	189.09	0.0	0.0	0.0	370.02
						55.0	-128.92	175.80	0.0	0.0	0.0	420.19
3	24	233.00	0.0	-1.16e-03	-26.57	0.0	-181.96	251.83	0.0	0.0	0.0	101.80
		101.80	0.0	0.0	0.0	27.5	-181.96	238.55	0.0	0.0	0.0	169.22
						55.0	-181.96	225.26	0.0	0.0	0.0	233.00
3	25	-45.82	0.0	-1.78e-03	-40.86	0.0	-120.14	411.73	0.0	0.0	0.0	-261.03
		-261.03	0.0	0.0	0.0	27.5	-123.24	391.30	0.0	0.0	0.0	-150.62
						55.0	-126.35	370.87	0.0	0.0	0.0	-45.82
3	26	-11.58	0.0	-1.61e-03	-46.97	0.0	-133.76	447.27	0.0	0.0	0.0	-244.66
		-244.66	0.0	0.0	0.0	27.5	-136.87	423.79	0.0	0.0	0.0	-124.89
						55.0	-139.97	400.30	0.0	0.0	0.0	-11.58
3	27	-382.89	0.0	-6.91e-04	-42.55	0.0	-172.82	631.80	0.0	0.0	0.0	-718.68
		-718.68	0.0	0.0	0.0	27.5	-172.82	610.52	0.0	0.0	0.0	-547.86
						55.0	-172.82	589.25	0.0	0.0	0.0	-382.89
3	28	-371.86	0.0	-1.17e-03	-50.71	0.0	-186.81	540.67	0.0	0.0	0.0	-655.29
		-655.29	0.0	0.0	0.0	27.5	-186.81	515.31	0.0	0.0	0.0	-510.09
						55.0	-186.81	489.95	0.0	0.0	0.0	-371.86
3	29	349.47	0.0	-1.92e-03	-35.86	0.0	-111.87	308.90	0.0	0.0	0.0	189.43
		189.43	0.0	0.0	0.0	27.5	-114.98	290.97	0.0	0.0	0.0	271.91
						55.0	-118.08	273.04	0.0	0.0	0.0	349.47
3	30	-432.57	0.0	-9.30e-04	-31.56	0.0	-235.36	393.05	0.0	0.0	0.0	-640.07
		-640.07	0.0	0.0	0.0	27.5	-238.46	377.27	0.0	0.0	0.0	-534.15



						55.0	-241.56	361.49	0.0	0.0	0.0	-432.57
3	31	-384.44	0.0	-8.87e-04	-37.68	0.0	-252.53	382.64	0.0	0.0	0.0	-584.53
		-584.53	0.0	0.0	0.0	27.5	-255.63	363.80	0.0	0.0	0.0	-481.89
						55.0	-258.73	344.96	0.0	0.0	0.0	-384.44
3	32	-345.12	0.0	-8.19e-04	-31.56	0.0	-294.95	312.63	0.0	0.0	0.0	-508.39
		-508.39	0.0	0.0	0.0	27.5	-298.05	296.85	0.0	0.0	0.0	-424.58
						55.0	-301.16	281.07	0.0	0.0	0.0	-345.12
3	33	345.82	0.0	-1.77e-03	-35.86	0.0	-121.73	307.81	0.0	0.0	0.0	186.38
		186.38	0.0	0.0	0.0	27.5	-124.83	289.88	0.0	0.0	0.0	268.57
						55.0	-127.93	271.95	0.0	0.0	0.0	345.82
3	34	-259.83	0.0	-3.29e-04	-30.28	0.0	-101.45	406.62	0.0	0.0	0.0	-475.15
		-475.15	0.0	0.0	0.0	27.5	-101.45	391.48	0.0	0.0	0.0	-365.41
						55.0	-101.45	376.34	0.0	0.0	0.0	-259.83
3	35	-170.75	0.0	-4.59e-04	-34.81	0.0	-112.44	389.76	0.0	0.0	0.0	-375.55
		-375.55	0.0	0.0	0.0	27.5	-112.44	372.36	0.0	0.0	0.0	-270.76
						55.0	-112.44	354.95	0.0	0.0	0.0	-170.75
3	36	-470.55	0.0	-5.32e-04	-30.28	0.0	-175.13	390.50	0.0	0.0	0.0	-677.00
		-677.00	0.0	0.0	0.0	27.5	-175.13	375.36	0.0	0.0	0.0	-571.69
						55.0	-175.13	360.22	0.0	0.0	0.0	-470.55
3	37	-400.84	0.0	-5.93e-04	-34.81	0.0	-177.94	377.75	0.0	0.0	0.0	-599.02
		-599.02	0.0	0.0	0.0	27.5	-177.94	360.34	0.0	0.0	0.0	-497.54
						55.0	-177.94	342.93	0.0	0.0	0.0	-400.84
3	38	-313.58	0.0	-6.92e-04	-30.28	0.0	-192.94	316.72	0.0	0.0	0.0	-479.45
		-479.45	0.0	0.0	0.0	27.5	-192.94	301.58	0.0	0.0	0.0	-394.44
						55.0	-192.94	286.44	0.0	0.0	0.0	-313.58
3	39	-343.00	0.0	-2.55e-04	-30.28	0.0	-123.71	406.62	0.0	0.0	0.0	-558.31
		-558.31	0.0	0.0	0.0	27.5	-123.71	391.48	0.0	0.0	0.0	-448.57
						55.0	-123.71	376.34	0.0	0.0	0.0	-343.00
3	40	-296.96	0.0	-2.33e-04	-34.81	0.0	-116.51	398.89	0.0	0.0	0.0	-506.78
		-506.78	0.0	0.0	0.0	27.5	-116.51	381.48	0.0	0.0	0.0	-399.48
						55.0	-116.51	364.07	0.0	0.0	0.0	-296.96
3	41	-387.39	0.0	-6.06e-04	-30.28	0.0	-152.88	390.50	0.0	0.0	0.0	-593.83
		-593.83	0.0	0.0	0.0	27.5	-152.88	375.36	0.0	0.0	0.0	-488.53
						55.0	-152.88	360.22	0.0	0.0	0.0	-387.39
3	42	-317.67	0.0	-6.67e-04	-34.81	0.0	-155.68	377.75	0.0	0.0	0.0	-515.86
		-515.86	0.0	0.0	0.0	27.5	-155.68	360.34	0.0	0.0	0.0	-414.37
						55.0	-155.68	342.93	0.0	0.0	0.0	-317.67
3	43	-230.42	0.0	-7.66e-04	-30.28	0.0	-170.69	316.72	0.0	0.0	0.0	-396.29
		-396.29	0.0	0.0	0.0	27.5	-170.69	301.58	0.0	0.0	0.0	-311.27
						55.0	-170.69	286.44	0.0	0.0	0.0	-230.42



3	44	-240.86	0.0	-6.71e-04	-30.28	0.0	-180.18	411.47	0.0	0.0	0.0	-458.84
		-458.84	0.0	0.0	0.0	27.5	-180.18	396.33	0.0	0.0	0.0	-347.77
						55.0	-180.18	381.19	0.0	0.0	0.0	-240.86
3	45	3.40	0.0	-7.38e-04	-26.57	0.0	-151.72	274.19	0.0	0.0	0.0	-140.10
		-140.10	0.0	0.0	0.0	27.5	-151.72	260.91	0.0	0.0	0.0	-66.53
						55.0	-151.72	247.62	0.0	0.0	0.0	3.40
3	46	-300.27	0.0	-3.61e-04	-31.52	0.0	-104.82	440.70	0.0	0.0	0.0	-533.98
		-533.98	0.0	0.0	0.0	27.5	-104.82	424.94	0.0	0.0	0.0	-414.96
						55.0	-104.82	409.18	0.0	0.0	0.0	-300.27
3	47	-238.89	0.0	-3.31e-04	-37.56	0.0	-95.22	430.39	0.0	0.0	0.0	-465.27
		-465.27	0.0	0.0	0.0	27.5	-95.22	411.61	0.0	0.0	0.0	-349.50
						55.0	-95.22	392.83	0.0	0.0	0.0	-238.89
3	48	-179.03	0.0	-3.43e-04	-30.28	0.0	-91.78	406.62	0.0	0.0	0.0	-394.34
		-394.34	0.0	0.0	0.0	27.5	-91.78	391.48	0.0	0.0	0.0	-284.60
						55.0	-91.78	376.34	0.0	0.0	0.0	-179.03
3	49	-132.99	0.0	-3.21e-04	-34.81	0.0	-84.58	398.89	0.0	0.0	0.0	-342.81
		-342.81	0.0	0.0	0.0	27.5	-84.58	381.48	0.0	0.0	0.0	-235.51
						55.0	-84.58	364.07	0.0	0.0	0.0	-132.99
3	50	-260.06	0.0	-1.04e-03	-30.28	0.0	-122.64	353.86	0.0	0.0	0.0	-446.36
		-446.36	0.0	0.0	0.0	27.5	-124.94	338.72	0.0	0.0	0.0	-351.13
						55.0	-127.23	323.58	0.0	0.0	0.0	-260.06
3	51	-190.35	0.0	-1.11e-03	-34.81	0.0	-125.44	341.11	0.0	0.0	0.0	-368.39
		-368.39	0.0	0.0	0.0	27.5	-127.74	323.71	0.0	0.0	0.0	-276.97
						55.0	-130.04	306.30	0.0	0.0	0.0	-190.35
3	52	-103.09	0.0	-1.20e-03	-30.28	0.0	-140.45	280.08	0.0	0.0	0.0	-248.81
		-248.81	0.0	0.0	0.0	27.5	-142.75	264.95	0.0	0.0	0.0	-173.87
						55.0	-145.05	249.81	0.0	0.0	0.0	-103.09
3	53	-551.35	0.0	-5.18e-04	-30.28	0.0	-184.81	390.50	0.0	0.0	0.0	-757.80
		-757.80	0.0	0.0	0.0	27.5	-184.81	375.36	0.0	0.0	0.0	-652.50
						55.0	-184.81	360.22	0.0	0.0	0.0	-551.35
3	54	-481.64	0.0	-5.79e-04	-34.81	0.0	-187.62	377.75	0.0	0.0	0.0	-679.83
		-679.83	0.0	0.0	0.0	27.5	-187.62	360.34	0.0	0.0	0.0	-578.34
						55.0	-187.62	342.93	0.0	0.0	0.0	-481.64
3	55	-394.39	0.0	-6.78e-04	-30.28	0.0	-202.62	316.72	0.0	0.0	0.0	-560.26
		-560.26	0.0	0.0	0.0	27.5	-202.62	301.58	0.0	0.0	0.0	-475.24
						55.0	-202.62	286.44	0.0	0.0	0.0	-394.39
3	56	-342.73	0.0	-3.24e-04	-31.52	0.0	-116.18	440.70	0.0	0.0	0.0	-576.45
		-576.45	0.0	0.0	0.0	27.5	-116.18	424.94	0.0	0.0	0.0	-457.42
						55.0	-116.18	409.19	0.0	0.0	0.0	-342.73
3	57	-281.35	0.0	-2.93e-04	-37.56	0.0	-106.59	430.39	0.0	0.0	0.0	-507.74



		-507.74	0.0	0.0	0.0	27.5	-106.59	411.61	0.0	0.0	0.0	-391.96
						55.0	-106.59	392.83	0.0	0.0	0.0	-281.35
3	58	-249.81	0.0	-2.80e-04	-30.28	0.0	-110.72	406.62	0.0	0.0	0.0	-465.12
		-465.12	0.0	0.0	0.0	27.5	-110.72	391.48	0.0	0.0	0.0	-355.38
						55.0	-110.72	376.34	0.0	0.0	0.0	-249.81
3	59	-203.77	0.0	-2.58e-04	-34.81	0.0	-103.52	398.89	0.0	0.0	0.0	-413.59
		-413.59	0.0	0.0	0.0	27.5	-103.52	381.48	0.0	0.0	0.0	-306.28
						55.0	-103.52	364.07	0.0	0.0	0.0	-203.77
3	60	-176.90	0.0	-1.12e-03	-30.28	0.0	-100.38	353.86	0.0	0.0	0.0	-363.20
		-363.20	0.0	0.0	0.0	27.5	-102.68	338.72	0.0	0.0	0.0	-267.97
						55.0	-104.98	323.58	0.0	0.0	0.0	-176.90
3	61	-107.19	0.0	-1.18e-03	-34.81	0.0	-103.19	341.11	0.0	0.0	0.0	-285.22
		-285.22	0.0	0.0	0.0	27.5	-105.49	323.70	0.0	0.0	0.0	-193.81
						55.0	-107.79	306.30	0.0	0.0	0.0	-107.19
3	62	-19.93	0.0	-1.28e-03	-30.28	0.0	-118.19	280.08	0.0	0.0	0.0	-165.65
		-165.65	0.0	0.0	0.0	27.5	-120.49	264.94	0.0	0.0	0.0	-90.71
						55.0	-122.79	249.81	0.0	0.0	0.0	-19.93
3	63	-439.88	0.0	-6.17e-04	-30.28	0.0	-154.98	390.50	0.0	0.0	0.0	-646.33
		-646.33	0.0	0.0	0.0	27.5	-154.98	375.36	0.0	0.0	0.0	-541.02
						55.0	-154.98	360.22	0.0	0.0	0.0	-439.88
3	64	-370.17	0.0	-6.78e-04	-34.81	0.0	-157.78	377.75	0.0	0.0	0.0	-568.35
		-568.35	0.0	0.0	0.0	27.5	-157.78	360.34	0.0	0.0	0.0	-466.87
						55.0	-157.78	342.93	0.0	0.0	0.0	-370.17
3	65	-282.91	0.0	-7.77e-04	-30.28	0.0	-172.79	316.72	0.0	0.0	0.0	-448.78
		-448.78	0.0	0.0	0.0	27.5	-172.79	301.58	0.0	0.0	0.0	-363.77
						55.0	-172.79	286.44	0.0	0.0	0.0	-282.91
3	66	-119.27	0.0	-8.91e-04	-30.28	0.0	-92.90	393.00	0.0	0.0	0.0	-327.10
		-327.10	0.0	0.0	0.0	27.5	-95.20	377.86	0.0	0.0	0.0	-221.11
						55.0	-97.50	362.73	0.0	0.0	0.0	-119.27
3	67	-382.26	0.0	-3.90e-04	-30.28	0.0	-147.50	429.64	0.0	0.0	0.0	-610.23
		-610.23	0.0	0.0	0.0	27.5	-147.50	414.50	0.0	0.0	0.0	-494.16
						55.0	-147.50	399.36	0.0	0.0	0.0	-382.26
3	68	213.89	0.0	-1.25e-03	-26.57	0.0	-99.22	237.55	0.0	0.0	0.0	90.54
		90.54	0.0	0.0	0.0	27.5	-101.52	224.27	0.0	0.0	0.0	154.04
						55.0	-103.82	210.99	0.0	0.0	0.0	213.89
3	69	84.20	0.0	-7.52e-04	-26.57	0.0	-142.04	274.19	0.0	0.0	0.0	-59.30
		-59.30	0.0	0.0	0.0	27.5	-142.04	260.91	0.0	0.0	0.0	14.28
						55.0	-142.04	247.62	0.0	0.0	0.0	84.20
3	70	-158.73	0.0	-2.30e-04	-26.57	0.0	-93.78	304.37	0.0	0.0	0.0	-318.83
		-318.83	0.0	0.0	0.0	27.5	-93.78	291.09	0.0	0.0	0.0	-236.96



						55.0	-93.78	277.81	0.0	0.0	0.0	-158.73
3	71	-348.42	0.0	-3.71e-04	-26.57	0.0	-154.43	292.36	0.0	0.0	0.0	-501.91
		-501.91	0.0	0.0	0.0	27.5	-154.43	279.08	0.0	0.0	0.0	-423.34
						55.0	-154.43	265.79	0.0	0.0	0.0	-348.42
3	72	-234.82	0.0	-1.62e-04	-26.57	0.0	-114.14	304.37	0.0	0.0	0.0	-394.92
		-394.92	0.0	0.0	0.0	27.5	-114.14	291.09	0.0	0.0	0.0	-313.04
						55.0	-114.14	277.81	0.0	0.0	0.0	-234.82
3	73	-272.33	0.0	-4.39e-04	-26.57	0.0	-134.07	292.36	0.0	0.0	0.0	-425.82
		-425.82	0.0	0.0	0.0	27.5	-134.07	279.07	0.0	0.0	0.0	-347.25
						55.0	-134.07	265.79	0.0	0.0	0.0	-272.33
3	74	-105.71	0.0	-4.42e-04	-26.57	0.0	-119.35	292.36	0.0	0.0	0.0	-259.20
		-259.20	0.0	0.0	0.0	27.5	-119.35	279.08	0.0	0.0	0.0	-180.63
						55.0	-119.35	265.79	0.0	0.0	0.0	-105.71
3	75	9.89	0.0	-9.08e-04	-30.59	0.0	-151.89	307.12	0.0	0.0	0.0	-150.61
		-150.61	0.0	0.0	0.0	27.5	-153.09	291.82	0.0	0.0	0.0	-68.26
						55.0	-154.30	276.53	0.0	0.0	0.0	9.89
3	76	331.64	0.0	-2.36e-03	-27.77	0.0	-214.12	173.80	0.0	0.0	0.0	243.68
		243.68	0.0	0.0	0.0	27.5	-218.14	159.92	0.0	0.0	0.0	289.57
						55.0	-222.16	146.03	0.0	0.0	0.0	331.64
3	77	-66.19	0.0	-8.40e-04	-30.59	0.0	-172.25	307.12	0.0	0.0	0.0	-226.70
		-226.70	0.0	0.0	0.0	27.5	-173.46	291.83	0.0	0.0	0.0	-144.34
						55.0	-174.66	276.53	0.0	0.0	0.0	-66.19
3	78	407.72	0.0	-2.43e-03	-27.77	0.0	-193.76	173.80	0.0	0.0	0.0	319.77
		319.77	0.0	0.0	0.0	27.5	-197.78	159.92	0.0	0.0	0.0	365.65
						55.0	-201.80	146.03	0.0	0.0	0.0	407.72
3	79	593.43	0.0	-2.41e-03	-25.36	0.0	-181.11	146.16	0.0	0.0	0.0	520.01
		520.01	0.0	0.0	0.0	27.5	-185.13	133.48	0.0	0.0	0.0	558.47
						55.0	-189.15	120.80	0.0	0.0	0.0	593.43
9	1	-393.61	0.0	-5.68e-04	-42.55	0.0	-93.61	-552.12	0.0	0.0	0.0	-393.61
		-708.98	0.0	0.0	0.0	27.5	-93.61	-573.39	0.0	0.0	0.0	-548.37
						55.0	-93.61	-594.66	0.0	0.0	0.0	-708.98
9	2	-310.76	0.0	-5.27e-04	-50.71	0.0	-80.66	-530.04	0.0	0.0	0.0	-310.76
		-616.23	0.0	0.0	0.0	27.5	-80.66	-555.40	0.0	0.0	0.0	-460.01
						55.0	-80.66	-580.75	0.0	0.0	0.0	-616.23
9	3	-241.74	0.0	-5.39e-04	-40.86	0.0	-77.42	-507.47	0.0	0.0	0.0	-241.74
		-532.08	0.0	0.0	0.0	27.5	-77.42	-527.90	0.0	0.0	0.0	-384.10
						55.0	-77.42	-548.33	0.0	0.0	0.0	-532.08
9	4	-179.76	0.0	-5.08e-04	-46.97	0.0	-67.73	-490.95	0.0	0.0	0.0	-179.76
		-462.69	0.0	0.0	0.0	27.5	-67.73	-514.43	0.0	0.0	0.0	-318.00
						55.0	-67.73	-537.92	0.0	0.0	0.0	-462.69



9	5	-1200.96	0.0	-9.38e-04	-40.86	0.0	-273.55	-590.53	0.0	0.0	0.0	-1200.96
		-1536.99	0.0	0.0	0.0	27.5	-276.65	-610.96	0.0	0.0	0.0	-1366.17
						55.0	-279.75	-631.39	0.0	0.0	0.0	-1536.99
9	6	-1184.82	0.0	-1.09e-03	-46.97	0.0	-277.33	-580.77	0.0	0.0	0.0	-1184.82
		-1517.16	0.0	0.0	0.0	27.5	-280.43	-604.26	0.0	0.0	0.0	-1347.76
						55.0	-283.54	-627.74	0.0	0.0	0.0	-1517.16
9	7	-1207.52	0.0	-1.36e-03	-40.86	0.0	-297.54	-529.08	0.0	0.0	0.0	-1207.52
		-1509.75	0.0	0.0	0.0	27.5	-300.64	-549.51	0.0	0.0	0.0	-1355.83
						55.0	-303.74	-569.94	0.0	0.0	0.0	-1509.75
9	8	-1013.29	0.0	-2.63e-04	-40.86	0.0	-220.03	-541.07	0.0	0.0	0.0	-1013.29
		-1322.12	0.0	0.0	0.0	27.5	-220.03	-561.50	0.0	0.0	0.0	-1164.90
						55.0	-220.03	-581.93	0.0	0.0	0.0	-1322.12
9	9	-997.15	0.0	-4.19e-04	-46.97	0.0	-223.81	-531.31	0.0	0.0	0.0	-997.15
		-1302.29	0.0	0.0	0.0	27.5	-223.81	-554.79	0.0	0.0	0.0	-1146.49
						55.0	-223.81	-578.28	0.0	0.0	0.0	-1302.29
9	10	-1019.85	0.0	-6.80e-04	-40.86	0.0	-244.02	-479.62	0.0	0.0	0.0	-1019.85
		-1294.88	0.0	0.0	0.0	27.5	-244.02	-500.05	0.0	0.0	0.0	-1154.56
						55.0	-244.02	-520.48	0.0	0.0	0.0	-1294.88
9	11	-493.39	0.0	-4.80e-04	-42.55	0.0	-120.32	-552.12	0.0	0.0	0.0	-493.39
		-808.75	0.0	0.0	0.0	27.5	-120.32	-573.39	0.0	0.0	0.0	-648.14
						55.0	-120.32	-594.66	0.0	0.0	0.0	-808.75
9	12	-410.54	0.0	-4.39e-04	-50.71	0.0	-107.37	-530.04	0.0	0.0	0.0	-410.54
		-716.00	0.0	0.0	0.0	27.5	-107.37	-555.39	0.0	0.0	0.0	-559.78
						55.0	-107.37	-580.75	0.0	0.0	0.0	-716.00
9	13	-375.48	0.0	-4.21e-04	-40.86	0.0	-113.22	-507.46	0.0	0.0	0.0	-375.48
		-665.82	0.0	0.0	0.0	27.5	-113.22	-527.89	0.0	0.0	0.0	-517.84
						55.0	-113.22	-548.33	0.0	0.0	0.0	-665.82
9	14	-313.50	0.0	-3.90e-04	-46.97	0.0	-103.53	-490.94	0.0	0.0	0.0	-313.50
		-596.43	0.0	0.0	0.0	27.5	-103.53	-514.43	0.0	0.0	0.0	-451.74
						55.0	-103.53	-537.92	0.0	0.0	0.0	-596.43
9	15	-1101.19	0.0	-8.50e-04	-40.86	0.0	-246.84	-590.53	0.0	0.0	0.0	-1101.19
		-1437.22	0.0	0.0	0.0	27.5	-249.94	-610.96	0.0	0.0	0.0	-1266.39
						55.0	-253.05	-631.39	0.0	0.0	0.0	-1437.22
9	16	-1085.04	0.0	-1.01e-03	-46.97	0.0	-250.62	-580.77	0.0	0.0	0.0	-1085.04
		-1417.38	0.0	0.0	0.0	27.5	-253.73	-604.26	0.0	0.0	0.0	-1247.98
						55.0	-256.83	-627.74	0.0	0.0	0.0	-1417.38
9	17	-1107.75	0.0	-1.27e-03	-40.86	0.0	-270.83	-529.08	0.0	0.0	0.0	-1107.75
		-1409.98	0.0	0.0	0.0	27.5	-273.93	-549.51	0.0	0.0	0.0	-1256.05
						55.0	-277.04	-569.94	0.0	0.0	0.0	-1409.98
9	18	-879.55	0.0	-1.45e-04	-40.86	0.0	-184.23	-541.07	0.0	0.0	0.0	-879.55



		-1188.38	0.0	0.0	0.0	27.5	-184.23	-561.50	0.0	0.0	0.0	-1031.16
						55.0	-184.23	-581.93	0.0	0.0	0.0	-1188.38
9	19	-863.41	0.0	-3.01e-04	-46.97	0.0	-188.01	-531.31	0.0	0.0	0.0	-863.41
		-1168.55	0.0	0.0	0.0	27.5	-188.01	-554.80	0.0	0.0	0.0	-1012.75
						55.0	-188.01	-578.28	0.0	0.0	0.0	-1168.55
9	20	-886.11	0.0	-5.62e-04	-40.86	0.0	-208.22	-479.62	0.0	0.0	0.0	-886.11
		-1161.14	0.0	0.0	0.0	27.5	-208.22	-500.05	0.0	0.0	0.0	-1020.82
						55.0	-208.22	-520.48	0.0	0.0	0.0	-1161.14
9	21	-1041.32	0.0	-6.01e-04	-40.86	0.0	-236.77	-537.82	0.0	0.0	0.0	-1041.32
		-1348.36	0.0	0.0	0.0	27.5	-239.87	-558.25	0.0	0.0	0.0	-1192.03
						55.0	-242.98	-578.68	0.0	0.0	0.0	-1348.36
9	22	-819.68	0.0	-1.04e-04	-40.86	0.0	-174.16	-488.36	0.0	0.0	0.0	-819.68
		-1099.52	0.0	0.0	0.0	27.5	-174.16	-508.79	0.0	0.0	0.0	-956.79
						55.0	-174.16	-529.22	0.0	0.0	0.0	-1099.52
9	23	-751.90	0.0	-1.41e-03	-26.57	0.0	-258.70	-379.65	0.0	0.0	0.0	-751.90
		-968.01	0.0	0.0	0.0	27.5	-261.81	-392.93	0.0	0.0	0.0	-858.13
						55.0	-264.91	-406.21	0.0	0.0	0.0	-968.01
9	24	-370.30	0.0	-7.05e-04	-26.57	0.0	-181.96	-330.19	0.0	0.0	0.0	-370.30
		-559.21	0.0	0.0	0.0	27.5	-181.96	-343.47	0.0	0.0	0.0	-462.93
						55.0	-181.96	-356.75	0.0	0.0	0.0	-559.21
9	25	-994.29	0.0	-1.08e-03	-40.86	0.0	-256.13	-644.33	0.0	0.0	0.0	-994.29
		-1359.91	0.0	0.0	0.0	27.5	-259.24	-664.76	0.0	0.0	0.0	-1174.29
						55.0	-262.34	-685.19	0.0	0.0	0.0	-1359.91
9	26	-1055.52	0.0	-9.34e-04	-46.97	0.0	-269.76	-581.86	0.0	0.0	0.0	-1055.52
		-1388.46	0.0	0.0	0.0	27.5	-272.86	-605.34	0.0	0.0	0.0	-1218.76
						55.0	-275.97	-628.83	0.0	0.0	0.0	-1388.46
9	27	-791.44	0.0	-2.21e-04	-42.55	0.0	-172.82	-515.27	0.0	0.0	0.0	-791.44
		-1086.53	0.0	0.0	0.0	27.5	-172.82	-536.54	0.0	0.0	0.0	-936.06
						55.0	-172.82	-557.81	0.0	0.0	0.0	-1086.53
9	28	-834.45	0.0	-2.78e-04	-50.71	0.0	-186.81	-570.40	0.0	0.0	0.0	-834.45
		-1162.12	0.0	0.0	0.0	27.5	-186.81	-595.76	0.0	0.0	0.0	-994.79
						55.0	-186.81	-621.12	0.0	0.0	0.0	-1162.12
9	29	-822.29	0.0	-1.31e-03	-35.86	0.0	-247.87	-476.82	0.0	0.0	0.0	-822.29
		-1094.41	0.0	0.0	0.0	27.5	-250.97	-494.75	0.0	0.0	0.0	-955.89
						55.0	-254.08	-512.68	0.0	0.0	0.0	-1094.41
9	30	-995.03	0.0	-5.13e-04	-31.56	0.0	-371.35	-459.30	0.0	0.0	0.0	-995.03
		-1256.32	0.0	0.0	0.0	27.5	-374.46	-475.09	0.0	0.0	0.0	-1123.50
						55.0	-377.56	-490.87	0.0	0.0	0.0	-1256.32
9	31	-946.91	0.0	-5.56e-04	-37.68	0.0	-388.52	-442.79	0.0	0.0	0.0	-946.91
		-1200.80	0.0	0.0	0.0	27.5	-391.63	-461.62	0.0	0.0	0.0	-1071.26



						55.0	-394.73	-480.46	0.0	0.0	0.0	-1200.80
9	32	-907.72	0.0	-6.29e-04	-31.56	0.0	-430.95	-378.91	0.0	0.0	0.0	-907.72
		-1124.80	0.0	0.0	0.0	27.5	-434.05	-394.70	0.0	0.0	0.0	-1014.09
						55.0	-437.15	-410.48	0.0	0.0	0.0	-1124.80
9	33	-838.44	0.0	-1.17e-03	-35.86	0.0	-257.72	-477.91	0.0	0.0	0.0	-838.44
		-1111.16	0.0	0.0	0.0	27.5	-260.83	-495.84	0.0	0.0	0.0	-972.33
						55.0	-263.93	-513.77	0.0	0.0	0.0	-1111.16
9	34	-258.70	0.0	-3.70e-04	-30.28	0.0	-101.45	-376.14	0.0	0.0	0.0	-258.70
		-473.91	0.0	0.0	0.0	27.5	-101.45	-391.28	0.0	0.0	0.0	-364.23
						55.0	-101.45	-406.42	0.0	0.0	0.0	-473.91
9	35	-274.56	0.0	-1.79e-04	-34.81	0.0	-112.44	-373.00	0.0	0.0	0.0	-274.56
		-489.28	0.0	0.0	0.0	27.5	-112.44	-390.41	0.0	0.0	0.0	-379.53
						55.0	-112.44	-407.82	0.0	0.0	0.0	-489.28
9	36	-654.79	0.0	-2.47e-05	-30.28	0.0	-175.13	-392.26	0.0	0.0	0.0	-654.79
		-878.86	0.0	0.0	0.0	27.5	-175.13	-407.40	0.0	0.0	0.0	-764.74
						55.0	-175.13	-422.54	0.0	0.0	0.0	-878.86
9	37	-642.80	0.0	-1.40e-04	-34.81	0.0	-177.94	-385.02	0.0	0.0	0.0	-642.80
		-864.13	0.0	0.0	0.0	27.5	-177.94	-402.42	0.0	0.0	0.0	-751.07
						55.0	-177.94	-419.83	0.0	0.0	0.0	-864.13
9	38	-659.66	0.0	-3.35e-04	-30.28	0.0	-192.94	-346.63	0.0	0.0	0.0	-659.66
		-858.63	0.0	0.0	0.0	27.5	-192.94	-361.77	0.0	0.0	0.0	-757.06
						55.0	-192.94	-376.91	0.0	0.0	0.0	-858.63
9	39	-341.85	0.0	-2.97e-04	-30.28	0.0	-123.71	-376.14	0.0	0.0	0.0	-341.85
		-557.05	0.0	0.0	0.0	27.5	-123.71	-391.28	0.0	0.0	0.0	-447.37
						55.0	-123.71	-406.42	0.0	0.0	0.0	-557.05
9	40	-295.82	0.0	-2.74e-04	-34.81	0.0	-116.51	-363.88	0.0	0.0	0.0	-295.82
		-505.53	0.0	0.0	0.0	27.5	-116.51	-381.28	0.0	0.0	0.0	-398.28
						55.0	-116.51	-398.69	0.0	0.0	0.0	-505.53
9	41	-571.64	0.0	-4.87e-05	-30.28	0.0	-152.88	-392.26	0.0	0.0	0.0	-571.64
		-795.71	0.0	0.0	0.0	27.5	-152.88	-407.40	0.0	0.0	0.0	-681.59
						55.0	-152.88	-422.54	0.0	0.0	0.0	-795.71
9	42	-559.65	0.0	-6.70e-05	-34.81	0.0	-155.68	-385.02	0.0	0.0	0.0	-559.65
		-780.99	0.0	0.0	0.0	27.5	-155.68	-402.42	0.0	0.0	0.0	-667.93
						55.0	-155.68	-419.83	0.0	0.0	0.0	-780.99
9	43	-576.51	0.0	-2.61e-04	-30.28	0.0	-170.69	-346.63	0.0	0.0	0.0	-576.51
		-775.49	0.0	0.0	0.0	27.5	-170.69	-361.77	0.0	0.0	0.0	-673.92
						55.0	-170.69	-376.91	0.0	0.0	0.0	-775.49
9	44	-647.22	0.0	-8.60e-05	-30.28	0.0	-180.18	-371.29	0.0	0.0	0.0	-647.22
		-859.76	0.0	0.0	0.0	27.5	-180.18	-386.43	0.0	0.0	0.0	-751.41
						55.0	-180.18	-401.57	0.0	0.0	0.0	-859.76



9	45	-342.76	0.0	-2.92e-04	-26.57	0.0	-151.72	-307.83	0.0	0.0	0.0	-342.76
		-519.37	0.0	0.0	0.0	27.5	-151.72	-321.11	0.0	0.0	0.0	-429.24
						55.0	-151.72	-334.39	0.0	0.0	0.0	-519.37
9	46	-299.08	0.0	-4.04e-04	-31.52	0.0	-104.82	-408.98	0.0	0.0	0.0	-299.08
		-532.68	0.0	0.0	0.0	27.5	-104.82	-424.73	0.0	0.0	0.0	-413.71
						55.0	-104.82	-440.49	0.0	0.0	0.0	-532.68
9	47	-237.71	0.0	-3.74e-04	-37.56	0.0	-95.22	-392.62	0.0	0.0	0.0	-237.71
		-463.98	0.0	0.0	0.0	27.5	-95.22	-411.40	0.0	0.0	0.0	-348.26
						55.0	-95.22	-430.19	0.0	0.0	0.0	-463.98
9	48	-177.90	0.0	-3.85e-04	-30.28	0.0	-91.78	-376.14	0.0	0.0	0.0	-177.90
		-393.10	0.0	0.0	0.0	27.5	-91.78	-391.28	0.0	0.0	0.0	-283.42
						55.0	-91.78	-406.42	0.0	0.0	0.0	-393.10
9	49	-131.87	0.0	-3.62e-04	-34.81	0.0	-84.58	-363.88	0.0	0.0	0.0	-131.87
		-341.58	0.0	0.0	0.0	27.5	-84.58	-381.28	0.0	0.0	0.0	-234.33
						55.0	-84.58	-398.69	0.0	0.0	0.0	-341.58
9	50	-865.63	0.0	-5.37e-04	-30.28	0.0	-223.37	-428.90	0.0	0.0	0.0	-865.63
		-1109.85	0.0	0.0	0.0	27.5	-225.67	-444.04	0.0	0.0	0.0	-985.66
						55.0	-227.97	-459.18	0.0	0.0	0.0	-1109.85
9	51	-853.64	0.0	-6.53e-04	-34.81	0.0	-226.18	-421.65	0.0	0.0	0.0	-853.64
		-1095.12	0.0	0.0	0.0	27.5	-228.48	-439.06	0.0	0.0	0.0	-971.99
						55.0	-230.78	-456.47	0.0	0.0	0.0	-1095.12
9	52	-870.50	0.0	-8.47e-04	-30.28	0.0	-241.19	-383.27	0.0	0.0	0.0	-870.50
		-1089.62	0.0	0.0	0.0	27.5	-243.49	-398.41	0.0	0.0	0.0	-977.98
						55.0	-245.79	-413.55	0.0	0.0	0.0	-1089.62
9	53	-735.59	0.0	-3.88e-05	-30.28	0.0	-184.81	-392.26	0.0	0.0	0.0	-735.59
		-959.66	0.0	0.0	0.0	27.5	-184.81	-407.40	0.0	0.0	0.0	-845.54
						55.0	-184.81	-422.54	0.0	0.0	0.0	-959.66
9	54	-723.60	0.0	-1.55e-04	-34.81	0.0	-187.62	-385.02	0.0	0.0	0.0	-723.60
		-944.94	0.0	0.0	0.0	27.5	-187.62	-402.42	0.0	0.0	0.0	-831.88
						55.0	-187.62	-419.83	0.0	0.0	0.0	-944.94
9	55	-740.46	0.0	-3.49e-04	-30.28	0.0	-202.62	-346.63	0.0	0.0	0.0	-740.46
		-939.44	0.0	0.0	0.0	27.5	-202.62	-361.77	0.0	0.0	0.0	-837.87
						55.0	-202.62	-376.91	0.0	0.0	0.0	-939.44
9	56	-341.53	0.0	-3.67e-04	-31.52	0.0	-116.18	-408.98	0.0	0.0	0.0	-341.53
		-575.14	0.0	0.0	0.0	27.5	-116.18	-424.73	0.0	0.0	0.0	-456.17
						55.0	-116.18	-440.49	0.0	0.0	0.0	-575.14
9	57	-280.16	0.0	-3.36e-04	-37.56	0.0	-106.59	-392.62	0.0	0.0	0.0	-280.16
		-506.44	0.0	0.0	0.0	27.5	-106.59	-411.40	0.0	0.0	0.0	-390.72
						55.0	-106.59	-430.19	0.0	0.0	0.0	-506.44
9	58	-248.66	0.0	-3.22e-04	-30.28	0.0	-110.72	-376.14	0.0	0.0	0.0	-248.66



		-463.87	0.0	0.0	0.0	27.5	-110.72	-391.28	0.0	0.0	0.0	-354.18
						55.0	-110.72	-406.42	0.0	0.0	0.0	-463.87
9	59	-202.63	0.0	-2.99e-04	-34.81	0.0	-103.52	-363.88	0.0	0.0	0.0	-202.63
		-412.34	0.0	0.0	0.0	27.5	-103.52	-381.28	0.0	0.0	0.0	-305.09
						55.0	-103.52	-398.69	0.0	0.0	0.0	-412.34
9	60	-782.48	0.0	-4.64e-04	-30.28	0.0	-201.12	-428.90	0.0	0.0	0.0	-782.48
		-1026.70	0.0	0.0	0.0	27.5	-203.42	-444.04	0.0	0.0	0.0	-902.51
						55.0	-205.72	-459.18	0.0	0.0	0.0	-1026.70
9	61	-770.49	0.0	-5.79e-04	-34.81	0.0	-203.93	-421.65	0.0	0.0	0.0	-770.49
		-1011.98	0.0	0.0	0.0	27.5	-206.23	-439.06	0.0	0.0	0.0	-888.84
						55.0	-208.52	-456.47	0.0	0.0	0.0	-1011.98
9	62	-787.35	0.0	-7.74e-04	-30.28	0.0	-218.93	-383.27	0.0	0.0	0.0	-787.35
		-1006.48	0.0	0.0	0.0	27.5	-221.23	-398.41	0.0	0.0	0.0	-894.83
						55.0	-223.53	-413.55	0.0	0.0	0.0	-1006.48
9	63	-624.14	0.0	-5.96e-05	-30.28	0.0	-154.98	-392.26	0.0	0.0	0.0	-624.14
		-848.21	0.0	0.0	0.0	27.5	-154.98	-407.40	0.0	0.0	0.0	-734.09
						55.0	-154.98	-422.54	0.0	0.0	0.0	-848.21
9	64	-612.15	0.0	-5.61e-05	-34.81	0.0	-157.78	-385.02	0.0	0.0	0.0	-612.15
		-833.49	0.0	0.0	0.0	27.5	-157.78	-402.42	0.0	0.0	0.0	-720.43
						55.0	-157.78	-419.83	0.0	0.0	0.0	-833.49
9	65	-629.01	0.0	-2.50e-04	-30.28	0.0	-172.79	-346.63	0.0	0.0	0.0	-629.01
		-827.99	0.0	0.0	0.0	27.5	-172.79	-361.77	0.0	0.0	0.0	-726.42
						55.0	-172.79	-376.91	0.0	0.0	0.0	-827.99
9	66	-738.02	0.0	-2.79e-04	-30.28	0.0	-193.64	-389.76	0.0	0.0	0.0	-738.02
		-960.72	0.0	0.0	0.0	27.5	-195.94	-404.90	0.0	0.0	0.0	-847.29
						55.0	-198.24	-420.04	0.0	0.0	0.0	-960.72
9	67	-579.68	0.0	-2.44e-04	-30.28	0.0	-147.50	-353.12	0.0	0.0	0.0	-579.68
		-782.23	0.0	0.0	0.0	27.5	-147.50	-368.26	0.0	0.0	0.0	-678.87
						55.0	-147.50	-383.40	0.0	0.0	0.0	-782.23
9	68	-553.61	0.0	-8.04e-04	-26.57	0.0	-199.96	-344.46	0.0	0.0	0.0	-553.61
		-750.37	0.0	0.0	0.0	27.5	-202.26	-357.75	0.0	0.0	0.0	-650.16
						55.0	-204.56	-371.03	0.0	0.0	0.0	-750.37
9	69	-261.96	0.0	-2.78e-04	-26.57	0.0	-142.04	-307.83	0.0	0.0	0.0	-261.96
		-438.57	0.0	0.0	0.0	27.5	-142.04	-321.11	0.0	0.0	0.0	-348.44
						55.0	-142.04	-334.39	0.0	0.0	0.0	-438.57
9	70	-157.79	0.0	-2.65e-04	-26.57	0.0	-93.78	-277.64	0.0	0.0	0.0	-157.79
		-317.80	0.0	0.0	0.0	27.5	-93.78	-290.93	0.0	0.0	0.0	-235.97
						55.0	-93.78	-304.21	0.0	0.0	0.0	-317.80
9	71	-485.63	0.0	-4.70e-05	-26.57	0.0	-154.43	-289.66	0.0	0.0	0.0	-485.63
		-652.25	0.0	0.0	0.0	27.5	-154.43	-302.94	0.0	0.0	0.0	-567.11



						55.0	-154.43	-316.22	0.0	0.0	0.0	-652.25
9	72	-233.86	0.0	-1.98e-04	-26.57	0.0	-114.14	-277.64	0.0	0.0	0.0	-233.86
		-393.87	0.0	0.0	0.0	27.5	-114.14	-290.92	0.0	0.0	0.0	-312.04
						55.0	-114.14	-304.21	0.0	0.0	0.0	-393.87
9	73	-409.56	0.0	-2.02e-05	-26.57	0.0	-134.07	-289.66	0.0	0.0	0.0	-409.56
		-576.18	0.0	0.0	0.0	27.5	-134.07	-302.94	0.0	0.0	0.0	-491.04
						55.0	-134.07	-316.22	0.0	0.0	0.0	-576.18
9	74	-242.93	0.0	-2.42e-05	-26.57	0.0	-119.35	-289.66	0.0	0.0	0.0	-242.93
		-409.55	0.0	0.0	0.0	27.5	-119.35	-302.94	0.0	0.0	0.0	-324.41
						55.0	-119.35	-316.22	0.0	0.0	0.0	-409.55
9	75	-487.20	0.0	-4.16e-04	-30.59	0.0	-204.74	-362.98	0.0	0.0	0.0	-487.20
		-695.25	0.0	0.0	0.0	27.5	-205.95	-378.28	0.0	0.0	0.0	-589.12
						55.0	-207.15	-393.57	0.0	0.0	0.0	-695.25
9	76	-1327.86	0.0	-2.14e-03	-27.77	0.0	-390.29	-434.64	0.0	0.0	0.0	-1327.86
		-1574.55	0.0	0.0	0.0	27.5	-394.31	-448.52	0.0	0.0	0.0	-1449.29
						55.0	-398.33	-462.41	0.0	0.0	0.0	-1574.55
9	77	-563.27	0.0	-4.83e-04	-30.59	0.0	-225.10	-362.98	0.0	0.0	0.0	-563.27
		-771.32	0.0	0.0	0.0	27.5	-226.31	-378.27	0.0	0.0	0.0	-665.19
						55.0	-227.51	-393.57	0.0	0.0	0.0	-771.32
9	78	-1251.79	0.0	-2.07e-03	-27.77	0.0	-369.93	-434.64	0.0	0.0	0.0	-1251.79
		-1498.48	0.0	0.0	0.0	27.5	-373.95	-448.53	0.0	0.0	0.0	-1373.22
						55.0	-377.97	-462.41	0.0	0.0	0.0	-1498.48
9	79	-1066.15	0.0	-2.10e-03	-25.36	0.0	-357.28	-409.43	0.0	0.0	0.0	-1066.15
		-1298.31	0.0	0.0	0.0	27.5	-361.30	-422.11	0.0	0.0	0.0	-1180.49
						55.0	-365.32	-434.79	0.0	0.0	0.0	-1298.31
12	1	1401.82	0.0	-4.42e-03	-1104.52	0.0	-93.61	552.40	0.0	0.0	0.0	-395.22
		-395.22	0.0	0.0	0.0	575.0	-93.61	0.14	0.0	0.0	0.0	1401.82
						1150.0	-93.61	-552.12	0.0	0.0	0.0	-393.61
12	2	1212.70	0.0	-3.96e-03	-1060.36	0.0	-80.66	530.32	0.0	0.0	0.0	-312.36
		-312.36	0.0	0.0	0.0	575.0	-80.66	0.14	0.0	0.0	0.0	1212.70
						1150.0	-80.66	-530.04	0.0	0.0	0.0	-310.76
12	3	1372.82	0.0	-4.10e-03	-1015.20	0.0	-77.42	507.73	0.0	0.0	0.0	-243.26
		-243.26	0.0	0.0	0.0	575.0	-77.42	0.13	0.0	0.0	0.0	1372.82
						1150.0	-77.42	-507.47	0.0	0.0	0.0	-241.74
12	4	1231.34	0.0	-3.76e-03	-982.16	0.0	-67.73	491.21	0.0	0.0	0.0	-181.27
		-181.27	0.0	0.0	0.0	575.0	-67.73	0.13	0.0	0.0	0.0	1231.34
						1150.0	-67.73	-490.95	0.0	0.0	0.0	-179.76
12	5	920.52	0.0	-0.02	-1015.20	0.0	-143.76	424.67	0.0	0.0	0.0	-247.26
		-1200.96	0.0	0.0	0.0	575.0	-208.65	-82.93	0.0	0.0	0.0	891.21
						1150.0	-273.55	-590.53	0.0	0.0	0.0	-1200.96

12	6	785.16	0.0	-0.03	-982.16	0.0	-147.54	401.39	0.0	0.0	0.0	-153.38
		-1184.82	0.0	0.0	0.0	575.0	-212.43	-89.69	0.0	0.0	0.0	742.75
						1150.0	-277.33	-580.77	0.0	0.0	0.0	-1184.82
12	7	676.18	0.0	-0.03	-854.39	0.0	-167.75	325.31	0.0	0.0	0.0	-35.88
		-1207.52	0.0	0.0	0.0	575.0	-232.64	-101.88	0.0	0.0	0.0	606.49
						1150.0	-297.54	-529.08	0.0	0.0	0.0	-1207.52
12	8	794.48	0.0	-0.01	-1015.20	0.0	-220.03	474.13	0.0	0.0	0.0	-628.39
		-1013.29	0.0	0.0	0.0	575.0	-220.03	-33.47	0.0	0.0	0.0	794.48
						1150.0	-220.03	-541.07	0.0	0.0	0.0	-1013.29
12	9	652.88	0.0	-0.01	-982.16	0.0	-223.81	450.85	0.0	0.0	0.0	-534.51
		-997.15	0.0	0.0	0.0	575.0	-223.81	-40.23	0.0	0.0	0.0	646.02
						1150.0	-223.81	-531.31	0.0	0.0	0.0	-997.15
12	10	528.25	0.0	-0.02	-854.39	0.0	-244.02	374.77	0.0	0.0	0.0	-417.00
		-1019.85	0.0	0.0	0.0	575.0	-244.02	-52.42	0.0	0.0	0.0	509.76
						1150.0	-244.02	-479.62	0.0	0.0	0.0	-1019.85
12	11	1302.03	0.0	-3.99e-03	-1104.52	0.0	-120.32	552.40	0.0	0.0	0.0	-495.01
		-495.01	0.0	0.0	0.0	575.0	-120.32	0.14	0.0	0.0	0.0	1302.03
						1150.0	-120.32	-552.12	0.0	0.0	0.0	-493.39
12	12	1112.92	0.0	-3.53e-03	-1060.36	0.0	-107.37	530.32	0.0	0.0	0.0	-412.15
		-412.15	0.0	0.0	0.0	575.0	-107.37	0.14	0.0	0.0	0.0	1112.92
						1150.0	-107.37	-530.04	0.0	0.0	0.0	-410.54
12	13	1239.07	0.0	-3.52e-03	-1015.20	0.0	-113.22	507.73	0.0	0.0	0.0	-377.03
		-377.03	0.0	0.0	0.0	575.0	-113.22	0.13	0.0	0.0	0.0	1239.07
						1150.0	-113.22	-507.46	0.0	0.0	0.0	-375.48
12	14	1097.58	0.0	-3.17e-03	-982.16	0.0	-103.53	491.21	0.0	0.0	0.0	-315.04
		-315.04	0.0	0.0	0.0	575.0	-103.53	0.13	0.0	0.0	0.0	1097.58
						1150.0	-103.53	-490.94	0.0	0.0	0.0	-313.50
12	15	1020.31	0.0	-0.02	-1015.20	0.0	-117.05	424.67	0.0	0.0	0.0	-147.47
		-1101.19	0.0	0.0	0.0	575.0	-181.95	-82.93	0.0	0.0	0.0	991.00
						1150.0	-246.84	-590.53	0.0	0.0	0.0	-1101.19
12	16	884.94	0.0	-0.03	-982.16	0.0	-120.83	401.39	0.0	0.0	0.0	-53.59
		-1085.04	0.0	0.0	0.0	575.0	-185.73	-89.69	0.0	0.0	0.0	842.54
						1150.0	-250.62	-580.77	0.0	0.0	0.0	-1085.04
12	17	775.97	0.0	-0.03	-854.39	0.0	-141.04	325.31	0.0	0.0	0.0	63.92
		-1107.75	0.0	0.0	0.0	575.0	-205.93	-101.88	0.0	0.0	0.0	706.27
						1150.0	-270.83	-529.08	0.0	0.0	0.0	-1107.75
12	18	928.24	0.0	-0.01	-1015.20	0.0	-184.23	474.13	0.0	0.0	0.0	-494.62
		-879.55	0.0	0.0	0.0	575.0	-184.23	-33.47	0.0	0.0	0.0	928.24
						1150.0	-184.23	-541.07	0.0	0.0	0.0	-879.55
12	19	786.64	0.0	-0.01	-982.16	0.0	-188.01	450.85	0.0	0.0	0.0	-400.74

		-863.41	0.0	0.0	0.0	575.0	-188.01	-40.23	0.0	0.0	0.0	779.78
						1150.0	-188.01	-531.31	0.0	0.0	0.0	-863.41
12	20	662.01	0.0	-0.02	-854.39	0.0	-208.22	374.77	0.0	0.0	0.0	-283.23
		-886.11	0.0	0.0	0.0	575.0	-208.22	-52.42	0.0	0.0	0.0	643.52
						1150.0	-208.22	-479.62	0.0	0.0	0.0	-886.11
12	21	905.21	0.0	-0.02	-1015.20	0.0	-106.98	477.38	0.0	0.0	0.0	-69.86
		-1041.32	0.0	0.0	0.0	575.0	-171.87	-110.62	0.0	0.0	0.0	822.95
						1150.0	-236.77	-537.82	0.0	0.0	0.0	-1041.32
12	22	784.96	0.0	-6.09e-03	-1015.20	0.0	-174.16	526.84	0.0	0.0	0.0	-417.02
		-819.68	0.0	0.0	0.0	575.0	-174.16	-61.16	0.0	0.0	0.0	760.19
						1150.0	-174.16	-488.36	0.0	0.0	0.0	-819.68
12	23	740.09	0.0	-0.03	-555.45	0.0	-128.92	175.80	0.0	0.0	0.0	420.19
		-751.90	0.0	0.0	0.0	575.0	-193.81	-101.92	0.0	0.0	0.0	632.60
						1150.0	-258.70	-379.65	0.0	0.0	0.0	-751.90
12	24	755.32	0.0	-0.02	-555.45	0.0	-181.96	225.26	0.0	0.0	0.0	233.00
		-370.30	0.0	0.0	0.0	575.0	-181.96	-52.46	0.0	0.0	0.0	729.81
						1150.0	-181.96	-330.19	0.0	0.0	0.0	-370.30
12	25	879.78	0.0	-0.03	-1015.20	0.0	-126.35	370.87	0.0	0.0	0.0	-45.82
		-994.29	0.0	0.0	0.0	575.0	-191.24	-56.33	0.0	0.0	0.0	858.49
						1150.0	-256.13	-644.33	0.0	0.0	0.0	-994.29
12	26	921.49	0.0	-0.02	-982.16	0.0	-139.97	400.30	0.0	0.0	0.0	-11.58
		-1055.52	0.0	0.0	0.0	575.0	-204.87	-90.78	0.0	0.0	0.0	878.30
						1150.0	-269.76	-581.86	0.0	0.0	0.0	-1055.52
12	27	923.25	0.0	-4.97e-03	-1104.52	0.0	-172.82	589.25	0.0	0.0	0.0	-382.89
		-791.44	0.0	0.0	0.0	575.0	-172.82	-70.48	0.0	0.0	0.0	892.58
						1150.0	-172.82	-515.27	0.0	0.0	0.0	-791.44
12	28	926.20	0.0	-0.01	-1060.36	0.0	-186.81	489.95	0.0	0.0	0.0	-371.86
		-834.45	0.0	0.0	0.0	575.0	-186.81	-40.22	0.0	0.0	0.0	921.11
						1150.0	-186.81	-570.40	0.0	0.0	0.0	-834.45
12	29	920.61	0.0	-0.03	-749.86	0.0	-118.08	273.04	0.0	0.0	0.0	349.47
		-822.29	0.0	0.0	0.0	575.0	-182.98	-101.89	0.0	0.0	0.0	841.51
						1150.0	-247.87	-476.82	0.0	0.0	0.0	-822.29
12	30	631.29	0.0	-0.01	-820.79	0.0	-241.56	361.49	0.0	0.0	0.0	-432.57
		-995.03	0.0	0.0	0.0	575.0	-306.46	-48.91	0.0	0.0	0.0	622.07
						1150.0	-371.35	-459.30	0.0	0.0	0.0	-995.03
12	31	484.18	0.0	-0.01	-787.75	0.0	-258.73	344.96	0.0	0.0	0.0	-384.44
		-946.91	0.0	0.0	0.0	575.0	-323.63	-48.91	0.0	0.0	0.0	466.72
						1150.0	-388.52	-442.79	0.0	0.0	0.0	-946.91
12	32	342.65	0.0	-0.01	-659.99	0.0	-301.16	281.07	0.0	0.0	0.0	-345.12
		-907.72	0.0	0.0	0.0	575.0	-366.05	-48.92	0.0	0.0	0.0	322.31



						1150.0	-430.95	-378.91	0.0	0.0	0.0	-907.72
12	33	912.27	0.0	-0.03	-749.86	0.0	-127.93	271.95	0.0	0.0	0.0	345.82
		-838.44	0.0	0.0	0.0	575.0	-192.83	-102.98	0.0	0.0	0.0	831.61
						1150.0	-257.72	-477.91	0.0	0.0	0.0	-838.44
12	34	938.25	0.0	-2.91e-03	-752.48	0.0	-101.45	376.34	0.0	0.0	0.0	-259.83
		-259.83	0.0	0.0	0.0	575.0	-101.45	0.10	0.0	0.0	0.0	938.25
						1150.0	-101.45	-376.14	0.0	0.0	0.0	-258.70
12	35	823.77	0.0	-3.80e-03	-727.95	0.0	-112.44	354.95	0.0	0.0	0.0	-170.75
		-274.56	0.0	0.0	0.0	575.0	-112.44	-9.03	0.0	0.0	0.0	823.77
						1150.0	-112.44	-373.00	0.0	0.0	0.0	-274.56
12	36	634.85	0.0	-5.36e-03	-752.48	0.0	-175.13	360.22	0.0	0.0	0.0	-470.55
		-654.79	0.0	0.0	0.0	575.0	-175.13	-16.02	0.0	0.0	0.0	634.85
						1150.0	-175.13	-392.26	0.0	0.0	0.0	-654.79
12	37	524.61	0.0	-6.85e-03	-727.95	0.0	-177.94	342.93	0.0	0.0	0.0	-400.84
		-642.80	0.0	0.0	0.0	575.0	-177.94	-21.04	0.0	0.0	0.0	524.61
						1150.0	-177.94	-385.02	0.0	0.0	0.0	-642.80
12	38	430.84	0.0	-9.57e-03	-633.08	0.0	-192.94	286.44	0.0	0.0	0.0	-313.58
		-659.66	0.0	0.0	0.0	575.0	-192.94	-30.09	0.0	0.0	0.0	423.43
						1150.0	-192.94	-346.63	0.0	0.0	0.0	-659.66
12	39	855.10	0.0	-2.54e-03	-752.48	0.0	-123.71	376.34	0.0	0.0	0.0	-343.00
		-343.00	0.0	0.0	0.0	575.0	-123.71	0.10	0.0	0.0	0.0	855.10
						1150.0	-123.71	-376.14	0.0	0.0	0.0	-341.85
12	40	750.04	0.0	-2.29e-03	-727.95	0.0	-116.51	364.07	0.0	0.0	0.0	-296.96
		-296.96	0.0	0.0	0.0	575.0	-116.51	0.10	0.0	0.0	0.0	750.04
						1150.0	-116.51	-363.88	0.0	0.0	0.0	-295.82
12	41	718.01	0.0	-5.67e-03	-752.48	0.0	-152.88	360.22	0.0	0.0	0.0	-387.39
		-571.64	0.0	0.0	0.0	575.0	-152.88	-16.02	0.0	0.0	0.0	718.01
						1150.0	-152.88	-392.26	0.0	0.0	0.0	-571.64
12	42	607.77	0.0	-6.85e-03	-727.95	0.0	-155.68	342.93	0.0	0.0	0.0	-317.67
		-559.65	0.0	0.0	0.0	575.0	-155.68	-21.04	0.0	0.0	0.0	607.77
						1150.0	-155.68	-385.02	0.0	0.0	0.0	-559.65
12	43	513.99	0.0	-9.57e-03	-633.08	0.0	-170.69	286.44	0.0	0.0	0.0	-230.42
		-576.51	0.0	0.0	0.0	575.0	-170.69	-30.09	0.0	0.0	0.0	506.58
						1150.0	-170.69	-346.63	0.0	0.0	0.0	-576.51
12	44	602.79	0.0	-6.21e-03	-752.48	0.0	-180.18	381.19	0.0	0.0	0.0	-240.86
		-647.22	0.0	0.0	0.0	575.0	-180.18	-54.75	0.0	0.0	0.0	577.65
						1150.0	-180.18	-371.29	0.0	0.0	0.0	-647.22
12	45	637.94	0.0	-9.59e-03	-555.45	0.0	-151.72	247.62	0.0	0.0	0.0	3.40
		-342.76	0.0	0.0	0.0	575.0	-151.72	-30.10	0.0	0.0	0.0	628.78
						1150.0	-151.72	-307.83	0.0	0.0	0.0	-342.76



12	46	1030.87	0.0	-3.19e-03	-818.16	0.0	-104.82	409.18	0.0	0.0	0.0	-300.27
		-300.27	0.0	0.0	0.0	575.0	-104.82	0.10	0.0	0.0	0.0	1030.87
						1150.0	-104.82	-408.98	0.0	0.0	0.0	-299.08
12	47	890.79	0.0	-2.85e-03	-785.45	0.0	-95.22	392.83	0.0	0.0	0.0	-238.89
		-238.89	0.0	0.0	0.0	575.0	-95.22	0.10	0.0	0.0	0.0	890.79
						1150.0	-95.22	-392.62	0.0	0.0	0.0	-237.71
12	48	1019.06	0.0	-2.96e-03	-752.48	0.0	-91.78	376.34	0.0	0.0	0.0	-179.03
		-179.03	0.0	0.0	0.0	575.0	-91.78	0.10	0.0	0.0	0.0	1019.06
						1150.0	-91.78	-376.14	0.0	0.0	0.0	-177.90
12	49	913.99	0.0	-2.71e-03	-727.95	0.0	-84.58	364.07	0.0	0.0	0.0	-132.99
		-132.99	0.0	0.0	0.0	575.0	-84.58	0.10	0.0	0.0	0.0	913.99
						1150.0	-84.58	-363.88	0.0	0.0	0.0	-131.87
12	50	650.06	0.0	-0.01	-752.48	0.0	-127.23	323.58	0.0	0.0	0.0	-260.06
		-865.63	0.0	0.0	0.0	575.0	-175.30	-52.66	0.0	0.0	0.0	634.68
						1150.0	-223.37	-428.90	0.0	0.0	0.0	-865.63
12	51	549.54	0.0	-0.02	-727.95	0.0	-130.04	306.30	0.0	0.0	0.0	-190.35
		-853.64	0.0	0.0	0.0	575.0	-178.11	-57.68	0.0	0.0	0.0	524.43
						1150.0	-226.18	-421.65	0.0	0.0	0.0	-853.64
12	52	462.30	0.0	-0.02	-633.08	0.0	-145.05	249.81	0.0	0.0	0.0	-103.09
		-870.50	0.0	0.0	0.0	575.0	-193.12	-66.73	0.0	0.0	0.0	423.25
						1150.0	-241.19	-383.27	0.0	0.0	0.0	-870.50
12	53	554.05	0.0	-5.31e-03	-752.48	0.0	-184.81	360.22	0.0	0.0	0.0	-551.35
		-735.59	0.0	0.0	0.0	575.0	-184.81	-16.02	0.0	0.0	0.0	554.05
						1150.0	-184.81	-392.26	0.0	0.0	0.0	-735.59
12	54	443.81	0.0	-6.85e-03	-727.95	0.0	-187.62	342.93	0.0	0.0	0.0	-481.64
		-723.60	0.0	0.0	0.0	575.0	-187.62	-21.04	0.0	0.0	0.0	443.81
						1150.0	-187.62	-385.02	0.0	0.0	0.0	-723.60
12	55	350.03	0.0	-9.57e-03	-633.08	0.0	-202.62	286.44	0.0	0.0	0.0	-394.39
		-740.46	0.0	0.0	0.0	575.0	-202.62	-30.09	0.0	0.0	0.0	342.62
						1150.0	-202.62	-346.63	0.0	0.0	0.0	-740.46
12	56	988.41	0.0	-3.01e-03	-818.16	0.0	-116.18	409.19	0.0	0.0	0.0	-342.73
		-342.73	0.0	0.0	0.0	575.0	-116.18	0.10	0.0	0.0	0.0	988.41
						1150.0	-116.18	-408.98	0.0	0.0	0.0	-341.53
12	57	848.33	0.0	-2.67e-03	-785.45	0.0	-106.59	392.83	0.0	0.0	0.0	-281.35
		-281.35	0.0	0.0	0.0	575.0	-106.59	0.10	0.0	0.0	0.0	848.33
						1150.0	-106.59	-392.62	0.0	0.0	0.0	-280.16
12	58	948.29	0.0	-2.65e-03	-752.48	0.0	-110.72	376.34	0.0	0.0	0.0	-249.81
		-249.81	0.0	0.0	0.0	575.0	-110.72	0.10	0.0	0.0	0.0	948.29
						1150.0	-110.72	-376.14	0.0	0.0	0.0	-248.66
12	59	843.23	0.0	-2.40e-03	-727.95	0.0	-103.52	364.07	0.0	0.0	0.0	-203.77



		-203.77	0.0	0.0	0.0	575.0	-103.52	0.10	0.0	0.0	0.0	843.23
						1150.0	-103.52	-363.88	0.0	0.0	0.0	-202.63
12	60	733.21	0.0	-0.01	-752.48	0.0	-104.98	323.58	0.0	0.0	0.0	-176.90
		-782.48	0.0	0.0	0.0	575.0	-153.05	-52.66	0.0	0.0	0.0	717.83
						1150.0	-201.12	-428.90	0.0	0.0	0.0	-782.48
12	61	632.70	0.0	-0.02	-727.95	0.0	-107.79	306.30	0.0	0.0	0.0	-107.19
		-770.49	0.0	0.0	0.0	575.0	-155.86	-57.68	0.0	0.0	0.0	607.59
						1150.0	-203.93	-421.65	0.0	0.0	0.0	-770.49
12	62	545.45	0.0	-0.02	-633.08	0.0	-122.79	249.81	0.0	0.0	0.0	-19.93
		-787.35	0.0	0.0	0.0	575.0	-170.86	-66.73	0.0	0.0	0.0	506.40
						1150.0	-218.93	-383.27	0.0	0.0	0.0	-787.35
12	63	665.51	0.0	-5.73e-03	-752.48	0.0	-154.98	360.22	0.0	0.0	0.0	-439.88
		-624.14	0.0	0.0	0.0	575.0	-154.98	-16.02	0.0	0.0	0.0	665.51
						1150.0	-154.98	-392.26	0.0	0.0	0.0	-624.14
12	64	555.27	0.0	-6.86e-03	-727.95	0.0	-157.78	342.93	0.0	0.0	0.0	-370.17
		-612.15	0.0	0.0	0.0	575.0	-157.78	-21.04	0.0	0.0	0.0	555.27
						1150.0	-157.78	-385.02	0.0	0.0	0.0	-612.15
12	65	461.49	0.0	-9.57e-03	-633.08	0.0	-172.79	286.44	0.0	0.0	0.0	-282.91
		-629.01	0.0	0.0	0.0	575.0	-172.79	-30.10	0.0	0.0	0.0	454.08
						1150.0	-172.79	-346.63	0.0	0.0	0.0	-629.01
12	66	641.42	0.0	-9.81e-03	-752.48	0.0	-97.50	362.73	0.0	0.0	0.0	-119.27
		-738.02	0.0	0.0	0.0	575.0	-145.57	-73.22	0.0	0.0	0.0	593.04
						1150.0	-193.64	-389.76	0.0	0.0	0.0	-738.02
12	67	552.80	0.0	-2.68e-03	-752.48	0.0	-147.50	399.36	0.0	0.0	0.0	-382.26
		-579.68	0.0	0.0	0.0	575.0	-147.50	-36.58	0.0	0.0	0.0	540.72
						1150.0	-147.50	-353.12	0.0	0.0	0.0	-579.68
12	68	674.63	0.0	-0.02	-555.45	0.0	-103.82	210.99	0.0	0.0	0.0	213.89
		-553.61	0.0	0.0	0.0	575.0	-151.89	-66.74	0.0	0.0	0.0	628.60
						1150.0	-199.96	-344.46	0.0	0.0	0.0	-553.61
12	69	718.74	0.0	-9.59e-03	-555.45	0.0	-142.04	247.62	0.0	0.0	0.0	84.20
		-261.96	0.0	0.0	0.0	575.0	-142.04	-30.10	0.0	0.0	0.0	709.58
						1150.0	-142.04	-307.83	0.0	0.0	0.0	-261.96
12	70	640.20	0.0	-2.03e-03	-555.45	0.0	-93.78	277.81	0.0	0.0	0.0	-158.73
		-158.73	0.0	0.0	0.0	575.0	-93.78	0.08	0.0	0.0	0.0	640.20
						1150.0	-93.78	-277.64	0.0	0.0	0.0	-157.79
12	71	381.44	0.0	-3.91e-03	-555.45	0.0	-154.43	265.79	0.0	0.0	0.0	-348.42
		-485.63	0.0	0.0	0.0	575.0	-154.43	-11.93	0.0	0.0	0.0	381.44
						1150.0	-154.43	-289.66	0.0	0.0	0.0	-485.63
12	72	564.12	0.0	-1.70e-03	-555.45	0.0	-114.14	277.81	0.0	0.0	0.0	-234.82
		-234.82	0.0	0.0	0.0	575.0	-114.14	0.08	0.0	0.0	0.0	564.12



						1150.0	-114.14	-277.64	0.0	0.0	0.0	-233.86
12	73	457.51	0.0	-4.13e-03	-555.45	0.0	-134.07	265.79	0.0	0.0	0.0	-272.33
		-409.56	0.0	0.0	0.0	575.0	-134.07	-11.93	0.0	0.0	0.0	457.51
						1150.0	-134.07	-289.66	0.0	0.0	0.0	-409.56
12	74	624.14	0.0	-4.12e-03	-555.45	0.0	-119.35	265.79	0.0	0.0	0.0	-105.71
		-242.93	0.0	0.0	0.0	575.0	-119.35	-11.93	0.0	0.0	0.0	624.14
						1150.0	-119.35	-289.66	0.0	0.0	0.0	-242.93
12	75	697.35	0.0	-0.01	-639.51	0.0	-154.30	276.53	0.0	0.0	0.0	9.89
		-487.20	0.0	0.0	0.0	575.0	-179.52	-43.23	0.0	0.0	0.0	680.65
						1150.0	-204.74	-362.98	0.0	0.0	0.0	-487.20
12	76	542.80	0.0	-0.04	-580.67	0.0	-222.16	146.03	0.0	0.0	0.0	331.64
		-1327.86	0.0	0.0	0.0	575.0	-306.23	-144.30	0.0	0.0	0.0	336.60
						1150.0	-390.29	-434.64	0.0	0.0	0.0	-1327.86
12	77	621.28	0.0	-0.01	-639.51	0.0	-174.66	276.53	0.0	0.0	0.0	-66.19
		-563.27	0.0	0.0	0.0	575.0	-199.88	-43.22	0.0	0.0	0.0	604.57
						1150.0	-225.10	-362.98	0.0	0.0	0.0	-563.27
12	78	618.88	0.0	-0.04	-580.67	0.0	-201.80	146.03	0.0	0.0	0.0	407.72
		-1251.79	0.0	0.0	0.0	575.0	-285.86	-144.31	0.0	0.0	0.0	412.68
						1150.0	-369.93	-434.64	0.0	0.0	0.0	-1251.79
12	79	750.19	0.0	-0.04	-530.23	0.0	-189.15	120.80	0.0	0.0	0.0	593.43
		-1066.15	0.0	0.0	0.0	575.0	-273.22	-144.31	0.0	0.0	0.0	525.84
						1150.0	-357.28	-409.43	0.0	0.0	0.0	-1066.15
16	1	0.0	0.0	-4.61e-04	-42.55	0.0	0.0	0.0	0.0	0.0	0.0	0.0
		-11.70	0.0	0.0	0.0	27.5	0.0	-21.27	0.0	0.0	0.0	-2.92
						55.0	0.0	-42.55	0.0	0.0	0.0	-11.70
16	2	0.0	0.0	-4.25e-04	-50.71	0.0	0.0	0.0	0.0	0.0	0.0	0.0
		-13.95	0.0	0.0	0.0	27.5	0.0	-25.36	0.0	0.0	0.0	-3.49
						55.0	0.0	-50.71	0.0	0.0	0.0	-13.95
16	3	0.0	0.0	-4.43e-04	-40.86	0.0	0.0	0.0	0.0	0.0	0.0	0.0
		-11.24	0.0	0.0	0.0	27.5	0.0	-20.43	0.0	0.0	0.0	-2.81
						55.0	0.0	-40.86	0.0	0.0	0.0	-11.24
16	4	0.0	0.0	-4.16e-04	-46.97	0.0	0.0	0.0	0.0	0.0	0.0	0.0
		-12.92	0.0	0.0	0.0	27.5	0.0	-23.49	0.0	0.0	0.0	-3.23
						55.0	0.0	-46.97	0.0	0.0	0.0	-12.92
16	5	0.0	0.0	-1.62e-03	-40.86	0.0	0.0	0.0	0.0	0.0	0.0	0.0
		-11.24	0.0	0.0	0.0	27.5	-3.10	-20.43	0.0	0.0	0.0	-2.81
						55.0	-6.21	-40.86	0.0	0.0	0.0	-11.24
16	6	0.0	0.0	-1.71e-03	-46.97	0.0	0.0	0.0	0.0	0.0	0.0	0.0
		-12.92	0.0	0.0	0.0	27.5	-3.10	-23.49	0.0	0.0	0.0	-3.23
						55.0	-6.21	-46.97	0.0	0.0	0.0	-12.92



16	7	0.0	0.0	-1.85e-03	-40.86	0.0	0.0	0.0	0.0	0.0	0.0	0.0
		-11.24	0.0	0.0	0.0	27.5	-3.10	-20.43	0.0	0.0	0.0	-2.81
						55.0	-6.21	-40.86	0.0	0.0	0.0	-11.24
16	8	0.0	0.0	-8.97e-04	-40.86	0.0	0.0	0.0	0.0	0.0	0.0	0.0
		-11.24	0.0	0.0	0.0	27.5	0.0	-20.43	0.0	0.0	0.0	-2.81
						55.0	0.0	-40.86	0.0	0.0	0.0	-11.24
16	9	0.0	0.0	-9.84e-04	-46.97	0.0	0.0	0.0	0.0	0.0	0.0	0.0
		-12.92	0.0	0.0	0.0	27.5	0.0	-23.49	0.0	0.0	0.0	-3.23
						55.0	0.0	-46.97	0.0	0.0	0.0	-12.92
16	10	0.0	0.0	-1.13e-03	-40.86	0.0	0.0	0.0	0.0	0.0	0.0	0.0
		-11.24	0.0	0.0	0.0	27.5	0.0	-20.43	0.0	0.0	0.0	-2.81
						55.0	0.0	-40.86	0.0	0.0	0.0	-11.24
16	11	0.0	0.0	-3.68e-04	-42.55	0.0	0.0	0.0	0.0	0.0	0.0	0.0
		-11.70	0.0	0.0	0.0	27.5	0.0	-21.27	0.0	0.0	0.0	-2.92
						55.0	0.0	-42.55	0.0	0.0	0.0	-11.70
16	12	0.0	0.0	-3.32e-04	-50.71	0.0	0.0	0.0	0.0	0.0	0.0	0.0
		-13.95	0.0	0.0	0.0	27.5	0.0	-25.36	0.0	0.0	0.0	-3.49
						55.0	0.0	-50.71	0.0	0.0	0.0	-13.95
16	13	0.0	0.0	-3.19e-04	-40.86	0.0	0.0	0.0	0.0	0.0	0.0	0.0
		-11.24	0.0	0.0	0.0	27.5	0.0	-20.43	0.0	0.0	0.0	-2.81
						55.0	0.0	-40.86	0.0	0.0	0.0	-11.24
16	14	0.0	0.0	-2.92e-04	-46.97	0.0	0.0	0.0	0.0	0.0	0.0	0.0
		-12.92	0.0	0.0	0.0	27.5	0.0	-23.49	0.0	0.0	0.0	-3.23
						55.0	0.0	-46.97	0.0	0.0	0.0	-12.92
16	15	0.0	0.0	-1.72e-03	-40.86	0.0	0.0	0.0	0.0	0.0	0.0	0.0
		-11.24	0.0	0.0	0.0	27.5	-3.10	-20.43	0.0	0.0	0.0	-2.81
						55.0	-6.21	-40.86	0.0	0.0	0.0	-11.24
16	16	0.0	0.0	-1.80e-03	-46.97	0.0	0.0	0.0	0.0	0.0	0.0	0.0
		-12.92	0.0	0.0	0.0	27.5	-3.10	-23.49	0.0	0.0	0.0	-3.23
						55.0	-6.21	-46.97	0.0	0.0	0.0	-12.92
16	17	0.0	0.0	-1.95e-03	-40.86	0.0	0.0	0.0	0.0	0.0	0.0	0.0
		-11.24	0.0	0.0	0.0	27.5	-3.10	-20.43	0.0	0.0	0.0	-2.81
						55.0	-6.21	-40.86	0.0	0.0	0.0	-11.24
16	18	0.0	0.0	-1.02e-03	-40.86	0.0	0.0	0.0	0.0	0.0	0.0	0.0
		-11.24	0.0	0.0	0.0	27.5	0.0	-20.43	0.0	0.0	0.0	-2.81
						55.0	0.0	-40.86	0.0	0.0	0.0	-11.24
16	19	0.0	0.0	-1.11e-03	-46.97	0.0	0.0	0.0	0.0	0.0	0.0	0.0
		-12.92	0.0	0.0	0.0	27.5	0.0	-23.49	0.0	0.0	0.0	-3.23
						55.0	0.0	-46.97	0.0	0.0	0.0	-12.92
16	20	0.0	0.0	-1.25e-03	-40.86	0.0	0.0	0.0	0.0	0.0	0.0	0.0



		-11.24	0.0	0.0	0.0	27.5	0.0	-20.43	0.0	0.0	0.0	-2.81
						55.0	0.0	-40.86	0.0	0.0	0.0	-11.24
16	21	0.0	0.0	-1.41e-03	-40.86	0.0	0.0	0.0	0.0	0.0	0.0	0.0
		-11.24	0.0	0.0	0.0	27.5	-3.10	-20.43	0.0	0.0	0.0	-2.81
						55.0	-6.21	-40.86	0.0	0.0	0.0	-11.24
16	22	0.0	0.0	-7.16e-04	-40.86	0.0	0.0	0.0	0.0	0.0	0.0	0.0
		-11.24	0.0	0.0	0.0	27.5	0.0	-20.43	0.0	0.0	0.0	-2.81
						55.0	0.0	-40.86	0.0	0.0	0.0	-11.24
16	23	0.0	0.0	-1.84e-03	-26.57	0.0	0.0	0.0	0.0	0.0	0.0	0.0
		-7.31	0.0	0.0	0.0	27.5	-3.10	-13.28	0.0	0.0	0.0	-1.83
						55.0	-6.21	-26.56	0.0	0.0	0.0	-7.31
16	24	0.0	0.0	-1.15e-03	-26.57	0.0	0.0	0.0	0.0	0.0	0.0	0.0
		-7.31	0.0	0.0	0.0	27.5	0.0	-13.28	0.0	0.0	0.0	-1.83
						55.0	0.0	-26.56	0.0	0.0	0.0	-7.31
16	25	0.0	0.0	-1.76e-03	-40.86	0.0	0.0	0.0	0.0	0.0	0.0	0.0
		-11.24	0.0	0.0	0.0	27.5	-3.10	-20.43	0.0	0.0	0.0	-2.81
						55.0	-6.21	-40.86	0.0	0.0	0.0	-11.24
16	26	0.0	0.0	-1.59e-03	-46.97	0.0	0.0	0.0	0.0	0.0	0.0	0.0
		-12.92	0.0	0.0	0.0	27.5	-3.10	-23.49	0.0	0.0	0.0	-3.23
						55.0	-6.21	-46.97	0.0	0.0	0.0	-12.92
16	27	0.0	0.0	-6.41e-04	-42.55	0.0	0.0	0.0	0.0	0.0	0.0	0.0
		-11.70	0.0	0.0	0.0	27.5	0.0	-21.27	0.0	0.0	0.0	-2.92
						55.0	0.0	-42.55	0.0	0.0	0.0	-11.70
16	28	0.0	0.0	-1.13e-03	-50.71	0.0	0.0	0.0	0.0	0.0	0.0	0.0
		-13.95	0.0	0.0	0.0	27.5	0.0	-25.36	0.0	0.0	0.0	-3.49
						55.0	0.0	-50.71	0.0	0.0	0.0	-13.95
16	29	0.0	0.0	-1.92e-03	-35.86	0.0	0.0	0.0	0.0	0.0	0.0	0.0
		-9.86	0.0	0.0	0.0	27.5	-3.10	-17.93	0.0	0.0	0.0	-2.47
						55.0	-6.21	-35.86	0.0	0.0	0.0	-9.86
16	30	0.0	0.0	-8.91e-04	-31.56	0.0	0.0	0.0	0.0	0.0	0.0	0.0
		-8.68	0.0	0.0	0.0	27.5	-3.10	-15.78	0.0	0.0	0.0	-2.17
						55.0	-6.21	-31.56	0.0	0.0	0.0	-8.68
16	31	0.0	0.0	-8.51e-04	-37.68	0.0	0.0	0.0	0.0	0.0	0.0	0.0
		-10.36	0.0	0.0	0.0	27.5	-3.10	-18.84	0.0	0.0	0.0	-2.59
						55.0	-6.21	-37.67	0.0	0.0	0.0	-10.36
16	32	0.0	0.0	-7.88e-04	-31.56	0.0	0.0	0.0	0.0	0.0	0.0	0.0
		-8.68	0.0	0.0	0.0	27.5	-3.10	-15.78	0.0	0.0	0.0	-2.17
						55.0	-6.21	-31.56	0.0	0.0	0.0	-8.68
16	33	0.0	0.0	-1.77e-03	-35.86	0.0	0.0	0.0	0.0	0.0	0.0	0.0
		-9.86	0.0	0.0	0.0	27.5	-3.10	-17.93	0.0	0.0	0.0	-2.47



						55.0	-6.21	-35.86	0.0	0.0	0.0	-9.86
16	34	0.0	0.0	-2.97e-04	-30.28	0.0	0.0	0.0	0.0	0.0	0.0	0.0
		-8.33	0.0	0.0	0.0	27.5	0.0	-15.14	0.0	0.0	0.0	-2.08
						55.0	0.0	-30.28	0.0	0.0	0.0	-8.33
16	35	0.0	0.0	-4.31e-04	-34.81	0.0	0.0	0.0	0.0	0.0	0.0	0.0
		-9.57	0.0	0.0	0.0	27.5	0.0	-17.41	0.0	0.0	0.0	-2.39
						55.0	0.0	-34.81	0.0	0.0	0.0	-9.57
16	36	0.0	0.0	-4.92e-04	-30.28	0.0	0.0	0.0	0.0	0.0	0.0	0.0
		-8.33	0.0	0.0	0.0	27.5	0.0	-15.14	0.0	0.0	0.0	-2.08
						55.0	0.0	-30.28	0.0	0.0	0.0	-8.33
16	37	0.0	0.0	-5.56e-04	-34.81	0.0	0.0	0.0	0.0	0.0	0.0	0.0
		-9.57	0.0	0.0	0.0	27.5	0.0	-17.41	0.0	0.0	0.0	-2.39
						55.0	0.0	-34.81	0.0	0.0	0.0	-9.57
16	38	0.0	0.0	-6.63e-04	-30.28	0.0	0.0	0.0	0.0	0.0	0.0	0.0
		-8.33	0.0	0.0	0.0	27.5	0.0	-15.14	0.0	0.0	0.0	-2.08
						55.0	0.0	-30.28	0.0	0.0	0.0	-8.33
16	39	0.0	0.0	-2.19e-04	-30.28	0.0	0.0	0.0	0.0	0.0	0.0	0.0
		-8.33	0.0	0.0	0.0	27.5	0.0	-15.14	0.0	0.0	0.0	-2.08
						55.0	0.0	-30.28	0.0	0.0	0.0	-8.33
16	40	0.0	0.0	-1.99e-04	-34.81	0.0	0.0	0.0	0.0	0.0	0.0	0.0
		-9.57	0.0	0.0	0.0	27.5	0.0	-17.41	0.0	0.0	0.0	-2.39
						55.0	0.0	-34.81	0.0	0.0	0.0	-9.57
16	41	0.0	0.0	-5.69e-04	-30.28	0.0	0.0	0.0	0.0	0.0	0.0	0.0
		-8.33	0.0	0.0	0.0	27.5	0.0	-15.14	0.0	0.0	0.0	-2.08
						55.0	0.0	-30.28	0.0	0.0	0.0	-8.33
16	42	0.0	0.0	-6.34e-04	-34.81	0.0	0.0	0.0	0.0	0.0	0.0	0.0
		-9.57	0.0	0.0	0.0	27.5	0.0	-17.41	0.0	0.0	0.0	-2.39
						55.0	0.0	-34.81	0.0	0.0	0.0	-9.57
16	43	0.0	0.0	-7.40e-04	-30.28	0.0	0.0	0.0	0.0	0.0	0.0	0.0
		-8.33	0.0	0.0	0.0	27.5	0.0	-15.14	0.0	0.0	0.0	-2.08
						55.0	0.0	-30.28	0.0	0.0	0.0	-8.33
16	44	0.0	0.0	-6.39e-04	-30.28	0.0	0.0	0.0	0.0	0.0	0.0	0.0
		-8.33	0.0	0.0	0.0	27.5	0.0	-15.14	0.0	0.0	0.0	-2.08
						55.0	0.0	-30.28	0.0	0.0	0.0	-8.33
16	45	0.0	0.0	-7.23e-04	-26.57	0.0	0.0	0.0	0.0	0.0	0.0	0.0
		-7.31	0.0	0.0	0.0	27.5	0.0	-13.28	0.0	0.0	0.0	-1.83
						55.0	0.0	-26.56	0.0	0.0	0.0	-7.31
16	46	0.0	0.0	-3.25e-04	-31.52	0.0	0.0	0.0	0.0	0.0	0.0	0.0
		-8.67	0.0	0.0	0.0	27.5	0.0	-15.76	0.0	0.0	0.0	-2.17
						55.0	0.0	-31.51	0.0	0.0	0.0	-8.67



16	47	0.0	0.0	-2.98e-04	-37.56	0.0	0.0	0.0	0.0	0.0	0.0	0.0
		-10.33	0.0	0.0	0.0	27.5	0.0	-18.78	0.0	0.0	0.0	-2.58
						55.0	0.0	-37.56	0.0	0.0	0.0	-10.33
16	48	0.0	0.0	-3.14e-04	-30.28	0.0	0.0	0.0	0.0	0.0	0.0	0.0
		-8.33	0.0	0.0	0.0	27.5	0.0	-15.14	0.0	0.0	0.0	-2.08
						55.0	0.0	-30.28	0.0	0.0	0.0	-8.33
16	49	0.0	0.0	-2.94e-04	-34.81	0.0	0.0	0.0	0.0	0.0	0.0	0.0
		-9.57	0.0	0.0	0.0	27.5	0.0	-17.41	0.0	0.0	0.0	-2.39
						55.0	0.0	-34.81	0.0	0.0	0.0	-9.57
16	50	0.0	0.0	-1.01e-03	-30.28	0.0	0.0	0.0	0.0	0.0	0.0	0.0
		-8.33	0.0	0.0	0.0	27.5	-2.30	-15.14	0.0	0.0	0.0	-2.08
						55.0	-4.60	-30.28	0.0	0.0	0.0	-8.33
16	51	0.0	0.0	-1.08e-03	-34.81	0.0	0.0	0.0	0.0	0.0	0.0	0.0
		-9.57	0.0	0.0	0.0	27.5	-2.30	-17.41	0.0	0.0	0.0	-2.39
						55.0	-4.60	-34.81	0.0	0.0	0.0	-9.57
16	52	0.0	0.0	-1.19e-03	-30.28	0.0	0.0	0.0	0.0	0.0	0.0	0.0
		-8.33	0.0	0.0	0.0	27.5	-2.30	-15.14	0.0	0.0	0.0	-2.08
						55.0	-4.60	-30.28	0.0	0.0	0.0	-8.33
16	53	0.0	0.0	-4.74e-04	-30.28	0.0	0.0	0.0	0.0	0.0	0.0	0.0
		-8.33	0.0	0.0	0.0	27.5	0.0	-15.14	0.0	0.0	0.0	-2.08
						55.0	0.0	-30.28	0.0	0.0	0.0	-8.33
16	54	0.0	0.0	-5.39e-04	-34.81	0.0	0.0	0.0	0.0	0.0	0.0	0.0
		-9.57	0.0	0.0	0.0	27.5	0.0	-17.41	0.0	0.0	0.0	-2.39
						55.0	0.0	-34.81	0.0	0.0	0.0	-9.57
16	55	0.0	0.0	-6.45e-04	-30.28	0.0	0.0	0.0	0.0	0.0	0.0	0.0
		-8.33	0.0	0.0	0.0	27.5	0.0	-15.14	0.0	0.0	0.0	-2.08
						55.0	0.0	-30.28	0.0	0.0	0.0	-8.33
16	56	0.0	0.0	-2.86e-04	-31.52	0.0	0.0	0.0	0.0	0.0	0.0	0.0
		-8.67	0.0	0.0	0.0	27.5	0.0	-15.76	0.0	0.0	0.0	-2.17
						55.0	0.0	-31.51	0.0	0.0	0.0	-8.67
16	57	0.0	0.0	-2.59e-04	-37.56	0.0	0.0	0.0	0.0	0.0	0.0	0.0
		-10.33	0.0	0.0	0.0	27.5	0.0	-18.78	0.0	0.0	0.0	-2.58
						55.0	0.0	-37.56	0.0	0.0	0.0	-10.33
16	58	0.0	0.0	-2.48e-04	-30.28	0.0	0.0	0.0	0.0	0.0	0.0	0.0
		-8.33	0.0	0.0	0.0	27.5	0.0	-15.14	0.0	0.0	0.0	-2.08
						55.0	0.0	-30.28	0.0	0.0	0.0	-8.33
16	59	0.0	0.0	-2.28e-04	-34.81	0.0	0.0	0.0	0.0	0.0	0.0	0.0
		-9.57	0.0	0.0	0.0	27.5	0.0	-17.41	0.0	0.0	0.0	-2.39
						55.0	0.0	-34.81	0.0	0.0	0.0	-9.57
16	60	0.0	0.0	-1.09e-03	-30.28	0.0	0.0	0.0	0.0	0.0	0.0	0.0



		-8.33	0.0	0.0	0.0	27.5	-2.30	-15.14	0.0	0.0	0.0	-2.08
						55.0	-4.60	-30.28	0.0	0.0	0.0	-8.33
16	61	0.0	0.0	-1.16e-03	-34.81	0.0	0.0	0.0	0.0	0.0	0.0	0.0
		-9.57	0.0	0.0	0.0	27.5	-2.30	-17.41	0.0	0.0	0.0	-2.39
						55.0	-4.60	-34.81	0.0	0.0	0.0	-9.57
16	62	0.0	0.0	-1.26e-03	-30.28	0.0	0.0	0.0	0.0	0.0	0.0	0.0
		-8.33	0.0	0.0	0.0	27.5	-2.30	-15.14	0.0	0.0	0.0	-2.08
						55.0	-4.60	-30.28	0.0	0.0	0.0	-8.33
16	63	0.0	0.0	-5.78e-04	-30.28	0.0	0.0	0.0	0.0	0.0	0.0	0.0
		-8.33	0.0	0.0	0.0	27.5	0.0	-15.14	0.0	0.0	0.0	-2.08
						55.0	0.0	-30.28	0.0	0.0	0.0	-8.33
16	64	0.0	0.0	-6.43e-04	-34.81	0.0	0.0	0.0	0.0	0.0	0.0	0.0
		-9.57	0.0	0.0	0.0	27.5	0.0	-17.41	0.0	0.0	0.0	-2.39
						55.0	0.0	-34.81	0.0	0.0	0.0	-9.57
16	65	0.0	0.0	-7.49e-04	-30.28	0.0	0.0	0.0	0.0	0.0	0.0	0.0
		-8.33	0.0	0.0	0.0	27.5	0.0	-15.14	0.0	0.0	0.0	-2.08
						55.0	0.0	-30.28	0.0	0.0	0.0	-8.33
16	66	0.0	0.0	-8.65e-04	-30.28	0.0	0.0	0.0	0.0	0.0	0.0	0.0
		-8.33	0.0	0.0	0.0	27.5	-2.30	-15.14	0.0	0.0	0.0	-2.08
						55.0	-4.60	-30.28	0.0	0.0	0.0	-8.33
16	67	0.0	0.0	-3.51e-04	-30.28	0.0	0.0	0.0	0.0	0.0	0.0	0.0
		-8.33	0.0	0.0	0.0	27.5	0.0	-15.14	0.0	0.0	0.0	-2.08
						55.0	0.0	-30.28	0.0	0.0	0.0	-8.33
16	68	0.0	0.0	-1.25e-03	-26.57	0.0	0.0	0.0	0.0	0.0	0.0	0.0
		-7.31	0.0	0.0	0.0	27.5	-2.30	-13.28	0.0	0.0	0.0	-1.83
						55.0	-4.60	-26.56	0.0	0.0	0.0	-7.31
16	69	0.0	0.0	-7.40e-04	-26.57	0.0	0.0	0.0	0.0	0.0	0.0	0.0
		-7.31	0.0	0.0	0.0	27.5	0.0	-13.28	0.0	0.0	0.0	-1.83
						55.0	0.0	-26.56	0.0	0.0	0.0	-7.31
16	70	0.0	0.0	-2.07e-04	-26.57	0.0	0.0	0.0	0.0	0.0	0.0	0.0
		-7.31	0.0	0.0	0.0	27.5	0.0	-13.28	0.0	0.0	0.0	-1.83
						55.0	0.0	-26.56	0.0	0.0	0.0	-7.31
16	71	0.0	0.0	-3.41e-04	-26.57	0.0	0.0	0.0	0.0	0.0	0.0	0.0
		-7.31	0.0	0.0	0.0	27.5	0.0	-13.28	0.0	0.0	0.0	-1.83
						55.0	0.0	-26.56	0.0	0.0	0.0	-7.31
16	72	0.0	0.0	-1.36e-04	-26.57	0.0	0.0	0.0	0.0	0.0	0.0	0.0
		-7.31	0.0	0.0	0.0	27.5	0.0	-13.28	0.0	0.0	0.0	-1.83
						55.0	0.0	-26.56	0.0	0.0	0.0	-7.31
16	73	0.0	0.0	-4.12e-04	-26.57	0.0	0.0	0.0	0.0	0.0	0.0	0.0
		-7.31	0.0	0.0	0.0	27.5	0.0	-13.28	0.0	0.0	0.0	-1.83



						55.0	0.0	-26.56	0.0	0.0	0.0	-7.31
16	74	0.0	0.0	-4.22e-04	-26.57	0.0	0.0	0.0	0.0	0.0	0.0	0.0
		-7.31	0.0	0.0	0.0	27.5	0.0	-13.28	0.0	0.0	0.0	-1.83
						55.0	0.0	-26.56	0.0	0.0	0.0	-7.31
16	75	0.0	0.0	-8.91e-04	-30.59	0.0	0.0	0.0	0.0	0.0	0.0	0.0
		-8.41	0.0	0.0	0.0	27.5	-1.21	-15.29	0.0	0.0	0.0	-2.10
						55.0	-2.41	-30.59	0.0	0.0	0.0	-8.41
16	76	0.0	0.0	-2.37e-03	-27.77	0.0	0.0	0.0	0.0	0.0	0.0	0.0
		-7.64	0.0	0.0	0.0	27.5	-4.02	-13.89	0.0	0.0	0.0	-1.91
						55.0	-8.04	-27.77	0.0	0.0	0.0	-7.64
16	77	0.0	0.0	-8.20e-04	-30.59	0.0	0.0	0.0	0.0	0.0	0.0	0.0
		-8.41	0.0	0.0	0.0	27.5	-1.21	-15.29	0.0	0.0	0.0	-2.10
						55.0	-2.41	-30.59	0.0	0.0	0.0	-8.41
16	78	0.0	0.0	-2.44e-03	-27.77	0.0	0.0	0.0	0.0	0.0	0.0	0.0
		-7.64	0.0	0.0	0.0	27.5	-4.02	-13.89	0.0	0.0	0.0	-1.91
						55.0	-8.04	-27.77	0.0	0.0	0.0	-7.64
16	79	0.0	0.0	-2.43e-03	-25.36	0.0	0.0	0.0	0.0	0.0	0.0	0.0
		-6.97	0.0	0.0	0.0	27.5	-4.02	-12.68	0.0	0.0	0.0	-1.74
						55.0	-8.04	-25.36	0.0	0.0	0.0	-6.97

Trave	M3 mx/mn	M2 mx/mn	D 2 / D 3	Q 2 / Q 3	N	V 2	V 3	T
	-1574.55	0.0	-0.04	-1104.52	-437.15	-685.19	0.0	0.0
	1401.82	0.0	0.0	0.0	8.04	631.80	0.0	0.0

Trave f.	Cmb	M3 mx/mn	M2 mx/mn	D 2 / D 3	Pt	Pos.	N	V 2	V 3	T	M 2	M 3
		kN m	kN m	m	kN/ m2	cm	kN	kN	kN	kN m	kN m	kN m
10	1	1192.94	0.0	4.14e-04	-214.27	0.0	-333.91	755.67	0.0	0.0	0.0	751.24
		751.24	0.0	0.0		27.5	-333.91	803.04	0.0	0.0	0.0	965.56
						55.0	-333.91	850.69	0.0	0.0	0.0	1192.94
10	2	1201.90	0.0	4.00e-04	-213.20	0.0	-346.82	751.30	0.0	0.0	0.0	762.77
		762.77	0.0	0.0		27.5	-346.82	798.39	0.0	0.0	0.0	975.84
						55.0	-346.82	845.75	0.0	0.0	0.0	1201.90
10	3	1144.68	0.0	3.84e-04	-206.78	0.0	-350.04	717.39	0.0	0.0	0.0	725.16
		725.16	0.0	0.0		27.5	-350.04	762.73	0.0	0.0	0.0	928.67
						55.0	-350.04	808.34	0.0	0.0	0.0	1144.68
10	4	1151.39	0.0	3.74e-04	-205.98	0.0	-359.70	714.13	0.0	0.0	0.0	733.78
		733.78	0.0	0.0		27.5	-359.70	759.25	0.0	0.0	0.0	936.36
						55.0	-359.70	804.64	0.0	0.0	0.0	1151.39
10	5	491.56	0.0	1.75e-03	-274.05	0.0	-179.62	711.39	0.0	0.0	0.0	65.85
		65.85	0.0	0.0		27.5	-179.62	773.82	0.0	0.0	0.0	270.03



						55.0	-179.62	837.45	0.0	0.0	0.0	491.56
10	6	441.21	0.0	1.86e-03	-279.26	0.0	-179.76	706.90	0.0	0.0	0.0	17.23
		17.23	0.0	0.0		27.5	-179.76	770.65	0.0	0.0	0.0	220.37
						55.0	-179.76	835.67	0.0	0.0	0.0	441.21
10	7	272.44	0.0	2.01e-03	-277.27	0.0	-163.67	645.34	0.0	0.0	0.0	-117.29
		-117.29	0.0	0.0		27.5	-163.67	708.38	0.0	0.0	0.0	68.81
						55.0	-163.67	772.80	0.0	0.0	0.0	272.44
10	8	796.78	0.0	1.05e-03	-239.42	0.0	-234.24	707.79	0.0	0.0	0.0	377.93
		377.93	0.0	0.0		27.5	-234.24	761.42	0.0	0.0	0.0	579.93
						55.0	-234.24	815.76	0.0	0.0	0.0	796.78
10	9	746.43	0.0	1.16e-03	-244.63	0.0	-234.38	703.30	0.0	0.0	0.0	329.32
		329.32	0.0	0.0		27.5	-234.38	758.24	0.0	0.0	0.0	530.27
						55.0	-234.38	813.99	0.0	0.0	0.0	746.43
10	10	577.66	0.0	1.31e-03	-242.64	0.0	-218.29	641.73	0.0	0.0	0.0	194.79
		194.79	0.0	0.0		27.5	-218.29	695.98	0.0	0.0	0.0	378.71
						55.0	-218.29	751.12	0.0	0.0	0.0	577.66
10	11	1078.21	0.0	4.93e-04	-215.63	0.0	-307.29	753.81	0.0	0.0	0.0	637.38
		637.38	0.0	0.0		27.5	-307.29	801.46	0.0	0.0	0.0	851.22
						55.0	-307.29	849.46	0.0	0.0	0.0	1078.21
10	12	1087.18	0.0	4.80e-04	-214.56	0.0	-320.20	749.44	0.0	0.0	0.0	648.90
		648.90	0.0	0.0		27.5	-320.20	796.81	0.0	0.0	0.0	861.50
						55.0	-320.20	844.52	0.0	0.0	0.0	1087.18
10	13	990.90	0.0	4.90e-04	-208.60	0.0	-314.37	714.89	0.0	0.0	0.0	572.53
		572.53	0.0	0.0		27.5	-314.37	760.62	0.0	0.0	0.0	775.40
						55.0	-314.37	806.69	0.0	0.0	0.0	990.90
10	14	997.61	0.0	4.80e-04	-207.80	0.0	-324.02	711.62	0.0	0.0	0.0	581.15
		581.15	0.0	0.0		27.5	-324.02	757.14	0.0	0.0	0.0	783.10
						55.0	-324.02	802.99	0.0	0.0	0.0	997.61
10	15	606.28	0.0	1.67e-03	-272.69	0.0	-206.24	713.26	0.0	0.0	0.0	179.71
		179.71	0.0	0.0		27.5	-206.24	775.40	0.0	0.0	0.0	384.37
						55.0	-206.24	838.68	0.0	0.0	0.0	606.28
10	16	555.93	0.0	1.78e-03	-277.90	0.0	-206.38	708.77	0.0	0.0	0.0	131.10
		131.10	0.0	0.0		27.5	-206.38	772.22	0.0	0.0	0.0	334.71
						55.0	-206.38	836.90	0.0	0.0	0.0	555.93
10	17	387.17	0.0	1.93e-03	-275.91	0.0	-190.29	647.20	0.0	0.0	0.0	-3.43
		-3.43	0.0	0.0		27.5	-190.29	709.95	0.0	0.0	0.0	183.15
						55.0	-190.29	774.03	0.0	0.0	0.0	387.17
10	18	950.56	0.0	9.43e-04	-237.60	0.0	-269.92	710.29	0.0	0.0	0.0	530.56
		530.56	0.0	0.0		27.5	-269.92	763.53	0.0	0.0	0.0	733.20
						55.0	-269.92	817.41	0.0	0.0	0.0	950.56



10	19	900.21	0.0	1.05e-03	-242.81	0.0	-270.06	705.80	0.0	0.0	0.0	481.95
		481.95	0.0	0.0		27.5	-270.06	760.35	0.0	0.0	0.0	683.53
						55.0	-270.06	815.63	0.0	0.0	0.0	900.21
10	20	731.45	0.0	1.20e-03	-240.82	0.0	-253.97	644.23	0.0	0.0	0.0	347.42
		347.42	0.0	0.0		27.5	-253.97	698.09	0.0	0.0	0.0	531.97
						55.0	-253.97	752.77	0.0	0.0	0.0	731.45
10	21	593.27	0.0	1.36e-03	-255.54	0.0	-216.28	683.15	0.0	0.0	0.0	185.70
		185.70	0.0	0.0		27.5	-216.28	740.89	0.0	0.0	0.0	381.48
						55.0	-216.28	799.57	0.0	0.0	0.0	593.27
10	22	937.55	0.0	6.32e-04	-220.45	0.0	-279.96	680.18	0.0	0.0	0.0	536.55
		536.55	0.0	0.0		27.5	-279.96	729.02	0.0	0.0	0.0	730.30
						55.0	-279.96	778.30	0.0	0.0	0.0	937.55
10	23	41.15	0.0	1.83e-03	-218.64	0.0	-202.37	440.79	0.0	0.0	0.0	-228.89
		-228.89	0.0	0.0		27.5	-202.37	490.77	0.0	0.0	0.0	-100.83
						55.0	-202.37	542.02	0.0	0.0	0.0	41.15
10	24	339.45	0.0	1.14e-03	-184.10	0.0	-280.14	437.07	0.0	0.0	0.0	76.32
		76.32	0.0	0.0		27.5	-280.14	478.28	0.0	0.0	0.0	202.17
						55.0	-280.14	520.26	0.0	0.0	0.0	339.45
10	25	461.13	0.0	1.88e-03	-296.37	0.0	-196.98	736.08	0.0	0.0	0.0	18.53
		18.53	0.0	0.0		27.5	-196.98	804.50	0.0	0.0	0.0	230.33
						55.0	-196.98	874.22	0.0	0.0	0.0	461.13
10	26	374.76	0.0	1.70e-03	-284.71	0.0	-187.30	701.09	0.0	0.0	0.0	-46.92
		-46.92	0.0	0.0		27.5	-187.30	766.50	0.0	0.0	0.0	154.84
						55.0	-187.30	833.08	0.0	0.0	0.0	374.76
10	27	935.44	0.0	5.88e-04	-222.71	0.0	-281.29	707.58	0.0	0.0	0.0	519.01
		519.01	0.0	0.0		27.5	-281.29	757.08	0.0	0.0	0.0	720.39
						55.0	-281.29	806.99	0.0	0.0	0.0	935.44
10	28	904.74	0.0	1.11e-03	-250.58	0.0	-271.27	742.23	0.0	0.0	0.0	465.30
		465.30	0.0	0.0		27.5	-271.27	798.86	0.0	0.0	0.0	677.18
						55.0	-271.27	856.25	0.0	0.0	0.0	904.74
10	29	255.32	0.0	1.94e-03	-267.03	0.0	-213.17	596.51	0.0	0.0	0.0	-106.05
		-106.05	0.0	0.0		27.5	-213.17	656.81	0.0	0.0	0.0	66.25
						55.0	-213.17	718.44	0.0	0.0	0.0	255.32
10	30	597.15	0.0	9.21e-04	-217.01	0.0	-421.75	533.44	0.0	0.0	0.0	275.94
		275.94	0.0	0.0		27.5	-421.75	583.92	0.0	0.0	0.0	429.56
						55.0	-421.75	635.04	0.0	0.0	0.0	597.15
10	31	620.68	0.0	8.99e-04	-216.01	0.0	-458.93	530.45	0.0	0.0	0.0	301.25
		301.25	0.0	0.0		27.5	-458.93	580.68	0.0	0.0	0.0	454.02
						55.0	-458.93	631.53	0.0	0.0	0.0	620.68
10	32	558.87	0.0	8.42e-04	-203.97	0.0	-472.93	470.00	0.0	0.0	0.0	274.48



		274.48	0.0	0.0		27.5	-472.93	516.97	0.0	0.0	0.0	410.18
						55.0	-472.93	564.53	0.0	0.0	0.0	558.87
10	33	194.06	0.0	1.78e-03	-272.42	0.0	-203.35	590.79	0.0	0.0	0.0	-165.05
		-165.05	0.0	0.0		27.5	-203.35	652.74	0.0	0.0	0.0	5.90
						55.0	-203.35	715.90	0.0	0.0	0.0	194.06
10	34	891.24	0.0	2.55e-04	-152.70	0.0	-326.09	532.36	0.0	0.0	0.0	580.01
		580.01	0.0	0.0		27.5	-326.09	565.85	0.0	0.0	0.0	731.01
						55.0	-326.09	599.51	0.0	0.0	0.0	891.24
10	35	819.20	0.0	4.09e-04	-160.23	0.0	-320.41	528.30	0.0	0.0	0.0	509.15
		509.15	0.0	0.0		27.5	-320.41	563.69	0.0	0.0	0.0	659.29
						55.0	-320.41	599.37	0.0	0.0	0.0	819.20
10	36	707.90	0.0	5.82e-04	-168.31	0.0	-264.21	527.79	0.0	0.0	0.0	396.99
		396.99	0.0	0.0		27.5	-264.21	565.23	0.0	0.0	0.0	547.27
						55.0	-264.21	603.07	0.0	0.0	0.0	707.90
10	37	670.51	0.0	6.64e-04	-172.18	0.0	-264.31	524.46	0.0	0.0	0.0	360.89
		360.89	0.0	0.0		27.5	-264.31	562.88	0.0	0.0	0.0	510.39
						55.0	-264.31	601.75	0.0	0.0	0.0	670.51
10	38	545.19	0.0	7.76e-04	-170.70	0.0	-252.36	478.74	0.0	0.0	0.0	260.99
		260.99	0.0	0.0		27.5	-252.36	516.64	0.0	0.0	0.0	397.85
						55.0	-252.36	555.07	0.0	0.0	0.0	545.19
10	39	795.63	0.0	3.21e-04	-153.84	0.0	-303.91	530.81	0.0	0.0	0.0	485.12
		485.12	0.0	0.0		27.5	-303.91	564.54	0.0	0.0	0.0	635.72
						55.0	-303.91	598.48	0.0	0.0	0.0	795.63
10	40	800.62	0.0	3.14e-04	-153.24	0.0	-311.09	528.38	0.0	0.0	0.0	491.52
		491.52	0.0	0.0		27.5	-311.09	561.95	0.0	0.0	0.0	641.44
						55.0	-311.09	595.74	0.0	0.0	0.0	800.62
10	41	803.51	0.0	5.16e-04	-167.18	0.0	-286.39	529.35	0.0	0.0	0.0	491.88
		491.88	0.0	0.0		27.5	-286.39	566.54	0.0	0.0	0.0	642.55
						55.0	-286.39	604.10	0.0	0.0	0.0	803.51
10	42	766.12	0.0	5.98e-04	-171.05	0.0	-286.49	526.01	0.0	0.0	0.0	455.78
		455.78	0.0	0.0		27.5	-286.49	564.19	0.0	0.0	0.0	605.67
						55.0	-286.49	602.78	0.0	0.0	0.0	766.12
10	43	640.80	0.0	7.10e-04	-169.57	0.0	-274.54	480.30	0.0	0.0	0.0	355.88
		355.88	0.0	0.0		27.5	-274.54	517.95	0.0	0.0	0.0	493.13
						55.0	-274.54	556.09	0.0	0.0	0.0	640.80
10	44	648.60	0.0	5.94e-04	-169.89	0.0	-267.45	504.71	0.0	0.0	0.0	350.15
		350.15	0.0	0.0		27.5	-267.45	542.57	0.0	0.0	0.0	494.14
						55.0	-267.45	580.84	0.0	0.0	0.0	648.60
10	45	536.63	0.0	7.21e-04	-163.05	0.0	-293.45	442.55	0.0	0.0	0.0	273.46
		273.46	0.0	0.0		27.5	-293.45	478.40	0.0	0.0	0.0	400.08



						55.0	-293.45	514.74	0.0	0.0	0.0	536.63
10	46	924.18	0.0	2.79e-04	-158.24	0.0	-322.74	560.46	0.0	0.0	0.0	596.66
		596.66	0.0	0.0		27.5	-322.74	595.45	0.0	0.0	0.0	755.59
						55.0	-322.74	630.62	0.0	0.0	0.0	924.18
10	47	930.82	0.0	2.69e-04	-157.45	0.0	-332.30	557.23	0.0	0.0	0.0	605.20
		605.20	0.0	0.0		27.5	-332.30	592.00	0.0	0.0	0.0	763.21
						55.0	-332.30	626.97	0.0	0.0	0.0	930.82
10	48	888.35	0.0	2.57e-04	-152.74	0.0	-335.74	532.31	0.0	0.0	0.0	577.14
		577.14	0.0	0.0		27.5	-335.74	565.81	0.0	0.0	0.0	728.13
						55.0	-335.74	599.48	0.0	0.0	0.0	888.35
10	49	893.33	0.0	2.50e-04	-152.14	0.0	-342.91	529.89	0.0	0.0	0.0	583.55
		583.55	0.0	0.0		27.5	-342.91	563.22	0.0	0.0	0.0	733.84
						55.0	-342.91	596.73	0.0	0.0	0.0	893.33
10	50	484.38	0.0	1.10e-03	-193.93	0.0	-215.17	530.50	0.0	0.0	0.0	168.36
		168.36	0.0	0.0		27.5	-215.17	574.46	0.0	0.0	0.0	320.27
						55.0	-215.17	619.16	0.0	0.0	0.0	484.38
10	51	446.99	0.0	1.18e-03	-197.80	0.0	-215.28	527.17	0.0	0.0	0.0	132.26
		132.26	0.0	0.0		27.5	-215.28	572.10	0.0	0.0	0.0	283.39
						55.0	-215.28	617.84	0.0	0.0	0.0	446.99
10	52	321.67	0.0	1.29e-03	-196.32	0.0	-203.33	481.45	0.0	0.0	0.0	32.36
		32.36	0.0	0.0		27.5	-203.33	525.86	0.0	0.0	0.0	170.85
						55.0	-203.33	571.16	0.0	0.0	0.0	321.67
10	53	710.79	0.0	5.80e-04	-168.27	0.0	-254.56	527.84	0.0	0.0	0.0	399.85
		399.85	0.0	0.0		27.5	-254.56	565.27	0.0	0.0	0.0	550.15
						55.0	-254.56	603.10	0.0	0.0	0.0	710.79
10	54	673.40	0.0	6.62e-04	-172.15	0.0	-254.66	524.50	0.0	0.0	0.0	363.76
		363.76	0.0	0.0		27.5	-254.66	562.92	0.0	0.0	0.0	513.26
						55.0	-254.66	601.78	0.0	0.0	0.0	673.40
10	55	548.08	0.0	7.74e-04	-170.67	0.0	-242.72	478.79	0.0	0.0	0.0	263.86
		263.86	0.0	0.0		27.5	-242.72	516.68	0.0	0.0	0.0	400.72
						55.0	-242.72	555.10	0.0	0.0	0.0	548.08
10	56	875.36	0.0	3.12e-04	-158.82	0.0	-311.42	559.67	0.0	0.0	0.0	548.21
		548.21	0.0	0.0		27.5	-311.42	594.78	0.0	0.0	0.0	706.94
						55.0	-311.42	630.10	0.0	0.0	0.0	875.36
10	57	882.00	0.0	3.02e-04	-158.03	0.0	-320.98	556.43	0.0	0.0	0.0	556.74
		556.74	0.0	0.0		27.5	-320.98	591.33	0.0	0.0	0.0	714.56
						55.0	-320.98	626.44	0.0	0.0	0.0	882.00
10	58	806.99	0.0	3.13e-04	-153.70	0.0	-316.86	530.99	0.0	0.0	0.0	496.39
		496.39	0.0	0.0		27.5	-316.86	564.69	0.0	0.0	0.0	647.04
						55.0	-316.86	598.61	0.0	0.0	0.0	806.99

10	59	811.97	0.0	3.06e-04	-153.11	0.0	-324.04	528.56	0.0	0.0	0.0	502.79
		502.79	0.0	0.0		27.5	-324.04	562.11	0.0	0.0	0.0	652.75
						55.0	-324.04	595.86	0.0	0.0	0.0	811.97
10	60	579.98	0.0	1.03e-03	-192.80	0.0	-237.35	532.06	0.0	0.0	0.0	263.24
		263.24	0.0	0.0		27.5	-237.35	575.77	0.0	0.0	0.0	415.55
						55.0	-237.35	620.19	0.0	0.0	0.0	579.98
10	61	542.59	0.0	1.11e-03	-196.67	0.0	-237.46	528.72	0.0	0.0	0.0	227.15
		227.15	0.0	0.0		27.5	-237.46	573.41	0.0	0.0	0.0	378.67
						55.0	-237.46	618.87	0.0	0.0	0.0	542.59
10	62	417.27	0.0	1.23e-03	-195.19	0.0	-225.51	483.01	0.0	0.0	0.0	127.25
		127.25	0.0	0.0		27.5	-225.51	527.17	0.0	0.0	0.0	266.13
						55.0	-225.51	572.18	0.0	0.0	0.0	417.27
10	63	838.94	0.0	4.92e-04	-166.76	0.0	-284.29	529.93	0.0	0.0	0.0	527.04
		527.04	0.0	0.0		27.5	-284.29	567.03	0.0	0.0	0.0	677.87
						55.0	-284.29	604.48	0.0	0.0	0.0	838.94
10	64	801.55	0.0	5.73e-04	-170.63	0.0	-284.39	526.59	0.0	0.0	0.0	490.94
		490.94	0.0	0.0		27.5	-284.39	564.67	0.0	0.0	0.0	640.98
						55.0	-284.39	603.16	0.0	0.0	0.0	801.55
10	65	676.23	0.0	6.85e-04	-169.15	0.0	-272.45	480.87	0.0	0.0	0.0	391.05
		391.05	0.0	0.0		27.5	-272.45	518.44	0.0	0.0	0.0	528.44
						55.0	-272.45	556.47	0.0	0.0	0.0	676.23
10	66	570.32	0.0	8.00e-04	-180.06	0.0	-244.81	509.70	0.0	0.0	0.0	267.69
		267.69	0.0	0.0		27.5	-244.81	550.15	0.0	0.0	0.0	413.41
						55.0	-244.81	591.14	0.0	0.0	0.0	570.32
10	67	829.28	0.0	2.61e-04	-154.03	0.0	-291.75	507.57	0.0	0.0	0.0	531.49
		531.49	0.0	0.0		27.5	-291.75	541.41	0.0	0.0	0.0	675.72
						55.0	-291.75	575.43	0.0	0.0	0.0	829.28
10	68	313.10	0.0	1.24e-03	-188.67	0.0	-244.42	445.26	0.0	0.0	0.0	44.83
		44.83	0.0	0.0		27.5	-244.42	487.62	0.0	0.0	0.0	173.09
						55.0	-244.42	530.83	0.0	0.0	0.0	313.10
10	69	533.74	0.0	7.23e-04	-163.08	0.0	-303.10	442.50	0.0	0.0	0.0	270.60
		270.60	0.0	0.0		27.5	-303.10	478.36	0.0	0.0	0.0	397.21
						55.0	-303.10	514.71	0.0	0.0	0.0	533.74
10	70	793.16	0.0	1.84e-04	-136.09	0.0	-333.74	448.07	0.0	0.0	0.0	530.76
		530.76	0.0	0.0		27.5	-333.74	477.06	0.0	0.0	0.0	657.97
						55.0	-333.74	506.17	0.0	0.0	0.0	793.16
10	71	643.02	0.0	4.39e-04	-148.06	0.0	-282.46	444.20	0.0	0.0	0.0	381.08
		381.08	0.0	0.0		27.5	-282.46	476.22	0.0	0.0	0.0	507.63
						55.0	-282.46	508.54	0.0	0.0	0.0	643.02
10	72	705.69	0.0	2.44e-04	-137.13	0.0	-313.45	446.64	0.0	0.0	0.0	443.95



		443.95	0.0	0.0		27.5	-313.45	475.85	0.0	0.0	0.0	570.79
						55.0	-313.45	505.23	0.0	0.0	0.0	705.69
10	73	730.49	0.0	3.79e-04	-147.02	0.0	-302.75	445.62	0.0	0.0	0.0	467.89
		467.89	0.0	0.0		27.5	-302.75	477.42	0.0	0.0	0.0	594.80
						55.0	-302.75	509.47	0.0	0.0	0.0	730.49
10	74	682.59	0.0	4.12e-04	-147.59	0.0	-317.43	444.84	0.0	0.0	0.0	420.35
		420.35	0.0	0.0		27.5	-317.43	476.76	0.0	0.0	0.0	547.06
						55.0	-317.43	508.96	0.0	0.0	0.0	682.59
10	75	602.16	0.0	8.89e-04	-182.15	0.0	-345.52	509.36	0.0	0.0	0.0	299.45
		299.45	0.0	0.0		27.5	-345.52	550.29	0.0	0.0	0.0	445.13
						55.0	-345.52	591.83	0.0	0.0	0.0	602.16
10	76	-242.60	0.0	2.50e-03	-254.25	0.0	-148.84	459.81	0.0	0.0	0.0	-528.16
		-528.16	0.0	0.0		27.5	-148.84	518.90	0.0	0.0	0.0	-393.62
						55.0	-148.84	579.71	0.0	0.0	0.0	-242.60
10	77	514.69	0.0	9.49e-04	-183.19	0.0	-325.23	507.93	0.0	0.0	0.0	212.63
		212.63	0.0	0.0		27.5	-325.23	549.08	0.0	0.0	0.0	357.96
						55.0	-325.23	590.89	0.0	0.0	0.0	514.69
10	78	-155.13	0.0	2.44e-03	-253.22	0.0	-169.13	461.23	0.0	0.0	0.0	-441.34
		-441.34	0.0	0.0		27.5	-169.13	520.10	0.0	0.0	0.0	-306.45
						55.0	-169.13	580.65	0.0	0.0	0.0	-155.13
10	79	-254.71	0.0	2.44e-03	-246.47	0.0	-181.73	422.72	0.0	0.0	0.0	-518.71
		-518.71	0.0	0.0		27.5	-181.73	479.72	0.0	0.0	0.0	-394.67
						55.0	-181.73	538.41	0.0	0.0	0.0	-254.71
11	1	1191.27	0.0	-4.75e-04	-217.59	0.0	-333.95	-856.86	0.0	0.0	0.0	1191.27
		746.67	0.0	0.0		27.5	-333.95	-808.32	0.0	0.0	0.0	962.32
						55.0	-333.95	-760.10	0.0	0.0	0.0	746.67
11	2	1200.23	0.0	4.60e-04	-216.50	0.0	-346.86	-851.76	0.0	0.0	0.0	1200.23
		758.27	0.0	0.0		27.5	-346.86	-803.51	0.0	0.0	0.0	972.63
						55.0	-346.86	-755.58	0.0	0.0	0.0	758.27
11	3	1143.17	0.0	-4.42e-04	-209.95	0.0	-350.09	-814.22	0.0	0.0	0.0	1143.17
		720.87	0.0	0.0		27.5	-350.09	-767.77	0.0	0.0	0.0	925.65
						55.0	-350.09	-721.62	0.0	0.0	0.0	720.87
11	4	1149.86	0.0	-4.32e-04	-209.13	0.0	-359.75	-810.41	0.0	0.0	0.0	1149.86
		729.54	0.0	0.0		27.5	-359.75	-764.17	0.0	0.0	0.0	933.37
						55.0	-359.75	-718.24	0.0	0.0	0.0	729.54
11	5	1826.92	0.0	-9.47e-04	-146.41	0.0	-626.74	-782.21	0.0	0.0	0.0	1826.92
		1412.25	0.0	0.0		27.5	-626.74	-754.05	0.0	0.0	0.0	1615.67
						55.0	-626.74	-725.23	0.0	0.0	0.0	1412.25
11	6	1907.15	0.0	-1.09e-03	-140.03	0.0	-673.55	-776.34	0.0	0.0	0.0	1907.15
		1494.67	0.0	0.0		27.5	-673.55	-750.08	0.0	0.0	0.0	1697.25



						55.0	-673.55	-723.07	0.0	0.0	0.0	1494.67
11	7	1936.90	0.0	-1.35e-03	-119.09	0.0	-705.85	-704.13	0.0	0.0	0.0	1936.90
		1560.84	0.0	0.0		27.5	-705.85	-683.90	0.0	0.0	0.0	1746.02
						55.0	-705.85	-662.74	0.0	0.0	0.0	1560.84
11	8	1530.57	0.0	-2.53e-04	-177.79	0.0	-548.88	-805.67	0.0	0.0	0.0	1530.57
		1108.10	0.0	0.0		27.5	-548.88	-768.17	0.0	0.0	0.0	1314.16
						55.0	-548.88	-730.49	0.0	0.0	0.0	1108.10
11	9	1610.80	0.0	-3.95e-04	-171.41	0.0	-595.70	-799.80	0.0	0.0	0.0	1610.80
		1190.51	0.0	0.0		27.5	-595.70	-764.20	0.0	0.0	0.0	1395.74
						55.0	-595.70	-728.33	0.0	0.0	0.0	1190.51
11	10	1640.55	0.0	-6.55e-04	-150.47	0.0	-627.99	-727.60	0.0	0.0	0.0	1640.55
		1256.68	0.0	0.0		27.5	-627.99	-698.02	0.0	0.0	0.0	1444.52
						55.0	-627.99	-667.99	0.0	0.0	0.0	1256.68
11	11	1076.51	0.0	-5.54e-04	-218.98	0.0	-307.33	-855.70	0.0	0.0	0.0	1076.51
		632.73	0.0	0.0		27.5	-307.33	-806.81	0.0	0.0	0.0	847.92
						55.0	-307.33	-758.29	0.0	0.0	0.0	632.73
11	12	1085.47	0.0	5.40e-04	-217.89	0.0	-320.24	-850.60	0.0	0.0	0.0	1085.47
		644.33	0.0	0.0		27.5	-320.24	-802.00	0.0	0.0	0.0	858.24
						55.0	-320.24	-753.77	0.0	0.0	0.0	644.33
11	13	989.33	0.0	-5.49e-04	-211.82	0.0	-314.40	-812.67	0.0	0.0	0.0	989.33
		568.14	0.0	0.0		27.5	-314.40	-765.74	0.0	0.0	0.0	772.31
						55.0	-314.40	-719.18	0.0	0.0	0.0	568.14
11	14	996.03	0.0	-5.38e-04	-211.00	0.0	-324.06	-808.85	0.0	0.0	0.0	996.03
		576.82	0.0	0.0		27.5	-324.06	-762.14	0.0	0.0	0.0	780.03
						55.0	-324.06	-715.80	0.0	0.0	0.0	576.82
11	15	1941.68	0.0	-1.03e-03	-145.41	0.0	-653.36	-783.37	0.0	0.0	0.0	1941.68
		1526.19	0.0	0.0		27.5	-653.36	-755.56	0.0	0.0	0.0	1730.06
						55.0	-653.36	-727.05	0.0	0.0	0.0	1526.19
11	16	2021.91	0.0	-1.17e-03	-139.03	0.0	-700.17	-777.50	0.0	0.0	0.0	2021.91
		1608.61	0.0	0.0		27.5	-700.17	-751.59	0.0	0.0	0.0	1811.64
						55.0	-700.17	-724.89	0.0	0.0	0.0	1608.61
11	17	2051.66	0.0	-1.43e-03	-118.10	0.0	-732.47	-705.29	0.0	0.0	0.0	2051.66
		1674.77	0.0	0.0		27.5	-732.47	-685.41	0.0	0.0	0.0	1860.41
						55.0	-732.47	-664.55	0.0	0.0	0.0	1674.77
11	18	1684.40	0.0	-3.60e-04	-176.45	0.0	-584.57	-807.23	0.0	0.0	0.0	1684.40
		1260.82	0.0	0.0		27.5	-584.57	-770.20	0.0	0.0	0.0	1467.50
						55.0	-584.57	-732.92	0.0	0.0	0.0	1260.82
11	19	1764.63	0.0	-5.02e-04	-170.08	0.0	-631.38	-801.36	0.0	0.0	0.0	1764.63
		1343.23	0.0	0.0		27.5	-631.38	-766.23	0.0	0.0	0.0	1549.08
						55.0	-631.38	-730.76	0.0	0.0	0.0	1343.23



11	20	1794.38	0.0	-7.62e-04	-149.14	0.0	-663.68	-729.15	0.0	0.0	0.0	1794.38
		1409.40	0.0	0.0		27.5	-663.68	-700.05	0.0	0.0	0.0	1597.85
						55.0	-663.68	-670.42	0.0	0.0	0.0	1409.40
11	21	1978.63	0.0	-7.30e-04	-160.95	0.0	-663.40	-823.49	0.0	0.0	0.0	1978.63
		1543.57	0.0	0.0		27.5	-663.40	-791.11	0.0	0.0	0.0	1756.61
						55.0	-663.40	-758.22	0.0	0.0	0.0	1543.57
11	22	1721.35	0.0	-6.34e-05	-191.99	0.0	-594.61	-847.35	0.0	0.0	0.0	1721.35
		1278.20	0.0	0.0		27.5	-594.61	-805.74	0.0	0.0	0.0	1494.05
						55.0	-594.61	-764.09	0.0	0.0	0.0	1278.20
11	23	1706.09	0.0	-1.54e-03	-60.51	0.0	-744.55	-471.58	0.0	0.0	0.0	1706.09
		1450.56	0.0	0.0		27.5	-744.55	-464.77	0.0	0.0	0.0	1577.31
						55.0	-744.55	-456.90	0.0	0.0	0.0	1450.56
11	24	1402.81	0.0	-8.45e-04	-91.95	0.0	-689.85	-494.98	0.0	0.0	0.0	1402.81
		1139.52	0.0	0.0		27.5	-689.85	-478.80	0.0	0.0	0.0	1268.90
						55.0	-689.85	-462.04	0.0	0.0	0.0	1139.52
11	25	1736.99	0.0	-1.15e-03	-152.16	0.0	-644.10	-725.42	0.0	0.0	0.0	1736.99
		1354.32	0.0	0.0		27.5	-644.10	-695.89	0.0	0.0	0.0	1541.54
						55.0	-644.10	-665.56	0.0	0.0	0.0	1354.32
11	26	1831.17	0.0	-9.79e-04	-161.52	0.0	-681.10	-759.54	0.0	0.0	0.0	1831.17
		1431.25	0.0	0.0		27.5	-681.10	-727.25	0.0	0.0	0.0	1626.72
						55.0	-681.10	-694.30	0.0	0.0	0.0	1431.25
11	27	1735.90	0.0	-1.01e-04	-205.60	0.0	-595.94	-903.04	0.0	0.0	0.0	1735.90
		1264.18	0.0	0.0		27.5	-595.94	-857.66	0.0	0.0	0.0	1493.81
						55.0	-595.94	-812.35	0.0	0.0	0.0	1264.18
11	28	1769.00	0.0	-4.41e-04	-177.69	0.0	-632.58	-842.25	0.0	0.0	0.0	1769.00
		1326.29	0.0	0.0		27.5	-632.58	-804.97	0.0	0.0	0.0	1542.50
						55.0	-632.58	-767.38	0.0	0.0	0.0	1326.29
11	29	1919.97	0.0	-1.42e-03	-109.01	0.0	-755.35	-649.36	0.0	0.0	0.0	1919.97
		1572.48	0.0	0.0		27.5	-755.35	-631.97	0.0	0.0	0.0	1743.77
						55.0	-755.35	-613.61	0.0	0.0	0.0	1572.48
11	30	1200.84	0.0	5.23e-04	-146.58	0.0	-554.29	-601.21	0.0	0.0	0.0	1200.84
		887.55	0.0	0.0		27.5	-554.29	-569.68	0.0	0.0	0.0	1039.83
						55.0	-554.29	-537.79	0.0	0.0	0.0	887.55
11	31	1224.37	0.0	5.45e-04	-145.67	0.0	-591.48	-597.61	0.0	0.0	0.0	1224.37
		912.91	0.0	0.0		27.5	-591.48	-566.35	0.0	0.0	0.0	1064.32
						55.0	-591.48	-534.72	0.0	0.0	0.0	912.91
11	32	1162.80	0.0	-6.07e-04	-133.70	0.0	-605.48	-530.17	0.0	0.0	0.0	1162.80
		886.59	0.0	0.0		27.5	-605.48	-502.27	0.0	0.0	0.0	1020.83
						55.0	-605.48	-473.95	0.0	0.0	0.0	886.59
11	33	1849.20	0.0	-1.32e-03	-130.46	0.0	-745.53	-632.61	0.0	0.0	0.0	1849.20



		1514.21	0.0	0.0		27.5	-745.53	-609.21	0.0	0.0	0.0	1678.42
						55.0	-745.53	-584.92	0.0	0.0	0.0	1514.21
11	34	890.11	0.0	2.98e-04	-155.04	0.0	-326.13	-603.81	0.0	0.0	0.0	890.11
		576.85	0.0	0.0		27.5	-326.13	-569.52	0.0	0.0	0.0	728.78
						55.0	-326.13	-535.44	0.0	0.0	0.0	576.85
11	35	994.34	0.0	1.12e-04	-145.96	0.0	-383.46	-598.19	0.0	0.0	0.0	994.34
		682.85	0.0	0.0		27.5	-383.46	-566.34	0.0	0.0	0.0	834.22
						55.0	-383.46	-534.55	0.0	0.0	0.0	682.85
11	36	1048.71	0.0	-1.35e-05	-139.66	0.0	-402.13	-599.26	0.0	0.0	0.0	1048.71
		735.69	0.0	0.0		27.5	-402.13	-569.12	0.0	0.0	0.0	888.06
						55.0	-402.13	-538.96	0.0	0.0	0.0	735.69
11	37	1108.28	0.0	-1.19e-04	-134.91	0.0	-436.89	-594.91	0.0	0.0	0.0	1108.28
		796.90	0.0	0.0		27.5	-436.89	-566.17	0.0	0.0	0.0	948.63
						55.0	-436.89	-537.36	0.0	0.0	0.0	796.90
11	38	1130.38	0.0	-3.12e-04	-119.37	0.0	-460.88	-541.29	0.0	0.0	0.0	1130.38
		846.03	0.0	0.0		27.5	-460.88	-517.03	0.0	0.0	0.0	984.85
						55.0	-460.88	-492.55	0.0	0.0	0.0	846.03
11	39	794.48	0.0	3.64e-04	-156.20	0.0	-303.95	-602.85	0.0	0.0	0.0	794.48
		481.91	0.0	0.0		27.5	-303.95	-568.26	0.0	0.0	0.0	633.45
						55.0	-303.95	-533.93	0.0	0.0	0.0	481.91
11	40	799.45	0.0	3.56e-04	-155.59	0.0	-311.12	-600.01	0.0	0.0	0.0	799.45
		488.35	0.0	0.0		27.5	-311.12	-565.59	0.0	0.0	0.0	639.18
						55.0	-311.12	-531.42	0.0	0.0	0.0	488.35
11	41	1144.34	0.0	-8.00e-05	-138.82	0.0	-424.31	-600.23	0.0	0.0	0.0	1144.34
		830.64	0.0	0.0		27.5	-424.31	-570.38	0.0	0.0	0.0	983.38
						55.0	-424.31	-540.47	0.0	0.0	0.0	830.64
11	42	1203.92	0.0	-1.86e-04	-134.08	0.0	-459.08	-595.87	0.0	0.0	0.0	1203.92
		891.84	0.0	0.0		27.5	-459.08	-567.43	0.0	0.0	0.0	1043.96
						55.0	-459.08	-538.87	0.0	0.0	0.0	891.84
11	43	1226.01	0.0	-3.79e-04	-118.54	0.0	-483.06	-542.26	0.0	0.0	0.0	1226.01
		940.98	0.0	0.0		27.5	-483.06	-518.29	0.0	0.0	0.0	1080.18
						55.0	-483.06	-494.06	0.0	0.0	0.0	940.98
11	44	1350.03	0.0	-1.93e-04	-136.03	0.0	-504.32	-623.76	0.0	0.0	0.0	1350.03
		1022.90	0.0	0.0		27.5	-504.32	-594.79	0.0	0.0	0.0	1182.47
						55.0	-504.32	-565.69	0.0	0.0	0.0	1022.90
11	45	1121.96	0.0	-3.70e-04	-111.84	0.0	-501.97	-500.66	0.0	0.0	0.0	1121.96
		858.80	0.0	0.0		27.5	-501.97	-478.52	0.0	0.0	0.0	987.32
						55.0	-501.97	-456.14	0.0	0.0	0.0	858.80
11	46	922.94	0.0	3.23e-04	-160.68	0.0	-322.78	-635.14	0.0	0.0	0.0	922.94
		593.30	0.0	0.0		27.5	-322.78	-599.31	0.0	0.0	0.0	753.21



						55.0	-322.78	-563.70	0.0	0.0	0.0	593.30
11	47	929.57	0.0	3.13e-04	-159.88	0.0	-332.35	-631.36	0.0	0.0	0.0	929.57
		601.89	0.0	0.0		27.5	-332.35	-595.75	0.0	0.0	0.0	760.85
						55.0	-332.35	-560.35	0.0	0.0	0.0	601.89
11	48	887.22	0.0	3.00e-04	-155.07	0.0	-335.78	-603.78	0.0	0.0	0.0	887.22
		573.99	0.0	0.0		27.5	-335.78	-569.49	0.0	0.0	0.0	725.90
						55.0	-335.78	-535.39	0.0	0.0	0.0	573.99
11	49	892.20	0.0	2.92e-04	-154.47	0.0	-342.95	-600.95	0.0	0.0	0.0	892.20
		580.43	0.0	0.0		27.5	-342.95	-566.82	0.0	0.0	0.0	731.64
						55.0	-342.95	-532.88	0.0	0.0	0.0	580.43
11	50	1270.79	0.0	-5.30e-04	-116.38	0.0	-451.23	-581.91	0.0	0.0	0.0	1270.79
		963.54	0.0	0.0		27.5	-451.23	-558.69	0.0	0.0	0.0	1113.95
						55.0	-451.23	-535.11	0.0	0.0	0.0	963.54
11	51	1330.36	0.0	-6.35e-04	-111.64	0.0	-485.99	-577.55	0.0	0.0	0.0	1330.36
		1024.74	0.0	0.0		27.5	-485.99	-555.75	0.0	0.0	0.0	1174.53
						55.0	-485.99	-533.50	0.0	0.0	0.0	1024.74
11	52	1352.46	0.0	-8.28e-04	-96.10	0.0	-509.97	-523.93	0.0	0.0	0.0	1352.46
		1073.88	0.0	0.0		27.5	-509.97	-506.60	0.0	0.0	0.0	1210.75
						55.0	-509.97	-488.70	0.0	0.0	0.0	1073.88
11	53	1051.60	0.0	-1.55e-05	-139.63	0.0	-392.48	-599.29	0.0	0.0	0.0	1051.60
		738.56	0.0	0.0		27.5	-392.48	-569.16	0.0	0.0	0.0	890.93
						55.0	-392.48	-539.01	0.0	0.0	0.0	738.56
11	54	1111.17	0.0	-1.21e-04	-134.89	0.0	-427.25	-594.94	0.0	0.0	0.0	1111.17
		799.76	0.0	0.0		27.5	-427.25	-566.21	0.0	0.0	0.0	951.51
						55.0	-427.25	-537.40	0.0	0.0	0.0	799.76
11	55	1133.26	0.0	-3.14e-04	-119.34	0.0	-451.23	-541.32	0.0	0.0	0.0	1133.26
		848.90	0.0	0.0		27.5	-451.23	-517.07	0.0	0.0	0.0	987.73
						55.0	-451.23	-492.60	0.0	0.0	0.0	848.90
11	56	874.10	0.0	3.57e-04	-161.28	0.0	-311.45	-634.65	0.0	0.0	0.0	874.10
		544.82	0.0	0.0		27.5	-311.45	-598.66	0.0	0.0	0.0	704.53
						55.0	-311.45	-562.92	0.0	0.0	0.0	544.82
11	57	880.73	0.0	3.47e-04	-160.47	0.0	-321.02	-630.87	0.0	0.0	0.0	880.73
		553.41	0.0	0.0		27.5	-321.02	-595.10	0.0	0.0	0.0	712.17
						55.0	-321.02	-559.58	0.0	0.0	0.0	553.41
11	58	805.83	0.0	3.56e-04	-156.06	0.0	-316.90	-602.96	0.0	0.0	0.0	805.83
		493.18	0.0	0.0		27.5	-316.90	-568.41	0.0	0.0	0.0	644.77
						55.0	-316.90	-534.11	0.0	0.0	0.0	493.18
11	59	810.81	0.0	3.48e-04	-155.46	0.0	-324.07	-600.13	0.0	0.0	0.0	810.81
		499.63	0.0	0.0		27.5	-324.07	-565.74	0.0	0.0	0.0	650.51
						55.0	-324.07	-531.59	0.0	0.0	0.0	499.63



11	60	1366.43	0.0	-5.96e-04	-115.55	0.0	-473.41	-582.87	0.0	0.0	0.0	1366.43
		1058.49	0.0	0.0		27.5	-473.41	-559.95	0.0	0.0	0.0	1209.28
						55.0	-473.41	-536.62	0.0	0.0	0.0	1058.49
11	61	1426.00	0.0	-7.02e-04	-110.81	0.0	-508.17	-578.52	0.0	0.0	0.0	1426.00
		1119.69	0.0	0.0		27.5	-508.17	-557.01	0.0	0.0	0.0	1269.85
						55.0	-508.17	-535.02	0.0	0.0	0.0	1119.69
11	62	1448.09	0.0	-8.95e-04	-95.27	0.0	-532.16	-524.90	0.0	0.0	0.0	1448.09
		1168.82	0.0	0.0		27.5	-532.16	-507.86	0.0	0.0	0.0	1306.07
						55.0	-532.16	-490.21	0.0	0.0	0.0	1168.82
11	63	1179.79	0.0	-1.05e-04	-138.51	0.0	-422.22	-600.59	0.0	0.0	0.0	1179.79
		865.83	0.0	0.0		27.5	-422.22	-570.85	0.0	0.0	0.0	1018.71
						55.0	-422.22	-541.03	0.0	0.0	0.0	865.83
11	64	1239.36	0.0	-2.10e-04	-133.78	0.0	-456.98	-596.23	0.0	0.0	0.0	1239.36
		927.03	0.0	0.0		27.5	-456.98	-567.90	0.0	0.0	0.0	1079.29
						55.0	-456.98	-539.43	0.0	0.0	0.0	927.03
11	65	1261.45	0.0	-4.03e-04	-118.23	0.0	-480.97	-542.61	0.0	0.0	0.0	1261.45
		976.16	0.0	0.0		27.5	-480.97	-518.76	0.0	0.0	0.0	1115.51
						55.0	-480.97	-494.62	0.0	0.0	0.0	976.16
11	66	1393.86	0.0	-3.76e-04	-127.09	0.0	-480.87	-612.67	0.0	0.0	0.0	1393.86
		1071.39	0.0	0.0		27.5	-480.87	-586.35	0.0	0.0	0.0	1228.99
						55.0	-480.87	-559.77	0.0	0.0	0.0	1071.39
11	67	1207.22	0.0	-1.15e-04	-150.63	0.0	-429.68	-630.38	0.0	0.0	0.0	1207.22
		878.73	0.0	0.0		27.5	-429.68	-597.24	0.0	0.0	0.0	1038.43
						55.0	-429.68	-564.18	0.0	0.0	0.0	878.73
11	68	1344.04	0.0	-8.86e-04	-88.57	0.0	-551.07	-483.30	0.0	0.0	0.0	1344.04
		1086.65	0.0	0.0		27.5	-551.07	-468.10	0.0	0.0	0.0	1213.21
						55.0	-551.07	-452.28	0.0	0.0	0.0	1086.65
11	69	1119.07	0.0	-3.68e-04	-111.87	0.0	-511.62	-500.63	0.0	0.0	0.0	1119.07
		855.93	0.0	0.0		27.5	-511.62	-478.49	0.0	0.0	0.0	984.44
						55.0	-511.62	-456.09	0.0	0.0	0.0	855.93
11	70	792.35	0.0	2.20e-04	-138.09	0.0	-333.78	-509.83	0.0	0.0	0.0	792.35
		528.24	0.0	0.0		27.5	-333.78	-480.18	0.0	0.0	0.0	656.23
						55.0	-333.78	-450.68	0.0	0.0	0.0	528.24
11	71	904.85	0.0	-1.02e-05	-126.52	0.0	-392.04	-506.53	0.0	0.0	0.0	904.85
		640.86	0.0	0.0		27.5	-392.04	-480.00	0.0	0.0	0.0	769.21
						55.0	-392.04	-453.45	0.0	0.0	0.0	640.86
11	72	704.86	0.0	2.81e-04	-139.15	0.0	-313.49	-508.95	0.0	0.0	0.0	704.86
		441.38	0.0	0.0		27.5	-313.49	-479.02	0.0	0.0	0.0	569.01
						55.0	-313.49	-449.29	0.0	0.0	0.0	441.38
11	73	992.35	0.0	-7.08e-05	-125.75	0.0	-412.33	-507.42	0.0	0.0	0.0	992.35



		727.72	0.0	0.0		27.5	-412.33	-481.15	0.0	0.0	0.0	856.42
						55.0	-412.33	-454.84	0.0	0.0	0.0	727.72
11	74	944.44	0.0	-3.75e-05	-126.17	0.0	-427.01	-506.93	0.0	0.0	0.0	944.44
		680.15	0.0	0.0		27.5	-427.01	-480.52	0.0	0.0	0.0	808.66
						55.0	-427.01	-454.08	0.0	0.0	0.0	680.15
11	75	1278.00	0.0	-4.80e-04	-117.26	0.0	-548.14	-563.19	0.0	0.0	0.0	1278.00
		981.20	0.0	0.0		27.5	-548.14	-539.68	0.0	0.0	0.0	1126.35
						55.0	-548.14	-515.84	0.0	0.0	0.0	981.20
11	76	2012.56	0.0	-2.16e-03	-35.44	0.0	-824.09	-473.98	0.0	0.0	0.0	2012.56
		1751.61	0.0	0.0		27.5	-824.09	-474.70	0.0	0.0	0.0	1882.09
						55.0	-824.09	-473.94	0.0	0.0	0.0	1751.61
11	77	1190.50	0.0	-4.19e-04	-118.02	0.0	-527.85	-562.31	0.0	0.0	0.0	1190.50
		894.34	0.0	0.0		27.5	-527.85	-538.53	0.0	0.0	0.0	1039.13
						55.0	-527.85	-514.46	0.0	0.0	0.0	894.34
11	78	2100.06	0.0	-2.23e-03	-34.68	0.0	-844.39	-474.86	0.0	0.0	0.0	2100.06
		1838.48	0.0	0.0		27.5	-844.39	-475.86	0.0	0.0	0.0	1969.30
						55.0	-844.39	-475.32	0.0	0.0	0.0	1838.48
11	79	2000.61	0.0	-2.22e-03	-27.77	0.0	-856.99	-432.39	0.0	0.0	0.0	2000.61
		1761.35	0.0	0.0		27.5	-856.99	-435.28	0.0	0.0	0.0	1881.27
						55.0	-856.99	-436.64	0.0	0.0	0.0	1761.35
13	1	19.69	0.0	-5.17e-04	-216.85	0.0	0.42	-85.61	0.0	0.0	0.0	19.69
		-1.29	0.0	0.0		37.5	0.42	-19.87	0.0	0.0	0.0	-0.16
						75.0	0.42	0.11	0.0	0.0	0.0	0.04
13	2	19.38	0.0	-4.97e-04	-215.69	0.0	0.43	-84.80	0.0	0.0	0.0	19.38
		-1.34	0.0	0.0		37.5	0.43	-19.47	0.0	0.0	0.0	-0.24
						75.0	0.43	0.08	0.0	0.0	0.0	0.03
13	3	17.55	0.0	-4.78e-04	-209.17	0.0	0.44	-79.93	0.0	0.0	0.0	17.55
		-1.59	0.0	0.0		37.5	0.44	-17.01	0.0	0.0	0.0	-0.70
						75.0	0.44	0.11	0.0	0.0	0.0	0.04
13	4	17.32	0.0	-4.64e-04	-208.30	0.0	0.45	-79.32	0.0	0.0	0.0	17.32
		-1.63	0.0	0.0		37.5	0.45	-16.71	0.0	0.0	0.0	-0.76
						75.0	0.45	0.09	0.0	0.0	0.0	0.03
13	5	38.25	0.0	-2.37e-03	-285.87	0.0	-13.51	-133.94	0.0	0.0	0.0	38.25
		0.03	0.0	0.0		37.5	-13.51	-44.91	0.0	0.0	0.0	4.58
						75.0	-13.51	0.08	0.0	0.0	0.0	0.03
13	6	39.86	0.0	-2.52e-03	-291.85	0.0	-14.94	-138.16	0.0	0.0	0.0	39.86
		0.02	0.0	0.0		37.5	-14.94	-47.11	0.0	0.0	0.0	4.99
						75.0	-14.94	0.06	0.0	0.0	0.0	0.02
13	7	39.51	0.0	-2.73e-03	-290.92	0.0	-16.45	-137.07	0.0	0.0	0.0	39.51
		0.02	0.0	0.0		37.5	-16.45	-46.66	0.0	0.0	0.0	4.91



						75.0	-16.45	0.05	0.0	0.0	0.0	0.02
13	8	27.61	0.0	-1.40e-03	-246.42	0.0	-9.37	-106.18	0.0	0.0	0.0	27.61
		-0.48	0.0	0.0		37.5	-9.37	-30.59	0.0	0.0	0.0	1.86
						75.0	-9.37	0.06	0.0	0.0	0.0	0.02
13	9	29.23	0.0	-1.55e-03	-252.39	0.0	-10.81	-110.40	0.0	0.0	0.0	29.23
		-0.33	0.0	0.0		37.5	-10.81	-32.78	0.0	0.0	0.0	2.27
						75.0	-10.81	0.04	0.0	0.0	0.0	0.01
13	10	28.87	0.0	-1.77e-03	-251.47	0.0	-12.31	-109.31	0.0	0.0	0.0	28.87
		-0.35	0.0	0.0		37.5	-12.31	-32.34	0.0	0.0	0.0	2.20
						75.0	-12.31	0.03	0.0	0.0	0.0	0.01
13	11	20.18	0.0	-6.30e-04	-218.78	0.0	0.38	-86.84	0.0	0.0	0.0	20.18
		-1.22	0.0	0.0		37.5	0.38	-20.54	0.0	0.0	0.0	-0.04
						75.0	0.38	0.11	0.0	0.0	0.0	0.04
13	12	19.87	0.0	-6.11e-04	-217.61	0.0	0.40	-86.04	0.0	0.0	0.0	19.87
		-1.26	0.0	0.0		37.5	0.40	-20.14	0.0	0.0	0.0	-0.12
						75.0	0.40	0.08	0.0	0.0	0.0	0.03
13	13	18.20	0.0	-6.30e-04	-211.75	0.0	0.39	-81.58	0.0	0.0	0.0	18.20
		-1.49	0.0	0.0		37.5	0.39	-17.91	0.0	0.0	0.0	-0.53
						75.0	0.39	0.10	0.0	0.0	0.0	0.04
13	14	17.97	0.0	-6.15e-04	-210.88	0.0	0.40	-80.97	0.0	0.0	0.0	17.97
		-1.53	0.0	0.0		37.5	0.40	-17.61	0.0	0.0	0.0	-0.59
						75.0	0.40	0.08	0.0	0.0	0.0	0.03
13	15	37.76	0.0	-2.25e-03	-283.95	0.0	-13.48	-132.71	0.0	0.0	0.0	37.76
		0.03	0.0	0.0		37.5	-13.48	-44.24	0.0	0.0	0.0	4.45
						75.0	-13.48	0.08	0.0	0.0	0.0	0.03
13	16	39.38	0.0	-2.40e-03	-289.92	0.0	-14.91	-136.93	0.0	0.0	0.0	39.38
		0.02	0.0	0.0		37.5	-14.91	-46.44	0.0	0.0	0.0	4.86
						75.0	-14.91	0.06	0.0	0.0	0.0	0.02
13	17	39.02	0.0	-2.62e-03	-289.00	0.0	-16.42	-135.84	0.0	0.0	0.0	39.02
		0.02	0.0	0.0		37.5	-16.42	-45.99	0.0	0.0	0.0	4.79
						75.0	-16.42	0.06	0.0	0.0	0.0	0.02
13	18	26.96	0.0	-1.25e-03	-243.84	0.0	-9.33	-104.53	0.0	0.0	0.0	26.96
		-0.55	0.0	0.0		37.5	-9.33	-29.69	0.0	0.0	0.0	1.69
						75.0	-9.33	0.06	0.0	0.0	0.0	0.02
13	19	28.57	0.0	-1.40e-03	-249.82	0.0	-10.76	-108.75	0.0	0.0	0.0	28.57
		-0.39	0.0	0.0		37.5	-10.76	-31.88	0.0	0.0	0.0	2.10
						75.0	-10.76	0.04	0.0	0.0	0.0	0.01
13	20	28.21	0.0	-1.61e-03	-248.89	0.0	-12.27	-107.66	0.0	0.0	0.0	28.21
		-0.42	0.0	0.0		37.5	-12.27	-31.44	0.0	0.0	0.0	2.02
						75.0	-12.27	0.04	0.0	0.0	0.0	0.01



13	21	32.54	0.0	-1.83e-03	-264.68	0.0	-13.46	-119.06	0.0	0.0	0.0	32.54
		-0.08	0.0	0.0		37.5	-13.46	-37.22	0.0	0.0	0.0	3.12
						75.0	-13.46	0.07	0.0	0.0	0.0	0.03
13	22	21.74	0.0	-8.24e-04	-224.57	0.0	-9.31	-90.88	0.0	0.0	0.0	21.74
		-1.07	0.0	0.0		37.5	-9.31	-22.67	0.0	0.0	0.0	0.36
						75.0	-9.31	0.05	0.0	0.0	0.0	0.02
13	23	33.44	0.0	-2.50e-03	-231.13	0.0	-16.40	-112.37	0.0	0.0	0.0	33.44
		9.50e-03	0.0	0.0		37.5	-16.40	-40.21	0.0	0.0	0.0	4.71
						75.0	-16.40	0.03	0.0	0.0	0.0	9.50e-03
13	24	22.83	0.0	-1.54e-03	-191.79	0.0	-12.23	-84.69	0.0	0.0	0.0	22.83
		-0.15	0.0	0.0		37.5	-12.23	-25.93	0.0	0.0	0.0	2.00
						75.0	-12.23	0.01	0.0	0.0	0.0	2.92e-03
13	25	44.71	0.0	-2.55e-03	-309.14	0.0	-13.49	-151.05	0.0	0.0	0.0	44.71
		0.02	0.0	0.0		37.5	-13.49	-53.56	0.0	0.0	0.0	6.21
						75.0	-13.49	0.07	0.0	0.0	0.0	0.02
13	26	41.20	0.0	-2.30e-03	-296.23	0.0	-14.93	-141.85	0.0	0.0	0.0	41.20
		0.02	0.0	0.0		37.5	-14.93	-48.85	0.0	0.0	0.0	5.31
						75.0	-14.93	0.05	0.0	0.0	0.0	0.02
13	27	22.32	0.0	-7.65e-04	-226.54	0.0	-9.31	-92.46	0.0	0.0	0.0	22.32
		-1.02	0.0	0.0		37.5	-9.31	-23.44	0.0	0.0	0.0	0.50
						75.0	-9.31	0.06	0.0	0.0	0.0	0.02
13	28	30.83	0.0	-1.48e-03	-257.97	0.0	-10.76	-114.72	0.0	0.0	0.0	30.83
		-0.22	0.0	0.0		37.5	-10.76	-34.91	0.0	0.0	0.0	2.67
						75.0	-10.76	0.03	0.0	0.0	0.0	0.01
13	29	36.53	0.0	-2.64e-03	-280.20	0.0	-16.39	-129.21	0.0	0.0	0.0	36.53
		0.02	0.0	0.0		37.5	-16.39	-42.68	0.0	0.0	0.0	4.17
						75.0	-16.39	0.06	0.0	0.0	0.0	0.02
13	30	31.76	0.0	1.23e-03	-223.17	0.0	-3.54	-108.69	0.0	0.0	0.0	31.76
		0.04	0.0	0.0		37.5	-3.54	-37.73	0.0	0.0	0.0	4.23
						75.0	-3.54	0.12	0.0	0.0	0.0	0.04
13	31	31.47	0.0	1.20e-03	-222.02	0.0	-3.50	-107.93	0.0	0.0	0.0	31.47
		0.03	0.0	0.0		37.5	-3.50	-37.36	0.0	0.0	0.0	4.15
						75.0	-3.50	0.08	0.0	0.0	0.0	0.03
13	32	28.00	0.0	1.13e-03	-209.61	0.0	-3.48	-98.73	0.0	0.0	0.0	28.00
		0.03	0.0	0.0		37.5	-3.48	-32.72	0.0	0.0	0.0	3.28
						75.0	-3.48	0.10	0.0	0.0	0.0	0.03
13	33	37.85	0.0	-2.42e-03	-284.50	0.0	-16.40	-132.84	0.0	0.0	0.0	37.85
		0.02	0.0	0.0		37.5	-16.40	-44.40	0.0	0.0	0.0	4.48
						75.0	-16.40	0.05	0.0	0.0	0.0	0.02
13	34	12.83	0.0	-3.12e-04	-154.26	0.0	0.41	-58.77	0.0	0.0	0.0	12.83



		-1.21	0.0	0.0		37.5	0.41	-12.36	0.0	0.0	0.0	-0.57
						75.0	0.41	0.08	0.0	0.0	0.0	0.03
13	35	15.15	0.0	-5.25e-04	-162.86	0.0	-1.54	-64.84	0.0	0.0	0.0	15.15
		-0.89	0.0	0.0		37.5	-1.54	-15.51	0.0	0.0	0.0	0.03
						75.0	-1.54	0.06	0.0	0.0	0.0	0.02
13	36	17.65	0.0	-7.66e-04	-172.14	0.0	-3.91	-71.36	0.0	0.0	0.0	17.65
		-0.64	0.0	0.0		37.5	-3.91	-18.89	0.0	0.0	0.0	0.67
						75.0	-3.91	0.05	0.0	0.0	0.0	0.02
13	37	18.86	0.0	-8.79e-04	-176.57	0.0	-4.97	-74.49	0.0	0.0	0.0	18.86
		-0.52	0.0	0.0		37.5	-4.97	-20.51	0.0	0.0	0.0	0.97
						75.0	-4.97	0.03	0.0	0.0	0.0	9.67e-03
13	38	18.59	0.0	-1.04e-03	-175.89	0.0	-6.09	-73.68	0.0	0.0	0.0	18.59
		-0.54	0.0	0.0		37.5	-6.09	-20.18	0.0	0.0	0.0	0.91
						75.0	-6.09	0.03	0.0	0.0	0.0	8.89e-03
13	39	13.24	0.0	-4.06e-04	-155.87	0.0	0.38	-59.80	0.0	0.0	0.0	13.24
		-1.14	0.0	0.0		37.5	0.38	-12.92	0.0	0.0	0.0	-0.46
						75.0	0.38	0.08	0.0	0.0	0.0	0.03
13	40	13.06	0.0	-3.95e-04	-155.22	0.0	0.39	-59.35	0.0	0.0	0.0	13.06
		-1.17	0.0	0.0		37.5	0.39	-12.70	0.0	0.0	0.0	-0.50
						75.0	0.39	0.06	0.0	0.0	0.0	0.02
13	41	17.25	0.0	-6.72e-04	-170.54	0.0	-3.88	-70.33	0.0	0.0	0.0	17.25
		-0.68	0.0	0.0		37.5	-3.88	-18.33	0.0	0.0	0.0	0.56
						75.0	-3.88	0.05	0.0	0.0	0.0	0.02
13	42	18.45	0.0	-7.85e-04	-174.97	0.0	-4.94	-73.47	0.0	0.0	0.0	18.45
		-0.56	0.0	0.0		37.5	-4.94	-19.96	0.0	0.0	0.0	0.86
						75.0	-4.94	0.03	0.0	0.0	0.0	0.01
13	43	18.18	0.0	-9.43e-04	-174.29	0.0	-6.06	-72.66	0.0	0.0	0.0	18.18
		-0.58	0.0	0.0		37.5	-6.06	-19.63	0.0	0.0	0.0	0.81
						75.0	-6.06	0.03	0.0	0.0	0.0	9.73e-03
13	44	18.12	0.0	-7.84e-04	-173.81	0.0	-6.94	-72.60	0.0	0.0	0.0	18.12
		-0.59	0.0	0.0		37.5	-6.94	-19.53	0.0	0.0	0.0	0.78
						75.0	-6.94	0.03	0.0	0.0	0.0	9.03e-03
13	45	16.37	0.0	-9.63e-04	-167.86	0.0	-6.04	-67.80	0.0	0.0	0.0	16.37
		-0.76	0.0	0.0		37.5	-6.04	-17.21	0.0	0.0	0.0	0.35
						75.0	-6.04	0.03	0.0	0.0	0.0	9.80e-03
13	46	14.41	0.0	-3.43e-04	-159.95	0.0	0.40	-62.98	0.0	0.0	0.0	14.41
		-0.98	0.0	0.0		37.5	0.40	-14.48	0.0	0.0	0.0	-0.17
						75.0	0.40	0.08	0.0	0.0	0.0	0.03
13	47	14.19	0.0	-3.28e-04	-159.09	0.0	0.42	-62.38	0.0	0.0	0.0	14.19
		-1.02	0.0	0.0		37.5	0.42	-14.19	0.0	0.0	0.0	-0.23



						75.0	0.42	0.06	0.0	0.0	0.0	0.02
13	48	12.84	0.0	-3.15e-04	-154.31	0.0	0.42	-58.81	0.0	0.0	0.0	12.84
		-1.20	0.0	0.0		37.5	0.42	-12.38	0.0	0.0	0.0	-0.56
						75.0	0.42	0.08	0.0	0.0	0.0	0.03
13	49	12.67	0.0	-3.04e-04	-153.66	0.0	0.43	-58.36	0.0	0.0	0.0	12.67
		-1.23	0.0	0.0		37.5	0.43	-12.16	0.0	0.0	0.0	-0.61
						75.0	0.43	0.06	0.0	0.0	0.0	0.02
13	50	25.52	0.0	-1.48e-03	-201.32	0.0	-6.98	-91.90	0.0	0.0	0.0	25.52
		0.02	0.0	0.0		37.5	-6.98	-29.48	0.0	0.0	0.0	2.67
						75.0	-6.98	0.06	0.0	0.0	0.0	0.02
13	51	26.72	0.0	-1.59e-03	-205.76	0.0	-8.05	-95.03	0.0	0.0	0.0	26.72
		0.01	0.0	0.0		37.5	-8.05	-31.11	0.0	0.0	0.0	2.98
						75.0	-8.05	0.04	0.0	0.0	0.0	0.01
13	52	26.46	0.0	-1.75e-03	-205.07	0.0	-9.16	-94.22	0.0	0.0	0.0	26.46
		0.01	0.0	0.0		37.5	-9.16	-30.78	0.0	0.0	0.0	2.92
						75.0	-9.16	0.04	0.0	0.0	0.0	0.01
13	53	17.64	0.0	-7.63e-04	-172.09	0.0	-3.92	-71.33	0.0	0.0	0.0	17.64
		-0.64	0.0	0.0		37.5	-3.92	-18.87	0.0	0.0	0.0	0.66
						75.0	-3.92	0.05	0.0	0.0	0.0	0.02
13	54	18.84	0.0	-8.76e-04	-176.53	0.0	-4.98	-74.46	0.0	0.0	0.0	18.84
		-0.52	0.0	0.0		37.5	-4.98	-20.50	0.0	0.0	0.0	0.97
						75.0	-4.98	0.03	0.0	0.0	0.0	9.44e-03
13	55	18.58	0.0	-1.03e-03	-175.84	0.0	-6.10	-73.65	0.0	0.0	0.0	18.58
		-0.54	0.0	0.0		37.5	-6.10	-20.17	0.0	0.0	0.0	0.91
						75.0	-6.10	0.03	0.0	0.0	0.0	8.65e-03
13	56	14.62	0.0	-3.91e-04	-160.77	0.0	0.39	-63.51	0.0	0.0	0.0	14.62
		-0.95	0.0	0.0		37.5	0.39	-14.77	0.0	0.0	0.0	-0.11
						75.0	0.39	0.08	0.0	0.0	0.0	0.03
13	57	14.39	0.0	-3.77e-04	-159.91	0.0	0.40	-62.91	0.0	0.0	0.0	14.39
		-0.99	0.0	0.0		37.5	0.40	-14.47	0.0	0.0	0.0	-0.17
						75.0	0.40	0.06	0.0	0.0	0.0	0.02
13	58	13.19	0.0	-3.95e-04	-155.68	0.0	0.40	-59.68	0.0	0.0	0.0	13.19
		-1.15	0.0	0.0		37.5	0.40	-12.86	0.0	0.0	0.0	-0.47
						75.0	0.40	0.08	0.0	0.0	0.0	0.03
13	59	13.02	0.0	-3.84e-04	-155.03	0.0	0.40	-59.23	0.0	0.0	0.0	13.02
		-1.18	0.0	0.0		37.5	0.40	-12.63	0.0	0.0	0.0	-0.52
						75.0	0.40	0.06	0.0	0.0	0.0	0.02
13	60	25.12	0.0	-1.38e-03	-199.72	0.0	-6.95	-90.87	0.0	0.0	0.0	25.12
		0.02	0.0	0.0		37.5	-6.95	-28.92	0.0	0.0	0.0	2.57
						75.0	-6.95	0.06	0.0	0.0	0.0	0.02



13	61	26.32	0.0	-1.50e-03	-204.15	0.0	-8.02	-94.00	0.0	0.0	0.0	26.32
		0.02	0.0	0.0		37.5	-8.02	-30.55	0.0	0.0	0.0	2.87
						75.0	-8.02	0.05	0.0	0.0	0.0	0.02
13	62	26.05	0.0	-1.66e-03	-203.47	0.0	-9.14	-93.19	0.0	0.0	0.0	26.05
		0.01	0.0	0.0		37.5	-9.14	-30.22	0.0	0.0	0.0	2.82
						75.0	-9.14	0.04	0.0	0.0	0.0	0.01
13	63	17.10	0.0	-6.37e-04	-169.94	0.0	-3.88	-69.95	0.0	0.0	0.0	17.10
		-0.70	0.0	0.0		37.5	-3.88	-18.12	0.0	0.0	0.0	0.52
						75.0	-3.88	0.05	0.0	0.0	0.0	0.02
13	64	18.30	0.0	-7.50e-04	-174.38	0.0	-4.95	-73.09	0.0	0.0	0.0	18.30
		-0.58	0.0	0.0		37.5	-4.95	-19.75	0.0	0.0	0.0	0.82
						75.0	-4.95	0.03	0.0	0.0	0.0	0.01
13	65	18.03	0.0	-9.08e-04	-173.69	0.0	-6.06	-72.28	0.0	0.0	0.0	18.03
		-0.60	0.0	0.0		37.5	-6.06	-19.42	0.0	0.0	0.0	0.77
						75.0	-6.06	0.03	0.0	0.0	0.0	9.69e-03
13	66	21.24	0.0	-1.07e-03	-185.41	0.0	-6.94	-80.74	0.0	0.0	0.0	21.24
		-0.28	0.0	0.0		37.5	-6.94	-23.71	0.0	0.0	0.0	1.58
						75.0	-6.94	0.06	0.0	0.0	0.0	0.02
13	67	13.22	0.0	-3.22e-04	-155.63	0.0	-3.87	-59.82	0.0	0.0	0.0	13.22
		-1.16	0.0	0.0		37.5	-3.87	-12.91	0.0	0.0	0.0	-0.47
						75.0	-3.87	0.04	0.0	0.0	0.0	0.01
13	68	24.23	0.0	-1.68e-03	-197.04	0.0	-9.11	-88.34	0.0	0.0	0.0	24.23
		-0.04	0.0	0.0		37.5	-9.11	-27.80	0.0	0.0	0.0	2.36
						75.0	-9.11	0.04	0.0	0.0	0.0	0.01
13	69	16.38	0.0	-9.65e-04	-167.91	0.0	-6.03	-67.83	0.0	0.0	0.0	16.38
		-0.76	0.0	0.0		37.5	-6.03	-17.22	0.0	0.0	0.0	0.36
						75.0	-6.03	0.03	0.0	0.0	0.0	0.01
13	70	8.07	0.0	-2.18e-04	-137.18	0.0	0.42	-46.15	0.0	0.0	0.0	8.07
		-1.94	0.0	0.0		37.5	0.42	-6.01	0.0	0.0	0.0	-1.76
						75.0	0.42	0.07	0.0	0.0	0.0	0.03
13	71	11.78	0.0	-5.73e-04	-150.92	0.0	-3.01	-55.82	0.0	0.0	0.0	11.78
		-1.35	0.0	0.0		37.5	-3.01	-11.03	0.0	0.0	0.0	-0.82
						75.0	-3.01	0.04	0.0	0.0	0.0	0.01
13	72	8.44	0.0	-3.05e-04	-138.65	0.0	0.39	-47.09	0.0	0.0	0.0	8.44
		-1.86	0.0	0.0		37.5	0.39	-6.52	0.0	0.0	0.0	-1.66
						75.0	0.39	0.07	0.0	0.0	0.0	0.03
13	73	11.41	0.0	-4.87e-04	-149.46	0.0	-2.99	-54.88	0.0	0.0	0.0	11.41
		-1.40	0.0	0.0		37.5	-2.99	-10.51	0.0	0.0	0.0	-0.91
						75.0	-2.99	0.04	0.0	0.0	0.0	0.02
13	74	11.61	0.0	-5.34e-04	-150.26	0.0	-2.97	-55.39	0.0	0.0	0.0	11.61



		-1.37	0.0	0.0		37.5	-2.97	-10.79	0.0	0.0	0.0	-0.86
						75.0	-2.97	0.04	0.0	0.0	0.0	0.02
13	75	21.92	0.0	-1.19e-03	-188.09	0.0	-5.79	-82.48	0.0	0.0	0.0	21.92
		-0.21	0.0	0.0		37.5	-5.79	-24.62	0.0	0.0	0.0	1.76
						75.0	-5.79	0.10	0.0	0.0	0.0	0.04
13	76	44.26	0.0	-3.42e-03	-271.34	0.0	-20.56	-140.66	0.0	0.0	0.0	44.26
		0.06	0.0	0.0		37.5	-20.56	-54.71	0.0	0.0	0.0	7.48
						75.0	-20.56	0.18	0.0	0.0	0.0	0.06
13	77	22.30	0.0	-1.27e-03	-189.56	0.0	-5.82	-83.42	0.0	0.0	0.0	22.30
		-0.18	0.0	0.0		37.5	-5.82	-25.13	0.0	0.0	0.0	1.86
						75.0	-5.82	0.10	0.0	0.0	0.0	0.04
13	78	43.89	0.0	-3.33e-03	-269.87	0.0	-20.53	-139.72	0.0	0.0	0.0	43.89
		0.07	0.0	0.0		37.5	-20.53	-54.20	0.0	0.0	0.0	7.39
						75.0	-20.53	0.18	0.0	0.0	0.0	0.07
13	79	42.00	0.0	-3.34e-03	-263.19	0.0	-20.52	-134.68	0.0	0.0	0.0	42.00
		0.07	0.0	0.0		37.5	-20.52	-51.69	0.0	0.0	0.0	6.92
						75.0	-20.52	0.18	0.0	0.0	0.0	0.07
14	1	16.47	0.0	-5.59e-04	-220.38	0.0	0.39	-0.08	0.0	0.0	0.0	0.03
		-1.21	0.0	0.0		35.0	0.39	17.06	0.0	0.0	0.0	-0.41
						70.0	0.39	79.29	0.0	0.0	0.0	16.47
14	2	16.18	0.0	5.41e-04	-219.20	0.0	0.41	-0.08	0.0	0.0	0.0	0.03
		-1.25	0.0	0.0		35.0	0.41	16.65	0.0	0.0	0.0	-0.48
						70.0	0.41	78.48	0.0	0.0	0.0	16.18
14	3	14.57	0.0	-5.20e-04	-212.55	0.0	0.41	-0.07	0.0	0.0	0.0	0.02
		-1.48	0.0	0.0		35.0	0.41	14.34	0.0	0.0	0.0	-0.88
						70.0	0.41	73.88	0.0	0.0	0.0	14.57
14	4	14.35	0.0	5.06e-04	-211.66	0.0	0.42	-0.08	0.0	0.0	0.0	0.03
		-1.51	0.0	0.0		35.0	0.42	14.03	0.0	0.0	0.0	-0.94
						70.0	0.42	73.27	0.0	0.0	0.0	14.35
14	5	0.01	0.0	-1.28e-03	-141.67	0.0	13.55	-0.04	0.0	0.0	0.0	0.01
		-6.24	0.0	0.0		35.0	13.55	-11.88	0.0	0.0	0.0	-5.52
						70.0	13.55	22.97	0.0	0.0	0.0	-3.62
14	6	0.02	0.0	-1.46e-03	-134.58	0.0	14.95	-0.06	0.0	0.0	0.0	0.02
		-7.17	0.0	0.0		35.0	14.95	-14.62	0.0	0.0	0.0	-6.01
						70.0	14.95	17.66	0.0	0.0	0.0	-5.51
14	7	0.01	0.0	-1.79e-03	-112.35	0.0	16.37	-0.04	0.0	0.0	0.0	0.01
		-11.22	0.0	0.0		35.0	16.37	-22.82	0.0	0.0	0.0	-7.45
						70.0	16.37	1.54	0.0	0.0	0.0	-11.22
14	8	5.64	0.0	-3.81e-04	-176.53	0.0	9.66	-0.08	0.0	0.0	0.0	0.03
		-3.16	0.0	0.0		35.0	9.66	1.45	0.0	0.0	0.0	-3.16



						70.0	9.66	48.90	0.0	0.0	0.0	5.64
14	9	3.75	0.0	-5.65e-04	-169.44	0.0	11.06	-0.10	0.0	0.0	0.0	0.03
		-3.64	0.0	0.0		35.0	11.06	-1.29	0.0	0.0	0.0	-3.64
						70.0	11.06	43.59	0.0	0.0	0.0	3.75
14	10	0.03	0.0	-8.98e-04	-147.20	0.0	12.48	-0.08	0.0	0.0	0.0	0.03
		-5.52	0.0	0.0		35.0	12.48	-9.49	0.0	0.0	0.0	-5.09
						70.0	12.48	27.47	0.0	0.0	0.0	-1.97
14	11	16.90	0.0	-6.66e-04	-222.31	0.0	0.36	-0.08	0.0	0.0	0.0	0.03
		-1.15	0.0	0.0		35.0	0.36	17.69	0.0	0.0	0.0	-0.29
						70.0	0.36	80.45	0.0	0.0	0.0	16.90
14	12	16.61	0.0	6.47e-04	-221.13	0.0	0.38	-0.09	0.0	0.0	0.0	0.03
		-1.19	0.0	0.0		35.0	0.38	17.27	0.0	0.0	0.0	-0.36
						70.0	0.38	79.64	0.0	0.0	0.0	16.61
14	13	15.14	0.0	-6.62e-04	-215.13	0.0	0.37	-0.07	0.0	0.0	0.0	0.02
		-1.40	0.0	0.0		35.0	0.37	15.18	0.0	0.0	0.0	-0.73
						70.0	0.37	75.43	0.0	0.0	0.0	15.14
14	14	14.93	0.0	6.49e-04	-214.25	0.0	0.38	-0.08	0.0	0.0	0.0	0.03
		-1.43	0.0	0.0		35.0	0.38	14.87	0.0	0.0	0.0	-0.79
						70.0	0.38	74.83	0.0	0.0	0.0	14.93
14	15	0.01	0.0	-1.38e-03	-140.28	0.0	13.58	-0.04	0.0	0.0	0.0	0.01
		-6.45	0.0	0.0		35.0	13.58	-12.51	0.0	0.0	0.0	-5.64
						70.0	13.58	21.81	0.0	0.0	0.0	-4.05
14	16	0.02	0.0	-1.57e-03	-133.19	0.0	14.98	-0.06	0.0	0.0	0.0	0.02
		-7.42	0.0	0.0		35.0	14.98	-15.25	0.0	0.0	0.0	-6.12
						70.0	14.98	16.50	0.0	0.0	0.0	-5.94
14	17	0.01	0.0	-1.90e-03	-110.95	0.0	16.40	-0.04	0.0	0.0	0.0	0.01
		-11.65	0.0	0.0		35.0	16.40	-23.45	0.0	0.0	0.0	-7.57
						70.0	16.40	0.38	0.0	0.0	0.0	-11.65
14	18	5.07	0.0	-5.24e-04	-174.66	0.0	9.70	-0.08	0.0	0.0	0.0	0.03
		-3.31	0.0	0.0		35.0	9.70	0.61	0.0	0.0	0.0	-3.31
						70.0	9.70	47.34	0.0	0.0	0.0	5.07
14	19	3.17	0.0	-7.08e-04	-167.57	0.0	11.10	-0.09	0.0	0.0	0.0	0.03
		-3.79	0.0	0.0		35.0	11.10	-2.13	0.0	0.0	0.0	-3.79
						70.0	11.10	42.04	0.0	0.0	0.0	3.17
14	20	0.02	0.0	-1.04e-03	-145.33	0.0	12.52	-0.07	0.0	0.0	0.0	0.02
		-5.75	0.0	0.0		35.0	12.52	-10.33	0.0	0.0	0.0	-5.24
						70.0	12.52	25.91	0.0	0.0	0.0	-2.54
14	21	0.44	0.0	-1.01e-03	-157.30	0.0	13.60	-0.02	0.0	0.0	0.0	4.93e-03
		-4.65	0.0	0.0		35.0	13.60	-6.04	0.0	0.0	0.0	-4.50
						70.0	13.60	34.40	0.0	0.0	0.0	0.44

14	22	9.55	0.0	-1.48e-04	-191.68	0.0	9.72	-0.06	0.0	0.0	0.0	0.02
		-2.34	0.0	0.0		35.0	9.72	7.09	0.0	0.0	0.0	-2.17
						70.0	9.72	59.93	0.0	0.0	0.0	9.55
14	23	9.47e-03	0.0	-2.03e-03	-52.79	0.0	16.42	-0.03	0.0	0.0	0.0	9.47e-03
		-16.35	0.0	0.0		35.0	16.42	-28.48	0.0	0.0	0.0	-7.56
						70.0	16.42	-21.40	0.0	0.0	0.0	-16.35
14	24	0.02	0.0	-1.13e-03	-87.73	0.0	12.55	-0.07	0.0	0.0	0.0	0.02
		-7.24	0.0	0.0		35.0	12.55	-15.11	0.0	0.0	0.0	-5.19
						70.0	12.55	4.60	0.0	0.0	0.0	-7.06
14	25	5.62e-03	0.0	-1.53e-03	-146.42	0.0	13.57	-0.02	0.0	0.0	0.0	5.62e-03
		-5.83	0.0	0.0		35.0	13.57	-10.54	0.0	0.0	0.0	-5.30
						70.0	13.57	25.86	0.0	0.0	0.0	-2.66
14	26	0.02	0.0	-1.32e-03	-156.63	0.0	14.95	-0.05	0.0	0.0	0.0	0.02
		-4.80	0.0	0.0		35.0	14.95	-6.71	0.0	0.0	0.0	-4.62
						70.0	14.95	33.36	0.0	0.0	0.0	9.67e-03
14	27	13.13	0.0	-6.07e-05	-205.91	0.0	9.72	-0.05	0.0	0.0	0.0	0.02
		-1.70	0.0	0.0		35.0	9.72	12.24	0.0	0.0	0.0	-1.27
						70.0	9.72	70.05	0.0	0.0	0.0	13.13
14	28	5.17	0.0	-6.31e-04	-175.49	0.0	11.10	-0.10	0.0	0.0	0.0	0.03
		-3.29	0.0	0.0		35.0	11.10	0.74	0.0	0.0	0.0	-3.29
						70.0	11.10	47.71	0.0	0.0	0.0	5.17
14	29	0.01	0.0	-1.89e-03	-101.89	0.0	16.43	-0.04	0.0	0.0	0.0	0.01
		-13.86	0.0	0.0		35.0	16.43	-26.61	0.0	0.0	0.0	-8.12
						70.0	16.43	-5.95	0.0	0.0	0.0	-13.86
14	30	7.05	0.0	-7.12e-04	-143.97	0.0	4.45	-0.10	0.0	0.0	0.0	0.03
		-1.76	0.0	0.0		35.0	4.45	5.10	0.0	0.0	0.0	-1.64
						70.0	4.45	44.68	0.0	0.0	0.0	7.05
14	31	6.77	0.0	-7.42e-04	-142.95	0.0	4.49	-0.11	0.0	0.0	0.0	0.04
		-1.81	0.0	0.0		35.0	4.49	4.69	0.0	0.0	0.0	-1.71
						70.0	4.49	43.90	0.0	0.0	0.0	6.77
14	32	3.72	0.0	-8.18e-04	-130.67	0.0	4.51	-0.05	0.0	0.0	0.0	0.02
		-2.48	0.0	0.0		35.0	4.51	0.35	0.0	0.0	0.0	-2.48
						70.0	4.51	35.23	0.0	0.0	0.0	3.72
14	33	0.01	0.0	-1.75e-03	-123.87	0.0	16.42	-0.03	0.0	0.0	0.0	0.01
		-8.92	0.0	0.0		35.0	16.42	-18.73	0.0	0.0	0.0	-6.74
						70.0	16.42	9.69	0.0	0.0	0.0	-8.36
14	34	10.64	0.0	3.45e-04	-156.76	0.0	0.38	-0.06	0.0	0.0	0.0	0.02
		-1.12	0.0	0.0		35.0	0.38	10.40	0.0	0.0	0.0	-0.69
						70.0	0.38	54.31	0.0	0.0	0.0	10.64
14	35	8.21	0.0	1.04e-04	-146.49	0.0	2.26	-0.07	0.0	0.0	0.0	0.02



		-1.50	0.0	0.0		35.0	2.26	6.89	0.0	0.0	0.0	-1.31
						70.0	2.26	47.53	0.0	0.0	0.0	8.21
14	36	6.53	0.0	-5.76e-05	-139.58	0.0	4.42	-0.05	0.0	0.0	0.0	0.02
		-1.83	0.0	0.0		35.0	4.42	4.47	0.0	0.0	0.0	-1.74
						70.0	4.42	42.79	0.0	0.0	0.0	6.53
14	37	5.12	0.0	-1.95e-04	-134.32	0.0	5.46	-0.06	0.0	0.0	0.0	0.02
		-2.11	0.0	0.0		35.0	5.46	2.43	0.0	0.0	0.0	-2.10
						70.0	5.46	38.86	0.0	0.0	0.0	5.12
14	38	0.88	0.0	-4.41e-04	-117.81	0.0	6.52	-0.05	0.0	0.0	0.0	0.02
		-3.25	0.0	0.0		35.0	6.52	-3.66	0.0	0.0	0.0	-3.18
						70.0	6.52	26.88	0.0	0.0	0.0	0.88
14	39	11.00	0.0	4.34e-04	-158.37	0.0	0.36	-0.06	0.0	0.0	0.0	0.02
		-1.07	0.0	0.0		35.0	0.36	10.92	0.0	0.0	0.0	-0.60
						70.0	0.36	55.28	0.0	0.0	0.0	11.00
14	40	10.84	0.0	4.24e-04	-157.71	0.0	0.37	-0.06	0.0	0.0	0.0	0.02
		-1.09	0.0	0.0		35.0	0.37	10.69	0.0	0.0	0.0	-0.64
						70.0	0.37	54.83	0.0	0.0	0.0	10.84
14	41	6.17	0.0	-1.46e-04	-138.42	0.0	4.45	-0.05	0.0	0.0	0.0	0.02
		-1.91	0.0	0.0		35.0	4.45	3.94	0.0	0.0	0.0	-1.84
						70.0	4.45	41.83	0.0	0.0	0.0	6.17
14	42	4.76	0.0	-2.83e-04	-133.16	0.0	5.49	-0.06	0.0	0.0	0.0	0.02
		-2.20	0.0	0.0		35.0	5.49	1.91	0.0	0.0	0.0	-2.20
						70.0	5.49	37.89	0.0	0.0	0.0	4.76
14	43	0.52	0.0	-5.30e-04	-116.64	0.0	6.54	-0.05	0.0	0.0	0.0	0.02
		-3.37	0.0	0.0		35.0	6.54	-4.18	0.0	0.0	0.0	-3.27
						70.0	6.54	25.91	0.0	0.0	0.0	0.52
14	44	5.22	0.0	-2.98e-04	-135.06	0.0	7.38	-0.05	0.0	0.0	0.0	0.02
		-2.09	0.0	0.0		35.0	7.38	2.57	0.0	0.0	0.0	-2.08
						70.0	7.38	39.21	0.0	0.0	0.0	5.22
14	45	0.02	0.0	-5.15e-04	-109.99	0.0	6.57	-0.05	0.0	0.0	0.0	0.02
		-3.94	0.0	0.0		35.0	6.57	-6.49	0.0	0.0	0.0	-3.67
						70.0	6.57	21.28	0.0	0.0	0.0	-1.10
14	46	12.05	0.0	-3.77e-04	-162.57	0.0	0.38	-0.06	0.0	0.0	0.0	0.02
		-0.92	0.0	0.0		35.0	0.38	12.41	0.0	0.0	0.0	-0.34
						70.0	0.38	58.32	0.0	0.0	0.0	12.05
14	47	11.84	0.0	3.63e-04	-161.69	0.0	0.39	-0.07	0.0	0.0	0.0	0.02
		-0.95	0.0	0.0		35.0	0.39	12.11	0.0	0.0	0.0	-0.39
						70.0	0.39	57.72	0.0	0.0	0.0	11.84
14	48	10.65	0.0	3.48e-04	-156.81	0.0	0.39	-0.06	0.0	0.0	0.0	0.02
		-1.12	0.0	0.0		35.0	0.39	10.41	0.0	0.0	0.0	-0.69



						70.0	0.39	54.34	0.0	0.0	0.0	10.65
14	49	10.49	0.0	3.38e-04	-156.15	0.0	0.40	-0.06	0.0	0.0	0.0	0.02
		-1.14	0.0	0.0		35.0	0.40	10.18	0.0	0.0	0.0	-0.73
						70.0	0.40	53.90	0.0	0.0	0.0	10.49
14	50	7.34e-03	0.0	-7.24e-04	-113.73	0.0	7.30	-0.02	0.0	0.0	0.0	7.34e-03
		-3.66	0.0	0.0		35.0	7.30	-5.43	0.0	0.0	0.0	-3.50
						70.0	7.30	23.56	0.0	0.0	0.0	-0.34
14	51	0.01	0.0	-8.61e-04	-108.47	0.0	8.33	-0.04	0.0	0.0	0.0	0.01
		-4.21	0.0	0.0		35.0	8.33	-7.46	0.0	0.0	0.0	-3.85
						70.0	8.33	19.62	0.0	0.0	0.0	-1.75
14	52	6.81e-03	0.0	1.11e-03	-91.96	0.0	9.39	-0.02	0.0	0.0	0.0	6.81e-03
		-6.46	0.0	0.0		35.0	9.39	-13.55	0.0	0.0	0.0	-4.93
						70.0	9.39	7.65	0.0	0.0	0.0	-5.99
14	53	6.51	0.0	-6.03e-05	-139.55	0.0	4.41	-0.05	0.0	0.0	0.0	0.02
		-1.84	0.0	0.0		35.0	4.41	4.45	0.0	0.0	0.0	-1.75
						70.0	4.41	42.77	0.0	0.0	0.0	6.51
14	54	5.11	0.0	-1.97e-04	-134.28	0.0	5.45	-0.07	0.0	0.0	0.0	0.02
		-2.11	0.0	0.0		35.0	5.45	2.41	0.0	0.0	0.0	-2.10
						70.0	5.45	38.83	0.0	0.0	0.0	5.11
14	55	0.87	0.0	-4.44e-04	-117.77	0.0	6.51	-0.05	0.0	0.0	0.0	0.02
		-3.26	0.0	0.0		35.0	6.51	-3.67	0.0	0.0	0.0	-3.18
						70.0	6.51	26.85	0.0	0.0	0.0	0.87
14	56	12.23	0.0	-4.22e-04	-163.39	0.0	0.37	-0.06	0.0	0.0	0.0	0.02
		-0.89	0.0	0.0		35.0	0.37	12.68	0.0	0.0	0.0	-0.29
						70.0	0.37	58.81	0.0	0.0	0.0	12.23
14	57	12.02	0.0	4.08e-04	-162.51	0.0	0.38	-0.07	0.0	0.0	0.0	0.02
		-0.92	0.0	0.0		35.0	0.38	12.37	0.0	0.0	0.0	-0.35
						70.0	0.38	58.22	0.0	0.0	0.0	12.02
14	58	10.95	0.0	4.23e-04	-158.18	0.0	0.37	-0.06	0.0	0.0	0.0	0.02
		-1.07	0.0	0.0		35.0	0.37	10.86	0.0	0.0	0.0	-0.61
						70.0	0.37	55.17	0.0	0.0	0.0	10.95
14	59	10.80	0.0	4.13e-04	-157.52	0.0	0.38	-0.06	0.0	0.0	0.0	0.02
		-1.09	0.0	0.0		35.0	0.38	10.63	0.0	0.0	0.0	-0.65
						70.0	0.38	54.72	0.0	0.0	0.0	10.80
14	60	7.13e-03	0.0	-8.13e-04	-112.57	0.0	7.32	-0.02	0.0	0.0	0.0	7.13e-03
		-3.80	0.0	0.0		35.0	7.32	-5.95	0.0	0.0	0.0	-3.59
						70.0	7.32	22.59	0.0	0.0	0.0	-0.70
14	61	0.01	0.0	9.50e-04	-107.31	0.0	8.36	-0.04	0.0	0.0	0.0	0.01
		-4.36	0.0	0.0		35.0	8.36	-7.99	0.0	0.0	0.0	-3.95
						70.0	8.36	18.66	0.0	0.0	0.0	-2.11



14	62	6.59e-03	0.0	1.20e-03	-90.80	0.0	9.41	-0.02	0.0	0.0	0.0	6.59e-03
		-6.70	0.0	0.0		35.0	9.41	-14.07	0.0	0.0	0.0	-5.02
						70.0	9.41	6.68	0.0	0.0	0.0	-6.35
14	63	6.04	0.0	-1.79e-04	-137.99	0.0	4.45	-0.05	0.0	0.0	0.0	0.02
		-1.93	0.0	0.0		35.0	4.45	3.75	0.0	0.0	0.0	-1.87
						70.0	4.45	41.47	0.0	0.0	0.0	6.04
14	64	4.63	0.0	-3.16e-04	-132.72	0.0	5.48	-0.06	0.0	0.0	0.0	0.02
		-2.23	0.0	0.0		35.0	5.48	1.71	0.0	0.0	0.0	-2.23
						70.0	5.48	37.53	0.0	0.0	0.0	4.63
14	65	0.39	0.0	-5.63e-04	-116.21	0.0	6.54	-0.05	0.0	0.0	0.0	0.02
		-3.41	0.0	0.0		35.0	6.54	-4.37	0.0	0.0	0.0	-3.30
						70.0	6.54	25.55	0.0	0.0	0.0	0.39
14	66	2.63	0.0	-5.34e-04	-125.21	0.0	7.33	-8.49e-03	0.0	0.0	0.0	1.58e-03
		-2.75	0.0	0.0		35.0	7.33	-1.15	0.0	0.0	0.0	-2.75
						70.0	7.33	31.94	0.0	0.0	0.0	2.63
14	67	9.37	0.0	-9.98e-05	-151.13	0.0	4.46	-0.04	0.0	0.0	0.0	0.01
		-1.31	0.0	0.0		35.0	4.46	8.56	0.0	0.0	0.0	-1.03
						70.0	4.46	50.82	0.0	0.0	0.0	9.37
14	68	8.07e-03	0.0	1.18e-03	-84.14	0.0	9.44	-0.03	0.0	0.0	0.0	8.07e-03
		-8.00	0.0	0.0		35.0	9.44	-16.39	0.0	0.0	0.0	-5.43
						70.0	9.44	2.05	0.0	0.0	0.0	-7.97
14	69	0.02	0.0	-5.12e-04	-110.03	0.0	6.58	-0.05	0.0	0.0	0.0	0.02
		-3.93	0.0	0.0		35.0	6.58	-6.48	0.0	0.0	0.0	-3.67
						70.0	6.58	21.31	0.0	0.0	0.0	-1.09
14	70	6.41	0.0	2.50e-04	-139.34	0.0	0.39	-0.05	0.0	0.0	0.0	0.02
		-1.84	0.0	0.0		35.0	0.39	4.35	0.0	0.0	0.0	-1.76
						70.0	0.39	42.29	0.0	0.0	0.0	6.41
14	71	3.32	0.0	-4.75e-05	-126.46	0.0	3.60	-0.04	0.0	0.0	0.0	0.01
		-2.55	0.0	0.0		35.0	3.60	-0.10	0.0	0.0	0.0	-2.55
						70.0	3.60	33.64	0.0	0.0	0.0	3.32
14	72	6.74	0.0	3.31e-04	-140.81	0.0	0.37	-0.05	0.0	0.0	0.0	0.02
		-1.78	0.0	0.0		35.0	0.37	4.83	0.0	0.0	0.0	-1.67
						70.0	0.37	43.18	0.0	0.0	0.0	6.74
14	73	3.00	0.0	-1.29e-04	-125.40	0.0	3.62	-0.04	0.0	0.0	0.0	0.01
		-2.63	0.0	0.0		35.0	3.62	-0.58	0.0	0.0	0.0	-2.63
						70.0	3.62	32.75	0.0	0.0	0.0	3.00
14	74	3.17	0.0	-8.42e-05	-125.98	0.0	3.64	-0.04	0.0	0.0	0.0	0.01
		-2.58	0.0	0.0		35.0	3.64	-0.32	0.0	0.0	0.0	-2.58
						70.0	3.64	33.24	0.0	0.0	0.0	3.17
14	75	0.02	0.0	-6.61e-04	-114.87	0.0	6.45	-0.05	0.0	0.0	0.0	0.02



		-3.55	0.0	0.0		35.0	6.45	-4.98	0.0	0.0	0.0	-3.41
						70.0	6.45	24.43	0.0	0.0	0.0	-0.02
14	76	-0.02	0.0	-2.84e-03	-24.61	0.0	20.32	0.04	0.0	0.0	0.0	-0.02
		-23.88	0.0	0.0		35.0	20.32	-39.33	0.0	0.0	0.0	-9.50
						70.0	20.32	-42.46	0.0	0.0	0.0	-23.88
14	77	0.30	0.0	-5.80e-04	-115.93	0.0	6.43	-0.06	0.0	0.0	0.0	0.02
		-3.44	0.0	0.0		35.0	6.43	-4.50	0.0	0.0	0.0	-3.33
						70.0	6.43	25.32	0.0	0.0	0.0	0.30
14	78	-0.02	0.0	-2.92e-03	-23.55	0.0	20.35	0.04	0.0	0.0	0.0	-0.02
		-24.21	0.0	0.0		35.0	20.35	-39.81	0.0	0.0	0.0	-9.58
						70.0	20.35	-43.34	0.0	0.0	0.0	-24.21
14	79	-0.01	0.0	-2.91e-03	-16.67	0.0	20.36	0.03	0.0	0.0	0.0	-0.01
		-25.89	0.0	0.0		35.0	20.36	-42.21	0.0	0.0	0.0	-10.00
						70.0	20.36	-48.15	0.0	0.0	0.0	-25.89
15	1	751.34	0.0	3.77e-03	-215.22	0.0	-331.69	-760.22	0.0	0.0	0.0	746.64
		-1374.06	0.0	0.0		575.0	-331.69	1.82	0.0	0.0	0.0	-1374.06
						1150.0	-331.69	755.32	0.0	0.0	0.0	751.34
15	2	762.85	0.0	3.70e-03	-214.19	0.0	-344.52	-755.85	0.0	0.0	0.0	758.19
		-1351.11	0.0	0.0		575.0	-344.52	1.81	0.0	0.0	0.0	-1351.11
						1150.0	-344.52	750.99	0.0	0.0	0.0	762.85
15	3	725.25	0.0	3.54e-03	-207.74	0.0	-347.72	-721.76	0.0	0.0	0.0	720.83
		-1293.13	0.0	0.0		575.0	-347.72	1.73	0.0	0.0	0.0	-1293.13
						1150.0	-347.72	717.07	0.0	0.0	0.0	725.25
15	4	733.86	0.0	3.48e-03	-206.98	0.0	-357.31	-718.49	0.0	0.0	0.0	729.47
		-1275.95	0.0	0.0		575.0	-357.31	1.72	0.0	0.0	0.0	-1275.95
						1150.0	-357.31	713.83	0.0	0.0	0.0	733.86
15	5	1412.24	0.0	0.02	-265.31	0.0	-400.48	-725.27	0.0	0.0	0.0	1412.24
		-1392.30	0.0	0.0		575.0	-400.48	-170.47	0.0	0.0	0.0	-1274.38
						1150.0	-400.48	711.04	0.0	0.0	0.0	65.94
15	6	1494.64	0.0	0.03	-269.98	0.0	-423.80	-723.20	0.0	0.0	0.0	1494.64
		-1390.76	0.0	0.0		575.0	-423.80	-186.81	0.0	0.0	0.0	-1249.34
						1150.0	-423.80	706.59	0.0	0.0	0.0	17.32
15	7	1560.79	0.0	0.03	-267.23	0.0	-431.85	-662.92	0.0	0.0	0.0	1560.79
		-1301.96	0.0	0.0		575.0	-431.85	-212.45	0.0	0.0	0.0	-1114.19
						1150.0	-431.85	645.07	0.0	0.0	0.0	-117.22
15	8	1108.08	0.0	0.01	-234.17	0.0	-388.94	-730.55	0.0	0.0	0.0	1108.08
		-1305.74	0.0	0.0		575.0	-388.94	-88.62	0.0	0.0	0.0	-1272.93
						1150.0	-388.94	707.44	0.0	0.0	0.0	378.03
15	9	1190.47	0.0	0.01	-238.84	0.0	-412.26	-728.48	0.0	0.0	0.0	1190.47
		-1292.50	0.0	0.0		575.0	-412.26	-104.96	0.0	0.0	0.0	-1247.89



						1150.0	-412.26	702.99	0.0	0.0	0.0	329.41
15	10	1256.62	0.0	0.02	-236.09	0.0	-420.31	-668.20	0.0	0.0	0.0	1256.62
		-1185.16	0.0	0.0		575.0	-420.31	-130.59	0.0	0.0	0.0	-1112.74
						1150.0	-420.31	641.47	0.0	0.0	0.0	194.87
15	11	637.47	0.0	4.16e-03	-216.21	0.0	-305.25	-758.40	0.0	0.0	0.0	632.70
		-1477.34	0.0	0.0		575.0	-305.25	1.84	0.0	0.0	0.0	-1477.34
						1150.0	-305.25	753.46	0.0	0.0	0.0	637.47
15	12	648.99	0.0	4.08e-03	-215.19	0.0	-318.08	-754.04	0.0	0.0	0.0	644.26
		-1454.38	0.0	0.0		575.0	-318.08	1.83	0.0	0.0	0.0	-1454.38
						1150.0	-318.08	749.12	0.0	0.0	0.0	648.99
15	13	572.62	0.0	4.06e-03	-209.08	0.0	-312.28	-719.32	0.0	0.0	0.0	568.11
		-1431.56	0.0	0.0		575.0	-312.28	1.76	0.0	0.0	0.0	-1431.56
						1150.0	-312.28	714.57	0.0	0.0	0.0	572.62
15	14	581.23	0.0	4.00e-03	-208.31	0.0	-321.87	-716.05	0.0	0.0	0.0	576.75
		-1414.38	0.0	0.0		575.0	-321.87	1.75	0.0	0.0	0.0	-1414.38
						1150.0	-321.87	711.32	0.0	0.0	0.0	581.23
15	15	1526.18	0.0	0.02	-264.35	0.0	-426.92	-727.08	0.0	0.0	0.0	1526.18
		-1288.08	0.0	0.0		575.0	-426.92	-170.49	0.0	0.0	0.0	-1171.11
						1150.0	-426.92	712.91	0.0	0.0	0.0	179.81
15	16	1608.57	0.0	0.03	-269.02	0.0	-450.24	-725.02	0.0	0.0	0.0	1608.57
		-1286.54	0.0	0.0		575.0	-450.24	-186.84	0.0	0.0	0.0	-1146.07
						1150.0	-450.24	708.45	0.0	0.0	0.0	131.19
15	17	1674.72	0.0	0.03	-266.27	0.0	-458.29	-664.74	0.0	0.0	0.0	1674.72
		-1197.74	0.0	0.0		575.0	-458.29	-212.47	0.0	0.0	0.0	-1010.92
						1150.0	-458.29	646.94	0.0	0.0	0.0	-3.36
15	18	1260.80	0.0	0.01	-232.88	0.0	-424.38	-732.99	0.0	0.0	0.0	1260.80
		-1167.00	0.0	0.0		575.0	-424.38	-88.65	0.0	0.0	0.0	-1134.50
						1150.0	-424.38	709.94	0.0	0.0	0.0	530.66
15	19	1343.19	0.0	0.01	-237.55	0.0	-447.70	-730.92	0.0	0.0	0.0	1343.19
		-1153.76	0.0	0.0		575.0	-447.70	-104.99	0.0	0.0	0.0	-1109.46
						1150.0	-447.70	705.49	0.0	0.0	0.0	482.03
15	20	1409.34	0.0	0.02	-234.81	0.0	-455.75	-670.64	0.0	0.0	0.0	1409.34
		-1045.46	0.0	0.0		575.0	-455.75	-130.62	0.0	0.0	0.0	-974.31
						1150.0	-455.75	643.98	0.0	0.0	0.0	347.49
15	21	1543.55	0.0	0.02	-248.76	0.0	-436.89	-758.27	0.0	0.0	0.0	1543.55
		-1259.96	0.0	0.0		575.0	-436.89	-156.77	0.0	0.0	0.0	-1161.56
						1150.0	-436.89	682.85	0.0	0.0	0.0	185.78
15	22	1278.17	0.0	5.06e-03	-217.30	0.0	-434.35	-764.17	0.0	0.0	0.0	1278.17
		-1147.71	0.0	0.0		575.0	-434.35	-74.92	0.0	0.0	0.0	-1124.95
						1150.0	-434.35	679.89	0.0	0.0	0.0	536.63



15	23	1450.53	0.0	0.03	-209.50	0.0	-470.29	-456.99	0.0	0.0	0.0	1450.53
		-919.47	0.0	0.0		575.0	-470.29	-212.96	0.0	0.0	0.0	-654.56
						1150.0	-470.29	440.51	0.0	0.0	0.0	-228.81
15	24	1139.49	0.0	0.02	-178.42	0.0	-481.75	-462.17	0.0	0.0	0.0	1139.49
		-766.93	0.0	0.0		575.0	-481.75	-131.10	0.0	0.0	0.0	-659.35
						1150.0	-481.75	436.80	0.0	0.0	0.0	76.40
15	25	1353.97	0.0	0.03	-274.65	0.0	-417.72	-665.72	0.0	0.0	0.0	1353.97
		-1360.10	0.0	0.0		575.0	-417.72	-251.71	0.0	0.0	0.0	-1142.07
						1150.0	-417.72	587.64	0.0	0.0	0.0	-455.53
15	26	1430.89	0.0	0.02	-265.17	0.0	-431.29	-694.47	0.0	0.0	0.0	1430.89
		-1351.33	0.0	0.0		575.0	-431.29	-254.32	0.0	0.0	0.0	-1128.19
						1150.0	-431.29	560.02	0.0	0.0	0.0	-498.61
15	27	1264.17	0.0	3.62e-03	-219.77	0.0	-435.68	-812.41	0.0	0.0	0.0	1264.17
		-1261.97	0.0	0.0		575.0	-435.68	-70.20	0.0	0.0	0.0	-1244.07
						1150.0	-435.68	707.28	0.0	0.0	0.0	519.09
15	28	1326.25	0.0	0.01	-245.02	0.0	-448.90	-767.55	0.0	0.0	0.0	1326.25
		-1268.77	0.0	0.0		575.0	-448.90	-104.90	0.0	0.0	0.0	-1226.01
						1150.0	-448.90	741.91	0.0	0.0	0.0	465.39
15	29	1572.43	0.0	0.03	-257.34	0.0	-481.02	-613.77	0.0	0.0	0.0	1572.43
		-1172.92	0.0	0.0		575.0	-481.02	-212.57	0.0	0.0	0.0	-968.37
						1150.0	-481.02	596.21	0.0	0.0	0.0	-105.97
15	30	887.30	0.0	0.01	-212.41	0.0	-484.75	-537.80	0.0	0.0	0.0	887.30
		-730.30	0.0	0.0		575.0	-484.75	-53.78	0.0	0.0	0.0	-705.09
						1150.0	-484.75	533.40	0.0	0.0	0.0	275.70
15	31	912.64	0.0	0.01	-211.52	0.0	-521.68	-534.80	0.0	0.0	0.0	912.64
		-698.08	0.0	0.0		575.0	-521.68	-53.80	0.0	0.0	0.0	-672.78
						1150.0	-521.68	530.43	0.0	0.0	0.0	301.01
15	32	886.31	0.0	-0.01	-199.76	0.0	-535.59	-474.08	0.0	0.0	0.0	886.31
		-564.08	0.0	0.0		575.0	-535.59	-53.94	0.0	0.0	0.0	-531.33
						1150.0	-535.59	470.05	0.0	0.0	0.0	274.22
15	33	1513.84	0.0	0.03	-252.04	0.0	-471.26	-585.13	0.0	0.0	0.0	1513.84
		-1158.95	0.0	0.0		575.0	-471.26	-280.08	0.0	0.0	0.0	-842.55
						1150.0	-471.26	459.01	0.0	0.0	0.0	-540.79
15	34	580.09	0.0	2.48e-03	-153.55	0.0	-323.93	-535.53	0.0	0.0	0.0	576.83
		-919.56	0.0	0.0		575.0	-323.93	1.28	0.0	0.0	0.0	-919.56
						1150.0	-323.93	532.07	0.0	0.0	0.0	580.09
15	35	682.80	0.0	2.87e-03	-158.18	0.0	-349.58	-534.72	0.0	0.0	0.0	682.80
		-896.19	0.0	0.0		575.0	-349.58	-20.78	0.0	0.0	0.0	-896.19
						1150.0	-349.58	528.03	0.0	0.0	0.0	509.22
15	36	735.68	0.0	5.15e-03	-165.40	0.0	-330.94	-539.00	0.0	0.0	0.0	735.68

		-936.11	0.0	0.0		575.0	-330.94	-40.91	0.0	0.0	0.0	-929.56
						1150.0	-330.94	527.51	0.0	0.0	0.0	397.07
15	37	796.87	0.0	6.79e-03	-168.86	0.0	-348.25	-537.46	0.0	0.0	0.0	796.87
		-926.28	0.0	0.0		575.0	-348.25	-53.05	0.0	0.0	0.0	-910.97
						1150.0	-348.25	524.20	0.0	0.0	0.0	360.96
15	38	845.99	0.0	9.49e-03	-166.82	0.0	-354.23	-492.70	0.0	0.0	0.0	845.99
		-841.43	0.0	0.0		575.0	-354.23	-72.08	0.0	0.0	0.0	-810.61
						1150.0	-354.23	478.52	0.0	0.0	0.0	261.05
15	39	485.20	0.0	2.80e-03	-154.38	0.0	-301.90	-534.01	0.0	0.0	0.0	481.89
		-1005.63	0.0	0.0		575.0	-301.90	1.30	0.0	0.0	0.0	-1005.63
						1150.0	-301.90	530.52	0.0	0.0	0.0	485.20
15	40	491.60	0.0	2.76e-03	-153.81	0.0	-309.02	-531.59	0.0	0.0	0.0	488.31
		-992.87	0.0	0.0		575.0	-309.02	1.29	0.0	0.0	0.0	-992.87
						1150.0	-309.02	528.11	0.0	0.0	0.0	491.60
15	41	830.63	0.0	5.15e-03	-164.59	0.0	-352.97	-540.52	0.0	0.0	0.0	830.63
		-849.86	0.0	0.0		575.0	-352.97	-40.93	0.0	0.0	0.0	-843.50
						1150.0	-352.97	529.06	0.0	0.0	0.0	491.95
15	42	891.81	0.0	6.80e-03	-168.06	0.0	-370.28	-538.98	0.0	0.0	0.0	891.81
		-840.03	0.0	0.0		575.0	-370.28	-53.07	0.0	0.0	0.0	-824.90
						1150.0	-370.28	525.76	0.0	0.0	0.0	455.85
15	43	940.93	0.0	9.50e-03	-166.02	0.0	-376.26	-494.22	0.0	0.0	0.0	940.93
		-755.18	0.0	0.0		575.0	-376.26	-72.10	0.0	0.0	0.0	-724.54
						1150.0	-376.26	480.08	0.0	0.0	0.0	355.94
15	44	1022.87	0.0	6.18e-03	-166.93	0.0	-383.30	-565.79	0.0	0.0	0.0	1022.87
		-848.82	0.0	0.0		575.0	-383.30	-71.71	0.0	0.0	0.0	-820.40
						1150.0	-383.30	504.46	0.0	0.0	0.0	350.22
15	45	858.76	0.0	9.52e-03	-159.44	0.0	-395.05	-456.27	0.0	0.0	0.0	858.76
		-730.95	0.0	0.0		575.0	-395.05	-72.17	0.0	0.0	0.0	-698.59
						1150.0	-395.05	442.31	0.0	0.0	0.0	273.53
15	46	596.74	0.0	2.66e-03	-159.07	0.0	-320.60	-563.77	0.0	0.0	0.0	593.28
		-981.37	0.0	0.0		575.0	-320.60	1.34	0.0	0.0	0.0	-981.37
						1150.0	-320.60	560.16	0.0	0.0	0.0	596.74
15	47	605.27	0.0	2.60e-03	-158.31	0.0	-330.10	-560.53	0.0	0.0	0.0	601.84
		-964.36	0.0	0.0		575.0	-330.10	1.33	0.0	0.0	0.0	-964.36
						1150.0	-330.10	556.95	0.0	0.0	0.0	605.27
15	48	577.22	0.0	2.49e-03	-153.58	0.0	-333.51	-535.48	0.0	0.0	0.0	573.97
		-922.16	0.0	0.0		575.0	-333.51	1.28	0.0	0.0	0.0	-922.16
						1150.0	-333.51	532.03	0.0	0.0	0.0	577.22
15	49	583.62	0.0	2.44e-03	-153.01	0.0	-340.63	-533.05	0.0	0.0	0.0	580.39
		-909.41	0.0	0.0		575.0	-340.63	1.27	0.0	0.0	0.0	-909.41



						1150.0	-340.63	529.62	0.0	0.0	0.0	583.62
15	50	963.54	0.0	0.01	-188.44	0.0	-330.97	-535.13	0.0	0.0	0.0	963.54
		-980.52	0.0	0.0		575.0	-330.97	-101.54	0.0	0.0	0.0	-928.32
						1150.0	-330.97	530.22	0.0	0.0	0.0	168.44
15	51	1024.72	0.0	0.02	-191.91	0.0	-348.28	-533.59	0.0	0.0	0.0	1024.72
		-979.37	0.0	0.0		575.0	-348.28	-113.68	0.0	0.0	0.0	-909.73
						1150.0	-348.28	526.91	0.0	0.0	0.0	132.33
15	52	1073.84	0.0	0.02	-189.87	0.0	-354.26	-488.83	0.0	0.0	0.0	1073.84
		-913.43	0.0	0.0		575.0	-354.26	-132.71	0.0	0.0	0.0	-809.37
						1150.0	-354.26	481.23	0.0	0.0	0.0	32.42
15	53	738.55	0.0	5.15e-03	-165.37	0.0	-321.35	-539.05	0.0	0.0	0.0	738.55
		-933.51	0.0	0.0		575.0	-321.35	-40.91	0.0	0.0	0.0	-926.96
						1150.0	-321.35	527.55	0.0	0.0	0.0	399.93
15	54	799.73	0.0	6.79e-03	-168.84	0.0	-338.67	-537.51	0.0	0.0	0.0	799.73
		-923.68	0.0	0.0		575.0	-338.67	-53.05	0.0	0.0	0.0	-908.37
						1150.0	-338.67	524.25	0.0	0.0	0.0	363.83
15	55	848.85	0.0	9.49e-03	-166.80	0.0	-344.65	-492.75	0.0	0.0	0.0	848.85
		-838.83	0.0	0.0		575.0	-344.65	-72.08	0.0	0.0	0.0	-808.01
						1150.0	-344.65	478.57	0.0	0.0	0.0	263.92
15	56	548.29	0.0	2.82e-03	-159.49	0.0	-309.35	-562.99	0.0	0.0	0.0	544.80
		-1025.32	0.0	0.0		575.0	-309.35	1.35	0.0	0.0	0.0	-1025.32
						1150.0	-309.35	559.36	0.0	0.0	0.0	548.29
15	57	556.82	0.0	2.77e-03	-158.73	0.0	-318.85	-559.76	0.0	0.0	0.0	553.36
		-1008.31	0.0	0.0		575.0	-318.85	1.34	0.0	0.0	0.0	-1008.31
						1150.0	-318.85	556.15	0.0	0.0	0.0	556.82
15	58	496.47	0.0	2.76e-03	-154.28	0.0	-314.76	-534.19	0.0	0.0	0.0	493.16
		-995.41	0.0	0.0		575.0	-314.76	1.29	0.0	0.0	0.0	-995.41
						1150.0	-314.76	530.70	0.0	0.0	0.0	496.47
15	59	502.86	0.0	2.72e-03	-153.71	0.0	-321.88	-531.76	0.0	0.0	0.0	499.58
		-982.65	0.0	0.0		575.0	-321.88	1.29	0.0	0.0	0.0	-982.65
						1150.0	-321.88	528.29	0.0	0.0	0.0	502.86
15	60	1058.48	0.0	0.01	-187.64	0.0	-353.00	-536.64	0.0	0.0	0.0	1058.48
		-893.67	0.0	0.0		575.0	-353.00	-101.56	0.0	0.0	0.0	-842.26
						1150.0	-353.00	531.77	0.0	0.0	0.0	263.32
15	61	1119.67	0.0	0.02	-191.10	0.0	-370.32	-535.11	0.0	0.0	0.0	1119.67
		-892.52	0.0	0.0		575.0	-370.32	-113.70	0.0	0.0	0.0	-823.67
						1150.0	-370.32	528.47	0.0	0.0	0.0	227.22
15	62	1168.79	0.0	0.02	-189.07	0.0	-376.29	-490.34	0.0	0.0	0.0	1168.79
		-826.58	0.0	0.0		575.0	-376.29	-132.73	0.0	0.0	0.0	-723.31
						1150.0	-376.29	482.79	0.0	0.0	0.0	127.31



15	63	865.82	0.0	5.16e-03	-164.30	0.0	-350.89	-541.08	0.0	0.0	0.0	865.82
		-817.89	0.0	0.0		575.0	-350.89	-40.94	0.0	0.0	0.0	-811.60
						1150.0	-350.89	529.64	0.0	0.0	0.0	527.12
15	64	927.00	0.0	6.80e-03	-167.76	0.0	-368.20	-539.54	0.0	0.0	0.0	927.00
		-808.06	0.0	0.0		575.0	-368.20	-53.07	0.0	0.0	0.0	-793.01
						1150.0	-368.20	526.34	0.0	0.0	0.0	491.01
15	65	976.12	0.0	9.50e-03	-165.72	0.0	-374.18	-494.78	0.0	0.0	0.0	976.12
		-723.21	0.0	0.0		575.0	-374.18	-72.11	0.0	0.0	0.0	-692.65
						1150.0	-374.18	480.66	0.0	0.0	0.0	391.11
15	66	1071.39	0.0	9.79e-03	-176.06	0.0	-360.40	-559.80	0.0	0.0	0.0	1071.39
		-877.68	0.0	0.0		575.0	-360.40	-91.37	0.0	0.0	0.0	-835.17
						1150.0	-360.40	509.45	0.0	0.0	0.0	267.76
15	67	878.72	0.0	2.05e-03	-152.72	0.0	-358.29	-564.23	0.0	0.0	0.0	878.72
		-804.51	0.0	0.0		575.0	-358.29	-30.74	0.0	0.0	0.0	-804.51
						1150.0	-358.29	507.32	0.0	0.0	0.0	531.55
15	68	1086.61	0.0	0.02	-182.48	0.0	-395.08	-452.40	0.0	0.0	0.0	1086.61
		-807.44	0.0	0.0		575.0	-395.08	-132.80	0.0	0.0	0.0	-697.35
						1150.0	-395.08	445.02	0.0	0.0	0.0	44.90
15	69	855.89	0.0	9.52e-03	-159.47	0.0	-404.63	-456.23	0.0	0.0	0.0	855.89
		-733.55	0.0	0.0		575.0	-404.63	-72.17	0.0	0.0	0.0	-701.18
						1150.0	-404.63	442.26	0.0	0.0	0.0	270.67
15	70	530.83	0.0	1.94e-03	-136.99	0.0	-331.53	-450.81	0.0	0.0	0.0	528.20
		-733.50	0.0	0.0		575.0	-331.53	1.08	0.0	0.0	0.0	-733.50
						1150.0	-331.53	447.82	0.0	0.0	0.0	530.83
15	71	640.83	0.0	3.87e-03	-145.86	0.0	-334.99	-453.54	0.0	0.0	0.0	640.83
		-752.72	0.0	0.0		575.0	-334.99	-31.19	0.0	0.0	0.0	-749.57
						1150.0	-334.99	443.97	0.0	0.0	0.0	381.14
15	72	444.02	0.0	2.23e-03	-137.75	0.0	-311.37	-449.43	0.0	0.0	0.0	441.34
		-812.24	0.0	0.0		575.0	-311.37	1.10	0.0	0.0	0.0	-812.24
						1150.0	-311.37	446.40	0.0	0.0	0.0	444.02
15	73	727.70	0.0	3.87e-03	-145.13	0.0	-355.15	-454.92	0.0	0.0	0.0	727.70
		-673.80	0.0	0.0		575.0	-355.15	-31.21	0.0	0.0	0.0	-670.83
						1150.0	-355.15	445.39	0.0	0.0	0.0	467.95
15	74	680.13	0.0	3.87e-03	-145.53	0.0	-369.72	-454.16	0.0	0.0	0.0	680.13
		-717.02	0.0	0.0		575.0	-369.72	-31.20	0.0	0.0	0.0	-713.95
						1150.0	-369.72	444.61	0.0	0.0	0.0	420.41
15	75	981.18	0.0	0.01	-177.71	0.0	-443.84	-515.94	0.0	0.0	0.0	981.18
		-842.06	0.0	0.0		575.0	-443.84	-86.43	0.0	0.0	0.0	-802.23
						1150.0	-443.84	509.18	0.0	0.0	0.0	299.49
15	76	1751.59	0.0	0.04	-241.78	0.0	-483.20	-474.01	0.0	0.0	0.0	1751.59



		-1151.57	0.0	0.0		575.0	-483.20	-291.02	0.0	0.0	0.0	-703.17
						1150.0	-483.20	459.43	0.0	0.0	0.0	-528.05
15	77	894.31	0.0	0.01	-178.44	0.0	-423.68	-514.56	0.0	0.0	0.0	894.31
		-920.98	0.0	0.0		575.0	-423.68	-86.41	0.0	0.0	0.0	-880.96
						1150.0	-423.68	507.76	0.0	0.0	0.0	212.68
15	78	1838.46	0.0	0.04	-241.04	0.0	-503.36	-475.40	0.0	0.0	0.0	1838.46
		-1070.09	0.0	0.0		575.0	-503.36	-291.03	0.0	0.0	0.0	-624.43
						1150.0	-503.36	460.85	0.0	0.0	0.0	-441.24
15	79	1761.33	0.0	0.04	-234.26	0.0	-515.88	-436.72	0.0	0.0	0.0	1761.33
		-1065.54	0.0	0.0		575.0	-515.88	-291.11	0.0	0.0	0.0	-591.67
						1150.0	-515.88	422.36	0.0	0.0	0.0	-518.62
Trave f.		M3 mx/mn	M2 mx/mn	D 2 / D 3	Pt		N	V 2	V 3		T	
		-1477.34	0.0	-0.01	-309.14		-856.99	-903.04	0.0		0.0	
		2100.06	0.0	0.04	-16.67		20.36	874.22	0.0		0.0	

10. ALLEGATO C. – TABELLE PER IL CALCOLO DELLE SOLLECITAZIONI TRASVERSALI NELLA SOLETTA SUPERIORE

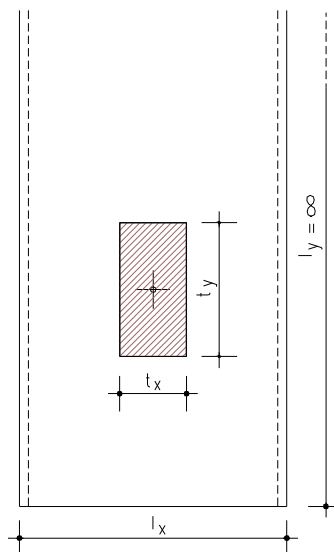

Piastra rettangolare appoggiata sui quattro lati caricata uniformemente su una zona rettangolare centrale

Valori di α_{ym}

t_x/l_x	1.00	0.90	0.80	0.70	0.60	0.50	0.40	0.30	0.20	0.10	0.05
t_y/l_x											
1.00	0.0210	0.0230	0.0250	0.0268	0.0285	0.0299	0.0312	0.0322	0.0330	0.0334	0.0335
0.90	0.0245	0.0269	0.0292	0.0313	0.0333	0.0351	0.0366	0.0378	0.0388	0.0393	0.0395
0.80	0.0286	0.0314	0.0341	0.0366	0.0390	0.0411	0.0430	0.0445	0.0456	0.0463	0.0465
0.70	0.0333	0.0366	0.0398	0.0428	0.0457	0.0483	0.0506	0.0525	0.0539	0.0548	0.0550
0.60	0.0388	0.0427	0.0464	0.0501	0.0535	0.0567	0.0596	0.0620	0.0639	0.0651	0.0654
0.50	0.0452	0.0496	0.0541	0.0585	0.0627	0.0667	0.0704	0.0736	0.0761	0.0778	0.0782
0.40	0.0525	0.0578	0.0630	0.0683	0.0735	0.0786	0.0834	0.0878	0.0914	0.0938	0.0945
0.30	0.0608	0.0670	0.0732	0.0796	0.0861	0.0927	0.0993	0.1055	0.1111	0.1150	0.1161



0.20	0.0703	0.0774	0.0849	0.0926	0.1008	0.1095	0.1186	0.1280	0.1372	0.1449	0.1471
0.10	0.0809	0.0892	0.0981	0.1075	0.1179	0.1293	0.1422	0.1569	0.1739	0.1921	0.1993
0.05	0.0867	0.0957	0.1053	0.1157	0.1273	0.1405	0.1558	0.1745	0.1979	0.2290	0.2472

$$l_y = \infty$$

$$P = p * t_x * t_y$$

$$M_{ym} = \alpha_{ym} * P$$