

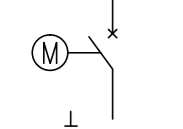

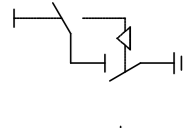

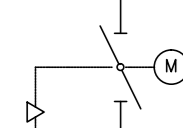
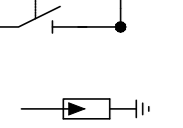
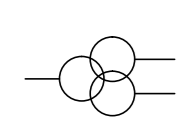
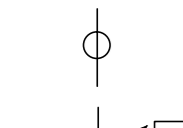
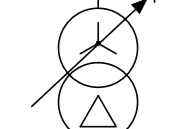
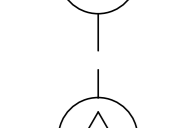
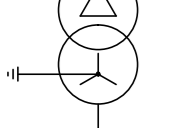
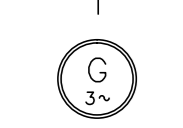
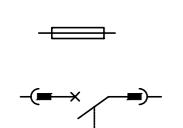
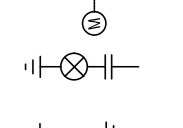
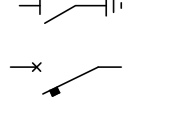
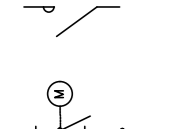
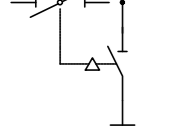
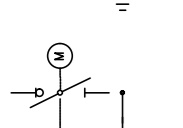
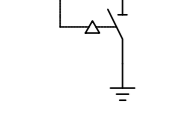

LEGENDA

-  INTERRUTTORE AT CON COMANDO MOTORIZZATO
-  SEZIONATORE MANUALE AT CON INTERBLOCCO LAME DI TERRA
-  SEZIONATORE MOTORIZZATO ROTATIVO AT CON INTERBLOCCO LAME DI TERRA
-  SCARICATORE
-  TRASFORMATORE DI TENSIONE
-  TRASFORMATORE DI CORRENTE
-  TRASFORMATORE DI POTENZA (COMMUTATORE SOTTO CARICO MOTORIZZATO)
-  TRASFORMATORE SERVIZI AUSILIARI
-  GENERATORE ASINCRONO
-  FUSIBILE
-  INTERRUTTORE MT ASPORTABILE CON COMANDO MOTORIZZATO
-  INDICATORE CAPACITIVO PRESENZA TENSIONE
-  LAME DI MESSA A TERRA
-  INTERRUTTORE AUTOMATICO
-  CONTATTATORE DI MANOVRA
-  SEZIONATORE ROTATIVO CON MESSA A TERRA
-  SEZIONATORE ROTATIVO SOTTOCARICO CON MESSA A TERRA
-  LAMPADA DI SEGNALAZIONE
-  BLOCCO A CHIAVE, CHIAVE LIBERA IN APERTO
-  BLOCCO A CHIAVE, CHIAVE LIBERA IN CHIUSO
-  CONTATORE DI ENERGIA ATTIVA/REATTIVA ENTRANTE-USCENTE PER MISURE FISCALI

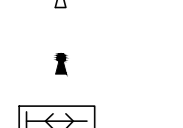
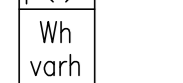

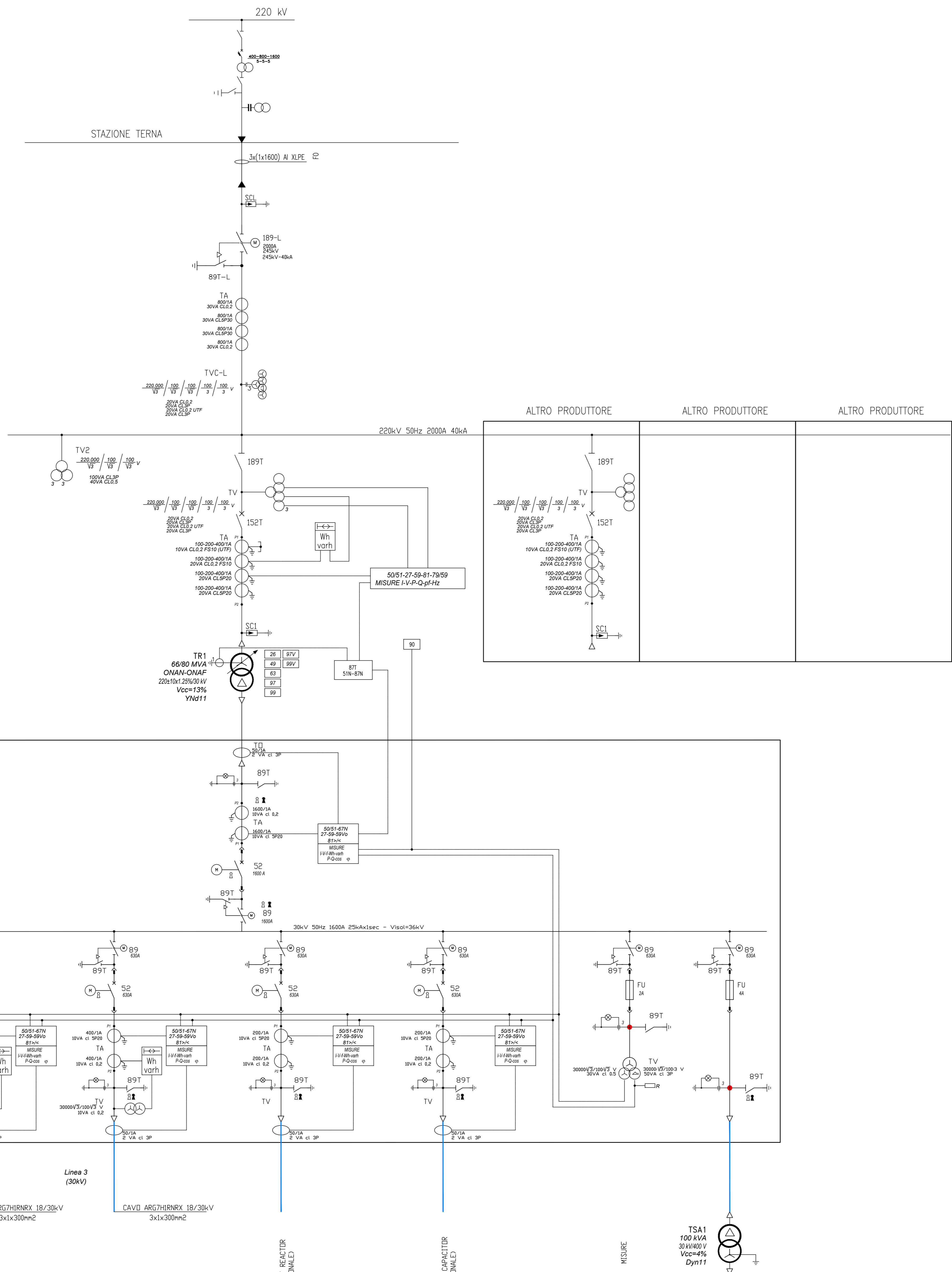

**REGIONE SICILIANA**  
PROVINCIA DI TRAPANI  
COMUNE DI MARSALA



**PROGETTO DI UN IMPIANTO EOLICO E DELLE RELATIVE OPERE DI CONNESSIONE DA REALIZZARE IN AGRO DI MARSALA (TP) IN LOCALITA' C.DA MESSINELLO DI POTENZA COMPLESSIVA DI 56,00 MW DENOMINATO "Marsa-Allah"**



**PROGETTO DEFINITIVO**

COMITATA	FASE	ELABORATO	REV.
MRS	PD	E_02	0

ELABORATO: SCHEMA ELETTRICO UNIFILARE DELL'IMPIANTO UTENTE E RTN

DATA	DESCRIZIONE	REDATTO	VERIFICATO	APPROVATO
Novembre 2021	Primo emissione	GB	MO	LG

**GRV WIND SICILIA 2 S.r.l.**  
Sede Legale: Via Duino 8, 91022 Marsala  
PEC: grvwind@grvwind.it  
Cod. Fisc. n. P. IVA n. 03421100905



**Intax**  
Sede Legale: Via Duino 8, 91022 Marsala  
PEC: intax@intax.it  
Cod. Fisc. n. P. IVA n. 03421100905

