

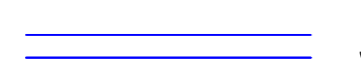

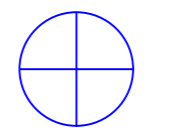

LEGENDA

-  Strade interne
-  Aerogeneratori
-  Cavidotti interrati 33 kV - Sottocampo 1
-  Cavidotti interrati 33 kV - Sottocampo 2
-  Cavidotti interrati 33 kV - Sottocampo 3
-  Cavidotti interrati 33 kV - Sottocampo 4

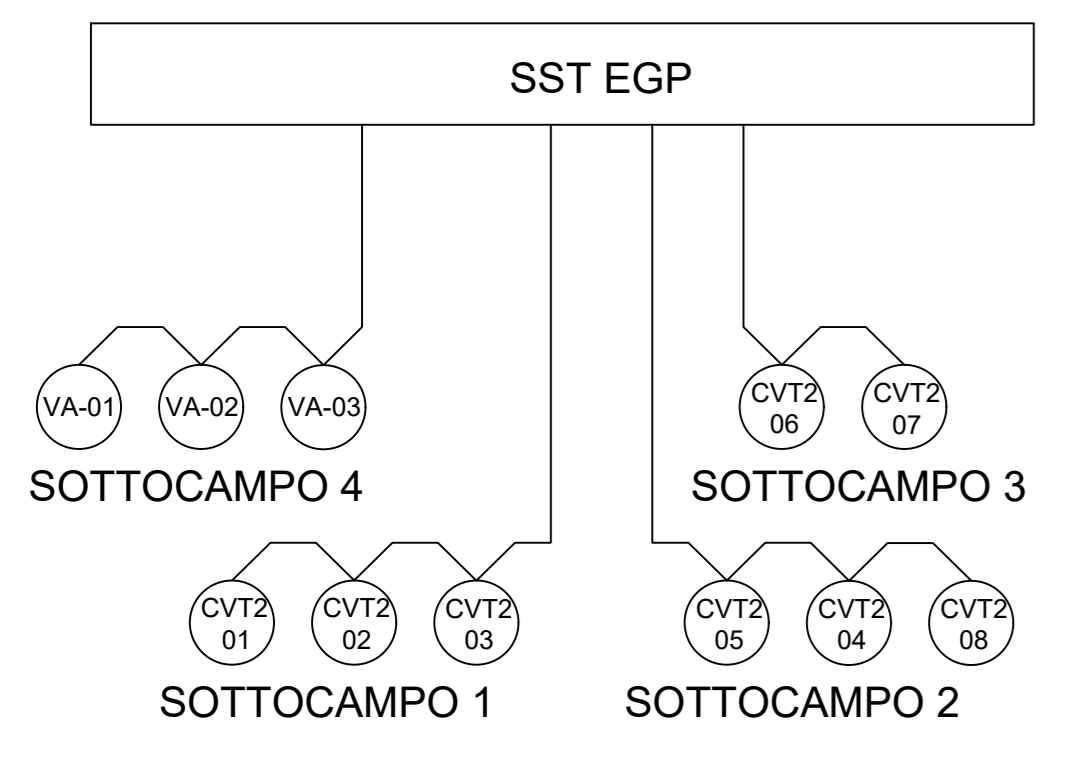

01	2021.02.10	Integrati commenti	D. Sargano	N. Novati	D. Sargano
00	2020.11.20	EMISSIONE	D. Sargano	N. Novati	D. Sargano
REV.	DATE	DESCRIPTION	PREPARED	CHECKED	APPROVED
<p>Stantec</p> <p>FILE NAME: GRE.EEC.D.73.IT.W.11633.12.003.00 - Planimetria cavidotti con individuazione tratti di posa</p> <p>CLASSIFICATION: PUBLIC FORMAT: A0 SCALE: - PLOT SCALE: 1:1 SHEET: 3 di 5</p> <p>UTILIZATION SCOPE: BASIC DESIGN TITLE: Planimetria cavidotti con sezioni di posa</p> <p>EGP VALIDATION</p> <p>VALIDATED BY: Lucifano</p> <p>VERIFIED BY: Bellorini GROUP: FUNCTION: TYPE: SKLER: COUNTRY: TEC: PLANT: SYSTEM: PROGRESSIVE: REVISION:</p> <p>COORDINATOR: Sabatino GRE.EEC.D.73.IT.W.11633.12.003.00</p>					