

ADEGUAMENTO S.S. n°87 "SANNITICA"

Interventi localizzati per garantire la percorribilità immediata
Tratto "Campobasso – Bivio S.Elia"
Lotti A2 e A3

PROGETTO DEFINITIVO

COD. CB 150

PROGETTAZIONE:

(Mandatario)

bonifica spa

(Mandante)



(Mandante)

FRANCHETTI

PROGETTISTA:

Ing. Franco Persio Bocchetto – Ordine Ing. Roma n.°8664–Sez A
Ing. Luigi Albert – Ordine Ing. Milano n.°14725–Sez A
Ing. Paolo Franchetti – Ordine Ing. Vicenza n.°2013–Sez A

GEOLOGO:

Geol. Dott. Anna Maria Bruna
Ordine Geol. Lazio n. 1531

RESPONSABILE DELL'INTEGRAZIONE DELLE DISCIPLINE SPECIALISTICHE:

Ing. Franco Persio Bocchetto – Ordine Ing. Roma n.°8664–Sez A

COORDINATORE DELLA SICUREZZA:

Ing. Andrea Maria Enea Failla – Ordine Ing. Catania n.°A6701

VISTO: IL RESPONSABILE DEL PROCEDIMENTO

Ing. CLAUDIO BUCCI

04 PS–PROGETTO STRADALE
04.01 Generale
Quaderno delle sezioni trasversali

CODICE PROGETTO		NOME FILE		REVISIONE	SCALA:
PROGETTO	LIV. PROG.	ANNO			
DPCB0150	D	22	T00PS00TRASZ01	B	1:200
C					
B	ISTRUTTORIA ANAS LUGLIO 2022	Luglio 2022	Geom. M.D'Amadio	Ing. A.Tosiani	Ing. F.P.Bocchetto
A	EMISSIONE	Aprile 2022	Geom. M.D'Amadio	Ing. A.Tosiani	Ing. F.P.Bocchetto
REV.	DESCRIZIONE	DATA	REDATTO	VERIFICATO	APPROVATO

PROFILO: Asse-SS87
 SEZIONE: 3
 PROGRESSIVA: 80.00

MOVIMENTI DI TERRA	
SCOTICO	2.02 mq
GRADONATURE	0.00 mq
SCAVO	3.99 mq
RILEVATO	3.28 mq
VEGETALE	2.90 mq

PAVIMENTAZIONI	
USURA	0.29 mq
BINDER	0.38 mq
BASE	0.95 mq
FONDAZIONE	4.87 mq

830.00
 200 200

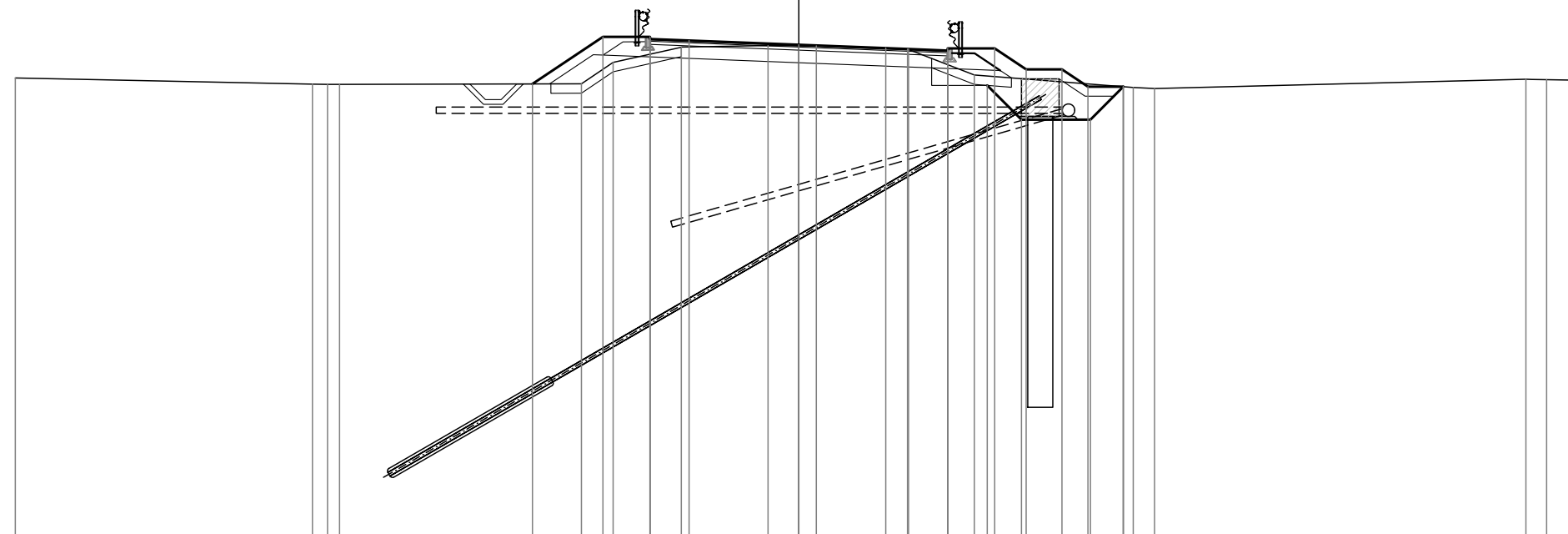

DISTANZE PARZIALI PROGETTO				2.25	1.50	1.25	3.50		3.50	1.25	1.50	1.00	1.25	0.83	1.03											
DISTANZE PROGRESSIVE PROGETTO				844.38	845.88	845.88	845.81	845.76	845.63	845.49	845.44	845.51	844.33	845.51	843.24	844.84	844.84	844.29	843.24	844.29	844.29	10.35	10.35			
QUOTE PROGETTO				844.38	845.88	845.88	845.81	845.76	845.63	845.49	845.44	845.51	844.33	845.51	843.24	844.84	844.84	844.29	843.24	844.29	844.29	10.35	10.35			
DISTANZE PARZIALI TERRENO		9.48	0.48	0.39	7.71	1.01	2.18	2.77	1.54	2.21	0.70	2.13	5.07									11.85	0.66	1.14		
DISTANZE PROGRESSIVE TERRENO	844.57	25.00	15.52	15.04	14.65	6.94	5.93	3.75	0.98	0.56	2.77	3.47	5.60									10.67	11.35	23.20	23.86	25.00
QUOTE TERRENO	844.57	25.00	15.52	15.04	14.65	6.94	5.93	3.75	0.98	0.56	2.77	3.47	5.60									10.67	11.35	23.20	23.86	25.00

PROFILO: Asse-SS87
 SEZIONE: 6
 PROGRESSIVA: 174.70

MOVIMENTI DI TERRA	
SCOTICO	6.43 mq
GRADONATURE	0.00 mq
SCAVO	1.79 mq
RILEVATO	11.27 mq
VEGETALE	2.30 mq

PAVIMENTAZIONI	
USURA	0.63 mq
BINDER	0.84 mq
BASE	2.11 mq
FONDAZIONE	9.56 mq

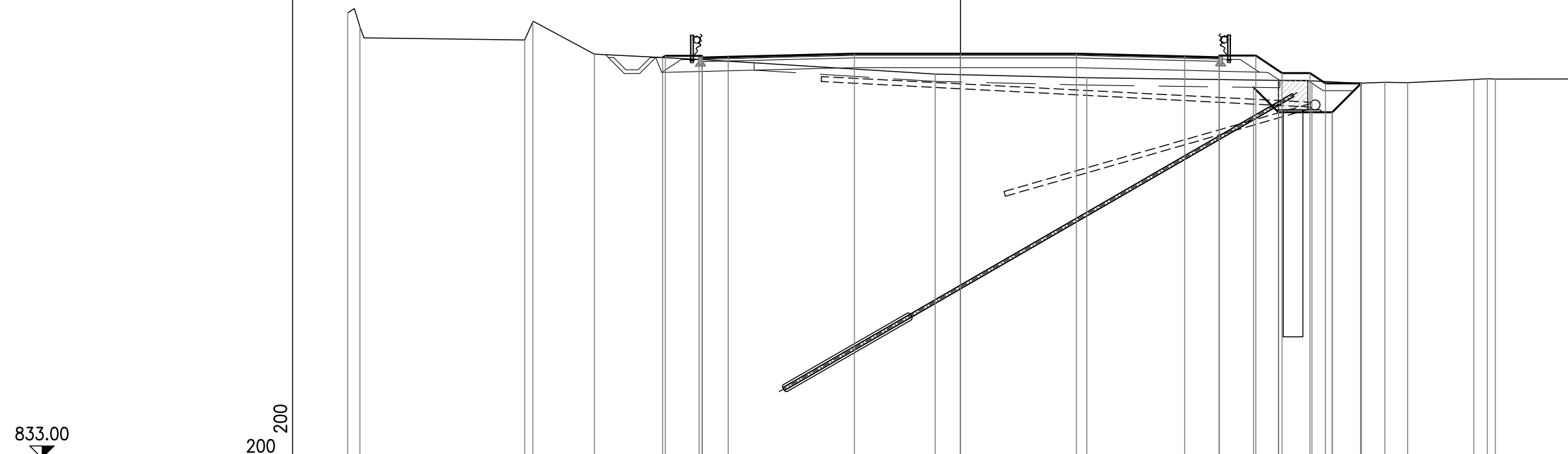

DISTANZE PARZIALI PROGETTO				0.11	1.50	1.06	5.15	4.33	4.73	4.42	1.39	1.50	1.07	1.22	0.83	1.49															
DISTANZE PROGRESSIVE PROGETTO				849.35	849.42	849.42	849.35	849.38	849.51	849.51	849.51	849.40	849.36	849.43	848.13	849.43	847.12	847.12	848.72	848.72	848.30	847.12	847.12	848.30	848.30						
QUOTE PROGETTO				849.35	849.42	849.42	849.35	849.38	849.51	849.51	849.51	849.40	849.36	849.43	848.13	849.43	847.12	847.12	848.72	848.72	848.30	847.12	847.12	848.30	848.30						
DISTANZE PARZIALI TERRENO	0.50	6.72	0.33	2.51	4.28		9.63		6.18		9.19			1.98	0.99	0.93	2.70	0.55	0.32	3.19											
DISTANZE PROGRESSIVE TERRENO	851.18	850.61	850.07	850.82	849.49	849.28	848.68	848.53	848.53	848.53	848.53	849.40	849.36	849.43	848.13	849.43	847.12	847.12	848.72	848.72	848.30	847.12	847.12	848.30	848.30	848.34	848.33	848.46	848.45	848.47	848.48
QUOTE TERRENO	851.18	850.61	850.07	850.82	849.49	849.28	848.68	848.53	848.53	848.53	848.53	849.40	849.36	849.43	848.13	849.43	847.12	847.12	848.72	848.72	848.30	847.12	847.12	848.30	848.30	848.34	848.33	848.46	848.45	848.47	848.48

PROFILO: Asse-SS87

SEZIONE: 7

PROGRESSIVA: 224.71

MOVIMENTI DI TERRA	
SCOTICO	0,00 mq
GRADONATURE	0,00 mq
SCAVO	106,84 mq
RILEVATO	0,00 mq
VEGETALE	2,87 mq

PAVIMENTAZIONI	
USURA	0,63 mq
BINDER	0,85 mq
BASE	2,11 mq
FONDAZIONE	8,46 mq

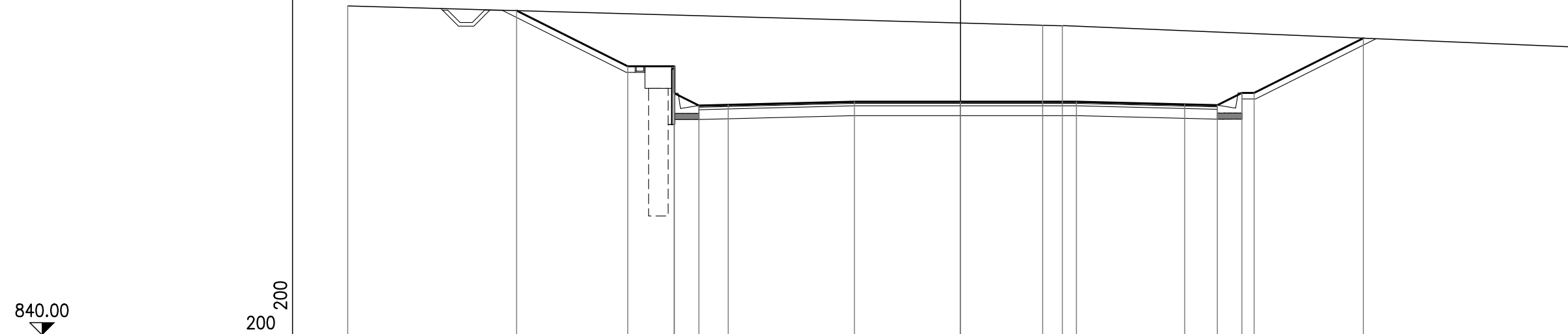

DISTANZE PARZIALI PROGETTO		4.53	1.90	1.00	1.20	5.15	4.33	4.73	4.42	1.33	1.00	0.50	4.46		
DISTANZE PROGRESSIVE PROGETTO		18.11	13.58	11.68	10.68	9.48	4.33	0.00	4.73	9.15	10.48	11.48	11.98	16.44	
QUOTE PROGETTO		853.22	850.95	849.85	850.95	849.35	849.38	849.51	849.51	849.51	849.40	849.36	849.86	849.86	852.09
DISTANZE PARZIALI TERRENO				28.35					0.80		20.85				
DISTANZE PROGRESSIVE TERRENO	25.00								3.35	4.15				25.00	
QUOTE TERRENO	853.41								852.62	852.60				851.74	

PROFILO: Asse-SS87
 SEZIONE: 8
 PROGRESSIVA: 252.00

MOVIMENTI DI TERRA	
SCOTICO	0.00 mq
GRADONATURE	0.00 mq
SCAVO	112.57 mq
RILEVATO	0.00 mq
VEGETALE	4.40 mq

PAVIMENTAZIONI	
USURA	0.29 mq
BINDER	0.38 mq
BASE	0.95 mq
FONDAZIONE	3.80 mq

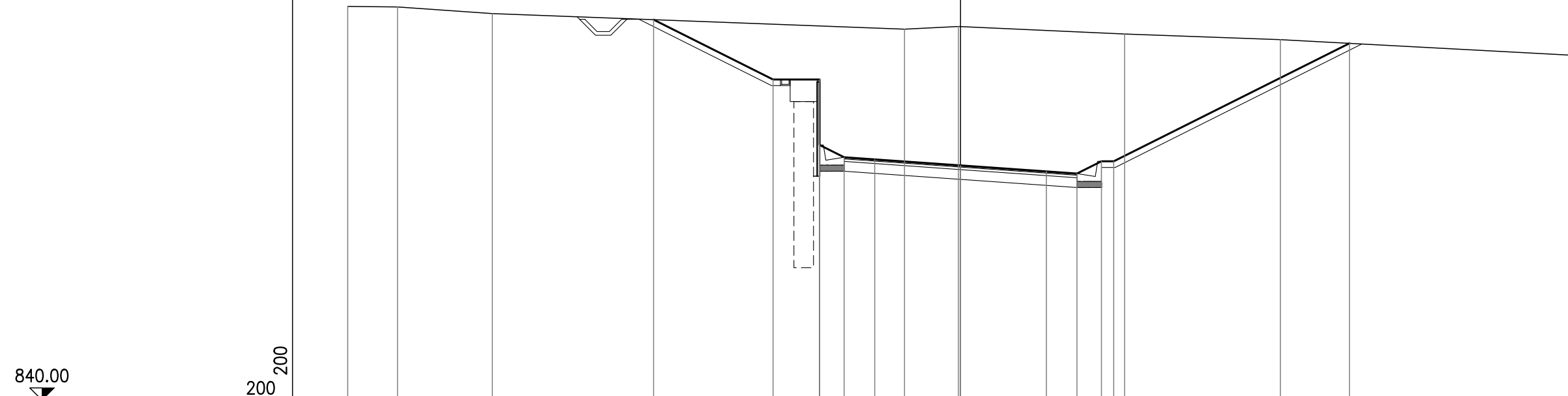

DISTANZE PARZIALI PROGETTO				4.87	1.90	1.00	1.25	3.50	3.50	1.25	1.00	0.50	9.62		
DISTANZE PROGRESSIVE PROGETTO				855.51	853.07	850.40	853.07	849.90	849.81	849.57	849.32	849.23	849.73	849.73	854.54
QUOTE PROGETTO															
DISTANZE PARZIALI TERRENO		2.03	3.87	16.81				2.20		6.78		6.35		11.96	
DISTANZE PROGRESSIVE TERRENO	856.05	856.03	855.75					855.12	855.23				854.92	854.69	854.05
QUOTE TERRENO	25.00	22.97	19.10					-2.29	-0.09				6.69	13.04	25.00

840.00

200 200

PROFILO: Asse-SS87
 SEZIONE: 9
 PROGRESSIVA: 280.00

MOVIMENTI DI TERRA	
SCOTICO	0.00 mq
GRADONATURE	0.00 mq
SCAVO	121.63 mq
RILEVATO	0.00 mq
VEGETALE	4.69 mq

PAVIMENTAZIONI	
USURA	0.29 mq
BINDER	0.38 mq
BASE	0.95 mq
FONDAZIONE	3.80 mq

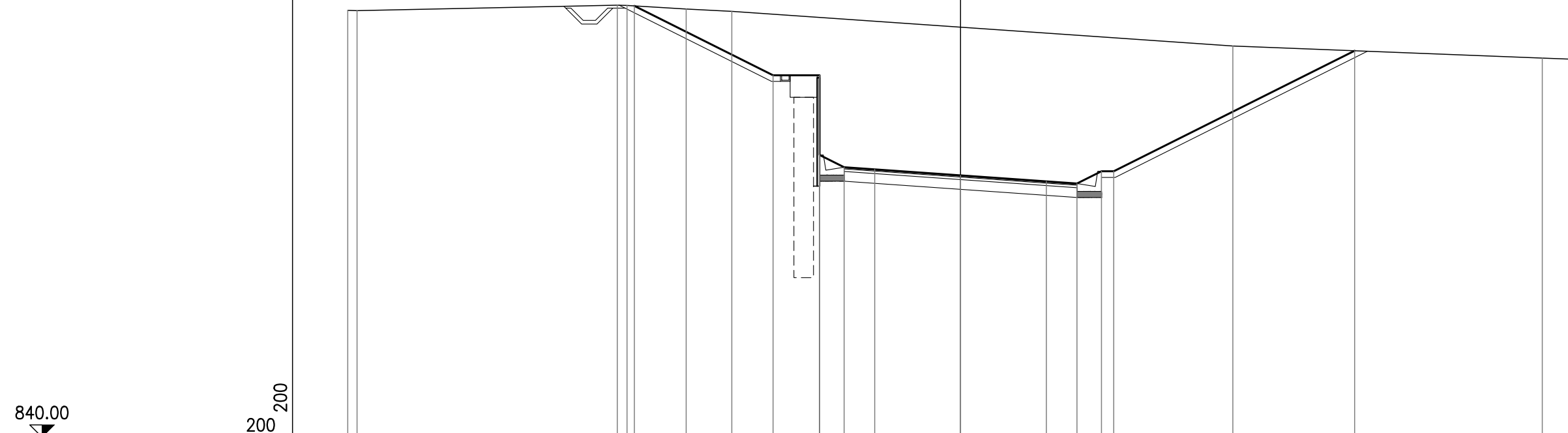

DISTANZE PARZIALI PROGETTO				5.66		1.90	1.00	1.25		3.50		3.50	1.25	1.00	0.50		9.83				
DISTANZE PROGRESSIVE PROGETTO																					
QUOTE PROGETTO																					
DISTANZE PARZIALI TERRENO	0.38		10.61									20.44						12.62		1.27	
DISTANZE PROGRESSIVE TERRENO																					
QUOTE TERRENO	857.40 857.39		857.61 857.60		857.46 857.36		857.36 857.36		854.75 851.50 854.75		851.00 850.92		850.67 850.43		850.34 850.84 850.84		855.95		855.75		855.45 855.41

PROFILO: Asse-SS87
 SEZIONE: 10
 PROGRESSIVA: 320.00

MOVIMENTI DI TERRA	
SCOTICO	0.00 mq
GRADONATURE	0.00 mq
SCAVO	85.38 mq
RILEVATO	0.00 mq
VEGETALE	4.27 mq

PAVIMENTAZIONI	
USURA	0.29 mq
BINDER	0.38 mq
BASE	0.95 mq
FONDAZIONE	3.80 mq

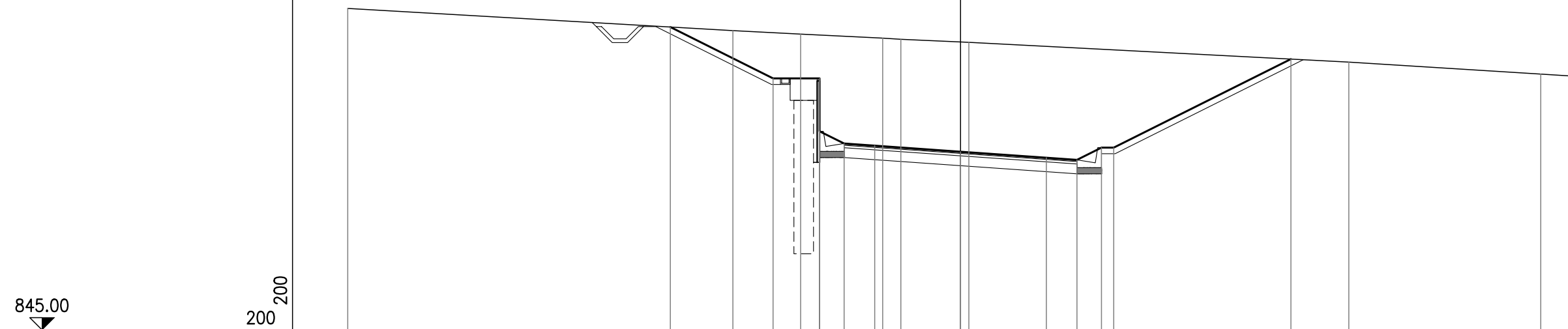

DISTANZE PARZIALI PROGETTO		4.19	1.90	1.00	1.25	3.50	3.50	1.25	1.00	0.50	7.23	
DISTANZE PROGRESSIVE PROGETTO		857.36	855.27	853.11	852.27	852.03	851.94	852.44	852.44	856.05		
QUOTE PROGETTO		-11.84	-7.65	-5.75	-4.75	-3.50	0.00	3.50	4.75	5.75	6.25	13.48
DISTANZE PARZIALI TERRENO	15.71		2.76	3.35	0.75	2.77		15.50		7.83	1.33	
DISTANZE PROGRESSIVE TERRENO	858.12	857.21	857.07	856.91	856.86	856.74	855.93	855.44	855.36			
QUOTE TERRENO	-25.00	-9.29	-6.53	-3.18	-2.43	0.34	-15.84	-23.67	-25.00			

PROFILO: Asse-SS87
 SEZIONE: 11
 PROGRESSIVA: 360.00

MOVIMENTI DI TERRA	
SCOTICO	0.00 mq
GRADONATURE	0.00 mq
SCAVO	26.91 mq
RILEVATO	0.00 mq
VEGETALE	1.45 mq

PAVIMENTAZIONI	
USURA	0.29 mq
BINDER	0.38 mq
BASE	0.95 mq
FONDAZIONE	3.80 mq

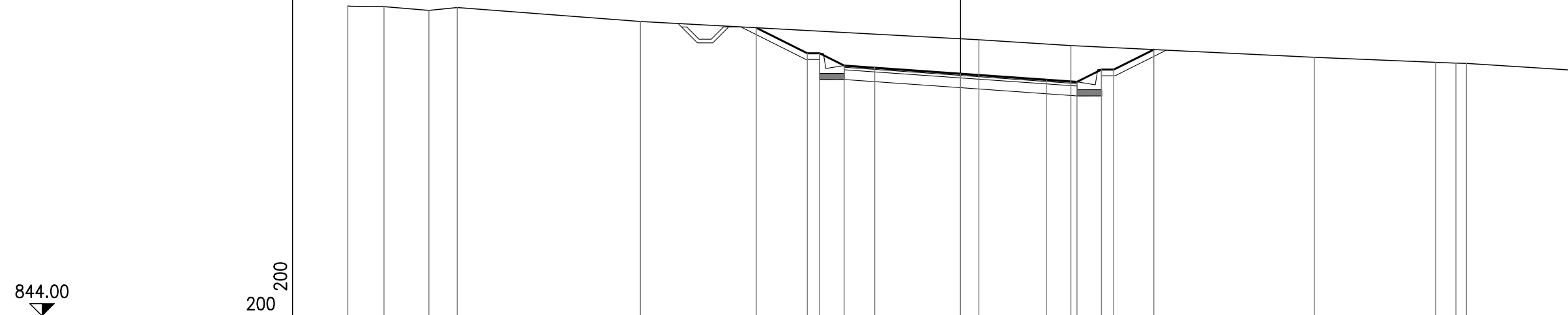

844.00 ▼											200	200						
DISTANZE PARZIALI PROGETTO					2.08	0.50	1.00	1.25	3.50	3.50	1.25	1.00	0.50	1.63				
DISTANZE PROGRESSIVE PROGETTO					-8.33	-6.25	-5.75	-4.75	-3.50	0.00	3.50	4.75	5.75	6.25	7.88			
QUOTE PROGETTO					855.75	854.71	854.71	854.21	854.12	853.87	853.63	853.54	854.04	854.04	854.86			
DISTANZE PARZIALI TERRENO	1.48	1.83	1.16	7.47	13.81				3.75	9.93				4.95	0.83	0.43	4.36	
DISTANZE PROGRESSIVE TERRENO	25.00	23.52	21.69	20.53	13.06	0.75				4.50	14.43				19.38	20.21	20.64	25.00
QUOTE TERRENO	856.63	856.61	856.46	856.57	856.00	855.26				855.02	854.54				854.34	854.30	854.29	854.02

PROFILO: Asse-SS87
 SEZIONE: 14
 PROGRESSIVA: 480.00

MOVIMENTI DI TERRA	
SCOTICO	5.63 mq
GRADONATURE	0.00 mq
SCAVO	0.00 mq
RILEVATO	34.97 mq
VEGETALE	4.17 mq

PAVIMENTAZIONI	
USURA	0.29 mq
BINDER	0.38 mq
BASE	0.95 mq
FONDAZIONE	4.92 mq

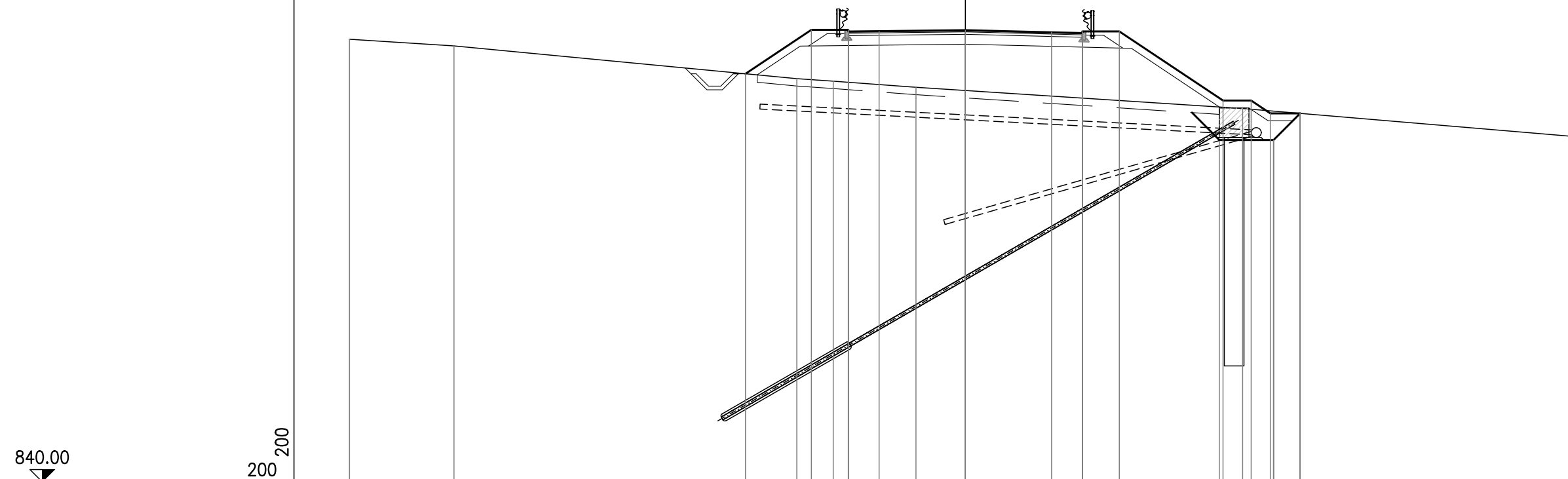

DISTANZE PARZIALI PROGETTO			2.68	1.50	1.25	3.50		3.50	1.25	1.50	4.21	1.25	0.78	1.88	
DISTANZE PROGRESSIVE PROGETTO			856.56	858.34	858.34	858.27	858.29	858.33	858.24	858.21	858.28	858.28	853.87	855.47	855.47
QUOTE PROGETTO			856.56	858.34	858.34	858.27	858.29	858.33	858.24	858.21	858.28	858.28	853.87	855.47	855.47
DISTANZE PARZIALI TERRENO	4.24	13.92		1.48	3.35				13.26					13.75	
DISTANZE PROGRESSIVE TERRENO	857.96	857.69		856.36	856.26		856.01						855.15		853.99
QUOTE TERRENO	857.96	857.69		856.36	856.26		856.01						855.15		853.99

PROFILO: Asse-SS87
 SEZIONE: 16
 PROGRESSIVA: 560.00

MOVIMENTI DI TERRA	
SCOTICO	2.12 mq
GRADONATURE	0.00 mq
SCAVO	3.71 mq
RILEVATO	1.66 mq
VEGETALE	1.76 mq

PAVIMENTAZIONI	
USURA	0.29 mq
BINDER	0.38 mq
BASE	0.95 mq
FONDAZIONE	4.36 mq

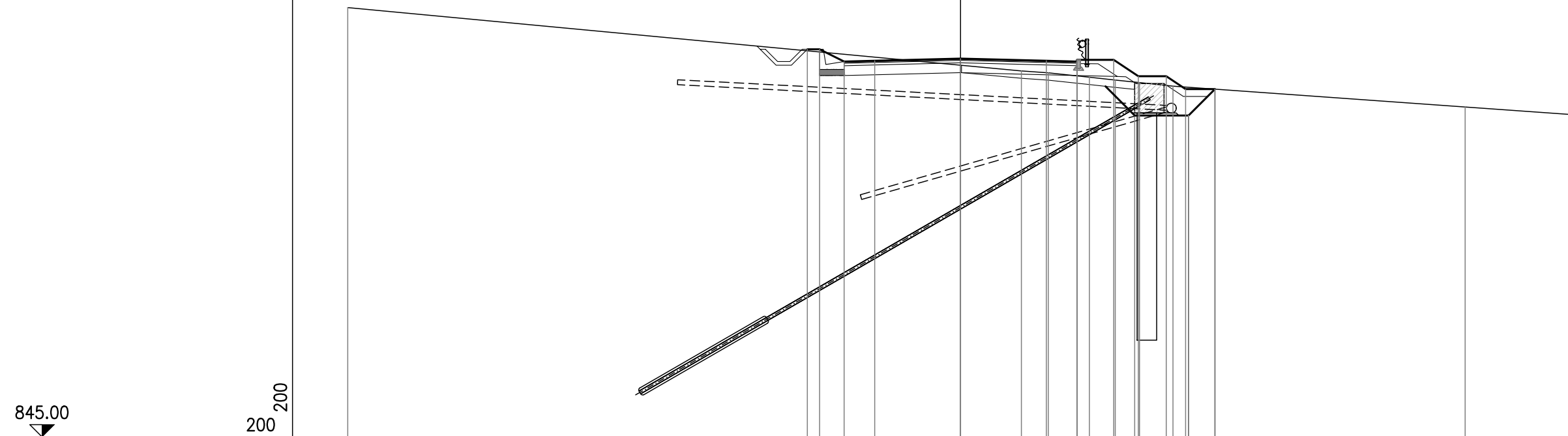

DISTANZE PARZIALI PROGETTO			0.50	1.00	1.25	3.50		3.50	1.25	1.50	1.00	1.25	0.75	1.00						
DISTANZE PROGRESSIVE PROGETTO			860.81	860.81	860.31	860.34	860.43	860.43	860.34	860.31	860.38	860.38	859.11	859.71	859.71	859.19	858.11	859.19	859.19	
QUOTE PROGETTO			860.81	860.81	860.31	860.34	860.43	860.43	860.34	860.31	860.38	860.38	859.11	859.71	859.71	859.19	858.11	859.19	859.19	
DISTANZE PARZIALI TERRENO		27.48							1.10	1.68	1.05	0.99	1.37		11.91		4.42			
DISTANZE PROGRESSIVE TERRENO	862.51	25.00							859.93	859.85	859.67	859.56	859.46	859.31		858.46	20.58		858.14	25.00
QUOTE TERRENO	862.51	25.00							859.93	859.85	859.67	859.56	859.46	859.31		858.46	20.58		858.14	25.00

PROFILO: Asse-SS87
 SEZIONE: 17
 PROGRESSIVA: 595.00

MOVIMENTI DI TERRA	
SCOTICO	0,00 mq
GRADONATURE	0,00 mq
SCAVO	29,19 mq
RILEVATO	0,00 mq
VEGETALE	1,68 mq

PAVIMENTAZIONI	
USURA	0,29 mq
BINDER	0,38 mq
BASE	0,95 mq
FONDAZIONE	3,80 mq

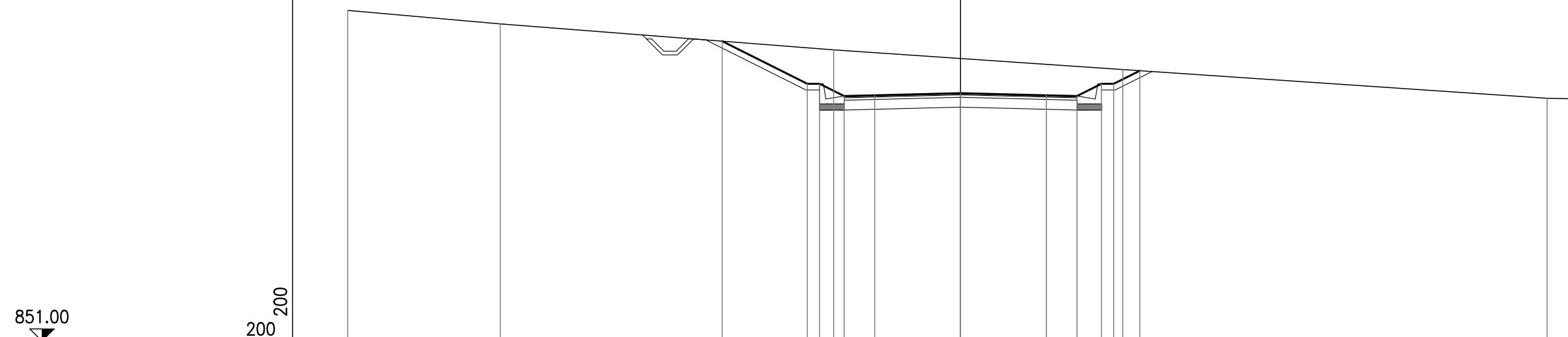

DISTANZE PARZIALI PROGETTO			3.48	0.50	1.00	1.25	3.50	3.50	1.25	1.00	0.50	1.07		
DISTANZE PROGRESSIVE PROGETTO			-9.73	-6.25	-5.75	-4.75	-3.50	0.00	3.50	4.75	5.75	6.25	7.32	
QUOTE PROGETTO			863.24	861.50	861.50	861.00	861.03	861.12	861.03	861.00	861.50	861.50	862.03	
DISTANZE PARZIALI TERRENO		6.23		13.59				11.80				17.31	1.07	
DISTANZE PROGRESSIVE TERRENO	25.00		18.77										23.93	25.00
QUOTE TERRENO	864.49		863.94										860.91	860.89

PROFILO: Asse-SS87
 SEZIONE: 17a
 PROGRESSIVA: 615.00

MOVIMENTI DI TERRA	
SCOTICO	0,00 mq
GRADONATURE	0,00 mq
SCAVO	60,84 mq
RILEVATO	0,00 mq
VEGETALE	1,89 mq

PAVIMENTAZIONI	
USURA	0,39 mq
BINDER	0,52 mq
BASE	1,30 mq
FONDAZIONE	5,20 mq

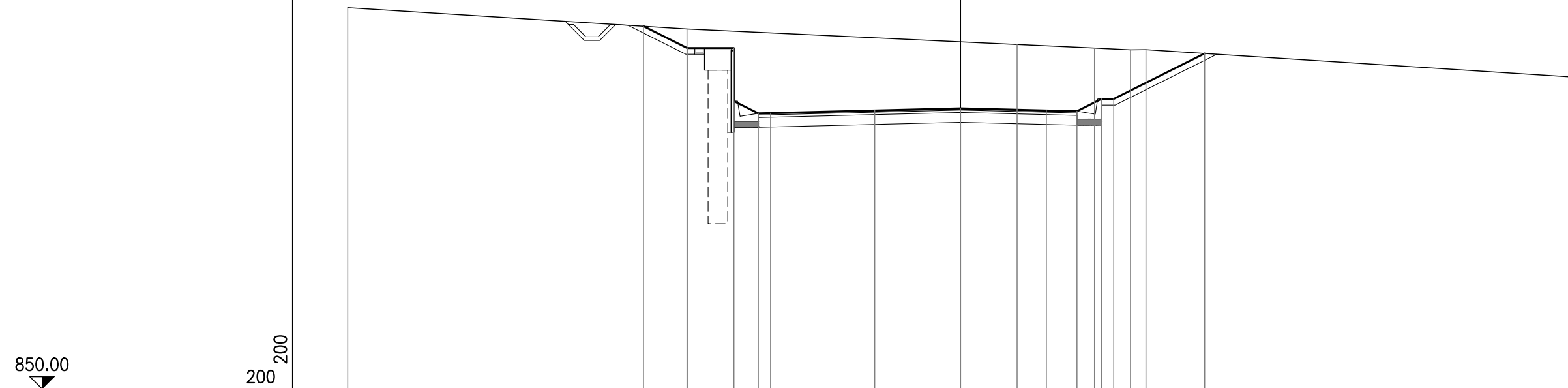

DISTANZE PARZIALI PROGETTO		1.78	1.90	1.00	0.50	4.25	3.50	3.50	1.25	1.00	0.50	3.71		
DISTANZE PROGRESSIVE PROGETTO		864.79	863.89	861.73	863.89	861.23	861.25	861.35	861.44	861.35	861.32	861.82	861.82	863.68
QUOTE PROGETTO		865.54	864.68	863.90	863.83	864.04	863.90	863.82	863.83	862.71				
DISTANZE PARZIALI TERRENO	13.84					13.47			3.15	1.47	0.63		17.44	
DISTANZE PROGRESSIVE TERRENO	25.00	11.16						2.31		5.46	6.93	7.56	25.00	
QUOTE TERRENO	865.54	864.68	863.90	863.83	864.04	863.90	863.82	863.83	862.71				862.71	

PROFILO: Asse-SS87
 SEZIONE: 18
 PROGRESSIVA: 640.00

MOVIMENTI DI TERRA	
SCOTICO	0.00 mq
GRADONATURE	0.00 mq
SCAVO	89.28 mq
RILEVATO	0.00 mq
VEGETALE	3.09 mq

PAVIMENTAZIONI	
USURA	0.39 mq
BINDER	0.52 mq
BASE	1.30 mq
FONDAZIONE	5.20 mq

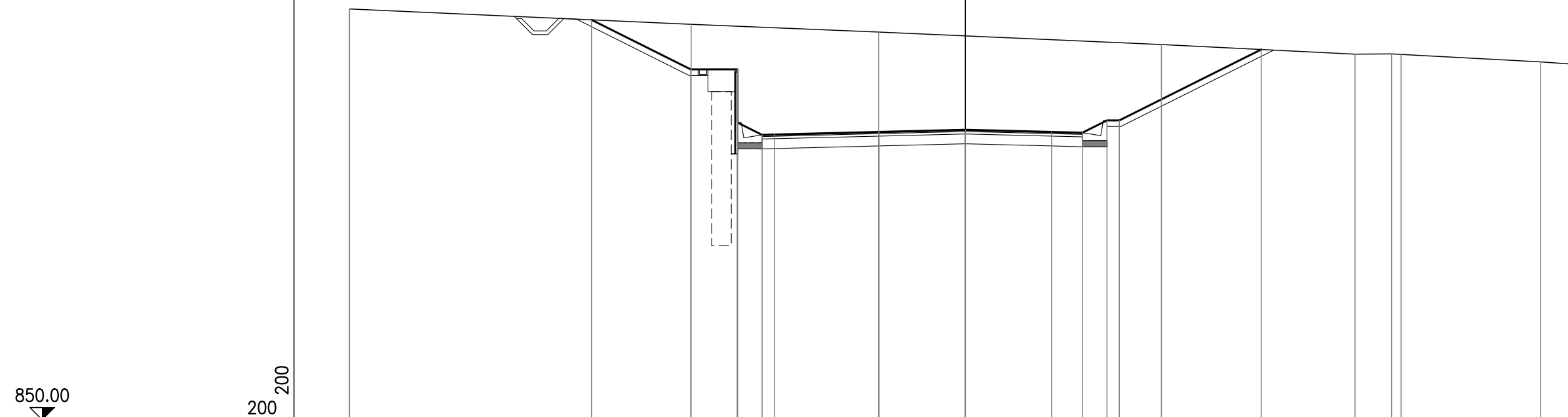

DISTANZE PARZIALI PROGETTO		4.02	1.90	1.00	0.50	4.25	3.50	3.50	1.25	1.00	0.50	5.76						
DISTANZE PROGRESSIVE PROGETTO		-15.17	-11.15	-9.25	-9.25	-9.25	-7.75	-3.50	0.00	3.50	4.75	5.75	6.25	12.01				
QUOTE PROGETTO		866.25	864.24	862.08	862.08	864.24	861.58	861.69	861.78	861.69	861.66	862.16	862.16	865.04				
DISTANZE PARZIALI TERRENO	13.87					7.61			11.48			7.86	1.48	0.38	5.67	1.65		
DISTANZE PROGRESSIVE TERRENO	25.00		-11.13					-3.52				7.96		15.82	17.30	17.68	23.35	25.00
QUOTE TERRENO	866.69		866.07					865.75				865.24		864.85	864.87	864.84	864.54	864.42

PROFILO: Asse-SS87
 SEZIONE: 18a
 PROGRESSIVA: 660.00

MOVIMENTI DI TERRA	
SCOTICO	0,00 mq
GRADONATURE	0,00 mq
SCAVO	76,32 mq
RILEVATO	0,00 mq
VEGETALE	3,14 mq

PAVIMENTAZIONI	
USURA	0,29 mq
BINDER	0,38 mq
BASE	0,95 mq
FONDAZIONE	3,80 mq

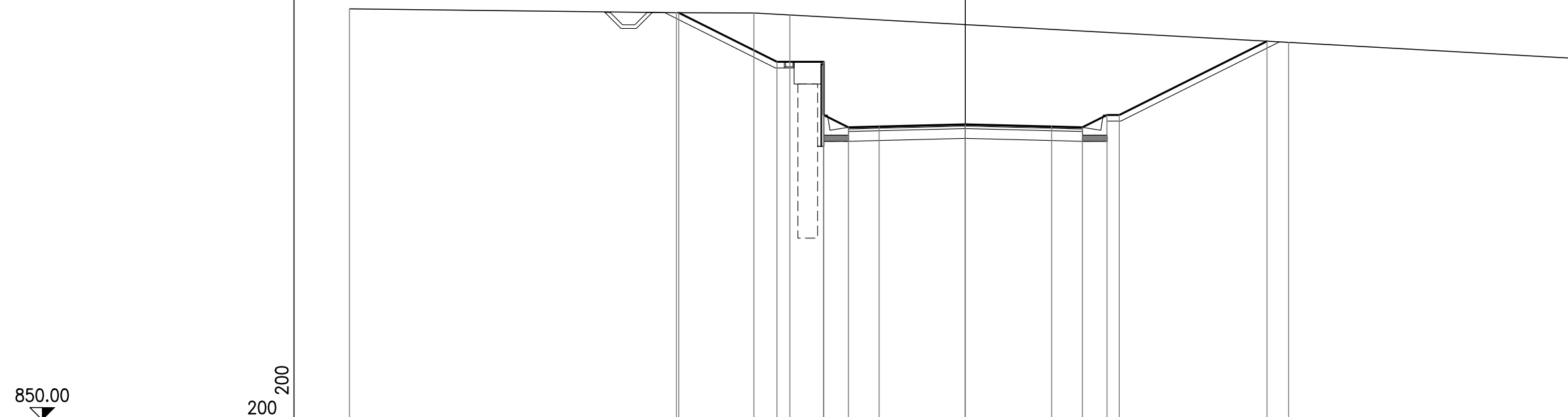

DISTANZE PARZIALI PROGETTO			3.98	1.90	1.00	1.25	3.50	3.50	1.25	1.00	0.50	5.99	
DISTANZE PROGRESSIVE PROGETTO			866.53	864.54	862.38	861.88	861.91	862.00	861.91	861.88	862.38	862.38	865.38
QUOTE PROGETTO			866.53	864.54	862.38	861.88	861.91	862.00	861.91	861.88	862.38	862.38	865.38
DISTANZE PARZIALI TERRENO		13.27	3.15	1.46			20.24					11.88	
DISTANZE PROGRESSIVE TERRENO	866.69	866.69	866.53	866.45								865.33	864.67
QUOTE TERRENO	866.69	866.53	866.45									865.33	864.67

PROFILO: Asse-SS87
 SEZIONE: 19
 PROGRESSIVA: 680.00

MOVIMENTI DI TERRA	
SCOTICO	0.00 mq
GRADONATURE	0.00 mq
SCAVO	71.97 mq
RILEVATO	0.00 mq
VEGETALE	3.05 mq

PAVIMENTAZIONI	
USURA	0.29 mq
BINDER	0.38 mq
BASE	0.95 mq
FONDAZIONE	3.80 mq

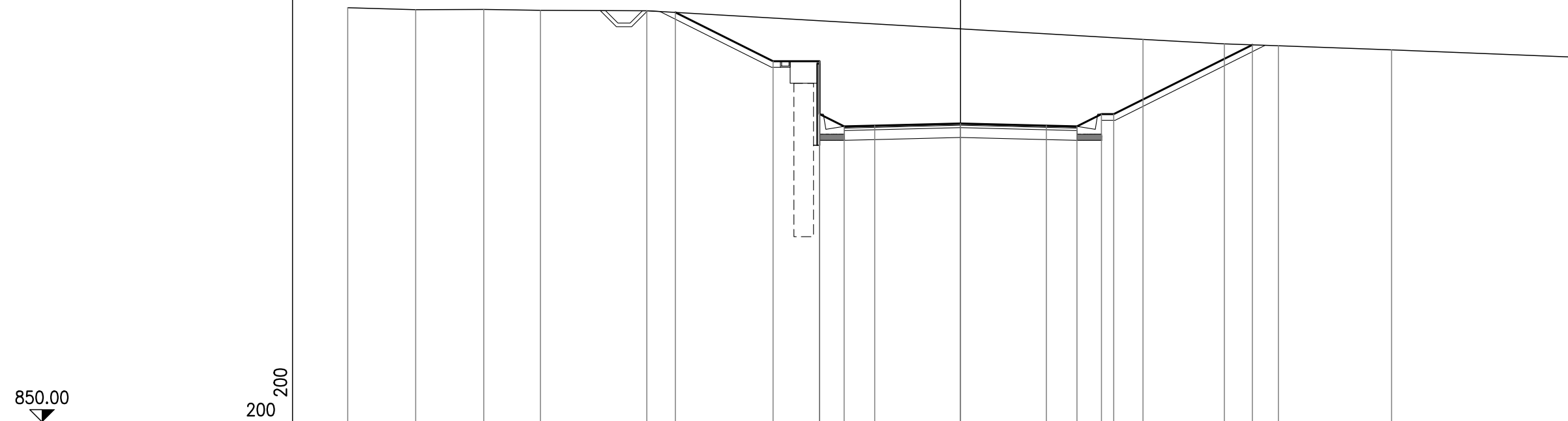

DISTANZE PARZIALI PROGETTO						3.98	1.90	1.00	1.25	3.50	3.50	1.25	1.00	0.50	5.65				
DISTANZE PROGRESSIVE PROGETTO						11.63	7.65	5.75	4.75	3.50	0.00	3.50	4.75	5.75	6.25	11.90			
QUOTE PROGETTO						866.71	864.72	862.56	864.72	862.06	862.09	862.06	862.56	862.56		865.38			
DISTANZE PARZIALI TERRENO		2.77	2.78	2.31	4.34					20.24					3.32	2.21	4.61	7.42	
DISTANZE PROGRESSIVE TERRENO	25.00	28.23	31.45	34.14	38.48	12.80									7.44	10.76	12.97	17.58	25.00
QUOTE TERRENO	866.90	866.82	866.83	866.79	866.77										865.60	865.42	865.34	865.18	864.88

PROFILO: Asse-SS87
 SEZIONE: 19a
 PROGRESSIVA: 700.00

MOVIMENTI DI TERRA	
SCOTICO	0,00 mq
GRADONATURE	0,00 mq
SCAVO	79,48 mq
RILEVATO	0,00 mq
VEGETALE	2,54 mq

PAVIMENTAZIONI	
USURA	0,39 mq
BINDER	0,52 mq
BASE	1,30 mq
FONDAZIONE	5,20 mq

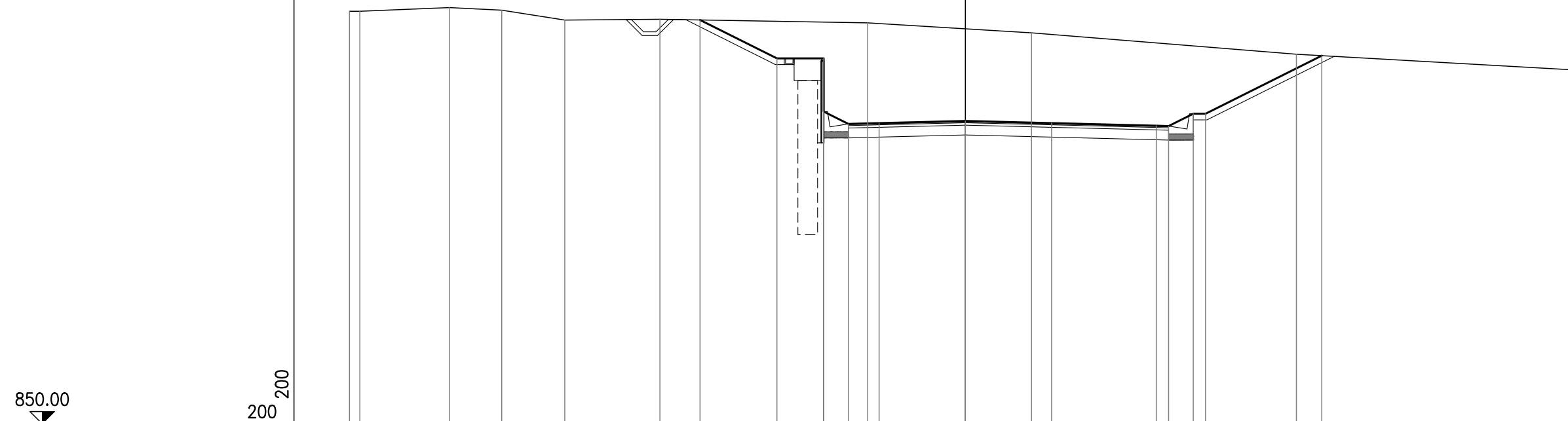

DISTANZE PARZIALI PROGETTO						3.12	1.90	1.00	1.25	3.50	3.50	4.25	0.50	1.00	0.50	4.72		
DISTANZE PROGRESSIVE PROGETTO						866.40	864.84	862.68	864.84	862.18	862.21	862.30	862.21	862.11	862.09	862.59	862.59	864.95
QUOTE PROGETTO						866.40	864.84	862.68	864.84	862.18	862.21	862.30	862.21	862.11	862.09	862.59	862.59	864.95
DISTANZE PARZIALI TERRENO	0.42	3.63	2.13	2.56	3.86		8.43			6.65			10.76			11.56		
DISTANZE PROGRESSIVE TERRENO	866.76	866.76	866.91	866.80	866.40	866.43				866.28		865.88		865.01			864.36	
QUOTE TERRENO	866.76	866.76	866.91	866.80	866.40	866.43				866.28		865.88		865.01			864.36	

PROFILO: Asse-SS87
 SEZIONE: 20
 PROGRESSIVA: 725.00

MOVIMENTI DI TERRA	
SCOTICO	0.00 mq
GRADONATURE	0.00 mq
SCAVO	55.59 mq
RILEVATO	0.00 mq
VEGETALE	1.98 mq

PAVIMENTAZIONI	
USURA	0.39 mq
BINDER	0.52 mq
BASE	1.30 mq
FONDAZIONE	5.20 mq

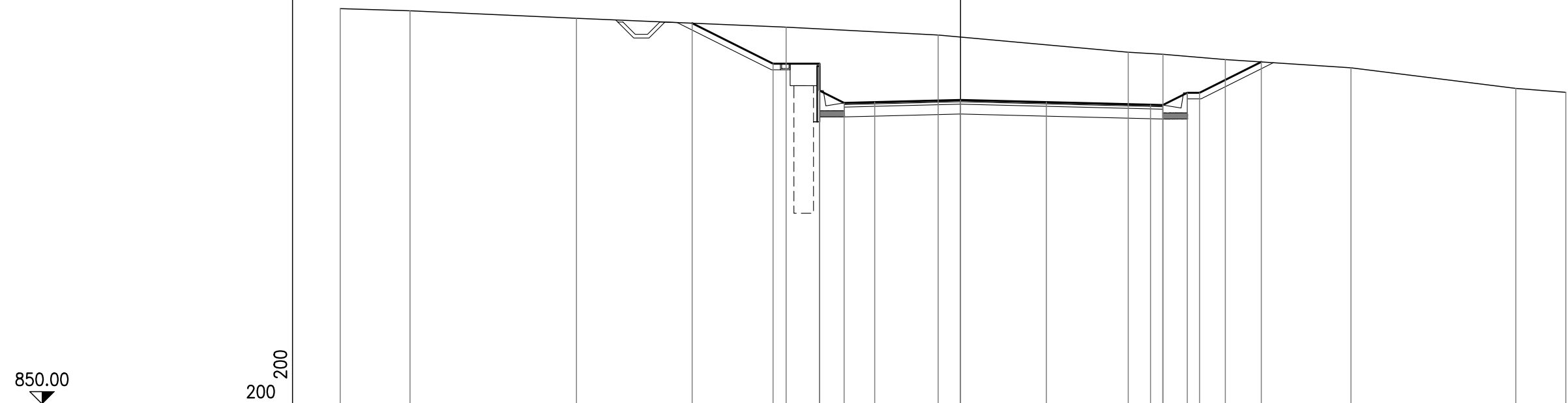

DISTANZE PARZIALI PROGETTO				3.30	1.90	1.00	1.25	3.50	3.50	4.25	0.50	1.00	0.50	2.52		
DISTANZE PROGRESSIVE PROGETTO				865.52	863.87	862.77	862.27	862.30	862.39	862.30	862.20	862.18	862.68	862.68	863.94	
QUOTE PROGETTO				865.52	863.87	862.77	862.27	862.30	862.39	862.30	862.20	862.18	862.68	862.68	863.94	
DISTANZE PARZIALI TERRENO	2.85	6.79	8.56			6.20		7.75		1.41	2.55	5.13	6.72	2.04		
DISTANZE PROGRESSIVE TERRENO	866.12	866.03	865.72		865.36		865.04		864.34	864.25		864.04	863.70	862.86	862.70	
QUOTE TERRENO	866.12	866.03	865.72	865.36		865.04		864.34	864.25		864.04	863.70	862.86	862.70		

PROFILO: Asse-SS87
 SEZIONE: 21
 PROGRESSIVA: 760.00

MOVIMENTI DI TERRA	
SCOTICO	0.00 mq
GRADONATURE	0.00 mq
SCAVO	27.95 mq
RILEVATO	0.00 mq
VEGETALE	1.56 mq

PAVIMENTAZIONI	
USURA	0.29 mq
BINDER	0.38 mq
BASE	0.95 mq
FONDAZIONE	3.62 mq

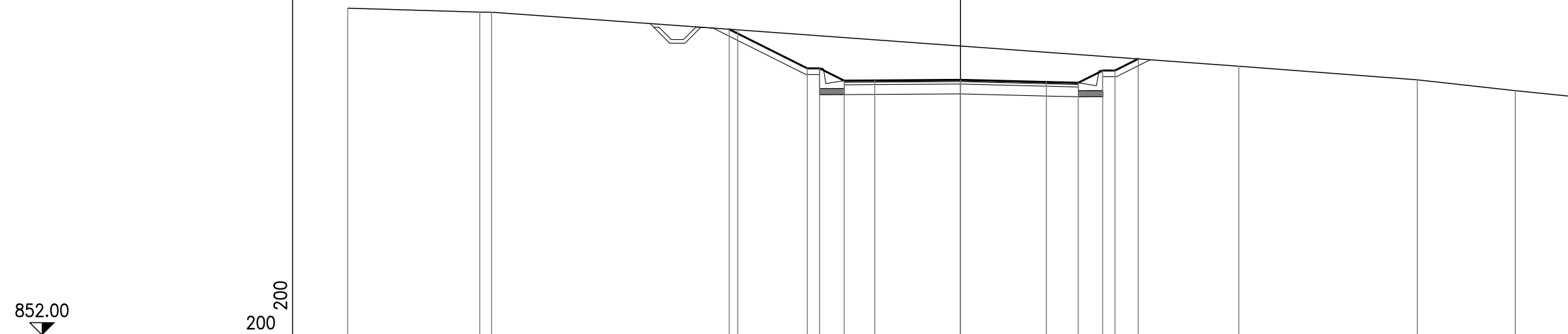

DISTANZE PARZIALI PROGETTO				3.19	0.50	1.00	1.25	3.50	3.50	1.30	1.00	0.50	0.95										
DISTANZE PROGRESSIVE PROGETTO				864.46	862.86	862.86	862.36	862.37	862.39	862.31	862.27	862.77	862.77	863.25									
QUOTE PROGETTO				864.46	862.86	862.86	862.36	862.37	862.39	862.31	862.27	862.77	862.77	863.25									
DISTANZE PARZIALI TERRENO		5.39	0.48						20.44				7.28	4.00	2.37								
DISTANZE PROGRESSIVE TERRENO	865.31	25.00	865.15	19.61	865.15	19.13		864.43	9.09				862.95	11.35		862.40	18.63		861.95	22.63		861.71	25.00
QUOTE TERRENO	865.31	25.00	865.15	19.61	865.15	19.13		864.43	9.09				862.95	11.35		862.40	18.63		861.95	22.63		861.71	25.00

PROFILO: Asse-SS87
 SEZIONE: 22
 PROGRESSIVA: 800.00

MOVIMENTI DI TERRA	
SCOTICO	0.00 mq
GRADONATURE	0.00 mq
SCAVO	16.66 mq
RILEVATO	0.00 mq
VEGETALE	0.77 mq

PAVIMENTAZIONI	
USURA	0.31 mq
BINDER	0.41 mq
BASE	1.03 mq
FONDAZIONE	4.11 mq

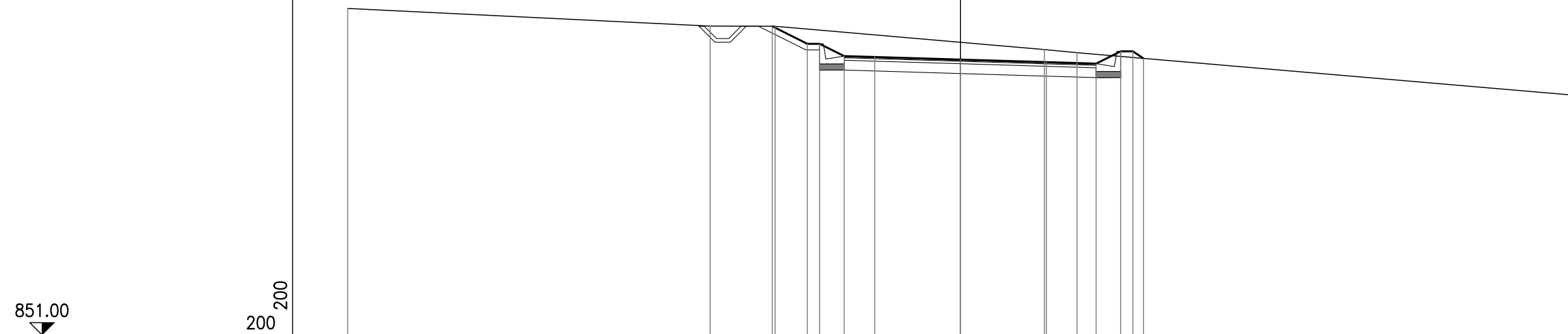

DISTANZE PARZIALI PROGETTO			1.43	0.50	1.00	1.25	3.50	3.50	2.03	1.00	0.50	0.43	
DISTANZE PROGRESSIVE PROGETTO			-7.68	-6.25	-5.75	-4.75	-3.50	0.00	3.50	5.53	6.53	7.03	7.46
QUOTE PROGETTO			863.58	862.86	862.86	862.36	862.33	862.22	862.12	862.06	862.56	862.56	862.27
DISTANZE PARZIALI TERRENO		14.79	2.64				10.99		1.33			20.25	
DISTANZE PROGRESSIVE TERRENO	864.31	25.00	10.21	7.57					3.42	4.75			25.00
QUOTE TERRENO	864.31		863.58	863.58					862.63	862.50			860.77

PROFILO: Asse-SS87
 SEZIONE: 24
 PROGRESSIVA: 864.00

MOVIMENTI DI TERRA	
SCOTICO	8.13 mq
GRADONATURE	0.00 mq
SCAVO	0.00 mq
RILEVATO	91.78 mq
VEGETALE	6.56 mq

PAVIMENTAZIONI	
USURA	0.34 mq
BINDER	0.45 mq
BASE	1.12 mq
FONDAZIONE	5.55 mq

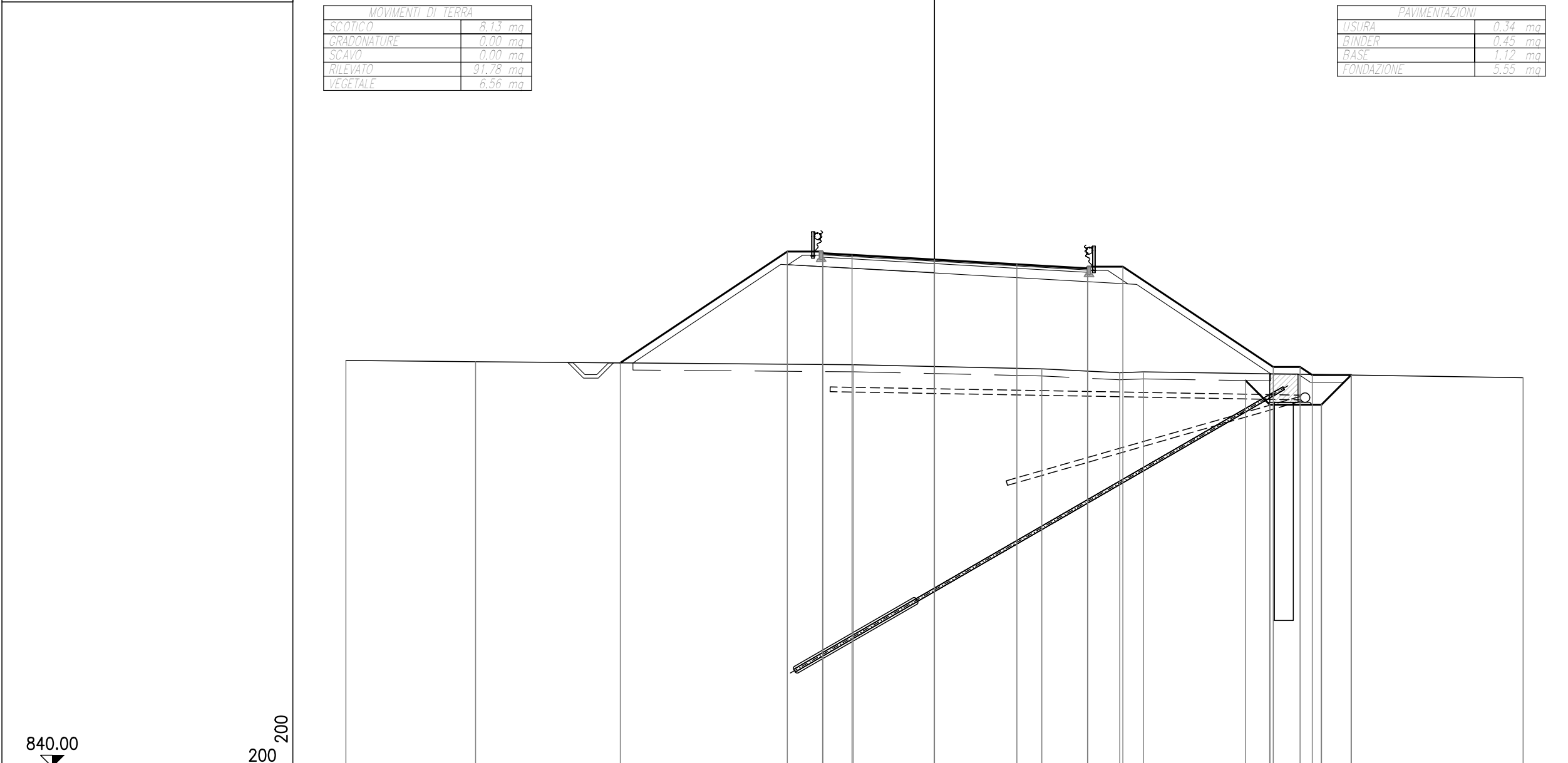

DISTANZE PARZIALI PROGETTO			7.09	1.50	1.25	3.50	3.50	3.00	1.50	6.39	1.03	1.24	0.52	1.26									
DISTANZE PROGRESSIVE PROGETTO			857.17	861.89	861.89	861.83	861.75	861.55	861.35	861.18	861.25	861.25	856.42	855.39	855.39	856.99	856.99	856.65	855.39	855.39	856.65	856.65	
QUOTE PROGETTO			857.17	861.89	861.89	861.83	861.75	861.55	861.35	861.18	861.25	861.25	856.42	855.39	855.39	856.99	856.99	856.65	855.39	855.39	856.65	856.65	
DISTANZE PARZIALI TERRENO	5.51		16.04					8.01		3.31	1.00							16.13					
DISTANZE PROGRESSIVE TERRENO	857.27	857.22	857.09					856.91		856.75	856.78								856.54				
QUOTE TERRENO	857.27	857.22	857.09					856.91		856.75	856.78								856.54				

PROFILO: Asse-SS87
 SEZIONE: 24A
 PROGRESSIVA: 873.20

MOVIMENTI DI TERRA	
SCOTICO	0.00 mq
GRADONATURE	0.00 mq
SCAVO	0.00 mq
RILEVATO	50.72 mq
VEGETALE	0.00 mq

PAVIMENTAZIONI	
USURA	0.34 mq
BINDER	0.45 mq
BASE	1.12 mq
FONDAZIONE	5.57 mq

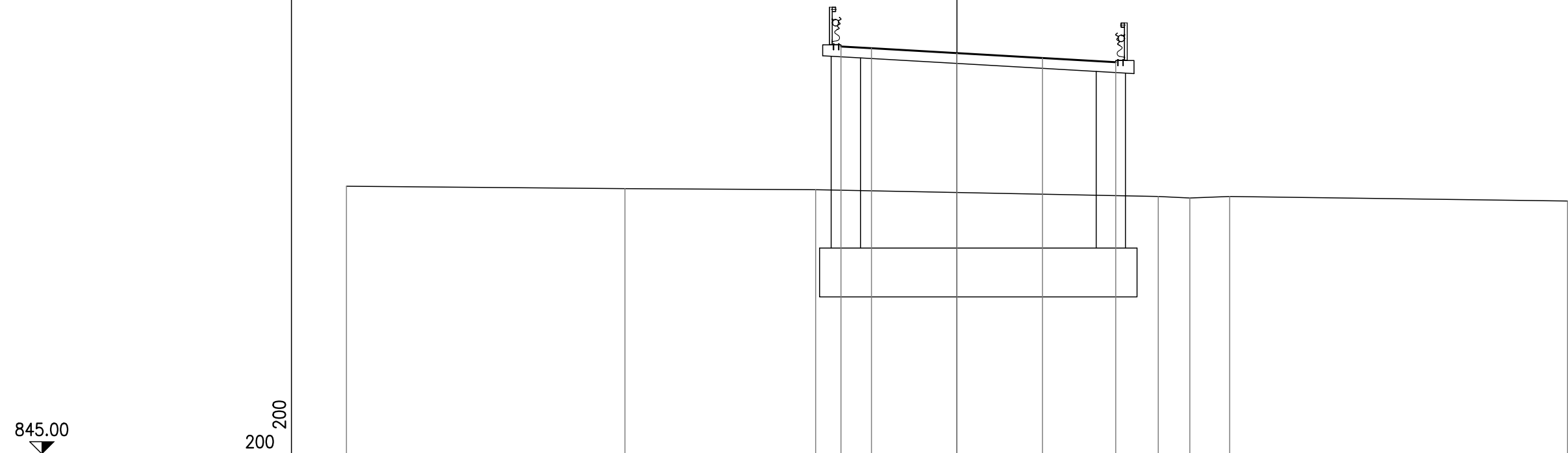

DISTANZE PARZIALI PROGETTO				1.25	3.50	3.50	3.00			
DISTANZE PROGRESSIVE PROGETTO				-4.75	-3.50	0.00	3.50	6.50		
QUOTE PROGETTO				861.69	861.62	861.42	861.22	861.05		
DISTANZE PARZIALI TERRENO		11.40	7.81			14.03	1.29	1.64	13.83	
DISTANZE PROGRESSIVE TERRENO	25.00	13.60	5.79			8.24	9.53	11.17		25.00
QUOTE TERRENO	855.97	855.87	855.82			855.54	855.48	855.54		855.36

PROFILO: Asse-SS87
 SEZIONE: 25
 PROGRESSIVA: 907.50

MOVIMENTI DI TERRA	
SCOTICO	0.00 mq
GRADONATURE	0.00 mq
SCAVO	0.00 mq
RILEVATO	0.00 mq
VEGETALE	0.00 mq

PAVIMENTAZIONI	
USURA	0.00 mq
BINDER	0.00 mq
BASE	0.00 mq
FONDAZIONE	0.00 mq

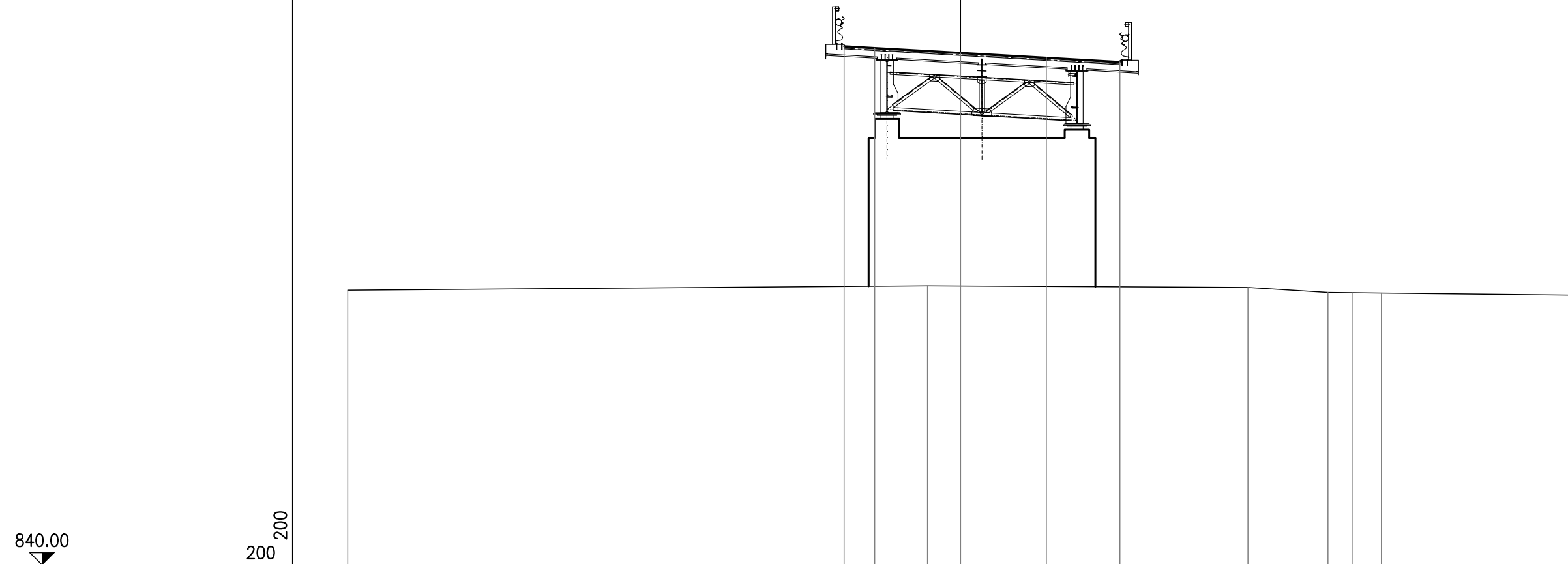

DISTANZE PARZIALI PROGETTO			1.25	3.50	3.50	3.00						
DISTANZE PROGRESSIVE PROGETTO			-4.75	-3.50	0.00	3.50	6.50					
QUOTE PROGETTO			861.15	861.08	860.88	860.68	860.51					
DISTANZE PARZIALI TERRENO		23.65				13.08		3.26	0.99	1.19	7.83	
DISTANZE PROGRESSIVE TERRENO	25.00			-1.35				11.73	14.99	15.98	17.17	25.00
QUOTE TERRENO	851.20			851.38				851.31	851.11	851.10	851.08	851.00

PROFILO: Asse-SS87
 SEZIONE: 27A
 PROGRESSIVA: 1031.80

MOVIMENTI DI TERRA	
SCOTICO	0.00 mq
GRADONATURE	0.00 mq
SCAVO	0.00 mq
RILEVATO	38.34 mq
VEGETALE	0.00 mq

PAVIMENTAZIONI	
USURA	0.34 mq
BINDER	0.45 mq
BASE	1.12 mq
FONDAZIONE	5.57 mq

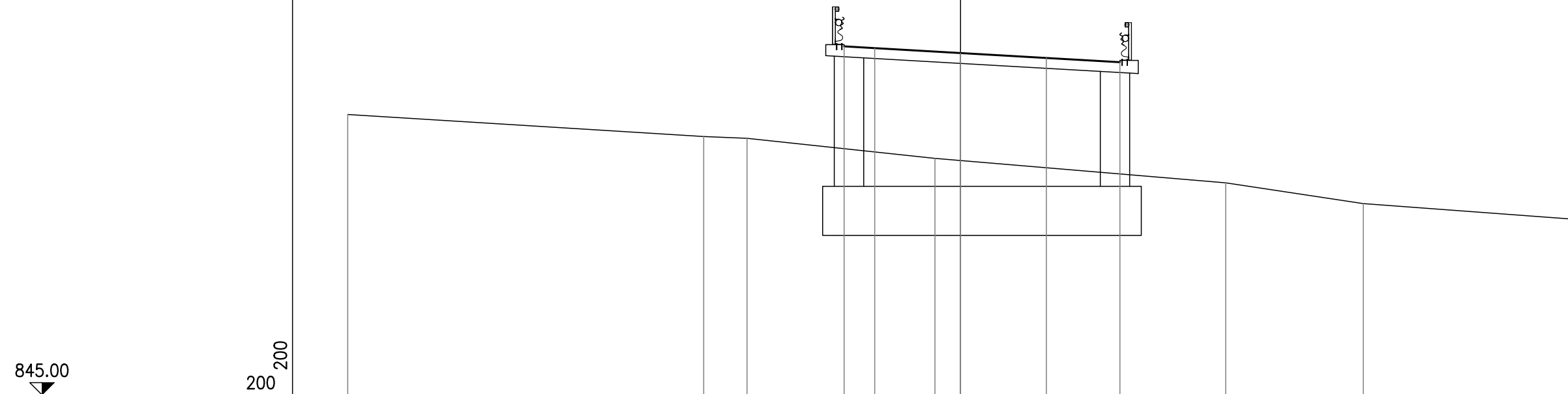

DISTANZE PARZIALI PROGETTO				1.25	3.50		3.50	3.00		
DISTANZE PROGRESSIVE PROGETTO				4.75	8.25		11.75	14.75		
QUOTE PROGETTO				859.21	859.13		858.93	858.73	858.56	
DISTANZE PARZIALI TERRENO		14.52	1.77	7.67			11.86	5.61	8.57	
DISTANZE PROGRESSIVE TERRENO	25.00	39.52	41.29	48.96			60.82	66.43	75.00	
QUOTE TERRENO	856.43	855.53	855.46		854.64		853.64	852.80	852.16	852.16

PROFILO: Asse-SS87

SEZIONE: 31

PROGRESSIVA: 1160.00

MOVIMENTI DI TERRA	
SCOTICO	0.00 mq
GRADONATURE	0.00 mq
SCAVO	27.87 mq
RILEVATO	0.00 mq
VEGETALE	1.54 mq

PAVIMENTAZIONI	
USURA	0.29 mq
BINDER	0.38 mq
BASE	0.95 mq
FONDAZIONE	3.80 mq

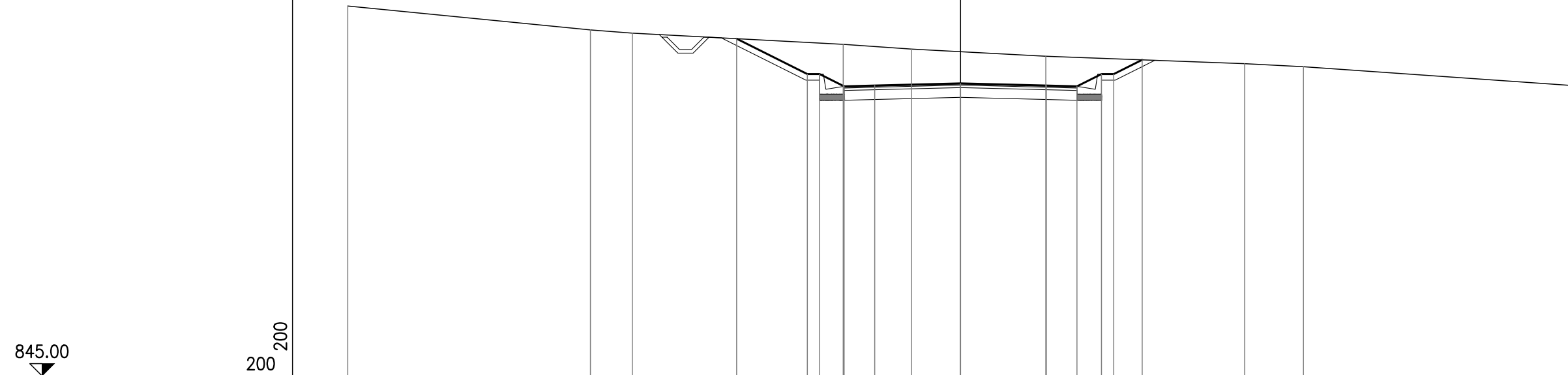

DISTANZE PARZIALI PROGETTO					2.88	0.50	1.00	1.25		3.50		3.50	1.25	1.00	0.50	1.16			
DISTANZE PROGRESSIVE PROGETTO					-9.13	-6.25	-5.75	-4.75	-3.50	0.00	3.50	4.75	5.75	6.25	7.41				
QUOTE PROGETTO					856.75	857.31	857.31	856.81	856.84	856.92	856.84	856.81	857.31	857.31	857.89				
DISTANZE PARZIALI TERRENO		9.90	1.71	8.60			2.79		5.48		8.11	2.40		11.01					
DISTANZE PROGRESSIVE TERRENO	25.00		15.10	13.39			4.79		2.00		3.48		11.59	13.99					
QUOTE TERRENO	856.08	859.11	858.97			858.52		858.32		858.03		857.73	857.60					856.83	

PROFILO: Asse-SS87

SEZIONE: 34

PROGRESSIVA: 1280.00

MOVIMENTI DI TERRA	
SCOTICO	8.30 mq
GRADONATURE	6.70 mq
SCAVO	0.00 mq
RILEVATO	83.46 mq
VEGETALE	7.22 mq

PAVIMENTAZIONI	
USURA	0.29 mq
BINDER	0.38 mq
BASE	0.95 mq
FONDAZIONE	4.92 mq

835.00

200
200

DISTANZE PARZIALI PROGETTO					4.53	1.50	1.25	3.50	3.50	1.25	1.50	7.50	2.00	1.92	1.24	2.99	0.93						
DISTANZE PROGRESSIVE PROGETTO									0.00				13.75	15.75	16.35	17.47	17.70	18.84	19.67	19.83	20.56	20.56	
QUOTE PROGETTO					851.98	855.01	855.01	854.94	854.97	855.01	855.01	855.01	850.01	850.01	848.28	847.16	848.71	848.71	847.16	848.05	848.05		
DISTANZE PARZIALI TERRENO		1.60	8.84	2.96	6.78	5.00	5.51	17.46														1.85	
DISTANZE PROGRESSIVE TERRENO	853.53	853.38		852.21	852.06			850.99														847.62	847.40
QUOTE TERRENO	25.00	23.40		14.56	11.60			0.18														23.15	25.00

PROFILO: Asse-SS87
 SEZIONE: 35
 PROGRESSIVA: 1320.00

MOVIMENTI DI TERRA	
SCOTICO	6,78 mq
GRADONATURE	5,28 mq
SCAVO	0,00 mq
RILEVATO	67,00 mq
VEGETALE	7,09 mq

PAVIMENTAZIONI	
USURA	0,29 mq
BINDER	0,38 mq
BASE	0,95 mq
FONDAZIONE	4,90 mq

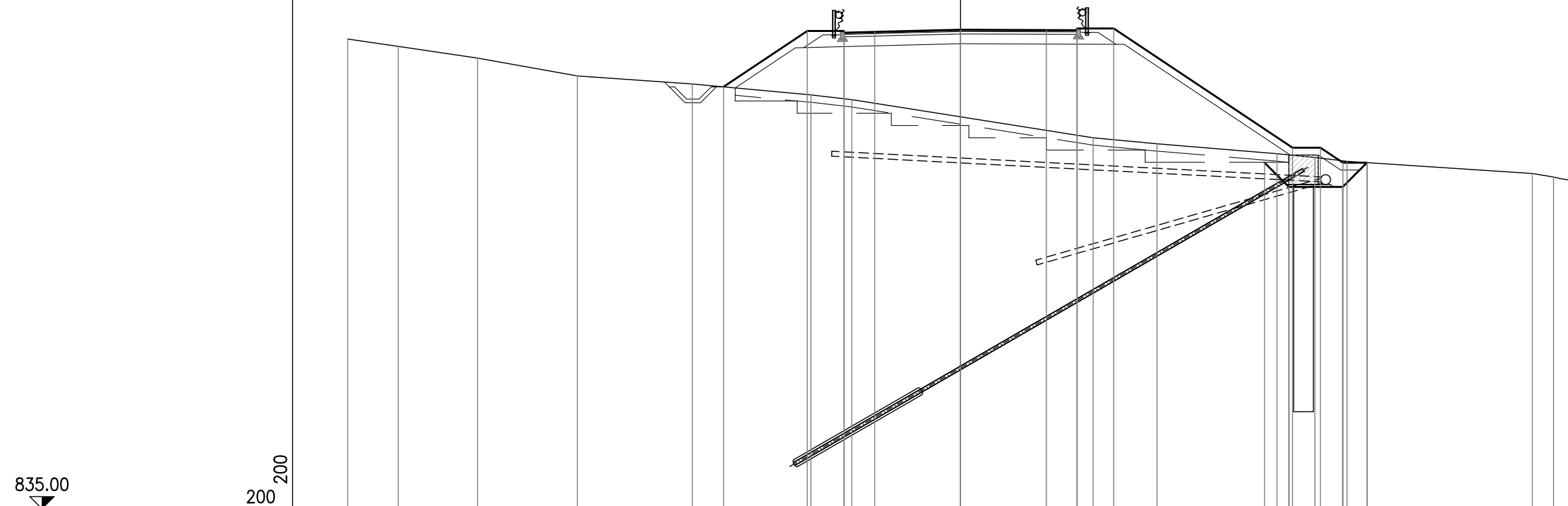

DISTANZE PARZIALI PROGETTO							3.42	1.50	1.25	3.50	3.50	1.25	1.50	7.29	0.99	1.12	2.09	2.09	0.98							
DISTANZE PROGRESSIVE PROGETTO							852.21	854.48	854.48	854.42	854.45	854.54	854.52	854.52	854.59	854.59	849.12	848.13	848.13	849.73	849.73	848.13	848.13	849.12	849.12	849.12
QUOTE PROGETTO							852.21	854.48	854.48	854.42	854.45	854.54	854.52	854.52	854.59	854.59	849.12	848.13	848.13	849.73	849.73	848.13	848.13	849.12	849.12	849.12
DISTANZE PARZIALI TERRENO		2.06	3.24	4.07	4.69	4.84		1.66			9.85		2.60	4.90	1.54	1.32			7.56		0.86	0.81				
DISTANZE PROGRESSIVE TERRENO	854.16	853.86	853.38	852.65	852.32	851.88	851.69	850.13	849.89	849.89	849.89	849.89	849.89	849.89	849.89	849.89	849.17	849.17	849.17	849.17	849.17	848.67	848.53	848.37	848.37	848.37
QUOTE TERRENO	854.16	853.86	853.38	852.65	852.32	851.88	851.69	850.13	849.89	849.89	849.89	849.89	849.89	849.89	849.89	849.17	849.17	849.17	849.17	849.17	848.67	848.53	848.37	848.37	848.37	848.37

PROFILO: Asse-SS87
 SEZIONE: 36
 PROGRESSIVA: 1360.00

MOVIMENTI DI TERRA	
SCOTICO	3,79 mq
GRADONATURE	3,19 mq
SCAVO	2,20 mq
RILEVATO	13,91 mq
VEGETALE	3,90 mq

PAVIMENTAZIONI	
USURA	0,31 mq
BINDER	0,41 mq
BASE	1,03 mq
FONDAZIONE	5,15 mq

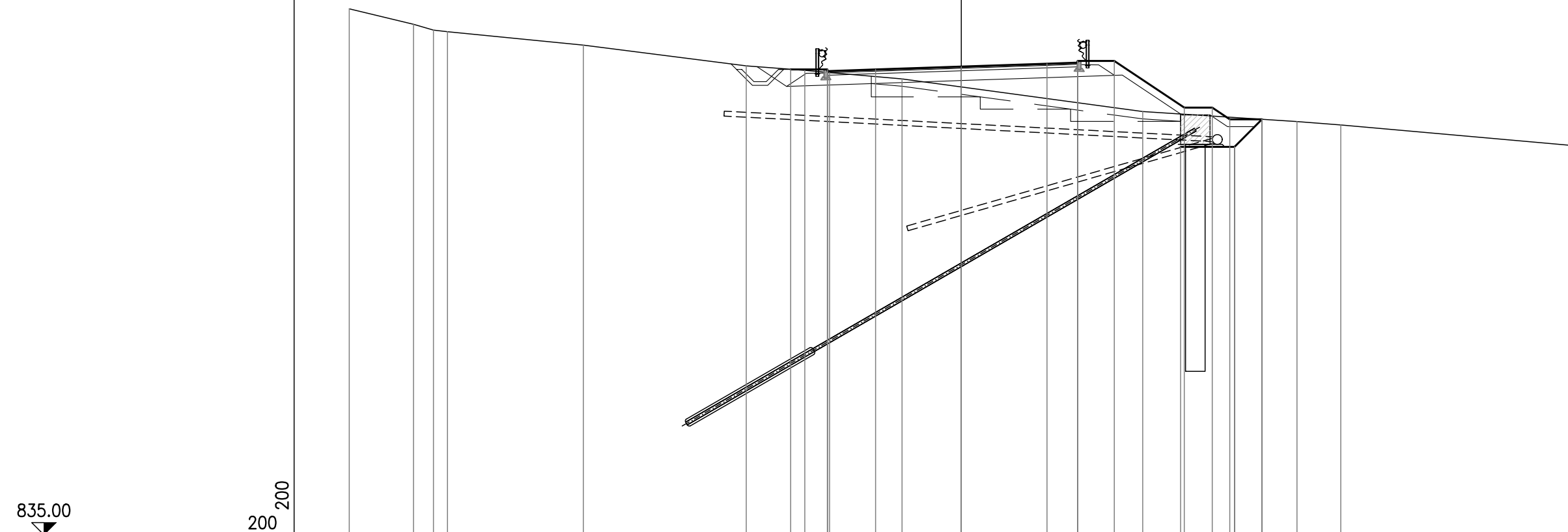

835.00 ▼												200 200																						
DISTANZE PARZIALI PROGETTO												1.50 1.97 3.50 3.50 1.25 1.50 2.86 1.22 0.71 1.12																						
DISTANZE PROGRESSIVE PROGETTO												-6.97 -5.47 -5.47 -3.50 0.00 3.50 4.75 4.75 6.25 8.96 9.11 10.25 10.96 11.16 11.16 12.28 12.28																						
QUOTE PROGETTO												854.00 854.00 853.94 854.00 854.12 854.24 854.28 854.35 854.35 850.84 852.44 852.44 851.97 850.84 850.84 851.97 851.97																						
DISTANZE PARZIALI TERRENO	2.62	0.82	0.57			5.55			6.66			2.39	1.01			2.96				9.83			6.30			1.79			9.50					
DISTANZE PROGRESSIVE TERRENO	-25.00	-22.38	-21.56	-20.99			-15.44			-8.78	-6.39	-5.38			-2.42				7.41	-7.41	-9.11	-10.25	-10.96	-11.16	-12.28	-12.28			-13.71	-15.50			-25.00	
QUOTE TERRENO	856.48	855.85	855.61	855.54			855.00			854.15	853.97	853.88			853.62				852.28	852.28	852.44	852.44	851.97	850.84	850.84	851.97	851.97			851.87	851.74			850.90

PROFILO: Asse-SS87
 SEZIONE: 37
 PROGRESSIVA: 1400.00

MOVIMENTI DI TERRA	
SCOTICO	0.00 mq
GRADONATURE	0.00 mq
SCAVO	26.78 mq
RILEVATO	0.00 mq
VEGETALE	1.77 mq

PAVIMENTAZIONI	
USURA	0.33 mq
BINDER	0.44 mq
BASE	1.11 mq
FONDAZIONE	4.90 mq

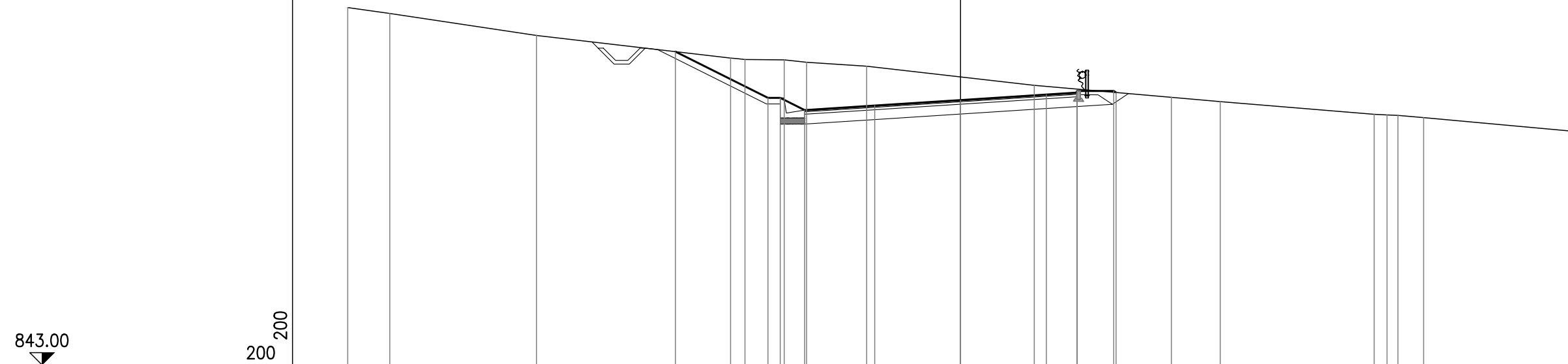

DISTANZE PARZIALI PROGETTO					3.77	0.50	1.00	2.86	3.50	3.50	1.25	1.50	0.10							
DISTANZE PROGRESSIVE PROGETTO					-11.63	-7.86	-7.36	-6.36	-3.50	0.00	3.50	4.75	6.25	6.35						
QUOTE PROGETTO					855.79	853.90	853.90	853.40	853.59	853.81	854.04	854.12	854.19	854.12						
DISTANZE PARZIALI TERRENO		1.72	5.98	7.92		0.59	1.60	0.91	2.45	6.84		5.59	1.99	6.28	0.53	0.44	1.05	6.11		
DISTANZE PROGRESSIVE TERRENO	25.00	23.28		17.30		9.38	8.79	7.19	6.28	3.83		3.01	8.60	10.59		16.87	17.40	17.84	18.89	25.00
QUOTE TERRENO	857.59	857.35		856.45		855.53	855.47	855.46	855.36	855.20		854.41	853.92	853.75		853.23	853.20	853.19	853.10	852.54

PROFILO: Asse-SS87
 SEZIONE: 38
 PROGRESSIVA: 1440.00

MOVIMENTI DI TERRA	
SCOTICO	0.00 mq
GRADONATURE	0.00 mq
SCAVO	47.03 mq
RILEVATO	0.00 mq
VEGETALE	1.93 mq

PAVIMENTAZIONI	
USURA	0.34 mq
BINDER	0.45 mq
BASE	1.13 mq
FONDAZIONE	4.50 mq

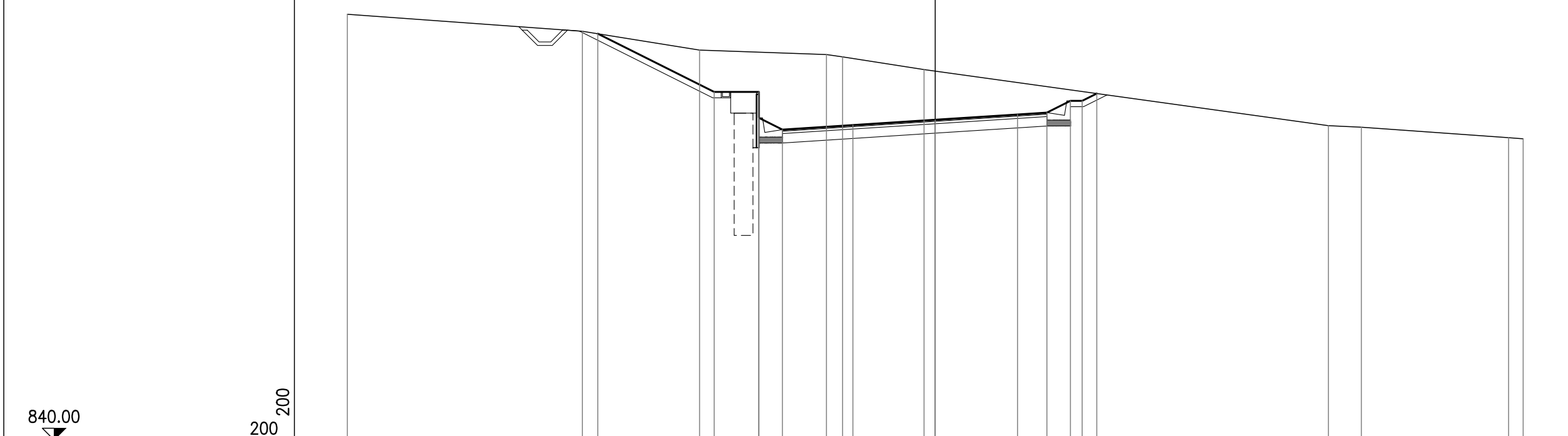

DISTANZE PARZIALI PROGETTO			4.95	1.90	1.00	3.00	3.50	3.50	1.25	1.00	0.50	0.62								
DISTANZE PROGRESSIVE PROGETTO			857.27	854.79	853.69	854.79	853.19	853.39	853.61	853.84	853.92	854.42	854.42	854.73						
QUOTE PROGETTO			857.27	854.79	853.69	854.79	853.19	853.39	853.61	853.84	853.92	854.42	854.42	854.73						
DISTANZE PARZIALI TERRENO		10.00	4.98	5.39	0.69	3.47						17.19	1.40	6.26	0.62					
DISTANZE PROGRESSIVE TERRENO	858.09	25.00	857.37	15.00	856.57	10.02	856.38	4.63	856.28	3.94	855.75	0.47	853.36	16.72	853.29	18.12	852.85	24.38	852.80	25.00
QUOTE TERRENO	858.09		857.37		856.57		856.38		856.28		855.75		853.36		853.29		852.85		852.80	

PROFILO: Asse-SS87
 SEZIONE: 40
 PROGRESSIVA: 1520.00

MOVIMENTI DI TERRA	
SCOTICO	1.45 mq
GRADONATURE	0.00 mq
SCAVO	12.49 mq
RILEVATO	1.52 mq
VEGETALE	2.51 mq

PAVIMENTAZIONI	
USURA	0.34 mq
BINDER	0.45 mq
BASE	1.12 mq
FONDAZIONE	4.96 mq

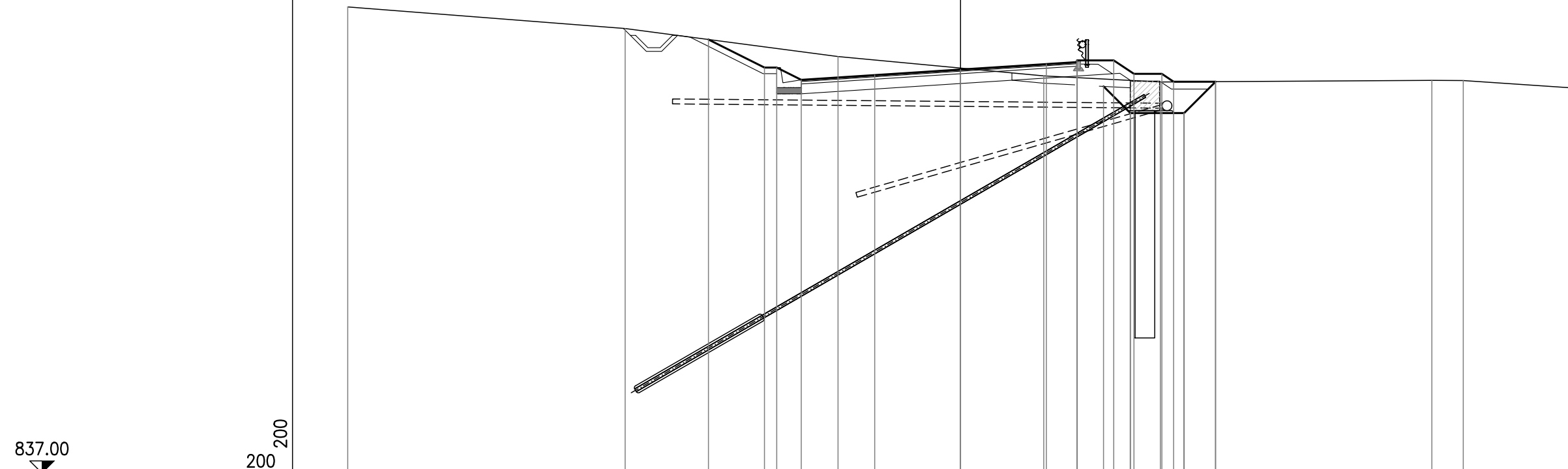

DISTANZE PARZIALI PROGETTO			2.29	0.50	1.00	3.00	3.50	3.50	1.25	1.50	0.82	1.24	0.48	1.17	
DISTANZE PROGRESSIVE PROGETTO			10.29	8.00	7.50	6.50	3.50	0.00	3.50	4.75	5.83	6.25	6.92	7.07	8.21
QUOTE PROGETTO			854.68	853.53	853.53	853.03	853.23	853.45	853.68	853.76	853.82	852.77	853.82	851.68	853.28
DISTANZE PARZIALI TERRENO		11.32		8.68			8.39		4.76			11.08		1.28	4.49
DISTANZE PROGRESSIVE TERRENO	25.00	13.68				5.00		3.39			8.15		19.23	20.51	25.00
QUOTE TERRENO	856.00	855.12				853.98		853.19			852.94		853.01	853.00	852.70

PROFILO: Asse-SS87

SEZIONE: 43a

PROGRESSIVA: 1660.00

MOVIMENTI DI TERRA	
SCOTICO	0.00 mq
GRADONATURE	0.00 mq
SCAVO	13.98 mq
RILEVATO	0.00 mq
VEGETALE	1.29 mq

PAVIMENTAZIONI	
USURA	0.29 mq
BINDER	0.38 mq
BASE	0.95 mq
FONDAZIONE	4.36 mq

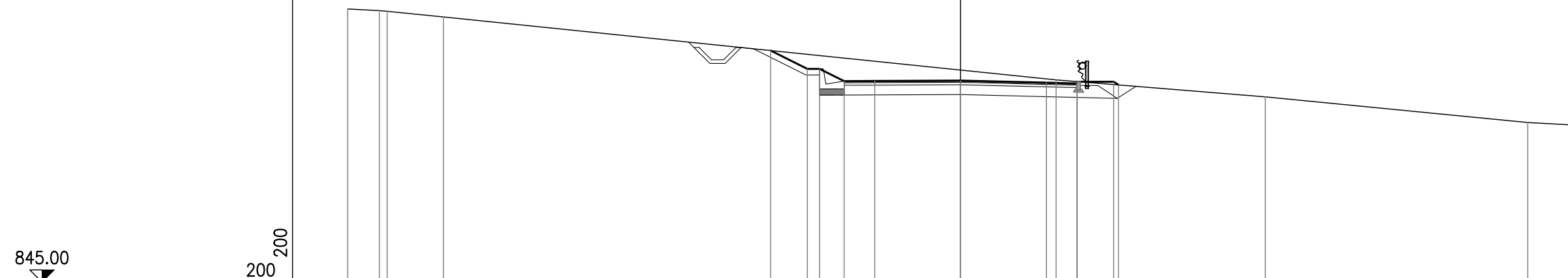

DISTANZE PARZIALI PROGETTO				1.50	0.50	1.00	1.25	3.50	3.50	1.25	1.50	0.19						
DISTANZE PROGRESSIVE PROGETTO				7.75	6.25	5.75	4.75	3.50	0.00	3.50	4.75	6.25	6.44					
QUOTE PROGETTO				854.46	853.71	853.71	853.21	853.22	853.23	853.15	853.12	853.18	853.18	853.05				
DISTANZE PARZIALI TERRENO		1.29	0.32	2.30				24.99					8.53			10.71	1.86	
DISTANZE PROGRESSIVE TERRENO		25.00	23.71	23.39			21.09				3.90			12.43			23.14	25.00
QUOTE TERRENO	856.15	856.09	856.06		855.83					853.26				852.57			851.52	851.42

PROFILO: Asse-SS87

SEZIONE: 44

PROGRESSIVA: 1680.00

MOVIMENTI DI TERRA	
SCOTICO	0.00 mq
GRADONATURE	0.00 mq
SCAVO	26.00 mq
RILEVATO	0.00 mq
VEGETALE	1.48 mq

PAVIMENTAZIONI	
USURA	0.29 mq
BINDER	0.38 mq
BASE	0.95 mq
FONDAZIONE	3.80 mq

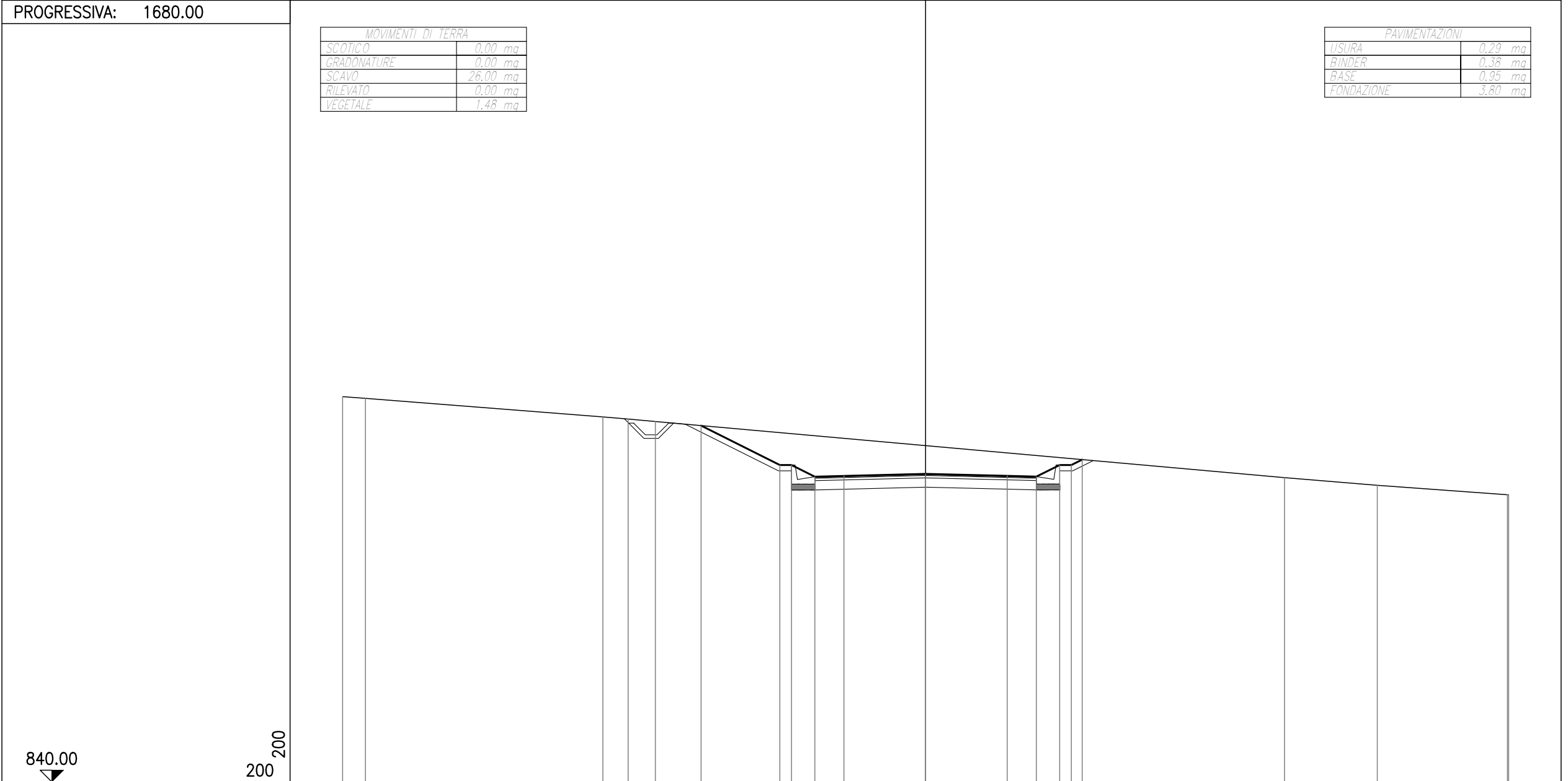

DISTANZE PARZIALI PROGETTO					3.38	0.50	1.00	1.25		3.50		3.50	1.25	1.00	0.50	0.46			
DISTANZE PROGRESSIVE PROGETTO					9.63	6.25	5.75	4.75	3.50	0.00	3.50	4.75	5.75	6.25	6.71				
QUOTE PROGETTO					855.27	853.58	853.58	853.08	853.11	853.20	853.11	853.08	853.58	853.58	853.81				
DISTANZE PARZIALI TERRENO	0.98		10.18	1.08	1.17					26.98			3.98		5.58	0.05			
DISTANZE PROGRESSIVE TERRENO	25.00	24.02		13.84	12.76	11.59					15.39		19.37		24.95	25.00			
QUOTE TERRENO	856.51	856.44		855.64	855.55	855.44					853.04		852.71		852.31	852.30			

PROFILO: Asse-SS87
 SEZIONE: 45
 PROGRESSIVA: 1725.00

MOVIMENTI DI TERRA	
SCOTICO	0.00 mq
GRADONATURE	0.00 mq
SCAVO	29.37 mq
RILEVATO	0.00 mq
VEGETALE	1.13 mq

PAVIMENTAZIONI	
USURA	0.39 mq
BINDER	0.52 mq
BASE	1.30 mq
FONDAZIONE	5.20 mq

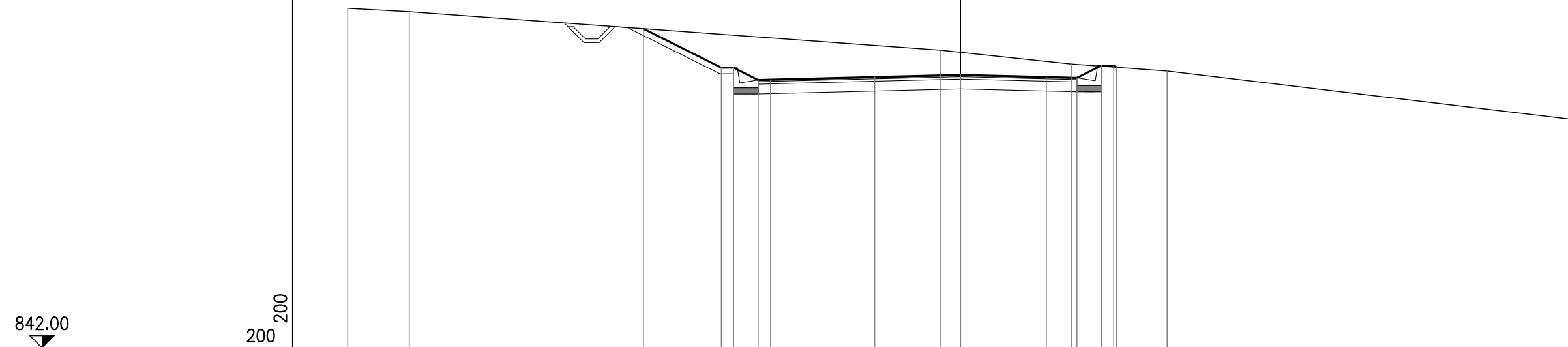

DISTANZE PARZIALI PROGETTO			3.18	0.50	1.00	0.51	4.25	3.50	3.50	1.25	1.00	0.50	0.11	
DISTANZE PROGRESSIVE PROGETTO			855.01	853.42	853.42	852.92	852.93	853.04	853.13	853.04	853.01	853.51	853.51	853.44
QUOTE PROGETTO			855.01	853.42	853.42	852.92	852.93	853.04	853.13	853.04	853.01	853.51	853.51	853.44
DISTANZE PARZIALI TERRENO	2.51		21.68						5.35		3.89		16.57	
DISTANZE PROGRESSIVE TERRENO	855.84	855.70						854.13		853.57		853.29	851.31	
QUOTE TERRENO	855.84	855.70					854.13		853.57		853.29	851.31		

PROFILO: Asse-SS87
 SEZIONE: 45a
 PROGRESSIVA: 1745.00

MOVIMENTI DI TERRA	
SCOTICO	4.07 mq
GRADONATURE	0.00 mq
SCAVO	0.27 mq
RILEVATO	7.24 mq
VEGETALE	2.51 mq

PAVIMENTAZIONI	
USURA	0.29 mq
BINDER	0.38 mq
BASE	0.95 mq
FONDAZIONE	4.92 mq

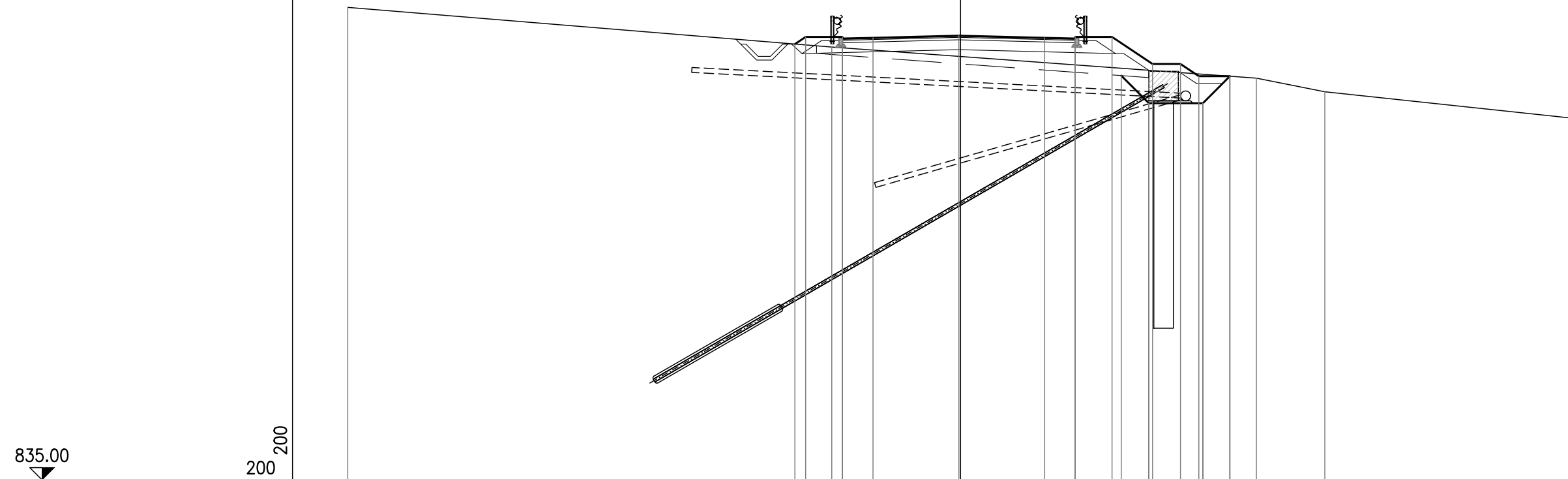

DISTANZE PARZIALI PROGETTO			0.44	1.50	1.25	3.50		3.50	1.25	1.50	1.62	1.24	0.75	1.27												
DISTANZE PROGRESSIVE PROGETTO			-6.76	-6.32	-4.82	-4.82	-3.57		-0.07		3.43	4.68	4.68	6.18	6.56	7.68	7.68	8.97	9.72	9.88	9.88	10.99	10.99			
QUOTE PROGETTO			852.76	853.05	853.05	852.98	853.01		853.10		853.01	852.98	853.05	853.05	851.47	850.35	850.35	851.95	851.45	850.35	850.35	851.45	851.45			
DISTANZE PARZIALI TERRENO		19.75								17.32								2.79			10.14					
DISTANZE PROGRESSIVE TERRENO	854.25	25.00			-5.25																	12.07		14.86		25.00
QUOTE TERRENO	854.25				852.63																	851.37		850.81		849.73

PROFILO: Asse-SS87
 SEZIONE: 50A
 PROGRESSIVA: 1941.00

MOVIMENTI DI TERRA	
SCOTICO	9,23 mq
GRADONATURE	4,81 mq
SCAVO	0,00 mq
RILEVATO	127,62 mq
VEGETALE	5,90 mq

PAVIMENTAZIONI	
USURA	0,29 mq
BINDER	0,38 mq
BASE	0,95 mq
FONDAZIONE	4,92 mq

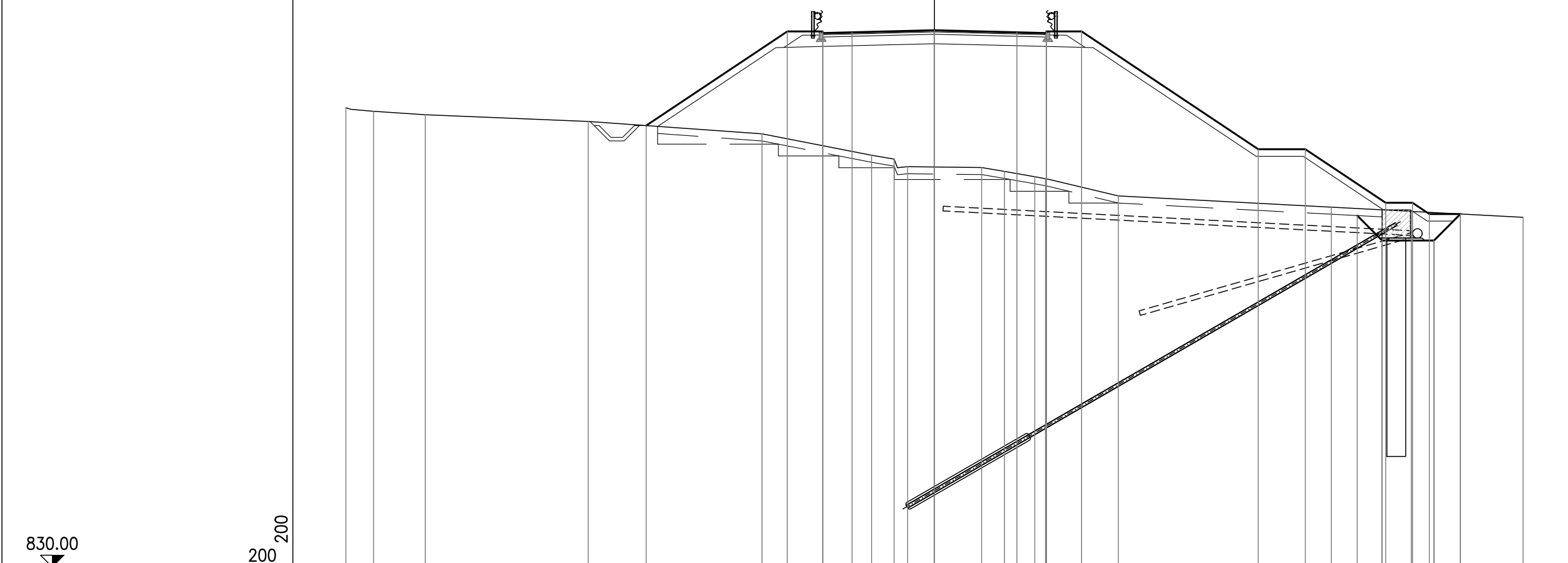

DISTANZE PARZIALI PROGETTO				6.00	1.50	1.25	3.50	3.50	1.25	1.50	7.50	2.00	3.41	1.05	1.24	0.72	1.33					
DISTANZE PROGRESSIVE PROGETTO				848.74	852.74	852.74	852.67	852.70	852.70	852.79	852.70	847.74	847.74	844.92	843.86	843.86	843.46	845.46	844.98	843.86	844.98	844.99
QUOTE PROGETTO				848.74	852.74	852.74	852.67	852.70	852.70	852.79	852.70	847.74	847.74	844.92	843.86	843.86	843.46	845.46	844.98	843.86	844.98	844.99
DISTANZE PARZIALI TERRENO		1.18	2.19	6.92	7.38	4.66	0.96	0.57	3.14	0.98	1.28	0.45	3.10	9.05	3.39	4.75						
DISTANZE PROGRESSIVE TERRENO	849.50	849.35	849.20	848.92	848.39	847.48	847.32	847.00	846.96	846.79	846.57	846.45	845.75	845.28	845.10	844.84						
QUOTE TERRENO	25.00	23.82	21.63	14.71	7.33	2.67	1.71	1.14	2.00	2.98	4.26	4.71	7.81	16.86	20.25	25.00						

PROFILO: Asse-SS87

SEZIONE: 51

PROGRESSIVA: 1960.00

MOVIMENTI DI TERRA	
SCOTICO	7.99 mq
GRADONATURE	5.83 mq
SCAVO	0.00 mq
RILEVATO	71.16 mq
VEGETALE	6.92 mq

PAVIMENTAZIONI	
USURA	0.29 mq
BINDER	0.38 mq
BASE	0.95 mq
FONDAZIONE	4.92 mq

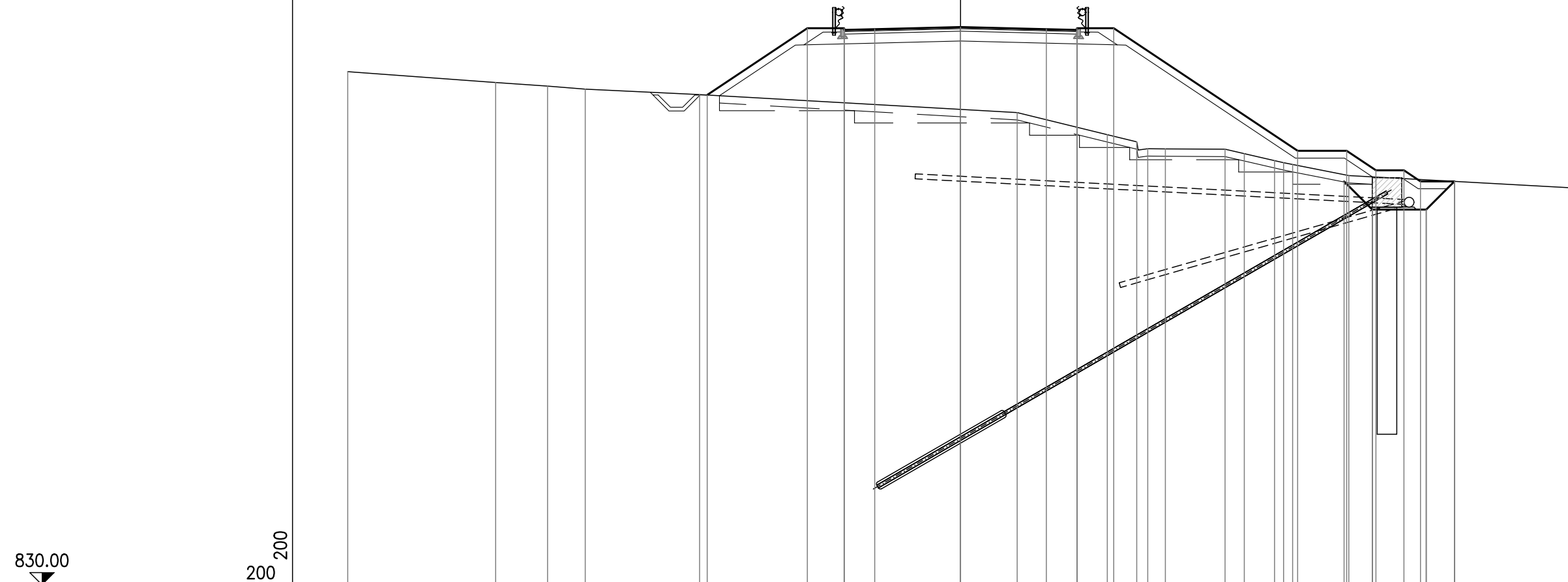

DISTANZE PARZIALI PROGETTO						4.09	1.50	1.25	3.50	3.50	1.25	1.50	7.50	2.00	1.25	1.25	0.87	1.35								
DISTANZE PROGRESSIVE PROGETTO					849.98	-10.34	-6.25	-4.75	-4.75	-3.50	0.00	3.50	4.75	4.75	6.25	13.75	15.65	15.75	16.80	16.95	18.09	18.76	19.00	19.00	20.15	20.15
QUOTE PROGETTO					850.00	852.71	852.71	852.64	852.71	852.67	852.76	852.67	852.64	852.71	852.71	847.71	846.46	847.71	845.31	845.31	846.91	846.46	845.31	845.31	846.46	846.46
DISTANZE PARZIALI TERRENO		6.04	2.11	1.54	4.67			12.95			3.68	1.20	0.44	0.73	2.43	0.78	1.24	0.37	0.37	2.29				9.16		
DISTANZE PROGRESSIVE TERRENO	850.94	25.00	18.96	16.85	15.31	10.64					2.31	5.99	7.19	7.63	8.36	10.79	11.57	12.81	13.18	13.55	15.84				25.00	
QUOTE TERRENO	850.94		850.49	850.35	850.22	850.00					849.27	848.36	848.07	847.79	847.78	847.77	847.59	847.31	847.22	847.15	846.70				846.19	

PROFILO: Asse-SS87

SEZIONE: 54

PROGRESSIVA: 2080.00

MOVIMENTI DI TERRA	
SCOTICO	0,00 mq
GRADONATURE	0,00 mq
SCAVO	66,98 mq
RILEVATO	0,00 mq
VEGETALE	2,79 mq

PAVIMENTAZIONI	
USURA	0,29 mq
BINDER	0,38 mq
BASE	0,95 mq
FONDAZIONE	3,80 mq

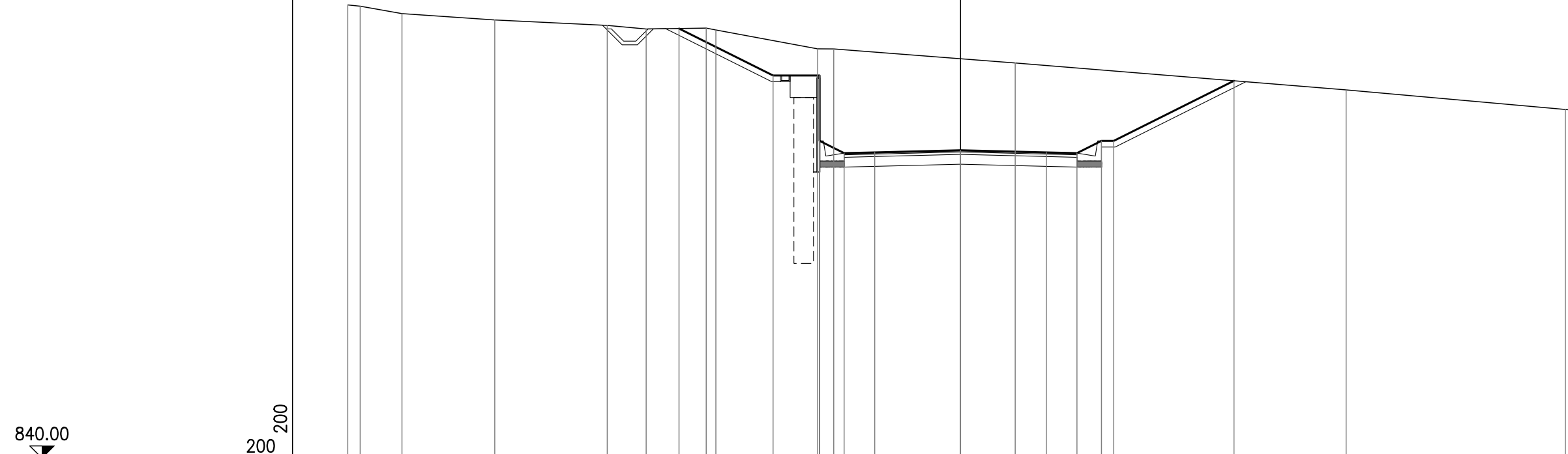

DISTANZE PARZIALI PROGETTO						3.83	1.90	1.00	1.25	3.50	3.50	1.25	1.00	0.50	4.91	
DISTANZE PROGRESSIVE PROGETTO						11.48	7.65	5.75	4.75	3.50	0.00	3.50	4.75	6.25	11.16	
QUOTE PROGETTO						857.54	855.62	852.95	852.62	852.45	852.45	852.95	852.95	855.40		
DISTANZE PARZIALI TERRENO	0.51	1.70	3.79	4.59	1.58	2.45	0.40	4.15	0.66	7.40		13.50		8.94	0.33	
DISTANZE PROGRESSIVE TERRENO	25.00	24.49	22.79	19.00	14.41	12.83	10.38	9.98	5.83	5.17	2.23	15.73		24.67	25.00	
QUOTE TERRENO	858.50	858.45	858.14	857.89	857.66	857.52	857.55	857.48	856.71	856.70	856.13	855.03		854.23	854.20	

840.00

200 200

PROFILO: Asse-SS87
 SEZIONE: 55
 PROGRESSIVA: 2120.00

MOVIMENTI DI TERRA	
SCOTICO	0,00 mq
GRADONATURE	0,00 mq
SCAVO	59,11 mq
RILEVATO	0,00 mq
VEGETALE	4,54 mq

PAVIMENTAZIONI	
USURA	0,29 mq
BINDER	0,38 mq
BASE	0,95 mq
FONDAZIONE	3,80 mq

840.00
 200 200

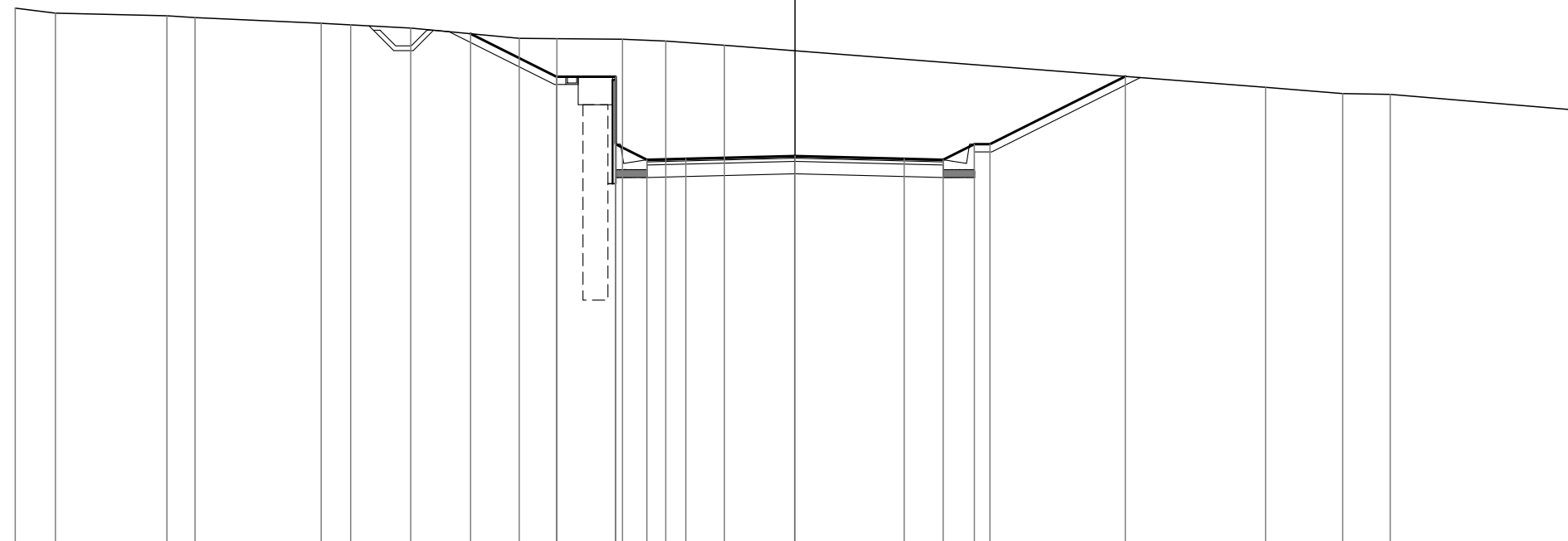

DISTANZE PARZIALI PROGETTO								2.75	1.90	1.00	1.25	3.50	3.50	1.25	1.00	0.50	4.34				
DISTANZE PROGRESSIVE PROGETTO								-10.40	-7.65	-5.75	-4.75	-3.50	0.00	3.50	4.75	5.75	6.25	10.59			
QUOTE PROGETTO								856.42	855.05	852.89	852.39	852.42	852.51	852.42	852.39	852.89	852.89	855.06			
DISTANZE PARZIALI TERRENO		1.29	3.57	0.91	4.04	0.94	1.93	3.48	1.21	2.10	1.39	1.88			17.35			2.47	1.52	5.92	
DISTANZE PROGRESSIVE TERRENO	857.24	857.08	857.00	856.94	856.76	856.71	856.60	856.28	856.27	856.25	856.19	856.05						854.71	854.51	854.48	853.98
QUOTE TERRENO	25.00	23.71	20.14	19.23	15.19	14.25	12.32	8.84	7.63	5.53	4.14	2.26						15.09	17.56	19.08	25.00

PROFILO: Asse-SS87
 SEZIONE: 61
 PROGRESSIVA: 2348.00

MOVIMENTI DI TERRA	
SCOTICO	0,00 mq
GRADONATURE	0,00 mq
SCAVO	0,00 mq
RILEVATO	0,00 mq
VEGETALE	0,00 mq

PAVIMENTAZIONI	
USURA	0,00 mq
BINDER	0,00 mq
BASE	0,00 mq
FONDAZIONE	0,00 mq

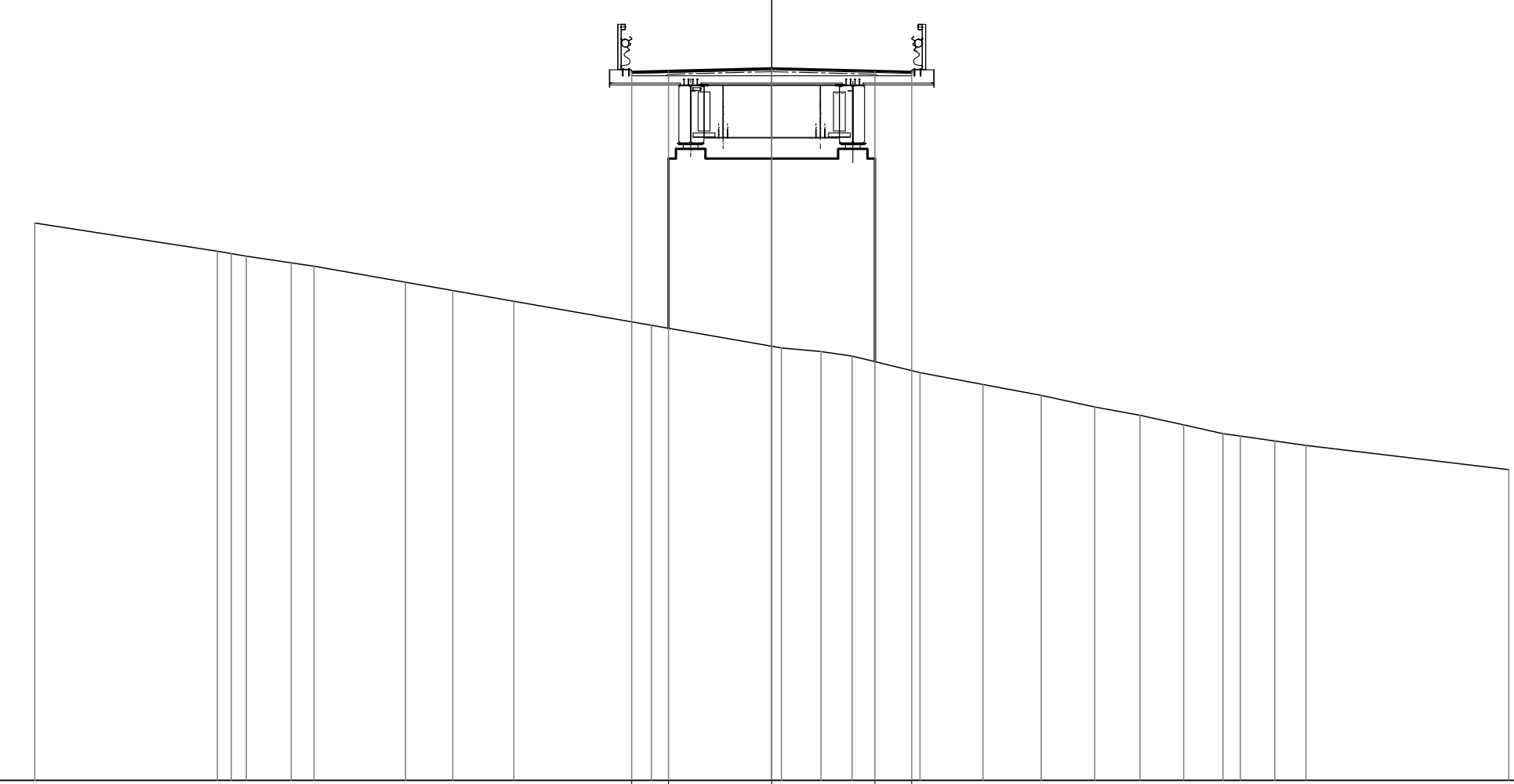

828.00

200 200

DISTANZE PARZIALI PROGETTO					1.25	3.50			3.50	1.25																
DISTANZE PROGRESSIVE PROGETTO					-4.75	-3.50			0.00	3.50	4.75															
QUOTE PROGETTO					852.03	852.06			852.15	852.06	852.03															
DISTANZE PARZIALI TERRENO	6.20		0.47	0.51	1.52	0.77	3.10	1.61	2.07	4.67	4.41	1.34	1.06	2.30	2.14	1.97	1.82	1.53	1.48	1.34	0.59	1.17	1.05	6.88		
DISTANZE PROGRESSIVE TERRENO	25.00			18.33	17.82	16.30	15.53	12.43	10.82	8.75	4.08	0.33	1.67	2.73	5.03	7.17	9.14	10.96	12.49	13.97	15.31	15.90	17.07	18.12	25.00	
QUOTE TERRENO	846.90			845.94	845.86	845.78	845.55	845.44	844.89	844.61	844.25	843.43	842.67	842.54	842.39	841.83	841.43	841.06	840.66	840.38	840.06	839.76	839.68	839.51	839.36	838.54

PROFILO: Asse-SS87

SEZIONE: 63

PROGRESSIVA: 2468.00

MOVIMENTI DI TERRA	
SCOTICO	0.00 mq
GRADONATURE	0.00 mq
SCAVO	0.00 mq
RILEVATO	0.00 mq
VEGETALE	0.00 mq

PAVIMENTAZIONI	
USURA	0.00 mq
BINDER	0.00 mq
BASE	0.00 mq
FONDAZIONE	0.00 mq

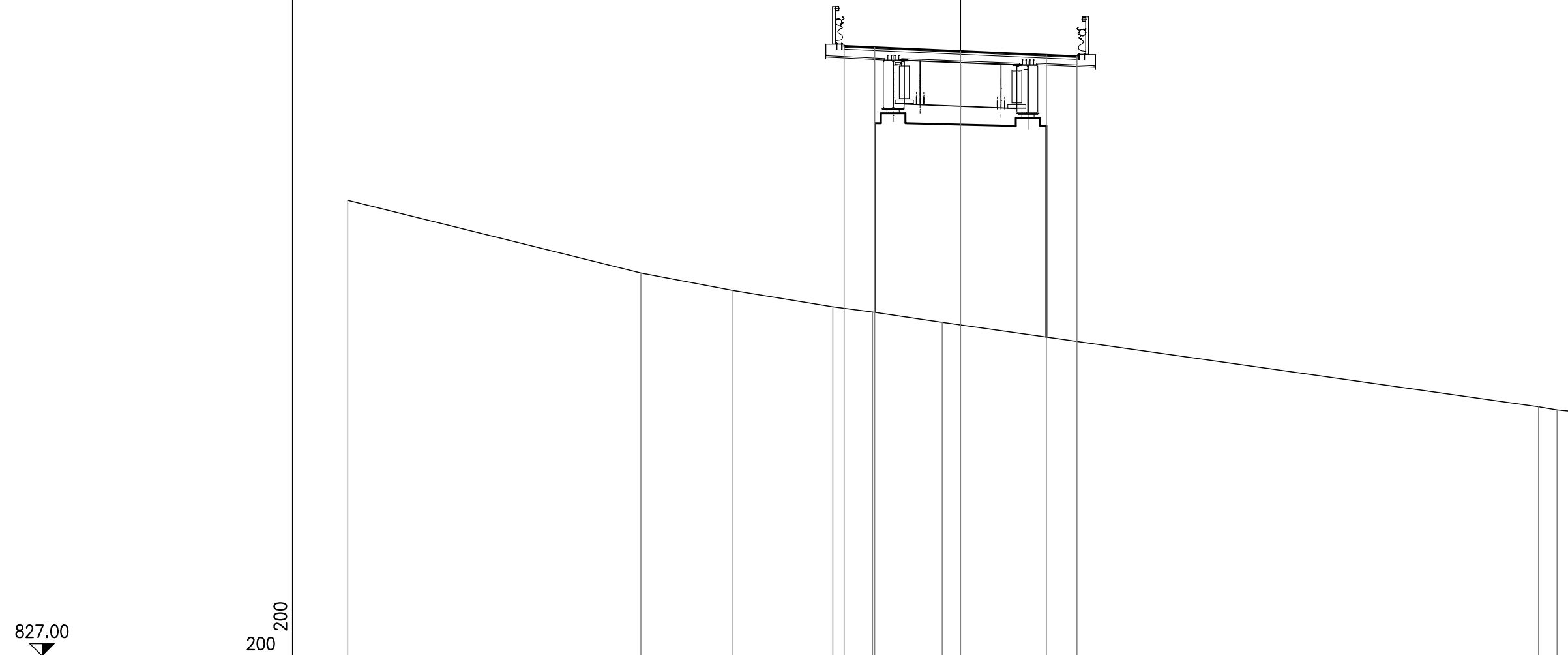

DISTANZE PARZIALI PROGETTO						1.25	3.50	3.50	1.25				
DISTANZE PROGRESSIVE PROGETTO						-4.75	-3.50	0.00	3.50	4.75			
QUOTE PROGETTO						851.86	851.80	851.65	851.49	851.43			
DISTANZE PARZIALI TERRENO		11.96	3.76	4.07	1.62	2.84				24.33	0.75	0.67	
DISTANZE PROGRESSIVE TERRENO	25.00	13.04	9.28	5.21	3.59	0.75					23.58	24.33	25.00
QUOTE TERRENO	845.57	842.61	841.89	841.22	841.01	840.59					837.15	837.02	836.96

PROFILO: Asse-SS87
 SEZIONE: 65
 PROGRESSIVA: 2571.80

MOVIMENTI DI TERRA	
SCOTICO	0.00 mq
GRADONATURE	0.00 mq
SCAVO	0.00 mq
RILEVATO	32.15 mq
VEGETALE	0.00 mq

PAVIMENTAZIONI	
USURA	0.00 mq
BINDER	0.00 mq
BASE	0.00 mq
FONDAZIONE	0.00 mq

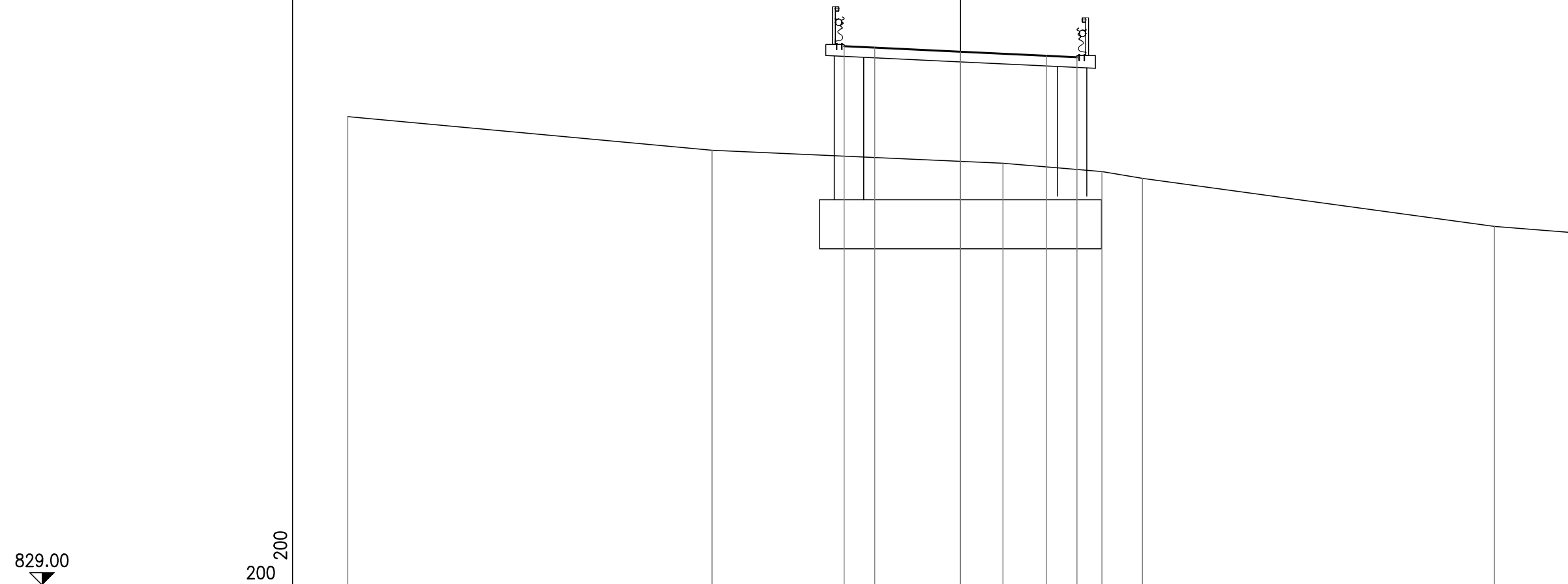

DISTANZE PARZIALI PROGETTO				1.25	3.50		3.50	1.25				
DISTANZE PROGRESSIVE PROGETTO				-4.75	-3.50		0.00	3.50	4.75			
QUOTE PROGETTO				850.98	850.92		850.75	850.58	850.52			
DISTANZE PARZIALI TERRENO		14.86		11.87			4.04	1.65		14.36	3.22	
DISTANZE PROGRESSIVE TERRENO	848.10	25.00	846.73	10.14			1.73	5.77	7.42		21.78	25.00
QUOTE TERRENO	848.10		846.73				846.20	845.86	845.58		843.62	843.37

PROFILO: Asse-SS87

SEZIONE: 66

PROGRESSIVA: 2581.00

MOVIMENTI DI TERRA	
SCOTICO	7,57 mq
GRADONATURE	3,77 mq
SCAVO	0,00 mq
RILEVATO	80,52 mq
VEGETALE	6,51 mq

PAVIMENTAZIONI	
USURA	0,29 mq
BINDER	0,38 mq
BASE	0,95 mq
FONDAZIONE	4,87 mq

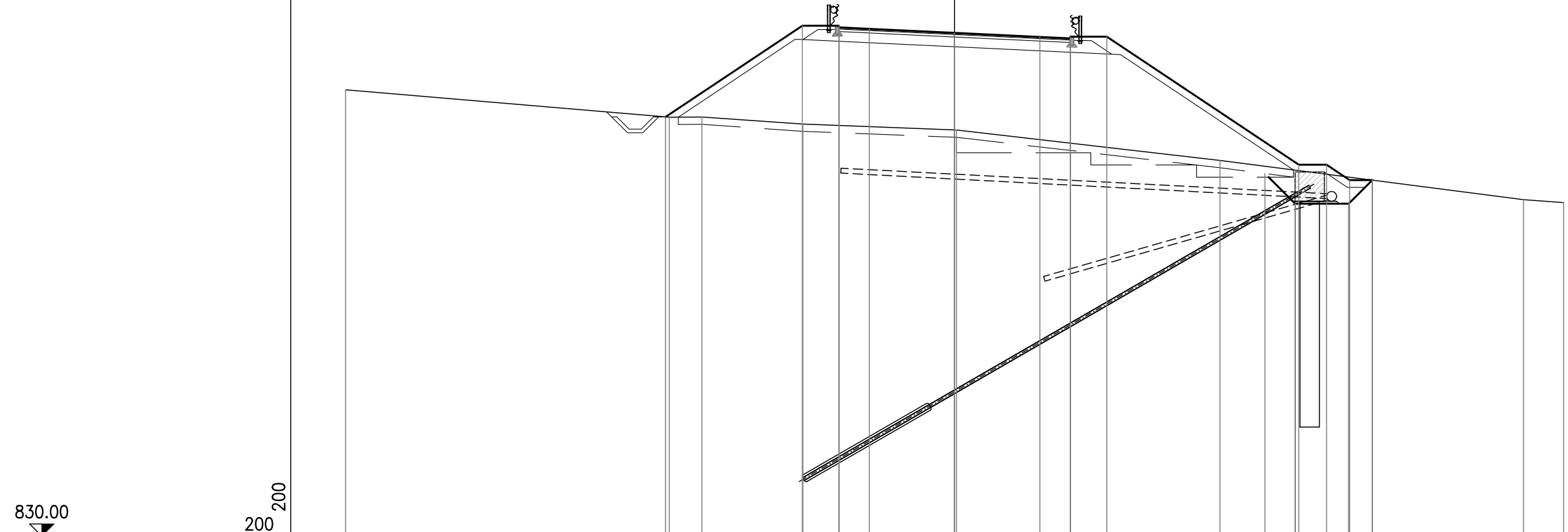

DISTANZE PARZIALI PROGETTO			5.61	1.50	1.25	3.50		3.50	1.25	1.50	7.88	1.24	1.12	20.95	0.99	0.92							
DISTANZE PROGRESSIVE PROGETTO			847.20	-11.86								12.74	13.98	13.98	14.13	15.27	16.18	16.18	16.22	17.14	17.14		
QUOTE PROGETTO			847.20									844.88	843.64	843.64	845.24	845.24	843.64	843.64	844.61	844.61			
DISTANZE PARZIALI TERRENO		13.29		1.34	4.14					10.81							12.46			1.65			
DISTANZE PROGRESSIVE TERRENO	848.31	-25.00		847.19	-11.71	847.20	-10.37													843.81	-23.35	843.68	-25.00
QUOTE TERRENO	848.31			847.19		847.20														843.81		843.68	

PROFILO: Asse-SS87

SEZIONE: 67

PROGRESSIVA: 2600.00

MOVIMENTI DI TERRA	
SCOTICO	6.31 mq
GRADONATURE	5.16 mq
SCAVO	0.00 mq
RILEVATO	52.45 mq
VEGETALE	4.96 mq

PAVIMENTAZIONI	
USURA	0.29 mq
BINDER	0.38 mq
BASE	0.95 mq
FONDAZIONE	4.87 mq

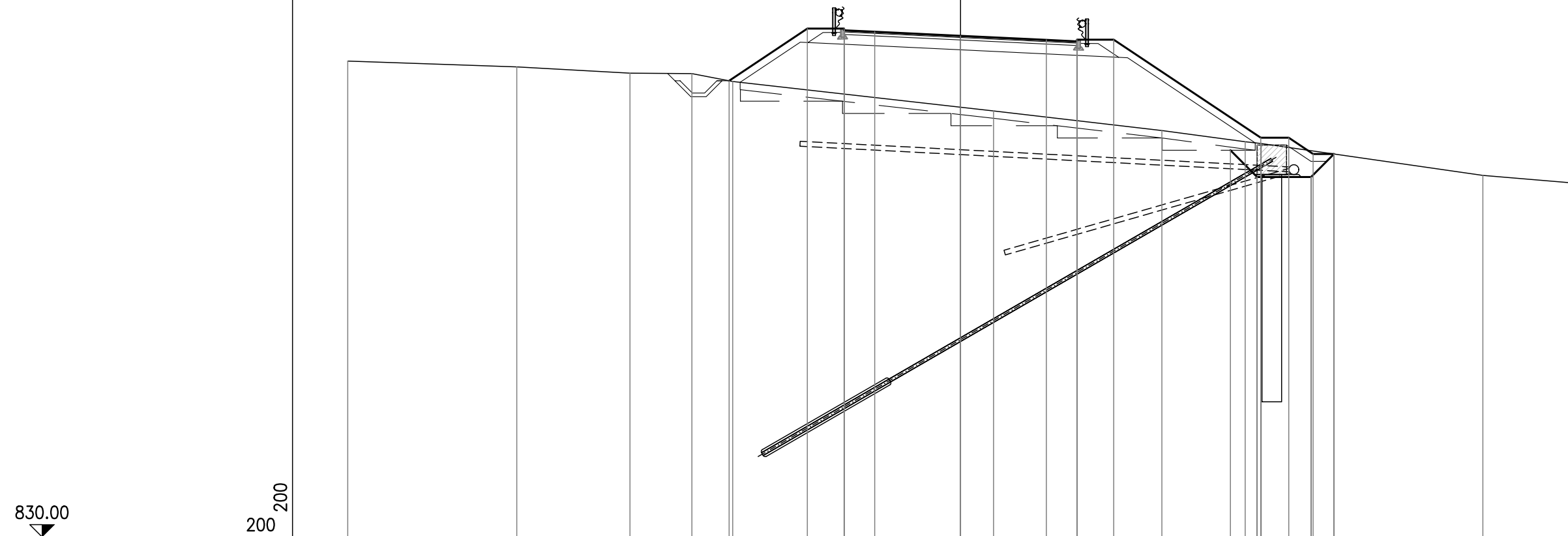

DISTANZE PARZIALI PROGETTO						3.19	1.50	1.25	3.50	3.50	1.25	1.50	6.00	1.09	1.12	20.99	0.85										
DISTANZE PROGRESSIVE PROGETTO																											
QUOTE PROGETTO						848.60	850.73	850.73	850.66	850.60	850.43	850.27	850.21	850.27	850.27	845.77	844.68	844.68	846.28	846.28	846.28	844.68	844.68	845.61	845.61	845.61	
DISTANZE PARZIALI TERRENO		6.90	4.62	2.52	1.66			10.65				6.86		3.40	0.66		9.04									3.69	
DISTANZE PROGRESSIVE TERRENO	849.40	25.00																									
QUOTE TERRENO	849.40		849.16		848.91		848.89		848.57		847.37		846.57		846.11		846.04									844.74	844.43

PROFILO: Asse-SS87

SEZIONE: 67a

PROGRESSIVA: 2620.00

MOVIMENTI DI TERRA	
SCOTICO	5.43 mq
GRADONATURE	4.77 mq
SCAVO	0.00 mq
RILEVATO	31.69 mq
VEGETALE	3.92 mq

PAVIMENTAZIONI	
USURA	0.29 mq
BINDER	0.38 mq
BASE	0.95 mq
FONDAZIONE	4.87 mq

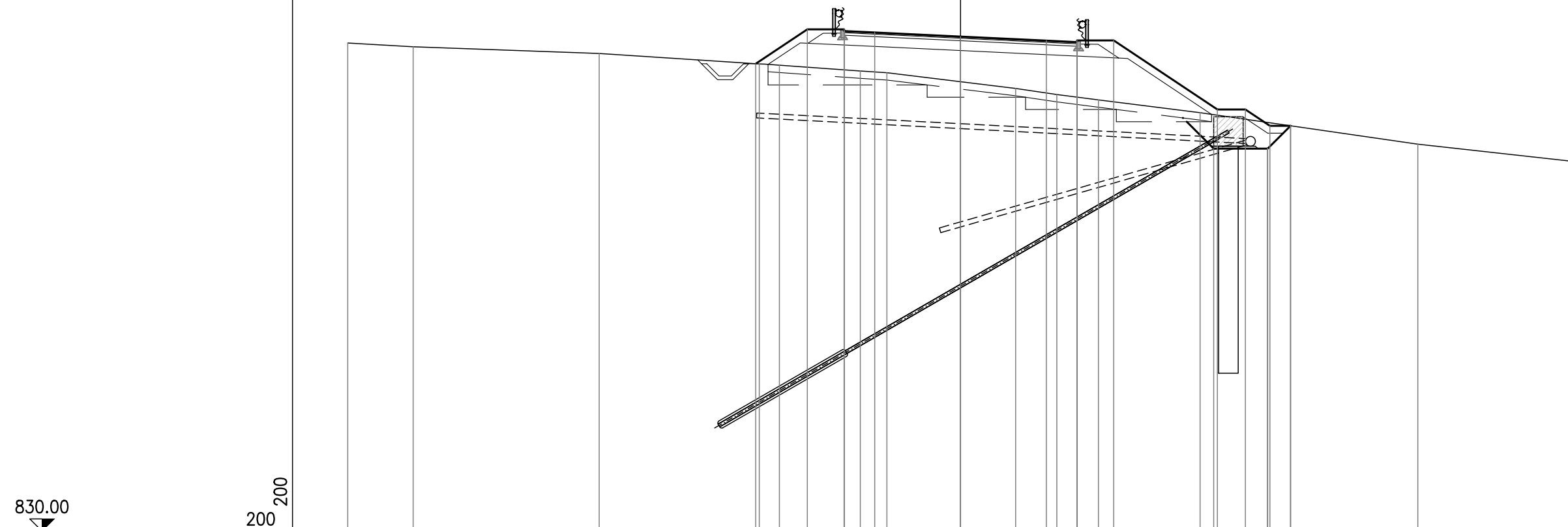

DISTANZE PARZIALI PROGETTO					2.10	1.50	1.25	3.50		3.50	1.25	1.50	4.23	1.20	0.00	0.94						
DISTANZE PROGRESSIVE PROGETTO					849.07	849.08	850.48	850.48	850.41	850.35	850.19	850.02	849.96	850.03	850.03	845.61	847.21	847.21	845.61	845.61	846.54	846.54
QUOTE PROGETTO					849.07	849.08	850.48	850.48	850.41	850.35	850.19	850.02	849.96	850.03	850.03	845.61	847.21	847.21	845.61	845.61	846.54	846.54
DISTANZE PARZIALI TERRENO		2.67	7.59	6.53	0.82	3.30	1.09	5.25	1.68	1.69	4.15			8.88		6.35						
DISTANZE PROGRESSIVE TERRENO	849.92	849.77	849.50	849.07	849.02	848.78	848.71	848.07	847.82	847.60	847.08	845.79	845.09									
QUOTE TERRENO	849.92	849.77	849.50	849.07	849.02	848.78	848.71	848.07	847.82	847.60	847.08	845.79	845.09									

830.00

200
200

PROFILO: Asse-SS87
 SEZIONE: 68
 PROGRESSIVA: 2640.00

MOVIMENTI DI TERRA	
SCOTICO	6.11 mq
GRADONATURE	4.79 mq
SCAVO	0.00 mq
RILEVATO	29.08 mq
VEGETALE	3.47 mq

PAVIMENTAZIONI	
USURA	0.39 mq
BINDER	0.52 mq
BASE	1.30 mq
FONDAZIONE	6.27 mq

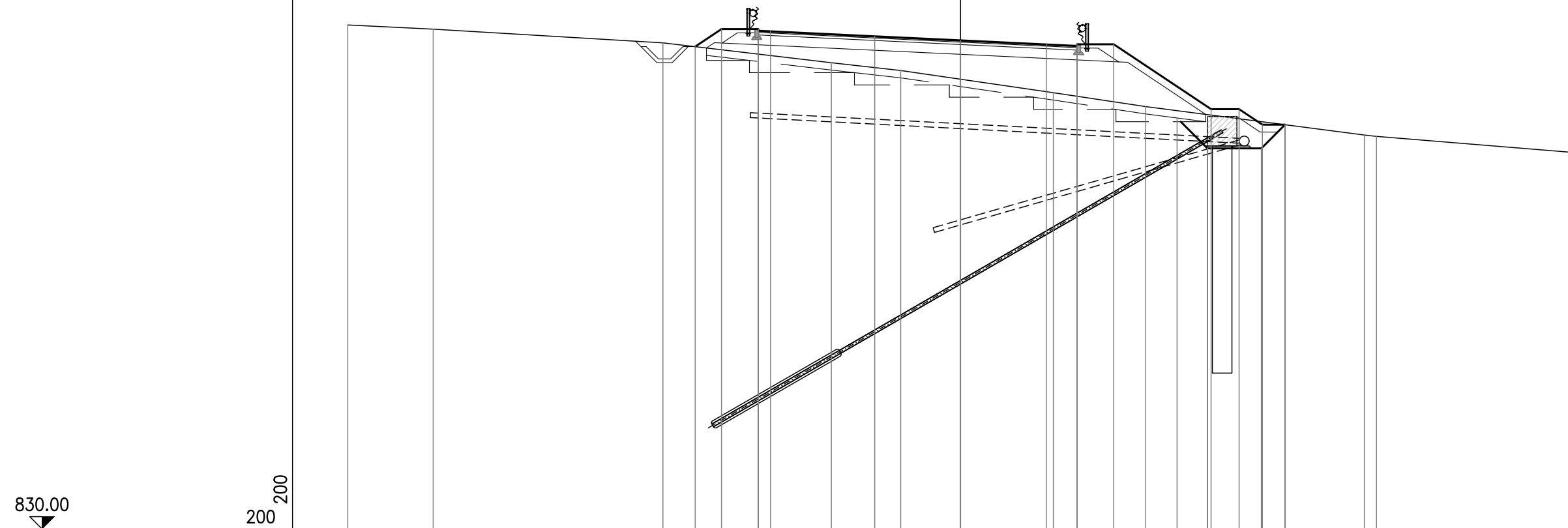

DISTANZE PARZIALI PROGETTO				1.08	1.50	0.50		4.25	3.50	3.50	1.25	1.50	3.97	1.24	1.12	2.09	0.95	0.73					
DISTANZE PROGRESSIVE PROGETTO				849.67	850.39	850.39	850.32	850.29	850.09	849.93	849.76	849.70	849.77	849.77	846.76	845.52	845.52	847.12	847.12	845.52	846.49	846.49	
QUOTE PROGETTO				849.67	850.39	850.39	850.32	850.29	850.09	849.93	849.76	849.70	849.77	849.77	846.76	845.52	845.52	847.12	847.12	845.52	846.49	846.49	
DISTANZE PARZIALI TERRENO		3.49	9.37			6.87		2.83		6.23		3.76			8.92		0.50		8.03				
DISTANZE PROGRESSIVE TERRENO	850.56	25.00	850.38	21.51		849.83	12.14	849.01	5.27	848.70	2.44	847.79	3.79	847.23	7.55	846.07	16.47	846.01	16.97			845.35	25.00
QUOTE TERRENO	850.56		850.38			849.83		849.01		848.70		847.79		847.23		846.07		846.01				845.35	

PROFILO: Asse-SS87

SEZIONE: 68a

PROGRESSIVA: 2665.00

MOVIMENTI DI TERRA	
SCOTICO	4,06 mq
GRADONATURE	3,46 mq
SCAVO	1,86 mq
RILEVATO	10,44 mq
VEGETALE	2,00 mq

PAVIMENTAZIONI	
USURA	0,39 mq
BINDER	0,52 mq
BASE	1,30 mq
FONDAZIONE	5,79 mq

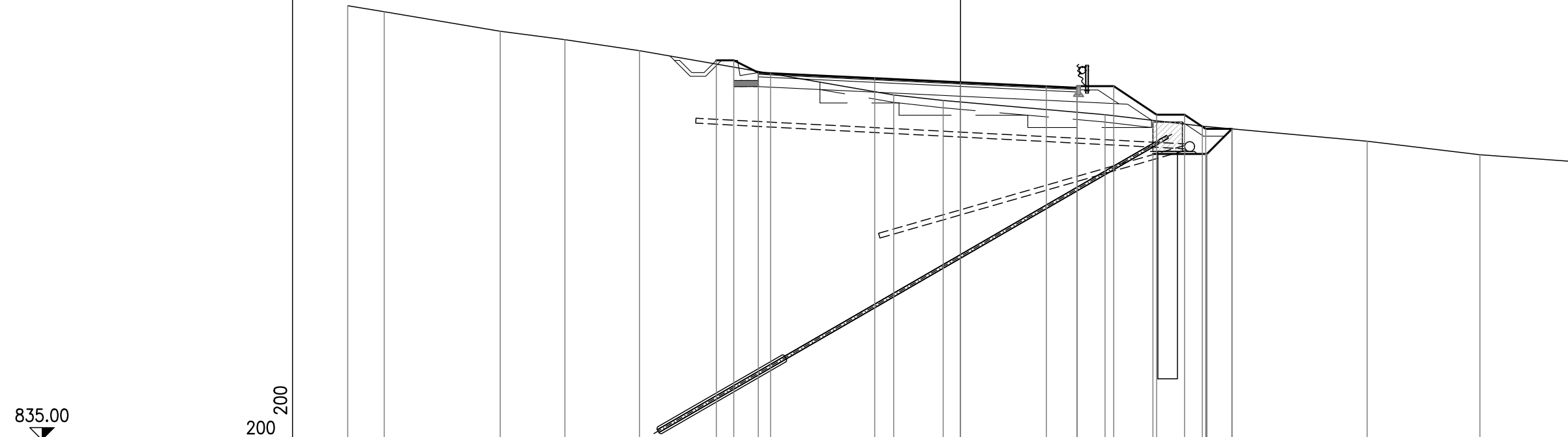

DISTANZE PARZIALI PROGETTO						0.71	1.00	0.50	4.25	3.50	3.50	1.25	1.50	1.75	1.12	2.08	1.08								
DISTANZE PROGRESSIVE PROGETTO						850.47	850.47	849.97	849.95	849.74	849.58	849.41	849.35	849.42	849.42	846.65	848.25	848.25	847.68	846.65	847.68	847.68	847.68	847.68	
QUOTE PROGETTO						850.47	850.47	849.97	849.95	849.74	849.58	849.41	849.35	849.42	849.42	846.65	848.25	848.25	847.68	846.65	847.68	847.68	847.68	847.68	
DISTANZE PARZIALI TERRENO		1.49	4.73	2.64	3.04			10.37		2.02		6.61			3.96			6.73		4.60		3.81			
DISTANZE PROGRESSIVE TERRENO	852.70	852.70	852.70	852.70	852.70	852.70	852.70	852.70	852.70	852.70	852.70	852.70	852.70	852.70	852.70	852.70	852.70	852.70	852.70	852.70	852.70	852.70	852.70	852.70	852.70
QUOTE TERRENO	852.70	852.45	851.66	851.31	850.86					849.06	848.83				848.26			847.17		846.62		846.35			846.35

PROFILO: Asse-SS87

SEZIONE: 69

PROGRESSIVA: 2680.00

MOVIMENTI DI TERRA	
SCOTICO	0.00 mq
GRADONATURE	0.00 mq
SCAVO	17.57 mq
RILEVATO	0.00 mq
VEGETALE	1.46 mq

PAVIMENTAZIONI	
USURA	0.31 mq
BINDER	0.41 mq
BASE	1.03 mq
FONDAZIONE	4.72 mq

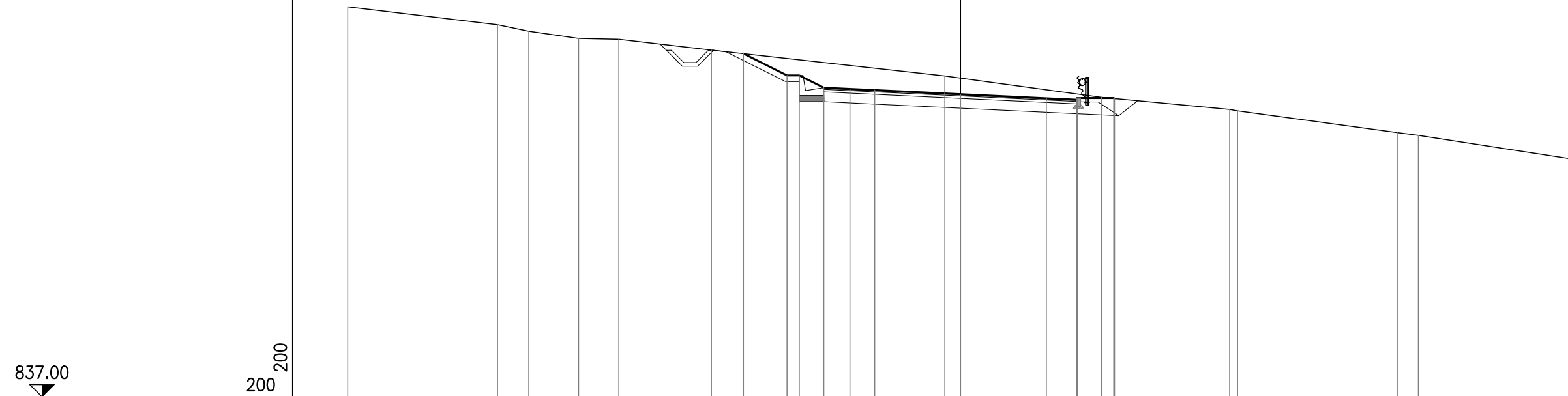

DISTANZE PARZIALI PROGETTO							1.78	0.50	1.00	1.07	1.01	3.50	3.50	1.25	1.50	0.03			
DISTANZE PROGRESSIVE PROGETTO							-8.86	-7.08	-6.58	-5.58	-4.51	-3.50	0.00	3.50	4.75	6.25	6.28		
QUOTE PROGETTO							851.01	850.12	850.12	849.62	849.57	849.52	849.36	849.19	849.13	849.20	849.20	849.18	
DISTANZE PARZIALI TERRENO		6.11	1.28	2.03	1.64	3.78			9.52			6.39		5.22	0.33	6.54	0.84	6.32	
DISTANZE PROGRESSIVE TERRENO	25.00	18.89	17.61	15.58	13.94	10.16						0.64		5.75	10.97	17.84	18.68		25.00
QUOTE TERRENO	852.92	852.19	851.93	851.64	851.60	851.16						850.10		849.23	848.74	848.68		847.79	846.70

PROFILO: Asse-SS87
 SEZIONE: 69a
 PROGRESSIVA: 2685.00

MOVIMENTI DI TERRA	
SCOTICO	0.00 mq
GRADONATURE	0.00 mq
SCAVO	22.26 mq
RILEVATO	0.00 mq
VEGETALE	1.99 mq

PAVIMENTAZIONI	
USURA	0.31 mq
BINDER	0.42 mq
BASE	1.04 mq
FONDAZIONE	4.77 mq

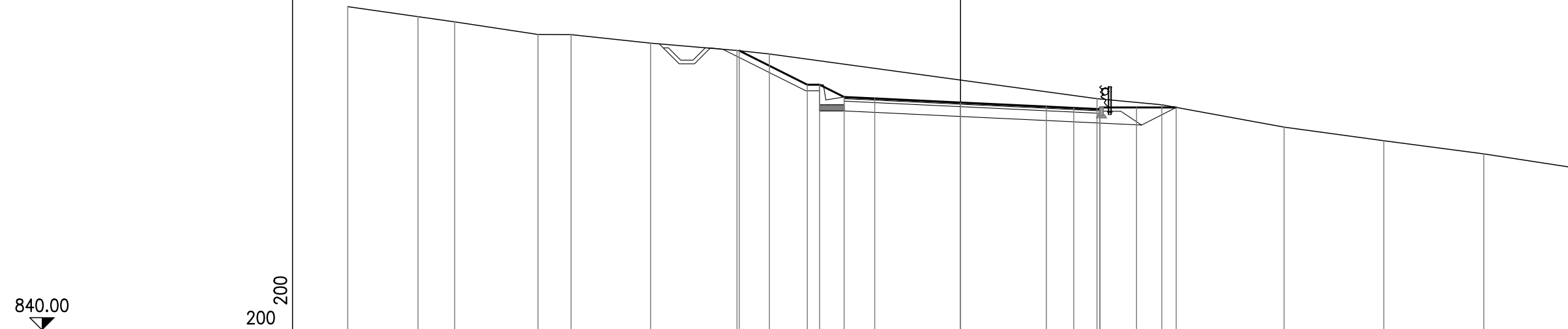

DISTANZE PARZIALI PROGETTO																	2.78	0.50	1.00	1.25	3.50			3.50	1.12	1.06	1.50	1.62																	
DISTANZE PROGRESSIVE PROGETTO																	851.39	-9.03	850.01	-6.25	850.01	-5.75	849.51	-4.75	849.45	-3.50	849.28	0.00	849.11	3.50	849.06	4.62	849.01	5.68	849.08	5.68	849.08	7.18	849.08	8.80					
QUOTE PROGETTO																	851.39		850.01		850.01		849.51		849.45		849.28		849.11		849.06		849.01		849.08		849.08		849.08						
DISTANZE PARZIALI TERRENO			2.87	1.49	3.40	1.35	3.25	3.52	1.32	13.37							2.64	4.99	4.07	4.07	3.66																								
DISTANZE PROGRESSIVE TERRENO	853.19	25.00	852.78	22.13	852.57	20.64	852.06	17.24	852.05	15.89	851.70	12.64	851.40	9.12	851.26	7.80											849.43	5.57	849.19	8.21	848.27	13.20	847.72	17.27	847.18	21.34	846.62	25.00							
QUOTE TERRENO	853.19		852.78		852.57		852.06		852.05		851.70		851.40		851.26												849.43		849.19		848.27		847.72		847.18		846.62								

PROFILO: Asse-SS87

SEZIONE: 69b

PROGRESSIVA: 2700.00

MOVIMENTI DI TERRA	
SCOTICO	0,00 mq
GRADONATURE	0,00 mq
SCAVO	19,33 mq
RILEVATO	0,00 mq
VEGETALE	4,36 mq

PAVIMENTAZIONI	
USURA	0,39 mq
BINDER	0,52 mq
BASE	1,30 mq
FONDAZIONE	5,79 mq

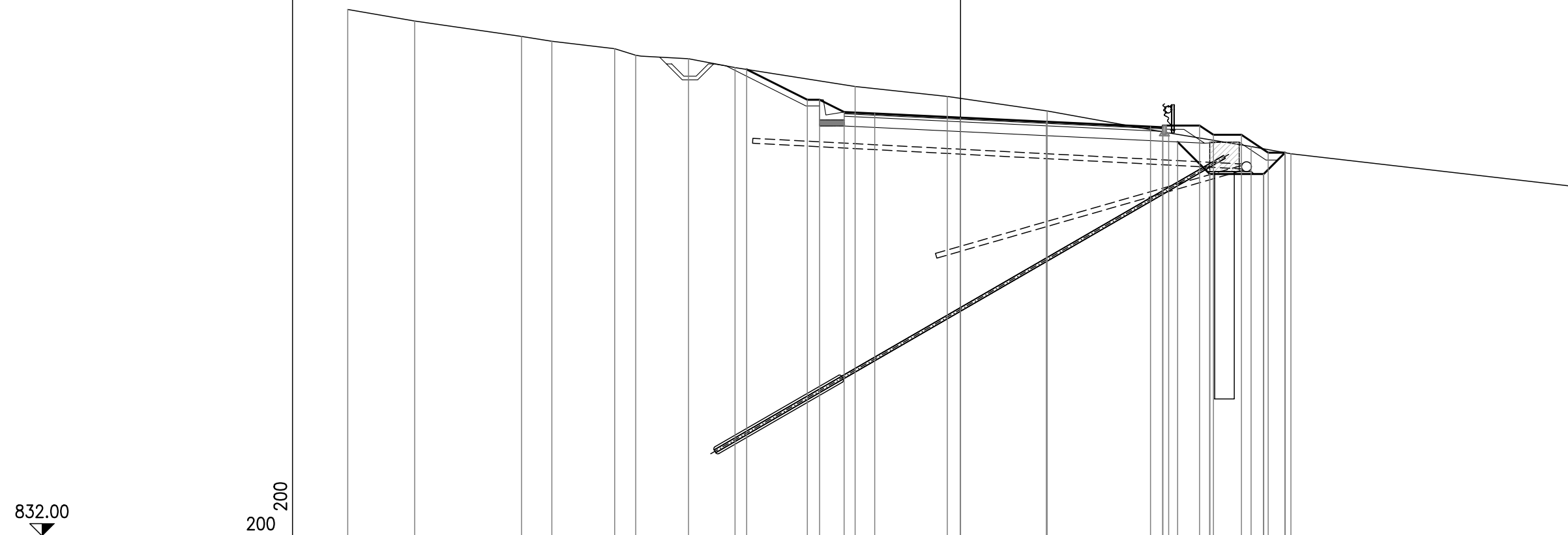

DISTANZE PARZIALI PROGETTO										2.47	0.50	1.00	1.25	3.50	3.50	4.25	0.50	1.50	0.37	1.24	0.09						
DISTANZE PROGRESSIVE PROGETTO										851.01	849.77	849.77	849.27	849.21	849.05	848.88	848.68	848.65	848.72	848.06	848.72	846.75	848.35	848.35	846.75	847.62	847.62
QUOTE PROGETTO										851.01	849.77	849.77	849.27	849.21	849.05	848.88	848.68	848.65	848.72	848.06	848.72	846.75	848.35	848.35	846.75	847.62	847.62
DISTANZE PARZIALI TERRENO		2.73	4.36	1.24	2.56	0.86	2.15	1.90		851.01	849.77	849.77	849.27	849.21	849.05	848.88	848.68	848.65	848.72	848.06	848.72	846.75	848.35	848.35	846.75	847.62	847.62
DISTANZE PROGRESSIVE TERRENO	853.45	25.00	28.27	17.91	16.67	14.11	13.25	11.10	9.20	851.01	849.77	849.77	849.27	849.21	849.05	848.88	848.68	848.65	848.72	848.06	848.72	846.75	848.35	848.35	846.75	847.62	847.62
QUOTE TERRENO	853.45	25.00	28.27	17.91	16.67	14.11	13.25	11.10	9.20	851.01	849.77	849.77	849.27	849.21	849.05	848.88	848.68	848.65	848.72	848.06	848.72	846.75	848.35	848.35	846.75	847.62	847.62

PROFILO: Asse-SS87
 SEZIONE: 70a
 PROGRESSIVA: 2745.00

MOVIMENTI DI TERRA	
SCOTICO	0.00 mq
GRADONATURE	0.00 mq
SCAVO	20.41 mq
RILEVATO	0.00 mq
VEGETALE	2.91 mq

PAVIMENTAZIONI	
USURA	0.31 mq
BINDER	0.41 mq
BASE	1.03 mq
FONDAZIONE	4.72 mq

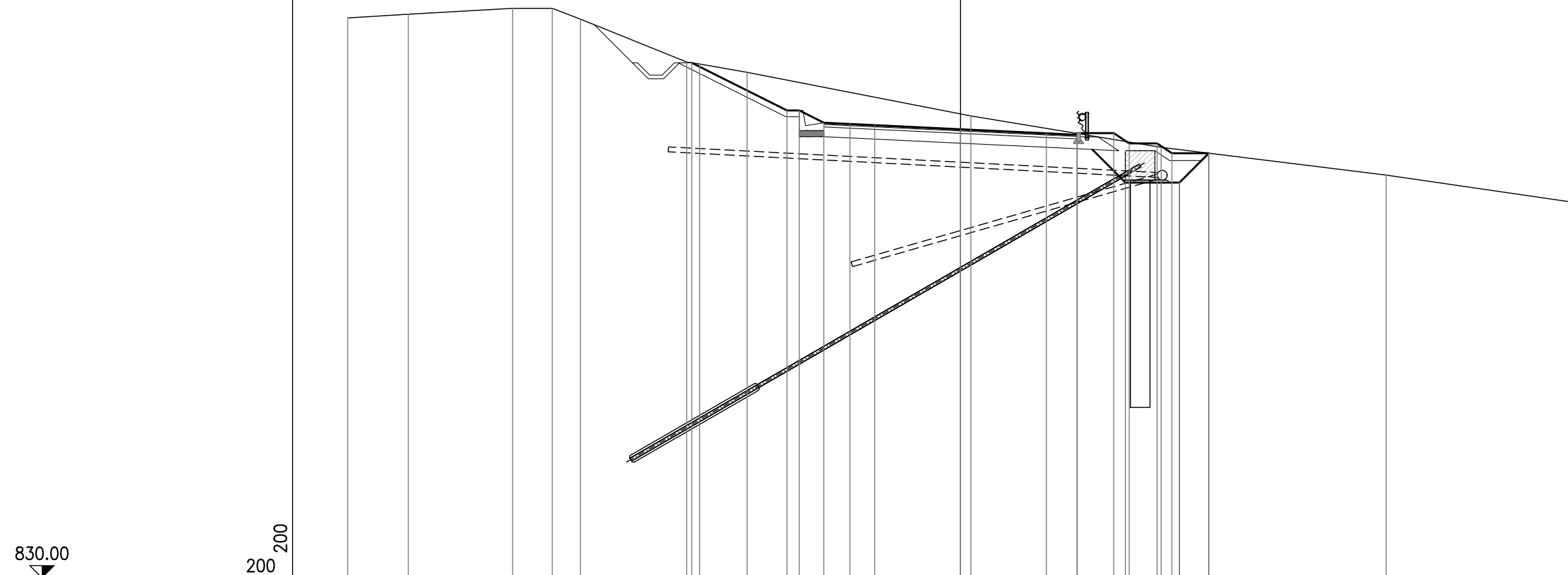

DISTANZE PARZIALI PROGETTO							3.88	0.50	1.00	1.07	1.01	3.50	3.50	1.25	1.50	0.63	1.24	0.80	1.50										
DISTANZE PROGRESSIVE PROGETTO								851.04	849.06	849.06	848.56	848.51	848.46	848.30	848.13	848.07	848.14	848.14	846.12	847.72	847.32	846.12	847.32	847.32	10.13				
QUOTE PROGETTO								851.00	849.06	849.06	848.56	848.51	848.46	848.30	848.13	848.07	848.14	848.14	846.12	847.72	847.32	846.12	847.32	847.32	10.13				
DISTANZE PARZIALI TERRENO		2.47	4.26	1.62	1.15	4.33	0.53	1.93			9.13			7.76					9.18			7.64							
DISTANZE PROGRESSIVE TERRENO	852.84	25.00	852.99	22.53		853.23	18.27	853.23	16.65	852.79	15.50		851.04	11.17	850.95	10.64		850.62	8.71			848.84	0.42		846.43	17.36		845.32	25.00
QUOTE TERRENO	852.84		852.99		853.23		853.23		852.79		851.04		850.95		850.62				848.84			846.43			845.32				

PROFILO: Asse-SS87
 SEZIONE: 73
 PROGRESSIVA: 2853.00

MOVIMENTI DI TERRA	
SCOTICO	9,00 mq
GRADONATURE	5,54 mq
SCAVO	0,00 mq
RILEVATO	89,49 mq
VEGETALE	8,10 mq

PAVIMENTAZIONI	
USURA	0,29 mq
BINDER	0,38 mq
BASE	0,95 mq
FONDAZIONE	4,87 mq

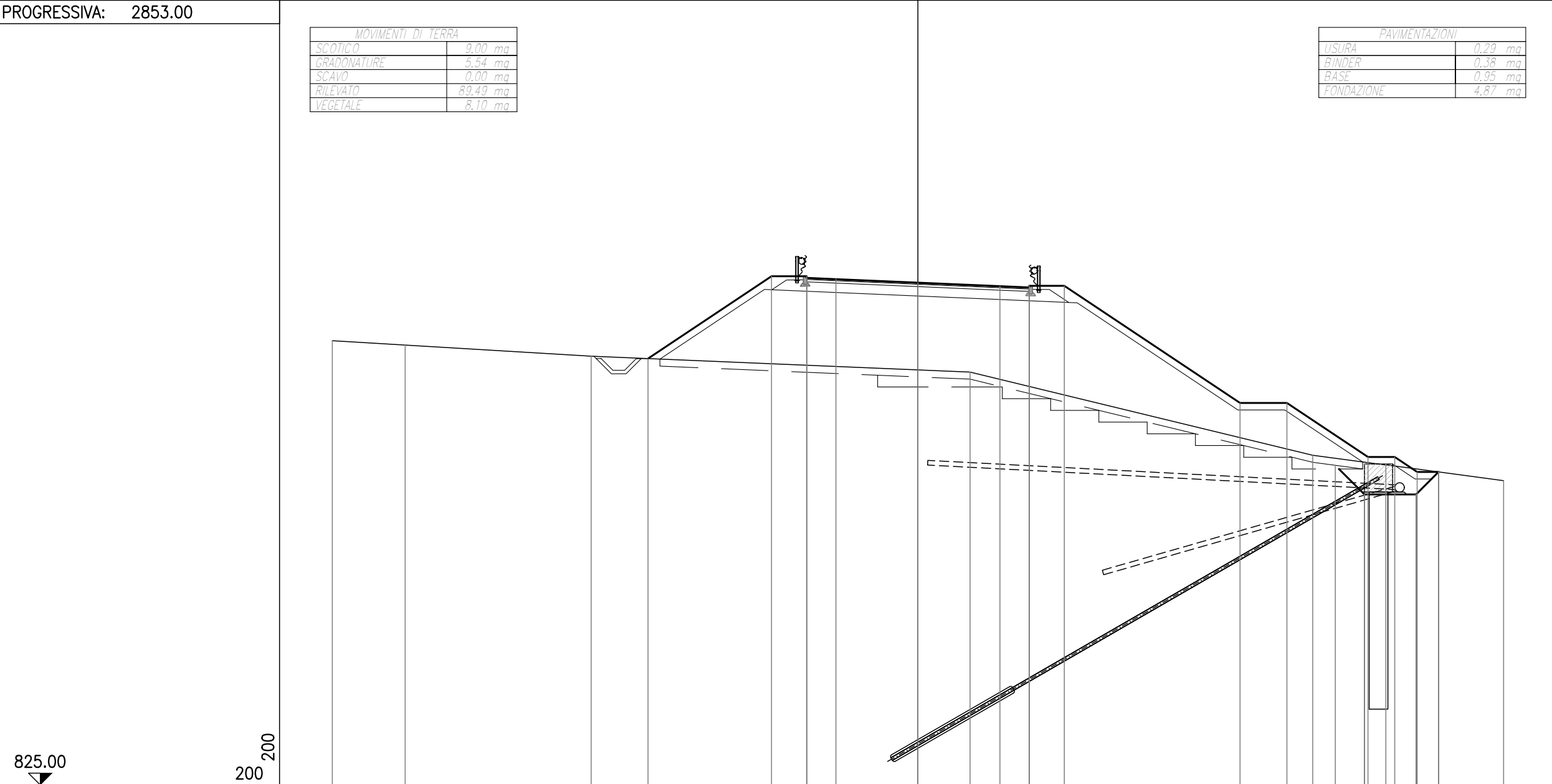

DISTANZE PARZIALI PROGETTO				5.27	1.50	1.25	3.50		3.50	1.25	1.50	7.50	2.00	3.46	1.24	1.12	20.96	0.99		
DISTANZE PROGRESSIVE PROGETTO				843.20	846.71	846.71	846.65	846.59	846.44	846.29	846.24	846.31	846.31	841.31	841.31	838.65	837.40	839.00	839.00	837.40
QUOTE PROGETTO				843.20	846.71	846.71	846.65	846.59	846.44	846.29	846.24	846.31	846.31	841.31	841.31	838.65	837.40	839.00	839.00	837.40
DISTANZE PARZIALI TERRENO		3.11	7.94				16.17					14.64			3.11		5.03			
DISTANZE PROGRESSIVE TERRENO	843.96	25.00	843.78	21.89			843.30	13.95				842.62	2.22		839.07	16.86		838.66	19.97	
QUOTE TERRENO	843.96		843.78				843.30					842.62			839.07			838.66		

PROFILO: Asse-SS87

SEZIONE: 75

PROGRESSIVA: 2906.00

MOVIMENTI DI TERRA	
SCOTICO	0.00 mq
GRADONATURE	0.00 mq
SCAVO	0.00 mq
RILEVATO	0.00 mq
VEGETALE	0.00 mq

PAVIMENTAZIONI	
USURA	0.00 mq
BINDER	0.00 mq
BASE	0.00 mq
FONDAZIONE	0.00 mq

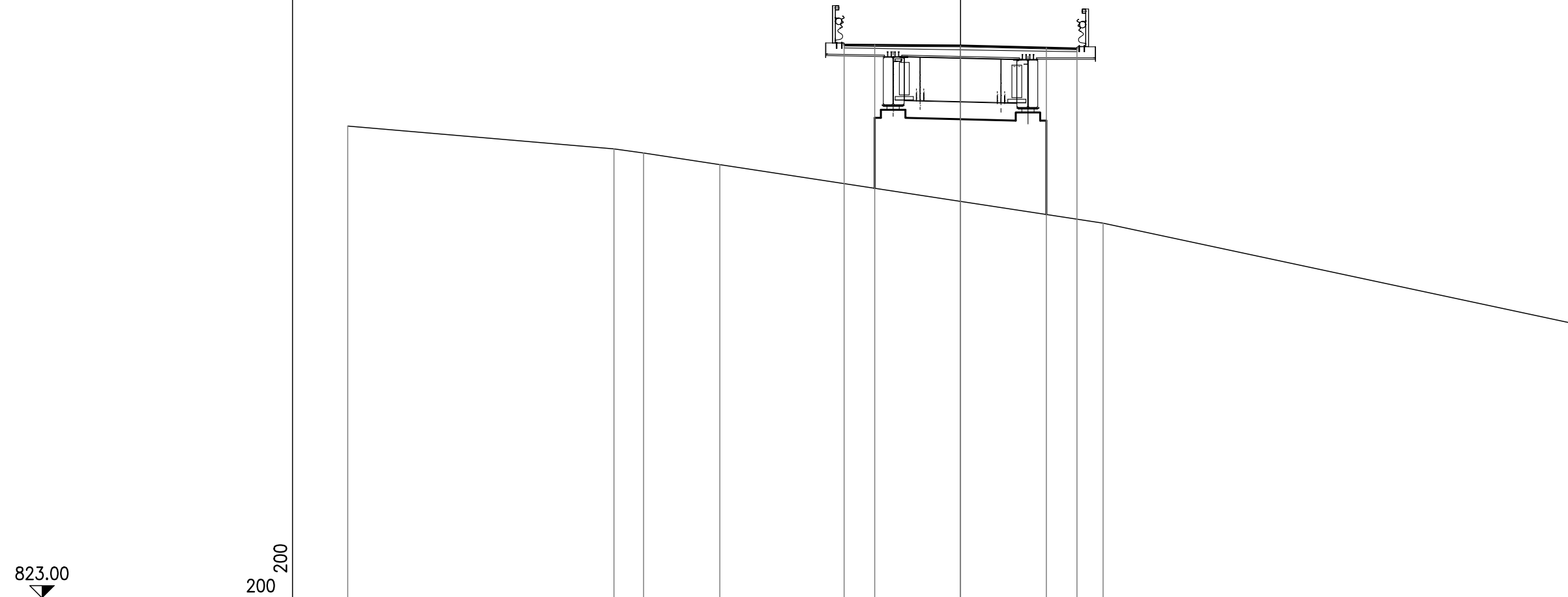

DISTANZE PARZIALI PROGETTO					1.25	3.50	3.50	1.25	
DISTANZE PROGRESSIVE PROGETTO					-4.75	-3.50	0.00	3.50	4.75
QUOTE PROGETTO					845.57	845.56	845.53	845.45	845.41
DISTANZE PARZIALI TERRENO		10.86	1.21	3.11		15.63		19.19	
DISTANZE PROGRESSIVE TERRENO	25.00		14.14	12.93	9.82		5.81		25.00
QUOTE TERRENO	842.25		841.32	841.15	840.68		838.29		834.19

PROFILO: Asse-SS87
 SEZIONE: 76
 PROGRESSIVA: 2966.00

MOVIMENTI DI TERRA	
SCOTICO	0.00 mq
GRADONATURE	0.00 mq
SCAVO	0.00 mq
RILEVATO	0.00 mq
VEGETALE	0.00 mq

PAVIMENTAZIONI	
USURA	0.00 mq
BINDER	0.00 mq
BASE	0.00 mq
FONDAZIONE	0.00 mq

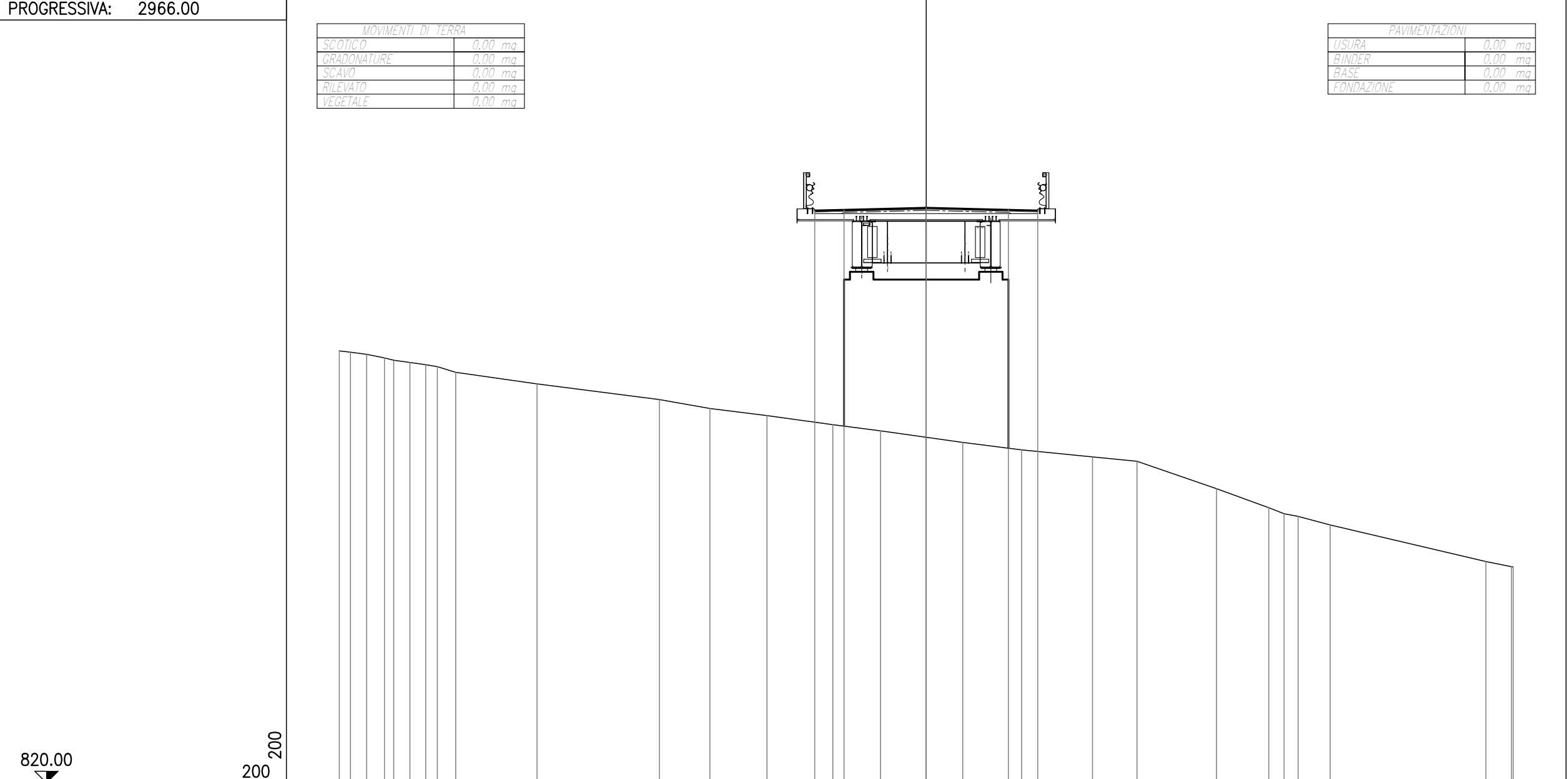

DISTANZE PARZIALI PROGETTO																															
DISTANZE PROGRESSIVE PROGETTO																															
QUOTE PROGETTO																															
DISTANZE PARZIALI TERRENO	0.47																														
DISTANZE PROGRESSIVE TERRENO	25.00	24.53	23.84	23.08	22.68	21.99	21.32	20.82	20.04		16.58		11.36	9.22	6.78	3.98	1.95	1.55	4.06	7.08	8.98	12.36	14.59	15.24	15.84	17.20	23.84	24.92	25.00		0.08
QUOTE TERRENO	838.41	838.35	838.26	838.10	838.01	837.91	837.82	837.73	837.49	837.00	836.33	835.95	835.65	835.26	835.00	834.50	834.19	833.89	833.70	832.53	831.72	831.47	831.35	830.99	829.43	829.21	829.20				

PROFILO: Asse-SS87
 SEZIONE: 80
 PROGRESSIVA: 3120.00

MOVIMENTI DI TERRA	
SCOTICO	7.33 mq
GRADONATURE	5.95 mq
SCAVO	0.00 mq
RILEVATO	13.28 mq
VEGETALE	6.08 mq

PAVIMENTAZIONI	
USURA	0.29 mq
BINDER	0.38 mq
BASE	0.95 mq
FONDAZIONE	4.88 mq

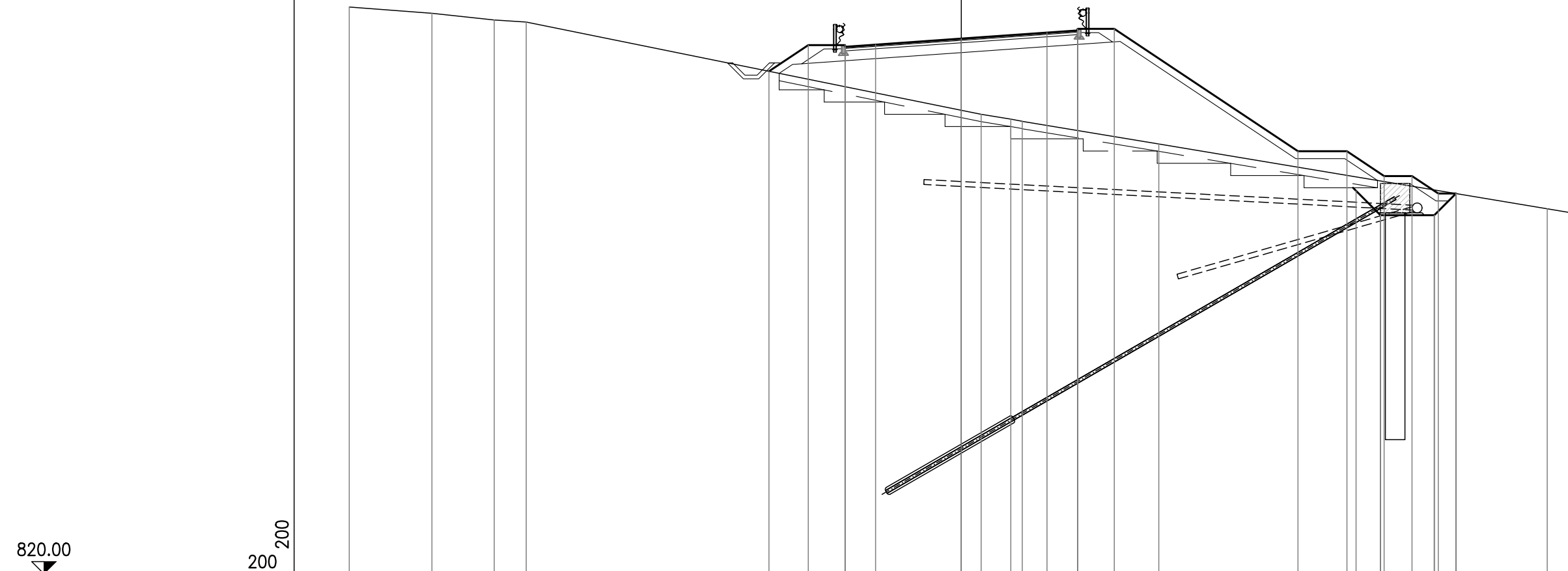

820.00 ↓																									
200																									
DISTANZE PARZIALI PROGETTO				1.61	1.50	1.25	3.50	3.50	1.25	1.50	7.50	2.00	1.50	1.25	0.70	0.82									
DISTANZE PROGRESSIVE PROGETTO				7.86	6.25	4.75	3.50	0.00	4.75	6.25	13.75	15.75	16.12	17.12	18.41	20.20									
QUOTE PROGETTO				840.52	841.59	841.59	841.52	841.61	841.86	842.10	842.19	842.26	842.26	837.26	837.26	835.64	834.64	834.64	836.24	836.24	836.24	834.64	834.64	835.53	835.53
DISTANZE PARZIALI TERRENO		3.38	2.54	1.31	18.58					1.21	0.47	5.58			15.86				1.07						
DISTANZE PROGRESSIVE TERRENO	25.00		21.62	19.08	17.77	0.81				2.02	2.49	8.07			23.93			25.00							
QUOTE TERRENO	843.15		842.89	842.62	842.53	838.77				838.57	838.48	837.55			834.91			834.73							

