

< SCALA 1: 10 >

Preparato CECCARANI	Data
Vagliato GENTILI	Data
Approvato ARANEO	Data

Committente
Virginia Energia S.r.l.
VIA PIETRO BORSIERI 2A, 00195 - ROMA

Progettato

GL ASSOCIATES S.r.l.
VIA GREGORIO VII 384
00165 ROMA - ITALIA
TEL./FAX: 06/58303719

OGGETTO
PARTICOLARI CAVIDOTTO MT
SEZIONE DI POSA A TRIFOGLIO SOTTO STRADA
PAUR IMPIANTO FOTOVOLTAICO DI 33 MW_p - CERIGNOLA

ATT.	COMMESSA	ORIGINE	FIN.	DISC.	PROG.	TIPO DOC.
D	2021-001	GHAD	C	010	ARC	

OPERA SOTTERRANEO DA OLTREPASSARE

CORDA IN RAME NUDD
SEZ. 1x95 mmq

RIEMPIMENTO CON
FANGO BENTONITICO

TUBAZIONE IN MATERIALE PLASTICO
DOPPIA PARETE Ø63mm
PER FIBRA OTTICA

TUBO PEAD Ø225mm

CAVO ARG7HIR 18/30 kV
HEPR 300mmq Al

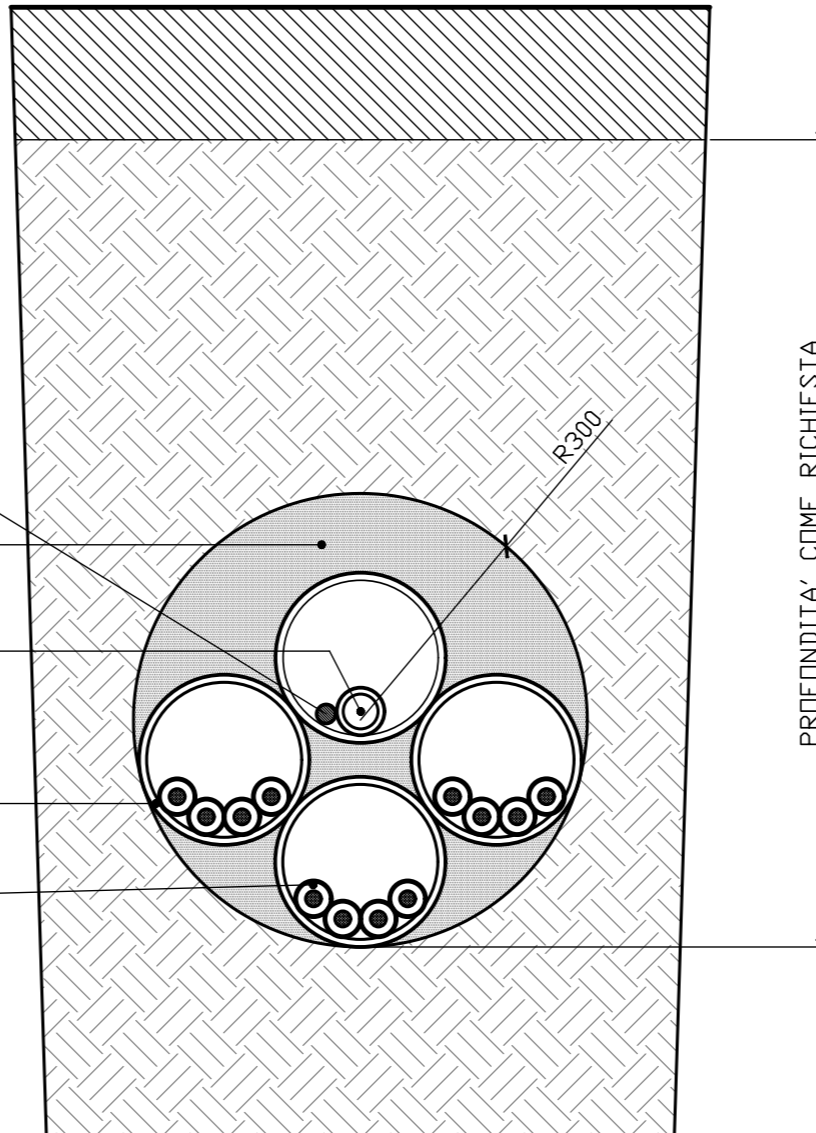

< SCALA 1: 10 >

Preparato CECCARANI	Data
Vagliato GENTILI	Data
Approvato ARANE0	Data

Committente
Virginia Energia S.r.l.
VIA PIETRO BORSIERI 2A, 00195 - ROMA

Progettato
 GL ASSOCIATES S.r.l.
VIA GREGORIO VII 384
00165 ROMA - ITALIA
TEL./FAX: 06/58303719

OGGETTO
PARTICOLARI CAVIDOTTO MT
CAVO POSATO CON TOC TELEGUIDATA
PAUR IMPIANTO FOTOVOLTAICO DI 33 MWp - CERIGNOLA

ATT. D	COMMESSA 2021-001	ORIGINE FIN. GHAD	DISC. C	PROG. 010	TIPO DOC. ARC
------------------	-----------------------------	-----------------------------	-------------------	---------------------	-------------------------

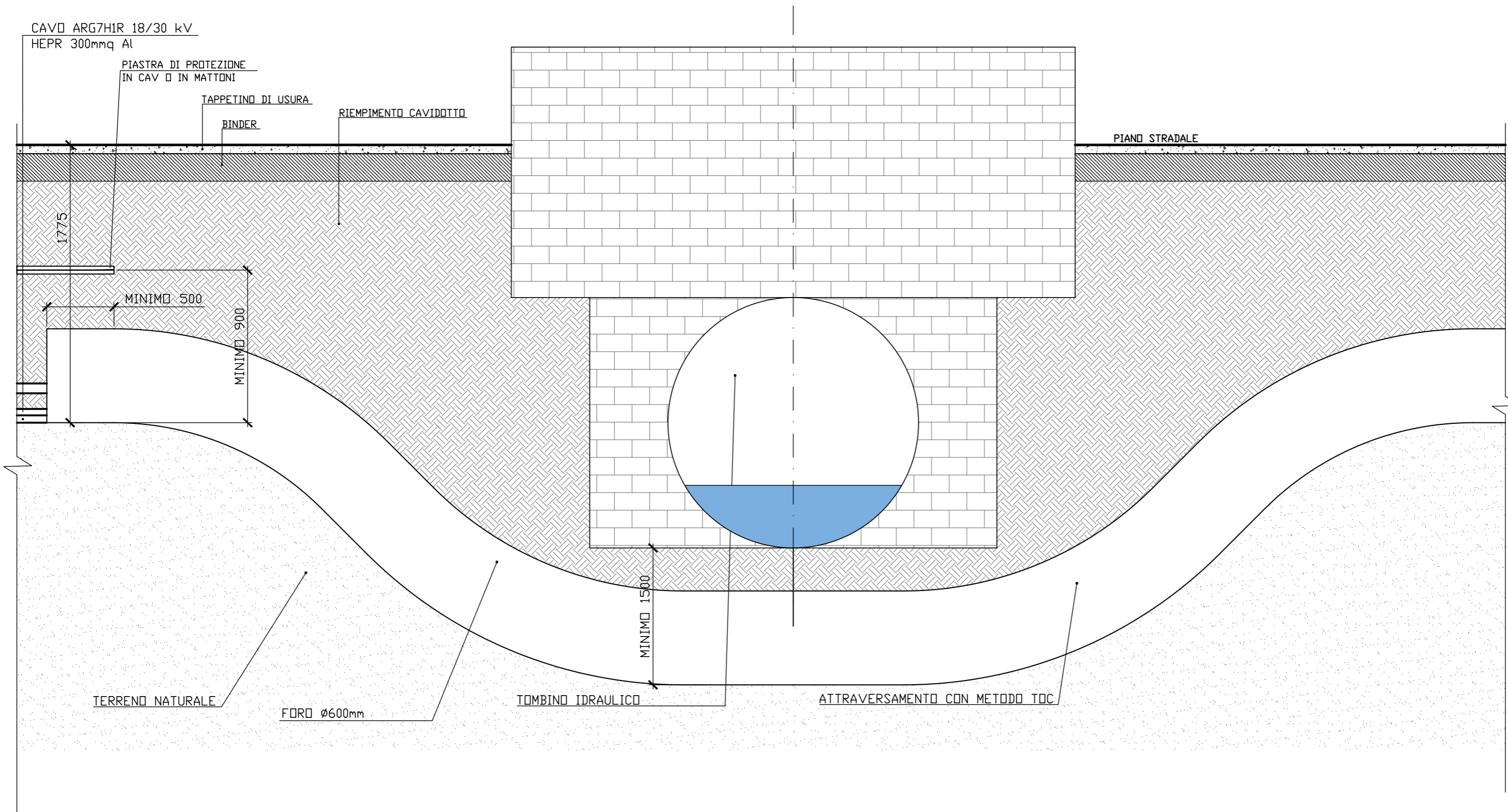

(SCALA 1:25)

Preparato CECCARANI	Data	Committente Virginia Energia S.r.l. VIA PIETRO BORSIERI 2A, 00195 - ROMA	Progettato  GL ASSOCIATES S.r.l. VIA GREGORIO VII 384 00165 ROMA - ITALIA TEL./FAX: 06/58303719	OGGETTO RISOLUZIONE INTERFERENZA TOMBINO IDRAULICO CON TOC TELEGUIDATA PAUR IMPIANTO FOTOVOLTAICO DI 33 MW _p - CERIGNOLA	ATT. D	COMMESSA 2021-001	ORIGINE FIN. DISC. PROG. TIPO DOC. GHAD C 010 ARC
------------------------	------	---	--	--	------------------	-----------------------------	---

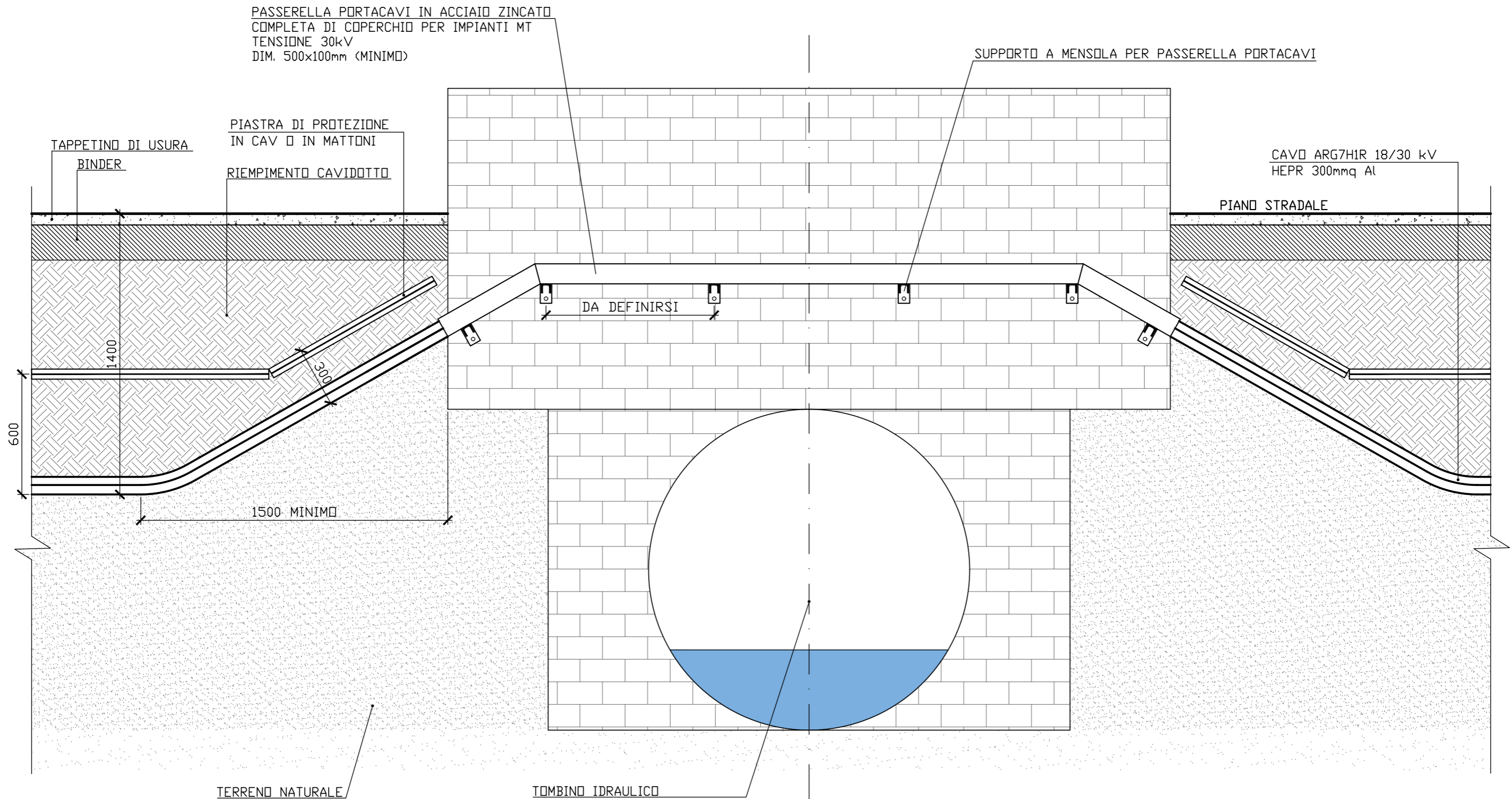

(SCALA 1:20)

Preparato CECCARANI	Data
Vagliato GENTILI	Data
Approvato ARANE0	Data

Committente
Virginia Energia S.r.l.
VIA PIETRO BORSIERI 2A, 00195 - ROMA

Progettato

GL ASSOCIATES S.r.l.
VIA GREGORIO VII 384
00165 ROMA - ITALIA
TEL./FAX: 06/58303719

OGGETTO **RISOLUZIONE INTERFERENZA TOMBINO IDRAULICO**
MEDIANTE REALIZZAZIONE DI CANALE IN LAMIERA ZINCATO
PAUR IMPIANTO FOTOVOLTAICO DI 33 MW_p - CERIGNOLA

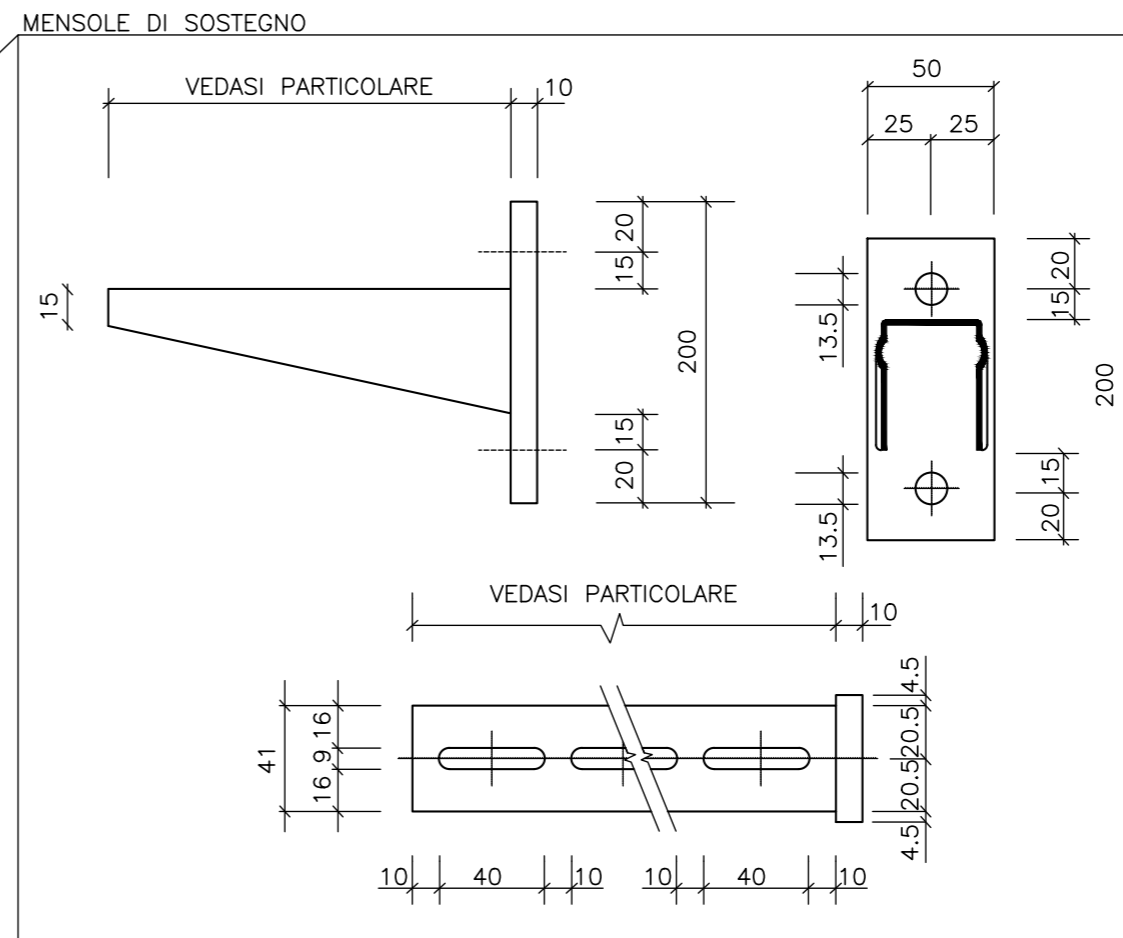
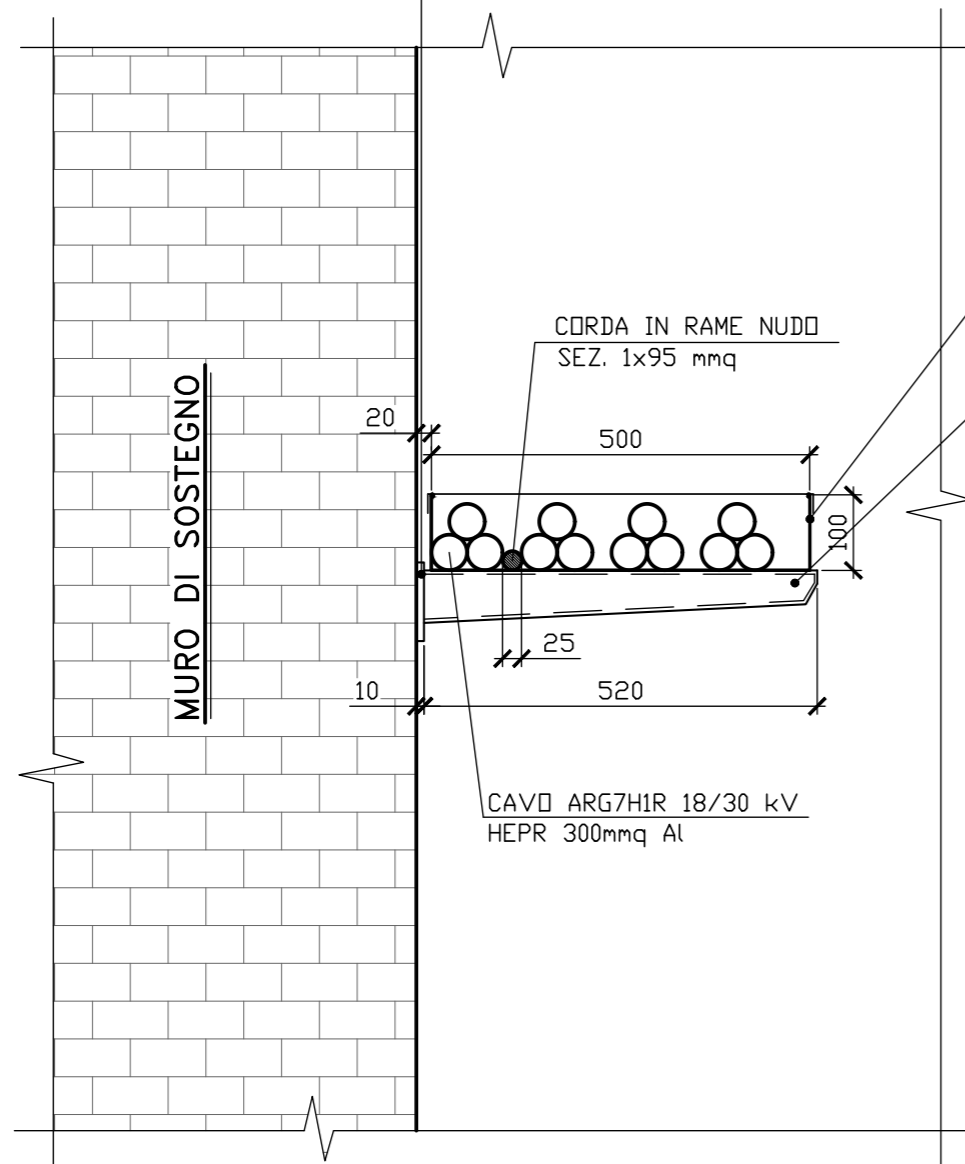
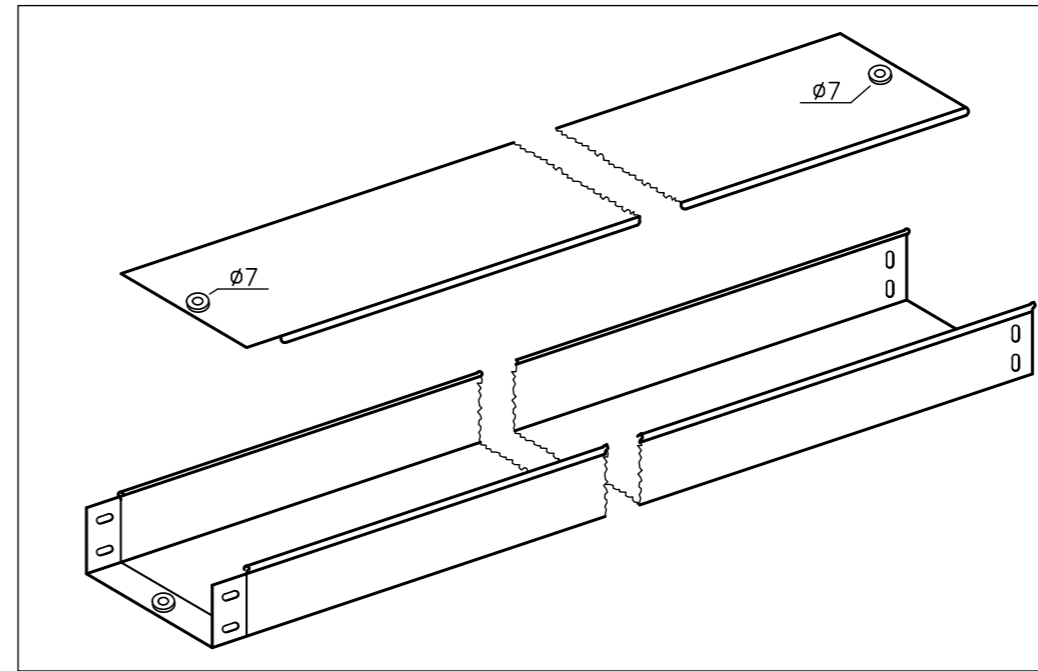
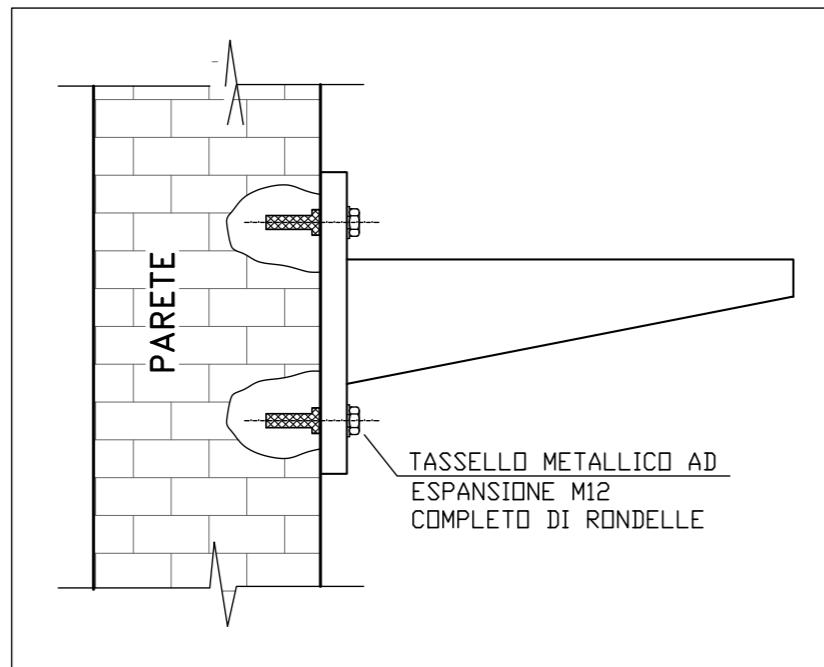
ATT.	COMMESSA	ORIGINE	FIN.	DISC.	PROG.	TIPO DOC.
D	2021-001	GHAD	C	010	ARC	



(SCALA 1: 10)

Preparato CECCARANI	Data
Vagliato GENTILI	Data
Approvato ARANEO	Data

Committente
Virginia Energia S.r.l.
VIA PIETRO BORSIERI 2A, 00195 - ROMA

Progettato

GL ASSOCIATES S.r.l.
VIA GREGORIO VII 384
00165 ROMA - ITALIA
TEL./FAX: 06/58303719

OGGETTO **RISOLUZIONE INTERFERENZA TOMBINO IDRAULICO
MEDIANTE REALIZZAZIONE DI CANALA IN LAMIERA ZINCATA
PAUR IMPIANTO FOTOVOLTAICO DI 33 MWp - CERIGNOLA**

ATT. D	COMMESSA 2021-001	ORIGINE FIN. DISC. GHAD C	PROG. 010	TIPO DOC. ARC
------------------	-----------------------------	-------------------------------------	---------------------	-------------------------