

CABINA TRASFORMAZIONE 1:40

CABINA PARALLELO INVERTER

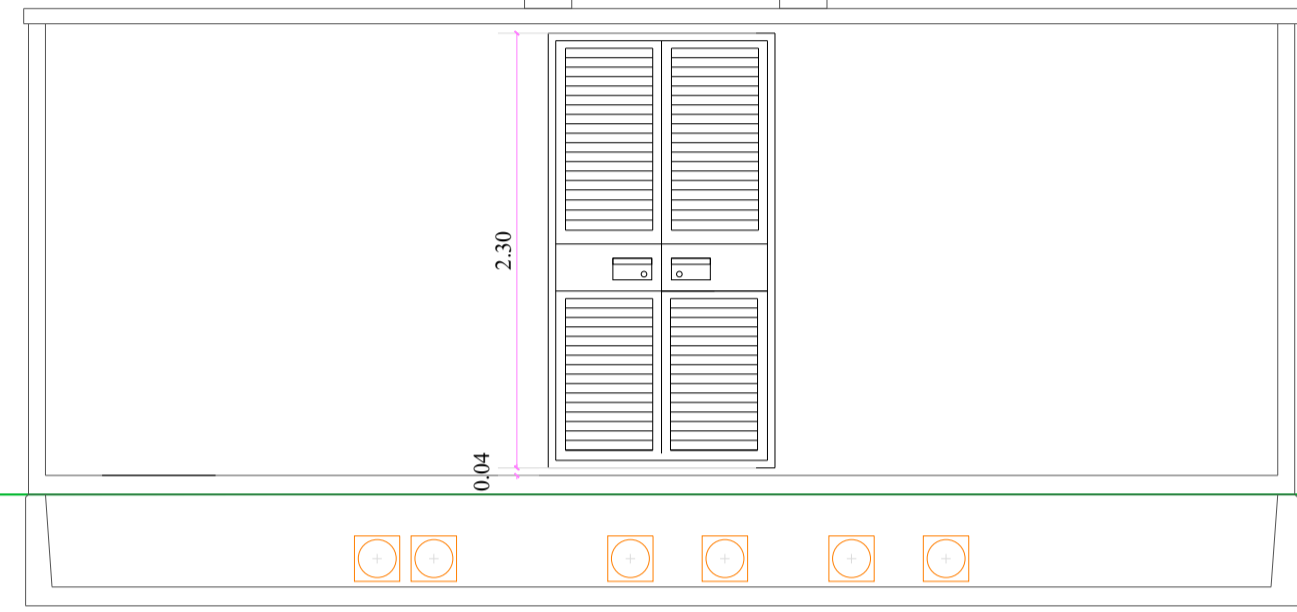
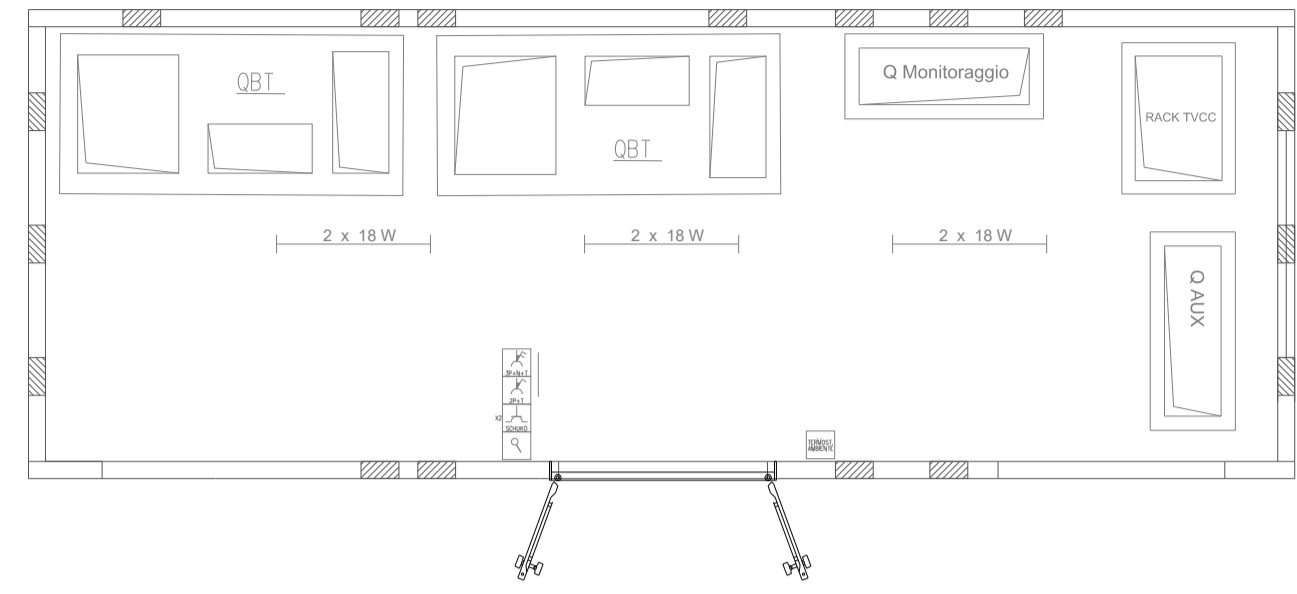

VISTA FRONTALE

TRASFORMATORE

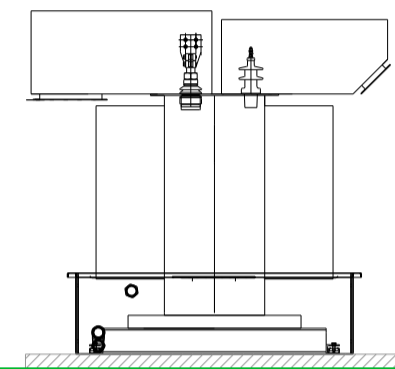
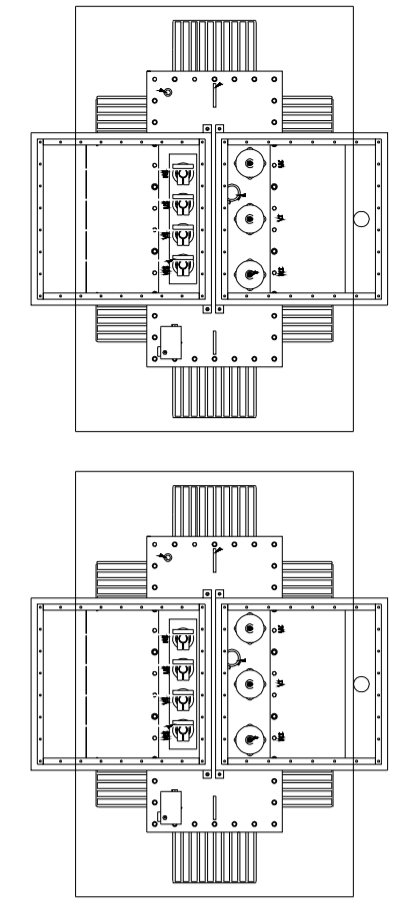

CABINA MT

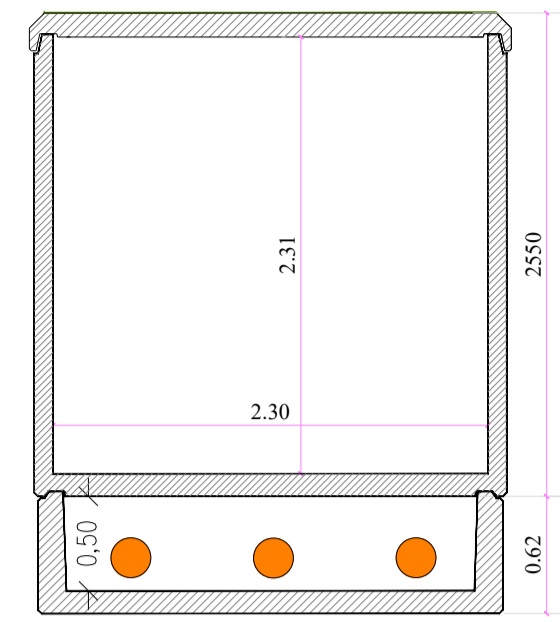
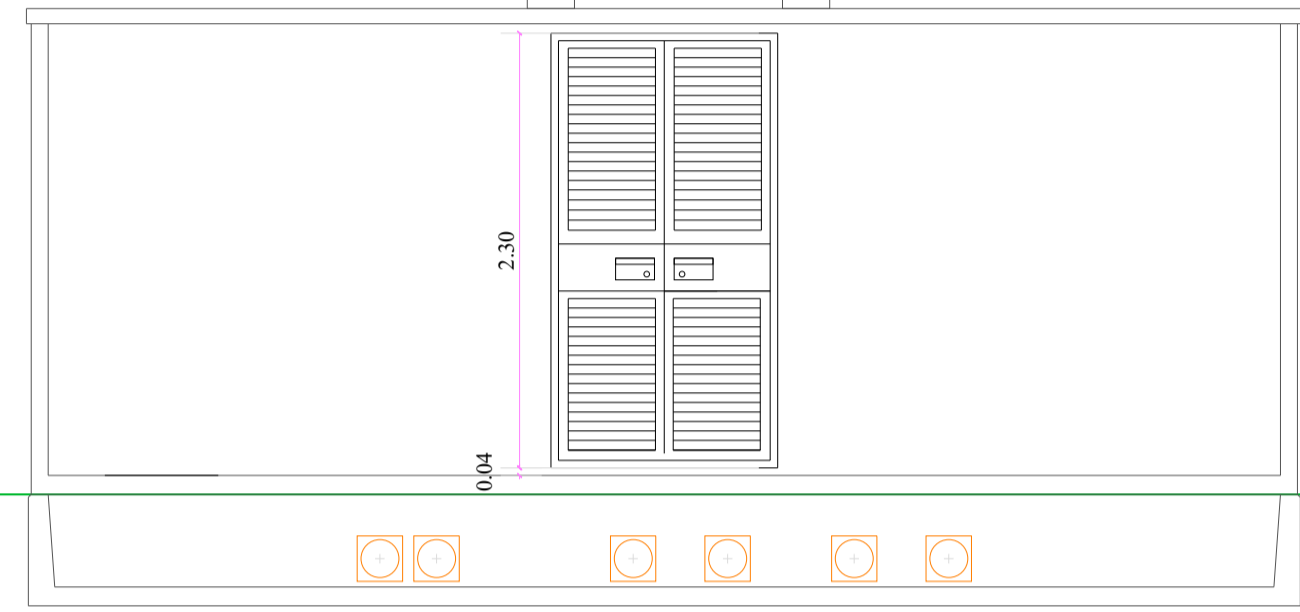
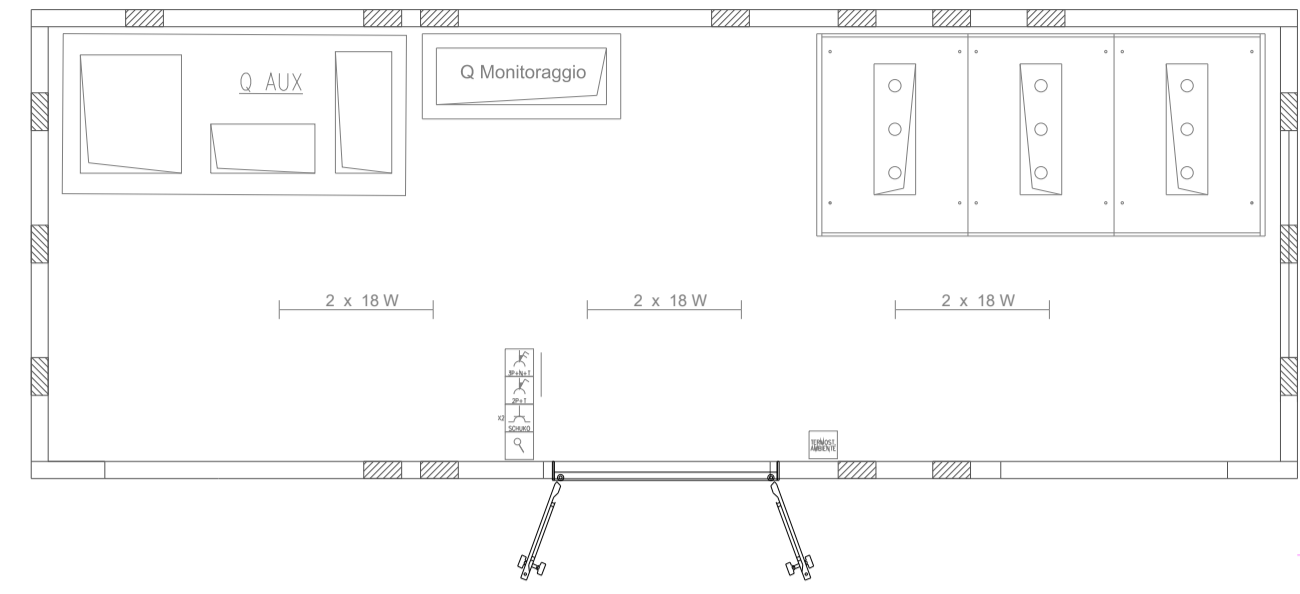

PASSANTE CAVO TEMPORANEO ø150
N. 2 GRIGLIE VTR 120X50

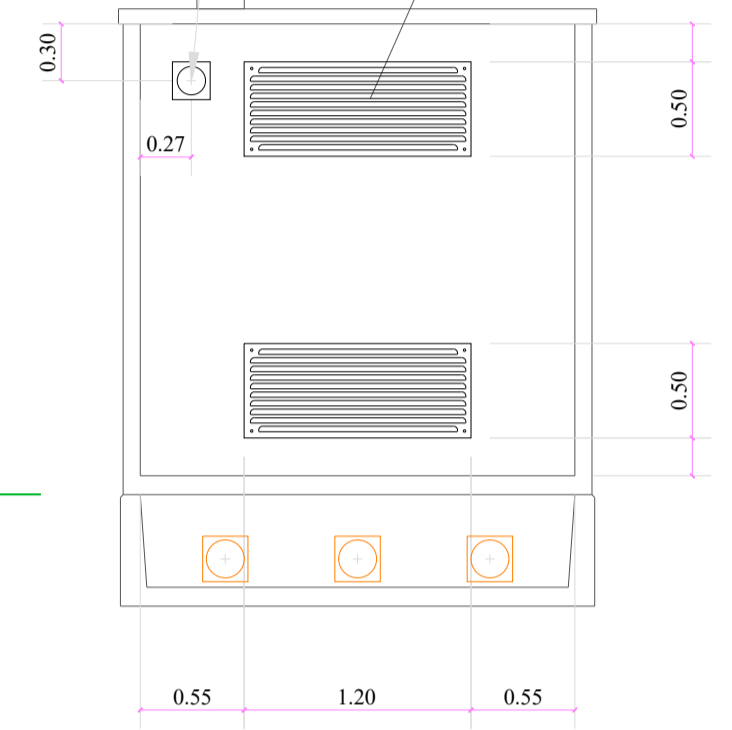

CABINA ENEL DG2092 ed.3 1:40

PORTA VTR 60X215 C/SERRATURA A SPILLO PRIVATA
PORTA VTR 120X215 C/SERRATURA A SPILLO ENEL NAZIONALE
PORTA VTR 120X215 C/SERRATURA A SPILLO ENEL NAZIONALE

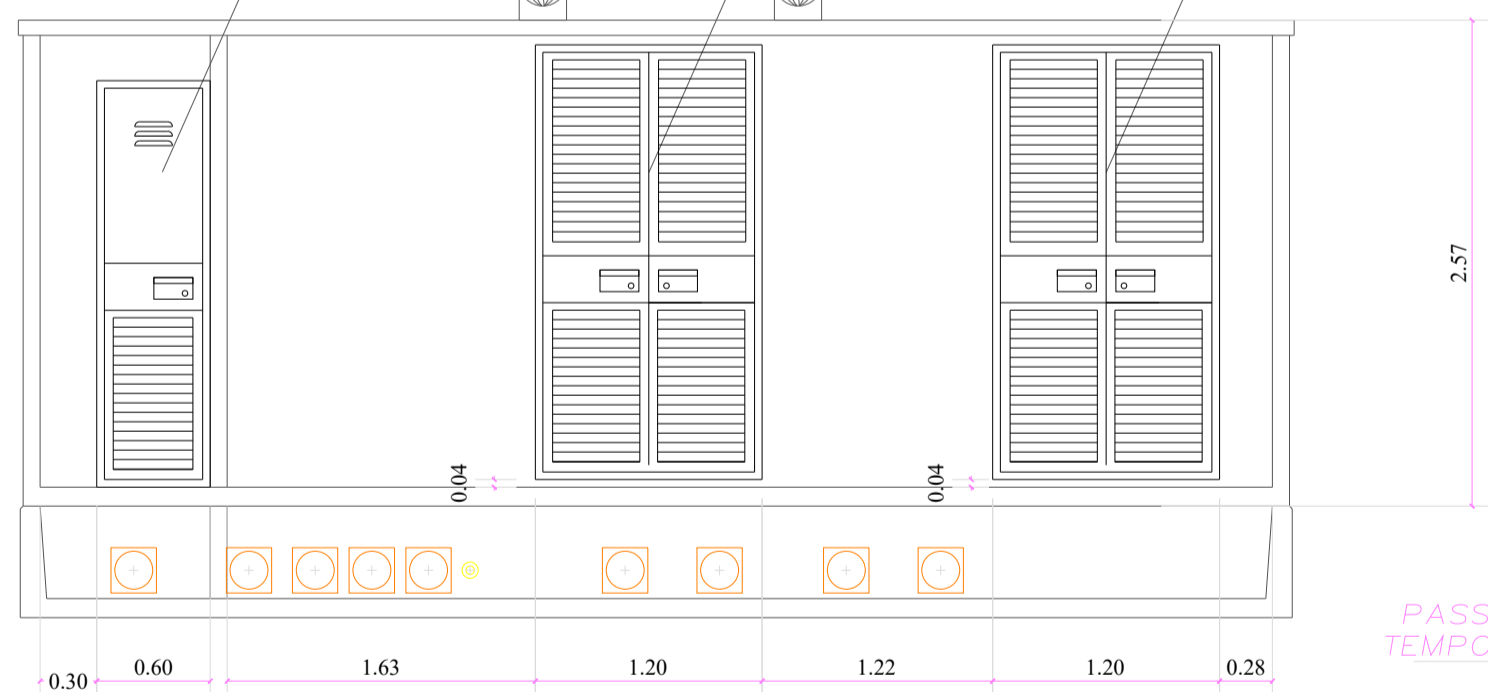

PASSANTE CAVO TEMPORANEO ø150
N. 2 GRIGLIE VTR 120X50

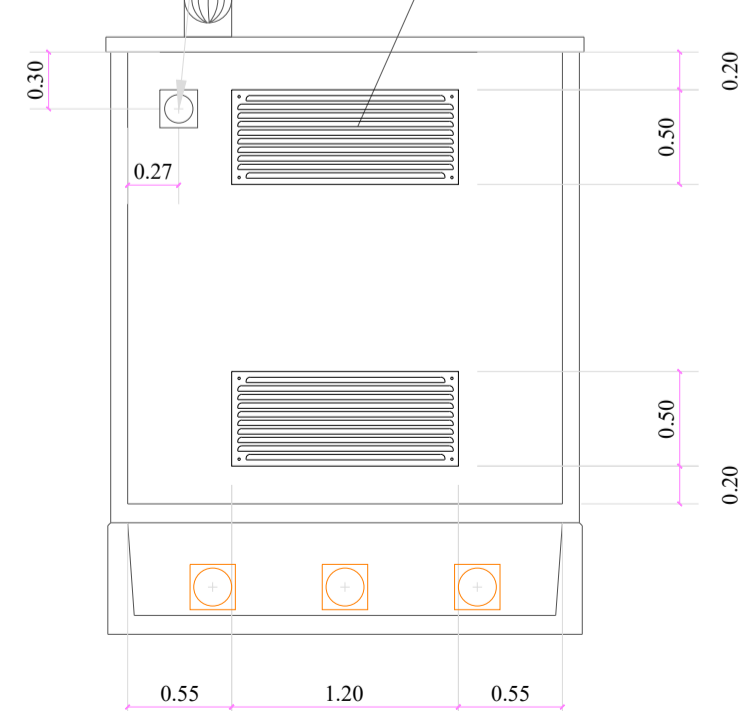

CABINA UTENTE 1:40

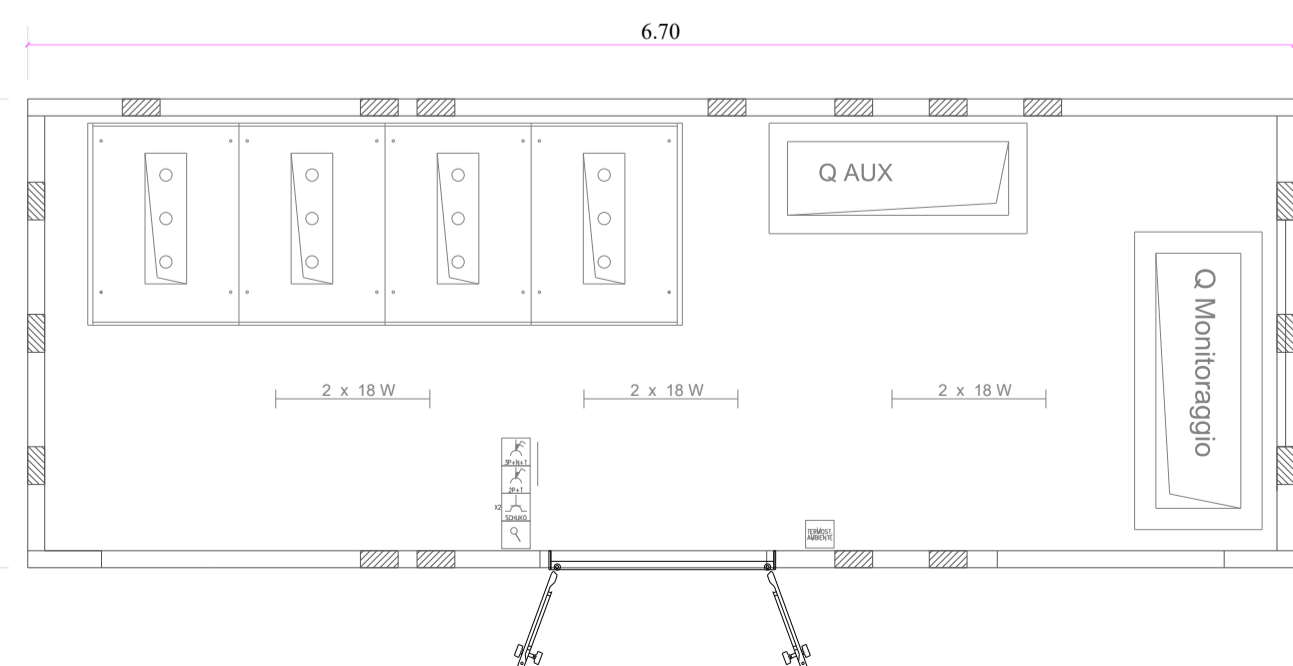
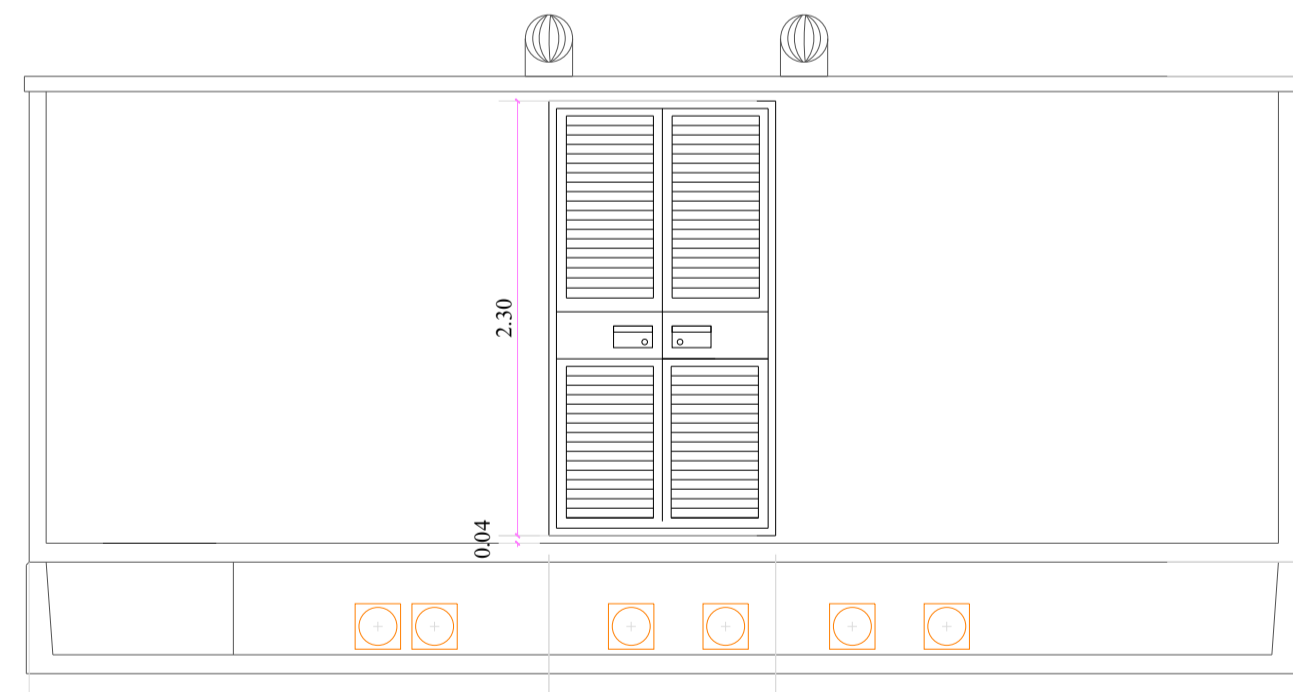

PASSANTE CAVO TEMPORANEO ø150
N. 2 GRIGLIE VTR 120X50

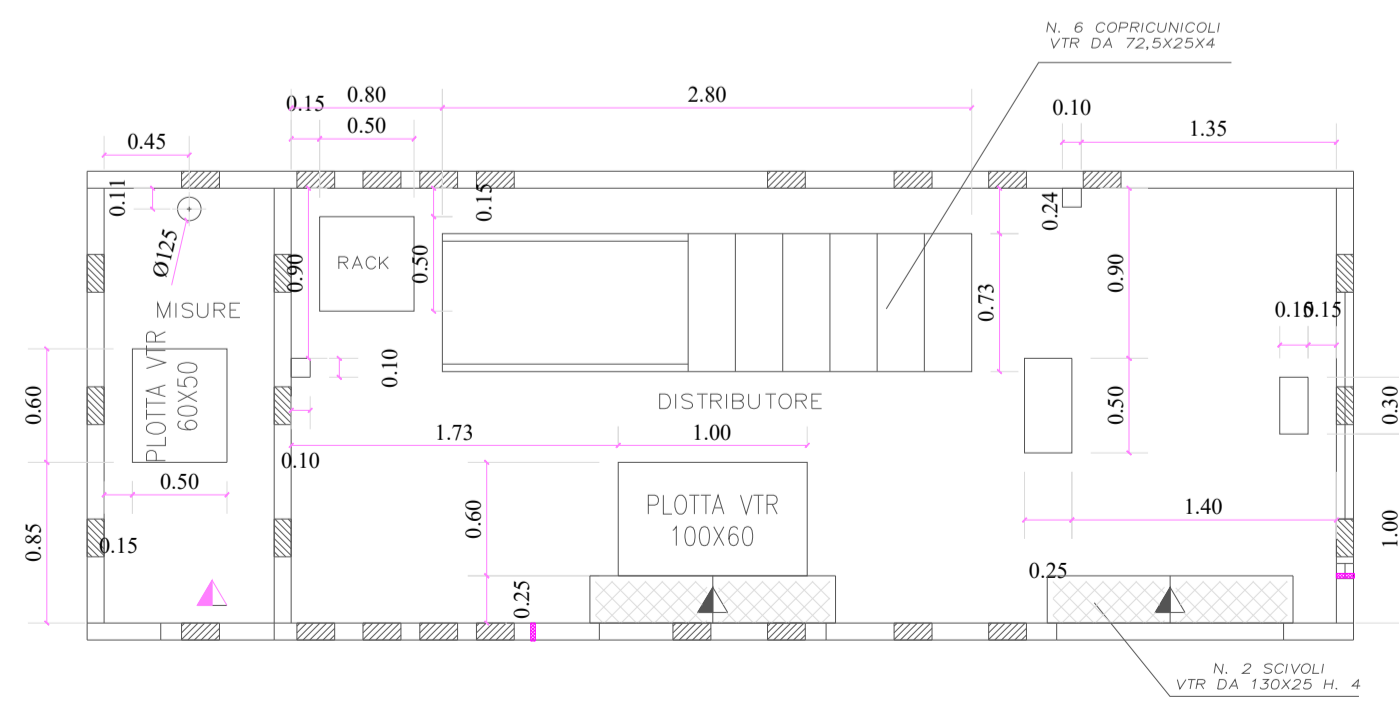
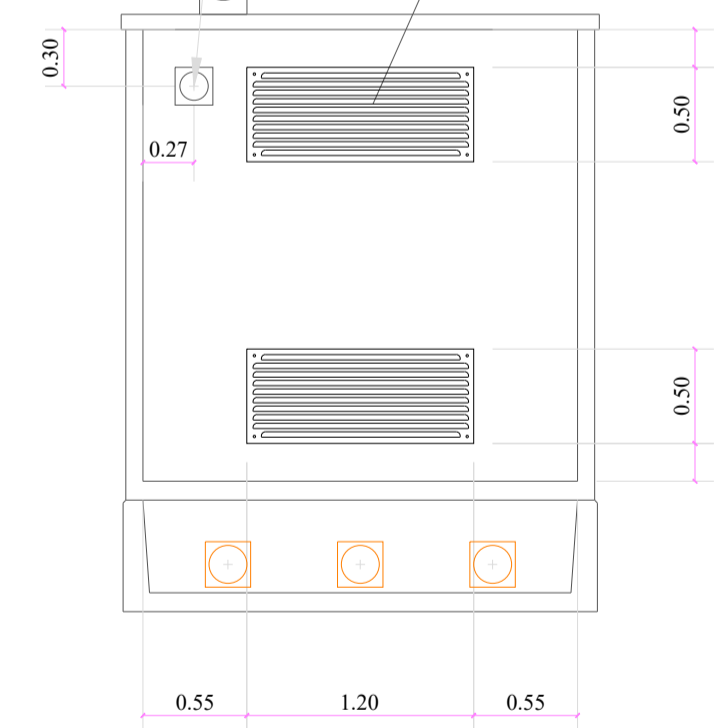

COMUNE DI CAMPOMARINO

PROVINCIA DI
CAMPOBASSO

REGIONE MOLISE

**REALIZZAZIONE DI UN IMPIANTO SOLARE AGRI-VOLTAICO
CONNESSO ALLA RETE DI TRASMISSIONE NAZIONALE DELLA
POTENZA MASSIMA IN IMMISSIONE DI 44,955 MWAC**

Denominazione Impianto:		IMPIANTO CAMPOMARINO FV																																
Ubicazione:		Comune di Campomarino (CB)																																
ELABORATO 3.9-PDEG	PARTICOLARI COSTRUTTIVI CABINE ELETTRICHE																																	
Renew-co engineering Piazza Giovanni XXIII, 5 Porto Sant'Elpidio (FM) 63821 ITALY P.IVA e C.F. 0253380442 info@renew-co.com www.renewco.com		Scala: Data: 31/01/2022	PROGETTO PRELIMINARE <input type="checkbox"/> DEFINITIVO <input checked="" type="checkbox"/> ESECUTIVO <input type="checkbox"/>																															
Tecnici: Ing. Antonio Palestini Albo degli Ingegneri Ascoli Piceno - Nr. A1616																																		
<table border="1" style="width: 100%; border-collapse: collapse;"> <thead> <tr> <th>Revisione</th> <th>Data</th> <th>Descrizione</th> <th>Redatto</th> <th>Approvato</th> <th>Autorizzato</th> </tr> </thead> <tbody> <tr> <td>01</td> <td>31/01/2022</td> <td>Progetto Definitivo</td> <td></td> <td></td> <td></td> </tr> <tr> <td>02</td> <td></td> <td></td> <td></td> <td></td> <td></td> </tr> <tr> <td>03</td> <td></td> <td></td> <td></td> <td></td> <td></td> </tr> <tr> <td>04</td> <td></td> <td></td> <td></td> <td></td> <td></td> </tr> </tbody> </table>	Revisione	Data	Descrizione	Redatto	Approvato	Autorizzato	01	31/01/2022	Progetto Definitivo				02						03						04						Il Richiedente: CATCH THE SUN 4 SRL SAN BENEDETTO DEL TRONTO (AP) VIA VENETA GIULIA 4 - 63074 C.F. P.IVA: 0247600448			
Revisione	Data	Descrizione	Redatto	Approvato	Autorizzato																													
01	31/01/2022	Progetto Definitivo																																
02																																		
03																																		
04																																		