

REGIONE: PUGLIA

PROVINCIA: LECCE

COMUNE: NARDO'

ELABORATO:

STRU-01

OGGETTO:

**PROGETTO PER LA REALIZZAZIONE DI UN IMPIANTO
FOTOVOLTAICO DA 96,8 MWP ED ISOLE VERDI**

PROGETTO DEFINITIVO

**IMPIANTO FV RELAZIONE DI CALCOLO
PRELIMINARE STRUTTURE PORTAMODULI**

PROPONENTE:

NARDO' SOLAR ENERGY S.R.L.

Corso Monforte, 2

20122 - Milano

nardosolarenergy@legalmail.it

ing. Massimo CANDEO

Ordine Ing. Bari n° 3755

Via Cancellotto, 3

70125 Bari

m.candeo@pec.it

ing. Gabriele CONVERSANO

Ordine Ing. Bari n° 8884

Via Michele Garruba 3

70122 Bari

gabrieleconversano@pec.it

Collaborazione:

ing. Marco EVANGELISTA

Ord. Ing.ri Bari n° 4245

Note:

DATA	REV	DESCRIZIONE	ELABORATO da:	APPROVATO da:
Maggio 2021	0	Emissione	Ing. Gabriele Conversano	ing. Massimo Candeo

PROPRIETÀ ESCLUSIVA DELLE SOCIETÀ SOPRA INDICATE,
UTILIZZO E DUPLICAZIONE VIETATE SENZA AUTORIZZAZIONE SCRITTA

DATI STRUTTURALI DI PROGETTO

La struttura di sostegno porta-pannelli trattata nella presente relazione è del tipo fisso, con i pannelli aventi un'inclinazione di 27° sull'orizzontale. Le strutture porta-moduli supporteranno 4 moduli per volta (2 superiori e due inferiori) per poter creare una lunga fila di strutture pannellabili. Le strutture rappresentate graficamente nell'"ElaboratoGrafico_00_09", per una mera questione di rappresentazione grafica supportano 24 moduli. Le dimensioni in pianta di ogni struttura sono pari a 13938 mm x 4912 mm (lunghezza inclinata), con altezza nel punto più alto pari a 3439 mm.

Ogni struttura è costituita da tre telai paralleli, e ciascun telaio è dotato di due montanti. E' prevista l'infissione dei montanti direttamente nel terreno. La lunghezza di infissione dovrà essere stabilita in fase di progetto esecutivo sulla base di test di portanza a compressione, a trazione e in direzione orizzontale, da eseguirsi in sito, e potrà essere diversa al variare delle caratteristiche specifiche del terreno.

I profili scelti sono:

- HEA 140 per i ritzi e per le travi trasversali in corrispondenza dei montanti (prima orditura) e per le 3 travi longitudinali (seconda orditura);
- profili tipo UPN 80 per i traversi portapannelli (terza orditura).

Per la completa descrizione delle opere strutturali in oggetto si rimanda agli elaborati grafici di progetto e alle specifiche prescrizioni progettuali dettagliate più avanti.

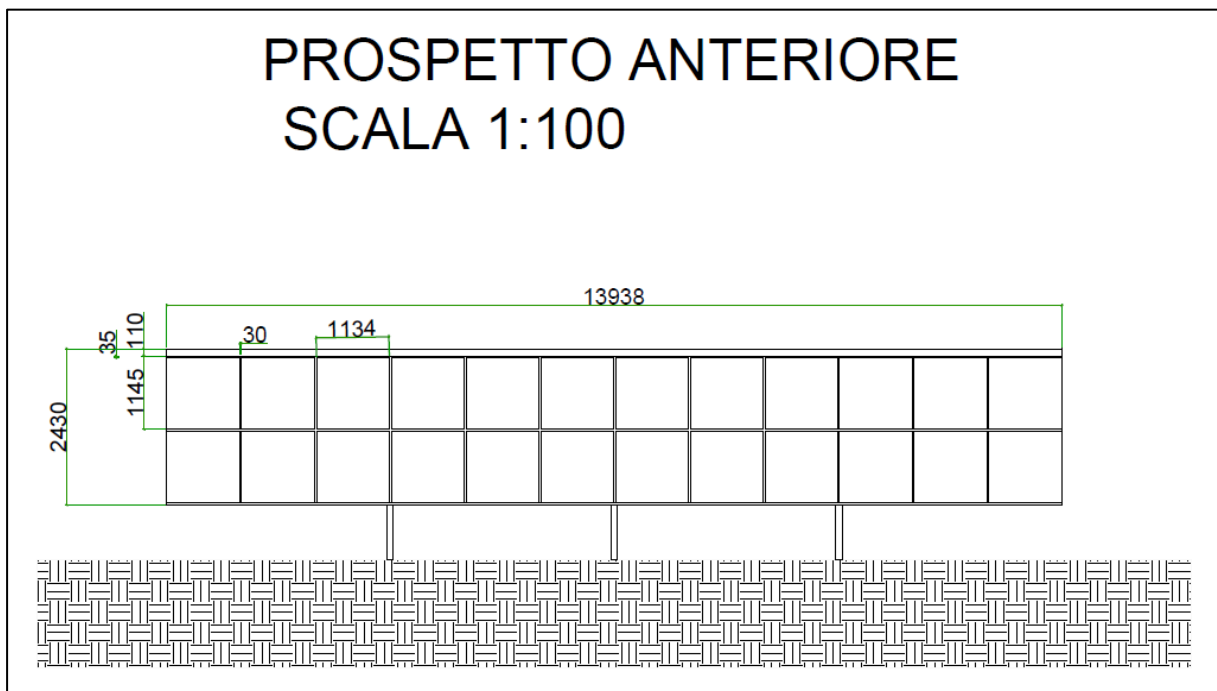

PROSPETTO POSTERIORE SCALA 1:100

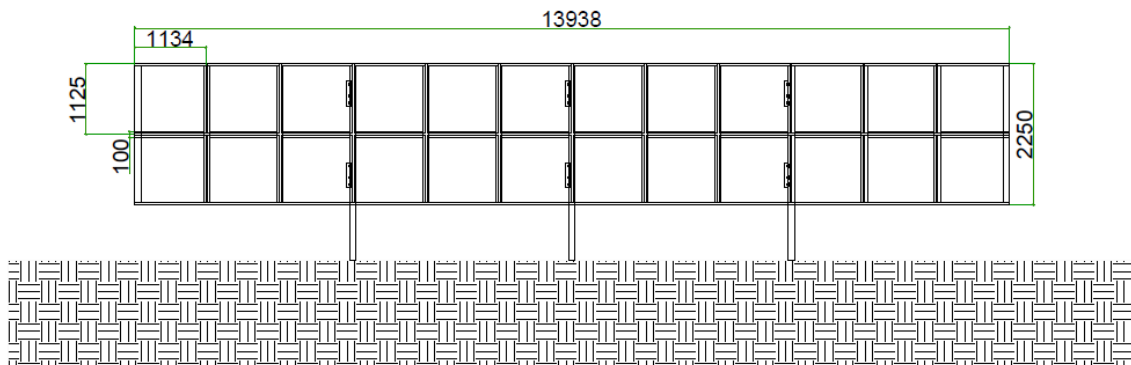

PROSPETTO LATERALE SCALA 1:50



Figura 1

1. **NORMATIVA TECNICA DI RIFERIMENTO**

- I. **Legge n. 1086 05.11.1971** “Norme per la disciplina delle opere di conglomerato cementizio armato, normale e precompresso ed a struttura metallica”;
- II. **Legge 02/02/1974 n. 64**, Provvedimenti per le costruzioni con particolari prescrizioni per le zone sismiche;
- III. **D.M. LL.PP. 11.03.1988** “Norme tecniche riguardanti le indagini sui terreni e sulle rocce, la stabilità dei pendii naturali e delle scarpate, i criteri generali e le prescrizioni per la progettazione, l’esecuzione ed il collaudo delle opere di sostegno delle terre e delle opere di fondazione.” e relativa **Circ. Min. LL.PP. n° 30483 del 24.09.1988**;
- IV. **ORDINANZA P.C.M. N: 3274 del 02/05/2003** (G.U. 08/05/2003, n. 105 suppl.) modificata ed integrata ai sensi della ORDINANZA P.C.M. N. 3316 del 02/10/2003 (G.U. 10/10//2003, n. 236) e della ORDINANZA P.C.M. N. 3431del 03/05/2005 (G.U. 10-5-2005, n. 107 -suppl.): Primi elementi in materia di criteri generali per la classificazione sismica del territorio nazionale e di normative tecniche per le costruzioni in zona sismica;
- V. **D.P.C.M. n° 3685 del 21/10/03**, G.U. n° 252, del 29/10/03;
- VI. **Presidenza del Consiglio dei Ministri, Dipartimento della Protezione Civile, Ufficio Servizio Sismico Nazionale, 29/03/04**: Elementi informativi sull’Ordinanza del Presidente del Consiglio dei Ministri n. 3274 del 20 marzo 2003, recante “Primi elementi in materia di criteri generali per la classificazione sismica del territorio nazionale e di normative tecniche per le costruzioni in zona sismica” (G.U. n. 105 del 8.5.2003);
- VII. **O.P.C.M. n° 3519 del 28/04/06, G.U. n° 108, del 11/05/06**;
- VIII. **D.M. 17 gennaio 2018**. Aggiornamento delle Norme Tecniche sulle Costruzioni.
- IX. **Circolare del del Ministero delle Infrastrutture e dei Trasporti del 21-01-2019 n. 7 del Consiglio Superiore dei Lavori Pubblici**, Istruzioni per l’applicazione dell’aggiornamento delle Norme Tecniche per le Costruzioni di cui al D.M. 17 gennaio 2018.
- X. **UNI EN 1990:2006 13/04/2006 Eurocodice 0** - Criteri generali di progettazione strutturale.
- XI. **EUROCODICE 2 (EN 1992)** – Progettazione delle strutture di calcestruzzo

- XII. **UNI EN 1991-1-1:2004 01/08/2004 Eurocodice 1** - Azioni sulle strutture - Parte 1-1: Azioni in generale - Pesi per unità di volume, pesi propri e sovraccarichi per gli edifici.
- XIII. **UNI EN 1991-1-3:2004 01/10/2004 Eurocodice 1** - Azioni sulle strutture - Parte 1-3: Azioni in generale - Carichi da neve.
- XIV. **UNI EN 1991-1-4:2005 01/07/2005 Eurocodice 1** - Azioni sulle strutture - Parte 1-4: Azioni in generale - Azioni del vento.
- XV. **UNI EN 1991-1-5:2004 01/10/2004 Eurocodice 1** - Azioni sulle strutture - Parte 1-5: Azioni in generale - Azioni termiche.
- XVI. **UNI EN 1993-1-1:2005 01/08/2005 Eurocodice 3** - Progettazione delle strutture di acciaio - Parte 1-1: Regole generali e regole per gli edifici.
- XVII. **UNI EN 1993-1-8:2005 01/08/2005 Eurocodice 3** - Progettazione delle strutture di acciaio - Parte 1-8: Progettazione dei collegamenti.
- XVIII. **UNI EN 1998-1:2005 01/03/2005 Eurocodice 8** - Progettazione delle strutture per la resistenza sismica - Parte 1: Regole generali, azioni sismiche e regole per gli edifici.
- XIX. **UNI EN 1998-3:2005 01/08/2005 Eurocodice 8** - Progettazione delle strutture per la resistenza sismica - Parte 3: Valutazione e adeguamento degli edifici.

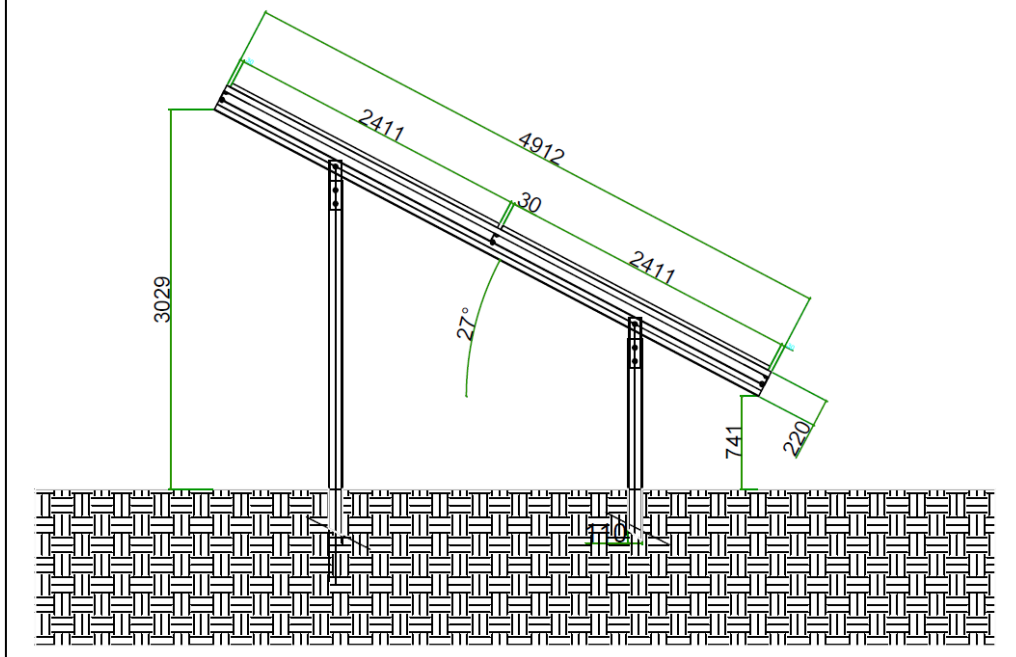
2. INPUT DI MODELLAZIONE NUMERICA FEM

CARATTERIZZAZIONE SISMICA DEL TERRITORIO

Ai fini sismici il territorio del Comune di Nardò è incluso nell'elenco delle località sismiche appartenenti alla zona 4. Tale classificazione, dettata dalla O.P.C.M. n. 3274 del 20/03/03 "Primi elementi in materia di criteri generali per la classificazione sismica del territorio nazionale e di normative tecniche per la costruzione in zona sismica", è stata recepita dalla Regione Puglia con Delibera Giunta Regionale n. 153 del 2 marzo 2004.

zona	accelerazione orizzontale con probabilità di superamento pari al 10 % in 50 anni [a _g /g]	accelerazione orizzontale di ancoraggio dello spettro di risposta elastico (Norme Tecniche) [a _g /g]
1	> 0,25	0,35
2	0,15-0,25	0,25
3	0,05-0,15	0,15
4	<0,05	0,05

Nel rispetto degli indirizzi e criteri stabiliti a livello nazionale, alcune Regioni hanno classificato il territorio nelle quattro zone proposte, altre Regioni hanno classificato diversamente il proprio territorio, ad esempio adottando solo tre zone (zona 1, 2 e 3) e introducendo, in alcuni casi, delle sottozone per meglio adattare le norme alle caratteristiche di sismicità.

Qualunque sia stata la scelta regionale, a ciascuna zona o sottozone è attribuito un valore di pericolosità di base, espressa in termini di accelerazione massima su suolo rigido (a_g). Tale valore di pericolosità di base non ha però influenza sulla progettazione, basandosi su una classificazione a priori:



Figura 2 Mappa sismica OPCM 3519 del 28 aprile 2006



ISTITUTO NAZIONALE DI GEOFISICA E VULCANOLOGIA

Mapa di pericolosità sismica del territorio nazionale

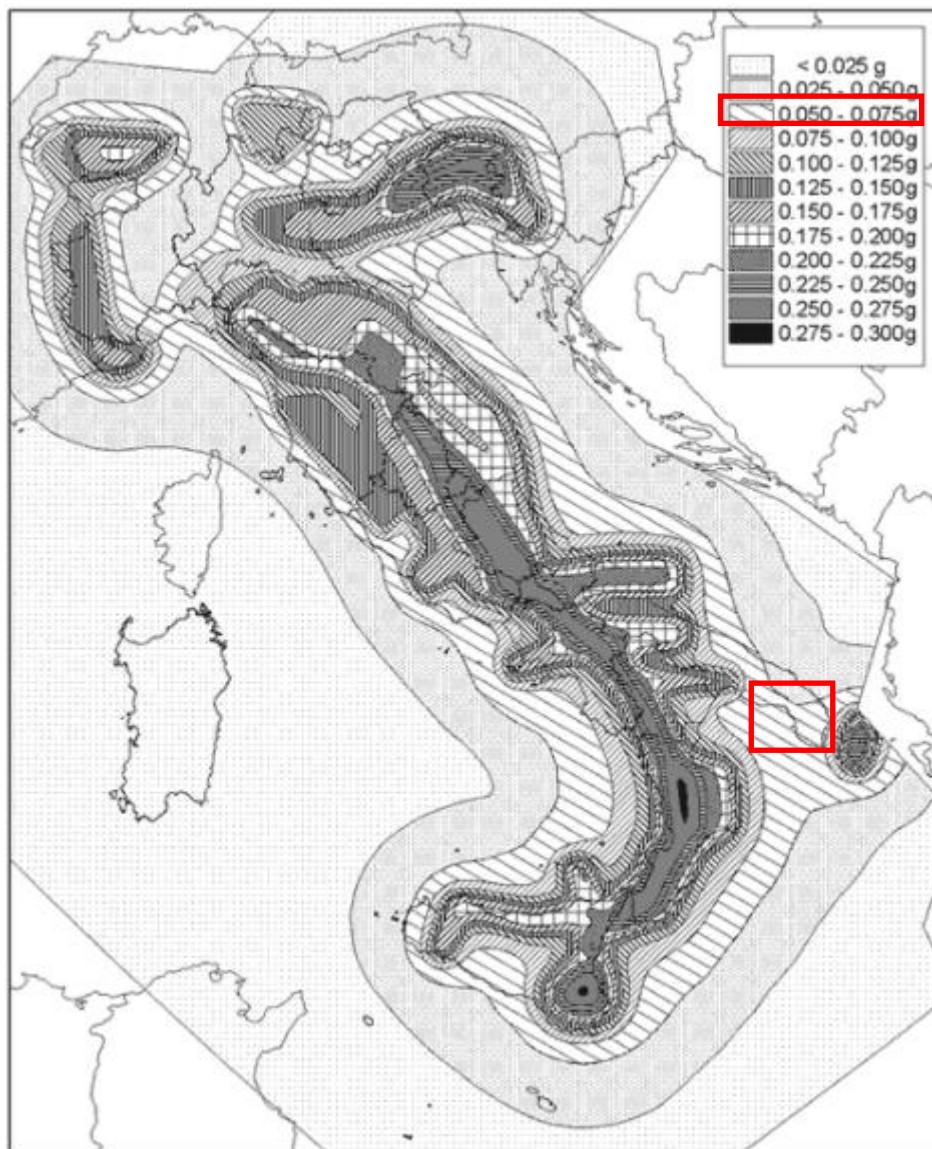
(riferimento: Ordinanza PCM del 28 aprile 2006 n.3519, All.1b)

espressa in termini di accelerazione massima del suolo

con probabilità di eccedenza del 10% in 50 anni

riferita a suoli rigidi ($V_{s30} > 800$ m/s; cat.A, punto 3.2.1 del D.M. 14.09.2005)

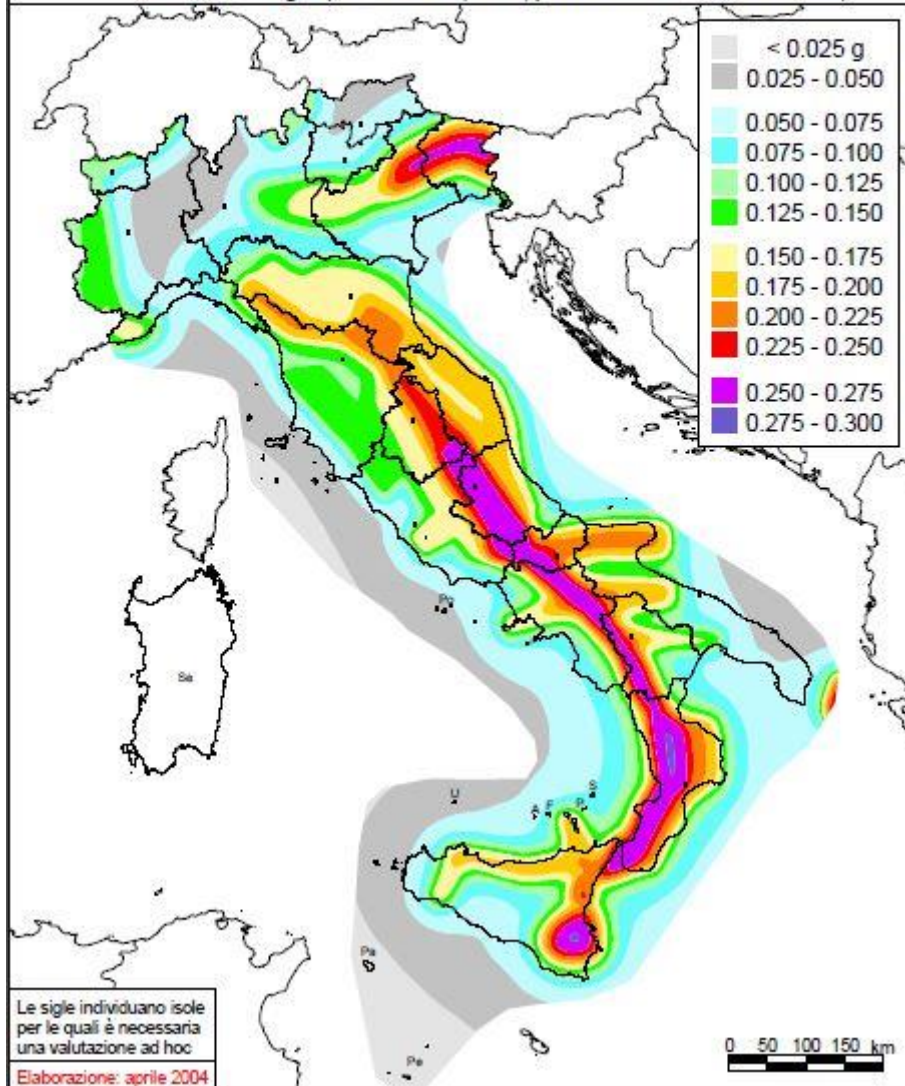



Figura 3 Mappa sismica aggiornata al gennaio 2019

Le attuali Norme Tecniche per le Costruzioni (Decreto Ministeriale del 14 gennaio 2008 e Decreto Ministeriale del 17 gennaio 2018), infatti, hanno modificato il ruolo che la classificazione sismica aveva ai fini progettuali: per ciascuna zona – e quindi territorio comunale – precedentemente veniva

fornito un valore di accelerazione di picco e quindi di spettro di risposta elastico da utilizzare per il calcolo delle azioni sismiche.

Dal 1 luglio 2009 con l'entrata in vigore delle Norme Tecniche per le Costruzioni del 2008, per ogni costruzione ci si deve riferire ad una accelerazione di riferimento "propria" individuata sulla base delle coordinate geografiche dell'area di progetto e in funzione della vita nominale dell'opera. Un valore di pericolosità di base, dunque, definito per ogni punto del territorio nazionale, su una maglia quadrata di 5 km di lato, indipendentemente dai confini amministrativi comunali.

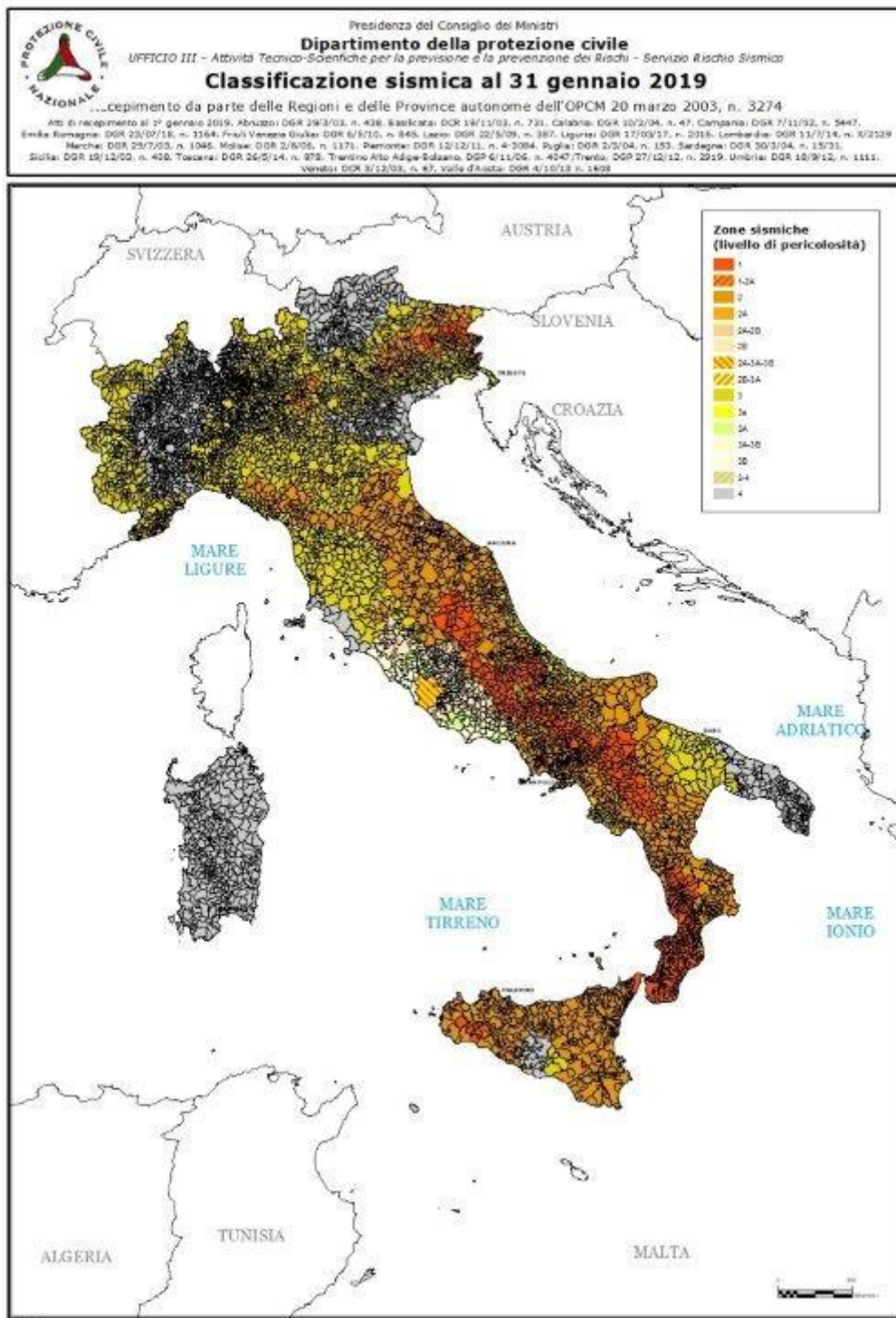
La classificazione sismica (zona sismica di appartenenza del comune) rimane utile solo per la gestione della pianificazione e per il controllo del territorio da parte degli enti preposti (Regione, Genio civile, ecc.) in base a quanto disposto dagli artt. 93 e 94 del DPR 380/2001.

I parametri di pericolosità sismica sono deducibili a partire dalle coordinate geografiche dall'allegato I alle NTC 14/01/2008.

I dati relativi al reticolo sismico sono riportati nel successivo paragrafo dedicato alla valutazione dell'azione sismica.

CATEGORIA DI SOTTOSUOLO E CONDIZIONI TOPOGRAFICHE

Per individuare la categoria sismica del suolo di fondazione dell'area indagata, in corrispondenza del sito di installazione dell'aerogeneratore sono state eseguite indagini sismiche in foro con metodologia Down-Hole: sembra opportuno soffermarsi su alcuni aspetti di carattere generale riguardanti la tematica in oggetto, utili all'inquadramento del "problema sismico".

La propagazione delle onde sismiche verso la superficie è influenzata dalla deformabilità dei terreni attraversati. Per tale ragione gli accelerogrammi registrati sui terreni di superficie possono differire notevolmente da quelli registrati al tetto della formazione di base, convenzionalmente definita come substrato nel quale le onde di taglio, che rappresentano la principale causa di trasmissione degli effetti delle azioni sismiche verso la superficie, si propagano con velocità maggiori o uguali a 1.000 m/sec.

*Attraverso l'analisi delle onde superficiali è possibile determinare il parametro $V_{s,30}$, come previsto dal Testo Unico per le costruzioni di cui al D.M. 17.01.2018, **$V_{s,eq}$** :*

Parametro $V_{s,eq}$:

$$V_{s,eq} = \frac{H}{\sum_{i=1}^N \frac{h_i}{V_{s,i}}}$$

In particolare risulta dalla allegata relazione geotecnica a firma del Dott. Geol. Luigi Buttiglione che il valore di $V_{s,eq}$ è superiore a 800 m/s.

*In definitiva, ai sensi del DM 17/01/2018 i terreni interessati dalle opere in progetto appartengono alla **Categoria A** - "Ammassi rocciosi affioranti o terreni molto rigidi caratterizzati da valori di $V_{s,30}$ superiori a 800 m/s, eventualmente comprendenti in superficie uno strato di alterazione, con spessore massimo pari a 3 m."*

Categoria di sottosuolo secondo NTC 17/01/2018 par. 3.2.2 tab.3.2.II

A Ammassi rocciosi affioranti o terreni molto rigidi caratterizzati da valori di $V_{s,30}$ superiori a 800 m/s, eventualmente comprendenti in superficie uno strato di alterazione, con spessore massimo pari a 3 m.

B Rocce tenere e depositi di terreni a grana grossa molto addensati o terreni a grana fina molto consistenti con spessori superiori a 30 m, caratterizzati da un graduale miglioramento delle proprietà meccaniche con la profondità e da valori di $V_{s,30}$ compresi tra 360 m/s e 800 m/s (ovvero $NSPT_{,30} > 50$ nei terreni a grana grossa e $c_{u,30} > 250$ kPa nei terreni a grana fina).

C Depositati di terreni a grana grossa mediamente addensati o terreni a grana fina mediamente consistenti con spessori superiori a 30 m, caratterizzati da un graduale miglioramento delle proprietà meccaniche con la profondità e da valori di $V_{s,30}$ compresi tra 180 m/s e 360 m/s (ovvero $15 < NSPT_{,30} < 50$ nei terreni a grana grossa e $70 < c_{u,30} < 250$ kPa nei terreni a grana fina).

D Depositati di terreni a grana grossa scarsamente addensati o di terreni a grana fina scarsamente consistenti, con spessori superiori a 30 m, caratterizzati da un graduale miglioramento delle proprietà meccaniche con la profondità e da valori di $V_{s,30}$ inferiori a 180 m/s (ovvero $NSPT_{,30} < 15$ nei terreni a grana grossa e $c_{u,30} < 70$ kPa nei terreni a grana fina).

E Terreni dei sottosuoli di tipo C o D per spessore non superiore a 20 m, posti sul substrato di riferimento (con $V_s > 800$ m/s).

In quanto segue si ipotizza per il suolo di fondazione la categoria A.

Per ciò che attiene la **classificazione delle condizioni topografiche** secondo quanto previsto nelle tabelle 3.2.III e 3.2.IV delle NTC, considerato l'assetto planoaltimetrico della porzione di territorio in esame, l'area d'intervento può essere classificata come appartenente alla

Categoria 'T1': "Superficie pianeggiante, pendii e rilievi isolati con inclinazione media $i \leq 15^\circ$ ".

IPOTESI DI PROGETTO E PARAMETRI SISMICI

Con riferimento alle Norme Tecniche per le Costruzioni DM 2018 [IX], l'azione sismica sull'opera in esame è stata valutata a partire da una "pericolosità sismica di base" in condizioni ideali di sito di riferimento rigido con superficie topografica orizzontale (di categoria A). Ad oggi, la pericolosità sismica su reticolo di riferimento nell'intervallo di riferimento è fornita dai dati pubblicati sul sito <http://esse1.mi.ingv.it/>.

Nello specifico, le azioni di progetto sono ricavate, ai sensi del DM 2018, a partire dalle accelerazioni a_g e dalle relative forme spettrali; quest'ultime sono definite, secondo norma, su sito di riferimento rigido orizzontale in funzione dei tre parametri $p(a_g, F_0, T^*_c)$ - Tabella B, [XI] - e da prescelte probabilità di superamento P_{VR} e vite di riferimento V_R .

Per il calcolo dei parametri sismici locali e delle accelerazioni e tempi di ritorno riferiti ai differenti stati limite considerati sono state assunte le seguenti ipotesi di progetto ai sensi del Par. 2.4. delle NTC 2018 [IX]:

- Tipo di costruzione: **2** “Opere ordinarie, ponti, opere infrastrutturali e dighe di dimensioni contenute o di importanza normale”
- Vita nominale: **$V_N = 50$ [anni]**
- Classe d’uso: **II**
- Periodo di riferimento: **$V_R = 35$ [anni]**
- Coordinate geografiche:
AREA IMPIANTO: Lat. **40° 14' 22.42" N (40.23956038°)** ; Long. **18° 0' 17.48" E (18.00485637°)** Comune di Nardò

La struttura è stata progettata per una Vita Nominale pari a 50 anni e per Classe d’Uso I, periodo di riferimento $V_R=35$ anni.

L’azione sismica sulle costruzioni è stata valutata a partire dalla “pericolosità sismica di base”, in condizioni ideali di sito di riferimento rigido con superficie topografica orizzontale.

Allo stato attuale, la pericolosità sismica su reticolo di riferimento nell’intervallo di riferimento è fornita dai dati pubblicati sul sito <http://esse1.mi.ingv.it/>. Per punti non coincidenti con il reticolo di riferimento e periodi di ritorno non contemplati direttamente si opera come indicato nell’ allegato alle NTC (rispettivamente media pesata e interpolazione).

L’ azione sismica viene definita in relazione ad un periodo di riferimento V_r che si ricava, per ciascun tipo di costruzione, moltiplicandone la vita nominale per il coefficiente d’uso (vedi tabella Parametri della struttura). Fissato il periodo di riferimento V_r e la probabilità di superamento P_{vr} associata a ciascuno degli stati limite considerati, si ottiene il periodo di ritorno T_r e i relativi parametri di pericolosità sismica (vedi tabella successiva):

ag: accelerazione orizzontale massima del terreno;

Fo: valore massimo del fattore di amplificazione dello spettro in accelerazione orizzontale;

T*c: periodo di inizio del tratto a velocità costante dello spettro in accelerazione orizzontale;

Parametri della struttura					
Classe d'uso	Vita V_n [anni]	Coeff. Uso	Periodo V_r [anni]	Tipo di suolo	Categoria topografica
II	50.0	0.7	35.0	A	T1

Individuati su reticolo di riferimento i parametri di pericolosità sismica si valutano i parametri spettrali riportati in tabella:

S è il coefficiente che tiene conto della categoria di sottosuolo e delle condizioni topografiche mediante la relazione seguente $S = S_s * S_t$ (3.2.3)

Fo è il fattore che quantifica l’amplificazione spettrale massima, su sito di riferimento rigido orizzontale

Tb è il periodo corrispondente all’inizio del tratto dello spettro ad accelerazione costante.

Tc è il periodo corrispondente all'inizio del tratto dello spettro a velocità costante.

Td è il periodo corrispondente all'inizio del tratto dello spettro a spostamento costante.

RETICOLO PER AREA IMPIANTO

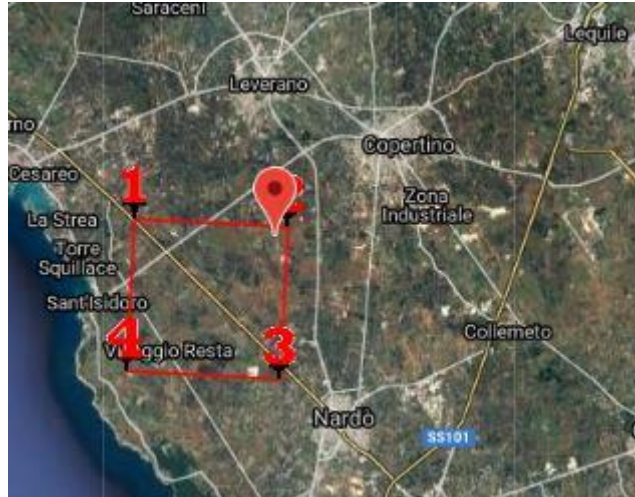

Id nodo	Longitudine	Latitudine	Distanza
			Km
Loc.	18.005	40.240	
35699	17.941	40.196	7.246
35700	18.006	40.194	5.050
35478	18.010	40.244	0.657
35477	17.944	40.246	5.197

SL	Pver	Tr	ag	Fo	T*c
		Anni	g		sec
SLO	81.0	30.0	0.015	2.370	0.160
SLD	63.0	35.0	0.016	2.370	0.180
SLV	10.0	332.0	0.045	2.440	0.460
SLC	5.0	682.0	0.057	2.520	0.540

SL	ag	S	Fo	Fv	Tb	Tc	Td
	g				sec	sec	sec
SLO	0.015	1.000	2.370	0.392	0.053	0.160	1.660
SLD	0.016	1.000	2.370	0.410	0.060	0.180	1.666
SLV	0.045	1.000	2.440	0.698	0.153	0.460	1.780
SLC	0.057	1.000	2.520	0.810	0.180	0.540	1.827

In quanto precede si assume per il suolo di fondazione la categoria A.

Per la definizione degli spettri di risposta, oltre all'accelerazione a_g al suolo (dipendente dalla classificazione sismica del Comune) occorre determinare il Fattore di Struttura q .

Si è assunto il Coefficiente di Amplificazione Topografica S_T pari a 1,00, il Coefficiente di Amplificazione Stratigrafica S_S è pari a 1,00.

L'opera è stata progettata per appartenere alla Classe II.

Per la struttura in esame sono stati determinati i seguenti valori:

Stato Limite di salvaguardia della Vita

Fattore di Struttura q per sisma orizzontale in direzione X: 1,00

Fattore di Struttura q per sisma orizzontale in direzione Y: 1,00

Gli spettri utilizzati sono riportati nella successiva figura.



Figura 4

Gli effetti del sisma sono stati valutati convenzionalmente mediante analisi statica della struttura soggetta ad un sistema di forze orizzontali parallele alle direzioni ipotizzate per il sisma, distribuite (sia planimetricamente che altimetricamente) in modo da simulare gli effetti dinamici del sisma.

Le sollecitazioni derivanti da tali azioni sono state composte poi con quelle derivanti da carichi verticali, orizzontali non sismici secondo le varie combinazioni di carico probabilistiche.

Il calcolo è stato effettuato mediante un programma agli elementi finiti le cui caratteristiche verranno descritte nel seguito.

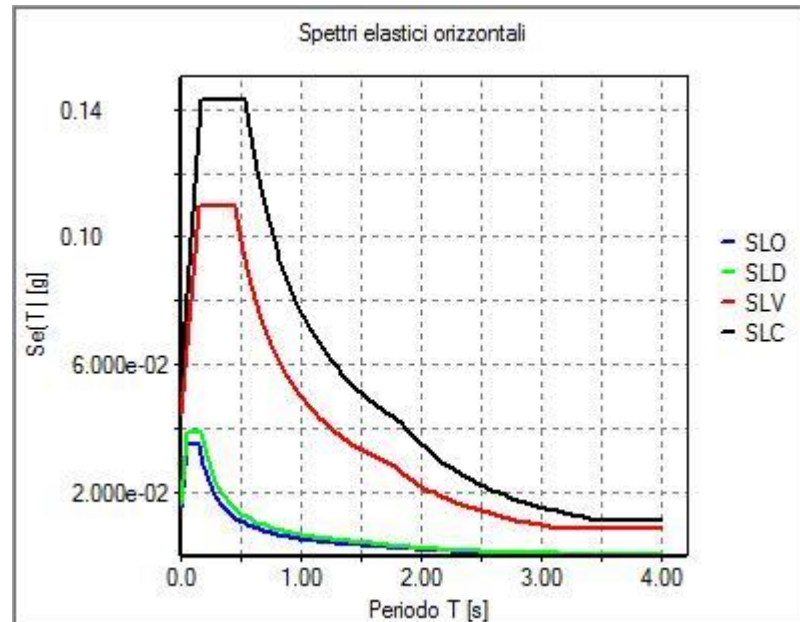
Il calcolo degli effetti dell'azione sismica è stato eseguito con riferimento alla struttura spaziale, tenendo cioè conto degli elementi interagenti fra loro secondo l'effettiva realizzazione escludendo i tamponamenti.

Sono stati considerati sei gradi di libertà per nodo; in ogni nodo della struttura sono state applicate le forze sismiche derivanti dalle masse circostanti.

Le sollecitazioni derivanti da tali forze sono state poi combinate con quelle derivanti dagli altri carichi come prima specificato.

Il sisma viene convenzionalmente considerato come agente separatamente in due direzioni tra loro ortogonali prefissate; per tenere conto che nella realtà il moto del terreno durante l'evento sismico ha direzione casuale e in accordo con le prescrizioni normative, per ottenere l'effetto complessivo

del sisma, a partire dagli effetti delle direzioni calcolati separatamente, si è provveduto a sommare i massimi ottenuti in una direzione con il 30% dei massimi ottenuti per l'azione applicata nell'altra direzione, con eccentricità rispetto al centro di massa pari a $\pm 5\%$ della dimensione in pianta misurata nella direzione normale a quella dell'azione sismica considerata.

CRITERI DI CONCEZIONE E DI SCHEMATIZZAZIONE STRUTTURALE: EFFICACIA DEL MODELLO

La progettazione e la verifica dell'opera strutturale in oggetto sono state eseguite con il codice di calcolo numerico ad elementi finiti denominato "2Si PRO_SAP Versione RY2019 150 nodi".

La struttura e il suo comportamento sotto le azioni statiche è stato adeguatamente valutato, interpretato e trasferito nel modello tridimensionale realizzato e descritto in premessa al fine di eseguire una corretta analisi ad elementi finiti FEA.

Tipo di analisi strutturale	
Carichi verticali	SI
Statica non lineare	NO
Sismica statica lineare	SI
Sismica dinamica lineare	NO
Sismica statica non lineare (prop. masse)	NO
Sismica statica non lineare (prop. modo)	NO
Sismica statica non lineare (triangolare)	NO
Non linearità geometriche (fattore P delta)	NO

Per ciò che attiene all'affidabilità dei codici utilizzati 2S.I. ha verificato l'affidabilità e la robustezza del codice di calcolo attraverso un numero significativo di casi prova in cui i risultati dell'analisi numerica sono stati confrontati con soluzioni teoriche.

E' possibile reperire la documentazione contenente alcuni dei più significativi casi trattati al seguente link: <https://www.2si.it/it/prodotti/affidabilita/>

Modellazione della geometria e proprietà meccaniche:	
nodi	31
elementi D2 (per aste, travi, pilastri...)	46
elementi D3 (per pareti, platee, gusci...)	0
elementi solaio	3
elementi solidi	0
Dimensione del modello strutturale [cm]:	
X min =	0.00
Xmax =	386.20
Ymin =	0.00
Ymax =	1570.00
Zmin =	0.00
Zmax =	300.00
Strutture verticali:	
Elementi di tipo asta	NO
Pilastri	SI
Pareti	NO

Setti (a comportamento membranale)	NO
Strutture non verticali:	
Elementi di tipo asta	SI
Travi	SI
Gusci	NO
Membrane	NO
Orizzontamenti:	
Solai con la proprietà piano rigido	NO
Solai senza la proprietà piano rigido	SI
Tipo di vincoli:	
Nodi vincolati rigidamente	SI
Nodi vincolati elasticamente	NO
Nodi con isolatori sismici	NO
Fondazioni puntuali (plinti/plinti su palo)	NO
Fondazioni di tipo trave	NO
Fondazioni di tipo platea	NO
Fondazioni con elementi solidi	NO

Combinazioni dei casi di carico	
APPROCCIO PROGETTUALE	Approccio 2
Tensioni ammissibili	NO
SLU	SI
SLV (SLU con sisma)	SI
SLC	NO
SLD	SI
SLO	NO
SLU GEO A2 (per approccio 1)	NO
SLU EQU	SI
Combinazione caratteristica (rara)	SI
Combinazione frequente	SI
Combinazione quasi permanente (SLE)	SI
SLA (accidentale quale incendio)	NO

Il calcolo è stato condotto mediante analisi statica lineare. Si ritiene che il modello utilizzato sia rappresentativo del comportamento reale della struttura. Sono stati, inoltre, valutati tutti i possibili effetti o le azioni che possano essere significative e avere implicazione per la struttura in esame.

Il programma prevede una serie di controlli automatici (check) che consentono l'individuazione di errori di modellazione. Al termine dell'analisi un controllo automatico identifica la presenza di spostamenti o rotazioni abnormi. Si può pertanto asserire che l'elaborazione sia corretta e completa. I risultati delle elaborazioni sono stati sottoposti a controlli che ne comprovano l'attendibilità. Tale valutazione ha compreso il confronto con i risultati di semplici calcoli, eseguiti con metodi tradizionali e adottati, anche in fase di primo proporzionamento della struttura. Inoltre, sulla base di considerazioni riguardanti gli stati tensionali e deformativi determinati, si è valutata la validità delle scelte operate in sede di schematizzazione e di modellazione della struttura e delle azioni. Si allega al termine della presente relazione elenco sintetico dei controlli svolti (verifiche di equilibrio tra reazioni vincolari e carichi applicati, comparazioni tra i risultati delle analisi e quelli di valutazioni semplificate, etc.) .

Nel capitolo relativo alla progettazione degli elementi strutturali agli SLU vengono indicate, con riferimento alla normativa adottata, le modalità ed i criteri seguiti per valutare la sicurezza della struttura nei confronti delle possibili situazioni di crisi ed i risultati delle valutazioni svolte. In via generale, oltre alle verifiche di resistenza e di spostamento, devono essere prese in considerazione verifiche nei confronti dei fenomeni di instabilità, locale e globale, di fatica, di duttilità, di degrado.

Verifiche agli stati limite di esercizio

Nel capitolo relativo alla progettazione degli elementi strutturali agli SLE vengono indicate, con riferimento alla normativa adottata, le modalità seguite per valutare l'affidabilità della struttura nei confronti delle possibili situazioni di perdita di funzionalità (per eccessive deformazioni, fessurazioni, vibrazioni, etc.) ed i risultati delle valutazioni svolte.

Il capitolo Materiali riporta informazioni esaustive relative all'elenco dei materiali impiegati e loro modalità di posa in opera e ai valori di calcolo.

Viene riportata di seguito una vista assonometrica, allo scopo di consentire una migliore comprensione della struttura oggetto della presente relazione:

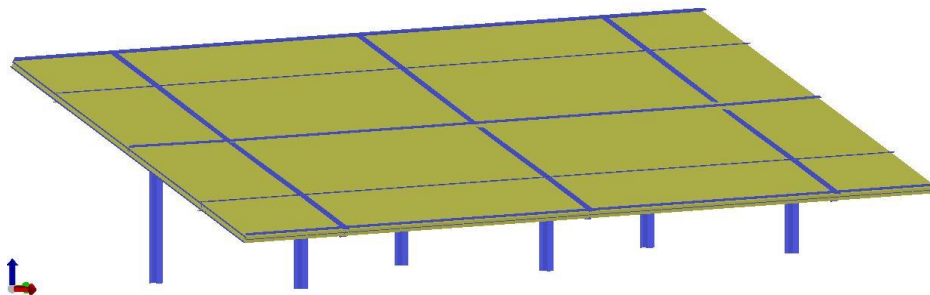

Vista 3D del modello

Il comportamento del terreno non è modellato in questa fase poiché il sistema di fondazione consiste in infissione dei montanti direttamente nel terreno .

3. ANALISI STRUTTURALE

VALORI DI PROGETTO DELLA RESISTENZA DEI MATERIALI STRUTTURALI

- Acciaio da carpenteria S275 per i profili laminati a caldo:

$$E = 210000 \text{ (N/mm}^2\text{)}$$

$$\nu = 0,300$$

$$G = 80769 \text{ (N/mm}^2\text{)}$$

$$\gamma = 78,5 \text{ (KN/m}^3\text{)}$$

$$\alpha = 0,000012 \text{ (1/}^\circ\text{C)}$$

$$f_{yk} = 275 \text{ (N/mm}^2\text{)}$$

$$f_{tk} = 430 \text{ (N/mm}^2\text{)}$$

$$f_{yd} = 261,9 \text{ (N/mm}^2\text{)}$$

MODELLO DI PROGETTO

Il modello è costituito da elementi *beam* per i profili metallici. Gli elementi *solaio- pannello* che schematizzano i pannelli fotovoltaici hanno la sola funzione di ripartire i carichi, non essendo dotati di alcuna rigidità. È stato realizzato un modello tridimensionale e condotta un'analisi statica lineare elastica per la determinazione delle sollecitazioni derivanti dai carichi permanenti e accidentali. Nei confronti delle azioni sismiche allo SLV è stata eseguita un'analisi statica lineare con spettro di risposta, utilizzando un fattore di comportamento $q = 1$.

Sono stati inseriti dei vincoli a incastro alla base dei montanti, in corrispondenza del punto di infissione nel terreno.

MODELLAZIONE DELLE SEZIONI

LEGENDA TABELLA DATI SEZIONI

Il programma consente l'uso di sezioni diverse. Sono previsti i seguenti tipi di sezione:

1. profilati semplici

Le sezioni utilizzate nella modellazione sono individuate da una sigla identificativa ed un codice numerico (gli elementi strutturali richiamano quest'ultimo nella propria descrizione). Per ogni sezione vengono riportati in tabella i seguenti dati:

Area	area della sezione
A V2	area della sezione/fattore di taglio (per il taglio in direzione 2)
A V3	area della sezione/fattore di taglio (per il taglio in direzione 3)
Jt	fattore torsionale di rigidità
J2-2	momento d'inerzia della sezione riferito all'asse 2
J3-3	momento d'inerzia della sezione riferito all'asse 3
W2-2	modulo di resistenza della sezione riferito all'asse 2
W3-3	modulo di resistenza della sezione riferito all'asse 3
Wp2-2	modulo di resistenza plastico della sezione riferito all'asse 2
Wp3-3	modulo di resistenza plastico della sezione riferito all'asse 3

La valutazione delle caratteristiche inerziali delle sezioni è condotta nel riferimento 2-3 dell'elemento.

Id	Tipo	Area	A V2	A V3	Jt	J 2-2	J 3-3	W 2-2	W 3-3	Wp 2-2	Wp 3-3
		cm2	cm2	cm2	cm4	cm4	cm4	cm3	cm3	cm3	cm3
3	UPN 80	11.00	0.0	0.0	2.16	19.40	106.00	6.30	26.50	12.10	31.80
5	HEA 140	31.40	0.0	0.0	8.10	389.00	1033.00	55.60	155.40	84.80	173.50

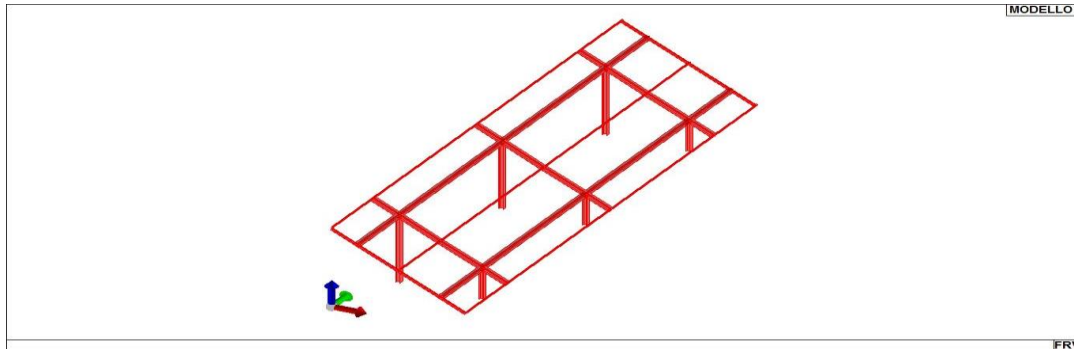

13_MOD_SEZIONI

MODELLAZIONE STRUTTURA: NODI

LEGENDA TABELLA DATI NODI

Il programma utilizza per la modellazione nodi strutturali.

Ogni nodo è individuato dalle coordinate cartesiane nel sistema di riferimento globale (X Y Z).

Ad ogni nodo è eventualmente associato un codice di vincolamento rigido, un codice di fondazione speciale, ed un set di sei molle (tre per le traslazioni, tre per le rotazioni). Le tabelle sottoriportate riflettono le succitate possibilità. In particolare per ogni nodo viene indicato in tabella:

Nodo	numero del nodo.
X	valore della coordinata X
Y	valore della coordinata Y
Z	valore della coordinata Z

Per i nodi ai quali sia associato un codice di vincolamento rigido, un codice di fondazione speciale o un set di molle viene indicato in tabella:

Nodo	numero del nodo.
X	valore della coordinata X
Y	valore della coordinata Y
Z	valore della coordinata Z
Note	eventuale codice di vincolo (es. v=110010 sei valori relativi ai sei gradi di libertà previsti per il nodo TxTyTzRxRyRz, il valore 1 indica che lo spostamento o rotazione relativo è impedito, il valore 0 indica che lo spostamento o rotazione relativo è libero).
Note	(FS = 1, 2,...) eventuale codice del tipo di fondazione speciale (1, 2,... fanno riferimento alle tipologie: plinto, palo, plinto su pali,...) che è collegato al nodo. (ISO = "id SIGLA") indice e sigla identificativa dell' eventuale isolatore sismico assegnato al nodo
Rig. TX	valore della rigidità dei vincoli elastici eventualmente applicati al nodo, nello specifico TX (idem per TY, TZ, RX, RY, RZ).

TABELLA DATI NODI

Nodo	X	Y	Z	Nodo	X	Y	Z	Nodo	X	Y	Z
	cm	cm	cm		cm	cm	cm		cm	cm	cm
7	386.2	0.0	77.0	8	386.2	226.0	77.0	9	386.2	785.0	77.0
10	386.2	1344.0	77.0	11	386.2	1570.0	77.0	12	313.2	0.0	119.5
13	313.2	226.0	119.5	14	313.2	785.0	119.5	15	313.2	1344.0	119.5
16	313.2	1570.0	119.5	17	193.1	226.0	186.8	18	193.1	785.0	186.8
19	193.1	1344.0	186.8	20	193.4	0.0	188.5	21	193.4	1570.0	188.5
22	73.6	0.0	257.5	23	73.6	226.0	257.5	24	73.6	785.0	257.5
25	73.6	1344.0	257.5	26	73.6	1570.0	257.5	27	0.0	0.0	300.0
28	0.0	226.0	300.0	29	0.0	785.0	300.0	30	0.0	1344.0	300.0
31	0.0	1570.0	300.0								

Nodo	X	Y	Z	Note
	cm	cm	cm	
1	73.6	226.0	0.0	v=111111
2	313.2	226.0	0.0	v=111111
3	73.6	785.0	0.0	v=111111
4	313.2	785.0	0.0	v=111111
5	73.6	1344.0	0.0	v=111111
6	313.2	1344.0	0.0	v=111111

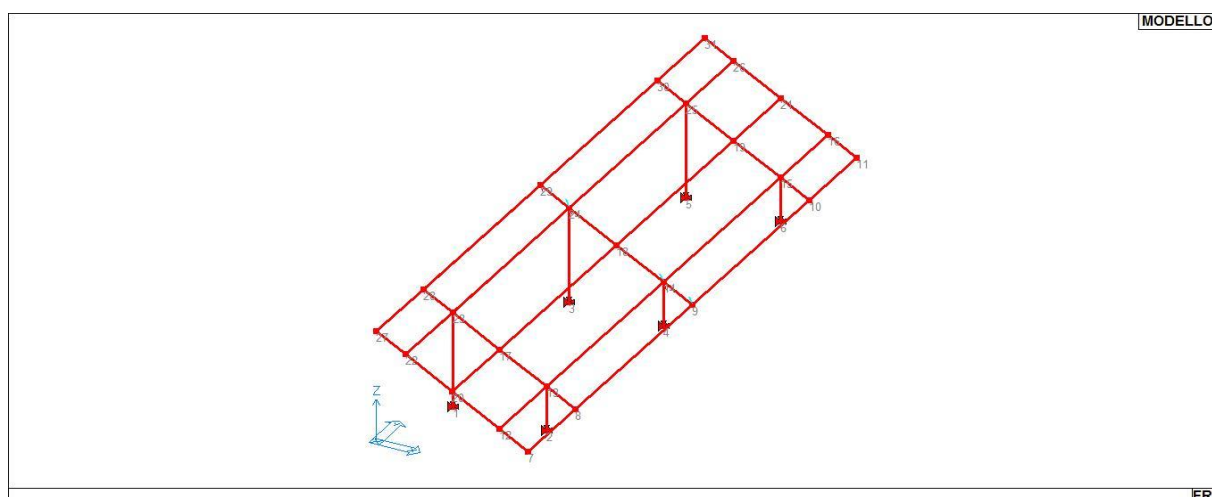

14_MOD_NUMERAZIONE_NODI

MODELLAZIONE STRUTTURA: ELEMENTI TRAVE

TABELLA DATI TRAVI

Il programma utilizza per la modellazione elementi a due nodi denominati in generale travi.

Ogni elemento trave è individuato dal nodo iniziale e dal nodo finale.

Ogni elemento è caratterizzato da un insieme di proprietà riportate in tabella che ne completano la modellazione.

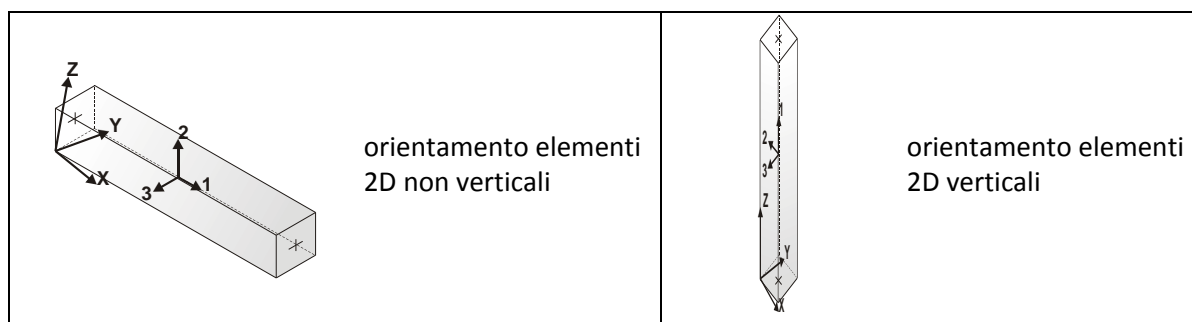

In particolare per ogni elemento viene indicato in tabella:

Elem.	numero dell'elemento
Note	codice di comportamento: trave, trave di fondazione, pilastro, asta, asta tesa, asta compressa,
Nodo I (J)	numero del nodo iniziale (finale)
Mat.	codice del materiale assegnato all'elemento
Sez.	codice della sezione assegnata all'elemento
Rotaz.	valore della rotazione dell'elemento, attorno al proprio asse, nel caso in cui l'orientamento di default non sia adottabile; l'orientamento di default prevede per gli elementi non verticali l'asse 2 contenuto nel piano verticale e l'asse 3 orizzontale, per gli elementi verticali l'asse 2 diretto secondo X negativo e l'asse 3 diretto secondo Y negativo
Svincolo I (J)	codici di svincolo per le azioni interne; i primi sei codici si riferiscono al nodo iniziale, i restanti sei al nodo finale (il valore 1 indica che la relativa azione interna non è attiva)
Wink V	costante di sottofondo (coefficiente di Winkler) per la modellazione della trave su suolo elastico
Wink O	costante di sottofondo (coefficiente di Winkler) per la modellazione del suolo elastico orizzontale

Elem.	Note	Nodo I	Nodo J	Mat.	Sez.
1	Asta	28	29	12	3
2	Asta	29	30	12	3
3	Asta	8	9	12	3
4	Asta	9	10	12	3
5	Asta	7	8	12	3
6	Asta	10	11	12	3
7	Asta	27	28	12	3
8	Asta	30	31	12	3
9	Asta	20	17	12	3
10	Asta	19	21	12	3
11	Asta	17	18	12	3
12	Asta	18	19	12	3
13	Trave	12	7	12	3
14	Trave	26	21	12	3
15	Trave	20	12	12	3
16	Trave	21	16	12	3
17	Trave	27	22	12	3
18	Trave	31	26	12	3
19	Trave	22	20	12	3
20	Trave	16	11	12	3
21	Trave	18	14	12	5
22	Trave	19	15	12	5
23	Trave	13	8	12	5
24	Trave	14	9	12	5
25	Trave	15	10	12	5
26	Pilas.	6	15	12	5
27	Trave	12	13	12	5
28	Trave	13	14	12	5
29	Trave	23	17	12	5
30	Trave	24	18	12	5
31	Trave	25	19	12	5
32	Trave	14	15	12	5
33	Trave	15	16	12	5
34	Trave	22	23	12	5
35	Trave	23	24	12	5
36	Trave	24	25	12	5
37	Trave	25	26	12	5
38	Pilas.	1	23	12	5
39	Trave	28	23	12	5
40	Trave	29	24	12	5
41	Trave	30	25	12	5
42	Pilas.	3	24	12	5
43	Pilas.	5	25	12	5
44	Pilas.	2	13	12	5
45	Pilas.	4	14	12	5
46	Trave	17	13	12	5

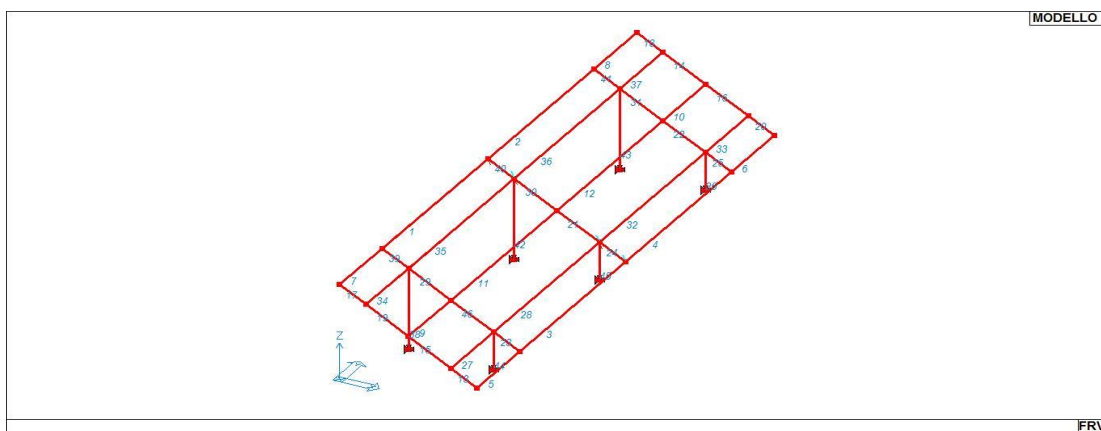

15_MOD_NUMERAZIONE_D2

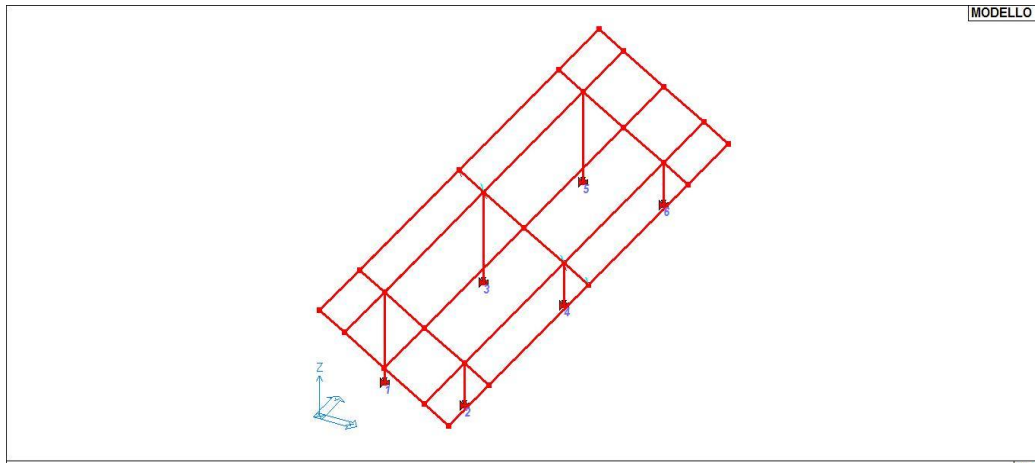

15_MOD_NUMERAZIONE_D2_PILASTRATE

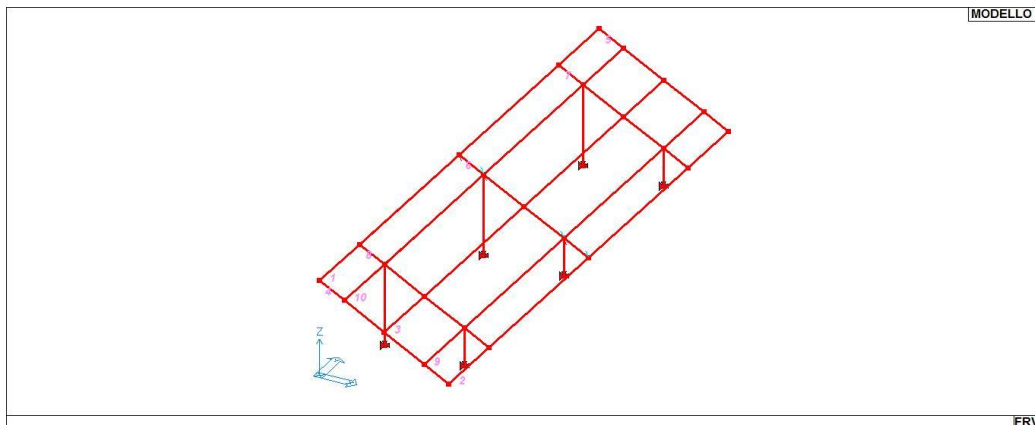

15_MOD_NUMERAZIONE_D2_TRAVATE

Aste acc.	1/7/..	2/8/..	3/9/..	4/10/..	5/11/..	6/12/..
Generalità						
Beta assegnato	0.80					
Verifica come controvento	No					
Usa condizioni I e II	Si					
Coefficiente gamma M0	1.05					
Coefficiente gamma M1	1.05					
Coefficiente gamma M2	1.25					

Pilastri acc.	1/7/..	2/8/..	3/9/..	4/10/..	5/11/..	6/12/..
Lunghezze libere						
Metodo di calcolo 2-2	Assegnato					
2-2 Beta assegnato	2.00					
2-2 Beta * L assegnato [cm]	0.0					
Metodo di calcolo 3-3	Assegnato					
3-3 Beta assegnato	2.00					
3-3 Beta * L assegnato [cm]	0.0					
1-1 Beta assegnato	1.00					
1-1 Beta * L assegnato [cm]	0.0					
Generalità						
Coefficiente gamma M0	1.05					
Coefficiente gamma M1	1.05					
Coefficiente gamma M2	1.25					
Effetti del 2 ordine	Si					
Momenti equivalenti	Si					
Usa condizioni I e II	Si					

Travi acc.	1/7/..	2/8/..	3/9/..	4/10/..	5/11/..	6/12/..
Lunghezze libere						
3-3 Beta * L automatico	Si					
3-3 Beta assegnato	1.00					
3-3 Beta assegnato [cm]	0.0					
2-2 Beta * L automatico	Si					
2-2 Beta assegnato	1.00					
2-2 Beta * L assegnato [cm]	0.0					
1-1 Beta * L automatico	Si					
1-1 Beta assegnato	1.00					
1-1 Beta * L assegnato [cm]	0.0					
Generalità						
Coefficiente gamma M0	1.05					
Coefficiente gamma M1	1.05					
Coefficiente gamma M2	1.25					
Luce di taglio per GR [cm]	1.00					
Usa condizioni I e II	Si					
Momenti equivalenti	Si					

AZIONI DI PROGETTO

3.1.1 CARICHI PERMANENTI

Carichi permanenti strutturali (G1)

Come carico permanente strutturale si è considerato il peso proprio delle strutture di acciaio ($\gamma_a = 78,5 \text{ kN/m}^3$).

Carichi permanenti non strutturali (G2)

Il **peso dei pannelli fotovoltaici**, considerato in questa fase progettuale pari a $15 \text{ kg/m}^2 = 0,15 \text{ kN/m}^2$ viene considerato compiutamente definito.

In fase di progetto esecutivo, quest'ultimo valore **dovrà essere confermato dal produttore**.

Il peso proprio dei pannelli è stato considerato come carico compiutamente definito in quanto, essendo fornito dal produttore, dovrà essere sostanzialmente privo di incertezze.

3.1.2 CARICHI VARIABILI

4.3.2.a CARICO NEVE

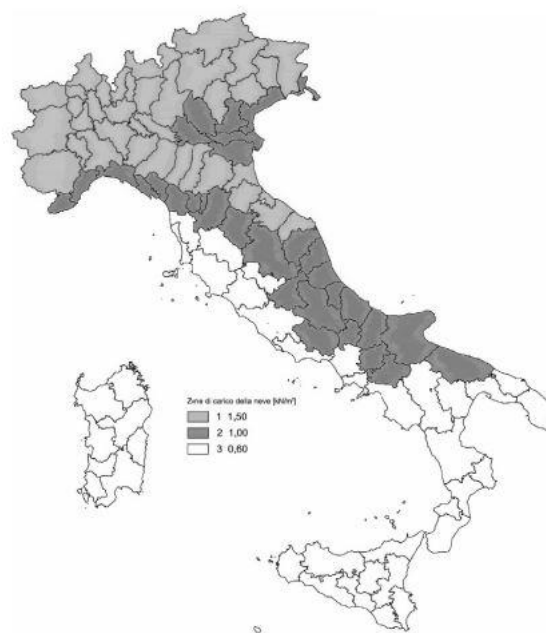

Fig. 3.4.1 – Zone di carico della neve.

Zona I - Alpina

Aosta, Belluno, Bergamo, Biella, Bolzano, Brescia, Como, Cuneo, Lecco, Pordenone, Sondrio, Torino, Trento, Udine, Verbanico-Cusio-Ossola, Vercelli, Vicenza:

$$q_{sk} = 1,50 \text{ kN/m}^2 \quad a_s \leq 200 \text{ m}$$

$$q_{sk} = 1,39 [1 + (a_s/728)^2] \text{ kN/m}^2 \quad a_s > 200 \text{ m}$$

[3.4.2]

Zona I - Mediterranea

Alessandria, Ancona, Asti, Bologna, Cremona, Forlì-Cesena, Lodi, Milano, Modena, Monza Brianza, Novara, Parma, Pavia, Pesaro e Urbino, Piacenza, Ravenna, Reggio Emilia, Rimini, Treviso, Varese:

$$q_{sk} = 1,50 \text{ kN/m}^2 \quad a_s \leq 200 \text{ m}$$

$$q_{sk} = 1,35 [1 + (a_s/602)^2] \text{ kN/m}^2 \quad a_s > 200 \text{ m}$$

[3.4.3]

Zona II

Arezzo, Ascoli Piceno, Avellino, Bari, Barletta-Andria-Trani, Benevento, Campobasso, Chieti, Fermo, Ferrara, Firenze, Foggia, Frosinone, Genova, Gorizia, Imperia, Isernia, L'Aquila, La Spezia, Lucca, Macerata, Mantova, Massa Carrara, Padova, Perugia, Pescara, Pistoia, Prato, Rieti, Rovigo, Savona, Teramo, Trieste, Venezia, Verona:

$$q_{sk} = 1,00 \text{ kN/m}^2 \quad a_s \leq 200 \text{ m}$$

$$q_{sk} = 0,85 [1 + (a_s/481)^2] \text{ kN/m}^2 \quad a_s > 200 \text{ m}$$

[3.4.4]

Zona III

Agrigento, Brindisi, Cagliari, Caltanissetta, Carbonia-Iglesias, Caserta, Catania, Catanzaro, Cosenza, Crotone, Enna, Grosseto, Latina, Lecce, Livorno, Matera, Medio Campidano, Messina, Napoli, Nuoro, Olgiastro, Olbia-Tempio, Oristano, Palermo, Pisa, Potenza, Ragusa, Reggio Calabria, Roma, Salerno, Sassari, Siena, Siracusa, Taranto, Terni, Trapani, Vibo Valentia, Viterbo:

$$q_{sk} = 0,60 \text{ kN/m}^2 \quad a_s \leq 200 \text{ m}$$

$$q_{sk} = 0,51 [1 + (a_s/481)^2] \text{ kN/m}^2 \quad a_s > 200 \text{ m}$$

[3.4.5]

ZONA: III (Nardò - Lecce)

Altitudine: $a_s = 45 \text{ m}$

$q_{sk} = 0,60 \text{ kN/m}^2$ ($a_s = 45 \text{ m} < 200 \text{ m}$)

Classe di topografia: Normale

Coefficiente di esposizione: $C_e = 0,90$

$C_{tr} = [(1 - V (6^{1/2} / \pi) \ln[-\ln(1-1/Tr) + 0.57722]) / (1 + 2.5923V)] = 0,93$

Coefficiente di forma per angoli da 0° a 30° : $\mu_1 = 0,8$

Quindi: $q_s = \mu_1 q_{sk} C_e C_{tr} = 0.50 \text{ kN/m}^2$

Tab. 3.4.II - Valori del coefficiente di forma

Coefficiente di forma	$0^\circ \leq \alpha \leq 30^\circ$	$30^\circ < \alpha < 60^\circ$	$\alpha \geq 60^\circ$
μ_1	0,8	$0,8 \cdot \frac{(60 - \alpha)}{30}$	0,0

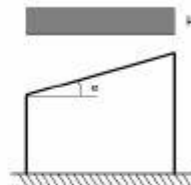

Fig. 3.4.2 - Condizioni di carico per coperture ad una falda

4.3.2.b AZIONI DEL VENTO



Fig. 3.3.1 - Mappa delle zone in cui è suddiviso il territorio italiano

Tab. 3.3.I - Valori dei parametri $v_{b,0}$, a_0 , k_s

Zona	Descrizione	$v_{b,0}$ [m/s]	a_0 [m]	k_s
1	Valle d'Aosta, Piemonte, Lombardia, Trentino Alto Adige, Veneto, Friuli Venezia Giulia (con l'eccezione della provincia di Trieste)	25	1000	0,40
2	Emilia Romagna	25	750	0,45
3	Toscana, Marche, Umbria, Lazio, Abruzzo, Molise, Puglia, Campania, Basilicata, Calabria (esclusa la provincia di Reggio Calabria)	27	500	0,37
4	Sicilia e provincia di Reggio Calabria	28	500	0,36
5	Sardegna (zona a oriente della retta congiungente Capo Teulada con l'Isola di Maddalena)	28	750	0,40
6	Sardegna (zona a occidente della retta congiungente Capo Teulada con l'Isola di Maddalena)	28	500	0,36
7	Liguria	28	1000	0,54
8	Provincia di Trieste	30	1500	0,50
9	Isole (con l'eccezione di Sicilia e Sardegna) e mare aperto	31	500	0,32

Tab. 3.3.II - Parametri per la definizione del coefficiente di esposizione

Categoria di esposizione del sito	K_T	z_0 [m]	z_{min} [m]
I	0,17	0,01	2
II	0,19	0,05	4
III	0,20	0,10	5
IV	0,22	0,30	8
V	0,23	0,70	12

Tab. 3.3.III - Classi di rugosità del terreno

Classe di rugosità del terreno	Descrizione
A	Aree urbane in cui almeno il 15% della superficie sia coperto da edifici la cui altezza media superi i 15 m
B	Aree urbane (non di classe A), suburbane, industriali e boschive
C	Aree con ostacoli diffusi (alberi, case, muri, recinzioni,...); aree con rugosità non riconducibile alle classi A, B, D
D	a) Mare e relativa fascia costiera (entro 2 km dalla costa); b) Lago (con larghezza massima pari ad almeno 1 km) e relativa fascia costiera (entro 1 km dalla costa) c) Aree prive di ostacoli o con al più rari ostacoli isolati (aperta campagna, aeroporti, aree agricole, pascoli, zone paludose o sabbiose, superfici innevate o ghiacciate, ...)

L'assegnazione della classe di rugosità non dipende dalla conformazione orografica e topografica del terreno. Si può assumere che il sito appartenga alla Classe A o B, purché la costruzione si trovi nell'area relativa per non meno di 1 km e comunque per non meno di 20 volte l'altezza della costruzione, per tutti i settori di provenienza del vento ampi almeno 30°. Si deve assumere che il sito appartenga alla Classe D, qualora la costruzione sorga nelle aree indicate con le lettere a) o b), oppure entro un raggio di 1 km da essa vi sia un settore ampio 30°, dove il 90% del terreno sia del tipo indicato con la lettera c). Laddove sussistano dubbi sulla scelta della classe di rugosità, si deve assegnare la classe più sfavorevole (l'azione del vento è in genere minima in Classe A e massima in Classe D).

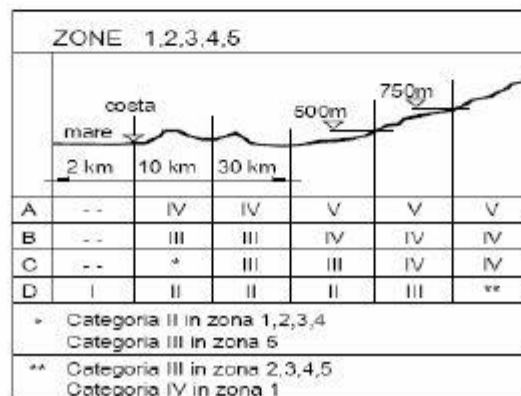

ZONA 9

		costa
	mare	
A	--	I
B	--	I
C	--	I
D	I	I

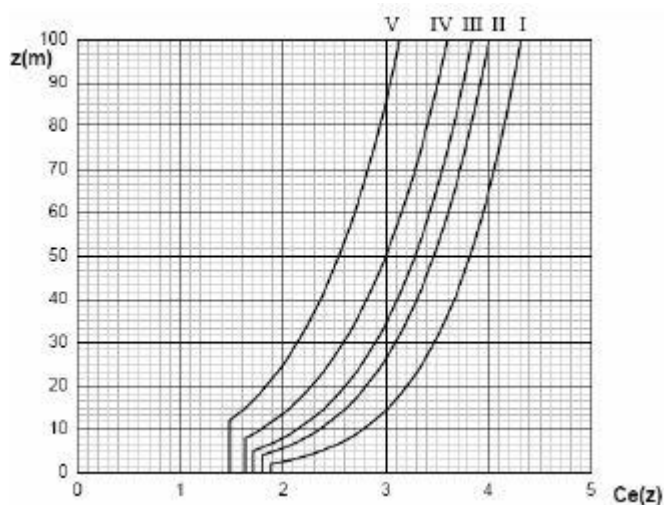

Puglia: zona 3; $v_b = 27$ m/s; $v_r (T_R = 50 \text{ anni}) = 27$ m/s
Zona vento = 3

Velocità base della zona, $V_{b.o} = 27 \text{ m/s}$ (Tab. 3.3.I)
 Altitudine base della zona, $A_o = 500 \text{ m}$ (Tab. 3.3.I)
 Altitudine del sito, $A_s = 45 \text{ m}$
 Velocità di riferimento, $V_b = 27,00 \text{ m/s}$ ($V_b = V_{b.o}$ per $A_s \leq A_o$)
 Periodo di ritorno, $T_r = 35 \text{ anni}$
 $C_r = 0,75 (1 - 0,2 \ln(-\ln(1-1/T_r)))^{1/2} = 0,98$
 Velocità riferita al periodo di ritorno di progetto, $V_r = V_b C_r = 26,47 \text{ m/s}$
 Classe di rugosità del terreno: D

[Aree prive di ostacoli o con al di più rari ostacoli isolati (aperta campagna, aeroporti, aree agricole, zone paludose o sabbiose, superfici innevate o ghiacciate, mare, laghi,...)]

Categoria esposizione: (Entroterra fino a 500 m di altitudine) tipo II
 ($K_r = 0,19$; $Z_o = 0,05 \text{ m}$; $Z_{\min} = 4 \text{ m}$)

Pressione cinetica di riferimento, $q_b = \frac{1}{2} \cdot \rho \cdot V_r^2 = 444 \text{ N/mq}$

Coefficiente di forma, $C_p = 1,00$

Coefficiente dinamico, $C_d = 1,00$

Coefficiente di esposizione, $C_e = 1,80$ formula:

$$c_e(z) = k_r^2 c_t \ln(z/z_0) [7 + c_t \ln(z/z_0)] \quad \text{per } z \geq z_{\min}$$

$$c_e(z) = c_e(z_{\min}) \quad \text{per } z < z_{\min}$$

Coefficiente di esposizione topografica, $C_t = 1,00$

Altezza dell'edificio, $h = 3,20 \text{ m}$

Pressione del vento, $p = q_b C_e C_p C_d = 790 \text{ N/mq}$

4.3.2.c AZIONI TERMICHE

Sono state considerate variazioni di temperatura uniformi pari a $\pm 25^\circ\text{C}$, come previsto dalle NTC2018 al §3.5.5 per strutture in acciaio esposte.

4.3.2.d AZIONI SISMICHE

Con riferimento alle Norme Tecniche per le Costruzioni DM 2018 [IX], l'azione sismica sull'opera in esame è stata valutata a partire da una "pericolosità sismica di base" in condizioni ideali di sito di riferimento rigido con superficie topografica orizzontale (di categoria A). Ad oggi, la pericolosità sismica su reticolo di riferimento nell'intervallo di riferimento è fornita dai dati pubblicati sul sito <http://esse1.mi.ingv.it/>.

Nello specifico, le azioni di progetto sono ricavate, ai sensi del DM 2018, a partire dalle accelerazioni a_g e dalle relative forme spettrali; quest'ultime sono definite, secondo norma, su sito di riferimento rigido orizzontale in funzione dei tre parametri $p(a_g, F_o, T^*c)$ - Tabella B, [XI] - e da prescelte probabilità di superamento P_{VR} e vite di riferimento V_R .

Per il calcolo dei parametri sismici locali e delle accelerazioni e tempi di ritorno riferiti ai differenti stati limite considerati sono state assunte le seguenti ipotesi di progetto ai sensi del Par. 2.4. delle NTC 2018 [IX]:

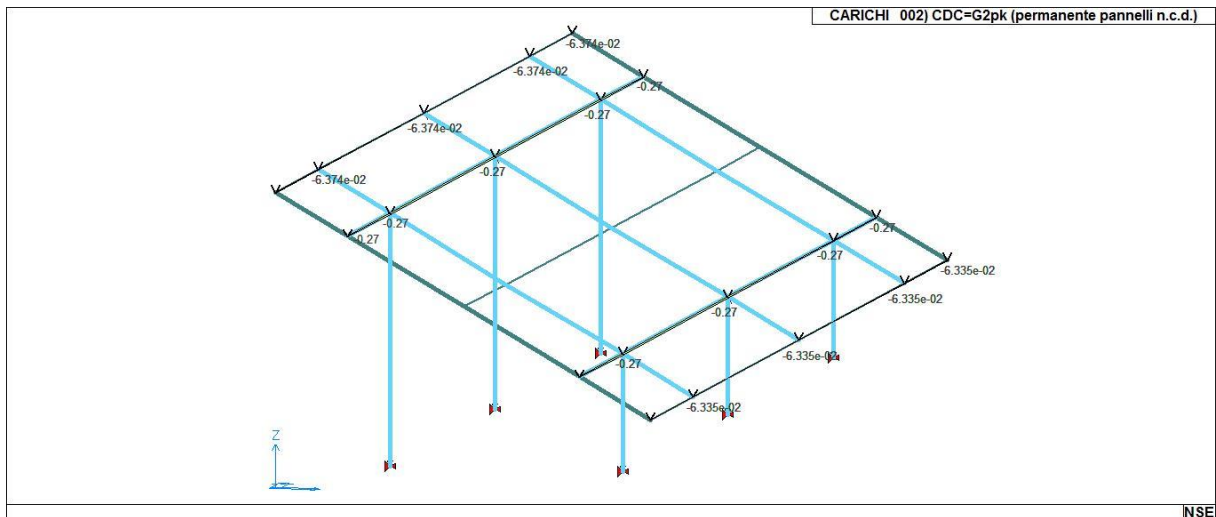

22_CDC_002_CDC=G2pk (permanente pannelli n.c.d.)

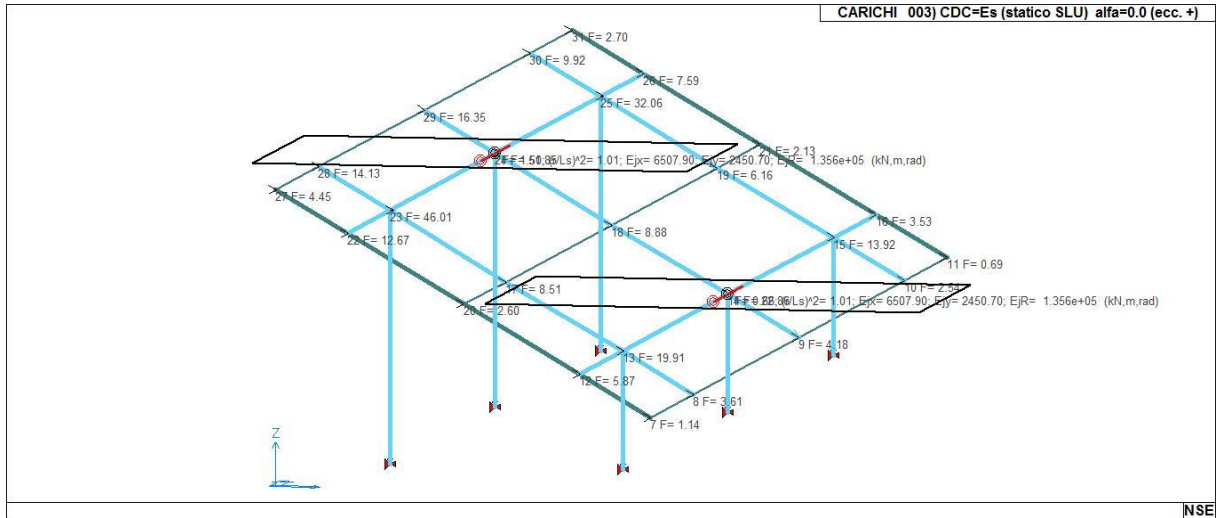

22_CDC_003_CDC=Es (statico SLU) alfa=0.0 (ecc. +)

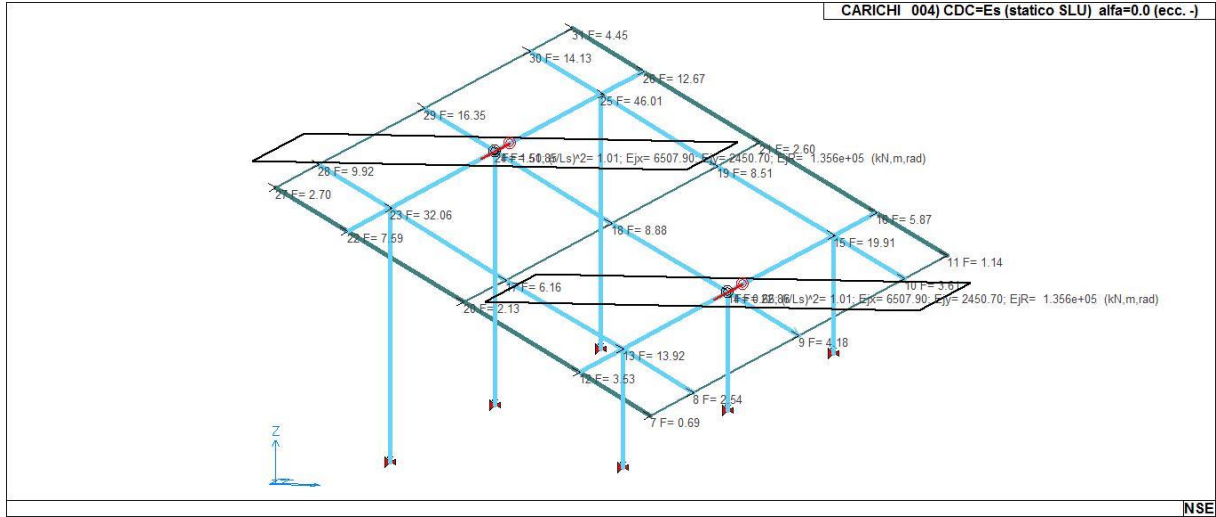

22_CDC_004_CDC=Es (statico SLU) alfa=0.0 (ecc. -)

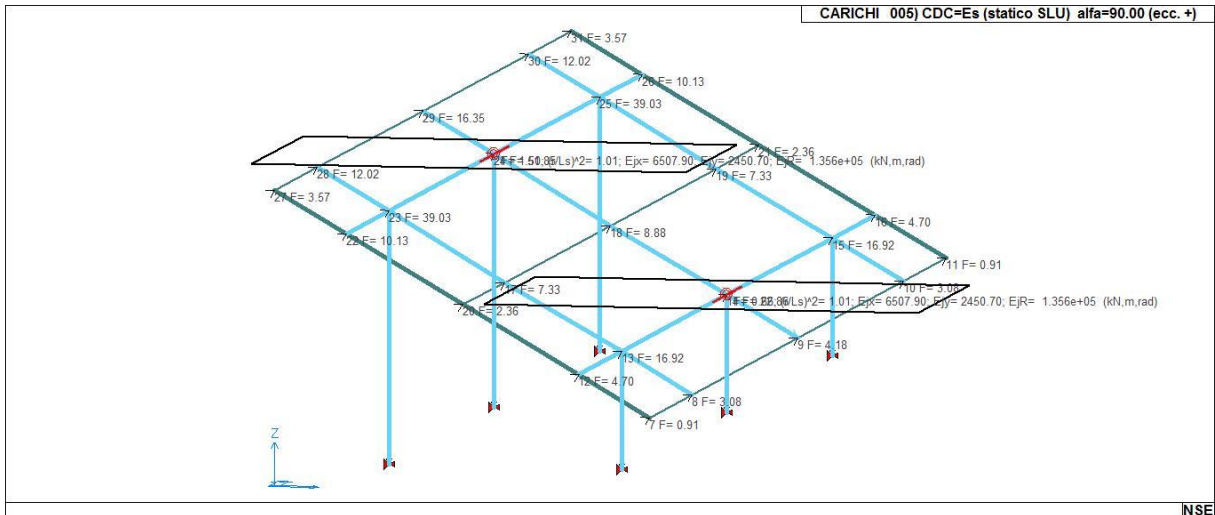

22_CDC_005_CDC=Es (statico SLU) alfa=90.00 (ecc. +)

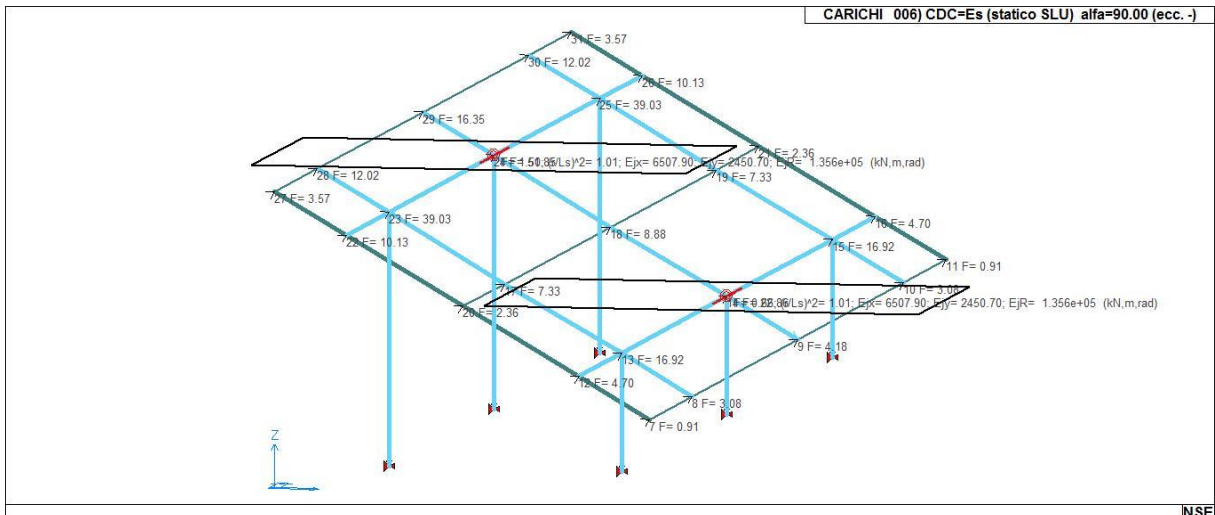

22_CDC_006_CDC=Es (statico SLU) alfa=90.00 (ecc. -)

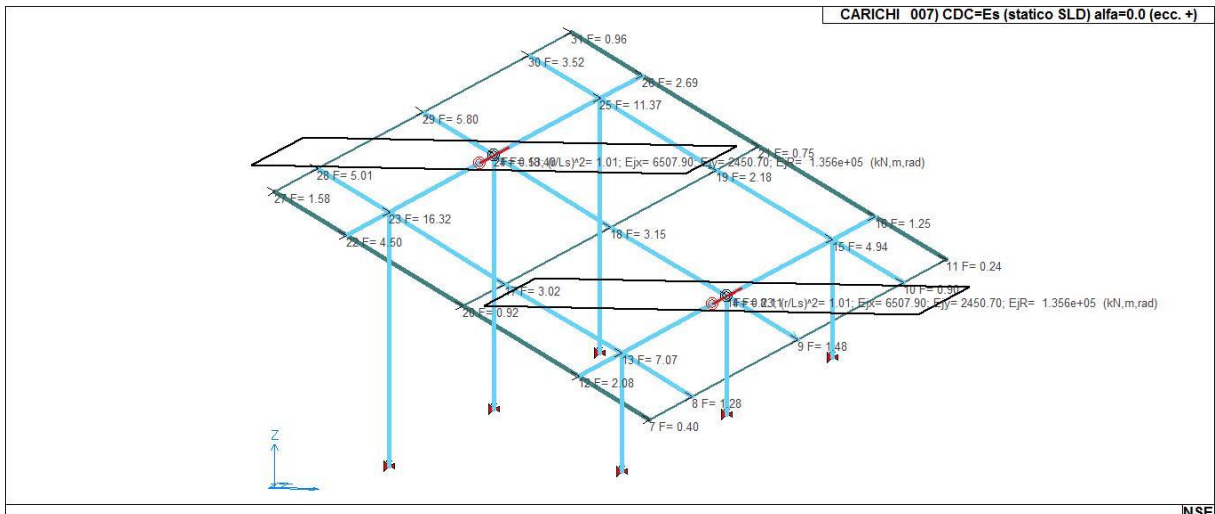

22_CDC_007_CDC=Es (statico SLD) alfa=0.0 (ecc. +)

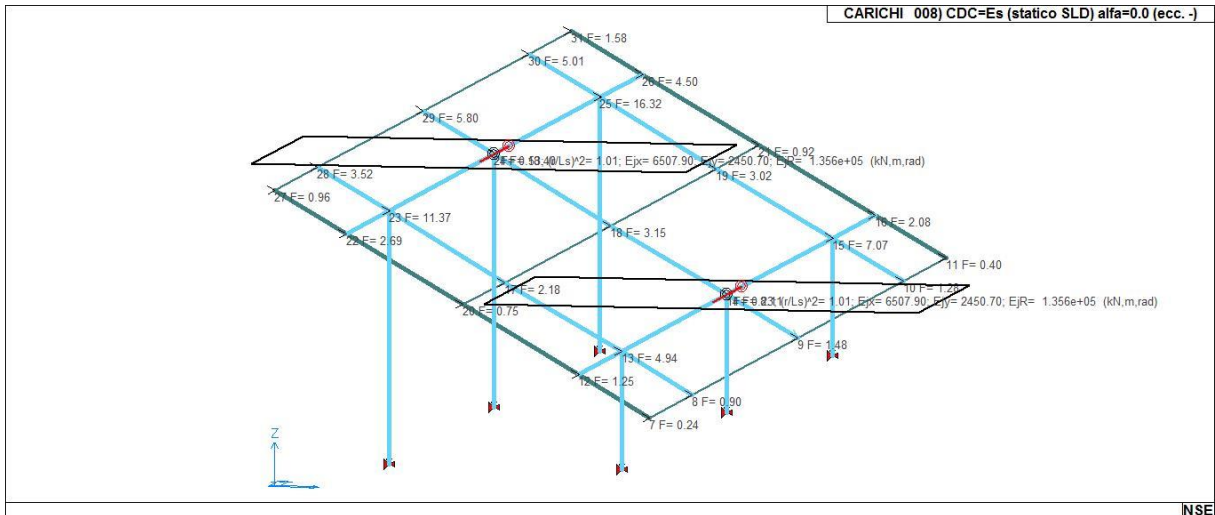

22_CDC_008_CDC=Es (statico SLD) alfa=0.0 (ecc. -)

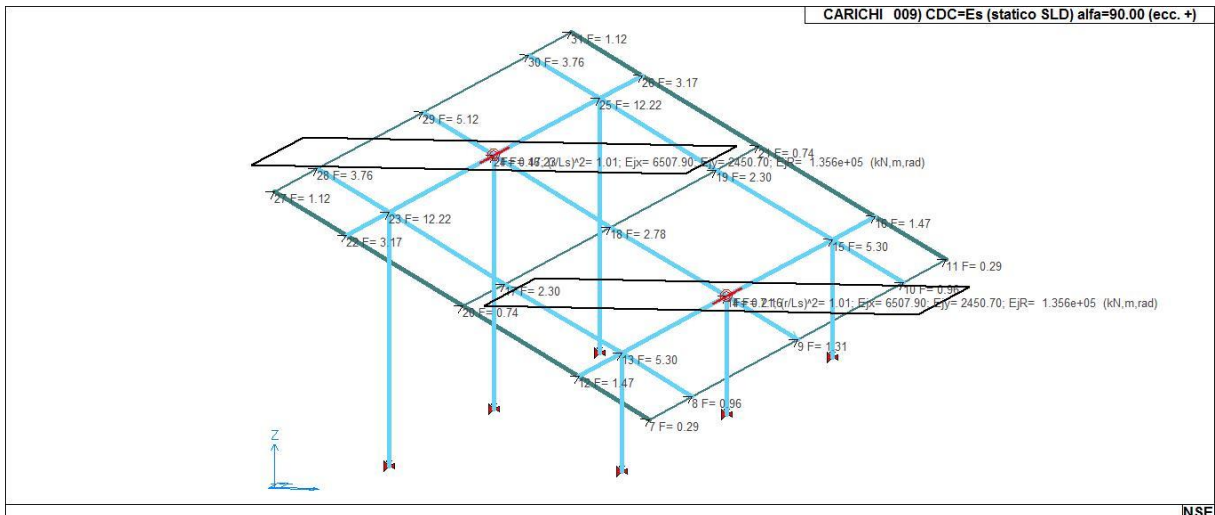

22_CDC_009_CDC=Es (statico SLD) alfa=90.00 (ecc. +)

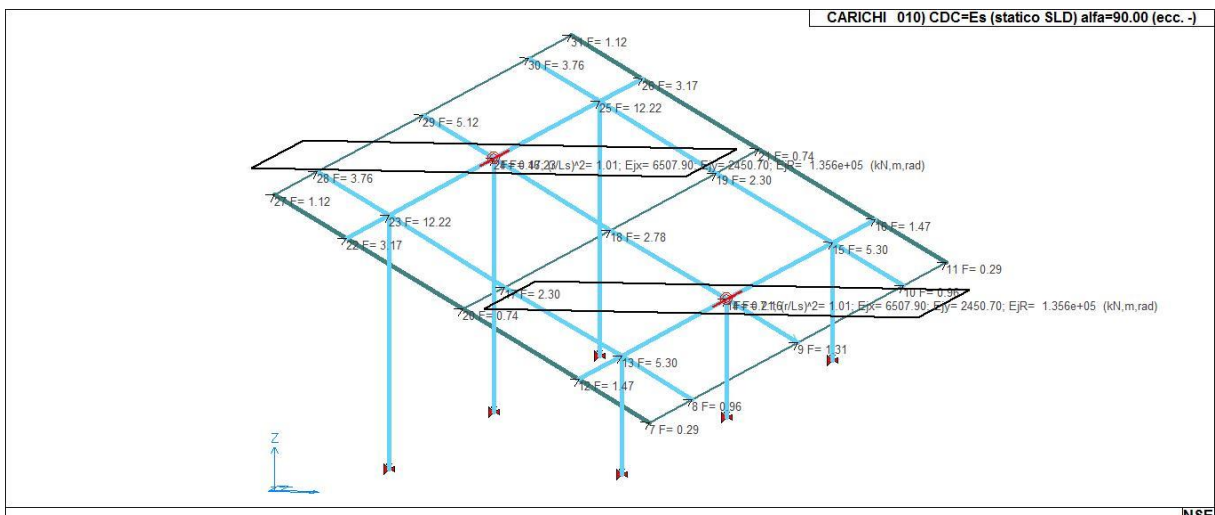

22_CDC_010_CDC=Es (statico SLD) alfa=90.00 (ecc. -)

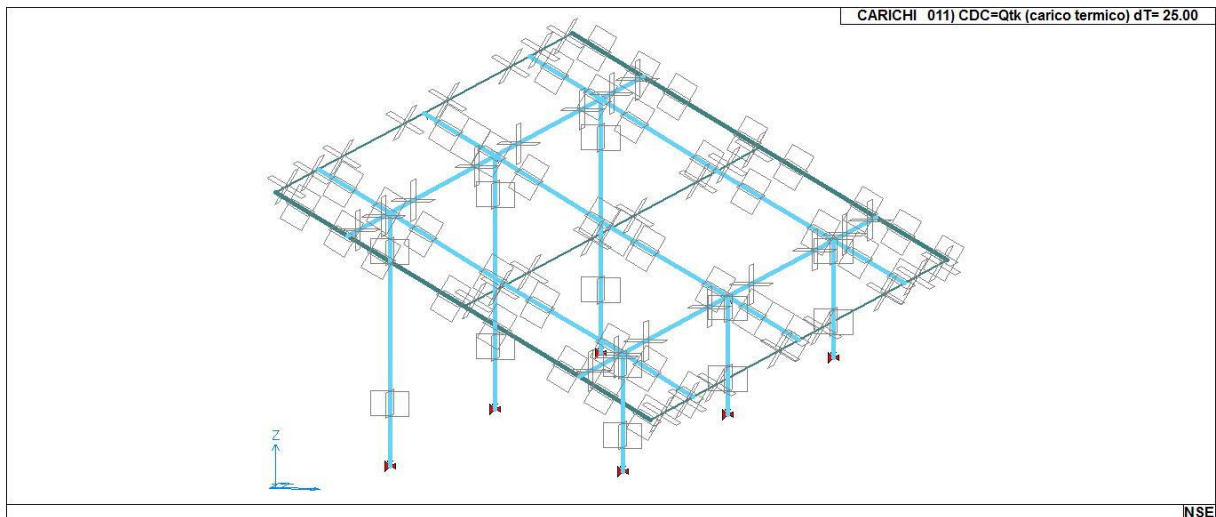

22_CDC_011_CDC=Qtk (carico termico) dT= 25.00

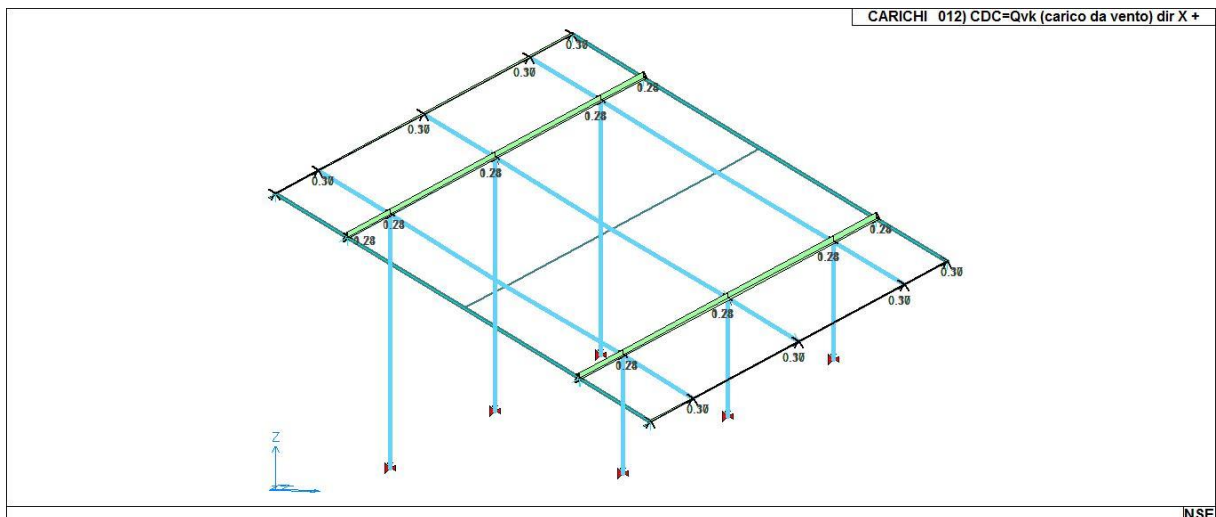

22_CDC_012_CDC=Qvk (carico da vento) dir X +

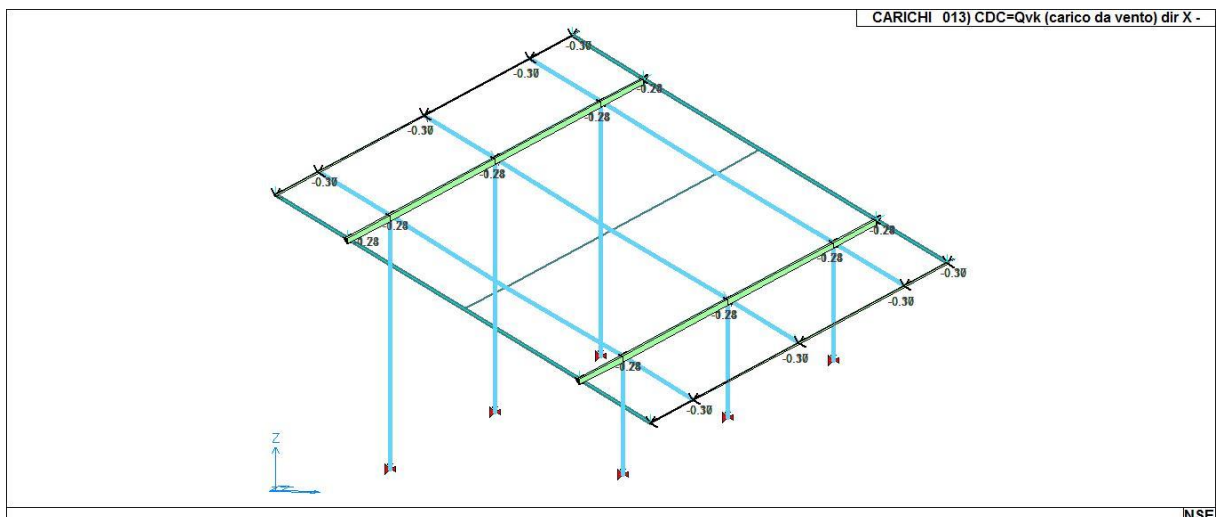

22_CDC_013_CDC=Qvk (carico da vento) dir X -

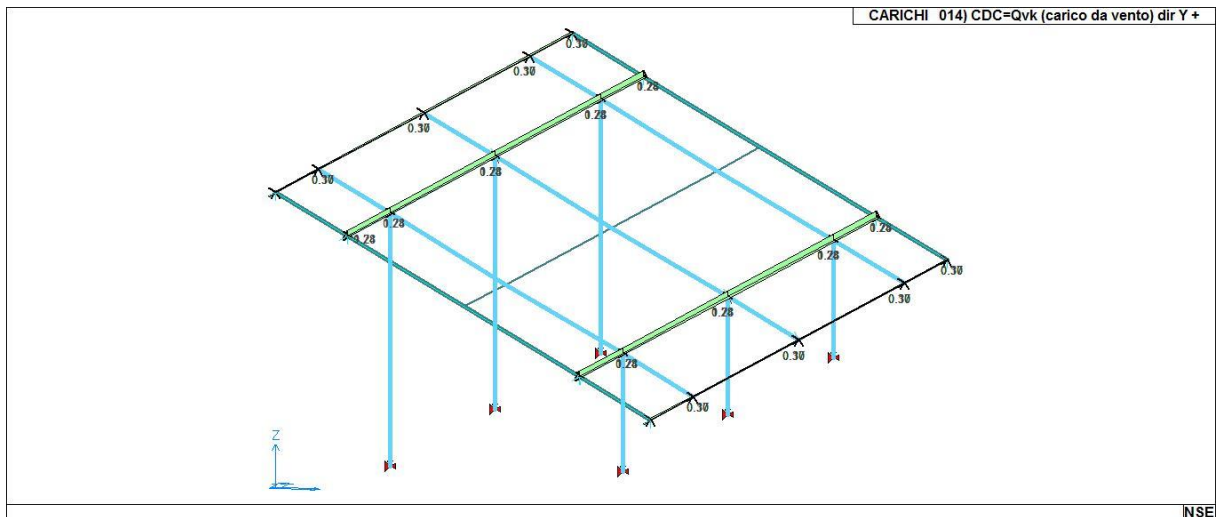

22_CDC_014_CDC=Qvk (carico da vento) dir Y +

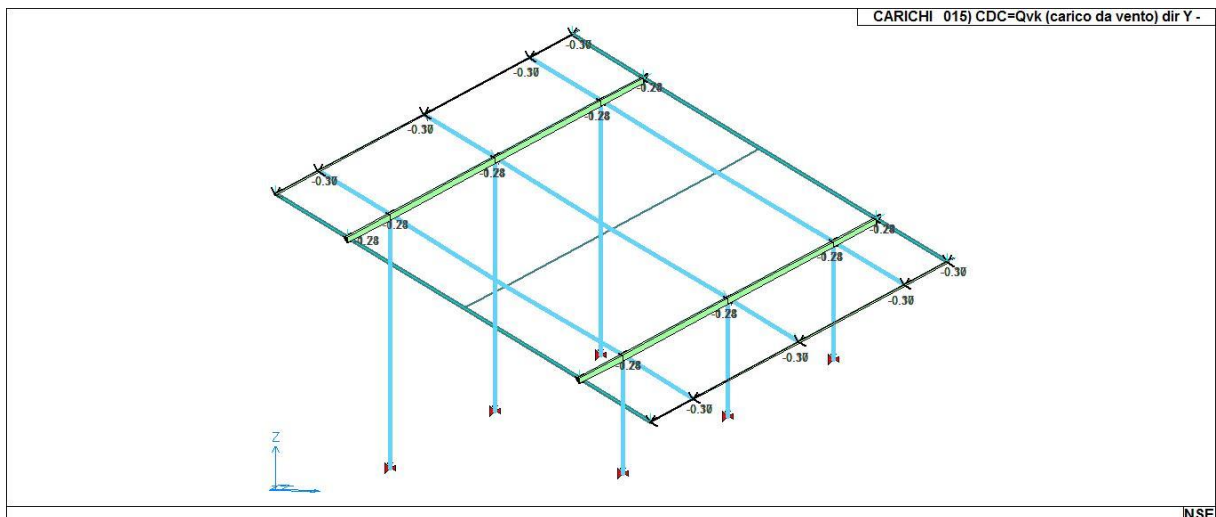

22_CDC_015_CDC=Qvk (carico da vento) dir Y -

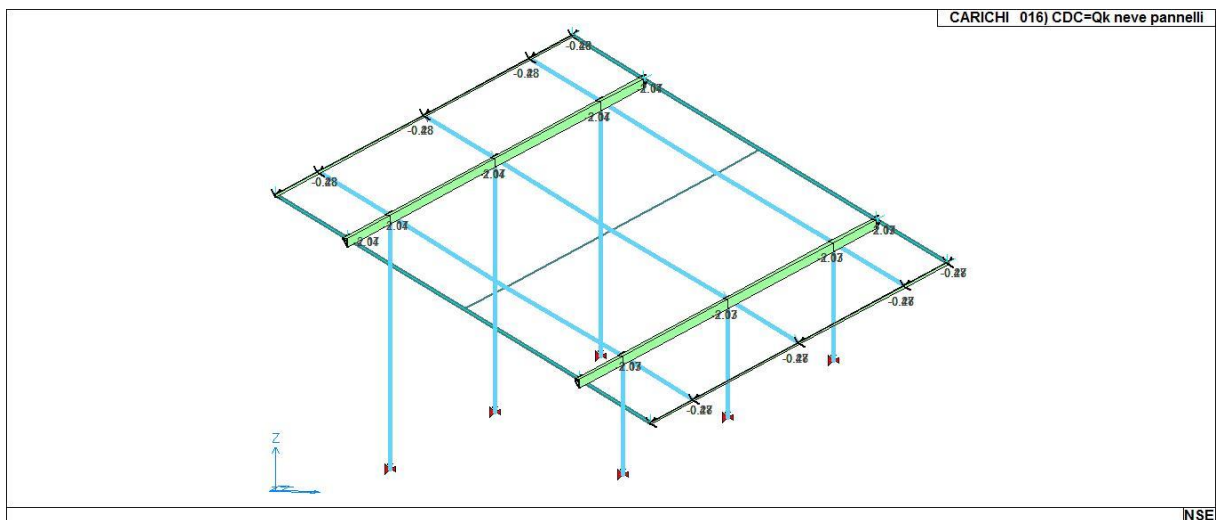

22_CDC_016_CDC=Qk neve pannelli

COMBINAZIONI DI CARICO

La progettazione strutturale è stata eseguita, ai sensi del D.M. 2018 [IX], verificando che l'opera

soddisfi i requisiti di sicurezza nei confronti degli Stati Limite Ultimi.

La progettazione strutturale è stata eseguita, ai sensi del D.M. 2008 [XI], verificando che l'opera soddisfi i requisiti di sicurezza nei confronti degli Stati Limite Ultimi SLU, degli Stati Limite di Esercizio SLE e dell'azione del sisma lungo le due direzioni x ed y.

Pertanto, sono state considerate combinazioni di carico per azioni verticali e orizzontali, tali da risultare più sfavorevoli ai fini delle singole verifiche, tenendo conto sia della probabilità ridotta di intervento simultaneo di tutte le azioni con i rispettivi valori più sfavorevoli sia della probabilità che l'azione si verifichi con specifica intensità in relazione alle diverse situazioni analizzate.

- Per gli Stati Limite Ultimi è stata adottata la combinazione fondamentale per soli carichi statici, affinché siano soddisfatte le verifiche allo Stato Limite di salvaguardia della Vita (SLV):

$$\gamma_{G1} \cdot G_1 + \gamma_{G2} \cdot G_2 + \gamma_P \cdot P + \gamma_{Q1} \cdot Q_{k1} + \gamma_{Q2} \cdot \psi_{02} \cdot Q_{k2} + \gamma_{Q3} \cdot \psi_{03} \cdot Q_{k3} + \dots \quad \text{Combinazione 1}$$

dove:

G_1 rappresenta il peso proprio di tutti gli elementi strutturali; peso proprio del terreno, quando pertinente; forze indotte dal terreno (esclusi gli effetti di carichi variabili applicati al terreno); forze risultanti dalla pressione dell'acqua (quando si configurino costanti nel tempo);

G_2 rappresenta il peso proprio di tutti gli elementi non strutturali;

P rappresenta pretensione e precompressione;

Q azioni sulla struttura o sull'elemento strutturale con valori istantanei che possono risultare sensibilmente diversi fra loro nel tempo

Q_{ki} rappresenta il valore caratteristico della i-esima azione variabile;

$\gamma_g, \gamma_q, \gamma_p$ coefficienti parziali come definiti nella tabella 6.2.I delle NTC;

ψ_{0j} sono i coefficienti di combinazione per tenere conto della ridotta probabilità di concomitanza delle azioni variabili con i rispettivi valori caratteristici, come definiti nella tabella 2.5.I. delle NTC

- Per gli Stati Limite di Esercizio degli elementi strutturali, degli elementi non strutturali e degli impianti le verifiche sono state condotte facendo riferimento alle seguenti combinazioni di carico:

$$G_1 + G_2 + P + \psi_{21} \cdot Q_{k1} + \psi_{22} \cdot Q_{k2} + \psi_{23} \cdot Q_{k3} + \dots \quad \text{Combinazione quasi permanente n°2}$$

$$G_1 + G_2 + P + \psi_{11} \cdot Q_{k1} + \psi_{22} \cdot Q_{k2} + \psi_{23} \cdot Q_{k3} + \dots \quad \text{Combinazione frequente n°3}$$

$$G_1 + G_2 + P + Q_{k1} + \psi_{02} \cdot Q_{k2} + \psi_{03} \cdot Q_{k3} + \dots \quad \text{Combinazione caratteristica (rara) n°4}$$

dove:

G_1 rappresenta il peso proprio di tutti gli elementi strutturali; peso proprio del terreno, quando pertinente; forze indotte dal terreno (esclusi gli effetti di carichi variabili applicati al terreno); forze risultanti dalla pressione dell'acqua (quando si configurino costanti nel tempo);

G_2 rappresenta il peso proprio di tutti gli elementi non strutturali;

P rappresenta pretensione e precompressione;

Q azioni sulla struttura o sull'elemento strutturale con valori istantanei che possono risultare sensibilmente diversi fra loro nel tempo

Q_{ki} rappresenta il valore caratteristico della i -esima azione variabile;

ψ_{0j} , ψ_{1j} , ψ_{2j} sono i coefficienti di combinazione per tenere conto della ridotta probabilità di concomitanza delle azioni variabili con i rispettivi valori caratteristici, come definiti nella tabella 2.5.I.

- In zona sismica, le sollecitazioni derivanti dalle sole azioni sismiche sono state poi combinate con quelle derivanti dai soli carichi statici secondo un'opportuna combinazione sismica:

$$E + G_1 + G_2 + P + \psi_{21} \cdot Q_{k1} + \psi_{22} \cdot Q_{k2} + \dots \text{ (Sisma X+, Sisma Y+)}$$

$$E + G_1 + G_2 + P + \psi_{21} \cdot Q_{k1} + \psi_{22} \cdot Q_{k2} + \dots \text{ (Sisma X+, Sisma Y-)}$$

$$E + G_1 + G_2 + P + \psi_{21} \cdot Q_{k1} + \psi_{22} \cdot Q_{k2} + \dots \text{ (Sisma X-, Sisma Y+)}$$

$$E + G_1 + G_2 + P + \psi_{21} \cdot Q_{k1} + \psi_{22} \cdot Q_{k2} + \dots \text{ (Sisma X-, Sisma Y-)}$$

dove:

E è l'azione sismica per lo stato limite e per la classe di importanza in esame;

G_1 rappresenta il peso proprio di tutti gli elementi strutturali;

G_2 rappresenta il peso proprio di tutti gli elementi non strutturali;

P rappresenta pretensione e precompressione;

ψ_{2i} coefficiente di combinazione delle azioni variabili Q_i come definiti in tab. 2.5.I. delle NTC

Q_{ki} valore caratteristico dell'azione variabile Q_i

$\gamma_E, \gamma_G, \gamma_P, \gamma_Q$ coefficienti parziali pari ad 1.

Dove:

NTC 2018 Tabella 2.5.I

Destinazione d'uso/azione	ψ_0	ψ_1	ψ_2
<i>Categoria A residenziali</i>	0,70	0,50	0,30
<i>Categoria B uffici</i>	0,70	0,50	0,30
<i>Categoria C ambienti suscettibili di affollamento</i>	0,70	0,70	0,60
<i>Categoria D ambienti ad uso commerciale</i>	0,70	0,70	0,60
<i>Categoria E biblioteche, archivi, magazzini, ...</i>	1,00	0,90	0,80
<i>Categoria F Rimesse e parcheggi (autoveicoli $\leq 30kN$)</i>	0,70	0,70	0,60
<i>Categoria G Rimesse e parcheggi (autoveicoli $> 30kN$)</i>	0,70	0,50	0,30
<i>Categoria H Coperture</i>	0,00	0,00	0,00
<i>Vento</i>	0,60	0,20	0,00
<i>Neve a quota ≤ 1000 m</i>	0,50	0,20	0,00
<i>Neve a quota > 1000 m</i>	0,70	0,50	0,20
<i>Variazioni Termiche</i>	0,60	0,50	0,00

Nelle verifiche possono essere adottati in alternativa due diversi approcci progettuali:

- per l'approccio 1 si considerano due diverse combinazioni di gruppi di coefficienti di sicurezza parziali per le azioni, per i materiali e per la resistenza globale (combinazione 1 con coefficienti A1 e combinazione 2 con coefficienti A2),

- per l'approccio 2 si definisce un'unica combinazione per le azioni, per la resistenza dei materiali e per la resistenza globale (con coefficienti A1).

NTC 2018 Tabella 2.6.1

		Coefficiente	EQU	A1	A2
		γ_f			
<i>Carichi permanenti</i>	<i>Favorevoli</i>	γ_{G1}	0,9	1,0	1,0
	<i>Sfavorevoli</i>		1,1	1,3	1,0
<i>Carichi permanenti non strutturali</i>	<i>Favorevoli</i>	γ_{G2}	0,8	0,8	0,8
	<i>Sfavorevoli</i>		1,5	1,5	1,3
<i>(Non compiutamente definiti)</i>					
<i>Carichi variabili</i>	<i>Favorevoli</i>	γ_{Qi}	0,0	0,0	0,0
	<i>Sfavorevoli</i>		1,5	1,5	1,3

Nella presente analisi si è adottato l'approccio 2

Cmb	Tipo	Sigla Id
1	SLU	Comb. SLU A1 13
2	SLU	Comb. SLU A1 14
3	SLU	Comb. SLU A1 17
4	SLU	Comb. SLU A1 18
5	SLU	Comb. SLU A1 25
6	SLU	Comb. SLU A1 26
7	SLU	Comb. SLU A1 29
8	SLU	Comb. SLU A1 30
9	SLU	Comb. SLU A1 37
10	SLU	Comb. SLU A1 38
11	SLU	Comb. SLU A1 41
12	SLU	Comb. SLU A1 42
13	SLU	Comb. SLU A1 45
14	SLU	Comb. SLU A1 46
15	SLU	Comb. SLU A1 53
16	SLU	Comb. SLU A1 54
17	SLU	Comb. SLU A1 57
18	SLU	Comb. SLU A1 58
19	SLU	Comb. SLU A1 61
20	SLU	Comb. SLU A1 62
21	SLU	Comb. SLU A1 69
22	SLU	Comb. SLU A1 70
23	SLU	Comb. SLU A1 73
24	SLU	Comb. SLU A1 74
25	SLU (Terr. G)	Comb. SLU TIPO EQU 91
26	SLU (Terr. G)	Comb. SLU TIPO EQU 92
27	SLU (Terr. G)	Comb. SLU TIPO EQU 95
28	SLU (Terr. G)	Comb. SLU TIPO EQU 96
29	SLU (Terr. G)	Comb. SLU TIPO EQU 103
30	SLU (Terr. G)	Comb. SLU TIPO EQU 104
31	SLU (Terr. G)	Comb. SLU TIPO EQU 107
32	SLU (Terr. G)	Comb. SLU TIPO EQU 108
33	SLU (Terr. G)	Comb. SLU TIPO EQU 115
34	SLU (Terr. G)	Comb. SLU TIPO EQU 116
35	SLU (Terr. G)	Comb. SLU TIPO EQU 119
36	SLU (Terr. G)	Comb. SLU TIPO EQU 120
37	SLU (Terr. G)	Comb. SLU TIPO EQU 123
38	SLU (Terr. G)	Comb. SLU TIPO EQU 124
39	SLU (Terr. G)	Comb. SLU TIPO EQU 131
40	SLU (Terr. G)	Comb. SLU TIPO EQU 132
41	SLU (Terr. G)	Comb. SLU TIPO EQU 135

Cmb	Tipo	Sigla Id
42	SLU (Terr. G)	Comb. SLU TIPO EQU 136
43	SLU (Terr. G)	Comb. SLU TIPO EQU 139
44	SLU (Terr. G)	Comb. SLU TIPO EQU 140
45	SLU (Terr. G)	Comb. SLU TIPO EQU 147
46	SLU (Terr. G)	Comb. SLU TIPO EQU 148
47	SLU (Terr. G)	Comb. SLU TIPO EQU 151
48	SLU (Terr. G)	Comb. SLU TIPO EQU 152
49	SLU	Comb. SLU A1 (SLV sism.) 49
50	SLU	Comb. SLU A1 (SLV sism.) 50
51	SLU	Comb. SLU A1 (SLV sism.) 51
52	SLU	Comb. SLU A1 (SLV sism.) 52
53	SLU	Comb. SLU A1 (SLV sism.) 53
54	SLU	Comb. SLU A1 (SLV sism.) 54
55	SLU	Comb. SLU A1 (SLV sism.) 55
56	SLU	Comb. SLU A1 (SLV sism.) 56
57	SLU	Comb. SLU A1 (SLV sism.) 57
58	SLU	Comb. SLU A1 (SLV sism.) 58
59	SLU	Comb. SLU A1 (SLV sism.) 59
60	SLU	Comb. SLU A1 (SLV sism.) 60
61	SLU	Comb. SLU A1 (SLV sism.) 61
62	SLU	Comb. SLU A1 (SLV sism.) 62
63	SLU	Comb. SLU A1 (SLV sism.) 63
64	SLU	Comb. SLU A1 (SLV sism.) 64
65	SLU	Comb. SLU A1 (SLV sism.) 65
66	SLU	Comb. SLU A1 (SLV sism.) 66
67	SLU	Comb. SLU A1 (SLV sism.) 67
68	SLU	Comb. SLU A1 (SLV sism.) 68
69	SLU	Comb. SLU A1 (SLV sism.) 69
70	SLU	Comb. SLU A1 (SLV sism.) 70
71	SLU	Comb. SLU A1 (SLV sism.) 71
72	SLU	Comb. SLU A1 (SLV sism.) 72
73	SLU	Comb. SLU A1 (SLV sism.) 73
74	SLU	Comb. SLU A1 (SLV sism.) 74
75	SLU	Comb. SLU A1 (SLV sism.) 75
76	SLU	Comb. SLU A1 (SLV sism.) 76
77	SLU	Comb. SLU A1 (SLV sism.) 77
78	SLU	Comb. SLU A1 (SLV sism.) 78
79	SLU	Comb. SLU A1 (SLV sism.) 79
80	SLU	Comb. SLU A1 (SLV sism.) 80
81	SLD(sis)	Comb. SLE (SLD Danno sism.) 81
82	SLD(sis)	Comb. SLE (SLD Danno sism.) 82
83	SLD(sis)	Comb. SLE (SLD Danno sism.) 83
84	SLD(sis)	Comb. SLE (SLD Danno sism.) 84
85	SLD(sis)	Comb. SLE (SLD Danno sism.) 85
86	SLD(sis)	Comb. SLE (SLD Danno sism.) 86
87	SLD(sis)	Comb. SLE (SLD Danno sism.) 87
88	SLD(sis)	Comb. SLE (SLD Danno sism.) 88
89	SLD(sis)	Comb. SLE (SLD Danno sism.) 89
90	SLD(sis)	Comb. SLE (SLD Danno sism.) 90
91	SLD(sis)	Comb. SLE (SLD Danno sism.) 91
92	SLD(sis)	Comb. SLE (SLD Danno sism.) 92
93	SLD(sis)	Comb. SLE (SLD Danno sism.) 93
94	SLD(sis)	Comb. SLE (SLD Danno sism.) 94
95	SLD(sis)	Comb. SLE (SLD Danno sism.) 95
96	SLD(sis)	Comb. SLE (SLD Danno sism.) 96
97	SLD(sis)	Comb. SLE (SLD Danno sism.) 97
98	SLD(sis)	Comb. SLE (SLD Danno sism.) 98
99	SLD(sis)	Comb. SLE (SLD Danno sism.) 99
100	SLD(sis)	Comb. SLE (SLD Danno sism.) 100
101	SLD(sis)	Comb. SLE (SLD Danno sism.) 101
102	SLD(sis)	Comb. SLE (SLD Danno sism.) 102
103	SLD(sis)	Comb. SLE (SLD Danno sism.) 103
104	SLD(sis)	Comb. SLE (SLD Danno sism.) 104
105	SLD(sis)	Comb. SLE (SLD Danno sism.) 105
106	SLD(sis)	Comb. SLE (SLD Danno sism.) 106
107	SLD(sis)	Comb. SLE (SLD Danno sism.) 107
108	SLD(sis)	Comb. SLE (SLD Danno sism.) 108
109	SLD(sis)	Comb. SLE (SLD Danno sism.) 109
110	SLD(sis)	Comb. SLE (SLD Danno sism.) 110
111	SLD(sis)	Comb. SLE (SLD Danno sism.) 111
112	SLD(sis)	Comb. SLE (SLD Danno sism.) 112
113	SLE(r)	Comb. SLE(rara) 119
114	SLE(r)	Comb. SLE(rara) 120

Cmb	Tipo	Sigla Id
115	SLE(r)	Comb. SLE(rara) 121
116	SLE(r)	Comb. SLE(rara) 122
117	SLE(r)	Comb. SLE(rara) 125
118	SLE(r)	Comb. SLE(rara) 126
119	SLE(r)	Comb. SLE(rara) 127
120	SLE(r)	Comb. SLE(rara) 128
121	SLE(r)	Comb. SLE(rara) 131
122	SLE(r)	Comb. SLE(rara) 132
123	SLE(r)	Comb. SLE(rara) 133
124	SLE(r)	Comb. SLE(rara) 134
125	SLE(r)	Comb. SLE(rara) 135
126	SLE(r)	Comb. SLE(rara) 136
127	SLE(r)	Comb. SLE(rara) 139
128	SLE(r)	Comb. SLE(rara) 140
129	SLE(r)	Comb. SLE(rara) 141
130	SLE(r)	Comb. SLE(rara) 142
131	SLE(r)	Comb. SLE(rara) 143
132	SLE(r)	Comb. SLE(rara) 144
133	SLE(r)	Comb. SLE(rara) 147
134	SLE(r)	Comb. SLE(rara) 148
135	SLE(r)	Comb. SLE(rara) 149
136	SLE(r)	Comb. SLE(rara) 150
137	SLE(f)	Comb. SLE(freq.) 137
138	SLE(f)	Comb. SLE(freq.) 138
139	SLE(f)	Comb. SLE(freq.) 140
140	SLE(f)	Comb. SLE(freq.) 141
141	SLE(f)	Comb. SLE(freq.) 142
142	SLE(f)	Comb. SLE(freq.) 143
143	SLE(f)	Comb. SLE(freq.) 144
144	SLE(p)	Comb. SLE(perm.) 144

Cmb	CDC 1/15...	CDC 2/16...	CDC 3/17...	CDC 4/18...	CDC 5/19...	CDC 6/20...	CDC 7/21...	CDC 8/22...	CDC 9/23...	CDC 10/24...	CDC 11/25...	CDC 12/26...	CDC 13/27...	CDC 14/28...
1	1.30	1.30	0.0	0.0	0.0	0.0	0.0	0.0	0.0	0.0	-1.50	0.90	0.0	0.0
	0.0	0.75												
2	1.30	1.30	0.0	0.0	0.0	0.0	0.0	0.0	0.0	0.0	1.50	0.90	0.0	0.0
	0.0	0.75												
3	1.30	1.30	0.0	0.0	0.0	0.0	0.0	0.0	0.0	0.0	-0.90	1.50	0.0	0.0
	0.0	0.75												
4	1.30	1.30	0.0	0.0	0.0	0.0	0.0	0.0	0.0	0.0	0.90	1.50	0.0	0.0
	0.0	0.75												
5	1.30	1.30	0.0	0.0	0.0	0.0	0.0	0.0	0.0	0.0	-0.90	0.90	0.0	0.0
	0.0	1.50												
6	1.30	1.30	0.0	0.0	0.0	0.0	0.0	0.0	0.0	0.0	0.90	0.90	0.0	0.0
	0.0	1.50												
7	1.30	1.30	0.0	0.0	0.0	0.0	0.0	0.0	0.0	0.0	-1.50	0.0	0.90	0.0
	0.0	0.75												
8	1.30	1.30	0.0	0.0	0.0	0.0	0.0	0.0	0.0	0.0	1.50	0.0	0.90	0.0
	0.0	0.75												
9	1.30	1.30	0.0	0.0	0.0	0.0	0.0	0.0	0.0	0.0	-0.90	0.0	1.50	0.0
	0.0	0.75												
10	1.30	1.30	0.0	0.0	0.0	0.0	0.0	0.0	0.0	0.0	0.90	0.0	1.50	0.0
	0.0	0.75												
11	1.30	1.30	0.0	0.0	0.0	0.0	0.0	0.0	0.0	0.0	-0.90	0.0	0.90	0.0
	0.0	1.50												
12	1.30	1.30	0.0	0.0	0.0	0.0	0.0	0.0	0.0	0.0	0.90	0.0	0.90	0.0
	0.0	1.50												
13	1.30	1.30	0.0	0.0	0.0	0.0	0.0	0.0	0.0	0.0	-1.50	0.0	0.0	0.90
	0.0	0.75												
14	1.30	1.30	0.0	0.0	0.0	0.0	0.0	0.0	0.0	0.0	1.50	0.0	0.0	0.90
	0.0	0.75												
15	1.30	1.30	0.0	0.0	0.0	0.0	0.0	0.0	0.0	0.0	-0.90	0.0	0.0	1.50
	0.0	0.75												
16	1.30	1.30	0.0	0.0	0.0	0.0	0.0	0.0	0.0	0.0	0.90	0.0	0.0	1.50
	0.0	0.75												
17	1.30	1.30	0.0	0.0	0.0	0.0	0.0	0.0	0.0	0.0	-0.90	0.0	0.0	0.90
	0.0	1.50												
18	1.30	1.30	0.0	0.0	0.0	0.0	0.0	0.0	0.0	0.0	0.90	0.0	0.0	0.90
	0.0	1.50												
19	1.30	1.30	0.0	0.0	0.0	0.0	0.0	0.0	0.0	0.0	-1.50	0.0	0.0	0.0
	0.90	0.75												
20	1.30	1.30	0.0	0.0	0.0	0.0	0.0	0.0	0.0	0.0	1.50	0.0	0.0	0.0

Cmb	CDC 1/15...	CDC 2/16...	CDC 3/17...	CDC 4/18...	CDC 5/19...	CDC 6/20...	CDC 7/21...	CDC 8/22...	CDC 9/23...	CDC 10/24...	CDC 11/25...	CDC 12/26...	CDC 13/27...	CDC 14/28...
	0.90	0.75												
21	1.30	1.30	0.0	0.0	0.0	0.0	0.0	0.0	0.0	0.0	-0.90	0.0	0.0	0.0
	1.50	0.75												
22	1.30	1.30	0.0	0.0	0.0	0.0	0.0	0.0	0.0	0.0	0.90	0.0	0.0	0.0
	1.50	0.75												
23	1.30	1.30	0.0	0.0	0.0	0.0	0.0	0.0	0.0	0.0	-0.90	0.0	0.0	0.0
	0.90	1.50												
24	1.30	1.30	0.0	0.0	0.0	0.0	0.0	0.0	0.0	0.0	0.90	0.0	0.0	0.0
	0.90	1.50												
25	0.90	0.90	0.0	0.0	0.0	0.0	0.0	0.0	0.0	0.0	-1.50	0.90	0.0	0.0
	0.0	0.75												
26	0.90	0.90	0.0	0.0	0.0	0.0	0.0	0.0	0.0	0.0	1.50	0.90	0.0	0.0
	0.0	0.75												
27	0.90	0.90	0.0	0.0	0.0	0.0	0.0	0.0	0.0	0.0	-0.90	1.50	0.0	0.0
	0.0	0.75												
28	0.90	0.90	0.0	0.0	0.0	0.0	0.0	0.0	0.0	0.0	0.90	1.50	0.0	0.0
	0.0	0.75												
29	0.90	0.90	0.0	0.0	0.0	0.0	0.0	0.0	0.0	0.0	-0.90	0.90	0.0	0.0
	0.0	1.50												
30	0.90	0.90	0.0	0.0	0.0	0.0	0.0	0.0	0.0	0.0	0.90	0.90	0.0	0.0
	0.0	1.50												
31	0.90	0.90	0.0	0.0	0.0	0.0	0.0	0.0	0.0	0.0	-1.50	0.0	0.90	0.0
	0.0	0.75												
32	0.90	0.90	0.0	0.0	0.0	0.0	0.0	0.0	0.0	0.0	1.50	0.0	0.90	0.0
	0.0	0.75												
33	0.90	0.90	0.0	0.0	0.0	0.0	0.0	0.0	0.0	0.0	-0.90	0.0	1.50	0.0
	0.0	0.75												
34	0.90	0.90	0.0	0.0	0.0	0.0	0.0	0.0	0.0	0.0	0.90	0.0	1.50	0.0
	0.0	0.75												
35	0.90	0.90	0.0	0.0	0.0	0.0	0.0	0.0	0.0	0.0	-0.90	0.0	0.90	0.0
	0.0	1.50												
36	0.90	0.90	0.0	0.0	0.0	0.0	0.0	0.0	0.0	0.0	0.90	0.0	0.90	0.0
	0.0	1.50												
37	0.90	0.90	0.0	0.0	0.0	0.0	0.0	0.0	0.0	0.0	-1.50	0.0	0.0	0.90
	0.0	0.75												
38	0.90	0.90	0.0	0.0	0.0	0.0	0.0	0.0	0.0	0.0	1.50	0.0	0.0	0.90
	0.0	0.75												
39	0.90	0.90	0.0	0.0	0.0	0.0	0.0	0.0	0.0	0.0	-0.90	0.0	0.0	1.50
	0.0	0.75												
40	0.90	0.90	0.0	0.0	0.0	0.0	0.0	0.0	0.0	0.0	0.90	0.0	0.0	1.50
	0.0	0.75												
41	0.90	0.90	0.0	0.0	0.0	0.0	0.0	0.0	0.0	0.0	-0.90	0.0	0.0	0.90
	0.0	1.50												
42	0.90	0.90	0.0	0.0	0.0	0.0	0.0	0.0	0.0	0.0	0.90	0.0	0.0	0.90
	0.0	1.50												
43	0.90	0.90	0.0	0.0	0.0	0.0	0.0	0.0	0.0	0.0	-1.50	0.0	0.0	0.0
	0.90	0.75												
44	0.90	0.90	0.0	0.0	0.0	0.0	0.0	0.0	0.0	0.0	1.50	0.0	0.0	0.0
	0.90	0.75												
45	0.90	0.90	0.0	0.0	0.0	0.0	0.0	0.0	0.0	0.0	-0.90	0.0	0.0	0.0
	1.50	0.75												
46	0.90	0.90	0.0	0.0	0.0	0.0	0.0	0.0	0.0	0.0	0.90	0.0	0.0	0.0
	1.50	0.75												
47	0.90	0.90	0.0	0.0	0.0	0.0	0.0	0.0	0.0	0.0	-0.90	0.0	0.0	0.0
	0.90	1.50												
48	0.90	0.90	0.0	0.0	0.0	0.0	0.0	0.0	0.0	0.0	0.90	0.0	0.0	0.0
	0.90	1.50												
49	1.00	1.00	-1.00	0.0	-0.30	0.0	0.0	0.0	0.0	0.0	0.0	0.0	0.0	0.0
	0.0	0.0												
50	1.00	1.00	-1.00	0.0	0.30	0.0	0.0	0.0	0.0	0.0	0.0	0.0	0.0	0.0
	0.0	0.0												
51	1.00	1.00	1.00	0.0	-0.30	0.0	0.0	0.0	0.0	0.0	0.0	0.0	0.0	0.0
	0.0	0.0												
52	1.00	1.00	1.00	0.0	0.30	0.0	0.0	0.0	0.0	0.0	0.0	0.0	0.0	0.0
	0.0	0.0												
53	1.00	1.00	-1.00	0.0	0.0	-0.30	0.0	0.0	0.0	0.0	0.0	0.0	0.0	0.0
	0.0	0.0												
54	1.00	1.00	-1.00	0.0	0.0	0.30	0.0	0.0	0.0	0.0	0.0	0.0	0.0	0.0
	0.0	0.0												
55	1.00	1.00	1.00	0.0	0.0	-0.30	0.0	0.0	0.0	0.0	0.0	0.0	0.0	0.0
	0.0	0.0												
56	1.00	1.00	1.00	0.0	0.0	0.30	0.0	0.0	0.0	0.0	0.0	0.0	0.0	0.0
	0.0	0.0												

Cmb	CDC 1/15...	CDC 2/16...	CDC 3/17...	CDC 4/18...	CDC 5/19...	CDC 6/20...	CDC 7/21...	CDC 8/22...	CDC 9/23...	CDC 10/24...	CDC 11/25...	CDC 12/26...	CDC 13/27...	CDC 14/28...
57	1.00	1.00	0.0	-1.00	-0.30	0.0	0.0	0.0	0.0	0.0	0.0	0.0	0.0	0.0
	0.0	0.0												
58	1.00	1.00	0.0	-1.00	0.30	0.0	0.0	0.0	0.0	0.0	0.0	0.0	0.0	0.0
	0.0	0.0												
59	1.00	1.00	0.0	1.00	-0.30	0.0	0.0	0.0	0.0	0.0	0.0	0.0	0.0	0.0
	0.0	0.0												
60	1.00	1.00	0.0	1.00	0.30	0.0	0.0	0.0	0.0	0.0	0.0	0.0	0.0	0.0
	0.0	0.0												
61	1.00	1.00	0.0	-1.00	0.0	-0.30	0.0	0.0	0.0	0.0	0.0	0.0	0.0	0.0
	0.0	0.0												
62	1.00	1.00	0.0	-1.00	0.0	0.30	0.0	0.0	0.0	0.0	0.0	0.0	0.0	0.0
	0.0	0.0												
63	1.00	1.00	0.0	1.00	0.0	-0.30	0.0	0.0	0.0	0.0	0.0	0.0	0.0	0.0
	0.0	0.0												
64	1.00	1.00	0.0	1.00	0.0	0.30	0.0	0.0	0.0	0.0	0.0	0.0	0.0	0.0
	0.0	0.0												
65	1.00	1.00	-0.30	0.0	-1.00	0.0	0.0	0.0	0.0	0.0	0.0	0.0	0.0	0.0
	0.0	0.0												
66	1.00	1.00	-0.30	0.0	1.00	0.0	0.0	0.0	0.0	0.0	0.0	0.0	0.0	0.0
	0.0	0.0												
67	1.00	1.00	0.30	0.0	-1.00	0.0	0.0	0.0	0.0	0.0	0.0	0.0	0.0	0.0
	0.0	0.0												
68	1.00	1.00	0.30	0.0	1.00	0.0	0.0	0.0	0.0	0.0	0.0	0.0	0.0	0.0
	0.0	0.0												
69	1.00	1.00	0.0	-0.30	-1.00	0.0	0.0	0.0	0.0	0.0	0.0	0.0	0.0	0.0
	0.0	0.0												
70	1.00	1.00	0.0	-0.30	1.00	0.0	0.0	0.0	0.0	0.0	0.0	0.0	0.0	0.0
	0.0	0.0												
71	1.00	1.00	0.0	0.30	-1.00	0.0	0.0	0.0	0.0	0.0	0.0	0.0	0.0	0.0
	0.0	0.0												
72	1.00	1.00	0.0	0.30	1.00	0.0	0.0	0.0	0.0	0.0	0.0	0.0	0.0	0.0
	0.0	0.0												
73	1.00	1.00	-0.30	0.0	0.0	-1.00	0.0	0.0	0.0	0.0	0.0	0.0	0.0	0.0
	0.0	0.0												
74	1.00	1.00	-0.30	0.0	0.0	1.00	0.0	0.0	0.0	0.0	0.0	0.0	0.0	0.0
	0.0	0.0												
75	1.00	1.00	0.30	0.0	0.0	-1.00	0.0	0.0	0.0	0.0	0.0	0.0	0.0	0.0
	0.0	0.0												
76	1.00	1.00	0.30	0.0	0.0	1.00	0.0	0.0	0.0	0.0	0.0	0.0	0.0	0.0
	0.0	0.0												
77	1.00	1.00	0.0	-0.30	0.0	-1.00	0.0	0.0	0.0	0.0	0.0	0.0	0.0	0.0
	0.0	0.0												
78	1.00	1.00	0.0	-0.30	0.0	1.00	0.0	0.0	0.0	0.0	0.0	0.0	0.0	0.0
	0.0	0.0												
79	1.00	1.00	0.0	0.30	0.0	-1.00	0.0	0.0	0.0	0.0	0.0	0.0	0.0	0.0
	0.0	0.0												
80	1.00	1.00	0.0	0.30	0.0	1.00	0.0	0.0	0.0	0.0	0.0	0.0	0.0	0.0
	0.0	0.0												
81	1.00	1.00	0.0	0.0	0.0	0.0	-1.00	0.0	-0.30	0.0	0.0	0.0	0.0	0.0
	0.0	0.0												
82	1.00	1.00	0.0	0.0	0.0	0.0	-1.00	0.0	0.30	0.0	0.0	0.0	0.0	0.0
	0.0	0.0												
83	1.00	1.00	0.0	0.0	0.0	0.0	1.00	0.0	-0.30	0.0	0.0	0.0	0.0	0.0
	0.0	0.0												
84	1.00	1.00	0.0	0.0	0.0	0.0	1.00	0.0	0.30	0.0	0.0	0.0	0.0	0.0
	0.0	0.0												
85	1.00	1.00	0.0	0.0	0.0	0.0	-1.00	0.0	0.0	-0.30	0.0	0.0	0.0	0.0
	0.0	0.0												
86	1.00	1.00	0.0	0.0	0.0	0.0	-1.00	0.0	0.0	0.30	0.0	0.0	0.0	0.0
	0.0	0.0												
87	1.00	1.00	0.0	0.0	0.0	0.0	1.00	0.0	0.0	-0.30	0.0	0.0	0.0	0.0
	0.0	0.0												
88	1.00	1.00	0.0	0.0	0.0	0.0	1.00	0.0	0.0	0.30	0.0	0.0	0.0	0.0
	0.0	0.0												
89	1.00	1.00	0.0	0.0	0.0	0.0	0.0	-1.00	-0.30	0.0	0.0	0.0	0.0	0.0
	0.0	0.0												
90	1.00	1.00	0.0	0.0	0.0	0.0	0.0	-1.00	0.30	0.0	0.0	0.0	0.0	0.0
	0.0	0.0												
91	1.00	1.00	0.0	0.0	0.0	0.0	0.0	1.00	-0.30	0.0	0.0	0.0	0.0	0.0
	0.0	0.0												
92	1.00	1.00	0.0	0.0	0.0	0.0	0.0	1.00	0.30	0.0	0.0	0.0	0.0	0.0
	0.0	0.0												
93	1.00	1.00	0.0	0.0	0.0	0.0	0.0	-1.00	0.0	-0.30	0.0	0.0	0.0	0.0

Cmb	CDC 1/15...	CDC 2/16...	CDC 3/17...	CDC 4/18...	CDC 5/19...	CDC 6/20...	CDC 7/21...	CDC 8/22...	CDC 9/23...	CDC 10/24...	CDC 11/25...	CDC 12/26...	CDC 13/27...	CDC 14/28...
	0.0	0.0												
94	1.00	1.00	0.0	0.0	0.0	0.0	0.0	-1.00	0.0	0.30	0.0	0.0	0.0	0.0
	0.0	0.0												
95	1.00	1.00	0.0	0.0	0.0	0.0	0.0	1.00	0.0	-0.30	0.0	0.0	0.0	0.0
	0.0	0.0												
96	1.00	1.00	0.0	0.0	0.0	0.0	0.0	1.00	0.0	0.30	0.0	0.0	0.0	0.0
	0.0	0.0												
97	1.00	1.00	0.0	0.0	0.0	0.0	-0.30	0.0	-1.00	0.0	0.0	0.0	0.0	0.0
	0.0	0.0												
98	1.00	1.00	0.0	0.0	0.0	0.0	-0.30	0.0	1.00	0.0	0.0	0.0	0.0	0.0
	0.0	0.0												
99	1.00	1.00	0.0	0.0	0.0	0.0	0.30	0.0	-1.00	0.0	0.0	0.0	0.0	0.0
	0.0	0.0												
100	1.00	1.00	0.0	0.0	0.0	0.0	0.30	0.0	1.00	0.0	0.0	0.0	0.0	0.0
	0.0	0.0												
101	1.00	1.00	0.0	0.0	0.0	0.0	0.0	-0.30	-1.00	0.0	0.0	0.0	0.0	0.0
	0.0	0.0												
102	1.00	1.00	0.0	0.0	0.0	0.0	0.0	-0.30	1.00	0.0	0.0	0.0	0.0	0.0
	0.0	0.0												
103	1.00	1.00	0.0	0.0	0.0	0.0	0.0	0.30	-1.00	0.0	0.0	0.0	0.0	0.0
	0.0	0.0												
104	1.00	1.00	0.0	0.0	0.0	0.0	0.0	0.30	1.00	0.0	0.0	0.0	0.0	0.0
	0.0	0.0												
105	1.00	1.00	0.0	0.0	0.0	0.0	-0.30	0.0	0.0	-1.00	0.0	0.0	0.0	0.0
	0.0	0.0												
106	1.00	1.00	0.0	0.0	0.0	0.0	-0.30	0.0	0.0	1.00	0.0	0.0	0.0	0.0
	0.0	0.0												
107	1.00	1.00	0.0	0.0	0.0	0.0	0.30	0.0	0.0	-1.00	0.0	0.0	0.0	0.0
	0.0	0.0												
108	1.00	1.00	0.0	0.0	0.0	0.0	0.30	0.0	0.0	1.00	0.0	0.0	0.0	0.0
	0.0	0.0												
109	1.00	1.00	0.0	0.0	0.0	0.0	0.0	-0.30	0.0	-1.00	0.0	0.0	0.0	0.0
	0.0	0.0												
110	1.00	1.00	0.0	0.0	0.0	0.0	0.0	-0.30	0.0	1.00	0.0	0.0	0.0	0.0
	0.0	0.0												
111	1.00	1.00	0.0	0.0	0.0	0.0	0.0	0.30	0.0	-1.00	0.0	0.0	0.0	0.0
	0.0	0.0												
112	1.00	1.00	0.0	0.0	0.0	0.0	0.0	0.30	0.0	1.00	0.0	0.0	0.0	0.0
	0.0	0.0												
113	1.00	1.00	0.0	0.0	0.0	0.0	0.0	0.0	0.0	0.0	-1.00	0.60	0.0	0.0
	0.0	0.50												
114	1.00	1.00	0.0	0.0	0.0	0.0	0.0	0.0	0.0	0.0	1.00	0.60	0.0	0.0
	0.0	0.50												
115	1.00	1.00	0.0	0.0	0.0	0.0	0.0	0.0	0.0	0.0	-0.60	1.00	0.0	0.0
	0.0	0.50												
116	1.00	1.00	0.0	0.0	0.0	0.0	0.0	0.0	0.0	0.0	0.60	1.00	0.0	0.0
	0.0	0.50												
117	1.00	1.00	0.0	0.0	0.0	0.0	0.0	0.0	0.0	0.0	-0.60	0.60	0.0	0.0
	0.0	1.00												
118	1.00	1.00	0.0	0.0	0.0	0.0	0.0	0.0	0.0	0.0	0.60	0.60	0.0	0.0
	0.0	1.00												
119	1.00	1.00	0.0	0.0	0.0	0.0	0.0	0.0	0.0	0.0	-1.00	0.0	0.60	0.0
	0.0	0.50												
120	1.00	1.00	0.0	0.0	0.0	0.0	0.0	0.0	0.0	0.0	1.00	0.0	0.60	0.0
	0.0	0.50												
121	1.00	1.00	0.0	0.0	0.0	0.0	0.0	0.0	0.0	0.0	-0.60	0.0	1.00	0.0
	0.0	0.50												
122	1.00	1.00	0.0	0.0	0.0	0.0	0.0	0.0	0.0	0.0	0.60	0.0	1.00	0.0
	0.0	0.50												
123	1.00	1.00	0.0	0.0	0.0	0.0	0.0	0.0	0.0	0.0	-0.60	0.0	0.60	0.0
	0.0	1.00												
124	1.00	1.00	0.0	0.0	0.0	0.0	0.0	0.0	0.0	0.0	0.60	0.0	0.60	0.0
	0.0	1.00												
125	1.00	1.00	0.0	0.0	0.0	0.0	0.0	0.0	0.0	0.0	-1.00	0.0	0.0	0.60
	0.0	0.50												
126	1.00	1.00	0.0	0.0	0.0	0.0	0.0	0.0	0.0	0.0	1.00	0.0	0.0	0.60
	0.0	0.50												
127	1.00	1.00	0.0	0.0	0.0	0.0	0.0	0.0	0.0	0.0	-0.60	0.0	0.0	1.00
	0.0	0.50												
128	1.00	1.00	0.0	0.0	0.0	0.0	0.0	0.0	0.0	0.0	0.60	0.0	0.0	1.00
	0.0	0.50												
129	1.00	1.00	0.0	0.0	0.0	0.0	0.0	0.0	0.0	0.0	-0.60	0.0	0.0	0.60
	0.0	1.00												

Cmb	CDC 1/15...	CDC 2/16...	CDC 3/17...	CDC 4/18...	CDC 5/19...	CDC 6/20...	CDC 7/21...	CDC 8/22...	CDC 9/23...	CDC 10/24...	CDC 11/25...	CDC 12/26...	CDC 13/27...	CDC 14/28...
130	1.00 0.0	1.00 1.00	0.0	0.0	0.0	0.0	0.0	0.0	0.0	0.0	0.60	0.0	0.0	0.60
131	1.00 0.60	1.00 0.50	0.0	0.0	0.0	0.0	0.0	0.0	0.0	0.0	-1.00	0.0	0.0	0.0
132	1.00 0.60	1.00 0.50	0.0	0.0	0.0	0.0	0.0	0.0	0.0	0.0	1.00	0.0	0.0	0.0
133	1.00 1.00	1.00 0.50	0.0	0.0	0.0	0.0	0.0	0.0	0.0	0.0	-0.60	0.0	0.0	0.0
134	1.00 1.00	1.00 0.50	0.0	0.0	0.0	0.0	0.0	0.0	0.0	0.0	0.60	0.0	0.0	0.0
135	1.00 0.60	1.00 1.00	0.0	0.0	0.0	0.0	0.0	0.0	0.0	0.0	-0.60	0.0	0.0	0.0
136	1.00 0.60	1.00 1.00	0.0	0.0	0.0	0.0	0.0	0.0	0.0	0.0	0.60	0.0	0.0	0.0
137	1.00 0.0	1.00 0.0	0.0	0.0	0.0	0.0	0.0	0.0	0.0	0.0	-0.50	0.0	0.0	0.0
138	1.00 0.0	1.00 0.0	0.0	0.0	0.0	0.0	0.0	0.0	0.0	0.0	0.50	0.0	0.0	0.0
139	1.00 0.0	1.00 0.20	0.0	0.0	0.0	0.0	0.0	0.0	0.0	0.0	0.0	0.0	0.0	0.0
140	1.00 0.0	1.00 0.0	0.0	0.0	0.0	0.0	0.0	0.0	0.0	0.0	0.0	0.20	0.0	0.0
141	1.00 0.0	1.00 0.0	0.0	0.0	0.0	0.0	0.0	0.0	0.0	0.0	0.0	0.0	0.20	0.0
142	1.00 0.0	1.00 0.0	0.0	0.0	0.0	0.0	0.0	0.0	0.0	0.0	0.0	0.0	0.0	0.20
143	1.00 0.20	1.00 0.0	0.0	0.0	0.0	0.0	0.0	0.0	0.0	0.0	0.0	0.0	0.0	0.0
144	1.00 0.0	1.00 0.0	0.0	0.0	0.0	0.0	0.0	0.0	0.0	0.0	0.0	0.0	0.0	0.0

5 ALLEGATI: PRINCIPALI RISULTATI DELLE ANALISI E VERIFICHE

RISULTATI ANALISI SISMICHE

LEGENDA TABELLA ANALISI SISMICHE

Sono previsti i seguenti casi di carico:

9. Esk caso di carico sismico con analisi statica equivalente

Ciascun caso di carico è caratterizzato da un angolo di ingresso e da una configurazione di masse determinante la forza sismica complessiva (si rimanda al capitolo relativo ai casi di carico per chiarimenti inerenti questo aspetto).

Nella colonna Note, in funzione della norma in uso sono riportati i parametri fondamentali che caratterizzano l'azione sismica: in particolare possono essere presenti i seguenti valori:

Angolo di ingresso	Angolo di ingresso dell'azione sismica orizzontale
Fattore di importanza	Fattore di importanza dell'edificio, in base alla categoria di appartenenza
Zona sismica	Zona sismica
Accelerazione ag	Accelerazione orizzontale massima sul suolo
Categoria suolo	Categoria di profilo stratigrafico del suolo di fondazione
Fattore q	Fattore di struttura/di comportamento. Dipendente dalla tipologia strutturale
Fattore di sito S	Fattore dipendente dalla stratigrafia e dal profilo topografico
Classe di duttilità CD	Classe di duttilità della struttura – "A" duttilità alta, "B" duttilità bassa
Fattore riduz. SLD	Fattore di riduzione dello spettro elastico per lo stato limite di danno
Periodo proprio T1	Periodo proprio di vibrazione della struttura
Coefficiente Lambda	Coefficiente dipendente dal periodo proprio T1 e dal numero di piani della struttura
Ordinata spettro Sd(T1)	Valore delle ordinate dello spettro di progetto per lo stato limite ultimo, componente orizzontale (verticale Svd)
Ordinata spettro Se(T1)	Valore delle ordinate dello spettro elastico ridotta del fattore SLD per lo stato limite di danno, componente orizzontale (verticale Sve)
Ordinata spettro S (Tb-Tc)	Valore dell' ordinata dello spettro in uso nel tratto costante
numero di modi considerati	Numero di modi di vibrare della struttura considerati nell'analisi dinamica

Per ciascun caso di carico sismico viene riportato l'insieme di dati sotto riportati (le masse sono espresse in unità di forza):

a) **analisi sismica statica equivalente:**

- quota, posizione del centro di applicazione e azione orizzontale risultante, posizione del baricentro delle rigidità, rapporto r/L_s (per strutture a nucleo), indici di regolarità e/r secondo EC8 4.2.3.2
- azione sismica complessiva

Per ciascuna combinazione sismica definita SLD o SLO viene riportato il livello di deformazione ϵ_T (dr) degli elementi strutturali verticali. Per semplicità di consultazione il livello è espresso anche in unità $1000 \cdot \epsilon_T/h$ da confrontare direttamente con i valori forniti nella norma (es. 5 per edifici con tamponamenti collegati rigidamente alla struttura, 10.0 per edifici con tamponamenti collegati elasticamente, 3 per edifici in muratura ordinaria, 4 per edifici in muratura armata).

CDC	Tipo	Sigla Id	Note
3	Esk	CDC=Es (statico SLU) alfa=0.0 (ecc. +)	
			categoria suolo: A
			fattore di sito S = 1.000
			ordinata spettro (tratto T_b-T_c) = 0.110 g
			angolo di ingresso:0.0
			eccentricità aggiuntiva: positiva
			periodo proprio T1: 0.153 sec.
			fattore q: 1.000
			fattore per spost. μ d: 1.000
			classe di duttilità CD: ND
			coefficiente Lambda: 1.000
			ordinata spettro $S_d(T1)$: 0.110

Quota	Forza Sismica	Tot. parziale	M Sismica x g	Pos. GX	Pos. GY	E agg. X-X	E agg. Y-Y	Pos. KX	Pos. KY	(r/Ls)^2	rapp. ex/rx	rapp. ey/ry
cm	daN	daN	daN	cm	cm	cm	cm	cm	cm			
300.00	47.54	47.54	274.41	0.0	785.00	0.0	-78.50	0.0	0.0	0.0	0.0	0.0
257.50	150.18	197.73	1009.89	73.60	785.00	0.0	-78.50	73.60	785.00	1.014	0.0	0.0
188.50	4.72	202.45	43.39	193.40	785.00	0.0	-78.50	0.0	0.0	0.0	0.0	0.0
186.80	23.55	226.00	218.29	193.10	785.00	0.0	-55.90	0.0	0.0	0.0	0.0	0.0
119.50	66.09	292.09	957.58	313.20	785.00	0.0	-78.50	313.20	785.00	1.014	0.0	0.0
77.00	12.16	304.25	273.56	386.20	785.00	0.0	-78.50	0.0	0.0	0.0	0.0	0.0
Risulta	304.25		2777.12									

CDC	Tipo	Sigla Id	Note
4	Esk	CDC=Es (statico SLU) alfa=0.0 (ecc. -)	
			categoria suolo: A
			fattore di sito S = 1.000
			ordinata spettro (tratto T_b-T_c) = 0.110 g
			angolo di ingresso:0.0
			eccentricità aggiuntiva: negativa
			periodo proprio T1: 0.153 sec.
			fattore q: 1.000
			fattore per spost. μ d: 1.000
			classe di duttilità CD: ND
			coefficiente Lambda: 1.000
			ordinata spettro $S_d(T1)$: 0.110

Quota	Forza Sismica	Tot. parziale	M Sismica x g	Pos. GX	Pos. GY	E agg. X-X	E agg. Y-Y	Pos. KX	Pos. KY	(r/Ls)^2	rapp. ex/rx	rapp. ey/ry
cm	daN	daN	daN	cm	cm	cm	cm	cm	cm			
300.00	47.54	47.54	274.41	0.0	785.00	0.0	78.50	0.0	0.0	0.0	0.0	0.0
257.50	150.18	197.73	1009.89	73.60	785.00	0.0	78.50	73.60	785.00	1.014	0.0	0.0
188.50	4.72	202.45	43.39	193.40	785.00	0.0	78.50	0.0	0.0	0.0	0.0	0.0
186.80	23.55	226.00	218.29	193.10	785.00	0.0	55.90	0.0	0.0	0.0	0.0	0.0
119.50	66.09	292.09	957.58	313.20	785.00	0.0	78.50	313.20	785.00	1.014	0.0	0.0
77.00	12.16	304.25	273.56	386.20	785.00	0.0	78.50	0.0	0.0	0.0	0.0	0.0
Risulta	304.25		2777.12									

CDC	Tipo	Sigla Id	Note
5	Esk	CDC=Es (statico SLU) alfa=90.00 (ecc. +)	
			categoria suolo: A
			fattore di sito S = 1.000
			ordinata spettro (tratto Tb-Tc) = 0.110 g
			angolo di ingresso:90.00
			eccentricità aggiuntiva: positiva
			periodo proprio T1: 0.204 sec.
			fattore q: 1.000
			fattore per spost. mu d: 1.000
			classe di duttilità CD: ND
			coefficiente Lambda: 1.000
			ordinata spettro Sd(T1): 0.110

Quota	Forza Sismica	Tot. parziale	M Sismica x g	Pos. GX	Pos. GY	E agg. X-X	E agg. Y-Y	Pos. KX	Pos. KY	(r/Ls)^2	rapp. ex/rx	rapp. ey/ry
cm	daN	daN	daN	cm	cm	cm	cm	cm	cm			
300.00	47.54	47.54	274.41	0.0	785.00	0.0	0.0	0.0	0.0	0.0	0.0	0.0
257.50	150.18	197.73	1009.89	73.60	785.00	0.0	0.0	73.60	785.00	1.014	0.0	0.0
188.50	4.72	202.45	43.39	193.40	785.00	0.0	0.0	0.0	0.0	0.0	0.0	0.0
186.80	23.55	226.00	218.29	193.10	785.00	0.0	0.0	0.0	0.0	0.0	0.0	0.0
119.50	66.09	292.09	957.58	313.20	785.00	0.0	0.0	313.20	785.00	1.014	0.0	0.0
77.00	12.16	304.25	273.56	386.20	785.00	0.0	0.0	0.0	0.0	0.0	0.0	0.0
Risulta	304.25		2777.12									

CDC	Tipo	Sigla Id	Note
6	Esk	CDC=Es (statico SLU) alfa=90.00 (ecc. -)	
			categoria suolo: A
			fattore di sito S = 1.000
			ordinata spettro (tratto Tb-Tc) = 0.110 g
			angolo di ingresso:90.00
			eccentricità aggiuntiva: negativa
			periodo proprio T1: 0.204 sec.
			fattore q: 1.000
			fattore per spost. mu d: 1.000
			classe di duttilità CD: ND
			coefficiente Lambda: 1.000
			ordinata spettro Sd(T1): 0.110

Quota	Forza Sismica	Tot. parziale	M Sismica x g	Pos. GX	Pos. GY	E agg. X-X	E agg. Y-Y	Pos. KX	Pos. KY	(r/Ls)^2	rapp. ex/rx	rapp. ey/ry
cm	daN	daN	daN	cm	cm	cm	cm	cm	cm			
300.00	47.54	47.54	274.41	0.0	785.00	0.0	0.0	0.0	0.0	0.0	0.0	0.0
257.50	150.18	197.73	1009.89	73.60	785.00	0.0	0.0	73.60	785.00	1.014	0.0	0.0
188.50	4.72	202.45	43.39	193.40	785.00	0.0	0.0	0.0	0.0	0.0	0.0	0.0
186.80	23.55	226.00	218.29	193.10	785.00	0.0	0.0	0.0	0.0	0.0	0.0	0.0
119.50	66.09	292.09	957.58	313.20	785.00	0.0	0.0	313.20	785.00	1.014	0.0	0.0
77.00	12.16	304.25	273.56	386.20	785.00	0.0	0.0	0.0	0.0	0.0	0.0	0.0
Risulta	304.25		2777.12									

CDC	Tipo	Sigla Id	Note
7	Esk	CDC=Es (statico SLD) alfa=0.0 (ecc. +)	
			categoria suolo: A
			fattore di sito S = 1.000
			ordinata spettro (tratto Tb-Tc) = 0.039 g
			angolo di ingresso:0.0
			eccentricità aggiuntiva: positiva
			periodo proprio T1: 0.153 sec.
			coefficiente Lambda: 1.000
			ordinata spettro Se(T1): 0.039

Quota	Forza Sismica	Tot. parziale	M Sismica x g	Pos. GX	Pos. GY	E agg. X-X	E agg. Y-Y	Pos. KX	Pos. KY	(r/Ls)^2	rapp. ex/rx	rapp. ey/ry
cm	daN	daN	daN	cm	cm	cm	cm	cm	cm			
300.00	16.87	16.87	274.41	0.0	785.00	0.0	-78.50	0.0	0.0	0.0	0.0	0.0
257.50	53.28	70.15	1009.89	73.60	785.00	0.0	-78.50	73.60	785.00	1.014	0.0	0.0
188.50	1.68	71.82	43.39	193.40	785.00	0.0	-78.50	0.0	0.0	0.0	0.0	0.0

Quota	Forza Sismica	Tot. parziale	M Sismica x g	Pos. GX	Pos. GY	E agg. X-X	E agg. Y-Y	Pos. KX	Pos. KY	(r/Ls)^2	rapp. ex/rx	rapp. ey/ry
186.80	8.35	80.18	218.29	193.10	785.00	0.0	-55.90	0.0	0.0	0.0	0.0	0.0
119.50	23.45	103.63	957.58	313.20	785.00	0.0	-78.50	313.20	785.00	1.014	0.0	0.0
77.00	4.32	107.94	273.56	386.20	785.00	0.0	-78.50	0.0	0.0	0.0	0.0	0.0
Risulta	107.94		2777.12									

CDC	Tipo	Sigla Id	Note
8	Esk	CDC=Es (statico SLD) alfa=0.0 (ecc. -)	
			categoria suolo: A
			fattore di sito S = 1.000
			ordinata spettro (tratto Tb-Tc) = 0.039 g
			angolo di ingresso:0.0
			eccentricità aggiuntiva: negativa
			periodo proprio T1: 0.153 sec.
			coefficiente Lambda: 1.000
			ordinata spettro Se(T1): 0.039

Quota	Forza Sismica	Tot. parziale	M Sismica x g	Pos. GX	Pos. GY	E agg. X-X	E agg. Y-Y	Pos. KX	Pos. KY	(r/Ls)^2	rapp. ex/rx	rapp. ey/ry
cm	daN	daN	daN	cm	cm	cm	cm	cm	cm			
300.00	16.87	16.87	274.41	0.0	785.00	0.0	78.50	0.0	0.0	0.0	0.0	0.0
257.50	53.28	70.15	1009.89	73.60	785.00	0.0	78.50	73.60	785.00	1.014	0.0	0.0
188.50	1.68	71.82	43.39	193.40	785.00	0.0	78.50	0.0	0.0	0.0	0.0	0.0
186.80	8.35	80.18	218.29	193.10	785.00	0.0	55.90	0.0	0.0	0.0	0.0	0.0
119.50	23.45	103.63	957.58	313.20	785.00	0.0	78.50	313.20	785.00	1.014	0.0	0.0
77.00	4.32	107.94	273.56	386.20	785.00	0.0	78.50	0.0	0.0	0.0	0.0	0.0
Risulta	107.94		2777.12									

CDC	Tipo	Sigla Id	Note
9	Esk	CDC=Es (statico SLD) alfa=90.00 (ecc. +)	
			categoria suolo: A
			fattore di sito S = 1.000
			ordinata spettro (tratto Tb-Tc) = 0.039 g
			angolo di ingresso:90.00
			eccentricità aggiuntiva: positiva
			periodo proprio T1: 0.204 sec.
			coefficiente Lambda: 1.000
			ordinata spettro Se(T1): 0.034

Quota	Forza Sismica	Tot. parziale	M Sismica x g	Pos. GX	Pos. GY	E agg. X-X	E agg. Y-Y	Pos. KX	Pos. KY	(r/Ls)^2	rapp. ex/rx	rapp. ey/ry
cm	daN	daN	daN	cm	cm	cm	cm	cm	cm			
300.00	14.88	14.88	274.41	0.0	785.00	0.0	0.0	0.0	0.0	0.0	0.0	0.0
257.50	47.01	61.90	1009.89	73.60	785.00	0.0	0.0	73.60	785.00	1.014	0.0	0.0
188.50	1.48	63.37	43.39	193.40	785.00	0.0	0.0	0.0	0.0	0.0	0.0	0.0
186.80	7.37	70.75	218.29	193.10	785.00	0.0	0.0	0.0	0.0	0.0	0.0	0.0
119.50	20.69	91.43	957.58	313.20	785.00	0.0	0.0	313.20	785.00	1.014	0.0	0.0
77.00	3.81	95.24	273.56	386.20	785.00	0.0	0.0	0.0	0.0	0.0	0.0	0.0
Risulta	95.24		2777.12									

CDC	Tipo	Sigla Id	Note
10	Esk	CDC=Es (statico SLD) alfa=90.00 (ecc. -)	
			categoria suolo: A
			fattore di sito S = 1.000
			ordinata spettro (tratto Tb-Tc) = 0.039 g
			angolo di ingresso:90.00
			eccentricità aggiuntiva: negativa
			periodo proprio T1: 0.204 sec.
			coefficiente Lambda: 1.000
			ordinata spettro Se(T1): 0.034

Quota	Forza Sismica	Tot. parziale	M Sismica x g	Pos. GX	Pos. GY	E agg. X-X	E agg. Y-Y	Pos. KX	Pos. KY	(r/Ls)^2	rapp. ex/rx	rapp. ey/ry
cm	daN	daN	daN	cm	cm	cm	cm	cm	cm			
300.00	14.88	14.88	274.41	0.0	785.00	0.0	0.0	0.0	0.0	0.0	0.0	0.0
257.50	47.01	61.90	1009.89	73.60	785.00	0.0	0.0	73.60	785.00	1.014	0.0	0.0
188.50	1.48	63.37	43.39	193.40	785.00	0.0	0.0	0.0	0.0	0.0	0.0	0.0
186.80	7.37	70.75	218.29	193.10	785.00	0.0	0.0	0.0	0.0	0.0	0.0	0.0
119.50	20.69	91.43	957.58	313.20	785.00	0.0	0.0	313.20	785.00	1.014	0.0	0.0
77.00	3.81	95.24	273.56	386.20	785.00	0.0	0.0	0.0	0.0	0.0	0.0	0.0
Risulta	95.24		2777.12									

Cmb	Pilas. 1000 etaT/h	etaT	inter. h	Pilas. 1000 etaT/h	etaT	inter. h	Pilas. 1000 etaT/h	etaT	inter. h
		mm	cm		mm	cm		mm	cm
81	26	0.02	119.5	38	0.05	257.5	42	0.04	257.5
	43	0.04	257.5	44	0.03	119.5	45	0.01	119.5
82	26	0.02	119.5	38	0.05	257.5	42	0.05	257.5
	43	0.05	257.5	44	0.03	119.5	45	0.01	119.5
83	26	0.04	119.5	38	0.06	257.5	42	0.06	257.5
	43	0.05	257.5	44	0.06	119.5	45	0.07	119.5
84	26	0.05	119.5	38	0.05	257.5	42	0.05	257.5
	43	0.05	257.5	44	0.06	119.5	45	0.07	119.5
85	26	0.02	119.5	38	0.05	257.5	42	0.04	257.5
	43	0.04	257.5	44	0.03	119.5	45	0.01	119.5
86	26	0.02	119.5	38	0.05	257.5	42	0.05	257.5
	43	0.05	257.5	44	0.03	119.5	45	0.01	119.5
87	26	0.04	119.5	38	0.06	257.5	42	0.06	257.5
	43	0.05	257.5	44	0.06	119.5	45	0.07	119.5
88	26	0.05	119.5	38	0.05	257.5	42	0.05	257.5
	43	0.05	257.5	44	0.06	119.5	45	0.07	119.5
89	26	0.03	119.5	38	0.05	257.5	42	0.05	257.5
	43	0.05	257.5	44	0.02	119.5	45	0.01	119.5
90	26	0.03	119.5	38	0.04	257.5	42	0.04	257.5
	43	0.05	257.5	44	0.02	119.5	45	0.01	119.5
91	26	0.06	119.5	38	0.05	257.5	42	0.05	257.5
	43	0.05	257.5	44	0.05	119.5	45	0.07	119.5
92	26	0.06	119.5	38	0.05	257.5	42	0.06	257.5
	43	0.06	257.5	44	0.04	119.5	45	0.07	119.5
93	26	0.03	119.5	38	0.05	257.5	42	0.05	257.5
	43	0.05	257.5	44	0.02	119.5	45	0.01	119.5
94	26	0.03	119.5	38	0.04	257.5	42	0.04	257.5
	43	0.05	257.5	44	0.02	119.5	45	0.01	119.5
95	26	0.06	119.5	38	0.05	257.5	42	0.05	257.5
	43	0.05	257.5	44	0.05	119.5	45	0.07	119.5
96	26	0.06	119.5	38	0.05	257.5	42	0.06	257.5
	43	0.06	257.5	44	0.04	119.5	45	0.07	119.5
97	26	0.04	119.5	38	0.16	257.5	42	0.16	257.5
	43	0.15	257.5	44	0.05	119.5	45	0.05	119.5
98	26	0.05	119.5	38	0.16	257.5	42	0.16	257.5
	43	0.16	257.5	44	0.04	119.5	45	0.05	119.5
99	26	0.04	119.5	38	0.16	257.5	42	0.16	257.5
	43	0.16	257.5	44	0.05	119.5	45	0.06	119.5
100	26	0.05	119.5	38	0.15	257.5	42	0.16	257.5
	43	0.16	257.5	44	0.04	119.5	45	0.06	119.5
101	26	0.04	119.5	38	0.16	257.5	42	0.16	257.5
	43	0.16	257.5	44	0.05	119.5	45	0.05	119.5
102	26	0.05	119.5	38	0.15	257.5	42	0.16	257.5
	43	0.16	257.5	44	0.04	119.5	45	0.05	119.5
103	26	0.04	119.5	38	0.16	257.5	42	0.16	257.5
	43	0.15	257.5	44	0.05	119.5	45	0.06	119.5
104	26	0.05	119.5	38	0.16	257.5	42	0.16	257.5
	43	0.16	257.5	44	0.04	119.5	45	0.06	119.5
105	26	0.04	119.5	38	0.16	257.5	42	0.16	257.5
	43	0.15	257.5	44	0.05	119.5	45	0.05	119.5
106	26	0.05	119.5	38	0.16	257.5	42	0.16	257.5
	43	0.16	257.5	44	0.04	119.5	45	0.05	119.5
107	26	0.04	119.5	38	0.16	257.5	42	0.16	257.5
	43	0.16	257.5	44	0.05	119.5	45	0.06	119.5
108	26	0.05	119.5	38	0.15	257.5	42	0.16	257.5
	43	0.16	257.5	44	0.04	119.5	45	0.06	119.5
109	26	0.04	119.5	38	0.16	257.5	42	0.16	257.5
	43	0.16	257.5	44	0.05	119.5	45	0.05	119.5
110	26	0.05	119.5	38	0.15	257.5	42	0.16	257.5
	43	0.16	257.5	44	0.04	119.5	45	0.05	119.5
111	26	0.04	119.5	38	0.16	257.5	42	0.16	257.5
	43	0.15	257.5	44	0.05	119.5	45	0.06	119.5

112	26	0.05	0.07	119.5	38	0.16	0.40	257.5	42	0.16	0.41	257.5
	43	0.16	0.41	257.5	44	0.04	0.05	119.5	45	0.06	0.07	119.5
Cmb		1000 etaT/h										
		0.16										

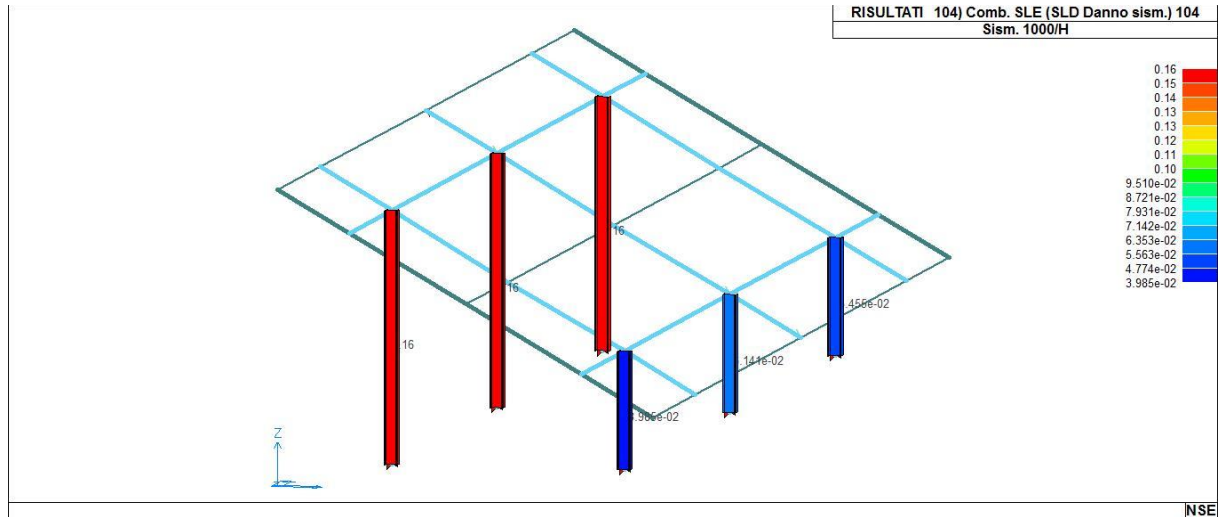

31_RIS_SLE_104_Comb. SLE (SLD Danno sism.) 104

RISULTATI NODALI

LEGENDA RISULTATI NODALI

Il controllo dei risultati delle analisi condotte, per quanto concerne i nodi strutturali, è possibile in relazione alle tabelle sottoriportate.

Una prima tabella riporta infatti per ogni nodo e per ogni combinazione (o caso di carico) gli spostamenti nodali.

Una seconda tabella riporta per ogni nodo a cui sia associato un vincolo rigido e/o elastico o una fondazione speciale e per ogni combinazione (o caso di carico) i valori delle azioni esercitate dalla struttura sui vincoli (reazioni vincolari cambiate di segno).

Una terza tabella, infine riassume per ogni nodo le sei combinazioni in cui si attingono i valori minimi e massimi della reazione Fz, della reazione Mx e della reazione My.

Nodo	Cmb	Traslazione X mm	Traslazione Y mm	Traslazione Z mm	Rotazione X	Rotazione Y	Rotazione Z
1	1	0.0	0.0	0.0	0.0	0.0	0.0
1	25	0.0	0.0	0.0	0.0	0.0	0.0
1	49	0.0	0.0	0.0	0.0	0.0	0.0

1	81	0.0	0.0	0.0	0.0	0.0	0.0	0.0
1	113	0.0	0.0	0.0	0.0	0.0	0.0	0.0
1	137	0.0	0.0	0.0	0.0	0.0	0.0	0.0
1	144	0.0	0.0	0.0	0.0	0.0	0.0	0.0
2	1	0.0	0.0	0.0	0.0	0.0	0.0	0.0
2	25	0.0	0.0	0.0	0.0	0.0	0.0	0.0
2	49	0.0	0.0	0.0	0.0	0.0	0.0	0.0
2	81	0.0	0.0	0.0	0.0	0.0	0.0	0.0
2	113	0.0	0.0	0.0	0.0	0.0	0.0	0.0
2	137	0.0	0.0	0.0	0.0	0.0	0.0	0.0
2	144	0.0	0.0	0.0	0.0	0.0	0.0	0.0
3	1	0.0	0.0	0.0	0.0	0.0	0.0	0.0
3	25	0.0	0.0	0.0	0.0	0.0	0.0	0.0
3	49	0.0	0.0	0.0	0.0	0.0	0.0	0.0
3	81	0.0	0.0	0.0	0.0	0.0	0.0	0.0
3	113	0.0	0.0	0.0	0.0	0.0	0.0	0.0
3	137	0.0	0.0	0.0	0.0	0.0	0.0	0.0
3	144	0.0	0.0	0.0	0.0	0.0	0.0	0.0
4	1	0.0	0.0	0.0	0.0	0.0	0.0	0.0
4	25	0.0	0.0	0.0	0.0	0.0	0.0	0.0
4	49	0.0	0.0	0.0	0.0	0.0	0.0	0.0
4	81	0.0	0.0	0.0	0.0	0.0	0.0	0.0
4	113	0.0	0.0	0.0	0.0	0.0	0.0	0.0
4	137	0.0	0.0	0.0	0.0	0.0	0.0	0.0
4	144	0.0	0.0	0.0	0.0	0.0	0.0	0.0
5	1	0.0	0.0	0.0	0.0	0.0	0.0	0.0
5	25	0.0	0.0	0.0	0.0	0.0	0.0	0.0
5	49	0.0	0.0	0.0	0.0	0.0	0.0	0.0
5	81	0.0	0.0	0.0	0.0	0.0	0.0	0.0
5	113	0.0	0.0	0.0	0.0	0.0	0.0	0.0
5	137	0.0	0.0	0.0	0.0	0.0	0.0	0.0
5	144	0.0	0.0	0.0	0.0	0.0	0.0	0.0
6	1	0.0	0.0	0.0	0.0	0.0	0.0	0.0
6	25	0.0	0.0	0.0	0.0	0.0	0.0	0.0
6	49	0.0	0.0	0.0	0.0	0.0	0.0	0.0
6	81	0.0	0.0	0.0	0.0	0.0	0.0	0.0
6	113	0.0	0.0	0.0	0.0	0.0	0.0	0.0
6	137	0.0	0.0	0.0	0.0	0.0	0.0	0.0
6	144	0.0	0.0	0.0	0.0	0.0	0.0	0.0
7	8	-14.91	-3.53	-17.67	8.08e-03	7.10e-03	-4.03e-03	
7	12	-20.69	-2.13	-21.41	0.01	9.54e-03	-4.70e-03	
7	32	-14.65	-3.53	-16.74	7.73e-03	6.85e-03	-3.76e-03	
7	36	-20.43	-2.13	-20.48	9.94e-03	9.29e-03	-4.43e-03	
7	50	-1.61	-0.04	-2.25	1.06e-03	6.16e-04	-7.36e-04	
7	67	0.26	0.06	-2.53	9.03e-04	4.68e-04	-4.93e-04	
7	71	0.16	0.05	-2.53	9.26e-04	4.65e-04	-5.05e-04	
7	82	-0.99	-0.01	-2.30	9.46e-04	6.19e-04	-6.97e-04	
7	99	-0.36	0.02	-2.39	8.85e-04	5.76e-04	-6.21e-04	
7	103	-0.40	0.02	-2.39	8.93e-04	5.75e-04	-6.25e-04	
7	120	-10.03	-2.35	-12.09	5.51e-03	4.82e-03	-2.78e-03	
7	124	-13.88	-1.42	-14.58	6.98e-03	6.44e-03	-3.22e-03	
7	137	0.11	1.17	-0.75	2.82e-04	2.34e-04	-2.92e-04	
7	138	-1.42	-1.17	-3.91	1.48e-03	1.01e-03	-1.07e-03	
7	139	-2.44	-8.45e-04	-3.83	1.66e-03	1.40e-03	-9.81e-04	
7	144	-0.66	1.56e-03	-2.33	8.80e-04	6.24e-04	-6.79e-04	
8	8	-1.17	-2.51	0.93	2.50e-03	-6.52e-04	-1.57e-03	
8	11	-2.68	1.48	1.05	-3.75e-05	-1.51e-03	1.88e-04	
8	12	-2.20	-1.52	1.31	2.07e-03	-1.30e-03	-1.23e-03	
8	32	-1.16	-2.51	0.96	2.42e-03	-7.08e-04	-1.53e-03	
8	35	-2.67	1.48	1.08	-1.21e-04	-1.56e-03	2.32e-04	
8	36	-2.19	-1.52	1.35	1.98e-03	-1.35e-03	-1.19e-03	
8	50	-0.12	-0.04	7.11e-04	2.23e-04	2.07e-05	-2.05e-04	
8	51	0.06	0.04	-0.18	1.93e-04	2.61e-04	-1.56e-05	
8	67	7.61e-03	0.06	-0.12	3.06e-04	1.88e-04	9.90e-05	
8	82	-0.06	-0.01	-0.06	2.15e-04	9.83e-05	-1.41e-04	
8	83	3.93e-03	0.01	-0.12	2.02e-04	1.83e-04	-7.91e-05	
8	99	-0.02	0.02	-0.10	2.38e-04	1.57e-04	-4.43e-05	
8	120	-0.79	-1.67	0.61	1.69e-03	-4.16e-04	-1.06e-03	
8	123	-1.79	0.99	0.69	2.75e-06	-9.85e-04	1.11e-04	
8	124	-1.47	-1.01	0.86	1.41e-03	-8.45e-04	-8.37e-04	
8	137	-0.16	0.83	-0.16	-3.76e-04	8.25e-05	2.85e-04	
8	139	-0.26	-9.11e-04	0.04	2.80e-04	-1.25e-05	-1.47e-04	
8	140	0.12	2.28e-03	-0.17	1.63e-04	2.37e-04	-8.71e-05	
8	144	-0.03	1.04e-03	-0.09	2.08e-04	1.41e-04	-1.10e-04	
9	11	-2.97	0.0	0.83	0.0	-1.09e-03	0.0	
9	12	-2.45	0.0	1.04	0.0	-8.18e-04	0.0	
9	35	-2.96	0.0	0.88	0.0	-1.18e-03	0.0	

9	36	-2.43	0.0	1.10	0.0	-9.04e-04	0.0
9	58	-0.10	6.85e-03	-0.07	-2.40e-05	1.23e-04	-4.45e-05
9	59	0.04	-6.85e-03	-0.21	2.40e-05	3.09e-04	4.45e-05
9	66	-0.05	-0.06	-0.11	-1.11e-04	1.88e-04	-2.35e-04
9	90	-0.06	3.04e-03	-0.11	-7.17e-06	1.83e-04	-1.30e-05
9	91	-3.20e-03	-3.04e-03	-0.16	7.17e-06	2.49e-04	1.30e-05
9	98	-0.04	-0.02	-0.13	-3.48e-05	2.06e-04	-7.37e-05
9	123	-1.99	0.0	0.53	0.0	-7.01e-04	0.0
9	124	-1.63	0.0	0.68	0.0	-5.17e-04	0.0
9	139	-0.29	0.0	-0.03	0.0	9.63e-05	0.0
9	140	0.13	0.0	-0.20	0.0	2.91e-04	0.0
9	144	-0.03	0.0	-0.14	0.0	2.16e-04	0.0
10	8	-1.17	2.51	0.93	-2.50e-03	-6.52e-04	1.57e-03
10	11	-2.68	-1.48	1.05	3.75e-05	-1.51e-03	-1.88e-04
10	12	-2.20	1.52	1.31	-2.07e-03	-1.30e-03	1.23e-03
10	32	-1.16	2.51	0.96	-2.42e-03	-7.08e-04	1.53e-03
10	35	-2.67	-1.48	1.08	1.21e-04	-1.56e-03	-2.32e-04
10	36	-2.19	1.52	1.35	-1.98e-03	-1.35e-03	1.19e-03
10	57	-0.12	0.04	7.11e-04	-2.23e-04	2.07e-05	2.05e-04
10	60	0.06	-0.04	-0.18	-1.93e-04	2.61e-04	1.56e-05
10	72	7.61e-03	-0.06	-0.12	-3.06e-04	1.88e-04	-9.90e-05
10	89	-0.06	0.01	-0.06	-2.15e-04	9.83e-05	1.41e-04
10	92	3.93e-03	-0.01	-0.12	-2.02e-04	1.83e-04	7.91e-05
10	104	-0.02	-0.02	-0.10	-2.38e-04	1.57e-04	4.43e-05
10	120	-0.79	1.67	0.61	-1.69e-03	-4.16e-04	1.06e-03
10	123	-1.79	-0.99	0.69	-2.75e-06	-9.85e-04	-1.11e-04
10	124	-1.47	1.01	0.86	-1.41e-03	-8.45e-04	8.37e-04
10	137	-0.16	-0.83	-0.16	3.76e-04	8.25e-05	-2.85e-04
10	139	-0.26	9.11e-04	0.04	-2.80e-04	-1.25e-05	1.47e-04
10	140	0.12	-2.28e-03	-0.17	-1.63e-04	2.37e-04	8.71e-05
10	144	-0.03	-1.04e-03	-0.09	-2.08e-04	1.41e-04	1.10e-04
11	8	-14.91	3.53	-17.67	-8.08e-03	7.10e-03	4.03e-03
11	12	-20.69	2.13	-21.41	-0.01	9.54e-03	4.70e-03
11	32	-14.65	3.53	-16.74	-7.73e-03	6.85e-03	3.76e-03
11	36	-20.43	2.13	-20.48	-9.94e-03	9.29e-03	4.43e-03
11	57	-1.61	0.04	-2.25	-1.06e-03	6.16e-04	7.36e-04
11	68	0.16	-0.05	-2.53	-9.26e-04	4.65e-04	5.05e-04
11	72	0.26	-0.06	-2.53	-9.03e-04	4.68e-04	4.93e-04
11	89	-0.99	0.01	-2.30	-9.46e-04	6.19e-04	6.97e-04
11	100	-0.40	-0.02	-2.39	-8.93e-04	5.75e-04	6.25e-04
11	104	-0.36	-0.02	-2.39	-8.85e-04	5.76e-04	6.21e-04
11	120	-10.03	2.35	-12.09	-5.51e-03	4.82e-03	2.78e-03
11	124	-13.88	1.42	-14.58	-6.98e-03	6.44e-03	3.22e-03
11	137	0.11	-1.17	-0.75	-2.82e-04	2.34e-04	2.92e-04
11	138	-1.42	1.17	-3.91	-1.48e-03	1.01e-03	1.07e-03
11	139	-2.44	8.45e-04	-3.83	-1.66e-03	1.40e-03	9.81e-04
11	144	-0.66	-1.56e-03	-2.33	-8.80e-04	6.24e-04	6.79e-04
12	8	-12.44	-3.49	-12.67	7.13e-03	5.52e-03	-5.67e-03
12	12	-17.14	-2.11	-14.87	8.56e-03	7.26e-03	-7.68e-03
12	32	-12.27	-3.49	-11.90	6.69e-03	5.37e-03	-5.55e-03
12	36	-16.97	-2.10	-14.09	8.11e-03	7.12e-03	-7.57e-03
12	50	-1.39	0.04	-1.86	-1.08e-03	3.38e-04	-7.07e-04
12	65	-0.04	-0.16	-2.26	1.26e-03	1.61e-04	-9.91e-05
12	71	0.32	-0.16	-2.25	1.25e-03	1.99e-04	5.70e-05
12	82	-0.76	6.98e-03	-1.91	1.10e-03	3.48e-04	-4.30e-04
12	97	-0.32	-0.05	-2.04	1.16e-03	2.94e-04	-2.29e-04
12	103	-0.19	-0.05	-2.04	1.16e-03	3.08e-04	-1.74e-04
12	120	-8.35	-2.33	-8.71	4.90e-03	3.72e-03	-3.82e-03
12	124	-11.49	-1.40	-10.17	5.85e-03	4.89e-03	-5.16e-03
12	138	-1.14	-1.16	-3.17	1.73e-03	7.46e-04	-6.28e-04
12	139	-1.91	-7.31e-03	-2.92	1.69e-03	9.45e-04	-9.30e-04
12	144	-0.43	-6.00e-03	-1.94	1.11e-03	3.56e-04	-2.83e-04
13	7	-2.14	2.44	-0.56	-1.20e-03	-1.56e-03	4.75e-04
13	8	-1.86	-2.47	0.51	2.58e-03	-1.21e-03	-1.43e-03
13	11	-3.24	1.45	-0.36	-2.01e-04	-2.32e-03	-9.36e-05
13	31	-2.15	2.44	-0.56	-1.28e-03	-1.58e-03	5.20e-04
13	32	-1.86	-2.47	0.51	2.50e-03	-1.23e-03	-1.38e-03
13	35	-3.24	1.45	-0.35	-2.84e-04	-2.34e-03	-4.81e-05
13	51	0.16	-0.05	-9.40e-03	2.27e-04	1.70e-04	4.21e-05
13	71	0.06	-0.16	-8.63e-03	3.36e-04	8.42e-05	1.27e-04
13	83	0.07	-0.02	-8.57e-03	2.12e-04	9.08e-05	-6.14e-05
13	103	0.03	-0.05	-8.29e-03	2.47e-04	5.98e-05	-3.81e-05
13	119	-1.43	1.63	-0.38	-7.71e-04	-1.03e-03	3.01e-04
13	120	-1.23	-1.65	0.34	1.75e-03	-8.02e-04	-9.68e-04
13	123	-2.15	0.97	-0.24	-1.07e-04	-1.54e-03	-7.75e-05
13	137	-0.03	0.81	-0.19	-4.24e-04	-1.08e-05	2.03e-04
13	138	0.07	-0.82	0.17	8.36e-04	1.05e-04	-4.31e-04

13	139	-0.29	-7.29e-03	-0.01	2.71e-04	-1.73e-04	-1.64e-04
13	144	0.02	-5.89e-03	-8.12e-03	2.06e-04	4.73e-05	-1.14e-04
14	7	-2.28	0.0	-0.57	0.0	-1.53e-03	0.0
14	11	-3.40	0.0	-0.36	0.0	-2.24e-03	0.0
14	12	-3.15	0.0	0.29	0.0	-1.97e-03	0.0
14	31	-2.29	0.0	-0.56	0.0	-1.57e-03	0.0
14	35	-3.42	0.0	-0.36	0.0	-2.28e-03	0.0
14	36	-3.17	0.0	0.29	0.0	-2.00e-03	0.0
14	51	0.16	-0.04	-9.07e-03	2.80e-05	1.84e-04	6.97e-05
14	59	0.16	-0.05	-9.07e-03	2.58e-05	1.84e-04	4.77e-05
14	65	9.61e-03	-0.15	-7.74e-03	8.94e-05	5.82e-05	1.92e-04
14	83	0.08	-0.01	-8.41e-03	8.81e-06	1.21e-04	2.23e-05
14	91	0.08	-0.02	-8.41e-03	8.05e-06	1.21e-04	1.45e-05
14	97	0.03	-0.05	-7.94e-03	2.80e-05	7.69e-05	6.01e-05
14	119	-1.51	0.0	-0.38	0.0	-1.01e-03	0.0
14	123	-2.26	0.0	-0.24	0.0	-1.48e-03	0.0
14	124	-2.09	0.0	0.19	0.0	-1.30e-03	0.0
14	137	-0.03	0.0	-0.19	0.0	1.05e-05	0.0
14	138	0.11	0.0	0.17	0.0	1.64e-04	0.0
14	139	-0.28	0.0	-0.01	0.0	-1.28e-04	0.0
14	144	0.04	0.0	-8.04e-03	0.0	8.71e-05	0.0
15	7	-2.14	-2.44	-0.56	1.20e-03	-1.56e-03	-4.75e-04
15	8	-1.86	2.47	0.51	-2.58e-03	-1.21e-03	1.43e-03
15	11	-3.24	-1.45	-0.36	2.01e-04	-2.32e-03	9.36e-05
15	31	-2.15	-2.44	-0.56	1.28e-03	-1.58e-03	-5.20e-04
15	32	-1.86	2.47	0.51	-2.50e-03	-1.23e-03	1.38e-03
15	35	-3.24	-1.45	-0.35	2.84e-04	-2.34e-03	4.81e-05
15	60	0.16	0.05	-9.40e-03	-2.27e-04	1.70e-04	-4.21e-05
15	68	0.06	0.16	-8.63e-03	-3.36e-04	8.42e-05	-1.27e-04
15	92	0.07	0.02	-8.57e-03	-2.12e-04	9.08e-05	6.14e-05
15	100	0.03	0.05	-8.29e-03	-2.47e-04	5.98e-05	3.81e-05
15	119	-1.43	-1.63	-0.38	7.71e-04	-1.03e-03	-3.01e-04
15	120	-1.23	1.65	0.34	-1.75e-03	-8.02e-04	9.68e-04
15	123	-2.15	-0.97	-0.24	1.07e-04	-1.54e-03	7.75e-05
15	137	-0.03	-0.81	-0.19	4.24e-04	-1.08e-05	-2.03e-04
15	138	0.07	0.82	0.17	-8.36e-04	1.05e-04	4.31e-04
15	139	-0.29	7.29e-03	-0.01	-2.71e-04	-1.73e-04	1.64e-04
15	144	0.02	5.89e-03	-8.12e-03	-2.06e-04	4.73e-05	1.14e-04
16	8	-12.44	3.49	-12.67	-7.13e-03	5.52e-03	5.67e-03
16	12	-17.14	2.11	-14.87	-8.56e-03	7.26e-03	7.68e-03
16	32	-12.27	3.49	-11.90	-6.69e-03	5.37e-03	5.55e-03
16	36	-16.97	2.10	-14.09	-8.11e-03	7.12e-03	7.57e-03
16	57	-1.39	-0.04	-1.86	-1.08e-03	3.38e-04	7.07e-04
16	68	0.32	0.16	-2.25	-1.25e-03	1.99e-04	-5.70e-05
16	70	-0.04	0.16	-2.26	-1.26e-03	1.61e-04	9.91e-05
16	89	-0.76	-6.98e-03	-1.91	-1.10e-03	3.48e-04	4.30e-04
16	100	-0.19	0.05	-2.04	-1.16e-03	3.08e-04	1.74e-04
16	102	-0.32	0.05	-2.04	-1.16e-03	2.94e-04	2.29e-04
16	120	-8.35	2.33	-8.71	-4.90e-03	3.72e-03	3.82e-03
16	124	-11.49	1.40	-10.17	-5.85e-03	4.89e-03	5.16e-03
16	138	-1.14	1.16	-3.17	-1.73e-03	7.46e-04	6.28e-04
16	139	-1.91	7.31e-03	-2.92	-1.69e-03	9.45e-04	9.30e-04
16	144	-0.43	6.00e-03	-1.94	-1.11e-03	3.56e-04	2.83e-04
17	7	-1.86	2.51	-1.27	-1.47e-04	4.29e-04	1.25e-04
17	12	-3.60	-1.50	0.16	1.84e-03	7.61e-04	-1.01e-03
17	31	-1.86	2.51	-1.26	-2.44e-04	4.31e-04	1.83e-04
17	36	-3.61	-1.50	0.17	1.74e-03	7.63e-04	-9.56e-04
17	50	-0.15	0.22	-0.04	2.45e-04	2.82e-05	-2.85e-04
17	51	0.18	-0.22	0.02	2.41e-04	-3.90e-05	-6.92e-06
17	66	-0.05	0.71	-0.02	-1.60e-05	7.99e-06	-5.27e-04
17	82	-0.04	0.07	-0.02	2.47e-04	6.46e-06	-1.91e-04
17	83	0.08	-0.07	1.90e-03	2.39e-04	-1.73e-05	-1.01e-04
17	98	-5.25e-03	0.22	-0.01	1.63e-04	0.0	-2.65e-04
17	119	-1.23	1.67	-0.85	-6.57e-05	2.85e-04	6.38e-05
17	124	-2.40	-1.00	0.11	1.26e-03	5.07e-04	-6.95e-04
17	137	0.12	0.84	-0.34	-1.03e-04	-1.82e-05	5.65e-05
17	139	-0.32	4.65e-04	-0.05	3.30e-04	6.66e-05	-1.90e-04
17	144	0.02	3.11e-04	-9.08e-03	2.43e-04	-5.40e-06	-1.46e-04
18	7	-1.95	0.0	-1.20	0.0	4.77e-04	0.0
18	8	-2.43	0.0	0.82	0.0	5.23e-04	0.0
18	12	-3.62	0.0	0.30	0.0	8.06e-04	0.0
18	31	-1.97	0.0	-1.20	0.0	4.81e-04	0.0
18	32	-2.45	0.0	0.81	0.0	5.27e-04	0.0
18	36	-3.64	0.0	0.30	0.0	8.09e-04	0.0
18	59	0.18	-0.20	0.03	5.70e-05	-3.63e-05	1.26e-04
18	72	0.09	0.71	0.01	-2.08e-04	-1.73e-05	-4.49e-04
18	91	0.10	-0.06	0.01	1.76e-05	-1.88e-05	3.92e-05

18	104	0.06	0.22	7.21e-03	-6.52e-05	-1.21e-05	-1.41e-04
18	119	-1.29	0.0	-0.80	0.0	3.17e-04	0.0
18	120	-1.61	0.0	0.54	0.0	3.48e-04	0.0
18	124	-2.40	0.0	0.20	0.0	5.36e-04	0.0
18	137	0.13	0.0	-0.33	0.0	-1.69e-05	0.0
18	138	-0.03	0.0	0.34	0.0	-1.51e-06	0.0
18	139	-0.29	0.0	-0.03	0.0	6.86e-05	0.0
18	144	0.05	0.0	4.68e-03	0.0	-9.19e-06	0.0
19	7	-1.86	-2.51	-1.27	1.47e-04	4.29e-04	-1.25e-04
19	12	-3.60	1.50	0.16	-1.84e-03	7.61e-04	1.01e-03
19	31	-1.86	-2.51	-1.26	2.44e-04	4.31e-04	-1.83e-04
19	36	-3.61	1.50	0.17	-1.74e-03	7.63e-04	9.56e-04
19	57	-0.15	-0.22	-0.04	-2.45e-04	2.82e-05	2.85e-04
19	60	0.18	0.22	0.02	-2.41e-04	-3.90e-05	6.92e-06
19	69	-0.05	-0.71	-0.02	1.60e-05	7.99e-06	5.27e-04
19	89	-0.04	-0.07	-0.02	-2.47e-04	6.46e-06	1.91e-04
19	92	0.08	0.07	1.90e-03	-2.39e-04	-1.73e-05	1.01e-04
19	101	-5.25e-03	-0.22	-0.01	-1.63e-04	0.0	2.65e-04
19	119	-1.23	-1.67	-0.85	6.57e-05	2.85e-04	-6.38e-05
19	124	-2.40	1.00	0.11	-1.26e-03	5.07e-04	6.95e-04
19	137	0.12	-0.84	-0.34	1.03e-04	-1.82e-05	-5.65e-05
19	139	-0.32	-4.65e-04	-0.05	-3.30e-04	6.66e-05	1.90e-04
19	144	0.02	-3.11e-04	-9.08e-03	-2.43e-04	-5.40e-06	1.46e-04
20	8	-10.86	-3.61	-8.67	7.73e-03	7.86e-04	-3.66e-03
20	12	-14.95	-2.21	-10.31	0.01	1.64e-04	-4.53e-03
20	32	-10.70	-3.60	-7.93	7.36e-03	8.24e-04	-3.37e-03
20	36	-14.80	-2.20	-9.57	9.88e-03	2.02e-04	-4.24e-03
20	50	-1.37	0.21	-1.82	1.12e-03	-1.35e-04	-8.35e-04
20	65	-0.13	-0.72	-2.43	1.32e-03	-2.98e-04	-3.68e-04
20	69	-0.02	-0.73	-2.41	1.29e-03	-2.90e-04	-3.62e-04
20	82	-0.73	0.06	-1.85	9.99e-04	-1.11e-04	-7.53e-04
20	97	-0.32	-0.24	-2.04	1.05e-03	-1.60e-04	-6.06e-04
20	101	-0.28	-0.24	-2.04	1.04e-03	-1.57e-04	-6.04e-04
20	120	-7.29	-2.41	-6.03	5.28e-03	5.11e-04	-2.53e-03
20	124	-10.02	-1.47	-7.12	6.96e-03	9.65e-05	-3.11e-03
20	138	-1.00	-1.20	-2.52	1.34e-03	2.97e-04	-9.49e-04
20	139	-1.68	-0.02	-2.51	1.73e-03	-1.36e-04	-1.02e-03
20	144	-0.39	-0.01	-1.86	9.27e-04	-9.50e-05	-7.15e-04
21	8	-10.86	3.61	-8.67	-7.73e-03	7.86e-04	3.66e-03
21	12	-14.95	2.21	-10.31	-0.01	1.64e-04	4.53e-03
21	32	-10.70	3.60	-7.93	-7.36e-03	8.24e-04	3.37e-03
21	36	-14.80	2.20	-9.57	-9.88e-03	2.02e-04	4.24e-03
21	57	-1.37	-0.21	-1.82	-1.12e-03	-1.35e-04	8.35e-04
21	66	-0.02	0.73	-2.41	-1.29e-03	-2.90e-04	3.62e-04
21	70	-0.13	0.72	-2.43	-1.32e-03	-2.98e-04	3.68e-04
21	89	-0.73	-0.06	-1.85	-9.99e-04	-1.11e-04	7.53e-04
21	98	-0.28	0.24	-2.04	-1.04e-03	-1.57e-04	6.04e-04
21	102	-0.32	0.24	-2.04	-1.05e-03	-1.60e-04	6.06e-04
21	120	-7.29	2.41	-6.03	-5.28e-03	5.11e-04	2.53e-03
21	124	-10.02	1.47	-7.12	-6.96e-03	9.65e-05	3.11e-03
21	138	-1.00	1.20	-2.52	-1.34e-03	2.97e-04	9.49e-04
21	139	-1.68	0.02	-2.51	-1.73e-03	-1.36e-04	1.02e-03
21	144	-0.39	0.01	-1.86	-9.27e-04	-9.50e-05	7.15e-04
22	8	-12.48	-3.53	-10.25	6.32e-03	-4.14e-03	-5.15e-03
22	12	-17.63	-2.13	-14.21	8.40e-03	-7.21e-03	-7.54e-03
22	32	-12.26	-3.53	-9.38	5.83e-03	-3.92e-03	-5.01e-03
22	36	-17.40	-2.13	-13.35	7.92e-03	-6.99e-03	-7.41e-03
22	50	-1.59	0.40	-2.21	1.25e-03	-6.56e-04	-8.00e-04
22	65	-0.45	-1.28	-2.98	1.58e-03	-7.71e-04	-3.01e-04
22	69	-0.34	-1.29	-2.96	1.56e-03	-7.53e-04	-2.47e-04
22	82	-0.92	0.13	-2.19	1.23e-03	-5.90e-04	-5.01e-04
22	97	-0.54	-0.40	-2.43	1.32e-03	-6.21e-04	-3.33e-04
22	101	-0.50	-0.41	-2.42	1.32e-03	-6.15e-04	-3.14e-04
22	120	-8.40	-2.36	-7.12	4.37e-03	-2.83e-03	-3.48e-03
22	124	-11.83	-1.42	-9.76	5.76e-03	-4.88e-03	-5.07e-03
22	138	-1.09	-1.18	-2.26	1.42e-03	-1.63e-04	-4.37e-04
22	139	-2.10	-2.53e-03	-3.25	1.83e-03	-1.25e-03	-1.01e-03
22	144	-0.56	-1.46e-03	-2.17	1.21e-03	-5.50e-04	-3.41e-04
23	7	-1.17	2.50	-1.28	4.24e-04	-4.69e-04	-3.65e-04
23	8	-3.04	-2.52	1.03	1.67e-03	-1.11e-03	-9.83e-04
23	12	-3.87	-1.52	0.51	1.80e-03	-1.40e-03	-1.12e-03
23	31	-1.17	2.50	-1.28	3.03e-04	-4.48e-04	-2.98e-04
23	32	-3.04	-2.52	1.04	1.55e-03	-1.09e-03	-9.16e-04
23	36	-3.88	-1.52	0.52	1.68e-03	-1.37e-03	-1.05e-03
23	49	-0.13	-0.37	-0.02	4.74e-04	-7.87e-05	-2.34e-04
23	51	0.16	-0.41	-0.02	3.28e-04	-2.90e-05	1.09e-05
23	69	-4.26e-03	-1.29	-0.02	6.49e-04	-5.80e-05	1.78e-06

23	81	-0.04	-0.11	-0.02	3.59e-04	-6.29e-05	-1.93e-04
23	83	0.06	-0.13	-0.02	3.07e-04	-4.53e-05	-1.06e-04
23	101	4.54e-03	-0.41	-0.02	4.11e-04	-5.56e-05	-1.14e-04
23	119	-0.78	1.67	-0.86	3.23e-04	-3.20e-04	-2.66e-04
23	120	-2.03	-1.68	0.69	1.16e-03	-7.50e-04	-6.77e-04
23	124	-2.58	-1.01	0.34	1.24e-03	-9.38e-04	-7.69e-04
23	137	0.32	0.83	-0.41	9.32e-05	5.32e-05	-6.35e-05
23	138	-0.30	-0.84	0.37	5.10e-04	-1.62e-04	-2.69e-04
23	144	0.01	-1.56e-03	-0.02	3.02e-04	-5.42e-05	-1.66e-04
24	7	-1.32	0.0	-1.29	0.0	-7.13e-04	0.0
24	8	-3.06	0.0	1.03	0.0	-1.35e-03	0.0
24	12	-3.98	0.0	0.50	0.0	-1.75e-03	0.0
24	31	-1.33	0.0	-1.29	0.0	-6.83e-04	0.0
24	32	-3.07	0.0	1.04	0.0	-1.32e-03	0.0
24	36	-3.99	0.0	0.51	0.0	-1.72e-03	0.0
24	57	-0.08	-0.41	-0.02	5.55e-05	-1.00e-04	7.89e-05
24	59	0.16	-0.36	-0.02	3.48e-05	-5.40e-05	6.36e-05
24	72	0.07	1.29	-0.02	-1.54e-04	-7.02e-05	-2.40e-04
24	89	-5.49e-03	-0.13	-0.02	1.78e-05	-8.53e-05	2.50e-05
24	91	0.08	-0.11	-0.02	1.05e-05	-6.89e-05	1.96e-05
24	104	0.05	0.40	-0.02	-4.82e-05	-7.47e-05	-7.51e-05
24	119	-0.87	0.0	-0.86	0.0	-4.86e-04	0.0
24	120	-2.03	0.0	0.68	0.0	-9.08e-04	0.0
24	124	-2.65	0.0	0.33	0.0	-1.18e-03	0.0
24	137	0.33	0.0	-0.41	0.0	2.85e-05	0.0
24	144	0.04	0.0	-0.02	0.0	-7.71e-05	0.0
25	7	-1.17	-2.50	-1.28	-4.24e-04	-4.69e-04	3.65e-04
25	8	-3.04	2.52	1.03	-1.67e-03	-1.11e-03	9.83e-04
25	12	-3.87	1.52	0.51	-1.80e-03	-1.40e-03	1.12e-03
25	31	-1.17	-2.50	-1.28	-3.03e-04	-4.48e-04	2.98e-04
25	32	-3.04	2.52	1.04	-1.55e-03	-1.09e-03	9.16e-04
25	36	-3.88	1.52	0.52	-1.68e-03	-1.37e-03	1.05e-03
25	58	-0.13	0.37	-0.02	-4.74e-04	-7.87e-05	2.34e-04
25	60	0.16	0.41	-0.02	-3.28e-04	-2.90e-05	-1.09e-05
25	66	-4.26e-03	1.29	-0.02	-6.49e-04	-5.80e-05	-1.78e-06
25	90	-0.04	0.11	-0.02	-3.59e-04	-6.29e-05	1.93e-04
25	92	0.06	0.13	-0.02	-3.07e-04	-4.53e-05	1.06e-04
25	98	4.54e-03	0.41	-0.02	-4.11e-04	-5.56e-05	1.14e-04
25	119	-0.78	-1.67	-0.86	-3.23e-04	-3.20e-04	2.66e-04
25	120	-2.03	1.68	0.69	-1.16e-03	-7.50e-04	6.77e-04
25	124	-2.58	1.01	0.34	-1.24e-03	-9.38e-04	7.69e-04
25	137	0.32	-0.83	-0.41	-9.32e-05	5.32e-05	6.35e-05
25	138	-0.30	0.84	0.37	-5.10e-04	-1.62e-04	2.69e-04
25	144	0.01	1.56e-03	-0.02	-3.02e-04	-5.42e-05	1.66e-04
26	8	-12.48	3.53	-10.25	-6.32e-03	-4.14e-03	5.15e-03
26	12	-17.63	2.13	-14.21	-8.40e-03	-7.21e-03	7.54e-03
26	32	-12.26	3.53	-9.38	-5.83e-03	-3.92e-03	5.01e-03
26	36	-17.40	2.13	-13.35	-7.92e-03	-6.99e-03	7.41e-03
26	57	-1.59	-0.40	-2.21	-1.25e-03	-6.56e-04	8.00e-04
26	66	-0.34	1.29	-2.96	-1.56e-03	-7.53e-04	2.47e-04
26	70	-0.45	1.28	-2.98	-1.58e-03	-7.71e-04	3.01e-04
26	89	-0.92	-0.13	-2.19	-1.23e-03	-5.90e-04	5.01e-04
26	98	-0.50	0.41	-2.42	-1.32e-03	-6.15e-04	3.14e-04
26	102	-0.54	0.40	-2.43	-1.32e-03	-6.21e-04	3.33e-04
26	120	-8.40	2.36	-7.12	-4.37e-03	-2.83e-03	3.48e-03
26	124	-11.83	1.42	-9.76	-5.76e-03	-4.88e-03	5.07e-03
26	138	-1.09	1.18	-2.26	-1.42e-03	-1.63e-04	4.37e-04
26	139	-2.10	2.53e-03	-3.25	-1.83e-03	-1.25e-03	1.01e-03
26	144	-0.56	1.46e-03	-2.17	-1.21e-03	-5.50e-04	3.41e-04
27	7	-12.22	3.55	-15.51	6.09e-03	-8.22e-03	-2.75e-03
27	11	-19.90	2.14	-21.58	9.41e-03	-0.01	-4.12e-03
27	12	-21.61	-2.10	-20.65	0.01	-9.78e-03	-4.55e-03
27	31	-11.87	3.55	-14.42	5.70e-03	-7.89e-03	-2.46e-03
27	35	-19.55	2.14	-20.50	9.02e-03	-0.01	-3.83e-03
27	36	-21.26	-2.10	-19.57	9.74e-03	-9.45e-03	-4.26e-03
27	50	-1.96	0.52	-2.84	1.20e-03	-9.65e-04	-8.88e-04
27	65	-0.86	-1.58	-3.69	1.44e-03	-1.05e-03	-5.35e-04
27	67	-0.27	-1.60	-3.45	1.24e-03	-9.38e-04	-4.87e-04
27	82	-1.25	0.16	-2.77	1.06e-03	-8.75e-04	-7.90e-04
27	97	-0.88	-0.49	-3.02	1.13e-03	-8.98e-04	-6.77e-04
27	99	-0.67	-0.50	-2.94	1.06e-03	-8.56e-04	-6.60e-04
27	119	-8.26	2.36	-10.70	4.19e-03	-5.59e-03	-1.94e-03
27	123	-13.39	1.43	-14.75	6.41e-03	-7.56e-03	-2.85e-03
27	124	-14.53	-1.40	-14.13	6.88e-03	-6.63e-03	-3.13e-03
27	138	-1.35	-1.18	-2.45	1.17e-03	-4.36e-04	-8.60e-04
27	139	-2.77	-1.92e-04	-4.41	1.80e-03	-1.73e-03	-1.07e-03
27	144	-0.87	-2.30e-03	-2.71	9.77e-04	-8.22e-04	-7.40e-04

28	7	-1.21	2.53	-2.13	4.77e-04	-1.10e-03	-2.72e-04
28	11	-3.24	1.53	-2.18	1.11e-03	-1.92e-03	-6.38e-04
28	12	-4.92	-1.50	-0.84	1.83e-03	-2.31e-03	-1.06e-03
28	31	-1.20	2.53	-2.08	3.59e-04	-1.04e-03	-2.02e-04
28	35	-3.22	1.53	-2.14	9.93e-04	-1.86e-03	-5.68e-04
28	36	-4.90	-1.50	-0.80	1.71e-03	-2.25e-03	-9.90e-04
28	50	-0.20	0.52	-0.13	2.95e-04	-1.86e-04	-3.11e-04
28	67	0.02	-1.60	-0.10	6.20e-04	-1.37e-04	6.97e-05
28	82	-0.10	0.16	-0.12	3.00e-04	-1.62e-04	-2.20e-04
28	99	-0.02	-0.50	-0.10	3.97e-04	-1.45e-04	-9.74e-05
28	119	-0.81	1.68	-1.43	3.58e-04	-7.51e-04	-2.05e-04
28	123	-2.16	1.02	-1.47	7.81e-04	-1.30e-03	-4.49e-04
28	124	-3.28	-1.00	-0.58	1.26e-03	-1.56e-03	-7.30e-04
28	137	0.43	0.84	-0.48	9.65e-05	-4.18e-05	-5.77e-05
28	138	-0.51	-0.84	0.26	4.97e-04	-2.57e-04	-2.92e-04
28	144	-0.04	-1.79e-03	-0.11	2.97e-04	-1.49e-04	-1.75e-04
29	1	0.90	0.0	-1.46	0.0	-1.82e-04	0.0
29	11	-3.68	0.0	-2.64	0.0	-2.66e-03	0.0
29	12	-5.28	0.0	-1.30	0.0	-3.04e-03	0.0
29	25	0.91	0.0	-1.40	0.0	-9.84e-05	0.0
29	35	-3.67	0.0	-2.59	0.0	-2.58e-03	0.0
29	36	-5.27	0.0	-1.24	0.0	-2.96e-03	0.0
29	57	-0.17	-0.52	-0.17	7.95e-05	-2.45e-04	1.20e-04
29	58	-0.17	0.44	-0.17	-4.39e-05	-2.45e-04	-7.93e-05
29	72	6.72e-03	1.60	-0.13	-2.11e-04	-1.97e-04	-3.39e-04
29	89	-0.08	-0.16	-0.15	2.56e-05	-2.21e-04	3.86e-05
29	90	-0.08	0.13	-0.15	-1.30e-05	-2.21e-04	-2.40e-05
29	104	-0.02	0.50	-0.14	-6.63e-05	-2.04e-04	-1.06e-04
29	113	0.60	0.0	-0.99	0.0	-1.49e-04	0.0
29	123	-2.46	0.0	-1.78	0.0	-1.80e-03	0.0
29	124	-3.53	0.0	-0.88	0.0	-2.06e-03	0.0
29	137	0.41	0.0	-0.51	0.0	-1.03e-04	0.0
29	138	-0.48	0.0	0.23	0.0	-3.14e-04	0.0
29	144	-0.03	0.0	-0.14	0.0	-2.08e-04	0.0
30	7	-1.21	-2.53	-2.13	-4.77e-04	-1.10e-03	2.72e-04
30	11	-3.24	-1.53	-2.18	-1.11e-03	-1.92e-03	6.38e-04
30	12	-4.92	1.50	-0.84	-1.83e-03	-2.31e-03	1.06e-03
30	31	-1.20	-2.53	-2.08	-3.59e-04	-1.04e-03	2.02e-04
30	35	-3.22	-1.53	-2.14	-9.93e-04	-1.86e-03	5.68e-04
30	36	-4.90	1.50	-0.80	-1.71e-03	-2.25e-03	9.90e-04
30	57	-0.20	-0.52	-0.13	-2.95e-04	-1.86e-04	3.11e-04
30	72	0.02	1.60	-0.10	-6.20e-04	-1.37e-04	-6.97e-05
30	89	-0.10	-0.16	-0.12	-3.00e-04	-1.62e-04	2.20e-04
30	104	-0.02	0.50	-0.10	-3.97e-04	-1.45e-04	9.74e-05
30	119	-0.81	-1.68	-1.43	-3.58e-04	-7.51e-04	2.05e-04
30	123	-2.16	-1.02	-1.47	-7.81e-04	-1.30e-03	4.49e-04
30	124	-3.28	1.00	-0.58	-1.26e-03	-1.56e-03	7.30e-04
30	137	0.43	-0.84	-0.48	-9.65e-05	-4.18e-05	5.77e-05
30	138	-0.51	0.84	0.26	-4.97e-04	-2.57e-04	2.92e-04
30	144	-0.04	1.79e-03	-0.11	-2.97e-04	-1.49e-04	1.75e-04
31	7	-12.22	-3.55	-15.51	-6.09e-03	-8.22e-03	2.75e-03
31	11	-19.90	-2.14	-21.58	-9.41e-03	-0.01	4.12e-03
31	12	-21.61	2.10	-20.65	-0.01	-9.78e-03	4.55e-03
31	31	-11.87	-3.55	-14.42	-5.70e-03	-7.89e-03	2.46e-03
31	35	-19.55	-2.14	-20.50	-9.02e-03	-0.01	3.83e-03
31	36	-21.26	2.10	-19.57	-9.74e-03	-9.45e-03	4.26e-03
31	57	-1.96	-0.52	-2.84	-1.20e-03	-9.65e-04	8.88e-04
31	70	-0.86	1.58	-3.69	-1.44e-03	-1.05e-03	5.35e-04
31	72	-0.27	1.60	-3.45	-1.24e-03	-9.38e-04	4.87e-04
31	89	-1.25	-0.16	-2.77	-1.06e-03	-8.75e-04	7.90e-04
31	102	-0.88	0.49	-3.02	-1.13e-03	-8.98e-04	6.77e-04
31	104	-0.67	0.50	-2.94	-1.06e-03	-8.56e-04	6.60e-04
31	119	-8.26	-2.36	-10.70	-4.19e-03	-5.59e-03	1.94e-03
31	123	-13.39	-1.43	-14.75	-6.41e-03	-7.56e-03	2.85e-03
31	124	-14.53	1.40	-14.13	-6.88e-03	-6.63e-03	3.13e-03
31	138	-1.35	1.18	-2.45	-1.17e-03	-4.36e-04	8.60e-04
31	139	-2.77	1.92e-04	-4.41	-1.80e-03	-1.73e-03	1.07e-03
31	144	-0.87	2.30e-03	-2.71	-9.77e-04	-8.22e-04	7.40e-04
Nodo		Traslazione X	Traslazione Y	Traslazione Z	Rotazione X	Rotazione Y	Rotazione Z
		-21.61	-3.61	-21.58	-0.01	-0.01	-7.68e-03
		0.91	3.61	1.35	0.01	9.54e-03	7.68e-03

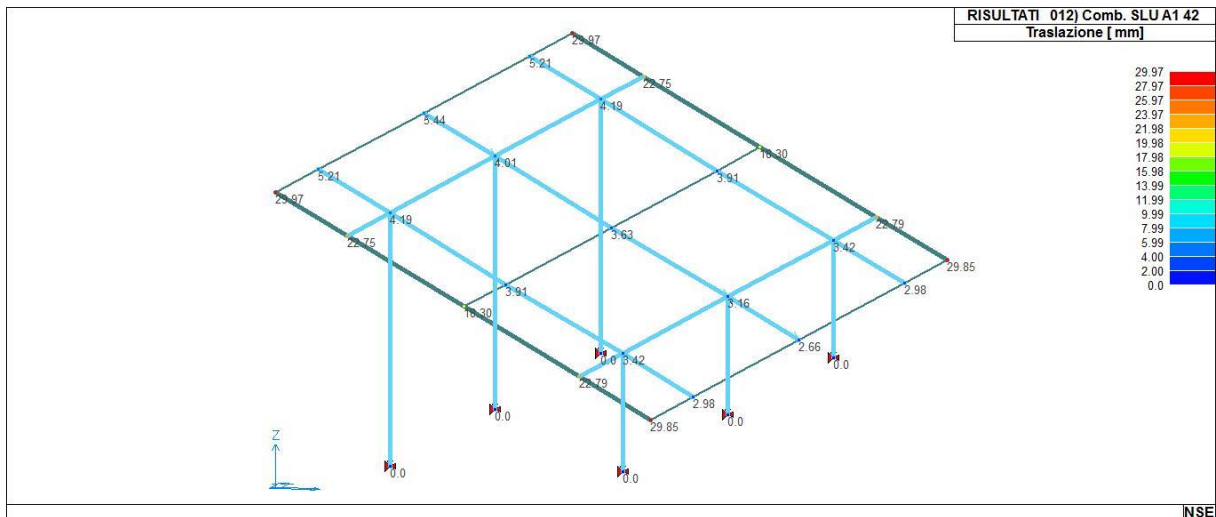

41_RIS_SPOSTAMENTI_012_Comb. SLU A1 42

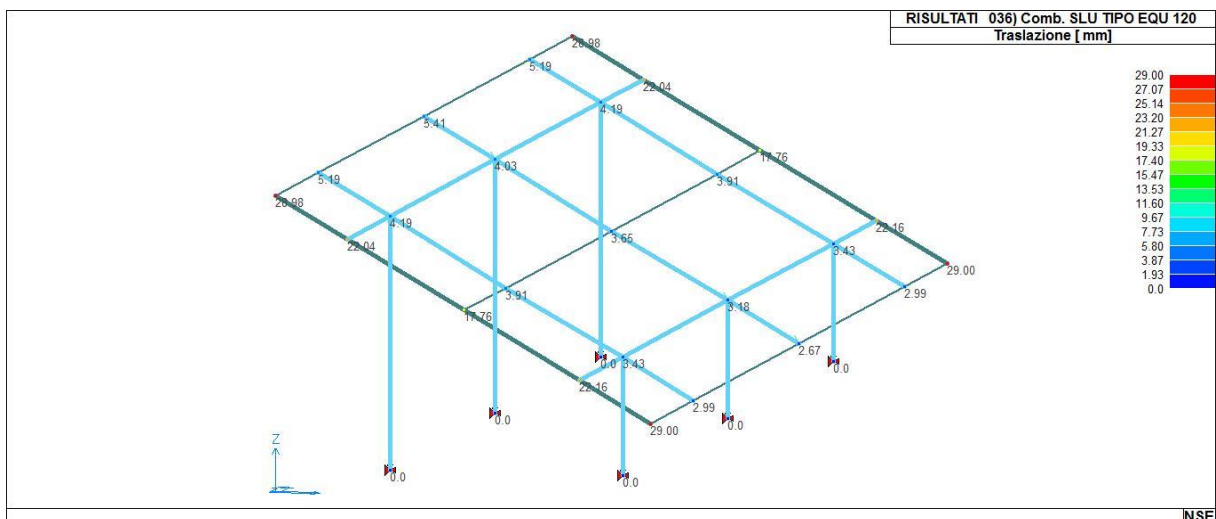

41_RIS_SPOSTAMENTI_036_Comb. SLU TIPO EQU 120

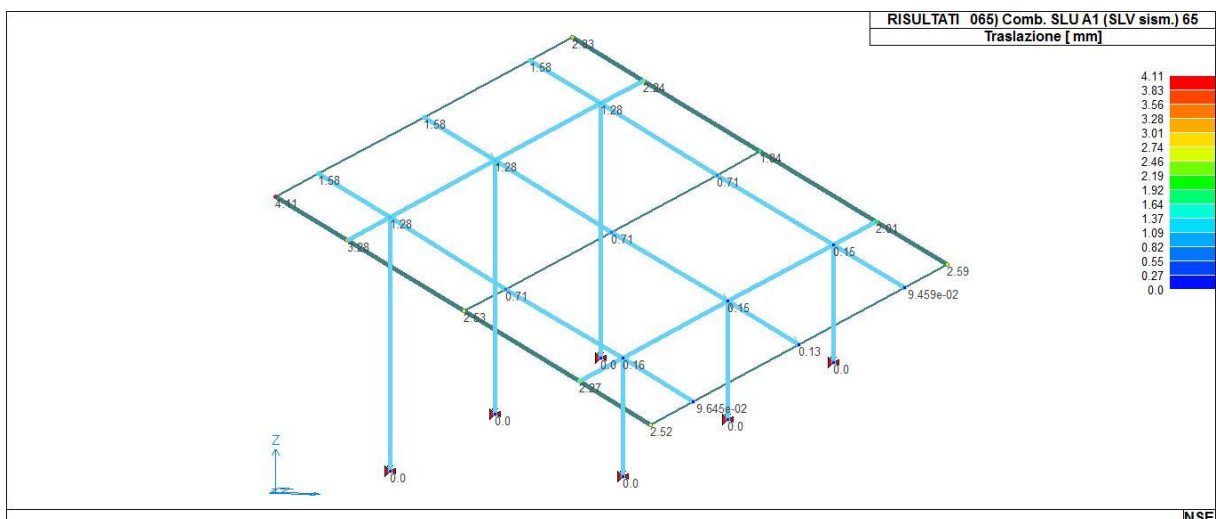

41_RIS_SPOSTAMENTI_065_Comb. SLU A1 (SLV sism.) 65

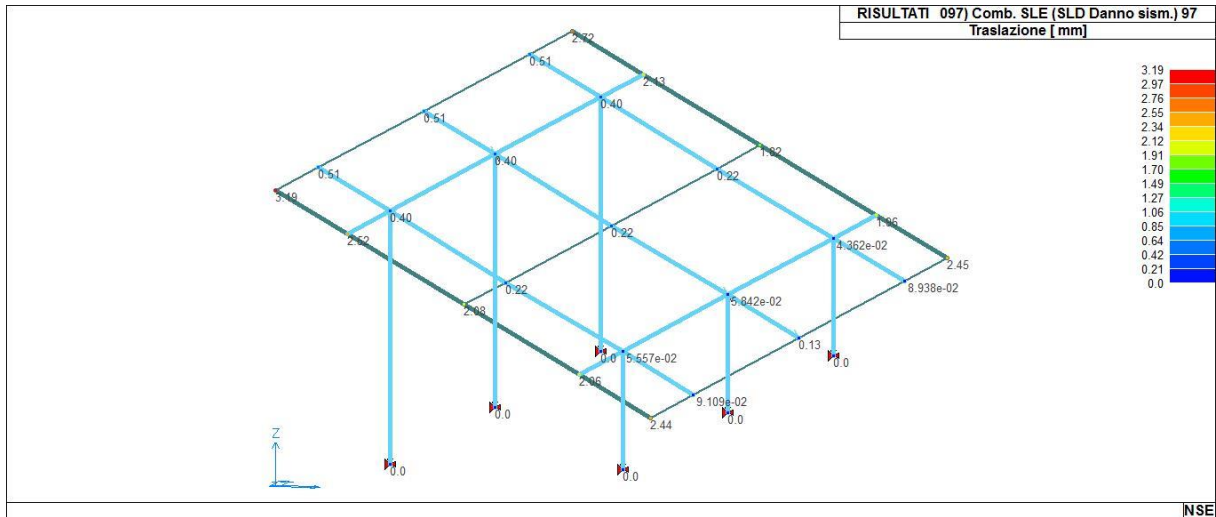

41_RIS_SPOSTAMENTI_097_Comb. SLE (SLD Danno sism.) 97

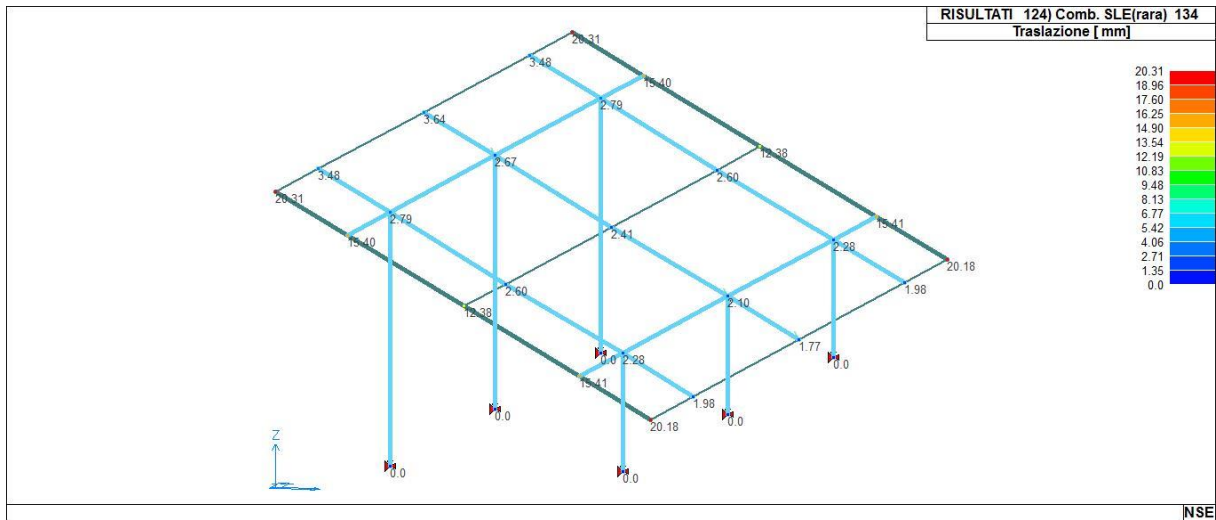

41_RIS_SPOSTAMENTI_124_Comb. SLE(rara) 134

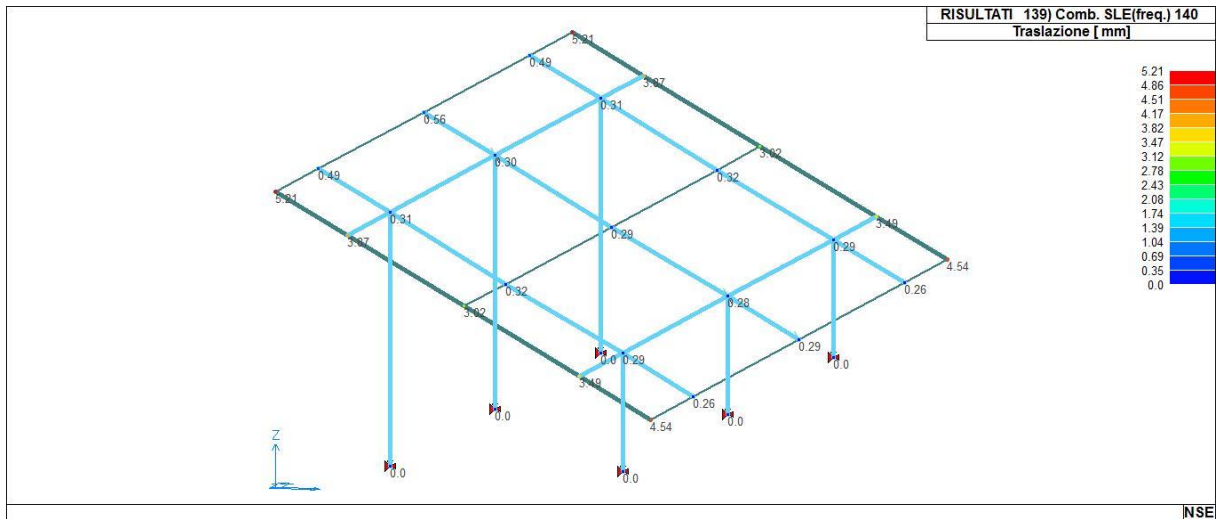

41_RIS_SPOSTAMENTI_139_Comb. SLE(freq.) 140

		-3.142e+04	-9901.48	-5.014e+04	-6735.22	-2.288e+04	-6.76
		3442.01	9901.48	116.64	6735.22	2865.04	6.76
Nodo	Cmb	Azione X	Azione Y	Azione Z	Azione RX	Azione RY	Azione RZ
		N	N	N	N m	N m	N m
1	12	-3163.29	458.74	-4.713e+04	-20.04	-5248.40	-2.84
	27	855.66	714.55	-760.78	-983.94	1313.89	0.26
	7	-862.31	1748.08	-3.230e+04	-2116.25	-1505.74	-0.93
	26	-933.86	-710.71	-8338.84	1228.48	-1598.95	-1.33
	36	-3212.15	369.89	-4.505e+04	56.07	-5293.04	-2.68
2	3	904.52	803.40	-2831.91	-1060.05	1358.53	0.09
	12	-2.752e+04	-1502.21	-1.944e+04	2310.02	-2.027e+04	-6.76
	27	2116.42	4973.62	-2393.23	-3662.95	1543.42	2.83
	7	-1.845e+04	9901.48	-1.329e+04	-6735.22	-1.386e+04	2.60
	26	-1983.86	-6824.73	-6224.24	5536.51	-1155.43	-6.02
3	11	-2.824e+04	7648.06	-1.833e+04	-4707.40	-2.108e+04	-0.51
	28	2839.28	-4176.65	-3500.49	3354.46	2355.20	-3.42
	11	-1785.11	0.0	-5.014e+04	0.0	-3452.10	0.0
	28	-1.29	0.0	116.64	0.0	-103.64	0.0
	72	248.02	627.77	-4812.49	-856.99	260.19	-0.61
4	69	166.58	-627.77	-5112.44	856.99	143.65	0.61
	36	-2713.81	0.0	-4.719e+04	0.0	-4942.07	0.0
	3	927.41	0.0	-2836.37	0.0	1386.33	0.0
	11	-3.142e+04	0.0	-2.014e+04	0.0	-2.285e+04	0.0
	28	3442.01	0.0	-2083.99	0.0	2831.72	0.0
5	68	133.08	580.64	-4755.38	-408.06	290.26	-1.05
	65	-383.70	-580.64	-4417.39	408.06	-123.63	1.05
	35	-3.137e+04	0.0	-1.831e+04	0.0	-2.288e+04	0.0
	4	3391.88	0.0	-3918.54	0.0	2865.04	0.0
	12	-3163.29	-458.74	-4.713e+04	20.04	-5248.40	2.84
6	27	855.66	-714.55	-760.78	983.94	1313.89	-0.26
	26	-933.86	710.71	-8338.84	-1228.48	-1598.95	1.33
	7	-862.31	-1748.08	-3.230e+04	2116.25	-1505.74	0.93
	36	-3212.15	-369.89	-4.505e+04	-56.07	-5293.04	2.68
	3	904.52	-803.40	-2831.91	1060.05	1358.53	-0.09
6	12	-2.752e+04	1502.21	-1.944e+04	-2310.02	-2.027e+04	6.76
	27	2116.42	-4973.62	-2393.23	3662.95	1543.42	-2.83
	26	-1983.86	6824.73	-6224.24	-5536.51	-1155.43	6.02
	7	-1.845e+04	-9901.48	-1.329e+04	6735.22	-1.386e+04	-2.60
	11	-2.824e+04	-7648.06	-1.833e+04	4707.40	-2.108e+04	0.51
	28	2839.28	4176.65	-3500.49	-3354.46	2355.20	3.42

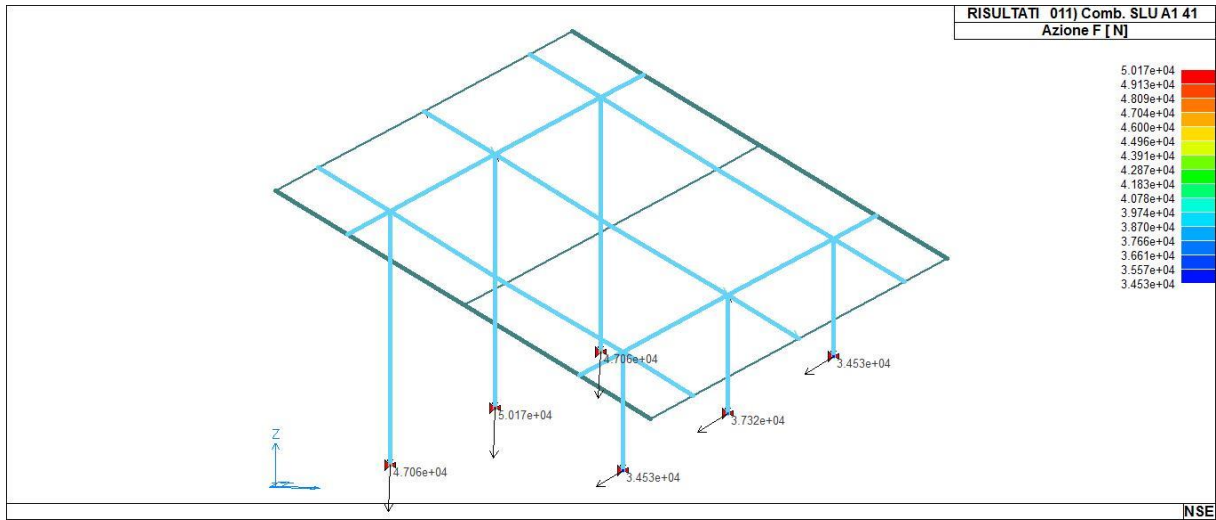

42_RIS_REAZIONI_011_Comb. SLU A1 41

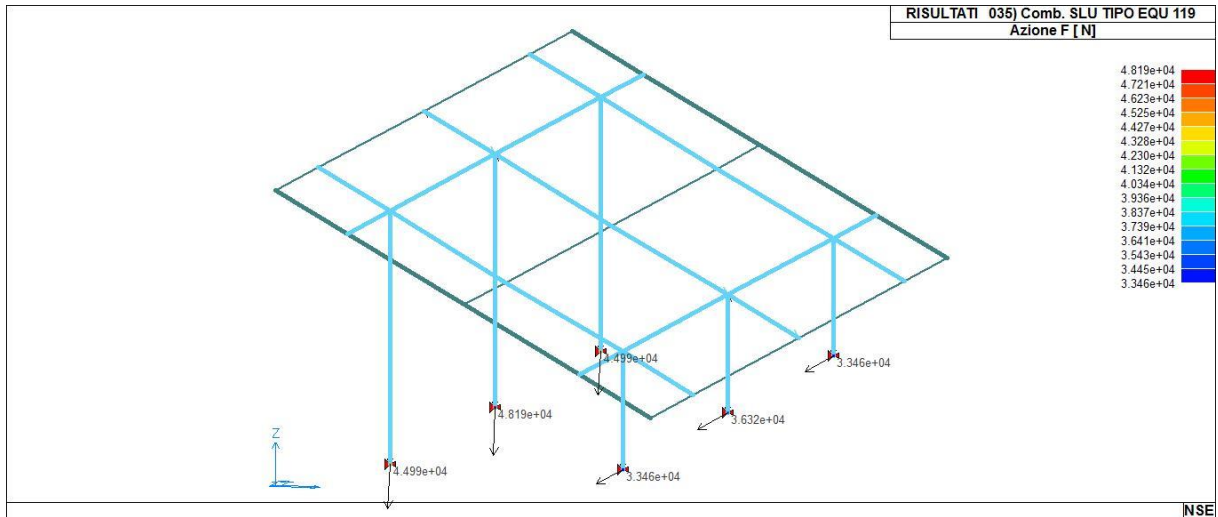

42_RIS_REAZIONI_035_Comb. SLU TIPO EQU 119

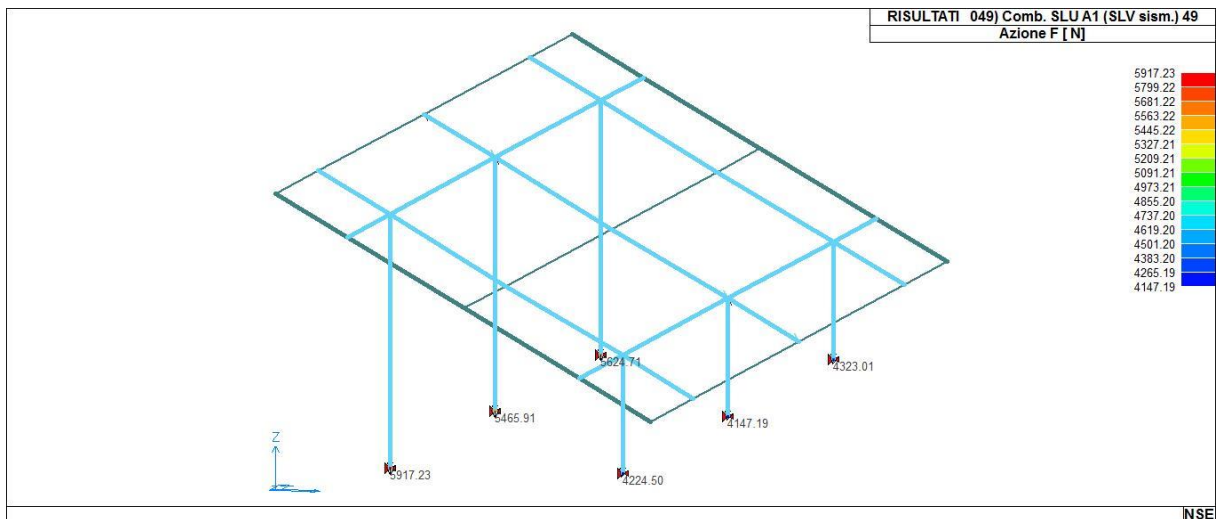

42_RIS_REAZIONI_049_Comb. SLU A1 (SLV sism.) 49

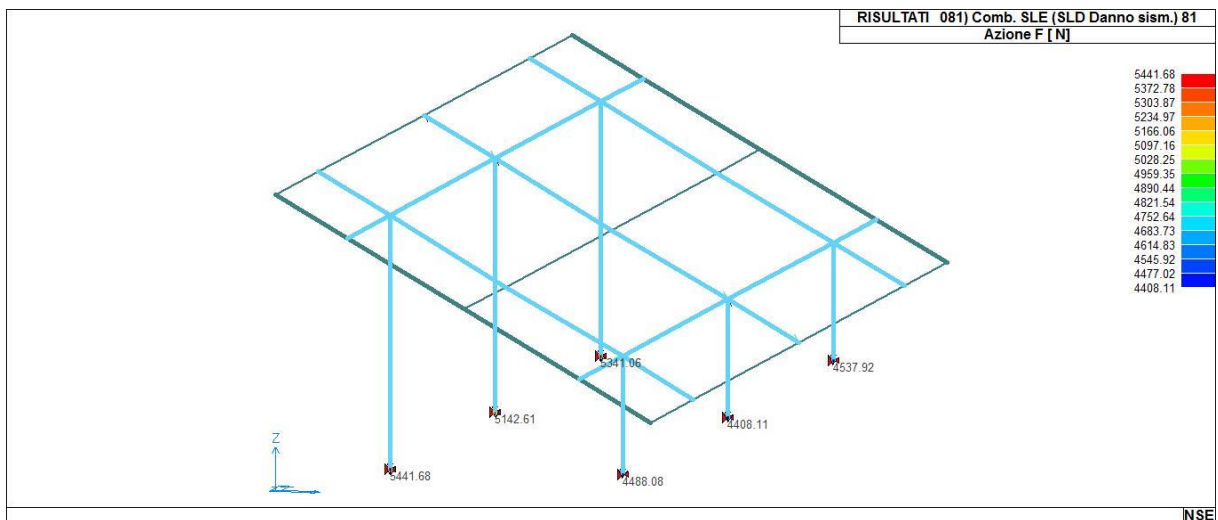

42_RIS_REAZIONI_081_Comb. SLE (SLD Danno sism.) 81

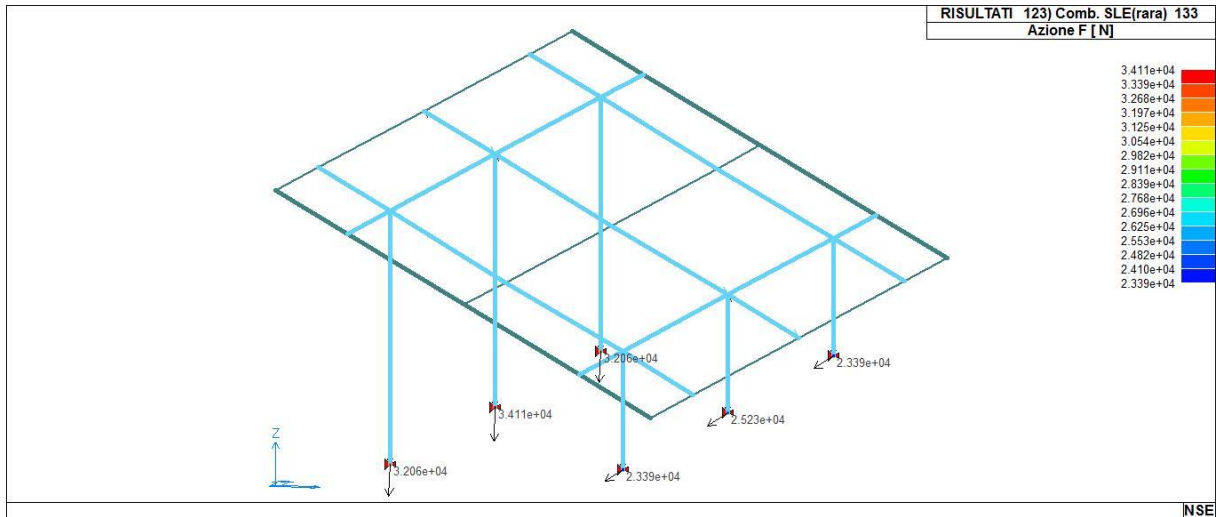

42_RIS_REAZIONI_123_Comb. SLE(rara) 133

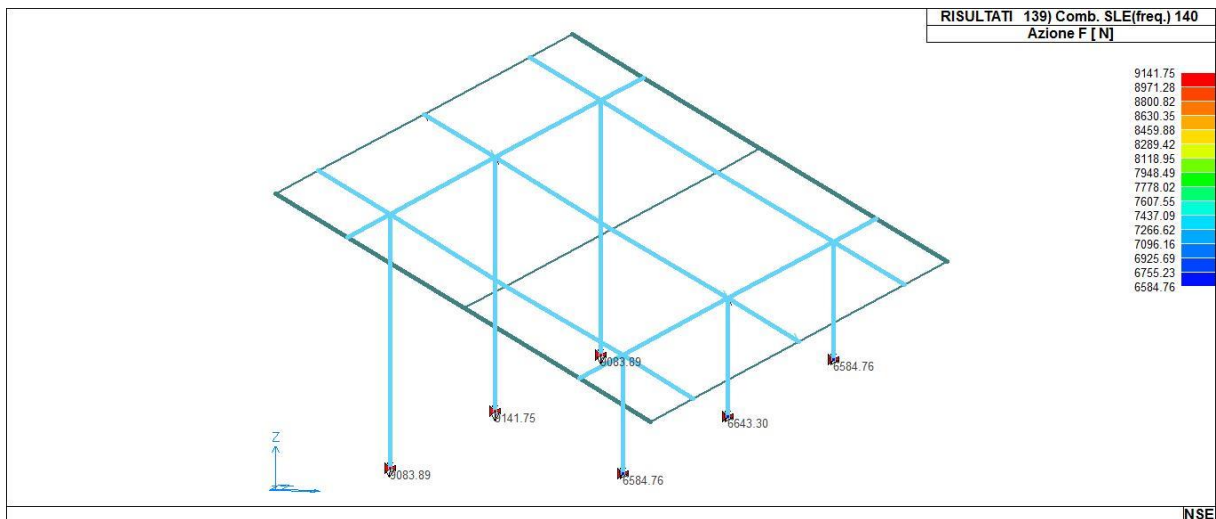

42_RIS_REAZIONI_139_Comb. SLE(freq.) 140

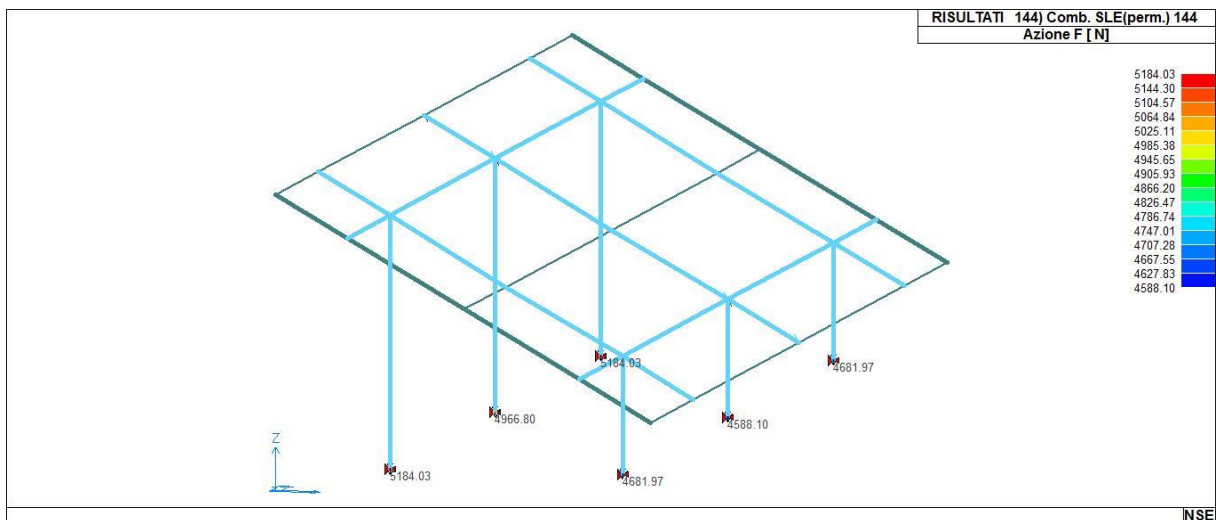

42_RIS_REAZIONI_144_Comb. SLE(perm.) 144

RISULTATI ELEMENTI TIPO TRAVE

LEGENDA RISULTATI ELEMENTI TIPO TRAVE

Il controllo dei risultati delle analisi condotte, per quanto concerne gli elementi tipo trave, è possibile in relazione alle tabelle sotto riportate.

Gli elementi vengono suddivisi in relazione alle proprietà in elementi:

- tipo **pilastro**
- tipo **trave in elevazione**
- tipo **trave in fondazione**

Per ogni elemento e per ogni combinazione (o caso di carico) vengono riportati i risultati più significativi.

Per gli elementi tipo *pilastro* sono riportati in tabella i seguenti valori:

Pilas.	numero dell'elemento pilastro
Cmb	combinazione in cui si verificano i valori riportati
M3 mx/mn	momento flettente in campata M3 max (prima riga) / min (seconda riga)
M2 mx/mn	momento flettente in campata M2 max (prima riga) / min (seconda riga)
D2/D3	freccia massima in direzione 2 (prima riga) / direzione 3 (seconda riga)
Q2/Q3	carico totale in direzione 2 (prima riga) / direzione 3 (seconda riga)
Pos.	ascissa del punto iniziale e finale dell'elemento
N, V2, ecc..	sei componenti di sollecitazione al piede ed in sommità dell'elemento

Per gli elementi tipo *trave in elevazione* sono riportati, oltre al numero dell'elemento, i medesimi risultati visti per i pilastri.

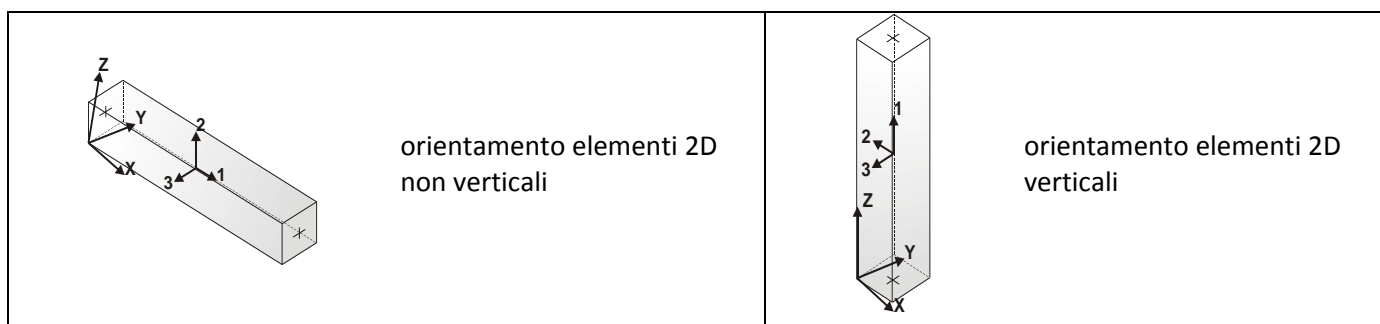

Pilas.	Cmb	M3 mx/mn	M2 mx/mn	D 2 / D 3	Q 2 / Q 3	Pos.	N	V 2	V 3	T	M 2	M 3
		N m	N m	m	N	cm	N	N	N	N m	N m	N m
26	2	1160.08	2401.49	1.14e-04	0.0	0.0	-8076.36	-2049.12	6555.02	6.27	-5431.76	1160.08
		-1288.61	-5431.76	-2.47e-03	0.0	119.5	-7693.43	-2049.12	6555.02	6.27	2401.49	-1288.61
26	3	912.37	3767.69	-2.38e-04	0.0	0.0	-4245.35	2051.16	-5243.33	-2.59	3767.69	-1538.76
		-1538.76	-2498.09	1.47e-03	0.0	119.5	-3862.42	2051.16	-5243.33	-2.59	-2498.09	912.37
26	7	1.386e+04	6735.22	2.14e-03	0.0	0.0	-1.329e+04	-1.845e+04	-9901.48	-2.60	6735.22	1.386e+04
		-8186.43	-5097.05	2.44e-03	0.0	119.5	-1.291e+04	-1.845e+04	-9901.48	-2.60	-5097.05	-8186.43
26	11	2.108e+04	4707.40	3.24e-03	0.0	0.0	-1.833e+04	-2.824e+04	-7648.06	0.51	4707.40	2.108e+04
		-1.267e+04	-4432.03	1.45e-03	0.0	119.5	-1.795e+04	-2.824e+04	-7648.06	0.51	-4432.03	-1.267e+04
26	12	2.027e+04	-514.87	3.06e-03	0.0	0.0	-1.944e+04	-2.752e+04	1502.21	6.76	-2310.02	2.027e+04
		-1.262e+04	-2310.02	-1.50e-03	0.0	119.5	-1.905e+04	-2.752e+04	1502.21	6.76	-514.87	-1.262e+04
26	26	1155.43	2619.05	1.20e-04	0.0	0.0	-6224.24	-1983.86	6824.73	6.02	-5536.51	1155.43
		-1215.28	-5536.51	-2.46e-03	0.0	119.5	-5959.14	-1983.86	6824.73	6.02	2619.05	-1215.28
26	27	985.70	3662.95	-2.31e-04	0.0	0.0	-2393.23	2116.42	-4973.62	-2.83	3662.95	-1543.42
		-1543.42	-2280.53	1.47e-03	0.0	119.5	-2128.13	2116.42	-4973.62	-2.83	-2280.53	985.70
26	31	1.385e+04	6630.48	2.15e-03	0.0	0.0	-1.144e+04	-1.838e+04	-9631.77	-2.85	6630.48	1.385e+04
		-8113.10	-4879.49	2.44e-03	0.0	119.5	-1.118e+04	-1.838e+04	-9631.77	-2.85	-4879.49	-8113.10
26	35	2.107e+04	4602.66	3.24e-03	0.0	0.0	-1.648e+04	-2.818e+04	-7378.35	0.26	4602.66	2.107e+04
		-1.259e+04	-4214.47	1.45e-03	0.0	119.5	-1.621e+04	-2.818e+04	-7378.35	0.26	-4214.47	-1.259e+04
26	36	2.026e+04	-297.31	3.07e-03	0.0	0.0	-1.759e+04	-2.745e+04	1771.92	6.52	-2414.76	2.026e+04
		-1.254e+04	-2414.76	-1.49e-03	0.0	119.5	-1.732e+04	-2.745e+04	1771.92	6.52	-297.31	-1.254e+04
26	57	881.50	377.30	1.27e-04	0.0	0.0	-3926.11	-1245.32	-843.83	1.48	377.30	881.50
		-606.66	-631.07	6.14e-05	0.0	119.5	-3631.56	-1245.32	-843.83	1.48	-631.07	-606.66
26	60	240.00	146.40	-1.62e-04	0.0	0.0	-5334.47	919.02	-504.72	-0.23	146.40	-858.23
		-858.23	-456.74	-4.78e-05	0.0	119.5	-5039.92	919.02	-504.72	-0.23	-456.74	240.00
26	65	271.98	617.39	2.61e-05	0.0	0.0	-4349.29	-486.81	-1120.73	1.94	617.39	271.98
		-309.76	-721.88	1.53e-04	0.0	119.5	-4054.73	-486.81	-1120.73	1.94	-721.88	-309.76
26	89	319.12	298.46	3.35e-05	0.0	0.0	-4382.30	-545.68	-729.05	0.91	298.46	319.12
		-332.97	-572.75	3.98e-05	0.0	119.5	-4087.75	-545.68	-729.05	0.91	-572.75	-332.97
26	92	-33.68	225.24	-6.86e-05	0.0	0.0	-4878.28	219.39	-619.50	0.34	225.24	-295.85
		-295.85	-515.06	2.41e-05	0.0	119.5	-4583.72	219.39	-619.50	0.34	-515.06	-33.68
26	97	100.25	373.50	4.12e-06	0.0	0.0	-4536.73	-273.33	-814.74	1.04	373.50	100.25
		-226.37	-600.11	6.38e-05	0.0	119.5	-4242.17	-273.33	-814.74	1.04	-600.11	-226.37
26	114	774.94	1528.47	7.42e-05	0.0	0.0	-6001.61	-1387.83	4280.11	4.26	-3586.26	774.94
		-883.52	-3586.26	-1.64e-03	0.0	119.5	-5707.05	-1387.83	4280.11	4.26	1528.47	-883.52
26	115	583.81	2546.71	-1.61e-04	0.0	0.0	-3447.60	1345.69	-3585.46	-1.64	2546.71	-1024.29
		-1024.29	-1737.91	9.78e-04	0.0	119.5	-3153.05	1345.69	-3585.46	-1.64	-1737.91	583.81
26	119	9239.37	4525.06	1.43e-03	0.0	0.0	-9480.63	-1.232e+04	-6690.89	-1.65	4525.06	9239.37
		-5482.06	-3470.55	1.63e-03	0.0	119.5	-9186.07	-1.232e+04	-6690.89	-1.65	-3470.55	-5482.06
26	123	1.405e+04	3173.18	2.15e-03	0.0	0.0	-1.284e+04	-1.885e+04	-5188.61	0.42	3173.18	1.405e+04
		-8469.96	-3027.21	9.67e-04	0.0	119.5	-1.254e+04	-1.885e+04	-5188.61	0.42	-3027.21	-8469.96
26	124	1.351e+04	-415.77	2.04e-03	0.0	0.0	-1.358e+04	-1.837e+04	911.57	4.59	-1505.10	1.351e+04
		-8435.27	-1505.10	-9.98e-04	0.0	119.5	-1.328e+04	-1.837e+04	911.57	4.59	-415.77	-8435.27
26	137	237.13	2211.13	3.03e-05	0.0	0.0	-4322.72	-363.94	-3216.02	-1.11	2211.13	237.13
		-197.78	-1632.01	8.13e-04	0.0	119.5	-4028.16	-363.94	-3216.02	-1.11	-1632.01	-197.78
26	138	-168.87	544.20	-6.55e-05	0.0	0.0	-4937.87	37.65	1867.47	2.36	-1687.43	-213.86
		-213.86	-1687.43	-8.25e-04	0.0	119.5	-4643.31	37.65	1867.47	2.36	544.20	-168.87
26	139	2009.84	344.87	2.89e-04	0.0	0.0	-5874.62	-2839.29	-886.72	0.90	344.87	2009.84
		-1383.11	-714.76	4.22e-05	0.0	119.5	-5580.07	-2839.29	-886.72	0.90	-714.76	-1383.11
26	140	573.46	209.49	-2.11e-04	0.0	0.0	-3845.41	1524.88	-540.27	0.45	209.49	-1248.77
		-1248.77	-436.13	2.55e-05	0.0	119.5	-3550.85	1524.88	-540.27	0.45	-436.13	573.46
26	144	11.64	261.85	-1.76e-05	0.0	0.0	-4630.29	-163.15	-674.27	0.62	261.85	11.64
		-183.33	-543.90	3.20e-05	0.0	119.5	-4335.74	-163.15	-674.27	0.62	-543.90	-183.33
38	3	970.61	1008.69	-8.90e-04	0.0	0.0	-2831.91	904.52	803.40	0.09	-1060.05	-1358.53
		-1358.53	-1060.05	-1.50e-03	0.0	257.5	-2006.78	904.52	803.40	0.09	1008.69	970.61
38	7	1505.74	2385.06	1.17e-03	0.0	0.0	-3.230e+04	-862.31	1748.08	-0.93	-2116.25	1505.74
		-714.71	-2116.25	-2.52e-03	0.0	257.5	-3.148e+04	-862.31	1748.08	-0.93	2385.06	-714.71
38	11	3697.74	2432.99	2.75e-03	0.0	0.0	-4.698e+04	-2211.89	1631.51	-1.90	-1768.14	3697.74
		-1997.88	-1768.14	-1.68e-03	0.0	257.5	-4.615e+04	-2211.89	1631.51	-1.90	2432.99	-1997.88
38	12	5248.40	1161.21	3.87e-03	0.0	0.0	-4.713e+04	-3163.29	458.74	-2.84	-20.04	5248.40
		-2897.06	-20.04	1.52e-03	0.0	257.5	-4.630e+04	-3163.29	458.74	-2.84	1161.21	-2897.06
38	27	889.44	856.01	-8.86e-04	0.0	0.0	-760.78	855.66	714.55	0.26	-983.94	-1313.89
		-1313.89	-983.94	-1.50e-03	0.0	257.5	-189.54	855.66	714.55	0.26	856.01	889.44
38	31	1550.38	2232.38	1.17e-03	0.0	0.0	-3.023e+04	-911.17	1659.23	-0.76	-2040.14	1550.38
		-795.88	-2040.14	-2.51e-03	0.0	257.5	-2.966e+04	-911.17	1659.23	-0.76	2232.38	-795.88
38	35	3742.38	2280.31	2.75e-03	0.0	0.0	-4.491e+04	-2260.75	1542.66	-1.73	-1692.03	3742.38
		-2079.05	-1692.03	-1.66e-03	0.0	257.5	-4.433e+04	-2260.75	1542.66	-1.73	2280.31	-2079.05
38	36	5293.04	1008.53	3.88e-03	0.0	0.0	-4.505e+04	-3212.15	369.89	-2.68	56.07	5293.04
		-2978.23	56.07	1.52e-03	0.0	257.5	-4.448e+04	-3212.15	369.89	-2.68	1008.53	-2978.23
38	49	123.93	331.32	1.31e-04	0.0	0.0	-5915.39	-44.78	140.45	-0.59	-30.33	123.93
		8.62	-30.33	3.66e-04	0.0	257.5	-5280.68	-44.78	140.45	-0.59	331.32	8.62
38	51	412.14	114.45	-1.62e-04	0.0	0.0	-4527.92	301.16	8.15	0.03	93.48	-363.34
		-363.34	93.48	4.08e-04	0.0	257.5	-3893.21	301.16	8.15	0.03	114.45	412.14
38	52	397.25	432.08	-1.53e-04	0.0	0.0	-4440.26	289.09	303.81	-0.25	-350.22	-347.15

		-347.15	-350.22	-3.79e-04	0.0	257.5	-3805.55	289.09	303.81	-0.25	432.08	397.25
38	66	117.59	943.61	4.82e-05	0.0	0.0	-5239.84	50.14	734.74	-0.98	-948.34	-11.53
		-11.53	-948.34	-1.29e-03	0.0	257.5	-4605.13	50.14	734.74	-0.98	943.61	117.59
38	81	133.69	370.46	3.99e-05	0.0	0.0	-5437.67	62.68	199.32	-0.49	-142.79	-27.71
		-27.71	-142.79	1.15e-04	0.0	257.5	-4802.96	62.68	199.32	-0.49	370.46	133.69
38	83	276.85	293.52	-7.17e-05	0.0	0.0	-4945.42	185.41	152.38	-0.27	-98.86	-200.58
		-200.58	-98.86	1.30e-04	0.0	257.5	-4310.71	185.41	152.38	-0.27	293.52	276.85
38	84	272.18	392.95	-6.91e-05	0.0	0.0	-4917.98	181.63	244.93	-0.36	-237.76	-195.51
		-195.51	-237.76	-1.83e-04	0.0	257.5	-4283.27	181.63	244.93	-0.36	392.95	272.18
38	98	173.69	558.96	-1.49e-05	0.0	0.0	-5205.92	97.44	383.42	-0.60	-428.35	-77.23
		-77.23	-428.35	-4.36e-04	0.0	257.5	-4571.21	97.44	383.42	-0.60	558.96	173.69
38	115	674.13	723.36	-5.95e-04	0.0	0.0	-2578.31	619.30	565.21	6.35e-03	-732.07	-920.57
		-920.57	-732.07	-1.00e-03	0.0	257.5	-1943.60	619.30	565.21	6.35e-03	723.36	674.13
38	119	988.94	1640.93	7.79e-04	0.0	0.0	-2.223e+04	-558.58	1195.01	-0.67	-1436.20	988.94
		-449.41	-1436.20	-1.68e-03	0.0	257.5	-2.159e+04	-558.58	1195.01	-0.67	1640.93	-449.41
38	123	2450.28	1672.89	1.83e-03	0.0	0.0	-3.201e+04	-1458.31	1117.29	-1.32	-1204.13	2450.28
		-1304.86	-1204.13	-1.13e-03	0.0	257.5	-3.137e+04	-1458.31	1117.29	-1.32	1672.89	-1304.86
38	124	3484.05	825.03	2.58e-03	0.0	0.0	-3.211e+04	-2092.57	335.44	-1.95	-38.73	3484.05
		-1904.32	-38.73	1.01e-03	0.0	257.5	-3.147e+04	-2092.57	335.44	-1.95	825.03	-1904.32
38	137	452.71	734.97	-3.22e-04	0.0	0.0	-5136.55	386.43	547.90	-0.16	-675.86	-542.35
		-542.35	-675.86	-8.38e-04	0.0	257.5	-4501.84	386.43	547.90	-0.16	734.97	452.71
38	139	335.09	507.53	3.11e-04	0.0	0.0	-9077.80	-153.17	295.29	-0.60	-252.83	335.09
		-59.32	-252.83	-1.49e-04	0.0	257.5	-8443.08	-153.17	295.29	-0.60	507.53	-59.32
38	140	368.35	302.33	-2.13e-04	0.0	0.0	-2717.84	295.82	175.98	-0.31	-150.82	-393.37
		-393.37	-150.82	-8.92e-05	0.0	257.5	-2083.13	295.82	175.98	-0.31	302.33	368.35
38	144	202.93	381.70	-2.83e-05	0.0	0.0	-5177.82	122.15	222.13	-0.42	-190.27	-111.61
		-111.61	-190.27	-1.13e-04	0.0	257.5	-4543.11	122.15	222.13	-0.42	381.70	202.93
42	4	233.08	0.0	1.42e-04	0.0	0.0	-1868.35	81.63	0.0	0.0	0.0	22.88
		22.88	0.0	0.0	0.0	257.5	-1043.22	81.63	0.0	0.0	0.0	233.08
42	11	3452.10	0.0	2.93e-03	0.0	0.0	-5.014e+04	-1785.11	0.0	0.0	0.0	3452.10
		-1144.56	0.0	0.0	0.0	257.5	-4.932e+04	-1785.11	0.0	0.0	0.0	-1144.56
42	12	4861.30	0.0	3.98e-03	0.0	0.0	-4.917e+04	-2630.89	0.0	0.0	0.0	4861.30
		-1913.23	0.0	0.0	0.0	257.5	-4.835e+04	-2630.89	0.0	0.0	0.0	-1913.23
42	28	103.64	0.0	1.57e-04	0.0	0.0	116.64	-1.29	0.0	0.0	0.0	103.64
		100.32	0.0	0.0	0.0	257.5	687.88	-1.29	0.0	0.0	0.0	100.32
42	35	3532.86	0.0	2.95e-03	0.0	0.0	-4.816e+04	-1868.03	0.0	0.0	0.0	3532.86
		-1277.31	0.0	0.0	0.0	257.5	-4.759e+04	-1868.03	0.0	0.0	0.0	-1277.31
42	36	4942.07	0.0	3.99e-03	0.0	0.0	-4.719e+04	-2713.81	0.0	0.0	0.0	4942.07
		-2045.98	0.0	0.0	0.0	257.5	-4.662e+04	-2713.81	0.0	0.0	0.0	-2045.98
42	49	176.61	246.41	8.22e-05	0.0	0.0	-5462.39	71.57	-182.80	0.16	246.41	-7.67
		-7.67	-224.30	3.63e-04	0.0	257.5	-4827.68	71.57	-182.80	0.16	-224.30	176.61
42	51	487.14	266.02	-1.62e-04	0.0	0.0	-4462.55	343.03	-192.95	0.20	266.02	-396.16
		-396.16	-230.81	4.07e-04	0.0	257.5	-3827.84	343.03	-192.95	0.20	-230.81	487.14
42	66	285.30	759.50	-3.23e-05	0.0	0.0	-5112.44	166.58	627.77	-0.61	-856.99	-143.65
		-143.65	-856.99	-1.29e-03	0.0	257.5	-4477.73	166.58	627.77	-0.61	759.50	285.30
42	67	378.46	856.99	-8.64e-05	0.0	0.0	-4812.49	248.02	-627.77	0.61	856.99	-260.19
		-260.19	-759.50	1.29e-03	0.0	257.5	-4177.78	248.02	-627.77	0.61	-759.50	378.46
42	81	276.79	76.73	-2.84e-05	0.0	0.0	-5139.83	159.15	-57.01	0.05	76.73	-133.01
		-133.01	-70.08	1.13e-04	0.0	257.5	-4505.12	159.15	-57.01	0.05	-70.08	276.79
42	83	386.96	83.68	-9.23e-05	0.0	0.0	-4785.11	255.45	-60.61	0.06	83.68	-270.83
		-270.83	-72.39	1.28e-04	0.0	257.5	-4150.40	255.45	-60.61	0.06	-72.39	386.96
42	98	315.35	237.79	-4.90e-05	0.0	0.0	-5015.68	192.85	196.58	-0.19	-268.40	-181.24
		-181.24	-268.40	-4.04e-04	0.0	257.5	-4380.96	192.85	196.58	-0.19	237.79	315.35
42	99	348.40	268.40	-6.85e-05	0.0	0.0	-4909.26	221.75	-196.58	0.19	268.40	-222.59
		-222.59	-237.79	4.04e-04	0.0	257.5	-4274.55	221.75	-196.58	0.19	-237.79	348.40
42	116	199.63	0.0	8.98e-05	0.0	0.0	-1907.23	82.06	0.0	0.0	0.0	-11.67
		-11.67	0.0	0.0	0.0	257.5	-1272.51	82.06	0.0	0.0	0.0	199.63
42	123	2274.48	0.0	1.95e-03	0.0	0.0	-3.409e+04	-1162.43	0.0	0.0	0.0	2274.48
		-718.79	0.0	0.0	0.0	257.5	-3.345e+04	-1162.43	0.0	0.0	0.0	-718.79
42	124	3213.94	0.0	2.65e-03	0.0	0.0	-3.344e+04	-1726.28	0.0	0.0	0.0	3213.94
		-1231.24	0.0	0.0	0.0	257.5	-3.281e+04	-1726.28	0.0	0.0	0.0	-1231.24
42	137	545.40	0.0	-3.27e-04	0.0	0.0	-5231.36	442.24	0.0	0.0	0.0	-593.36
		-593.36	0.0	0.0	0.0	257.5	-4596.65	442.24	0.0	0.0	0.0	545.40
42	138	189.53	0.0	2.53e-04	0.0	0.0	-4693.57	-27.64	0.0	0.0	0.0	189.53
		118.36	0.0	0.0	0.0	257.5	-4058.86	-27.64	0.0	0.0	0.0	118.36
42	139	225.53	0.0	3.02e-04	0.0	0.0	-9141.69	-32.34	0.0	0.0	0.0	225.53
		142.26	0.0	0.0	0.0	257.5	-8506.98	-32.34	0.0	0.0	0.0	142.26
42	140	451.48	0.0	-2.50e-04	0.0	0.0	-2326.34	358.46	0.0	0.0	0.0	-471.54
		-471.54	0.0	0.0	0.0	257.5	-1691.63	358.46	0.0	0.0	0.0	451.48
42	144	331.88	0.0	-5.88e-05	0.0	0.0	-4962.47	207.30	0.0	0.0	0.0	-201.92
		-201.92	0.0	0.0	0.0	257.5	-4327.76	207.30	0.0	0.0	0.0	331.88
43	3	970.61	1060.05	-8.90e-04	0.0	0.0	-2831.91	904.52	-803.40	-0.09	1060.05	-1358.53
		-1358.53	-1008.69	1.50e-03	0.0	257.5	-2006.78	904.52	-803.40	-0.09	-1008.69	970.61
43	7	1505.74	2116.25	1.17e-03	0.0	0.0	-3.230e+04	-862.31	-1748.08	0.93	2116.25	1505.74
		-714.71	-2385.06	2.52e-03	0.0	257.5	-3.148e+04	-862.31	-1748.08	0.93	-2385.06	-714.71
43	11	3697.74	1768.14	2.75e-03	0.0	0.0	-4.698e+04	-2211.89	-1631.51	1.90	1768.14	3697.74
		-1997.88	-2432.99	1.68e-03	0.0	257.5	-4.615e+04	-2211.89	-1631.51	1.90	-2432.99	-1997.88

43	12	5248.40	20.04	3.87e-03	0.0	0.0	-4.713e+04	-3163.29	-458.74	2.84	20.04	5248.40
		-2897.06	-1161.21	-1.52e-03	0.0	257.5	-4.630e+04	-3163.29	-458.74	2.84	-1161.21	-2897.06
43	27	889.44	983.94	-8.86e-04	0.0	0.0	-760.78	855.66	-714.55	-0.26	983.94	-1313.89
		-1313.89	-856.01	1.50e-03	0.0	257.5	-189.54	855.66	-714.55	-0.26	-856.01	889.44
43	31	1550.38	2040.14	1.17e-03	0.0	0.0	-3.023e+04	-911.17	-1659.23	0.76	2040.14	1550.38
		-795.88	-2232.38	2.51e-03	0.0	257.5	-2.966e+04	-911.17	-1659.23	0.76	-2232.38	-795.88
43	35	3742.38	1692.03	2.75e-03	0.0	0.0	-4.491e+04	-2260.75	-1542.66	1.73	1692.03	3742.38
		-2079.05	-2280.31	1.66e-03	0.0	257.5	-4.433e+04	-2260.75	-1542.66	1.73	-2280.31	-2079.05
43	36	5293.04	-56.07	3.88e-03	0.0	0.0	-4.505e+04	-3212.15	-369.89	2.68	-56.07	5293.04
		-2978.23	-1008.53	-1.52e-03	0.0	257.5	-4.448e+04	-3212.15	-369.89	2.68	-1008.53	-2978.23
43	58	123.93	30.33	1.31e-04	0.0	0.0	-5915.39	-44.78	-140.45	0.59	30.33	123.93
		8.62	-331.32	-3.66e-04	0.0	257.5	-5280.68	-44.78	-140.45	0.59	-331.32	8.62
43	59	397.25	350.22	-1.53e-04	0.0	0.0	-4440.26	289.09	-303.81	0.25	350.22	-347.15
		-347.15	-432.08	3.79e-04	0.0	257.5	-3805.55	289.09	-303.81	0.25	-432.08	397.25
43	60	412.14	-93.48	-1.62e-04	0.0	0.0	-4527.92	301.16	-8.15	-0.03	-93.48	-363.34
		-363.34	-114.45	-4.08e-04	0.0	257.5	-3893.21	301.16	-8.15	-0.03	-114.45	412.14
43	69	117.59	948.34	4.82e-05	0.0	0.0	-5239.84	50.14	-734.74	0.98	948.34	-11.53
		-11.53	-943.61	1.29e-03	0.0	257.5	-4605.13	50.14	-734.74	0.98	-943.61	117.59
43	90	133.69	142.79	3.99e-05	0.0	0.0	-5437.67	62.68	-199.32	0.49	142.79	-27.71
		-27.71	-370.46	-1.15e-04	0.0	257.5	-4802.96	62.68	-199.32	0.49	-370.46	133.69
43	91	272.18	237.76	-6.91e-05	0.0	0.0	-4917.98	181.63	-244.93	0.36	237.76	-195.51
		-195.51	-392.95	1.83e-04	0.0	257.5	-4283.27	181.63	-244.93	0.36	-392.95	272.18
43	92	276.85	98.86	-7.17e-05	0.0	0.0	-4945.42	185.41	-152.38	0.27	98.86	-200.58
		-200.58	-293.52	-1.30e-04	0.0	257.5	-4310.71	185.41	-152.38	0.27	-293.52	276.85
43	101	173.69	428.35	-1.49e-05	0.0	0.0	-5205.92	97.44	-383.42	0.60	428.35	-77.23
		-77.23	-558.96	4.36e-04	0.0	257.5	-4571.21	97.44	-383.42	0.60	-558.96	173.69
43	115	674.13	732.07	-5.95e-04	0.0	0.0	-2578.31	619.30	-565.21	-6.35e-03	732.07	-920.57
		-920.57	-723.36	1.00e-03	0.0	257.5	-1943.60	619.30	-565.21	-6.35e-03	-723.36	674.13
43	119	988.94	1436.20	7.79e-04	0.0	0.0	-2.223e+04	-558.58	-1195.01	0.67	1436.20	988.94
		-449.41	-1640.93	1.68e-03	0.0	257.5	-2.159e+04	-558.58	-1195.01	0.67	-1640.93	-449.41
43	123	2450.28	1204.13	1.83e-03	0.0	0.0	-3.201e+04	-1458.31	-1117.29	1.32	1204.13	2450.28
		-1304.86	-1672.89	1.13e-03	0.0	257.5	-3.137e+04	-1458.31	-1117.29	1.32	-1672.89	-1304.86
43	124	3484.05	38.73	2.58e-03	0.0	0.0	-3.211e+04	-2092.57	-335.44	1.95	38.73	3484.05
		-1904.32	-825.03	-1.01e-03	0.0	257.5	-3.147e+04	-2092.57	-335.44	1.95	-825.03	-1904.32
43	137	452.71	675.86	-3.22e-04	0.0	0.0	-5136.55	386.43	-547.90	0.16	675.86	-542.35
		-542.35	-734.97	8.38e-04	0.0	257.5	-4501.84	386.43	-547.90	0.16	-734.97	452.71
43	139	335.09	252.83	3.11e-04	0.0	0.0	-9077.80	-153.17	-295.29	0.60	252.83	335.09
		-59.32	-507.53	1.49e-04	0.0	257.5	-8443.08	-153.17	-295.29	0.60	-507.53	-59.32
43	140	368.35	150.82	-2.13e-04	0.0	0.0	-2717.84	295.82	-175.98	0.31	150.82	-393.37
		-393.37	-302.33	8.92e-05	0.0	257.5	-2083.13	295.82	-175.98	0.31	-302.33	368.35
43	144	202.93	190.27	-2.83e-05	0.0	0.0	-5177.82	122.15	-222.13	0.42	190.27	-111.61
		-111.61	-381.70	1.13e-04	0.0	257.5	-4543.11	122.15	-222.13	0.42	-381.70	202.93
44	2	1160.08	5431.76	1.14e-04	0.0	0.0	-8076.36	-2049.12	-6555.02	-6.27	5431.76	1160.08
		-1288.61	-2401.49	2.47e-03	0.0	119.5	-7693.43	-2049.12	-6555.02	-6.27	-2401.49	-1288.61
44	3	912.37	2498.09	-2.38e-04	0.0	0.0	-4245.35	2051.16	5243.33	2.59	2498.09	-1538.76
		-1538.76	-3767.69	-1.47e-03	0.0	119.5	-3862.42	2051.16	5243.33	2.59	-3767.69	912.37
44	7	1.386e+04	5097.05	2.14e-03	0.0	0.0	-1.329e+04	-1.845e+04	9901.48	2.60	5097.05	1.386e+04
		-8186.43	-6735.22	-2.44e-03	0.0	119.5	-1.291e+04	-1.845e+04	9901.48	2.60	-6735.22	-8186.43
44	11	2.108e+04	4432.03	3.24e-03	0.0	0.0	-1.833e+04	-2.824e+04	7648.06	-0.51	4432.03	2.108e+04
		-1.267e+04	-4707.40	-1.45e-03	0.0	119.5	-1.795e+04	-2.824e+04	7648.06	-0.51	-4707.40	-1.267e+04
44	12	2.027e+04	2310.02	3.06e-03	0.0	0.0	-1.944e+04	-2.752e+04	-1502.21	-6.76	2310.02	2.027e+04
		-1.262e+04	514.87	1.50e-03	0.0	119.5	-1.905e+04	-2.752e+04	-1502.21	-6.76	514.87	-1.262e+04
44	26	1155.43	5536.51	1.20e-04	0.0	0.0	-6224.24	-1983.86	-6824.73	-6.02	5536.51	1155.43
		-1215.28	-2619.05	2.46e-03	0.0	119.5	-5959.14	-1983.86	-6824.73	-6.02	-2619.05	-1215.28
44	27	985.70	2280.53	-2.31e-04	0.0	0.0	-2393.23	2116.42	4973.62	2.83	2280.53	-1543.42
		-1543.42	-3662.95	-1.47e-03	0.0	119.5	-2128.13	2116.42	4973.62	2.83	-3662.95	985.70
44	31	1.385e+04	4879.49	2.15e-03	0.0	0.0	-1.144e+04	-1.838e+04	9631.77	2.85	4879.49	1.385e+04
		-8113.10	-6630.48	-2.44e-03	0.0	119.5	-1.118e+04	-1.838e+04	9631.77	2.85	-6630.48	-8113.10
44	35	2.107e+04	4214.47	3.24e-03	0.0	0.0	-1.648e+04	-2.818e+04	7378.35	-0.26	4214.47	2.107e+04
		-1.259e+04	-4602.66	-1.45e-03	0.0	119.5	-1.621e+04	-2.818e+04	7378.35	-0.26	-4602.66	-1.259e+04
44	36	2.026e+04	2414.76	3.07e-03	0.0	0.0	-1.759e+04	-2.745e+04	-1771.92	-6.52	2414.76	2.026e+04
		-1.254e+04	297.31	1.49e-03	0.0	119.5	-1.732e+04	-2.745e+04	-1771.92	-6.52	297.31	-1.254e+04
44	50	881.50	631.07	1.27e-04	0.0	0.0	-3926.11	-1245.32	843.83	-1.48	631.07	881.50
		-606.66	-377.30	-6.14e-05	0.0	119.5	-3631.56	-1245.32	843.83	-1.48	-377.30	-606.66
44	51	240.00	456.74	-1.62e-04	0.0	0.0	-5334.47	919.02	504.72	0.23	456.74	-858.23
		-858.23	-146.40	4.78e-05	0.0	119.5	-5039.92	919.02	504.72	0.23	-146.40	240.00
44	70	271.98	721.88	2.61e-05	0.0	0.0	-4349.29	-486.81	1120.73	-1.94	721.88	271.98
		-309.76	-617.39	-1.53e-04	0.0	119.5	-4054.73	-486.81	1120.73	-1.94	-617.39	-309.76
44	82	319.12	572.75	3.35e-05	0.0	0.0	-4382.30	-545.68	729.05	-0.91	572.75	319.12
		-332.97	-298.46	-3.98e-05	0.0	119.5	-4087.75	-545.68	729.05	-0.91	-298.46	-332.97
44	83	-33.68	515.06	-6.86e-05	0.0	0.0	-4878.28	219.39	619.50	-0.34	515.06	-295.85
		-295.85	-225.24	-2.41e-05	0.0	119.5	-4583.72	219.39	619.50	-0.34	-225.24	-295.85
44	102	100.25	600.11	4.12e-06	0.0	0.0	-4536.73	-273.33	814.74	-1.04	600.11	100.25
		-226.37	-373.50	-6.38e-05	0.0	119.5	-4242.17	-273.33	814.74	-1.04	-373.50	-226.37
44	114	774.94	3586.26	7.42e-05	0.0	0.0	-6001.61	-1387.83	-4280.11	-4.26	3586.26	774.94
		-883.52	-1528.47	1.64e-03	0.0	119.5	-5707.05	-1387.83	-4280.11	-4.26	-1528.47	-883.52
44	115	583.81	1737.91	-1.61e-04	0.0	0.0	-3447.60	1345.69	3585.46	1.64	1737.91	583.81

		-1024.29	-2546.71	-9.78e-04	0.0	119.5	-3153.05	1345.69	3585.46	1.64	1737.91	583.81
44	119	9239.37	3470.55	1.43e-03	0.0	0.0	-9480.63	-1.232e+04	6690.89	1.65	-4525.06	9239.37
		-5482.06	-4525.06	-1.63e-03	0.0	119.5	-9186.07	-1.232e+04	6690.89	1.65	3470.55	-5482.06
44	123	1.405e+04	3027.21	2.15e-03	0.0	0.0	-1.284e+04	-1.885e+04	5188.61	-0.42	-3173.18	1.405e+04
		-8469.96	-3173.18	-9.67e-04	0.0	119.5	-1.254e+04	-1.885e+04	5188.61	-0.42	3027.21	-8469.96
44	124	1.351e+04	1505.10	2.04e-03	0.0	0.0	-1.358e+04	-1.837e+04	-911.57	-4.59	1505.10	1.351e+04
		-8435.27	415.77	9.98e-04	0.0	119.5	-1.328e+04	-1.837e+04	-911.57	-4.59	415.77	-8435.27
44	137	237.13	1632.01	3.03e-05	0.0	0.0	-4322.72	-363.94	3216.02	1.11	-2211.13	237.13
		-197.78	-2211.13	-8.13e-04	0.0	119.5	-4028.16	-363.94	3216.02	1.11	1632.01	-197.78
44	138	-168.87	1687.43	-6.55e-05	0.0	0.0	-4937.87	37.65	-1867.47	-2.36	1687.43	-213.86
		-213.86	-544.20	8.25e-04	0.0	119.5	-4643.31	37.65	-1867.47	-2.36	-544.20	-168.87
44	139	2009.84	714.76	2.89e-04	0.0	0.0	-5874.62	-2839.29	886.72	-0.90	-344.87	2009.84
		-1383.11	-344.87	-4.22e-05	0.0	119.5	-5580.07	-2839.29	886.72	-0.90	714.76	-1383.11
44	140	573.46	436.13	-2.11e-04	0.0	0.0	-3845.41	1524.88	540.27	-0.45	-209.49	573.46
		-1248.77	-209.49	-2.55e-05	0.0	119.5	-3550.85	1524.88	540.27	-0.45	436.13	-1248.77
44	144	11.64	543.90	-1.76e-05	0.0	0.0	-4630.29	-163.15	674.27	-0.62	-261.85	11.64
		-183.33	-261.85	-3.20e-05	0.0	119.5	-4335.74	-163.15	674.27	-0.62	543.90	-183.33
45	4	1188.26	0.0	-4.98e-04	0.0	0.0	-3918.54	3391.88	0.0	0.0	0.0	-2865.04
		-2865.04	0.0	0.0	0.0	119.5	-3535.62	3391.88	0.0	0.0	0.0	1188.26
45	11	2.285e+04	0.0	3.40e-03	0.0	0.0	-2.014e+04	-3.142e+04	0.0	0.0	0.0	2.285e+04
		-1.470e+04	0.0	0.0	0.0	119.5	-1.976e+04	-3.142e+04	0.0	0.0	0.0	-1.470e+04
45	12	2.157e+04	0.0	3.15e-03	0.0	0.0	-1.860e+04	-3.012e+04	0.0	0.0	0.0	2.157e+04
		-1.442e+04	0.0	0.0	0.0	119.5	-1.822e+04	-3.012e+04	0.0	0.0	0.0	-1.442e+04
45	28	1281.48	0.0	-4.81e-04	0.0	0.0	-2083.99	3442.01	0.0	0.0	0.0	-2831.71
		-2831.71	0.0	0.0	0.0	119.5	-1818.89	3442.01	0.0	0.0	0.0	1281.48
45	35	2.288e+04	0.0	3.42e-03	0.0	0.0	-1.831e+04	-3.137e+04	0.0	0.0	0.0	2.288e+04
		-1.461e+04	0.0	0.0	0.0	119.5	-1.804e+04	-3.137e+04	0.0	0.0	0.0	-1.461e+04
45	36	2.160e+04	0.0	3.17e-03	0.0	0.0	-1.676e+04	-3.007e+04	0.0	0.0	0.0	2.160e+04
		-1.433e+04	0.0	0.0	0.0	119.5	-1.650e+04	-3.007e+04	0.0	0.0	0.0	-1.433e+04
45	49	606.51	138.31	7.03e-05	0.0	0.0	-4023.06	-986.60	-201.92	0.26	138.31	606.51
		-572.48	-102.98	5.06e-05	0.0	119.5	-3728.51	-986.60	-201.92	0.26	-102.98	-572.48
45	50	606.51	65.09	7.03e-05	0.0	0.0	-4023.06	-986.60	140.98	-0.38	-103.38	606.51
		-572.48	-103.38	-4.13e-05	0.0	119.5	-3728.51	-986.60	140.98	-0.38	65.09	-572.48
45	51	106.35	103.38	-1.58e-04	0.0	0.0	-5149.71	735.98	-140.98	0.38	103.38	-773.14
		-773.14	-65.09	4.13e-05	0.0	119.5	-4855.15	735.98	-140.98	0.38	-65.09	106.35
45	65	123.63	408.06	-9.61e-06	0.0	0.0	-4417.39	-383.70	-580.64	1.05	408.06	123.63
		-334.89	-285.81	1.55e-04	0.0	119.5	-4122.83	-383.70	-580.64	1.05	-285.81	-334.89
45	68	-131.24	285.81	-7.81e-05	0.0	0.0	-4755.38	133.08	580.64	-1.05	-408.06	-290.26
		-290.26	-408.06	-1.55e-04	0.0	119.5	-4460.83	133.08	580.64	-1.05	285.81	-131.24
45	81	161.42	44.03	6.94e-06	0.0	0.0	-4386.53	-430.88	-64.48	0.08	44.03	161.42
		-353.48	-33.03	1.60e-05	0.0	119.5	-4091.98	-430.88	-64.48	0.08	-33.03	-353.48
45	82	161.42	19.59	6.94e-06	0.0	0.0	-4386.53	-430.88	42.86	-0.12	-31.63	161.42
		-353.48	-31.63	-1.27e-05	0.0	119.5	-4091.98	-430.88	42.86	-0.12	19.59	-353.48
45	83	-112.64	31.63	-8.43e-05	0.0	0.0	-4786.24	180.26	-42.86	0.12	31.63	-328.05
		-328.05	-19.59	1.27e-05	0.0	119.5	-4491.69	180.26	-42.86	0.12	-19.59	-112.64
45	97	-9.90	127.96	-3.17e-05	0.0	0.0	-4526.43	-216.98	-182.14	0.33	127.96	-9.90
		-269.19	-89.71	4.84e-05	0.0	119.5	-4231.87	-216.98	-182.14	0.33	-89.71	-269.19
45	100	-156.74	89.71	-5.60e-05	0.0	0.0	-4646.34	-33.64	182.14	-0.33	-127.96	-156.74
		-196.94	-127.96	-4.84e-05	0.0	119.5	-4351.79	-33.64	182.14	-0.33	89.71	-196.94
45	116	761.10	0.0	-3.38e-04	0.0	0.0	-3223.88	2244.55	0.0	0.0	0.0	-1921.14
		-1921.14	0.0	0.0	0.0	119.5	-2929.32	2244.55	0.0	0.0	0.0	761.10
45	123	1.522e+04	0.0	2.26e-03	0.0	0.0	-1.404e+04	-2.096e+04	0.0	0.0	0.0	1.522e+04
		-9830.77	0.0	0.0	0.0	119.5	-1.374e+04	-2.096e+04	0.0	0.0	0.0	-9830.77
45	124	1.437e+04	0.0	2.09e-03	0.0	0.0	-1.301e+04	-2.009e+04	0.0	0.0	0.0	1.437e+04
		-9645.91	0.0	0.0	0.0	119.5	-1.272e+04	-2.009e+04	0.0	0.0	0.0	-9645.91
45	138	-156.04	0.0	-1.13e-04	0.0	0.0	-4157.59	236.59	0.0	0.0	0.0	-438.76
		-438.76	0.0	0.0	0.0	119.5	-3863.03	236.59	0.0	0.0	0.0	-156.04
45	139	2075.12	0.0	2.78e-04	0.0	0.0	-5883.24	-3085.60	0.0	0.0	0.0	2075.12
		-1612.18	0.0	0.0	0.0	119.5	-5588.69	-3085.60	0.0	0.0	0.0	-1612.18
45	140	636.84	0.0	-2.47e-04	0.0	0.0	-3768.37	1741.95	0.0	0.0	0.0	-1444.79
		-1444.79	0.0	0.0	0.0	119.5	-3473.81	1741.95	0.0	0.0	0.0	636.84
45	144	-83.32	0.0	-4.39e-05	0.0	0.0	-4586.39	-125.31	0.0	0.0	0.0	-83.32
		-233.06	0.0	0.0	0.0	119.5	-4291.83	-125.31	0.0	0.0	0.0	-233.06

Pilas.	M3 mx/mn	M2 mx/mn	D 2 / D 3	Q 2 / Q 3	N	V 2	V 3	T
	-1.470e+04	-6735.22	-2.52e-03	0.0	-5.014e+04	-3.142e+04	-9901.48	-6.76
	2.288e+04	6735.22	3.99e-03	0.0	687.88	3442.01	9901.48	6.76

Trave	Cmb	M3 mx/mn	M2 mx/mn	D 2 / D 3	Q 2 / Q 3	Pos.	N	V 2	V 3	T	M 2	M 3
		N m	N m	m	N	cm	N	N	N	N m	N m	N m
1	4	236.77	0.0	0.0	-338.85	0.0	235.81	169.42	-272.70	0.0	0.0	0.0
		0.0	-381.10	0.0	545.40	559.0	235.81	-169.42	272.70	0.0	0.0	0.0
1	11	5121.71	0.0	0.0	-7329.82	0.0	-689.24	3664.91	-272.45	0.0	0.0	0.0
		0.0	-380.75	0.0	544.90	559.0	-689.24	-3664.91	272.45	0.0	0.0	0.0
1	28	33.68	0.0	0.0	-48.21	0.0	206.22	24.10	-188.80	0.0	0.0	0.0
		0.0	-263.85	0.0	377.60	559.0	206.22	-24.10	188.80	0.0	0.0	0.0

1	35	4918.62	0.0	0.0	-7039.17	0.0	-718.83	3519.59	-188.55	0.0	0.0	0.0
		0.0	-263.50	0.0	377.10	559.0	-718.83	-3519.59	188.55	0.0	0.0	0.0
1	50	507.72	0.0	0.0	-726.61	0.0	-120.29	363.30	-209.75	0.0	0.0	0.0
		0.0	-293.13	0.0	419.51	559.0	-120.29	-363.30	209.75	0.0	0.0	0.0
1	51	507.72	0.0	0.0	-726.61	0.0	268.21	363.30	-209.75	0.0	0.0	0.0
		0.0	-293.13	0.0	419.51	559.0	268.21	-363.30	209.75	0.0	0.0	0.0
1	82	507.72	0.0	0.0	-726.61	0.0	5.58	363.30	-209.75	0.0	0.0	0.0
		0.0	-293.13	0.0	419.51	559.0	5.58	-363.30	209.75	0.0	0.0	0.0
1	83	507.72	0.0	0.0	-726.61	0.0	142.34	363.30	-209.75	0.0	0.0	0.0
		0.0	-293.13	0.0	419.51	559.0	142.34	-363.30	209.75	0.0	0.0	0.0
1	116	225.54	0.0	0.0	-322.78	0.0	167.07	161.39	-209.77	0.0	0.0	0.0
		0.0	-293.15	0.0	419.54	559.0	167.07	-161.39	209.77	0.0	0.0	0.0
1	123	3482.17	0.0	0.0	-4983.42	0.0	-449.63	2491.71	-209.60	0.0	0.0	0.0
		0.0	-292.92	0.0	419.20	559.0	-449.63	-2491.71	209.60	0.0	0.0	0.0
1	139	939.28	0.0	0.0	-1344.23	0.0	4.96	672.11	-209.73	0.0	0.0	0.0
		0.0	-293.10	0.0	419.46	559.0	4.96	-672.11	209.73	0.0	0.0	0.0
1	140	235.50	0.0	0.0	-337.03	0.0	117.49	168.52	-209.77	0.0	0.0	0.0
		0.0	-293.15	0.0	419.54	559.0	117.49	-168.52	209.77	0.0	0.0	0.0
1	144	507.72	0.0	0.0	-726.61	0.0	73.96	363.30	-209.75	0.0	0.0	0.0
		0.0	-293.13	0.0	419.51	559.0	73.96	-363.30	209.75	0.0	0.0	0.0
2	4	236.77	0.0	0.0	-338.85	0.0	235.81	169.42	-272.70	0.0	0.0	0.0
		0.0	-381.10	0.0	545.40	559.0	235.81	-169.42	272.70	0.0	0.0	0.0
2	11	5121.71	0.0	0.0	-7329.82	0.0	-689.24	3664.91	-272.45	0.0	0.0	0.0
		0.0	-380.75	0.0	544.90	559.0	-689.24	-3664.91	272.45	0.0	0.0	0.0
2	28	33.68	0.0	0.0	-48.21	0.0	206.22	24.10	-188.80	0.0	0.0	0.0
		0.0	-263.85	0.0	377.60	559.0	206.22	-24.10	188.80	0.0	0.0	0.0
2	35	4918.62	0.0	0.0	-7039.17	0.0	-718.83	3519.59	-188.55	0.0	0.0	0.0
		0.0	-263.50	0.0	377.10	559.0	-718.83	-3519.59	188.55	0.0	0.0	0.0
2	57	507.72	0.0	0.0	-726.61	0.0	-120.29	363.30	-209.75	0.0	0.0	0.0
		0.0	-293.13	0.0	419.51	559.0	-120.29	-363.30	209.75	0.0	0.0	0.0
2	60	507.72	0.0	0.0	-726.61	0.0	268.21	363.30	-209.75	0.0	0.0	0.0
		0.0	-293.13	0.0	419.51	559.0	268.21	-363.30	209.75	0.0	0.0	0.0
2	89	507.72	0.0	0.0	-726.61	0.0	5.58	363.30	-209.75	0.0	0.0	0.0
		0.0	-293.13	0.0	419.51	559.0	5.58	-363.30	209.75	0.0	0.0	0.0
2	92	507.72	0.0	0.0	-726.61	0.0	142.34	363.30	-209.75	0.0	0.0	0.0
		0.0	-293.13	0.0	419.51	559.0	142.34	-363.30	209.75	0.0	0.0	0.0
2	116	225.54	0.0	0.0	-322.78	0.0	167.07	161.39	-209.77	0.0	0.0	0.0
		0.0	-293.15	0.0	419.54	559.0	167.07	-161.39	209.77	0.0	0.0	0.0
2	123	3482.17	0.0	0.0	-4983.42	0.0	-449.63	2491.71	-209.60	0.0	0.0	0.0
		0.0	-292.92	0.0	419.20	559.0	-449.63	-2491.71	209.60	0.0	0.0	0.0
2	139	939.28	0.0	0.0	-1344.23	0.0	4.96	672.11	-209.73	0.0	0.0	0.0
		0.0	-293.10	0.0	419.46	559.0	4.96	-672.11	209.73	0.0	0.0	0.0
2	140	235.50	0.0	0.0	-337.03	0.0	117.49	168.52	-209.77	0.0	0.0	0.0
		0.0	-293.15	0.0	419.54	559.0	117.49	-168.52	209.77	0.0	0.0	0.0
2	144	507.72	0.0	0.0	-726.61	0.0	73.96	363.30	-209.75	0.0	0.0	0.0
		0.0	-293.13	0.0	419.51	559.0	73.96	-363.30	209.75	0.0	0.0	0.0
3	2	1049.30	0.0	0.0	-1501.68	0.0	-617.12	750.84	-270.96	0.0	0.0	0.0
		0.0	-378.66	0.0	541.92	559.0	-617.12	-750.84	270.96	0.0	0.0	0.0
3	11	5092.72	0.0	0.0	-7288.33	0.0	1159.43	3644.16	-260.47	0.0	0.0	0.0
		0.0	-364.01	0.0	520.95	559.0	1159.43	-3644.16	260.47	0.0	0.0	0.0
3	26	846.74	0.0	0.0	-1211.79	0.0	-599.87	605.90	-187.27	0.0	0.0	0.0
		0.0	-261.72	0.0	374.55	559.0	-599.87	-605.90	187.27	0.0	0.0	0.0
3	35	4890.16	0.0	0.0	-6998.44	0.0	1176.67	3499.22	-176.79	0.0	0.0	0.0
		0.0	-247.07	0.0	353.58	559.0	1176.67	-3499.22	176.79	0.0	0.0	0.0
3	50	506.40	0.0	0.0	-724.72	0.0	155.37	362.36	-209.21	0.0	0.0	0.0
		0.0	-292.37	0.0	418.42	559.0	155.37	-362.36	209.21	0.0	0.0	0.0
3	51	506.40	0.0	0.0	-724.72	0.0	-241.59	362.36	-209.21	0.0	0.0	0.0
		0.0	-292.37	0.0	418.42	559.0	-241.59	-362.36	209.21	0.0	0.0	0.0
3	82	506.40	0.0	0.0	-724.72	0.0	26.52	362.36	-209.21	0.0	0.0	0.0
		0.0	-292.37	0.0	418.42	559.0	26.52	-362.36	209.21	0.0	0.0	0.0
3	83	506.40	0.0	0.0	-724.72	0.0	-112.73	362.36	-209.21	0.0	0.0	0.0
		0.0	-292.37	0.0	418.42	559.0	-112.73	-362.36	209.21	0.0	0.0	0.0
3	114	767.05	0.0	0.0	-1097.75	0.0	-417.16	548.88	-208.53	0.0	0.0	0.0
		0.0	-291.43	0.0	417.07	559.0	-417.16	-548.88	208.53	0.0	0.0	0.0
3	123	3462.67	0.0	0.0	-4955.51	0.0	767.20	2477.76	-201.54	0.0	0.0	0.0
		0.0	-281.66	0.0	403.09	559.0	767.20	-2477.76	201.54	0.0	0.0	0.0
3	137	506.40	0.0	0.0	-724.72	0.0	168.45	362.36	-209.21	0.0	0.0	0.0
		0.0	-292.37	0.0	418.42	559.0	168.45	-362.36	209.21	0.0	0.0	0.0
3	138	506.40	0.0	0.0	-724.72	0.0	-254.66	362.36	-209.21	0.0	0.0	0.0
		0.0	-292.37	0.0	418.42	559.0	-254.66	-362.36	209.21	0.0	0.0	0.0
3	144	506.40	0.0	0.0	-724.72	0.0	-43.11	362.36	-209.21	0.0	0.0	0.0
		0.0	-292.37	0.0	418.42	559.0	-43.11	-362.36	209.21	0.0	0.0	0.0
4	2	1049.30	0.0	0.0	-1501.68	0.0	-617.12	750.84	-270.96	0.0	0.0	0.0
		0.0	-378.66	0.0	541.92	559.0	-617.12	-750.84	270.96	0.0	0.0	0.0
4	11	5092.72	0.0	0.0	-7288.33	0.0	1159.43	3644.16	-260.47	0.0	0.0	0.0
		0.0	-364.01	0.0	520.95	559.0	1159.43	-3644.16	260.47	0.0	0.0	0.0
4	26	846.74	0.0	0.0	-1211.79	0.0	-599.87	605.90	-187.27	0.0	0.0	0.0

		0.0	-261.72	0.0	374.55	559.0	-599.87	-605.90	187.27	0.0	0.0	0.0
4	35	4890.16	0.0	0.0	-6998.44	0.0	1176.67	3499.22	-176.79	0.0	0.0	0.0
		0.0	-247.07	0.0	353.58	559.0	1176.67	-3499.22	176.79	0.0	0.0	0.0
4	57	506.40	0.0	0.0	-724.72	0.0	155.37	362.36	-209.21	0.0	0.0	0.0
		0.0	-292.37	0.0	418.42	559.0	155.37	-362.36	209.21	0.0	0.0	0.0
4	60	506.40	0.0	0.0	-724.72	0.0	-241.59	362.36	-209.21	0.0	0.0	0.0
		0.0	-292.37	0.0	418.42	559.0	-241.59	-362.36	209.21	0.0	0.0	0.0
4	89	506.40	0.0	0.0	-724.72	0.0	26.52	362.36	-209.21	0.0	0.0	0.0
		0.0	-292.37	0.0	418.42	559.0	26.52	-362.36	209.21	0.0	0.0	0.0
4	92	506.40	0.0	0.0	-724.72	0.0	-112.73	362.36	-209.21	0.0	0.0	0.0
		0.0	-292.37	0.0	418.42	559.0	-112.73	-362.36	209.21	0.0	0.0	0.0
4	114	767.05	0.0	0.0	-1097.75	0.0	-417.16	548.88	-208.53	0.0	0.0	0.0
		0.0	-291.43	0.0	417.07	559.0	-417.16	-548.88	208.53	0.0	0.0	0.0
4	123	3462.67	0.0	0.0	-4955.51	0.0	767.20	2477.76	-201.54	0.0	0.0	0.0
		0.0	-281.66	0.0	403.09	559.0	767.20	-2477.76	201.54	0.0	0.0	0.0
4	137	506.40	0.0	0.0	-724.72	0.0	168.45	362.36	-209.21	0.0	0.0	0.0
		0.0	-292.37	0.0	418.42	559.0	168.45	-362.36	209.21	0.0	0.0	0.0
4	138	506.40	0.0	0.0	-724.72	0.0	-254.66	362.36	-209.21	0.0	0.0	0.0
		0.0	-292.37	0.0	418.42	559.0	-254.66	-362.36	209.21	0.0	0.0	0.0
4	144	506.40	0.0	0.0	-724.72	0.0	-43.11	362.36	-209.21	0.0	0.0	0.0
		0.0	-292.37	0.0	418.42	559.0	-43.11	-362.36	209.21	0.0	0.0	0.0
5	4	38.84	0.0	0.0	-137.50	0.0	-122.65	68.75	-110.40	0.0	0.0	0.0
		0.0	-62.37	0.0	220.80	226.0	-122.65	-68.75	110.40	0.0	0.0	0.0
5	11	832.42	0.0	0.0	-2946.62	0.0	413.65	1473.31	-105.31	0.0	0.0	0.0
		0.0	-59.50	0.0	210.62	226.0	413.65	-1473.31	105.31	0.0	0.0	0.0
5	28	5.74	0.0	0.0	-20.30	0.0	-101.72	10.15	-76.56	0.0	0.0	0.0
		0.0	-43.26	0.0	153.13	226.0	-101.72	-10.15	76.56	0.0	0.0	0.0
5	35	799.31	0.0	0.0	-2829.42	0.0	434.58	1414.71	-71.48	0.0	0.0	0.0
		0.0	-40.38	0.0	142.95	226.0	434.58	-1414.71	71.48	0.0	0.0	0.0
5	50	82.77	0.0	0.0	-293.00	0.0	-6.58	146.50	-84.58	0.0	0.0	0.0
		0.0	-47.79	0.0	169.16	226.0	-6.58	-146.50	84.58	0.0	0.0	0.0
5	51	82.77	0.0	0.0	-293.00	0.0	-98.09	146.50	-84.58	0.0	0.0	0.0
		0.0	-47.79	0.0	169.16	226.0	-98.09	-146.50	84.58	0.0	0.0	0.0
5	82	82.77	0.0	0.0	-293.00	0.0	-36.15	146.50	-84.58	0.0	0.0	0.0
		0.0	-47.79	0.0	169.16	226.0	-36.15	-146.50	84.58	0.0	0.0	0.0
5	83	82.77	0.0	0.0	-293.00	0.0	-68.51	146.50	-84.58	0.0	0.0	0.0
		0.0	-47.79	0.0	169.16	226.0	-68.51	-146.50	84.58	0.0	0.0	0.0
5	116	36.93	0.0	0.0	-130.73	0.0	-88.74	65.37	-84.88	0.0	0.0	0.0
		0.0	-47.95	0.0	169.75	226.0	-88.74	-65.37	84.88	0.0	0.0	0.0
5	123	565.98	0.0	0.0	-2003.48	0.0	268.79	1001.74	-81.48	0.0	0.0	0.0
		0.0	-46.04	0.0	162.97	226.0	268.79	-1001.74	81.48	0.0	0.0	0.0
5	139	152.88	0.0	0.0	-541.17	0.0	-6.70	270.59	-84.13	0.0	0.0	0.0
		0.0	-47.53	0.0	168.26	226.0	-6.70	-270.59	84.13	0.0	0.0	0.0
5	140	38.55	0.0	0.0	-136.46	0.0	-81.12	68.23	-84.87	0.0	0.0	0.0
		0.0	-47.95	0.0	169.73	226.0	-81.12	-68.23	84.87	0.0	0.0	0.0
5	144	82.77	0.0	0.0	-293.00	0.0	-52.33	146.50	-84.58	0.0	0.0	0.0
		0.0	-47.79	0.0	169.16	226.0	-52.33	-146.50	84.58	0.0	0.0	0.0
6	4	38.84	0.0	0.0	-137.50	0.0	-122.65	68.75	-110.40	0.0	0.0	0.0
		0.0	-62.37	0.0	220.80	226.0	-122.65	-68.75	110.40	0.0	0.0	0.0
6	11	832.42	0.0	0.0	-2946.62	0.0	413.65	1473.31	-105.31	0.0	0.0	0.0
		0.0	-59.50	0.0	210.62	226.0	413.65	-1473.31	105.31	0.0	0.0	0.0
6	28	5.74	0.0	0.0	-20.30	0.0	-101.72	10.15	-76.56	0.0	0.0	0.0
		0.0	-43.26	0.0	153.13	226.0	-101.72	-10.15	76.56	0.0	0.0	0.0
6	35	799.31	0.0	0.0	-2829.42	0.0	434.58	1414.71	-71.48	0.0	0.0	0.0
		0.0	-40.38	0.0	142.95	226.0	434.58	-1414.71	71.48	0.0	0.0	0.0
6	57	82.77	0.0	0.0	-293.00	0.0	-6.58	146.50	-84.58	0.0	0.0	0.0
		0.0	-47.79	0.0	169.16	226.0	-6.58	-146.50	84.58	0.0	0.0	0.0
6	60	82.77	0.0	0.0	-293.00	0.0	-98.09	146.50	-84.58	0.0	0.0	0.0
		0.0	-47.79	0.0	169.16	226.0	-98.09	-146.50	84.58	0.0	0.0	0.0
6	89	82.77	0.0	0.0	-293.00	0.0	-36.15	146.50	-84.58	0.0	0.0	0.0
		0.0	-47.79	0.0	169.16	226.0	-36.15	-146.50	84.58	0.0	0.0	0.0
6	92	82.77	0.0	0.0	-293.00	0.0	-68.51	146.50	-84.58	0.0	0.0	0.0
		0.0	-47.79	0.0	169.16	226.0	-68.51	-146.50	84.58	0.0	0.0	0.0
6	116	36.93	0.0	0.0	-130.73	0.0	-88.74	65.37	-84.88	0.0	0.0	0.0
		0.0	-47.95	0.0	169.75	226.0	-88.74	-65.37	84.88	0.0	0.0	0.0
6	123	565.98	0.0	0.0	-2003.48	0.0	268.79	1001.74	-81.48	0.0	0.0	0.0
		0.0	-46.04	0.0	162.97	226.0	268.79	-1001.74	81.48	0.0	0.0	0.0
6	139	152.88	0.0	0.0	-541.17	0.0	-6.70	270.59	-84.13	0.0	0.0	0.0
		0.0	-47.53	0.0	168.26	226.0	-6.70	-270.59	84.13	0.0	0.0	0.0
6	140	38.55	0.0	0.0	-136.46	0.0	-81.12	68.23	-84.87	0.0	0.0	0.0
		0.0	-47.95	0.0	169.73	226.0	-81.12	-68.23	84.87	0.0	0.0	0.0
6	144	82.77	0.0	0.0	-293.00	0.0	-52.33	146.50	-84.58	0.0	0.0	0.0
		0.0	-47.79	0.0	169.16	226.0	-52.33	-146.50	84.58	0.0	0.0	0.0
7	4	38.70	0.0	0.0	-136.99	0.0	116.98	68.50	-110.25	0.0	0.0	0.0
		0.0	-62.29	0.0	220.50	226.0	116.98	-68.50	110.25	0.0	0.0	0.0
7	11	837.16	0.0	0.0	-2963.40	0.0	-400.08	1481.70	-110.15	0.0	0.0	0.0
		0.0	-62.23	0.0	220.30	226.0	-400.08	-1481.70	110.15	0.0	0.0	0.0

7	28	5.51	0.0	0.0	-19.49	0.0	96.14	9.74	-76.33	0.0	0.0	0.0
		0.0	-43.13	0.0	152.66	226.0	96.14	-9.74	76.33	0.0	0.0	0.0
7	35	803.96	0.0	0.0	-2845.89	0.0	-420.91	1422.95	-76.23	0.0	0.0	0.0
		0.0	-43.07	0.0	152.46	226.0	-420.91	-1422.95	76.23	0.0	0.0	0.0
7	50	82.99	0.0	0.0	-293.76	0.0	0.85	146.88	-84.80	0.0	0.0	0.0
		0.0	-47.91	0.0	169.60	226.0	0.85	-146.88	84.80	0.0	0.0	0.0
7	51	82.99	0.0	0.0	-293.76	0.0	103.31	146.88	-84.80	0.0	0.0	0.0
		0.0	-47.91	0.0	169.60	226.0	103.31	-146.88	84.80	0.0	0.0	0.0
7	82	82.99	0.0	0.0	-293.76	0.0	34.25	146.88	-84.80	0.0	0.0	0.0
		0.0	-47.91	0.0	169.60	226.0	34.25	-146.88	84.80	0.0	0.0	0.0
7	83	82.99	0.0	0.0	-293.76	0.0	69.92	146.88	-84.80	0.0	0.0	0.0
		0.0	-47.91	0.0	169.60	226.0	69.92	-146.88	84.80	0.0	0.0	0.0
7	116	36.87	0.0	0.0	-130.50	0.0	84.93	65.25	-84.81	0.0	0.0	0.0
		0.0	-47.92	0.0	169.62	226.0	84.93	-65.25	84.81	0.0	0.0	0.0
7	123	569.17	0.0	0.0	-2014.77	0.0	-259.77	1007.38	-84.74	0.0	0.0	0.0
		0.0	-47.88	0.0	169.48	226.0	-259.77	-1007.38	84.74	0.0	0.0	0.0
7	139	153.53	0.0	0.0	-543.46	0.0	7.36	271.73	-84.79	0.0	0.0	0.0
		0.0	-47.91	0.0	169.59	226.0	7.36	-271.73	84.79	0.0	0.0	0.0
7	140	38.49	0.0	0.0	-136.26	0.0	80.29	68.13	-84.81	0.0	0.0	0.0
		0.0	-47.92	0.0	169.62	226.0	80.29	-68.13	84.81	0.0	0.0	0.0
7	144	82.99	0.0	0.0	-293.76	0.0	52.08	146.88	-84.80	0.0	0.0	0.0
		0.0	-47.91	0.0	169.60	226.0	52.08	-146.88	84.80	0.0	0.0	0.0
8	4	38.70	0.0	0.0	-136.99	0.0	116.98	68.50	-110.25	0.0	0.0	0.0
		0.0	-62.29	0.0	220.50	226.0	116.98	-68.50	110.25	0.0	0.0	0.0
8	11	837.16	0.0	0.0	-2963.40	0.0	-400.08	1481.70	-110.15	0.0	0.0	0.0
		0.0	-62.23	0.0	220.30	226.0	-400.08	-1481.70	110.15	0.0	0.0	0.0
8	28	5.51	0.0	0.0	-19.49	0.0	96.14	9.74	-76.33	0.0	0.0	0.0
		0.0	-43.13	0.0	152.66	226.0	96.14	-9.74	76.33	0.0	0.0	0.0
8	35	803.96	0.0	0.0	-2845.89	0.0	-420.91	1422.95	-76.23	0.0	0.0	0.0
		0.0	-43.07	0.0	152.46	226.0	-420.91	-1422.95	76.23	0.0	0.0	0.0
8	57	82.99	0.0	0.0	-293.76	0.0	0.85	146.88	-84.80	0.0	0.0	0.0
		0.0	-47.91	0.0	169.60	226.0	0.85	-146.88	84.80	0.0	0.0	0.0
8	60	82.99	0.0	0.0	-293.76	0.0	103.31	146.88	-84.80	0.0	0.0	0.0
		0.0	-47.91	0.0	169.60	226.0	103.31	-146.88	84.80	0.0	0.0	0.0
8	89	82.99	0.0	0.0	-293.76	0.0	34.25	146.88	-84.80	0.0	0.0	0.0
		0.0	-47.91	0.0	169.60	226.0	34.25	-146.88	84.80	0.0	0.0	0.0
8	92	82.99	0.0	0.0	-293.76	0.0	69.92	146.88	-84.80	0.0	0.0	0.0
		0.0	-47.91	0.0	169.60	226.0	69.92	-146.88	84.80	0.0	0.0	0.0
8	116	36.87	0.0	0.0	-130.50	0.0	84.93	65.25	-84.81	0.0	0.0	0.0
		0.0	-47.92	0.0	169.62	226.0	84.93	-65.25	84.81	0.0	0.0	0.0
8	123	569.17	0.0	0.0	-2014.77	0.0	-259.77	1007.38	-84.74	0.0	0.0	0.0
		0.0	-47.88	0.0	169.48	226.0	-259.77	-1007.38	84.74	0.0	0.0	0.0
8	139	153.53	0.0	0.0	-543.46	0.0	7.36	271.73	-84.79	0.0	0.0	0.0
		0.0	-47.91	0.0	169.59	226.0	7.36	-271.73	84.79	0.0	0.0	0.0
8	140	38.49	0.0	0.0	-136.26	0.0	80.29	68.13	-84.81	0.0	0.0	0.0
		0.0	-47.92	0.0	169.62	226.0	80.29	-68.13	84.81	0.0	0.0	0.0
8	144	82.99	0.0	0.0	-293.76	0.0	52.08	146.88	-84.80	0.0	0.0	0.0
		0.0	-47.91	0.0	169.60	226.0	52.08	-146.88	84.80	0.0	0.0	0.0
9	1	62.07	0.0	0.0	-219.71	0.0	17.88	109.85	-63.42	0.0	0.0	0.0
		0.0	-35.84	0.0	126.85	226.0	15.97	-109.85	63.42	0.0	0.0	0.0
9	8	62.07	0.0	0.0	-219.71	0.0	-40.22	109.85	-63.42	0.0	0.0	0.0
		0.0	-35.84	0.0	126.85	226.0	-42.13	-109.85	63.42	0.0	0.0	0.0
9	25	42.97	0.0	0.0	-152.11	0.0	19.03	76.05	-43.91	0.0	0.0	0.0
		0.0	-24.81	0.0	87.82	226.0	17.71	-76.05	43.91	0.0	0.0	0.0
9	32	42.97	0.0	0.0	-152.11	0.0	-39.07	76.05	-43.91	0.0	0.0	0.0
		0.0	-24.81	0.0	87.82	226.0	-40.39	-76.05	43.91	0.0	0.0	0.0
9	66	47.75	0.0	0.0	-169.01	0.0	-31.62	84.50	-48.79	0.0	0.0	0.0
		0.0	-27.57	0.0	97.58	226.0	-33.09	-84.50	48.79	0.0	0.0	0.0
9	67	47.75	0.0	0.0	-169.01	0.0	25.88	84.50	-48.79	0.0	0.0	0.0
		0.0	-27.57	0.0	97.58	226.0	24.41	-84.50	48.79	0.0	0.0	0.0
9	98	47.75	0.0	0.0	-169.01	0.0	-11.88	84.50	-48.79	0.0	0.0	0.0
		0.0	-27.57	0.0	97.58	226.0	-13.35	-84.50	48.79	0.0	0.0	0.0
9	99	47.75	0.0	0.0	-169.01	0.0	6.14	84.50	-48.79	0.0	0.0	0.0
		0.0	-27.57	0.0	97.58	226.0	4.67	-84.50	48.79	0.0	0.0	0.0
9	113	47.75	0.0	0.0	-169.01	0.0	11.54	84.50	-48.79	0.0	0.0	0.0
		0.0	-27.57	0.0	97.58	226.0	10.07	-84.50	48.79	0.0	0.0	0.0
9	120	47.75	0.0	0.0	-169.01	0.0	-27.20	84.50	-48.79	0.0	0.0	0.0
		0.0	-27.57	0.0	97.58	226.0	-28.66	-84.50	48.79	0.0	0.0	0.0
9	137	47.75	0.0	0.0	-169.01	0.0	4.94	84.50	-48.79	0.0	0.0	0.0
		0.0	-27.57	0.0	97.58	226.0	3.47	-84.50	48.79	0.0	0.0	0.0
9	138	47.75	0.0	0.0	-169.01	0.0	-10.68	84.50	-48.79	0.0	0.0	0.0
		0.0	-27.57	0.0	97.58	226.0	-12.15	-84.50	48.79	0.0	0.0	0.0
9	144	47.75	0.0	0.0	-169.01	0.0	-2.87	84.50	-48.79	0.0	0.0	0.0
		0.0	-27.57	0.0	97.58	226.0	-4.34	-84.50	48.79	0.0	0.0	0.0
10	1	62.07	0.0	0.0	-219.71	0.0	15.97	109.85	-63.42	0.0	0.0	0.0
		0.0	-35.84	0.0	126.85	226.0	17.88	-109.85	63.42	0.0	0.0	0.0
10	8	62.07	0.0	0.0	-219.71	0.0	-42.13	109.85	-63.42	0.0	0.0	0.0

		0.0	-35.84	0.0	126.85	226.0	-40.22	-109.85	63.42	0.0	0.0	0.0
10	25	42.97	0.0	0.0	-152.11	0.0	17.71	76.05	-43.91	0.0	0.0	0.0
		0.0	-24.81	0.0	87.82	226.0	19.03	-76.05	43.91	0.0	0.0	0.0
10	32	42.97	0.0	0.0	-152.11	0.0	-40.39	76.05	-43.91	0.0	0.0	0.0
		0.0	-24.81	0.0	87.82	226.0	-39.07	-76.05	43.91	0.0	0.0	0.0
10	69	47.75	0.0	0.0	-169.01	0.0	-33.09	84.50	-48.79	0.0	0.0	0.0
		0.0	-27.57	0.0	97.58	226.0	-31.62	-84.50	48.79	0.0	0.0	0.0
10	72	47.75	0.0	0.0	-169.01	0.0	24.41	84.50	-48.79	0.0	0.0	0.0
		0.0	-27.57	0.0	97.58	226.0	25.88	-84.50	48.79	0.0	0.0	0.0
10	101	47.75	0.0	0.0	-169.01	0.0	-13.35	84.50	-48.79	0.0	0.0	0.0
		0.0	-27.57	0.0	97.58	226.0	-11.88	-84.50	48.79	0.0	0.0	0.0
10	104	47.75	0.0	0.0	-169.01	0.0	4.67	84.50	-48.79	0.0	0.0	0.0
		0.0	-27.57	0.0	97.58	226.0	6.14	-84.50	48.79	0.0	0.0	0.0
10	113	47.75	0.0	0.0	-169.01	0.0	10.07	84.50	-48.79	0.0	0.0	0.0
		0.0	-27.57	0.0	97.58	226.0	11.54	-84.50	48.79	0.0	0.0	0.0
10	120	47.75	0.0	0.0	-169.01	0.0	-28.66	84.50	-48.79	0.0	0.0	0.0
		0.0	-27.57	0.0	97.58	226.0	-27.20	-84.50	48.79	0.0	0.0	0.0
10	137	47.75	0.0	0.0	-169.01	0.0	3.47	84.50	-48.79	0.0	0.0	0.0
		0.0	-27.57	0.0	97.58	226.0	4.94	-84.50	48.79	0.0	0.0	0.0
10	138	47.75	0.0	0.0	-169.01	0.0	-12.15	84.50	-48.79	0.0	0.0	0.0
		0.0	-27.57	0.0	97.58	226.0	-10.68	-84.50	48.79	0.0	0.0	0.0
10	144	47.75	0.0	0.0	-169.01	0.0	-4.34	84.50	-48.79	0.0	0.0	0.0
		0.0	-27.57	0.0	97.58	226.0	-2.87	-84.50	48.79	0.0	0.0	0.0
11	1	379.73	0.0	0.0	-543.44	0.0	179.80	271.72	-156.88	0.0	0.0	0.0
		0.0	-219.23	0.0	313.75	559.0	179.80	-271.72	156.88	0.0	0.0	0.0
11	8	379.73	0.0	0.0	-543.44	0.0	-261.00	271.72	-156.88	0.0	0.0	0.0
		0.0	-219.23	0.0	313.75	559.0	-261.00	-271.72	156.88	0.0	0.0	0.0
11	25	262.89	0.0	0.0	-376.22	0.0	184.94	188.11	-108.61	0.0	0.0	0.0
		0.0	-151.78	0.0	217.21	559.0	184.94	-188.11	108.61	0.0	0.0	0.0
11	32	262.89	0.0	0.0	-376.22	0.0	-255.85	188.11	-108.61	0.0	0.0	0.0
		0.0	-151.78	0.0	217.21	559.0	-255.85	-188.11	108.61	0.0	0.0	0.0
11	66	292.10	0.0	0.0	-418.03	0.0	-22.48	209.01	-120.67	0.0	0.0	0.0
		0.0	-168.64	0.0	241.35	559.0	-22.48	-209.01	120.67	0.0	0.0	0.0
11	67	292.10	0.0	0.0	-418.03	0.0	-3.22	209.01	-120.67	0.0	0.0	0.0
		0.0	-168.64	0.0	241.35	559.0	-3.22	-209.01	120.67	0.0	0.0	0.0
11	98	292.10	0.0	0.0	-418.03	0.0	-15.88	209.01	-120.67	0.0	0.0	0.0
		0.0	-168.64	0.0	241.35	559.0	-15.88	-209.01	120.67	0.0	0.0	0.0
11	99	292.10	0.0	0.0	-418.03	0.0	-9.82	209.01	-120.67	0.0	0.0	0.0
		0.0	-168.64	0.0	241.35	559.0	-9.82	-209.01	120.67	0.0	0.0	0.0
11	113	292.10	0.0	0.0	-418.03	0.0	118.15	209.01	-120.67	0.0	0.0	0.0
		0.0	-168.64	0.0	241.35	559.0	118.15	-209.01	120.67	0.0	0.0	0.0
11	120	292.10	0.0	0.0	-418.03	0.0	-175.71	209.01	-120.67	0.0	0.0	0.0
		0.0	-168.64	0.0	241.35	559.0	-175.71	-209.01	120.67	0.0	0.0	0.0
11	137	292.10	0.0	0.0	-418.03	0.0	54.59	209.01	-120.67	0.0	0.0	0.0
		0.0	-168.64	0.0	241.35	559.0	54.59	-209.01	120.67	0.0	0.0	0.0
11	138	292.10	0.0	0.0	-418.03	0.0	-80.29	209.01	-120.67	0.0	0.0	0.0
		0.0	-168.64	0.0	241.35	559.0	-80.29	-209.01	120.67	0.0	0.0	0.0
11	144	292.10	0.0	0.0	-418.03	0.0	-12.85	209.01	-120.67	0.0	0.0	0.0
		0.0	-168.64	0.0	241.35	559.0	-12.85	-209.01	120.67	0.0	0.0	0.0
12	1	379.73	0.0	0.0	-543.44	0.0	179.80	271.72	-156.88	0.0	0.0	0.0
		0.0	-219.23	0.0	313.75	559.0	179.80	-271.72	156.88	0.0	0.0	0.0
12	8	379.73	0.0	0.0	-543.44	0.0	-261.00	271.72	-156.88	0.0	0.0	0.0
		0.0	-219.23	0.0	313.75	559.0	-261.00	-271.72	156.88	0.0	0.0	0.0
12	25	262.89	0.0	0.0	-376.22	0.0	184.94	188.11	-108.61	0.0	0.0	0.0
		0.0	-151.78	0.0	217.21	559.0	184.94	-188.11	108.61	0.0	0.0	0.0
12	32	262.89	0.0	0.0	-376.22	0.0	-255.85	188.11	-108.61	0.0	0.0	0.0
		0.0	-151.78	0.0	217.21	559.0	-255.85	-188.11	108.61	0.0	0.0	0.0
12	69	292.10	0.0	0.0	-418.03	0.0	-22.48	209.01	-120.67	0.0	0.0	0.0
		0.0	-168.64	0.0	241.35	559.0	-22.48	-209.01	120.67	0.0	0.0	0.0
12	72	292.10	0.0	0.0	-418.03	0.0	-3.22	209.01	-120.67	0.0	0.0	0.0
		0.0	-168.64	0.0	241.35	559.0	-3.22	-209.01	120.67	0.0	0.0	0.0
12	101	292.10	0.0	0.0	-418.03	0.0	-15.88	209.01	-120.67	0.0	0.0	0.0
		0.0	-168.64	0.0	241.35	559.0	-15.88	-209.01	120.67	0.0	0.0	0.0
12	104	292.10	0.0	0.0	-418.03	0.0	-9.82	209.01	-120.67	0.0	0.0	0.0
		0.0	-168.64	0.0	241.35	559.0	-9.82	-209.01	120.67	0.0	0.0	0.0
12	113	292.10	0.0	0.0	-418.03	0.0	118.15	209.01	-120.67	0.0	0.0	0.0
		0.0	-168.64	0.0	241.35	559.0	118.15	-209.01	120.67	0.0	0.0	0.0
12	120	292.10	0.0	0.0	-418.03	0.0	-175.71	209.01	-120.67	0.0	0.0	0.0
		0.0	-168.64	0.0	241.35	559.0	-175.71	-209.01	120.67	0.0	0.0	0.0
12	137	292.10	0.0	0.0	-418.03	0.0	54.59	209.01	-120.67	0.0	0.0	0.0
		0.0	-168.64	0.0	241.35	559.0	54.59	-209.01	120.67	0.0	0.0	0.0
12	138	292.10	0.0	0.0	-418.03	0.0	-80.29	209.01	-120.67	0.0	0.0	0.0
		0.0	-168.64	0.0	241.35	559.0	-80.29	-209.01	120.67	0.0	0.0	0.0
12	144	292.10	0.0	0.0	-418.03	0.0	-12.85	209.01	-120.67	0.0	0.0	0.0
		0.0	-168.64	0.0	241.35	559.0	-12.85	-209.01	120.67	0.0	0.0	0.0
13	4	-3.02	103.60	-5.90e-04	-81.95	0.0	158.35	150.30	-122.65	0.0	103.60	-95.36
		-95.36	0.0	-1.10e-04	0.0	84.5	110.65	68.35	-122.65	0.0	0.0	-3.02

13	5	14.34	0.0	-2.82e-03	-81.95	0.0	158.35	850.43	154.56	0.0	-130.56	-669.41
		-669.41	-130.56	1.34e-04	0.0	84.5	110.65	768.49	154.56	0.0	0.0	14.34
13	8	20.27	0.0	-5.56e-03	-81.95	0.0	158.35	1089.54	216.22	0.0	-182.64	-865.46
		-865.46	-182.64	2.23e-04	0.0	84.5	110.65	1007.59	216.22	0.0	0.0	20.27
13	11	31.81	0.0	-6.25e-03	-81.95	0.0	158.35	1554.87	413.65	0.0	-349.41	-1246.98
		-1246.98	-349.41	3.81e-04	0.0	84.5	110.65	1472.92	413.65	0.0	0.0	31.81
13	12	31.81	0.0	-7.44e-03	-81.95	0.0	158.35	1554.87	393.93	0.0	-332.76	-1246.98
		-1246.98	-332.76	3.86e-04	0.0	84.5	110.65	1472.92	393.93	0.0	0.0	31.81
13	28	-3.02	85.92	-4.08e-04	-56.73	0.0	109.63	66.60	-101.72	0.0	85.92	-35.32
		-35.32	0.0	-8.87e-05	0.0	84.5	76.60	9.87	-101.72	0.0	0.0	-3.02
13	29	14.34	0.0	-2.64e-03	-56.73	0.0	109.63	766.74	175.50	0.0	-148.24	-609.37
		-609.37	-148.24	1.54e-04	0.0	84.5	76.60	710.01	175.50	0.0	0.0	14.34
13	32	20.27	0.0	-5.38e-03	-56.73	0.0	109.63	1005.85	237.15	0.0	-200.33	-805.41
		-805.41	-200.33	2.44e-04	0.0	84.5	76.60	949.12	237.15	0.0	0.0	20.27
13	35	31.81	0.0	-6.07e-03	-56.73	0.0	109.63	1471.17	434.58	0.0	-367.09	-1186.94
		-1186.94	-367.09	4.03e-04	0.0	84.5	76.60	1414.44	434.58	0.0	0.0	31.81
13	36	31.81	0.0	-7.26e-03	-56.73	0.0	109.63	1471.17	414.87	0.0	-350.44	-1186.94
		-1186.94	-350.44	4.07e-04	0.0	84.5	76.60	1414.44	414.87	0.0	0.0	31.81
13	50	0.0	3.24	-4.44e-04	-63.04	0.0	111.97	214.96	-3.84	0.0	3.24	-154.95
		-154.95	0.0	7.57e-05	0.0	84.5	75.27	151.92	-3.84	0.0	0.0	0.0
13	51	0.0	85.17	-4.64e-04	-63.04	0.0	131.66	203.50	-100.83	0.0	85.17	-145.27
		-145.27	0.0	-1.39e-04	0.0	84.5	94.96	140.46	-100.83	0.0	0.0	0.0
13	67	0.0	66.70	-3.23e-04	-63.04	0.0	124.76	207.51	-78.96	0.0	66.70	-148.66
		-148.66	0.0	-2.18e-04	0.0	84.5	88.07	144.47	-78.96	0.0	0.0	0.0
13	68	0.0	44.28	-6.17e-04	-63.04	0.0	124.76	207.51	-52.42	0.0	44.28	-148.66
		-148.66	0.0	1.90e-04	0.0	84.5	88.07	144.47	-52.42	0.0	0.0	0.0
13	82	0.0	29.81	-4.49e-04	-63.04	0.0	118.32	211.26	-35.29	0.0	29.81	-151.83
		-151.83	0.0	-2.59e-05	0.0	84.5	81.62	148.23	-35.29	0.0	0.0	0.0
13	83	0.0	58.60	-4.59e-04	-63.04	0.0	125.30	207.19	-69.37	0.0	58.60	-148.40
		-148.40	0.0	-8.14e-05	0.0	84.5	88.61	144.16	-69.37	0.0	0.0	0.0
13	90	0.0	34.51	-4.52e-04	-63.04	0.0	119.70	210.46	-40.85	0.0	34.51	-151.15
		-151.15	0.0	-3.57e-05	0.0	84.5	83.00	147.42	-40.85	0.0	0.0	0.0
13	116	-2.01	74.96	-4.54e-04	-63.04	0.0	121.81	128.09	-88.74	0.0	74.96	-83.59
		-83.59	0.0	-8.02e-05	0.0	84.5	85.11	65.06	-88.74	0.0	0.0	-2.01
13	117	9.56	0.0	-1.94e-03	-63.04	0.0	121.81	594.85	96.07	0.0	-81.15	-466.29
		-466.29	-81.15	8.21e-05	0.0	84.5	85.11	531.82	96.07	0.0	0.0	9.56
13	120	13.51	0.0	-3.77e-03	-63.04	0.0	121.81	754.26	137.17	0.0	-115.87	-596.99
		-596.99	-115.87	1.42e-04	0.0	84.5	85.11	691.22	137.17	0.0	0.0	13.51
13	123	21.21	0.0	-4.23e-03	-63.04	0.0	121.81	1064.47	268.79	0.0	-227.05	-851.34
		-851.34	-227.05	2.47e-04	0.0	84.5	85.11	1001.44	268.79	0.0	0.0	21.21
13	124	21.21	0.0	-5.02e-03	-63.04	0.0	121.81	1064.47	255.64	0.0	-215.94	-851.34
		-851.34	-215.94	2.50e-04	0.0	84.5	85.11	1001.44	255.64	0.0	0.0	21.21
13	138	0.0	48.83	-7.83e-04	-63.04	0.0	121.81	209.23	-57.81	0.0	48.83	-150.11
		-150.11	0.0	-5.18e-05	0.0	84.5	85.11	146.19	-57.81	0.0	0.0	0.0
13	139	3.08	5.66	-1.06e-03	-63.04	0.0	121.81	333.32	-6.70	0.0	5.66	-251.85
		-251.85	0.0	-9.48e-06	0.0	84.5	85.11	270.28	-6.70	0.0	0.0	3.08
13	140	-1.94	68.52	-7.24e-05	-63.04	0.0	121.81	130.96	-81.12	0.0	68.52	-85.94
		-85.94	0.0	-8.05e-05	0.0	84.5	85.11	67.92	-81.12	0.0	0.0	-1.94
13	144	0.0	44.21	-4.54e-04	-63.04	0.0	121.81	209.23	-52.33	0.0	44.21	-150.11
		-150.11	0.0	-5.29e-05	0.0	84.5	85.11	146.19	-52.33	0.0	0.0	0.0
14	1	-119.31	-4.78	2.54e-03	-134.48	0.0	85.72	190.13	-0.45	1.03	-4.78	-289.21
		-289.21	-5.40	3.31e-05	0.0	138.2	8.26	55.65	-0.45	1.03	-5.40	-119.31
14	3	76.12	-3.57	9.32e-04	-134.48	0.0	92.31	185.61	35.86	0.61	-53.14	-87.52
		-87.52	-53.14	1.72e-04	0.0	138.2	14.85	51.13	35.86	0.61	-3.57	76.12
14	4	75.14	5.61	-1.01e-03	-134.48	0.0	123.11	188.62	52.32	-0.48	-66.73	-92.67
		-92.67	-66.73	1.74e-04	0.0	138.2	45.66	54.14	52.32	-0.48	5.61	75.14
14	8	-708.25	104.09	2.27e-03	-134.48	0.0	148.07	211.73	-65.48	-0.61	104.09	-908.00
		-908.00	13.57	-3.83e-04	0.0	138.2	70.61	77.25	-65.48	-0.61	13.57	-708.25
14	11	-1094.88	209.08	6.66e-03	-134.48	0.0	114.28	218.66	-148.51	0.96	209.08	-1304.22
		-1304.22	3.77	-6.60e-04	0.0	138.2	36.82	84.18	-148.51	0.96	3.77	-1094.88
14	12	-1095.87	195.49	4.72e-03	-134.48	0.0	145.08	221.67	-132.05	-0.13	195.49	-1309.37
		-1309.37	12.94	-6.59e-04	0.0	138.2	67.62	87.19	-132.05	-0.13	12.94	-1095.87
14	25	-111.36	6.68	2.40e-03	-93.10	0.0	51.99	131.68	-9.10	1.00	6.68	-229.05
		-229.05	-5.91	1.32e-05	0.0	138.2	-1.64	38.57	-9.10	1.00	-5.91	-111.36
14	27	84.07	-4.08	7.91e-04	-93.10	0.0	58.58	127.16	27.21	0.58	-41.69	-27.36
		-27.36	-41.69	1.41e-04	0.0	138.2	4.96	34.05	27.21	0.58	-4.08	84.07
14	28	83.09	5.10	-1.15e-03	-93.10	0.0	89.38	130.17	43.67	-0.51	-55.28	-32.51
		-32.51	-55.28	1.43e-04	0.0	138.2	35.76	37.07	43.67	-0.51	5.10	83.09
14	32	-700.30	115.54	2.14e-03	-93.10	0.0	114.34	153.27	-74.13	-0.64	115.54	-847.84
		-847.84	13.06	-4.14e-04	0.0	138.2	60.72	60.17	-74.13	-0.64	13.06	-700.30
14	35	-1086.94	220.53	6.52e-03	-93.10	0.0	80.55	160.20	-157.16	0.93	220.53	-1244.06
		-1244.06	3.26	-6.91e-04	0.0	138.2	26.92	67.10	-157.16	0.93	3.26	-1086.94
14	36	-1087.92	206.94	4.58e-03	-93.10	0.0	111.35	163.22	-140.70	-0.16	206.94	-1249.21
		-1249.21	12.43	-6.89e-04	0.0	138.2	57.73	70.11	-140.70	-0.16	12.43	-1087.92
14	57	-22.57	1.99	4.42e-04	-103.45	0.0	135.69	157.71	7.00	0.12	-7.69	-169.09
		-169.09	-7.69	-1.99e-04	0.0	138.2	76.11	54.26	7.00	0.12	1.99	-22.57
14	59	-17.25	1.43	1.30e-04	-103.45	0.0	47.16	134.74	41.45	-0.06	-55.87	-132.02

		-132.02	-55.87	-1.71e-04	0.0	138.2	-12.42	31.29	41.45	-0.06	1.43	-17.25
14	60	-17.17	0.56	2.62e-04	-103.45	0.0	32.95	134.57	36.26	0.02	-49.56	-131.71
		-131.71	-49.56	2.33e-04	0.0	138.2	-26.63	31.12	36.26	0.02	0.56	-17.17
14	69	-20.79	2.81	1.70e-04	-103.45	0.0	121.28	149.86	25.11	-0.04	-31.91	-156.47
		-156.47	-31.91	-5.90e-04	0.0	138.2	61.70	46.41	25.11	-0.04	2.81	-20.79
14	89	-20.83	1.51	3.87e-04	-103.45	0.0	102.25	150.24	16.33	0.09	-21.07	-157.03
		-157.03	-21.07	-7.15e-05	0.0	138.2	42.67	46.79	16.33	0.09	1.51	-20.83
14	91	-18.94	1.31	2.72e-04	-103.45	0.0	70.84	142.09	28.55	0.03	-38.16	-143.87
		-143.87	-38.16	8.73e-05	0.0	138.2	11.26	38.64	28.55	0.03	1.31	-18.94
14	92	-18.92	1.04	3.17e-04	-103.45	0.0	66.39	142.04	26.93	0.05	-36.19	-143.78
		-143.78	-36.19	1.26e-04	0.0	138.2	6.81	38.59	26.93	0.05	1.04	-18.92
14	101	-20.19	1.76	2.94e-04	-103.45	0.0	96.44	147.45	22.50	0.04	-29.35	-152.53
		-152.53	-29.35	-1.94e-04	0.0	138.2	36.86	44.00	22.50	0.04	1.76	-20.19
14	113	-82.19	-3.43	1.74e-03	-103.45	0.0	68.39	146.24	2.58	0.70	-7.00	-212.86
		-212.86	-7.00	3.19e-05	0.0	138.2	8.80	42.79	2.58	0.70	-3.43	-82.19
14	115	48.10	-2.21	6.69e-04	-103.45	0.0	72.78	143.23	26.79	0.41	-39.24	-78.40
		-78.40	-39.24	1.25e-04	0.0	138.2	13.20	39.78	26.79	0.41	-2.21	48.10
14	116	47.44	3.91	-6.25e-04	-103.45	0.0	93.32	145.23	37.76	-0.31	-48.30	-81.84
		-81.84	-48.30	1.26e-04	0.0	138.2	33.74	41.79	37.76	-0.31	3.91	47.44
14	120	-474.82	65.58	1.56e-03	-103.45	0.0	109.95	160.64	-40.77	-0.40	65.58	-625.39
		-625.39	65.58	-2.45e-04	0.0	138.2	50.37	57.19	-40.77	-0.40	9.21	-474.82
14	123	-732.57	135.57	4.49e-03	-103.45	0.0	87.43	165.26	-96.12	0.65	135.57	-889.53
		-889.53	135.57	-4.30e-04	0.0	138.2	27.84	61.81	-96.12	0.65	2.68	-732.57
14	124	-733.23	126.51	3.19e-03	-103.45	0.0	107.96	167.27	-85.15	-0.08	126.51	-892.97
		-892.97	126.51	-4.29e-04	0.0	138.2	48.38	63.82	-85.15	-0.08	8.80	-733.23
14	137	-19.60	-1.27	8.91e-04	-103.45	0.0	75.76	145.30	17.05	0.37	-24.85	-148.97
		-148.97	-24.85	7.67e-05	0.0	138.2	16.18	41.86	17.05	0.37	-1.27	-19.60
14	138	-20.14	3.82	-1.87e-04	-103.45	0.0	92.87	146.98	26.20	-0.23	-32.40	-151.83
		-151.83	-32.40	7.87e-05	0.0	138.2	33.29	43.53	26.20	-0.23	3.82	-20.14
14	139	-123.32	1.92	8.58e-04	-103.45	0.0	86.26	149.06	5.34	0.10	-5.46	-257.89
		-257.89	-5.46	-1.73e-05	0.0	138.2	26.68	45.61	5.34	0.10	1.92	-123.32
14	140	45.38	0.86	3.33e-05	-103.45	0.0	83.09	144.30	31.90	0.05	-43.24	-82.60
		-82.60	-43.24	1.23e-04	0.0	138.2	23.51	40.85	31.90	0.05	0.86	45.38
14	144	-19.87	1.27	3.52e-04	-103.45	0.0	84.32	146.14	21.63	0.07	-28.63	-150.40
		-150.40	-28.63	7.73e-05	0.0	138.2	24.74	42.69	21.63	0.07	1.27	-19.87
15	1	-119.31	5.40	1.16e-03	-134.48	0.0	-55.10	-54.39	-16.48	-1.03	5.40	-119.31
		-287.47	-17.38	8.25e-05	0.0	138.2	-132.55	-188.87	-16.48	-1.03	-17.38	-287.47
15	3	76.12	3.57	1.24e-03	-134.48	0.0	-48.49	-58.87	-47.17	-0.61	3.57	76.12
		-98.23	-61.65	2.00e-04	0.0	138.2	-125.94	-193.35	-47.17	-0.61	-61.65	-98.23
15	8	-708.25	133.88	-4.26e-03	-134.48	0.0	7.41	-32.38	106.65	0.61	-13.57	-708.25
		-845.98	-13.57	-4.38e-04	0.0	138.2	-70.05	-166.86	106.65	0.61	133.88	-845.98
15	11	-1094.88	216.94	-3.09e-03	-134.48	0.0	-26.46	-25.66	159.64	-0.96	-3.77	-1094.88
		-1223.33	-3.77	-6.47e-04	0.0	138.2	-103.92	-160.15	159.64	-0.96	216.94	-1223.33
15	12	-1095.87	223.86	-5.04e-03	-134.48	0.0	4.41	-22.45	171.29	0.13	-12.94	-1095.87
		-1219.87	-12.94	-6.98e-04	0.0	138.2	-73.04	-156.93	171.29	0.13	223.86	-1219.87
15	25	-111.36	5.91	1.20e-03	-93.10	0.0	-45.51	-37.66	-9.27	-1.00	5.91	-111.36
		-227.78	-6.91	6.70e-05	0.0	138.2	-99.14	-130.76	-9.27	-1.00	-6.91	-227.78
15	27	84.07	4.08	1.27e-03	-93.10	0.0	-38.90	-42.14	-39.96	-0.58	4.08	84.07
		-38.54	-51.17	1.70e-04	0.0	138.2	-92.53	-135.24	-39.96	-0.58	-51.17	-38.54
15	32	-700.30	144.35	-4.22e-03	-93.10	0.0	16.99	-15.65	113.86	0.64	-13.06	-700.30
		-786.29	-13.06	-4.68e-04	0.0	138.2	-36.64	-108.75	113.86	0.64	144.35	-786.29
15	35	-1086.94	227.42	-3.06e-03	-93.10	0.0	-16.88	-8.93	166.85	-0.93	-3.26	-1086.94
		-1163.64	-3.26	-6.78e-04	0.0	138.2	-70.50	-102.03	166.85	-0.93	227.42	-1163.64
15	36	-1087.92	234.34	-5.01e-03	-93.10	0.0	13.99	-5.72	178.50	0.16	-12.43	-1087.92
		-1160.18	-12.43	-7.29e-04	0.0	138.2	-39.63	-98.82	178.50	0.16	234.34	-1160.18
15	49	-22.49	0.62	1.44e-04	-103.45	0.0	35.70	-43.46	1.25	-0.21	-1.11	-22.49
		-154.08	-1.11	-1.65e-04	0.0	138.2	-23.88	-146.90	1.25	-0.21	0.62	-154.08
15	50	-22.57	-1.99	5.54e-05	-103.45	0.0	49.95	-43.17	-1.03	-0.12	-1.99	-22.57
		-153.76	-3.40	1.70e-04	0.0	138.2	-9.63	-146.62	-1.03	-0.12	-3.40	-153.76
15	51	-17.17	-0.56	-1.29e-04	-103.45	0.0	-97.86	-40.51	-35.02	-0.02	-0.56	-17.17
		-144.68	-48.98	-1.86e-04	0.0	138.2	-157.44	-143.95	-35.02	-0.02	-48.98	-144.68
15	52	-17.25	-1.43	-2.74e-04	-103.45	0.0	-83.61	-40.22	-37.30	0.06	-1.43	-17.25
		-144.36	-53.00	2.55e-04	0.0	138.2	-143.19	-143.67	-37.30	0.06	-53.00	-144.36
15	81	-20.80	-1.23	6.41e-05	-103.45	0.0	-2.49	-42.41	-11.23	-0.12	-1.23	-20.80
		-150.94	-16.76	-5.66e-05	0.0	138.2	-62.08	-145.85	-11.23	-0.12	-16.76	-150.94
15	82	-20.83	-1.51	-7.02e-05	-103.45	0.0	1.97	-42.32	-11.95	-0.09	-1.51	-20.83
		-150.84	-18.02	8.75e-05	0.0	138.2	-57.61	-145.76	-11.95	-0.09	-18.02	-150.84
15	83	-18.92	-1.04	-1.06e-04	-103.45	0.0	-49.88	-41.36	-24.10	-0.05	-1.04	-18.92
		-147.60	-34.36	7.16e-05	0.0	138.2	-109.46	-144.81	-24.10	-0.05	-34.36	-147.60
15	84	-18.94	-1.31	-1.51e-04	-103.45	0.0	-45.42	-41.27	-24.81	-0.03	-1.31	-18.94
		-147.50	-35.62	1.35e-04	0.0	138.2	-105.00	-144.72	-24.81	-0.03	-35.62	-147.50
15	99	-19.55	-0.79	6.27e-05	-103.45	0.0	-38.50	-41.83	-18.77	-0.10	-0.79	-19.55
		-148.89	-26.73	-1.84e-04	0.0	138.2	-98.08	-145.28	-18.77	-0.10	-26.73	-148.89
15	113	-82.19	3.43	7.62e-04	-103.45	0.0	-39.92	-41.84	-13.39	-0.70	3.43	-82.19
		-211.54	-15.08	6.37e-05	0.0	138.2	-99.51	-145.29	-13.39	-0.70	-15.08	-211.54
15	115	48.10	2.21	8.12e-04	-103.45	0.0	-35.52	-44.83	-33.85	-0.41	2.21	48.10
		-85.38	-44.59	1.43e-04	0.0	138.2	-95.10	-148.27	-33.85	-0.41	-44.59	-85.38

15	120	-474.82	85.76	-2.85e-03	-103.45	0.0	1.74	-27.17	68.70	0.40	-9.21	-474.82
		-583.88	-9.21	-2.82e-04	0.0	138.2	-57.84	-130.61	68.70	0.40	85.76	-583.88
15	123	-732.57	141.13	-2.07e-03	-103.45	0.0	-20.84	-22.69	104.03	-0.65	-2.68	-732.57
		-835.45	-2.68	-4.21e-04	0.0	138.2	-80.42	-126.14	104.03	-0.65	141.13	-835.45
15	124	-733.23	145.75	-3.37e-03	-103.45	0.0	-0.25	-20.55	111.79	0.08	-8.80	-733.23
		-833.14	-8.80	-4.55e-04	0.0	138.2	-59.83	-123.99	111.79	0.08	145.75	-833.14
15	137	-19.60	1.27	4.54e-04	-103.45	0.0	-32.53	-42.73	-21.26	-0.37	1.27	-19.60
		-150.18	-28.11	9.17e-05	0.0	138.2	-92.11	-146.18	-21.26	-0.37	-28.11	-150.18
15	138	-20.14	-3.82	-6.29e-04	-103.45	0.0	-15.38	-40.95	-14.79	0.23	-3.82	-20.14
		-148.26	-24.27	6.53e-05	0.0	138.2	-74.96	-144.39	-14.79	0.23	-24.27	-148.26
15	139	-123.32	-1.58	-4.70e-04	-103.45	0.0	-22.01	-38.90	0.25	-0.10	-1.92	-123.32
		-248.62	-1.92	-1.25e-05	0.0	138.2	-81.59	-142.35	0.25	-0.10	-1.58	-248.62
15	140	45.38	-0.86	1.53e-04	-103.45	0.0	-25.18	-43.69	-29.55	-0.05	-0.86	45.38
		-86.52	-41.71	1.25e-04	0.0	138.2	-84.76	-147.14	-29.55	-0.05	-41.71	-86.52
15	144	-19.87	-1.27	-8.78e-05	-103.45	0.0	-23.95	-41.84	-18.02	-0.07	-1.27	-19.87
		-149.22	-26.19	7.77e-05	0.0	138.2	-83.54	-145.29	-18.02	-0.07	-26.19	-149.22
16	1	-119.31	17.38	1.16e-03	-134.48	0.0	-55.10	-54.39	16.48	1.03	-5.40	-119.31
		-287.47	-5.40	-8.25e-05	0.0	138.2	-132.55	-188.87	16.48	1.03	17.38	-287.47
16	3	76.12	61.65	1.24e-03	-134.48	0.0	-48.49	-58.87	47.17	0.61	-3.57	76.12
		-98.23	-3.57	-2.00e-04	0.0	138.2	-125.94	-193.35	47.17	0.61	61.65	-98.23
16	8	-708.25	13.57	-4.26e-03	-134.48	0.0	7.41	-32.38	-106.65	-0.61	13.57	-708.25
		-845.98	-133.88	4.38e-04	0.0	138.2	-70.05	-166.86	-106.65	-0.61	-133.88	-845.98
16	11	-1094.88	3.77	-3.09e-03	-134.48	0.0	-26.46	-25.66	-159.64	0.96	3.77	-1094.88
		-1223.33	-216.94	6.47e-04	0.0	138.2	-103.92	-160.15	-159.64	0.96	-216.94	-1223.33
16	12	-1095.87	12.94	-5.04e-03	-134.48	0.0	4.41	-22.45	-171.29	-0.13	12.94	-1095.87
		-1219.87	-223.86	6.98e-04	0.0	138.2	-73.04	-156.93	-171.29	-0.13	-223.86	-1219.87
16	25	-111.36	6.91	1.20e-03	-93.10	0.0	-45.51	-37.66	9.27	1.00	-5.91	-111.36
		-227.78	-5.91	-6.70e-05	0.0	138.2	-99.14	-130.76	9.27	1.00	6.91	-227.78
16	27	84.07	51.17	1.27e-03	-93.10	0.0	-38.90	-42.14	39.96	0.58	-4.08	84.07
		-38.54	-4.08	-1.70e-04	0.0	138.2	-92.53	-135.24	39.96	0.58	51.17	-38.54
16	32	-700.30	13.06	-4.22e-03	-93.10	0.0	16.99	-15.65	-113.86	-0.64	13.06	-700.30
		-786.29	-144.35	4.68e-04	0.0	138.2	-36.64	-108.75	-113.86	-0.64	-144.35	-786.29
16	35	-1086.94	3.26	-3.06e-03	-93.10	0.0	-16.88	-8.93	-166.85	0.93	3.26	-1086.94
		-1163.64	-227.42	6.78e-04	0.0	138.2	-70.50	-102.03	-166.85	0.93	-227.42	-1163.64
16	36	-1087.92	12.43	-5.01e-03	-93.10	0.0	13.99	-5.72	-178.50	-0.16	12.43	-1087.92
		-1160.18	-234.34	7.29e-04	0.0	138.2	-39.63	-98.82	-178.50	-0.16	-234.34	-1160.18
16	57	-22.57	3.40	5.54e-05	-103.45	0.0	49.95	-43.17	1.03	0.12	1.99	-22.57
		-153.76	1.99	-1.70e-04	0.0	138.2	-9.63	-146.62	1.03	0.12	3.40	-153.76
16	58	-22.49	1.11	1.44e-04	-103.45	0.0	35.70	-43.46	-1.25	0.21	1.11	-22.49
		-154.08	-0.62	1.65e-04	0.0	138.2	-23.88	-146.90	-1.25	0.21	-0.62	-154.08
16	59	-17.25	53.00	-2.74e-04	-103.45	0.0	-83.61	-40.22	37.30	-0.06	1.43	-17.25
		-144.36	1.43	-2.55e-04	0.0	138.2	-143.19	-143.67	37.30	-0.06	53.00	-144.36
16	60	-17.17	48.98	-1.29e-04	-103.45	0.0	-97.86	-40.51	35.02	0.02	0.56	-17.17
		-144.68	0.56	1.86e-04	0.0	138.2	-157.44	-143.95	35.02	0.02	48.98	-144.68
16	89	-20.83	18.02	-7.02e-05	-103.45	0.0	1.97	-42.32	11.95	0.09	1.51	-20.83
		-150.84	1.51	-8.75e-05	0.0	138.2	-57.61	-145.76	11.95	0.09	18.02	-150.84
16	90	-20.80	16.76	6.41e-05	-103.45	0.0	-2.49	-42.41	11.23	0.12	1.23	-20.80
		-150.94	1.23	5.66e-05	0.0	138.2	-62.08	-145.85	11.23	0.12	16.76	-150.94
16	91	-18.94	35.62	-1.51e-04	-103.45	0.0	-45.42	-41.27	24.81	0.03	1.31	-18.94
		-147.50	1.31	-1.35e-04	0.0	138.2	-105.00	-144.72	24.81	0.03	35.62	-147.50
16	92	-18.92	34.36	-1.06e-04	-103.45	0.0	-49.88	-41.36	24.10	0.05	1.04	-18.92
		-147.60	1.04	-7.16e-05	0.0	138.2	-109.46	-144.81	24.10	0.05	34.36	-147.60
16	104	-19.55	26.73	6.27e-05	-103.45	0.0	-38.50	-41.83	18.77	0.10	0.79	-19.55
		-148.89	0.79	1.84e-04	0.0	138.2	-98.08	-145.28	18.77	0.10	26.73	-148.89
16	113	-82.19	15.08	7.62e-04	-103.45	0.0	-39.92	-41.84	13.39	0.70	-3.43	-82.19
		-211.54	-3.43	-6.37e-05	0.0	138.2	-99.51	-145.29	13.39	0.70	15.08	-211.54
16	115	48.10	44.59	8.12e-04	-103.45	0.0	-35.52	-44.83	33.85	0.41	-2.21	48.10
		-85.38	-2.21	-1.43e-04	0.0	138.2	-95.10	-148.27	33.85	0.41	44.59	-85.38
16	120	-474.82	9.21	-2.85e-03	-103.45	0.0	1.74	-27.17	-68.70	-0.40	9.21	-474.82
		-583.88	-9.21	2.82e-04	0.0	138.2	-57.84	-130.61	-68.70	-0.40	-85.76	-583.88
16	123	-732.57	141.13	-2.07e-03	-103.45	0.0	-20.84	-22.69	-104.03	0.65	2.68	-732.57
		-835.45	-141.13	4.21e-04	0.0	138.2	-80.42	-126.14	-104.03	0.65	-141.13	-835.45
16	124	-733.23	8.80	-3.37e-03	-103.45	0.0	-0.25	-20.55	-111.79	-0.08	8.80	-733.23
		-833.14	-8.80	4.55e-04	0.0	138.2	-59.83	-123.99	-111.79	-0.08	-145.75	-833.14
16	137	-19.60	1.27	4.54e-04	-103.45	0.0	-32.53	-42.73	21.26	0.37	-1.27	-19.60
		-150.18	-1.27	-9.17e-05	0.0	138.2	-92.11	-146.18	21.26	0.37	28.11	-150.18
16	138	-20.14	24.27	-6.29e-04	-103.45	0.0	-15.38	-40.95	14.79	-0.23	3.82	-20.14
		-148.26	3.82	-6.53e-05	0.0	138.2	-74.96	-144.39	14.79	-0.23	24.27	-148.26
16	139	-123.32	1.92	-4.70e-04	-103.45	0.0	-22.01	-38.90	-0.25	0.10	1.92	-123.32
		-248.62	1.58	1.25e-05	0.0	138.2	-81.59	-142.35	-0.25	0.10	1.58	-248.62
16	140	45.38	41.71	1.53e-04	-103.45	0.0	-25.18	-43.69	29.55	0.05	0.86	45.38
		-86.52	0.86	-1.25e-04	0.0	138.2	-84.76	-147.14	29.55	0.05	41.71	-86.52
16	144	-19.87	26.19	-8.78e-05	-103.45	0.0	-23.95	-41.84	18.02	0.07	1.27	-19.87
		-149.22	1.27	-7.77e-05	0.0	138.2	-83.54	-145.29	18.02	0.07	26.19	-149.22
17	4	3.02	0.0	-4.77e-04	-82.62	0.0	-110.26	-68.49	-116.98	0.0	0.0	3.02
		-90.30	-99.42	1.07e-04	0.0	85.0	-157.96	-151.11	-116.98	0.0	-99.42	-90.30
17	9	-26.09	269.41	7.43e-03	-82.62	0.0	-110.26	-1249.76	316.99	0.0	0.0	-26.09

		-1123.37	0.0	-2.88e-04	0.0	85.0	-157.96	-1332.38	316.99	0.0	269.41	-1123.37
17	11	-31.81	340.02	8.75e-03	-82.62	0.0	-110.26	-1481.69	400.08	0.0	0.0	-31.81
		-1326.20	0.0	-3.65e-04	0.0	85.0	-157.96	-1564.31	400.08	0.0	340.02	-1326.20
17	12	-31.81	330.83	7.57e-03	-82.62	0.0	-110.26	-1481.69	389.26	0.0	0.0	-31.81
		-1326.20	0.0	-3.62e-04	0.0	85.0	-157.96	-1564.31	389.26	0.0	330.83	-1326.20
17	28	3.02	0.0	-7.27e-04	-57.20	0.0	-76.33	-9.74	-96.14	0.0	0.0	3.02
		-29.57	-81.71	8.70e-05	0.0	85.0	-109.36	-66.94	-96.14	0.0	-81.71	-29.57
17	33	-26.09	287.12	7.18e-03	-57.20	0.0	-76.33	-1191.01	337.83	0.0	0.0	-26.09
		-1062.63	0.0	-3.08e-04	0.0	85.0	-109.36	-1248.21	337.83	0.0	287.12	-1062.63
17	35	-31.81	357.73	8.50e-03	-57.20	0.0	-76.33	-1422.94	420.91	0.0	0.0	-31.81
		-1265.46	0.0	-3.85e-04	0.0	85.0	-109.36	-1480.14	420.91	0.0	357.73	-1265.46
17	36	-31.81	348.54	7.32e-03	-57.20	0.0	-76.33	-1422.94	410.10	0.0	0.0	-31.81
		-1265.46	0.0	-3.82e-04	0.0	85.0	-109.36	-1480.14	410.10	0.0	348.54	-1265.46
17	49	0.0	0.0	8.24e-04	-63.55	0.0	-46.25	-169.14	-6.38	0.0	0.0	0.0
		-170.76	-5.43	-6.68e-05	0.0	85.0	-82.95	-232.70	-6.38	0.0	-5.43	-170.76
17	50	0.0	0.0	7.35e-04	-63.55	0.0	-46.25	-169.14	-11.58	0.0	0.0	0.0
		-170.76	-9.84	1.14e-04	0.0	85.0	-82.95	-232.70	-11.58	0.0	-9.84	-170.76
17	52	0.0	0.0	4.25e-04	-63.55	0.0	-123.37	-124.61	-97.78	0.0	0.0	0.0
		-132.91	-83.10	1.34e-04	0.0	85.0	-160.07	-188.16	-97.78	0.0	-83.10	-132.91
17	57	0.0	0.0	7.66e-04	-63.55	0.0	-61.47	-160.36	-20.94	0.0	0.0	0.0
		-163.29	-17.79	-1.05e-04	0.0	85.0	-98.17	-223.91	-20.94	0.0	-17.79	-163.29
17	66	0.0	0.0	5.23e-04	-63.55	0.0	-73.24	-153.56	-47.80	0.0	0.0	0.0
		-157.51	-40.63	3.09e-04	0.0	85.0	-109.94	-217.11	-47.80	0.0	-40.63	-157.51
17	82	0.0	0.0	6.65e-04	-63.55	0.0	-71.13	-154.78	-37.60	0.0	0.0	0.0
		-158.55	-31.96	5.92e-05	0.0	85.0	-107.83	-218.33	-37.60	0.0	-31.96	-158.55
17	83	0.0	0.0	5.83e-04	-63.55	0.0	-98.49	-138.98	-66.56	0.0	0.0	0.0
		-145.12	-56.57	4.37e-05	0.0	85.0	-135.19	-202.53	-66.56	0.0	-56.57	-145.12
17	84	0.0	0.0	5.55e-04	-63.55	0.0	-98.49	-138.98	-68.19	0.0	0.0	0.0
		-145.12	-57.95	7.70e-05	0.0	85.0	-135.19	-202.53	-68.19	0.0	-57.95	-145.12
17	90	0.0	0.0	6.45e-04	-63.55	0.0	-76.53	-151.66	-42.77	0.0	0.0	0.0
		-155.90	-36.35	5.51e-05	0.0	85.0	-113.23	-215.21	-42.77	0.0	-36.35	-155.90
17	98	0.0	0.0	5.95e-04	-63.55	0.0	-80.71	-149.25	-50.20	0.0	0.0	0.0
		-153.85	-42.67	1.14e-04	0.0	85.0	-117.41	-212.80	-50.20	0.0	-42.67	-153.85
17	116	2.01	0.0	-2.35e-04	-63.55	0.0	-84.81	-65.24	-84.93	0.0	0.0	2.01
		-80.44	-72.18	7.79e-05	0.0	85.0	-121.51	-128.80	-84.93	0.0	-72.18	-80.44
17	121	-17.40	173.71	5.04e-03	-63.55	0.0	-84.81	-852.76	204.38	0.0	0.0	-17.40
		-769.16	0.0	-1.85e-04	0.0	85.0	-121.51	-916.31	204.38	0.0	173.71	-769.16
17	123	-21.21	220.78	5.92e-03	-63.55	0.0	-84.81	-1007.38	259.77	0.0	0.0	-21.21
		-904.38	0.0	-2.37e-04	0.0	85.0	-121.51	-1070.93	259.77	0.0	220.78	-904.38
17	124	-21.21	214.65	5.13e-03	-63.55	0.0	-84.81	-1007.38	252.57	0.0	0.0	-21.21
		-904.38	0.0	-2.34e-04	0.0	85.0	-121.51	-1070.93	252.57	0.0	214.65	-904.38
17	137	0.0	0.0	9.53e-04	-63.55	0.0	-84.81	-146.88	-49.08	0.0	0.0	0.0
		-151.84	-41.71	4.89e-05	0.0	85.0	-121.51	-210.43	-49.08	0.0	-41.71	-151.84
17	139	-3.08	0.0	1.34e-03	-63.55	0.0	-84.81	-271.72	-7.36	0.0	0.0	-3.08
		-261.02	-6.25	8.50e-06	0.0	85.0	-121.51	-335.28	-7.36	0.0	-6.25	-261.02
17	140	1.94	0.0	1.76e-04	-63.55	0.0	-84.81	-68.12	-80.29	0.0	0.0	1.94
		-82.96	-68.24	7.59e-05	0.0	85.0	-121.51	-131.68	-80.29	0.0	-68.24	-82.96
17	141	-1.94	0.0	1.07e-03	-63.55	0.0	-84.81	-225.63	-23.87	0.0	0.0	-1.94
		-220.71	-20.29	2.37e-05	0.0	85.0	-121.51	-289.18	-23.87	0.0	-20.29	-220.71
17	144	0.0	0.0	6.24e-04	-63.55	0.0	-84.81	-146.88	-52.08	0.0	0.0	0.0
		-151.84	-44.26	4.98e-05	0.0	85.0	-121.51	-210.43	-52.08	0.0	-44.26	-151.84
18	3	3.02	90.23	7.06e-04	-82.62	0.0	-110.26	-68.49	106.16	0.0	0.0	3.02
		-90.30	0.0	-1.04e-04	0.0	85.0	-157.96	-151.11	106.16	0.0	90.23	-90.30
18	4	3.02	99.42	-4.77e-04	-82.62	0.0	-110.26	-68.49	116.98	0.0	0.0	3.02
		-90.30	0.0	-1.07e-04	0.0	85.0	-157.96	-151.11	116.98	0.0	99.42	-90.30
18	6	-14.34	0.0	3.53e-03	-82.62	0.0	-110.26	-772.93	-135.37	0.0	0.0	-14.34
		-706.36	-115.05	1.27e-04	0.0	85.0	-157.96	-855.55	-135.37	0.0	-115.05	-706.36
18	9	-26.09	0.0	7.43e-03	-82.62	0.0	-110.26	-1249.76	-316.99	0.0	0.0	-26.09
		-1123.37	-269.41	2.88e-04	0.0	85.0	-157.96	-1332.38	-316.99	0.0	-269.41	-1123.37
18	11	-31.81	0.0	8.75e-03	-82.62	0.0	-110.26	-1481.69	-400.08	0.0	0.0	-31.81
		-1326.20	-340.02	3.65e-04	0.0	85.0	-157.96	-1564.31	-400.08	0.0	-340.02	-1326.20
18	12	-31.81	0.0	7.57e-03	-82.62	0.0	-110.26	-1481.69	-389.26	0.0	0.0	-31.81
		-1326.20	-330.83	3.62e-04	0.0	85.0	-157.96	-1564.31	-389.26	0.0	-330.83	-1326.20
18	27	3.02	72.52	4.56e-04	-57.20	0.0	-76.33	-9.74	85.33	0.0	0.0	3.02
		-29.57	0.0	-8.39e-05	0.0	85.0	-109.36	-66.94	85.33	0.0	72.52	-29.57
18	28	3.02	81.71	-7.27e-04	-57.20	0.0	-76.33	-9.74	96.14	0.0	0.0	3.02
		-29.57	0.0	-8.70e-05	0.0	85.0	-109.36	-66.94	96.14	0.0	81.71	-29.57
18	30	-14.34	0.0	3.28e-03	-57.20	0.0	-76.33	-714.18	-156.20	0.0	0.0	-14.34
		-645.63	-132.76	1.47e-04	0.0	85.0	-109.36	-771.38	-156.20	0.0	-132.76	-645.63
18	33	-26.09	0.0	7.18e-03	-57.20	0.0	-76.33	-1191.01	-337.83	0.0	0.0	-26.09
		-1062.63	-287.12	3.08e-04	0.0	85.0	-109.36	-1248.21	-337.83	0.0	-287.12	-1062.63
18	35	-31.81	0.0	8.50e-03	-57.20	0.0	-76.33	-1422.94	-420.91	0.0	0.0	-31.81
		-1265.46	-357.73	3.85e-04	0.0	85.0	-109.36	-1480.14	-420.91	0.0	-357.73	-1265.46
18	36	-31.81	0.0	7.32e-03	-57.20	0.0	-76.33	-1422.94	-410.10	0.0	0.0	-31.81
		-1265.46	-348.54	3.82e-04	0.0	85.0	-109.36	-1480.14	-410.10	0.0	-348.54	-1265.46
18	57	0.0	9.84	7.35e-04	-63.55	0.0	-46.25	-169.14	11.58	0.0	0.0	0.0
		-170.76	0.0	-1.14e-04	0.0	85.0	-82.95	-232.70	11.58	0.0	9.84	-170.76

18	58	0.0	5.43	8.24e-04	-63.55	0.0	-46.25	-169.14	6.38	0.0	0.0	0.0
		-170.76	0.0	6.68e-05	0.0	85.0	-82.95	-232.70	6.38	0.0	5.43	-170.76
18	59	0.0	83.10	4.25e-04	-63.55	0.0	-123.37	-124.61	97.78	0.0	0.0	0.0
		-132.91	0.0	-1.34e-04	0.0	85.0	-160.07	-188.16	97.78	0.0	83.10	-132.91
18	71	0.0	62.61	4.30e-04	-63.55	0.0	-96.38	-140.20	73.67	0.0	0.0	0.0
		-146.16	0.0	-2.96e-04	0.0	85.0	-133.08	-203.75	73.67	0.0	62.61	-146.16
18	72	0.0	47.90	7.25e-04	-63.55	0.0	-96.38	-140.20	56.36	0.0	0.0	0.0
		-146.16	0.0	3.10e-04	0.0	85.0	-133.08	-203.75	56.36	0.0	47.90	-146.16
18	89	0.0	31.96	6.65e-04	-63.55	0.0	-71.13	-154.78	37.60	0.0	0.0	0.0
		-158.55	0.0	-5.92e-05	0.0	85.0	-107.83	-218.33	37.60	0.0	31.96	-158.55
18	90	0.0	30.58	6.93e-04	-63.55	0.0	-71.13	-154.78	35.98	0.0	0.0	0.0
		-158.55	0.0	-2.37e-05	0.0	85.0	-107.83	-218.33	35.98	0.0	30.58	-158.55
18	91	0.0	57.95	5.55e-04	-63.55	0.0	-98.49	-138.98	68.19	0.0	0.0	0.0
		-145.12	0.0	-7.70e-05	0.0	85.0	-135.19	-202.53	68.19	0.0	57.95	-145.12
18	97	0.0	43.98	5.88e-04	-63.55	0.0	-82.33	-148.31	51.75	0.0	0.0	0.0
		-153.05	0.0	-1.12e-04	0.0	85.0	-119.03	-211.86	51.75	0.0	43.98	-153.05
18	101	0.0	42.67	5.95e-04	-63.55	0.0	-80.71	-149.25	50.20	0.0	0.0	0.0
		-153.85	0.0	-1.14e-04	0.0	85.0	-117.41	-212.80	50.20	0.0	42.67	-153.85
18	115	2.01	66.05	5.54e-04	-63.55	0.0	-84.81	-65.24	77.72	0.0	0.0	2.01
		-80.44	0.0	-7.58e-05	0.0	85.0	-121.51	-128.80	77.72	0.0	66.05	-80.44
18	116	2.01	72.18	-2.35e-04	-63.55	0.0	-84.81	-65.24	84.93	0.0	0.0	2.01
		-80.44	0.0	-7.79e-05	0.0	85.0	-121.51	-128.80	84.93	0.0	72.18	-80.44
18	118	-9.56	0.0	2.44e-03	-63.55	0.0	-84.81	-534.87	-83.30	0.0	0.0	-9.56
		-491.15	-70.80	7.78e-05	0.0	85.0	-121.51	-598.42	-83.30	0.0	-70.80	-491.15
18	121	-17.40	0.0	5.04e-03	-63.55	0.0	-84.81	-852.76	-204.38	0.0	0.0	-17.40
		-769.16	-173.71	1.85e-04	0.0	85.0	-121.51	-916.31	-204.38	0.0	-173.71	-769.16
18	123	-21.21	0.0	5.92e-03	-63.55	0.0	-84.81	-1007.38	-259.77	0.0	0.0	-21.21
		-904.38	-220.78	2.37e-04	0.0	85.0	-121.51	-1070.93	-259.77	0.0	-220.78	-904.38
18	124	-21.21	0.0	5.13e-03	-63.55	0.0	-84.81	-1007.38	-252.57	0.0	0.0	-21.21
		-904.38	-214.65	2.34e-04	0.0	85.0	-121.51	-1070.93	-252.57	0.0	-214.65	-904.38
18	138	0.0	46.82	2.96e-04	-63.55	0.0	-84.81	-146.88	55.09	0.0	0.0	0.0
		-151.84	0.0	-5.07e-05	0.0	85.0	-121.51	-210.43	55.09	0.0	46.82	-151.84
18	139	-3.08	6.25	1.34e-03	-63.55	0.0	-84.81	-271.72	7.36	0.0	0.0	-3.08
		-261.02	0.0	-8.50e-06	0.0	85.0	-121.51	-335.28	7.36	0.0	6.25	-261.02
18	140	1.94	68.24	1.76e-04	-63.55	0.0	-84.81	-68.12	80.29	0.0	0.0	1.94
		-82.96	0.0	-7.59e-05	0.0	85.0	-121.51	-131.68	80.29	0.0	68.24	-82.96
18	141	-1.94	20.29	1.07e-03	-63.55	0.0	-84.81	-225.63	23.87	0.0	0.0	-1.94
		-220.71	0.0	-2.37e-05	0.0	85.0	-121.51	-289.18	23.87	0.0	20.29	-220.71
18	144	0.0	44.26	6.24e-04	-63.55	0.0	-84.81	-146.88	52.08	0.0	0.0	0.0
		-151.84	0.0	-4.98e-05	0.0	85.0	-121.51	-210.43	52.08	0.0	44.26	-151.84
19	1	-119.31	5.40	2.54e-03	-134.48	0.0	85.72	190.13	0.45	-1.03	4.78	-289.21
		-289.21	4.78	-3.31e-05	0.0	138.2	8.26	55.65	0.45	-1.03	5.40	-119.31
19	3	76.12	53.14	9.32e-04	-134.48	0.0	92.31	185.61	-35.86	-0.61	53.14	-87.52
		-87.52	3.57	-1.72e-04	0.0	138.2	14.85	51.13	-35.86	-0.61	3.57	76.12
19	4	75.14	66.73	-1.01e-03	-134.48	0.0	123.11	188.62	-52.32	0.48	66.73	-92.67
		-92.67	-5.61	-1.74e-04	0.0	138.2	45.66	54.14	-52.32	0.48	-5.61	75.14
19	8	-708.25	-13.57	2.27e-03	-134.48	0.0	148.07	211.73	65.48	0.61	-104.09	-908.00
		-908.00	-104.09	3.83e-04	0.0	138.2	70.61	77.25	65.48	0.61	-13.57	-708.25
19	11	-1094.88	-3.77	6.66e-03	-134.48	0.0	114.28	218.66	148.51	-0.96	-209.08	-1304.22
		-1304.22	-209.08	6.60e-04	0.0	138.2	36.82	84.18	148.51	-0.96	-3.77	-1094.88
19	12	-1095.87	-12.94	4.72e-03	-134.48	0.0	145.08	221.67	132.05	0.13	-195.49	-1309.37
		-1309.37	-195.49	6.59e-04	0.0	138.2	67.62	87.19	132.05	0.13	-12.94	-1095.87
19	25	-111.36	5.91	2.40e-03	-93.10	0.0	51.99	131.68	9.10	-1.00	-6.68	-229.05
		-229.05	-6.68	-1.32e-05	0.0	138.2	-1.64	38.57	9.10	-1.00	5.91	-111.36
19	27	84.07	41.69	7.91e-04	-93.10	0.0	58.58	127.16	-27.21	-0.58	41.69	-27.36
		-27.36	4.08	-1.41e-04	0.0	138.2	4.96	34.05	-27.21	-0.58	4.08	84.07
19	28	83.09	55.28	-1.15e-03	-93.10	0.0	89.38	130.17	-43.67	0.51	55.28	-32.51
		-32.51	-5.10	-1.43e-04	0.0	138.2	35.76	37.07	-43.67	0.51	-5.10	83.09
19	32	-700.30	-13.06	2.14e-03	-93.10	0.0	114.34	153.27	74.13	0.64	-115.54	-847.84
		-847.84	-115.54	4.14e-04	0.0	138.2	60.72	60.17	74.13	0.64	-13.06	-700.30
19	35	-1086.94	-3.26	6.52e-03	-93.10	0.0	80.55	160.20	157.16	-0.93	-220.53	-1244.06
		-1244.06	-220.53	6.91e-04	0.0	138.2	26.92	67.10	157.16	-0.93	-3.26	-1086.94
19	36	-1087.92	-12.43	4.58e-03	-93.10	0.0	111.35	163.22	140.70	0.16	-206.94	-1249.21
		-1249.21	-206.94	6.89e-04	0.0	138.2	57.73	70.11	140.70	0.16	-12.43	-1087.92
19	50	-22.57	7.69	4.42e-04	-103.45	0.0	135.69	157.71	-7.00	-0.12	7.69	-169.09
		-169.09	-1.99	1.99e-04	0.0	138.2	76.11	54.26	-7.00	-0.12	-1.99	-22.57
19	51	-17.17	49.56	2.62e-04	-103.45	0.0	32.95	134.57	-36.26	-0.02	49.56	-131.71
		-131.71	-0.56	-2.33e-04	0.0	138.2	-26.63	31.12	-36.26	-0.02	-0.56	-17.17
19	52	-17.25	55.87	1.30e-04	-103.45	0.0	47.16	134.74	-41.45	0.06	55.87	-132.02
		-132.02	-1.43	1.71e-04	0.0	138.2	-12.42	31.29	-41.45	0.06	-1.43	-17.25
19	66	-20.79	31.91	1.70e-04	-103.45	0.0	121.28	149.86	-25.11	0.04	31.91	-156.47
		-156.47	-2.81	5.90e-04	0.0	138.2	61.70	46.41	-25.11	0.04	-2.81	-20.79
19	82	-20.83	21.07	3.87e-04	-103.45	0.0	102.25	150.24	-16.33	-0.09	21.07	-157.03
		-157.03	-1.51	7.15e-05	0.0	138.2	42.67	46.79	-16.33	-0.09	-1.51	-20.83
19	83	-18.92	36.19	3.17e-04	-103.45	0.0	66.39	142.04	-26.93	-0.05	36.19	-143.78
		-143.78	-1.04	-1.26e-04	0.0	138.2	6.81	38.59	-26.93	-0.05	-1.04	-18.92
19	84	-18.94	38.16	2.72e-04	-103.45	0.0	70.84	142.09	-28.55	-0.03	38.16	-143.87

		-143.87	-1.31	-8.73e-05	0.0	138.2	11.26	38.64	-28.55	-0.03	-1.31	-18.94
19	98	-20.19	29.35	2.94e-04	-103.45	0.0	96.44	147.45	-22.50	-0.04	29.35	-152.53
		-152.53	-1.76	1.94e-04	0.0	138.2	36.86	44.00	-22.50	-0.04	-1.76	-20.19
19	113	-82.19	7.00	1.74e-03	-103.45	0.0	68.39	146.24	-2.58	-0.70	7.00	-212.86
		-212.86	3.43	-3.19e-05	0.0	138.2	8.80	42.79	-2.58	-0.70	3.43	-82.19
19	115	48.10	39.24	6.69e-04	-103.45	0.0	72.78	143.23	-26.79	-0.41	39.24	-78.40
		-78.40	2.21	-1.25e-04	0.0	138.2	13.20	39.78	-26.79	-0.41	2.21	48.10
19	116	47.44	48.30	-6.25e-04	-103.45	0.0	93.32	145.23	-37.76	0.31	48.30	-81.84
		-81.84	-3.91	-1.26e-04	0.0	138.2	33.74	41.79	-37.76	0.31	-3.91	47.44
19	120	-474.82	-9.21	1.56e-03	-103.45	0.0	109.95	160.64	40.77	0.40	-65.58	-625.39
		-625.39	-65.58	2.45e-04	0.0	138.2	50.37	57.19	40.77	0.40	-9.21	-474.82
19	123	-732.57	-2.68	4.49e-03	-103.45	0.0	87.43	165.26	96.12	-0.65	-135.57	-889.53
		-889.53	-135.57	4.30e-04	0.0	138.2	27.84	61.81	96.12	-0.65	-2.68	-732.57
19	124	-733.23	-8.80	3.19e-03	-103.45	0.0	107.96	167.27	85.15	0.08	-126.51	-892.97
		-892.97	-126.51	4.29e-04	0.0	138.2	48.38	63.82	85.15	0.08	-8.80	-733.23
19	137	-19.60	24.85	8.91e-04	-103.45	0.0	75.76	145.30	-17.05	-0.37	24.85	-148.97
		-148.97	1.27	-7.67e-05	0.0	138.2	16.18	41.86	-17.05	-0.37	1.27	-19.60
19	138	-20.14	32.40	-1.87e-04	-103.45	0.0	92.87	146.98	-26.20	0.23	32.40	-151.83
		-151.83	-3.82	-7.87e-05	0.0	138.2	33.29	43.53	-26.20	0.23	-3.82	-20.14
19	139	-123.32	5.46	8.58e-04	-103.45	0.0	86.26	149.06	-5.34	-0.10	5.46	-257.89
		-257.89	-1.92	1.73e-05	0.0	138.2	26.68	45.61	-5.34	-0.10	-1.92	-123.32
19	140	45.38	43.24	3.33e-05	-103.45	0.0	83.09	144.30	-31.90	-0.05	43.24	-82.60
		-82.60	-0.86	-1.23e-04	0.0	138.2	23.51	40.85	-31.90	-0.05	-0.86	45.38
19	144	-19.87	28.63	3.52e-04	-103.45	0.0	84.32	146.14	-21.63	-0.07	28.63	-150.40
		-150.40	-1.27	-7.73e-05	0.0	138.2	24.74	42.69	-21.63	-0.07	-1.27	-19.87
20	4	-3.02	0.0	-5.90e-04	-81.95	0.0	158.35	150.30	122.65	0.0	-103.60	-95.36
		-95.36	-103.60	1.10e-04	0.0	84.5	110.65	68.35	122.65	0.0	0.0	-3.02
20	5	14.34	130.56	-2.82e-03	-81.95	0.0	158.35	850.43	-154.56	0.0	130.56	-669.41
		-669.41	0.0	-1.34e-04	0.0	84.5	110.65	768.49	-154.56	0.0	0.0	14.34
20	10	26.09	261.14	-6.31e-03	-81.95	0.0	158.35	1324.35	-309.15	0.0	261.14	-1057.98
		-1057.98	0.0	-3.04e-04	0.0	84.5	110.65	1242.40	-309.15	0.0	0.0	26.09
20	11	31.81	349.41	-6.25e-03	-81.95	0.0	158.35	1554.87	-413.65	0.0	349.41	-1246.98
		-1246.98	0.0	-3.81e-04	0.0	84.5	110.65	1472.92	-413.65	0.0	0.0	31.81
20	28	-3.02	0.0	-4.08e-04	-56.73	0.0	109.63	66.60	101.72	0.0	-85.92	-35.32
		-35.32	-85.92	8.87e-05	0.0	84.5	76.60	9.87	101.72	0.0	0.0	-3.02
20	29	14.34	148.24	-2.64e-03	-56.73	0.0	109.63	766.74	-175.50	0.0	148.24	-609.37
		-609.37	0.0	-1.54e-04	0.0	84.5	76.60	710.01	-175.50	0.0	0.0	14.34
20	34	26.09	278.83	-6.13e-03	-56.73	0.0	109.63	1240.66	-330.09	0.0	278.83	-997.94
		-997.94	0.0	-3.25e-04	0.0	84.5	76.60	1183.93	-330.09	0.0	0.0	26.09
20	35	31.81	367.09	-6.07e-03	-56.73	0.0	109.63	1471.17	-434.58	0.0	367.09	-1186.94
		-1186.94	0.0	-4.03e-04	0.0	84.5	76.60	1414.44	-434.58	0.0	0.0	31.81
20	57	0.0	0.0	-4.44e-04	-63.04	0.0	111.97	214.96	3.84	0.0	-3.24	-154.95
		-154.95	-3.24	-7.57e-05	0.0	84.5	75.27	151.92	3.84	0.0	0.0	0.0
20	58	0.0	0.0	-3.56e-04	-63.04	0.0	111.97	214.96	11.80	0.0	-9.97	-154.95
		-154.95	-9.97	4.68e-05	0.0	84.5	75.27	151.92	11.80	0.0	0.0	0.0
20	59	0.0	0.0	-5.52e-04	-63.04	0.0	131.66	203.50	92.87	0.0	-78.44	-145.27
		-145.27	-78.44	7.53e-05	0.0	84.5	94.96	140.46	92.87	0.0	0.0	0.0
20	60	0.0	0.0	-4.64e-04	-63.04	0.0	131.66	203.50	100.83	0.0	-85.17	-145.27
		-145.27	-85.17	1.39e-04	0.0	84.5	94.96	140.46	100.83	0.0	0.0	0.0
20	67	0.0	0.0	-6.15e-04	-63.04	0.0	123.60	208.19	47.72	0.0	-40.31	-149.23
		-149.23	-40.31	-2.00e-04	0.0	84.5	86.90	145.15	47.72	0.0	0.0	0.0
20	89	0.0	0.0	-4.49e-04	-63.04	0.0	118.32	211.26	35.29	0.0	-29.81	-151.83
		-151.83	-29.81	2.59e-05	0.0	84.5	81.62	148.23	35.29	0.0	0.0	0.0
20	90	0.0	0.0	-4.21e-04	-63.04	0.0	118.32	211.26	37.79	0.0	-31.92	-151.83
		-151.83	-31.92	4.44e-05	0.0	84.5	81.62	148.23	37.79	0.0	0.0	0.0
20	91	0.0	0.0	-4.87e-04	-63.04	0.0	125.30	207.19	66.88	0.0	-56.49	-148.40
		-148.40	-56.49	6.17e-05	0.0	84.5	88.61	144.16	66.88	0.0	0.0	0.0
20	92	0.0	0.0	-4.59e-04	-63.04	0.0	125.30	207.19	69.37	0.0	-58.60	-148.40
		-148.40	-58.60	8.14e-05	0.0	84.5	88.61	144.16	69.37	0.0	0.0	0.0
20	116	-2.01	0.0	-4.54e-04	-63.04	0.0	121.81	128.09	88.74	0.0	-74.96	-83.59
		-83.59	-74.96	8.02e-05	0.0	84.5	85.11	65.06	88.74	0.0	0.0	-2.01
20	117	9.56	81.15	-1.94e-03	-63.04	0.0	121.81	594.85	-96.07	0.0	81.15	-466.29
		-466.29	0.0	-8.21e-05	0.0	84.5	85.11	531.82	-96.07	0.0	0.0	9.56
20	122	17.40	168.20	-4.27e-03	-63.04	0.0	121.81	910.80	-199.12	0.0	168.20	-725.34
		-725.34	0.0	-1.96e-04	0.0	84.5	85.11	847.76	-199.12	0.0	0.0	17.40
20	123	21.21	227.05	-4.23e-03	-63.04	0.0	121.81	1064.47	-268.79	0.0	227.05	-851.34
		-851.34	0.0	-2.47e-04	0.0	84.5	85.11	1001.44	-268.79	0.0	0.0	21.21
20	138	0.0	0.0	-7.83e-04	-63.04	0.0	121.81	209.23	57.81	0.0	-48.83	-150.11
		-150.11	-48.83	5.18e-05	0.0	84.5	85.11	146.19	57.81	0.0	0.0	0.0
20	139	3.08	0.0	-1.06e-03	-63.04	0.0	121.81	333.32	6.70	0.0	-5.66	-251.85
		-251.85	-5.66	9.48e-06	0.0	84.5	85.11	270.28	6.70	0.0	0.0	3.08
20	140	-1.94	0.0	-7.24e-05	-63.04	0.0	121.81	130.96	81.12	0.0	-68.52	-85.94
		-85.94	-68.52	8.05e-05	0.0	84.5	85.11	67.92	81.12	0.0	0.0	-1.94
20	141	1.94	0.0	-8.36e-04	-63.04	0.0	121.81	287.50	23.55	0.0	-19.89	-214.29
		-214.29	-19.89	2.53e-05	0.0	84.5	85.11	224.46	23.55	0.0	0.0	1.94
20	144	0.0	0.0	-4.54e-04	-63.04	0.0	121.81	209.23	52.33	0.0	-44.21	-150.11
		-150.11	-44.21	5.29e-05	0.0	84.5	85.11	146.19	52.33	0.0	0.0	0.0

21	1	586.95	0.0	2.00e-04	-384.84	0.0	2619.02	97.67	0.0	0.0	0.0	569.89
		439.44	0.0	0.0	0.0	137.7	2403.37	-287.18	0.0	0.0	0.0	439.44
21	4	-190.73	0.0	-1.65e-04	-384.84	0.0	-2297.38	-822.09	0.0	0.0	0.0	-190.73
		-1587.41	0.0	0.0	0.0	137.7	-2513.04	-1206.93	0.0	0.0	0.0	-1587.41
21	11	8603.43	0.0	4.43e-04	-384.84	0.0	2.014e+04	5837.59	0.0	0.0	0.0	831.68
		831.68	0.0	0.0	0.0	137.7	1.992e+04	5452.74	0.0	0.0	0.0	8603.43
21	12	8326.30	0.0	-3.70e-04	-384.84	0.0	1.914e+04	6003.59	0.0	0.0	0.0	326.00
		326.00	0.0	0.0	0.0	137.7	1.892e+04	5618.75	0.0	0.0	0.0	8326.30
21	25	634.34	0.0	2.06e-04	-266.43	0.0	2600.64	194.18	0.0	0.0	0.0	537.00
		537.00	0.0	0.0	0.0	137.7	2451.34	-72.25	0.0	0.0	0.0	620.94
21	28	-223.61	0.0	-1.59e-04	-266.43	0.0	-2315.76	-725.57	0.0	0.0	0.0	-223.61
		-1405.92	0.0	0.0	0.0	137.7	-2465.06	-992.00	0.0	0.0	0.0	-1405.92
21	35	8784.93	0.0	4.49e-04	-266.43	0.0	2.012e+04	5934.10	0.0	0.0	0.0	798.79
		798.79	0.0	0.0	0.0	137.7	1.997e+04	5667.67	0.0	0.0	0.0	8784.93
21	36	8507.79	0.0	-3.73e-04	-266.43	0.0	1.912e+04	6100.10	0.0	0.0	0.0	293.12
		293.12	0.0	0.0	0.0	137.7	1.897e+04	5833.67	0.0	0.0	0.0	8507.79
21	50	150.07	4.66	1.47e-05	-296.03	0.0	846.37	-56.94	-77.13	-5.44e-03	4.66	150.07
		-132.10	-101.52	1.79e-04	0.0	137.7	680.48	-352.97	-77.13	-5.44e-03	-101.52	-132.10
21	51	14.37	101.52	-4.40e-05	-296.03	0.0	-754.47	-425.63	77.13	5.44e-03	-4.66	14.37
		-775.37	-4.66	-1.79e-04	0.0	137.7	-920.36	-721.66	77.13	5.44e-03	101.52	-775.37
21	65	102.57	343.68	7.09e-06	-296.03	0.0	286.08	-185.98	261.19	0.11	-15.91	102.57
		-357.24	-15.91	-5.51e-04	0.0	137.7	120.19	-482.01	261.19	0.11	343.68	-357.24
21	68	61.86	15.91	-2.34e-05	-296.03	0.0	-194.18	-296.59	-261.19	-0.11	15.91	61.86
		-550.23	-343.68	5.51e-04	0.0	137.7	-360.07	-592.62	-261.19	-0.11	-343.68	-550.23
21	81	106.29	32.75	6.94e-06	-296.03	0.0	329.92	-175.88	24.90	0.02	-1.53	106.29
		-339.62	-1.53	-4.75e-05	0.0	137.7	164.03	-471.92	24.90	0.02	32.75	-339.62
21	82	106.29	1.45	6.94e-06	-296.03	0.0	329.92	-175.88	-24.10	-6.97e-04	1.45	106.29
		-339.62	-31.72	5.67e-05	0.0	137.7	164.03	-471.92	-24.10	-6.97e-04	-31.72	-339.62
21	83	58.15	31.72	-2.50e-05	-296.03	0.0	-238.02	-306.68	24.10	6.97e-04	-1.45	58.15
		-567.85	-1.45	-5.67e-05	0.0	137.7	-403.91	-602.72	24.10	6.97e-04	31.72	-567.85
21	97	89.44	107.60	-1.15e-05	-296.03	0.0	131.14	-221.66	81.78	0.03	-4.98	89.44
		-419.50	-4.98	-1.72e-04	0.0	137.7	-34.75	-517.70	81.78	0.03	107.60	-419.50
21	100	75.00	4.98	-1.78e-05	-296.03	0.0	-39.24	-260.90	-81.78	-0.03	4.98	75.00
		-487.97	-107.60	1.72e-04	0.0	137.7	-205.13	-556.94	-81.78	-0.03	-107.60	-487.97
21	113	393.38	0.0	1.31e-04	-296.03	0.0	1752.14	32.94	0.0	0.0	0.0	390.89
		232.46	0.0	0.0	0.0	137.7	1586.25	-263.09	0.0	0.0	0.0	232.46
21	116	-116.19	0.0	-1.12e-04	-296.03	0.0	-1525.46	-580.23	0.0	0.0	0.0	-116.19
		-1118.77	0.0	0.0	0.0	137.7	-1691.35	-876.26	0.0	0.0	0.0	-1118.77
21	123	5675.13	0.0	2.94e-04	-296.03	0.0	1.343e+04	3859.55	0.0	0.0	0.0	565.42
		565.42	0.0	0.0	0.0	137.7	1.326e+04	3563.52	0.0	0.0	0.0	5675.13
21	124	5490.37	0.0	-2.45e-04	-296.03	0.0	1.276e+04	3970.22	0.0	0.0	0.0	228.30
		228.30	0.0	0.0	0.0	137.7	1.260e+04	3674.19	0.0	0.0	0.0	5490.37
21	137	222.68	0.0	4.84e-05	-296.03	0.0	323.67	-287.39	0.0	0.0	0.0	222.68
		-376.75	0.0	0.0	0.0	137.7	157.78	-583.43	0.0	0.0	0.0	-376.75
21	138	-58.25	0.0	-7.73e-05	-296.03	0.0	-231.77	-195.17	0.0	0.0	0.0	-58.25
		-530.72	0.0	0.0	0.0	137.7	-397.66	-491.21	0.0	0.0	0.0	-530.72
21	139	422.09	0.0	-2.51e-05	-296.03	0.0	1939.58	361.73	0.0	0.0	0.0	127.87
		127.87	0.0	0.0	0.0	137.7	1773.70	65.70	0.0	0.0	0.0	422.09
21	140	53.42	0.0	-3.59e-05	-296.03	0.0	-1148.50	-621.65	0.0	0.0	0.0	53.42
		-1006.18	0.0	0.0	0.0	137.7	-1314.38	-917.68	0.0	0.0	0.0	-1006.18
21	144	82.22	0.0	-1.46e-05	-296.03	0.0	45.95	-241.28	0.0	0.0	0.0	82.22
		-453.73	0.0	0.0	0.0	137.7	-119.94	-537.32	0.0	0.0	0.0	-453.73
22	4	-188.66	65.54	-1.46e-04	-384.84	0.0	-1995.74	-596.59	9.94	-2.39	51.86	-188.66
		-1274.91	51.86	2.59e-05	0.0	137.7	-2211.39	-981.44	9.94	-2.39	65.54	-1274.91
22	8	5095.36	93.76	-2.31e-04	-384.84	0.0	1.050e+04	3723.46	-115.94	-3.49	93.76	234.14
		234.14	-65.86	3.58e-05	0.0	137.7	1.028e+04	3338.62	-115.94	-3.49	-65.86	5095.36
22	11	8334.63	-34.04	5.78e-04	-384.84	0.0	1.803e+04	5425.25	-142.57	3.75	-34.04	1130.54
		1130.54	-230.33	-5.66e-05	0.0	137.7	1.781e+04	5040.40	-142.57	3.75	-230.33	8334.63
22	28	-224.09	61.70	-1.47e-04	-266.43	0.0	-2029.23	-536.35	7.91	-2.48	50.80	-224.09
		-1145.89	50.80	2.84e-05	0.0	137.7	-2178.53	-802.78	7.91	-2.48	61.70	-1145.89
22	32	5224.38	92.70	-2.34e-04	-266.43	0.0	1.047e+04	3783.70	-117.96	-3.58	92.70	198.71
		198.71	-69.70	3.83e-05	0.0	137.7	1.032e+04	3517.27	-117.96	-3.58	-69.70	5224.38
22	35	8463.65	-35.10	5.78e-04	-266.43	0.0	1.800e+04	5485.49	-144.60	3.66	-35.10	1095.12
		1095.12	-234.17	-5.42e-05	0.0	137.7	1.785e+04	5219.06	-144.60	3.66	-234.17	8463.65
22	57	190.20	-0.55	3.92e-05	-296.03	0.0	992.45	83.22	-12.34	0.28	-0.55	174.29
		85.09	-17.54	-1.85e-04	0.0	137.7	826.56	-212.82	-12.34	0.28	-17.54	85.09
22	60	2.83	36.77	-3.70e-05	-296.03	0.0	-825.00	-384.42	22.47	0.17	5.84	2.83
		-730.18	5.84	1.73e-04	0.0	137.7	-990.88	-680.45	22.47	0.17	36.77	-730.18
22	70	104.61	17.07	1.14e-05	-296.03	0.0	310.31	-107.37	-207.13	0.58	17.07	104.61
		-246.98	-268.09	5.44e-04	0.0	137.7	144.42	-403.41	-207.13	0.58	-268.09	-246.98
22	71	72.51	287.32	1.05e-05	-296.03	0.0	-142.86	-193.83	217.25	-0.13	-11.78	72.51
		-398.11	-11.78	-5.57e-04	0.0	137.7	-308.74	-489.86	217.25	-0.13	287.32	-398.11
22	89	118.87	1.69	1.46e-05	-296.03	0.0	405.59	-67.96	-3.49	0.25	1.69	118.87
		-178.47	-3.12	-6.27e-05	0.0	137.7	239.71	-363.99	-3.49	0.25	-3.12	-178.47
22	92	58.26	22.34	-1.24e-05	-296.03	0.0	-238.14	-233.24	13.61	0.20	3.60	58.26
		-466.63	3.60	5.03e-05	0.0	137.7	-404.03	-529.28	13.61	0.20	22.34	-466.63
22	102	94.63	7.17	1.04e-05	-296.03	0.0	165.88	-134.23	-62.30	0.34	7.17	94.63

		-293.95	-78.59	1.66e-04	0.0	137.7	-0.01	-430.27	-62.30	0.34	-78.59	-293.95
22	103	82.50	97.81	1.03e-05	-296.03	0.0	1.58	-166.97	72.42	0.11	-1.88	82.50
		-351.15	-1.88	-1.78e-04	0.0	137.7	-164.31	-463.00	72.42	0.11	97.81	-351.15
22	116	-113.97	44.98	-9.73e-05	-296.03	0.0	-1319.33	-417.81	7.30	-1.56	34.93	-113.97
		-892.95	34.93	1.65e-05	0.0	137.7	-1485.22	-713.84	7.30	-1.56	44.98	-892.95
22	120	3353.90	62.86	-1.53e-04	-296.03	0.0	7011.04	2462.23	-76.62	-2.30	62.86	167.90
		167.90	-42.62	2.30e-05	0.0	137.7	6845.15	2166.19	-76.62	-2.30	-42.62	3353.90
22	123	5513.41	-22.34	3.86e-04	-296.03	0.0	1.203e+04	3596.75	-94.37	2.53	-22.34	765.50
		765.50	-152.27	-3.86e-05	0.0	137.7	1.187e+04	3300.72	-94.37	2.53	-152.27	5513.41
22	137	215.90	-8.81	5.81e-05	-296.03	0.0	332.00	-231.88	11.68	1.67	-24.89	215.90
		-307.11	-24.89	-2.42e-05	0.0	137.7	166.11	-527.92	11.68	1.67	-8.81	-307.11
22	138	-38.78	30.18	-5.59e-05	-296.03	0.0	-164.55	-69.32	-1.56	-1.22	30.18	-38.78
		-337.98	28.03	1.18e-05	0.0	137.7	-330.43	-365.35	-1.56	-1.22	28.03	-337.98
22	139	521.50	3.81	4.70e-05	-296.03	0.0	1773.92	407.25	-10.52	0.31	3.81	164.61
		164.61	-10.67	-7.75e-06	0.0	137.7	1608.04	111.22	-10.52	0.31	-10.67	521.50
22	140	40.59	22.40	-2.78e-05	-296.03	0.0	-982.40	-502.48	14.89	0.17	1.91	40.59
		-854.95	1.91	-6.93e-06	0.0	137.7	-1148.28	-798.51	14.89	0.17	22.40	-854.95
22	144	88.56	9.61	1.03e-05	-296.03	0.0	83.73	-150.60	5.06	0.23	2.64	88.56
		-322.55	2.64	-6.31e-06	0.0	137.7	-82.16	-446.63	5.06	0.23	9.61	-322.55
23	2	9.74	485.08	-1.34e-04	-233.92	0.0	520.51	1286.93	-574.25	0.0	485.08	-978.54
		-978.54	0.0	3.51e-05	0.0	84.5	384.32	1053.02	-574.25	0.0	0.0	9.74
23	6	49.82	165.01	4.78e-04	-233.92	0.0	520.51	2903.22	-195.35	0.0	165.01	-2303.75
		-2303.75	0.0	1.97e-05	0.0	84.5	384.32	2669.30	-195.35	0.0	0.0	49.82
23	7	70.41	0.0	9.99e-04	-233.92	0.0	520.51	3733.75	861.47	0.0	-727.68	-2984.70
		-2984.70	-727.68	-4.90e-05	0.0	84.5	384.32	3499.83	861.47	0.0	0.0	70.41
23	9	90.64	0.0	1.22e-03	-233.92	0.0	520.51	4549.35	680.58	0.0	-574.89	-3653.42
		-3653.42	-574.89	-3.05e-05	0.0	84.5	384.32	4315.43	680.58	0.0	0.0	90.64
23	12	110.49	0.0	1.32e-03	-233.92	0.0	520.51	5350.03	3.89	0.0	-3.29	-4309.91
		-4309.91	-3.29	2.29e-05	0.0	84.5	384.32	5116.12	3.89	0.0	0.0	110.49
23	26	9.74	488.19	-9.67e-05	-161.94	0.0	360.35	1011.84	-577.94	0.0	488.19	-776.57
		-776.57	0.0	3.79e-05	0.0	84.5	266.07	849.90	-577.94	0.0	0.0	9.74
23	30	49.82	168.13	5.16e-04	-161.94	0.0	360.35	2628.13	-199.04	0.0	168.13	-2101.78
		-2101.78	0.0	2.25e-05	0.0	84.5	266.07	2466.19	-199.04	0.0	0.0	49.82
23	31	70.41	0.0	1.04e-03	-161.94	0.0	360.35	3458.65	857.78	0.0	-724.57	-2782.73
		-2782.73	-724.57	-4.63e-05	0.0	84.5	266.07	3296.71	857.78	0.0	0.0	70.41
23	33	90.64	0.0	1.26e-03	-161.94	0.0	360.35	4274.26	676.89	0.0	-571.77	-3451.45
		-3451.45	-571.77	-2.78e-05	0.0	84.5	266.07	4112.31	676.89	0.0	0.0	90.64
23	36	110.49	0.0	1.35e-03	-161.94	0.0	360.35	5074.94	0.20	0.0	-0.17	-4107.94
		-4107.94	-0.17	2.56e-05	0.0	84.5	266.07	4913.00	0.20	0.0	0.0	110.49
23	49	0.0	0.0	1.14e-05	-179.94	0.0	369.16	705.92	117.33	0.0	-99.11	-520.29
		-520.29	-99.11	-4.66e-05	0.0	84.5	264.40	525.98	117.33	0.0	0.0	0.0
23	50	0.0	0.0	1.45e-05	-179.94	0.0	369.16	705.92	171.18	0.0	-144.60	-520.29
		-520.29	-144.60	7.58e-05	0.0	84.5	264.40	525.98	171.18	0.0	0.0	0.0
23	51	0.0	129.01	-1.95e-04	-179.94	0.0	431.63	669.55	-152.73	0.0	129.01	-489.57
		-489.57	0.0	-8.96e-05	0.0	84.5	326.87	489.61	-152.73	0.0	0.0	0.0
23	52	0.0	83.52	-1.89e-04	-179.94	0.0	431.63	669.55	-98.88	0.0	83.52	-489.57
		-489.57	0.0	3.27e-05	0.0	84.5	326.87	489.61	-98.88	0.0	0.0	0.0
23	81	0.0	0.0	-5.91e-05	-179.94	0.0	389.31	694.18	48.70	0.0	-41.14	-510.38
		-510.38	-41.14	-1.85e-05	0.0	84.5	284.55	514.25	48.70	0.0	0.0	0.0
23	82	0.0	0.0	-5.71e-05	-179.94	0.0	389.31	694.18	65.56	0.0	-55.38	-510.38
		-510.38	-55.38	1.99e-05	0.0	84.5	284.55	514.25	65.56	0.0	0.0	0.0
23	83	0.0	39.79	-1.29e-04	-179.94	0.0	411.47	681.28	-47.11	0.0	39.79	-499.48
		-499.48	0.0	-3.37e-05	0.0	84.5	306.72	501.34	-47.11	0.0	0.0	0.0
23	84	0.0	25.55	-1.27e-04	-179.94	0.0	411.47	681.28	-30.25	0.0	25.55	-499.48
		-499.48	0.0	4.59e-06	0.0	84.5	306.72	501.34	-30.25	0.0	0.0	0.0
23	114	6.49	322.34	-1.02e-04	-179.94	0.0	400.39	949.65	-381.61	0.0	322.34	-719.68
		-719.68	0.0	2.25e-05	0.0	84.5	295.63	769.72	-381.61	0.0	0.0	6.49
23	118	33.21	108.97	3.07e-04	-179.94	0.0	400.39	2027.18	-129.00	0.0	108.97	-1603.16
		-1603.16	0.0	1.22e-05	0.0	84.5	295.63	1847.24	-129.00	0.0	0.0	33.21
23	119	46.94	0.0	6.53e-04	-179.94	0.0	400.39	2580.86	575.54	0.0	-486.16	-2057.13
		-2057.13	-486.16	-3.36e-05	0.0	84.5	295.63	2400.92	575.54	0.0	0.0	46.94
23	121	60.42	0.0	8.00e-04	-179.94	0.0	400.39	3124.60	454.95	0.0	-384.30	-2502.94
		-2502.94	-384.30	-2.13e-05	0.0	84.5	295.63	2944.66	454.95	0.0	0.0	60.42
23	124	73.66	0.0	8.65e-04	-179.94	0.0	400.39	3658.39	3.83	0.0	-3.23	-2940.60
		-2940.60	-3.23	1.43e-05	0.0	84.5	295.63	3478.45	3.83	0.0	0.0	73.66
23	137	0.0	0.0	-4.41e-05	-179.94	0.0	400.39	687.73	215.30	0.0	-181.87	-504.93
		-504.93	-181.87	-2.15e-05	0.0	84.5	295.63	507.79	215.30	0.0	0.0	0.0
23	138	0.0	166.28	-1.42e-04	-179.94	0.0	400.39	687.73	-196.85	0.0	166.28	-504.93
		-504.93	0.0	7.62e-06	0.0	84.5	295.63	507.79	-196.85	0.0	0.0	0.0
23	139	10.69	0.0	5.44e-05	-179.94	0.0	400.39	1118.74	44.32	0.0	-37.44	-858.32
		-858.32	-37.44	-6.38e-06	0.0	84.5	295.63	938.80	44.32	0.0	0.0	10.69
23	141	6.74	0.0	1.45e-05	-179.94	0.0	400.39	959.60	31.36	0.0	-26.49	-727.84
		-727.84	-26.49	-6.58e-06	0.0	84.5	295.63	779.66	31.36	0.0	0.0	6.74
23	144	0.0	0.0	-9.32e-05	-179.94	0.0	400.39	687.73	9.23	0.0	-7.79	-504.93
		-504.93	-7.79	-6.93e-06	0.0	84.5	295.63	507.79	9.23	0.0	0.0	0.0
24	3	-14.93	0.0	-1.99e-04	-233.92	0.0	683.54	572.04	0.0	0.0	0.0	-399.34
		-399.34	0.0	0.0	0.0	84.5	547.36	338.12	0.0	0.0	0.0	-14.93

24	7	100.28	0.0	8.40e-04	-233.92	0.0	683.54	5218.39	0.0	0.0	0.0	-4208.91
		-4208.91	0.0	0.0	0.0	84.5	547.36	4984.47	0.0	0.0	0.0	100.28
24	11	157.36	0.0	1.24e-03	-233.92	0.0	683.54	7520.31	0.0	0.0	0.0	-6096.28
		-6096.28	0.0	0.0	0.0	84.5	547.36	7286.39	0.0	0.0	0.0	157.36
24	12	157.36	0.0	1.01e-03	-233.92	0.0	683.54	7520.31	0.0	0.0	0.0	-6096.28
		-6096.28	0.0	0.0	0.0	84.5	547.36	7286.39	0.0	0.0	0.0	157.36
24	27	-14.93	0.0	-1.40e-04	-161.94	0.0	473.22	210.78	0.0	0.0	0.0	-124.58
		-124.58	0.0	0.0	0.0	84.5	378.94	48.84	0.0	0.0	0.0	-14.93
24	31	100.28	0.0	8.99e-04	-161.94	0.0	473.22	4857.13	0.0	0.0	0.0	-3934.16
		-3934.16	0.0	0.0	0.0	84.5	378.94	4695.19	0.0	0.0	0.0	100.28
24	35	157.36	0.0	1.30e-03	-161.94	0.0	473.22	7159.05	0.0	0.0	0.0	-5821.53
		-5821.53	0.0	0.0	0.0	84.5	378.94	6997.11	0.0	0.0	0.0	157.36
24	36	157.36	0.0	1.06e-03	-161.94	0.0	473.22	7159.05	0.0	0.0	0.0	-5821.53
		-5821.53	0.0	0.0	0.0	84.5	378.94	6997.11	0.0	0.0	0.0	157.36
24	49	0.0	6.97	-6.73e-05	-179.94	0.0	489.64	924.19	-8.25	0.0	6.97	-704.67
		-704.67	0.0	-4.37e-05	0.0	84.5	384.88	744.26	-8.25	0.0	0.0	0.0
24	51	0.0	0.0	-2.26e-04	-179.94	0.0	561.96	882.09	58.89	0.0	-49.75	-669.11
		-669.11	-49.75	-7.73e-05	0.0	84.5	457.20	702.15	58.89	0.0	0.0	0.0
24	66	0.0	79.81	-1.23e-04	-179.94	0.0	514.95	909.46	-94.48	0.0	79.81	-692.22
		-692.22	0.0	2.07e-04	0.0	84.5	410.19	729.52	-94.48	0.0	0.0	0.0
24	67	0.0	0.0	-1.71e-04	-179.94	0.0	536.65	896.82	94.48	0.0	-79.81	-681.55
		-681.55	-79.81	-2.07e-04	0.0	84.5	431.89	716.89	94.48	0.0	0.0	0.0
24	81	0.0	3.36	-1.19e-04	-179.94	0.0	512.97	910.61	-3.98	0.0	3.36	-693.20
		-693.20	0.0	-1.30e-05	0.0	84.5	408.21	730.67	-3.98	0.0	0.0	0.0
24	82	0.0	16.76	-1.19e-04	-179.94	0.0	512.97	910.61	-19.84	0.0	16.76	-693.20
		-693.20	0.0	2.49e-05	0.0	84.5	408.21	730.67	-19.84	0.0	0.0	0.0
24	83	0.0	0.0	-1.75e-04	-179.94	0.0	538.63	895.67	19.84	0.0	-16.76	-680.58
		-680.58	-16.76	-2.49e-05	0.0	84.5	433.87	715.73	19.84	0.0	0.0	0.0
24	98	0.0	25.34	-1.38e-04	-179.94	0.0	521.95	905.38	-30.00	0.0	25.34	-688.78
		-688.78	0.0	6.49e-05	0.0	84.5	417.19	725.44	-30.00	0.0	0.0	0.0
24	99	0.0	0.0	-1.55e-04	-179.94	0.0	529.65	900.90	30.00	0.0	-25.34	-685.00
		-685.00	-25.34	-6.49e-05	0.0	84.5	424.89	720.96	30.00	0.0	0.0	0.0
24	115	-9.95	0.0	-1.52e-04	-179.94	0.0	525.80	501.78	0.0	0.0	0.0	-357.81
		-357.81	0.0	0.0	0.0	84.5	421.04	321.84	0.0	0.0	0.0	-9.95
24	119	66.85	0.0	5.40e-04	-179.94	0.0	525.80	3599.34	0.0	0.0	0.0	-2897.53
		-2897.53	0.0	0.0	0.0	84.5	421.04	3419.41	0.0	0.0	0.0	66.85
24	123	104.91	0.0	8.06e-04	-179.94	0.0	525.80	5133.96	0.0	0.0	0.0	-4155.77
		-4155.77	0.0	0.0	0.0	84.5	421.04	4954.02	0.0	0.0	0.0	104.91
24	124	104.91	0.0	6.51e-04	-179.94	0.0	525.80	5133.96	0.0	0.0	0.0	-4155.77
		-4155.77	0.0	0.0	0.0	84.5	421.04	4954.02	0.0	0.0	0.0	104.91
24	137	0.0	0.0	-8.21e-05	-179.94	0.0	525.80	903.14	0.0	0.0	0.0	-686.89
		-686.89	0.0	0.0	0.0	84.5	421.04	723.20	0.0	0.0	0.0	0.0
24	139	15.22	0.0	-1.99e-05	-179.94	0.0	525.80	1516.99	0.0	0.0	0.0	-1190.19
		-1190.19	0.0	0.0	0.0	84.5	421.04	1337.05	0.0	0.0	0.0	15.22
24	140	-9.60	0.0	-2.27e-04	-179.94	0.0	525.80	515.94	0.0	0.0	0.0	-369.42
		-369.42	0.0	0.0	0.0	84.5	421.04	336.01	0.0	0.0	0.0	-9.60
24	144	0.0	0.0	-1.47e-04	-179.94	0.0	525.80	903.14	0.0	0.0	0.0	-686.89
		-686.89	0.0	0.0	0.0	84.5	421.04	723.20	0.0	0.0	0.0	0.0
25	2	9.74	0.0	-1.34e-04	-233.92	0.0	520.51	1286.93	574.25	0.0	-485.08	-978.54
		-978.54	-485.08	-3.51e-05	0.0	84.5	384.32	1053.02	574.25	0.0	0.0	9.74
25	6	49.82	0.0	4.78e-04	-233.92	0.0	520.51	2903.22	195.35	0.0	-165.01	-2303.75
		-2303.75	-165.01	-1.97e-05	0.0	84.5	384.32	2669.30	195.35	0.0	0.0	49.82
25	7	70.41	727.68	9.99e-04	-233.92	0.0	520.51	3733.75	-861.47	0.0	727.68	-2984.70
		-2984.70	0.0	4.90e-05	0.0	84.5	384.32	3499.83	-861.47	0.0	0.0	70.41
25	11	110.49	629.97	1.49e-03	-233.92	0.0	520.51	5350.03	-745.78	0.0	629.97	-4309.91
		-4309.91	0.0	2.95e-05	0.0	84.5	384.32	5116.12	-745.78	0.0	0.0	110.49
25	12	110.49	3.29	1.32e-03	-233.92	0.0	520.51	5350.03	-3.89	0.0	3.29	-4309.91
		-4309.91	0.0	-2.29e-05	0.0	84.5	384.32	5116.12	-3.89	0.0	0.0	110.49
25	26	9.74	0.0	-9.67e-05	-161.94	0.0	360.35	1011.84	577.94	0.0	-488.19	-776.57
		-776.57	-488.19	-3.79e-05	0.0	84.5	266.07	849.90	577.94	0.0	0.0	9.74
25	30	49.82	0.0	5.16e-04	-161.94	0.0	360.35	2628.13	199.04	0.0	-168.13	-2101.78
		-2101.78	-168.13	-2.25e-05	0.0	84.5	266.07	2466.19	199.04	0.0	0.0	49.82
25	31	70.41	724.57	1.04e-03	-161.94	0.0	360.35	3458.65	-857.78	0.0	724.57	-2782.73
		-2782.73	0.0	4.63e-05	0.0	84.5	266.07	3296.71	-857.78	0.0	0.0	70.41
25	35	110.49	626.85	1.53e-03	-161.94	0.0	360.35	5074.94	-742.09	0.0	626.85	-4107.94
		-4107.94	0.0	2.67e-05	0.0	84.5	266.07	4913.00	-742.09	0.0	0.0	110.49
25	36	110.49	0.17	1.35e-03	-161.94	0.0	360.35	5074.94	-0.20	0.0	0.17	-4107.94
		-4107.94	0.0	-2.56e-05	0.0	84.5	266.07	4913.00	-0.20	0.0	0.0	110.49
25	57	0.0	144.60	1.45e-05	-179.94	0.0	369.16	705.92	-171.18	0.0	144.60	-520.29
		-520.29	0.0	-7.58e-05	0.0	84.5	264.40	525.98	-171.18	0.0	0.0	0.0
25	58	0.0	99.11	1.14e-05	-179.94	0.0	369.16	705.92	-117.33	0.0	99.11	-520.29
		-520.29	0.0	4.66e-05	0.0	84.5	264.40	525.98	-117.33	0.0	0.0	0.0
25	60	0.0	0.0	-1.95e-04	-179.94	0.0	431.63	669.55	152.73	0.0	-129.01	-489.57
		-489.57	-129.01	8.96e-05	0.0	84.5	326.87	489.61	152.73	0.0	0.0	0.0
25	84	0.0	0.0	-1.18e-04	-179.94	0.0	408.17	683.20	40.76	0.0	-34.43	-501.11
		-501.11	-34.43	2.15e-05	0.0	84.5	303.41	503.27	40.76	0.0	0.0	0.0
25	89	0.0	55.38	-5.71e-05	-179.94	0.0	389.31	694.18	-65.56	0.0	55.38	-510.38

		-510.38	0.0	-1.99e-05	0.0	84.5	284.55	514.25	-65.56	0.0	0.0	0.0
25	92	0.0	0.0	-1.29e-04	-179.94	0.0	411.47	681.28	47.11	0.0	-39.79	-499.48
		-499.48	-39.79	3.37e-05	0.0	84.5	306.72	501.34	47.11	0.0	0.0	0.0
25	114	6.49	0.0	-1.02e-04	-179.94	0.0	400.39	949.65	381.61	0.0	-322.34	-719.68
		-719.68	-322.34	-2.25e-05	0.0	84.5	295.63	769.72	381.61	0.0	0.0	6.49
25	118	33.21	0.0	3.07e-04	-179.94	0.0	400.39	2027.18	129.00	0.0	-108.97	-1603.16
		-1603.16	-108.97	-1.22e-05	0.0	84.5	295.63	1847.24	129.00	0.0	0.0	33.21
25	119	46.94	486.16	6.53e-04	-179.94	0.0	400.39	2580.86	-575.54	0.0	486.16	-2057.13
		-2057.13	0.0	3.36e-05	0.0	84.5	295.63	2400.92	-575.54	0.0	0.0	46.94
25	123	73.66	421.02	9.83e-04	-179.94	0.0	400.39	3658.39	-498.42	0.0	421.02	-2940.60
		-2940.60	0.0	2.06e-05	0.0	84.5	295.63	3478.45	-498.42	0.0	0.0	73.66
25	124	73.66	3.23	8.65e-04	-179.94	0.0	400.39	3658.39	-3.83	0.0	3.23	-2940.60
		-2940.60	0.0	-1.43e-05	0.0	84.5	295.63	3478.45	-3.83	0.0	0.0	73.66
25	137	0.0	181.87	-4.41e-05	-179.94	0.0	400.39	687.73	-215.30	0.0	181.87	-504.93
		-504.93	0.0	2.15e-05	0.0	84.5	295.63	507.79	-215.30	0.0	0.0	0.0
25	138	0.0	0.0	-1.42e-04	-179.94	0.0	400.39	687.73	196.85	0.0	-166.28	-504.93
		-504.93	-166.28	-7.62e-06	0.0	84.5	295.63	507.79	196.85	0.0	0.0	0.0
25	139	10.69	37.44	5.44e-05	-179.94	0.0	400.39	1118.74	-44.32	0.0	37.44	-858.32
		-858.32	0.0	6.38e-06	0.0	84.5	295.63	938.80	-44.32	0.0	0.0	10.69
25	144	0.0	7.79	-9.32e-05	-179.94	0.0	400.39	687.73	-9.23	0.0	7.79	-504.93
		-504.93	0.0	6.93e-06	0.0	84.5	295.63	507.79	-9.23	0.0	0.0	0.0
27	3	73.99	625.79	-9.94e-04	-618.83	0.0	55.77	-439.97	73.86	2.86	-128.87	73.99
		-1619.62	-128.87	-1.93e-03	520.11	226.0	55.77	-1058.80	593.97	2.86	625.79	-1619.62
27	4	79.86	561.10	4.09e-03	-618.83	0.0	87.12	-421.78	48.71	-0.59	-136.71	79.86
		-1572.63	-136.71	7.93e-04	520.11	226.0	87.12	-1040.60	568.82	-0.59	561.10	-1572.63
27	11	-284.91	489.47	0.01	-1.101e+04	0.0	-254.00	-1614.04	-635.33	-23.66	489.47	-284.91
		-1.638e+04	-7141.70	0.01	-5482.58	226.0	-254.00	-1.263e+04	-6117.91	-23.66	-7141.70	-1.638e+04
27	12	-279.04	481.62	0.02	-1.101e+04	0.0	-222.65	-1595.85	-660.48	-27.11	481.62	-279.04
		-1.633e+04	-7206.38	0.01	-5482.58	226.0	-222.65	-1.261e+04	-6143.06	-27.11	-7206.38	-1.633e+04
27	27	59.89	650.27	-1.77e-03	-151.26	0.0	42.04	-276.09	73.91	3.22	-104.49	59.89
		-735.01	-104.49	-2.11e-03	520.11	226.0	42.04	-427.36	594.02	3.22	650.27	-735.01
27	28	65.76	585.59	3.32e-03	-151.26	0.0	73.40	-257.90	48.76	-0.24	-112.34	65.76
		-688.02	-112.34	6.14e-04	520.11	226.0	73.40	-409.16	568.87	-0.24	585.59	-688.02
27	35	-299.01	513.84	9.30e-03	-1.055e+04	0.0	-267.73	-1450.16	-635.28	-23.30	513.84	-299.01
		-1.549e+04	-7117.21	0.01	-5482.58	226.0	-267.73	-1.200e+04	-6117.86	-23.30	-7117.21	-1.549e+04
27	36	-293.14	506.00	0.01	-1.055e+04	0.0	-236.37	-1431.97	-660.43	-26.76	506.00	-293.14
		-1.545e+04	-7181.90	0.01	-5482.58	226.0	-236.37	-1.198e+04	-6143.01	-26.76	-7181.90	-1.545e+04
27	50	3.22	-5.81	1.86e-03	-1168.91	0.0	-11.28	-373.96	-134.89	-1.20	-5.81	3.22
		-2162.80	-310.66	1.26e-03	0.0	226.0	-11.28	-1542.87	-134.89	-1.20	-310.66	-2162.80
27	51	67.28	188.23	2.00e-03	-1168.91	0.0	79.90	-445.43	134.64	-0.59	-116.06	67.28
		-2260.26	-116.06	-3.66e-04	0.0	226.0	79.90	-1614.34	134.64	-0.59	188.23	-2260.26
27	66	23.66	-40.80	1.62e-03	-1168.91	0.0	-37.64	-387.80	-59.07	-1.48	-40.80	23.66
		-2173.64	-174.30	1.25e-03	0.0	226.0	-37.64	-1556.72	-59.07	-1.48	-174.30	-2173.64
27	67	46.84	51.87	2.24e-03	-1168.91	0.0	106.26	-431.58	58.82	-0.31	-81.07	46.84
		-2249.41	-81.07	-3.51e-04	0.0	226.0	106.26	-1600.50	58.82	-0.31	51.87	-2249.41
27	82	23.92	-41.43	1.91e-03	-1168.91	0.0	18.94	-397.17	-47.68	-1.00	-41.43	23.92
		-2194.56	-149.18	7.29e-04	0.0	226.0	18.94	-1566.08	-47.68	-1.00	-149.18	-2194.56
27	83	46.59	26.76	1.95e-03	-1168.91	0.0	49.68	-422.22	47.43	-0.79	-80.44	46.59
		-2228.49	-80.44	1.67e-04	0.0	226.0	49.68	-1591.13	47.43	-0.79	26.76	-2228.49
27	98	31.23	-53.96	1.83e-03	-1168.91	0.0	11.46	-402.44	-20.19	-1.08	-53.96	31.23
		-2199.15	-99.58	7.06e-04	0.0	226.0	11.46	-1571.35	-20.19	-1.08	-99.58	-2199.15
27	99	39.27	-22.85	2.03e-03	-1168.91	0.0	57.16	-416.95	19.94	-0.71	-67.91	39.27
		-2223.90	-67.91	1.90e-04	0.0	226.0	57.16	-1585.86	19.94	-0.71	-22.85	-2223.90
27	115	54.03	409.03	-4.05e-04	-568.41	0.0	41.75	-347.94	49.23	1.79	-94.04	54.03
		-1374.61	-94.04	-1.23e-03	346.74	226.0	41.75	-916.35	395.97	1.79	409.03	-1374.61
27	116	57.94	365.91	2.99e-03	-568.41	0.0	62.66	-335.81	32.46	-0.51	-99.27	57.94
		-1343.29	-99.27	5.88e-04	346.74	226.0	62.66	-904.22	379.20	-0.51	365.91	-1343.29
27	123	-185.24	318.19	6.97e-03	-7498.94	0.0	-164.76	-1130.65	-423.57	-15.89	318.19	-185.24
		-1.121e+04	-4769.29	7.63e-03	-3655.05	226.0	-164.76	-8629.59	-4078.63	-15.89	-4769.29	-1.121e+04
27	124	-181.33	312.96	0.01	-7498.94	0.0	-143.86	-1118.52	-440.34	-18.19	312.96	-181.33
		-1.118e+04	-4812.42	9.45e-03	-3655.05	226.0	-143.86	-8617.46	-4095.39	-18.19	-4812.42	-1.118e+04
27	139	3.54	-6.31	2.91e-03	-2087.33	0.0	6.94	-513.42	-62.78	-3.24	-6.31	3.54
		-3515.46	-747.43	1.62e-03	-530.31	226.0	6.94	-2600.75	-593.09	-3.24	-747.43	-3515.46
27	140	55.25	371.63	1.31e-03	-589.60	0.0	51.57	-344.27	39.40	0.58	-95.39	55.25
		-1389.04	-95.39	-3.00e-04	334.50	226.0	51.57	-933.87	373.90	0.58	371.63	-1389.04
27	144	35.25	-60.93	1.93e-03	-1168.91	0.0	34.31	-409.69	-0.12	-0.89	-60.93	35.25
		-2211.53	-61.21	4.48e-04	0.0	226.0	34.31	-1578.61	-0.12	-0.89	-61.21	-2211.53
28	2	891.84	181.10	1.10e-03	-5829.33	0.0	-5907.49	3837.27	772.67	0.13	-1212.98	-6154.30
		-6154.30	-1212.98	5.66e-04	-1195.66	559.0	-5907.49	-1992.06	-422.99	0.13	-235.64	-996.93
28	7	4826.44	2082.22	-4.64e-03	-1.873e+04	0.0	8954.38	8864.29	4254.04	0.04	-3769.20	-6864.87
		-9650.99	-4143.61	-5.06e-03	-8642.04	559.0	8954.38	-9861.11	-4388.00	0.04	-4143.61	-9650.99
28	11	6423.77	3144.88	-5.68e-03	-2.724e+04	0.0	6790.85	1.354e+04	6804.37	0.09	-6397.67	-1.238e+04
		-1.285e+04	-6397.67	-7.33e-03	-1.356e+04	559.0	6790.85	-1.371e+04	-6756.52	0.09	-6263.91	-1.285e+04
28	12	5546.94	2978.00	-4.12e-03	-2.724e+04	0.0	-1562.34	1.448e+04	6979.13	0.16	-7052.99	-1.590e+04
		-1.590e+04	-7052.99	-6.50e-03	-1.356e+04	559.0	-1562.34	-1.276e+04	-6581.77	0.16	-5942.36	-1.109e+04
28	26	732.11	183.18	1.15e-03	-4672.83	0.0	-6185.21	3224.66	766.12	0.11	-1188.04	-5487.49
		-5487.49	-1188.04	5.33e-04	-1195.66	559.0	-6185.21	-1448.18	-429.54	0.11	-247.29	-522.23

28	31	4589.09	2088.87	-4.47e-03	-1.757e+04	0.0	8676.66	8251.67	4247.50	0.02	-3744.26	-6198.06
		-9176.29	-4155.26	-5.10e-03	-8642.04	559.0	8676.66	-9317.23	-4394.55	0.02	-4155.26	-9176.29
28	35	6186.43	3151.53	-5.50e-03	-2.609e+04	0.0	6513.13	1.293e+04	6797.83	0.07	-6372.73	-1.171e+04
		-1.237e+04	-6372.73	-7.37e-03	-1.356e+04	559.0	6513.13	-1.316e+04	-6763.06	0.07	-6275.55	-1.237e+04
28	36	5310.22	2984.65	-3.94e-03	-2.609e+04	0.0	-1840.06	1.387e+04	6972.58	0.14	-7028.05	-1.523e+04
		-1.523e+04	-7028.05	-6.53e-03	-1.356e+04	559.0	-1840.06	-1.222e+04	-6588.31	0.14	-5954.01	-1.061e+04
28	65	606.05	113.63	-4.31e-04	-2891.25	0.0	763.62	1626.22	-45.84	0.04	113.63	-1950.51
		-1950.51	-142.64	1.43e-04	0.0	559.0	763.62	-1265.03	-45.84	0.04	-142.64	-940.96
28	66	607.53	217.39	-4.69e-04	-2891.25	0.0	597.16	1441.35	86.83	0.07	-268.01	-1400.80
		-1424.67	-268.01	2.48e-04	0.0	559.0	597.16	-1449.89	86.83	0.07	217.39	-1424.67
28	67	609.16	143.31	-4.38e-04	-2891.25	0.0	791.44	1621.73	-54.11	0.02	143.31	-1933.28
		-1933.28	-159.16	1.22e-04	0.0	559.0	791.44	-1269.52	-54.11	0.02	-159.16	-948.84
28	68	612.20	200.87	-4.77e-04	-2891.25	0.0	624.98	1436.86	78.57	0.05	-238.34	-1383.57
		-1432.55	-238.34	2.07e-04	0.0	559.0	624.98	-1454.38	78.57	0.05	200.87	-1432.55
28	97	596.21	-7.88	-4.40e-04	-2891.25	0.0	715.42	1561.27	-2.94	0.04	-7.88	-1756.14
		-1756.14	-24.31	9.11e-05	0.0	559.0	715.42	-1329.97	-2.94	0.04	-24.31	-1109.65
28	98	597.70	88.40	-4.51e-04	-2891.25	0.0	663.31	1503.40	38.60	0.05	-127.35	-1584.06
		-1584.06	-127.35	1.46e-04	0.0	559.0	663.31	-1387.84	38.60	0.05	88.40	-1261.07
28	99	597.31	2.65	-4.43e-04	-2891.25	0.0	725.29	1559.68	-5.87	0.04	2.65	-1750.02
		-1750.02	-30.17	7.96e-05	0.0	559.0	725.29	-1331.57	-5.87	0.04	-30.17	-1112.44
28	100	599.36	82.53	-4.54e-04	-2891.25	0.0	673.18	1501.81	35.66	0.05	-116.82	-1577.94
		-1577.94	-116.82	1.30e-04	0.0	559.0	673.18	-1389.44	35.66	0.05	82.53	-1263.86
28	114	662.10	120.05	7.26e-04	-4271.72	0.0	-3845.75	2762.39	517.29	0.09	-816.97	-4325.14
		-4325.14	-816.97	3.88e-04	-797.11	559.0	-3845.75	-1509.33	-279.81	0.09	-153.21	-822.85
28	119	3296.74	1385.93	-3.15e-03	-1.287e+04	0.0	6062.16	6113.73	2838.21	0.03	-2521.11	-4798.85
		-6592.23	-2758.53	-3.36e-03	-5761.36	559.0	6062.16	-6755.37	-2923.15	0.03	-2758.53	-6592.23
28	123	4361.63	2094.37	-3.84e-03	-1.855e+04	0.0	4619.81	9229.98	4538.43	0.06	-4273.43	-8475.57
		-8722.35	-4273.43	-4.88e-03	-9040.60	559.0	4619.81	-9318.27	-4502.16	0.06	-4172.06	-8722.35
28	124	3776.87	1983.12	-2.80e-03	-1.855e+04	0.0	-948.99	9859.19	4654.93	0.12	-4710.31	-1.082e+04
		-1.082e+04	-4710.31	-4.32e-03	-9040.60	559.0	-948.99	-8689.07	-4385.66	0.12	-3957.69	-7550.38
28	137	867.81	119.68	-8.97e-04	-2891.25	0.0	3014.63	1269.37	-32.18	0.02	119.68	-689.84
		-1675.08	-60.20	-1.67e-04	0.0	559.0	3014.63	-1621.87	-32.18	0.02	-60.20	-1675.08
28	138	465.88	118.43	3.65e-04	-2891.25	0.0	-1626.03	1793.71	64.90	0.07	-244.39	-2644.24
		-2644.24	-244.39	3.68e-04	0.0	559.0	-1626.03	-1097.54	64.90	0.07	118.43	-698.43
28	139	1097.54	281.59	-8.60e-04	-5162.91	0.0	859.86	2694.15	680.92	0.05	-705.03	-2825.02
		-2825.02	-705.03	-5.88e-04	-1311.69	559.0	859.86	-2468.76	-630.78	0.05	-564.88	-2195.07
28	140	283.54	403.79	-1.87e-04	-1458.35	0.0	589.86	798.21	-402.82	0.04	343.03	-936.62
		-936.62	-204.72	5.22e-04	827.38	559.0	589.86	-660.15	424.56	0.04	403.79	-550.74
28	144	593.36	29.11	-4.45e-04	-2891.25	0.0	694.30	1531.54	16.36	0.05	-62.35	-1667.04
		-1667.04	-62.35	1.01e-04	0.0	559.0	694.30	-1359.70	16.36	0.05	29.11	-1186.76
29	2	-197.57	145.27	1.89e-04	-382.92	0.0	1368.50	1297.53	-167.42	1.91	145.27	-1733.32
		-1733.32	-87.19	-1.12e-05	0.0	138.8	1141.95	914.61	-167.42	1.91	-87.19	-197.57
29	4	-136.13	121.64	1.44e-04	-382.92	0.0	-1558.25	212.67	-124.99	1.17	121.64	-218.11
		-218.11	-51.90	-1.15e-05	0.0	138.8	-1784.80	-170.25	-124.99	1.17	-51.90	-188.66
29	11	1130.54	34.12	-3.69e-04	-382.92	0.0	1.860e+04	5762.73	192.52	-2.95	-233.19	-6605.04
		-6605.04	-233.19	2.47e-05	0.0	138.8	1.838e+04	5379.80	192.52	-2.95	34.12	1130.54
29	12	672.12	-65.11	3.24e-04	-382.92	0.0	1.772e+04	6076.45	1.70	-0.08	-67.47	-7499.06
		-7499.06	-67.47	1.39e-05	0.0	138.8	1.749e+04	5693.53	1.70	-0.08	-65.11	672.12
29	26	-233.00	138.38	1.84e-04	-265.10	0.0	1197.69	1124.03	-161.70	2.03	138.38	-1609.64
		-1609.64	-86.13	-1.01e-05	0.0	138.8	1040.85	858.93	-161.70	2.03	-86.13	-233.00
29	28	-90.51	114.75	1.40e-04	-265.10	0.0	-1729.06	39.17	-119.27	1.28	114.75	-94.43
		-224.09	-50.85	-1.04e-05	0.0	138.8	-1885.90	-225.93	-119.27	1.28	-50.85	-224.09
29	35	1095.12	35.18	-3.73e-04	-265.10	0.0	1.843e+04	5589.22	198.24	-2.83	-240.08	-6481.36
		-6481.36	-240.08	2.58e-05	0.0	138.8	1.828e+04	5324.12	198.24	-2.83	35.18	1095.12
29	36	636.70	-64.06	3.18e-04	-265.10	0.0	1.755e+04	5902.95	7.42	0.03	-74.36	-7375.38
		-7375.38	-74.36	1.51e-05	0.0	138.8	1.739e+04	5637.85	7.42	0.03	-64.06	636.70
29	50	174.29	0.56	-2.02e-05	-294.56	0.0	1267.77	689.58	30.24	-0.27	-41.43	-578.68
		-578.68	-41.43	1.84e-04	0.0	138.8	1093.50	395.02	30.24	-0.27	0.56	174.29
29	51	34.80	75.89	4.40e-05	-294.56	0.0	-413.72	177.93	-58.86	-0.31	75.89	-39.73
		-39.73	-5.83	-1.87e-04	0.0	138.8	-587.98	-116.62	-58.86	-0.31	-5.83	2.83
29	65	104.61	-17.05	1.37e-05	-294.56	0.0	632.51	484.45	105.04	-0.98	-162.90	-363.55
		-363.55	-162.90	-5.75e-04	0.0	138.8	458.24	189.90	105.04	-0.98	-17.05	104.61
29	68	72.51	197.36	1.71e-05	-294.56	0.0	221.54	383.06	-133.66	0.40	197.36	-254.86
		-254.86	11.78	5.71e-04	0.0	138.8	47.27	88.50	-133.66	0.40	11.78	72.51
29	82	118.87	-1.68	1.30e-05	-294.56	0.0	724.77	524.22	2.72	-0.29	-5.45	-404.50
		-404.50	-5.45	5.67e-05	0.0	138.8	550.50	229.66	2.72	-0.29	-1.68	118.87
29	83	58.26	39.91	2.33e-05	-294.56	0.0	129.29	343.29	-31.33	-0.29	39.91	-213.91
		-213.91	-3.59	-6.05e-05	0.0	138.8	-44.98	48.74	-31.33	-0.29	-3.59	58.26
29	97	94.63	-7.16	1.35e-05	-294.56	0.0	501.72	452.74	23.98	-0.51	-40.46	-329.50
		-329.50	-40.46	-1.81e-04	0.0	138.8	327.45	158.18	23.98	-0.51	-7.16	94.63
29	100	82.50	74.91	1.39e-05	-294.56	0.0	352.33	414.77	-52.59	-0.07	74.91	-288.91
		-288.91	1.89	1.77e-04	0.0	138.8	178.07	120.22	-52.59	-0.07	1.89	82.50
29	114	-119.91	99.14	1.28e-04	-294.56	0.0	969.27	922.85	-113.52	1.24	99.14	-1196.78
		-1196.78	-58.48	-7.84e-06	0.0	138.8	795.00	628.30	-113.52	1.24	-58.48	-119.91
29	116	-92.74	83.39	9.78e-05	-294.56	0.0	-981.90	199.61	-85.23	0.74	83.39	-186.64
		-186.64	-34.95	-8.05e-06	0.0	138.8	-1156.16	-94.94	-85.23	0.74	-34.95	-113.97
29	123	765.50	22.40	-2.44e-04	-294.56	0.0	1.246e+04	3899.65	126.44	-2.00	-153.16	-4444.59

		-4444.59	-153.16	1.61e-05	0.0	138.8	1.228e+04	3605.10	126.44	-2.00	22.40	765.50
29	124	459.89	-42.68	2.17e-04	-294.56	0.0	1.187e+04	4108.80	-0.78	-0.09	-42.68	-5040.60
		-5040.60	-43.76	8.84e-06	0.0	138.8	1.169e+04	3814.24	-0.78	-0.09	-43.76	459.89
29	137	215.90	24.93	-4.65e-05	-294.56	0.0	673.30	346.61	38.70	-1.08	-28.81	-60.87
		-60.87	-28.81	-3.11e-06	0.0	138.8	499.03	52.05	38.70	-1.08	24.93	215.90
29	138	-38.78	63.26	6.96e-05	-294.56	0.0	180.75	520.90	-67.31	0.51	63.26	-557.55
		-557.55	-30.20	-5.98e-06	0.0	138.8	6.48	226.35	-67.31	0.51	-30.20	-38.78
29	139	164.61	0.52	3.58e-05	-294.56	0.0	2129.86	951.79	-3.12	-0.40	0.52	-952.44
		-952.44	-3.81	-3.00e-06	0.0	138.8	1955.59	657.24	-3.12	-0.40	-3.81	164.61
29	140	123.48	27.77	2.91e-05	-294.56	0.0	-647.07	106.99	-21.37	-0.22	27.77	96.53
		40.59	-1.90	-4.44e-06	0.0	138.8	-821.34	-187.56	-21.37	-0.22	-1.90	40.59
29	144	88.56	17.23	1.36e-05	-294.56	0.0	427.03	433.76	-14.31	-0.29	17.23	-309.21
		-309.21	-2.64	-3.09e-06	0.0	138.8	252.76	139.20	-14.31	-0.29	-2.64	88.56
30	1	569.89	0.0	-1.65e-04	-382.92	0.0	3166.66	959.15	0.0	0.0	0.0	-496.03
		-496.03	0.0	0.0	0.0	138.8	2940.11	576.23	0.0	0.0	0.0	569.89
30	4	-96.83	0.0	1.61e-04	-382.92	0.0	-1769.98	155.06	0.0	0.0	0.0	-140.18
		-190.73	0.0	0.0	0.0	138.8	-1996.53	-227.86	0.0	0.0	0.0	-190.73
30	11	831.68	0.0	3.04e-04	-382.92	0.0	2.081e+04	6286.27	0.0	0.0	0.0	-7630.83
		-7630.83	0.0	0.0	0.0	138.8	2.059e+04	5903.34	0.0	0.0	0.0	831.68
30	12	326.00	0.0	4.59e-04	-382.92	0.0	1.982e+04	6475.69	0.0	0.0	0.0	-8399.52
		-8399.52	0.0	0.0	0.0	138.8	1.959e+04	6092.77	0.0	0.0	0.0	326.00
30	25	537.00	0.0	-1.76e-04	-265.10	0.0	2982.53	772.07	0.0	0.0	0.0	-350.96
		-350.96	0.0	0.0	0.0	138.8	2825.69	506.97	0.0	0.0	0.0	537.00
30	28	4.89	0.0	1.50e-04	-265.10	0.0	-1954.11	-32.02	0.0	0.0	0.0	4.89
		-223.61	0.0	0.0	0.0	138.8	-2110.95	-297.12	0.0	0.0	0.0	-223.61
30	35	798.79	0.0	2.95e-04	-265.10	0.0	2.063e+04	6099.19	0.0	0.0	0.0	-7485.76
		-7485.76	0.0	0.0	0.0	138.8	2.047e+04	5834.09	0.0	0.0	0.0	798.79
30	36	293.12	0.0	4.50e-04	-265.10	0.0	1.963e+04	6288.62	0.0	0.0	0.0	-8254.45
		-8254.45	0.0	0.0	0.0	138.8	1.948e+04	6023.52	0.0	0.0	0.0	293.12
30	50	150.07	65.60	2.26e-05	-294.56	0.0	1188.39	678.43	-43.89	0.10	65.60	-587.43
		-587.43	4.66	1.87e-04	0.0	138.8	1014.13	383.88	-43.89	0.10	4.66	150.07
30	51	17.70	-4.66	5.14e-05	-294.56	0.0	-267.74	256.96	43.89	-0.10	-65.60	-137.92
		-137.92	-65.60	-1.87e-04	0.0	138.8	-442.01	-37.60	43.89	-0.10	-4.66	17.70
30	65	102.57	-15.91	2.33e-05	-294.56	0.0	678.75	530.92	154.36	-0.27	-230.24	-430.10
		-430.10	-230.24	-5.73e-04	0.0	138.8	504.48	236.36	154.36	-0.27	-15.91	102.57
30	68	61.86	230.24	3.43e-05	-294.56	0.0	241.90	404.47	-154.36	0.27	230.24	-295.25
		-295.25	15.91	5.73e-04	0.0	138.8	67.64	109.92	-154.36	0.27	15.91	61.86
30	81	106.29	-1.53	2.31e-05	-294.56	0.0	718.63	542.46	15.22	-0.02	-22.66	-442.41
		-442.41	-22.66	-4.92e-05	0.0	138.8	544.36	247.90	15.22	-0.02	-1.53	106.29
30	83	58.15	-1.45	3.56e-05	-294.56	0.0	202.02	392.93	13.65	-0.03	-20.40	-282.94
		-282.94	-20.40	-5.91e-05	0.0	138.8	27.75	98.37	13.65	-0.03	-1.45	58.15
30	97	89.44	-4.98	2.44e-05	-294.56	0.0	537.82	490.12	48.35	-0.08	-72.11	-386.60
		-386.60	-72.11	-1.79e-04	0.0	138.8	363.55	195.57	48.35	-0.08	-4.98	89.44
30	100	75.00	72.11	2.96e-05	-294.56	0.0	382.83	445.27	-48.35	0.08	72.11	-338.75
		-338.75	4.98	1.79e-04	0.0	138.8	208.57	150.71	-48.35	0.08	4.98	75.00
30	113	390.89	0.0	-1.06e-04	-294.56	0.0	2172.48	701.79	0.0	0.0	0.0	-379.04
		-379.04	0.0	0.0	0.0	138.8	1998.21	407.24	0.0	0.0	0.0	390.89
30	116	-77.07	0.0	1.11e-04	-294.56	0.0	-1118.61	165.73	0.0	0.0	0.0	-141.81
		-141.81	0.0	0.0	0.0	138.8	-1292.88	-128.82	0.0	0.0	0.0	-141.81
30	123	565.42	0.0	2.06e-04	-294.56	0.0	1.394e+04	4253.20	0.0	0.0	0.0	-5135.58
		-5135.58	0.0	0.0	0.0	138.8	1.376e+04	3958.65	0.0	0.0	0.0	565.42
30	124	228.30	0.0	3.09e-04	-294.56	0.0	1.327e+04	4379.49	0.0	0.0	0.0	-5648.04
		-5648.04	0.0	0.0	0.0	138.8	1.310e+04	4084.93	0.0	0.0	0.0	228.30
30	137	222.68	0.0	-3.70e-05	-294.56	0.0	736.89	415.08	0.0	0.0	0.0	-149.15
		-149.15	0.0	0.0	0.0	138.8	562.62	120.52	0.0	0.0	0.0	222.68
30	138	-58.25	0.0	8.95e-05	-294.56	0.0	183.76	520.31	0.0	0.0	0.0	-576.20
		-576.20	0.0	0.0	0.0	138.8	9.49	225.76	0.0	0.0	0.0	-58.25
30	139	127.87	0.0	5.68e-05	-294.56	0.0	2367.59	1026.09	0.0	0.0	0.0	-1092.35
		-1092.35	0.0	0.0	0.0	138.8	2193.32	731.54	0.0	0.0	0.0	127.87
30	140	128.95	0.0	3.54e-05	-294.56	0.0	-742.72	115.47	0.0	0.0	0.0	97.58
		53.42	0.0	0.0	0.0	138.8	-916.99	-179.08	0.0	0.0	0.0	53.42
30	144	82.22	0.0	2.70e-05	-294.56	0.0	460.33	467.70	0.0	0.0	0.0	-362.67
		-362.67	0.0	0.0	0.0	138.8	286.06	173.14	0.0	0.0	0.0	82.22
31	2	-197.57	87.19	1.89e-04	-382.92	0.0	1368.50	1297.53	167.42	-1.91	-145.27	-1733.32
		-1733.32	-145.27	1.12e-05	0.0	138.8	1141.95	914.61	167.42	-1.91	87.19	-197.57
31	4	-136.13	51.90	1.44e-04	-382.92	0.0	-1558.25	212.67	124.99	-1.17	-121.64	-218.11
		-218.11	-121.64	1.15e-05	0.0	138.8	-1784.80	-170.25	124.99	-1.17	51.90	-188.66
31	11	1130.54	233.19	-3.69e-04	-382.92	0.0	1.860e+04	5762.73	-192.52	2.95	233.19	-6605.04
		-6605.04	-34.12	-2.47e-05	0.0	138.8	1.838e+04	5379.80	-192.52	2.95	-34.12	1130.54
31	12	672.12	67.47	3.24e-04	-382.92	0.0	1.772e+04	6076.45	-1.70	0.08	67.47	-7499.06
		-7499.06	65.11	-1.39e-05	0.0	138.8	1.749e+04	5693.53	-1.70	0.08	65.11	672.12
31	26	-233.00	86.13	1.84e-04	-265.10	0.0	1197.69	1124.03	161.70	-2.03	-138.38	-1609.64
		-1609.64	-138.38	1.01e-05	0.0	138.8	1040.85	858.93	161.70	-2.03	86.13	-233.00
31	28	-90.51	50.85	1.40e-04	-265.10	0.0	-1729.06	39.17	119.27	-1.28	-114.75	-94.43
		-224.09	-114.75	1.04e-05	0.0	138.8	-1885.90	-225.93	119.27	-1.28	50.85	-224.09
31	35	1095.12	240.08	-3.73e-04	-265.10	0.0	1.843e+04	5589.22	-198.24	2.83	240.08	-6481.36
		-6481.36	-35.18	-2.58e-05	0.0	138.8	1.828e+04	5324.12	-198.24	2.83	-35.18	1095.12

31	36	636.70	74.36	3.18e-04	-265.10	0.0	1.755e+04	5902.95	-7.42	-0.03	74.36	-7375.38
		-7375.38	64.06	-1.51e-05	0.0	138.8	1.739e+04	5637.85	-7.42	-0.03	64.06	636.70
31	57	174.29	41.43	-2.02e-05	-294.56	0.0	1267.77	689.58	-30.24	0.27	41.43	-578.68
		-578.68	-0.56	-1.84e-04	0.0	138.8	1093.50	395.02	-30.24	0.27	-0.56	174.29
31	60	34.80	5.83	4.40e-05	-294.56	0.0	-413.72	177.93	58.86	0.31	-75.89	-39.73
		-39.73	-75.89	1.87e-04	0.0	138.8	-587.98	-116.62	58.86	0.31	5.83	2.83
31	70	104.61	162.90	1.37e-05	-294.56	0.0	632.51	484.45	-105.04	0.98	162.90	-363.55
		-363.55	17.05	5.75e-04	0.0	138.8	458.24	189.90	-105.04	0.98	17.05	104.61
31	71	72.51	-11.78	1.71e-05	-294.56	0.0	221.54	383.06	133.66	-0.40	-197.36	-254.86
		-254.86	-197.36	-5.71e-04	0.0	138.8	47.27	88.50	133.66	-0.40	-11.78	72.51
31	89	118.87	5.45	1.30e-05	-294.56	0.0	724.77	524.22	-2.72	0.29	5.45	-404.50
		-404.50	1.68	-5.67e-05	0.0	138.8	550.50	229.66	-2.72	0.29	1.68	118.87
31	92	58.26	3.59	2.33e-05	-294.56	0.0	129.29	343.29	31.33	0.29	-39.91	-213.91
		-213.91	-39.91	6.05e-05	0.0	138.8	-44.98	48.74	31.33	0.29	3.59	58.26
31	102	94.63	40.46	1.35e-05	-294.56	0.0	501.72	452.74	-23.98	0.51	40.46	-329.50
		-329.50	7.16	1.81e-04	0.0	138.8	327.45	158.18	-23.98	0.51	7.16	94.63
31	103	82.50	-1.89	1.39e-05	-294.56	0.0	352.33	414.77	52.59	0.07	-74.91	-288.91
		-288.91	-74.91	-1.77e-04	0.0	138.8	178.07	120.22	52.59	0.07	-1.89	82.50
31	114	-119.91	58.48	1.28e-04	-294.56	0.0	969.27	922.85	113.52	-1.24	-99.14	-1196.78
		-1196.78	-99.14	7.84e-06	0.0	138.8	795.00	628.30	113.52	-1.24	58.48	-119.91
31	116	-92.74	34.95	9.78e-05	-294.56	0.0	-981.90	199.61	85.23	-0.74	-83.39	-186.64
		-186.64	-83.39	8.05e-06	0.0	138.8	-1156.16	-94.94	85.23	-0.74	34.95	-113.97
31	123	765.50	153.16	-2.44e-04	-294.56	0.0	1.246e+04	3899.65	-126.44	2.00	153.16	-4444.59
		-4444.59	-22.40	-1.61e-05	0.0	138.8	1.228e+04	3605.10	-126.44	2.00	-22.40	765.50
31	124	459.89	43.76	2.17e-04	-294.56	0.0	1.187e+04	4108.80	0.78	0.09	43.76	-5040.60
		-5040.60	42.68	-8.84e-06	0.0	138.8	1.169e+04	3814.24	0.78	0.09	42.68	459.89
31	137	215.90	28.81	-4.65e-05	-294.56	0.0	673.30	346.61	-38.70	1.08	28.81	-60.87
		-60.87	-24.93	3.11e-06	0.0	138.8	499.03	52.05	-38.70	1.08	-24.93	215.90
31	138	-38.78	30.20	6.96e-05	-294.56	0.0	180.75	520.90	67.31	-0.51	-63.26	-557.55
		-557.55	-63.26	5.98e-06	0.0	138.8	6.48	226.35	67.31	-0.51	30.20	-38.78
31	139	164.61	3.81	3.58e-05	-294.56	0.0	2129.86	951.79	3.12	0.40	-0.52	-952.44
		-952.44	-0.52	3.00e-06	0.0	138.8	1955.59	657.24	3.12	0.40	3.81	164.61
31	140	123.48	1.90	2.91e-05	-294.56	0.0	-647.07	106.99	21.37	0.22	-27.77	96.53
		96.53	40.59	-27.77	4.44e-06	0.0	138.8	-821.34	-187.56	21.37	1.90	123.48
31	144	88.56	2.64	1.36e-05	-294.56	0.0	427.03	433.76	14.31	0.29	-17.23	-309.21
		-309.21	-17.23	3.09e-06	0.0	138.8	252.76	139.20	14.31	0.29	2.64	88.56
32	2	891.84	181.10	1.10e-03	-5829.33	0.0	-5907.49	1992.06	422.99	-0.13	-235.64	-996.93
		-996.93	-1212.98	4.81e-04	-1195.66	559.0	-5907.49	-3837.27	-772.67	-0.13	-1212.98	-6154.30
32	7	4826.44	2082.22	-4.64e-03	-1.873e+04	0.0	8954.38	9861.11	4388.00	-0.04	-4143.61	-9650.99
		-9650.99	-4143.61	-4.93e-03	-8642.04	559.0	8954.38	-8864.29	-4254.04	-0.04	-3769.20	-6864.87
32	11	6423.77	3144.88	-5.67e-03	-2.724e+04	0.0	6790.85	1.371e+04	6756.52	-0.09	-6263.91	-1.285e+04
		-1.285e+04	-6397.67	-7.17e-03	-1.356e+04	559.0	6790.85	-1.354e+04	-6804.38	-0.09	-6397.67	-1.238e+04
32	12	5546.94	2978.00	-4.12e-03	-2.724e+04	0.0	-1562.34	1.276e+04	6581.77	-0.16	-5942.36	-1.109e+04
		-1.109e+04	-7052.99	-6.41e-03	-1.356e+04	559.0	-1562.34	-1.448e+04	-6979.13	-0.16	-7052.99	-1.590e+04
32	26	732.11	183.18	1.15e-03	-4672.83	0.0	-6185.21	1448.18	429.54	-0.11	-247.29	-522.23
		-522.23	-1188.04	4.59e-04	-1195.66	559.0	-6185.21	-3224.66	-766.12	-0.11	-1188.04	-5487.49
32	31	4589.09	2088.87	-4.46e-03	-1.757e+04	0.0	8676.66	9317.23	4394.55	-0.02	-4155.26	-9176.29
		-9176.29	-4155.26	-4.95e-03	-8642.04	559.0	8676.66	-8251.67	-4247.50	-0.02	-3744.26	-6198.06
32	35	6186.43	3151.53	-5.50e-03	-2.609e+04	0.0	6513.13	1.316e+04	6763.06	-0.07	-6275.55	-1.237e+04
		-1.237e+04	-6372.73	-7.19e-03	-1.356e+04	559.0	6513.13	-1.293e+04	-6797.83	-0.07	-6372.73	-1.171e+04
32	36	5310.22	2984.65	-3.94e-03	-2.609e+04	0.0	-1840.06	1.222e+04	6588.31	-0.14	-5954.01	-1.061e+04
		-1.061e+04	-7028.05	-6.44e-03	-1.356e+04	559.0	-1840.06	-1.387e+04	-6972.58	-0.14	-7028.05	-1.523e+04
32	69	607.53	217.39	-4.69e-04	-2891.25	0.0	597.16	1449.89	-86.83	-0.07	217.39	-1424.67
		-1424.67	-268.01	1.99e-04	0.0	559.0	597.16	-1441.35	-86.83	-0.07	-268.01	-1400.80
32	70	606.05	113.63	-4.31e-04	-2891.25	0.0	763.62	1265.03	45.84	-0.04	-142.64	-940.96
		-940.96	-1950.51	-142.64	1.24e-04	0.0	559.0	763.62	-1626.22	45.84	113.63	-1950.51
32	71	612.20	200.87	-4.77e-04	-2891.25	0.0	624.98	1454.38	-78.57	-0.05	200.87	-1432.55
		-1432.55	-238.34	1.73e-04	0.0	559.0	624.98	-1436.86	-78.57	-0.05	-238.34	-1383.57
32	72	609.16	143.31	-4.38e-04	-2891.25	0.0	791.44	1269.52	54.11	-0.02	-159.16	-948.84
		-948.84	-1933.28	-159.16	1.18e-04	0.0	559.0	791.44	-1621.73	54.11	143.31	-1933.28
32	101	597.70	88.40	-4.51e-04	-2891.25	0.0	663.31	1387.84	-38.60	-0.05	88.40	-1261.07
		-1261.07	-1584.06	-127.35	1.12e-04	0.0	559.0	663.31	-1503.40	-38.60	-127.35	-1584.06
32	102	596.21	-7.88	-4.40e-04	-2891.25	0.0	715.42	1329.97	2.94	-0.04	-24.31	-1109.65
		-1109.65	-1756.14	-24.31	6.67e-05	0.0	559.0	715.42	-1561.27	2.94	-7.88	-1756.14
32	103	599.36	82.53	-4.54e-04	-2891.25	0.0	673.18	1389.44	-35.66	-0.05	82.53	-1263.86
		-1263.86	-1577.94	-116.82	1.02e-04	0.0	559.0	673.18	-1501.81	-35.66	-116.82	-1577.94
32	104	597.31	2.65	-4.43e-04	-2891.25	0.0	725.29	1331.57	5.87	-0.04	-30.17	-1112.44
		-1112.44	-1750.02	-30.17	6.07e-05	0.0	559.0	725.29	-1559.68	5.87	2.65	-1750.02
32	114	662.10	120.05	7.23e-04	-4271.72	0.0	-3845.75	1509.33	279.81	-0.09	-153.21	-822.85
		-822.85	-4325.14	-816.97	3.28e-04	-797.11	559.0	-3845.75	-2762.39	-517.29	-816.97	-4325.14
32	119	3296.74	1385.93	-3.15e-03	-1.287e+04	0.0	6062.16	6755.37	2923.15	-0.03	-2758.53	-6592.23
		-6592.23	-2758.53	-3.28e-03	-5761.36	559.0	6062.16	-6113.73	-2838.21	-0.03	-2521.11	-4798.85
32	123	4361.63	2094.37	-3.84e-03	-1.855e+04	0.0	4619.81	9318.27	4502.16	-0.06	-4172.06	-8722.35
		-8722.35	-4273.43	-4.77e-03	-9040.60	559.0	4619.81	-9229.98	-4538.43	-0.06	-4273.43	-8475.57
32	124	3776.87	1983.12	-2.80e-03	-1.855e+04	0.0	-948.99	8689.07	4385.66	-0.12	-3957.69	-7550.38
		-7550.38	-4710.31	-4.26e-03	-9040.60	559.0	-948.99	-9859.19	-4654.93	-0.12	-4710.31	-1.082e+04
32	137	867.81	119.68	-8.96e-04	-2891.25	0.0	3014.63	1621.87	32.18	-0.02	-60.20	-1675.08

		-1675.08	-60.20	-1.72e-04	0.0	559.0	3014.63	-1269.37	32.18	-0.02	119.68	-689.84
32	138	465.88	118.43	3.64e-04	-2891.25	0.0	-1626.03	1097.54	-64.90	-0.07	118.43	-698.43
		-2644.24	-244.39	3.20e-04	0.0	559.0	-1626.03	-1793.71	-64.90	-0.07	-244.39	-2644.24
32	139	1097.54	281.59	-8.60e-04	-5162.91	0.0	859.86	2468.76	630.78	-0.05	-564.88	-2195.07
		-2825.02	-705.03	-5.99e-04	-1311.69	559.0	859.86	-2694.15	-680.92	-0.05	-705.03	-2825.02
32	140	283.54	403.79	-1.87e-04	-1458.35	0.0	589.86	660.15	-424.56	-0.04	403.79	-550.74
		-936.62	-204.72	4.86e-04	827.38	559.0	589.86	-798.21	402.82	-0.04	343.03	-936.62
32	144	593.36	29.11	-4.45e-04	-2891.25	0.0	694.30	1359.70	-16.36	-0.05	29.11	-1186.76
		-1667.04	-62.35	7.51e-05	0.0	559.0	694.30	-1531.54	-16.36	-0.05	-62.35	-1667.04
33	3	73.99	625.79	9.94e-04	-618.83	0.0	55.77	1058.80	-593.97	-2.86	625.79	-1619.62
		-1619.62	-128.87	1.93e-03	520.11	226.0	55.77	439.97	-73.86	-2.86	-128.87	73.99
33	4	79.86	561.10	-4.09e-03	-618.83	0.0	87.12	1040.60	-568.82	0.59	561.10	-1572.63
		-1572.63	-136.71	-7.93e-04	520.11	226.0	87.12	421.78	-48.71	0.59	-136.71	79.86
33	11	-284.91	489.47	-0.01	-1.101e+04	0.0	-254.00	1.263e+04	6117.91	23.66	-7141.70	-1.638e+04
		-1.638e+04	-7141.70	-0.01	-5482.58	226.0	-254.00	1614.04	635.33	23.66	489.47	-284.91
33	12	-279.04	481.62	-0.02	-1.101e+04	0.0	-222.65	1.261e+04	6143.06	27.11	-7206.38	-1.633e+04
		-1.633e+04	-7206.38	-0.01	-5482.58	226.0	-222.65	1595.85	660.48	27.11	481.62	-279.04
33	27	59.89	650.27	1.77e-03	-151.26	0.0	42.04	427.36	-594.02	-3.22	650.27	-735.01
		-735.01	-104.49	2.11e-03	520.11	226.0	42.04	276.09	-73.91	-3.22	-104.49	59.89
33	28	65.76	585.59	-3.32e-03	-151.26	0.0	73.40	409.16	-568.87	0.24	585.59	-688.02
		-688.02	-112.34	-6.14e-04	520.11	226.0	73.40	257.90	-48.76	0.24	-112.34	65.76
33	35	-299.01	513.84	-9.30e-03	-1.055e+04	0.0	-267.73	1.200e+04	6117.86	23.30	-7117.21	-1.549e+04
		-1.549e+04	-7117.21	-0.01	-5482.58	226.0	-267.73	1450.16	635.28	23.30	513.84	-299.01
33	36	-293.14	506.00	-0.01	-1.055e+04	0.0	-236.37	1.198e+04	6143.01	26.76	-7181.90	-1.545e+04
		-1.545e+04	-7181.90	-0.01	-5482.58	226.0	-236.37	1431.97	660.43	26.76	506.00	-293.14
33	57	3.22	-5.81	-1.86e-03	-1168.91	0.0	-11.28	1542.87	134.89	1.20	-310.66	-2162.80
		-2162.80	-310.66	-1.26e-03	0.0	226.0	-11.28	373.96	134.89	1.20	-5.81	3.22
33	60	67.28	188.23	-2.00e-03	-1168.91	0.0	79.90	1614.34	-134.64	0.59	188.23	-2260.26
		-2260.26	-116.06	3.66e-04	0.0	226.0	79.90	445.43	-134.64	0.59	-116.06	67.28
33	69	23.66	-40.80	-1.62e-03	-1168.91	0.0	-37.64	1556.72	59.07	1.48	-174.30	-2173.64
		-2173.64	-174.30	-1.25e-03	0.0	226.0	-37.64	387.80	59.07	1.48	-40.80	23.66
33	72	46.84	51.87	-2.24e-03	-1168.91	0.0	106.26	1600.50	-58.82	0.31	51.87	-2249.41
		-2249.41	-81.07	3.51e-04	0.0	226.0	106.26	431.58	-58.82	0.31	-81.07	46.84
33	89	23.92	-41.43	-1.91e-03	-1168.91	0.0	18.94	1566.08	47.68	1.00	-149.18	-2194.56
		-2194.56	-149.18	-7.29e-04	0.0	226.0	18.94	397.17	47.68	1.00	-41.43	23.92
33	92	46.59	26.76	-1.95e-03	-1168.91	0.0	49.68	1591.13	-47.43	0.79	26.76	-2228.49
		-2228.49	-80.44	-1.67e-04	0.0	226.0	49.68	422.22	-47.43	0.79	-80.44	46.59
33	101	31.23	-53.96	-1.83e-03	-1168.91	0.0	11.46	1571.35	20.19	1.08	-99.58	-2199.15
		-2199.15	-99.58	-7.06e-04	0.0	226.0	11.46	402.44	20.19	1.08	-53.96	31.23
33	104	39.27	-22.85	-2.03e-03	-1168.91	0.0	57.16	1585.86	-19.94	0.71	-22.85	-2223.90
		-2223.90	-67.91	-1.90e-04	0.0	226.0	57.16	416.95	-19.94	0.71	-67.91	39.27
33	115	54.03	409.03	4.05e-04	-568.41	0.0	41.75	916.35	-395.97	-1.79	409.03	-1374.61
		-1374.61	-94.04	1.23e-03	346.74	226.0	41.75	347.94	-49.23	-1.79	-94.04	54.03
33	116	57.94	365.91	-2.99e-03	-568.41	0.0	62.66	904.22	-379.20	0.51	365.91	-1343.29
		-1343.29	-99.27	-5.88e-04	346.74	226.0	62.66	335.81	-32.46	0.51	-99.27	57.94
33	123	-185.24	318.19	-6.97e-03	-7498.94	0.0	-164.76	8629.59	4078.63	15.89	-4769.29	-1.121e+04
		-1.121e+04	-4769.29	-7.63e-03	-3655.05	226.0	-164.76	1130.65	423.57	15.89	318.19	-185.24
33	124	-181.33	312.96	-0.01	-7498.94	0.0	-143.86	8617.46	4095.39	18.19	-4812.42	-1.118e+04
		-1.118e+04	-4812.42	-9.45e-03	-3655.05	226.0	-143.86	1118.52	440.34	18.19	312.96	-181.33
33	139	3.54	-6.31	-2.91e-03	-2087.33	0.0	6.94	2600.75	593.09	3.24	-747.43	-3515.46
		-3515.46	-747.43	-1.62e-03	-530.31	226.0	6.94	513.42	62.78	3.24	-6.31	3.54
33	140	55.25	371.63	-1.31e-03	-589.60	0.0	51.57	933.87	-373.90	-0.58	371.63	-1389.04
		-1389.04	-95.39	2.92e-04	334.50	226.0	51.57	344.27	-39.40	-0.58	-95.39	55.25
33	144	35.25	-60.93	-1.93e-03	-1168.91	0.0	34.31	1578.61	0.12	0.89	-61.21	-2211.53
		-2211.53	-61.21	-4.48e-04	0.0	226.0	34.31	409.69	0.12	0.89	-60.93	35.25
34	3	72.17	573.64	8.87e-04	-618.24	0.0	-70.31	-416.76	48.58	2.78	-123.88	72.17
		-1568.33	-123.88	-8.44e-04	520.11	226.0	-70.31	-1035.01	568.70	2.78	573.64	-1568.33
34	4	82.60	610.29	2.60e-03	-618.24	0.0	-64.66	-434.75	73.77	-2.37	-144.16	82.60
		-1598.54	-144.16	-1.52e-04	520.11	226.0	-64.66	-1052.99	593.88	-2.37	610.29	-1598.54
34	11	-273.55	476.11	0.01	-1.103e+04	0.0	251.57	-1680.18	-655.56	21.98	476.11	-273.55
		-1.654e+04	-7200.77	0.01	-5482.58	226.0	251.57	-1.271e+04	-6138.14	21.98	-7200.77	-1.654e+04
34	12	-263.12	455.84	0.01	-1.103e+04	0.0	257.22	-1698.16	-630.38	16.83	455.84	-263.12
		-1.657e+04	-7164.13	0.01	-5482.58	226.0	257.22	-1.273e+04	-6112.96	16.83	-7164.13	-1.657e+04
34	27	57.57	598.77	9.98e-05	-150.33	0.0	-58.12	-252.08	48.53	2.20	-98.64	57.57
		-681.99	-98.64	-1.07e-03	520.11	226.0	-58.12	-402.41	568.64	2.20	598.77	-681.99
34	28	68.01	635.42	1.74e-03	-150.33	0.0	-52.47	-270.06	73.72	-2.95	-118.92	68.01
		-712.20	-118.92	-3.43e-04	520.11	226.0	-52.47	-420.39	593.83	-2.95	635.42	-712.20
34	35	-288.14	501.35	0.01	-1.057e+04	0.0	263.75	-1515.50	-655.61	21.40	501.35	-288.14
		-1.565e+04	-7175.65	0.01	-5482.58	226.0	263.75	-1.208e+04	-6138.19	21.40	-7175.65	-1.565e+04
34	36	-277.71	481.08	0.01	-1.057e+04	0.0	269.40	-1533.48	-630.43	16.26	481.08	-277.71
		-1.568e+04	-7139.00	0.01	-5482.58	226.0	269.40	-1.210e+04	-6113.01	16.26	-7139.00	-1.568e+04
34	49	3.58	-5.80	2.63e-03	-1169.79	0.0	25.82	-440.14	-144.63	1.97	-5.80	3.58
		-2313.00	-332.66	1.23e-03	0.0	226.0	25.82	-1609.93	-144.63	1.97	-332.66	-2313.00
34	50	8.86	-15.12	2.18e-03	-1169.79	0.0	-34.97	-447.38	-132.40	1.67	-15.12	8.86
		-2324.07	-314.34	1.45e-03	0.0	226.0	-34.97	-1617.17	-132.40	1.67	-314.34	-2324.07
34	52	69.39	207.03	1.67e-03	-1169.79	0.0	-86.73	-383.29	144.88	0.90	-120.41	69.39
		-2118.71	-120.41	-1.03e-04	0.0	226.0	-86.73	-1553.08	144.88	0.90	207.03	-2118.71

34	65	18.60	-31.77	2.96e-03	-1169.79	0.0	78.62	-409.27	-61.85	2.06	-31.77	18.60
		-2228.20	-171.55	4.34e-04	0.0	226.0	78.62	-1579.06	-61.85	2.06	-171.55	-2228.20
34	68	54.36	45.92	1.33e-03	-1169.79	0.0	-139.53	-414.16	62.11	0.81	-94.44	54.36
		-2203.50	-94.44	7.11e-04	0.0	226.0	-139.53	-1583.95	62.11	0.81	45.92	-2203.50
34	81	24.92	-42.97	2.31e-03	-1169.79	0.0	-11.76	-421.95	-50.97	1.62	-42.97	24.92
		-2250.55	-158.17	8.10e-04	0.0	226.0	-11.76	-1591.74	-50.97	1.62	-158.17	-2250.55
34	82	26.57	-45.89	2.17e-03	-1169.79	0.0	-30.79	-424.21	-47.14	1.52	-45.89	26.57
		-2254.01	-152.43	8.79e-04	0.0	226.0	-30.79	-1594.01	-47.14	1.52	-152.43	-2254.01
34	84	48.05	32.54	1.99e-03	-1169.79	0.0	-49.15	-401.48	51.23	1.25	-83.24	48.05
		-2181.16	-83.24	3.36e-04	0.0	226.0	-49.15	-1571.27	51.23	1.25	32.54	-2181.16
34	97	30.51	-52.63	2.41e-03	-1169.79	0.0	4.01	-411.35	-21.01	1.63	-52.63	30.51
		-2221.00	-100.12	5.39e-04	0.0	226.0	4.01	-1581.14	-21.01	1.63	-100.12	-2221.00
34	100	42.46	-25.51	1.89e-03	-1169.79	0.0	-64.93	-412.08	21.27	1.23	-73.57	42.46
		-2210.70	-73.57	6.07e-04	0.0	226.0	-64.93	-1581.87	21.27	1.23	-25.51	-2210.70
34	115	52.98	374.05	8.75e-04	-568.13	0.0	-50.93	-332.74	32.41	2.04	-91.00	52.98
		-1341.00	-91.00	-4.86e-04	346.74	226.0	-50.93	-900.87	379.15	2.04	374.05	-1341.00
34	116	59.93	398.49	2.02e-03	-568.13	0.0	-47.17	-344.73	49.20	-1.39	-104.52	59.93
		-1361.14	-104.52	-4.26e-05	346.74	226.0	-47.17	-912.86	395.94	-1.39	398.49	-1361.14
34	123	-177.50	309.00	8.96e-03	-7511.97	0.0	163.65	-1175.02	-437.02	14.84	309.00	-177.50
		-1.132e+04	-4808.89	8.73e-03	-3655.05	226.0	163.65	-8686.98	-4092.08	14.84	-4808.89	-1.132e+04
34	124	-170.55	295.48	0.01	-7511.97	0.0	167.42	-1187.00	-420.23	11.41	295.48	-170.55
		-1.134e+04	-4784.46	9.25e-03	-3655.05	226.0	167.42	-8698.97	-4075.29	11.41	-4784.46	-1.134e+04
34	139	5.94	-10.10	3.22e-03	-2089.97	0.0	-2.02	-523.33	-62.08	3.13	-10.10	5.94
		-3538.45	-749.65	1.79e-03	-530.31	226.0	-2.02	-2613.30	-592.39	3.13	-749.65	-3538.45
34	140	55.75	370.42	1.47e-03	-589.37	0.0	-48.39	-341.31	39.37	0.36	-96.54	55.75
		-1381.59	-96.54	-2.16e-04	334.50	226.0	-48.39	-930.68	373.87	0.36	370.42	-1381.59
34	144	36.48	-62.81	2.15e-03	-1169.79	0.0	-30.46	-411.71	0.13	1.43	-63.10	36.48
		-2215.85	-63.10	5.73e-04	0.0	226.0	-30.46	-1581.50	0.13	1.43	-62.81	-2215.85
35	2	1026.51	210.05	-4.92e-04	-5836.13	0.0	-580.67	3379.32	685.49	-0.06	-888.00	-4438.13
		-4438.13	-888.00	-2.21e-04	-1195.66	559.0	-580.67	-2456.81	-510.17	-0.06	-397.98	-1859.71
35	11	5950.13	3049.11	-4.82e-03	-2.729e+04	0.0	1979.72	1.408e+04	6908.28	-0.42	-6783.85	-1.435e+04
		-1.435e+04	-6783.85	-6.88e-03	-1.356e+04	559.0	1979.72	-1.321e+04	-6652.62	-0.42	-6069.28	-1.190e+04
35	12	5658.80	2994.94	-4.29e-03	-2.729e+04	0.0	870.28	1.440e+04	6962.06	-0.41	-6988.34	-1.551e+04
		-1.551e+04	-6988.34	-6.59e-03	-1.356e+04	559.0	870.28	-1.290e+04	-6598.83	-0.41	-5973.13	-1.131e+04
35	26	798.86	216.34	3.54e-04	-4678.76	0.0	-654.31	2750.42	675.64	-0.05	-850.73	-3711.80
		-3711.80	-850.73	-2.67e-04	-1195.66	559.0	-654.31	-1928.34	-520.02	-0.05	-415.79	-1414.09
35	35	5727.39	3058.84	-4.67e-03	-2.613e+04	0.0	1906.08	1.346e+04	6898.42	-0.41	-6746.58	-1.362e+04
		-1.362e+04	-6746.58	-6.94e-03	-1.356e+04	559.0	1906.08	-1.268e+04	-6662.47	-0.41	-6087.09	-1.145e+04
35	36	5436.06	3004.67	-4.14e-03	-2.613e+04	0.0	796.64	1.377e+04	6952.21	-0.40	-6951.07	-1.478e+04
		-1.478e+04	-6951.07	-6.64e-03	-1.356e+04	559.0	796.64	-1.237e+04	-6608.69	-0.40	-5990.94	-1.087e+04
35	49	545.78	23.49	-3.10e-04	-2893.42	0.0	342.50	1658.56	23.94	-0.03	-110.35	-2110.55
		-2110.55	-110.35	2.39e-04	0.0	559.0	342.50	-1234.86	23.94	-0.03	23.49	-926.30
35	52	610.34	65.55	-4.73e-04	-2893.42	0.0	25.69	1485.95	25.32	-0.03	-76.00	-1521.11
		-1521.11	-76.00	6.21e-05	0.0	559.0	25.69	-1407.47	25.32	-0.03	65.55	-1301.78
35	65	584.01	60.48	-3.13e-04	-2893.42	0.0	237.14	1780.66	-34.94	-0.03	60.48	-2478.16
		-2478.16	-134.85	2.16e-04	0.0	559.0	237.14	-1112.76	-34.94	-0.03	-134.85	-611.37
35	66	617.19	245.51	-4.85e-04	-2893.42	0.0	225.01	1379.53	95.54	-0.02	-288.54	-1216.81
		-1592.36	-288.54	2.49e-04	0.0	559.0	225.01	-1513.89	95.54	-0.02	245.51	-1592.36
35	68	636.67	223.90	-5.21e-04	-2893.42	0.0	131.06	1363.85	84.21	-0.03	-246.82	-1153.50
		-1616.71	-246.82	1.90e-04	0.0	559.0	131.06	-1529.58	84.21	-0.03	223.90	-1616.71
35	81	560.84	39.44	-3.61e-04	-2893.42	0.0	240.22	1600.36	25.20	-0.03	-101.45	-1912.49
		-1912.49	-101.45	1.78e-04	0.0	559.0	240.22	-1293.06	25.20	-0.03	39.44	-1053.58
35	84	577.40	49.60	-4.14e-04	-2893.42	0.0	127.97	1544.15	24.06	-0.03	-84.90	-1719.17
		-1719.17	-84.90	1.13e-04	0.0	559.0	127.97	-1349.28	24.06	-0.03	49.60	-1174.50
35	97	566.63	-11.18	-3.56e-04	-2893.42	0.0	202.66	1637.82	6.22	-0.03	-45.95	-2024.49
		-2024.49	-45.95	1.49e-04	0.0	559.0	202.66	-1255.60	6.22	-0.03	-11.18	-956.17
35	98	575.33	107.89	-4.10e-04	-2893.42	0.0	198.87	1512.25	47.06	-0.03	-155.20	-1629.64
		-1629.64	-155.20	1.75e-04	0.0	559.0	198.87	-1381.17	47.06	-0.03	107.89	-1263.26
35	100	582.24	100.22	-4.22e-04	-2893.42	0.0	165.53	1506.69	43.05	-0.03	-140.40	-1607.18
		-1607.18	-140.40	1.53e-04	0.0	559.0	165.53	-1386.73	43.05	-0.03	100.22	-1271.90
35	114	760.22	137.94	-3.77e-04	-4276.55	0.0	-362.56	2462.52	460.28	-0.05	-604.42	-3200.87
		-3200.87	-604.42	1.45e-04	-797.11	559.0	-362.56	-1814.03	-336.83	-0.05	-259.38	-1388.34
35	123	4041.00	2029.49	-3.26e-03	-1.858e+04	0.0	1344.36	9599.19	4608.80	-0.28	-4534.99	-9805.62
		-9805.62	-4534.99	-4.57e-03	-9040.60	559.0	1344.36	-8981.29	-4431.79	-0.28	-4040.25	-8078.61
35	124	3846.78	1993.38	-2.91e-03	-1.858e+04	0.0	604.73	9807.22	4644.66	-0.28	-4671.32	-1.058e+04
		-1.058e+04	-4671.32	-4.37e-03	-9040.60	559.0	604.73	-8773.26	-4395.94	-0.28	-3976.15	-7691.38
35	137	637.77	17.81	-5.23e-04	-2893.42	0.0	492.28	1485.58	9.69	-0.03	-36.37	-1492.64
		-1492.64	-36.37	5.35e-05	0.0	559.0	492.28	-1407.85	9.69	-0.03	17.81	-1275.38
35	138	518.48	71.23	-2.63e-04	-2893.42	0.0	-124.08	1658.93	39.57	-0.02	-149.98	-2139.02
		-2139.02	-149.98	2.36e-04	0.0	559.0	-124.08	-1234.49	39.57	-0.02	71.23	-952.70
35	139	1050.26	271.04	-7.76e-04	-5169.45	0.0	298.78	2751.97	692.35	-0.06	-747.52	-3031.33
		-3031.33	-747.52	-5.38e-04	-1311.69	559.0	298.78	-2417.48	-619.35	-0.06	-543.48	-2096.43
35	140	265.63	415.42	-1.42e-04	-1457.78	0.0	111.76	828.13	-396.54	-3.44e-03	319.57	-1049.13
		-1049.13	-210.63	5.51e-04	827.38	559.0	111.76	-629.65	430.83	-3.44e-03	415.42	-494.38
35	144	569.12	44.52	-3.87e-04	-2893.42	0.0	184.10	1572.26	24.63	-0.03	-93.17	-1815.83
		-1815.83	-93.17	1.45e-04	0.0	559.0	184.10	-1321.17	24.63	-0.03	44.52	-1114.04
36	2	1026.51	210.05	-4.96e-04	-5836.13	0.0	-580.67	2456.81	510.17	0.06	-397.98	-1859.71

		-4438.13	-888.00	-3.04e-04	-1195.66	559.0	-580.67	-3379.32	-685.49	0.06	-888.00	-4438.13
36	11	5950.13	3049.11	-4.81e-03	-2.729e+04	0.0	1979.72	1.321e+04	6652.62	0.42	-6069.28	-1.190e+04
		-1.435e+04	-6783.85	-6.70e-03	-1.356e+04	559.0	1979.72	-1.408e+04	-6908.28	0.42	-6783.85	-1.435e+04
36	12	5658.80	2994.94	-4.28e-03	-2.729e+04	0.0	870.28	1.290e+04	6598.83	0.41	-5973.13	-1.131e+04
		-1.551e+04	-6988.34	-6.48e-03	-1.356e+04	559.0	870.28	-1.440e+04	-6962.06	0.41	-6988.34	-1.551e+04
36	26	798.86	216.34	3.51e-04	-4678.76	0.0	-654.31	1928.34	520.02	0.05	-415.79	-1414.09
		-3711.80	-850.73	-3.40e-04	-1195.66	559.0	-654.31	-2750.42	-675.64	0.05	-850.73	-3711.80
36	35	5727.39	3058.84	-4.65e-03	-2.613e+04	0.0	1906.08	1.268e+04	6662.47	0.41	-6087.09	-1.145e+04
		-1.362e+04	-6746.58	-6.74e-03	-1.356e+04	559.0	1906.08	-1.346e+04	-6898.42	0.41	-6746.58	-1.362e+04
36	36	5436.06	3004.67	-4.13e-03	-2.613e+04	0.0	796.64	1.237e+04	6608.69	0.40	-5990.94	-1.087e+04
		-1.478e+04	-6951.07	-6.52e-03	-1.356e+04	559.0	796.64	-1.377e+04	-6952.21	0.40	-6951.07	-1.478e+04
36	58	545.78	23.49	-3.12e-04	-2893.42	0.0	342.50	1234.86	-23.94	0.03	23.49	-926.30
		-2110.55	-110.35	1.90e-04	0.0	559.0	342.50	-1658.56	-23.94	0.03	-110.35	-2110.55
36	59	610.34	65.55	-4.73e-04	-2893.42	0.0	25.69	1407.47	-25.32	0.03	65.55	-1301.78
		-1521.11	-76.00	5.79e-05	0.0	559.0	25.69	-1485.95	-25.32	0.03	-76.00	-1521.11
36	69	617.19	245.51	-4.86e-04	-2893.42	0.0	225.01	1513.89	-95.54	0.02	245.51	-1592.36
		-1592.36	-288.54	2.00e-04	0.0	559.0	225.01	-1379.53	-95.54	0.02	-288.54	-1216.81
36	70	584.01	60.48	-3.15e-04	-2893.42	0.0	237.14	1112.76	34.94	0.03	-134.85	-611.37
		-2478.16	-134.85	1.97e-04	0.0	559.0	237.14	-1780.66	34.94	0.03	60.48	-2478.16
36	71	636.67	223.90	-5.21e-04	-2893.42	0.0	131.06	1529.58	-84.21	0.03	223.90	-1616.71
		-1616.71	-246.82	1.57e-04	0.0	559.0	131.06	-1363.85	-84.21	0.03	-246.82	-1153.50
36	90	560.84	39.44	-3.62e-04	-2893.42	0.0	240.22	1293.06	-25.20	0.03	39.44	-1053.58
		-1912.49	-101.45	1.44e-04	0.0	559.0	240.22	-1600.36	-25.20	0.03	-101.45	-1912.49
36	91	577.40	49.60	-4.14e-04	-2893.42	0.0	127.97	1349.28	-24.06	0.03	49.60	-1174.50
		-1719.17	-84.90	9.45e-05	0.0	559.0	127.97	-1544.15	-24.06	0.03	-84.90	-1719.17
36	101	575.33	107.89	-4.11e-04	-2893.42	0.0	198.87	1381.17	-47.06	0.03	107.89	-1263.26
		-1629.64	-155.20	1.42e-04	0.0	559.0	198.87	-1512.25	-47.06	0.03	-155.20	-1629.64
36	102	566.63	-11.18	-3.57e-04	-2893.42	0.0	202.66	1255.60	-6.22	0.03	-11.18	-956.17
		-2024.49	-45.95	1.24e-04	0.0	559.0	202.66	-1637.82	-6.22	0.03	-45.95	-2024.49
36	103	582.24	100.22	-4.23e-04	-2893.42	0.0	165.53	1386.73	-43.05	0.03	100.22	-1271.90
		-1607.18	-140.40	1.25e-04	0.0	559.0	165.53	-1506.69	-43.05	0.03	-140.40	-1607.18
36	114	760.22	137.94	-3.80e-04	-4276.55	0.0	-362.56	1814.03	336.83	0.05	-259.38	-1388.34
		-3200.87	-604.42	-1.92e-04	-797.11	559.0	-362.56	-2462.52	-460.28	0.05	-604.42	-3200.87
36	123	4041.00	2029.49	-3.25e-03	-1.858e+04	0.0	1344.36	8981.29	4431.79	0.28	-4040.25	-8078.61
		-9805.62	-4534.99	-4.45e-03	-9040.60	559.0	1344.36	-9599.19	-4608.80	0.28	-4534.99	-9805.62
36	124	3846.78	1993.38	-2.91e-03	-1.858e+04	0.0	604.73	8773.26	4395.94	0.28	-3976.15	-7691.38
		-1.058e+04	-4671.32	-4.31e-03	-9040.60	559.0	604.73	-9807.22	-4644.66	0.28	-4671.32	-1.058e+04
36	137	637.77	17.81	-5.22e-04	-2893.42	0.0	492.28	1407.85	-9.69	0.03	17.81	-1275.38
		-1492.64	-36.37	4.88e-05	0.0	559.0	492.28	-1485.58	-9.69	0.03	-36.37	-1492.64
36	138	518.48	71.23	-2.65e-04	-2893.42	0.0	-124.08	1234.49	-39.57	0.02	71.23	-952.70
		-2139.02	-149.98	1.88e-04	0.0	559.0	-124.08	-1658.93	-39.57	0.02	-149.98	-2139.02
36	139	1050.26	271.04	-7.75e-04	-5169.45	0.0	298.78	2417.48	619.35	0.06	-543.48	-2096.43
		-3031.33	-747.52	-5.47e-04	-1311.69	559.0	298.78	-2751.97	-692.35	0.06	-747.52	-3031.33
36	140	265.63	415.42	-1.44e-04	-1457.78	0.0	111.76	629.65	-430.83	3.44e-03	415.42	-494.38
		-1049.13	-210.63	5.13e-04	827.38	559.0	111.76	-828.13	396.54	3.44e-03	319.57	-1049.13
36	144	569.12	44.52	-3.88e-04	-2893.42	0.0	184.10	1321.17	-24.63	0.03	44.52	-1114.04
		-1815.83	-93.17	1.18e-04	0.0	559.0	184.10	-1572.26	-24.63	0.03	-93.17	-1815.83
37	3	72.17	573.64	-8.83e-04	-618.24	0.0	-70.31	1035.01	-568.70	-2.78	573.64	-1568.33
		-1568.33	-123.88	8.44e-04	520.11	226.0	-70.31	416.76	-48.58	-2.78	-123.88	72.17
37	4	82.60	610.29	-2.60e-03	-618.24	0.0	-64.66	1052.99	-593.88	2.37	610.29	-1598.54
		-1598.54	-144.16	-9.04e-05	520.11	226.0	-64.66	434.75	-73.77	2.37	-144.16	82.60
37	11	-273.55	476.11	-0.01	-1.103e+04	0.0	251.57	1.271e+04	6138.14	-21.98	-7200.77	-1.654e+04
		-1.654e+04	-7200.77	-0.01	-5482.58	226.0	251.57	1680.18	655.56	-21.98	476.11	-273.55
37	12	-263.12	455.84	-0.01	-1.103e+04	0.0	257.22	1.273e+04	6112.95	-16.83	-7164.13	-1.657e+04
		-1.657e+04	-7164.13	-0.01	-5482.58	226.0	257.22	1698.16	630.38	-16.83	455.84	-263.12
37	27	57.57	598.77	7.62e-05	-150.33	0.0	-58.12	402.41	-568.64	-2.20	598.77	-681.99
		-681.99	-98.64	1.07e-03	520.11	226.0	-58.12	252.08	-48.53	-2.20	-98.64	57.57
37	28	68.01	635.42	-1.74e-03	-150.33	0.0	-52.47	420.39	-593.83	2.95	635.42	-712.20
		-712.20	-118.92	2.91e-04	520.11	226.0	-52.47	270.06	-73.72	2.95	-118.92	68.01
37	35	-288.14	501.35	-0.01	-1.057e+04	0.0	263.75	1.208e+04	6138.19	-21.40	-7175.65	-1.565e+04
		-1.565e+04	-7175.65	-0.01	-5482.58	226.0	263.75	1515.50	655.61	-21.40	501.35	-288.14
37	36	-277.71	481.08	-0.01	-1.057e+04	0.0	269.40	1.210e+04	6113.01	-16.26	-7139.00	-1.568e+04
		-1.568e+04	-7139.00	-0.01	-5482.58	226.0	269.40	1533.48	630.43	-16.26	481.08	-277.71
37	57	8.86	-15.12	-2.18e-03	-1169.79	0.0	-34.97	1617.17	132.40	-1.67	-314.34	-2324.07
		-2324.07	-314.34	-1.45e-03	0.0	226.0	-34.97	447.38	132.40	-1.67	-15.12	8.86
37	58	3.58	-5.80	-2.63e-03	-1169.79	0.0	25.82	1609.93	144.63	-1.97	-332.66	-2313.00
		-2313.00	-332.66	-1.23e-03	0.0	226.0	25.82	440.14	144.63	-1.97	-5.80	3.58
37	59	69.39	207.03	-1.67e-03	-1169.79	0.0	-86.73	1553.08	-144.88	-0.90	207.03	-2118.71
		-2118.71	-120.41	8.15e-05	0.0	226.0	-86.73	383.29	-144.88	-0.90	-120.41	69.39
37	70	18.60	-31.77	-2.96e-03	-1169.79	0.0	78.62	1579.06	61.85	-2.06	-171.55	-2228.20
		-2228.20	-171.55	-4.34e-04	0.0	226.0	78.62	409.27	61.85	-2.06	-31.77	18.60
37	71	54.36	45.92	-1.33e-03	-1169.79	0.0	-139.53	1583.95	-62.11	-0.81	45.92	-2203.50
		-2203.50	-94.44	-7.11e-04	0.0	226.0	-139.53	414.16	-62.11	-0.81	-94.44	54.36
37	89	26.57	-45.89	-2.17e-03	-1169.79	0.0	-30.79	1594.01	47.14	-1.52	-152.43	-2254.01
		-2254.01	-152.43	-8.79e-04	0.0	226.0	-30.79	424.21	47.14	-1.52	-45.89	26.57
37	90	24.92	-42.97	-2.31e-03	-1169.79	0.0	-11.76	1591.74	50.97	-1.62	-158.17	-2250.55
		-2250.55	-158.17	-8.10e-04	0.0	226.0	-11.76	421.95	50.97	-1.62	-42.97	24.92

37	91	48.05	32.54	-1.99e-03	-1169.79	0.0	-49.15	1571.27	-51.23	-1.25	32.54	-2181.16
		-2181.16	-83.24	-3.36e-04	0.0	226.0	-49.15	401.48	-51.23	-1.25	-83.24	48.05
37	102	30.51	-52.63	-2.41e-03	-1169.79	0.0	4.01	1581.14	21.01	-1.63	-100.12	-2221.00
		-2221.00	-100.12	-5.39e-04	0.0	226.0	4.01	411.35	21.01	-1.63	-52.63	30.51
37	103	42.46	-25.51	-1.89e-03	-1169.79	0.0	-64.93	1581.87	-21.27	-1.23	-25.51	-2210.70
		-2210.70	-73.57	-6.07e-04	0.0	226.0	-64.93	412.08	-21.27	-1.23	-73.57	42.46
37	115	52.98	374.05	-8.75e-04	-568.13	0.0	-50.93	900.87	-379.15	-2.04	374.05	-1341.00
		-1341.00	-91.00	4.86e-04	346.74	226.0	-50.93	332.74	-32.41	-2.04	-91.00	52.98
37	116	59.93	398.49	-2.02e-03	-568.13	0.0	-47.17	912.86	-395.94	1.39	398.49	-1361.14
		-1361.14	-104.52	-7.80e-05	346.74	226.0	-47.17	344.73	-49.20	1.39	-104.52	59.93
37	123	-177.50	309.00	-8.96e-03	-7511.97	0.0	163.65	8686.98	4092.08	-14.84	-4808.89	-1.132e+04
		-1.132e+04	-4808.89	-8.73e-03	-3655.05	226.0	163.65	1175.02	437.02	-14.84	309.00	-177.50
37	124	-170.55	295.48	-0.01	-7511.97	0.0	167.42	8698.97	4075.29	-11.41	-4784.46	-1.134e+04
		-1.134e+04	-4784.46	-9.25e-03	-3655.05	226.0	167.42	1187.00	420.23	-11.41	295.48	-170.55
37	139	5.94	-10.10	-3.22e-03	-2089.97	0.0	-2.02	2613.30	592.39	-3.13	-749.65	-3538.45
		-3538.45	-749.65	-1.79e-03	-530.31	226.0	-2.02	523.33	62.08	-3.13	-10.10	5.94
37	140	55.75	370.42	-1.47e-03	-589.37	0.0	-48.39	930.68	-373.87	-0.36	370.42	-1381.59
		-1381.59	-96.54	1.97e-04	334.50	226.0	-48.39	341.31	-39.37	-0.36	-96.54	55.75
37	144	36.48	-62.81	-2.15e-03	-1169.79	0.0	-30.46	1581.50	-0.13	-1.43	-62.81	-2215.85
		-2215.85	-63.10	-5.73e-04	0.0	226.0	-30.46	411.71	-0.13	-1.43	-63.10	36.48
39	3	10.48	12.16	-1.67e-04	-235.84	0.0	-382.97	-237.89	14.31	0.0	0.0	10.48
		-291.92	0.0	3.56e-06	0.0	85.0	-519.16	-473.74	14.31	0.0	12.16	-291.92
39	4	10.48	0.0	1.62e-04	-235.84	0.0	-382.97	-237.89	-118.83	0.0	0.0	10.48
		-291.92	-100.99	-9.33e-06	0.0	85.0	-519.16	-473.74	-118.83	0.0	-100.99	-291.92
39	6	-49.82	15.45	9.28e-04	-235.84	0.0	-382.97	-2684.73	18.17	0.0	0.0	-49.82
		-2431.78	0.0	5.57e-06	0.0	85.0	-519.16	-2920.57	18.17	0.0	15.45	-2431.78
39	9	-90.64	207.42	1.12e-03	-235.84	0.0	-382.97	-4340.97	244.06	0.0	0.0	-90.64
		-3880.23	0.0	2.86e-05	0.0	85.0	-519.16	-4576.82	244.06	0.0	207.42	-3880.23
39	11	-110.49	245.76	1.37e-03	-235.84	0.0	-382.97	-5146.58	289.16	0.0	0.0	-110.49
		-4584.76	0.0	3.35e-05	0.0	85.0	-519.16	-5382.42	289.16	0.0	245.76	-4584.76
39	12	-110.49	132.60	1.70e-03	-235.84	0.0	-382.97	-5146.58	156.02	0.0	0.0	-110.49
		-4584.76	0.0	2.06e-05	0.0	85.0	-519.16	-5382.42	156.02	0.0	132.60	-4584.76
39	27	10.48	19.60	-2.07e-04	-163.27	0.0	-265.13	-33.83	23.06	0.0	0.0	10.48
		-87.65	0.0	3.65e-06	0.0	85.0	-359.42	-197.10	23.06	0.0	19.60	-87.65
39	28	10.48	0.0	1.22e-04	-163.27	0.0	-265.13	-33.83	-110.08	0.0	0.0	10.48
		-87.65	-93.56	-9.24e-06	0.0	85.0	-359.42	-197.10	-110.08	0.0	-93.56	-87.65
39	30	-49.82	22.89	8.88e-04	-163.27	0.0	-265.13	-2480.66	26.93	0.0	0.0	-49.82
		-2227.51	0.0	5.67e-06	0.0	85.0	-359.42	-2643.94	26.93	0.0	22.89	-2227.51
39	33	-90.64	214.86	1.08e-03	-163.27	0.0	-265.13	-4136.91	252.81	0.0	0.0	-90.64
		-3675.95	0.0	2.86e-05	0.0	85.0	-359.42	-4300.18	252.81	0.0	214.86	-3675.95
39	35	-110.49	253.20	1.33e-03	-163.27	0.0	-265.13	-4942.51	297.92	0.0	0.0	-110.49
		-4380.49	0.0	3.36e-05	0.0	85.0	-359.42	-5105.79	297.92	0.0	253.20	-4380.49
39	36	-110.49	140.04	1.66e-03	-163.27	0.0	-265.13	-4942.51	164.77	0.0	0.0	-110.49
		-4380.49	0.0	2.07e-05	0.0	85.0	-359.42	-5105.79	164.77	0.0	140.04	-4380.49
39	49	0.0	125.55	1.28e-04	-181.42	0.0	-172.26	-580.80	147.72	0.0	0.0	0.0
		-570.71	0.0	-6.67e-05	0.0	85.0	-277.02	-762.22	147.72	0.0	125.55	-570.71
39	50	0.0	72.31	1.29e-04	-181.42	0.0	-172.26	-580.80	85.08	0.0	0.0	0.0
		-570.71	0.0	1.15e-04	0.0	85.0	-277.02	-762.22	85.08	0.0	72.31	-570.71
39	52	0.0	0.0	7.31e-05	-181.42	0.0	-416.92	-439.53	-191.48	0.0	0.0	0.0
		-450.64	-162.74	6.62e-05	0.0	85.0	-521.68	-620.94	-191.48	0.0	-162.74	-450.64
39	81	0.0	31.43	1.10e-04	-181.42	0.0	-251.19	-535.23	36.98	0.0	0.0	0.0
		-531.98	0.0	-2.00e-05	0.0	85.0	-355.95	-716.64	36.98	0.0	31.43	-531.98
39	82	0.0	14.77	1.11e-04	-181.42	0.0	-251.19	-535.23	17.37	0.0	0.0	0.0
		-531.98	0.0	3.67e-05	0.0	85.0	-355.95	-716.64	17.37	0.0	14.77	-531.98
39	83	0.0	0.0	9.06e-05	-181.42	0.0	-337.99	-485.10	-61.13	0.0	0.0	0.0
		-489.38	-51.96	-3.72e-05	0.0	85.0	-442.75	-666.52	-61.13	0.0	-51.96	-489.38
39	84	0.0	0.0	9.09e-05	-181.42	0.0	-337.99	-485.10	-80.74	0.0	0.0	0.0
		-489.38	-68.62	1.96e-05	0.0	85.0	-442.75	-666.52	-80.74	0.0	-68.62	-489.38
39	115	6.99	5.63	-9.77e-05	-181.42	0.0	-294.59	-226.62	6.62	0.0	0.0	6.99
		-262.71	0.0	2.34e-06	0.0	85.0	-399.35	-408.03	6.62	0.0	5.63	-262.71
39	116	6.99	0.0	1.21e-04	-181.42	0.0	-294.59	-226.62	-82.14	0.0	0.0	6.99
		-262.71	-69.81	-6.25e-06	0.0	85.0	-399.35	-408.03	-82.14	0.0	-69.81	-262.71
39	118	-33.21	7.82	6.32e-04	-181.42	0.0	-294.59	-1857.84	9.20	0.0	0.0	-33.21
		-1689.28	0.0	3.69e-06	0.0	85.0	-399.35	-2039.26	9.20	0.0	7.82	-1689.28
39	121	-60.42	135.80	7.58e-04	-181.42	0.0	-294.59	-2962.00	159.79	0.0	0.0	-60.42
		-2654.91	0.0	1.90e-05	0.0	85.0	-399.35	-3143.42	159.79	0.0	135.80	-2654.91
39	123	-73.66	161.36	9.27e-04	-181.42	0.0	-294.59	-3499.07	189.86	0.0	0.0	-73.66
		-3124.60	0.0	2.23e-05	0.0	85.0	-399.35	-3680.49	189.86	0.0	161.36	-3124.60
39	124	-73.66	85.92	1.15e-03	-181.42	0.0	-294.59	-3499.07	101.10	0.0	0.0	-73.66
		-3124.60	0.0	1.37e-05	0.0	85.0	-399.35	-3680.49	101.10	0.0	85.92	-3124.60
39	137	0.0	12.84	1.61e-05	-181.42	0.0	-294.59	-510.16	15.10	0.0	0.0	0.0
		-510.68	0.0	3.35e-06	0.0	85.0	-399.35	-691.58	15.10	0.0	12.84	-510.68
39	138	0.0	0.0	1.92e-04	-181.42	0.0	-294.59	-510.16	-58.86	0.0	0.0	0.0
		-510.68	-50.03	-3.81e-06	0.0	85.0	-399.35	-691.58	-58.86	0.0	-50.03	-510.68
39	139	-10.69	2.04	2.36e-04	-181.42	0.0	-294.59	-943.82	2.40	0.0	0.0	-10.69
		-889.93	0.0	2.41e-06	0.0	85.0	-399.35	-1125.24	2.40	0.0	2.04	-889.93
39	140	6.74	0.0	1.59e-05	-181.42	0.0	-294.59	-236.63	-37.20	0.0	0.0	6.74

		-271.46	-31.61	-1.90e-06	0.0	85.0	-399.35	-418.04	-37.20	0.0	-31.61	-271.46
39	141	-6.74	0.0	1.86e-04	-181.42	0.0	-294.59	-783.70	-6.56	0.0	0.0	-6.74
		-749.90	-5.58	1.44e-06	0.0	85.0	-399.35	-965.12	-6.56	0.0	-5.58	-749.90
39	144	0.0	0.0	1.01e-04	-181.42	0.0	-294.59	-510.16	-21.88	0.0	0.0	0.0
		-510.68	-18.60	0.0	0.0	85.0	-399.35	-691.58	-21.88	0.0	-18.60	-510.68
40	2	-13.87	0.0	6.17e-04	-235.84	0.0	-545.43	-1507.53	0.0	0.0	0.0	-13.87
		-1395.34	0.0	0.0	0.0	85.0	-681.61	-1743.38	0.0	0.0	0.0	-1395.34
40	4	14.93	0.0	1.67e-04	-235.84	0.0	-545.43	-338.81	0.0	0.0	0.0	14.93
		-373.25	0.0	0.0	0.0	85.0	-681.61	-574.65	0.0	0.0	0.0	-373.25
40	11	-157.36	0.0	1.89e-03	-235.84	0.0	-545.43	-7329.78	0.0	0.0	0.0	-157.36
		-6487.12	0.0	0.0	0.0	85.0	-681.61	-7565.62	0.0	0.0	0.0	-6487.12
40	12	-157.36	0.0	2.21e-03	-235.84	0.0	-545.43	-7329.78	0.0	0.0	0.0	-157.36
		-6487.12	0.0	0.0	0.0	85.0	-681.61	-7565.62	0.0	0.0	0.0	-6487.12
40	26	-13.87	0.0	5.60e-04	-163.27	0.0	-377.60	-1216.90	0.0	0.0	0.0	-13.87
		-1117.50	0.0	0.0	0.0	85.0	-471.89	-1380.18	0.0	0.0	0.0	-1117.50
40	28	14.93	0.0	1.11e-04	-163.27	0.0	-377.60	-48.18	0.0	0.0	0.0	14.93
		-95.40	0.0	0.0	0.0	85.0	-471.89	-211.45	0.0	0.0	0.0	-95.40
40	35	-157.36	0.0	1.83e-03	-163.27	0.0	-377.60	-7039.15	0.0	0.0	0.0	-157.36
		-6209.27	0.0	0.0	0.0	85.0	-471.89	-7202.42	0.0	0.0	0.0	-6209.27
40	36	-157.36	0.0	2.16e-03	-163.27	0.0	-377.60	-7039.15	0.0	0.0	0.0	-157.36
		-6209.27	0.0	0.0	0.0	85.0	-471.89	-7202.42	0.0	0.0	0.0	-6209.27
40	49	0.0	34.88	1.68e-04	-181.42	0.0	-277.96	-808.34	41.04	0.0	0.0	0.0
		-764.10	0.0	-7.19e-05	0.0	85.0	-382.72	-989.76	41.04	0.0	34.88	-764.10
40	51	0.0	92.25	1.13e-04	-181.42	0.0	-561.16	-644.81	108.55	0.0	0.0	0.0
		-625.11	0.0	-1.09e-04	0.0	85.0	-665.92	-826.23	108.55	0.0	92.25	-625.11
40	59	0.0	34.88	1.13e-04	-181.42	0.0	-561.16	-644.81	41.04	0.0	0.0	0.0
		-625.11	0.0	-7.19e-05	0.0	85.0	-665.92	-826.23	41.04	0.0	34.88	-625.11
40	66	0.0	0.0	1.49e-04	-181.42	0.0	-377.08	-751.11	-259.44	0.0	0.0	0.0
		-715.46	-220.49	3.07e-04	0.0	85.0	-481.84	-932.52	-259.44	0.0	-220.49	-715.46
40	67	0.0	220.49	1.32e-04	-181.42	0.0	-462.04	-702.05	259.44	0.0	0.0	0.0
		-673.76	0.0	-3.07e-04	0.0	85.0	-566.80	-883.46	259.44	0.0	220.49	-673.76
40	81	0.0	9.72	1.50e-04	-181.42	0.0	-369.32	-755.59	11.44	0.0	0.0	0.0
		-719.26	0.0	-2.17e-05	0.0	85.0	-474.08	-937.00	11.44	0.0	9.72	-719.26
40	83	0.0	30.08	1.31e-04	-181.42	0.0	-469.80	-697.57	35.39	0.0	0.0	0.0
		-669.95	0.0	-3.48e-05	0.0	85.0	-574.55	-878.99	35.39	0.0	30.08	-669.95
40	92	0.0	0.0	1.31e-04	-181.42	0.0	-469.80	-697.57	-35.39	0.0	0.0	0.0
		-669.95	-30.08	3.48e-05	0.0	85.0	-574.55	-878.99	-35.39	0.0	-30.08	-669.95
40	98	0.0	0.0	1.43e-04	-181.42	0.0	-404.49	-735.28	-81.64	0.0	0.0	0.0
		-702.00	-69.38	9.62e-05	0.0	85.0	-509.25	-916.70	-81.64	0.0	-69.38	-702.00
40	99	0.0	69.38	1.38e-04	-181.42	0.0	-434.63	-717.88	81.64	0.0	0.0	0.0
		-687.21	0.0	-9.62e-05	0.0	85.0	-539.39	-899.29	81.64	0.0	69.38	-687.21
40	114	-9.25	0.0	4.30e-04	-181.42	0.0	-419.56	-1101.90	0.0	0.0	0.0	-9.25
		-1022.84	0.0	0.0	0.0	85.0	-524.32	-1283.32	0.0	0.0	0.0	-1022.84
40	116	9.95	0.0	1.30e-04	-181.42	0.0	-419.56	-322.75	0.0	0.0	0.0	9.95
		-341.44	0.0	0.0	0.0	85.0	-524.32	-504.17	0.0	0.0	0.0	-341.44
40	123	-104.91	0.0	1.28e-03	-181.42	0.0	-419.56	-4983.39	0.0	0.0	0.0	-104.91
		-4417.36	0.0	0.0	0.0	85.0	-524.32	-5164.81	0.0	0.0	0.0	-4417.36
40	124	-104.91	0.0	1.49e-03	-181.42	0.0	-419.56	-4983.39	0.0	0.0	0.0	-104.91
		-4417.36	0.0	0.0	0.0	85.0	-524.32	-5164.81	0.0	0.0	0.0	-4417.36
40	138	0.0	0.0	2.30e-04	-181.42	0.0	-419.56	-726.58	0.0	0.0	0.0	0.0
		-694.61	0.0	0.0	0.0	85.0	-524.32	-907.99	0.0	0.0	0.0	-694.61
40	139	-15.22	0.0	3.21e-04	-181.42	0.0	-419.56	-1344.20	0.0	0.0	0.0	-15.22
		-1234.74	0.0	0.0	0.0	85.0	-524.32	-1525.61	0.0	0.0	0.0	-1234.74
40	140	9.60	0.0	2.69e-05	-181.42	0.0	-419.56	-337.00	0.0	0.0	0.0	9.60
		-353.91	0.0	0.0	0.0	85.0	-524.32	-518.42	0.0	0.0	0.0	-353.91
40	144	0.0	0.0	1.41e-04	-181.42	0.0	-419.56	-726.58	0.0	0.0	0.0	0.0
		-694.61	0.0	0.0	0.0	85.0	-524.32	-907.99	0.0	0.0	0.0	-694.61
41	3	10.48	0.0	-1.67e-04	-235.84	0.0	-382.97	-237.89	-14.31	0.0	0.0	10.48
		-291.92	-12.16	-3.56e-06	0.0	85.0	-519.16	-473.74	-14.31	0.0	-12.16	-291.92
41	4	10.48	100.99	1.62e-04	-235.84	0.0	-382.97	-237.89	118.83	0.0	0.0	10.48
		-291.92	0.0	9.33e-06	0.0	85.0	-519.16	-473.74	118.83	0.0	100.99	-291.92
41	6	-49.82	0.0	9.28e-04	-235.84	0.0	-382.97	-2684.73	-18.17	0.0	0.0	-49.82
		-2431.78	-15.45	-5.57e-06	0.0	85.0	-519.16	-2920.57	-18.17	0.0	-15.45	-2431.78
41	7	-70.41	0.0	7.51e-04	-235.84	0.0	-382.97	-3520.36	-242.49	0.0	0.0	-70.41
		-3162.57	-206.09	-2.79e-05	0.0	85.0	-519.16	-3756.20	-242.49	0.0	-206.09	-3162.57
41	11	-110.49	0.0	1.37e-03	-235.84	0.0	-382.97	-5146.58	-289.16	0.0	0.0	-110.49
		-4584.76	-245.76	-3.35e-05	0.0	85.0	-519.16	-5382.42	-289.16	0.0	-245.76	-4584.76
41	12	-110.49	0.0	1.70e-03	-235.84	0.0	-382.97	-5146.58	-156.02	0.0	0.0	-110.49
		-4584.76	-132.60	-2.06e-05	0.0	85.0	-519.16	-5382.42	-156.02	0.0	-132.60	-4584.76
41	27	10.48	0.0	-2.07e-04	-163.27	0.0	-265.13	-33.83	-23.06	0.0	0.0	10.48
		-87.65	-19.60	-3.65e-06	0.0	85.0	-359.42	-197.10	-23.06	0.0	-19.60	-87.65
41	28	10.48	93.56	1.22e-04	-163.27	0.0	-265.13	-33.83	110.08	0.0	0.0	10.48
		-87.65	0.0	9.24e-06	0.0	85.0	-359.42	-197.10	110.08	0.0	93.56	-87.65
41	30	-49.82	0.0	8.88e-04	-163.27	0.0	-265.13	-2480.66	-26.93	0.0	0.0	-49.82
		-2227.51	-22.89	-5.67e-06	0.0	85.0	-359.42	-2643.94	-26.93	0.0	-22.89	-2227.51
41	31	-70.41	0.0	7.11e-04	-163.27	0.0	-265.13	-3316.29	-251.24	0.0	0.0	-70.41
		-2958.29	-213.53	-2.79e-05	0.0	85.0	-359.42	-3479.57	-251.24	0.0	-213.53	-2958.29

41	35	-110.49	0.0	1.33e-03	-163.27	0.0	-265.13	-4942.51	-297.92	0.0	0.0	-110.49
		-4380.49	-253.20	-3.36e-05	0.0	85.0	-359.42	-5105.79	-297.92	0.0	-253.20	-4380.49
41	36	-110.49	0.0	1.66e-03	-163.27	0.0	-265.13	-4942.51	-164.77	0.0	0.0	-110.49
		-4380.49	-140.04	-2.07e-05	0.0	85.0	-359.42	-5105.79	-164.77	0.0	-140.04	-4380.49
41	57	0.0	0.0	1.29e-04	-181.42	0.0	-172.26	-580.80	-85.08	0.0	0.0	0.0
		-570.71	-72.31	-1.15e-04	0.0	85.0	-277.02	-762.22	-85.08	0.0	-72.31	-570.71
41	58	0.0	0.0	1.28e-04	-181.42	0.0	-172.26	-580.80	-147.72	0.0	0.0	0.0
		-570.71	-125.55	6.67e-05	0.0	85.0	-277.02	-762.22	-147.72	0.0	-125.55	-570.71
41	59	0.0	162.74	7.31e-05	-181.42	0.0	-416.92	-439.53	191.48	0.0	0.0	0.0
		-450.64	0.0	-6.62e-05	0.0	85.0	-521.68	-620.94	191.48	0.0	162.74	-450.64
41	81	0.0	0.0	1.07e-04	-181.42	0.0	-264.12	-527.76	-10.56	0.0	0.0	0.0
		-525.63	-8.98	-2.32e-05	0.0	85.0	-368.88	-709.18	-10.56	0.0	-8.98	-525.63
41	89	0.0	0.0	1.11e-04	-181.42	0.0	-251.19	-535.23	-17.37	0.0	0.0	0.0
		-531.98	-14.77	-3.67e-05	0.0	85.0	-355.95	-716.64	-17.37	0.0	-14.77	-531.98
41	90	0.0	0.0	1.10e-04	-181.42	0.0	-251.19	-535.23	-36.98	0.0	0.0	0.0
		-531.98	-31.43	2.00e-05	0.0	85.0	-355.95	-716.64	-36.98	0.0	-31.43	-531.98
41	91	0.0	68.62	9.09e-05	-181.42	0.0	-337.99	-485.10	80.74	0.0	0.0	0.0
		-489.38	0.0	-1.96e-05	0.0	85.0	-442.75	-666.52	80.74	0.0	68.62	-489.38
41	92	0.0	51.96	9.06e-05	-181.42	0.0	-337.99	-485.10	61.13	0.0	0.0	0.0
		-489.38	0.0	3.72e-05	0.0	85.0	-442.75	-666.52	61.13	0.0	51.96	-489.38
41	115	6.99	0.0	-9.77e-05	-181.42	0.0	-294.59	-226.62	-6.62	0.0	0.0	6.99
		-262.71	-5.63	-2.34e-06	0.0	85.0	-399.35	-408.03	-6.62	0.0	-5.63	-262.71
41	116	6.99	69.81	1.21e-04	-181.42	0.0	-294.59	-226.62	82.14	0.0	0.0	6.99
		-262.71	0.0	6.25e-06	0.0	85.0	-399.35	-408.03	82.14	0.0	69.81	-262.71
41	118	-33.21	0.0	6.32e-04	-181.42	0.0	-294.59	-1857.84	-9.20	0.0	0.0	-33.21
		-1689.28	-7.82	-3.69e-06	0.0	85.0	-399.35	-2039.26	-9.20	0.0	-7.82	-1689.28
41	119	-46.94	0.0	5.14e-04	-181.42	0.0	-294.59	-2414.93	-158.74	0.0	0.0	-46.94
		-2176.47	-134.91	-1.85e-05	0.0	85.0	-399.35	-2596.34	-158.74	0.0	-134.91	-2176.47
41	123	-73.66	0.0	9.27e-04	-181.42	0.0	-294.59	-3499.07	-189.86	0.0	0.0	-73.66
		-3124.60	-161.36	-2.23e-05	0.0	85.0	-399.35	-3680.49	-189.86	0.0	-161.36	-3124.60
41	124	-73.66	0.0	1.15e-03	-181.42	0.0	-294.59	-3499.07	-101.10	0.0	0.0	-73.66
		-3124.60	-85.92	-1.37e-05	0.0	85.0	-399.35	-3680.49	-101.10	0.0	-85.92	-3124.60
41	137	0.0	0.0	1.61e-05	-181.42	0.0	-294.59	-510.16	-15.10	0.0	0.0	0.0
		-510.68	-12.84	-3.35e-06	0.0	85.0	-399.35	-691.58	-15.10	0.0	-12.84	-510.68
41	138	0.0	50.03	1.92e-04	-181.42	0.0	-294.59	-510.16	58.86	0.0	0.0	0.0
		-510.68	0.0	3.81e-06	0.0	85.0	-399.35	-691.58	58.86	0.0	50.03	-510.68
41	139	-10.69	0.0	2.36e-04	-181.42	0.0	-294.59	-943.82	-2.40	0.0	0.0	-10.69
		-889.93	-2.04	-2.41e-06	0.0	85.0	-399.35	-1125.24	-2.40	0.0	-2.04	-889.93
41	140	6.74	31.61	1.59e-05	-181.42	0.0	-294.59	-236.63	37.20	0.0	0.0	6.74
		-271.46	0.0	1.90e-06	0.0	85.0	-399.35	-418.04	37.20	0.0	31.61	-271.46
41	144	0.0	18.60	1.01e-04	-181.42	0.0	-294.59	-510.16	21.88	0.0	0.0	0.0
		-510.68	0.0	0.0	0.0	85.0	-399.35	-691.58	21.88	0.0	18.60	-510.68
46	4	-188.66	-51.86	-1.46e-04	-384.84	0.0	-1995.74	-596.59	-9.94	2.39	-51.86	-188.66
		-1274.91	-65.54	-2.59e-05	0.0	137.7	-2211.39	-981.44	-9.94	2.39	-65.54	-1274.91
46	8	5095.36	65.86	-2.31e-04	-384.84	0.0	1.050e+04	3723.46	115.94	3.49	-93.76	234.14
		234.14	-93.76	-3.58e-05	0.0	137.7	1.028e+04	3338.62	115.94	3.49	65.86	5095.36
46	11	8334.63	230.33	5.78e-04	-384.84	0.0	1.803e+04	5425.25	142.57	-3.75	34.04	1130.54
		1130.54	34.04	5.66e-05	0.0	137.7	1.781e+04	5040.40	142.57	-3.75	230.33	8334.63
46	28	-224.09	-50.80	-1.47e-04	-266.43	0.0	-2029.23	-536.35	-7.91	2.48	-50.80	-224.09
		-1145.89	-61.70	-2.84e-05	0.0	137.7	-2178.53	-802.78	-7.91	2.48	-61.70	-1145.89
46	32	5224.38	69.70	-2.34e-04	-266.43	0.0	1.047e+04	3783.70	117.96	3.58	-92.70	198.71
		198.71	-92.70	-3.83e-05	0.0	137.7	1.032e+04	3517.27	117.96	3.58	69.70	5224.38
46	35	8463.65	234.17	5.78e-04	-266.43	0.0	1.800e+04	5485.49	144.60	-3.66	35.10	1095.12
		1095.12	35.10	5.42e-05	0.0	137.7	1.785e+04	5219.06	144.60	-3.66	234.17	8463.65
46	50	190.20	17.54	3.92e-05	-296.03	0.0	992.45	83.22	12.34	-0.28	0.55	174.29
		85.09	0.55	1.85e-04	0.0	137.7	826.56	-212.82	12.34	-0.28	17.54	85.09
46	51	2.83	-5.84	-3.70e-05	-296.03	0.0	-825.00	-384.42	-22.47	-0.17	-5.84	2.83
		-730.18	-36.77	-1.73e-04	0.0	137.7	-990.88	-680.45	-22.47	-0.17	-36.77	-730.18
46	65	104.61	268.09	1.14e-05	-296.03	0.0	310.31	-107.37	207.13	-0.58	-17.07	104.61
		-246.98	-17.07	-5.44e-04	0.0	137.7	144.42	-403.41	207.13	-0.58	268.09	-246.98
46	68	72.51	11.78	1.05e-05	-296.03	0.0	-142.86	-193.83	-217.25	0.13	11.78	72.51
		-398.11	-287.32	5.57e-04	0.0	137.7	-308.74	-489.86	-217.25	0.13	-287.32	-398.11
46	82	118.87	3.12	1.46e-05	-296.03	0.0	405.59	-67.96	3.49	-0.25	-1.69	118.87
		-178.47	-1.69	6.27e-05	0.0	137.7	239.71	-363.99	3.49	-0.25	3.12	-178.47
46	83	58.26	-3.60	-1.24e-05	-296.03	0.0	-238.14	-233.24	-13.61	-0.20	-3.60	58.26
		-466.63	-22.34	-5.03e-05	0.0	137.7	-404.03	-529.28	-13.61	-0.20	-22.34	-466.63
46	97	94.63	78.59	1.04e-05	-296.03	0.0	165.88	-134.23	62.30	-0.34	-7.17	94.63
		-293.95	-7.17	-1.66e-04	0.0	137.7	-0.01	-430.27	62.30	-0.34	78.59	-293.95
46	100	82.50	1.88	1.03e-05	-296.03	0.0	1.58	-166.97	-72.42	-0.11	1.88	82.50
		-351.15	-97.81	1.78e-04	0.0	137.7	-164.31	-463.00	-72.42	-0.11	-97.81	-351.15
46	116	-113.97	-34.93	-9.73e-05	-296.03	0.0	-1319.33	-417.81	-7.30	1.56	-34.93	-113.97
		-892.95	-44.98	-1.65e-05	0.0	137.7	-1485.22	-713.84	-7.30	1.56	-44.98	-892.95
46	120	3353.90	42.62	-1.53e-04	-296.03	0.0	7011.04	2462.23	76.62	2.30	-62.86	167.90
		167.90	-62.86	-2.30e-05	0.0	137.7	6845.15	2166.19	76.62	2.30	42.62	3353.90
46	123	5513.41	152.27	3.86e-04	-296.03	0.0	1.203e+04	3596.75	94.37	-2.53	22.34	765.50
		765.50	22.34	3.86e-05	0.0	137.7	1.187e+04	3300.72	94.37	-2.53	152.27	5513.41
46	137	215.90	24.89	5.81e-05	-296.03	0.0	332.00	-231.88	-11.68	-1.67	24.89	215.90

		-307.11	8.81	2.42e-05	0.0	137.7	166.11	-527.92	-11.68	-1.67	8.81	-307.11
46	138	-38.78	-28.03	-5.59e-05	-296.03	0.0	-164.55	-69.32	1.56	1.22	-30.18	-38.78
		-337.98	-30.18	-1.18e-05	0.0	137.7	-330.43	-365.35	1.56	1.22	-28.03	-337.98
46	139	521.50	10.67	4.70e-05	-296.03	0.0	1773.92	407.25	10.52	-0.31	-3.81	164.61
		164.61	-3.81	7.75e-06	0.0	137.7	1608.04	111.22	10.52	-0.31	10.67	521.50
46	140	40.59	-1.91	-2.78e-05	-296.03	0.0	-982.40	-502.48	-14.89	-0.17	-1.91	40.59
		-854.95	-22.40	6.93e-06	0.0	137.7	-1148.28	-798.51	-14.89	-0.17	-22.40	-854.95
46	144	88.56	-2.64	1.03e-05	-296.03	0.0	83.73	-150.60	-5.06	-0.23	-2.64	88.56
		-322.55	-9.61	6.31e-06	0.0	137.7	-82.16	-446.63	-5.06	-0.23	-9.61	-322.55

Trave	M3 mx/mn	M2 mx/mn	D 2 / D 3	Q 2 / Q 3	N	V 2	V 3	T
	-1.657e+04	-7206.38	-0.02	-2.729e+04	-6185.21	-1.448e+04	-6979.13	-27.11
	8784.93	3151.53	0.02	827.38	2.081e+04	1.448e+04	6979.13	27.11

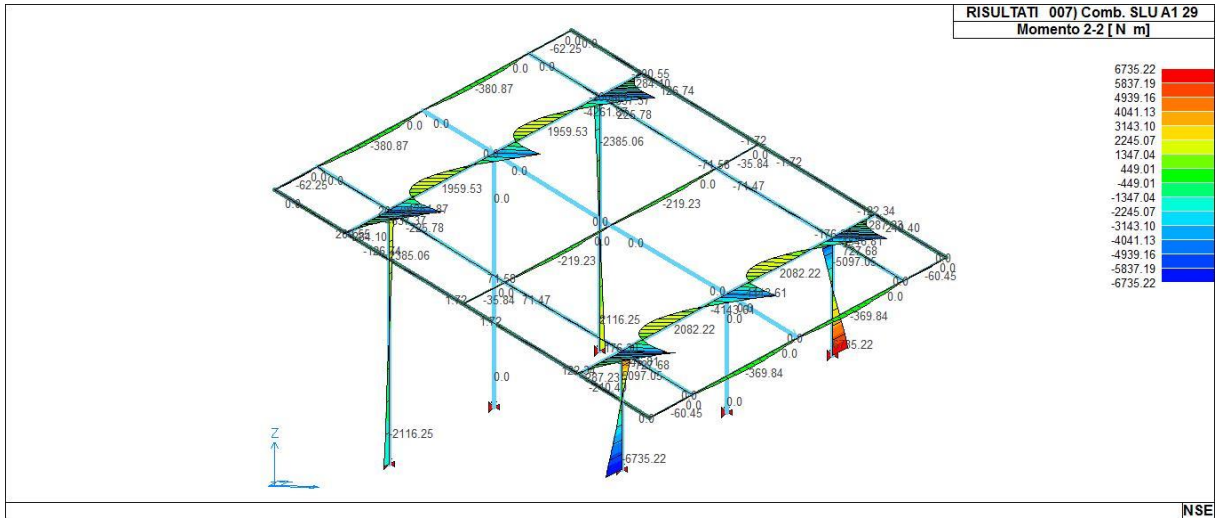

43_RIS_M2_007_Comb. SLU A1 29

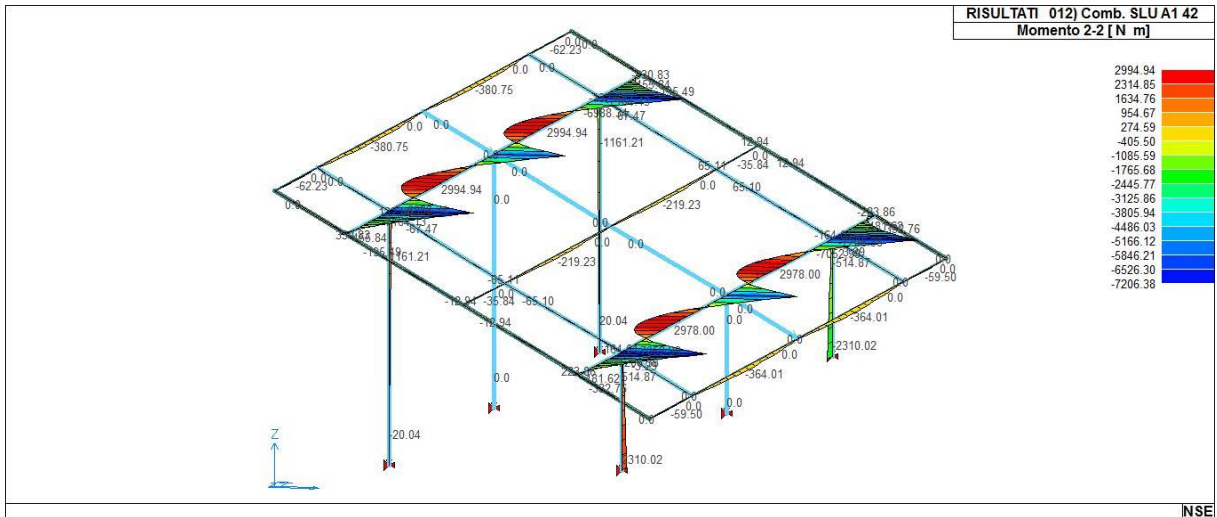

43_RIS_M2_012_Comb. SLU A1 42

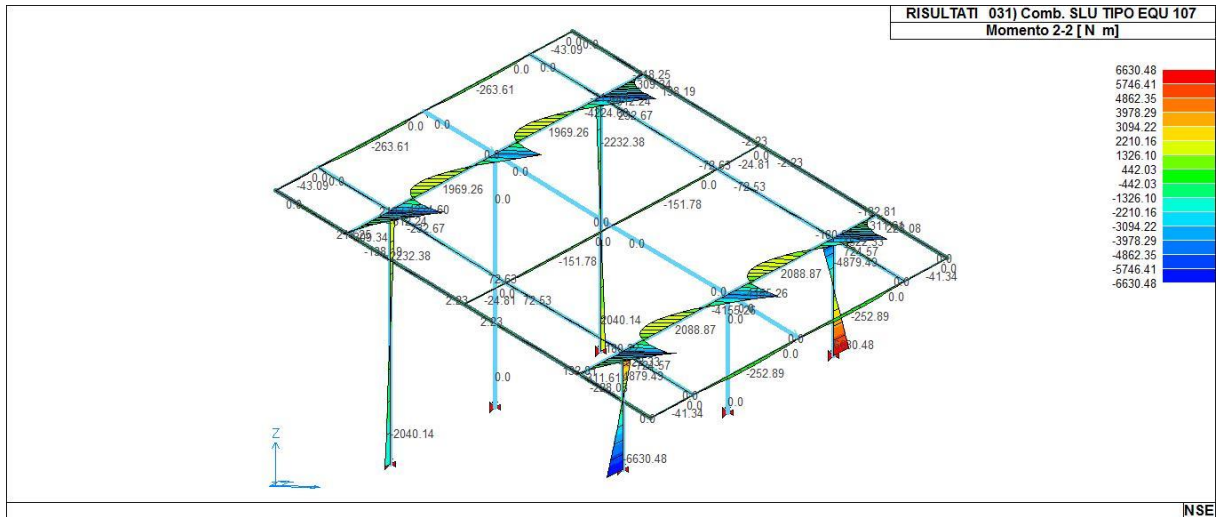

43_RIS_M2_031_Comb. SLU TIPO EQU 107

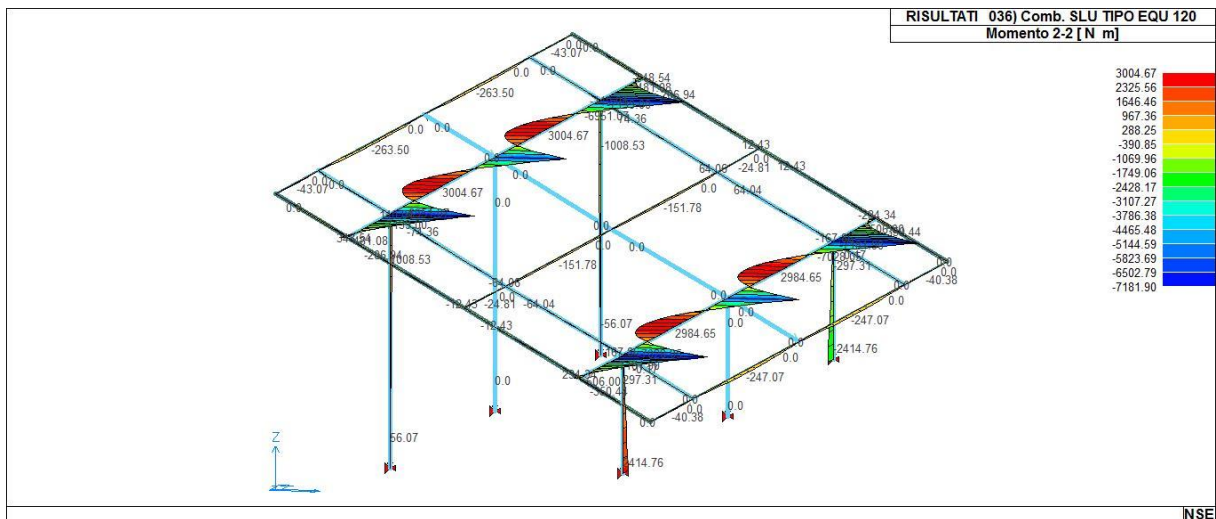

43_RIS_M2_036_Comb. SLU TIPO EQU 120

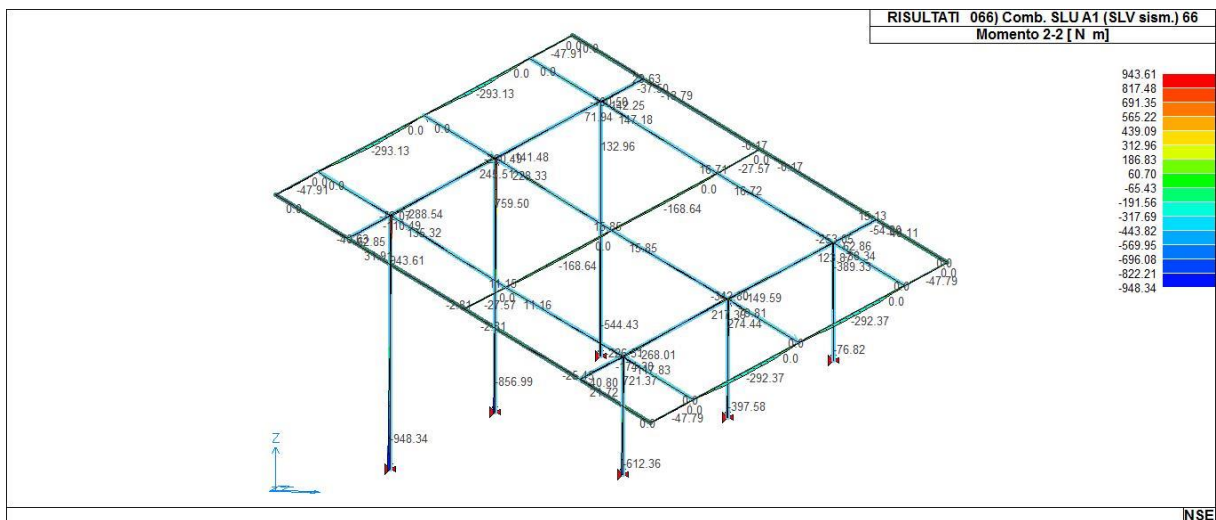

43_RIS_M2_066_Comb. SLU A1 (SLV sism.) 66

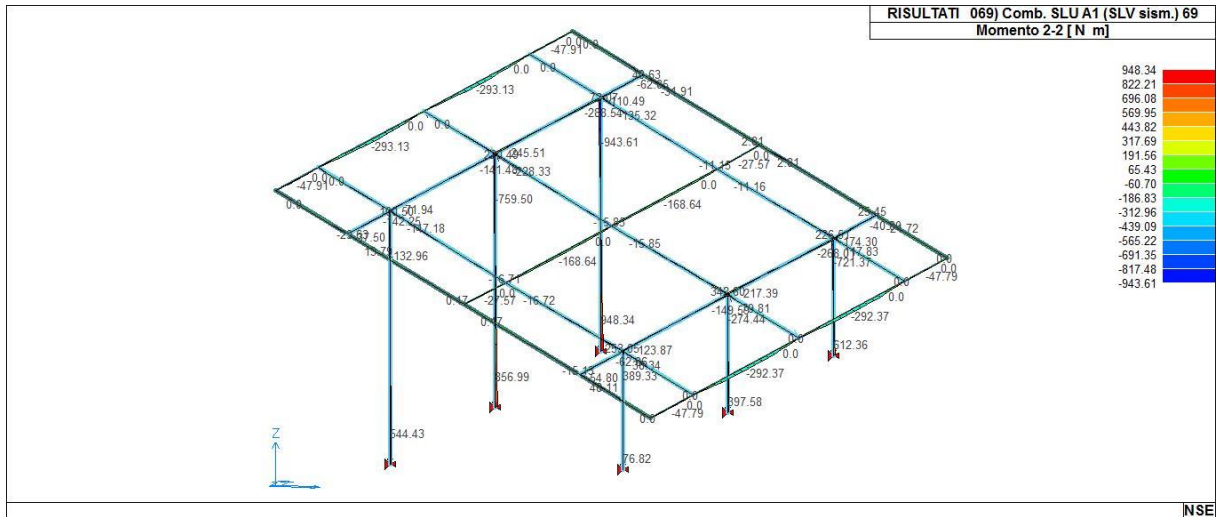

43_RIS_M2_069_Comb. SLU A1 (SLV sism.) 69

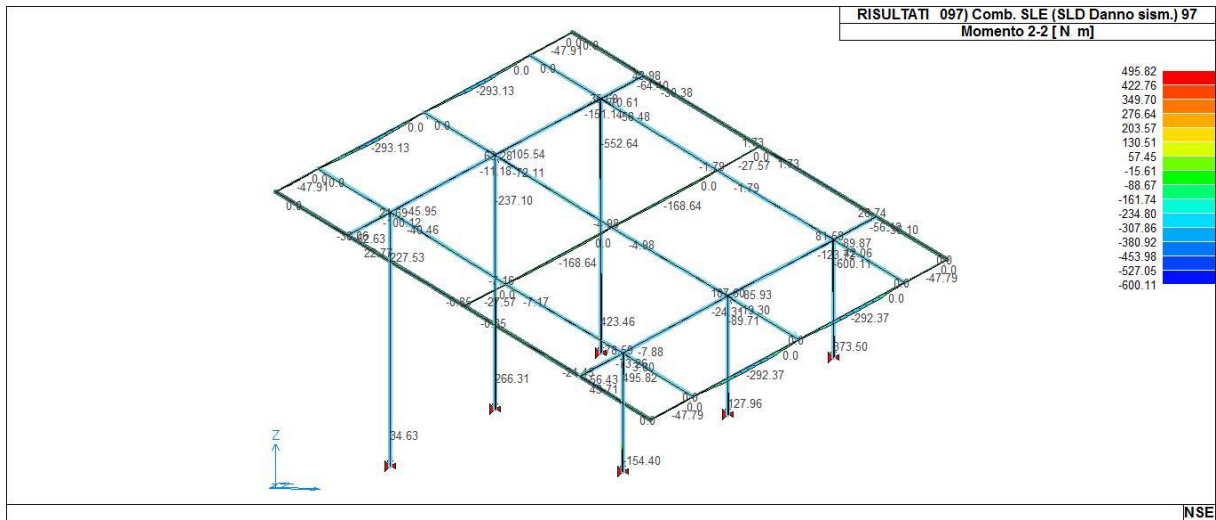

43_RIS_M2_097_Comb. SLE (SLD Danno sism.) 97

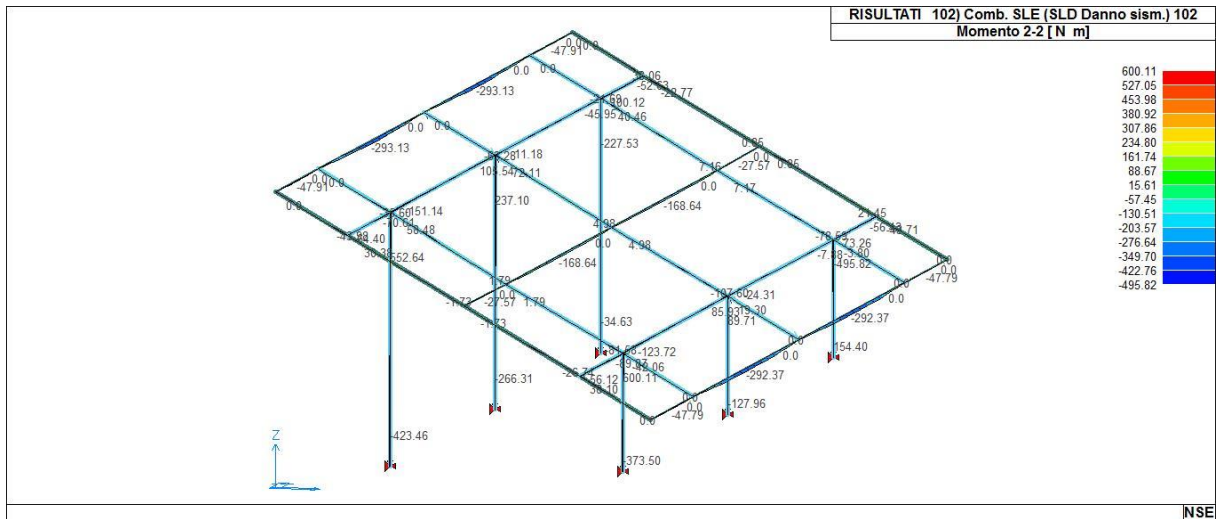

43_RIS_M2_102_Comb. SLE (SLD Danno sism.) 102

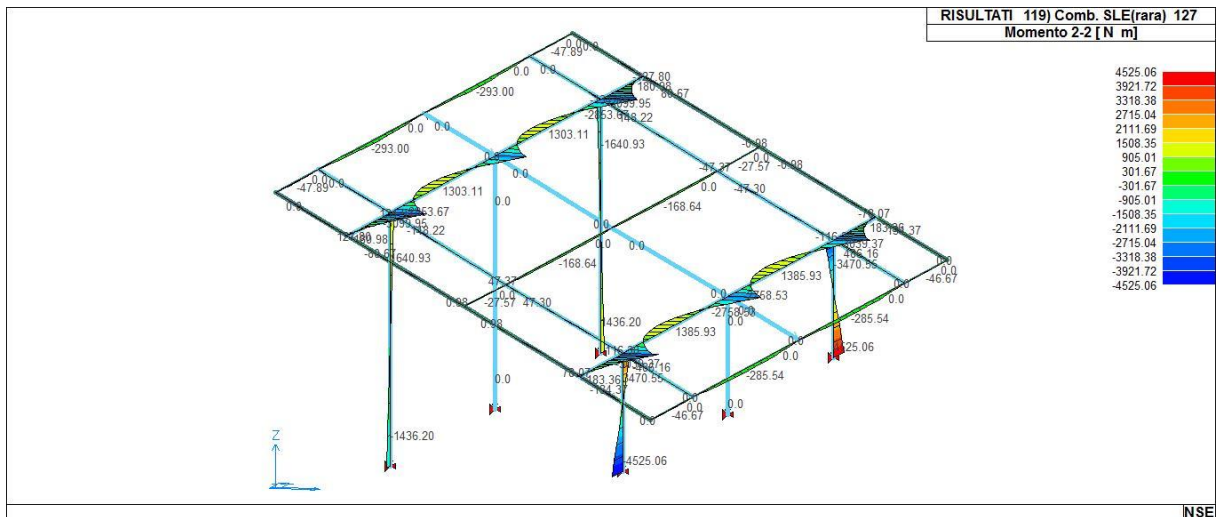

43_RIS_M2_119_Comb. SLE(rara) 127

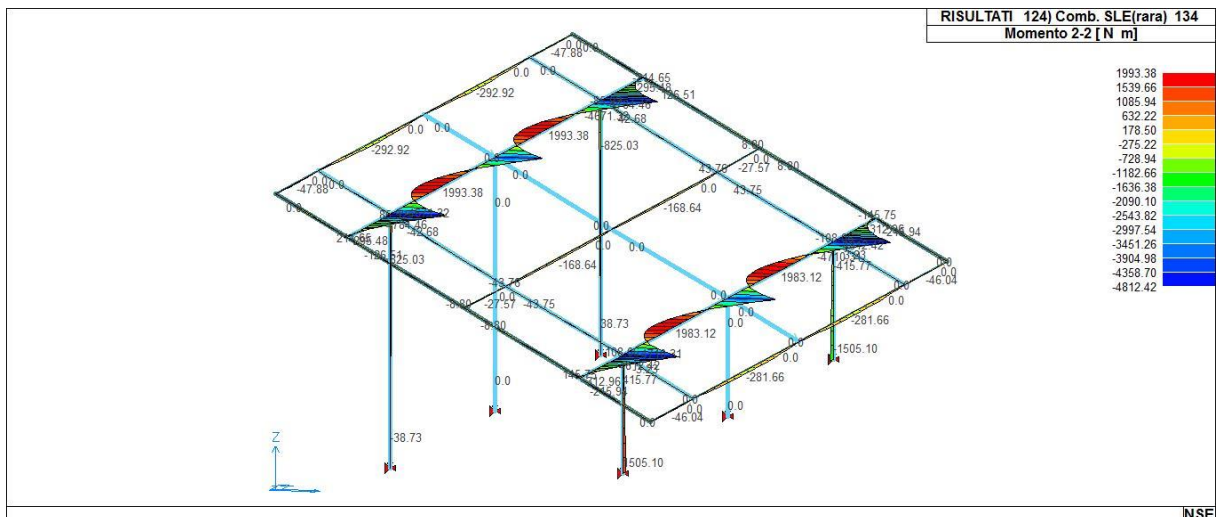

43_RIS_M2_124_Comb. SLE(rara) 134

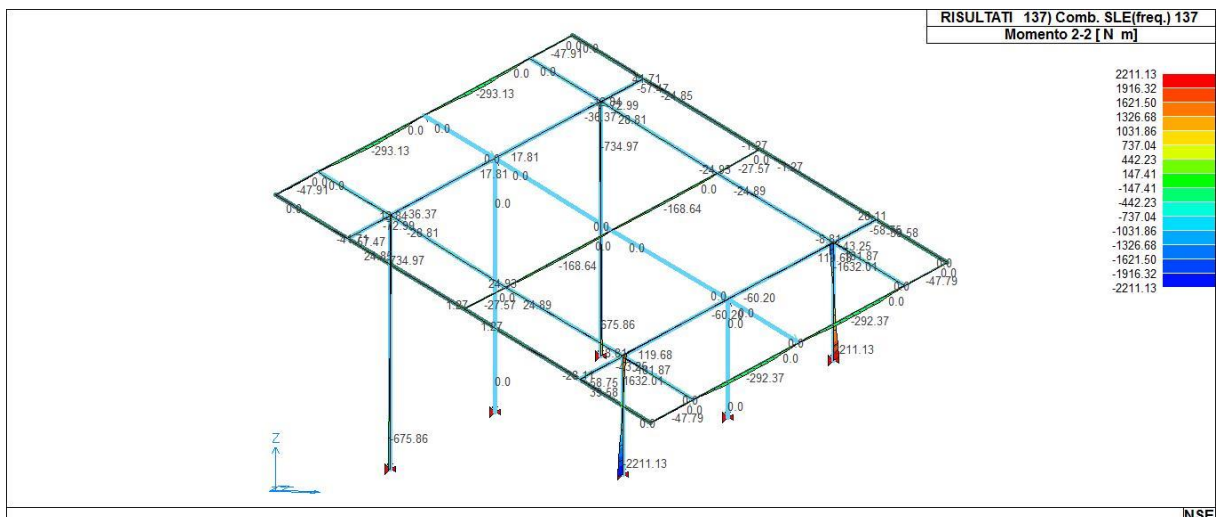

43_RIS_M2_137_Comb. SLE(freq.) 137

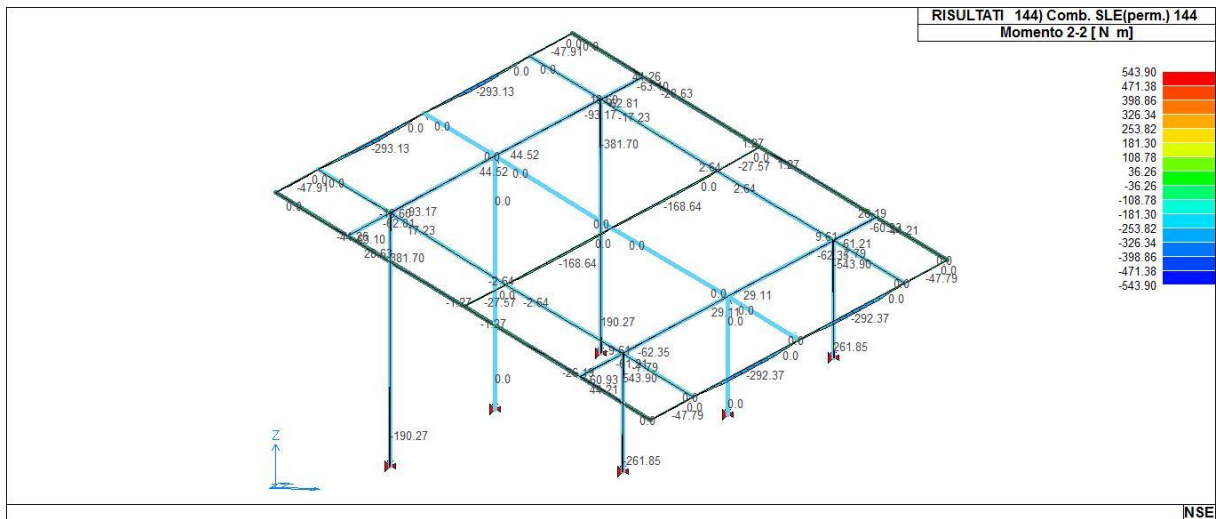

43_RIS_M2_144_Comb. SLE(perm.) 144

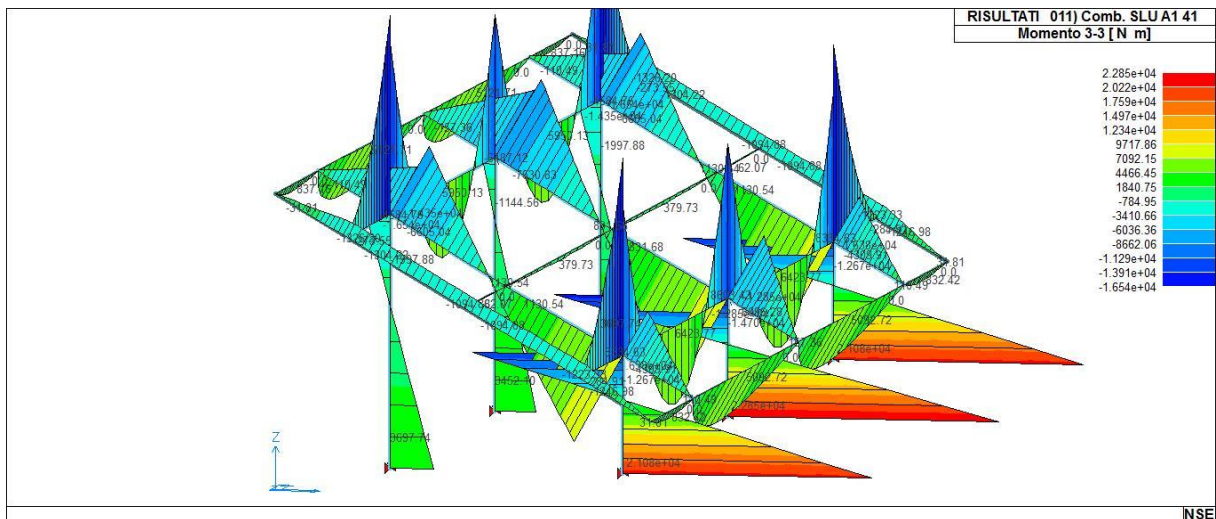

43_RIS_M3_011_Comb. SLU A1 41

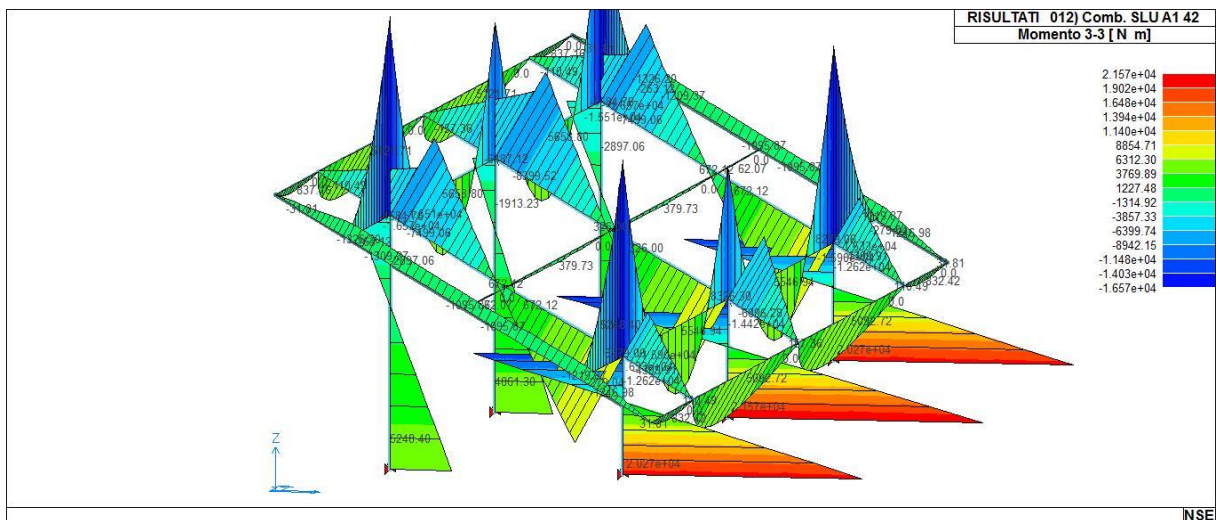

43_RIS_M3_012_Comb. SLU A1 42

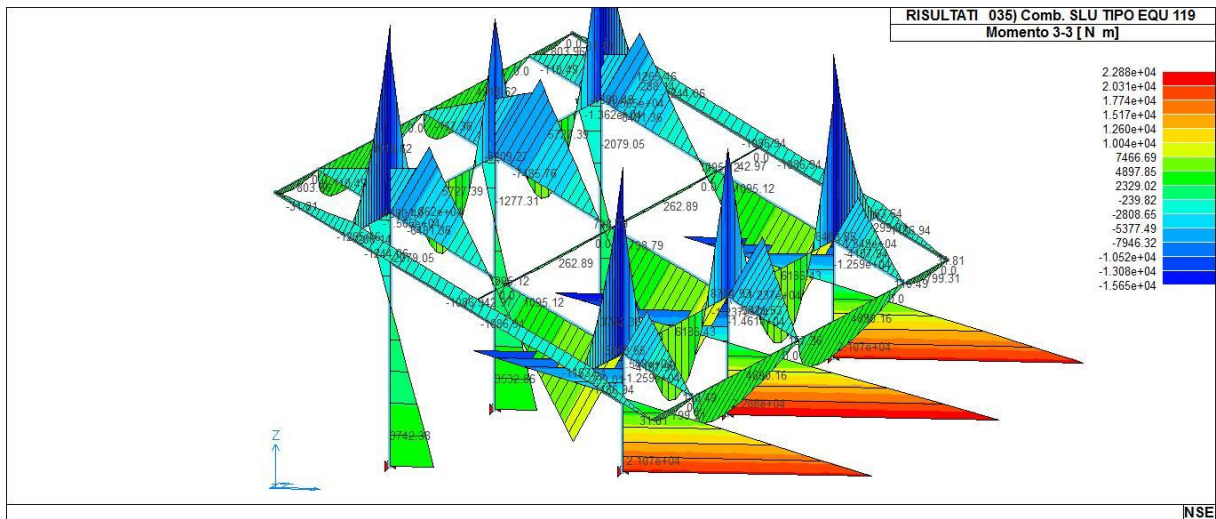

43_RIS_M3_035_Comb. SLU TIPO EQU 119

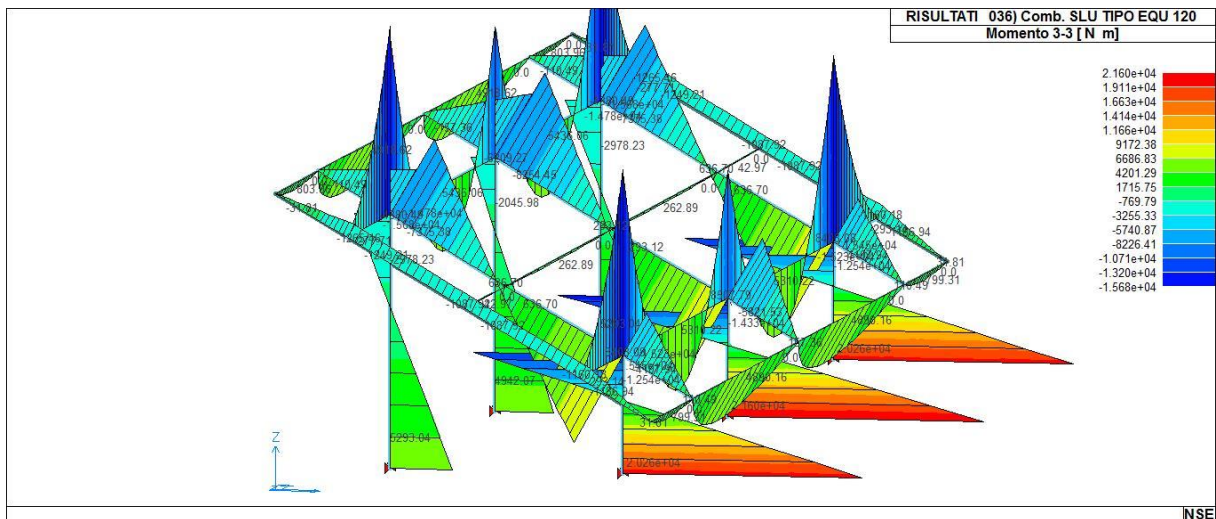

43_RIS_M3_036_Comb. SLU TIPO EQU 120

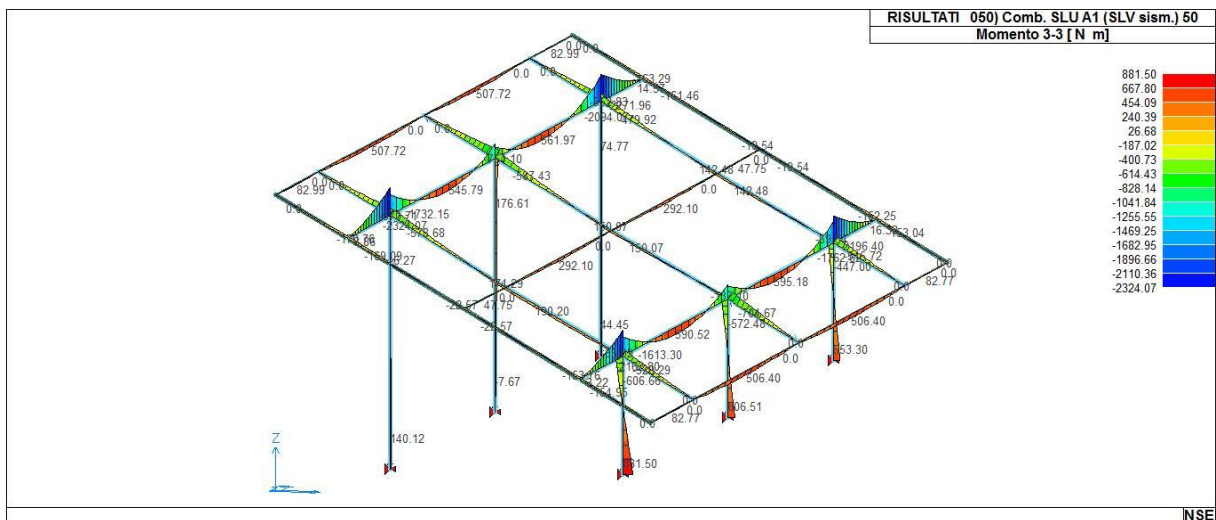

43_RIS_M3_050_Comb. SLU A1 (SLV sism.) 50

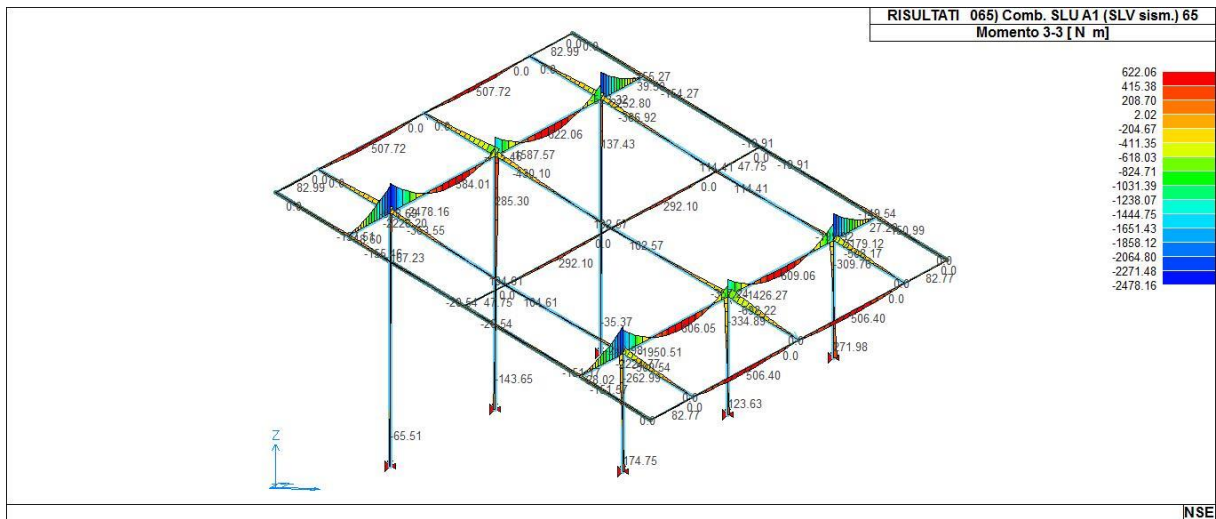

43_RIS_M3_065_Comb. SLU A1 (SLV sism.) 65

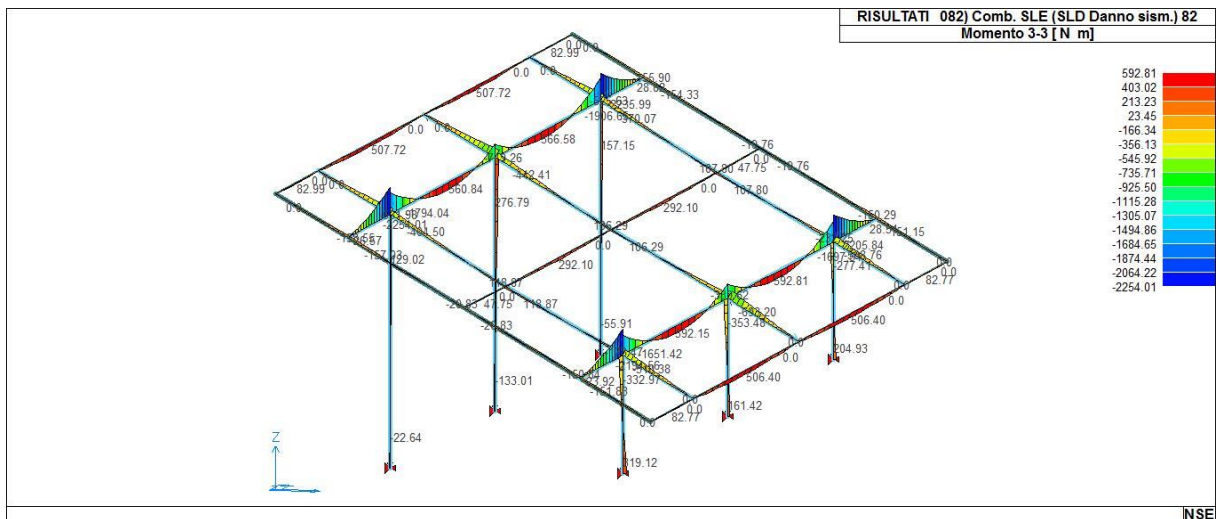

43_RIS_M3_082_Comb. SLE (SLD Danno sism.) 82

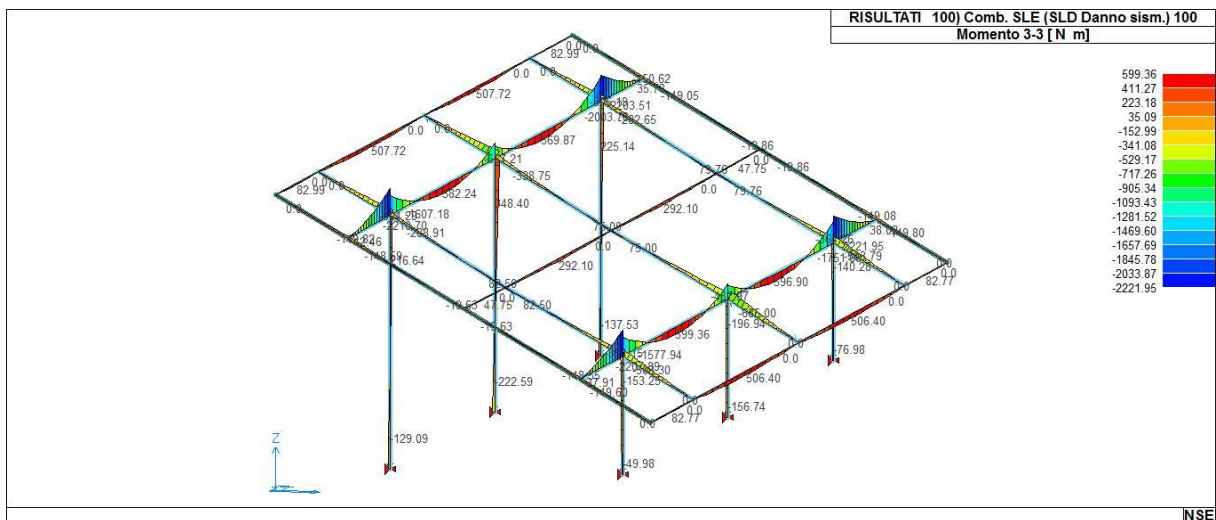

43_RIS_M3_100_Comb. SLE (SLD Danno sism.) 100

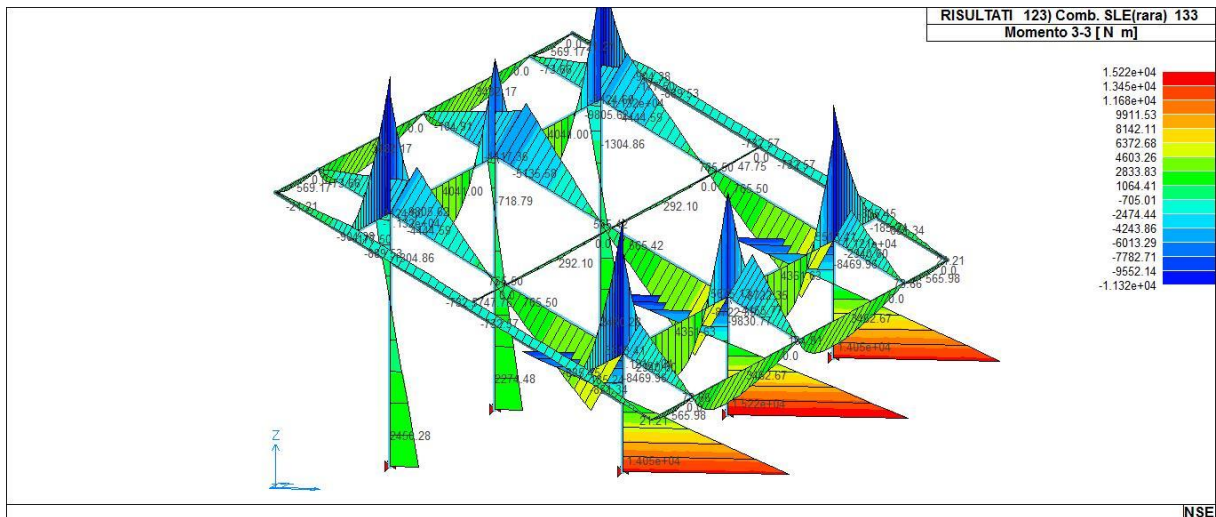

43_RIS_M3_123_Comb. SLE(rara) 133

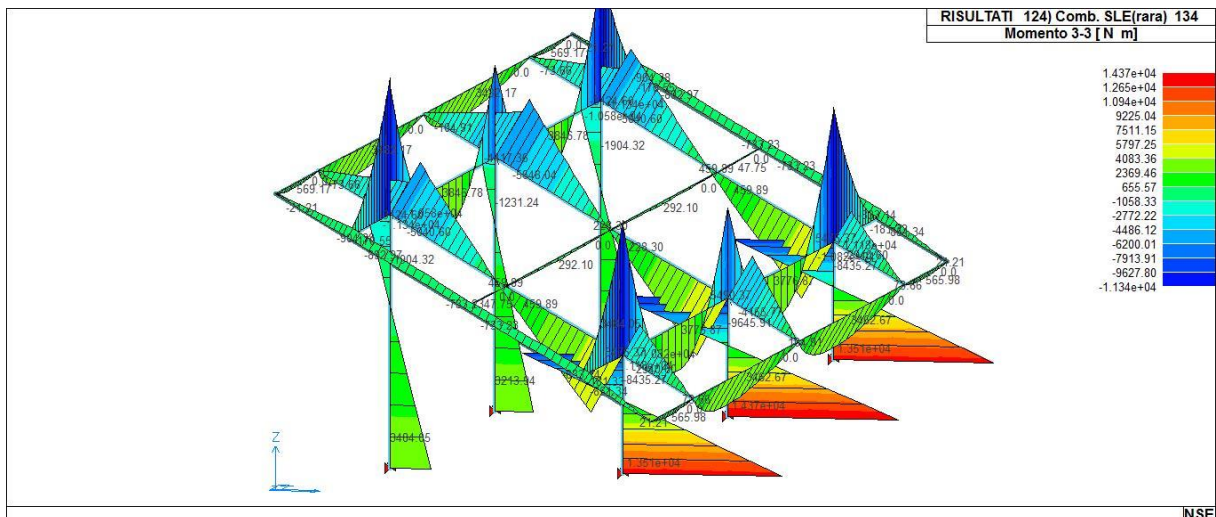

43_RIS_M3_124_Comb. SLE(rara) 134

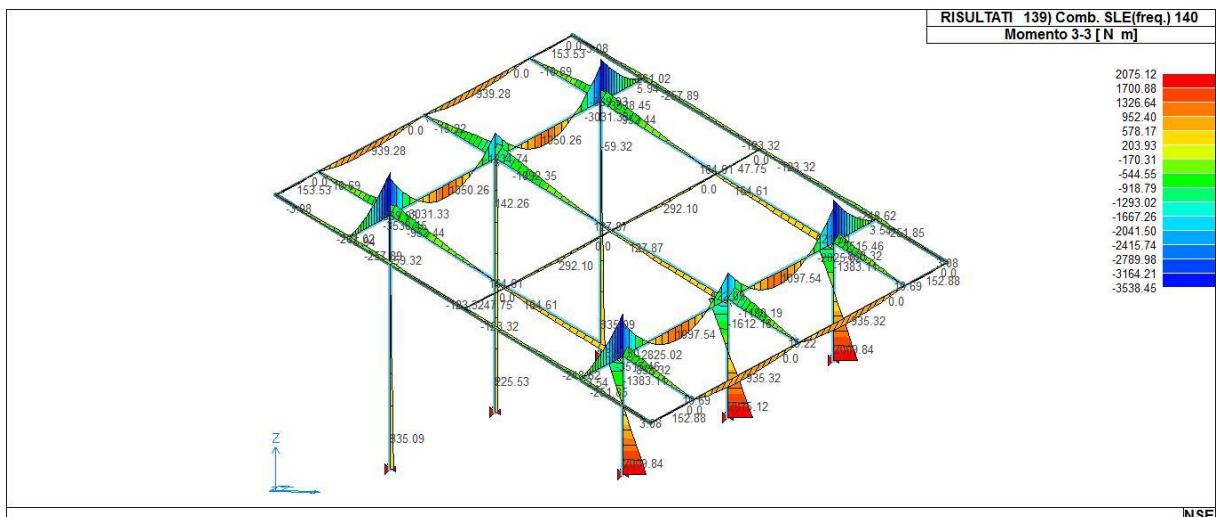

43_RIS_M3_139_Comb. SLE(freq.) 140

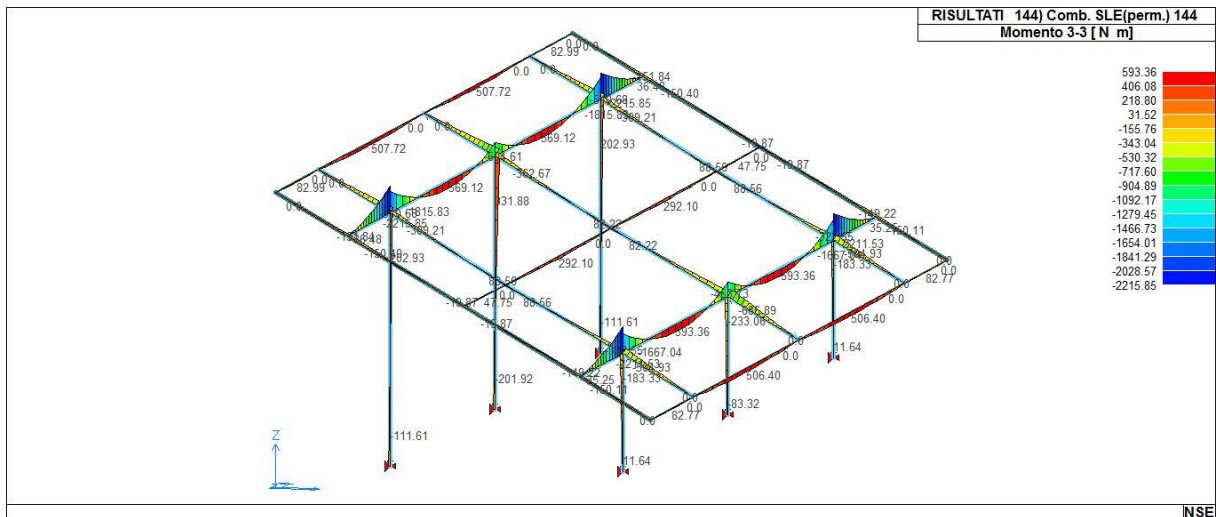

43_RIS_M3_144_Comb. SLE(perm.) 144

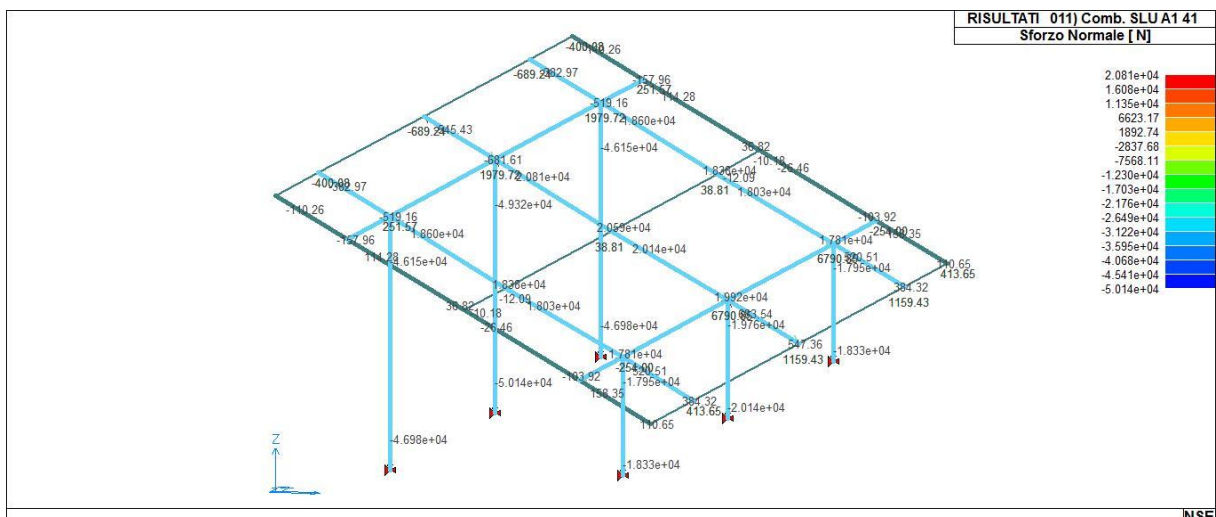

43_RIS_N_011_Comb. SLU A1 41

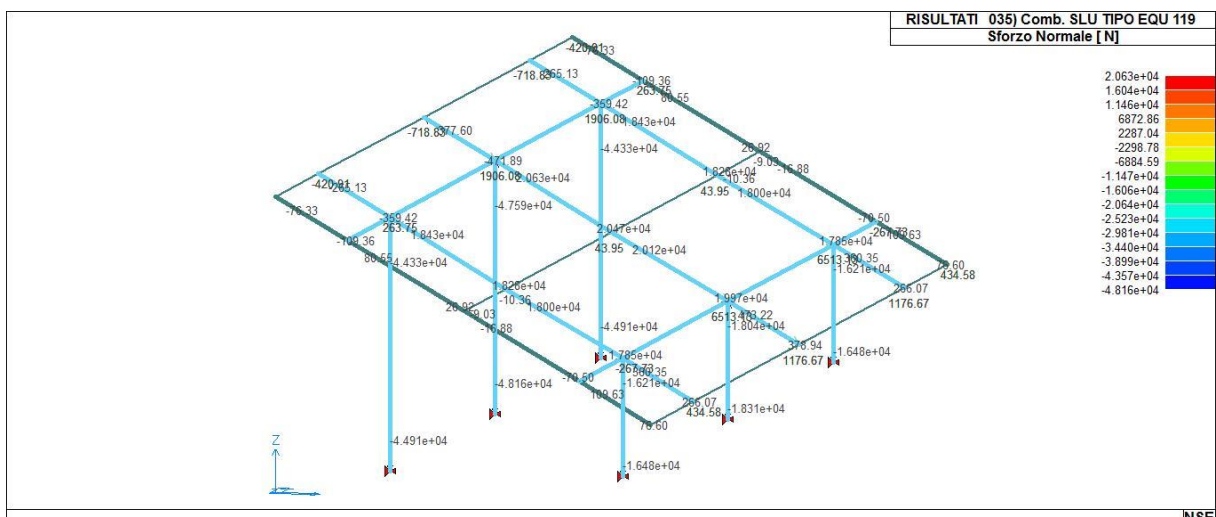

43_RIS_N_035_Comb. SLU TIPO EQU 119

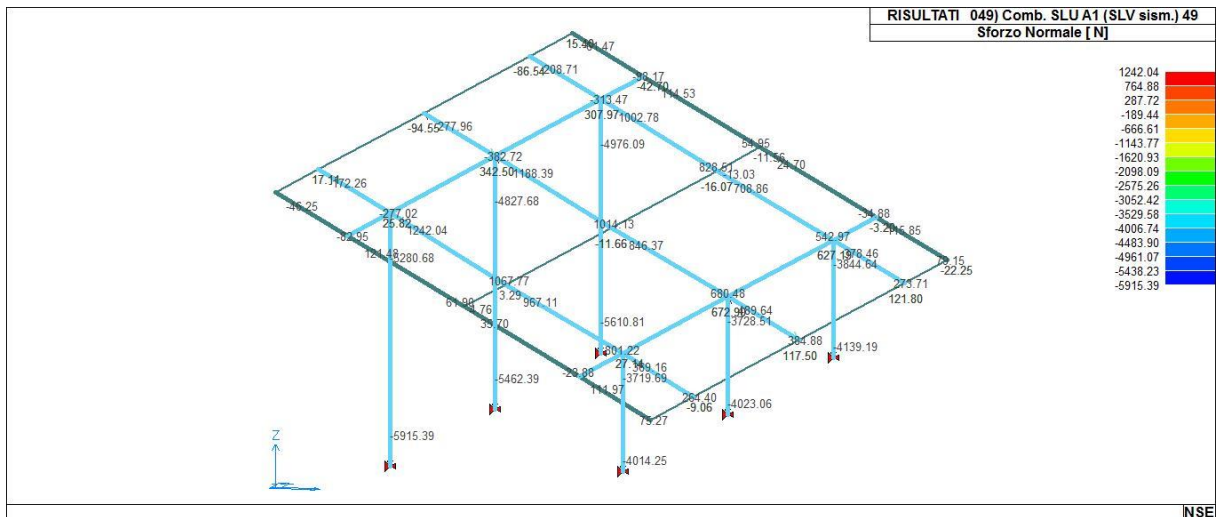

43_RIS_N_049_Comb. SLU A1 (SLV sism.) 49

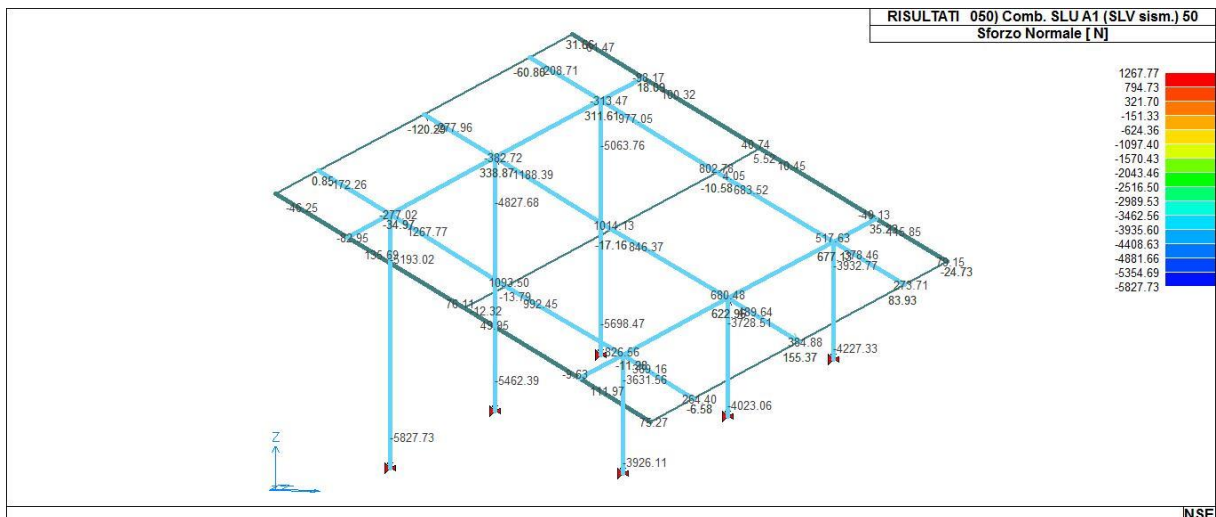

43_RIS_N_050_Comb. SLU A1 (SLV sism.) 50

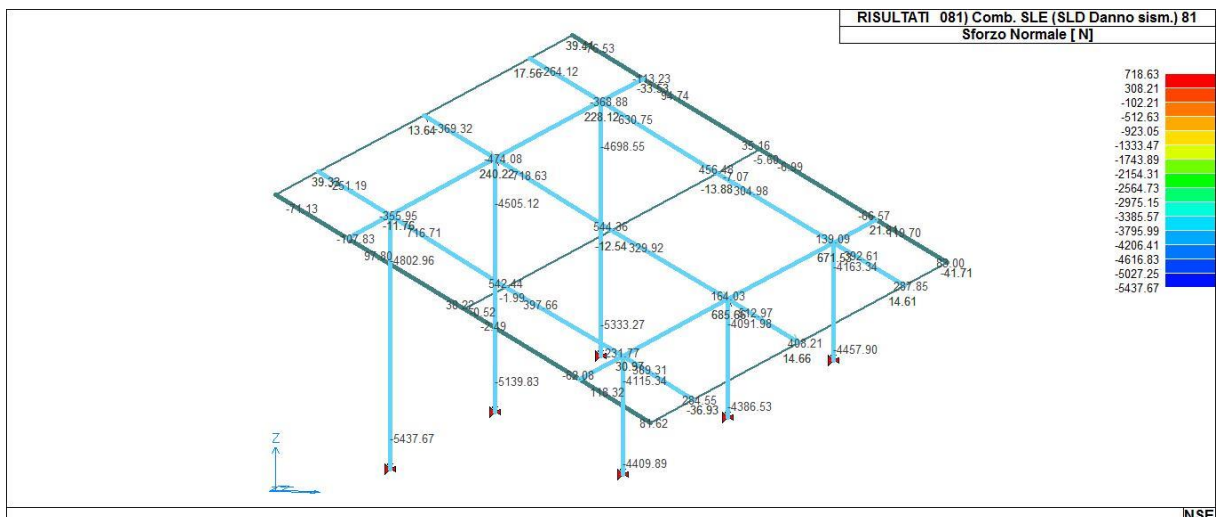

43_RIS_N_081_Comb. SLE (SLD Danno sism.) 81

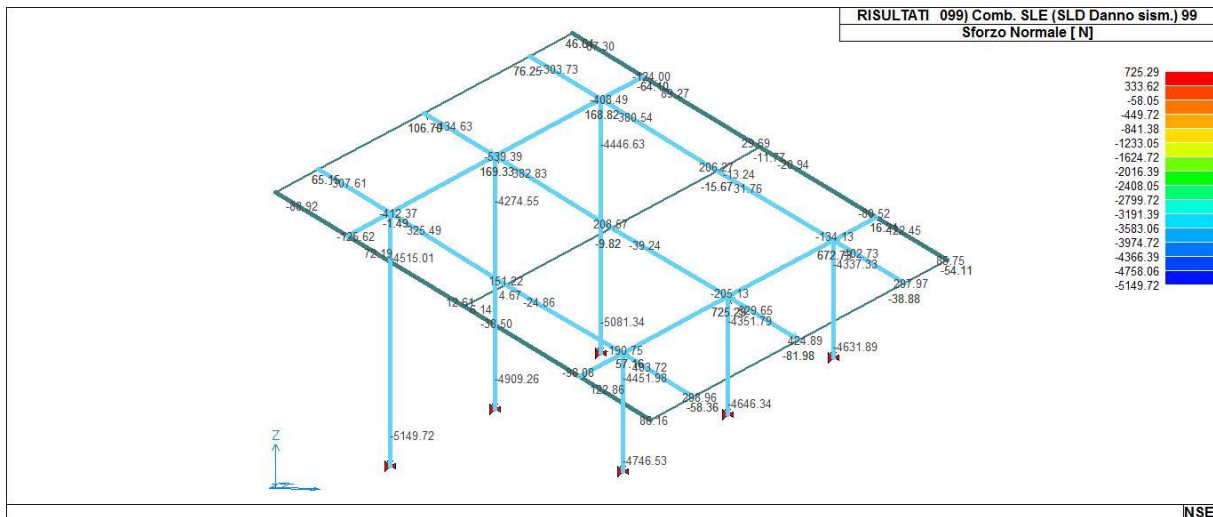

43_RIS_N_099_Comb. SLE (SLD Danno sism.) 99

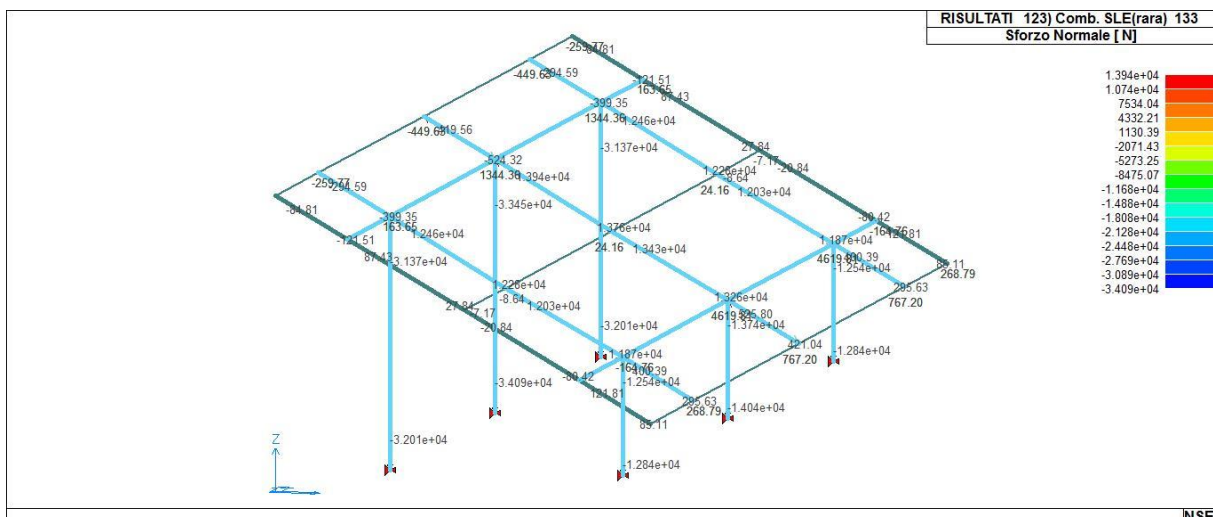

43_RIS_N_123_Comb. SLE(rara) 133

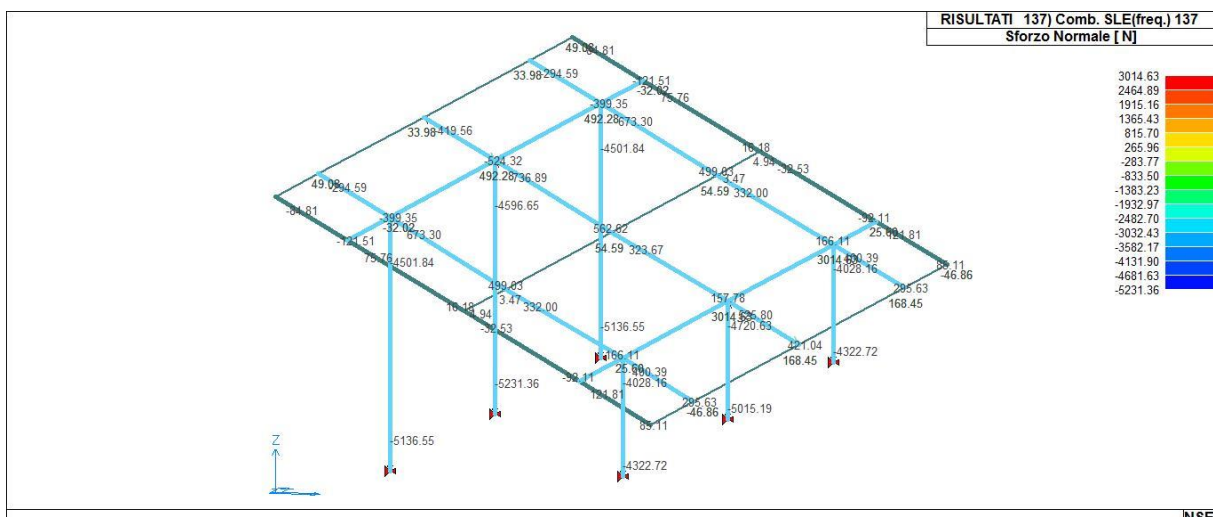

43_RIS_N_137_Comb. SLE(freq.) 137

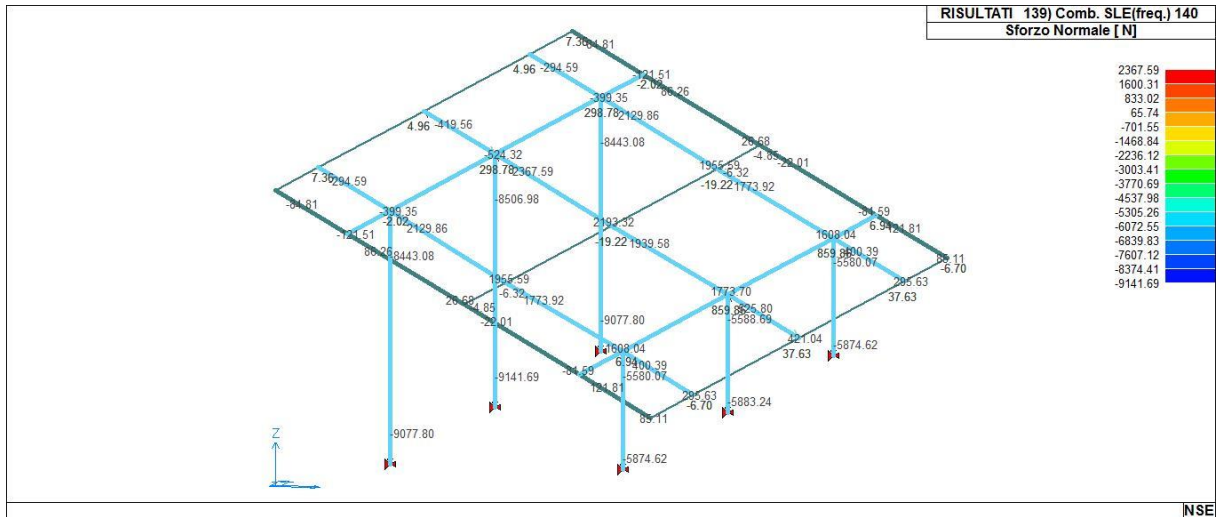

43_RIS_N_139_Comb. SLE(freq.) 140

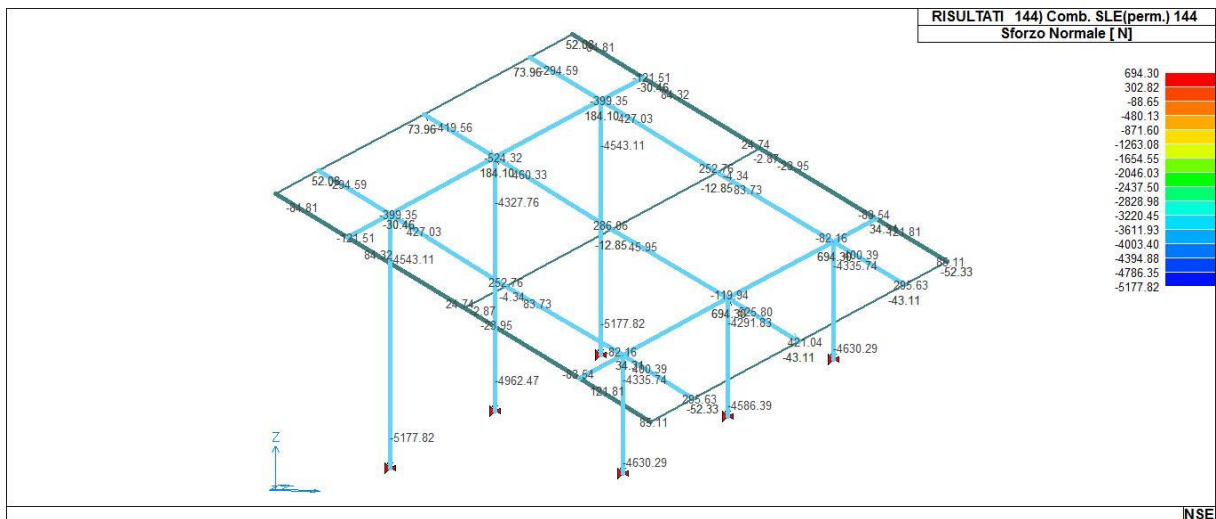

43_RIS_N_144_Comb. SLE(perm.) 144

VERIFICHE PER ELEMENTI IN ACCIAIO

LEGENDA TABELLA VERIFICHE PER ELEMENTI IN ACCIAIO

Il programma consente la verifica dei seguenti tipi di elementi:

1. aste
2. travi
3. pilastri

L'esito delle verifiche è espresso con un codice come di seguito indicato

- Ok:** verifica con esito positivo
- NV:** verifica con esito negativo
- Nr:** verifica non richiesta.

Per comodità gli elementi vengono raggruppati in tabelle in relazione al tipo.

Ai fini delle verifiche (come da D.M. 17 Gennaio 2018 e circolare 21 Gennaio 2019 n.7) i tipi elementi differiscono per i seguenti aspetti:

Verifica		Aste	Travi	Pilastr
4.2.3.1	Classificazione	X	X	X
4.2.4.1.2.1	Trazione	X	X	X
4.2.4.1.2.2	Compressione	X	X	X
4.2.4.1.2.4	Taglio		X	X
4.2.4.1.2.5	Torsione		X	X
	Flessione, taglio e forza assiale		X	X
4.2.4.1.3.1	Aste compresse	X	X	X
4.2.4.1.3.2	Instabilità flessio-torsionale		X	X
4.2.4.1.3.3	Membrature inflesse e compresse		X	X

Ai fini delle verifiche per strutture dissipative (come da D.M. 17 Gennaio 2018 e 2018 e circolare 21 Gennaio 2019 n.7) per strutture intelaiate e a controventi concentrici) si considerano le verifiche del capitolo 4 con azioni amplificate e le verifiche del capitolo 7:

Verifica		Travi	Pilastr
4.2.4.1.2.1	Trazione	X	X
4.2.4.1.2.2	Compressione	X	X
4.2.4.1.2.4	Taglio	X	X
4.2.4.1.2.5	Torsione	X	X
	Flessione, taglio e forza assiale	X	X
4.2.4.1.3.1	Aste compresse	X	X
4.2.4.1.3.2	Instabilità flessio-torsionale		X
7.5.3	Sfruttamento per momento	X	
7.5.4	Sfruttamento per sforzo normale	X	
7.5.5	Sfruttamento per taglio da capacità flessionale	X	
7.5.9	Sfruttamento per taglio amplificato		X

Le verifiche sono riportate in tabelle con il significato sotto indicato; le verifiche sono espresse dal rapporto tra l'azione di progetto e la capacità ultima, pertanto la verifica ha esito positivo per rapporti non superiori all'unità.

Asta	Trave	Pilastr	numero dell'elemento
Stato			codice di verifica per resistenza, stabilità, svergolamento
Note			sezione e materiali adottati per l'elemento
V N			(ASTE) verifica come da par. 4.2.4.1.2 per punto (4.2.6) e (4.2.10)

V V/T						(TRAVI E PILASTRI) verifica di resistenza come da par. 4.2.4.1.2 per azioni taglio-torsione (4.2.16 e 4.2.28)
V N/M						(TRAVI E PILASTRI) verifica di resistenza come da par. 4.2.4.1.2 per azioni composte (4.2.33) con riduzione per taglio (4.2.40) ove richiesto
N	M3	M2	V2	V3	T	sollecitazioni di interesse per la verifica
V stab						(ASTE) verifica come da par. 4.2.4.1.3.1 per punto (4.2.41)
V stab						(TRAVI E PILASTRI) verifica come da par. 4.2.4.1.3 per punti (C4.2.32) o (C4.2.36) (membrature inflesse e compresse senza/con presenza di instabilità flesso-torsionale)
BetaxL		B22xL		B33xL		lunghezze libere di inflessione (se indicato riferiti al piano di normale 22 o 33 rispettivamente)
Snellezza						snellezza massima
Classe						classe del profilo
Chi mn						coefficiente di riduzione (della capacità) per la modalità di instabilità pertinente
Rif. cmb						combinazioni in cui si sono rispettivamente attinti i valori di verifica più elevati
V flst						(TRAVI E PILASTRI) verifica di stabilità come da par. 4.2.4.1.3.2 per punto (4.2.48)
B1-1 x L						Beta1-1 x L: interasse tra i ritegni torsionali
Chi LT						coefficiente di riduzione (della capacità) per la modalità di instabilità flesso-torsionale
Snell adim						Valore della snellezza adimensionale, utilizzato per il controllo previsto al par. 7.5.5
v.Omeg						Valore del rapporto capacità/domanda per l'azione di interesse (momento per travi e azione assiale per aste) utilizzato per l'amplificazione delle azioni
f.Om. N						Fattore di amplificazione delle azioni assiali per travi e colonne (prodotto di 1.1 x Omega x gamma rd materiale); utilizzato come specificato al par. 7.5.5
f.Om. T						Fattore di amplificazione delle azioni (assiali, flettenti e taglianti) per colonne (prodotto di 1.1 x Omega x gamma rd materiale); utilizzato come specificato al par. 7.5.4
V.7.5.4 M Ed						Verifica come prevista al punto 7.5.4 e valore dell'azione flettente
V.7.5.5 N Ed						Verifica come prevista al punto 7.5.5 e valore dell'azione assiale
V.7.5.6 V Ed,G V Ed,M						Verifica come prevista al punto 7.5.6 e valore dei tagli dovuti ai carichi e alla capacità
V.7.5.10				V Ed		Verifica come prevista al punto 7.5.10 e valore dell'azione di taglio
sovr. Xi (Xf, Yi, Yf)						Valore della sovrarresistenza come prevista al par. 7.5.4.2 (i valori non sono normalizzati pertanto saranno maggiori uguali a gamma rd in base alla classe di duttilità)

Nel caso in cui λ_s sia minore di 0.2, oppure nel caso in cui la sollecitazione di calcolo NEd sia inferiore a 0.04 Ncr, gli effetti legati ai fenomeni di instabilità sono trascurati, come da paragrafo 4.2.4.1.3.1

	Asta	Stato	Note	V N N	N	V stab N	N	Cl. cm	Beta x L	Snell. LambDaS	Chi mn	v.Omeg	
1	ok	s=3,m=12	2.39e-03	-689.2			1	447.2	336.7	3.88	0.06	0.0	11,0
2	ok	s=3,m=12	2.39e-03	-689.2			1	447.2	336.7	3.88	0.06	0.0	11,0
3	ok	s=3,m=12	4.02e-03	1159.4			1	447.2	336.7	3.88	0.06	0.0	11,0
4	ok	s=3,m=12	4.02e-03	1159.4			1	447.2	336.7	3.88	0.06	0.0	11,0
5	ok	s=3,m=12	1.44e-03	413.6			1	180.8	136.1	1.57	0.29	0.0	11,0
6	ok	s=3,m=12	1.44e-03	413.6			1	180.8	136.1	1.57	0.29	0.0	11,0
7	ok	s=3,m=12	1.39e-03	-400.1			1	180.8	136.1	1.57	0.29	0.0	11,0
8	ok	s=3,m=12	1.39e-03	-400.1			1	180.8	136.1	1.57	0.29	0.0	11,0
9	ok	s=3,m=12	1.43e-04	-41.2			1	180.8	136.1	1.57	0.29	0.0	8,0
10	ok	s=3,m=12	1.43e-04	-41.2			1	180.8	136.1	1.57	0.29	0.0	8,0
11	ok	s=3,m=12	9.06e-04	-261.0			1	447.2	336.7	3.88	0.06	0.0	8,0
12	ok	s=3,m=12	9.06e-04	-261.0			1	447.2	336.7	3.88	0.06	0.0	8,0

Asta	V N	N	V stab	N	Beta x L	Snell. LambDaS	Chi mn	v.Omeg
	-689.24					1.57	0.06	0.0
	4.02e-03	1159.43			447.20	336.74	3.88	0.0

Trave	Stato	Note	V V/T	V N/M	V stab	Cl.LamS 22LamS 33	Snell.	Chi mn	V flstLamS LT	Chi LT	Rif. cmb	
13	ok	s=3,m=12	0.02	0.26		1			0.15	0.2	1.00	12,11,0,11
14	ok	s=3,m=12	2.98e-03	0.22		1			0.20	0.5	0.77	12,11,0,12
15	ok	s=3,m=12	2.96e-03	0.22		1			0.19	0.5	0.77	7,12,0,11
16	ok	s=3,m=12	2.96e-03	0.22		1			0.19	0.5	0.77	7,12,0,11
17	ok	s=3,m=12	0.02	0.27		1			0.16	0.2	0.99	12,11,0,12
18	ok	s=3,m=12	0.02	0.27		1			0.16	0.2	0.99	12,11,0,12
19	ok	s=3,m=12	2.98e-03	0.22		1			0.20	0.5	0.77	12,11,0,12
20	ok	s=3,m=12	0.02	0.26		1			0.15	0.2	1.00	11,11,0,11
21	ok	s=5,m=12	0.04	0.19		1			0.19	0.2	1.00	12,11,0,11
22	ok	s=5,m=12	0.04	0.19		1			0.18	0.2	1.00	12,11,0,11
23	ok	s=5,m=12	0.04	0.12		1			0.09	8.76e-02	1.00	12,11,0,12
24	ok	s=5,m=12	0.05	0.13		1			0.13	8.76e-02	1.00	11,11,0,11
25	ok	s=5,m=12	0.04	0.12		1			0.09	8.76e-02	1.00	11,11,0,12
27	ok	s=5,m=12	0.08	0.68		1			0.36	0.4	1.00	11,12,0,11
28	ok	s=5,m=12	0.09	0.67		1			0.41	0.8	0.86	12,12,0,12
29	ok	s=5,m=12	0.04	0.17		1			0.17	0.2	1.00	12,12,0,12
30	ok	s=5,m=12	0.04	0.18		1			0.18	0.2	1.00	12,12,0,12
31	ok	s=5,m=12	0.04	0.17		1			0.17	0.2	1.00	12,12,0,12
32	ok	s=5,m=12	0.09	0.67		1			0.41	0.8	0.86	12,12,0,12
33	ok	s=5,m=12	0.08	0.68		1			0.36	0.4	1.00	11,12,0,11
34	ok	s=5,m=12	0.08	0.69		1			0.36	0.4	1.00	11,11,0,12
35	ok	s=5,m=12	0.09	0.66		1			0.40	0.8	0.86	12,12,0,12
36	ok	s=5,m=12	0.09	0.66		1			0.40	0.8	0.86	12,12,0,12
37	ok	s=5,m=12	0.08	0.69		1			0.36	0.4	1.00	11,11,0,12
39	ok	s=5,m=12	0.04	0.11		1			0.10	8.88e-02	1.00	11,11,0,12
40	ok	s=5,m=12	0.05	0.14		1			0.14	8.88e-02	1.00	12,12,0,12
41	ok	s=5,m=12	0.04	0.11		1			0.10	8.88e-02	1.00	12,11,0,12
46	ok	s=5,m=12	0.04	0.19		1			0.18	0.2	1.00	12,11,0,11

Trave	V V/T	V N/M	V stab	LamS 22LamS 33	Snell.	Chi mn	V flstLamS LT	Chi LT
	0.09	0.69					0.41	0.80
								0.77

Trave	v.Omeg	f.Om. N	Stato	V N/M	V stab	Rif. cmb	V[7.5.4]	M Ed N m	V[7.5.5]	N Ed N	V[7.5.6]	V Ed,G N	V Ed,M N
13							0.0	0.0	0.0	0.0	0.0	0.0	0.0
14							0.0	0.0	0.0	0.0	0.0	0.0	0.0
15							0.0	0.0	0.0	0.0	0.0	0.0	0.0
16							0.0	0.0	0.0	0.0	0.0	0.0	0.0
17							0.0	0.0	0.0	0.0	0.0	0.0	0.0
18							0.0	0.0	0.0	0.0	0.0	0.0	0.0
19							0.0	0.0	0.0	0.0	0.0	0.0	0.0
20							0.0	0.0	0.0	0.0	0.0	0.0	0.0
21							0.0	0.0	0.0	0.0	0.0	0.0	0.0
22							0.0	0.0	0.0	0.0	0.0	0.0	0.0
23							0.0	0.0	0.0	0.0	0.0	0.0	0.0
24							0.0	0.0	0.0	0.0	0.0	0.0	0.0
25							0.0	0.0	0.0	0.0	0.0	0.0	0.0
27							0.0	0.0	0.0	0.0	0.0	0.0	0.0
28							0.0	0.0	0.0	0.0	0.0	0.0	0.0
29							0.0	0.0	0.0	0.0	0.0	0.0	0.0
30							0.0	0.0	0.0	0.0	0.0	0.0	0.0
31							0.0	0.0	0.0	0.0	0.0	0.0	0.0
32							0.0	0.0	0.0	0.0	0.0	0.0	0.0
33							0.0	0.0	0.0	0.0	0.0	0.0	0.0

34	0.0	0.0	0.0	0.0	0.0	0.0	0.0
35	0.0	0.0	0.0	0.0	0.0	0.0	0.0
36	0.0	0.0	0.0	0.0	0.0	0.0	0.0
37	0.0	0.0	0.0	0.0	0.0	0.0	0.0
39	0.0	0.0	0.0	0.0	0.0	0.0	0.0
40	0.0	0.0	0.0	0.0	0.0	0.0	0.0
41	0.0	0.0	0.0	0.0	0.0	0.0	0.0
46	0.0	0.0	0.0	0.0	0.0	0.0	0.0

Trave v.Omeg	V N/M	V stab	V[7.5.4]	M Ed	V[7.5.5]	N Ed	V[7.5.6]	V Ed,G	V Ed,M
			0.0	0.0	0.0	0.0	0.0	0.0	0.0

Pilas.	Stato	Note	V V/T	V N/M	V stab	CI.LamS 22	LamS 33	Snell.	Chi mn	V flstLamS LT	Chi LT	Rif. cmb		
26	ok	s=5,m=12	0.18	0.68		1				0.46	0.1	1.00	11,11,0,11	
38	ok	s=5,m=12	0.02	0.16	0.31	1	1.7	1.0	146.3	0.26	0.12	0.4	1.00	12,11,11,12
42	ok	s=5,m=12	0.02	0.11	0.28	1	1.7	1.0	146.3	0.26	0.11	0.4	1.00	12,12,12,12
43	ok	s=5,m=12	0.02	0.16	0.31	1	1.7	1.0	146.3	0.26	0.12	0.4	1.00	12,11,11,12
44	ok	s=5,m=12	0.18	0.68		1				0.46	0.1	1.00	11,11,0,11	
45	ok	s=5,m=12	0.21	0.50		1				0.50	0.1	1.00	11,11,0,11	

Pilas.	V V/T	V N/M	V stab	LamS 22	LamS 33	Snell.	Chi mn	V flstLamS LT	Chi LT	
	0.21	0.68	0.31	1.69	1.03	146.32	0.26	0.50	0.37	1.00

Pilas.	f.Om. N	f.Om. T	Stato	V V/T	V N/M	V stab	V flst	Rif. cmbV[7.5.10]	V Ed sovr.	Xi sovr.	Xf sovr.	Yi sovr.	Yf
26	0.0	0.0	ok	0.0	0.0			0,0,0,0	N				
38	0.0	0.0	ok	0.0	0.0			0,0,0,0					
42	0.0	0.0	ok	0.0	0.0			0,0,0,0					
43	0.0	0.0	ok	0.0	0.0			0,0,0,0					
44	0.0	0.0	ok	0.0	0.0			0,0,0,0					
45	0.0	0.0	ok	0.0	0.0			0,0,0,0					

Pilas.	V V/T	V N/M	V stab	V flst	V[7.5.10]	V Ed sovr.	Xi sovr.	Xf sovr.	Yi sovr.	Yf
	0.0	0.0								