

PARTICOLARE COLLEGAMENTO TRACKER

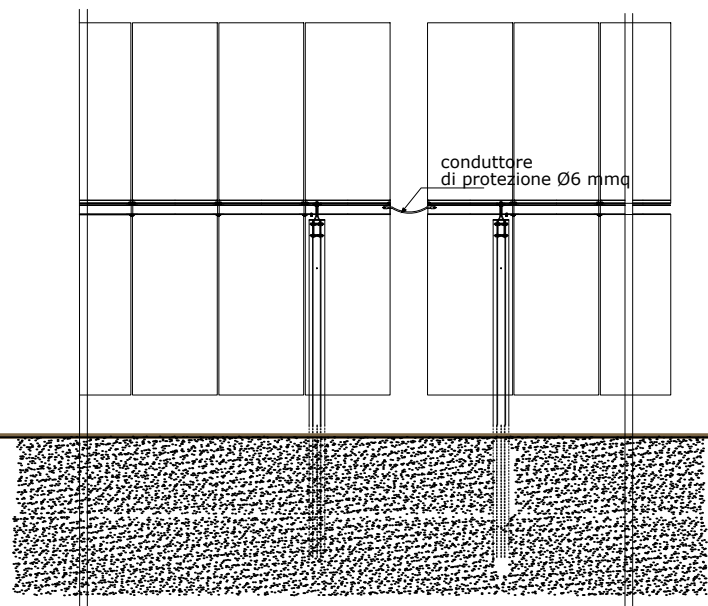

scala 1:100

PARTICOLARE TESTA TRACKER

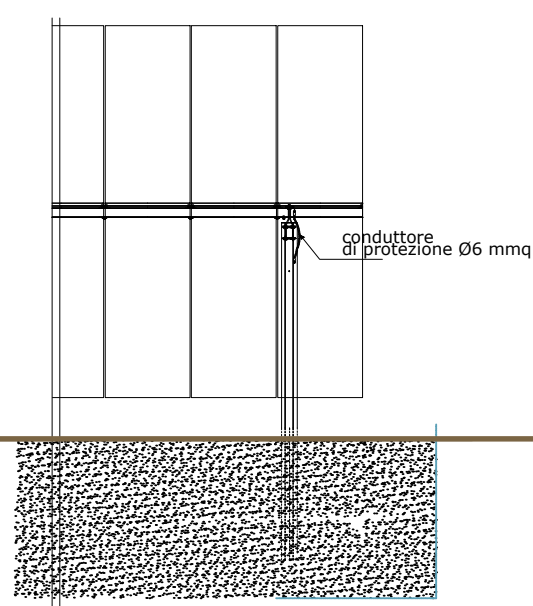

scala 1:100

PARTICOLARE PICCHETTO

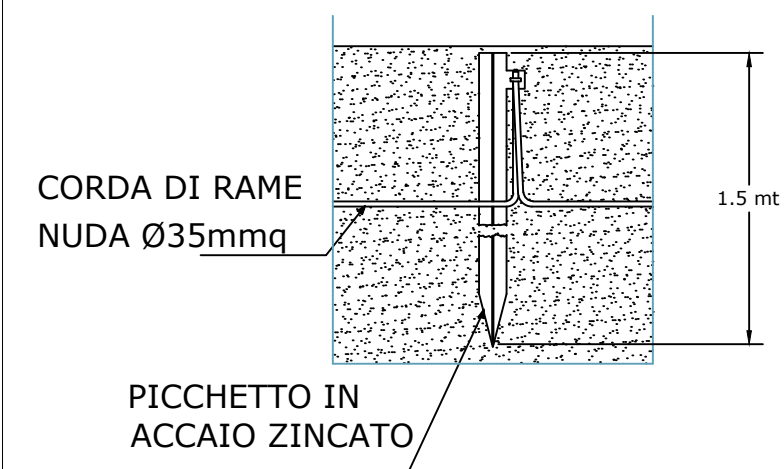

scala 1:100

PARTICOLARE POZZETTO 1

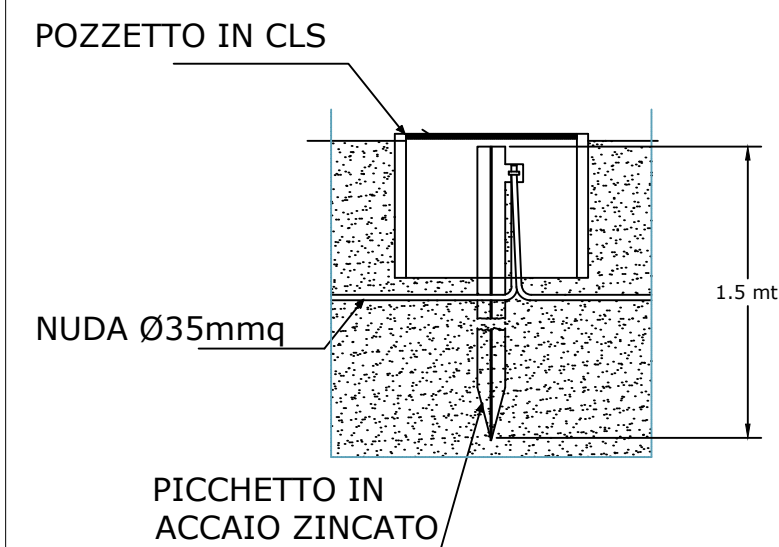





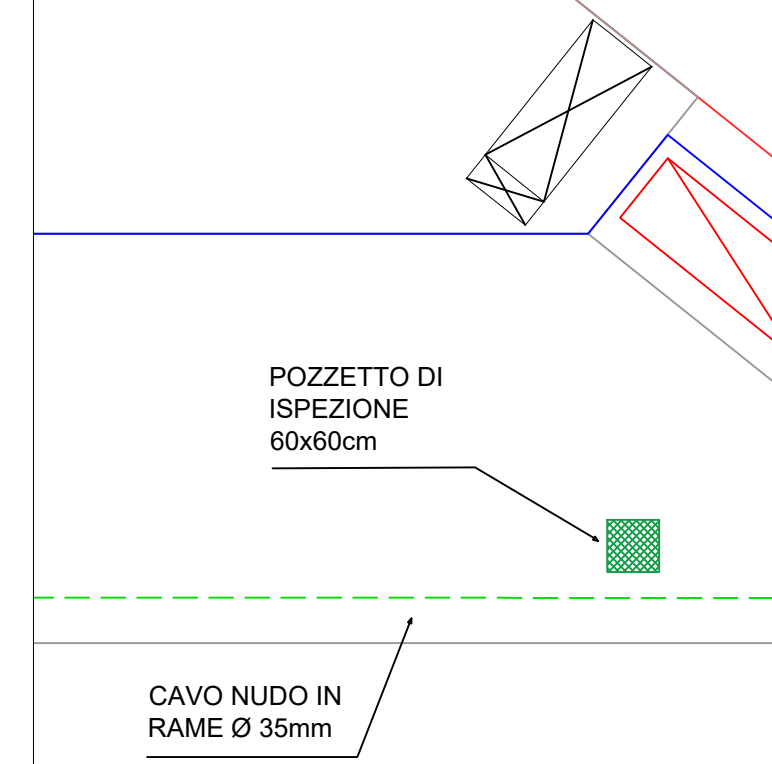





scala 1:100

PARTICOLARE POZZETTO 2



scala 1:250

LEGENDA

-  Cabina di consegna
-  Cabina quadro MT
-  Cabina trasformatori
-  Cabina di raccolta
-  Cabina ausiliari
-  Cavo nudo in rame Ø35mm
-  Pozzetto di messa a terra 60x60cm compreso di dispersore a croce lunghezza 1,50 m
-  Perimetro impianto
-  Recinzione impianto
-  Videosorveglianza

BUILLI 2

BUILLI 1

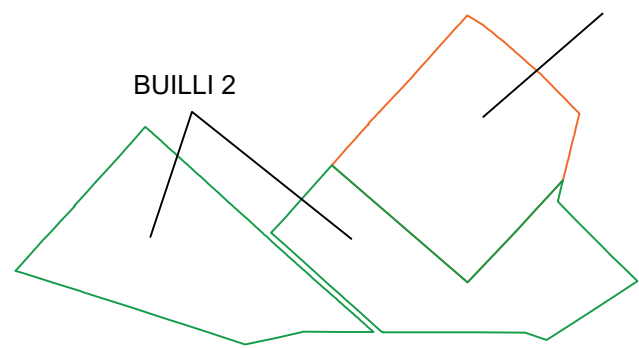

scala 1:2000

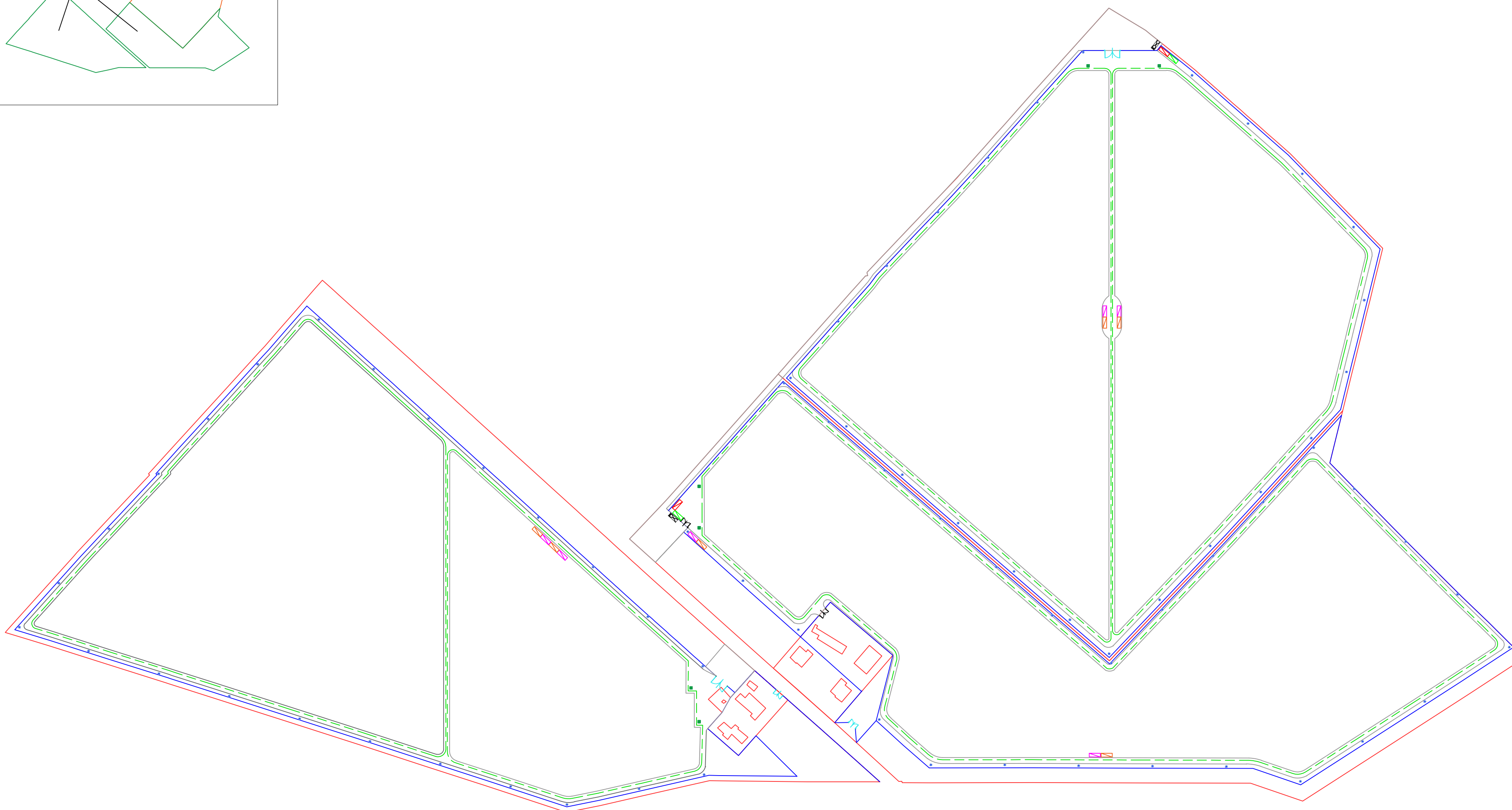
COMUNE DI NARDÒ
 PROVINCIA DI LECCE
 Progetto agrovoltatico "Builli"

 PROGETTO
Ingveprogetti s.r.l.s.
 via Geofilo n.7-72023, Mesagne (BR)
 email: info@ingveprogetti.it

 RESPONSABILE DEL PROGETTO
 Ing. Giorgio Vece

COSTRUZIONE ED ESERCIZIO DI UN IMPIANTO AGROVOLTAICO INTEGRATO DI PRODUZIONE ELETTRICA DA FONTE FOTOVOLTAICA E DI PRODUZIONE AGRICOLA, DENOMINATO "BUILLI", SITO NEL COMUNE DI NARDÒ (LE), IN LOCALITÀ BUILLI, E DELLE OPERE ED INFRASTRUTTURE CONNESSE NEI COMUNI DI NARDÒ, COPERTINO E LEVERANO (LE), CON POTENZA NOMINALE PARI A 14.250,00 KWN E POTENZA DI PICCO (POTENZA MODULI) PARI A 16.564,80 KWP.

Oggetto: Impianto di messa a terra

 ELABORATO:
 AG7SE31_ElaboratoGrafico_18_Rev1

 PROGETTISTA:
 Ing. Giorgio Vece

 SCALA:
 1:2000
 1:250
 1:100

TIMBRO E FIRMA:



STATO DI PROGETTO PROGETTO DEFINITIVO

N°	DATA	DESCRIZIONE	PROCEDURA	PROGETTO	VERIFICATO	APPROVATO
00	AGOSTO 2020	Prima emissione	AU	Ing. Giorgio Vece	Ing. Giorgio Vece	GR Value Development S.r.l.
01	DICEMBRE 2021	Prima emissione	PUA	Ing. Giorgio Vece	Ing. Giorgio Vece	GR Value Development S.r.l.
02						
03						
04						

 Committente: LECCE 2 PV S.R.L.
 (scissione da GR Value Development S.r.l.)

 Via Durini n°9
 20122 Milano,
 Cod. Fisc & P. IVA 12262240968