

TITLE: RELAZIONE PRELIMINARE DI CALCOLO DELLE FONDAZIONI AEROGENERATORI

AVAILABLE LANGUAGE: IT

**“IMPIANTO EOLICO DI 43,4 MW IN LOCALITÀ MONTE SANT'ANTONIO”  
COMUNI DI SINDIA E MACOMER (NU)  
Progetto definitivo**

**RELAZIONE PRELIMINARE DI CALCOLO DELLE FONDAZIONI  
AEROGENERATORI**

Il Tecnico  
Ing. Leonardo Sblendido



File: Relazione preliminare di calcolo delle fondazioni aerogeneratori.pdf

REV.	DATE	DESCRIPTION	PREPARED	VERIFIED	APPROVED
00	28/04/2022	Prima Emissione	E.Napoli	M.Barresi	L.Sblendido
<b>VALIDATION</b>					
COLLABORATORS		VERIFIED BY		VALIDATED BY	
PROJECT / PLANT EO SINDIA		<b>INTERNAL CODE</b> <b>C21BLN001CWR00300</b>			
CLASSIFICATION COMPANY			UTILIZATION SCOPE		

## INDICE

1. RELAZIONE DI CALCOLO .....	3
1.1. Premessa .....	3
1.2. Descrizione generale dell'opera .....	3
1.3. Quadro normativo di riferimento adottato .....	4
1.4. Azioni di progetto sulla costruzione .....	4
1.5. Modello numerico .....	5
1.5.1. Informazioni sul codice di calcolo .....	5
1.6. Modellazione delle azioni .....	6
1.7. Combinazioni e/o percorsi di carico .....	6
1.8. Verifiche agli stati limite ultimi .....	7
1.9. Verifiche agli stati limite di esercizio .....	7
1.10. RELAZIONE SUI MATERIALI .....	7
2. NORMATIVA DI RIFERIMENTO .....	8
3. CARATTERISTICHE MATERIALI UTILIZZATI .....	12
3.1. LEGENDA TABELLA DATI MATERIALI .....	12
4. MODELLAZIONE DELLE SEZIONI .....	17
4.1. LEGENDA TABELLA DATI SEZIONI .....	17
5. MODELLAZIONE STRUTTURA: NODI .....	19
5.1. LEGENDA TABELLA DATI NODI .....	19
5.1.1. TABELLA DATI NODI .....	19
6. MODELLAZIONE STRUTTURA: ELEMENTI SHELL .....	23
6.1. LEGENDA TABELLA DATI SHELL .....	23
7. MODELLAZIONE DELLE AZIONI .....	33
7.1. LEGENDA TABELLA DATI AZIONI .....	33
8. SCHEMATIZZAZIONE DEI CASI DI CARICO .....	36
8.1. LEGENDA TABELLA CASI DI CARICO .....	36
9. DEFINIZIONE DELLE COMBINAZIONI .....	45
9.1. LEGENDA TABELLA COMBINAZIONI DI CARICO .....	45
10. RISULTATI NODALI .....	47
10.1. LEGENDA RISULTATI NODALI .....	47
11. RISULTATI OPERE DI FONDAZIONE .....	64
11.1. LEGENDA RISULTATI OPERE DI FONDAZIONE .....	64
12. RISULTATI ELEMENTI TIPO SHELL .....	74
12.1. LEGENDA RISULTATI ELEMENTI TIPO SHELL .....	74
13. VERIFICHE ELEMENTI PARETE E/O GUSCIO IN C.A. ....	91
13.1. LEGENDA TABELLA VERIFICHE ELEMENTI PARETE E GUSCIO IN C.A. ....	91
13.2. PROGETTAZIONE DELLE FONDAZIONI .....	94
14. STATI LIMITE D' ESERCIZIO .....	111
14.1. LEGENDA TABELLA STATI LIMITE D' ESERCIZIO .....	111
15. CONCLUSIONI .....	119

## 1. Relazione di calcolo

### 1.1. Premessa

La presente relazione di calcolo strutturale, in conformità al §10.1 del DM 17/01/18, ha per oggetto il calcolo preliminare dei plinti di fondazione in calcestruzzo armato degli Aerogeneratori, previsti nell'impianto di produzione dell'energia elettrica da fonte Eolica proposto da Wind Energy Sindia Srl, riferito al Parco Eolico costituito da n.7 aerogeneratori, ricadenti nei territori comunali di Sindia (NU) e Macomer (NU), di potenza nominale complessiva pari a 43,4 MW.

### 1.2. Descrizione generale dell'opera

La struttura in esame è stata progettata con l'obiettivo di fornire supporto in qualità di fondazione ad un modello tipologico di Aerogeneratore fornito dalla committenza.

La fondazione di forma tronco-conica ha diametro 24.5 metri ed un'altezza variabile massima in corrispondenza del posizionamento dell'Aerogeneratore. Maggiori informazioni sono riportate nell'immagine seguente e nell'elaborato "Tipologico fondazione aerogeneratore".

Considerata l'assenza di indagini geotecniche sul terreno, e basandosi su di uno studio preliminare del terreno in sito si è optato preventivamente per una soluzione di fondazione superficiale, non si esclude la possibilità di modificare le caratteristiche geometriche della stessa. Si rimanda tale verifica in fase esecutiva a valle di specifiche indagini geotecniche.

In questa prima fase si assume che una fondazione di plinto conico sia sufficiente nei confronti delle azioni cui è soggetta e delle caratteristiche del terreno.

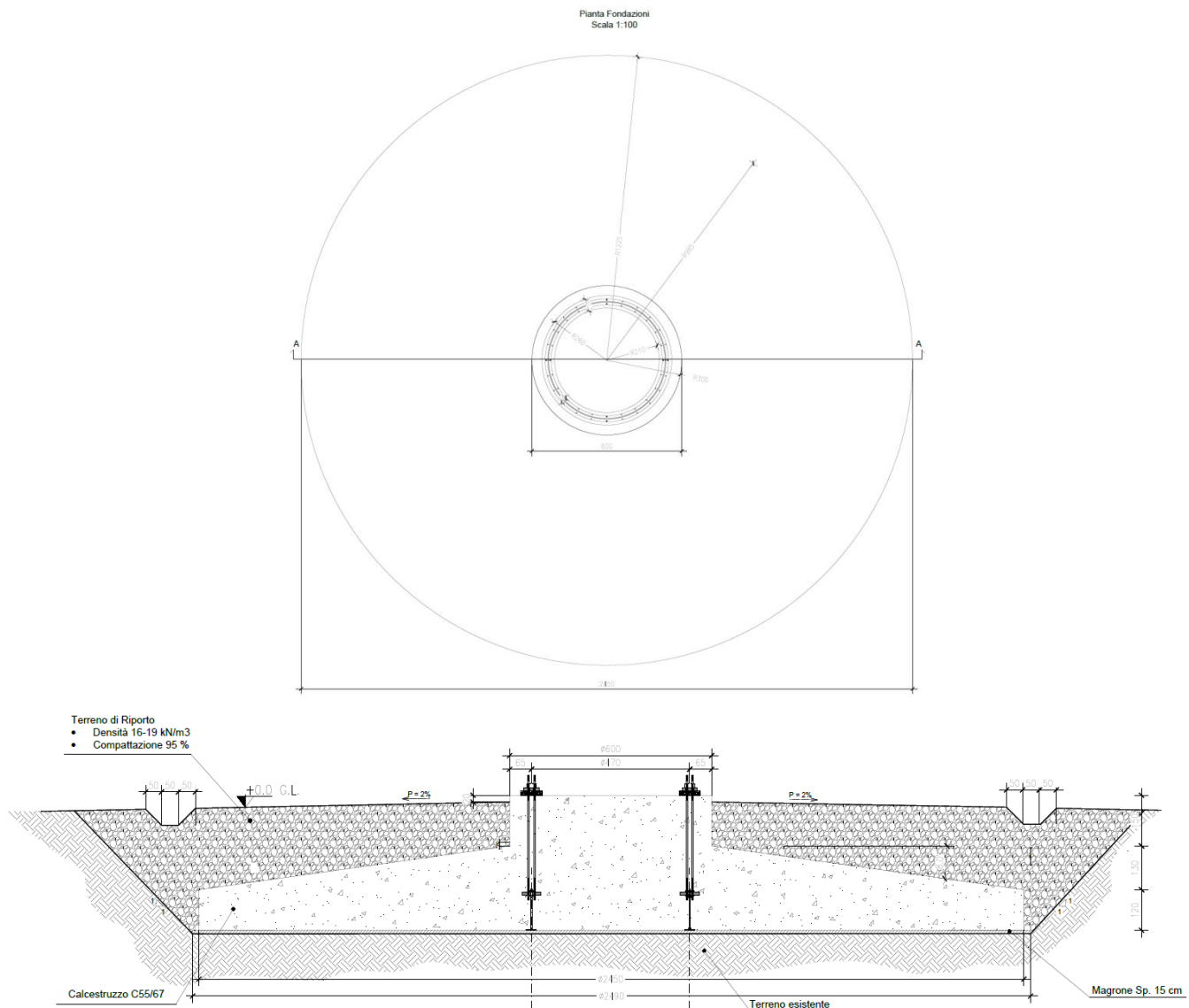

### Descrizione generale dell'opera

Fabbricato ad uso	Fondazione Aerogeneratore
Ubicazione	Sindia (NU)
Tipo di fondazione	Plinto Conico

### Parametri della struttura

Classe d'uso	Vita Vn [anni]	Coeff. Uso	Periodo Vr [anni]
IV	50	2.0	100

### Fattore di struttura/comportamento

NON DISSIPATIVA

### 1.3. Quadro normativo di riferimento adottato

Le norme ed i documenti assunti quale riferimento per la progettazione strutturale vengono indicati di seguito. Nel capitolo "normativa di riferimento" è comunque presente l'elenco completo delle normative disponibili.

### Progetto-verifica degli elementi

Progetto cemento armato	D.M. 17-01-2018
Progetto acciaio	D.M. 17-01-2018
Progetto legno	D.M. 14-01-2008
Progetto muratura	D.M. 14-01-2008
<b>Azione sismica</b>	
Norma applicata per l' azione sismica	D.M. 17-01-2018

### 1.4. Azioni di progetto sulla costruzione

Nei capitoli "modellazione delle azioni" e "schematizzazione dei casi di carico" sono indicate le azioni sulla costruzioni.

Nel prosieguo si indicano tipo di analisi strutturale condotta (statico, dinamico, lineare o non lineare) e il metodo adottato per la risoluzione del problema strutturale nonché le metodologie seguite per la verifica o per il progetto-verifica delle sezioni. Si riportano le combinazioni di carico adottate e, nel caso di calcoli non lineari, i percorsi di carico seguiti; le configurazioni studiate per la struttura in esame *sono risultate effettivamente esaustive per la progettazione-verifica.*

La verifica della sicurezza degli elementi strutturali avviene con i metodi della scienza delle costruzioni. L'analisi strutturale è condotta con il metodo degli spostamenti per la valutazione dello stato tensedeformativo indotto da carichi statici. L'analisi strutturale è condotta con il metodo dell'analisi modale e dello spettro di risposta in termini di accelerazione per la valutazione dello stato tensedeformativo indotto da carichi dinamici (tra cui quelli di tipo sismico).

L'analisi strutturale viene effettuata con il metodo degli elementi finiti. Il metodo sopraindicato si basa sulla schematizzazione della struttura in elementi connessi solo in corrispondenza di un numero prefissato di punti denominati nodi. I nodi sono definiti dalle tre coordinate cartesiane in un sistema di riferimento globale. Le incognite del problema (nell'ambito del metodo degli spostamenti) sono le componenti di spostamento dei nodi riferite al sistema di riferimento globale (traslazioni secondo X, Y, Z, rotazioni attorno X, Y, Z). La soluzione del problema si ottiene con un sistema di equazioni algebriche lineari i cui termini noti sono costituiti dai carichi agenti sulla struttura opportunamente concentrati ai nodi:

$$\mathbf{K} * \mathbf{u} = \mathbf{F}$$

dove  $\mathbf{K}$  = matrice di rigidità  
 $\mathbf{u}$  = vettore spostamenti nodali  
 $\mathbf{F}$  = vettore forze nodali

Dagli spostamenti ottenuti con la risoluzione del sistema vengono quindi dedotte le sollecitazioni e/o le tensioni di ogni elemento, riferite generalmente ad una terna locale all'elemento stesso.

Il sistema di riferimento utilizzato è costituito da una terna cartesiana destrorsa XYZ. Si assume l'asse Z verticale ed orientato verso l'alto.

Gli elementi utilizzati per la modellazione dello schema statico della struttura sono i seguenti:

- Elemento tipo **TRUSS** (biella-D2)
- Elemento tipo **BEAM** (trave-D2)
- Elemento tipo **MEMBRANE** (membrana-D3)
- Elemento tipo **PLATE** (piastra-guscio-D3)
- Elemento tipo **BOUNDARY** (molla)
- Elemento tipo **STIFFNESS** (matrice di rigidità)
- Elemento tipo **BRICK** (elemento solido)
- Elemento tipo **SOLAIO** (macro elemento composto da più membrane)

## 1.5. Modello numerico

In questa parte viene descritto il modello numerico utilizzato (o i modelli numerici utilizzati) per l'analisi della struttura. La presentazione delle informazioni deve essere, coerentemente con le prescrizioni del paragrafo 10.2 e relativi sottoparagrafi delle NTC-18, tale da garantirne la leggibilità, la corretta interpretazione e la riproducibilità

### Tipo di analisi strutturale

Carichi verticali	SI
Statica non lineare	NO
Sismica statica lineare	NO
Sismica dinamica lineare	NO
Sismica statica non lineare (prop. masse)	NO
Sismica statica non lineare (prop. modo)	NO
Sismica statica non lineare (triangolare)	NO
Non linearità geometriche (fattore P delta)	NO

Di seguito si indicano l'origine e le caratteristiche dei codici di calcolo utilizzati riportando titolo, produttore e distributore, versione, estremi della licenza d'uso:

#### 1.5.1. Informazioni sul codice di calcolo

Titolo:	PRO_SAP PROfessional Structural Analysis Program
Versione:	PROFESSIONAL (build 2020-01-187)
Produttore-Distributore:	2S.I. Software e Servizi per l'Ingegneria s.r.l., Ferrara
Codice Licenza:	Licenza dsi5451

Un attento esame preliminare della documentazione a corredo del software **ha consentito di valutarne l'affidabilità e soprattutto l'idoneità al caso specifico**. La documentazione, fornita dal produttore e distributore del software, contiene una esauriente descrizione delle basi teoriche e degli algoritmi impiegati, l'individuazione dei campi d'impiego, nonché casi prova interamente risolti e commentati, corredatai dei file di input necessari a riprodurre l'elaborazione:

#### Affidabilità dei codici utilizzati

2S.I. ha verificato l'affidabilità e la robustezza del codice di calcolo attraverso un numero significativo di casi prova in cui i risultati dell'analisi numerica sono stati confrontati con soluzioni teoriche.

E' possibile reperire la documentazione contenente alcuni dei più significativi casi trattati al seguente link:  
<https://www.2si.it/it/prodotti/affidabilita/>

#### Modellazione della geometria e proprietà meccaniche:

nodi	529
elementi D2 (per aste, travi, pilastri...)	0
elementi D3 (per pareti, platee, gusci...)	528
elementi solaio	0
elementi solidi	0

#### Dimensione del modello strutturale [cm]:

X min =	-1160.00
Xmax =	1160.00
Ymin =	-1160.00
Ymax =	1160.00
Zmin =	0.00
Zmax =	0.00

#### Strutture verticali:

Elementi di tipo asta	NO
Pilastri	NO
Pareti	NO
Setti (a comportamento membranale)	NO

#### Strutture non verticali:

Elementi di tipo asta	NO
Travi	NO
Gusci	NO
Membrane	NO

**Orizzontamenti:**

Solai con la proprietà piano rigido	NO
Solai senza la proprietà piano rigido	NO

**Tipo di vincoli:**

Nodi vincolati rigidamente	NO
Nodi vincolati elasticamente	NO
Nodi con isolatori sismici	NO
Fondazioni puntuali (plinti/plinti su palo)	NO
Fondazioni di tipo trave	NO
Fondazioni di tipo platea	SI
Fondazioni con elementi solidi	NO

**1.6. Modellazione delle azioni**

Si veda il capitolo **“Schematizzazione dei casi di carico”** per le informazioni necessarie alla comprensione ed alla ricostruzione delle azioni applicate al modello numerico, coerentemente con quanto indicato nella parte **“2.6. Azioni di progetto sulla costruzione”**.

**1.7. Combinazioni e/o percorsi di carico**

Si veda il capitolo **“Definizione delle combinazioni”** in cui sono indicate le combinazioni di carico adottate e, nel caso di calcoli non lineari, i percorsi di carico seguiti.

**Combinazioni dei casi di carico**

APPROCCIO PROGETTUALE	Approccio 2
Tensioni ammissibili	NO
SLU	SI
SLV (SLU con sisma)	NO
SLC	NO
SLD	NO
SLO	NO
SLU GEO A2 (per approccio 1)	NO
SLU EQU	NO
Combinazione caratteristica (rara)	NO
Combinazione frequente	SI
Combinazione quasi permanente (SLE)	NO
SLA (accidentale quale incendio)	NO

**Principali risultati**

I risultati devono costituire una sintesi completa ed efficace, presentata in modo da riassumere il comportamento della struttura, per ogni tipo di analisi svolta.

Nella presente relazione di calcolo sono riportati i seguenti risultati che il progettista ritiene di interesse per la descrizione e la comprensione del/i modello/i e del comportamento della struttura:

per l'analisi modale:

- periodi dei modi di vibrare della struttura
- masse eccitate dai singoli modi
- massa eccitata totale

deformate e sollecitazioni:

- spostamenti e rotazioni dei singoli nodi della struttura
- reazioni vincolari (nel caso siano presenti nodi vincolati rigidamente)
- pressioni sul terreno (nel caso siano presenti elementi di fondazione)
- sollecitazioni sugli elementi d2 nelle combinazioni di calcolo più significative
- tensioni sugli elementi d3 nelle combinazioni di calcolo più significative
- sollecitazioni sui macroelementi da elementi d3 nelle combinazioni di calcolo più significative

La presente relazione, oltre ad illustrare in modo esaustivo i dati in ingresso ed i risultati delle analisi in forma tabellare, riporta una serie di immagini:

per i dati in ingresso:

- modello solido della struttura
- numerazione di nodi e ed elementi
- configurazioni di carico statiche
- configurazioni di carico sismiche con baricentri delle masse e eccentricità

per le combinazioni più significative (statisticamente più gravose per la struttura):

- configurazioni deformate
- diagrammi e involuipi delle azioni interne
- mappe delle tensioni
- reazioni vincolari

- mappe delle pressioni sul terreno

per il progetto-verifica degli elementi:

- diagrammi di armatura
- percentuali di sfruttamento
- mappe delle verifiche più significative per i vari stati limite

#### **Informazioni generali sull'elaborazione e giudizio motivato di accettabilità dei risultati.**

Il programma prevede una serie di controlli automatici (check) che consentono l'individuazione di errori di modellazione. Al termine dell'analisi un controllo automatico identifica la presenza di spostamenti o rotazioni anormali. Si può pertanto asserire che l'elaborazione sia corretta e completa. I risultati delle elaborazioni sono stati sottoposti a controlli che ne comprovano l'attendibilità. Tale valutazione ha compreso il confronto con i risultati di semplici calcoli, eseguiti con metodi tradizionali e adottati, anche in fase di primo dimensionamento della struttura. Inoltre, sulla base di considerazioni riguardanti gli stati tensionali e deformativi determinati, si è valutata la validità delle scelte operate in sede di schematizzazione e di modellazione della struttura e delle azioni. Si allega al termine della presente relazione elenco sintetico dei controlli svolti (verifiche di equilibrio tra reazioni vincolari e carichi applicati, comparazioni tra i risultati delle analisi e quelli di valutazioni semplificate, etc.) .

#### **1.8. Verifiche agli stati limite ultimi**

Nel capitolo relativo alla progettazione degli elementi strutturali agli SLU vengono indicate, con riferimento alla normativa adottata, le modalità ed i criteri seguiti per valutare la sicurezza della struttura nei confronti delle possibili situazioni di crisi ed i risultati delle valutazioni svolte. In via generale, oltre alle verifiche di resistenza e di spostamento, devono essere prese in considerazione verifiche nei confronti dei fenomeni di instabilità, locale e globale, di fatica, di duttilità, di degrado.

#### **1.9. Verifiche agli stati limite di esercizio**

Nel capitolo relativo alla progettazione degli elementi strutturali agli SLE vengono indicate, con riferimento alla normativa adottata, le modalità seguite per valutare l'affidabilità della struttura nei confronti delle possibili situazioni di perdita di funzionalità (per eccessive deformazioni, fessurazioni, vibrazioni, etc.) ed i risultati delle valutazioni svolte.

#### **1.10. RELAZIONE SUI MATERIALI**

Il capitolo Materiali riporta informazioni esaustive relative all'elenco dei materiali impiegati e loro modalità di posa in opera e ai valori di calcolo.



## 2. NORMATIVA DI RIFERIMENTO

1. D.Min. Infrastrutture Min. Interni e Prot. Civile 17 Gennaio 2018 e allegate "Norme tecniche per le costruzioni".
2. Circolare 21/01/19, n. 7 C.S.LL.PP "Istruzioni per l'applicazione dell'aggiornamento delle Norme Tecniche delle Costruzioni di cui al decreto ministeriale 17 gennaio 2018"
3. D.Min. Infrastrutture e trasporti 14 Settembre 2005 e allegate "Norme tecniche per le costruzioni".
4. D.M. LL.PP. 9 Gennaio 1996 "Norme tecniche per il calcolo, l'esecuzione ed il collaudo delle strutture in cemento armato, normale e precompresso e per le strutture metalliche".
5. D.M. LL.PP. 16 Gennaio 1996 "Norme tecniche relative ai <<Criteri generali per la verifica di sicurezza delle costruzioni e dei carichi e sovraccarichi>>".
6. D.M. LL.PP. 16 Gennaio 1996 "Norme tecniche per le costruzioni in zone sismiche".
7. Circolare 4/07/96, n.156AA.GG./STC. istruzioni per l'applicazione delle "Norme tecniche relative ai <<Criteri generali per la verifica di sicurezza delle costruzioni e dei carichi e sovraccarichi>>" di cui al D.M. 16/01/96.
8. Circolare 10/04/97, n.65AA.GG. istruzioni per l'applicazione delle "Norme tecniche per le costruzioni in zone sismiche" di cui al D.M. 16/01/96.
9. D.M. LL.PP. 20 Novembre 1987 "Norme tecniche per la progettazione, esecuzione e collaudo degli edifici in muratura e per il loro consolidamento".
10. Circolare 4 Gennaio 1989 n. 30787 "Istruzioni in merito alle norme tecniche per la progettazione, esecuzione e collaudo degli edifici in muratura e per il loro consolidamento".
11. D.M. LL.PP. 11 Marzo 1988 "Norme tecniche riguardanti le indagini sui terreni e sulle rocce, la stabilità dei pendii naturali e delle scarpate, i criteri generali e le prescrizioni per la progettazione, l'esecuzione e il collaudo delle opere di sostegno delle terre e delle opere di fondazione".
12. D.M. LL.PP. 3 Dicembre 1987 "Norme tecniche per la progettazione, esecuzione e collaudo delle costruzioni prefabbricate".
13. UNI 9502 - Procedimento analitico per valutare la resistenza al fuoco degli elementi costruttivi di conglomerato cementizio armato, normale e precompresso - edizione maggio 2001
14. Ordinanza del Presidente del Consiglio dei Ministri n. 3274 del 20 marzo 2003 "Primi elementi in materia di criteri generali per la classificazione sismica del territorio nazionale e di normative tecniche per le costruzioni in zona sismica" e successive modificazioni e integrazioni.
15. UNI EN 1990:2006 13/04/2006 Eurocodice 0 - Criteri generali di progettazione strutturale.
16. UNI EN 1991-1-1:2004 01/08/2004 Eurocodice 1 - Azioni sulle strutture - Parte 1-1: Azioni in generale - Pesi per unità di volume, pesi propri e sovraccarichi per gli edifici.
17. UNI EN 1991-2:2005 01/03/2005 Eurocodice 1 - Azioni sulle strutture - Parte 2: Carichi da traffico sui ponti.
18. UNI EN 1991-1-3:2004 01/10/2004 Eurocodice 1 - Azioni sulle strutture - Parte 1-3: Azioni in generale - Carichi da neve.
19. UNI EN 1991-1-4:2005 01/07/2005 Eurocodice 1 - Azioni sulle strutture - Parte 1-4: Azioni in generale - Azioni del vento.
20. UNI EN 1991-1-5:2004 01/10/2004 Eurocodice 1 - Azioni sulle strutture - Parte 1-5: Azioni in generale - Azioni termiche.
21. UNI EN 1992-1-1:2005 24/11/2005 Eurocodice 2 - Progettazione delle strutture di calcestruzzo - Parte 1-1: Regole generali e regole per gli edifici.
22. UNI EN 1992-1-2:2005 01/04/2005 Eurocodice 2 - Progettazione delle strutture di calcestruzzo - Parte 1-2: Regole generali - Progettazione strutturale contro l'incendio.
23. UNI EN 1993-1-1:2005 01/08/2005 Eurocodice 3 - Progettazione delle strutture di acciaio - Parte 1-1: Regole generali e regole per gli edifici.
24. UNI EN 1993-1-8:2005 01/08/2005 Eurocodice 3 - Progettazione delle strutture di acciaio - Parte 1-8: Progettazione dei collegamenti.
25. UNI EN 1994-1-1:2005 01/03/2005 Eurocodice 4 - Progettazione delle strutture composte acciaio-calcestruzzo - Parte 1-1: Regole generali e regole per gli edifici.
26. UNI EN 1994-2:2006 12/01/2006 Eurocodice 4 - Progettazione delle strutture composte acciaio-calcestruzzo - Parte 2: Regole generali e regole per i ponti.
27. UNI EN 1995-1-1:2005 01/02/2005 Eurocodice 5 - Progettazione delle strutture di legno - Parte 1-1: Regole generali - Regole comuni e regole per gli edifici.
28. UNI EN 1995-2:2005 01/01/2005 Eurocodice 5 - Progettazione delle strutture di legno - Parte 2: Ponti.
29. UNI EN 1996-1-1:2006 26/01/2006 Eurocodice 6 - Progettazione delle strutture di muratura - Parte 1-1: Regole generali per strutture di muratura armata e non armata.
30. UNI EN 1996-3:2006 09/03/2006 Eurocodice 6 - Progettazione delle strutture di muratura - Parte 3: Metodi di calcolo semplificato per strutture di muratura non armata.
31. UNI EN 1997-1:2005 01/02/2005 Eurocodice 7 - Progettazione geotecnica - Parte 1: Regole generali.



32. UNI EN 1998-1:2005 01/03/2005 Eurocodice 8 - Progettazione delle strutture per la resistenza sismica - Parte 1: Regole generali, azioni sismiche e regole per gli edifici.
33. UNI EN 1998-3:2005 01/08/2005 Eurocodice 8 - Progettazione delle strutture per la resistenza sismica - Parte 3: Valutazione e adeguamento degli edifici.
34. UNI EN 1998-5:2005 01/01/2005 Eurocodice 8 - Progettazione delle strutture per la resistenza sismica - Parte 5: Fondazioni, strutture di contenimento ed aspetti geotecnici.

**NOTA il capitolo "normativa di riferimento": riporta l'elenco delle normative implementate nel software. Le norme utilizzate per la struttura oggetto della presente relazione sono indicate nel precedente capitolo "RELAZIONE DI CALCOLO STRUTTURALE" "ANALISI E VERIFICHE SVOLTE CON L'AUSILIO DI CODICI DI CALCOLO".** Laddove nei capitoli successivi vengano richiamate norme antecedenti al DM 17.01.18 è dovuto o a progettazione simulata di edificio esistente.

MODELLO

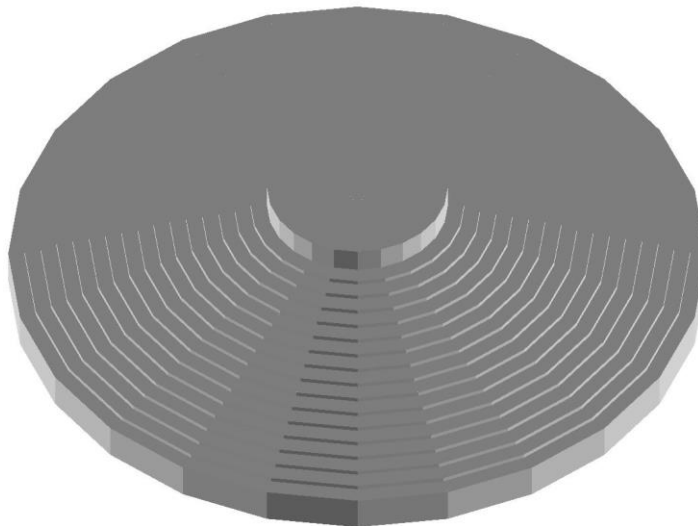

01\_INT\_VISTA\_SOLIDATA\_001

MODELLO

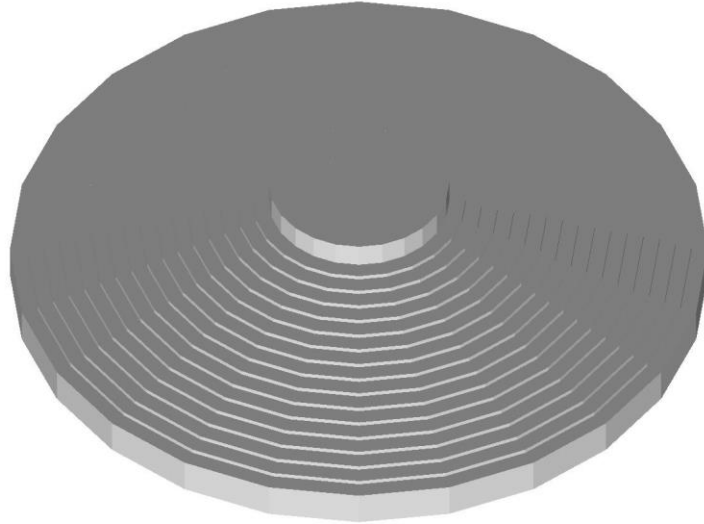

01\_INT\_VISTA\_SOLIDATA\_002

MODELLO

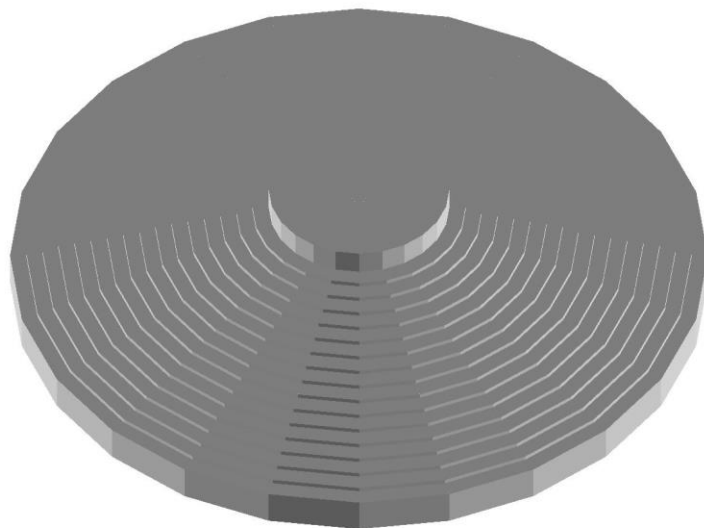

01\_INT\_VISTA\_SOLIDATA\_003



Wind Energy  
Sindia Srl

grEen &  
grEen  
WE ENGINEERING

CODE

C21BLN001CWR00300

PAGE

11 di/of 119

MODELLO

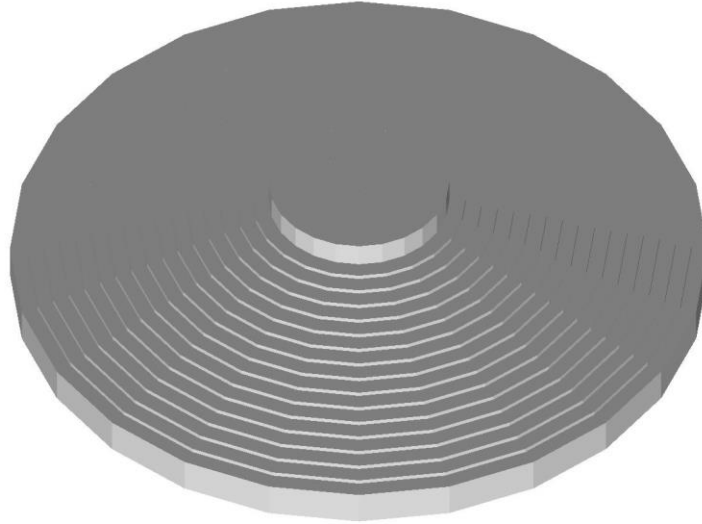

01\_INT\_VISTA\_SOLIDATA\_004

### 3. CARATTERISTICHE MATERIALI UTILIZZATI

#### 3.1. LEGENDA TABELLA DATI MATERIALI

Il programma consente l'uso di materiali diversi. Sono previsti i seguenti tipi di materiale:

1	materiale tipo cemento armato
2	materiale tipo acciaio
3	materiale tipo muratura
4	materiale tipo legno
5	materiale tipo generico

I materiali utilizzati nella modellazione sono individuati da una sigla identificativa ed un codice numerico (gli elementi strutturali richiamano quest'ultimo nella propria descrizione). Per ogni materiale vengono riportati in tabella i seguenti dati:

Young	modulo di elasticità normale E
Poisson	coefficiente di contrazione trasversale $\nu$
G	modulo di elasticità tangenziale
Gamma	peso specifico
Alfa	coefficiente di dilatazione termica
Fattore di confidenza FC <sub>m</sub>	Fattore di confidenza specifico per materiale; (è riportato solo se diverso da quello globale della struttura)
Fattore di confidenza FC <sub>a</sub>	Fattore di confidenza specifico per l'armatura (è riportato solo se diverso da quello globale della struttura)
Elasto-plastico	Materiale elastico perfettamente plastico per aste non lineari
Massima compressione	Massima tensione di compressione per aste non lineari
Massima trazione	Massima tensione di trazione per aste non lineari
Fattore attrito	Coefficiente di attrito per aste non lineari
Rapporto HRDb	Rapporto di hardening a flessione
Rapporto HRDv	Rapporto di hardening a taglio

I dati soprariportati vengono utilizzati per la modellazione dello schema statico e per la determinazione dei carichi inerziali e termici. In relazione al tipo di materiale vengono riportati inoltre:

1	cemento armato	Resistenza Rc	resistenza a compressione cubica
		Resistenza fctm	resistenza media a trazione semplice
		Coefficiente ksb	Coefficiente di riduzione della resistenza a compressione da utilizzare nello stress block
2	acciaio	Tensione ft	Valore della tensione di rottura
		Tensione fy	Valore della tensione di snervamento
		Resistenza fd	Resistenza di calcolo per SL CNR-UNI 10011
		Resistenza fd (>40)	Resistenza di calcolo per SL CNR-UNI 10011 per spessori > 40mm
		Tensione ammissibile	Tensione ammissibile CNR-UNI 10011
		Tensione ammissibile (>40)	Tensione ammissibile CNR-UNI 10011 per spessori > 40mm
3	muratura	Muratura consolidata	Muratura per la quale si prevedono interventi di rinforzo"
		Incremento resistenza	Incremento conseguito in termini di resistenza
		Incremento rigidezza	Incremento conseguito in termini di rigidezza
		Resistenza f	Valore della resistenza a compressione
		Resistenza fv0	Valore della resistenza a taglio in assenza di tensioni normali

	Resistenza fh Resistenza fb	Valore della resistenza a compressione orizzontale Valore della resistenza a compressione dei blocchi
	Resistenza fbh	Valore della resistenza a compressione dei blocchi in direzione orizzontale
	Resistenza fv0h	Valore della resistenza a taglio in assenza di tensioni normali per le travi
	Resistenza ft	Valore della resistenza a trazione per fessurazione diagonale
	Resistenza fvlim	Valore della massima resistenza a taglio
	Resistenza fbt	Valore della resistenza a trazione dei blocchi
	Coefficiente mu	Coefficiente d'attrito utilizzato per la resistenza a taglio (tipicamente 0.4)
	Coefficiente fi	Coefficiente d'ingranamento utilizzato per la resistenza a taglio
	Coefficiente ksb	Coefficiente di riduzione della resistenza a compressione da utilizzare nello stress block
4	legno	
	E0,05	Modulo di elasticità corrispondente ad un frattile del 5%
	Resistenza fc0	Valore della resistenza a compressione parallela
	Resistenza ft0	Valore della resistenza a trazione parallela
	Resistenza fm	Valore della resistenza a flessione
	Resistenza fv	Valore della resistenza a taglio
	Resist. ft0k	Resistenza caratteristica (tensione amm. per REGLES) per trazione
	Resist. fmk	Resistenza caratteristica (tensione amm. per REGLES) per flessione
	Resist. fvk	Resistenza caratteristica (tensione amm. per REGLES) per taglio
	Modulo E0,05	Modulo elastico parallelo caratteristico
	Lamellare	lamellare o massiccio

Nel tabulato si riportano sia i valori caratteristici che medi utilizzando gli uni e/o gli altri in relazione alle richieste di normativa ed alla tipologia di verifica. (Cap.7 NTC18 per materiali nuovi, Cap.8 NTC18 e relativa circolare 21/01/2019 per materiali esistenti, Linee Guida Reluis per incamiciatura CAM, CNR-DT 200 per interventi con FRP)

Vengono inoltre riportate le tabelle contenenti il riassunto delle informazioni assegnate nei criteri di progetto in uso.

Con riferimento al **Documento di Affidabilità** "Test di validazione del software di calcolo PRO\_SAP e dei moduli aggiuntivi PRO\_SAP Modulo Geotecnico, PRO\_CAD nodi acciaio e PRO\_MST" - versione Maggio 2011, disponibile per il download sul sito [www.2si.it](http://www.2si.it), si segnalano i seguenti esempi applicativi:

Modellazione di strutture in c.a.

Test N°	Titolo
41	GERARCHIA DELLE RESISTENZE PER TRAVI IN C.A.
42	GERARCHIA DELLE RESISTENZE PER PILASTRI IN C.A.
43	VERIFICA ALLE TA DI STRUTTURE IN C.A.
44	VERIFICA AGLI SLU DI STRUTTURE IN C.A.
45	VERIFICA A PUNZONAMENTO ALLO SLU DI PIASTRE IN C.A.
46	VERIFICA A PUNZONAMENTO ALLO SLU DI TRAVI IN C.A.
47	PROGETTAZIONE A TAGLIO DI STRUTTURE IN C.A. SECONDO IL D.M. 9/1/96
48	PROGETTAZIONE A TAGLIO DI STRUTTURE IN C.A. SECONDO IL D.M. 14/1/2008
49	VERIFICA ALLO SLE (TENSIONI E FESSURAZIONE) DI STRUTTURE IN C.A.
50	VERIFICA ALLO SLE (DEFORMAZIONE) DI STRUTTURE IN C.A.
51	FATTORE DI STRUTTURA
52	SOVRARESISTENZE
53	DETTAGLI COSTRUTTIVI C.A.: LIMITI D'ARMATURA PILASTRI E NODI TRAVE-PILASTRO
54	PARETI IN C.A. SNELLE IN ZONA SISMICA
80	ANALISI PUSHOVER DI UN EDIFICIO IN C.A.
120	PROGETTO E VERIFICA DI TRAVI PREM

## Modellazione di strutture in acciaio

Test N°	Titolo
55	VERIFICA DI STABILITA' DI ASTE COMPRESSE IN ACCIAIO – METODO OMEGA
56	LUCE LIBERA DI TRAVI E ASTE IN ACCIAIO
57	LUCE LIBERA DI COLONNE IN ACCIAIO
58	SVERGOLAMENTO DI TRAVI IN ACCIAIO
59	FATTORE DI STRUTTURA
60	ACCIAIO D.M.2008
61	ACCIAIO EC3
62	GERARCHIA RESISTENZE STRUTTURE IN ACCIAIO
63	STABILITA' DI ASTE COMPOSTE IN ACCIAIO
73	COLLEGAMENTI IN ACCIAIO: NODO TRAVE COLONNA FLANGIATO CON PRESENZA IRRIGIDIMENTI TRASVERSALI
74	COLLEGAMENTI IN ACCIAIO: NODO TRAVE COLONNA FLANGIATO CON PRESENZA DI UN PIATTO DI RINFORZO SALDATO ALL'ANIMA DELLA COLONNA
75	COLLEGAMENTI IN ACCIAIO: NODO TRAVE COLONNA FLANGIATO CON PRESENZA DI DUE PIATTI DI RINFORZO SALDATI ALL'ANIMA DELLA COLONNA
76	COLLEGAMENTI IN ACCIAIO: NODO TRAVE COLONNA FLANGIATO A DUE VIE SU ALI COLONNA
77	COLLEGAMENTI IN ACCIAIO: NODO TRAVE COLONNA FLANGIATO A UNA VIA CON DUE COMBINAZIONI DI CARICO
78	COLLEGAMENTI IN ACCIAIO: NODO TRAVE COLONNA FLANGIATO SU ANIMA SENZA RINFORZI A QUATTRO FILE DI BULLONI DI CUI UNA SU PIASTRA INFERIORE E UNA SU PIASTRA SUPERIORE
79	VERIFICA DELLA PIASTRA NODO TRAVE COLONNA
85	TELAIO ACCIAIO: CONTROVENTI CONCENTRICI

## Modellazione di strutture in muratura

Test N°	Titolo
81	ANALISI PUSHOVER DI UNA STRUTTURA IN MURATURA
84	ANALISI ELASTO PLASTICA INCREMENTALE, PARETE IN MURATURA
86	VERIFICA NON SISMICA DELLE MURATURE (D.M. 87 TA)
87	VERIFICA NON SISMICA DELLE MURATURE (D.M. 2005 SL)
88	FATTORE DI STRUTTURA

## Modellazione di strutture in legno

Test N°	Titolo
17	SOLAIO: MISTO LEGNO-CALCESTRUZZO
89	VERIFICA ALLO SLU DI STRUTTURE IN LEGNO SECONDO EC5
90	VERIFICA ALLO SLE DI STRUTTURE IN LEGNO SECONDO EC5
91	FATTORE DI STRUTTURA
92	VERIFICHE EC5
93	SNELLEZZE EC5
94	VERIFICA AL FUOCO DI STRUTTURE IN LEGNO SECONDO EC5
117	PROGETTO E VERIFICA DI GUSCI IN MATERIALE XLAM
118	PROGETTO E VERIFICA DI PARETI IN MATERIALE XLAM E RELATIVI COLLEGAMENTI

119

PROGETTO E VERIFICA DI SOLAI IN MATERIALE XLAM

Id	Tipo / Note	V. caratt.	V. medio	Young	Poisson	G	Gamma	Alfa	Altri
		daN/cm <sup>2</sup>	daN/cm <sup>2</sup>	daN/cm <sup>2</sup>		daN/cm <sup>2</sup>	daN/cm <sup>3</sup>		
9	Calcestruzzo Classe C55/67			3.830e+05	0.20	1.596e+05	2.50e-03	1.00e-05	
	Resistenza Rc	670.0							
	Resistenza fctm		42.3						
	Rapporto Rfessurata								1.00
	Coefficiente ksb								0.85
	Rapporto HRDb								1.00e-05
	Rapporto HRDv								1.00e-05

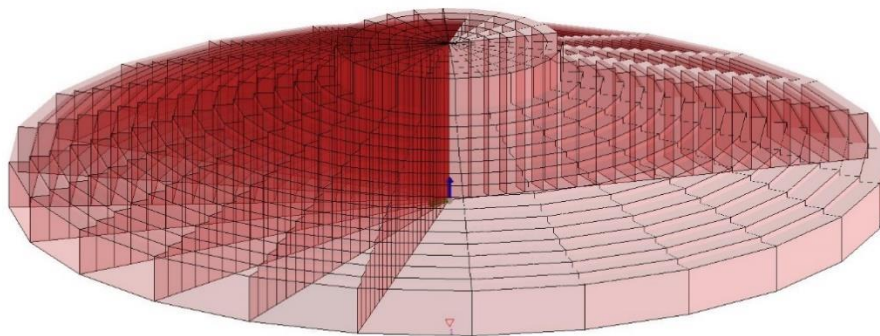

MODELLO

11\_MOD\_MATERIALI\_D3

Gusci c.a.	1/7/..	2/8/..	3/9/..	4/10/..	5/11/..	6/12/..
<b>Armatura</b>						
Inclinazione Ax [ gradi ]	0.0	0.0				
Angolo Ax-Ay [ gradi ]	90.00	90.00				
Minima tesa	0.31	0.20				
Massima tesa	5000.00	5000.00				
Maglia unica centrale	No	No				
Copriferro [ cm ]	4.00	4.00				
<b>Maglia x</b>						
diametro	30	32				
passo	10	10				
diametro aggiuntivi	30	32				
<b>Maglia y</b>						
diametro	30	32				
passo	10	10				
diametro aggiuntivi	30	32				
<b>Stati limite ultimi</b>						
Tensione fy [daN/cm <sup>2</sup> ]	4500.00	4500.00				
Tipo acciaio	tipo C	tipo C				
Coefficiente gamma s	1.15	1.15				
Coefficiente gamma c	1.50	1.50				
Verifiche con N costante	Si	Si				
Applica SLU da DIN	No	No				
<b>Tensioni ammissibili</b>						





Wind Energy  
Sindia Srl

grEen &  
grEen  
WE ENGINEERING

CODE

C21BLN001CWR00300

PAGE

16 di/of 119

Gusci c.a.	1/7/..	2/8/..	3/9/..	4/10/..	5/11/..	6/12/..
Tensione amm. cls [daN/cm <sup>2</sup> ]	97.50	97.50				
Tensione amm. acciaio [daN/cm <sup>2</sup> ]	2600.00	2600.00				
Rapporto omogeneizzazione N	15.00	15.00				
Massimo rapporto area compressa/tesa	1.00	1.00				
<b>Resistenza al fuoco</b>						
3- intradosso	No	No				
3+ estradosso	No	No				
Tempo di esposizione R	15	15				

## 4. MODELLAZIONE DELLE SEZIONI

### 4.1. LEGENDA TABELLA DATI SEZIONI

Il programma consente l'uso di sezioni diverse. Sono previsti i seguenti tipi di sezione:

1. sezione di tipo generico
2. profilati semplici
3. profilati accoppiati e speciali

Le sezioni utilizzate nella modellazione sono individuate da una sigla identificativa ed un codice numerico (gli elementi strutturali richiamano quest'ultimo nella propria descrizione). Per ogni sezione vengono riportati in tabella i seguenti dati:

<b>Area</b>	area della sezione
<b>A V2</b>	area della sezione/fattore di taglio (per il taglio in direzione 2)
<b>A V3</b>	area della sezione/fattore di taglio (per il taglio in direzione 3)
<b>Jt</b>	fattore torsionale di rigidezza
<b>J2-2</b>	momento d'inerzia della sezione riferito all'asse 2
<b>J3-3</b>	momento d'inerzia della sezione riferito all'asse 3
<b>W2-2</b>	modulo di resistenza della sezione riferito all'asse 2
<b>W3-3</b>	modulo di resistenza della sezione riferito all'asse 3
<b>Wp2-2</b>	modulo di resistenza plastico della sezione riferito all'asse 2
<b>Wp3-3</b>	modulo di resistenza plastico della sezione riferito all'asse 3

I dati sopra riportati vengono utilizzati per la determinazione dei carichi inerziali e per la definizione delle rigidezze degli elementi strutturali; qualora il valore di Area V2 (e/o Area V3) sia nullo la deformabilità per taglio V2 (e/o V3) è trascurata. La valutazione delle caratteristiche inerziali delle sezioni è condotta nel riferimento 2-3 dell'elemento.

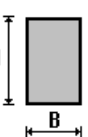
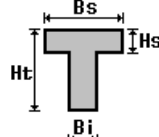
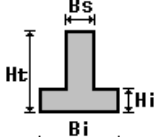
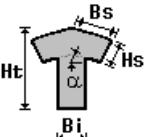
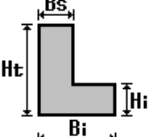
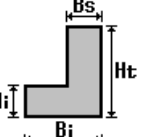
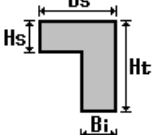
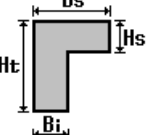
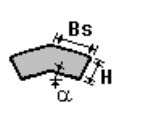
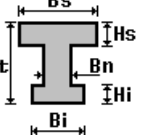
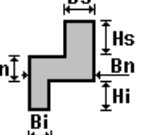
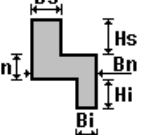
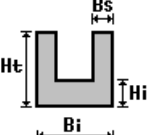
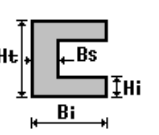
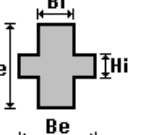
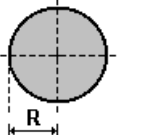
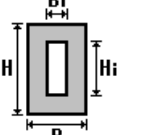
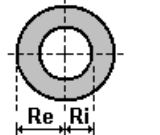
 rettangolare	 a T	 a T rovescia	 a T di colmo	 a L	 a L specchiata
 a L specchiata rovescia	 a L rovescia	 a L di colmo	 a doppio T	 a quattro specchiata	 a quattro
 a U	 a C	 a croce	 circolare	 rettangolare cava	 circolare cava

Per quanto concerne i profilati semplici ed accoppiati l'asse 2 del riferimento coincide con l'asse x riportato nei più diffusi profilati.

Per quanto concerne le sezioni di tipo generico (tipo 1.):  
 i valori dimensionali con prefisso B sono riferiti all'asse 2  
 i valori dimensionali con prefisso H sono riferiti all'asse 3

Con riferimento al Documento di Affidabilità "Test di validazione del software di calcolo PRO\_SAP e dei moduli aggiuntivi PRO\_SAP Modulo Geotecnico, PRO\_CAD nodi acciaio e PRO\_MST" - versione Settembre 2014, disponibile per il download sul sito [www.2si.it](http://www.2si.it), si segnalano i seguenti esempi applicativi:

Test N°	Titolo
1	CARATTERISTICHE GEOMETRICHE E INERZIALI
45	VERIFICA AGLI SLU DI STRUTTURE IN C.A.
48	PROGETTAZIONE A TAGLIO DI STRUTTURE IN C.A. SECONDO IL D.M. 9/1/96
49	PROGETTAZIONE A TAGLIO DI STRUTTURE IN C.A. SECONDO IL D.M. 14/1/2008
50	VERIFICA ALLO SLE (TENSIONI E FESSURAZIONE) DI STRUTTURE IN C.A.
51	VERIFICA ALLO SLE (DEFORMAZIONE) DI STRUTTURE IN C.A.
104	ANALISI DI RESISTENZA AL FUOCO

Id	Tipo	Area	A V2	A V3	Jt	J 2-2	J 3-3	W 2-2	W 3-3	Wp 2-2	Wp 3-3
		cm2	cm2	cm2	cm4	cm4	cm4	cm3	cm3	cm3	cm3

## 5. MODELLAZIONE STRUTTURA: NODI

### 5.1. LEGENDA TABELLA DATI NODI

Il programma utilizza per la modellazione nodi strutturali.

Ogni nodo è individuato dalle coordinate cartesiane nel sistema di riferimento globale (X Y Z).

Ad ogni nodo è eventualmente associato un codice di vincolamento rigido, un codice di fondazione speciale, ed un set di sei molle (tre per le traslazioni, tre per le rotazioni). Le tabelle sottoriportate riflettono le succitate possibilità. In particolare per ogni nodo viene indicato in tabella:

<b>Nodo</b>	numero del nodo.
<b>X</b>	valore della coordinata X
<b>Y</b>	valore della coordinata Y
<b>Z</b>	valore della coordinata Z

Per i nodi ai quali sia associato un codice di vincolamento rigido, un codice di fondazione speciale o un set di molle viene indicato in tabella:

<b>Nodo</b>	numero del nodo.
<b>X</b>	valore della coordinata X
<b>Y</b>	valore della coordinata Y
<b>Z</b>	valore della coordinata Z
<b>Note</b>	eventuale codice di vincolo (es. v=110010 sei valori relativi ai sei gradi di libertà previsti per il nodo TxTyTzRxRyRz, il valore 1 indica che lo spostamento o rotazione relativo è impedito, il valore 0 indica che lo spostamento o rotazione relativo è libero).
<b>Note</b>	(FS = 1, 2,...) eventuale codice del tipo di fondazione speciale (1, 2,... fanno riferimento alle tipologie: plinto, palo, plinto su pali,...) che è collegato al nodo. (ISO = "id SIGLA") indice e sigla identificativa dell' eventuale isolatore sismico assegnato al nodo
<b>Rig. TX</b>	valore della rigidezza dei vincoli elastici eventualmente applicati al nodo, nello specifico TX (idem per TY, TZ, RX, RY, RZ).

Per strutture sismicamente isolate viene inoltre inserita la tabella delle caratteristiche per gli isolatori utilizzati; le caratteristiche sono indicate in conformità al cap. 7.10 del D.M. 17/01/18

#### 5.1.1. TABELLA DATI NODI

Nodo	X	YZ	Nodo	X	Y	Z	Nodo	X	Y	Z	cm
	cm	cm	cm		cm	cm	cm		cm	cm	cm
1	0.0	-1160.0	0.0	2	-300.2	-1120.5	0.0	3	300.2	-1120.5	0.0
4	0.0	-1106.2	0.0	5	-286.3	-1068.6	0.0	6	286.3	-1068.6	0.0
7	0.0	-1052.5	0.0	8	-272.4	-1016.6	0.0	9	272.4	-1016.6	0.0
10	-580.0	-1004.6	0.0	11	580.0	-1004.6	0.0	12	0.0	-998.8	0.0
13	-258.5	-964.7	0.0	14	258.5	-964.7	0.0	15	-553.1	-958.0	0.0
16	553.1	-958.0	0.0	17	0.0	-945.0	0.0	18	-244.6	-912.8	0.0
19	244.6	-912.8	0.0	20	-526.3	-911.5	0.0	21	526.2	-911.5	0.0
22	0.0	-891.2	0.0	23	-499.4	-864.9	0.0	24	499.4	-864.9	0.0
25	-230.7	-860.8	0.0	26	230.7	-860.8	0.0	27	0.0	-837.5	0.0
28	-820.2	-820.2	0.0	29	820.2	-820.2	0.0	30	-472.5	-818.4	0.0
31	472.5	-818.4	0.0	32	-216.8	-809.0	0.0	33	216.8	-809.0	0.0
34	0.0	-783.8	0.0	35	-782.2	-782.2	0.0	36	782.2	-782.2	0.0
37	-445.6	-771.8	0.0	38	445.6	-771.8	0.0	39	-202.8	-757.0	0.0
40	202.8	-757.0	0.0	41	-744.2	-744.2	0.0	42	744.2	-744.2	0.0
43	0.0	-730.0	0.0	44	-418.8	-725.3	0.0	45	418.7	-725.3	0.0
46	-706.2	-706.2	0.0	47	706.2	-706.2	0.0	48	-188.9	-705.1	0.0
49	188.9	-705.1	0.0	50	-391.9	-678.7	0.0	51	391.9	-678.7	0.0
52	0.0	-676.3	0.0	53	-668.2	-668.2	0.0	54	668.2	-668.2	0.0
55	-175.0	-653.2	0.0	56	175.0	-653.2	0.0	57	-365.0	-632.2	0.0
58	365.0	-632.2	0.0	59	-630.2	-630.2	0.0	60	630.2	-630.2	0.0
61	0.0	-622.5	0.0	62	-161.1	-601.3	0.0	63	161.1	-601.3	0.0
64	-592.2	-592.2	0.0	65	592.2	-592.2	0.0	66	-338.1	-585.6	0.0
67	338.1	-585.6	0.0	68	-1004.6	-580.0	0.0	69	1004.6	-580.0	0.0
70	0.0	-568.8	0.0	71	-554.2	-554.2	0.0	72	554.2	-554.2	0.0
73	-958.0	-553.1	0.0	74	958.0	-553.1	0.0	75	-147.2	-549.4	0.0
76	147.2	-549.4	0.0	77	-311.3	-539.1	0.0	78	311.2	-539.1	0.0
79	-911.5	-526.3	0.0	80	911.5	-526.3	0.0	81	-516.2	-516.2	0.0
82	516.2	-516.2	0.0	83	0.0	-515.0	0.0	84	-864.9	-499.4	0.0
85	864.9	-499.4	0.0	86	-133.3	-497.5	0.0	87	133.3	-497.5	0.0

88	-284.4	-492.6	0.0	89	284.4	-492.6	0.0	90	-478.2	-478.2	0.0
91	478.2	-478.2	0.0	92	-818.4	-472.5	0.0	93	818.4	-472.5	0.0
94	0.0	-461.3	0.0	95	-257.5	-446.0	0.0	96	257.5	-446.0	0.0
97	-771.8	-445.6	0.0	98	771.8	-445.6	0.0	99	-119.4	-445.5	0.0
100	119.4	-445.5	0.0	101	-440.2	-440.2	0.0	102	440.2	-440.2	0.0
103	-725.3	-418.8	0.0	104	725.3	-418.8	0.0	105	0.0	-407.5	0.0
106	-402.2	-402.2	0.0	107	402.2	-402.2	0.0	108	-230.6	-399.5	0.0
109	230.6	-399.5	0.0	110	-105.5	-393.6	0.0	111	105.5	-393.6	0.0
112	-678.7	-391.9	0.0	113	678.7	-391.9	0.0	114	-632.2	-365.0	0.0
115	632.2	-365.0	0.0	116	-364.2	-364.2	0.0	117	364.2	-364.2	0.0
118	0.0	-353.8	0.0	119	-203.8	-352.9	0.0	120	203.7	-352.9	0.0
121	-91.6	-341.7	0.0	122	91.6	-341.7	0.0	123	-585.6	-338.1	0.0
124	585.6	-338.1	0.0	125	-326.2	-326.2	0.0	126	326.2	-326.2	0.0
127	-539.1	-311.3	0.0	128	539.1	-311.3	0.0	129	-176.9	-306.4	0.0
130	176.9	-306.4	0.0	131	-1120.5	-300.2	0.0	132	1120.5	-300.2	0.0
133	0.0	-300.0	0.0	134	-77.6	-289.8	0.0	135	77.6	-289.8	0.0
136	-288.1	-288.1	0.0	137	288.1	-288.1	0.0	138	-1068.6	-286.3	0.0
139	1068.6	-286.3	0.0	140	-492.6	-284.4	0.0	141	492.6	-284.4	0.0
142	-1016.6	-272.4	0.0	143	1016.6	-272.4	0.0	144	0.0	-260.0	0.0
145	-150.0	-259.8	0.0	146	150.0	-259.8	0.0	147	-964.7	-258.5	0.0
148	964.7	-258.5	0.0	149	-446.0	-257.5	0.0	150	446.0	-257.5	0.0
151	-67.3	-251.1	0.0	152	67.3	-251.1	0.0	153	-250.1	-250.1	0.0
154	250.1	-250.1	0.0	155	-912.8	-244.6	0.0	156	912.8	-244.6	0.0
157	-860.8	-230.7	0.0	158	-399.5	-230.6	0.0	159	399.5	-230.6	0.0
160	860.8	-230.7	0.0	161	-130.0	-225.2	0.0	162	130.0	-225.2	0.0
163	-809.0	-216.8	0.0	164	809.0	-216.8	0.0	165	-212.1	-212.1	0.0
166	212.1	-212.1	0.0	167	0.0	-210.0	0.0	168	-352.9	-203.8	0.0
169	352.9	-203.8	0.0	170	-757.0	-202.8	0.0	171	-54.4	-202.8	0.0
172	54.4	-202.8	0.0	173	757.0	-202.8	0.0	174	-705.1	-188.9	0.0
175	705.1	-188.9	0.0	176	-183.8	-183.8	0.0	177	183.8	-183.8	0.0
178	-105.0	-181.9	0.0	179	105.0	-181.9	0.0	180	-306.4	-176.9	0.0
181	306.4	-176.9	0.0	182	-653.2	-175.0	0.0	183	653.2	-175.0	0.0
184	-601.3	-161.1	0.0	185	601.3	-161.1	0.0	186	0.0	-160.0	0.0
187	-41.4	-154.5	0.0	188	41.4	-154.5	0.0	189	-259.8	-150.0	0.0
190	259.8	-150.0	0.0	191	-148.5	-148.5	0.0	192	148.5	-148.5	0.0
193	-549.4	-147.2	0.0	194	549.4	-147.2	0.0	195	-80.0	-138.6	0.0
196	80.0	-138.6	0.0	197	-497.5	-133.3	0.0	198	497.5	-133.3	0.0
199	-225.2	-130.0	0.0	200	225.2	-130.0	0.0	201	-445.5	-119.4	0.0
202	445.5	-119.4	0.0	203	-113.1	-113.1	0.0	204	113.1	-113.1	0.0
205	0.0	-110.0	0.0	206	-28.5	-106.3	0.0	207	28.5	-106.3	0.0
208	-393.6	-105.5	0.0	209	393.6	-105.5	0.0	210	-181.9	-105.0	0.0
211	181.9	-105.0	0.0	212	-55.0	-95.3	0.0	213	55.0	-95.3	0.0
214	-341.7	-91.6	0.0	215	341.7	-91.6	0.0	216	-138.6	-80.0	0.0
217	138.6	-80.0	0.0	218	-77.8	-77.8	0.0	219	77.8	-77.8	0.0
220	-289.8	-77.6	0.0	221	289.8	-77.6	0.0	222	-251.1	-67.3	0.0
223	251.1	-67.3	0.0	224	0.0	-60.0	0.0	225	-15.5	-58.0	0.0
226	15.5	-58.0	0.0	227	-95.3	-55.0	0.0	228	95.3	-55.0	0.0
229	-202.8	-54.4	0.0	230	202.8	-54.4	0.0	231	-30.0	-52.0	0.0
232	30.0	-52.0	0.0	233	-42.4	-42.4	0.0	234	42.4	-42.4	0.0
235	-154.5	-41.4	0.0	236	154.5	-41.4	0.0	237	-52.0	-30.0	0.0
238	52.0	-30.0	0.0	239	-106.3	-28.5	0.0	240	106.3	-28.5	0.0
241	-58.0	-15.5	0.0	242	58.0	-15.5	0.0	243	-1160.0	0.0	0.0
244	-1106.3	0.0	0.0	245	-1052.5	0.0	0.0	246	-998.8	0.0	0.0
247	-945.0	0.0	0.0	248	-891.2	0.0	0.0	249	-837.5	0.0	0.0
250	-783.8	0.0	0.0	251	-730.0	0.0	0.0	252	-676.3	0.0	0.0
253	-622.5	0.0	0.0	254	-568.8	0.0	0.0	255	-515.0	0.0	0.0
256	-461.3	0.0	0.0	257	-407.5	0.0	0.0	258	-353.8	0.0	0.0
259	-300.0	0.0	0.0	260	-260.0	0.0	0.0	261	-210.0	0.0	0.0
262	-160.0	0.0	0.0	263	-110.0	0.0	0.0	264	-60.0	0.0	0.0
265	0.0	0.0	0.0	266	60.0	0.0	0.0	267	110.0	0.0	0.0
268	160.0	0.0	0.0	269	210.0	0.0	0.0	270	260.0	0.0	0.0
271	300.0	0.0	0.0	272	353.8	0.0	0.0	273	407.5	0.0	0.0
274	461.3	0.0	0.0	275	515.0	0.0	0.0	276	568.8	0.0	0.0
277	622.5	0.0	0.0	278	676.3	0.0	0.0	279	730.0	0.0	0.0
280	783.8	0.0	0.0	281	837.5	0.0	0.0	282	891.2	0.0	0.0
283	945.0	0.0	0.0	284	998.8	0.0	0.0	285	1052.5	0.0	0.0
286	1106.2	0.0	0.0	287	1160.0	0.0	0.0	288	-58.0	15.5	0.0
289	58.0	15.5	0.0	290	-106.3	28.5	0.0	291	106.3	28.5	0.0
292	-52.0	30.0	0.0	293	52.0	30.0	0.0	294	-154.5	41.4	0.0
295	154.5	41.4	0.0	296	-42.4	42.4	0.0	297	42.4	42.4	0.0
298	-30.0	52.0	0.0	299	30.0	52.0	0.0	300	-202.8	54.4	0.0
301	202.8	54.4	0.0	302	-95.3	55.0	0.0	303	95.3	55.0	0.0
304	-15.5	58.0	0.0	305	15.5	58.0	0.0	306	0.0	60.0	0.0
307	-251.1	67.3	0.0	308	251.1	67.3	0.0	309	-289.8	77.6	0.0
310	289.8	77.6	0.0	311	-77.8	77.8	0.0	312	77.8	77.8	0.0
313	-138.6	80.0	0.0	314	138.6	80.0	0.0	315	-341.7	91.6	0.0



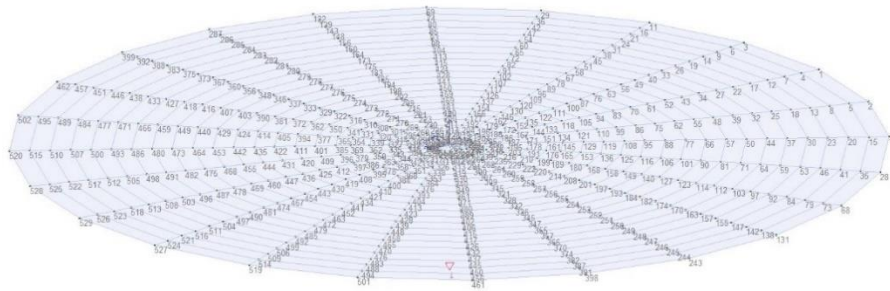

14\_MOD\_NUMERAZIONE\_NODI



## 6. MODELLAZIONE STRUTTURA: ELEMENTI SHELL

### 6.1. LEGENDA TABELLA DATI SHELL

Il programma utilizza per la modellazione elementi a tre o quattro nodi denominati in generale shell. Ogni elemento shell è individuato dai nodi I, J, K, L (L=I per gli elementi a tre nodi). Ogni elemento è caratterizzato da un insieme di proprietà riportate in tabella che ne completano la modellazione.

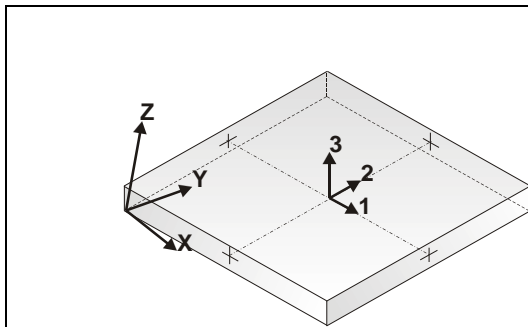

orientamento elementi 3D non verticali

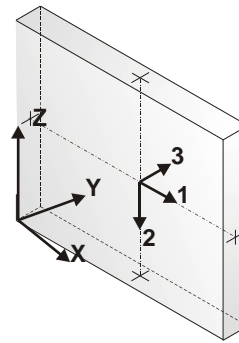

orientamento elementi 3D verticali

In particolare per ogni elemento viene indicato in tabella:

<b>Elem.</b>	numero dell'elemento
<b>Note</b>	codice di comportamento: <i>Guscio</i> (elemento guscio in elevazione non verticale) <i>Guscio fond.</i> (elemento guscio su suolo elastico) <i>Setto</i> (elemento guscio in elevazione verticale) <i>Membrana</i> (elemento guscio con comportamento membranale)
<b>Nodo I (J, K, L)</b>	numero del nodo I (J, K, L)
<b>Mat.</b>	codice del materiale assegnato all'elemento
<b>Spessore</b>	spessore dell'elemento (costante)
<b>Wink V</b>	costante di sottofondo (coefficiente di Winkler) per la modellazione del suolo elastico verticale
<b>Wink O</b>	costante di sottofondo (coefficiente di Winkler) per la modellazione del suolo elastico orizzontale

Con riferimento al **Documento di Affidabilità** "Test di validazione del software di calcolo PRO\_SAP e dei moduli aggiuntivi PRO\_SAP Modulo Geotecnico, PRO\_CAD nodi acciaio e PRO\_MST" - versione Maggio 2011, disponibile per il download sul sito **www.2si.it**, si segnalano i seguenti esempi applicativi:

Test N°	Titolo
8	MENSOLE CON ELEMENTI PLATE E MATERIALE ORTOTROPO
10	PIASTRA CON ELEMENTI PLATE E MATERIALE ORTOTROPO
21	DRILLING
25	TENSIONI DI ELEMENTI PLATE
31	REALIZZAZIONE DI MESH PIANA SU GEOMETRIA CON PUNTI FISSI IMPORTATA DA FILE .DXF
32	REALIZZAZIONE DI MESH PIANA SU GEOMETRIA CON SEGMENTI E FORI INTERNI IMPORTATA DA FILE .DXF
33	REALIZZAZIONE DI MESH PIANE SU GEOMETRIE COSTRUITE IN PRO_SAP
34	ANALISI DI BUCKLING DI PIASTRA ISOTROPA
35	ANALISI DI BUCKLING DI UN CILINDRO COMPRESSO INCASTRATO ALLA BASE
36	ANALISI DI PARETI FORATE
37	BIMETALLIC STRIP (NAFEMS EXERCISE 6)
38	ANALISI ELASTICA DI PIASTRA CON INTAGLIO CIRCOLARE (FLAT BAR WITH EDGE NOTCHES-NAFEMS EXERCISE 9)
39	PLATEA NERVATA
45	VERIFICA A PUNZONAMENTO ALLO SLU DI PIASTRE IN C.A.
117	PROGETTO E VERIFICA DI GUSCI IN MATERIALE XLAM
118	PROGETTO E VERIFICA DI PARETI IN MATERIALE XLAM E RELATIVI COLLEGAMENTI

Elem.	Note	Nodo I	Nodo J	Nodo K	Nodo L	Mat.	Spessore	Svincolo	Wink V	Wink O
					cm		daN/cm3	daN/cm3		
1	Guscio fond.	2 1	4	5	9	125.0		1.85	0.66	
2	Guscio fond.	5 4	7	8	9	140.0		1.85	0.66	
3	Guscio fond.	8 7	12	13	9	155.0		1.85	0.66	
4	Guscio fond.	13 12	17	18	9	170.0		1.85	0.66	
5	Guscio fond.	18 17	22	25	9	185.0		1.85	0.66	
6	Guscio fond.	25 22	27	32	9	200.0		1.85	0.66	
7	Guscio fond.	32 27	34	39	9	215.0		1.85	0.66	
8	Guscio fond.	39 34	43	48	9	230.0		1.85	0.66	
9	Guscio fond.	48 43	52	55	9	245.0		1.85	0.66	
10	Guscio fond.	55 52	61	62	9	260.0		1.85	0.66	
11	Guscio fond.	62 61	70	75	9	275.0		1.85	0.66	
12	Guscio fond.	75 70	83	86	9	290.0		1.85	0.66	
13	Guscio fond.	86 83	94	99	9	305.0		1.85	0.66	
14	Guscio fond.	99 94	105	110	9	320.0		1.84	0.66	
15	Guscio fond.	110105	118	121	9	335.0		1.84	0.66	
16	Guscio fond.	121118	133	134	9	350.0		1.84	0.66	
17	Guscio fond.	134133	144	151	9	435.0		1.84	0.66	
18	Guscio fond.	151144	167	171	9	435.0		1.84	0.66	
19	Guscio fond.	171167	186	187	9	435.0		1.84	0.66	
20	Guscio fond.	187186	205	206	9	435.0		1.84	0.66	
21	Guscio fond.	206205	224	225	9	435.0		1.84	0.66	
22	Guscio fond.	225224	265		9	435.0		1.84	0.66	
23	Guscio fond.	1 3	6	4	9	125.0		1.85	0.66	
24	Guscio fond.	4 6	9	7	9	140.0		1.85	0.66	
25	Guscio fond.	7 9	14	12	9	155.0		1.85	0.66	
26	Guscio fond.	12 14	19	17	9	170.0		1.85	0.66	
27	Guscio fond.	17 19	26	22	9	185.0		1.85	0.66	
28	Guscio fond.	22 26	33	27	9	200.0		1.85	0.66	
29	Guscio fond.	27 33	40	34	9	215.0		1.85	0.66	
30	Guscio fond.	34 40	49	43	9	230.0		1.85	0.66	
31	Guscio fond.	43 49	56	52	9	245.0		1.85	0.66	
32	Guscio fond.	52 56	63	61	9	260.0		1.85	0.66	
33	Guscio fond.	61 63	76	70	9	275.0		1.85	0.66	
34	Guscio fond.	70 76	87	83	9	290.0		1.85	0.66	
35	Guscio fond.	83 87	100	94	9	305.0		1.85	0.66	
36	Guscio fond.	94100	111	105	9	320.0		1.84	0.66	
37	Guscio fond.	105111	122	118	9	335.0		1.84	0.66	
38	Guscio fond.	118122	135	133	9	350.0		1.84	0.66	

39Guscio fond.	133135	152	144	9	435.0	1.84	0.66
40Guscio fond.	144152	172	167	9	435.0	1.84	0.66
41Guscio fond.	167172	188	186	9	435.0	1.84	0.66
42Guscio fond.	186188	207	205	9	435.0	1.84	0.66
43Guscio fond.	205207	226	224	9	435.0	1.84	0.66
44Guscio fond.	224226	265		9	435.0	1.84	0.66
45Guscio fond.	3 11	16	6	9	125.0	1.85	0.66
46Guscio fond.	6 16	21	9	9	140.0	1.85	0.66
47Guscio fond.	9 21	24	14	9	155.0	1.85	0.66
48Guscio fond.	14 24	31	19	9	170.0	1.85	0.66
49Guscio fond.	19 31	38	26	9	185.0	1.85	0.66
50Guscio fond.	26 38	45	33	9	200.0	1.85	0.66
51Guscio fond.	33 45	51	40	9	215.0	1.85	0.66
52Guscio fond.	40 51	58	49	9	230.0	1.85	0.66
53Guscio fond.	49 58	67	56	9	245.0	1.85	0.66
54Guscio fond.	56 67	78	63	9	260.0	1.85	0.66
55Guscio fond.	63 78	89	76	9	275.0	1.85	0.66
56Guscio fond.	76 89	96	87	9	290.0	1.85	0.66
57Guscio fond.	87 96	109	100	9	305.0	1.85	0.66
58Guscio fond.	100109	120	111	9	320.0	1.84	0.66
59Guscio fond.	111120	130	122	9	335.0	1.84	0.66
60Guscio fond.	122130	146	135	9	350.0	1.84	0.66
61Guscio fond.	135146	162	152	9	435.0	1.84	0.66
62Guscio fond.	152162	179	172	9	435.0	1.84	0.66
63Guscio fond.	172179	196	188	9	435.0	1.84	0.66
64Guscio fond.	188196	213	207	9	435.0	1.84	0.66
65Guscio fond.	207213	232	226	9	435.0	1.84	0.66
66Guscio fond.	265226	232		9	435.0	1.84	0.66
67Guscio fond.	11 29	36	16	9	125.0	1.85	0.66
68Guscio fond.	16 36	42	21	9	140.0	1.85	0.66
69Guscio fond.	21 42	47	24	9	155.0	1.85	0.66
70Guscio fond.	24 47	54	31	9	170.0	1.85	0.66
71Guscio fond.	31 54	60	38	9	185.0	1.85	0.66
72Guscio fond.	38 60	65	45	9	200.0	1.85	0.66
73Guscio fond.	45 65	72	51	9	215.0	1.85	0.66
74Guscio fond.	51 72	82	58	9	230.0	1.85	0.66
75Guscio fond.	58 82	91	67	9	245.0	1.85	0.66
76Guscio fond.	67 91	102	78	9	260.0	1.85	0.66
77Guscio fond.	78102	107	89	9	275.0	1.85	0.66
78Guscio fond.	89107	117	96	9	290.0	1.85	0.66
79Guscio fond.	96117	126	109	9	305.0	1.85	0.66
80Guscio fond.	109126	137	120	9	320.0	1.84	0.66
81Guscio fond.	120137	154	130	9	335.0	1.84	0.66
82Guscio fond.	130154	166	146	9	350.0	1.84	0.66
83Guscio fond.	146166	177	162	9	435.0	1.84	0.66
84Guscio fond.	162177	192	179	9	435.0	1.84	0.66
85Guscio fond.	179192	204	196	9	435.0	1.84	0.66
86Guscio fond.	196204	219	213	9	435.0	1.84	0.66
87Guscio fond.	213219	234	232	9	435.0	1.84	0.66
88Guscio fond.	265232	234		9	435.0	1.84	0.66
89Guscio fond.	36 29	69	74	9	125.0	1.85	0.66
90Guscio fond.	42 36	74	80	9	140.0	1.85	0.66
91Guscio fond.	47 42	80	85	9	155.0	1.85	0.66
92Guscio fond.	54 47	85	93	9	170.0	1.85	0.66
93Guscio fond.	60 54	93	98	9	185.0	1.85	0.66
94Guscio fond.	65 60	98	104	9	200.0	1.85	0.66
95Guscio fond.	72 65	104	113	9	215.0	1.85	0.66
96Guscio fond.	82 72	113	115	9	230.0	1.85	0.66
97Guscio fond.	91 82	115	124	9	245.0	1.85	0.66
98Guscio fond.	10291	124	128	9	260.0	1.85	0.66
99Guscio fond.	107102	128	141	9	275.0	1.85	0.66
100Guscio fond.	117107	141	150	9	290.0	1.85	0.66
101Guscio fond.	126117	150	159	9	305.0	1.85	0.66
102Guscio fond.	137126	159	169	9	320.0	1.84	0.66
103Guscio fond.	154137	169	181	9	335.0	1.84	0.66
104Guscio fond.	166154	181	190	9	350.0	1.84	0.66
105Guscio fond.	177166	190	200	9	435.0	1.84	0.66
106Guscio fond.	192177	200	211	9	435.0	1.84	0.66
107Guscio fond.	204192	211	217	9	435.0	1.84	0.66
108Guscio fond.	219204	217	228	9	435.0	1.84	0.66
109Guscio fond.	234219	228	238	9	435.0	1.84	0.66
110Guscio fond.	265234	238		9	435.0	1.84	0.66
111Guscio fond.	74 69	132	139	9	125.0	1.85	0.66
112Guscio fond.	80 74	139	143	9	140.0	1.85	0.66
113Guscio fond.	85 80	143	148	9	155.0	1.85	0.66
114Guscio fond.	93 85	148	156	9	170.0	1.85	0.66

115Guscio fond.	98 93	156	160	9	185.0	1.85	0.66
116Guscio fond.	10498	160	164	9	200.0	1.85	0.66
117Guscio fond.	113104	164	173	9	215.0	1.85	0.66
118Guscio fond.	115113	173	175	9	230.0	1.85	0.66
119Guscio fond.	124115	175	183	9	245.0	1.85	0.66
120Guscio fond.	128124	183	185	9	260.0	1.85	0.66
121Guscio fond.	141128	185	194	9	275.0	1.85	0.66
122Guscio fond.	150141	194	198	9	290.0	1.85	0.66
123Guscio fond.	159150	198	202	9	305.0	1.85	0.66
124Guscio fond.	169159	202	209	9	320.0	1.84	0.66
125Guscio fond.	181169	209	215	9	335.0	1.84	0.66
126Guscio fond.	190181	215	221	9	350.0	1.84	0.66
127Guscio fond.	200190	221	223	9	435.0	1.84	0.66
128Guscio fond.	211200	223	230	9	435.0	1.84	0.66
129Guscio fond.	217211	230	236	9	435.0	1.84	0.66
130Guscio fond.	228217	236	240	9	435.0	1.84	0.66
131Guscio fond.	238228	240	242	9	435.0	1.84	0.66
132Guscio fond.	265238	242		9	435.0	1.84	0.66
133Guscio fond.	139132	287	286	9	125.0	1.85	0.66
134Guscio fond.	143139	286	285	9	140.0	1.85	0.66
135Guscio fond.	148143	285	284	9	155.0	1.85	0.66
136Guscio fond.	156148	284	283	9	170.0	1.85	0.66
137Guscio fond.	160156	283	282	9	185.0	1.85	0.66
138Guscio fond.	164160	282	281	9	200.0	1.85	0.66
139Guscio fond.	173164	281	280	9	215.0	1.85	0.66
140Guscio fond.	175173	280	279	9	230.0	1.85	0.66
141Guscio fond.	183175	279	278	9	245.0	1.85	0.66
142Guscio fond.	185183	278	277	9	260.0	1.85	0.66
143Guscio fond.	194185	277	276	9	275.0	1.85	0.66
144Guscio fond.	198194	276	275	9	290.0	1.85	0.66
145Guscio fond.	202198	275	274	9	305.0	1.85	0.66
146Guscio fond.	209202	274	273	9	320.0	1.84	0.66
147Guscio fond.	215209	273	272	9	335.0	1.84	0.66
148Guscio fond.	221215	272	271	9	350.0	1.84	0.66
149Guscio fond.	223221	271	270	9	435.0	1.84	0.66
150Guscio fond.	230223	270	269	9	435.0	1.84	0.66
151Guscio fond.	236230	269	268	9	435.0	1.84	0.66
152Guscio fond.	240236	268	267	9	435.0	1.84	0.66
153Guscio fond.	242240	267	266	9	435.0	1.84	0.66
154Guscio fond.	265242	266		9	435.0	1.84	0.66
155Guscio fond.	286287	399	392	9	125.0	1.85	0.66
156Guscio fond.	285286	392	388	9	140.0	1.85	0.66
157Guscio fond.	284285	388	383	9	155.0	1.85	0.66
158Guscio fond.	283284	383	375	9	170.0	1.85	0.66
159Guscio fond.	282283	375	373	9	185.0	1.85	0.66
160Guscio fond.	281282	373	367	9	200.0	1.85	0.66
161Guscio fond.	280281	367	360	9	215.0	1.85	0.66
162Guscio fond.	279280	360	356	9	230.0	1.85	0.66
163Guscio fond.	278279	356	348	9	245.0	1.85	0.66
164Guscio fond.	277278	348	346	9	260.0	1.85	0.66
165Guscio fond.	276277	346	337	9	275.0	1.85	0.66
166Guscio fond.	275276	337	333	9	290.0	1.85	0.66
167Guscio fond.	274275	333	329	9	305.0	1.85	0.66
168Guscio fond.	273274	329	322	9	320.0	1.84	0.66
169Guscio fond.	272273	322	316	9	335.0	1.84	0.66
170Guscio fond.	271272	316	310	9	350.0	1.84	0.66
171Guscio fond.	270271	310	308	9	435.0	1.84	0.66
172Guscio fond.	269270	308	301	9	435.0	1.84	0.66
173Guscio fond.	268269	301	295	9	435.0	1.84	0.66
174Guscio fond.	267268	295	291	9	435.0	1.84	0.66
175Guscio fond.	266267	291	289	9	435.0	1.84	0.66
176Guscio fond.	265266	289		9	435.0	1.84	0.66
177Guscio fond.	392399	462	457	9	125.0	1.85	0.66
178Guscio fond.	388392	457	451	9	140.0	1.85	0.66
179Guscio fond.	383388	451	446	9	155.0	1.85	0.66
180Guscio fond.	375383	446	438	9	170.0	1.85	0.66
181Guscio fond.	373375	438	433	9	185.0	1.85	0.66
182Guscio fond.	367373	433	427	9	200.0	1.85	0.66
183Guscio fond.	360367	427	418	9	215.0	1.85	0.66
184Guscio fond.	356360	418	416	9	230.0	1.85	0.66
185Guscio fond.	348356	416	407	9	245.0	1.85	0.66
186Guscio fond.	346348	407	403	9	260.0	1.85	0.66
187Guscio fond.	337346	403	390	9	275.0	1.85	0.66
188Guscio fond.	333337	390	381	9	290.0	1.85	0.66
189Guscio fond.	329333	381	372	9	305.0	1.85	0.66
190Guscio fond.	322329	372	362	9	320.0	1.84	0.66

191Guscio fond.	316322	362	350	9	335.0	1.84	0.66
192Guscio fond.	310316	350	341	9	350.0	1.84	0.66
193Guscio fond.	308310	341	331	9	435.0	1.84	0.66
194Guscio fond.	301308	331	320	9	435.0	1.84	0.66
195Guscio fond.	295301	320	314	9	435.0	1.84	0.66
196Guscio fond.	291295	314	303	9	435.0	1.84	0.66
197Guscio fond.	289291	303	293	9	435.0	1.84	0.66
198Guscio fond.	265289	293		9	435.0	1.84	0.66
199Guscio fond.	457462	502	495	9	125.0	1.85	0.66
200Guscio fond.	451457	495	489	9	140.0	1.85	0.66
201Guscio fond.	446451	489	484	9	155.0	1.85	0.66
202Guscio fond.	438446	484	477	9	170.0	1.85	0.66
203Guscio fond.	433438	477	471	9	185.0	1.85	0.66
204Guscio fond.	427433	471	466	9	200.0	1.85	0.66
205Guscio fond.	418427	466	459	9	215.0	1.85	0.66
206Guscio fond.	416418	459	449	9	230.0	1.85	0.66
207Guscio fond.	407416	449	440	9	245.0	1.85	0.66
208Guscio fond.	403407	440	429	9	260.0	1.85	0.66
209Guscio fond.	390403	429	424	9	275.0	1.85	0.66
210Guscio fond.	381390	424	414	9	290.0	1.85	0.66
211Guscio fond.	372381	414	405	9	305.0	1.85	0.66
212Guscio fond.	362372	405	394	9	320.0	1.84	0.66
213Guscio fond.	350362	394	377	9	335.0	1.84	0.66
214Guscio fond.	341350	377	365	9	350.0	1.84	0.66
215Guscio fond.	331341	365	354	9	435.0	1.84	0.66
216Guscio fond.	320331	354	339	9	435.0	1.84	0.66
217Guscio fond.	314320	339	327	9	435.0	1.84	0.66
218Guscio fond.	303314	327	312	9	435.0	1.84	0.66
219Guscio fond.	293303	312	297	9	435.0	1.84	0.66
220Guscio fond.	265293	297		9	435.0	1.84	0.66
221Guscio fond.	515495	502	520	9	125.0	1.85	0.66
222Guscio fond.	510489	495	515	9	140.0	1.85	0.66
223Guscio fond.	507484	489	510	9	155.0	1.85	0.66
224Guscio fond.	500477	484	507	9	170.0	1.85	0.66
225Guscio fond.	493471	477	500	9	185.0	1.85	0.66
226Guscio fond.	486466	471	493	9	200.0	1.85	0.66
227Guscio fond.	480459	466	486	9	215.0	1.85	0.66
228Guscio fond.	473449	459	480	9	230.0	1.85	0.66
229Guscio fond.	464440	449	473	9	245.0	1.85	0.66
230Guscio fond.	453429	440	464	9	260.0	1.85	0.66
231Guscio fond.	442424	429	453	9	275.0	1.85	0.66
232Guscio fond.	435414	424	442	9	290.0	1.85	0.66
233Guscio fond.	422405	414	435	9	305.0	1.85	0.66
234Guscio fond.	411394	405	422	9	320.0	1.84	0.66
235Guscio fond.	401377	394	411	9	335.0	1.84	0.66
236Guscio fond.	385365	377	401	9	350.0	1.84	0.66
237Guscio fond.	369354	365	385	9	435.0	1.84	0.66
238Guscio fond.	352339	354	369	9	435.0	1.84	0.66
239Guscio fond.	335327	339	352	9	435.0	1.84	0.66
240Guscio fond.	318312	327	335	9	435.0	1.84	0.66
241Guscio fond.	299297	312	318	9	435.0	1.84	0.66
242Guscio fond.	265297	299		9	435.0	1.84	0.66
243Guscio fond.	525515	520	528	9	125.0	1.85	0.66
244Guscio fond.	522510	515	525	9	140.0	1.85	0.66
245Guscio fond.	517507	510	522	9	155.0	1.85	0.66
246Guscio fond.	512500	507	517	9	170.0	1.85	0.66
247Guscio fond.	505493	500	512	9	185.0	1.85	0.66
248Guscio fond.	498486	493	505	9	200.0	1.85	0.66
249Guscio fond.	491480	486	498	9	215.0	1.85	0.66
250Guscio fond.	482473	480	491	9	230.0	1.85	0.66
251Guscio fond.	475464	473	482	9	245.0	1.85	0.66
252Guscio fond.	468453	464	475	9	260.0	1.85	0.66
253Guscio fond.	455442	453	468	9	275.0	1.85	0.66
254Guscio fond.	444435	442	455	9	290.0	1.85	0.66
255Guscio fond.	431422	435	444	9	305.0	1.85	0.66
256Guscio fond.	420411	422	431	9	320.0	1.84	0.66
257Guscio fond.	409401	411	420	9	335.0	1.84	0.66
258Guscio fond.	396385	401	409	9	350.0	1.84	0.66
259Guscio fond.	379369	385	396	9	435.0	1.84	0.66
260Guscio fond.	359352	369	379	9	435.0	1.84	0.66
261Guscio fond.	343335	352	359	9	435.0	1.84	0.66
262Guscio fond.	324318	335	343	9	435.0	1.84	0.66
263Guscio fond.	305299	318	324	9	435.0	1.84	0.66
264Guscio fond.	265299	305		9	435.0	1.84	0.66
265Guscio fond.	526525	528	529	9	125.0	1.85	0.66
266Guscio fond.	523522	525	526	9	140.0	1.85	0.66



267Guscio fond.	518517	522	523	9	155.0	1.85	0.66
268Guscio fond.	513512	517	518	9	170.0	1.85	0.66
269Guscio fond.	508505	512	513	9	185.0	1.85	0.66
270Guscio fond.	503498	505	508	9	200.0	1.85	0.66
271Guscio fond.	496491	498	503	9	215.0	1.85	0.66
272Guscio fond.	487482	491	496	9	230.0	1.85	0.66
273Guscio fond.	478475	482	487	9	245.0	1.85	0.66
274Guscio fond.	469468	475	478	9	260.0	1.85	0.66
275Guscio fond.	460455	468	469	9	275.0	1.85	0.66
276Guscio fond.	447444	455	460	9	290.0	1.85	0.66
277Guscio fond.	436431	444	447	9	305.0	1.85	0.66
278Guscio fond.	425420	431	436	9	320.0	1.84	0.66
279Guscio fond.	412409	420	425	9	335.0	1.84	0.66
280Guscio fond.	397396	409	412	9	350.0	1.84	0.66
281Guscio fond.	386379	396	397	9	435.0	1.84	0.66
282Guscio fond.	363359	379	386	9	435.0	1.84	0.66
283Guscio fond.	344343	359	363	9	435.0	1.84	0.66
284Guscio fond.	325324	343	344	9	435.0	1.84	0.66
285Guscio fond.	306305	324	325	9	435.0	1.84	0.66
286Guscio fond.	306265	305		9	435.0	1.84	0.66
287Guscio fond.	524526	529	527	9	125.0	1.85	0.66
288Guscio fond.	521523	526	524	9	140.0	1.85	0.66
289Guscio fond.	516518	523	521	9	155.0	1.85	0.66
290Guscio fond.	511513	518	516	9	170.0	1.85	0.66
291Guscio fond.	504508	513	511	9	185.0	1.85	0.66
292Guscio fond.	497503	508	504	9	200.0	1.85	0.66
293Guscio fond.	490496	503	497	9	215.0	1.85	0.66
294Guscio fond.	481487	496	490	9	230.0	1.85	0.66
295Guscio fond.	474478	487	481	9	245.0	1.85	0.66
296Guscio fond.	467469	478	474	9	260.0	1.85	0.66
297Guscio fond.	454460	469	467	9	275.0	1.85	0.66
298Guscio fond.	443447	460	454	9	290.0	1.85	0.66
299Guscio fond.	430436	447	443	9	305.0	1.85	0.66
300Guscio fond.	419425	436	430	9	320.0	1.84	0.66
301Guscio fond.	408412	425	419	9	335.0	1.84	0.66
302Guscio fond.	395397	412	408	9	350.0	1.84	0.66
303Guscio fond.	378386	397	395	9	435.0	1.84	0.66
304Guscio fond.	358363	386	378	9	435.0	1.84	0.66
305Guscio fond.	342344	363	358	9	435.0	1.84	0.66
306Guscio fond.	323325	344	342	9	435.0	1.84	0.66
307Guscio fond.	304306	325	323	9	435.0	1.84	0.66
308Guscio fond.	304265	306		9	435.0	1.84	0.66
309Guscio fond.	514524	527	519	9	125.0	1.85	0.66
310Guscio fond.	509521	524	514	9	140.0	1.85	0.66
311Guscio fond.	506516	521	509	9	155.0	1.85	0.66
312Guscio fond.	499511	516	506	9	170.0	1.85	0.66
313Guscio fond.	492504	511	499	9	185.0	1.85	0.66
314Guscio fond.	485497	504	492	9	200.0	1.85	0.66
315Guscio fond.	479490	497	485	9	215.0	1.85	0.66
316Guscio fond.	472481	490	479	9	230.0	1.85	0.66
317Guscio fond.	463474	481	472	9	245.0	1.85	0.66
318Guscio fond.	452467	474	463	9	260.0	1.85	0.66
319Guscio fond.	441454	467	452	9	275.0	1.85	0.66
320Guscio fond.	434443	454	441	9	290.0	1.85	0.66
321Guscio fond.	421430	443	434	9	305.0	1.85	0.66
322Guscio fond.	410419	430	421	9	320.0	1.84	0.66
323Guscio fond.	400408	419	410	9	335.0	1.84	0.66
324Guscio fond.	384395	408	400	9	350.0	1.84	0.66
325Guscio fond.	368378	395	384	9	435.0	1.84	0.66
326Guscio fond.	351358	378	368	9	435.0	1.84	0.66
327Guscio fond.	334342	358	351	9	435.0	1.84	0.66
328Guscio fond.	317323	342	334	9	435.0	1.84	0.66
329Guscio fond.	298304	323	317	9	435.0	1.84	0.66
330Guscio fond.	298265	304		9	435.0	1.84	0.66
331Guscio fond.	494514	519	501	9	125.0	1.85	0.66
332Guscio fond.	488509	514	494	9	140.0	1.85	0.66
333Guscio fond.	483506	509	488	9	155.0	1.85	0.66
334Guscio fond.	476499	506	483	9	170.0	1.85	0.66
335Guscio fond.	470492	499	476	9	185.0	1.85	0.66
336Guscio fond.	465485	492	470	9	200.0	1.85	0.66
337Guscio fond.	458479	485	465	9	215.0	1.85	0.66
338Guscio fond.	448472	479	458	9	230.0	1.85	0.66
339Guscio fond.	439463	472	448	9	245.0	1.85	0.66
340Guscio fond.	428452	463	439	9	260.0	1.85	0.66
341Guscio fond.	423441	452	428	9	275.0	1.85	0.66
342Guscio fond.	413434	441	423	9	290.0	1.85	0.66

343Guscio fond.	404421	434	413	9	305.0	1.85	0.66
344Guscio fond.	393410	421	404	9	320.0	1.84	0.66
345Guscio fond.	376400	410	393	9	335.0	1.84	0.66
346Guscio fond.	364384	400	376	9	350.0	1.84	0.66
347Guscio fond.	353368	384	364	9	435.0	1.84	0.66
348Guscio fond.	338351	368	353	9	435.0	1.84	0.66
349Guscio fond.	326334	351	338	9	435.0	1.84	0.66
350Guscio fond.	311317	334	326	9	435.0	1.84	0.66
351Guscio fond.	296298	317	311	9	435.0	1.84	0.66
352Guscio fond.	296265	298		9	435.0	1.84	0.66
353Guscio fond.	461456	494	501	9	125.0	1.85	0.66
354Guscio fond.	456450	488	494	9	140.0	1.85	0.66
355Guscio fond.	450445	483	488	9	155.0	1.85	0.66
356Guscio fond.	445437	476	483	9	170.0	1.85	0.66
357Guscio fond.	437432	470	476	9	185.0	1.85	0.66
358Guscio fond.	432426	465	470	9	200.0	1.85	0.66
359Guscio fond.	426417	458	465	9	215.0	1.85	0.66
360Guscio fond.	417415	448	458	9	230.0	1.85	0.66
361Guscio fond.	415406	439	448	9	245.0	1.85	0.66
362Guscio fond.	406402	428	439	9	260.0	1.85	0.66
363Guscio fond.	402389	423	428	9	275.0	1.85	0.66
364Guscio fond.	389380	413	423	9	290.0	1.85	0.66
365Guscio fond.	380371	404	413	9	305.0	1.85	0.66
366Guscio fond.	371361	393	404	9	320.0	1.84	0.66
367Guscio fond.	361349	376	393	9	335.0	1.84	0.66
368Guscio fond.	349340	364	376	9	350.0	1.84	0.66
369Guscio fond.	340330	353	364	9	435.0	1.84	0.66
370Guscio fond.	330319	338	353	9	435.0	1.84	0.66
371Guscio fond.	319313	326	338	9	435.0	1.84	0.66
372Guscio fond.	313302	311	326	9	435.0	1.84	0.66
373Guscio fond.	302292	296	311	9	435.0	1.84	0.66
374Guscio fond.	292265	296		9	435.0	1.84	0.66
375Guscio fond.	398391	456	461	9	125.0	1.85	0.66
376Guscio fond.	391387	450	456	9	140.0	1.85	0.66
377Guscio fond.	387382	445	450	9	155.0	1.85	0.66
378Guscio fond.	382374	437	445	9	170.0	1.85	0.66
379Guscio fond.	374370	432	437	9	185.0	1.85	0.66
380Guscio fond.	370366	426	432	9	200.0	1.85	0.66
381Guscio fond.	366357	417	426	9	215.0	1.85	0.66
382Guscio fond.	357355	415	417	9	230.0	1.85	0.66
383Guscio fond.	355347	406	415	9	245.0	1.85	0.66
384Guscio fond.	347345	402	406	9	260.0	1.85	0.66
385Guscio fond.	345336	389	402	9	275.0	1.85	0.66
386Guscio fond.	336332	380	389	9	290.0	1.85	0.66
387Guscio fond.	332328	371	380	9	305.0	1.85	0.66
388Guscio fond.	328321	361	371	9	320.0	1.84	0.66
389Guscio fond.	321315	349	361	9	335.0	1.84	0.66
390Guscio fond.	315309	340	349	9	350.0	1.84	0.66
391Guscio fond.	309307	330	340	9	435.0	1.84	0.66
392Guscio fond.	307300	319	330	9	435.0	1.84	0.66
393Guscio fond.	300294	313	319	9	435.0	1.84	0.66
394Guscio fond.	294290	302	313	9	435.0	1.84	0.66
395Guscio fond.	290288	292	302	9	435.0	1.84	0.66
396Guscio fond.	288265	292		9	435.0	1.84	0.66
397Guscio fond.	243244	391	398	9	125.0	1.85	0.66
398Guscio fond.	244245	387	391	9	140.0	1.85	0.66
399Guscio fond.	245246	382	387	9	155.0	1.85	0.66
400Guscio fond.	246247	374	382	9	170.0	1.85	0.66
401Guscio fond.	247248	370	374	9	185.0	1.85	0.66
402Guscio fond.	248249	366	370	9	200.0	1.85	0.66
403Guscio fond.	249250	357	366	9	215.0	1.85	0.66
404Guscio fond.	250251	355	357	9	230.0	1.85	0.66
405Guscio fond.	251252	347	355	9	245.0	1.85	0.66
406Guscio fond.	252253	345	347	9	260.0	1.85	0.66
407Guscio fond.	253254	336	345	9	275.0	1.85	0.66
408Guscio fond.	254255	332	336	9	290.0	1.85	0.66
409Guscio fond.	255256	328	332	9	305.0	1.85	0.66
410Guscio fond.	256257	321	328	9	320.0	1.84	0.66
411Guscio fond.	257258	315	321	9	335.0	1.84	0.66
412Guscio fond.	258259	309	315	9	350.0	1.84	0.66
413Guscio fond.	259260	307	309	9	435.0	1.84	0.66
414Guscio fond.	260261	300	307	9	435.0	1.84	0.66
415Guscio fond.	261262	294	300	9	435.0	1.84	0.66
416Guscio fond.	262263	290	294	9	435.0	1.84	0.66
417Guscio fond.	263264	288	290	9	435.0	1.84	0.66
418Guscio fond.	264265	288		9	435.0	1.84	0.66



419Guscio fond.	131138	244	243	9	125.0	1.85	0.66
420Guscio fond.	138142	245	244	9	140.0	1.85	0.66
421Guscio fond.	142147	246	245	9	155.0	1.85	0.66
422Guscio fond.	147155	247	246	9	170.0	1.85	0.66
423Guscio fond.	155157	248	247	9	185.0	1.85	0.66
424Guscio fond.	157163	249	248	9	200.0	1.85	0.66
425Guscio fond.	163170	250	249	9	215.0	1.85	0.66
426Guscio fond.	170174	251	250	9	230.0	1.85	0.66
427Guscio fond.	174182	252	251	9	245.0	1.85	0.66
428Guscio fond.	182184	253	252	9	260.0	1.85	0.66
429Guscio fond.	184193	254	253	9	275.0	1.85	0.66
430Guscio fond.	193197	255	254	9	290.0	1.85	0.66
431Guscio fond.	197201	256	255	9	305.0	1.85	0.66
432Guscio fond.	201208	257	256	9	320.0	1.84	0.66
433Guscio fond.	208214	258	257	9	335.0	1.84	0.66
434Guscio fond.	214220	259	258	9	350.0	1.84	0.66
435Guscio fond.	220222	260	259	9	435.0	1.84	0.66
436Guscio fond.	222229	261	260	9	435.0	1.84	0.66
437Guscio fond.	229235	262	261	9	435.0	1.84	0.66
438Guscio fond.	235239	263	262	9	435.0	1.84	0.66
439Guscio fond.	239241	264	263	9	435.0	1.84	0.66
440Guscio fond.	264241	265		9	435.0	1.84	0.66
441Guscio fond.	68 73	138	131	9	125.0	1.85	0.66
442Guscio fond.	73 79	142	138	9	140.0	1.85	0.66
443Guscio fond.	79 84	147	142	9	155.0	1.85	0.66
444Guscio fond.	84 92	155	147	9	170.0	1.85	0.66
445Guscio fond.	92 97	157	155	9	185.0	1.85	0.66
446Guscio fond.	97103	163	157	9	200.0	1.85	0.66
447Guscio fond.	103112	170	163	9	215.0	1.85	0.66
448Guscio fond.	112114	174	170	9	230.0	1.85	0.66
449Guscio fond.	114123	182	174	9	245.0	1.85	0.66
450Guscio fond.	123127	184	182	9	260.0	1.85	0.66
451Guscio fond.	127140	193	184	9	275.0	1.85	0.66
452Guscio fond.	140149	197	193	9	290.0	1.85	0.66
453Guscio fond.	149158	201	197	9	305.0	1.85	0.66
454Guscio fond.	158168	208	201	9	320.0	1.84	0.66
455Guscio fond.	168180	214	208	9	335.0	1.84	0.66
456Guscio fond.	180189	220	214	9	350.0	1.84	0.66
457Guscio fond.	189199	222	220	9	435.0	1.84	0.66
458Guscio fond.	199210	229	222	9	435.0	1.84	0.66
459Guscio fond.	210216	235	229	9	435.0	1.84	0.66
460Guscio fond.	216227	239	235	9	435.0	1.84	0.66
461Guscio fond.	227237	241	239	9	435.0	1.84	0.66
462Guscio fond.	241237	265		9	435.0	1.84	0.66
463Guscio fond.	28 35	73	68	9	125.0	1.85	0.66
464Guscio fond.	35 41	79	73	9	140.0	1.85	0.66
465Guscio fond.	41 46	84	79	9	155.0	1.85	0.66
466Guscio fond.	46 53	92	84	9	170.0	1.85	0.66
467Guscio fond.	53 59	97	92	9	185.0	1.85	0.66
468Guscio fond.	59 64	103	97	9	200.0	1.85	0.66
469Guscio fond.	64 71	112	103	9	215.0	1.85	0.66
470Guscio fond.	71 81	114	112	9	230.0	1.85	0.66
471Guscio fond.	81 90	123	114	9	245.0	1.85	0.66
472Guscio fond.	90101	127	123	9	260.0	1.85	0.66
473Guscio fond.	101106	140	127	9	275.0	1.85	0.66
474Guscio fond.	106116	149	140	9	290.0	1.85	0.66
475Guscio fond.	116125	158	149	9	305.0	1.85	0.66
476Guscio fond.	125136	168	158	9	320.0	1.84	0.66
477Guscio fond.	136153	180	168	9	335.0	1.84	0.66
478Guscio fond.	153165	189	180	9	350.0	1.84	0.66
479Guscio fond.	165176	199	189	9	435.0	1.84	0.66
480Guscio fond.	176191	210	199	9	435.0	1.84	0.66
481Guscio fond.	191203	216	210	9	435.0	1.84	0.66
482Guscio fond.	203218	227	216	9	435.0	1.84	0.66
483Guscio fond.	218233	237	227	9	435.0	1.84	0.66
484Guscio fond.	237233	265		9	435.0	1.84	0.66
485Guscio fond.	28 10	15	35	9	125.0	1.85	0.66
486Guscio fond.	35 15	20	41	9	140.0	1.85	0.66
487Guscio fond.	41 20	23	46	9	155.0	1.85	0.66
488Guscio fond.	46 23	30	53	9	170.0	1.85	0.66
489Guscio fond.	53 30	37	59	9	185.0	1.85	0.66
490Guscio fond.	59 37	44	64	9	200.0	1.85	0.66
491Guscio fond.	64 44	50	71	9	215.0	1.85	0.66
492Guscio fond.	71 50	57	81	9	230.0	1.85	0.66
493Guscio fond.	81 57	66	90	9	245.0	1.85	0.66
494Guscio fond.	90 66	77	101	9	260.0	1.85	0.66

495Guscio fond.	10177	88	106	9	275.0	1.85	0.66
496Guscio fond.	10688	95	116	9	290.0	1.85	0.66
497Guscio fond.	11695	108	125	9	305.0	1.85	0.66
498Guscio fond.	125108	119	136	9	320.0	1.84	0.66
499Guscio fond.	136119	129	153	9	335.0	1.84	0.66
500Guscio fond.	153129	145	165	9	350.0	1.84	0.66
501Guscio fond.	165145	161	176	9	435.0	1.84	0.66
502Guscio fond.	176161	178	191	9	435.0	1.84	0.66
503Guscio fond.	191178	195	203	9	435.0	1.84	0.66
504Guscio fond.	203195	212	218	9	435.0	1.84	0.66
505Guscio fond.	218212	231	233	9	435.0	1.84	0.66
506Guscio fond.	233231	265		9	435.0	1.84	0.66
507Guscio fond.	10 2	5	15	9	125.0	1.85	0.66
508Guscio fond.	15 5	8	20	9	140.0	1.85	0.66
509Guscio fond.	20 8	13	23	9	155.0	1.85	0.66
510Guscio fond.	23 13	18	30	9	170.0	1.85	0.66
511Guscio fond.	30 18	25	37	9	185.0	1.85	0.66
512Guscio fond.	37 25	32	44	9	200.0	1.85	0.66
513Guscio fond.	44 32	39	50	9	215.0	1.85	0.66
514Guscio fond.	50 39	48	57	9	230.0	1.85	0.66
515Guscio fond.	57 48	55	66	9	245.0	1.85	0.66
516Guscio fond.	66 55	62	77	9	260.0	1.85	0.66
517Guscio fond.	77 62	75	88	9	275.0	1.85	0.66
518Guscio fond.	88 75	86	95	9	290.0	1.85	0.66
519Guscio fond.	95 86	99	108	9	305.0	1.85	0.66
520Guscio fond.	10899	110	119	9	320.0	1.84	0.66
521Guscio fond.	119110	121	129	9	335.0	1.84	0.66
522Guscio fond.	129121	134	145	9	350.0	1.84	0.66
523Guscio fond.	145134	151	161	9	435.0	1.84	0.66
524Guscio fond.	161151	171	178	9	435.0	1.84	0.66
525Guscio fond.	178171	187	195	9	435.0	1.84	0.66
526Guscio fond.	195187	206	212	9	435.0	1.84	0.66
527Guscio fond.	212206	225	231	9	435.0	1.84	0.66
528Guscio fond.	231225	265		9	435.0	1.84	0.66

MODELLO

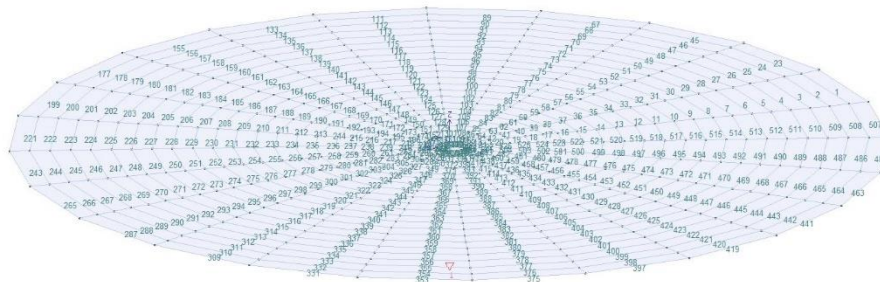



Wind Energy  
Sindia Srl

green &  
green  
WE ENGINEERING

CODE

C21BLN001CWR00300

PAGE

32 di/of 119

MODELLO

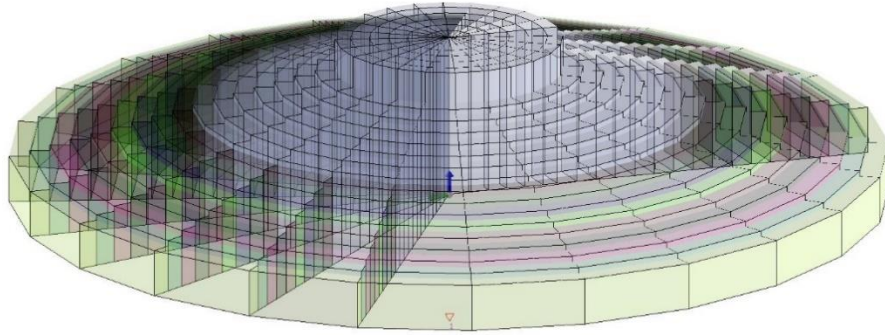

16\_MOD\_SPESSORI\_D3

## 7. MODELLAZIONE DELLE AZIONI

### 7.1. LEGENDA TABELLA DATI AZIONI

Il programma consente l'uso di diverse tipologie di carico (azioni). Le azioni utilizzate nella modellazione sono individuate da una sigla identificativa ed un codice numerico (gli elementi strutturali richiamano quest'ultimo nella propria descrizione). Per ogni azione applicata alla struttura viene di riportato il codice, il tipo e la sigla identificativa. Le tabelle successive dettagliano i valori caratteristici di ogni azione in relazione al tipo. Le tabelle riportano infatti i seguenti dati in relazione al tipo:

<b>1</b>	<b>carico concentrato nodale</b> 6 dati (forza $F_x$ , $F_y$ , $F_z$ , momento $M_x$ , $M_y$ , $M_z$ )
<b>2</b>	<b>spostamento nodale impresso</b> 6 dati (spostamento $T_x$ , $T_y$ , $T_z$ , rotazione $R_x$ , $R_y$ , $R_z$ )
<b>3</b>	<b>carico distribuito globale su elemento tipo trave</b> 7 dati ( $f_x$ , $f_y$ , $f_z$ , $m_x$ , $m_y$ , $m_z$ , ascissa di inizio carico) 7 dati ( $f_x$ , $f_y$ , $f_z$ , $m_x$ , $m_y$ , $m_z$ , ascissa di fine carico)
<b>4</b>	<b>carico distribuito locale su elemento tipo trave</b> 7 dati ( $f_1$ , $f_2$ , $f_3$ , $m_1$ , $m_2$ , $m_3$ , ascissa di inizio carico) 7 dati ( $f_1$ , $f_2$ , $f_3$ , $m_1$ , $m_2$ , $m_3$ , ascissa di fine carico)
<b>5</b>	<b>carico concentrato globale su elemento tipo trave</b> 7 dati ( $F_x$ , $F_y$ , $F_z$ , $M_x$ , $M_y$ , $M_z$ , ascissa di carico)
<b>6</b>	<b>carico concentrato locale su elemento tipo trave</b> 7 dati ( $F_1$ , $F_2$ , $F_3$ , $M_1$ , $M_2$ , $M_3$ , ascissa di carico)
<b>7</b>	<b>variazione termica applicata ad elemento tipo trave</b> 7 dati (variazioni termiche: uniforme, media e differenza in altezza e larghezza al nodo iniziale e finale)
<b>8</b>	<b>carico di pressione uniforme su elemento tipo piastra</b> 1 dato (pressione)
<b>9</b>	<b>carico di pressione variabile su elemento tipo piastra</b> 4 dati (pressione, quota, pressione, quota)
<b>10</b>	<b>variazione termica applicata ad elemento tipo piastra</b> 2 dati (variazioni termiche: media e differenza nello spessore)
<b>11</b>	<b>carico variabile generale su elementi tipo trave e piastra</b> 1 dato descrizione della tipologia 4 dati per segmento (posizione, valore, posizione, valore) la tipologia precisa l'ascissa di definizione, la direzione del carico, la modalità di carico e la larghezza d'influenza per gli elementi tipo trave
<b>12</b>	<b>gruppo di carichi con impronta su piastra</b> 9 dati (numero di ripetizioni in direzione X e Y, valore di ciascun carico, posizione centrale del primo, dimensioni dell'impronta, interasse tra i carichi)

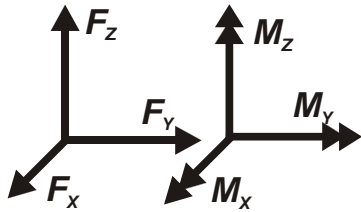

Carico concentrato  
nodale

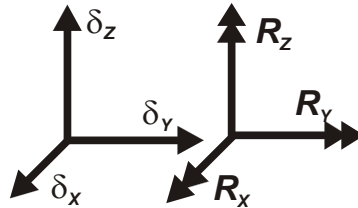

Spostamento  
impresso

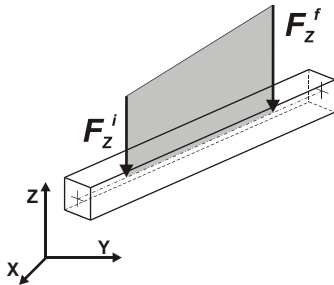

Carico distribuito  
globale

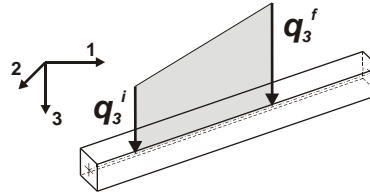

Carico distribuito  
locale

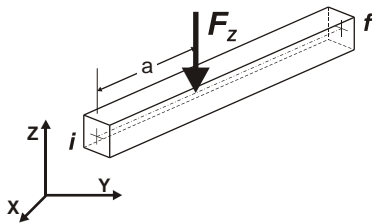

Carico concentrato  
globale

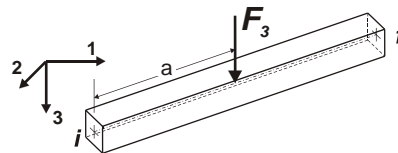

Carico concentrato  
locale

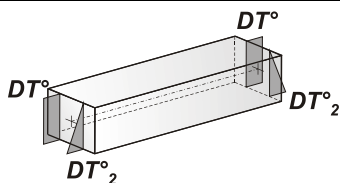

Carico termico 2D

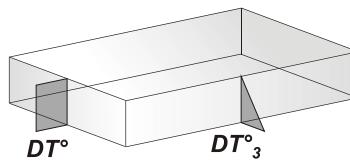

Carico termico 3D

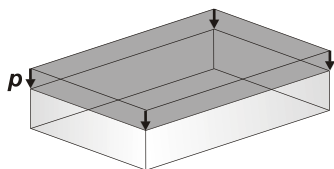

Carico pressione  
uniforme

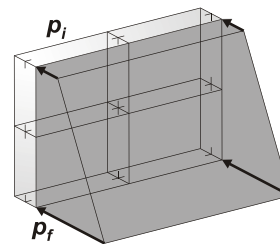

Carico pressione  
variabile

**Tipo carico concentrato nodale**

Id	Tipo	Fx	Fy	Fz	Mx	My	Mz
		daN	daN	daN	daN cm	daN cm	daN cm
1	struttura sovrastante	0.0	0.0	-3.068e+04	0.0	0.0	0.0
2	azione sismica orizzontale	213.21	0.0	0.0	0.0	0.0	0.0
3	azione sismica 1	0.0	0.0	6.523e+04	0.0	0.0	0.0
4	azione sismica 2-24	0.0	0.0	6.300e+04	0.0	0.0	0.0
5	azione sismica 3-23	0.0	0.0	5.649e+04	0.0	0.0	0.0
6	azione sismica 4-22	0.0	0.0	4.612e+04	0.0	0.0	0.0
7	azione sismica 5-21	0.0	0.0	3.261e+04	0.0	0.0	0.0
8	azione sismica 6-20	0.0	0.0	1.688e+04	0.0	0.0	0.0
9	azione sismica 8-18	0.0	0.0	-1.688e+04	0.0	0.0	0.0
10	azione sismica 9-17	0.0	0.0	-3.261e+04	0.0	0.0	0.0
11	azione sismica 10-16	0.0	0.0	-4.612e+04	0.0	0.0	0.0
12	azione sismica 11-15	0.0	0.0	-5.649e+04	0.0	0.0	0.0
13	azione sismica 12-14	0.0	0.0	-6.300e+04	0.0	0.0	0.0
14	azione sismica 13	0.0	0.0	-6.523e+04	0.0	0.0	0.0
15	vento azione orizzontale	2.132e+04	0.0	0.0	0.0	0.0	0.0
16	Vento 1	0.0	0.0	-1.053e+06	0.0	0.0	0.0
17	Vento 2-24	0.0	0.0	-1.017e+06	0.0	0.0	0.0
18	Vento 3-23	0.0	0.0	-9.115e+05	0.0	0.0	0.0

Id	Tipo	Fx	Fy	Fz	Mx	My	Mz
19	Vento 4-22	0.0	0.0	-7.442e+05	0.0	0.0	0.0
20	Vento 5-21	0.0	0.0	-5.263e+05	0.0	0.0	0.0
21	Vento 6-20	0.0	0.0	-2.724e+05	0.0	0.0	0.0
22	Vento 8-18	0.0	0.0	2.724e+05	0.0	0.0	0.0
23	Vento 9-17	0.0	0.0	5.263e+05	0.0	0.0	0.0
24	Vento 10-16	0.0	0.0	7.442e+05	0.0	0.0	0.0
25	Vento 11-15	0.0	0.0	9.115e+05	0.0	0.0	0.0
26	Vento 12-14	0.0	0.0	1.017e+06	0.0	0.0	0.0
27	Vento 13	0.0	0.0	1.053e+06	0.0	0.0	0.0

**Tipo carico variabile generale**

Id	Tipo	ascissa cm	valore daN/cm2	ascissa cm	valore daN/cm2
28	Terreno Riporto 1				
	Unif. Qz Area L2=0.0		-0.59		
29	Terreno Riporto 2				
	Unif. Qz Area L2=0.0		-0.56		
30	Terreno Riporto 3				
	Unif. Qz Area L2=0.0		-0.53		
31	Terreno Riporto 4				
	Unif. Qz Area L2=0.0		-0.50		
32	Terreno Riporto 5				
	Unif. Qz Area L2=0.0		-0.47		
33	Terreno Riporto 6				
	Unif. Qz Area L2=0.0		-0.44		
34	Terreno Riporto 7				
	Unif. Qz Area L2=0.0		-0.41		
35	Terreno Riporto 8				
	Unif. Qz Area L2=0.0		-0.38		
36	Terreno Riporto 9				
	Unif. Qz Area L2=0.0		-0.35		
37	Terreno Riporto 10				
	Unif. Qz Area L2=0.0		-0.29		
38	Terreno Riporto 11				
	Unif. Qz Area L2=0.0		-0.29		
39	Terreno Riporto 12				
	Unif. Qz Area L2=0.0		-0.24		
40	Terreno Riporto 13				
	Unif. Qz Area L2=0.0		-0.24		
41	Terreno Riporto 14				
	Unif. Qz Area L2=0.0		-0.21		
42	Terreno Riporto 15				
	Unif. Qz Area L2=0.0		-0.05		
43	Terreno Riporto 16				
	Unif. Qz Area L2=0.0		-0.15		

**Tipo gruppo di carichi con impronta su piastra**

Id	Tipo	Ripet. X	Ripet. Y	Carico FZ daN	Centro X cm	Centro Y cm	dim. X cm	dim. Y cm	Passo X cm	Passo Y cm
44	PROVA	0	0	1.000e+04	0.0	0.0	5.00	5.00	20.00	10.00



## 8. SCHEMATIZZAZIONE DEI CASI DI CARICO

### 8.1. LEGENDA TABELLA CASI DI CARICO

Il programma consente l'applicazione di diverse tipologie di casi di carico.

Sono previsti i seguenti 11 tipi di casi di carico:

	<b>Sigla</b>	<b>Tipo</b>	<b>Descrizione</b>
1	<b>Ggk</b>	A	caso di carico comprensivo del peso proprio struttura
2	<b>Gk</b>	NA	caso di carico con azioni permanenti
3	<b>Qk</b>	NA	caso di carico con azioni variabili
4	<b>Gsk</b>	A	caso di carico comprensivo dei carichi permanenti sui solai e sulle coperture
5	<b>Qsk</b>	A	caso di carico comprensivo dei carichi variabili sui solai
6	<b>Qnk</b>	A	caso di carico comprensivo dei carichi di neve sulle coperture
7	<b>Qtk</b>	SA	caso di carico comprensivo di una variazione termica agente sulla struttura
8	<b>Qvk</b>	NA	caso di carico comprensivo di azioni da vento sulla struttura
9	<b>Esk</b>	SA	caso di carico sismico con analisi statica equivalente
10	<b>Edk</b>	SA	caso di carico sismico con analisi dinamica
11	<b>Etk</b>	NA	caso di carico comprensivo di azioni derivanti dall' incremento di spinta delle terre in condizione sismica
12	<b>Pk</b>	NA	caso di carico comprensivo di azioni derivanti da coazioni, cedimenti e precompressioni

Sono di tipo automatico A (ossia non prevedono introduzione dati da parte dell'utente) i seguenti casi di carico: 1-Ggk; 4-Gsk; 5-Qsk; 6-Qnk.

Sono di tipo semi-automatico SA (ossia prevedono una minima introduzione dati da parte dell'utente) i seguenti casi di carico:

7-Qtk, in quanto richiede solo il valore della variazione termica;

9-Esk e 10-Edk, in quanto richiedono il valore dell'angolo di ingresso del sisma e l'individuazione dei casi di carico partecipanti alla definizione delle masse.

Sono di tipo non automatico NA ossia prevedono la diretta applicazione di carichi generici agli elementi strutturali (si veda il precedente punto Modellazione delle Azioni) i restanti casi di carico.

Nella tabella successiva vengono riportati i casi di carico agenti sulla struttura, con l'indicazione dei dati relativi al caso di carico stesso:

*Numero Tipo e Sigla identificativa, Valore di riferimento del caso di carico (se previsto).*

In successione, per i casi di carico non automatici, viene riportato l'elenco di nodi ed elementi direttamente caricati con la sigla identificativa del carico.

Per i casi di carico di tipo sismico (9-Esk e 10-Edk), viene riportata la tabella di definizione delle masse: per ogni caso di carico partecipante alla definizione delle masse viene indicata la relativa aliquota (partecipazione) considerata. Si precisa che per i caso di carico 5-Qsk e 6-Qnk la partecipazione è prevista localmente per ogni elemento solaio o copertura presente nel modello (si confronti il valore Sksol nel capitolo relativo agli elementi solaio) e pertanto la loro partecipazione è di norma pari a uno.

<b>CDC</b>	<b>Tipo</b>	<b>Sigla Id</b>	<b>Note</b>
1	Ggk	CDC=Ggk (peso proprio della struttura)	
2	Gk	CDC=G1k (struttura sovrastante)	Azioni applicate:
			Nodo: 144 Azione : struttura sovrastante
			Nodo:da 151 a 152 Azione : struttura sovrastante
			Nodo:da 161 a 162 Azione : struttura sovrastante
			Nodo:da 176 a 177 Azione : struttura sovrastante
			Nodo:da 199 a 200 Azione : struttura sovrastante
			Nodo:da 222 a 223 Azione : struttura sovrastante
			Nodo: 260 Azione : struttura sovrastante
			Nodo: 270 Azione : struttura sovrastante
			Nodo:da 307 a 308 Azione : struttura sovrastante
			Nodo:da 330 a 331 Azione : struttura sovrastante
			Nodo:da 353 a 354 Azione : struttura sovrastante
			Nodo:da 368 a 369 Azione : struttura sovrastante
			Nodo:da 378 a 379 Azione : struttura sovrastante
			Nodo: 386 Azione : struttura sovrastante
			D3 : 266 Azione : PROVA



CDC	Tipo	Sigla Id	Note
3	Gk	CDC=G1k (sisma x)	Azioni applicate: Nodo: 144 Azione : azione sismica orizzontale Nodo:da 151 a 152 Azione : azione sismica orizzontale Nodo:da 151 a 152 Azione : azione sismica 8-18 Nodo:da 161 a 162 Azione : azione sismica orizzontale Nodo:da 161 a 162 Azione : azione sismica 9-17 Nodo:da 176 a 177 Azione : azione sismica orizzontale Nodo:da 176 a 177 Azione : azione sismica 10-16 Nodo:da 199 a 200 Azione : azione sismica orizzontale Nodo:da 199 a 200 Azione : azione sismica 11-15 Nodo:da 222 a 223 Azione : azione sismica orizzontale Nodo:da 222 a 223 Azione : azione sismica 12-14 Nodo: 260 Azione : azione sismica orizzontale Nodo: 260 Azione : azione sismica 13 Nodo: 270 Azione : azione sismica orizzontale Nodo: 270 Azione : azione sismica 1 Nodo:da 307 a 308 Azione : azione sismica orizzontale Nodo:da 307 a 308 Azione : azione sismica 12-14 Nodo:da 330 a 331 Azione : azione sismica orizzontale Nodo:da 330 a 331 Azione : azione sismica 11-15 Nodo:da 353 a 354 Azione : azione sismica orizzontale Nodo:da 353 a 354 Azione : azione sismica 10-16 Nodo:da 368 a 369 Azione : azione sismica orizzontale Nodo:da 368 a 369 Azione : azione sismica 9-17 Nodo:da 378 a 379 Azione : azione sismica orizzontale Nodo:da 378 a 379 Azione : azione sismica 8-18 Nodo: 386 Azione : azione sismica orizzontale
4	Gk	CDC=G1k (terreno di riporto)	Azioni applicate: D3 :da 1 a 2 Azione : Terreno Riporto 1 D3 : 3 Azione : Terreno Riporto 3 D3 : 4 Azione : Terreno Riporto 4 D3 :da 5 a 6 Azione : Terreno Riporto 5 D3 : 7 Azione : Terreno Riporto 7 D3 : 8 Azione : Terreno Riporto 8 D3 : 9 Azione : Terreno Riporto 9 D3 : 10 Azione : Terreno Riporto 10 D3 : 11 Azione : Terreno Riporto 11 D3 : 12 Azione : Terreno Riporto 12 D3 : 13 Azione : Terreno Riporto 13 D3 : 14 Azione : Terreno Riporto 14 D3 : 15 Azione : Terreno Riporto 15 D3 : 16 Azione : Terreno Riporto 16 D3 :da 23 a 24 Azione : Terreno Riporto 1 D3 : 25 Azione : Terreno Riporto 3 D3 : 26 Azione : Terreno Riporto 4 D3 :da 27 a 28 Azione : Terreno Riporto 5 D3 : 29 Azione : Terreno Riporto 7 D3 : 30 Azione : Terreno Riporto 8 D3 : 31 Azione : Terreno Riporto 9 D3 : 32 Azione : Terreno Riporto 10 D3 : 33 Azione : Terreno Riporto 11 D3 : 34 Azione : Terreno Riporto 12 D3 : 35 Azione : Terreno Riporto 13 D3 : 36 Azione : Terreno Riporto 14 D3 : 37 Azione : Terreno Riporto 15 D3 : 38 Azione : Terreno Riporto 16 D3 :da 45 a 46 Azione : Terreno Riporto 1 D3 : 47 Azione : Terreno Riporto 3 D3 : 48 Azione : Terreno Riporto 4 D3 :da 49 a 50 Azione : Terreno Riporto 5 D3 : 51 Azione : Terreno Riporto 7 D3 : 52 Azione : Terreno Riporto 8 D3 : 53 Azione : Terreno Riporto 9 D3 : 54 Azione : Terreno Riporto 10 D3 : 55 Azione : Terreno Riporto 11 D3 : 56 Azione : Terreno Riporto 12 D3 : 57 Azione : Terreno Riporto 13 D3 : 58 Azione : Terreno Riporto 14 D3 : 59 Azione : Terreno Riporto 15 D3 : 60 Azione : Terreno Riporto 16 D3 :da 67 a 68 Azione : Terreno Riporto 1 D3 : 69 Azione : Terreno Riporto 3 D3 : 70 Azione : Terreno Riporto 4

CDC	Tipo	Sigla Id	Note
			D3 :da 71 a 72 Azione : Terreno Riporto 5
			D3 : 73 Azione : Terreno Riporto 7
			D3 : 74 Azione : Terreno Riporto 8
			D3 : 75 Azione : Terreno Riporto 9
			D3 : 76 Azione : Terreno Riporto 10
			D3 : 77 Azione : Terreno Riporto 11
			D3 : 78 Azione : Terreno Riporto 12
			D3 : 79 Azione : Terreno Riporto 13
			D3 : 80 Azione : Terreno Riporto 14
			D3 : 81 Azione : Terreno Riporto 15
			D3 : 82 Azione : Terreno Riporto 16
			D3 :da 89 a 90 Azione : Terreno Riporto 1
			D3 : 91 Azione : Terreno Riporto 3
			D3 : 92 Azione : Terreno Riporto 4
			D3 :da 93 a 94 Azione : Terreno Riporto 5
			D3 : 95 Azione : Terreno Riporto 7
			D3 : 96 Azione : Terreno Riporto 8
			D3 : 97 Azione : Terreno Riporto 9
			D3 : 98 Azione : Terreno Riporto 10
			D3 : 99 Azione : Terreno Riporto 11
			D3 : 100 Azione : Terreno Riporto 12
			D3 : 101 Azione : Terreno Riporto 13
			D3 : 102 Azione : Terreno Riporto 14
			D3 : 103 Azione : Terreno Riporto 15
			D3 : 104 Azione : Terreno Riporto 16
			D3 :da 111 a 112 Azione : Terreno Riporto 1
			D3 : 113 Azione : Terreno Riporto 3
			D3 : 114 Azione : Terreno Riporto 4
			D3 :da 115 a 116 Azione : Terreno Riporto 5
			D3 : 117 Azione : Terreno Riporto 7
			D3 : 118 Azione : Terreno Riporto 8
			D3 : 119 Azione : Terreno Riporto 9
			D3 : 120 Azione : Terreno Riporto 10
			D3 : 121 Azione : Terreno Riporto 11
			D3 : 122 Azione : Terreno Riporto 12
			D3 : 123 Azione : Terreno Riporto 13
			D3 : 124 Azione : Terreno Riporto 14
			D3 : 125 Azione : Terreno Riporto 15
			D3 : 126 Azione : Terreno Riporto 16
			D3 :da 133 a 134 Azione : Terreno Riporto 1
			D3 : 135 Azione : Terreno Riporto 3
			D3 : 136 Azione : Terreno Riporto 4
			D3 :da 137 a 138 Azione : Terreno Riporto 5
			D3 : 139 Azione : Terreno Riporto 7
			D3 : 140 Azione : Terreno Riporto 8
			D3 : 141 Azione : Terreno Riporto 9
			D3 : 142 Azione : Terreno Riporto 10
			D3 : 143 Azione : Terreno Riporto 11
			D3 : 144 Azione : Terreno Riporto 12
			D3 : 145 Azione : Terreno Riporto 13
			D3 : 146 Azione : Terreno Riporto 14
			D3 : 147 Azione : Terreno Riporto 15
			D3 : 148 Azione : Terreno Riporto 16
			D3 :da 155 a 156 Azione : Terreno Riporto 1
			D3 : 157 Azione : Terreno Riporto 3
			D3 : 158 Azione : Terreno Riporto 4
			D3 :da 159 a 160 Azione : Terreno Riporto 5
			D3 : 161 Azione : Terreno Riporto 7
			D3 : 162 Azione : Terreno Riporto 8
			D3 : 163 Azione : Terreno Riporto 9
			D3 : 164 Azione : Terreno Riporto 10
			D3 : 165 Azione : Terreno Riporto 11
			D3 : 166 Azione : Terreno Riporto 12
			D3 : 167 Azione : Terreno Riporto 13
			D3 : 168 Azione : Terreno Riporto 14
			D3 : 169 Azione : Terreno Riporto 15
			D3 : 170 Azione : Terreno Riporto 16
			D3 :da 177 a 178 Azione : Terreno Riporto 1
			D3 : 179 Azione : Terreno Riporto 3
			D3 : 180 Azione : Terreno Riporto 4
			D3 :da 181 a 182 Azione : Terreno Riporto 5
			D3 : 183 Azione : Terreno Riporto 7
			D3 : 184 Azione : Terreno Riporto 8

CDC	Tipo	Sigla Id	Note
			D3 : 185 Azione : Terreno Riporto 9
			D3 : 186 Azione : Terreno Riporto 10
			D3 : 187 Azione : Terreno Riporto 11
			D3 : 188 Azione : Terreno Riporto 12
			D3 : 189 Azione : Terreno Riporto 13
			D3 : 190 Azione : Terreno Riporto 14
			D3 : 191 Azione : Terreno Riporto 15
			D3 : 192 Azione : Terreno Riporto 16
			D3 :da 199 a 200 Azione : Terreno Riporto 1
			D3 : 201 Azione : Terreno Riporto 3
			D3 : 202 Azione : Terreno Riporto 4
			D3 :da 203 a 204 Azione : Terreno Riporto 5
			D3 : 205 Azione : Terreno Riporto 7
			D3 : 206 Azione : Terreno Riporto 8
			D3 : 207 Azione : Terreno Riporto 9
			D3 : 208 Azione : Terreno Riporto 10
			D3 : 209 Azione : Terreno Riporto 11
			D3 : 210 Azione : Terreno Riporto 12
			D3 : 211 Azione : Terreno Riporto 13
			D3 : 212 Azione : Terreno Riporto 14
			D3 : 213 Azione : Terreno Riporto 15
			D3 : 214 Azione : Terreno Riporto 16
			D3 :da 221 a 222 Azione : Terreno Riporto 1
			D3 : 223 Azione : Terreno Riporto 3
			D3 : 224 Azione : Terreno Riporto 4
			D3 :da 225 a 226 Azione : Terreno Riporto 5
			D3 : 227 Azione : Terreno Riporto 7
			D3 : 228 Azione : Terreno Riporto 8
			D3 : 229 Azione : Terreno Riporto 9
			D3 : 230 Azione : Terreno Riporto 10
			D3 : 231 Azione : Terreno Riporto 11
			D3 : 232 Azione : Terreno Riporto 12
			D3 : 233 Azione : Terreno Riporto 13
			D3 : 234 Azione : Terreno Riporto 14
			D3 : 235 Azione : Terreno Riporto 15
			D3 : 236 Azione : Terreno Riporto 16
			D3 :da 243 a 244 Azione : Terreno Riporto 1
			D3 : 245 Azione : Terreno Riporto 3
			D3 : 246 Azione : Terreno Riporto 4
			D3 :da 247 a 248 Azione : Terreno Riporto 5
			D3 : 249 Azione : Terreno Riporto 7
			D3 : 250 Azione : Terreno Riporto 8
			D3 : 251 Azione : Terreno Riporto 9
			D3 : 252 Azione : Terreno Riporto 10
			D3 : 253 Azione : Terreno Riporto 11
			D3 : 254 Azione : Terreno Riporto 12
			D3 : 255 Azione : Terreno Riporto 13
			D3 : 256 Azione : Terreno Riporto 14
			D3 : 257 Azione : Terreno Riporto 15
			D3 : 258 Azione : Terreno Riporto 16
			D3 :da 265 a 266 Azione : Terreno Riporto 1
			D3 : 267 Azione : Terreno Riporto 3
			D3 : 268 Azione : Terreno Riporto 4
			D3 :da 269 a 270 Azione : Terreno Riporto 5
			D3 : 271 Azione : Terreno Riporto 7
			D3 : 272 Azione : Terreno Riporto 8
			D3 : 273 Azione : Terreno Riporto 9
			D3 : 274 Azione : Terreno Riporto 10
			D3 : 275 Azione : Terreno Riporto 11
			D3 : 276 Azione : Terreno Riporto 12
			D3 : 277 Azione : Terreno Riporto 13
			D3 : 278 Azione : Terreno Riporto 14
			D3 : 279 Azione : Terreno Riporto 15
			D3 : 280 Azione : Terreno Riporto 16
			D3 :da 287 a 288 Azione : Terreno Riporto 1
			D3 : 289 Azione : Terreno Riporto 3
			D3 : 290 Azione : Terreno Riporto 4
			D3 :da 291 a 292 Azione : Terreno Riporto 5
			D3 : 293 Azione : Terreno Riporto 7
			D3 : 294 Azione : Terreno Riporto 8
			D3 : 295 Azione : Terreno Riporto 9
			D3 : 296 Azione : Terreno Riporto 10
			D3 : 297 Azione : Terreno Riporto 11

CDC	Tipo	Sigla Id	Note
			D3 : 298 Azione : Terreno Riporto 12
			D3 : 299 Azione : Terreno Riporto 13
			D3 : 300 Azione : Terreno Riporto 14
			D3 : 301 Azione : Terreno Riporto 15
			D3 : 302 Azione : Terreno Riporto 16
			D3 :da 309 a 310 Azione : Terreno Riporto 1
			D3 : 311 Azione : Terreno Riporto 3
			D3 : 312 Azione : Terreno Riporto 4
			D3 :da 313 a 314 Azione : Terreno Riporto 5
			D3 : 315 Azione : Terreno Riporto 7
			D3 : 316 Azione : Terreno Riporto 8
			D3 : 317 Azione : Terreno Riporto 9
			D3 : 318 Azione : Terreno Riporto 10
			D3 : 319 Azione : Terreno Riporto 11
			D3 : 320 Azione : Terreno Riporto 12
			D3 : 321 Azione : Terreno Riporto 13
			D3 : 322 Azione : Terreno Riporto 14
			D3 : 323 Azione : Terreno Riporto 15
			D3 : 324 Azione : Terreno Riporto 16
			D3 :da 331 a 332 Azione : Terreno Riporto 1
			D3 : 333 Azione : Terreno Riporto 3
			D3 : 334 Azione : Terreno Riporto 4
			D3 :da 335 a 336 Azione : Terreno Riporto 5
			D3 : 337 Azione : Terreno Riporto 7
			D3 : 338 Azione : Terreno Riporto 8
			D3 : 339 Azione : Terreno Riporto 9
			D3 : 340 Azione : Terreno Riporto 10
			D3 : 341 Azione : Terreno Riporto 11
			D3 : 342 Azione : Terreno Riporto 12
			D3 : 343 Azione : Terreno Riporto 13
			D3 : 344 Azione : Terreno Riporto 14
			D3 : 345 Azione : Terreno Riporto 15
			D3 : 346 Azione : Terreno Riporto 16
			D3 : 353 Azione : Terreno Riporto 1
			D3 : 354 Azione : Terreno Riporto 2
			D3 : 355 Azione : Terreno Riporto 3
			D3 : 356 Azione : Terreno Riporto 4
			D3 :da 357 a 358 Azione : Terreno Riporto 5
			D3 : 359 Azione : Terreno Riporto 7
			D3 : 360 Azione : Terreno Riporto 8
			D3 : 361 Azione : Terreno Riporto 9
			D3 : 362 Azione : Terreno Riporto 10
			D3 : 363 Azione : Terreno Riporto 11
			D3 : 364 Azione : Terreno Riporto 12
			D3 : 365 Azione : Terreno Riporto 13
			D3 : 366 Azione : Terreno Riporto 14
			D3 : 367 Azione : Terreno Riporto 15
			D3 : 368 Azione : Terreno Riporto 16
			D3 :da 375 a 376 Azione : Terreno Riporto 1
			D3 : 377 Azione : Terreno Riporto 3
			D3 : 378 Azione : Terreno Riporto 4
			D3 :da 379 a 380 Azione : Terreno Riporto 5
			D3 : 381 Azione : Terreno Riporto 7
			D3 : 382 Azione : Terreno Riporto 8
			D3 : 383 Azione : Terreno Riporto 9
			D3 : 384 Azione : Terreno Riporto 10
			D3 : 385 Azione : Terreno Riporto 11
			D3 : 386 Azione : Terreno Riporto 12
			D3 : 387 Azione : Terreno Riporto 13
			D3 : 388 Azione : Terreno Riporto 14
			D3 : 389 Azione : Terreno Riporto 15
			D3 : 390 Azione : Terreno Riporto 16
			D3 :da 397 a 398 Azione : Terreno Riporto 1
			D3 : 399 Azione : Terreno Riporto 3
			D3 : 400 Azione : Terreno Riporto 4
			D3 : 401 Azione : Terreno Riporto 5
			D3 : 402 Azione : Terreno Riporto 6
			D3 : 403 Azione : Terreno Riporto 7
			D3 : 404 Azione : Terreno Riporto 8
			D3 : 405 Azione : Terreno Riporto 9
			D3 : 406 Azione : Terreno Riporto 10
			D3 : 407 Azione : Terreno Riporto 11
			D3 : 408 Azione : Terreno Riporto 12

CDC	Tipo	Sigla Id	Note
			D3 : 409 Azione : Terreno Riporto 13
			D3 : 410 Azione : Terreno Riporto 14
			D3 : 411 Azione : Terreno Riporto 15
			D3 : 412 Azione : Terreno Riporto 16
			D3 :da 419 a 420 Azione : Terreno Riporto 1
			D3 : 421 Azione : Terreno Riporto 3
			D3 : 422 Azione : Terreno Riporto 4
			D3 :da 423 a 424 Azione : Terreno Riporto 5
			D3 : 425 Azione : Terreno Riporto 7
			D3 : 426 Azione : Terreno Riporto 8
			D3 : 427 Azione : Terreno Riporto 9
			D3 : 428 Azione : Terreno Riporto 10
			D3 : 429 Azione : Terreno Riporto 11
			D3 : 430 Azione : Terreno Riporto 12
			D3 : 431 Azione : Terreno Riporto 13
			D3 : 432 Azione : Terreno Riporto 14
			D3 : 433 Azione : Terreno Riporto 15
			D3 : 434 Azione : Terreno Riporto 16
			D3 :da 441 a 442 Azione : Terreno Riporto 1
			D3 : 443 Azione : Terreno Riporto 3
			D3 : 444 Azione : Terreno Riporto 4
			D3 :da 445 a 446 Azione : Terreno Riporto 5
			D3 : 447 Azione : Terreno Riporto 7
			D3 : 448 Azione : Terreno Riporto 8
			D3 : 449 Azione : Terreno Riporto 9
			D3 : 450 Azione : Terreno Riporto 10
			D3 : 451 Azione : Terreno Riporto 11
			D3 : 452 Azione : Terreno Riporto 12
			D3 : 453 Azione : Terreno Riporto 13
			D3 : 454 Azione : Terreno Riporto 14
			D3 : 455 Azione : Terreno Riporto 15
			D3 : 456 Azione : Terreno Riporto 16
			D3 :da 463 a 464 Azione : Terreno Riporto 1
			D3 : 465 Azione : Terreno Riporto 3
			D3 : 466 Azione : Terreno Riporto 4
			D3 :da 467 a 468 Azione : Terreno Riporto 5
			D3 : 469 Azione : Terreno Riporto 7
			D3 : 470 Azione : Terreno Riporto 8
			D3 : 471 Azione : Terreno Riporto 9
			D3 : 472 Azione : Terreno Riporto 10
			D3 : 473 Azione : Terreno Riporto 11
			D3 : 474 Azione : Terreno Riporto 12
			D3 : 475 Azione : Terreno Riporto 13
			D3 : 476 Azione : Terreno Riporto 14
			D3 : 477 Azione : Terreno Riporto 15
			D3 : 478 Azione : Terreno Riporto 16
			D3 :da 485 a 486 Azione : Terreno Riporto 1
			D3 : 487 Azione : Terreno Riporto 3
			D3 : 488 Azione : Terreno Riporto 4
			D3 :da 489 a 490 Azione : Terreno Riporto 5
			D3 : 491 Azione : Terreno Riporto 7
			D3 : 492 Azione : Terreno Riporto 8
			D3 : 493 Azione : Terreno Riporto 9
			D3 : 494 Azione : Terreno Riporto 10
			D3 : 495 Azione : Terreno Riporto 11
			D3 : 496 Azione : Terreno Riporto 12
			D3 : 497 Azione : Terreno Riporto 13
			D3 : 498 Azione : Terreno Riporto 14
			D3 : 499 Azione : Terreno Riporto 15
			D3 : 500 Azione : Terreno Riporto 16
			D3 :da 507 a 508 Azione : Terreno Riporto 1
			D3 : 509 Azione : Terreno Riporto 3
			D3 : 510 Azione : Terreno Riporto 4
			D3 :da 511 a 512 Azione : Terreno Riporto 5
			D3 : 513 Azione : Terreno Riporto 7
			D3 : 514 Azione : Terreno Riporto 8
			D3 : 515 Azione : Terreno Riporto 9
			D3 : 516 Azione : Terreno Riporto 10
			D3 : 517 Azione : Terreno Riporto 11
			D3 : 518 Azione : Terreno Riporto 12
			D3 : 519 Azione : Terreno Riporto 13
			D3 : 520 Azione : Terreno Riporto 14
			D3 : 521 Azione : Terreno Riporto 15

CDC	Tipo	Sigla Id	Note
			D3 : 522 Azione : Terreno Riporto 16
5	Qvk	CDC=Qvk (carico da vento) .....	Azioni applicate:
			Nodo: 144 Azione : vento azione orizzontale
			Nodo: 151 Azione : Vento 8-18
			Nodo:da 151 a 152 Azione : vento azione orizzontale
			Nodo: 161 Azione : Vento 9-17
			Nodo:da 161 a 162 Azione : vento azione orizzontale
			Nodo: 176 Azione : Vento 10-16
			Nodo:da 176 a 177 Azione : vento azione orizzontale
			Nodo: 199 Azione : Vento 11-15
			Nodo:da 199 a 200 Azione : vento azione orizzontale
			Nodo: 222 Azione : Vento 12-14
			Nodo:da 222 a 223 Azione : vento azione orizzontale
			Nodo: 260 Azione : Vento 13
			Nodo: 260 Azione : vento azione orizzontale
			Nodo: 270 Azione : Vento 1
			Nodo: 270 Azione : vento azione orizzontale
			Nodo: 307 Azione : Vento 12-14
			Nodo:da 307 a 308 Azione : vento azione orizzontale
			Nodo: 330 Azione : Vento 11-15
			Nodo:da 330 a 331 Azione : vento azione orizzontale
			Nodo: 353 Azione : Vento 10-16
			Nodo:da 353 a 354 Azione : vento azione orizzontale
			Nodo: 368 Azione : Vento 9-17
			Nodo:da 368 a 369 Azione : vento azione orizzontale
			Nodo: 378 Azione : Vento 8-18
			Nodo:da 378 a 379 Azione : vento azione orizzontale
			Nodo:da 378 a 379 Azione : vento azione orizzontale
			Nodo: 386 Azione : vento azione orizzontale

CARICHI 001) CDC=Ggk (peso proprio della struttura)

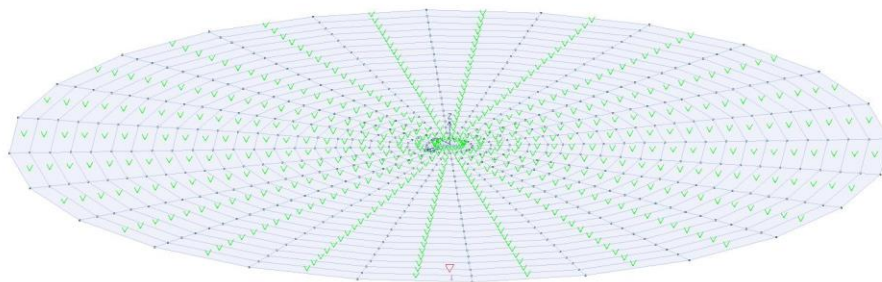

22\_CDC\_001\_CDC=Ggk (peso proprio della struttura)



CARICHI 002) CDC=G1k (struttura sovrastante)

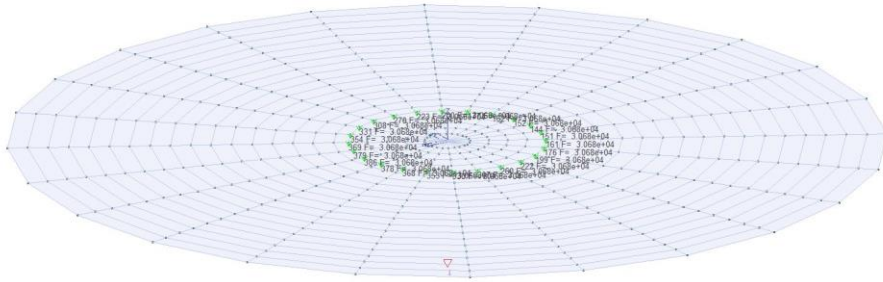

22\_CDC\_002\_CDC=G1k (struttura sovrastante)

CARICHI 003) CDC=G1k (sisma x)

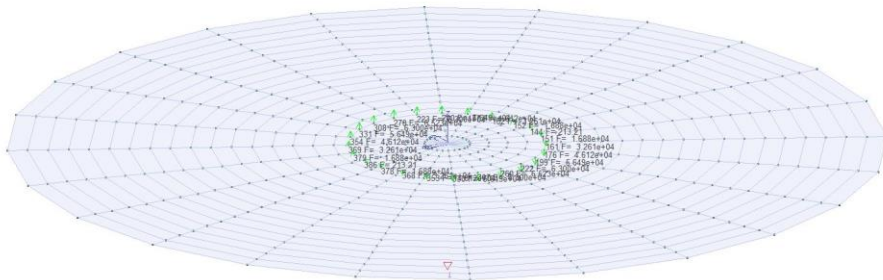

22\_CDC\_003\_CDC=G1k (sisma x)





## 9. DEFINIZIONE DELLE COMBINAZIONI

### 9.1. LEGENDA TABELLA COMBINAZIONI DI CARICO

Il programma combina i diversi tipi di casi di carico (CDC) secondo le regole previste dalla normativa vigente. Le combinazioni previste sono destinate al controllo di sicurezza della struttura ed alla verifica degli spostamenti e delle sollecitazioni.

La prima tabella delle combinazioni riportata di seguito comprende le seguenti informazioni: Numero, Tipo, Sigla identificativa. Una seconda tabella riporta il peso nella combinazione assunto per ogni caso di carico.

Ai fini delle verifiche degli stati limite si definiscono le seguenti combinazioni delle azioni:

#### Combinazione fondamentale SLU

$$\gamma G1 \cdot G1 + \gamma G2 \cdot G2 + \gamma P \cdot P + \gamma Q1 \cdot Qk1 + \gamma Q2 \cdot \psi 02 \cdot Qk2 + \gamma Q3 \cdot \psi 03 \cdot Qk3 + \dots$$

#### Combinazione caratteristica (rara) SLE

$$G1 + G2 + P + Qk1 + \psi 02 \cdot Qk2 + \psi 03 \cdot Qk3 + \dots$$

#### Combinazione frequente SLE

$$G1 + G2 + P + \psi 11 \cdot Qk1 + \psi 22 \cdot Qk2 + \psi 23 \cdot Qk3 + \dots$$

#### Combinazione quasi permanente SLE

$$G1 + G2 + P + \psi 21 \cdot Qk1 + \psi 22 \cdot Qk2 + \psi 23 \cdot Qk3 + \dots$$

#### Combinazione sismica, impiegata per gli stati limite ultimi e di esercizio connessi all'azione sismica E

$$E + G1 + G2 + P + \psi 21 \cdot Qk1 + \psi 22 \cdot Qk2 + \dots$$

#### Combinazione eccezionale, impiegata per gli stati limite connessi alle azioni eccezionali

$$G1 + G2 + Ad + P + \psi 21 \cdot Qk1 + \psi 22 \cdot Qk2 + \dots$$

Dove:

NTC 2018 Tabella 2.5.I

Destinazione d'uso/azione	$\psi 0$	$\psi 1$	$\psi 2$
Categoria A residenziali	0,70	0,50	0,30
Categoria B uffici	0,70	0,50	0,30
Categoria C ambienti suscettibili di affollamento	0,70	0,70	0,60
Categoria D ambienti ad uso commerciale	0,70	0,70	0,60
Categoria E biblioteche, archivi, magazzini, ...	1,00	0,90	0,80
Categoria F Rimesse e parcheggi (autoveicoli $\leq 30kN$ )	0,70	0,70	0,60
Categoria G Rimesse e parcheggi (autoveicoli $> 30kN$ )	0,70	0,50	0,30
Categoria H Coperture	0,00	0,00	0,00
Vento	0,60	0,20	0,00
Neve a quota $\leq 1000 m$	0,50	0,20	0,00
Neve a quota $> 1000 m$	0,70	0,50	0,20
Variazioni Termiche	0,60	0,50	0,00

Nelle verifiche possono essere adottati in alternativa due diversi approcci progettuali:

- per l'approccio 1 si considerano due diverse combinazioni di gruppi di coefficienti di sicurezza parziali per le azioni, per i materiali e per la resistenza globale (combinazione 1 con coefficienti A1 e combinazione 2 con coefficienti A2),
- per l'approccio 2 si definisce un'unica combinazione per le azioni, per la resistenza dei materiali e per la resistenza globale (con coefficienti A1).

NTC 2018 Tabella 2.6.I

		Coefficiente	EQU	A1	A2
		$\gamma f$			
Carichi permanenti	Favorevoli	$\gamma G1$	0,9	1,0	1,0
	Sfavorevoli		1,1	1,3	1,0
Carichi permanenti non strutturali (Non compiutamente definiti)	Favorevoli	$\gamma G2$	0,8	0,8	0,8
	Sfavorevoli		1,5	1,5	1,3
Carichi variabili	Favorevoli	$\gamma Qi$	0,0	0,0	0,0
	Sfavorevoli		1,5	1,5	1,3



## 10. RISULTATI NODALI

### 10.1. LEGENDA RISULTATI NODALI

Il controllo dei risultati delle analisi condotte, per quanto concerne i nodi strutturali, è possibile in relazione alle tabelle sottoriportate.

Una prima tabella riporta infatti per ogni nodo e per ogni combinazione (o caso di carico) gli spostamenti nodali.

Una seconda tabella riporta per ogni nodo a cui sia associato un vincolo rigido e/o elastico o una fondazione speciale e per ogni combinazione (o caso di carico) i valori delle azioni esercitate dalla struttura sui vincoli (reazioni vincolari cambiate di segno).

Una terza tabella, infine riassume per ogni nodo le sei combinazioni in cui si attingono i valori minimi e massimi della reazione Fz, della reazione Mx e della reazione My.

Nodo	Cmb	Traslazione X	Traslazione Y	Traslazione Z	Rotazione X	Rotazione Y	Rotazione Z
	mm	mm	mm	mm			
1 1	2.42	-0.06	-7.81	-4.63e-05	1.60e-03		0.0
1 2	1.86	-0.05	-6.01	-3.56e-05	1.23e-03		0.0
2 1	2.43	0.04	-3.09	2.29e-05	1.59e-03		0.0
2 2	1.87	0.03	-2.38	1.76e-05	1.23e-03		0.0
3 1	2.46	-0.16	-12.53	-1.12e-04	1.57e-03		0.0
3 2	1.89	-0.12	-9.64	-8.63e-05	1.21e-03		0.0
4 1	2.43	-0.06	-7.83	-4.63e-05	1.60e-03		0.0
4 2	1.87	-0.05	-6.02	-3.56e-05	1.23e-03		0.0
5 1	2.44	0.04	-3.30	2.21e-05	1.59e-03		0.0
5 2	1.88	0.03	-2.54	1.70e-05	1.22e-03		0.0
6 1	2.47	-0.15	-12.37	-1.12e-04	1.57e-03		0.0
6 2	1.90	-0.12	-9.51	-8.58e-05	1.21e-03		0.0
7 1	2.44	-0.06	-7.86	-4.62e-05	1.61e-03		0.0
7 2	1.87	-0.05	-6.04	-3.55e-05	1.24e-03		0.0
8 1	2.44	0.03	-3.51	2.35e-05	1.60e-03		0.0
8 2	1.88	0.03	-2.70	1.81e-05	1.23e-03		0.0
9 1	2.48	-0.15	-12.21	-1.13e-04	1.58e-03		0.0
9 2	1.90	-0.12	-9.39	-8.67e-05	1.21e-03		0.0
10 1	2.48	0.12	1.31	7.70e-05	1.55e-03		0.0
10 2	1.91	0.09	1.01	5.92e-05	1.20e-03		0.0
11 1	2.54	-0.22	-16.92	-1.57e-04	1.51e-03		0.0
11 2	1.96	-0.17	-13.02	-1.21e-04	1.16e-03		0.0
12 1	2.43	-0.06	-7.88	-4.57e-05	1.62e-03		0.0
12 2	1.87	-0.05	-6.06	-3.52e-05	1.25e-03		0.0
13 1	2.44	0.03	-3.71	2.51e-05	1.61e-03		0.0
13 2	1.88	0.03	-2.86	1.93e-05	1.24e-03		0.0
14 1	2.47	-0.15	-12.05	-1.13e-04	1.59e-03		0.0
14 2	1.90	-0.12	-9.27	-8.72e-05	1.22e-03		0.0
15 1	2.49	0.11	0.93	7.57e-05	1.55e-03		0.0
15 2	1.92	0.09	0.71	5.82e-05	1.20e-03		0.0
16 1	2.55	-0.22	-16.59	-1.56e-04	1.51e-03		0.0
16 2	1.96	-0.17	-12.76	-1.20e-04	1.16e-03		0.0
17 1	2.43	-0.06	-7.91	-4.49e-05	1.64e-03		0.0
17 2	1.87	-0.05	-6.08	-3.45e-05	1.26e-03		0.0
18 1	2.43	0.03	-3.92	2.62e-05	1.63e-03		0.0
18 2	1.87	0.03	-3.02	2.02e-05	1.25e-03		0.0
19 1	2.46	-0.15	-11.90	-1.13e-04	1.61e-03		0.0
19 2	1.90	-0.12	-9.15	-8.68e-05	1.24e-03		0.0
20 1	2.49	0.11	0.55	7.80e-05	1.56e-03		0.0
20 2	1.92	0.09	0.42	6.00e-05	1.20e-03		0.0
21 1	2.56	-0.22	-16.27	-1.58e-04	1.52e-03		0.0
21 2	1.97	-0.17	-12.51	-1.22e-04	1.17e-03		0.0
22 1	2.41	-0.06	-7.93	-4.36e-05	1.65e-03		0.0
22 2	1.86	-0.05	-6.10	-3.36e-05	1.27e-03		0.0
23 1	2.49	0.11	0.17	8.03e-05	1.57e-03		0.0
23 2	1.92	0.08	0.13	6.18e-05	1.21e-03		0.0
23 3	1.93	0.08	-0.25	5.58e-05	1.14e-03		0.0
24 1	2.55	-0.22	-15.94	-1.59e-04	1.53e-03		0.0
24 2	1.96	-0.17	-12.26	-1.23e-04	1.18e-03		0.0
25 1	2.42	0.03	-4.13	2.69e-05	1.65e-03		0.0
25 2	1.86	0.03	-3.18	2.07e-05	1.27e-03		0.0
26 1	2.45	-0.15	-11.74	-1.11e-04	1.62e-03		0.0
26 2	1.89	-0.12	-9.03	-8.55e-05	1.25e-03		0.0

27 1	2.40	-0.06	-7.96	-4.21e-05	1.67e-03	0.0
27 2	1.85	-0.05	-6.12	-3.24e-05	1.28e-03	0.0
28 1	2.56	0.16	5.08	1.02e-04	1.50e-03	0.0
28 2	1.97	0.12	3.91	7.88e-05	1.15e-03	0.0
29 1	2.65	-0.24	-20.70	-1.68e-04	1.43e-03	0.0
29 2	2.04	-0.19	-15.92	-1.29e-04	1.10e-03	0.0
30 1	2.48	0.11	-0.21	8.16e-05	1.59e-03	0.0
30 2	1.91	0.08	-0.16	6.28e-05	1.22e-03	0.0
30 3	1.93	0.08	-0.53	5.68e-05	1.15e-03	0.0
31 1	2.54	-0.22	-15.61	-1.59e-04	1.54e-03	0.0
31 2	1.96	-0.17	-12.01	-1.23e-04	1.19e-03	0.0
32 1	2.41	0.03	-4.35	2.72e-05	1.66e-03	0.0
32 2	1.85	0.03	-3.34	2.09e-05	1.28e-03	0.0
33 1	2.44	-0.15	-11.57	-1.08e-04	1.64e-03	0.0
33 2	1.88	-0.11	-8.90	-8.34e-05	1.26e-03	0.0
34 1	2.38	-0.06	-7.98	-4.02e-05	1.69e-03	0.0
34 2	1.83	-0.04	-6.14	-3.09e-05	1.30e-03	0.0
35 1	2.57	0.15	4.56	1.01e-04	1.50e-03	0.0
35 2	1.98	0.12	3.51	7.76e-05	1.15e-03	0.0
36 1	2.66	-0.24	-20.22	-1.66e-04	1.43e-03	0.0
36 2	2.04	-0.18	-15.56	-1.28e-04	1.10e-03	0.0
37 1	2.47	0.11	-0.59	8.18e-05	1.61e-03	0.0
37 2	1.90	0.08	-0.46	6.29e-05	1.23e-03	0.0
37 3	1.92	0.08	-0.81	5.70e-05	1.16e-03	0.0
38 1	2.53	-0.21	-15.28	-1.57e-04	1.56e-03	0.0
38 2	1.95	-0.16	-11.75	-1.21e-04	1.20e-03	0.0
39 1	2.39	0.03	-4.56	2.71e-05	1.68e-03	0.0
39 2	1.84	0.03	-3.51	2.08e-05	1.29e-03	0.0
40 1	2.42	-0.15	-11.41	-1.05e-04	1.66e-03	0.0
40 2	1.86	-0.11	-8.77	-8.06e-05	1.28e-03	0.0
41 1	2.57	0.15	4.03	1.04e-04	1.50e-03	0.0
41 2	1.98	0.12	3.10	7.97e-05	1.16e-03	0.0
42 1	2.66	-0.24	-19.75	-1.69e-04	1.44e-03	0.0
42 2	2.04	-0.18	-15.19	-1.30e-04	1.11e-03	0.0
43 1	2.36	-0.06	-8.01	-3.81e-05	1.71e-03	0.0
43 2	1.82	-0.04	-6.16	-2.93e-05	1.31e-03	0.0
44 1	2.46	0.11	-0.98	8.10e-05	1.62e-03	0.0
44 2	1.89	0.08	-0.75	6.23e-05	1.25e-03	0.0
44 3	1.91	0.08	-1.09	5.65e-05	1.17e-03	0.0
45 1	2.52	-0.21	-14.94	-1.54e-04	1.58e-03	0.0
45 2	1.94	-0.16	-11.49	-1.18e-04	1.22e-03	0.0
46 1	2.57	0.15	3.51	1.06e-04	1.51e-03	0.0
46 2	1.97	0.12	2.70	8.16e-05	1.17e-03	0.0
47 1	2.65	-0.24	-19.27	-1.71e-04	1.45e-03	0.0
47 2	2.04	-0.18	-14.83	-1.31e-04	1.12e-03	0.0
48 1	2.37	0.03	-4.78	2.66e-05	1.70e-03	0.0
48 2	1.82	0.03	-3.67	2.05e-05	1.31e-03	0.0
49 1	2.40	-0.14	-11.24	-1.00e-04	1.68e-03	0.0
49 2	1.84	-0.11	-8.64	-7.71e-05	1.29e-03	0.0
50 1	2.44	0.11	-1.37	7.93e-05	1.64e-03	0.0
50 2	1.88	0.08	-1.05	6.10e-05	1.26e-03	0.0
51 1	2.50	-0.21	-14.60	-1.49e-04	1.60e-03	0.0
51 2	1.92	-0.16	-11.23	-1.15e-04	1.23e-03	0.0
52 1	2.34	-0.05	-8.03	-3.58e-05	1.73e-03	0.0
52 2	1.80	-0.04	-6.18	-2.75e-05	1.33e-03	0.0
53 1	2.56	0.15	2.98	1.07e-04	1.53e-03	0.0
53 2	1.97	0.11	2.29	8.26e-05	1.18e-03	0.0
54 1	2.65	-0.24	-18.80	-1.71e-04	1.47e-03	0.0
54 2	2.04	-0.18	-14.46	-1.31e-04	1.13e-03	0.0
55 1	2.34	0.03	-5.00	2.59e-05	1.72e-03	0.0
55 2	1.80	0.02	-3.84	1.99e-05	1.32e-03	0.0
56 1	2.37	-0.14	-11.06	-9.50e-05	1.70e-03	0.0
56 2	1.82	-0.11	-8.51	-7.31e-05	1.31e-03	0.0
57 1	2.42	0.10	-1.77	7.68e-05	1.66e-03	0.0
57 2	1.86	0.08	-1.36	5.91e-05	1.28e-03	0.0
58 1	2.47	-0.20	-14.25	-1.43e-04	1.62e-03	0.0
58 2	1.90	-0.15	-10.96	-1.10e-04	1.25e-03	0.0
59 1	2.55	0.15	2.45	1.07e-04	1.55e-03	0.0
59 2	1.96	0.11	1.88	8.25e-05	1.19e-03	0.0
60 1	2.63	-0.23	-18.32	-1.69e-04	1.48e-03	0.0
60 2	2.03	-0.18	-14.09	-1.30e-04	1.14e-03	0.0
61 1	2.31	-0.05	-8.05	-3.33e-05	1.75e-03	0.0
61 2	1.77	-0.04	-6.19	-2.56e-05	1.34e-03	0.0
62 1	2.31	0.03	-5.22	2.49e-05	1.74e-03	0.0
62 2	1.78	0.02	-4.01	1.92e-05	1.34e-03	0.0
63 1	2.34	-0.13	-10.88	-8.91e-05	1.72e-03	0.0

63 2	1.80	-0.10	-8.37	-6.86e-05	1.32e-03	0.0
64 1	2.53	0.15	1.91	1.06e-04	1.56e-03	0.0
64 2	1.95	0.11	1.47	8.14e-05	1.20e-03	0.0
65 1	2.62	-0.23	-17.83	-1.65e-04	1.50e-03	0.0
65 2	2.01	-0.18	-13.72	-1.27e-04	1.16e-03	0.0
66 1	2.39	0.10	-2.17	7.37e-05	1.68e-03	0.0
66 2	1.84	0.08	-1.67	5.67e-05	1.29e-03	0.0
67 1	2.44	-0.19	-13.89	-1.36e-04	1.65e-03	0.0
67 2	1.88	-0.15	-10.68	-1.04e-04	1.27e-03	0.0
68 1	2.65	0.16	7.98	9.39e-05	1.44e-03	0.0
68 2	2.04	0.12	6.14	7.22e-05	1.11e-03	0.0
69 1	2.75	-0.22	-23.60	-1.40e-04	1.36e-03	0.0
69 2	2.12	-0.17	-18.15	-1.08e-04	1.04e-03	0.0
70 1	2.28	-0.05	-8.07	-3.05e-05	1.77e-03	0.0
70 2	1.75	-0.04	-6.21	-2.35e-05	1.36e-03	0.0
71 1	2.51	0.14	1.37	1.03e-04	1.58e-03	0.0
71 2	1.93	0.11	1.05	7.95e-05	1.22e-03	0.0
72 1	2.59	-0.22	-17.34	-1.60e-04	1.53e-03	0.0
72 2	2.00	-0.17	-13.34	-1.23e-04	1.17e-03	0.0
73 1	2.65	0.15	7.34	9.26e-05	1.44e-03	0.0
73 2	2.04	0.12	5.65	7.12e-05	1.11e-03	0.0
74 1	2.76	-0.21	-23.01	-1.39e-04	1.36e-03	0.0
74 2	2.12	-0.16	-17.70	-1.07e-04	1.04e-03	0.0
75 1	2.28	0.03	-5.44	2.37e-05	1.76e-03	0.0
75 2	1.76	0.02	-4.19	1.82e-05	1.35e-03	0.0
76 1	2.31	-0.12	-10.70	-8.26e-05	1.74e-03	0.0
76 2	1.78	-0.10	-8.23	-6.36e-05	1.34e-03	0.0
77 1	2.36	0.10	-2.58	7.00e-05	1.71e-03	0.0
77 2	1.82	0.08	-1.98	5.38e-05	1.31e-03	0.0
78 1	2.41	-0.19	-13.52	-1.28e-04	1.67e-03	0.0
78 2	1.85	-0.14	-10.40	-9.81e-05	1.29e-03	0.0
79 1	2.65	0.15	6.70	9.49e-05	1.44e-03	0.0
79 2	2.04	0.11	5.16	7.30e-05	1.11e-03	0.0
80 1	2.76	-0.21	-22.42	-1.41e-04	1.36e-03	0.0
80 2	2.12	-0.16	-17.25	-1.08e-04	1.05e-03	0.0
81 1	2.49	0.14	0.82	9.99e-05	1.61e-03	0.0
81 2	1.91	0.11	0.63	7.68e-05	1.24e-03	0.0
82 1	2.57	-0.22	-16.83	-1.54e-04	1.55e-03	0.0
82 2	1.98	-0.17	-12.95	-1.18e-04	1.19e-03	0.0
83 1	2.24	-0.04	-8.09	-2.76e-05	1.79e-03	0.0
83 2	1.72	-0.03	-6.22	-2.12e-05	1.37e-03	0.0
84 1	2.65	0.15	6.07	9.71e-05	1.45e-03	0.0
84 2	2.04	0.11	4.67	7.47e-05	1.12e-03	0.0
85 1	2.76	-0.21	-21.83	-1.43e-04	1.37e-03	0.0
85 2	2.12	-0.16	-16.79	-1.10e-04	1.06e-03	0.0
86 1	2.25	0.03	-5.67	2.22e-05	1.78e-03	0.0
86 2	1.73	0.02	-4.36	1.71e-05	1.37e-03	0.0
87 1	2.27	-0.12	-10.51	-7.55e-05	1.77e-03	0.0
87 2	1.75	-0.09	-8.08	-5.81e-05	1.36e-03	0.0
88 1	2.33	0.09	-2.99	6.57e-05	1.73e-03	0.0
88 2	1.79	0.07	-2.30	5.05e-05	1.33e-03	0.0
89 1	2.38	-0.18	-13.15	-1.18e-04	1.70e-03	0.0
89 2	1.83	-0.14	-10.11	-9.12e-05	1.31e-03	0.0
90 1	2.46	0.14	0.26	9.56e-05	1.63e-03	0.0
90 2	1.89	0.10	0.20	7.35e-05	1.25e-03	0.0
91 1	2.54	-0.21	-16.32	-1.46e-04	1.58e-03	0.0
91 2	1.95	-0.16	-12.55	-1.12e-04	1.22e-03	0.0
92 1	2.64	0.14	5.43	9.80e-05	1.47e-03	0.0
92 2	2.03	0.11	4.17	7.54e-05	1.13e-03	0.0
93 1	2.75	-0.21	-21.24	-1.43e-04	1.39e-03	0.0
93 2	2.11	-0.16	-16.34	-1.10e-04	1.07e-03	0.0
94 1	2.20	-0.04	-8.11	-2.44e-05	1.81e-03	0.0
94 2	1.70	-0.03	-6.24	-1.88e-05	1.39e-03	0.0
95 1	2.29	0.09	-3.42	6.07e-05	1.75e-03	0.0
95 2	1.76	0.07	-2.63	4.67e-05	1.35e-03	0.0
96 1	2.34	-0.17	-12.76	-1.08e-04	1.72e-03	0.0
96 2	1.80	-0.13	-9.82	-8.34e-05	1.33e-03	0.0
97 1	2.63	0.14	4.78	9.78e-05	1.48e-03	0.0
97 2	2.02	0.11	3.68	7.52e-05	1.14e-03	0.0
98 1	2.73	-0.20	-20.65	-1.41e-04	1.41e-03	0.0
98 2	2.10	-0.16	-15.88	-1.09e-04	1.08e-03	0.0
99 1	2.21	0.03	-5.90	2.04e-05	1.80e-03	0.0
99 2	1.70	0.02	-4.54	1.57e-05	1.39e-03	0.0
1001	2.23	-0.11	-10.31	-6.76e-05	1.79e-03	0.0
1002	1.72	-0.08	-7.93	-5.20e-05	1.38e-03	0.0
1011	2.43	0.13	-0.31	9.05e-05	1.66e-03	0.0

1012	1.87	0.10	-0.24	6.96e-05	1.27e-03	0.0
1013	1.89	0.09	-0.61	6.41e-05	1.20e-03	0.0
1021	2.50	-0.20	-15.79	-1.37e-04	1.61e-03	0.0
1022	1.92	-0.16	-12.15	-1.06e-04	1.24e-03	0.0
1031	2.61	0.14	4.13	9.64e-05	1.50e-03	0.0
1032	2.01	0.11	3.18	7.42e-05	1.16e-03	0.0
1041	2.71	-0.20	-20.05	-1.38e-04	1.43e-03	0.0
1042	2.09	-0.15	-15.42	-1.06e-04	1.10e-03	0.0
1051	2.16	-0.04	-8.12	-2.10e-05	1.83e-03	0.0
1052	1.66	-0.03	-6.25	-1.62e-05	1.41e-03	0.0
1061	2.39	0.13	-0.89	8.48e-05	1.68e-03	0.0
1062	1.84	0.10	-0.69	6.52e-05	1.29e-03	0.0
1063	1.86	0.09	-1.03	6.00e-05	1.21e-03	0.0
1071	2.46	-0.19	-15.25	-1.28e-04	1.64e-03	0.0
1072	1.89	-0.15	-11.73	-9.83e-05	1.26e-03	0.0
1081	2.25	0.08	-3.85	5.50e-05	1.78e-03	0.0
1082	1.73	0.06	-2.96	4.23e-05	1.37e-03	0.0
1091	2.29	-0.16	-12.37	-9.73e-05	1.75e-03	0.0
1092	1.76	-0.12	-9.51	-7.48e-05	1.35e-03	0.0
1101	2.17	0.03	-6.13	1.81e-05	1.82e-03	0.0
1102	1.67	0.02	-4.72	1.39e-05	1.40e-03	0.0
1111	2.19	-0.10	-10.11	-5.87e-05	1.81e-03	0.0
1112	1.68	-0.07	-7.78	-4.51e-05	1.39e-03	0.0
1121	2.59	0.14	3.47	9.40e-05	1.53e-03	0.0
1122	1.99	0.11	2.67	7.23e-05	1.17e-03	0.0
1131	2.69	-0.20	-19.44	-1.34e-04	1.46e-03	0.0
1132	2.07	-0.15	-14.95	-1.03e-04	1.12e-03	0.0
1141	2.57	0.13	2.80	9.08e-05	1.55e-03	0.0
1142	1.97	0.10	2.15	6.98e-05	1.19e-03	0.0
1151	2.66	-0.19	-18.81	-1.29e-04	1.48e-03	0.0
1152	2.05	-0.15	-14.47	-9.90e-05	1.14e-03	0.0
1161	2.35	0.12	-1.48	7.82e-05	1.71e-03	0.0
1162	1.81	0.09	-1.14	6.02e-05	1.31e-03	0.0
1171	2.42	-0.18	-14.70	-1.17e-04	1.67e-03	0.0
1172	1.86	-0.14	-11.31	-9.01e-05	1.28e-03	0.0
1181	2.12	-0.03	-8.14	-1.73e-05	1.85e-03	0.0
1182	1.63	-0.02	-6.26	-1.33e-05	1.42e-03	0.0
1191	2.21	0.08	-4.28	4.83e-05	1.80e-03	0.0
1192	1.70	0.06	-3.29	3.71e-05	1.39e-03	0.0
1201	2.24	-0.14	-11.97	-8.46e-05	1.78e-03	0.0
1202	1.73	-0.11	-9.20	-6.51e-05	1.37e-03	0.0
1211	2.13	0.02	-6.37	1.50e-05	1.85e-03	0.0
1212	1.64	0.02	-4.90	1.15e-05	1.42e-03	0.0
1221	2.14	-0.08	-9.91	-4.84e-05	1.84e-03	0.0
1222	1.65	-0.06	-7.62	-3.72e-05	1.41e-03	0.0
1231	2.54	0.13	2.12	8.68e-05	1.58e-03	0.0
1232	1.95	0.10	1.63	6.68e-05	1.21e-03	0.0
1241	2.63	-0.18	-18.18	-1.22e-04	1.51e-03	0.0
1242	2.02	-0.14	-13.98	-9.42e-05	1.16e-03	0.0
1251	2.31	0.11	-2.08	7.07e-05	1.74e-03	0.0
1252	1.78	0.09	-1.60	5.44e-05	1.34e-03	0.0
1261	2.37	-0.17	-14.13	-1.05e-04	1.70e-03	0.0
1262	1.82	-0.13	-10.87	-8.09e-05	1.31e-03	0.0
1271	2.50	0.13	1.43	8.21e-05	1.60e-03	0.0
1272	1.92	0.10	1.10	6.32e-05	1.23e-03	0.0
1281	2.59	-0.18	-17.53	-1.15e-04	1.55e-03	0.0
1282	1.99	-0.14	-13.48	-8.86e-05	1.19e-03	0.0
1291	2.16	0.07	-4.72	3.99e-05	1.83e-03	0.0
1292	1.66	0.05	-3.63	3.07e-05	1.40e-03	0.0
1301	2.19	-0.12	-11.55	-6.98e-05	1.81e-03	0.0
1302	1.68	-0.09	-8.89	-5.37e-05	1.39e-03	0.0
1311	2.72	0.11	9.80	5.56e-05	1.39e-03	0.0
1312	2.09	0.09	7.54	4.28e-05	1.07e-03	0.0
1321	2.83	-0.14	-25.42	-7.93e-05	1.30e-03	0.0
1322	2.18	-0.11	-19.55	-6.10e-05	1.00e-03	0.0
1331	2.08	-0.02	-8.15	-1.31e-05	1.87e-03	0.0
1332	1.60	-0.02	-6.27	-1.01e-05	1.44e-03	0.0
1341	2.08	0.02	-6.61	1.06e-05	1.87e-03	0.0
1342	1.60	0.01	-5.08	8.17e-06	1.44e-03	0.0
1351	2.10	-0.07	-9.70	-3.59e-05	1.86e-03	0.0
1352	1.61	-0.05	-7.46	-2.76e-05	1.43e-03	0.0
1361	2.26	0.10	-2.69	6.19e-05	1.77e-03	0.0
1362	1.74	0.08	-2.07	4.76e-05	1.36e-03	0.0
1371	2.31	-0.15	-13.56	-9.15e-05	1.74e-03	0.0
1372	1.78	-0.12	-10.43	-7.04e-05	1.34e-03	0.0
1381	2.72	0.11	9.09	5.49e-05	1.39e-03	0.0



1382	2.09	0.08	6.99	4.22e-05	1.07e-03	0.0
1391	2.84	-0.14	-24.76	-7.86e-05	1.30e-03	0.0
1392	2.18	-0.11	-19.04	-6.04e-05	1.00e-03	0.0
1401	2.46	0.12	0.72	7.68e-05	1.63e-03	0.0
1402	1.89	0.09	0.56	5.91e-05	1.26e-03	0.0
1411	2.55	-0.17	-16.86	-1.07e-04	1.58e-03	0.0
1412	1.96	-0.13	-12.97	-8.25e-05	1.22e-03	0.0
1421	2.72	0.11	8.38	5.62e-05	1.40e-03	0.0
1422	2.09	0.08	6.45	4.32e-05	1.08e-03	0.0
1431	2.84	-0.14	-24.10	-7.98e-05	1.31e-03	0.0
1432	2.18	-0.11	-18.54	-6.14e-05	1.01e-03	0.0
1441	2.07	-0.02	-8.16	-1.14e-05	1.87e-03	0.0
1442	1.59	-0.02	-6.28	-8.79e-06	1.44e-03	0.0
1451	2.11	0.05	-5.17	2.90e-05	1.85e-03	0.0
1452	1.62	0.04	-3.97	2.23e-05	1.43e-03	0.0
1461	2.13	-0.09	-11.14	-5.16e-05	1.84e-03	0.0
1462	1.64	-0.07	-8.57	-3.97e-05	1.42e-03	0.0
1471	2.71	0.10	7.68	5.74e-05	1.41e-03	0.0
1472	2.09	0.08	5.91	4.42e-05	1.08e-03	0.0
1481	2.83	-0.14	-23.44	-8.08e-05	1.32e-03	0.0
1482	2.18	-0.10	-18.03	-6.21e-05	1.01e-03	0.0
1491	2.42	0.11	4.22e-03	7.08e-05	1.66e-03	0.0
1492	1.86	0.09	3.25e-03	5.45e-05	1.28e-03	0.0
1493	1.88	0.08	-0.38	5.04e-05	1.20e-03	0.0
1501	2.50	-0.16	-16.18	-9.82e-05	1.62e-03	0.0
1502	1.92	-0.12	-12.45	-7.56e-05	1.24e-03	0.0
1511	2.07	0.01	-6.77	6.92e-06	1.87e-03	0.0
1512	1.59	8.68e-03	-5.21	5.32e-06	1.44e-03	0.0
1521	2.08	-0.05	-9.55	-2.90e-05	1.87e-03	0.0
1522	1.60	-0.04	-7.35	-2.23e-05	1.43e-03	0.0
1531	2.21	0.09	-3.31	5.12e-05	1.80e-03	0.0
1532	1.70	0.07	-2.54	3.94e-05	1.38e-03	0.0
1541	2.25	-0.13	-12.97	-7.55e-05	1.77e-03	0.0
1542	1.73	-0.10	-9.98	-5.81e-05	1.36e-03	0.0
1551	2.70	0.10	6.97	5.80e-05	1.42e-03	0.0
1552	2.08	0.08	5.36	4.46e-05	1.09e-03	0.0
1561	2.82	-0.13	-22.78	-8.09e-05	1.33e-03	0.0
1562	2.17	-0.10	-17.53	-6.22e-05	1.03e-03	0.0
1571	2.69	0.10	6.25	5.78e-05	1.44e-03	0.0
1572	2.07	0.08	4.81	4.44e-05	1.11e-03	0.0
1581	2.37	0.11	-0.73	6.40e-05	1.70e-03	0.0
1582	1.82	0.08	-0.56	4.92e-05	1.31e-03	0.0
1583	1.85	0.08	-0.91	4.55e-05	1.23e-03	0.0
1591	2.44	-0.15	-15.49	-8.82e-05	1.65e-03	0.0
1592	1.88	-0.11	-11.91	-6.79e-05	1.27e-03	0.0
1601	2.81	-0.13	-22.12	-8.01e-05	1.35e-03	0.0
1602	2.16	-0.10	-17.01	-6.16e-05	1.04e-03	0.0
1611	2.09	0.04	-5.47	2.12e-05	1.86e-03	0.0
1612	1.61	0.03	-4.21	1.63e-05	1.43e-03	0.0
1621	2.11	-0.08	-10.85	-4.10e-05	1.85e-03	0.0
1622	1.62	-0.06	-8.35	-3.15e-05	1.42e-03	0.0
1631	2.67	0.10	5.53	5.69e-05	1.46e-03	0.0
1632	2.06	0.07	4.25	4.38e-05	1.12e-03	0.0
1641	2.79	-0.13	-21.44	-7.84e-05	1.38e-03	0.0
1642	2.15	-0.10	-16.49	-6.03e-05	1.06e-03	0.0
1651	2.14	0.07	-3.93	3.73e-05	1.83e-03	0.0
1652	1.65	0.05	-3.02	2.87e-05	1.41e-03	0.0
1661	2.18	-0.10	-12.37	-5.57e-05	1.81e-03	0.0
1662	1.68	-0.08	-9.52	-4.29e-05	1.40e-03	0.0
1671	2.04	-0.02	-8.17	-9.19e-06	1.88e-03	0.0
1672	1.57	-0.01	-6.28	-7.07e-06	1.45e-03	0.0
1681	2.32	0.10	-1.47	5.60e-05	1.73e-03	0.0
1682	1.78	0.07	-1.13	4.30e-05	1.33e-03	0.0
1691	2.38	-0.13	-14.78	-7.68e-05	1.69e-03	0.0
1692	1.83	-0.10	-11.37	-5.91e-05	1.30e-03	0.0
1701	2.65	0.09	4.79	5.55e-05	1.48e-03	0.0
1702	2.04	0.07	3.69	4.27e-05	1.14e-03	0.0
1711	2.04	4.23e-03	-7.05	2.72e-06	1.88e-03	0.0
1712	1.57	3.25e-03	-5.42	2.09e-06	1.45e-03	0.0
1721	2.05	-0.04	-9.28	-2.05e-05	1.88e-03	0.0
1722	1.57	-0.03	-7.14	-1.57e-05	1.44e-03	0.0
1731	2.76	-0.12	-20.76	-7.60e-05	1.40e-03	0.0
1732	2.13	-0.10	-15.97	-5.85e-05	1.08e-03	0.0
1741	2.62	0.09	4.05	5.35e-05	1.51e-03	0.0
1742	2.02	0.07	3.11	4.12e-05	1.16e-03	0.0
1751	2.73	-0.12	-20.06	-7.30e-05	1.43e-03	0.0

1752	2.10	-0.09	-15.43	-5.62e-05	1.10e-03	0.0
1761	2.11	0.05	-4.36	2.79e-05	1.85e-03	0.0
1762	1.63	0.04	-3.35	2.14e-05	1.42e-03	0.0
1771	2.14	-0.08	-11.97	-4.39e-05	1.83e-03	0.0
1772	1.65	-0.06	-9.20	-3.38e-05	1.41e-03	0.0
1781	2.05	0.02	-6.01	1.21e-05	1.87e-03	0.0
1782	1.58	0.02	-4.62	9.33e-06	1.44e-03	0.0
1791	2.07	-0.05	-10.32	-2.80e-05	1.87e-03	0.0
1792	1.59	-0.04	-7.94	-2.15e-05	1.43e-03	0.0
1801	2.25	0.08	-2.22	4.63e-05	1.77e-03	0.0
1802	1.73	0.06	-1.71	3.56e-05	1.36e-03	0.0
1811	2.31	-0.11	-14.06	-6.34e-05	1.74e-03	0.0
1812	1.77	-0.09	-10.81	-4.88e-05	1.34e-03	0.0
1821	2.59	0.09	3.29	5.12e-05	1.53e-03	0.0
1822	1.99	0.07	2.53	3.94e-05	1.18e-03	0.0
1831	2.70	-0.12	-19.35	-6.95e-05	1.47e-03	0.0
1832	2.08	-0.09	-14.88	-5.34e-05	1.13e-03	0.0
1841	2.56	0.08	2.52	4.84e-05	1.57e-03	0.0
1842	1.97	0.07	1.94	3.72e-05	1.20e-03	0.0
1851	2.66	-0.11	-18.62	-6.54e-05	1.50e-03	0.0
1852	2.04	-0.09	-14.32	-5.03e-05	1.15e-03	0.0
1861	2.02	-0.01	-8.17	-6.96e-06	1.89e-03	0.0
1862	1.55	-0.01	-6.28	-5.35e-06	1.45e-03	0.0
1871	2.02	-3.47e-04	-7.32	0.0	1.89e-03	0.0
1872	1.55	-2.67e-04	-5.63	0.0	1.45e-03	0.0
1873	1.59	-8.04e-04	-5.67	0.0	1.36e-03	0.0
1881	2.02	-0.03	-9.02	-1.34e-05	1.88e-03	0.0
1882	1.56	-0.02	-6.94	-1.03e-05	1.45e-03	0.0
1891	2.18	0.06	-2.98	3.38e-05	1.81e-03	0.0
1892	1.68	0.05	-2.29	2.60e-05	1.39e-03	0.0
1901	2.22	-0.09	-13.32	-4.67e-05	1.79e-03	0.0
1902	1.71	-0.07	-10.25	-3.59e-05	1.38e-03	0.0
1911	2.07	0.03	-5.11	1.67e-05	1.87e-03	0.0
1912	1.59	0.02	-3.93	1.29e-05	1.43e-03	0.0
1921	2.09	-0.06	-11.22	-2.96e-05	1.85e-03	0.0
1922	1.61	-0.04	-8.63	-2.28e-05	1.42e-03	0.0
1931	2.52	0.08	1.74	4.53e-05	1.60e-03	0.0
1932	1.94	0.06	1.34	3.48e-05	1.23e-03	0.0
1941	2.61	-0.11	-17.88	-6.08e-05	1.54e-03	0.0
1942	2.01	-0.08	-13.75	-4.68e-05	1.18e-03	0.0
1951	2.02	0.01	-6.52	5.57e-06	1.89e-03	0.0
1952	1.55	8.08e-03	-5.01	4.28e-06	1.45e-03	0.0
1961	2.03	-0.03	-9.82	-1.76e-05	1.88e-03	0.0
1962	1.56	-0.03	-7.55	-1.35e-05	1.44e-03	0.0
1971	2.47	0.08	0.94	4.17e-05	1.63e-03	0.0
1972	1.90	0.06	0.72	3.21e-05	1.25e-03	0.0
1981	2.56	-0.10	-17.12	-5.58e-05	1.58e-03	0.0
1982	1.97	-0.08	-13.17	-4.29e-05	1.21e-03	0.0
1991	2.14	0.05	-3.50	2.54e-05	1.83e-03	0.0
1992	1.65	0.04	-2.70	1.96e-05	1.41e-03	0.0
2001	2.18	-0.07	-12.82	-3.67e-05	1.81e-03	0.0
2002	1.68	-0.05	-9.86	-2.82e-05	1.39e-03	0.0
2011	2.42	0.07	0.13	3.77e-05	1.67e-03	0.0
2012	1.86	0.05	0.10	2.90e-05	1.28e-03	0.0
2013	1.88	0.05	-0.30	2.68e-05	1.20e-03	0.0
2021	2.50	-0.09	-16.34	-5.01e-05	1.62e-03	0.0
2022	1.92	-0.07	-12.57	-3.85e-05	1.25e-03	0.0
2031	2.03	0.02	-5.84	8.48e-06	1.88e-03	0.0
2032	1.56	0.01	-4.49	6.53e-06	1.45e-03	0.0
2041	2.05	-0.04	-10.50	-1.82e-05	1.87e-03	0.0
2042	1.58	-0.03	-8.08	-1.40e-05	1.44e-03	0.0
2051	2.00	-9.22e-03	-8.17	-4.73e-06	1.89e-03	0.0
2052	1.54	-7.09e-03	-6.29	-3.64e-06	1.46e-03	0.0
2061	2.00	-2.66e-03	-7.58	-1.42e-06	1.89e-03	0.0
2062	1.54	-2.05e-03	-5.83	-1.09e-06	1.46e-03	0.0
2071	2.00	-0.02	-8.76	-7.71e-06	1.89e-03	0.0
2072	1.54	-0.01	-6.74	-5.93e-06	1.45e-03	0.0
2081	2.36	0.06	-0.70	3.30e-05	1.71e-03	0.0
2082	1.81	0.05	-0.54	2.54e-05	1.31e-03	0.0
2083	1.84	0.05	-0.89	2.35e-05	1.23e-03	0.0
2091	2.43	-0.08	-15.55	-4.36e-05	1.66e-03	0.0
2092	1.87	-0.06	-11.96	-3.35e-05	1.28e-03	0.0
2101	2.08	0.03	-4.43	1.55e-05	1.86e-03	0.0
2102	1.60	0.02	-3.41	1.20e-05	1.43e-03	0.0
2111	2.11	-0.05	-11.90	-2.46e-05	1.84e-03	0.0
2112	1.63	-0.04	-9.16	-1.89e-05	1.41e-03	0.0

2121	2.00	3.04e-03	-7.03	1.36e-06	1.89e-03	0.0
2122	1.54	2.34e-03	-5.41	1.05e-06	1.46e-03	0.0
2131	2.01	-0.02	-9.31	-9.51e-06	1.89e-03	0.0
2132	1.55	-0.01	-7.16	-7.32e-06	1.45e-03	0.0
2141	2.29	0.05	-1.54	2.73e-05	1.75e-03	0.0
2142	1.76	0.04	-1.18	2.10e-05	1.34e-03	0.0
2151	2.35	-0.07	-14.74	-3.60e-05	1.71e-03	0.0
2152	1.81	-0.05	-11.34	-2.77e-05	1.32e-03	0.0
2161	2.04	0.02	-5.31	8.16e-06	1.87e-03	0.0
2162	1.57	0.01	-4.09	6.28e-06	1.44e-03	0.0
2171	2.06	-0.03	-11.03	-1.50e-05	1.86e-03	0.0
2172	1.59	-0.02	-8.48	-1.15e-05	1.43e-03	0.0
2181	2.01	6.75e-03	-6.56	2.98e-06	1.89e-03	0.0
2182	1.54	5.19e-03	-5.05	2.29e-06	1.45e-03	0.0
2191	2.02	-0.02	-9.78	-9.58e-06	1.88e-03	0.0
2192	1.55	-0.02	-7.52	-7.37e-06	1.45e-03	0.0
2201	2.21	0.04	-2.38	1.99e-05	1.80e-03	0.0
2202	1.70	0.03	-1.83	1.53e-05	1.38e-03	0.0
2211	2.26	-0.06	-13.92	-2.65e-05	1.77e-03	0.0
2212	1.74	-0.04	-10.71	-2.04e-05	1.36e-03	0.0
2221	2.16	0.03	-2.97	1.51e-05	1.82e-03	0.0
2222	1.67	0.03	-2.28	1.16e-05	1.40e-03	0.0
2231	2.21	-0.04	-13.36	-2.07e-05	1.79e-03	0.0
2232	1.70	-0.03	-10.28	-1.59e-05	1.38e-03	0.0
2241	1.99	-5.07e-03	-8.17	-2.51e-06	1.90e-03	0.0
2242	1.53	-3.90e-03	-6.29	-1.93e-06	1.46e-03	0.0
2251	1.99	-2.78e-03	-7.85	-1.49e-06	1.90e-03	0.0
2252	1.53	-2.14e-03	-6.04	-1.15e-06	1.46e-03	0.0
2261	1.99	-7.01e-03	-8.50	-3.35e-06	1.90e-03	0.0
2262	1.53	-5.39e-03	-6.54	-2.58e-06	1.46e-03	0.0
2271	2.01	7.91e-03	-6.20	3.15e-06	1.89e-03	0.0
2272	1.55	6.09e-03	-4.77	2.42e-06	1.45e-03	0.0
2281	2.03	-0.02	-10.14	-7.72e-06	1.88e-03	0.0
2282	1.56	-0.01	-7.80	-5.94e-06	1.45e-03	0.0
2291	2.10	0.02	-4.00	9.30e-06	1.85e-03	0.0
2292	1.61	0.02	-3.07	7.16e-06	1.42e-03	0.0
2301	2.13	-0.03	-12.34	-1.38e-05	1.83e-03	0.0
2302	1.64	-0.02	-9.49	-1.06e-05	1.41e-03	0.0
2311	1.99	-6.21e-04	-7.55	0.0	1.90e-03	0.0
2312	1.53	-4.77e-04	-5.81	0.0	1.46e-03	0.0
2321	2.00	-8.18e-03	-8.80	-3.76e-06	1.89e-03	0.0
2322	1.53	-6.29e-03	-6.77	-2.89e-06	1.46e-03	0.0
2331	1.99	1.05e-03	-7.29	0.0	1.90e-03	0.0
2332	1.53	8.08e-04	-5.61	0.0	1.46e-03	0.0
2341	2.00	-8.26e-03	-9.05	-3.59e-06	1.89e-03	0.0
2342	1.54	-6.35e-03	-6.96	-2.76e-06	1.46e-03	0.0
2351	2.05	0.01	-4.98	4.98e-06	1.87e-03	0.0
2352	1.58	0.01	-3.83	3.83e-06	1.44e-03	0.0
2361	2.07	-0.02	-11.36	-8.34e-06	1.86e-03	0.0
2362	1.60	-0.02	-8.74	-6.41e-06	1.43e-03	0.0
2371	1.99	2.03e-03	-7.10	0.0	1.90e-03	0.0
2372	1.53	1.56e-03	-5.46	0.0	1.46e-03	0.0
2381	2.00	-7.18e-03	-9.25	-2.79e-06	1.89e-03	0.0
2382	1.54	-5.52e-03	-7.12	-2.14e-06	1.45e-03	0.0
2391	2.01	6.75e-03	-5.97	2.03e-06	1.89e-03	0.0
2392	1.55	5.19e-03	-4.60	1.56e-06	1.45e-03	0.0
2401	2.03	-0.01	-10.37	-4.23e-06	1.88e-03	0.0
2402	1.56	-8.92e-03	-7.98	-3.26e-06	1.44e-03	0.0
2411	1.99	2.34e-03	-6.97	0.0	1.90e-03	0.0
2412	1.53	1.80e-03	-5.36	0.0	1.46e-03	0.0
2421	2.00	-5.08e-03	-9.38	-1.46e-06	1.89e-03	0.0
2422	1.54	-3.91e-03	-7.21	-1.12e-06	1.45e-03	0.0
2431	2.75	0.04	10.43	0.0	1.38e-03	0.0
2432	2.11	0.03	8.02	0.0	1.06e-03	0.0
2441	2.75	0.04	9.69	0.0	1.38e-03	0.0
2442	2.11	0.03	7.45	0.0	1.06e-03	0.0
2451	2.75	0.04	8.96	0.0	1.38e-03	0.0
2452	2.11	0.03	6.89	0.0	1.06e-03	0.0
2461	2.74	0.04	8.23	0.0	1.39e-03	0.0
2462	2.11	0.03	6.33	0.0	1.07e-03	0.0
2471	2.73	0.04	7.49	0.0	1.40e-03	0.0
2472	2.10	0.03	5.76	0.0	1.08e-03	0.0
2481	2.72	0.03	6.75	0.0	1.42e-03	0.0
2482	2.09	0.03	5.19	0.0	1.09e-03	0.0
2491	2.70	0.03	6.00	0.0	1.44e-03	0.0
2492	2.08	0.02	4.62	0.0	1.11e-03	0.0

2501	2.68	0.03	5.24	0.0	1.46e-03	0.0
2502	2.06	0.02	4.03	0.0	1.13e-03	0.0
2511	2.65	0.03	4.47	0.0	1.49e-03	0.0
2512	2.04	0.02	3.44	0.0	1.15e-03	0.0
2521	2.62	0.03	3.69	0.0	1.52e-03	0.0
2522	2.01	0.02	2.84	0.0	1.17e-03	0.0
2531	2.58	0.02	2.89	0.0	1.55e-03	0.0
2532	1.99	0.02	2.23	0.0	1.19e-03	0.0
2541	2.54	0.02	2.08	0.0	1.58e-03	0.0
2542	1.95	0.02	1.60	0.0	1.22e-03	0.0
2551	2.49	0.02	1.26	0.0	1.62e-03	0.0
2552	1.92	0.01	0.97	0.0	1.25e-03	0.0
2561	2.44	0.02	0.42	0.0	1.66e-03	0.0
2562	1.87	0.01	0.32	0.0	1.27e-03	0.0
2571	2.38	0.02	-0.44	0.0	1.70e-03	0.0
2572	1.83	0.01	-0.34	0.0	1.30e-03	0.0
2573	1.85	0.01	-0.70	0.0	1.22e-03	0.0
2581	2.31	0.01	-1.31	0.0	1.74e-03	0.0
2582	1.77	0.01	-1.00	0.0	1.34e-03	0.0
2583	1.80	0.01	-1.33	0.0	1.26e-03	0.0
2591	2.22	0.01	-2.18	0.0	1.79e-03	0.0
2592	1.71	8.59e-03	-1.68	0.0	1.38e-03	0.0
2601	2.17	9.69e-03	-2.78	0.0	1.81e-03	0.0
2602	1.67	7.46e-03	-2.14	0.0	1.39e-03	0.0
2611	2.11	7.84e-03	-3.85	0.0	1.84e-03	0.0
2612	1.62	6.03e-03	-2.96	0.0	1.42e-03	0.0
2621	2.05	5.97e-03	-4.87	0.0	1.87e-03	0.0
2622	1.58	4.59e-03	-3.75	0.0	1.44e-03	0.0
2631	2.02	4.08e-03	-5.90	0.0	1.89e-03	0.0
2632	1.55	3.14e-03	-4.54	0.0	1.45e-03	0.0
2641	1.99	2.18e-03	-6.93	0.0	1.90e-03	0.0
2642	1.53	1.68e-03	-5.33	0.0	1.46e-03	0.0
2651	1.99	-9.92e-05	-8.18	0.0	1.90e-03	0.0
2652	1.53	-7.63e-05	-6.29	0.0	1.46e-03	0.0
2661	2.00	-2.34e-03	-9.42	0.0	1.89e-03	0.0
2662	1.54	-1.80e-03	-7.24	0.0	1.45e-03	0.0
2671	2.03	-4.19e-03	-10.45	0.0	1.88e-03	0.0
2672	1.56	-3.22e-03	-8.04	0.0	1.44e-03	0.0
2681	2.08	-6.02e-03	-11.47	0.0	1.85e-03	0.0
2682	1.60	-4.63e-03	-8.82	0.0	1.43e-03	0.0
2691	2.14	-7.85e-03	-12.48	0.0	1.83e-03	0.0
2692	1.65	-6.04e-03	-9.60	0.0	1.40e-03	0.0
2701	2.22	-9.68e-03	-13.54	0.0	1.79e-03	0.0
2702	1.71	-7.45e-03	-10.42	0.0	1.38e-03	0.0
2711	2.27	-0.01	-14.12	0.0	1.76e-03	0.0
2712	1.75	-8.58e-03	-10.86	0.0	1.36e-03	0.0
2721	2.37	-0.01	-14.97	0.0	1.71e-03	0.0
2722	1.82	-0.01	-11.52	0.0	1.31e-03	0.0
2731	2.45	-0.02	-15.81	0.0	1.65e-03	0.0
2732	1.88	-0.01	-12.16	0.0	1.27e-03	0.0
2741	2.52	-0.02	-16.63	0.0	1.61e-03	0.0
2742	1.94	-0.01	-12.79	0.0	1.24e-03	0.0
2751	2.58	-0.02	-17.43	0.0	1.56e-03	0.0
2752	1.99	-0.01	-13.41	0.0	1.20e-03	0.0
2761	2.64	-0.02	-18.22	0.0	1.52e-03	0.0
2762	2.03	-0.02	-14.02	0.0	1.17e-03	0.0
2771	2.68	-0.02	-18.99	0.0	1.48e-03	0.0
2772	2.06	-0.02	-14.61	0.0	1.14e-03	0.0
2781	2.73	-0.03	-19.75	0.0	1.45e-03	0.0
2782	2.10	-0.02	-15.19	0.0	1.11e-03	0.0
2791	2.76	-0.03	-20.48	0.0	1.41e-03	0.0
2792	2.13	-0.02	-15.76	0.0	1.09e-03	0.0
2801	2.80	-0.03	-21.21	0.0	1.38e-03	0.0
2802	2.15	-0.02	-16.31	0.0	1.06e-03	0.0
2811	2.82	-0.03	-21.92	0.0	1.36e-03	0.0
2812	2.17	-0.02	-16.86	0.0	1.04e-03	0.0
2821	2.84	-0.03	-22.62	0.0	1.33e-03	0.0
2822	2.19	-0.03	-17.40	0.0	1.02e-03	0.0
2831	2.86	-0.04	-23.31	0.0	1.31e-03	0.0
2832	2.20	-0.03	-17.93	0.0	1.01e-03	0.0
2841	2.87	-0.04	-23.99	0.0	1.30e-03	0.0
2842	2.20	-0.03	-18.45	0.0	9.99e-04	0.0
2851	2.87	-0.04	-24.67	0.0	1.29e-03	0.0
2852	2.21	-0.03	-18.98	0.0	9.91e-04	0.0
2861	2.87	-0.04	-25.35	0.0	1.28e-03	0.0
2862	2.21	-0.03	-19.50	0.0	9.88e-04	0.0

2871	2.87	-0.04	-26.04	0.0	1.28e-03	0.0
2872	2.21	-0.03	-20.03	0.0	9.86e-04	0.0
2881	1.99	1.86e-03	-6.97	0.0	1.90e-03	0.0
2882	1.53	1.43e-03	-5.36	0.0	1.46e-03	0.0
2891	2.00	5.47e-04	-9.38	1.78e-06	1.89e-03	0.0
2892	1.54	4.21e-04	-7.21	1.37e-06	1.45e-03	0.0
2901	2.02	1.14e-03	-5.97	-1.73e-06	1.89e-03	0.0
2902	1.55	8.75e-04	-4.60	-1.33e-06	1.45e-03	0.0
2911	2.03	3.49e-03	-10.37	4.58e-06	1.88e-03	0.0
2912	1.56	2.69e-03	-7.98	3.52e-06	1.44e-03	0.0
2921	1.99	1.71e-03	-7.10	0.0	1.90e-03	0.0
2922	1.53	1.32e-03	-5.46	0.0	1.46e-03	0.0
2931	2.00	3.08e-03	-9.25	3.10e-06	1.89e-03	0.0
2932	1.54	2.37e-03	-7.12	2.38e-06	1.45e-03	0.0
2941	2.05	-1.79e-03	-4.98	-4.69e-06	1.87e-03	0.0
2942	1.58	-1.38e-03	-3.83	-3.61e-06	1.44e-03	0.0
2951	2.08	8.66e-03	-11.36	8.72e-06	1.86e-03	0.0
2952	1.60	6.66e-03	-8.74	6.71e-06	1.43e-03	0.0
2961	1.99	1.96e-03	-7.29	0.0	1.90e-03	0.0
2962	1.53	1.51e-03	-5.61	0.0	1.46e-03	0.0
2971	2.00	4.87e-03	-9.05	3.89e-06	1.89e-03	0.0
2972	1.54	3.75e-03	-6.96	2.99e-06	1.46e-03	0.0
2981	1.99	2.68e-03	-7.55	0.0	1.90e-03	0.0
2982	1.53	2.06e-03	-5.81	0.0	1.46e-03	0.0
2991	2.00	5.71e-03	-8.80	4.06e-06	1.89e-03	0.0
2992	1.54	4.39e-03	-6.77	3.12e-06	1.46e-03	0.0
3001	2.10	-7.03e-03	-4.00	-9.03e-06	1.85e-03	0.0
3002	1.62	-5.40e-03	-3.07	-6.94e-06	1.42e-03	0.0
3011	2.14	0.02	-12.34	1.42e-05	1.83e-03	0.0
3012	1.64	0.01	-9.49	1.09e-05	1.41e-03	0.0
3021	2.01	-8.58e-04	-6.20	-2.85e-06	1.89e-03	0.0
3022	1.55	-6.60e-04	-4.77	-2.19e-06	1.45e-03	0.0
3031	2.03	9.89e-03	-10.14	8.05e-06	1.88e-03	0.0
3032	1.56	7.60e-03	-7.80	6.19e-06	1.45e-03	0.0
3041	1.99	3.74e-03	-7.85	1.78e-06	1.90e-03	0.0
3042	1.53	2.88e-03	-6.04	1.37e-06	1.46e-03	0.0
3051	2.00	5.63e-03	-8.50	3.64e-06	1.90e-03	0.0
3052	1.54	4.33e-03	-6.54	2.80e-06	1.46e-03	0.0
3061	2.00	4.85e-03	-8.17	2.80e-06	1.90e-03	0.0
3062	1.54	3.73e-03	-6.29	2.15e-06	1.46e-03	0.0
3071	2.17	-0.01	-2.97	-1.48e-05	1.82e-03	0.0
3072	1.67	-0.01	-2.28	-1.14e-05	1.40e-03	0.0
3081	2.21	0.03	-13.36	2.12e-05	1.79e-03	0.0
3082	1.70	0.02	-10.27	1.63e-05	1.38e-03	0.0
3091	2.22	-0.02	-2.38	-1.97e-05	1.80e-03	0.0
3092	1.70	-0.02	-1.83	-1.52e-05	1.38e-03	0.0
3101	2.26	0.03	-13.92	2.70e-05	1.77e-03	0.0
3102	1.74	0.03	-10.71	2.07e-05	1.36e-03	0.0
3111	2.01	-1.02e-03	-6.56	-2.69e-06	1.89e-03	0.0
3112	1.55	-7.88e-04	-5.05	-2.07e-06	1.45e-03	0.0
3121	2.02	0.01	-9.78	9.90e-06	1.88e-03	0.0
3122	1.56	0.01	-7.52	7.61e-06	1.45e-03	0.0
3131	2.05	-7.22e-03	-5.31	-7.86e-06	1.87e-03	0.0
3132	1.57	-5.56e-03	-4.09	-6.04e-06	1.44e-03	0.0
3141	2.07	0.02	-11.03	1.53e-05	1.86e-03	0.0
3142	1.59	0.02	-8.48	1.18e-05	1.43e-03	0.0
3151	2.30	-0.03	-1.54	-2.71e-05	1.75e-03	0.0
3152	1.77	-0.02	-1.18	-2.09e-05	1.34e-03	0.0
3161	2.36	0.05	-14.74	3.65e-05	1.71e-03	0.0
3162	1.81	0.03	-11.34	2.81e-05	1.32e-03	0.0
3171	2.01	9.18e-04	-7.03	-1.08e-06	1.89e-03	0.0
3172	1.55	7.06e-04	-5.41	0.0	1.46e-03	0.0
3173	1.59	1.14e-03	-5.47	0.0	1.37e-03	0.0
3181	2.02	0.01	-9.31	9.81e-06	1.89e-03	0.0
3182	1.55	0.01	-7.16	7.55e-06	1.45e-03	0.0
3191	2.09	-0.02	-4.43	-1.52e-05	1.85e-03	0.0
3192	1.61	-0.01	-3.41	-1.17e-05	1.43e-03	0.0
3201	2.12	0.04	-11.90	2.50e-05	1.84e-03	0.0
3202	1.63	0.03	-9.16	1.92e-05	1.41e-03	0.0
3211	2.37	-0.03	-0.70	-3.28e-05	1.71e-03	0.0
3212	1.82	-0.03	-0.54	-2.53e-05	1.31e-03	0.0
3213	1.85	-0.02	-0.89	-2.34e-05	1.23e-03	0.0
3221	2.44	0.05	-15.55	4.42e-05	1.66e-03	0.0
3222	1.87	0.04	-11.96	3.40e-05	1.28e-03	0.0
3231	2.01	4.57e-03	-7.58	1.70e-06	1.89e-03	0.0
3232	1.54	3.51e-03	-5.83	1.30e-06	1.46e-03	0.0

3241	2.01	0.01	-8.76	7.98e-06	1.89e-03	0.0
3242	1.55	9.82e-03	-6.74	6.14e-06	1.45e-03	0.0
3251	2.01	8.96e-03	-8.17	5.00e-06	1.89e-03	0.0
3252	1.55	6.89e-03	-6.29	3.84e-06	1.46e-03	0.0
3261	2.04	-8.36e-03	-5.84	-8.17e-06	1.88e-03	0.0
3262	1.57	-6.43e-03	-4.49	-6.28e-06	1.45e-03	0.0
3271	2.06	0.03	-10.50	1.86e-05	1.87e-03	0.0
3272	1.58	0.02	-8.08	1.43e-05	1.44e-03	0.0
3281	2.43	-0.04	0.13	-3.76e-05	1.67e-03	0.0
3282	1.87	-0.03	0.10	-2.89e-05	1.28e-03	0.0
3283	1.89	-0.03	-0.30	-2.68e-05	1.20e-03	0.0
3291	2.51	0.06	-16.34	5.07e-05	1.62e-03	0.0
3292	1.93	0.04	-12.57	3.90e-05	1.25e-03	0.0
3301	2.15	-0.03	-3.50	-2.52e-05	1.83e-03	0.0
3302	1.66	-0.02	-2.70	-1.93e-05	1.41e-03	0.0
3311	2.19	0.05	-12.82	3.71e-05	1.81e-03	0.0
3312	1.68	0.04	-9.86	2.86e-05	1.39e-03	0.0
3321	2.48	-0.04	0.94	-4.17e-05	1.63e-03	0.0
3322	1.91	-0.03	0.72	-3.20e-05	1.25e-03	0.0
3331	2.57	0.06	-17.12	5.64e-05	1.58e-03	0.0
3332	1.97	0.05	-13.17	4.34e-05	1.21e-03	0.0
3341	2.03	-4.58e-03	-6.52	-5.26e-06	1.88e-03	0.0
3342	1.56	-3.53e-03	-5.01	-4.05e-06	1.45e-03	0.0
3351	2.05	0.03	-9.82	1.79e-05	1.88e-03	0.0
3352	1.57	0.02	-7.55	1.38e-05	1.44e-03	0.0
3361	2.53	-0.04	1.74	-4.52e-05	1.60e-03	0.0
3362	1.94	-0.03	1.34	-3.48e-05	1.23e-03	0.0
3371	2.62	0.06	-17.88	6.15e-05	1.54e-03	0.0
3372	2.02	0.05	-13.75	4.73e-05	1.18e-03	0.0
3381	2.08	-0.02	-5.11	-1.64e-05	1.86e-03	0.0
3382	1.60	-0.02	-3.93	-1.26e-05	1.43e-03	0.0
3391	2.10	0.05	-11.22	3.00e-05	1.85e-03	0.0
3392	1.62	0.03	-8.63	2.31e-05	1.42e-03	0.0
3401	2.19	-0.04	-2.98	-3.35e-05	1.81e-03	0.0
3402	1.69	-0.03	-2.29	-2.58e-05	1.39e-03	0.0
3411	2.24	0.07	-13.32	4.72e-05	1.79e-03	0.0
3412	1.72	0.05	-10.25	3.63e-05	1.38e-03	0.0
3421	2.03	3.20e-03	-7.31	0.0	1.89e-03	0.0
3422	1.56	2.46e-03	-5.63	0.0	1.45e-03	0.0
3431	2.04	0.02	-9.02	1.37e-05	1.88e-03	0.0
3432	1.57	0.02	-6.94	1.05e-05	1.45e-03	0.0
3441	2.03	0.01	-8.17	7.19e-06	1.89e-03	0.0
3442	1.56	0.01	-6.28	5.53e-06	1.45e-03	0.0
3451	2.57	-0.04	2.52	-4.84e-05	1.57e-03	0.0
3452	1.98	-0.03	1.94	-3.72e-05	1.20e-03	0.0
3461	2.67	0.07	-18.62	6.60e-05	1.50e-03	0.0
3462	2.05	0.05	-14.32	5.08e-05	1.15e-03	0.0
3471	2.61	-0.04	3.29	-5.11e-05	1.53e-03	0.0
3472	2.01	-0.03	2.53	-3.93e-05	1.18e-03	0.0
3481	2.71	0.07	-19.35	7.01e-05	1.47e-03	0.0
3482	2.09	0.05	-14.88	5.39e-05	1.13e-03	0.0
3491	2.27	-0.06	-2.22	-4.61e-05	1.77e-03	0.0
3492	1.74	-0.05	-1.71	-3.55e-05	1.36e-03	0.0
3501	2.32	0.09	-14.05	6.39e-05	1.74e-03	0.0
3502	1.79	0.07	-10.81	4.92e-05	1.34e-03	0.0
3511	2.06	-0.01	-6.01	-1.18e-05	1.87e-03	0.0
3512	1.59	-0.01	-4.62	-9.04e-06	1.44e-03	0.0
3521	2.08	0.04	-10.32	2.83e-05	1.87e-03	0.0
3522	1.60	0.03	-7.94	2.18e-05	1.43e-03	0.0
3531	2.13	-0.04	-4.36	-2.75e-05	1.84e-03	0.0
3532	1.64	-0.03	-3.35	-2.12e-05	1.42e-03	0.0
3541	2.16	0.07	-11.96	4.43e-05	1.83e-03	0.0
3542	1.66	0.05	-9.20	3.41e-05	1.41e-03	0.0
3551	2.64	-0.04	4.05	-5.35e-05	1.51e-03	0.0
3552	2.03	-0.03	3.11	-4.12e-05	1.16e-03	0.0
3561	2.75	0.07	-20.06	7.37e-05	1.43e-03	0.0
3562	2.11	0.05	-15.43	5.67e-05	1.10e-03	0.0
3571	2.67	-0.04	4.79	-5.54e-05	1.48e-03	0.0
3572	2.05	-0.03	3.69	-4.26e-05	1.14e-03	0.0
3581	2.06	-4.19e-04	-7.05	-2.47e-06	1.88e-03	0.0
3582	1.58	-3.22e-04	-5.42	-1.90e-06	1.45e-03	0.0
3583	1.62	6.15e-04	-5.47	-1.33e-06	1.36e-03	0.0
3591	2.06	0.03	-9.28	2.08e-05	1.88e-03	0.0
3592	1.59	0.03	-7.14	1.60e-05	1.44e-03	0.0
3601	2.78	0.07	-20.76	7.67e-05	1.40e-03	0.0
3602	2.14	0.05	-15.97	5.90e-05	1.08e-03	0.0



3611	2.33	-0.07	-1.47	-5.58e-05	1.73e-03	0.0
3612	1.79	-0.05	-1.13	-4.29e-05	1.33e-03	0.0
3621	2.39	0.11	-14.78	7.73e-05	1.69e-03	0.0
3622	1.84	0.08	-11.37	5.95e-05	1.30e-03	0.0
3631	2.06	0.02	-8.17	9.41e-06	1.88e-03	0.0
3632	1.58	0.01	-6.28	7.24e-06	1.45e-03	0.0
3641	2.16	-0.05	-3.93	-3.70e-05	1.83e-03	0.0
3642	1.66	-0.04	-3.02	-2.85e-05	1.41e-03	0.0
3651	2.20	0.09	-12.37	5.62e-05	1.81e-03	0.0
3652	1.69	0.07	-9.52	4.32e-05	1.40e-03	0.0
3661	2.69	-0.04	5.53	-5.68e-05	1.46e-03	0.0
3662	2.07	-0.03	4.25	-4.37e-05	1.12e-03	0.0
3671	2.81	0.07	-21.44	7.91e-05	1.38e-03	0.0
3672	2.16	0.05	-16.49	6.08e-05	1.06e-03	0.0
3681	2.11	-0.03	-5.47	-2.09e-05	1.86e-03	0.0
3682	1.62	-0.02	-4.21	-1.61e-05	1.43e-03	0.0
3691	2.13	0.07	-10.85	4.13e-05	1.85e-03	0.0
3692	1.64	0.05	-8.35	3.18e-05	1.42e-03	0.0
3701	2.71	-0.04	6.25	-5.77e-05	1.44e-03	0.0
3702	2.08	-0.03	4.81	-4.44e-05	1.11e-03	0.0
3711	2.39	-0.08	-0.73	-6.38e-05	1.70e-03	0.0
3712	1.84	-0.06	-0.56	-4.91e-05	1.30e-03	0.0
3713	1.86	-0.05	-0.91	-4.54e-05	1.23e-03	0.0
3721	2.46	0.12	-15.49	8.88e-05	1.65e-03	0.0
3722	1.89	0.09	-11.91	6.83e-05	1.27e-03	0.0
3731	2.83	0.07	-22.12	8.07e-05	1.35e-03	0.0
3732	2.17	0.05	-17.01	6.21e-05	1.04e-03	0.0
3741	2.72	-0.03	6.97	-5.79e-05	1.42e-03	0.0
3742	2.09	-0.03	5.36	-4.45e-05	1.09e-03	0.0
3751	2.84	0.07	-22.78	8.16e-05	1.33e-03	0.0
3752	2.19	0.05	-17.52	6.27e-05	1.03e-03	0.0
3761	2.23	-0.07	-3.31	-5.10e-05	1.80e-03	0.0
3762	1.71	-0.05	-2.54	-3.92e-05	1.38e-03	0.0
3771	2.27	0.11	-12.97	7.60e-05	1.77e-03	0.0
3772	1.75	0.09	-9.98	5.85e-05	1.36e-03	0.0
3781	2.10	-6.28e-03	-6.77	-6.61e-06	1.87e-03	0.0
3782	1.61	-4.83e-03	-5.21	-5.08e-06	1.44e-03	0.0
3791	2.10	0.05	-9.55	2.93e-05	1.86e-03	0.0
3792	1.62	0.04	-7.35	2.26e-05	1.43e-03	0.0
3801	2.44	-0.08	4.23e-03	-7.07e-05	1.66e-03	0.0
3802	1.88	-0.06	3.26e-03	-5.44e-05	1.28e-03	0.0
3803	1.90	-0.06	-0.38	-5.03e-05	1.20e-03	0.0
3811	2.52	0.13	-16.18	9.88e-05	1.62e-03	0.0
3812	1.94	0.10	-12.45	7.60e-05	1.24e-03	0.0
3821	2.73	-0.03	7.68	-5.73e-05	1.41e-03	0.0
3822	2.10	-0.02	5.91	-4.41e-05	1.08e-03	0.0
3831	2.85	0.06	-23.44	8.15e-05	1.32e-03	0.0
3832	2.19	0.05	-18.03	6.27e-05	1.01e-03	0.0
3841	2.13	-0.04	-5.17	-2.87e-05	1.85e-03	0.0
3842	1.64	-0.03	-3.97	-2.21e-05	1.43e-03	0.0
3851	2.15	0.08	-11.14	5.20e-05	1.84e-03	0.0
3852	1.66	0.06	-8.57	4.00e-05	1.42e-03	0.0
3861	2.09	0.02	-8.16	1.18e-05	1.87e-03	0.0
3862	1.61	0.02	-6.28	9.06e-06	1.44e-03	0.0
3871	2.74	-0.03	8.39	-5.61e-05	1.40e-03	0.0
3872	2.11	-0.02	6.45	-4.31e-05	1.08e-03	0.0
3881	2.86	0.06	-24.10	8.05e-05	1.31e-03	0.0
3882	2.20	0.05	-18.54	6.19e-05	1.01e-03	0.0
3891	2.48	-0.08	0.72	-7.67e-05	1.63e-03	0.0
3892	1.91	-0.06	0.56	-5.90e-05	1.26e-03	0.0
3901	2.57	0.13	-16.86	1.08e-04	1.58e-03	0.0
3902	1.98	0.10	-12.97	8.29e-05	1.22e-03	0.0
3911	2.74	-0.03	9.09	-5.47e-05	1.39e-03	0.0
3912	2.11	-0.02	6.99	-4.21e-05	1.07e-03	0.0
3921	2.86	0.06	-24.75	7.92e-05	1.30e-03	0.0
3922	2.20	0.05	-19.04	6.10e-05	1.00e-03	0.0
3931	2.28	-0.08	-2.69	-6.17e-05	1.77e-03	0.0
3932	1.76	-0.06	-2.07	-4.75e-05	1.36e-03	0.0
3941	2.33	0.13	-13.56	9.20e-05	1.74e-03	0.0
3942	1.79	0.10	-10.43	7.08e-05	1.34e-03	0.0
3951	2.11	-0.01	-6.61	-1.04e-05	1.87e-03	0.0
3952	1.62	-9.20e-03	-5.08	-8.00e-06	1.44e-03	0.0
3961	2.12	0.06	-9.70	3.63e-05	1.86e-03	0.0
3962	1.63	0.05	-7.46	2.79e-05	1.43e-03	0.0
3971	2.11	0.03	-8.15	1.35e-05	1.87e-03	0.0
3972	1.62	0.02	-6.27	1.04e-05	1.44e-03	0.0



3981	2.74	-0.03	9.80	-5.55e-05	1.39e-03	0.0
3982	2.11	-0.02	7.54	-4.27e-05	1.07e-03	0.0
3991	2.86	0.06	-25.41	8.00e-05	1.30e-03	0.0
3992	2.20	0.05	-19.55	6.15e-05	1.00e-03	0.0
4001	2.18	-0.05	-4.72	-3.98e-05	1.83e-03	0.0
4002	1.68	-0.04	-3.63	-3.06e-05	1.40e-03	0.0
4011	2.21	0.11	-11.55	7.03e-05	1.81e-03	0.0
4012	1.70	0.08	-8.89	5.41e-05	1.39e-03	0.0
4021	2.52	-0.09	1.43	-8.20e-05	1.60e-03	0.0
4022	1.94	-0.07	1.10	-6.31e-05	1.23e-03	0.0
4031	2.61	0.14	-17.53	1.16e-04	1.55e-03	0.0
4032	2.01	0.11	-13.48	8.91e-05	1.19e-03	0.0
4041	2.33	-0.09	-2.08	-7.05e-05	1.74e-03	0.0
4042	1.80	-0.07	-1.60	-5.42e-05	1.34e-03	0.0
4051	2.39	0.15	-14.13	1.06e-04	1.70e-03	0.0
4052	1.84	0.11	-10.87	8.13e-05	1.31e-03	0.0
4061	2.56	-0.09	2.12	-8.67e-05	1.58e-03	0.0
4062	1.97	-0.07	1.63	-6.67e-05	1.21e-03	0.0
4071	2.65	0.14	-18.18	1.23e-04	1.51e-03	0.0
4072	2.04	0.11	-13.98	9.46e-05	1.16e-03	0.0
4081	2.16	-0.02	-6.37	-1.48e-05	1.84e-03	0.0
4082	1.66	-0.01	-4.90	-1.14e-05	1.42e-03	0.0
4091	2.17	0.08	-9.91	4.88e-05	1.84e-03	0.0
4092	1.67	0.06	-7.62	3.75e-05	1.41e-03	0.0
4101	2.23	-0.06	-4.28	-4.81e-05	1.80e-03	0.0
4102	1.72	-0.05	-3.29	-3.70e-05	1.38e-03	0.0
4111	2.27	0.12	-11.96	8.51e-05	1.78e-03	0.0
4112	1.75	0.10	-9.20	6.54e-05	1.37e-03	0.0
4121	2.15	0.03	-8.14	1.77e-05	1.85e-03	0.0
4122	1.66	0.02	-6.26	1.36e-05	1.42e-03	0.0
4131	2.38	-0.09	-1.48	-7.80e-05	1.71e-03	0.0
4132	1.83	-0.07	-1.14	-6.00e-05	1.31e-03	0.0
4141	2.44	0.16	-14.70	1.18e-04	1.67e-03	0.0
4142	1.88	0.12	-11.30	9.05e-05	1.28e-03	0.0
4151	2.59	-0.09	2.80	-9.07e-05	1.55e-03	0.0
4152	1.99	-0.07	2.15	-6.97e-05	1.19e-03	0.0
4161	2.69	0.14	-18.81	1.29e-04	1.48e-03	0.0
4162	2.07	0.11	-14.47	9.95e-05	1.14e-03	0.0
4171	2.62	-0.09	3.47	-9.39e-05	1.53e-03	0.0
4172	2.02	-0.07	2.67	-7.22e-05	1.17e-03	0.0
4181	2.72	0.15	-19.43	1.35e-04	1.46e-03	0.0
4182	2.09	0.11	-14.95	1.04e-04	1.12e-03	0.0
4191	2.20	-0.02	-6.13	-1.78e-05	1.82e-03	0.0
4192	1.69	-0.01	-4.72	-1.37e-05	1.40e-03	0.0
4201	2.22	0.09	-10.11	5.91e-05	1.81e-03	0.0
4202	1.71	0.07	-7.78	4.54e-05	1.39e-03	0.0
4211	2.28	-0.07	-3.85	-5.48e-05	1.78e-03	0.0
4212	1.76	-0.05	-2.96	-4.22e-05	1.37e-03	0.0
4221	2.32	0.14	-12.37	9.77e-05	1.75e-03	0.0
4222	1.79	0.11	-9.51	7.52e-05	1.35e-03	0.0
4231	2.42	-0.10	-0.89	-8.46e-05	1.68e-03	0.0
4232	1.86	-0.07	-0.69	-6.51e-05	1.29e-03	0.0
4233	1.89	-0.07	-1.03	-5.99e-05	1.21e-03	0.0
4241	2.49	0.16	-15.25	1.28e-04	1.64e-03	0.0
4242	1.92	0.13	-11.73	9.87e-05	1.26e-03	0.0
4251	2.20	0.04	-8.12	2.14e-05	1.83e-03	0.0
4252	1.69	0.03	-6.25	1.65e-05	1.41e-03	0.0
4261	2.64	-0.09	4.13	-9.63e-05	1.50e-03	0.0
4262	2.03	-0.07	3.18	-7.40e-05	1.16e-03	0.0
4271	2.75	0.15	-20.05	1.39e-04	1.43e-03	0.0
4272	2.11	0.11	-15.42	1.07e-04	1.10e-03	0.0
4281	2.46	-0.10	-0.31	-9.04e-05	1.66e-03	0.0
4282	1.89	-0.08	-0.24	-6.95e-05	1.27e-03	0.0
4283	1.91	-0.07	-0.61	-6.39e-05	1.20e-03	0.0
4291	2.53	0.17	-15.79	1.38e-04	1.61e-03	0.0
4292	1.95	0.13	-12.14	1.06e-04	1.24e-03	0.0
4301	2.25	-0.02	-5.90	-2.01e-05	1.80e-03	0.0
4302	1.73	-0.02	-4.54	-1.55e-05	1.39e-03	0.0
4311	2.27	0.10	-10.31	6.80e-05	1.79e-03	0.0
4312	1.74	0.08	-7.93	5.23e-05	1.38e-03	0.0
4321	2.66	-0.09	4.78	-9.76e-05	1.48e-03	0.0
4322	2.05	-0.07	3.68	-7.51e-05	1.14e-03	0.0
4331	2.77	0.15	-20.65	1.42e-04	1.41e-03	0.0
4332	2.13	0.11	-15.88	1.09e-04	1.08e-03	0.0
4341	2.32	-0.07	-3.42	-6.05e-05	1.75e-03	0.0
4342	1.79	-0.05	-2.63	-4.65e-05	1.35e-03	0.0

4351	2.37	0.15	-12.76	1.09e-04	1.72e-03	0.0
4352	1.82	0.11	-9.82	8.38e-05	1.33e-03	0.0
4361	2.24	0.04	-8.11	2.48e-05	1.81e-03	0.0
4362	1.72	0.03	-6.24	1.91e-05	1.39e-03	0.0
4371	2.68	-0.08	5.43	-9.79e-05	1.47e-03	0.0
4372	2.06	-0.06	4.18	-7.53e-05	1.13e-03	0.0
4381	2.78	0.14	-21.24	1.43e-04	1.39e-03	0.0
4382	2.14	0.11	-16.34	1.10e-04	1.07e-03	0.0
4391	2.50	-0.10	0.26	-9.54e-05	1.63e-03	0.0
4392	1.92	-0.08	0.20	-7.34e-05	1.25e-03	0.0
4401	2.57	0.18	-16.31	1.47e-04	1.58e-03	0.0
4402	1.98	0.14	-12.55	1.13e-04	1.21e-03	0.0
4411	2.36	-0.07	-2.99	-6.54e-05	1.73e-03	0.0
4412	1.82	-0.06	-2.30	-5.03e-05	1.33e-03	0.0
4421	2.41	0.16	-13.14	1.19e-04	1.70e-03	0.0
4422	1.86	0.12	-10.11	9.15e-05	1.31e-03	0.0
4431	2.29	-0.02	-5.67	-2.19e-05	1.78e-03	0.0
4432	1.76	-0.02	-4.36	-1.69e-05	1.37e-03	0.0
4441	2.31	0.11	-10.51	7.59e-05	1.77e-03	0.0
4442	1.78	0.08	-8.08	5.84e-05	1.36e-03	0.0
4451	2.69	-0.08	6.07	-9.69e-05	1.45e-03	0.0
4452	2.07	-0.06	4.67	-7.45e-05	1.12e-03	0.0
4461	2.79	0.14	-21.83	1.43e-04	1.37e-03	0.0
4462	2.15	0.11	-16.79	1.10e-04	1.06e-03	0.0
4471	2.28	0.05	-8.09	2.79e-05	1.79e-03	0.0
4472	1.75	0.03	-6.22	2.15e-05	1.37e-03	0.0
4481	2.53	-0.10	0.82	-9.97e-05	1.61e-03	0.0
4482	1.94	-0.08	0.63	-7.67e-05	1.24e-03	0.0
4491	2.61	0.18	-16.83	1.54e-04	1.55e-03	0.0
4492	2.01	0.14	-12.94	1.19e-04	1.19e-03	0.0
4501	2.69	-0.08	6.71	-9.47e-05	1.44e-03	0.0
4502	2.07	-0.06	5.16	-7.29e-05	1.11e-03	0.0
4511	2.80	0.14	-22.42	1.42e-04	1.36e-03	0.0
4512	2.15	0.11	-17.24	1.09e-04	1.05e-03	0.0
4521	2.40	-0.07	-2.58	-6.97e-05	1.71e-03	0.0
4522	1.85	-0.06	-1.98	-5.36e-05	1.31e-03	0.0
4531	2.45	0.16	-13.52	1.28e-04	1.67e-03	0.0
4532	1.89	0.13	-10.40	9.84e-05	1.29e-03	0.0
4541	2.33	-0.02	-5.44	-2.34e-05	1.76e-03	0.0
4542	1.79	-0.02	-4.19	-1.80e-05	1.35e-03	0.0
4551	2.35	0.11	-10.70	8.30e-05	1.74e-03	0.0
4552	1.81	0.09	-8.23	6.39e-05	1.34e-03	0.0
4561	2.69	-0.08	7.34	-9.24e-05	1.44e-03	0.0
4562	2.07	-0.06	5.65	-7.11e-05	1.11e-03	0.0
4571	2.80	0.14	-23.00	1.39e-04	1.36e-03	0.0
4572	2.15	0.11	-17.69	1.07e-04	1.04e-03	0.0
4581	2.55	-0.10	1.37	-1.03e-04	1.58e-03	0.0
4582	1.97	-0.08	1.05	-7.93e-05	1.22e-03	0.0
4591	2.64	0.18	-17.33	1.61e-04	1.53e-03	0.0
4592	2.03	0.14	-13.33	1.24e-04	1.17e-03	0.0
4601	2.32	0.05	-8.07	3.08e-05	1.77e-03	0.0
4602	1.78	0.04	-6.21	2.37e-05	1.36e-03	0.0
4611	2.69	-0.08	7.98	-9.37e-05	1.44e-03	0.0
4612	2.07	-0.06	6.14	-7.21e-05	1.11e-03	0.0
4621	2.80	0.14	-23.59	1.41e-04	1.36e-03	0.0
4622	2.15	0.11	-18.15	1.08e-04	1.04e-03	0.0
4631	2.43	-0.08	-2.17	-7.34e-05	1.68e-03	0.0
4632	1.87	-0.06	-1.67	-5.65e-05	1.29e-03	0.0
4641	2.49	0.17	-13.89	1.36e-04	1.65e-03	0.0
4642	1.91	0.13	-10.68	1.05e-04	1.27e-03	0.0
4651	2.58	-0.10	1.91	-1.06e-04	1.56e-03	0.0
4652	1.98	-0.08	1.47	-8.13e-05	1.20e-03	0.0
4661	2.66	0.19	-17.83	1.66e-04	1.50e-03	0.0
4662	2.05	0.14	-13.71	1.27e-04	1.16e-03	0.0
4671	2.36	-0.02	-5.22	-2.46e-05	1.74e-03	0.0
4672	1.82	-0.02	-4.01	-1.89e-05	1.34e-03	0.0
4681	2.39	0.12	-10.88	8.95e-05	1.72e-03	0.0
4682	1.84	0.09	-8.37	6.88e-05	1.32e-03	0.0
4691	2.35	0.05	-8.05	3.36e-05	1.75e-03	0.0
4692	1.81	0.04	-6.19	2.58e-05	1.34e-03	0.0
4701	2.60	-0.10	2.45	-1.07e-04	1.55e-03	0.0
4702	2.00	-0.08	1.88	-8.23e-05	1.19e-03	0.0
4711	2.68	0.19	-18.31	1.69e-04	1.48e-03	0.0
4712	2.06	0.14	-14.09	1.30e-04	1.14e-03	0.0
4721	2.46	-0.08	-1.77	-7.66e-05	1.66e-03	0.0
4722	1.90	-0.06	-1.36	-5.89e-05	1.28e-03	0.0

4731	2.52	0.17	-14.24	1.43e-04	1.62e-03	0.0
4732	1.94	0.13	-10.96	1.10e-04	1.25e-03	0.0
4741	2.39	-0.02	-4.99	-2.56e-05	1.72e-03	0.0
4742	1.84	-0.01	-3.84	-1.97e-05	1.32e-03	0.0
4751	2.42	0.12	-11.06	9.53e-05	1.70e-03	0.0
4752	1.86	0.10	-8.51	7.33e-05	1.31e-03	0.0
4761	2.61	-0.10	2.98	-1.07e-04	1.53e-03	0.0
4762	2.01	-0.08	2.29	-8.24e-05	1.18e-03	0.0
4771	2.70	0.19	-18.79	1.71e-04	1.47e-03	0.0
4772	2.07	0.14	-14.46	1.32e-04	1.13e-03	0.0
4781	2.39	0.05	-8.03	3.61e-05	1.73e-03	0.0
4782	1.84	0.04	-6.17	2.78e-05	1.33e-03	0.0
4791	2.49	-0.08	-1.37	-7.90e-05	1.64e-03	0.0
4792	1.92	-0.06	-1.05	-6.08e-05	1.26e-03	0.0
4801	2.55	0.18	-14.59	1.49e-04	1.60e-03	0.0
4802	1.96	0.14	-11.23	1.15e-04	1.23e-03	0.0
4811	2.42	-0.02	-4.78	-2.63e-05	1.70e-03	0.0
4812	1.86	-0.01	-3.67	-2.02e-05	1.31e-03	0.0
4821	2.45	0.13	-11.23	1.01e-04	1.68e-03	0.0
4822	1.89	0.10	-8.64	7.73e-05	1.29e-03	0.0
4831	2.62	-0.10	3.51	-1.06e-04	1.52e-03	0.0
4832	2.02	-0.08	2.70	-8.15e-05	1.17e-03	0.0
4841	2.71	0.18	-19.27	1.71e-04	1.45e-03	0.0
4842	2.08	0.14	-14.82	1.32e-04	1.12e-03	0.0
4851	2.51	-0.08	-0.98	-8.07e-05	1.62e-03	0.0
4852	1.93	-0.06	-0.75	-6.21e-05	1.25e-03	0.0
4853	1.95	-0.05	-1.09	-5.63e-05	1.17e-03	0.0
4861	2.57	0.18	-14.94	1.54e-04	1.58e-03	0.0
4862	1.98	0.14	-11.49	1.19e-04	1.22e-03	0.0
4871	2.42	0.06	-8.00	3.84e-05	1.71e-03	0.0
4872	1.86	0.04	-6.16	2.95e-05	1.31e-03	0.0
4881	2.63	-0.10	4.03	-1.03e-04	1.50e-03	0.0
4882	2.02	-0.07	3.10	-7.95e-05	1.16e-03	0.0
4891	2.71	0.18	-19.74	1.69e-04	1.44e-03	0.0
4892	2.09	0.14	-15.19	1.30e-04	1.11e-03	0.0
4901	2.45	-0.02	-4.56	-2.68e-05	1.68e-03	0.0
4902	1.88	-0.01	-3.51	-2.06e-05	1.29e-03	0.0
4911	2.48	0.13	-11.40	1.05e-04	1.66e-03	0.0
4912	1.91	0.10	-8.77	8.08e-05	1.28e-03	0.0
4921	2.53	-0.08	-0.59	-8.16e-05	1.61e-03	0.0
4922	1.95	-0.06	-0.46	-6.27e-05	1.23e-03	0.0
4923	1.96	-0.05	-0.81	-5.68e-05	1.16e-03	0.0
4931	2.59	0.18	-15.27	1.58e-04	1.56e-03	0.0
4932	1.99	0.14	-11.75	1.21e-04	1.20e-03	0.0
4941	2.63	-0.09	4.56	-1.01e-04	1.50e-03	0.0
4942	2.02	-0.07	3.51	-7.75e-05	1.15e-03	0.0
4951	2.72	0.18	-20.22	1.67e-04	1.43e-03	0.0
4952	2.09	0.14	-15.55	1.28e-04	1.10e-03	0.0
4961	2.44	0.06	-7.98	4.05e-05	1.69e-03	0.0
4962	1.88	0.04	-6.14	3.12e-05	1.30e-03	0.0
4971	2.47	-0.02	-4.34	-2.69e-05	1.66e-03	0.0
4972	1.90	-0.01	-3.34	-2.07e-05	1.28e-03	0.0
4981	2.50	0.13	-11.57	1.09e-04	1.64e-03	0.0
4982	1.92	0.10	-8.90	8.36e-05	1.26e-03	0.0
4991	2.55	-0.07	-0.21	-8.14e-05	1.59e-03	0.0
4992	1.96	-0.06	-0.16	-6.26e-05	1.22e-03	0.0
4993	1.97	-0.05	-0.53	-5.66e-05	1.15e-03	0.0
5001	2.61	0.18	-15.61	1.60e-04	1.54e-03	0.0
5002	2.00	0.14	-12.00	1.23e-04	1.19e-03	0.0
5011	2.63	-0.10	5.09	-1.02e-04	1.50e-03	0.0
5012	2.02	-0.08	3.91	-7.87e-05	1.15e-03	0.0
5021	2.71	0.18	-20.69	1.68e-04	1.43e-03	0.0
5022	2.09	0.14	-15.92	1.29e-04	1.10e-03	0.0
5031	2.46	0.06	-7.96	4.23e-05	1.67e-03	0.0
5032	1.89	0.05	-6.12	3.26e-05	1.28e-03	0.0
5041	2.49	-0.02	-4.13	-2.66e-05	1.65e-03	0.0
5042	1.91	-0.01	-3.18	-2.05e-05	1.27e-03	0.0
5051	2.52	0.13	-11.73	1.11e-04	1.62e-03	0.0
5052	1.94	0.10	-9.02	8.58e-05	1.25e-03	0.0
5061	2.56	-0.07	0.17	-8.01e-05	1.57e-03	0.0
5062	1.97	-0.06	0.13	-6.16e-05	1.21e-03	0.0
5063	1.98	-0.05	-0.25	-5.57e-05	1.14e-03	0.0
5071	2.62	0.18	-15.93	1.60e-04	1.53e-03	0.0
5072	2.01	0.14	-12.26	1.23e-04	1.18e-03	0.0
5081	2.48	0.06	-7.93	4.39e-05	1.65e-03	0.0
5082	1.91	0.05	-6.10	3.38e-05	1.27e-03	0.0

5091	2.56	-0.07	0.55	-7.78e-05	1.56e-03	0.0
5092	1.97	-0.06	0.42	-5.99e-05	1.20e-03	0.0
5101	2.62	0.18	-16.26	1.58e-04	1.52e-03	0.0
5102	2.02	0.14	-12.51	1.22e-04	1.17e-03	0.0
5111	2.50	-0.02	-3.92	-2.60e-05	1.63e-03	0.0
5112	1.92	-0.01	-3.02	-2.00e-05	1.25e-03	0.0
5121	2.53	0.13	-11.89	1.13e-04	1.61e-03	0.0
5122	1.95	0.10	-9.15	8.71e-05	1.24e-03	0.0
5131	2.50	0.06	-7.91	4.51e-05	1.64e-03	0.0
5132	1.92	0.05	-6.08	3.47e-05	1.26e-03	0.0
5141	2.56	-0.07	0.93	-7.55e-05	1.55e-03	0.0
5142	1.97	-0.05	0.72	-5.80e-05	1.20e-03	0.0
5151	2.63	0.18	-16.59	1.56e-04	1.51e-03	0.0
5152	2.02	0.14	-12.76	1.20e-04	1.16e-03	0.0
5161	2.51	-0.01	-3.71	-2.48e-05	1.61e-03	0.0
5162	1.93	-0.01	-2.86	-1.91e-05	1.24e-03	0.0
5171	2.55	0.13	-12.05	1.14e-04	1.59e-03	0.0
5172	1.96	0.10	-9.27	8.74e-05	1.22e-03	0.0
5181	2.51	0.06	-7.88	4.60e-05	1.62e-03	0.0
5182	1.93	0.05	-6.06	3.54e-05	1.25e-03	0.0
5191	2.56	-0.07	1.31	-7.68e-05	1.55e-03	0.0
5192	1.97	-0.06	1.01	-5.91e-05	1.20e-03	0.0
5201	2.62	0.18	-16.92	1.57e-04	1.51e-03	0.0
5202	2.02	0.14	-13.01	1.21e-04	1.16e-03	0.0
5211	2.52	-0.01	-3.50	-2.33e-05	1.60e-03	0.0
5212	1.94	-0.01	-2.70	-1.79e-05	1.23e-03	0.0
5221	2.55	0.13	-12.21	1.13e-04	1.58e-03	0.0
5222	1.96	0.10	-9.39	8.69e-05	1.21e-03	0.0
5231	2.52	0.06	-7.85	4.64e-05	1.61e-03	0.0
5232	1.93	0.05	-6.04	3.57e-05	1.24e-03	0.0
5241	2.52	-0.01	-3.29	-2.19e-05	1.59e-03	0.0
5242	1.94	-0.01	-2.53	-1.68e-05	1.22e-03	0.0
5251	2.55	0.13	-12.36	1.12e-04	1.57e-03	0.0
5252	1.96	0.10	-9.51	8.60e-05	1.21e-03	0.0
5261	2.52	0.06	-7.83	4.66e-05	1.60e-03	0.0
5262	1.94	0.05	-6.02	3.58e-05	1.23e-03	0.0
5271	2.52	-0.02	-3.09	-2.27e-05	1.59e-03	0.0
5272	1.94	-0.01	-2.37	-1.74e-05	1.23e-03	0.0
5281	2.55	0.13	-12.52	1.13e-04	1.57e-03	0.0
5282	1.96	0.10	-9.63	8.66e-05	1.21e-03	0.0
5291	2.51	0.06	-7.80	4.65e-05	1.60e-03	0.0
5292	1.93	0.05	-6.00	3.58e-05	1.23e-03	0.0

Nodo	Traslazione X	Traslazione Y	Traslazione Z	Rotazione X	Rotazione Y	Rotazione Z
1.53	-0.24	-26.04	-1.71e-04	9.86e-04	0.0	0.0
2.87	0.19	10.43	1.71e-04	1.90e-03	0.0	0.0

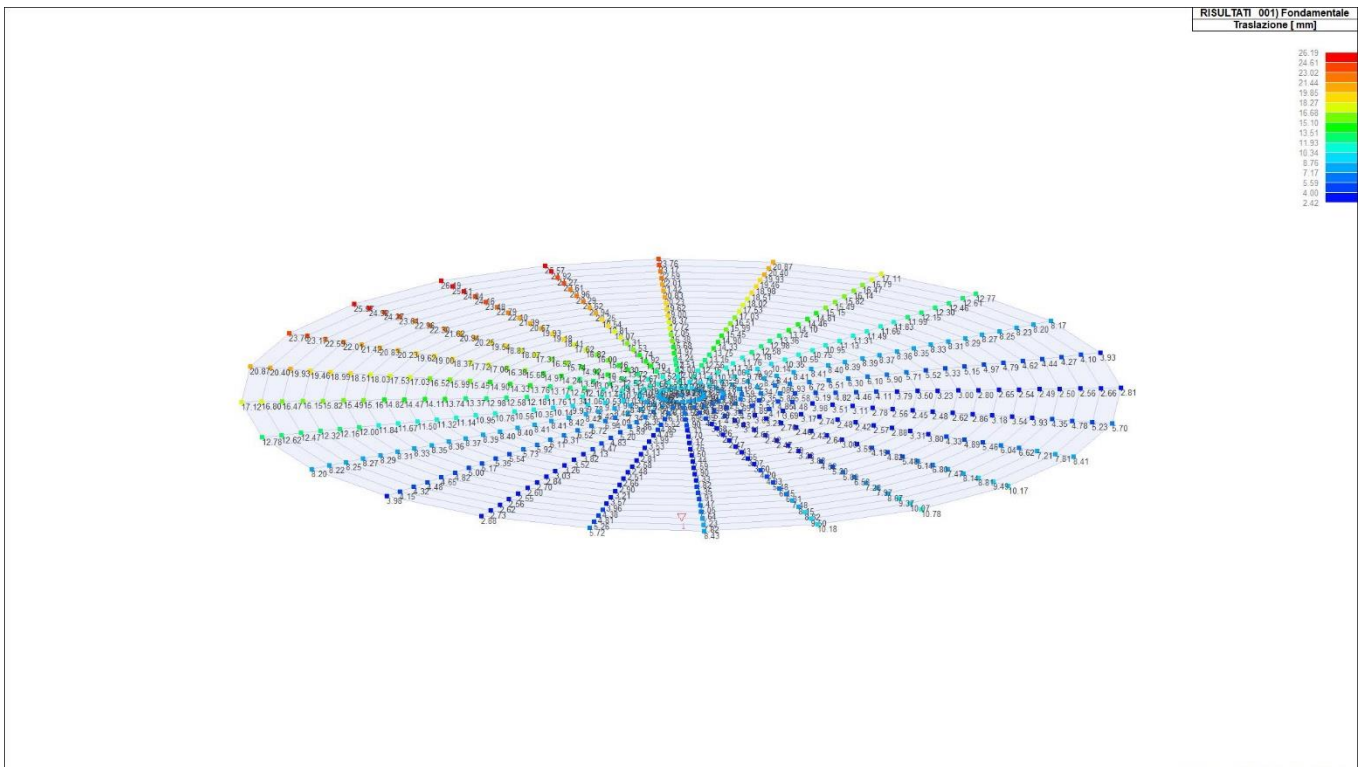

41\_RIS\_SPOSTAMENTI\_001\_Fondamentale

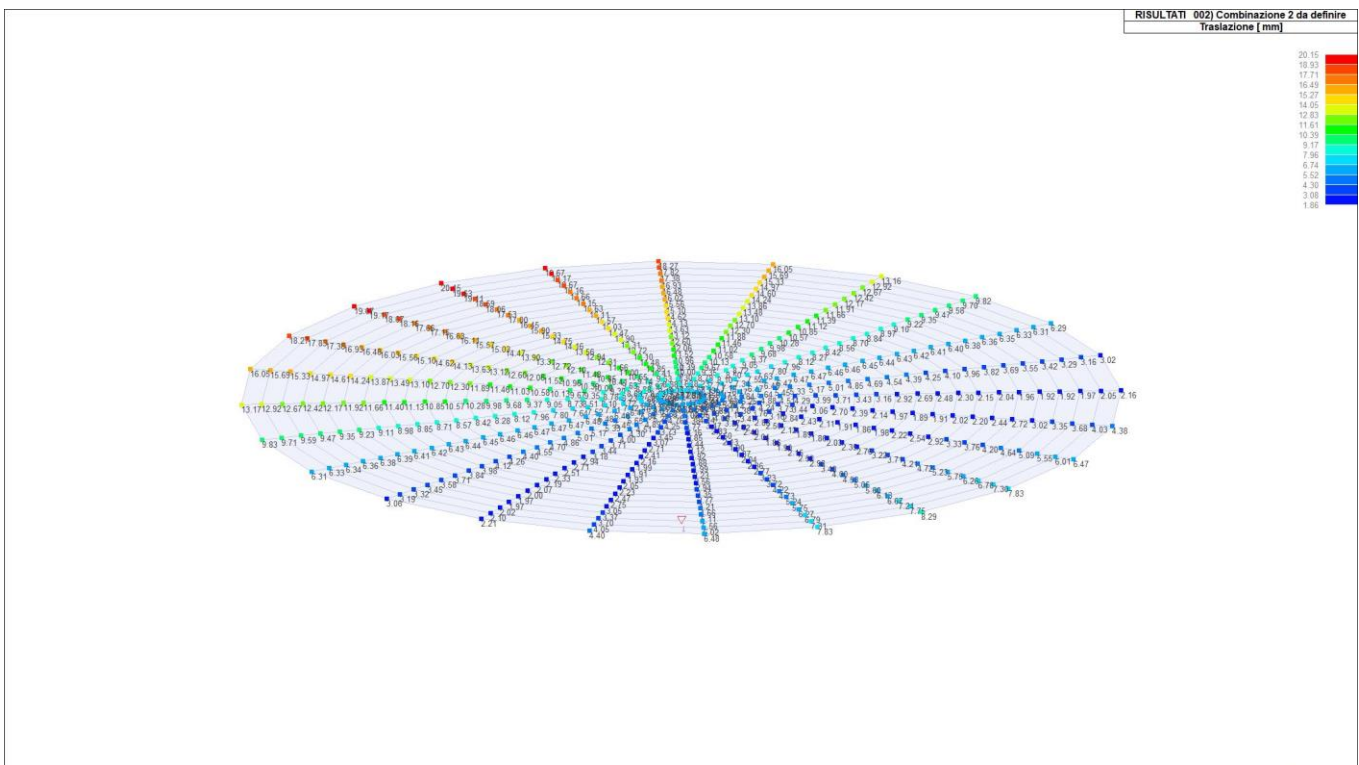

41\_RIS\_SPOSTAMENTI\_002\_Combinazione 2 da definire

Nodo	Cmb N	Azione X N	Azione Y N	Azione Z N mm	Azione RX N mm	Azione RY N mm	Azione RZ
Nodo		Azione X	Azione Y	Azione Z	Azione RX	Azione RY	Azione RZ
Nodo	Cmb N	Azione X N	Azione Y N	Azione Z N mm	Azione RX N mm	Azione RY N mm	Azione RZ



Wind Energy  
Sindia Srl



CODE

**C21BLN001CWR00300**

PAGE

63 di/of 119

## 11. RISULTATI OPERE DI FONDAZIONE

### 11.1. LEGENDA RISULTATI OPERE DI FONDAZIONE

Il controllo dei risultati delle analisi condotte, per quanto concerne le opere di fondazione, è possibile in relazione alle tabelle sotto riportate.

La prima tabella è riferita alle fondazioni tipo palo e plinto su pali.

Per questo tipo di fondazione vengono riportate le sei componenti di sollecitazione (espresse nel riferimento globale della struttura) per ogni palo componente l'opera.

In particolare viene riportato:

<b>Nodo</b>	numero del nodo a cui è applicato il plinto
<b>Tipo</b>	codice corrispondente al nome assegnato al tipo di plinto di fondazione: 3) palo singolo ( <i>PALO</i> ) 4) plinto su palo 5) plinto su due pali ( <i>PL.2P</i> ) 6) plinto su tre pali ( <i>PL.3P</i> ) 7) plinto su quattro pali ( <i>PL.4P</i> ) 8) plinto rettangolare su cinque pali ( <i>PL.5P.R</i> ) 9) plinto pentagonale su cinque pali ( <i>PL.5P</i> ) 10) plinto su sei pali ( <i>PL.6P</i> )
<b>Palo</b>	numero del palo
<b>Comb.</b>	combinazione di carico in cui si verificano le sei componenti di sollecitazione.
<b>Quota</b>	quota assoluta della sezione del palo per cui si riportano le sei componenti di sollecitazione.

L'azione  $F_z$  ( corrispondente allo sforzo normale nel palo) è costante poiché il peso del palo stesso non è considerato nella modellazione.

La seconda tabella è riferita alle fondazioni tipo plinto su suolo elastico.

Per questo tipo di fondazione vengono riportate le pressioni nei quattro vertici dell'impronta sul terreno.

In particolare viene riportato:

<b>Nodo</b>	numero del nodo a cui è applicato il plinto
<b>Tipo</b>	Codice identificativo del nome assegnato al plinto
<b>area</b>	area dell'impronta del plinto
<b>Wink O</b> <b>Wink V</b>	coefficienti di Winkler (orizzontale e verticale) adottati
<b>Comb</b>	Combinazione di carico in cui si verificano i valori riportati
<b>Pt (P1 P2 P3 P4)</b>	valori di pressione nei vertici

La terza tabella è riferita alle fondazioni tipo platea su suolo elastico.

Per questo tipo di fondazione vengono riportate le pressioni in ogni vertice (nodo) degli elementi costituenti la platea.

La quarta tabella è riferita alle fondazioni tipo trave su suolo elastico.

Per questo tipo di fondazione vengono riportate le pressioni alle estremità dell'elemento e la massima (in valore assoluto) pressione lungo lo sviluppo dell'elemento.

Vengono inoltre riportati, con funzione statistica, i valori massimo e minimo delle pressioni che compaiono nella tabella.



Con riferimento al **Documento di Affidabilità** "Test di validazione del software di calcolo PRO\_SAP e dei moduli aggiuntivi PRO\_SAP Modulo Geotecnico, PRO\_CAD nodi acciaio e PRO\_MST" - versione Settembre 2014, disponibile per il download sul sito [www.2si.it](http://www.2si.it), si segnalano i seguenti esempi applicativi:

Test N°	Titolo
105	PLINTO SUPERFICIALE
106	PLINTO SUPERFICIALE
107	PLINTO SUPERFICIALE
108	PLINTO SUPERFICIALE
109	PLINTO SUPERFICIALE
110	PLINTO SUPERFICIALE
111	PLINTO SUPERFICIALE
112	PLINTO SUPERFICIALE
113	PLINTO SUPERFICIALE
114	PLINTO SUPERFICIALE
115	PLINTO SUPERFICIALE
116	PLINTO SUPERFICIALE
117	PLINTO SUPERFICIALE
118	PLINTO SUPERFICIALE
119	PLINTO SUPERFICIALE
120	PLINTO SUPERFICIALE
121	PLINTO SUPERFICIALE
122	PLINTO SUPERFICIALE
123	PLINTO SUPERFICIALE
124	FONDAZIONE NASTRIFORME
125	CALCOLO DEI K DI WINKLER

Nodo (G)	Pt 1/12 daN/cm2	Pt 2/13 daN/cm2	Pt 3... daN/cm2	Pt 4...
1	-1.44	-1.11		
2	-0.57	-0.44		
3	-2.31	-1.78		
4	-1.45	-1.11		
5	-0.61	-0.47		
6	-2.28	-1.76		
7	-1.45	-1.12		
8	-0.65	-0.50		
9	-2.25	-1.73		
10	0.19	0.11		
11	-3.12	-2.40		
12	-1.45	-1.12		
13	-0.69	-0.53		
14	-2.22	-1.71		
15	0.13	0.05		
16	-3.06	-2.36		
17	-1.46	-1.12		
18	-0.72	-0.56		
19	-2.20	-1.69		
20	0.08	4.17e-03		
21	-3.00	-2.31		
22	-1.46	-1.13		
23	0.02	-0.05		
24	-2.94	-2.26		
25	-0.76	-0.59		
26	-2.17	-1.67		
27	-1.47	-1.13		
28	0.72	0.61		
29	-3.82	-2.94		
30	-0.03	-0.10		
31	-2.88	-2.22		
32	-0.80	-0.62		



Wind Energy  
Sindia Srl

grEen &  
grEen  
WE ENGINEERING

CODE

C21BLN001CWR00300

PAGE

66 di/of 119

33	-2.14	-1.64
34	-1.47	-1.13
35	0.65	0.54
36	-3.73	-2.87
37	-0.08	-0.15
38	-2.82	-2.17
39	-0.84	-0.65
40	-2.10	-1.62
41	0.57	0.47
42	-3.64	-2.80
43	-1.48	-1.14
44	-0.14	-0.20
45	-2.76	-2.12
46	0.50	0.40
47	-3.56	-2.74
48	-0.88	-0.68
49	-2.07	-1.59
50	-0.25	-0.19
51	-2.69	-2.07
52	-1.48	-1.14
53	0.42	0.33
54	-3.47	-2.67
55	-0.92	-0.71
56	-2.04	-1.57
57	-0.33	-0.25
58	-2.63	-2.02
59	0.35	0.26
60	-3.38	-2.60
61	-1.49	-1.14
62	-0.96	-0.74
63	-2.01	-1.54
64	0.27	0.18
65	-3.29	-2.53
66	-0.40	-0.31
67	-2.56	-1.97
68	1.13	0.99
69	-4.35	-3.35
70	-1.49	-1.15
71	0.19	0.11
72	-3.20	-2.46
73	1.04	0.91
74	-4.25	-3.27
75	-1.00	-0.77
76	-1.97	-1.52
77	-0.48	-0.37
78	-2.50	-1.92
79	0.95	0.82
80	-4.14	-3.18
81	0.12	0.04
82	-3.11	-2.39
83	-1.49	-1.15
84	0.86	0.74
85	-4.03	-3.10
86	-1.05	-0.80
87	-1.94	-1.49
88	-0.55	-0.43
89	-2.43	-1.87
90	0.04	-0.04
91	-3.01	-2.32
92	0.77	0.65
93	-3.92	-3.02
94	-1.50	-1.15
95	-0.63	-0.48
96	-2.35	-1.81
97	0.68	0.57
98	-3.81	-2.93
99	-1.09	-0.84
100	-1.90	-1.46
101	-0.04	-0.11
102	-2.91	-2.24
103	0.59	0.48
104	-3.70	-2.85
105	-1.50	-1.15
106	-0.13	-0.19
107	-2.81	-2.16
108	-0.71	-0.55



Wind Energy  
Sindia Srl

grEen &  
grEen  
WE ENGINEERING

CODE

C21BLN001CWR00300

PAGE

67 di/of 119

109	-2.28	-1.76
110	-1.13	-0.87
111	-1.87	-1.44
112	0.49	0.39
113	-3.59	-2.76
114	0.40	0.30
115	-3.47	-2.67
116	-0.27	-0.21
117	-2.71	-2.09
118	-1.50	-1.15
119	-0.79	-0.61
120	-2.21	-1.70
121	-1.18	-0.90
122	-1.83	-1.41
123	0.30	0.21
124	-3.35	-2.58
125	-0.38	-0.30
126	-2.61	-2.01
127	0.20	0.12
128	-3.23	-2.49
129	-0.87	-0.67
130	-2.13	-1.64
131	1.39	1.24
132	-4.69	-3.61
133	-1.50	-1.16
134	-1.22	-0.94
135	-1.79	-1.38
136	-0.50	-0.38
137	-2.50	-1.92
138	1.29	1.14
139	-4.57	-3.51
140	0.10	0.02
141	-3.11	-2.39
142	1.19	1.05
143	-4.45	-3.42
144	-1.51	-1.16
145	-0.95	-0.73
146	-2.05	-1.58
147	1.09	0.95
148	-4.33	-3.33
149	5.99e-04	-0.07
150	-2.99	-2.30
151	-1.25	-0.96
152	-1.76	-1.36
153	-0.61	-0.47
154	-2.39	-1.84
155	0.99	0.86
156	-4.20	-3.23
157	0.89	0.76
158	-0.10	-0.17
159	-2.86	-2.20
160	-4.08	-3.14
161	-1.01	-0.78
162	-2.00	-1.54
163	0.78	0.67
164	-3.96	-3.04
165	-0.73	-0.56
166	-2.28	-1.76
167	-1.51	-1.16
168	-0.27	-0.21
169	-2.73	-2.10
170	0.68	0.57
171	-1.30	-1.00
172	-1.71	-1.32
173	-3.83	-2.95
174	0.57	0.47
175	-3.70	-2.85
176	-0.80	-0.62
177	-2.21	-1.70
178	-1.11	-0.85
179	-1.90	-1.46
180	-0.41	-0.32
181	-2.59	-1.99
182	0.47	0.37
183	-3.57	-2.75
184	0.36	0.26



Wind Energy  
Sindia Srl

grEen &  
grEen  
WE ENGINEERING

CODE

C21BLN001CWR00300

PAGE

68 di/of 119

185	-3.44	-2.64
186	-1.51	-1.16
187	-1.35	-1.04
188	-1.66	-1.28
189	-0.55	-0.42
190	-2.46	-1.89
191	-0.94	-0.73
192	-2.07	-1.59
193	0.25	0.16
194	-3.30	-2.54
195	-1.20	-0.92
196	-1.81	-1.39
197	0.13	0.05
198	-3.16	-2.43
199	-0.65	-0.50
200	-2.36	-1.82
201	0.02	-0.05
202	-3.01	-2.32
203	-1.08	-0.83
204	-1.94	-1.49
205	-1.51	-1.16
206	-1.40	-1.08
207	-1.62	-1.24
208	-0.10	-0.16
209	-2.87	-2.21
210	-0.82	-0.63
211	-2.20	-1.69
212	-1.30	-1.00
213	-1.72	-1.32
214	-0.28	-0.22
215	-2.72	-2.09
216	-0.98	-0.75
217	-2.03	-1.56
218	-1.21	-0.93
219	-1.80	-1.39
220	-0.44	-0.34
221	-2.57	-1.98
222	-0.55	-0.42
223	-2.46	-1.90
224	-1.51	-1.16
225	-1.45	-1.11
226	-1.57	-1.21
227	-1.14	-0.88
228	-1.87	-1.44
229	-0.74	-0.57
230	-2.28	-1.75
231	-1.39	-1.07
232	-1.62	-1.25
233	-1.35	-1.04
234	-1.67	-1.28
235	-0.92	-0.71
236	-2.09	-1.61
237	-1.31	-1.01
238	-1.71	-1.31
239	-1.10	-0.85
240	-1.91	-1.47
241	-1.29	-0.99
242	-1.73	-1.33
243	1.48	1.32
244	1.38	1.22
245	1.27	1.12
246	1.17	1.03
247	1.06	0.93
248	0.96	0.83
249	0.85	0.73
250	0.74	0.63
251	0.63	0.52
252	0.52	0.42
253	0.41	0.31
254	0.30	0.21
255	0.18	0.10
256	0.06	-0.02
257	-0.06	-0.13
258	-0.19	-0.25
259	-0.40	-0.31
260	-0.51	-0.40



Wind Energy  
Sindia Srl

grEen &  
grEen  
WE ENGINEERING

CODE

C21BLN001CWR00300

PAGE

69 di/of 119

261	-0.71	-0.55
262	-0.90	-0.69
263	-1.09	-0.84
264	-1.28	-0.98
265	-1.51	-1.16
266	-1.74	-1.34
267	-1.93	-1.48
268	-2.12	-1.63
269	-2.30	-1.77
270	-2.50	-1.92
271	-2.61	-2.00
272	-2.76	-2.12
273	-2.92	-2.24
274	-3.07	-2.36
275	-3.22	-2.47
276	-3.36	-2.59
277	-3.50	-2.70
278	-3.64	-2.80
279	-3.78	-2.91
280	-3.91	-3.01
281	-4.04	-3.11
282	-4.17	-3.21
283	-4.30	-3.31
284	-4.43	-3.41
285	-4.55	-3.50
286	-4.68	-3.60
287	-4.81	-3.70
288	-1.29	-0.99
289	-1.73	-1.33
290	-1.10	-0.85
291	-1.91	-1.47
292	-1.31	-1.01
293	-1.71	-1.31
294	-0.92	-0.71
295	-2.09	-1.61
296	-1.35	-1.03
297	-1.67	-1.28
298	-1.39	-1.07
299	-1.62	-1.25
300	-0.74	-0.57
301	-2.28	-1.75
302	-1.14	-0.88
303	-1.87	-1.44
304	-1.45	-1.11
305	-1.57	-1.21
306	-1.51	-1.16
307	-0.55	-0.42
308	-2.46	-1.90
309	-0.44	-0.34
310	-2.57	-1.98
311	-1.21	-0.93
312	-1.80	-1.39
313	-0.98	-0.75
314	-2.03	-1.56
315	-0.28	-0.22
316	-2.72	-2.09
317	-1.30	-1.00
318	-1.72	-1.32
319	-0.82	-0.63
320	-2.20	-1.69
321	-0.10	-0.16
322	-2.87	-2.21
323	-1.40	-1.08
324	-1.62	-1.24
325	-1.51	-1.16
326	-1.08	-0.83
327	-1.94	-1.49
328	0.02	-0.05
329	-3.01	-2.32
330	-0.65	-0.50
331	-2.36	-1.82
332	0.13	0.05
333	-3.16	-2.43
334	-1.20	-0.92
335	-1.81	-1.39
336	0.25	0.16



Wind Energy  
Sindia Srl

grEen &  
grEen  
WE ENGINEERING

CODE

C21BLN001CWR00300

PAGE

70 di/of 119

337	-3.30	-2.54
338	-0.94	-0.73
339	-2.07	-1.59
340	-0.55	-0.42
341	-2.46	-1.89
342	-1.35	-1.04
343	-1.66	-1.28
344	-1.51	-1.16
345	0.36	0.26
346	-3.44	-2.64
347	0.47	0.37
348	-3.57	-2.75
349	-0.41	-0.32
350	-2.59	-1.99
351	-1.11	-0.85
352	-1.90	-1.46
353	-0.80	-0.62
354	-2.21	-1.70
355	0.57	0.47
356	-3.70	-2.85
357	0.68	0.57
358	-1.30	-1.00
359	-1.71	-1.32
360	-3.83	-2.95
361	-0.27	-0.21
362	-2.73	-2.10
363	-1.51	-1.16
364	-0.73	-0.56
365	-2.28	-1.76
366	0.78	0.67
367	-3.96	-3.04
368	-1.01	-0.78
369	-2.00	-1.54
370	0.89	0.76
371	-0.10	-0.17
372	-2.86	-2.20
373	-4.08	-3.14
374	0.99	0.86
375	-4.20	-3.23
376	-0.61	-0.47
377	-2.39	-1.84
378	-1.25	-0.96
379	-1.76	-1.36
380	6.01e-04	-0.07
381	-2.99	-2.30
382	1.09	0.95
383	-4.33	-3.33
384	-0.95	-0.73
385	-2.05	-1.58
386	-1.51	-1.16
387	1.19	1.05
388	-4.45	-3.42
389	0.10	0.02
390	-3.11	-2.39
391	1.29	1.14
392	-4.57	-3.51
393	-0.50	-0.38
394	-2.50	-1.92
395	-1.22	-0.94
396	-1.79	-1.38
397	-1.50	-1.16
398	1.39	1.24
399	-4.69	-3.61
400	-0.87	-0.67
401	-2.13	-1.64
402	0.20	0.12
403	-3.23	-2.49
404	-0.38	-0.30
405	-2.61	-2.01
406	0.30	0.21
407	-3.35	-2.58
408	-1.18	-0.90
409	-1.83	-1.41
410	-0.79	-0.61
411	-2.21	-1.70
412	-1.50	-1.15



Wind Energy  
Sindia Srl

grEen &  
grEen  
WE ENGINEERING

CODE

C21BLN001CWR00300

PAGE

71 di/of 119

413	-0.27	-0.21
414	-2.71	-2.09
415	0.40	0.30
416	-3.47	-2.67
417	0.49	0.39
418	-3.59	-2.76
419	-1.13	-0.87
420	-1.87	-1.43
421	-0.71	-0.55
422	-2.28	-1.76
423	-0.13	-0.19
424	-2.81	-2.16
425	-1.50	-1.15
426	0.59	0.48
427	-3.70	-2.85
428	-0.04	-0.11
429	-2.91	-2.24
430	-1.09	-0.84
431	-1.90	-1.46
432	0.68	0.57
433	-3.81	-2.93
434	-0.63	-0.48
435	-2.35	-1.81
436	-1.50	-1.15
437	0.77	0.65
438	-3.92	-3.02
439	0.04	-0.04
440	-3.01	-2.32
441	-0.55	-0.42
442	-2.43	-1.87
443	-1.05	-0.80
444	-1.94	-1.49
445	0.86	0.74
446	-4.03	-3.10
447	-1.49	-1.15
448	0.12	0.04
449	-3.11	-2.39
450	0.95	0.82
451	-4.14	-3.18
452	-0.48	-0.37
453	-2.49	-1.92
454	-1.00	-0.77
455	-1.97	-1.52
456	1.04	0.91
457	-4.25	-3.27
458	0.19	0.11
459	-3.20	-2.46
460	-1.49	-1.15
461	1.13	0.99
462	-4.35	-3.35
463	-0.40	-0.31
464	-2.56	-1.97
465	0.27	0.18
466	-3.29	-2.53
467	-0.96	-0.74
468	-2.01	-1.54
469	-1.49	-1.14
470	0.35	0.26
471	-3.38	-2.60
472	-0.33	-0.25
473	-2.63	-2.02
474	-0.92	-0.71
475	-2.04	-1.57
476	0.42	0.33
477	-3.47	-2.67
478	-1.48	-1.14
479	-0.25	-0.19
480	-2.69	-2.07
481	-0.88	-0.68
482	-2.07	-1.59
483	0.50	0.40
484	-3.56	-2.74
485	-0.14	-0.20
486	-2.76	-2.12
487	-1.48	-1.14
488	0.57	0.47





489	-3.64	-2.80
490	-0.84	-0.65
491	-2.10	-1.62
492	-0.08	-0.15
493	-2.82	-2.17
494	0.65	0.54
495	-3.73	-2.87
496	-1.47	-1.13
497	-0.80	-0.62
498	-2.13	-1.64
499	-0.03	-0.10
500	-2.88	-2.22
501	0.72	0.61
502	-3.82	-2.94
503	-1.47	-1.13
504	-0.76	-0.59
505	-2.16	-1.67
506	0.02	-0.05
507	-2.94	-2.26
508	-1.46	-1.13
509	0.08	4.39e-03
510	-3.00	-2.31
511	-0.72	-0.56
512	-2.19	-1.69
513	-1.46	-1.12
514	0.13	0.06
515	-3.06	-2.36
516	-0.69	-0.53
517	-2.22	-1.71
518	-1.45	-1.12
519	0.19	0.11
520	-3.12	-2.40
521	-0.65	-0.50
522	-2.25	-1.73
523	-1.45	-1.12
524	-0.61	-0.47
525	-2.28	-1.76
526	-1.44	-1.11
527	-0.57	-0.44
528	-2.31	-1.78
529	-1.44	-1.11

Nodo (G)	Pt 1/12	Pt 2/13	Pt 3...	Pt 4...
	-4.81			
	1.48			

RISULTATI 001) Fondamentale

Pressione totale [daN/cm<sup>2</sup>]

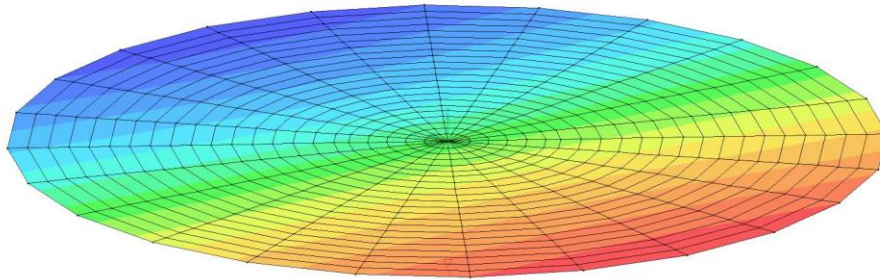
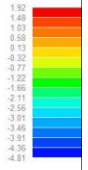

46\_RIS\_PRESSIONI\_001\_Fondamentale

RISULTATI 002) Combinazione 2 da definire

Pressione totale [daN/cm<sup>2</sup>]

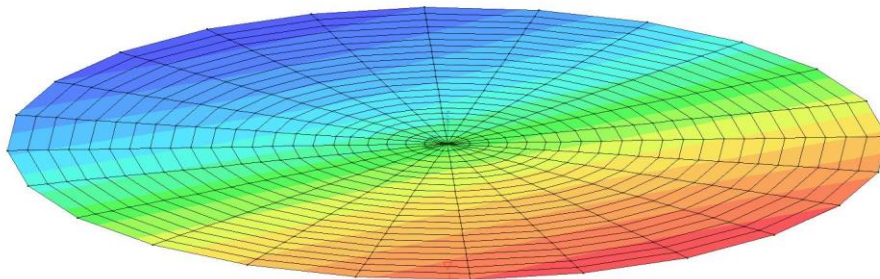
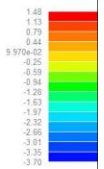

46\_RIS\_PRESSIONI\_002\_Combinazione 2 da definire

## 12. RISULTATI ELEMENTI TIPO SHELL

### 12.1. LEGENDA RISULTATI ELEMENTI TIPO SHELL

Il controllo dei risultati delle analisi condotte, per quanto concerne gli elementi tipo shell, è possibile in relazione alle tabelle sottoriportate.

Per ogni elemento, e per ogni combinazione(o caso di carico) vengono riportati i risultati più significativi.

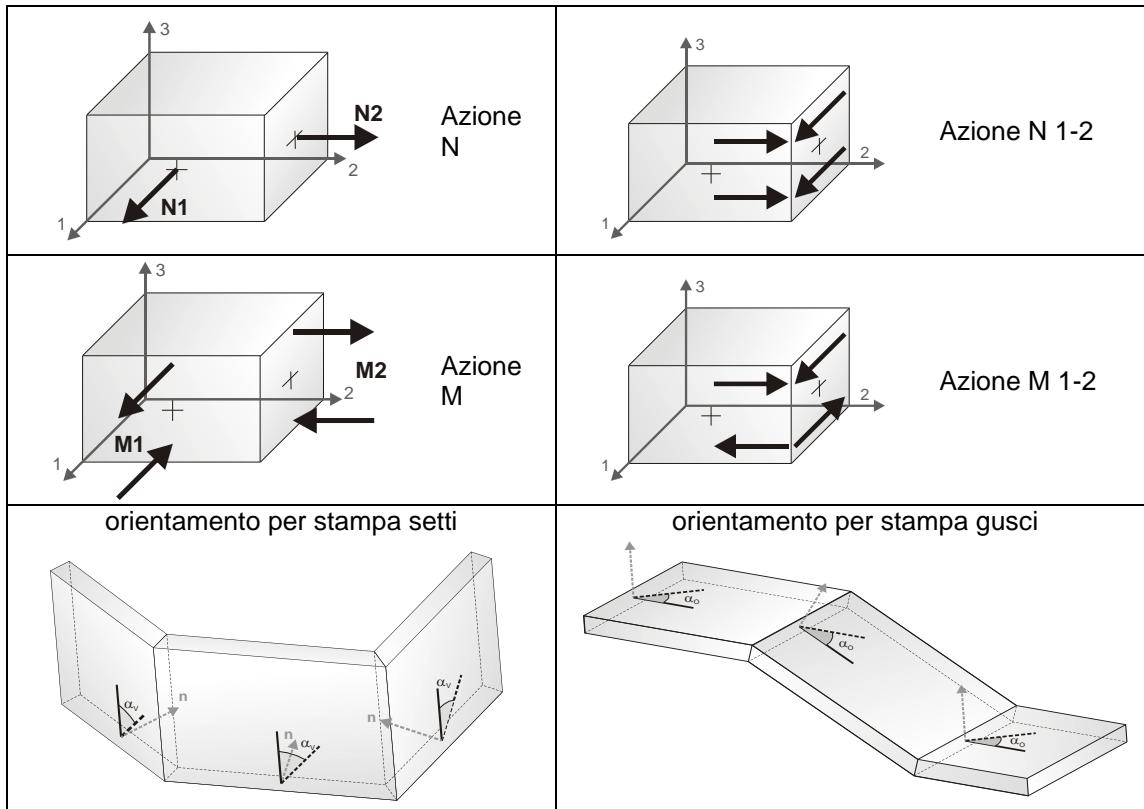

In particolare vengono riportati in ogni nodo di un elemento per ogni combinazione:

<b>tensione di Von Mises</b>	(valore riassuntivo del complessivo stato di sollecitazione)	
<b>N max</b>	sforzo membranale principale massimo	
<b>N min</b>	sforzo membranale principale minimo	
<b>M max</b>	sforzo flessionale principale massimo	
<b>M min</b>	sforzo flessionale principale minimo	
<b>N1</b>	<b>N2</b>	sforzi membranali e flessionali in direzione locale 1 e 2 dell'elemento (lo sforzo 2-1 è uguale allo sforzo 1-2 per la reciprocità delle tensioni tangenziali)
<b>N1-2</b>	<b>M1</b>	
<b>M2</b>	<b>M1-2</b>	

I suddetti risultati possono a scelta del progettista essere preceduti o sostituiti da valori di sollecitazione non più riferiti al sistema locale dell'elemento ma al sistema globale.

In questo caso gli elementi vengono raggruppati in gruppi (M\_S: macro gusci o macro setti, raggruppati per materiale, spessore, e posizione fisica) per la valutazione dei valori mediati ai nodi appartenenti agli elementi dei gruppi stessi.

I valori di sollecitazione sono, in questo caso, riferiti ad una terna specifica del gruppo ruotata di  $\alpha_o$  attorno all'asse Z per i gusci e ruotata di  $\alpha_v$  attorno alla normale (che per definizione è orizzontale) al piano del setto.

Per i setti, in particolare, se  $\alpha_v$  è zero, l'asse '1-1' rappresenta la verticale e l'asse '2-2' l'orizzontale contenuta nel setto.

Le azioni sui setti possono essere espresse anche con formato macro, cioè riferite all'intero macroelemento.

In particolare vengono riportati per ogni quota Z dei nodi e per ogni combinazione i seguenti valori:

<b>N memb.</b>	Azione membranale complessiva agente sulla parete in direzione Z
<b>V memb.</b>	Azione complessiva di taglio agente nel piano del macroelemento
<b>V orto</b>	Azione complessiva di taglio agente in direzione perpendicolare al macroelemento

<b>M memb.</b>	Azione flessionale compressiva agente nel piano del macroelemento
<b>M orto</b>	Azione flessionale compressiva agente in direzione perpendicolare al macroelemento
<b>T</b>	Azione torsionale compressiva agente nel piano orizzontale

Macro	Tipo	Angolo 1-X (gradi)
1	Guscio	0.0

M_G	Cmb	Nodo	N max	N min	N 1	N 2	N 1-2	M max	M min	M 1	M 2	M 1-2
			N/mm	N/mm	N/mm	N/mm	N	N	N	N	N	N
1	1	1	132.82-1.88	132.27	-1.33	8.58	-393.63	-2.446e+04	-2.446e+04	-393.63	-0.47	
1	1	2	2.03-53.37	-44.42	-6.92	20.39	9890.80	665.64	9274.06	1282.38	-2304.16	
1	1	3	316.84-3.64	291.04	22.16	87.18	-1452.85	-5.882e+04	-5.498e+04	-5294.51	-1.434e+04	
1	1	4	147.16-16.51	1138.88	-8.23	-35.86	1.041e+05	-1.395e+05	-3.198e+04	-3410.78	1.209e+05	
1	1	5	23.66-64.49	-61.34	20.51	-16.38	1.282e+05	-1.056e+05	7.324e+04	-5.070e+04	9.911e+04	
1	1	6	328.82-26.71	1319.37	-17.26	57.17	7.464e+04	-1.680e+05	-1.334e+05	4.005e+04	8.482e+04	
1	1	7	169.05-40.72	144.57	-16.24	-67.35	1.846e+05	-2.455e+05	-4.811e+04	-1.281e+04	2.143e+05	
1	1	8	56.99-82.39	-66.82	41.42	-43.90	2.357e+05	-1.783e+05	1.326e+05	-7.516e+04	1.790e+05	
1	1	9	337.80-55.77	334.39	-52.35	36.51	1.204e+05	-2.997e+05	-2.241e+05	4.481e+04	1.614e+05	
1	1	10	2.96-224.19	-160.86	-60.36	101.85	4.189e+04	1652.72	3.184e+04	1.170e+04	-1.742e+04	
1	1	11	488.53-5.49	358.56	124.49	217.53	-2439.47	-9.084e+04	-6.875e+04	-2.453e+04	-3.827e+04	
1	1	12	195.50-73.12	147.56	-25.18	-102.86	2.722e+05	-3.705e+05	-6.940e+04	-2.892e+04	3.207e+05	
1	1	13	98.31-104.92	-71.32	64.71	-75.50	3.672e+05	-2.526e+05	2.056e+05	-9.097e+04	1.614e+05	
1	1	14	343.54-92.19	343.26	-91.91	10.89	1.559e+05	-4.671e+05	-3.389e+05	2.770e+04	2.519e+05	
1	1	15	24.80-225.45	-187.86	-12.80	89.41	1.451e+05	-6.863e+04	1.396e+05	-6.309e+04	3.397e+04	
1	1	16	501.03-39.13	392.01	69.89	216.80	4.233e+04	-1.896e+05	-1.893e+05	4.196e+04	9207.07	
1	1	17	225.09-112.45	147.79	-35.14	-141.84	3.758e+05	-5.249e+05	-9.644e+04	-5.261e+04	4.498e+05	
1	1	18	145.70-130.26	-74.61	90.06	-110.72	5.319e+05	-3.380e+05	2.969e+05	-1.030e+05	3.863e+05	
1	1	19	346.41-136.58	345.64	-135.82	-19.24	1.891e+05	-6.811e+05	-4.839e+05	-8083.26	3.643e+05	
1	1	20	51.90-220.57	-196.46	27.79	77.39	2.703e+05	-1.025e+05	2.533e+05	-8.550e+04	7.778e+04	
1	1	21	502.43-77.16	405.12	20.15	216.63	4.807e+04	-3.377e+05	-3.319e+05	4.221e+04	4.718e+04	
1	1	22	256.83-157.84	145.21	-46.21	-183.93	5.000e+05	-7.140e+05	-1.298e+05	-8.424e+04	6.066e+05	
1	1	23	87.20-214.03	-201.35	74.51	60.51	4.343e+05	-1.213e+05	3.991e+05	-8.609e+04	1.354e+05	
1	1	24	493.05-121.52	410.01	-38.48	210.09	2.647e+04	-5.361e+05	-5.176e+05	7981.34	1.003e+05	
1	1	25	198.16-157.78	-76.77	117.16	-149.23	7.352e+05	-4.390e+05	4.095e+05	-1.133e+05	5.257e+05	
1	1	26	346.90-189.31	341.51	-183.92	-53.49	2.239e+05	-9.481e+05	-6.629e+05	-6.131e+04	5.029e+05	
1	1	27	289.67-208.29	139.77	-58.39	-228.42	6.479e+05	-9.412e+05	-1.697e+05	-1.236e+05	7.942e+05	
1	1	28	4.49-371.67	-177.57	-189.61	187.99	6.934e+04	2500.88	3.595e+04	3.590e+04	-3.342e+04	
1	1	29	636.02-7.11	308.44	320.48	321.51	-3286.97	-1.183e+05	-6.083e+04	-6.078e+04	-5.752e+04	
1	1	30	131.53-206.68	-202.12	126.97	39.00	6.466e+05	-1.333e+05	5.849e+05	-7.161e+04	2.105e+05	
1	1	31	473.42-173.03	406.13	-105.74	197.41	-1.537e+04	-7.961e+05	-7.559e+05	-5.557e+04	1.725e+05	
1	1	32	254.59-186.86	-77.84	145.57	-190.37	9.810e+05	-5.577e+05	5.457e+05	-1.224e+05	6.930e+05	
1	1	33	345.12-250.10	10330.78	-235.76	-91.26	2.623e+05	-1.272e+06	-8.789e+05	-1.310e+05	6.699e+05	
1	1	34	322.90-263.08	131.52	-71.70	-274.80	8.224e+05	-1.211e+06	-2.167e+05	-1.715e+05	1.016e+06	
1	1	35	34.53-372.48	-194.42	-143.54	201.91	1.542e+05	-3.137e+04	1.469e+05	-2.412e+04	-3.595e+04	
1	1	36	649.44-50.31	324.98	274.14	348.95	1.032e+04	-2.040e+05	-1.823e+05	-1.131e+04	-6.456e+04	
1	1	37	185.11-199.35	-198.90	184.66	13.16	9.134e+05	-1.419e+05	8.161e+05	-4.454e+04	3.053e+05	
1	1	38	444.64-232.46	393.49	-181.30	178.94	-7.451e+04	-1.125e+06	-1.053e+06	-1.468e+05	2.659e+05	
1	1	39	314.12-217.17	-77.96	174.92	-233.62	1.274e+06	-6.966e+05	7.079e+05	-1.309e+05	8.913e+05	
1	1	40	341.27-318.59	13.73	-291.06	-131.96	3.056e+05	-1.659e+06	-1.135e+06	-2.181e+05	8.687e+05	
1	1	41	66.96-358.73	-193.68	-98.09	207.41	2.861e+05	-2.360e+04	2.828e+05	-2.030e+04	-3.181e+04	
1	1	42	645.37-97.08	321.89	226.40	368.14	-2.646e+04	-3.579e+05	-3.437e+05	-4.068e+04	-6.716e+04	
1	1	43	355.62-321.33	120.51	-86.22	-322.31	1.025e+06	-1.526e+06	-2.714e+05	-2.291e+05	1.275e+06	
1	1	44	247.34-192.35	-191.73	246.72	-16.49	1.239e+06	-1.481e+05	1.097e+06	-5631.85	4.211e+05	
1	1	45	407.86-300.13	372.05	-264.32	155.14	-1.497e+05	-1.528e+06	-1.413e+06	-2.647e+05	3.811e+05	
1	1	46	104.86-334.99	-188.05	-42.08	207.46	4.689e+05	1.440e+04	4.684e+05	1.484e+04	-1.407e+04	
1	1	47	624.42-149.66	310.29	164.47	380.11	-1.067e+05	-5.733e+05	-5.668e+05	-1.132e+05	-5.463e+04	
1	1	48	375.60-248.24	-77.30	204.66	-278.24	1.617e+06	-8.575e+05	8.985e+05	-1.393e+05	1.123e+06	
1	1	49	335.20-394.00	290.57	-349.36	-174.80	3.538e+05	-2.114e+06	-1.436e+06	-3.246e+05	1.102e+06	
1	1	50	317.36-185.81	-180.92	312.46	-49.39	1.629e+06	-1.527e+05	1.431e+06	4.515e+04	5.598e+05	
1	1	51	364.51-376.45	342.19	-354.13	126.65	-2.415e+05	-2.011e+06	-1.842e+06	-4.108e+05	5.205e+05	
1	1	52	386.97-382.16	106.83	-102.03	-370.11	1.259e+06	-1.891e+06	-3.341e+05	-2.976e+05	1.575e+06	
1	1	53	149.23-302.23	-177.15	24.15	202.04	7.123e+05	7.529e+04	7.119e+05	7.572e+04	1.670e+04	
1	1	54	586.88-208.71	289.63	88.54	384.88	-2.237e+05	-8.621e+05	-8.610e+05	-2.249e+05	-2.723e+04	
1	1	55	437.78-279.61	-76.07	234.24	-323.41	2.015e+06	-1.041e+06	1.120e+06	-1.468e+05	1.391e+06	
1	1	56	326.71-475.27	261.70	-410.26	-218.89	4.066e+05	-2.643e+06	-1.783e+06	-4.534e+05	1.372e+06	
1	1	57	393.70-179.62	-166.78	380.86	-84.83	2.088e+06	-1.555e+05	1.825e+06	1.083e+05	7.229e+05	
1	1	58	315.85-461.39	304.24	-449.78	94.27	-3.518e+05	-2.582e+06	-2.346e+06	-5.878e+05	6.861e+05	
1	1	59	201.08-262.28	-161.12	99.92	191.42	1.023e+06	1.567e+05	1.019e+06	1.609e+05	6.030e+04	
1	1	60	533.88-274.80	259.91	-0.84	382.75	-3.748e+05	-1.233e+06	-1.233e+06	-3.750e+05	1.465e+04	

1	1	61	416.07-444.6090.69	-119.22	-417.34	1.524e+06	-2.308e+06	-4.052e+05	-3.790e+05	1.916e+06
1	1	62	499.34-310.83-74.54	263.05	-368.24	2.472e+06	-1.249e+06	1.375e+06	-1.516e+05	1.696e+06
1	1	63	315.54-561.11227.74	-473.31	-263.17	4.619e+05	-3.253e+06	-2.181e+06	-6.100e+05	1.683e+06
1	1	64	261.22-217.20-140.09	184.12	175.90	1.406e+06	2.585e+05	1.394e+06	2.705e+05	1.166e+05
1	1	65	466.84-348.20221.24	-102.60	373.97	-5.595e+05	-1.692e+06	-1.687e+06	-5.639e+05	7.037e+04
1	1	66	474.65-173.56-149.74	450.82	-121.97	2.624e+06	-1.553e+05	2.282e+06	1.866e+05	9.128e+05
1	1	67	263.04-554.53258.76	-550.25	59.00	-4.832e+05	-3.249e+06	-2.932e+06	-8.001e+05	8.810e+05
1	1	68	5.72-485.02-113.34	-365.96	210.36	9.038e+04	3151.53	2.499e+04	6.854e+04	-3.779e+04
1	1	69	749.26-8.36177.41	563.49	325.93	-3936.51	-1.394e+05	-3.784e+04	-1.055e+05	-5.869e+04
1	1	70	442.08-507.6772.42	-138.00	-463.07	1.820e+06	-2.780e+06	-4.846e+05	-4.754e+05	2.300e+06
1	1	71	330.42-169.19-114.43	275.66	156.07	1.867e+06	3.820e+05	1.843e+06	4.057e+05	1.862e+05
1	1	72	387.80-429.47173.97	-215.64	359.21	-7.804e+05	-2.245e+06	-2.231e+06	-7.941e+05	1.408e+05
1	1	73	42.81-486.22-105.41	-338.00	237.58	1.559e+05	2428.24	1.079e+05	5.038e+04	-7.112e+04
1	1	74	763.51-59.04162.42	542.05	364.85	-1.759e+04	-2.116e+05	-1.290e+05	-1.001e+05	-9.592e+04
1	1	75	558.80-341.46-73.13	290.47	-411.78	2.993e+06	-1.477e+06	1.665e+06	-1.489e+05	2.042e+06
1	1	76	301.52-650.04189.70	-538.21	-306.44	5.155e+05	-3.952e+06	-2.633e+06	-8.032e+05	2.038e+06
1	1	77	558.25-167.47-130.40	521.18	-159.79	3.242e+06	-1.492e+05	2.809e+06	2.845e+05	1.133e+06
1	1	78	207.15-654.99206.58	-654.43	22.13	-6.405e+05	-4.021e+06	-3.606e+06	-1.056e+06	2.110e+06
1	1	79	81.13-467.45-86.48	-299.84	252.69	2.829e+05	5.213e+04	2.389e+05	9.619e+04	-9.070e+04
1	1	80	755.52-112.80134.29	508.43	391.79	-9.584e+04	-3.612e+05	-2.822e+05	-1.749e+05	-1.214e+05
1	1	81	408.70-120.14-84.51	373.07	132.56	2.412e+06	5.289e+05	2.372e+06	5.684e+05	2.699e+05
1	1	82	298.97-519.02118.47	-338.52	339.22	-1.041e+06	-2.901e+06	-2.873e+06	-1.069e+06	2.274e+05
1	1	83	464.35-570.4552.58	-158.68	-506.50	2.146e+06	-3.307e+06	-5.718e+05	-5.897e+05	2.726e+06
1	1	84	123.72-433.19-62.86	-246.62	262.86	4.687e+05	1.451e+05	4.349e+05	1.789e+05	-9.899e+04
1	1	85	726.15-172.1598.73	455.26	412.26	-2.333e+05	-5.774e+05	-5.131e+05	-2.977e+05	-1.342e+05
1	1	86	614.68-371.25-72.50	315.93	-453.09	3.582e+06	-1.719e+06	1.992e+06	-1.291e+05	2.429e+06
1	1	87	284.84-740.46149.27	-604.89	-347.31	5.590e+05	-4.745e+06	-3.138e+06	-1.048e+06	2.437e+06
1	1	88	642.28-161.27-109.63	590.65	-197.04	3.954e+06	-1.313e+05	3.411e+06	4.117e+05	1.387e+06
1	1	89	149.22-761.40148.98	-761.16	-14.64	-8.311e+05	-4.912e+06	-4.376e+06	-1.367e+06	1.379e+06
1	1	90	495.34-71.51-50.86	474.69	106.20	3.049e+06	7.029e+05	2.989e+06	7.627e+05	3.697e+05
1	1	91	202.86-617.1255.28	-469.54	315.01	-1.346e+06	-3.670e+06	-3.621e+06	-1.395e+06	3.329e+05
1	1	92	171.06-383.88-34.30	-178.51	267.94	7.244e+05	2.736e+05	7.015e+05	2.964e+05	-9.893e+04
1	1	93	675.40-237.5355.31	382.56	426.13	-4.215e+05	-8.749e+05	-8.287e+05	-4.676e+05	-1.371e+05
1	1	94	482.78-632.4332.14	-181.79	-547.25	2.489e+06	-3.881e+06	-6.652e+05	-7.263e+05	3.185e+06
1	1	95	724.31-155.13-88.85	658.02	-232.16	4.772e+06	-9.081e+04	4.096e+06	5.856e+05	1.683e+06
1	1	96	90.56-871.9288.06	-869.42	-49.00	-1.067e+06	-5.938e+06	-5.248e+06	-1.756e+06	1.698e+06
1	1	97	223.67-320.97-0.96	-96.34	268.11	1.057e+06	4.354e+05	1.043e+06	4.493e+05	-9.203e+04
1	1	98	604.29-309.214.04	291.04	433.62	-6.564e+05	-1.265e+06	-1.235e+06	-6.863e+05	-1.317e+05
1	1	99	665.72-400.52-73.92	339.11	-491.49	4.239e+06	-1.959e+06	2.354e+06	-7.341e+04	2.852e+06
1	1	100	266.51-831.00109.44	-673.94	-384.33	5.752e+05	-5.639e+06	-3.692e+06	-1.371e+06	2.882e+06
1	1	101	588.75-24.24-14.11	578.63	78.12	3.790e+06	9.089e+05	3.704e+06	9.946e+05	4.893e+05
1	1	102	102.15-723.73-14.87	-606.72	288.01	-1.702e+06	-4.566e+06	-4.489e+06	-1.779e+06	4.629e+05
1	1	103	282.01-246.4436.90	-1.33	263.53	1.472e+06	6.317e+05	1.465e+06	6.392e+05	-7.925e+04
1	1	104	514.17-387.16-54.85	181.86	434.85	-9.380e+05	-1.753e+06	-1.735e+06	-9.559e+05	-1.194e+05
1	1	105	498.88-694.3012.86	-208.28	-586.25	2.825e+06	-4.478e+06	-7.612e+05	-8.920e+05	3.651e+06
1	1	106	686.4421.07 24.82	682.69	49.79	4.649e+06	1.155e+06	4.529e+06	1.275e+06	6.362e+05
1	1	107	-0.33-838.34-90.93	-747.74	260.22	-2.119e+06	-5.606e+06	-5.489e+06	-2.236e+06	6.267e+05
1	1	108	801.76-149.92-70.56	722.39	-263.12	5.710e+06	-8300.14	4.864e+06	8.383e+05	2.031e+06
1	1	109	33.47-984.5827.52	-978.63	-77.58	-1.367e+06	-7.118e+06	-6.225e+06	-2.261e+06	2.084e+06
1	1	110	711.62-430.97-79.91	360.56	-527.13	4.957e+06	-2.163e+06	2.738e+06	5.605e+04	3.298e+06
1	1	111	249.73-921.2175.90	-747.38	-416.34	5.295e+05	-6.630e+06	-4.278e+06	-1.823e+06	3.363e+06
1	1	112	347.02-163.0378.95	105.04	254.69	1.975e+06	8.656e+05	1.972e+06	8.689e+05	-6.081e+04
1	1	113	407.18-471.69-121.06	56.55	430.37	-1.271e+06	-2.347e+06	-2.338e+06	-1.280e+06	-1.003e+05
1	1	114	419.66-73.95124.80	220.91	242.08	2.573e+06	1.141e+06	2.572e+06	1.142e+06	-3.660e+04
1	1	115	285.81-563.06-194.26	-83.00	420.77	-1.660e+06	-3.055e+06	-3.052e+06	-1.664e+06	-7.358e+04
1	1	116	785.1663.84 64.60	784.40	23.37	5.647e+06	1.454e+06	5.479e+06	1.622e+06	8.237e+05
1	1	117	-101.44 -959.71	-171.30	-889.85	234.69	-2.609e+06	-6.816e+06	-6.640e+06	-2.784e+06
1	1	118	519.19-760.31-1.76	-239.36	-628.62	3.082e+06	-5.036e+06	-8.524e+05	-1.102e+06	4.057e+06
1	1	119	872.43-148.08-59.62	783.96	-287.15	6.786e+06	1.520e+05	5.706e+06	1.232e+06	2.449e+06
1	1	120	-17.15-1098.00-25.62	-1089.53	-95.29	-1.764e+06	-8.481e+06	-7.294e+06	-2.951e+06	2.562e+06
1	1	121	755.16-469.06-96.61	382.71	-563.24	5.696e+06	-2.253e+06	3.107e+06	3.361e+05	3.726e+06
1	1	122	244.79-1013.1361.15	-829.49	-444.16	3.481e+05	-7.699e+06	-4.845e+06	-2.506e+06	3.850e+06
1	1	123	500.9017.17173.98	344.09	226.41	3.274e+06	1.462e+06	3.274e+06	1.462e+06	-4990.45
1	1	124	153.15-661.66-274.06	-234.45	406.93	-2.112e+06	-3.889e+06	-3.888e+06	-2.113e+06	-3.698e+04
1	1	125	880.99102.98102.99	880.99	2.24	6.817e+06	1.823e+06	6.572e+06	2.067e+06	1.077e+06
1	1	126	-197.14 -1086.06	-253.33	-1029.87	216.31	-3.188e+06	-8.235e+06	-7.964e+06	-3.459e+06
1	1	127	591.16106.77226.00	471.92	208.66	4.094e+06	1.837e+06	4.093e+06	1.837e+06	3.758e+04
1	1	128	12.98-767.95-360.04	-394.94	390.08	-2.635e+06	-4.865e+06	-4.865e+06	-2.635e+06	1.452e+04
1	1	129	935.43-157.95-67.61	845.09	-301.03	8.018e+06	4.542e+05	6.581e+06	1.819e+06	2.967e+06
1	1	130	-47.36-1212.32-55.13	-1204.55	-94.82	-2.310e+06	-1.007e+07	-8.410e+06	-3.970e+06	3.182e+06
1	1	131	6.50-556.46 -30.17	-519.79	138.92	1.036e+05	3561.00	1.029e+04	9.686e+04	-2.506e+04
1	1	132	820.52-9.15 45.38	765.99	205.60	-4345.41	-1.527e+05	-1.431e+04	-1.427e+05	-3.713e+04
1	1	133	454.66-866.60-131.67	-280.26	-656.44	3.091e+06	-5.571e+06	-1.148e+06	-1.333e+06	4.330e+06
1	1	134	853.98-440.12-0.65	414.52	-612.85	6.516e+06	-2.033e+06	3.573e+06	9.107e+05	4.062e+06
1	1	135	15.73-1253.46-282.71	-955.02	-538.24	-4.067e+05	-9.038e+06	-5.893e+06	-3.551e+06	4.154e+06
1	1	136	969.73135.79135.86	969.66	-7.87	8.207e+06	2.289e+06	7.831e+06	2.666e+06	1.445e+06



1	1	137	-280.48	-1215.77	-332.06	-1164.19	213.50	-3.877e+06	-9.927e+06	-9.484e+06	-4.320e+06	1.576e+06
1	1	138	48.17	-558.05	2.68	-512.56	159.71	1.529e+05	2.764e+04	5.893e+04	1.216e+05	-5.424e+04
1	1	139	835.32	-64.56	0.53	770.23	233.11	-3.711e+04	-2.144e+05	-6.960e+04	-1.819e+05	-6.859e+04
1	1	140	689.58	191.87	280.29	601.16	190.23	5.050e+06	2.273e+06	5.047e+06	2.276e+06	9.879e+04
1	1	141	-130.22	-882.34	-451.74	-560.81	372.09	-3.239e+06	-6.006e+06	-6.003e+06	-3.242e+06	9.048e+04
1	1	142	90.55	-536.46	39.18	-485.09	171.97	2.649e+05	1.158e+05	1.749e+05	2.058e+05	-7.292e+04
1	1	143	824.96	-122.80	-50.15	752.30	252.15	-1.496e+05	-3.531e+05	-2.053e+05	-2.975e+05	-9.067e+04
1	1	144	379.01	-940.95	-280.88	-281.07	-659.98	3.059e+06	-5.997e+06	-1.465e+06	-1.473e+06	4.528e+06
1	1	145	1188.17	-4.72	185.91	997.54	-437.10	9.640e+06	1.333e+06	7.844e+06	3.129e+06	3.420e+06
1	1	146	-433.69	-1573.63	-524.01	-1483.31	-307.90	-3.732e+06	-1.220e+07	-1.023e+07	-5.702e+06	3.579e+06
1	1	147	136.68	-496.19	79.63	-439.14	181.25	4.350e+05	2.609e+05	3.665e+05	3.294e+05	-8.509e+04
1	1	148	790.40	-186.54	-106.89	710.75	267.34	-3.396e+05	-5.532e+05	-4.298e+05	-4.631e+05	-1.055e+05
1	1	149	793.42	270.50	336.18	727.74	173.30	6.176e+06	2.781e+06	6.165e+06	2.792e+06	1.937e+05
1	1	150	-271.07	-1004.91	-548.70	-727.28	-727.28	355.89	-3.933e+06	-7.349e+06	-7.336e+06	-3.945e+06
1	1	151	855.30	-483.99	42.72	328.59	-654.21	7.352e+06	-1.762e+06	3.877e+06	1.713e+06	4.426e+06
1	1	152	-78.41	-1416.82	-604.65	-890.57	-653.76	-1.175e+06	-1.029e+07	-6.809e+06	-4.658e+06	4.429e+06
1	1	153	1047.03	152.60	152.61	1047.02	1047.02	2.86	9.909e+06	2.881e+06	9.265e+06	3.525e+06
1	1	154	-433.77	-1347.99	-394.61	-1287.15	240.84	-4.687e+06	-1.201e+07	-1.122e+07	-5.480e+06	2.276e+06
1	1	155	186.73	-437.27	124.15	-374.69	187.44	6.823e+05	4.478e+05	6.361e+05	4.939e+05	-9.326e+04
1	1	156	731.51	-256.06	-169.98	645.43	278.56	-5.943e+05	-8.343e+05	-7.473e+05	-6.813e+05	-1.154e+05
1	1	157	240.70	-360.78	172.56	-292.64	190.63	1.018e+06	6.711e+05	9.873e+05	7.019e+05	-9.871e+04
1	1	158	897.86	341.24	392.87	846.24	161.46	7.519e+06	3.373e+06	7.489e+06	3.404e+06	3.517e+05
1	1	159	-402.92	-1135.29	-650.44	-887.76	-887.76	346.43	-4.727e+06	-8.951e+06	-8.912e+06	-4.766e+06
1	1	160	649.15	-331.42	-239.41	557.14	285.93	-8.993e+05	-1.218e+06	-1.162e+06	-9.558e+05	-1.218e+05
1	1	161	1315.53	-74.52	320.48	920.53	920.53	-626.94	1.140e+07	2.133e+06	8.932e+06	4.605e+06
1	1	162	-488.33	-1876.64	-882.90	-1482.07	-1482.07	-626.18	-5.069e+06	-1.435e+07	-1.187e+07	-7.548e+06
1	1	163	298.44	-268.24	224.49	-194.29	190.88	1.445e+06	9.350e+05	1.423e+06	9.565e+05	-1.023e+05
1	1	164	544.59	-412.30	-314.80	447.08	289.47	-1.253e+06	-1.714e+06	-1.677e+06	-1.290e+06	-1.257e+05
1	1	165	1437.84	406.62	455.00	1389.46	1389.46	-218.07	1.227e+07	4.279e+06	1.134e+07	5.207e+06
1	1	166	-862.86	-1805.45	-867.93	-1800.38	-1800.38	-68.97	-6.640e+06	-1.487e+07	-1.382e+07	-7.690e+06
1	1	167	368.52	-931.37	-281.13	-281.72	-649.94	2.535e+06	-5.464e+06	-1.462e+06	-1.467e+06	3.999e+06
1	1	168	996.59	401.74	449.28	949.05	161.31	9.167e+06	4.059e+06	9.087e+06	4.138e+06	6.321e+05
1	1	169	-515.79	-1273.12	-756.41	-1032.50	-1032.50	352.61	-5.621e+06	-1.091e+07	-1.081e+07	-5.728e+06
1	1	170	360.14	-161.84	279.67	-81.37	188.49	1.966e+06	1.246e+06	1.951e+06	1.262e+06	-1.044e+05
1	1	171	733.43	-568.39	-84.85	249.89	-629.02	5.999e+06	-2.007e+06	3.022e+06	9.703e+05	3.870e+06
1	1	172	4.92	-1295.68	-477.64	-813.11	-628.29	-9.209e+05	-8.928e+06	-5.946e+06	-3.903e+06	3.871e+06
1	1	173	419.84	-498.72	-395.97	317.09	289.52	-1.664e+06	-2.326e+06	-2.300e+06	-1.690e+06	-1.275e+05
1	1	174	426.05	-44.36	337.72	43.98	183.71	2.588e+06	1.610e+06	2.577e+06	1.622e+06	-1.051e+05
1	1	175	277.31	-590.58	-482.64	169.37	286.41	-2.142e+06	-3.059e+06	-3.041e+06	-2.160e+06	-1.267e+05
1	1	176	172.28	265.68	523.81	1464.14	1464.14	-556.21	1.492e+07	5.438e+06	1.339e+07	6.974e+06
1	1	177	-829.00	-2282.96	-1086.94	-2025.02	-2025.02	-555.43	-8.373e+06	-1.786e+07	-1.632e+07	-9.915e+06
1	1	178	1074.73	-231.36	96.27	747.10	747.10	-566.19	9.234e+06	1.207e+06	7.210e+06	3.231e+06
1	1	179	-332.75	-1636.38	-659.43	-1309.70	-1309.70	-564.93	-4.134e+06	-1.216e+07	-1.014e+07	-6.162e+06
1	1	180	1082.11	441.82	500.67	1023.27	1023.27	184.98	1.128e+07	4.821e+06	1.107e+07	5.036e+06
1	1	181	-587.58	-1418.32	-861.94	-1143.95	-1143.95	390.70	-6.580e+06	-1.343e+07	-1.314e+07	-6.868e+06
1	1	182	496.85	80.58	398.27	179.16	176.97	3.321e+06	2.034e+06	3.313e+06	2.042e+06	-1.035e+05
1	1	183	120.09	-687.94	-574.57	6.72	280.64	-2.694e+06	-3.926e+06	-3.914e+06	-2.706e+06	-1.222e+05
1	1	184	573.79	208.20	461.02	320.96	168.85	4.180e+06	2.523e+06	4.175e+06	2.529e+06	-9.742e+04
1	1	185	-47.88	-791.09	-671.66	-167.30	272.94	-3.329e+06	-4.945e+06	-4.937e+06	-3.337e+06	-1.110e+05
1	1	186	235.42	-797.69	-281.24	-281.03	-516.56	1.622e+06	-4.544e+06	-1.459e+06	-1.463e+06	3.083e+06
1	1	187	504.87	-529.35	-146.89	122.41	-499.27	4.257e+06	-1.914e+06	1.966e+06	3.767e+06	2.981e+06
1	1	188	-33.40	-1066.67	-415.71	-684.36	-498.87	-1.008e+06	-7.179e+06	-4.885e+06	-3.302e+06	2.982e+06
1	1	189	1593.31	758.67	761.79	1590.18	1590.18	-50.97	1.424e+07	6.578e+06	1.387e+07	6.951e+06
1	1	190	-1240.80	-1934.96	-1249.64	-1926.12	-1926.12	77.84	-8.908e+06	-1.687e+07	-1.644e+07	-9.343e+06
1	1	191	1368.94	57.08	249.37	1176.65	1176.65	-463.99	1.202e+07	3.960e+06	1.082e+07	5.156e+06
1	1	192	-621.87	-1929.96	-813.51	-1738.31	-1738.31	-462.56	-6.888e+06	-1.495e+07	-1.375e+07	-8.086e+06
1	1	193	658.59	332.51	525.79	465.30	160.21	5.191e+06	3.086e+06	5.188e+06	3.090e+06	-8.197e+04
1	1	194	-221.45	-900.61	-774.06	-348.00	-348.00	264.45	-4.055e+06	-6.144e+06	-6.141e+06	-4.059e+06
8.694e+04												
1	1	195	756.61	-279.92	-22.38	499.07	-447.91	6.716e+06	5.331e+05	5.163e+06	2.085e+06	2.681e+06
1	1	196	-283.37	-1317.95	-540.62	-1060.69	-1060.69	-447.18	-3.455e+06	-9.638e+06	-8.083e+06	-5.010e+06
1	1	197	752.29	447.14	592.71	606.72	152.41	6.392e+06	3.730e+06	6.391e+06	3.731e+06	-4.725e+04
1	1	198	-393.75	-1017.54	-882.38	-528.90	-528.90	256.99	-4.877e+06	-7.570e+06	-7.570e+06	-4.878e+06
3.847e+04												
1	1	199	2041.00	520.36	648.90	1912.46	1912.46	-423.01	1.764e+07	7.951e+06	1.690e+07	8.690e+06
1	1	200	-1084.19	-2601.17	-1212.84	-2472.53	-2472.53	-422.62	-1.089e+07	-2.059e+07	-1.984e+07	-1.163e+07
1	1	201	852.48	547.53	662.52	737.49	147.80	7.851e+06	4.457e+06	7.850e+06	4.457e+06	2.638e+04
1	1	202	-555.28	-1143.54	-998.30	-700.52	-700.52	253.66	-5.796e+06	-9.297e+06	-9.296e+06	-5.797e+06
1	1	203	973.50	-66.30	83.67	823.53	-365.30	8.830e+06	2.631e+06	7.916e+06	3.544e+06	2.197e+06
1	1	204	-497.60	-1534.31	-647.30	-1384.62	-1384.62	-364.40	-5.553e+06	-1.175e+07	-1.084e+07	-6.468e+06
1	1	205	74.86	-637.66	-281.59	-281.20	-356.26	6.801e+05	-3.597e+06	-1.457e+06	-1.459e+06	2.138e+06
1	1	206	259.32	-453.90	-191.61	-2.97	-343.91	2.489e+06	-1.789e+06	9.052e+05	-2.057e+05	2.066e+06
1	1	207	-109.38	-821.65	-371.68	-559.36	-559.36	-343.55	-1.127e+06	-5.405e+06	-3.820e+06	-2.713e+06
1	1	208	951.64	631.41	737.41	845.64	150.70	9.681e+06	5.258e+06	9.674e+06	5.266e+06	1.789e+05
1	1	209	-691.71	-1281.56	-1125.51	-847.76	-847.76	260.18	-6.795e+06	-1.145e+07	-1.144e+07	-6.808e+06
1	1	210	1595.70	277.67	364.87	1508.50	1508.50	-327.61	1.416e+07	6.068e+06	1.361e+07	6.618e+06

1	1	211	-843.20	-2156.01	-930.17	-2069.04	-326.51	-8.996e+06	-1.709e+07	-1.654e+07	-9.548e+06	2.040e+06
1	1	212	431.49-282.94-107.72	256.28	-307.37	4.175e+06	-1.063e+05	3.108e+06	9.615e+05	1.852e+06		
1	1	213	-280.89	-993.38	-455.88	-818.40	-306.68	-2.811e+06	-7.092e+06	-6.023e+06	-3.880e+06	1.853e+06
1	1	214	1039.55	688.99	819.10	909.44	169.36	1.210e+07	6.085e+06	1.206e+07	6.126e+06	4.950e+05
1	1	215	-775.06	-1435.06	-1267.58	-942.54	287.21	-7.807e+06	-1.429e+07	-1.423e+07	-7.867e+06	6.205e+05
1	1	216	1140.76	97.04	164.36	1073.44	-256.39	1.045e+07	4.237e+06	1.004e+07	4.656e+06	1.557e+06
1	1	217	-661.66	-1700.95	-728.82	-1633.79	-255.52	-7.160e+06	-1.338e+07	-1.296e+07	-7.579e+06	1.559e+06
1	1	218	579.79-136.48-35.56	478.86	-249.21	5.624e+06	1.338e+06	5.000e+06	1.962e+06	1.512e+06		
1	1	219	-427.96	-1141.23	-528.55	-1040.64	-248.25	-4.255e+06	-8.540e+06	-7.915e+06	-4.880e+06	1.512e+06
1	1	220	1661.30	1010.33	1010.76	1660.87	16.81	1.546e+07	8.042e+06	1.537e+07	8.127e+06	7.896e+05
1	1	221	-1533.47	-1961.72	-1553.48	-1941.72	90.37	-1.035e+07	-1.812e+07	-1.801e+07	-1.045e+07	8.833e+05
1	1	222	2244.51	677.82	711.28	2211.05	-226.50	1.936e+07	9.518e+06	1.917e+07	9.712e+06	1.365e+06
1	1	223	-1242.20	-2804.02	-1275.93	-2770.29	-227.02	-1.246e+07	-2.231e+07	-2.211e+07	-1.265e+07	1.370e+06
1	1	224	-93.68-469.98-282.10	-281.57	-188.15	-2.935e+05	-2.619e+06	-1.456e+06	-1.456e+06	1.163e+06		
1	1	225	7.42-370.18-231.63	-131.13	-181.99	6.930e+05	-1.634e+06	-1.680e+05	-7.728e+05	1.123e+06		
1	1	226	-193.93	-570.69	-332.62	-432.00	-181.71	-1.279e+06	-3.605e+06	-2.744e+06	-2.140e+06	1.123e+06
1	1	227	694.27-24.64-19.97	649.65	-173.44	6.737e+06	2.444e+06	6.453e+06	2.728e+06	1.067e+06		
1	1	228	-286.56	-1255.26	-584.79	-1210.98	-172.30	-5.362e+06	-9.652e+06	-9.368e+06	-5.646e+06	1.067e+06
1	1	229	1739.36	415.79	436.84	1718.32	-165.57	1.550e+07	7.389e+06	1.536e+07	7.528e+06	1.053e+06
1	1	230	-982.14	-2298.78	-1003.24	-2277.67	-165.36	-1.032e+07	-1.843e+07	-1.829e+07	-1.046e+07	1.056e+06
1	1	231	102.47-278.05-185.27	9.68	-163.40	1.614e+06	-7.174e+05	1.033e+06	-1.369e+05	1.008e+06		
1	1	232	-286.56	-665.42	-379.18	-572.80	-162.82	-2.195e+06	-4.525e+06	-3.945e+06	-2.776e+06	1.008e+06
1	1	233	184.96-199.80-146.40	131.55	-133.03	2.406e+06	6.836e+04	2.066e+06	4.075e+05	8.231e+05		
1	1	234	-365.34	-747.66	-418.37	-694.63	-132.15	-2.981e+06	-5.317e+06	-4.978e+06	-3.319e+06	8.224e+05
1	1	235	1247.10	198.99	214.93	1231.17	-128.26	1.148e+07	5.244e+06	1.137e+07	5.349e+06	8.029e+05
1	1	236	-764.52	-1806.49	-780.41	-1790.60	-127.69	-8.168e+06	-1.440e+07	-1.429e+07	-8.273e+06	8.040e+05
1	1	237	249.18-140.67-117.42	225.92	-92.33	3.014e+06	6.700e+05	2.861e+06	8.236e+05	5.801e+05		
1	1	238	-424.99	-811.75	-447.82	-788.92	-91.15	-3.582e+06	-5.925e+06	-5.772e+06	-3.735e+06	5.789e+05
1	1	239	767.3244.80	55.01	757.12	-85.24	7.437e+06	3.138e+06	7.367e+06	3.209e+06	5.469e+05	
1	1	240	-610.76	-1327.89	-620.74	-1317.92	-83.99	-6.056e+06	-1.035e+07	-1.028e+07	-6.126e+06	5.461e+05
1	1	241	290.65-104.60-99.69	285.73	-43.80	3.399e+06	1.047e+06	3.361e+06	1.084e+06	2.951e+05		
1	1	242	-461.50	-853.30	-466.13	-848.66	-42.36	-3.958e+06	-6.309e+06	-6.271e+06	-3.995e+06	2.933e+05
1	1	243	6.77-581.18	6.77	-581.18	0.17	1.081e+05	3700.72	3700.78	1.081e+05	-78.14	
1	1	244	50.03-582.8950.03	-582.89	0.29	1.508e+05	3.740e+04	3.740e+04	1.508e+05	29.11		
1	1	245	93.84-560.3693.84	-560.36	0.57	2.503e+05	1.459e+05	1.459e+05	2.503e+05	71.31		
1	1	246	141.26-518.07141.26	-518.07	0.87	3.901e+05	3.338e+05	3.338e+05	3.901e+05	120.21		
1	1	247	192.32-455.92192.32	-455.92	1.21	6.023e+05	5.730e+05	6.023e+05	5.730e+05	185.53		
1	1	248	246.85-374.85246.85	-374.84	1.59	9.544e+05	8.023e+05	9.544e+05	8.023e+05	268.42		
1	1	249	304.43-276.14304.43	-276.13	2.01	1.393e+06	1.082e+06	1.393e+06	1.082e+06	348.28		
1	1	250	364.84-161.64364.83	-161.63	2.49	1.924e+06	1.416e+06	1.924e+06	1.416e+06	410.34		
1	1	251	427.69-33.59427.68	-33.57	3.03	2.555e+06	1.809e+06	2.555e+06	1.809e+06	428.12		
1	1	252	492.67105.27492.64	105.31	3.65	3.298e+06	2.267e+06	3.298e+06	2.267e+06	357.56		
1	1	253	559.57251.53559.51	251.59	4.36	4.170e+06	2.797e+06	4.170e+06	2.797e+06	163.13		
1	1	254	628.39400.75628.27	400.87	5.17	5.198e+06	3.403e+06	5.198e+06	3.403e+06	-208.55		
1	1	255	699.59546.95699.34	547.19	6.06	6.427e+06	4.090e+06	6.427e+06	4.090e+06	-837.53		
1	1	256	774.65681.39774.12	681.93	7.04	7.930e+06	4.858e+06	7.930e+06	4.858e+06	-1834.88		
1	1	257	857.08790.39856.10	791.37	8.04	9.832e+06	5.689e+06	9.832e+06	5.689e+06	-3338.44		
1	1	258	950.48849.50949.69	850.30	8.94	1.236e+07	6.524e+06	1.236e+07	6.524e+06	-5486.07		
1	1	259	1673.58	1108.48	1108.64	1673.42	9.49	1.587e+07	8.543e+06	1.587e+07	8.543e+06	-9979.72
1	1	260	2315.74	730.89	730.95	2315.67	10.24	1.995e+07	1.005e+07	1.995e+07	1.005e+07	-
1.310e+04	1	261	1790.23	462.26	462.34	1790.14	10.60	1.596e+07	7.835e+06	1.596e+07	7.835e+06	-
1.381e+04	1	262	1285.54	232.53	232.63	1285.44	10.22	1.183e+07	5.583e+06	1.183e+07	5.583e+06	-
1.345e+04	1	263	794.1766.93	67.05	794.05	9.41	7.678e+06	3.372e+06	7.678e+06	3.372e+06	-1.250e+04	
1	1	264	306.44-94.01-93.81	306.24	9.00	3.532e+06	1.173e+06	3.532e+06	1.173e+06	-1.218e+04		
1	1	265	-273.01	-292.35	-282.89	-282.47	9.67	-1.440e+06	-1.467e+06	-1.454e+06	-1.453e+06	-
1.331e+04	1	266	-472.36	-869.50	-472.65	-869.22	10.65	-4.083e+06	-6.441e+06	-6.441e+06	-4.083e+06	-
1.459e+04	1	267	-633.80	-1354.45	-633.96	-1354.29	10.77	-6.289e+06	-1.059e+07	-1.059e+07	-6.289e+06	-
1.427e+04	1	268	-799.22	-1843.83	-799.32	-1843.73	10.20	-8.508e+06	-1.475e+07	-1.475e+07	-8.509e+06	-
1.290e+04	1	269	-1029.57	-2348.37	-1029.63	-2348.31	9.26	-1.077e+07	-1.889e+07	-1.889e+07	-1.077e+07	-
1.112e+04	1	270	-1295.85	-2874.26	-1295.89	-2874.21	8.17	-1.299e+07	-2.289e+07	-2.289e+07	-1.299e+07	-9341.59
1	1	271	-1670.98	-1934.04	-1671.18	-1933.84	7.27	-1.084e+07	-1.854e+07	-1.854e+07	-1.084e+07	-6512.64
1	1	272	-851.17	-1429.53	-1429.45	-851.24	6.48	-8.232e+06	-1.457e+07	-1.457e+07	-8.232e+06	-3377.25
1	1	273	-763.85	-1273.07	-1273.01	-763.92	5.68	-7.214e+06	-1.162e+07	-1.162e+07	-7.214e+06	-2155.58
1	1	274	-616.55	-1137.68	-1137.64	-616.60	4.94	-6.190e+06	-9.385e+06	-9.385e+06	-6.190e+06	-1355.96
1	1	275	-441.50	-1016.43	-1016.40	-441.53	4.26	-5.235e+06	-7.609e+06	-7.609e+06	-5.235e+06	-838.99
1	1	276	-255.89	-903.89	-903.87	-255.92	3.66	-4.373e+06	-6.151e+06	-6.151e+06	-4.373e+06	-509.75
1	1	277	-70.36-797.53-797.51	-70.37	3.12	-3.608e+06	-4.929e+06	-4.929e+06	-3.608e+06	-303.56		
1	1	278	107.99-696.27-696.27	107.98	2.65	-2.937e+06	-3.894e+06	-3.894e+06	-2.937e+06	-177.25		



1	1	279	274.08-599.74-599.73	274.07	2.23-2.353e+06	-3.014e+06	-3.014e+06	-2.353e+06	-102.15	
1	1	280	424.07-507.90-507.90	424.07	1.85-1.850e+06	-2.267e+06	-2.267e+06	-1.850e+06	-59.49	
1	1	281	554.99-420.91-420.91	554.99	1.51-1.421e+06	-1.640e+06	-1.640e+06	-1.421e+06	-37.00	
1	1	282	664.55-339.04-339.04	664.54	1.21-1.062e+06	-1.123e+06	-1.123e+06	-1.062e+06	-26.51	
1	1	283	750.77-262.42-262.42	750.77	0.93-7.074e+05	-7.661e+05	-7.074e+05	-7.661e+05	-23.30	
1	1	284	812.46-191.49-191.49	812.46	0.68-3.916e+05	-5.291e+05	-3.916e+05	-5.291e+05	-23.65	
1	1	285	848.78-126.24-126.24	848.78	0.45-1.715e+05	-3.467e+05	-1.715e+05	-3.467e+05	-25.74	
1	1	286	859.96-66.46-66.46	859.96	0.23-4.422e+04	-2.149e+05	-4.422e+04	-2.149e+05	-28.21	
1	1	287	844.99-9.43 -9.43	844.99	0.16	-4484.30-1.571e+05	-4484.35-1.571e+05		-86.53	
1	1	288	295.39-109.61-99.92	285.70	61.89	3.405e+06	1.041e+06	3.361e+06	1.085e+06	-3.197e+05
1	1	289	-456.82 -859.35	-467.17	-849.00	63.72-3.948e+06	-6.314e+06	-6.270e+06	-3.993e+06	-
3.226e+05										
1	1	290	773.0740.03 55.14	757.96	104.14	7.443e+06	3.129e+06	7.366e+06	3.206e+06	-5.722e+05
1	1	291	-607.84 -1333.43	-623.57	-1317.69	105.68	-6.046e+06	-1.035e+07	-1.028e+07	-6.124e+06
5.751e+05										
1	1	292	258.20-150.45-117.88	225.63	110.66	3.028e+06	6.586e+05	2.861e+06	8.249e+05	-6.053e+05
1	1	293	-415.89 -823.61	-449.82	-789.68	112.61	-3.563e+06	-5.936e+06	-5.768e+06	-3.731e+06
6.087e+05										
1	1	294	1253.93 195.08	216.52	1232.49	149.15	1.148e+07	5.231e+06	1.137e+07	5.343e+06
8.310e+05										
1	1	295	-763.33 -1810.75	-784.75	-1789.33	148.24	-8.159e+06	-1.440e+07	-1.428e+07	-8.271e+06
8.305e+05										
1	1	296	197.52-213.97-147.15	130.70	151.76	2.425e+06	5.250e+04	2.067e+06	4.104e+05	-8.492e+05
1	1	297	-352.37 -764.65	-421.13	-695.90	153.68	-2.954e+06	-5.333e+06	-4.973e+06	-3.314e+06
8.528e+05										
1	1	298	117.77-296.06-186.45	8.17	182.61	1.640e+06	-7.369e+05	1.035e+06	-1.320e+05	-1.035e+06
1	1	299	-270.64 -686.28	-382.32	-574.60	184.25	-2.162e+06	-4.546e+06	-3.939e+06	-2.768e+06
1.038e+06										
1	1	300	1745.45 413.81	440.77	1718.48	187.55	1.550e+07	7.374e+06	1.535e+07	7.521e+06
1.083e+06										
1	1	301	-982.40 -2301.53	-1008.54	-2275.39	183.84	-1.031e+07	-1.843e+07	-1.828e+07	-1.046e+07
1.079e+06										
1	1	302	705.18-34.0820.00	651.10	192.50	6.749e+06	2.428e+06	6.452e+06	2.725e+06	-1.093e+06
1	1	303	-534.36 -1266.66	-590.27	-1210.74	194.48	-5.341e+06	-9.658e+06	-9.358e+06	-5.641e+06
1.098e+06										
1	1	304	24.67-391.13-233.45	-133.01	201.74	7.245e+05	-1.656e+06	-1.651e+05	-7.665e+05	-1.152e+06
1	1	305	-176.26 -593.52	-335.67	-434.11	202.74	-1.243e+06	-3.628e+06	-2.739e+06	-2.132e+06
1.154e+06										
1	1	306	-75.58-492.70-284.63	-283.65	208.56	-2.584e+05	-2.642e+06	-1.452e+06	-1.449e+06	-1.192e+06
1	1	307	2249.20 677.17	717.19	2209.17	247.62	1.936e+07	9.504e+06	1.916e+07	9.705e+06
1.394e+06										
1	1	308	-1242.78 -2806.06	-1281.54	-2767.30	243.08	-1.245e+07	-2.230e+07	-2.210e+07	-1.265e+07
1.389e+06										
1	1	309	1658.72 1017.86	1017.87	1658.71	2.60	1.545e+07	8.034e+06	1.536e+07	8.124e+06
8.108e+05										
1	1	310	-1544.34 -1953.68	-1559.02	-1939.00	-76.11	-1.035e+07	-1.811e+07	-1.801e+07	-1.045e+07
8.963e+05										
1	1	311	594.18-150.30-35.90	479.77	268.48	5.643e+06	1.317e+06	4.999e+06	1.960e+06	-1.540e+06
1	1	312	-418.04 -1159.04	-536.22	-1040.87	271.30	-4.223e+06	-8.551e+06	-7.901e+06	-4.872e+06
1.546e+06										
1	1	313	1155.16 88.58	167.10	1076.65	278.52	1.046e+07	4.210e+06	1.003e+07	4.644e+06
1.589e+06										
1	1	314	-659.02 -1710.10	-737.71	-1631.41	276.61	-7.140e+06	-1.338e+07	-1.294e+07	-7.575e+06
1.588e+06										
1	1	315	1023.66 710.59	827.68	906.57	-151.48	1.209e+07	6.081e+06	1.205e+07	6.124e+06
5.062e+05										
1	1	316	-785.23 -1427.84	-1273.25	-939.83	-274.67	-7.804e+06	-1.428e+07	-1.422e+07	-7.866e+06
6.271e+05										
1	1	317	447.36-301.52-108.88	254.72	327.34	4.203e+06	-1.287e+05	3.109e+06	9.659e+05	-1.882e+06
1	1	318	-266.78 -1017.83	-464.78	-819.84	330.91	-2.766e+06	-7.108e+06	-6.006e+06	-3.869e+06
1.890e+06										
1	1	319	1609.68 273.12	373.50	1509.30	352.27	1.416e+07	6.035e+06	1.359e+07	6.604e+06
2.073e+06										
1	1	320	-843.74 -2162.00	-941.22	-2064.52	344.97	-8.980e+06	-1.708e+07	-1.652e+07	-9.545e+06
2.064e+06										
1	1	321	937.41650.43746.12	841.72	-135.29	9.674e+06	5.256e+06	9.666e+06	5.264e+06	-1.856e+05
1	1	322	-700.35 -1275.40	-1130.90	-844.85	-249.43	-6.793e+06	-1.145e+07	-1.144e+07	-6.806e+06
2.490e+05										
1	1	323	276.52-478.06-194.71	-6.83	365.41	2.529e+06	-1.813e+06	9.104e+05	-1.939e+05	-2.100e+06
1	1	324	-91.93-850.84-380.15	-562.62	368.32	-1.074e+06	-5.428e+06	-3.804e+06	-2.698e+06	-2.105e+06
1	1	325	93.11-666.55-287.69	-285.75	379.83	7.316e+05	-3.621e+06	-1.446e+06	-1.444e+06	-2.177e+06
1	1	326	996.34-80.4286.06	829.86	389.28	8.847e+06	2.589e+06	7.909e+06	3.527e+06	-2.233e+06
1	1	327	-492.79 -1549.77	-661.03	-1381.53	386.68	-5.520e+06	-1.175e+07	-1.081e+07	-6.462e+06
2.232e+06										
1	1	328	840.33563.49670.69	733.13	-134.86	7.845e+06	4.454e+06	7.844e+06	4.455e+06	-3.003e+04
1	1	329	-562.08 -1138.75	-1003.24	-697.59	-244.51	-5.795e+06	-9.295e+06	-9.294e+06	-5.796e+06



1	1	383	790.71-186.55-107.62	711.78	-266.29	-3.396e+05	-5.529e+05	-4.297e+05	-4.628e+05	1.054e+05	
1	1	384	1180.12 116.67	326.72	970.07	423.38	9.470e+06	1.325e+06	7.629e+06	3.166e+06	-
3.406e+06											
1	1	385	-455.98 -1569.59	-552.97	-1472.60	314.01	-3.715e+06	-1.218e+07	-1.019e+07	-5.703e+06	-
3.587e+06											
1	1	386	372.64-932.78-324.14	-236.00	651.22	3.091e+06	-5.972e+06	-1.317e+06	-1.564e+06	-4.530e+06	
1	1	387	90.62-537.3339.79	-486.51	-171.27	2.648e+05	1.155e+05	1.749e+05	2.054e+05	7.309e+04	
1	1	388	825.34-122.83-50.62	753.13	-251.50	-1.496e+05	-3.529e+05	-2.052e+05	-2.973e+05	9.059e+04	
1	1	389	682.63203.20291.67	594.16	-185.98	5.044e+06	2.269e+06	5.041e+06	2.272e+06	-9.957e+04	
1	1	390	-136.52 -878.56	-458.95	-556.13	-367.82	-3.236e+06	-6.003e+06	-6.000e+06	-3.239e+06	-
9.183e+04											
1	1	391	48.22-558.97 2.97	-513.71	-159.46	1.528e+05	2.752e+04	5.894e+04	1.214e+05	5.430e+04	
1	1	392	835.75-64.58 0.30	770.86	-232.82	-3.712e+04	-2.143e+05	-6.956e+04	-1.818e+05	6.851e+04	
1	1	393	958.62166.04166.14	958.51	9.21	8.182e+06	2.284e+06	7.804e+06	2.663e+06	-1.446e+06	
1	1	394	-297.56 -1207.53	-348.28	-1156.81	-208.77	-3.871e+06	-9.917e+06	-9.472e+06	-4.316e+06	-
1.578e+06											
1	1	395	827.32-373.1418.68	435.50	562.89	6.466e+06	-2.016e+06	3.579e+06	8.701e+05	-4.019e+06	
1	1	396	-21.75-1251.96-327.04	-946.67	531.38	-3.874e+05	-8.990e+06	-5.825e+06	-3.553e+06	-4.149e+06	
1	1	397	347.64-858.70-209.91	-301.15	601.44	3.089e+06	-5.420e+06	-1.030e+06	-1.301e+06	-4.252e+06	
1	1	398	6.50-557.48 -30.07	-520.91	-138.89	1.034e+05	3570.19	1.020e+04	9.678e+04	2.486e+04	
1	1	399	821.01-9.16 45.25	766.61	-205.44	-4345.10	-1.525e+05	-1.422e+04	-1.427e+05	3.696e+04	
1	1	400	922.65-101.32-19.22	840.55	278.08	7.959e+06	4.582e+05	6.530e+06	1.886e+06	-2.945e+06	
1	1	401	-73.22-1203.87-81.42	-1195.67	95.93	-2.302e+06	-1.005e+07	-8.387e+06	-3.967e+06	-3.183e+06	
1	1	402	586.12114.75235.21	465.66	-205.60	4.089e+06	1.833e+06	4.088e+06	1.834e+06	-3.793e+04	
1	1	403	8.50-765.31-366.13	-390.68	-386.71	-2.633e+06	-4.863e+06	-4.863e+06	-2.633e+06	-1.555e+04	
1	1	404	872.42125.03125.05	872.40	-3.89	6.800e+06	1.817e+06	6.555e+06	2.062e+06	-1.077e+06	
1	1	405	-210.77 -1079.40	-266.90	-1023.26	-213.57	-3.183e+06	-8.228e+06	-7.956e+06	-3.455e+06	-
1.140e+06											
1	1	406	497.5122.37181.36	338.52	-224.20	3.271e+06	1.459e+06	3.271e+06	1.459e+06	4896.57	
1	1	407	150.12-659.90-279.17	-230.61	-404.29	-2.110e+06	-3.888e+06	-3.887e+06	-2.111e+06	3.618e+04	
1	1	408	750.53-449.65-93.69	394.57	548.19	5.673e+06	-2.250e+06	3.101e+06	3.227e+05	-3.710e+06	
1	1	409	210.51-1005.8629.40	-824.75	433.01	3.534e+05	-7.671e+06	-4.817e+06	-2.501e+06	-3.841e+06	
1	1	410	866.06-117.24-35.59	784.42	271.32	6.757e+06	1.484e+05	5.682e+06	1.223e+06	-2.439e+06	
1	1	411	-37.35-1091.14-45.69	-1082.80	93.40	-1.757e+06	-8.468e+06	-7.279e+06	-2.946e+06	-2.562e+06	
1	1	412	485.58-756.59-17.22	-253.79	609.72	3.082e+06	-5.004e+06	-8.384e+05	-1.084e+06	-2.041e+06	
1	1	413	778.5979.77 80.73	777.63	-25.94	5.636e+06	1.448e+06	5.467e+06	1.617e+06	-8.239e+05	
1	1	414	-112.02 -954.49	-182.47	-884.04	-233.22	-2.604e+06	-6.811e+06	-6.634e+06	-2.780e+06	-
8.431e+05											
1	1	415	417.58-70.94130.65	215.99	-240.50	2.570e+06	1.138e+06	2.569e+06	1.139e+06	3.666e+04	
1	1	416	283.90-561.94-198.48	-79.56	-418.72	-1.658e+06	-3.054e+06	-3.050e+06	-1.662e+06	7.294e+04	
1	1	417	345.85-161.6483.53	100.68	-253.60	1.973e+06	8.634e+05	1.970e+06	8.668e+05	6.097e+04	
1	1	418	406.12-471.02-124.50	59.60	-428.80	-1.269e+06	-2.346e+06	-2.337e+06	-1.279e+06	9.981e+04	
1	1	419	709.62-420.61-78.93	367.94	519.07	4.946e+06	-2.165e+06	2.733e+06	4.797e+04	-3.292e+06	
1	1	420	227.21-916.6557.88	-747.32	406.22	5.354e+05	-6.613e+06	-4.263e+06	-1.815e+06	-3.358e+06	
1	1	421	797.93-131.05-56.79	723.66	251.94	5.694e+06	-1.416e+04	4.849e+06	8.304e+05	-2.027e+06	
1	1	422	18.14-979.3012.54	-973.70	74.51	-1.360e+06	-7.109e+06	-6.214e+06	-2.255e+06	-2.084e+06	
1	1	423	681.4232.46 36.73	677.15	-52.49	4.640e+06	1.150e+06	4.520e+06	1.270e+06	-6.367e+05	
1	1	424	-8.29-834.38-100.02	-742.66	-259.54	-2.115e+06	-5.602e+06	-5.485e+06	-2.232e+06	-2.282e+05	
1	1	425	483.09-693.256.43	-216.59	577.51	2.827e+06	-4.466e+06	-7.556e+05	-8.831e+05	-3.646e+06	
1	1	426	281.44-246.2140.40	-5.17	-262.84	1.471e+06	6.299e+05	1.463e+06	6.375e+05	7.949e+04	
1	1	427	513.74-386.79-57.59	184.54	-433.68	-9.370e+05	-1.752e+06	-1.734e+06	-9.548e+05	1.190e+05	
1	1	428	584.97-16.28 -5.25	573.94	-80.68	3.784e+06	9.045e+05	3.698e+06	9.904e+05	-4.899e+05	
1	1	429	96.36-720.85-22.22	-602.28	-287.82	-1.699e+06	-4.563e+06	-4.486e+06	-1.776e+06	-4.642e+05	
1	1	430	664.58-394.28-73.76	344.07	486.47	4.233e+06	-1.962e+06	2.350e+06	-7.863e+04	-2.850e+06	
1	1	431	251.53-828.2298.54	-675.23	376.55	5.813e+05	-5.629e+06	-3.683e+06	-1.365e+06	-2.881e+06	
1	1	432	223.46-321.521.63	-99.70	-267.74	1.056e+06	4.340e+05	1.042e+06	4.480e+05	9.230e+04	
1	1	433	604.32-309.041.91	293.37	-432.80	-6.557e+05	-1.264e+06	-1.234e+06	-6.855e+05	1.313e+05	
1	1	434	721.65-142.89-80.34	659.10	223.98	4.762e+06	-9.662e+04	4.086e+06	5.793e+05	-1.681e+06	
1	1	435	79.12-867.9376.91	-865.72	45.70	-1.061e+06	-5.932e+06	-5.241e+06	-1.751e+06	-1.699e+06	
1	1	436	474.01-632.0528.77	-186.81	542.42	2.492e+06	-3.876e+06	-6.621e+05	-7.215e+05	-3.184e+06	
1	1	437	171.05-384.97-32.48	-181.43	-267.85	7.238e+05	2.726e+05	7.008e+05	2.956e+05	9.921e+04	
1	1	438	675.76-237.4853.73	384.55	-425.61	-4.211e+05	-8.744e+05	-8.284e+05	-4.670e+05	1.368e+05	
1	1	439	492.57-66.20-44.25	470.62	-108.55	3.044e+06	6.993e+05	2.984e+06	7.593e+05	-3.701e+05	
1	1	440	198.84-615.1149.38	-465.65	-315.15	-1.343e+06	-3.668e+06	-3.619e+06	-1.392e+06	-3.340e+05	
1	1	441	640.24-153.07-104.14	591.32	190.84	3.947e+06	-1.363e+05	3.404e+06	4.070e+05	-1.387e+06	
1	1	442	140.80-758.41140.65	-758.26	11.51	-8.260e+05	-4.908e+06	-4.371e+06	-1.363e+06	-1.380e+06	
1	1	443	613.80-367.18-72.74	319.36	449.60	3.578e+06	-1.722e+06	1.989e+06	-1.325e+05	-2.428e+06	
1	1	444	274.66-738.67142.34	-606.35	341.43	5.645e+05	-4.739e+06	-3.132e+06	-1.043e+06	-2.438e+06	
1	1	445	123.80-434.61-61.70	-249.12	-263.01	4.685e+05	1.445e+05	4.346e+05	1.784e+05	9.922e+04	
1	1	446	726.74-172.1797.65	456.92	-412.00	-2.331e+05	-5.770e+05	-5.129e+05	-2.972e+05	1.340e+05	
1	1	447	458.94-570.2350.53	-161.82	503.51	2.148e+06	-3.305e+06	-5.698e+05	-5.869e+05	-2.727e+06	
1	1	448	406.77-116.90-79.61	369.49	-134.67	2.408e+06	5.262e+05	2.368e+06	5.658e+05	-2.703e+05	
1	1	449	296.36-517.69113.78	-335.11	-339.55	-1.039e+06	-2.899e+06	-2.871e+06	-1.067e+06	-2.283e+05	
1	1	450	81.23-469.06-85.88	-301.95	-253.05	2.830e+05	5.194e+04	2.389e+05	9.607e+04	9.082e+04	
1	1	451	756.26-112.84133.66	509.77	-391.75	-9.576e+04	-3.609e+05	-2.820e+05	-1.746e+05	1.212e+05	
1	1	452	556.59-161.92-126.79	521.46	154.94	3.237e+06	-1.531e+05	2.803e+06	2.811e+05	-1.133e+06	

1	1	453	201.07-652.79200.34	-652.06	-24.96	-6.363e+05	-4.018e+06	-3.602e+06	-1.052e+06	-1.111e+06
1	1	454	557.98-338.66-73.57	292.89	409.17	2.990e+06	-1.479e+06	1.662e+06	-1.511e+05	-2.042e+06
1	1	455	294.46-648.80185.12	-539.46	301.96	5.201e+05	-3.948e+06	-2.628e+06	-7.995e+05	-2.038e+06
1	1	456	42.88-487.93-105.32	-339.73	-238.12	1.560e+05	2466.65	1.080e+05	5.045e+04	7.117e+04
1	1	457	764.33-59.07162.19	543.06	-365.01	-1.759e+04	-2.113e+05	-1.289e+05	-9.999e+04	9.579e+04
1	1	458	329.18-167.57-110.86	272.47	-157.97	1.864e+06	3.799e+05	1.840e+06	4.038e+05	-1.865e+05
1	1	459	386.29-428.65170.30	-212.66	-359.67	-7.786e+05	-2.244e+06	-2.230e+06	-7.924e+05	-1.416e+05
1	1	460	438.47-507.4771.05	-140.04	461.04	1.822e+06	-2.779e+06	-4.832e+05	-4.737e+05	-2.301e+06
1	1	461	5.72-486.76-113.50	-367.54	-210.95	9.047e+04	3142.57	2.486e+04	6.876e+04	3.775e+04
1	1	462	750.21-8.37177.36	564.48	-326.18	-3936.06	-1.392e+05	-3.764e+04	-1.055e+05	5.851e+04
1	1	463	473.25-169.87-147.40	450.78	118.09	2.619e+06	-1.583e+05	2.277e+06	1.841e+05	-9.132e+05
1	1	464	258.77-552.94254.09	-548.25	-61.51	-4.798e+05	-3.247e+06	-2.929e+06	-7.976e+05	-8.822e+05
1	1	465	260.52-216.83-137.58	181.27	-177.62	1.403e+06	2.571e+05	1.391e+06	2.691e+05	-1.168e+05
1	1	466	466.17-347.73218.44	-100.00	-374.51	-5.582e+05	-1.691e+06	-1.686e+06	-5.627e+05	-7.101e+04
1	1	467	498.52-308.87-75.11	264.76	366.18	2.469e+06	-1.251e+06	1.372e+06	-1.530e+05	-1.697e+06
1	1	468	310.58-560.19224.65	-474.26	259.69	4.655e+05	-3.251e+06	-2.178e+06	-6.073e+05	-1.684e+06
1	1	469	413.51-444.3789.71	-120.57	415.86	1.525e+06	-2.307e+06	-4.042e+05	-3.779e+05	-1.916e+06
1	1	470	200.76-262.84-159.46	97.37	-192.98	1.021e+06	1.558e+05	1.017e+06	1.600e+05	-6.035e+04
1	1	471	533.85-274.58257.86	1.41	-383.34	-3.739e+05	-1.232e+06	-1.232e+06	-3.741e+05	-1.517e+04
1	1	472	392.52-177.28-165.33	380.57	81.65	2.085e+06	-1.578e+05	1.821e+06	1.067e+05	-7.233e+05
1	1	473	313.00-460.27300.77	-448.04	-96.48	-3.492e+05	-2.581e+06	-2.344e+06	-5.858e+05	-6.871e+05
1	1	474	436.95-278.23-76.72	235.44	321.73	2.013e+06	-1.043e+06	1.117e+06	-1.476e+05	-1.391e+06
1	1	475	323.23-474.55259.60	-410.92	216.13	4.094e+05	-2.641e+06	-1.780e+06	-4.515e+05	-1.373e+06
1	1	476	149.14-303.45-176.20	21.89	-203.47	7.108e+05	7.475e+04	7.104e+05	7.519e+04	-1.670e+04
1	1	477	587.32-208.64288.22	90.45	-385.50	-2.231e+05	-8.615e+05	-8.604e+05	-2.242e+05	2.683e+04
1	1	478	385.07-381.90106.10	-102.93	368.97	1.260e+06	-1.890e+06	-3.334e+05	-2.969e+05	-1.575e+06
1	1	479	316.39-184.53-180.13	311.99	46.74	1.626e+06	-1.543e+05	1.428e+06	4.405e+04	-5.602e+05
1	1	480	362.78-375.71339.67	-352.60	-128.58	-2.396e+05	-2.010e+06	-1.840e+06	-4.093e+05	-5.213e+05
1	1	481	374.75-247.28-78.01	205.49	276.83	1.615e+06	-8.586e+05	8.963e+05	-1.398e+05	-1.123e+06
1	1	482	332.80-393.43289.17	-349.79	172.58	3.559e+05	-2.113e+06	-1.433e+06	-3.233e+05	-1.102e+06
1	1	483	104.91-336.66-187.69	-44.06	-208.78	4.679e+05	1.419e+04	4.675e+05	1.463e+04	1.408e+04
1	1	484	625.19-149.68309.45	166.06	-380.74	-1.064e+05	-5.728e+05	-5.664e+05	-1.128e+05	5.431e+04
1	1	485	246.59-191.91-191.45	246.13	14.25	1.237e+06	-1.492e+05	1.094e+06	-6315.07	-4.214e+05
1	1	486	407.00-299.68370.29	-262.97	-156.83	-1.483e+05	-1.527e+06	-1.412e+06	-2.636e+05	-3.818e+05
1	1	487	354.16-321.05119.94	-86.83	321.38	1.026e+06	-1.525e+06	-2.710e+05	-2.286e+05	-1.276e+06
1	1	488	67.07-360.69-193.83	-99.78	-208.64	2.856e+05	-2.348e+04	2.823e+05	-2.018e+04	3.175e+04
1	1	489	646.36-97.13321.56	227.67	-368.77	-2.629e+04	-3.575e+05	-3.434e+05	-4.041e+04	6.692e+04
1	1	490	313.28-216.53-78.72	175.47	232.43	1.272e+06	-6.973e+05	7.061e+05	-1.311e+05	-8.914e+05
1	1	491	339.69-318.14312.84	-291.29	130.15	3.071e+05	-1.658e+06	-1.134e+06	-2.172e+05	-8.691e+05
1	1	492	184.58-199.62-199.03	183.99	-15.07	9.116e+05	-1.425e+05	8.139e+05	-4.491e+04	-3.056e+05
1	1	493	444.47-232.22392.36	-180.11	-180.41	-7.349e+04	-1.124e+06	-1.052e+06	-1.460e+05	-2.664e+05
1	1	494	34.61-374.59-195.04	-144.94	-203.06	1.540e+05	-3.115e+04	1.467e+05	-2.391e+04	3.589e+04
1	1	495	650.57-50.36325.10	275.10	-349.57	1.037e+04	-2.037e+05	-1.821e+05	-1.116e+04	6.438e+04
1	1	496	321.75-262.78131.08	-72.11	274.04	8.227e+05	-1.210e+06	-2.164e+05	-1.711e+05	-1.016e+06
1	1	497	253.78-186.50-78.63	145.91	189.35	9.798e+05	-5.582e+05	5.441e+05	-1.225e+05	-6.930e+05
1	1	498	344.19-249.75330.29	-235.86	89.78	2.634e+05	-1.271e+06	-8.776e+05	-1.304e+05	-6.703e+05
1	1	499	131.22-207.53-202.58	126.27	-40.63	6.451e+05	-1.337e+05	5.832e+05	-7.178e+04	-2.108e+05
1	1	500	473.77-172.94405.54	-104.70	-198.68	-1.469e+04	-7.955e+05	-7.551e+05	-5.508e+04	-1.729e+05
1	1	501	4.50-373.89-178.35	-191.04	-189.09	6.929e+04	2493.86	3.575e+04	3.604e+04	3.340e+04
1	1	502	637.33-7.12308.77	321.45	-322.16	-3286.48	-1.181e+05	-6.052e+04	-6.082e+04	5.738e+04
1	1	503	288.78-208.00139.43	-58.66	227.79	6.481e+05	-9.410e+05	-1.695e+05	-1.234e+05	-7.942e+05
1	1	504	197.39-157.64-77.61	117.36	148.36	7.343e+05	-4.394e+05	4.082e+05	-1.133e+05	-5.257e+05
1	1	505	346.49-189.06341.33	-183.91	52.28	2.246e+05	-9.475e+05	-6.620e+05	-6.089e+04	-5.031e+05
1	1	506	87.08-215.34-202.09	73.82	-61.91	4.331e+05	-1.215e+05	3.977e+05	-8.613e+04	-1.356e+05
1	1	507	493.79-121.52409.87	-37.60	-211.18	2.689e+04	-5.357e+05	-5.171e+05	8286.12	-1.006e+05
1	1	508	256.14-157.57144.95	-46.39	183.41	5.001e+05	-7.139e+05	-1.297e+05	-8.408e+04	-6.065e+05
1	1	509	51.91-222.22-197.45	27.14	-78.59	2.694e+05	-1.026e+05	2.522e+05	-8.552e+04	-7.797e+04
1	1	510	503.45-77.20405.38	20.86	-217.55	4.829e+04	-3.374e+05	-3.315e+05	4.238e+04	-4.739e+04
1	1	511	145.00-130.34-75.48	90.14	109.98	5.312e+05	-3.383e+05	2.959e+05	-1.030e+05	-3.863e+05
1	1	512	346.43-136.43345.74	-135.74	18.25	1.896e+05	-6.807e+05	-4.832e+05	-7826.05	-3.645e+05
1	1	513	224.58-112.22147.61	-35.25	141.42	3.758e+05	-5.248e+05	-9.641e+04	-5.251e+04	-4.498e+05
1	1	514	24.85-227.30-189.07	-13.37	-90.43	1.444e+05	-6.870e+04	1.388e+05	-6.309e+04	-3.414e+04
1	1	515	502.23-39.18392.62	70.42	-217.55	4.242e+04	-1.893e+05	-1.890e+05	4.204e+04	-9348.67
1	1	516	97.71-105.20-72.21	64.72	74.87	3.666e+05	-2.528e+05	2.048e+05	-9.095e+04	-2.721e+05
1	1	517	343.90-92.12343.59	-91.80	-11.68	1.562e+05	-4.668e+05	-3.384e+05	-2.784e+04	-1.520e+05
1	1	518	195.16-72.94147.46	-25.24	102.53	2.722e+05	-3.704e+05	-6.940e+04	-2.886e+04	-3.207e+05
1	1	519	2.98-226.35-162.20	-61.17	-102.94	4.134e+04	1665.90	3.128e+04	1.173e+04	1.726e+04
1	1	520	489.95-5.50359.34	125.11	-218.29	-2438.69	-9.055e+04	-6.838e+04	-2.461e+04	3.824e+04
1	1	521	56.54-82.90-67.75	41.39	43.40	2.353e+05	-1.784e+05	1.321e+05	-7.513e+04	-1.790e+05
1	1	522	338.44-55.76334.92	-52.23	-37.11	1.206e+05	-2.995e+05	-2.238e+05	4.487e+04	-1.614e+05
1	1	523	168.87-40.61144.53	-16.27	67.13	1.845e+05	-2.454e+05	-4.813e+04	-1.278e+04	-2.142e+05
1	1	524	23.44-65.28-62.29	20.45	16.00	1.278e+05	-1.057e+05	7.282e+04	-5.068e+04	-9.911e+04
1	1	525	329.66-26.73320.09	-17.16	-57.60	2.471e+04	-1.678e+05	-1.331e+05	4.006e+04	-8.485e+04
1	1	526	147.14-16.47138.91	-8.25	35.75	1.040e+05	-1.394e+05	-3.201e+04	-3403.64	-1.209e+05
1	1	527	2.10-54.62-45.37	-7.15	-20.95	9584.44	667.20	8892.99	1358.64	2384.88
1	1	528	317.88-3.65291.84	22.38	-87.71	-1450.97	-5.863e+04	-5.471e+04	-5368.37	1.444e+04



1	1	529	132.93-1.91 132.34	-1.33	-8.89	-389.21	-2.449e+04	-2.449e+04	-390.55	179.86
1	2	1	102.17-1.44 101.75	-1.02	6.60	-302.79	-1.882e+04	-1.882e+04	-302.79	-0.36
1	2	2	1.56-41.05 -34.17	-5.32	15.68	7608.31	512.03	7133.89	986.45	-1772.43
1	2	3	243.72-2.80 223.88	17.04	67.06	-1117.58	-4.525e+04	-4.229e+04	-4072.70	-1.103e+04
1	2	4	113.20-12.70 106.83	-6.33	-27.58	8.006e+04	-1.073e+05	-2.460e+04	-2623.68	9.302e+04
1	2	5	18.20-49.61 -47.18	15.77	-12.60	9.858e+04	-8.125e+04	5.634e+04	-3.900e+04	7.624e+04
1	2	6	252.94-20.54 245.67	-13.28	43.98	5.741e+04	-1.292e+05	-1.026e+05	3.081e+04	6.524e+04
1	2	7	130.04-31.33 111.20	-12.49	-51.81	1.420e+05	-1.888e+05	-3.701e+04	-9852.52	1.648e+05
1	2	8	43.84-63.37 -51.40	31.86	-33.77	1.813e+05	-1.371e+05	1.020e+05	-5.782e+04	1.377e+05
1	2	9	259.85-42.90 257.22	-40.27	28.08	9.261e+04	-2.305e+05	-1.724e+05	3.447e+04	1.241e+05
1	2	10	2.28-172.45 -123.74	-46.43	78.35	3.222e+04	1271.32	2.449e+04	9002.00	-1.340e+04
1	2	11	375.79-4.22 275.81	95.76	167.33	-1876.51	-6.988e+04	-5.289e+04	-1.887e+04	-2.944e+04
1	2	12	150.38-56.25 113.51	-19.37	-79.12	2.094e+05	-2.850e+05	-5.338e+04	-2.225e+04	2.467e+05
1	2	13	75.62-80.70 -54.86	49.78	-58.07	2.825e+05	-1.943e+05	1.581e+05	-6.997e+04	2.093e+05
1	2	14	264.26-70.91 264.05	-70.70	8.37	1.199e+05	-3.593e+05	-2.607e+05	2.131e+04	1.937e+05
1	2	15	19.07-173.42 -144.50	-9.85	68.78	1.116e+05	-5.279e+04	1.074e+05	-4.853e+04	2.613e+04
1	2	16	385.40-30.10 301.54	53.76	166.77	3.256e+04	-1.459e+05	-1.456e+05	3.228e+04	7082.36
1	2	17	173.15-86.50 113.68	-27.03	-109.11	3.891e+05	-4.037e+05	-7.418e+04	-4.047e+04	3.460e+05
1	2	18	112.08-100.20 -57.39	69.27	-85.17	4.091e+05	-2.600e+05	2.284e+05	-7.925e+04	2.971e+05
1	2	19	266.47-105.06 265.88	-104.47	-14.80	1.455e+05	-5.239e+05	-3.722e+05	-6217.89	2.803e+05
1	2	20	39.92-169.67 -151.12	21.37	59.53	2.079e+05	-7.885e+04	1.948e+05	-6.577e+04	5.983e+04
1	2	21	386.49-59.35 311.63	15.50	166.64	3.698e+04	-2.598e+05	-2.553e+05	3.247e+04	3.629e+04
1	2	22	197.57-121.42 111.70	-35.55	-141.48	3.846e+05	-5.492e+05	-9.981e+04	-6.480e+04	4.666e+05
1	2	23	67.08-164.64 -154.88	57.32	46.54	3.341e+05	-9.332e+04	3.070e+05	-6.622e+04	1.041e+05
1	2	24	379.27-93.48 315.39	-29.60	161.61	2.036e+04	-4.124e+05	-3.982e+05	6139.49	7.714e+04
1	2	25	152.43-121.37 -59.06	90.13	-114.79	5.655e+05	-3.377e+05	3.150e+05	-8.714e+04	4.044e+05
1	2	26	266.84-145.62 262.70	-141.48	-41.15	1.722e+05	-7.293e+05	-5.099e+05	-4.716e+04	3.868e+05
1	2	27	222.83-160.22 107.51	-44.91	-175.71	4.984e+05	-7.240e+05	-1.305e+05	-9.508e+04	6.109e+05
1	2	28	3.45-285.90 -136.59	-145.85	144.60	5.334e+04	1923.75	2.765e+04	2.761e+04	-2.571e+04
1	2	29	489.25-5.47 237.26	246.52	247.31	-2528.44	-9.102e+04	-4.680e+04	-4.676e+04	-4.425e+04
1	2	30	101.18-158.99 -155.48	97.67	30.00	4.974e+05	-1.026e+05	4.499e+05	-5.509e+04	1.620e+05
1	2	31	364.17-133.10 312.41	-81.34	151.86	-1.183e+04	-6.124e+05	-5.815e+05	-4.274e+04	1.327e+05
1	2	32	195.84-143.74 -59.87	111.98	-146.44	7.546e+05	-4.290e+05	4.197e+05	-9.413e+04	5.331e+05
1	2	33	265.48-192.38 254.45	-181.36	-70.20	2.017e+05	-9.786e+05	-6.761e+05	-1.008e+05	5.153e+05
1	2	34	248.38-202.37 101.17	-55.16	-211.39	6.326e+05	-9.312e+05	-1.667e+05	-1.319e+05	7.817e+05
1	2	35	26.56-286.53 -149.55	-110.41	155.31	1.186e+05	-2.413e+04	1.130e+05	-1.856e+04	-2.765e+04
1	2	36	499.57-38.70 249.98	210.88	268.42	7940.17	-1.569e+05	-1.403e+05	-8699.45	-4.966e+04
1	2	37	142.39-153.35 -153.00	142.04	10.12	7.026e+05	-1.091e+05	6.278e+05	-3.426e+04	2.349e+05
1	2	38	342.03-178.81 302.68	-139.46	137.65	-5.732e+04	-8.655e+05	-8.099e+05	-1.129e+05	2.045e+05
1	2	39	241.63-167.05 -59.97	134.55	-179.71	9.797e+05	-5.358e+05	5.446e+05	-1.007e+05	6.857e+05
1	2	40	262.51-245.07 241.33	-223.89	-101.51	2.350e+05	-1.276e+06	-8.733e+05	-1.678e+05	6.682e+05
1	2	41	51.51-275.94 -148.98	-75.45	159.55	2.201e+05	-1.815e+04	2.175e+05	-1.561e+04	-2.447e+04
1	2	42	496.44-74.67 247.61	174.15	283.18	-2.036e+04	-2.753e+05	-2.644e+05	-3.129e+04	-5.166e+04
1	2	43	273.55-247.18 92.70	-66.33	-247.93	7.887e+05	-1.174e+06	-2.088e+05	-1.726e+05	9.811e+05
1	2	44	190.26-147.96 -147.48	189.79	-12.68	9.531e+05	-1.139e+05	8.435e+05	-4332.19	3.240e+05
1	2	45	313.74-230.87 286.19	-203.33	119.34	-1.152e+05	-1.175e+06	-1.087e+06	-2.036e+05	2.932e+05
1	2	46	80.66-257.68 -144.65	-32.37	159.58	3.607e+05	1.108e+04	3.603e+05	1.141e+04	-1.082e+04
1	2	47	480.32-115.13 238.68	126.51	292.39	-8.212e+04	-4.410e+05	-4.360e+05	-8.710e+04	-4.202e+04
1	2	48	288.92-190.95 -59.46	157.43	-214.03	1.244e+06	-6.596e+05	6.911e+05	-1.071e+05	8.638e+05
1	2	49	257.85-303.08 223.52	-268.74	-134.46	2.721e+05	-1.626e+06	-1.104e+06	-2.497e+05	8.475e+05
1	2	50	244.12-142.93 -139.17	240.36	-37.99	1.253e+06	-1.175e+05	1.101e+06	3.473e+04	4.306e+05
1	2	51	280.39-289.58 263.22	-272.41	97.42	-1.858e+05	-1.547e+06	-1.417e+06	-3.160e+05	4.004e+05
1	2	52	297.67-293.97 82.18	-78.48	-284.70	9.683e+05	-1.454e+06	-2.570e+05	-2.289e+05	1.211e+06
1	2	53	114.79-232.48 -136.27	18.58	155.42	5.479e+05	5.791e+04	5.476e+05	5.825e+04	1.284e+04
1	2	54	451.45-160.55 222.79	68.11	296.06	-1.721e+05	-6.632e+05	-6.623e+05	-1.730e+05	-2.095e+04
1	2	55	336.76-215.09 -58.51	180.18	-248.77	1.550e+06	-8.011e+05	8.614e+05	-1.129e+05	1.070e+06
1	2	56	251.31-365.59 201.30	-315.58	-168.38	3.128e+05	-2.033e+06	-1.372e+06	-3.487e+05	1.056e+06
1	2	57	302.85-138.17 -128.29	292.97	-65.26	1.607e+06	-1.197e+05	1.404e+06	8.335e+04	5.561e+05
1	2	58	242.96-354.91 234.03	-345.99	72.51	-2.706e+05	-1.986e+06	-1.805e+06	-4.522e+05	5.278e+05
1	2	59	154.68-201.76 -123.94	76.86	147.24	7.869e+05	1.205e+05	7.837e+05	1.238e+05	4.638e+04
1	2	60	410.68-211.39 199.93	-0.64	294.42	-2.883e+05	-9.485e+05	-9.484e+05	-2.885e+05	1.127e+04
1	2	61	320.06-342.00 69.77	-91.71	-321.03	1.172e+06	-1.775e+06	-3.117e+05	-2.915e+05	1.474e+06
1	2	62	384.11-239.10 -57.34	202.35	-283.26	1.901e+06	-9.605e+05	1.057e+06	-1.166e+05	1.305e+06
1	2	63	242.72-431.62 175.18	-364.08	-202.44	3.553e+05	-2.503e+06	-1.678e+06	-4.692e+05	1.295e+06
1	2	64	200.94-167.07 -107.76	141.63	135.31	1.081e+06	1.988e+05	1.072e+06	5.281e+05	8.970e+04
1	2	65	359.10-267.85 170.18	-78.92	287.67	-4.304e+05	-1.301e+06	-1.298e+06	-4.338e+05	5.413e+04
1	2	66	365.12-133.51 -115.18	346.79	-93.83	2.018e+06	-1.195e+05	1.755e+06	1.435e+05	7.021e+05
1	2	67	202.34-426.56 199.05	-423.27	45.38	-3.717e+05	-2.499e+06	-2.255e+06	-6.155e+05	6.777e+05
1	2	68	4.40-373.09 -87.19	-281.51	161.82	6.952e+04	2424.25	1.923e+04	2.72e+04	-2.907e+04
1	2	69	576.35-6.43 136.47	433.45	250.72	-3028.09	-1.072e+05	-2.911e+04	-8.116e+04	-4.514e+04
1	2	70	340.06-390.51 55.71	-106.16	-356.21	1.400e+06	-2.139e+06	-3.728e+05	-3.657e+05	1.770e+06
1	2	71	254.17-130.14 -88.02	212.05	120.05	1.436e+06	2.938e+05	1.418e+06	3.121e+05	1.433e+05
1	2	72	298.30-330.37 133.82	-165.88	276.32	-6.003e+05	-1.727e+06	-1.716e+06	-6.108e+05	1.083e+05
1	2	73	32.93-374.02 -81.09	-260.00	182.75	1.199e+05	1867.88	8.300e+04	3.875e+04	-5.471e+04
1	2	74	587.31-45.41 124.94	416.96	280.65	-1.353e+04	-1.628e+05	-9.927e+04	-7.704e+04	-7.379e+04
1	2	75	429.84-262.66 -56.25	223.44	-316.75	2.302e+06	-1.136e+06	1.281e+06	-1.145e+05	1.571e+06

1	2	76	231.94-500.03145.92	-414.01	-235.72	3.965e+05	-3.040e+06	-2.025e+06	-6.178e+05	1.567e+06
1	2	77	429.43-128.83-100.30	400.90	-122.92	2.494e+06	-1.147e+05	2.161e+06	2.189e+05	8.712e+05
1	2	78	159.35-503.84158.91	-503.40	17.02	-4.927e+05	-3.093e+06	-2.774e+06	-8.121e+05	8.536e+05
1	2	79	62.41-359.58-66.52	-230.64	194.38	2.176e+05	4.010e+04	1.837e+05	7.399e+04	-6.977e+04
1	2	80	581.17-86.77103.30	391.10	301.38	-7.372e+04	-2.779e+05	-2.171e+05	-1.345e+05	-9.336e+04
1	2	81	314.38-92.42-65.01	286.98	101.97	1.855e+06	4.069e+05	1.825e+06	4.373e+05	2.076e+05
1	2	82	229.98-399.2591.13	-260.40	260.94	-8.007e+05	-2.232e+06	-2.210e+06	-8.224e+05	1.749e+05
1	2	83	357.19-438.8040.44	-122.06	-389.62	1.650e+06	-2.544e+06	-4.398e+05	-4.536e+05	2.097e+06
1	2	84	95.17-333.23-48.36	-189.70	202.20	3.606e+05	1.116e+05	3.346e+05	1.376e+05	-7.614e+04
1	2	85	558.57-132.4375.95	350.20	317.12	-1.795e+05	-4.442e+05	-3.947e+05	-2.290e+05	-1.032e+05
1	2	86	472.83-285.58-55.77	243.02	-348.53	2.755e+06	-1.322e+06	1.532e+06	-9.931e+04	1.868e+06
1	2	87	219.11-569.58114.82	-465.30	-267.16	4.300e+05	-3.650e+06	-2.414e+06	-8.061e+05	1.875e+06
1	2	88	494.06-124.05-84.33	454.34	-151.57	3.042e+06	-1.010e+05	2.624e+06	3.167e+05	1.067e+06
1	2	89	114.78-585.69114.60	-585.51	-11.27	-6.393e+05	-3.779e+06	-3.366e+06	-1.052e+06	1.061e+06
1	2	90	381.03-55.01-39.12	365.15	81.70	2.346e+06	5.407e+05	2.300e+06	5.867e+05	2.844e+05
1	2	91	156.05-474.7142.52	-361.18	242.32	-1.035e+06	-2.823e+06	-2.786e+06	-1.073e+06	2.561e+05
1	2	92	131.59-295.29-26.39	-137.32	206.11	5.572e+05	2.104e+05	5.396e+05	2.280e+05	-7.610e+04
1	2	93	519.54-182.7142.55	294.28	327.79	-3.242e+05	-6.730e+05	-6.375e+05	-3.597e+05	-1.054e+05
1	2	94	371.37-486.4924.72	-139.84	-420.96	1.915e+06	-2.985e+06	-5.117e+05	-5.587e+05	2.450e+06
1	2	95	557.16-119.33-68.35	506.17	-178.59	3.671e+06	-6.985e+04	3.151e+06	4.504e+05	1.294e+06
1	2	96	69.66-670.7167.74	-668.78	-37.69	-8.206e+05	-4.568e+06	-4.037e+06	-1.351e+06	1.306e+06
1	2	97	172.05-246.90-0.74	-74.11	206.24	8.133e+05	3.349e+05	8.026e+05	3.456e+05	-7.079e+04
1	2	98	464.84-237.863.11	223.87	333.56	-5.049e+05	-9.729e+05	-9.498e+05	-5.280e+05	-1.013e+05
1	2	99	512.09-308.09-56.86	260.86	-378.07	3.261e+06	-1.507e+06	1.811e+06	-5.647e+04	2.194e+06
1	2	100	205.00-639.2384.18	-518.41	-295.64	4.425e+05	-4.338e+06	-2.840e+06	-1.055e+06	2.217e+06
1	2	101	452.88-18.64-10.86	445.10	60.09	2.915e+06	6.992e+05	2.849e+06	7.651e+05	3.764e+05
1	2	102	78.58-556.72-11.43	-466.71	221.54	-1.309e+06	-3.512e+06	-3.453e+06	-1.369e+06	3.561e+05
1	2	103	216.93-189.5728.38	-1.02	202.72	1.132e+06	4.859e+05	1.127e+06	4.917e+05	-6.096e+04
1	2	104	395.52-297.82-42.19	139.89	334.50	-7.215e+05	-1.348e+06	-1.335e+06	-7.353e+05	-9.186e+04
1	2	105	383.75-534.089.89	-160.21	-450.97	2.173e+06	-3.444e+06	-5.855e+05	-6.862e+05	2.808e+06
1	2	106	528.0316.21 19.09	525.15	38.30	3.576e+06	8.886e+05	3.484e+06	9.809e+05	4.894e+05
1	2	107	-0.25-644.87-69.94	-575.18	200.17	-1.630e+06	-4.312e+06	-4.222e+06	-1.720e+06	4.821e+05
1	2	108	616.74-115.33-54.28	555.69	-202.40	4.393e+06	-6384.73	3.741e+06	6.449e+05	1.562e+06
1	2	109	25.74-757.3721.17	-752.79	-59.67	-1.052e+06	-5.476e+06	-4.788e+06	-1.739e+06	1.603e+06
1	2	110	547.40-331.51-61.47	277.35	-405.49	3.813e+06	-1.664e+06	2.106e+06	4.312e+04	2.537e+06
1	2	111	192.10-708.6358.38	-574.91	-320.26	4.073e+05	-5.100e+06	-3.291e+06	-1.402e+06	2.587e+06
1	2	112	266.94-125.4160.73	80.80	195.92	1.519e+06	6.658e+05	1.517e+06	6.684e+05	-4.677e+04
1	2	113	313.22-362.84-93.12	43.50	331.05	-9.774e+05	-1.805e+06	-1.798e+06	-9.847e+05	-7.717e+04
1	2	114	322.82-56.8896.00	169.93	186.22	1.979e+06	8.775e+05	1.978e+06	8.782e+05	-2.815e+04
1	2	115	219.85-433.12-149.43	-63.84	323.67	-1.277e+06	-2.350e+06	-2.347e+06	-1.280e+06	-5.660e+04
1	2	116	603.9749.11 49.69	603.38	17.98	4.344e+06	1.118e+06	4.214e+06	1.248e+06	6.336e+05
1	2	117	-78.03-738.24-131.77	-684.50	180.53	-2.007e+06	-5.243e+06	-5.108e+06	-2.142e+06	6.472e+05
1	2	118	399.38-584.86-1.35	-184.13	-483.56	2.371e+06	-3.874e+06	-6.557e+05	-8.473e+05	3.121e+06
1	2	119	671.10-113.91-45.86	603.05	-220.88	5.220e+06	1.170e+05	4.389e+06	9.478e+05	1.884e+06
1	2	120	-13.19-844.61-19.71	-838.10	-73.30	-1.357e+06	-6.524e+06	-5.611e+06	-2.270e+06	1.971e+06
1	2	121	580.89-360.81-74.32	294.40	-433.26	4.382e+06	-1.733e+06	2.390e+06	2.585e+05	2.866e+06
1	2	122	188.30-779.3347.04	-638.07	-341.66	2.677e+05	-5.922e+06	-3.727e+06	-1.928e+06	2.961e+06
1	2	123	385.3013.21133.83	264.68	174.16	2.519e+06	1.125e+06	2.519e+06	1.125e+06	-3838.81
1	2	124	117.81-508.97-210.82	-180.35	313.02	-1.625e+06	-2.992e+06	-2.991e+06	-1.625e+06	-2.845e+04
1	2	125	677.6979.22 79.22	677.68	1.72	5.244e+06	1.402e+06	5.056e+06	1.590e+06	8.285e+05
1	2	126	-151.65 -835.43	-194.87	-792.21	166.39	-2.453e+06	-6.335e+06	-6.126e+06	-2.661e+06 8.753e+05
1	2	127	454.7382.13173.85	363.01	160.51	3.149e+06	1.413e+06	3.148e+06	1.413e+06	2.891e+04
1	2	128	9.98-590.73-276.95	-303.80	300.06	-2.027e+06	-3.742e+06	-3.742e+06	-2.027e+06	1.117e+04
1	2	129	719.56-121.50-52.01	650.07	-231.56	6.168e+06	3.494e+05	5.063e+06	1.455e+06	2.282e+06
1	2	130	-36.43-932.56-42.41	-926.58	-72.94	-1.777e+06	-7.746e+06	-6.470e+06	-3.054e+06	2.448e+06
1	2	131	5.00-428.05 -23.21	-399.84	106.86	7.969e+04	2739.23	7916.74	7.451e+04	-1.928e+04
1	2	132	631.17-7.04 34.91	589.22	158.15	-3342.62	-1.174e+05	-1.101e+04	-1.098e+05	-2.856e+04
1	2	133	349.74-666.61-101.28	-215.59	-504.95	2.378e+06	-4.286e+06	-8.829e+05	-1.025e+06	3.331e+06
1	2	134	656.91-338.55-0.50	318.86	-471.42	5.013e+06	-1.563e+06	2.748e+06	7.006e+06	3.125e+06
1	2	135	12.10-964.20-217.47	-734.63	-414.03	-3.128e+05	-6.952e+06	-4.533e+06	-2.732e+06	3.195e+06
1	2	136	745.95104.45104.51	745.89	-6.06	6.313e+06	1.761e+06	6.023e+06	2.051e+06	1.112e+06
1	2	137	-215.76 -935.21	-255.43	-895.53	164.23	-2.983e+06	-7.636e+06	-7.295e+06	-3.323e+06 1.212e+06
1	2	138	37.05-429.27 2.06	-394.28	122.85	1.176e+05	2.126e+04	4.533e+04	9.358e+04	-4.172e+04
1	2	139	642.55-49.66 0.41	592.48	179.31	-2.855e+04	-1.649e+05	-5.354e+04	-1.399e+05	-5.276e+04
1	2	140	530.45147.59215.60	462.43	146.33	3.885e+06	1.748e+06	3.882e+06	1.751e+06	7.599e+04
1	2	141	-100.17 -678.72	-347.49	-431.39	286.22	-2.491e+06	-4.620e+06	-4.618e+06	-2.494e+06 6.960e+04
1	2	142	69.65-412.6630.14	-373.15	132.28	2.037e+05	8.908e+04	1.345e+05	1.583e+05	-5.609e+04
1	2	143	634.58-94.47-38.58	578.69	193.96	-1.151e+05	-2.716e+05	-1.579e+05	-2.288e+05	-6.975e+04
1	2	144	291.55-723.81-216.06	-216.21	-507.68	2.353e+06	-4.613e+06	-1.127e+06	-1.133e+06	3.483e+06
1	2	145	913.98-3.63143.01	767.34	-336.23	7.416e+06	1.025e+06	6.034e+06	2.407e+06	2.631e+06
1	2	146	-333.61 -1210.49	-403.08	-1141.01	-236.84	-2.871e+06	-9.387e+06	-7.871e+06	-4.387e+06 2.753e+06
1	2	147	105.14-381.6861.25	-337.80	139.42	3.346e+05	2.007e+05	2.819e+05	2.534e+05	-6.546e+04
1	2	148	608.00-143.50-82.22	546.73	205.65	-2.612e+05	-4.255e+05	-3.306e+05	-3.562e+05	-8.114e+04
1	2	149	610.32208.08258.60	559.80	133.30	4.751e+06	2.139e+06	4.742e+06	2.148e+06	1.490e+05
1	2	150	-208.52 -773.01	-422.08	-559.45	273.76	-3.025e+06	-5.653e+06	-5.643e+06	-3.035e+06 1.607e+05
1	2	151	657.92-372.3032.86	252.76	-503.24	5.655e+06	-1.355e+06	2.982e+06	1.318e+06	3.405e+06

1	2	152	-60.31-1089.86-465.12	-685.06	-502.89	-9.042e+05	-7.916e+06	-5.238e+06	-3.583e+06	3.407e+06			
1	2	153	805.41117.39117.39	805.40	2.20	7.622e+06	2.216e+06	7.127e+06	2.711e+06	1.559e+06			
1	2	154	-256.75	-1036.91	-303.55	-990.12	185.26	-3.605e+06	-9.240e+06	-8.630e+06	-4.215e+06	1.751e+06	
1	2	155	143.64-336.3695.50	-288.22	144.18	5.248e+05	3.444e+05	4.893e+05	3.799e+05	-7.174e+04			
1	2	156	562.70-196.97-130.75	496.49	214.28	-4.571e+05	-6.418e+05	-5.748e+05	-5.241e+05	-8.877e+04			
1	2	157	185.15-277.52132.74	-225.11	146.64	7.832e+05	5.162e+05	7.595e+05	5.399e+05	-7.593e+04			
1	2	158	690.66262.49302.21	650.95	124.20	5.784e+06	2.595e+06	5.761e+06	2.618e+06	2.706e+05			
1	2	159	-309.94	-873.30	-500.34	-682.90	266.48	-3.636e+06	-6.885e+06	-6.855e+06	-3.666e+06	3.112e+05	
1	2	160	499.35-254.94-184.16	428.57	219.94	-6.918e+05	-9.373e+05	-8.939e+05	-7.352e+05	-9.367e+04			
1	2	161	1011.95	-57.32	246.53	708.10	-482.26	8.772e+06	1.641e+06	6.871e+06	3.542e+06	3.154e+06	
1	2	162	-375.64	-1443.57	-679.15	-1140.05	-481.68	-3.899e+06	-1.103e+07	-9.128e+06	-5.806e+06	3.158e+06	
1	2	163	229.57-206.34172.68	-149.45	146.83	1.111e+06	7.193e+05	1.095e+06	7.358e+05	-7.869e+04			
1	2	164	418.91-317.16-242.15	343.91	222.67	-9.638e+05	-1.319e+06	-1.290e+06	-9.925e+05	-9.671e+04			
1	2	165	1106.03	312.78	350.00	1068.82	-167.74	9.435e+06	3.291e+06	8.721e+06	4.006e+06	1.969e+06	
1	2	166	-663.74	-1388.81	-667.64	-1384.91	-53.05	-5.108e+06	-1.144e+07	-1.063e+07	-5.915e+06	2.111e+06	
1	2	167	283.47-716.43-216.25	-216.71	-499.95	1.950e+06	-4.203e+06	-1.124e+06	-1.128e+06	3.077e+06			
1	2	168	766.61309.03345.60	730.04	124.08	7.051e+06	3.122e+06	6.990e+06	3.183e+06	4.863e+05			
1	2	169	-396.76	-979.32	-581.85	-794.23	271.24	-4.324e+06	-8.395e+06	-8.312e+06	-4.406e+06	5.734e+05	
1	2	170	277.03-124.49215.13	-62.60	144.99	1.513e+06	9.587e+05	1.501e+06	9.705e+05	-8.029e+04			
1	2	171	564.17-437.22-65.27	192.22	-483.86	4.615e+06	-1.544e+06	2.325e+06	7.464e+05	2.977e+06			
1	2	172	3.78-996.67-367.42	-625.47	-483.30	-7.083e+05	-6.868e+06	-4.574e+06	-3.002e+06	2.978e+06			
1	2	173	322.95-383.63-304.59	243.92	222.71	-1.280e+06	-1.789e+06	-1.770e+06	-1.300e+06	-9.806e+04			
1	2	174	327.73-34.12259.78	33.83	141.32	1.991e+06	1.239e+06	1.982e+06	1.248e+06	-8.082e+04			
1	2	175	213.32-454.29-371.26	130.28	220.32	-1.648e+06	-2.353e+06	-2.340e+06	-1.661e+06	-9.748e+04			
1	2	176	1324.83	204.37	402.93	1126.27	-427.85	1.148e+07	4.183e+06	1.030e+07	5.364e+06	2.687e+06	
1	2	177	-637.69	-1756.12	-836.11	-1557.71	-427.25	-6.441e+06	-1.374e+07	-1.256e+07	-7.627e+06	2.692e+06	
1	2	178	826.72-177.9774.06	574.69	-435.53	7.103e+06	9.281e+05	5.546e+06	2.485e+06	2.682e+06			
1	2	179	-255.96	-1258.75	-507.26	-1007.46	-434.56	-3.180e+06	-9.357e+06	-7.797e+06	-4.740e+06	2.684e+06	
1	2	180	832.39339.86385.13	787.13	142.29	8.677e+06	3.709e+06	8.512e+06	3.874e+06	8.915e+05			
1	2	181	-451.98	-1091.01	-663.03	-879.96	300.54	-5.061e+06	-1.033e+07	-1.011e+07	-5.283e+06	1.058e+06	
1	2	182	382.1961.98306.36	137.82	136.13	2.555e+06	1.565e+06	2.548e+06	1.571e+06	-7.959e+04			
1	2	183	92.38-529.19-441.98	5.17	215.87	-2.072e+06	-3.020e+06	-3.010e+06	-2.082e+06	-9.404e+04			
1	2	184	441.38160.15354.63	246.90	129.89	3.216e+06	1.941e+06	3.211e+06	1.946e+06	-7.494e+04			
1	2	185	-36.83-608.53-516.66	-128.69	209.95	-2.561e+06	-3.804e+06	-3.798e+06	-2.567e+06	-8.538e+04			
1	2	186	181.09-613.61-216.34	-216.18	-397.35	1.248e+06	-3.496e+06	-1.122e+06	-1.125e+06	2.372e+06			
1	2	187	388.36-407.19-113.00	94.16	-384.05	3.275e+06	-1.472e+06	1.513e+06	2.897e+05	2.293e+06			
1	2	188	-25.69-820.52-319.78	-526.43	-383.75	-7.752e+05	-5.522e+06	-3.758e+06	-2.540e+06	2.294e+06			
1	2	189	1225.62	583.59	585.99	1223.22	-39.21	1.095e+07	5.060e+06	1.067e+07	5.347e+06	1.268e+06	
1	2	190	-954.46	-1488.43	-961.26	-1481.63	59.88	-6.852e+06	-1.298e+07	-1.265e+07	-7.187e+06	1.391e+06	
1	2	191	1053.03	43.90	191.82	905.11	-356.91	9.244e+06	3.046e+06	8.325e+06	3.966e+06	2.203e+06	
1	2	192	-478.36	-1484.58	-625.78	-1337.16	-355.81	-5.298e+06	-1.150e+07	-1.058e+07	-6.220e+06	2.206e+06	
1	2	193	506.61255.77404.46	357.92	123.24	3.993e+06	2.374e+06	3.990e+06	2.377e+06	-6.306e+04			
1	2	194	-170.34	-692.78	-595.43	-267.69	203.42	-3.119e+06	-4.726e+06	-4.724e+06	-3.122e+06	-	
6.688e+04	1	2	195	582.01-215.32-17.21	383.90	-344.54	5.166e+06	4.100e+05	3.972e+06	1.604e+06	2.062e+06		
1	2	196	-217.97	-1013.81	-415.86	-815.92	-343.99	-2.658e+06	-7.414e+06	-6.218e+06	-3.854e+06	2.064e+06	
1	2	197	578.69343.96455.93	466.71	117.24	4.917e+06	2.869e+06	4.917e+06	2.870e+06	-3.635e+04			
1	2	198	-302.88	-782.72	-678.76	-406.85	197.68	-3.752e+06	-5.823e+06	-5.823e+06	-3.752e+06	-	
2.960e+04	1	2	199	1570.00	400.27	499.15	1471.12	-325.40	1.357e+07	6.116e+06	1.300e+07	6.684e+06	1.978e+06
1	2	200	-833.99	-2000.90	-932.95	-1901.94	-325.09	-8.374e+06	-1.584e+07	-1.526e+07	-8.945e+06	1.983e+06	
1	2	201	655.76421.18509.63	567.30	113.69	6.039e+06	3.428e+06	6.039e+06	3.429e+06	2.029e+04			
1	2	202	-427.14	-879.65	-767.93	-538.86	195.12	-4.459e+06	-7.152e+06	-7.151e+06	-4.460e+06	4.388e+04	
1	2	203	748.85-51.0064.36	633.49	-281.00	6.792e+06	2.024e+06	6.090e+06	2.726e+06	1.690e+06			
1	2	204	-382.77	-1180.24	-497.92	-1065.09	-280.30	-4.271e+06	-9.040e+06	-8.336e+06	-4.975e+06	1.692e+06	
1	2	205	57.59-490.50-216.61	-216.31	-274.04	5.232e+05	-2.767e+06	-1.121e+06	-1.123e+06	1.645e+06			
1	2	206	199.47-349.15-147.39	-2.29	-264.55	1.914e+06	-1.376e+06	6.963e+05	-1.582e+05	1.589e+06			
1	2	207	-84.14-632.04-285.91	-430.28	-264.27	-8.673e+05	-4.158e+06	-2.939e+06	-2.087e+06	1.589e+06			
1	2	208	732.03485.70567.24	650.49	115.92	7.447e+06	4.045e+06	7.441e+06	4.050e+06	1.376e+05			
1	2	209	-532.09	-985.82	-865.78	-652.12	200.14	-5.227e+06	-8.811e+06	-8.801e+06	-5.237e+06	1.883e+05	
1	2	210	1227.46	213.59	280.67	1160.38	-252.01	1.089e+07	4.668e+06	1.047e+07	5.091e+06	1.566e+06	
1	2	211	-648.61	-1658.47	-715.51	-1591.57	-251.16	-6.920e+06	-1.314e+07	-1.272e+07	-7.345e+06	1.569e+06	
1	2	212	331.92-217.64-82.86	197.14	-236.44	3.212e+06	-8.174e+04	2.390e+06	7.396e+05	1.425e+06			
1	2	213	-216.07	-764.14	-350.67	-629.54	-235.91	-2.162e+06	-5.455e+06	-4.633e+06	-2.984e+06	1.425e+06	
1	2	214	799.66529.99630.08	699.57	130.28	9.305e+06	4.681e+06	9.274e+06	4.712e+06	3.808e+05			
1	2	215	-596.20	-1103.89	-975.06	-725.03	220.93	-6.005e+06	-1.099e+07	-1.094e+07	-6.051e+06	4.773e+05	
1	2	216	877.5174.64126.43	825.72	-197.23	8.041e+06	3.259e+06	7.720e+06	3.581e+06	1.198e+06			
1	2	217	-508.97	-1308.43	-560.63	-1256.76	-196.55	-5.508e+06	-1.029e+07	-9.967e+06	-5.830e+06	1.199e+06	
1	2	218	445.99-104.99-27.35	368.36	-191.70	4.326e+06	1.029e+06	3.846e+06	1.509e+06	1.163e+06			
1	2	219	-329.20	-877.87	-406.58	-800.49	-190.96	-3.273e+06	-6.569e+06	-6.089e+06	-3.754e+06	1.163e+06	
1	2	220	1277.92	777.18	777.51	1277.59	12.93	1.189e+07	6.186e+06	1.183e+07	6.252e+06	6.074e+05	
1	2	221	-1179.59	-1509.02	-1194.98	-1493.63	69.52	-7.962e+06	-1.394e+07	-1.386e+07	-8.040e+06	6.794e+05	
1	2	222	1726.54	521.40	547.14	1700.80	-174.23	1.489e+07	7.322e+06	1.474e+07	7.470e+06	1.050e+06	
1	2	223	-955.54	-2156.94	-981.48	-2130.99	-174.63	-9.581e+06	-1.716e+07	-1.701e+07	-9.730e+06	1.054e+06	
1	2	224	-72.06-361.53-217.00	-216.59	-144.73	-2.258e+05	-2.014e+06	-1.120e+06	-1.120e+06	8.943e+05			
1	2	225	5.70-284.76-178.18	-100.87	-139.99	5.331e+05	-1.257e+06	-1.293e+05	-5.945e+05	8.642e+05			





1	2	294	964.56150.06166.56	948.07	114.73	8.830e+06	4.024e+06	8.744e+06	4.110e+06	-6.392e+05	-		
1	2	295	-587.18 -1392.88	-603.65	-1376.41	114.03	-6.276e+06	-1.107e+07	-1.099e+07	-6.362e+06	-		
6.389e+05	1	2	296	151.94-164.59-113.19	100.54	116.74	1.866e+06	4.038e+04	1.590e+06	3.157e+05	-6.532e+05	-	
6.560e+05	1	2	297	-271.06 -588.20	-323.94	-535.31	118.22	-2.272e+06	-4.102e+06	-3.825e+06	-2.549e+06	-	
7.987e+05	1	2	298	90.59-227.74-143.42	6.28	140.47	1.261e+06	-5.668e+05	7.961e+05	-1.016e+05	-7.963e+05	-	
8.332e+05	1	2	299	-208.18 -527.91	-294.09	-442.00	141.73	-1.663e+06	-3.497e+06	-3.030e+06	-2.130e+06	-	
8.301e+05	1	2	300	1342.65 318.32	339.06	1321.91	144.27	1.192e+07	5.672e+06	1.181e+07	5.786e+06	-	
8.443e+05	1	2	301	-755.69 -1770.41	-775.80	-1750.30	141.42	-7.932e+06	-1.418e+07	-1.406e+07	-8.044e+06	-	
8.874e+05	1	2	302	542.45-26.22	15.38	500.85	148.08	5.191e+06	1.867e+06	4.963e+06	2.096e+06	-8.409e+05	-
1.072e+06	1	2	303	-411.04 -974.35	-454.06	-931.34	149.60	-4.109e+06	-7.429e+06	-7.199e+06	-4.339e+06	-	
1.069e+06	1	2	304	18.98-300.87-179.57	-102.32	155.19	5.573e+05	-1.274e+06	-1.270e+05	-5.896e+05	-8.859e+05	-	
6.237e+05	1	2	305	-135.58 -456.55	-258.21	-333.93	155.96	-9.559e+05	-2.791e+06	-2.107e+06	-1.640e+06	-	
6.894e+05	1	2	306	-58.14-379.00-218.95	-218.19	160.43	-1.988e+05	-2.033e+06	-1.117e+06	-1.115e+06	-9.169e+05	-	
1.189e+06	1	2	307	1730.15 520.90	551.69	1699.37	190.48	1.489e+07	7.310e+06	1.474e+07	7.465e+06	-	
1.222e+06	1	2	308	-955.98 -2158.51	-985.80	-2128.69	186.99	-9.575e+06	-1.716e+07	-1.700e+07	-9.729e+06	-	
4.824e+05	1	2	309	1275.94 782.97	782.97	1275.93	2.00	1.189e+07	6.180e+06	1.182e+07	6.249e+06	-	
1.454e+06	1	2	310	-1187.95 -1502.83	-1199.24	-1491.54	-58.54	-7.959e+06	-1.393e+07	-1.385e+07	-8.040e+06	-	
1.595e+06	1	2	311	457.06-115.62-27.62	369.06	206.53	4.341e+06	1.013e+06	3.845e+06	1.508e+06	-1.184e+06	-	
1.588e+06	1	2	312	-321.57 -891.57	-412.48	-800.67	208.69	-3.248e+06	-6.577e+06	-6.078e+06	-3.748e+06	-	
1.915e+05	1	2	313	888.5968.14128.54	828.19	214.25	8.048e+06	3.238e+06	7.714e+06	3.572e+06	-1.222e+06	-	
1.717e+06	1	2	314	-506.94 -1315.46	-567.47	-1254.93	212.78	-5.493e+06	-1.029e+07	-9.955e+06	-5.827e+06	-	
4.597e+04	1	2	315	787.43546.61636.68	697.36	-116.52	9.299e+06	4.678e+06	9.266e+06	4.711e+06	-3.894e+05	-	
2.007e+06	1	2	316	-604.03 -1098.34	-979.42	-722.95	-211.28	-6.003e+06	-1.099e+07	-1.094e+07	-6.051e+06	-	
1.999e+06	1	2	317	344.12-231.94-83.76	195.94	251.80	3.233e+06	-9.897e+04	2.391e+06	7.430e+05	-1.448e+06	-	
2.095e+06	1	2	318	-205.22 -782.95	-357.52	-630.65	254.55	-2.128e+06	-5.468e+06	-4.620e+06	-2.976e+06	-	
2.243e+06	1	2	319	1238.22 210.09	287.31	1161.00	270.97	1.089e+07	4.642e+06	1.045e+07	5.080e+06	-	
2.228e+06	1	2	320	-649.03 -1663.08	-724.02	-1588.09	265.36	-6.907e+06	-1.314e+07	-1.270e+07	-7.342e+06	-	
1.287e+06	1	2	321	721.09500.33573.94	647.48	-104.07	7.441e+06	4.043e+06	7.435e+06	4.049e+06	-1.427e+05	-	
1.401e+06	1	2	322	-538.73 -981.08	-869.92	-649.88	-191.87	-5.225e+06	-8.809e+06	-8.798e+06	-5.236e+06	-	
	1	2	323	212.71-367.74-149.78	-5.25	281.09	1.946e+06	-1.394e+06	7.003e+05	-1.492e+05	-1.615e+06	-	
	1	2	324	-70.72-654.49-292.42	-432.78	283.33	-8.264e+05	-4.175e+06	-2.926e+06	-2.075e+06	-1.619e+06	-	
	1	2	325	71.63-512.73-221.30	-219.81	292.18	5.628e+05	-2.786e+06	-1.112e+06	-1.110e+06	-1.674e+06	-	
	1	2	326	766.41-61.8666.20	638.35	299.45	6.805e+06	1.992e+06	6.084e+06	2.713e+06	-1.718e+06	-	
	1	2	327	-379.07 -1192.13	-508.48	-1062.72	297.44	-4.247e+06	-9.041e+06	-8.317e+06	-4.971e+06	-	
	1	2	328	646.41433.45515.92	563.95	-103.74	6.034e+06	3.427e+06	6.034e+06	3.427e+06	-2.310e+04	-	
	1	2	329	-432.37 -875.96	-771.72	-536.61	-188.08	-4.457e+06	-7.150e+06	-7.149e+06	-4.458e+06	-	
	1	2	330	1578.23 399.10	509.51	1467.81	343.51	1.356e+07	6.091e+06	1.298e+07	6.676e+06	-	
	1	2	331	-835.15 -2004.16	-941.95	-1897.35	336.82	-8.363e+06	-1.583e+07	-1.525e+07	-8.943e+06	-	
	1	2	332	571.41353.46461.55	463.32	-108.97	4.914e+06	2.867e+06	4.913e+06	2.868e+06	3.501e+04	-	
	1	2	333	-306.75 -780.06	-682.15	-404.66	-191.71	-3.751e+06	-5.822e+06	-5.822e+06	-3.751e+06	2.826e+04	-
	1	2	334	598.63-229.16-15.68	385.16	362.13	5.188e+06	3.797e+05	3.969e+06	1.599e+06	-2.092e+06	-	
	1	2	335	-211.35 -1032.66	-430.22	-813.79	363.12	-2.619e+06	-7.419e+06	-6.190e+06	-3.847e+06	-	
	1	2	336	501.57262.42409.33	354.66	-116.41	3.990e+06	2.372e+06	3.988e+06	2.375e+06	6.261e+04	-	
	1	2	337	-173.09 -690.95	-598.42	-265.63	-198.39	-3.118e+06	-4.725e+06	-4.723e+06	-3.121e+06	6.602e+04	-
	1	2	338	1074.49 36.78	202.88	908.39	380.49	9.249e+06	3.001e+06	8.299e+06	3.950e+06	-	
	1	2	339	-478.96 -1492.61	-639.59	-1331.98	370.16	-5.277e+06	-1.149e+07	-1.055e+07	-6.218e+06	-	
	1	2	340	1223.88 595.06	599.85	1219.09	54.66	1.094e+07	5.047e+06	1.064e+07	5.343e+06	-	
	1	2	341	-965.43 -1482.19	-970.25	-1477.37	-49.67	-6.846e+06	-1.297e+07	-1.263e+07	-7.185e+06	-	
	1	2	342	401.34-428.56-115.42	88.20	402.27	3.317e+06	-1.493e+06	1.518e+06	3.060e+05	-2.327e+06	-	

1	2	343	-13.77-849.90-337.39	-526.28	407.26	-7.160e+05	-5.537e+06	-3.724e+06	-2.529e+06	-2.335e+06		
1	2	344	195.89-646.87-229.20	-221.78	421.36	1.318e+06	-3.519e+06	-1.096e+06	-1.105e+06	-2.419e+06		
1	2	345	438.22164.40358.77	243.86	-124.27	3.214e+06	1.940e+06	3.209e+06	1.944e+06	7.502e+04		
1	2	346	-38.71-607.32-519.25	-126.78	-205.71	-2.560e+06	-3.803e+06	-3.797e+06	-2.566e+06	8.482e+04		
1	2	347	380.3564.51309.82	135.03	-131.53	2.553e+06	1.563e+06	2.547e+06	1.570e+06	7.996e+04		
1	2	348	91.14-528.41-444.20	6.92	-212.33	-2.072e+06	-3.019e+06	-3.010e+06	-2.081e+06	9.367e+04		
1	2	349	821.47361.28401.08	781.67	-129.35	8.664e+06	3.703e+06	8.494e+06	3.873e+06	-9.000e+05		
1	2	350	-464.64 -1083.25	-672.10	-875.79	-292.05	-5.058e+06	-1.033e+07	-1.010e+07	-5.281e+06	-	
1.062e+06	1	2	351	879.12-192.5593.44	593.13	474.02	7.137e+06	8.176e+05	5.521e+06	2.433e+06	-2.757e+06	
1	2	352	-256.40 -1272.29	-528.13	-1000.56	449.67	-3.147e+06	-9.349e+06	-7.756e+06	-4.740e+06	-	
2.710e+06	1	2	353	1339.95 199.62	421.39	1118.17	451.35	1.147e+07	4.138e+06	1.025e+07	5.358e+06	-
2.730e+06	1	2	354	-640.15 -1761.33	-850.71	-1550.77	437.88	-6.424e+06	-1.373e+07	-1.253e+07	-7.625e+06	-
2.709e+06	1	2	355	326.71-32.76262.64	31.31	-137.58	1.990e+06	1.238e+06	1.981e+06	1.246e+06	8.131e+04	
1	2	356	212.55-453.81-373.13	131.88	-217.37	-1.647e+06	-2.353e+06	-2.339e+06	-1.661e+06	9.723e+04		
1	2	357	276.51-123.91217.45	-64.85	-141.99	1.512e+06	9.577e+05	1.500e+06	9.697e+05	8.081e+04		
1	2	358	559.25-441.41-51.23	169.07	488.06	4.655e+06	-1.548e+06	2.309e+06	7.979e+05	-3.008e+06		
1	2	359	5.37-1022.07-398.92	-617.78	501.93	-6.508e+05	-6.862e+06	-4.509e+06	-3.004e+06	-3.013e+06		
1	2	360	322.54-383.35-306.15	245.35	-220.30	-1.280e+06	-1.789e+06	-1.769e+06	-1.299e+06	9.788e+04		
1	2	361	756.85327.14360.38	723.60	-114.81	7.039e+06	3.118e+06	6.977e+06	3.181e+06	-4.908e+05		
1	2	362	-407.33 -972.83	-590.22	-789.94	-264.53	-4.320e+06	-8.390e+06	-8.307e+06	-4.404e+06	-	
5.764e+05	1	2	363	296.77-787.05-282.21	-208.07	540.64	2.119e+06	-4.235e+06	-9.929e+05	-1.123e+06	-3.176e+06	
1	2	364	1105.93 338.13	383.22	1060.84	180.51	9.401e+06	3.271e+06	8.668e+06	4.004e+06	-	
1.989e+06	1	2	365	-676.95 -1383.84	-682.35	-1378.44	61.53	-5.098e+06	-1.142e+07	-1.061e+07	-5.914e+06	-
2.120e+06	1	2	366	229.34-206.26174.53	-151.45	-144.47	1.111e+06	7.185e+05	1.095e+06	7.352e+05	7.915e+04	
1	2	367	418.75-317.00-243.43	345.18	-220.73	-9.634e+05	-1.318e+06	-1.290e+06	-9.920e+05	9.658e+04		
1	2	368	1032.68 -78.24	267.45	686.99	514.32	8.824e+06	1.566e+06	6.814e+06	3.577e+06	-	
3.248e+06	1	2	369	-380.24 -1451.15	-701.32	-1130.07	490.67	-3.874e+06	-1.102e+07	-9.083e+06	-5.808e+06	-
3.174e+06	1	2	370	185.09-277.77134.17	-226.86	-144.82	7.834e+05	5.157e+05	7.595e+05	5.395e+05	7.631e+04	
1	2	371	682.26277.31315.03	644.54	-117.70	5.775e+06	2.591e+06	5.751e+06	2.615e+06	-2.729e+05		
1	2	372	-318.42 -868.09	-507.78	-678.73	-261.20	-3.633e+06	-6.882e+06	-6.851e+06	-3.663e+06	-	
3.132e+05	1	2	373	499.37-254.87-185.18	429.68	-218.42	-6.916e+05	-9.370e+05	-8.937e+05	-7.349e+05	9.357e+04	
1	2	374	143.65-336.8396.57	-289.74	-142.85	5.250e+05	3.439e+05	4.893e+05	3.796e+05	7.205e+04		
1	2	375	562.85-196.95-131.53	497.44	-213.13	-4.570e+05	-6.415e+05	-5.747e+05	-5.238e+05	8.868e+04		
1	2	376	795.07148.29148.34	795.03	5.37	7.596e+06	2.211e+06	7.095e+06	2.712e+06	1.564e+06		
1	2	377	-272.74 -1029.27	-317.94	-984.07	-179.32	-3.600e+06	-9.231e+06	-8.618e+06	-4.213e+06	-	
1.754e+06	1	2	378	659.48-367.0537.98	254.45	501.72	5.704e+06	-1.387e+06	2.997e+06	1.320e+06	-3.445e+06	
1	2	379	-66.69-1098.90-498.40	-667.19	509.16	-8.706e+05	-7.889e+06	-5.163e+06	-3.597e+06	-3.421e+06		
1	2	380	603.43219.71269.30	553.84	-128.72	4.744e+06	2.136e+06	4.735e+06	2.144e+06	-1.502e+05		
1	2	381	-215.07 -769.02	-428.54	-555.54	-269.60	-3.023e+06	-5.650e+06	-5.640e+06	-3.033e+06	-	
1.622e+05	1	2	382	105.19-382.2862.01	-339.09	-138.51	3.347e+05	2.003e+05	2.819e+05	2.531e+05	6.567e+04	
1	2	383	608.24-143.50-82.78	547.52	-204.84	-2.612e+05	-4.253e+05	-3.305e+05	-3.560e+05	8.107e+04		
1	2	384	907.7889.75251.32	746.21	325.68	7.284e+06	1.020e+06	5.869e+06	2.435e+06	-2.620e+06		
1	2	385	-350.76 -1207.38	-425.36	-1132.77	241.54	-2.858e+06	-9.366e+06	-7.837e+06	-4.387e+06	-	
2.759e+06	1	2	386	286.65-717.52-249.34	-181.54	500.94	2.378e+06	-4.594e+06	-1.013e+06	-1.203e+06	-3.484e+06	
1	2	387	69.71-413.3330.61	-374.23	-131.75	2.037e+05	8.884e+04	1.345e+05	1.580e+05	5.622e+04		
1	2	388	634.88-94.48-38.94	579.33	-193.46	-1.151e+05	-2.714e+05	-1.579e+05	-2.287e+05	6.968e+04		
1	2	389	525.10156.31224.36	457.04	-143.06	3.880e+06	1.745e+06	3.877e+06	1.748e+06	-7.660e+04		
1	2	390	-105.02 -675.81	-353.03	-427.79	-282.94	-2.489e+06	-4.618e+06	-4.616e+06	-2.491e+06	-	
7.064e+04	1	2	391	37.09-429.97 2.28	-395.16	-122.66	1.175e+05	2.117e+04	4.534e+04	9.336e+04	4.177e+04	
1	2	392	642.88-49.68 0.23	592.97	-179.09	-2.855e+04	-1.648e+05	-5.351e+04	-1.399e+05	5.270e+04		
1	2	393	737.40127.72127.80	737.32	7.09	6.294e+06	1.757e+06	6.003e+06	2.048e+06	-1.112e+06		
1	2	394	-228.89 -928.87	-267.91	-889.85	-160.59	-2.978e+06	-7.628e+06	-7.286e+06	-3.320e+06	-	
1.214e+06	1	2	395	636.40-287.0314.37	335.00	432.99	4.974e+06	-1.551e+06	2.753e+06	6.693e+05	-3.091e+06	
1	2	396	-16.73-963.05-251.57	-728.21	408.76	-2.980e+05	-6.915e+06	-4.481e+06	-2.733e+06	-3.191e+06		
1	2	397	267.42-660.54-161.47	-231.65	462.65	2.376e+06	-4.169e+06	-7.920e+05	-1.001e+06	-3.271e+06		
1	2	398	5.00-428.83 -23.13	-400.70	-106.84	7.955e+04	2746.30	7848.65	7.444e+04	1.913e+04		
1	2	399	631.55-7.04 34.80	589.70	-158.03	-3342.38	-1.173e+05	-1.094e+04	-1.097e+05	2.843e+04		
1	2	400	709.73-77.94-14.79	646.58	213.91	6.122e+06	3.525e+05	5.023e+06	1.451e+06	-2.265e+06		
1	2	401	-56.33-926.05-62.63	-919.75	73.79	-1.771e+06	-7.732e+06	-6.452e+06	-3.051e+06	-2.448e+06		
1	2	402	450.8688.27180.93	358.20	-158.15	3.145e+06	1.410e+06	3.145e+06	1.411e+06	-2.918e+04		
1	2	403	6.54-588.70-281.64	-300.52	-297.47	-2.025e+06	-3.741e+06	-3.740e+06	-2.025e+06	-1.196e+04		

1	2	404	671.1096.18 96.19	671.08	-2.99	5.230e+06	1.398e+06	5.042e+06	1.586e+06	-8.285e+05	
1	2	405	-162.13 -830.31	-205.31	-787.13	-164.28	-2.448e+06	-6.329e+06	-6.120e+06	-2.658e+06	-
8.769e+05											
1	2	406	382.7017.21139.50	260.40	-172.46	2.516e+06	1.122e+06	2.516e+06	1.122e+06	3766.59	
1	2	407	115.48-507.62-214.74	-177.39	-310.99	-1.623e+06	-2.990e+06	-2.990e+06	-1.624e+06	2.783e+04	
1	2	408	577.33-345.88-72.07	303.52	421.68	4.364e+06	-1.731e+06	2.385e+06	2.483e+05	-2.854e+06	
1	2	409	161.93-773.7422.61	-634.42	333.09	2.719e+05	-5.900e+06	-3.705e+06	-1.924e+06	-2.955e+06	
1	2	410	666.20-90.18-27.38	603.40	208.71	5.198e+06	1.141e+05	4.371e+06	9.411e+05	-1.876e+06	
1	2	411	-28.73-839.34-35.15	-832.92	71.84	-1.352e+06	-6.514e+06	-5.599e+06	-2.266e+06	-1.971e+06	
1	2	412	373.52-581.99-13.25	-195.22	469.01	2.371e+06	-3.850e+06	-6.449e+05	-8.340e+05	-3.109e+06	
1	2	413	598.9261.36 62.10	598.17	-19.95	4.335e+06	1.114e+06	4.205e+06	1.244e+06	-6.338e+05	
1	2	414	-86.17-734.22-140.36	-680.03	-179.40	-2.003e+06	-5.239e+06	-5.103e+06	-2.139e+06	-6.485e+05	
1	2	415	321.21-54.57100.50	166.14	-185.00	1.977e+06	8.754e+05	1.976e+06	8.762e+05	2.820e+04	
1	2	416	218.38-432.26-152.68	-61.20	-322.09	-1.275e+06	-2.349e+06	-2.347e+06	-1.278e+06	5.611e+04	
1	2	417	266.04-124.3464.25	77.45	-195.08	1.518e+06	6.642e+05	1.515e+06	6.667e+05	4.690e+04	
1	2	418	312.40-362.32-95.77	45.85	-329.85	-9.764e+05	-1.805e+06	-1.798e+06	-9.836e+05	7.678e+04	
1	2	419	545.86-323.55-60.71	283.03	399.29	3.805e+06	-1.665e+06	2.103e+06	3.690e+04	-2.533e+06	
1	2	420	174.78-705.1244.52	-574.86	312.48	4.118e+05	-5.087e+06	-3.279e+06	-1.396e+06	-2.583e+06	
1	2	421	613.79-100.81-43.68	556.66	193.80	4.380e+06	-1.089e+04	3.730e+06	6.388e+05	-1.559e+06	
1	2	422	13.95-753.30 9.65	-749.00	57.32	-1.046e+06	-5.469e+06	-4.780e+06	-1.735e+06	-1.603e+06	
1	2	423	524.1724.97 28.25	520.88	-40.38	3.570e+06	8.845e+05	3.477e+06	9.770e+05	-4.897e+05	
1	2	424	-6.38-641.83-76.94	-571.28	-199.65	-1.627e+06	-4.309e+06	-4.219e+06	-1.717e+06	-4.833e+05	
1	2	425	371.61-533.274.95	-166.61	444.23	2.175e+06	-3.435e+06	-5.812e+05	-6.793e+05	-2.805e+06	
1	2	426	216.49-189.3931.08	-3.97	-202.18	1.131e+06	4.846e+05	1.125e+06	4.904e+05	6.114e+04	
1	2	427	395.18-297.53-44.30	141.96	-333.60	-7.208e+05	-1.348e+06	-1.334e+06	-7.344e+05	9.155e+04	
1	2	428	449.97-12.52 -4.04	441.49	-62.06	2.911e+06	6.958e+05	2.844e+06	7.619e+05	-3.768e+05	
1	2	429	74.12-554.50-17.09	-463.29	-221.40	-1.307e+06	-3.510e+06	-3.450e+06	-1.366e+06	-3.571e+05	
1	2	430	511.22-303.29-56.74	264.67	374.21	3.257e+06	-1.509e+06	1.808e+06	-6.048e+04	-2.192e+06	
1	2	431	193.49-637.0975.80	-519.41	289.65	4.471e+05	-4.330e+06	-2.833e+06	-1.050e+06	-2.216e+06	
1	2	432	171.89-247.331.26	-76.69	-205.95	8.125e+05	3.339e+05	8.018e+05	3.446e+05	7.100e+04	
1	2	433	464.86-237.721.47	225.67	-332.93	-5.044e+05	-9.724e+05	-9.495e+05	-5.273e+05	1.010e+05	
1	2	434	555.12-109.91-61.80	507.00	172.29	3.663e+06	-7.432e+04	3.143e+06	4.456e+05	-1.293e+06	
1	2	435	60.86-667.6459.16	-665.93	35.15	-8.160e+05	-4.563e+06	-4.032e+06	-1.347e+06	-1.307e+06	
1	2	436	364.62-486.1922.13	-143.70	417.25	1.917e+06	-2.981e+06	-5.093e+05	-5.550e+05	-2.449e+06	
1	2	437	131.58-296.13-24.98	-139.57	-206.04	5.568e+05	2.097e+05	5.391e+05	2.274e+05	6.731e+04	
1	2	438	519.82-182.6841.33	295.81	-327.39	-3.239e+05	-6.726e+05	-6.372e+05	-3.592e+05	1.052e+05	
1	2	439	378.90-50.92-34.04	362.02	-83.50	2.342e+06	5.380e+05	2.296e+06	5.841e+05	-2.847e+05	
1	2	440	152.95-473.1637.98	-358.19	-242.42	-1.033e+06	-2.822e+06	-2.784e+06	-1.071e+06	-2.569e+05	
1	2	441	492.50-117.74-80.11	454.86	146.80	3.036e+06	-1.048e+05	2.618e+06	3.131e+05	-1.067e+06	
1	2	442	108.31-583.39108.19	-583.28	8.85	-6.354e+05	-3.775e+06	-3.362e+06	-1.049e+06	-1.062e+06	
1	2	443	472.15-282.44-55.95	245.66	345.85	2.752e+06	-1.324e+06	1.530e+06	-1.019e+05	-1.868e+06	
1	2	444	211.27-568.21109.49	-466.42	262.64	4.342e+05	-3.646e+06	-2.409e+06	-8.022e+05	-1.875e+06	
1	2	445	95.23-334.32-47.46	-191.63	-202.31	3.604e+05	1.112e+05	3.343e+05	1.373e+05	7.632e+04	
1	2	446	559.03-132.4475.12	351.47	-116.92	-1.793e+05	-4.438e+05	-3.945e+05	-2.286e+05	1.030e+05	
1	2	447	353.03-438.6438.87	-124.48	387.32	1.653e+06	-2.542e+06	-4.383e+05	-4.515e+05	-2.097e+06	
1	2	448	312.90-89.92-61.24	284.22	-103.59	1.852e+06	4.048e+05	1.822e+06	4.353e+05	-2.079e+05	
1	2	449	227.97-398.2287.52	-257.77	-261.19	-7.989e+05	-2.230e+06	-2.208e+06	-8.208e+05	-1.756e+05	
1	2	450	62.49-360.82-66.06	-232.27	-194.65	2.177e+05	3.996e+04	1.838e+05	7.390e+04	6.986e+04	
1	2	451	581.74-86.80102.82	392.13	-301.35	-7.366e+04	-2.776e+05	-2.170e+05	-1.343e+05	9.323e+04	
1	2	452	428.14-124.56-97.53	401.12	119.18	2.490e+06	-1.178e+05	2.156e+06	2.162e+05	-8.715e+05	
1	2	453	154.67-502.14154.11	-501.58	-19.20	-4.894e+05	-3.091e+06	-2.771e+06	-8.096e+05	-8.546e+05	
1	2	454	429.22-260.51-56.59	225.30	314.75	2.300e+06	-1.138e+06	1.278e+06	-1.163e+05	-1.571e+06	
1	2	455	226.51-499.07142.40	-414.97	232.27	4.001e+05	-3.037e+06	-2.022e+06	-6.150e+05	-1.568e+06	
1	2	456	32.98-375.33-81.02	-261.33	-183.17	1.200e+05	1897.43	8.310e+04	3.881e+04	5.474e+04	
1	2	457	587.95-45.44124.77	417.74	-280.78	-1.353e+04	-1.626e+05	-9.918e+04	-7.692e+04	7.368e+04	
1	2	458	253.22-128.90-85.27	209.59	-121.52	1.433e+06	2.923e+05	1.415e+06	3.106e+05	-1.435e+05	
1	2	459	297.14-329.73131.00	-163.58	-276.67	5.989e+05	-1.726e+06	-1.715e+06	-6.096e+05	-1.089e+05	
1	2	460	337.29-390.3654.65	-107.72	354.65	1.402e+06	-2.138e+06	-3.717e+05	-3.644e+05	-1.770e+06	
1	2	461	4.40-374.43 -87.30	-282.72	-162.27	6.959e+04	2417.36	1.912e+04	5.289e+04	2.904e+04	
1	2	462	577.08-6.44136.43	434.21	-250.91	-3027.74	-1.071e+05	-2.896e+04	-8.116e+04	4.501e+04	
1	2	463	364.04-130.67-113.38	346.75	90.84	2.015e+06	-1.218e+05	1.751e+06	1.416e+05	-7.025e+05	
1	2	464	199.06-425.34195.45	-421.73	-47.32	-3.691e+05	-2.497e+06	-2.253e+06	-6.135e+05	-6.786e+05	
1	2	465	200.40-166.79-105.83	139.44	-136.63	1.079e+06	1.978e+05	1.070e+06	2.070e+05	-8.981e+04	
1	2	466	358.59-267.49168.03	-76.92	-288.09	-4.294e+05	-1.300e+06	-1.297e+06	-4.328e+05	-5.462e+04	
1	2	467	383.48-237.59-57.77	203.66	281.68	1.900e+06	-9.621e+05	1.055e+06	-1.177e+05	-1.305e+06	
1	2	468	238.91-430.91172.81	-364.81	199.76	3.581e+05	-2.501e+06	-1.675e+06	-4.672e+05	-1.295e+06	
1	2	469	318.09-341.8269.01	-92.74	319.89	1.173e+06	-1.775e+06	-3.109e+05	-2.907e+05	-1.474e+06	
1	2	470	154.43-202.19-122.66	74.90	-148.45	7.854e+05	1.198e+05	7.821e+05	1.231e+05	-4.642e+04	
1	2	471	410.65-211.21198.35	1.09	-294.87	-2.876e+05	-9.479e+05	-9.477e+05	-2.878e+05	-1.167e+04	
1	2	472	301.94-136.37-127.18	292.74	62.81	1.604e+06	-1.214e+05	1.400e+06	8.206e+04	-5.564e+05	
1	2	473	240.77-354.06231.36	-344.65	-74.21	-2.686e+05	-1.985e+06	-1.803e+06	-4.507e+05	-5.285e+05	
1	2	474	336.12-214.02-59.01	181.11	247.48	1.548e+06	-8.023e+05	8.595e+05	-1.136e+05	-1.070e+06	
1	2	475	248.64-365.04199.69	-316.09	166.26	3.149e+05	-2.032e+06	-1.370e+06	-3.473e+05	-1.056e+06	
1	2	476	114.73-233.43-135.54	16.84	-156.52	5.468e+05	5.750e+04	5.465e+05	5.784e+04	-1.284e+04	
1	2	477	451.78-160.50221.71	69.58	-296.54	-1.716e+05	-6.627e+05	-6.618e+05	-1.725e+05	2.064e+04	
1	2	478	296.20-293.7781.61	-79.18	283.82	9.690e+05	-1.454e+06	-2.565e+05	-2.284e+05	-1.211e+06	

1	2	479	243.38-141.95-138.56	239.99	35.95	1.251e+06	-1.187e+05	1.098e+06	3.388e+04	-4.309e+05
1	2	480	279.06-289.01261.28	-271.23	-98.91	-1.843e+05	-1.546e+06	-1.416e+06	-3.149e+05	-4.010e+05
1	2	481	288.27-190.21-60.01	158.07	212.95	1.242e+06	-6.604e+05	6.895e+05	-1.075e+05	-8.639e+05
1	2	482	256.00-302.64222.44	-269.07	132.76	2.738e+05	-1.625e+06	-1.103e+06	-2.487e+05	-8.480e+05
1	2	483	80.70-258.97-144.38	-33.89	-160.60	3.599e+05	1.092e+04	3.596e+05	1.125e+04	1.083e+04
1	2	484	480.92-115.14238.04	127.74	-292.88	-8.184e+04	-4.406e+05	-4.357e+05	-8.677e+04	4.178e+04
1	2	485	189.69-147.62-147.27	189.33	10.96	9.514e+05	-1.148e+05	8.415e+05	-4857.75	-3.242e+05
1	2	486	313.08-230.52284.84	-202.28	-120.64	-1.140e+05	-1.175e+06	-1.086e+06	-2.028e+05	-2.937e+05
1	2	487	272.43-246.9692.26	-66.79	247.22	7.892e+05	-1.173e+06	-2.084e+05	-1.759e+05	-9.812e+05
1	2	488	51.59-277.45-149.10	-76.76	-160.49	2.197e+05	-1.806e+04	2.171e+05	-3.455e+04	2.442e+04
1	2	489	497.20-74.71247.35	175.13	-283.67	-2.022e+04	-2.750e+05	-2.642e+05	-3.109e+04	5.148e+04
1	2	490	240.99-166.56-60.55	134.97	178.79	9.787e+05	-5.364e+05	5.431e+05	-1.009e+05	-6.857e+05
1	2	491	261.30-244.72240.65	-224.07	100.12	2.362e+05	-1.275e+06	-8.720e+05	-1.671e+05	-6.686e+05
1	2	492	141.98-153.55-153.10	141.53	-11.59	7.012e+05	-1.096e+05	6.261e+05	-3.455e+04	2.351e+05
1	2	493	341.90-178.63301.82	-138.54	-138.77	-5.653e+04	-8.649e+05	-8.091e+05	-1.123e+05	-2.049e+05
1	2	494	26.62-288.14-150.03	-111.49	-156.20	1.184e+05	-2.396e+04	1.129e+05	-1.839e+04	2.761e+04
1	2	495	500.44-38.74250.08	211.62	-268.90	7977.90	-1.567e+05	-1.401e+05	-8587.19	4.953e+04
1	2	496	247.50-202.14100.83	-55.47	210.80	6.329e+05	-9.310e+05	-1.665e+05	-1.316e+05	-1.817e+05
1	2	497	195.21-143.46-60.49	112.24	145.66	7.537e+05	-4.294e+05	4.186e+05	-9.424e+04	-5.331e+05
1	2	498	264.76-192.12254.07	-181.43	69.06	2.026e+05	-9.780e+05	-6.751e+05	-1.003e+05	-5.156e+05
1	2	499	100.94-159.64-155.83	97.13	-31.25	4.963e+05	-1.029e+05	4.486e+05	-5.521e+04	-1.621e+05
1	2	500	364.44-133.03311.95	-80.54	-152.83	-1.130e+04	-6.119e+05	-5.809e+05	-4.237e+04	-1.330e+05
1	2	501	3.46-287.61-137.19	-146.95	-145.45	5.330e+04	1918.35	2.750e+04	2.772e+04	2.569e+04
1	2	502	490.26-5.48237.51	247.27	-247.82	-2528.06	-9.081e+04	-4.656e+04	-4.678e+04	4.414e+04
1	2	503	222.14-160.00107.25	-45.12	175.22	4.985e+05	-7.238e+05	-1.304e+05	-9.490e+04	-6.109e+05
1	2	504	151.84-121.26-59.70	90.28	114.12	5.648e+05	-3.380e+05	3.140e+05	-8.718e+04	-4.044e+05
1	2	505	266.53-145.43262.56	-141.47	40.21	2.028e+05	-7.288e+05	-5.092e+05	-4.684e+04	-3.870e+05
1	2	506	66.98-165.65-155.45	56.79	-47.62	3.332e+05	-9.349e+04	3.059e+05	-6.626e+04	-1.043e+05
1	2	507	379.84-93.48315.29	-28.92	-162.44	2.068e+04	-4.120e+05	-3.977e+05	6373.94	-7.737e+04
1	2	508	197.03-121.21111.50	-35.68	141.08	3.847e+05	-5.491e+05	-9.975e+04	-6.467e+04	-4.666e+05
1	2	509	39.93-170.94-151.88	20.88	-60.45	2.072e+05	-7.896e+04	1.940e+05	-6.578e+04	-5.997e+04
1	2	510	387.27-59.39311.83	16.05	-167.34	3.715e+04	-2.595e+05	-2.550e+05	3.260e+04	-3.646e+04
1	2	511	111.54-100.26-58.06	69.34	84.60	4.086e+05	-2.602e+05	2.276e+05	-7.925e+04	-2.971e+05
1	2	512	266.48-104.95265.95	-104.42	14.04	1.459e+05	-5.236e+05	-3.717e+05	-6020.04	-2.804e+05
1	2	513	172.76-86.32113.55	-27.11	108.79	2.891e+05	-4.037e+05	-7.416e+04	-4.039e+04	-3.460e+05
1	2	514	19.12-174.84-145.44	-10.29	-69.56	1.111e+05	-5.285e+04	1.068e+05	-4.853e+04	-2.626e+04
1	2	515	386.33-30.14302.02	54.17	-167.34	3.263e+04	-1.456e+05	-1.454e+05	3.234e+04	-7191.29
1	2	516	75.16-80.93 -55.55	49.78	57.59	2.820e+05	-1.945e+05	1.575e+05	-6.996e+04	-2.093e+05
1	2	517	264.54-70.86264.30	-70.62	-8.98	1.202e+05	-3.591e+05	-2.603e+05	2.142e+04	-1.938e+05
1	2	518	150.12-56.11113.43	-19.42	78.87	2.094e+05	-2.850e+05	-5.339e+04	-2.220e+04	-2.467e+05
1	2	519	2.29-174.11-124.77	-47.05	-79.18	3.180e+04	1281.46	2.406e+04	9020.40	1.328e+04
1	2	520	376.88-4.23276.41	96.24	-167.92	-1875.92	-6.966e+04	-5.260e+04	-1.893e+04	2.941e+04
1	2	521	43.49-63.77 -52.11	31.84	33.38	1.810e+05	-1.372e+05	1.016e+05	-5.780e+04	-1.377e+05
1	2	522	260.34-42.89257.63	-40.18	-28.55	9.274e+04	-2.304e+05	-1.721e+05	3.452e+04	-1.242e+05
1	2	523	129.90-31.24111.18	-12.52	51.64	1.419e+05	-1.888e+05	-3.702e+04	-9832.97	-1.648e+05
1	2	524	18.03-50.22 -47.92	15.73	12.31	9.834e+04	-8.131e+04	5.602e+04	-3.898e+04	-7.624e+04
1	2	525	253.58-20.56246.22	-13.20	-44.31	5.747e+04	-1.291e+05	-1.024e+05	3.082e+04	-6.527e+04
1	2	526	113.18-12.67106.85	-6.34	27.50	8.002e+04	-1.073e+05	-2.462e+04	-2618.19	-9.299e+04
1	2	527	1.62-42.01 -34.90	-5.50	-16.12	7372.64	513.23	6840.76	1045.11	1834.52
1	2	528	244.52-2.81224.49	17.22	-67.47	-1116.13	-4.510e+04	-4.209e+04	-4129.52	1.111e+04
1	2	529	102.25-1.47101.80	-1.02	-6.84	-299.39	-1.884e+04	-1.884e+04	-300.42	138.35

M_G	N max	N min	N 1	N 2	N 1-2	M max	M min	M 1	M 2	M 1-2
	-2874.26	-1671.18	-2874.21	-659.98		-2.289e+07	-2.289e+07	-1.299e+07	-4.530e+06	
	2315.74		1108.64	2315.67	702.84	1.995e+07		1.995e+07	1.005e+07	4.528e+06



### 13. VERIFICHE ELEMENTI PARETE E/O GUSCIO IN C.A.

#### 13.1. LEGENDA TABELLA VERIFICHE ELEMENTI PARETE E GUSCIO IN C.A.

Per le pareti in c.a., in ottemperanza al cap. 7 del DM 17-01-18, viene effettuata una doppia progettazione: sia come *Singolo Elemento* sia come *Parete Sismica* o *Parete Debolmente Armata*.

Per la progettazione come *Singolo Elemento* di ogni elemento vengono riportati il codice dello stato di verifica con le sigle **Ok** e **NV**, il rapporto  $x/d$ , la verifica per sollecitazioni ultime (verifica a compressione media gli sforzi membranali, verifica a presso-flessionale e verifica a sollecitazioni taglianti), gli sforzi membranali e flessionali, il quantitativo di armatura nella direzione principale e secondaria sia inferiore che superiore e il quantitativo di armatura a taglio.

Per la progettazione come *Parete Sismica* o *Parete Debolmente Armata* vengono riportate invece le caratteristiche geometriche della parete e delle zone dissipative (quest'ultime solo nel caso di parete sismica), i coefficienti di verifica a compressione assiale, pressoflessione e sollecitazioni taglianti.

Inoltre vengono riportate per ogni quota significativa l'armatura principale e secondaria, l'armatura in zona confinata (solo per parete sismica) e non confinata, l'armatura concentrata all'estremità (per pareti debolmente armate), lo sforzo assiale aggiuntivo per  $q$  superiore a 2 e i valori di involuppo di taglio e momento. Per le pareti debolmente armate viene riportato anche lo stato di verifica relativo alla snellezza.

Le azioni derivate dall'analisi, in ogni combinazione di calcolo, sono elaborate come previsto al punto 7.4.4.5.1: traslazione del momento, incremento e variazione diagramma taglio, incremento e decremento sforzo assiale

La progettazione nel caso dei gusci viene effettuata una progettazione come *Singolo Elemento*, riportando in tabella il rapporto  $x/d$ , la verifica per sollecitazioni ultime, (verifica a compressione media gli sforzi membranali, verifica a presso-flessionale e verifica a sollecitazioni taglianti) di ogni elemento.

Per ogni elemento, viene riportata inoltre la maglia di armatura necessaria in relazione alle risultanze della progettazione dei nodi dell'elemento stesso. Le quantità di armature necessarie sono armature (disposte rispettivamente in direzione principale e secondaria, inferiore e superiore) distribuite nell'elemento ed espresse in centimetri quadri per sviluppo lineare pari ad un metro.

Nel caso dei gusci viene effettuata, inoltre, la verifica a punzonamento, riportando in tabella il codice dello stato di verifica, il coefficiente di verifica per piastre prive di armature a taglio lungo il perimetro resistente e lungo il perimetro del pilastro, coefficiente di incremento dovuto ai momenti flettenti, fattore di amplificazione per le fondazioni, il fattore di amplificazione dell'altezza utile per individuare il perimetro di verifica lungo il quale l'armatura a taglio non è richiesta, il quantitativo di armatura a punzonamento, il numero di serie di armature, il numero di braccia di armatura ed il riferimento alla combinazione più gravosa.

#### Simbologia adottata nelle tabelle di verifica

Per gli elementi con progettazione "*Singolo Elemento ...*" è presente una tabella con i simboli di seguito descritti:

Macro Guscio	Numero del macroelemento di tipo guscio (elementi non verticali contigui ed analoghi per proprietà)
Macro Setto	Numero del macroelemento di tipo setto (elementi verticali contigui ed analoghi per proprietà)
Spessore	Spessore della parete
Id Materiale	Codice del materiale assegnato all'elemento
Id Criterio	Codice del criterio di progetto assegnato all'elemento
Progettazione	Sigla tipo di Elemento: - Singolo Elemento; - Singolo Elemento FONDAZIONE; - Singolo Elemento NON DISSIPATIVO

Per gli elementi con progettazione "*Parete Sismica* o *Parete Debolmente Armata*" è presente una tabella con i simboli di seguito descritti:

Parete	Numero della PARETE SISMICA
Parete PDA	Numero della PARETE DEBOLMENTE ARMATA
H totale	Altezza complessiva della parete
Spessore	Spessore della parete
H critica	Altezza come da punto 7.4.4.5.1 per traslazione momento (solo in Parete Sismica)

H critica V	Altezza della zona dissipativa (solo in Parete Sismica)
L totale	Larghezza di base della parete
L confinata	Lunghezza della zona dissipativa (solo in Parete Sismica)
Verif. N	Verifica di cui al punto 7.4.4.5.1 compressione semplice
Verif. N-M	Verifica di cui al punto 7.4.4.5.1 pressoflessione
Fattore V	Fattore di amplificazione del taglio di cui al punto 7.4.4.5.1
Diagramma V	Diagramma elaborato per effetto modi superiori come da fig. 7.4.4
Verif. V	Verifica di cui al punto 7.4.4.5.1 taglio (compressione cls, trazione acciaio, scorrimento in zona critica) (solo in Parete Sismica)
Verifica Snellezza	Verifica di cui al punto 7.4.4.5.1 limitazione compressione per prevenire l'instabilità (solo in Parete Debolmente Armata)
Prog. composta	Sigla per la progettazione composta

Per le verifiche degli elementi con progettazione “Singolo Elemento ...” e Progettazione Composta è presente una tabella con i simboli di seguito descritti:

Nodo	numero del nodo
Stato	codice di verifica dell'elemento <b>ok</b> o <b>NV</b>
x/d	rapporto tra posizione dell'asse neutro e altezza utile alla rottura della sezione (per sola flessione)
V N/M	Verifica delle sollecitazioni Normali (momento e sforzo normale)
Ver. rid	Rapporto Nd/Nu (Nu ottenuto con riduzione del 25% di fcd)
Af pr+	quantità di armatura richiesta in direzione principale relativa alla faccia positiva (estradosso piastre) (valore derivante da calcolo o minimo normativo)
Af pr-	quantità di armatura richiesta in direzione principale relativa alla faccia negativa (intradosso piastre) (valore derivante da calcolo o minimo normativo)
Af sec+	quantità di armatura richiesta in direzione secondaria relativa alla faccia positiva (estradosso piastre) (valore derivante da calcolo o minimo normativo)
Af sec-	quantità di armatura richiesta in direzione secondaria relativa alla faccia negativa (intradosso piastre) (valore derivante da calcolo o minimo normativo)
Nz No Nzo	Sforzi membranali per pareti e\o setti verticali
Mz Mo Mzo	Sforzi flessionali per pareti e\o setti verticali
Nx Ny Nxy	Sforzi membranali per gusci orizzontali
Mx My Mxy	Sforzi flessionali per gusci orizzontali

Nodo	numero del nodo
Stato	codice di verifica dell'elemento <b>ok</b> o <b>NV</b>
Max tau	Tensione tangenziale Massima
Ver V pr	Verifica a taglio nella direzione principale lato calcestruzzo
Ver V sec	Verifica a taglio nella direzione secondaria lato calcestruzzo
Af V pr	Armatura nella direzione principale
V pr-	Verifica dell'armatura nella direzione principale
Af V sec	Armatura nella direzione secondaria
V sec-	Verifica dell'armatura nella direzione secondaria

Per le verifiche degli elementi con progettazione “Parete Sismica o Parete Debolmente Armata”, oltre alla tabella con le verifiche per gli elementi con progettazione “Singolo Elemento ...”, è presente una tabella con i simboli di seguito descritti:

Quota	Ascissa verticale di riferimento
Af conf.	Numero e diametro armatura presente in una zona confinata
Af std	Diametro e passo armatura in zona non confinata (doppia maglia)
Af estremi	Diametro dei ferri di estremità del pannello; se posto uguale 0, viene utilizzato il diametro standard
Af V (ori)	Diametro e passo armatura orizzontale (doppia maglia)
Ver. N	Rapporto tra azione di calcolo e resistenza a compressione (normalizzato a 1 in quanto da confrontare con 40% in CDB e 35 % in CDA)
Ver. N/M	Rapporto tra azione di calcolo e resistenza a pressoflessione
Ver. V acc(7)	Rapporto tra azione di calcolo e resistenza a taglio-trazione per alfaS minore di 2 secondo paragrafo 7.4.4.5.1
Ver. V cls	Rapporto tra azione di calcolo e resistenza a taglio-compressione



Ver. V acc	Rapporto tra azione di calcolo e resistenza a taglio-trazione
Ver. V scorr.	Rapporto tra azione di calcolo e resistenza a taglio scorrimento
N add	Sforzo assiale di cui al punto 7.4.4.5.1 da sommare e sottrarre nelle verifiche quando q supera 2
N invil M invil	Involuppo del Momento e Sforzo Normale come al punto 7.4.4.5.1 (informativo) (solo in Parete Sismica)

Quota	Ascissa verticale di riferimento
N v.N	Valore dello sforzo assiale per cui Ver. N attinge il massimo valore
N v.M/N, M v.M/N	Valore dello sforzo assiale e momento per cui Ver. N/M attinge il massimo valore
N v.M/N, M v.M/N Mo v.M/N	Valore dello sforzo assiale e dei momenti per cui Ver. N/M attinge il massimo valore (per le pareti estese debolmente armate)
N v.Vcls, V v.Vcls,	Valore dello sforzo assiale e taglio per cui Ver. V. cls attinge il massimo valore
N v.Vacc, M v.Vacc, V v.Vacc,	Valore dello sforzo assiale, momento e taglio per cui Ver. V. acc attinge il massimo valore
N v.Vscorr, M v.Vscorr, V v.Vscorr,	Valore dello sforzo assiale, momento e taglio per cui Ver. V. scorr.e attinge il massimo valore
N v.N	Valore dello sforzo assiale per cui Ver. N attinge il massimo valore
N v.M/N, M v.M/N	Valore dello sforzo assiale e momento per cui Ver. N/M attinge il massimo valore
N v.M/N, M v.M/N Mo v.M/N	Valore dello sforzo assiale e dei momenti per cui Ver. N/M attinge il massimo valore (per le pareti estese debolmente armate)
N v.Vcls, V v.Vcls,	Valore dello sforzo assiale e taglio per cui Ver. V. cls attinge il massimo valore

Quota	Ascissa verticale di riferimento
CtgT Vcls	Valore di ctg(teta) adottato nella verifica V compressione cls
Vrsd Vcls	Valore della resistenza a taglio trazione (armatura di calcolo)
Vrcd Vcls	Valore della resistenza a taglio compressione
CtgT Vacc	Valore di ctg(teta) adottato nella verifica V trazione armatura
Vrsd Vacc	Valore della resistenza a taglio trazione (armatura presente)
Vrcd Vacc	Valore della resistenza a taglio compressione
Vdd	Valore del contributo alla resistenza allo scorrimento come da [7.4.20]
Vid	Valore del contributo alla resistenza allo scorrimento come da [7.4.21]
A s.i.	Somma delle aree di armature
Incli.	Angolo di inclinazione delle armature
Dist.	Distanza alla base tra le armature inclinate

Quota	Ascissa verticale di riferimento
V[7.4.16]	Verifica a taglio-trazione dell'armatura dell'anima (7.4.16)
N M V	Sollecitazioni di calcolo della condizione più gravosa
Alfas	Rapporto di Taglio
Vrd,c	Resistenza a taglio degli elementi non armati
VRd,s	Resistenza a taglio nei confronti dello scorrimento
V[7.4.17]	Verifica a taglio-trazione dell'armatura dell'anima (7.4.17)
roH	Rapporto tra l'armatura orizzontale e l'area della sezione relativa di calcestruzzo
roV	Rapporto tra l'armatura verticale e l'area della sezione relativa di calcestruzzo
roN	Sforzo normale adimensionalizzato Ned/(bw fyd)

**Per la verifica a *Punzonamento* è presente una tabella con i simboli di seguito descritti:**

Nodo	numero del nodo
Stato	codice di verifica dell'elemento <b>ok</b> o <b>NV</b>
V. 6.47	Fattore di sicurezza per la verifica per piastre prive di armature a taglio lungo il perimetro resistente U1
V. 6.53	Fattore di sicurezza per la verifica per piastre prive di armature a taglio lungo il perimetro del pilastro U0
Beta	Fattore di incremento dovuto ai momenti flettenti
f. a fon	fattore di amplificazione per le fondazioni (solo per gusci di fondazione)

f. Uout	fattore di amplificazione dell'altezza utile per individuare il perimetro di verifica lungo il quale l'armatura a taglio non è richiesta
Aw tot	Quantitativo di armatura per la verifica di piastre munite di armatura (formula 6.52 dell'EC2)
Asw,min	Quantitativo minimo di armatura previsto dai dettagli costruttivi (formula 9.11 dell'EC2)
n. x serie	Numero di serie di armature
n.ser 0(R)	Numero di braccia delle armatura in direzione 0 (o numero di braccia radiale)
n.ser 90	Numero di braccia delle armatura in direzione 90 (solo se armatura cruciforme)
Rif. cmb	Riferimento combinazioni da cui si generano le verifiche più gravose

### 13.2. PROGETTAZIONE DELLE FONDAZIONI

Il D.M.17/01/2018 - par: 7.2.5 prevede:

“Sia per CD“A” sia per CD“B” il dimensionamento delle strutture di fondazione e la verifica di sicurezza del complesso fondazione-terreno devono essere eseguiti assumendo come azione in fondazione, trasmessa dagli elementi soprastanti, una tra le seguenti:

- quella derivante dall'analisi strutturale eseguita ipotizzando comportamento strutturale non dissipativo;
- [...];
- quella trasferita dagli elementi soprastanti nell'ipotesi di comportamento strutturale dissipativo, amplificata di un coefficiente pari a 1,30 in CD“A” e 1,10 in CD“B”;

Nel contesto visualizzazione risultati e nella stampa della relazione sulle fondazioni PRO\_SAP mostra le sollecitazioni che derivano dall'analisi non incrementate sia in termini di pressioni sul terreno che in termini di sollecitazioni.

La progettazione degli elementi strutturali con proprietà fondazione è effettuata da PRO\_SAP (per travi e platee) o da PRO\_CAD Plinti (per plinti e pali di fondazione) incrementando le sollecitazioni delle combinazioni con sisma di un coefficiente pari 1.1 in CDB e 1.3 in CDA per pali, plinti, travi e platee.

Per i bicchieri dei plinti di fondazione prefabbricati l'incremento delle sollecitazioni ha un fattore pari a 1.2 in CDB e 1.35 in CDA.

N.B.: nel caso di comportamento strutturale non dissipativo la progettazione viene effettuata senza nessun incremento.

Le verifiche geotecniche vengono effettuate dal modulo geotecnico incrementando automaticamente le sollecitazioni del fattore 1.1 in CDB e 1.3 in CDA per pali, plinti, travi e platee.

N.B.: nel caso di comportamento strutturale non dissipativo le verifiche geotecniche vengono effettuate senza nessun incremento.

Macro Guscio	Spessore	Id Materiale	Id Criterio	Progettazione
	cm			
1	125.00	9	2	Singolo elemento

Nodo	Statox/d	V N/M	ver. rid	Af pr-	Af pr+	Af sec-	Af sec+	N x	N y	N xy	M x	M y	M xy
								N/mm	N/mm	N	N	N	N
1	ok 0.08	8.66e-03	8.94e-04	145.4	145.4	145.4	145.4	206.1	-36.2	9.5-5.525e+04	2280.2	-3318.9	
2	ok 0.08	6.91e-03	3.03e-03	145.4	145.4	145.4	145.4	-108.9	19.9	46.33.395e+04	3755.7-1.539e+04		
3	ok 0.08	3.82e-02	9.12e-04	145.4	145.4	145.4	145.4	354.6	-3.7	114.7-7.634e+04-1.109e+04-3.317e+04			
4	ok 0.08	2.61e-02	1.24e-03	145.4	145.4	145.4	145.4	160.2	23.2	-42.1-7.339e+04	-8614.0	1.228e+05	
5	ok 0.08	2.42e-02	2.47e-03	145.4	145.4	145.4	145.4	-91.7	-2.0	-30.71.140e+05-4.311e+04	9.049e+04		
6	ok 0.08	4.16e-02	1.38e-03	145.4	145.4	145.4	145.4	348.7	6.7	44.5-1.624e+053.055e+04	7.548e+04		
7	ok 0.07	3.74e-02	1.60e-03	145.4	145.4	145.4	145.4	172.5	10.0	-73.6-8.965e+04-2.041e+04	2.134e+05		
8	ok 0.07	3.58e-02	2.77e-03	145.4	145.4	145.4	145.4	-102.4	22.7	-54.81.729e+05-6.431e+04	1.689e+05		
9	ok 0.07	4.41e-02	1.81e-03	145.4	145.4	145.4	145.4	346.2	-70.8	46.9-2.720e+053.854e+04	1.387e+05		
10	ok 0.08	1.24e-02	7.04e-03	145.4	145.4	145.4	145.4	-201.2	-53.8	142.63.889e+04	2.898e+04-3.708e+04		
11	ok 0.08	4.86e-02	8.72e-04	145.4	145.4	145.4	145.4	397.2	119.6	259.3-7.005e+04-4.755e+04-6.125e+04			
12	ok 0.06	4.88e-02	2.11e-03	145.4	145.4	145.4	145.4	172.8	-1.9	-109.7-1.101e+05-3.838e+04	3.182e+05		
13	ok 0.06	4.78e-02	2.99e-03	145.4	145.4	145.4	145.4	-87.4	80.9	-62.42.391e+05-8.937e+04	2.608e+05		
14	ok 0.06	6.01e-02	2.37e-03	145.4	145.4	145.4	145.4	353.1	-109.7	20.9-3.862e+052.465e+04	2.320e+05		
15	ok 0.08	2.59e-02	6.21e-03	145.4	145.4	145.4	145.4	-164.4	4.7	98.21.112e+05-8.661e+04	5.977e+04		
16	ok 0.08	6.93e-02	1.58e-03	145.4	145.4	145.4	145.4	366.9	90.4	205.3-1.858e+056.106e+04	2.399e+04		
17	ok 0.06	6.15e-02	2.67e-03	145.4	145.4	145.4	145.4	170.0	-14.5	-149.1-1.367e+05-6.347e+04	4.456e+05		

18	ok	0.06	6.13e-02	3.22e-03	145.4	145.4	145.4	145.4	-91.6	105.2	-97.13.266e+05-1.043e+05	3.780e+05
19	ok	0.06	7.84e-02	3.01e-03	145.4	145.4	145.4	145.4	352.9	-152.9	-9.8-5.310e+05	-7896.5 3.463e+05
20	ok	0.07	3.94e-02	5.86e-03	145.4	145.4	145.4	145.4	-167.0	9.1	64.12.436e+05-1.012e+05	9.107e+04
21	ok	0.07	6.94e-02	2.19e-03	145.4	145.4	145.4	145.4	371.8	38.6	202.5-3.361e+055.950e+04	5.636e+04
22	ok	0.05	9.39e-02	3.26e-03	145.4	145.4	145.4	145.4	164.5	-28.1	-191.5-1.701e+05-9.623e+04	6.007e+05
23	ok	0.06	5.48e-02	5.36e-03	145.4	145.4	145.4	145.4	-164.5	58.3	43.73.975e+05-9.942e+04	1.440e+05
24	ok	0.06	6.78e-02	2.88e-03	145.4	145.4	145.4	145.4	366.2	-23.1	191.0-5.322e+052.221e+04	1.028e+05
25	ok	0.05	7.62e-02	3.46e-03	145.4	145.4	145.4	145.4	-94.2	131.0	-135.34.358e+05-1.174e+05	5.201e+05
26	ok	0.05	0.1	3.71e-03	145.4	145.4	145.4	145.4	345.6	-200.2	-45.0-7.107e+05-5.772e+04	4.862e+05
27	ok	0.05	9.15e-02	3.87e-03	145.4	145.4	145.4	145.4	156.4	-42.7	-236.2-2.104e+05-1.366e+05	7.867e+05
28	ok	0.08	1.67e-02	1.04e-02	145.4	145.4	145.4	145.4	-190.8	-204.0	226.32.432e+04	6.735e+04-4.521e+04
29	ok	0.08	4.64e-02	7.74e-04	145.4	145.4	145.4	145.4	319.8	336.7	359.8-4.257e+04-9.887e+04	-6.931e+04
30	ok	0.06	7.27e-02	4.89e-03	145.4	145.4	145.4	145.4	-158.1	113.4	18.95.922e+05-8.242e+04	2.145e+05
31	ok	0.06	0.1	3.63e-03	145.4	145.4	145.4	145.4	400.0	-123.6	201.6-7.959e+05-7.302e+04	1.359e+05
32	ok	0.05	9.26e-02	3.70e-03	145.4	145.4	145.4	145.4	-95.4	158.1	-176.55.686e+05-1.294e+05	6.898e+05
33	ok	0.05	0.1	4.46e-03	145.4	145.4	145.4	145.4	263.1	-218.1	-99.6-9.121e+05-1.243e+05	6.739e+05
34	ok	0.04	0.1	4.47e-03	145.4	145.4	145.4	145.4	145.5	-58.4	-282.7-2.582e+05-1.853e+05	1.007e+06
35	ok	0.08	2.60e-02	9.71e-03	145.4	145.4	145.4	145.4	-175.8	-156.0	183.31.521e+05-4.934e+04	-2.860e+04
36	ok	0.08	8.22e-02	1.72e-03	145.4	145.4	145.4	145.4	327.2	264.9	362.8-1.835e+05-6.491e+04	-9.528e+04
37	ok	0.05	9.29e-02	4.46e-03	145.4	145.4	145.4	145.4	-148.0	173.7	-10.08.331e+05-5.313e+04	3.049e+05
38	ok	0.05	0.1	4.42e-03	145.4	145.4	145.4	145.4	382.0	-200.3	179.6-1.097e+06-1.610e+05	2.273e+05
39	ok	0.04	0.1	3.93e-03	145.4	145.4	145.4	145.4	-95.7	186.0	-220.07.277e+05-1.410e+05	8.905e+05
40	ok	0.04	0.1	5.24e-03	145.4	145.4	145.4	145.4	237.9	-275.2	-141.4-1.183e+06-2.116e+05	8.712e+05
41	ok	0.07	4.02e-02	8.92e-03	145.4	145.4	145.4	145.4	-194.2	-84.4	217.02.904e+05	1.777e+04-5.859e+04
42	ok	0.07	9.86e-02	2.53e-03	145.4	145.4	145.4	145.4	321.5	209.4	376.0-3.529e+05-8.956e+04	-1.014e+05
43	ok	0.04	0.1	5.06e-03	145.4	145.4	145.4	145.4	131.8	-75.3	-330.2-3.140e+05-2.438e+05	1.264e+06
44	ok	0.05	0.1	4.07e-03	145.4	145.4	145.4	145.4	-134.0	238.5	-42.31.124e+06-1.231e+04	4.165e+05
45	ok	0.05	0.1	5.25e-03	145.4	145.4	145.4	145.4	298.0	-259.4	122.3-1.466e+06-2.587e+05	3.634e+05
46	ok	0.06	5.77e-02	7.91e-03	145.4	145.4	145.4	145.4	-185.3	-25.9	213.84.797e+05	4.905e+04-4.260e+04
47	ok	0.06	0.1	3.38e-03	145.4	145.4	145.4	145.4	305.1	142.9	382.9-5.814e+05-1.593e+05	-9.272e+04
48	ok	0.04	0.1	4.15e-03	145.4	145.4	145.4	145.4	-20.0	190.0	-284.39.213e+05-1.401e+05	1.132e+06
49	ok	0.04	0.2	6.04e-03	145.4	145.4	145.4	145.4	206.6	-335.6	-185.3-1.499e+06-3.181e+05	1.103e+06
50	ok	0.04	0.1	3.71e-03	145.4	145.4	145.4	145.4	-227.2	305.7	-44.71.440e+06	6.317e+04
51	ok	0.04	0.2	6.11e-03	145.4	145.4	145.4	145.4	258.1	-352.7	89.7-1.911e+06-4.070e+05	4.958e+05
52	ok	0.04	0.1	5.62e-03	145.4	145.4	145.4	145.4	48.8	-90.2	-359.5-3.663e+05-3.038e+05	1.591e+06
53	ok	0.06	7.87e-02	6.86e-03	145.4	145.4	145.4	145.4	-170.8	43.0	204.87.265e+05	1.073e+05-1.438e+04
54	ok	0.06	0.1	4.24e-03	145.4	145.4	145.4	145.4	279.2	62.1	382.2-8.804e+05-2.701e+05	-7.026e+04
55	ok	0.04	0.2	4.35e-03	145.4	145.4	145.4	145.4	-14.6	221.6	-329.71.153e+06-1.469e+05	1.400e+06
56	ok	0.04	0.2	6.83e-03	145.4	145.4	145.4	145.4	169.8	-398.6	-230.4-1.863e+06-4.467e+05	1.372e+06
57	ok	0.04	0.2	3.39e-03	145.4	145.4	145.4	145.4	-95.4	378.2	-115.51.877e+06	1.051e+05
58	ok	0.04	0.2	7.00e-03	145.4	145.4	145.4	145.4	210.1	-452.0	53.4-2.432e+06-5.860e+05	6.542e+05
59	ok	0.05	0.1	5.79e-03	145.4	145.4	145.4	145.4	-212.1	88.2	208.81.021e+06	1.672e+05
60	ok	0.05	0.1	5.12e-03	145.4	145.4	145.4	145.4	244.2	-32.5	374.2-1.257e+06-4.206e+05	-3.429e+04
61	ok	0.04	0.2	6.15e-03	145.4	145.4	145.4	145.4	28.6	-109.5	-406.4-4.481e+05-3.864e+05	1.935e+06
62	ok	0.04	0.2	4.53e-03	145.4	145.4	145.4	145.4	-8.9	252.5	-374.81.420e+06-1.510e+05	1.706e+06
63	ok	0.04	0.2	7.60e-03	145.4	145.4	145.4	145.4	128.0	-463.9	-275.5-2.279e+06-6.029e+05	1.682e+06
64	ok	0.05	0.1	4.75e-03	145.4	145.4	145.4	145.4	-191.6	168.3	197.01.394e+06	2.724e+05
65	ok	0.05	0.2	6.01e-03	145.4	145.4	145.4	145.4	158.8	-124.4	321.6-1.739e+06-5.775e+05	2.686e+04
66	ok	0.04	0.2	3.10e-03	145.4	145.4	145.4	145.4	-71.5	451.1	-154.82.348e+06	1.847e+05
67	ok	0.04	0.2	7.92e-03	145.4	145.4	145.4	145.4	154.6	-556.1	14.3-3.036e+06-8.000e+05	8.417e+05
68	ok	0.08	1.95e-02	1.28e-02	145.4	145.4	145.4	145.4	-108.8	-390.0	233.3	4336.4
69	ok	0.08	9.29e-02	6.25e-04	145.4	145.4	145.4	145.4	171.3	589.2	347.9-1.144e+04-1.459e+05	-4.899e+04
70	ok	0.03	0.2	6.71e-03	145.4	145.4	145.4	145.4	6.5	-130.5	-451.8-5.386e+05-4.838e+05	2.323e+06
71	ok	0.04	0.2	3.75e-03	145.4	145.4	145.4	145.4	-57.1	295.3	108.41.887e+06	4.163e+05
72	ok	0.04	0.2	6.93e-03	145.4	145.4	145.4	145.4	102.5	-244.7	300.1-2.295e+06-8.155e+05	8.602e+04
73	ok	0.08	2.60e-02	1.24e-02	145.4	145.4	145.4	145.4	-105.4	-330.2	249.49.482e+04	1.026e+05
74	ok	0.08	9.02e-02	1.77e-03	145.4	145.4	145.4	145.4	162.3	533.7	377.0-1.132e+05-1.650e+05	-1.056e+05
75	ok	0.03	0.2	4.79e-03	145.4	145.4	145.4	145.4	-3.4	282.2	-418.51.722e+06-1.480e+05	2.053e+06
76	ok	0.03	0.3	8.37e-03	145.4	145.4	145.4	145.4	82.4	-531.2	-319.6-2.748e+06-7.953e+05	2.036e+06
77	ok	0.04	0.2	2.86e-03	145.4	145.4	145.4	145.4	-45.4	524.4	-194.72.890e+06	2.838e+05
78	ok	0.04	0.3	8.90e-03	145.4	145.4	145.4	145.4	92.6	-663.9	-26.1-3.730e+06-1.057e+06	1.110e+06
79	ok	0.07	3.83e-02	1.13e-02	145.4	145.4	145.4	145.4	-86.1	-283.1	261.22.306e+05	1.468e+05
80	ok	0.07	0.1	2.76e-03	145.4	145.4	145.4	145.4	133.7	487.7	399.5-2.723e+05-2.394e+05	-1.387e+05
81	ok	0.04	0.2	2.82e-03	145.4	145.4	145.4	145.4	-20.3	398.1	80.22.428e+06	5.848e+05
82	ok	0.04	0.2	7.86e-03	145.4	145.4	145.4	145.4	37.8	-374.8	273.5-2.950e+06-1.098e+06	1.606e+05
83	ok	0.03	0.2	7.23e-03	145.4	145.4	145.4	145.4	-17.0	-153.5	-495.0-6.374e+05-5.985e+05	2.752e+06
84	ok	0.06	5.64e-02	9.93e-03	145.4	145.4	145.4	145.4	-60.1	-223.1	267.24.297e+05	2.295e+05
85	ok	0.06	8.99e-02	3.75e-03	145.4	145.4	145.4	145.4	95.1	424.8	414.2-5.070e+05-3.643e+05	-1.586e+05
86	ok	0.03	0.2	5.01e-03	145.4	145.4	145.4	145.4	1.1	309.9	-459.92.063e+06-1.286e+05	2.440e+06
87	ok	0.03	0.3	9.15e-03	145.4	145.4	145.4	145.4	34.8	-600.2	-361.1-3.273e+06-1.038e+06	2.435e+06
88	ok	0.03	0.3	2.73e-03	145.4	145.4	145.4	145.4	-18.0	596.8	-233.93.509e+06	4.117e+05
89	ok	0.03	0.3	9.88e-03	145.4	145.4	145.4	145.4	25.4	-774.2	-66.3-4.521e+06-1.369e+06	1.324e+06
90	ok	0.04	0.2	1.96e-03	145.4	145.4	145.4	145.4	20.4	505.2	49.43.057e+06	7.847e+05
91	ok	0.04	0.3	8.84e-03	145.4	145.4	145.4	145.4	-34.6	-512.9	242.9-3.714e+06-1.431e+06	2.532e+05
92	ok	0.06	7.90e-02	8.49e-03	145.4	145.4	145.4	145.4	-28.9	-148.0	267.76.988e+05	3.488e+05
93	ok	0.06	0.1	4.72e-03	145.4	145.4	145.4	145.4	48.3	341.9	422.0-8.254e+05-5.390e+05	-1.688e+05

94	ok	0.03	0.2	7.69e-03	145.4	145.4	145.4	145.4	-41.1	-179.0	-535.5-7.427e+05-7.344e+05	3.214e+06
95	ok	0.03	0.3	2.61e-03	145.4	145.4	145.4	145.4	9.1	667.0	-270.84.211e+06	5.856e+05 1.650e+06
96	ok	0.03	0.4	1.08e-02	145.4	145.4	145.4	145.4	-44.6	-885.9	-103.6-5.416e+06-1.758e+06	1.634e+06
97	ok	0.05	0.1	6.97e-03	145.4	145.4	145.4	145.4	6.8	-58.2	263.21.043e+06	5.053e+05-1.213e+05
98	ok	0.05	0.1	5.68e-03	145.4	145.4	145.4	145.4	-6.2	239.7	423.2-1.234e+06-7.644e+05-1.714e+05	
99	ok	0.03	0.2	5.21e-03	145.4	145.4	145.4	145.4	3.6	335.4	-498.32.438e+06-7.459e+04	2.863e+06
100	ok	0.03	0.3	9.87e-03	145.4	145.4	145.4	145.4	-11.6	-671.7	-398.6-3.847e+06-1.358e+06	2.878e+06
101	ok	0.04	0.3	1.24e-03	145.4	145.4	145.4	145.4	64.1	614.5	17.03.785e+06	1.022e+06 4.272e+05
102	ok	0.04	0.3	9.89e-03	145.4	145.4	145.4	145.4	-113.9	-657.0	209.6-4.598e+06-1.823e+06	3.694e+05
103	ok	0.05	0.1	5.43e-03	145.4	145.4	145.4	145.4	46.8	44.8	254.01.465e+06	7.005e+05-1.143e+05
104	ok	0.05	0.2	6.63e-03	145.4	145.4	145.4	145.4	-93.9	126.7	377.9-1.765e+06-1.006e+06	-1.768e+05
105	ok	0.03	0.3	8.13e-03	145.4	145.4	145.4	145.4	-68.9	-209.3	-574.1-8.530e+05-8.973e+05	3.684e+06
106	ok	0.03	0.3	6.63e-04	145.4	145.4	145.4	145.4	109.9	723.7	-15.54.625e+06	1.308e+06 5.634e+05
107	ok	0.03	0.4	1.10e-02	145.4	145.4	145.4	145.4	-199.0	-804.7	176.0-5.616e+06-2.287e+06	-5.186e+05
108	ok	0.03	0.3	2.51e-03	145.4	145.4	145.4	145.4	33.5	734.0	-303.14.996e+06	8.368e+05 1.992e+06
109	ok	0.03	0.4	1.17e-02	145.4	145.4	145.4	145.4	-113.5	-998.3	-134.5-6.414e+06-2.261e+06	2.011e+06
110	ok	0.03	0.3	5.41e-03	145.4	145.4	145.4	145.4	6.2	360.7	-534.32.839e+06	5.050e+04 3.310e+06
111	ok	0.03	0.4	1.05e-02	145.4	145.4	145.4	145.4	-55.5	-748.8	-431.0-4.454e+06-1.803e+06	-1.355e+06
112	ok	0.04	0.2	3.90e-03	145.4	145.4	145.4	145.4	115.8	156.9	201.51.999e+06	9.119e+05-1.098e+05
113	ok	0.04	0.2	7.58e-03	145.4	145.4	145.4	145.4	-166.0	-10.7	366.1-2.374e+06-1.345e+06	-1.693e+05
114	ok	0.04	0.2	2.42e-03	145.4	145.4	145.4	145.4	166.6	282.0	183.52.605e+06	1.196e+06-9.551e+04
115	ok	0.04	0.2	8.52e-03	145.4	145.4	145.4	145.4	-245.4	-162.3	349.3-3.094e+06-1.744e+06	-1.559e+05
116	ok	0.03	0.4	1.71e-04	145.4	145.4	145.4	145.4	156.4	830.2	-45.65.590e+06	1.660e+06 7.393e+05
117	ok	0.03	0.4	1.20e-02	145.4	145.4	145.4	145.4	-288.0	-953.0	145.1-6.786e+06-2.842e+06	7.177e+05
118	ok	0.03	0.3	8.81e-03	145.4	145.4	145.4	145.4	-164.0	-263.4	-613.6-1.015e+06-1.109e+06	4.105e+06
119	ok	0.03	0.4	2.46e-03	145.4	145.4	145.4	145.4	53.9	799.4	-328.75.859e+06	1.226e+06 2.404e+06
120	ok	0.03	0.5	1.26e-02	145.4	145.4	145.4	145.4	-177.6	-1112.9	-154.4-7.508e+06-2.945e+06	2.480e+06
121	ok	0.03	0.3	5.77e-03	145.4	145.4	145.4	145.4	67.6	405.4	-577.03.282e+06	3.282e+05 3.735e+06
122	ok	0.03	0.4	1.15e-02	145.4	145.4	145.4	145.4	-149.2	-850.5	-462.8-5.101e+06-2.478e+06	3.848e+06
123	ok	0.04	0.3	1.03e-03	145.4	145.4	145.4	145.4	220.8	414.2	162.43.315e+06	1.529e+06-7.490e+04
124	ok	0.04	0.3	9.47e-03	145.4	145.4	145.4	145.4	-331.4	-325.5	328.2-3.939e+06-2.209e+06	-1.333e+05
125	ok	0.03	0.4	0.0145.4	145.4	145.4	145.4	201.2	930.9	-69.96.700e+06	2.108e+06 9.800e+05	
126	ok	0.03	0.5	1.31e-02	145.4	145.4	145.4	145.4	-378.0	-1098.2	122.2-8.128e+06-3.523e+06	9.978e+05
127	ok	0.04	0.3	0.0145.4	145.4	145.4	145.4	277.9	551.0	139.44.141e+06	1.917e+06-4.442e+04	
128	ok	0.04	0.3	1.04e-02	145.4	145.4	145.4	145.4	-423.7	-497.5	304.3-4.924e+06-2.748e+06	-9.739e+04
129	ok	0.03	0.4	2.65e-03	145.4	145.4	145.4	145.4	116.4	878.8	-355.76.806e+06	1.878e+06 2.904e+06
130	ok	0.03	0.5	1.35e-02	145.4	145.4	145.4	145.4	-279.6	-1242.3	-165.6-8.703e+06-3.949e+06	3.084e+06
131	ok	0.08	2.08e-02	1.41e-02	145.4	145.4	145.4	145.4	-37.6	-502.2	133.02.570e+06	7.431e+04-4.947e+04
132	ok	0.08	9.26e-02	4.36e-04	145.4	145.4	145.4	145.4	53.7	747.5	201.4-3.304e+06-1.168e+05	-6.729e+04
133	ok	0.03	0.3	1.17e-02	145.4	145.4	145.4	145.4	380.9	-67.2	-608.3-1.712e+06-1.489e+06	4.486e+06
134	ok	0.03	0.3	7.63e-03	145.4	145.4	145.4	145.4	-463.3	201.9	-537.74.132e+06	1.065e+06 4.093e+06
135	ok	0.03	0.5	1.68e-02	145.4	145.4	145.4	145.4	-81.0	-778.1	-556.6-6.909e+06-3.667e+06	3.976e+06
136	ok	0.03	0.5	0.0145.4	145.4	145.4	145.4	242.9	1023.7	-83.27.974e+06	2.708e+06 1.334e+06	
137	ok	0.03	0.5	1.40e-02	145.4	145.4	145.4	145.4	-466.8	-1237.0	115.3-9.666e+06-4.384e+06	1.417e+06
138	ok	0.08	2.65e-02	1.40e-02	145.4	145.4	145.4	145.4	7.3	-508.4	141.26.836e+06	1.192e+05-7.916e+04
139	ok	0.08	0.1	1.73e-03	145.4	145.4	145.4	145.4	-4.8	766.2	214.4-8.196e+06-1.865e+05	-1.012e+05
140	ok	0.03	0.3	0.0145.4	145.4	145.4	145.4	337.2	688.7	115.95.104e+06	2.368e+06 3531.6	
141	ok	0.03	0.4	1.15e-02	145.4	145.4	145.4	145.4	-521.6	-674.4	279.5-6.072e+06-3.371e+06	-3.832e+04
142	ok	0.07	3.73e-02	1.27e-02	145.4	145.4	145.4	145.4	46.2	-471.4	149.01.814e+06	2.140e+05-9.760e+04
143	ok	0.07	0.1	2.86e-03	145.4	145.4	145.4	145.4	-58.4	735.7	227.3-2.138e+05-3.160e+05	-1.231e+05
144	ok	0.02	0.4	1.30e-02	145.4	145.4	145.4	145.4	280.9	-215.2	-846.3-2.707e+06-1.766e+06	4.942e+06
145	ok	0.03	0.5	4.67e-03	145.4	145.4	145.4	145.4	-14.7	905.7	-476.98.613e+06	3.421e+06 3.081e+06
146	ok	0.03	0.6	2.13e-02	145.4	145.4	145.4	145.4	-522.6	-1489.0	-485.0-1.132e+07-6.093e+06	2.936e+06
147	ok	0.06	5.25e-02	1.12e-02	145.4	145.4	145.4	145.4	88.0	-412.6	154.83.707e+06	3.500e+05-1.109e+05
148	ok	0.06	0.1	3.95e-03	145.4	145.4	145.4	145.4	-116.8	677.9	237.8-4.355e+05-4.975e+05	-1.398e+05
149	ok	0.03	0.4	0.0145.4	145.4	145.4	145.4	398.1	823.2	94.26.231e+06	2.897e+06 8.407e+04	
150	ok	0.03	0.4	1.26e-02	145.4	145.4	145.4	145.4	-624.7	-850.9	257.0-7.415e+06-4.092e+06	6.208e+04
151	ok	0.02	0.3	9.13e-03	145.4	145.4	145.4	145.4	-609.2	332.5	-772.25.316e+06	1.891e+06 4.687e+06
152	ok	0.02	0.5	1.73e-02	145.4	145.4	145.4	145.4	45.9	-896.6	-769.0-8.240e+06-4.844e+06	4.678e+06
153	ok	0.03	0.5	0.0145.4	145.4	145.4	145.4	317.9	1113.9	-92.29.468e+06	3.560e+06 1.883e+06	
154	ok	0.03	0.6	1.48e-02	145.4	145.4	145.4	145.4	-589.9	-1368.5	122.6-1.147e+07-5.531e+06	2.082e+06
155	ok	0.06	7.39e-02	9.49e-03	145.4	145.4	145.4	145.4	133.8	-335.0	157.56.388e+05	5.279e+05-1.213e+05
156	ok	0.06	0.1	5.00e-03	145.4	145.4	145.4	145.4	-181.6	595.9	244.4-7.510e+05-7.326e+05	-1.532e+05
157	ok	0.05	0.1	7.72e-03	145.4	145.4	145.4	145.4	183.8	-239.9	157.29.890e+06	7.500e+05-1.303e+05
158	ok	0.03	0.5	0.0145.4	145.4	145.4	145.4	459.7	948.2	78.17.564e+06	3.520e+06 2.266e+06	
159	ok	0.03	0.5	1.37e-02	145.4	145.4	145.4	145.4	-732.3	-1019.7	242.1-9.001e+06-4.927e+06	2.386e+05
160	ok	0.05	0.2	6.02e-03	145.4	145.4	145.4	145.4	-253.0	491.0	247.0-1.164e+06-1.025e+06	-1.644e+05
161	ok	0.02	0.5	5.36e-03	145.4	145.4	145.4	145.4	-366.2	986.3	-626.71.042e+07	4.702e+06 4.124e+06
162	ok	0.02	0.6	2.13e-02	145.4	145.4	145.4	145.4	-199.0	-1548.5	-623.4-1.335e+07-7.657e+06	4.123e+06
163	ok	0.05	0.1	5.88e-03	145.4	145.4	145.4	145.4	237.6	-128.6	153.61.425e+06	1.019e+06-1.387e+05
164	ok	0.05	0.2	7.02e-03	145.4	145.4	145.4	145.4	-330.6	364.5	245.6-1.678e+06-1.379e+06	-1.744e+05
165	ok	0.03	0.7	1.55e-03	145.4	145.4	145.4	145.4	374.0	1570.7	-373.11.194e+07	5.922e+06 1.934e+06
166	ok	0.03	0.7	2.51e-02	145.4	145.4	145.4	145.4	-910.6	-2154.7	-368.4-1.458e+07-8.671e+06	1.799e+06
167	ok	0.02	0.3	9.64e-03	145.4	145.4	145.4	145.4	68.1	-260.4	-611.0-2.112e+06-1.628e+06	4.003e+06
168	ok	0.03	0.5	0.0145.4	145.4	145.4	145.4	522.9	1056.2	73.79.170e+06	4.265e+06 4.896e+05	
169	ok	0.03	0.6	1.47e-02	145.4	145.4	145.4	145.4	-845.8	-1170.4	243.0-1.090e+07-5.901e+06	5.583e+05



170	ok	0.04	0.2	4.02e-03	145.4	145.4	145.4	145.4	294.8	-3.0	147.21.952e+06	1.341e+06	-1.467e+05	
171	ok	0.02	0.3	6.11e-03	145.4	145.4	145.4	145.4	-387.2	215.4	-533.03.668e+06	1.107e+06	3.833e+06	
172	ok	0.02	0.4	1.31e-02	145.4	145.4	145.4	145.4	-176.1	-779.7	-531.3-6.600e+06	4.032e+06	3.846e+06	
173	ok	0.04	0.2	7.99e-03	145.4	145.4	145.4	145.4	-414.2	218.1	240.5-2.301e+06	-1.799e+06	-1.838e+05	
174	ok	0.04	0.2	2.18e-03	145.4	145.4	145.4	145.4	355.0	135.0	138.42.579e+06	1.718e+06	-1.544e+05	
175	ok	0.04	0.2	8.94e-03	145.4	145.4	145.4	145.4	-503.5	54.2	232.1-3.042e+06	-2.291e+06	-1.920e+05	
176	ok	0.02	0.7	1.87e-03	145.4	145.4	145.4	145.4	-115.1	1551.5	-417.41.476e+07	7.049e+06	3.276e+06	
177	ok	0.02	0.8	2.45e-02	145.4	145.4	145.4	145.4	-451.9	-2111.9	-414.9-1.769e+07	-1.000e+07	3.282e+06	
178	ok	0.02	0.4	2.84e-03	145.4	145.4	145.4	145.4	-125.6	690.7	-436.87.837e+06	3.304e+06	3.395e+06	
179	ok	0.02	0.5	1.61e-02	145.4	145.4	145.4	145.4	-438.9	-1253.9	-434.6-1.077e+07	-6.224e+06	3.403e+06	
180	ok	0.03	0.6	0.0145.4	145.4	145.4	145.4	615.7	1137.5	71.61.119e+07	5.165e+06	9.733e+05		
181	ok	0.03	0.7	1.57e-02	145.4	145.4	145.4	145.4	-994.4	-1285.3	253.4-1.328e+07	-7.038e+06	1.139e+06	
182	ok	0.04	0.3	4.01e-04	145.4	145.4	145.4	145.4	417.9	282.6	127.63.316e+06	2.156e+06	-1.611e+05	
183	ok	0.04	0.3	9.87e-03	145.4	145.4	145.4	145.4	-598.1	-124.4	221.1-3.915e+06	-2.861e+06	-1.980e+05	
184	ok	0.04	0.3	0.0145.4	145.4	145.4	145.4	483.0	436.6	115.44.179e+06	2.662e+06	-1.645e+05		
185	ok	0.04	0.3	1.08e-02	145.4	145.4	145.4	145.4	-698.0	-314.0	208.1-4.939e+06	-3.516e+06	-1.986e+05	
186	ok	0.02	0.2	7.24e-03	145.4	145.4	145.4	145.4	-222.0	-276.0	-512.4-1.553e+06	-1.477e+06	3.086e+06	
187	ok	0.02	0.2	4.84e-03	145.4	145.4	145.4	145.4	-199.8	114.2	-485.72.057e+06	3.924e+06	2.972e+06	
188	ok	0.02	0.3	9.62e-03	145.4	145.4	145.4	145.4	-362.8	-676.3	-485.3-4.977e+06	-3.317e+06	2.974e+06	
189	ok	0.03	0.8	0.0145.4	145.4	145.4	145.4	695.4	2132.4	-207.01.409e+07	8.205e+06	1.038e+06		
190	ok	0.03	0.8	2.78e-02	145.4	145.4	145.4	145.4	-1238.2	-2710.3	-190.9-1.666e+07	-1.101e+07	9.500e+05	
191	ok	0.02	0.5	3.47e-04	145.4	145.4	145.4	145.4	119.3	1105.8	-331.51.139e+07	5.162e+06	2.683e+06	
192	ok	0.02	0.6	1.85e-02	145.4	145.4	145.4	145.4	-685.2	-1667.6	-329.5-1.433e+07	-8.080e+06	2.685e+06	
193	ok	0.03	0.4	0.0145.4	145.4	145.4	145.4	550.2	592.6	102.75.193e+06	3.242e+06	-1.598e+05		
194	ok	0.03	0.4	1.17e-02	145.4	145.4	145.4	145.4	-803.2	-509.6	194.5-6.144e+06	4.263e+06	-1.876e+05	
195	ok	0.02	0.3	2.61e-03	145.4	145.4	145.4	145.4	-63.5	486.6	-429.15.245e+06	2.102e+06	2.663e+06	
196	ok	0.02	0.4	1.18e-02	145.4	145.4	145.4	145.4	-499.5	-1048.4	-428.3-8.166e+06	-5.025e+06	2.665e+06	
197	ok	0.03	0.4	0.0145.4	145.4	145.4	145.4	619.6	744.8	91.16.399e+06	3.903e+06	-1.369e+05		
198	ok	0.03	0.4	1.26e-02	145.4	145.4	145.4	145.4	-914.4	-704.1	182.1-7.574e+06	-5.108e+06	-1.534e+05	
199	ok	0.02	0.8	0.0145.4	145.4	145.4	145.4	140.9	1975.7	-166.01.802e+07	8.789e+06	2.171e+06		
200	ok	0.02	0.8	2.65e-02	145.4	145.4	145.4	145.4	-709.3	-2534.8	-165.2-2.095e+07	-1.174e+07	2.184e+06	
201	ok	0.03	0.5	0.0145.4	145.4	145.4	145.4	692.0	884.6	82.87.859e+06	4.650e+06	-7.606e+04		
202	ok	0.03	0.5	1.36e-02	145.4	145.4	145.4	145.4	-1033.2	-887.1	174.2-9.300e+06	-6.053e+06	-7.293e+04	
203	ok	0.02	0.4	6.91e-04	145.4	145.4	145.4	145.4	56.1	808.7	-346.17.984e+06	3.559e+06	2.172e+06	
204	ok	0.02	0.5	1.37e-02	145.4	145.4	145.4	145.4	-619.7	-1369.9	-345.1-1.091e+07	-6.481e+06	2.174e+06	
205	ok	0.02	0.2	5.63e-03	145.4	145.4	145.4	145.4	-271.6	-281.3	-356.1-1.473e+06	-1.460e+06	2.140e+06	
206	ok	0.02	0.1	4.02e-03	145.4	145.4	145.4	145.4	-201.1	-4.5	-342.59.213e+05	-2.024e+05	2.065e+06	
207	ok	0.02	0.2	7.24e-03	145.4	145.4	145.4	145.4	-362.2	-557.9	-342.2-3.836e+06	-2.716e+06	2.066e+06	
208	ok	0.03	0.6	0.0145.4	145.4	145.4	145.4	740.7	998.0	136.49.630e+06	5.492e+06	1.404e+05		
209	ok	0.03	0.6	1.47e-02	145.4	145.4	145.4	145.4	-1130.1	-1045.4	238.4-1.138e+07	-7.109e+06	1.898e+05	
210	ok	0.02	0.6	0.0145.4	145.4	145.4	145.4	317.6	1445.9	-213.81.404e+06	7.587e+06	1.749e+06		
211	ok	0.02	0.7	2.02e-02	145.4	145.4	145.4	145.4	-884.9	-2006.4	-212.5-1.698e+07	-9.507e+06	1.745e+06	
212	ok	0.02	0.2	2.53e-03	145.4	145.4	145.4	145.4	-116.2	253.6	-305.63.123e+06	9.668e+06	1.851e+06	
213	ok	0.02	0.3	8.74e-03	145.4	145.4	145.4	145.4	-447.3	-815.7	-305.0-6.039e+06	-3.885e+06	1.852e+06	
214	ok	0.03	0.7	0.0145.4	145.4	145.4	145.4	798.6	1054.2	185.21.198e+06	7.365e+06	4.829e+05		
215	ok	0.03	0.7	1.59e-02	145.4	145.4	145.4	145.4	-1245.5	-1133.5	298.2-1.413e+07	-8.187e+06	5.967e+05	
216	ok	0.02	0.4	0.0145.4	145.4	145.4	145.4	148.9	1060.5	-239.91.009e+07	4.667e+06	1.528e+06		
217	ok	0.02	0.5	1.51e-02	145.4	145.4	145.4	145.4	-713.5	-1621.0	-238.9-1.301e+07	-7.589e+06	1.529e+06	
218	ok	0.02	0.2	1.25e-03	145.4	145.4	145.4	145.4	-43.3	476.0	-247.65.016e+06	1.968e+06	1.511e+06	
219	ok	0.02	0.3	1.00e-02	145.4	145.4	145.4	145.4	-520.7	-1037.8	-246.7-7.931e+06	-4.885e+06	1.512e+06	
220	ok	0.03	0.9	0.0145.4	145.4	145.4	145.4	959.9	2520.4	15.41.526e+07	9.757e+06	5.344e+05		
221	ok	0.03	0.8	2.90e-02	145.4	145.4	145.4	145.4	-1513.7	-3087.3	38.2-1.781e+07	-1.260e+07	5.178e+05	
222	ok	0.02	0.9	0.0145.4	145.4	145.4	145.4	755.7	2184.7	-513.31.928e+07	9.703e+06	1.828e+06		
223	ok	0.02	0.9	2.71e-02	145.4	145.4	145.4	145.4	-1322.5	-2745.2	-511.1-2.223e+07	-1.263e+07	1.821e+06	
224	ok	0.02	0.1	4.12e-03	145.4	145.4	145.4	145.4	-283.1	-281.1	-188.8-1.456e+06	-1.458e+06	1.164e+06	
225	ok	0.02	6.77e-02	3.27e-03	145.4	145.4	145.4	145.4	-228.8	-129.7	-179.6-1.743e+05	-7.757e+05	1.120e+06	
226	ok	0.02	0.1	5.01e-03	145.4	145.4	145.4	145.4	-332.3	-430.3	-184.2-2.746e+06	-2.144e+06	1.127e+06	
227	ok	0.02	0.3	3.25e-04	145.4	145.4	145.4	145.4	12.6	647.5	-171.96.469e+06	2.733e+06	1.065e+06	
228	ok	0.02	0.4	1.10e-02	145.4	145.4	145.4	145.4	-577.4	-1208.9	-170.7-9.385e+06	-5.650e+06	1.065e+06	
229	ok	0.02	0.7	0.0145.4	145.4	145.4	145.4	554.3	1781.7	-251.01.510e+07	7.570e+06	1.413e+06		
230	ok	0.02	0.7	2.09e-02	145.4	145.4	145.4	145.4	-1121.8	-2341.9	-249.8-1.803e+07	-1.051e+07	1.427e+06	
231	ok	0.02	6.73e-02	2.49e-03	145.4	145.4	145.4	145.4	-188.6	8.5	-167.21.040e+06	-1.328e+05	1.013e+06	
232	ok	0.02	0.2	5.85e-03	145.4	145.4	145.4	145.4	-375.9	-571.6	-166.6-3.952e+06	-2.780e+06	1.013e+06	
233	ok	0.02	9.96e-02	1.82e-03	145.4	145.4	145.4	145.4	-153.4	132.0	-136.62.078e+06	4.101e+05	8.284e+05	
234	ok	0.02	0.2	6.58e-03	145.4	145.4	145.4	145.4	-411.4	-695.0	-135.7-4.989e+06	-3.322e+06	8.277e+05	
235	ok	0.02	0.5	0.0145.4	145.4	145.4	145.4	226.4	1240.6	-143.61.136e+07	5.344e+06	8.396e+05		
236	ok	0.02	0.6	1.59e-02	145.4	145.4	145.4	145.4	-792.1	-1800.1	-143.1-1.428e+07	-8.269e+06	8.421e+05	
237	ok	0.02	0.1	1.32e-03	145.4	145.4	145.4	145.4	-120.4	220.1	-97.12.869e+06	8.308e+05	5.865e+05	
238	ok	0.02	0.2	7.14e-03	145.4	145.4	145.4	145.4	-444.8	-783.1	-95.9-5.780e+06	-3.742e+06	5.853e+05	
239	ok	0.02	0.3	0.0145.4	145.4	145.4	145.4	52.0	757.7	-90.37.376e+06	3.209e+06	5.558e+05		
240	ok	0.02	0.4	1.16e-02	145.4	145.4	145.4	145.4	-617.8	-1318.5	-89.1-1.029e+07	-6.127e+06	5.552e+05	
241	ok	0.02	0.1	1.01e-03	145.4	145.4	145.4	145.4	-105.9	282.3	-49.43.373e+06	1.089e+06	3.015e+05	
242	ok	0.02	0.3	7.49e-03	145.4	145.4	145.4	145.4	-459.9	-845.2	-48.0-6.284e+06	-4.000e+06	2.998e+05	
243	ok	0.08	2.05e-02	1.42e-02	145.4	145.4	145.4	145.4	7.3	-581.5	1.4	3661.0	1.083e+05	-3.192e+04
244	ok	0.08	2.66e-02	1.45e-02	145.4	145.4	145.4	145.4	51.5	-575.2	-14.43.341e+04	1.746e+05	-2.653e+04	
245	ok	0.07	3.64e-02	1.31e-02	145.4	145.4	145.4	145.4	95.6	-541.0	-16.51.400e+05	2.828e+05	-2.189e+04	

246	ok	0.06	4.90e-02	1.15e-02	145.4	145.4	145.4	145.4	143.2	-485.3	-16.23.258e+05	4.331e+05	-1.851e+04
247	ok	0.06	6.86e-02	9.77e-03	145.4	145.4	145.4	145.4	194.4	-409.5	-15.75.922e+05	6.280e+05	-1.614e+04
248	ok	0.05	0.1	7.92e-03	145.4	145.4	145.4	145.4	249.2	-314.5	-15.59.421e+05	8.709e+05	-1.475e+04
249	ok	0.05	0.1	5.99e-03	145.4	145.4	145.4	145.4	307.1	-201.8	-15.61.378e+06	1.165e+06	-1.442e+04
250	ok	0.04	0.2	4.03e-03	145.4	145.4	145.4	145.4	367.4	-73.1	20.91.907e+06	1.515e+06	1.546e+04
251	ok	0.04	0.2	2.07e-03	145.4	145.4	145.4	145.4	430.7	68.9	22.32.535e+06	1.927e+06	1.698e+04
252	ok	0.04	0.3	1.58e-04	145.4	145.4	145.4	145.4	496.1	221.5	23.93.276e+06	2.405e+06	1.930e+04
253	ok	0.04	0.3	0.0145.4	145.4	145.4	145.4	563.8	381.1	-16.94.145e+06	2.956e+06	-2.250e+04	
254	ok	0.03	0.4	0.0145.4	145.4	145.4	145.4	633.0	543.4	-17.25.170e+06	3.585e+06	-2.711e+04	
255	ok	0.03	0.4	0.0145.4	145.4	145.4	145.4	704.6	701.8	-17.66.396e+06	4.296e+06	-3.274e+04	
256	ok	0.03	0.5	0.0145.4	145.4	145.4	145.4	780.0	846.8	-18.27.894e+06	5.087e+06	-3.940e+04	
257	ok	0.03	0.6	0.0145.4	145.4	145.4	145.4	862.8	962.5	-20.49.789e+06	5.940e+06	-4.744e+04	
258	ok	0.03	0.7	0.0145.4	145.4	145.4	145.4	954.8	1018.6	-51.11.231e+07	6.790e+06	-8.699e+04	
259	ok	0.03	0.9	0.0145.4	145.4	145.4	145.4	1176.2	2682.3	-241.51.568e+07	1.017e+07	-2.858e+05	
260	ok	0.02	0.9	0.0145.4	145.4	145.4	145.4	605.6	2291.1	335.92.037e+07	1.014e+07	-5.096e+05	
261	ok	0.02	0.7	0.0145.4	145.4	145.4	145.4	530.1	1810.1	90.81.594e+07	7.845e+06	-4.131e+05	
262	ok	0.02	0.5	0.0145.4	145.4	145.4	145.4	235.1	1287.4	23.41.183e+07	5.583e+06	-4.915e+04	
263	ok	0.02	0.3	0.0145.4	145.4	145.4	145.4	61.6	794.3	13.07.692e+06	3.372e+06	-1.862e+04	
264	ok	0.02	0.1	9.07e-04	145.4	145.4	145.4	145.4	-103.1	305.6	13.63.548e+06	1.175e+06	-1.652e+04
265	ok	0.02	6.18e-02	2.64e-03	145.4	145.4	145.4	145.4	-274.9	-282.6	13.6-1.475e+06	1.453e+06	-2.298e+04
266	ok	0.02	0.3	7.62e-03	145.4	145.4	145.4	145.4	-463.4	-868.6	15.2-6.457e+06	4.085e+06	-1.897e+04
267	ok	0.02	0.4	1.19e-02	145.4	145.4	145.4	145.4	-628.5	-1354.5	14.4-1.060e+07	6.290e+06	-2.056e+04
268	ok	0.02	0.6	1.62e-02	145.4	145.4	145.4	145.4	-801.9	-1845.8	23.4-1.476e+07	8.509e+06	-5.014e+04
269	ok	0.02	0.7	2.08e-02	145.4	145.4	145.4	145.4	-1098.9	-2368.7	88.7-1.887e+07	1.078e+07	-4.236e+05
270	ok	0.02	0.9	2.64e-02	145.4	145.4	145.4	145.4	-1174.0	-2849.7	331.7-2.332e+07	1.308e+07	-4.915e+05
271	ok	0.03	0.9	2.88e-02	145.4	145.4	145.4	145.4	-1742.8	-3235.8	-268.4-1.824e+07	1.300e+07	-3.386e+05
272	ok	0.03	0.7	1.58e-02	145.4	145.4	145.4	145.4	-1433.7	-1065.0	-61.3-1.449e+07	8.579e+06	-9.994e+04
273	ok	0.03	0.6	1.46e-02	145.4	145.4	145.4	145.4	-1280.1	-981.2	-27.3-1.156e+07	7.543e+06	-5.418e+04
274	ok	0.03	0.5	1.36e-02	145.4	145.4	145.4	145.4	-1144.0	-825.9	-24.4-9.335e+06	6.492e+06	-4.580e+04
275	ok	0.03	0.4	1.26e-02	145.4	145.4	145.4	145.4	-1022.1	-637.9	-23.2-7.566e+06	5.508e+06	-3.928e+04
276	ok	0.03	0.4	1.18e-02	145.4	145.4	145.4	145.4	-909.1	-437.0	-22.2-6.113e+06	4.316e+06	-3.342e+04
277	ok	0.04	0.3	1.09e-02	145.4	145.4	145.4	145.4	-802.2	-234.8	-21.3-4.895e+06	3.821e+06	-2.848e+04
278	ok	0.04	0.3	1.00e-02	145.4	145.4	145.4	145.4	-700.5	-39.1	-20.4-3.864e+06	3.122e+06	-2.449e+04
279	ok	0.04	0.2	9.07e-03	145.4	145.4	145.4	145.4	-603.6	144.7	-19.5-2.988e+06	2.513e+06	-2.156e+04
280	ok	0.04	0.2	8.12e-03	145.4	145.4	145.4	145.4	-511.3	312.5	-18.8-2.244e+06	1.986e+06	-1.973e+04
281	ok	0.05	0.2	7.14e-03	145.4	145.4	145.4	145.4	-424.0	461.4	-18.2-1.621e+06	1.536e+06	-1.899e+04
282	ok	0.05	0.1	6.12e-03	145.4	145.4	145.4	145.4	-341.8	588.9	-17.8-1.107e+06	1.156e+06	-1.935e+04
283	ok	0.06	0.1	5.07e-03	145.4	145.4	145.4	145.4	-264.9	692.9	-17.7-6.946e+05	8.422e+05	-2.069e+04
284	ok	0.06	9.69e-02	3.97e-03	145.4	145.4	145.4	145.4	-193.8	772.2	-17.9-3.816e+05	5.892e+05	-2.292e+04
285	ok	0.07	0.1	2.83e-03	145.4	145.4	145.4	145.4	-128.4	825.7	-17.8-1.643e+05	3.928e+05	-2.662e+04
286	ok	0.08	0.1	1.62e-03	145.4	145.4	145.4	145.4	-68.4	852.1	-14.9-3.960e+04	2.492e+05	-3.221e+04
287	ok	0.08	6.78e-02	2.43e-04	145.4	145.4	145.4	145.4	-9.9	845.4	3.3 -4444.5	-1.574e+05	-3.855e+04
288	ok	0.02	0.1	1.05e-03	145.4	145.4	145.4	145.4	-106.1	282.2	67.53.374e+06	1.090e+06	-3.260e+05
289	ok	0.02	0.3	7.54e-03	145.4	145.4	145.4	145.4	-461.0	-845.5	69.4-6.282e+06	3.998e+06	-3.292e+05
290	ok	0.02	0.3	0.0145.4	145.4	145.4	145.4	52.1	758.7	109.27.375e+06	3.206e+06	-5.811e+05	
291	ok	0.02	0.4	1.17e-02	145.4	145.4	145.4	145.4	-620.6	-1318.2	110.7-1.029e+07	6.125e+06	-5.842e+05
292	ok	0.02	0.1	1.40e-03	145.4	145.4	145.4	145.4	-120.8	219.8	115.42.869e+06	8.324e+05	-6.114e+05
293	ok	0.02	0.2	7.24e-03	145.4	145.4	145.4	145.4	-446.8	-783.8	117.4-5.776e+06	3.738e+06	-6.152e+05
294	ok	0.02	0.5	0.0145.4	145.4	145.4	145.4	228.1	1242.0	164.41.135e+07	5.338e+06	-8.677e+05	
295	ok	0.02	0.6	1.60e-02	145.4	145.4	145.4	145.4	-796.4	-1798.8	163.6-1.427e+07	8.267e+06	-8.685e+05
296	ok	0.02	0.1	1.95e-03	145.4	145.4	145.4	145.4	-154.1	131.3	155.32.079e+06	4.130e+05	-8.544e+05
297	ok	0.02	0.2	6.73e-03	145.4	145.4	145.4	145.4	-414.1	-696.4	157.3-4.985e+06	3.316e+06	-8.581e+05
298	ok	0.02	6.83e-02	2.65e-03	145.4	145.4	145.4	145.4	-189.8	7.0	186.51.041e+06	1.282e+05	-1.041e+06
299	ok	0.02	0.2	6.03e-03	145.4	145.4	145.4	145.4	-379.0	-573.7	188.2-3.946e+06	2.772e+06	-1.044e+06
300	ok	0.02	0.7	0.0145.4	145.4	145.4	145.4	558.3	1781.7	272.91.510e+07	7.563e+06	-1.443e+06	
301	ok	0.02	0.7	2.10e-02	145.4	145.4	145.4	145.4	-1127.1	-2339.6	268.3-1.802e+07	1.051e+07	-1.449e+06
302	ok	0.02	0.3	3.89e-04	145.4	145.4	145.4	145.4	12.5	649.0	191.16.468e+06	2.729e+06	-1.092e+06
303	ok	0.02	0.4	1.11e-02	145.4	145.4	145.4	145.4	-582.8	-1208.6	192.9-9.375e+06	5.645e+06	-1.096e+06
304	ok	0.02	6.87e-02	3.45e-03	145.4	145.4	145.4	145.4	-230.7	-131.7	199.4-1.710e+05	7.692e+05	-1.148e+06
305	ok	0.02	0.1	5.21e-03	145.4	145.4	145.4	145.4	-335.4	-432.7	205.3-2.741e+06	2.135e+06	-1.157e+06
306	ok	0.02	0.1	4.32e-03	145.4	145.4	145.4	145.4	-285.7	-283.2	209.2-1.451e+06	1.450e+06	-1.194e+06
307	ok	0.02	0.9	0.0145.4	145.4	145.4	145.4	761.9	2182.7	534.51.927e+07	9.697e+06	-1.857e+06	
308	ok	0.02	0.9	2.72e-02	145.4	145.4	145.4	145.4	-1328.2	-2742.2	527.1-2.222e+07	1.263e+07	-1.840e+06
309	ok	0.03	0.9	0.0145.4	145.4	145.4	145.4	966.8	2517.2	3.81.525e+07	9.752e+06	-5.602e+05	
310	ok	0.03	0.8	2.91e-02	145.4	145.4	145.4	145.4	-1519.3	-3084.0	-24.0-1.780e+07	1.260e+07	-5.340e+05
311	ok	0.02	0.2	1.37e-03	145.4	145.4	145.4	145.4	-43.8	476.3	266.85.016e+06	1.966e+06	-1.538e+06
312	ok	0.02	0.3	1.02e-02	145.4	145.4	145.4	145.4	-528.3	-1037.9	269.8-7.917e+06	4.878e+06	-1.545e+06
313	ok	0.02	0.4	0.0145.4	145.4	145.4	145.4	151.4	1063.6	262.41.008e+07	4.655e+06	-1.560e+06	
314	ok	0.02	0.5	1.52e-02	145.4	145.4	145.4	145.4	-722.3	-1618.5	260.0-1.299e+07	7.585e+06	-1.557e+06
315	ok	0.03	0.7	0.0145.4	145.4	145.4	145.4	807.1	1051.1	-167.51.197e+07	6.363e+06	-4.947e+05	
316	ok	0.03	0.7	1.58e-02	145.4	145.4	145.4	145.4	-1251.3	-1130.6	-285.7-1.413e+07	8.186e+06	-6.038e+05
317	ok	0.02	0.2	2.69e-03	145.4	145.4	145.4	145.4	-117.8	251.0	324.83.126e+06	9.728e+05	-1.880e+06
318	ok	0.02	0.3	8.96e-03	145.4	145.4	145.4	145.4	-456.2	-816.9	329.3-6.022e+06	3.874e+06	-1.889e+06
319	ok	0.02	0.6	0.0145.4	145.4	145.4	145.4	326.3	1446.9	238.61.402e+07	6.573e+06	-1.786e+06	
320	ok	0.02	0.7	2.03e-02	145.4	145.4	145.4	145.4	-895.9	-2001.8	230.9-1.696e+07	9.504e+06	-1.769e+06
321	ok	0.03	0.6	0.0145.4	145.4	145.4	145.4	749.5	993.8	-121.29.622e+06	5.490e+06	-1.476e+05	

322	ok 0.03	0.6	1.46e-02	145.4	145.4	145.4	145.4	-1135.6	-1042.3	-227.7	-1.138e+07	-7.108e+06	-1.945e+05
323	ok 0.02	0.1	4.23e-03	145.4	145.4	145.4	145.4	-205.5	-8.1	363.19	3.00e+05	-1.903e+05	-2.097e+06
324	ok 0.02	0.2	7.51e-03	145.4	145.4	145.4	145.4	-370.3	-560.7	366.5	-3.821e+06	-2.702e+06	-2.105e+06
325	ok 0.02	0.2	5.89e-03	145.4	145.4	145.4	145.4	-276.0	-285.7	378.7	-1.466e+06	-1.444e+06	-2.177e+06
326	ok 0.02	0.4	8.17e-04	145.4	145.4	145.4	145.4	58.3	812.3	370.57	9.78e+06	3.544e+06	-2.209e+06
327	ok 0.02	0.5	1.38e-02	145.4	145.4	145.4	145.4	-633.4	-1366.7	367.4	-1.088e+07	-6.476e+06	-2.207e+06
328	ok 0.03	0.5	0.0145.4	145.4	145.4	145.4	700.1	880.3	-69.77	852e+06	6.47e+06	7.170e+04	
329	ok 0.03	0.5	1.35e-02	145.4	145.4	145.4	145.4	-1038.1	-884.2	-164.9	-9.297e+06	-6.051e+06	6.970e+04
330	ok 0.02	0.8	0.0145.4	145.4	145.4	145.4	155.8	1972.0	188.51	7.99e+07	8.776e+06	-2.206e+06	
331	ok 0.02	0.8	2.66e-02	145.4	145.4	145.4	145.4	-720.9	-2528.8	180.5	-2.093e+07	-1.174e+07	-2.204e+06
332	ok 0.03	0.5	0.0145.4	145.4	145.4	145.4	626.8	740.4	-80.16	3.94e+06	6.3901e+06	1.345e+05	
333	ok 0.03	0.4	1.26e-02	145.4	145.4	145.4	145.4	-918.7	-701.3	-174.2	-7.572e+06	-5.107e+06	1.512e+05
334	ok 0.02	0.3	2.76e-03	145.4	145.4	145.4	145.4	-65.7	482.2	446.35	2.46e+06	2.101e+06	-2.694e+06
335	ok 0.02	0.4	1.21e-02	145.4	145.4	145.4	145.4	-518.1	-1044.8	453.4	-8.130e+06	-5.017e+06	-2.703e+06
336	ok 0.03	0.4	0.0145.4	145.4	145.4	145.4	556.4	588.4	-93.75	1.90e+06	6.3239e+06	1.587e+05	
337	ok 0.03	0.4	1.17e-02	145.4	145.4	145.4	145.4	-806.9	-506.9	-187.7	-6.142e+06	-4.262e+06	1.860e+05
338	ok 0.02	0.5	3.93e-04	145.4	145.4	145.4	145.4	134.3	1108.2	363.21	1.35e+07	5.138e+06	-2.736e+06
339	ok 0.02	0.6	1.87e-02	145.4	145.4	145.4	145.4	-703.2	-1660.9	348.1	-1.429e+07	-8.077e+06	-2.713e+06
340	ok 0.03	0.8	0.0145.4	145.4	145.4	145.4	710.3	2124.6	226.81	4.06e+07	8.197e+06	-1.069e+06	
341	ok 0.03	0.8	2.78e-02	145.4	145.4	145.4	145.4	-1249.6	-2703.8	203.6	-1.664e+07	-1.101e+07	-9.665e+05
342	ok 0.02	0.2	5.10e-03	145.4	145.4	145.4	145.4	-217.4	106.5	501.42	0.90e+06	4.154e+05	-3.001e+06
343	ok 0.02	0.3	1.00e-02	145.4	145.4	145.4	145.4	-384.7	-672.5	514.1	-4.933e+06	-3.306e+06	-3.026e+06
344	ok 0.02	0.2	7.70e-03	145.4	145.4	145.4	145.4	-226.9	-281.8	538.7	-1.533e+06	-1.452e+06	-3.142e+06
345	ok 0.04	0.3	0.0145.4	145.4	145.4	145.4	488.2	432.7	-107.94	1.76e+06	6.659e+06	1.641e+05	
346	ok 0.04	0.3	1.08e-02	145.4	145.4	145.4	145.4	-701.1	-311.5	-202.4	-4.938e+06	-3.515e+06	1.974e+05
347	ok 0.04	0.3	3.64e-04	145.4	145.4	145.4	145.4	422.2	279.0	-121.43	3.14e+06	2.154e+06	1.611e+05
348	ok 0.04	0.3	9.86e-03	145.4	145.4	145.4	145.4	-600.7	-122.1	-216.2	-3.914e+06	-2.860e+06	1.971e+05
349	ok 0.03	0.6	0.0145.4	145.4	145.4	145.4	639.5	1130.3	-54.21	1.116e+07	5.162e+06	-9.857e+05	
350	ok 0.03	0.7	1.56e-02	145.4	145.4	145.4	145.4	-1006.3	-1279.7	-242.3	-1.327e+07	-7.036e+06	-1.145e+06
351	ok 0.02	0.4	2.94e-03	145.4	145.4	145.4	145.4	-106.2	680.6	473.07	8.04e+06	3.272e+06	-3.490e+06
352	ok 0.02	0.5	1.63e-02	145.4	145.4	145.4	145.4	-466.3	-1244.5	454.4	-1.072e+07	-6.223e+06	-3.437e+06
353	ok 0.02	0.7	1.67e-03	145.4	145.4	145.4	145.4	-80.8	1539.3	436.91	4.70e+07	7.026e+06	-3.323e+06
354	ok 0.02	0.8	2.47e-02	145.4	145.4	145.4	145.4	-471.0	-2103.0	428.8	-1.765e+07	-1.000e+07	-3.304e+06
355	ok 0.04	0.2	2.16e-03	145.4	145.4	145.4	145.4	358.5	131.8	-133.32	5.77e+06	1.716e+06	1.546e+05
356	ok 0.04	0.2	8.94e-03	145.4	145.4	145.4	145.4	-505.6	56.2	-228.1	-3.042e+06	-2.290e+06	1.193e+05
357	ok 0.04	0.2	4.01e-03	145.4	145.4	145.4	145.4	297.5	-5.8	-143.11	9.951e+06	1.339e+06	1.469e+05
358	ok 0.02	0.3	6.53e-03	145.4	145.4	145.4	145.4	-516.6	173.7	443.73	9.19e+06	1.197e+06	-3.715e+06
359	ok 0.02	0.4	1.36e-02	145.4	145.4	145.4	145.4	-219.0	-763.9	554.3	-6.513e+06	-4.040e+06	-3.893e+06
360	ok 0.04	0.2	8.00e-03	145.4	145.4	145.4	145.4	-415.9	219.9	-237.1	-2.301e+06	-1.798e+06	1.832e+05
361	ok 0.03	0.6	0.0145.4	145.4	145.4	145.4	542.8	1047.6	-61.39	1.152e+06	6.4262e+06	-4.964e+05	
362	ok 0.03	0.6	1.46e-02	145.4	145.4	145.4	145.4	-856.7	-1164.7	-234.2	-1.090e+07	-5.899e+06	-5.627e+05
363	ok 0.02	0.3	1.15e-02	145.4	145.4	145.4	145.4	15.2	-220.3	628.0	-1.973e+06	-1.671e+06	-4.083e+06
364	ok 0.03	0.7	1.26e-03	145.4	145.4	145.4	145.4	395.9	1554.2	394.61	1.87e+07	5.922e+06	-1.974e+06
365	ok 0.03	0.7	2.52e-02	145.4	145.4	145.4	145.4	-928.7	-2145.1	378.5	-1.454e+07	-8.669e+06	-1.815e+06
366	ok 0.05	0.1	5.88e-03	145.4	145.4	145.4	145.4	239.6	-131.1	-150.21	4.24e+06	1.018e+06	1.389e+05
367	ok 0.05	0.2	7.03e-03	145.4	145.4	145.4	145.4	-331.9	366.0	-242.8	-1.678e+06	-1.378e+06	1.739e+05
368	ok 0.02	0.5	6.58e-03	145.4	145.4	145.4	145.4	-532.3	580.6	540.61	0.23e+07	5.099e+06	-4.071e+06
369	ok 0.02	0.6	2.15e-02	145.4	145.4	145.4	145.4	-228.4	-1535.5	634.3	-1.329e+07	-7.660e+06	-4.144e+06
370	ok 0.05	0.1	7.73e-03	145.4	145.4	145.4	145.4	185.2	-242.0	-154.49	8.90e+05	7.491e+05	1.304e+05
371	ok 0.03	0.5	0.0145.4	145.4	145.4	145.4	476.7	939.6	-69.67	5.51e+06	6.3516e+06	-2.303e+05	
372	ok 0.03	0.5	1.36e-02	145.4	145.4	145.4	145.4	-742.0	-1014.2	-235.1	-8.995e+06	-4.924e+06	-2.417e+05
373	ok 0.05	0.2	6.04e-03	145.4	145.4	145.4	145.4	-253.9	492.3	-244.7	-1.164e+06	-1.024e+06	1.639e+05
374	ok 0.06	7.40e-02	9.51e-03	145.4	145.4	145.4	145.4	134.7	-336.8	-155.46	3.88e+05	5.269e+05	1.214e+05
375	ok 0.06	0.1	5.02e-03	145.4	145.4	145.4	145.4	-182.1	597.0	-242.5	-7.508e+05	-7.318e+05	1.528e+05
376	ok 0.03	0.5	0.0145.4	145.4	145.4	145.4	369.1	1099.9	104.29	4.20e+06	6.3563e+06	-1.892e+06	
377	ok 0.03	0.6	1.47e-02	145.4	145.4	145.4	145.4	-609.1	-1360.5	-115.0	-1.145e+07	-5.528e+06	-2.087e+06
378	ok 0.02	0.4	1.44e-02	145.4	145.4	145.4	145.4	-1165.5	391.7	993.76	4.99e+06	1.835e+06	-5.247e+06
379	ok 0.02	0.5	1.76e-02	145.4	145.4	145.4	145.4	3.1	-868.6	764.6	-8.143e+06	-4.866e+06	-4.693e+06
380	ok 0.03	0.4	0.0145.4	145.4	145.4	145.4	412.2	815.1	-88.26	2.21e+06	6.893e+06	-8.619e+04	
381	ok 0.03	0.4	1.25e-02	145.4	145.4	145.4	145.4	-633.1	-845.7	-251.4	-7.411e+06	-4.088e+06	-6.440e+04
382	ok 0.06	5.24e-02	1.12e-02	145.4	145.4	145.4	145.4	88.4	-414.1	-153.23	7.08e+05	3.491e+05	1.109e+05
383	ok 0.06	0.1	3.97e-03	145.4	145.4	145.4	145.4	-117.0	678.8	-236.3	-4.354e+05	-4.967e+05	1.393e+05
384	ok 0.03	0.5	3.68e-03	145.4	145.4	145.4	145.4	-14.1	862.5	498.08	4.95e+06	3.464e+06	-3.129e+06
385	ok 0.03	0.6	2.15e-02	145.4	145.4	145.4	145.4	-548.1	-1476.1	490.9	-1.127e+07	-6.095e+06	-2.948e+06
386	ok 0.02	0.4	1.38e-02	145.4	145.4	145.4	145.4	326.1	-149.5	708.0	-2.670e+06	-1.900e+06	-4.739e+06
387	ok 0.07	3.72e-02	1.27e-02	145.4	145.4	145.4	145.4	46.2	-472.7	-147.91	8.13e+05	2.130e+05	9.747e+04
388	ok 0.07	0.1	2.88e-03	145.4	145.4	145.4	145.4	-58.3	736.3	-226.2	-2.137e+05	-3.153e+05	1.227e+05
389	ok 0.03	0.3	0.0145.4	145.4	145.4	145.4	348.6	681.5	-111.65	0.97e+06	6.2364e+06	-4812.2	
390	ok 0.03	0.4	1.15e-02	145.4	145.4	145.4	145.4	-528.8	-669.5	-275.1	-6.069e+06	-3.368e+06	3.651e+04
391	ok 0.08	2.66e-02	1.40e-02	145.4	145.4	145.4	145.4	6.9	-509.4	-140.56	8.29e+04	1.183e+05	7.893e+04
392	ok 0.08	9.26e-02	1.76e-03	145.4	145.4	145.4	145.4	-4.3	766.6	-213.6	-8.188e+04	-1.859e+05	1.008e+05
393	ok 0.03	0.5	0.0145.4	145.4	145.4	145.4	275.2	1012.2	84.07	9.45e+06	6.2705e+06	-1.335e+06	
394	ok 0.03	0.5	1.39e-02	145.4	145.4	145.4	145.4	-483.3	-1229.4	-110.6	-9.654e+06	-4.381e+06	-1.421e+06
395	ok 0.03	0.3	7.63e-03	145.4	145.4	145.4	145.4	-714.8	213.1	411.54	5.21e+06	1.018e+06	-3.958e+06
396	ok 0.03	0.5	1.69e-02	145.4	145.4	145.4	145.4	-112.2	-758.5	556.7	-6.826e+06	-3.677e+06	-3.975e+06
397	ok 0.03	0.3	1.20e-02	145.4	145.4	145.4	145.4	373.4	-24.3	606.0	-1.602e+06	-1.528e+06	-4.447e+06



398	ok	0.08	2.09e-02	1.41e-02	145.4	145.4	145.4	145.4	-38.3	-502.7	-132.62.565e+04	7.373e+04	4.912e+04	
399	ok	0.08	9.52e-02	4.61e-04	145.4	145.4	145.4	145.4	54.5	747.4	-200.8-3.299e+04-1.164e+05	6.697e+04		
400	ok	0.03		2.07e-03	145.4	145.4	145.4	145.4	175.4	882.7	327.96.752e+06	1.867e+06	2.876e+06	
401	ok	0.03		1.34e-02	145.4	145.4	145.4	145.4	-308.3	-1233.7	165.8-8.678e+06-3.946e+06-3.084e+06			
402	ok	0.04		0.0145.4	145.4	145.4	145.4	287.0	544.5	-136.24.136e+06	1.913e+06	4.361e+04		
403	ok	0.04		1.04e-02	145.4	145.4	145.4	145.4	-429.7	-493.1	-300.7-4.922e+06-2.745e+06	9.592e+04		
404	ok	0.03		0.0145.4	145.4	145.4	145.4	223.5	922.1	67.76.681e+06	2.103e+06	9.801e+05		
405	ok	0.03		1.30e-02	145.4	145.4	145.4	145.4	-391.7	-1091.4	-119.4-8.119e+06-3.518e+06-1.000e+06			
406	ok	0.04		9.67e-04	145.4	145.4	145.4	145.4	228.0	408.5	-160.13.311e+06	1.526e+06	7.436e+04	
407	ok	0.04		9.46e-03	145.4	145.4	145.4	145.4	-336.4	-321.5	-325.3-3.937e+06-2.207e+06	1.320e+05		
408	ok	0.03		5.62e-03	145.4	145.4	145.4	145.4	91.9	418.4	571.43.266e+06	3.171e+05	-3.726e+06	
409	ok	0.03		1.14e-02	145.4	145.4	145.4	145.4	-189.2	-847.3	447.9-5.067e+06-2.473e+06-3.837e+06			
410	ok	0.03		2.12e-03	145.4	145.4	145.4	145.4	77.3	802.3	312.25.834e+06	1.215e+06	-2.392e+06	
411	ok	0.03		1.25e-02	145.4	145.4	145.4	145.4	-198.4	-1106.0	152.2-7.491e+06-2.941e+06-2.480e+06			
412	ok	0.03		8.83e-03	145.4	145.4	145.4	145.4	-186.6	-284.4	593.4-1.001e+06-1.087e+06-4.090e+06			
413	ok	0.03		0.0145.4	145.4	145.4	145.4	172.5	823.3	42.75.577e+06	1.654e+06	7.397e+05		
414	ok	0.03		1.20e-02	145.4	145.4	145.4	145.4	-299.2	-946.9	-143.5-6.779e+06-2.838e+06-7.198e+05			
415	ok	0.04		2.38e-03	145.4	145.4	145.4	145.4	172.2	276.8	-181.72.602e+06	1.194e+06	9.515e+04	
416	ok	0.04		8.52e-03	145.4	145.4	145.4	145.4	-249.5	-158.7	-346.9-3.093e+06-1.742e+06	1.545e+05		
417	ok	0.04		3.88e-03	145.4	145.4	145.4	145.4	120.2	152.3	-200.21.997e+06	9.097e+05	1.096e+05	
418	ok	0.04		7.58e-03	145.4	145.4	145.4	145.4	-169.3	-7.5	-364.3-2.372e+06-1.343e+06	1.684e+05		
419	ok	0.03		5.31e-03	145.4	145.4	145.4	145.4	9.6	366.9	528.42.833e+06	4.360e+06	3.306e+06	
420	ok	0.03		1.05e-02	145.4	145.4	145.4	145.4	-74.1	-749.7	420.0-4.438e+06-1.795e+06-3.353e+06			
421	ok	0.03		2.29e-03	145.4	145.4	145.4	145.4	46.2	736.3	291.84.981e+06	8.281e+05	-1.988e+06	
422	ok	0.03		1.17e-02	145.4	145.4	145.4	145.4	-128.6	-993.2	131.3-6.403e+06-2.256e+06-2.012e+06			
423	ok	0.03		5.19e-04	145.4	145.4	145.4	145.4	121.7	718.0	12.54.615e+06	1.303e+06	-5.640e+05	
424	ok	0.03		1.09e-02	145.4	145.4	145.4	145.4	-208.1	-799.4	-175.2-5.611e+06-2.283e+06-5.205e+05			
425	ok	0.03		8.10e-03	145.4	145.4	145.4	145.4	-76.0	-218.2	566.4-8.471e+05-8.878e+05-3.681e+06			
426	ok	0.05		5.43e-03	145.4	145.4	145.4	145.4	50.7	40.6	-253.61.463e+06	6.991e+05	1.146e+05	
427	ok	0.05		6.64e-03	145.4	145.4	145.4	145.4	-96.4	129.6	-376.4-1.764e+06-1.004e+06	1.759e+05		
428	ok	0.04		1.13e-03	145.4	145.4	145.4	145.4	72.7	609.6	-19.73.778e+06	1.018e+06	4.281e+05	
429	ok	0.04		9.85e-03	145.4	145.4	145.4	145.4	-121.2	-652.3	-209.4-4.594e+06-1.820e+06-3.711e+05			
430	ok	0.03		5.14e-03	145.4	145.4	145.4	145.4	4.3	339.4	494.22.433e+06	-7.927e+04	-2.862e+06	
431	ok	0.03		9.84e-03	145.4	145.4	145.4	145.4	-22.2	-673.4	390.6-3.837e+06-1.351e+06-2.876e+06			
432	ok	0.05		6.99e-03	145.4	145.4	145.4	145.4	9.9	-62.0	-263.21.041e+06	5.043e+05	1.217e+05	
433	ok	0.05		5.70e-03	145.4	145.4	145.4	145.4	-8.8	242.4	-422.8-1.233e+06-7.640e+05	1.712e+05		
434	ok	0.03		2.46e-03	145.4	145.4	145.4	145.4	16.9	668.5	262.64.200e+06	5.790e+05	-1.648e+06	
435	ok	0.03		1.08e-02	145.4	145.4	145.4	145.4	-55.7	-882.1	100.2-5.407e+06-1.753e+06-1.636e+06			
436	ok	0.03		7.68e-03	145.4	145.4	145.4	145.4	-44.6	-183.7	531.4-7.393e+05-7.295e+05-3.213e+06			
437	ok	0.06	7.90e-02	8.52e-03	145.4	145.4	145.4	145.4	-26.6	-151.3	-267.96.980e+05	3.483e+05	1.230e+05	
438	ok	0.06	9.85e-02	4.74e-03	145.4	145.4	145.4	145.4	46.2	344.3	-421.8-8.250e+05-5.388e+05	1.687e+05		
439	ok	0.04		1.89e-03	145.4	145.4	145.4	145.4	26.7	500.9	-51.83.051e+06	7.812e+05	-3.184e+05	
440	ok	0.04		8.81e-03	145.4	145.4	145.4	145.4	-40.4	-508.7	-242.9-3.711e+06-1.429e+06-2.547e+05			
441	ok	0.03		2.63e-03	145.4	145.4	145.4	145.4	-13.0	597.5	227.83.501e+06	4.069e+06	1.359e+06	
442	ok	0.03		9.84e-03	145.4	145.4	145.4	145.4	17.1	-771.2	63.1-4.515e+06-1.365e+06-1.325e+06			
443	ok	0.03		4.97e-03	145.4	145.4	145.4	145.4	1.1	312.6	456.92.058e+06	-1.317e+05	-2.439e+06	
444	ok	0.03		9.13e-03	145.4	145.4	145.4	145.4	28.2	-601.9	355.3-3.266e+06-1.033e+06-2.434e+06			
445	ok	0.06	5.64e-02	9.98e-03	145.4	145.4	145.4	145.4	-58.3	-226.0	-267.74.294e+05	2.294e+05	1.177e+05	
446	ok	0.06		3.77e-03	145.4	145.4	145.4	145.4	93.4	426.8	-414.4-5.067e+05-3.644e+05	1.585e+05		
447	ok	0.03		7.22e-03	145.4	145.4	145.4	145.4	-19.2	-156.2	492.4-6.350e+05-5.958e+05-2.752e+06			
448	ok	0.04		2.78e-03	145.4	145.4	145.4	145.4	-15.6	394.3	-82.32.423e+06	5.821e+05	-2.278e+05	
449	ok	0.04		7.85e-03	145.4	145.4	145.4	145.4	33.2	-371.1	-273.6-2.948e+06-1.096e+06-1.619e+05			
450	ok	0.07	3.84e-02	1.13e-02	145.4	145.4	145.4	145.4	-84.9	-285.5	-262.02.307e+05	1.472e+05	1.043e+05	
451	ok	0.07		2.79e-03	145.4	145.4	145.4	145.4	132.5	489.4	-399.9-2.721e+05-2.396e+05	1.387e+05		
452	ok	0.04		2.79e-03	145.4	145.4	145.4	145.4	-42.2	524.6	190.02.883e+06	2.803e+05	-1.110e+06	
453	ok	0.04		8.87e-03	145.4	145.4	145.4	145.4	86.4	-661.3	23.3-3.725e+06-1.054e+06-1.064e+06			
454	ok	0.03		4.75e-03	145.4	145.4	145.4	145.4	-3.7	284.0	416.21.718e+06	-1.501e+05	-2.053e+06	
455	ok	0.03		8.35e-03	145.4	145.4	145.4	145.4	78.0	-532.4	315.2-2.743e+06-7.915e+05-2.036e+06			
456	ok	0.08	2.61e-02	1.24e-02	145.4	145.4	145.4	145.4	-104.6	-332.3	-250.49.499e+04	1.033e+05	7.911e+04	
457	ok	0.08		1.81e-03	145.4	145.4	145.4	145.4	161.4	535.1	-377.7-1.131e+05-1.653e+05	1.057e+05		
458	ok	0.04		3.73e-03	145.4	145.4	145.4	145.4	-53.8	291.8	-110.11.883e+06	4.143e+05	-1.527e+05	
459	ok	0.04		6.93e-03	145.4	145.4	145.4	145.4	98.9	-241.4	-300.3-2.293e+06-8.138e+05-8.717e+04			
460	ok	0.03		6.70e-03	145.4	145.4	145.4	145.4	4.9	-132.2	450.0-5.369e+05-4.822e+05-2.323e+06			
461	ok	0.08	1.97e-02	1.28e-02	145.4	145.4	145.4	145.4	-108.4	-391.9	-234.6	4259.0	1.038e+05	3.163e+04
462	ok	0.08	7.89e-02	6.50e-04	145.4	145.4	145.4	145.4	170.6	590.5	-348.9-1.131e+04-1.462e+05	4.907e+04		
463	ok	0.04		3.05e-03	145.4	145.4	145.4	145.4	-69.5	450.8	151.12.342e+06	1.823e+05	-8.955e+05	
464	ok	0.04		7.90e-03	145.4	145.4	145.4	145.4	150.0	-553.8	-16.8-3.032e+06-7.975e+05-8.430e+05			
465	ok	0.05		4.75e-03	145.4	145.4	145.4	145.4	-189.7	165.0	-198.51.392e+06	2.713e+05	-1.327e+05	
466	ok	0.05		6.02e-03	145.4	145.4	145.4	145.4	156.1	-121.4	-321.8-1.737e+06-5.762e+05	2.786e+04		
467	ok	0.04		4.51e-03	145.4	145.4	145.4	145.4	-9.3	253.7	372.91.416e+06	-1.523e+05	-1.707e+06	
468	ok	0.04		7.60e-03	145.4	145.4	145.4	145.4	125.0	-464.7	272.1-2.274e+06-6.002e+05-1.683e+06			
469	ok	0.04		6.15e-03	145.4	145.4	145.4	145.4	27.4	-110.4	405.0-4.468e+05-3.854e+05-1.935e+06			
470	ok	0.05		5.81e-03	145.4	145.4	145.4	145.4	211.2	85.1	-210.21.019e+06	1.665e+06	-7.139e+04	
471	ok	0.05		5.13e-03	145.4	145.4	145.4	145.4	241.9	-30.2	-375.3-1.256e+06-4.199e+05	3.400e+04		
472	ok	0.04		3.36e-03	145.4	145.4	145.4	145.4	-94.1	377.6	112.41.872e+06	1.034e+05	-7.101e+05	
473	ok	0.04		7.00e-03	145.4	145.4	145.4	145.4	206.7	-449.9	-55.5-2.429e+06-5.841e+05-6.554e+05			



CODE  
C21BLN001CWR00300

PAGE  
101 di/of 119

474	ok	0.04	0.2	4.34e-03	145.4	145.4	145.4	145.4	-15.1	222.3	328.21.150e+06-1.476e+05-1.400e+06
475	ok	0.04	0.2	6.83e-03	145.4	145.4	145.4	145.4	167.7	-399.0	227.7-1.859e+06-4.449e+05-1.373e+06
476	ok	0.06	7.86e-02	6.89e-03	145.4	145.4	145.4	145.4	-169.6	40.6	-206.97.251e+05 1.070e+05 1.464e+04
477	ok	0.06	0.1	4.26e-03	145.4	145.4	145.4	145.4	277.5	64.2	-383.4-8.798e+05-2.697e+05 7.011e+04
478	ok	0.04	0.2	5.63e-03	145.4	145.4	145.4	145.4	47.7	-90.6	358.3-3.653e+05-3.032e+05-1.591e+06
479	ok	0.04	0.1	3.70e-03	145.4	145.4	145.4	145.4	-226.8	304.7	42.31.438e+06 6.230e+04-5.612e+05
480	ok	0.04	0.2	6.11e-03	145.4	145.4	145.4	145.4	255.6	-350.8	-91.5-1.908e+06-4.056e+05-4.968e+05
481	ok	0.04	0.1	4.14e-03	145.4	145.4	145.4	145.4	-20.6	190.3	283.09.185e+05-1.406e+05-1.132e+06
482	ok	0.04	0.2	6.04e-03	145.4	145.4	145.4	145.4	205.2	-335.6	183.2-1.496e+06-3.169e+05-1.104e+06
483	ok	0.06	5.77e-02	7.96e-03	145.4	145.4	145.4	145.4	-184.6	-28.0	-215.84.789e+05 4.907e+04 1.268e+04
484	ok	0.06	9.92e-02	3.40e-03	145.4	145.4	145.4	145.4	304.0	144.6	-384.2-5.810e+05-1.592e+05 9.268e+04
485	ok	0.05	0.1	4.07e-03	145.4	145.4	145.4	145.4	-133.8	237.4	40.21.121e+06-1.298e+04-4.170e+05
486	ok	0.05	0.1	5.25e-03	145.4	145.4	145.4	145.4	296.2	-257.5	-123.8-1.464e+06-2.577e+05-3.643e+05
487	ok	0.04	0.1	5.06e-03	145.4	145.4	145.4	145.4	131.7	-75.4	329.4-3.139e+05-2.436e+05-1.264e+06
488	ok	0.07	4.02e-02	8.98e-03	145.4	145.4	145.4	145.4	-194.0	-86.2	-218.92.901e+05 1.808e+04 5.882e+04
489	ok	0.07	9.71e-02	2.56e-03	145.4	145.4	145.4	145.4	320.9	210.8	-377.4-3.526e+05-8.963e+04 1.014e+05
490	ok	0.04	0.1	3.93e-03	145.4	145.4	145.4	145.4	-96.8	186.9	218.37.260e+05-1.413e+05-8.903e+05
491	ok	0.04	0.2	5.25e-03	145.4	145.4	145.4	145.4	236.9	-275.0	139.7-1.181e+06-2.108e+05-8.716e+05
492	ok	0.05	9.28e-02	4.47e-03	145.4	145.4	145.4	145.4	-148.2	172.5	8.38.302e+05-5.350e+04-3.054e+05
493	ok	0.05	0.1	4.43e-03	145.4	145.4	145.4	145.4	380.9	-199.3	-181.7-1.096e+06-1.604e+05-2.276e+05
494	ok	0.08	2.61e-02	9.78e-03	145.4	145.4	145.4	145.4	-196.8	-136.4	-217.41.486e+05 1.938e+04 6.133e+04
495	ok	0.08	5.59e-02	1.75e-03	145.4	145.4	145.4	145.4	327.0	265.9	-364.2-1.833e+05-6.508e+04 9.539e+04
496	ok	0.04	0.1	4.48e-03	145.4	145.4	145.4	145.4	145.6	-58.2	282.0-2.584e+05-1.852e+05-1.007e+06
497	ok	0.05	9.25e-02	3.71e-03	145.4	145.4	145.4	145.4	-96.6	158.9	175.05.672e+05-1.296e+05-6.896e+05
498	ok	0.05	0.1	4.47e-03	145.4	145.4	145.4	145.4	262.5	-217.7	98.2-9.102e+05-1.238e+05-6.742e+05
499	ok	0.06	7.26e-02	4.92e-03	145.4	145.4	145.4	145.4	-158.6	112.1	-20.25.898e+05-8.260e+04-2.150e+05
500	ok	0.06	0.1	3.65e-03	145.4	145.4	145.4	145.4	399.5	-122.8	-203.5-7.952e+05-7.269e+05-1.360e+05
501	ok	0.08	1.68e-02	1.04e-02	145.4	145.4	145.4	145.4	-191.4	-205.4	-228.32.429e+04 6.768e+04 4.545e+04
502	ok	0.08	6.04e-02	7.99e-04	145.4	145.4	145.4	145.4	319.9	337.6	-361.4-4.248e+04-9.909e+04 6.946e+04
503	ok	0.05	9.15e-02	3.88e-03	145.4	145.4	145.4	145.4	156.7	-42.2	235.6-2.107e+05-1.366e+05-7.869e+05
504	ok	0.05	7.62e-02	3.48e-03	145.4	145.4	145.4	145.4	-95.4	131.7	134.04.348e+05-1.175e+05-1.199e+05
505	ok	0.05	0.1	3.73e-03	145.4	145.4	145.4	145.4	383.3	-169.9	58.3-6.773e+05-7.923e+04-4.980e+05
506	ok	0.06	5.48e-02	5.41e-03	145.4	145.4	145.4	145.4	-165.2	56.9	-44.83.956e+05-9.948e+04-1.444e+05
507	ok	0.06	6.78e-02	2.91e-03	145.4	145.4	145.4	145.4	365.9	-21.6	-191.7-5.310e+05-2.247e+04-1.033e+05
508	ok	0.05	8.77e-02	3.28e-03	145.4	145.4	145.4	145.4	165.0	-27.5	191.1-1.705e+05-9.633e+04-6.008e+05
509	ok	0.07	3.93e-02	5.91e-03	145.4	145.4	145.4	145.4	-168.0	7.8	-64.92.420e+05-1.012e+05-9.150e+04
510	ok	0.07	8.37e-02	2.22e-03	145.4	145.4	145.4	145.4	371.9	40.0	-203.0-3.350e+05-5.963e+04-5.680e+04
511	ok	0.06	6.13e-02	3.24e-03	145.4	145.4	145.4	145.4	-92.8	105.8	95.83.259e+05-1.043e+05-3.778e+05
512	ok	0.06	7.85e-02	3.03e-03	145.4	145.4	145.4	145.4	387.0	-119.8	25.7-5.024e+05-2.468e+04-2.319e+05
513	ok	0.06	6.16e-02	2.69e-03	145.4	145.4	145.4	145.4	170.6	-13.7	148.8-1.372e+05-6.363e+04-4.457e+05
514	ok	0.08	2.59e-02	6.28e-03	145.4	145.4	145.4	145.4	-164.5	5.5	-99.11.103e+05-8.693e+04-6.003e+04
515	ok	0.08	5.41e-02	1.61e-03	145.4	145.4	145.4	145.4	367.3	91.6	-205.6-1.849e+05-6.111e+04-2.435e+04
516	ok	0.06	4.78e-02	3.01e-03	145.4	145.4	145.4	145.4	-88.7	81.5	61.32.387e+05-8.934e+04-2.605e+05
517	ok	0.06	6.01e-02	2.39e-03	145.4	145.4	145.4	145.4	353.8	-110.2	-22.2-3.860e+05-2.478e+04-2.319e+05
518	ok	0.06	4.89e-02	2.13e-03	145.4	145.4	145.4	145.4	173.6	-1.0	109.6-1.106e+05-3.857e+04-3.183e+05
519	ok	0.08	1.24e-02	7.11e-03	145.4	145.4	145.4	145.4	-202.9	-54.2	-144.63.863e+04 2.904e+04 3.714e+04
520	ok	0.08	6.69e-02	8.97e-04	145.4	145.4	145.4	145.4	398.3	119.7	-260.9-7.004e+04-4.767e+04 6.145e+04
521	ok	0.07	3.58e-02	2.80e-03	145.4	145.4	145.4	145.4	-104.3	21.6	54.61.729e+05-6.408e+04-1.690e+05
522	ok	0.07	7.03e-02	1.83e-03	145.4	145.4	145.4	145.4	347.1	-71.3	-48.0-2.721e+05-3.859e+04-1.385e+05
523	ok	0.07	3.74e-02	1.63e-03	145.4	145.4	145.4	145.4	173.5	11.1	73.6-9.013e+04-2.063e+04-2.135e+05
524	ok	0.08	2.43e-02	2.52e-03	145.4	145.4	145.4	145.4	-93.6	-3.2	30.61.141e+05-4.289e+04-9.054e+04
525	ok	0.08	2.97e-02	1.41e-03	145.4	145.4	145.4	145.4	350.5	8.0	-44.7-1.627e+05-3.038e+04-7.558e+04
526	ok	0.08	2.62e-02	1.27e-03	145.4	145.4	145.4	145.4	161.2	24.5	42.2-7.385e+04 -8843.0-1.228e+05
527	ok	0.08	6.95e-03	3.08e-03	145.4	145.4	145.4	145.4	-110.8	20.6	-47.43.399e+04 3789.0 1.561e+04
528	ok	0.08	1.44e-02	9.38e-04	145.4	145.4	145.4	145.4	356.2	-4.4	-115.8-7.651e+04-1.111e+04 3.340e+04
529	ok	0.08	8.74e-03	9.20e-04	145.4	145.4	145.4	145.4	207.3	-37.3	-9.9-5.574e+04 2364.5 3488.1

**Nodo**    **x/d**    **V N/M**    **ver. rid**    **Af pr-** **Af pr+****Af sec-****Af sec+**    **N x**    **N y**    **N xy**    **M x**    **M y**    **M xy**  
                  0.08    0.91    0.03145.41145.41 145.41 145.411176.192682.26    -1742.84-3235.81-846.33-2.332e+07-1.308e+07-5.247e+06    993.682.037e+071.017e+07 4.942e+06

<b>Nodo</b>	<b>Stato</b> daN/cm2	<b>Max tau</b>	<b>Ver V pr</b>	<b>Ver V sec</b>	<b>Af V pr</b>	<b>Af V sec</b> N/mm	<b>V pr</b> N/mm	<b>V sec</b>
1ok	2.54							
2ok	2.92							
3ok	3.68							
4ok	1.19							
5ok	1.60							
6ok	2.29							
7ok	0.93							
8ok	1.36							
9ok	2.07							
10ok	3.84							
11ok	4.61							
12ok	0.87							
13ok	1.28							

14ok	2.08						
15ok	2.57						
16ok	3.25						
17ok	0.81						
18ok	1.25						
19ok	2.13						
20ok	2.38						
21ok	3.09						
22ok	0.73						
23ok	2.39						
24ok	3.19						
25ok	1.23						
26ok	2.18						
27ok	0.71						
28ok	4.47						
29ok	5.24						
30ok	2.46						
31ok	3.34						
32ok	1.22						
33ok	2.26						
34ok	0.85						
35ok	3.34						
36ok	4.02						
37ok	2.56						
38ok	3.51						
39ok	1.37						
40ok	2.45						
41ok	3.21						
42ok	3.92						
43ok	1.14						
44ok	2.67						
45ok	3.70						
46ok	3.31						
47ok	4.11						
48ok	1.61						
49ok	2.76						
50ok	2.85						
51ok	3.95						
52ok	1.60						
53ok	3.48						
54ok	4.36						
55ok	1.99						
56ok	3.16						
57ok	3.17						
58ok	4.36						
59ok	3.68						
60ok	4.63						
61ok	2.26						
62ok	2.56						
63ok	3.72						
64ok	3.90						
65ok	4.93						
66ok	3.56						
67ok	4.85						
68ok	4.78						
69ok	5.55						
70ok	3.15						
71ok	4.15						
72ok Av	5.28	0.09	0.09	4.7	5.0	927.6	974.7
73ok	3.86						
74ok	4.54						
75ok	3.38						
76ok	4.50						
77ok	4.08						
78ok Av	5.45	0.03	0.11	1.5	6.1	347.8	1403.8
79ok	3.81						
80ok	4.52						
81ok	4.53						
82ok Av	5.73	0.08	0.10	4.7	5.5	987.3	1140.4
83ok	4.36						
84ok	3.98						
85ok	4.77						
86ok	4.53						
87ok Av	5.59	0.06	0.10	3.6	5.3	942.8	1330.9
88ok Av	4.80	0.01	0.10	0.6	5.4	146.5	1301.4
89ok Av	6.24	0.02	0.13	0.9	7.1	218.0	1710.9

90ok Av	5.00	0.06	0.09	3.5	5.0	773.0	1077.6	
91ok Av	6.32	0.08	0.11	4.7	6.1	1043.3	1348.1	
92ok	4.23							
93ok	5.11							
94ok Av	6.02	0.12	0.02	6.7	1.2	1847.7	323.8	
95ok Av	5.82	0.02	0.12	1.3	6.5	348.3	1648.3	
96ok Av	7.31	7.84e-03	0.15	0.4	8.3	114.2	2115.2	
97ok	4.52							
98ok Av	5.47	0.11	0.08	6.1	4.3	1030.3	734.1	
99ok Av	6.13	0.10	0.07	5.7	4.1	1562.7	1088.9	
100	ok Av	7.14	0.09	0.11	5.2	6.3	1427.3	1663.8
101	ok Av	5.57	0.06	0.10	3.3	5.7	785.8	1304.0
102	ok Av	7.00	0.08	0.13	4.6	6.9	1091.5	1610.0
103	ok	4.83						
104	ok Av	5.86	0.11	0.08	6.4	4.5	1162.6	817.8
105	ok Av	8.35	0.17	0.02	9.4	1.4	2698.7	374.0
106	ok Av	6.31	0.06	0.12	3.2	6.6	786.6	1603.5
107	ok Av	7.86	0.08	0.14	4.5	8.0	1131.1	1948.4
108	ok Av	7.28	0.04	0.14	2.4	8.0	649.1	2130.4
109	ok Av	8.80	0.02	0.18	1.3	9.9	367.0	2660.7
110	ok Av	8.37	0.14	0.09	8.0	5.3	2302.3	1452.4
111	ok Av	9.37	0.13	0.14	7.4	7.7	2147.5	2143.8
112	ok Av	5.16	0.10	0.07	5.4	3.9	1064.2	757.1
113	ok Av	6.30	0.12	0.08	6.6	4.7	1303.4	923.4
114	ok Av	5.57	0.10	0.07	5.6	4.2	1178.7	869.6
115	ok Av	6.78	0.12	0.09	6.9	5.0	1452.2	1053.4
116	ok Av	7.31	0.05	0.14	2.9	7.8	772.0	2007.4
117	ok Av	8.97	0.08	0.17	4.4	9.3	1162.1	2397.9
118	ok Av	11.72	0.24	0.03	13.2	1.5	3991.7	465.2
119	ok Av	9.37	0.07	0.18	3.8	10.0	1091.7	2812.5
120	ok Av	10.96	0.05	0.22	2.6	12.2	763.3	3440.4
121	ok Av	11.83	0.21	0.12	11.5	6.9	3485.9	2071.2
122	ok Av	12.86	0.20	0.17	11.0	9.6	3319.7	2898.3
123	ok Av	6.11	0.11	0.08	5.8	4.6	1301.0	1013.1
124	ok Av	7.43	0.13	0.10	7.3	5.5	1616.2	1220.4
125	ok Av	8.71	0.05	0.17	2.7	9.5	742.3	2569.4
126	ok Av	10.48	0.08	0.20	4.3	11.2	1181.1	3008.8
127	ok Av	6.74	0.11	0.09	6.1	5.2	1439.2	1203.1
128	ok Av	8.19	0.14	0.11	7.6	6.1	1799.2	1434.2
129	ok Av	12.74	0.11	0.23	6.2	13.1	1882.6	3939.0
130	ok Av	14.39	0.09	0.28	5.0	15.6	1508.2	4695.1
131	ok	4.73						
132	ok	5.50						
133	ok Av	18.93	0.38	0.07	21.1	4.0	7957.7	1494.0
134	ok Av	22.61	0.40	0.23	22.3	12.7	8403.5	4788.3
135	ok Av	24.48	0.41	0.28	23.0	15.7	8647.7	5904.6
136	ok Av	10.71	0.05	0.21	2.5	11.9	689.5	3367.2
137	ok Av	12.63	0.08	0.25	4.3	13.7	1206.2	3888.9
138	ok	4.09						
139	ok	4.77						
140	ok Av	7.53	0.12	0.11	6.4	5.9	1601.7	1457.4
141	ok Av	9.12	0.15	0.13	8.1	6.9	2011.0	1714.1
142	ok	4.12						
143	ok	4.83						
144	ok Av	23.34	0.43	0.20	23.9	11.4	9020.1	4286.3
145	ok Av	26.72	0.34	0.43	18.8	23.8	7090.7	8966.4
146	ok Av	28.79	0.34	0.48	18.7	26.8	7037.9	1.011e+04
147	ok	4.35						
148	ok	5.14						
149	ok Av	8.56	0.12	0.13	6.9	7.0	1801.3	1802.8
150	ok Av	10.29	0.16	0.15	8.7	8.1	2268.0	2090.4
151	ok Av	33.92	0.64	0.39	35.6	21.9	1.342e+04	8259.1
152	ok Av	37.83	0.70	0.45	39.1	25.3	1.472e+04	9512.8
153	ok Av	13.86	0.04	0.28	2.4	15.7	725.6	4733.2
154	ok Av	15.91	0.08	0.32	4.5	17.8	1358.3	5366.8
155	ok	4.66						
156	ok	5.54						
157	ok	5.02						
158	ok Av	9.96	0.14	0.15	7.6	8.4	2063.5	2287.0
159	ok Av	11.85	0.17	0.17	9.6	9.6	2593.5	2605.6
160	ok Av	5.97	0.12	0.06	6.8	3.5	1150.4	597.8
161	ok Av	46.09	0.92	0.70	50.9	38.8	1.916e+04	1.461e+04
162	ok Av	49.96	0.98	0.77	54.2	42.8	2.040e+04	1.613e+04
163	ok Av	5.40	0.11	0.05	6.1	2.9	1120.3	524.8
164	ok Av	6.43	0.13	0.06	7.3	3.4	1335.2	626.9
165	ok Av	29.24	0.19	0.57	10.3	31.6	3876.2	1.189e+04

166	ok Av	31.44	0.21	0.62	11.4	34.5	4299.5	1.298e+04
167	ok Av	26.37	0.54	0.05	29.8	2.9	1.123e+04	1094.0
168	ok Av	11.94	0.16	0.19	8.6	10.5	2419.7	2978.3
169	ok Av	14.03	0.19	0.21	10.8	11.8	3047.1	3358.3
170	ok Av	5.79	0.12	0.05	6.5	2.9	1283.0	559.2
171	ok Av	31.02	0.63	0.03	35.2	1.9	1.327e+04	723.9
172	ok Av	32.33	0.66	0.03	36.7	1.5	1.383e+04	567.7
173	ok Av	6.93	0.14	0.06	7.8	3.4	1535.4	670.3
174	ok Av	6.23	0.13	0.05	7.0	2.9	1462.0	609.8
175	ok Av	7.47	0.15	0.06	8.4	3.5	1754.0	728.0
176	ok Av	55.01	1.00	0.99	66.9	55.0	2.258e+04	2.071e+04
177	ok Av	58.87	1.00	1.00	75.4	65.4	2.367e+04	2.238e+04
178	ok Av	35.50	0.72	0.09	40.0	5.1	1.506e+04	1928.3
179	ok Av	36.75	0.74	0.11	41.3	5.9	1.557e+04	2210.9
180	ok Av	14.85	0.18	0.25	10.3	14.1	3059.0	4253.0
181	ok Av	17.18	0.23	0.28	12.7	15.6	3814.4	4721.1
182	ok Av	6.78	0.13	0.05	7.5	3.0	1662.4	678.5
183	ok Av	8.10	0.16	0.07	9.0	3.6	2001.2	808.3
184	ok Av	7.46	0.14	0.06	8.0	3.3	1896.9	775.5
185	ok Av	8.91	0.17	0.07	9.7	3.9	2286.8	915.9
186	ok Av	23.85	0.49	4.10e-03	27.1	0.2	1.020e+04	85.8
187	ok Av	24.24	0.50	1.73e-03	27.5	9.62e-02	1.037e+04	36.2
188	ok Av	24.37	0.50	2.34e-03	27.7	0.1	1.042e+04	48.9
189	ok Av	29.89	0.31	0.61	17.4	33.9	6546.1	1.278e+04
190	ok Av	32.21	0.37	0.66	20.4	36.5	7686.7	1.375e+04
191	ok Av	37.93	0.74	0.22	41.3	12.3	1.555e+04	4625.4
192	ok Av	39.13	0.76	0.24	42.4	13.4	1.597e+04	5028.9
193	ok Av	8.29	0.16	0.07	8.8	3.7	2182.0	910.9
194	ok Av	9.89	0.19	0.08	10.6	4.3	2628.4	1062.1
195	ok Av	24.63	0.50	6.67e-03	28.0	0.4	1.054e+04	139.5
196	ok Av	24.76	0.51	8.68e-03	28.1	0.5	1.059e+04	181.6
197	ok Av	9.35	0.18	0.08	9.8	4.2	2542.6	1099.6
198	ok Av	11.11	0.21	0.09	11.8	4.8	3054.4	1264.7
199	ok Av	60.50	1.00	1.00	68.3	86.4	2.277e+04	2.490e+04
200	ok Av	63.91	1.00	1.00	75.0	104.8	2.362e+04	2.661e+04
201	ok Av	10.77	0.20	0.09	11.2	5.0	3022.3	1370.9
202	ok Av	12.71	0.24	0.10	13.4	5.6	3607.6	1547.1
203	ok Av	24.81	0.51	0.02	28.2	0.9	1.061e+04	355.8
204	ok Av	24.93	0.51	0.02	28.3	1.1	1.066e+04	405.3
205	ok Av	23.84	0.49	6.56e-04	27.1	3.65e-02	1.020e+04	13.7
206	ok Av	23.88	0.49	5.49e-04	27.1	3.05e-02	1.022e+04	11.5
207	ok Av	23.90	0.49	1.24e-03	27.2	6.87e-02	1.023e+04	25.9
208	ok Av	12.77	0.24	0.11	13.2	6.1	3684.5	1764.0
209	ok Av	14.93	0.28	0.12	15.5	6.9	4375.9	1976.7
210	ok Av	38.08	0.70	0.34	38.8	19.1	1.462e+04	7188.5
211	ok Av	39.22	0.71	0.37	39.6	20.4	1.491e+04	7685.5
212	ok Av	23.94	0.49	1.69e-03	27.2	9.41e-02	1.024e+04	35.5
213	ok Av	23.97	0.49	2.58e-03	27.2	0.1	1.026e+04	53.9
214	ok Av	15.68	0.29	0.16	16.1	8.8	4730.0	2643.5
215	ok Av	18.13	0.34	0.17	18.8	9.7	5556.9	2914.3
216	ok Av	24.73	0.51	0.03	28.1	1.5	1.057e+04	567.9
217	ok Av	24.83	0.51	0.03	28.2	1.6	1.061e+04	621.4
218	ok Av	23.99	0.49	3.01e-03	27.2	0.2	1.026e+04	63.1
219	ok Av	24.03	0.49	3.85e-03	27.3	0.2	1.028e+04	80.5
220	ok Av	28.62	0.38	0.55	21.3	30.3	8019.0	1.142e+04
221	ok Av	31.04	0.44	0.58	24.3	32.4	9134.8	1.219e+04
222	ok Av	62.26	0.94	1.00	52.3	98.4	1.970e+04	2.606e+04
223	ok Av	65.12	0.97	1.00	53.8	119.2	2.027e+04	2.769e+04
224	ok Av	23.93	0.49	3.65e-04	27.2	2.03e-02	1.024e+04	7.6
225	ok Av	23.93	0.49	1.75e-04	27.2	9.71e-03	1.024e+04	3.7
226	ok Av	23.94	0.49	6.36e-04	27.2	3.53e-02	1.024e+04	13.3
227	ok Av	24.01	0.49	3.97e-03	27.3	0.2	1.027e+04	83.1
228	ok Av	24.05	0.49	4.71e-03	27.3	0.3	1.029e+04	98.5
229	ok Av	35.94	0.60	0.43	33.2	23.7	1.252e+04	8921.2
230	ok Av	37.00	0.61	0.45	33.7	25.2	1.268e+04	9477.9
231	ok Av	23.94	0.49	3.39e-04	27.2	1.88e-02	1.024e+04	7.1
232	ok Av	23.95	0.49	8.59e-04	27.2	4.77e-02	1.025e+04	18.0
233	ok Av	23.95	0.49	4.53e-04	27.2	2.52e-02	1.025e+04	9.5
234	ok Av	23.97	0.49	9.70e-04	27.2	5.39e-02	1.025e+04	20.3
235	ok Av	24.41	0.50	0.03	27.7	1.9	1.042e+04	718.9
236	ok Av	24.50	0.50	0.04	27.8	2.1	1.045e+04	772.9
237	ok Av	23.96	0.49	5.22e-04	27.2	2.90e-02	1.025e+04	10.9
238	ok Av	23.99	0.49	9.30e-04	27.2	5.17e-02	1.026e+04	19.5
239	ok Av	24.00	0.49	4.33e-03	27.3	0.2	1.027e+04	90.6
240	ok Av	24.04	0.49	4.93e-03	27.3	0.3	1.028e+04	103.2
241	ok Av	23.97	0.49	4.52e-04	27.2	2.51e-02	1.025e+04	9.5



242	ok Av	24.00	0.49	7.46e-04	27.3	4.15e-02	1.027e+04	15.6
243	ok	4.34						
244	ok	4.02						
245	ok	4.12						
246	ok	4.40						
247	ok	4.75						
248	ok	5.14						
249	ok Av	5.56	0.11	0.03	6.1	1.4	1124.5	260.8
250	ok Av	5.99	0.12	0.02	6.7	1.2	1314.0	229.2
251	ok Av	6.46	0.13	0.02	7.3	1.0	1522.7	200.1
252	ok Av	6.99	0.14	0.01	7.9	0.8	1757.7	171.2
253	ok Av	7.65	0.16	0.01	8.7	0.6	2033.1	145.7
254	ok Av	8.50	0.17	8.88e-03	9.6	0.5	2368.1	122.8
255	ok Av	9.58	0.20	6.97e-03	10.9	0.4	2792.6	101.5
256	ok Av	11.01	0.23	5.58e-03	12.5	0.3	3356.1	85.3
257	ok Av	13.03	0.27	4.56e-03	14.8	0.3	4134.2	73.1
258	ok Av	15.97	0.33	0.02	18.1	1.2	5283.4	364.4
259	ok Av	25.55	0.41	0.39	23.0	21.7	7237.8	8189.9
260	ok Av	59.73	0.68	1.00	37.8	77.3	1.422e+04	2.390e+04
261	ok Av	31.75	0.50	0.45	27.9	24.9	1.049e+04	9366.3
262	ok Av	23.95	0.49	0.04	27.2	2.0	1.025e+04	768.6
263	ok Av	23.96	0.49	4.01e-03	27.2	0.2	1.025e+04	83.9
264	ok Av	23.97	0.49	2.81e-04	27.2	1.56e-02	1.025e+04	5.9
265	ok Av	24.05	0.49	1.98e-03	27.3	0.1	1.029e+04	41.4
266	ok Av	24.00	0.49	5.49e-04	27.3	3.05e-02	1.027e+04	11.5
267	ok Av	24.00	0.49	4.45e-03	27.3	0.2	1.027e+04	93.2
268	ok Av	24.00	0.49	0.04	27.2	2.2	1.026e+04	819.3
269	ok Av	32.71	0.50	0.48	27.9	26.4	1.053e+04	9942.2
270	ok Av	62.56	0.69	1.00	38.4	90.6	1.447e+04	2.534e+04
271	ok Av	28.05	0.47	0.42	26.2	23.1	8252.9	8711.5
272	ok Av	18.45	0.38	0.02	21.0	1.4	6125.8	415.7
273	ok Av	15.20	0.31	6.28e-03	17.3	0.3	4842.8	100.7
274	ok Av	12.97	0.27	6.85e-03	14.7	0.4	3957.1	104.7
275	ok Av	11.34	0.23	9.01e-03	12.9	0.5	3314.8	131.2
276	ok Av	10.10	0.21	0.01	11.5	0.6	2821.5	157.1
277	ok Av	9.11	0.19	0.01	10.3	0.8	2426.4	185.3
278	ok Av	8.34	0.17	0.02	9.4	1.0	2097.3	214.7
279	ok Av	7.70	0.16	0.02	8.7	1.2	1813.6	244.7
280	ok Av	7.12	0.14	0.03	8.0	1.4	1562.9	278.0
281	ok Av	6.59	0.13	0.03	7.3	1.7	1334.3	311.3
282	ok Av	6.10	0.12	0.04	6.6	2.1	1123.0	348.5
283	ok	5.63						
284	ok	5.19						
285	ok	4.83						
286	ok	4.71						
287	ok	5.11						
288	ok Av	23.97	0.49	4.71e-04	27.2	2.62e-02	1.025e+04	9.9
289	ok Av	24.00	0.49	3.39e-04	27.3	1.88e-02	1.027e+04	7.1
290	ok Av	24.00	0.49	4.06e-03	27.3	0.2	1.027e+04	84.9
291	ok Av	24.04	0.49	4.36e-03	27.3	0.2	1.029e+04	91.2
292	ok Av	23.96	0.49	5.82e-04	27.2	3.23e-02	1.025e+04	12.2
293	ok Av	23.99	0.49	4.18e-04	27.2	2.32e-02	1.026e+04	8.7
294	ok Av	24.42	0.50	0.03	27.7	1.9	1.042e+04	708.1
295	ok Av	24.50	0.50	0.04	27.8	2.0	1.046e+04	761.3
296	ok Av	23.96	0.49	5.78e-04	27.2	3.21e-02	1.025e+04	12.1
297	ok Av	23.98	0.49	4.74e-04	27.2	2.63e-02	1.026e+04	9.9
298	ok Av	23.95	0.49	5.36e-04	27.2	2.98e-02	1.024e+04	11.2
299	ok Av	23.96	0.49	3.93e-04	27.2	2.19e-02	1.025e+04	8.2
300	ok Av	35.96	0.60	0.43	33.2	23.7	1.252e+04	8934.7
301	ok Av	37.02	0.61	0.45	33.7	25.2	1.268e+04	9488.4
302	ok Av	24.01	0.49	3.75e-03	27.3	0.2	1.027e+04	78.5
303	ok Av	24.06	0.49	4.14e-03	27.3	0.2	1.029e+04	86.5
304	ok Av	23.94	0.49	4.52e-04	27.2	2.51e-02	1.024e+04	9.5
305	ok Av	23.94	0.49	2.17e-04	27.2	1.21e-02	1.024e+04	4.5
306	ok Av	23.94	0.49	2.74e-04	27.2	1.52e-02	1.024e+04	5.7
307	ok Av	62.29	0.94	1.00	52.3	98.6	1.970e+04	2.608e+04
308	ok Av	65.14	0.97	1.00	53.8	119.5	2.027e+04	2.770e+04
309	ok Av	28.65	0.38	0.55	21.3	30.3	8014.3	1.143e+04
310	ok Av	31.05	0.44	0.58	24.2	32.4	9132.0	1.220e+04
311	ok Av	23.99	0.49	2.91e-03	27.2	0.2	1.026e+04	60.9
312	ok Av	24.04	0.49	3.27e-03	27.3	0.2	1.028e+04	68.5
313	ok Av	24.74	0.51	0.03	28.1	1.5	1.057e+04	557.5
314	ok Av	24.84	0.51	0.03	28.2	1.6	1.061e+04	609.8
315	ok Av	15.68	0.29	0.16	16.0	8.8	4726.1	2652.0
316	ok Av	18.13	0.34	0.17	18.8	9.7	5554.9	2918.9
317	ok Av	23.95	0.49	1.77e-03	27.2	9.85e-02	1.024e+04	37.1



318	ok Av	23.99	0.49	2.01e-03	27.2	0.1	1.026e+04	42.0
319	ok Av	38.10	0.70	0.34	38.8	19.1	1.462e+04	7202.4
320	ok Av	39.24	0.71	0.37	39.6	20.4	1.492e+04	7695.8
321	ok Av	12.76	0.24	0.11	13.1	6.1	3681.3	1770.0
322	ok Av	14.93	0.28	0.12	15.5	6.9	4374.4	1979.7
323	ok Av	23.89	0.49	8.17e-04	27.1	4.54e-02	1.022e+04	17.1
324	ok Av	23.92	0.49	6.98e-04	27.2	3.88e-02	1.023e+04	14.6
325	ok Av	23.85	0.49	2.66e-04	27.1	1.48e-02	1.020e+04	5.6
326	ok Av	24.82	0.51	0.02	28.2	0.9	1.061e+04	346.6
327	ok Av	24.95	0.51	0.02	28.3	1.0	1.067e+04	393.5
328	ok Av	10.77	0.20	0.09	11.2	5.0	3019.7	1374.9
329	ok Av	12.71	0.24	0.10	13.4	5.7	3606.5	1549.0
330	ok Av	60.54	1.00	1.00	68.3	86.5	2.277e+04	2.492e+04
331	ok Av	63.93	1.00	1.00	75.1	104.8	2.363e+04	2.662e+04
332	ok Av	9.34	0.18	0.08	9.8	4.2	2540.6	1102.1
333	ok Av	11.10	0.21	0.09	11.8	4.8	3053.5	1265.8
334	ok Av	24.65	0.50	6.52e-03	28.0	0.4	1.054e+04	136.5
335	ok Av	24.78	0.51	8.10e-03	28.1	0.4	1.060e+04	169.5
336	ok Av	8.28	0.16	0.07	8.8	3.7	2180.4	912.2
337	ok Av	9.89	0.19	0.08	10.6	4.3	2627.9	1062.5
338	ok Av	37.96	0.74	0.22	41.3	12.3	1.556e+04	4639.7
339	ok Av	39.16	0.76	0.24	42.4	13.4	1.598e+04	5038.9
340	ok Av	29.92	0.31	0.61	17.4	34.0	6535.3	1.280e+04
341	ok Av	32.23	0.37	0.66	20.4	36.5	7680.9	1.375e+04
342	ok Av	24.26	0.50	2.03e-03	27.6	0.1	1.038e+04	42.4
343	ok Av	24.40	0.50	1.73e-03	27.7	9.64e-02	1.044e+04	36.3
344	ok Av	23.88	0.49	3.77e-03	27.1	0.2	1.022e+04	78.9
345	ok Av	7.45	0.14	0.06	8.0	3.3	1895.7	776.0
346	ok Av	8.91	0.17	0.07	9.7	3.9	2286.4	916.0
347	ok Av	6.77	0.13	0.05	7.5	3.0	1661.4	678.5
348	ok Av	8.10	0.16	0.07	9.0	3.6	2000.9	808.1
349	ok Av	14.85	0.18	0.25	10.2	14.1	3050.5	4260.2
350	ok Av	17.19	0.23	0.28	12.6	15.7	3810.4	4724.8
351	ok Av	35.54	0.72	0.09	40.0	5.2	1.508e+04	1942.1
352	ok Av	36.79	0.74	0.11	41.4	5.9	1.558e+04	2220.6
353	ok Av	55.06	1.00	0.99	67.1	55.0	2.260e+04	2.073e+04
354	ok Av	58.89	1.00	1.00	75.5	65.5	2.367e+04	2.239e+04
355	ok Av	6.23	0.13	0.05	7.0	2.9	1461.1	609.4
356	ok Av	7.46	0.15	0.06	8.4	3.5	1753.8	727.6
357	ok Av	5.79	0.12	0.05	6.5	2.8	1282.0	558.4
358	ok Av	31.04	0.63	0.03	35.3	1.9	1.328e+04	710.5
359	ok Av	32.38	0.66	0.03	36.8	1.5	1.385e+04	577.1
360	ok Av	6.93	0.14	0.06	7.8	3.4	1535.3	669.9
361	ok Av	11.94	0.16	0.19	8.6	10.5	2413.0	2982.5
362	ok Av	14.03	0.19	0.21	10.8	11.8	3044.1	3360.5
363	ok Av	26.44	0.54	0.05	29.9	2.9	1.126e+04	1104.6
364	ok Av	29.28	0.19	0.57	10.3	31.6	3896.5	1.190e+04
365	ok Av	31.46	0.21	0.62	11.4	34.5	4290.2	1.299e+04
366	ok Av	5.39	0.11	0.05	6.1	2.9	1118.9	523.1
367	ok Av	6.43	0.13	0.06	7.3	3.4	1335.2	626.3
368	ok Av	46.16	0.92	0.70	50.9	38.8	1.919e+04	1.463e+04
369	ok Av	50.00	0.98	0.77	54.2	42.8	2.042e+04	1.613e+04
370	ok	5.02						
371	ok Av	9.96	0.14	0.15	7.6	8.4	2058.5	2289.2
372	ok Av	11.84	0.17	0.17	9.6	9.6	2591.3	2606.7
373	ok Av	5.97	0.12	0.06	6.8	3.5	1150.4	597.3
374	ok	4.66						
375	ok	5.54						
376	ok Av	13.87	0.04	0.28	2.4	15.7	711.1	4736.4
377	ok Av	15.92	0.08	0.32	4.5	17.8	1352.1	5368.8
378	ok Av	34.09	0.65	0.40	35.9	21.9	1.350e+04	8264.2
379	ok Av	37.87	0.70	0.45	39.2	25.3	1.475e+04	9515.1
380	ok Av	8.55	0.12	0.13	6.9	7.0	1797.8	1803.7
381	ok Av	10.28	0.16	0.15	8.7	8.1	2266.5	2090.8
382	ok	4.35						
383	ok	5.14						
384	ok Av	26.78	0.34	0.43	18.9	23.8	7126.2	8971.5
385	ok Av	28.82	0.34	0.48	18.7	26.8	7051.6	1.011e+04
386	ok Av	23.41	0.43	0.20	24.0	11.4	9051.6	4280.5
387	ok	4.12						
388	ok	4.83						
389	ok Av	7.52	0.12	0.11	6.4	5.9	1599.2	1457.5
390	ok Av	9.11	0.15	0.13	8.1	6.9	2010.0	1714.1
391	ok	4.09						
392	ok	4.77						
393	ok Av	10.71	0.04	0.21	2.5	11.9	680.5	3367.3

394	ok Av	12.63	0.08	0.25	4.3	13.7	1201.9	3889.4
395	ok Av	22.65	0.40	0.23	22.4	12.7	8429.2	4774.8
396	ok Av	24.51	0.41	0.28	23.0	15.7	8667.3	5903.0
397	ok Av	18.99	0.38	0.07	21.2	3.9	7985.1	1485.0
398	ok	4.74						
399	ok	5.50						
400	ok Av	12.74	0.11	0.23	6.3	13.0	1899.4	3933.3
401	ok Av	14.39	0.09	0.28	5.0	15.6	1516.2	4694.2
402	ok Av	6.74	0.11	0.09	6.1	5.2	1437.4	1202.7
403	ok Av	8.19	0.14	0.11	7.6	6.1	1798.6	1433.8
404	ok Av	8.70	0.05	0.17	2.7	9.5	736.2	2568.1
405	ok Av	10.48	0.08	0.20	4.3	11.2	1178.2	3008.5
406	ok Av	6.10	0.11	0.08	5.8	4.6	1299.7	1012.5
407	ok Av	7.43	0.13	0.10	7.3	5.5	1615.8	1219.9
408	ok Av	11.83	0.21	0.12	11.6	6.9	3490.3	2064.2
409	ok Av	12.87	0.20	0.17	11.0	9.6	3328.7	2893.2
410	ok Av	9.36	0.07	0.18	3.8	10.0	1099.4	2806.4
411	ok Av	10.96	0.05	0.22	2.7	12.2	768.2	3438.4
412	ok Av	11.74	0.24	0.03	13.2	1.5	3997.7	456.8
413	ok Av	7.30	0.05	0.14	2.9	7.8	768.4	2005.6
414	ok Av	8.96	0.08	0.17	4.4	9.3	1160.2	2397.2
415	ok Av	5.56	0.10	0.07	5.6	4.2	1177.7	868.9
416	ok Av	6.77	0.12	0.09	6.9	5.0	1452.0	1052.8
417	ok Av	5.16	0.10	0.07	5.4	3.9	1063.4	756.4
418	ok Av	6.30	0.12	0.08	6.6	4.7	1303.3	922.7
419	ok Av	8.35	0.14	0.09	8.0	5.2	2301.2	1447.4
420	ok Av	9.37	0.13	0.14	7.5	7.7	2151.1	2138.7
421	ok Av	7.27	0.04	0.14	2.4	8.0	652.2	2125.2
422	ok Av	8.79	0.02	0.18	1.3	9.9	369.6	2658.4
423	ok Av	6.30	0.06	0.12	3.2	6.6	784.4	1601.8
424	ok Av	7.85	0.08	0.14	4.5	8.0	1130.0	1947.5
425	ok Av	8.35	0.17	0.02	9.4	1.3	2698.0	368.8
426	ok	4.83						
427	ok Av	5.86	0.11	0.08	6.4	4.5	1162.6	817.1
428	ok Av	5.57	0.06	0.10	3.3	5.7	784.5	1302.3
429	ok Av	7.00	0.08	0.12	4.6	6.9	1090.9	1609.0
430	ok Av	6.12	0.10	0.07	5.7	4.1	1559.5	1086.1
431	ok Av	7.13	0.09	0.11	5.2	6.3	1428.0	1659.5
432	ok	4.52						
433	ok Av	5.47	0.11	0.08	6.1	4.3	1030.4	733.5
434	ok Av	5.81	0.02	0.12	1.3	6.5	349.1	1644.1
435	ok Av	7.30	7.93e-03	0.15	0.4	8.3	115.4	2112.9
436	ok Av	6.01	0.12	0.02	6.7	1.2	1844.6	320.5
437	ok	4.22						
438	ok	5.11						
439	ok Av	4.99	0.06	0.09	3.5	4.9	772.2	1076.1
440	ok Av	6.31	0.08	0.11	4.7	6.1	1043.0	1347.1
441	ok Av	4.79	0.01	0.10	0.6	5.4	146.3	1298.2
442	ok Av	6.23	0.02	0.13	0.9	7.1	217.5	1708.9
443	ok	4.52						
444	ok Av	5.58	0.06	0.10	3.6	5.3	942.0	1327.3
445	ok	3.97						
446	ok	4.77						
447	ok	4.35						
448	ok	4.53						
449	ok Av	5.73	0.08	0.10	4.7	5.5	987.3	1139.4
450	ok	3.80						
451	ok	4.52						
452	ok	4.07						
453	ok Av	5.45	0.03	0.11	1.5	6.1	347.9	1402.0
454	ok	3.37						
455	ok	4.49						
456	ok	3.85						
457	ok	4.54						
458	ok	4.14						
459	ok Av	5.28	0.09	0.09	4.7	5.0	927.6	973.8
460	ok	3.14						
461	ok	4.78						
462	ok	5.55						
463	ok	3.55						
464	ok	4.84						
465	ok	3.90						
466	ok	4.93						
467	ok	2.55						
468	ok	3.71						
469	ok	2.24						

470	ok	3.68
471	ok	4.63
472	ok	3.16
473	ok	4.36
474	ok	1.98
475	ok	3.16
476	ok	3.47
477	ok	4.36
478	ok	1.59
479	ok	2.85
480	ok	3.94
481	ok	1.60
482	ok	2.75
483	ok	3.30
484	ok	4.11
485	ok	2.67
486	ok	3.70
487	ok	1.13
488	ok	3.20
489	ok	3.93
490	ok	1.36
491	ok	2.44
492	ok	2.56
493	ok	3.51
494	ok	3.33
495	ok	4.03
496	ok	0.85
497	ok	1.22
498	ok	2.25
499	ok	2.46
500	ok	3.34
501	ok	4.47
502	ok	5.24
503	ok	0.71
504	ok	1.23
505	ok	2.18
506	ok	2.39
507	ok	3.19
508	ok	0.73
509	ok	2.38
510	ok	3.09
511	ok	1.25
512	ok	2.13
513	ok	0.81
514	ok	2.57
515	ok	3.26
516	ok	1.29
517	ok	2.08
518	ok	0.87
519	ok	3.84
520	ok	4.61
521	ok	1.36
522	ok	2.07
523	ok	0.94
524	ok	1.61
525	ok	2.29
526	ok	1.19
527	ok	2.92
528	ok	3.69
529	ok	2.54

Nodo	Max tau	Ver V pr	Ver V sec	Af V pr	Af V sec	V pr	V sec
65.14	1.00	1.00	75.51	119.47	2.367e+04	2.770e+04	

PROGETTO  
Verifica NM

0.91
0.85
0.79
0.73
0.67
0.61
0.55
0.49
0.43
0.37
0.31
0.24
0.18
0.12
6.205e-02
1.139e-03

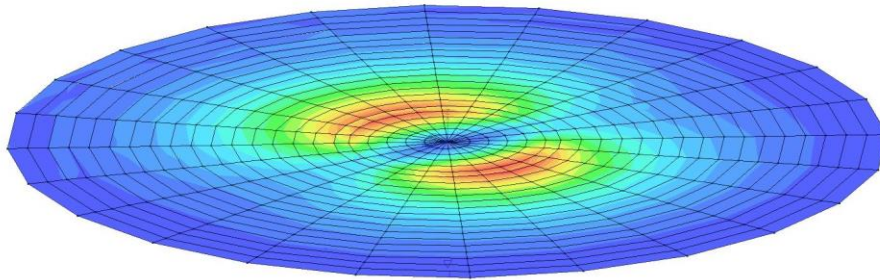

72\_PRO\_CA\_D3\_VER\_NM

PROGETTO  
Verifica V cis princ.

1.00
0.93
0.87
0.80
0.73
0.67
0.60
0.53
0.47
0.40
0.33
0.27
0.20
0.13
6.669e-02
0.0

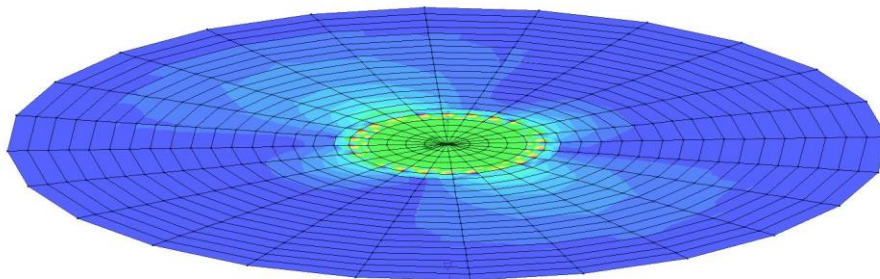

72\_PRO\_CA\_D3\_VER\_VI



Wind Energy  
Sindia Srl

grEen &  
grEen  
WE ENGINEERING

CODE

C21BLN001CWR00300

PAGE

110 di/of 119

PROGETTO  
Verifica V cis sec.  
1.00  
0.93  
0.87  
0.80  
0.73  
0.67  
0.60  
0.53  
0.47  
0.40  
0.33  
0.27  
0.20  
0.13  
6.670e-02  
0.0

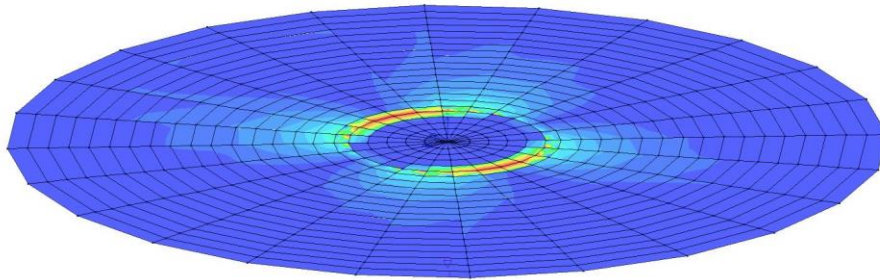

72\_PRO\_CA\_D3\_VER\_VII

## 14. STATI LIMITE D' ESERCIZIO

### 14.1. LEGENDA TABELLA STATI LIMITE D' ESERCIZIO

In tabella vengono riportati i valori di interesse per il controllo degli stati limite d'esercizio.

In particolare vengono riportati, in relazione al tipo di elemento strutturale, i risultati relativi alle tre categorie di combinazione considerate:

- Combinazioni rare
- Combinazioni frequenti
- Combinazioni quasi permanenti.

I valori di interesse sono i seguenti:

<b>rRfck</b>	rapporto tra la massima compressione nel calcestruzzo e la tensione fck in combinazioni rare [normalizzato a 1]
<b>rRfyk</b>	rapporto tra la massima tensione nell'acciaio e la tensione fyk in combinazioni rare [normalizzato a 1]
<b>rPfck</b>	rapporto tra la massima compressione nel calcestruzzo e la tensione fck in combinazioni quasi permanenti [normalizzato a 1]
<b>wR</b>	apertura caratteristica delle fessure in combinazioni rare [mm]
<b>wF</b>	apertura caratteristica delle fessure in combinazioni frequenti [mm]
<b>wP</b>	apertura caratteristica delle fessure in combinazioni quasi permanenti [mm]
<b>dR</b>	massima deformazione in combinazioni rare
<b>dF</b>	massima deformazione in combinazioni frequenti
<b>dP</b>	massima deformazione in combinazioni quasi permanenti

Per ognuno dei nove valori soprariportati viene indicata (Rif.cmb) la combinazione in cui si è verificato.

In relazione al tipo di elemento strutturale i valori sono selezionati nel modo seguente:

pilastrati	<b>rRfck</b>	<b>rRfyk</b>	<b>rPfck</b>	per sezioni significative
travi	<b>rRfck</b>	<b>rRfyk</b>	<b>rPfck</b>	per sezioni significative
	<b>wR</b>	<b>wF</b>	<b>wP</b>	per sezioni significative
	<b>dR</b>	<b>dF</b>	<b>dP</b>	massimi in campata
	<b>rRfck</b>	<b>rRfyk</b>	<b>rPfck</b>	massimi nei nodi dell'elemento
setti e gusci	<b>wR</b>	<b>wF</b>	<b>wP</b>	massimi nei nodi dell'elemento

Si precisa che i valori di massima deformazione per travi sono riferiti al piano verticale (piano locale 1-2 con momenti flettenti 3-3).



<b>Guscio</b>	<b>rRfck</b>	<b>rRfyk</b>	<b>rPfck</b>	<b>Rif. cmb mm</b>	<b>wR mm</b>	<b>wF mm</b>	<b>wP</b>	<b>Rif. cmb</b>
10.0	0.0	0.0	0,0,0	0.0	0.0	0.0	0,0,0	
20.0	0.0	0.0	0,0,0	0.0	0.0	0.0	0,0,0	
30.0	0.0	0.0	0,0,0	0.0	0.0	0.0	0,0,0	
40.0	0.0	0.0	0,0,0	0.0	0.0	0.0	0,0,0	
50.0	0.0	0.0	0,0,0	0.0	0.0	0.0	0,0,0	
60.0	0.0	0.0	0,0,0	0.0	0.0	0.0	0,0,0	
70.0	0.0	0.0	0,0,0	0.0	0.0	0.0	0,0,0	
80.0	0.0	0.0	0,0,0	0.0	0.0	0.0	0,0,0	
90.0	0.0	0.0	0,0,0	0.0	0.0	0.0	0,0,0	
100.0	0.0	0.0	0,0,0	0.0	0.0	0.0	0,0,0	
110.0	0.0	0.0	0,0,0	0.0	0.0	0.0	0,0,0	
120.0	0.0	0.0	0,0,0	0.0	0.0	0.0	0,0,0	
130.0	0.0	0.0	0,0,0	0.0	0.0	0.0	0,0,0	
140.0	0.0	0.0	0,0,0	0.0	0.0	0.0	0,0,0	
150.0	0.0	0.0	0,0,0	0.0	0.0	0.0	0,0,0	
160.0	0.0	0.0	0,0,0	0.0	0.0	0.0	0,0,0	
170.0	0.0	0.0	0,0,0	0.0	0.0	0.0	0,0,0	
180.0	0.0	0.0	0,0,0	0.0	0.0	0.0	0,0,0	
190.0	0.0	0.0	0,0,0	0.0	0.0	0.0	0,0,0	
200.0	0.0	0.0	0,0,0	0.0	0.0	0.0	0,0,0	
210.0	0.0	0.0	0,0,0	0.0	0.0	0.0	0,0,0	
220.0	0.0	0.0	0,0,0	0.0	0.0	0.0	0,0,0	
230.0	0.0	0.0	0,0,0	0.0	0.0	0.0	0,0,0	
240.0	0.0	0.0	0,0,0	0.0	0.0	0.0	0,0,0	
250.0	0.0	0.0	0,0,0	0.0	0.0	0.0	0,0,0	
260.0	0.0	0.0	0,0,0	0.0	0.0	0.0	0,0,0	
270.0	0.0	0.0	0,0,0	0.0	0.0	0.0	0,0,0	
280.0	0.0	0.0	0,0,0	0.0	0.0	0.0	0,0,0	
290.0	0.0	0.0	0,0,0	0.0	0.0	0.0	0,0,0	
300.0	0.0	0.0	0,0,0	0.0	0.0	0.0	0,0,0	
310.0	0.0	0.0	0,0,0	0.0	0.0	0.0	0,0,0	
320.0	0.0	0.0	0,0,0	0.0	0.0	0.0	0,0,0	
330.0	0.0	0.0	0,0,0	0.0	0.0	0.0	0,0,0	
340.0	0.0	0.0	0,0,0	0.0	0.0	0.0	0,0,0	
350.0	0.0	0.0	0,0,0	0.0	0.0	0.0	0,0,0	
360.0	0.0	0.0	0,0,0	0.0	0.0	0.0	0,0,0	
370.0	0.0	0.0	0,0,0	0.0	0.0	0.0	0,0,0	
380.0	0.0	0.0	0,0,0	0.0	0.0	0.0	0,0,0	
390.0	0.0	0.0	0,0,0	0.0	0.0	0.0	0,0,0	
400.0	0.0	0.0	0,0,0	0.0	0.0	0.0	0,0,0	
410.0	0.0	0.0	0,0,0	0.0	0.0	0.0	0,0,0	
420.0	0.0	0.0	0,0,0	0.0	0.0	0.0	0,0,0	
430.0	0.0	0.0	0,0,0	0.0	0.0	0.0	0,0,0	
440.0	0.0	0.0	0,0,0	0.0	0.0	0.0	0,0,0	
450.0	0.0	0.0	0,0,0	0.0	0.0	0.0	0,0,0	
460.0	0.0	0.0	0,0,0	0.0	0.0	0.0	0,0,0	
470.0	0.0	0.0	0,0,0	0.0	0.0	0.0	0,0,0	
480.0	0.0	0.0	0,0,0	0.0	0.0	0.0	0,0,0	
490.0	0.0	0.0	0,0,0	0.0	0.0	0.0	0,0,0	
500.0	0.0	0.0	0,0,0	0.0	0.0	0.0	0,0,0	
510.0	0.0	0.0	0,0,0	0.0	0.0	0.0	0,0,0	
520.0	0.0	0.0	0,0,0	0.0	0.0	0.0	0,0,0	
530.0	0.0	0.0	0,0,0	0.0	0.0	0.0	0,0,0	
540.0	0.0	0.0	0,0,0	0.0	0.0	0.0	0,0,0	
550.0	0.0	0.0	0,0,0	0.0	0.0	0.0	0,0,0	
560.0	0.0	0.0	0,0,0	0.0	0.0	0.0	0,0,0	
570.0	0.0	0.0	0,0,0	0.0	0.0	0.0	0,0,0	
580.0	0.0	0.0	0,0,0	0.0	0.0	0.0	0,0,0	
590.0	0.0	0.0	0,0,0	0.0	0.0	0.0	0,0,0	
600.0	0.0	0.0	0,0,0	0.0	0.16	0.0	0,2,0	
610.0	0.0	0.0	0,0,0	0.0	0.0	0.0	0,0,0	
620.0	0.0	0.0	0,0,0	0.0	0.0	0.0	0,0,0	
630.0	0.0	0.0	0,0,0	0.0	0.0	0.0	0,0,0	
640.0	0.0	0.0	0,0,0	0.0	0.0	0.0	0,0,0	
650.0	0.0	0.0	0,0,0	0.0	0.0	0.0	0,0,0	
660.0	0.0	0.0	0,0,0	0.0	0.0	0.0	0,0,0	
670.0	0.0	0.0	0,0,0	0.0	0.0	0.0	0,0,0	
680.0	0.0	0.0	0,0,0	0.0	0.0	0.0	0,0,0	
690.0	0.0	0.0	0,0,0	0.0	0.0	0.0	0,0,0	
700.0	0.0	0.0	0,0,0	0.0	0.0	0.0	0,0,0	
710.0	0.0	0.0	0,0,0	0.0	0.0	0.0	0,0,0	
720.0	0.0	0.0	0,0,0	0.0	0.0	0.0	0,0,0	
730.0	0.0	0.0	0,0,0	0.0	0.0	0.0	0,0,0	

740.0	0.0	0.0	0,0,0	0.0	0.0	0.0	0,0,0	
750.0	0.0	0.0	0,0,0	0.0	0.0	0.0	0,0,0	
760.0	0.0	0.0	0,0,0	0.0	0.0	0.0	0,0,0	
770.0	0.0	0.0	0,0,0	0.0	0.0	0.0	0,0,0	
780.0	0.0	0.0	0,0,0	0.0	0.0	0.0	0,0,0	
790.0	0.0	0.0	0,0,0	0.0	0.0	0.0	0,0,0	
800.0	0.0	0.0	0,0,0	0.0	0.14	0.0	0,2,0	
810.0	0.0	0.0	0,0,0	0.0	0.16	0.0	0,2,0	
820.0	0.0	0.0	0,0,0	0.0	0.19	0.0	0,2,0	
830.0	0.0	0.0	0,0,0	0.0	0.19	0.0	0,2,0	
840.0	0.0	0.0	0,0,0	0.0	0.20	0.0	0,2,0	
850.0	0.0	0.0	0,0,0	0.0	0.0	0.0	0,0,0	
860.0	0.0	0.0	0,0,0	0.0	0.0	0.0	0,0,0	
870.0	0.0	0.0	0,0,0	0.0	0.0	0.0	0,0,0	
880.0	0.0	0.0	0,0,0	0.0	0.0	0.0	0,0,0	
890.0	0.0	0.0	0,0,0	0.0	0.0	0.0	0,0,0	
900.0	0.0	0.0	0,0,0	0.0	0.0	0.0	0,0,0	
910.0	0.0	0.0	0,0,0	0.0	0.0	0.0	0,0,0	
920.0	0.0	0.0	0,0,0	0.0	0.0	0.0	0,0,0	
930.0	0.0	0.0	0,0,0	0.0	0.0	0.0	0,0,0	
940.0	0.0	0.0	0,0,0	0.0	0.0	0.0	0,0,0	
950.0	0.0	0.0	0,0,0	0.0	0.0	0.0	0,0,0	
960.0	0.0	0.0	0,0,0	0.0	0.0	0.0	0,0,0	
970.0	0.0	0.0	0,0,0	0.0	0.0	0.0	0,0,0	
980.0	0.0	0.0	0,0,0	0.0	0.0	0.0	0,0,0	
990.0	0.0	0.0	0,0,0	0.0	0.0	0.0	0,0,0	
100	0.0	0.0	0.0	0,0,0	0.0	0.0	0.0	0,0,0
101	0.0	0.0	0.0	0,0,0	0.0	0.12	0.0	0,2,0
102	0.0	0.0	0.0	0,0,0	0.0	0.15	0.0	0,2,0
103	0.0	0.0	0.0	0,0,0	0.0	0.18	0.0	0,2,0
104	0.0	0.0	0.0	0,0,0	0.0	0.21	0.0	0,2,0
105	0.0	0.0	0.0	0,0,0	0.0	0.22	0.0	0,2,0
106	0.0	0.0	0.0	0,0,0	0.0	0.23	0.0	0,2,0
107	0.0	0.0	0.0	0,0,0	0.0	0.17	0.0	0,2,0
108	0.0	0.0	0.0	0,0,0	0.0	0.0	0.0	0,0,0
109	0.0	0.0	0.0	0,0,0	0.0	0.0	0.0	0,0,0
110	0.0	0.0	0.0	0,0,0	0.0	0.0	0.0	0,0,0
111	0.0	0.0	0.0	0,0,0	0.0	0.0	0.0	0,0,0
112	0.0	0.0	0.0	0,0,0	0.0	0.0	0.0	0,0,0
113	0.0	0.0	0.0	0,0,0	0.0	0.0	0.0	0,0,0
114	0.0	0.0	0.0	0,0,0	0.0	0.0	0.0	0,0,0
115	0.0	0.0	0.0	0,0,0	0.0	0.0	0.0	0,0,0
116	0.0	0.0	0.0	0,0,0	0.0	0.0	0.0	0,0,0
117	0.0	0.0	0.0	0,0,0	0.0	0.0	0.0	0,0,0
118	0.0	0.0	0.0	0,0,0	0.0	0.0	0.0	0,0,0
119	0.0	0.0	0.0	0,0,0	0.0	0.0	0.0	0,0,0
120	0.0	0.0	0.0	0,0,0	0.0	0.0	0.0	0,0,0
121	0.0	0.0	0.0	0,0,0	0.0	0.0	0.0	0,0,0
122	0.0	0.0	0.0	0,0,0	0.0	0.0	0.0	0,0,0
123	0.0	0.0	0.0	0,0,0	0.0	0.12	0.0	0,2,0
124	0.0	0.0	0.0	0,0,0	0.0	0.15	0.0	0,2,0
125	0.0	0.0	0.0	0,0,0	0.0	0.18	0.0	0,2,0
126	0.0	0.0	0.0	0,0,0	0.0	0.23	0.0	0,2,0
127	0.0	0.0	0.0	0,0,0	0.0	0.23	0.0	0,2,0
128	0.0	0.0	0.0	0,0,0	0.0	0.24	0.0	0,2,0
129	0.0	0.0	0.0	0,0,0	0.0	0.19	0.0	0,2,0
130	0.0	0.0	0.0	0,0,0	0.0	0.0	0.0	0,0,0
131	0.0	0.0	0.0	0,0,0	0.0	0.0	0.0	0,0,0
132	0.0	0.0	0.0	0,0,0	0.0	0.0	0.0	0,0,0
133	0.0	0.0	0.0	0,0,0	0.0	0.0	0.0	0,0,0
134	0.0	0.0	0.0	0,0,0	0.0	0.0	0.0	0,0,0
135	0.0	0.0	0.0	0,0,0	0.0	0.0	0.0	0,0,0
136	0.0	0.0	0.0	0,0,0	0.0	0.0	0.0	0,0,0
137	0.0	0.0	0.0	0,0,0	0.0	0.0	0.0	0,0,0
138	0.0	0.0	0.0	0,0,0	0.0	0.0	0.0	0,0,0
139	0.0	0.0	0.0	0,0,0	0.0	0.0	0.0	0,0,0
140	0.0	0.0	0.0	0,0,0	0.0	0.0	0.0	0,0,0
141	0.0	0.0	0.0	0,0,0	0.0	0.0	0.0	0,0,0
142	0.0	0.0	0.0	0,0,0	0.0	0.0	0.0	0,0,0
143	0.0	0.0	0.0	0,0,0	0.0	0.0	0.0	0,0,0
144	0.0	0.0	0.0	0,0,0	0.0	0.0	0.0	0,0,0
145	0.0	0.0	0.0	0,0,0	0.0	0.12	0.0	0,2,0
146	0.0	0.0	0.0	0,0,0	0.0	0.15	0.0	0,2,0
147	0.0	0.0	0.0	0,0,0	0.0	0.19	0.0	0,2,0
148	0.0	0.0	0.0	0,0,0	0.0	0.24	0.0	0,2,0
149	0.0	0.0	0.0	0,0,0	0.0	0.23	0.0	0,2,0

150	0.0	0.0	0.0	0,0,0	0.0	0.24	0.0	0,2,0
151	0.0	0.0	0.0	0,0,0	0.0	0.19	0.0	0,2,0
152	0.0	0.0	0.0	0,0,0	0.0	0.0	0.0	0,0,0
153	0.0	0.0	0.0	0,0,0	0.0	0.0	0.0	0,0,0
154	0.0	0.0	0.0	0,0,0	0.0	0.0	0.0	0,0,0
155	0.0	0.0	0.0	0,0,0	0.0	0.0	0.0	0,0,0
156	0.0	0.0	0.0	0,0,0	0.0	0.0	0.0	0,0,0
157	0.0	0.0	0.0	0,0,0	0.0	0.0	0.0	0,0,0
158	0.0	0.0	0.0	0,0,0	0.0	0.0	0.0	0,0,0
159	0.0	0.0	0.0	0,0,0	0.0	0.0	0.0	0,0,0
160	0.0	0.0	0.0	0,0,0	0.0	0.0	0.0	0,0,0
161	0.0	0.0	0.0	0,0,0	0.0	0.0	0.0	0,0,0
162	0.0	0.0	0.0	0,0,0	0.0	0.0	0.0	0,0,0
163	0.0	0.0	0.0	0,0,0	0.0	0.0	0.0	0,0,0
164	0.0	0.0	0.0	0,0,0	0.0	0.0	0.0	0,0,0
165	0.0	0.0	0.0	0,0,0	0.0	0.0	0.0	0,0,0
166	0.0	0.0	0.0	0,0,0	0.0	0.0	0.0	0,0,0
167	0.0	0.0	0.0	0,0,0	0.0	0.12	0.0	0,2,0
168	0.0	0.0	0.0	0,0,0	0.0	0.15	0.0	0,2,0
169	0.0	0.0	0.0	0,0,0	0.0	0.19	0.0	0,2,0
170	0.0	0.0	0.0	0,0,0	0.0	0.24	0.0	0,2,0
171	0.0	0.0	0.0	0,0,0	0.0	0.23	0.0	0,2,0
172	0.0	0.0	0.0	0,0,0	0.0	0.24	0.0	0,2,0
173	0.0	0.0	0.0	0,0,0	0.0	0.19	0.0	0,2,0
174	0.0	0.0	0.0	0,0,0	0.0	0.0	0.0	0,0,0
175	0.0	0.0	0.0	0,0,0	0.0	0.0	0.0	0,0,0
176	0.0	0.0	0.0	0,0,0	0.0	0.0	0.0	0,0,0
177	0.0	0.0	0.0	0,0,0	0.0	0.0	0.0	0,0,0
178	0.0	0.0	0.0	0,0,0	0.0	0.0	0.0	0,0,0
179	0.0	0.0	0.0	0,0,0	0.0	0.0	0.0	0,0,0
180	0.0	0.0	0.0	0,0,0	0.0	0.0	0.0	0,0,0
181	0.0	0.0	0.0	0,0,0	0.0	0.0	0.0	0,0,0
182	0.0	0.0	0.0	0,0,0	0.0	0.0	0.0	0,0,0
183	0.0	0.0	0.0	0,0,0	0.0	0.0	0.0	0,0,0
184	0.0	0.0	0.0	0,0,0	0.0	0.0	0.0	0,0,0
185	0.0	0.0	0.0	0,0,0	0.0	0.0	0.0	0,0,0
186	0.0	0.0	0.0	0,0,0	0.0	0.0	0.0	0,0,0
187	0.0	0.0	0.0	0,0,0	0.0	0.0	0.0	0,0,0
188	0.0	0.0	0.0	0,0,0	0.0	0.0	0.0	0,0,0
189	0.0	0.0	0.0	0,0,0	0.0	0.12	0.0	0,2,0
190	0.0	0.0	0.0	0,0,0	0.0	0.15	0.0	0,2,0
191	0.0	0.0	0.0	0,0,0	0.0	0.18	0.0	0,2,0
192	0.0	0.0	0.0	0,0,0	0.0	0.23	0.0	0,2,0
193	0.0	0.0	0.0	0,0,0	0.0	0.23	0.0	0,2,0
194	0.0	0.0	0.0	0,0,0	0.0	0.24	0.0	0,2,0
195	0.0	0.0	0.0	0,0,0	0.0	0.19	0.0	0,2,0
196	0.0	0.0	0.0	0,0,0	0.0	0.0	0.0	0,0,0
197	0.0	0.0	0.0	0,0,0	0.0	0.0	0.0	0,0,0
198	0.0	0.0	0.0	0,0,0	0.0	0.0	0.0	0,0,0
199	0.0	0.0	0.0	0,0,0	0.0	0.0	0.0	0,0,0
200	0.0	0.0	0.0	0,0,0	0.0	0.0	0.0	0,0,0
201	0.0	0.0	0.0	0,0,0	0.0	0.0	0.0	0,0,0
202	0.0	0.0	0.0	0,0,0	0.0	0.0	0.0	0,0,0
203	0.0	0.0	0.0	0,0,0	0.0	0.0	0.0	0,0,0
204	0.0	0.0	0.0	0,0,0	0.0	0.0	0.0	0,0,0
205	0.0	0.0	0.0	0,0,0	0.0	0.0	0.0	0,0,0
206	0.0	0.0	0.0	0,0,0	0.0	0.0	0.0	0,0,0
207	0.0	0.0	0.0	0,0,0	0.0	0.0	0.0	0,0,0
208	0.0	0.0	0.0	0,0,0	0.0	0.0	0.0	0,0,0
209	0.0	0.0	0.0	0,0,0	0.0	0.0	0.0	0,0,0
210	0.0	0.0	0.0	0,0,0	0.0	0.0	0.0	0,0,0
211	0.0	0.0	0.0	0,0,0	0.0	0.12	0.0	0,2,0
212	0.0	0.0	0.0	0,0,0	0.0	0.15	0.0	0,2,0
213	0.0	0.0	0.0	0,0,0	0.0	0.17	0.0	0,2,0
214	0.0	0.0	0.0	0,0,0	0.0	0.21	0.0	0,2,0
215	0.0	0.0	0.0	0,0,0	0.0	0.22	0.0	0,2,0
216	0.0	0.0	0.0	0,0,0	0.0	0.23	0.0	0,2,0
217	0.0	0.0	0.0	0,0,0	0.0	0.17	0.0	0,2,0
218	0.0	0.0	0.0	0,0,0	0.0	0.0	0.0	0,0,0
219	0.0	0.0	0.0	0,0,0	0.0	0.0	0.0	0,0,0
220	0.0	0.0	0.0	0,0,0	0.0	0.0	0.0	0,0,0
221	0.0	0.0	0.0	0,0,0	0.0	0.0	0.0	0,0,0
222	0.0	0.0	0.0	0,0,0	0.0	0.0	0.0	0,0,0
223	0.0	0.0	0.0	0,0,0	0.0	0.0	0.0	0,0,0
224	0.0	0.0	0.0	0,0,0	0.0	0.0	0.0	0,0,0
225	0.0	0.0	0.0	0,0,0	0.0	0.0	0.0	0,0,0





378	0.0	0.0	0.0	0,0,0	0.0	0.0	0.0	0,0,0
379	0.0	0.0	0.0	0,0,0	0.0	0.0	0.0	0,0,0
380	0.0	0.0	0.0	0,0,0	0.0	0.0	0.0	0,0,0
381	0.0	0.0	0.0	0,0,0	0.0	0.0	0.0	0,0,0
382	0.0	0.0	0.0	0,0,0	0.0	0.0	0.0	0,0,0
383	0.0	0.0	0.0	0,0,0	0.0	0.0	0.0	0,0,0
384	0.0	0.0	0.0	0,0,0	0.0	0.0	0.0	0,0,0
385	0.0	0.0	0.0	0,0,0	0.0	0.0	0.0	0,0,0
386	0.0	0.0	0.0	0,0,0	0.0	0.0	0.0	0,0,0
387	0.0	0.0	0.0	0,0,0	0.0	0.0	0.0	0,0,0
388	0.0	0.0	0.0	0,0,0	0.0	0.16	0.0	0,2,0
389	0.0	0.0	0.0	0,0,0	0.0	0.19	0.0	0,2,0
390	0.0	0.0	0.0	0,0,0	0.0	0.24	0.0	0,2,0
391	0.0	0.0	0.0	0,0,0	0.0	0.23	0.0	0,2,0
392	0.0	0.0	0.0	0,0,0	0.0	0.24	0.0	0,2,0
393	0.0	0.0	0.0	0,0,0	0.0	0.0	0.0	0,0,0
394	0.0	0.0	0.0	0,0,0	0.0	0.0	0.0	0,0,0
395	0.0	0.0	0.0	0,0,0	0.0	0.0	0.0	0,0,0
396	0.0	0.0	0.0	0,0,0	0.0	0.0	0.0	0,0,0
397	0.0	0.0	0.0	0,0,0	0.0	0.0	0.0	0,0,0
398	0.0	0.0	0.0	0,0,0	0.0	0.0	0.0	0,0,0
399	0.0	0.0	0.0	0,0,0	0.0	0.0	0.0	0,0,0
400	0.0	0.0	0.0	0,0,0	0.0	0.0	0.0	0,0,0
401	0.0	0.0	0.0	0,0,0	0.0	0.0	0.0	0,0,0
402	0.0	0.0	0.0	0,0,0	0.0	0.0	0.0	0,0,0
403	0.0	0.0	0.0	0,0,0	0.0	0.0	0.0	0,0,0
404	0.0	0.0	0.0	0,0,0	0.0	0.0	0.0	0,0,0
405	0.0	0.0	0.0	0,0,0	0.0	0.0	0.0	0,0,0
406	0.0	0.0	0.0	0,0,0	0.0	0.0	0.0	0,0,0
407	0.0	0.0	0.0	0,0,0	0.0	0.0	0.0	0,0,0
408	0.0	0.0	0.0	0,0,0	0.0	0.0	0.0	0,0,0
409	0.0	0.0	0.0	0,0,0	0.0	0.14	0.0	0,2,0
410	0.0	0.0	0.0	0,0,0	0.0	0.17	0.0	0,2,0
411	0.0	0.0	0.0	0,0,0	0.0	0.20	0.0	0,2,0
412	0.0	0.0	0.0	0,0,0	0.0	0.25	0.0	0,2,0
413	0.0	0.0	0.0	0,0,0	0.0	0.24	0.0	0,2,0
414	0.0	0.0	0.0	0,0,0	0.0	0.24	0.0	0,2,0
415	0.0	0.0	0.0	0,0,0	0.0	0.19	0.0	0,2,0
416	0.0	0.0	0.0	0,0,0	0.0	0.0	0.0	0,0,0
417	0.0	0.0	0.0	0,0,0	0.0	0.0	0.0	0,0,0
418	0.0	0.0	0.0	0,0,0	0.0	0.0	0.0	0,0,0
419	0.0	0.0	0.0	0,0,0	0.0	0.0	0.0	0,0,0
420	0.0	0.0	0.0	0,0,0	0.0	0.0	0.0	0,0,0
421	0.0	0.0	0.0	0,0,0	0.0	0.0	0.0	0,0,0
422	0.0	0.0	0.0	0,0,0	0.0	0.0	0.0	0,0,0
423	0.0	0.0	0.0	0,0,0	0.0	0.0	0.0	0,0,0
424	0.0	0.0	0.0	0,0,0	0.0	0.0	0.0	0,0,0
425	0.0	0.0	0.0	0,0,0	0.0	0.0	0.0	0,0,0
426	0.0	0.0	0.0	0,0,0	0.0	0.0	0.0	0,0,0
427	0.0	0.0	0.0	0,0,0	0.0	0.0	0.0	0,0,0
428	0.0	0.0	0.0	0,0,0	0.0	0.0	0.0	0,0,0
429	0.0	0.0	0.0	0,0,0	0.0	0.0	0.0	0,0,0
430	0.0	0.0	0.0	0,0,0	0.0	0.0	0.0	0,0,0
431	0.0	0.0	0.0	0,0,0	0.0	0.14	0.0	0,2,0
432	0.0	0.0	0.0	0,0,0	0.0	0.17	0.0	0,2,0
433	0.0	0.0	0.0	0,0,0	0.0	0.20	0.0	0,2,0
434	0.0	0.0	0.0	0,0,0	0.0	0.25	0.0	0,2,0
435	0.0	0.0	0.0	0,0,0	0.0	0.24	0.0	0,2,0
436	0.0	0.0	0.0	0,0,0	0.0	0.24	0.0	0,2,0
437	0.0	0.0	0.0	0,0,0	0.0	0.19	0.0	0,2,0
438	0.0	0.0	0.0	0,0,0	0.0	0.0	0.0	0,0,0
439	0.0	0.0	0.0	0,0,0	0.0	0.0	0.0	0,0,0
440	0.0	0.0	0.0	0,0,0	0.0	0.0	0.0	0,0,0
441	0.0	0.0	0.0	0,0,0	0.0	0.0	0.0	0,0,0
442	0.0	0.0	0.0	0,0,0	0.0	0.0	0.0	0,0,0
443	0.0	0.0	0.0	0,0,0	0.0	0.0	0.0	0,0,0
444	0.0	0.0	0.0	0,0,0	0.0	0.0	0.0	0,0,0
445	0.0	0.0	0.0	0,0,0	0.0	0.0	0.0	0,0,0
446	0.0	0.0	0.0	0,0,0	0.0	0.0	0.0	0,0,0
447	0.0	0.0	0.0	0,0,0	0.0	0.0	0.0	0,0,0
448	0.0	0.0	0.0	0,0,0	0.0	0.0	0.0	0,0,0
449	0.0	0.0	0.0	0,0,0	0.0	0.0	0.0	0,0,0
450	0.0	0.0	0.0	0,0,0	0.0	0.0	0.0	0,0,0
451	0.0	0.0	0.0	0,0,0	0.0	0.0	0.0	0,0,0
452	0.0	0.0	0.0	0,0,0	0.0	0.0	0.0	0,0,0
453	0.0	0.0	0.0	0,0,0	0.0	0.0	0.0	0,0,0



454	0.0	0.0	0.0	0,0,0	0.0	0.16	0.0	0,2,0
455	0.0	0.0	0.0	0,0,0	0.0	0.19	0.0	0,2,0
456	0.0	0.0	0.0	0,0,0	0.0	0.24	0.0	0,2,0
457	0.0	0.0	0.0	0,0,0	0.0	0.23	0.0	0,2,0
458	0.0	0.0	0.0	0,0,0	0.0	0.24	0.0	0,2,0
459	0.0	0.0	0.0	0,0,0	0.0	0.0	0.0	0,0,0
460	0.0	0.0	0.0	0,0,0	0.0	0.0	0.0	0,0,0
461	0.0	0.0	0.0	0,0,0	0.0	0.0	0.0	0,0,0
462	0.0	0.0	0.0	0,0,0	0.0	0.0	0.0	0,0,0
463	0.0	0.0	0.0	0,0,0	0.0	0.0	0.0	0,0,0
464	0.0	0.0	0.0	0,0,0	0.0	0.0	0.0	0,0,0
465	0.0	0.0	0.0	0,0,0	0.0	0.0	0.0	0,0,0
466	0.0	0.0	0.0	0,0,0	0.0	0.0	0.0	0,0,0
467	0.0	0.0	0.0	0,0,0	0.0	0.0	0.0	0,0,0
468	0.0	0.0	0.0	0,0,0	0.0	0.0	0.0	0,0,0
469	0.0	0.0	0.0	0,0,0	0.0	0.0	0.0	0,0,0
470	0.0	0.0	0.0	0,0,0	0.0	0.0	0.0	0,0,0
471	0.0	0.0	0.0	0,0,0	0.0	0.0	0.0	0,0,0
472	0.0	0.0	0.0	0,0,0	0.0	0.0	0.0	0,0,0
473	0.0	0.0	0.0	0,0,0	0.0	0.0	0.0	0,0,0
474	0.0	0.0	0.0	0,0,0	0.0	0.0	0.0	0,0,0
475	0.0	0.0	0.0	0,0,0	0.0	0.0	0.0	0,0,0
476	0.0	0.0	0.0	0,0,0	0.0	0.14	0.0	0,2,0
477	0.0	0.0	0.0	0,0,0	0.0	0.17	0.0	0,2,0
478	0.0	0.0	0.0	0,0,0	0.0	0.21	0.0	0,2,0
479	0.0	0.0	0.0	0,0,0	0.0	0.21	0.0	0,2,0
480	0.0	0.0	0.0	0,0,0	0.0	0.21	0.0	0,2,0
481	0.0	0.0	0.0	0,0,0	0.0	0.0	0.0	0,0,0
482	0.0	0.0	0.0	0,0,0	0.0	0.0	0.0	0,0,0
483	0.0	0.0	0.0	0,0,0	0.0	0.0	0.0	0,0,0
484	0.0	0.0	0.0	0,0,0	0.0	0.0	0.0	0,0,0
485	0.0	0.0	0.0	0,0,0	0.0	0.0	0.0	0,0,0
486	0.0	0.0	0.0	0,0,0	0.0	0.0	0.0	0,0,0
487	0.0	0.0	0.0	0,0,0	0.0	0.0	0.0	0,0,0
488	0.0	0.0	0.0	0,0,0	0.0	0.0	0.0	0,0,0
489	0.0	0.0	0.0	0,0,0	0.0	0.0	0.0	0,0,0
490	0.0	0.0	0.0	0,0,0	0.0	0.0	0.0	0,0,0
491	0.0	0.0	0.0	0,0,0	0.0	0.0	0.0	0,0,0
492	0.0	0.0	0.0	0,0,0	0.0	0.0	0.0	0,0,0
493	0.0	0.0	0.0	0,0,0	0.0	0.0	0.0	0,0,0
494	0.0	0.0	0.0	0,0,0	0.0	0.0	0.0	0,0,0
495	0.0	0.0	0.0	0,0,0	0.0	0.0	0.0	0,0,0
496	0.0	0.0	0.0	0,0,0	0.0	0.0	0.0	0,0,0
497	0.0	0.0	0.0	0,0,0	0.0	0.0	0.0	0,0,0
498	0.0	0.0	0.0	0,0,0	0.0	0.0	0.0	0,0,0
499	0.0	0.0	0.0	0,0,0	0.0	0.14	0.0	0,2,0
500	0.0	0.0	0.0	0,0,0	0.0	0.17	0.0	0,2,0
501	0.0	0.0	0.0	0,0,0	0.0	0.0	0.0	0,0,0
502	0.0	0.0	0.0	0,0,0	0.0	0.0	0.0	0,0,0
503	0.0	0.0	0.0	0,0,0	0.0	0.0	0.0	0,0,0
504	0.0	0.0	0.0	0,0,0	0.0	0.0	0.0	0,0,0
505	0.0	0.0	0.0	0,0,0	0.0	0.0	0.0	0,0,0
506	0.0	0.0	0.0	0,0,0	0.0	0.0	0.0	0,0,0
507	0.0	0.0	0.0	0,0,0	0.0	0.0	0.0	0,0,0
508	0.0	0.0	0.0	0,0,0	0.0	0.0	0.0	0,0,0
509	0.0	0.0	0.0	0,0,0	0.0	0.0	0.0	0,0,0
510	0.0	0.0	0.0	0,0,0	0.0	0.0	0.0	0,0,0
511	0.0	0.0	0.0	0,0,0	0.0	0.0	0.0	0,0,0
512	0.0	0.0	0.0	0,0,0	0.0	0.0	0.0	0,0,0
513	0.0	0.0	0.0	0,0,0	0.0	0.0	0.0	0,0,0
514	0.0	0.0	0.0	0,0,0	0.0	0.0	0.0	0,0,0
515	0.0	0.0	0.0	0,0,0	0.0	0.0	0.0	0,0,0
516	0.0	0.0	0.0	0,0,0	0.0	0.0	0.0	0,0,0
517	0.0	0.0	0.0	0,0,0	0.0	0.0	0.0	0,0,0
518	0.0	0.0	0.0	0,0,0	0.0	0.0	0.0	0,0,0
519	0.0	0.0	0.0	0,0,0	0.0	0.0	0.0	0,0,0
520	0.0	0.0	0.0	0,0,0	0.0	0.0	0.0	0,0,0
521	0.0	0.0	0.0	0,0,0	0.0	0.0	0.0	0,0,0
522	0.0	0.0	0.0	0,0,0	0.0	0.0	0.0	0,0,0
523	0.0	0.0	0.0	0,0,0	0.0	0.0	0.0	0,0,0
524	0.0	0.0	0.0	0,0,0	0.0	0.0	0.0	0,0,0
525	0.0	0.0	0.0	0,0,0	0.0	0.0	0.0	0,0,0
526	0.0	0.0	0.0	0,0,0	0.0	0.0	0.0	0,0,0
527	0.0	0.0	0.0	0,0,0	0.0	0.0	0.0	0,0,0
528	0.0	0.0	0.0	0,0,0	0.0	0.0	0.0	0,0,0

Guscio      rRfck   rRfyk   rPfck  
0.0          0.0   0.0

0.0

wR  
0.25

wF  
0.0

wP

## 15. CONCLUSIONI

Considerato quanto sopra, le verifiche sul sistema di fondazione analizzato risultano essere soddisfatte. Si precisa ancora una volta che il calcolo ha carattere preliminare, dovrà essere verificato in fase esecutiva considerando i carichi effettivamente trasmessi dalla sovrastruttura.

Il Tecnico  
Ing. Leonardo Sblendido

