

PIANTA

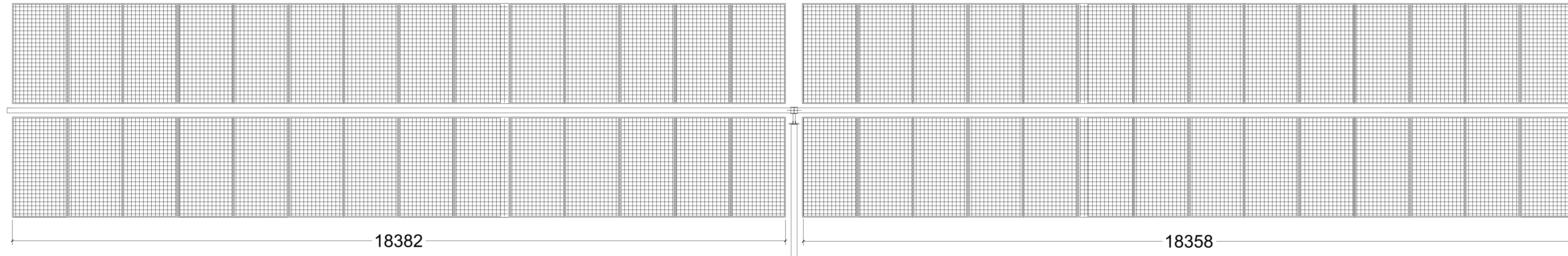

PROSPETTO LONGITUDINALE A RIPOSO + 0°

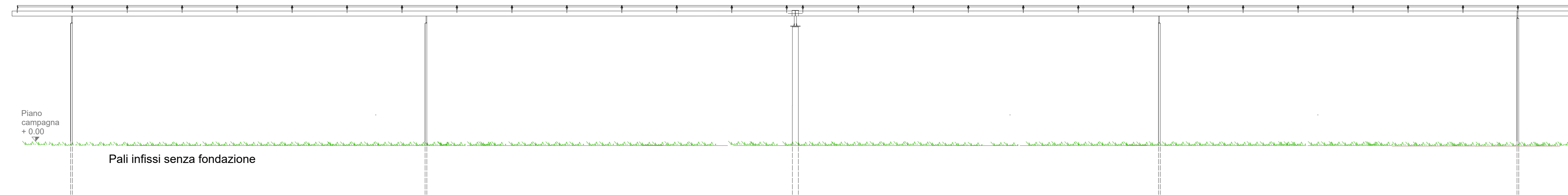

PROSPETTO LONGITUDINALE A INCLINAZIONE MASSIMA + 55°

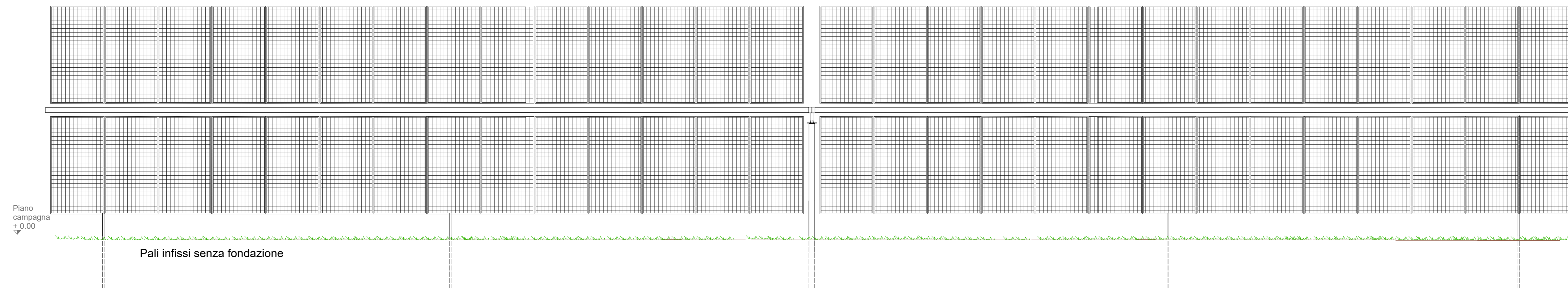

VISTA TRASVERSALE IN CAMPO E POSIZIONI TRACKER

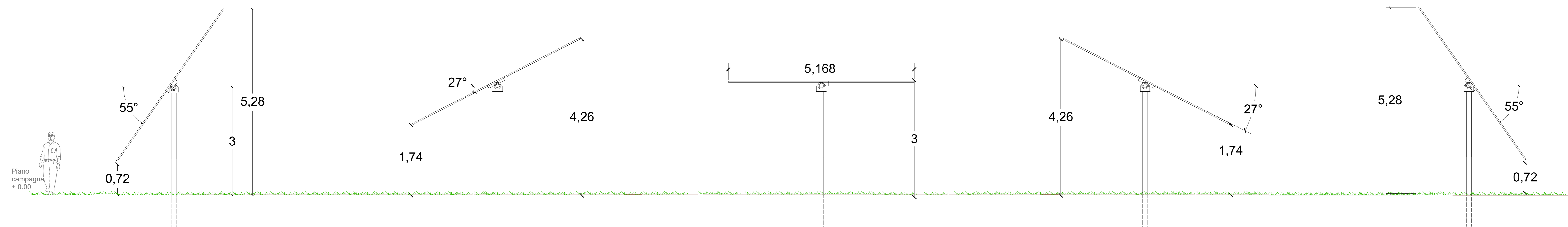

MODULO

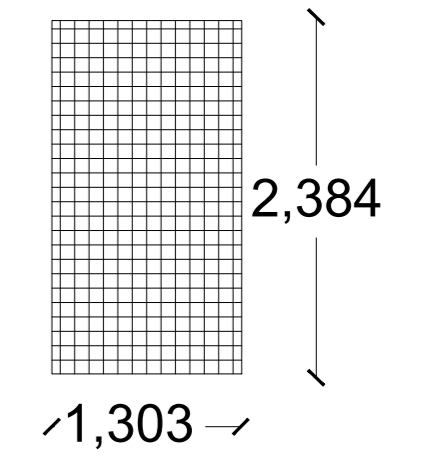

POSIZIONE + 0°

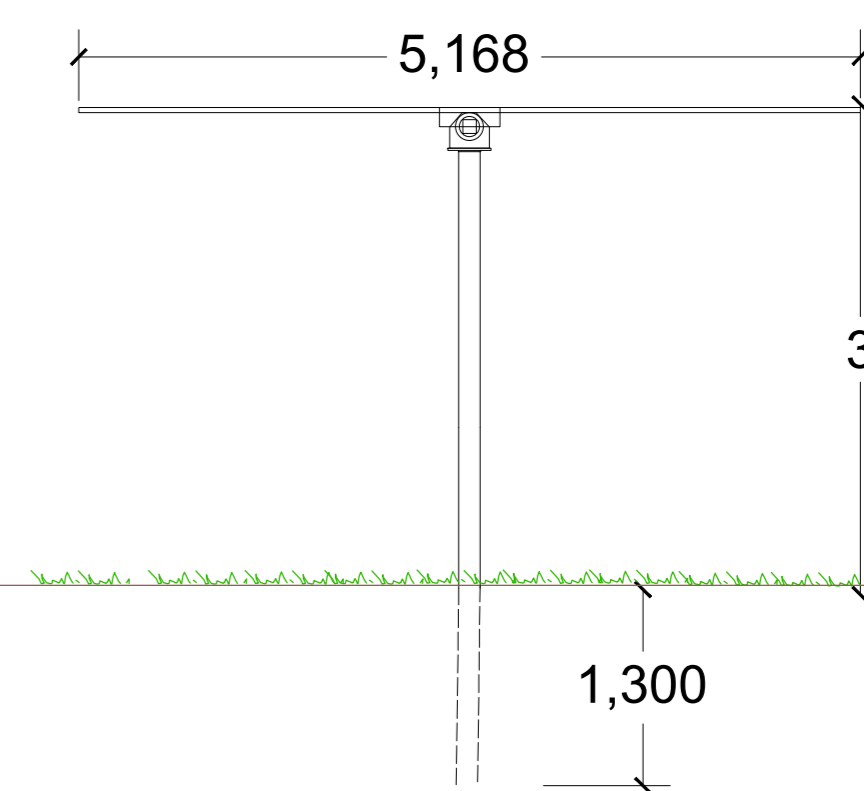

POSIZIONE + 55° (inclinazione massima)

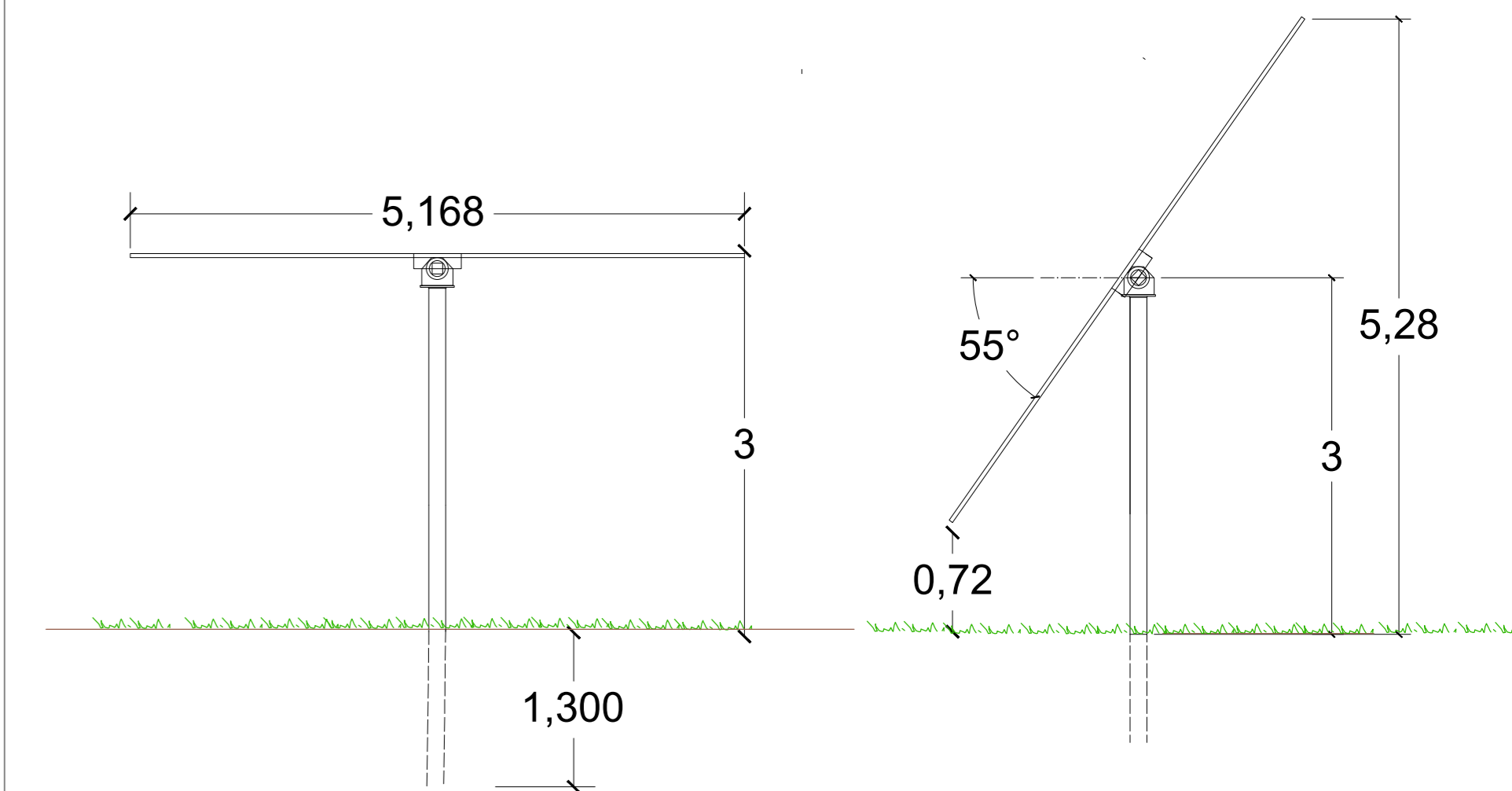

REGIONE PIEMONTE
 Provincia di Vercelli
 Comune di Roasio
FATTORIA SOLARE ROGGIA DELLA BARDESA

Valutazione impatto ambientale
 ai sensi dell'art. 23 D.Lgs 152/2006
 COORDINAMENTO GENERALE



PROGETTISTA



Arch. Luca Menci
 mail: lucamenci@studiomenci.com

PROPONENTE



Salta Santa Caterina 21 - 16123 Genova
 mail: ren192@pec.it
 P.IVA: 0268900090

OGGETTO

Particolari Costruttivi Tracker

ELABORATO 6.1 PARAGRAFO 6 - Dettagli e particolari

CODICE ELABORATO R-6.1-ROA-DP-0

DATA 9 Maggio 2022 SCALA FORMATO A1

REDATTO DA APPROVATO DA Luca Menci

Abdallah Hamdar



REN 192 S.R.L.
 0268900090