

VISTA in PIANTA

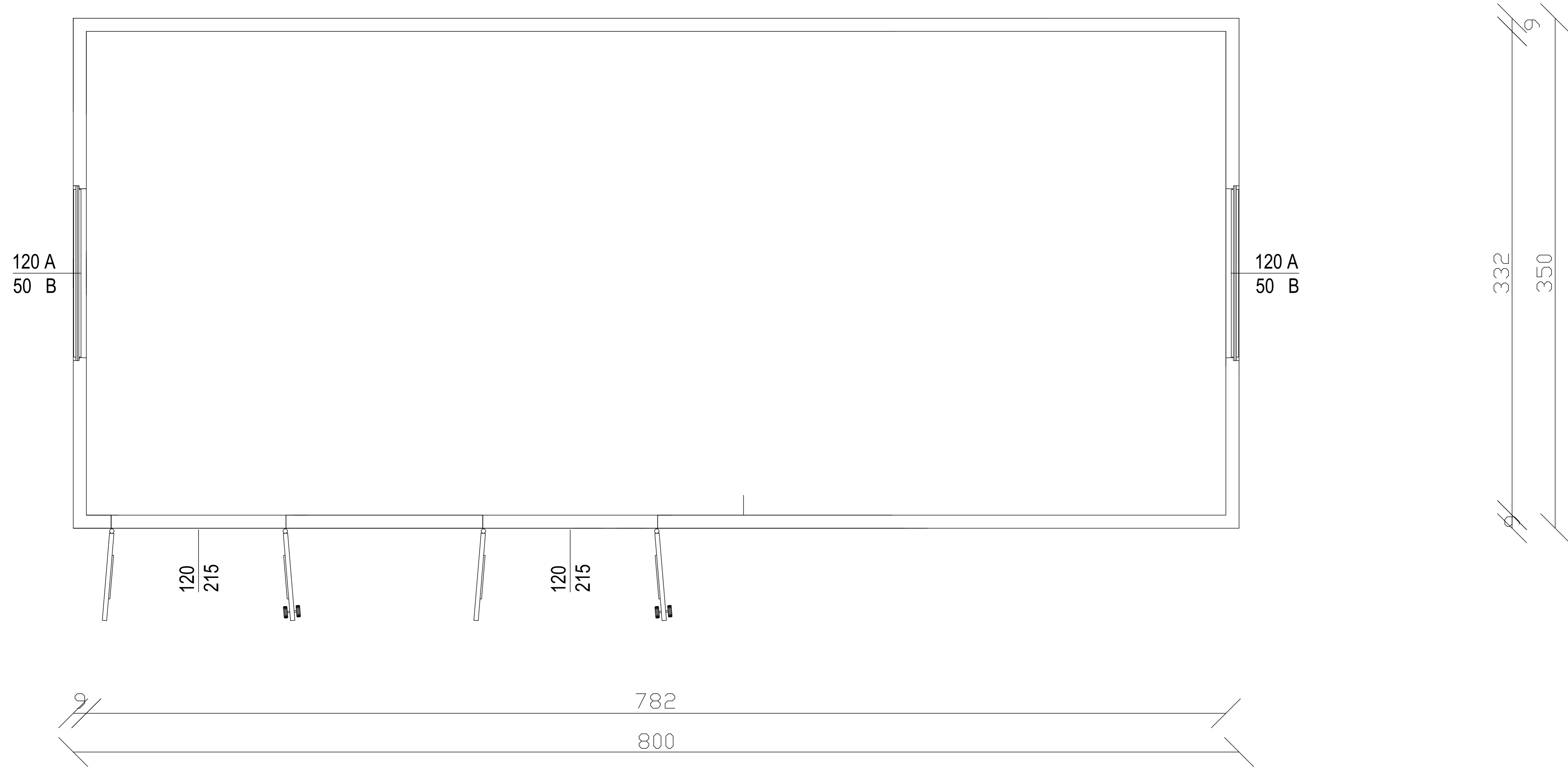

Sezione tipo

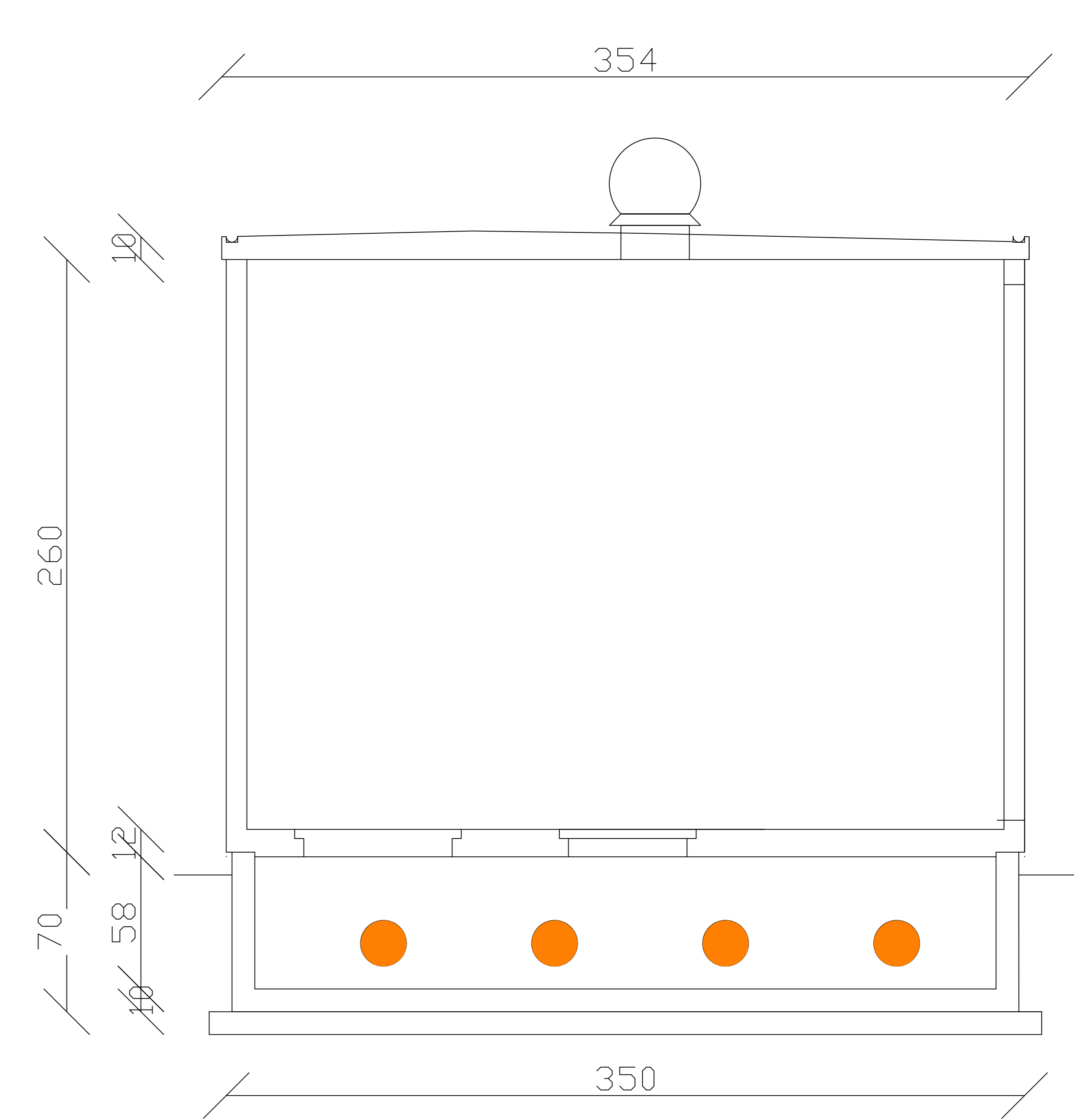

Prospetto LATO STRADA

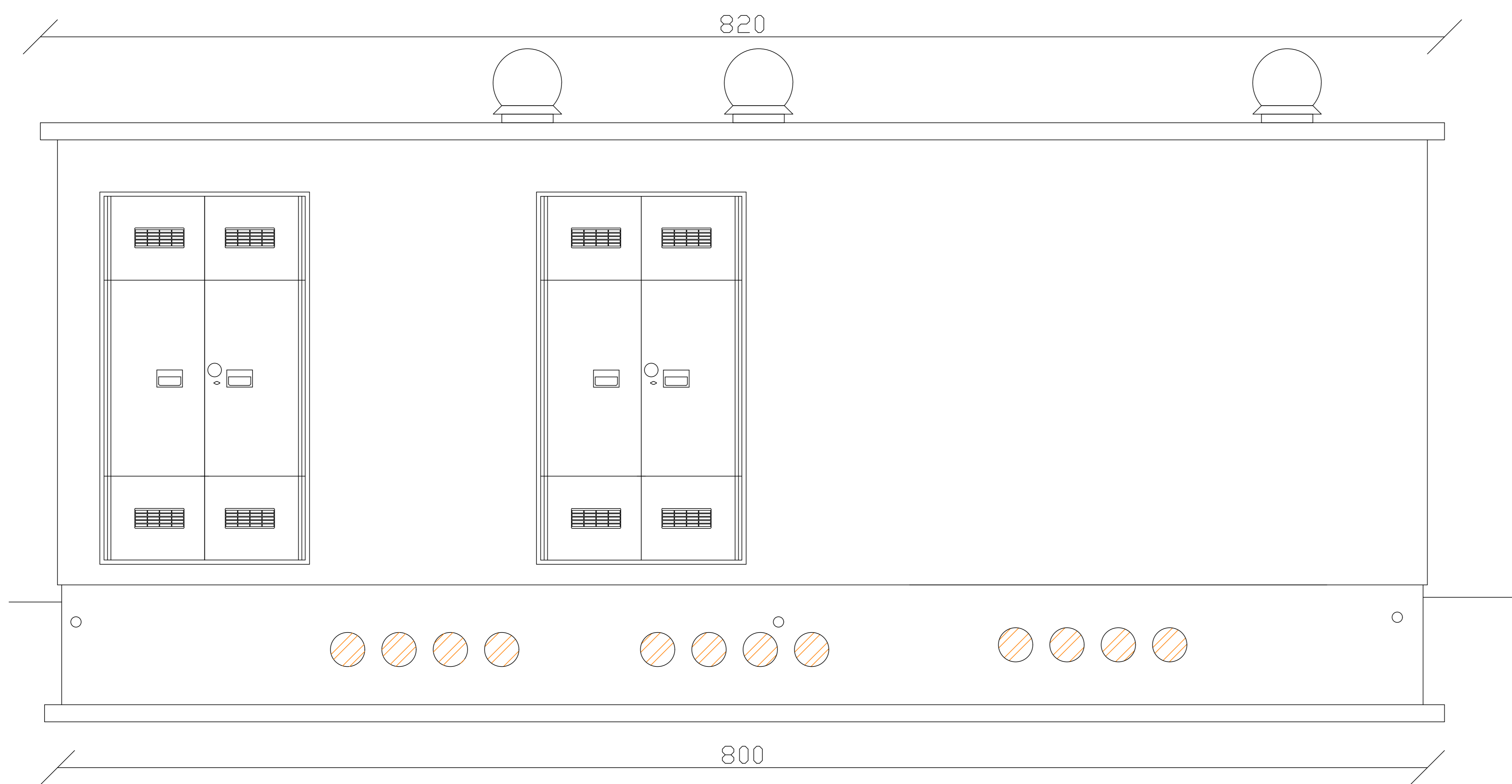

FLYNIS PV 2 SRL
Via Statuto, 10 - 20121 Milano - Italy
pec: flynispv2@regainmail.it

PROCEDIMENTO VIA NAZIONALE
ai sensi dell'art. 23 bis del D.Lgs. 152/06 e s.m.i.

Denominazione progetto: **IMPIANTO FOTOVOLTAICO "LA COMUNA" di potenza 20,2176 MWp**

Sito in: **COMUNE DI ARGENTA(FE)**

Titolo elaborato: **PARTICOLARI COSTRUTTIVI DELLA CABINA CONTROLLO E MONITORAGGIO**



Elaborato n. **TV15** Scala: **--**

Responsabile coordinamento e revisione progetto: **Dott.ssa Eliana Santoro**

Progettisti: **Ing. Nicodemo Agostino - Ordine degli Ingegneri di Vercelli - n° 1266A**

Collaboratori: **Graphic Designer Lorenza Zani**



REV.	REDAZIONE:	CONTROLLO:	DATA:	FIRMA/TIMBRO COMMITTENTE:
00	Ing. Nicodemo Agostino	Dott.ssa Eliana Santoro	20/10/2021	 
01	Ing. Nicodemo Agostino	Dott.ssa Eliana Santoro	28/10/2022	
02				
03				
04				



FLYREN
THE CULTURE OF CLEAN ENERGY

Flyren Development S.r.l.
Lungo Po Antenaldi, 21 - 10153 Torino (TO)
tel. 011/8125575 - fax 011/8127828
email: info@flyren.eu
web: www.flyren.eu
C.F./P. IVA n. 1206240010