

COMMITTENTE:



PROGETTAZIONE:



DIREZIONE TECNICA

S.O. COORDINAMENTO INGEGNERIA DI SISTEMA E PFTE

PROGETTO DI FATTIBILITA' TECNICO ECONOMICA

Collegamento Aeroporto di Olbia

Book sezioni trasversali

SCALA :

1:200

COMMESSA LOTTO FASE ENTE TIPO DOC. OPERA/DISCIPLINA PROGR. REV.

RR00 10 R 13 W9 IF 00 0 1 001 A

Revis.	Descrizione	Redatto	Data	Verificato	Data	Approvato	Data	Autorizzato	Data
A	Emissione definitiva	A.Fantuz 	Ott 2022	R.Sciannameo 	Ott 2022	T.Paoletti 	Ott 2022	V.Conforti Ott 2022	



File: RR0010R13W9IF0001001A.dgn

n. Elab.:

Materiale	Area(m2)
Inerbimento	0.000
Scotico	12.127
Subballast	1.489
SuperCompattato	3.898
Scavo	3.595
Rilevato	0.013
Riempimento	0.000
Volume	0.000

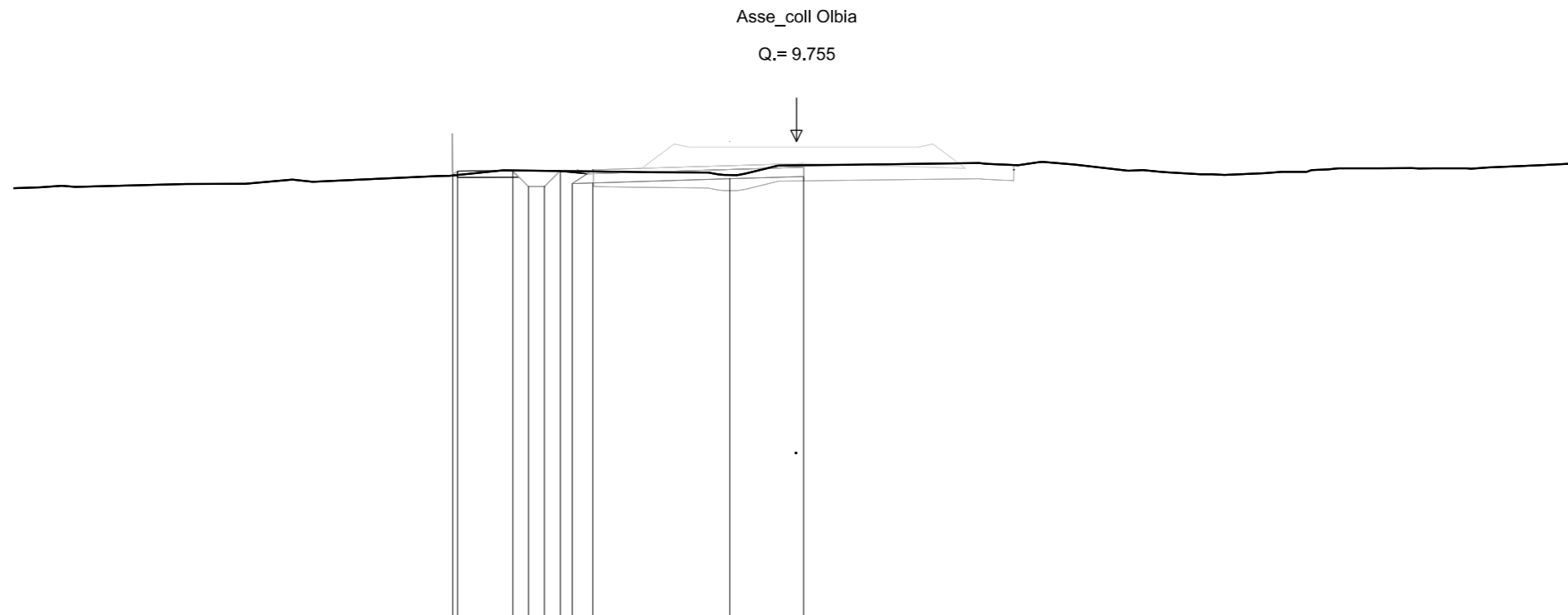

Prog. = 0+050.000

Q. Rif. = -6.000

Quote Terreno	8.668	8.830	8.824	8.817	8.817	8.807	8.799	8.686	8.999	
Quote Progetto	8.706	8.809	8.818	8.320	8.323	8.826	8.409	8.430	8.565	8.636
Dist. Progr. Progetto	-10.979	-10.820	-9.060	-8.555	-8.049	-7.543	-7.163	-6.500	-2.132	0.229
Dist. Parziali	0.159	1.760	0.505	0.506	0.506	0.380	0.663	4.368	2.361	

Materiale	Area(m2)
Inerbimento	0.000
Scotico	7.272
Subballast	2.016
SuperCompattato	5.040
Scavo	8.445
Rilevato	0.011
Riempimento	0.000
Volume	0.000

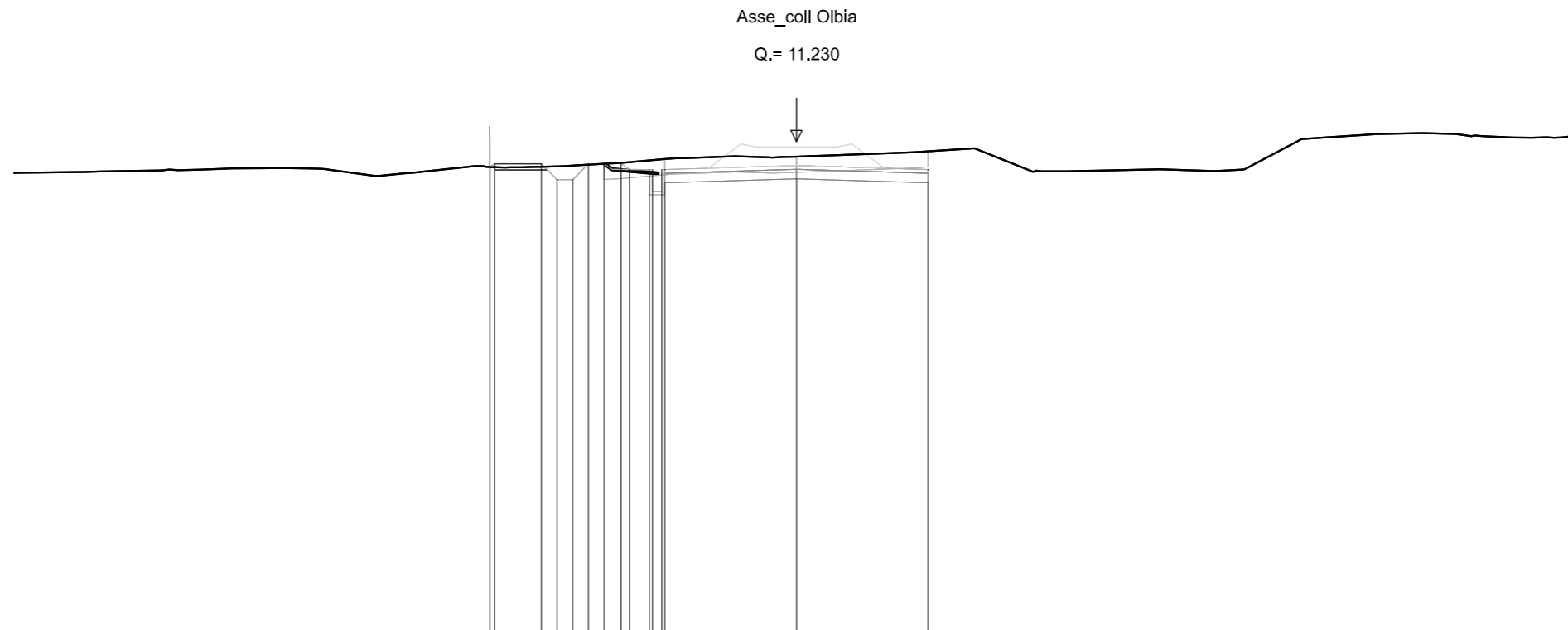

Prog. = 0+150.000

Q. Rif. = -5.000

Quote Terreno	10.418 10.426 10.440 10.463 10.494 10.519 10.519 10.567 10.624 10.660	10.743	10.917
Quote Progetto	10.418 10.519 10.519 10.019 10.019 10.519 10.519 10.519 10.340 10.334 10.334 10.334 9.914	10.040	9.914
Dist. Progr. Progetto	-9.794 -9.644 -8.144 -7.644 -7.144 -6.644 -6.144 -5.603 -5.335 -4.700 -4.600 -4.300 -4.200	-0.000	4.200
Dist. Parziali	0.150 1.500 0.500 0.500 0.500 0.500 0.288 0.288 0.635 0.500	4.200	4.200

Materiale	Area(m2)
Inerbimento	0.692
Scotico	7.656
Subballast	2.061
SuperCompattato	5.549
Scavo	2.961
Rilevato	3.544
Riempimento	0.000
Volume	0.000

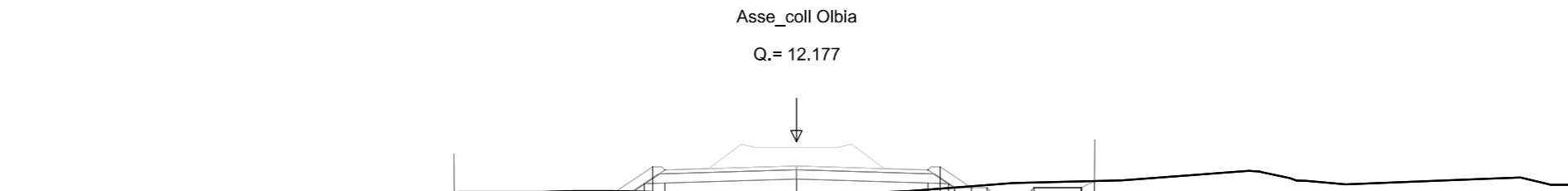

Prog. = 0+200.000

Q. Rif. = -4.000

Quote Terreno	10.496	10.588	10.516	10.654	10.917
Quote Progetto	10.496	10.598	10.987	10.861	10.928
Dist. Progr. Progetto	-10.928	-7.766	-0.000	4.200	9.095
Dist. Parziali	0.152	3.010	4.200	4.200	0.419

Materiale	Area(m2)
Inerbimento	2.497
Scotico	11.070
Subballast	2.061
SuperCompattato	5.549
Scavo	1.515
Rilevato	21.961
Riempimento	0.000
Volume	0.000

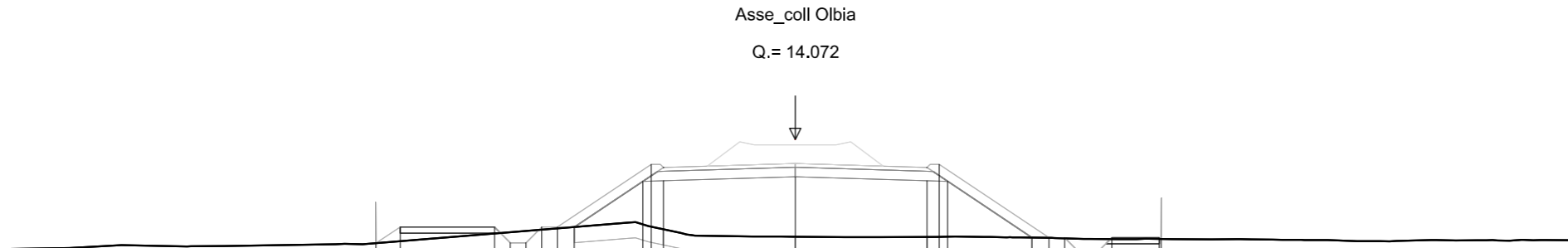

Prog. = 0+300.000

Q. Rif. = -4.000

Quote Terreno		10.765	10.828	11.073	11.114	11.155	11.195	11.236	11.280	11.363	11.404	10.967	10.863	10.916	10.944	10.934	10.918	10.901	10.900	10.895	10.901	10.901	
Quote Progetto		10.765	11.280	11.280	10.780	11.280	11.280	11.280	11.280	12.736	13.275	12.755	12.881	12.755	13.275	12.736	10.944	10.944	10.944	10.444	10.944	10.944	
Dist. Progr. Progetto		-13.366	-12.594	-9.584	-9.084	-8.584	-8.084	-7.584	-7.043	-4.860	-4.591	-4.200	0.000	4.200	4.591	4.860	7.548	8.089	8.589	9.089	9.589	10.089	11.599
Dist. Parziali		0.772	3.010	0.500	0.500	0.500	0.500	0.541	2.183	0.660	4.200	4.200	0.660	2.688	0.541	0.500	0.500	0.500	0.500	0.500	1.510	0.064	

Materiale	Area(m2)
Inerbimento	3.731
Scotico	13.720
Subballast	2.061
SuperCompattato	5.549
Scavo	2.252
Rilevato	38.376
Riempimento	0.000
Volume	0.000

Asse_coll Olbia
Q.= 15.019

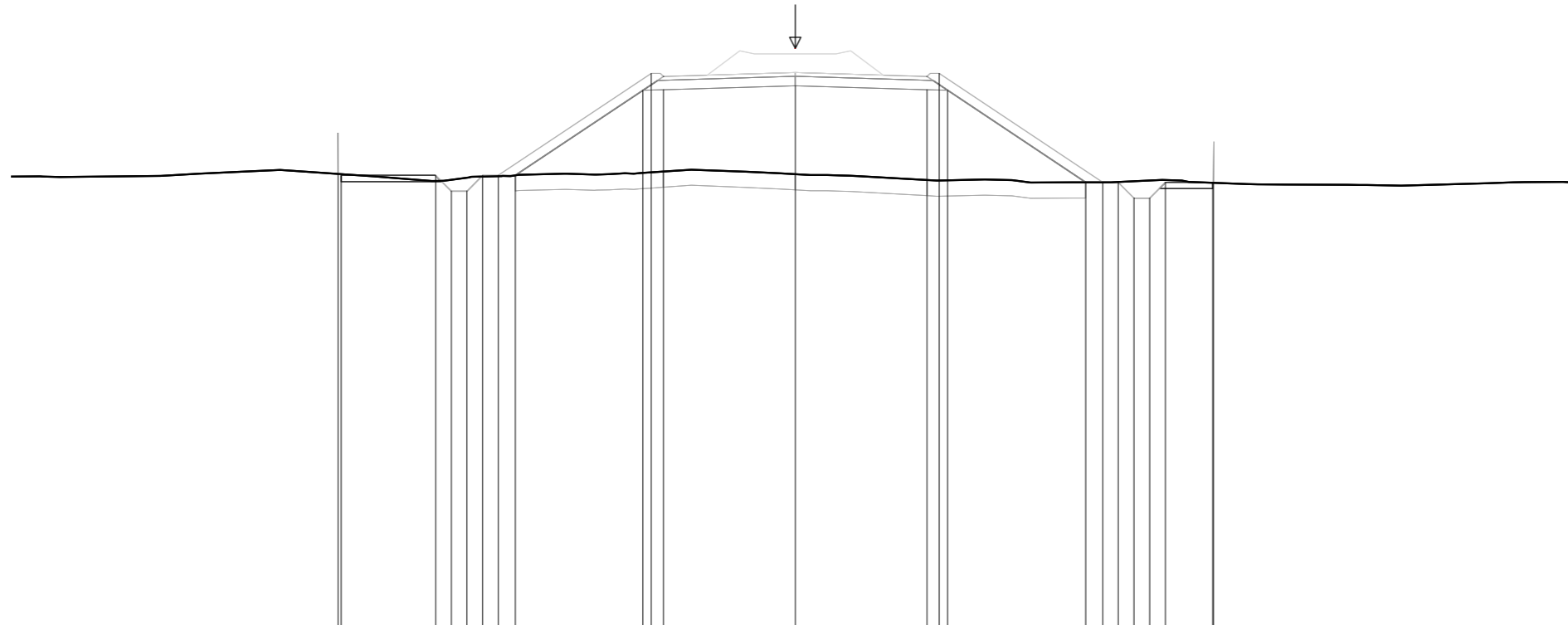

Prog. = 0+350.000

Q. Rif. = -4.000

Quote Terreno	11.022	10.973	10.793	10.830	10.895	10.937	10.948	10.973	11.068	11.065	11.010	10.825	10.848	10.750	10.749	10.760	10.784	10.809	10.824	10.736			
Quote Progetto	11.022	10.973	10.973	10.473	10.473	10.973	10.973	10.973	13.683	14.223	13.703	13.829	13.703	14.223	13.683	10.750	10.750	10.750	10.250	10.750	10.750	10.735	
Dist. Progr. Progetto	-14.573	-14.475	-11.465	-10.965	-10.465	-9.965	-9.465	-8.924	-4.860	-4.591	-4.200	0.000	4.200	4.591	4.860	9.259	9.800	10.300	10.800	11.300	11.800	13.310	13.332
Dist. Parziali	0.098	3.010	0.500	0.500	0.500	0.500	0.541	4.064	0.660	4.200	4.200	0.660	4.399	0.541	0.500	0.500	0.500	0.500	1.510	0.022			

Materiale	Area(m2)
Inerbimento	3.752
Scotico	13.484
Subballast	2.061
SuperCompattato	5.549
Scavo	2.220
Rilevato	36.923
Riempimento	0.000
Volume	0.000

Asse_coll Olbia

Q.= 15.966

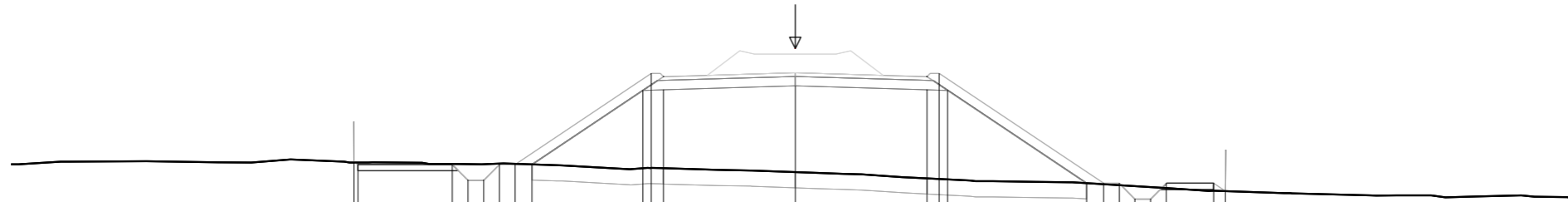

Prog. = 0+400.000

Q. Rif. = -3.000

Quote Terreno	12.337 12.338	12.292 12.285 12.281 12.300 12.293 12.276	12.155 12.154	12.034	11.831 11.800	11.678 11.645 11.614 11.584 11.553 11.523	11.441 11.428
Quote Progetto	12.337 12.276	12.276 11.776 11.776 12.276 12.276 12.276	14.630 15.170 14.650	14.776	14.650 15.170 14.630	11.678 11.678 11.678 11.178 11.178 11.678	11.678 11.428
Dist. Progr. Progetto	-14.065 -13.942	-10.932 -10.432 -9.932 -9.432 -8.932 -8.391	-4.860 -4.591 -4.200	-0.000	4.200 4.591 4.860	9.288 9.829 10.329 10.829 11.329 11.829	13.339 13.714
Dist. Parziali	0.123	3.010 0.500 0.500 0.500 0.541	3.531 0.660	4.200	4.200 0.660	4.428 0.541 0.500 0.500 0.500	1.510 0.375

Materiale	Area(m2)
Inerbimento	5.212
Scotico	15.607
Subballast	2.061
SuperCompattato	5.549
Scavo	5.481
Rilevato	54.214
Riempimento	0.000
Volume	0.000

Asse_coll Olbia
Q.= 16.914

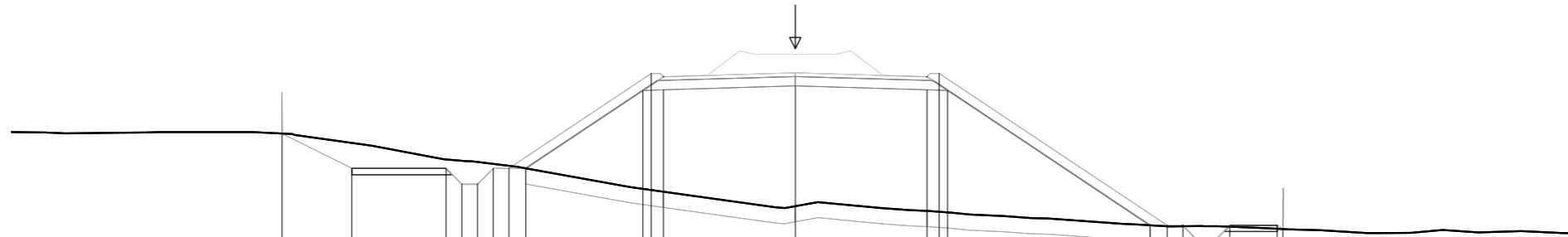

Prog. = 0+450.000

Q. Rif. = -4.000

Quote Terreno	14.201	13.902	13.377	13.335	13.297	13.236	13.174	13.091	12.486	12.344	11.883	11.732	11.683	11.275	11.243	11.242	11.247	11.244	11.228	11.164	
Quote Progetto	14.201	13.091	13.091	12.591	12.591	13.091	13.091	13.091	15.577	16.117	15.577	15.597	16.117	15.577	11.275	11.275	11.275	10.775	11.244	11.275	11.275
Dist. Progr. Progetto	-16.359	-14.140	-11.130	-10.630	-10.130	-9.630	-9.130	-8.589	-4.860	-4.591	-4.200	-0.000	4.200	4.591	4.860	11.313	11.854	12.354	12.854	13.354	13.854
Dist. Parziali		2.219	3.010	0.500	0.500	0.500	0.500	0.541	3.729	0.660	4.200	4.200	0.660	6.453	0.541	0.500	0.500	0.500	0.500	1.510	0.184

Materiale	Area(m2)
Inerbimento	4.146
Scotico	15.875
Subballast	2.061
SuperCompattato	5.549
Scavo	2.704
Rilevato	82.774
Riempimento	0.000
Volume	0.000

Asse_coll Olbia
Q.= 17.848

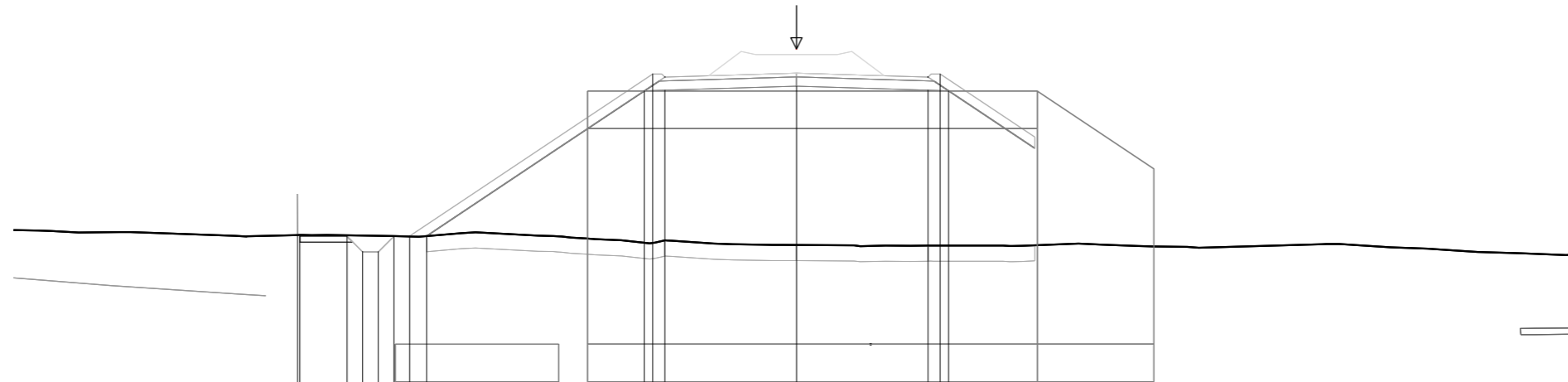

Prog. = 0+500.000

Q. Rif. = -3.000

Quote Terreno	11.910	11.878	11.900	11.892	11.884	11.877	11.864	11.878	11.662	11.739	11.593	11.575	11.573
Quote Progetto	11.910	11.878	11.878	11.378	11.378	11.878	11.878	11.878	16.512	17.052	16.658	16.532	17.052
Dist. Progr. Progetto	-15.926	-15.862	-14.352	-13.852	-13.352	-12.852	-12.352	-11.811	-4.860	-4.591	-0.000	4.200	4.591
Dist. Parziali	0.064	1.510	0.500	0.500	0.500	0.500	0.541	6.951	0.660	4.200	4.200	0.660	

Materiale	Area(m2)
Inerbimento	1.024
Scotico	0.000
Subballast	2.353
SuperCompattato	6.070
Scavo	1.551
Rilevato	38.221
Riempimento	0.000
Volume	0.000

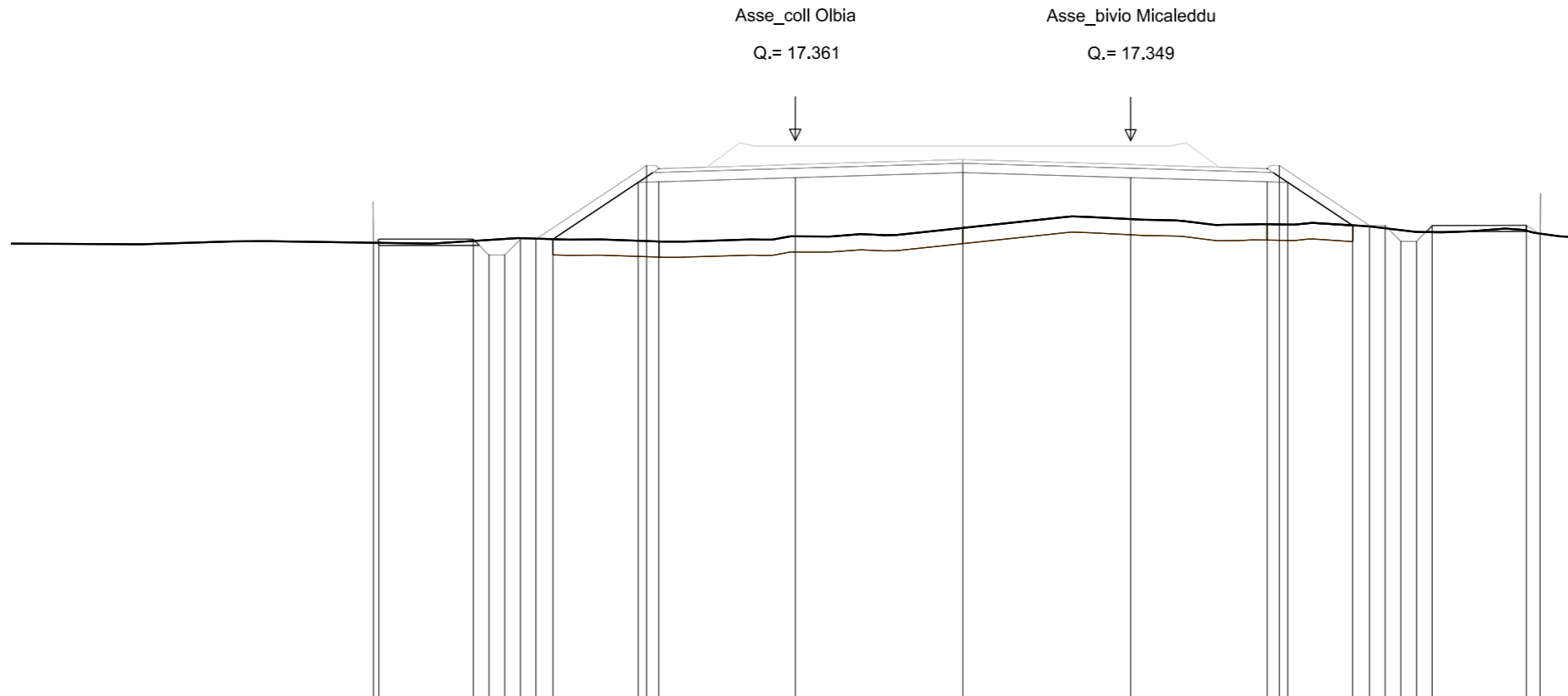

Prog. = 0+700.000

Q. Rif. = -1.000

Quote Terreno	14.895	14.154 14.186 14.219 14.244 14.228 14.211	14.160 14.138	14.301	14.569	14.850	14.687 14.679	14.651 14.616 14.558 14.499 14.442 14.429	14.478 14.386
Quote Progetto	14.095 14.211	14.211 13.711 13.711 14.211 14.211 14.211	16.020 16.560 16.040	16.170	16.331	16.170	16.039 16.559 16.019	14.645 14.645 14.646 14.147 14.148 14.648	14.653 14.362
Dist. Progr. Progetto	-13.449 -13.274	-10.264 -9.764 -9.264 -8.764 -8.264 -7.724	-5.010 -4.741 -4.350	-0.000	5.344	10.689	15.044 15.435 15.704	17.767 18.307 18.806 19.305 19.805 20.304	23.309 23.746
Dist. Parziali	0.175 3.010	0.500 0.500 0.500 0.540	2.714 0.660	4.350	5.344	5.345	4.355 0.660 2.063	0.540 0.499 0.499 0.500 0.499	3.005 0.437

Materiale	Area(m2)
Inerbimento	0.026
Scotico	0.000
Subballast	2.532
SuperCompattato	6.427
Scavo	8.551
Rilevato	0.067
Riempimento	0.000
Volume	0.000

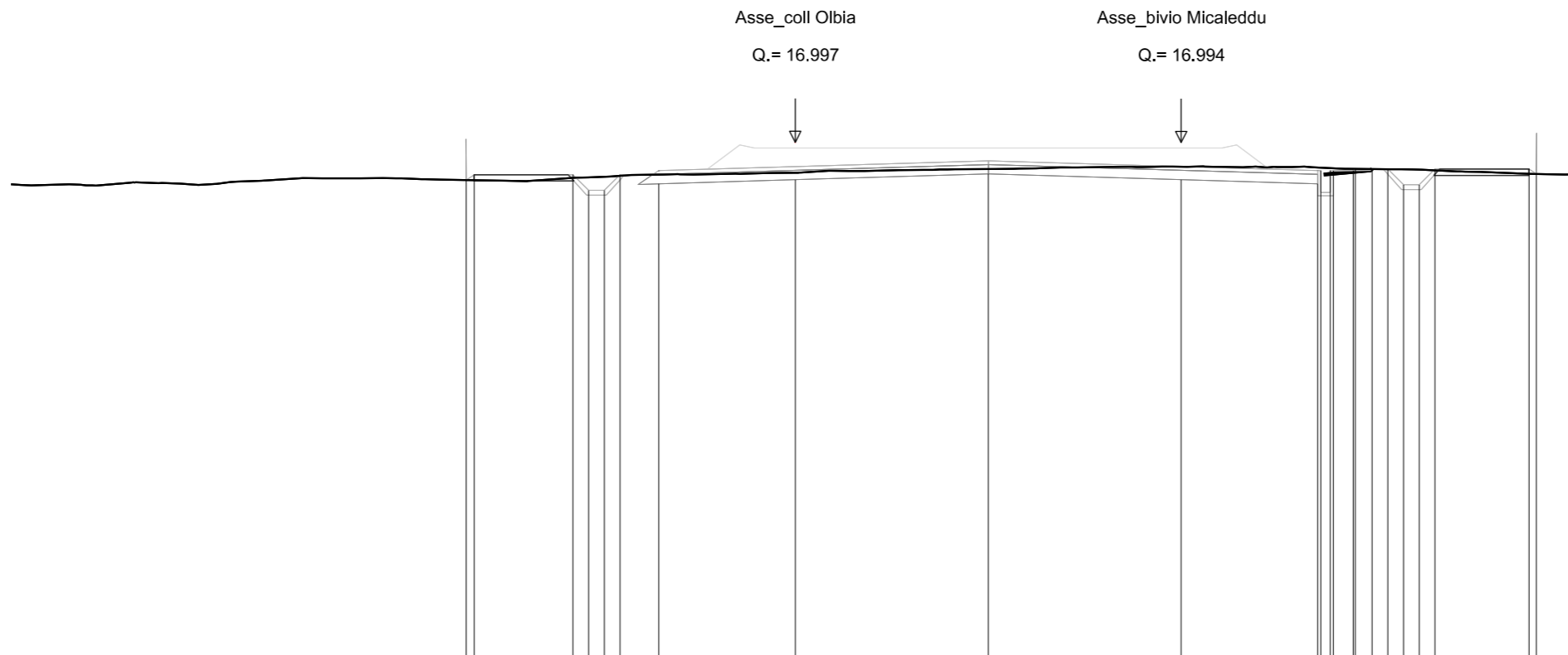

Prog. = 0+750.000

Q. Rif. = 0.000

Quote Terreno		15.798	15.864	15.970	16.028	16.145	16.218	16.198	16.178	16.154	16.144	16.138	16.137	16.130	16.104	15.997
Quote Progetto		15.798	15.967	15.676	15.807	15.991	15.807	15.676	16.096	16.096	16.096	16.103	16.144	16.144	16.144	16.144
Dist. Progr. Progetto		-10.490	-10.236	-4.350	0.000	6.151	12.303	16.653	16.753	17.053	17.153	17.788	17.851	18.392	18.892	19.892
Dist. Parziali		0.254	3.150	0.500	0.500	0.500	1.236	4.350	6.151	6.152	4.350	0.500	0.635	0.635	0.500	0.500

Materiale	Area(m2)
Inerbimento	0.890
Scotico	0.000
Subballast	2.306
SuperCompattato	5.786
Scavo	49.539
Rilevato	0.031
Riempimento	0.000
Volume	0.000

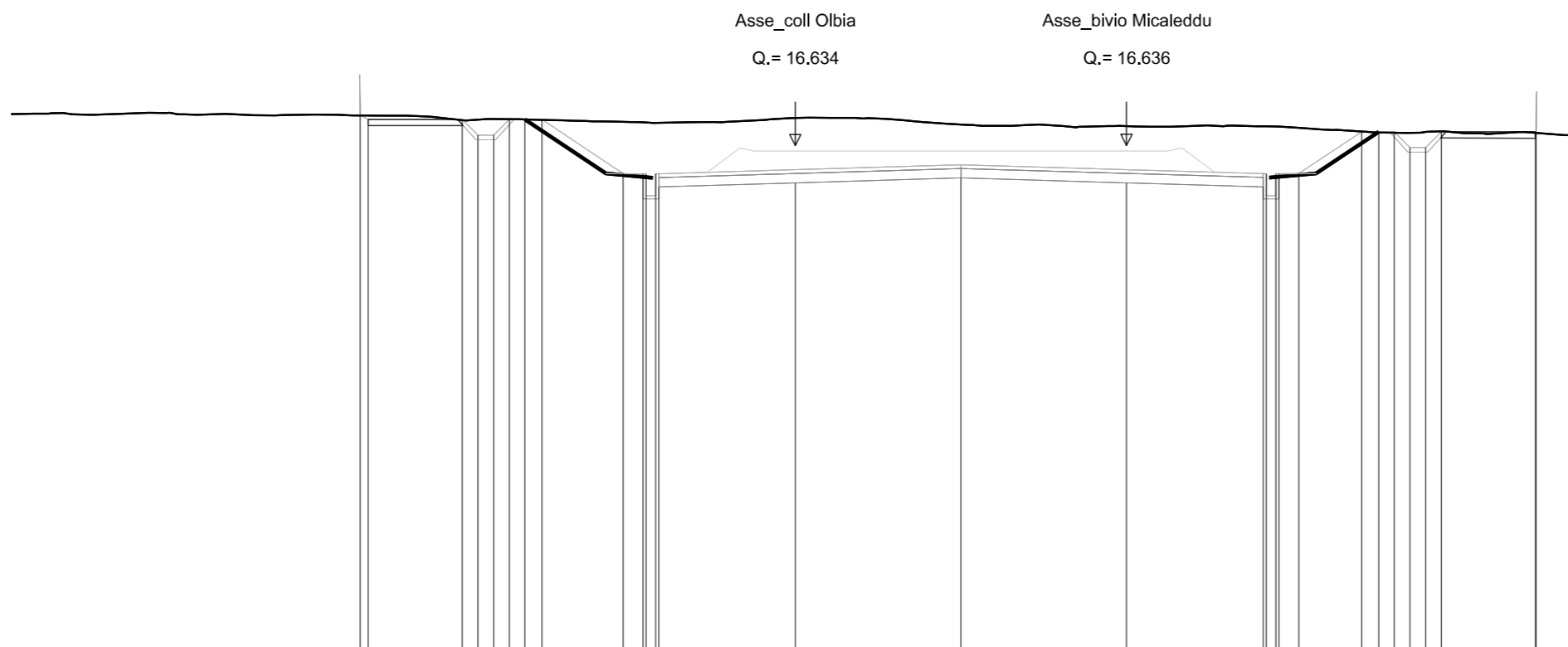

Prog. = 0+800.000
Q. Rif. = 0.000

Quote Terreno	17.593	17.445	17.459	17.480	17.475	17.466	17.453	17.388	17.369	17.510	17.305	17.252	17.249	17.237	17.197	17.081	17.050	17.044	17.041	17.069	17.083	17.038				
Quote Progetto	17.593	17.467	17.467	16.967	17.467	17.467	17.467	15.739	15.733	15.443	15.602	15.443	15.315	15.735	15.735	15.742	17.074	17.074	17.073	16.573	17.072	17.072	17.070			
Dist. Progr. Progetto	-13.871	-13.617	-10.617	-10.117	-9.617	-9.117	-8.617	-8.076	-5.485	-4.850	0.000	5.280	10.559	14.918	15.018	15.319	15.419	16.056	18.057	18.598	19.098	19.598	20.098	20.598		
Dist. Parziali	0.254	3.000	0.500	0.500	0.500	0.500	0.541	2.042	0.549	0.635	0.500	4.350	5.280	5.279	4.359	0.501	0.637	0.550	1.451	0.541	0.500	0.500	0.500	0.500	3.001	0.021

Materiale	Area(m2)
Inerbimento	1.772
Scotico	0.000
Subballast	1.876
SuperCompattato	4.707
Scavo	88.037
Rilevato	0.117
Riempimento	0.000
Volume	0.000

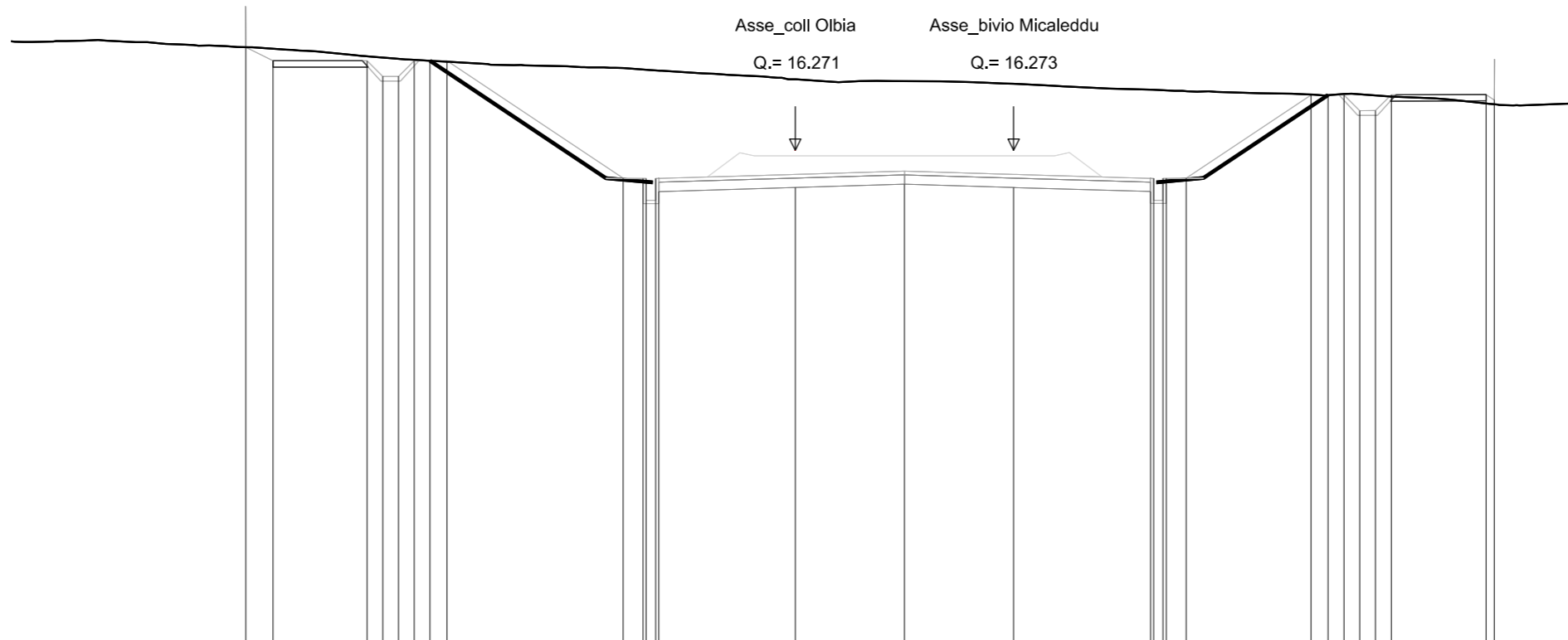

Prog. = 0+850.000

Q. Rif. = 0.000

Quote Terreno	19.558	19.510	19.267	19.225	19.183	19.152	19.124	19.093	18.892	18.815	18.810	18.532	18.473	18.391	18.208	18.189	18.153	18.050	18.029	18.063	18.056	18.019	17.982	17.764	
Quote Progetto	19.558	19.124	19.124	18.624	18.624	19.124	19.124	19.124	15.376	15.370	15.370	15.080	15.185	15.080	14.952	15.372	15.372	15.372	18.028	18.030	18.032	17.533	17.534	18.036	18.045
Dist. Progr. Progetto	-17.516	-16.648	-13.648	-13.148	-12.648	-12.148	-11.648	-11.107	-5.485	-4.850	-4.750	0.000	3.481	6.962	11.324	11.424	11.725	11.825	16.444	16.989	17.492	17.995	18.498	19.001	22.020
Dist. Parziali	0.868	3.000	0.500	0.500	0.500	0.500	0.541	5.072	0.550	0.635	0.500	4.350	3.481	3.481	4.362	0.501	0.637	0.551	3.431	0.545	0.503	0.503	0.503	3.019	0.262

Materiale	Area(m2)
Inerbimento	1.200
Scotico	0.000
Subballast	1.590
SuperCompattato	3.972
Scavo	51.726
Rilevato	0.032
Riempimento	0.000
Volume	0.000

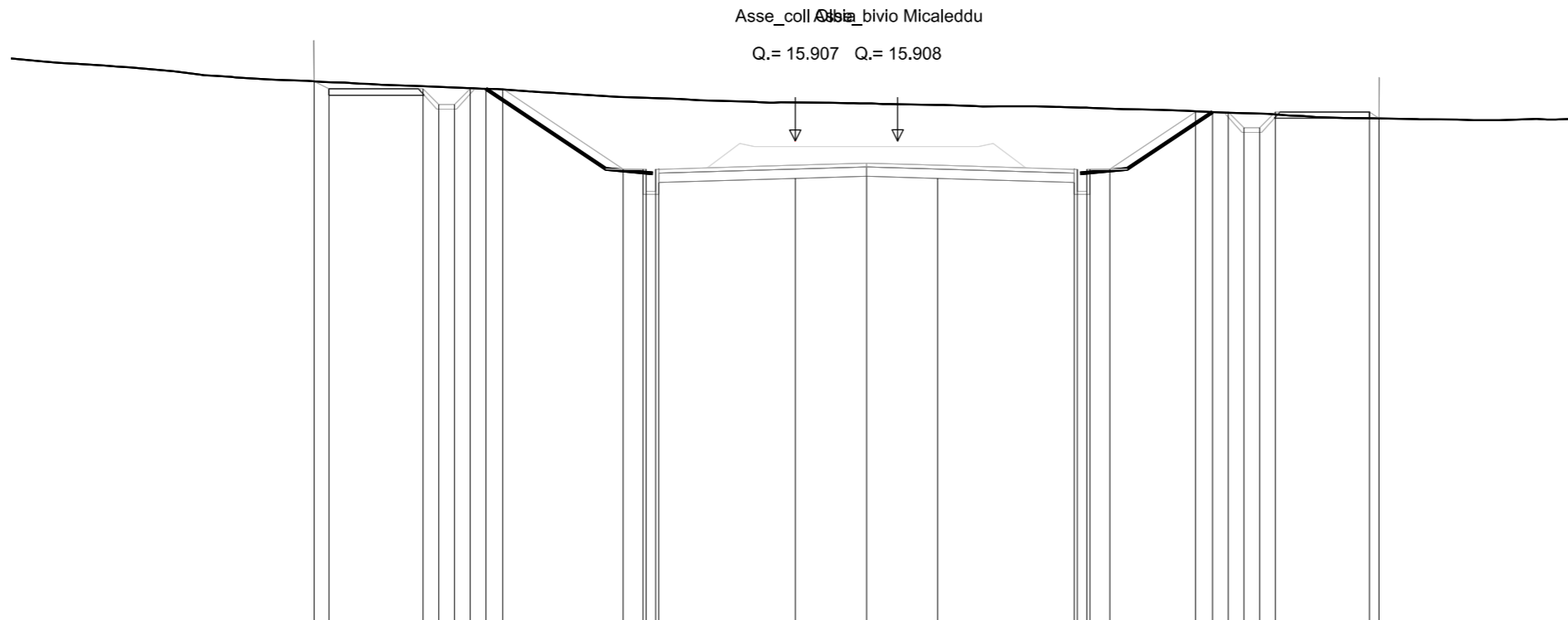

Prog. = 0+900.000

Q. Rif. = 0.000

Quote Terreno	17.808 17.783	17.654 17.633 17.613 17.594 17.571 17.550	17.310 17.288 17.273	17.137 17.107 17.056	16.977 16.966 16.938	16.856 16.831 16.812 16.798 16.784 16.756	16.627
Quote Progetto	17.808 17.571	17.571 17.071 17.071 17.571 17.571 17.571	15.013 15.006 15.006 15.006 14.586	14.717 14.785 14.717	14.586 15.006 15.006 15.012	16.833 16.833 16.834 16.334 16.334 16.834	16.834 16.635
Dist. Progr. Progetto	-15.338 -14.864	-11.864 -11.364 -10.864 -10.364 -9.864 -9.323	-5.485 -4.850 -4.750 -4.450 -4.350	0.000 2.271 4.542	8.892 8.992 9.292 9.392 10.026	12.761 13.302 13.803 14.303 14.803 15.304	18.306 18.605
Dist. Parziali	0.474 3.000	0.500 0.500 0.500 0.500 0.541	3.288 0.550 0.635 0.500	4.350 2.271 2.271	4.350 0.500 0.636 0.549	2.184 0.541 0.501 0.500 0.500 0.501	3.002 0.299

Materiale	Area(m2)
Inerbimento	1.638
Scotico	0.000
Subballast	1.698
SuperCompattato	4.241
Scavo	66.201
Rilevato	0.008
Riempimento	0.000
Volume	0.000

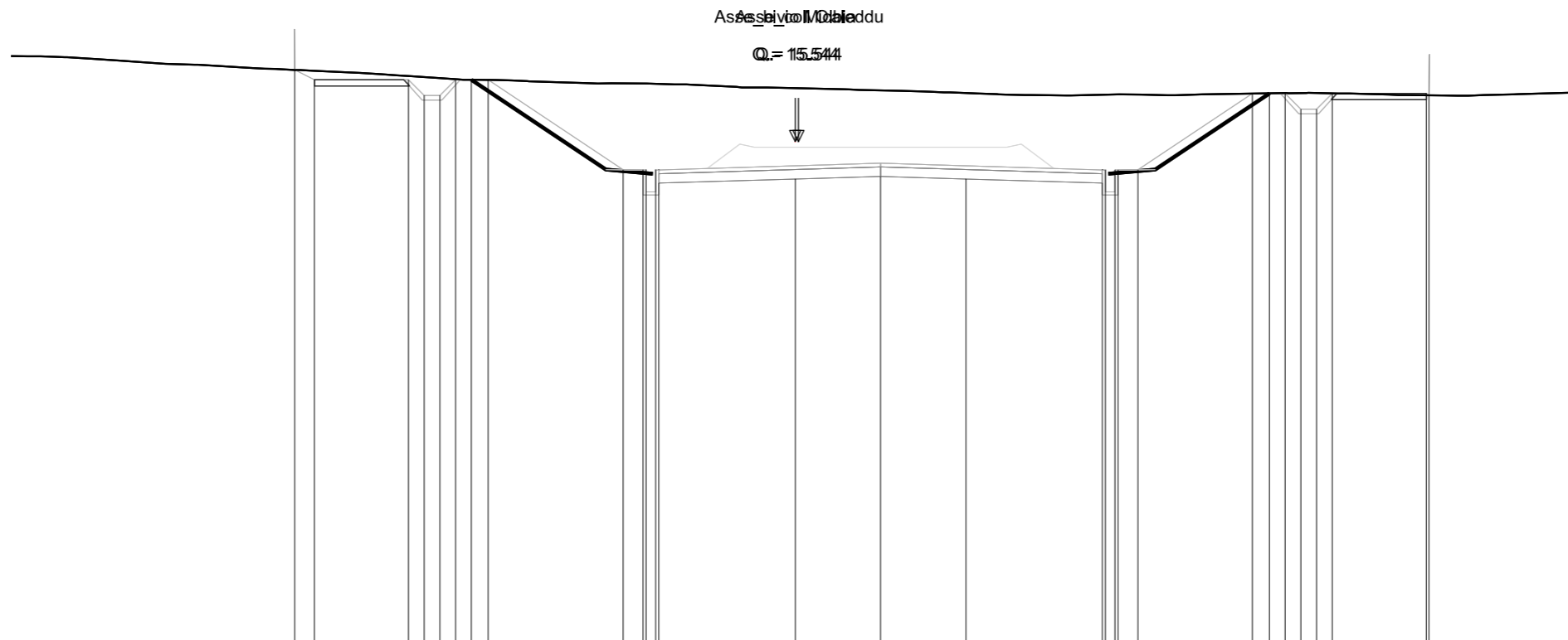

Quote Terreno	17.832 17.802	17.640 17.607 17.572 17.537 17.518 17.512	17.404 17.385 17.366	17.249	17.182	17.094	17.045 17.045 17.045	17.077 17.085 17.092 17.094 17.093 17.081	17.024
Quote Progetto	17.832 17.518	17.518 17.018 17.518 17.518 17.518 17.518	14.649 14.643 14.643 14.643 14.223	14.353	14.435	14.353	14.222 14.642 14.642 14.642 14.648	17.080 17.080 17.080 16.580 16.581 17.081	17.082 17.026
Dist. Progr. Progetto	-15.958 -15.330	-12.330 -11.830 -11.330 -10.830 -10.330 -9.789	-5.485 -4.850 -4.750 -4.450 -4.350	0.000	2.720	5.440	9.790 9.890 10.190 10.290 10.926	14.574 15.116 15.616 16.117 16.617 17.118	20.121 20.205
Dist. Parziali	0.628 3.000	0.500 0.500 0.500 0.500 0.541	3.754 0.550 0.635 0.500	4.350	2.720 2.720	4.350	0.500 0.636 0.549 3.099	0.542 0.500 0.501 0.500 0.501 3.003	0.084

Materiale	Area(m2)
Inerbimento	4.532
Scotico	12.165
Subballast	1.008
SuperCompattato	2.520
Scavo	79.178
Rilevato	0.001
Riempimento	0.000
Volume	0.000

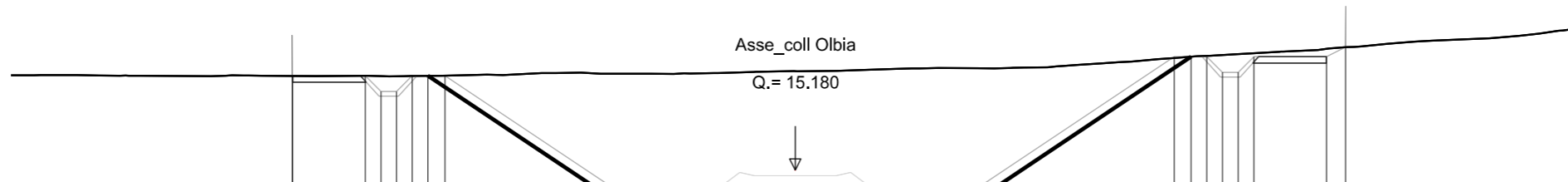

Prog. = 1+000.000

Q. Rif. = -1.000

Quote Terreno	18.172	18.177	18.170	18.162	18.175	18.179	18.184	18.243	18.242	18.240	18.325	18.420	18.420	18.421	18.747	18.786	18.810	18.840	18.872	18.900	19.037	19.088	
Quote Progetto	18.172	18.179	18.179	17.679	17.679	18.179	18.179	14.290	14.284	14.284	13.990	13.864	14.284	14.284	18.786	18.786	18.786	18.286	18.286	18.786	18.786	19.088	19.088
Dist. Progr. Progetto	-16.035	-16.025	-13.709	-13.209	-12.709	-12.209	-11.709	-5.335	-4.700	-4.600	0.000	4.200	4.300	4.600	12.080	12.620	13.120	13.620	14.120	14.620	16.936	17.540	17.540
Dist. Parziali	0.010	2.316	0.500	0.500	0.500	0.500	0.540	5.284	0.550	0.635	0.500	4.200	0.500	0.635	0.550	6.195	0.540	0.500	0.500	0.500	2.316	0.604	0.604

Materiale	Area(m2)
Inerbimento	0.000
Scotico	0.000
Subballast	0.000
SuperCompattato	0.000
Scavo	60.871
Rilevato	0.000
Riempimento	3.738
Volume	0.000

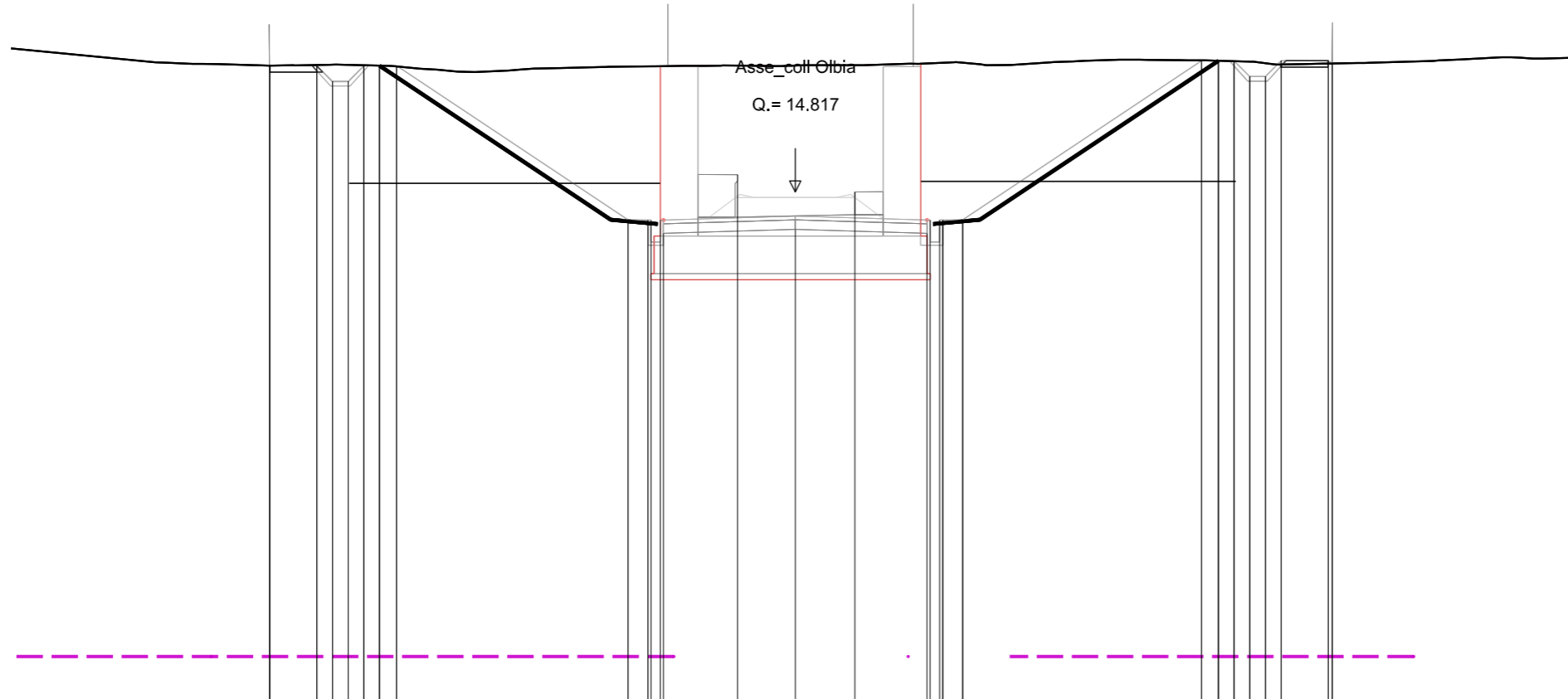

Prog. = 1+050.000

Q. Rif. = -2.000

Quote Terreno	18.849 18.865 18.874 18.869 18.857 18.844 18.818 18.816 18.821 18.826 18.846 18.851 18.859 18.918 18.919 18.942 19.014 19.002 19.002 18.989 18.975 18.924 18.881 18.918
Quote Progetto	18.849 18.849 18.844 18.844 18.844 18.844 18.344 18.344 18.344 18.844 18.844 18.844 18.844 18.844 18.844 18.844 13.926 13.927 13.920 13.921 13.921 13.921 13.501 15.367 13.627 14.817 13.501 13.921 13.921 13.921 4.700 13.920 13.927 13.926 19.002 19.002 19.002 19.002 19.002 19.002 18.502 18.502 18.502 18.502 19.002 19.002 19.002 18.915
Dist. Progr. Progetto	-16.762 -16.762 -16.755 -16.753 -15.253 -15.253 -14.753 -14.253 -14.253 -13.753 -13.753 -13.253 -13.253 -12.712 -12.712 -5.335 -4.700 -4.700 -4.600 -4.300 -4.200 -1.840 0.000 1.900 4.200 4.300 4.600 4.700 4.700 5.335 5.335 12.948 12.949 13.489 13.489 13.989 13.989 14.489 14.489 14.989 14.989 15.489 15.489 16.989 16.989 17.119 17.119
Dist. Parziali	0.000 1.500 0.000 0.000 0.000 0.000 0.000 0.000 0.000 6.827 0.000 0.000 0.000 0.000 4.200 4.200 0.000 0.000 0.000 7.063 0.000 0.000 0.000 1.500 0.000

Materiale	Area(m2)
Inerbimento	0.000
Scotico	0.000
Subballast	0.000
SuperCompattato	0.000
Scavo	57.936
Rilevato	0.000
Riempimento	3.738
Volume	0.000

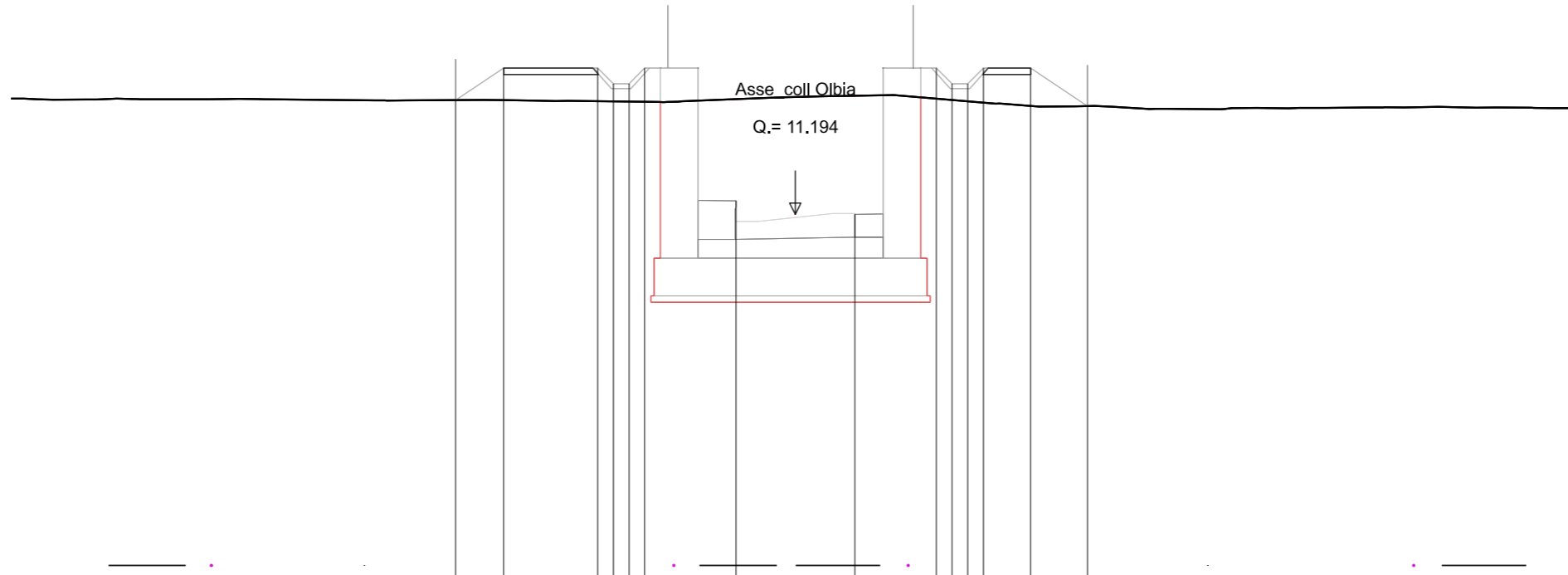

Prog. = 1+700.000

Q. Rif. = -6.000

Quote Terreno	14.832	14.835	14.801	14.794	14.788	14.781	14.865	14.975	14.881	14.839	14.796	14.754	14.649	14.642
Quote Progetto	14.832	15.852	15.852	15.352	15.352	15.852	11.624	11.194	15.852	15.352	15.352	15.852	15.852	14.642
Dist. Progr. Progetto	-10.829	-9.300	-6.300	-5.800	-5.300	-4.800	-1.891	1.900	4.500	5.000	5.500	6.000	7.500	9.315
Dist. Parziali	1.529	3.000	0.500	0.500	0.500	0.500	8.300		0.500	0.500	0.500	1.500	1.815	

Materiale	Area(m2)
Inerbimento	4.220
Scotico	11.732
Subballast	1.008
SuperCompattato	2.520
Scavo	73.627
Rilevato	0.007
Riempimento	0.000
Volume	0.000

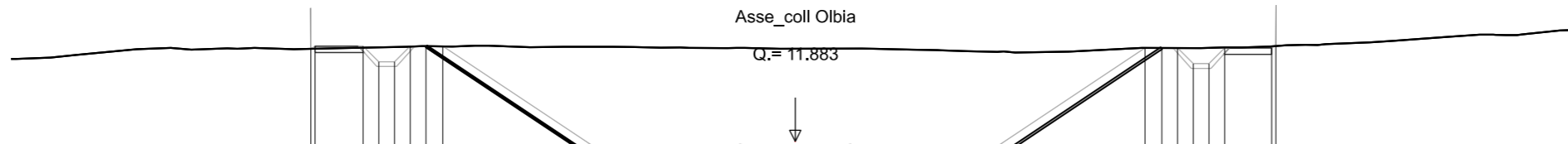

Prog. = 1+750.000

Q. Rif. = -4.000

Quote Terreno	14.840	14.877	14.888	14.899	14.911	14.925	14.919	14.898	14.884	14.876	14.846	14.885	14.788	14.768	14.871	14.868	14.865	14.862	14.866	14.869	14.884	14.882	
Quote Progetto	14.840	14.925	14.925	14.425	14.425	14.925	14.925	10.993	10.986	10.986	10.692	10.566	10.986	10.986	10.986	10.993	14.868	14.868	14.868	14.368	14.368	14.868	14.868
Dist. Progr. Progetto	-15.440	-15.312	-13.775	-13.275	-12.275	-12.275	-11.775	-5.335	-4.700	-4.600	0.000	4.200	4.300	4.600	4.700	5.335	11.148	11.689	12.189	12.689	13.189	13.689	15.189
Dist. Parziali	0.128	1.537	0.500	0.500	0.500	0.500	0.540	5.350	0.550	0.635	0.500	4.200	0.500	0.635	0.550	5.263	0.541	0.500	0.500	0.500	0.500	1.500	0.128

Materiale	Area(m2)
Inerbimento	2.708
Scotico	9.636
Subballast	1.008
SuperCompattato	2.520
Scavo	37.756
Rilevato	0.043
Riempimento	0.000
Volume	0.000

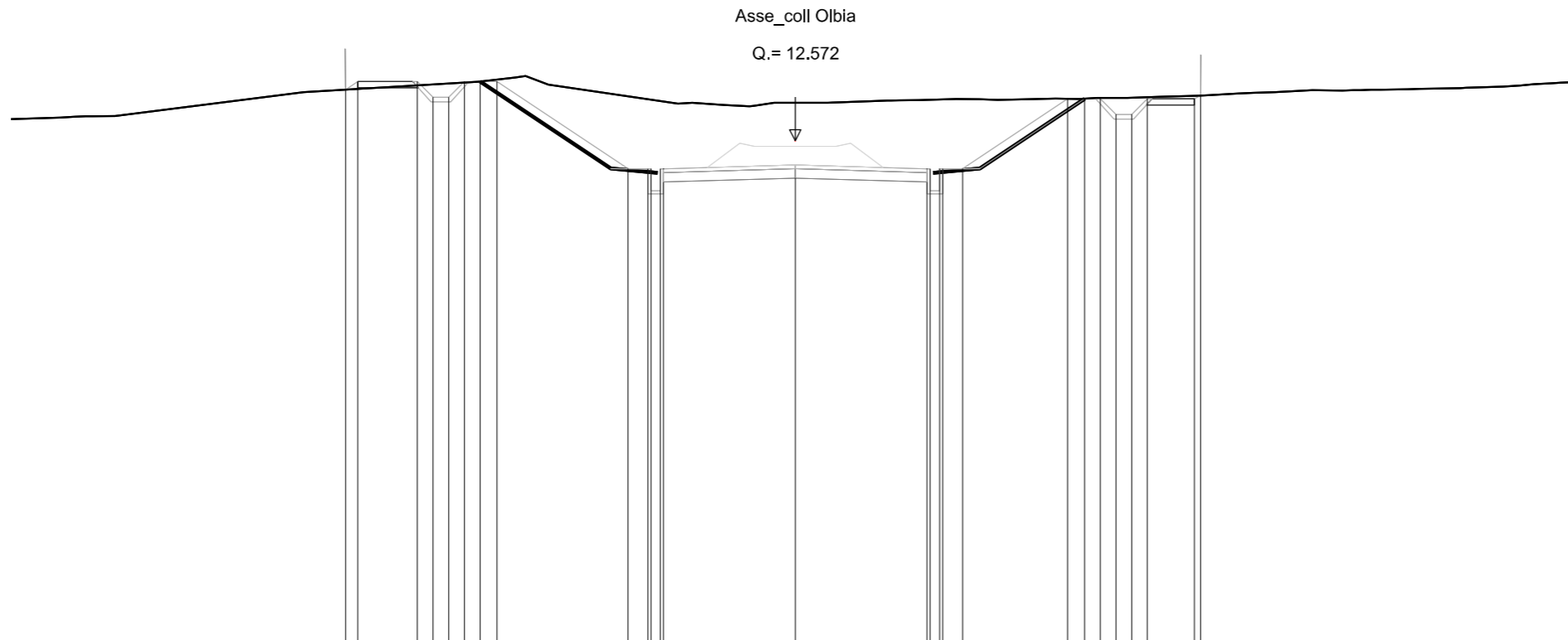

Prog. = 1+800.000

Q. Rif. = -4.000

Quote Terreno	14.204	14.224	14.340	14.370	14.399	14.429	14.462	14.522	13.990	13.887	13.887	13.784	13.879	13.862	13.903	13.910	13.913	13.938	13.940	13.944	13.962	14.004	
Quote Progetto	14.204	14.462	14.462	13.962	14.370	14.462	14.462	14.462	11.681	11.675	11.675	11.381	11.255	11.675	11.675	11.681	13.913	13.913	13.913	13.413	13.913	13.913	14.011
Dist. Progr. Progetto	-14.338	-13.950	-12.048	-11.548	-11.048	-10.548	-10.048	-9.507	-5.335	-4.700	-4.300	0.000	4.200	4.300	4.600	4.700	8.683	9.224	9.724	10.224	10.724	11.224	12.724
Dist. Parziali	0.388	1.902	0.500	0.500	0.500	0.500	0.541	3.622	0.550	0.635	0.500	4.200	0.500	0.635	0.550	2.798	0.541	0.500	0.500	0.500	0.500	1.500	0.196

Materiale	Area(m2)
Inerbimento	1.568
Scotico	8.055
Subballast	1.008
SuperCompattato	2.520
Scavo	26.806
Rilevato	0.003
Riempimento	0.000
Volume	0.000

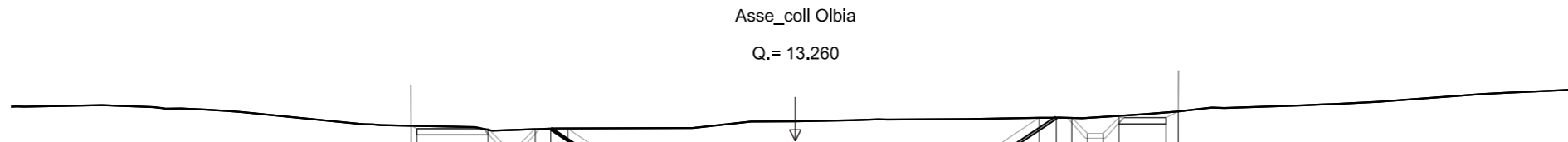

Prog. = 1+850.000

Q. Rif. = -3.000

Quote Terreno		13.741	13.610	13.597	13.614	13.631	13.647	13.654	13.663	13.666	13.879	13.645	13.945	13.953	13.994	13.998	13.989	13.992	14.024	14.056	14.162	14.183		
Quote Progetto		13.741	13.647	13.647	13.147	13.647	13.647	13.647	12.370	12.364	12.364	12.070	12.364	12.364	12.364	12.370	13.998	13.998	13.998	13.498	13.498	13.998	14.193	
Dist. Progr. Progetto		-12.247	-12.060	-9.792	-9.292	-8.792	-8.292	-7.792	-5.335	-4.700	-4.600	0.000	4.200	4.300	4.600	4.700	7.777	8.318	8.818	9.318	9.818	10.318	11.818	12.209
Dist. Parziali		0.187	2.268	0.500	0.500	0.500	0.500	0.541	1.366	0.550	0.635	4.200	0.500	0.635	0.550	1.892	0.541	0.500	0.500	0.500	0.500	1.500	0.391	

Materiale	Area(m2)
Inerbimento	3.028
Scotico	10.079
Subballast	1.008
SuperCompattato	2.520
Scavo	50.997
Rilevato	0.017
Riempimento	0.000
Volume	0.000

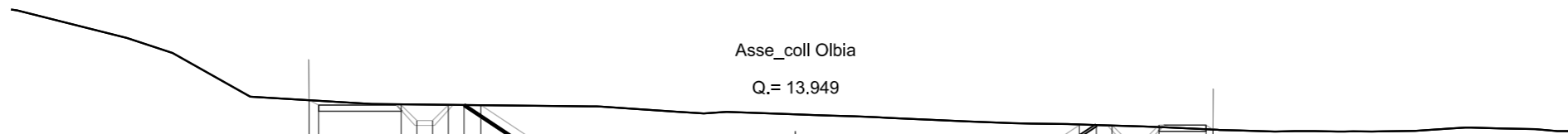

Prog. = 1+900.000

Q. Rif. = -2.000

Quote Terreno		16.336	16.338	16.205	16.200	16.194	16.188	16.183	16.177		16.073	16.029	16.000	15.882	15.715	15.662	15.664	15.558	15.539	15.524	15.508	15.493	15.477	15.495	15.495	
Quote Progetto		16.336	16.183	16.183	15.683	15.683	16.183	16.183	16.183		13.059	13.053	13.053	12.759	12.633	13.053	13.053	13.053	15.539	15.539	15.539	15.039	15.039	15.539	15.539	15.394
Dist. Progr. Progetto		-15.503	-15.196	-12.562	-12.062	-11.562	-11.062	-10.562	-10.021		-5.335	-4.700	-4.300	0.000	4.200	4.300	4.600	4.700	9.056	9.597	10.097	10.597	11.097	11.597	13.097	13.314
Dist. Parziali		0.307	2.634	0.500	0.500	0.500	0.500	0.541	4.136		0.550	0.635	0.500	4.200	0.500	0.635	0.550	3.171	0.541	0.500	0.500	0.500	0.500	1.500	0.217	

Materiale	Area(m2)
Inerbimento	0.024
Scotico	4.200
Subballast	1.008
SuperCompattato	2.520
Scavo	6.459
Rilevato	0.185
Riempimento	0.000
Volume	0.000

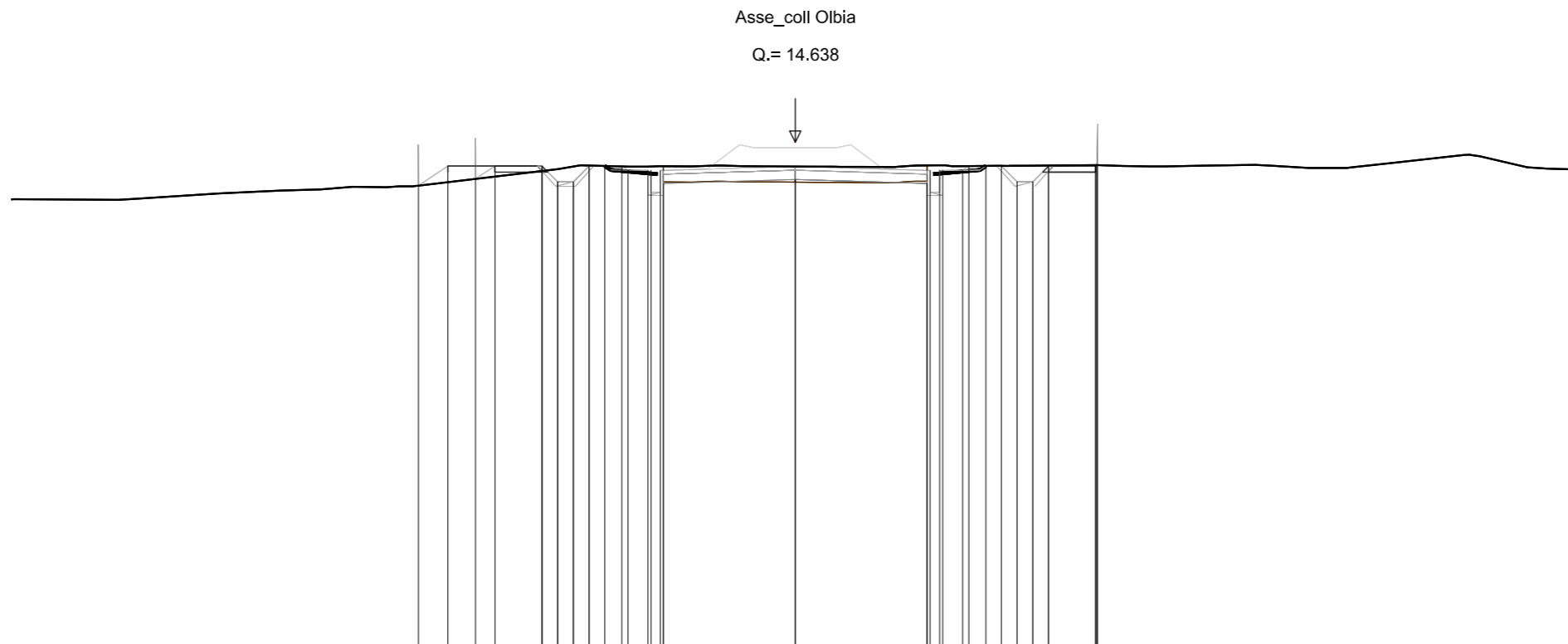

Prog. = 1+950.000

Q. Rif. = -2.000

Quote Terreno	13.253 13.365 13.468 13.541 13.717 13.776 13.861 13.892 13.879 13.866 13.876 13.863 13.895 13.904 13.875 13.880 13.883 13.885 13.887 13.892 13.907
Quote Progetto	13.253 13.879 13.469 13.879 13.879 13.379 13.379 13.379 13.379 13.879 13.879 13.879 13.748 13.742 13.742 13.742 13.322 13.322 13.448 13.448 13.322 13.322 13.742 13.742 13.742 13.748 13.880 13.880 13.880 13.880 13.879 13.380 13.379 13.880 13.880 13.879 13.880 13.907 13.907
Dist. Progr. Progetto	-12.012 -11.073 -10.190 -9.574 -8.073 -7.573 -7.573 -7.073 -7.073 -6.573 -6.073 -5.532 -5.335 -4.700 -4.600 -4.300 -4.200 -4.200 -0.000 -0.000 4.200 4.200 4.300 4.600 4.700 5.335 5.532 6.074 6.574 6.574 7.074 7.074 7.574 8.074 8.074 8.574 9.575 9.629 9.630
Dist. Parziali	0.939 0.883 0.616 1.501 0.000 0.000 0.000 0.000 0.000 0.000 0.000 0.000 0.000 0.000 0.000 0.000 0.000 0.000 4.200 0.000 4.200 0.900 0.635 0.100 0.300 0.500 0.500 0.500 0.500 0.500 0.500 1.500 0.004

Materiale	Area(m2)
Inerbimento	2.311
Scotico	7.289
Subballast	1.031
SuperCompattato	2.774
Scavo	3.023
Rilevato	20.372
Riempimento	0.000
Volume	0.000

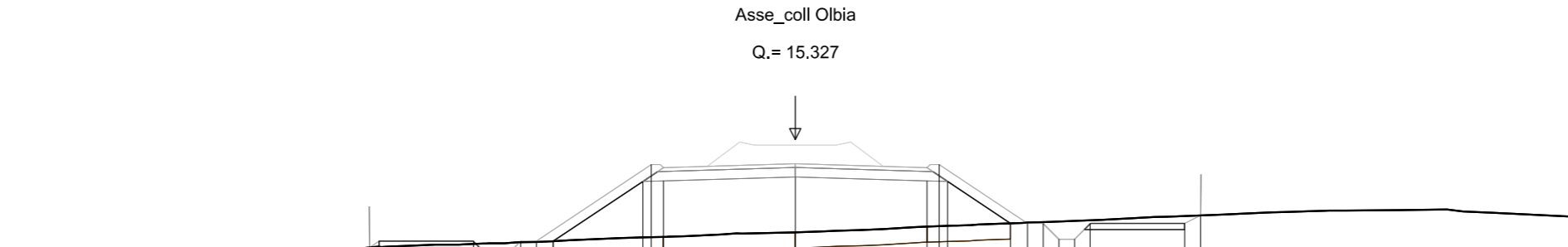

Prog. = 2+000.000

Q. Rif. = -3.000

Quote Terreno	11.886	11.998	12.016	12.017	12.055	12.058	12.087	12.210	12.221	12.367	12.551	12.598	12.655	12.684	12.695	12.711	12.733	12.752	12.891	12.911			
Quote Progetto	11.886	12.087	12.087	11.587	11.587	12.087	12.087	13.991	14.530	14.136	14.010	14.530	13.991	12.655	12.655	12.655	12.155	12.655	12.655	12.655	12.910		
Dist. Progr. Progetto	-13.567	-13.266	-10.256	-9.756	-9.256	-8.756	-8.256	-7.715	-4.860	-4.591	-4.200	0.000	4.200	4.591	4.860	6.863	7.403	7.903	8.403	8.903	9.403	12.413	12.924
Dist. Parziali	0.301	3.010	0.500	0.500	0.500	0.500	0.541	2.855	0.660	4.200	4.200	0.660	2.003	0.540	0.500	0.500	0.500	0.500	0.500	3.010	0.511		

Materiale	Area(m2)
Inerbimento	5.883
Scotico	12.243
Subballast	1.031
SuperCompattato	2.774
Scavo	2.382
Rilevato	81.891
Riempimento	0.000
Volume	0.000

Asse_coll Olbia
Q.= 16.016

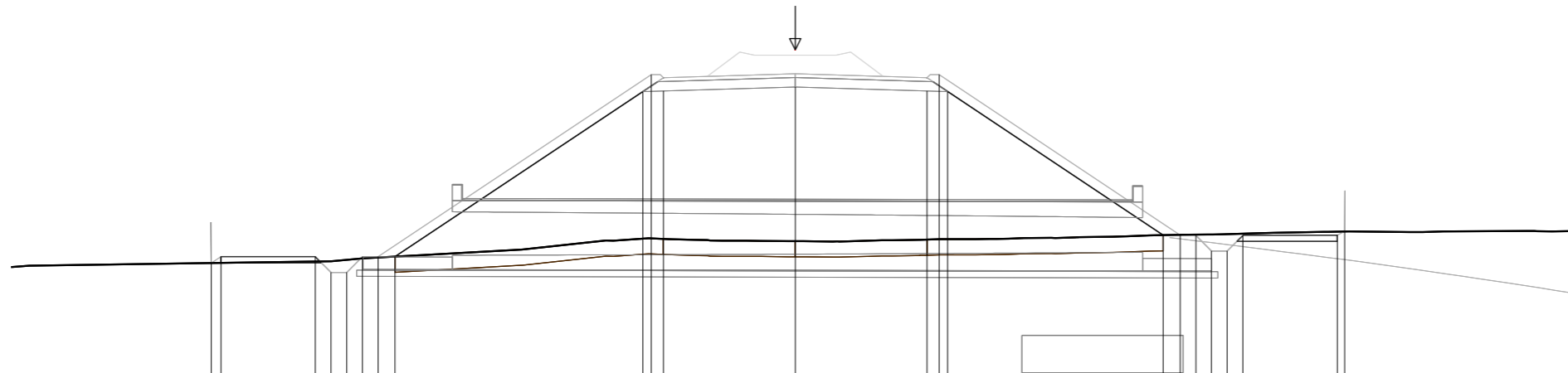

Prog. = 2+050.000

Q. Rif. = -6.000

Quote Terreno	9.207 9.211	9.255 9.262 9.309 9.356 9.384 9.414	9.988 9.981	9.906	9.959 9.970	10.100 10.113 10.118 10.122 10.132 10.146	10.216
Quote Progetto	9.207 9.414	9.414 8.914 8.914 9.414 9.414 9.414	14.679 15.219 14.699	14.825	14.699 15.219 14.679	10.100 10.100 10.100 9.600 10.100	10.100 10.216
Dist. Progr. Progetto	-18.620 -18.309	-15.299 -14.799 -14.299 -13.799 -13.299 -12.758	-4.860 -4.591 -4.200	-0.000	4.200 4.591 4.860	11.729 12.270 12.770 13.270 13.770 14.270	17.280 17.512
Dist. Parziali	0.311 3.010	0.500 0.500 0.500 0.500 0.541	7.898 0.660	4.200 4.200	0.660 6.869	0.541 0.500 0.500 0.500 3.010	0.232

Materiale	Area(m2)
Inerbimento	0.000
Scotico	12.127
Subballast	1.489
SuperCompattato	3.898
Scavo	3.595
Rilevato	0.013
Riempimento	0.000
Volume	0.000

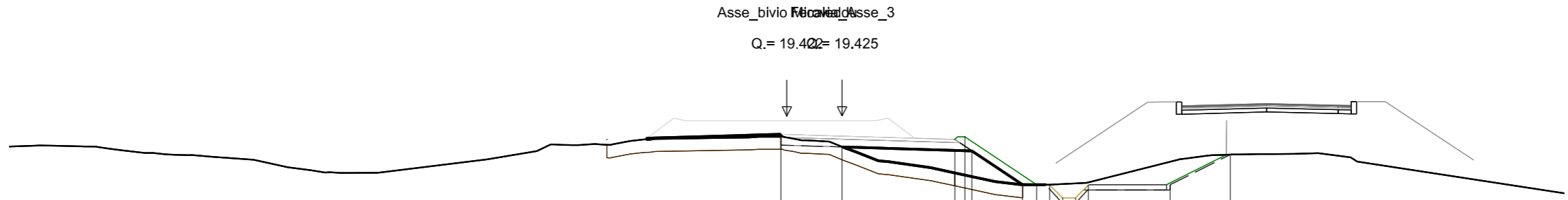

Prog. = 0+050.000

Q. Rif. = 1.000

Quote Terreno	18.643	18.239	17.235	17.084	16.778	16.777	16.783	16.807	16.831	16.870	17.664	17.939	
Quote Progetto	18.302	18.231	18.101	18.621	18.081	16.778	16.778	16.278	16.278	16.778	16.778	17.939	
Dist. Progr. Progetto	-0.231	2.131	6.481	6.872	7.141	9.095	9.636	10.136	10.636	11.136	11.636	14.786	17.106
Dist. Parziali		2.362	4.350	0.660	1.954	0.541	0.500	0.500	0.500	0.500	3.150	2.320	

Materiale	Area(m2)
Inerbimento	0.000
Scotico	15.602
Subballast	1.524
SuperCompattato	3.810
Scavo	20.116
Rilevato	0.001
Riempimento	0.000
Volume	0.000

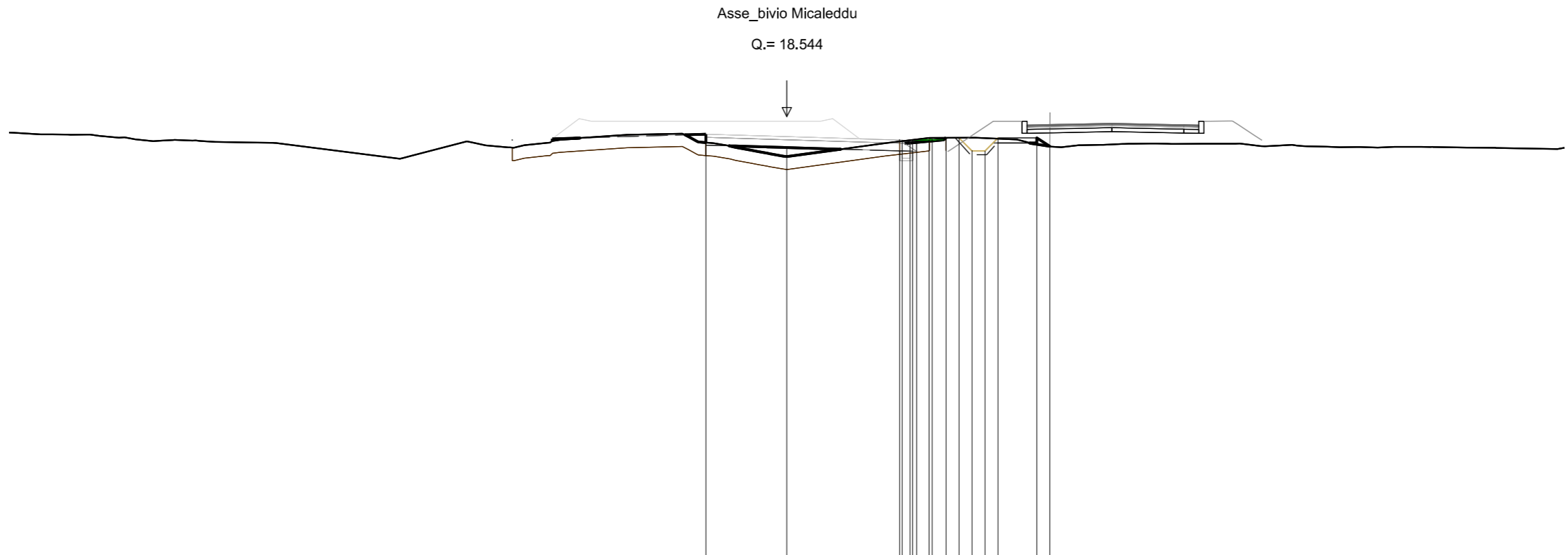

Prog. = 0+100.000

Q. Rif. = 1.000

Quote Terreno	17.545	17.007	17.690	17.690	17.690	17.729	17.729	17.730	17.731	17.716	17.694	17.477	17.398	
Quote Progetto	17.447	17.353	17.223	17.643	17.643	17.643	17.203	17.649	17.729	17.729	17.729	17.229	17.729	17.398
Dist. Progr. Progetto	-3.121	0.000	4.350	4.450	4.750	4.850	5.010	5.485	5.605	6.146	6.646	7.146	8.146	9.646
Dist. Parziali		3.121	4.350	0.500	0.476	0.428	0.500	0.500	0.500	0.500	1.500	0.495		

Materiale	Area(m2)
Inerbimento	0.000
Scotico	7.272
Subballast	2.016
SuperCompattato	5.040
Scavo	8.445
Rilevato	0.011
Riempimento	0.000
Volume	0.000

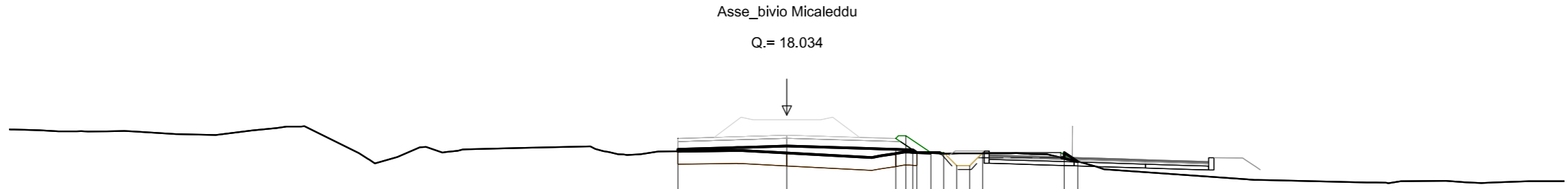

Prog. = 0+150.000

Q. Rif. = 0.000

Quote Terreno		16.644	16.577	16.555	16.505	16.574	16.555	16.561	16.562	16.369	16.247	
Quote Progetto		16.718	16.844	16.718	17.238	16.698	16.595	16.595	16.595	16.595	16.595	16.247
Dist. Progr. Progetto		-4.200	0.000	4.200	4.591	4.860	5.014	5.554	6.054	6.554	7.054	10.704
Dist. Parziali			4.200	4.200	0.660	0.150	0.520	0.500	0.500	0.500	3.150	0.522

Materiale	Area(m2)
Inerbimento	0,692
Scotico	7,656
Subballast	2,061
SuperCompattato	5,549
Scavo	2,961
Rilevato	3,544
Riempimento	0,000
Volume	0,000

Asse_bivio Micaleddu

Q.= 18.319

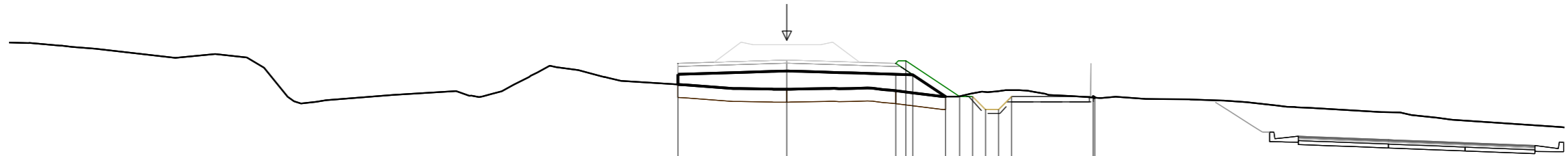

Prog. = 0+200.000

Q. Rif. = 0,000

Quote Terreno	16.606	16.424	16.363	16.359	16.139	16.153	16.264	16.321	16.350	16.386	16.098		
Quote Progetto	17.002	17.128	17.002	17.522	16.982	16.139	16.139	16.139	15.639	15.639	16.139	16.139	16.098
Dist. Progr. Progetto	-4.200	0.000	4.200	4.591	4.860	6.125	6.666	7.166	7.666	8.166	8.666	11.816	11.877
Dist. Parziali		4.200	4.200	0.660	1.265	0.541	0.500	0.500	0.500	0.500	3.150	0.061	

Materiale	Area(m2)
Inerbimento	1.311
Scotico	9.206
Subballast	2.061
SuperCompattato	5.549
Scavo	2.527
Rilevato	11.156
Riempimento	0.000
Volume	0.000

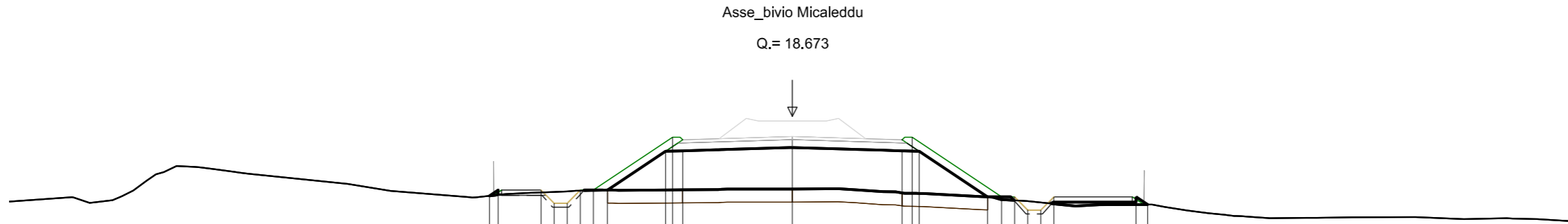

Prog. = 0+250.000

Q. Rif. = 0.000

Quote Terreno		15.634 15.683	15.765 15.783 15.805 15.835 15.846 15.855	15.855 15.863	15.896	15.749 15.728	15.594 15.492 15.461 15.430 15.379 15.329	15.297 15.299	
Quote Progetto		15.634 15.855	15.855 15.355 15.355 15.855 15.855 15.855	17.337 17.877 17.357	17.483	17.357 17.877 17.337	15.594 15.594 15.594 15.094 15.094 15.594	15.594 15.299	
Dist. Progr. Progetto		-11.604 -11.274	-9.624 -9.124 -8.624 -8.124 -7.624 -7.083	-4.860 -4.591 -4.200	-0.000	4.200 4.591 4.860	7.474 8.014 8.514 9.014 9.514 10.014	13.164 13.607	
Dist. Parziali		0.330 1.650	0.500 0.500 0.500 0.500 0.541	2.223 0.660	4.200	4.200 0.660	2.614 0.540 0.500 0.500 0.500	3.150 0.443	

Materiale	Area(m2)
Inerbimento	2.497
Scotico	11.070
Subballast	2.061
SuperCompattato	5.549
Scavo	1.515
Rilevato	21.961
Riempimento	0.000
Volume	0.000

Asse_bivio Micaleddu

Q.= 19.028

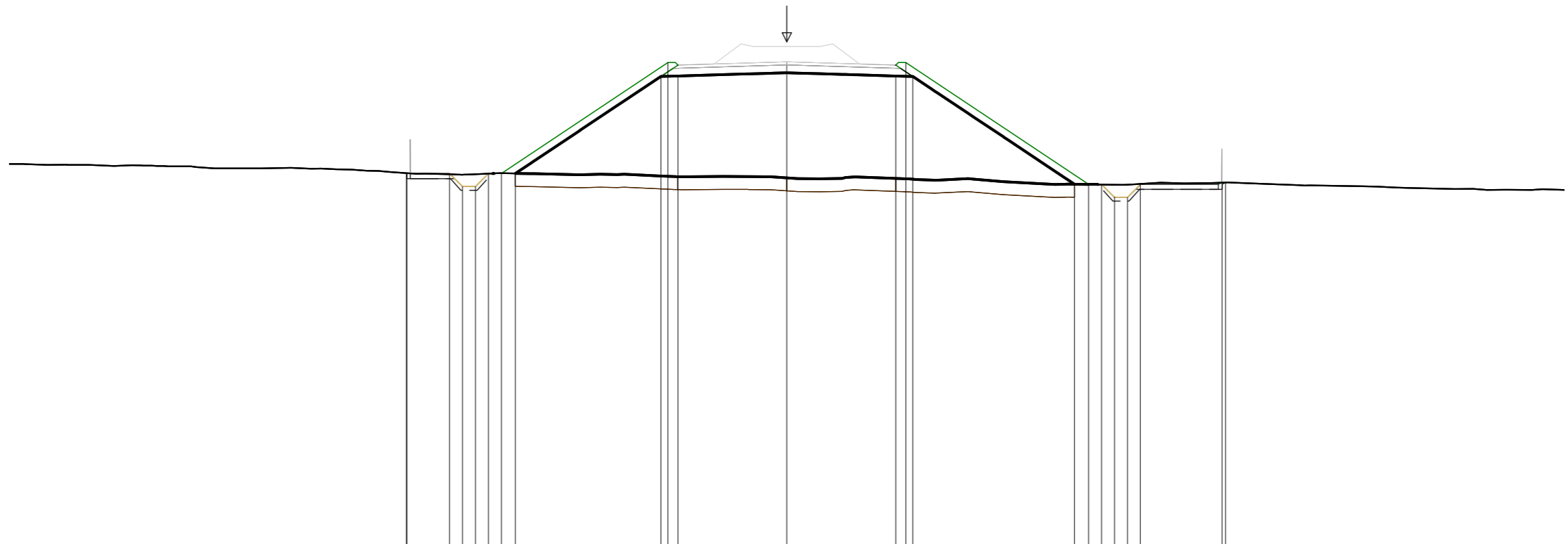

Prog. = 0+300.000

Q. Rif. = -1.000

Quote Terreno	13.960	13.919	13.901	13.918	13.941	13.960	13.951	13.852	13.824	13.777	13.755	13.727	13.532	13.525	13.518	13.513	13.516	13.548	13.606				
Quote Progetto	13.961	13.951	13.951	13.451	13.451	13.951	13.951	17.691	18.231	17.711	17.837	17.711	18.231	17.691	13.532	13.532	13.032	13.032	13.532	13.532	13.600		
Dist. Progr. Progetto	-14.681	-14.660	-13.010	-12.510	-12.010	-11.510	-11.010	-10.470	-4.860	-4.591	-4.200	-0.000	4.200	4.591	4.860	11.098	11.639	12.139	12.639	13.139	13.639	16.789	16.925
Dist. Parziali	0.021	1.650	0.500	0.500	0.500	0.500	0.540	5.610	0.660	4.200	4.200	0.660	6.238	0.541	0.500	0.500	0.500	0.500	3.150	0.136			

Materiale	Area(m2)
Inerbimento	3.731
Scotico	13.720
Subballast	2.061
SuperCompattato	5.549
Scavo	2.252
Rilevato	38.376
Riempimento	0.000
Volume	0.000

Asse_bivio Micaleddu

Q.= 19.382

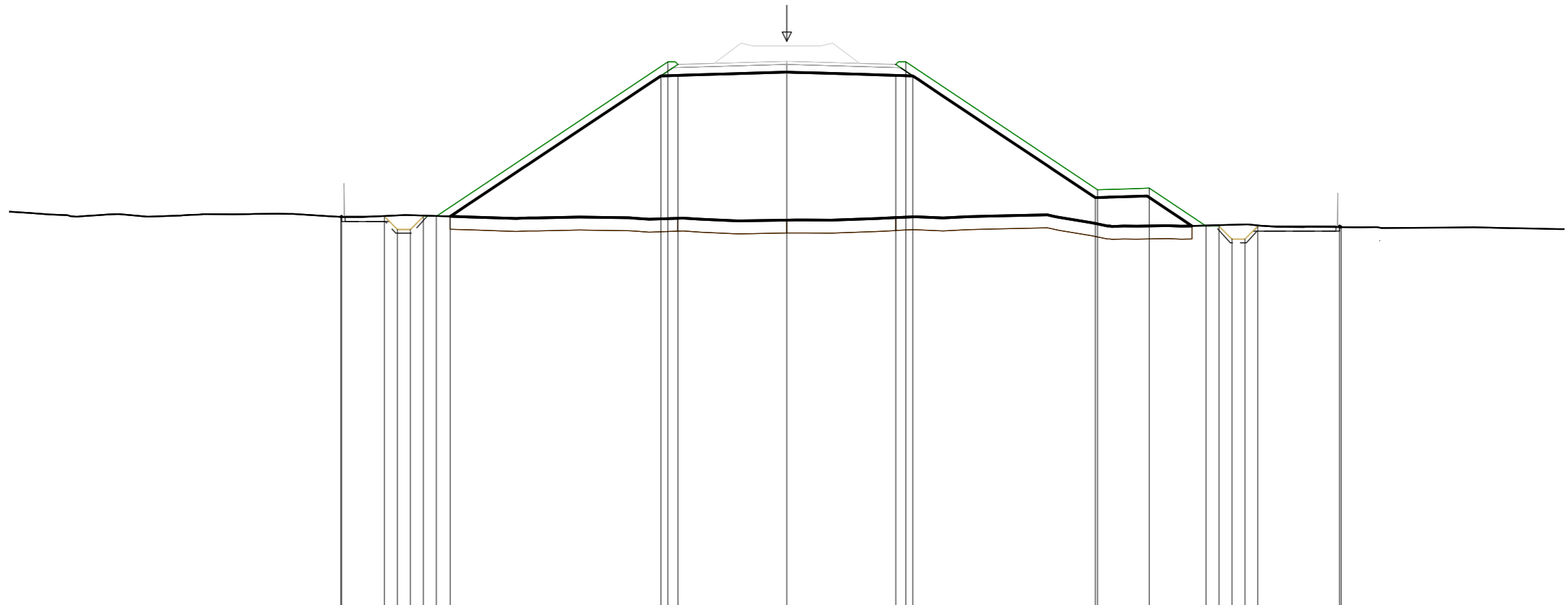

Prog. = 0+350.000

Q. Rif. = -3.000

Quote Terreno	12.609 12.631	12.643 12.667 12.677 12.662 12.647 12.631	12.524 12.558	12.487	12.584 12.616	12.956	12.261	12.276 12.291 12.306 12.321 12.283	12.216
Quote Progetto	12.609 12.631	12.631 12.131 12.131 12.631 12.631 12.631	18.046 18.586 18.066	18.192	18.066 18.586 18.046	13.354 13.656	13.716	12.260 12.260 11.760 11.760 12.260	12.260 12.215
Dist. Progr. Progetto	-17.205 -17.173	-15.523 -15.023 -14.523 -14.023 -13.523 -12.982	-4.860 -4.591 -4.200	-0.000	4.200 4.591 4.860	11.898 11.984	13.984	16.169 16.669 17.169 17.669 18.169	21.319 21.386
Dist. Parziali	0.032 1.650	0.500 0.500 0.500 0.500 0.541	8.122	0.660 4.200	4.200 7.038	0.086 1.914	1.730	0.541 0.500 0.500 0.500 3.150	0.067

Materiale	Area(m2)
Inerbimento	3.752
Scotico	13.484
Subballast	2.061
SuperCompattato	5.549
Scavo	2.220
Rilevato	36.923
Riempimento	0.000
Volume	0.000

Asse_bivio Micaleddu

Q.= 19.412

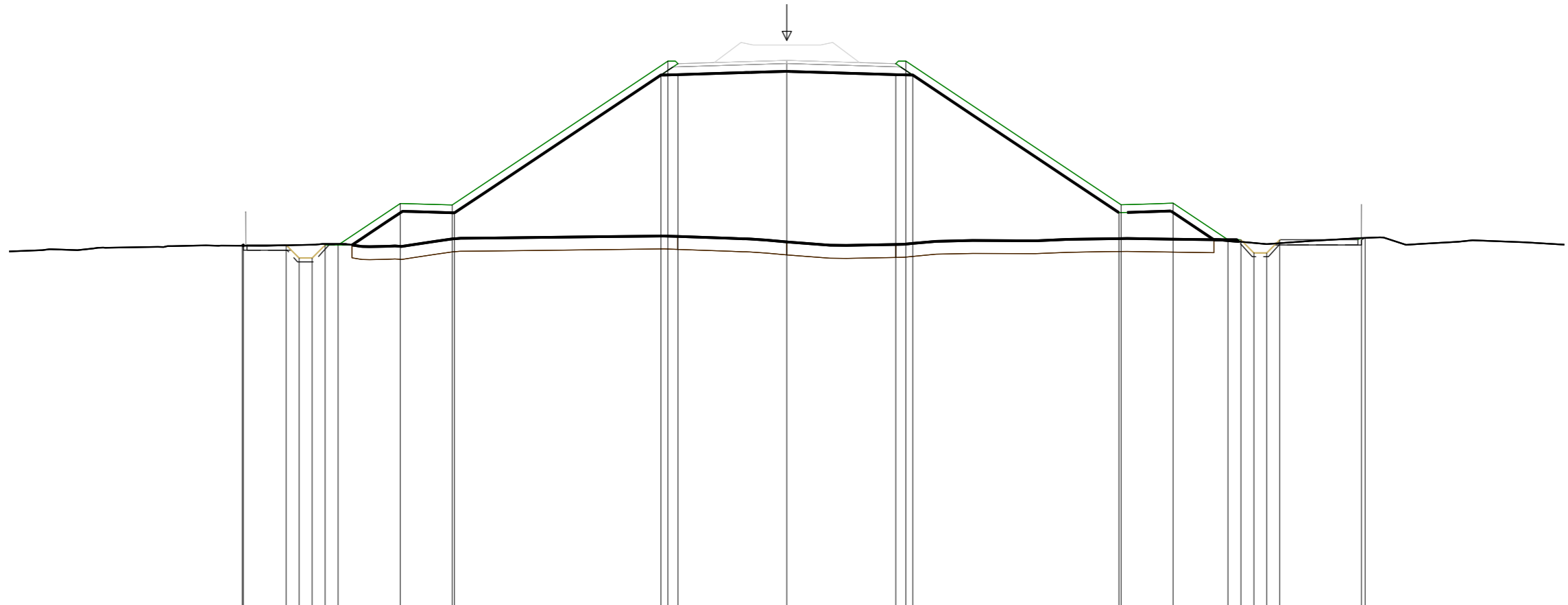

Prog. = 0+400.000

Q. Rif. = -3.000

Quote Terreno	11.400	11.513	11.525	11.538	11.567	11.567	11.474	11.760	11.873	11.856	11.646	11.548	11.586	11.776	11.751	11.696	11.652	11.607	11.564	11.598	11.798	
Quote Progetto	11.500	11.528	11.528	11.028	11.528	11.528	13.129	13.069	18.076	18.615	18.221	18.095	18.615	12.774	13.077	13.137	11.726	11.726	11.226	11.226	11.726	11.726
Dist. Progr. Progetto	-21.004	-20.962	-19.312	-18.812	-18.312	-17.812	-14.910	-12.910	-4.860	-4.591	-0.000	4.200	4.591	12.811	12.898	14.898	17.015	17.515	18.015	18.515	19.015	22.165
Dist. Parziali	0.042	1.650	0.500	0.500	0.500	0.500	1.948	1.914	0.086	7.964	0.660	4.200	4.200	0.087	1.913	1.663	0.541	0.500	0.500	0.500	3.150	0.144

Materiale	Area(m2)
Inerbimento	5.212
Scotico	15.607
Subballast	2.061
SuperCompattato	5.549
Scavo	5.481
Rilevato	54.214
Riempimento	0.000
Volume	0.000

Asse_bivio Micaleddu

Q.= 19.049

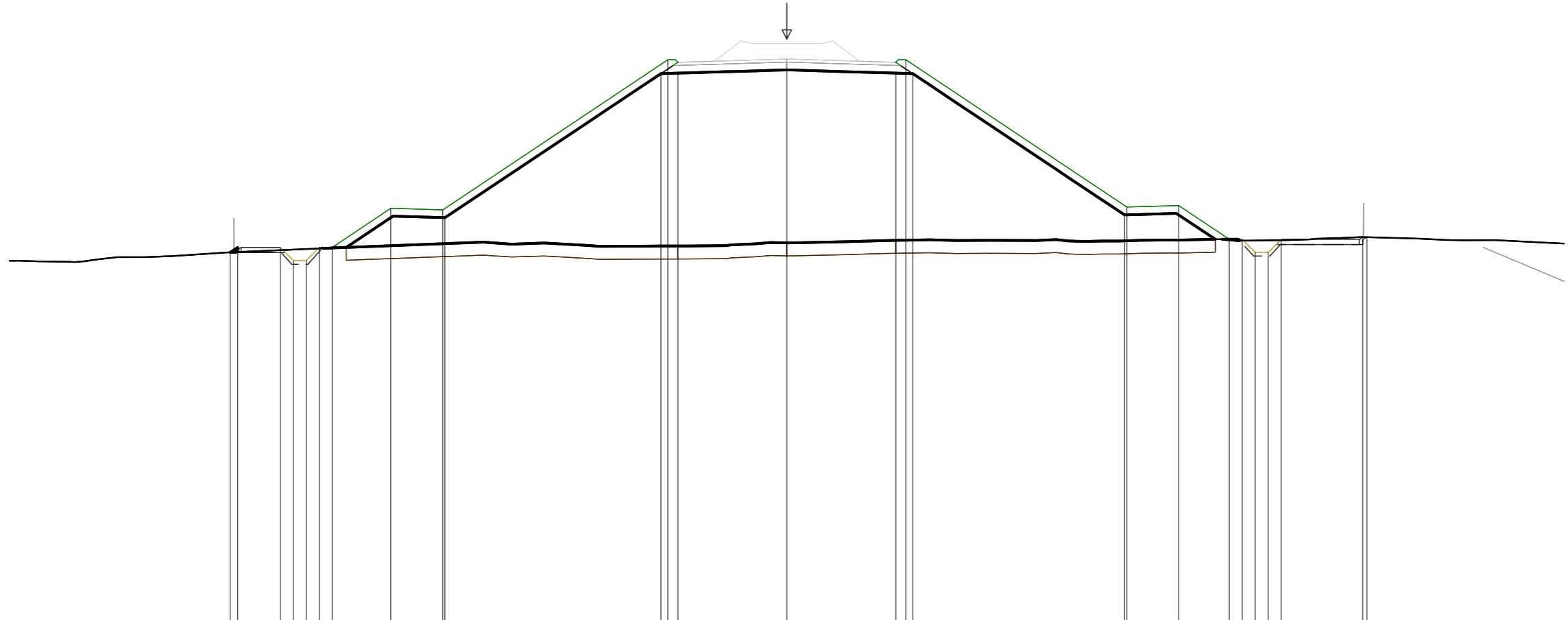

Prog. = 0+450.000

Q. Rif. = -4.000

Quote Terreno	10.834	10.908	10.929	10.951	10.972	10.994	11.079	11.155	11.066	11.068	11.189	11.284	11.288	11.266	11.296	11.306	11.276	11.280	11.285	11.290	11.408						
Quote Progetto	10.824	11.015	11.015	10.515	10.515	11.015	12.521	12.461	17.712	18.252	17.732	17.858	17.732	18.252	17.712	12.266	12.569	12.629	11.327	11.327	10.827	11.327	11.327	11.406			
Dist. Progr. Progetto	-21.472	-21.187	-19.537	-19.037	-18.537	-18.037	-17.537	-15.278	-13.278	-13.191	-4.860	-4.591	-4.200	0.000	4.200	4.591	4.860	13.029	13.116	15.116	17.069	17.569	18.069	18.569	19.069	22.219	22.377
Dist. Parziali	0.285	1.650	0.500	0.500	0.500	0.500	1.805	1.913	0.087	8.331	0.660	4.200	4.200	0.660	8.169	0.087	1.913	1.499	0.541	0.500	0.500	0.500	0.500	3.150	0.158		

Materiale	Area(m2)
Inerbimento	4.146
Scotico	15.875
Subballast	2.061
SuperCompattato	5.549
Scavo	2.704
Rilevato	82.774
Riempimento	0.000
Volume	0.000

Asse_bivio Micaleddu

Q.= 18.685

Prog. = 0+500.000

Q. Rif. = -4.000

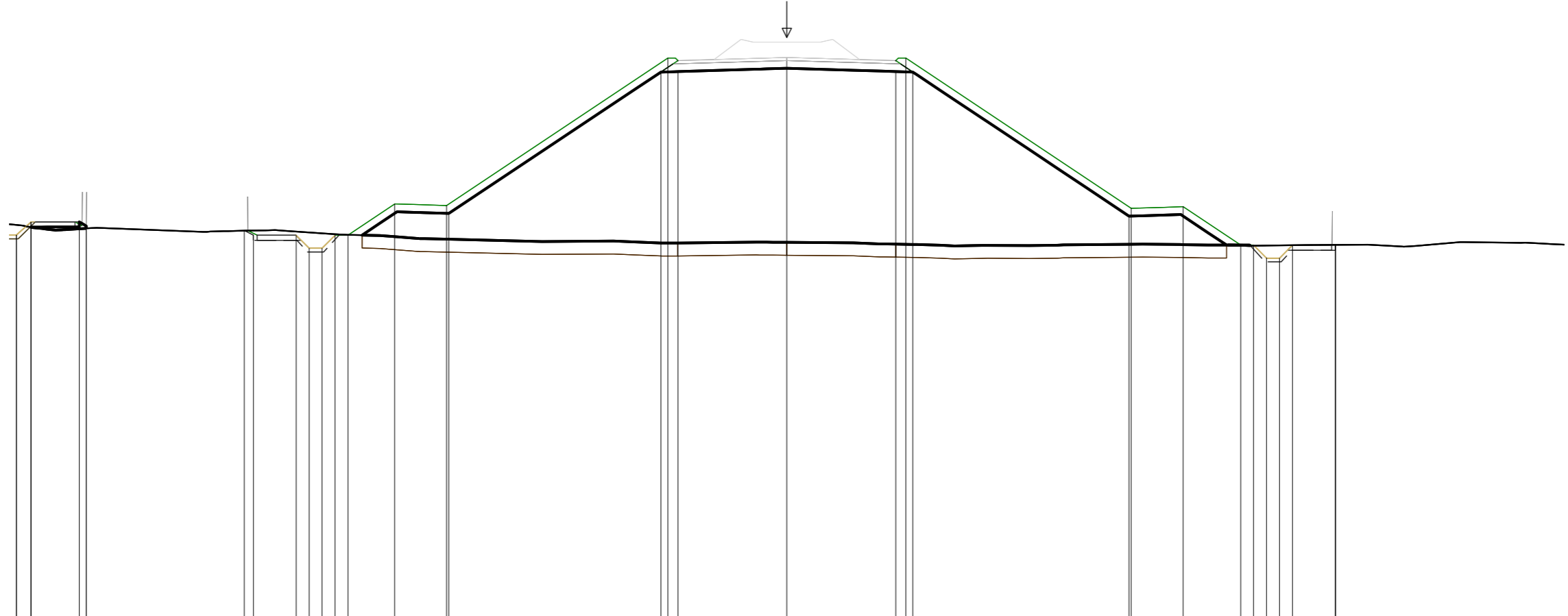

	-29.718	-29.718	-29.155	-27.297	-27.024	-27.024	-20.928	-20.578	-18.928	-18.428	-17.928	-17.428	-16.928	-15.126	-13.126	-13.040	-4.860	-4.591	-4.200	-0.000	4.200	4.591	4.860	13.200	13.287	15.287	17.507	18.007	18.507	19.007	19.507	21.157	21.174		
Quote Terreno	11.449	11.362	11.308	11.232	11.057	11.057	11.193	11.158	11.124	11.092	11.070	10.996	10.800	10.751	10.748	10.777	10.706	10.688	10.705	10.690	10.666	10.649	10.655	10.662	10.669	10.680	10.671	10.671	10.671	10.671	10.671	10.671	10.680	10.680	
Quote Progetto	11.066	11.066	11.567	11.570	11.409	11.409	11.057	11.057	10.557	10.557	11.057	12.258	12.198	11.896	17.349	17.889	17.369	17.889	17.349	17.495	17.369	17.889	17.349	11.789	12.091	12.151	10.671	10.671	10.171	10.171	10.671	10.671	10.671	10.680	10.680
Dist. Progr. Progetto	-29.718	-29.718	-29.155	-27.297	-27.024	-27.024	-20.928	-20.578	-18.928	-18.428	-17.928	-17.428	-16.928	-15.126	-13.126	-13.040	-4.860	-4.591	-4.200	-0.000	4.200	4.591	4.860	13.200	13.287	15.287	17.507	18.007	18.507	19.007	19.507	21.157	21.174		
Dist. Parziali	0.000	0.000	1.858	0.000	6.096	0.350	1.650	0.500	0.500	0.500	0.500	0.541	1.347	1.914	0.086	8.180	0.660	4.200	4.200	0.660	8.340	0.087	1.913	1.766	0.541	0.500	0.500	0.500	0.500	1.650	0.017				

Materiale	Area(m2)
Inerbimento	14.707
Scotico	16.230
Subballast	2.111
SuperCompattato	5.676
Scavo	4.127
Rilevato	61.898
Riempimento	0.000
Volume	0.000

Asse_coll Olbia
Q.= 17.992

Asse_bivio Micaleddu
Q.= 17.958

Prog. = 0+600.000

Q. Rif. = -4.000

Quote Terreno	10.952	11.006	10.971	10.991	10.966	10.939	10.878	10.709	10.832	11.101	11.118	11.160	11.187	11.286	11.336	
Quote Progetto	10.948	10.656	10.695	10.201	10.208	10.714	10.726	12.207	12.154	16.657	17.196	16.803	16.995	16.792	16.661	
Dist. Progr. Progetto	-25.724	-25.108	-21.874	-21.360	-20.847	-20.333	-19.307	-17.069	-15.043	-7.689	-7.419	-2.645	4.000	10.559	14.909	
Dist. Parziali	0.616	3.234	0.514	0.513	0.514	1.026	0.556	1.770	1.938	0.088	7.266	0.664	4.380	6.645	6.559	4.350

Materiale	Area(m2)
Inerbimento	0.000
Scotico	0.000
Subballast	3.472
SuperCompattato	8.802
Scavo	1.871
Rilevato	92.472
Riempimento	0.000
Volume	0.000

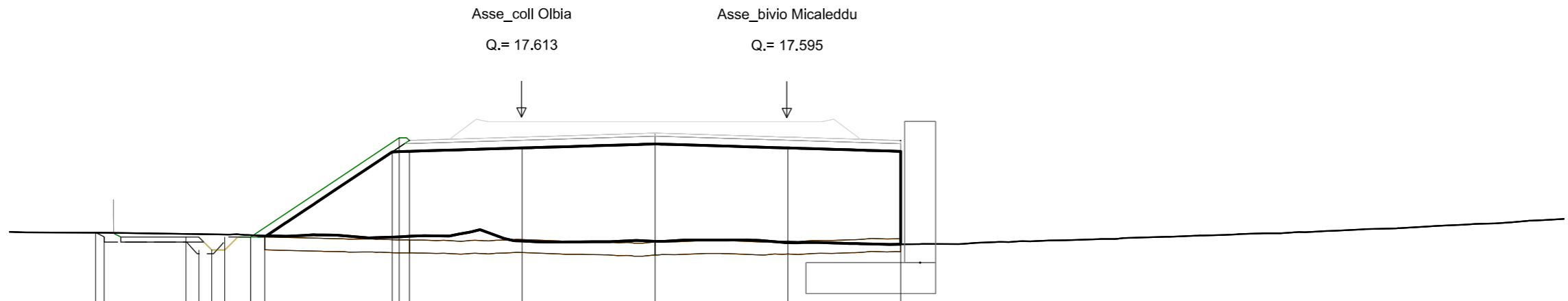

Prog. = 0+650.000

Q. Rif. = -2.000

Quote Terreno	13.158	13.108	13.092	13.084	13.062	13.043	12.832	12.825	12.772	12.710	
Quote Progetto	13.157	12.993	12.993	12.493	12.493	12.993	16.274	16.577	16.423	16.293	
Dist. Progr. Progetto	-26.663	-26.334	-23.183	-22.683	-22.183	-21.683	-15.221	-5.084	0.043	4.392	
Dist. Parziali	0.329	3.151	0.500	0.500	0.500	1.000	0.660	4.350	5.127	5.127	4.349

Materiale	Area(m2)
Inerbimento	1.024
Scotico	0.000
Subballast	2.353
SuperCompattato	6.070
Scavo	1.551
Rilevato	38.221
Riempimento	0.000
Volume	0.000

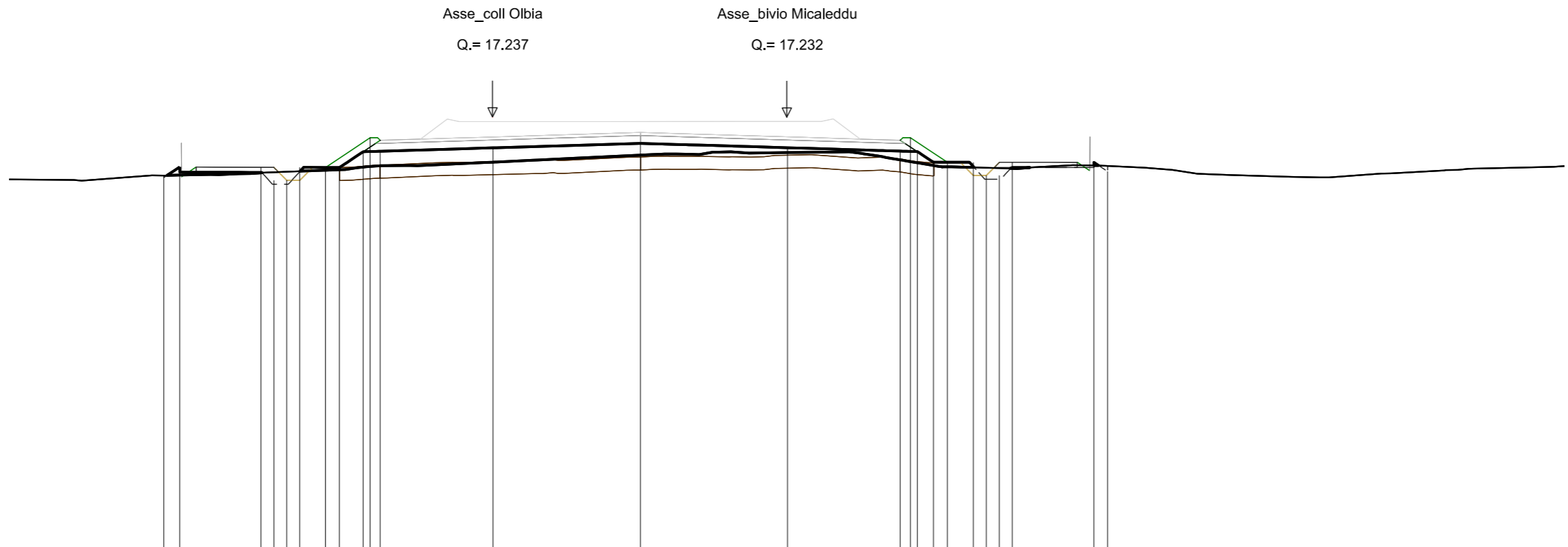

Quote Terreno	14.979 14.994	15.082 15.106 15.126 15.145	15.183 15.203 15.303 15.326 15.355	15.494	15.765	15.864	15.583 15.572 15.368 15.313 15.291 15.278 15.264 15.251	15.367 15.347
Quote Progetto	14.903 15.307	15.298 14.796 14.794 15.293 15.290 15.291	15.288 15.896 16.436 15.916	16.048	16.220	16.051	15.921 16.441 15.901 15.488 15.488 15.488 14.988 14.988 15.488	15.488 15.137
Dist. Progr. Progetto	-24.031 -23.424	-20.286 -19.788 -19.290 -18.792 -17.795 -17.258 -16.346 -16.076 -15.685		-11.331	-5.648	0.025	4.374 4.765 5.034 5.654 6.195 7.195 7.695 8.195 8.695	11.845 12.370
Dist. Parziali	0.607 3.138	0.498 0.498 0.996	0.538 0.912 0.661	4.354	5.683	5.673	4.349 0.660 0.620 0.541 1.000 0.500 0.500 0.500	3.150 0.525

Materiale	Area(m2)
Inerbimento	0.026
Scotico	0.000
Subballast	2.532
SuperCompattato	6.427
Scavo	8.551
Rilevato	0.067
Riempimento	0.000
Volume	0.000

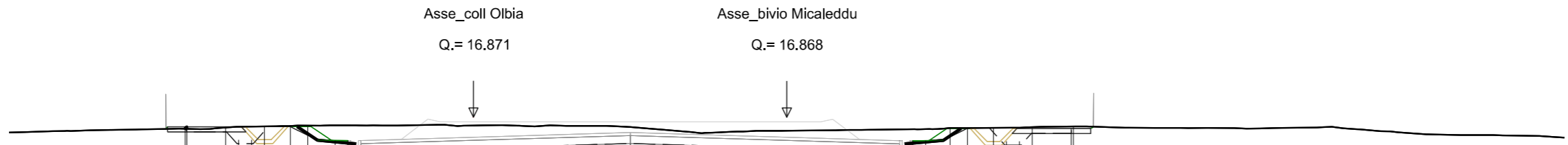

Prog. = 0+750.000

Q. Rif. = 0.000

Quote Terreno	16.420	16.471	16.499	16.507	16.515	16.534	16.546	16.554	16.554	16.552	16.549	16.489	16.346	16.402	16.409	16.413	16.455	16.454	16.460	16.462	16.467	16.487	16.514	
Quote Progetto	16.459	16.501	16.502	16.003	16.504	16.505	16.505	15.977	16.554	15.552	15.681	15.861	15.679	15.548	15.968	15.973	16.448	16.448	16.448	15.948	15.948	16.448	16.448	
Dist. Progr. Progetto	-23.207	-23.144	-21.647	-21.148	-20.649	-20.150	-19.152	-18.483	-17.426	-16.926	-16.426	-12.075	-6.035	-0.000	4.350	4.850	5.350	6.299	6.970	7.970	8.470	8.970	9.470	10.970
Dist. Parziali	0.063	1.497	0.499	0.499	0.499	0.998	0.669	0.878	0.500	0.500	4.351	6.040	6.035	4.350	0.500	0.500	0.685	0.671	1.000	0.500	0.500	0.500	1.500	0.083

Materiale	Area(m2)
Inerbimento	0.890
Scotico	0.000
Subballast	2.306
SuperCompattato	5.786
Scavo	49.539
Rilevato	0.031
Riempimento	0.000
Volume	0.000

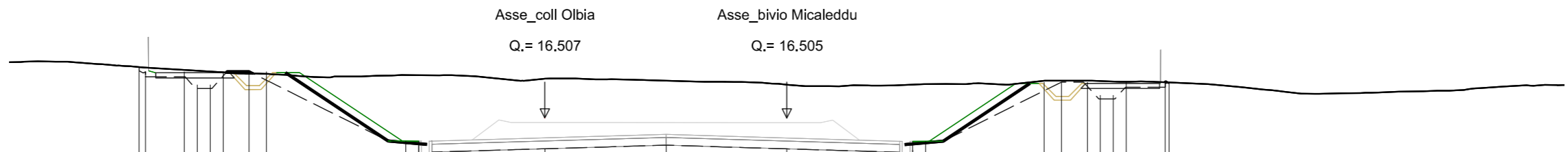

Prog. = 0+800.000

Q. Rif. = 0.000

Quote Terreno	18.453	18.362	18.333	18.301	18.272	18.234	18.210	18.164	18.161	18.156	18.022	17.945	17.790	17.769	17.791	17.811	17.941	17.945	17.946	17.932	17.911	17.902	17.899	17.899	
Quote Progetto	18.325	18.294	18.296	17.796	18.297	18.298	18.299	15.615	15.609	15.189	15.317	15.455	15.312	15.182	15.602	15.607	17.893	17.893	17.893	17.393	17.393	17.893	17.893	17.826	
Dist. Progr. Progetto	-24.987	-24.742	-23.242	-22.742	-22.243	-21.743	-20.743	-20.072	-14.696	-14.195	-13.694	-9.333	-4.654	0.000	4.350	4.850	5.350	9.923	10.594	11.594	12.094	12.594	13.094	14.594	14.744
Dist. Parziali	0.245	1.500	0.500	0.499	0.500	1.000	0.671	4.689	0.889	0.501	0.501	4.361	4.679	4.654	4.350	0.500	0.500	3.888	0.671	1.000	0.500	0.500	0.500	1.500	0.150

Materiale	Area(m2)
Inerbimento	1.772
Scotico	0.000
Subballast	1.876
SuperCompattato	4.707
Scavo	88.037
Rilevato	0.117
Riempimento	0.000
Volume	0.000

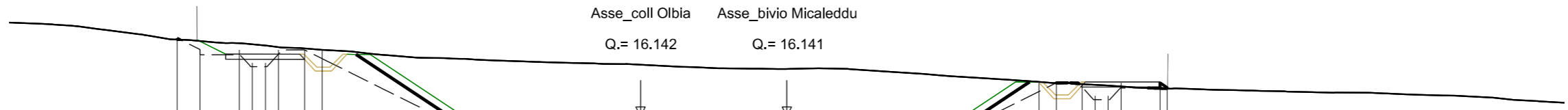

Prog. = 0+850.000

Q. Rif. = 0.000

Quote Terreno	19.109	19.051	18.966	18.924	18.875	18.814	18.764	18.712		18.290	18.273	18.256	18.137	18.006	17.970		17.840	17.805	17.770		17.469	17.426	17.381	17.354	17.327	17.294	17.217	17.217
Quote Progetto	19.162	18.720	18.714	18.212	18.211	18.709	18.705	18.703		15.250	15.245	14.825	14.953	15.036	14.950		14.819	15.239	15.244		17.432	17.432	17.432	16.932	16.932	17.432	17.432	17.248
Dist. Progr. Progetto	-23.522	-22.636	-21.123	-20.618	-20.114	-19.609	-18.600	-17.924		-11.007	-10.506	-10.005	-5.643	-2.814	0.000		4.350	4.850	5.350		9.725	10.395	11.395	11.895	12.395	12.895	14.395	14.671
Dist. Parziali	0.886	1.513	0.505	0.504	0.505	1.009	0.676		6.230	0.889	0.501	0.501	4.362		2.829	2.814		4.350	0.500	0.500	0.685	3.690	0.670	1.000	0.500	0.500	1.500	0.276

Materiale	Area(m2)
Inerbimento	1.200
Scotico	0.000
Subballast	1.590
SuperCompattato	3.972
Scavo	51.726
Rilevato	0.032
Riempimento	0.000
Volume	0.000

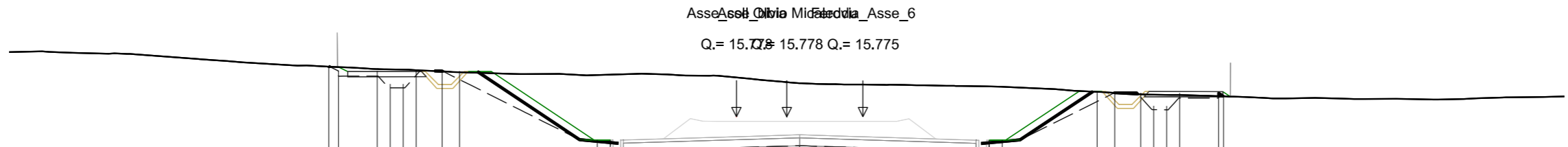

Prog. = 0+900.000

Q. Rif. = 0,000

Quote Terreno	17.702	17.686	17.613	17.599	17.588	17.568	17.526	17.485	17.384	17.398	17.413	17.287	17.065	17.013	16.951	16.942	16.929	16.731	16.694	16.641	16.625	16.619	16.610	16.562	
Quote Progetto	17.720	17.536	17.537	17.038	17.038	17.538	17.539	17.540	14.886	14.881	14.460	14.589	14.660	14.586	14.453	14.872	14.877	16.699	16.698	16.697	16.196	16.195	16.694	16.692	16.563
Dist. Progr. Progetto	-17.667	-17.297	-15.797	-15.297	-14.797	-14.297	-13.297	-12.626	-7.310	-6.808	-6.307	-1.945	0.493	2.935	7.304	7.806	8.308	11.973	12.646	13.648	14.149	14.650	15.151	16.655	16.848
Dist. Parziali	0.370	1.500	0.500	0.500	0.500	1.000	0.671	4.630	8.888	0.502	0.501	4.362	2.438	2.442	4.369	0.502	0.686	2.978	0.673	1.002	0.501	0.501	1.504	0.193	

Materiale	Area(m2)
-----------	----------

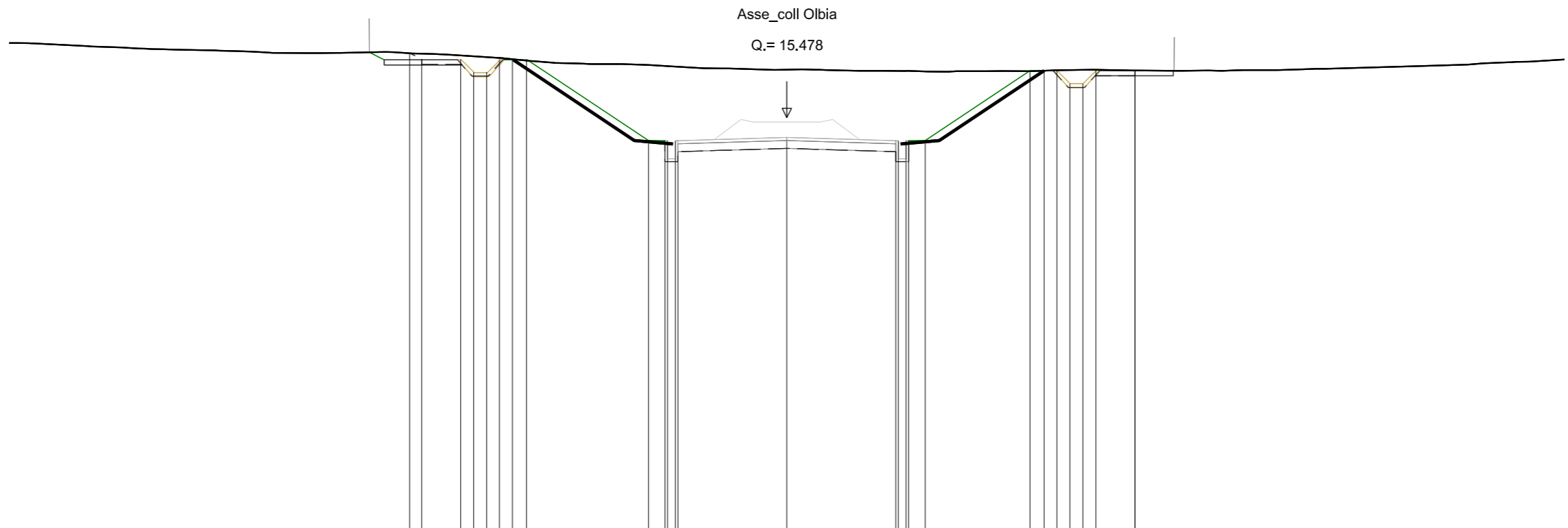

Prog. = 0+941.270

Q. Rif. = -1.000

Quote Terreno	17.959 17.943	17.872 17.841 17.809 17.776 17.726 17.673	17.501 17.482 17.463	17.323	17.274 17.253	17.267 17.284 17.301 17.309 17.317 17.320	17.290
Quote Progetto	17.959 17.726	17.726 17.226 17.226 17.726 17.726 17.726	14.587 14.581 14.581 14.581 14.161	14.287	14.161 14.581 14.581 14.581 14.587	17.284 17.284 17.284 16.784 16.784 17.284	17.284 17.290
Dist. Progr. Progetto	-14.550 -14.084	-12.584 -12.084 -11.584 -11.084 -10.584 -10.043	-5.335 -4.700 -4.600 -4.300 -4.200	-0.000	4.200 4.300 4.600 4.700 5.335	9.381 9.922 10.422 10.922 11.422 11.922	13.422 13.433
Dist. Parziali	0.466 1.500	0.500 0.500 0.500 0.500 0.541	4.158	0.550 0.635 0.500	4.200	0.500 0.635 0.550	3.496