

PARTICOLARE "A"  
SCALA 1:20  
PARTICOLARE WATER-STOP  
PROFILO LONGITUDINALE C-C

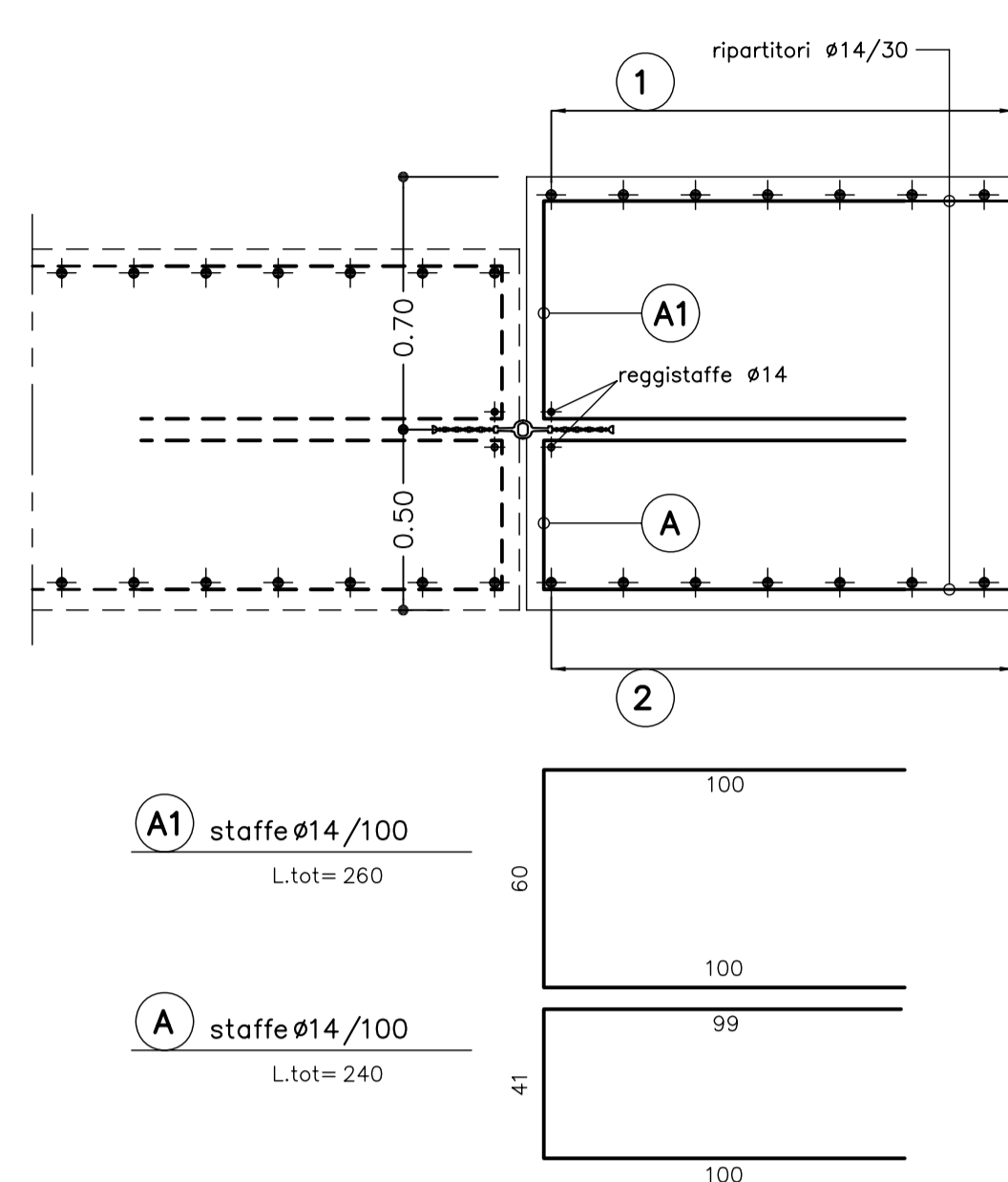

PARTICOLARE "B"  
SCALA 1:20  
PARTICOLARE WATER-STOP  
PIANTA D-D

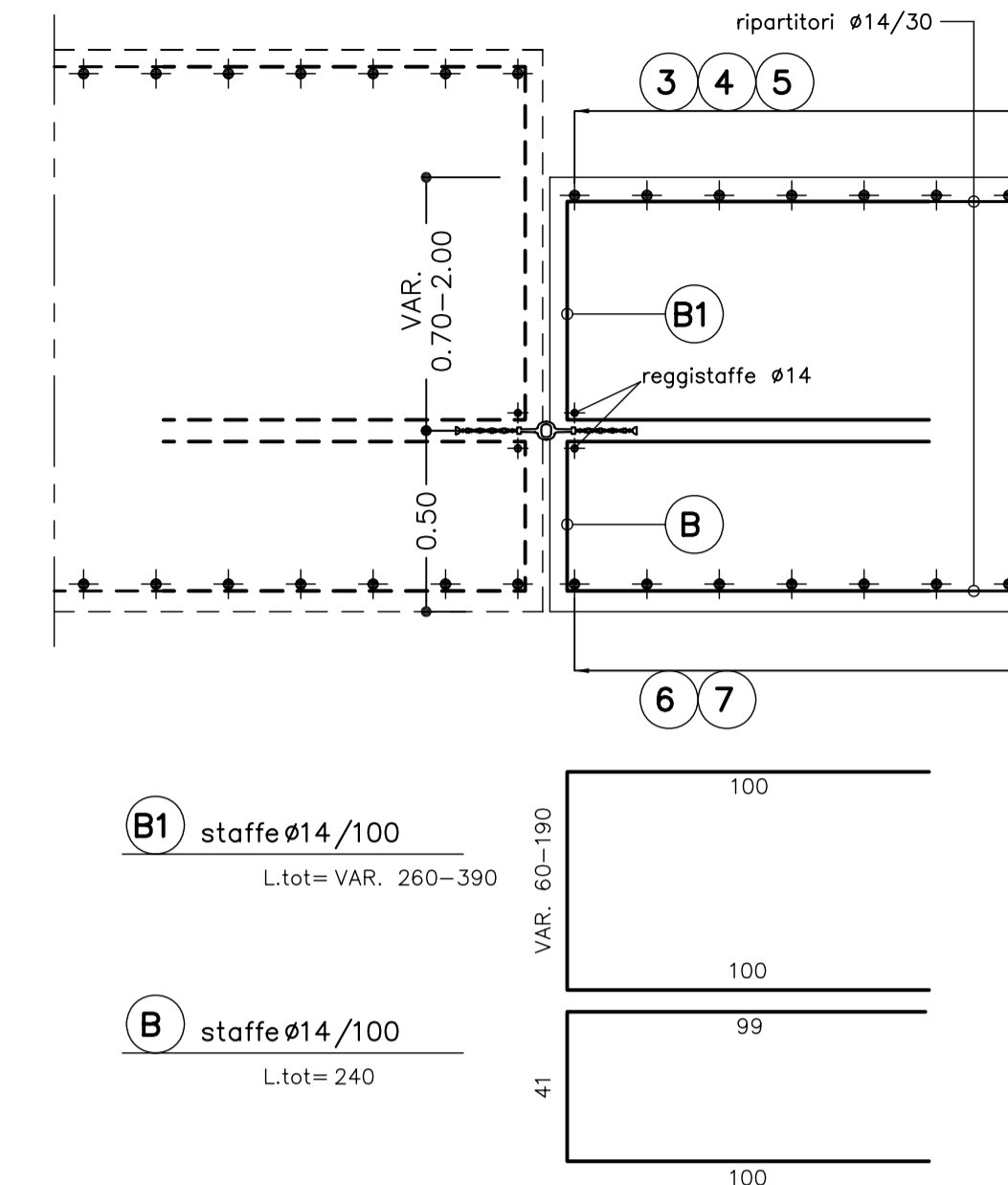

PARTICOLARE "C"  
SCALA 1:20  
PARTICOLARE WATER-STOP  
PROFILO LONGITUDINALE C-C

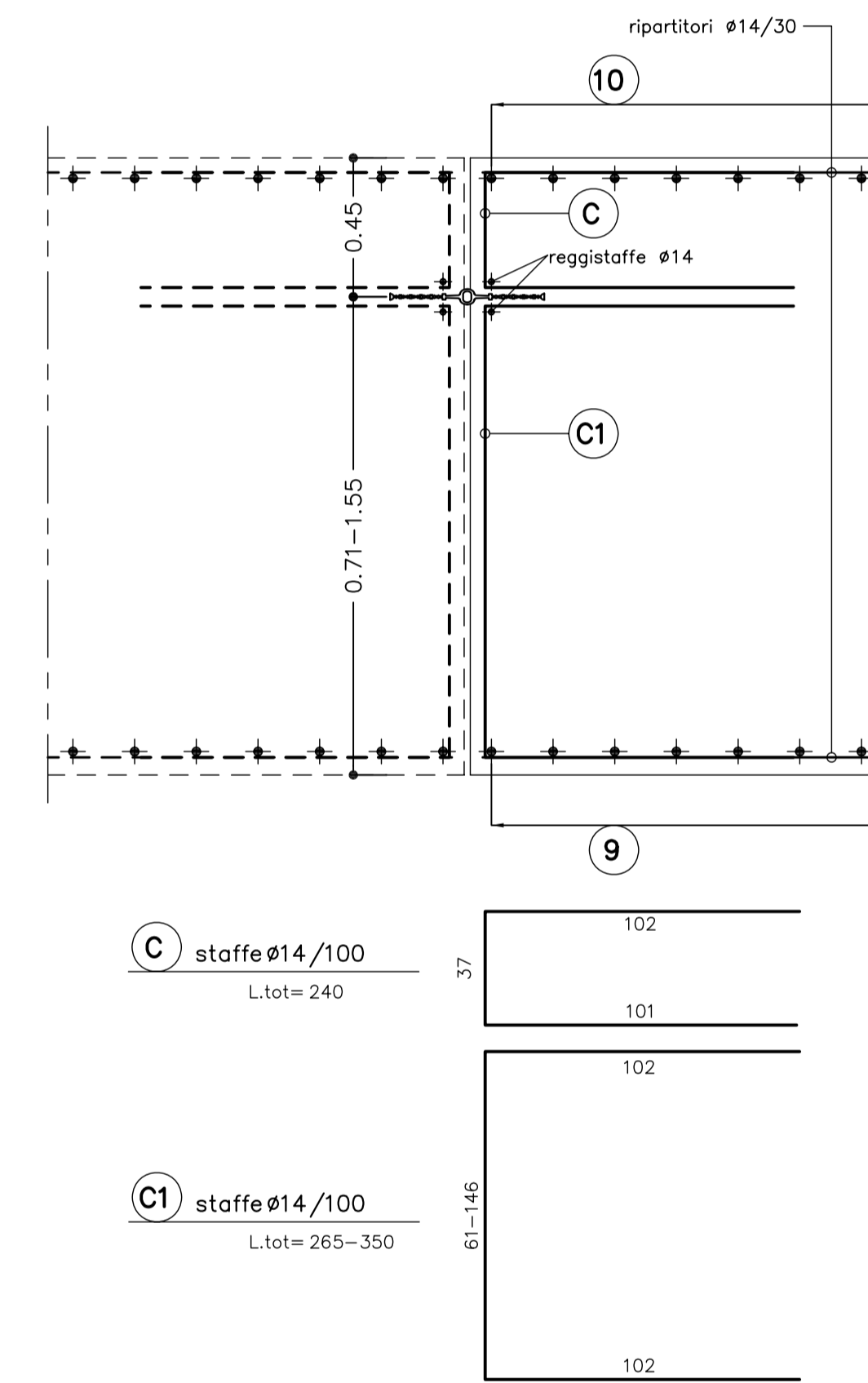

PARTICOLARE "D"  
SCALA 1:20  
PARTICOLARE WATER-STOP  
PROFILO LONGITUDINALE C-C

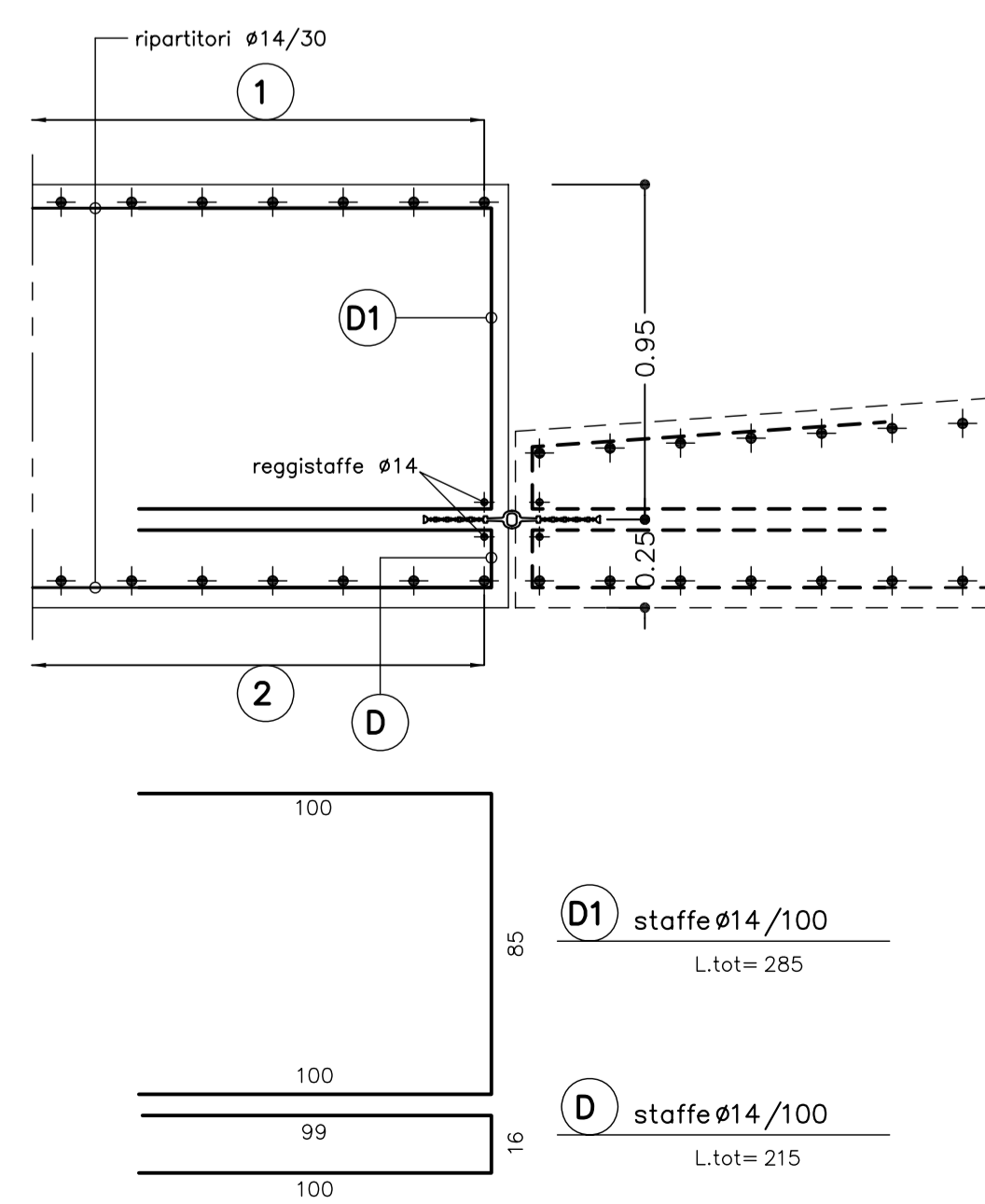

PARTICOLARE "E"  
SCALA 1:20  
PARTICOLARE WATER-STOP  
PIANTA D-D



TABELLA MATERIALI	
ACCIAIO ARMATURE	F48 44s controllato
COPRIFERRO	(vedi schema)

LEGENDA	
- P.C.	PIANO DEI CENTRI
- Q.P.	QUOTA PROGETTO
- P.I.M.	PIANO IMPOSTA MURETTE

NOTA	
I CAVALLOTTI NON SONO DA CONSIDERARSI STRUTTURALI E POSSONO ESSERE EVENTUALMENTE SOSTITUITI CON ELEMENTI ALTERNATIVI	

COMMITTENTE:

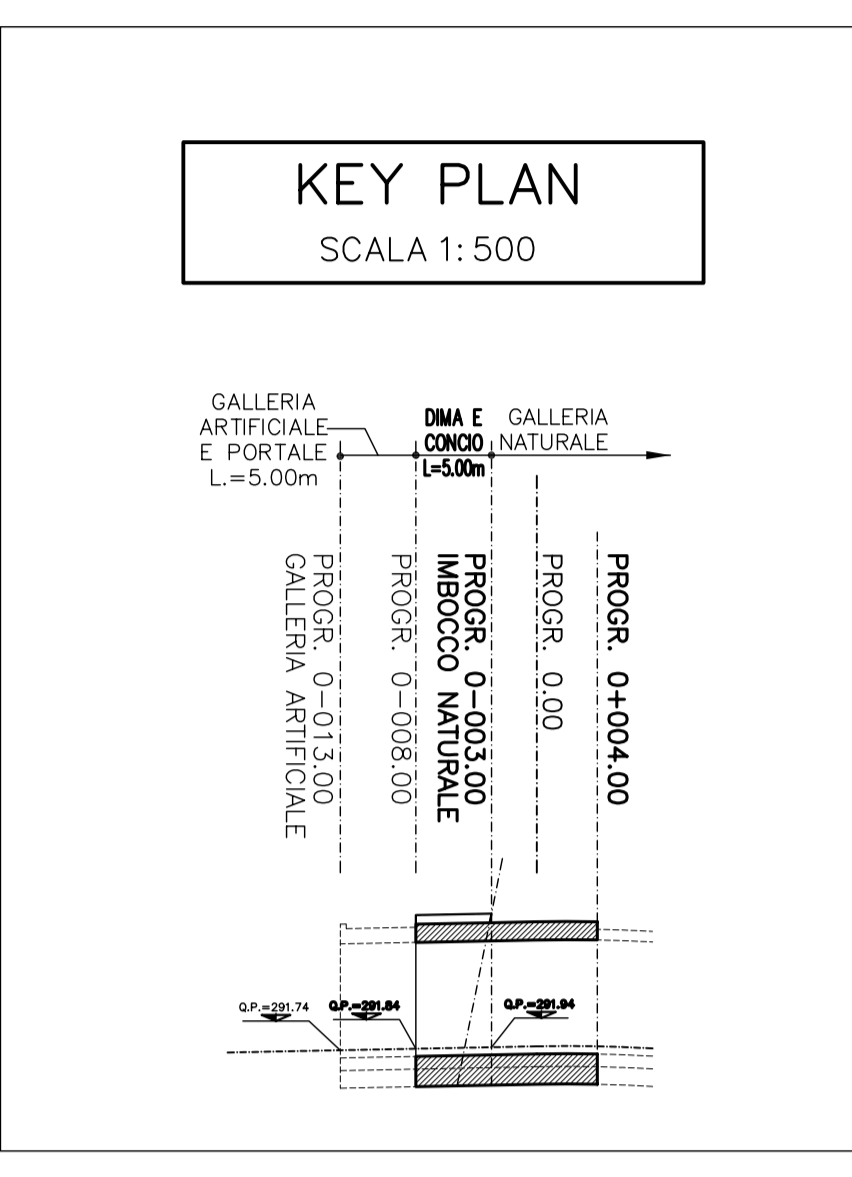
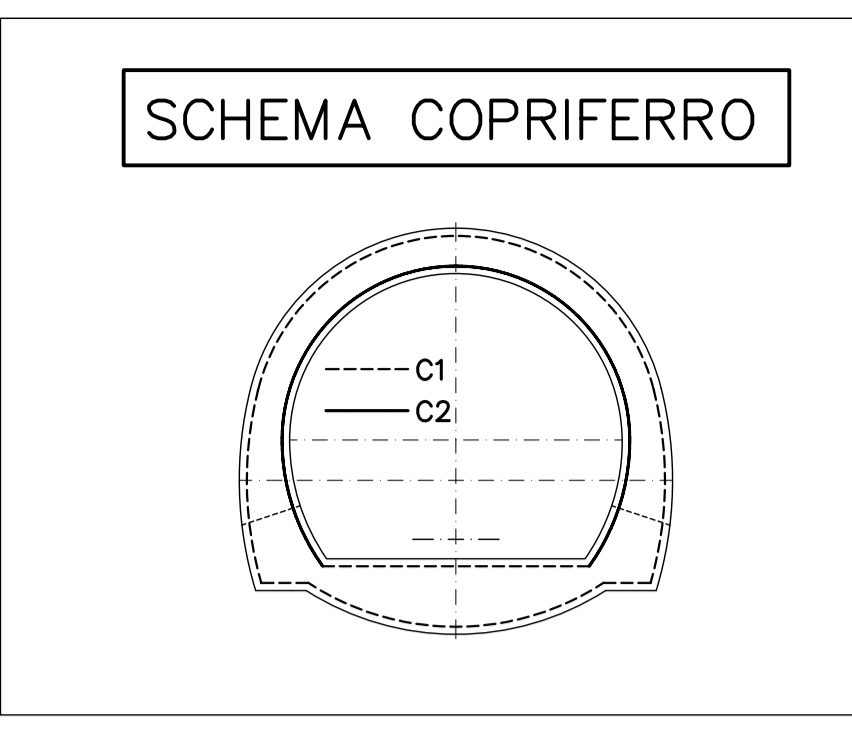
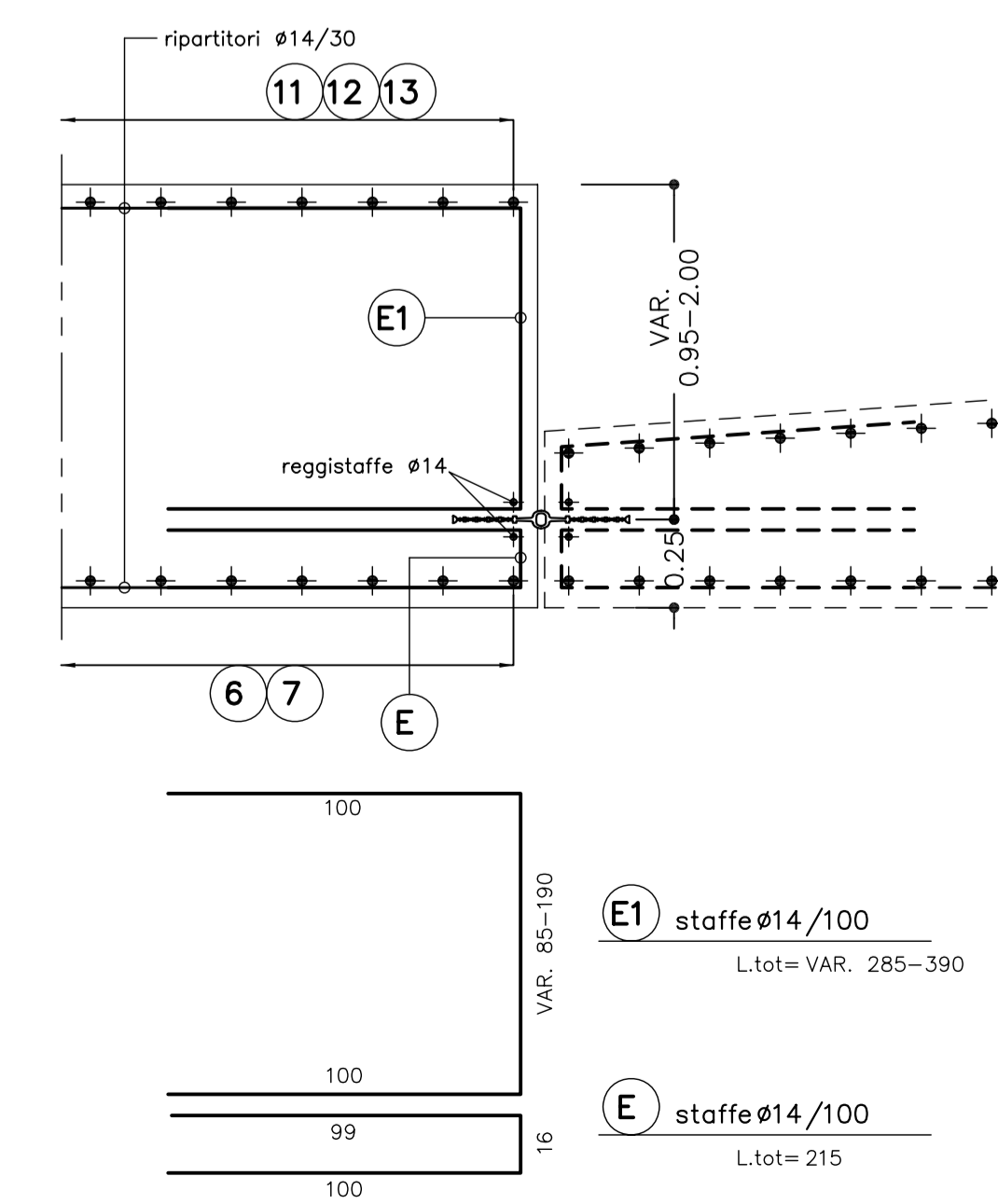
ALTA Sorveglianza:

GENERAL CONTRACTOR:

**INFRASTRUTTURE FERROVIARIE STRATEGICHE DEFINITE DALLA LEGGE OBIETTIVO N.443/01**

**TRATTA A.V./A.C. TERZO VALICO DEI GIOVI**

**PROGETTO ESECUTIVO**

**IMBOCCO FINESTRA CRAVASCO**

Opere di imbocco  
Dima e Concio d'attacco - Armatura - Tav.1/2

GENERAL CONTRACTOR		DIRETTORE LAVORI		SCALA:					
<b>Cociv</b>				1:50 - 1:20					
COMMISSIONE <b>I G 5 1</b> LOTTO <b>01</b> FASE <b>E</b> ENTE <b>CV</b> TIPO DOC <b>BZ</b> OPERA/DISCIPLINA <b>GA1E0D</b> PROG. <b>003</b> REV. <b>A</b>									
PROGETTAZIONE	Rev.	Descrizione emissione	Redatto	Data	Verificato	Data	Firma/Incarico	Data	IL PROGETTISTA
A00		Prima emissione	Ing. F. Cola	23/05/2012	Ing. E. Pagani	31/05/2012	Ing. E. Cola		

