

**IMPIANTO DI RETE PER LA CONNESSIONE A 20 KV
DELL'IMPIANTO DI PRODUZIONE DA FONTE SOLARE
POTENZA in IMMISSIONE massima 28.800 kW -
cod. rintr. T0738883 - 298706177
UBICATO IN COMUNE DI SCLAFANI BAGNI (PA)**

PROGETTO DEFINITIVO

**DOCUMENTAZIONE GENERALE
INQUADRAMENTO SU CATASTALE**

IDENTIFICAZIONE ELABORATO

Livello prog.	Codice Rintracciabilità	Tipo docum.	N° elaborato	N° foglio	Tot. fogli	NOME FILE	DATA	SCALA
PD	T0738883-298706177		TAV02_B	1	17	298706177_tav02_B	03/02/2023	1:20000 - 1:5000

REVISIONI

REV.	DATA	DESCRIZIONE	ESEGUITO	VERIFICATO	APPROVATO
00	26/01/2023	Prima emissione progetto definitivo	RUSSO	MARCHICA	MARCHICA
01	03/02/2023	Integrazione progetto definitivo	RUSSO	MARCHICA	MARCHICA

Progettazione

Timbro e firma:



Flyren S.r.l.
Via Lungo Po Antonelli, 21
10154 Torino (TO)

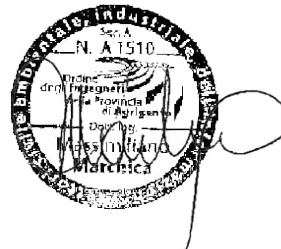

Gestore Rete Elettrica:

Il richiedente:

FLYNIS PV 8 S.r.l.

Via Statuto, 10 - 20121 Milano
flynispv8srl@legalmail.it

LEGENDA



Quadrupla terna interrata di cavo MT 3x1x240mm² e cavo ottico dielettrico costituito da 24 fibre come da norma ITU-T/G.652



Singola terna interrata di cavo MT 3x1x240mm² per richiusura tra le cabine di consegna

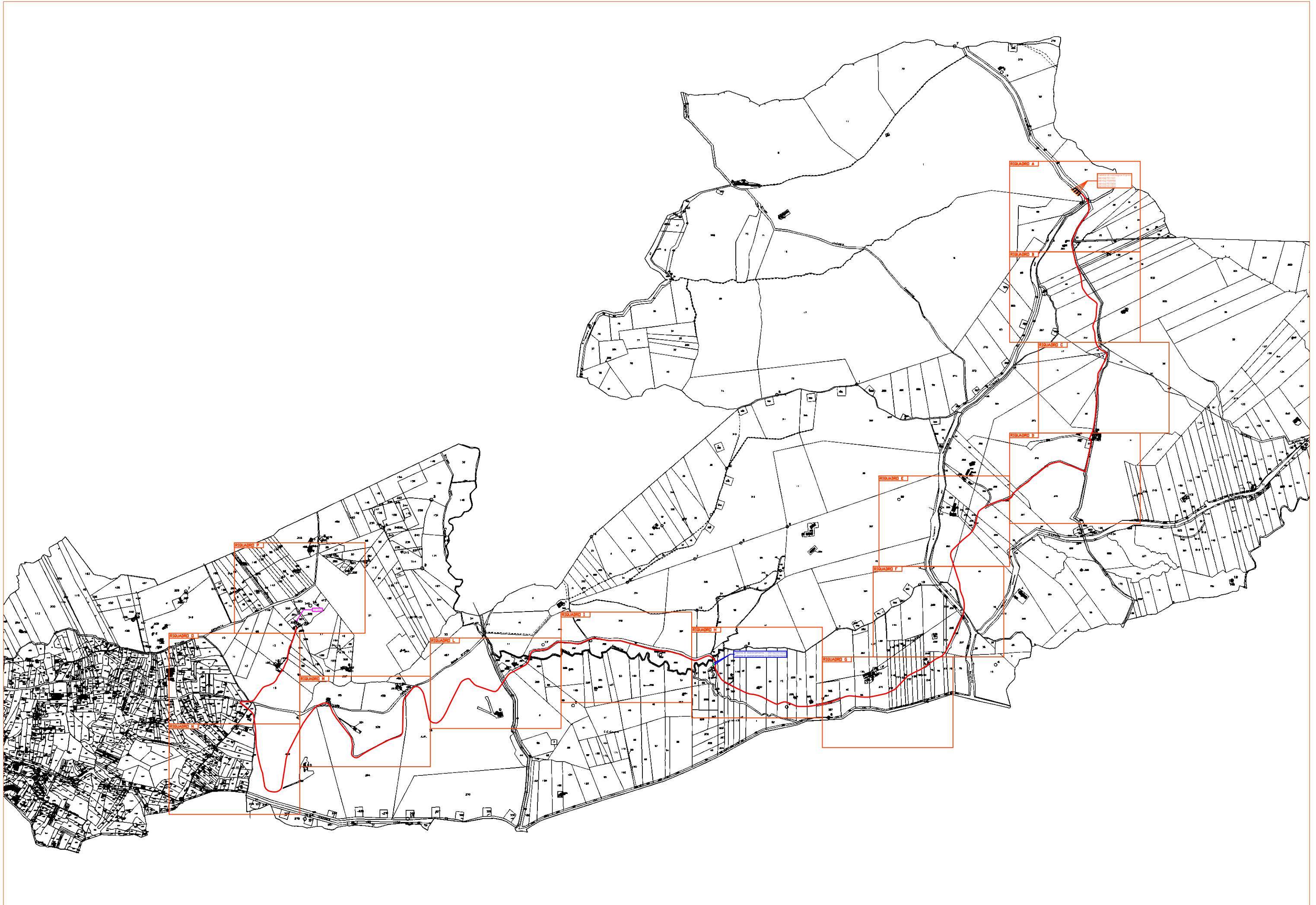

RIQUADRO A

Cabine di consegna Flyren
D8102751101
D8102750998
D8102751000
D8102751002

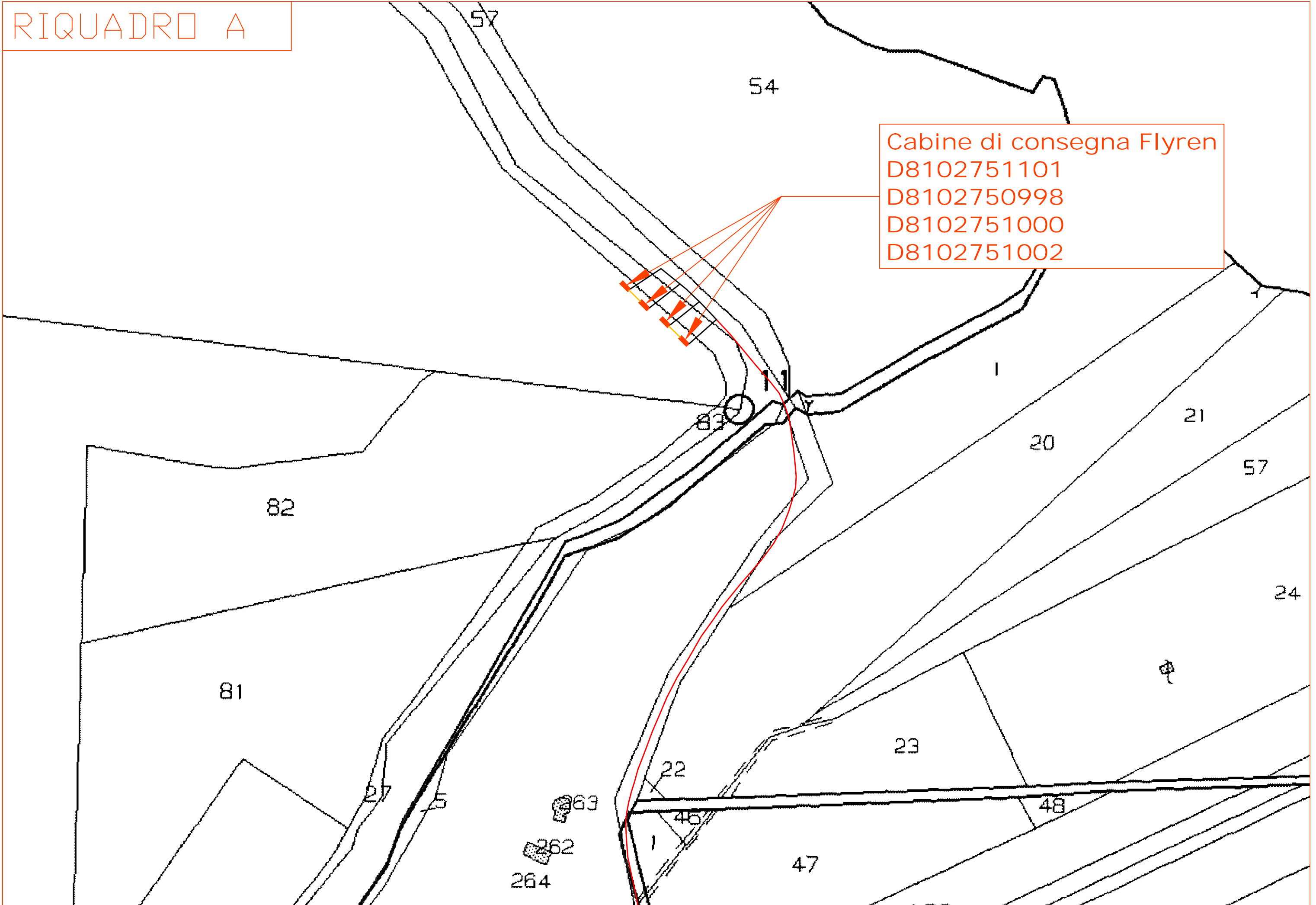

RIQUADRO B

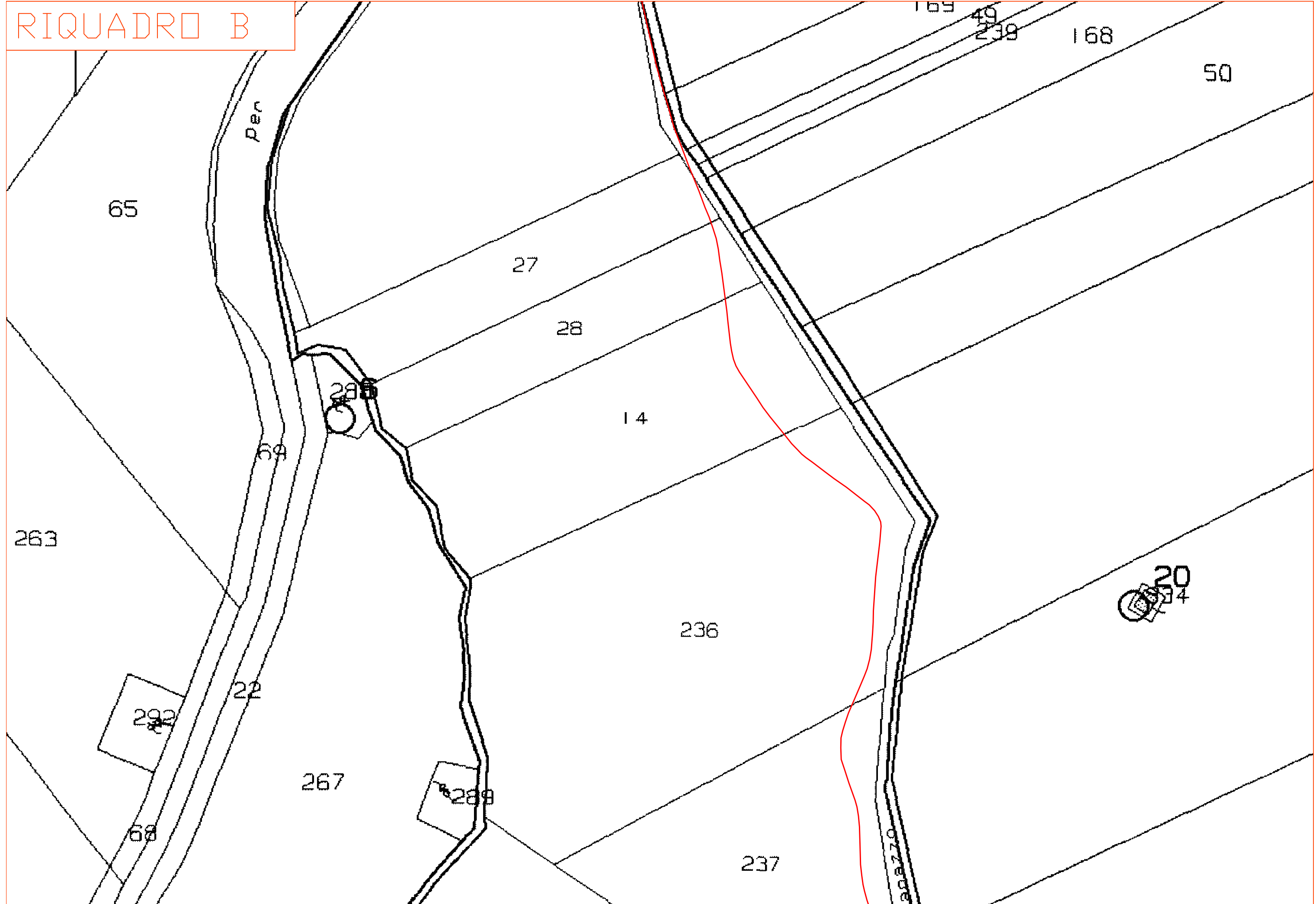

RIQUADRO C

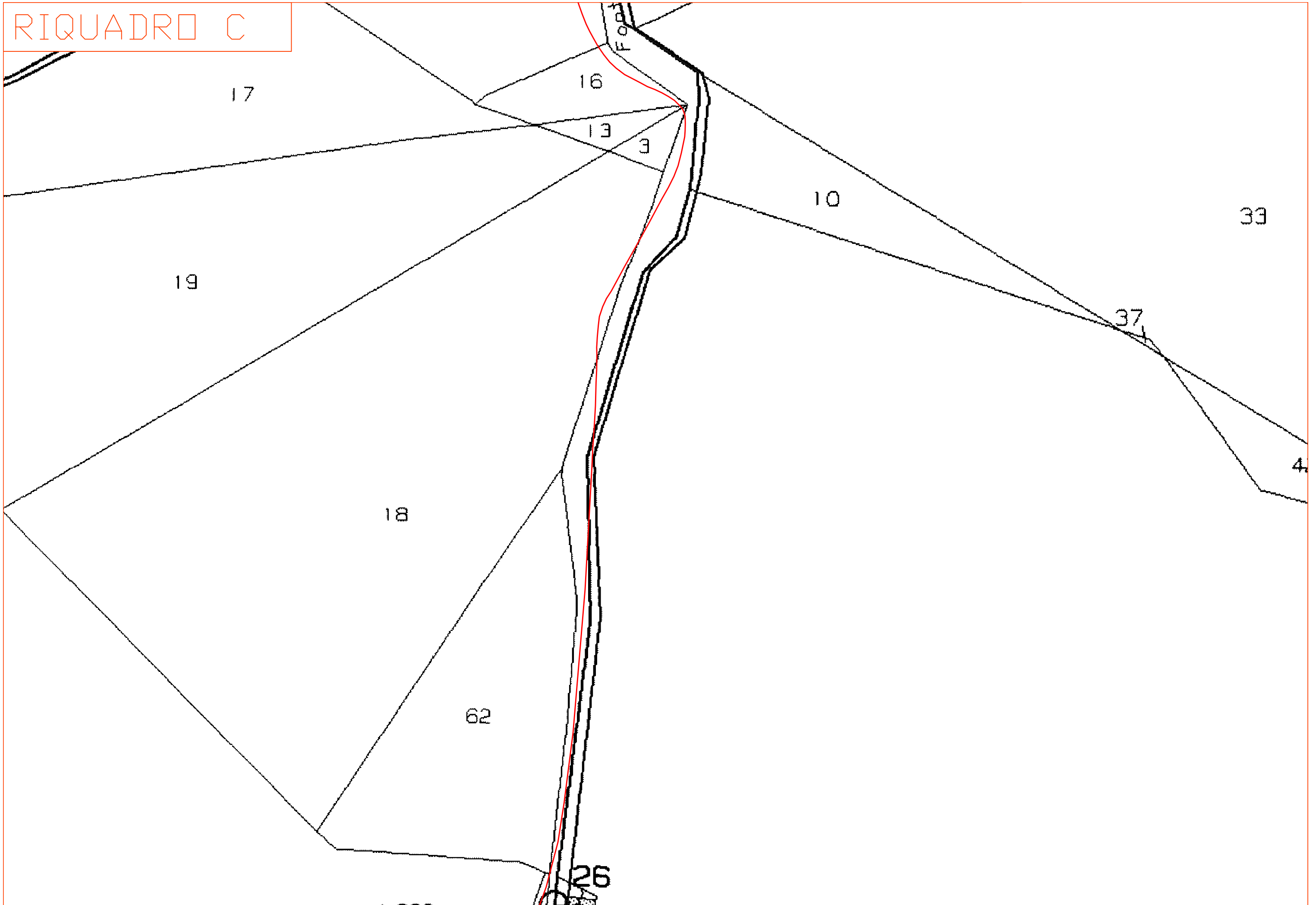

RIQUADRO D

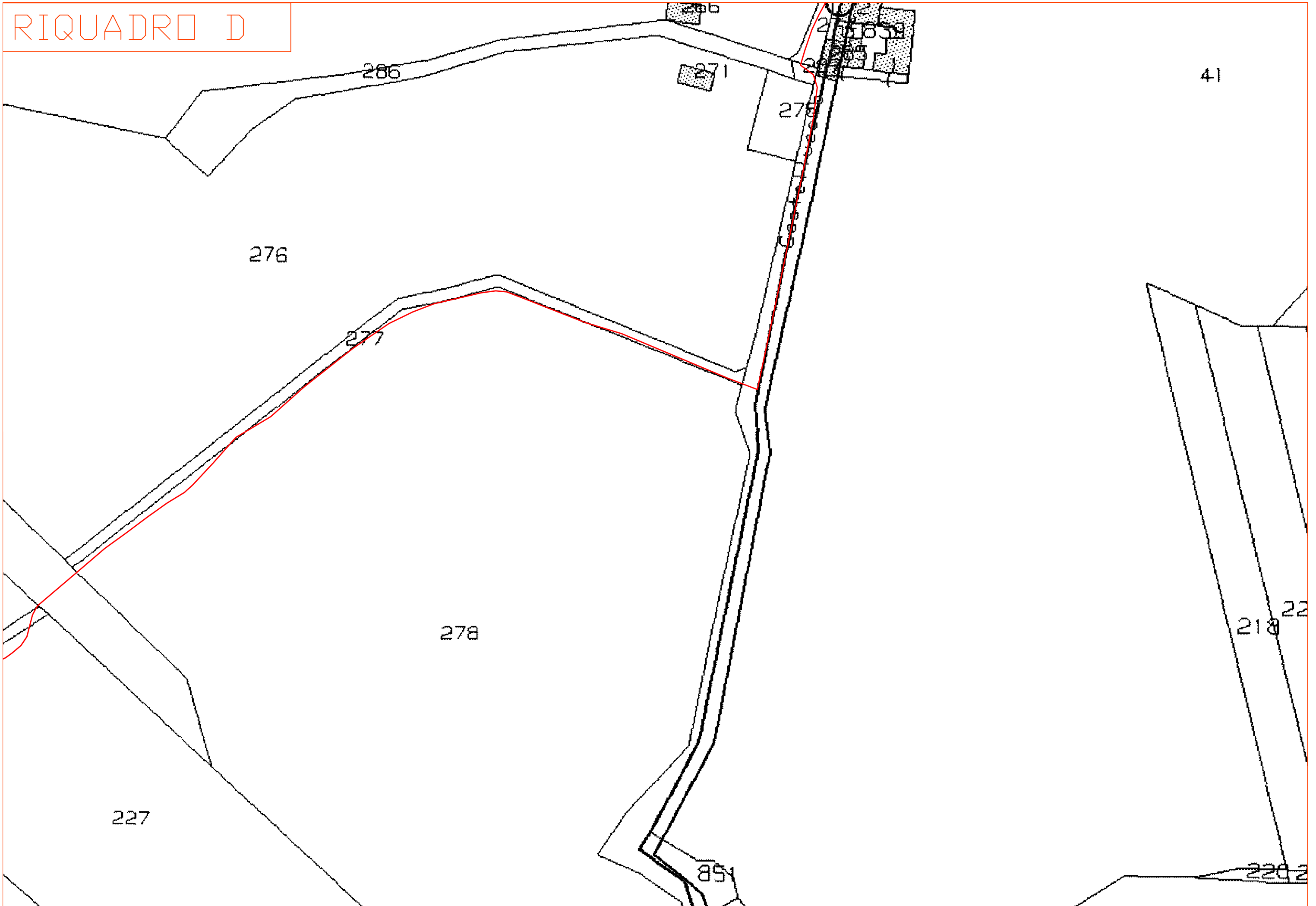

RIQUADRO E

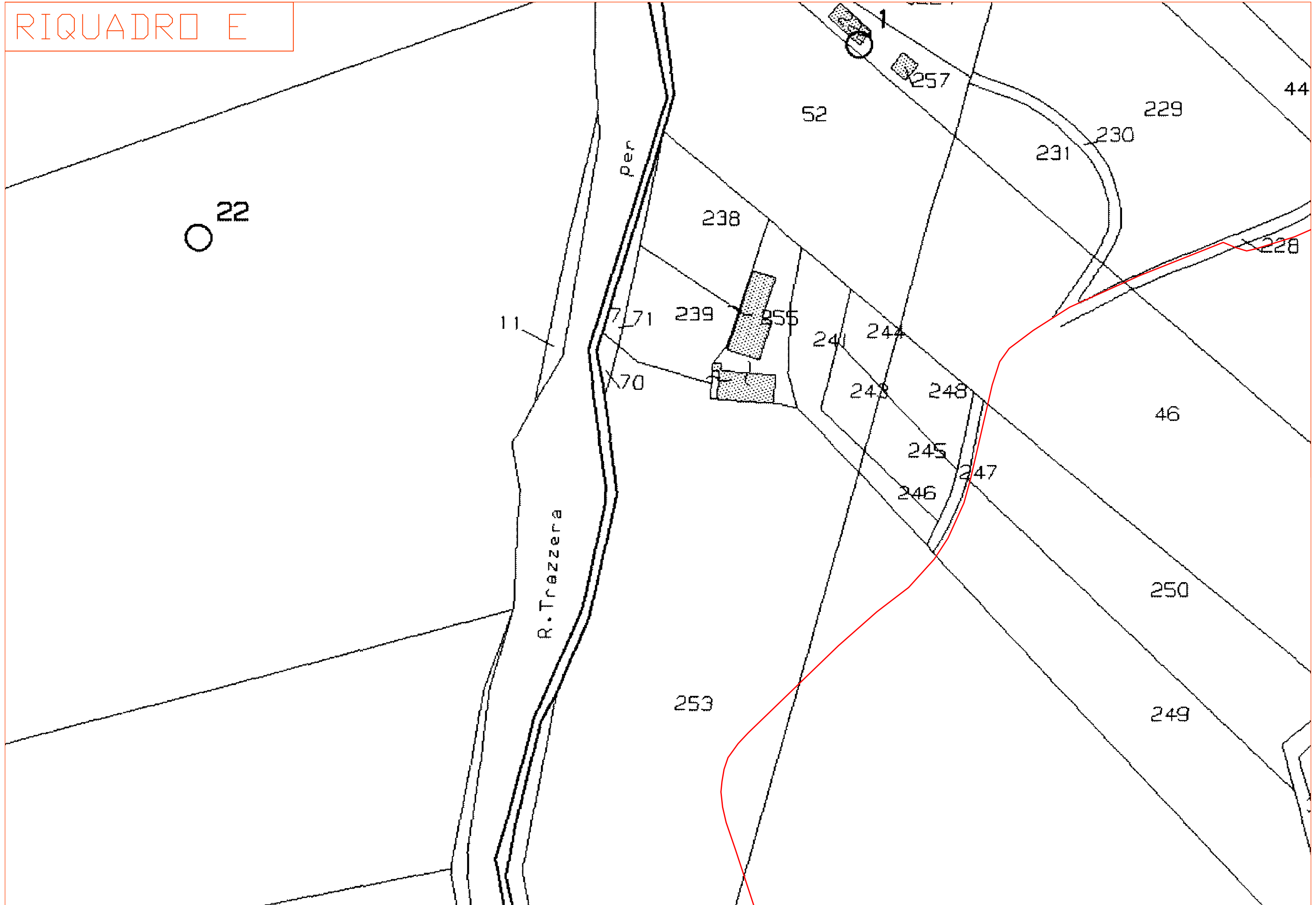

RIQUADRO F

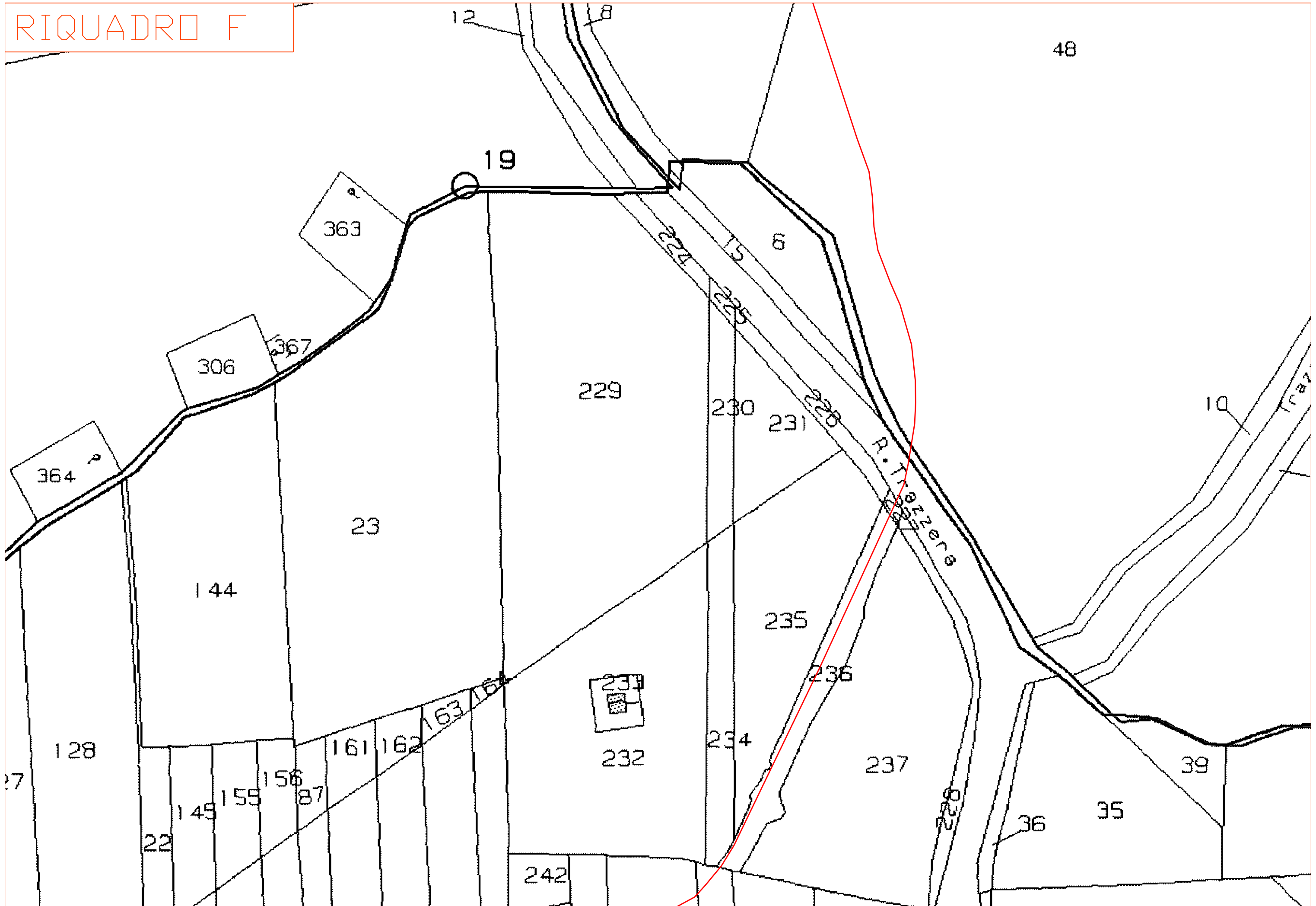

RIQUADRO G

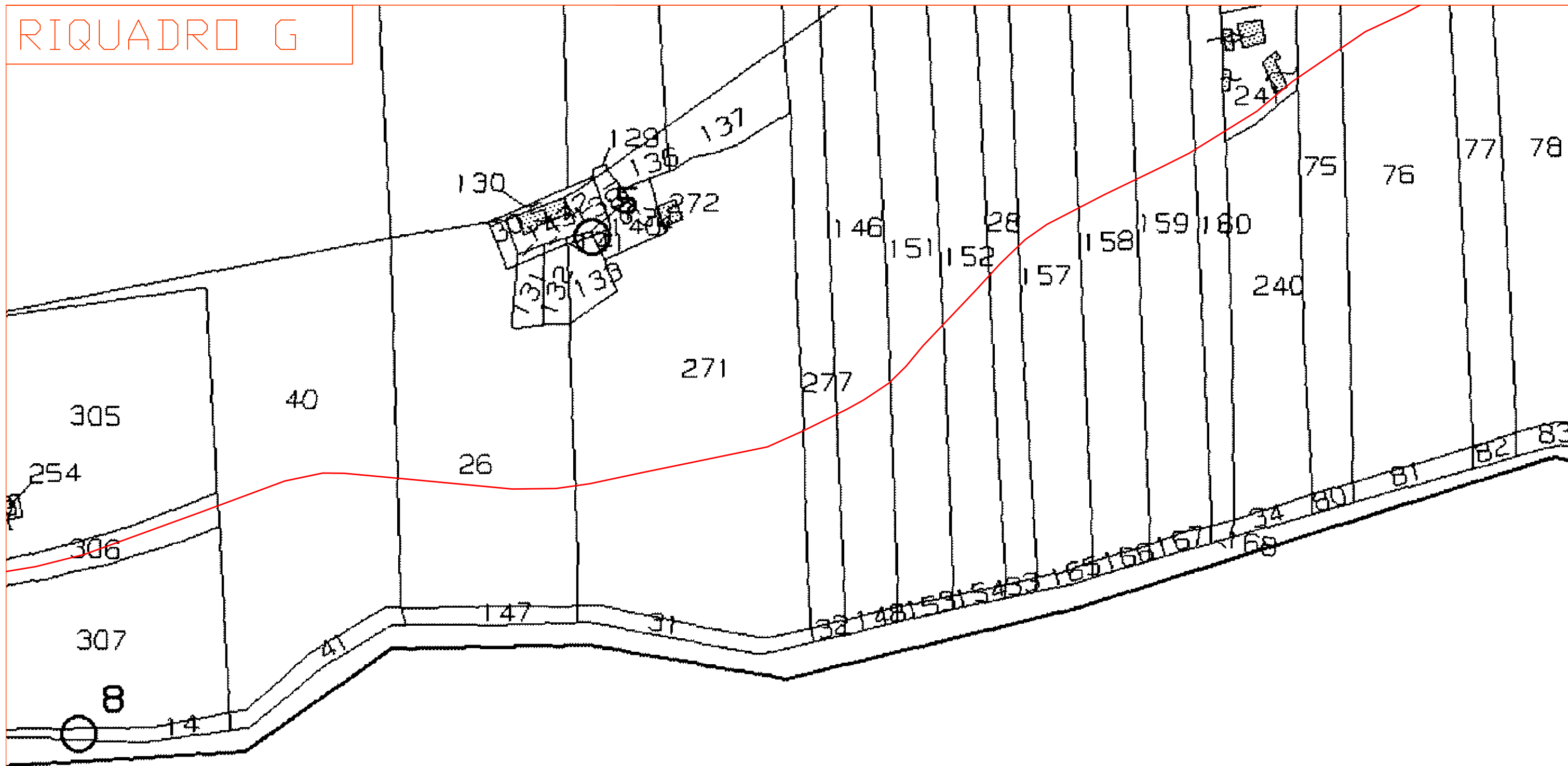

RIQUADRO H

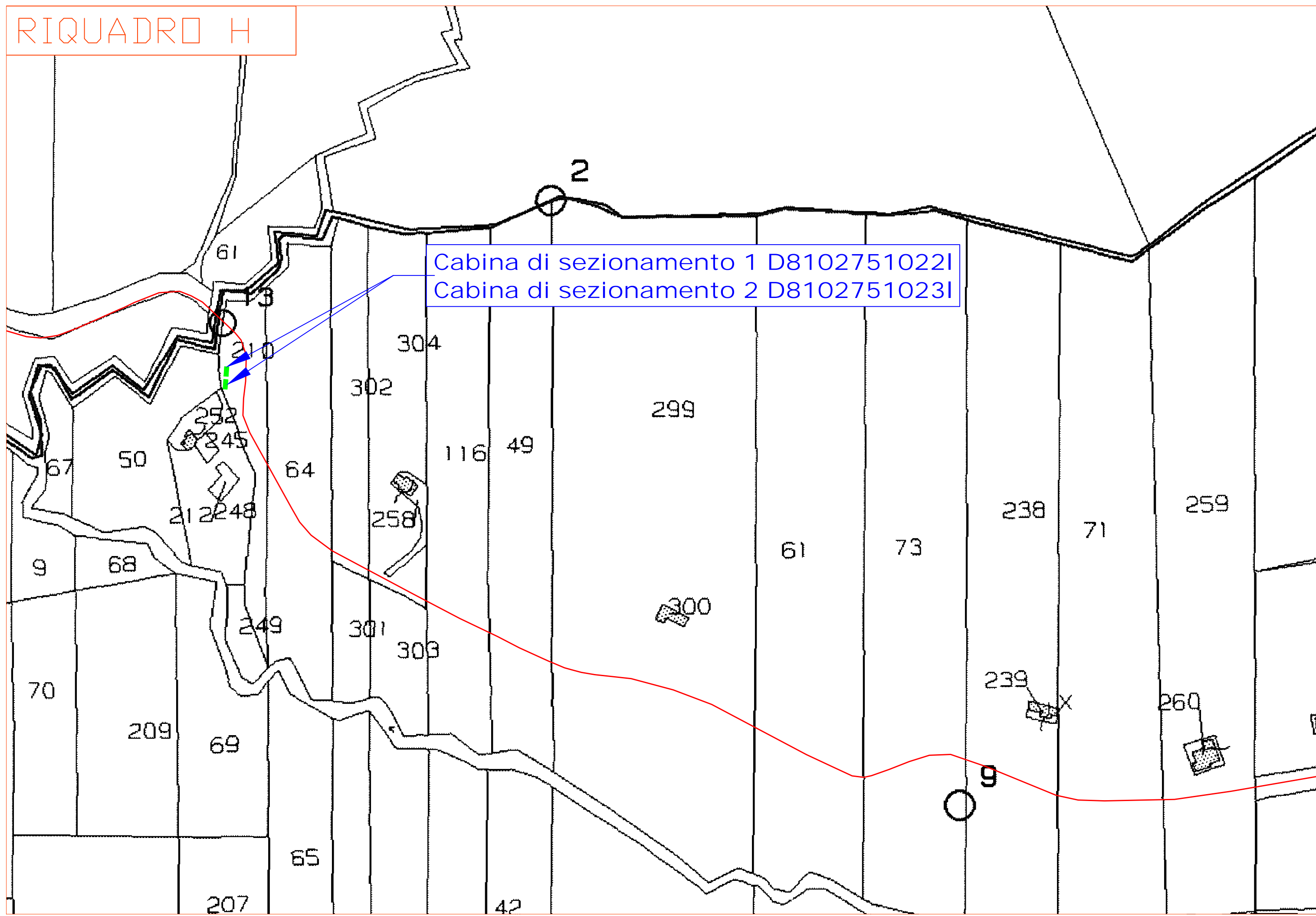

Cabina di sezionamento 1 D8102751022I
Cabina di sezionamento 2 D8102751023I

RIQUADRO I

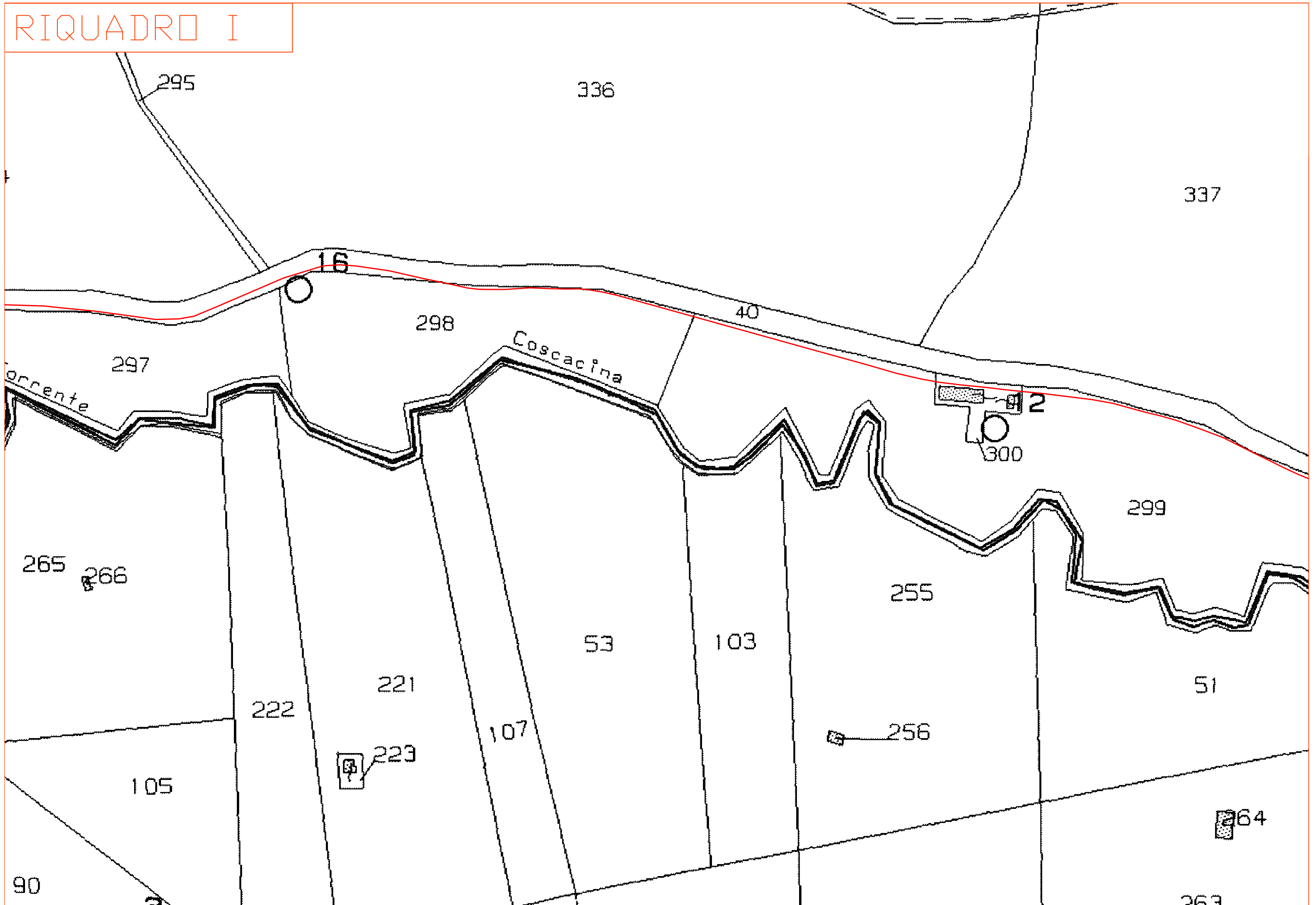

RIQUADRO L

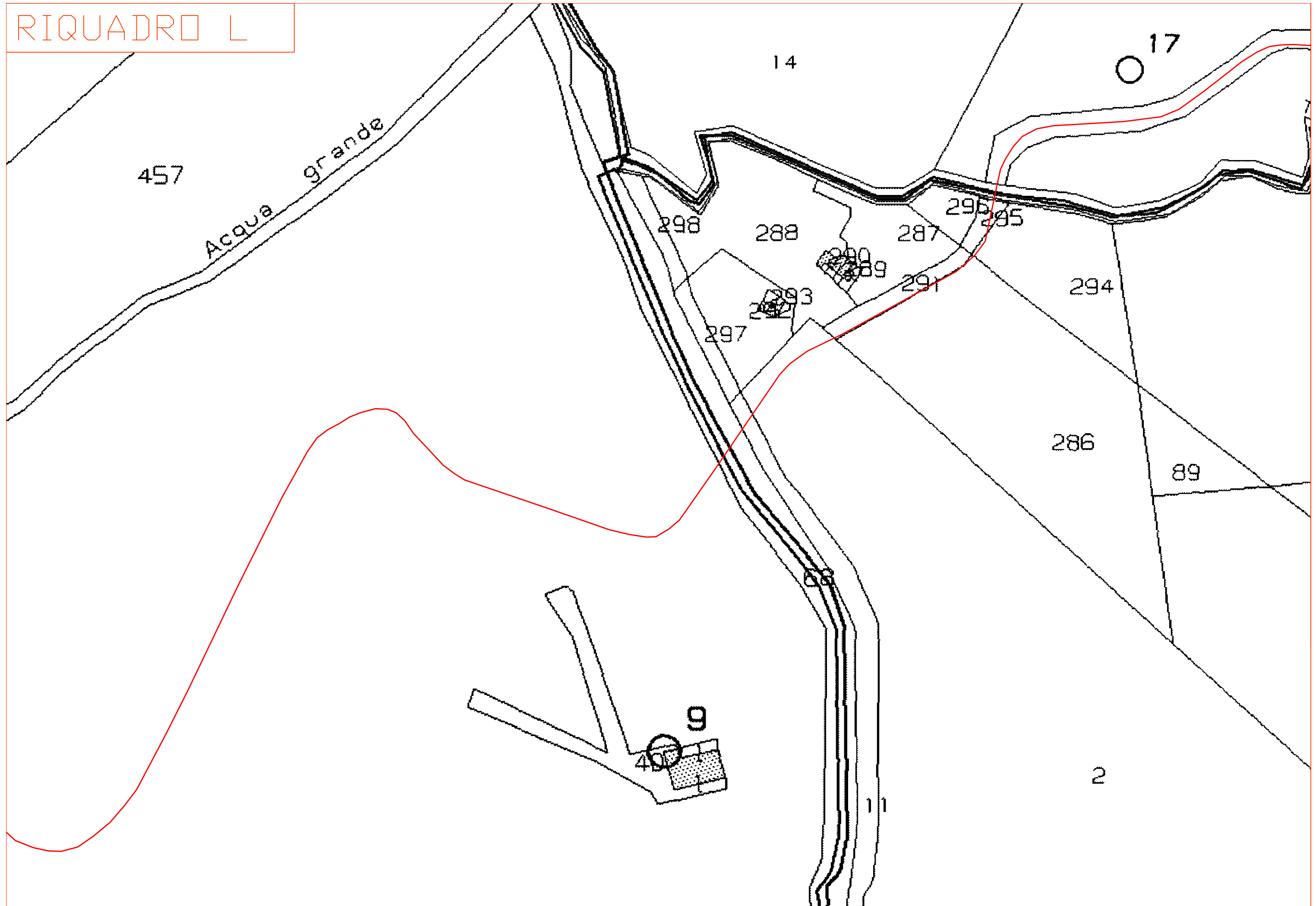

RIQUADRO M

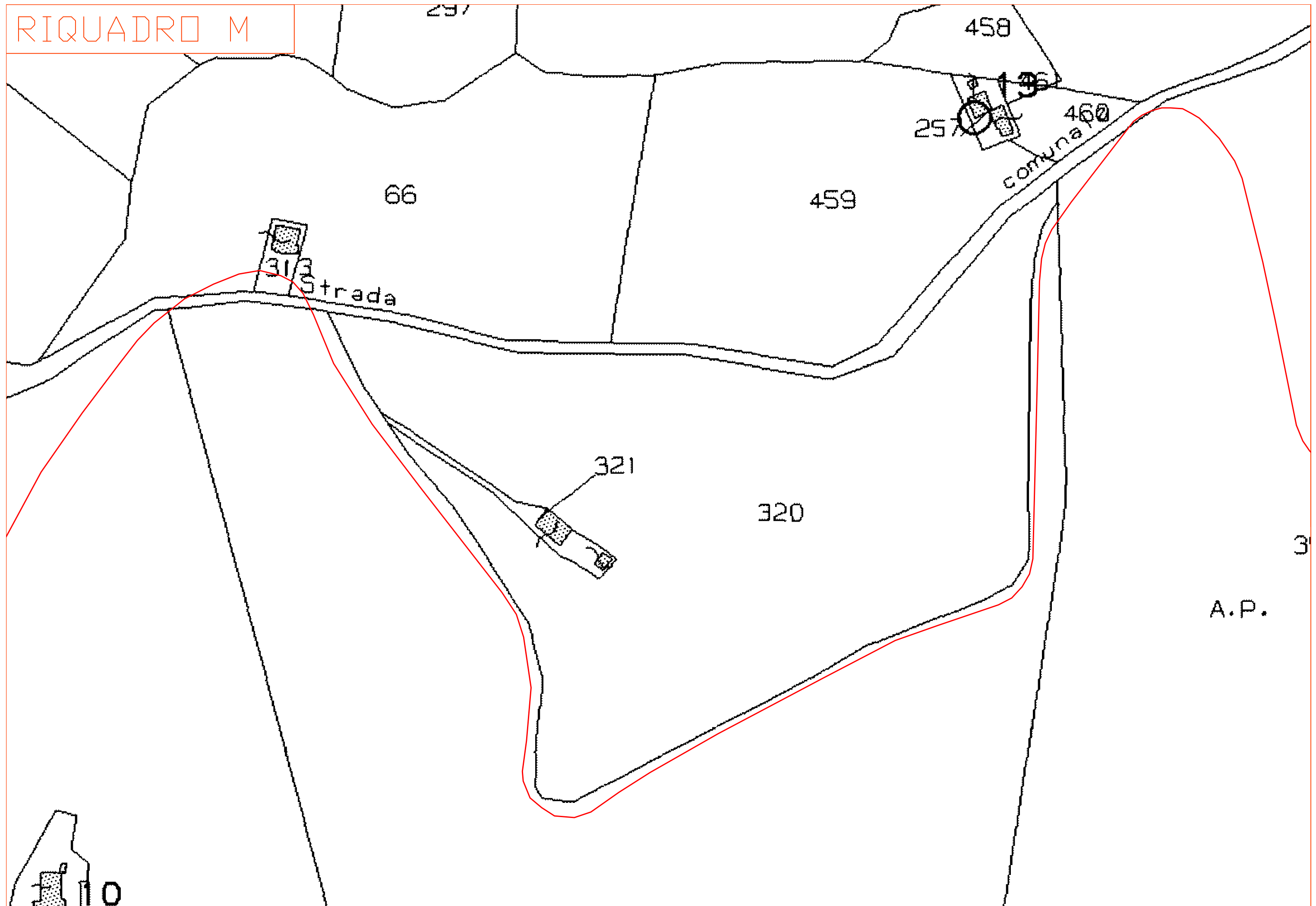

RIQUADRO

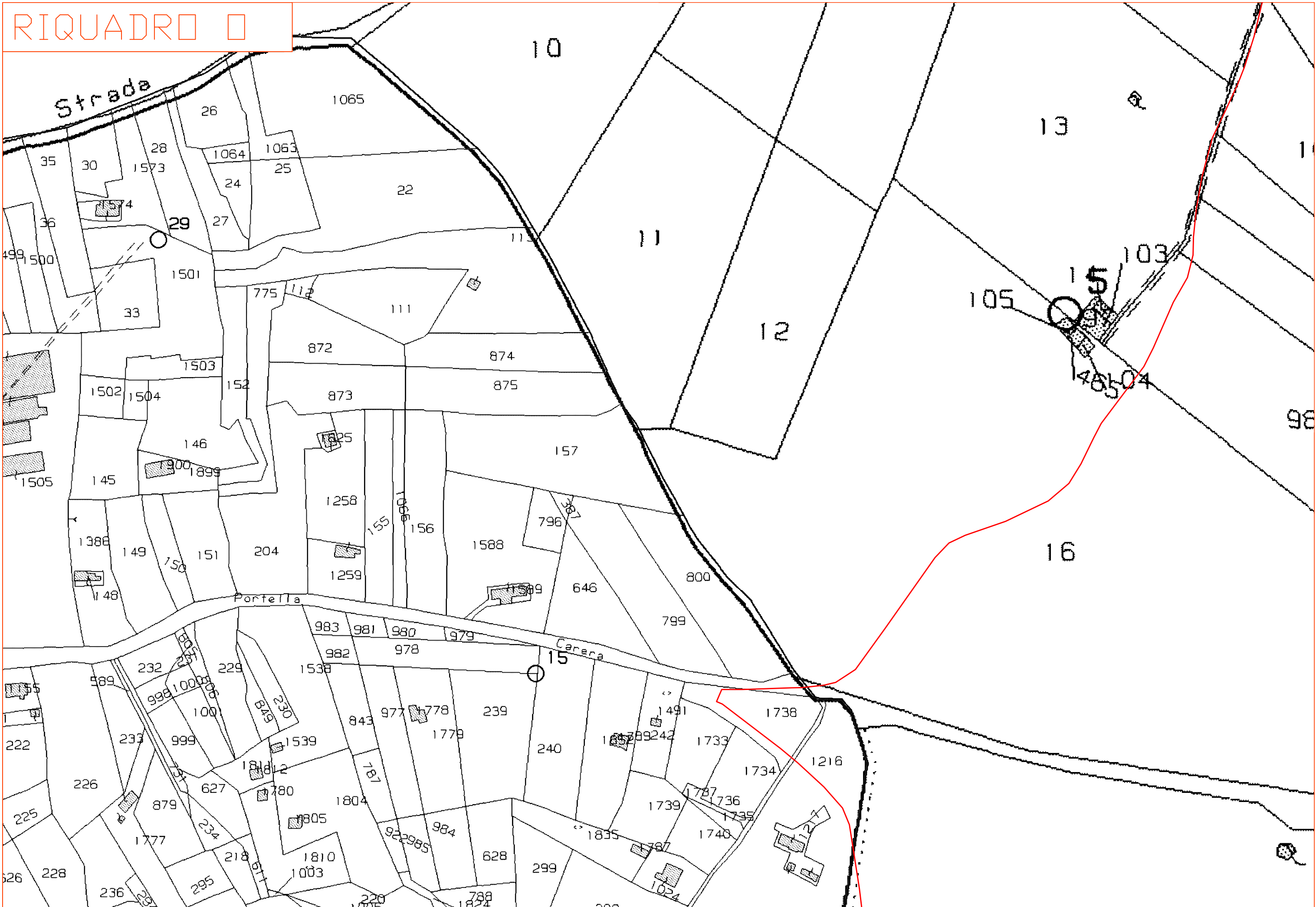

RIQUADRO P

