

ENERGY
ENVIRONMENT
ENGINEERING

3E Ingegneria SrL

CLIENTE - CUSTOMER

Tekno Sigma

TITOLO - TITLE

NUOVO ELETTRODOTTO 150 kV IN CAVO INTERRATO "SE MELFI 380-SE VALLE"

PARTICOLARI COSTRUTTIVI



02	Realizzazione in cavo interrato	Santoni	Saraceno	SET. 22	SIGLA - TAG
01	Revisione - Sostituita corda di guardia	Daidone	Saraceno	Ott. 20	045.20.01.R12
00	Prima emissione	Samaritani	Saraceno	LUG. 20	LINGUA-LANG. PAG. / TOT.
REV	DESCRIZIONE - DESCRIPTION	EMESSO-ISSUED	APPROV.	DATE	I 1 / 17



ENERGY
ENVIRONMENT
ENGINEERING

NUOVO ELETTRODOTTO 150 kV "SE MELFI 380-SE VALLE"
Particolari costruttivi

Tekno Sigma

OGGETTO / SUBJECT

045.20.01.R12

02

Set. 2022

2/17

TAG

REV

DATE

PAG / TOT

CLIENTE / CUSTOMER

SCHEMA TIPICO DEL CAVO INTERRATO

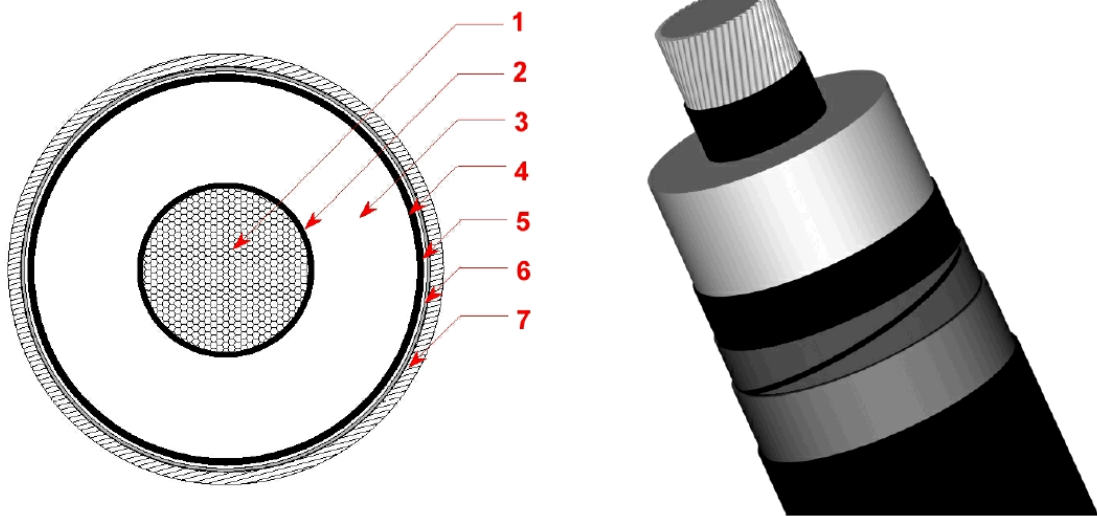

1	Conduttore compatto di Alluminio
2	Schermo del conduttore (Strato semiconduttivo interno)
3	Isolante
4	Schermo dell'isolante (Strato semiconduttivo esterno)
5	Barriera igroscopica
6	Schermo metallico
7	Guaina esterna termoplastica



ENERGY
ENVIRONMENT
ENGINEERING

NUOVO ELETTRODOTTO 150 KV "SE MELFI 380-SE VALLE"
Particolari costruttivi

Tekno Sigma

OGGETTO / SUBJECT

045.20.01.R12

02

Set. 2022

3/17

TAG

REV

DATE

PAG / TOT

CLIENTE / CUSTOMER

SISTEMI DI TELECOMUNICAZIONE

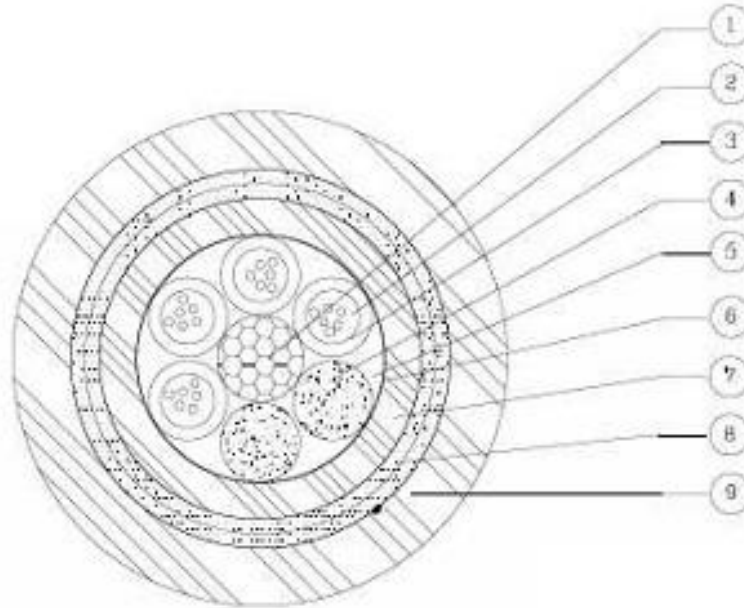

(24f illustrate)



ENERGY
ENVIRONMENT
ENGINEERING

NUOVO ELETTRODOTTO 150 KV "SE MELFI 380-SE VALLE"
Particolari costruttivi

Tekno Sigma

OGGETTO / SUBJECT

045.20.01.R12

02

Set. 2022

4/17

TAG

REV

DATE

PAG / TOT

CLIENTE / CUSTOMER

- 1- Elemento centrale di supporto dielettrico
- 2- Fibre ottiche
- 3- Tubetti loose tamponanti con jelly
- 4- Riempitivi
- 5- Tamponatura nucleo
- 6- Fasciatura con nastro sintetico
- 7- Guaina interna in PE
- 8- Filati aramidici
- 9- Guaina esterna in PE



ENERGY
ENVIRONMENT
ENGINEERING

NUOVO ELETTRODOTTO 150 kV "SE MELFI 380-SE VALLE"
Particolari costruttivi

Tekno Sigma

OGGETTO / SUBJECT

045.20.01.R12

02

Set. 2022

5/17

TAG

REV

DATE

PAG / TOT

CLIENTE / CUSTOMER



PRESCRIZIONI PER IL PROGETTO ELETTRICO
E LA PROGETTAZIONE DEL TRACCIATO DEI
COLLEGAMENTI IN CAVO

Codifica:

BOZZA - UX LK401

Rev. 00

Pag. 19 di 31

CAVO 150-220 kV a trifoglio

ALLEGATO "A1"

POSA IN TERRENO AGRICOLO

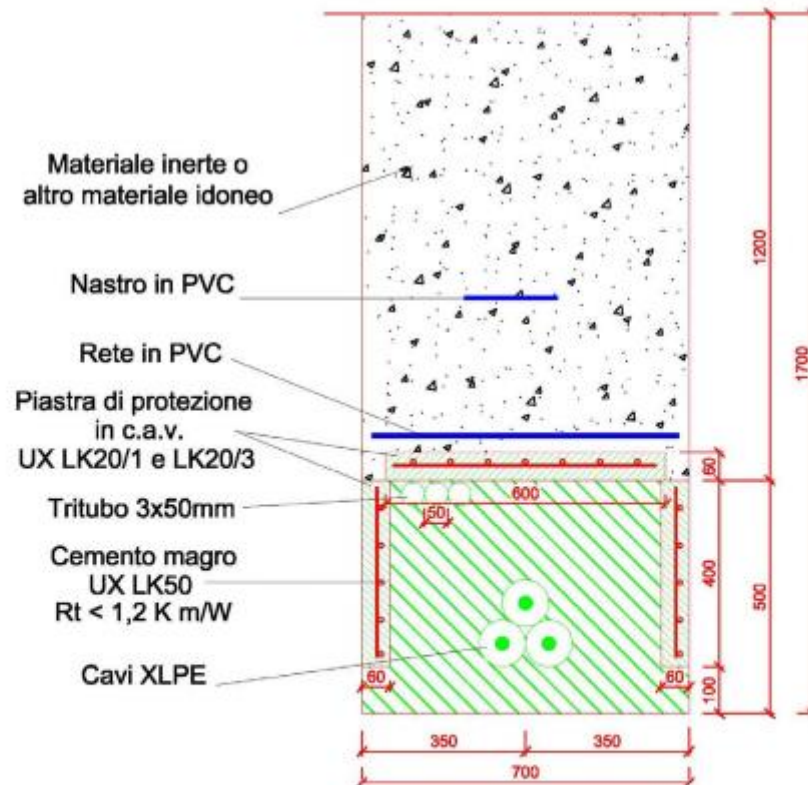



ENERGY
ENVIRONMENT
ENGINEERING

NUOVO ELETTRODOTTO 150 kV "SE MELFI 380-SE VALLE"
Particolari costruttivi

Tekno Sigma

OGGETTO / SUBJECT

045.20.01.R12

02

Set. 2022

6/17

TAG

REV

DATE

PAG / TOT

CLIENTE / CUSTOMER



PRESCRIZIONI PER IL PROGETTO ELETTRICO
E LA PROGETTAZIONE DEL TRACCIATO DEI
COLLEGAMENTI IN CAVO

Codifica:

BOZZA - UX LK401

Rev. 00

Pag. 20 di 31

CAVO 150-220 kV a trifoglio allargato

ALLEGATO "A2"

POSA IN TERRENO AGRICOLO

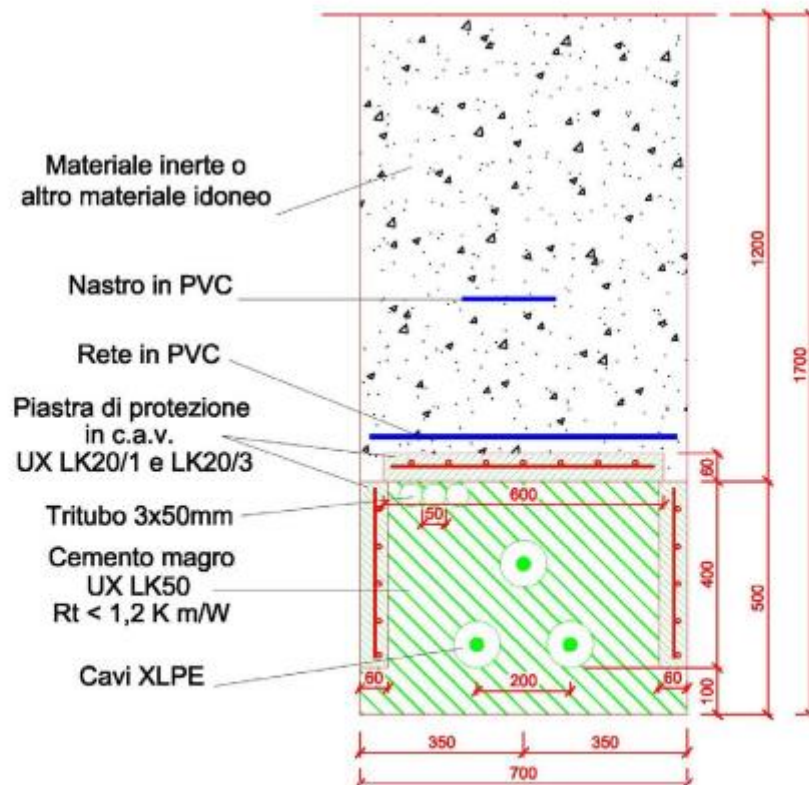



ENERGY
ENVIRONMENT
ENGINEERING

NUOVO ELETTRODOTTO 150 kV "SE MELFI 380-SE VALLE"
Particolari costruttivi

Tekno Sigma

OGGETTO / SUBJECT

045.20.01.R12

02

Set. 2022

7/17

TAG

REV

DATE

PAG / TOT

CLIENTE / CUSTOMER



PRESCRIZIONI PER IL PROGETTO ELETTRICO
E LA PROGETTAZIONE DEL TRACCIATO DEI
COLLEGAMENTI IN CAVO

Codifica:

BOZZA - UX LK401

Rev. 00

Pag. 21 di 31

CAVO 220-380 kV in piano

ALLEGATO "A3"

POSA IN TERRENO AGRICOLO

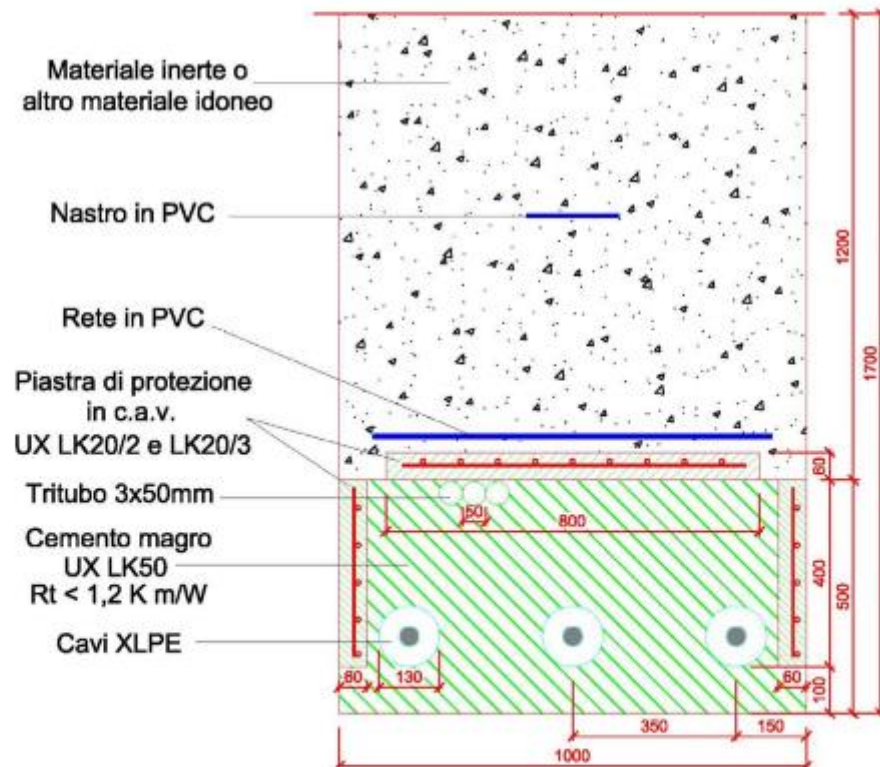



ENERGY
ENVIRONMENT
ENGINEERING

NUOVO ELETTRODOTTO 150 kV "SE MELFI 380-SE VALLE"
Particolari costruttivi

Tekno Sigma

OGGETTO / SUBJECT

045.20.01.R12

02

Set. 2022

8/17

TAG

REV

DATE

PAG / TOT

CLIENTE / CUSTOMER



PRESCRIZIONI PER IL PROGETTO ELETTRICO
E LA PROGETTAZIONE DEL TRACCIATO DEI
COLLEGAMENTI IN CAVO

Codifica:

BOZZA - UX LK401

Rev. 00

Pag. 22 di 31

CAVO 150-220 kV a trifoglio

ALLEGATO "B1"

POSA SU STRADE URBANE ED EXTRAURBANE

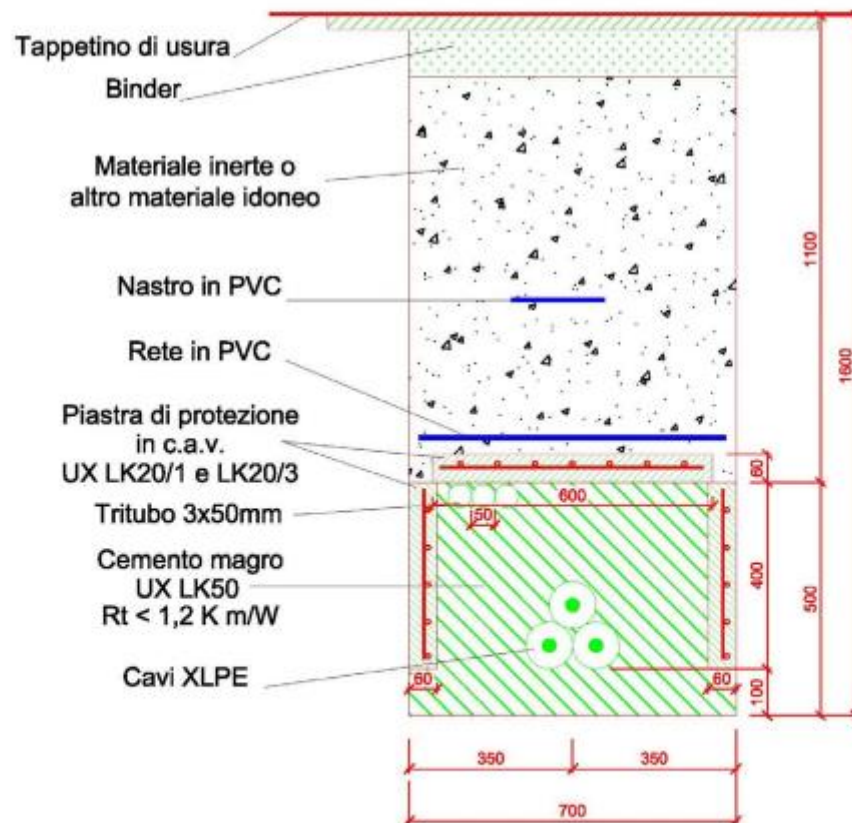



ENERGY
ENVIRONMENT
ENGINEERING

NUOVO ELETTRODOTTO 150 kV "SE MELFI 380-SE VALLE"
Particolari costruttivi

Tekno Sigma

OGGETTO / SUBJECT

045.20.01.R12

02

Set. 2022

9/17

TAG

REV

DATE

PAG / TOT

CLIENTE / CUSTOMER



PRESCRIZIONI PER IL PROGETTO ELETTRICO
E LA PROGETTAZIONE DEL TRACCIATO DEI
COLLEGAMENTI IN CAVO

Codifica:

BOZZA - UX LK401

Rev. 00

Pag. 23 di 31

CAVO 150-220 kV a trifoglio allargato

ALLEGATO "B2"

POSA SU STRADE URBANE ED EXTRAURBANE

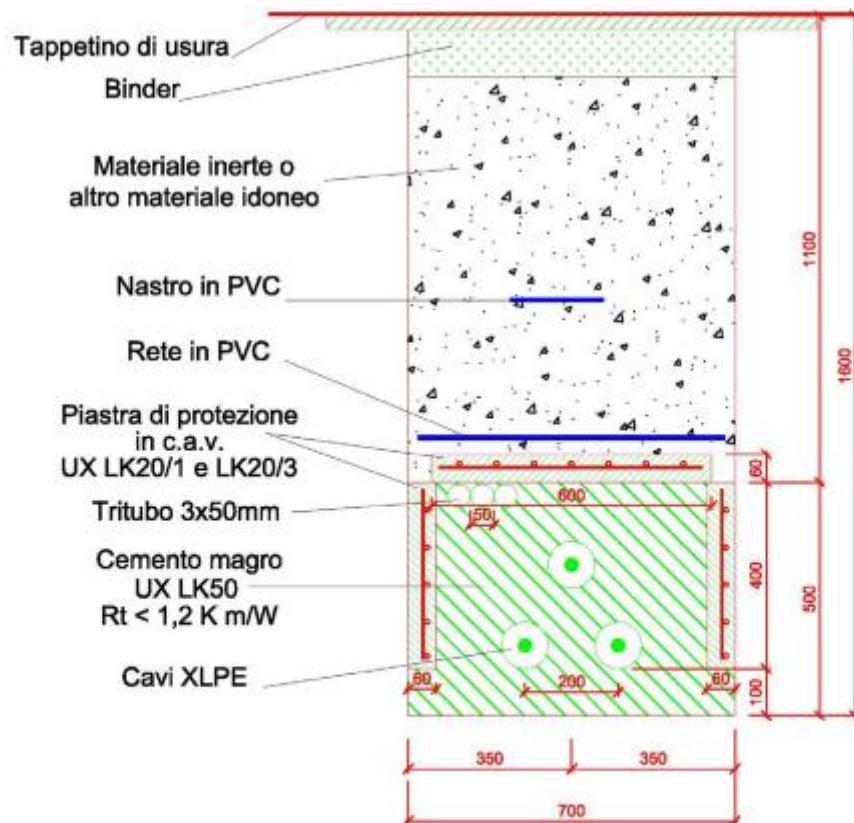



ENERGY
ENVIRONMENT
ENGINEERING

NUOVO ELETTRODOTTO 150 kV "SE MELFI 380-SE VALLE"
Particolari costruttivi

Tekno Sigma

OGGETTO / SUBJECT

045.20.01.R12

02

Set. 2022

10/17

TAG

REV

DATE

PAG / TOT

CLIENTE / CUSTOMER



PRESCRIZIONI PER IL PROGETTO ELETTRICO
E LA PROGETTAZIONE DEL TRACCIATO DEI
COLLEGAMENTI IN CAVO

Codifica:

BOZZA - UX LK401

Rev. 00

Pag. 24 di 31

CAVO 220-380 kV in piano

ALLEGATO "B3"

POSA SU STRADE URBANE ED EXTRAURBANE

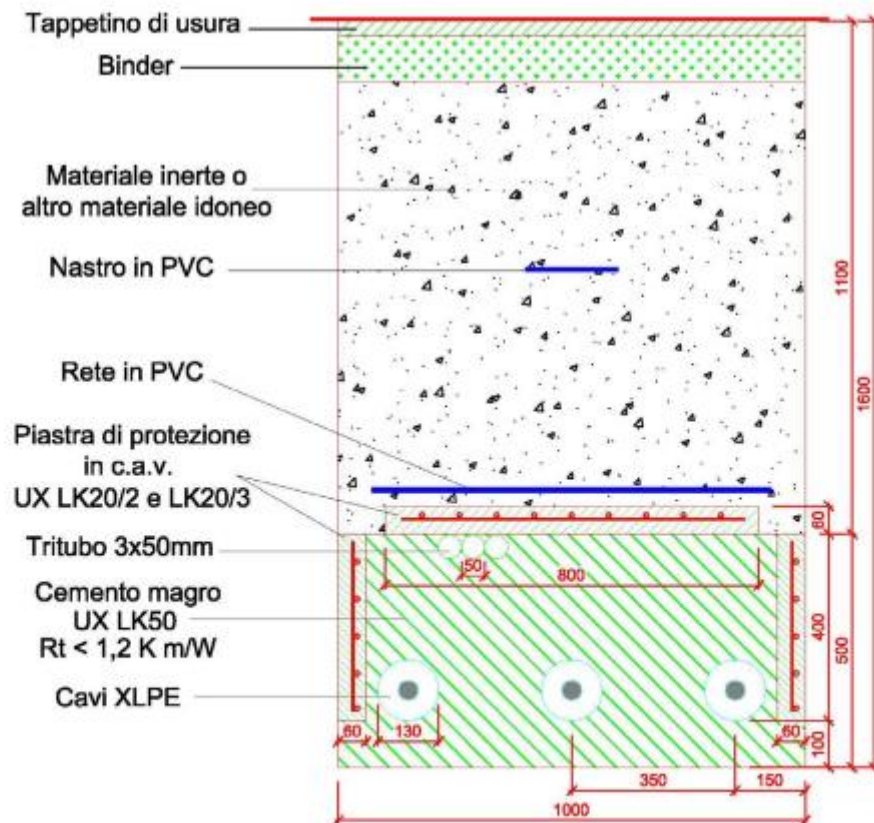



ENERGY
ENVIRONMENT
ENGINEERING

NUOVO ELETTRODOTTO 150 kV "SE MELFI 380-SE VALLE"
Particolari costruttivi

Tekno Sigma

OGGETTO / SUBJECT

045.20.01.R12

02

Set. 2022

11/17

TAG

REV

DATE

PAG / TOT

CLIENTE / CUSTOMER



PRESCRIZIONI PER IL PROGETTO ELETTRICO
E LA PROGETTAZIONE DEL TRACCIATO DEI
COLLEGAMENTI IN CAVO

Codifica:

BOZZA - UX LK401

Rev. 00

Pag. 25 di 31

CAVO 150-220 kV a trifoglio

ALLEGATO "C1"

POSA IN ATTRAVERSAMENTO STRADALE

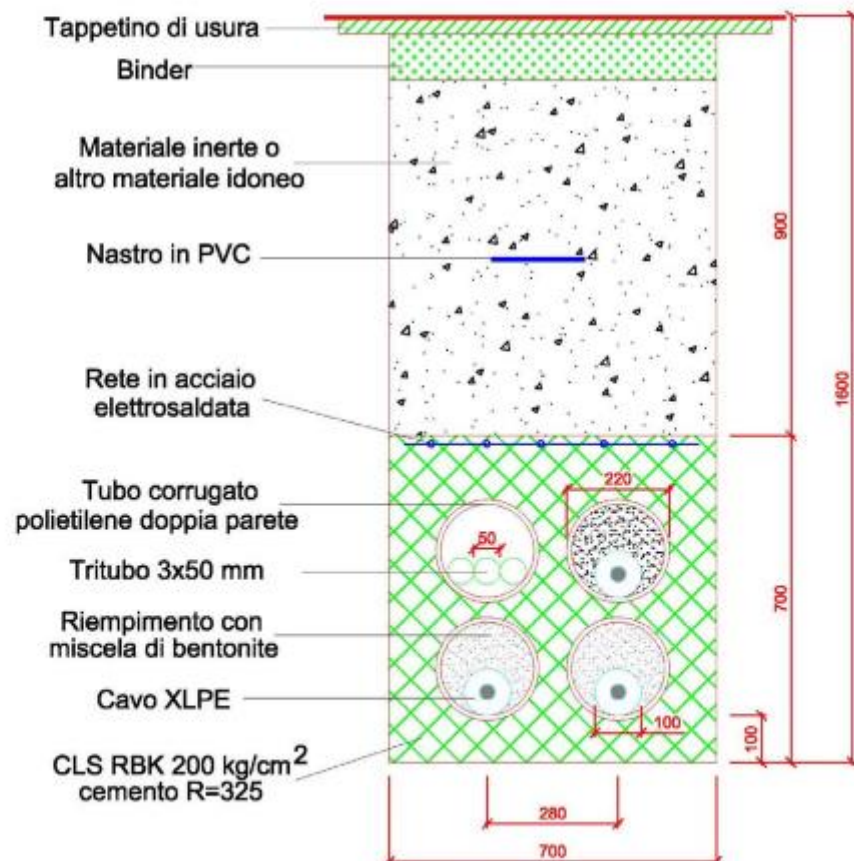



ENERGY
ENVIRONMENT
ENGINEERING

NUOVO ELETTRODOTTO 150 kV "SE MELFI 380-SE VALLE"
Particolari costruttivi

Tekno Sigma

OGGETTO / SUBJECT

045.20.01.R12

02

Set. 2022

12/17

TAG

REV

DATE

PAG / TOT

CLIENTE / CUSTOMER



PRESCRIZIONI PER IL PROGETTO ELETTRICO
E LA PROGETTAZIONE DEL TRACCIATO DEI
COLLEGAMENTI IN CAVO

Codifica:

BOZZA - UX LK401

Rev. 00

Pag. 26 di 31

CAVO 220-380 kV in piano

ALLEGATO "C2"

POSA IN ATTRAVERSAMENTO STRADALE

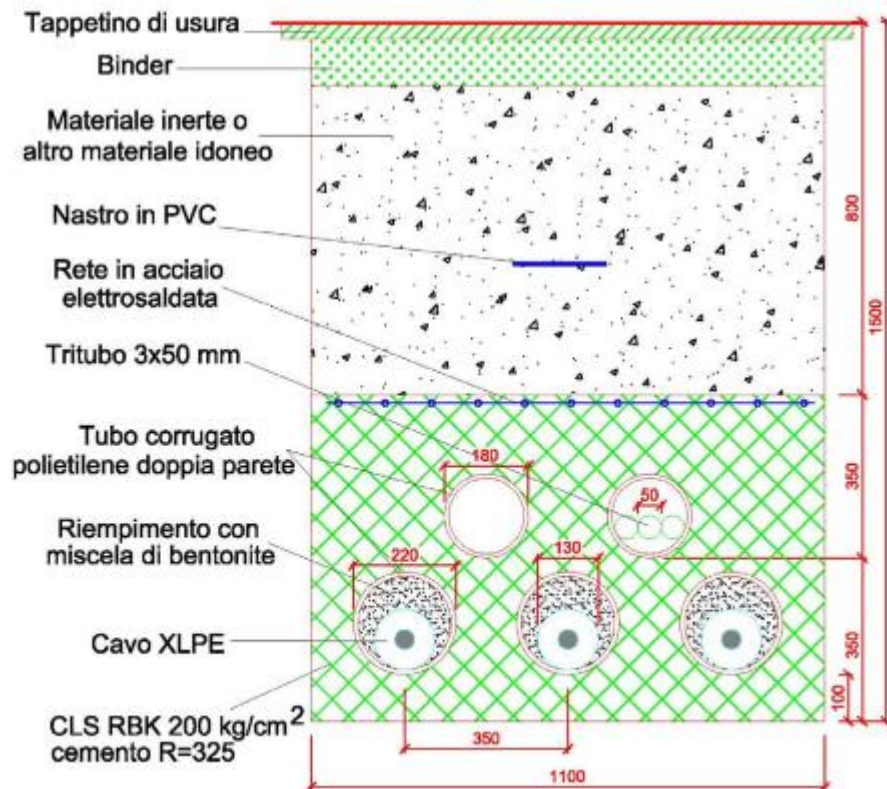



ENERGY
ENVIRONMENT
ENGINEERING

NUOVO ELETTRODOTTO 150 kV "SE MELFI 380-SE VALLE"
Particolari costruttivi

Tekno Sigma

OGGETTO / SUBJECT

045.20.01.R12

02

Set. 2022

13/17

TAG

REV

DATE

PAG / TOT

CLIENTE / CUSTOMER



PRESCRIZIONI PER IL PROGETTO ELETTRICO
E LA PROGETTAZIONE DEL TRACCIATO DEI
COLLEGAMENTI IN CAVO

Codifica:

BOZZA - UX LK401

Rev. 00

Pag. 27 di 31

CAVO 150-220 kV a trifoglio

ALLEGATO "D1"

POSA IN CUNICOLO IN C.A.V.

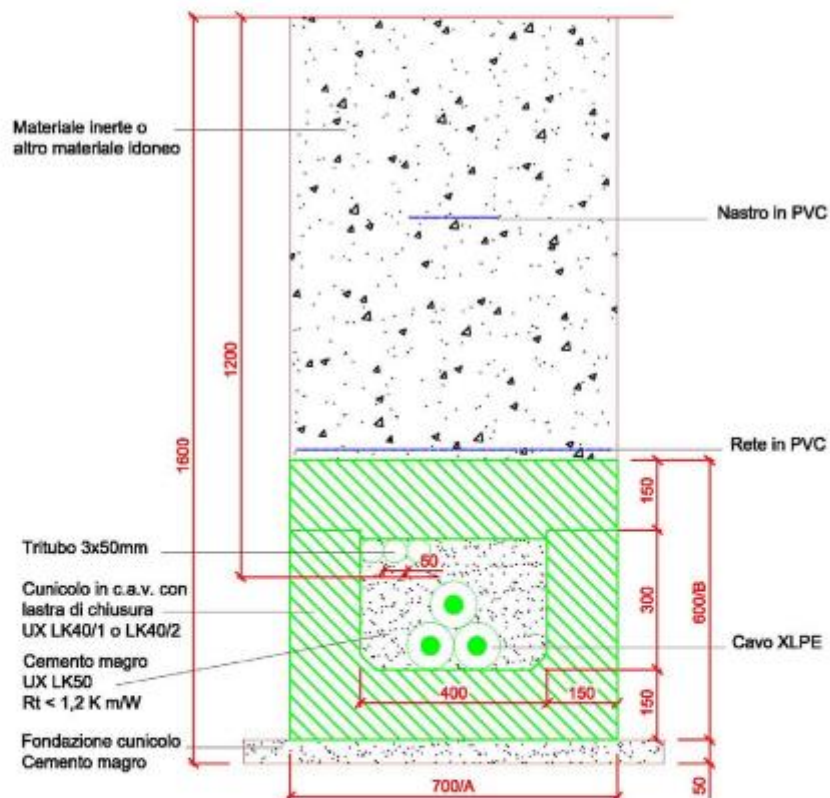

CODIFICA	MATRICOLA SAP	LIVELLO DI TENSIONE	DESCRIZIONE	INTERASSE TRA LE FASI	DIMENSIONI			LUNGHEZZA MASSIMA
					A	B	INTERNE	
UX LK40/1	150-220kV	POSA A TRIFOGLIO	-	70	60	40X30	200
UX LK40/2	220-380kV	POSA A TRIFOGLIO ALLARGATO	20	80	70	50X40	200



ENERGY
ENVIRONMENT
ENGINEERING

NUOVO ELETTRODOTTO 150 kV "SE MELFI 380-SE VALLE"
Particolari costruttivi

Tekno Sigma

OGGETTO / SUBJECT

045.20.01.R12

02

Set. 2022

15/17

TAG

REV

DATE

PAG / TOT

CLIENTE / CUSTOMER



LINEE A 132-150 kV
TERMINALE PER ESTERNO
PER CAVI
IN ISOLAMENTO ESTRUSO

Disegno fuori scala

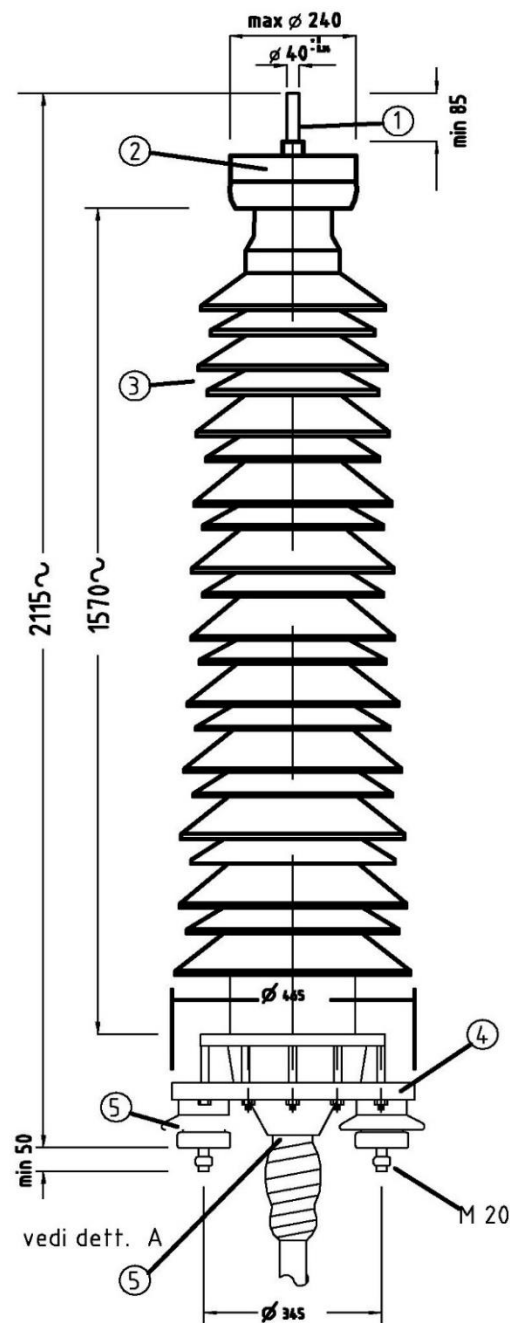

- 1 = Codolo in rame
- 2 = Schermo
- 3 = Isolatore
- 4 = Flangia in acciaio
- 5 = Collegamenti in rame
- 6 = Isolatori di supporto di base in porcellana

TIPO	A (max)	B (min)
j246/1	1685	1300
j246/2	1950	



ENERGY
ENVIRONMENT
ENGINEERING

NUOVO ELETTRODOTTO 150 KV "SE MELFI 380-SE VALLE"
Particolari costruttivi

Tekno Sigma

OGGETTO / SUBJECT

045.20.01.R12

02

Set. 2022

16/17

TAG

REV

DATE

PAG / TOT

CLIENTE / CUSTOMER

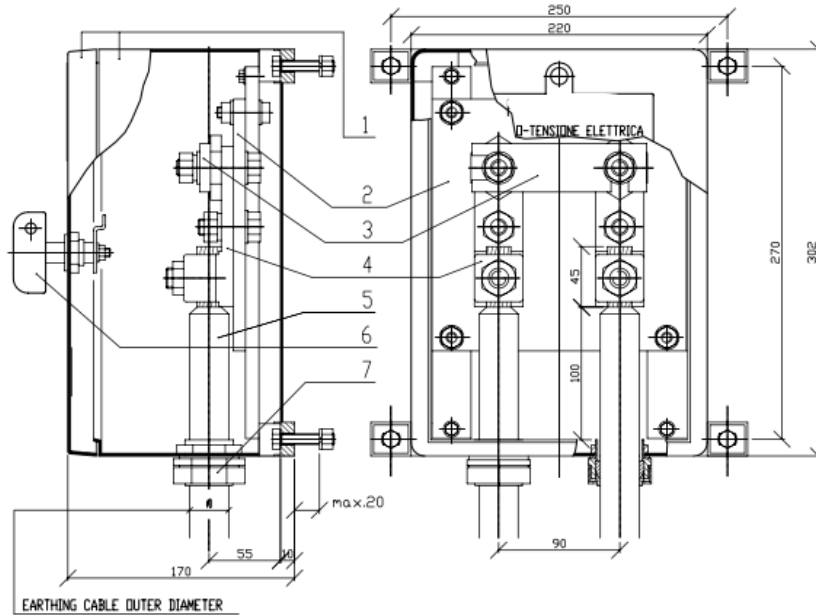

EARTHING CABLE OUTER DIAMETER

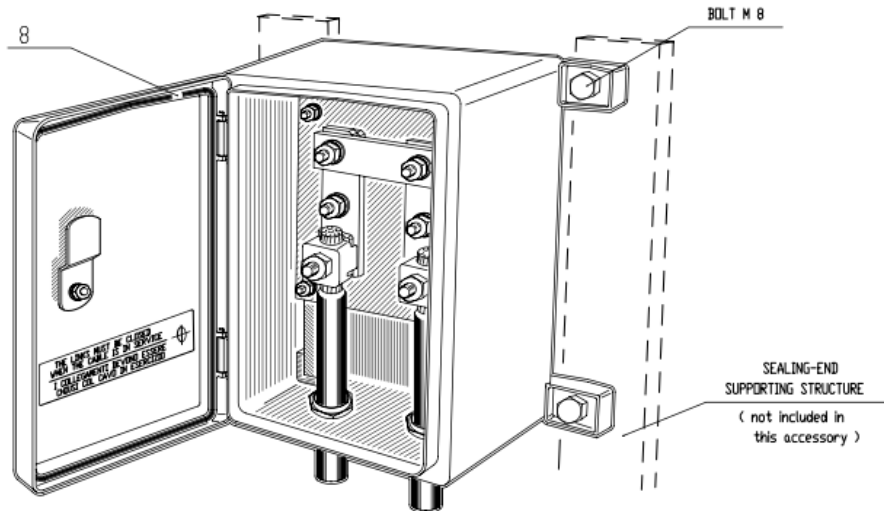

SEALING-END
SUPPORTING STRUCTURE
(not included in
this accessory)

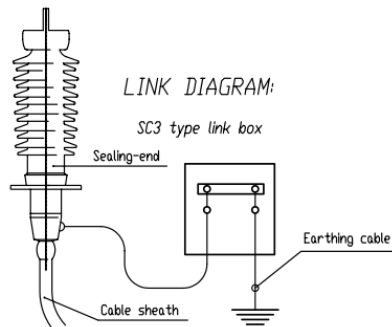

LINK DIAGRAM:

SC3 type link box

Sealing-end

Earthing cable

Cable sheath

- 1 - CASE (Polyester)
- 2 - INSULATING PLATE (Glass fibre)
- 3 - MOVABLE CONNECTION (Copper)
- 4 - EARTHING-CABLE END-CONNECTOR (Bronze)
- 5 - SINGLE-CORE EARTHING -CABLE
- 6 - KEY
- 7 - COMPRESSION-TYPE GLAND (Brass)
- 8 - GASKET (Rubber)

NOTES

- Link box approx. mass: 6 Kg
- Colour: Beige RAL 7032



ENERGY
ENVIRONMENT
ENGINEERING

NUOVO ELETTRODOTTO 150 KV "SE MELFI 380-SE VALLE"
Particolari costruttivi

Tekno Sigma

OGGETTO / SUBJECT

045.20.01.R12

02

Set. 2022

17/17

TAG

REV

DATE

PAG / TOT

CLIENTE / CUSTOMER

