

COMMITTENTE:



ALTA Sorveglianza:



GENERAL CONTRACTOR:



**INFRASTRUTTURE FERROVIARIE STRATEGICHE DEFINITE DALLA
 LEGGE OBIETTIVO N.443/01
 TRATTA A.V./A.C. TERZO VALICO DEI GIOVI
 PROGETTO ESECUTIVO**

**Adeguamento S.P.4
 Impianti
 Schemi unifilari dei quadri elettrici**

DIRETTORE LAVORI

Consorzio
COCIV
 Ing. G. Guagnozzi

SCALA:

-

COMMESSA **IG51** LOTTO **01** FASE **E** ENTE **CV** TIPO DOC. **DX** OPERA/DISCIPLINA **NV0800** PROGR. **002** REV. **A**

PROGETTAZIONE

Rev.	Descrizione emissione	Redatto	Data	Verificato	Data	Progettista Integratore	Data	IL PROGETTISTA
A00	Prima emissione	ENERGY SYSTEMS <i>E. Pagani</i>	25/09/2012	Ing. D. Re <i>D. Re</i>	27/09/2012	E. Pagani <i>E. Pagani</i>	28/09/2012	Ing. I. BARILLI Dott. Ing. IVANO BARILLI ALBO DEGLI INGEGNERI Provincia C.C.N. 122

n. Elab.











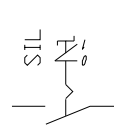
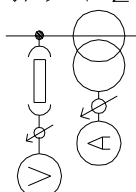
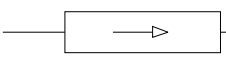
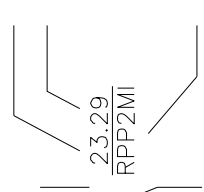
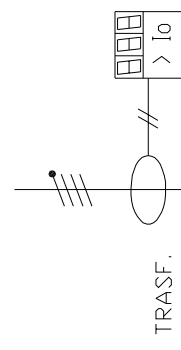

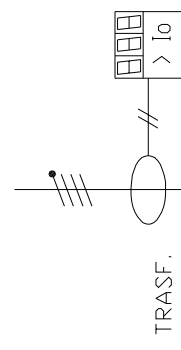
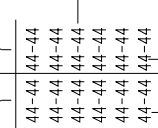

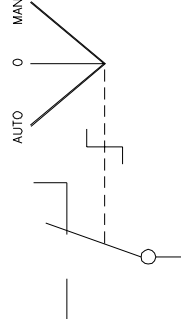

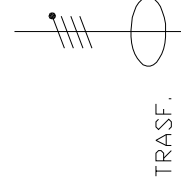
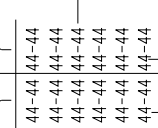
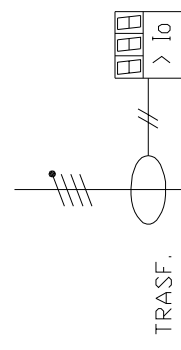

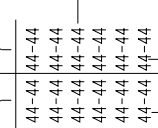



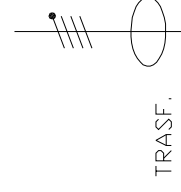
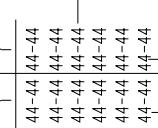
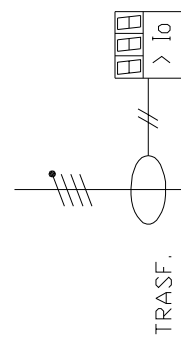

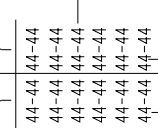



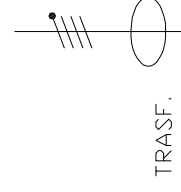
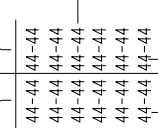
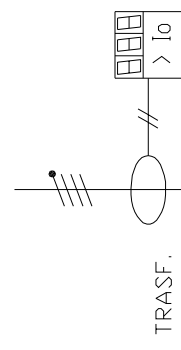

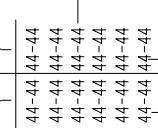



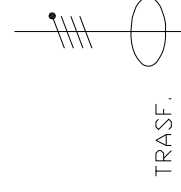
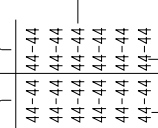
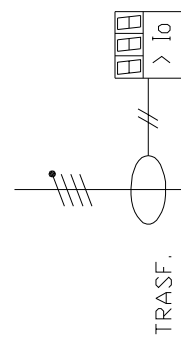

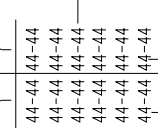



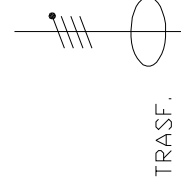
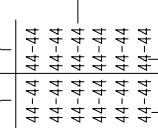
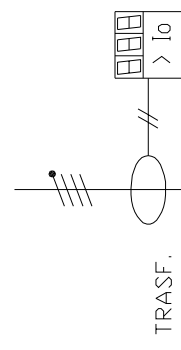

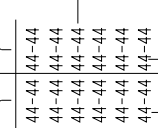



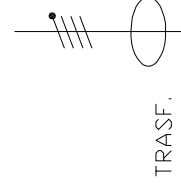
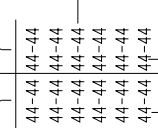
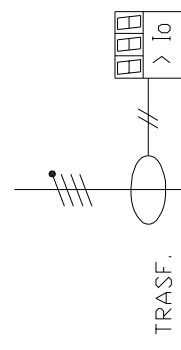

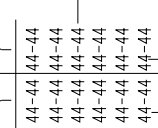



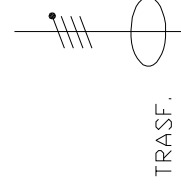
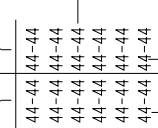
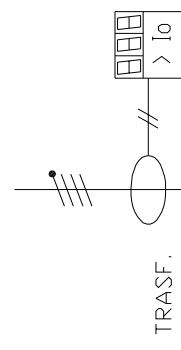

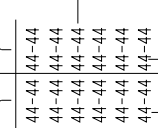



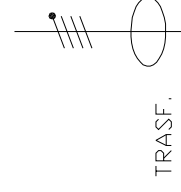
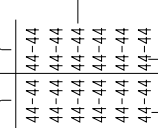
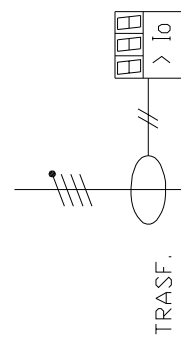

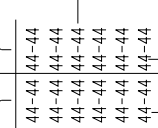
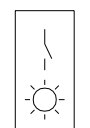

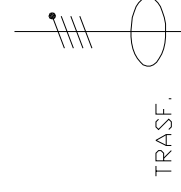
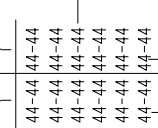
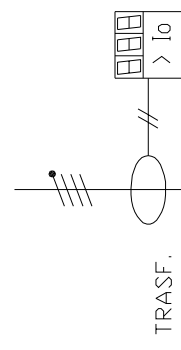

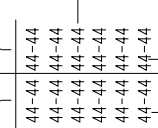
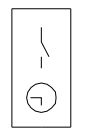

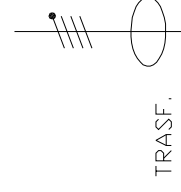
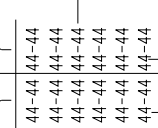
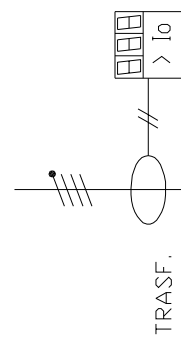

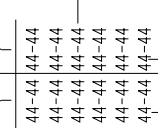
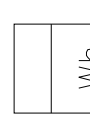

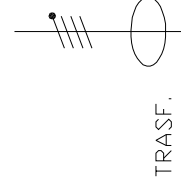
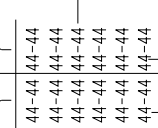
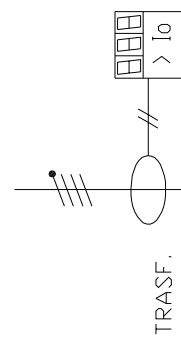
Nome File: IG51-01-E-CV-DX-NV08-00-002-A00
 CUP: F81H9200000008

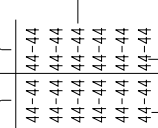
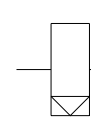
A

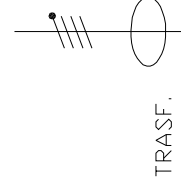
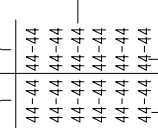
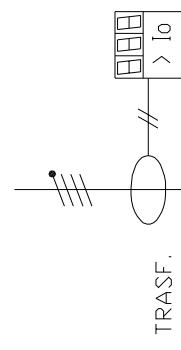
B

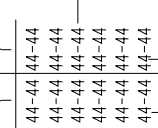
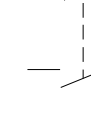
C

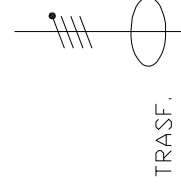
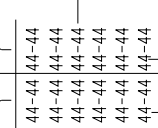
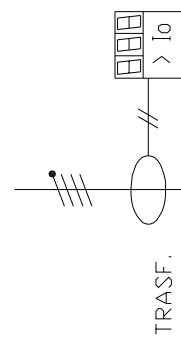
D

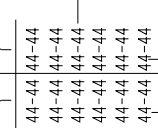
4	5	6	7	8	9	10	11	12	13	14	15	16	17	18	19		
<p>CONTATTO NORMALMENTE APERTO (CONTATTATORE)</p> 		<p>SELETTORE 2 POSIZIONI FISSE</p> 		<p>STRUMENTI DI MISURA: VOLTMETRO+COMMUTATORE VOLTMETRICO +FUSIBILI N°3 AMPEROMETRI N°3 TRASFORMATORI AMPEROMETRICI</p> 		<p>SCARICATORE</p> 		<p>NUMERO DELLA PAGINA PUNTO DI INSERZIONE NELLA PAGINA</p> 		<p>DISPOSITIVO DIFFERENZIALE A TOROIDE SEPARATO CON DISPLAY</p> 		<p>CONTATTO AUSILIARIO (NA) CONTATTO AUSILIARIO (NC)</p> 		<p>DISPOSITIVO DIFFERENZIALE A TOROIDE SEPARATO CON DISPLAY</p> 		<p>NUMERO DELLA PAGINA</p> 	
<p>CONTATTO NORMALMENTE CHIUSO (IN APERTURA)</p> 		<p>SELETTORE 3 POSIZIONI FISSE</p> 		<p>BOBINA</p> 		<p>TRASF. TOROIDALE</p> 		<p>NUMERO DELLA PAGINA</p> 		<p>DISPOSITIVO DIFFERENZIALE A TOROIDE SEPARATO CON DISPLAY</p> 		<p>CONTATTO AUSILIARIO (NA) CONTATTO AUSILIARIO (NC)</p> 		<p>NUMERO DELLA PAGINA</p> 			
<p>CONTATTO DI RELE' TEMPORIZZATO ALL' ECCITAZIONE</p> 		<p>BOBINA DI RELE' TEMPORIZZATO ALL' ECCITAZIONE</p> 		<p>INTERRUTTORE MAGNETOTERMICO</p> 		<p>TRASF. TOROIDALE</p> 		<p>NUMERO DELLA PAGINA</p> 		<p>DISPOSITIVO DIFFERENZIALE A TOROIDE SEPARATO CON DISPLAY</p> 		<p>CONTATTO AUSILIARIO (NA) CONTATTO AUSILIARIO (NC)</p> 		<p>NUMERO DELLA PAGINA</p> 			
<p>CONTATTO DI RELE' TEMPORIZZATO ALLA DISECCITAZIONE</p> 		<p>BOBINA DI RELE' TEMPORIZZATO ALLA DISECCITAZIONE</p> 		<p>INTERRUTTORE MAGNETOTERMICO DIFFERENZIALE</p> 		<p>TRASF. TOROIDALE</p> 		<p>NUMERO DELLA PAGINA</p> 		<p>DISPOSITIVO DIFFERENZIALE A TOROIDE SEPARATO CON DISPLAY</p> 		<p>CONTATTO AUSILIARIO (NA) CONTATTO AUSILIARIO (NC)</p> 		<p>NUMERO DELLA PAGINA</p> 			
<p>BOBINA DI RELE' TEMPORIZZATO ALL' ECCITAZ. ED ALLA DISECCITAZIONE</p> 		<p>SEZIONATORE SOTTO CARICO</p> 		<p>RELE' CRONOMETRICO PROGRAMMABILE</p> 		<p>TRASF. TOROIDALE</p> 		<p>NUMERO DELLA PAGINA</p> 		<p>DISPOSITIVO DIFFERENZIALE A TOROIDE SEPARATO CON DISPLAY</p> 		<p>CONTATTO AUSILIARIO (NA) CONTATTO AUSILIARIO (NC)</p> 		<p>NUMERO DELLA PAGINA</p> 			
<p>BOBINA DI RELE' TEMP. ALLA DISECCITAZIONE</p> 		<p>BOBINA DI APERTURA</p> 		<p>BOBINA DI RELE' TEMP. ALLA DISECCITAZIONE</p> 		<p>TRASF. TOROIDALE</p> 		<p>NUMERO DELLA PAGINA</p> 		<p>DISPOSITIVO DIFFERENZIALE A TOROIDE SEPARATO CON DISPLAY</p> 		<p>CONTATTO AUSILIARIO (NA) CONTATTO AUSILIARIO (NC)</p> 		<p>NUMERO DELLA PAGINA</p> 			
<p>BOBINA DI RELE' TEMP. ALLA DISECCITAZIONE</p> 		<p>TRASF. TOROIDALE</p> 		<p>RELE' CRONOMETRICO PROGRAMMABILE</p> 		<p>TRASF. TOROIDALE</p> 		<p>NUMERO DELLA PAGINA</p> 		<p>DISPOSITIVO DIFFERENZIALE A TOROIDE SEPARATO CON DISPLAY</p> 		<p>CONTATTO AUSILIARIO (NA) CONTATTO AUSILIARIO (NC)</p> 		<p>NUMERO DELLA PAGINA</p> 			
<p>SEZIONATORE SOTTO CARICO PORTAFUSIBILE</p> 		<p>BOBINA DI APERTURA</p> 		<p>RELE' CRONOMETRICO PROGRAMMABILE</p> 		<p>TRASF. TOROIDALE</p> 		<p>NUMERO DELLA PAGINA</p> 		<p>DISPOSITIVO DIFFERENZIALE A TOROIDE SEPARATO CON DISPLAY</p> 		<p>CONTATTO AUSILIARIO (NA) CONTATTO AUSILIARIO (NC)</p> 		<p>NUMERO DELLA PAGINA</p> 			
<p>LAMPADINA DI SEGNALE</p> 		<p>TRASF. TOROIDALE</p> 		<p>RELE' CRONOMETRICO PROGRAMMABILE</p> 		<p>TRASF. TOROIDALE</p> 		<p>NUMERO DELLA PAGINA</p> 		<p>DISPOSITIVO DIFFERENZIALE A TOROIDE SEPARATO CON DISPLAY</p> 		<p>CONTATTO AUSILIARIO (NA) CONTATTO AUSILIARIO (NC)</p> 		<p>NUMERO DELLA PAGINA</p> 			
<p>INTERRUTTORE CREPUSCOLARE</p> 		<p>TRASF. TOROIDALE</p> 		<p>RELE' CRONOMETRICO PROGRAMMABILE</p> 		<p>TRASF. TOROIDALE</p> 		<p>NUMERO DELLA PAGINA</p> 		<p>DISPOSITIVO DIFFERENZIALE A TOROIDE SEPARATO CON DISPLAY</p> 		<p>CONTATTO AUSILIARIO (NA) CONTATTO AUSILIARIO (NC)</p> 		<p>NUMERO DELLA PAGINA</p> 			
<p>OROLOGIO</p> 		<p>TRASF. TOROIDALE</p> 		<p>RELE' CRONOMETRICO PROGRAMMABILE</p> 		<p>TRASF. TOROIDALE</p> 		<p>NUMERO DELLA PAGINA</p> 		<p>DISPOSITIVO DIFFERENZIALE A TOROIDE SEPARATO CON DISPLAY</p> 		<p>CONTATTO AUSILIARIO (NA) CONTATTO AUSILIARIO (NC)</p> 		<p>NUMERO DELLA PAGINA</p> 			
<p>CONTATORE ENERGIA ATTIVA</p> 		<p>TRASF. TOROIDALE</p> 		<p>RELE' CRONOMETRICO PROGRAMMABILE</p> 		<p>TRASF. TOROIDALE</p> 		<p>NUMERO DELLA PAGINA</p> 		<p>DISPOSITIVO DIFFERENZIALE A TOROIDE SEPARATO CON DISPLAY</p> 		<p>CONTATTO AUSILIARIO (NA) CONTATTO AUSILIARIO (NC)</p> 		<p>NUMERO DELLA PAGINA</p> 			
<p>BOBINA DI RELE' PASSO-PASSO</p> 		<p>TRASF. TOROIDALE</p> 		<p>RELE' CRONOMETRICO PROGRAMMABILE</p> 		<p>TRASF. TOROIDALE</p> 		<p>NUMERO DELLA PAGINA</p> 		<p>DISPOSITIVO DIFFERENZIALE A TOROIDE SEPARATO CON DISPLAY</p> 		<p>CONTATTO AUSILIARIO (NA) CONTATTO AUSILIARIO (NC)</p> 		<p>NUMERO DELLA PAGINA</p> 			
<p>CONTATTO DI RELE' TEMPORIZZATO ALL' ECCITAZIONE</p> 		<p>TRASF. TOROIDALE</p> 		<p>RELE' CRONOMETRICO PROGRAMMABILE</p> 		<p>TRASF. TOROIDALE</p> 		<p>NUMERO DELLA PAGINA</p> 		<p>DISPOSITIVO DIFFERENZIALE A TOROIDE SEPARATO CON DISPLAY</p> 		<p>CONTATTO AUSILIARIO (NA) CONTATTO AUSILIARIO (NC)</p> 		<p>NUMERO DELLA PAGINA</p> 			

<p>Disegn.: _____</p>		<p>Committente _____</p>		<p>Titolo: COCIV - NV08</p>	
<p>Contr.: _____</p>		<p>Progetto PROGETTO ESECUTIVO</p>		<p>Foglio: 3</p>	
<p>Visto: _____</p>		<p>Descrizione _____</p>		<p>Tot. fogli: 4</p>	
Nr.	Data	Descrizione			

QUADRO ILLUMINAZIONE Q01

TARGA DA APPLICARE AL
QUADRO

IN MODO INAMOVIBILE CON SCRITTE
INDELEBILI

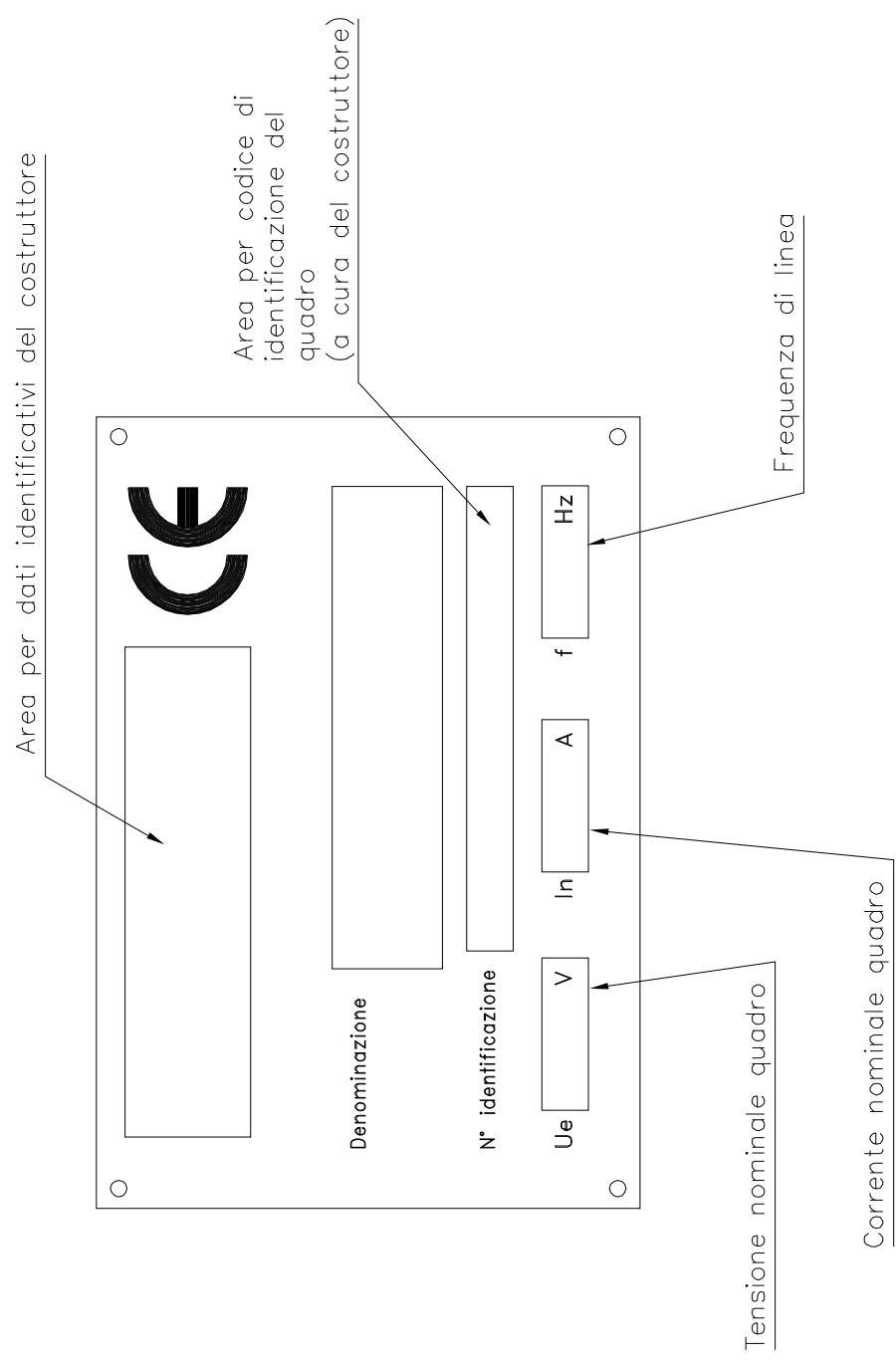

Y	Committente		Titolo:		COCIV - NV08	
	Progetto		Descrizione		TARGHETTA QUADRO	
Z	Disegn.:		Foglio:		Segue: 5	
	Contr.:		Foglio: 4		Tot. fogli:	
	Visto:					
X	Nr.	Data	Descrizione			

Non e' permesso consegnare a terzi o riprodurre questo documento, ne utilizzarne il contenuto o renderlo comunque a terzi senza esplicita autorizzazione di SINA SPA. Ogni infrazione comporta il risarcimento dei danni subiti. E' fatta riserva di tutti i diritti derivanti da brevetti o modelli.

Copying of this document and giving it to others and the use or communication of the contents thereof are forbidden without express authority of SINA SPA. Offenders are liable to the payment of damages.

All rights are reserved in the event of the grant of a patent or the registration of a utility model or design.

ARRIVO LINEA DA ENTE DISTRIBUTORE

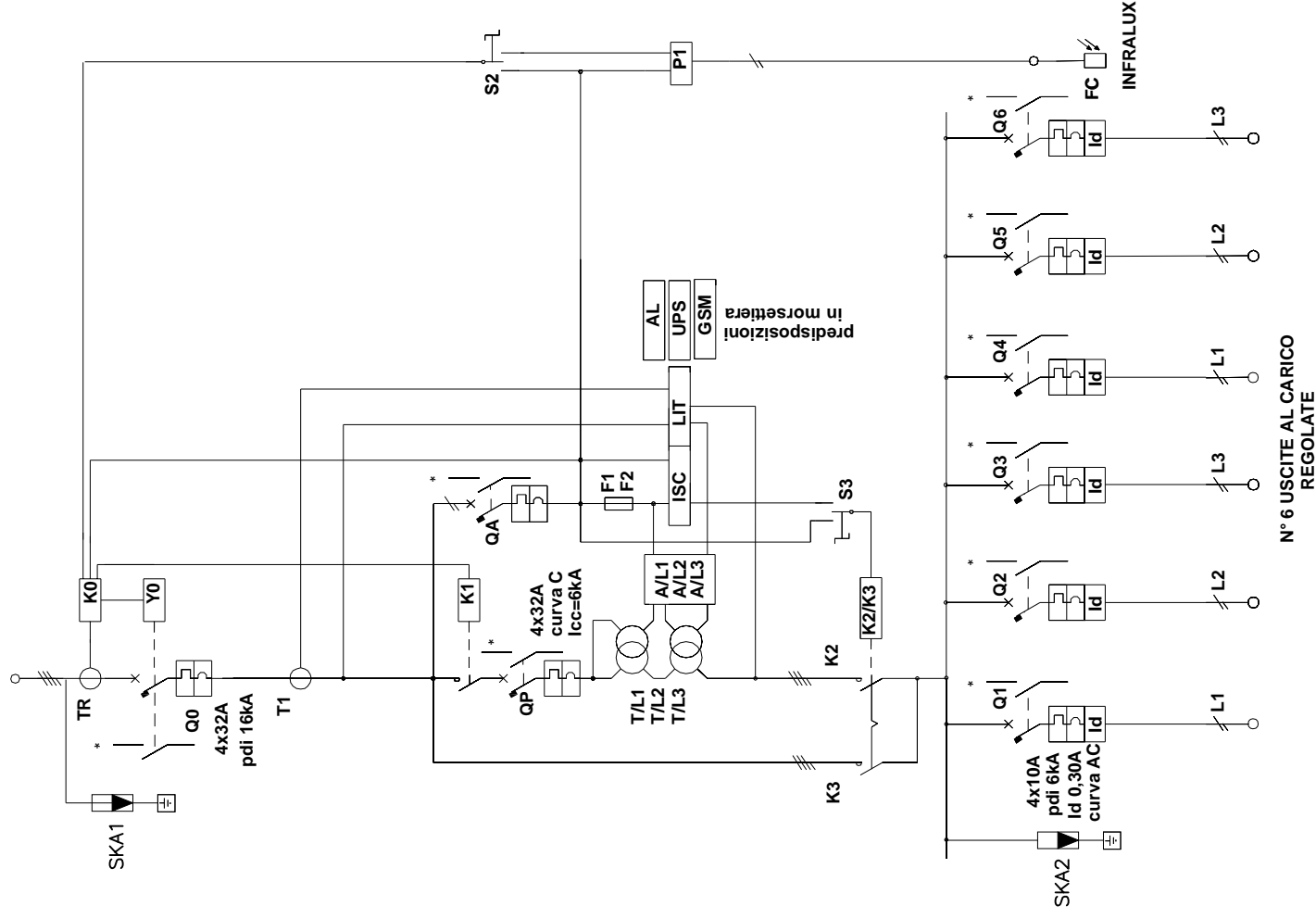

LEGENDA	
SIGLA	DESCRIZIONE
Q0	Interruttore generale - 4x32A / curva C / Icc=16kA
T1...T3	Trasformatori amperometrici
T/L1...T/L3	Unità di regolazione da 3x3kVA / 3x16A
A/L1...A/L3	Schede relè di regolazione
LIT	Modulo a microprocessore
ISC	Alimentatore con led di segnalazione 220/24V
F1 - F2	Fusibili protezione ausiliari
QA	Interruttore ausiliari - 2x6A / curva C / Icc=6kA
TR	Toroide differenziale
K0	Differenziale a riarmo automatico con Id regolabile
K1	Contattore di linea
Y0	Bobina di sgancio
S2	Selettore accensione impianto man./aut.
P1	Interruttore crepuscolare
FC	Foresistenza crepuscolare ad infrarossi Infralux
Q1 - Q6	Interruttori protezione linee uscita al carico
K2 - K3	Contattori di By Pass generale 2x40A
S3	Selettore inserzione By Pass generale a contattori man./aut.
QP	Interruttore automatico protezione unità 4x32A / C / Icc=6kA
SKA1-SKA2	Scaricatori di sovratensione

* contatti di stato a morsetteria per futuro telecontrollo

NOTA
IL REGOLATORE DI FLUSSO SARA' DOTATO DI INTERFACCIA RS 232 PER CONNESSIONE A MODEM E PC (PER TELECONTROLLO E TELEGESTIONE)



Committente
PROGETTO ESECUTIVO

Disegn.:
 Contr.:
 Visto:

Nr.	Data	Descrizione

Titolo:
COCIV - NV08
 Descrizione:
SCHEMA REGOLATORE

Foglio: **5**
 Segue: **6**
 Tot. fogli:

Non e' permesso consegnare a terzi o riprodurre questo documento, ne' utilizzarne il contenuto o fare fotocopia senza autorizzazione di SINA SPA. Ogni infrazione comporta l'adozione di tutte le azioni legali. E' fatta riserva di tutti i diritti derivanti da brevetti o modelli. All rights are reserved in the event of the grant of a patent or the registration of the contents thereof or design. rendering communique to third parties or reproducing this document, or using its content or making copies without the express authorization of SINA SPA. Any infringement will be liable to the payment of damages. The copyright owner reserves all rights deriving from patents or models.

RIF. CIRCUITO _____ E9B

DENOMINAZIONE QUADRO
QUADRO ILLUMINAZIONE Q01
OPERA NV08

ALIMENTAZIONE DA _____ E9A

ENTE DISTRIBUTORE _____ E8

CARATT. ELETTRICHE GENERALI

TENSIONE DI ESERCIZIO 400V

TENSIONI AUSILIARIE 110 Vc.a.

TENUTA AL COPPIO CIRCUITO DELLE BARRE 16 KA

TIPO DI SEGREGAZIONE FORMA 2

MISURE DI PROTEZIONE DELLE PERSONE(7.4) CEI 17-13

GRADO DI PROTEZIONE DEL QUADRO IP 55

SISTEMA DI TERRA TT

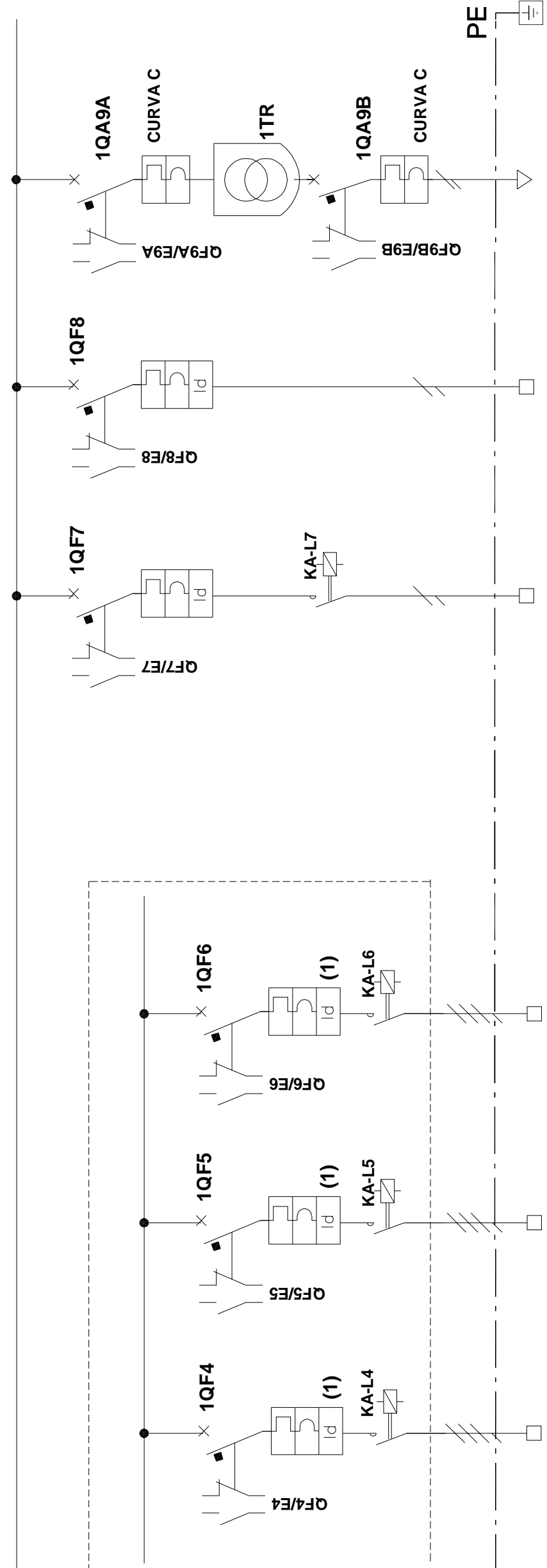

NUM. INVOLUCRO	A	A	A	A	A	A	A	A
NUMERAZ. MORSETTIERA	E-4	E-5	E-6	E-7	E-8	E-9		
POTENZA kW/KVA/KVAR	0,54 kW	0,54 kW	0,54 kW	0,3 kW	0,1 kW	300 VA		
Corrente d'impiego Ib (A)	0,9	0,9	0,9	1,50	0,5	1,5		
INTERRUTTI. o SEZIONATI.	MODULARE	MODULARE	MODULARE	MODULARE	MODULARE	MODULARE		
CONTATTATORE	4x10	4x10	4x10	2x6	2x6	2x16		
R. TERMICO (o CURVA)	AC7a	AC7a	AC7a	AC7a				
DIFFERENZ.	20	20	16	16				
LINEA di POTENZA	C	C	C	C	C	C		
DESTINAZIONE / UTENZA	10	10	10	6	6	16		
	AC 0,3	AC 0,3	AC 0,3	AC 0,03	AC 0,03			
	3(1x6)+6N	3(1x6)+6N	3(1x6)+6N	3G1,5	3G1,5	3G1,5		
	FG7R	FG7R	FG7R	FG7OR	FG7OR	FG7OR		
	170 61	195 61	220 61	1 15	1 15	1 15		
	31	31	31	26	26	26		
	ciruito 4; PALI 13-16-19	ciruito 5; PALI 14-17-20	ciruito 6; PALI 15-18-21					
				ALIMENTAZIONE SCALDAGLIA	INTERRUTTORE CREPUSCOLARE	ALIMENTAZIONE TRASF. AUX.		

Disegni: _____

Contr.: _____

Visto: _____

Committente _____

Progetto **PROGETTO ESECUTIVO**

SINA
 STUDIO E PROGETTI - MILANO

Titolo: **COCIV - NV08**

Descrizione: **SCHEMA UNIFILARE DI POTENZA**

Foglio: **7**

Segue: **8**

Tot. fogli: **8**

Non e' permesso consegnare a terzi o riprodurre questo documento, ne utilizzarne il contenuto o renderlo comunemente a terzi senza esplicita autorizzazione di SINA SPA. Ogni infrazione comporta il risarcimento dei danni subiti. E' fatta riserva di tutti i diritti derivanti da brevetti o modelli.

Copying of this document and giving it to others and the use or communication of the contents thereof are forbidden without express authority of SINA SPA. Offenders are liable to the payment of damages.

All rights are reserved in the event of the grant of a patent or the registration of a utility model or design.

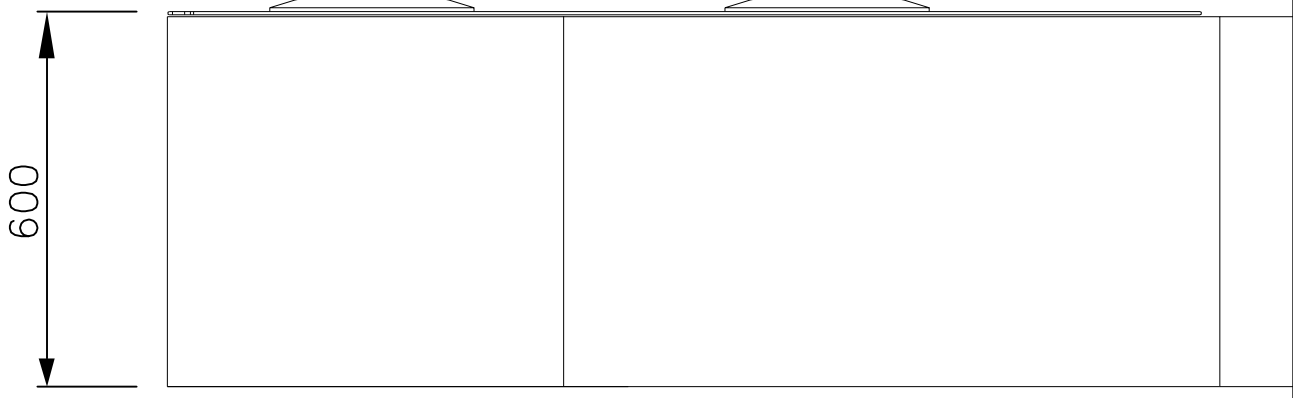
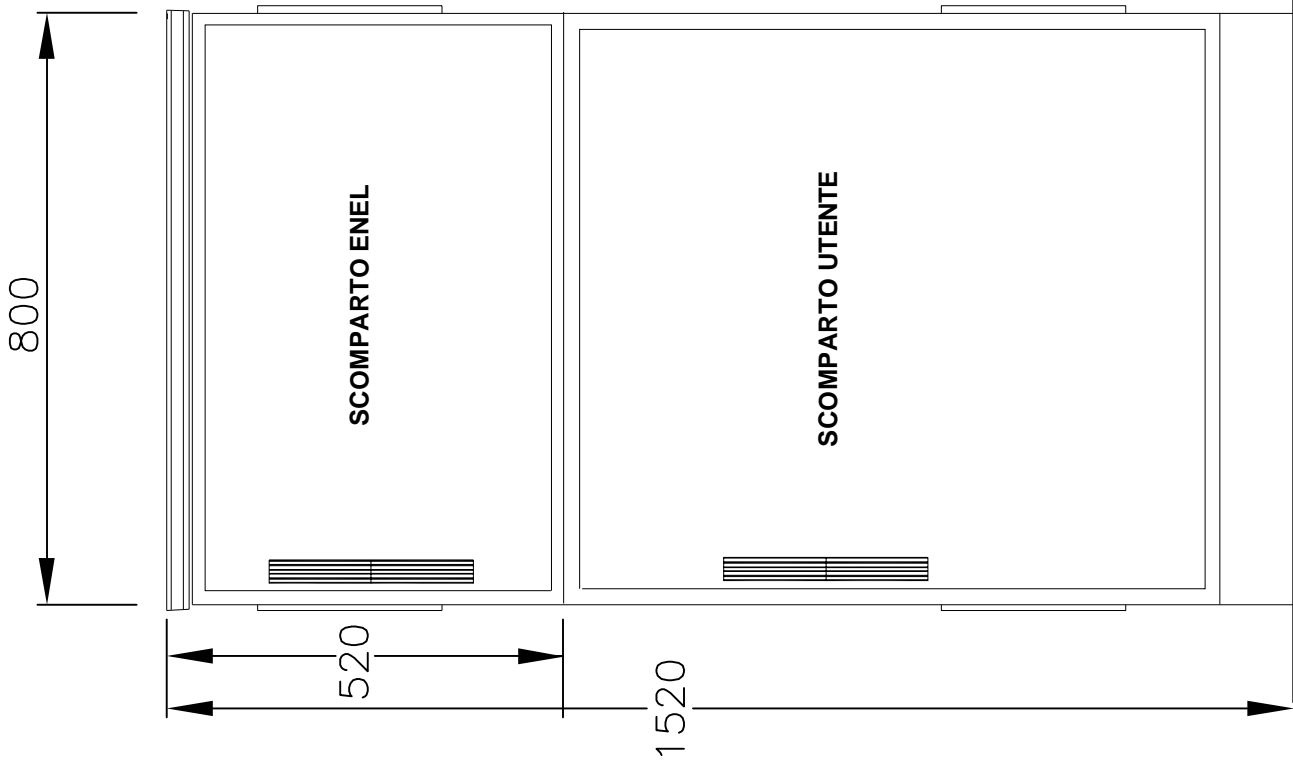

Armadio stampato in resina (SMC) per posa a pavimento con telaio di ancoraggio
 Porta frontale cieca incernierata completa di chiusura tipo cremonese azionabile con maniglia a scomparsa con serratura cifrata
 Parete di fondo dotata di inserti annegati di stampaggio in ottone per applicazione apparecchiature direttamente attraverso piastra di fondo
 Grado di protezione: IP44 secondo CEI EN 60529
 Colore RAL 7040
 Prese d'aria inferiori e sottotetto per ventilazione naturale interna

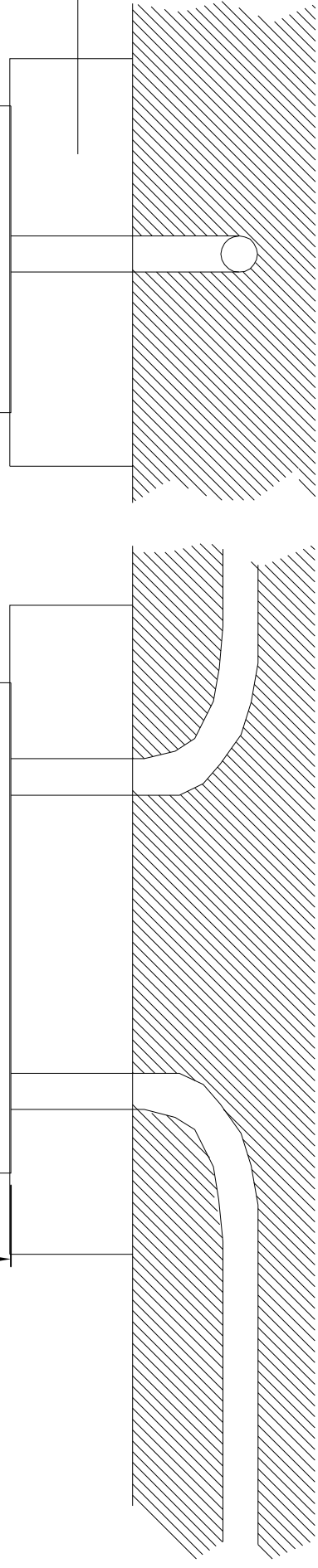

NOTA :
IL QUADRO DOVRA' ESSERE DI TIPO STRADALE IN SMC (VETRORESINA) CORREDATO DI PIEDISTALLO DA FISSARE SU BASAMENTO IN CLS

Nr.	Data	Descrizione	Disegn.:	Committente			Foglio:	Tot. fogli:
			Contr.:	PROGETTO ESECUTIVO			8	9
			Visto:					
					TITOLO: COCIV - NV08			
					DESCRIZIONE: FRONTEQUADRO E SEZIONI			

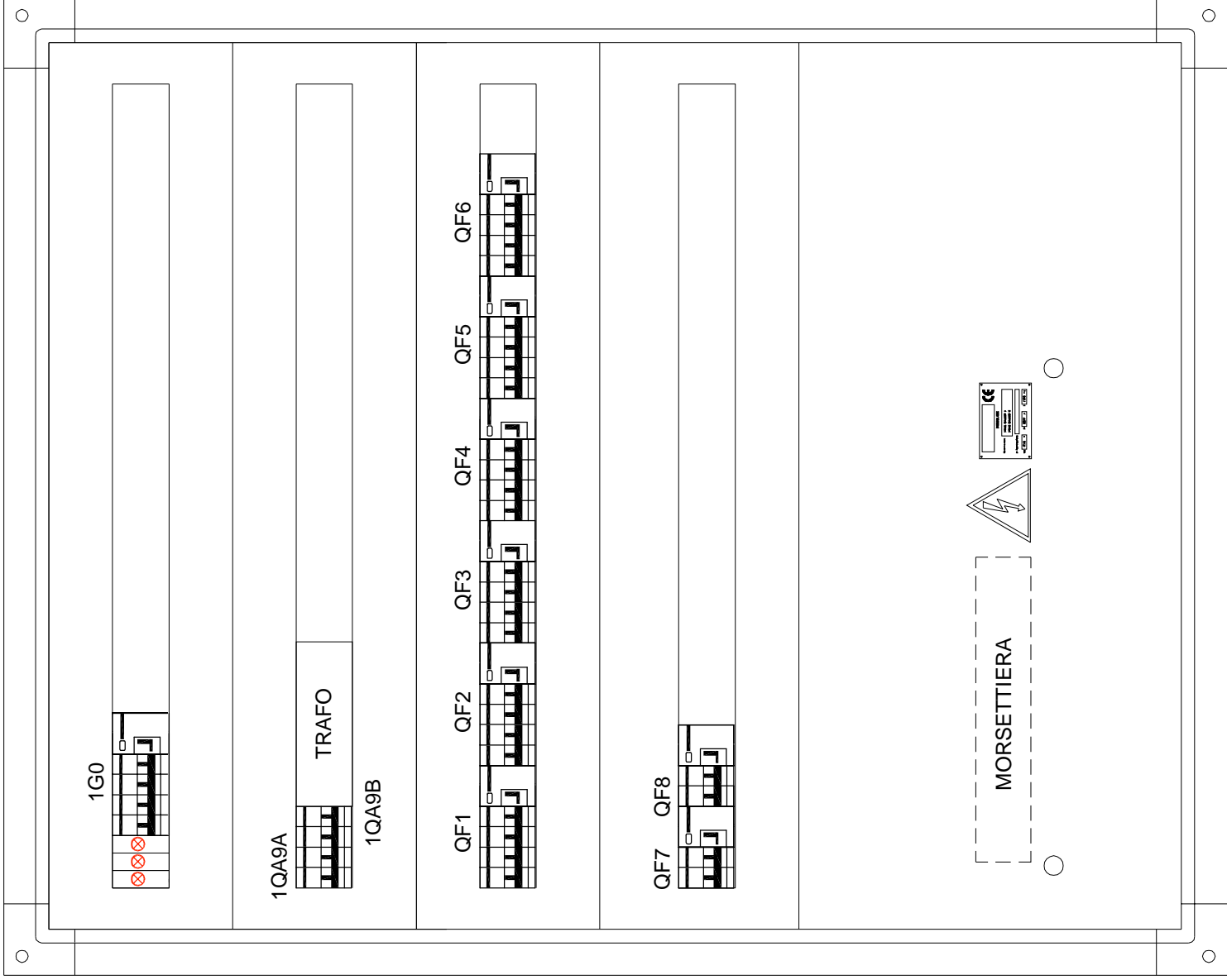

Fronte quadro quadro illuminazione

Nr.	Data	Descrizione	Disegn.:		Committente		Titolo:		Foglio:	Segue:	Tot. fogli:
			Contr.:		Progetto		Descrizione				
					PROGETTO ESECUTIVO		COCIV - NV08		9	10	
FRONTEQUADRO											

| Nr.

 | Data | Descrizione
 | Disegni: | Contr.: | Visto: | Commitente | 
PROGETTO ESECUTIVO | | COCIV - NV08 | | Foglio: | Segue: | Tot. fogli: |

 | |
 | | | | | | | | | | | |

 | | | | | | | | | | | | | |

 | | | | | | | | | | | | | | | | | | | | | | | | | | | | | | | | | | | | | | | | | | | | | | | | | | | | | | | | | | | | | | | | | | | | | | | | | | | | | | | | | | | | | |

 | | | | | | | | | | | | | |

 |

 |
 | | | | | | | | | | | | |

 | | | | | | | | | | | | | | | | | | | | | | | | | | | |

 | | | | | | | | | | | | | | | | | | | | | | | | | | | | | | | | | | | | | | | | | | | | | |
 | | | | | | | | | | | | | | | | | | | | | | | | |
 | |
 | | | | | | | | | | | |

 |

 | |
 | | | | | | | | | | | |

 | | | | | | | | | | | | | | | | | | | | | | | | | | | |

 | | | | | | | | | | | | | | | | | | | | | | | | | | | | | | | | | | | | | | | | | | | | | | | | | | | | | | | | | | | | | | | | | | | | | | | |
 | |
 | | | | | | | | | | | |
 |

 | |
 | | | | | | | | | | | |
 | |
 | | | | | | | | | | | | | | | | | | | | | | | | | |

 | | | | | | | | | | | | | | | | | | | | | | | | | | | | | | | | | | | | | | | | | | | | | | | | | | | | | | | | | | | | | | | | | | | | | | | |
 | | | | | | | | | | | | | |
 |
 |
 | | | | | | | | | | | | |
 | |
 | | | | | | | | | | | | | | | | | | | | | | | | | |
 | |
 | | | | | | | | | | | | | | | | | | | | | | | | | | | | | | | | | | | | | | | | | | | | | | | | | | | | | | | | | | | | | | | | | | | | | | | | | | | | | | | | | | | | |
 |
 | | | | | | | | | | | | | | | | | | | | | | | | | | | | | | | | | | | | | | | | | | | | | | | | | | | | | | | | | | | | | | | | | | | | | | | | | | | | | | | | | | | | | | | |
 | | | | | | | | | | | | | | | | | | | | | | | | | | | |
 | | | | | | | | | | | | | | | | | | | | | | | | | | | | | | | | | | | | | | | | | | | | | | | | | | | | | | | | | | | | | | | | | | | | | | | | | | | | | | | | | | | | | | | |
 | | | | | | | | | | | | | | | | | | | | | | | | | | | | | | | | | | | | | | | | | | | | | | | | | | | | | | | | | | | | | | | | | | | | | |

--
--|---
---|----------|---------|--------|------------|--|-----|---------------------|----|---------|--------|-------------
--
--
--
---|--|---|-----|-----|-----|-----|-----|-----|-----|-----|----|----|----
--
--
--
--|----|----|----|-----|-----|-----|-----|-----|-----|-----|-----|----|----
--
--
--
---|----|---|---|---|---|---|-----|-----|-----|-----|-----|----|----|----|----|----|----|-----|-----|-----|-----|-----|-----|-----|-----|----|----|----|----|----|---|---|---|---|-----|-----|-----|-----|-----|----|----|----|----|----|---|---|---|---|-----|-----|-----|-----|-----|----|----|----|----|----|---|---|---|---|-----|-----|-----|-----|-----|----|----|----|----|----|---|---|---|---|-----|-----|-----|-----|-----|----|----|----|----
--
--
--|---|--|---|---|-----|-----|-----|-----|-----|----|----|----|----
--
--

--
--

--|--|---|---|-----|-----|-----|-----|-----|-----|----|----|----
--
--
---|----
--|----|---|-----|-----|-----|-----|-----|-----|-----|----|----|----|----|----|----|---|-----|-----|-----|-----|-----|-----|-----|----|----
--
--
---|----
--|---|---|---|---|-----|-----|-----|-----|-----|----|----|----|----|----|----|---|---|---|-----|-----|-----|-----|-----|----|----|----|----|----|---|---|---|---|-----|-----|-----|-----|-----|----|----|----|----|----|---|---|---|---|-----|-----|-----|-----|-----|----|----|----|----|----|---|---|---|---|-----|-----|-----|-----|-----|----|----|----|----
--
---|---
--|---|---|-----|-----|-----|-----|-----|----|----|----|----
--
--
--
--
--
--|--
--|---|---|-----|-----|-----|-----|-----|-----|----|----|----
--
--
--|----|--|----|---|-----|-----|-----|-----|-----|-----|-----|----|----|----|----|----|----|---|-----|-----|-----|-----|-----|-----|-----|----|----
--
--
--|----|--|---|---|---|---|-----|-----|-----|-----|-----|----|----|----|----|----|----|---|---|---|-----|-----|-----|-----|-----|----|----|----|----|----|---|---|---|---|-----|-----|-----|-----|-----|----|----|----|----|----|---|---|---|---|-----|-----|-----|-----|-----|----|----|----|----|----|---|---|---|---|-----|-----|-----|-----|-----|----|----|----|----
--
--|---|--|---|---|-----|-----|-----|-----|-----|----|----|----|----
--

--

--|--|---|---|-----|-----|-----|-----|-----|-----|----|----|----
--
---|----
--|----|---|-----|-----|-----|-----|-----|-----|-----|----|----|----|----|----|----|---|-----|-----|-----|-----|-----|-----|-----|----|----
--
---|----
--|---|---|---|---|-----|-----|-----|-----|-----|----|----|----|----|----|----|---|---|---|-----|-----|-----|-----|-----|----|----|----|----|----|---|---|---|---|-----|-----|-----|-----|-----|----|----|----|----|----|---|---|---|---|-----|-----|-----|-----|-----|----|----|----|----|----|---|---|---|---|-----|-----|-----|-----|-----|----|----|----|----
---|---
--|---|---|-----|-----|-----|-----|-----|----|----|----|----
--
--
--
--|--
--|---|---|-----|-----|-----|-----|-----|-----|----|----|----
--
--|----|--|----|---|-----|-----|-----|-----|-----|-----|-----|----|----|----|----|----|----|---|-----|-----|-----|-----|-----|-----|-----|----|----
--
--|----|--|---|---|---|---|-----|-----|-----|-----|-----|----|----|----|----|----|----|---|---|---|-----|-----|-----|-----|-----|----|----|----|----|----|---|---|---|---|-----|-----|-----|-----|-----|----|----|----|----|----|---|---|---|---|-----|-----|-----|-----|-----|----|----|----|----|----|---|---|---|---|-----|-----|-----|-----|-----|----|----|----|----|--|---|--|---|---|-----|-----|-----|-----|-----|----|----|----|----

--|--|---|---|-----|-----|-----|-----|-----|-----|----|----|----
---|---
--|----|---|-----|-----|-----|-----|-----|-----|-----|----|----|----|----|----|----|---|-----|-----|-----|-----|-----|-----|-----|----|----
---|----
--|---|---|---|---|-----|-----|-----|-----|-----|----|----|----|----|----|----|---|---|---|-----|-----|-----|-----|-----|----|----|----|----|----|---|---|---|---|-----|-----|-----|-----|-----|----|----|----|----|----|---|---|---|---|-----|-----|-----|-----|-----|----|----|----|----|----|---|---|---|---|-----|-----|-----|-----|-----|----|----|----|----|----|---|---|---|---|-----|-----|-----|-----|-----|----|----|----|----|--|--|--|--|---|---|-----|-----|-----|-----|----|----|----|----|----
--|---|--|----|---|-----|-----|-----|-----|-----|-----|-----|----|----|----|---|---|----|---|-----|-----|-----|-----|-----|-----|-----|----|----|--|--|--|--|--|--|--|--|--|--|--|--|--|--|--|--|--|----|---|---|---|---|-----|-----|-----|-----|----|----|----|
|

 | |
 | | | | | | | | | 10 | 11 | 11 |

 | |
 | | | | | | | | | | | |

 | | | | | | | | | | | | | |

 | | | | | | | | | | | | | | | | | | | | | | | | | | | | | | | | | | | | | | | | | | | | | | | | | | | | | | | | | | | | | | | | | | | | | | | | | | | | | | | | | | | | | |

 | | | | | | | | | | | | | |

 |

 |
 | | | | | | | | | | | | |

 | | | | | | | | | | | | | | | | | | | | | | | | | | | |

 | | | | | | | | | | | | | | | | | | | | | | | | | | | | | | | | | | | | | | | | | | | | | | | | | | | | | | | | | | | | | | | |
| | | | | | | |
 | |
 | | | | | | | | | | | |

 |

 | |
 | | | | | | | | | | | |

 | | | | | | | | | | | | | | | | | | | | | | | | | | | |

 | | | | | | | | | | | | | | | | | | | | | | | | | | | | | | | | | | | | | | | | | | | | | | | | | | | | | | | | | | | | | | | | | | | | | | | |
 | |
 | | | | | | | | | | | |
 |

 | |
 | | | | | | | | | | | |
 | |
 | | | | | | | | | | | | | | | | | | | | | | | | | |

 | | | | | | | | | | | | | | | | | | | | | | | | | | | | | | | | | | | | | | | | | | | | | | | | | | | | | | | | | | | | | | | | | | | | | | | |
 | | | | | | | | | | | | | |
 |
 |
 | | | | | | | | | | | | |
 | |
 | | | | | | | | | | | | | | | | | | | | | | | | | |
 | |
 | | | | | | | | | | | | | | | | | | | | | | | | | | | | | | | | | | | | | | | | | | | | | | | | | | | | | | | | | | | | | | | | | | | | | | | | | | | | | | | | | | | | |
 | |
 | | | | | | | | | | | | | | | | | | | | | | | | | | | | | | | | | | | | | | | | | | | | | | | | | | | | | | | | | | | | | | | | | | | | | | | | | | | | | | | | | | | | | | | |
 | | | | | | | | | | | | | | | | | | | | | | | | | | | |
 | | | | | | | | | | | | | | | | | | | | | | | | | | | | | | | | | | | | | | | | | | | | | | | | | | | | | | | | | | | | | | | | | | | | | | | | | | | | | | | | | | | | | | | |
 | | | | | | | | | | | | | | | | | | | | | | | | | | | | | | | | | | | | | | | | | | | | | | | | | | | | | | | | | | | | | | | | | | | | | |
| MORSETTIERA DI POTENZA

 | |
 | | | | | | | | | | | |

 | |
 | | | | | | | | | | | |

 | | | | | | | | | | | | | |

 | | | | | | | | | | | | | | | | | | | | | | | | | | | | | | | | | | | | | | | | | | | | | | | | | | | | | | | | | | | | | | | | | | | | | | | | | | | | | | | | | | | | | |

 | | | | | | | | | | | | | |

 |

 |
 | | | | | | | | | | | | |

 | | | | | | | | | | | | | | | | | | | | | | | | | | | |

 | | | | | | | | | | | | | | | | | | | | | | | | | | | | | | | | | | | | | | | | | | | | | | | | | | | | | | | | | | | | | | | |
| | | | | | | |
 | |
 | | | | | | | | | | | |

 |

 | |
 | | | | | | | | | | | |

 | | | | | | | | | | | | | | | | | | | | | | | | | | | |

 | | | | | | | | | | | | | | | | | | | | | | | | | | | | | | | | | | | | | | | | | | | | | | | | | | | | | | | | | | | | | | | | | | | | | | | |
 | |
 | | | | | | | | | | | |
 |

 | |
 | | | | | | | | | | | |
 | |
 | | | | | | | | | | | | | | | | | | | | | | | | | |

 | | | | | | | | | | | | | | | | | | | | | | | | | | | | | | | | | | | | | | | | | | | | | | | | | | | | | | | | | | | | | | | | | | | | | | | |
 | | | | | | | | | | | | | |
 |
 |
 | | | | | | | | | | | | |
 | |
 | | | | | | | | | | | | | | | | | | | | | | | | | |
 | |
 | | | | | | | | | | | | | | | | | | | | | | | | | | | | | | | | | | | | | | | | | | | | | | | | | | | | | | | | | | | | | | | | | | | | | | | | | | | | | | | | | | | | |
 | |
 | | | | | | | | | | | | | | | | | | | | | | | | | | | | | | | | | | | | | | | | | | | | | | | | | | | | | | | | | | | | | | | | | | | | | | | | | | | | | | | | | | | | | | | |
 | | | | | | | | | | | | | | | | | | | | | | | | | | | |
 | | | | | | | | | | | | | | | | | | | | | | | | | | | | | | | | | | | | | | | | | | | | | | | | | | | | | | | | | | | | | | | | | | | | | | | | | | | | | | | | | | | | | | | |
 | | | | | | | | | | | | | | | | | | | | | | | | | | | | | | | | | | | | | | | | | | | | | | | | | | | | | | | | | | | | | | | | | | | | | |
| Titolo:

 | |
 | | | | | | | | | | | |

 | |
 | | | | | | | | | | | |

 | | | | | | | | | | | | | |

 | | | | | | | | | | | | | | | | | | | | | | | | | | | | | | | | | | | | | | | | | | | | | | | | | | | | | | | | | | | | | | | | | | | | | | | | | | | | | | | | | | | | | |

 | | | | | | | | | | | | | |

 |

 |
 | | | | | | | | | | | | |

 | | | | | | | | | | | | | | | | | | | | | | | | | | | |

 | | | | | | | | | | | | | | | | | | | | | | | | | | | | | | | | | | | | | | | | | | | | | | | | | | | | | | | | | | | | | | | |
| | | | | | | |
 | |
 | | | | | | | | | | | |

 |

 | |
 | | | | | | | | | | | |

 | | | | | | | | | | | | | | | | | | | | | | | | | | | |

 | | | | | | | | | | | | | | | | | | | | | | | | | | | | | | | | | | | | | | | | | | | | | | | | | | | | | | | | | | | | | | | | | | | | | | | |
 | |
 | | | | | | | | | | | |
 |

 | |
 | | | | | | | | | | | |
 | |
 | | | | | | | | | | | | | | | | | | | | | | | | | |

 | | | | | | | | | | | | | | | | | | | | | | | | | | | | | | | | | | | | | | | | | | | | | | | | | | | | | | | | | | | | | | | | | | | | | | | |
 | | | | | | | | | | | | | |
 |
 |
 | | | | | | | | | | | | |
 | |
 | | | | | | | | | | | | | | | | | | | | | | | | | |
 | |
 | | | | | | | | | | | | | | | | | | | | | | | | | | | | | | | | | | | | | | | | | | | | | | | | | | | | | | | | | | | | | | | | | | | | | | | | | | | | | | | | | | | | |
 | |
 | | | | | | | | | | | | | | | | | | | | | | | | | | | | | | | | | | | | | | | | | | | | | | | | | | | | | | | | | | | | | | | | | | | | | | | | | | | | | | | | | | | | | | | |
 | | | | | | | | | | | | | | | | | | | | | | | | | | | |
 | | | | | | | | | | | | | | | | | | | | | | | | | | | | | | | | | | | | | | | | | | | | | | | | | | | | | | | | | | | | | | | | | | | | | | | | | | | | | | | | | | | | | | | |
 | | | | | | | | | | | | | | | | | | | | | | | | | | | | | | | | | | | | | | | | | | | | | | | | | | | | | | | | | | | | | | | | | | | | | |
| Descrizione

 | |
 | | | | | | | | | | | |

 | |
 | | | | | | | | | | | |

 | | | | | | | | | | | | | |

 | | | | | | | | | | | | | | | | | | | | | | | | | | | | | | | | | | | | | | | | | | | | | | | | | | | | | | | | | | | | | | | | | | | | | | | | | | | | | | | | | | | | | |

 | | | | | | | | | | | | | |

 |

 |
 | | | | | | | | | | | | |

 | | | | | | | | | | | | | | | | | | | | | | | | | | | |

 | | | | | | | | | | | | | | | | | | | | | | | | | | | | | | | | | | | | | | | | | | | | | | | | | | | | | | | | | | | | | | | |
| | | | | | | |
 | |
 | | | | | | | | | | | |

 |

 | |
 | | | | | | | | | | | |

 | | | | | | | | | | | | | | | | | | | | | | | | | | | |

 | | | | | | | | | | | | | | | | | | | | | | | | | | | | | | | | | | | | | | | | | | | | | | | | | | | | | | | | | | | | | | | | | | | | | | | |
 | |
 | | | | | | | | | | | |
 |

 | |
 | | | | | | | | | | | |
 | |
 | | | | | | | | | | | | | | | | | | | | | | | | | |

 | | | | | | | | | | | | | | | | | | | | | | | | | | | | | | | | | | | | | | | | | | | | | | | | | | | | | | | | | | | | | | | | | | | | | | | |
 | | | | | | | | | | | | | |
 |
 |
 | | | | | | | | | | | | |
 | |
 | | | | | | | | | | | | | | | | | | | | | | | | | |
 | |
 | | | | | | | | | | | | | | | | | | | | | | | | | | | | | | | | | | | | | | | | | | | | | | | | | | | | | | | | | | | | | | | | | | | | | | | | | | | | | | | | | | | | |
 | |
 | | | | | | | | | | | | | | | | | | | | | | | | | | | | | | | | | | | | | | | | | | | | | | | | | | | | | | | | | | | | | | | | | | | | | | | | | | | | | | | | | | | | | | | |
 | | | | | | | | | | | | | | | | | | | | | | | | | | | |
 | | | | | | | | | | | | | | | | | | | | | | | | | | | | | | | | | | | | | | | | | | | | | | | | | | | | | | | | | | | | | | | | | | | | | | | | | | | | | | | | | | | | | | | |
 | | | | | | | | | | | | | | | | | | | | | | | | | | | | | | | | | | | | | | | | | | | | | | | | | | | | | | | | | | | | | | | | | | | | | |
| <table border="0" style="width: 100%; border-collapse: collapse;"> <tr> <td style="width: 10%;"></td> <td style="width: 10%;"></td> <td style="width: 10%;"></td> <td style="width: 10%;"></td> <td style="width: 10%;"></td> <td style="width: 10%;"></td> <td style="width: 10%;"></td> <td style="width: 10%;"></td> <td style="width: 10%;"></td> <td style="width: 10%;"></td> <td style="width: 10%;"></td> <td style="width: 10%;"></td> <td style="width: 10%;"></td> <td style="width: 10%;"></td> </tr> <tr> <td colspan="14" style="text-align: center;"> <table border="0" style="width: 100%;"> <tr> <td style="width: 50%; vertical-align: top;"> <table border="0" style="width: 100%;"> <tr> <td style="width: 50%;"></td> <td style="width: 50%; text-align: center;"> <table border="0"> <tr> <td style="width: 10%;"></td> <td style="width: 10%;"></td> <td style="width: 10%;"></td> <td style="width: 10%;"></td> <td style="width: 10%;"></td> <td style="width: 10%;"></td> <td style="width: 10%;"></td> <td style="width: 10%;"></td> <td style="width: 10%;"></td> <td style="width: 10%;"></td> <td style="width: 10%;"></td> <td style="width: 10%;"></td> <td style="width: 10%;"></td> <td style="width: 10%;"></td> </tr> <tr> <td style="text-align: center;">XA</td> <td style="text-align: center;">1/G</td> <td style="text-align: center;">2/G</td> <td style="text-align: center;">3/G</td> <td style="text-align: center;">4/G</td> <td style="text-align: center;">R</td> <td style="text-align: center;">S</td> <td style="text-align: center;">T</td> <td style="text-align: center;">N</td> <td style="text-align: center;">E0</td> <td style="text-align: center;">E0</td> <td style="text-align: center;">E0</td> <td style="text-align: center;">E0</td> <td style="text-align: center;">E0</td> </tr> <tr> <td></td> <td style="text-align: center;">1</td> <td style="text-align: center;">2</td> <td style="text-align: center;">3</td> <td style="text-align: center;">4</td> <td style="text-align: center;">R01</td> <td style="text-align: center;">S01</td> <td style="text-align: center;">T01</td> <td style="text-align: center;">N01</td> <td style="text-align: center;">E1</td> <td style="text-align: center;">E1</td> <td style="text-align: center;">E1</td> <td style="text-align: center;">E1</td> <td style="text-align: center;">E1</td> </tr> <tr> <td></td> <td style="text-align: center;">1</td> <td style="text-align: center;">2</td> <td style="text-align: center;">3</td> <td style="text-align: center;">4</td> <td style="text-align: center;">R02</td> <td style="text-align: center;">S02</td> <td style="text-align: center;">T02</td> <td style="text-align: center;">N02</td> <td style="text-align: center;">E2</td> <td style="text-align: center;">E2</td> <td style="text-align: center;">E2</td> <td style="text-align: center;">E2</td> <td style="text-align: center;">E2</td> </tr> <tr> <td></td> <td style="text-align: center;">1</td> <td style="text-align: center;">2</td> <td style="text-align: center;">3</td> <td style="text-align: center;">4</td> <td style="text-align: center;">R03</td> <td style="text-align: center;">S03</td> <td style="text-align: center;">T03</td> <td style="text-align: center;">N03</td> <td style="text-align: center;">E3</td> <td style="text-align: center;">E3</td> <td style="text-align: center;">E3</td> <td style="text-align: center;">E3</td> <td style="text-align: center;">E3</td> </tr> <tr> <td></td> <td style="text-align: center;">1</td> <td style="text-align: center;">2</td> <td style="text-align: center;">3</td> <td style="text-align: center;">4</td> <td style="text-align: center;">R04</td> <td style="text-align: center;">S04</td> <td style="text-align: center;">T04</td> <td style="text-align: center;">N04</td> <td style="text-align: center;">E4</td> <td style="text-align: center;">E4</td> <td style="text-align: center;">E4</td> <td style="text-align: center;">E4</td> <td style="text-align: center;">E4</td> </tr> <tr> <td></td> <td style="text-align: center;">1</td> <td style="text-align: center;">2</td> <td style="text-align: center;">3</td> <td style="text-align: center;">4</td> <td style="text-align: center;">R05</td> <td style="text-align: center;">S05</td> <td style="text-align: center;">T05</td> <td style="text-align: center;">N05</td> <td style="text-align: center;">E5</td> <td style="text-align: center;">E5</td> <td style="text-align: center;">E5</td> <td style="text-align: center;">E5</td> <td style="text-align: center;">E5</td> </tr> <tr> <td></td> <td style="text-align: center;">1</td> <td style="text-align: center;">2</td> <td style="text-align: center;">3</td> <td style="text-align: center;">4</td> <td style="text-align: center;">R06</td> <td style="text-align: center;">S06</td> <td style="text-align: center;">T06</td> <td style="text-align: center;">N06</td> <td style="text-align: center;">E6</td> <td style="text-align: center;">E6</td> <td style="text-align: center;">E6</td> <td style="text-align: center;">E6</td> <td style="text-align: center;">E6</td> </tr> <tr> <td></td> <td style="text-align: center;">1</td> <td style="text-align: center;">2</td> <td style="text-align: center;">3</td> <td style="text-align: center;">4</td> <td style="text-align: center;">R07</td> <td style="text-align: center;">S07</td> <td style="text-align: center;">T07</td> <td style="text-align: center;">N07</td> <td style="text-align: center;">E7</td> <td style="text-align: center;">E7</td> <td style="text-align: center;">E7</td> <td style="text-align: center;">E7</td> <td style="text-align: center;">E7</td> </tr> <tr> <td></td> <td style="text-align: center;">1</td> <td style="text-align: center;">2</td> <td style="text-align: center;">3</td> <td style="text-align: center;">4</td> <td style="text-align: center;">R08</td> <td style="text-align: center;">S08</td> <td style="text-align: center;">T08</td> <td style="text-align: center;">N08</td> <td style="text-align: center;">E8</td> <td style="text-align: center;">E8</td> <td style="text-align: center;">E8</td> <td style="text-align: center;">E8</td> <td style="text-align: center;">E8</td> </tr> </table> </td> <td style="width: 50%; vertical-align: top;"> <table border="0" style="width: 100%;"> <tr> <td style="width: 50%;"></td> <td style="width: 50%; text-align: center;"> <table border="0"> <tr> <td style="width: 10%;"></td> <td style="width: 10%;"></td> <td style="width: 10%;"></td> <td style="width: 10%;"></td> <td style="width: 10%;"></td> <td style="width: 10%;"></td> <td style="width: 10%;"></td> <td style="width: 10%;"></td> <td style="width: 10%;"></td> <td style="width: 10%;"></td> <td style="width: 10%;"></td> <td style="width: 10%;"></td> <td style="width: 10%;"></td> <td style="width: 10%;"></td> </tr> <tr> <td style="text-align: center;">XA</td> <td style="text-align: center;">1</td> <td style="text-align: center;">2</td> <td style="text-align: center;">3</td> <td style="text-align: center;">4</td> <td style="text-align: center;">R01</td> <td style="text-align: center;">S01</td> <td style="text-align: center;">T01</td> <td style="text-align: center;">N01</td> <td style="text-align: center;">E1</td> <td style="text-align: center;">E1</td> <td style="text-align: center;">E1</td> <td style="text-align: center;">E1</td> <td style="text-align: center;">E1</td> </tr> <tr> <td></td> <td style="text-align: center;">1</td> <td style="text-align: center;">2</td> <td style="text-align: center;">3</td> <td style="text-align: center;">4</td> <td style="text-align: center;">R02</td> <td style="text-align: center;">S02</td> <td style="text-align: center;">T02</td> <td style="text-align: center;">N02</td> <td style="text-align: center;">E2</td> <td style="text-align: center;">E2</td> <td style="text-align: center;">E2</td> <td style="text-align: center;">E2</td> <td style="text-align: center;">E2</td> </tr> <tr> <td></td> <td style="text-align: center;">1</td> <td style="text-align: center;">2</td> <td style="text-align: center;">3</td> <td style="text-align: center;">4</td> <td style="text-align: center;">R03</td> <td style="text-align: center;">S03</td> <td style="text-align: center;">T03</td> <td style="text-align: center;">N03</td> <td style="text-align: center;">E3</td> <td style="text-align: center;">E3</td> <td style="text-align: center;">E3</td> <td style="text-align: center;">E3</td> <td style="text-align: center;">E3</td> </tr> <tr> <td></td> <td style="text-align: center;">1</td> <td style="text-align: center;">2</td> <td style="text-align: center;">3</td> <td style="text-align: center;">4</td> <td style="text-align: center;">R04</td> <td style="text-align: center;">S04</td> <td style="text-align: center;">T04</td> <td style="text-align: center;">N04</td> <td style="text-align: center;">E4</td> <td style="text-align: center;">E4</td> <td style="text-align: center;">E4</td> <td style="text-align: center;">E4</td> <td style="text-align: center;">E4</td> </tr> <tr> <td></td> <td style="text-align: center;">1</td> <td style="text-align: center;">2</td> <td style="text-align: center;">3</td> <td style="text-align: center;">4</td> <td style="text-align: center;">R05</td> <td style="text-align: center;">S05</td> <td style="text-align: center;">T05</td> <td style="text-align: center;">N05</td> <td style="text-align: center;">E5</td> <td style="text-align: center;">E5</td> <td style="text-align: center;">E5</td> <td style="text-align: center;">E5</td> <td style="text-align: center;">E5</td> </tr> <tr> <td></td> <td style="text-align: center;">1</td> <td style="text-align: center;">2</td> <td style="text-align: center;">3</td> <td style="text-align: center;">4</td> <td style="text-align: center;">R06</td> <td style="text-align: center;">S06</td> <td style="text-align: center;">T06</td> <td style="text-align: center;">N06</td> <td style="text-align: center;">E6</td> <td style="text-align: center;">E6</td> <td style="text-align: center;">E6</td> <td style="text-align: center;">E6</td> <td style="text-align:
center;">E6</td> </tr> <tr> <td></td> <td style="text-align: center;">1</td> <td style="text-align: center;">2</td> <td style="text-align: center;">3</td> <td style="text-align: center;">4</td> <td style="text-align: center;">R07</td> <td style="text-align: center;">S07</td> <td style="text-align: center;">T07</td> <td style="text-align: center;">N07</td> <td style="text-align: center;">E7</td> <td style="text-align: center;">E7</td> <td style="text-align: center;">E7</td> <td style="text-align: center;">E7</td> <td style="text-align: center;">E7</td> </tr> <tr> <td></td> <td style="text-align: center;">1</td> <td style="text-align: center;">2</td> <td style="text-align: center;">3</td> <td style="text-align: center;">4</td> <td style="text-align: center;">R08</td> <td style="text-align: center;">S08</td> <td style="text-align: center;">T08</td> <td style="text-align: center;">N08</td> <td style="text-align: center;">E8</td> <td style="text-align: center;">E8</td> <td style="text-align: center;">E8</td> <td style="text-align: center;">E8</td> <td style="text-align: center;">E8</td> </tr> </table> </td> <td style="width: 50%; vertical-align: top;"> <table border="0" style="width: 100%;"> <tr> <td style="width: 50%;"></td> <td style="width: 50%; text-align: center;"> <table border="0"> <tr> <td style="width: 10%;"></td> <td style="width: 10%;"></td> <td style="width: 10%;"></td> <td style="width: 10%;"></td> <td style="width: 10%;"></td> <td style="width: 10%;"></td> <td style="width: 10%;"></td> <td style="width: 10%;"></td> <td style="width: 10%;"></td> <td style="width: 10%;"></td> <td style="width: 10%;"></td> <td style="width: 10%;"></td> <td style="width: 10%;"></td> <td style="width: 10%;"></td> </tr> <tr> <td style="text-align: center;">XA</td> <td style="text-align: center;">1</td> <td style="text-align: center;">2</td> <td style="text-align: center;">3</td> <td style="text-align: center;">4</td> <td style="text-align: center;">R01</td> <td style="text-align: center;">S01</td> <td style="text-align: center;">T01</td> <td style="text-align: center;">N01</td> <td style="text-align: center;">E1</td> <td style="text-align: center;">E1</td> <td style="text-align: center;">E1</td> <td style="text-align: center;">E1</td> <td style="text-align: center;">E1</td> </tr> <tr> <td></td> <td style="text-align: center;">1</td> <td style="text-align: center;">2</td> <td style="text-align: center;">3</td> <td style="text-align: center;">4</td> <td style="text-align: center;">R02</td> <td style="text-align: center;">S02</td> <td style="text-align: center;">T02</td> <td style="text-align: center;">N02</td> <td style="text-align: center;">E2</td> <td style="text-align: center;">E2</td> <td style="text-align: center;">E2</td> <td style="text-align: center;">E2</td> <td style="text-align: center;">E2</td> </tr> <tr> <td></td> <td style="text-align: center;">1</td> <td style="text-align: center;">2</td> <td style="text-align: center;">3</td> <td style="text-align: center;">4</td> <td style="text-align: center;">R03</td> <td style="text-align: center;">S03</td> <td style="text-align: center;">T03</td> <td style="text-align: center;">N03</td> <td style="text-align: center;">E3</td> <td style="text-align: center;">E3</td> <td style="text-align: center;">E3</td> <td style="text-align: center;">E3</td> <td style="text-align: center;">E3</td> </tr> <tr> <td></td> <td style="text-align: center;">1</td> <td style="text-align: center;">2</td> <td style="text-align: center;">3</td> <td style="text-align: center;">4</td> <td style="text-align: center;">R04</td> <td style="text-align: center;">S04</td> <td style="text-align: center;">T04</td> <td style="text-align: center;">N04</td> <td style="text-align: center;">E4</td> <td style="text-align: center;">E4</td> <td style="text-align: center;">E4</td> <td style="text-align: center;">E4</td> <td style="text-align: center;">E4</td> </tr> <tr> <td></td> <td style="text-align: center;">1</td> <td style="text-align: center;">2</td> <td style="text-align: center;">3</td> <td style="text-align: center;">4</td> <td style="text-align: center;">R05</td> <td style="text-align: center;">S05</td> <td style="text-align: center;">T05</td> <td style="text-align: center;">N05</td> <td style="text-align: center;">E5</td> <td style="text-align: center;">E5</td> <td style="text-align: center;">E5</td> <td style="text-align: center;">E5</td> <td style="text-align: center;">E5</td> </tr> <tr> <td></td> <td style="text-align: center;">1</td> <td style="text-align: center;">2</td> <td style="text-align: center;">3</td> <td style="text-align: center;">4</td> <td style="text-align: center;">R06</td> <td style="text-align: center;">S06</td> <td style="text-align: center;">T06</td> <td style="text-align: center;">N06</td> <td style="text-align: center;">E6</td> <td style="text-align: center;">E6</td> <td style="text-align: center;">E6</td> <td style="text-align: center;">E6</td> <td style="text-align: center;">E6</td> </tr> <tr> <td></td> <td style="text-align: center;">1</td> <td style="text-align: center;">2</td> <td style="text-align: center;">3</td> <td style="text-align: center;">4</td> <td style="text-align: center;">R07</td> <td style="text-align: center;">S07</td> <td style="text-align: center;">T07</td> <td style="text-align: center;">N07</td> <td style="text-align: center;">E7</td> <td style="text-align: center;">E7</td> <td style="text-align: center;">E7</td> <td style="text-align: center;">E7</td> <td style="text-align: center;">E7</td> </tr> <tr> <td></td> <td style="text-align: center;">1</td> <td style="text-align: center;">2</td> <td style="text-align: center;">3</td> <td style="text-align: center;">4</td> <td style="text-align: center;">R08</td> <td style="text-align: center;">S08</td> <td style="text-align: center;">T08</td> <td style="text-align: center;">N08</td> <td style="text-align: center;">E8</td> <td style="text-align: center;">E8</td> <td style="text-align: center;">E8</td> <td style="text-align: center;">E8</td> <td style="text-align: center;">E8</td> </tr> </table> </td> <td style="width: 50%; vertical-align: top;"> <table border="0" style="width: 100%;"> <tr> <td style="width: 50%;"></td> <td style="width: 50%; text-align: center;"> <table border="0"> <tr> <td style="width: 10%;"></td> <td style="width: 10%;"></td> <td style="width: 10%;"></td> <td style="width: 10%;"></td> <td style="width: 10%;"></td> <td style="width: 10%;"></td> <td style="width: 10%;"></td> <td style="width: 10%;"></td> <td style="width: 10%;"></td> <td style="width: 10%;"></td> <td style="width: 10%;"></td> <td style="width: 10%;"></td> <td style="width: 10%;"></td> <td style="width: 10%;"></td> </tr> <tr> <td style="text-align: center;">XA</td> <td style="text-align: center;">1</td> <td style="text-align: center;">2</td> <td style="text-align: center;">3</td> <td style="text-align: center;">4</td> <td style="text-align: center;">R01</td> <td style="text-align: center;">S01</td> <td style="text-align: center;">T01</td> <td style="text-align: center;">N01</td> <td style="text-align: center;">E1</td> <td style="text-align: center;">E1</td> <td style="text-align: center;">E1</td> <td style="text-align: center;">E1</td> <td style="text-align: center;">E1</td> </tr> <tr> <td></td> <td style="text-align: center;">1</td> <td style="text-align: center;">2</td> <td style="text-align: center;">3</td> <td style="text-align: center;">4</td> <td style="text-align: center;">R02</td> <td style="text-align: center;">S02</td> <td style="text-align: center;">T02</td> <td style="text-align: center;">N02</td> <td style="text-align: center;">E2</td> <td style="text-align: center;">E2</td> <td style="text-align: center;">E2</td> <td style="text-align: center;">E2</td> <td style="text-align: center;">E2</td> </tr> <tr> <td></td> <td style="text-align: center;">1</td> <td style="text-align: center;">2</td> <td style="text-align: center;">3</td> <td style="text-align: center;">4</td> <td style="text-align: center;">R03</td> <td style="text-align: center;">S03</td> <td style="text-align: center;">T03</td> <td style="text-align: center;">N03</td> <td style="text-align: center;">E3</td> <td style="text-align: center;">E3</td> <td style="text-align: center;">E3</td> <td style="text-align: center;">E3</td> <td style="text-align: center;">E3</td> </tr> <tr> <td></td> <td style="text-align: center;">1</td> <td style="text-align: center;">2</td> <td style="text-align: center;">3</td> <td style="text-align: center;">4</td> <td style="text-align: center;">R04</td> <td style="text-align: center;">S04</td> <td style="text-align: center;">T04</td> <td style="text-align: center;">N04</td> <td style="text-align: center;">E4</td> <td style="text-align: center;">E4</td> <td style="text-align: center;">E4</td> <td style="text-align: center;">E4</td> <td style="text-align: center;">E4</td> </tr> <tr> <td></td> <td style="text-align: center;">1</td> <td style="text-align: center;">2</td> <td style="text-align: center;">3</td> <td style="text-align: center;">4</td> <td style="text-align: center;">R05</td> <td style="text-align: center;">S05</td> <td style="text-align: center;">T05</td> <td style="text-align: center;">N05</td> <td style="text-align: center;">E5</td> <td style="text-align: center;">E5</td> <td style="text-align: center;">E5</td> <td style="text-align: center;">E5</td> <td style="text-align: center;">E5</td> </tr> <tr> <td></td> <td style="text-align: center;">1</td> <td style="text-align: center;">2</td> <td style="text-align: center;">3</td> <td style="text-align: center;">4</td> <td style="text-align: center;">R06</td> <td style="text-align: center;">S06</td> <td style="text-align: center;">T06</td> <td style="text-align: center;">N06</td> <td style="text-align: center;">E6</td> <td style="text-align: center;">E6</td> <td style="text-align: center;">E6</td> <td style="text-align: center;">E6</td> <td style="text-align: center;">E6</td>
</tr> <tr> <td></td> <td style="text-align: center;">1</td> <td style="text-align: center;">2</td> <td style="text-align: center;">3</td> <td style="text-align: center;">4</td> <td style="text-align: center;">R07</td> <td style="text-align: center;">S07</td> <td style="text-align: center;">T07</td> <td style="text-align: center;">N07</td> <td style="text-align: center;">E7</td> <td style="text-align: center;">E7</td> <td style="text-align: center;">E7</td> <td style="text-align: center;">E7</td> <td style="text-align: center;">E7</td> </tr> <tr> <td></td> <td style="text-align: center;">1</td> <td style="text-align: center;">2</td> <td style="text-align: center;">3</td> <td style="text-align: center;">4</td> <td style="text-align: center;">R08</td> <td style="text-align: center;">S08</td> <td style="text-align: center;">T08</td> <td style="text-align: center;">N08</td> <td style="text-align: center;">E8</td> <td style="text-align: center;">E8</td> <td style="text-align: center;">E8</td> <td style="text-align: center;">E8</td> <td style="text-align: center;">E8</td> </tr> </table> </td> <td style="width: 50%; vertical-align: top;"> <table border="0" style="width: 100%;"> <tr> <td style="width: 50%;"></td> <td style="width: 50%; text-align: center;"> <table border="0"> <tr> <td style="width: 10%;"></td> <td style="width: 10%;"></td> <td style="width: 10%;"></td> <td style="width: 10%;"></td> <td style="width: 10%;"></td> <td style="width: 10%;"></td> <td style="width: 10%;"></td> <td style="width: 10%;"></td> <td style="width: 10%;"></td> <td style="width: 10%;"></td> <td style="width: 10%;"></td> <td style="width: 10%;"></td> <td style="width: 10%;"></td> <td style="width: 10%;"></td> </tr> <tr> <td style="text-align: center;">XA</td> <td style="text-align: center;">1</td> <td style="text-align: center;">2</td> <td style="text-align: center;">3</td> <td style="text-align: center;">4</td> <td style="text-align: center;">R01</td> <td style="text-align: center;">S01</td> <td style="text-align: center;">T01</td> <td style="text-align: center;">N01</td> <td style="text-align: center;">E1</td> <td style="text-align: center;">E1</td> <td style="text-align: center;">E1</td> <td style="text-align: center;">E1</td> <td style="text-align: center;">E1</td> </tr> <tr> <td></td> <td style="text-align: center;">1</td> <td style="text-align: center;">2</td> <td style="text-align: center;">3</td> <td style="text-align: center;">4</td> <td style="text-align: center;">R02</td> <td style="text-align: center;">S02</td> <td style="text-align: center;">T02</td> <td style="text-align: center;">N02</td> <td style="text-align: center;">E2</td> <td style="text-align: center;">E2</td> <td style="text-align: center;">E2</td> <td style="text-align: center;">E2</td> <td style="text-align: center;">E2</td> </tr> <tr> <td></td> <td style="text-align: center;">1</td> <td style="text-align: center;">2</td> <td style="text-align: center;">3</td> <td style="text-align: center;">4</td> <td style="text-align: center;">R03</td> <td style="text-align: center;">S03</td> <td style="text-align: center;">T03</td> <td style="text-align: center;">N03</td> <td style="text-align: center;">E3</td> <td style="text-align: center;">E3</td> <td style="text-align: center;">E3</td> <td style="text-align: center;">E3</td> <td style="text-align: center;">E3</td> </tr> <tr> <td></td> <td style="text-align: center;">1</td> <td style="text-align: center;">2</td> <td style="text-align: center;">3</td> <td style="text-align: center;">4</td> <td style="text-align: center;">R04</td> <td style="text-align: center;">S04</td> <td style="text-align: center;">T04</td> <td style="text-align: center;">N04</td> <td style="text-align: center;">E4</td> <td style="text-align: center;">E4</td> <td style="text-align: center;">E4</td> <td style="text-align: center;">E4</td> <td style="text-align: center;">E4</td> </tr> <tr> <td></td> <td style="text-align: center;">1</td> <td style="text-align: center;">2</td> <td style="text-align: center;">3</td> <td style="text-align: center;">4</td> <td style="text-align: center;">R05</td> <td style="text-align: center;">S05</td> <td style="text-align: center;">T05</td> <td style="text-align: center;">N05</td> <td style="text-align: center;">E5</td> <td style="text-align: center;">E5</td> <td style="text-align: center;">E5</td> <td style="text-align: center;">E5</td> <td style="text-align: center;">E5</td> </tr> <tr> <td></td> <td style="text-align: center;">1</td> <td style="text-align: center;">2</td> <td style="text-align: center;">3</td> <td style="text-align: center;">4</td> <td style="text-align: center;">R06</td> <td style="text-align: center;">S06</td> <td style="text-align: center;">T06</td> <td style="text-align: center;">N06</td> <td style="text-align: center;">E6</td> <td style="text-align: center;">E6</td> <td style="text-align: center;">E6</td> <td style="text-align: center;">E6</td> <td style="text-align: center;">E6</td> </tr> <tr> <td></td> <td style="text-align: center;">1</td> <td style="text-align: center;">2</td> <td style="text-align: center;">3</td> <td style="text-align: center;">4</td> <td style="text-align: center;">R07</td> <td style="text-align: center;">S07</td> <td style="text-align: center;">T07</td> <td style="text-align: center;">N07</td> <td style="text-align: center;">E7</td> <td style="text-align: center;">E7</td> <td style="text-align: center;">E7</td> <td style="text-align: center;">E7</td> <td style="text-align: center;">E7</td> </tr> <tr> <td></td> <td style="text-align: center;">1</td> <td style="text-align: center;">2</td> <td style="text-align: center;">3</td> <td style="text-align: center;">4</td> <td style="text-align: center;">R08</td> <td style="text-align: center;">S08</td> <td style="text-align: center;">T08</td> <td style="text-align: center;">N08</td> <td style="text-align: center;">E8</td> <td style="text-align: center;">E8</td> <td style="text-align: center;">E8</td> <td style="text-align: center;">E8</td> <td style="text-align: center;">E8</td> </tr> </table> </td> <td style="width: 50%; vertical-align: top;"> <table border="0" style="width: 100%;"> <tr> <td style="width: 50%;"></td> <td style="width: 50%; text-align: center;"> <table border="0"> <tr> <td style="width: 10%;"></td> <td style="width: 10%;"></td> <td style="width: 10%;"></td> <td style="width: 10%;"></td> <td style="width: 10%;"></td> <td style="width: 10%;"></td> <td style="width: 10%;"></td> <td style="width: 10%;"></td> <td style="width: 10%;"></td> <td style="width: 10%;"></td> <td style="width: 10%;"></td> <td style="width: 10%;"></td> <td style="width: 10%;"></td> <td style="width: 10%;"></td> </tr> <tr> <td style="text-align: center;">XA</td> <td style="text-align: center;">1</td> <td style="text-align: center;">2</td> <td style="text-align: center;">3</td> <td style="text-align: center;">4</td> <td style="text-align: center;">R01</td> <td style="text-align: center;">S01</td> <td style="text-align: center;">T01</td> <td style="text-align: center;">N01</td> <td style="text-align: center;">E1</td> <td style="text-align: center;">E1</td> <td style="text-align: center;">E1</td> <td style="text-align: center;">E1</td> <td style="text-align: center;">E1</td> </tr> <tr> <td></td> <td style="text-align: center;">1</td> <td style="text-align: center;">2</td> <td style="text-align: center;">3</td> <td style="text-align: center;">4</td> <td style="text-align: center;">R02</td> <td style="text-align: center;">S02</td> <td style="text-align: center;">T02</td> <td style="text-align: center;">N02</td> <td style="text-align: center;">E2</td> <td style="text-align: center;">E2</td> <td style="text-align: center;">E2</td> <td style="text-align: center;">E2</td> <td style="text-align: center;">E2</td> </tr> <tr> <td></td> <td style="text-align: center;">1</td> <td style="text-align: center;">2</td> <td style="text-align: center;">3</td> <td style="text-align: center;">4</td> <td style="text-align: center;">R03</td> <td style="text-align: center;">S03</td> <td style="text-align: center;">T03</td> <td style="text-align: center;">N03</td> <td style="text-align: center;">E3</td> <td style="text-align: center;">E3</td> <td style="text-align: center;">E3</td> <td style="text-align: center;">E3</td> <td style="text-align: center;">E3</td> </tr> <tr> <td></td> <td style="text-align: center;">1</td> <td style="text-align: center;">2</td> <td style="text-align: center;">3</td> <td style="text-align: center;">4</td> <td style="text-align: center;">R04</td> <td style="text-align: center;">S04</td> <td style="text-align: center;">T04</td> <td style="text-align: center;">N04</td> <td style="text-align: center;">E4</td> <td style="text-align: center;">E4</td> <td style="text-align: center;">E4</td> <td style="text-align: center;">E4</td> <td style="text-align: center;">E4</td> </tr> <tr> <td></td> <td style="text-align: center;">1</td> <td style="text-align: center;">2</td> <td style="text-align: center;">3</td> <td style="text-align: center;">4</td> <td style="text-align: center;">R05</td> <td style="text-align: center;">S05</td> <td style="text-align: center;">T05</td> <td style="text-align: center;">N05</td> <td style="text-align: center;">E5</td> <td style="text-align: center;">E5</td> <td style="text-align: center;">E5</td> <td style="text-align: center;">E5</td> <td style="text-align: center;">E5</td> </tr> <tr> <td></td> <td style="text-align: center;">1</td> <td style="text-align: center;">2</td> <td style="text-align: center;">3</td> <td style="text-align: center;">4</td> <td style="text-align: center;">R06</td> <td style="text-align: center;">S06</td> <td style="text-align: center;">T06</td> <td style="text-align: center;">N06</td> <td style="text-align: center;">E6</td> <td style="text-align: center;">E6</td> <td style="text-align: center;">E6</td> <td style="text-align: center;">E6</td> <td style="text-align: center;">E6</td> </tr> <tr> <td></td>
<td style="text-align: center;">1</td> <td style="text-align: center;">2</td> <td style="text-align: center;">3</td> <td style="text-align: center;">4</td> <td style="text-align: center;">R07</td> <td style="text-align: center;">S07</td> <td style="text-align: center;">T07</td> <td style="text-align: center;">N07</td> <td style="text-align: center;">E7</td> <td style="text-align: center;">E7</td> <td style="text-align: center;">E7</td> <td style="text-align: center;">E7</td> <td style="text-align: center;">E7</td> </tr> <tr> <td></td> <td style="text-align: center;">1</td> <td style="text-align: center;">2</td> <td style="text-align: center;">3</td> <td style="text-align: center;">4</td> <td style="text-align: center;">R08</td> <td style="text-align: center;">S08</td> <td style="text-align: center;">T08</td> <td style="text-align: center;">N08</td> <td style="text-align: center;">E8</td> <td style="text-align: center;">E8</td> <td style="text-align: center;">E8</td> <td style="text-align: center;">E8</td> <td style="text-align: center;">E8</td> </tr> </table> </td> <td style="width: 50%; vertical-align: top;"> <table border="0" style="width: 100%;"> <tr> <td style="width: 50%;"></td> <td style="width: 50%; text-align: center;"> <table border="0"> <tr> <td style="width: 10%;"></td> <td style="width: 10%;"></td> <td style="width: 10%;"></td> <td style="width: 10%;"></td> <td style="width: 10%;"></td> <td style="width: 10%;"></td> <td style="width: 10%;"></td> <td style="width: 10%;"></td> <td style="width: 10%;"></td> <td style="width: 10%;"></td> <td style="width: 10%;"></td> <td style="width: 10%;"></td> <td style="width: 10%;"></td> <td style="width: 10%;"></td> </tr> <tr> <td style="text-align: center;">XA</td> <td style="text-align: center;">1</td> <td style="text-align: center;">2</td> <td style="text-align: center;">3</td> <td style="text-align: center;">4</td> <td style="text-align: center;">R01</td> <td style="text-align: center;">S01</td> <td style="text-align: center;">T01</td> <td style="text-align: center;">N01</td> <td style="text-align: center;">E1</td> <td style="text-align: center;">E1</td> <td style="text-align: center;">E1</td> </tr></table></td></tr></table></td></tr></table></td></tr></table></td></tr></table></td></tr></table></td></tr></table></td></tr></table></td></tr></table></td></tr></table> | |
 | | | | | | | | | | | |

 | |
 | | | | | | | | | | | | <table border="0" style="width: 100%;"> <tr> <td style="width: 50%; vertical-align: top;"> <table border="0" style="width: 100%;"> <tr> <td style="width: 50%;"></td> <td style="width: 50%; text-align: center;"> <table border="0"> <tr> <td style="width: 10%;"></td> <td style="width: 10%;"></td> <td style="width: 10%;"></td> <td style="width: 10%;"></td> <td style="width: 10%;"></td> <td style="width: 10%;"></td> <td style="width: 10%;"></td> <td style="width: 10%;"></td> <td style="width: 10%;"></td> <td style="width: 10%;"></td> <td style="width: 10%;"></td> <td style="width: 10%;"></td> <td style="width: 10%;"></td> <td style="width: 10%;"></td> </tr> <tr> <td style="text-align: center;">XA</td> <td style="text-align: center;">1/G</td> <td style="text-align: center;">2/G</td> <td style="text-align: center;">3/G</td> <td style="text-align: center;">4/G</td> <td style="text-align: center;">R</td> <td style="text-align: center;">S</td> <td style="text-align: center;">T</td> <td style="text-align: center;">N</td> <td style="text-align: center;">E0</td> <td style="text-align: center;">E0</td> <td style="text-align: center;">E0</td> <td style="text-align: center;">E0</td> <td style="text-align: center;">E0</td> </tr> <tr> <td></td> <td style="text-align: center;">1</td> <td style="text-align: center;">2</td> <td style="text-align: center;">3</td> <td style="text-align: center;">4</td> <td style="text-align: center;">R01</td> <td style="text-align: center;">S01</td> <td style="text-align: center;">T01</td> <td style="text-align: center;">N01</td> <td style="text-align: center;">E1</td> <td style="text-align: center;">E1</td> <td style="text-align: center;">E1</td> <td style="text-align: center;">E1</td> <td style="text-align: center;">E1</td> </tr> <tr> <td></td> <td style="text-align: center;">1</td> <td style="text-align: center;">2</td> <td style="text-align: center;">3</td> <td style="text-align: center;">4</td> <td style="text-align: center;">R02</td> <td style="text-align: center;">S02</td> <td style="text-align: center;">T02</td> <td style="text-align: center;">N02</td> <td style="text-align: center;">E2</td> <td style="text-align: center;">E2</td> <td style="text-align: center;">E2</td> <td style="text-align: center;">E2</td> <td style="text-align: center;">E2</td> </tr> <tr> <td></td> <td style="text-align: center;">1</td> <td style="text-align: center;">2</td> <td style="text-align: center;">3</td> <td style="text-align: center;">4</td> <td style="text-align: center;">R03</td> <td style="text-align: center;">S03</td> <td style="text-align: center;">T03</td> <td style="text-align: center;">N03</td> <td style="text-align: center;">E3</td> <td style="text-align: center;">E3</td> <td style="text-align: center;">E3</td> <td style="text-align: center;">E3</td> <td style="text-align: center;">E3</td> </tr> <tr> <td></td> <td style="text-align: center;">1</td> <td style="text-align: center;">2</td> <td style="text-align: center;">3</td> <td style="text-align: center;">4</td> <td style="text-align: center;">R04</td> <td style="text-align: center;">S04</td> <td style="text-align: center;">T04</td> <td style="text-align: center;">N04</td> <td style="text-align: center;">E4</td> <td style="text-align: center;">E4</td> <td style="text-align: center;">E4</td> <td style="text-align: center;">E4</td> <td style="text-align: center;">E4</td> </tr> <tr> <td></td> <td style="text-align: center;">1</td> <td style="text-align: center;">2</td> <td style="text-align: center;">3</td> <td style="text-align: center;">4</td> <td style="text-align: center;">R05</td> <td style="text-align: center;">S05</td> <td style="text-align: center;">T05</td> <td style="text-align: center;">N05</td> <td style="text-align: center;">E5</td> <td style="text-align: center;">E5</td> <td style="text-align: center;">E5</td> <td style="text-align: center;">E5</td> <td style="text-align: center;">E5</td> </tr> <tr> <td></td> <td style="text-align: center;">1</td> <td style="text-align: center;">2</td> <td style="text-align: center;">3</td> <td style="text-align: center;">4</td> <td style="text-align: center;">R06</td> <td style="text-align: center;">S06</td> <td style="text-align: center;">T06</td> <td style="text-align: center;">N06</td> <td style="text-align: center;">E6</td> <td style="text-align: center;">E6</td> <td style="text-align: center;">E6</td> <td style="text-align: center;">E6</td> <td style="text-align: center;">E6</td> </tr> <tr> <td></td> <td style="text-align: center;">1</td> <td style="text-align: center;">2</td> <td style="text-align: center;">3</td> <td style="text-align: center;">4</td> <td style="text-align: center;">R07</td> <td style="text-align: center;">S07</td> <td style="text-align: center;">T07</td> <td style="text-align: center;">N07</td> <td style="text-align: center;">E7</td> <td style="text-align: center;">E7</td> <td style="text-align: center;">E7</td> <td style="text-align: center;">E7</td> <td style="text-align: center;">E7</td> </tr> <tr> <td></td> <td style="text-align: center;">1</td> <td style="text-align: center;">2</td> <td style="text-align: center;">3</td> <td style="text-align: center;">4</td> <td style="text-align: center;">R08</td> <td style="text-align: center;">S08</td> <td style="text-align: center;">T08</td> <td style="text-align: center;">N08</td> <td style="text-align: center;">E8</td> <td style="text-align: center;">E8</td> <td style="text-align: center;">E8</td> <td style="text-align: center;">E8</td> <td style="text-align: center;">E8</td> </tr> </table> </td> <td style="width: 50%; vertical-align: top;"> <table border="0" style="width: 100%;"> <tr> <td style="width: 50%;"></td> <td style="width: 50%; text-align: center;"> <table border="0"> <tr> <td style="width: 10%;"></td> <td style="width: 10%;"></td> <td style="width: 10%;"></td> <td style="width: 10%;"></td> <td style="width: 10%;"></td> <td style="width: 10%;"></td> <td style="width: 10%;"></td> <td style="width: 10%;"></td> <td style="width: 10%;"></td> <td style="width: 10%;"></td> <td style="width: 10%;"></td> <td style="width: 10%;"></td> <td style="width: 10%;"></td> <td style="width: 10%;"></td> </tr> <tr> <td style="text-align: center;">XA</td> <td style="text-align: center;">1</td> <td style="text-align: center;">2</td> <td style="text-align: center;">3</td> <td style="text-align: center;">4</td> <td style="text-align: center;">R01</td> <td style="text-align: center;">S01</td> <td style="text-align: center;">T01</td> <td style="text-align: center;">N01</td> <td style="text-align: center;">E1</td> <td style="text-align: center;">E1</td> <td style="text-align: center;">E1</td> <td style="text-align: center;">E1</td> <td style="text-align: center;">E1</td> </tr> <tr> <td></td> <td style="text-align: center;">1</td> <td style="text-align: center;">2</td> <td style="text-align: center;">3</td> <td style="text-align: center;">4</td> <td style="text-align: center;">R02</td> <td style="text-align: center;">S02</td> <td style="text-align: center;">T02</td> <td style="text-align: center;">N02</td> <td style="text-align: center;">E2</td> <td style="text-align: center;">E2</td> <td style="text-align: center;">E2</td> <td style="text-align: center;">E2</td> <td style="text-align: center;">E2</td> </tr> <tr> <td></td> <td style="text-align: center;">1</td> <td style="text-align: center;">2</td> <td style="text-align: center;">3</td> <td style="text-align: center;">4</td> <td style="text-align: center;">R03</td> <td style="text-align: center;">S03</td> <td style="text-align: center;">T03</td> <td style="text-align: center;">N03</td> <td style="text-align: center;">E3</td> <td style="text-align: center;">E3</td> <td style="text-align: center;">E3</td> <td style="text-align: center;">E3</td> <td style="text-align: center;">E3</td> </tr> <tr> <td></td> <td style="text-align: center;">1</td> <td style="text-align: center;">2</td> <td style="text-align: center;">3</td> <td style="text-align: center;">4</td> <td style="text-align: center;">R04</td> <td style="text-align: center;">S04</td> <td style="text-align: center;">T04</td> <td style="text-align: center;">N04</td> <td style="text-align: center;">E4</td> <td style="text-align: center;">E4</td> <td style="text-align: center;">E4</td> <td style="text-align: center;">E4</td> <td style="text-align: center;">E4</td> </tr> <tr> <td></td> <td style="text-align: center;">1</td> <td style="text-align: center;">2</td> <td style="text-align: center;">3</td> <td style="text-align: center;">4</td> <td style="text-align: center;">R05</td> <td style="text-align: center;">S05</td> <td style="text-align: center;">T05</td> <td style="text-align: center;">N05</td> <td style="text-align: center;">E5</td> <td style="text-align: center;">E5</td> <td style="text-align: center;">E5</td> <td style="text-align: center;">E5</td> <td style="text-align: center;">E5</td> </tr> <tr> <td></td> <td style="text-align: center;">1</td> <td style="text-align: center;">2</td> <td style="text-align: center;">3</td> <td style="text-align: center;">4</td> <td style="text-align: center;">R06</td> <td style="text-align: center;">S06</td> <td style="text-align: center;">T06</td> <td style="text-align: center;">N06</td> <td style="text-align: center;">E6</td> <td style="text-align: center;">E6</td> <td style="text-align: center;">E6</td> <td style="text-align: center;">E6</td> <td style="text-align: center;">E6</td> </tr> <tr> <td></td> <td style="text-align: center;">1</td> <td style="text-align: center;">2</td> <td style="text-align:
center;">3</td> <td style="text-align: center;">4</td> <td style="text-align: center;">R07</td> <td style="text-align: center;">S07</td> <td style="text-align: center;">T07</td> <td style="text-align: center;">N07</td> <td style="text-align: center;">E7</td> <td style="text-align: center;">E7</td> <td style="text-align: center;">E7</td> <td style="text-align: center;">E7</td> <td style="text-align: center;">E7</td> </tr> <tr> <td></td> <td style="text-align: center;">1</td> <td style="text-align: center;">2</td> <td style="text-align: center;">3</td> <td style="text-align: center;">4</td> <td style="text-align: center;">R08</td> <td style="text-align: center;">S08</td> <td style="text-align: center;">T08</td> <td style="text-align: center;">N08</td> <td style="text-align: center;">E8</td> <td style="text-align: center;">E8</td> <td style="text-align: center;">E8</td> <td style="text-align: center;">E8</td> <td style="text-align: center;">E8</td> </tr> </table> </td> <td style="width: 50%; vertical-align: top;"> <table border="0" style="width: 100%;"> <tr> <td style="width: 50%;"></td> <td style="width: 50%; text-align: center;"> <table border="0"> <tr> <td style="width: 10%;"></td> <td style="width: 10%;"></td> <td style="width: 10%;"></td> <td style="width: 10%;"></td> <td style="width: 10%;"></td> <td style="width: 10%;"></td> <td style="width: 10%;"></td> <td style="width: 10%;"></td> <td style="width: 10%;"></td> <td style="width: 10%;"></td> <td style="width: 10%;"></td> <td style="width: 10%;"></td> <td style="width: 10%;"></td> <td style="width: 10%;"></td> </tr> <tr> <td style="text-align: center;">XA</td> <td style="text-align: center;">1</td> <td style="text-align: center;">2</td> <td style="text-align: center;">3</td> <td style="text-align: center;">4</td> <td style="text-align: center;">R01</td> <td style="text-align: center;">S01</td> <td style="text-align: center;">T01</td> <td style="text-align: center;">N01</td> <td style="text-align: center;">E1</td> <td style="text-align: center;">E1</td> <td style="text-align: center;">E1</td> <td style="text-align: center;">E1</td> <td style="text-align: center;">E1</td> </tr> <tr> <td></td> <td style="text-align: center;">1</td> <td style="text-align: center;">2</td> <td style="text-align: center;">3</td> <td style="text-align: center;">4</td> <td style="text-align: center;">R02</td> <td style="text-align: center;">S02</td> <td style="text-align: center;">T02</td> <td style="text-align: center;">N02</td> <td style="text-align: center;">E2</td> <td style="text-align: center;">E2</td> <td style="text-align: center;">E2</td> <td style="text-align: center;">E2</td> <td style="text-align: center;">E2</td> </tr> <tr> <td></td> <td style="text-align: center;">1</td> <td style="text-align: center;">2</td> <td style="text-align: center;">3</td> <td style="text-align: center;">4</td> <td style="text-align: center;">R03</td> <td style="text-align: center;">S03</td> <td style="text-align: center;">T03</td> <td style="text-align: center;">N03</td> <td style="text-align: center;">E3</td> <td style="text-align: center;">E3</td> <td style="text-align: center;">E3</td> <td style="text-align: center;">E3</td> <td style="text-align: center;">E3</td> </tr> <tr> <td></td> <td style="text-align: center;">1</td> <td style="text-align: center;">2</td> <td style="text-align: center;">3</td> <td style="text-align: center;">4</td> <td style="text-align: center;">R04</td> <td style="text-align: center;">S04</td> <td style="text-align: center;">T04</td> <td style="text-align: center;">N04</td> <td style="text-align: center;">E4</td> <td style="text-align: center;">E4</td> <td style="text-align: center;">E4</td> <td style="text-align: center;">E4</td> <td style="text-align: center;">E4</td> </tr> <tr> <td></td> <td style="text-align: center;">1</td> <td style="text-align: center;">2</td> <td style="text-align: center;">3</td> <td style="text-align: center;">4</td> <td style="text-align: center;">R05</td> <td style="text-align: center;">S05</td> <td style="text-align: center;">T05</td> <td style="text-align: center;">N05</td> <td style="text-align: center;">E5</td> <td style="text-align: center;">E5</td> <td style="text-align: center;">E5</td> <td style="text-align: center;">E5</td> <td style="text-align: center;">E5</td> </tr> <tr> <td></td> <td style="text-align: center;">1</td> <td style="text-align: center;">2</td> <td style="text-align: center;">3</td> <td style="text-align: center;">4</td> <td style="text-align: center;">R06</td> <td style="text-align: center;">S06</td> <td style="text-align: center;">T06</td> <td style="text-align: center;">N06</td> <td style="text-align: center;">E6</td> <td style="text-align: center;">E6</td> <td style="text-align: center;">E6</td> <td style="text-align: center;">E6</td> <td style="text-align: center;">E6</td> </tr> <tr> <td></td> <td style="text-align: center;">1</td> <td style="text-align: center;">2</td> <td style="text-align: center;">3</td> <td style="text-align: center;">4</td> <td style="text-align: center;">R07</td> <td style="text-align: center;">S07</td> <td style="text-align: center;">T07</td> <td style="text-align: center;">N07</td> <td style="text-align: center;">E7</td> <td style="text-align: center;">E7</td> <td style="text-align: center;">E7</td> <td style="text-align: center;">E7</td> <td style="text-align: center;">E7</td> </tr> <tr> <td></td> <td style="text-align: center;">1</td> <td style="text-align: center;">2</td> <td style="text-align: center;">3</td> <td style="text-align: center;">4</td> <td style="text-align: center;">R08</td> <td style="text-align: center;">S08</td> <td style="text-align: center;">T08</td> <td style="text-align: center;">N08</td> <td style="text-align: center;">E8</td> <td style="text-align: center;">E8</td> <td style="text-align: center;">E8</td> <td style="text-align: center;">E8</td> <td style="text-align: center;">E8</td> </tr> </table> </td> <td style="width: 50%; vertical-align: top;"> <table border="0" style="width: 100%;"> <tr> <td style="width: 50%;"></td> <td style="width: 50%; text-align: center;"> <table border="0"> <tr> <td style="width: 10%;"></td> <td style="width: 10%;"></td> <td style="width: 10%;"></td> <td style="width: 10%;"></td> <td style="width: 10%;"></td> <td style="width: 10%;"></td> <td style="width: 10%;"></td> <td style="width: 10%;"></td> <td style="width: 10%;"></td> <td style="width: 10%;"></td> <td style="width: 10%;"></td> <td style="width: 10%;"></td> <td style="width: 10%;"></td> <td style="width: 10%;"></td> </tr> <tr> <td style="text-align: center;">XA</td> <td style="text-align: center;">1</td> <td style="text-align: center;">2</td> <td style="text-align: center;">3</td> <td style="text-align: center;">4</td> <td style="text-align: center;">R01</td> <td style="text-align: center;">S01</td> <td style="text-align: center;">T01</td> <td style="text-align: center;">N01</td> <td style="text-align: center;">E1</td> <td style="text-align: center;">E1</td> <td style="text-align: center;">E1</td> <td style="text-align: center;">E1</td> <td style="text-align: center;">E1</td> </tr> <tr> <td></td> <td style="text-align: center;">1</td> <td style="text-align: center;">2</td> <td style="text-align: center;">3</td> <td style="text-align: center;">4</td> <td style="text-align: center;">R02</td> <td style="text-align: center;">S02</td> <td style="text-align: center;">T02</td> <td style="text-align: center;">N02</td> <td style="text-align: center;">E2</td> <td style="text-align: center;">E2</td> <td style="text-align: center;">E2</td> <td style="text-align: center;">E2</td> <td style="text-align: center;">E2</td> </tr> <tr> <td></td> <td style="text-align: center;">1</td> <td style="text-align: center;">2</td> <td style="text-align: center;">3</td> <td style="text-align: center;">4</td> <td style="text-align: center;">R03</td> <td style="text-align: center;">S03</td> <td style="text-align: center;">T03</td> <td style="text-align: center;">N03</td> <td style="text-align: center;">E3</td> <td style="text-align: center;">E3</td> <td style="text-align: center;">E3</td> <td style="text-align: center;">E3</td> <td style="text-align: center;">E3</td> </tr> <tr> <td></td> <td style="text-align: center;">1</td> <td style="text-align: center;">2</td> <td style="text-align: center;">3</td> <td style="text-align: center;">4</td> <td style="text-align: center;">R04</td> <td style="text-align: center;">S04</td> <td style="text-align: center;">T04</td> <td style="text-align: center;">N04</td> <td style="text-align: center;">E4</td> <td style="text-align: center;">E4</td> <td style="text-align: center;">E4</td> <td style="text-align: center;">E4</td> <td style="text-align: center;">E4</td> </tr> <tr> <td></td> <td style="text-align: center;">1</td> <td style="text-align: center;">2</td> <td style="text-align: center;">3</td> <td style="text-align: center;">4</td> <td style="text-align: center;">R05</td> <td style="text-align: center;">S05</td> <td style="text-align: center;">T05</td> <td style="text-align: center;">N05</td> <td style="text-align: center;">E5</td> <td style="text-align: center;">E5</td> <td style="text-align: center;">E5</td> <td style="text-align: center;">E5</td> <td style="text-align: center;">E5</td> </tr> <tr> <td></td> <td style="text-align: center;">1</td> <td style="text-align: center;">2</td> <td style="text-align: center;">3</td> <td style="text-align: center;">4</td> <td style="text-align: center;">R06</td> <td style="text-align: center;">S06</td> <td style="text-align: center;">T06</td> <td style="text-align: center;">N06</td> <td style="text-align: center;">E6</td> <td style="text-align: center;">E6</td> <td style="text-align: center;">E6</td> <td style="text-align: center;">E6</td> <td style="text-align: center;">E6</td> </tr> <tr> <td></td> <td style="text-align: center;">1</td> <td style="text-align: center;">2</td> <td style="text-align: center;">3</td> <td
style="text-align: center;">4</td> <td style="text-align: center;">R07</td> <td style="text-align: center;">S07</td> <td style="text-align: center;">T07</td> <td style="text-align: center;">N07</td> <td style="text-align: center;">E7</td> <td style="text-align: center;">E7</td> <td style="text-align: center;">E7</td> <td style="text-align: center;">E7</td> <td style="text-align: center;">E7</td> </tr> <tr> <td></td> <td style="text-align: center;">1</td> <td style="text-align: center;">2</td> <td style="text-align: center;">3</td> <td style="text-align: center;">4</td> <td style="text-align: center;">R08</td> <td style="text-align: center;">S08</td> <td style="text-align: center;">T08</td> <td style="text-align: center;">N08</td> <td style="text-align: center;">E8</td> <td style="text-align: center;">E8</td> <td style="text-align: center;">E8</td> <td style="text-align: center;">E8</td> <td style="text-align: center;">E8</td> </tr> </table> </td> <td style="width: 50%; vertical-align: top;"> <table border="0" style="width: 100%;"> <tr> <td style="width: 50%;"></td> <td style="width: 50%; text-align: center;"> <table border="0"> <tr> <td style="width: 10%;"></td> <td style="width: 10%;"></td> <td style="width: 10%;"></td> <td style="width: 10%;"></td> <td style="width: 10%;"></td> <td style="width: 10%;"></td> <td style="width: 10%;"></td> <td style="width: 10%;"></td> <td style="width: 10%;"></td> <td style="width: 10%;"></td> <td style="width: 10%;"></td> <td style="width: 10%;"></td> <td style="width: 10%;"></td> <td style="width: 10%;"></td> </tr> <tr> <td style="text-align: center;">XA</td> <td style="text-align: center;">1</td> <td style="text-align: center;">2</td> <td style="text-align: center;">3</td> <td style="text-align: center;">4</td> <td style="text-align: center;">R01</td> <td style="text-align: center;">S01</td> <td style="text-align: center;">T01</td> <td style="text-align: center;">N01</td> <td style="text-align: center;">E1</td> <td style="text-align: center;">E1</td> <td style="text-align: center;">E1</td> <td style="text-align: center;">E1</td> <td style="text-align: center;">E1</td> </tr> <tr> <td></td> <td style="text-align: center;">1</td> <td style="text-align: center;">2</td> <td style="text-align: center;">3</td> <td style="text-align: center;">4</td> <td style="text-align: center;">R02</td> <td style="text-align: center;">S02</td> <td style="text-align: center;">T02</td> <td style="text-align: center;">N02</td> <td style="text-align: center;">E2</td> <td style="text-align: center;">E2</td> <td style="text-align: center;">E2</td> <td style="text-align: center;">E2</td> <td style="text-align: center;">E2</td> </tr> <tr> <td></td> <td style="text-align: center;">1</td> <td style="text-align: center;">2</td> <td style="text-align: center;">3</td> <td style="text-align: center;">4</td> <td style="text-align: center;">R03</td> <td style="text-align: center;">S03</td> <td style="text-align: center;">T03</td> <td style="text-align: center;">N03</td> <td style="text-align: center;">E3</td> <td style="text-align: center;">E3</td> <td style="text-align: center;">E3</td> <td style="text-align: center;">E3</td> <td style="text-align: center;">E3</td> </tr> <tr> <td></td> <td style="text-align: center;">1</td> <td style="text-align: center;">2</td> <td style="text-align: center;">3</td> <td style="text-align: center;">4</td> <td style="text-align: center;">R04</td> <td style="text-align: center;">S04</td> <td style="text-align: center;">T04</td> <td style="text-align: center;">N04</td> <td style="text-align: center;">E4</td> <td style="text-align: center;">E4</td> <td style="text-align: center;">E4</td> <td style="text-align: center;">E4</td> <td style="text-align: center;">E4</td> </tr> <tr> <td></td> <td style="text-align: center;">1</td> <td style="text-align: center;">2</td> <td style="text-align: center;">3</td> <td style="text-align: center;">4</td> <td style="text-align: center;">R05</td> <td style="text-align: center;">S05</td> <td style="text-align: center;">T05</td> <td style="text-align: center;">N05</td> <td style="text-align: center;">E5</td> <td style="text-align: center;">E5</td> <td style="text-align: center;">E5</td> <td style="text-align: center;">E5</td> <td style="text-align: center;">E5</td> </tr> <tr> <td></td> <td style="text-align: center;">1</td> <td style="text-align: center;">2</td> <td style="text-align: center;">3</td> <td style="text-align: center;">4</td> <td style="text-align: center;">R06</td> <td style="text-align: center;">S06</td> <td style="text-align: center;">T06</td> <td style="text-align: center;">N06</td> <td style="text-align: center;">E6</td> <td style="text-align: center;">E6</td> <td style="text-align: center;">E6</td> <td style="text-align: center;">E6</td> <td style="text-align: center;">E6</td> </tr> <tr> <td></td> <td style="text-align: center;">1</td> <td style="text-align: center;">2</td> <td style="text-align: center;">3</td> <td style="text-align: center;">4</td> <td style="text-align: center;">R07</td> <td style="text-align: center;">S07</td> <td style="text-align: center;">T07</td> <td style="text-align: center;">N07</td> <td style="text-align: center;">E7</td> <td style="text-align: center;">E7</td> <td style="text-align: center;">E7</td> <td style="text-align: center;">E7</td> <td style="text-align: center;">E7</td> </tr> <tr> <td></td> <td style="text-align: center;">1</td> <td style="text-align: center;">2</td> <td style="text-align: center;">3</td> <td style="text-align: center;">4</td> <td style="text-align: center;">R08</td> <td style="text-align: center;">S08</td> <td style="text-align: center;">T08</td> <td style="text-align: center;">N08</td> <td style="text-align: center;">E8</td> <td style="text-align: center;">E8</td> <td style="text-align: center;">E8</td> <td style="text-align: center;">E8</td> <td style="text-align: center;">E8</td> </tr> </table> </td> <td style="width: 50%; vertical-align: top;"> <table border="0" style="width: 100%;"> <tr> <td style="width: 50%;"></td> <td style="width: 50%; text-align: center;"> <table border="0"> <tr> <td style="width: 10%;"></td> <td style="width: 10%;"></td> <td style="width: 10%;"></td> <td style="width: 10%;"></td> <td style="width: 10%;"></td> <td style="width: 10%;"></td> <td style="width: 10%;"></td> <td style="width: 10%;"></td> <td style="width: 10%;"></td> <td style="width: 10%;"></td> <td style="width: 10%;"></td> <td style="width: 10%;"></td> <td style="width: 10%;"></td> <td style="width: 10%;"></td> </tr> <tr> <td style="text-align: center;">XA</td> <td style="text-align: center;">1</td> <td style="text-align: center;">2</td> <td style="text-align: center;">3</td> <td style="text-align: center;">4</td> <td style="text-align: center;">R01</td> <td style="text-align: center;">S01</td> <td style="text-align: center;">T01</td> <td style="text-align: center;">N01</td> <td style="text-align: center;">E1</td> <td style="text-align: center;">E1</td> <td style="text-align: center;">E1</td> <td style="text-align: center;">E1</td> <td style="text-align: center;">E1</td> </tr> <tr> <td></td> <td style="text-align: center;">1</td> <td style="text-align: center;">2</td> <td style="text-align: center;">3</td> <td style="text-align: center;">4</td> <td style="text-align: center;">R02</td> <td style="text-align: center;">S02</td> <td style="text-align: center;">T02</td> <td style="text-align: center;">N02</td> <td style="text-align: center;">E2</td> <td style="text-align: center;">E2</td> <td style="text-align: center;">E2</td> <td style="text-align: center;">E2</td> <td style="text-align: center;">E2</td> </tr> <tr> <td></td> <td style="text-align: center;">1</td> <td style="text-align: center;">2</td> <td style="text-align: center;">3</td> <td style="text-align: center;">4</td> <td style="text-align: center;">R03</td> <td style="text-align: center;">S03</td> <td style="text-align: center;">T03</td> <td style="text-align: center;">N03</td> <td style="text-align: center;">E3</td> <td style="text-align: center;">E3</td> <td style="text-align: center;">E3</td> <td style="text-align: center;">E3</td> <td style="text-align: center;">E3</td> </tr> <tr> <td></td> <td style="text-align: center;">1</td> <td style="text-align: center;">2</td> <td style="text-align: center;">3</td> <td style="text-align: center;">4</td> <td style="text-align: center;">R04</td> <td style="text-align: center;">S04</td> <td style="text-align: center;">T04</td> <td style="text-align: center;">N04</td> <td style="text-align: center;">E4</td> <td style="text-align: center;">E4</td> <td style="text-align: center;">E4</td> <td style="text-align: center;">E4</td> <td style="text-align: center;">E4</td> </tr> <tr> <td></td> <td style="text-align: center;">1</td> <td style="text-align: center;">2</td> <td style="text-align: center;">3</td> <td style="text-align: center;">4</td> <td style="text-align: center;">R05</td> <td style="text-align: center;">S05</td> <td style="text-align: center;">T05</td> <td style="text-align: center;">N05</td> <td style="text-align: center;">E5</td> <td style="text-align: center;">E5</td> <td style="text-align: center;">E5</td> <td style="text-align: center;">E5</td> <td style="text-align: center;">E5</td> </tr> <tr> <td></td> <td style="text-align: center;">1</td> <td style="text-align: center;">2</td> <td style="text-align: center;">3</td> <td style="text-align: center;">4</td> <td style="text-align: center;">R06</td> <td style="text-align: center;">S06</td> <td style="text-align: center;">T06</td> <td style="text-align: center;">N06</td> <td style="text-align: center;">E6</td> <td style="text-align: center;">E6</td> <td style="text-align: center;">E6</td> <td style="text-align: center;">E6</td> <td style="text-align: center;">E6</td> </tr> <tr> <td></td> <td style="text-align: center;">1</td> <td style="text-align: center;">2</td> <td style="text-align: center;">3</td> <td style="text-align:
center;">4</td> <td style="text-align: center;">R07</td> <td style="text-align: center;">S07</td> <td style="text-align: center;">T07</td> <td style="text-align: center;">N07</td> <td style="text-align: center;">E7</td> <td style="text-align: center;">E7</td> <td style="text-align: center;">E7</td> <td style="text-align: center;">E7</td> <td style="text-align: center;">E7</td> </tr> <tr> <td></td> <td style="text-align: center;">1</td> <td style="text-align: center;">2</td> <td style="text-align: center;">3</td> <td style="text-align: center;">4</td> <td style="text-align: center;">R08</td> <td style="text-align: center;">S08</td> <td style="text-align: center;">T08</td> <td style="text-align: center;">N08</td> <td style="text-align: center;">E8</td> <td style="text-align: center;">E8</td> <td style="text-align: center;">E8</td> <td style="text-align: center;">E8</td> <td style="text-align: center;">E8</td> </tr> </table> </td> <td style="width: 50%; vertical-align: top;"> <table border="0" style="width: 100%;"> <tr> <td style="width: 50%;"></td> <td style="width: 50%; text-align: center;"> <table border="0"> <tr> <td style="width: 10%;"></td> <td style="width: 10%;"></td> <td style="width: 10%;"></td> <td style="width: 10%;"></td> <td style="width: 10%;"></td> <td style="width: 10%;"></td> <td style="width: 10%;"></td> <td style="width: 10%;"></td> <td style="width: 10%;"></td> <td style="width: 10%;"></td> <td style="width: 10%;"></td> <td style="width: 10%;"></td> <td style="width: 10%;"></td> <td style="width: 10%;"></td> </tr> <tr> <td style="text-align: center;">XA</td> <td style="text-align: center;">1</td> <td style="text-align: center;">2</td> <td style="text-align: center;">3</td> <td style="text-align: center;">4</td> <td style="text-align: center;">R01</td> <td style="text-align: center;">S01</td> <td style="text-align: center;">T01</td> <td style="text-align: center;">N01</td> <td style="text-align: center;">E1</td> <td style="text-align: center;">E1</td> <td style="text-align: center;">E1</td> </tr></table></td></tr></table></td></tr></table></td></tr></table></td></tr></table></td></tr></table></td></tr></table></td></tr></table></td></tr></table> | | | | | | | | | | | | | | <table border="0" style="width: 100%;"> <tr> <td style="width: 50%;"></td> <td style="width: 50%; text-align: center;"> <table border="0"> <tr> <td style="width: 10%;"></td> <td style="width: 10%;"></td> <td style="width: 10%;"></td> <td style="width: 10%;"></td> <td style="width: 10%;"></td> <td style="width: 10%;"></td> <td style="width: 10%;"></td> <td style="width: 10%;"></td> <td style="width: 10%;"></td> <td style="width: 10%;"></td> <td style="width: 10%;"></td> <td style="width: 10%;"></td> <td style="width: 10%;"></td> <td style="width: 10%;"></td> </tr> <tr> <td style="text-align: center;">XA</td> <td style="text-align: center;">1/G</td> <td style="text-align: center;">2/G</td> <td style="text-align: center;">3/G</td> <td style="text-align: center;">4/G</td> <td style="text-align: center;">R</td> <td style="text-align: center;">S</td> <td style="text-align: center;">T</td> <td style="text-align: center;">N</td> <td style="text-align: center;">E0</td> <td style="text-align: center;">E0</td> <td style="text-align: center;">E0</td> <td style="text-align: center;">E0</td> <td style="text-align: center;">E0</td> </tr> <tr> <td></td> <td style="text-align: center;">1</td> <td style="text-align: center;">2</td> <td style="text-align: center;">3</td> <td style="text-align: center;">4</td> <td style="text-align: center;">R01</td> <td style="text-align: center;">S01</td> <td style="text-align: center;">T01</td> <td style="text-align: center;">N01</td> <td style="text-align: center;">E1</td> <td style="text-align: center;">E1</td> <td style="text-align: center;">E1</td> <td style="text-align: center;">E1</td> <td style="text-align: center;">E1</td> </tr> <tr> <td></td> <td style="text-align: center;">1</td> <td style="text-align: center;">2</td> <td style="text-align: center;">3</td> <td style="text-align: center;">4</td> <td style="text-align: center;">R02</td> <td style="text-align: center;">S02</td> <td style="text-align: center;">T02</td> <td style="text-align: center;">N02</td> <td style="text-align: center;">E2</td> <td style="text-align: center;">E2</td> <td style="text-align: center;">E2</td> <td style="text-align: center;">E2</td> <td style="text-align: center;">E2</td> </tr> <tr> <td></td> <td style="text-align: center;">1</td> <td style="text-align: center;">2</td> <td style="text-align: center;">3</td> <td style="text-align: center;">4</td> <td style="text-align: center;">R03</td> <td style="text-align: center;">S03</td> <td style="text-align: center;">T03</td> <td style="text-align: center;">N03</td> <td style="text-align: center;">E3</td> <td style="text-align: center;">E3</td> <td style="text-align: center;">E3</td> <td style="text-align: center;">E3</td> <td style="text-align: center;">E3</td> </tr> <tr> <td></td> <td style="text-align: center;">1</td> <td style="text-align: center;">2</td> <td style="text-align: center;">3</td> <td style="text-align: center;">4</td> <td style="text-align: center;">R04</td> <td style="text-align: center;">S04</td> <td style="text-align: center;">T04</td> <td style="text-align: center;">N04</td> <td style="text-align: center;">E4</td> <td style="text-align: center;">E4</td> <td style="text-align: center;">E4</td> <td style="text-align: center;">E4</td> <td style="text-align: center;">E4</td> </tr> <tr> <td></td> <td style="text-align: center;">1</td> <td style="text-align: center;">2</td> <td style="text-align: center;">3</td> <td style="text-align: center;">4</td> <td style="text-align: center;">R05</td> <td style="text-align: center;">S05</td> <td style="text-align: center;">T05</td> <td style="text-align: center;">N05</td> <td style="text-align: center;">E5</td> <td style="text-align: center;">E5</td> <td style="text-align: center;">E5</td> <td style="text-align: center;">E5</td> <td style="text-align: center;">E5</td> </tr> <tr> <td></td> <td style="text-align: center;">1</td> <td style="text-align: center;">2</td> <td style="text-align: center;">3</td> <td style="text-align: center;">4</td> <td style="text-align: center;">R06</td> <td style="text-align: center;">S06</td> <td style="text-align: center;">T06</td> <td style="text-align: center;">N06</td> <td style="text-align: center;">E6</td> <td style="text-align: center;">E6</td> <td style="text-align: center;">E6</td> <td style="text-align: center;">E6</td> <td style="text-align: center;">E6</td> </tr> <tr> <td></td> <td style="text-align: center;">1</td> <td style="text-align: center;">2</td> <td style="text-align: center;">3</td> <td style="text-align: center;">4</td> <td style="text-align: center;">R07</td> <td style="text-align: center;">S07</td> <td style="text-align: center;">T07</td> <td style="text-align: center;">N07</td> <td style="text-align: center;">E7</td> <td style="text-align: center;">E7</td> <td style="text-align: center;">E7</td> <td style="text-align: center;">E7</td> <td style="text-align: center;">E7</td> </tr> <tr> <td></td> <td style="text-align: center;">1</td> <td style="text-align: center;">2</td> <td style="text-align: center;">3</td> <td style="text-align: center;">4</td> <td style="text-align: center;">R08</td> <td style="text-align: center;">S08</td> <td style="text-align: center;">T08</td> <td style="text-align: center;">N08</td> <td style="text-align: center;">E8</td> <td style="text-align: center;">E8</td> <td style="text-align: center;">E8</td> <td style="text-align: center;">E8</td> <td style="text-align: center;">E8</td> </tr> </table> </td> <td style="width: 50%; vertical-align: top;"> <table border="0" style="width: 100%;"> <tr> <td style="width: 50%;"></td> <td style="width: 50%; text-align: center;"> <table border="0"> <tr> <td style="width: 10%;"></td> <td style="width: 10%;"></td> <td style="width: 10%;"></td> <td style="width: 10%;"></td> <td style="width: 10%;"></td> <td style="width: 10%;"></td> <td style="width: 10%;"></td> <td style="width: 10%;"></td> <td style="width: 10%;"></td> <td style="width: 10%;"></td> <td style="width: 10%;"></td> <td style="width: 10%;"></td> <td style="width: 10%;"></td> <td style="width: 10%;"></td> </tr> <tr> <td style="text-align: center;">XA</td> <td style="text-align: center;">1</td> <td style="text-align: center;">2</td> <td style="text-align: center;">3</td> <td style="text-align: center;">4</td> <td style="text-align: center;">R01</td> <td style="text-align: center;">S01</td> <td style="text-align: center;">T01</td> <td style="text-align: center;">N01</td> <td style="text-align: center;">E1</td> <td style="text-align: center;">E1</td> <td style="text-align: center;">E1</td> <td style="text-align: center;">E1</td> <td style="text-align: center;">E1</td> </tr> <tr> <td></td> <td style="text-align: center;">1</td> <td style="text-align: center;">2</td> <td style="text-align: center;">3</td> <td style="text-align: center;">4</td> <td style="text-align: center;">R02</td> <td style="text-align: center;">S02</td> <td style="text-align: center;">T02</td> <td style="text-align: center;">N02</td> <td style="text-align: center;">E2</td> <td style="text-align: center;">E2</td> <td style="text-align: center;">E2</td> <td style="text-align: center;">E2</td> <td style="text-align: center;">E2</td> </tr> <tr> <td></td> <td style="text-align: center;">1</td> <td style="text-align: center;">2</td> <td style="text-align: center;">3</td> <td style="text-align: center;">4</td> <td style="text-align: center;">R03</td> <td style="text-align: center;">S03</td> <td style="text-align: center;">T03</td> <td style="text-align: center;">N03</td> <td style="text-align: center;">E3</td> <td style="text-align: center;">E3</td> <td style="text-align: center;">E3</td> <td style="text-align: center;">E3</td> <td
style="text-align: center;">E3</td> </tr> <tr> <td></td> <td style="text-align: center;">1</td> <td style="text-align: center;">2</td> <td style="text-align: center;">3</td> <td style="text-align: center;">4</td> <td style="text-align: center;">R04</td> <td style="text-align: center;">S04</td> <td style="text-align: center;">T04</td> <td style="text-align: center;">N04</td> <td style="text-align: center;">E4</td> <td style="text-align: center;">E4</td> <td style="text-align: center;">E4</td> <td style="text-align: center;">E4</td> <td style="text-align: center;">E4</td> </tr> <tr> <td></td> <td style="text-align: center;">1</td> <td style="text-align: center;">2</td> <td style="text-align: center;">3</td> <td style="text-align: center;">4</td> <td style="text-align: center;">R05</td> <td style="text-align: center;">S05</td> <td style="text-align: center;">T05</td> <td style="text-align: center;">N05</td> <td style="text-align: center;">E5</td> <td style="text-align: center;">E5</td> <td style="text-align: center;">E5</td> <td style="text-align: center;">E5</td> <td style="text-align: center;">E5</td> </tr> <tr> <td></td> <td style="text-align: center;">1</td> <td style="text-align: center;">2</td> <td style="text-align: center;">3</td> <td style="text-align: center;">4</td> <td style="text-align: center;">R06</td> <td style="text-align: center;">S06</td> <td style="text-align: center;">T06</td> <td style="text-align: center;">N06</td> <td style="text-align: center;">E6</td> <td style="text-align: center;">E6</td> <td style="text-align: center;">E6</td> <td style="text-align: center;">E6</td> <td style="text-align: center;">E6</td> </tr> <tr> <td></td> <td style="text-align: center;">1</td> <td style="text-align: center;">2</td> <td style="text-align: center;">3</td> <td style="text-align: center;">4</td> <td style="text-align: center;">R07</td> <td style="text-align: center;">S07</td> <td style="text-align: center;">T07</td> <td style="text-align: center;">N07</td> <td style="text-align: center;">E7</td> <td style="text-align: center;">E7</td> <td style="text-align: center;">E7</td> <td style="text-align: center;">E7</td> <td style="text-align: center;">E7</td> </tr> <tr> <td></td> <td style="text-align: center;">1</td> <td style="text-align: center;">2</td> <td style="text-align: center;">3</td> <td style="text-align: center;">4</td> <td style="text-align: center;">R08</td> <td style="text-align: center;">S08</td> <td style="text-align: center;">T08</td> <td style="text-align: center;">N08</td> <td style="text-align: center;">E8</td> <td style="text-align: center;">E8</td> <td style="text-align: center;">E8</td> <td style="text-align: center;">E8</td> <td style="text-align: center;">E8</td> </tr> </table> </td> <td style="width: 50%; vertical-align: top;"> <table border="0" style="width: 100%;"> <tr> <td style="width: 50%;"></td> <td style="width: 50%; text-align: center;"> <table border="0"> <tr> <td style="width: 10%;"></td> <td style="width: 10%;"></td> <td style="width: 10%;"></td> <td style="width: 10%;"></td> <td style="width: 10%;"></td> <td style="width: 10%;"></td> <td style="width: 10%;"></td> <td style="width: 10%;"></td> <td style="width: 10%;"></td> <td style="width: 10%;"></td> <td style="width: 10%;"></td> <td style="width: 10%;"></td> <td style="width: 10%;"></td> <td style="width: 10%;"></td> </tr> <tr> <td style="text-align: center;">XA</td> <td style="text-align: center;">1</td> <td style="text-align: center;">2</td> <td style="text-align: center;">3</td> <td style="text-align: center;">4</td> <td style="text-align: center;">R01</td> <td style="text-align: center;">S01</td> <td style="text-align: center;">T01</td> <td style="text-align: center;">N01</td> <td style="text-align: center;">E1</td> <td style="text-align: center;">E1</td> <td style="text-align: center;">E1</td> <td style="text-align: center;">E1</td> <td style="text-align: center;">E1</td> </tr> <tr> <td></td> <td style="text-align: center;">1</td> <td style="text-align: center;">2</td> <td style="text-align: center;">3</td> <td style="text-align: center;">4</td> <td style="text-align: center;">R02</td> <td style="text-align: center;">S02</td> <td style="text-align: center;">T02</td> <td style="text-align: center;">N02</td> <td style="text-align: center;">E2</td> <td style="text-align: center;">E2</td> <td style="text-align: center;">E2</td> <td style="text-align: center;">E2</td> <td style="text-align: center;">E2</td> </tr> <tr> <td></td> <td style="text-align: center;">1</td> <td style="text-align: center;">2</td> <td style="text-align: center;">3</td> <td style="text-align: center;">4</td> <td style="text-align: center;">R03</td> <td style="text-align: center;">S03</td> <td style="text-align: center;">T03</td> <td style="text-align: center;">N03</td> <td style="text-align: center;">E3</td> <td style="text-align: center;">E3</td> <td style="text-align: center;">E3</td> <td style="text-align: center;">E3</td> <td style="text-align: center;">E3</td> </tr> <tr> <td></td> <td style="text-align: center;">1</td> <td style="text-align: center;">2</td> <td style="text-align: center;">3</td> <td style="text-align: center;">4</td> <td style="text-align: center;">R04</td> <td style="text-align: center;">S04</td> <td style="text-align: center;">T04</td> <td style="text-align: center;">N04</td> <td style="text-align: center;">E4</td> <td style="text-align: center;">E4</td> <td style="text-align: center;">E4</td> <td style="text-align: center;">E4</td> <td style="text-align: center;">E4</td> </tr> <tr> <td></td> <td style="text-align: center;">1</td> <td style="text-align: center;">2</td> <td style="text-align: center;">3</td> <td style="text-align: center;">4</td> <td style="text-align: center;">R05</td> <td style="text-align: center;">S05</td> <td style="text-align: center;">T05</td> <td style="text-align: center;">N05</td> <td style="text-align: center;">E5</td> <td style="text-align: center;">E5</td> <td style="text-align: center;">E5</td> <td style="text-align: center;">E5</td> <td style="text-align: center;">E5</td> </tr> <tr> <td></td> <td style="text-align: center;">1</td> <td style="text-align: center;">2</td> <td style="text-align: center;">3</td> <td style="text-align: center;">4</td> <td style="text-align: center;">R06</td> <td style="text-align: center;">S06</td> <td style="text-align: center;">T06</td> <td style="text-align: center;">N06</td> <td style="text-align: center;">E6</td> <td style="text-align: center;">E6</td> <td style="text-align: center;">E6</td> <td style="text-align: center;">E6</td> <td style="text-align: center;">E6</td> </tr> <tr> <td></td> <td style="text-align: center;">1</td> <td style="text-align: center;">2</td> <td style="text-align: center;">3</td> <td style="text-align: center;">4</td> <td style="text-align: center;">R07</td> <td style="text-align: center;">S07</td> <td style="text-align: center;">T07</td> <td style="text-align: center;">N07</td> <td style="text-align: center;">E7</td> <td style="text-align: center;">E7</td> <td style="text-align: center;">E7</td> <td style="text-align: center;">E7</td> <td style="text-align: center;">E7</td> </tr> <tr> <td></td> <td style="text-align: center;">1</td> <td style="text-align: center;">2</td> <td style="text-align: center;">3</td> <td style="text-align: center;">4</td> <td style="text-align: center;">R08</td> <td style="text-align: center;">S08</td> <td style="text-align: center;">T08</td> <td style="text-align: center;">N08</td> <td style="text-align: center;">E8</td> <td style="text-align: center;">E8</td> <td style="text-align: center;">E8</td> <td style="text-align: center;">E8</td> <td style="text-align: center;">E8</td> </tr> </table> </td> <td style="width: 50%; vertical-align: top;"> <table border="0" style="width: 100%;"> <tr> <td style="width: 50%;"></td> <td style="width: 50%; text-align: center;"> <table border="0"> <tr> <td style="width: 10%;"></td> <td style="width: 10%;"></td> <td style="width: 10%;"></td> <td style="width: 10%;"></td> <td style="width: 10%;"></td> <td style="width: 10%;"></td> <td style="width: 10%;"></td> <td style="width: 10%;"></td> <td style="width: 10%;"></td> <td style="width: 10%;"></td> <td style="width: 10%;"></td> <td style="width: 10%;"></td> <td style="width: 10%;"></td> <td style="width: 10%;"></td> </tr> <tr> <td style="text-align: center;">XA</td> <td style="text-align: center;">1</td> <td style="text-align: center;">2</td> <td style="text-align: center;">3</td> <td style="text-align: center;">4</td> <td style="text-align: center;">R01</td> <td style="text-align: center;">S01</td> <td style="text-align: center;">T01</td> <td style="text-align: center;">N01</td> <td style="text-align: center;">E1</td> <td style="text-align: center;">E1</td> <td style="text-align: center;">E1</td> <td style="text-align: center;">E1</td> <td style="text-align: center;">E1</td> </tr> <tr> <td></td> <td style="text-align: center;">1</td> <td style="text-align: center;">2</td> <td style="text-align: center;">3</td> <td style="text-align: center;">4</td> <td style="text-align: center;">R02</td> <td style="text-align: center;">S02</td> <td style="text-align: center;">T02</td> <td style="text-align: center;">N02</td> <td style="text-align: center;">E2</td> <td style="text-align: center;">E2</td> <td style="text-align: center;">E2</td> <td style="text-align: center;">E2</td> <td style="text-align: center;">E2</td> </tr> <tr> <td></td> <td style="text-align: center;">1</td> <td style="text-align: center;">2</td> <td style="text-align: center;">3</td> <td style="text-align: center;">4</td> <td style="text-align: center;">R03</td> <td style="text-align: center;">S03</td> <td style="text-align: center;">T03</td> <td style="text-align: center;">N03</td> <td style="text-align: center;">E3</td> <td style="text-align: center;">E3</td> <td style="text-align: center;">E3</td> <td style="text-align: center;">E3</td> <td style="text-align:
center;">E3</td> </tr> <tr> <td></td> <td style="text-align: center;">1</td> <td style="text-align: center;">2</td> <td style="text-align: center;">3</td> <td style="text-align: center;">4</td> <td style="text-align: center;">R04</td> <td style="text-align: center;">S04</td> <td style="text-align: center;">T04</td> <td style="text-align: center;">N04</td> <td style="text-align: center;">E4</td> <td style="text-align: center;">E4</td> <td style="text-align: center;">E4</td> <td style="text-align: center;">E4</td> <td style="text-align: center;">E4</td> </tr> <tr> <td></td> <td style="text-align: center;">1</td> <td style="text-align: center;">2</td> <td style="text-align: center;">3</td> <td style="text-align: center;">4</td> <td style="text-align: center;">R05</td> <td style="text-align: center;">S05</td> <td style="text-align: center;">T05</td> <td style="text-align: center;">N05</td> <td style="text-align: center;">E5</td> <td style="text-align: center;">E5</td> <td style="text-align: center;">E5</td> <td style="text-align: center;">E5</td> <td style="text-align: center;">E5</td> </tr> <tr> <td></td> <td style="text-align: center;">1</td> <td style="text-align: center;">2</td> <td style="text-align: center;">3</td> <td style="text-align: center;">4</td> <td style="text-align: center;">R06</td> <td style="text-align: center;">S06</td> <td style="text-align: center;">T06</td> <td style="text-align: center;">N06</td> <td style="text-align: center;">E6</td> <td style="text-align: center;">E6</td> <td style="text-align: center;">E6</td> <td style="text-align: center;">E6</td> <td style="text-align: center;">E6</td> </tr> <tr> <td></td> <td style="text-align: center;">1</td> <td style="text-align: center;">2</td> <td style="text-align: center;">3</td> <td style="text-align: center;">4</td> <td style="text-align: center;">R07</td> <td style="text-align: center;">S07</td> <td style="text-align: center;">T07</td> <td style="text-align: center;">N07</td> <td style="text-align: center;">E7</td> <td style="text-align: center;">E7</td> <td style="text-align: center;">E7</td> <td style="text-align: center;">E7</td> <td style="text-align: center;">E7</td> </tr> <tr> <td></td> <td style="text-align: center;">1</td> <td style="text-align: center;">2</td> <td style="text-align: center;">3</td> <td style="text-align: center;">4</td> <td style="text-align: center;">R08</td> <td style="text-align: center;">S08</td> <td style="text-align: center;">T08</td> <td style="text-align: center;">N08</td> <td style="text-align: center;">E8</td> <td style="text-align: center;">E8</td> <td style="text-align: center;">E8</td> <td style="text-align: center;">E8</td> <td style="text-align: center;">E8</td> </tr> </table> </td> <td style="width: 50%; vertical-align: top;"> <table border="0" style="width: 100%;"> <tr> <td style="width: 50%;"></td> <td style="width: 50%; text-align: center;"> <table border="0"> <tr> <td style="width: 10%;"></td> <td style="width: 10%;"></td> <td style="width: 10%;"></td> <td style="width: 10%;"></td> <td style="width: 10%;"></td> <td style="width: 10%;"></td> <td style="width: 10%;"></td> <td style="width: 10%;"></td> <td style="width: 10%;"></td> <td style="width: 10%;"></td> <td style="width: 10%;"></td> <td style="width: 10%;"></td> <td style="width: 10%;"></td> <td style="width: 10%;"></td> </tr> <tr> <td style="text-align: center;">XA</td> <td style="text-align: center;">1</td> <td style="text-align: center;">2</td> <td style="text-align: center;">3</td> <td style="text-align: center;">4</td> <td style="text-align: center;">R01</td> <td style="text-align: center;">S01</td> <td style="text-align: center;">T01</td> <td style="text-align: center;">N01</td> <td style="text-align: center;">E1</td> <td style="text-align: center;">E1</td> <td style="text-align: center;">E1</td> <td style="text-align: center;">E1</td> <td style="text-align: center;">E1</td> </tr> <tr> <td></td> <td style="text-align: center;">1</td> <td style="text-align: center;">2</td> <td style="text-align: center;">3</td> <td style="text-align: center;">4</td> <td style="text-align: center;">R02</td> <td style="text-align: center;">S02</td> <td style="text-align: center;">T02</td> <td style="text-align: center;">N02</td> <td style="text-align: center;">E2</td> <td style="text-align: center;">E2</td> <td style="text-align: center;">E2</td> <td style="text-align: center;">E2</td> <td style="text-align: center;">E2</td> </tr> <tr> <td></td> <td style="text-align: center;">1</td> <td style="text-align: center;">2</td> <td style="text-align: center;">3</td> <td style="text-align: center;">4</td> <td style="text-align: center;">R03</td> <td style="text-align: center;">S03</td> <td style="text-align: center;">T03</td> <td style="text-align: center;">N03</td> <td style="text-align: center;">E3</td> <td style="text-align: center;">E3</td> <td style="text-align: center;">E3</td> <td style="text-align: center;">E3</td> <td style="text-align: center;">E3</td> </tr> <tr> <td></td> <td style="text-align: center;">1</td> <td style="text-align: center;">2</td> <td style="text-align: center;">3</td> <td style="text-align: center;">4</td> <td style="text-align: center;">R04</td> <td style="text-align: center;">S04</td> <td style="text-align: center;">T04</td> <td style="text-align: center;">N04</td> <td style="text-align: center;">E4</td> <td style="text-align: center;">E4</td> <td style="text-align: center;">E4</td> <td style="text-align: center;">E4</td> <td style="text-align: center;">E4</td> </tr> <tr> <td></td> <td style="text-align: center;">1</td> <td style="text-align: center;">2</td> <td style="text-align: center;">3</td> <td style="text-align: center;">4</td> <td style="text-align: center;">R05</td> <td style="text-align: center;">S05</td> <td style="text-align: center;">T05</td> <td style="text-align: center;">N05</td> <td style="text-align: center;">E5</td> <td style="text-align: center;">E5</td> <td style="text-align: center;">E5</td> <td style="text-align: center;">E5</td> <td style="text-align: center;">E5</td> </tr> <tr> <td></td> <td style="text-align: center;">1</td> <td style="text-align: center;">2</td> <td style="text-align: center;">3</td> <td style="text-align: center;">4</td> <td style="text-align: center;">R06</td> <td style="text-align: center;">S06</td> <td style="text-align: center;">T06</td> <td style="text-align: center;">N06</td> <td style="text-align: center;">E6</td> <td style="text-align: center;">E6</td> <td style="text-align: center;">E6</td> <td style="text-align: center;">E6</td> <td style="text-align: center;">E6</td> </tr> <tr> <td></td> <td style="text-align: center;">1</td> <td style="text-align: center;">2</td> <td style="text-align: center;">3</td> <td style="text-align: center;">4</td> <td style="text-align: center;">R07</td> <td style="text-align: center;">S07</td> <td style="text-align: center;">T07</td> <td style="text-align: center;">N07</td> <td style="text-align: center;">E7</td> <td style="text-align: center;">E7</td> <td style="text-align: center;">E7</td> <td style="text-align: center;">E7</td> <td style="text-align: center;">E7</td> </tr> <tr> <td></td> <td style="text-align: center;">1</td> <td style="text-align: center;">2</td> <td style="text-align: center;">3</td> <td style="text-align: center;">4</td> <td style="text-align: center;">R08</td> <td style="text-align: center;">S08</td> <td style="text-align: center;">T08</td> <td style="text-align: center;">N08</td> <td style="text-align: center;">E8</td> <td style="text-align: center;">E8</td> <td style="text-align: center;">E8</td> <td style="text-align: center;">E8</td> <td style="text-align: center;">E8</td> </tr> </table> </td> <td style="width: 50%; vertical-align: top;"> <table border="0" style="width: 100%;"> <tr> <td style="width: 50%;"></td> <td style="width: 50%; text-align: center;"> <table border="0"> <tr> <td style="width: 10%;"></td> <td style="width: 10%;"></td> <td style="width: 10%;"></td> <td style="width: 10%;"></td> <td style="width: 10%;"></td> <td style="width: 10%;"></td> <td style="width: 10%;"></td> <td style="width: 10%;"></td> <td style="width: 10%;"></td> <td style="width: 10%;"></td> <td style="width: 10%;"></td> <td style="width: 10%;"></td> <td style="width: 10%;"></td> <td style="width: 10%;"></td> </tr> <tr> <td style="text-align: center;">XA</td> <td style="text-align: center;">1</td> <td style="text-align: center;">2</td> <td style="text-align: center;">3</td> <td style="text-align: center;">4</td> <td style="text-align: center;">R01</td> <td style="text-align: center;">S01</td> <td style="text-align: center;">T01</td> <td style="text-align: center;">N01</td> <td style="text-align: center;">E1</td> <td style="text-align: center;">E1</td> <td style="text-align: center;">E1</td> <td style="text-align: center;">E1</td> <td style="text-align: center;">E1</td> </tr> <tr> <td></td> <td style="text-align: center;">1</td> <td style="text-align: center;">2</td> <td style="text-align: center;">3</td> <td style="text-align: center;">4</td> <td style="text-align: center;">R02</td> <td style="text-align: center;">S02</td> <td style="text-align: center;">T02</td> <td style="text-align: center;">N02</td> <td style="text-align: center;">E2</td> <td style="text-align: center;">E2</td> <td style="text-align: center;">E2</td> <td style="text-align: center;">E2</td> <td style="text-align: center;">E2</td> </tr> <tr> <td></td> <td style="text-align: center;">1</td> <td style="text-align: center;">2</td> <td style="text-align: center;">3</td> <td style="text-align: center;">4</td> <td style="text-align: center;">R03</td> <td style="text-align: center;">S03</td> <td style="text-align: center;">T03</td> <td style="text-align: center;">N03</td> <td style="text-align: center;">E3</td> <td style="text-align: center;">E3</td> <td style="text-align: center;">E3</td> <td style="text-align: center;">E3</td> <td style="text-align: center;">E3</td>
</tr> <tr> <td></td> <td style="text-align: center;">1</td> <td style="text-align: center;">2</td> <td style="text-align: center;">3</td> <td style="text-align: center;">4</td> <td style="text-align: center;">R04</td> <td style="text-align: center;">S04</td> <td style="text-align: center;">T04</td> <td style="text-align: center;">N04</td> <td style="text-align: center;">E4</td> <td style="text-align: center;">E4</td> <td style="text-align: center;">E4</td> <td style="text-align: center;">E4</td> <td style="text-align: center;">E4</td> </tr> <tr> <td></td> <td style="text-align: center;">1</td> <td style="text-align: center;">2</td> <td style="text-align: center;">3</td> <td style="text-align: center;">4</td> <td style="text-align: center;">R05</td> <td style="text-align: center;">S05</td> <td style="text-align: center;">T05</td> <td style="text-align: center;">N05</td> <td style="text-align: center;">E5</td> <td style="text-align: center;">E5</td> <td style="text-align: center;">E5</td> <td style="text-align: center;">E5</td> <td style="text-align: center;">E5</td> </tr> <tr> <td></td> <td style="text-align: center;">1</td> <td style="text-align: center;">2</td> <td style="text-align: center;">3</td> <td style="text-align: center;">4</td> <td style="text-align: center;">R06</td> <td style="text-align: center;">S06</td> <td style="text-align: center;">T06</td> <td style="text-align: center;">N06</td> <td style="text-align: center;">E6</td> <td style="text-align: center;">E6</td> <td style="text-align: center;">E6</td> <td style="text-align: center;">E6</td> <td style="text-align: center;">E6</td> </tr> <tr> <td></td> <td style="text-align: center;">1</td> <td style="text-align: center;">2</td> <td style="text-align: center;">3</td> <td style="text-align: center;">4</td> <td style="text-align: center;">R07</td> <td style="text-align: center;">S07</td> <td style="text-align: center;">T07</td> <td style="text-align: center;">N07</td> <td style="text-align: center;">E7</td> <td style="text-align: center;">E7</td> <td style="text-align: center;">E7</td> <td style="text-align: center;">E7</td> <td style="text-align: center;">E7</td> </tr> <tr> <td></td> <td style="text-align: center;">1</td> <td style="text-align: center;">2</td> <td style="text-align: center;">3</td> <td style="text-align: center;">4</td> <td style="text-align: center;">R08</td> <td style="text-align: center;">S08</td> <td style="text-align: center;">T08</td> <td style="text-align: center;">N08</td> <td style="text-align: center;">E8</td> <td style="text-align: center;">E8</td> <td style="text-align: center;">E8</td> <td style="text-align: center;">E8</td> <td style="text-align: center;">E8</td> </tr> </table> </td> <td style="width: 50%; vertical-align: top;"> <table border="0" style="width: 100%;"> <tr> <td style="width: 50%;"></td> <td style="width: 50%; text-align: center;"> <table border="0"> <tr> <td style="width: 10%;"></td> <td style="width: 10%;"></td> <td style="width: 10%;"></td> <td style="width: 10%;"></td> <td style="width: 10%;"></td> <td style="width: 10%;"></td> <td style="width: 10%;"></td> <td style="width: 10%;"></td> <td style="width: 10%;"></td> <td style="width: 10%;"></td> <td style="width: 10%;"></td> <td style="width: 10%;"></td> <td style="width: 10%;"></td> <td style="width: 10%;"></td> </tr> <tr> <td style="text-align: center;">XA</td> <td style="text-align: center;">1</td> <td style="text-align: center;">2</td> <td style="text-align: center;">3</td> <td style="text-align: center;">4</td> <td style="text-align: center;">R01</td> <td style="text-align: center;">S01</td> <td style="text-align: center;">T01</td> <td style="text-align: center;">N01</td> <td style="text-align: center;">E1</td> <td style="text-align: center;">E1</td> <td style="text-align: center;">E1</td> </tr></table></td></tr></table></td></tr></table></td></tr></table></td></tr></table></td></tr></table></td></tr></table></td></tr></table> | | <table border="0"> <tr> <td style="width: 10%;"></td> <td style="width: 10%;"></td> <td style="width: 10%;"></td> <td style="width: 10%;"></td> <td style="width: 10%;"></td> <td style="width: 10%;"></td> <td style="width: 10%;"></td> <td style="width: 10%;"></td> <td style="width: 10%;"></td> <td style="width: 10%;"></td> <td style="width: 10%;"></td> <td style="width: 10%;"></td> <td style="width: 10%;"></td> <td style="width: 10%;"></td> </tr> <tr> <td style="text-align: center;">XA</td> <td style="text-align: center;">1/G</td> <td style="text-align: center;">2/G</td> <td style="text-align: center;">3/G</td> <td style="text-align: center;">4/G</td> <td style="text-align: center;">R</td> <td style="text-align: center;">S</td> <td style="text-align: center;">T</td> <td style="text-align: center;">N</td> <td style="text-align: center;">E0</td> <td style="text-align: center;">E0</td> <td style="text-align: center;">E0</td> <td style="text-align: center;">E0</td> <td style="text-align: center;">E0</td> </tr> <tr> <td></td> <td style="text-align: center;">1</td> <td style="text-align: center;">2</td> <td style="text-align: center;">3</td> <td style="text-align: center;">4</td> <td style="text-align: center;">R01</td> <td style="text-align: center;">S01</td> <td style="text-align: center;">T01</td> <td style="text-align: center;">N01</td> <td style="text-align: center;">E1</td> <td style="text-align: center;">E1</td> <td style="text-align: center;">E1</td> <td style="text-align: center;">E1</td> <td style="text-align: center;">E1</td> </tr> <tr> <td></td> <td style="text-align: center;">1</td> <td style="text-align: center;">2</td> <td style="text-align: center;">3</td> <td style="text-align: center;">4</td> <td style="text-align: center;">R02</td> <td style="text-align: center;">S02</td> <td style="text-align: center;">T02</td> <td style="text-align: center;">N02</td> <td style="text-align: center;">E2</td> <td style="text-align: center;">E2</td> <td style="text-align: center;">E2</td> <td style="text-align: center;">E2</td> <td style="text-align: center;">E2</td> </tr> <tr> <td></td> <td style="text-align: center;">1</td> <td style="text-align: center;">2</td> <td style="text-align: center;">3</td> <td style="text-align: center;">4</td> <td style="text-align: center;">R03</td> <td style="text-align: center;">S03</td> <td style="text-align: center;">T03</td> <td style="text-align: center;">N03</td> <td style="text-align: center;">E3</td> <td style="text-align: center;">E3</td> <td style="text-align: center;">E3</td> <td style="text-align: center;">E3</td> <td style="text-align: center;">E3</td> </tr> <tr> <td></td> <td style="text-align: center;">1</td> <td style="text-align: center;">2</td> <td style="text-align: center;">3</td> <td style="text-align: center;">4</td> <td style="text-align: center;">R04</td> <td style="text-align: center;">S04</td> <td style="text-align: center;">T04</td> <td style="text-align: center;">N04</td> <td style="text-align: center;">E4</td> <td style="text-align: center;">E4</td> <td style="text-align: center;">E4</td> <td style="text-align: center;">E4</td> <td style="text-align: center;">E4</td> </tr> <tr> <td></td> <td style="text-align: center;">1</td> <td style="text-align: center;">2</td> <td style="text-align: center;">3</td> <td style="text-align: center;">4</td> <td style="text-align: center;">R05</td> <td style="text-align: center;">S05</td> <td style="text-align: center;">T05</td> <td style="text-align: center;">N05</td> <td style="text-align: center;">E5</td> <td style="text-align: center;">E5</td> <td style="text-align: center;">E5</td> <td style="text-align: center;">E5</td> <td style="text-align: center;">E5</td> </tr> <tr> <td></td> <td style="text-align: center;">1</td> <td style="text-align: center;">2</td> <td style="text-align: center;">3</td> <td style="text-align: center;">4</td> <td style="text-align: center;">R06</td> <td style="text-align: center;">S06</td> <td style="text-align: center;">T06</td> <td style="text-align: center;">N06</td> <td style="text-align: center;">E6</td> <td style="text-align: center;">E6</td> <td style="text-align: center;">E6</td> <td style="text-align: center;">E6</td> <td style="text-align: center;">E6</td> </tr> <tr> <td></td> <td style="text-align: center;">1</td> <td style="text-align: center;">2</td> <td style="text-align: center;">3</td> <td style="text-align: center;">4</td> <td style="text-align: center;">R07</td> <td style="text-align: center;">S07</td> <td style="text-align: center;">T07</td> <td style="text-align: center;">N07</td> <td style="text-align: center;">E7</td> <td style="text-align: center;">E7</td> <td style="text-align: center;">E7</td> <td style="text-align: center;">E7</td> <td style="text-align: center;">E7</td> </tr> <tr> <td></td> <td style="text-align: center;">1</td> <td style="text-align: center;">2</td> <td style="text-align: center;">3</td> <td style="text-align: center;">4</td> <td style="text-align: center;">R08</td> <td style="text-align: center;">S08</td> <td style="text-align: center;">T08</td> <td style="text-align: center;">N08</td> <td style="text-align: center;">E8</td> <td style="text-align: center;">E8</td> <td style="text-align: center;">E8</td> <td style="text-align: center;">E8</td> <td style="text-align: center;">E8</td> </tr> </table> | | | | | | | | | | | | | | | XA | 1/G | 2/G | 3/G | 4/G | R | S | T | N | E0 | E0 | E0 | E0 | E0 | | 1 | 2 | 3 | 4 | R01 | S01 | T01 | N01 | E1 | E1 | E1 | E1 | E1 | | 1 | 2 | 3 | 4 | R02 | S02 | T02 | N02 | E2 | E2 | E2 | E2 | E2 | | 1 | 2 | 3 | 4 | R03 | S03 | T03 | N03 | E3 | E3 | E3 | E3 | E3 | | 1 | 2 | 3 | 4 | R04 | S04 | T04 | N04 | E4 | E4 | E4 | E4 | E4

 | | 1 | 2 | 3 | 4 | R05 | S05 | T05 | N05 | E5 | E5 | E5 | E5 | E5

 |

 | 1
 | 2 | 3 | 4 | R06 | S06 | T06 | N06 | E6 | E6 | E6 | E6 | E6 |

 | 1 | 2 | 3 | 4 | R07 | S07 | T07 | N07 | E7 | E7 | E7 | E7 | E7 | | 1 | 2 | 3 | 4 | R08 | S08 | T08 | N08 | E8 | E8 | E8 | E8 | E8 | <table border="0" style="width: 100%;"> <tr> <td style="width: 50%;"></td> <td style="width: 50%; text-align: center;"> <table border="0"> <tr> <td style="width: 10%;"></td> <td style="width: 10%;"></td> <td style="width: 10%;"></td> <td style="width: 10%;"></td> <td style="width: 10%;"></td> <td style="width: 10%;"></td> <td style="width: 10%;"></td> <td style="width: 10%;"></td> <td style="width: 10%;"></td> <td style="width: 10%;"></td> <td style="width: 10%;"></td> <td style="width: 10%;"></td> <td style="width: 10%;"></td> <td style="width: 10%;"></td> </tr> <tr> <td style="text-align: center;">XA</td> <td style="text-align: center;">1</td> <td style="text-align: center;">2</td> <td style="text-align: center;">3</td> <td style="text-align: center;">4</td> <td style="text-align: center;">R01</td> <td style="text-align: center;">S01</td> <td style="text-align: center;">T01</td> <td style="text-align: center;">N01</td> <td style="text-align: center;">E1</td> <td style="text-align: center;">E1</td> <td style="text-align: center;">E1</td> <td style="text-align: center;">E1</td> <td style="text-align: center;">E1</td> </tr> <tr> <td></td> <td style="text-align: center;">1</td> <td
style="text-align: center;">2</td> <td style="text-align: center;">3</td> <td style="text-align: center;">4</td> <td style="text-align: center;">R02</td> <td style="text-align: center;">S02</td> <td style="text-align: center;">T02</td> <td style="text-align: center;">N02</td> <td style="text-align: center;">E2</td> <td style="text-align: center;">E2</td> <td style="text-align: center;">E2</td> <td style="text-align: center;">E2</td> <td style="text-align: center;">E2</td> </tr> <tr> <td></td> <td style="text-align: center;">1</td> <td style="text-align: center;">2</td> <td style="text-align: center;">3</td> <td style="text-align: center;">4</td> <td style="text-align: center;">R03</td> <td style="text-align: center;">S03</td> <td style="text-align: center;">T03</td> <td style="text-align: center;">N03</td> <td style="text-align: center;">E3</td> <td style="text-align: center;">E3</td> <td style="text-align: center;">E3</td> <td style="text-align: center;">E3</td> <td style="text-align: center;">E3</td> </tr> <tr> <td></td> <td style="text-align: center;">1</td> <td style="text-align: center;">2</td> <td style="text-align: center;">3</td> <td style="text-align: center;">4</td> <td style="text-align: center;">R04</td> <td style="text-align: center;">S04</td> <td style="text-align: center;">T04</td> <td style="text-align: center;">N04</td> <td style="text-align: center;">E4</td> <td style="text-align: center;">E4</td> <td style="text-align: center;">E4</td> <td style="text-align: center;">E4</td> <td style="text-align: center;">E4</td> </tr> <tr> <td></td> <td style="text-align: center;">1</td> <td style="text-align: center;">2</td> <td style="text-align: center;">3</td> <td style="text-align: center;">4</td> <td style="text-align: center;">R05</td> <td style="text-align: center;">S05</td> <td style="text-align: center;">T05</td> <td style="text-align: center;">N05</td> <td style="text-align: center;">E5</td> <td style="text-align: center;">E5</td> <td style="text-align: center;">E5</td> <td style="text-align: center;">E5</td> <td style="text-align: center;">E5</td> </tr> <tr> <td></td> <td style="text-align: center;">1</td> <td style="text-align: center;">2</td> <td style="text-align: center;">3</td> <td style="text-align: center;">4</td> <td style="text-align: center;">R06</td> <td style="text-align: center;">S06</td> <td style="text-align: center;">T06</td> <td style="text-align: center;">N06</td> <td style="text-align: center;">E6</td> <td style="text-align: center;">E6</td> <td style="text-align: center;">E6</td> <td style="text-align: center;">E6</td> <td style="text-align: center;">E6</td> </tr> <tr> <td></td> <td style="text-align: center;">1</td> <td style="text-align: center;">2</td> <td style="text-align: center;">3</td> <td style="text-align: center;">4</td> <td style="text-align: center;">R07</td> <td style="text-align: center;">S07</td> <td style="text-align: center;">T07</td> <td style="text-align: center;">N07</td> <td style="text-align: center;">E7</td> <td style="text-align: center;">E7</td> <td style="text-align: center;">E7</td> <td style="text-align: center;">E7</td> <td style="text-align: center;">E7</td> </tr> <tr> <td></td> <td style="text-align: center;">1</td> <td style="text-align: center;">2</td> <td style="text-align: center;">3</td> <td style="text-align: center;">4</td> <td style="text-align: center;">R08</td> <td style="text-align: center;">S08</td> <td style="text-align: center;">T08</td> <td style="text-align: center;">N08</td> <td style="text-align: center;">E8</td> <td style="text-align: center;">E8</td> <td style="text-align: center;">E8</td> <td style="text-align: center;">E8</td> <td style="text-align: center;">E8</td> </tr> </table> </td> <td style="width: 50%; vertical-align: top;"> <table border="0" style="width: 100%;"> <tr> <td style="width: 50%;"></td> <td style="width: 50%; text-align: center;"> <table border="0"> <tr> <td style="width: 10%;"></td> <td style="width: 10%;"></td> <td style="width: 10%;"></td> <td style="width: 10%;"></td> <td style="width: 10%;"></td> <td style="width: 10%;"></td> <td style="width: 10%;"></td> <td style="width: 10%;"></td> <td style="width: 10%;"></td> <td style="width: 10%;"></td> <td style="width: 10%;"></td> <td style="width: 10%;"></td> <td style="width: 10%;"></td> <td style="width: 10%;"></td> </tr> <tr> <td style="text-align: center;">XA</td> <td style="text-align: center;">1</td> <td style="text-align: center;">2</td> <td style="text-align: center;">3</td> <td style="text-align: center;">4</td> <td style="text-align: center;">R01</td> <td style="text-align: center;">S01</td> <td style="text-align: center;">T01</td> <td style="text-align: center;">N01</td> <td style="text-align: center;">E1</td> <td style="text-align: center;">E1</td> <td style="text-align: center;">E1</td> <td style="text-align: center;">E1</td> <td style="text-align: center;">E1</td> </tr> <tr> <td></td> <td style="text-align: center;">1</td> <td style="text-align: center;">2</td> <td style="text-align: center;">3</td> <td style="text-align: center;">4</td> <td style="text-align: center;">R02</td> <td style="text-align: center;">S02</td> <td style="text-align: center;">T02</td> <td style="text-align: center;">N02</td> <td style="text-align: center;">E2</td> <td style="text-align: center;">E2</td> <td style="text-align: center;">E2</td> <td style="text-align: center;">E2</td> <td style="text-align: center;">E2</td> </tr> <tr> <td></td> <td style="text-align: center;">1</td> <td style="text-align: center;">2</td> <td style="text-align: center;">3</td> <td style="text-align: center;">4</td> <td style="text-align: center;">R03</td> <td style="text-align: center;">S03</td> <td style="text-align: center;">T03</td> <td style="text-align: center;">N03</td> <td style="text-align: center;">E3</td> <td style="text-align: center;">E3</td> <td style="text-align: center;">E3</td> <td style="text-align: center;">E3</td> <td style="text-align: center;">E3</td> </tr> <tr> <td></td> <td style="text-align: center;">1</td> <td style="text-align: center;">2</td> <td style="text-align: center;">3</td> <td style="text-align: center;">4</td> <td style="text-align: center;">R04</td> <td style="text-align: center;">S04</td> <td style="text-align: center;">T04</td> <td style="text-align: center;">N04</td> <td style="text-align: center;">E4</td> <td style="text-align: center;">E4</td> <td style="text-align: center;">E4</td> <td style="text-align: center;">E4</td> <td style="text-align: center;">E4</td> </tr> <tr> <td></td> <td style="text-align: center;">1</td> <td style="text-align: center;">2</td> <td style="text-align: center;">3</td> <td style="text-align: center;">4</td> <td style="text-align: center;">R05</td> <td style="text-align: center;">S05</td> <td style="text-align: center;">T05</td> <td style="text-align: center;">N05</td> <td style="text-align: center;">E5</td> <td style="text-align: center;">E5</td> <td style="text-align: center;">E5</td> <td style="text-align: center;">E5</td> <td style="text-align: center;">E5</td> </tr> <tr> <td></td> <td style="text-align: center;">1</td> <td style="text-align: center;">2</td> <td style="text-align: center;">3</td> <td style="text-align: center;">4</td> <td style="text-align: center;">R06</td> <td style="text-align: center;">S06</td> <td style="text-align: center;">T06</td> <td style="text-align: center;">N06</td> <td style="text-align: center;">E6</td> <td style="text-align: center;">E6</td> <td style="text-align: center;">E6</td> <td style="text-align: center;">E6</td> <td style="text-align: center;">E6</td> </tr> <tr> <td></td> <td style="text-align: center;">1</td> <td style="text-align: center;">2</td> <td style="text-align: center;">3</td> <td style="text-align: center;">4</td> <td style="text-align: center;">R07</td> <td style="text-align: center;">S07</td> <td style="text-align: center;">T07</td> <td style="text-align: center;">N07</td> <td style="text-align: center;">E7</td> <td style="text-align: center;">E7</td> <td style="text-align: center;">E7</td> <td style="text-align: center;">E7</td> <td style="text-align: center;">E7</td> </tr> <tr> <td></td> <td style="text-align: center;">1</td> <td style="text-align: center;">2</td> <td style="text-align: center;">3</td> <td style="text-align: center;">4</td> <td style="text-align: center;">R08</td> <td style="text-align: center;">S08</td> <td style="text-align: center;">T08</td> <td style="text-align: center;">N08</td> <td style="text-align: center;">E8</td> <td style="text-align: center;">E8</td> <td style="text-align: center;">E8</td> <td style="text-align: center;">E8</td> <td style="text-align: center;">E8</td> </tr> </table> </td> <td style="width: 50%; vertical-align: top;"> <table border="0" style="width: 100%;"> <tr> <td style="width: 50%;"></td> <td style="width: 50%; text-align: center;"> <table border="0"> <tr> <td style="width: 10%;"></td> <td style="width: 10%;"></td> <td style="width: 10%;"></td> <td style="width: 10%;"></td> <td style="width: 10%;"></td> <td style="width: 10%;"></td> <td style="width: 10%;"></td> <td style="width: 10%;"></td> <td style="width: 10%;"></td> <td style="width: 10%;"></td> <td style="width: 10%;"></td> <td style="width: 10%;"></td> <td style="width: 10%;"></td> <td style="width: 10%;"></td> </tr> <tr> <td style="text-align: center;">XA</td> <td style="text-align: center;">1</td> <td style="text-align: center;">2</td> <td style="text-align: center;">3</td> <td style="text-align: center;">4</td> <td style="text-align: center;">R01</td> <td style="text-align: center;">S01</td> <td style="text-align: center;">T01</td> <td style="text-align: center;">N01</td> <td style="text-align: center;">E1</td> <td style="text-align: center;">E1</td> <td style="text-align: center;">E1</td> <td style="text-align: center;">E1</td> <td style="text-align: center;">E1</td> </tr> <tr> <td></td> <td style="text-align: center;">1</td> <td style="text-align:
center;">2</td> <td style="text-align: center;">3</td> <td style="text-align: center;">4</td> <td style="text-align: center;">R02</td> <td style="text-align: center;">S02</td> <td style="text-align: center;">T02</td> <td style="text-align: center;">N02</td> <td style="text-align: center;">E2</td> <td style="text-align: center;">E2</td> <td style="text-align: center;">E2</td> <td style="text-align: center;">E2</td> <td style="text-align: center;">E2</td> </tr> <tr> <td></td> <td style="text-align: center;">1</td> <td style="text-align: center;">2</td> <td style="text-align: center;">3</td> <td style="text-align: center;">4</td> <td style="text-align: center;">R03</td> <td style="text-align: center;">S03</td> <td style="text-align: center;">T03</td> <td style="text-align: center;">N03</td> <td style="text-align: center;">E3</td> <td style="text-align: center;">E3</td> <td style="text-align: center;">E3</td> <td style="text-align: center;">E3</td> <td style="text-align: center;">E3</td> </tr> <tr> <td></td> <td style="text-align: center;">1</td> <td style="text-align: center;">2</td> <td style="text-align: center;">3</td> <td style="text-align: center;">4</td> <td style="text-align: center;">R04</td> <td style="text-align: center;">S04</td> <td style="text-align: center;">T04</td> <td style="text-align: center;">N04</td> <td style="text-align: center;">E4</td> <td style="text-align: center;">E4</td> <td style="text-align: center;">E4</td> <td style="text-align: center;">E4</td> <td style="text-align: center;">E4</td> </tr> <tr> <td></td> <td style="text-align: center;">1</td> <td style="text-align: center;">2</td> <td style="text-align: center;">3</td> <td style="text-align: center;">4</td> <td style="text-align: center;">R05</td> <td style="text-align: center;">S05</td> <td style="text-align: center;">T05</td> <td style="text-align: center;">N05</td> <td style="text-align: center;">E5</td> <td style="text-align: center;">E5</td> <td style="text-align: center;">E5</td> <td style="text-align: center;">E5</td> <td style="text-align: center;">E5</td> </tr> <tr> <td></td> <td style="text-align: center;">1</td> <td style="text-align: center;">2</td> <td style="text-align: center;">3</td> <td style="text-align: center;">4</td> <td style="text-align: center;">R06</td> <td style="text-align: center;">S06</td> <td style="text-align: center;">T06</td> <td style="text-align: center;">N06</td> <td style="text-align: center;">E6</td> <td style="text-align: center;">E6</td> <td style="text-align: center;">E6</td> <td style="text-align: center;">E6</td> <td style="text-align: center;">E6</td> </tr> <tr> <td></td> <td style="text-align: center;">1</td> <td style="text-align: center;">2</td> <td style="text-align: center;">3</td> <td style="text-align: center;">4</td> <td style="text-align: center;">R07</td> <td style="text-align: center;">S07</td> <td style="text-align: center;">T07</td> <td style="text-align: center;">N07</td> <td style="text-align: center;">E7</td> <td style="text-align: center;">E7</td> <td style="text-align: center;">E7</td> <td style="text-align: center;">E7</td> <td style="text-align: center;">E7</td> </tr> <tr> <td></td> <td style="text-align: center;">1</td> <td style="text-align: center;">2</td> <td style="text-align: center;">3</td> <td style="text-align: center;">4</td> <td style="text-align: center;">R08</td> <td style="text-align: center;">S08</td> <td style="text-align: center;">T08</td> <td style="text-align: center;">N08</td> <td style="text-align: center;">E8</td> <td style="text-align: center;">E8</td> <td style="text-align: center;">E8</td> <td style="text-align: center;">E8</td> <td style="text-align: center;">E8</td> </tr> </table> </td> <td style="width: 50%; vertical-align: top;"> <table border="0" style="width: 100%;"> <tr> <td style="width: 50%;"></td> <td style="width: 50%; text-align: center;"> <table border="0"> <tr> <td style="width: 10%;"></td> <td style="width: 10%;"></td> <td style="width: 10%;"></td> <td style="width: 10%;"></td> <td style="width: 10%;"></td> <td style="width: 10%;"></td> <td style="width: 10%;"></td> <td style="width: 10%;"></td> <td style="width: 10%;"></td> <td style="width: 10%;"></td> <td style="width: 10%;"></td> <td style="width: 10%;"></td> <td style="width: 10%;"></td> <td style="width: 10%;"></td> </tr> <tr> <td style="text-align: center;">XA</td> <td style="text-align: center;">1</td> <td style="text-align: center;">2</td> <td style="text-align: center;">3</td> <td style="text-align: center;">4</td> <td style="text-align: center;">R01</td> <td style="text-align: center;">S01</td> <td style="text-align: center;">T01</td> <td style="text-align: center;">N01</td> <td style="text-align: center;">E1</td> <td style="text-align: center;">E1</td> <td style="text-align: center;">E1</td> <td style="text-align: center;">E1</td> <td style="text-align: center;">E1</td> </tr> <tr> <td></td> <td style="text-align: center;">1</td> <td style="text-align: center;">2</td> <td style="text-align: center;">3</td> <td style="text-align: center;">4</td> <td style="text-align: center;">R02</td> <td style="text-align: center;">S02</td> <td style="text-align: center;">T02</td> <td style="text-align: center;">N02</td> <td style="text-align: center;">E2</td> <td style="text-align: center;">E2</td> <td style="text-align: center;">E2</td> <td style="text-align: center;">E2</td> <td style="text-align: center;">E2</td> </tr> <tr> <td></td> <td style="text-align: center;">1</td> <td style="text-align: center;">2</td> <td style="text-align: center;">3</td> <td style="text-align: center;">4</td> <td style="text-align: center;">R03</td> <td style="text-align: center;">S03</td> <td style="text-align: center;">T03</td> <td style="text-align: center;">N03</td> <td style="text-align: center;">E3</td> <td style="text-align: center;">E3</td> <td style="text-align: center;">E3</td> <td style="text-align: center;">E3</td> <td style="text-align: center;">E3</td> </tr> <tr> <td></td> <td style="text-align: center;">1</td> <td style="text-align: center;">2</td> <td style="text-align: center;">3</td> <td style="text-align: center;">4</td> <td style="text-align: center;">R04</td> <td style="text-align: center;">S04</td> <td style="text-align: center;">T04</td> <td style="text-align: center;">N04</td> <td style="text-align: center;">E4</td> <td style="text-align: center;">E4</td> <td style="text-align: center;">E4</td> <td style="text-align: center;">E4</td> <td style="text-align: center;">E4</td> </tr> <tr> <td></td> <td style="text-align: center;">1</td> <td style="text-align: center;">2</td> <td style="text-align: center;">3</td> <td style="text-align: center;">4</td> <td style="text-align: center;">R05</td> <td style="text-align: center;">S05</td> <td style="text-align: center;">T05</td> <td style="text-align: center;">N05</td> <td style="text-align: center;">E5</td> <td style="text-align: center;">E5</td> <td style="text-align: center;">E5</td> <td style="text-align: center;">E5</td> <td style="text-align: center;">E5</td> </tr> <tr> <td></td> <td style="text-align: center;">1</td> <td style="text-align: center;">2</td> <td style="text-align: center;">3</td> <td style="text-align: center;">4</td> <td style="text-align: center;">R06</td> <td style="text-align: center;">S06</td> <td style="text-align: center;">T06</td> <td style="text-align: center;">N06</td> <td style="text-align: center;">E6</td> <td style="text-align: center;">E6</td> <td style="text-align: center;">E6</td> <td style="text-align: center;">E6</td> <td style="text-align: center;">E6</td> </tr> <tr> <td></td> <td style="text-align: center;">1</td> <td style="text-align: center;">2</td> <td style="text-align: center;">3</td> <td style="text-align: center;">4</td> <td style="text-align: center;">R07</td> <td style="text-align: center;">S07</td> <td style="text-align: center;">T07</td> <td style="text-align: center;">N07</td> <td style="text-align: center;">E7</td> <td style="text-align: center;">E7</td> <td style="text-align: center;">E7</td> <td style="text-align: center;">E7</td> <td style="text-align: center;">E7</td> </tr> <tr> <td></td> <td style="text-align: center;">1</td> <td style="text-align: center;">2</td> <td style="text-align: center;">3</td> <td style="text-align: center;">4</td> <td style="text-align: center;">R08</td> <td style="text-align: center;">S08</td> <td style="text-align: center;">T08</td> <td style="text-align: center;">N08</td> <td style="text-align: center;">E8</td> <td style="text-align: center;">E8</td> <td style="text-align: center;">E8</td> <td style="text-align: center;">E8</td> <td style="text-align: center;">E8</td> </tr> </table> </td> <td style="width: 50%; vertical-align: top;"> <table border="0" style="width: 100%;"> <tr> <td style="width: 50%;"></td> <td style="width: 50%; text-align: center;"> <table border="0"> <tr> <td style="width: 10%;"></td> <td style="width: 10%;"></td> <td style="width: 10%;"></td> <td style="width: 10%;"></td> <td style="width: 10%;"></td> <td style="width: 10%;"></td> <td style="width: 10%;"></td> <td style="width: 10%;"></td> <td style="width: 10%;"></td> <td style="width: 10%;"></td> <td style="width: 10%;"></td> <td style="width: 10%;"></td> <td style="width: 10%;"></td> <td style="width: 10%;"></td> </tr> <tr> <td style="text-align: center;">XA</td> <td style="text-align: center;">1</td> <td style="text-align: center;">2</td> <td style="text-align: center;">3</td> <td style="text-align: center;">4</td> <td style="text-align: center;">R01</td> <td style="text-align: center;">S01</td> <td style="text-align: center;">T01</td> <td style="text-align: center;">N01</td> <td style="text-align: center;">E1</td> <td style="text-align: center;">E1</td> <td style="text-align: center;">E1</td> <td style="text-align: center;">E1</td> <td style="text-align: center;">E1</td> </tr> <tr> <td></td> <td style="text-align: center;">1</td> <td style="text-align: center;">2</td> <td
style="text-align: center;">3</td> <td style="text-align: center;">4</td> <td style="text-align: center;">R02</td> <td style="text-align: center;">S02</td> <td style="text-align: center;">T02</td> <td style="text-align: center;">N02</td> <td style="text-align: center;">E2</td> <td style="text-align: center;">E2</td> <td style="text-align: center;">E2</td> <td style="text-align: center;">E2</td> <td style="text-align: center;">E2</td> </tr> <tr> <td></td> <td style="text-align: center;">1</td> <td style="text-align: center;">2</td> <td style="text-align: center;">3</td> <td style="text-align: center;">4</td> <td style="text-align: center;">R03</td> <td style="text-align: center;">S03</td> <td style="text-align: center;">T03</td> <td style="text-align: center;">N03</td> <td style="text-align: center;">E3</td> <td style="text-align: center;">E3</td> <td style="text-align: center;">E3</td> <td style="text-align: center;">E3</td> <td style="text-align: center;">E3</td> </tr> <tr> <td></td> <td style="text-align: center;">1</td> <td style="text-align: center;">2</td> <td style="text-align: center;">3</td> <td style="text-align: center;">4</td> <td style="text-align: center;">R04</td> <td style="text-align: center;">S04</td> <td style="text-align: center;">T04</td> <td style="text-align: center;">N04</td> <td style="text-align: center;">E4</td> <td style="text-align: center;">E4</td> <td style="text-align: center;">E4</td> <td style="text-align: center;">E4</td> <td style="text-align: center;">E4</td> </tr> <tr> <td></td> <td style="text-align: center;">1</td> <td style="text-align: center;">2</td> <td style="text-align: center;">3</td> <td style="text-align: center;">4</td> <td style="text-align: center;">R05</td> <td style="text-align: center;">S05</td> <td style="text-align: center;">T05</td> <td style="text-align: center;">N05</td> <td style="text-align: center;">E5</td> <td style="text-align: center;">E5</td> <td style="text-align: center;">E5</td> <td style="text-align: center;">E5</td> <td style="text-align: center;">E5</td> </tr> <tr> <td></td> <td style="text-align: center;">1</td> <td style="text-align: center;">2</td> <td style="text-align: center;">3</td> <td style="text-align: center;">4</td> <td style="text-align: center;">R06</td> <td style="text-align: center;">S06</td> <td style="text-align: center;">T06</td> <td style="text-align: center;">N06</td> <td style="text-align: center;">E6</td> <td style="text-align: center;">E6</td> <td style="text-align: center;">E6</td> <td style="text-align: center;">E6</td> <td style="text-align: center;">E6</td> </tr> <tr> <td></td> <td style="text-align: center;">1</td> <td style="text-align: center;">2</td> <td style="text-align: center;">3</td> <td style="text-align: center;">4</td> <td style="text-align: center;">R07</td> <td style="text-align: center;">S07</td> <td style="text-align: center;">T07</td> <td style="text-align: center;">N07</td> <td style="text-align: center;">E7</td> <td style="text-align: center;">E7</td> <td style="text-align: center;">E7</td> <td style="text-align: center;">E7</td> <td style="text-align: center;">E7</td> </tr> <tr> <td></td> <td style="text-align: center;">1</td> <td style="text-align: center;">2</td> <td style="text-align: center;">3</td> <td style="text-align: center;">4</td> <td style="text-align: center;">R08</td> <td style="text-align: center;">S08</td> <td style="text-align: center;">T08</td> <td style="text-align: center;">N08</td> <td style="text-align: center;">E8</td> <td style="text-align: center;">E8</td> <td style="text-align: center;">E8</td> <td style="text-align: center;">E8</td> <td style="text-align: center;">E8</td> </tr> </table> </td> <td style="width: 50%; vertical-align: top;"> <table border="0" style="width: 100%;"> <tr> <td style="width: 50%;"></td> <td style="width: 50%; text-align: center;"> <table border="0"> <tr> <td style="width: 10%;"></td> <td style="width: 10%;"></td> <td style="width: 10%;"></td> <td style="width: 10%;"></td> <td style="width: 10%;"></td> <td style="width: 10%;"></td> <td style="width: 10%;"></td> <td style="width: 10%;"></td> <td style="width: 10%;"></td> <td style="width: 10%;"></td> <td style="width: 10%;"></td> <td style="width: 10%;"></td> <td style="width: 10%;"></td> <td style="width: 10%;"></td> </tr> <tr> <td style="text-align: center;">XA</td> <td style="text-align: center;">1</td> <td style="text-align: center;">2</td> <td style="text-align: center;">3</td> <td style="text-align: center;">4</td> <td style="text-align: center;">R01</td> <td style="text-align: center;">S01</td> <td style="text-align: center;">T01</td> <td style="text-align: center;">N01</td> <td style="text-align: center;">E1</td> <td style="text-align: center;">E1</td> <td style="text-align: center;">E1</td> </tr></table></td></tr></table></td></tr></table></td></tr></table></td></tr></table></td></tr></table></td></tr></table> | | <table border="0"> <tr> <td style="width: 10%;"></td> <td style="width: 10%;"></td> <td style="width: 10%;"></td> <td style="width: 10%;"></td> <td style="width: 10%;"></td> <td style="width: 10%;"></td> <td style="width: 10%;"></td> <td style="width: 10%;"></td> <td style="width: 10%;"></td> <td style="width: 10%;"></td> <td style="width: 10%;"></td> <td style="width: 10%;"></td> <td style="width: 10%;"></td> <td style="width: 10%;"></td> </tr> <tr> <td style="text-align: center;">XA</td> <td style="text-align: center;">1</td> <td style="text-align: center;">2</td> <td style="text-align: center;">3</td> <td style="text-align: center;">4</td> <td style="text-align: center;">R01</td> <td style="text-align: center;">S01</td> <td style="text-align: center;">T01</td> <td style="text-align: center;">N01</td> <td style="text-align: center;">E1</td> <td style="text-align: center;">E1</td> <td style="text-align: center;">E1</td> <td style="text-align: center;">E1</td> <td style="text-align: center;">E1</td> </tr> <tr> <td></td> <td style="text-align: center;">1</td> <td style="text-align: center;">2</td> <td style="text-align: center;">3</td> <td style="text-align: center;">4</td> <td style="text-align: center;">R02</td> <td style="text-align: center;">S02</td> <td style="text-align: center;">T02</td> <td style="text-align: center;">N02</td> <td style="text-align: center;">E2</td> <td style="text-align: center;">E2</td> <td style="text-align: center;">E2</td> <td style="text-align: center;">E2</td> <td style="text-align: center;">E2</td> </tr> <tr> <td></td> <td style="text-align: center;">1</td> <td style="text-align: center;">2</td> <td style="text-align: center;">3</td> <td style="text-align: center;">4</td> <td style="text-align: center;">R03</td> <td style="text-align: center;">S03</td> <td style="text-align: center;">T03</td> <td style="text-align: center;">N03</td> <td style="text-align: center;">E3</td> <td style="text-align: center;">E3</td> <td style="text-align: center;">E3</td> <td style="text-align: center;">E3</td> <td style="text-align: center;">E3</td> </tr> <tr> <td></td> <td style="text-align: center;">1</td> <td style="text-align: center;">2</td> <td style="text-align: center;">3</td> <td style="text-align: center;">4</td> <td style="text-align: center;">R04</td> <td style="text-align: center;">S04</td> <td style="text-align: center;">T04</td> <td style="text-align: center;">N04</td> <td style="text-align: center;">E4</td> <td style="text-align: center;">E4</td> <td style="text-align: center;">E4</td> <td style="text-align: center;">E4</td> <td style="text-align: center;">E4</td> </tr> <tr> <td></td> <td style="text-align: center;">1</td> <td style="text-align: center;">2</td> <td style="text-align: center;">3</td> <td style="text-align: center;">4</td> <td style="text-align: center;">R05</td> <td style="text-align: center;">S05</td> <td style="text-align: center;">T05</td> <td style="text-align: center;">N05</td> <td style="text-align: center;">E5</td> <td style="text-align: center;">E5</td> <td style="text-align: center;">E5</td> <td style="text-align: center;">E5</td> <td style="text-align: center;">E5</td> </tr> <tr> <td></td> <td style="text-align: center;">1</td> <td style="text-align: center;">2</td> <td style="text-align: center;">3</td> <td style="text-align: center;">4</td> <td style="text-align: center;">R06</td> <td style="text-align: center;">S06</td> <td style="text-align: center;">T06</td> <td style="text-align: center;">N06</td> <td style="text-align: center;">E6</td> <td style="text-align: center;">E6</td> <td style="text-align: center;">E6</td> <td style="text-align: center;">E6</td> <td style="text-align: center;">E6</td> </tr> <tr> <td></td> <td style="text-align: center;">1</td> <td style="text-align: center;">2</td> <td style="text-align: center;">3</td> <td style="text-align: center;">4</td> <td style="text-align: center;">R07</td> <td style="text-align: center;">S07</td> <td style="text-align: center;">T07</td> <td style="text-align: center;">N07</td> <td style="text-align: center;">E7</td> <td style="text-align: center;">E7</td> <td style="text-align: center;">E7</td> <td style="text-align: center;">E7</td> <td style="text-align: center;">E7</td> </tr> <tr> <td></td> <td style="text-align: center;">1</td> <td style="text-align: center;">2</td> <td style="text-align: center;">3</td> <td style="text-align: center;">4</td> <td style="text-align: center;">R08</td> <td style="text-align: center;">S08</td> <td style="text-align: center;">T08</td> <td style="text-align: center;">N08</td> <td style="text-align: center;">E8</td> <td style="text-align: center;">E8</td> <td style="text-align: center;">E8</td> <td style="text-align: center;">E8</td> <td style="text-align: center;">E8</td> </tr> </table> | | | | | | | | | | | | | | | XA | 1 | 2 | 3 | 4 | R01 | S01 | T01 | N01 | E1 | E1 | E1 | E1 | E1 | | 1 | 2 | 3 | 4 | R02 | S02 | T02 | N02 | E2 | E2 | E2 | E2 | E2 | | 1 | 2 | 3 | 4 | R03 | S03
| T03 | N03 | E3 | E3 | E3 | E3 | E3 | | 1 | 2 | 3 | 4 | R04 | S04 | T04 | N04 | E4 | E4 | E4 | E4 | E4
 | | 1
 | 2 | 3 | 4 | R05 | S05 | T05 | N05 | E5 | E5 | E5 | E5 | E5

 |

 | 1 | 2
 | 3 | 4 | R06 | S06 | T06 | N06 | E6 | E6 | E6 | E6 | E6 |

 | 1 | 2 | 3 | 4 | R07 | S07 | T07 | N07 | E7 | E7 | E7 | E7 | E7 | | 1 | 2 | 3 | 4 | R08 | S08 | T08 | N08 | E8 | E8 | E8 | E8 | E8 | <table border="0" style="width: 100%;"> <tr> <td style="width: 50%;"></td> <td style="width: 50%; text-align: center;"> <table border="0"> <tr> <td style="width: 10%;"></td> <td style="width: 10%;"></td> <td style="width: 10%;"></td> <td style="width: 10%;"></td> <td style="width: 10%;"></td> <td style="width: 10%;"></td> <td style="width: 10%;"></td> <td style="width: 10%;"></td> <td style="width: 10%;"></td> <td style="width: 10%;"></td> <td style="width: 10%;"></td> <td style="width: 10%;"></td> <td style="width: 10%;"></td> <td style="width: 10%;"></td> </tr> <tr> <td style="text-align: center;">XA</td> <td style="text-align: center;">1</td> <td style="text-align: center;">2</td> <td style="text-align: center;">3</td> <td style="text-align: center;">4</td> <td style="text-align: center;">R01</td> <td style="text-align: center;">S01</td> <td style="text-align: center;">T01</td>
<td style="text-align: center;">N01</td> <td style="text-align: center;">E1</td> <td style="text-align: center;">E1</td> <td style="text-align: center;">E1</td> <td style="text-align: center;">E1</td> <td style="text-align: center;">E1</td> </tr> <tr> <td></td> <td style="text-align: center;">1</td> <td style="text-align: center;">2</td> <td style="text-align: center;">3</td> <td style="text-align: center;">4</td> <td style="text-align: center;">R02</td> <td style="text-align: center;">S02</td> <td style="text-align: center;">T02</td> <td style="text-align: center;">N02</td> <td style="text-align: center;">E2</td> <td style="text-align: center;">E2</td> <td style="text-align: center;">E2</td> <td style="text-align: center;">E2</td> <td style="text-align: center;">E2</td> </tr> <tr> <td></td> <td style="text-align: center;">1</td> <td style="text-align: center;">2</td> <td style="text-align: center;">3</td> <td style="text-align: center;">4</td> <td style="text-align: center;">R03</td> <td style="text-align: center;">S03</td> <td style="text-align: center;">T03</td> <td style="text-align: center;">N03</td> <td style="text-align: center;">E3</td> <td style="text-align: center;">E3</td> <td style="text-align: center;">E3</td> <td style="text-align: center;">E3</td> <td style="text-align: center;">E3</td> </tr> <tr> <td></td> <td style="text-align: center;">1</td> <td style="text-align: center;">2</td> <td style="text-align: center;">3</td> <td style="text-align: center;">4</td> <td style="text-align: center;">R04</td> <td style="text-align: center;">S04</td> <td style="text-align: center;">T04</td> <td style="text-align: center;">N04</td> <td style="text-align: center;">E4</td> <td style="text-align: center;">E4</td> <td style="text-align: center;">E4</td> <td style="text-align: center;">E4</td> <td style="text-align: center;">E4</td> </tr> <tr> <td></td> <td style="text-align: center;">1</td> <td style="text-align: center;">2</td> <td style="text-align: center;">3</td> <td style="text-align: center;">4</td> <td style="text-align: center;">R05</td> <td style="text-align: center;">S05</td> <td style="text-align: center;">T05</td> <td style="text-align: center;">N05</td> <td style="text-align: center;">E5</td> <td style="text-align: center;">E5</td> <td style="text-align: center;">E5</td> <td style="text-align: center;">E5</td> <td style="text-align: center;">E5</td> </tr> <tr> <td></td> <td style="text-align: center;">1</td> <td style="text-align: center;">2</td> <td style="text-align: center;">3</td> <td style="text-align: center;">4</td> <td style="text-align: center;">R06</td> <td style="text-align: center;">S06</td> <td style="text-align: center;">T06</td> <td style="text-align: center;">N06</td> <td style="text-align: center;">E6</td> <td style="text-align: center;">E6</td> <td style="text-align: center;">E6</td> <td style="text-align: center;">E6</td> <td style="text-align: center;">E6</td> </tr> <tr> <td></td> <td style="text-align: center;">1</td> <td style="text-align: center;">2</td> <td style="text-align: center;">3</td> <td style="text-align: center;">4</td> <td style="text-align: center;">R07</td> <td style="text-align: center;">S07</td> <td style="text-align: center;">T07</td> <td style="text-align: center;">N07</td> <td style="text-align: center;">E7</td> <td style="text-align: center;">E7</td> <td style="text-align: center;">E7</td> <td style="text-align: center;">E7</td> <td style="text-align: center;">E7</td> </tr> <tr> <td></td> <td style="text-align: center;">1</td> <td style="text-align: center;">2</td> <td style="text-align: center;">3</td> <td style="text-align: center;">4</td> <td style="text-align: center;">R08</td> <td style="text-align: center;">S08</td> <td style="text-align: center;">T08</td> <td style="text-align: center;">N08</td> <td style="text-align: center;">E8</td> <td style="text-align: center;">E8</td> <td style="text-align: center;">E8</td> <td style="text-align: center;">E8</td> <td style="text-align: center;">E8</td> </tr> </table> </td> <td style="width: 50%; vertical-align: top;"> <table border="0" style="width: 100%;"> <tr> <td style="width: 50%;"></td> <td style="width: 50%; text-align: center;"> <table border="0"> <tr> <td style="width: 10%;"></td> <td style="width: 10%;"></td> <td style="width: 10%;"></td> <td style="width: 10%;"></td> <td style="width: 10%;"></td> <td style="width: 10%;"></td> <td style="width: 10%;"></td> <td style="width: 10%;"></td> <td style="width: 10%;"></td> <td style="width: 10%;"></td> <td style="width: 10%;"></td> <td style="width: 10%;"></td> <td style="width: 10%;"></td> <td style="width: 10%;"></td> </tr> <tr> <td style="text-align: center;">XA</td> <td style="text-align: center;">1</td> <td style="text-align: center;">2</td> <td style="text-align: center;">3</td> <td style="text-align: center;">4</td> <td style="text-align: center;">R01</td> <td style="text-align: center;">S01</td> <td style="text-align: center;">T01</td> <td style="text-align: center;">N01</td> <td style="text-align: center;">E1</td> <td style="text-align: center;">E1</td> <td style="text-align: center;">E1</td> <td style="text-align: center;">E1</td> <td style="text-align: center;">E1</td> </tr> <tr> <td></td> <td style="text-align: center;">1</td> <td style="text-align: center;">2</td> <td style="text-align: center;">3</td> <td style="text-align: center;">4</td> <td style="text-align: center;">R02</td> <td style="text-align: center;">S02</td> <td style="text-align: center;">T02</td> <td style="text-align: center;">N02</td> <td style="text-align: center;">E2</td> <td style="text-align: center;">E2</td> <td style="text-align: center;">E2</td> <td style="text-align: center;">E2</td> <td style="text-align: center;">E2</td> </tr> <tr> <td></td> <td style="text-align: center;">1</td> <td style="text-align: center;">2</td> <td style="text-align: center;">3</td> <td style="text-align: center;">4</td> <td style="text-align: center;">R03</td> <td style="text-align: center;">S03</td> <td style="text-align: center;">T03</td> <td style="text-align: center;">N03</td> <td style="text-align: center;">E3</td> <td style="text-align: center;">E3</td> <td style="text-align: center;">E3</td> <td style="text-align: center;">E3</td> <td style="text-align: center;">E3</td> </tr> <tr> <td></td> <td style="text-align: center;">1</td> <td style="text-align: center;">2</td> <td style="text-align: center;">3</td> <td style="text-align: center;">4</td> <td style="text-align: center;">R04</td> <td style="text-align: center;">S04</td> <td style="text-align: center;">T04</td> <td style="text-align: center;">N04</td> <td style="text-align: center;">E4</td> <td style="text-align: center;">E4</td> <td style="text-align: center;">E4</td> <td style="text-align: center;">E4</td> <td style="text-align: center;">E4</td> </tr> <tr> <td></td> <td style="text-align: center;">1</td> <td style="text-align: center;">2</td> <td style="text-align: center;">3</td> <td style="text-align: center;">4</td> <td style="text-align: center;">R05</td> <td style="text-align: center;">S05</td> <td style="text-align: center;">T05</td> <td style="text-align: center;">N05</td> <td style="text-align: center;">E5</td> <td style="text-align: center;">E5</td> <td style="text-align: center;">E5</td> <td style="text-align: center;">E5</td> <td style="text-align: center;">E5</td> </tr> <tr> <td></td> <td style="text-align: center;">1</td> <td style="text-align: center;">2</td> <td style="text-align: center;">3</td> <td style="text-align: center;">4</td> <td style="text-align: center;">R06</td> <td style="text-align: center;">S06</td> <td style="text-align: center;">T06</td> <td style="text-align: center;">N06</td> <td style="text-align: center;">E6</td> <td style="text-align: center;">E6</td> <td style="text-align: center;">E6</td> <td style="text-align: center;">E6</td> <td style="text-align: center;">E6</td> </tr> <tr> <td></td> <td style="text-align: center;">1</td> <td style="text-align: center;">2</td> <td style="text-align: center;">3</td> <td style="text-align: center;">4</td> <td style="text-align: center;">R07</td> <td style="text-align: center;">S07</td> <td style="text-align: center;">T07</td> <td style="text-align: center;">N07</td> <td style="text-align: center;">E7</td> <td style="text-align: center;">E7</td> <td style="text-align: center;">E7</td> <td style="text-align: center;">E7</td> <td style="text-align: center;">E7</td> </tr> <tr> <td></td> <td style="text-align: center;">1</td> <td style="text-align: center;">2</td> <td style="text-align: center;">3</td> <td style="text-align: center;">4</td> <td style="text-align: center;">R08</td> <td style="text-align: center;">S08</td> <td style="text-align: center;">T08</td> <td style="text-align: center;">N08</td> <td style="text-align: center;">E8</td> <td style="text-align: center;">E8</td> <td style="text-align: center;">E8</td> <td style="text-align: center;">E8</td> <td style="text-align: center;">E8</td> </tr> </table> </td> <td style="width: 50%; vertical-align: top;"> <table border="0" style="width: 100%;"> <tr> <td style="width: 50%;"></td> <td style="width: 50%; text-align: center;"> <table border="0"> <tr> <td style="width: 10%;"></td> <td style="width: 10%;"></td> <td style="width: 10%;"></td> <td style="width: 10%;"></td> <td style="width: 10%;"></td> <td style="width: 10%;"></td> <td style="width: 10%;"></td> <td style="width: 10%;"></td> <td style="width: 10%;"></td> <td style="width: 10%;"></td> <td style="width: 10%;"></td> <td style="width: 10%;"></td> <td style="width: 10%;"></td> <td style="width: 10%;"></td> </tr> <tr> <td style="text-align: center;">XA</td> <td style="text-align: center;">1</td> <td style="text-align: center;">2</td> <td style="text-align: center;">3</td> <td style="text-align: center;">4</td> <td style="text-align: center;">R01</td> <td style="text-align: center;">S01</td> <td style="text-align: center;">T01</td> <td
style="text-align: center;">N01</td> <td style="text-align: center;">E1</td> <td style="text-align: center;">E1</td> <td style="text-align: center;">E1</td> <td style="text-align: center;">E1</td> <td style="text-align: center;">E1</td> </tr> <tr> <td></td> <td style="text-align: center;">1</td> <td style="text-align: center;">2</td> <td style="text-align: center;">3</td> <td style="text-align: center;">4</td> <td style="text-align: center;">R02</td> <td style="text-align: center;">S02</td> <td style="text-align: center;">T02</td> <td style="text-align: center;">N02</td> <td style="text-align: center;">E2</td> <td style="text-align: center;">E2</td> <td style="text-align: center;">E2</td> <td style="text-align: center;">E2</td> <td style="text-align: center;">E2</td> </tr> <tr> <td></td> <td style="text-align: center;">1</td> <td style="text-align: center;">2</td> <td style="text-align: center;">3</td> <td style="text-align: center;">4</td> <td style="text-align: center;">R03</td> <td style="text-align: center;">S03</td> <td style="text-align: center;">T03</td> <td style="text-align: center;">N03</td> <td style="text-align: center;">E3</td> <td style="text-align: center;">E3</td> <td style="text-align: center;">E3</td> <td style="text-align: center;">E3</td> <td style="text-align: center;">E3</td> </tr> <tr> <td></td> <td style="text-align: center;">1</td> <td style="text-align: center;">2</td> <td style="text-align: center;">3</td> <td style="text-align: center;">4</td> <td style="text-align: center;">R04</td> <td style="text-align: center;">S04</td> <td style="text-align: center;">T04</td> <td style="text-align: center;">N04</td> <td style="text-align: center;">E4</td> <td style="text-align: center;">E4</td> <td style="text-align: center;">E4</td> <td style="text-align: center;">E4</td> <td style="text-align: center;">E4</td> </tr> <tr> <td></td> <td style="text-align: center;">1</td> <td style="text-align: center;">2</td> <td style="text-align: center;">3</td> <td style="text-align: center;">4</td> <td style="text-align: center;">R05</td> <td style="text-align: center;">S05</td> <td style="text-align: center;">T05</td> <td style="text-align: center;">N05</td> <td style="text-align: center;">E5</td> <td style="text-align: center;">E5</td> <td style="text-align: center;">E5</td> <td style="text-align: center;">E5</td> <td style="text-align: center;">E5</td> </tr> <tr> <td></td> <td style="text-align: center;">1</td> <td style="text-align: center;">2</td> <td style="text-align: center;">3</td> <td style="text-align: center;">4</td> <td style="text-align: center;">R06</td> <td style="text-align: center;">S06</td> <td style="text-align: center;">T06</td> <td style="text-align: center;">N06</td> <td style="text-align: center;">E6</td> <td style="text-align: center;">E6</td> <td style="text-align: center;">E6</td> <td style="text-align: center;">E6</td> <td style="text-align: center;">E6</td> </tr> <tr> <td></td> <td style="text-align: center;">1</td> <td style="text-align: center;">2</td> <td style="text-align: center;">3</td> <td style="text-align: center;">4</td> <td style="text-align: center;">R07</td> <td style="text-align: center;">S07</td> <td style="text-align: center;">T07</td> <td style="text-align: center;">N07</td> <td style="text-align: center;">E7</td> <td style="text-align: center;">E7</td> <td style="text-align: center;">E7</td> <td style="text-align: center;">E7</td> <td style="text-align: center;">E7</td> </tr> <tr> <td></td> <td style="text-align: center;">1</td> <td style="text-align: center;">2</td> <td style="text-align: center;">3</td> <td style="text-align: center;">4</td> <td style="text-align: center;">R08</td> <td style="text-align: center;">S08</td> <td style="text-align: center;">T08</td> <td style="text-align: center;">N08</td> <td style="text-align: center;">E8</td> <td style="text-align: center;">E8</td> <td style="text-align: center;">E8</td> <td style="text-align: center;">E8</td> <td style="text-align: center;">E8</td> </tr> </table> </td> <td style="width: 50%; vertical-align: top;"> <table border="0" style="width: 100%;"> <tr> <td style="width: 50%;"></td> <td style="width: 50%; text-align: center;"> <table border="0"> <tr> <td style="width: 10%;"></td> <td style="width: 10%;"></td> <td style="width: 10%;"></td> <td style="width: 10%;"></td> <td style="width: 10%;"></td> <td style="width: 10%;"></td> <td style="width: 10%;"></td> <td style="width: 10%;"></td> <td style="width: 10%;"></td> <td style="width: 10%;"></td> <td style="width: 10%;"></td> <td style="width: 10%;"></td> <td style="width: 10%;"></td> <td style="width: 10%;"></td> </tr> <tr> <td style="text-align: center;">XA</td> <td style="text-align: center;">1</td> <td style="text-align: center;">2</td> <td style="text-align: center;">3</td> <td style="text-align: center;">4</td> <td style="text-align: center;">R01</td> <td style="text-align: center;">S01</td> <td style="text-align: center;">T01</td> <td style="text-align: center;">N01</td> <td style="text-align: center;">E1</td> <td style="text-align: center;">E1</td> <td style="text-align: center;">E1</td> <td style="text-align: center;">E1</td> <td style="text-align: center;">E1</td> </tr> <tr> <td></td> <td style="text-align: center;">1</td> <td style="text-align: center;">2</td> <td style="text-align: center;">3</td> <td style="text-align: center;">4</td> <td style="text-align: center;">R02</td> <td style="text-align: center;">S02</td> <td style="text-align: center;">T02</td> <td style="text-align: center;">N02</td> <td style="text-align: center;">E2</td> <td style="text-align: center;">E2</td> <td style="text-align: center;">E2</td> <td style="text-align: center;">E2</td> <td style="text-align: center;">E2</td> </tr> <tr> <td></td> <td style="text-align: center;">1</td> <td style="text-align: center;">2</td> <td style="text-align: center;">3</td> <td style="text-align: center;">4</td> <td style="text-align: center;">R03</td> <td style="text-align: center;">S03</td> <td style="text-align: center;">T03</td> <td style="text-align: center;">N03</td> <td style="text-align: center;">E3</td> <td style="text-align: center;">E3</td> <td style="text-align: center;">E3</td> <td style="text-align: center;">E3</td> <td style="text-align: center;">E3</td> </tr> <tr> <td></td> <td style="text-align: center;">1</td> <td style="text-align: center;">2</td> <td style="text-align: center;">3</td> <td style="text-align: center;">4</td> <td style="text-align: center;">R04</td> <td style="text-align: center;">S04</td> <td style="text-align: center;">T04</td> <td style="text-align: center;">N04</td> <td style="text-align: center;">E4</td> <td style="text-align: center;">E4</td> <td style="text-align: center;">E4</td> <td style="text-align: center;">E4</td> <td style="text-align: center;">E4</td> </tr> <tr> <td></td> <td style="text-align: center;">1</td> <td style="text-align: center;">2</td> <td style="text-align: center;">3</td> <td style="text-align: center;">4</td> <td style="text-align: center;">R05</td> <td style="text-align: center;">S05</td> <td style="text-align: center;">T05</td> <td style="text-align: center;">N05</td> <td style="text-align: center;">E5</td> <td style="text-align: center;">E5</td> <td style="text-align: center;">E5</td> <td style="text-align: center;">E5</td> <td style="text-align: center;">E5</td> </tr> <tr> <td></td> <td style="text-align: center;">1</td> <td style="text-align: center;">2</td> <td style="text-align: center;">3</td> <td style="text-align: center;">4</td> <td style="text-align: center;">R06</td> <td style="text-align: center;">S06</td> <td style="text-align: center;">T06</td> <td style="text-align: center;">N06</td> <td style="text-align: center;">E6</td> <td style="text-align: center;">E6</td> <td style="text-align: center;">E6</td> <td style="text-align: center;">E6</td> <td style="text-align: center;">E6</td> </tr> <tr> <td></td> <td style="text-align: center;">1</td> <td style="text-align: center;">2</td> <td style="text-align: center;">3</td> <td style="text-align: center;">4</td> <td style="text-align: center;">R07</td> <td style="text-align: center;">S07</td> <td style="text-align: center;">T07</td> <td style="text-align: center;">N07</td> <td style="text-align: center;">E7</td> <td style="text-align: center;">E7</td> <td style="text-align: center;">E7</td> <td style="text-align: center;">E7</td> <td style="text-align: center;">E7</td> </tr> <tr> <td></td> <td style="text-align: center;">1</td> <td style="text-align: center;">2</td> <td style="text-align: center;">3</td> <td style="text-align: center;">4</td> <td style="text-align: center;">R08</td> <td style="text-align: center;">S08</td> <td style="text-align: center;">T08</td> <td style="text-align: center;">N08</td> <td style="text-align: center;">E8</td> <td style="text-align: center;">E8</td> <td style="text-align: center;">E8</td> <td style="text-align: center;">E8</td> <td style="text-align: center;">E8</td> </tr> </table> </td> <td style="width: 50%; vertical-align: top;"> <table border="0" style="width: 100%;"> <tr> <td style="width: 50%;"></td> <td style="width: 50%; text-align: center;"> <table border="0"> <tr> <td style="width: 10%;"></td> <td style="width: 10%;"></td> <td style="width: 10%;"></td> <td style="width: 10%;"></td> <td style="width: 10%;"></td> <td style="width: 10%;"></td> <td style="width: 10%;"></td> <td style="width: 10%;"></td> <td style="width: 10%;"></td> <td style="width: 10%;"></td> <td style="width: 10%;"></td> <td style="width: 10%;"></td> <td style="width: 10%;"></td> <td style="width: 10%;"></td> </tr> <tr> <td style="text-align: center;">XA</td> <td style="text-align: center;">1</td> <td style="text-align: center;">2</td> <td style="text-align: center;">3</td> <td style="text-align: center;">4</td> <td style="text-align: center;">R01</td> <td style="text-align: center;">S01</td> <td style="text-align: center;">T01</td> <td style="text-align:
center;">N01</td> <td style="text-align: center;">E1</td> <td style="text-align: center;">E1</td> <td style="text-align: center;">E1</td> </tr></table></td></tr></table></td></tr></table></td></tr></table></td></tr></table></td></tr></table> | | <table border="0"> <tr> <td style="width: 10%;"></td> <td style="width: 10%;"></td> <td style="width: 10%;"></td> <td style="width: 10%;"></td> <td style="width: 10%;"></td> <td style="width: 10%;"></td> <td style="width: 10%;"></td> <td style="width: 10%;"></td> <td style="width: 10%;"></td> <td style="width: 10%;"></td> <td style="width: 10%;"></td> <td style="width: 10%;"></td> <td style="width: 10%;"></td> <td style="width: 10%;"></td> </tr> <tr> <td style="text-align: center;">XA</td> <td style="text-align: center;">1</td> <td style="text-align: center;">2</td> <td style="text-align: center;">3</td> <td style="text-align: center;">4</td> <td style="text-align: center;">R01</td> <td style="text-align: center;">S01</td> <td style="text-align: center;">T01</td> <td style="text-align: center;">N01</td> <td style="text-align: center;">E1</td> <td style="text-align: center;">E1</td> <td style="text-align: center;">E1</td> <td style="text-align: center;">E1</td> <td style="text-align: center;">E1</td> </tr> <tr> <td></td> <td style="text-align: center;">1</td> <td style="text-align: center;">2</td> <td style="text-align: center;">3</td> <td style="text-align: center;">4</td> <td style="text-align: center;">R02</td> <td style="text-align: center;">S02</td> <td style="text-align: center;">T02</td> <td style="text-align: center;">N02</td> <td style="text-align: center;">E2</td> <td style="text-align: center;">E2</td> <td style="text-align: center;">E2</td> <td style="text-align: center;">E2</td> <td style="text-align: center;">E2</td> </tr> <tr> <td></td> <td style="text-align: center;">1</td> <td style="text-align: center;">2</td> <td style="text-align: center;">3</td> <td style="text-align: center;">4</td> <td style="text-align: center;">R03</td> <td style="text-align: center;">S03</td> <td style="text-align: center;">T03</td> <td style="text-align: center;">N03</td> <td style="text-align: center;">E3</td> <td style="text-align: center;">E3</td> <td style="text-align: center;">E3</td> <td style="text-align: center;">E3</td> <td style="text-align: center;">E3</td> </tr> <tr> <td></td> <td style="text-align: center;">1</td> <td style="text-align: center;">2</td> <td style="text-align: center;">3</td> <td style="text-align: center;">4</td> <td style="text-align: center;">R04</td> <td style="text-align: center;">S04</td> <td style="text-align: center;">T04</td> <td style="text-align: center;">N04</td> <td style="text-align: center;">E4</td> <td style="text-align: center;">E4</td> <td style="text-align: center;">E4</td> <td style="text-align: center;">E4</td> <td style="text-align: center;">E4</td> </tr> <tr> <td></td> <td style="text-align: center;">1</td> <td style="text-align: center;">2</td> <td style="text-align: center;">3</td> <td style="text-align: center;">4</td> <td style="text-align: center;">R05</td> <td style="text-align: center;">S05</td> <td style="text-align: center;">T05</td> <td style="text-align: center;">N05</td> <td style="text-align: center;">E5</td> <td style="text-align: center;">E5</td> <td style="text-align: center;">E5</td> <td style="text-align: center;">E5</td> <td style="text-align: center;">E5</td> </tr> <tr> <td></td> <td style="text-align: center;">1</td> <td style="text-align: center;">2</td> <td style="text-align: center;">3</td> <td style="text-align: center;">4</td> <td style="text-align: center;">R06</td> <td style="text-align: center;">S06</td> <td style="text-align: center;">T06</td> <td style="text-align: center;">N06</td> <td style="text-align: center;">E6</td> <td style="text-align: center;">E6</td> <td style="text-align: center;">E6</td> <td style="text-align: center;">E6</td> <td style="text-align: center;">E6</td> </tr> <tr> <td></td> <td style="text-align: center;">1</td> <td style="text-align: center;">2</td> <td style="text-align: center;">3</td> <td style="text-align: center;">4</td> <td style="text-align: center;">R07</td> <td style="text-align: center;">S07</td> <td style="text-align: center;">T07</td> <td style="text-align: center;">N07</td> <td style="text-align: center;">E7</td> <td style="text-align: center;">E7</td> <td style="text-align: center;">E7</td> <td style="text-align: center;">E7</td> <td style="text-align: center;">E7</td> </tr> <tr> <td></td> <td style="text-align: center;">1</td> <td style="text-align: center;">2</td> <td style="text-align: center;">3</td> <td style="text-align: center;">4</td> <td style="text-align: center;">R08</td> <td style="text-align: center;">S08</td> <td style="text-align: center;">T08</td> <td style="text-align: center;">N08</td> <td style="text-align: center;">E8</td> <td style="text-align: center;">E8</td> <td style="text-align: center;">E8</td> <td style="text-align: center;">E8</td> <td style="text-align: center;">E8</td> </tr> </table> | | | | | | | | | | | | | | | XA | 1 | 2 | 3 | 4 | R01 | S01 | T01 | N01 | E1 | E1 | E1 | E1 | E1 | | 1 | 2 | 3 | 4 | R02 | S02 | T02 | N02 | E2 | E2 | E2 | E2 | E2 | | 1 | 2 | 3 | 4 | R03 | S03 | T03 | N03 | E3 | E3 | E3 | E3 | E3 | | 1 | 2 | 3 | 4 | R04 | S04 | T04 | N04 | E4 | E4 | E4 | E4 | E4
 | | 1
 | 2 | 3 | 4 | R05 | S05 | T05 | N05 | E5 | E5 | E5 | E5 | E5
 |

 | 1 | 2
 | 3 | 4 | R06 | S06 | T06 | N06 | E6 | E6 | E6 | E6 | E6 |
 | 1 | 2
 | 3 | 4 | R07 | S07 | T07 | N07 | E7 | E7 | E7 | E7 | E7 | | 1 | 2 | 3 | 4 | R08 | S08 | T08 | N08 | E8 | E8 | E8 | E8 | E8 | <table border="0" style="width: 100%;"> <tr> <td style="width: 50%;"></td> <td style="width: 50%; text-align: center;"> <table border="0"> <tr> <td style="width: 10%;"></td> <td style="width: 10%;"></td> <td style="width: 10%;"></td> <td style="width: 10%;"></td> <td style="width: 10%;"></td> <td style="width: 10%;"></td> <td style="width: 10%;"></td> <td style="width: 10%;"></td> <td style="width: 10%;"></td> <td style="width: 10%;"></td> <td style="width: 10%;"></td> <td style="width: 10%;"></td> <td style="width: 10%;"></td> <td style="width: 10%;"></td> </tr> <tr> <td style="text-align: center;">XA</td> <td style="text-align: center;">1</td> <td style="text-align: center;">2</td> <td style="text-align: center;">3</td> <td style="text-align: center;">4</td> <td style="text-align: center;">R01</td> <td style="text-align: center;">S01</td> <td style="text-align: center;">T01</td> <td style="text-align: center;">N01</td> <td style="text-align: center;">E1</td> <td style="text-align: center;">E1</td> <td style="text-align: center;">E1</td> <td style="text-align: center;">E1</td> <td style="text-align: center;">E1</td> </tr> <tr> <td></td> <td style="text-align: center;">1</td> <td style="text-align: center;">2</td> <td style="text-align: center;">3</td> <td style="text-align: center;">4</td> <td style="text-align: center;">R02</td> <td style="text-align: center;">S02</td> <td style="text-align: center;">T02</td> <td style="text-align: center;">N02</td> <td style="text-align: center;">E2</td> <td style="text-align: center;">E2</td> <td style="text-align: center;">E2</td> <td style="text-align: center;">E2</td> <td style="text-align: center;">E2</td> </tr> <tr> <td></td> <td style="text-align: center;">1</td> <td style="text-align: center;">2</td> <td style="text-align: center;">3</td> <td style="text-align: center;">4</td> <td style="text-align: center;">R03</td> <td style="text-align: center;">S03</td> <td style="text-align: center;">T03</td> <td style="text-align: center;">N03</td> <td style="text-align: center;">E3</td> <td style="text-align: center;">E3</td> <td style="text-align: center;">E3</td> <td style="text-align: center;">E3</td> <td style="text-align: center;">E3</td> </tr> <tr> <td></td> <td style="text-align: center;">1</td> <td style="text-align: center;">2</td> <td style="text-align: center;">3</td> <td style="text-align: center;">4</td> <td style="text-align: center;">R04</td> <td style="text-align: center;">S04</td> <td style="text-align: center;">T04</td> <td style="text-align: center;">N04</td> <td style="text-align: center;">E4</td> <td style="text-align: center;">E4</td> <td style="text-align: center;">E4</td> <td style="text-align: center;">E4</td> <td style="text-align: center;">E4</td> </tr> <tr> <td></td> <td style="text-align: center;">1</td> <td style="text-align: center;">2</td> <td style="text-align: center;">3</td> <td style="text-align: center;">4</td> <td style="text-align: center;">R05</td> <td style="text-align: center;">S05</td> <td style="text-align: center;">T05</td> <td style="text-align: center;">N05</td> <td style="text-align: center;">E5</td> <td style="text-align: center;">E5</td> <td style="text-align: center;">E5</td> <td style="text-align: center;">E5</td> <td style="text-align: center;">E5</td> </tr> <tr> <td></td> <td style="text-align: center;">1</td> <td style="text-align: center;">2</td> <td style="text-align: center;">3</td> <td style="text-align: center;">4</td> <td style="text-align: center;">R06</td> <td style="text-align: center;">S06</td> <td style="text-align: center;">T06</td> <td style="text-align: center;">N06</td> <td style="text-align: center;">E6</td> <td style="text-align: center;">E6</td> <td style="text-align: center;">E6</td> <td style="text-align: center;">E6</td> <td style="text-align: center;">E6</td> </tr> <tr> <td></td> <td style="text-align: center;">1</td> <td style="text-align: center;">2</td> <td style="text-align: center;">3</td> <td style="text-align: center;">4</td> <td style="text-align: center;">R07</td> <td style="text-align: center;">S07</td> <td style="text-align: center;">T07</td> <td style="text-align: center;">N07</td> <td style="text-align: center;">E7</td> <td style="text-align: center;">E7</td> <td style="text-align: center;">E7</td> <td style="text-align: center;">E7</td> <td style="text-align: center;">E7</td> </tr> <tr> <td></td> <td style="text-align: center;">1</td> <td style="text-align: center;">2</td> <td style="text-align: center;">3</td> <td style="text-align: center;">4</td> <td style="text-align: center;">R08</td> <td style="text-align: center;">S08</td> <td style="text-align: center;">T08</td> <td style="text-align: center;">N08</td> <td style="text-align: center;">E8</td> <td style="text-align: center;">E8</td> <td style="text-align: center;">E8</td> <td style="text-align: center;">E8</td> <td style="text-align: center;">E8</td> </tr> </table> </td> <td style="width: 50%; vertical-align: top;"> <table border="0" style="width: 100%;"> <tr> <td style="width: 50%;"></td> <td style="width: 50%; text-align: center;"> <table border="0"> <tr> <td style="width: 10%;"></td> <td style="width: 10%;"></td> <td style="width: 10%;"></td> <td style="width: 10%;"></td> <td style="width: 10%;"></td> <td style="width: 10%;"></td> <td style="width: 10%;"></td> <td style="width: 10%;"></td> <td style="width: 10%;"></td> <td style="width: 10%;"></td> <td style="width: 10%;"></td> <td style="width: 10%;"></td> <td style="width: 10%;"></td> <td style="width: 10%;"></td> </tr> <tr> <td style="text-align: center;">XA</td> <td
style="text-align: center;">1</td> <td style="text-align: center;">2</td> <td style="text-align: center;">3</td> <td style="text-align: center;">4</td> <td style="text-align: center;">R01</td> <td style="text-align: center;">S01</td> <td style="text-align: center;">T01</td> <td style="text-align: center;">N01</td> <td style="text-align: center;">E1</td> <td style="text-align: center;">E1</td> <td style="text-align: center;">E1</td> <td style="text-align: center;">E1</td> <td style="text-align: center;">E1</td> </tr> <tr> <td></td> <td style="text-align: center;">1</td> <td style="text-align: center;">2</td> <td style="text-align: center;">3</td> <td style="text-align: center;">4</td> <td style="text-align: center;">R02</td> <td style="text-align: center;">S02</td> <td style="text-align: center;">T02</td> <td style="text-align: center;">N02</td> <td style="text-align: center;">E2</td> <td style="text-align: center;">E2</td> <td style="text-align: center;">E2</td> <td style="text-align: center;">E2</td> <td style="text-align: center;">E2</td> </tr> <tr> <td></td> <td style="text-align: center;">1</td> <td style="text-align: center;">2</td> <td style="text-align: center;">3</td> <td style="text-align: center;">4</td> <td style="text-align: center;">R03</td> <td style="text-align: center;">S03</td> <td style="text-align: center;">T03</td> <td style="text-align: center;">N03</td> <td style="text-align: center;">E3</td> <td style="text-align: center;">E3</td> <td style="text-align: center;">E3</td> <td style="text-align: center;">E3</td> <td style="text-align: center;">E3</td> </tr> <tr> <td></td> <td style="text-align: center;">1</td> <td style="text-align: center;">2</td> <td style="text-align: center;">3</td> <td style="text-align: center;">4</td> <td style="text-align: center;">R04</td> <td style="text-align: center;">S04</td> <td style="text-align: center;">T04</td> <td style="text-align: center;">N04</td> <td style="text-align: center;">E4</td> <td style="text-align: center;">E4</td> <td style="text-align: center;">E4</td> <td style="text-align: center;">E4</td> <td style="text-align: center;">E4</td> </tr> <tr> <td></td> <td style="text-align: center;">1</td> <td style="text-align: center;">2</td> <td style="text-align: center;">3</td> <td style="text-align: center;">4</td> <td style="text-align: center;">R05</td> <td style="text-align: center;">S05</td> <td style="text-align: center;">T05</td> <td style="text-align: center;">N05</td> <td style="text-align: center;">E5</td> <td style="text-align: center;">E5</td> <td style="text-align: center;">E5</td> <td style="text-align: center;">E5</td> <td style="text-align: center;">E5</td> </tr> <tr> <td></td> <td style="text-align: center;">1</td> <td style="text-align: center;">2</td> <td style="text-align: center;">3</td> <td style="text-align: center;">4</td> <td style="text-align: center;">R06</td> <td style="text-align: center;">S06</td> <td style="text-align: center;">T06</td> <td style="text-align: center;">N06</td> <td style="text-align: center;">E6</td> <td style="text-align: center;">E6</td> <td style="text-align: center;">E6</td> <td style="text-align: center;">E6</td> <td style="text-align: center;">E6</td> </tr> <tr> <td></td> <td style="text-align: center;">1</td> <td style="text-align: center;">2</td> <td style="text-align: center;">3</td> <td style="text-align: center;">4</td> <td style="text-align: center;">R07</td> <td style="text-align: center;">S07</td> <td style="text-align: center;">T07</td> <td style="text-align: center;">N07</td> <td style="text-align: center;">E7</td> <td style="text-align: center;">E7</td> <td style="text-align: center;">E7</td> <td style="text-align: center;">E7</td> <td style="text-align: center;">E7</td> </tr> <tr> <td></td> <td style="text-align: center;">1</td> <td style="text-align: center;">2</td> <td style="text-align: center;">3</td> <td style="text-align: center;">4</td> <td style="text-align: center;">R08</td> <td style="text-align: center;">S08</td> <td style="text-align: center;">T08</td> <td style="text-align: center;">N08</td> <td style="text-align: center;">E8</td> <td style="text-align: center;">E8</td> <td style="text-align: center;">E8</td> <td style="text-align: center;">E8</td> <td style="text-align: center;">E8</td> </tr> </table> </td> <td style="width: 50%; vertical-align: top;"> <table border="0" style="width: 100%;"> <tr> <td style="width: 50%;"></td> <td style="width: 50%; text-align: center;"> <table border="0"> <tr> <td style="width: 10%;"></td> <td style="width: 10%;"></td> <td style="width: 10%;"></td> <td style="width: 10%;"></td> <td style="width: 10%;"></td> <td style="width: 10%;"></td> <td style="width: 10%;"></td> <td style="width: 10%;"></td> <td style="width: 10%;"></td> <td style="width: 10%;"></td> <td style="width: 10%;"></td> <td style="width: 10%;"></td> <td style="width: 10%;"></td> <td style="width: 10%;"></td> </tr> <tr> <td style="text-align: center;">XA</td> <td style="text-align: center;">1</td> <td style="text-align: center;">2</td> <td style="text-align: center;">3</td> <td style="text-align: center;">4</td> <td style="text-align: center;">R01</td> <td style="text-align: center;">S01</td> <td style="text-align: center;">T01</td> <td style="text-align: center;">N01</td> <td style="text-align: center;">E1</td> <td style="text-align: center;">E1</td> <td style="text-align: center;">E1</td> <td style="text-align: center;">E1</td> <td style="text-align: center;">E1</td> </tr> <tr> <td></td> <td style="text-align: center;">1</td> <td style="text-align: center;">2</td> <td style="text-align: center;">3</td> <td style="text-align: center;">4</td> <td style="text-align: center;">R02</td> <td style="text-align: center;">S02</td> <td style="text-align: center;">T02</td> <td style="text-align: center;">N02</td> <td style="text-align: center;">E2</td> <td style="text-align: center;">E2</td> <td style="text-align: center;">E2</td> <td style="text-align: center;">E2</td> <td style="text-align: center;">E2</td> </tr> <tr> <td></td> <td style="text-align: center;">1</td> <td style="text-align: center;">2</td> <td style="text-align: center;">3</td> <td style="text-align: center;">4</td> <td style="text-align: center;">R03</td> <td style="text-align: center;">S03</td> <td style="text-align: center;">T03</td> <td style="text-align: center;">N03</td> <td style="text-align: center;">E3</td> <td style="text-align: center;">E3</td> <td style="text-align: center;">E3</td> <td style="text-align: center;">E3</td> <td style="text-align: center;">E3</td> </tr> <tr> <td></td> <td style="text-align: center;">1</td> <td style="text-align: center;">2</td> <td style="text-align: center;">3</td> <td style="text-align: center;">4</td> <td style="text-align: center;">R04</td> <td style="text-align: center;">S04</td> <td style="text-align: center;">T04</td> <td style="text-align: center;">N04</td> <td style="text-align: center;">E4</td> <td style="text-align: center;">E4</td> <td style="text-align: center;">E4</td> <td style="text-align: center;">E4</td> <td style="text-align: center;">E4</td> </tr> <tr> <td></td> <td style="text-align: center;">1</td> <td style="text-align: center;">2</td> <td style="text-align: center;">3</td> <td style="text-align: center;">4</td> <td style="text-align: center;">R05</td> <td style="text-align: center;">S05</td> <td style="text-align: center;">T05</td> <td style="text-align: center;">N05</td> <td style="text-align: center;">E5</td> <td style="text-align: center;">E5</td> <td style="text-align: center;">E5</td> <td style="text-align: center;">E5</td> <td style="text-align: center;">E5</td> </tr> <tr> <td></td> <td style="text-align: center;">1</td> <td style="text-align: center;">2</td> <td style="text-align: center;">3</td> <td style="text-align: center;">4</td> <td style="text-align: center;">R06</td> <td style="text-align: center;">S06</td> <td style="text-align: center;">T06</td> <td style="text-align: center;">N06</td> <td style="text-align: center;">E6</td> <td style="text-align: center;">E6</td> <td style="text-align: center;">E6</td> <td style="text-align: center;">E6</td> <td style="text-align: center;">E6</td> </tr> <tr> <td></td> <td style="text-align: center;">1</td> <td style="text-align: center;">2</td> <td style="text-align: center;">3</td> <td style="text-align: center;">4</td> <td style="text-align: center;">R07</td> <td style="text-align: center;">S07</td> <td style="text-align: center;">T07</td> <td style="text-align: center;">N07</td> <td style="text-align: center;">E7</td> <td style="text-align: center;">E7</td> <td style="text-align: center;">E7</td> <td style="text-align: center;">E7</td> <td style="text-align: center;">E7</td> </tr> <tr> <td></td> <td style="text-align: center;">1</td> <td style="text-align: center;">2</td> <td style="text-align: center;">3</td> <td style="text-align: center;">4</td> <td style="text-align: center;">R08</td> <td style="text-align: center;">S08</td> <td style="text-align: center;">T08</td> <td style="text-align: center;">N08</td> <td style="text-align: center;">E8</td> <td style="text-align: center;">E8</td> <td style="text-align: center;">E8</td> <td style="text-align: center;">E8</td> <td style="text-align: center;">E8</td> </tr> </table> </td> <td style="width: 50%; vertical-align: top;"> <table border="0" style="width: 100%;"> <tr> <td style="width: 50%;"></td> <td style="width: 50%; text-align: center;"> <table border="0"> <tr> <td style="width: 10%;"></td> <td style="width: 10%;"></td> <td style="width: 10%;"></td> <td style="width: 10%;"></td> <td style="width: 10%;"></td> <td style="width: 10%;"></td> <td style="width: 10%;"></td> <td style="width: 10%;"></td> <td style="width: 10%;"></td> <td style="width: 10%;"></td> <td style="width: 10%;"></td> <td style="width: 10%;"></td> <td style="width: 10%;"></td> <td style="width: 10%;"></td> </tr> <tr> <td style="text-align: center;">XA</td> <td style="text-align:
center;">1</td> <td style="text-align: center;">2</td> <td style="text-align: center;">3</td> <td style="text-align: center;">4</td> <td style="text-align: center;">R01</td> <td style="text-align: center;">S01</td> <td style="text-align: center;">T01</td> <td style="text-align: center;">N01</td> <td style="text-align: center;">E1</td> <td style="text-align: center;">E1</td> <td style="text-align: center;">E1</td> </tr></table></td></tr></table></td></tr></table></td></tr></table></td></tr></table> | | <table border="0"> <tr> <td style="width: 10%;"></td> <td style="width: 10%;"></td> <td style="width: 10%;"></td> <td style="width: 10%;"></td> <td style="width: 10%;"></td> <td style="width: 10%;"></td> <td style="width: 10%;"></td> <td style="width: 10%;"></td> <td style="width: 10%;"></td> <td style="width: 10%;"></td> <td style="width: 10%;"></td> <td style="width: 10%;"></td> <td style="width: 10%;"></td> <td style="width: 10%;"></td> </tr> <tr> <td style="text-align: center;">XA</td> <td style="text-align: center;">1</td> <td style="text-align: center;">2</td> <td style="text-align: center;">3</td> <td style="text-align: center;">4</td> <td style="text-align: center;">R01</td> <td style="text-align: center;">S01</td> <td style="text-align: center;">T01</td> <td style="text-align: center;">N01</td> <td style="text-align: center;">E1</td> <td style="text-align: center;">E1</td> <td style="text-align: center;">E1</td> <td style="text-align: center;">E1</td> <td style="text-align: center;">E1</td> </tr> <tr> <td></td> <td style="text-align: center;">1</td> <td style="text-align: center;">2</td> <td style="text-align: center;">3</td> <td style="text-align: center;">4</td> <td style="text-align: center;">R02</td> <td style="text-align: center;">S02</td> <td style="text-align: center;">T02</td> <td style="text-align: center;">N02</td> <td style="text-align: center;">E2</td> <td style="text-align: center;">E2</td> <td style="text-align: center;">E2</td> <td style="text-align: center;">E2</td> <td style="text-align: center;">E2</td> </tr> <tr> <td></td> <td style="text-align: center;">1</td> <td style="text-align: center;">2</td> <td style="text-align: center;">3</td> <td style="text-align: center;">4</td> <td style="text-align: center;">R03</td> <td style="text-align: center;">S03</td> <td style="text-align: center;">T03</td> <td style="text-align: center;">N03</td> <td style="text-align: center;">E3</td> <td style="text-align: center;">E3</td> <td style="text-align: center;">E3</td> <td style="text-align: center;">E3</td> <td style="text-align: center;">E3</td> </tr> <tr> <td></td> <td style="text-align: center;">1</td> <td style="text-align: center;">2</td> <td style="text-align: center;">3</td> <td style="text-align: center;">4</td> <td style="text-align: center;">R04</td> <td style="text-align: center;">S04</td> <td style="text-align: center;">T04</td> <td style="text-align: center;">N04</td> <td style="text-align: center;">E4</td> <td style="text-align: center;">E4</td> <td style="text-align: center;">E4</td> <td style="text-align: center;">E4</td> <td style="text-align: center;">E4</td> </tr> <tr> <td></td> <td style="text-align: center;">1</td> <td style="text-align: center;">2</td> <td style="text-align: center;">3</td> <td style="text-align: center;">4</td> <td style="text-align: center;">R05</td> <td style="text-align: center;">S05</td> <td style="text-align: center;">T05</td> <td style="text-align: center;">N05</td> <td style="text-align: center;">E5</td> <td style="text-align: center;">E5</td> <td style="text-align: center;">E5</td> <td style="text-align: center;">E5</td> <td style="text-align: center;">E5</td> </tr> <tr> <td></td> <td style="text-align: center;">1</td> <td style="text-align: center;">2</td> <td style="text-align: center;">3</td> <td style="text-align: center;">4</td> <td style="text-align: center;">R06</td> <td style="text-align: center;">S06</td> <td style="text-align: center;">T06</td> <td style="text-align: center;">N06</td> <td style="text-align: center;">E6</td> <td style="text-align: center;">E6</td> <td style="text-align: center;">E6</td> <td style="text-align: center;">E6</td> <td style="text-align: center;">E6</td> </tr> <tr> <td></td> <td style="text-align: center;">1</td> <td style="text-align: center;">2</td> <td style="text-align: center;">3</td> <td style="text-align: center;">4</td> <td style="text-align: center;">R07</td> <td style="text-align: center;">S07</td> <td style="text-align: center;">T07</td> <td style="text-align: center;">N07</td> <td style="text-align: center;">E7</td> <td style="text-align: center;">E7</td> <td style="text-align: center;">E7</td> <td style="text-align: center;">E7</td> <td style="text-align: center;">E7</td> </tr> <tr> <td></td> <td style="text-align: center;">1</td> <td style="text-align: center;">2</td> <td style="text-align: center;">3</td> <td style="text-align: center;">4</td> <td style="text-align: center;">R08</td> <td style="text-align: center;">S08</td> <td style="text-align: center;">T08</td> <td style="text-align: center;">N08</td> <td style="text-align: center;">E8</td> <td style="text-align: center;">E8</td> <td style="text-align: center;">E8</td> <td style="text-align: center;">E8</td> <td style="text-align: center;">E8</td> </tr> </table> | | | | | | | | | | | | | | | XA | 1 | 2 | 3 | 4 | R01 | S01 | T01 | N01 | E1 | E1 | E1 | E1 | E1 | | 1 | 2 | 3 | 4 | R02 | S02 | T02 | N02 | E2 | E2 | E2 | E2 | E2 | | 1 | 2 | 3 | 4 | R03 | S03 | T03 | N03 | E3 | E3 | E3 | E3 | E3 | | 1 | 2 | 3 | 4 | R04 | S04 | T04 | N04 | E4 | E4 | E4 | E4 | E4
 | | 1 | 2 | 3 | 4 | R05 | S05 | T05 | N05 | E5 | E5 | E5 | E5 | E5
 |
 | 1
 | 2 | 3 | 4 | R06 | S06 | T06 | N06 | E6 | E6 | E6 | E6 | E6 |
 | 1 | 2
 | 3 | 4 | R07 | S07 | T07 | N07 | E7 | E7 | E7 | E7 | E7 | | 1 | 2 | 3 | 4 | R08 | S08 | T08 | N08 | E8 | E8 | E8 | E8 | E8 | <table border="0" style="width: 100%;"> <tr> <td style="width: 50%;"></td> <td style="width: 50%; text-align: center;"> <table border="0"> <tr> <td style="width: 10%;"></td> <td style="width: 10%;"></td> <td style="width: 10%;"></td> <td style="width: 10%;"></td> <td style="width: 10%;"></td> <td style="width: 10%;"></td> <td style="width: 10%;"></td> <td style="width: 10%;"></td> <td style="width: 10%;"></td> <td style="width: 10%;"></td> <td style="width: 10%;"></td> <td style="width: 10%;"></td> <td style="width: 10%;"></td> <td style="width: 10%;"></td> </tr> <tr> <td style="text-align: center;">XA</td> <td style="text-align: center;">1</td> <td style="text-align: center;">2</td> <td style="text-align: center;">3</td> <td style="text-align: center;">4</td> <td style="text-align: center;">R01</td> <td style="text-align: center;">S01</td> <td style="text-align: center;">T01</td> <td style="text-align: center;">N01</td> <td style="text-align: center;">E1</td> <td style="text-align: center;">E1</td> <td style="text-align: center;">E1</td> <td style="text-align: center;">E1</td> <td style="text-align: center;">E1</td> </tr> <tr> <td></td> <td style="text-align: center;">1</td> <td style="text-align: center;">2</td> <td style="text-align: center;">3</td> <td style="text-align: center;">4</td> <td style="text-align: center;">R02</td> <td style="text-align: center;">S02</td> <td style="text-align: center;">T02</td> <td style="text-align: center;">N02</td> <td style="text-align: center;">E2</td> <td style="text-align: center;">E2</td> <td style="text-align: center;">E2</td> <td style="text-align: center;">E2</td> <td style="text-align: center;">E2</td> </tr> <tr> <td></td> <td style="text-align: center;">1</td> <td style="text-align: center;">2</td> <td style="text-align: center;">3</td> <td style="text-align: center;">4</td> <td style="text-align: center;">R03</td> <td style="text-align: center;">S03</td> <td style="text-align: center;">T03</td> <td style="text-align: center;">N03</td> <td style="text-align: center;">E3</td> <td style="text-align: center;">E3</td> <td style="text-align: center;">E3</td> <td style="text-align: center;">E3</td> <td style="text-align: center;">E3</td> </tr> <tr> <td></td> <td style="text-align: center;">1</td> <td style="text-align: center;">2</td> <td style="text-align: center;">3</td> <td style="text-align: center;">4</td> <td style="text-align: center;">R04</td> <td style="text-align: center;">S04</td> <td style="text-align: center;">T04</td> <td style="text-align: center;">N04</td> <td style="text-align: center;">E4</td> <td style="text-align: center;">E4</td> <td style="text-align: center;">E4</td> <td style="text-align: center;">E4</td> <td style="text-align: center;">E4</td> </tr> <tr> <td></td> <td style="text-align: center;">1</td> <td style="text-align: center;">2</td> <td style="text-align: center;">3</td> <td style="text-align: center;">4</td> <td style="text-align: center;">R05</td> <td style="text-align: center;">S05</td> <td style="text-align: center;">T05</td> <td style="text-align: center;">N05</td> <td style="text-align: center;">E5</td> <td style="text-align: center;">E5</td> <td style="text-align: center;">E5</td> <td style="text-align: center;">E5</td> <td style="text-align: center;">E5</td> </tr> <tr> <td></td> <td style="text-align: center;">1</td> <td style="text-align: center;">2</td> <td style="text-align: center;">3</td> <td style="text-align: center;">4</td> <td style="text-align: center;">R06</td> <td style="text-align: center;">S06</td> <td style="text-align: center;">T06</td> <td style="text-align: center;">N06</td> <td style="text-align: center;">E6</td> <td style="text-align: center;">E6</td> <td style="text-align: center;">E6</td> <td style="text-align: center;">E6</td> <td style="text-align: center;">E6</td> </tr> <tr> <td></td> <td style="text-align: center;">1</td> <td style="text-align: center;">2</td> <td style="text-align: center;">3</td> <td style="text-align: center;">4</td> <td style="text-align: center;">R07</td> <td style="text-align: center;">S07</td> <td style="text-align: center;">T07</td> <td style="text-align: center;">N07</td> <td style="text-align: center;">E7</td> <td style="text-align: center;">E7</td> <td style="text-align: center;">E7</td> <td style="text-align: center;">E7</td> <td style="text-align: center;">E7</td> </tr> <tr> <td></td> <td style="text-align: center;">1</td> <td style="text-align: center;">2</td> <td style="text-align: center;">3</td> <td style="text-align: center;">4</td> <td style="text-align: center;">R08</td> <td style="text-align: center;">S08</td> <td style="text-align: center;">T08</td> <td style="text-align: center;">N08</td> <td style="text-align: center;">E8</td> <td style="text-align: center;">E8</td> <td style="text-align: center;">E8</td> <td style="text-align: center;">E8</td> <td style="text-align: center;">E8</td> </tr> </table> </td> <td style="width: 50%; vertical-align: top;"> <table border="0" style="width: 100%;"> <tr> <td style="width: 50%;"></td> <td style="width: 50%; text-align: center;"> <table border="0"> <tr> <td style="width: 10%;"></td> <td style="width: 10%;"></td> <td style="width: 10%;"></td> <td style="width: 10%;"></td> <td style="width: 10%;"></td> <td style="width: 10%;"></td> <td style="width: 10%;"></td> <td style="width: 10%;"></td>
<td style="width: 10%;"></td> <td style="width: 10%;"></td> <td style="width: 10%;"></td> <td style="width: 10%;"></td> <td style="width: 10%;"></td> <td style="width: 10%;"></td> </tr> <tr> <td style="text-align: center;">XA</td> <td style="text-align: center;">1</td> <td style="text-align: center;">2</td> <td style="text-align: center;">3</td> <td style="text-align: center;">4</td> <td style="text-align: center;">R01</td> <td style="text-align: center;">S01</td> <td style="text-align: center;">T01</td> <td style="text-align: center;">N01</td> <td style="text-align: center;">E1</td> <td style="text-align: center;">E1</td> <td style="text-align: center;">E1</td> <td style="text-align: center;">E1</td> <td style="text-align: center;">E1</td> </tr> <tr> <td></td> <td style="text-align: center;">1</td> <td style="text-align: center;">2</td> <td style="text-align: center;">3</td> <td style="text-align: center;">4</td> <td style="text-align: center;">R02</td> <td style="text-align: center;">S02</td> <td style="text-align: center;">T02</td> <td style="text-align: center;">N02</td> <td style="text-align: center;">E2</td> <td style="text-align: center;">E2</td> <td style="text-align: center;">E2</td> <td style="text-align: center;">E2</td> <td style="text-align: center;">E2</td> </tr> <tr> <td></td> <td style="text-align: center;">1</td> <td style="text-align: center;">2</td> <td style="text-align: center;">3</td> <td style="text-align: center;">4</td> <td style="text-align: center;">R03</td> <td style="text-align: center;">S03</td> <td style="text-align: center;">T03</td> <td style="text-align: center;">N03</td> <td style="text-align: center;">E3</td> <td style="text-align: center;">E3</td> <td style="text-align: center;">E3</td> <td style="text-align: center;">E3</td> <td style="text-align: center;">E3</td> </tr> <tr> <td></td> <td style="text-align: center;">1</td> <td style="text-align: center;">2</td> <td style="text-align: center;">3</td> <td style="text-align: center;">4</td> <td style="text-align: center;">R04</td> <td style="text-align: center;">S04</td> <td style="text-align: center;">T04</td> <td style="text-align: center;">N04</td> <td style="text-align: center;">E4</td> <td style="text-align: center;">E4</td> <td style="text-align: center;">E4</td> <td style="text-align: center;">E4</td> <td style="text-align: center;">E4</td> </tr> <tr> <td></td> <td style="text-align: center;">1</td> <td style="text-align: center;">2</td> <td style="text-align: center;">3</td> <td style="text-align: center;">4</td> <td style="text-align: center;">R05</td> <td style="text-align: center;">S05</td> <td style="text-align: center;">T05</td> <td style="text-align: center;">N05</td> <td style="text-align: center;">E5</td> <td style="text-align: center;">E5</td> <td style="text-align: center;">E5</td> <td style="text-align: center;">E5</td> <td style="text-align: center;">E5</td> </tr> <tr> <td></td> <td style="text-align: center;">1</td> <td style="text-align: center;">2</td> <td style="text-align: center;">3</td> <td style="text-align: center;">4</td> <td style="text-align: center;">R06</td> <td style="text-align: center;">S06</td> <td style="text-align: center;">T06</td> <td style="text-align: center;">N06</td> <td style="text-align: center;">E6</td> <td style="text-align: center;">E6</td> <td style="text-align: center;">E6</td> <td style="text-align: center;">E6</td> <td style="text-align: center;">E6</td> </tr> <tr> <td></td> <td style="text-align: center;">1</td> <td style="text-align: center;">2</td> <td style="text-align: center;">3</td> <td style="text-align: center;">4</td> <td style="text-align: center;">R07</td> <td style="text-align: center;">S07</td> <td style="text-align: center;">T07</td> <td style="text-align: center;">N07</td> <td style="text-align: center;">E7</td> <td style="text-align: center;">E7</td> <td style="text-align: center;">E7</td> <td style="text-align: center;">E7</td> <td style="text-align: center;">E7</td> </tr> <tr> <td></td> <td style="text-align: center;">1</td> <td style="text-align: center;">2</td> <td style="text-align: center;">3</td> <td style="text-align: center;">4</td> <td style="text-align: center;">R08</td> <td style="text-align: center;">S08</td> <td style="text-align: center;">T08</td> <td style="text-align: center;">N08</td> <td style="text-align: center;">E8</td> <td style="text-align: center;">E8</td> <td style="text-align: center;">E8</td> <td style="text-align: center;">E8</td> <td style="text-align: center;">E8</td> </tr> </table> </td> <td style="width: 50%; vertical-align: top;"> <table border="0" style="width: 100%;"> <tr> <td style="width: 50%;"></td> <td style="width: 50%; text-align: center;"> <table border="0"> <tr> <td style="width: 10%;"></td> <td style="width: 10%;"></td> <td style="width: 10%;"></td> <td style="width: 10%;"></td> <td style="width: 10%;"></td> <td style="width: 10%;"></td> <td style="width: 10%;"></td> <td style="width: 10%;"></td> <td style="width: 10%;"></td> <td style="width: 10%;"></td> <td style="width: 10%;"></td> <td style="width: 10%;"></td> <td style="width: 10%;"></td> <td style="width: 10%;"></td> </tr> <tr> <td style="text-align: center;">XA</td> <td style="text-align: center;">1</td> <td style="text-align: center;">2</td> <td style="text-align: center;">3</td> <td style="text-align: center;">4</td> <td style="text-align: center;">R01</td> <td style="text-align: center;">S01</td> <td style="text-align: center;">T01</td> <td style="text-align: center;">N01</td> <td style="text-align: center;">E1</td> <td style="text-align: center;">E1</td> <td style="text-align: center;">E1</td> </tr></table></td></tr></table></td></tr></table></td></tr></table> | | <table border="0"> <tr> <td style="width: 10%;"></td> <td style="width: 10%;"></td> <td style="width: 10%;"></td> <td style="width: 10%;"></td> <td style="width: 10%;"></td> <td style="width: 10%;"></td> <td style="width: 10%;"></td> <td style="width: 10%;"></td> <td style="width: 10%;"></td> <td style="width: 10%;"></td> <td style="width: 10%;"></td> <td style="width: 10%;"></td> <td style="width: 10%;"></td> <td style="width: 10%;"></td> </tr> <tr> <td style="text-align: center;">XA</td> <td style="text-align: center;">1</td> <td style="text-align: center;">2</td> <td style="text-align: center;">3</td> <td style="text-align: center;">4</td> <td style="text-align: center;">R01</td> <td style="text-align: center;">S01</td> <td style="text-align: center;">T01</td> <td style="text-align: center;">N01</td> <td style="text-align: center;">E1</td> <td style="text-align: center;">E1</td> <td style="text-align: center;">E1</td> <td style="text-align: center;">E1</td> <td style="text-align: center;">E1</td> </tr> <tr> <td></td> <td style="text-align: center;">1</td> <td style="text-align: center;">2</td> <td style="text-align: center;">3</td> <td style="text-align: center;">4</td> <td style="text-align: center;">R02</td> <td style="text-align: center;">S02</td> <td style="text-align: center;">T02</td> <td style="text-align: center;">N02</td> <td style="text-align: center;">E2</td> <td style="text-align: center;">E2</td> <td style="text-align: center;">E2</td> <td style="text-align: center;">E2</td> <td style="text-align: center;">E2</td> </tr> <tr> <td></td> <td style="text-align: center;">1</td> <td style="text-align: center;">2</td> <td style="text-align: center;">3</td> <td style="text-align: center;">4</td> <td style="text-align: center;">R03</td> <td style="text-align: center;">S03</td> <td style="text-align: center;">T03</td> <td style="text-align: center;">N03</td> <td style="text-align: center;">E3</td> <td style="text-align: center;">E3</td> <td style="text-align: center;">E3</td> <td style="text-align: center;">E3</td> <td style="text-align: center;">E3</td> </tr> <tr> <td></td> <td style="text-align: center;">1</td> <td style="text-align: center;">2</td> <td style="text-align: center;">3</td> <td style="text-align: center;">4</td> <td style="text-align: center;">R04</td> <td style="text-align: center;">S04</td> <td style="text-align: center;">T04</td> <td style="text-align: center;">N04</td> <td style="text-align: center;">E4</td> <td style="text-align: center;">E4</td> <td style="text-align: center;">E4</td> <td style="text-align: center;">E4</td> <td style="text-align: center;">E4</td> </tr> <tr> <td></td> <td style="text-align: center;">1</td> <td style="text-align: center;">2</td> <td style="text-align: center;">3</td> <td style="text-align: center;">4</td> <td style="text-align: center;">R05</td> <td style="text-align: center;">S05</td> <td style="text-align: center;">T05</td> <td style="text-align: center;">N05</td> <td style="text-align: center;">E5</td> <td style="text-align: center;">E5</td> <td style="text-align: center;">E5</td> <td style="text-align: center;">E5</td> <td style="text-align: center;">E5</td> </tr> <tr> <td></td> <td style="text-align: center;">1</td> <td style="text-align: center;">2</td> <td style="text-align: center;">3</td> <td style="text-align: center;">4</td> <td style="text-align: center;">R06</td> <td style="text-align: center;">S06</td> <td style="text-align: center;">T06</td> <td style="text-align: center;">N06</td> <td style="text-align: center;">E6</td> <td style="text-align: center;">E6</td> <td style="text-align: center;">E6</td> <td style="text-align: center;">E6</td> <td style="text-align: center;">E6</td> </tr> <tr> <td></td> <td style="text-align: center;">1</td> <td style="text-align: center;">2</td> <td style="text-align: center;">3</td> <td style="text-align: center;">4</td> <td style="text-align: center;">R07</td> <td style="text-align: center;">S07</td> <td style="text-align: center;">T07</td> <td style="text-align: center;">N07</td> <td style="text-align: center;">E7</td> <td style="text-align: center;">E7</td> <td style="text-align: center;">E7</td> <td style="text-align: center;">E7</td> <td style="text-align: center;">E7</td>
</tr> <tr> <td></td> <td style="text-align: center;">1</td> <td style="text-align: center;">2</td> <td style="text-align: center;">3</td> <td style="text-align: center;">4</td> <td style="text-align: center;">R08</td> <td style="text-align: center;">S08</td> <td style="text-align: center;">T08</td> <td style="text-align: center;">N08</td> <td style="text-align: center;">E8</td> <td style="text-align: center;">E8</td> <td style="text-align: center;">E8</td> <td style="text-align: center;">E8</td> <td style="text-align: center;">E8</td> </tr> </table> | | | | | | | | | | | | | | | XA | 1 | 2 | 3 | 4 | R01 | S01 | T01 | N01 | E1 | E1 | E1 | E1 | E1 | | 1 | 2 | 3 | 4 | R02 | S02 | T02 | N02 | E2 | E2 | E2 | E2 | E2 | | 1 | 2 | 3 | 4 | R03 | S03 | T03 | N03 | E3 | E3 | E3 | E3 | E3 | | 1 | 2 | 3 | 4 | R04 | S04 | T04 | N04 | E4 | E4 | E4 | E4 | E4 | | 1 | 2 | 3 | 4 | R05 | S05 | T05 | N05 | E5 | E5 | E5 | E5 | E5 |
 | 1
 | 2 | 3 | 4 | R06 | S06 | T06 | N06 | E6 | E6 | E6 | E6 | E6 |
 | 1 | 2 | 3 | 4 | R07 | S07 | T07 | N07 | E7 | E7 | E7 | E7 | E7 | | 1 | 2 | 3 | 4 | R08 | S08 | T08 | N08 | E8 | E8 | E8 | E8 | E8 | <table border="0" style="width: 100%;"> <tr> <td style="width: 50%;"></td> <td style="width: 50%; text-align: center;"> <table border="0"> <tr> <td style="width: 10%;"></td> <td style="width: 10%;"></td> <td style="width: 10%;"></td> <td style="width: 10%;"></td> <td style="width: 10%;"></td> <td style="width: 10%;"></td> <td style="width: 10%;"></td> <td style="width: 10%;"></td> <td style="width: 10%;"></td> <td style="width: 10%;"></td> <td style="width: 10%;"></td> <td style="width: 10%;"></td> <td style="width: 10%;"></td> <td style="width: 10%;"></td> </tr> <tr> <td style="text-align: center;">XA</td> <td style="text-align: center;">1</td> <td style="text-align: center;">2</td> <td style="text-align: center;">3</td> <td style="text-align: center;">4</td> <td style="text-align: center;">R01</td> <td style="text-align: center;">S01</td> <td style="text-align: center;">T01</td> <td style="text-align: center;">N01</td> <td style="text-align: center;">E1</td> <td style="text-align: center;">E1</td> <td style="text-align: center;">E1</td> <td style="text-align: center;">E1</td> <td style="text-align: center;">E1</td> </tr> <tr> <td></td> <td style="text-align: center;">1</td> <td style="text-align: center;">2</td> <td style="text-align: center;">3</td> <td style="text-align: center;">4</td> <td style="text-align: center;">R02</td> <td style="text-align: center;">S02</td> <td style="text-align: center;">T02</td> <td style="text-align: center;">N02</td> <td style="text-align: center;">E2</td> <td style="text-align: center;">E2</td> <td style="text-align: center;">E2</td> <td style="text-align: center;">E2</td> <td style="text-align: center;">E2</td> </tr> <tr> <td></td> <td style="text-align: center;">1</td> <td style="text-align: center;">2</td> <td style="text-align: center;">3</td> <td style="text-align: center;">4</td> <td style="text-align: center;">R03</td> <td style="text-align: center;">S03</td> <td style="text-align: center;">T03</td> <td style="text-align: center;">N03</td> <td style="text-align: center;">E3</td> <td style="text-align: center;">E3</td> <td style="text-align: center;">E3</td> <td style="text-align: center;">E3</td> <td style="text-align: center;">E3</td> </tr> <tr> <td></td> <td style="text-align: center;">1</td> <td style="text-align: center;">2</td> <td style="text-align: center;">3</td> <td style="text-align: center;">4</td> <td style="text-align: center;">R04</td> <td style="text-align: center;">S04</td> <td style="text-align: center;">T04</td> <td style="text-align: center;">N04</td> <td style="text-align: center;">E4</td> <td style="text-align: center;">E4</td> <td style="text-align: center;">E4</td> <td style="text-align: center;">E4</td> <td style="text-align: center;">E4</td> </tr> <tr> <td></td> <td style="text-align: center;">1</td> <td style="text-align: center;">2</td> <td style="text-align: center;">3</td> <td style="text-align: center;">4</td> <td style="text-align: center;">R05</td> <td style="text-align: center;">S05</td> <td style="text-align: center;">T05</td> <td style="text-align: center;">N05</td> <td style="text-align: center;">E5</td> <td style="text-align: center;">E5</td> <td style="text-align: center;">E5</td> <td style="text-align: center;">E5</td> <td style="text-align: center;">E5</td> </tr> <tr> <td></td> <td style="text-align: center;">1</td> <td style="text-align: center;">2</td> <td style="text-align: center;">3</td> <td style="text-align: center;">4</td> <td style="text-align: center;">R06</td> <td style="text-align: center;">S06</td> <td style="text-align: center;">T06</td> <td style="text-align: center;">N06</td> <td style="text-align: center;">E6</td> <td style="text-align: center;">E6</td> <td style="text-align: center;">E6</td> <td style="text-align: center;">E6</td> <td style="text-align: center;">E6</td> </tr> <tr> <td></td> <td style="text-align: center;">1</td> <td style="text-align: center;">2</td> <td style="text-align: center;">3</td> <td style="text-align: center;">4</td> <td style="text-align:
center;">R07</td> <td style="text-align: center;">S07</td> <td style="text-align: center;">T07</td> <td style="text-align: center;">N07</td> <td style="text-align: center;">E7</td> <td style="text-align: center;">E7</td> <td style="text-align: center;">E7</td> <td style="text-align: center;">E7</td> <td style="text-align: center;">E7</td> </tr> <tr> <td></td> <td style="text-align: center;">1</td> <td style="text-align: center;">2</td> <td style="text-align: center;">3</td> <td style="text-align: center;">4</td> <td style="text-align: center;">R08</td> <td style="text-align: center;">S08</td> <td style="text-align: center;">T08</td> <td style="text-align: center;">N08</td> <td style="text-align: center;">E8</td> <td style="text-align: center;">E8</td> <td style="text-align: center;">E8</td> <td style="text-align: center;">E8</td> <td style="text-align: center;">E8</td> </tr> </table> </td> <td style="width: 50%; vertical-align: top;"> <table border="0" style="width: 100%;"> <tr> <td style="width: 50%;"></td> <td style="width: 50%; text-align: center;"> <table border="0"> <tr> <td style="width: 10%;"></td> <td style="width: 10%;"></td> <td style="width: 10%;"></td> <td style="width: 10%;"></td> <td style="width: 10%;"></td> <td style="width: 10%;"></td> <td style="width: 10%;"></td> <td style="width: 10%;"></td> <td style="width: 10%;"></td> <td style="width: 10%;"></td> <td style="width: 10%;"></td> <td style="width: 10%;"></td> <td style="width: 10%;"></td> <td style="width: 10%;"></td> </tr> <tr> <td style="text-align: center;">XA</td> <td style="text-align: center;">1</td> <td style="text-align: center;">2</td> <td style="text-align: center;">3</td> <td style="text-align: center;">4</td> <td style="text-align: center;">R01</td> <td style="text-align: center;">S01</td> <td style="text-align: center;">T01</td> <td style="text-align: center;">N01</td> <td style="text-align: center;">E1</td> <td style="text-align: center;">E1</td> <td style="text-align: center;">E1</td> </tr></table></td></tr></table></td></tr></table> | | <table border="0"> <tr> <td style="width: 10%;"></td> <td style="width: 10%;"></td> <td style="width: 10%;"></td> <td style="width: 10%;"></td> <td style="width: 10%;"></td> <td style="width: 10%;"></td> <td style="width: 10%;"></td> <td style="width: 10%;"></td> <td style="width: 10%;"></td> <td style="width: 10%;"></td> <td style="width: 10%;"></td> <td style="width: 10%;"></td> <td style="width: 10%;"></td> <td style="width: 10%;"></td> </tr> <tr> <td style="text-align: center;">XA</td> <td style="text-align: center;">1</td> <td style="text-align: center;">2</td> <td style="text-align: center;">3</td> <td style="text-align: center;">4</td> <td style="text-align: center;">R01</td> <td style="text-align: center;">S01</td> <td style="text-align: center;">T01</td> <td style="text-align: center;">N01</td> <td style="text-align: center;">E1</td> <td style="text-align: center;">E1</td> <td style="text-align: center;">E1</td> <td style="text-align: center;">E1</td> <td style="text-align: center;">E1</td> </tr> <tr> <td></td> <td style="text-align: center;">1</td> <td style="text-align: center;">2</td> <td style="text-align: center;">3</td> <td style="text-align: center;">4</td> <td style="text-align: center;">R02</td> <td style="text-align: center;">S02</td> <td style="text-align: center;">T02</td> <td style="text-align: center;">N02</td> <td style="text-align: center;">E2</td> <td style="text-align: center;">E2</td> <td style="text-align: center;">E2</td> <td style="text-align: center;">E2</td> <td style="text-align: center;">E2</td> </tr> <tr> <td></td> <td style="text-align: center;">1</td> <td style="text-align: center;">2</td> <td style="text-align: center;">3</td> <td style="text-align: center;">4</td> <td style="text-align: center;">R03</td> <td style="text-align: center;">S03</td> <td style="text-align: center;">T03</td> <td style="text-align: center;">N03</td> <td style="text-align: center;">E3</td> <td style="text-align: center;">E3</td> <td style="text-align: center;">E3</td> <td style="text-align: center;">E3</td> <td style="text-align: center;">E3</td> </tr> <tr> <td></td> <td style="text-align: center;">1</td> <td style="text-align: center;">2</td> <td style="text-align: center;">3</td> <td style="text-align: center;">4</td> <td style="text-align: center;">R04</td> <td style="text-align: center;">S04</td> <td style="text-align: center;">T04</td> <td style="text-align: center;">N04</td> <td style="text-align: center;">E4</td> <td style="text-align: center;">E4</td> <td style="text-align: center;">E4</td> <td style="text-align: center;">E4</td> <td style="text-align: center;">E4</td> </tr> <tr> <td></td> <td style="text-align: center;">1</td> <td style="text-align: center;">2</td> <td style="text-align: center;">3</td> <td style="text-align: center;">4</td> <td style="text-align: center;">R05</td> <td style="text-align: center;">S05</td> <td style="text-align: center;">T05</td> <td style="text-align: center;">N05</td> <td style="text-align: center;">E5</td> <td style="text-align: center;">E5</td> <td style="text-align: center;">E5</td> <td style="text-align: center;">E5</td> <td style="text-align: center;">E5</td> </tr> <tr> <td></td> <td style="text-align: center;">1</td> <td style="text-align: center;">2</td> <td style="text-align: center;">3</td> <td style="text-align: center;">4</td> <td style="text-align: center;">R06</td> <td style="text-align: center;">S06</td> <td style="text-align: center;">T06</td> <td style="text-align: center;">N06</td> <td style="text-align: center;">E6</td> <td style="text-align: center;">E6</td> <td style="text-align: center;">E6</td> <td style="text-align: center;">E6</td> <td style="text-align: center;">E6</td> </tr> <tr> <td></td> <td style="text-align: center;">1</td> <td style="text-align: center;">2</td> <td style="text-align: center;">3</td> <td style="text-align: center;">4</td> <td style="text-align: center;">R07</td> <td style="text-align: center;">S07</td> <td style="text-align: center;">T07</td> <td style="text-align: center;">N07</td> <td style="text-align: center;">E7</td> <td style="text-align: center;">E7</td> <td style="text-align: center;">E7</td> <td style="text-align: center;">E7</td> <td style="text-align: center;">E7</td> </tr> <tr> <td></td> <td style="text-align: center;">1</td> <td style="text-align: center;">2</td> <td style="text-align: center;">3</td> <td style="text-align: center;">4</td> <td style="text-align: center;">R08</td> <td style="text-align: center;">S08</td> <td style="text-align: center;">T08</td> <td style="text-align: center;">N08</td> <td style="text-align: center;">E8</td> <td style="text-align: center;">E8</td> <td style="text-align: center;">E8</td> <td style="text-align: center;">E8</td> <td style="text-align: center;">E8</td> </tr> </table> | | | | | | | | | | | | | | | XA | 1 | 2 | 3 | 4 | R01 | S01 | T01 | N01 | E1 | E1 | E1 | E1 | E1 | | 1 | 2 | 3 | 4 | R02 | S02 | T02 | N02 | E2 | E2 | E2 | E2 | E2 | | 1 | 2 | 3 | 4 | R03 | S03 | T03 | N03 | E3 | E3 | E3 | E3 | E3 | | 1 | 2 | 3 | 4 | R04 | S04 | T04 | N04 | E4 | E4 | E4 | E4 | E4 | | 1 | 2 | 3 | 4 | R05 | S05 | T05 | N05 | E5 | E5 | E5 | E5 | E5 | | 1
 | 2 | 3 | 4 | R06 | S06 | T06 | N06 | E6 | E6 | E6 | E6 | E6 | | 1 | 2 | 3 | 4 | R07 | S07 | T07 | N07 | E7 | E7 | E7 | E7 | E7 | | 1 | 2 | 3 | 4 | R08 | S08 | T08 | N08 | E8 | E8 | E8 | E8 | E8 | <table border="0" style="width: 100%;"> <tr> <td style="width: 50%;"></td> <td style="width: 50%; text-align: center;"> <table border="0"> <tr> <td style="width: 10%;"></td> <td style="width: 10%;"></td> <td style="width: 10%;"></td> <td style="width: 10%;"></td> <td style="width: 10%;"></td> <td style="width: 10%;"></td> <td style="width: 10%;"></td> <td style="width: 10%;"></td> <td style="width: 10%;"></td> <td style="width: 10%;"></td> <td style="width: 10%;"></td> <td style="width: 10%;"></td> <td style="width: 10%;"></td> <td style="width: 10%;"></td> </tr> <tr> <td style="text-align: center;">XA</td> <td style="text-align: center;">1</td> <td style="text-align: center;">2</td> <td style="text-align: center;">3</td> <td style="text-align: center;">4</td> <td style="text-align: center;">R01</td> <td style="text-align: center;">S01</td> <td style="text-align: center;">T01</td> <td style="text-align: center;">N01</td> <td style="text-align: center;">E1</td> <td style="text-align: center;">E1</td> <td style="text-align: center;">E1</td> </tr></table></td></tr></table> | | <table border="0"> <tr> <td style="width: 10%;"></td> <td style="width: 10%;"></td> <td style="width: 10%;"></td> <td style="width: 10%;"></td> <td style="width: 10%;"></td> <td style="width: 10%;"></td> <td style="width: 10%;"></td> <td style="width: 10%;"></td> <td style="width: 10%;"></td> <td style="width: 10%;"></td> <td style="width: 10%;"></td> <td style="width: 10%;"></td> <td style="width: 10%;"></td> <td style="width: 10%;"></td> </tr> <tr> <td style="text-align: center;">XA</td> <td style="text-align: center;">1</td> <td style="text-align: center;">2</td> <td style="text-align: center;">3</td> <td style="text-align: center;">4</td> <td style="text-align: center;">R01</td> <td style="text-align: center;">S01</td> <td style="text-align: center;">T01</td> <td style="text-align: center;">N01</td> <td style="text-align: center;">E1</td> <td style="text-align: center;">E1</td> <td style="text-align: center;">E1</td> </tr></table> | | | | | | | | | | | | | | | XA | 1 | 2 | 3 | 4 | R01 | S01 | T01 | N01 | E1 | E1 | E1 |
|

 | |
 | | | | | | | | | | | |

 | |
 | | | | | | | | | | | |

 | | | | | | | | | | | | | |

 | | | | | | | | | | | | | | | | | | | | | | | | | | | | | | | | | | | | | | | | | | | | | | | | | | | | | | | | | | | | | | | | | | | | | | | | | | | | | | | | | | | | | |

 | | | | | | | | | | | | | |

 |

 |
 | | | | | | | | | | | | |

 | | | | | | | | | | | | | | | | | | | | | | | | | | | |

 | | | | | | | | | | | | | | | | | | | | | | | | | | | | | | | | | | | | | | | | | | | | | | | | | | | | | | | | | | | | | | | |
| | | | | | | |
 | |
 | | | | | | | | | | | |

 |

 | |
 | | | | | | | | | | | |

 | | | | | | | | | | | | | | | | | | | | | | | | | | | |

 | | | | | | | | | | | | | | | | | | | | | | | | | | | | | | | | | | | | | | | | | | | | | | | | | | | | | | | | | | | | | | | | | | | | | | | |
 | |
 | | | | | | | | | | | |
 |

 | |
 | | | | | | | | | | | |
 | |
 | | | | | | | | | | | | | | | | | | | | | | | | | |

 | | | | | | | | | | | | | | | | | | | | | | | | | | | | | | | | | | | | | | | | | | | | | | | | | | | | | | | | | | | | | | | | | | | | | | | |
 | | | | | | | | | | | | | |
 |
 |
 | | | | | | | | | | | | |
 | |
 | | | | | | | | | | | | | | | | | | | | | | | | | |
 | |
 | | | | | | | | | | | | | | | | | | | | | | | | | | | | | | | | | | | | | | | | | | | | | | | | | | | | | | | | | | | | | | | | | | | | | | | | | | | | | | | | | | | | |
 | |
 | | | | | | | | | | | | | | | | | | | | | | | | | | | | | | | | | | | | | | | | | | | | | | | | | | | | | | | | | | | | | | | | | | | | | | | | | | | | | | | | | | | | | | | |
 | | | | | | | | | | | | | | | | | | | | | | | | | | | |
 | | | | | | | | | | | | | | | | | | | | | | | | | | | | | | | | | | | | | | | | | | | | | | | | | | | | | | | | | | | | | | | | | | | | | | | | | | | | | | | | | | | | | | | |
 | | | | | | | | | | | | | | | | | | | | | | | | | | | | | | | | | | | | | | | | | | | | | | | | | | | | | | | | | | | | | | | | | | | | | |
| <table border="0" style="width: 100%;"> <tr> <td style="width: 50%; vertical-align: top;"> <table border="0" style="width: 100%;"> <tr> <td style="width: 50%;"></td> <td style="width: 50%; text-align: center;"> <table border="0"> <tr> <td style="width: 10%;"></td> <td style="width: 10%;"></td> <td style="width: 10%;"></td> <td style="width: 10%;"></td> <td style="width: 10%;"></td> <td style="width: 10%;"></td> <td style="width: 10%;"></td> <td style="width: 10%;"></td> <td style="width: 10%;"></td> <td style="width: 10%;"></td> <td style="width: 10%;"></td> <td style="width: 10%;"></td> <td style="width: 10%;"></td> <td style="width: 10%;"></td> </tr> <tr> <td style="text-align: center;">XA</td> <td style="text-align: center;">1/G</td> <td style="text-align: center;">2/G</td> <td style="text-align: center;">3/G</td> <td style="text-align: center;">4/G</td> <td style="text-align: center;">R</td> <td style="text-align: center;">S</td> <td style="text-align: center;">T</td> <td style="text-align: center;">N</td> <td style="text-align: center;">E0</td> <td style="text-align: center;">E0</td> <td style="text-align: center;">E0</td> <td style="text-align: center;">E0</td> <td style="text-align: center;">E0</td> </tr> <tr> <td></td> <td style="text-align: center;">1</td> <td style="text-align: center;">2</td> <td style="text-align: center;">3</td> <td style="text-align: center;">4</td> <td style="text-align: center;">R01</td> <td style="text-align: center;">S01</td> <td style="text-align: center;">T01</td> <td style="text-align: center;">N01</td> <td style="text-align: center;">E1</td> <td style="text-align: center;">E1</td> <td style="text-align: center;">E1</td> <td style="text-align: center;">E1</td> <td style="text-align: center;">E1</td> </tr> <tr> <td></td> <td style="text-align: center;">1</td> <td style="text-align: center;">2</td> <td style="text-align: center;">3</td> <td style="text-align: center;">4</td> <td style="text-align: center;">R02</td> <td style="text-align: center;">S02</td> <td style="text-align: center;">T02</td> <td style="text-align: center;">N02</td> <td style="text-align: center;">E2</td> <td style="text-align: center;">E2</td> <td style="text-align: center;">E2</td> <td style="text-align: center;">E2</td> <td style="text-align: center;">E2</td> </tr> <tr> <td></td> <td style="text-align: center;">1</td> <td style="text-align: center;">2</td> <td style="text-align: center;">3</td> <td style="text-align: center;">4</td> <td style="text-align: center;">R03</td> <td style="text-align: center;">S03</td> <td style="text-align: center;">T03</td> <td style="text-align: center;">N03</td> <td style="text-align: center;">E3</td> <td style="text-align: center;">E3</td> <td style="text-align: center;">E3</td> <td style="text-align: center;">E3</td> <td style="text-align: center;">E3</td> </tr> <tr> <td></td> <td style="text-align: center;">1</td> <td style="text-align: center;">2</td> <td style="text-align: center;">3</td> <td style="text-align: center;">4</td> <td style="text-align: center;">R04</td> <td style="text-align: center;">S04</td> <td style="text-align: center;">T04</td> <td style="text-align: center;">N04</td> <td style="text-align: center;">E4</td> <td style="text-align: center;">E4</td> <td style="text-align: center;">E4</td> <td style="text-align: center;">E4</td> <td style="text-align: center;">E4</td> </tr> <tr> <td></td> <td style="text-align: center;">1</td> <td style="text-align: center;">2</td> <td style="text-align: center;">3</td> <td style="text-align: center;">4</td> <td style="text-align: center;">R05</td> <td style="text-align: center;">S05</td> <td style="text-align: center;">T05</td> <td style="text-align: center;">N05</td> <td style="text-align: center;">E5</td> <td style="text-align: center;">E5</td> <td style="text-align: center;">E5</td> <td style="text-align: center;">E5</td> <td style="text-align: center;">E5</td> </tr> <tr> <td></td> <td style="text-align: center;">1</td> <td style="text-align: center;">2</td> <td style="text-align: center;">3</td> <td style="text-align: center;">4</td> <td style="text-align: center;">R06</td> <td style="text-align: center;">S06</td> <td style="text-align: center;">T06</td> <td style="text-align: center;">N06</td> <td style="text-align: center;">E6</td> <td style="text-align: center;">E6</td> <td style="text-align: center;">E6</td> <td style="text-align: center;">E6</td> <td style="text-align: center;">E6</td> </tr> <tr> <td></td> <td style="text-align: center;">1</td> <td style="text-align: center;">2</td> <td style="text-align: center;">3</td> <td style="text-align: center;">4</td> <td style="text-align: center;">R07</td> <td style="text-align: center;">S07</td> <td style="text-align: center;">T07</td> <td style="text-align: center;">N07</td> <td style="text-align: center;">E7</td> <td style="text-align: center;">E7</td> <td style="text-align: center;">E7</td> <td style="text-align: center;">E7</td> <td style="text-align: center;">E7</td> </tr> <tr> <td></td> <td style="text-align: center;">1</td> <td style="text-align: center;">2</td> <td style="text-align: center;">3</td> <td style="text-align: center;">4</td> <td style="text-align: center;">R08</td> <td style="text-align: center;">S08</td> <td style="text-align: center;">T08</td> <td style="text-align: center;">N08</td> <td style="text-align: center;">E8</td> <td style="text-align: center;">E8</td> <td style="text-align: center;">E8</td> <td style="text-align: center;">E8</td> <td style="text-align: center;">E8</td> </tr> </table> </td> <td style="width: 50%; vertical-align: top;"> <table border="0" style="width: 100%;"> <tr> <td style="width: 50%;"></td> <td style="width: 50%; text-align: center;"> <table border="0"> <tr> <td style="width: 10%;"></td> <td style="width: 10%;"></td> <td style="width: 10%;"></td> <td style="width: 10%;"></td> <td style="width: 10%;"></td> <td style="width: 10%;"></td> <td style="width: 10%;"></td> <td style="width: 10%;"></td> <td style="width: 10%;"></td> <td style="width: 10%;"></td> <td style="width: 10%;"></td> <td style="width: 10%;"></td> <td style="width: 10%;"></td> <td style="width: 10%;"></td> </tr> <tr> <td style="text-align: center;">XA</td> <td style="text-align: center;">1</td> <td style="text-align: center;">2</td> <td style="text-align: center;">3</td> <td style="text-align: center;">4</td> <td style="text-align: center;">R01</td> <td style="text-align: center;">S01</td> <td style="text-align: center;">T01</td> <td style="text-align: center;">N01</td> <td style="text-align: center;">E1</td> <td style="text-align: center;">E1</td> <td style="text-align: center;">E1</td> <td style="text-align: center;">E1</td> <td style="text-align: center;">E1</td> </tr> <tr> <td></td> <td style="text-align: center;">1</td> <td style="text-align: center;">2</td> <td style="text-align: center;">3</td> <td style="text-align: center;">4</td> <td style="text-align: center;">R02</td> <td style="text-align: center;">S02</td> <td style="text-align: center;">T02</td> <td style="text-align: center;">N02</td> <td style="text-align: center;">E2</td> <td style="text-align: center;">E2</td> <td style="text-align: center;">E2</td> <td style="text-align: center;">E2</td> <td style="text-align: center;">E2</td> </tr> <tr> <td></td> <td style="text-align: center;">1</td> <td style="text-align: center;">2</td> <td style="text-align: center;">3</td> <td style="text-align: center;">4</td> <td style="text-align: center;">R03</td> <td style="text-align: center;">S03</td> <td style="text-align: center;">T03</td> <td style="text-align: center;">N03</td> <td style="text-align: center;">E3</td> <td style="text-align: center;">E3</td> <td style="text-align: center;">E3</td> <td style="text-align: center;">E3</td> <td style="text-align: center;">E3</td> </tr> <tr> <td></td> <td style="text-align: center;">1</td> <td style="text-align: center;">2</td> <td style="text-align: center;">3</td> <td style="text-align: center;">4</td> <td style="text-align: center;">R04</td> <td style="text-align: center;">S04</td> <td style="text-align: center;">T04</td> <td style="text-align: center;">N04</td> <td style="text-align: center;">E4</td> <td style="text-align: center;">E4</td> <td style="text-align: center;">E4</td> <td style="text-align: center;">E4</td> <td style="text-align: center;">E4</td> </tr> <tr> <td></td> <td style="text-align: center;">1</td> <td style="text-align: center;">2</td> <td style="text-align: center;">3</td> <td style="text-align: center;">4</td> <td style="text-align: center;">R05</td> <td style="text-align: center;">S05</td> <td style="text-align: center;">T05</td> <td style="text-align: center;">N05</td> <td style="text-align: center;">E5</td> <td style="text-align: center;">E5</td> <td style="text-align: center;">E5</td> <td style="text-align: center;">E5</td> <td style="text-align: center;">E5</td> </tr> <tr> <td></td> <td style="text-align: center;">1</td> <td style="text-align: center;">2</td> <td style="text-align: center;">3</td> <td style="text-align: center;">4</td> <td style="text-align: center;">R06</td> <td style="text-align: center;">S06</td> <td style="text-align: center;">T06</td> <td style="text-align: center;">N06</td> <td style="text-align: center;">E6</td> <td style="text-align: center;">E6</td> <td style="text-align: center;">E6</td> <td style="text-align: center;">E6</td> <td style="text-align: center;">E6</td> </tr> <tr> <td></td> <td style="text-align: center;">1</td> <td style="text-align: center;">2</td> <td style="text-align: center;">3</td> <td style="text-align: center;">4</td> <td style="text-align: center;">R07</td> <td style="text-align: center;">S07</td> <td style="text-align: center;">T07</td> <td style="text-align: center;">N07</td> <td style="text-align: center;">E7</td> <td style="text-align: center;">E7</td> <td style="text-align: center;">E7</td> <td style="text-align: center;">E7</td> <td style="text-align:
center;">E7</td> </tr> <tr> <td></td> <td style="text-align: center;">1</td> <td style="text-align: center;">2</td> <td style="text-align: center;">3</td> <td style="text-align: center;">4</td> <td style="text-align: center;">R08</td> <td style="text-align: center;">S08</td> <td style="text-align: center;">T08</td> <td style="text-align: center;">N08</td> <td style="text-align: center;">E8</td> <td style="text-align: center;">E8</td> <td style="text-align: center;">E8</td> <td style="text-align: center;">E8</td> <td style="text-align: center;">E8</td> </tr> </table> </td> <td style="width: 50%; vertical-align: top;"> <table border="0" style="width: 100%;"> <tr> <td style="width: 50%;"></td> <td style="width: 50%; text-align: center;"> <table border="0"> <tr> <td style="width: 10%;"></td> <td style="width: 10%;"></td> <td style="width: 10%;"></td> <td style="width: 10%;"></td> <td style="width: 10%;"></td> <td style="width: 10%;"></td> <td style="width: 10%;"></td> <td style="width: 10%;"></td> <td style="width: 10%;"></td> <td style="width: 10%;"></td> <td style="width: 10%;"></td> <td style="width: 10%;"></td> <td style="width: 10%;"></td> <td style="width: 10%;"></td> </tr> <tr> <td style="text-align: center;">XA</td> <td style="text-align: center;">1</td> <td style="text-align: center;">2</td> <td style="text-align: center;">3</td> <td style="text-align: center;">4</td> <td style="text-align: center;">R01</td> <td style="text-align: center;">S01</td> <td style="text-align: center;">T01</td> <td style="text-align: center;">N01</td> <td style="text-align: center;">E1</td> <td style="text-align: center;">E1</td> <td style="text-align: center;">E1</td> <td style="text-align: center;">E1</td> <td style="text-align: center;">E1</td> </tr> <tr> <td></td> <td style="text-align: center;">1</td> <td style="text-align: center;">2</td> <td style="text-align: center;">3</td> <td style="text-align: center;">4</td> <td style="text-align: center;">R02</td> <td style="text-align: center;">S02</td> <td style="text-align: center;">T02</td> <td style="text-align: center;">N02</td> <td style="text-align: center;">E2</td> <td style="text-align: center;">E2</td> <td style="text-align: center;">E2</td> <td style="text-align: center;">E2</td> <td style="text-align: center;">E2</td> </tr> <tr> <td></td> <td style="text-align: center;">1</td> <td style="text-align: center;">2</td> <td style="text-align: center;">3</td> <td style="text-align: center;">4</td> <td style="text-align: center;">R03</td> <td style="text-align: center;">S03</td> <td style="text-align: center;">T03</td> <td style="text-align: center;">N03</td> <td style="text-align: center;">E3</td> <td style="text-align: center;">E3</td> <td style="text-align: center;">E3</td> <td style="text-align: center;">E3</td> <td style="text-align: center;">E3</td> </tr> <tr> <td></td> <td style="text-align: center;">1</td> <td style="text-align: center;">2</td> <td style="text-align: center;">3</td> <td style="text-align: center;">4</td> <td style="text-align: center;">R04</td> <td style="text-align: center;">S04</td> <td style="text-align: center;">T04</td> <td style="text-align: center;">N04</td> <td style="text-align: center;">E4</td> <td style="text-align: center;">E4</td> <td style="text-align: center;">E4</td> <td style="text-align: center;">E4</td> <td style="text-align: center;">E4</td> </tr> <tr> <td></td> <td style="text-align: center;">1</td> <td style="text-align: center;">2</td> <td style="text-align: center;">3</td> <td style="text-align: center;">4</td> <td style="text-align: center;">R05</td> <td style="text-align: center;">S05</td> <td style="text-align: center;">T05</td> <td style="text-align: center;">N05</td> <td style="text-align: center;">E5</td> <td style="text-align: center;">E5</td> <td style="text-align: center;">E5</td> <td style="text-align: center;">E5</td> <td style="text-align: center;">E5</td> </tr> <tr> <td></td> <td style="text-align: center;">1</td> <td style="text-align: center;">2</td> <td style="text-align: center;">3</td> <td style="text-align: center;">4</td> <td style="text-align: center;">R06</td> <td style="text-align: center;">S06</td> <td style="text-align: center;">T06</td> <td style="text-align: center;">N06</td> <td style="text-align: center;">E6</td> <td style="text-align: center;">E6</td> <td style="text-align: center;">E6</td> <td style="text-align: center;">E6</td> <td style="text-align: center;">E6</td> </tr> <tr> <td></td> <td style="text-align: center;">1</td> <td style="text-align: center;">2</td> <td style="text-align: center;">3</td> <td style="text-align: center;">4</td> <td style="text-align: center;">R07</td> <td style="text-align: center;">S07</td> <td style="text-align: center;">T07</td> <td style="text-align: center;">N07</td> <td style="text-align: center;">E7</td> <td style="text-align: center;">E7</td> <td style="text-align: center;">E7</td> <td style="text-align: center;">E7</td> <td style="text-align: center;">E7</td> </tr> <tr> <td></td> <td style="text-align: center;">1</td> <td style="text-align: center;">2</td> <td style="text-align: center;">3</td> <td style="text-align: center;">4</td> <td style="text-align: center;">R08</td> <td style="text-align: center;">S08</td> <td style="text-align: center;">T08</td> <td style="text-align: center;">N08</td> <td style="text-align: center;">E8</td> <td style="text-align: center;">E8</td> <td style="text-align: center;">E8</td> <td style="text-align: center;">E8</td> <td style="text-align: center;">E8</td> </tr> </table> </td> <td style="width: 50%; vertical-align: top;"> <table border="0" style="width: 100%;"> <tr> <td style="width: 50%;"></td> <td style="width: 50%; text-align: center;"> <table border="0"> <tr> <td style="width: 10%;"></td> <td style="width: 10%;"></td> <td style="width: 10%;"></td> <td style="width: 10%;"></td> <td style="width: 10%;"></td> <td style="width: 10%;"></td> <td style="width: 10%;"></td> <td style="width: 10%;"></td> <td style="width: 10%;"></td> <td style="width: 10%;"></td> <td style="width: 10%;"></td> <td style="width: 10%;"></td> <td style="width: 10%;"></td> <td style="width: 10%;"></td> </tr> <tr> <td style="text-align: center;">XA</td> <td style="text-align: center;">1</td> <td style="text-align: center;">2</td> <td style="text-align: center;">3</td> <td style="text-align: center;">4</td> <td style="text-align: center;">R01</td> <td style="text-align: center;">S01</td> <td style="text-align: center;">T01</td> <td style="text-align: center;">N01</td> <td style="text-align: center;">E1</td> <td style="text-align: center;">E1</td> <td style="text-align: center;">E1</td> <td style="text-align: center;">E1</td> <td style="text-align: center;">E1</td> </tr> <tr> <td></td> <td style="text-align: center;">1</td> <td style="text-align: center;">2</td> <td style="text-align: center;">3</td> <td style="text-align: center;">4</td> <td style="text-align: center;">R02</td> <td style="text-align: center;">S02</td> <td style="text-align: center;">T02</td> <td style="text-align: center;">N02</td> <td style="text-align: center;">E2</td> <td style="text-align: center;">E2</td> <td style="text-align: center;">E2</td> <td style="text-align: center;">E2</td> <td style="text-align: center;">E2</td> </tr> <tr> <td></td> <td style="text-align: center;">1</td> <td style="text-align: center;">2</td> <td style="text-align: center;">3</td> <td style="text-align: center;">4</td> <td style="text-align: center;">R03</td> <td style="text-align: center;">S03</td> <td style="text-align: center;">T03</td> <td style="text-align: center;">N03</td> <td style="text-align: center;">E3</td> <td style="text-align: center;">E3</td> <td style="text-align: center;">E3</td> <td style="text-align: center;">E3</td> <td style="text-align: center;">E3</td> </tr> <tr> <td></td> <td style="text-align: center;">1</td> <td style="text-align: center;">2</td> <td style="text-align: center;">3</td> <td style="text-align: center;">4</td> <td style="text-align: center;">R04</td> <td style="text-align: center;">S04</td> <td style="text-align: center;">T04</td> <td style="text-align: center;">N04</td> <td style="text-align: center;">E4</td> <td style="text-align: center;">E4</td> <td style="text-align: center;">E4</td> <td style="text-align: center;">E4</td> <td style="text-align: center;">E4</td> </tr> <tr> <td></td> <td style="text-align: center;">1</td> <td style="text-align: center;">2</td> <td style="text-align: center;">3</td> <td style="text-align: center;">4</td> <td style="text-align: center;">R05</td> <td style="text-align: center;">S05</td> <td style="text-align: center;">T05</td> <td style="text-align: center;">N05</td> <td style="text-align: center;">E5</td> <td style="text-align: center;">E5</td> <td style="text-align: center;">E5</td> <td style="text-align: center;">E5</td> <td style="text-align: center;">E5</td> </tr> <tr> <td></td> <td style="text-align: center;">1</td> <td style="text-align: center;">2</td> <td style="text-align: center;">3</td> <td style="text-align: center;">4</td> <td style="text-align: center;">R06</td> <td style="text-align: center;">S06</td> <td style="text-align: center;">T06</td> <td style="text-align: center;">N06</td> <td style="text-align: center;">E6</td> <td style="text-align: center;">E6</td> <td style="text-align: center;">E6</td> <td style="text-align: center;">E6</td> <td style="text-align: center;">E6</td> </tr> <tr> <td></td> <td style="text-align: center;">1</td> <td style="text-align: center;">2</td> <td style="text-align: center;">3</td> <td style="text-align: center;">4</td> <td style="text-align: center;">R07</td> <td style="text-align: center;">S07</td> <td style="text-align: center;">T07</td> <td style="text-align: center;">N07</td> <td style="text-align: center;">E7</td> <td style="text-align: center;">E7</td> <td style="text-align: center;">E7</td> <td style="text-align: center;">E7</td> <td style="text-align: center;">E7</td>
</tr> <tr> <td></td> <td style="text-align: center;">1</td> <td style="text-align: center;">2</td> <td style="text-align: center;">3</td> <td style="text-align: center;">4</td> <td style="text-align: center;">R08</td> <td style="text-align: center;">S08</td> <td style="text-align: center;">T08</td> <td style="text-align: center;">N08</td> <td style="text-align: center;">E8</td> <td style="text-align: center;">E8</td> <td style="text-align: center;">E8</td> <td style="text-align: center;">E8</td> <td style="text-align: center;">E8</td> </tr> </table> </td> <td style="width: 50%; vertical-align: top;"> <table border="0" style="width: 100%;"> <tr> <td style="width: 50%;"></td> <td style="width: 50%; text-align: center;"> <table border="0"> <tr> <td style="width: 10%;"></td> <td style="width: 10%;"></td> <td style="width: 10%;"></td> <td style="width: 10%;"></td> <td style="width: 10%;"></td> <td style="width: 10%;"></td> <td style="width: 10%;"></td> <td style="width: 10%;"></td> <td style="width: 10%;"></td> <td style="width: 10%;"></td> <td style="width: 10%;"></td> <td style="width: 10%;"></td> <td style="width: 10%;"></td> <td style="width: 10%;"></td> </tr> <tr> <td style="text-align: center;">XA</td> <td style="text-align: center;">1</td> <td style="text-align: center;">2</td> <td style="text-align: center;">3</td> <td style="text-align: center;">4</td> <td style="text-align: center;">R01</td> <td style="text-align: center;">S01</td> <td style="text-align: center;">T01</td> <td style="text-align: center;">N01</td> <td style="text-align: center;">E1</td> <td style="text-align: center;">E1</td> <td style="text-align: center;">E1</td> <td style="text-align: center;">E1</td> <td style="text-align: center;">E1</td> </tr> <tr> <td></td> <td style="text-align: center;">1</td> <td style="text-align: center;">2</td> <td style="text-align: center;">3</td> <td style="text-align: center;">4</td> <td style="text-align: center;">R02</td> <td style="text-align: center;">S02</td> <td style="text-align: center;">T02</td> <td style="text-align: center;">N02</td> <td style="text-align: center;">E2</td> <td style="text-align: center;">E2</td> <td style="text-align: center;">E2</td> <td style="text-align: center;">E2</td> <td style="text-align: center;">E2</td> </tr> <tr> <td></td> <td style="text-align: center;">1</td> <td style="text-align: center;">2</td> <td style="text-align: center;">3</td> <td style="text-align: center;">4</td> <td style="text-align: center;">R03</td> <td style="text-align: center;">S03</td> <td style="text-align: center;">T03</td> <td style="text-align: center;">N03</td> <td style="text-align: center;">E3</td> <td style="text-align: center;">E3</td> <td style="text-align: center;">E3</td> <td style="text-align: center;">E3</td> <td style="text-align: center;">E3</td> </tr> <tr> <td></td> <td style="text-align: center;">1</td> <td style="text-align: center;">2</td> <td style="text-align: center;">3</td> <td style="text-align: center;">4</td> <td style="text-align: center;">R04</td> <td style="text-align: center;">S04</td> <td style="text-align: center;">T04</td> <td style="text-align: center;">N04</td> <td style="text-align: center;">E4</td> <td style="text-align: center;">E4</td> <td style="text-align: center;">E4</td> <td style="text-align: center;">E4</td> <td style="text-align: center;">E4</td> </tr> <tr> <td></td> <td style="text-align: center;">1</td> <td style="text-align: center;">2</td> <td style="text-align: center;">3</td> <td style="text-align: center;">4</td> <td style="text-align: center;">R05</td> <td style="text-align: center;">S05</td> <td style="text-align: center;">T05</td> <td style="text-align: center;">N05</td> <td style="text-align: center;">E5</td> <td style="text-align: center;">E5</td> <td style="text-align: center;">E5</td> <td style="text-align: center;">E5</td> <td style="text-align: center;">E5</td> </tr> <tr> <td></td> <td style="text-align: center;">1</td> <td style="text-align: center;">2</td> <td style="text-align: center;">3</td> <td style="text-align: center;">4</td> <td style="text-align: center;">R06</td> <td style="text-align: center;">S06</td> <td style="text-align: center;">T06</td> <td style="text-align: center;">N06</td> <td style="text-align: center;">E6</td> <td style="text-align: center;">E6</td> <td style="text-align: center;">E6</td> <td style="text-align: center;">E6</td> <td style="text-align: center;">E6</td> </tr> <tr> <td></td> <td style="text-align: center;">1</td> <td style="text-align: center;">2</td> <td style="text-align: center;">3</td> <td style="text-align: center;">4</td> <td style="text-align: center;">R07</td> <td style="text-align: center;">S07</td> <td style="text-align: center;">T07</td> <td style="text-align: center;">N07</td> <td style="text-align: center;">E7</td> <td style="text-align: center;">E7</td> <td style="text-align: center;">E7</td> <td style="text-align: center;">E7</td> <td style="text-align: center;">E7</td> </tr> <tr> <td></td> <td style="text-align: center;">1</td> <td style="text-align: center;">2</td> <td style="text-align: center;">3</td> <td style="text-align: center;">4</td> <td style="text-align: center;">R08</td> <td style="text-align: center;">S08</td> <td style="text-align: center;">T08</td> <td style="text-align: center;">N08</td> <td style="text-align: center;">E8</td> <td style="text-align: center;">E8</td> <td style="text-align: center;">E8</td> <td style="text-align: center;">E8</td> <td style="text-align: center;">E8</td> </tr> </table> </td> <td style="width: 50%; vertical-align: top;"> <table border="0" style="width: 100%;"> <tr> <td style="width: 50%;"></td> <td style="width: 50%; text-align: center;"> <table border="0"> <tr> <td style="width: 10%;"></td> <td style="width: 10%;"></td> <td style="width: 10%;"></td> <td style="width: 10%;"></td> <td style="width: 10%;"></td> <td style="width: 10%;"></td> <td style="width: 10%;"></td> <td style="width: 10%;"></td> <td style="width: 10%;"></td> <td style="width: 10%;"></td> <td style="width: 10%;"></td> <td style="width: 10%;"></td> <td style="width: 10%;"></td> <td style="width: 10%;"></td> </tr> <tr> <td style="text-align: center;">XA</td> <td style="text-align: center;">1</td> <td style="text-align: center;">2</td> <td style="text-align: center;">3</td> <td style="text-align: center;">4</td> <td style="text-align: center;">R01</td> <td style="text-align: center;">S01</td> <td style="text-align: center;">T01</td> <td style="text-align: center;">N01</td> <td style="text-align: center;">E1</td> <td style="text-align: center;">E1</td> <td style="text-align: center;">E1</td> <td style="text-align: center;">E1</td> <td style="text-align: center;">E1</td> </tr> <tr> <td></td> <td style="text-align: center;">1</td> <td style="text-align: center;">2</td> <td style="text-align: center;">3</td> <td style="text-align: center;">4</td> <td style="text-align: center;">R02</td> <td style="text-align: center;">S02</td> <td style="text-align: center;">T02</td> <td style="text-align: center;">N02</td> <td style="text-align: center;">E2</td> <td style="text-align: center;">E2</td> <td style="text-align: center;">E2</td> <td style="text-align: center;">E2</td> <td style="text-align: center;">E2</td> </tr> <tr> <td></td> <td style="text-align: center;">1</td> <td style="text-align: center;">2</td> <td style="text-align: center;">3</td> <td style="text-align: center;">4</td> <td style="text-align: center;">R03</td> <td style="text-align: center;">S03</td> <td style="text-align: center;">T03</td> <td style="text-align: center;">N03</td> <td style="text-align: center;">E3</td> <td style="text-align: center;">E3</td> <td style="text-align: center;">E3</td> <td style="text-align: center;">E3</td> <td style="text-align: center;">E3</td> </tr> <tr> <td></td> <td style="text-align: center;">1</td> <td style="text-align: center;">2</td> <td style="text-align: center;">3</td> <td style="text-align: center;">4</td> <td style="text-align: center;">R04</td> <td style="text-align: center;">S04</td> <td style="text-align: center;">T04</td> <td style="text-align: center;">N04</td> <td style="text-align: center;">E4</td> <td style="text-align: center;">E4</td> <td style="text-align: center;">E4</td> <td style="text-align: center;">E4</td> <td style="text-align: center;">E4</td> </tr> <tr> <td></td> <td style="text-align: center;">1</td> <td style="text-align: center;">2</td> <td style="text-align: center;">3</td> <td style="text-align: center;">4</td> <td style="text-align: center;">R05</td> <td style="text-align: center;">S05</td> <td style="text-align: center;">T05</td> <td style="text-align: center;">N05</td> <td style="text-align: center;">E5</td> <td style="text-align: center;">E5</td> <td style="text-align: center;">E5</td> <td style="text-align: center;">E5</td> <td style="text-align: center;">E5</td> </tr> <tr> <td></td> <td style="text-align: center;">1</td> <td style="text-align: center;">2</td> <td style="text-align: center;">3</td> <td style="text-align: center;">4</td> <td style="text-align: center;">R06</td> <td style="text-align: center;">S06</td> <td style="text-align: center;">T06</td> <td style="text-align: center;">N06</td> <td style="text-align: center;">E6</td> <td style="text-align: center;">E6</td> <td style="text-align: center;">E6</td> <td style="text-align: center;">E6</td> <td style="text-align: center;">E6</td> </tr> <tr> <td></td> <td style="text-align: center;">1</td> <td style="text-align: center;">2</td> <td style="text-align: center;">3</td> <td style="text-align: center;">4</td> <td style="text-align: center;">R07</td> <td style="text-align: center;">S07</td> <td style="text-align: center;">T07</td> <td style="text-align: center;">N07</td> <td style="text-align: center;">E7</td> <td style="text-align: center;">E7</td> <td style="text-align: center;">E7</td> <td style="text-align: center;">E7</td> <td style="text-align: center;">E7</td> </tr> <tr> <td></td>
<td style="text-align: center;">1</td> <td style="text-align: center;">2</td> <td style="text-align: center;">3</td> <td style="text-align: center;">4</td> <td style="text-align: center;">R08</td> <td style="text-align: center;">S08</td> <td style="text-align: center;">T08</td> <td style="text-align: center;">N08</td> <td style="text-align: center;">E8</td> <td style="text-align: center;">E8</td> <td style="text-align: center;">E8</td> <td style="text-align: center;">E8</td> <td style="text-align: center;">E8</td> </tr> </table> </td> <td style="width: 50%; vertical-align: top;"> <table border="0" style="width: 100%;"> <tr> <td style="width: 50%;"></td> <td style="width: 50%; text-align: center;"> <table border="0"> <tr> <td style="width: 10%;"></td> <td style="width: 10%;"></td> <td style="width: 10%;"></td> <td style="width: 10%;"></td> <td style="width: 10%;"></td> <td style="width: 10%;"></td> <td style="width: 10%;"></td> <td style="width: 10%;"></td> <td style="width: 10%;"></td> <td style="width: 10%;"></td> <td style="width: 10%;"></td> <td style="width: 10%;"></td> <td style="width: 10%;"></td> <td style="width: 10%;"></td> </tr> <tr> <td style="text-align: center;">XA</td> <td style="text-align: center;">1</td> <td style="text-align: center;">2</td> <td style="text-align: center;">3</td> <td style="text-align: center;">4</td> <td style="text-align: center;">R01</td> <td style="text-align: center;">S01</td> <td style="text-align: center;">T01</td> <td style="text-align: center;">N01</td> <td style="text-align: center;">E1</td> <td style="text-align: center;">E1</td> <td style="text-align: center;">E1</td> </tr></table></td></tr></table></td></tr></table></td></tr></table></td></tr></table></td></tr></table></td></tr></table></td></tr></table></td></tr></table> | |
 | | | | | | | | | | | | <table border="0" style="width: 100%;"> <tr> <td style="width: 50%;"></td> <td style="width: 50%; text-align: center;"> <table border="0"> <tr> <td style="width: 10%;"></td> <td style="width: 10%;"></td> <td style="width: 10%;"></td> <td style="width: 10%;"></td> <td style="width: 10%;"></td> <td style="width: 10%;"></td> <td style="width: 10%;"></td> <td style="width: 10%;"></td> <td style="width: 10%;"></td> <td style="width: 10%;"></td> <td style="width: 10%;"></td> <td style="width: 10%;"></td> <td style="width: 10%;"></td> <td style="width: 10%;"></td> </tr> <tr> <td style="text-align: center;">XA</td> <td style="text-align: center;">1/G</td> <td style="text-align: center;">2/G</td> <td style="text-align: center;">3/G</td> <td style="text-align: center;">4/G</td> <td style="text-align: center;">R</td> <td style="text-align: center;">S</td> <td style="text-align: center;">T</td> <td style="text-align: center;">N</td> <td style="text-align: center;">E0</td> <td style="text-align: center;">E0</td> <td style="text-align: center;">E0</td> <td style="text-align: center;">E0</td> <td style="text-align: center;">E0</td> </tr> <tr> <td></td> <td style="text-align: center;">1</td> <td style="text-align: center;">2</td> <td style="text-align: center;">3</td> <td style="text-align: center;">4</td> <td style="text-align: center;">R01</td> <td style="text-align: center;">S01</td> <td style="text-align: center;">T01</td> <td style="text-align: center;">N01</td> <td style="text-align: center;">E1</td> <td style="text-align: center;">E1</td> <td style="text-align: center;">E1</td> <td style="text-align: center;">E1</td> <td style="text-align: center;">E1</td> </tr> <tr> <td></td> <td style="text-align: center;">1</td> <td style="text-align: center;">2</td> <td style="text-align: center;">3</td> <td style="text-align: center;">4</td> <td style="text-align: center;">R02</td> <td style="text-align: center;">S02</td> <td style="text-align: center;">T02</td> <td style="text-align: center;">N02</td> <td style="text-align: center;">E2</td> <td style="text-align: center;">E2</td> <td style="text-align: center;">E2</td> <td style="text-align: center;">E2</td> <td style="text-align: center;">E2</td> </tr> <tr> <td></td> <td style="text-align: center;">1</td> <td style="text-align: center;">2</td> <td style="text-align: center;">3</td> <td style="text-align: center;">4</td> <td style="text-align: center;">R03</td> <td style="text-align: center;">S03</td> <td style="text-align: center;">T03</td> <td style="text-align: center;">N03</td> <td style="text-align: center;">E3</td> <td style="text-align: center;">E3</td> <td style="text-align: center;">E3</td> <td style="text-align: center;">E3</td> <td style="text-align: center;">E3</td> </tr> <tr> <td></td> <td style="text-align: center;">1</td> <td style="text-align: center;">2</td> <td style="text-align: center;">3</td> <td style="text-align: center;">4</td> <td style="text-align: center;">R04</td> <td style="text-align: center;">S04</td> <td style="text-align: center;">T04</td> <td style="text-align: center;">N04</td> <td style="text-align: center;">E4</td> <td style="text-align: center;">E4</td> <td style="text-align: center;">E4</td> <td style="text-align: center;">E4</td> <td style="text-align: center;">E4</td> </tr> <tr> <td></td> <td style="text-align: center;">1</td> <td style="text-align: center;">2</td> <td style="text-align: center;">3</td> <td style="text-align: center;">4</td> <td style="text-align: center;">R05</td> <td style="text-align: center;">S05</td> <td style="text-align: center;">T05</td> <td style="text-align: center;">N05</td> <td style="text-align: center;">E5</td> <td style="text-align: center;">E5</td> <td style="text-align: center;">E5</td> <td style="text-align: center;">E5</td> <td style="text-align: center;">E5</td> </tr> <tr> <td></td> <td style="text-align: center;">1</td> <td style="text-align: center;">2</td> <td style="text-align: center;">3</td> <td style="text-align: center;">4</td> <td style="text-align: center;">R06</td> <td style="text-align: center;">S06</td> <td style="text-align: center;">T06</td> <td style="text-align: center;">N06</td> <td style="text-align: center;">E6</td> <td style="text-align: center;">E6</td> <td style="text-align: center;">E6</td> <td style="text-align: center;">E6</td> <td style="text-align: center;">E6</td> </tr> <tr> <td></td> <td style="text-align: center;">1</td> <td style="text-align: center;">2</td> <td style="text-align: center;">3</td> <td style="text-align: center;">4</td> <td style="text-align: center;">R07</td> <td style="text-align: center;">S07</td> <td style="text-align: center;">T07</td> <td style="text-align: center;">N07</td> <td style="text-align: center;">E7</td> <td style="text-align: center;">E7</td> <td style="text-align: center;">E7</td> <td style="text-align: center;">E7</td> <td style="text-align: center;">E7</td> </tr> <tr> <td></td> <td style="text-align: center;">1</td> <td style="text-align: center;">2</td> <td style="text-align: center;">3</td> <td style="text-align: center;">4</td> <td style="text-align: center;">R08</td> <td style="text-align: center;">S08</td> <td style="text-align: center;">T08</td> <td style="text-align: center;">N08</td> <td style="text-align: center;">E8</td> <td style="text-align: center;">E8</td> <td style="text-align: center;">E8</td> <td style="text-align: center;">E8</td> <td style="text-align: center;">E8</td> </tr> </table> </td> <td style="width: 50%; vertical-align: top;"> <table border="0" style="width: 100%;"> <tr> <td style="width: 50%;"></td> <td style="width: 50%; text-align: center;"> <table border="0"> <tr> <td style="width: 10%;"></td> <td style="width: 10%;"></td> <td style="width: 10%;"></td> <td style="width: 10%;"></td> <td style="width: 10%;"></td> <td style="width: 10%;"></td> <td style="width: 10%;"></td> <td style="width: 10%;"></td> <td style="width: 10%;"></td> <td style="width: 10%;"></td> <td style="width: 10%;"></td> <td style="width: 10%;"></td> <td style="width: 10%;"></td> <td style="width: 10%;"></td> </tr> <tr> <td style="text-align: center;">XA</td> <td style="text-align: center;">1</td> <td style="text-align: center;">2</td> <td style="text-align: center;">3</td> <td style="text-align: center;">4</td> <td style="text-align: center;">R01</td> <td style="text-align: center;">S01</td> <td style="text-align: center;">T01</td> <td style="text-align: center;">N01</td> <td style="text-align: center;">E1</td> <td style="text-align: center;">E1</td> <td style="text-align: center;">E1</td> <td style="text-align: center;">E1</td> <td style="text-align: center;">E1</td> </tr> <tr>
<td></td> <td style="text-align: center;">1</td> <td style="text-align: center;">2</td> <td style="text-align: center;">3</td> <td style="text-align: center;">4</td> <td style="text-align: center;">R02</td> <td style="text-align: center;">S02</td> <td style="text-align: center;">T02</td> <td style="text-align: center;">N02</td> <td style="text-align: center;">E2</td> <td style="text-align: center;">E2</td> <td style="text-align: center;">E2</td> <td style="text-align: center;">E2</td> <td style="text-align: center;">E2</td> </tr> <tr> <td></td> <td style="text-align: center;">1</td> <td style="text-align: center;">2</td> <td style="text-align: center;">3</td> <td style="text-align: center;">4</td> <td style="text-align: center;">R03</td> <td style="text-align: center;">S03</td> <td style="text-align: center;">T03</td> <td style="text-align: center;">N03</td> <td style="text-align: center;">E3</td> <td style="text-align: center;">E3</td> <td style="text-align: center;">E3</td> <td style="text-align: center;">E3</td> <td style="text-align: center;">E3</td> </tr> <tr> <td></td> <td style="text-align: center;">1</td> <td style="text-align: center;">2</td> <td style="text-align: center;">3</td> <td style="text-align: center;">4</td> <td style="text-align: center;">R04</td> <td style="text-align: center;">S04</td> <td style="text-align: center;">T04</td> <td style="text-align: center;">N04</td> <td style="text-align: center;">E4</td> <td style="text-align: center;">E4</td> <td style="text-align: center;">E4</td> <td style="text-align: center;">E4</td> <td style="text-align: center;">E4</td> </tr> <tr> <td></td> <td style="text-align: center;">1</td> <td style="text-align: center;">2</td> <td style="text-align: center;">3</td> <td style="text-align: center;">4</td> <td style="text-align: center;">R05</td> <td style="text-align: center;">S05</td> <td style="text-align: center;">T05</td> <td style="text-align: center;">N05</td> <td style="text-align: center;">E5</td> <td style="text-align: center;">E5</td> <td style="text-align: center;">E5</td> <td style="text-align: center;">E5</td> <td style="text-align: center;">E5</td> </tr> <tr> <td></td> <td style="text-align: center;">1</td> <td style="text-align: center;">2</td> <td style="text-align: center;">3</td> <td style="text-align: center;">4</td> <td style="text-align: center;">R06</td> <td style="text-align: center;">S06</td> <td style="text-align: center;">T06</td> <td style="text-align: center;">N06</td> <td style="text-align: center;">E6</td> <td style="text-align: center;">E6</td> <td style="text-align: center;">E6</td> <td style="text-align: center;">E6</td> <td style="text-align: center;">E6</td> </tr> <tr> <td></td> <td style="text-align: center;">1</td> <td style="text-align: center;">2</td> <td style="text-align: center;">3</td> <td style="text-align: center;">4</td> <td style="text-align: center;">R07</td> <td style="text-align: center;">S07</td> <td style="text-align: center;">T07</td> <td style="text-align: center;">N07</td> <td style="text-align: center;">E7</td> <td style="text-align: center;">E7</td> <td style="text-align: center;">E7</td> <td style="text-align: center;">E7</td> <td style="text-align: center;">E7</td> </tr> <tr> <td></td> <td style="text-align: center;">1</td> <td style="text-align: center;">2</td> <td style="text-align: center;">3</td> <td style="text-align: center;">4</td> <td style="text-align: center;">R08</td> <td style="text-align: center;">S08</td> <td style="text-align: center;">T08</td> <td style="text-align: center;">N08</td> <td style="text-align: center;">E8</td> <td style="text-align: center;">E8</td> <td style="text-align: center;">E8</td> <td style="text-align: center;">E8</td> <td style="text-align: center;">E8</td> </tr> </table> </td> <td style="width: 50%; vertical-align: top;"> <table border="0" style="width: 100%;"> <tr> <td style="width: 50%;"></td> <td style="width: 50%; text-align: center;"> <table border="0"> <tr> <td style="width: 10%;"></td> <td style="width: 10%;"></td> <td style="width: 10%;"></td> <td style="width: 10%;"></td> <td style="width: 10%;"></td> <td style="width: 10%;"></td> <td style="width: 10%;"></td> <td style="width: 10%;"></td> <td style="width: 10%;"></td> <td style="width: 10%;"></td> <td style="width: 10%;"></td> <td style="width: 10%;"></td> <td style="width: 10%;"></td> <td style="width: 10%;"></td> </tr> <tr> <td style="text-align: center;">XA</td> <td style="text-align: center;">1</td> <td style="text-align: center;">2</td> <td style="text-align: center;">3</td> <td style="text-align: center;">4</td> <td style="text-align: center;">R01</td> <td style="text-align: center;">S01</td> <td style="text-align: center;">T01</td> <td style="text-align: center;">N01</td> <td style="text-align: center;">E1</td> <td style="text-align: center;">E1</td> <td style="text-align: center;">E1</td> <td style="text-align: center;">E1</td> <td style="text-align: center;">E1</td> </tr> <tr> <td></td> <td style="text-align: center;">1</td> <td style="text-align: center;">2</td> <td style="text-align: center;">3</td> <td style="text-align: center;">4</td> <td style="text-align: center;">R02</td> <td style="text-align: center;">S02</td> <td style="text-align: center;">T02</td> <td style="text-align: center;">N02</td> <td style="text-align: center;">E2</td> <td style="text-align: center;">E2</td> <td style="text-align: center;">E2</td> <td style="text-align: center;">E2</td> <td style="text-align: center;">E2</td> </tr> <tr> <td></td> <td style="text-align: center;">1</td> <td style="text-align: center;">2</td> <td style="text-align: center;">3</td> <td style="text-align: center;">4</td> <td style="text-align: center;">R03</td> <td style="text-align: center;">S03</td> <td style="text-align: center;">T03</td> <td style="text-align: center;">N03</td> <td style="text-align: center;">E3</td> <td style="text-align: center;">E3</td> <td style="text-align: center;">E3</td> <td style="text-align: center;">E3</td> <td style="text-align: center;">E3</td> </tr> <tr> <td></td> <td style="text-align: center;">1</td> <td style="text-align: center;">2</td> <td style="text-align: center;">3</td> <td style="text-align: center;">4</td> <td style="text-align: center;">R04</td> <td style="text-align: center;">S04</td> <td style="text-align: center;">T04</td> <td style="text-align: center;">N04</td> <td style="text-align: center;">E4</td> <td style="text-align: center;">E4</td> <td style="text-align: center;">E4</td> <td style="text-align: center;">E4</td> <td style="text-align: center;">E4</td> </tr> <tr> <td></td> <td style="text-align: center;">1</td> <td style="text-align: center;">2</td> <td style="text-align: center;">3</td> <td style="text-align: center;">4</td> <td style="text-align: center;">R05</td> <td style="text-align: center;">S05</td> <td style="text-align: center;">T05</td> <td style="text-align: center;">N05</td> <td style="text-align: center;">E5</td> <td style="text-align: center;">E5</td> <td style="text-align: center;">E5</td> <td style="text-align: center;">E5</td> <td style="text-align: center;">E5</td> </tr> <tr> <td></td> <td style="text-align: center;">1</td> <td style="text-align: center;">2</td> <td style="text-align: center;">3</td> <td style="text-align: center;">4</td> <td style="text-align: center;">R06</td> <td style="text-align: center;">S06</td> <td style="text-align: center;">T06</td> <td style="text-align: center;">N06</td> <td style="text-align: center;">E6</td> <td style="text-align: center;">E6</td> <td style="text-align: center;">E6</td> <td style="text-align: center;">E6</td> <td style="text-align: center;">E6</td> </tr> <tr> <td></td> <td style="text-align: center;">1</td> <td style="text-align: center;">2</td> <td style="text-align: center;">3</td> <td style="text-align: center;">4</td> <td style="text-align: center;">R07</td> <td style="text-align: center;">S07</td> <td style="text-align: center;">T07</td> <td style="text-align: center;">N07</td> <td style="text-align: center;">E7</td> <td style="text-align: center;">E7</td> <td style="text-align: center;">E7</td> <td style="text-align: center;">E7</td> <td style="text-align: center;">E7</td> </tr> <tr> <td></td> <td style="text-align: center;">1</td> <td style="text-align: center;">2</td> <td style="text-align: center;">3</td> <td style="text-align: center;">4</td> <td style="text-align: center;">R08</td> <td style="text-align: center;">S08</td> <td style="text-align: center;">T08</td> <td style="text-align: center;">N08</td> <td style="text-align: center;">E8</td> <td style="text-align: center;">E8</td> <td style="text-align: center;">E8</td> <td style="text-align: center;">E8</td> <td style="text-align: center;">E8</td> </tr> </table> </td> <td style="width: 50%; vertical-align: top;"> <table border="0" style="width: 100%;"> <tr> <td style="width: 50%;"></td> <td style="width: 50%; text-align: center;"> <table border="0"> <tr> <td style="width: 10%;"></td> <td style="width: 10%;"></td> <td style="width: 10%;"></td> <td style="width: 10%;"></td> <td style="width: 10%;"></td> <td style="width: 10%;"></td> <td style="width: 10%;"></td> <td style="width: 10%;"></td> <td style="width: 10%;"></td> <td style="width: 10%;"></td> <td style="width: 10%;"></td> <td style="width: 10%;"></td> <td style="width: 10%;"></td> <td style="width: 10%;"></td> </tr> <tr> <td style="text-align: center;">XA</td> <td style="text-align: center;">1</td> <td style="text-align: center;">2</td> <td style="text-align: center;">3</td> <td style="text-align: center;">4</td> <td style="text-align: center;">R01</td> <td style="text-align: center;">S01</td> <td style="text-align: center;">T01</td> <td style="text-align: center;">N01</td> <td style="text-align: center;">E1</td> <td style="text-align: center;">E1</td> <td style="text-align: center;">E1</td> <td style="text-align: center;">E1</td> <td style="text-align: center;">E1</td> </tr> <tr> <td></td> <td
style="text-align: center;">1</td> <td style="text-align: center;">2</td> <td style="text-align: center;">3</td> <td style="text-align: center;">4</td> <td style="text-align: center;">R02</td> <td style="text-align: center;">S02</td> <td style="text-align: center;">T02</td> <td style="text-align: center;">N02</td> <td style="text-align: center;">E2</td> <td style="text-align: center;">E2</td> <td style="text-align: center;">E2</td> <td style="text-align: center;">E2</td> <td style="text-align: center;">E2</td> </tr> <tr> <td></td> <td style="text-align: center;">1</td> <td style="text-align: center;">2</td> <td style="text-align: center;">3</td> <td style="text-align: center;">4</td> <td style="text-align: center;">R03</td> <td style="text-align: center;">S03</td> <td style="text-align: center;">T03</td> <td style="text-align: center;">N03</td> <td style="text-align: center;">E3</td> <td style="text-align: center;">E3</td> <td style="text-align: center;">E3</td> <td style="text-align: center;">E3</td> <td style="text-align: center;">E3</td> </tr> <tr> <td></td> <td style="text-align: center;">1</td> <td style="text-align: center;">2</td> <td style="text-align: center;">3</td> <td style="text-align: center;">4</td> <td style="text-align: center;">R04</td> <td style="text-align: center;">S04</td> <td style="text-align: center;">T04</td> <td style="text-align: center;">N04</td> <td style="text-align: center;">E4</td> <td style="text-align: center;">E4</td> <td style="text-align: center;">E4</td> <td style="text-align: center;">E4</td> <td style="text-align: center;">E4</td> </tr> <tr> <td></td> <td style="text-align: center;">1</td> <td style="text-align: center;">2</td> <td style="text-align: center;">3</td> <td style="text-align: center;">4</td> <td style="text-align: center;">R05</td> <td style="text-align: center;">S05</td> <td style="text-align: center;">T05</td> <td style="text-align: center;">N05</td> <td style="text-align: center;">E5</td> <td style="text-align: center;">E5</td> <td style="text-align: center;">E5</td> <td style="text-align: center;">E5</td> <td style="text-align: center;">E5</td> </tr> <tr> <td></td> <td style="text-align: center;">1</td> <td style="text-align: center;">2</td> <td style="text-align: center;">3</td> <td style="text-align: center;">4</td> <td style="text-align: center;">R06</td> <td style="text-align: center;">S06</td> <td style="text-align: center;">T06</td> <td style="text-align: center;">N06</td> <td style="text-align: center;">E6</td> <td style="text-align: center;">E6</td> <td style="text-align: center;">E6</td> <td style="text-align: center;">E6</td> <td style="text-align: center;">E6</td> </tr> <tr> <td></td> <td style="text-align: center;">1</td> <td style="text-align: center;">2</td> <td style="text-align: center;">3</td> <td style="text-align: center;">4</td> <td style="text-align: center;">R07</td> <td style="text-align: center;">S07</td> <td style="text-align: center;">T07</td> <td style="text-align: center;">N07</td> <td style="text-align: center;">E7</td> <td style="text-align: center;">E7</td> <td style="text-align: center;">E7</td> <td style="text-align: center;">E7</td> <td style="text-align: center;">E7</td> </tr> <tr> <td></td> <td style="text-align: center;">1</td> <td style="text-align: center;">2</td> <td style="text-align: center;">3</td> <td style="text-align: center;">4</td> <td style="text-align: center;">R08</td> <td style="text-align: center;">S08</td> <td style="text-align: center;">T08</td> <td style="text-align: center;">N08</td> <td style="text-align: center;">E8</td> <td style="text-align: center;">E8</td> <td style="text-align: center;">E8</td> <td style="text-align: center;">E8</td> <td style="text-align: center;">E8</td> </tr> </table> </td> <td style="width: 50%; vertical-align: top;"> <table border="0" style="width: 100%;"> <tr> <td style="width: 50%;"></td> <td style="width: 50%; text-align: center;"> <table border="0"> <tr> <td style="width: 10%;"></td> <td style="width: 10%;"></td> <td style="width: 10%;"></td> <td style="width: 10%;"></td> <td style="width: 10%;"></td> <td style="width: 10%;"></td> <td style="width: 10%;"></td> <td style="width: 10%;"></td> <td style="width: 10%;"></td> <td style="width: 10%;"></td> <td style="width: 10%;"></td> <td style="width: 10%;"></td> <td style="width: 10%;"></td> <td style="width: 10%;"></td> </tr> <tr> <td style="text-align: center;">XA</td> <td style="text-align: center;">1</td> <td style="text-align: center;">2</td> <td style="text-align: center;">3</td> <td style="text-align: center;">4</td> <td style="text-align: center;">R01</td> <td style="text-align: center;">S01</td> <td style="text-align: center;">T01</td> <td style="text-align: center;">N01</td> <td style="text-align: center;">E1</td> <td style="text-align: center;">E1</td> <td style="text-align: center;">E1</td> <td style="text-align: center;">E1</td> <td style="text-align: center;">E1</td> </tr> <tr> <td></td> <td style="text-align: center;">1</td> <td style="text-align: center;">2</td> <td style="text-align: center;">3</td> <td style="text-align: center;">4</td> <td style="text-align: center;">R02</td> <td style="text-align: center;">S02</td> <td style="text-align: center;">T02</td> <td style="text-align: center;">N02</td> <td style="text-align: center;">E2</td> <td style="text-align: center;">E2</td> <td style="text-align: center;">E2</td> <td style="text-align: center;">E2</td> <td style="text-align: center;">E2</td> </tr> <tr> <td></td> <td style="text-align: center;">1</td> <td style="text-align: center;">2</td> <td style="text-align: center;">3</td> <td style="text-align: center;">4</td> <td style="text-align: center;">R03</td> <td style="text-align: center;">S03</td> <td style="text-align: center;">T03</td> <td style="text-align: center;">N03</td> <td style="text-align: center;">E3</td> <td style="text-align: center;">E3</td> <td style="text-align: center;">E3</td> <td style="text-align: center;">E3</td> <td style="text-align: center;">E3</td> </tr> <tr> <td></td> <td style="text-align: center;">1</td> <td style="text-align: center;">2</td> <td style="text-align: center;">3</td> <td style="text-align: center;">4</td> <td style="text-align: center;">R04</td> <td style="text-align: center;">S04</td> <td style="text-align: center;">T04</td> <td style="text-align: center;">N04</td> <td style="text-align: center;">E4</td> <td style="text-align: center;">E4</td> <td style="text-align: center;">E4</td> <td style="text-align: center;">E4</td> <td style="text-align: center;">E4</td> </tr> <tr> <td></td> <td style="text-align: center;">1</td> <td style="text-align: center;">2</td> <td style="text-align: center;">3</td> <td style="text-align: center;">4</td> <td style="text-align: center;">R05</td> <td style="text-align: center;">S05</td> <td style="text-align: center;">T05</td> <td style="text-align: center;">N05</td> <td style="text-align: center;">E5</td> <td style="text-align: center;">E5</td> <td style="text-align: center;">E5</td> <td style="text-align: center;">E5</td> <td style="text-align: center;">E5</td> </tr> <tr> <td></td> <td style="text-align: center;">1</td> <td style="text-align: center;">2</td> <td style="text-align: center;">3</td> <td style="text-align: center;">4</td> <td style="text-align: center;">R06</td> <td style="text-align: center;">S06</td> <td style="text-align: center;">T06</td> <td style="text-align: center;">N06</td> <td style="text-align: center;">E6</td> <td style="text-align: center;">E6</td> <td style="text-align: center;">E6</td> <td style="text-align: center;">E6</td> <td style="text-align: center;">E6</td> </tr> <tr> <td></td> <td style="text-align: center;">1</td> <td style="text-align: center;">2</td> <td style="text-align: center;">3</td> <td style="text-align: center;">4</td> <td style="text-align: center;">R07</td> <td style="text-align: center;">S07</td> <td style="text-align: center;">T07</td> <td style="text-align: center;">N07</td> <td style="text-align: center;">E7</td> <td style="text-align: center;">E7</td> <td style="text-align: center;">E7</td> <td style="text-align: center;">E7</td> <td style="text-align: center;">E7</td> </tr> <tr> <td></td> <td style="text-align: center;">1</td> <td style="text-align: center;">2</td> <td style="text-align: center;">3</td> <td style="text-align: center;">4</td> <td style="text-align: center;">R08</td> <td style="text-align: center;">S08</td> <td style="text-align: center;">T08</td> <td style="text-align: center;">N08</td> <td style="text-align: center;">E8</td> <td style="text-align: center;">E8</td> <td style="text-align: center;">E8</td> <td style="text-align: center;">E8</td> <td style="text-align: center;">E8</td> </tr> </table> </td> <td style="width: 50%; vertical-align: top;"> <table border="0" style="width: 100%;"> <tr> <td style="width: 50%;"></td> <td style="width: 50%; text-align: center;"> <table border="0"> <tr> <td style="width: 10%;"></td> <td style="width: 10%;"></td> <td style="width: 10%;"></td> <td style="width: 10%;"></td> <td style="width: 10%;"></td> <td style="width: 10%;"></td> <td style="width: 10%;"></td> <td style="width: 10%;"></td> <td style="width: 10%;"></td> <td style="width: 10%;"></td> <td style="width: 10%;"></td> <td style="width: 10%;"></td> <td style="width: 10%;"></td> <td style="width: 10%;"></td> </tr> <tr> <td style="text-align: center;">XA</td> <td style="text-align: center;">1</td> <td style="text-align: center;">2</td> <td style="text-align: center;">3</td> <td style="text-align: center;">4</td> <td style="text-align: center;">R01</td> <td style="text-align: center;">S01</td> <td style="text-align: center;">T01</td> <td style="text-align: center;">N01</td> <td style="text-align: center;">E1</td> <td style="text-align: center;">E1</td> <td style="text-align: center;">E1</td> <td style="text-align: center;">E1</td> <td style="text-align: center;">E1</td> </tr> <tr> <td></td> <td style="text-align:
center;">1</td> <td style="text-align: center;">2</td> <td style="text-align: center;">3</td> <td style="text-align: center;">4</td> <td style="text-align: center;">R02</td> <td style="text-align: center;">S02</td> <td style="text-align: center;">T02</td> <td style="text-align: center;">N02</td> <td style="text-align: center;">E2</td> <td style="text-align: center;">E2</td> <td style="text-align: center;">E2</td> <td style="text-align: center;">E2</td> <td style="text-align: center;">E2</td> </tr> <tr> <td></td> <td style="text-align: center;">1</td> <td style="text-align: center;">2</td> <td style="text-align: center;">3</td> <td style="text-align: center;">4</td> <td style="text-align: center;">R03</td> <td style="text-align: center;">S03</td> <td style="text-align: center;">T03</td> <td style="text-align: center;">N03</td> <td style="text-align: center;">E3</td> <td style="text-align: center;">E3</td> <td style="text-align: center;">E3</td> <td style="text-align: center;">E3</td> <td style="text-align: center;">E3</td> </tr> <tr> <td></td> <td style="text-align: center;">1</td> <td style="text-align: center;">2</td> <td style="text-align: center;">3</td> <td style="text-align: center;">4</td> <td style="text-align: center;">R04</td> <td style="text-align: center;">S04</td> <td style="text-align: center;">T04</td> <td style="text-align: center;">N04</td> <td style="text-align: center;">E4</td> <td style="text-align: center;">E4</td> <td style="text-align: center;">E4</td> <td style="text-align: center;">E4</td> <td style="text-align: center;">E4</td> </tr> <tr> <td></td> <td style="text-align: center;">1</td> <td style="text-align: center;">2</td> <td style="text-align: center;">3</td> <td style="text-align: center;">4</td> <td style="text-align: center;">R05</td> <td style="text-align: center;">S05</td> <td style="text-align: center;">T05</td> <td style="text-align: center;">N05</td> <td style="text-align: center;">E5</td> <td style="text-align: center;">E5</td> <td style="text-align: center;">E5</td> <td style="text-align: center;">E5</td> <td style="text-align: center;">E5</td> </tr> <tr> <td></td> <td style="text-align: center;">1</td> <td style="text-align: center;">2</td> <td style="text-align: center;">3</td> <td style="text-align: center;">4</td> <td style="text-align: center;">R06</td> <td style="text-align: center;">S06</td> <td style="text-align: center;">T06</td> <td style="text-align: center;">N06</td> <td style="text-align: center;">E6</td> <td style="text-align: center;">E6</td> <td style="text-align: center;">E6</td> <td style="text-align: center;">E6</td> <td style="text-align: center;">E6</td> </tr> <tr> <td></td> <td style="text-align: center;">1</td> <td style="text-align: center;">2</td> <td style="text-align: center;">3</td> <td style="text-align: center;">4</td> <td style="text-align: center;">R07</td> <td style="text-align: center;">S07</td> <td style="text-align: center;">T07</td> <td style="text-align: center;">N07</td> <td style="text-align: center;">E7</td> <td style="text-align: center;">E7</td> <td style="text-align: center;">E7</td> <td style="text-align: center;">E7</td> <td style="text-align: center;">E7</td> </tr> <tr> <td></td> <td style="text-align: center;">1</td> <td style="text-align: center;">2</td> <td style="text-align: center;">3</td> <td style="text-align: center;">4</td> <td style="text-align: center;">R08</td> <td style="text-align: center;">S08</td> <td style="text-align: center;">T08</td> <td style="text-align: center;">N08</td> <td style="text-align: center;">E8</td> <td style="text-align: center;">E8</td> <td style="text-align: center;">E8</td> <td style="text-align: center;">E8</td> <td style="text-align: center;">E8</td> </tr> </table> </td> <td style="width: 50%; vertical-align: top;"> <table border="0" style="width: 100%;"> <tr> <td style="width: 50%;"></td> <td style="width: 50%; text-align: center;"> <table border="0"> <tr> <td style="width: 10%;"></td> <td style="width: 10%;"></td> <td style="width: 10%;"></td> <td style="width: 10%;"></td> <td style="width: 10%;"></td> <td style="width: 10%;"></td> <td style="width: 10%;"></td> <td style="width: 10%;"></td> <td style="width: 10%;"></td> <td style="width: 10%;"></td> <td style="width: 10%;"></td> <td style="width: 10%;"></td> <td style="width: 10%;"></td> <td style="width: 10%;"></td> </tr> <tr> <td style="text-align: center;">XA</td> <td style="text-align: center;">1</td> <td style="text-align: center;">2</td> <td style="text-align: center;">3</td> <td style="text-align: center;">4</td> <td style="text-align: center;">R01</td> <td style="text-align: center;">S01</td> <td style="text-align: center;">T01</td> <td style="text-align: center;">N01</td> <td style="text-align: center;">E1</td> <td style="text-align: center;">E1</td> <td style="text-align: center;">E1</td> </tr></table></td></tr></table></td></tr></table></td></tr></table></td></tr></table></td></tr></table></td></tr></table></td></tr></table> | | <table border="0"> <tr> <td style="width: 10%;"></td> <td style="width: 10%;"></td> <td style="width: 10%;"></td> <td style="width: 10%;"></td> <td style="width: 10%;"></td> <td style="width: 10%;"></td> <td style="width: 10%;"></td> <td style="width: 10%;"></td> <td style="width: 10%;"></td> <td style="width: 10%;"></td> <td style="width: 10%;"></td> <td style="width: 10%;"></td> <td style="width: 10%;"></td> <td style="width: 10%;"></td> </tr> <tr> <td style="text-align: center;">XA</td> <td style="text-align: center;">1/G</td> <td style="text-align: center;">2/G</td> <td style="text-align: center;">3/G</td> <td style="text-align: center;">4/G</td> <td style="text-align: center;">R</td> <td style="text-align: center;">S</td> <td style="text-align: center;">T</td> <td style="text-align: center;">N</td> <td style="text-align: center;">E0</td> <td style="text-align: center;">E0</td> <td style="text-align: center;">E0</td> <td style="text-align: center;">E0</td> <td style="text-align: center;">E0</td> </tr> <tr> <td></td> <td style="text-align: center;">1</td> <td style="text-align: center;">2</td> <td style="text-align: center;">3</td> <td style="text-align: center;">4</td> <td style="text-align: center;">R01</td> <td style="text-align: center;">S01</td> <td style="text-align: center;">T01</td> <td style="text-align: center;">N01</td> <td style="text-align: center;">E1</td> <td style="text-align: center;">E1</td> <td style="text-align: center;">E1</td> <td style="text-align: center;">E1</td> <td style="text-align: center;">E1</td> </tr> <tr> <td></td> <td style="text-align: center;">1</td> <td style="text-align: center;">2</td> <td style="text-align: center;">3</td> <td style="text-align: center;">4</td> <td style="text-align: center;">R02</td> <td style="text-align: center;">S02</td> <td style="text-align: center;">T02</td> <td style="text-align: center;">N02</td> <td style="text-align: center;">E2</td> <td style="text-align: center;">E2</td> <td style="text-align: center;">E2</td> <td style="text-align: center;">E2</td> <td style="text-align: center;">E2</td> </tr> <tr> <td></td> <td style="text-align: center;">1</td> <td style="text-align: center;">2</td> <td style="text-align: center;">3</td> <td style="text-align: center;">4</td> <td style="text-align: center;">R03</td> <td style="text-align: center;">S03</td> <td style="text-align: center;">T03</td> <td style="text-align: center;">N03</td> <td style="text-align: center;">E3</td> <td style="text-align: center;">E3</td> <td style="text-align: center;">E3</td> <td style="text-align: center;">E3</td> <td style="text-align: center;">E3</td> </tr> <tr> <td></td> <td style="text-align: center;">1</td> <td style="text-align: center;">2</td> <td style="text-align: center;">3</td> <td style="text-align: center;">4</td> <td style="text-align: center;">R04</td> <td style="text-align: center;">S04</td> <td style="text-align: center;">T04</td> <td style="text-align: center;">N04</td> <td style="text-align: center;">E4</td> <td style="text-align: center;">E4</td> <td style="text-align: center;">E4</td> <td style="text-align: center;">E4</td> <td style="text-align: center;">E4</td> </tr> <tr> <td></td> <td style="text-align: center;">1</td> <td style="text-align: center;">2</td> <td style="text-align: center;">3</td> <td style="text-align: center;">4</td> <td style="text-align: center;">R05</td> <td style="text-align: center;">S05</td> <td style="text-align: center;">T05</td> <td style="text-align: center;">N05</td> <td style="text-align: center;">E5</td> <td style="text-align: center;">E5</td> <td style="text-align: center;">E5</td> <td style="text-align: center;">E5</td> <td style="text-align: center;">E5</td> </tr> <tr> <td></td> <td style="text-align: center;">1</td> <td style="text-align: center;">2</td> <td style="text-align: center;">3</td> <td style="text-align: center;">4</td> <td style="text-align: center;">R06</td> <td style="text-align: center;">S06</td> <td style="text-align: center;">T06</td> <td style="text-align: center;">N06</td> <td style="text-align: center;">E6</td> <td style="text-align: center;">E6</td> <td style="text-align: center;">E6</td> <td style="text-align: center;">E6</td> <td style="text-align: center;">E6</td> </tr> <tr> <td></td> <td style="text-align: center;">1</td> <td style="text-align: center;">2</td> <td style="text-align: center;">3</td> <td style="text-align: center;">4</td> <td style="text-align: center;">R07</td> <td style="text-align: center;">S07</td> <td style="text-align: center;">T07</td> <td style="text-align: center;">N07</td> <td style="text-align: center;">E7</td> <td style="text-align: center;">E7</td> <td style="text-align: center;">E7</td> <td style="text-align: center;">E7</td> <td style="text-align: center;">E7</td> </tr> <tr> <td></td> <td style="text-align: center;">1</td> <td style="text-align: center;">2</td> <td style="text-align: center;">3</td> <td style="text-align: center;">4</td> <td
style="text-align: center;">R08</td> <td style="text-align: center;">S08</td> <td style="text-align: center;">T08</td> <td style="text-align: center;">N08</td> <td style="text-align: center;">E8</td> <td style="text-align: center;">E8</td> <td style="text-align: center;">E8</td> <td style="text-align: center;">E8</td> <td style="text-align: center;">E8</td> </tr> </table> | | | | | | | | | | | |

 | | | XA | 1/G | 2/G | 3/G | 4/G | R | S | T | N | E0 | E0 | E0

 | E0 | E0 | | 1 | 2 | 3 | 4 | R01 | S01 | T01 | N01 | E1 | E1 | E1 | E1 | E1 | | 1 | 2 | 3 | 4 | R02 | S02 | T02 | N02 | E2 | E2 | E2 | E2 | E2 | | 1 | 2 | 3 | 4 | R03 | S03 | T03 | N03 | E3 | E3 | E3 | E3 | E3 | | 1 | 2 | 3 | 4 | R04 | S04 | T04 | N04 | E4 | E4 | E4 | E4 | E4 | | 1 | 2 | 3 | 4 | R05 | S05 | T05 | N05 | E5 | E5 | E5 | E5 | E5 | | 1 | 2 | 3 | 4 | R06 | S06 | T06 | N06 | E6 | E6 | E6 | E6 | E6

 | | 1 | 2 | 3 | 4 | R07 | S07 | T07 | N07 | E7 | E7 | E7 | E7 | E7

 |

 | 1
 | 2 | 3 | 4 | R08 | S08 | T08 | N08 | E8 | E8 | E8 | E8 | E8 | <table border="0" style="width: 100%;"> <tr> <td style="width: 50%;"></td> <td style="width: 50%; text-align: center;"> <table border="0"> <tr> <td style="width: 10%;"></td> <td style="width: 10%;"></td> <td style="width: 10%;"></td> <td style="width: 10%;"></td> <td style="width: 10%;"></td> <td style="width: 10%;"></td> <td style="width: 10%;"></td> <td style="width: 10%;"></td> <td style="width: 10%;"></td> <td style="width: 10%;"></td> <td style="width: 10%;"></td> <td style="width: 10%;"></td> <td style="width: 10%;"></td> <td style="width: 10%;"></td> </tr> <tr> <td style="text-align: center;">XA</td> <td style="text-align: center;">1</td> <td style="text-align: center;">2</td> <td style="text-align: center;">3</td> <td style="text-align: center;">4</td> <td style="text-align: center;">R01</td> <td style="text-align: center;">S01</td> <td style="text-align: center;">T01</td> <td style="text-align: center;">N01</td> <td style="text-align: center;">E1</td> <td style="text-align: center;">E1</td> <td style="text-align: center;">E1</td> <td style="text-align: center;">E1</td> <td style="text-align: center;">E1</td> </tr> <tr> <td></td> <td style="text-align: center;">1</td> <td style="text-align: center;">2</td> <td style="text-align: center;">3</td> <td style="text-align: center;">4</td> <td style="text-align: center;">R02</td> <td style="text-align: center;">S02</td> <td style="text-align: center;">T02</td> <td style="text-align: center;">N02</td> <td style="text-align: center;">E2</td> <td style="text-align: center;">E2</td> <td style="text-align: center;">E2</td> <td style="text-align: center;">E2</td> <td style="text-align: center;">E2</td> </tr> <tr> <td></td> <td style="text-align: center;">1</td> <td style="text-align: center;">2</td> <td style="text-align: center;">3</td> <td style="text-align: center;">4</td> <td style="text-align: center;">R03</td> <td style="text-align: center;">S03</td> <td style="text-align: center;">T03</td> <td style="text-align: center;">N03</td> <td style="text-align: center;">E3</td> <td style="text-align: center;">E3</td> <td style="text-align: center;">E3</td> <td style="text-align: center;">E3</td> <td style="text-align: center;">E3</td> </tr> <tr> <td></td> <td style="text-align: center;">1</td> <td
style="text-align: center;">2</td> <td style="text-align: center;">3</td> <td style="text-align: center;">4</td> <td style="text-align: center;">R04</td> <td style="text-align: center;">S04</td> <td style="text-align: center;">T04</td> <td style="text-align: center;">N04</td> <td style="text-align: center;">E4</td> <td style="text-align: center;">E4</td> <td style="text-align: center;">E4</td> <td style="text-align: center;">E4</td> <td style="text-align: center;">E4</td> </tr> <tr> <td></td> <td style="text-align: center;">1</td> <td style="text-align: center;">2</td> <td style="text-align: center;">3</td> <td style="text-align: center;">4</td> <td style="text-align: center;">R05</td> <td style="text-align: center;">S05</td> <td style="text-align: center;">T05</td> <td style="text-align: center;">N05</td> <td style="text-align: center;">E5</td> <td style="text-align: center;">E5</td> <td style="text-align: center;">E5</td> <td style="text-align: center;">E5</td> <td style="text-align: center;">E5</td> </tr> <tr> <td></td> <td style="text-align: center;">1</td> <td style="text-align: center;">2</td> <td style="text-align: center;">3</td> <td style="text-align: center;">4</td> <td style="text-align: center;">R06</td> <td style="text-align: center;">S06</td> <td style="text-align: center;">T06</td> <td style="text-align: center;">N06</td> <td style="text-align: center;">E6</td> <td style="text-align: center;">E6</td> <td style="text-align: center;">E6</td> <td style="text-align: center;">E6</td> <td style="text-align: center;">E6</td> </tr> <tr> <td></td> <td style="text-align: center;">1</td> <td style="text-align: center;">2</td> <td style="text-align: center;">3</td> <td style="text-align: center;">4</td> <td style="text-align: center;">R07</td> <td style="text-align: center;">S07</td> <td style="text-align: center;">T07</td> <td style="text-align: center;">N07</td> <td style="text-align: center;">E7</td> <td style="text-align: center;">E7</td> <td style="text-align: center;">E7</td> <td style="text-align: center;">E7</td> <td style="text-align: center;">E7</td> </tr> <tr> <td></td> <td style="text-align: center;">1</td> <td style="text-align: center;">2</td> <td style="text-align: center;">3</td> <td style="text-align: center;">4</td> <td style="text-align: center;">R08</td> <td style="text-align: center;">S08</td> <td style="text-align: center;">T08</td> <td style="text-align: center;">N08</td> <td style="text-align: center;">E8</td> <td style="text-align: center;">E8</td> <td style="text-align: center;">E8</td> <td style="text-align: center;">E8</td> <td style="text-align: center;">E8</td> </tr> </table> </td> <td style="width: 50%; vertical-align: top;"> <table border="0" style="width: 100%;"> <tr> <td style="width: 50%;"></td> <td style="width: 50%; text-align: center;"> <table border="0"> <tr> <td style="width: 10%;"></td> <td style="width: 10%;"></td> <td style="width: 10%;"></td> <td style="width: 10%;"></td> <td style="width: 10%;"></td> <td style="width: 10%;"></td> <td style="width: 10%;"></td> <td style="width: 10%;"></td> <td style="width: 10%;"></td> <td style="width: 10%;"></td> <td style="width: 10%;"></td> <td style="width: 10%;"></td> <td style="width: 10%;"></td> <td style="width: 10%;"></td> </tr> <tr> <td style="text-align: center;">XA</td> <td style="text-align: center;">1</td> <td style="text-align: center;">2</td> <td style="text-align: center;">3</td> <td style="text-align: center;">4</td> <td style="text-align: center;">R01</td> <td style="text-align: center;">S01</td> <td style="text-align: center;">T01</td> <td style="text-align: center;">N01</td> <td style="text-align: center;">E1</td> <td style="text-align: center;">E1</td> <td style="text-align: center;">E1</td> <td style="text-align: center;">E1</td> <td style="text-align: center;">E1</td> </tr> <tr> <td></td> <td style="text-align: center;">1</td> <td style="text-align: center;">2</td> <td style="text-align: center;">3</td> <td style="text-align: center;">4</td> <td style="text-align: center;">R02</td> <td style="text-align: center;">S02</td> <td style="text-align: center;">T02</td> <td style="text-align: center;">N02</td> <td style="text-align: center;">E2</td> <td style="text-align: center;">E2</td> <td style="text-align: center;">E2</td> <td style="text-align: center;">E2</td> <td style="text-align: center;">E2</td> </tr> <tr> <td></td> <td style="text-align: center;">1</td> <td style="text-align: center;">2</td> <td style="text-align: center;">3</td> <td style="text-align: center;">4</td> <td style="text-align: center;">R03</td> <td style="text-align: center;">S03</td> <td style="text-align: center;">T03</td> <td style="text-align: center;">N03</td> <td style="text-align: center;">E3</td> <td style="text-align: center;">E3</td> <td style="text-align: center;">E3</td> <td style="text-align: center;">E3</td> <td style="text-align: center;">E3</td> </tr> <tr> <td></td> <td style="text-align: center;">1</td> <td style="text-align: center;">2</td> <td style="text-align: center;">3</td> <td style="text-align: center;">4</td> <td style="text-align: center;">R04</td> <td style="text-align: center;">S04</td> <td style="text-align: center;">T04</td> <td style="text-align: center;">N04</td> <td style="text-align: center;">E4</td> <td style="text-align: center;">E4</td> <td style="text-align: center;">E4</td> <td style="text-align: center;">E4</td> <td style="text-align: center;">E4</td> </tr> <tr> <td></td> <td style="text-align: center;">1</td> <td style="text-align: center;">2</td> <td style="text-align: center;">3</td> <td style="text-align: center;">4</td> <td style="text-align: center;">R05</td> <td style="text-align: center;">S05</td> <td style="text-align: center;">T05</td> <td style="text-align: center;">N05</td> <td style="text-align: center;">E5</td> <td style="text-align: center;">E5</td> <td style="text-align: center;">E5</td> <td style="text-align: center;">E5</td> <td style="text-align: center;">E5</td> </tr> <tr> <td></td> <td style="text-align: center;">1</td> <td style="text-align: center;">2</td> <td style="text-align: center;">3</td> <td style="text-align: center;">4</td> <td style="text-align: center;">R06</td> <td style="text-align: center;">S06</td> <td style="text-align: center;">T06</td> <td style="text-align: center;">N06</td> <td style="text-align: center;">E6</td> <td style="text-align: center;">E6</td> <td style="text-align: center;">E6</td> <td style="text-align: center;">E6</td> <td style="text-align: center;">E6</td> </tr> <tr> <td></td> <td style="text-align: center;">1</td> <td style="text-align: center;">2</td> <td style="text-align: center;">3</td> <td style="text-align: center;">4</td> <td style="text-align: center;">R07</td> <td style="text-align: center;">S07</td> <td style="text-align: center;">T07</td> <td style="text-align: center;">N07</td> <td style="text-align: center;">E7</td> <td style="text-align: center;">E7</td> <td style="text-align: center;">E7</td> <td style="text-align: center;">E7</td> <td style="text-align: center;">E7</td> </tr> <tr> <td></td> <td style="text-align: center;">1</td> <td style="text-align: center;">2</td> <td style="text-align: center;">3</td> <td style="text-align: center;">4</td> <td style="text-align: center;">R08</td> <td style="text-align: center;">S08</td> <td style="text-align: center;">T08</td> <td style="text-align: center;">N08</td> <td style="text-align: center;">E8</td> <td style="text-align: center;">E8</td> <td style="text-align: center;">E8</td> <td style="text-align: center;">E8</td> <td style="text-align: center;">E8</td> </tr> </table> </td> <td style="width: 50%; vertical-align: top;"> <table border="0" style="width: 100%;"> <tr> <td style="width: 50%;"></td> <td style="width: 50%; text-align: center;"> <table border="0"> <tr> <td style="width: 10%;"></td> <td style="width: 10%;"></td> <td style="width: 10%;"></td> <td style="width: 10%;"></td> <td style="width: 10%;"></td> <td style="width: 10%;"></td> <td style="width: 10%;"></td> <td style="width: 10%;"></td> <td style="width: 10%;"></td> <td style="width: 10%;"></td> <td style="width: 10%;"></td> <td style="width: 10%;"></td> <td style="width: 10%;"></td> <td style="width: 10%;"></td> </tr> <tr> <td style="text-align: center;">XA</td> <td style="text-align: center;">1</td> <td style="text-align: center;">2</td> <td style="text-align: center;">3</td> <td style="text-align: center;">4</td> <td style="text-align: center;">R01</td> <td style="text-align: center;">S01</td> <td style="text-align: center;">T01</td> <td style="text-align: center;">N01</td> <td style="text-align: center;">E1</td> <td style="text-align: center;">E1</td> <td style="text-align: center;">E1</td> <td style="text-align: center;">E1</td> <td style="text-align: center;">E1</td> </tr> <tr> <td></td> <td style="text-align: center;">1</td> <td style="text-align: center;">2</td> <td style="text-align: center;">3</td> <td style="text-align: center;">4</td> <td style="text-align: center;">R02</td> <td style="text-align: center;">S02</td> <td style="text-align: center;">T02</td> <td style="text-align: center;">N02</td> <td style="text-align: center;">E2</td> <td style="text-align: center;">E2</td> <td style="text-align: center;">E2</td> <td style="text-align: center;">E2</td> <td style="text-align: center;">E2</td> </tr> <tr> <td></td> <td style="text-align: center;">1</td> <td style="text-align: center;">2</td> <td style="text-align: center;">3</td> <td style="text-align: center;">4</td> <td style="text-align: center;">R03</td> <td style="text-align: center;">S03</td> <td style="text-align: center;">T03</td> <td style="text-align: center;">N03</td> <td style="text-align: center;">E3</td> <td style="text-align: center;">E3</td> <td style="text-align: center;">E3</td> <td style="text-align: center;">E3</td> <td style="text-align: center;">E3</td> </tr> <tr> <td></td> <td style="text-align: center;">1</td> <td style="text-align:
center;">2</td> <td style="text-align: center;">3</td> <td style="text-align: center;">4</td> <td style="text-align: center;">R04</td> <td style="text-align: center;">S04</td> <td style="text-align: center;">T04</td> <td style="text-align: center;">N04</td> <td style="text-align: center;">E4</td> <td style="text-align: center;">E4</td> <td style="text-align: center;">E4</td> <td style="text-align: center;">E4</td> <td style="text-align: center;">E4</td> </tr> <tr> <td></td> <td style="text-align: center;">1</td> <td style="text-align: center;">2</td> <td style="text-align: center;">3</td> <td style="text-align: center;">4</td> <td style="text-align: center;">R05</td> <td style="text-align: center;">S05</td> <td style="text-align: center;">T05</td> <td style="text-align: center;">N05</td> <td style="text-align: center;">E5</td> <td style="text-align: center;">E5</td> <td style="text-align: center;">E5</td> <td style="text-align: center;">E5</td> <td style="text-align: center;">E5</td> </tr> <tr> <td></td> <td style="text-align: center;">1</td> <td style="text-align: center;">2</td> <td style="text-align: center;">3</td> <td style="text-align: center;">4</td> <td style="text-align: center;">R06</td> <td style="text-align: center;">S06</td> <td style="text-align: center;">T06</td> <td style="text-align: center;">N06</td> <td style="text-align: center;">E6</td> <td style="text-align: center;">E6</td> <td style="text-align: center;">E6</td> <td style="text-align: center;">E6</td> <td style="text-align: center;">E6</td> </tr> <tr> <td></td> <td style="text-align: center;">1</td> <td style="text-align: center;">2</td> <td style="text-align: center;">3</td> <td style="text-align: center;">4</td> <td style="text-align: center;">R07</td> <td style="text-align: center;">S07</td> <td style="text-align: center;">T07</td> <td style="text-align: center;">N07</td> <td style="text-align: center;">E7</td> <td style="text-align: center;">E7</td> <td style="text-align: center;">E7</td> <td style="text-align: center;">E7</td> <td style="text-align: center;">E7</td> </tr> <tr> <td></td> <td style="text-align: center;">1</td> <td style="text-align: center;">2</td> <td style="text-align: center;">3</td> <td style="text-align: center;">4</td> <td style="text-align: center;">R08</td> <td style="text-align: center;">S08</td> <td style="text-align: center;">T08</td> <td style="text-align: center;">N08</td> <td style="text-align: center;">E8</td> <td style="text-align: center;">E8</td> <td style="text-align: center;">E8</td> <td style="text-align: center;">E8</td> <td style="text-align: center;">E8</td> </tr> </table> </td> <td style="width: 50%; vertical-align: top;"> <table border="0" style="width: 100%;"> <tr> <td style="width: 50%;"></td> <td style="width: 50%; text-align: center;"> <table border="0"> <tr> <td style="width: 10%;"></td> <td style="width: 10%;"></td> <td style="width: 10%;"></td> <td style="width: 10%;"></td> <td style="width: 10%;"></td> <td style="width: 10%;"></td> <td style="width: 10%;"></td> <td style="width: 10%;"></td> <td style="width: 10%;"></td> <td style="width: 10%;"></td> <td style="width: 10%;"></td> <td style="width: 10%;"></td> <td style="width: 10%;"></td> <td style="width: 10%;"></td> </tr> <tr> <td style="text-align: center;">XA</td> <td style="text-align: center;">1</td> <td style="text-align: center;">2</td> <td style="text-align: center;">3</td> <td style="text-align: center;">4</td> <td style="text-align: center;">R01</td> <td style="text-align: center;">S01</td> <td style="text-align: center;">T01</td> <td style="text-align: center;">N01</td> <td style="text-align: center;">E1</td> <td style="text-align: center;">E1</td> <td style="text-align: center;">E1</td> <td style="text-align: center;">E1</td> <td style="text-align: center;">E1</td> </tr> <tr> <td></td> <td style="text-align: center;">1</td> <td style="text-align: center;">2</td> <td style="text-align: center;">3</td> <td style="text-align: center;">4</td> <td style="text-align: center;">R02</td> <td style="text-align: center;">S02</td> <td style="text-align: center;">T02</td> <td style="text-align: center;">N02</td> <td style="text-align: center;">E2</td> <td style="text-align: center;">E2</td> <td style="text-align: center;">E2</td> <td style="text-align: center;">E2</td> <td style="text-align: center;">E2</td> </tr> <tr> <td></td> <td style="text-align: center;">1</td> <td style="text-align: center;">2</td> <td style="text-align: center;">3</td> <td style="text-align: center;">4</td> <td style="text-align: center;">R03</td> <td style="text-align: center;">S03</td> <td style="text-align: center;">T03</td> <td style="text-align: center;">N03</td> <td style="text-align: center;">E3</td> <td style="text-align: center;">E3</td> <td style="text-align: center;">E3</td> <td style="text-align: center;">E3</td> <td style="text-align: center;">E3</td> </tr> <tr> <td></td> <td style="text-align: center;">1</td> <td style="text-align: center;">2</td> <td style="text-align: center;">3</td> <td style="text-align: center;">4</td> <td style="text-align: center;">R04</td> <td style="text-align: center;">S04</td> <td style="text-align: center;">T04</td> <td style="text-align: center;">N04</td> <td style="text-align: center;">E4</td> <td style="text-align: center;">E4</td> <td style="text-align: center;">E4</td> <td style="text-align: center;">E4</td> <td style="text-align: center;">E4</td> </tr> <tr> <td></td> <td style="text-align: center;">1</td> <td style="text-align: center;">2</td> <td style="text-align: center;">3</td> <td style="text-align: center;">4</td> <td style="text-align: center;">R05</td> <td style="text-align: center;">S05</td> <td style="text-align: center;">T05</td> <td style="text-align: center;">N05</td> <td style="text-align: center;">E5</td> <td style="text-align: center;">E5</td> <td style="text-align: center;">E5</td> <td style="text-align: center;">E5</td> <td style="text-align: center;">E5</td> </tr> <tr> <td></td> <td style="text-align: center;">1</td> <td style="text-align: center;">2</td> <td style="text-align: center;">3</td> <td style="text-align: center;">4</td> <td style="text-align: center;">R06</td> <td style="text-align: center;">S06</td> <td style="text-align: center;">T06</td> <td style="text-align: center;">N06</td> <td style="text-align: center;">E6</td> <td style="text-align: center;">E6</td> <td style="text-align: center;">E6</td> <td style="text-align: center;">E6</td> <td style="text-align: center;">E6</td> </tr> <tr> <td></td> <td style="text-align: center;">1</td> <td style="text-align: center;">2</td> <td style="text-align: center;">3</td> <td style="text-align: center;">4</td> <td style="text-align: center;">R07</td> <td style="text-align: center;">S07</td> <td style="text-align: center;">T07</td> <td style="text-align: center;">N07</td> <td style="text-align: center;">E7</td> <td style="text-align: center;">E7</td> <td style="text-align: center;">E7</td> <td style="text-align: center;">E7</td> <td style="text-align: center;">E7</td> </tr> <tr> <td></td> <td style="text-align: center;">1</td> <td style="text-align: center;">2</td> <td style="text-align: center;">3</td> <td style="text-align: center;">4</td> <td style="text-align: center;">R08</td> <td style="text-align: center;">S08</td> <td style="text-align: center;">T08</td> <td style="text-align: center;">N08</td> <td style="text-align: center;">E8</td> <td style="text-align: center;">E8</td> <td style="text-align: center;">E8</td> <td style="text-align: center;">E8</td> <td style="text-align: center;">E8</td> </tr> </table> </td> <td style="width: 50%; vertical-align: top;"> <table border="0" style="width: 100%;"> <tr> <td style="width: 50%;"></td> <td style="width: 50%; text-align: center;"> <table border="0"> <tr> <td style="width: 10%;"></td> <td style="width: 10%;"></td> <td style="width: 10%;"></td> <td style="width: 10%;"></td> <td style="width: 10%;"></td> <td style="width: 10%;"></td> <td style="width: 10%;"></td> <td style="width: 10%;"></td> <td style="width: 10%;"></td> <td style="width: 10%;"></td> <td style="width: 10%;"></td> <td style="width: 10%;"></td> <td style="width: 10%;"></td> <td style="width: 10%;"></td> </tr> <tr> <td style="text-align: center;">XA</td> <td style="text-align: center;">1</td> <td style="text-align: center;">2</td> <td style="text-align: center;">3</td> <td style="text-align: center;">4</td> <td style="text-align: center;">R01</td> <td style="text-align: center;">S01</td> <td style="text-align: center;">T01</td> <td style="text-align: center;">N01</td> <td style="text-align: center;">E1</td> <td style="text-align: center;">E1</td> <td style="text-align: center;">E1</td> <td style="text-align: center;">E1</td> <td style="text-align: center;">E1</td> </tr> <tr> <td></td> <td style="text-align: center;">1</td> <td style="text-align: center;">2</td> <td style="text-align: center;">3</td> <td style="text-align: center;">4</td> <td style="text-align: center;">R02</td> <td style="text-align: center;">S02</td> <td style="text-align: center;">T02</td> <td style="text-align: center;">N02</td> <td style="text-align: center;">E2</td> <td style="text-align: center;">E2</td> <td style="text-align: center;">E2</td> <td style="text-align: center;">E2</td> <td style="text-align: center;">E2</td> </tr> <tr> <td></td> <td style="text-align: center;">1</td> <td style="text-align: center;">2</td> <td style="text-align: center;">3</td> <td style="text-align: center;">4</td> <td style="text-align: center;">R03</td> <td style="text-align: center;">S03</td> <td style="text-align: center;">T03</td> <td style="text-align: center;">N03</td> <td style="text-align: center;">E3</td> <td style="text-align: center;">E3</td> <td style="text-align: center;">E3</td> <td style="text-align: center;">E3</td> <td style="text-align: center;">E3</td> </tr> <tr> <td></td> <td style="text-align: center;">1</td> <td style="text-align: center;">2</td> <td
style="text-align: center;">3</td> <td style="text-align: center;">4</td> <td style="text-align: center;">R04</td> <td style="text-align: center;">S04</td> <td style="text-align: center;">T04</td> <td style="text-align: center;">N04</td> <td style="text-align: center;">E4</td> <td style="text-align: center;">E4</td> <td style="text-align: center;">E4</td> <td style="text-align: center;">E4</td> <td style="text-align: center;">E4</td> </tr> <tr> <td></td> <td style="text-align: center;">1</td> <td style="text-align: center;">2</td> <td style="text-align: center;">3</td> <td style="text-align: center;">4</td> <td style="text-align: center;">R05</td> <td style="text-align: center;">S05</td> <td style="text-align: center;">T05</td> <td style="text-align: center;">N05</td> <td style="text-align: center;">E5</td> <td style="text-align: center;">E5</td> <td style="text-align: center;">E5</td> <td style="text-align: center;">E5</td> <td style="text-align: center;">E5</td> </tr> <tr> <td></td> <td style="text-align: center;">1</td> <td style="text-align: center;">2</td> <td style="text-align: center;">3</td> <td style="text-align: center;">4</td> <td style="text-align: center;">R06</td> <td style="text-align: center;">S06</td> <td style="text-align: center;">T06</td> <td style="text-align: center;">N06</td> <td style="text-align: center;">E6</td> <td style="text-align: center;">E6</td> <td style="text-align: center;">E6</td> <td style="text-align: center;">E6</td> <td style="text-align: center;">E6</td> </tr> <tr> <td></td> <td style="text-align: center;">1</td> <td style="text-align: center;">2</td> <td style="text-align: center;">3</td> <td style="text-align: center;">4</td> <td style="text-align: center;">R07</td> <td style="text-align: center;">S07</td> <td style="text-align: center;">T07</td> <td style="text-align: center;">N07</td> <td style="text-align: center;">E7</td> <td style="text-align: center;">E7</td> <td style="text-align: center;">E7</td> <td style="text-align: center;">E7</td> <td style="text-align: center;">E7</td> </tr> <tr> <td></td> <td style="text-align: center;">1</td> <td style="text-align: center;">2</td> <td style="text-align: center;">3</td> <td style="text-align: center;">4</td> <td style="text-align: center;">R08</td> <td style="text-align: center;">S08</td> <td style="text-align: center;">T08</td> <td style="text-align: center;">N08</td> <td style="text-align: center;">E8</td> <td style="text-align: center;">E8</td> <td style="text-align: center;">E8</td> <td style="text-align: center;">E8</td> <td style="text-align: center;">E8</td> </tr> </table> </td> <td style="width: 50%; vertical-align: top;"> <table border="0" style="width: 100%;"> <tr> <td style="width: 50%;"></td> <td style="width: 50%; text-align: center;"> <table border="0"> <tr> <td style="width: 10%;"></td> <td style="width: 10%;"></td> <td style="width: 10%;"></td> <td style="width: 10%;"></td> <td style="width: 10%;"></td> <td style="width: 10%;"></td> <td style="width: 10%;"></td> <td style="width: 10%;"></td> <td style="width: 10%;"></td> <td style="width: 10%;"></td> <td style="width: 10%;"></td> <td style="width: 10%;"></td> <td style="width: 10%;"></td> <td style="width: 10%;"></td> </tr> <tr> <td style="text-align: center;">XA</td> <td style="text-align: center;">1</td> <td style="text-align: center;">2</td> <td style="text-align: center;">3</td> <td style="text-align: center;">4</td> <td style="text-align: center;">R01</td> <td style="text-align: center;">S01</td> <td style="text-align: center;">T01</td> <td style="text-align: center;">N01</td> <td style="text-align: center;">E1</td> <td style="text-align: center;">E1</td> <td style="text-align: center;">E1</td> </tr></table></td></tr></table></td></tr></table></td></tr></table></td></tr></table></td></tr></table></td></tr></table> | | <table border="0"> <tr> <td style="width: 10%;"></td> <td style="width: 10%;"></td> <td style="width: 10%;"></td> <td style="width: 10%;"></td> <td style="width: 10%;"></td> <td style="width: 10%;"></td> <td style="width: 10%;"></td> <td style="width: 10%;"></td> <td style="width: 10%;"></td> <td style="width: 10%;"></td> <td style="width: 10%;"></td> <td style="width: 10%;"></td> <td style="width: 10%;"></td> <td style="width: 10%;"></td> </tr> <tr> <td style="text-align: center;">XA</td> <td style="text-align: center;">1</td> <td style="text-align: center;">2</td> <td style="text-align: center;">3</td> <td style="text-align: center;">4</td> <td style="text-align: center;">R01</td> <td style="text-align: center;">S01</td> <td style="text-align: center;">T01</td> <td style="text-align: center;">N01</td> <td style="text-align: center;">E1</td> <td style="text-align: center;">E1</td> <td style="text-align: center;">E1</td> <td style="text-align: center;">E1</td> <td style="text-align: center;">E1</td> </tr> <tr> <td></td> <td style="text-align: center;">1</td> <td style="text-align: center;">2</td> <td style="text-align: center;">3</td> <td style="text-align: center;">4</td> <td style="text-align: center;">R02</td> <td style="text-align: center;">S02</td> <td style="text-align: center;">T02</td> <td style="text-align: center;">N02</td> <td style="text-align: center;">E2</td> <td style="text-align: center;">E2</td> <td style="text-align: center;">E2</td> <td style="text-align: center;">E2</td> <td style="text-align: center;">E2</td> </tr> <tr> <td></td> <td style="text-align: center;">1</td> <td style="text-align: center;">2</td> <td style="text-align: center;">3</td> <td style="text-align: center;">4</td> <td style="text-align: center;">R03</td> <td style="text-align: center;">S03</td> <td style="text-align: center;">T03</td> <td style="text-align: center;">N03</td> <td style="text-align: center;">E3</td> <td style="text-align: center;">E3</td> <td style="text-align: center;">E3</td> <td style="text-align: center;">E3</td> <td style="text-align: center;">E3</td> </tr> <tr> <td></td> <td style="text-align: center;">1</td> <td style="text-align: center;">2</td> <td style="text-align: center;">3</td> <td style="text-align: center;">4</td> <td style="text-align: center;">R04</td> <td style="text-align: center;">S04</td> <td style="text-align: center;">T04</td> <td style="text-align: center;">N04</td> <td style="text-align: center;">E4</td> <td style="text-align: center;">E4</td> <td style="text-align: center;">E4</td> <td style="text-align: center;">E4</td> <td style="text-align: center;">E4</td> </tr> <tr> <td></td> <td style="text-align: center;">1</td> <td style="text-align: center;">2</td> <td style="text-align: center;">3</td> <td style="text-align: center;">4</td> <td style="text-align: center;">R05</td> <td style="text-align: center;">S05</td> <td style="text-align: center;">T05</td> <td style="text-align: center;">N05</td> <td style="text-align: center;">E5</td> <td style="text-align: center;">E5</td> <td style="text-align: center;">E5</td> <td style="text-align: center;">E5</td> <td style="text-align: center;">E5</td> </tr> <tr> <td></td> <td style="text-align: center;">1</td> <td style="text-align: center;">2</td> <td style="text-align: center;">3</td> <td style="text-align: center;">4</td> <td style="text-align: center;">R06</td> <td style="text-align: center;">S06</td> <td style="text-align: center;">T06</td> <td style="text-align: center;">N06</td> <td style="text-align: center;">E6</td> <td style="text-align: center;">E6</td> <td style="text-align: center;">E6</td> <td style="text-align: center;">E6</td> <td style="text-align: center;">E6</td> </tr> <tr> <td></td> <td style="text-align: center;">1</td> <td style="text-align: center;">2</td> <td style="text-align: center;">3</td> <td style="text-align: center;">4</td> <td style="text-align: center;">R07</td> <td style="text-align: center;">S07</td> <td style="text-align: center;">T07</td> <td style="text-align: center;">N07</td> <td style="text-align: center;">E7</td> <td style="text-align: center;">E7</td> <td style="text-align: center;">E7</td> <td style="text-align: center;">E7</td> <td style="text-align: center;">E7</td> </tr> <tr> <td></td> <td style="text-align: center;">1</td> <td style="text-align: center;">2</td> <td style="text-align: center;">3</td> <td style="text-align: center;">4</td> <td style="text-align: center;">R08</td> <td style="text-align: center;">S08</td> <td style="text-align: center;">T08</td> <td style="text-align: center;">N08</td> <td style="text-align: center;">E8</td> <td style="text-align: center;">E8</td> <td style="text-align: center;">E8</td> <td style="text-align: center;">E8</td> <td style="text-align: center;">E8</td> </tr> </table> | | | | | | | | | | | | | | | XA | 1 | 2 | 3 | 4 | R01 | S01 | T01 | N01 | E1 | E1 | E1

 | E1 | E1 | | 1 | 2 | 3 | 4 | R02 | S02 | T02 | N02 | E2 | E2 | E2 | E2 | E2 | | 1 | 2 | 3 | 4 | R03 | S03 | T03 | N03 | E3 | E3 | E3 | E3 | E3 | | 1 | 2 | 3 | 4 | R04 | S04 | T04 | N04 | E4 | E4 | E4 | E4 | E4 | | 1 | 2 | 3 | 4 | R05 |
S05 | T05 | N05 | E5 | E5 | E5 | E5 | E5 | | 1 | 2 | 3 | 4 | R06 | S06 | T06 | N06 | E6 | E6 | E6 | E6 | E6
 | | 1
 | 2 | 3 | 4 | R07 | S07 | T07 | N07 | E7 | E7 | E7 | E7 | E7

 |

 | 1 | 2
 | 3 | 4 | R08 | S08 | T08 | N08 | E8 | E8 | E8 | E8 | E8 | <table border="0" style="width: 100%;"> <tr> <td style="width: 50%;"></td> <td style="width: 50%; text-align: center;"> <table border="0"> <tr> <td style="width: 10%;"></td> <td style="width: 10%;"></td> <td style="width: 10%;"></td> <td style="width: 10%;"></td> <td style="width: 10%;"></td> <td style="width: 10%;"></td> <td style="width: 10%;"></td> <td style="width: 10%;"></td> <td style="width: 10%;"></td> <td style="width: 10%;"></td> <td style="width: 10%;"></td> <td style="width: 10%;"></td> <td style="width: 10%;"></td> <td style="width: 10%;"></td> </tr> <tr> <td style="text-align: center;">XA</td> <td style="text-align: center;">1</td> <td style="text-align: center;">2</td> <td style="text-align: center;">3</td> <td style="text-align: center;">4</td> <td style="text-align: center;">R01</td> <td style="text-align: center;">S01</td> <td style="text-align: center;">T01</td> <td style="text-align: center;">N01</td> <td style="text-align: center;">E1</td> <td style="text-align: center;">E1</td> <td style="text-align: center;">E1</td> <td style="text-align: center;">E1</td> <td style="text-align: center;">E1</td> </tr> <tr> <td></td> <td style="text-align: center;">1</td> <td style="text-align: center;">2</td> <td style="text-align: center;">3</td> <td style="text-align: center;">4</td> <td style="text-align: center;">R02</td> <td style="text-align: center;">S02</td> <td style="text-align: center;">T02</td> <td style="text-align: center;">N02</td> <td style="text-align: center;">E2</td> <td style="text-align: center;">E2</td> <td style="text-align: center;">E2</td> <td style="text-align: center;">E2</td> <td style="text-align: center;">E2</td> </tr> <tr> <td></td> <td style="text-align: center;">1</td> <td style="text-align: center;">2</td> <td style="text-align: center;">3</td> <td style="text-align: center;">4</td> <td style="text-align: center;">R03</td> <td style="text-align: center;">S03</td> <td style="text-align: center;">T03</td> <td style="text-align: center;">N03</td> <td style="text-align: center;">E3</td> <td style="text-align: center;">E3</td> <td style="text-align: center;">E3</td> <td style="text-align: center;">E3</td> <td style="text-align: center;">E3</td> </tr> <tr> <td></td> <td style="text-align: center;">1</td> <td style="text-align: center;">2</td> <td style="text-align: center;">3</td> <td style="text-align: center;">4</td> <td style="text-align: center;">R04</td> <td style="text-align: center;">S04</td> <td style="text-align: center;">T04</td> <td style="text-align: center;">N04</td> <td style="text-align: center;">E4</td> <td style="text-align: center;">E4</td> <td style="text-align: center;">E4</td> <td style="text-align: center;">E4</td> <td style="text-align: center;">E4</td> </tr> <tr> <td></td> <td style="text-align: center;">1</td> <td style="text-align: center;">2</td> <td style="text-align: center;">3</td> <td style="text-align: center;">4</td> <td style="text-align: center;">R05</td> <td style="text-align: center;">S05</td> <td style="text-align: center;">T05</td> <td style="text-align: center;">N05</td> <td style="text-align: center;">E5</td> <td style="text-align: center;">E5</td> <td style="text-align: center;">E5</td> <td style="text-align: center;">E5</td> <td style="text-align: center;">E5</td> </tr> <tr> <td></td> <td style="text-align: center;">1</td> <td style="text-align: center;">2</td> <td style="text-align: center;">3</td> <td style="text-align: center;">4</td> <td style="text-align: center;">R06</td> <td style="text-align: center;">S06</td> <td style="text-align: center;">T06</td> <td style="text-align: center;">N06</td> <td style="text-align: center;">E6</td> <td style="text-align: center;">E6</td> <td style="text-align: center;">E6</td> <td style="text-align: center;">E6</td> <td style="text-align: center;">E6</td> </tr> <tr> <td></td> <td style="text-align: center;">1</td> <td style="text-align: center;">2</td> <td style="text-align: center;">3</td> <td style="text-align: center;">4</td> <td style="text-align: center;">R07</td> <td style="text-align: center;">S07</td> <td style="text-align: center;">T07</td> <td style="text-align: center;">N07</td> <td style="text-align: center;">E7</td> <td style="text-align: center;">E7</td> <td style="text-align: center;">E7</td> <td style="text-align: center;">E7</td> <td style="text-align: center;">E7</td> </tr> <tr> <td></td> <td style="text-align: center;">1</td> <td style="text-align: center;">2</td> <td style="text-align: center;">3</td> <td style="text-align: center;">4</td> <td style="text-align: center;">R08</td> <td style="text-align: center;">S08</td> <td style="text-align: center;">T08</td> <td style="text-align: center;">N08</td> <td style="text-align: center;">E8</td> <td style="text-align: center;">E8</td> <td style="text-align: center;">E8</td> <td style="text-align: center;">E8</td> <td style="text-align: center;">E8</td> </tr> </table> </td> <td style="width: 50%; vertical-align: top;"> <table border="0" style="width: 100%;"> <tr> <td style="width: 50%;"></td> <td style="width: 50%; text-align: center;"> <table border="0"> <tr> <td style="width: 10%;"></td> <td style="width: 10%;"></td> <td style="width: 10%;"></td> <td style="width: 10%;"></td> <td style="width: 10%;"></td> <td style="width: 10%;"></td> <td style="width: 10%;"></td> <td style="width: 10%;"></td> <td style="width: 10%;"></td> <td style="width: 10%;"></td> <td style="width: 10%;"></td> <td style="width: 10%;"></td> <td style="width: 10%;"></td> <td style="width: 10%;"></td> </tr> <tr> <td style="text-align: center;">XA</td> <td style="text-align: center;">1</td> <td style="text-align: center;">2</td> <td style="text-align: center;">3</td> <td style="text-align: center;">4</td> <td style="text-align: center;">R01</td> <td style="text-align: center;">S01</td> <td style="text-align: center;">T01</td> <td style="text-align: center;">N01</td> <td style="text-align: center;">E1</td> <td style="text-align: center;">E1</td> <td style="text-align: center;">E1</td> <td style="text-align: center;">E1</td> <td style="text-align: center;">E1</td> </tr> <tr> <td></td> <td style="text-align: center;">1</td> <td style="text-align: center;">2</td> <td style="text-align: center;">3</td> <td style="text-align: center;">4</td> <td style="text-align: center;">R02</td> <td style="text-align: center;">S02</td> <td style="text-align: center;">T02</td> <td style="text-align: center;">N02</td> <td style="text-align: center;">E2</td> <td style="text-align: center;">E2</td> <td style="text-align: center;">E2</td> <td style="text-align: center;">E2</td> <td style="text-align: center;">E2</td> </tr> <tr> <td></td> <td style="text-align: center;">1</td> <td style="text-align: center;">2</td> <td style="text-align: center;">3</td> <td style="text-align: center;">4</td> <td style="text-align: center;">R03</td> <td style="text-align: center;">S03</td> <td style="text-align: center;">T03</td> <td
style="text-align: center;">N03</td> <td style="text-align: center;">E3</td> <td style="text-align: center;">E3</td> <td style="text-align: center;">E3</td> <td style="text-align: center;">E3</td> <td style="text-align: center;">E3</td> </tr> <tr> <td></td> <td style="text-align: center;">1</td> <td style="text-align: center;">2</td> <td style="text-align: center;">3</td> <td style="text-align: center;">4</td> <td style="text-align: center;">R04</td> <td style="text-align: center;">S04</td> <td style="text-align: center;">T04</td> <td style="text-align: center;">N04</td> <td style="text-align: center;">E4</td> <td style="text-align: center;">E4</td> <td style="text-align: center;">E4</td> <td style="text-align: center;">E4</td> <td style="text-align: center;">E4</td> </tr> <tr> <td></td> <td style="text-align: center;">1</td> <td style="text-align: center;">2</td> <td style="text-align: center;">3</td> <td style="text-align: center;">4</td> <td style="text-align: center;">R05</td> <td style="text-align: center;">S05</td> <td style="text-align: center;">T05</td> <td style="text-align: center;">N05</td> <td style="text-align: center;">E5</td> <td style="text-align: center;">E5</td> <td style="text-align: center;">E5</td> <td style="text-align: center;">E5</td> <td style="text-align: center;">E5</td> </tr> <tr> <td></td> <td style="text-align: center;">1</td> <td style="text-align: center;">2</td> <td style="text-align: center;">3</td> <td style="text-align: center;">4</td> <td style="text-align: center;">R06</td> <td style="text-align: center;">S06</td> <td style="text-align: center;">T06</td> <td style="text-align: center;">N06</td> <td style="text-align: center;">E6</td> <td style="text-align: center;">E6</td> <td style="text-align: center;">E6</td> <td style="text-align: center;">E6</td> <td style="text-align: center;">E6</td> </tr> <tr> <td></td> <td style="text-align: center;">1</td> <td style="text-align: center;">2</td> <td style="text-align: center;">3</td> <td style="text-align: center;">4</td> <td style="text-align: center;">R07</td> <td style="text-align: center;">S07</td> <td style="text-align: center;">T07</td> <td style="text-align: center;">N07</td> <td style="text-align: center;">E7</td> <td style="text-align: center;">E7</td> <td style="text-align: center;">E7</td> <td style="text-align: center;">E7</td> <td style="text-align: center;">E7</td> </tr> <tr> <td></td> <td style="text-align: center;">1</td> <td style="text-align: center;">2</td> <td style="text-align: center;">3</td> <td style="text-align: center;">4</td> <td style="text-align: center;">R08</td> <td style="text-align: center;">S08</td> <td style="text-align: center;">T08</td> <td style="text-align: center;">N08</td> <td style="text-align: center;">E8</td> <td style="text-align: center;">E8</td> <td style="text-align: center;">E8</td> <td style="text-align: center;">E8</td> <td style="text-align: center;">E8</td> </tr> </table> </td> <td style="width: 50%; vertical-align: top;"> <table border="0" style="width: 100%;"> <tr> <td style="width: 50%;"></td> <td style="width: 50%; text-align: center;"> <table border="0"> <tr> <td style="width: 10%;"></td> <td style="width: 10%;"></td> <td style="width: 10%;"></td> <td style="width: 10%;"></td> <td style="width: 10%;"></td> <td style="width: 10%;"></td> <td style="width: 10%;"></td> <td style="width: 10%;"></td> <td style="width: 10%;"></td> <td style="width: 10%;"></td> <td style="width: 10%;"></td> <td style="width: 10%;"></td> <td style="width: 10%;"></td> <td style="width: 10%;"></td> </tr> <tr> <td style="text-align: center;">XA</td> <td style="text-align: center;">1</td> <td style="text-align: center;">2</td> <td style="text-align: center;">3</td> <td style="text-align: center;">4</td> <td style="text-align: center;">R01</td> <td style="text-align: center;">S01</td> <td style="text-align: center;">T01</td> <td style="text-align: center;">N01</td> <td style="text-align: center;">E1</td> <td style="text-align: center;">E1</td> <td style="text-align: center;">E1</td> <td style="text-align: center;">E1</td> <td style="text-align: center;">E1</td> </tr> <tr> <td></td> <td style="text-align: center;">1</td> <td style="text-align: center;">2</td> <td style="text-align: center;">3</td> <td style="text-align: center;">4</td> <td style="text-align: center;">R02</td> <td style="text-align: center;">S02</td> <td style="text-align: center;">T02</td> <td style="text-align: center;">N02</td> <td style="text-align: center;">E2</td> <td style="text-align: center;">E2</td> <td style="text-align: center;">E2</td> <td style="text-align: center;">E2</td> <td style="text-align: center;">E2</td> </tr> <tr> <td></td> <td style="text-align: center;">1</td> <td style="text-align: center;">2</td> <td style="text-align: center;">3</td> <td style="text-align: center;">4</td> <td style="text-align: center;">R03</td> <td style="text-align: center;">S03</td> <td style="text-align: center;">T03</td> <td style="text-align: center;">N03</td> <td style="text-align: center;">E3</td> <td style="text-align: center;">E3</td> <td style="text-align: center;">E3</td> <td style="text-align: center;">E3</td> <td style="text-align: center;">E3</td> </tr> <tr> <td></td> <td style="text-align: center;">1</td> <td style="text-align: center;">2</td> <td style="text-align: center;">3</td> <td style="text-align: center;">4</td> <td style="text-align: center;">R04</td> <td style="text-align: center;">S04</td> <td style="text-align: center;">T04</td> <td style="text-align: center;">N04</td> <td style="text-align: center;">E4</td> <td style="text-align: center;">E4</td> <td style="text-align: center;">E4</td> <td style="text-align: center;">E4</td> <td style="text-align: center;">E4</td> </tr> <tr> <td></td> <td style="text-align: center;">1</td> <td style="text-align: center;">2</td> <td style="text-align: center;">3</td> <td style="text-align: center;">4</td> <td style="text-align: center;">R05</td> <td style="text-align: center;">S05</td> <td style="text-align: center;">T05</td> <td style="text-align: center;">N05</td> <td style="text-align: center;">E5</td> <td style="text-align: center;">E5</td> <td style="text-align: center;">E5</td> <td style="text-align: center;">E5</td> <td style="text-align: center;">E5</td> </tr> <tr> <td></td> <td style="text-align: center;">1</td> <td style="text-align: center;">2</td> <td style="text-align: center;">3</td> <td style="text-align: center;">4</td> <td style="text-align: center;">R06</td> <td style="text-align: center;">S06</td> <td style="text-align: center;">T06</td> <td style="text-align: center;">N06</td> <td style="text-align: center;">E6</td> <td style="text-align: center;">E6</td> <td style="text-align: center;">E6</td> <td style="text-align: center;">E6</td> <td style="text-align: center;">E6</td> </tr> <tr> <td></td> <td style="text-align: center;">1</td> <td style="text-align: center;">2</td> <td style="text-align: center;">3</td> <td style="text-align: center;">4</td> <td style="text-align: center;">R07</td> <td style="text-align: center;">S07</td> <td style="text-align: center;">T07</td> <td style="text-align: center;">N07</td> <td style="text-align: center;">E7</td> <td style="text-align: center;">E7</td> <td style="text-align: center;">E7</td> <td style="text-align: center;">E7</td> <td style="text-align: center;">E7</td> </tr> <tr> <td></td> <td style="text-align: center;">1</td> <td style="text-align: center;">2</td> <td style="text-align: center;">3</td> <td style="text-align: center;">4</td> <td style="text-align: center;">R08</td> <td style="text-align: center;">S08</td> <td style="text-align: center;">T08</td> <td style="text-align: center;">N08</td> <td style="text-align: center;">E8</td> <td style="text-align: center;">E8</td> <td style="text-align: center;">E8</td> <td style="text-align: center;">E8</td> <td style="text-align: center;">E8</td> </tr> </table> </td> <td style="width: 50%; vertical-align: top;"> <table border="0" style="width: 100%;"> <tr> <td style="width: 50%;"></td> <td style="width: 50%; text-align: center;"> <table border="0"> <tr> <td style="width: 10%;"></td> <td style="width: 10%;"></td> <td style="width: 10%;"></td> <td style="width: 10%;"></td> <td style="width: 10%;"></td> <td style="width: 10%;"></td> <td style="width: 10%;"></td> <td style="width: 10%;"></td> <td style="width: 10%;"></td> <td style="width: 10%;"></td> <td style="width: 10%;"></td> <td style="width: 10%;"></td> <td style="width: 10%;"></td> <td style="width: 10%;"></td> </tr> <tr> <td style="text-align: center;">XA</td> <td style="text-align: center;">1</td> <td style="text-align: center;">2</td> <td style="text-align: center;">3</td> <td style="text-align: center;">4</td> <td style="text-align: center;">R01</td> <td style="text-align: center;">S01</td> <td style="text-align: center;">T01</td> <td style="text-align: center;">N01</td> <td style="text-align: center;">E1</td> <td style="text-align: center;">E1</td> <td style="text-align: center;">E1</td> <td style="text-align: center;">E1</td> <td style="text-align: center;">E1</td> </tr> <tr> <td></td> <td style="text-align: center;">1</td> <td style="text-align: center;">2</td> <td style="text-align: center;">3</td> <td style="text-align: center;">4</td> <td style="text-align: center;">R02</td> <td style="text-align: center;">S02</td> <td style="text-align: center;">T02</td> <td style="text-align: center;">N02</td> <td style="text-align: center;">E2</td> <td style="text-align: center;">E2</td> <td style="text-align: center;">E2</td> <td style="text-align: center;">E2</td> <td style="text-align: center;">E2</td> </tr> <tr> <td></td> <td style="text-align: center;">1</td> <td style="text-align: center;">2</td> <td style="text-align: center;">3</td> <td style="text-align: center;">4</td> <td style="text-align: center;">R03</td> <td style="text-align: center;">S03</td> <td style="text-align: center;">T03</td> <td style="text-align:
center;">N03</td> <td style="text-align: center;">E3</td> <td style="text-align: center;">E3</td> <td style="text-align: center;">E3</td> <td style="text-align: center;">E3</td> <td style="text-align: center;">E3</td> </tr> <tr> <td></td> <td style="text-align: center;">1</td> <td style="text-align: center;">2</td> <td style="text-align: center;">3</td> <td style="text-align: center;">4</td> <td style="text-align: center;">R04</td> <td style="text-align: center;">S04</td> <td style="text-align: center;">T04</td> <td style="text-align: center;">N04</td> <td style="text-align: center;">E4</td> <td style="text-align: center;">E4</td> <td style="text-align: center;">E4</td> <td style="text-align: center;">E4</td> <td style="text-align: center;">E4</td> </tr> <tr> <td></td> <td style="text-align: center;">1</td> <td style="text-align: center;">2</td> <td style="text-align: center;">3</td> <td style="text-align: center;">4</td> <td style="text-align: center;">R05</td> <td style="text-align: center;">S05</td> <td style="text-align: center;">T05</td> <td style="text-align: center;">N05</td> <td style="text-align: center;">E5</td> <td style="text-align: center;">E5</td> <td style="text-align: center;">E5</td> <td style="text-align: center;">E5</td> <td style="text-align: center;">E5</td> </tr> <tr> <td></td> <td style="text-align: center;">1</td> <td style="text-align: center;">2</td> <td style="text-align: center;">3</td> <td style="text-align: center;">4</td> <td style="text-align: center;">R06</td> <td style="text-align: center;">S06</td> <td style="text-align: center;">T06</td> <td style="text-align: center;">N06</td> <td style="text-align: center;">E6</td> <td style="text-align: center;">E6</td> <td style="text-align: center;">E6</td> <td style="text-align: center;">E6</td> <td style="text-align: center;">E6</td> </tr> <tr> <td></td> <td style="text-align: center;">1</td> <td style="text-align: center;">2</td> <td style="text-align: center;">3</td> <td style="text-align: center;">4</td> <td style="text-align: center;">R07</td> <td style="text-align: center;">S07</td> <td style="text-align: center;">T07</td> <td style="text-align: center;">N07</td> <td style="text-align: center;">E7</td> <td style="text-align: center;">E7</td> <td style="text-align: center;">E7</td> <td style="text-align: center;">E7</td> <td style="text-align: center;">E7</td> </tr> <tr> <td></td> <td style="text-align: center;">1</td> <td style="text-align: center;">2</td> <td style="text-align: center;">3</td> <td style="text-align: center;">4</td> <td style="text-align: center;">R08</td> <td style="text-align: center;">S08</td> <td style="text-align: center;">T08</td> <td style="text-align: center;">N08</td> <td style="text-align: center;">E8</td> <td style="text-align: center;">E8</td> <td style="text-align: center;">E8</td> <td style="text-align: center;">E8</td> <td style="text-align: center;">E8</td> </tr> </table> </td> <td style="width: 50%; vertical-align: top;"> <table border="0" style="width: 100%;"> <tr> <td style="width: 50%;"></td> <td style="width: 50%; text-align: center;"> <table border="0"> <tr> <td style="width: 10%;"></td> <td style="width: 10%;"></td> <td style="width: 10%;"></td> <td style="width: 10%;"></td> <td style="width: 10%;"></td> <td style="width: 10%;"></td> <td style="width: 10%;"></td> <td style="width: 10%;"></td> <td style="width: 10%;"></td> <td style="width: 10%;"></td> <td style="width: 10%;"></td> <td style="width: 10%;"></td> <td style="width: 10%;"></td> <td style="width: 10%;"></td> </tr> <tr> <td style="text-align: center;">XA</td> <td style="text-align: center;">1</td> <td style="text-align: center;">2</td> <td style="text-align: center;">3</td> <td style="text-align: center;">4</td> <td style="text-align: center;">R01</td> <td style="text-align: center;">S01</td> <td style="text-align: center;">T01</td> <td style="text-align: center;">N01</td> <td style="text-align: center;">E1</td> <td style="text-align: center;">E1</td> <td style="text-align: center;">E1</td> </tr></table></td></tr></table></td></tr></table></td></tr></table></td></tr></table></td></tr></table> | | <table border="0"> <tr> <td style="width: 10%;"></td> <td style="width: 10%;"></td> <td style="width: 10%;"></td> <td style="width: 10%;"></td> <td style="width: 10%;"></td> <td style="width: 10%;"></td> <td style="width: 10%;"></td> <td style="width: 10%;"></td> <td style="width: 10%;"></td> <td style="width: 10%;"></td> <td style="width: 10%;"></td> <td style="width: 10%;"></td> <td style="width: 10%;"></td> <td style="width: 10%;"></td> </tr> <tr> <td style="text-align: center;">XA</td> <td style="text-align: center;">1</td> <td style="text-align: center;">2</td> <td style="text-align: center;">3</td> <td style="text-align: center;">4</td> <td style="text-align: center;">R01</td> <td style="text-align: center;">S01</td> <td style="text-align: center;">T01</td> <td style="text-align: center;">N01</td> <td style="text-align: center;">E1</td> <td style="text-align: center;">E1</td> <td style="text-align: center;">E1</td> <td style="text-align: center;">E1</td> <td style="text-align: center;">E1</td> </tr> <tr> <td></td> <td style="text-align: center;">1</td> <td style="text-align: center;">2</td> <td style="text-align: center;">3</td> <td style="text-align: center;">4</td> <td style="text-align: center;">R02</td> <td style="text-align: center;">S02</td> <td style="text-align: center;">T02</td> <td style="text-align: center;">N02</td> <td style="text-align: center;">E2</td> <td style="text-align: center;">E2</td> <td style="text-align: center;">E2</td> <td style="text-align: center;">E2</td> <td style="text-align: center;">E2</td> </tr> <tr> <td></td> <td style="text-align: center;">1</td> <td style="text-align: center;">2</td> <td style="text-align: center;">3</td> <td style="text-align: center;">4</td> <td style="text-align: center;">R03</td> <td style="text-align: center;">S03</td> <td style="text-align: center;">T03</td> <td style="text-align: center;">N03</td> <td style="text-align: center;">E3</td> <td style="text-align: center;">E3</td> <td style="text-align: center;">E3</td> <td style="text-align: center;">E3</td> <td style="text-align: center;">E3</td> </tr> <tr> <td></td> <td style="text-align: center;">1</td> <td style="text-align: center;">2</td> <td style="text-align: center;">3</td> <td style="text-align: center;">4</td> <td style="text-align: center;">R04</td> <td style="text-align: center;">S04</td> <td style="text-align: center;">T04</td> <td style="text-align: center;">N04</td> <td style="text-align: center;">E4</td> <td style="text-align: center;">E4</td> <td style="text-align: center;">E4</td> <td style="text-align: center;">E4</td> <td style="text-align: center;">E4</td> </tr> <tr> <td></td> <td style="text-align: center;">1</td> <td style="text-align: center;">2</td> <td style="text-align: center;">3</td> <td style="text-align: center;">4</td> <td style="text-align: center;">R05</td> <td style="text-align: center;">S05</td> <td style="text-align: center;">T05</td> <td style="text-align: center;">N05</td> <td style="text-align: center;">E5</td> <td style="text-align: center;">E5</td> <td style="text-align: center;">E5</td> <td style="text-align: center;">E5</td> <td style="text-align: center;">E5</td> </tr> <tr> <td></td> <td style="text-align: center;">1</td> <td style="text-align: center;">2</td> <td style="text-align: center;">3</td> <td style="text-align: center;">4</td> <td style="text-align: center;">R06</td> <td style="text-align: center;">S06</td> <td style="text-align: center;">T06</td> <td style="text-align: center;">N06</td> <td style="text-align: center;">E6</td> <td style="text-align: center;">E6</td> <td style="text-align: center;">E6</td> <td style="text-align: center;">E6</td> <td style="text-align: center;">E6</td> </tr> <tr> <td></td> <td style="text-align: center;">1</td> <td style="text-align: center;">2</td> <td style="text-align: center;">3</td> <td style="text-align: center;">4</td> <td style="text-align: center;">R07</td> <td style="text-align: center;">S07</td> <td style="text-align: center;">T07</td> <td style="text-align: center;">N07</td> <td style="text-align: center;">E7</td> <td style="text-align: center;">E7</td> <td style="text-align: center;">E7</td> <td style="text-align: center;">E7</td> <td style="text-align: center;">E7</td> </tr> <tr> <td></td> <td style="text-align: center;">1</td> <td style="text-align: center;">2</td> <td style="text-align: center;">3</td> <td style="text-align: center;">4</td> <td style="text-align: center;">R08</td> <td style="text-align: center;">S08</td> <td style="text-align: center;">T08</td> <td style="text-align: center;">N08</td> <td style="text-align: center;">E8</td> <td style="text-align: center;">E8</td> <td style="text-align: center;">E8</td> <td style="text-align: center;">E8</td> <td style="text-align: center;">E8</td> </tr> </table> | | | | | | | | | | | | | | | XA | 1 | 2 | 3 | 4 | R01 | S01 | T01 | N01 | E1 | E1 | E1

 | E1 | E1 | | 1 | 2 | 3 | 4 | R02 | S02 | T02 | N02 | E2 | E2 | E2 | E2 | E2 | | 1 | 2 | 3 | 4 | R03 | S03 | T03 | N03 | E3 | E3 | E3 | E3 | E3 | | 1 | 2 | 3 | 4 | R04 | S04 | T04 | N04 | E4 | E4 | E4 | E4 | E4 | | 1 | 2 | 3 | 4 | R05 | S05 | T05 | N05 | E5 | E5 | E5 | E5 | E5 | | 1 | 2 | 3 | 4 | R06 | S06 | T06 | N06 | E6 | E6 | E6 | E6 | E6
 | | 1
 | 2 | 3 | 4 | R07 | S07 | T07 | N07 | E7 | E7 | E7 | E7 | E7
 |

 | 1 | 2
 | 3 | 4 | R08 | S08 | T08 | N08 | E8 | E8 | E8 | E8 | E8 | <table border="0" style="width: 100%;"> <tr> <td style="width: 50%;"></td> <td style="width: 50%; text-align: center;"> <table border="0"> <tr> <td style="width: 10%;"></td> <td style="width: 10%;"></td> <td style="width: 10%;"></td> <td style="width: 10%;"></td> <td style="width: 10%;"></td> <td style="width: 10%;"></td> <td style="width: 10%;"></td> <td style="width: 10%;"></td> <td style="width: 10%;"></td> <td style="width: 10%;"></td> <td style="width: 10%;"></td> <td style="width: 10%;"></td> <td style="width: 10%;"></td> <td style="width: 10%;"></td> </tr> <tr> <td style="text-align: center;">XA</td> <td style="text-align: center;">1</td> <td style="text-align: center;">2</td> <td style="text-align: center;">3</td> <td style="text-align: center;">4</td> <td style="text-align: center;">R01</td> <td style="text-align: center;">S01</td> <td style="text-align: center;">T01</td> <td style="text-align: center;">N01</td> <td style="text-align: center;">E1</td> <td style="text-align: center;">E1</td> <td style="text-align: center;">E1</td> <td style="text-align: center;">E1</td> <td style="text-align: center;">E1</td> </tr> <tr> <td></td> <td style="text-align: center;">1</td> <td style="text-align: center;">2</td> <td style="text-align: center;">3</td> <td style="text-align: center;">4</td> <td style="text-align: center;">R02</td> <td style="text-align: center;">S02</td> <td style="text-align: center;">T02</td> <td style="text-align: center;">N02</td> <td style="text-align: center;">E2</td> <td style="text-align: center;">E2</td> <td style="text-align: center;">E2</td> <td style="text-align: center;">E2</td> <td style="text-align: center;">E2</td> </tr> <tr> <td></td> <td style="text-align: center;">1</td> <td style="text-align: center;">2</td> <td style="text-align: center;">3</td> <td style="text-align: center;">4</td> <td style="text-align: center;">R03</td> <td style="text-align: center;">S03</td> <td style="text-align: center;">T03</td> <td style="text-align: center;">N03</td> <td style="text-align: center;">E3</td> <td style="text-align: center;">E3</td> <td style="text-align: center;">E3</td> <td style="text-align: center;">E3</td> <td style="text-align: center;">E3</td> </tr> <tr> <td></td> <td style="text-align: center;">1</td> <td style="text-align: center;">2</td> <td style="text-align: center;">3</td> <td style="text-align: center;">4</td> <td style="text-align: center;">R04</td> <td style="text-align: center;">S04</td> <td style="text-align: center;">T04</td> <td style="text-align: center;">N04</td> <td style="text-align: center;">E4</td> <td style="text-align: center;">E4</td> <td style="text-align: center;">E4</td> <td style="text-align: center;">E4</td> <td style="text-align: center;">E4</td> </tr> <tr> <td></td> <td style="text-align: center;">1</td> <td style="text-align: center;">2</td> <td style="text-align: center;">3</td> <td style="text-align: center;">4</td> <td style="text-align: center;">R05</td> <td style="text-align: center;">S05</td> <td style="text-align: center;">T05</td> <td style="text-align: center;">N05</td> <td style="text-align: center;">E5</td> <td style="text-align: center;">E5</td> <td style="text-align: center;">E5</td> <td style="text-align: center;">E5</td> <td style="text-align: center;">E5</td> </tr> <tr> <td></td> <td style="text-align: center;">1</td> <td style="text-align: center;">2</td> <td style="text-align: center;">3</td> <td style="text-align: center;">4</td> <td style="text-align: center;">R06</td> <td style="text-align: center;">S06</td> <td style="text-align: center;">T06</td> <td style="text-align: center;">N06</td> <td style="text-align: center;">E6</td> <td style="text-align: center;">E6</td> <td style="text-align: center;">E6</td> <td style="text-align: center;">E6</td> <td style="text-align: center;">E6</td> </tr> <tr> <td></td> <td style="text-align: center;">1</td> <td style="text-align: center;">2</td> <td style="text-align: center;">3</td> <td style="text-align: center;">4</td> <td style="text-align: center;">R07</td> <td style="text-align: center;">S07</td> <td style="text-align: center;">T07</td> <td style="text-align: center;">N07</td> <td style="text-align: center;">E7</td> <td style="text-align: center;">E7</td> <td style="text-align: center;">E7</td> <td style="text-align: center;">E7</td> <td style="text-align: center;">E7</td> </tr> <tr> <td></td> <td style="text-align: center;">1</td> <td style="text-align: center;">2</td> <td style="text-align: center;">3</td> <td style="text-align: center;">4</td> <td style="text-align: center;">R08</td> <td style="text-align: center;">S08</td> <td style="text-align: center;">T08</td> <td style="text-align: center;">N08</td> <td style="text-align: center;">E8</td> <td style="text-align: center;">E8</td> <td style="text-align: center;">E8</td> <td style="text-align: center;">E8</td> <td style="text-align: center;">E8</td> </tr> </table> </td> <td style="width: 50%; vertical-align: top;"> <table border="0" style="width: 100%;"> <tr> <td style="width: 50%;"></td> <td style="width: 50%; text-align: center;"> <table border="0"> <tr> <td style="width: 10%;"></td> <td style="width: 10%;"></td> <td style="width: 10%;"></td> <td style="width: 10%;"></td> <td style="width: 10%;"></td> <td style="width: 10%;"></td> <td style="width: 10%;"></td> <td style="width: 10%;"></td> <td style="width: 10%;"></td> <td style="width: 10%;"></td> <td style="width: 10%;"></td> <td style="width: 10%;"></td> <td style="width: 10%;"></td> <td style="width: 10%;"></td> </tr> <tr> <td style="text-align: center;">XA</td> <td style="text-align: center;">1</td> <td style="text-align: center;">2</td> <td style="text-align: center;">3</td> <td style="text-align: center;">4</td> <td style="text-align: center;">R01</td> <td style="text-align: center;">S01</td> <td style="text-align: center;">T01</td> <td style="text-align: center;">N01</td> <td style="text-align: center;">E1</td> <td style="text-align: center;">E1</td> <td style="text-align: center;">E1</td> <td style="text-align: center;">E1</td> <td style="text-align: center;">E1</td> </tr> <tr> <td></td> <td style="text-align: center;">1</td> <td style="text-align: center;">2</td> <td style="text-align: center;">3</td> <td style="text-align: center;">4</td> <td style="text-align: center;">R02</td> <td style="text-align: center;">S02</td> <td style="text-align: center;">T02</td> <td style="text-align: center;">N02</td> <td style="text-align: center;">E2</td> <td style="text-align: center;">E2</td> <td style="text-align: center;">E2</td> <td style="text-align: center;">E2</td> <td style="text-align: center;">E2</td> </tr> <tr> <td></td> <td
style="text-align: center;">1</td> <td style="text-align: center;">2</td> <td style="text-align: center;">3</td> <td style="text-align: center;">4</td> <td style="text-align: center;">R03</td> <td style="text-align: center;">S03</td> <td style="text-align: center;">T03</td> <td style="text-align: center;">N03</td> <td style="text-align: center;">E3</td> <td style="text-align: center;">E3</td> <td style="text-align: center;">E3</td> <td style="text-align: center;">E3</td> <td style="text-align: center;">E3</td> </tr> <tr> <td></td> <td style="text-align: center;">1</td> <td style="text-align: center;">2</td> <td style="text-align: center;">3</td> <td style="text-align: center;">4</td> <td style="text-align: center;">R04</td> <td style="text-align: center;">S04</td> <td style="text-align: center;">T04</td> <td style="text-align: center;">N04</td> <td style="text-align: center;">E4</td> <td style="text-align: center;">E4</td> <td style="text-align: center;">E4</td> <td style="text-align: center;">E4</td> <td style="text-align: center;">E4</td> </tr> <tr> <td></td> <td style="text-align: center;">1</td> <td style="text-align: center;">2</td> <td style="text-align: center;">3</td> <td style="text-align: center;">4</td> <td style="text-align: center;">R05</td> <td style="text-align: center;">S05</td> <td style="text-align: center;">T05</td> <td style="text-align: center;">N05</td> <td style="text-align: center;">E5</td> <td style="text-align: center;">E5</td> <td style="text-align: center;">E5</td> <td style="text-align: center;">E5</td> <td style="text-align: center;">E5</td> </tr> <tr> <td></td> <td style="text-align: center;">1</td> <td style="text-align: center;">2</td> <td style="text-align: center;">3</td> <td style="text-align: center;">4</td> <td style="text-align: center;">R06</td> <td style="text-align: center;">S06</td> <td style="text-align: center;">T06</td> <td style="text-align: center;">N06</td> <td style="text-align: center;">E6</td> <td style="text-align: center;">E6</td> <td style="text-align: center;">E6</td> <td style="text-align: center;">E6</td> <td style="text-align: center;">E6</td> </tr> <tr> <td></td> <td style="text-align: center;">1</td> <td style="text-align: center;">2</td> <td style="text-align: center;">3</td> <td style="text-align: center;">4</td> <td style="text-align: center;">R07</td> <td style="text-align: center;">S07</td> <td style="text-align: center;">T07</td> <td style="text-align: center;">N07</td> <td style="text-align: center;">E7</td> <td style="text-align: center;">E7</td> <td style="text-align: center;">E7</td> <td style="text-align: center;">E7</td> <td style="text-align: center;">E7</td> </tr> <tr> <td></td> <td style="text-align: center;">1</td> <td style="text-align: center;">2</td> <td style="text-align: center;">3</td> <td style="text-align: center;">4</td> <td style="text-align: center;">R08</td> <td style="text-align: center;">S08</td> <td style="text-align: center;">T08</td> <td style="text-align: center;">N08</td> <td style="text-align: center;">E8</td> <td style="text-align: center;">E8</td> <td style="text-align: center;">E8</td> <td style="text-align: center;">E8</td> <td style="text-align: center;">E8</td> </tr> </table> </td> <td style="width: 50%; vertical-align: top;"> <table border="0" style="width: 100%;"> <tr> <td style="width: 50%;"></td> <td style="width: 50%; text-align: center;"> <table border="0"> <tr> <td style="width: 10%;"></td> <td style="width: 10%;"></td> <td style="width: 10%;"></td> <td style="width: 10%;"></td> <td style="width: 10%;"></td> <td style="width: 10%;"></td> <td style="width: 10%;"></td> <td style="width: 10%;"></td> <td style="width: 10%;"></td> <td style="width: 10%;"></td> <td style="width: 10%;"></td> <td style="width: 10%;"></td> <td style="width: 10%;"></td> <td style="width: 10%;"></td> </tr> <tr> <td style="text-align: center;">XA</td> <td style="text-align: center;">1</td> <td style="text-align: center;">2</td> <td style="text-align: center;">3</td> <td style="text-align: center;">4</td> <td style="text-align: center;">R01</td> <td style="text-align: center;">S01</td> <td style="text-align: center;">T01</td> <td style="text-align: center;">N01</td> <td style="text-align: center;">E1</td> <td style="text-align: center;">E1</td> <td style="text-align: center;">E1</td> <td style="text-align: center;">E1</td> <td style="text-align: center;">E1</td> </tr> <tr> <td></td> <td style="text-align: center;">1</td> <td style="text-align: center;">2</td> <td style="text-align: center;">3</td> <td style="text-align: center;">4</td> <td style="text-align: center;">R02</td> <td style="text-align: center;">S02</td> <td style="text-align: center;">T02</td> <td style="text-align: center;">N02</td> <td style="text-align: center;">E2</td> <td style="text-align: center;">E2</td> <td style="text-align: center;">E2</td> <td style="text-align: center;">E2</td> <td style="text-align: center;">E2</td> </tr> <tr> <td></td> <td style="text-align: center;">1</td> <td style="text-align: center;">2</td> <td style="text-align: center;">3</td> <td style="text-align: center;">4</td> <td style="text-align: center;">R03</td> <td style="text-align: center;">S03</td> <td style="text-align: center;">T03</td> <td style="text-align: center;">N03</td> <td style="text-align: center;">E3</td> <td style="text-align: center;">E3</td> <td style="text-align: center;">E3</td> <td style="text-align: center;">E3</td> <td style="text-align: center;">E3</td> </tr> <tr> <td></td> <td style="text-align: center;">1</td> <td style="text-align: center;">2</td> <td style="text-align: center;">3</td> <td style="text-align: center;">4</td> <td style="text-align: center;">R04</td> <td style="text-align: center;">S04</td> <td style="text-align: center;">T04</td> <td style="text-align: center;">N04</td> <td style="text-align: center;">E4</td> <td style="text-align: center;">E4</td> <td style="text-align: center;">E4</td> <td style="text-align: center;">E4</td> <td style="text-align: center;">E4</td> </tr> <tr> <td></td> <td style="text-align: center;">1</td> <td style="text-align: center;">2</td> <td style="text-align: center;">3</td> <td style="text-align: center;">4</td> <td style="text-align: center;">R05</td> <td style="text-align: center;">S05</td> <td style="text-align: center;">T05</td> <td style="text-align: center;">N05</td> <td style="text-align: center;">E5</td> <td style="text-align: center;">E5</td> <td style="text-align: center;">E5</td> <td style="text-align: center;">E5</td> <td style="text-align: center;">E5</td> </tr> <tr> <td></td> <td style="text-align: center;">1</td> <td style="text-align: center;">2</td> <td style="text-align: center;">3</td> <td style="text-align: center;">4</td> <td style="text-align: center;">R06</td> <td style="text-align: center;">S06</td> <td style="text-align: center;">T06</td> <td style="text-align: center;">N06</td> <td style="text-align: center;">E6</td> <td style="text-align: center;">E6</td> <td style="text-align: center;">E6</td> <td style="text-align: center;">E6</td> <td style="text-align: center;">E6</td> </tr> <tr> <td></td> <td style="text-align: center;">1</td> <td style="text-align: center;">2</td> <td style="text-align: center;">3</td> <td style="text-align: center;">4</td> <td style="text-align: center;">R07</td> <td style="text-align: center;">S07</td> <td style="text-align: center;">T07</td> <td style="text-align: center;">N07</td> <td style="text-align: center;">E7</td> <td style="text-align: center;">E7</td> <td style="text-align: center;">E7</td> <td style="text-align: center;">E7</td> <td style="text-align: center;">E7</td> </tr> <tr> <td></td> <td style="text-align: center;">1</td> <td style="text-align: center;">2</td> <td style="text-align: center;">3</td> <td style="text-align: center;">4</td> <td style="text-align: center;">R08</td> <td style="text-align: center;">S08</td> <td style="text-align: center;">T08</td> <td style="text-align: center;">N08</td> <td style="text-align: center;">E8</td> <td style="text-align: center;">E8</td> <td style="text-align: center;">E8</td> <td style="text-align: center;">E8</td> <td style="text-align: center;">E8</td> </tr> </table> </td> <td style="width: 50%; vertical-align: top;"> <table border="0" style="width: 100%;"> <tr> <td style="width: 50%;"></td> <td style="width: 50%; text-align: center;"> <table border="0"> <tr> <td style="width: 10%;"></td> <td style="width: 10%;"></td> <td style="width: 10%;"></td> <td style="width: 10%;"></td> <td style="width: 10%;"></td> <td style="width: 10%;"></td> <td style="width: 10%;"></td> <td style="width: 10%;"></td> <td style="width: 10%;"></td> <td style="width: 10%;"></td> <td style="width: 10%;"></td> <td style="width: 10%;"></td> <td style="width: 10%;"></td> <td style="width: 10%;"></td> </tr> <tr> <td style="text-align: center;">XA</td> <td style="text-align: center;">1</td> <td style="text-align: center;">2</td> <td style="text-align: center;">3</td> <td style="text-align: center;">4</td> <td style="text-align: center;">R01</td> <td style="text-align: center;">S01</td> <td style="text-align: center;">T01</td> <td style="text-align: center;">N01</td> <td style="text-align: center;">E1</td> <td style="text-align: center;">E1</td> <td style="text-align: center;">E1</td> </tr></table></td></tr></table></td></tr></table></td></tr></table></td></tr></table> | | <table border="0"> <tr> <td style="width: 10%;"></td> <td style="width: 10%;"></td> <td style="width: 10%;"></td> <td style="width: 10%;"></td> <td style="width: 10%;"></td> <td style="width: 10%;"></td> <td style="width: 10%;"></td> <td style="width: 10%;"></td> <td style="width: 10%;"></td> <td style="width: 10%;"></td> <td style="width: 10%;"></td> <td style="width: 10%;"></td> <td style="width: 10%;"></td> <td style="width: 10%;"></td> </tr> <tr> <td style="text-align: center;">XA</td> <td style="text-align: center;">1</td> <td style="text-align: center;">2</td>
<td style="text-align: center;">3</td> <td style="text-align: center;">4</td> <td style="text-align: center;">R01</td> <td style="text-align: center;">S01</td> <td style="text-align: center;">T01</td> <td style="text-align: center;">N01</td> <td style="text-align: center;">E1</td> <td style="text-align: center;">E1</td> <td style="text-align: center;">E1</td> <td style="text-align: center;">E1</td> <td style="text-align: center;">E1</td> </tr> <tr> <td></td> <td style="text-align: center;">1</td> <td style="text-align: center;">2</td> <td style="text-align: center;">3</td> <td style="text-align: center;">4</td> <td style="text-align: center;">R02</td> <td style="text-align: center;">S02</td> <td style="text-align: center;">T02</td> <td style="text-align: center;">N02</td> <td style="text-align: center;">E2</td> <td style="text-align: center;">E2</td> <td style="text-align: center;">E2</td> <td style="text-align: center;">E2</td> <td style="text-align: center;">E2</td> </tr> <tr> <td></td> <td style="text-align: center;">1</td> <td style="text-align: center;">2</td> <td style="text-align: center;">3</td> <td style="text-align: center;">4</td> <td style="text-align: center;">R03</td> <td style="text-align: center;">S03</td> <td style="text-align: center;">T03</td> <td style="text-align: center;">N03</td> <td style="text-align: center;">E3</td> <td style="text-align: center;">E3</td> <td style="text-align: center;">E3</td> <td style="text-align: center;">E3</td> <td style="text-align: center;">E3</td> </tr> <tr> <td></td> <td style="text-align: center;">1</td> <td style="text-align: center;">2</td> <td style="text-align: center;">3</td> <td style="text-align: center;">4</td> <td style="text-align: center;">R04</td> <td style="text-align: center;">S04</td> <td style="text-align: center;">T04</td> <td style="text-align: center;">N04</td> <td style="text-align: center;">E4</td> <td style="text-align: center;">E4</td> <td style="text-align: center;">E4</td> <td style="text-align: center;">E4</td> <td style="text-align: center;">E4</td> </tr> <tr> <td></td> <td style="text-align: center;">1</td> <td style="text-align: center;">2</td> <td style="text-align: center;">3</td> <td style="text-align: center;">4</td> <td style="text-align: center;">R05</td> <td style="text-align: center;">S05</td> <td style="text-align: center;">T05</td> <td style="text-align: center;">N05</td> <td style="text-align: center;">E5</td> <td style="text-align: center;">E5</td> <td style="text-align: center;">E5</td> <td style="text-align: center;">E5</td> <td style="text-align: center;">E5</td> </tr> <tr> <td></td> <td style="text-align: center;">1</td> <td style="text-align: center;">2</td> <td style="text-align: center;">3</td> <td style="text-align: center;">4</td> <td style="text-align: center;">R06</td> <td style="text-align: center;">S06</td> <td style="text-align: center;">T06</td> <td style="text-align: center;">N06</td> <td style="text-align: center;">E6</td> <td style="text-align: center;">E6</td> <td style="text-align: center;">E6</td> <td style="text-align: center;">E6</td> <td style="text-align: center;">E6</td> </tr> <tr> <td></td> <td style="text-align: center;">1</td> <td style="text-align: center;">2</td> <td style="text-align: center;">3</td> <td style="text-align: center;">4</td> <td style="text-align: center;">R07</td> <td style="text-align: center;">S07</td> <td style="text-align: center;">T07</td> <td style="text-align: center;">N07</td> <td style="text-align: center;">E7</td> <td style="text-align: center;">E7</td> <td style="text-align: center;">E7</td> <td style="text-align: center;">E7</td> <td style="text-align: center;">E7</td> </tr> <tr> <td></td> <td style="text-align: center;">1</td> <td style="text-align: center;">2</td> <td style="text-align: center;">3</td> <td style="text-align: center;">4</td> <td style="text-align: center;">R08</td> <td style="text-align: center;">S08</td> <td style="text-align: center;">T08</td> <td style="text-align: center;">N08</td> <td style="text-align: center;">E8</td> <td style="text-align: center;">E8</td> <td style="text-align: center;">E8</td> <td style="text-align: center;">E8</td> <td style="text-align: center;">E8</td> </tr> </table> | | | | | | | | | | | | | | | XA | 1 | 2 | 3 | 4 | R01 | S01 | T01 | N01 | E1 | E1 | E1

 | E1 | E1 | | 1 | 2 | 3 | 4 | R02 | S02 | T02 | N02 | E2 | E2 | E2 | E2 | E2 | | 1 | 2 | 3 | 4 | R03 | S03 | T03 | N03 | E3 | E3 | E3 | E3 | E3 | | 1 | 2 | 3 | 4 | R04 | S04 | T04 | N04 | E4 | E4 | E4 | E4 | E4 | | 1 | 2 | 3 | 4 | R05 | S05 | T05 | N05 | E5 | E5 | E5 | E5 | E5 | | 1 | 2 | 3 | 4 | R06 | S06 | T06 | N06 | E6 | E6 | E6 | E6 | E6
 | | 1 | 2 | 3 | 4 | R07 | S07 | T07 | N07 | E7 | E7 | E7 | E7 | E7
 |
 | 1
 | 2 | 3 | 4 | R08 | S08 | T08 | N08 | E8 | E8 | E8 | E8 | E8 | <table border="0" style="width: 100%;"> <tr> <td style="width: 50%;"></td> <td style="width: 50%; text-align: center;"> <table border="0"> <tr> <td style="width: 10%;"></td> <td style="width: 10%;"></td> <td style="width: 10%;"></td> <td style="width: 10%;"></td> <td style="width: 10%;"></td> <td style="width: 10%;"></td> <td style="width: 10%;"></td> <td style="width: 10%;"></td> <td style="width: 10%;"></td> <td style="width: 10%;"></td> <td style="width: 10%;"></td> <td style="width: 10%;"></td> <td style="width: 10%;"></td> <td style="width: 10%;"></td> </tr> <tr> <td style="text-align: center;">XA</td> <td style="text-align: center;">1</td> <td style="text-align: center;">2</td> <td style="text-align: center;">3</td> <td style="text-align: center;">4</td> <td style="text-align: center;">R01</td> <td style="text-align: center;">S01</td> <td style="text-align: center;">T01</td> <td style="text-align: center;">N01</td> <td style="text-align: center;">E1</td> <td style="text-align: center;">E1</td> <td style="text-align: center;">E1</td> <td style="text-align: center;">E1</td> <td style="text-align: center;">E1</td> </tr> <tr> <td></td> <td style="text-align: center;">1</td> <td style="text-align: center;">2</td> <td style="text-align: center;">3</td> <td style="text-align: center;">4</td> <td style="text-align: center;">R02</td> <td style="text-align: center;">S02</td> <td style="text-align: center;">T02</td> <td
style="text-align: center;">N02</td> <td style="text-align: center;">E2</td> <td style="text-align: center;">E2</td> <td style="text-align: center;">E2</td> <td style="text-align: center;">E2</td> <td style="text-align: center;">E2</td> </tr> <tr> <td></td> <td style="text-align: center;">1</td> <td style="text-align: center;">2</td> <td style="text-align: center;">3</td> <td style="text-align: center;">4</td> <td style="text-align: center;">R03</td> <td style="text-align: center;">S03</td> <td style="text-align: center;">T03</td> <td style="text-align: center;">N03</td> <td style="text-align: center;">E3</td> <td style="text-align: center;">E3</td> <td style="text-align: center;">E3</td> <td style="text-align: center;">E3</td> <td style="text-align: center;">E3</td> </tr> <tr> <td></td> <td style="text-align: center;">1</td> <td style="text-align: center;">2</td> <td style="text-align: center;">3</td> <td style="text-align: center;">4</td> <td style="text-align: center;">R04</td> <td style="text-align: center;">S04</td> <td style="text-align: center;">T04</td> <td style="text-align: center;">N04</td> <td style="text-align: center;">E4</td> <td style="text-align: center;">E4</td> <td style="text-align: center;">E4</td> <td style="text-align: center;">E4</td> <td style="text-align: center;">E4</td> </tr> <tr> <td></td> <td style="text-align: center;">1</td> <td style="text-align: center;">2</td> <td style="text-align: center;">3</td> <td style="text-align: center;">4</td> <td style="text-align: center;">R05</td> <td style="text-align: center;">S05</td> <td style="text-align: center;">T05</td> <td style="text-align: center;">N05</td> <td style="text-align: center;">E5</td> <td style="text-align: center;">E5</td> <td style="text-align: center;">E5</td> <td style="text-align: center;">E5</td> <td style="text-align: center;">E5</td> </tr> <tr> <td></td> <td style="text-align: center;">1</td> <td style="text-align: center;">2</td> <td style="text-align: center;">3</td> <td style="text-align: center;">4</td> <td style="text-align: center;">R06</td> <td style="text-align: center;">S06</td> <td style="text-align: center;">T06</td> <td style="text-align: center;">N06</td> <td style="text-align: center;">E6</td> <td style="text-align: center;">E6</td> <td style="text-align: center;">E6</td> <td style="text-align: center;">E6</td> <td style="text-align: center;">E6</td> </tr> <tr> <td></td> <td style="text-align: center;">1</td> <td style="text-align: center;">2</td> <td style="text-align: center;">3</td> <td style="text-align: center;">4</td> <td style="text-align: center;">R07</td> <td style="text-align: center;">S07</td> <td style="text-align: center;">T07</td> <td style="text-align: center;">N07</td> <td style="text-align: center;">E7</td> <td style="text-align: center;">E7</td> <td style="text-align: center;">E7</td> <td style="text-align: center;">E7</td> <td style="text-align: center;">E7</td> </tr> <tr> <td></td> <td style="text-align: center;">1</td> <td style="text-align: center;">2</td> <td style="text-align: center;">3</td> <td style="text-align: center;">4</td> <td style="text-align: center;">R08</td> <td style="text-align: center;">S08</td> <td style="text-align: center;">T08</td> <td style="text-align: center;">N08</td> <td style="text-align: center;">E8</td> <td style="text-align: center;">E8</td> <td style="text-align: center;">E8</td> <td style="text-align: center;">E8</td> <td style="text-align: center;">E8</td> </tr> </table> </td> <td style="width: 50%; vertical-align: top;"> <table border="0" style="width: 100%;"> <tr> <td style="width: 50%;"></td> <td style="width: 50%; text-align: center;"> <table border="0"> <tr> <td style="width: 10%;"></td> <td style="width: 10%;"></td> <td style="width: 10%;"></td> <td style="width: 10%;"></td> <td style="width: 10%;"></td> <td style="width: 10%;"></td> <td style="width: 10%;"></td> <td style="width: 10%;"></td> <td style="width: 10%;"></td> <td style="width: 10%;"></td> <td style="width: 10%;"></td> <td style="width: 10%;"></td> <td style="width: 10%;"></td> <td style="width: 10%;"></td> </tr> <tr> <td style="text-align: center;">XA</td> <td style="text-align: center;">1</td> <td style="text-align: center;">2</td> <td style="text-align: center;">3</td> <td style="text-align: center;">4</td> <td style="text-align: center;">R01</td> <td style="text-align: center;">S01</td> <td style="text-align: center;">T01</td> <td style="text-align: center;">N01</td> <td style="text-align: center;">E1</td> <td style="text-align: center;">E1</td> <td style="text-align: center;">E1</td> <td style="text-align: center;">E1</td> <td style="text-align: center;">E1</td> </tr> <tr> <td></td> <td style="text-align: center;">1</td> <td style="text-align: center;">2</td> <td style="text-align: center;">3</td> <td style="text-align: center;">4</td> <td style="text-align: center;">R02</td> <td style="text-align: center;">S02</td> <td style="text-align: center;">T02</td> <td style="text-align: center;">N02</td> <td style="text-align: center;">E2</td> <td style="text-align: center;">E2</td> <td style="text-align: center;">E2</td> <td style="text-align: center;">E2</td> <td style="text-align: center;">E2</td> </tr> <tr> <td></td> <td style="text-align: center;">1</td> <td style="text-align: center;">2</td> <td style="text-align: center;">3</td> <td style="text-align: center;">4</td> <td style="text-align: center;">R03</td> <td style="text-align: center;">S03</td> <td style="text-align: center;">T03</td> <td style="text-align: center;">N03</td> <td style="text-align: center;">E3</td> <td style="text-align: center;">E3</td> <td style="text-align: center;">E3</td> <td style="text-align: center;">E3</td> <td style="text-align: center;">E3</td> </tr> <tr> <td></td> <td style="text-align: center;">1</td> <td style="text-align: center;">2</td> <td style="text-align: center;">3</td> <td style="text-align: center;">4</td> <td style="text-align: center;">R04</td> <td style="text-align: center;">S04</td> <td style="text-align: center;">T04</td> <td style="text-align: center;">N04</td> <td style="text-align: center;">E4</td> <td style="text-align: center;">E4</td> <td style="text-align: center;">E4</td> <td style="text-align: center;">E4</td> <td style="text-align: center;">E4</td> </tr> <tr> <td></td> <td style="text-align: center;">1</td> <td style="text-align: center;">2</td> <td style="text-align: center;">3</td> <td style="text-align: center;">4</td> <td style="text-align: center;">R05</td> <td style="text-align: center;">S05</td> <td style="text-align: center;">T05</td> <td style="text-align: center;">N05</td> <td style="text-align: center;">E5</td> <td style="text-align: center;">E5</td> <td style="text-align: center;">E5</td> <td style="text-align: center;">E5</td> <td style="text-align: center;">E5</td> </tr> <tr> <td></td> <td style="text-align: center;">1</td> <td style="text-align: center;">2</td> <td style="text-align: center;">3</td> <td style="text-align: center;">4</td> <td style="text-align: center;">R06</td> <td style="text-align: center;">S06</td> <td style="text-align: center;">T06</td> <td style="text-align: center;">N06</td> <td style="text-align: center;">E6</td> <td style="text-align: center;">E6</td> <td style="text-align: center;">E6</td> <td style="text-align: center;">E6</td> <td style="text-align: center;">E6</td> </tr> <tr> <td></td> <td style="text-align: center;">1</td> <td style="text-align: center;">2</td> <td style="text-align: center;">3</td> <td style="text-align: center;">4</td> <td style="text-align: center;">R07</td> <td style="text-align: center;">S07</td> <td style="text-align: center;">T07</td> <td style="text-align: center;">N07</td> <td style="text-align: center;">E7</td> <td style="text-align: center;">E7</td> <td style="text-align: center;">E7</td> <td style="text-align: center;">E7</td> <td style="text-align: center;">E7</td> </tr> <tr> <td></td> <td style="text-align: center;">1</td> <td style="text-align: center;">2</td> <td style="text-align: center;">3</td> <td style="text-align: center;">4</td> <td style="text-align: center;">R08</td> <td style="text-align: center;">S08</td> <td style="text-align: center;">T08</td> <td style="text-align: center;">N08</td> <td style="text-align: center;">E8</td> <td style="text-align: center;">E8</td> <td style="text-align: center;">E8</td> <td style="text-align: center;">E8</td> <td style="text-align: center;">E8</td> </tr> </table> </td> <td style="width: 50%; vertical-align: top;"> <table border="0" style="width: 100%;"> <tr> <td style="width: 50%;"></td> <td style="width: 50%; text-align: center;"> <table border="0"> <tr> <td style="width: 10%;"></td> <td style="width: 10%;"></td> <td style="width: 10%;"></td> <td style="width: 10%;"></td> <td style="width: 10%;"></td> <td style="width: 10%;"></td> <td style="width: 10%;"></td> <td style="width: 10%;"></td> <td style="width: 10%;"></td> <td style="width: 10%;"></td> <td style="width: 10%;"></td> <td style="width: 10%;"></td> <td style="width: 10%;"></td> <td style="width: 10%;"></td> </tr> <tr> <td style="text-align: center;">XA</td> <td style="text-align: center;">1</td> <td style="text-align: center;">2</td> <td style="text-align: center;">3</td> <td style="text-align: center;">4</td> <td style="text-align: center;">R01</td> <td style="text-align: center;">S01</td> <td style="text-align: center;">T01</td> <td style="text-align: center;">N01</td> <td style="text-align: center;">E1</td> <td style="text-align: center;">E1</td> <td style="text-align: center;">E1</td> </tr></table></td></tr></table></td></tr></table></td></tr></table> | | <table border="0"> <tr> <td style="width: 10%;"></td> <td style="width: 10%;"></td> <td style="width: 10%;"></td> <td style="width: 10%;"></td> <td style="width: 10%;"></td> <td style="width: 10%;"></td> <td style="width: 10%;"></td> <td style="width: 10%;"></td> <td style="width: 10%;"></td> <td style="width: 10%;"></td> <td
style="width: 10%;"></td> <td style="width: 10%;"></td> <td style="width: 10%;"></td> <td style="width: 10%;"></td> </tr> <tr> <td style="text-align: center;">XA</td> <td style="text-align: center;">1</td> <td style="text-align: center;">2</td> <td style="text-align: center;">3</td> <td style="text-align: center;">4</td> <td style="text-align: center;">R01</td> <td style="text-align: center;">S01</td> <td style="text-align: center;">T01</td> <td style="text-align: center;">N01</td> <td style="text-align: center;">E1</td> <td style="text-align: center;">E1</td> <td style="text-align: center;">E1</td> <td style="text-align: center;">E1</td> <td style="text-align: center;">E1</td> </tr> <tr> <td></td> <td style="text-align: center;">1</td> <td style="text-align: center;">2</td> <td style="text-align: center;">3</td> <td style="text-align: center;">4</td> <td style="text-align: center;">R02</td> <td style="text-align: center;">S02</td> <td style="text-align: center;">T02</td> <td style="text-align: center;">N02</td> <td style="text-align: center;">E2</td> <td style="text-align: center;">E2</td> <td style="text-align: center;">E2</td> <td style="text-align: center;">E2</td> <td style="text-align: center;">E2</td> </tr> <tr> <td></td> <td style="text-align: center;">1</td> <td style="text-align: center;">2</td> <td style="text-align: center;">3</td> <td style="text-align: center;">4</td> <td style="text-align: center;">R03</td> <td style="text-align: center;">S03</td> <td style="text-align: center;">T03</td> <td style="text-align: center;">N03</td> <td style="text-align: center;">E3</td> <td style="text-align: center;">E3</td> <td style="text-align: center;">E3</td> <td style="text-align: center;">E3</td> <td style="text-align: center;">E3</td> </tr> <tr> <td></td> <td style="text-align: center;">1</td> <td style="text-align: center;">2</td> <td style="text-align: center;">3</td> <td style="text-align: center;">4</td> <td style="text-align: center;">R04</td> <td style="text-align: center;">S04</td> <td style="text-align: center;">T04</td> <td style="text-align: center;">N04</td> <td style="text-align: center;">E4</td> <td style="text-align: center;">E4</td> <td style="text-align: center;">E4</td> <td style="text-align: center;">E4</td> <td style="text-align: center;">E4</td> </tr> <tr> <td></td> <td style="text-align: center;">1</td> <td style="text-align: center;">2</td> <td style="text-align: center;">3</td> <td style="text-align: center;">4</td> <td style="text-align: center;">R05</td> <td style="text-align: center;">S05</td> <td style="text-align: center;">T05</td> <td style="text-align: center;">N05</td> <td style="text-align: center;">E5</td> <td style="text-align: center;">E5</td> <td style="text-align: center;">E5</td> <td style="text-align: center;">E5</td> <td style="text-align: center;">E5</td> </tr> <tr> <td></td> <td style="text-align: center;">1</td> <td style="text-align: center;">2</td> <td style="text-align: center;">3</td> <td style="text-align: center;">4</td> <td style="text-align: center;">R06</td> <td style="text-align: center;">S06</td> <td style="text-align: center;">T06</td> <td style="text-align: center;">N06</td> <td style="text-align: center;">E6</td> <td style="text-align: center;">E6</td> <td style="text-align: center;">E6</td> <td style="text-align: center;">E6</td> <td style="text-align: center;">E6</td> </tr> <tr> <td></td> <td style="text-align: center;">1</td> <td style="text-align: center;">2</td> <td style="text-align: center;">3</td> <td style="text-align: center;">4</td> <td style="text-align: center;">R07</td> <td style="text-align: center;">S07</td> <td style="text-align: center;">T07</td> <td style="text-align: center;">N07</td> <td style="text-align: center;">E7</td> <td style="text-align: center;">E7</td> <td style="text-align: center;">E7</td> <td style="text-align: center;">E7</td> <td style="text-align: center;">E7</td> </tr> <tr> <td></td> <td style="text-align: center;">1</td> <td style="text-align: center;">2</td> <td style="text-align: center;">3</td> <td style="text-align: center;">4</td> <td style="text-align: center;">R08</td> <td style="text-align: center;">S08</td> <td style="text-align: center;">T08</td> <td style="text-align: center;">N08</td> <td style="text-align: center;">E8</td> <td style="text-align: center;">E8</td> <td style="text-align: center;">E8</td> <td style="text-align: center;">E8</td> <td style="text-align: center;">E8</td> </tr> </table> | | | | | | | | | | | | | | | XA | 1 | 2 | 3 | 4 | R01 | S01 | T01 | N01 | E1 | E1 | E1
 | E1 | E1
 | | 1 | 2 | 3 | 4 | R02 | S02 | T02 | N02 | E2 | E2 | E2 | E2 | E2 | | 1 | 2 | 3 | 4 | R03 | S03 | T03 | N03 | E3 | E3 | E3 | E3 | E3 | | 1 | 2 | 3 | 4 | R04 | S04 | T04 | N04 | E4 | E4 | E4 | E4 | E4 | | 1 | 2 | 3 | 4 | R05 | S05 | T05 | N05 | E5 | E5 | E5 | E5 | E5 | | 1 | 2 | 3 | 4 | R06 | S06 | T06 | N06 | E6 | E6 | E6 | E6 | E6 | | 1 | 2 | 3 | 4 | R07 | S07 | T07 | N07 | E7 | E7 | E7 | E7 | E7 |
 | 1
 | 2 | 3 | 4 | R08 | S08 | T08 | N08 | E8 | E8 | E8 | E8 | E8 | <table border="0" style="width: 100%;"> <tr> <td style="width: 50%;"></td> <td style="width: 50%; text-align: center;"> <table border="0"> <tr> <td style="width: 10%;"></td> <td style="width: 10%;"></td> <td style="width: 10%;"></td> <td style="width: 10%;"></td> <td style="width: 10%;"></td> <td style="width: 10%;"></td> <td style="width: 10%;"></td> <td style="width: 10%;"></td> <td style="width: 10%;"></td> <td style="width: 10%;"></td> <td style="width: 10%;"></td> <td style="width: 10%;"></td> <td style="width: 10%;"></td> <td style="width: 10%;"></td> </tr> <tr> <td style="text-align: center;">XA</td> <td style="text-align: center;">1</td> <td style="text-align: center;">2</td> <td style="text-align: center;">3</td> <td style="text-align: center;">4</td> <td style="text-align: center;">R01</td> <td style="text-align: center;">S01</td> <td style="text-align: center;">T01</td> <td style="text-align: center;">N01</td> <td style="text-align: center;">E1</td> <td style="text-align: center;">E1</td> <td style="text-align: center;">E1</td> <td style="text-align: center;">E1</td> <td style="text-align: center;">E1</td> </tr> <tr> <td></td> <td style="text-align: center;">1</td> <td style="text-align: center;">2</td> <td style="text-align: center;">3</td> <td style="text-align: center;">4</td> <td style="text-align: center;">R02</td> <td style="text-align: center;">S02</td> <td style="text-align: center;">T02</td> <td style="text-align: center;">N02</td> <td style="text-align: center;">E2</td> <td style="text-align: center;">E2</td> <td style="text-align: center;">E2</td> <td style="text-align: center;">E2</td> <td style="text-align: center;">E2</td> </tr> <tr> <td></td> <td style="text-align: center;">1</td> <td style="text-align: center;">2</td> <td style="text-align: center;">3</td> <td style="text-align: center;">4</td> <td style="text-align: center;">R03</td> <td style="text-align: center;">S03</td> <td style="text-align: center;">T03</td> <td style="text-align: center;">N03</td> <td style="text-align: center;">E3</td> <td style="text-align: center;">E3</td> <td style="text-align: center;">E3</td> <td style="text-align: center;">E3</td> <td style="text-align: center;">E3</td> </tr> <tr> <td></td> <td style="text-align: center;">1</td> <td style="text-align: center;">2</td> <td style="text-align: center;">3</td> <td style="text-align: center;">4</td> <td style="text-align: center;">R04</td> <td style="text-align: center;">S04</td> <td style="text-align: center;">T04</td> <td style="text-align: center;">N04</td> <td style="text-align: center;">E4</td> <td style="text-align: center;">E4</td> <td style="text-align: center;">E4</td> <td style="text-align: center;">E4</td> <td style="text-align: center;">E4</td> </tr> <tr> <td></td> <td style="text-align: center;">1</td> <td style="text-align: center;">2</td> <td style="text-align: center;">3</td> <td style="text-align: center;">4</td> <td style="text-align: center;">R05</td> <td style="text-align: center;">S05</td> <td style="text-align: center;">T05</td> <td style="text-align: center;">N05</td> <td style="text-align: center;">E5</td> <td style="text-align: center;">E5</td> <td style="text-align: center;">E5</td> <td style="text-align: center;">E5</td> <td style="text-align: center;">E5</td> </tr> <tr> <td></td> <td style="text-align: center;">1</td> <td style="text-align: center;">2</td> <td style="text-align: center;">3</td> <td style="text-align: center;">4</td> <td style="text-align: center;">R06</td> <td style="text-align: center;">S06</td> <td style="text-align: center;">T06</td> <td style="text-align: center;">N06</td> <td style="text-align: center;">E6</td> <td style="text-align: center;">E6</td> <td style="text-align: center;">E6</td> <td style="text-align: center;">E6</td> <td style="text-align: center;">E6</td> </tr> <tr> <td></td> <td style="text-align: center;">1</td> <td style="text-align: center;">2</td> <td style="text-align: center;">3</td> <td style="text-align: center;">4</td> <td style="text-align: center;">R07</td> <td style="text-align: center;">S07</td> <td style="text-align: center;">T07</td> <td style="text-align: center;">N07</td> <td style="text-align: center;">E7</td> <td style="text-align: center;">E7</td> <td style="text-align: center;">E7</td> <td style="text-align: center;">E7</td> <td style="text-align: center;">E7</td> </tr> <tr> <td></td> <td style="text-align: center;">1</td> <td style="text-align: center;">2</td> <td style="text-align: center;">3</td> <td style="text-align: center;">4</td> <td style="text-align: center;">R08</td> <td style="text-align: center;">S08</td> <td style="text-align: center;">T08</td> <td style="text-align: center;">N08</td> <td style="text-align: center;">E8</td> <td style="text-align: center;">E8</td> <td style="text-align: center;">E8</td> <td style="text-align: center;">E8</td> <td style="text-align: center;">E8</td> </tr> </table> </td> <td style="width: 50%; vertical-align: top;"> <table border="0" style="width: 100%;"> <tr> <td style="width: 50%;"></td> <td style="width: 50%; text-align:
center;"> <table border="0"> <tr> <td style="width: 10%;"></td> <td style="width: 10%;"></td> <td style="width: 10%;"></td> <td style="width: 10%;"></td> <td style="width: 10%;"></td> <td style="width: 10%;"></td> <td style="width: 10%;"></td> <td style="width: 10%;"></td> <td style="width: 10%;"></td> <td style="width: 10%;"></td> <td style="width: 10%;"></td> <td style="width: 10%;"></td> <td style="width: 10%;"></td> <td style="width: 10%;"></td> </tr> <tr> <td style="text-align: center;">XA</td> <td style="text-align: center;">1</td> <td style="text-align: center;">2</td> <td style="text-align: center;">3</td> <td style="text-align: center;">4</td> <td style="text-align: center;">R01</td> <td style="text-align: center;">S01</td> <td style="text-align: center;">T01</td> <td style="text-align: center;">N01</td> <td style="text-align: center;">E1</td> <td style="text-align: center;">E1</td> <td style="text-align: center;">E1</td> </tr></table></td></tr></table></td></tr></table> | | <table border="0"> <tr> <td style="width: 10%;"></td> <td style="width: 10%;"></td> <td style="width: 10%;"></td> <td style="width: 10%;"></td> <td style="width: 10%;"></td> <td style="width: 10%;"></td> <td style="width: 10%;"></td> <td style="width: 10%;"></td> <td style="width: 10%;"></td> <td style="width: 10%;"></td> <td style="width: 10%;"></td> <td style="width: 10%;"></td> <td style="width: 10%;"></td> <td style="width: 10%;"></td> </tr> <tr> <td style="text-align: center;">XA</td> <td style="text-align: center;">1</td> <td style="text-align: center;">2</td> <td style="text-align: center;">3</td> <td style="text-align: center;">4</td> <td style="text-align: center;">R01</td> <td style="text-align: center;">S01</td> <td style="text-align: center;">T01</td> <td style="text-align: center;">N01</td> <td style="text-align: center;">E1</td> <td style="text-align: center;">E1</td> <td style="text-align: center;">E1</td> <td style="text-align: center;">E1</td> <td style="text-align: center;">E1</td> </tr> <tr> <td></td> <td style="text-align: center;">1</td> <td style="text-align: center;">2</td> <td style="text-align: center;">3</td> <td style="text-align: center;">4</td> <td style="text-align: center;">R02</td> <td style="text-align: center;">S02</td> <td style="text-align: center;">T02</td> <td style="text-align: center;">N02</td> <td style="text-align: center;">E2</td> <td style="text-align: center;">E2</td> <td style="text-align: center;">E2</td> <td style="text-align: center;">E2</td> <td style="text-align: center;">E2</td> </tr> <tr> <td></td> <td style="text-align: center;">1</td> <td style="text-align: center;">2</td> <td style="text-align: center;">3</td> <td style="text-align: center;">4</td> <td style="text-align: center;">R03</td> <td style="text-align: center;">S03</td> <td style="text-align: center;">T03</td> <td style="text-align: center;">N03</td> <td style="text-align: center;">E3</td> <td style="text-align: center;">E3</td> <td style="text-align: center;">E3</td> <td style="text-align: center;">E3</td> <td style="text-align: center;">E3</td> </tr> <tr> <td></td> <td style="text-align: center;">1</td> <td style="text-align: center;">2</td> <td style="text-align: center;">3</td> <td style="text-align: center;">4</td> <td style="text-align: center;">R04</td> <td style="text-align: center;">S04</td> <td style="text-align: center;">T04</td> <td style="text-align: center;">N04</td> <td style="text-align: center;">E4</td> <td style="text-align: center;">E4</td> <td style="text-align: center;">E4</td> <td style="text-align: center;">E4</td> <td style="text-align: center;">E4</td> </tr> <tr> <td></td> <td style="text-align: center;">1</td> <td style="text-align: center;">2</td> <td style="text-align: center;">3</td> <td style="text-align: center;">4</td> <td style="text-align: center;">R05</td> <td style="text-align: center;">S05</td> <td style="text-align: center;">T05</td> <td style="text-align: center;">N05</td> <td style="text-align: center;">E5</td> <td style="text-align: center;">E5</td> <td style="text-align: center;">E5</td> <td style="text-align: center;">E5</td> <td style="text-align: center;">E5</td> </tr> <tr> <td></td> <td style="text-align: center;">1</td> <td style="text-align: center;">2</td> <td style="text-align: center;">3</td> <td style="text-align: center;">4</td> <td style="text-align: center;">R06</td> <td style="text-align: center;">S06</td> <td style="text-align: center;">T06</td> <td style="text-align: center;">N06</td> <td style="text-align: center;">E6</td> <td style="text-align: center;">E6</td> <td style="text-align: center;">E6</td> <td style="text-align: center;">E6</td> <td style="text-align: center;">E6</td> </tr> <tr> <td></td> <td style="text-align: center;">1</td> <td style="text-align: center;">2</td> <td style="text-align: center;">3</td> <td style="text-align: center;">4</td> <td style="text-align: center;">R07</td> <td style="text-align: center;">S07</td> <td style="text-align: center;">T07</td> <td style="text-align: center;">N07</td> <td style="text-align: center;">E7</td> <td style="text-align: center;">E7</td> <td style="text-align: center;">E7</td> <td style="text-align: center;">E7</td> <td style="text-align: center;">E7</td> </tr> <tr> <td></td> <td style="text-align: center;">1</td> <td style="text-align: center;">2</td> <td style="text-align: center;">3</td> <td style="text-align: center;">4</td> <td style="text-align: center;">R08</td> <td style="text-align: center;">S08</td> <td style="text-align: center;">T08</td> <td style="text-align: center;">N08</td> <td style="text-align: center;">E8</td> <td style="text-align: center;">E8</td> <td style="text-align: center;">E8</td> <td style="text-align: center;">E8</td> <td style="text-align: center;">E8</td> </tr> </table> | | | | | | | | | | | | | | | XA | 1 | 2 | 3 | 4 | R01 | S01 | T01 | N01 | E1 | E1 | E1
 | E1 | E1 | | 1 | 2 | 3 | 4 | R02 | S02 | T02 | N02 | E2 | E2 | E2 | E2 | E2 | | 1 | 2 | 3 | 4 | R03 | S03 | T03 | N03 | E3 | E3 | E3 | E3 | E3 | | 1 | 2 | 3 | 4 | R04 | S04 | T04 | N04 | E4 | E4 | E4 | E4 | E4 | | 1 | 2 | 3 | 4 | R05 | S05 | T05 | N05 | E5 | E5 | E5 | E5 | E5 | | 1 | 2 | 3 | 4 | R06 | S06 | T06 | N06 | E6 | E6 | E6 | E6 | E6 | | 1 | 2 | 3 | 4 | R07 | S07 | T07 | N07 | E7 | E7 | E7 | E7 | E7 | | 1
 | 2 | 3 | 4 | R08 | S08 | T08 | N08 | E8 | E8 | E8 | E8 | E8 | <table border="0" style="width: 100%;"> <tr> <td style="width: 50%;"></td> <td style="width: 50%; text-align: center;"> <table border="0"> <tr> <td style="width: 10%;"></td> <td style="width: 10%;"></td> <td style="width: 10%;"></td> <td style="width: 10%;"></td> <td style="width: 10%;"></td> <td style="width: 10%;"></td> <td style="width: 10%;"></td> <td style="width: 10%;"></td> <td style="width: 10%;"></td> <td style="width: 10%;"></td> <td style="width: 10%;"></td> <td style="width: 10%;"></td> <td style="width: 10%;"></td> <td style="width: 10%;"></td> </tr> <tr> <td style="text-align: center;">XA</td> <td style="text-align: center;">1</td> <td style="text-align: center;">2</td> <td style="text-align: center;">3</td> <td style="text-align: center;">4</td> <td style="text-align: center;">R01</td> <td style="text-align: center;">S01</td> <td style="text-align: center;">T01</td> <td style="text-align: center;">N01</td> <td style="text-align: center;">E1</td> <td style="text-align: center;">E1</td> <td style="text-align: center;">E1</td> </tr></table></td></tr></table> | | <table border="0"> <tr> <td style="width: 10%;"></td> <td style="width: 10%;"></td> <td style="width: 10%;"></td> <td style="width: 10%;"></td> <td style="width: 10%;"></td> <td style="width: 10%;"></td> <td style="width: 10%;"></td> <td style="width: 10%;"></td> <td style="width: 10%;"></td> <td style="width: 10%;"></td> <td style="width: 10%;"></td> <td style="width: 10%;"></td> <td style="width: 10%;"></td> <td style="width: 10%;"></td> </tr> <tr> <td style="text-align: center;">XA</td> <td style="text-align: center;">1</td> <td style="text-align: center;">2</td> <td style="text-align: center;">3</td> <td style="text-align: center;">4</td> <td style="text-align: center;">R01</td> <td style="text-align: center;">S01</td> <td style="text-align: center;">T01</td> <td style="text-align: center;">N01</td> <td style="text-align: center;">E1</td> <td style="text-align: center;">E1</td> <td style="text-align: center;">E1</td> </tr></table> | | | | | | | | | | | | | | | XA | 1 | 2 | 3 | 4 | R01 | S01 | T01 | N01 | E1 | E1 | E1 | | | | | | | | | | | | | | | | | | | | | | | | | | | | |
| <table border="0" style="width: 100%;"> <tr> <td style="width: 50%;"></td> <td style="width: 50%; text-align: center;"> <table border="0"> <tr> <td style="width: 10%;"></td> <td style="width: 10%;"></td> <td style="width: 10%;"></td> <td style="width: 10%;"></td> <td style="width: 10%;"></td> <td style="width: 10%;"></td> <td style="width: 10%;"></td> <td style="width: 10%;"></td> <td style="width: 10%;"></td> <td style="width: 10%;"></td> <td style="width: 10%;"></td> <td style="width: 10%;"></td> <td style="width: 10%;"></td> <td style="width: 10%;"></td> </tr> <tr> <td style="text-align: center;">XA</td> <td style="text-align: center;">1/G</td> <td style="text-align: center;">2/G</td> <td style="text-align: center;">3/G</td> <td style="text-align: center;">4/G</td> <td style="text-align: center;">R</td> <td style="text-align: center;">S</td> <td style="text-align: center;">T</td> <td style="text-align: center;">N</td> <td style="text-align: center;">E0</td> <td style="text-align: center;">E0</td> <td style="text-align: center;">E0</td> <td style="text-align: center;">E0</td> <td style="text-align: center;">E0</td> </tr> <tr> <td></td> <td style="text-align: center;">1</td> <td style="text-align: center;">2</td> <td style="text-align: center;">3</td> <td style="text-align: center;">4</td> <td style="text-align: center;">R01</td> <td style="text-align: center;">S01</td> <td style="text-align: center;">T01</td> <td style="text-align: center;">N01</td> <td style="text-align: center;">E1</td> <td style="text-align: center;">E1</td> <td style="text-align: center;">E1</td> <td style="text-align: center;">E1</td> <td style="text-align: center;">E1</td> </tr> <tr> <td></td> <td style="text-align: center;">1</td> <td style="text-align: center;">2</td> <td style="text-align: center;">3</td> <td style="text-align: center;">4</td> <td style="text-align: center;">R02</td> <td style="text-align: center;">S02</td> <td style="text-align: center;">T02</td> <td style="text-align: center;">N02</td> <td style="text-align: center;">E2</td> <td style="text-align: center;">E2</td> <td style="text-align: center;">E2</td> <td style="text-align: center;">E2</td> <td style="text-align: center;">E2</td> </tr> <tr> <td></td> <td style="text-align: center;">1</td> <td style="text-align: center;">2</td> <td style="text-align: center;">3</td> <td style="text-align: center;">4</td> <td style="text-align: center;">R03</td> <td style="text-align: center;">S03</td> <td style="text-align: center;">T03</td> <td style="text-align: center;">N03</td> <td style="text-align: center;">E3</td> <td style="text-align: center;">E3</td> <td style="text-align: center;">E3</td> <td style="text-align: center;">E3</td> <td style="text-align: center;">E3</td> </tr> <tr> <td></td> <td style="text-align: center;">1</td> <td style="text-align: center;">2</td> <td style="text-align: center;">3</td> <td style="text-align: center;">4</td> <td style="text-align: center;">R04</td> <td style="text-align: center;">S04</td> <td style="text-align: center;">T04</td> <td style="text-align: center;">N04</td> <td style="text-align: center;">E4</td> <td style="text-align: center;">E4</td> <td style="text-align: center;">E4</td> <td style="text-align: center;">E4</td> <td style="text-align: center;">E4</td> </tr> <tr> <td></td> <td style="text-align: center;">1</td> <td style="text-align: center;">2</td> <td style="text-align: center;">3</td> <td style="text-align: center;">4</td> <td style="text-align: center;">R05</td> <td style="text-align: center;">S05</td> <td style="text-align: center;">T05</td> <td style="text-align: center;">N05</td> <td style="text-align: center;">E5</td> <td style="text-align: center;">E5</td> <td style="text-align: center;">E5</td> <td style="text-align: center;">E5</td> <td style="text-align: center;">E5</td> </tr> <tr> <td></td> <td style="text-align: center;">1</td> <td style="text-align: center;">2</td> <td style="text-align: center;">3</td> <td style="text-align: center;">4</td> <td style="text-align: center;">R06</td> <td style="text-align: center;">S06</td> <td style="text-align: center;">T06</td> <td style="text-align: center;">N06</td> <td style="text-align: center;">E6</td> <td style="text-align: center;">E6</td> <td style="text-align: center;">E6</td> <td style="text-align: center;">E6</td> <td style="text-align: center;">E6</td> </tr> <tr> <td></td> <td style="text-align: center;">1</td> <td style="text-align: center;">2</td> <td style="text-align: center;">3</td> <td style="text-align: center;">4</td> <td style="text-align: center;">R07</td> <td style="text-align: center;">S07</td> <td style="text-align: center;">T07</td> <td style="text-align: center;">N07</td> <td style="text-align: center;">E7</td> <td style="text-align: center;">E7</td> <td style="text-align: center;">E7</td> <td style="text-align: center;">E7</td> <td style="text-align: center;">E7</td> </tr> <tr> <td></td> <td style="text-align: center;">1</td> <td style="text-align: center;">2</td> <td style="text-align: center;">3</td> <td style="text-align: center;">4</td> <td style="text-align: center;">R08</td> <td style="text-align: center;">S08</td> <td style="text-align: center;">T08</td> <td style="text-align: center;">N08</td> <td style="text-align: center;">E8</td> <td style="text-align: center;">E8</td> <td style="text-align: center;">E8</td> <td style="text-align: center;">E8</td> <td style="text-align: center;">E8</td> </tr> </table> </td> <td style="width: 50%; vertical-align: top;"> <table border="0" style="width: 100%;"> <tr> <td style="width: 50%;"></td> <td style="width: 50%; text-align: center;"> <table border="0"> <tr> <td style="width: 10%;"></td> <td style="width: 10%;"></td> <td style="width: 10%;"></td> <td style="width: 10%;"></td> <td style="width: 10%;"></td> <td style="width: 10%;"></td> <td style="width: 10%;"></td> <td style="width: 10%;"></td> <td style="width: 10%;"></td> <td style="width: 10%;"></td> <td style="width: 10%;"></td> <td style="width: 10%;"></td> <td style="width: 10%;"></td> <td style="width: 10%;"></td> </tr> <tr> <td style="text-align: center;">XA</td> <td style="text-align: center;">1</td> <td style="text-align: center;">2</td> <td style="text-align: center;">3</td> <td style="text-align: center;">4</td> <td style="text-align: center;">R01</td> <td style="text-align: center;">S01</td> <td style="text-align: center;">T01</td> <td style="text-align: center;">N01</td> <td style="text-align: center;">E1</td> <td style="text-align: center;">E1</td> <td style="text-align: center;">E1</td> <td style="text-align: center;">E1</td> <td style="text-align: center;">E1</td> </tr> <tr> <td></td> <td style="text-align: center;">1</td> <td style="text-align: center;">2</td> <td style="text-align: center;">3</td> <td style="text-align: center;">4</td> <td style="text-align: center;">R02</td> <td style="text-align: center;">S02</td> <td style="text-align: center;">T02</td> <td style="text-align: center;">N02</td> <td style="text-align: center;">E2</td> <td style="text-align: center;">E2</td> <td style="text-align: center;">E2</td> <td style="text-align: center;">E2</td> <td style="text-align: center;">E2</td> </tr> <tr> <td></td> <td style="text-align: center;">1</td> <td style="text-align: center;">2</td> <td style="text-align: center;">3</td> <td style="text-align: center;">4</td> <td style="text-align: center;">R03</td> <td style="text-align: center;">S03</td> <td style="text-align: center;">T03</td> <td style="text-align: center;">N03</td> <td style="text-align: center;">E3</td> <td style="text-align: center;">E3</td> <td style="text-align: center;">E3</td> <td style="text-align: center;">E3</td> <td style="text-align: center;">E3</td> </tr> <tr> <td></td> <td style="text-align: center;">1</td> <td style="text-align: center;">2</td> <td style="text-align: center;">3</td> <td style="text-align: center;">4</td> <td style="text-align: center;">R04</td> <td style="text-align: center;">S04</td> <td style="text-align: center;">T04</td> <td style="text-align: center;">N04</td> <td style="text-align: center;">E4</td> <td style="text-align: center;">E4</td> <td style="text-align: center;">E4</td> <td style="text-align: center;">E4</td> <td style="text-align: center;">E4</td> </tr> <tr> <td></td> <td style="text-align: center;">1</td> <td style="text-align: center;">2</td> <td style="text-align: center;">3</td> <td style="text-align: center;">4</td> <td style="text-align: center;">R05</td> <td style="text-align: center;">S05</td> <td style="text-align: center;">T05</td> <td style="text-align: center;">N05</td> <td style="text-align: center;">E5</td> <td style="text-align: center;">E5</td> <td style="text-align: center;">E5</td> <td style="text-align: center;">E5</td> <td style="text-align: center;">E5</td> </tr> <tr> <td></td> <td style="text-align: center;">1</td> <td style="text-align: center;">2</td> <td style="text-align: center;">3</td> <td style="text-align: center;">4</td> <td style="text-align: center;">R06</td> <td style="text-align: center;">S06</td> <td style="text-align: center;">T06</td> <td style="text-align: center;">N06</td> <td style="text-align: center;">E6</td> <td style="text-align: center;">E6</td> <td style="text-align: center;">E6</td> <td style="text-align: center;">E6</td> <td style="text-align: center;">E6</td> </tr> <tr> <td></td> <td style="text-align: center;">1</td> <td style="text-align: center;">2</td> <td style="text-align: center;">3</td> <td style="text-align: center;">4</td> <td style="text-align: center;">R07</td> <td style="text-align: center;">S07</td> <td style="text-align: center;">T07</td> <td style="text-align: center;">N07</td> <td style="text-align: center;">E7</td> <td style="text-align: center;">E7</td> <td style="text-align: center;">E7</td> <td style="text-align: center;">E7</td> <td style="text-align: center;">E7</td> </tr> <tr> <td></td> <td style="text-align: center;">1</td> <td style="text-align:
center;">2</td> <td style="text-align: center;">3</td> <td style="text-align: center;">4</td> <td style="text-align: center;">R08</td> <td style="text-align: center;">S08</td> <td style="text-align: center;">T08</td> <td style="text-align: center;">N08</td> <td style="text-align: center;">E8</td> <td style="text-align: center;">E8</td> <td style="text-align: center;">E8</td> <td style="text-align: center;">E8</td> <td style="text-align: center;">E8</td> </tr> </table> </td> <td style="width: 50%; vertical-align: top;"> <table border="0" style="width: 100%;"> <tr> <td style="width: 50%;"></td> <td style="width: 50%; text-align: center;"> <table border="0"> <tr> <td style="width: 10%;"></td> <td style="width: 10%;"></td> <td style="width: 10%;"></td> <td style="width: 10%;"></td> <td style="width: 10%;"></td> <td style="width: 10%;"></td> <td style="width: 10%;"></td> <td style="width: 10%;"></td> <td style="width: 10%;"></td> <td style="width: 10%;"></td> <td style="width: 10%;"></td> <td style="width: 10%;"></td> <td style="width: 10%;"></td> <td style="width: 10%;"></td> </tr> <tr> <td style="text-align: center;">XA</td> <td style="text-align: center;">1</td> <td style="text-align: center;">2</td> <td style="text-align: center;">3</td> <td style="text-align: center;">4</td> <td style="text-align: center;">R01</td> <td style="text-align: center;">S01</td> <td style="text-align: center;">T01</td> <td style="text-align: center;">N01</td> <td style="text-align: center;">E1</td> <td style="text-align: center;">E1</td> <td style="text-align: center;">E1</td> <td style="text-align: center;">E1</td> <td style="text-align: center;">E1</td> </tr> <tr> <td></td> <td style="text-align: center;">1</td> <td style="text-align: center;">2</td> <td style="text-align: center;">3</td> <td style="text-align: center;">4</td> <td style="text-align: center;">R02</td> <td style="text-align: center;">S02</td> <td style="text-align: center;">T02</td> <td style="text-align: center;">N02</td> <td style="text-align: center;">E2</td> <td style="text-align: center;">E2</td> <td style="text-align: center;">E2</td> <td style="text-align: center;">E2</td> <td style="text-align: center;">E2</td> </tr> <tr> <td></td> <td style="text-align: center;">1</td> <td style="text-align: center;">2</td> <td style="text-align: center;">3</td> <td style="text-align: center;">4</td> <td style="text-align: center;">R03</td> <td style="text-align: center;">S03</td> <td style="text-align: center;">T03</td> <td style="text-align: center;">N03</td> <td style="text-align: center;">E3</td> <td style="text-align: center;">E3</td> <td style="text-align: center;">E3</td> <td style="text-align: center;">E3</td> <td style="text-align: center;">E3</td> </tr> <tr> <td></td> <td style="text-align: center;">1</td> <td style="text-align: center;">2</td> <td style="text-align: center;">3</td> <td style="text-align: center;">4</td> <td style="text-align: center;">R04</td> <td style="text-align: center;">S04</td> <td style="text-align: center;">T04</td> <td style="text-align: center;">N04</td> <td style="text-align: center;">E4</td> <td style="text-align: center;">E4</td> <td style="text-align: center;">E4</td> <td style="text-align: center;">E4</td> <td style="text-align: center;">E4</td> </tr> <tr> <td></td> <td style="text-align: center;">1</td> <td style="text-align: center;">2</td> <td style="text-align: center;">3</td> <td style="text-align: center;">4</td> <td style="text-align: center;">R05</td> <td style="text-align: center;">S05</td> <td style="text-align: center;">T05</td> <td style="text-align: center;">N05</td> <td style="text-align: center;">E5</td> <td style="text-align: center;">E5</td> <td style="text-align: center;">E5</td> <td style="text-align: center;">E5</td> <td style="text-align: center;">E5</td> </tr> <tr> <td></td> <td style="text-align: center;">1</td> <td style="text-align: center;">2</td> <td style="text-align: center;">3</td> <td style="text-align: center;">4</td> <td style="text-align: center;">R06</td> <td style="text-align: center;">S06</td> <td style="text-align: center;">T06</td> <td style="text-align: center;">N06</td> <td style="text-align: center;">E6</td> <td style="text-align: center;">E6</td> <td style="text-align: center;">E6</td> <td style="text-align: center;">E6</td> <td style="text-align: center;">E6</td> </tr> <tr> <td></td> <td style="text-align: center;">1</td> <td style="text-align: center;">2</td> <td style="text-align: center;">3</td> <td style="text-align: center;">4</td> <td style="text-align: center;">R07</td> <td style="text-align: center;">S07</td> <td style="text-align: center;">T07</td> <td style="text-align: center;">N07</td> <td style="text-align: center;">E7</td> <td style="text-align: center;">E7</td> <td style="text-align: center;">E7</td> <td style="text-align: center;">E7</td> <td style="text-align: center;">E7</td> </tr> <tr> <td></td> <td style="text-align: center;">1</td> <td style="text-align: center;">2</td> <td style="text-align: center;">3</td> <td style="text-align: center;">4</td> <td style="text-align: center;">R08</td> <td style="text-align: center;">S08</td> <td style="text-align: center;">T08</td> <td style="text-align: center;">N08</td> <td style="text-align: center;">E8</td> <td style="text-align: center;">E8</td> <td style="text-align: center;">E8</td> <td style="text-align: center;">E8</td> <td style="text-align: center;">E8</td> </tr> </table> </td> <td style="width: 50%; vertical-align: top;"> <table border="0" style="width: 100%;"> <tr> <td style="width: 50%;"></td> <td style="width: 50%; text-align: center;"> <table border="0"> <tr> <td style="width: 10%;"></td> <td style="width: 10%;"></td> <td style="width: 10%;"></td> <td style="width: 10%;"></td> <td style="width: 10%;"></td> <td style="width: 10%;"></td> <td style="width: 10%;"></td> <td style="width: 10%;"></td> <td style="width: 10%;"></td> <td style="width: 10%;"></td> <td style="width: 10%;"></td> <td style="width: 10%;"></td> <td style="width: 10%;"></td> <td style="width: 10%;"></td> </tr> <tr> <td style="text-align: center;">XA</td> <td style="text-align: center;">1</td> <td style="text-align: center;">2</td> <td style="text-align: center;">3</td> <td style="text-align: center;">4</td> <td style="text-align: center;">R01</td> <td style="text-align: center;">S01</td> <td style="text-align: center;">T01</td> <td style="text-align: center;">N01</td> <td style="text-align: center;">E1</td> <td style="text-align: center;">E1</td> <td style="text-align: center;">E1</td> <td style="text-align: center;">E1</td> <td style="text-align: center;">E1</td> </tr> <tr> <td></td> <td style="text-align: center;">1</td> <td style="text-align: center;">2</td> <td style="text-align: center;">3</td> <td style="text-align: center;">4</td> <td style="text-align: center;">R02</td> <td style="text-align: center;">S02</td> <td style="text-align: center;">T02</td> <td style="text-align: center;">N02</td> <td style="text-align: center;">E2</td> <td style="text-align: center;">E2</td> <td style="text-align: center;">E2</td> <td style="text-align: center;">E2</td> <td style="text-align: center;">E2</td> </tr> <tr> <td></td> <td style="text-align: center;">1</td> <td style="text-align: center;">2</td> <td style="text-align: center;">3</td> <td style="text-align: center;">4</td> <td style="text-align: center;">R03</td> <td style="text-align: center;">S03</td> <td style="text-align: center;">T03</td> <td style="text-align: center;">N03</td> <td style="text-align: center;">E3</td> <td style="text-align: center;">E3</td> <td style="text-align: center;">E3</td> <td style="text-align: center;">E3</td> <td style="text-align: center;">E3</td> </tr> <tr> <td></td> <td style="text-align: center;">1</td> <td style="text-align: center;">2</td> <td style="text-align: center;">3</td> <td style="text-align: center;">4</td> <td style="text-align: center;">R04</td> <td style="text-align: center;">S04</td> <td style="text-align: center;">T04</td> <td style="text-align: center;">N04</td> <td style="text-align: center;">E4</td> <td style="text-align: center;">E4</td> <td style="text-align: center;">E4</td> <td style="text-align: center;">E4</td> <td style="text-align: center;">E4</td> </tr> <tr> <td></td> <td style="text-align: center;">1</td> <td style="text-align: center;">2</td> <td style="text-align: center;">3</td> <td style="text-align: center;">4</td> <td style="text-align: center;">R05</td> <td style="text-align: center;">S05</td> <td style="text-align: center;">T05</td> <td style="text-align: center;">N05</td> <td style="text-align: center;">E5</td> <td style="text-align: center;">E5</td> <td style="text-align: center;">E5</td> <td style="text-align: center;">E5</td> <td style="text-align: center;">E5</td> </tr> <tr> <td></td> <td style="text-align: center;">1</td> <td style="text-align: center;">2</td> <td style="text-align: center;">3</td> <td style="text-align: center;">4</td> <td style="text-align: center;">R06</td> <td style="text-align: center;">S06</td> <td style="text-align: center;">T06</td> <td style="text-align: center;">N06</td> <td style="text-align: center;">E6</td> <td style="text-align: center;">E6</td> <td style="text-align: center;">E6</td> <td style="text-align: center;">E6</td> <td style="text-align: center;">E6</td> </tr> <tr> <td></td> <td style="text-align: center;">1</td> <td style="text-align: center;">2</td> <td style="text-align: center;">3</td> <td style="text-align: center;">4</td> <td style="text-align: center;">R07</td> <td style="text-align: center;">S07</td> <td style="text-align: center;">T07</td> <td style="text-align: center;">N07</td> <td style="text-align: center;">E7</td> <td style="text-align: center;">E7</td> <td style="text-align: center;">E7</td> <td style="text-align: center;">E7</td> <td style="text-align: center;">E7</td> </tr> <tr> <td></td> <td style="text-align: center;">1</td> <td style="text-align: center;">2</td> <td
style="text-align: center;">3</td> <td style="text-align: center;">4</td> <td style="text-align: center;">R08</td> <td style="text-align: center;">S08</td> <td style="text-align: center;">T08</td> <td style="text-align: center;">N08</td> <td style="text-align: center;">E8</td> <td style="text-align: center;">E8</td> <td style="text-align: center;">E8</td> <td style="text-align: center;">E8</td> <td style="text-align: center;">E8</td> </tr> </table> </td> <td style="width: 50%; vertical-align: top;"> <table border="0" style="width: 100%;"> <tr> <td style="width: 50%;"></td> <td style="width: 50%; text-align: center;"> <table border="0"> <tr> <td style="width: 10%;"></td> <td style="width: 10%;"></td> <td style="width: 10%;"></td> <td style="width: 10%;"></td> <td style="width: 10%;"></td> <td style="width: 10%;"></td> <td style="width: 10%;"></td> <td style="width: 10%;"></td> <td style="width: 10%;"></td> <td style="width: 10%;"></td> <td style="width: 10%;"></td> <td style="width: 10%;"></td> <td style="width: 10%;"></td> <td style="width: 10%;"></td> </tr> <tr> <td style="text-align: center;">XA</td> <td style="text-align: center;">1</td> <td style="text-align: center;">2</td> <td style="text-align: center;">3</td> <td style="text-align: center;">4</td> <td style="text-align: center;">R01</td> <td style="text-align: center;">S01</td> <td style="text-align: center;">T01</td> <td style="text-align: center;">N01</td> <td style="text-align: center;">E1</td> <td style="text-align: center;">E1</td> <td style="text-align: center;">E1</td> <td style="text-align: center;">E1</td> <td style="text-align: center;">E1</td> </tr> <tr> <td></td> <td style="text-align: center;">1</td> <td style="text-align: center;">2</td> <td style="text-align: center;">3</td> <td style="text-align: center;">4</td> <td style="text-align: center;">R02</td> <td style="text-align: center;">S02</td> <td style="text-align: center;">T02</td> <td style="text-align: center;">N02</td> <td style="text-align: center;">E2</td> <td style="text-align: center;">E2</td> <td style="text-align: center;">E2</td> <td style="text-align: center;">E2</td> <td style="text-align: center;">E2</td> </tr> <tr> <td></td> <td style="text-align: center;">1</td> <td style="text-align: center;">2</td> <td style="text-align: center;">3</td> <td style="text-align: center;">4</td> <td style="text-align: center;">R03</td> <td style="text-align: center;">S03</td> <td style="text-align: center;">T03</td> <td style="text-align: center;">N03</td> <td style="text-align: center;">E3</td> <td style="text-align: center;">E3</td> <td style="text-align: center;">E3</td> <td style="text-align: center;">E3</td> <td style="text-align: center;">E3</td> </tr> <tr> <td></td> <td style="text-align: center;">1</td> <td style="text-align: center;">2</td> <td style="text-align: center;">3</td> <td style="text-align: center;">4</td> <td style="text-align: center;">R04</td> <td style="text-align: center;">S04</td> <td style="text-align: center;">T04</td> <td style="text-align: center;">N04</td> <td style="text-align: center;">E4</td> <td style="text-align: center;">E4</td> <td style="text-align: center;">E4</td> <td style="text-align: center;">E4</td> <td style="text-align: center;">E4</td> </tr> <tr> <td></td> <td style="text-align: center;">1</td> <td style="text-align: center;">2</td> <td style="text-align: center;">3</td> <td style="text-align: center;">4</td> <td style="text-align: center;">R05</td> <td style="text-align: center;">S05</td> <td style="text-align: center;">T05</td> <td style="text-align: center;">N05</td> <td style="text-align: center;">E5</td> <td style="text-align: center;">E5</td> <td style="text-align: center;">E5</td> <td style="text-align: center;">E5</td> <td style="text-align: center;">E5</td> </tr> <tr> <td></td> <td style="text-align: center;">1</td> <td style="text-align: center;">2</td> <td style="text-align: center;">3</td> <td style="text-align: center;">4</td> <td style="text-align: center;">R06</td> <td style="text-align: center;">S06</td> <td style="text-align: center;">T06</td> <td style="text-align: center;">N06</td> <td style="text-align: center;">E6</td> <td style="text-align: center;">E6</td> <td style="text-align: center;">E6</td> <td style="text-align: center;">E6</td> <td style="text-align: center;">E6</td> </tr> <tr> <td></td> <td style="text-align: center;">1</td> <td style="text-align: center;">2</td> <td style="text-align: center;">3</td> <td style="text-align: center;">4</td> <td style="text-align: center;">R07</td> <td style="text-align: center;">S07</td> <td style="text-align: center;">T07</td> <td style="text-align: center;">N07</td> <td style="text-align: center;">E7</td> <td style="text-align: center;">E7</td> <td style="text-align: center;">E7</td> <td style="text-align: center;">E7</td> <td style="text-align: center;">E7</td> </tr> <tr> <td></td> <td style="text-align: center;">1</td> <td style="text-align: center;">2</td> <td style="text-align: center;">3</td> <td style="text-align: center;">4</td> <td style="text-align: center;">R08</td> <td style="text-align: center;">S08</td> <td style="text-align: center;">T08</td> <td style="text-align: center;">N08</td> <td style="text-align: center;">E8</td> <td style="text-align: center;">E8</td> <td style="text-align: center;">E8</td> <td style="text-align: center;">E8</td> <td style="text-align: center;">E8</td> </tr> </table> </td> <td style="width: 50%; vertical-align: top;"> <table border="0" style="width: 100%;"> <tr> <td style="width: 50%;"></td> <td style="width: 50%; text-align: center;"> <table border="0"> <tr> <td style="width: 10%;"></td> <td style="width: 10%;"></td> <td style="width: 10%;"></td> <td style="width: 10%;"></td> <td style="width: 10%;"></td> <td style="width: 10%;"></td> <td style="width: 10%;"></td> <td style="width: 10%;"></td> <td style="width: 10%;"></td> <td style="width: 10%;"></td> <td style="width: 10%;"></td> <td style="width: 10%;"></td> <td style="width: 10%;"></td> <td style="width: 10%;"></td> </tr> <tr> <td style="text-align: center;">XA</td> <td style="text-align: center;">1</td> <td style="text-align: center;">2</td> <td style="text-align: center;">3</td> <td style="text-align: center;">4</td> <td style="text-align: center;">R01</td> <td style="text-align: center;">S01</td> <td style="text-align: center;">T01</td> <td style="text-align: center;">N01</td> <td style="text-align: center;">E1</td> <td style="text-align: center;">E1</td> <td style="text-align: center;">E1</td> <td style="text-align: center;">E1</td> <td style="text-align: center;">E1</td> </tr> <tr> <td></td> <td style="text-align: center;">1</td> <td style="text-align: center;">2</td> <td style="text-align: center;">3</td> <td style="text-align: center;">4</td> <td style="text-align: center;">R02</td> <td style="text-align: center;">S02</td> <td style="text-align: center;">T02</td> <td style="text-align: center;">N02</td> <td style="text-align: center;">E2</td> <td style="text-align: center;">E2</td> <td style="text-align: center;">E2</td> <td style="text-align: center;">E2</td> <td style="text-align: center;">E2</td> </tr> <tr> <td></td> <td style="text-align: center;">1</td> <td style="text-align: center;">2</td> <td style="text-align: center;">3</td> <td style="text-align: center;">4</td> <td style="text-align: center;">R03</td> <td style="text-align: center;">S03</td> <td style="text-align: center;">T03</td> <td style="text-align: center;">N03</td> <td style="text-align: center;">E3</td> <td style="text-align: center;">E3</td> <td style="text-align: center;">E3</td> <td style="text-align: center;">E3</td> <td style="text-align: center;">E3</td> </tr> <tr> <td></td> <td style="text-align: center;">1</td> <td style="text-align: center;">2</td> <td style="text-align: center;">3</td> <td style="text-align: center;">4</td> <td style="text-align: center;">R04</td> <td style="text-align: center;">S04</td> <td style="text-align: center;">T04</td> <td style="text-align: center;">N04</td> <td style="text-align: center;">E4</td> <td style="text-align: center;">E4</td> <td style="text-align: center;">E4</td> <td style="text-align: center;">E4</td> <td style="text-align: center;">E4</td> </tr> <tr> <td></td> <td style="text-align: center;">1</td> <td style="text-align: center;">2</td> <td style="text-align: center;">3</td> <td style="text-align: center;">4</td> <td style="text-align: center;">R05</td> <td style="text-align: center;">S05</td> <td style="text-align: center;">T05</td> <td style="text-align: center;">N05</td> <td style="text-align: center;">E5</td> <td style="text-align: center;">E5</td> <td style="text-align: center;">E5</td> <td style="text-align: center;">E5</td> <td style="text-align: center;">E5</td> </tr> <tr> <td></td> <td style="text-align: center;">1</td> <td style="text-align: center;">2</td> <td style="text-align: center;">3</td> <td style="text-align: center;">4</td> <td style="text-align: center;">R06</td> <td style="text-align: center;">S06</td> <td style="text-align: center;">T06</td> <td style="text-align: center;">N06</td> <td style="text-align: center;">E6</td> <td style="text-align: center;">E6</td> <td style="text-align: center;">E6</td> <td style="text-align: center;">E6</td> <td style="text-align: center;">E6</td> </tr> <tr> <td></td> <td style="text-align: center;">1</td> <td style="text-align: center;">2</td> <td style="text-align: center;">3</td> <td style="text-align: center;">4</td> <td style="text-align: center;">R07</td> <td style="text-align: center;">S07</td> <td style="text-align: center;">T07</td> <td style="text-align: center;">N07</td> <td style="text-align: center;">E7</td> <td style="text-align: center;">E7</td> <td style="text-align: center;">E7</td> <td style="text-align: center;">E7</td> <td style="text-align: center;">E7</td> </tr> <tr> <td></td> <td style="text-align: center;">1</td> <td style="text-align: center;">2</td> <td style="text-align:
center;">3</td> <td style="text-align: center;">4</td> <td style="text-align: center;">R08</td> <td style="text-align: center;">S08</td> <td style="text-align: center;">T08</td> <td style="text-align: center;">N08</td> <td style="text-align: center;">E8</td> <td style="text-align: center;">E8</td> <td style="text-align: center;">E8</td> <td style="text-align: center;">E8</td> <td style="text-align: center;">E8</td> </tr> </table> </td> <td style="width: 50%; vertical-align: top;"> <table border="0" style="width: 100%;"> <tr> <td style="width: 50%;"></td> <td style="width: 50%; text-align: center;"> <table border="0"> <tr> <td style="width: 10%;"></td> <td style="width: 10%;"></td> <td style="width: 10%;"></td> <td style="width: 10%;"></td> <td style="width: 10%;"></td> <td style="width: 10%;"></td> <td style="width: 10%;"></td> <td style="width: 10%;"></td> <td style="width: 10%;"></td> <td style="width: 10%;"></td> <td style="width: 10%;"></td> <td style="width: 10%;"></td> <td style="width: 10%;"></td> <td style="width: 10%;"></td> </tr> <tr> <td style="text-align: center;">XA</td> <td style="text-align: center;">1</td> <td style="text-align: center;">2</td> <td style="text-align: center;">3</td> <td style="text-align: center;">4</td> <td style="text-align: center;">R01</td> <td style="text-align: center;">S01</td> <td style="text-align: center;">T01</td> <td style="text-align: center;">N01</td> <td style="text-align: center;">E1</td> <td style="text-align: center;">E1</td> <td style="text-align: center;">E1</td> </tr></table></td></tr></table></td></tr></table></td></tr></table></td></tr></table></td></tr></table></td></tr></table></td></tr></table> | | <table border="0"> <tr> <td style="width: 10%;"></td> <td style="width: 10%;"></td> <td style="width: 10%;"></td> <td style="width: 10%;"></td> <td style="width: 10%;"></td> <td style="width: 10%;"></td> <td style="width: 10%;"></td> <td style="width: 10%;"></td> <td style="width: 10%;"></td> <td style="width: 10%;"></td> <td style="width: 10%;"></td> <td style="width: 10%;"></td> <td style="width: 10%;"></td> <td style="width: 10%;"></td> </tr> <tr> <td style="text-align: center;">XA</td> <td style="text-align: center;">1/G</td> <td style="text-align: center;">2/G</td> <td style="text-align: center;">3/G</td> <td style="text-align: center;">4/G</td> <td style="text-align: center;">R</td> <td style="text-align: center;">S</td> <td style="text-align: center;">T</td> <td style="text-align: center;">N</td> <td style="text-align: center;">E0</td> <td style="text-align: center;">E0</td> <td style="text-align: center;">E0</td> <td style="text-align: center;">E0</td> <td style="text-align: center;">E0</td> </tr> <tr> <td></td> <td style="text-align: center;">1</td> <td style="text-align: center;">2</td> <td style="text-align: center;">3</td> <td style="text-align: center;">4</td> <td style="text-align: center;">R01</td> <td style="text-align: center;">S01</td> <td style="text-align: center;">T01</td> <td style="text-align: center;">N01</td> <td style="text-align: center;">E1</td> <td style="text-align: center;">E1</td> <td style="text-align: center;">E1</td> <td style="text-align: center;">E1</td> <td style="text-align: center;">E1</td> </tr> <tr> <td></td> <td style="text-align: center;">1</td> <td style="text-align: center;">2</td> <td style="text-align: center;">3</td> <td style="text-align: center;">4</td> <td style="text-align: center;">R02</td> <td style="text-align: center;">S02</td> <td style="text-align: center;">T02</td> <td style="text-align: center;">N02</td> <td style="text-align: center;">E2</td> <td style="text-align: center;">E2</td> <td style="text-align: center;">E2</td> <td style="text-align: center;">E2</td> <td style="text-align: center;">E2</td> </tr> <tr> <td></td> <td style="text-align: center;">1</td> <td style="text-align: center;">2</td> <td style="text-align: center;">3</td> <td style="text-align: center;">4</td> <td
style="text-align: center;">R03</td> <td style="text-align: center;">S03</td> <td style="text-align: center;">T03</td> <td style="text-align: center;">N03</td> <td style="text-align: center;">E3</td> <td style="text-align: center;">E3</td> <td style="text-align: center;">E3</td> <td style="text-align: center;">E3</td> <td style="text-align: center;">E3</td> </tr> <tr> <td></td> <td style="text-align: center;">1</td> <td style="text-align: center;">2</td> <td style="text-align: center;">3</td> <td style="text-align: center;">4</td> <td style="text-align: center;">R04</td> <td style="text-align: center;">S04</td> <td style="text-align: center;">T04</td> <td style="text-align: center;">N04</td> <td style="text-align: center;">E4</td> <td style="text-align: center;">E4</td> <td style="text-align: center;">E4</td> <td style="text-align: center;">E4</td> <td style="text-align: center;">E4</td> </tr> <tr> <td></td> <td style="text-align: center;">1</td> <td style="text-align: center;">2</td> <td style="text-align: center;">3</td> <td style="text-align: center;">4</td> <td style="text-align: center;">R05</td> <td style="text-align: center;">S05</td> <td style="text-align: center;">T05</td> <td style="text-align: center;">N05</td> <td style="text-align: center;">E5</td> <td style="text-align: center;">E5</td> <td style="text-align: center;">E5</td> <td style="text-align: center;">E5</td> <td style="text-align: center;">E5</td> </tr> <tr> <td></td> <td style="text-align: center;">1</td> <td style="text-align: center;">2</td> <td style="text-align: center;">3</td> <td style="text-align: center;">4</td> <td style="text-align: center;">R06</td> <td style="text-align: center;">S06</td> <td style="text-align: center;">T06</td> <td style="text-align: center;">N06</td> <td style="text-align: center;">E6</td> <td style="text-align: center;">E6</td> <td style="text-align: center;">E6</td> <td style="text-align: center;">E6</td> <td style="text-align: center;">E6</td> </tr> <tr> <td></td> <td style="text-align: center;">1</td> <td style="text-align: center;">2</td> <td style="text-align: center;">3</td> <td style="text-align: center;">4</td> <td style="text-align: center;">R07</td> <td style="text-align: center;">S07</td> <td style="text-align: center;">T07</td> <td style="text-align: center;">N07</td> <td style="text-align: center;">E7</td> <td style="text-align: center;">E7</td> <td style="text-align: center;">E7</td> <td style="text-align: center;">E7</td> <td style="text-align: center;">E7</td> </tr> <tr> <td></td> <td style="text-align: center;">1</td> <td style="text-align: center;">2</td> <td style="text-align: center;">3</td> <td style="text-align: center;">4</td> <td style="text-align: center;">R08</td> <td style="text-align: center;">S08</td> <td style="text-align: center;">T08</td> <td style="text-align: center;">N08</td> <td style="text-align: center;">E8</td> <td style="text-align: center;">E8</td> <td style="text-align: center;">E8</td> <td style="text-align: center;">E8</td> <td style="text-align: center;">E8</td> </tr> </table> | | | | | | | | | | | |

 | |
 | XA | 1/G | 2/G | 3/G | 4/G | R | S | T | N | E0 | E0 | E0

 | E0 | E0 | | 1 | 2 | 3 | 4 | R01 | S01 | T01 | N01 | E1 | E1 | E1

 | E1 | E1 | | 1 | 2 | 3 | 4 | R02 | S02 | T02 | N02 | E2 | E2 | E2 | E2 | E2 | | 1 | 2 | 3 | 4 | R03 | S03 | T03 | N03 | E3 | E3 | E3 | E3 | E3 | | 1 | 2 | 3 | 4 | R04 | S04 | T04 | N04 | E4 | E4 | E4 | E4 | E4 | | 1 | 2 | 3 | 4 | R05 | S05 | T05 | N05 | E5 | E5 | E5 | E5 | E5 | | 1 | 2 | 3 | 4 | R06 | S06 | T06 | N06 | E6 | E6 | E6 | E6 | E6 | | 1 | 2 | 3 | 4 | R07 | S07 | T07 | N07 | E7 | E7 | E7 | E7 | E7

 | | 1 | 2 | 3 | 4 | R08 | S08 | T08 | N08 | E8 | E8 | E8 | E8 | E8

 | <table border="0" style="width: 100%;"> <tr> <td style="width: 50%;"></td> <td style="width: 50%; text-align: center;"> <table border="0"> <tr> <td style="width: 10%;"></td> <td style="width: 10%;"></td> <td style="width: 10%;"></td> <td style="width: 10%;"></td> <td style="width: 10%;"></td> <td style="width: 10%;"></td> <td style="width: 10%;"></td> <td style="width: 10%;"></td> <td style="width: 10%;"></td> <td style="width: 10%;"></td> <td style="width: 10%;"></td> <td style="width: 10%;"></td> <td style="width: 10%;"></td> <td style="width: 10%;"></td> </tr> <tr> <td style="text-align: center;">XA</td> <td style="text-align: center;">1</td> <td style="text-align: center;">2</td> <td style="text-align: center;">3</td> <td style="text-align: center;">4</td> <td style="text-align: center;">R01</td> <td style="text-align: center;">S01</td> <td style="text-align: center;">T01</td> <td style="text-align: center;">N01</td> <td style="text-align: center;">E1</td> <td style="text-align: center;">E1</td> <td style="text-align: center;">E1</td> <td style="text-align: center;">E1</td> <td style="text-align: center;">E1</td> </tr> <tr> <td></td> <td style="text-align: center;">1</td> <td style="text-align: center;">2</td> <td style="text-align: center;">3</td> <td style="text-align: center;">4</td> <td style="text-align: center;">R02</td> <td style="text-align: center;">S02</td> <td style="text-align: center;">T02</td> <td style="text-align: center;">N02</td> <td style="text-align: center;">E2</td> <td style="text-align: center;">E2</td> <td style="text-align: center;">E2</td> <td style="text-align: center;">E2</td> <td style="text-align: center;">E2</td> </tr> <tr> <td></td> <td style="text-align: center;">1</td> <td style="text-align: center;">2</td> <td style="text-align: center;">3</td> <td style="text-align: center;">4</td> <td style="text-align: center;">R03</td> <td style="text-align: center;">S03</td> <td style="text-align: center;">T03</td> <td style="text-align: center;">N03</td> <td style="text-align: center;">E3</td> <td style="text-align: center;">E3</td> <td style="text-align: center;">E3</td> <td style="text-align: center;">E3</td> <td style="text-align: center;">E3</td> </tr> <tr> <td></td> <td style="text-align: center;">1</td> <td style="text-align: center;">2</td> <td style="text-align: center;">3</td> <td style="text-align: center;">4</td> <td style="text-align: center;">R04</td> <td style="text-align: center;">S04</td> <td style="text-align: center;">T04</td> <td style="text-align: center;">N04</td> <td style="text-align: center;">E4</td> <td style="text-align: center;">E4</td> <td style="text-align: center;">E4</td> <td style="text-align: center;">E4</td> <td style="text-align: center;">E4</td> </tr> <tr> <td></td> <td style="text-align: center;">1</td> <td style="text-align: center;">2</td> <td style="text-align: center;">3</td> <td style="text-align: center;">4</td> <td style="text-align: center;">R05</td> <td style="text-align: center;">S05</td> <td style="text-align: center;">T05</td> <td style="text-align: center;">N05</td> <td style="text-align: center;">E5</td> <td style="text-align: center;">E5</td> <td style="text-align: center;">E5</td> <td style="text-align: center;">E5</td> <td style="text-align: center;">E5</td> </tr> <tr> <td></td> <td style="text-align: center;">1</td> <td style="text-align: center;">2</td> <td style="text-align: center;">3</td> <td style="text-align: center;">4</td> <td style="text-align: center;">R06</td> <td style="text-align: center;">S06</td> <td style="text-align: center;">T06</td> <td style="text-align: center;">N06</td> <td style="text-align: center;">E6</td> <td style="text-align: center;">E6</td> <td style="text-align: center;">E6</td> <td style="text-align: center;">E6</td> <td style="text-align: center;">E6</td> </tr> <tr> <td></td> <td style="text-align: center;">1</td> <td style="text-align: center;">2</td> <td style="text-align: center;">3</td> <td style="text-align: center;">4</td> <td style="text-align: center;">R07</td> <td style="text-align: center;">S07</td> <td style="text-align: center;">T07</td> <td style="text-align: center;">N07</td> <td style="text-align: center;">E7</td> <td style="text-align: center;">E7</td> <td style="text-align: center;">E7</td> <td style="text-align: center;">E7</td> <td style="text-align: center;">E7</td> </tr> <tr> <td></td> <td style="text-align: center;">1</td> <td style="text-align: center;">2</td> <td style="text-align: center;">3</td> <td style="text-align: center;">4</td> <td style="text-align: center;">R08</td> <td style="text-align: center;">S08</td> <td style="text-align: center;">T08</td> <td style="text-align: center;">N08</td> <td style="text-align: center;">E8</td> <td style="text-align: center;">E8</td> <td style="text-align: center;">E8</td> <td style="text-align: center;">E8</td> <td style="text-align: center;">E8</td> </tr> </table> </td> <td style="width: 50%; vertical-align: top;"> <table border="0" style="width: 100%;"> <tr> <td style="width: 50%;"></td> <td style="width: 50%; text-align: center;"> <table border="0"> <tr> <td style="width: 10%;"></td> <td style="width: 10%;"></td> <td style="width: 10%;"></td> <td style="width: 10%;"></td> <td style="width: 10%;"></td> <td style="width: 10%;"></td> <td style="width: 10%;"></td> <td style="width: 10%;"></td> <td style="width: 10%;"></td> <td style="width: 10%;"></td> <td style="width: 10%;"></td> <td style="width: 10%;"></td> <td style="width: 10%;"></td> <td style="width: 10%;"></td> </tr> <tr> <td style="text-align: center;">XA</td> <td style="text-align: center;">1</td> <td style="text-align: center;">2</td> <td style="text-align: center;">3</td> <td style="text-align: center;">4</td> <td style="text-align: center;">R01</td> <td style="text-align: center;">S01</td> <td style="text-align: center;">T01</td> <td style="text-align: center;">N01</td> <td style="text-align: center;">E1</td> <td style="text-align: center;">E1</td> <td style="text-align: center;">E1</td> <td style="text-align: center;">E1</td> <td style="text-align: center;">E1</td> </tr> <tr> <td></td> <td style="text-align: center;">1</td> <td style="text-align: center;">2</td> <td style="text-align: center;">3</td> <td style="text-align: center;">4</td> <td style="text-align: center;">R02</td> <td style="text-align: center;">S02</td> <td style="text-align: center;">T02</td> <td style="text-align: center;">N02</td> <td style="text-align: center;">E2</td> <td style="text-align: center;">E2</td> <td style="text-align: center;">E2</td> <td style="text-align: center;">E2</td> <td style="text-align: center;">E2</td> </tr> <tr> <td></td> <td style="text-align: center;">1</td> <td style="text-align: center;">2</td> <td style="text-align: center;">3</td> <td style="text-align: center;">4</td> <td style="text-align: center;">R03</td> <td style="text-align: center;">S03</td> <td style="text-align: center;">T03</td> <td style="text-align: center;">N03</td> <td style="text-align: center;">E3</td> <td style="text-align: center;">E3</td> <td style="text-align: center;">E3</td> <td style="text-align: center;">E3</td> <td style="text-align: center;">E3</td> </tr> <tr> <td></td> <td style="text-align: center;">1</td> <td style="text-align: center;">2</td> <td style="text-align: center;">3</td> <td style="text-align: center;">4</td> <td style="text-align: center;">R04</td> <td style="text-align: center;">S04</td> <td style="text-align: center;">T04</td> <td style="text-align: center;">N04</td> <td style="text-align: center;">E4</td> <td style="text-align: center;">E4</td> <td style="text-align: center;">E4</td> <td style="text-align: center;">E4</td> <td style="text-align: center;">E4</td> </tr> <tr> <td></td> <td style="text-align: center;">1</td> <td style="text-align: center;">2</td> <td style="text-align: center;">3</td> <td style="text-align: center;">4</td> <td style="text-align: center;">R05</td> <td style="text-align: center;">S05</td> <td style="text-align: center;">T05</td> <td style="text-align: center;">N05</td> <td style="text-align: center;">E5</td> <td style="text-align:
center;">E5</td> <td style="text-align: center;">E5</td> <td style="text-align: center;">E5</td> <td style="text-align: center;">E5</td> </tr> <tr> <td></td> <td style="text-align: center;">1</td> <td style="text-align: center;">2</td> <td style="text-align: center;">3</td> <td style="text-align: center;">4</td> <td style="text-align: center;">R06</td> <td style="text-align: center;">S06</td> <td style="text-align: center;">T06</td> <td style="text-align: center;">N06</td> <td style="text-align: center;">E6</td> <td style="text-align: center;">E6</td> <td style="text-align: center;">E6</td> <td style="text-align: center;">E6</td> <td style="text-align: center;">E6</td> </tr> <tr> <td></td> <td style="text-align: center;">1</td> <td style="text-align: center;">2</td> <td style="text-align: center;">3</td> <td style="text-align: center;">4</td> <td style="text-align: center;">R07</td> <td style="text-align: center;">S07</td> <td style="text-align: center;">T07</td> <td style="text-align: center;">N07</td> <td style="text-align: center;">E7</td> <td style="text-align: center;">E7</td> <td style="text-align: center;">E7</td> <td style="text-align: center;">E7</td> <td style="text-align: center;">E7</td> </tr> <tr> <td></td> <td style="text-align: center;">1</td> <td style="text-align: center;">2</td> <td style="text-align: center;">3</td> <td style="text-align: center;">4</td> <td style="text-align: center;">R08</td> <td style="text-align: center;">S08</td> <td style="text-align: center;">T08</td> <td style="text-align: center;">N08</td> <td style="text-align: center;">E8</td> <td style="text-align: center;">E8</td> <td style="text-align: center;">E8</td> <td style="text-align: center;">E8</td> <td style="text-align: center;">E8</td> </tr> </table> </td> <td style="width: 50%; vertical-align: top;"> <table border="0" style="width: 100%;"> <tr> <td style="width: 50%;"></td> <td style="width: 50%; text-align: center;"> <table border="0"> <tr> <td style="width: 10%;"></td> <td style="width: 10%;"></td> <td style="width: 10%;"></td> <td style="width: 10%;"></td> <td style="width: 10%;"></td> <td style="width: 10%;"></td> <td style="width: 10%;"></td> <td style="width: 10%;"></td> <td style="width: 10%;"></td> <td style="width: 10%;"></td> <td style="width: 10%;"></td> <td style="width: 10%;"></td> <td style="width: 10%;"></td> <td style="width: 10%;"></td> </tr> <tr> <td style="text-align: center;">XA</td> <td style="text-align: center;">1</td> <td style="text-align: center;">2</td> <td style="text-align: center;">3</td> <td style="text-align: center;">4</td> <td style="text-align: center;">R01</td> <td style="text-align: center;">S01</td> <td style="text-align: center;">T01</td> <td style="text-align: center;">N01</td> <td style="text-align: center;">E1</td> <td style="text-align: center;">E1</td> <td style="text-align: center;">E1</td> <td style="text-align: center;">E1</td> <td style="text-align: center;">E1</td> </tr> <tr> <td></td> <td style="text-align: center;">1</td> <td style="text-align: center;">2</td> <td style="text-align: center;">3</td> <td style="text-align: center;">4</td> <td style="text-align: center;">R02</td> <td style="text-align: center;">S02</td> <td style="text-align: center;">T02</td> <td style="text-align: center;">N02</td> <td style="text-align: center;">E2</td> <td style="text-align: center;">E2</td> <td style="text-align: center;">E2</td> <td style="text-align: center;">E2</td> <td style="text-align: center;">E2</td> </tr> <tr> <td></td> <td style="text-align: center;">1</td> <td style="text-align: center;">2</td> <td style="text-align: center;">3</td> <td style="text-align: center;">4</td> <td style="text-align: center;">R03</td> <td style="text-align: center;">S03</td> <td style="text-align: center;">T03</td> <td style="text-align: center;">N03</td> <td style="text-align: center;">E3</td> <td style="text-align: center;">E3</td> <td style="text-align: center;">E3</td> <td style="text-align: center;">E3</td> <td style="text-align: center;">E3</td> </tr> <tr> <td></td> <td style="text-align: center;">1</td> <td style="text-align: center;">2</td> <td style="text-align: center;">3</td> <td style="text-align: center;">4</td> <td style="text-align: center;">R04</td> <td style="text-align: center;">S04</td> <td style="text-align: center;">T04</td> <td style="text-align: center;">N04</td> <td style="text-align: center;">E4</td> <td style="text-align: center;">E4</td> <td style="text-align: center;">E4</td> <td style="text-align: center;">E4</td> <td style="text-align: center;">E4</td> </tr> <tr> <td></td> <td style="text-align: center;">1</td> <td style="text-align: center;">2</td> <td style="text-align: center;">3</td> <td style="text-align: center;">4</td> <td style="text-align: center;">R05</td> <td style="text-align: center;">S05</td> <td style="text-align: center;">T05</td> <td style="text-align: center;">N05</td> <td style="text-align: center;">E5</td> <td style="text-align: center;">E5</td> <td style="text-align: center;">E5</td> <td style="text-align: center;">E5</td> <td style="text-align: center;">E5</td> </tr> <tr> <td></td> <td style="text-align: center;">1</td> <td style="text-align: center;">2</td> <td style="text-align: center;">3</td> <td style="text-align: center;">4</td> <td style="text-align: center;">R06</td> <td style="text-align: center;">S06</td> <td style="text-align: center;">T06</td> <td style="text-align: center;">N06</td> <td style="text-align: center;">E6</td> <td style="text-align: center;">E6</td> <td style="text-align: center;">E6</td> <td style="text-align: center;">E6</td> <td style="text-align: center;">E6</td> </tr> <tr> <td></td> <td style="text-align: center;">1</td> <td style="text-align: center;">2</td> <td style="text-align: center;">3</td> <td style="text-align: center;">4</td> <td style="text-align: center;">R07</td> <td style="text-align: center;">S07</td> <td style="text-align: center;">T07</td> <td style="text-align: center;">N07</td> <td style="text-align: center;">E7</td> <td style="text-align: center;">E7</td> <td style="text-align: center;">E7</td> <td style="text-align: center;">E7</td> <td style="text-align: center;">E7</td> </tr> <tr> <td></td> <td style="text-align: center;">1</td> <td style="text-align: center;">2</td> <td style="text-align: center;">3</td> <td style="text-align: center;">4</td> <td style="text-align: center;">R08</td> <td style="text-align: center;">S08</td> <td style="text-align: center;">T08</td> <td style="text-align: center;">N08</td> <td style="text-align: center;">E8</td> <td style="text-align: center;">E8</td> <td style="text-align: center;">E8</td> <td style="text-align: center;">E8</td> <td style="text-align: center;">E8</td> </tr> </table> </td> <td style="width: 50%; vertical-align: top;"> <table border="0" style="width: 100%;"> <tr> <td style="width: 50%;"></td> <td style="width: 50%; text-align: center;"> <table border="0"> <tr> <td style="width: 10%;"></td> <td style="width: 10%;"></td> <td style="width: 10%;"></td> <td style="width: 10%;"></td> <td style="width: 10%;"></td> <td style="width: 10%;"></td> <td style="width: 10%;"></td> <td style="width: 10%;"></td> <td style="width: 10%;"></td> <td style="width: 10%;"></td> <td style="width: 10%;"></td> <td style="width: 10%;"></td> <td style="width: 10%;"></td> <td style="width: 10%;"></td> </tr> <tr> <td style="text-align: center;">XA</td> <td style="text-align: center;">1</td> <td style="text-align: center;">2</td> <td style="text-align: center;">3</td> <td style="text-align: center;">4</td> <td style="text-align: center;">R01</td> <td style="text-align: center;">S01</td> <td style="text-align: center;">T01</td> <td style="text-align: center;">N01</td> <td style="text-align: center;">E1</td> <td style="text-align: center;">E1</td> <td style="text-align: center;">E1</td> <td style="text-align: center;">E1</td> <td style="text-align: center;">E1</td> </tr> <tr> <td></td> <td style="text-align: center;">1</td> <td style="text-align: center;">2</td> <td style="text-align: center;">3</td> <td style="text-align: center;">4</td> <td style="text-align: center;">R02</td> <td style="text-align: center;">S02</td> <td style="text-align: center;">T02</td> <td style="text-align: center;">N02</td> <td style="text-align: center;">E2</td> <td style="text-align: center;">E2</td> <td style="text-align: center;">E2</td> <td style="text-align: center;">E2</td> <td style="text-align: center;">E2</td> </tr> <tr> <td></td> <td style="text-align: center;">1</td> <td style="text-align: center;">2</td> <td style="text-align: center;">3</td> <td style="text-align: center;">4</td> <td style="text-align: center;">R03</td> <td style="text-align: center;">S03</td> <td style="text-align: center;">T03</td> <td style="text-align: center;">N03</td> <td style="text-align: center;">E3</td> <td style="text-align: center;">E3</td> <td style="text-align: center;">E3</td> <td style="text-align: center;">E3</td> <td style="text-align: center;">E3</td> </tr> <tr> <td></td> <td style="text-align: center;">1</td> <td style="text-align: center;">2</td> <td style="text-align: center;">3</td> <td style="text-align: center;">4</td> <td style="text-align: center;">R04</td> <td style="text-align: center;">S04</td> <td style="text-align: center;">T04</td> <td style="text-align: center;">N04</td> <td style="text-align: center;">E4</td> <td style="text-align: center;">E4</td> <td style="text-align: center;">E4</td> <td style="text-align: center;">E4</td> <td style="text-align: center;">E4</td> </tr> <tr> <td></td> <td style="text-align: center;">1</td> <td style="text-align: center;">2</td> <td style="text-align: center;">3</td> <td style="text-align: center;">4</td> <td style="text-align: center;">R05</td> <td style="text-align: center;">S05</td> <td style="text-align: center;">T05</td> <td style="text-align: center;">N05</td> <td style="text-align: center;">E5</td> <td style="text-align: center;">E5</td> <td
style="text-align: center;">E5</td> <td style="text-align: center;">E5</td> <td style="text-align: center;">E5</td> </tr> <tr> <td></td> <td style="text-align: center;">1</td> <td style="text-align: center;">2</td> <td style="text-align: center;">3</td> <td style="text-align: center;">4</td> <td style="text-align: center;">R06</td> <td style="text-align: center;">S06</td> <td style="text-align: center;">T06</td> <td style="text-align: center;">N06</td> <td style="text-align: center;">E6</td> <td style="text-align: center;">E6</td> <td style="text-align: center;">E6</td> <td style="text-align: center;">E6</td> <td style="text-align: center;">E6</td> </tr> <tr> <td></td> <td style="text-align: center;">1</td> <td style="text-align: center;">2</td> <td style="text-align: center;">3</td> <td style="text-align: center;">4</td> <td style="text-align: center;">R07</td> <td style="text-align: center;">S07</td> <td style="text-align: center;">T07</td> <td style="text-align: center;">N07</td> <td style="text-align: center;">E7</td> <td style="text-align: center;">E7</td> <td style="text-align: center;">E7</td> <td style="text-align: center;">E7</td> <td style="text-align: center;">E7</td> </tr> <tr> <td></td> <td style="text-align: center;">1</td> <td style="text-align: center;">2</td> <td style="text-align: center;">3</td> <td style="text-align: center;">4</td> <td style="text-align: center;">R08</td> <td style="text-align: center;">S08</td> <td style="text-align: center;">T08</td> <td style="text-align: center;">N08</td> <td style="text-align: center;">E8</td> <td style="text-align: center;">E8</td> <td style="text-align: center;">E8</td> <td style="text-align: center;">E8</td> <td style="text-align: center;">E8</td> </tr> </table> </td> <td style="width: 50%; vertical-align: top;"> <table border="0" style="width: 100%;"> <tr> <td style="width: 50%;"></td> <td style="width: 50%; text-align: center;"> <table border="0"> <tr> <td style="width: 10%;"></td> <td style="width: 10%;"></td> <td style="width: 10%;"></td> <td style="width: 10%;"></td> <td style="width: 10%;"></td> <td style="width: 10%;"></td> <td style="width: 10%;"></td> <td style="width: 10%;"></td> <td style="width: 10%;"></td> <td style="width: 10%;"></td> <td style="width: 10%;"></td> <td style="width: 10%;"></td> <td style="width: 10%;"></td> <td style="width: 10%;"></td> </tr> <tr> <td style="text-align: center;">XA</td> <td style="text-align: center;">1</td> <td style="text-align: center;">2</td> <td style="text-align: center;">3</td> <td style="text-align: center;">4</td> <td style="text-align: center;">R01</td> <td style="text-align: center;">S01</td> <td style="text-align: center;">T01</td> <td style="text-align: center;">N01</td> <td style="text-align: center;">E1</td> <td style="text-align: center;">E1</td> <td style="text-align: center;">E1</td> <td style="text-align: center;">E1</td> <td style="text-align: center;">E1</td> </tr> <tr> <td></td> <td style="text-align: center;">1</td> <td style="text-align: center;">2</td> <td style="text-align: center;">3</td> <td style="text-align: center;">4</td> <td style="text-align: center;">R02</td> <td style="text-align: center;">S02</td> <td style="text-align: center;">T02</td> <td style="text-align: center;">N02</td> <td style="text-align: center;">E2</td> <td style="text-align: center;">E2</td> <td style="text-align: center;">E2</td> <td style="text-align: center;">E2</td> <td style="text-align: center;">E2</td> </tr> <tr> <td></td> <td style="text-align: center;">1</td> <td style="text-align: center;">2</td> <td style="text-align: center;">3</td> <td style="text-align: center;">4</td> <td style="text-align: center;">R03</td> <td style="text-align: center;">S03</td> <td style="text-align: center;">T03</td> <td style="text-align: center;">N03</td> <td style="text-align: center;">E3</td> <td style="text-align: center;">E3</td> <td style="text-align: center;">E3</td> <td style="text-align: center;">E3</td> <td style="text-align: center;">E3</td> </tr> <tr> <td></td> <td style="text-align: center;">1</td> <td style="text-align: center;">2</td> <td style="text-align: center;">3</td> <td style="text-align: center;">4</td> <td style="text-align: center;">R04</td> <td style="text-align: center;">S04</td> <td style="text-align: center;">T04</td> <td style="text-align: center;">N04</td> <td style="text-align: center;">E4</td> <td style="text-align: center;">E4</td> <td style="text-align: center;">E4</td> <td style="text-align: center;">E4</td> <td style="text-align: center;">E4</td> </tr> <tr> <td></td> <td style="text-align: center;">1</td> <td style="text-align: center;">2</td> <td style="text-align: center;">3</td> <td style="text-align: center;">4</td> <td style="text-align: center;">R05</td> <td style="text-align: center;">S05</td> <td style="text-align: center;">T05</td> <td style="text-align: center;">N05</td> <td style="text-align: center;">E5</td> <td style="text-align: center;">E5</td> <td style="text-align: center;">E5</td> <td style="text-align: center;">E5</td> <td style="text-align: center;">E5</td> </tr> <tr> <td></td> <td style="text-align: center;">1</td> <td style="text-align: center;">2</td> <td style="text-align: center;">3</td> <td style="text-align: center;">4</td> <td style="text-align: center;">R06</td> <td style="text-align: center;">S06</td> <td style="text-align: center;">T06</td> <td style="text-align: center;">N06</td> <td style="text-align: center;">E6</td> <td style="text-align: center;">E6</td> <td style="text-align: center;">E6</td> <td style="text-align: center;">E6</td> <td style="text-align: center;">E6</td> </tr> <tr> <td></td> <td style="text-align: center;">1</td> <td style="text-align: center;">2</td> <td style="text-align: center;">3</td> <td style="text-align: center;">4</td> <td style="text-align: center;">R07</td> <td style="text-align: center;">S07</td> <td style="text-align: center;">T07</td> <td style="text-align: center;">N07</td> <td style="text-align: center;">E7</td> <td style="text-align: center;">E7</td> <td style="text-align: center;">E7</td> <td style="text-align: center;">E7</td> <td style="text-align: center;">E7</td> </tr> <tr> <td></td> <td style="text-align: center;">1</td> <td style="text-align: center;">2</td> <td style="text-align: center;">3</td> <td style="text-align: center;">4</td> <td style="text-align: center;">R08</td> <td style="text-align: center;">S08</td> <td style="text-align: center;">T08</td> <td style="text-align: center;">N08</td> <td style="text-align: center;">E8</td> <td style="text-align: center;">E8</td> <td style="text-align: center;">E8</td> <td style="text-align: center;">E8</td> <td style="text-align: center;">E8</td> </tr> </table> </td> <td style="width: 50%; vertical-align: top;"> <table border="0" style="width: 100%;"> <tr> <td style="width: 50%;"></td> <td style="width: 50%; text-align: center;"> <table border="0"> <tr> <td style="width: 10%;"></td> <td style="width: 10%;"></td> <td style="width: 10%;"></td> <td style="width: 10%;"></td> <td style="width: 10%;"></td> <td style="width: 10%;"></td> <td style="width: 10%;"></td> <td style="width: 10%;"></td> <td style="width: 10%;"></td> <td style="width: 10%;"></td> <td style="width: 10%;"></td> <td style="width: 10%;"></td> <td style="width: 10%;"></td> <td style="width: 10%;"></td> </tr> <tr> <td style="text-align: center;">XA</td> <td style="text-align: center;">1</td> <td style="text-align: center;">2</td> <td style="text-align: center;">3</td> <td style="text-align: center;">4</td> <td style="text-align: center;">R01</td> <td style="text-align: center;">S01</td> <td style="text-align: center;">T01</td> <td style="text-align: center;">N01</td> <td style="text-align: center;">E1</td> <td style="text-align: center;">E1</td> <td style="text-align: center;">E1</td> </tr></table></td></tr></table></td></tr></table></td></tr></table></td></tr></table></td></tr></table></td></tr></table> |
 | <table border="0"> <tr> <td style="width: 10%;"></td> <td style="width: 10%;"></td> <td style="width: 10%;"></td> <td style="width: 10%;"></td> <td style="width: 10%;"></td> <td style="width: 10%;"></td> <td style="width: 10%;"></td> <td style="width: 10%;"></td> <td style="width: 10%;"></td> <td style="width: 10%;"></td> <td style="width: 10%;"></td> <td style="width: 10%;"></td> <td style="width: 10%;"></td> <td style="width: 10%;"></td> </tr> <tr> <td style="text-align: center;">XA</td> <td style="text-align: center;">1</td> <td style="text-align: center;">2</td> <td style="text-align: center;">3</td> <td style="text-align: center;">4</td> <td style="text-align: center;">R01</td> <td style="text-align: center;">S01</td> <td style="text-align: center;">T01</td> <td style="text-align: center;">N01</td> <td style="text-align: center;">E1</td> <td style="text-align: center;">E1</td> <td style="text-align: center;">E1</td> <td style="text-align: center;">E1</td> <td style="text-align: center;">E1</td> </tr> <tr> <td></td> <td style="text-align: center;">1</td> <td style="text-align: center;">2</td> <td style="text-align: center;">3</td> <td style="text-align: center;">4</td> <td style="text-align: center;">R02</td> <td style="text-align: center;">S02</td> <td style="text-align: center;">T02</td> <td style="text-align: center;">N02</td> <td style="text-align: center;">E2</td> <td style="text-align: center;">E2</td> <td style="text-align: center;">E2</td> <td style="text-align: center;">E2</td> <td style="text-align: center;">E2</td> </tr> <tr> <td></td> <td style="text-align: center;">1</td> <td style="text-align: center;">2</td> <td style="text-align: center;">3</td> <td style="text-align: center;">4</td> <td style="text-align: center;">R03</td> <td style="text-align: center;">S03</td> <td style="text-align: center;">T03</td> <td style="text-align: center;">N03</td> <td style="text-align: center;">E3</td> <td style="text-align: center;">E3</td> <td style="text-align: center;">E3</td> <td style="text-align: center;">E3</td> <td style="text-align: center;">E3</td> </tr> <tr> <td></td> <td style="text-align: center;">1</td> <td style="text-align: center;">2</td> <td style="text-align: center;">3</td> <td style="text-align: center;">4</td> <td style="text-align: center;">R04</td> <td style="text-align: center;">S04</td> <td style="text-align: center;">T04</td> <td style="text-align: center;">N04</td> <td style="text-align: center;">E4</td> <td style="text-align: center;">E4</td> <td style="text-align: center;">E4</td> <td style="text-align: center;">E4</td> <td style="text-align: center;">E4</td> </tr> <tr> <td></td> <td style="text-align: center;">1</td> <td style="text-align: center;">2</td> <td style="text-align: center;">3</td> <td style="text-align: center;">4</td> <td style="text-align: center;">R05</td> <td style="text-align: center;">S05</td> <td style="text-align: center;">T05</td> <td style="text-align: center;">N05</td> <td style="text-align: center;">E5</td> <td style="text-align: center;">E5</td> <td style="text-align: center;">E5</td> <td style="text-align: center;">E5</td> <td style="text-align: center;">E5</td> </tr> <tr> <td></td> <td style="text-align: center;">1</td> <td style="text-align: center;">2</td> <td style="text-align: center;">3</td> <td style="text-align: center;">4</td> <td style="text-align: center;">R06</td> <td style="text-align: center;">S06</td> <td style="text-align: center;">T06</td> <td style="text-align: center;">N06</td> <td style="text-align: center;">E6</td> <td style="text-align: center;">E6</td> <td style="text-align: center;">E6</td> <td style="text-align: center;">E6</td> <td style="text-align: center;">E6</td> </tr> <tr> <td></td> <td style="text-align: center;">1</td> <td style="text-align: center;">2</td> <td style="text-align: center;">3</td> <td style="text-align: center;">4</td> <td style="text-align: center;">R07</td> <td style="text-align: center;">S07</td> <td style="text-align: center;">T07</td> <td style="text-align: center;">N07</td> <td style="text-align: center;">E7</td> <td style="text-align: center;">E7</td> <td style="text-align: center;">E7</td> <td style="text-align: center;">E7</td> <td style="text-align: center;">E7</td> </tr> <tr> <td></td> <td style="text-align: center;">1</td> <td style="text-align: center;">2</td> <td style="text-align: center;">3</td> <td style="text-align: center;">4</td> <td style="text-align: center;">R08</td> <td style="text-align: center;">S08</td> <td style="text-align: center;">T08</td> <td style="text-align: center;">N08</td> <td style="text-align: center;">E8</td> <td style="text-align: center;">E8</td> <td style="text-align: center;">E8</td> <td style="text-align: center;">E8</td> <td style="text-align: center;">E8</td> </tr> </table> | | | | | | | | | | | |

 | | | XA | 1 | 2 | 3 | 4 | R01 | S01 | T01 | N01 | E1 | E1 | E1 | E1 | E1 | | 1 | 2 | 3 | 4 | R02 | S02 | T02 | N02 | E2 | E2 | E2

 | E2 | E2 | | 1 | 2 | 3 | 4 | R03 | S03 | T03 | N03 | E3 | E3 | E3 | E3 | E3 | | 1 | 2 | 3 | 4 | R04 | S04 | T04 | N04 | E4 | E4 | E4 | E4 | E4 | | 1 | 2 | 3 | 4 | R05 | S05 | T05 | N05 | E5 | E5 | E5 | E5 | E5 | | 1 | 2 | 3 | 4 | R06 | S06 | T06 | N06 | E6 | E6 | E6 | E6 | E6 | | 1 | 2
 3 | 4 | R07 | S07 | T07 | N07 | E7 | E7 | E7 | E7 | E7
 | | 1
 | 2 | 3 | 4 | R08 | S08 | T08 | N08 | E8 | E8 | E8 | E8 | E8

 | <table border="0" style="width: 100%;"> <tr> <td style="width: 50%;"></td> <td style="width: 50%; text-align: center;"> <table border="0"> <tr> <td style="width: 10%;"></td> <td style="width: 10%;"></td> <td style="width: 10%;"></td> <td style="width: 10%;"></td> <td style="width: 10%;"></td> <td style="width: 10%;"></td> <td style="width: 10%;"></td> <td style="width: 10%;"></td> <td style="width: 10%;"></td> <td style="width: 10%;"></td> <td style="width: 10%;"></td> <td style="width: 10%;"></td> <td style="width: 10%;"></td> <td style="width: 10%;"></td> </tr> <tr> <td style="text-align: center;">XA</td> <td style="text-align: center;">1</td> <td style="text-align: center;">2</td> <td style="text-align: center;">3</td> <td style="text-align: center;">4</td> <td style="text-align: center;">R01</td> <td style="text-align: center;">S01</td> <td style="text-align: center;">T01</td> <td style="text-align: center;">N01</td> <td style="text-align: center;">E1</td> <td style="text-align: center;">E1</td> <td style="text-align: center;">E1</td> <td style="text-align: center;">E1</td> <td style="text-align: center;">E1</td> </tr> <tr> <td></td> <td style="text-align: center;">1</td> <td style="text-align: center;">2</td> <td style="text-align: center;">3</td> <td style="text-align: center;">4</td> <td style="text-align: center;">R02</td> <td style="text-align: center;">S02</td> <td style="text-align: center;">T02</td> <td style="text-align: center;">N02</td> <td style="text-align: center;">E2</td> <td style="text-align: center;">E2</td> <td style="text-align: center;">E2</td> <td style="text-align: center;">E2</td> <td style="text-align: center;">E2</td> </tr> <tr> <td></td> <td style="text-align: center;">1</td> <td style="text-align: center;">2</td> <td style="text-align: center;">3</td> <td style="text-align: center;">4</td> <td style="text-align: center;">R03</td> <td style="text-align: center;">S03</td> <td style="text-align: center;">T03</td> <td style="text-align: center;">N03</td> <td style="text-align: center;">E3</td> <td style="text-align: center;">E3</td> <td style="text-align: center;">E3</td> <td style="text-align: center;">E3</td> <td style="text-align: center;">E3</td> </tr> <tr> <td></td> <td style="text-align: center;">1</td> <td style="text-align: center;">2</td> <td style="text-align: center;">3</td> <td style="text-align: center;">4</td> <td style="text-align: center;">R04</td> <td style="text-align: center;">S04</td> <td style="text-align: center;">T04</td> <td style="text-align: center;">N04</td> <td style="text-align: center;">E4</td> <td style="text-align: center;">E4</td> <td style="text-align: center;">E4</td> <td style="text-align: center;">E4</td> <td style="text-align: center;">E4</td> </tr> <tr> <td></td> <td style="text-align: center;">1</td> <td style="text-align: center;">2</td> <td style="text-align: center;">3</td> <td style="text-align: center;">4</td> <td style="text-align: center;">R05</td> <td style="text-align: center;">S05</td> <td style="text-align: center;">T05</td> <td style="text-align: center;">N05</td> <td style="text-align: center;">E5</td> <td style="text-align: center;">E5</td> <td style="text-align: center;">E5</td> <td style="text-align: center;">E5</td> <td style="text-align: center;">E5</td> </tr> <tr> <td></td> <td style="text-align: center;">1</td> <td style="text-align: center;">2</td> <td style="text-align: center;">3</td> <td style="text-align: center;">4</td> <td style="text-align: center;">R06</td> <td style="text-align: center;">S06</td> <td style="text-align: center;">T06</td> <td style="text-align: center;">N06</td> <td style="text-align: center;">E6</td> <td style="text-align: center;">E6</td> <td style="text-align: center;">E6</td> <td style="text-align: center;">E6</td> <td style="text-align: center;">E6</td> </tr> <tr> <td></td> <td style="text-align: center;">1</td> <td style="text-align: center;">2</td> <td style="text-align: center;">3</td> <td style="text-align: center;">4</td> <td style="text-align: center;">R07</td> <td style="text-align: center;">S07</td> <td style="text-align: center;">T07</td> <td style="text-align: center;">N07</td> <td style="text-align: center;">E7</td> <td style="text-align: center;">E7</td> <td style="text-align: center;">E7</td> <td style="text-align: center;">E7</td> <td style="text-align: center;">E7</td> </tr> <tr> <td></td> <td style="text-align: center;">1</td> <td style="text-align: center;">2</td> <td style="text-align: center;">3</td> <td style="text-align: center;">4</td> <td style="text-align: center;">R08</td> <td style="text-align: center;">S08</td> <td style="text-align: center;">T08</td> <td style="text-align: center;">N08</td> <td style="text-align: center;">E8</td> <td style="text-align: center;">E8</td> <td style="text-align: center;">E8</td> <td style="text-align: center;">E8</td> <td style="text-align: center;">E8</td> </tr> </table> </td> <td style="width: 50%; vertical-align: top;"> <table border="0" style="width: 100%;"> <tr> <td style="width: 50%;"></td> <td style="width: 50%; text-align: center;"> <table border="0"> <tr> <td style="width: 10%;"></td> <td style="width: 10%;"></td> <td style="width: 10%;"></td> <td style="width: 10%;"></td> <td style="width: 10%;"></td> <td style="width: 10%;"></td> <td style="width: 10%;"></td> <td style="width: 10%;"></td> <td style="width: 10%;"></td> <td style="width: 10%;"></td> <td style="width: 10%;"></td> <td style="width: 10%;"></td> <td style="width: 10%;"></td> <td style="width: 10%;"></td> </tr> <tr> <td style="text-align: center;">XA</td> <td style="text-align: center;">1</td> <td style="text-align: center;">2</td> <td style="text-align: center;">3</td> <td style="text-align: center;">4</td> <td style="text-align: center;">R01</td> <td style="text-align: center;">S01</td> <td style="text-align: center;">T01</td> <td style="text-align: center;">N01</td> <td style="text-align: center;">E1</td> <td style="text-align: center;">E1</td> <td style="text-align: center;">E1</td> <td style="text-align: center;">E1</td> <td style="text-align: center;">E1</td> </tr> <tr> <td></td> <td style="text-align: center;">1</td> <td style="text-align: center;">2</td> <td style="text-align: center;">3</td> <td style="text-align: center;">4</td> <td style="text-align: center;">R02</td> <td style="text-align: center;">S02</td> <td style="text-align: center;">T02</td> <td style="text-align: center;">N02</td> <td style="text-align: center;">E2</td> <td style="text-align: center;">E2</td> <td style="text-align: center;">E2</td> <td style="text-align: center;">E2</td> <td style="text-align: center;">E2</td> </tr> <tr> <td></td> <td style="text-align: center;">1</td> <td style="text-align: center;">2</td> <td style="text-align: center;">3</td> <td style="text-align: center;">4</td> <td style="text-align: center;">R03</td> <td style="text-align: center;">S03</td> <td style="text-align: center;">T03</td> <td style="text-align: center;">N03</td> <td style="text-align: center;">E3</td> <td style="text-align: center;">E3</td> <td style="text-align: center;">E3</td> <td style="text-align: center;">E3</td> <td style="text-align: center;">E3</td> </tr> <tr> <td></td> <td style="text-align: center;">1</td> <td style="text-align: center;">2</td> <td style="text-align: center;">3</td> <td style="text-align: center;">4</td> <td style="text-align: center;">R04</td> <td style="text-align: center;">S04</td> <td style="text-align: center;">T04</td> <td style="text-align: center;">N04</td> <td style="text-align: center;">E4</td> <td style="text-align: center;">E4</td> <td style="text-align: center;">E4</td> <td style="text-align: center;">E4</td> <td style="text-align: center;">E4</td> </tr> <tr> <td></td> <td style="text-align: center;">1</td> <td style="text-align:
center;">2</td> <td style="text-align: center;">3</td> <td style="text-align: center;">4</td> <td style="text-align: center;">R05</td> <td style="text-align: center;">S05</td> <td style="text-align: center;">T05</td> <td style="text-align: center;">N05</td> <td style="text-align: center;">E5</td> <td style="text-align: center;">E5</td> <td style="text-align: center;">E5</td> <td style="text-align: center;">E5</td> <td style="text-align: center;">E5</td> </tr> <tr> <td></td> <td style="text-align: center;">1</td> <td style="text-align: center;">2</td> <td style="text-align: center;">3</td> <td style="text-align: center;">4</td> <td style="text-align: center;">R06</td> <td style="text-align: center;">S06</td> <td style="text-align: center;">T06</td> <td style="text-align: center;">N06</td> <td style="text-align: center;">E6</td> <td style="text-align: center;">E6</td> <td style="text-align: center;">E6</td> <td style="text-align: center;">E6</td> <td style="text-align: center;">E6</td> </tr> <tr> <td></td> <td style="text-align: center;">1</td> <td style="text-align: center;">2</td> <td style="text-align: center;">3</td> <td style="text-align: center;">4</td> <td style="text-align: center;">R07</td> <td style="text-align: center;">S07</td> <td style="text-align: center;">T07</td> <td style="text-align: center;">N07</td> <td style="text-align: center;">E7</td> <td style="text-align: center;">E7</td> <td style="text-align: center;">E7</td> <td style="text-align: center;">E7</td> <td style="text-align: center;">E7</td> </tr> <tr> <td></td> <td style="text-align: center;">1</td> <td style="text-align: center;">2</td> <td style="text-align: center;">3</td> <td style="text-align: center;">4</td> <td style="text-align: center;">R08</td> <td style="text-align: center;">S08</td> <td style="text-align: center;">T08</td> <td style="text-align: center;">N08</td> <td style="text-align: center;">E8</td> <td style="text-align: center;">E8</td> <td style="text-align: center;">E8</td> <td style="text-align: center;">E8</td> <td style="text-align: center;">E8</td> </tr> </table> </td> <td style="width: 50%; vertical-align: top;"> <table border="0" style="width: 100%;"> <tr> <td style="width: 50%;"></td> <td style="width: 50%; text-align: center;"> <table border="0"> <tr> <td style="width: 10%;"></td> <td style="width: 10%;"></td> <td style="width: 10%;"></td> <td style="width: 10%;"></td> <td style="width: 10%;"></td> <td style="width: 10%;"></td> <td style="width: 10%;"></td> <td style="width: 10%;"></td> <td style="width: 10%;"></td> <td style="width: 10%;"></td> <td style="width: 10%;"></td> <td style="width: 10%;"></td> <td style="width: 10%;"></td> <td style="width: 10%;"></td> </tr> <tr> <td style="text-align: center;">XA</td> <td style="text-align: center;">1</td> <td style="text-align: center;">2</td> <td style="text-align: center;">3</td> <td style="text-align: center;">4</td> <td style="text-align: center;">R01</td> <td style="text-align: center;">S01</td> <td style="text-align: center;">T01</td> <td style="text-align: center;">N01</td> <td style="text-align: center;">E1</td> <td style="text-align: center;">E1</td> <td style="text-align: center;">E1</td> <td style="text-align: center;">E1</td> <td style="text-align: center;">E1</td> </tr> <tr> <td></td> <td style="text-align: center;">1</td> <td style="text-align: center;">2</td> <td style="text-align: center;">3</td> <td style="text-align: center;">4</td> <td style="text-align: center;">R02</td> <td style="text-align: center;">S02</td> <td style="text-align: center;">T02</td> <td style="text-align: center;">N02</td> <td style="text-align: center;">E2</td> <td style="text-align: center;">E2</td> <td style="text-align: center;">E2</td> <td style="text-align: center;">E2</td> <td style="text-align: center;">E2</td> </tr> <tr> <td></td> <td style="text-align: center;">1</td> <td style="text-align: center;">2</td> <td style="text-align: center;">3</td> <td style="text-align: center;">4</td> <td style="text-align: center;">R03</td> <td style="text-align: center;">S03</td> <td style="text-align: center;">T03</td> <td style="text-align: center;">N03</td> <td style="text-align: center;">E3</td> <td style="text-align: center;">E3</td> <td style="text-align: center;">E3</td> <td style="text-align: center;">E3</td> <td style="text-align: center;">E3</td> </tr> <tr> <td></td> <td style="text-align: center;">1</td> <td style="text-align: center;">2</td> <td style="text-align: center;">3</td> <td style="text-align: center;">4</td> <td style="text-align: center;">R04</td> <td style="text-align: center;">S04</td> <td style="text-align: center;">T04</td> <td style="text-align: center;">N04</td> <td style="text-align: center;">E4</td> <td style="text-align: center;">E4</td> <td style="text-align: center;">E4</td> <td style="text-align: center;">E4</td> <td style="text-align: center;">E4</td> </tr> <tr> <td></td> <td style="text-align: center;">1</td> <td style="text-align: center;">2</td> <td style="text-align: center;">3</td> <td style="text-align: center;">4</td> <td style="text-align: center;">R05</td> <td style="text-align: center;">S05</td> <td style="text-align: center;">T05</td> <td style="text-align: center;">N05</td> <td style="text-align: center;">E5</td> <td style="text-align: center;">E5</td> <td style="text-align: center;">E5</td> <td style="text-align: center;">E5</td> <td style="text-align: center;">E5</td> </tr> <tr> <td></td> <td style="text-align: center;">1</td> <td style="text-align: center;">2</td> <td style="text-align: center;">3</td> <td style="text-align: center;">4</td> <td style="text-align: center;">R06</td> <td style="text-align: center;">S06</td> <td style="text-align: center;">T06</td> <td style="text-align: center;">N06</td> <td style="text-align: center;">E6</td> <td style="text-align: center;">E6</td> <td style="text-align: center;">E6</td> <td style="text-align: center;">E6</td> <td style="text-align: center;">E6</td> </tr> <tr> <td></td> <td style="text-align: center;">1</td> <td style="text-align: center;">2</td> <td style="text-align: center;">3</td> <td style="text-align: center;">4</td> <td style="text-align: center;">R07</td> <td style="text-align: center;">S07</td> <td style="text-align: center;">T07</td> <td style="text-align: center;">N07</td> <td style="text-align: center;">E7</td> <td style="text-align: center;">E7</td> <td style="text-align: center;">E7</td> <td style="text-align: center;">E7</td> <td style="text-align: center;">E7</td> </tr> <tr> <td></td> <td style="text-align: center;">1</td> <td style="text-align: center;">2</td> <td style="text-align: center;">3</td> <td style="text-align: center;">4</td> <td style="text-align: center;">R08</td> <td style="text-align: center;">S08</td> <td style="text-align: center;">T08</td> <td style="text-align: center;">N08</td> <td style="text-align: center;">E8</td> <td style="text-align: center;">E8</td> <td style="text-align: center;">E8</td> <td style="text-align: center;">E8</td> <td style="text-align: center;">E8</td> </tr> </table> </td> <td style="width: 50%; vertical-align: top;"> <table border="0" style="width: 100%;"> <tr> <td style="width: 50%;"></td> <td style="width: 50%; text-align: center;"> <table border="0"> <tr> <td style="width: 10%;"></td> <td style="width: 10%;"></td> <td style="width: 10%;"></td> <td style="width: 10%;"></td> <td style="width: 10%;"></td> <td style="width: 10%;"></td> <td style="width: 10%;"></td> <td style="width: 10%;"></td> <td style="width: 10%;"></td> <td style="width: 10%;"></td> <td style="width: 10%;"></td> <td style="width: 10%;"></td> <td style="width: 10%;"></td> <td style="width: 10%;"></td> </tr> <tr> <td style="text-align: center;">XA</td> <td style="text-align: center;">1</td> <td style="text-align: center;">2</td> <td style="text-align: center;">3</td> <td style="text-align: center;">4</td> <td style="text-align: center;">R01</td> <td style="text-align: center;">S01</td> <td style="text-align: center;">T01</td> <td style="text-align: center;">N01</td> <td style="text-align: center;">E1</td> <td style="text-align: center;">E1</td> <td style="text-align: center;">E1</td> <td style="text-align: center;">E1</td> <td style="text-align: center;">E1</td> </tr> <tr> <td></td> <td style="text-align: center;">1</td> <td style="text-align: center;">2</td> <td style="text-align: center;">3</td> <td style="text-align: center;">4</td> <td style="text-align: center;">R02</td> <td style="text-align: center;">S02</td> <td style="text-align: center;">T02</td> <td style="text-align: center;">N02</td> <td style="text-align: center;">E2</td> <td style="text-align: center;">E2</td> <td style="text-align: center;">E2</td> <td style="text-align: center;">E2</td> <td style="text-align: center;">E2</td> </tr> <tr> <td></td> <td style="text-align: center;">1</td> <td style="text-align: center;">2</td> <td style="text-align: center;">3</td> <td style="text-align: center;">4</td> <td style="text-align: center;">R03</td> <td style="text-align: center;">S03</td> <td style="text-align: center;">T03</td> <td style="text-align: center;">N03</td> <td style="text-align: center;">E3</td> <td style="text-align: center;">E3</td> <td style="text-align: center;">E3</td> <td style="text-align: center;">E3</td> <td style="text-align: center;">E3</td> </tr> <tr> <td></td> <td style="text-align: center;">1</td> <td style="text-align: center;">2</td> <td style="text-align: center;">3</td> <td style="text-align: center;">4</td> <td style="text-align: center;">R04</td> <td style="text-align: center;">S04</td> <td style="text-align: center;">T04</td> <td style="text-align: center;">N04</td> <td style="text-align: center;">E4</td> <td style="text-align: center;">E4</td> <td style="text-align: center;">E4</td> <td style="text-align: center;">E4</td> <td style="text-align: center;">E4</td> </tr> <tr> <td></td> <td style="text-align: center;">1</td> <td style="text-align: center;">2</td> <td
style="text-align: center;">3</td> <td style="text-align: center;">4</td> <td style="text-align: center;">R05</td> <td style="text-align: center;">S05</td> <td style="text-align: center;">T05</td> <td style="text-align: center;">N05</td> <td style="text-align: center;">E5</td> <td style="text-align: center;">E5</td> <td style="text-align: center;">E5</td> <td style="text-align: center;">E5</td> <td style="text-align: center;">E5</td> </tr> <tr> <td></td> <td style="text-align: center;">1</td> <td style="text-align: center;">2</td> <td style="text-align: center;">3</td> <td style="text-align: center;">4</td> <td style="text-align: center;">R06</td> <td style="text-align: center;">S06</td> <td style="text-align: center;">T06</td> <td style="text-align: center;">N06</td> <td style="text-align: center;">E6</td> <td style="text-align: center;">E6</td> <td style="text-align: center;">E6</td> <td style="text-align: center;">E6</td> <td style="text-align: center;">E6</td> </tr> <tr> <td></td> <td style="text-align: center;">1</td> <td style="text-align: center;">2</td> <td style="text-align: center;">3</td> <td style="text-align: center;">4</td> <td style="text-align: center;">R07</td> <td style="text-align: center;">S07</td> <td style="text-align: center;">T07</td> <td style="text-align: center;">N07</td> <td style="text-align: center;">E7</td> <td style="text-align: center;">E7</td> <td style="text-align: center;">E7</td> <td style="text-align: center;">E7</td> <td style="text-align: center;">E7</td> </tr> <tr> <td></td> <td style="text-align: center;">1</td> <td style="text-align: center;">2</td> <td style="text-align: center;">3</td> <td style="text-align: center;">4</td> <td style="text-align: center;">R08</td> <td style="text-align: center;">S08</td> <td style="text-align: center;">T08</td> <td style="text-align: center;">N08</td> <td style="text-align: center;">E8</td> <td style="text-align: center;">E8</td> <td style="text-align: center;">E8</td> <td style="text-align: center;">E8</td> <td style="text-align: center;">E8</td> </tr> </table> </td> <td style="width: 50%; vertical-align: top;"> <table border="0" style="width: 100%;"> <tr> <td style="width: 50%;"></td> <td style="width: 50%; text-align: center;"> <table border="0"> <tr> <td style="width: 10%;"></td> <td style="width: 10%;"></td> <td style="width: 10%;"></td> <td style="width: 10%;"></td> <td style="width: 10%;"></td> <td style="width: 10%;"></td> <td style="width: 10%;"></td> <td style="width: 10%;"></td> <td style="width: 10%;"></td> <td style="width: 10%;"></td> <td style="width: 10%;"></td> <td style="width: 10%;"></td> <td style="width: 10%;"></td> <td style="width: 10%;"></td> </tr> <tr> <td style="text-align: center;">XA</td> <td style="text-align: center;">1</td> <td style="text-align: center;">2</td> <td style="text-align: center;">3</td> <td style="text-align: center;">4</td> <td style="text-align: center;">R01</td> <td style="text-align: center;">S01</td> <td style="text-align: center;">T01</td> <td style="text-align: center;">N01</td> <td style="text-align: center;">E1</td> <td style="text-align: center;">E1</td> <td style="text-align: center;">E1</td> </tr></table></td></tr></table></td></tr></table></td></tr></table></td></tr></table></td></tr></table> | | <table border="0"> <tr> <td style="width: 10%;"></td> <td style="width: 10%;"></td> <td style="width: 10%;"></td> <td style="width: 10%;"></td> <td style="width: 10%;"></td> <td style="width: 10%;"></td> <td style="width: 10%;"></td> <td style="width: 10%;"></td> <td style="width: 10%;"></td> <td style="width: 10%;"></td> <td style="width: 10%;"></td> <td style="width: 10%;"></td> <td style="width: 10%;"></td> <td style="width: 10%;"></td> </tr> <tr> <td style="text-align: center;">XA</td> <td style="text-align: center;">1</td> <td style="text-align: center;">2</td> <td style="text-align: center;">3</td> <td style="text-align: center;">4</td> <td style="text-align: center;">R01</td> <td style="text-align: center;">S01</td> <td style="text-align: center;">T01</td> <td style="text-align: center;">N01</td> <td style="text-align: center;">E1</td> <td style="text-align: center;">E1</td> <td style="text-align: center;">E1</td> <td style="text-align: center;">E1</td> <td style="text-align: center;">E1</td> </tr> <tr> <td></td> <td style="text-align: center;">1</td> <td style="text-align: center;">2</td> <td style="text-align: center;">3</td> <td style="text-align: center;">4</td> <td style="text-align: center;">R02</td> <td style="text-align: center;">S02</td> <td style="text-align: center;">T02</td> <td style="text-align: center;">N02</td> <td style="text-align: center;">E2</td> <td style="text-align: center;">E2</td> <td style="text-align: center;">E2</td> <td style="text-align: center;">E2</td> <td style="text-align: center;">E2</td> </tr> <tr> <td></td> <td style="text-align: center;">1</td> <td style="text-align: center;">2</td> <td style="text-align: center;">3</td> <td style="text-align: center;">4</td> <td style="text-align: center;">R03</td> <td style="text-align: center;">S03</td> <td style="text-align: center;">T03</td> <td style="text-align:
center;">N03</td> <td style="text-align: center;">E3</td> <td style="text-align: center;">E3</td> <td style="text-align: center;">E3</td> <td style="text-align: center;">E3</td> <td style="text-align: center;">E3</td> </tr> <tr> <td></td> <td style="text-align: center;">1</td> <td style="text-align: center;">2</td> <td style="text-align: center;">3</td> <td style="text-align: center;">4</td> <td style="text-align: center;">R04</td> <td style="text-align: center;">S04</td> <td style="text-align: center;">T04</td> <td style="text-align: center;">N04</td> <td style="text-align: center;">E4</td> <td style="text-align: center;">E4</td> <td style="text-align: center;">E4</td> <td style="text-align: center;">E4</td> <td style="text-align: center;">E4</td> </tr> <tr> <td></td> <td style="text-align: center;">1</td> <td style="text-align: center;">2</td> <td style="text-align: center;">3</td> <td style="text-align: center;">4</td> <td style="text-align: center;">R05</td> <td style="text-align: center;">S05</td> <td style="text-align: center;">T05</td> <td style="text-align: center;">N05</td> <td style="text-align: center;">E5</td> <td style="text-align: center;">E5</td> <td style="text-align: center;">E5</td> <td style="text-align: center;">E5</td> <td style="text-align: center;">E5</td> </tr> <tr> <td></td> <td style="text-align: center;">1</td> <td style="text-align: center;">2</td> <td style="text-align: center;">3</td> <td style="text-align: center;">4</td> <td style="text-align: center;">R06</td> <td style="text-align: center;">S06</td> <td style="text-align: center;">T06</td> <td style="text-align: center;">N06</td> <td style="text-align: center;">E6</td> <td style="text-align: center;">E6</td> <td style="text-align: center;">E6</td> <td style="text-align: center;">E6</td> <td style="text-align: center;">E6</td> </tr> <tr> <td></td> <td style="text-align: center;">1</td> <td style="text-align: center;">2</td> <td style="text-align: center;">3</td> <td style="text-align: center;">4</td> <td style="text-align: center;">R07</td> <td style="text-align: center;">S07</td> <td style="text-align: center;">T07</td> <td style="text-align: center;">N07</td> <td style="text-align: center;">E7</td> <td style="text-align: center;">E7</td> <td style="text-align: center;">E7</td> <td style="text-align: center;">E7</td> <td style="text-align: center;">E7</td> </tr> <tr> <td></td> <td style="text-align: center;">1</td> <td style="text-align: center;">2</td> <td style="text-align: center;">3</td> <td style="text-align: center;">4</td> <td style="text-align: center;">R08</td> <td style="text-align: center;">S08</td> <td style="text-align: center;">T08</td> <td style="text-align: center;">N08</td> <td style="text-align: center;">E8</td> <td style="text-align: center;">E8</td> <td style="text-align: center;">E8</td> <td style="text-align: center;">E8</td> <td style="text-align: center;">E8</td> </tr> </table> | | | | | | | | | | | |

 | | | XA | 1 | 2 | 3 | 4 | R01 | S01 | T01 | N01 | E1 | E1 | E1 | E1 | E1 | | 1 | 2 | 3 | 4 | R02 | S02 | T02 | N02 | E2 | E2 | E2

 | E2 | E2 | | 1 | 2 | 3 | 4 | R03 | S03 | T03 | N03 | E3 | E3 | E3 | E3 | E3 | | 1 | 2 | 3 | 4 | R04 | S04 | T04 | N04 | E4 | E4 | E4 | E4 | E4 | | 1 | 2 | 3 | 4 | R05 | S05 | T05 | N05 | E5 | E5 | E5 | E5 | E5 | | 1 | 2 | 3 | 4 | R06 | S06 | T06 | N06 | E6 | E6 | E6 | E6 | E6 | | 1 | 2 | 3 | 4 | R07 | S07 | T07 | N07 | E7 | E7 | E7 | E7 | E7
 | | 1
 | 2 | 3 | 4 | R08 | S08 | T08 | N08 | E8 | E8 | E8 | E8 | E8
 | <table border="0" style="width: 100%;"> <tr> <td style="width: 50%;"></td> <td style="width: 50%; text-align: center;"> <table border="0"> <tr> <td style="width: 10%;"></td> <td style="width: 10%;"></td> <td style="width: 10%;"></td> <td style="width: 10%;"></td> <td style="width: 10%;"></td> <td style="width: 10%;"></td> <td style="width: 10%;"></td> <td style="width: 10%;"></td> <td style="width: 10%;"></td> <td style="width: 10%;"></td> <td style="width: 10%;"></td> <td style="width: 10%;"></td> <td style="width: 10%;"></td> <td style="width: 10%;"></td> </tr> <tr> <td style="text-align: center;">XA</td> <td style="text-align: center;">1</td> <td style="text-align: center;">2</td> <td style="text-align: center;">3</td> <td style="text-align: center;">4</td> <td style="text-align: center;">R01</td> <td style="text-align: center;">S01</td> <td style="text-align: center;">T01</td> <td style="text-align: center;">N01</td> <td style="text-align: center;">E1</td> <td style="text-align: center;">E1</td> <td style="text-align: center;">E1</td> <td style="text-align: center;">E1</td> <td style="text-align: center;">E1</td> </tr> <tr> <td></td> <td style="text-align: center;">1</td> <td style="text-align: center;">2</td> <td style="text-align: center;">3</td> <td style="text-align: center;">4</td> <td style="text-align: center;">R02</td> <td style="text-align: center;">S02</td> <td style="text-align: center;">T02</td> <td style="text-align: center;">N02</td> <td style="text-align: center;">E2</td> <td style="text-align: center;">E2</td> <td style="text-align: center;">E2</td> <td style="text-align: center;">E2</td> <td style="text-align: center;">E2</td> </tr> <tr> <td></td> <td style="text-align: center;">1</td> <td style="text-align: center;">2</td> <td style="text-align: center;">3</td> <td style="text-align: center;">4</td> <td style="text-align: center;">R03</td> <td style="text-align: center;">S03</td> <td style="text-align: center;">T03</td> <td style="text-align: center;">N03</td> <td style="text-align: center;">E3</td> <td style="text-align: center;">E3</td> <td style="text-align: center;">E3</td> <td style="text-align: center;">E3</td> <td style="text-align: center;">E3</td> </tr> <tr> <td></td> <td style="text-align: center;">1</td> <td style="text-align: center;">2</td> <td style="text-align: center;">3</td> <td style="text-align: center;">4</td> <td style="text-align: center;">R04</td> <td style="text-align: center;">S04</td> <td style="text-align: center;">T04</td> <td
style="text-align: center;">N04</td> <td style="text-align: center;">E4</td> <td style="text-align: center;">E4</td> <td style="text-align: center;">E4</td> <td style="text-align: center;">E4</td> <td style="text-align: center;">E4</td> </tr> <tr> <td></td> <td style="text-align: center;">1</td> <td style="text-align: center;">2</td> <td style="text-align: center;">3</td> <td style="text-align: center;">4</td> <td style="text-align: center;">R05</td> <td style="text-align: center;">S05</td> <td style="text-align: center;">T05</td> <td style="text-align: center;">N05</td> <td style="text-align: center;">E5</td> <td style="text-align: center;">E5</td> <td style="text-align: center;">E5</td> <td style="text-align: center;">E5</td> <td style="text-align: center;">E5</td> </tr> <tr> <td></td> <td style="text-align: center;">1</td> <td style="text-align: center;">2</td> <td style="text-align: center;">3</td> <td style="text-align: center;">4</td> <td style="text-align: center;">R06</td> <td style="text-align: center;">S06</td> <td style="text-align: center;">T06</td> <td style="text-align: center;">N06</td> <td style="text-align: center;">E6</td> <td style="text-align: center;">E6</td> <td style="text-align: center;">E6</td> <td style="text-align: center;">E6</td> <td style="text-align: center;">E6</td> </tr> <tr> <td></td> <td style="text-align: center;">1</td> <td style="text-align: center;">2</td> <td style="text-align: center;">3</td> <td style="text-align: center;">4</td> <td style="text-align: center;">R07</td> <td style="text-align: center;">S07</td> <td style="text-align: center;">T07</td> <td style="text-align: center;">N07</td> <td style="text-align: center;">E7</td> <td style="text-align: center;">E7</td> <td style="text-align: center;">E7</td> <td style="text-align: center;">E7</td> <td style="text-align: center;">E7</td> </tr> <tr> <td></td> <td style="text-align: center;">1</td> <td style="text-align: center;">2</td> <td style="text-align: center;">3</td> <td style="text-align: center;">4</td> <td style="text-align: center;">R08</td> <td style="text-align: center;">S08</td> <td style="text-align: center;">T08</td> <td style="text-align: center;">N08</td> <td style="text-align: center;">E8</td> <td style="text-align: center;">E8</td> <td style="text-align: center;">E8</td> <td style="text-align: center;">E8</td> <td style="text-align: center;">E8</td> </tr> </table> </td> <td style="width: 50%; vertical-align: top;"> <table border="0" style="width: 100%;"> <tr> <td style="width: 50%;"></td> <td style="width: 50%; text-align: center;"> <table border="0"> <tr> <td style="width: 10%;"></td> <td style="width: 10%;"></td> <td style="width: 10%;"></td> <td style="width: 10%;"></td> <td style="width: 10%;"></td> <td style="width: 10%;"></td> <td style="width: 10%;"></td> <td style="width: 10%;"></td> <td style="width: 10%;"></td> <td style="width: 10%;"></td> <td style="width: 10%;"></td> <td style="width: 10%;"></td> <td style="width: 10%;"></td> <td style="width: 10%;"></td> </tr> <tr> <td style="text-align: center;">XA</td> <td style="text-align: center;">1</td> <td style="text-align: center;">2</td> <td style="text-align: center;">3</td> <td style="text-align: center;">4</td> <td style="text-align: center;">R01</td> <td style="text-align: center;">S01</td> <td style="text-align: center;">T01</td> <td style="text-align: center;">N01</td> <td style="text-align: center;">E1</td> <td style="text-align: center;">E1</td> <td style="text-align: center;">E1</td> <td style="text-align: center;">E1</td> <td style="text-align: center;">E1</td> </tr> <tr> <td></td> <td style="text-align: center;">1</td> <td style="text-align: center;">2</td> <td style="text-align: center;">3</td> <td style="text-align: center;">4</td> <td style="text-align: center;">R02</td> <td style="text-align: center;">S02</td> <td style="text-align: center;">T02</td> <td style="text-align: center;">N02</td> <td style="text-align: center;">E2</td> <td style="text-align: center;">E2</td> <td style="text-align: center;">E2</td> <td style="text-align: center;">E2</td> <td style="text-align: center;">E2</td> </tr> <tr> <td></td> <td style="text-align: center;">1</td> <td style="text-align: center;">2</td> <td style="text-align: center;">3</td> <td style="text-align: center;">4</td> <td style="text-align: center;">R03</td> <td style="text-align: center;">S03</td> <td style="text-align: center;">T03</td> <td style="text-align: center;">N03</td> <td style="text-align: center;">E3</td> <td style="text-align: center;">E3</td> <td style="text-align: center;">E3</td> <td style="text-align: center;">E3</td> <td style="text-align: center;">E3</td> </tr> <tr> <td></td> <td style="text-align: center;">1</td> <td style="text-align: center;">2</td> <td style="text-align: center;">3</td> <td style="text-align: center;">4</td> <td style="text-align: center;">R04</td> <td style="text-align: center;">S04</td> <td style="text-align: center;">T04</td> <td style="text-align: center;">N04</td> <td style="text-align: center;">E4</td> <td style="text-align: center;">E4</td> <td style="text-align: center;">E4</td> <td style="text-align: center;">E4</td> <td style="text-align: center;">E4</td> </tr> <tr> <td></td> <td style="text-align: center;">1</td> <td style="text-align: center;">2</td> <td style="text-align: center;">3</td> <td style="text-align: center;">4</td> <td style="text-align: center;">R05</td> <td style="text-align: center;">S05</td> <td style="text-align: center;">T05</td> <td style="text-align: center;">N05</td> <td style="text-align: center;">E5</td> <td style="text-align: center;">E5</td> <td style="text-align: center;">E5</td> <td style="text-align: center;">E5</td> <td style="text-align: center;">E5</td> </tr> <tr> <td></td> <td style="text-align: center;">1</td> <td style="text-align: center;">2</td> <td style="text-align: center;">3</td> <td style="text-align: center;">4</td> <td style="text-align: center;">R06</td> <td style="text-align: center;">S06</td> <td style="text-align: center;">T06</td> <td style="text-align: center;">N06</td> <td style="text-align: center;">E6</td> <td style="text-align: center;">E6</td> <td style="text-align: center;">E6</td> <td style="text-align: center;">E6</td> <td style="text-align: center;">E6</td> </tr> <tr> <td></td> <td style="text-align: center;">1</td> <td style="text-align: center;">2</td> <td style="text-align: center;">3</td> <td style="text-align: center;">4</td> <td style="text-align: center;">R07</td> <td style="text-align: center;">S07</td> <td style="text-align: center;">T07</td> <td style="text-align: center;">N07</td> <td style="text-align: center;">E7</td> <td style="text-align: center;">E7</td> <td style="text-align: center;">E7</td> <td style="text-align: center;">E7</td> <td style="text-align: center;">E7</td> </tr> <tr> <td></td> <td style="text-align: center;">1</td> <td style="text-align: center;">2</td> <td style="text-align: center;">3</td> <td style="text-align: center;">4</td> <td style="text-align: center;">R08</td> <td style="text-align: center;">S08</td> <td style="text-align: center;">T08</td> <td style="text-align: center;">N08</td> <td style="text-align: center;">E8</td> <td style="text-align: center;">E8</td> <td style="text-align: center;">E8</td> <td style="text-align: center;">E8</td> <td style="text-align: center;">E8</td> </tr> </table> </td> <td style="width: 50%; vertical-align: top;"> <table border="0" style="width: 100%;"> <tr> <td style="width: 50%;"></td> <td style="width: 50%; text-align: center;"> <table border="0"> <tr> <td style="width: 10%;"></td> <td style="width: 10%;"></td> <td style="width: 10%;"></td> <td style="width: 10%;"></td> <td style="width: 10%;"></td> <td style="width: 10%;"></td> <td style="width: 10%;"></td> <td style="width: 10%;"></td> <td style="width: 10%;"></td> <td style="width: 10%;"></td> <td style="width: 10%;"></td> <td style="width: 10%;"></td> <td style="width: 10%;"></td> <td style="width: 10%;"></td> </tr> <tr> <td style="text-align: center;">XA</td> <td style="text-align: center;">1</td> <td style="text-align: center;">2</td> <td style="text-align: center;">3</td> <td style="text-align: center;">4</td> <td style="text-align: center;">R01</td> <td style="text-align: center;">S01</td> <td style="text-align: center;">T01</td> <td style="text-align: center;">N01</td> <td style="text-align: center;">E1</td> <td style="text-align: center;">E1</td> <td style="text-align: center;">E1</td> <td style="text-align: center;">E1</td> <td style="text-align: center;">E1</td> </tr> <tr> <td></td> <td style="text-align: center;">1</td> <td style="text-align: center;">2</td> <td style="text-align: center;">3</td> <td style="text-align: center;">4</td> <td style="text-align: center;">R02</td> <td style="text-align: center;">S02</td> <td style="text-align: center;">T02</td> <td style="text-align: center;">N02</td> <td style="text-align: center;">E2</td> <td style="text-align: center;">E2</td> <td style="text-align: center;">E2</td> <td style="text-align: center;">E2</td> <td style="text-align: center;">E2</td> </tr> <tr> <td></td> <td style="text-align: center;">1</td> <td style="text-align: center;">2</td> <td style="text-align: center;">3</td> <td style="text-align: center;">4</td> <td style="text-align: center;">R03</td> <td style="text-align: center;">S03</td> <td style="text-align: center;">T03</td> <td style="text-align: center;">N03</td> <td style="text-align: center;">E3</td> <td style="text-align: center;">E3</td> <td style="text-align: center;">E3</td> <td style="text-align: center;">E3</td> <td style="text-align: center;">E3</td> </tr> <tr> <td></td> <td style="text-align: center;">1</td> <td style="text-align: center;">2</td> <td style="text-align: center;">3</td> <td style="text-align: center;">4</td> <td style="text-align: center;">R04</td> <td style="text-align: center;">S04</td> <td style="text-align: center;">T04</td> <td style="text-align:
center;">N04</td> <td style="text-align: center;">E4</td> <td style="text-align: center;">E4</td> <td style="text-align: center;">E4</td> <td style="text-align: center;">E4</td> <td style="text-align: center;">E4</td> </tr> <tr> <td></td> <td style="text-align: center;">1</td> <td style="text-align: center;">2</td> <td style="text-align: center;">3</td> <td style="text-align: center;">4</td> <td style="text-align: center;">R05</td> <td style="text-align: center;">S05</td> <td style="text-align: center;">T05</td> <td style="text-align: center;">N05</td> <td style="text-align: center;">E5</td> <td style="text-align: center;">E5</td> <td style="text-align: center;">E5</td> <td style="text-align: center;">E5</td> <td style="text-align: center;">E5</td> </tr> <tr> <td></td> <td style="text-align: center;">1</td> <td style="text-align: center;">2</td> <td style="text-align: center;">3</td> <td style="text-align: center;">4</td> <td style="text-align: center;">R06</td> <td style="text-align: center;">S06</td> <td style="text-align: center;">T06</td> <td style="text-align: center;">N06</td> <td style="text-align: center;">E6</td> <td style="text-align: center;">E6</td> <td style="text-align: center;">E6</td> <td style="text-align: center;">E6</td> <td style="text-align: center;">E6</td> </tr> <tr> <td></td> <td style="text-align: center;">1</td> <td style="text-align: center;">2</td> <td style="text-align: center;">3</td> <td style="text-align: center;">4</td> <td style="text-align: center;">R07</td> <td style="text-align: center;">S07</td> <td style="text-align: center;">T07</td> <td style="text-align: center;">N07</td> <td style="text-align: center;">E7</td> <td style="text-align: center;">E7</td> <td style="text-align: center;">E7</td> <td style="text-align: center;">E7</td> <td style="text-align: center;">E7</td> </tr> <tr> <td></td> <td style="text-align: center;">1</td> <td style="text-align: center;">2</td> <td style="text-align: center;">3</td> <td style="text-align: center;">4</td> <td style="text-align: center;">R08</td> <td style="text-align: center;">S08</td> <td style="text-align: center;">T08</td> <td style="text-align: center;">N08</td> <td style="text-align: center;">E8</td> <td style="text-align: center;">E8</td> <td style="text-align: center;">E8</td> <td style="text-align: center;">E8</td> <td style="text-align: center;">E8</td> </tr> </table> </td> <td style="width: 50%; vertical-align: top;"> <table border="0" style="width: 100%;"> <tr> <td style="width: 50%;"></td> <td style="width: 50%; text-align: center;"> <table border="0"> <tr> <td style="width: 10%;"></td> <td style="width: 10%;"></td> <td style="width: 10%;"></td> <td style="width: 10%;"></td> <td style="width: 10%;"></td> <td style="width: 10%;"></td> <td style="width: 10%;"></td> <td style="width: 10%;"></td> <td style="width: 10%;"></td> <td style="width: 10%;"></td> <td style="width: 10%;"></td> <td style="width: 10%;"></td> <td style="width: 10%;"></td> <td style="width: 10%;"></td> </tr> <tr> <td style="text-align: center;">XA</td> <td style="text-align: center;">1</td> <td style="text-align: center;">2</td> <td style="text-align: center;">3</td> <td style="text-align: center;">4</td> <td style="text-align: center;">R01</td> <td style="text-align: center;">S01</td> <td style="text-align: center;">T01</td> <td style="text-align: center;">N01</td> <td style="text-align: center;">E1</td> <td style="text-align: center;">E1</td> <td style="text-align: center;">E1</td> </tr></table></td></tr></table></td></tr></table></td></tr></table></td></tr></table> | | <table border="0"> <tr> <td style="width: 10%;"></td> <td style="width: 10%;"></td> <td style="width: 10%;"></td> <td style="width: 10%;"></td> <td style="width: 10%;"></td> <td style="width: 10%;"></td> <td style="width: 10%;"></td> <td style="width: 10%;"></td> <td style="width: 10%;"></td> <td style="width: 10%;"></td> <td style="width: 10%;"></td> <td style="width: 10%;"></td> <td style="width: 10%;"></td> <td style="width: 10%;"></td> </tr> <tr> <td style="text-align: center;">XA</td> <td style="text-align: center;">1</td> <td style="text-align: center;">2</td> <td style="text-align: center;">3</td> <td style="text-align: center;">4</td> <td style="text-align: center;">R01</td> <td style="text-align: center;">S01</td> <td style="text-align: center;">T01</td> <td style="text-align: center;">N01</td> <td style="text-align: center;">E1</td> <td style="text-align: center;">E1</td> <td style="text-align: center;">E1</td> <td style="text-align: center;">E1</td> <td style="text-align: center;">E1</td> </tr> <tr> <td></td> <td style="text-align: center;">1</td> <td style="text-align: center;">2</td> <td style="text-align: center;">3</td> <td style="text-align: center;">4</td> <td style="text-align: center;">R02</td> <td style="text-align: center;">S02</td> <td style="text-align: center;">T02</td> <td style="text-align: center;">N02</td> <td style="text-align: center;">E2</td> <td style="text-align: center;">E2</td> <td style="text-align: center;">E2</td> <td style="text-align: center;">E2</td> <td style="text-align: center;">E2</td> </tr> <tr> <td></td> <td
style="text-align: center;">1</td> <td style="text-align: center;">2</td> <td style="text-align: center;">3</td> <td style="text-align: center;">4</td> <td style="text-align: center;">R03</td> <td style="text-align: center;">S03</td> <td style="text-align: center;">T03</td> <td style="text-align: center;">N03</td> <td style="text-align: center;">E3</td> <td style="text-align: center;">E3</td> <td style="text-align: center;">E3</td> <td style="text-align: center;">E3</td> <td style="text-align: center;">E3</td> </tr> <tr> <td></td> <td style="text-align: center;">1</td> <td style="text-align: center;">2</td> <td style="text-align: center;">3</td> <td style="text-align: center;">4</td> <td style="text-align: center;">R04</td> <td style="text-align: center;">S04</td> <td style="text-align: center;">T04</td> <td style="text-align: center;">N04</td> <td style="text-align: center;">E4</td> <td style="text-align: center;">E4</td> <td style="text-align: center;">E4</td> <td style="text-align: center;">E4</td> <td style="text-align: center;">E4</td> </tr> <tr> <td></td> <td style="text-align: center;">1</td> <td style="text-align: center;">2</td> <td style="text-align: center;">3</td> <td style="text-align: center;">4</td> <td style="text-align: center;">R05</td> <td style="text-align: center;">S05</td> <td style="text-align: center;">T05</td> <td style="text-align: center;">N05</td> <td style="text-align: center;">E5</td> <td style="text-align: center;">E5</td> <td style="text-align: center;">E5</td> <td style="text-align: center;">E5</td> <td style="text-align: center;">E5</td> </tr> <tr> <td></td> <td style="text-align: center;">1</td> <td style="text-align: center;">2</td> <td style="text-align: center;">3</td> <td style="text-align: center;">4</td> <td style="text-align: center;">R06</td> <td style="text-align: center;">S06</td> <td style="text-align: center;">T06</td> <td style="text-align: center;">N06</td> <td style="text-align: center;">E6</td> <td style="text-align: center;">E6</td> <td style="text-align: center;">E6</td> <td style="text-align: center;">E6</td> <td style="text-align: center;">E6</td> </tr> <tr> <td></td> <td style="text-align: center;">1</td> <td style="text-align: center;">2</td> <td style="text-align: center;">3</td> <td style="text-align: center;">4</td> <td style="text-align: center;">R07</td> <td style="text-align: center;">S07</td> <td style="text-align: center;">T07</td> <td style="text-align: center;">N07</td> <td style="text-align: center;">E7</td> <td style="text-align: center;">E7</td> <td style="text-align: center;">E7</td> <td style="text-align: center;">E7</td> <td style="text-align: center;">E7</td> </tr> <tr> <td></td> <td style="text-align: center;">1</td> <td style="text-align: center;">2</td> <td style="text-align: center;">3</td> <td style="text-align: center;">4</td> <td style="text-align: center;">R08</td> <td style="text-align: center;">S08</td> <td style="text-align: center;">T08</td> <td style="text-align: center;">N08</td> <td style="text-align: center;">E8</td> <td style="text-align: center;">E8</td> <td style="text-align: center;">E8</td> <td style="text-align: center;">E8</td> <td style="text-align: center;">E8</td> </tr> </table> | | | | | | | | | | | |
 | |
 | XA | 1 | 2 | 3 | 4 | R01 | S01 | T01 | N01 | E1 | E1 | E1 | E1 | E1 | | 1 | 2 | 3 | 4 | R02 | S02 | T02 | N02 | E2 | E2 | E2

 | E2 | E2 | | 1 | 2 | 3 | 4 | R03 | S03 | T03 | N03 | E3 | E3 | E3 | E3 | E3 | | 1 | 2 | 3 | 4 | R04 | S04 | T04 | N04 | E4 | E4 | E4 | E4 | E4 | | 1 | 2 | 3 | 4 | R05 | S05 | T05 | N05 | E5 | E5 | E5 | E5 | E5 | | 1 | 2 | 3 | 4 | R06 | S06 | T06 | N06 | E6 | E6 | E6 | E6 | E6 | | 1 | 2 | 3 | 4 | R07 | S07 | T07 | N07 | E7 | E7 | E7 | E7 | E7
 | | 1 | 2 | 3 | 4 | R08 | S08 | T08 | N08 | E8 | E8 | E8 | E8 | E8
 | <table border="0" style="width: 100%;"> <tr> <td style="width: 50%;"></td> <td style="width: 50%; text-align: center;"> <table border="0"> <tr> <td style="width: 10%;"></td> <td style="width: 10%;"></td> <td style="width: 10%;"></td> <td style="width: 10%;"></td> <td style="width: 10%;"></td> <td style="width: 10%;"></td> <td style="width: 10%;"></td> <td style="width: 10%;"></td> <td style="width: 10%;"></td> <td style="width: 10%;"></td> <td style="width: 10%;"></td> <td style="width: 10%;"></td> <td style="width: 10%;"></td> <td style="width: 10%;"></td> </tr> <tr> <td style="text-align: center;">XA</td> <td style="text-align: center;">1</td> <td style="text-align: center;">2</td> <td style="text-align: center;">3</td> <td style="text-align: center;">4</td> <td style="text-align: center;">R01</td> <td style="text-align: center;">S01</td> <td style="text-align: center;">T01</td> <td style="text-align: center;">N01</td> <td style="text-align: center;">E1</td> <td style="text-align: center;">E1</td> <td style="text-align: center;">E1</td> <td style="text-align: center;">E1</td> <td style="text-align: center;">E1</td> </tr> <tr> <td></td> <td style="text-align: center;">1</td> <td style="text-align: center;">2</td> <td style="text-align: center;">3</td> <td style="text-align: center;">4</td> <td style="text-align: center;">R02</td> <td style="text-align: center;">S02</td> <td style="text-align: center;">T02</td> <td style="text-align: center;">N02</td> <td style="text-align: center;">E2</td> <td style="text-align: center;">E2</td> <td style="text-align: center;">E2</td> <td style="text-align: center;">E2</td> <td style="text-align: center;">E2</td> </tr> <tr> <td></td> <td style="text-align: center;">1</td> <td style="text-align: center;">2</td> <td style="text-align: center;">3</td> <td style="text-align: center;">4</td> <td style="text-align: center;">R03</td> <td style="text-align: center;">S03</td> <td style="text-align: center;">T03</td> <td style="text-align: center;">N03</td> <td style="text-align: center;">E3</td> <td style="text-align: center;">E3</td> <td style="text-align: center;">E3</td> <td style="text-align: center;">E3</td> <td style="text-align: center;">E3</td> </tr> <tr> <td></td> <td style="text-align:
center;">1</td> <td style="text-align: center;">2</td> <td style="text-align: center;">3</td> <td style="text-align: center;">4</td> <td style="text-align: center;">R04</td> <td style="text-align: center;">S04</td> <td style="text-align: center;">T04</td> <td style="text-align: center;">N04</td> <td style="text-align: center;">E4</td> <td style="text-align: center;">E4</td> <td style="text-align: center;">E4</td> <td style="text-align: center;">E4</td> <td style="text-align: center;">E4</td> </tr> <tr> <td></td> <td style="text-align: center;">1</td> <td style="text-align: center;">2</td> <td style="text-align: center;">3</td> <td style="text-align: center;">4</td> <td style="text-align: center;">R05</td> <td style="text-align: center;">S05</td> <td style="text-align: center;">T05</td> <td style="text-align: center;">N05</td> <td style="text-align: center;">E5</td> <td style="text-align: center;">E5</td> <td style="text-align: center;">E5</td> <td style="text-align: center;">E5</td> <td style="text-align: center;">E5</td> </tr> <tr> <td></td> <td style="text-align: center;">1</td> <td style="text-align: center;">2</td> <td style="text-align: center;">3</td> <td style="text-align: center;">4</td> <td style="text-align: center;">R06</td> <td style="text-align: center;">S06</td> <td style="text-align: center;">T06</td> <td style="text-align: center;">N06</td> <td style="text-align: center;">E6</td> <td style="text-align: center;">E6</td> <td style="text-align: center;">E6</td> <td style="text-align: center;">E6</td> <td style="text-align: center;">E6</td> </tr> <tr> <td></td> <td style="text-align: center;">1</td> <td style="text-align: center;">2</td> <td style="text-align: center;">3</td> <td style="text-align: center;">4</td> <td style="text-align: center;">R07</td> <td style="text-align: center;">S07</td> <td style="text-align: center;">T07</td> <td style="text-align: center;">N07</td> <td style="text-align: center;">E7</td> <td style="text-align: center;">E7</td> <td style="text-align: center;">E7</td> <td style="text-align: center;">E7</td> <td style="text-align: center;">E7</td> </tr> <tr> <td></td> <td style="text-align: center;">1</td> <td style="text-align: center;">2</td> <td style="text-align: center;">3</td> <td style="text-align: center;">4</td> <td style="text-align: center;">R08</td> <td style="text-align: center;">S08</td> <td style="text-align: center;">T08</td> <td style="text-align: center;">N08</td> <td style="text-align: center;">E8</td> <td style="text-align: center;">E8</td> <td style="text-align: center;">E8</td> <td style="text-align: center;">E8</td> <td style="text-align: center;">E8</td> </tr> </table> </td> <td style="width: 50%; vertical-align: top;"> <table border="0" style="width: 100%;"> <tr> <td style="width: 50%;"></td> <td style="width: 50%; text-align: center;"> <table border="0"> <tr> <td style="width: 10%;"></td> <td style="width: 10%;"></td> <td style="width: 10%;"></td> <td style="width: 10%;"></td> <td style="width: 10%;"></td> <td style="width: 10%;"></td> <td style="width: 10%;"></td> <td style="width: 10%;"></td> <td style="width: 10%;"></td> <td style="width: 10%;"></td> <td style="width: 10%;"></td> <td style="width: 10%;"></td> <td style="width: 10%;"></td> <td style="width: 10%;"></td> </tr> <tr> <td style="text-align: center;">XA</td> <td style="text-align: center;">1</td> <td style="text-align: center;">2</td> <td style="text-align: center;">3</td> <td style="text-align: center;">4</td> <td style="text-align: center;">R01</td> <td style="text-align: center;">S01</td> <td style="text-align: center;">T01</td> <td style="text-align: center;">N01</td> <td style="text-align: center;">E1</td> <td style="text-align: center;">E1</td> <td style="text-align: center;">E1</td> <td style="text-align: center;">E1</td> <td style="text-align: center;">E1</td> </tr> <tr> <td></td> <td style="text-align: center;">1</td> <td style="text-align: center;">2</td> <td style="text-align: center;">3</td> <td style="text-align: center;">4</td> <td style="text-align: center;">R02</td> <td style="text-align: center;">S02</td> <td style="text-align: center;">T02</td> <td style="text-align: center;">N02</td> <td style="text-align: center;">E2</td> <td style="text-align: center;">E2</td> <td style="text-align: center;">E2</td> <td style="text-align: center;">E2</td> <td style="text-align: center;">E2</td> </tr> <tr> <td></td> <td style="text-align: center;">1</td> <td style="text-align: center;">2</td> <td style="text-align: center;">3</td> <td style="text-align: center;">4</td> <td style="text-align: center;">R03</td> <td style="text-align: center;">S03</td> <td style="text-align: center;">T03</td> <td style="text-align: center;">N03</td> <td style="text-align: center;">E3</td> <td style="text-align: center;">E3</td> <td style="text-align: center;">E3</td> <td style="text-align: center;">E3</td> <td style="text-align: center;">E3</td> </tr> <tr> <td></td> <td style="text-align: center;">1</td> <td style="text-align: center;">2</td> <td style="text-align: center;">3</td> <td style="text-align: center;">4</td> <td style="text-align: center;">R04</td> <td style="text-align: center;">S04</td> <td style="text-align: center;">T04</td> <td style="text-align: center;">N04</td> <td style="text-align: center;">E4</td> <td style="text-align: center;">E4</td> <td style="text-align: center;">E4</td> <td style="text-align: center;">E4</td> <td style="text-align: center;">E4</td> </tr> <tr> <td></td> <td style="text-align: center;">1</td> <td style="text-align: center;">2</td> <td style="text-align: center;">3</td> <td style="text-align: center;">4</td> <td style="text-align: center;">R05</td> <td style="text-align: center;">S05</td> <td style="text-align: center;">T05</td> <td style="text-align: center;">N05</td> <td style="text-align: center;">E5</td> <td style="text-align: center;">E5</td> <td style="text-align: center;">E5</td> <td style="text-align: center;">E5</td> <td style="text-align: center;">E5</td> </tr> <tr> <td></td> <td style="text-align: center;">1</td> <td style="text-align: center;">2</td> <td style="text-align: center;">3</td> <td style="text-align: center;">4</td> <td style="text-align: center;">R06</td> <td style="text-align: center;">S06</td> <td style="text-align: center;">T06</td> <td style="text-align: center;">N06</td> <td style="text-align: center;">E6</td> <td style="text-align: center;">E6</td> <td style="text-align: center;">E6</td> <td style="text-align: center;">E6</td> <td style="text-align: center;">E6</td> </tr> <tr> <td></td> <td style="text-align: center;">1</td> <td style="text-align: center;">2</td> <td style="text-align: center;">3</td> <td style="text-align: center;">4</td> <td style="text-align: center;">R07</td> <td style="text-align: center;">S07</td> <td style="text-align: center;">T07</td> <td style="text-align: center;">N07</td> <td style="text-align: center;">E7</td> <td style="text-align: center;">E7</td> <td style="text-align: center;">E7</td> <td style="text-align: center;">E7</td> <td style="text-align: center;">E7</td> </tr> <tr> <td></td> <td style="text-align: center;">1</td> <td style="text-align: center;">2</td> <td style="text-align: center;">3</td> <td style="text-align: center;">4</td> <td style="text-align: center;">R08</td> <td style="text-align: center;">S08</td> <td style="text-align: center;">T08</td> <td style="text-align: center;">N08</td> <td style="text-align: center;">E8</td> <td style="text-align: center;">E8</td> <td style="text-align: center;">E8</td> <td style="text-align: center;">E8</td> <td style="text-align: center;">E8</td> </tr> </table> </td> <td style="width: 50%; vertical-align: top;"> <table border="0" style="width: 100%;"> <tr> <td style="width: 50%;"></td> <td style="width: 50%; text-align: center;"> <table border="0"> <tr> <td style="width: 10%;"></td> <td style="width: 10%;"></td> <td style="width: 10%;"></td> <td style="width: 10%;"></td> <td style="width: 10%;"></td> <td style="width: 10%;"></td> <td style="width: 10%;"></td> <td style="width: 10%;"></td> <td style="width: 10%;"></td> <td style="width: 10%;"></td> <td style="width: 10%;"></td> <td style="width: 10%;"></td> <td style="width: 10%;"></td> <td style="width: 10%;"></td> </tr> <tr> <td style="text-align: center;">XA</td> <td style="text-align: center;">1</td> <td style="text-align: center;">2</td> <td style="text-align: center;">3</td> <td style="text-align: center;">4</td> <td style="text-align: center;">R01</td> <td style="text-align: center;">S01</td> <td style="text-align: center;">T01</td> <td style="text-align: center;">N01</td> <td style="text-align: center;">E1</td> <td style="text-align: center;">E1</td> <td style="text-align: center;">E1</td> </tr></table></td></tr></table></td></tr></table></td></tr></table> |
 | <table border="0"> <tr> <td style="width: 10%;"></td> <td style="width: 10%;"></td> <td style="width: 10%;"></td> <td style="width: 10%;"></td> <td style="width: 10%;"></td> <td style="width: 10%;"></td> <td style="width: 10%;"></td> <td style="width: 10%;"></td> <td style="width: 10%;"></td> <td style="width: 10%;"></td> <td style="width: 10%;"></td> <td style="width: 10%;"></td> <td style="width: 10%;"></td> <td style="width: 10%;"></td> </tr> <tr> <td style="text-align: center;">XA</td> <td style="text-align: center;">1</td> <td style="text-align: center;">2</td> <td style="text-align: center;">3</td> <td style="text-align: center;">4</td> <td style="text-align: center;">R01</td> <td style="text-align: center;">S01</td> <td style="text-align: center;">T01</td> <td style="text-align: center;">N01</td> <td style="text-align: center;">E1</td> <td style="text-align: center;">E1</td> <td style="text-align: center;">E1</td> <td style="text-align: center;">E1</td> <td style="text-align: center;">E1</td> </tr> <tr> <td></td> <td style="text-align: center;">1</td> <td style="text-align: center;">2</td> <td style="text-align: center;">3</td> <td style="text-align: center;">4</td> <td style="text-align: center;">R02</td> <td style="text-align: center;">S02</td> <td style="text-align: center;">T02</td> <td style="text-align: center;">N02</td> <td style="text-align: center;">E2</td> <td style="text-align: center;">E2</td> <td style="text-align: center;">E2</td> <td style="text-align: center;">E2</td> <td style="text-align: center;">E2</td> </tr> <tr> <td></td> <td style="text-align: center;">1</td> <td style="text-align: center;">2</td> <td style="text-align: center;">3</td> <td style="text-align: center;">4</td> <td style="text-align: center;">R03</td> <td style="text-align: center;">S03</td> <td style="text-align: center;">T03</td> <td style="text-align: center;">N03</td> <td style="text-align: center;">E3</td> <td style="text-align: center;">E3</td> <td style="text-align: center;">E3</td> <td style="text-align: center;">E3</td> <td style="text-align: center;">E3</td> </tr> <tr> <td></td> <td style="text-align: center;">1</td> <td style="text-align: center;">2</td> <td style="text-align: center;">3</td> <td style="text-align: center;">4</td> <td style="text-align: center;">R04</td> <td style="text-align: center;">S04</td> <td style="text-align: center;">T04</td> <td style="text-align: center;">N04</td> <td style="text-align: center;">E4</td> <td style="text-align: center;">E4</td> <td style="text-align: center;">E4</td> <td style="text-align: center;">E4</td> <td style="text-align: center;">E4</td> </tr> <tr> <td></td> <td style="text-align: center;">1</td> <td style="text-align: center;">2</td> <td style="text-align: center;">3</td> <td style="text-align: center;">4</td> <td style="text-align: center;">R05</td> <td style="text-align: center;">S05</td> <td style="text-align: center;">T05</td> <td style="text-align: center;">N05</td> <td style="text-align: center;">E5</td> <td style="text-align: center;">E5</td> <td style="text-align: center;">E5</td> <td style="text-align: center;">E5</td> <td style="text-align: center;">E5</td> </tr> <tr> <td></td> <td style="text-align: center;">1</td> <td style="text-align: center;">2</td> <td style="text-align: center;">3</td> <td style="text-align: center;">4</td> <td style="text-align: center;">R06</td> <td style="text-align: center;">S06</td> <td style="text-align: center;">T06</td> <td style="text-align: center;">N06</td> <td style="text-align: center;">E6</td> <td style="text-align: center;">E6</td> <td style="text-align: center;">E6</td> <td style="text-align: center;">E6</td> <td style="text-align: center;">E6</td> </tr> <tr> <td></td> <td style="text-align: center;">1</td> <td style="text-align: center;">2</td> <td style="text-align: center;">3</td> <td style="text-align: center;">4</td> <td style="text-align: center;">R07</td> <td style="text-align: center;">S07</td> <td style="text-align: center;">T07</td> <td style="text-align: center;">N07</td> <td style="text-align: center;">E7</td> <td style="text-align: center;">E7</td> <td style="text-align: center;">E7</td> <td style="text-align: center;">E7</td> <td style="text-align: center;">E7</td> </tr> <tr> <td></td> <td style="text-align: center;">1</td> <td style="text-align: center;">2</td> <td style="text-align: center;">3</td> <td style="text-align: center;">4</td> <td style="text-align: center;">R08</td> <td style="text-align: center;">S08</td> <td style="text-align: center;">T08</td> <td style="text-align: center;">N08</td> <td style="text-align: center;">E8</td> <td style="text-align: center;">E8</td> <td style="text-align: center;">E8</td> <td style="text-align: center;">E8</td> <td style="text-align: center;">E8</td> </tr> </table> | | | | | | | | | | | |
 | |
 | XA | 1 | 2 | 3 | 4 | R01 | S01 | T01 | N01 | E1 | E1 | E1 | E1 | E1 | | 1 | 2 | 3 | 4 | R02 | S02 | T02 | N02 | E2 | E2 | E2
 | E2 | E2
 | | 1 | 2 | 3 | 4 | R03 | S03 | T03 | N03 | E3 | E3 | E3 | E3 | E3 | | 1 | 2 | 3 | 4 | R04 | S04 | T04 | N04 | E4 | E4 | E4 | E4 | E4 | | 1 | 2 | 3 | 4 | R05 | S05 | T05 | N05 | E5 | E5 | E5 | E5 | E5 | | 1 | 2 | 3 | 4 | R06 | S06 | T06 | N06 | E6 | E6 | E6 | E6 | E6 | | 1 | 2 | 3 | 4 | R07 | S07 | T07 | N07 | E7 | E7 | E7 | E7 | E7 | | 1 | 2 | 3 | 4 | R08 | S08 | T08 | N08 | E8 | E8 | E8 | E8 | E8 | <table border="0" style="width: 100%;"> <tr> <td style="width: 50%;"></td> <td style="width: 50%; text-align: center;"> <table border="0"> <tr> <td style="width: 10%;"></td> <td style="width: 10%;"></td> <td style="width: 10%;"></td> <td style="width: 10%;"></td> <td style="width: 10%;"></td> <td style="width: 10%;"></td> <td style="width: 10%;"></td> <td style="width: 10%;"></td> <td style="width: 10%;"></td> <td style="width: 10%;"></td> <td style="width: 10%;"></td> <td style="width: 10%;"></td> <td style="width: 10%;"></td> <td style="width: 10%;"></td> </tr> <tr> <td style="text-align: center;">XA</td> <td style="text-align: center;">1</td> <td style="text-align: center;">2</td> <td style="text-align: center;">3</td> <td style="text-align: center;">4</td> <td style="text-align: center;">R01</td> <td style="text-align: center;">S01</td> <td style="text-align: center;">T01</td> <td style="text-align:
center;">N01</td> <td style="text-align: center;">E1</td> <td style="text-align: center;">E1</td> <td style="text-align: center;">E1</td> <td style="text-align: center;">E1</td> <td style="text-align: center;">E1</td> </tr> <tr> <td></td> <td style="text-align: center;">1</td> <td style="text-align: center;">2</td> <td style="text-align: center;">3</td> <td style="text-align: center;">4</td> <td style="text-align: center;">R02</td> <td style="text-align: center;">S02</td> <td style="text-align: center;">T02</td> <td style="text-align: center;">N02</td> <td style="text-align: center;">E2</td> <td style="text-align: center;">E2</td> <td style="text-align: center;">E2</td> <td style="text-align: center;">E2</td> <td style="text-align: center;">E2</td> </tr> <tr> <td></td> <td style="text-align: center;">1</td> <td style="text-align: center;">2</td> <td style="text-align: center;">3</td> <td style="text-align: center;">4</td> <td style="text-align: center;">R03</td> <td style="text-align: center;">S03</td> <td style="text-align: center;">T03</td> <td style="text-align: center;">N03</td> <td style="text-align: center;">E3</td> <td style="text-align: center;">E3</td> <td style="text-align: center;">E3</td> <td style="text-align: center;">E3</td> <td style="text-align: center;">E3</td> </tr> <tr> <td></td> <td style="text-align: center;">1</td> <td style="text-align: center;">2</td> <td style="text-align: center;">3</td> <td style="text-align: center;">4</td> <td style="text-align: center;">R04</td> <td style="text-align: center;">S04</td> <td style="text-align: center;">T04</td> <td style="text-align: center;">N04</td> <td style="text-align: center;">E4</td> <td style="text-align: center;">E4</td> <td style="text-align: center;">E4</td> <td style="text-align: center;">E4</td> <td style="text-align: center;">E4</td> </tr> <tr> <td></td> <td style="text-align: center;">1</td> <td style="text-align: center;">2</td> <td style="text-align: center;">3</td> <td style="text-align: center;">4</td> <td style="text-align: center;">R05</td> <td style="text-align: center;">S05</td> <td style="text-align: center;">T05</td> <td style="text-align: center;">N05</td> <td style="text-align: center;">E5</td> <td style="text-align: center;">E5</td> <td style="text-align: center;">E5</td> <td style="text-align: center;">E5</td> <td style="text-align: center;">E5</td> </tr> <tr> <td></td> <td style="text-align: center;">1</td> <td style="text-align: center;">2</td> <td style="text-align: center;">3</td> <td style="text-align: center;">4</td> <td style="text-align: center;">R06</td> <td style="text-align: center;">S06</td> <td style="text-align: center;">T06</td> <td style="text-align: center;">N06</td> <td style="text-align: center;">E6</td> <td style="text-align: center;">E6</td> <td style="text-align: center;">E6</td> <td style="text-align: center;">E6</td> <td style="text-align: center;">E6</td> </tr> <tr> <td></td> <td style="text-align: center;">1</td> <td style="text-align: center;">2</td> <td style="text-align: center;">3</td> <td style="text-align: center;">4</td> <td style="text-align: center;">R07</td> <td style="text-align: center;">S07</td> <td style="text-align: center;">T07</td> <td style="text-align: center;">N07</td> <td style="text-align: center;">E7</td> <td style="text-align: center;">E7</td> <td style="text-align: center;">E7</td> <td style="text-align: center;">E7</td> <td style="text-align: center;">E7</td> </tr> <tr> <td></td> <td style="text-align: center;">1</td> <td style="text-align: center;">2</td> <td style="text-align: center;">3</td> <td style="text-align: center;">4</td> <td style="text-align: center;">R08</td> <td style="text-align: center;">S08</td> <td style="text-align: center;">T08</td> <td style="text-align: center;">N08</td> <td style="text-align: center;">E8</td> <td style="text-align: center;">E8</td> <td style="text-align: center;">E8</td> <td style="text-align: center;">E8</td> <td style="text-align: center;">E8</td> </tr> </table> </td> <td style="width: 50%; vertical-align: top;"> <table border="0" style="width: 100%;"> <tr> <td style="width: 50%;"></td> <td style="width: 50%; text-align: center;"> <table border="0"> <tr> <td style="width: 10%;"></td> <td style="width: 10%;"></td> <td style="width: 10%;"></td> <td style="width: 10%;"></td> <td style="width: 10%;"></td> <td style="width: 10%;"></td> <td style="width: 10%;"></td> <td style="width: 10%;"></td> <td style="width: 10%;"></td> <td style="width: 10%;"></td> <td style="width: 10%;"></td> <td style="width: 10%;"></td> <td style="width: 10%;"></td> <td style="width: 10%;"></td> </tr> <tr> <td style="text-align: center;">XA</td> <td style="text-align: center;">1</td> <td style="text-align: center;">2</td> <td style="text-align: center;">3</td> <td style="text-align: center;">4</td> <td style="text-align: center;">R01</td> <td style="text-align: center;">S01</td> <td style="text-align: center;">T01</td> <td style="text-align: center;">N01</td> <td style="text-align: center;">E1</td> <td style="text-align: center;">E1</td> <td style="text-align: center;">E1</td> </tr></table></td></tr></table></td></tr></table> | |
<table border="0"> <tr> <td style="width: 10%;"></td> <td style="width: 10%;"></td> <td style="width: 10%;"></td> <td style="width: 10%;"></td> <td style="width: 10%;"></td> <td style="width: 10%;"></td> <td style="width: 10%;"></td> <td style="width: 10%;"></td> <td style="width: 10%;"></td> <td style="width: 10%;"></td> <td style="width: 10%;"></td> <td style="width: 10%;"></td> <td style="width: 10%;"></td> <td style="width: 10%;"></td> </tr> <tr> <td style="text-align: center;">XA</td> <td style="text-align: center;">1</td> <td style="text-align: center;">2</td> <td style="text-align: center;">3</td> <td style="text-align: center;">4</td> <td style="text-align: center;">R01</td> <td style="text-align: center;">S01</td> <td style="text-align: center;">T01</td> <td style="text-align: center;">N01</td> <td style="text-align: center;">E1</td> <td style="text-align: center;">E1</td> <td style="text-align: center;">E1</td> <td style="text-align: center;">E1</td> <td style="text-align: center;">E1</td> </tr> <tr> <td></td> <td style="text-align: center;">1</td> <td style="text-align: center;">2</td> <td style="text-align: center;">3</td> <td style="text-align: center;">4</td> <td style="text-align: center;">R02</td> <td style="text-align: center;">S02</td> <td style="text-align: center;">T02</td> <td style="text-align: center;">N02</td> <td style="text-align: center;">E2</td> <td style="text-align: center;">E2</td> <td style="text-align: center;">E2</td> <td style="text-align: center;">E2</td> <td style="text-align: center;">E2</td> </tr> <tr> <td></td> <td style="text-align: center;">1</td> <td style="text-align: center;">2</td> <td style="text-align: center;">3</td> <td style="text-align: center;">4</td> <td style="text-align: center;">R03</td> <td style="text-align: center;">S03</td> <td style="text-align: center;">T03</td> <td style="text-align: center;">N03</td> <td style="text-align: center;">E3</td> <td style="text-align: center;">E3</td> <td style="text-align: center;">E3</td> <td style="text-align: center;">E3</td> <td style="text-align: center;">E3</td> </tr> <tr> <td></td> <td style="text-align: center;">1</td> <td style="text-align: center;">2</td> <td style="text-align: center;">3</td> <td style="text-align: center;">4</td> <td style="text-align: center;">R04</td> <td style="text-align: center;">S04</td> <td style="text-align: center;">T04</td> <td style="text-align: center;">N04</td> <td style="text-align: center;">E4</td> <td style="text-align: center;">E4</td> <td style="text-align: center;">E4</td> <td style="text-align: center;">E4</td> <td style="text-align: center;">E4</td> </tr> <tr> <td></td> <td style="text-align: center;">1</td> <td style="text-align: center;">2</td> <td style="text-align: center;">3</td> <td style="text-align: center;">4</td> <td style="text-align: center;">R05</td> <td style="text-align: center;">S05</td> <td style="text-align: center;">T05</td> <td style="text-align: center;">N05</td> <td style="text-align: center;">E5</td> <td style="text-align: center;">E5</td> <td style="text-align: center;">E5</td> <td style="text-align: center;">E5</td> <td style="text-align: center;">E5</td> </tr> <tr> <td></td> <td style="text-align: center;">1</td> <td style="text-align: center;">2</td> <td style="text-align: center;">3</td> <td style="text-align: center;">4</td> <td style="text-align: center;">R06</td> <td style="text-align: center;">S06</td> <td style="text-align: center;">T06</td> <td style="text-align: center;">N06</td> <td style="text-align: center;">E6</td> <td style="text-align: center;">E6</td> <td style="text-align: center;">E6</td> <td style="text-align: center;">E6</td> <td style="text-align: center;">E6</td> </tr> <tr> <td></td> <td style="text-align: center;">1</td> <td style="text-align: center;">2</td> <td style="text-align: center;">3</td> <td style="text-align: center;">4</td> <td style="text-align: center;">R07</td> <td style="text-align: center;">S07</td> <td style="text-align: center;">T07</td> <td style="text-align: center;">N07</td> <td style="text-align: center;">E7</td> <td style="text-align: center;">E7</td> <td style="text-align: center;">E7</td> <td style="text-align: center;">E7</td> <td style="text-align: center;">E7</td> </tr> <tr> <td></td> <td style="text-align: center;">1</td> <td style="text-align: center;">2</td> <td style="text-align: center;">3</td> <td style="text-align: center;">4</td> <td style="text-align: center;">R08</td> <td style="text-align: center;">S08</td> <td style="text-align: center;">T08</td> <td style="text-align: center;">N08</td> <td style="text-align: center;">E8</td> <td style="text-align: center;">E8</td> <td style="text-align: center;">E8</td> <td style="text-align: center;">E8</td> <td style="text-align: center;">E8</td> </tr> </table> | | | | | | | | | | | |
 | | | XA | 1 | 2 | 3 | 4 | R01 | S01 | T01 | N01 | E1 | E1 | E1 | E1 | E1 | | 1 | 2 | 3 | 4 | R02 | S02 | T02 | N02 | E2 | E2 | E2
 | E2 | E2 | | 1 | 2 | 3 | 4 | R03 | S03 | T03 | N03 | E3 | E3 | E3 | E3 | E3 | | 1 | 2 | 3 | 4 | R04 | S04 | T04 | N04 | E4 | E4 | E4 | E4 | E4 | | 1 | 2 | 3 | 4 | R05 | S05 | T05 | N05 | E5 | E5 | E5 | E5 | E5 | | 1 | 2 | 3 | 4 | R06 | S06 | T06 | N06 | E6 | E6 | E6 | E6 | E6 | | 1 | 2 | 3 | 4 | R07 | S07 | T07 | N07 | E7 | E7 | E7 | E7 | E7 | | 1 | 2 | 3 | 4 | R08 | S08 | T08 | N08 | E8 | E8 | E8 | E8 | E8 | <table border="0" style="width: 100%;"> <tr> <td style="width: 50%;"></td> <td style="width: 50%; text-align: center;"> <table border="0"> <tr> <td style="width: 10%;"></td> <td style="width: 10%;"></td> <td style="width: 10%;"></td> <td style="width: 10%;"></td> <td style="width: 10%;"></td> <td style="width: 10%;"></td> <td style="width: 10%;"></td> <td style="width: 10%;"></td> <td style="width: 10%;"></td> <td style="width: 10%;"></td> <td style="width: 10%;"></td> <td style="width: 10%;"></td> <td style="width: 10%;"></td> <td style="width: 10%;"></td> </tr> <tr> <td style="text-align: center;">XA</td> <td style="text-align: center;">1</td> <td style="text-align: center;">2</td> <td style="text-align: center;">3</td> <td style="text-align: center;">4</td> <td style="text-align: center;">R01</td> <td style="text-align: center;">S01</td> <td style="text-align: center;">T01</td> <td style="text-align: center;">N01</td> <td style="text-align: center;">E1</td> <td style="text-align: center;">E1</td> <td style="text-align: center;">E1</td> </tr></table></td></tr></table> |
 | <table border="0"> <tr> <td style="width: 10%;"></td> <td style="width: 10%;"></td> <td style="width: 10%;"></td> <td style="width: 10%;"></td> <td style="width: 10%;"></td> <td style="width: 10%;"></td> <td style="width: 10%;"></td> <td style="width: 10%;"></td> <td style="width: 10%;"></td> <td style="width: 10%;"></td> <td style="width: 10%;"></td> <td style="width: 10%;"></td> <td style="width: 10%;"></td> <td style="width: 10%;"></td> </tr> <tr> <td style="text-align: center;">XA</td> <td style="text-align: center;">1</td> <td style="text-align: center;">2</td> <td style="text-align: center;">3</td> <td style="text-align: center;">4</td> <td style="text-align: center;">R01</td> <td style="text-align: center;">S01</td> <td style="text-align: center;">T01</td> <td style="text-align: center;">N01</td> <td style="text-align: center;">E1</td> <td style="text-align: center;">E1</td> <td style="text-align: center;">E1</td> </tr></table> | | | | | | | | | | | | | | | XA | 1 | 2 | 3 | 4 | R01 | S01 | T01 | N01 | E1 | E1 | E1 | | | | | | | | | | | | | | | | | | | | | | | | | | | | | | | | | | | | | | | | | | |
|

 | <table border="0"> <tr> <td style="width: 10%;"></td> <td style="width: 10%;"></td> <td style="width: 10%;"></td> <td style="width: 10%;"></td> <td style="width: 10%;"></td> <td style="width: 10%;"></td> <td style="width: 10%;"></td> <td style="width: 10%;"></td> <td style="width: 10%;"></td> <td style="width: 10%;"></td> <td style="width: 10%;"></td> <td style="width: 10%;"></td> <td style="width: 10%;"></td> <td style="width: 10%;"></td> </tr> <tr> <td style="text-align: center;">XA</td> <td style="text-align: center;">1/G</td> <td style="text-align: center;">2/G</td> <td style="text-align: center;">3/G</td> <td style="text-align: center;">4/G</td> <td style="text-align: center;">R</td> <td style="text-align: center;">S</td> <td style="text-align: center;">T</td> <td style="text-align: center;">N</td> <td style="text-align: center;">E0</td> <td style="text-align: center;">E0</td> <td style="text-align: center;">E0</td> <td style="text-align: center;">E0</td> <td style="text-align: center;">E0</td> </tr> <tr> <td></td> <td style="text-align: center;">1</td> <td style="text-align: center;">2</td> <td style="text-align: center;">3</td> <td style="text-align: center;">4</td> <td style="text-align: center;">R01</td> <td style="text-align: center;">S01</td> <td style="text-align: center;">T01</td> <td style="text-align: center;">N01</td> <td style="text-align: center;">E1</td> <td style="text-align: center;">E1</td> <td style="text-align: center;">E1</td> <td style="text-align: center;">E1</td> <td style="text-align: center;">E1</td> </tr> <tr> <td></td> <td style="text-align: center;">1</td> <td style="text-align: center;">2</td> <td style="text-align: center;">3</td> <td style="text-align: center;">4</td> <td style="text-align: center;">R02</td> <td style="text-align: center;">S02</td> <td style="text-align: center;">T02</td> <td style="text-align: center;">N02</td> <td style="text-align: center;">E2</td> <td style="text-align: center;">E2</td> <td style="text-align: center;">E2</td> <td style="text-align: center;">E2</td> <td style="text-align: center;">E2</td> </tr> <tr> <td></td> <td style="text-align: center;">1</td> <td style="text-align: center;">2</td> <td style="text-align: center;">3</td> <td style="text-align: center;">4</td> <td style="text-align: center;">R03</td> <td style="text-align: center;">S03</td> <td style="text-align: center;">T03</td> <td style="text-align: center;">N03</td> <td style="text-align: center;">E3</td> <td style="text-align: center;">E3</td> <td style="text-align: center;">E3</td> <td style="text-align: center;">E3</td> <td style="text-align: center;">E3</td> </tr> <tr> <td></td> <td style="text-align: center;">1</td> <td style="text-align: center;">2</td> <td style="text-align: center;">3</td> <td style="text-align: center;">4</td> <td style="text-align: center;">R04</td> <td style="text-align: center;">S04</td> <td style="text-align: center;">T04</td> <td style="text-align: center;">N04</td> <td style="text-align: center;">E4</td> <td style="text-align: center;">E4</td> <td style="text-align: center;">E4</td> <td style="text-align: center;">E4</td> <td style="text-align: center;">E4</td> </tr> <tr> <td></td> <td style="text-align: center;">1</td> <td style="text-align: center;">2</td> <td style="text-align: center;">3</td> <td style="text-align: center;">4</td> <td style="text-align: center;">R05</td> <td style="text-align: center;">S05</td> <td style="text-align: center;">T05</td> <td style="text-align: center;">N05</td> <td style="text-align: center;">E5</td> <td style="text-align: center;">E5</td> <td style="text-align: center;">E5</td> <td style="text-align: center;">E5</td> <td style="text-align: center;">E5</td> </tr> <tr> <td></td> <td style="text-align: center;">1</td> <td style="text-align: center;">2</td> <td style="text-align: center;">3</td> <td style="text-align: center;">4</td> <td style="text-align: center;">R06</td> <td style="text-align: center;">S06</td> <td style="text-align: center;">T06</td> <td style="text-align: center;">N06</td> <td style="text-align: center;">E6</td> <td style="text-align: center;">E6</td> <td style="text-align: center;">E6</td> <td style="text-align: center;">E6</td> <td style="text-align: center;">E6</td> </tr> <tr> <td></td> <td style="text-align: center;">1</td> <td style="text-align: center;">2</td> <td style="text-align: center;">3</td> <td style="text-align: center;">4</td> <td style="text-align: center;">R07</td> <td style="text-align: center;">S07</td> <td style="text-align: center;">T07</td> <td style="text-align: center;">N07</td> <td style="text-align: center;">E7</td> <td style="text-align: center;">E7</td> <td style="text-align: center;">E7</td> <td style="text-align: center;">E7</td> <td style="text-align: center;">E7</td> </tr> <tr> <td></td> <td style="text-align: center;">1</td> <td style="text-align: center;">2</td> <td style="text-align: center;">3</td> <td style="text-align: center;">4</td> <td style="text-align: center;">R08</td> <td style="text-align: center;">S08</td> <td style="text-align: center;">T08</td> <td style="text-align: center;">N08</td> <td style="text-align: center;">E8</td> <td style="text-align: center;">E8</td> <td style="text-align: center;">E8</td> <td style="text-align: center;">E8</td> <td style="text-align: center;">E8</td> </tr> </table> |
 | | | | | | | | | | | |

 | | XA
 | 1/G | 2/G | 3/G | 4/G | R | S | T | N | E0 | E0 | E0 | E0

 | E0 | | 1 | 2 | 3 | 4 | R01 | S01 | T01 | N01 | E1 | E1 | E1 | E1

 | E1 | | 1 | 2 | 3 | 4 | R02 | S02 | T02 | N02 | E2 | E2 | E2 | E2 | E2 | | 1 | 2 | 3 | 4 | R03 | S03 | T03 | N03 | E3 | E3 | E3 | E3 | E3 | | 1 | 2 | 3 | 4 | R04 | S04 | T04 | N04 | E4 | E4 | E4 | E4 | E4 | | 1 | 2 | 3 | 4 | R05 | S05 | T05 | N05 | E5 | E5 | E5 | E5 | E5 | | 1 | 2 | 3 | 4 | R06 | S06 | T06 | N06 | E6 | E6 | E6 | E6 | E6 | | 1 | 2 | 3 | 4 | R07 | S07 | T07 | N07 | E7 | E7 | E7 | E7 | E7 |

 | 1 | 2 | 3 | 4 | R08 | S08 | T08 | N08 | E8 | E8 | E8 | E8 | E8 | <table border="0" style="width: 100%;"> <tr> <td style="width: 50%;"></td> <td style="width: 50%; text-align: center;"> <table border="0"> <tr> <td style="width: 10%;"></td> <td style="width: 10%;"></td> <td style="width: 10%;"></td> <td style="width: 10%;"></td> <td style="width: 10%;"></td> <td style="width: 10%;"></td> <td style="width: 10%;"></td> <td style="width: 10%;"></td> <td style="width: 10%;"></td> <td style="width: 10%;"></td> <td style="width: 10%;"></td> <td style="width: 10%;"></td> <td style="width: 10%;"></td> <td style="width: 10%;"></td> </tr> <tr> <td style="text-align: center;">XA</td> <td style="text-align: center;">1</td> <td style="text-align: center;">2</td> <td style="text-align: center;">3</td> <td style="text-align: center;">4</td> <td style="text-align: center;">R01</td> <td style="text-align: center;">S01</td> <td style="text-align: center;">T01</td> <td style="text-align: center;">N01</td> <td style="text-align: center;">E1</td> <td style="text-align: center;">E1</td> <td style="text-align: center;">E1</td> <td style="text-align: center;">E1</td> <td style="text-align: center;">E1</td> </tr> <tr> <td></td> <td style="text-align: center;">1</td> <td style="text-align: center;">2</td> <td style="text-align: center;">3</td> <td style="text-align: center;">4</td> <td style="text-align: center;">R02</td> <td style="text-align: center;">S02</td> <td style="text-align: center;">T02</td> <td style="text-align: center;">N02</td> <td style="text-align: center;">E2</td> <td style="text-align: center;">E2</td> <td style="text-align: center;">E2</td> <td style="text-align: center;">E2</td> <td style="text-align: center;">E2</td> </tr> <tr> <td></td> <td style="text-align: center;">1</td> <td style="text-align: center;">2</td> <td style="text-align: center;">3</td> <td style="text-align: center;">4</td> <td style="text-align: center;">R03</td> <td style="text-align: center;">S03</td> <td style="text-align: center;">T03</td> <td style="text-align: center;">N03</td> <td style="text-align: center;">E3</td> <td style="text-align: center;">E3</td> <td style="text-align: center;">E3</td> <td style="text-align: center;">E3</td> <td style="text-align: center;">E3</td> </tr> <tr> <td></td> <td style="text-align: center;">1</td> <td style="text-align: center;">2</td> <td style="text-align: center;">3</td> <td style="text-align: center;">4</td> <td style="text-align: center;">R04</td> <td style="text-align: center;">S04</td> <td style="text-align: center;">T04</td> <td style="text-align: center;">N04</td> <td style="text-align: center;">E4</td> <td style="text-align: center;">E4</td> <td style="text-align: center;">E4</td> <td style="text-align: center;">E4</td> <td style="text-align: center;">E4</td> </tr> <tr> <td></td> <td style="text-align: center;">1</td> <td style="text-align: center;">2</td> <td style="text-align: center;">3</td> <td style="text-align: center;">4</td> <td style="text-align: center;">R05</td> <td style="text-align: center;">S05</td> <td style="text-align: center;">T05</td> <td style="text-align: center;">N05</td> <td style="text-align: center;">E5</td> <td style="text-align: center;">E5</td> <td style="text-align: center;">E5</td> <td style="text-align: center;">E5</td> <td style="text-align: center;">E5</td> </tr> <tr> <td></td> <td style="text-align: center;">1</td> <td style="text-align: center;">2</td> <td style="text-align: center;">3</td> <td style="text-align: center;">4</td> <td style="text-align: center;">R06</td> <td style="text-align: center;">S06</td> <td style="text-align: center;">T06</td> <td style="text-align: center;">N06</td> <td style="text-align: center;">E6</td> <td style="text-align: center;">E6</td> <td style="text-align: center;">E6</td> <td style="text-align: center;">E6</td> <td style="text-align: center;">E6</td> </tr> <tr> <td></td> <td style="text-align: center;">1</td> <td style="text-align: center;">2</td> <td style="text-align: center;">3</td> <td style="text-align: center;">4</td> <td style="text-align: center;">R07</td> <td style="text-align: center;">S07</td> <td style="text-align: center;">T07</td> <td style="text-align: center;">N07</td> <td style="text-align: center;">E7</td> <td style="text-align: center;">E7</td> <td style="text-align:
center;">E7</td> <td style="text-align: center;">E7</td> <td style="text-align: center;">E7</td> </tr> <tr> <td></td> <td style="text-align: center;">1</td> <td style="text-align: center;">2</td> <td style="text-align: center;">3</td> <td style="text-align: center;">4</td> <td style="text-align: center;">R08</td> <td style="text-align: center;">S08</td> <td style="text-align: center;">T08</td> <td style="text-align: center;">N08</td> <td style="text-align: center;">E8</td> <td style="text-align: center;">E8</td> <td style="text-align: center;">E8</td> <td style="text-align: center;">E8</td> <td style="text-align: center;">E8</td> </tr> </table> </td> <td style="width: 50%; vertical-align: top;"> <table border="0" style="width: 100%;"> <tr> <td style="width: 50%;"></td> <td style="width: 50%; text-align: center;"> <table border="0"> <tr> <td style="width: 10%;"></td> <td style="width: 10%;"></td> <td style="width: 10%;"></td> <td style="width: 10%;"></td> <td style="width: 10%;"></td> <td style="width: 10%;"></td> <td style="width: 10%;"></td> <td style="width: 10%;"></td> <td style="width: 10%;"></td> <td style="width: 10%;"></td> <td style="width: 10%;"></td> <td style="width: 10%;"></td> <td style="width: 10%;"></td> <td style="width: 10%;"></td> </tr> <tr> <td style="text-align: center;">XA</td> <td style="text-align: center;">1</td> <td style="text-align: center;">2</td> <td style="text-align: center;">3</td> <td style="text-align: center;">4</td> <td style="text-align: center;">R01</td> <td style="text-align: center;">S01</td> <td style="text-align: center;">T01</td> <td style="text-align: center;">N01</td> <td style="text-align: center;">E1</td> <td style="text-align: center;">E1</td> <td style="text-align: center;">E1</td> <td style="text-align: center;">E1</td> <td style="text-align: center;">E1</td> </tr> <tr> <td></td> <td style="text-align: center;">1</td> <td style="text-align: center;">2</td> <td style="text-align: center;">3</td> <td style="text-align: center;">4</td> <td style="text-align: center;">R02</td> <td style="text-align: center;">S02</td> <td style="text-align: center;">T02</td> <td style="text-align: center;">N02</td> <td style="text-align: center;">E2</td> <td style="text-align: center;">E2</td> <td style="text-align: center;">E2</td> <td style="text-align: center;">E2</td> <td style="text-align: center;">E2</td> </tr> <tr> <td></td> <td style="text-align: center;">1</td> <td style="text-align: center;">2</td> <td style="text-align: center;">3</td> <td style="text-align: center;">4</td> <td style="text-align: center;">R03</td> <td style="text-align: center;">S03</td> <td style="text-align: center;">T03</td> <td style="text-align: center;">N03</td> <td style="text-align: center;">E3</td> <td style="text-align: center;">E3</td> <td style="text-align: center;">E3</td> <td style="text-align: center;">E3</td> <td style="text-align: center;">E3</td> </tr> <tr> <td></td> <td style="text-align: center;">1</td> <td style="text-align: center;">2</td> <td style="text-align: center;">3</td> <td style="text-align: center;">4</td> <td style="text-align: center;">R04</td> <td style="text-align: center;">S04</td> <td style="text-align: center;">T04</td> <td style="text-align: center;">N04</td> <td style="text-align: center;">E4</td> <td style="text-align: center;">E4</td> <td style="text-align: center;">E4</td> <td style="text-align: center;">E4</td> <td style="text-align: center;">E4</td> </tr> <tr> <td></td> <td style="text-align: center;">1</td> <td style="text-align: center;">2</td> <td style="text-align: center;">3</td> <td style="text-align: center;">4</td> <td style="text-align: center;">R05</td> <td style="text-align: center;">S05</td> <td style="text-align: center;">T05</td> <td style="text-align: center;">N05</td> <td style="text-align: center;">E5</td> <td style="text-align: center;">E5</td> <td style="text-align: center;">E5</td> <td style="text-align: center;">E5</td> <td style="text-align: center;">E5</td> </tr> <tr> <td></td> <td style="text-align: center;">1</td> <td style="text-align: center;">2</td> <td style="text-align: center;">3</td> <td style="text-align: center;">4</td> <td style="text-align: center;">R06</td> <td style="text-align: center;">S06</td> <td style="text-align: center;">T06</td> <td style="text-align: center;">N06</td> <td style="text-align: center;">E6</td> <td style="text-align: center;">E6</td> <td style="text-align: center;">E6</td> <td style="text-align: center;">E6</td> <td style="text-align: center;">E6</td> </tr> <tr> <td></td> <td style="text-align: center;">1</td> <td style="text-align: center;">2</td> <td style="text-align: center;">3</td> <td style="text-align: center;">4</td> <td style="text-align: center;">R07</td> <td style="text-align: center;">S07</td> <td style="text-align: center;">T07</td> <td style="text-align: center;">N07</td> <td style="text-align: center;">E7</td> <td style="text-align: center;">E7</td> <td style="text-align: center;">E7</td> <td style="text-align: center;">E7</td> <td style="text-align: center;">E7</td> </tr> <tr> <td></td> <td style="text-align: center;">1</td> <td style="text-align: center;">2</td> <td style="text-align: center;">3</td> <td style="text-align: center;">4</td> <td style="text-align: center;">R08</td> <td style="text-align: center;">S08</td> <td style="text-align: center;">T08</td> <td style="text-align: center;">N08</td> <td style="text-align: center;">E8</td> <td style="text-align: center;">E8</td> <td style="text-align: center;">E8</td> <td style="text-align: center;">E8</td> <td style="text-align: center;">E8</td> </tr> </table> </td> <td style="width: 50%; vertical-align: top;"> <table border="0" style="width: 100%;"> <tr> <td style="width: 50%;"></td> <td style="width: 50%; text-align: center;"> <table border="0"> <tr> <td style="width: 10%;"></td> <td style="width: 10%;"></td> <td style="width: 10%;"></td> <td style="width: 10%;"></td> <td style="width: 10%;"></td> <td style="width: 10%;"></td> <td style="width: 10%;"></td> <td style="width: 10%;"></td> <td style="width: 10%;"></td> <td style="width: 10%;"></td> <td style="width: 10%;"></td> <td style="width: 10%;"></td> <td style="width: 10%;"></td> <td style="width: 10%;"></td> </tr> <tr> <td style="text-align: center;">XA</td> <td style="text-align: center;">1</td> <td style="text-align: center;">2</td> <td style="text-align: center;">3</td> <td style="text-align: center;">4</td> <td style="text-align: center;">R01</td> <td style="text-align: center;">S01</td> <td style="text-align: center;">T01</td> <td style="text-align: center;">N01</td> <td style="text-align: center;">E1</td> <td style="text-align: center;">E1</td> <td style="text-align: center;">E1</td> <td style="text-align: center;">E1</td> <td style="text-align: center;">E1</td> </tr> <tr> <td></td> <td style="text-align: center;">1</td> <td style="text-align: center;">2</td> <td style="text-align: center;">3</td> <td style="text-align: center;">4</td> <td style="text-align: center;">R02</td> <td style="text-align: center;">S02</td> <td style="text-align: center;">T02</td> <td style="text-align: center;">N02</td> <td style="text-align: center;">E2</td> <td style="text-align: center;">E2</td> <td style="text-align: center;">E2</td> <td style="text-align: center;">E2</td> <td style="text-align: center;">E2</td> </tr> <tr> <td></td> <td style="text-align: center;">1</td> <td style="text-align: center;">2</td> <td style="text-align: center;">3</td> <td style="text-align: center;">4</td> <td style="text-align: center;">R03</td> <td style="text-align: center;">S03</td> <td style="text-align: center;">T03</td> <td style="text-align: center;">N03</td> <td style="text-align: center;">E3</td> <td style="text-align: center;">E3</td> <td style="text-align: center;">E3</td> <td style="text-align: center;">E3</td> <td style="text-align: center;">E3</td> </tr> <tr> <td></td> <td style="text-align: center;">1</td> <td style="text-align: center;">2</td> <td style="text-align: center;">3</td> <td style="text-align: center;">4</td> <td style="text-align: center;">R04</td> <td style="text-align: center;">S04</td> <td style="text-align: center;">T04</td> <td style="text-align: center;">N04</td> <td style="text-align: center;">E4</td> <td style="text-align: center;">E4</td> <td style="text-align: center;">E4</td> <td style="text-align: center;">E4</td> <td style="text-align: center;">E4</td> </tr> <tr> <td></td> <td style="text-align: center;">1</td> <td style="text-align: center;">2</td> <td style="text-align: center;">3</td> <td style="text-align: center;">4</td> <td style="text-align: center;">R05</td> <td style="text-align: center;">S05</td> <td style="text-align: center;">T05</td> <td style="text-align: center;">N05</td> <td style="text-align: center;">E5</td> <td style="text-align: center;">E5</td> <td style="text-align: center;">E5</td> <td style="text-align: center;">E5</td> <td style="text-align: center;">E5</td> </tr> <tr> <td></td> <td style="text-align: center;">1</td> <td style="text-align: center;">2</td> <td style="text-align: center;">3</td> <td style="text-align: center;">4</td> <td style="text-align: center;">R06</td> <td style="text-align: center;">S06</td> <td style="text-align: center;">T06</td> <td style="text-align: center;">N06</td> <td style="text-align: center;">E6</td> <td style="text-align: center;">E6</td> <td style="text-align: center;">E6</td> <td style="text-align: center;">E6</td> <td style="text-align: center;">E6</td> </tr> <tr> <td></td> <td style="text-align: center;">1</td> <td style="text-align: center;">2</td> <td style="text-align: center;">3</td> <td style="text-align: center;">4</td> <td style="text-align: center;">R07</td> <td style="text-align: center;">S07</td> <td style="text-align: center;">T07</td> <td style="text-align: center;">N07</td> <td style="text-align: center;">E7</td> <td style="text-align: center;">E7</td> <td style="text-align: center;">E7</td> <td
style="text-align: center;">E7</td> <td style="text-align: center;">E7</td> </tr> <tr> <td></td> <td style="text-align: center;">1</td> <td style="text-align: center;">2</td> <td style="text-align: center;">3</td> <td style="text-align: center;">4</td> <td style="text-align: center;">R08</td> <td style="text-align: center;">S08</td> <td style="text-align: center;">T08</td> <td style="text-align: center;">N08</td> <td style="text-align: center;">E8</td> <td style="text-align: center;">E8</td> <td style="text-align: center;">E8</td> <td style="text-align: center;">E8</td> <td style="text-align: center;">E8</td> </tr> </table> </td> <td style="width: 50%; vertical-align: top;"> <table border="0" style="width: 100%;"> <tr> <td style="width: 50%;"></td> <td style="width: 50%; text-align: center;"> <table border="0"> <tr> <td style="width: 10%;"></td> <td style="width: 10%;"></td> <td style="width: 10%;"></td> <td style="width: 10%;"></td> <td style="width: 10%;"></td> <td style="width: 10%;"></td> <td style="width: 10%;"></td> <td style="width: 10%;"></td> <td style="width: 10%;"></td> <td style="width: 10%;"></td> <td style="width: 10%;"></td> <td style="width: 10%;"></td> <td style="width: 10%;"></td> <td style="width: 10%;"></td> </tr> <tr> <td style="text-align: center;">XA</td> <td style="text-align: center;">1</td> <td style="text-align: center;">2</td> <td style="text-align: center;">3</td> <td style="text-align: center;">4</td> <td style="text-align: center;">R01</td> <td style="text-align: center;">S01</td> <td style="text-align: center;">T01</td> <td style="text-align: center;">N01</td> <td style="text-align: center;">E1</td> <td style="text-align: center;">E1</td> <td style="text-align: center;">E1</td> <td style="text-align: center;">E1</td> <td style="text-align: center;">E1</td> </tr> <tr> <td></td> <td style="text-align: center;">1</td> <td style="text-align: center;">2</td> <td style="text-align: center;">3</td> <td style="text-align: center;">4</td> <td style="text-align: center;">R02</td> <td style="text-align: center;">S02</td> <td style="text-align: center;">T02</td> <td style="text-align: center;">N02</td> <td style="text-align: center;">E2</td> <td style="text-align: center;">E2</td> <td style="text-align: center;">E2</td> <td style="text-align: center;">E2</td> <td style="text-align: center;">E2</td> </tr> <tr> <td></td> <td style="text-align: center;">1</td> <td style="text-align: center;">2</td> <td style="text-align: center;">3</td> <td style="text-align: center;">4</td> <td style="text-align: center;">R03</td> <td style="text-align: center;">S03</td> <td style="text-align: center;">T03</td> <td style="text-align: center;">N03</td> <td style="text-align: center;">E3</td> <td style="text-align: center;">E3</td> <td style="text-align: center;">E3</td> <td style="text-align: center;">E3</td> <td style="text-align: center;">E3</td> </tr> <tr> <td></td> <td style="text-align: center;">1</td> <td style="text-align: center;">2</td> <td style="text-align: center;">3</td> <td style="text-align: center;">4</td> <td style="text-align: center;">R04</td> <td style="text-align: center;">S04</td> <td style="text-align: center;">T04</td> <td style="text-align: center;">N04</td> <td style="text-align: center;">E4</td> <td style="text-align: center;">E4</td> <td style="text-align: center;">E4</td> <td style="text-align: center;">E4</td> <td style="text-align: center;">E4</td> </tr> <tr> <td></td> <td style="text-align: center;">1</td> <td style="text-align: center;">2</td> <td style="text-align: center;">3</td> <td style="text-align: center;">4</td> <td style="text-align: center;">R05</td> <td style="text-align: center;">S05</td> <td style="text-align: center;">T05</td> <td style="text-align: center;">N05</td> <td style="text-align: center;">E5</td> <td style="text-align: center;">E5</td> <td style="text-align: center;">E5</td> <td style="text-align: center;">E5</td> <td style="text-align: center;">E5</td> </tr> <tr> <td></td> <td style="text-align: center;">1</td> <td style="text-align: center;">2</td> <td style="text-align: center;">3</td> <td style="text-align: center;">4</td> <td style="text-align: center;">R06</td> <td style="text-align: center;">S06</td> <td style="text-align: center;">T06</td> <td style="text-align: center;">N06</td> <td style="text-align: center;">E6</td> <td style="text-align: center;">E6</td> <td style="text-align: center;">E6</td> <td style="text-align: center;">E6</td> <td style="text-align: center;">E6</td> </tr> <tr> <td></td> <td style="text-align: center;">1</td> <td style="text-align: center;">2</td> <td style="text-align: center;">3</td> <td style="text-align: center;">4</td> <td style="text-align: center;">R07</td> <td style="text-align: center;">S07</td> <td style="text-align: center;">T07</td> <td style="text-align: center;">N07</td> <td style="text-align: center;">E7</td> <td style="text-align: center;">E7</td> <td style="text-align: center;">E7</td> <td style="text-align: center;">E7</td> <td style="text-align: center;">E7</td> </tr> <tr> <td></td> <td style="text-align: center;">1</td> <td style="text-align: center;">2</td> <td style="text-align: center;">3</td> <td style="text-align: center;">4</td> <td style="text-align: center;">R08</td> <td style="text-align: center;">S08</td> <td style="text-align: center;">T08</td> <td style="text-align: center;">N08</td> <td style="text-align: center;">E8</td> <td style="text-align: center;">E8</td> <td style="text-align: center;">E8</td> <td style="text-align: center;">E8</td> <td style="text-align: center;">E8</td> </tr> </table> </td> <td style="width: 50%; vertical-align: top;"> <table border="0" style="width: 100%;"> <tr> <td style="width: 50%;"></td> <td style="width: 50%; text-align: center;"> <table border="0"> <tr> <td style="width: 10%;"></td> <td style="width: 10%;"></td> <td style="width: 10%;"></td> <td style="width: 10%;"></td> <td style="width: 10%;"></td> <td style="width: 10%;"></td> <td style="width: 10%;"></td> <td style="width: 10%;"></td> <td style="width: 10%;"></td> <td style="width: 10%;"></td> <td style="width: 10%;"></td> <td style="width: 10%;"></td> <td style="width: 10%;"></td> <td style="width: 10%;"></td> </tr> <tr> <td style="text-align: center;">XA</td> <td style="text-align: center;">1</td> <td style="text-align: center;">2</td> <td style="text-align: center;">3</td> <td style="text-align: center;">4</td> <td style="text-align: center;">R01</td> <td style="text-align: center;">S01</td> <td style="text-align: center;">T01</td> <td style="text-align: center;">N01</td> <td style="text-align: center;">E1</td> <td style="text-align: center;">E1</td> <td style="text-align: center;">E1</td> <td style="text-align: center;">E1</td> <td style="text-align: center;">E1</td> </tr> <tr> <td></td> <td style="text-align: center;">1</td> <td style="text-align: center;">2</td> <td style="text-align: center;">3</td> <td style="text-align: center;">4</td> <td style="text-align: center;">R02</td> <td style="text-align: center;">S02</td> <td style="text-align: center;">T02</td> <td style="text-align: center;">N02</td> <td style="text-align: center;">E2</td> <td style="text-align: center;">E2</td> <td style="text-align: center;">E2</td> <td style="text-align: center;">E2</td> <td style="text-align: center;">E2</td> </tr> <tr> <td></td> <td style="text-align: center;">1</td> <td style="text-align: center;">2</td> <td style="text-align: center;">3</td> <td style="text-align: center;">4</td> <td style="text-align: center;">R03</td> <td style="text-align: center;">S03</td> <td style="text-align: center;">T03</td> <td style="text-align: center;">N03</td> <td style="text-align: center;">E3</td> <td style="text-align: center;">E3</td> <td style="text-align: center;">E3</td> <td style="text-align: center;">E3</td> <td style="text-align: center;">E3</td> </tr> <tr> <td></td> <td style="text-align: center;">1</td> <td style="text-align: center;">2</td> <td style="text-align: center;">3</td> <td style="text-align: center;">4</td> <td style="text-align: center;">R04</td> <td style="text-align: center;">S04</td> <td style="text-align: center;">T04</td> <td style="text-align: center;">N04</td> <td style="text-align: center;">E4</td> <td style="text-align: center;">E4</td> <td style="text-align: center;">E4</td> <td style="text-align: center;">E4</td> <td style="text-align: center;">E4</td> </tr> <tr> <td></td> <td style="text-align: center;">1</td> <td style="text-align: center;">2</td> <td style="text-align: center;">3</td> <td style="text-align: center;">4</td> <td style="text-align: center;">R05</td> <td style="text-align: center;">S05</td> <td style="text-align: center;">T05</td> <td style="text-align: center;">N05</td> <td style="text-align: center;">E5</td> <td style="text-align: center;">E5</td> <td style="text-align: center;">E5</td> <td style="text-align: center;">E5</td> <td style="text-align: center;">E5</td> </tr> <tr> <td></td> <td style="text-align: center;">1</td> <td style="text-align: center;">2</td> <td style="text-align: center;">3</td> <td style="text-align: center;">4</td> <td style="text-align: center;">R06</td> <td style="text-align: center;">S06</td> <td style="text-align: center;">T06</td> <td style="text-align: center;">N06</td> <td style="text-align: center;">E6</td> <td style="text-align: center;">E6</td> <td style="text-align: center;">E6</td> <td style="text-align: center;">E6</td> <td style="text-align: center;">E6</td> </tr> <tr> <td></td> <td style="text-align: center;">1</td> <td style="text-align: center;">2</td> <td style="text-align: center;">3</td> <td style="text-align: center;">4</td> <td style="text-align: center;">R07</td> <td style="text-align: center;">S07</td> <td style="text-align: center;">T07</td> <td style="text-align: center;">N07</td> <td style="text-align: center;">E7</td> <td style="text-align: center;">E7</td> <td style="text-align: center;">E7</td> <td style="text-align:
center;">E7</td> <td style="text-align: center;">E7</td> </tr> <tr> <td></td> <td style="text-align: center;">1</td> <td style="text-align: center;">2</td> <td style="text-align: center;">3</td> <td style="text-align: center;">4</td> <td style="text-align: center;">R08</td> <td style="text-align: center;">S08</td> <td style="text-align: center;">T08</td> <td style="text-align: center;">N08</td> <td style="text-align: center;">E8</td> <td style="text-align: center;">E8</td> <td style="text-align: center;">E8</td> <td style="text-align: center;">E8</td> <td style="text-align: center;">E8</td> </tr> </table> </td> <td style="width: 50%; vertical-align: top;"> <table border="0" style="width: 100%;"> <tr> <td style="width: 50%;"></td> <td style="width: 50%; text-align: center;"> <table border="0"> <tr> <td style="width: 10%;"></td> <td style="width: 10%;"></td> <td style="width: 10%;"></td> <td style="width: 10%;"></td> <td style="width: 10%;"></td> <td style="width: 10%;"></td> <td style="width: 10%;"></td> <td style="width: 10%;"></td> <td style="width: 10%;"></td> <td style="width: 10%;"></td> <td style="width: 10%;"></td> <td style="width: 10%;"></td> <td style="width: 10%;"></td> <td style="width: 10%;"></td> </tr> <tr> <td style="text-align: center;">XA</td> <td style="text-align: center;">1</td> <td style="text-align: center;">2</td> <td style="text-align: center;">3</td> <td style="text-align: center;">4</td> <td style="text-align: center;">R01</td> <td style="text-align: center;">S01</td> <td style="text-align: center;">T01</td> <td style="text-align: center;">N01</td> <td style="text-align: center;">E1</td> <td style="text-align: center;">E1</td> <td style="text-align: center;">E1</td> </tr></table></td></tr></table></td></tr></table></td></tr></table></td></tr></table></td></tr></table></td></tr></table> |

 | <table border="0"> <tr> <td style="width: 10%;"></td> <td style="width: 10%;"></td> <td style="width: 10%;"></td> <td style="width: 10%;"></td> <td style="width: 10%;"></td> <td style="width: 10%;"></td> <td style="width: 10%;"></td> <td style="width: 10%;"></td> <td style="width: 10%;"></td> <td style="width: 10%;"></td> <td style="width: 10%;"></td> <td style="width: 10%;"></td> <td style="width: 10%;"></td> <td style="width: 10%;"></td> </tr> <tr> <td style="text-align: center;">XA</td> <td style="text-align: center;">1</td> <td style="text-align: center;">2</td> <td style="text-align: center;">3</td> <td style="text-align: center;">4</td> <td style="text-align: center;">R01</td> <td style="text-align: center;">S01</td> <td style="text-align: center;">T01</td> <td style="text-align: center;">N01</td> <td style="text-align: center;">E1</td> <td style="text-align: center;">E1</td> <td style="text-align: center;">E1</td> <td style="text-align: center;">E1</td> <td style="text-align: center;">E1</td> </tr> <tr> <td></td> <td style="text-align: center;">1</td> <td style="text-align: center;">2</td> <td style="text-align: center;">3</td> <td style="text-align: center;">4</td> <td style="text-align: center;">R02</td> <td style="text-align: center;">S02</td> <td style="text-align: center;">T02</td> <td style="text-align: center;">N02</td> <td style="text-align: center;">E2</td> <td style="text-align: center;">E2</td> <td style="text-align: center;">E2</td> <td style="text-align: center;">E2</td> <td style="text-align: center;">E2</td> </tr> <tr> <td></td> <td style="text-align: center;">1</td> <td style="text-align: center;">2</td> <td style="text-align: center;">3</td> <td style="text-align: center;">4</td> <td style="text-align: center;">R03</td> <td style="text-align: center;">S03</td> <td style="text-align: center;">T03</td> <td style="text-align: center;">N03</td> <td style="text-align: center;">E3</td> <td style="text-align: center;">E3</td> <td style="text-align: center;">E3</td> <td
style="text-align: center;">E3</td> <td style="text-align: center;">E3</td> </tr> <tr> <td></td> <td style="text-align: center;">1</td> <td style="text-align: center;">2</td> <td style="text-align: center;">3</td> <td style="text-align: center;">4</td> <td style="text-align: center;">R04</td> <td style="text-align: center;">S04</td> <td style="text-align: center;">T04</td> <td style="text-align: center;">N04</td> <td style="text-align: center;">E4</td> <td style="text-align: center;">E4</td> <td style="text-align: center;">E4</td> <td style="text-align: center;">E4</td> <td style="text-align: center;">E4</td> </tr> <tr> <td></td> <td style="text-align: center;">1</td> <td style="text-align: center;">2</td> <td style="text-align: center;">3</td> <td style="text-align: center;">4</td> <td style="text-align: center;">R05</td> <td style="text-align: center;">S05</td> <td style="text-align: center;">T05</td> <td style="text-align: center;">N05</td> <td style="text-align: center;">E5</td> <td style="text-align: center;">E5</td> <td style="text-align: center;">E5</td> <td style="text-align: center;">E5</td> <td style="text-align: center;">E5</td> </tr> <tr> <td></td> <td style="text-align: center;">1</td> <td style="text-align: center;">2</td> <td style="text-align: center;">3</td> <td style="text-align: center;">4</td> <td style="text-align: center;">R06</td> <td style="text-align: center;">S06</td> <td style="text-align: center;">T06</td> <td style="text-align: center;">N06</td> <td style="text-align: center;">E6</td> <td style="text-align: center;">E6</td> <td style="text-align: center;">E6</td> <td style="text-align: center;">E6</td> <td style="text-align: center;">E6</td> </tr> <tr> <td></td> <td style="text-align: center;">1</td> <td style="text-align: center;">2</td> <td style="text-align: center;">3</td> <td style="text-align: center;">4</td> <td style="text-align: center;">R07</td> <td style="text-align: center;">S07</td> <td style="text-align: center;">T07</td> <td style="text-align: center;">N07</td> <td style="text-align: center;">E7</td> <td style="text-align: center;">E7</td> <td style="text-align: center;">E7</td> <td style="text-align: center;">E7</td> <td style="text-align: center;">E7</td> </tr> <tr> <td></td> <td style="text-align: center;">1</td> <td style="text-align: center;">2</td> <td style="text-align: center;">3</td> <td style="text-align: center;">4</td> <td style="text-align: center;">R08</td> <td style="text-align: center;">S08</td> <td style="text-align: center;">T08</td> <td style="text-align: center;">N08</td> <td style="text-align: center;">E8</td> <td style="text-align: center;">E8</td> <td style="text-align: center;">E8</td> <td style="text-align: center;">E8</td> <td style="text-align: center;">E8</td> </tr> </table> | | | | | | | | | | | | |

 | | XA | 1 | 2 | 3 | 4 | R01 | S01 | T01 | N01 | E1 | E1 | E1 | E1 | E1 | | 1 | 2 | 3 | 4 | R02 | S02 | T02 | N02 | E2 | E2 | E2 | E2

 | E2 | | 1 | 2 | 3 | 4 | R03 | S03 | T03 | N03 | E3 | E3 | E3 | E3 | E3 | | 1 | 2 | 3 | 4 | R04 | S04 | T04 | N04 | E4 | E4 | E4 | E4 | E4 | | 1 | 2 | 3 | 4 | R05 | S05 | T05 | N05 | E5 | E5 | E5 | E5 | E5 | | 1 | 2 | 3 | 4 | R06 | S06 | T06 | N06 | E6 | E6 | E6 | E6 | E6 | | 1 | 2
| 3 | 4 | R07 | S07 | T07 | N07 | E7 | E7 | E7 | E7 | E7 |
 | 1 | 2
 | 3 | 4 | R08 | S08 | T08 | N08 | E8 | E8 | E8 | E8 | E8 | <table border="0" style="width: 100%;"> <tr> <td style="width: 50%;"></td> <td style="width: 50%; text-align: center;"> <table border="0"> <tr> <td style="width: 10%;"></td> <td style="width: 10%;"></td> <td style="width: 10%;"></td> <td style="width: 10%;"></td> <td style="width: 10%;"></td> <td style="width: 10%;"></td> <td style="width: 10%;"></td> <td style="width: 10%;"></td> <td style="width: 10%;"></td> <td style="width: 10%;"></td> <td style="width: 10%;"></td> <td style="width: 10%;"></td> <td style="width: 10%;"></td> <td style="width: 10%;"></td> </tr> <tr> <td style="text-align: center;">XA</td> <td style="text-align: center;">1</td> <td style="text-align: center;">2</td> <td style="text-align: center;">3</td> <td style="text-align: center;">4</td> <td style="text-align: center;">R01</td> <td style="text-align: center;">S01</td> <td style="text-align: center;">T01</td> <td style="text-align: center;">N01</td> <td style="text-align: center;">E1</td> <td style="text-align: center;">E1</td> <td style="text-align: center;">E1</td> <td style="text-align: center;">E1</td> <td style="text-align: center;">E1</td> </tr> <tr> <td></td> <td style="text-align: center;">1</td> <td style="text-align: center;">2</td> <td style="text-align: center;">3</td> <td style="text-align: center;">4</td> <td style="text-align: center;">R02</td> <td style="text-align: center;">S02</td> <td style="text-align: center;">T02</td> <td style="text-align: center;">N02</td> <td style="text-align: center;">E2</td> <td style="text-align: center;">E2</td> <td style="text-align: center;">E2</td> <td style="text-align: center;">E2</td> <td style="text-align: center;">E2</td> </tr> <tr> <td></td> <td style="text-align: center;">1</td> <td style="text-align: center;">2</td> <td style="text-align: center;">3</td> <td style="text-align: center;">4</td> <td style="text-align: center;">R03</td> <td style="text-align: center;">S03</td> <td style="text-align: center;">T03</td> <td style="text-align: center;">N03</td> <td style="text-align: center;">E3</td> <td style="text-align: center;">E3</td> <td style="text-align: center;">E3</td> <td style="text-align: center;">E3</td> <td style="text-align: center;">E3</td> </tr> <tr> <td></td> <td style="text-align: center;">1</td> <td style="text-align: center;">2</td> <td style="text-align: center;">3</td> <td style="text-align: center;">4</td> <td style="text-align: center;">R04</td> <td style="text-align: center;">S04</td> <td style="text-align: center;">T04</td> <td style="text-align: center;">N04</td> <td style="text-align: center;">E4</td> <td style="text-align: center;">E4</td> <td style="text-align: center;">E4</td> <td style="text-align: center;">E4</td> <td style="text-align: center;">E4</td> </tr> <tr> <td></td> <td style="text-align: center;">1</td> <td style="text-align: center;">2</td> <td style="text-align: center;">3</td> <td style="text-align: center;">4</td> <td style="text-align: center;">R05</td> <td style="text-align: center;">S05</td> <td style="text-align: center;">T05</td> <td style="text-align: center;">N05</td> <td style="text-align: center;">E5</td> <td style="text-align: center;">E5</td> <td style="text-align: center;">E5</td> <td style="text-align: center;">E5</td> <td style="text-align: center;">E5</td> </tr> <tr> <td></td> <td style="text-align: center;">1</td> <td style="text-align: center;">2</td> <td style="text-align: center;">3</td> <td style="text-align: center;">4</td> <td style="text-align: center;">R06</td> <td style="text-align: center;">S06</td> <td style="text-align: center;">T06</td> <td style="text-align: center;">N06</td> <td style="text-align: center;">E6</td> <td style="text-align: center;">E6</td> <td style="text-align: center;">E6</td> <td style="text-align: center;">E6</td> <td style="text-align: center;">E6</td> </tr> <tr> <td></td> <td style="text-align: center;">1</td> <td style="text-align: center;">2</td> <td style="text-align: center;">3</td> <td style="text-align: center;">4</td> <td style="text-align: center;">R07</td> <td style="text-align: center;">S07</td> <td style="text-align: center;">T07</td> <td style="text-align: center;">N07</td> <td style="text-align: center;">E7</td> <td style="text-align: center;">E7</td> <td style="text-align: center;">E7</td> <td style="text-align: center;">E7</td> <td style="text-align: center;">E7</td> </tr> <tr> <td></td> <td style="text-align: center;">1</td> <td style="text-align: center;">2</td> <td style="text-align: center;">3</td> <td style="text-align: center;">4</td> <td style="text-align: center;">R08</td> <td style="text-align: center;">S08</td> <td style="text-align: center;">T08</td> <td style="text-align: center;">N08</td> <td style="text-align: center;">E8</td> <td style="text-align: center;">E8</td> <td style="text-align: center;">E8</td> <td style="text-align: center;">E8</td> <td style="text-align: center;">E8</td> </tr> </table> </td> <td style="width: 50%; vertical-align: top;"> <table border="0" style="width: 100%;"> <tr> <td style="width: 50%;"></td> <td style="width: 50%; text-align: center;"> <table border="0"> <tr> <td style="width: 10%;"></td> <td style="width: 10%;"></td> <td style="width: 10%;"></td> <td style="width: 10%;"></td> <td style="width: 10%;"></td> <td style="width: 10%;"></td> <td style="width: 10%;"></td> <td style="width: 10%;"></td> <td style="width: 10%;"></td> <td style="width: 10%;"></td> <td style="width: 10%;"></td> <td style="width: 10%;"></td> <td style="width: 10%;"></td> <td style="width: 10%;"></td> </tr> <tr> <td style="text-align: center;">XA</td> <td style="text-align: center;">1</td> <td style="text-align: center;">2</td> <td style="text-align: center;">3</td> <td style="text-align: center;">4</td> <td style="text-align: center;">R01</td> <td style="text-align: center;">S01</td> <td style="text-align: center;">T01</td> <td style="text-align: center;">N01</td> <td style="text-align: center;">E1</td> <td style="text-align: center;">E1</td> <td style="text-align: center;">E1</td> <td style="text-align: center;">E1</td> <td style="text-align: center;">E1</td> </tr> <tr> <td></td> <td style="text-align: center;">1</td> <td style="text-align: center;">2</td> <td style="text-align: center;">3</td> <td style="text-align: center;">4</td> <td style="text-align: center;">R02</td> <td style="text-align: center;">S02</td> <td style="text-align: center;">T02</td> <td style="text-align: center;">N02</td> <td style="text-align: center;">E2</td> <td style="text-align: center;">E2</td> <td style="text-align: center;">E2</td> <td style="text-align: center;">E2</td> <td style="text-align: center;">E2</td> </tr> <tr> <td></td> <td style="text-align: center;">1</td> <td style="text-align: center;">2</td> <td style="text-align: center;">3</td> <td style="text-align: center;">4</td> <td style="text-align: center;">R03</td> <td style="text-align: center;">S03</td> <td style="text-align: center;">T03</td> <td style="text-align: center;">N03</td> <td style="text-align: center;">E3</td> <td style="text-align: center;">E3</td> <td style="text-align: center;">E3</td> <td style="text-align: center;">E3</td> <td style="text-align: center;">E3</td> </tr> <tr> <td></td> <td style="text-align: center;">1</td> <td style="text-align: center;">2</td> <td style="text-align: center;">3</td> <td style="text-align: center;">4</td> <td style="text-align: center;">R04</td> <td style="text-align: center;">S04</td> <td style="text-align: center;">T04</td> <td style="text-align: center;">N04</td> <td style="text-align: center;">E4</td> <td style="text-align: center;">E4</td> <td style="text-align: center;">E4</td> <td style="text-align: center;">E4</td> <td style="text-align: center;">E4</td> </tr> <tr> <td></td> <td style="text-align: center;">1</td> <td style="text-align: center;">2</td> <td style="text-align: center;">3</td> <td style="text-align: center;">4</td> <td style="text-align: center;">R05</td> <td style="text-align: center;">S05</td> <td style="text-align: center;">T05</td> <td style="text-align: center;">N05</td> <td style="text-align: center;">E5</td> <td style="text-align: center;">E5</td> <td style="text-align: center;">E5</td> <td style="text-align: center;">E5</td> <td style="text-align: center;">E5</td> </tr> <tr> <td></td> <td style="text-align: center;">1</td> <td style="text-align: center;">2</td> <td style="text-align: center;">3</td> <td style="text-align: center;">4</td> <td style="text-align: center;">R06</td> <td style="text-align: center;">S06</td> <td style="text-align: center;">T06</td> <td style="text-align: center;">N06</td> <td style="text-align: center;">E6</td> <td style="text-align: center;">E6</td> <td style="text-align: center;">E6</td> <td style="text-align: center;">E6</td> <td style="text-align: center;">E6</td> </tr> <tr> <td></td> <td style="text-align: center;">1</td> <td style="text-align: center;">2</td> <td
style="text-align: center;">3</td> <td style="text-align: center;">4</td> <td style="text-align: center;">R07</td> <td style="text-align: center;">S07</td> <td style="text-align: center;">T07</td> <td style="text-align: center;">N07</td> <td style="text-align: center;">E7</td> <td style="text-align: center;">E7</td> <td style="text-align: center;">E7</td> <td style="text-align: center;">E7</td> <td style="text-align: center;">E7</td> </tr> <tr> <td></td> <td style="text-align: center;">1</td> <td style="text-align: center;">2</td> <td style="text-align: center;">3</td> <td style="text-align: center;">4</td> <td style="text-align: center;">R08</td> <td style="text-align: center;">S08</td> <td style="text-align: center;">T08</td> <td style="text-align: center;">N08</td> <td style="text-align: center;">E8</td> <td style="text-align: center;">E8</td> <td style="text-align: center;">E8</td> <td style="text-align: center;">E8</td> <td style="text-align: center;">E8</td> </tr> </table> </td> <td style="width: 50%; vertical-align: top;"> <table border="0" style="width: 100%;"> <tr> <td style="width: 50%;"></td> <td style="width: 50%; text-align: center;"> <table border="0"> <tr> <td style="width: 10%;"></td> <td style="width: 10%;"></td> <td style="width: 10%;"></td> <td style="width: 10%;"></td> <td style="width: 10%;"></td> <td style="width: 10%;"></td> <td style="width: 10%;"></td> <td style="width: 10%;"></td> <td style="width: 10%;"></td> <td style="width: 10%;"></td> <td style="width: 10%;"></td> <td style="width: 10%;"></td> <td style="width: 10%;"></td> <td style="width: 10%;"></td> </tr> <tr> <td style="text-align: center;">XA</td> <td style="text-align: center;">1</td> <td style="text-align: center;">2</td> <td style="text-align: center;">3</td> <td style="text-align: center;">4</td> <td style="text-align: center;">R01</td> <td style="text-align: center;">S01</td> <td style="text-align: center;">T01</td> <td style="text-align: center;">N01</td> <td style="text-align: center;">E1</td> <td style="text-align: center;">E1</td> <td style="text-align: center;">E1</td> <td style="text-align: center;">E1</td> <td style="text-align: center;">E1</td> </tr> <tr> <td></td> <td style="text-align: center;">1</td> <td style="text-align: center;">2</td> <td style="text-align: center;">3</td> <td style="text-align: center;">4</td> <td style="text-align: center;">R02</td> <td style="text-align: center;">S02</td> <td style="text-align: center;">T02</td> <td style="text-align: center;">N02</td> <td style="text-align: center;">E2</td> <td style="text-align: center;">E2</td> <td style="text-align: center;">E2</td> <td style="text-align: center;">E2</td> <td style="text-align: center;">E2</td> </tr> <tr> <td></td> <td style="text-align: center;">1</td> <td style="text-align: center;">2</td> <td style="text-align: center;">3</td> <td style="text-align: center;">4</td> <td style="text-align: center;">R03</td> <td style="text-align: center;">S03</td> <td style="text-align: center;">T03</td> <td style="text-align: center;">N03</td> <td style="text-align: center;">E3</td> <td style="text-align: center;">E3</td> <td style="text-align: center;">E3</td> <td style="text-align: center;">E3</td> <td style="text-align: center;">E3</td> </tr> <tr> <td></td> <td style="text-align: center;">1</td> <td style="text-align: center;">2</td> <td style="text-align: center;">3</td> <td style="text-align: center;">4</td> <td style="text-align: center;">R04</td> <td style="text-align: center;">S04</td> <td style="text-align: center;">T04</td> <td style="text-align: center;">N04</td> <td style="text-align: center;">E4</td> <td style="text-align: center;">E4</td> <td style="text-align: center;">E4</td> <td style="text-align: center;">E4</td> <td style="text-align: center;">E4</td> </tr> <tr> <td></td> <td style="text-align: center;">1</td> <td style="text-align: center;">2</td> <td style="text-align: center;">3</td> <td style="text-align: center;">4</td> <td style="text-align: center;">R05</td> <td style="text-align: center;">S05</td> <td style="text-align: center;">T05</td> <td style="text-align: center;">N05</td> <td style="text-align: center;">E5</td> <td style="text-align: center;">E5</td> <td style="text-align: center;">E5</td> <td style="text-align: center;">E5</td> <td style="text-align: center;">E5</td> </tr> <tr> <td></td> <td style="text-align: center;">1</td> <td style="text-align: center;">2</td> <td style="text-align: center;">3</td> <td style="text-align: center;">4</td> <td style="text-align: center;">R06</td> <td style="text-align: center;">S06</td> <td style="text-align: center;">T06</td> <td style="text-align: center;">N06</td> <td style="text-align: center;">E6</td> <td style="text-align: center;">E6</td> <td style="text-align: center;">E6</td> <td style="text-align: center;">E6</td> <td style="text-align: center;">E6</td> </tr> <tr> <td></td> <td style="text-align: center;">1</td> <td style="text-align: center;">2</td> <td style="text-align: center;">3</td> <td style="text-align: center;">4</td> <td style="text-align: center;">R07</td> <td style="text-align: center;">S07</td> <td style="text-align: center;">T07</td> <td style="text-align: center;">N07</td> <td style="text-align: center;">E7</td> <td style="text-align: center;">E7</td> <td style="text-align: center;">E7</td> <td style="text-align: center;">E7</td> <td style="text-align: center;">E7</td> </tr> <tr> <td></td> <td style="text-align: center;">1</td> <td style="text-align: center;">2</td> <td style="text-align: center;">3</td> <td style="text-align: center;">4</td> <td style="text-align: center;">R08</td> <td style="text-align: center;">S08</td> <td style="text-align: center;">T08</td> <td style="text-align: center;">N08</td> <td style="text-align: center;">E8</td> <td style="text-align: center;">E8</td> <td style="text-align: center;">E8</td> <td style="text-align: center;">E8</td> <td style="text-align: center;">E8</td> </tr> </table> </td> <td style="width: 50%; vertical-align: top;"> <table border="0" style="width: 100%;"> <tr> <td style="width: 50%;"></td> <td style="width: 50%; text-align: center;"> <table border="0"> <tr> <td style="width: 10%;"></td> <td style="width: 10%;"></td> <td style="width: 10%;"></td> <td style="width: 10%;"></td> <td style="width: 10%;"></td> <td style="width: 10%;"></td> <td style="width: 10%;"></td> <td style="width: 10%;"></td> <td style="width: 10%;"></td> <td style="width: 10%;"></td> <td style="width: 10%;"></td> <td style="width: 10%;"></td> <td style="width: 10%;"></td> <td style="width: 10%;"></td> </tr> <tr> <td style="text-align: center;">XA</td> <td style="text-align: center;">1</td> <td style="text-align: center;">2</td> <td style="text-align: center;">3</td> <td style="text-align: center;">4</td> <td style="text-align: center;">R01</td> <td style="text-align: center;">S01</td> <td style="text-align: center;">T01</td> <td style="text-align: center;">N01</td> <td style="text-align: center;">E1</td> <td style="text-align: center;">E1</td> <td style="text-align: center;">E1</td> <td style="text-align: center;">E1</td> <td style="text-align: center;">E1</td> </tr> <tr> <td></td> <td style="text-align: center;">1</td> <td style="text-align: center;">2</td> <td style="text-align: center;">3</td> <td style="text-align: center;">4</td> <td style="text-align: center;">R02</td> <td style="text-align: center;">S02</td> <td style="text-align: center;">T02</td> <td style="text-align: center;">N02</td> <td style="text-align: center;">E2</td> <td style="text-align: center;">E2</td> <td style="text-align: center;">E2</td> <td style="text-align: center;">E2</td> <td style="text-align: center;">E2</td> </tr> <tr> <td></td> <td style="text-align: center;">1</td> <td style="text-align: center;">2</td> <td style="text-align: center;">3</td> <td style="text-align: center;">4</td> <td style="text-align: center;">R03</td> <td style="text-align: center;">S03</td> <td style="text-align: center;">T03</td> <td style="text-align: center;">N03</td> <td style="text-align: center;">E3</td> <td style="text-align: center;">E3</td> <td style="text-align: center;">E3</td> <td style="text-align: center;">E3</td> <td style="text-align: center;">E3</td> </tr> <tr> <td></td> <td style="text-align: center;">1</td> <td style="text-align: center;">2</td> <td style="text-align: center;">3</td> <td style="text-align: center;">4</td> <td style="text-align: center;">R04</td> <td style="text-align: center;">S04</td> <td style="text-align: center;">T04</td> <td style="text-align: center;">N04</td> <td style="text-align: center;">E4</td> <td style="text-align: center;">E4</td> <td style="text-align: center;">E4</td> <td style="text-align: center;">E4</td> <td style="text-align: center;">E4</td> </tr> <tr> <td></td> <td style="text-align: center;">1</td> <td style="text-align: center;">2</td> <td style="text-align: center;">3</td> <td style="text-align: center;">4</td> <td style="text-align: center;">R05</td> <td style="text-align: center;">S05</td> <td style="text-align: center;">T05</td> <td style="text-align: center;">N05</td> <td style="text-align: center;">E5</td> <td style="text-align: center;">E5</td> <td style="text-align: center;">E5</td> <td style="text-align: center;">E5</td> <td style="text-align: center;">E5</td> </tr> <tr> <td></td> <td style="text-align: center;">1</td> <td style="text-align: center;">2</td> <td style="text-align: center;">3</td> <td style="text-align: center;">4</td> <td style="text-align: center;">R06</td> <td style="text-align: center;">S06</td> <td style="text-align: center;">T06</td> <td style="text-align: center;">N06</td> <td style="text-align: center;">E6</td> <td style="text-align: center;">E6</td> <td style="text-align: center;">E6</td> <td style="text-align: center;">E6</td> <td style="text-align: center;">E6</td> </tr> <tr> <td></td> <td style="text-align: center;">1</td> <td style="text-align: center;">2</td> <td style="text-align:
center;">3</td> <td style="text-align: center;">4</td> <td style="text-align: center;">R07</td> <td style="text-align: center;">S07</td> <td style="text-align: center;">T07</td> <td style="text-align: center;">N07</td> <td style="text-align: center;">E7</td> <td style="text-align: center;">E7</td> <td style="text-align: center;">E7</td> <td style="text-align: center;">E7</td> <td style="text-align: center;">E7</td> </tr> <tr> <td></td> <td style="text-align: center;">1</td> <td style="text-align: center;">2</td> <td style="text-align: center;">3</td> <td style="text-align: center;">4</td> <td style="text-align: center;">R08</td> <td style="text-align: center;">S08</td> <td style="text-align: center;">T08</td> <td style="text-align: center;">N08</td> <td style="text-align: center;">E8</td> <td style="text-align: center;">E8</td> <td style="text-align: center;">E8</td> <td style="text-align: center;">E8</td> <td style="text-align: center;">E8</td> </tr> </table> </td> <td style="width: 50%; vertical-align: top;"> <table border="0" style="width: 100%;"> <tr> <td style="width: 50%;"></td> <td style="width: 50%; text-align: center;"> <table border="0"> <tr> <td style="width: 10%;"></td> <td style="width: 10%;"></td> <td style="width: 10%;"></td> <td style="width: 10%;"></td> <td style="width: 10%;"></td> <td style="width: 10%;"></td> <td style="width: 10%;"></td> <td style="width: 10%;"></td> <td style="width: 10%;"></td> <td style="width: 10%;"></td> <td style="width: 10%;"></td> <td style="width: 10%;"></td> <td style="width: 10%;"></td> <td style="width: 10%;"></td> </tr> <tr> <td style="text-align: center;">XA</td> <td style="text-align: center;">1</td> <td style="text-align: center;">2</td> <td style="text-align: center;">3</td> <td style="text-align: center;">4</td> <td style="text-align: center;">R01</td> <td style="text-align: center;">S01</td> <td style="text-align: center;">T01</td> <td style="text-align: center;">N01</td> <td style="text-align: center;">E1</td> <td style="text-align: center;">E1</td> <td style="text-align: center;">E1</td> </tr></table></td></tr></table></td></tr></table></td></tr></table></td></tr></table></td></tr></table> |

 | <table border="0"> <tr> <td style="width: 10%;"></td> <td style="width: 10%;"></td> <td style="width: 10%;"></td> <td style="width: 10%;"></td> <td style="width: 10%;"></td> <td style="width: 10%;"></td> <td style="width: 10%;"></td> <td style="width: 10%;"></td> <td style="width: 10%;"></td> <td style="width: 10%;"></td> <td style="width: 10%;"></td> <td style="width: 10%;"></td> <td style="width: 10%;"></td> <td style="width: 10%;"></td> </tr> <tr> <td style="text-align: center;">XA</td> <td style="text-align: center;">1</td> <td style="text-align: center;">2</td> <td style="text-align: center;">3</td> <td style="text-align: center;">4</td> <td style="text-align: center;">R01</td> <td style="text-align: center;">S01</td> <td style="text-align: center;">T01</td> <td style="text-align: center;">N01</td> <td style="text-align: center;">E1</td> <td style="text-align: center;">E1</td> <td style="text-align: center;">E1</td> <td style="text-align: center;">E1</td> <td style="text-align: center;">E1</td> </tr> <tr> <td></td> <td style="text-align: center;">1</td> <td style="text-align: center;">2</td> <td style="text-align: center;">3</td> <td style="text-align: center;">4</td> <td style="text-align: center;">R02</td> <td style="text-align: center;">S02</td> <td style="text-align: center;">T02</td> <td style="text-align: center;">N02</td> <td style="text-align: center;">E2</td> <td style="text-align: center;">E2</td> <td style="text-align: center;">E2</td> <td style="text-align: center;">E2</td> <td style="text-align: center;">E2</td> </tr> <tr> <td></td> <td style="text-align: center;">1</td> <td style="text-align: center;">2</td> <td style="text-align: center;">3</td> <td style="text-align: center;">4</td> <td style="text-align: center;">R03</td> <td style="text-align: center;">S03</td> <td style="text-align: center;">T03</td> <td style="text-align: center;">N03</td> <td style="text-align: center;">E3</td> <td style="text-align: center;">E3</td> <td style="text-align: center;">E3</td> <td style="text-align: center;">E3</td> <td style="text-align: center;">E3</td> </tr> <tr> <td></td> <td style="text-align: center;">1</td> <td style="text-align: center;">2</td> <td style="text-align: center;">3</td> <td style="text-align: center;">4</td> <td style="text-align: center;">R04</td> <td style="text-align: center;">S04</td> <td style="text-align: center;">T04</td> <td style="text-align: center;">N04</td> <td style="text-align: center;">E4</td> <td style="text-align: center;">E4</td> <td style="text-align: center;">E4</td> <td style="text-align: center;">E4</td> <td style="text-align: center;">E4</td> </tr> <tr> <td></td> <td style="text-align: center;">1</td> <td style="text-align: center;">2</td> <td style="text-align: center;">3</td> <td style="text-align: center;">4</td> <td style="text-align: center;">R05</td> <td style="text-align: center;">S05</td> <td style="text-align: center;">T05</td> <td style="text-align: center;">N05</td> <td style="text-align: center;">E5</td> <td style="text-align: center;">E5</td> <td style="text-align: center;">E5</td> <td style="text-align: center;">E5</td> <td style="text-align: center;">E5</td> </tr> <tr> <td></td> <td style="text-align: center;">1</td> <td style="text-align: center;">2</td> <td style="text-align: center;">3</td> <td style="text-align: center;">4</td> <td style="text-align: center;">R06</td> <td style="text-align: center;">S06</td> <td style="text-align: center;">T06</td> <td style="text-align: center;">N06</td> <td style="text-align: center;">E6</td> <td style="text-align: center;">E6</td> <td style="text-align: center;">E6</td> <td style="text-align: center;">E6</td> <td style="text-align: center;">E6</td> </tr> <tr> <td></td> <td style="text-align: center;">1</td> <td style="text-align: center;">2</td> <td style="text-align: center;">3</td> <td style="text-align: center;">4</td> <td style="text-align: center;">R07</td> <td style="text-align: center;">S07</td> <td style="text-align: center;">T07</td> <td style="text-align: center;">N07</td> <td style="text-align: center;">E7</td> <td style="text-align: center;">E7</td> <td style="text-align: center;">E7</td> <td style="text-align: center;">E7</td> <td style="text-align: center;">E7</td> </tr> <tr> <td></td> <td style="text-align: center;">1</td> <td style="text-align: center;">2</td> <td style="text-align: center;">3</td> <td style="text-align: center;">4</td> <td style="text-align: center;">R08</td> <td style="text-align: center;">S08</td> <td style="text-align: center;">T08</td> <td style="text-align: center;">N08</td> <td style="text-align: center;">E8</td> <td style="text-align: center;">E8</td> <td style="text-align: center;">E8</td> <td style="text-align: center;">E8</td> <td style="text-align: center;">E8</td> </tr> </table> |
 | | | | | | | | | | | |

 | | XA | 1 | 2 | 3 | 4 | R01 | S01 | T01 | N01 | E1 | E1 | E1 | E1 | E1 | | 1 | 2 | 3 | 4 | R02 | S02 | T02 | N02 | E2 | E2 | E2 | E2

 | E2 | | 1 | 2 | 3 | 4 | R03 | S03 | T03 | N03 | E3 | E3 | E3 | E3 | E3 | | 1 | 2 | 3 | 4 | R04 | S04 | T04 | N04 | E4 | E4 | E4 | E4 | E4 | | 1 | 2 | 3 | 4 | R05 | S05 | T05 | N05 | E5 | E5 | E5 | E5 | E5 | | 1 | 2 | 3 | 4 | R06 | S06 | T06 | N06 | E6 | E6 | E6 | E6 | E6 | | 1 | 2 | 3 | 4 | R07 | S07 | T07 | N07 | E7 | E7 | E7 | E7 | E7 |
 | 1 | 2
 | 3 | 4 | R08 | S08 | T08 | N08 | E8 | E8 | E8 | E8 | E8 | <table border="0" style="width: 100%;"> <tr> <td style="width: 50%;"></td> <td style="width: 50%; text-align: center;"> <table border="0"> <tr> <td style="width: 10%;"></td> <td style="width: 10%;"></td> <td style="width: 10%;"></td> <td style="width: 10%;"></td> <td style="width: 10%;"></td> <td style="width: 10%;"></td> <td style="width: 10%;"></td> <td style="width: 10%;"></td> <td style="width: 10%;"></td> <td style="width: 10%;"></td> <td style="width: 10%;"></td> <td style="width: 10%;"></td> <td style="width: 10%;"></td> <td style="width: 10%;"></td> </tr> <tr> <td style="text-align: center;">XA</td> <td style="text-align: center;">1</td> <td style="text-align: center;">2</td> <td style="text-align: center;">3</td> <td style="text-align: center;">4</td> <td style="text-align: center;">R01</td> <td style="text-align: center;">S01</td> <td style="text-align: center;">T01</td> <td style="text-align: center;">N01</td> <td style="text-align: center;">E1</td> <td style="text-align: center;">E1</td> <td style="text-align: center;">E1</td> <td style="text-align: center;">E1</td> <td style="text-align: center;">E1</td> </tr> <tr> <td></td> <td style="text-align: center;">1</td> <td style="text-align: center;">2</td> <td style="text-align: center;">3</td> <td style="text-align: center;">4</td> <td style="text-align: center;">R02</td> <td style="text-align: center;">S02</td> <td style="text-align: center;">T02</td> <td style="text-align: center;">N02</td> <td style="text-align: center;">E2</td> <td style="text-align: center;">E2</td> <td style="text-align: center;">E2</td> <td style="text-align: center;">E2</td> <td style="text-align: center;">E2</td> </tr> <tr> <td></td> <td style="text-align: center;">1</td> <td style="text-align: center;">2</td> <td style="text-align: center;">3</td> <td style="text-align: center;">4</td> <td style="text-align: center;">R03</td> <td style="text-align: center;">S03</td> <td style="text-align: center;">T03</td> <td style="text-align: center;">N03</td> <td style="text-align: center;">E3</td> <td style="text-align: center;">E3</td> <td style="text-align: center;">E3</td> <td style="text-align: center;">E3</td> <td style="text-align: center;">E3</td> </tr> <tr> <td></td> <td style="text-align: center;">1</td> <td style="text-align: center;">2</td> <td style="text-align: center;">3</td> <td style="text-align: center;">4</td> <td style="text-align: center;">R04</td> <td style="text-align: center;">S04</td> <td style="text-align: center;">T04</td> <td style="text-align: center;">N04</td> <td style="text-align: center;">E4</td> <td style="text-align: center;">E4</td> <td style="text-align: center;">E4</td> <td style="text-align: center;">E4</td> <td style="text-align: center;">E4</td> </tr> <tr> <td></td> <td style="text-align: center;">1</td> <td style="text-align: center;">2</td> <td style="text-align: center;">3</td> <td style="text-align: center;">4</td> <td style="text-align: center;">R05</td> <td style="text-align: center;">S05</td> <td style="text-align: center;">T05</td> <td style="text-align: center;">N05</td> <td style="text-align: center;">E5</td> <td style="text-align: center;">E5</td> <td style="text-align: center;">E5</td> <td style="text-align: center;">E5</td> <td style="text-align: center;">E5</td> </tr> <tr> <td></td> <td style="text-align: center;">1</td> <td style="text-align: center;">2</td> <td style="text-align: center;">3</td> <td style="text-align: center;">4</td> <td style="text-align: center;">R06</td> <td style="text-align: center;">S06</td> <td style="text-align: center;">T06</td> <td style="text-align: center;">N06</td> <td style="text-align: center;">E6</td> <td style="text-align: center;">E6</td> <td style="text-align: center;">E6</td> <td style="text-align: center;">E6</td> <td style="text-align: center;">E6</td> </tr> <tr> <td></td> <td style="text-align: center;">1</td> <td style="text-align: center;">2</td> <td style="text-align: center;">3</td> <td style="text-align: center;">4</td> <td style="text-align: center;">R07</td> <td style="text-align: center;">S07</td> <td style="text-align: center;">T07</td> <td style="text-align: center;">N07</td> <td style="text-align: center;">E7</td> <td style="text-align: center;">E7</td> <td style="text-align: center;">E7</td> <td style="text-align: center;">E7</td> <td style="text-align: center;">E7</td> </tr> <tr> <td></td> <td style="text-align: center;">1</td> <td style="text-align: center;">2</td> <td style="text-align: center;">3</td> <td style="text-align: center;">4</td> <td style="text-align: center;">R08</td> <td style="text-align: center;">S08</td> <td style="text-align: center;">T08</td> <td style="text-align: center;">N08</td> <td style="text-align: center;">E8</td> <td style="text-align: center;">E8</td> <td style="text-align: center;">E8</td> <td style="text-align: center;">E8</td> <td style="text-align: center;">E8</td> </tr> </table> </td> <td style="width: 50%; vertical-align: top;"> <table border="0" style="width: 100%;"> <tr> <td style="width: 50%;"></td> <td style="width: 50%; text-align: center;"> <table border="0"> <tr> <td style="width: 10%;"></td> <td style="width: 10%;"></td> <td style="width: 10%;"></td> <td style="width: 10%;"></td> <td style="width: 10%;"></td> <td style="width: 10%;"></td> <td style="width: 10%;"></td> <td style="width: 10%;"></td> <td style="width: 10%;"></td> <td style="width: 10%;"></td> <td style="width: 10%;"></td> <td style="width: 10%;"></td> <td style="width: 10%;"></td> <td style="width: 10%;"></td> </tr> <tr> <td style="text-align: center;">XA</td> <td style="text-align: center;">1</td> <td style="text-align: center;">2</td> <td style="text-align: center;">3</td> <td style="text-align: center;">4</td> <td style="text-align: center;">R01</td> <td style="text-align: center;">S01</td> <td style="text-align: center;">T01</td> <td style="text-align: center;">N01</td> <td style="text-align: center;">E1</td> <td style="text-align: center;">E1</td> <td style="text-align: center;">E1</td> <td style="text-align: center;">E1</td> <td style="text-align: center;">E1</td> </tr> <tr> <td></td> <td style="text-align: center;">1</td> <td style="text-align: center;">2</td> <td style="text-align: center;">3</td> <td style="text-align: center;">4</td> <td style="text-align: center;">R02</td> <td style="text-align: center;">S02</td> <td style="text-align: center;">T02</td> <td style="text-align: center;">N02</td> <td style="text-align: center;">E2</td> <td style="text-align: center;">E2</td> <td style="text-align: center;">E2</td> <td style="text-align: center;">E2</td> <td style="text-align: center;">E2</td> </tr> <tr> <td></td> <td style="text-align: center;">1</td> <td style="text-align: center;">2</td> <td style="text-align: center;">3</td> <td style="text-align: center;">4</td> <td style="text-align: center;">R03</td> <td style="text-align: center;">S03</td> <td style="text-align: center;">T03</td> <td style="text-align: center;">N03</td> <td style="text-align: center;">E3</td> <td style="text-align: center;">E3</td> <td style="text-align: center;">E3</td> <td style="text-align: center;">E3</td> <td style="text-align: center;">E3</td> </tr> <tr> <td></td> <td style="text-align: center;">1</td> <td style="text-align: center;">2</td> <td style="text-align: center;">3</td> <td style="text-align: center;">4</td> <td style="text-align: center;">R04</td> <td style="text-align: center;">S04</td> <td style="text-align: center;">T04</td> <td style="text-align: center;">N04</td> <td style="text-align: center;">E4</td> <td style="text-align: center;">E4</td> <td style="text-align: center;">E4</td> <td style="text-align: center;">E4</td> <td style="text-align: center;">E4</td> </tr> <tr> <td></td> <td style="text-align: center;">1</td> <td style="text-align: center;">2</td> <td style="text-align: center;">3</td> <td style="text-align: center;">4</td> <td style="text-align: center;">R05</td> <td style="text-align: center;">S05</td> <td style="text-align: center;">T05</td> <td style="text-align: center;">N05</td> <td style="text-align: center;">E5</td> <td style="text-align: center;">E5</td> <td style="text-align: center;">E5</td> <td style="text-align: center;">E5</td> <td style="text-align: center;">E5</td> </tr> <tr> <td></td> <td style="text-align: center;">1</td> <td style="text-align: center;">2</td> <td style="text-align: center;">3</td> <td style="text-align: center;">4</td> <td style="text-align: center;">R06</td> <td style="text-align: center;">S06</td> <td style="text-align: center;">T06</td> <td style="text-align: center;">N06</td> <td
style="text-align: center;">E6</td> <td style="text-align: center;">E6</td> <td style="text-align: center;">E6</td> <td style="text-align: center;">E6</td> <td style="text-align: center;">E6</td> </tr> <tr> <td></td> <td style="text-align: center;">1</td> <td style="text-align: center;">2</td> <td style="text-align: center;">3</td> <td style="text-align: center;">4</td> <td style="text-align: center;">R07</td> <td style="text-align: center;">S07</td> <td style="text-align: center;">T07</td> <td style="text-align: center;">N07</td> <td style="text-align: center;">E7</td> <td style="text-align: center;">E7</td> <td style="text-align: center;">E7</td> <td style="text-align: center;">E7</td> <td style="text-align: center;">E7</td> </tr> <tr> <td></td> <td style="text-align: center;">1</td> <td style="text-align: center;">2</td> <td style="text-align: center;">3</td> <td style="text-align: center;">4</td> <td style="text-align: center;">R08</td> <td style="text-align: center;">S08</td> <td style="text-align: center;">T08</td> <td style="text-align: center;">N08</td> <td style="text-align: center;">E8</td> <td style="text-align: center;">E8</td> <td style="text-align: center;">E8</td> <td style="text-align: center;">E8</td> <td style="text-align: center;">E8</td> </tr> </table> </td> <td style="width: 50%; vertical-align: top;"> <table border="0" style="width: 100%;"> <tr> <td style="width: 50%;"></td> <td style="width: 50%; text-align: center;"> <table border="0"> <tr> <td style="width: 10%;"></td> <td style="width: 10%;"></td> <td style="width: 10%;"></td> <td style="width: 10%;"></td> <td style="width: 10%;"></td> <td style="width: 10%;"></td> <td style="width: 10%;"></td> <td style="width: 10%;"></td> <td style="width: 10%;"></td> <td style="width: 10%;"></td> <td style="width: 10%;"></td> <td style="width: 10%;"></td> <td style="width: 10%;"></td> <td style="width: 10%;"></td> </tr> <tr> <td style="text-align: center;">XA</td> <td style="text-align: center;">1</td> <td style="text-align: center;">2</td> <td style="text-align: center;">3</td> <td style="text-align: center;">4</td> <td style="text-align: center;">R01</td> <td style="text-align: center;">S01</td> <td style="text-align: center;">T01</td> <td style="text-align: center;">N01</td> <td style="text-align: center;">E1</td> <td style="text-align: center;">E1</td> <td style="text-align: center;">E1</td> <td style="text-align: center;">E1</td> <td style="text-align: center;">E1</td> </tr> <tr> <td></td> <td style="text-align: center;">1</td> <td style="text-align: center;">2</td> <td style="text-align: center;">3</td> <td style="text-align: center;">4</td> <td style="text-align: center;">R02</td> <td style="text-align: center;">S02</td> <td style="text-align: center;">T02</td> <td style="text-align: center;">N02</td> <td style="text-align: center;">E2</td> <td style="text-align: center;">E2</td> <td style="text-align: center;">E2</td> <td style="text-align: center;">E2</td> <td style="text-align: center;">E2</td> </tr> <tr> <td></td> <td style="text-align: center;">1</td> <td style="text-align: center;">2</td> <td style="text-align: center;">3</td> <td style="text-align: center;">4</td> <td style="text-align: center;">R03</td> <td style="text-align: center;">S03</td> <td style="text-align: center;">T03</td> <td style="text-align: center;">N03</td> <td style="text-align: center;">E3</td> <td style="text-align: center;">E3</td> <td style="text-align: center;">E3</td> <td style="text-align: center;">E3</td> <td style="text-align: center;">E3</td> </tr> <tr> <td></td> <td style="text-align: center;">1</td> <td style="text-align: center;">2</td> <td style="text-align: center;">3</td> <td style="text-align: center;">4</td> <td style="text-align: center;">R04</td> <td style="text-align: center;">S04</td> <td style="text-align: center;">T04</td> <td style="text-align: center;">N04</td> <td style="text-align: center;">E4</td> <td style="text-align: center;">E4</td> <td style="text-align: center;">E4</td> <td style="text-align: center;">E4</td> <td style="text-align: center;">E4</td> </tr> <tr> <td></td> <td style="text-align: center;">1</td> <td style="text-align: center;">2</td> <td style="text-align: center;">3</td> <td style="text-align: center;">4</td> <td style="text-align: center;">R05</td> <td style="text-align: center;">S05</td> <td style="text-align: center;">T05</td> <td style="text-align: center;">N05</td> <td style="text-align: center;">E5</td> <td style="text-align: center;">E5</td> <td style="text-align: center;">E5</td> <td style="text-align: center;">E5</td> <td style="text-align: center;">E5</td> </tr> <tr> <td></td> <td style="text-align: center;">1</td> <td style="text-align: center;">2</td> <td style="text-align: center;">3</td> <td style="text-align: center;">4</td> <td style="text-align: center;">R06</td> <td style="text-align: center;">S06</td> <td style="text-align: center;">T06</td> <td style="text-align: center;">N06</td> <td style="text-align: center;">E6</td> <td style="text-align: center;">E6</td> <td style="text-align: center;">E6</td> <td style="text-align: center;">E6</td> <td style="text-align: center;">E6</td> </tr> <tr> <td></td> <td style="text-align: center;">1</td> <td style="text-align: center;">2</td> <td style="text-align: center;">3</td> <td style="text-align: center;">4</td> <td style="text-align: center;">R07</td> <td style="text-align: center;">S07</td> <td style="text-align: center;">T07</td> <td style="text-align: center;">N07</td> <td style="text-align: center;">E7</td> <td style="text-align: center;">E7</td> <td style="text-align: center;">E7</td> <td style="text-align: center;">E7</td> <td style="text-align: center;">E7</td> </tr> <tr> <td></td> <td style="text-align: center;">1</td> <td style="text-align: center;">2</td> <td style="text-align: center;">3</td> <td style="text-align: center;">4</td> <td style="text-align: center;">R08</td> <td style="text-align: center;">S08</td> <td style="text-align: center;">T08</td> <td style="text-align: center;">N08</td> <td style="text-align: center;">E8</td> <td style="text-align: center;">E8</td> <td style="text-align: center;">E8</td> <td style="text-align: center;">E8</td> <td style="text-align: center;">E8</td> </tr> </table> </td> <td style="width: 50%; vertical-align: top;"> <table border="0" style="width: 100%;"> <tr> <td style="width: 50%;"></td> <td style="width: 50%; text-align: center;"> <table border="0"> <tr> <td style="width: 10%;"></td> <td style="width: 10%;"></td> <td style="width: 10%;"></td> <td style="width: 10%;"></td> <td style="width: 10%;"></td> <td style="width: 10%;"></td> <td style="width: 10%;"></td> <td style="width: 10%;"></td> <td style="width: 10%;"></td> <td style="width: 10%;"></td> <td style="width: 10%;"></td> <td style="width: 10%;"></td> <td style="width: 10%;"></td> <td style="width: 10%;"></td> </tr> <tr> <td style="text-align: center;">XA</td> <td style="text-align: center;">1</td> <td style="text-align: center;">2</td> <td style="text-align: center;">3</td> <td style="text-align: center;">4</td> <td style="text-align: center;">R01</td> <td style="text-align: center;">S01</td> <td style="text-align: center;">T01</td> <td style="text-align: center;">N01</td> <td style="text-align: center;">E1</td> <td style="text-align: center;">E1</td> <td style="text-align: center;">E1</td> </tr></table></td></tr></table></td></tr></table></td></tr></table></td></tr></table> |

 | <table border="0"> <tr> <td style="width: 10%;"></td> <td style="width: 10%;"></td> <td style="width: 10%;"></td> <td style="width: 10%;"></td> <td style="width: 10%;"></td> <td style="width: 10%;"></td> <td style="width: 10%;"></td> <td style="width: 10%;"></td> <td style="width: 10%;"></td> <td style="width: 10%;"></td> <td style="width: 10%;"></td> <td style="width: 10%;"></td> <td style="width: 10%;"></td> <td style="width: 10%;"></td> </tr> <tr> <td style="text-align: center;">XA</td> <td style="text-align: center;">1</td> <td style="text-align: center;">2</td> <td style="text-align: center;">3</td> <td style="text-align: center;">4</td> <td style="text-align: center;">R01</td> <td style="text-align: center;">S01</td> <td style="text-align: center;">T01</td> <td style="text-align: center;">N01</td> <td style="text-align: center;">E1</td> <td style="text-align: center;">E1</td> <td style="text-align: center;">E1</td> <td style="text-align: center;">E1</td> <td style="text-align: center;">E1</td> </tr> <tr> <td></td> <td style="text-align: center;">1</td> <td style="text-align: center;">2</td> <td style="text-align: center;">3</td> <td style="text-align: center;">4</td> <td style="text-align: center;">R02</td> <td style="text-align: center;">S02</td> <td style="text-align: center;">T02</td> <td style="text-align: center;">N02</td> <td style="text-align: center;">E2</td> <td style="text-align: center;">E2</td> <td style="text-align: center;">E2</td> <td style="text-align: center;">E2</td> <td style="text-align: center;">E2</td> </tr> <tr> <td></td> <td style="text-align: center;">1</td> <td style="text-align: center;">2</td> <td style="text-align: center;">3</td> <td style="text-align: center;">4</td> <td style="text-align: center;">R03</td> <td style="text-align: center;">S03</td> <td style="text-align: center;">T03</td> <td style="text-align: center;">N03</td> <td style="text-align: center;">E3</td> <td style="text-align: center;">E3</td> <td style="text-align: center;">E3</td> <td style="text-align: center;">E3</td> <td style="text-align: center;">E3</td> </tr> <tr> <td></td> <td style="text-align: center;">1</td> <td style="text-align: center;">2</td> <td style="text-align: center;">3</td> <td style="text-align: center;">4</td> <td style="text-align: center;">R04</td> <td style="text-align: center;">S04</td> <td style="text-align: center;">T04</td> <td style="text-align: center;">N04</td> <td style="text-align: center;">E4</td> <td style="text-align: center;">E4</td> <td style="text-align: center;">E4</td> <td style="text-align: center;">E4</td> <td style="text-align: center;">E4</td> </tr> <tr> <td></td> <td style="text-align: center;">1</td> <td style="text-align: center;">2</td> <td style="text-align: center;">3</td> <td style="text-align: center;">4</td> <td style="text-align: center;">R05</td> <td style="text-align: center;">S05</td> <td style="text-align: center;">T05</td> <td style="text-align: center;">N05</td> <td style="text-align: center;">E5</td> <td style="text-align: center;">E5</td> <td style="text-align: center;">E5</td> <td style="text-align: center;">E5</td> <td style="text-align: center;">E5</td> </tr> <tr> <td></td> <td style="text-align: center;">1</td> <td style="text-align: center;">2</td> <td style="text-align: center;">3</td> <td style="text-align: center;">4</td> <td style="text-align: center;">R06</td> <td style="text-align: center;">S06</td> <td style="text-align: center;">T06</td> <td style="text-align: center;">N06</td> <td style="text-align: center;">E6</td> <td style="text-align: center;">E6</td> <td style="text-align: center;">E6</td> <td style="text-align: center;">E6</td> <td style="text-align: center;">E6</td> </tr> <tr> <td></td> <td style="text-align: center;">1</td> <td style="text-align: center;">2</td> <td style="text-align: center;">3</td> <td style="text-align: center;">4</td> <td style="text-align: center;">R07</td> <td style="text-align: center;">S07</td> <td style="text-align: center;">T07</td> <td style="text-align: center;">N07</td> <td style="text-align: center;">E7</td> <td style="text-align: center;">E7</td> <td style="text-align: center;">E7</td> <td style="text-align: center;">E7</td> <td style="text-align: center;">E7</td> </tr> <tr> <td></td> <td style="text-align: center;">1</td> <td style="text-align: center;">2</td> <td style="text-align: center;">3</td> <td style="text-align: center;">4</td> <td style="text-align: center;">R08</td> <td style="text-align: center;">S08</td> <td style="text-align: center;">T08</td> <td style="text-align: center;">N08</td> <td style="text-align: center;">E8</td> <td style="text-align: center;">E8</td> <td style="text-align: center;">E8</td> <td style="text-align: center;">E8</td> <td style="text-align: center;">E8</td> </tr> </table> |
 | | | | | | | | | | | |
 | | XA
 | 1 | 2 | 3 | 4 | R01 | S01 | T01 | N01 | E1 | E1 | E1 | E1 | E1 | | 1 | 2 | 3 | 4 | R02 | S02 | T02 | N02 | E2 | E2 | E2 | E2

 | E2 | | 1 | 2 | 3 | 4 | R03 | S03 | T03 | N03 | E3 | E3 | E3 | E3 | E3 | | 1 | 2 | 3 | 4 | R04 | S04 | T04 | N04 | E4 | E4 | E4 | E4 | E4 | | 1 | 2 | 3 | 4 | R05 | S05 | T05 | N05 | E5 | E5 | E5 | E5 | E5 | | 1 | 2 | 3 | 4 | R06 | S06 | T06 | N06 | E6 | E6 | E6 | E6 | E6 | | 1 | 2 | 3 | 4 | R07 | S07 | T07 | N07 | E7 | E7 | E7 | E7 | E7 |
 | 1 | 2 | 3 | 4 | R08 | S08 | T08 | N08 | E8 | E8 | E8 | E8 | E8 | <table border="0" style="width: 100%;"> <tr> <td style="width: 50%;"></td> <td style="width: 50%; text-align: center;"> <table border="0"> <tr> <td style="width: 10%;"></td> <td style="width: 10%;"></td> <td style="width: 10%;"></td> <td style="width: 10%;"></td> <td style="width: 10%;"></td> <td style="width: 10%;"></td> <td style="width: 10%;"></td> <td style="width: 10%;"></td> <td style="width: 10%;"></td> <td style="width: 10%;"></td> <td style="width: 10%;"></td> <td style="width: 10%;"></td> <td style="width: 10%;"></td> <td style="width: 10%;"></td> </tr> <tr> <td style="text-align: center;">XA</td> <td style="text-align: center;">1</td> <td style="text-align: center;">2</td> <td style="text-align: center;">3</td> <td style="text-align: center;">4</td> <td style="text-align: center;">R01</td> <td style="text-align: center;">S01</td> <td style="text-align: center;">T01</td> <td style="text-align: center;">N01</td> <td style="text-align: center;">E1</td> <td style="text-align: center;">E1</td> <td style="text-align: center;">E1</td> <td style="text-align: center;">E1</td> <td style="text-align: center;">E1</td> </tr> <tr> <td></td> <td style="text-align: center;">1</td> <td style="text-align: center;">2</td> <td style="text-align: center;">3</td> <td style="text-align: center;">4</td> <td style="text-align: center;">R02</td> <td style="text-align: center;">S02</td> <td style="text-align: center;">T02</td> <td style="text-align: center;">N02</td> <td style="text-align: center;">E2</td> <td style="text-align: center;">E2</td> <td style="text-align: center;">E2</td> <td style="text-align: center;">E2</td> <td style="text-align: center;">E2</td> </tr> <tr> <td></td> <td style="text-align: center;">1</td> <td style="text-align: center;">2</td> <td style="text-align: center;">3</td> <td style="text-align: center;">4</td> <td style="text-align: center;">R03</td> <td style="text-align: center;">S03</td> <td style="text-align: center;">T03</td> <td style="text-align: center;">N03</td> <td style="text-align: center;">E3</td> <td style="text-align: center;">E3</td> <td style="text-align: center;">E3</td> <td style="text-align: center;">E3</td> <td style="text-align: center;">E3</td> </tr> <tr> <td></td> <td style="text-align: center;">1</td> <td style="text-align: center;">2</td> <td style="text-align: center;">3</td> <td style="text-align: center;">4</td> <td style="text-align: center;">R04</td> <td style="text-align: center;">S04</td> <td style="text-align: center;">T04</td> <td style="text-align: center;">N04</td> <td style="text-align: center;">E4</td> <td style="text-align: center;">E4</td> <td style="text-align: center;">E4</td> <td style="text-align: center;">E4</td> <td style="text-align: center;">E4</td> </tr> <tr> <td></td> <td style="text-align: center;">1</td> <td style="text-align: center;">2</td> <td style="text-align: center;">3</td> <td style="text-align: center;">4</td> <td style="text-align: center;">R05</td> <td style="text-align: center;">S05</td> <td style="text-align: center;">T05</td> <td style="text-align: center;">N05</td> <td style="text-align: center;">E5</td> <td style="text-align: center;">E5</td> <td style="text-align: center;">E5</td> <td style="text-align: center;">E5</td> <td style="text-align: center;">E5</td> </tr> <tr> <td></td> <td style="text-align: center;">1</td> <td style="text-align:
center;">2</td> <td style="text-align: center;">3</td> <td style="text-align: center;">4</td> <td style="text-align: center;">R06</td> <td style="text-align: center;">S06</td> <td style="text-align: center;">T06</td> <td style="text-align: center;">N06</td> <td style="text-align: center;">E6</td> <td style="text-align: center;">E6</td> <td style="text-align: center;">E6</td> <td style="text-align: center;">E6</td> <td style="text-align: center;">E6</td> </tr> <tr> <td></td> <td style="text-align: center;">1</td> <td style="text-align: center;">2</td> <td style="text-align: center;">3</td> <td style="text-align: center;">4</td> <td style="text-align: center;">R07</td> <td style="text-align: center;">S07</td> <td style="text-align: center;">T07</td> <td style="text-align: center;">N07</td> <td style="text-align: center;">E7</td> <td style="text-align: center;">E7</td> <td style="text-align: center;">E7</td> <td style="text-align: center;">E7</td> <td style="text-align: center;">E7</td> </tr> <tr> <td></td> <td style="text-align: center;">1</td> <td style="text-align: center;">2</td> <td style="text-align: center;">3</td> <td style="text-align: center;">4</td> <td style="text-align: center;">R08</td> <td style="text-align: center;">S08</td> <td style="text-align: center;">T08</td> <td style="text-align: center;">N08</td> <td style="text-align: center;">E8</td> <td style="text-align: center;">E8</td> <td style="text-align: center;">E8</td> <td style="text-align: center;">E8</td> <td style="text-align: center;">E8</td> </tr> </table> </td> <td style="width: 50%; vertical-align: top;"> <table border="0" style="width: 100%;"> <tr> <td style="width: 50%;"></td> <td style="width: 50%; text-align: center;"> <table border="0"> <tr> <td style="width: 10%;"></td> <td style="width: 10%;"></td> <td style="width: 10%;"></td> <td style="width: 10%;"></td> <td style="width: 10%;"></td> <td style="width: 10%;"></td> <td style="width: 10%;"></td> <td style="width: 10%;"></td> <td style="width: 10%;"></td> <td style="width: 10%;"></td> <td style="width: 10%;"></td> <td style="width: 10%;"></td> <td style="width: 10%;"></td> <td style="width: 10%;"></td> </tr> <tr> <td style="text-align: center;">XA</td> <td style="text-align: center;">1</td> <td style="text-align: center;">2</td> <td style="text-align: center;">3</td> <td style="text-align: center;">4</td> <td style="text-align: center;">R01</td> <td style="text-align: center;">S01</td> <td style="text-align: center;">T01</td> <td style="text-align: center;">N01</td> <td style="text-align: center;">E1</td> <td style="text-align: center;">E1</td> <td style="text-align: center;">E1</td> <td style="text-align: center;">E1</td> <td style="text-align: center;">E1</td> </tr> <tr> <td></td> <td style="text-align: center;">1</td> <td style="text-align: center;">2</td> <td style="text-align: center;">3</td> <td style="text-align: center;">4</td> <td style="text-align: center;">R02</td> <td style="text-align: center;">S02</td> <td style="text-align: center;">T02</td> <td style="text-align: center;">N02</td> <td style="text-align: center;">E2</td> <td style="text-align: center;">E2</td> <td style="text-align: center;">E2</td> <td style="text-align: center;">E2</td> <td style="text-align: center;">E2</td> </tr> <tr> <td></td> <td style="text-align: center;">1</td> <td style="text-align: center;">2</td> <td style="text-align: center;">3</td> <td style="text-align: center;">4</td> <td style="text-align: center;">R03</td> <td style="text-align: center;">S03</td> <td style="text-align: center;">T03</td> <td style="text-align: center;">N03</td> <td style="text-align: center;">E3</td> <td style="text-align: center;">E3</td> <td style="text-align: center;">E3</td> <td style="text-align: center;">E3</td> <td style="text-align: center;">E3</td> </tr> <tr> <td></td> <td style="text-align: center;">1</td> <td style="text-align: center;">2</td> <td style="text-align: center;">3</td> <td style="text-align: center;">4</td> <td style="text-align: center;">R04</td> <td style="text-align: center;">S04</td> <td style="text-align: center;">T04</td> <td style="text-align: center;">N04</td> <td style="text-align: center;">E4</td> <td style="text-align: center;">E4</td> <td style="text-align: center;">E4</td> <td style="text-align: center;">E4</td> <td style="text-align: center;">E4</td> </tr> <tr> <td></td> <td style="text-align: center;">1</td> <td style="text-align: center;">2</td> <td style="text-align: center;">3</td> <td style="text-align: center;">4</td> <td style="text-align: center;">R05</td> <td style="text-align: center;">S05</td> <td style="text-align: center;">T05</td> <td style="text-align: center;">N05</td> <td style="text-align: center;">E5</td> <td style="text-align: center;">E5</td> <td style="text-align: center;">E5</td> <td style="text-align: center;">E5</td> <td style="text-align: center;">E5</td> </tr> <tr> <td></td> <td style="text-align: center;">1</td> <td style="text-align: center;">2</td> <td style="text-align: center;">3</td> <td style="text-align: center;">4</td> <td style="text-align: center;">R06</td> <td style="text-align: center;">S06</td> <td style="text-align: center;">T06</td> <td style="text-align: center;">N06</td> <td style="text-align: center;">E6</td> <td style="text-align: center;">E6</td> <td style="text-align: center;">E6</td> <td style="text-align: center;">E6</td> <td style="text-align: center;">E6</td> </tr> <tr> <td></td> <td style="text-align: center;">1</td> <td style="text-align: center;">2</td> <td style="text-align: center;">3</td> <td style="text-align: center;">4</td> <td style="text-align: center;">R07</td> <td style="text-align: center;">S07</td> <td style="text-align: center;">T07</td> <td style="text-align: center;">N07</td> <td style="text-align: center;">E7</td> <td style="text-align: center;">E7</td> <td style="text-align: center;">E7</td> <td style="text-align: center;">E7</td> <td style="text-align: center;">E7</td> </tr> <tr> <td></td> <td style="text-align: center;">1</td> <td style="text-align: center;">2</td> <td style="text-align: center;">3</td> <td style="text-align: center;">4</td> <td style="text-align: center;">R08</td> <td style="text-align: center;">S08</td> <td style="text-align: center;">T08</td> <td style="text-align: center;">N08</td> <td style="text-align: center;">E8</td> <td style="text-align: center;">E8</td> <td style="text-align: center;">E8</td> <td style="text-align: center;">E8</td> <td style="text-align: center;">E8</td> </tr> </table> </td> <td style="width: 50%; vertical-align: top;"> <table border="0" style="width: 100%;"> <tr> <td style="width: 50%;"></td> <td style="width: 50%; text-align: center;"> <table border="0"> <tr> <td style="width: 10%;"></td> <td style="width: 10%;"></td> <td style="width: 10%;"></td> <td style="width: 10%;"></td> <td style="width: 10%;"></td> <td style="width: 10%;"></td> <td style="width: 10%;"></td> <td style="width: 10%;"></td> <td style="width: 10%;"></td> <td style="width: 10%;"></td> <td style="width: 10%;"></td> <td style="width: 10%;"></td> <td style="width: 10%;"></td> <td style="width: 10%;"></td> </tr> <tr> <td style="text-align: center;">XA</td> <td style="text-align: center;">1</td> <td style="text-align: center;">2</td> <td style="text-align: center;">3</td> <td style="text-align: center;">4</td> <td style="text-align: center;">R01</td> <td style="text-align: center;">S01</td> <td style="text-align: center;">T01</td> <td style="text-align: center;">N01</td> <td style="text-align: center;">E1</td> <td style="text-align: center;">E1</td> <td style="text-align: center;">E1</td> </tr></table></td></tr></table></td></tr></table></td></tr></table> |
 | <table border="0"> <tr> <td style="width: 10%;"></td> <td style="width: 10%;"></td> <td style="width: 10%;"></td> <td style="width: 10%;"></td> <td style="width: 10%;"></td> <td style="width: 10%;"></td> <td style="width: 10%;"></td> <td style="width: 10%;"></td> <td style="width: 10%;"></td> <td style="width: 10%;"></td> <td style="width: 10%;"></td> <td style="width: 10%;"></td> <td style="width: 10%;"></td> <td style="width: 10%;"></td> </tr> <tr> <td style="text-align: center;">XA</td> <td style="text-align: center;">1</td> <td style="text-align: center;">2</td> <td style="text-align: center;">3</td> <td style="text-align: center;">4</td> <td style="text-align: center;">R01</td> <td style="text-align: center;">S01</td> <td style="text-align: center;">T01</td> <td style="text-align: center;">N01</td> <td style="text-align: center;">E1</td> <td style="text-align: center;">E1</td> <td style="text-align: center;">E1</td> <td style="text-align: center;">E1</td> <td style="text-align: center;">E1</td> </tr> <tr> <td></td> <td style="text-align: center;">1</td> <td style="text-align: center;">2</td> <td style="text-align: center;">3</td> <td style="text-align:
center;">4</td> <td style="text-align: center;">R02</td> <td style="text-align: center;">S02</td> <td style="text-align: center;">T02</td> <td style="text-align: center;">N02</td> <td style="text-align: center;">E2</td> <td style="text-align: center;">E2</td> <td style="text-align: center;">E2</td> <td style="text-align: center;">E2</td> <td style="text-align: center;">E2</td> </tr> <tr> <td></td> <td style="text-align: center;">1</td> <td style="text-align: center;">2</td> <td style="text-align: center;">3</td> <td style="text-align: center;">4</td> <td style="text-align: center;">R03</td> <td style="text-align: center;">S03</td> <td style="text-align: center;">T03</td> <td style="text-align: center;">N03</td> <td style="text-align: center;">E3</td> <td style="text-align: center;">E3</td> <td style="text-align: center;">E3</td> <td style="text-align: center;">E3</td> <td style="text-align: center;">E3</td> </tr> <tr> <td></td> <td style="text-align: center;">1</td> <td style="text-align: center;">2</td> <td style="text-align: center;">3</td> <td style="text-align: center;">4</td> <td style="text-align: center;">R04</td> <td style="text-align: center;">S04</td> <td style="text-align: center;">T04</td> <td style="text-align: center;">N04</td> <td style="text-align: center;">E4</td> <td style="text-align: center;">E4</td> <td style="text-align: center;">E4</td> <td style="text-align: center;">E4</td> <td style="text-align: center;">E4</td> </tr> <tr> <td></td> <td style="text-align: center;">1</td> <td style="text-align: center;">2</td> <td style="text-align: center;">3</td> <td style="text-align: center;">4</td> <td style="text-align: center;">R05</td> <td style="text-align: center;">S05</td> <td style="text-align: center;">T05</td> <td style="text-align: center;">N05</td> <td style="text-align: center;">E5</td> <td style="text-align: center;">E5</td> <td style="text-align: center;">E5</td> <td style="text-align: center;">E5</td> <td style="text-align: center;">E5</td> </tr> <tr> <td></td> <td style="text-align: center;">1</td> <td style="text-align: center;">2</td> <td style="text-align: center;">3</td> <td style="text-align: center;">4</td> <td style="text-align: center;">R06</td> <td style="text-align: center;">S06</td> <td style="text-align: center;">T06</td> <td style="text-align: center;">N06</td> <td style="text-align: center;">E6</td> <td style="text-align: center;">E6</td> <td style="text-align: center;">E6</td> <td style="text-align: center;">E6</td> <td style="text-align: center;">E6</td> </tr> <tr> <td></td> <td style="text-align: center;">1</td> <td style="text-align: center;">2</td> <td style="text-align: center;">3</td> <td style="text-align: center;">4</td> <td style="text-align: center;">R07</td> <td style="text-align: center;">S07</td> <td style="text-align: center;">T07</td> <td style="text-align: center;">N07</td> <td style="text-align: center;">E7</td> <td style="text-align: center;">E7</td> <td style="text-align: center;">E7</td> <td style="text-align: center;">E7</td> <td style="text-align: center;">E7</td> </tr> <tr> <td></td> <td style="text-align: center;">1</td> <td style="text-align: center;">2</td> <td style="text-align: center;">3</td> <td style="text-align: center;">4</td> <td style="text-align: center;">R08</td> <td style="text-align: center;">S08</td> <td style="text-align: center;">T08</td> <td style="text-align: center;">N08</td> <td style="text-align: center;">E8</td> <td style="text-align: center;">E8</td> <td style="text-align: center;">E8</td> <td style="text-align: center;">E8</td> <td style="text-align: center;">E8</td> </tr> </table> | | | | | | | | | | | | |
 | | XA
 | 1 | 2 | 3 | 4 | R01 | S01 | T01 | N01 | E1 | E1 | E1 | E1 | E1 | | 1 | 2 | 3 | 4 | R02 | S02 | T02 | N02 | E2 | E2 | E2 | E2
 | E2 |
 | 1 | 2 | 3 | 4 | R03 | S03 | T03 | N03 | E3 | E3 | E3 | E3 | E3 | | 1 | 2 | 3 | 4 | R04 | S04 | T04 | N04 | E4 | E4 | E4 | E4 | E4 | | 1 | 2 | 3 | 4 | R05 | S05 | T05 | N05 | E5 | E5 | E5 | E5 | E5 | | 1 | 2 | 3 | 4 | R06 | S06 | T06 | N06 | E6 | E6 | E6 | E6 | E6 | | 1 | 2 | 3 | 4 | R07 | S07 | T07 | N07 | E7 | E7 | E7 | E7 | E7 | | 1 | 2 | 3 | 4 | R08 | S08 | T08 | N08 | E8 | E8 | E8 | E8 | E8 | <table border="0" style="width: 100%;"> <tr> <td style="width: 50%;"></td> <td style="width: 50%; text-align: center;"> <table border="0"> <tr> <td style="width: 10%;"></td> <td style="width: 10%;"></td> <td style="width: 10%;"></td> <td style="width: 10%;"></td> <td style="width: 10%;"></td> <td style="width: 10%;"></td> <td style="width: 10%;"></td> <td style="width: 10%;"></td> <td style="width: 10%;"></td> <td style="width: 10%;"></td> <td style="width: 10%;"></td> <td style="width: 10%;"></td> <td style="width: 10%;"></td> <td style="width: 10%;"></td> </tr> <tr> <td style="text-align: center;">XA</td> <td style="text-align: center;">1</td> <td style="text-align: center;">2</td> <td style="text-align: center;">3</td> <td style="text-align: center;">4</td> <td style="text-align: center;">R01</td> <td style="text-align: center;">S01</td> <td style="text-align: center;">T01</td> <td style="text-align: center;">N01</td> <td style="text-align: center;">E1</td> <td style="text-align: center;">E1</td> <td style="text-align: center;">E1</td> <td style="text-align: center;">E1</td> <td style="text-align: center;">E1</td> </tr> <tr> <td></td> <td style="text-align: center;">1</td> <td style="text-align: center;">2</td> <td style="text-align: center;">3</td> <td style="text-align: center;">4</td> <td style="text-align: center;">R02</td> <td style="text-align: center;">S02</td> <td style="text-align: center;">T02</td> <td style="text-align: center;">N02</td> <td style="text-align: center;">E2</td> <td style="text-align: center;">E2</td> <td style="text-align: center;">E2</td> <td style="text-align: center;">E2</td> <td style="text-align: center;">E2</td> </tr> <tr> <td></td> <td style="text-align: center;">1</td> <td style="text-align: center;">2</td> <td style="text-align: center;">3</td> <td style="text-align: center;">4</td> <td style="text-align: center;">R03</td> <td style="text-align: center;">S03</td> <td style="text-align: center;">T03</td> <td style="text-align: center;">N03</td> <td style="text-align: center;">E3</td> <td style="text-align: center;">E3</td> <td style="text-align: center;">E3</td> <td style="text-align: center;">E3</td> <td style="text-align: center;">E3</td> </tr> <tr> <td></td> <td style="text-align: center;">1</td> <td style="text-align: center;">2</td> <td style="text-align: center;">3</td> <td style="text-align: center;">4</td> <td style="text-align: center;">R04</td> <td style="text-align: center;">S04</td> <td style="text-align: center;">T04</td> <td style="text-align: center;">N04</td> <td style="text-align: center;">E4</td> <td style="text-align: center;">E4</td> <td style="text-align: center;">E4</td> <td style="text-align: center;">E4</td> <td style="text-align: center;">E4</td> </tr> <tr> <td></td> <td style="text-align: center;">1</td> <td style="text-align: center;">2</td> <td style="text-align: center;">3</td> <td style="text-align: center;">4</td> <td style="text-align: center;">R05</td> <td style="text-align: center;">S05</td> <td style="text-align: center;">T05</td> <td style="text-align: center;">N05</td> <td style="text-align: center;">E5</td> <td style="text-align: center;">E5</td> <td style="text-align: center;">E5</td> <td style="text-align: center;">E5</td> <td style="text-align: center;">E5</td> </tr> <tr> <td></td> <td style="text-align: center;">1</td> <td style="text-align: center;">2</td> <td style="text-align: center;">3</td> <td style="text-align: center;">4</td> <td style="text-align: center;">R06</td> <td style="text-align: center;">S06</td> <td style="text-align: center;">T06</td> <td style="text-align: center;">N06</td> <td style="text-align: center;">E6</td> <td style="text-align: center;">E6</td> <td style="text-align: center;">E6</td> <td style="text-align: center;">E6</td> <td style="text-align: center;">E6</td> </tr> <tr> <td></td> <td style="text-align: center;">1</td> <td style="text-align: center;">2</td> <td style="text-align: center;">3</td> <td style="text-align: center;">4</td> <td style="text-align: center;">R07</td> <td style="text-align: center;">S07</td> <td style="text-align: center;">T07</td> <td style="text-align: center;">N07</td> <td style="text-align: center;">E7</td> <td style="text-align: center;">E7</td> <td style="text-align: center;">E7</td> <td style="text-align: center;">E7</td> <td style="text-align: center;">E7</td> </tr> <tr> <td></td> <td style="text-align: center;">1</td> <td style="text-align: center;">2</td> <td style="text-align: center;">3</td> <td style="text-align: center;">4</td> <td style="text-align: center;">R08</td> <td style="text-align: center;">S08</td> <td style="text-align: center;">T08</td> <td style="text-align: center;">N08</td> <td style="text-align: center;">E8</td> <td style="text-align: center;">E8</td> <td style="text-align: center;">E8</td> <td style="text-align: center;">E8</td> <td style="text-align: center;">E8</td> </tr> </table> </td> <td style="width: 50%; vertical-align: top;"> <table border="0" style="width: 100%;"> <tr> <td style="width: 50%;"></td> <td style="width: 50%; text-align: center;"> <table border="0"> <tr> <td style="width: 10%;"></td> <td style="width: 10%;"></td> <td style="width: 10%;"></td> <td style="width: 10%;"></td> <td style="width: 10%;"></td> <td style="width: 10%;"></td> <td style="width: 10%;"></td> <td style="width: 10%;"></td> <td style="width: 10%;"></td> <td style="width: 10%;"></td> <td style="width: 10%;"></td> <td style="width: 10%;"></td> <td style="width: 10%;"></td> <td style="width: 10%;"></td> </tr> <tr> <td style="text-align: center;">XA</td> <td style="text-align: center;">1</td> <td style="text-align: center;">2</td> <td style="text-align: center;">3</td> <td style="text-align: center;">4</td> <td style="text-align: center;">R01</td> <td style="text-align: center;">S01</td> <td style="text-align: center;">T01</td> <td style="text-align: center;">N01</td> <td style="text-align: center;">E1</td> <td style="text-align: center;">E1</td> <td style="text-align: center;">E1</td> </tr></table></td></tr></table></td></tr></table> |
 | <table border="0"> <tr> <td style="width: 10%;"></td> <td style="width: 10%;"></td> <td style="width: 10%;"></td> <td style="width: 10%;"></td> <td style="width: 10%;"></td> <td style="width: 10%;"></td> <td style="width: 10%;"></td> <td style="width: 10%;"></td> <td style="width: 10%;"></td> <td style="width: 10%;"></td> <td style="width: 10%;"></td> <td style="width: 10%;"></td> <td style="width: 10%;"></td> <td style="width: 10%;"></td> </tr> <tr> <td style="text-align: center;">XA</td> <td style="text-align: center;">1</td> <td style="text-align: center;">2</td> <td style="text-align: center;">3</td> <td style="text-align: center;">4</td> <td style="text-align: center;">R01</td> <td style="text-align: center;">S01</td> <td style="text-align: center;">T01</td> <td style="text-align: center;">N01</td> <td style="text-align: center;">E1</td> <td style="text-align: center;">E1</td> <td style="text-align: center;">E1</td> <td style="text-align: center;">E1</td> <td style="text-align: center;">E1</td> </tr> <tr> <td></td> <td style="text-align: center;">1</td> <td style="text-align: center;">2</td> <td style="text-align: center;">3</td> <td style="text-align: center;">4</td> <td style="text-align: center;">R02</td> <td style="text-align: center;">S02</td> <td style="text-align: center;">T02</td> <td style="text-align: center;">N02</td> <td style="text-align: center;">E2</td> <td style="text-align: center;">E2</td> <td style="text-align: center;">E2</td> <td style="text-align: center;">E2</td> <td style="text-align: center;">E2</td> </tr> <tr> <td></td> <td style="text-align: center;">1</td> <td style="text-align: center;">2</td> <td style="text-align: center;">3</td> <td style="text-align: center;">4</td> <td style="text-align: center;">R03</td> <td style="text-align: center;">S03</td> <td style="text-align: center;">T03</td> <td style="text-align: center;">N03</td> <td style="text-align: center;">E3</td> <td style="text-align: center;">E3</td> <td style="text-align: center;">E3</td> <td style="text-align: center;">E3</td> <td style="text-align: center;">E3</td> </tr> <tr> <td></td> <td style="text-align: center;">1</td> <td style="text-align: center;">2</td> <td style="text-align: center;">3</td> <td style="text-align: center;">4</td> <td style="text-align: center;">R04</td> <td style="text-align: center;">S04</td> <td style="text-align: center;">T04</td> <td style="text-align: center;">N04</td> <td style="text-align: center;">E4</td> <td style="text-align: center;">E4</td> <td style="text-align: center;">E4</td> <td style="text-align: center;">E4</td> <td style="text-align: center;">E4</td> </tr> <tr> <td></td> <td style="text-align: center;">1</td> <td style="text-align: center;">2</td> <td style="text-align: center;">3</td> <td style="text-align: center;">4</td> <td style="text-align: center;">R05</td> <td style="text-align: center;">S05</td> <td style="text-align: center;">T05</td> <td style="text-align: center;">N05</td> <td style="text-align: center;">E5</td> <td style="text-align: center;">E5</td> <td style="text-align: center;">E5</td> <td style="text-align: center;">E5</td> <td style="text-align: center;">E5</td> </tr> <tr> <td></td> <td style="text-align: center;">1</td> <td style="text-align: center;">2</td> <td style="text-align: center;">3</td> <td style="text-align: center;">4</td> <td style="text-align: center;">R06</td> <td style="text-align: center;">S06</td> <td style="text-align: center;">T06</td> <td style="text-align: center;">N06</td> <td style="text-align: center;">E6</td> <td style="text-align: center;">E6</td> <td style="text-align: center;">E6</td> <td style="text-align: center;">E6</td> <td style="text-align: center;">E6</td> </tr> <tr> <td></td> <td style="text-align: center;">1</td> <td style="text-align: center;">2</td> <td style="text-align: center;">3</td> <td style="text-align: center;">4</td> <td style="text-align: center;">R07</td> <td style="text-align: center;">S07</td> <td style="text-align: center;">T07</td> <td style="text-align: center;">N07</td> <td style="text-align: center;">E7</td> <td style="text-align: center;">E7</td> <td style="text-align: center;">E7</td> <td style="text-align: center;">E7</td> <td style="text-align: center;">E7</td> </tr> <tr> <td></td> <td style="text-align: center;">1</td> <td style="text-align: center;">2</td> <td style="text-align: center;">3</td> <td style="text-align: center;">4</td> <td style="text-align: center;">R08</td> <td style="text-align: center;">S08</td> <td style="text-align: center;">T08</td> <td style="text-align: center;">N08</td> <td style="text-align: center;">E8</td> <td style="text-align: center;">E8</td> <td style="text-align: center;">E8</td> <td style="text-align: center;">E8</td> <td style="text-align: center;">E8</td> </tr> </table> |
 | | | | | | | | | | | |
 | | XA | 1 | 2 | 3 | 4 | R01 | S01 | T01 | N01 | E1 | E1 | E1 | E1 | E1 | | 1 | 2 | 3 | 4 | R02 | S02 | T02 | N02 | E2 | E2 | E2 | E2
 | E2 | | 1 | 2 | 3 | 4 | R03 | S03 | T03 | N03 | E3 | E3 | E3 | E3 | E3 | | 1 | 2 | 3 | 4 | R04 | S04 | T04 | N04 | E4 | E4 | E4 | E4 | E4 | | 1 | 2 | 3 | 4 | R05 | S05 | T05 | N05 | E5 | E5 | E5 | E5 | E5 | | 1 | 2 | 3 | 4 | R06 | S06 | T06 | N06 | E6 | E6 | E6 | E6 | E6 | | 1 | 2 | 3 | 4 | R07 | S07 | T07 | N07 | E7 | E7 | E7 | E7 | E7 | | 1 | 2 | 3 | 4 | R08 | S08 | T08 | N08 | E8 | E8 | E8 | E8 | E8 | <table border="0" style="width: 100%;"> <tr> <td style="width: 50%;"></td> <td style="width: 50%; text-align: center;"> <table border="0"> <tr> <td style="width: 10%;"></td> <td style="width: 10%;"></td> <td style="width: 10%;"></td> <td style="width: 10%;"></td> <td style="width: 10%;"></td> <td style="width: 10%;"></td> <td style="width: 10%;"></td> <td style="width: 10%;"></td> <td style="width: 10%;"></td> <td style="width: 10%;"></td> <td style="width: 10%;"></td> <td style="width: 10%;"></td> <td style="width: 10%;"></td> <td style="width: 10%;"></td> </tr> <tr> <td style="text-align: center;">XA</td> <td style="text-align: center;">1</td> <td style="text-align: center;">2</td> <td style="text-align: center;">3</td> <td style="text-align: center;">4</td> <td style="text-align: center;">R01</td> <td style="text-align: center;">S01</td> <td style="text-align: center;">T01</td> <td style="text-align: center;">N01</td> <td style="text-align: center;">E1</td> <td style="text-align: center;">E1</td> <td style="text-align: center;">E1</td> </tr></table></td></tr></table> | | <table border="0"> <tr> <td style="width: 10%;"></td> <td style="width: 10%;"></td> <td style="width: 10%;"></td> <td style="width: 10%;"></td> <td style="width: 10%;"></td> <td style="width: 10%;"></td> <td style="width: 10%;"></td> <td style="width: 10%;"></td> <td style="width: 10%;"></td> <td style="width: 10%;"></td> <td style="width: 10%;"></td> <td style="width: 10%;"></td> <td style="width: 10%;"></td> <td style="width: 10%;"></td> </tr> <tr> <td style="text-align: center;">XA</td> <td style="text-align: center;">1</td> <td style="text-align:
center;">2</td> <td style="text-align: center;">3</td> <td style="text-align: center;">4</td> <td style="text-align: center;">R01</td> <td style="text-align: center;">S01</td> <td style="text-align: center;">T01</td> <td style="text-align: center;">N01</td> <td style="text-align: center;">E1</td> <td style="text-align: center;">E1</td> <td style="text-align: center;">E1</td> </tr></table> | | | | | | | | | | | | | | | XA | 1 | 2 | 3 | 4 | R01 | S01 | T01 | N01 | E1 | E1 | E1 | | | | | | | | | | | | | | | | | | | | | | | | | | | | | | | | | | | | | | | | | | | |
|

 | |
 | | | | | | | | | | | |

 | |
 | | | | | | | | | | | |

 | | | | | | | | | | | | | |

 | | | | | | | | | | | | | | | | | | | | | | | | | | | | | | | | | | | | | | | | | | | | | | | | | | | | | | | | | | | | | | | | | | | | | | | | | | | | | | | | | | | | | |

 | | | | | | | | | | | | | |

 |

 |
 | | | | | | | | | | | | |

 | | | | | | | | | | | | | | | | | | | | | | | | | | | |

 | | | | | | | | | | | | | | | | | | | | | | | | | | | | | | | | | | | | | | | | | | | | | | | | | | | | | | | | | | | | | | | |
| | | | | | | |
 | |
 | | | | | | | | | | | |

 |

 | |
 | | | | | | | | | | | |

 | | | | | | | | | | | | | | | | | | | | | | | | | | | |

 | | | | | | | | | | | | | | | | | | | | | | | | | | | | | | | | | | | | | | | | | | | | | | | | | | | | | | | | | | | | | | | | | | | | | | | |
 | |
 | | | | | | | | | | | |
 |

 | |
 | | | | | | | | | | | |
 | |
 | | | | | | | | | | | | | | | | | | | | | | | | | |

 | | | | | | | | | | | | | | | | | | | | | | | | | | | | | | | | | | | | | | | | | | | | | | | | | | | | | | | | | | | | | | | | | | | | | | | |
 | | | | | | | | | | | | | |
 |
 |
 | | | | | | | | | | | | |
 | |
 | | | | | | | | | | | | | | | | | | | | | | | | | |
 | |
 | | | | | | | | | | | | | | | | | | | | | | | | | | | | | | | | | | | | | | | | | | | | | | | | | | | | | | | | | | | | | | | | | | | | | | | | | | | | | | | | | | | | |
 | |
 | | | | | | | | | | | | | | | | | | | | | | | | | | | | | | | | | | | | | | | | | | | | | | | | | | | | | | | | | | | | | | | | | | | | | | | | | | | | | | | | | | | | | | | |
 | | | | | | | | | | | | | | | | | | | | | | | | | | | |
 | | | | | | | | | | | | | | | | | | | | | | | | | | | | | | | | | | | | | | | | | | | | | | | | | | | | | | | | | | | | | | | | | | | | | | | | | | | | | | | | | | | | | | | |
 | | | | | | | | | | | | | | | | | | | | | | | | | | | | | | | | | | | | | | | | | | | | | | | | | | | | | | | | | | | | | | | | | | | | | |
| XA

 | 1/G | 2/G
 | 3/G | 4/G | R | S | T | N | E0 | E0 | E0 | E0 | E0 |

 | |
 | | | | | | | | | | | |

 | | | | | | | | | | | | | |

 | | | | | | | | | | | | | | | | | | | | | | | | | | | | | | | | | | | | | | | | | | | | | | | | | | | | | | | | | | | | | | | | | | | | | | | | | | | | | | | | | | | | | |

 | | | | | | | | | | | | | |

 |

 |
 | | | | | | | | | | | | |

 | | | | | | | | | | | | | | | | | | | | | | | | | | | |

 | | | | | | | | | | | | | | | | | | | | | | | | | | | | | | | | | | | | | | | | | | | | | | | | | | | | | | | | | | | | | | | |
| | | | | | | |
 | |
 | | | | | | | | | | | |

 |

 | |
 | | | | | | | | | | | |

 | | | | | | | | | | | | | | | | | | | | | | | | | | | |

 | | | | | | | | | | | | | | | | | | | | | | | | | | | | | | | | | | | | | | | | | | | | | | | | | | | | | | | | | | | | | | | | | | | | | | | |
 | |
 | | | | | | | | | | | |
 |

 | |
 | | | | | | | | | | | |
 | |
 | | | | | | | | | | | | | | | | | | | | | | | | | |

 | | | | | | | | | | | | | | | | | | | | | | | | | | | | | | | | | | | | | | | | | | | | | | | | | | | | | | | | | | | | | | | | | | | | | | | |
 | | | | | | | | | | | | | |
 |
 |
 | | | | | | | | | | | | |
 | |
 | | | | | | | | | | | | | | | | | | | | | | | | | |
 | |
 | | | | | | | | | | | | | | | | | | | | | | | | | | | | | | | | | | | | | | | | | | | | | | | | | | | | | | | | | | | | | | | | | | | | | | | | | | | | | | | | | | | | |
 | |
 | | | | | | | | | | | | | | | | | | | | | | | | | | | | | | | | | | | | | | | | | | | | | | | | | | | | | | | | | | | | | | | | | | | | | | | | | | | | | | | | | | | | | | | |
 | | | | | | | | | | | | | | | | | | | | | | | | | | | |
 | | | | | | | | | | | | | | | | | | | | | | | | | | | | | | | | | | | | | | | | | | | | | | | | | | | | | | | | | | | | | | | | | | | | | | | | | | | | | | | | | | | | | | | |
 | | | | | | | | | | | | | | | | | | | | | | | | | | | | | | | | | | | | | | | | | | | | | | | | | | | | | | | | | | | | | | | | | | | | | |
|

 | 1 | 2
 | 3 | 4 | R01 | S01 | T01 | N01 | E1 | E1 | E1 | E1 | E1 |

 | |
 | | | | | | | | | | | |

 | | | | | | | | | | | | | |

 | | | | | | | | | | | | | | | | | | | | | | | | | | | | | | | | | | | | | | | | | | | | | | | | | | | | | | | | | | | | | | | | | | | | | | | | | | | | | | | | | | | | | |

 | | | | | | | | | | | | | |

 |

 |
 | | | | | | | | | | | | |

 | | | | | | | | | | | | | | | | | | | | | | | | | | | |

 | | | | | | | | | | | | | | | | | | | | | | | | | | | | | | | | | | | | | | | | | | | | | | | | | | | | | | | | | | | | | | | |
| | | | | | | |
 | |
 | | | | | | | | | | | |

 |

 | |
 | | | | | | | | | | | |

 | | | | | | | | | | | | | | | | | | | | | | | | | | | |

 | | | | | | | | | | | | | | | | | | | | | | | | | | | | | | | | | | | | | | | | | | | | | | | | | | | | | | | | | | | | | | | | | | | | | | | |
 | |
 | | | | | | | | | | | |
 |

 | |
 | | | | | | | | | | | |
 | |
 | | | | | | | | | | | | | | | | | | | | | | | | | |

 | | | | | | | | | | | | | | | | | | | | | | | | | | | | | | | | | | | | | | | | | | | | | | | | | | | | | | | | | | | | | | | | | | | | | | | |
 | | | | | | | | | | | | | |
 |
 |
 | | | | | | | | | | | | |
 | |
 | | | | | | | | | | | | | | | | | | | | | | | | | |
 | |
 | | | | | | | | | | | | | | | | | | | | | | | | | | | | | | | | | | | | | | | | | | | | | | | | | | | | | | | | | | | | | | | | | | | | | | | | | | | | | | | | | | | | |
 | |
 | | | | | | | | | | | | | | | | | | | | | | | | | | | | | | | | | | | | | | | | | | | | | | | | | | | | | | | | | | | | | | | | | | | | | | | | | | | | | | | | | | | | | | | |
 | | | | | | | | | | | | | | | | | | | | | | | | | | | |
 | | | | | | | | | | | | | | | | | | | | | | | | | | | | | | | | | | | | | | | | | | | | | | | | | | | | | | | | | | | | | | | | | | | | | | | | | | | | | | | | | | | | | | | |
 | | | | | | | | | | | | | | | | | | | | | | | | | | | | | | | | | | | | | | | | | | | | | | | | | | | | | | | | | | | | | | | | | | | | | |
|

 | 1 | 2
 | 3 | 4 | R02 | S02 | T02 | N02 | E2 | E2 | E2 | E2 | E2 |

 | |
 | | | | | | | | | | | |

 | | | | | | | | | | | | | |

 | | | | | | | | | | | | | | | | | | | | | | | | | | | | | | | | | | | | | | | | | | | | | | | | | | | | | | | | | | | | | | | | | | | | | | | | | | | | | | | | | | | | | |

 | | | | | | | | | | | | | |

 |

 |
 | | | | | | | | | | | | |

 | | | | | | | | | | | | | | | | | | | | | | | | | | | |

 | | | | | | | | | | | | | | | | | | | | | | | | | | | | | | | | | | | | | | | | | | | | | | | | | | | | | | | | | | | | | | | |
| | | | | | | |
 | |
 | | | | | | | | | | | |

 |

 | |
 | | | | | | | | | | | |

 | | | | | | | | | | | | | | | | | | | | | | | | | | | |

 | | | | | | | | | | | | | | | | | | | | | | | | | | | | | | | | | | | | | | | | | | | | | | | | | | | | | | | | | | | | | | | | | | | | | | | |
 | |
 | | | | | | | | | | | |
 |

 | |
 | | | | | | | | | | | |
 | |
 | | | | | | | | | | | | | | | | | | | | | | | | | |

 | | | | | | | | | | | | | | | | | | | | | | | | | | | | | | | | | | | | | | | | | | | | | | | | | | | | | | | | | | | | | | | | | | | | | | | |
 | | | | | | | | | | | | | |
 |
 |
 | | | | | | | | | | | | |
 | |
 | | | | | | | | | | | | | | | | | | | | | | | | | |
 | |
 | | | | | | | | | | | | | | | | | | | | | | | | | | | | | | | | | | | | | | | | | | | | | | | | | | | | | | | | | | | | | | | | | | | | | | | | | | | | | | | | | | | | |
 | |
 | | | | | | | | | | | | | | | | | | | | | | | | | | | | | | | | | | | | | | | | | | | | | | | | | | | | | | | | | | | | | | | | | | | | | | | | | | | | | | | | | | | | | | | |
 | | | | | | | | | | | | | | | | | | | | | | | | | | | |
 | | | | | | | | | | | | | | | | | | | | | | | | | | | | | | | | | | | | | | | | | | | | | | | | | | | | | | | | | | | | | | | | | | | | | | | | | | | | | | | | | | | | | | | |
 | | | | | | | | | | | | | | | | | | | | | | | | | | | | | | | | | | | | | | | | | | | | | | | | | | | | | | | | | | | | | | | | | | | | | |
|

 | 1 | 2
 | 3 | 4 | R03 | S03 | T03 | N03 | E3 | E3 | E3 | E3 | E3 |

 | |
 | | | | | | | | | | | |

 | | | | | | | | | | | | | |

 | | | | | | | | | | | | | | | | | | | | | | | | | | | | | | | | | | | | | | | | | | | | | | | | | | | | | | | | | | | | | | | | | | | | | | | | | | | | | | | | | | | | | |

 | | | | | | | | | | | | | |

 |

 |
 | | | | | | | | | | | | |

 | | | | | | | | | | | | | | | | | | | | | | | | | | | |

 | | | | | | | | | | | | | | | | | | | | | | | | | | | | | | | | | | | | | | | | | | | | | | | | | | | | | | | | | | | | | | | |
| | | | | | | |
 | |
 | | | | | | | | | | | |

 |

 | |
 | | | | | | | | | | | |

 | | | | | | | | | | | | | | | | | | | | | | | | | | | |

 | | | | | | | | | | | | | | | | | | | | | | | | | | | | | | | | | | | | | | | | | | | | | | | | | | | | | | | | | | | | | | | | | | | | | | | |
 | |
 | | | | | | | | | | | |
 |

 | |
 | | | | | | | | | | | |
 | |
 | | | | | | | | | | | | | | | | | | | | | | | | | |

 | | | | | | | | | | | | | | | | | | | | | | | | | | | | | | | | | | | | | | | | | | | | | | | | | | | | | | | | | | | | | | | | | | | | | | | |
 | | | | | | | | | | | | | |
 |
 |
 | | | | | | | | | | | | |
 | |
 | | | | | | | | | | | | | | | | | | | | | | | | | |
 | |
 | | | | | | | | | | | | | | | | | | | | | | | | | | | | | | | | | | | | | | | | | | | | | | | | | | | | | | | | | | | | | | | | | | | | | | | | | | | | | | | | | | | | |
 | |
 | | | | | | | | | | | | | | | | | | | | | | | | | | | | | | | | | | | | | | | | | | | | | | | | | | | | | | | | | | | | | | | | | | | | | | | | | | | | | | | | | | | | | | | |
 | | | | | | | | | | | | | | | | | | | | | | | | | | | |
 | | | | | | | | | | | | | | | | | | | | | | | | | | | | | | | | | | | | | | | | | | | | | | | | | | | | | | | | | | | | | | | | | | | | | | | | | | | | | | | | | | | | | | | |
 | | | | | | | | | | | | | | | | | | | | | | | | | | | | | | | | | | | | | | | | | | | | | | | | | | | | | | | | | | | | | | | | | | | | | |
|

 | 1 | 2
 | 3 | 4 | R04 | S04 | T04 | N04 | E4 | E4 | E4 | E4 | E4 |

 | |
 | | | | | | | | | | | |

 | | | | | | | | | | | | | |

 | | | | | | | | | | | | | | | | | | | | | | | | | | | | | | | | | | | | | | | | | | | | | | | | | | | | | | | | | | | | | | | | | | | | | | | | | | | | | | | | | | | | | |

 | | | | | | | | | | | | | |

 |

 |
 | | | | | | | | | | | | |

 | | | | | | | | | | | | | | | | | | | | | | | | | | | |

 | | | | | | | | | | | | | | | | | | | | | | | | | | | | | | | | | | | | | | | | | | | | | | | | | | | | | | | | | | | | | | | |
| | | | | | | |
 | |
 | | | | | | | | | | | |

 |

 | |
 | | | | | | | | | | | |

 | | | | | | | | | | | | | | | | | | | | | | | | | | | |

 | | | | | | | | | | | | | | | | | | | | | | | | | | | | | | | | | | | | | | | | | | | | | | | | | | | | | | | | | | | | | | | | | | | | | | | |
 | |
 | | | | | | | | | | | |
 |

 | |
 | | | | | | | | | | | |
 | |
 | | | | | | | | | | | | | | | | | | | | | | | | | |

 | | | | | | | | | | | | | | | | | | | | | | | | | | | | | | | | | | | | | | | | | | | | | | | | | | | | | | | | | | | | | | | | | | | | | | | |
 | | | | | | | | | | | | | |
 |
 |
 | | | | | | | | | | | | |
 | |
 | | | | | | | | | | | | | | | | | | | | | | | | | |
 | |
 | | | | | | | | | | | | | | | | | | | | | | | | | | | | | | | | | | | | | | | | | | | | | | | | | | | | | | | | | | | | | | | | | | | | | | | | | | | | | | | | | | | | |
 | |
 | | | | | | | | | | | | | | | | | | | | | | | | | | | | | | | | | | | | | | | | | | | | | | | | | | | | | | | | | | | | | | | | | | | | | | | | | | | | | | | | | | | | | | | |
 | | | | | | | | | | | | | | | | | | | | | | | | | | | |
 | | | | | | | | | | | | | | | | | | | | | | | | | | | | | | | | | | | | | | | | | | | | | | | | | | | | | | | | | | | | | | | | | | | | | | | | | | | | | | | | | | | | | | | |
 | | | | | | | | | | | | | | | | | | | | | | | | | | | | | | | | | | | | | | | | | | | | | | | | | | | | | | | | | | | | | | | | | | | | | |
|

 | 1 | 2
 | 3 | 4 | R05 | S05 | T05 | N05 | E5 | E5 | E5 | E5 | E5 |

 | |
 | | | | | | | | | | | |

 | | | | | | | | | | | | | |

 | | | | | | | | | | | | | | | | | | | | | | | | | | | | | | | | | | | | | | | | | | | | | | | | | | | | | | | | | | | | | | | | | | | | | | | | | | | | | | | | | | | | | |

 | | | | | | | | | | | | | |

 |

 |
 | | | | | | | | | | | | |

 | | | | | | | | | | | | | | | | | | | | | | | | | | | |

 | | | | | | | | | | | | | | | | | | | | | | | | | | | | | | | | | | | | | | | | | | | | | | | | | | | | | | | | | | | | | | | |
| | | | | | | |
 | |
 | | | | | | | | | | | |

 |

 | |
 | | | | | | | | | | | |

 | | | | | | | | | | | | | | | | | | | | | | | | | | | |

 | | | | | | | | | | | | | | | | | | | | | | | | | | | | | | | | | | | | | | | | | | | | | | | | | | | | | | | | | | | | | | | | | | | | | | | |
 | |
 | | | | | | | | | | | |
 |

 | |
 | | | | | | | | | | | |
 | |
 | | | | | | | | | | | | | | | | | | | | | | | | | |

 | | | | | | | | | | | | | | | | | | | | | | | | | | | | | | | | | | | | | | | | | | | | | | | | | | | | | | | | | | | | | | | | | | | | | | | |
 | | | | | | | | | | | | | |
 |
 |
 | | | | | | | | | | | | |
 | |
 | | | | | | | | | | | | | | | | | | | | | | | | | |
 | |
 | | | | | | | | | | | | | | | | | | | | | | | | | | | | | | | | | | | | | | | | | | | | | | | | | | | | | | | | | | | | | | | | | | | | | | | | | | | | | | | | | | | | |
 | |
 | | | | | | | | | | | | | | | | | | | | | | | | | | | | | | | | | | | | | | | | | | | | | | | | | | | | | | | | | | | | | | | | | | | | | | | | | | | | | | | | | | | | | | | |
 | | | | | | | | | | | | | | | | | | | | | | | | | | | |
 | | | | | | | | | | | | | | | | | | | | | | | | | | | | | | | | | | | | | | | | | | | | | | | | | | | | | | | | | | | | | | | | | | | | | | | | | | | | | | | | | | | | | | | |
 | | | | | | | | | | | | | | | | | | | | | | | | | | | | | | | | | | | | | | | | | | | | | | | | | | | | | | | | | | | | | | | | | | | | | |
|

 | 1 | 2
 | 3 | 4 | R06 | S06 | T06 | N06 | E6 | E6 | E6 | E6 | E6 |

 | |
 | | | | | | | | | | | |

 | | | | | | | | | | | | | |

 | | | | | | | | | | | | | | | | | | | | | | | | | | | | | | | | | | | | | | | | | | | | | | | | | | | | | | | | | | | | | | | | | | | | | | | | | | | | | | | | | | | | | |

 | | | | | | | | | | | | | |

 |

 |
 | | | | | | | | | | | | |

 | | | | | | | | | | | | | | | | | | | | | | | | | | | |

 | | | | | | | | | | | | | | | | | | | | | | | | | | | | | | | | | | | | | | | | | | | | | | | | | | | | | | | | | | | | | | | |
| | | | | | | |
 | |
 | | | | | | | | | | | |

 |

 | |
 | | | | | | | | | | | |

 | | | | | | | | | | | | | | | | | | | | | | | | | | | |

 | | | | | | | | | | | | | | | | | | | | | | | | | | | | | | | | | | | | | | | | | | | | | | | | | | | | | | | | | | | | | | | | | | | | | | | |
 | |
 | | | | | | | | | | | |
 |

 | |
 | | | | | | | | | | | |
 | |
 | | | | | | | | | | | | | | | | | | | | | | | | | |

 | | | | | | | | | | | | | | | | | | | | | | | | | | | | | | | | | | | | | | | | | | | | | | | | | | | | | | | | | | | | | | | | | | | | | | | |
 | | | | | | | | | | | | | |
 |
 |
 | | | | | | | | | | | | |
 | |
 | | | | | | | | | | | | | | | | | | | | | | | | | |
 | |
 | | | | | | | | | | | | | | | | | | | | | | | | | | | | | | | | | | | | | | | | | | | | | | | | | | | | | | | | | | | | | | | | | | | | | | | | | | | | | | | | | | | | |
 | |
 | | | | | | | | | | | | | | | | | | | | | | | | | | | | | | | | | | | | | | | | | | | | | | | | | | | | | | | | | | | | | | | | | | | | | | | | | | | | | | | | | | | | | | | |
 | | | | | | | | | | | | | | | | | | | | | | | | | | | |
 | | | | | | | | | | | | | | | | | | | | | | | | | | | | | | | | | | | | | | | | | | | | | | | | | | | | | | | | | | | | | | | | | | | | | | | | | | | | | | | | | | | | | | | |
 | | | | | | | | | | | | | | | | | | | | | | | | | | | | | | | | | | | | | | | | | | | | | | | | | | | | | | | | | | | | | | | | | | | | | |
|

 | 1 | 2
 | 3 | 4 | R07 | S07 | T07 | N07 | E7 | E7 | E7 | E7 | E7 |

 | |
 | | | | | | | | | | | |

 | | | | | | | | | | | | | |

 | | | | | | | | | | | | | | | | | | | | | | | | | | | | | | | | | | | | | | | | | | | | | | | | | | | | | | | | | | | | | | | | | | | | | | | | | | | | | | | | | | | | | |

 | | | | | | | | | | | | | |

 |

 |
 | | | | | | | | | | | | |

 | | | | | | | | | | | | | | | | | | | | | | | | | | | |

 | | | | | | | | | | | | | | | | | | | | | | | | | | | | | | | | | | | | | | | | | | | | | | | | | | | | | | | | | | | | | | | |
| | | | | | | |
 | |
 | | | | | | | | | | | |

 |

 | |
 | | | | | | | | | | | |

 | | | | | | | | | | | | | | | | | | | | | | | | | | | |

 | | | | | | | | | | | | | | | | | | | | | | | | | | | | | | | | | | | | | | | | | | | | | | | | | | | | | | | | | | | | | | | | | | | | | | | |
 | |
 | | | | | | | | | | | |
 |

 | |
 | | | | | | | | | | | |
 | |
 | | | | | | | | | | | | | | | | | | | | | | | | | |

 | | | | | | | | | | | | | | | | | | | | | | | | | | | | | | | | | | | | | | | | | | | | | | | | | | | | | | | | | | | | | | | | | | | | | | | |
 | | | | | | | | | | | | | |
 |
 |
 | | | | | | | | | | | | |
 | |
 | | | | | | | | | | | | | | | | | | | | | | | | | |
 | |
 | | | | | | | | | | | | | | | | | | | | | | | | | | | | | | | | | | | | | | | | | | | | | | | | | | | | | | | | | | | | | | | | | | | | | | | | | | | | | | | | | | | | |
 | |
 | | | | | | | | | | | | | | | | | | | | | | | | | | | | | | | | | | | | | | | | | | | | | | | | | | | | | | | | | | | | | | | | | | | | | | | | | | | | | | | | | | | | | | | |
 | | | | | | | | | | | | | | | | | | | | | | | | | | | |
 | | | | | | | | | | | | | | | | | | | | | | | | | | | | | | | | | | | | | | | | | | | | | | | | | | | | | | | | | | | | | | | | | | | | | | | | | | | | | | | | | | | | | | | |
 | | | | | | | | | | | | | | | | | | | | | | | | | | | | | | | | | | | | | | | | | | | | | | | | | | | | | | | | | | | | | | | | | | | | | |
|

 | 1 | 2
 | 3 | 4 | R08 | S08 | T08 | N08 | E8 | E8 | E8 | E8 | E8 |

 | |
 | | | | | | | | | | | |

 | | | | | | | | | | | | | |

 | | | | | | | | | | | | | | | | | | | | | | | | | | | | | | | | | | | | | | | | | | | | | | | | | | | | | | | | | | | | | | | | | | | | | | | | | | | | | | | | | | | | | |

 | | | | | | | | | | | | | |

 |

 |
 | | | | | | | | | | | | |

 | | | | | | | | | | | | | | | | | | | | | | | | | | | |

 | | | | | | | | | | | | | | | | | | | | | | | | | | | | | | | | | | | | | | | | | | | | | | | | | | | | | | | | | | | | | | | |
| | | | | | | |
 | |
 | | | | | | | | | | | |

 |

 | |
 | | | | | | | | | | | |

 | | | | | | | | | | | | | | | | | | | | | | | | | | | |

 | | | | | | | | | | | | | | | | | | | | | | | | | | | | | | | | | | | | | | | | | | | | | | | | | | | | | | | | | | | | | | | | | | | | | | | |
 | |
 | | | | | | | | | | | |
 |

 | |
 | | | | | | | | | | | |
 | |
 | | | | | | | | | | | | | | | | | | | | | | | | | |

 | | | | | | | | | | | | | | | | | | | | | | | | | | | | | | | | | | | | | | | | | | | | | | | | | | | | | | | | | | | | | | | | | | | | | | | |
 | | | | | | | | | | | | | |
 |
 |
 | | | | | | | | | | | | |
 | |
 | | | | | | | | | | | | | | | | | | | | | | | | | |
 | |
 | | | | | | | | | | | | | | | | | | | | | | | | | | | | | | | | | | | | | | | | | | | | | | | | | | | | | | | | | | | | | | | | | | | | | | | | | | | | | | | | | | | | |
 | |
 | | | | | | | | | | | | | | | | | | | | | | | | | | | | | | | | | | | | | | | | | | | | | | | | | | | | | | | | | | | | | | | | | | | | | | | | | | | | | | | | | | | | | | | |
 | | | | | | | | | | | | | | | | | | | | | | | | | | | |
 | | | | | | | | | | | | | | | | | | | | | | | | | | | | | | | | | | | | | | | | | | | | | | | | | | | | | | | | | | | | | | | | | | | | | | | | | | | | | | | | | | | | | | | |
 | | | | | | | | | | | | | | | | | | | | | | | | | | | | | | | | | | | | | | | | | | | | | | | | | | | | | | | | | | | | | | | | | | | | | |
|

 | <table border="0"> <tr> <td style="width: 10%;"></td> <td style="width: 10%;"></td> <td style="width: 10%;"></td> <td style="width: 10%;"></td> <td style="width: 10%;"></td> <td style="width: 10%;"></td> <td style="width: 10%;"></td> <td style="width: 10%;"></td> <td style="width: 10%;"></td> <td style="width: 10%;"></td> <td style="width: 10%;"></td> <td style="width: 10%;"></td> <td style="width: 10%;"></td> <td style="width: 10%;"></td> </tr> <tr> <td style="text-align: center;">XA</td> <td style="text-align: center;">1</td> <td style="text-align: center;">2</td> <td style="text-align: center;">3</td> <td style="text-align: center;">4</td> <td style="text-align: center;">R01</td> <td style="text-align: center;">S01</td> <td style="text-align: center;">T01</td> <td style="text-align: center;">N01</td> <td style="text-align: center;">E1</td> <td style="text-align: center;">E1</td> <td style="text-align: center;">E1</td> <td style="text-align: center;">E1</td> <td style="text-align: center;">E1</td> </tr> <tr> <td></td> <td style="text-align: center;">1</td> <td style="text-align: center;">2</td> <td style="text-align: center;">3</td> <td style="text-align: center;">4</td> <td style="text-align: center;">R02</td> <td style="text-align: center;">S02</td> <td style="text-align: center;">T02</td> <td style="text-align: center;">N02</td> <td style="text-align: center;">E2</td> <td style="text-align: center;">E2</td> <td style="text-align: center;">E2</td> <td style="text-align: center;">E2</td> <td style="text-align: center;">E2</td> </tr> <tr> <td></td> <td style="text-align: center;">1</td> <td style="text-align: center;">2</td> <td style="text-align: center;">3</td> <td style="text-align: center;">4</td> <td style="text-align: center;">R03</td> <td style="text-align: center;">S03</td> <td style="text-align: center;">T03</td> <td style="text-align: center;">N03</td> <td style="text-align: center;">E3</td> <td style="text-align: center;">E3</td> <td style="text-align: center;">E3</td> <td style="text-align: center;">E3</td> <td style="text-align: center;">E3</td> </tr> <tr> <td></td> <td style="text-align: center;">1</td> <td style="text-align: center;">2</td> <td style="text-align: center;">3</td> <td style="text-align: center;">4</td> <td style="text-align: center;">R04</td> <td style="text-align: center;">S04</td> <td style="text-align: center;">T04</td> <td style="text-align: center;">N04</td> <td style="text-align: center;">E4</td> <td style="text-align: center;">E4</td> <td style="text-align: center;">E4</td> <td style="text-align: center;">E4</td> <td style="text-align: center;">E4</td> </tr> <tr> <td></td> <td style="text-align: center;">1</td> <td style="text-align: center;">2</td> <td style="text-align: center;">3</td> <td style="text-align: center;">4</td> <td style="text-align: center;">R05</td> <td style="text-align: center;">S05</td> <td style="text-align: center;">T05</td> <td style="text-align: center;">N05</td> <td style="text-align: center;">E5</td> <td style="text-align: center;">E5</td> <td style="text-align: center;">E5</td> <td style="text-align: center;">E5</td> <td style="text-align: center;">E5</td> </tr> <tr> <td></td> <td style="text-align: center;">1</td> <td style="text-align: center;">2</td> <td style="text-align: center;">3</td> <td style="text-align: center;">4</td> <td style="text-align: center;">R06</td> <td style="text-align: center;">S06</td> <td style="text-align: center;">T06</td> <td style="text-align: center;">N06</td> <td style="text-align: center;">E6</td> <td style="text-align: center;">E6</td> <td style="text-align: center;">E6</td> <td style="text-align: center;">E6</td> <td style="text-align: center;">E6</td> </tr> <tr> <td></td> <td style="text-align: center;">1</td> <td style="text-align: center;">2</td> <td style="text-align: center;">3</td> <td style="text-align: center;">4</td> <td style="text-align: center;">R07</td> <td style="text-align: center;">S07</td> <td style="text-align: center;">T07</td> <td style="text-align: center;">N07</td> <td style="text-align: center;">E7</td> <td style="text-align: center;">E7</td> <td style="text-align: center;">E7</td> <td style="text-align: center;">E7</td> <td style="text-align: center;">E7</td> </tr> <tr> <td></td> <td style="text-align: center;">1</td> <td style="text-align: center;">2</td> <td style="text-align: center;">3</td> <td style="text-align: center;">4</td> <td style="text-align: center;">R08</td> <td style="text-align: center;">S08</td> <td style="text-align: center;">T08</td> <td style="text-align: center;">N08</td> <td style="text-align: center;">E8</td> <td style="text-align: center;">E8</td> <td style="text-align: center;">E8</td> <td style="text-align: center;">E8</td> <td style="text-align: center;">E8</td> </tr> </table> |
 | | | | | | | | | | | |

 | | XA
 | 1 | 2 | 3 | 4 | R01 | S01 | T01 | N01 | E1 | E1 | E1 | E1

 | E1 | | 1 | 2 | 3 | 4 | R02 | S02 | T02 | N02 | E2 | E2 | E2 | E2

 | E2 | | 1 | 2 | 3 | 4 | R03 | S03 | T03 | N03 | E3 | E3 | E3 | E3 | E3 | | 1 | 2 | 3 | 4 | R04 | S04 | T04 | N04 | E4 | E4 | E4 | E4 | E4 | | 1 | 2 | 3 | 4 | R05 | S05 | T05 | N05 | E5 | E5 | E5 | E5 | E5 | | 1 | 2 | 3 | 4 | R06 | S06 | T06 | N06 | E6 | E6 | E6 | E6 | E6 | | 1 | 2 | 3 | 4 | R07 | S07 | T07 | N07 | E7 | E7 | E7 | E7 | E7 | | 1 | 2 | 3 | 4 | R08 | S08 | T08 | N08 | E8 | E8 | E8 | E8 | E8 | <table border="0" style="width: 100%;"> <tr> <td style="width: 50%;"></td> <td style="width: 50%; text-align: center;"> <table border="0"> <tr> <td style="width: 10%;"></td> <td style="width: 10%;"></td> <td style="width: 10%;"></td> <td style="width: 10%;"></td> <td style="width:
10%;"></td> <td style="width: 10%;"></td> <td style="width: 10%;"></td> <td style="width: 10%;"></td> <td style="width: 10%;"></td> <td style="width: 10%;"></td> <td style="width: 10%;"></td> <td style="width: 10%;"></td> <td style="width: 10%;"></td> <td style="width: 10%;"></td> </tr> <tr> <td style="text-align: center;">XA</td> <td style="text-align: center;">1</td> <td style="text-align: center;">2</td> <td style="text-align: center;">3</td> <td style="text-align: center;">4</td> <td style="text-align: center;">R01</td> <td style="text-align: center;">S01</td> <td style="text-align: center;">T01</td> <td style="text-align: center;">N01</td> <td style="text-align: center;">E1</td> <td style="text-align: center;">E1</td> <td style="text-align: center;">E1</td> <td style="text-align: center;">E1</td> <td style="text-align: center;">E1</td> </tr> <tr> <td></td> <td style="text-align: center;">1</td> <td style="text-align: center;">2</td> <td style="text-align: center;">3</td> <td style="text-align: center;">4</td> <td style="text-align: center;">R02</td> <td style="text-align: center;">S02</td> <td style="text-align: center;">T02</td> <td style="text-align: center;">N02</td> <td style="text-align: center;">E2</td> <td style="text-align: center;">E2</td> <td style="text-align: center;">E2</td> <td style="text-align: center;">E2</td> <td style="text-align: center;">E2</td> </tr> <tr> <td></td> <td style="text-align: center;">1</td> <td style="text-align: center;">2</td> <td style="text-align: center;">3</td> <td style="text-align: center;">4</td> <td style="text-align: center;">R03</td> <td style="text-align: center;">S03</td> <td style="text-align: center;">T03</td> <td style="text-align: center;">N03</td> <td style="text-align: center;">E3</td> <td style="text-align: center;">E3</td> <td style="text-align: center;">E3</td> <td style="text-align: center;">E3</td> <td style="text-align: center;">E3</td> </tr> <tr> <td></td> <td style="text-align: center;">1</td> <td style="text-align: center;">2</td> <td style="text-align: center;">3</td> <td style="text-align: center;">4</td> <td style="text-align: center;">R04</td> <td style="text-align: center;">S04</td> <td style="text-align: center;">T04</td> <td style="text-align: center;">N04</td> <td style="text-align: center;">E4</td> <td style="text-align: center;">E4</td> <td style="text-align: center;">E4</td> <td style="text-align: center;">E4</td> <td style="text-align: center;">E4</td> </tr> <tr> <td></td> <td style="text-align: center;">1</td> <td style="text-align: center;">2</td> <td style="text-align: center;">3</td> <td style="text-align: center;">4</td> <td style="text-align: center;">R05</td> <td style="text-align: center;">S05</td> <td style="text-align: center;">T05</td> <td style="text-align: center;">N05</td> <td style="text-align: center;">E5</td> <td style="text-align: center;">E5</td> <td style="text-align: center;">E5</td> <td style="text-align: center;">E5</td> <td style="text-align: center;">E5</td> </tr> <tr> <td></td> <td style="text-align: center;">1</td> <td style="text-align: center;">2</td> <td style="text-align: center;">3</td> <td style="text-align: center;">4</td> <td style="text-align: center;">R06</td> <td style="text-align: center;">S06</td> <td style="text-align: center;">T06</td> <td style="text-align: center;">N06</td> <td style="text-align: center;">E6</td> <td style="text-align: center;">E6</td> <td style="text-align: center;">E6</td> <td style="text-align: center;">E6</td> <td style="text-align: center;">E6</td> </tr> <tr> <td></td> <td style="text-align: center;">1</td> <td style="text-align: center;">2</td> <td style="text-align: center;">3</td> <td style="text-align: center;">4</td> <td style="text-align: center;">R07</td> <td style="text-align: center;">S07</td> <td style="text-align: center;">T07</td> <td style="text-align: center;">N07</td> <td style="text-align: center;">E7</td> <td style="text-align: center;">E7</td> <td style="text-align: center;">E7</td> <td style="text-align: center;">E7</td> <td style="text-align: center;">E7</td> </tr> <tr> <td></td> <td style="text-align: center;">1</td> <td style="text-align: center;">2</td> <td style="text-align: center;">3</td> <td style="text-align: center;">4</td> <td style="text-align: center;">R08</td> <td style="text-align: center;">S08</td> <td style="text-align: center;">T08</td> <td style="text-align: center;">N08</td> <td style="text-align: center;">E8</td> <td style="text-align: center;">E8</td> <td style="text-align: center;">E8</td> <td style="text-align: center;">E8</td> <td style="text-align: center;">E8</td> </tr> </table> </td> <td style="width: 50%; vertical-align: top;"> <table border="0" style="width: 100%;"> <tr> <td style="width: 50%;"></td> <td style="width: 50%; text-align: center;"> <table border="0"> <tr> <td style="width: 10%;"></td> <td style="width: 10%;"></td> <td style="width: 10%;"></td> <td style="width: 10%;"></td> <td style="width: 10%;"></td> <td style="width: 10%;"></td> <td style="width: 10%;"></td> <td style="width: 10%;"></td> <td style="width: 10%;"></td> <td style="width: 10%;"></td> <td style="width: 10%;"></td> <td style="width: 10%;"></td> <td style="width: 10%;"></td> <td style="width: 10%;"></td> </tr> <tr> <td style="text-align: center;">XA</td> <td style="text-align: center;">1</td> <td style="text-align: center;">2</td> <td style="text-align: center;">3</td> <td style="text-align: center;">4</td> <td style="text-align: center;">R01</td> <td style="text-align: center;">S01</td> <td style="text-align: center;">T01</td> <td style="text-align: center;">N01</td> <td style="text-align: center;">E1</td> <td style="text-align: center;">E1</td> <td style="text-align: center;">E1</td> <td style="text-align: center;">E1</td> <td style="text-align: center;">E1</td> </tr> <tr> <td></td> <td style="text-align: center;">1</td> <td style="text-align: center;">2</td> <td style="text-align: center;">3</td> <td style="text-align: center;">4</td> <td style="text-align: center;">R02</td> <td style="text-align: center;">S02</td> <td style="text-align: center;">T02</td> <td style="text-align: center;">N02</td> <td style="text-align: center;">E2</td> <td style="text-align: center;">E2</td> <td style="text-align: center;">E2</td> <td style="text-align: center;">E2</td> <td style="text-align: center;">E2</td> </tr> <tr> <td></td> <td style="text-align: center;">1</td> <td style="text-align: center;">2</td> <td style="text-align: center;">3</td> <td style="text-align: center;">4</td> <td style="text-align: center;">R03</td> <td style="text-align: center;">S03</td> <td style="text-align: center;">T03</td> <td style="text-align: center;">N03</td> <td style="text-align: center;">E3</td> <td style="text-align: center;">E3</td> <td style="text-align: center;">E3</td> <td style="text-align: center;">E3</td> <td style="text-align: center;">E3</td> </tr> <tr> <td></td> <td style="text-align: center;">1</td> <td style="text-align: center;">2</td> <td style="text-align: center;">3</td> <td style="text-align: center;">4</td> <td style="text-align: center;">R04</td> <td style="text-align: center;">S04</td> <td style="text-align: center;">T04</td> <td style="text-align: center;">N04</td> <td style="text-align: center;">E4</td> <td style="text-align: center;">E4</td> <td style="text-align: center;">E4</td> <td style="text-align: center;">E4</td> <td style="text-align: center;">E4</td> </tr> <tr> <td></td> <td style="text-align: center;">1</td> <td style="text-align: center;">2</td> <td style="text-align: center;">3</td> <td style="text-align: center;">4</td> <td style="text-align: center;">R05</td> <td style="text-align: center;">S05</td> <td style="text-align: center;">T05</td> <td style="text-align: center;">N05</td> <td style="text-align: center;">E5</td> <td style="text-align: center;">E5</td> <td style="text-align: center;">E5</td> <td style="text-align: center;">E5</td> <td style="text-align: center;">E5</td> </tr> <tr> <td></td> <td style="text-align: center;">1</td> <td style="text-align: center;">2</td> <td style="text-align: center;">3</td> <td style="text-align: center;">4</td> <td style="text-align: center;">R06</td> <td style="text-align: center;">S06</td> <td style="text-align: center;">T06</td> <td style="text-align: center;">N06</td> <td style="text-align: center;">E6</td> <td style="text-align: center;">E6</td> <td style="text-align: center;">E6</td> <td style="text-align: center;">E6</td> <td style="text-align: center;">E6</td> </tr> <tr> <td></td> <td style="text-align: center;">1</td> <td style="text-align: center;">2</td> <td style="text-align: center;">3</td> <td style="text-align: center;">4</td> <td style="text-align: center;">R07</td> <td style="text-align: center;">S07</td> <td style="text-align: center;">T07</td> <td style="text-align: center;">N07</td> <td style="text-align: center;">E7</td> <td style="text-align: center;">E7</td> <td style="text-align: center;">E7</td> <td style="text-align: center;">E7</td> <td style="text-align: center;">E7</td> </tr> <tr> <td></td> <td style="text-align: center;">1</td> <td style="text-align: center;">2</td> <td style="text-align: center;">3</td> <td style="text-align: center;">4</td> <td style="text-align: center;">R08</td> <td style="text-align: center;">S08</td> <td style="text-align: center;">T08</td> <td style="text-align: center;">N08</td> <td style="text-align: center;">E8</td> <td style="text-align: center;">E8</td> <td style="text-align: center;">E8</td> <td style="text-align: center;">E8</td> <td style="text-align: center;">E8</td> </tr> </table> </td> <td style="width: 50%; vertical-align: top;"> <table border="0" style="width: 100%;"> <tr> <td style="width: 50%;"></td> <td style="width: 50%; text-align: center;"> <table border="0"> <tr> <td style="width: 10%;"></td> <td style="width: 10%;"></td> <td style="width: 10%;"></td> <td style="width: 10%;"></td> <td style="width: 10%;"></td> <td
style="width: 10%;"></td> <td style="width: 10%;"></td> <td style="width: 10%;"></td> <td style="width: 10%;"></td> <td style="width: 10%;"></td> <td style="width: 10%;"></td> <td style="width: 10%;"></td> <td style="width: 10%;"></td> <td style="width: 10%;"></td> </tr> <tr> <td style="text-align: center;">XA</td> <td style="text-align: center;">1</td> <td style="text-align: center;">2</td> <td style="text-align: center;">3</td> <td style="text-align: center;">4</td> <td style="text-align: center;">R01</td> <td style="text-align: center;">S01</td> <td style="text-align: center;">T01</td> <td style="text-align: center;">N01</td> <td style="text-align: center;">E1</td> <td style="text-align: center;">E1</td> <td style="text-align: center;">E1</td> <td style="text-align: center;">E1</td> <td style="text-align: center;">E1</td> </tr> <tr> <td></td> <td style="text-align: center;">1</td> <td style="text-align: center;">2</td> <td style="text-align: center;">3</td> <td style="text-align: center;">4</td> <td style="text-align: center;">R02</td> <td style="text-align: center;">S02</td> <td style="text-align: center;">T02</td> <td style="text-align: center;">N02</td> <td style="text-align: center;">E2</td> <td style="text-align: center;">E2</td> <td style="text-align: center;">E2</td> <td style="text-align: center;">E2</td> <td style="text-align: center;">E2</td> </tr> <tr> <td></td> <td style="text-align: center;">1</td> <td style="text-align: center;">2</td> <td style="text-align: center;">3</td> <td style="text-align: center;">4</td> <td style="text-align: center;">R03</td> <td style="text-align: center;">S03</td> <td style="text-align: center;">T03</td> <td style="text-align: center;">N03</td> <td style="text-align: center;">E3</td> <td style="text-align: center;">E3</td> <td style="text-align: center;">E3</td> <td style="text-align: center;">E3</td> <td style="text-align: center;">E3</td> </tr> <tr> <td></td> <td style="text-align: center;">1</td> <td style="text-align: center;">2</td> <td style="text-align: center;">3</td> <td style="text-align: center;">4</td> <td style="text-align: center;">R04</td> <td style="text-align: center;">S04</td> <td style="text-align: center;">T04</td> <td style="text-align: center;">N04</td> <td style="text-align: center;">E4</td> <td style="text-align: center;">E4</td> <td style="text-align: center;">E4</td> <td style="text-align: center;">E4</td> <td style="text-align: center;">E4</td> </tr> <tr> <td></td> <td style="text-align: center;">1</td> <td style="text-align: center;">2</td> <td style="text-align: center;">3</td> <td style="text-align: center;">4</td> <td style="text-align: center;">R05</td> <td style="text-align: center;">S05</td> <td style="text-align: center;">T05</td> <td style="text-align: center;">N05</td> <td style="text-align: center;">E5</td> <td style="text-align: center;">E5</td> <td style="text-align: center;">E5</td> <td style="text-align: center;">E5</td> <td style="text-align: center;">E5</td> </tr> <tr> <td></td> <td style="text-align: center;">1</td> <td style="text-align: center;">2</td> <td style="text-align: center;">3</td> <td style="text-align: center;">4</td> <td style="text-align: center;">R06</td> <td style="text-align: center;">S06</td> <td style="text-align: center;">T06</td> <td style="text-align: center;">N06</td> <td style="text-align: center;">E6</td> <td style="text-align: center;">E6</td> <td style="text-align: center;">E6</td> <td style="text-align: center;">E6</td> <td style="text-align: center;">E6</td> </tr> <tr> <td></td> <td style="text-align: center;">1</td> <td style="text-align: center;">2</td> <td style="text-align: center;">3</td> <td style="text-align: center;">4</td> <td style="text-align: center;">R07</td> <td style="text-align: center;">S07</td> <td style="text-align: center;">T07</td> <td style="text-align: center;">N07</td> <td style="text-align: center;">E7</td> <td style="text-align: center;">E7</td> <td style="text-align: center;">E7</td> <td style="text-align: center;">E7</td> <td style="text-align: center;">E7</td> </tr> <tr> <td></td> <td style="text-align: center;">1</td> <td style="text-align: center;">2</td> <td style="text-align: center;">3</td> <td style="text-align: center;">4</td> <td style="text-align: center;">R08</td> <td style="text-align: center;">S08</td> <td style="text-align: center;">T08</td> <td style="text-align: center;">N08</td> <td style="text-align: center;">E8</td> <td style="text-align: center;">E8</td> <td style="text-align: center;">E8</td> <td style="text-align: center;">E8</td> <td style="text-align: center;">E8</td> </tr> </table> </td> <td style="width: 50%; vertical-align: top;"> <table border="0" style="width: 100%;"> <tr> <td style="width: 50%;"></td> <td style="width: 50%; text-align: center;"> <table border="0"> <tr> <td style="width: 10%;"></td> <td style="width: 10%;"></td> <td style="width: 10%;"></td> <td style="width: 10%;"></td> <td style="width: 10%;"></td> <td style="width: 10%;"></td> <td style="width: 10%;"></td> <td style="width: 10%;"></td> <td style="width: 10%;"></td> <td style="width: 10%;"></td> <td style="width: 10%;"></td> <td style="width: 10%;"></td> <td style="width: 10%;"></td> <td style="width: 10%;"></td> </tr> <tr> <td style="text-align: center;">XA</td> <td style="text-align: center;">1</td> <td style="text-align: center;">2</td> <td style="text-align: center;">3</td> <td style="text-align: center;">4</td> <td style="text-align: center;">R01</td> <td style="text-align: center;">S01</td> <td style="text-align: center;">T01</td> <td style="text-align: center;">N01</td> <td style="text-align: center;">E1</td> <td style="text-align: center;">E1</td> <td style="text-align: center;">E1</td> <td style="text-align: center;">E1</td> <td style="text-align: center;">E1</td> </tr> <tr> <td></td> <td style="text-align: center;">1</td> <td style="text-align: center;">2</td> <td style="text-align: center;">3</td> <td style="text-align: center;">4</td> <td style="text-align: center;">R02</td> <td style="text-align: center;">S02</td> <td style="text-align: center;">T02</td> <td style="text-align: center;">N02</td> <td style="text-align: center;">E2</td> <td style="text-align: center;">E2</td> <td style="text-align: center;">E2</td> <td style="text-align: center;">E2</td> <td style="text-align: center;">E2</td> </tr> <tr> <td></td> <td style="text-align: center;">1</td> <td style="text-align: center;">2</td> <td style="text-align: center;">3</td> <td style="text-align: center;">4</td> <td style="text-align: center;">R03</td> <td style="text-align: center;">S03</td> <td style="text-align: center;">T03</td> <td style="text-align: center;">N03</td> <td style="text-align: center;">E3</td> <td style="text-align: center;">E3</td> <td style="text-align: center;">E3</td> <td style="text-align: center;">E3</td> <td style="text-align: center;">E3</td> </tr> <tr> <td></td> <td style="text-align: center;">1</td> <td style="text-align: center;">2</td> <td style="text-align: center;">3</td> <td style="text-align: center;">4</td> <td style="text-align: center;">R04</td> <td style="text-align: center;">S04</td> <td style="text-align: center;">T04</td> <td style="text-align: center;">N04</td> <td style="text-align: center;">E4</td> <td style="text-align: center;">E4</td> <td style="text-align: center;">E4</td> <td style="text-align: center;">E4</td> <td style="text-align: center;">E4</td> </tr> <tr> <td></td> <td style="text-align: center;">1</td> <td style="text-align: center;">2</td> <td style="text-align: center;">3</td> <td style="text-align: center;">4</td> <td style="text-align: center;">R05</td> <td style="text-align: center;">S05</td> <td style="text-align: center;">T05</td> <td style="text-align: center;">N05</td> <td style="text-align: center;">E5</td> <td style="text-align: center;">E5</td> <td style="text-align: center;">E5</td> <td style="text-align: center;">E5</td> <td style="text-align: center;">E5</td> </tr> <tr> <td></td> <td style="text-align: center;">1</td> <td style="text-align: center;">2</td> <td style="text-align: center;">3</td> <td style="text-align: center;">4</td> <td style="text-align: center;">R06</td> <td style="text-align: center;">S06</td> <td style="text-align: center;">T06</td> <td style="text-align: center;">N06</td> <td style="text-align: center;">E6</td> <td style="text-align: center;">E6</td> <td style="text-align: center;">E6</td> <td style="text-align: center;">E6</td> <td style="text-align: center;">E6</td> </tr> <tr> <td></td> <td style="text-align: center;">1</td> <td style="text-align: center;">2</td> <td style="text-align: center;">3</td> <td style="text-align: center;">4</td> <td style="text-align: center;">R07</td> <td style="text-align: center;">S07</td> <td style="text-align: center;">T07</td> <td style="text-align: center;">N07</td> <td style="text-align: center;">E7</td> <td style="text-align: center;">E7</td> <td style="text-align: center;">E7</td> <td style="text-align: center;">E7</td> <td style="text-align: center;">E7</td> </tr> <tr> <td></td> <td style="text-align: center;">1</td> <td style="text-align: center;">2</td> <td style="text-align: center;">3</td> <td style="text-align: center;">4</td> <td style="text-align: center;">R08</td> <td style="text-align: center;">S08</td> <td style="text-align: center;">T08</td> <td style="text-align: center;">N08</td> <td style="text-align: center;">E8</td> <td style="text-align: center;">E8</td> <td style="text-align: center;">E8</td> <td style="text-align: center;">E8</td> <td style="text-align: center;">E8</td> </tr> </table> </td> <td style="width: 50%; vertical-align: top;"> <table border="0" style="width: 100%;"> <tr> <td style="width: 50%;"></td> <td style="width: 50%; text-align: center;"> <table border="0"> <tr> <td style="width: 10%;"></td> <td style="width: 10%;"></td> <td style="width: 10%;"></td> <td style="width: 10%;"></td> <td style="width: 10%;"></td> <td style="width:
10%;"></td> <td style="width: 10%;"></td> <td style="width: 10%;"></td> <td style="width: 10%;"></td> <td style="width: 10%;"></td> <td style="width: 10%;"></td> <td style="width: 10%;"></td> <td style="width: 10%;"></td> <td style="width: 10%;"></td> </tr> <tr> <td style="text-align: center;">XA</td> <td style="text-align: center;">1</td> <td style="text-align: center;">2</td> <td style="text-align: center;">3</td> <td style="text-align: center;">4</td> <td style="text-align: center;">R01</td> <td style="text-align: center;">S01</td> <td style="text-align: center;">T01</td> <td style="text-align: center;">N01</td> <td style="text-align: center;">E1</td> <td style="text-align: center;">E1</td> <td style="text-align: center;">E1</td> </tr></table></td></tr></table></td></tr></table></td></tr></table></td></tr></table></td></tr></table> | | <table border="0"> <tr> <td style="width: 10%;"></td> <td style="width: 10%;"></td> <td style="width: 10%;"></td> <td style="width: 10%;"></td> <td style="width: 10%;"></td> <td style="width: 10%;"></td> <td style="width: 10%;"></td> <td style="width: 10%;"></td> <td style="width: 10%;"></td> <td style="width: 10%;"></td> <td style="width: 10%;"></td> <td style="width: 10%;"></td> <td style="width: 10%;"></td> <td style="width: 10%;"></td> </tr> <tr> <td style="text-align: center;">XA</td> <td style="text-align: center;">1</td> <td style="text-align: center;">2</td> <td style="text-align: center;">3</td> <td style="text-align: center;">4</td> <td style="text-align: center;">R01</td> <td style="text-align: center;">S01</td> <td style="text-align: center;">T01</td> <td style="text-align: center;">N01</td> <td style="text-align: center;">E1</td> <td style="text-align: center;">E1</td> <td style="text-align: center;">E1</td> <td style="text-align: center;">E1</td> <td style="text-align: center;">E1</td> </tr> <tr> <td></td> <td style="text-align: center;">1</td> <td style="text-align: center;">2</td> <td style="text-align: center;">3</td> <td style="text-align: center;">4</td> <td style="text-align: center;">R02</td> <td style="text-align: center;">S02</td> <td style="text-align: center;">T02</td> <td style="text-align: center;">N02</td> <td style="text-align: center;">E2</td> <td style="text-align: center;">E2</td> <td style="text-align: center;">E2</td> <td style="text-align: center;">E2</td> <td style="text-align: center;">E2</td> </tr> <tr> <td></td> <td style="text-align: center;">1</td> <td style="text-align: center;">2</td> <td style="text-align: center;">3</td> <td style="text-align: center;">4</td> <td style="text-align: center;">R03</td> <td style="text-align: center;">S03</td> <td style="text-align: center;">T03</td> <td style="text-align: center;">N03</td> <td style="text-align: center;">E3</td> <td style="text-align: center;">E3</td> <td style="text-align: center;">E3</td> <td style="text-align: center;">E3</td> <td style="text-align: center;">E3</td> </tr> <tr> <td></td> <td style="text-align: center;">1</td> <td style="text-align: center;">2</td> <td style="text-align: center;">3</td> <td style="text-align: center;">4</td> <td style="text-align: center;">R04</td> <td style="text-align: center;">S04</td> <td style="text-align: center;">T04</td> <td style="text-align: center;">N04</td> <td style="text-align: center;">E4</td> <td style="text-align: center;">E4</td> <td style="text-align: center;">E4</td> <td style="text-align: center;">E4</td> <td style="text-align: center;">E4</td> </tr> <tr> <td></td> <td style="text-align: center;">1</td> <td style="text-align: center;">2</td> <td style="text-align: center;">3</td> <td style="text-align: center;">4</td> <td style="text-align: center;">R05</td> <td style="text-align: center;">S05</td> <td style="text-align: center;">T05</td> <td style="text-align: center;">N05</td> <td style="text-align: center;">E5</td> <td style="text-align: center;">E5</td> <td style="text-align: center;">E5</td> <td style="text-align: center;">E5</td> <td style="text-align: center;">E5</td> </tr> <tr> <td></td> <td style="text-align: center;">1</td> <td style="text-align: center;">2</td> <td style="text-align: center;">3</td> <td style="text-align: center;">4</td> <td style="text-align: center;">R06</td> <td style="text-align: center;">S06</td> <td style="text-align: center;">T06</td> <td style="text-align: center;">N06</td> <td style="text-align: center;">E6</td> <td style="text-align: center;">E6</td> <td style="text-align: center;">E6</td> <td style="text-align: center;">E6</td> <td style="text-align: center;">E6</td> </tr> <tr> <td></td> <td style="text-align: center;">1</td> <td style="text-align: center;">2</td> <td style="text-align: center;">3</td> <td style="text-align: center;">4</td> <td style="text-align: center;">R07</td> <td style="text-align: center;">S07</td> <td style="text-align: center;">T07</td> <td style="text-align: center;">N07</td> <td style="text-align: center;">E7</td> <td style="text-align: center;">E7</td> <td style="text-align: center;">E7</td> <td style="text-align: center;">E7</td> <td style="text-align: center;">E7</td> </tr> <tr> <td></td> <td style="text-align: center;">1</td> <td style="text-align: center;">2</td> <td style="text-align: center;">3</td> <td style="text-align: center;">4</td> <td style="text-align: center;">R08</td> <td style="text-align: center;">S08</td> <td style="text-align: center;">T08</td> <td style="text-align: center;">N08</td> <td style="text-align: center;">E8</td> <td style="text-align: center;">E8</td> <td style="text-align: center;">E8</td> <td style="text-align: center;">E8</td> <td style="text-align: center;">E8</td> </tr> </table> | | | | | | | | | | | |

 |

 |
 | XA | 1 | 2 | 3 | 4 | R01 | S01 | T01 | N01 | E1 | E1 | E1 | E1

 | E1 | | 1 | 2 | 3 | 4 | R02 | S02 | T02 | N02 | E2 | E2 | E2 | E2 | E2 | | 1 | 2 | 3 | 4 | R03 | S03 | T03 | N03 | E3 | E3 | E3 | E3

 | E3 | | 1 | 2 | 3 | 4 | R04 | S04 | T04 | N04 | E4 | E4 | E4 | E4 | E4 | | 1 | 2 | 3 | 4 | R05 | S05 | T05 | N05 | E5 | E5 | E5 | E5 | E5 | | 1 | 2 | 3 | 4 | R06 | S06 | T06 | N06 | E6 | E6 | E6 | E6 | E6 | | 1 | 2 | 3 | 4 | R07 | S07 | T07 | N07 | E7 | E7 | E7 | E7 | E7 | | 1 | 2
 3 | 4 | R08 | S08 | T08 | N08 | E8 | E8 | E8 | E8 | E8 | <table border="0" style="width: 100%;"> <tr> <td style="width: 50%;"></td> <td style="width: 50%; text-align: center;"> <table border="0"> <tr> <td style="width: 10%;"></td> <td style="width: 10%;"></td> <td style="width: 10%;"></td> <td style="width: 10%;"></td> <td style="width: 10%;"></td> <td style="width: 10%;"></td> <td style="width: 10%;"></td> <td style="width: 10%;"></td> <td style="width: 10%;"></td> <td style="width: 10%;"></td> <td style="width: 10%;"></td> <td style="width: 10%;"></td> <td style="width: 10%;"></td> <td style="width: 10%;"></td> </tr> <tr> <td style="text-align: center;">XA</td> <td style="text-align: center;">1</td> <td style="text-align: center;">2</td> <td style="text-align: center;">3</td> <td style="text-align: center;">4</td> <td style="text-align: center;">R01</td> <td style="text-align: center;">S01</td> <td style="text-align: center;">T01</td> <td style="text-align: center;">N01</td> <td style="text-align: center;">E1</td> <td style="text-align: center;">E1</td> <td style="text-align: center;">E1</td> <td style="text-align: center;">E1</td> <td style="text-align: center;">E1</td> </tr> <tr> <td></td> <td style="text-align: center;">1</td> <td style="text-align: center;">2</td> <td style="text-align: center;">3</td> <td style="text-align: center;">4</td> <td style="text-align: center;">R02</td> <td style="text-align: center;">S02</td> <td style="text-align: center;">T02</td> <td style="text-align: center;">N02</td> <td style="text-align: center;">E2</td> <td style="text-align: center;">E2</td> <td style="text-align: center;">E2</td> <td style="text-align: center;">E2</td> <td style="text-align: center;">E2</td> </tr> <tr> <td></td> <td style="text-align: center;">1</td> <td style="text-align: center;">2</td> <td style="text-align: center;">3</td> <td style="text-align: center;">4</td> <td style="text-align: center;">R03</td> <td style="text-align: center;">S03</td> <td style="text-align: center;">T03</td> <td style="text-align: center;">N03</td> <td style="text-align: center;">E3</td> <td style="text-align: center;">E3</td> <td style="text-align: center;">E3</td> <td style="text-align: center;">E3</td> <td style="text-align: center;">E3</td> </tr> <tr> <td></td> <td style="text-align: center;">1</td> <td style="text-align: center;">2</td> <td style="text-align: center;">3</td> <td style="text-align: center;">4</td> <td style="text-align: center;">R04</td> <td style="text-align: center;">S04</td> <td style="text-align: center;">T04</td> <td style="text-align: center;">N04</td> <td style="text-align: center;">E4</td> <td style="text-align: center;">E4</td> <td style="text-align: center;">E4</td> <td style="text-align: center;">E4</td> <td style="text-align: center;">E4</td> </tr> <tr> <td></td> <td style="text-align: center;">1</td> <td style="text-align: center;">2</td> <td style="text-align: center;">3</td> <td style="text-align: center;">4</td> <td style="text-align: center;">R05</td> <td style="text-align: center;">S05</td> <td style="text-align: center;">T05</td> <td style="text-align: center;">N05</td> <td style="text-align: center;">E5</td> <td style="text-align: center;">E5</td> <td style="text-align: center;">E5</td> <td style="text-align: center;">E5</td> <td style="text-align: center;">E5</td> </tr> <tr> <td></td> <td style="text-align: center;">1</td> <td style="text-align: center;">2</td> <td style="text-align: center;">3</td> <td style="text-align: center;">4</td> <td style="text-align: center;">R06</td> <td style="text-align: center;">S06</td> <td style="text-align: center;">T06</td> <td style="text-align: center;">N06</td> <td style="text-align: center;">E6</td> <td style="text-align: center;">E6</td> <td style="text-align: center;">E6</td> <td style="text-align: center;">E6</td> <td style="text-align: center;">E6</td> </tr> <tr> <td></td> <td style="text-align: center;">1</td> <td style="text-align: center;">2</td> <td style="text-align: center;">3</td> <td style="text-align: center;">4</td> <td style="text-align: center;">R07</td> <td style="text-align: center;">S07</td> <td style="text-align: center;">T07</td> <td style="text-align: center;">N07</td> <td style="text-align: center;">E7</td> <td style="text-align: center;">E7</td> <td style="text-align: center;">E7</td> <td style="text-align: center;">E7</td> <td style="text-align: center;">E7</td> </tr> <tr> <td></td> <td style="text-align: center;">1</td> <td style="text-align: center;">2</td> <td style="text-align: center;">3</td> <td style="text-align: center;">4</td> <td style="text-align: center;">R08</td> <td style="text-align: center;">S08</td> <td style="text-align: center;">T08</td> <td style="text-align: center;">N08</td> <td style="text-align: center;">E8</td> <td style="text-align: center;">E8</td> <td style="text-align: center;">E8</td> <td style="text-align: center;">E8</td> <td style="text-align: center;">E8</td> </tr> </table> </td> <td style="width: 50%; vertical-align: top;"> <table border="0" style="width: 100%;"> <tr> <td style="width: 50%;"></td> <td style="width: 50%; text-align: center;"> <table border="0"> <tr> <td style="width: 10%;"></td> <td style="width: 10%;"></td> <td style="width: 10%;"></td> <td style="width: 10%;"></td> <td style="width: 10%;"></td> <td style="width: 10%;"></td> <td style="width: 10%;"></td> <td style="width: 10%;"></td> <td style="width: 10%;"></td> <td style="width: 10%;"></td> <td style="width: 10%;"></td> <td style="width: 10%;"></td> <td style="width: 10%;"></td> <td style="width: 10%;"></td> </tr> <tr> <td style="text-align: center;">XA</td> <td style="text-align: center;">1</td> <td style="text-align: center;">2</td> <td style="text-align: center;">3</td> <td style="text-align: center;">4</td> <td style="text-align: center;">R01</td> <td style="text-align: center;">S01</td> <td style="text-align: center;">T01</td> <td style="text-align: center;">N01</td> <td style="text-align: center;">E1</td> <td style="text-align: center;">E1</td> <td style="text-align: center;">E1</td> <td style="text-align: center;">E1</td> <td style="text-align: center;">E1</td> </tr> <tr> <td></td> <td style="text-align: center;">1</td> <td style="text-align: center;">2</td> <td style="text-align: center;">3</td> <td style="text-align: center;">4</td> <td style="text-align: center;">R02</td> <td style="text-align: center;">S02</td> <td style="text-align: center;">T02</td> <td style="text-align: center;">N02</td> <td style="text-align: center;">E2</td> <td style="text-align: center;">E2</td> <td style="text-align: center;">E2</td> <td style="text-align: center;">E2</td> <td style="text-align: center;">E2</td> </tr> <tr> <td></td> <td style="text-align: center;">1</td> <td style="text-align: center;">2</td> <td style="text-align: center;">3</td> <td style="text-align: center;">4</td> <td style="text-align: center;">R03</td> <td style="text-align: center;">S03</td> <td style="text-align: center;">T03</td> <td style="text-align: center;">N03</td> <td style="text-align: center;">E3</td> <td style="text-align: center;">E3</td> <td style="text-align: center;">E3</td> <td style="text-align: center;">E3</td> <td style="text-align: center;">E3</td> </tr> <tr> <td></td> <td style="text-align: center;">1</td> <td style="text-align: center;">2</td> <td style="text-align: center;">3</td> <td style="text-align: center;">4</td> <td style="text-align: center;">R04</td> <td style="text-align: center;">S04</td> <td style="text-align: center;">T04</td> <td style="text-align: center;">N04</td> <td style="text-align: center;">E4</td> <td style="text-align: center;">E4</td> <td style="text-align: center;">E4</td> <td style="text-align: center;">E4</td> <td style="text-align: center;">E4</td> </tr> <tr> <td></td> <td style="text-align: center;">1</td> <td style="text-align: center;">2</td> <td style="text-align: center;">3</td> <td style="text-align: center;">4</td> <td style="text-align: center;">R05</td> <td style="text-align: center;">S05</td> <td style="text-align: center;">T05</td> <td style="text-align: center;">N05</td> <td style="text-align: center;">E5</td> <td style="text-align: center;">E5</td> <td style="text-align: center;">E5</td> <td style="text-align: center;">E5</td> <td style="text-align: center;">E5</td> </tr> <tr> <td></td> <td style="text-align: center;">1</td> <td style="text-align: center;">2</td> <td style="text-align: center;">3</td> <td style="text-align: center;">4</td> <td style="text-align: center;">R06</td> <td style="text-align: center;">S06</td> <td style="text-align: center;">T06</td> <td style="text-align: center;">N06</td> <td style="text-align: center;">E6</td> <td style="text-align: center;">E6</td> <td style="text-align: center;">E6</td> <td style="text-align: center;">E6</td> <td style="text-align: center;">E6</td> </tr> <tr> <td></td> <td style="text-align: center;">1</td> <td style="text-align: center;">2</td> <td style="text-align: center;">3</td> <td style="text-align: center;">4</td> <td style="text-align: center;">R07</td> <td style="text-align: center;">S07</td> <td style="text-align: center;">T07</td> <td style="text-align: center;">N07</td> <td style="text-align: center;">E7</td> <td style="text-align: center;">E7</td> <td style="text-align: center;">E7</td> <td style="text-align: center;">E7</td> <td style="text-align: center;">E7</td> </tr> <tr> <td></td> <td style="text-align: center;">1</td> <td style="text-align: center;">2</td> <td style="text-align: center;">3</td> <td style="text-align: center;">4</td> <td style="text-align: center;">R08</td> <td style="text-align: center;">S08</td> <td style="text-align: center;">T08</td> <td style="text-align: center;">N08</td> <td style="text-align: center;">E8</td> <td style="text-align: center;">E8</td> <td style="text-align: center;">E8</td> <td style="text-align: center;">E8</td> <td style="text-align: center;">E8</td> </tr> </table> </td> <td
style="width: 50%; vertical-align: top;"> <table border="0" style="width: 100%;"> <tr> <td style="width: 50%;"></td> <td style="width: 50%; text-align: center;"> <table border="0"> <tr> <td style="width: 10%;"></td> <td style="width: 10%;"></td> <td style="width: 10%;"></td> <td style="width: 10%;"></td> <td style="width: 10%;"></td> <td style="width: 10%;"></td> <td style="width: 10%;"></td> <td style="width: 10%;"></td> <td style="width: 10%;"></td> <td style="width: 10%;"></td> <td style="width: 10%;"></td> <td style="width: 10%;"></td> <td style="width: 10%;"></td> <td style="width: 10%;"></td> </tr> <tr> <td style="text-align: center;">XA</td> <td style="text-align: center;">1</td> <td style="text-align: center;">2</td> <td style="text-align: center;">3</td> <td style="text-align: center;">4</td> <td style="text-align: center;">R01</td> <td style="text-align: center;">S01</td> <td style="text-align: center;">T01</td> <td style="text-align: center;">N01</td> <td style="text-align: center;">E1</td> <td style="text-align: center;">E1</td> <td style="text-align: center;">E1</td> <td style="text-align: center;">E1</td> <td style="text-align: center;">E1</td> </tr> <tr> <td></td> <td style="text-align: center;">1</td> <td style="text-align: center;">2</td> <td style="text-align: center;">3</td> <td style="text-align: center;">4</td> <td style="text-align: center;">R02</td> <td style="text-align: center;">S02</td> <td style="text-align: center;">T02</td> <td style="text-align: center;">N02</td> <td style="text-align: center;">E2</td> <td style="text-align: center;">E2</td> <td style="text-align: center;">E2</td> <td style="text-align: center;">E2</td> <td style="text-align: center;">E2</td> </tr> <tr> <td></td> <td style="text-align: center;">1</td> <td style="text-align: center;">2</td> <td style="text-align: center;">3</td> <td style="text-align: center;">4</td> <td style="text-align: center;">R03</td> <td style="text-align: center;">S03</td> <td style="text-align: center;">T03</td> <td style="text-align: center;">N03</td> <td style="text-align: center;">E3</td> <td style="text-align: center;">E3</td> <td style="text-align: center;">E3</td> <td style="text-align: center;">E3</td> <td style="text-align: center;">E3</td> </tr> <tr> <td></td> <td style="text-align: center;">1</td> <td style="text-align: center;">2</td> <td style="text-align: center;">3</td> <td style="text-align: center;">4</td> <td style="text-align: center;">R04</td> <td style="text-align: center;">S04</td> <td style="text-align: center;">T04</td> <td style="text-align: center;">N04</td> <td style="text-align: center;">E4</td> <td style="text-align: center;">E4</td> <td style="text-align: center;">E4</td> <td style="text-align: center;">E4</td> <td style="text-align: center;">E4</td> </tr> <tr> <td></td> <td style="text-align: center;">1</td> <td style="text-align: center;">2</td> <td style="text-align: center;">3</td> <td style="text-align: center;">4</td> <td style="text-align: center;">R05</td> <td style="text-align: center;">S05</td> <td style="text-align: center;">T05</td> <td style="text-align: center;">N05</td> <td style="text-align: center;">E5</td> <td style="text-align: center;">E5</td> <td style="text-align: center;">E5</td> <td style="text-align: center;">E5</td> <td style="text-align: center;">E5</td> </tr> <tr> <td></td> <td style="text-align: center;">1</td> <td style="text-align: center;">2</td> <td style="text-align: center;">3</td> <td style="text-align: center;">4</td> <td style="text-align: center;">R06</td> <td style="text-align: center;">S06</td> <td style="text-align: center;">T06</td> <td style="text-align: center;">N06</td> <td style="text-align: center;">E6</td> <td style="text-align: center;">E6</td> <td style="text-align: center;">E6</td> <td style="text-align: center;">E6</td> <td style="text-align: center;">E6</td> </tr> <tr> <td></td> <td style="text-align: center;">1</td> <td style="text-align: center;">2</td> <td style="text-align: center;">3</td> <td style="text-align: center;">4</td> <td style="text-align: center;">R07</td> <td style="text-align: center;">S07</td> <td style="text-align: center;">T07</td> <td style="text-align: center;">N07</td> <td style="text-align: center;">E7</td> <td style="text-align: center;">E7</td> <td style="text-align: center;">E7</td> <td style="text-align: center;">E7</td> <td style="text-align: center;">E7</td> </tr> <tr> <td></td> <td style="text-align: center;">1</td> <td style="text-align: center;">2</td> <td style="text-align: center;">3</td> <td style="text-align: center;">4</td> <td style="text-align: center;">R08</td> <td style="text-align: center;">S08</td> <td style="text-align: center;">T08</td> <td style="text-align: center;">N08</td> <td style="text-align: center;">E8</td> <td style="text-align: center;">E8</td> <td style="text-align: center;">E8</td> <td style="text-align: center;">E8</td> <td style="text-align: center;">E8</td> </tr> </table> </td> <td style="width: 50%; vertical-align: top;"> <table border="0" style="width: 100%;"> <tr> <td style="width: 50%;"></td> <td style="width: 50%; text-align: center;"> <table border="0"> <tr> <td style="width: 10%;"></td> <td style="width: 10%;"></td> <td style="width: 10%;"></td> <td style="width: 10%;"></td> <td style="width: 10%;"></td> <td style="width: 10%;"></td> <td style="width: 10%;"></td> <td style="width: 10%;"></td> <td style="width: 10%;"></td> <td style="width: 10%;"></td> <td style="width: 10%;"></td> <td style="width: 10%;"></td> <td style="width: 10%;"></td> <td style="width: 10%;"></td> </tr> <tr> <td style="text-align: center;">XA</td> <td style="text-align: center;">1</td> <td style="text-align: center;">2</td> <td style="text-align: center;">3</td> <td style="text-align: center;">4</td> <td style="text-align: center;">R01</td> <td style="text-align: center;">S01</td> <td style="text-align: center;">T01</td> <td style="text-align: center;">N01</td> <td style="text-align: center;">E1</td> <td style="text-align: center;">E1</td> <td style="text-align: center;">E1</td> </tr></table></td></tr></table></td></tr></table></td></tr></table></td></tr></table> | | <table border="0"> <tr> <td style="width: 10%;"></td> <td style="width: 10%;"></td> <td style="width: 10%;"></td> <td style="width: 10%;"></td> <td style="width: 10%;"></td> <td style="width: 10%;"></td> <td style="width: 10%;"></td> <td style="width: 10%;"></td> <td style="width: 10%;"></td> <td style="width: 10%;"></td> <td style="width: 10%;"></td> <td style="width: 10%;"></td> <td style="width: 10%;"></td> <td style="width: 10%;"></td> </tr> <tr> <td style="text-align: center;">XA</td> <td style="text-align: center;">1</td> <td style="text-align: center;">2</td> <td style="text-align: center;">3</td> <td style="text-align: center;">4</td> <td style="text-align: center;">R01</td> <td style="text-align: center;">S01</td> <td style="text-align: center;">T01</td> <td style="text-align: center;">N01</td> <td style="text-align: center;">E1</td> <td style="text-align: center;">E1</td> <td style="text-align: center;">E1</td> <td style="text-align: center;">E1</td> <td style="text-align: center;">E1</td> </tr> <tr> <td></td> <td style="text-align: center;">1</td> <td style="text-align: center;">2</td> <td style="text-align: center;">3</td> <td style="text-align: center;">4</td> <td style="text-align: center;">R02</td> <td style="text-align: center;">S02</td> <td style="text-align: center;">T02</td> <td style="text-align: center;">N02</td> <td style="text-align: center;">E2</td> <td style="text-align: center;">E2</td> <td style="text-align: center;">E2</td> <td style="text-align: center;">E2</td> <td style="text-align: center;">E2</td> </tr> <tr> <td></td> <td style="text-align: center;">1</td> <td style="text-align: center;">2</td> <td style="text-align: center;">3</td> <td style="text-align: center;">4</td> <td style="text-align: center;">R03</td> <td style="text-align: center;">S03</td> <td style="text-align: center;">T03</td> <td style="text-align: center;">N03</td> <td style="text-align: center;">E3</td> <td style="text-align: center;">E3</td> <td style="text-align: center;">E3</td> <td style="text-align: center;">E3</td> <td style="text-align: center;">E3</td> </tr> <tr> <td></td> <td style="text-align: center;">1</td> <td style="text-align: center;">2</td> <td style="text-align: center;">3</td> <td style="text-align: center;">4</td> <td style="text-align: center;">R04</td> <td style="text-align: center;">S04</td> <td style="text-align: center;">T04</td> <td style="text-align: center;">N04</td> <td style="text-align: center;">E4</td> <td style="text-align: center;">E4</td> <td style="text-align: center;">E4</td> <td style="text-align: center;">E4</td> <td style="text-align: center;">E4</td> </tr> <tr> <td></td> <td style="text-align: center;">1</td> <td style="text-align: center;">2</td> <td style="text-align: center;">3</td> <td style="text-align: center;">4</td> <td style="text-align: center;">R05</td> <td style="text-align: center;">S05</td> <td style="text-align: center;">T05</td> <td style="text-align: center;">N05</td> <td style="text-align: center;">E5</td> <td style="text-align: center;">E5</td> <td style="text-align: center;">E5</td> <td style="text-align: center;">E5</td> <td style="text-align: center;">E5</td> </tr> <tr> <td></td> <td style="text-align: center;">1</td> <td style="text-align: center;">2</td> <td style="text-align: center;">3</td> <td style="text-align: center;">4</td> <td style="text-align: center;">R06</td> <td style="text-align: center;">S06</td> <td style="text-align: center;">T06</td> <td style="text-align: center;">N06</td> <td style="text-align: center;">E6</td> <td style="text-align: center;">E6</td> <td style="text-align: center;">E6</td> <td style="text-align: center;">E6</td> <td style="text-align: center;">E6</td> </tr> <tr> <td></td> <td style="text-align: center;">1</td> <td style="text-align: center;">2</td>
<td style="text-align: center;">3</td> <td style="text-align: center;">4</td> <td style="text-align: center;">R07</td> <td style="text-align: center;">S07</td> <td style="text-align: center;">T07</td> <td style="text-align: center;">N07</td> <td style="text-align: center;">E7</td> <td style="text-align: center;">E7</td> <td style="text-align: center;">E7</td> <td style="text-align: center;">E7</td> <td style="text-align: center;">E7</td> </tr> <tr> <td></td> <td style="text-align: center;">1</td> <td style="text-align: center;">2</td> <td style="text-align: center;">3</td> <td style="text-align: center;">4</td> <td style="text-align: center;">R08</td> <td style="text-align: center;">S08</td> <td style="text-align: center;">T08</td> <td style="text-align: center;">N08</td> <td style="text-align: center;">E8</td> <td style="text-align: center;">E8</td> <td style="text-align: center;">E8</td> <td style="text-align: center;">E8</td> <td style="text-align: center;">E8</td> </tr> </table> | | | | | | | | | | | |

 |

 | | XA
 | 1 | 2 | 3 | 4 | R01 | S01 | T01 | N01 | E1 | E1 | E1 | E1

 | E1 | | 1 | 2 | 3 | 4 | R02 | S02 | T02 | N02 | E2 | E2 | E2 | E2 | E2 | | 1 | 2 | 3 | 4 | R03 | S03 | T03 | N03 | E3 | E3 | E3 | E3

 | E3 | | 1 | 2 | 3 | 4 | R04 | S04 | T04 | N04 | E4 | E4 | E4 | E4 | E4 | | 1 | 2 | 3 | 4 | R05 | S05 | T05 | N05 | E5 | E5 | E5 | E5 | E5 | | 1 | 2 | 3 | 4 | R06 | S06 | T06 | N06 | E6 | E6 | E6 | E6 | E6 | | 1 | 2 | 3 | 4 | R07 | S07 | T07 | N07 | E7 | E7 | E7 | E7 | E7 | | 1 | 2 | 3 | 4 | R08 | S08 | T08 | N08 | E8 | E8 | E8 | E8 | E8 | <table border="0" style="width: 100%;"> <tr> <td style="width: 50%;"></td> <td style="width: 50%; text-align: center;"> <table border="0"> <tr> <td style="width: 10%;"></td> <td style="width: 10%;"></td> <td style="width: 10%;"></td> <td style="width: 10%;"></td> <td style="width: 10%;"></td> <td style="width: 10%;"></td> <td style="width: 10%;"></td> <td style="width: 10%;"></td> <td style="width: 10%;"></td> <td style="width: 10%;"></td> <td style="width: 10%;"></td> <td style="width: 10%;"></td> <td style="width: 10%;"></td> <td style="width: 10%;"></td> </tr> <tr> <td style="text-align: center;">XA</td> <td style="text-align: center;">1</td> <td style="text-align: center;">2</td> <td style="text-align: center;">3</td> <td style="text-align: center;">4</td> <td style="text-align: center;">R01</td> <td style="text-align: center;">S01</td> <td style="text-align: center;">T01</td> <td style="text-align: center;">N01</td> <td style="text-align: center;">E1</td> <td style="text-align: center;">E1</td> <td style="text-align: center;">E1</td> <td style="text-align: center;">E1</td> <td style="text-align: center;">E1</td> </tr> <tr> <td></td> <td style="text-align: center;">1</td> <td style="text-align: center;">2</td> <td style="text-align: center;">3</td> <td style="text-align: center;">4</td> <td style="text-align: center;">R02</td> <td style="text-align: center;">S02</td> <td style="text-align: center;">T02</td> <td style="text-align: center;">N02</td> <td style="text-align: center;">E2</td> <td style="text-align: center;">E2</td> <td style="text-align: center;">E2</td> <td style="text-align: center;">E2</td> <td style="text-align: center;">E2</td> </tr> <tr> <td></td> <td style="text-align: center;">1</td> <td style="text-align: center;">2</td> <td style="text-align: center;">3</td> <td style="text-align: center;">4</td> <td style="text-align: center;">R03</td> <td style="text-align: center;">S03</td> <td style="text-align: center;">T03</td> <td style="text-align: center;">N03</td> <td style="text-align: center;">E3</td> <td style="text-align: center;">E3</td> <td style="text-align: center;">E3</td> <td style="text-align: center;">E3</td> <td style="text-align: center;">E3</td> </tr> <tr> <td></td> <td style="text-align: center;">1</td> <td style="text-align: center;">2</td> <td style="text-align: center;">3</td> <td style="text-align: center;">4</td> <td style="text-align: center;">R04</td> <td style="text-align: center;">S04</td> <td style="text-align: center;">T04</td> <td style="text-align: center;">N04</td> <td style="text-align: center;">E4</td> <td style="text-align: center;">E4</td> <td style="text-align: center;">E4</td> <td style="text-align: center;">E4</td> <td style="text-align: center;">E4</td> </tr> <tr> <td></td> <td style="text-align: center;">1</td> <td style="text-align: center;">2</td> <td style="text-align: center;">3</td> <td style="text-align: center;">4</td> <td style="text-align: center;">R05</td> <td style="text-align: center;">S05</td> <td style="text-align: center;">T05</td> <td style="text-align: center;">N05</td> <td style="text-align: center;">E5</td> <td style="text-align: center;">E5</td> <td style="text-align: center;">E5</td> <td style="text-align: center;">E5</td> <td style="text-align: center;">E5</td> </tr> <tr> <td></td> <td style="text-align: center;">1</td> <td style="text-align: center;">2</td> <td style="text-align: center;">3</td> <td style="text-align: center;">4</td> <td style="text-align: center;">R06</td> <td style="text-align: center;">S06</td> <td style="text-align: center;">T06</td> <td style="text-align: center;">N06</td> <td style="text-align: center;">E6</td> <td style="text-align: center;">E6</td> <td style="text-align: center;">E6</td> <td style="text-align: center;">E6</td> <td style="text-align: center;">E6</td> </tr> <tr> <td></td> <td style="text-align: center;">1</td> <td style="text-align: center;">2</td> <td style="text-align: center;">3</td> <td style="text-align: center;">4</td> <td style="text-align: center;">R07</td> <td style="text-align: center;">S07</td> <td style="text-align: center;">T07</td> <td style="text-align: center;">N07</td> <td style="text-align: center;">E7</td> <td style="text-align: center;">E7</td> <td style="text-align: center;">E7</td> <td style="text-align: center;">E7</td> <td style="text-align: center;">E7</td> </tr> <tr> <td></td> <td style="text-align: center;">1</td> <td style="text-align: center;">2</td> <td style="text-align: center;">3</td> <td style="text-align: center;">4</td> <td style="text-align: center;">R08</td> <td style="text-align: center;">S08</td>
<td style="text-align: center;">T08</td> <td style="text-align: center;">N08</td> <td style="text-align: center;">E8</td> <td style="text-align: center;">E8</td> <td style="text-align: center;">E8</td> <td style="text-align: center;">E8</td> <td style="text-align: center;">E8</td> </tr> </table> </td> <td style="width: 50%; vertical-align: top;"> <table border="0" style="width: 100%;"> <tr> <td style="width: 50%;"></td> <td style="width: 50%; text-align: center;"> <table border="0"> <tr> <td style="width: 10%;"></td> <td style="width: 10%;"></td> <td style="width: 10%;"></td> <td style="width: 10%;"></td> <td style="width: 10%;"></td> <td style="width: 10%;"></td> <td style="width: 10%;"></td> <td style="width: 10%;"></td> <td style="width: 10%;"></td> <td style="width: 10%;"></td> <td style="width: 10%;"></td> <td style="width: 10%;"></td> <td style="width: 10%;"></td> <td style="width: 10%;"></td> </tr> <tr> <td style="text-align: center;">XA</td> <td style="text-align: center;">1</td> <td style="text-align: center;">2</td> <td style="text-align: center;">3</td> <td style="text-align: center;">4</td> <td style="text-align: center;">R01</td> <td style="text-align: center;">S01</td> <td style="text-align: center;">T01</td> <td style="text-align: center;">N01</td> <td style="text-align: center;">E1</td> <td style="text-align: center;">E1</td> <td style="text-align: center;">E1</td> <td style="text-align: center;">E1</td> <td style="text-align: center;">E1</td> </tr> <tr> <td></td> <td style="text-align: center;">1</td> <td style="text-align: center;">2</td> <td style="text-align: center;">3</td> <td style="text-align: center;">4</td> <td style="text-align: center;">R02</td> <td style="text-align: center;">S02</td> <td style="text-align: center;">T02</td> <td style="text-align: center;">N02</td> <td style="text-align: center;">E2</td> <td style="text-align: center;">E2</td> <td style="text-align: center;">E2</td> <td style="text-align: center;">E2</td> <td style="text-align: center;">E2</td> </tr> <tr> <td></td> <td style="text-align: center;">1</td> <td style="text-align: center;">2</td> <td style="text-align: center;">3</td> <td style="text-align: center;">4</td> <td style="text-align: center;">R03</td> <td style="text-align: center;">S03</td> <td style="text-align: center;">T03</td> <td style="text-align: center;">N03</td> <td style="text-align: center;">E3</td> <td style="text-align: center;">E3</td> <td style="text-align: center;">E3</td> <td style="text-align: center;">E3</td> <td style="text-align: center;">E3</td> </tr> <tr> <td></td> <td style="text-align: center;">1</td> <td style="text-align: center;">2</td> <td style="text-align: center;">3</td> <td style="text-align: center;">4</td> <td style="text-align: center;">R04</td> <td style="text-align: center;">S04</td> <td style="text-align: center;">T04</td> <td style="text-align: center;">N04</td> <td style="text-align: center;">E4</td> <td style="text-align: center;">E4</td> <td style="text-align: center;">E4</td> <td style="text-align: center;">E4</td> <td style="text-align: center;">E4</td> </tr> <tr> <td></td> <td style="text-align: center;">1</td> <td style="text-align: center;">2</td> <td style="text-align: center;">3</td> <td style="text-align: center;">4</td> <td style="text-align: center;">R05</td> <td style="text-align: center;">S05</td> <td style="text-align: center;">T05</td> <td style="text-align: center;">N05</td> <td style="text-align: center;">E5</td> <td style="text-align: center;">E5</td> <td style="text-align: center;">E5</td> <td style="text-align: center;">E5</td> <td style="text-align: center;">E5</td> </tr> <tr> <td></td> <td style="text-align: center;">1</td> <td style="text-align: center;">2</td> <td style="text-align: center;">3</td> <td style="text-align: center;">4</td> <td style="text-align: center;">R06</td> <td style="text-align: center;">S06</td> <td style="text-align: center;">T06</td> <td style="text-align: center;">N06</td> <td style="text-align: center;">E6</td> <td style="text-align: center;">E6</td> <td style="text-align: center;">E6</td> <td style="text-align: center;">E6</td> <td style="text-align: center;">E6</td> </tr> <tr> <td></td> <td style="text-align: center;">1</td> <td style="text-align: center;">2</td> <td style="text-align: center;">3</td> <td style="text-align: center;">4</td> <td style="text-align: center;">R07</td> <td style="text-align: center;">S07</td> <td style="text-align: center;">T07</td> <td style="text-align: center;">N07</td> <td style="text-align: center;">E7</td> <td style="text-align: center;">E7</td> <td style="text-align: center;">E7</td> <td style="text-align: center;">E7</td> <td style="text-align: center;">E7</td> </tr> <tr> <td></td> <td style="text-align: center;">1</td> <td style="text-align: center;">2</td> <td style="text-align: center;">3</td> <td style="text-align: center;">4</td> <td style="text-align: center;">R08</td> <td style="text-align: center;">S08</td> <td style="text-align: center;">T08</td> <td style="text-align: center;">N08</td> <td style="text-align: center;">E8</td> <td style="text-align: center;">E8</td> <td style="text-align: center;">E8</td> <td style="text-align: center;">E8</td> <td style="text-align: center;">E8</td> </tr> </table> </td> <td style="width: 50%; vertical-align: top;"> <table border="0" style="width: 100%;"> <tr> <td style="width: 50%;"></td> <td style="width: 50%; text-align: center;"> <table border="0"> <tr> <td style="width: 10%;"></td> <td style="width: 10%;"></td> <td style="width: 10%;"></td> <td style="width: 10%;"></td> <td style="width: 10%;"></td> <td style="width: 10%;"></td> <td style="width: 10%;"></td> <td style="width: 10%;"></td> <td style="width: 10%;"></td> <td style="width: 10%;"></td> <td style="width: 10%;"></td> <td style="width: 10%;"></td> <td style="width: 10%;"></td> <td style="width: 10%;"></td> </tr> <tr> <td style="text-align: center;">XA</td> <td style="text-align: center;">1</td> <td style="text-align: center;">2</td> <td style="text-align: center;">3</td> <td style="text-align: center;">4</td> <td style="text-align: center;">R01</td> <td style="text-align: center;">S01</td> <td style="text-align: center;">T01</td> <td style="text-align: center;">N01</td> <td style="text-align: center;">E1</td> <td style="text-align: center;">E1</td> <td style="text-align: center;">E1</td> </tr></table></td></tr></table></td></tr></table></td></tr></table> | | <table border="0"> <tr> <td style="width: 10%;"></td> <td style="width: 10%;"></td> <td style="width: 10%;"></td> <td style="width: 10%;"></td> <td style="width: 10%;"></td> <td style="width: 10%;"></td> <td style="width: 10%;"></td> <td style="width: 10%;"></td> <td style="width: 10%;"></td> <td style="width: 10%;"></td> <td style="width: 10%;"></td> <td style="width: 10%;"></td> <td style="width: 10%;"></td> <td style="width: 10%;"></td> </tr> <tr> <td style="text-align: center;">XA</td> <td style="text-align: center;">1</td> <td style="text-align: center;">2</td> <td style="text-align: center;">3</td> <td style="text-align: center;">4</td> <td style="text-align: center;">R01</td> <td style="text-align: center;">S01</td> <td style="text-align: center;">T01</td> <td style="text-align: center;">N01</td> <td style="text-align: center;">E1</td> <td style="text-align: center;">E1</td> <td style="text-align: center;">E1</td> <td style="text-align: center;">E1</td> <td style="text-align: center;">E1</td> </tr> <tr> <td></td> <td style="text-align: center;">1</td> <td style="text-align: center;">2</td> <td style="text-align: center;">3</td> <td style="text-align: center;">4</td> <td style="text-align: center;">R02</td> <td style="text-align: center;">S02</td> <td style="text-align: center;">T02</td> <td style="text-align: center;">N02</td> <td style="text-align: center;">E2</td> <td style="text-align: center;">E2</td> <td style="text-align: center;">E2</td> <td style="text-align: center;">E2</td> <td style="text-align: center;">E2</td> </tr> <tr> <td></td> <td style="text-align: center;">1</td> <td style="text-align: center;">2</td> <td style="text-align: center;">3</td> <td style="text-align: center;">4</td> <td style="text-align: center;">R03</td> <td style="text-align: center;">S03</td> <td style="text-align: center;">T03</td> <td style="text-align: center;">N03</td> <td style="text-align: center;">E3</td> <td style="text-align: center;">E3</td> <td style="text-align: center;">E3</td> <td style="text-align: center;">E3</td> <td style="text-align: center;">E3</td> </tr> <tr> <td></td> <td style="text-align: center;">1</td> <td style="text-align: center;">2</td> <td style="text-align: center;">3</td> <td style="text-align: center;">4</td> <td style="text-align: center;">R04</td> <td style="text-align: center;">S04</td> <td style="text-align: center;">T04</td> <td style="text-align: center;">N04</td> <td style="text-align: center;">E4</td> <td style="text-align: center;">E4</td> <td style="text-align: center;">E4</td> <td style="text-align: center;">E4</td> <td style="text-align: center;">E4</td> </tr> <tr> <td></td> <td style="text-align: center;">1</td> <td style="text-align: center;">2</td> <td style="text-align: center;">3</td> <td style="text-align: center;">4</td> <td style="text-align: center;">R05</td> <td style="text-align: center;">S05</td> <td style="text-align: center;">T05</td> <td style="text-align: center;">N05</td> <td style="text-align: center;">E5</td> <td style="text-align: center;">E5</td> <td style="text-align: center;">E5</td> <td style="text-align: center;">E5</td> <td style="text-align: center;">E5</td> </tr> <tr> <td></td> <td style="text-align: center;">1</td> <td style="text-align: center;">2</td> <td style="text-align: center;">3</td> <td style="text-align: center;">4</td> <td style="text-align: center;">R06</td> <td style="text-align: center;">S06</td> <td style="text-align: center;">T06</td> <td style="text-align: center;">N06</td> <td
style="text-align: center;">E6</td> <td style="text-align: center;">E6</td> <td style="text-align: center;">E6</td> <td style="text-align: center;">E6</td> <td style="text-align: center;">E6</td> </tr> <tr> <td></td> <td style="text-align: center;">1</td> <td style="text-align: center;">2</td> <td style="text-align: center;">3</td> <td style="text-align: center;">4</td> <td style="text-align: center;">R07</td> <td style="text-align: center;">S07</td> <td style="text-align: center;">T07</td> <td style="text-align: center;">N07</td> <td style="text-align: center;">E7</td> <td style="text-align: center;">E7</td> <td style="text-align: center;">E7</td> <td style="text-align: center;">E7</td> <td style="text-align: center;">E7</td> </tr> <tr> <td></td> <td style="text-align: center;">1</td> <td style="text-align: center;">2</td> <td style="text-align: center;">3</td> <td style="text-align: center;">4</td> <td style="text-align: center;">R08</td> <td style="text-align: center;">S08</td> <td style="text-align: center;">T08</td> <td style="text-align: center;">N08</td> <td style="text-align: center;">E8</td> <td style="text-align: center;">E8</td> <td style="text-align: center;">E8</td> <td style="text-align: center;">E8</td> <td style="text-align: center;">E8</td> </tr> </table> | | | | | | | | | | | |
 |

 | | XA
 | 1 | 2 | 3 | 4 | R01 | S01 | T01 | N01 | E1 | E1 | E1 | E1
 | E1 |
 | 1 | 2 | 3 | 4 | R02 | S02 | T02 | N02 | E2 | E2 | E2 | E2 | E2 | | 1 | 2 | 3 | 4 | R03 | S03 | T03 | N03 | E3 | E3 | E3 | E3

 | E3 | | 1 | 2 | 3 | 4 | R04 | S04 | T04 | N04 | E4 | E4 | E4 | E4 | E4 | | 1 | 2 | 3 | 4 | R05 | S05 | T05 | N05 | E5 | E5 | E5 | E5 | E5 | | 1 | 2 | 3 | 4 | R06 | S06 | T06 | N06 | E6 | E6 | E6 | E6 | E6 | | 1 | 2 | 3 | 4 | R07 | S07 | T07 | N07 | E7 | E7 | E7 | E7 | E7 | | 1 | 2 | 3 | 4 | R08 | S08 | T08 | N08 | E8 | E8 | E8 | E8 | E8 | <table border="0" style="width: 100%;"> <tr> <td style="width: 50%;"></td> <td style="width: 50%; text-align: center;"> <table border="0"> <tr> <td style="width: 10%;"></td> <td style="width: 10%;"></td> <td style="width: 10%;"></td> <td style="width: 10%;"></td> <td style="width: 10%;"></td> <td style="width: 10%;"></td> <td style="width: 10%;"></td> <td style="width: 10%;"></td> <td style="width: 10%;"></td> <td style="width: 10%;"></td> <td style="width: 10%;"></td> <td style="width: 10%;"></td> <td style="width: 10%;"></td> <td style="width: 10%;"></td> </tr> <tr> <td style="text-align: center;">XA</td> <td style="text-align: center;">1</td> <td style="text-align: center;">2</td> <td style="text-align: center;">3</td> <td style="text-align: center;">4</td> <td style="text-align: center;">R01</td> <td style="text-align: center;">S01</td> <td style="text-align: center;">T01</td> <td style="text-align: center;">N01</td> <td style="text-align: center;">E1</td> <td style="text-align: center;">E1</td> <td style="text-align: center;">E1</td> <td style="text-align: center;">E1</td> <td style="text-align: center;">E1</td> </tr> <tr> <td></td> <td style="text-align: center;">1</td> <td style="text-align: center;">2</td> <td style="text-align: center;">3</td> <td style="text-align: center;">4</td> <td style="text-align: center;">R02</td> <td style="text-align: center;">S02</td> <td style="text-align: center;">T02</td> <td style="text-align: center;">N02</td> <td style="text-align: center;">E2</td> <td style="text-align: center;">E2</td> <td style="text-align: center;">E2</td> <td style="text-align: center;">E2</td> <td style="text-align: center;">E2</td> </tr> <tr> <td></td> <td style="text-align: center;">1</td> <td style="text-align: center;">2</td> <td style="text-align: center;">3</td> <td style="text-align: center;">4</td> <td style="text-align: center;">R03</td> <td style="text-align: center;">S03</td> <td style="text-align: center;">T03</td> <td style="text-align: center;">N03</td> <td style="text-align: center;">E3</td> <td style="text-align: center;">E3</td> <td style="text-align: center;">E3</td> <td style="text-align: center;">E3</td> <td style="text-align: center;">E3</td> </tr> <tr> <td></td> <td style="text-align: center;">1</td> <td style="text-align: center;">2</td> <td style="text-align: center;">3</td> <td style="text-align: center;">4</td> <td style="text-align: center;">R04</td> <td style="text-align: center;">S04</td> <td style="text-align: center;">T04</td> <td style="text-align: center;">N04</td> <td style="text-align: center;">E4</td> <td style="text-align: center;">E4</td> <td style="text-align: center;">E4</td> <td style="text-align: center;">E4</td> <td style="text-align: center;">E4</td> </tr> <tr> <td></td> <td style="text-align: center;">1</td> <td style="text-align: center;">2</td> <td style="text-align: center;">3</td> <td style="text-align: center;">4</td> <td style="text-align: center;">R05</td> <td style="text-align: center;">S05</td> <td style="text-align: center;">T05</td> <td style="text-align: center;">N05</td> <td style="text-align: center;">E5</td> <td style="text-align: center;">E5</td> <td style="text-align: center;">E5</td> <td style="text-align: center;">E5</td> <td style="text-align: center;">E5</td> </tr> <tr> <td></td> <td style="text-align: center;">1</td> <td style="text-align: center;">2</td> <td style="text-align: center;">3</td> <td style="text-align: center;">4</td> <td style="text-align: center;">R06</td> <td style="text-align: center;">S06</td> <td style="text-align: center;">T06</td> <td style="text-align: center;">N06</td> <td style="text-align: center;">E6</td> <td style="text-align: center;">E6</td> <td style="text-align: center;">E6</td> <td style="text-align: center;">E6</td> <td style="text-align: center;">E6</td> </tr> <tr> <td></td> <td style="text-align: center;">1</td> <td style="text-align: center;">2</td> <td style="text-align: center;">3</td> <td style="text-align: center;">4</td> <td style="text-align: center;">R07</td> <td style="text-align: center;">S07</td> <td style="text-align: center;">T07</td> <td style="text-align: center;">N07</td> <td style="text-align: center;">E7</td> <td style="text-align: center;">E7</td> <td style="text-align: center;">E7</td> <td style="text-align: center;">E7</td> <td style="text-align:
center;">E7</td> </tr> <tr> <td></td> <td style="text-align: center;">1</td> <td style="text-align: center;">2</td> <td style="text-align: center;">3</td> <td style="text-align: center;">4</td> <td style="text-align: center;">R08</td> <td style="text-align: center;">S08</td> <td style="text-align: center;">T08</td> <td style="text-align: center;">N08</td> <td style="text-align: center;">E8</td> <td style="text-align: center;">E8</td> <td style="text-align: center;">E8</td> <td style="text-align: center;">E8</td> <td style="text-align: center;">E8</td> </tr> </table> </td> <td style="width: 50%; vertical-align: top;"> <table border="0" style="width: 100%;"> <tr> <td style="width: 50%;"></td> <td style="width: 50%; text-align: center;"> <table border="0"> <tr> <td style="width: 10%;"></td> <td style="width: 10%;"></td> <td style="width: 10%;"></td> <td style="width: 10%;"></td> <td style="width: 10%;"></td> <td style="width: 10%;"></td> <td style="width: 10%;"></td> <td style="width: 10%;"></td> <td style="width: 10%;"></td> <td style="width: 10%;"></td> <td style="width: 10%;"></td> <td style="width: 10%;"></td> <td style="width: 10%;"></td> <td style="width: 10%;"></td> </tr> <tr> <td style="text-align: center;">XA</td> <td style="text-align: center;">1</td> <td style="text-align: center;">2</td> <td style="text-align: center;">3</td> <td style="text-align: center;">4</td> <td style="text-align: center;">R01</td> <td style="text-align: center;">S01</td> <td style="text-align: center;">T01</td> <td style="text-align: center;">N01</td> <td style="text-align: center;">E1</td> <td style="text-align: center;">E1</td> <td style="text-align: center;">E1</td> </tr></table></td></tr></table></td></tr></table> | | <table border="0"> <tr> <td style="width: 10%;"></td> <td style="width: 10%;"></td> <td style="width: 10%;"></td> <td style="width: 10%;"></td> <td style="width: 10%;"></td> <td style="width: 10%;"></td> <td style="width: 10%;"></td> <td style="width: 10%;"></td> <td style="width: 10%;"></td> <td style="width: 10%;"></td> <td style="width: 10%;"></td> <td style="width: 10%;"></td> <td style="width: 10%;"></td> <td style="width: 10%;"></td> </tr> <tr> <td style="text-align: center;">XA</td> <td style="text-align: center;">1</td> <td style="text-align: center;">2</td> <td style="text-align: center;">3</td> <td style="text-align: center;">4</td> <td style="text-align: center;">R01</td> <td style="text-align: center;">S01</td> <td style="text-align: center;">T01</td> <td style="text-align: center;">N01</td> <td style="text-align: center;">E1</td> <td style="text-align: center;">E1</td> <td style="text-align: center;">E1</td> <td style="text-align: center;">E1</td> <td style="text-align: center;">E1</td> </tr> <tr> <td></td> <td style="text-align: center;">1</td> <td style="text-align: center;">2</td> <td style="text-align: center;">3</td> <td style="text-align: center;">4</td> <td style="text-align: center;">R02</td> <td style="text-align: center;">S02</td> <td style="text-align: center;">T02</td> <td style="text-align: center;">N02</td> <td style="text-align: center;">E2</td> <td style="text-align: center;">E2</td> <td style="text-align: center;">E2</td> <td style="text-align: center;">E2</td> <td style="text-align: center;">E2</td> </tr> <tr> <td></td> <td style="text-align: center;">1</td> <td style="text-align: center;">2</td> <td style="text-align: center;">3</td> <td style="text-align: center;">4</td> <td style="text-align: center;">R03</td> <td style="text-align: center;">S03</td> <td style="text-align: center;">T03</td> <td style="text-align: center;">N03</td> <td style="text-align: center;">E3</td> <td style="text-align: center;">E3</td> <td style="text-align: center;">E3</td> <td style="text-align: center;">E3</td> <td style="text-align: center;">E3</td> </tr> <tr> <td></td> <td style="text-align: center;">1</td> <td style="text-align: center;">2</td> <td style="text-align: center;">3</td> <td style="text-align: center;">4</td> <td style="text-align: center;">R04</td> <td style="text-align: center;">S04</td> <td style="text-align: center;">T04</td> <td style="text-align: center;">N04</td> <td style="text-align: center;">E4</td> <td style="text-align: center;">E4</td> <td style="text-align: center;">E4</td> <td style="text-align: center;">E4</td> <td style="text-align: center;">E4</td> </tr> <tr> <td></td> <td style="text-align: center;">1</td> <td style="text-align: center;">2</td> <td style="text-align: center;">3</td> <td style="text-align: center;">4</td> <td style="text-align: center;">R05</td> <td style="text-align: center;">S05</td> <td style="text-align: center;">T05</td> <td style="text-align: center;">N05</td> <td style="text-align: center;">E5</td> <td style="text-align: center;">E5</td> <td style="text-align: center;">E5</td> <td style="text-align: center;">E5</td> <td style="text-align: center;">E5</td> </tr> <tr> <td></td> <td style="text-align: center;">1</td> <td style="text-align: center;">2</td> <td style="text-align: center;">3</td> <td style="text-align: center;">4</td> <td style="text-align: center;">R06</td> <td style="text-align: center;">S06</td> <td style="text-align: center;">T06</td> <td style="text-align: center;">N06</td> <td style="text-align: center;">E6</td> <td style="text-align: center;">E6</td> <td style="text-align: center;">E6</td> <td style="text-align: center;">E6</td> <td style="text-align: center;">E6</td> </tr> <tr> <td></td> <td style="text-align: center;">1</td> <td style="text-align: center;">2</td> <td style="text-align: center;">3</td> <td style="text-align: center;">4</td> <td style="text-align: center;">R07</td> <td style="text-align: center;">S07</td> <td style="text-align: center;">T07</td> <td style="text-align: center;">N07</td> <td style="text-align: center;">E7</td> <td style="text-align: center;">E7</td> <td style="text-align: center;">E7</td> <td style="text-align: center;">E7</td> <td style="text-align: center;">E7</td> </tr> <tr> <td></td> <td style="text-align: center;">1</td> <td style="text-align: center;">2</td> <td style="text-align: center;">3</td> <td style="text-align: center;">4</td> <td style="text-align: center;">R08</td> <td style="text-align: center;">S08</td> <td style="text-align: center;">T08</td> <td style="text-align: center;">N08</td> <td style="text-align: center;">E8</td> <td style="text-align: center;">E8</td> <td style="text-align: center;">E8</td> <td style="text-align: center;">E8</td> <td style="text-align: center;">E8</td> </tr> </table> | | | | | | | | | | | |
 |
 |
 | XA | 1 | 2 | 3 | 4 | R01 | S01 | T01 | N01 | E1 | E1 | E1 | E1
 | E1 |
 | 1 | 2 | 3 | 4 | R02 | S02 | T02 | N02 | E2 | E2 | E2 | E2 | E2 | | 1 | 2 | 3 | 4 | R03 | S03 | T03 | N03 | E3 | E3 | E3 | E3
 | E3 |
 | 1 | 2 | 3 | 4 | R04 | S04 | T04 | N04 | E4 | E4 | E4 | E4 | E4 | | 1 | 2 | 3 | 4 | R05 | S05 | T05 | N05 | E5 | E5 | E5 | E5 | E5 | | 1 | 2 | 3 | 4 | R06 | S06 | T06 | N06 | E6 | E6 | E6 | E6 | E6 | | 1 | 2 | 3 | 4 | R07 | S07 | T07 | N07 | E7 | E7 | E7 | E7 | E7 | | 1 | 2 | 3 | 4 | R08 | S08 | T08 | N08 | E8 | E8 | E8 | E8 | E8 | <table border="0" style="width: 100%;"> <tr> <td style="width: 50%;"></td> <td style="width: 50%; text-align: center;"> <table border="0"> <tr> <td style="width: 10%;"></td> <td style="width: 10%;"></td> <td style="width: 10%;"></td> <td style="width: 10%;"></td> <td style="width: 10%;"></td> <td style="width: 10%;"></td> <td style="width: 10%;"></td> <td style="width: 10%;"></td> <td style="width: 10%;"></td> <td style="width: 10%;"></td> <td style="width: 10%;"></td> <td style="width: 10%;"></td> <td style="width: 10%;"></td> <td style="width: 10%;"></td> </tr> <tr> <td style="text-align: center;">XA</td> <td style="text-align: center;">1</td> <td style="text-align: center;">2</td> <td style="text-align: center;">3</td> <td style="text-align: center;">4</td> <td style="text-align: center;">R01</td> <td style="text-align: center;">S01</td> <td style="text-align: center;">T01</td> <td style="text-align: center;">N01</td> <td style="text-align: center;">E1</td> <td style="text-align: center;">E1</td> <td style="text-align: center;">E1</td> </tr></table></td></tr></table> | | <table border="0"> <tr> <td style="width: 10%;"></td> <td style="width: 10%;"></td> <td style="width: 10%;"></td> <td style="width: 10%;"></td> <td style="width: 10%;"></td> <td style="width: 10%;"></td> <td style="width: 10%;"></td> <td style="width: 10%;"></td> <td style="width: 10%;"></td> <td style="width: 10%;"></td> <td style="width: 10%;"></td> <td style="width: 10%;"></td> <td style="width: 10%;"></td> <td style="width: 10%;"></td> </tr> <tr> <td style="text-align: center;">XA</td> <td style="text-align: center;">1</td> <td style="text-align: center;">2</td> <td style="text-align: center;">3</td> <td style="text-align: center;">4</td> <td style="text-align: center;">R01</td> <td style="text-align: center;">S01</td> <td style="text-align: center;">T01</td> <td style="text-align: center;">N01</td> <td style="text-align: center;">E1</td> <td style="text-align: center;">E1</td> <td style="text-align: center;">E1</td> </tr></table> | | | | | | | | | | | | |
 | | XA
 | 1 | 2 | 3 | 4 | R01 | S01 | T01 | N01 | E1 | E1 | E1 | | | | | | | | | | | | | | | | | | | | | | | | | | | | | | | | | | | | | | | | | | | | | | | | | | | | | | | | | | | | | | | | | | | | | | | | | | | | |
 | | | | | | | | | | | | | | | | | | | | | | | | | | | |
 | | | | | | | | | | | | | | | | | | | | | | | | | | | | | | | | | | | | | | | | | | | | | | | | | | | | | | | | | | | | | | | | | | | | | | | | | | | | | | | | | | | | | | | |
 | | | | | | | | | | | | | | | | | | | | | | | | | | | | | | | | | | | | | | | | | | | | | | | | | | | | | | | | | | | | | | | | | | | | | |
|

 | |
 | | | | | | | | | | | |

 | |
 | | | | | | | | | | | |

 | | | | | | | | | | | | | |

 | | | | | | | | | | | | | | | | | | | | | | | | | | | | | | | | | | | | | | | | | | | | | | | | | | | | | | | | | | | | | | | | | | | | | | | | | | | | | | | | | | | | | |

 | | | | | | | | | | | | | |

 |

 |
 | | | | | | | | | | | | |

 | | | | | | | | | | | | | | | | | | | | | | | | | | | |

 | | | | | | | | | | | | | | | | | | | | | | | | | | | | | | | | | | | | | | | | | | | | | | | | | | | | | | | | | | | | | | | |
| | | | | | | |
 | |
 | | | | | | | | | | | |

 |

 | |
 | | | | | | | | | | | |

 | | | | | | | | | | | | | | | | | | | | | | | | | | | |

 | | | | | | | | | | | | | | | | | | | | | | | | | | | | | | | | | | | | | | | | | | | | | | | | | | | | | | | | | | | | | | | | | | | | | | | |
 | |
 | | | | | | | | | | | |
 |

 | |
 | | | | | | | | | | | |
 | |
 | | | | | | | | | | | | | | | | | | | | | | | | | |

 | | | | | | | | | | | | | | | | | | | | | | | | | | | | | | | | | | | | | | | | | | | | | | | | | | | | | | | | | | | | | | | | | | | | | | | |
 | | | | | | | | | | | | | |
 |
 |
 | | | | | | | | | | | | |
 | |
 | | | | | | | | | | | | | | | | | | | | | | | | | |
 | |
 | | | | | | | | | | | | | | | | | | | | | | | | | | | | | | | | | | | | | | | | | | | | | | | | | | | | | | | | | | | | | | | | | | | | | | | | | | | | | | | | | | | | |
 | |
 | | | | | | | | | | | | | | | | | | | | | | | | | | | | | | | | | | | | | | | | | | | | | | | | | | | | | | | | | | | | | | | | | | | | | | | | | | | | | | | | | | | | | | | |
 | | | | | | | | | | | | | | | | | | | | | | | | | | | |
 | | | | | | | | | | | | | | | | | | | | | | | | | | | | | | | | | | | | | | | | | | | | | | | | | | | | | | | | | | | | | | | | | | | | | | | | | | | | | | | | | | | | | | | |
 | | | | | | | | | | | | | | | | | | | | | | | | | | | | | | | | | | | | | | | | | | | | | | | | | | | | | | | | | | | | | | | | | | | | | |
| XA

 | 1 | 2
 | 3 | 4 | R01 | S01 | T01 | N01 | E1 | E1 | E1 | E1 | E1 |

 | |
 | | | | | | | | | | | |

 | | | | | | | | | | | | | |

 | | | | | | | | | | | | | | | | | | | | | | | | | | | | | | | | | | | | | | | | | | | | | | | | | | | | | | | | | | | | | | | | | | | | | | | | | | | | | | | | | | | | | |

 | | | | | | | | | | | | | |

 |

 |
 | | | | | | | | | | | | |

 | | | | | | | | | | | | | | | | | | | | | | | | | | | |

 | | | | | | | | | | | | | | | | | | | | | | | | | | | | | | | | | | | | | | | | | | | | | | | | | | | | | | | | | | | | | | | |
| | | | | | | |
 | |
 | | | | | | | | | | | |

 |

 | |
 | | | | | | | | | | | |

 | | | | | | | | | | | | | | | | | | | | | | | | | | | |

 | | | | | | | | | | | | | | | | | | | | | | | | | | | | | | | | | | | | | | | | | | | | | | | | | | | | | | | | | | | | | | | | | | | | | | | |
 | |
 | | | | | | | | | | | |
 |

 | |
 | | | | | | | | | | | |
 | |
 | | | | | | | | | | | | | | | | | | | | | | | | | |

 | | | | | | | | | | | | | | | | | | | | | | | | | | | | | | | | | | | | | | | | | | | | | | | | | | | | | | | | | | | | | | | | | | | | | | | |
 | | | | | | | | | | | | | |
 |
 |
 | | | | | | | | | | | | |
 | |
 | | | | | | | | | | | | | | | | | | | | | | | | | |
 | |
 | | | | | | | | | | | | | | | | | | | | | | | | | | | | | | | | | | | | | | | | | | | | | | | | | | | | | | | | | | | | | | | | | | | | | | | | | | | | | | | | | | | | |
 | |
 | | | | | | | | | | | | | | | | | | | | | | | | | | | | | | | | | | | | | | | | | | | | | | | | | | | | | | | | | | | | | | | | | | | | | | | | | | | | | | | | | | | | | | | |
 | | | | | | | | | | | | | | | | | | | | | | | | | | | |
 | | | | | | | | | | | | | | | | | | | | | | | | | | | | | | | | | | | | | | | | | | | | | | | | | | | | | | | | | | | | | | | | | | | | | | | | | | | | | | | | | | | | | | | |
 | | | | | | | | | | | | | | | | | | | | | | | | | | | | | | | | | | | | | | | | | | | | | | | | | | | | | | | | | | | | | | | | | | | | | |
|

 | 1 | 2
 | 3 | 4 | R02 | S02 | T02 | N02 | E2 | E2 | E2 | E2 | E2 |

 | |
 | | | | | | | | | | | |

 | | | | | | | | | | | | | |

 | | | | | | | | | | | | | | | | | | | | | | | | | | | | | | | | | | | | | | | | | | | | | | | | | | | | | | | | | | | | | | | | | | | | | | | | | | | | | | | | | | | | | |

 | | | | | | | | | | | | | |

 |

 |
 | | | | | | | | | | | | |

 | | | | | | | | | | | | | | | | | | | | | | | | | | | |

 | | | | | | | | | | | | | | | | | | | | | | | | | | | | | | | | | | | | | | | | | | | | | | | | | | | | | | | | | | | | | | | |
| | | | | | | |
 | |
 | | | | | | | | | | | |

 |

 | |
 | | | | | | | | | | | |

 | | | | | | | | | | | | | | | | | | | | | | | | | | | |

 | | | | | | | | | | | | | | | | | | | | | | | | | | | | | | | | | | | | | | | | | | | | | | | | | | | | | | | | | | | | | | | | | | | | | | | |
 | |
 | | | | | | | | | | | |
 |

 | |
 | | | | | | | | | | | |
 | |
 | | | | | | | | | | | | | | | | | | | | | | | | | |

 | | | | | | | | | | | | | | | | | | | | | | | | | | | | | | | | | | | | | | | | | | | | | | | | | | | | | | | | | | | | | | | | | | | | | | | |
 | | | | | | | | | | | | | |
 |
 |
 | | | | | | | | | | | | |
 | |
 | | | | | | | | | | | | | | | | | | | | | | | | | |
 | |
 | | | | | | | | | | | | | | | | | | | | | | | | | | | | | | | | | | | | | | | | | | | | | | | | | | | | | | | | | | | | | | | | | | | | | | | | | | | | | | | | | | | | |
 | |
 | | | | | | | | | | | | | | | | | | | | | | | | | | | | | | | | | | | | | | | | | | | | | | | | | | | | | | | | | | | | | | | | | | | | | | | | | | | | | | | | | | | | | | | |
 | | | | | | | | | | | | | | | | | | | | | | | | | | | |
 | | | | | | | | | | | | | | | | | | | | | | | | | | | | | | | | | | | | | | | | | | | | | | | | | | | | | | | | | | | | | | | | | | | | | | | | | | | | | | | | | | | | | | | |
 | | | | | | | | | | | | | | | | | | | | | | | | | | | | | | | | | | | | | | | | | | | | | | | | | | | | | | | | | | | | | | | | | | | | | |
|

 | 1 | 2
 | 3 | 4 | R03 | S03 | T03 | N03 | E3 | E3 | E3 | E3 | E3 |

 | |
 | | | | | | | | | | | |

 | | | | | | | | | | | | | |

 | | | | | | | | | | | | | | | | | | | | | | | | | | | | | | | | | | | | | | | | | | | | | | | | | | | | | | | | | | | | | | | | | | | | | | | | | | | | | | | | | | | | | |

 | | | | | | | | | | | | | |

 |

 |
 | | | | | | | | | | | | |

 | | | | | | | | | | | | | | | | | | | | | | | | | | | |

 | | | | | | | | | | | | | | | | | | | | | | | | | | | | | | | | | | | | | | | | | | | | | | | | | | | | | | | | | | | | | | | |
| | | | | | | |
 | |
 | | | | | | | | | | | |

 |

 | |
 | | | | | | | | | | | |

 | | | | | | | | | | | | | | | | | | | | | | | | | | | |

 | | | | | | | | | | | | | | | | | | | | | | | | | | | | | | | | | | | | | | | | | | | | | | | | | | | | | | | | | | | | | | | | | | | | | | | |
 | |
 | | | | | | | | | | | |
 |

 | |
 | | | | | | | | | | | |
 | |
 | | | | | | | | | | | | | | | | | | | | | | | | | |

 | | | | | | | | | | | | | | | | | | | | | | | | | | | | | | | | | | | | | | | | | | | | | | | | | | | | | | | | | | | | | | | | | | | | | | | |
 | | | | | | | | | | | | | |
 |
 |
 | | | | | | | | | | | | |
 | |
 | | | | | | | | | | | | | | | | | | | | | | | | | |
 | |
 | | | | | | | | | | | | | | | | | | | | | | | | | | | | | | | | | | | | | | | | | | | | | | | | | | | | | | | | | | | | | | | | | | | | | | | | | | | | | | | | | | | | |
 | |
 | | | | | | | | | | | | | | | | | | | | | | | | | | | | | | | | | | | | | | | | | | | | | | | | | | | | | | | | | | | | | | | | | | | | | | | | | | | | | | | | | | | | | | | |
 | | | | | | | | | | | | | | | | | | | | | | | | | | | |
 | | | | | | | | | | | | | | | | | | | | | | | | | | | | | | | | | | | | | | | | | | | | | | | | | | | | | | | | | | | | | | | | | | | | | | | | | | | | | | | | | | | | | | | |
 | | | | | | | | | | | | | | | | | | | | | | | | | | | | | | | | | | | | | | | | | | | | | | | | | | | | | | | | | | | | | | | | | | | | | |
|

 | 1 | 2
 | 3 | 4 | R04 | S04 | T04 | N04 | E4 | E4 | E4 | E4 | E4 |

 | |
 | | | | | | | | | | | |

 | | | | | | | | | | | | | |

 | | | | | | | | | | | | | | | | | | | | | | | | | | | | | | | | | | | | | | | | | | | | | | | | | | | | | | | | | | | | | | | | | | | | | | | | | | | | | | | | | | | | | |

 | | | | | | | | | | | | | |

 |

 |
 | | | | | | | | | | | | |

 | | | | | | | | | | | | | | | | | | | | | | | | | | | |

 | | | | | | | | | | | | | | | | | | | | | | | | | | | | | | | | | | | | | | | | | | | | | | | | | | | | | | | | | | | | | | | |
| | | | | | | |
 | |
 | | | | | | | | | | | |

 |

 | |
 | | | | | | | | | | | |

 | | | | | | | | | | | | | | | | | | | | | | | | | | | |

 | | | | | | | | | | | | | | | | | | | | | | | | | | | | | | | | | | | | | | | | | | | | | | | | | | | | | | | | | | | | | | | | | | | | | | | |
 | |
 | | | | | | | | | | | |
 |

 | |
 | | | | | | | | | | | |
 | |
 | | | | | | | | | | | | | | | | | | | | | | | | | |

 | | | | | | | | | | | | | | | | | | | | | | | | | | | | | | | | | | | | | | | | | | | | | | | | | | | | | | | | | | | | | | | | | | | | | | | |
 | | | | | | | | | | | | | |
 |
 |
 | | | | | | | | | | | | |
 | |
 | | | | | | | | | | | | | | | | | | | | | | | | | |
 | |
 | | | | | | | | | | | | | | | | | | | | | | | | | | | | | | | | | | | | | | | | | | | | | | | | | | | | | | | | | | | | | | | | | | | | | | | | | | | | | | | | | | | | |
 | |
 | | | | | | | | | | | | | | | | | | | | | | | | | | | | | | | | | | | | | | | | | | | | | | | | | | | | | | | | | | | | | | | | | | | | | | | | | | | | | | | | | | | | | | | |
 | | | | | | | | | | | | | | | | | | | | | | | | | | | |
 | | | | | | | | | | | | | | | | | | | | | | | | | | | | | | | | | | | | | | | | | | | | | | | | | | | | | | | | | | | | | | | | | | | | | | | | | | | | | | | | | | | | | | | |
 | | | | | | | | | | | | | | | | | | | | | | | | | | | | | | | | | | | | | | | | | | | | | | | | | | | | | | | | | | | | | | | | | | | | | |
|

 | 1 | 2
 | 3 | 4 | R05 | S05 | T05 | N05 | E5 | E5 | E5 | E5 | E5 |

 | |
 | | | | | | | | | | | |

 | | | | | | | | | | | | | |

 | | | | | | | | | | | | | | | | | | | | | | | | | | | | | | | | | | | | | | | | | | | | | | | | | | | | | | | | | | | | | | | | | | | | | | | | | | | | | | | | | | | | | |

 | | | | | | | | | | | | | |

 |

 |
 | | | | | | | | | | | | |

 | | | | | | | | | | | | | | | | | | | | | | | | | | | |

 | | | | | | | | | | | | | | | | | | | | | | | | | | | | | | | | | | | | | | | | | | | | | | | | | | | | | | | | | | | | | | | |
| | | | | | | |
 | |
 | | | | | | | | | | | |

 |

 | |
 | | | | | | | | | | | |

 | | | | | | | | | | | | | | | | | | | | | | | | | | | |

 | | | | | | | | | | | | | | | | | | | | | | | | | | | | | | | | | | | | | | | | | | | | | | | | | | | | | | | | | | | | | | | | | | | | | | | |
 | |
 | | | | | | | | | | | |
 |

 | |
 | | | | | | | | | | | |
 | |
 | | | | | | | | | | | | | | | | | | | | | | | | | |

 | | | | | | | | | | | | | | | | | | | | | | | | | | | | | | | | | | | | | | | | | | | | | | | | | | | | | | | | | | | | | | | | | | | | | | | |
 | | | | | | | | | | | | | |
 |
 |
 | | | | | | | | | | | | |
 | |
 | | | | | | | | | | | | | | | | | | | | | | | | | |
 | |
 | | | | | | | | | | | | | | | | | | | | | | | | | | | | | | | | | | | | | | | | | | | | | | | | | | | | | | | | | | | | | | | | | | | | | | | | | | | | | | | | | | | | |
 | |
 | | | | | | | | | | | | | | | | | | | | | | | | | | | | | | | | | | | | | | | | | | | | | | | | | | | | | | | | | | | | | | | | | | | | | | | | | | | | | | | | | | | | | | | |
 | | | | | | | | | | | | | | | | | | | | | | | | | | | |
 | | | | | | | | | | | | | | | | | | | | | | | | | | | | | | | | | | | | | | | | | | | | | | | | | | | | | | | | | | | | | | | | | | | | | | | | | | | | | | | | | | | | | | | |
 | | | | | | | | | | | | | | | | | | | | | | | | | | | | | | | | | | | | | | | | | | | | | | | | | | | | | | | | | | | | | | | | | | | | | |
|

 | 1 | 2
 | 3 | 4 | R06 | S06 | T06 | N06 | E6 | E6 | E6 | E6 | E6 |

 | |
 | | | | | | | | | | | |

 | | | | | | | | | | | | | |

 | | | | | | | | | | | | | | | | | | | | | | | | | | | | | | | | | | | | | | | | | | | | | | | | | | | | | | | | | | | | | | | | | | | | | | | | | | | | | | | | | | | | | |

 | | | | | | | | | | | | | |

 |

 |
 | | | | | | | | | | | | |

 | | | | | | | | | | | | | | | | | | | | | | | | | | | |

 | | | | | | | | | | | | | | | | | | | | | | | | | | | | | | | | | | | | | | | | | | | | | | | | | | | | | | | | | | | | | | | |
| | | | | | | |
 | |
 | | | | | | | | | | | |

 |

 | |
 | | | | | | | | | | | |

 | | | | | | | | | | | | | | | | | | | | | | | | | | | |

 | | | | | | | | | | | | | | | | | | | | | | | | | | | | | | | | | | | | | | | | | | | | | | | | | | | | | | | | | | | | | | | | | | | | | | | |
 | |
 | | | | | | | | | | | |
 |

 | |
 | | | | | | | | | | | |
 | |
 | | | | | | | | | | | | | | | | | | | | | | | | | |

 | | | | | | | | | | | | | | | | | | | | | | | | | | | | | | | | | | | | | | | | | | | | | | | | | | | | | | | | | | | | | | | | | | | | | | | |
 | | | | | | | | | | | | | |
 |
 |
 | | | | | | | | | | | | |
 | |
 | | | | | | | | | | | | | | | | | | | | | | | | | |
 | |
 | | | | | | | | | | | | | | | | | | | | | | | | | | | | | | | | | | | | | | | | | | | | | | | | | | | | | | | | | | | | | | | | | | | | | | | | | | | | | | | | | | | | |
 | |
 | | | | | | | | | | | | | | | | | | | | | | | | | | | | | | | | | | | | | | | | | | | | | | | | | | | | | | | | | | | | | | | | | | | | | | | | | | | | | | | | | | | | | | | |
 | | | | | | | | | | | | | | | | | | | | | | | | | | | |
 | | | | | | | | | | | | | | | | | | | | | | | | | | | | | | | | | | | | | | | | | | | | | | | | | | | | | | | | | | | | | | | | | | | | | | | | | | | | | | | | | | | | | | | |
 | | | | | | | | | | | | | | | | | | | | | | | | | | | | | | | | | | | | | | | | | | | | | | | | | | | | | | | | | | | | | | | | | | | | | |
|

 | 1 | 2
 | 3 | 4 | R07 | S07 | T07 | N07 | E7 | E7 | E7 | E7 | E7 |

 | |
 | | | | | | | | | | | |

 | | | | | | | | | | | | | |

 | | | | | | | | | | | | | | | | | | | | | | | | | | | | | | | | | | | | | | | | | | | | | | | | | | | | | | | | | | | | | | | | | | | | | | | | | | | | | | | | | | | | | |

 | | | | | | | | | | | | | |

 |

 |
 | | | | | | | | | | | | |

 | | | | | | | | | | | | | | | | | | | | | | | | | | | |

 | | | | | | | | | | | | | | | | | | | | | | | | | | | | | | | | | | | | | | | | | | | | | | | | | | | | | | | | | | | | | | | |
| | | | | | | |
 | |
 | | | | | | | | | | | |

 |

 | |
 | | | | | | | | | | | |

 | | | | | | | | | | | | | | | | | | | | | | | | | | | |

 | | | | | | | | | | | | | | | | | | | | | | | | | | | | | | | | | | | | | | | | | | | | | | | | | | | | | | | | | | | | | | | | | | | | | | | |
 | |
 | | | | | | | | | | | |
 |

 | |
 | | | | | | | | | | | |
 | |
 | | | | | | | | | | | | | | | | | | | | | | | | | |

 | | | | | | | | | | | | | | | | | | | | | | | | | | | | | | | | | | | | | | | | | | | | | | | | | | | | | | | | | | | | | | | | | | | | | | | |
 | | | | | | | | | | | | | |
 |
 |
 | | | | | | | | | | | | |
 | |
 | | | | | | | | | | | | | | | | | | | | | | | | | |
 | |
 | | | | | | | | | | | | | | | | | | | | | | | | | | | | | | | | | | | | | | | | | | | | | | | | | | | | | | | | | | | | | | | | | | | | | | | | | | | | | | | | | | | | |
 | |
 | | | | | | | | | | | | | | | | | | | | | | | | | | | | | | | | | | | | | | | | | | | | | | | | | | | | | | | | | | | | | | | | | | | | | | | | | | | | | | | | | | | | | | | |
 | | | | | | | | | | | | | | | | | | | | | | | | | | | |
 | | | | | | | | | | | | | | | | | | | | | | | | | | | | | | | | | | | | | | | | | | | | | | | | | | | | | | | | | | | | | | | | | | | | | | | | | | | | | | | | | | | | | | | |
 | | | | | | | | | | | | | | | | | | | | | | | | | | | | | | | | | | | | | | | | | | | | | | | | | | | | | | | | | | | | | | | | | | | | | |
|

 | 1 | 2
 | 3 | 4 | R08 | S08 | T08 | N08 | E8 | E8 | E8 | E8 | E8 |

 | |
 | | | | | | | | | | | |

 | | | | | | | | | | | | | |

 | | | | | | | | | | | | | | | | | | | | | | | | | | | | | | | | | | | | | | | | | | | | | | | | | | | | | | | | | | | | | | | | | | | | | | | | | | | | | | | | | | | | | |

 | | | | | | | | | | | | | |

 |

 |
 | | | | | | | | | | | | |

 | | | | | | | | | | | | | | | | | | | | | | | | | | | |

 | | | | | | | | | | | | | | | | | | | | | | | | | | | | | | | | | | | | | | | | | | | | | | | | | | | | | | | | | | | | | | | |
| | | | | | | |
 | |
 | | | | | | | | | | | |

 |

 | |
 | | | | | | | | | | | |

 | | | | | | | | | | | | | | | | | | | | | | | | | | | |

 | | | | | | | | | | | | | | | | | | | | | | | | | | | | | | | | | | | | | | | | | | | | | | | | | | | | | | | | | | | | | | | | | | | | | | | |
 | |
 | | | | | | | | | | | |
 |

 | |
 | | | | | | | | | | | |
 | |
 | | | | | | | | | | | | | | | | | | | | | | | | | |

 | | | | | | | | | | | | | | | | | | | | | | | | | | | | | | | | | | | | | | | | | | | | | | | | | | | | | | | | | | | | | | | | | | | | | | | |
 | | | | | | | | | | | | | |
 |
 |
 | | | | | | | | | | | | |
 | |
 | | | | | | | | | | | | | | | | | | | | | | | | | |
 | |
 | | | | | | | | | | | | | | | | | | | | | | | | | | | | | | | | | | | | | | | | | | | | | | | | | | | | | | | | | | | | | | | | | | | | | | | | | | | | | | | | | | | | |
 | |
 | | | | | | | | | | | | | | | | | | | | | | | | | | | | | | | | | | | | | | | | | | | | | | | | | | | | | | | | | | | | | | | | | | | | | | | | | | | | | | | | | | | | | | | |
 | | | | | | | | | | | | | | | | | | | | | | | | | | | |
 | | | | | | | | | | | | | | | | | | | | | | | | | | | | | | | | | | | | | | | | | | | | | | | | | | | | | | | | | | | | | | | | | | | | | | | | | | | | | | | | | | | | | | | |
 | | | | | | | | | | | | | | | | | | | | | | | | | | | | | | | | | | | | | | | | | | | | | | | | | | | | | | | | | | | | | | | | | | | | | |
|

 | <table border="0"> <tr> <td style="width: 10%;"></td> <td style="width: 10%;"></td> <td style="width: 10%;"></td> <td style="width: 10%;"></td> <td style="width: 10%;"></td> <td style="width: 10%;"></td> <td style="width: 10%;"></td> <td style="width: 10%;"></td> <td style="width: 10%;"></td> <td style="width: 10%;"></td> <td style="width: 10%;"></td> <td style="width: 10%;"></td> <td style="width: 10%;"></td> <td style="width: 10%;"></td> </tr> <tr> <td style="text-align: center;">XA</td> <td style="text-align: center;">1</td> <td style="text-align: center;">2</td> <td style="text-align: center;">3</td> <td style="text-align: center;">4</td> <td style="text-align: center;">R01</td> <td style="text-align: center;">S01</td> <td style="text-align: center;">T01</td> <td style="text-align: center;">N01</td> <td style="text-align: center;">E1</td> <td style="text-align: center;">E1</td> <td style="text-align: center;">E1</td> <td style="text-align: center;">E1</td> <td style="text-align: center;">E1</td> </tr> <tr> <td></td> <td style="text-align: center;">1</td> <td style="text-align: center;">2</td> <td style="text-align: center;">3</td> <td style="text-align: center;">4</td> <td style="text-align: center;">R02</td> <td style="text-align: center;">S02</td> <td style="text-align: center;">T02</td> <td style="text-align: center;">N02</td> <td style="text-align: center;">E2</td> <td style="text-align: center;">E2</td> <td style="text-align: center;">E2</td> <td style="text-align: center;">E2</td> <td style="text-align: center;">E2</td> </tr> <tr> <td></td> <td style="text-align: center;">1</td> <td style="text-align: center;">2</td> <td style="text-align: center;">3</td> <td style="text-align: center;">4</td> <td style="text-align: center;">R03</td> <td style="text-align: center;">S03</td> <td style="text-align: center;">T03</td> <td style="text-align: center;">N03</td> <td style="text-align: center;">E3</td> <td style="text-align: center;">E3</td> <td style="text-align: center;">E3</td> <td style="text-align: center;">E3</td> <td style="text-align: center;">E3</td> </tr> <tr> <td></td> <td style="text-align: center;">1</td> <td style="text-align: center;">2</td> <td style="text-align: center;">3</td> <td style="text-align: center;">4</td> <td style="text-align: center;">R04</td> <td style="text-align: center;">S04</td> <td style="text-align: center;">T04</td> <td style="text-align: center;">N04</td> <td style="text-align: center;">E4</td> <td style="text-align: center;">E4</td> <td style="text-align: center;">E4</td> <td style="text-align: center;">E4</td> <td style="text-align: center;">E4</td> </tr> <tr> <td></td> <td style="text-align: center;">1</td> <td style="text-align: center;">2</td> <td style="text-align: center;">3</td> <td style="text-align: center;">4</td> <td style="text-align: center;">R05</td> <td style="text-align: center;">S05</td> <td style="text-align: center;">T05</td> <td style="text-align: center;">N05</td> <td style="text-align: center;">E5</td> <td style="text-align: center;">E5</td> <td style="text-align: center;">E5</td> <td style="text-align: center;">E5</td> <td style="text-align: center;">E5</td> </tr> <tr> <td></td> <td style="text-align: center;">1</td> <td style="text-align: center;">2</td> <td style="text-align: center;">3</td> <td style="text-align: center;">4</td> <td style="text-align: center;">R06</td> <td style="text-align: center;">S06</td> <td style="text-align: center;">T06</td> <td style="text-align: center;">N06</td> <td style="text-align: center;">E6</td> <td style="text-align: center;">E6</td> <td style="text-align: center;">E6</td> <td style="text-align: center;">E6</td> <td style="text-align: center;">E6</td> </tr> <tr> <td></td> <td style="text-align: center;">1</td> <td style="text-align: center;">2</td> <td style="text-align: center;">3</td> <td style="text-align: center;">4</td> <td style="text-align: center;">R07</td> <td style="text-align: center;">S07</td> <td style="text-align: center;">T07</td> <td style="text-align: center;">N07</td> <td style="text-align: center;">E7</td> <td style="text-align: center;">E7</td> <td style="text-align: center;">E7</td> <td style="text-align: center;">E7</td> <td style="text-align: center;">E7</td> </tr> <tr> <td></td> <td style="text-align: center;">1</td> <td style="text-align: center;">2</td> <td style="text-align: center;">3</td> <td style="text-align: center;">4</td> <td style="text-align: center;">R08</td> <td style="text-align: center;">S08</td> <td style="text-align: center;">T08</td> <td style="text-align: center;">N08</td> <td style="text-align: center;">E8</td> <td style="text-align: center;">E8</td> <td style="text-align: center;">E8</td> <td style="text-align: center;">E8</td> <td style="text-align: center;">E8</td> </tr> </table> |
 | | | | | | | | | | | |

 | | XA
 | 1 | 2 | 3 | 4 | R01 | S01 | T01 | N01 | E1 | E1 | E1 | E1

 | E1 | | 1 | 2 | 3 | 4 | R02 | S02 | T02 | N02 | E2 | E2 | E2 | E2

 | E2 | | 1 | 2 | 3 | 4 | R03 | S03 | T03 | N03 | E3 | E3 | E3 | E3 | E3 | | 1 | 2 | 3 | 4 | R04 | S04 | T04 | N04 | E4 | E4 | E4 | E4 | E4 | | 1 | 2 | 3 | 4 | R05 | S05 | T05 | N05 | E5 | E5 | E5 | E5 | E5 | | 1 | 2 | 3 | 4 | R06 | S06 | T06 | N06 | E6 | E6 | E6 | E6 | E6 | | 1 | 2 | 3 | 4 | R07 | S07 | T07 | N07 | E7 | E7 | E7 | E7 | E7 | | 1 | 2 | 3 | 4 | R08 | S08 | T08 | N08 | E8 | E8 | E8 | E8 | E8 | <table border="0" style="width: 100%;"> <tr> <td style="width: 50%;"></td> <td style="width: 50%; text-align: center;"> <table border="0"> <tr> <td style="width: 10%;"></td> <td style="width: 10%;"></td> <td style="width: 10%;"></td> <td style="width: 10%;"></td> <td style="width:
10%;"></td> <td style="width: 10%;"></td> <td style="width: 10%;"></td> <td style="width: 10%;"></td> <td style="width: 10%;"></td> <td style="width: 10%;"></td> <td style="width: 10%;"></td> <td style="width: 10%;"></td> <td style="width: 10%;"></td> <td style="width: 10%;"></td> </tr> <tr> <td style="text-align: center;">XA</td> <td style="text-align: center;">1</td> <td style="text-align: center;">2</td> <td style="text-align: center;">3</td> <td style="text-align: center;">4</td> <td style="text-align: center;">R01</td> <td style="text-align: center;">S01</td> <td style="text-align: center;">T01</td> <td style="text-align: center;">N01</td> <td style="text-align: center;">E1</td> <td style="text-align: center;">E1</td> <td style="text-align: center;">E1</td> <td style="text-align: center;">E1</td> <td style="text-align: center;">E1</td> </tr> <tr> <td></td> <td style="text-align: center;">1</td> <td style="text-align: center;">2</td> <td style="text-align: center;">3</td> <td style="text-align: center;">4</td> <td style="text-align: center;">R02</td> <td style="text-align: center;">S02</td> <td style="text-align: center;">T02</td> <td style="text-align: center;">N02</td> <td style="text-align: center;">E2</td> <td style="text-align: center;">E2</td> <td style="text-align: center;">E2</td> <td style="text-align: center;">E2</td> <td style="text-align: center;">E2</td> </tr> <tr> <td></td> <td style="text-align: center;">1</td> <td style="text-align: center;">2</td> <td style="text-align: center;">3</td> <td style="text-align: center;">4</td> <td style="text-align: center;">R03</td> <td style="text-align: center;">S03</td> <td style="text-align: center;">T03</td> <td style="text-align: center;">N03</td> <td style="text-align: center;">E3</td> <td style="text-align: center;">E3</td> <td style="text-align: center;">E3</td> <td style="text-align: center;">E3</td> <td style="text-align: center;">E3</td> </tr> <tr> <td></td> <td style="text-align: center;">1</td> <td style="text-align: center;">2</td> <td style="text-align: center;">3</td> <td style="text-align: center;">4</td> <td style="text-align: center;">R04</td> <td style="text-align: center;">S04</td> <td style="text-align: center;">T04</td> <td style="text-align: center;">N04</td> <td style="text-align: center;">E4</td> <td style="text-align: center;">E4</td> <td style="text-align: center;">E4</td> <td style="text-align: center;">E4</td> <td style="text-align: center;">E4</td> </tr> <tr> <td></td> <td style="text-align: center;">1</td> <td style="text-align: center;">2</td> <td style="text-align: center;">3</td> <td style="text-align: center;">4</td> <td style="text-align: center;">R05</td> <td style="text-align: center;">S05</td> <td style="text-align: center;">T05</td> <td style="text-align: center;">N05</td> <td style="text-align: center;">E5</td> <td style="text-align: center;">E5</td> <td style="text-align: center;">E5</td> <td style="text-align: center;">E5</td> <td style="text-align: center;">E5</td> </tr> <tr> <td></td> <td style="text-align: center;">1</td> <td style="text-align: center;">2</td> <td style="text-align: center;">3</td> <td style="text-align: center;">4</td> <td style="text-align: center;">R06</td> <td style="text-align: center;">S06</td> <td style="text-align: center;">T06</td> <td style="text-align: center;">N06</td> <td style="text-align: center;">E6</td> <td style="text-align: center;">E6</td> <td style="text-align: center;">E6</td> <td style="text-align: center;">E6</td> <td style="text-align: center;">E6</td> </tr> <tr> <td></td> <td style="text-align: center;">1</td> <td style="text-align: center;">2</td> <td style="text-align: center;">3</td> <td style="text-align: center;">4</td> <td style="text-align: center;">R07</td> <td style="text-align: center;">S07</td> <td style="text-align: center;">T07</td> <td style="text-align: center;">N07</td> <td style="text-align: center;">E7</td> <td style="text-align: center;">E7</td> <td style="text-align: center;">E7</td> <td style="text-align: center;">E7</td> <td style="text-align: center;">E7</td> </tr> <tr> <td></td> <td style="text-align: center;">1</td> <td style="text-align: center;">2</td> <td style="text-align: center;">3</td> <td style="text-align: center;">4</td> <td style="text-align: center;">R08</td> <td style="text-align: center;">S08</td> <td style="text-align: center;">T08</td> <td style="text-align: center;">N08</td> <td style="text-align: center;">E8</td> <td style="text-align: center;">E8</td> <td style="text-align: center;">E8</td> <td style="text-align: center;">E8</td> <td style="text-align: center;">E8</td> </tr> </table> </td> <td style="width: 50%; vertical-align: top;"> <table border="0" style="width: 100%;"> <tr> <td style="width: 50%;"></td> <td style="width: 50%; text-align: center;"> <table border="0"> <tr> <td style="width: 10%;"></td> <td style="width: 10%;"></td> <td style="width: 10%;"></td> <td style="width: 10%;"></td> <td style="width: 10%;"></td> <td style="width: 10%;"></td> <td style="width: 10%;"></td> <td style="width: 10%;"></td> <td style="width: 10%;"></td> <td style="width: 10%;"></td> <td style="width: 10%;"></td> <td style="width: 10%;"></td> <td style="width: 10%;"></td> <td style="width: 10%;"></td> </tr> <tr> <td style="text-align: center;">XA</td> <td style="text-align: center;">1</td> <td style="text-align: center;">2</td> <td style="text-align: center;">3</td> <td style="text-align: center;">4</td> <td style="text-align: center;">R01</td> <td style="text-align: center;">S01</td> <td style="text-align: center;">T01</td> <td style="text-align: center;">N01</td> <td style="text-align: center;">E1</td> <td style="text-align: center;">E1</td> <td style="text-align: center;">E1</td> <td style="text-align: center;">E1</td> <td style="text-align: center;">E1</td> </tr> <tr> <td></td> <td style="text-align: center;">1</td> <td style="text-align: center;">2</td> <td style="text-align: center;">3</td> <td style="text-align: center;">4</td> <td style="text-align: center;">R02</td> <td style="text-align: center;">S02</td> <td style="text-align: center;">T02</td> <td style="text-align: center;">N02</td> <td style="text-align: center;">E2</td> <td style="text-align: center;">E2</td> <td style="text-align: center;">E2</td> <td style="text-align: center;">E2</td> <td style="text-align: center;">E2</td> </tr> <tr> <td></td> <td style="text-align: center;">1</td> <td style="text-align: center;">2</td> <td style="text-align: center;">3</td> <td style="text-align: center;">4</td> <td style="text-align: center;">R03</td> <td style="text-align: center;">S03</td> <td style="text-align: center;">T03</td> <td style="text-align: center;">N03</td> <td style="text-align: center;">E3</td> <td style="text-align: center;">E3</td> <td style="text-align: center;">E3</td> <td style="text-align: center;">E3</td> <td style="text-align: center;">E3</td> </tr> <tr> <td></td> <td style="text-align: center;">1</td> <td style="text-align: center;">2</td> <td style="text-align: center;">3</td> <td style="text-align: center;">4</td> <td style="text-align: center;">R04</td> <td style="text-align: center;">S04</td> <td style="text-align: center;">T04</td> <td style="text-align: center;">N04</td> <td style="text-align: center;">E4</td> <td style="text-align: center;">E4</td> <td style="text-align: center;">E4</td> <td style="text-align: center;">E4</td> <td style="text-align: center;">E4</td> </tr> <tr> <td></td> <td style="text-align: center;">1</td> <td style="text-align: center;">2</td> <td style="text-align: center;">3</td> <td style="text-align: center;">4</td> <td style="text-align: center;">R05</td> <td style="text-align: center;">S05</td> <td style="text-align: center;">T05</td> <td style="text-align: center;">N05</td> <td style="text-align: center;">E5</td> <td style="text-align: center;">E5</td> <td style="text-align: center;">E5</td> <td style="text-align: center;">E5</td> <td style="text-align: center;">E5</td> </tr> <tr> <td></td> <td style="text-align: center;">1</td> <td style="text-align: center;">2</td> <td style="text-align: center;">3</td> <td style="text-align: center;">4</td> <td style="text-align: center;">R06</td> <td style="text-align: center;">S06</td> <td style="text-align: center;">T06</td> <td style="text-align: center;">N06</td> <td style="text-align: center;">E6</td> <td style="text-align: center;">E6</td> <td style="text-align: center;">E6</td> <td style="text-align: center;">E6</td> <td style="text-align: center;">E6</td> </tr> <tr> <td></td> <td style="text-align: center;">1</td> <td style="text-align: center;">2</td> <td style="text-align: center;">3</td> <td style="text-align: center;">4</td> <td style="text-align: center;">R07</td> <td style="text-align: center;">S07</td> <td style="text-align: center;">T07</td> <td style="text-align: center;">N07</td> <td style="text-align: center;">E7</td> <td style="text-align: center;">E7</td> <td style="text-align: center;">E7</td> <td style="text-align: center;">E7</td> <td style="text-align: center;">E7</td> </tr> <tr> <td></td> <td style="text-align: center;">1</td> <td style="text-align: center;">2</td> <td style="text-align: center;">3</td> <td style="text-align: center;">4</td> <td style="text-align: center;">R08</td> <td style="text-align: center;">S08</td> <td style="text-align: center;">T08</td> <td style="text-align: center;">N08</td> <td style="text-align: center;">E8</td> <td style="text-align: center;">E8</td> <td style="text-align: center;">E8</td> <td style="text-align: center;">E8</td> <td style="text-align: center;">E8</td> </tr> </table> </td> <td style="width: 50%; vertical-align: top;"> <table border="0" style="width: 100%;"> <tr> <td style="width: 50%;"></td> <td style="width: 50%; text-align: center;"> <table border="0"> <tr> <td style="width: 10%;"></td> <td style="width: 10%;"></td> <td style="width: 10%;"></td> <td style="width: 10%;"></td> <td style="width: 10%;"></td> <td
style="width: 10%;"></td> <td style="width: 10%;"></td> <td style="width: 10%;"></td> <td style="width: 10%;"></td> <td style="width: 10%;"></td> <td style="width: 10%;"></td> <td style="width: 10%;"></td> <td style="width: 10%;"></td> <td style="width: 10%;"></td> </tr> <tr> <td style="text-align: center;">XA</td> <td style="text-align: center;">1</td> <td style="text-align: center;">2</td> <td style="text-align: center;">3</td> <td style="text-align: center;">4</td> <td style="text-align: center;">R01</td> <td style="text-align: center;">S01</td> <td style="text-align: center;">T01</td> <td style="text-align: center;">N01</td> <td style="text-align: center;">E1</td> <td style="text-align: center;">E1</td> <td style="text-align: center;">E1</td> <td style="text-align: center;">E1</td> <td style="text-align: center;">E1</td> </tr> <tr> <td></td> <td style="text-align: center;">1</td> <td style="text-align: center;">2</td> <td style="text-align: center;">3</td> <td style="text-align: center;">4</td> <td style="text-align: center;">R02</td> <td style="text-align: center;">S02</td> <td style="text-align: center;">T02</td> <td style="text-align: center;">N02</td> <td style="text-align: center;">E2</td> <td style="text-align: center;">E2</td> <td style="text-align: center;">E2</td> <td style="text-align: center;">E2</td> <td style="text-align: center;">E2</td> </tr> <tr> <td></td> <td style="text-align: center;">1</td> <td style="text-align: center;">2</td> <td style="text-align: center;">3</td> <td style="text-align: center;">4</td> <td style="text-align: center;">R03</td> <td style="text-align: center;">S03</td> <td style="text-align: center;">T03</td> <td style="text-align: center;">N03</td> <td style="text-align: center;">E3</td> <td style="text-align: center;">E3</td> <td style="text-align: center;">E3</td> <td style="text-align: center;">E3</td> <td style="text-align: center;">E3</td> </tr> <tr> <td></td> <td style="text-align: center;">1</td> <td style="text-align: center;">2</td> <td style="text-align: center;">3</td> <td style="text-align: center;">4</td> <td style="text-align: center;">R04</td> <td style="text-align: center;">S04</td> <td style="text-align: center;">T04</td> <td style="text-align: center;">N04</td> <td style="text-align: center;">E4</td> <td style="text-align: center;">E4</td> <td style="text-align: center;">E4</td> <td style="text-align: center;">E4</td> <td style="text-align: center;">E4</td> </tr> <tr> <td></td> <td style="text-align: center;">1</td> <td style="text-align: center;">2</td> <td style="text-align: center;">3</td> <td style="text-align: center;">4</td> <td style="text-align: center;">R05</td> <td style="text-align: center;">S05</td> <td style="text-align: center;">T05</td> <td style="text-align: center;">N05</td> <td style="text-align: center;">E5</td> <td style="text-align: center;">E5</td> <td style="text-align: center;">E5</td> <td style="text-align: center;">E5</td> <td style="text-align: center;">E5</td> </tr> <tr> <td></td> <td style="text-align: center;">1</td> <td style="text-align: center;">2</td> <td style="text-align: center;">3</td> <td style="text-align: center;">4</td> <td style="text-align: center;">R06</td> <td style="text-align: center;">S06</td> <td style="text-align: center;">T06</td> <td style="text-align: center;">N06</td> <td style="text-align: center;">E6</td> <td style="text-align: center;">E6</td> <td style="text-align: center;">E6</td> <td style="text-align: center;">E6</td> <td style="text-align: center;">E6</td> </tr> <tr> <td></td> <td style="text-align: center;">1</td> <td style="text-align: center;">2</td> <td style="text-align: center;">3</td> <td style="text-align: center;">4</td> <td style="text-align: center;">R07</td> <td style="text-align: center;">S07</td> <td style="text-align: center;">T07</td> <td style="text-align: center;">N07</td> <td style="text-align: center;">E7</td> <td style="text-align: center;">E7</td> <td style="text-align: center;">E7</td> <td style="text-align: center;">E7</td> <td style="text-align: center;">E7</td> </tr> <tr> <td></td> <td style="text-align: center;">1</td> <td style="text-align: center;">2</td> <td style="text-align: center;">3</td> <td style="text-align: center;">4</td> <td style="text-align: center;">R08</td> <td style="text-align: center;">S08</td> <td style="text-align: center;">T08</td> <td style="text-align: center;">N08</td> <td style="text-align: center;">E8</td> <td style="text-align: center;">E8</td> <td style="text-align: center;">E8</td> <td style="text-align: center;">E8</td> <td style="text-align: center;">E8</td> </tr> </table> </td> <td style="width: 50%; vertical-align: top;"> <table border="0" style="width: 100%;"> <tr> <td style="width: 50%;"></td> <td style="width: 50%; text-align: center;"> <table border="0"> <tr> <td style="width: 10%;"></td> <td style="width: 10%;"></td> <td style="width: 10%;"></td> <td style="width: 10%;"></td> <td style="width: 10%;"></td> <td style="width: 10%;"></td> <td style="width: 10%;"></td> <td style="width: 10%;"></td> <td style="width: 10%;"></td> <td style="width: 10%;"></td> <td style="width: 10%;"></td> <td style="width: 10%;"></td> <td style="width: 10%;"></td> <td style="width: 10%;"></td> </tr> <tr> <td style="text-align: center;">XA</td> <td style="text-align: center;">1</td> <td style="text-align: center;">2</td> <td style="text-align: center;">3</td> <td style="text-align: center;">4</td> <td style="text-align: center;">R01</td> <td style="text-align: center;">S01</td> <td style="text-align: center;">T01</td> <td style="text-align: center;">N01</td> <td style="text-align: center;">E1</td> <td style="text-align: center;">E1</td> <td style="text-align: center;">E1</td> </tr></table></td></tr></table></td></tr></table></td></tr></table></td></tr></table>
 | | <table border="0"> <tr> <td style="width: 10%;"></td> <td style="width: 10%;"></td> <td style="width: 10%;"></td> <td style="width: 10%;"></td> <td style="width: 10%;"></td> <td style="width: 10%;"></td> <td style="width: 10%;"></td> <td style="width: 10%;"></td> <td style="width: 10%;"></td> <td style="width: 10%;"></td> <td style="width: 10%;"></td> <td style="width: 10%;"></td> <td style="width: 10%;"></td> <td style="width: 10%;"></td> </tr> <tr> <td style="text-align: center;">XA</td> <td style="text-align: center;">1</td> <td style="text-align: center;">2</td> <td style="text-align: center;">3</td> <td style="text-align: center;">4</td> <td style="text-align: center;">R01</td> <td style="text-align: center;">S01</td> <td style="text-align: center;">T01</td> <td style="text-align: center;">N01</td> <td style="text-align: center;">E1</td> <td style="text-align: center;">E1</td> <td style="text-align: center;">E1</td> <td style="text-align: center;">E1</td> <td style="text-align: center;">E1</td> </tr> <tr> <td></td> <td style="text-align: center;">1</td> <td style="text-align: center;">2</td> <td style="text-align: center;">3</td> <td style="text-align: center;">4</td> <td style="text-align: center;">R02</td> <td style="text-align: center;">S02</td> <td style="text-align: center;">T02</td> <td style="text-align: center;">N02</td> <td style="text-align: center;">E2</td> <td style="text-align: center;">E2</td> <td style="text-align: center;">E2</td> <td style="text-align: center;">E2</td> <td style="text-align: center;">E2</td> </tr> <tr> <td></td> <td style="text-align: center;">1</td> <td style="text-align: center;">2</td> <td style="text-align: center;">3</td> <td style="text-align: center;">4</td> <td style="text-align: center;">R03</td> <td style="text-align: center;">S03</td> <td style="text-align: center;">T03</td> <td style="text-align: center;">N03</td> <td style="text-align: center;">E3</td> <td style="text-align: center;">E3</td> <td style="text-align: center;">E3</td> <td style="text-align: center;">E3</td> <td style="text-align: center;">E3</td> </tr> <tr> <td></td> <td style="text-align: center;">1</td> <td style="text-align: center;">2</td> <td style="text-align: center;">3</td> <td style="text-align: center;">4</td> <td style="text-align: center;">R04</td> <td style="text-align: center;">S04</td> <td style="text-align: center;">T04</td> <td style="text-align: center;">N04</td> <td style="text-align: center;">E4</td> <td style="text-align: center;">E4</td> <td style="text-align: center;">E4</td> <td style="text-align: center;">E4</td> <td style="text-align: center;">E4</td> </tr> <tr> <td></td> <td style="text-align: center;">1</td> <td style="text-align: center;">2</td> <td style="text-align: center;">3</td> <td style="text-align: center;">4</td> <td style="text-align: center;">R05</td> <td style="text-align: center;">S05</td> <td style="text-align: center;">T05</td> <td style="text-align: center;">N05</td> <td style="text-align: center;">E5</td> <td style="text-align: center;">E5</td> <td style="text-align: center;">E5</td> <td style="text-align: center;">E5</td> <td style="text-align: center;">E5</td> </tr> <tr> <td></td> <td style="text-align: center;">1</td> <td style="text-align: center;">2</td> <td style="text-align: center;">3</td> <td style="text-align: center;">4</td> <td style="text-align: center;">R06</td> <td style="text-align: center;">S06</td> <td style="text-align: center;">T06</td> <td style="text-align: center;">N06</td> <td style="text-align: center;">E6</td> <td style="text-align: center;">E6</td> <td style="text-align: center;">E6</td> <td style="text-align: center;">E6</td> <td style="text-align: center;">E6</td> </tr> <tr> <td></td> <td style="text-align: center;">1</td> <td style="text-align: center;">2</td> <td style="text-align: center;">3</td> <td style="text-align: center;">4</td> <td style="text-align: center;">R07</td> <td style="text-align: center;">S07</td> <td style="text-align: center;">T07</td> <td style="text-align: center;">N07</td> <td style="text-align: center;">E7</td> <td style="text-align: center;">E7</td> <td style="text-align: center;">E7</td> <td style="text-align: center;">E7</td> <td style="text-align: center;">E7</td> </tr> <tr> <td></td> <td style="text-align: center;">1</td> <td style="text-align: center;">2</td> <td style="text-align: center;">3</td> <td style="text-align: center;">4</td> <td style="text-align: center;">R08</td> <td style="text-align: center;">S08</td> <td style="text-align: center;">T08</td> <td style="text-align: center;">N08</td> <td style="text-align: center;">E8</td> <td style="text-align: center;">E8</td> <td style="text-align: center;">E8</td> <td style="text-align: center;">E8</td> <td style="text-align: center;">E8</td> </tr> </table> | | | | | | | | | | | |

 |

 |
 | XA | 1 | 2 | 3 | 4 | R01 | S01 | T01 | N01 | E1 | E1 | E1 | E1

 | E1 | | 1 | 2 | 3 | 4 | R02 | S02 | T02 | N02 | E2 | E2 | E2 | E2 | E2 | | 1 | 2 | 3 | 4 | R03 | S03 | T03 | N03 | E3 | E3 | E3 | E3

 | E3 | | 1 | 2 | 3 | 4 | R04 | S04 | T04 | N04 | E4 | E4 | E4 | E4 | E4 | | 1 | 2 | 3 | 4 | R05 | S05 | T05 | N05 | E5 | E5 | E5 | E5 | E5 | | 1 | 2 | 3 | 4 | R06 | S06 | T06 | N06 | E6 | E6 | E6 | E6 | E6 | | 1 | 2 | 3 | 4 | R07 | S07 | T07 | N07 | E7 | E7 | E7 | E7 | E7 | | 1 | 2 | 3 | 4
 R08 | S08 | T08 | N08 | E8 | E8 | E8 | E8 | E8 | <table border="0" style="width: 100%;"> <tr> <td style="width: 50%;"></td> <td style="width: 50%; text-align: center;"> <table border="0"> <tr> <td style="width: 10%;"></td> <td style="width: 10%;"></td> <td style="width: 10%;"></td> <td style="width: 10%;"></td> <td style="width: 10%;"></td> <td style="width: 10%;"></td> <td style="width: 10%;"></td> <td style="width: 10%;"></td> <td style="width: 10%;"></td> <td style="width: 10%;"></td> <td style="width: 10%;"></td> <td style="width: 10%;"></td> <td style="width: 10%;"></td> <td style="width: 10%;"></td> </tr> <tr> <td style="text-align: center;">XA</td> <td style="text-align: center;">1</td> <td style="text-align: center;">2</td> <td style="text-align: center;">3</td> <td style="text-align: center;">4</td> <td style="text-align: center;">R01</td> <td style="text-align: center;">S01</td> <td style="text-align: center;">T01</td> <td style="text-align: center;">N01</td> <td style="text-align: center;">E1</td> <td style="text-align: center;">E1</td> <td style="text-align: center;">E1</td> <td style="text-align: center;">E1</td> <td style="text-align: center;">E1</td> </tr> <tr> <td></td> <td style="text-align: center;">1</td> <td style="text-align: center;">2</td> <td style="text-align: center;">3</td> <td style="text-align: center;">4</td> <td style="text-align: center;">R02</td> <td style="text-align: center;">S02</td> <td style="text-align: center;">T02</td> <td style="text-align: center;">N02</td> <td style="text-align: center;">E2</td> <td style="text-align: center;">E2</td> <td style="text-align: center;">E2</td> <td style="text-align: center;">E2</td> <td style="text-align: center;">E2</td> </tr> <tr> <td></td> <td style="text-align: center;">1</td> <td style="text-align: center;">2</td> <td style="text-align: center;">3</td> <td style="text-align: center;">4</td> <td style="text-align: center;">R03</td> <td style="text-align: center;">S03</td> <td style="text-align: center;">T03</td> <td style="text-align: center;">N03</td> <td style="text-align: center;">E3</td> <td style="text-align: center;">E3</td> <td style="text-align: center;">E3</td> <td style="text-align: center;">E3</td> <td style="text-align: center;">E3</td> </tr> <tr> <td></td> <td style="text-align: center;">1</td> <td style="text-align: center;">2</td> <td style="text-align: center;">3</td> <td style="text-align: center;">4</td> <td style="text-align: center;">R04</td> <td style="text-align: center;">S04</td> <td style="text-align: center;">T04</td> <td style="text-align: center;">N04</td> <td style="text-align: center;">E4</td> <td style="text-align: center;">E4</td> <td style="text-align: center;">E4</td> <td style="text-align: center;">E4</td> <td style="text-align: center;">E4</td> </tr> <tr> <td></td> <td style="text-align: center;">1</td> <td style="text-align: center;">2</td> <td style="text-align: center;">3</td> <td style="text-align: center;">4</td> <td style="text-align: center;">R05</td> <td style="text-align: center;">S05</td> <td style="text-align: center;">T05</td> <td style="text-align: center;">N05</td> <td style="text-align: center;">E5</td> <td style="text-align: center;">E5</td> <td style="text-align: center;">E5</td> <td style="text-align: center;">E5</td> <td style="text-align: center;">E5</td> </tr> <tr> <td></td> <td style="text-align: center;">1</td> <td style="text-align: center;">2</td> <td style="text-align: center;">3</td> <td style="text-align: center;">4</td> <td style="text-align: center;">R06</td> <td style="text-align: center;">S06</td> <td style="text-align: center;">T06</td> <td style="text-align: center;">N06</td> <td style="text-align: center;">E6</td> <td style="text-align: center;">E6</td> <td style="text-align: center;">E6</td> <td style="text-align: center;">E6</td> <td style="text-align: center;">E6</td> </tr> <tr> <td></td> <td style="text-align: center;">1</td> <td style="text-align: center;">2</td> <td style="text-align: center;">3</td> <td style="text-align: center;">4</td> <td style="text-align: center;">R07</td> <td style="text-align: center;">S07</td> <td style="text-align: center;">T07</td> <td style="text-align: center;">N07</td> <td style="text-align: center;">E7</td> <td style="text-align: center;">E7</td> <td style="text-align: center;">E7</td> <td style="text-align: center;">E7</td> <td style="text-align: center;">E7</td> </tr> <tr> <td></td> <td style="text-align: center;">1</td> <td style="text-align: center;">2</td> <td style="text-align: center;">3</td> <td style="text-align: center;">4</td> <td style="text-align: center;">R08</td> <td style="text-align: center;">S08</td> <td style="text-align: center;">T08</td> <td style="text-align: center;">N08</td> <td style="text-align: center;">E8</td> <td style="text-align: center;">E8</td> <td style="text-align: center;">E8</td> <td style="text-align: center;">E8</td> <td style="text-align: center;">E8</td> </tr> </table> </td> <td style="width: 50%; vertical-align: top;"> <table border="0" style="width: 100%;"> <tr> <td style="width: 50%;"></td> <td style="width: 50%; text-align: center;"> <table border="0"> <tr> <td style="width: 10%;"></td> <td style="width: 10%;"></td> <td style="width: 10%;"></td> <td style="width: 10%;"></td> <td style="width: 10%;"></td> <td style="width: 10%;"></td> <td style="width: 10%;"></td> <td style="width: 10%;"></td> <td style="width: 10%;"></td> <td style="width: 10%;"></td> <td style="width: 10%;"></td> <td style="width: 10%;"></td> <td style="width: 10%;"></td> <td style="width: 10%;"></td> </tr> <tr> <td style="text-align: center;">XA</td> <td style="text-align: center;">1</td> <td style="text-align: center;">2</td> <td style="text-align: center;">3</td> <td style="text-align: center;">4</td> <td style="text-align: center;">R01</td> <td style="text-align: center;">S01</td> <td style="text-align: center;">T01</td> <td style="text-align: center;">N01</td> <td style="text-align: center;">E1</td> <td style="text-align: center;">E1</td> <td style="text-align: center;">E1</td> <td style="text-align: center;">E1</td> <td style="text-align: center;">E1</td> </tr> <tr> <td></td> <td style="text-align: center;">1</td> <td style="text-align: center;">2</td> <td style="text-align: center;">3</td> <td style="text-align: center;">4</td> <td style="text-align: center;">R02</td> <td style="text-align: center;">S02</td> <td style="text-align: center;">T02</td> <td style="text-align: center;">N02</td> <td style="text-align: center;">E2</td> <td style="text-align: center;">E2</td> <td style="text-align: center;">E2</td> <td style="text-align: center;">E2</td> <td style="text-align: center;">E2</td> </tr> <tr> <td></td> <td style="text-align: center;">1</td> <td style="text-align: center;">2</td> <td style="text-align: center;">3</td> <td style="text-align: center;">4</td> <td style="text-align: center;">R03</td> <td style="text-align: center;">S03</td> <td style="text-align: center;">T03</td> <td style="text-align: center;">N03</td> <td style="text-align: center;">E3</td> <td style="text-align: center;">E3</td> <td style="text-align: center;">E3</td> <td style="text-align: center;">E3</td> <td style="text-align: center;">E3</td> </tr> <tr> <td></td> <td style="text-align: center;">1</td> <td style="text-align: center;">2</td> <td style="text-align: center;">3</td> <td style="text-align: center;">4</td> <td style="text-align: center;">R04</td> <td style="text-align: center;">S04</td> <td style="text-align: center;">T04</td> <td style="text-align: center;">N04</td> <td style="text-align: center;">E4</td> <td style="text-align: center;">E4</td> <td style="text-align: center;">E4</td> <td style="text-align: center;">E4</td> <td style="text-align: center;">E4</td> </tr> <tr> <td></td> <td style="text-align: center;">1</td> <td style="text-align: center;">2</td> <td style="text-align: center;">3</td> <td style="text-align: center;">4</td> <td style="text-align: center;">R05</td> <td style="text-align: center;">S05</td> <td style="text-align: center;">T05</td> <td style="text-align: center;">N05</td> <td style="text-align: center;">E5</td> <td style="text-align: center;">E5</td> <td style="text-align: center;">E5</td> <td style="text-align: center;">E5</td> <td style="text-align: center;">E5</td> </tr> <tr> <td></td> <td style="text-align: center;">1</td> <td style="text-align: center;">2</td> <td style="text-align: center;">3</td> <td style="text-align: center;">4</td> <td style="text-align: center;">R06</td> <td style="text-align: center;">S06</td> <td style="text-align: center;">T06</td> <td style="text-align: center;">N06</td> <td style="text-align: center;">E6</td> <td style="text-align: center;">E6</td> <td style="text-align: center;">E6</td> <td style="text-align: center;">E6</td> <td style="text-align: center;">E6</td> </tr> <tr> <td></td> <td style="text-align: center;">1</td> <td style="text-align: center;">2</td> <td style="text-align: center;">3</td> <td style="text-align: center;">4</td> <td style="text-align: center;">R07</td> <td style="text-align: center;">S07</td> <td style="text-align: center;">T07</td> <td style="text-align: center;">N07</td> <td style="text-align: center;">E7</td> <td style="text-align: center;">E7</td> <td style="text-align: center;">E7</td> <td style="text-align: center;">E7</td> <td style="text-align: center;">E7</td> </tr> <tr> <td></td> <td style="text-align: center;">1</td> <td style="text-align: center;">2</td> <td style="text-align: center;">3</td> <td style="text-align: center;">4</td> <td style="text-align: center;">R08</td> <td style="text-align: center;">S08</td> <td style="text-align: center;">T08</td> <td style="text-align: center;">N08</td> <td style="text-align: center;">E8</td> <td style="text-align: center;">E8</td> <td style="text-align: center;">E8</td> <td style="text-align: center;">E8</td> <td style="text-align: center;">E8</td> </tr> </table> </td> <td
style="width: 50%; vertical-align: top;"> <table border="0" style="width: 100%;"> <tr> <td style="width: 50%;"></td> <td style="width: 50%; text-align: center;"> <table border="0"> <tr> <td style="width: 10%;"></td> <td style="width: 10%;"></td> <td style="width: 10%;"></td> <td style="width: 10%;"></td> <td style="width: 10%;"></td> <td style="width: 10%;"></td> <td style="width: 10%;"></td> <td style="width: 10%;"></td> <td style="width: 10%;"></td> <td style="width: 10%;"></td> <td style="width: 10%;"></td> <td style="width: 10%;"></td> <td style="width: 10%;"></td> <td style="width: 10%;"></td> </tr> <tr> <td style="text-align: center;">XA</td> <td style="text-align: center;">1</td> <td style="text-align: center;">2</td> <td style="text-align: center;">3</td> <td style="text-align: center;">4</td> <td style="text-align: center;">R01</td> <td style="text-align: center;">S01</td> <td style="text-align: center;">T01</td> <td style="text-align: center;">N01</td> <td style="text-align: center;">E1</td> <td style="text-align: center;">E1</td> <td style="text-align: center;">E1</td> </tr></table></td></tr></table></td></tr></table></td></tr></table> | | <table border="0"> <tr> <td style="width: 10%;"></td> <td style="width: 10%;"></td> <td style="width: 10%;"></td> <td style="width: 10%;"></td> <td style="width: 10%;"></td> <td style="width: 10%;"></td> <td style="width: 10%;"></td> <td style="width: 10%;"></td> <td style="width: 10%;"></td> <td style="width: 10%;"></td> <td style="width: 10%;"></td> <td style="width: 10%;"></td> <td style="width: 10%;"></td> <td style="width: 10%;"></td> </tr> <tr> <td style="text-align: center;">XA</td> <td style="text-align: center;">1</td> <td style="text-align: center;">2</td> <td style="text-align: center;">3</td> <td style="text-align: center;">4</td> <td style="text-align: center;">R01</td> <td style="text-align: center;">S01</td> <td style="text-align: center;">T01</td> <td style="text-align: center;">N01</td> <td style="text-align: center;">E1</td> <td style="text-align: center;">E1</td> <td style="text-align: center;">E1</td> <td style="text-align: center;">E1</td> <td style="text-align: center;">E1</td> </tr> <tr> <td></td> <td style="text-align: center;">1</td> <td style="text-align: center;">2</td> <td style="text-align: center;">3</td> <td style="text-align: center;">4</td> <td style="text-align: center;">R02</td> <td style="text-align: center;">S02</td> <td style="text-align: center;">T02</td> <td style="text-align: center;">N02</td> <td style="text-align: center;">E2</td> <td style="text-align: center;">E2</td> <td style="text-align: center;">E2</td> <td style="text-align: center;">E2</td> <td style="text-align: center;">E2</td> </tr> <tr> <td></td> <td style="text-align: center;">1</td> <td style="text-align: center;">2</td> <td style="text-align: center;">3</td> <td style="text-align: center;">4</td> <td style="text-align: center;">R03</td> <td style="text-align: center;">S03</td> <td style="text-align: center;">T03</td> <td style="text-align: center;">N03</td> <td style="text-align: center;">E3</td> <td style="text-align: center;">E3</td> <td style="text-align: center;">E3</td> <td style="text-align: center;">E3</td> <td style="text-align: center;">E3</td> </tr> <tr> <td></td> <td style="text-align: center;">1</td> <td style="text-align: center;">2</td> <td style="text-align: center;">3</td> <td style="text-align: center;">4</td> <td style="text-align: center;">R04</td> <td style="text-align: center;">S04</td> <td style="text-align: center;">T04</td> <td style="text-align: center;">N04</td> <td style="text-align: center;">E4</td> <td style="text-align: center;">E4</td> <td style="text-align: center;">E4</td> <td style="text-align: center;">E4</td> <td style="text-align: center;">E4</td> </tr> <tr> <td></td> <td style="text-align: center;">1</td> <td style="text-align: center;">2</td> <td style="text-align: center;">3</td> <td style="text-align: center;">4</td> <td style="text-align: center;">R05</td> <td style="text-align: center;">S05</td> <td style="text-align: center;">T05</td> <td style="text-align: center;">N05</td> <td style="text-align: center;">E5</td> <td style="text-align: center;">E5</td> <td style="text-align: center;">E5</td> <td style="text-align: center;">E5</td> <td style="text-align: center;">E5</td> </tr> <tr> <td></td> <td style="text-align: center;">1</td> <td style="text-align: center;">2</td> <td style="text-align: center;">3</td> <td style="text-align: center;">4</td> <td style="text-align: center;">R06</td> <td style="text-align: center;">S06</td> <td style="text-align: center;">T06</td> <td style="text-align: center;">N06</td> <td style="text-align: center;">E6</td> <td style="text-align: center;">E6</td> <td style="text-align: center;">E6</td> <td style="text-align: center;">E6</td> <td style="text-align: center;">E6</td> </tr> <tr> <td></td> <td style="text-align: center;">1</td> <td style="text-align: center;">2</td>
<td style="text-align: center;">3</td> <td style="text-align: center;">4</td> <td style="text-align: center;">R07</td> <td style="text-align: center;">S07</td> <td style="text-align: center;">T07</td> <td style="text-align: center;">N07</td> <td style="text-align: center;">E7</td> <td style="text-align: center;">E7</td> <td style="text-align: center;">E7</td> <td style="text-align: center;">E7</td> <td style="text-align: center;">E7</td> </tr> <tr> <td></td> <td style="text-align: center;">1</td> <td style="text-align: center;">2</td> <td style="text-align: center;">3</td> <td style="text-align: center;">4</td> <td style="text-align: center;">R08</td> <td style="text-align: center;">S08</td> <td style="text-align: center;">T08</td> <td style="text-align: center;">N08</td> <td style="text-align: center;">E8</td> <td style="text-align: center;">E8</td> <td style="text-align: center;">E8</td> <td style="text-align: center;">E8</td> <td style="text-align: center;">E8</td> </tr> </table> | | | | | | | | | | | |

 |

 | | XA
 | 1 | 2 | 3 | 4 | R01 | S01 | T01 | N01 | E1 | E1 | E1 | E1

 | E1 | | 1 | 2 | 3 | 4 | R02 | S02 | T02 | N02 | E2 | E2 | E2 | E2 | E2 | | 1 | 2 | 3 | 4 | R03 | S03 | T03 | N03 | E3 | E3 | E3 | E3

 | E3 | | 1 | 2 | 3 | 4 | R04 | S04 | T04 | N04 | E4 | E4 | E4 | E4 | E4 | | 1 | 2 | 3 | 4 | R05 | S05 | T05 | N05 | E5 | E5 | E5 | E5 | E5 | | 1 | 2 | 3 | 4 | R06 | S06 | T06 | N06 | E6 | E6 | E6 | E6 | E6 | | 1 | 2 | 3 | 4 | R07 | S07 | T07 | N07 | E7 | E7 | E7 | E7 | E7 | | 1 | 2 | 3 | 4 | R08 | S08 | T08 | N08 | E8 | E8 | E8 | E8 | E8 | <table border="0" style="width: 100%;"> <tr> <td style="width: 50%;"></td> <td style="width: 50%; text-align: center;"> <table border="0"> <tr> <td style="width: 10%;"></td> <td style="width: 10%;"></td> <td style="width: 10%;"></td> <td style="width: 10%;"></td> <td style="width: 10%;"></td> <td style="width: 10%;"></td> <td style="width: 10%;"></td> <td style="width: 10%;"></td> <td style="width: 10%;"></td> <td style="width: 10%;"></td> <td style="width: 10%;"></td> <td style="width: 10%;"></td> <td style="width: 10%;"></td> <td style="width: 10%;"></td> </tr> <tr> <td style="text-align: center;">XA</td> <td style="text-align: center;">1</td> <td style="text-align: center;">2</td> <td style="text-align: center;">3</td> <td style="text-align: center;">4</td> <td style="text-align: center;">R01</td> <td style="text-align: center;">S01</td> <td style="text-align: center;">T01</td> <td style="text-align: center;">N01</td> <td style="text-align: center;">E1</td> <td style="text-align: center;">E1</td> <td style="text-align: center;">E1</td> <td style="text-align: center;">E1</td> <td style="text-align: center;">E1</td> </tr> <tr> <td></td> <td style="text-align: center;">1</td> <td style="text-align: center;">2</td> <td style="text-align: center;">3</td> <td style="text-align: center;">4</td> <td style="text-align: center;">R02</td> <td style="text-align: center;">S02</td> <td style="text-align: center;">T02</td> <td style="text-align: center;">N02</td> <td style="text-align: center;">E2</td> <td style="text-align: center;">E2</td> <td style="text-align: center;">E2</td> <td style="text-align: center;">E2</td> <td style="text-align: center;">E2</td> </tr> <tr> <td></td> <td style="text-align: center;">1</td> <td style="text-align: center;">2</td> <td style="text-align: center;">3</td> <td style="text-align: center;">4</td> <td style="text-align: center;">R03</td> <td style="text-align: center;">S03</td> <td style="text-align: center;">T03</td> <td style="text-align: center;">N03</td> <td style="text-align: center;">E3</td> <td style="text-align: center;">E3</td> <td style="text-align: center;">E3</td> <td style="text-align: center;">E3</td> <td style="text-align: center;">E3</td> </tr> <tr> <td></td> <td style="text-align: center;">1</td> <td style="text-align: center;">2</td> <td style="text-align: center;">3</td> <td style="text-align: center;">4</td> <td style="text-align: center;">R04</td> <td style="text-align: center;">S04</td> <td style="text-align: center;">T04</td> <td style="text-align: center;">N04</td> <td style="text-align: center;">E4</td> <td style="text-align: center;">E4</td> <td style="text-align: center;">E4</td> <td style="text-align: center;">E4</td> <td style="text-align: center;">E4</td> </tr> <tr> <td></td> <td style="text-align: center;">1</td> <td style="text-align: center;">2</td> <td style="text-align: center;">3</td> <td style="text-align: center;">4</td> <td style="text-align: center;">R05</td> <td style="text-align: center;">S05</td> <td style="text-align: center;">T05</td> <td style="text-align: center;">N05</td> <td style="text-align: center;">E5</td> <td style="text-align: center;">E5</td> <td style="text-align: center;">E5</td> <td style="text-align: center;">E5</td> <td style="text-align: center;">E5</td> </tr> <tr> <td></td> <td style="text-align: center;">1</td> <td style="text-align: center;">2</td> <td style="text-align: center;">3</td> <td style="text-align: center;">4</td> <td style="text-align: center;">R06</td> <td style="text-align: center;">S06</td> <td style="text-align: center;">T06</td> <td style="text-align: center;">N06</td> <td style="text-align: center;">E6</td> <td style="text-align: center;">E6</td> <td style="text-align: center;">E6</td> <td style="text-align: center;">E6</td> <td style="text-align: center;">E6</td> </tr> <tr> <td></td> <td style="text-align: center;">1</td> <td style="text-align: center;">2</td> <td style="text-align: center;">3</td> <td style="text-align: center;">4</td> <td style="text-align: center;">R07</td> <td style="text-align: center;">S07</td> <td style="text-align: center;">T07</td> <td style="text-align: center;">N07</td> <td style="text-align: center;">E7</td> <td style="text-align: center;">E7</td> <td style="text-align: center;">E7</td> <td style="text-align: center;">E7</td> <td style="text-align: center;">E7</td> </tr> <tr> <td></td> <td style="text-align: center;">1</td> <td style="text-align: center;">2</td> <td style="text-align: center;">3</td> <td style="text-align: center;">4</td> <td style="text-align: center;">R08</td> <td style="text-align: center;">S08</td>
<td style="text-align: center;">T08</td> <td style="text-align: center;">N08</td> <td style="text-align: center;">E8</td> <td style="text-align: center;">E8</td> <td style="text-align: center;">E8</td> <td style="text-align: center;">E8</td> <td style="text-align: center;">E8</td> </tr> </table> </td> <td style="width: 50%; vertical-align: top;"> <table border="0" style="width: 100%;"> <tr> <td style="width: 50%;"></td> <td style="width: 50%; text-align: center;"> <table border="0"> <tr> <td style="width: 10%;"></td> <td style="width: 10%;"></td> <td style="width: 10%;"></td> <td style="width: 10%;"></td> <td style="width: 10%;"></td> <td style="width: 10%;"></td> <td style="width: 10%;"></td> <td style="width: 10%;"></td> <td style="width: 10%;"></td> <td style="width: 10%;"></td> <td style="width: 10%;"></td> <td style="width: 10%;"></td> <td style="width: 10%;"></td> <td style="width: 10%;"></td> </tr> <tr> <td style="text-align: center;">XA</td> <td style="text-align: center;">1</td> <td style="text-align: center;">2</td> <td style="text-align: center;">3</td> <td style="text-align: center;">4</td> <td style="text-align: center;">R01</td> <td style="text-align: center;">S01</td> <td style="text-align: center;">T01</td> <td style="text-align: center;">N01</td> <td style="text-align: center;">E1</td> <td style="text-align: center;">E1</td> <td style="text-align: center;">E1</td> </tr></table></td></tr></table></td></tr></table> | | <table border="0"> <tr> <td style="width: 10%;"></td> <td style="width: 10%;"></td> <td style="width: 10%;"></td> <td style="width: 10%;"></td> <td style="width: 10%;"></td> <td style="width: 10%;"></td> <td style="width: 10%;"></td> <td style="width: 10%;"></td> <td style="width: 10%;"></td> <td style="width: 10%;"></td> <td style="width: 10%;"></td> <td style="width: 10%;"></td> <td style="width: 10%;"></td> <td style="width: 10%;"></td> </tr> <tr> <td style="text-align: center;">XA</td> <td style="text-align: center;">1</td> <td style="text-align: center;">2</td> <td style="text-align: center;">3</td> <td style="text-align: center;">4</td> <td style="text-align: center;">R01</td> <td style="text-align: center;">S01</td> <td style="text-align: center;">T01</td> <td style="text-align: center;">N01</td> <td style="text-align: center;">E1</td> <td style="text-align: center;">E1</td> <td style="text-align: center;">E1</td> <td style="text-align: center;">E1</td> <td style="text-align: center;">E1</td> </tr> <tr> <td></td> <td style="text-align: center;">1</td> <td style="text-align: center;">2</td> <td style="text-align: center;">3</td> <td style="text-align: center;">4</td> <td style="text-align: center;">R02</td> <td style="text-align: center;">S02</td> <td style="text-align: center;">T02</td> <td style="text-align: center;">N02</td> <td style="text-align: center;">E2</td> <td style="text-align: center;">E2</td> <td style="text-align: center;">E2</td> <td style="text-align: center;">E2</td> <td style="text-align: center;">E2</td> </tr> <tr> <td></td> <td style="text-align: center;">1</td> <td style="text-align: center;">2</td> <td style="text-align: center;">3</td> <td style="text-align: center;">4</td> <td style="text-align: center;">R03</td> <td style="text-align: center;">S03</td> <td style="text-align: center;">T03</td> <td style="text-align: center;">N03</td> <td style="text-align: center;">E3</td> <td style="text-align: center;">E3</td> <td style="text-align: center;">E3</td> <td style="text-align: center;">E3</td> <td style="text-align: center;">E3</td> </tr> <tr> <td></td> <td style="text-align: center;">1</td> <td style="text-align: center;">2</td> <td style="text-align: center;">3</td> <td style="text-align: center;">4</td> <td style="text-align: center;">R04</td> <td style="text-align: center;">S04</td> <td style="text-align: center;">T04</td> <td style="text-align: center;">N04</td> <td style="text-align: center;">E4</td> <td style="text-align: center;">E4</td> <td style="text-align: center;">E4</td> <td style="text-align: center;">E4</td> <td style="text-align: center;">E4</td> </tr> <tr> <td></td> <td style="text-align: center;">1</td> <td style="text-align: center;">2</td> <td style="text-align: center;">3</td> <td style="text-align: center;">4</td> <td style="text-align: center;">R05</td> <td style="text-align: center;">S05</td> <td style="text-align: center;">T05</td> <td style="text-align: center;">N05</td> <td style="text-align: center;">E5</td> <td style="text-align: center;">E5</td> <td style="text-align: center;">E5</td> <td style="text-align: center;">E5</td> <td style="text-align: center;">E5</td> </tr> <tr> <td></td> <td style="text-align: center;">1</td> <td style="text-align: center;">2</td> <td style="text-align: center;">3</td> <td style="text-align: center;">4</td> <td style="text-align: center;">R06</td> <td style="text-align: center;">S06</td> <td style="text-align: center;">T06</td> <td style="text-align: center;">N06</td> <td
style="text-align: center;">E6</td> <td style="text-align: center;">E6</td> <td style="text-align: center;">E6</td> <td style="text-align: center;">E6</td> <td style="text-align: center;">E6</td> </tr> <tr> <td></td> <td style="text-align: center;">1</td> <td style="text-align: center;">2</td> <td style="text-align: center;">3</td> <td style="text-align: center;">4</td> <td style="text-align: center;">R07</td> <td style="text-align: center;">S07</td> <td style="text-align: center;">T07</td> <td style="text-align: center;">N07</td> <td style="text-align: center;">E7</td> <td style="text-align: center;">E7</td> <td style="text-align: center;">E7</td> <td style="text-align: center;">E7</td> <td style="text-align: center;">E7</td> </tr> <tr> <td></td> <td style="text-align: center;">1</td> <td style="text-align: center;">2</td> <td style="text-align: center;">3</td> <td style="text-align: center;">4</td> <td style="text-align: center;">R08</td> <td style="text-align: center;">S08</td> <td style="text-align: center;">T08</td> <td style="text-align: center;">N08</td> <td style="text-align: center;">E8</td> <td style="text-align: center;">E8</td> <td style="text-align: center;">E8</td> <td style="text-align: center;">E8</td> <td style="text-align: center;">E8</td> </tr> </table> | | | | | | | | | | | |
 |

 | | XA
 | 1 | 2 | 3 | 4 | R01 | S01 | T01 | N01 | E1 | E1 | E1 | E1
 | E1 |
 | 1 | 2 | 3 | 4 | R02 | S02 | T02 | N02 | E2 | E2 | E2 | E2 | E2 | | 1 | 2 | 3 | 4 | R03 | S03 | T03 | N03 | E3 | E3 | E3 | E3

 | E3 | | 1 | 2 | 3 | 4 | R04 | S04 | T04 | N04 | E4 | E4 | E4 | E4 | E4 | | 1 | 2 | 3 | 4 | R05 | S05 | T05 | N05 | E5 | E5 | E5 | E5 | E5 | | 1 | 2 | 3 | 4 | R06 | S06 | T06 | N06 | E6 | E6 | E6 | E6 | E6 | | 1 | 2 | 3 | 4 | R07 | S07 | T07 | N07 | E7 | E7 | E7 | E7 | E7 | | 1 | 2 | 3 | 4 | R08 | S08 | T08 | N08 | E8 | E8 | E8 | E8 | E8 | <table border="0" style="width: 100%;"> <tr> <td style="width: 50%;"></td> <td style="width: 50%; text-align: center;"> <table border="0"> <tr> <td style="width: 10%;"></td> <td style="width: 10%;"></td> <td style="width: 10%;"></td> <td style="width: 10%;"></td> <td style="width: 10%;"></td> <td style="width: 10%;"></td> <td style="width: 10%;"></td> <td style="width: 10%;"></td> <td style="width: 10%;"></td> <td style="width: 10%;"></td> <td style="width: 10%;"></td> <td style="width: 10%;"></td> <td style="width: 10%;"></td> <td style="width: 10%;"></td> </tr> <tr> <td style="text-align: center;">XA</td> <td style="text-align: center;">1</td> <td style="text-align: center;">2</td> <td style="text-align: center;">3</td> <td style="text-align: center;">4</td> <td style="text-align: center;">R01</td> <td style="text-align: center;">S01</td> <td style="text-align: center;">T01</td> <td style="text-align: center;">N01</td> <td style="text-align: center;">E1</td> <td style="text-align: center;">E1</td> <td style="text-align: center;">E1</td> </tr></table></td></tr></table>
 | | <table border="0"> <tr> <td style="width: 10%;"></td> <td style="width: 10%;"></td> <td style="width: 10%;"></td> <td style="width: 10%;"></td> <td style="width: 10%;"></td> <td style="width: 10%;"></td> <td style="width: 10%;"></td> <td style="width: 10%;"></td> <td style="width: 10%;"></td> <td style="width: 10%;"></td> <td style="width: 10%;"></td> <td style="width: 10%;"></td> <td style="width: 10%;"></td> <td style="width: 10%;"></td> </tr> <tr> <td style="text-align: center;">XA</td> <td style="text-align: center;">1</td> <td style="text-align: center;">2</td> <td style="text-align: center;">3</td> <td style="text-align: center;">4</td> <td style="text-align: center;">R01</td> <td style="text-align: center;">S01</td> <td style="text-align: center;">T01</td> <td style="text-align: center;">N01</td> <td style="text-align: center;">E1</td> <td style="text-align: center;">E1</td> <td style="text-align: center;">E1</td> </tr></table> | | | | | | | | | | | |
 |
 |
 | XA | 1 | 2 | 3 | 4 | R01 | S01 | T01 | N01 | E1 | E1 | E1 |
 | |
 | | | | | | | | | | | | | | | | | | | | | | | | | |
 | |
 | | | | | | | | | | | | | | | | | | | | | | | | | | | | | | | | | | | | | | | | | | | | | | | | | | | | | | | | | | | | | | | | | | | | | | | | | | | | | | | | | | | | |
 | |
 | | | | | | | | | | | | | | | | | | | | | | | | | | | | | | | | | | | | | | | | | | | | | | | | | | | | | | | | | | | | | | | | | | | | | | | | | | | | | | | | | | | | | | | |
 | | | | | | | | | | | | | | | | | | | | | | | | | | | |
 | | | | | | | | | | | | | | | | | | | | | | | | | | | | | | | | | | | | | | | | | | | | | | | | | | | | | | | | | | | | | | | | | | | | | | | | | | | | | | | | | | | | | | | |
 | | | | | | | | | | | | | | | | | | | | | | | | | | | | | | | | | | | | | | | | | | | | | | | | | | | | | | | | | | | | | | | | | | | | | |
|

 | |
 | | | | | | | | | | | |

 | |
 | | | | | | | | | | | |

 | | | | | | | | | | | | | |

 | | | | | | | | | | | | | | | | | | | | | | | | | | | | | | | | | | | | | | | | | | | | | | | | | | | | | | | | | | | | | | | | | | | | | | | | | | | | | | | | | | | | | |

 | | | | | | | | | | | | | |

 |

 |
 | | | | | | | | | | | | |

 | | | | | | | | | | | | | | | | | | | | | | | | | | | |

 | | | | | | | | | | | | | | | | | | | | | | | | | | | | | | | | | | | | | | | | | | | | | | | | | | | | | | | | | | | | | | | |
| | | | | | | |
 | |
 | | | | | | | | | | | |

 |

 | |
 | | | | | | | | | | | |

 | | | | | | | | | | | | | | | | | | | | | | | | | | | |

 | | | | | | | | | | | | | | | | | | | | | | | | | | | | | | | | | | | | | | | | | | | | | | | | | | | | | | | | | | | | | | | | | | | | | | | |
 | |
 | | | | | | | | | | | |
 |

 | |
 | | | | | | | | | | | |
 | |
 | | | | | | | | | | | | | | | | | | | | | | | | | |

 | | | | | | | | | | | | | | | | | | | | | | | | | | | | | | | | | | | | | | | | | | | | | | | | | | | | | | | | | | | | | | | | | | | | | | | |
 | | | | | | | | | | | | | |
 |
 |
 | | | | | | | | | | | | |
 | |
 | | | | | | | | | | | | | | | | | | | | | | | | | |
 | |
 | | | | | | | | | | | | | | | | | | | | | | | | | | | | | | | | | | | | | | | | | | | | | | | | | | | | | | | | | | | | | | | | | | | | | | | | | | | | | | | | | | | | |
 | |
 | | | | | | | | | | | | | | | | | | | | | | | | | | | | | | | | | | | | | | | | | | | | | | | | | | | | | | | | | | | | | | | | | | | | | | | | | | | | | | | | | | | | | | | |
 | | | | | | | | | | | | | | | | | | | | | | | | | | | |
 | | | | | | | | | | | | | | | | | | | | | | | | | | | | | | | | | | | | | | | | | | | | | | | | | | | | | | | | | | | | | | | | | | | | | | | | | | | | | | | | | | | | | | | |
 | | | | | | | | | | | | | | | | | | | | | | | | | | | | | | | | | | | | | | | | | | | | | | | | | | | | | | | | | | | | | | | | | | | | | |
| XA

 | 1 | 2
 | 3 | 4 | R01 | S01 | T01 | N01 | E1 | E1 | E1 | E1 | E1 |

 | |
 | | | | | | | | | | | |

 | | | | | | | | | | | | | |

 | | | | | | | | | | | | | | | | | | | | | | | | | | | | | | | | | | | | | | | | | | | | | | | | | | | | | | | | | | | | | | | | | | | | | | | | | | | | | | | | | | | | | |

 | | | | | | | | | | | | | |

 |

 |
 | | | | | | | | | | | | |

 | | | | | | | | | | | | | | | | | | | | | | | | | | | |

 | | | | | | | | | | | | | | | | | | | | | | | | | | | | | | | | | | | | | | | | | | | | | | | | | | | | | | | | | | | | | | | |
| | | | | | | |
 | |
 | | | | | | | | | | | |

 |

 | |
 | | | | | | | | | | | |

 | | | | | | | | | | | | | | | | | | | | | | | | | | | |

 | | | | | | | | | | | | | | | | | | | | | | | | | | | | | | | | | | | | | | | | | | | | | | | | | | | | | | | | | | | | | | | | | | | | | | | |
 | |
 | | | | | | | | | | | |
 |

 | |
 | | | | | | | | | | | |
 | |
 | | | | | | | | | | | | | | | | | | | | | | | | | |

 | | | | | | | | | | | | | | | | | | | | | | | | | | | | | | | | | | | | | | | | | | | | | | | | | | | | | | | | | | | | | | | | | | | | | | | |
 | | | | | | | | | | | | | |
 |
 |
 | | | | | | | | | | | | |
 | |
 | | | | | | | | | | | | | | | | | | | | | | | | | |
 | |
 | | | | | | | | | | | | | | | | | | | | | | | | | | | | | | | | | | | | | | | | | | | | | | | | | | | | | | | | | | | | | | | | | | | | | | | | | | | | | | | | | | | | |
 | |
 | | | | | | | | | | | | | | | | | | | | | | | | | | | | | | | | | | | | | | | | | | | | | | | | | | | | | | | | | | | | | | | | | | | | | | | | | | | | | | | | | | | | | | | |
 | | | | | | | | | | | | | | | | | | | | | | | | | | | |
 | | | | | | | | | | | | | | | | | | | | | | | | | | | | | | | | | | | | | | | | | | | | | | | | | | | | | | | | | | | | | | | | | | | | | | | | | | | | | | | | | | | | | | | |
 | | | | | | | | | | | | | | | | | | | | | | | | | | | | | | | | | | | | | | | | | | | | | | | | | | | | | | | | | | | | | | | | | | | | | |
|

 | 1 | 2
 | 3 | 4 | R02 | S02 | T02 | N02 | E2 | E2 | E2 | E2 | E2 |

 | |
 | | | | | | | | | | | |

 | | | | | | | | | | | | | |

 | | | | | | | | | | | | | | | | | | | | | | | | | | | | | | | | | | | | | | | | | | | | | | | | | | | | | | | | | | | | | | | | | | | | | | | | | | | | | | | | | | | | | |

 | | | | | | | | | | | | | |

 |

 |
 | | | | | | | | | | | | |

 | | | | | | | | | | | | | | | | | | | | | | | | | | | |

 | | | | | | | | | | | | | | | | | | | | | | | | | | | | | | | | | | | | | | | | | | | | | | | | | | | | | | | | | | | | | | | |
| | | | | | | |
 | |
 | | | | | | | | | | | |

 |

 | |
 | | | | | | | | | | | |

 | | | | | | | | | | | | | | | | | | | | | | | | | | | |

 | | | | | | | | | | | | | | | | | | | | | | | | | | | | | | | | | | | | | | | | | | | | | | | | | | | | | | | | | | | | | | | | | | | | | | | |
 | |
 | | | | | | | | | | | |
 |

 | |
 | | | | | | | | | | | |
 | |
 | | | | | | | | | | | | | | | | | | | | | | | | | |

 | | | | | | | | | | | | | | | | | | | | | | | | | | | | | | | | | | | | | | | | | | | | | | | | | | | | | | | | | | | | | | | | | | | | | | | |
 | | | | | | | | | | | | | |
 |
 |
 | | | | | | | | | | | | |
 | |
 | | | | | | | | | | | | | | | | | | | | | | | | | |
 | |
 | | | | | | | | | | | | | | | | | | | | | | | | | | | | | | | | | | | | | | | | | | | | | | | | | | | | | | | | | | | | | | | | | | | | | | | | | | | | | | | | | | | | |
 | |
 | | | | | | | | | | | | | | | | | | | | | | | | | | | | | | | | | | | | | | | | | | | | | | | | | | | | | | | | | | | | | | | | | | | | | | | | | | | | | | | | | | | | | | | |
 | | | | | | | | | | | | | | | | | | | | | | | | | | | |
 | | | | | | | | | | | | | | | | | | | | | | | | | | | | | | | | | | | | | | | | | | | | | | | | | | | | | | | | | | | | | | | | | | | | | | | | | | | | | | | | | | | | | | | |
 | | | | | | | | | | | | | | | | | | | | | | | | | | | | | | | | | | | | | | | | | | | | | | | | | | | | | | | | | | | | | | | | | | | | | |
|

 | 1 | 2
 | 3 | 4 | R03 | S03 | T03 | N03 | E3 | E3 | E3 | E3 | E3 |

 | |
 | | | | | | | | | | | |

 | | | | | | | | | | | | | |

 | | | | | | | | | | | | | | | | | | | | | | | | | | | | | | | | | | | | | | | | | | | | | | | | | | | | | | | | | | | | | | | | | | | | | | | | | | | | | | | | | | | | | |

 | | | | | | | | | | | | | |

 |

 |
 | | | | | | | | | | | | |

 | | | | | | | | | | | | | | | | | | | | | | | | | | | |

 | | | | | | | | | | | | | | | | | | | | | | | | | | | | | | | | | | | | | | | | | | | | | | | | | | | | | | | | | | | | | | | |
| | | | | | | |
 | |
 | | | | | | | | | | | |

 |

 | |
 | | | | | | | | | | | |

 | | | | | | | | | | | | | | | | | | | | | | | | | | | |

 | | | | | | | | | | | | | | | | | | | | | | | | | | | | | | | | | | | | | | | | | | | | | | | | | | | | | | | | | | | | | | | | | | | | | | | |
 | |
 | | | | | | | | | | | |
 |

 | |
 | | | | | | | | | | | |
 | |
 | | | | | | | | | | | | | | | | | | | | | | | | | |

 | | | | | | | | | | | | | | | | | | | | | | | | | | | | | | | | | | | | | | | | | | | | | | | | | | | | | | | | | | | | | | | | | | | | | | | |
 | | | | | | | | | | | | | |
 |
 |
 | | | | | | | | | | | | |
 | |
 | | | | | | | | | | | | | | | | | | | | | | | | | |
 | |
 | | | | | | | | | | | | | | | | | | | | | | | | | | | | | | | | | | | | | | | | | | | | | | | | | | | | | | | | | | | | | | | | | | | | | | | | | | | | | | | | | | | | |
 | |
 | | | | | | | | | | | | | | | | | | | | | | | | | | | | | | | | | | | | | | | | | | | | | | | | | | | | | | | | | | | | | | | | | | | | | | | | | | | | | | | | | | | | | | | |
 | | | | | | | | | | | | | | | | | | | | | | | | | | | |
 | | | | | | | | | | | | | | | | | | | | | | | | | | | | | | | | | | | | | | | | | | | | | | | | | | | | | | | | | | | | | | | | | | | | | | | | | | | | | | | | | | | | | | | |
 | | | | | | | | | | | | | | | | | | | | | | | | | | | | | | | | | | | | | | | | | | | | | | | | | | | | | | | | | | | | | | | | | | | | | |
|

 | 1 | 2
 | 3 | 4 | R04 | S04 | T04 | N04 | E4 | E4 | E4 | E4 | E4 |

 | |
 | | | | | | | | | | | |

 | | | | | | | | | | | | | |

 | | | | | | | | | | | | | | | | | | | | | | | | | | | | | | | | | | | | | | | | | | | | | | | | | | | | | | | | | | | | | | | | | | | | | | | | | | | | | | | | | | | | | |

 | | | | | | | | | | | | | |

 |

 |
 | | | | | | | | | | | | |

 | | | | | | | | | | | | | | | | | | | | | | | | | | | |

 | | | | | | | | | | | | | | | | | | | | | | | | | | | | | | | | | | | | | | | | | | | | | | | | | | | | | | | | | | | | | | | |
| | | | | | | |
 | |
 | | | | | | | | | | | |

 |

 | |
 | | | | | | | | | | | |

 | | | | | | | | | | | | | | | | | | | | | | | | | | | |

 | | | | | | | | | | | | | | | | | | | | | | | | | | | | | | | | | | | | | | | | | | | | | | | | | | | | | | | | | | | | | | | | | | | | | | | |
 | |
 | | | | | | | | | | | |
 |

 | |
 | | | | | | | | | | | |
 | |
 | | | | | | | | | | | | | | | | | | | | | | | | | |

 | | | | | | | | | | | | | | | | | | | | | | | | | | | | | | | | | | | | | | | | | | | | | | | | | | | | | | | | | | | | | | | | | | | | | | | |
 | | | | | | | | | | | | | |
 |
 |
 | | | | | | | | | | | | |
 | |
 | | | | | | | | | | | | | | | | | | | | | | | | | |
 | |
 | | | | | | | | | | | | | | | | | | | | | | | | | | | | | | | | | | | | | | | | | | | | | | | | | | | | | | | | | | | | | | | | | | | | | | | | | | | | | | | | | | | | |
 | |
 | | | | | | | | | | | | | | | | | | | | | | | | | | | | | | | | | | | | | | | | | | | | | | | | | | | | | | | | | | | | | | | | | | | | | | | | | | | | | | | | | | | | | | | |
 | | | | | | | | | | | | | | | | | | | | | | | | | | | |
 | | | | | | | | | | | | | | | | | | | | | | | | | | | | | | | | | | | | | | | | | | | | | | | | | | | | | | | | | | | | | | | | | | | | | | | | | | | | | | | | | | | | | | | |
 | | | | | | | | | | | | | | | | | | | | | | | | | | | | | | | | | | | | | | | | | | | | | | | | | | | | | | | | | | | | | | | | | | | | | |
|

 | 1 | 2
 | 3 | 4 | R05 | S05 | T05 | N05 | E5 | E5 | E5 | E5 | E5 |

 | |
 | | | | | | | | | | | |

 | | | | | | | | | | | | | |

 | | | | | | | | | | | | | | | | | | | | | | | | | | | | | | | | | | | | | | | | | | | | | | | | | | | | | | | | | | | | | | | | | | | | | | | | | | | | | | | | | | | | | |

 | | | | | | | | | | | | | |

 |

 |
 | | | | | | | | | | | | |

 | | | | | | | | | | | | | | | | | | | | | | | | | | | |

 | | | | | | | | | | | | | | | | | | | | | | | | | | | | | | | | | | | | | | | | | | | | | | | | | | | | | | | | | | | | | | | |
| | | | | | | |
 | |
 | | | | | | | | | | | |

 |

 | |
 | | | | | | | | | | | |

 | | | | | | | | | | | | | | | | | | | | | | | | | | | |

 | | | | | | | | | | | | | | | | | | | | | | | | | | | | | | | | | | | | | | | | | | | | | | | | | | | | | | | | | | | | | | | | | | | | | | | |
 | |
 | | | | | | | | | | | |
 |

 | |
 | | | | | | | | | | | |
 | |
 | | | | | | | | | | | | | | | | | | | | | | | | | |

 | | | | | | | | | | | | | | | | | | | | | | | | | | | | | | | | | | | | | | | | | | | | | | | | | | | | | | | | | | | | | | | | | | | | | | | |
 | | | | | | | | | | | | | |
 |
 |
 | | | | | | | | | | | | |
 | |
 | | | | | | | | | | | | | | | | | | | | | | | | | |
 | |
 | | | | | | | | | | | | | | | | | | | | | | | | | | | | | | | | | | | | | | | | | | | | | | | | | | | | | | | | | | | | | | | | | | | | | | | | | | | | | | | | | | | | |
 | |
 | | | | | | | | | | | | | | | | | | | | | | | | | | | | | | | | | | | | | | | | | | | | | | | | | | | | | | | | | | | | | | | | | | | | | | | | | | | | | | | | | | | | | | | |
 | | | | | | | | | | | | | | | | | | | | | | | | | | | |
 | | | | | | | | | | | | | | | | | | | | | | | | | | | | | | | | | | | | | | | | | | | | | | | | | | | | | | | | | | | | | | | | | | | | | | | | | | | | | | | | | | | | | | | |
 | | | | | | | | | | | | | | | | | | | | | | | | | | | | | | | | | | | | | | | | | | | | | | | | | | | | | | | | | | | | | | | | | | | | | |
|

 | 1 | 2
 | 3 | 4 | R06 | S06 | T06 | N06 | E6 | E6 | E6 | E6 | E6 |

 | |
 | | | | | | | | | | | |

 | | | | | | | | | | | | | |

 | | | | | | | | | | | | | | | | | | | | | | | | | | | | | | | | | | | | | | | | | | | | | | | | | | | | | | | | | | | | | | | | | | | | | | | | | | | | | | | | | | | | | |

 | | | | | | | | | | | | | |

 |

 |
 | | | | | | | | | | | | |

 | | | | | | | | | | | | | | | | | | | | | | | | | | | |

 | | | | | | | | | | | | | | | | | | | | | | | | | | | | | | | | | | | | | | | | | | | | | | | | | | | | | | | | | | | | | | | |
| | | | | | | |
 | |
 | | | | | | | | | | | |

 |

 | |
 | | | | | | | | | | | |

 | | | | | | | | | | | | | | | | | | | | | | | | | | | |

 | | | | | | | | | | | | | | | | | | | | | | | | | | | | | | | | | | | | | | | | | | | | | | | | | | | | | | | | | | | | | | | | | | | | | | | |
 | |
 | | | | | | | | | | | |
 |

 | |
 | | | | | | | | | | | |
 | |
 | | | | | | | | | | | | | | | | | | | | | | | | | |

 | | | | | | | | | | | | | | | | | | | | | | | | | | | | | | | | | | | | | | | | | | | | | | | | | | | | | | | | | | | | | | | | | | | | | | | |
 | | | | | | | | | | | | | |
 |
 |
 | | | | | | | | | | | | |
 | |
 | | | | | | | | | | | | | | | | | | | | | | | | | |
 | |
 | | | | | | | | | | | | | | | | | | | | | | | | | | | | | | | | | | | | | | | | | | | | | | | | | | | | | | | | | | | | | | | | | | | | | | | | | | | | | | | | | | | | |
 | |
 | | | | | | | | | | | | | | | | | | | | | | | | | | | | | | | | | | | | | | | | | | | | | | | | | | | | | | | | | | | | | | | | | | | | | | | | | | | | | | | | | | | | | | | |
 | | | | | | | | | | | | | | | | | | | | | | | | | | | |
 | | | | | | | | | | | | | | | | | | | | | | | | | | | | | | | | | | | | | | | | | | | | | | | | | | | | | | | | | | | | | | | | | | | | | | | | | | | | | | | | | | | | | | | |
 | | | | | | | | | | | | | | | | | | | | | | | | | | | | | | | | | | | | | | | | | | | | | | | | | | | | | | | | | | | | | | | | | | | | | |
|

 | 1 | 2
 | 3 | 4 | R07 | S07 | T07 | N07 | E7 | E7 | E7 | E7 | E7 |

 | |
 | | | | | | | | | | | |

 | | | | | | | | | | | | | |

 | | | | | | | | | | | | | | | | | | | | | | | | | | | | | | | | | | | | | | | | | | | | | | | | | | | | | | | | | | | | | | | | | | | | | | | | | | | | | | | | | | | | | |

 | | | | | | | | | | | | | |

 |

 |
 | | | | | | | | | | | | |

 | | | | | | | | | | | | | | | | | | | | | | | | | | | |

 | | | | | | | | | | | | | | | | | | | | | | | | | | | | | | | | | | | | | | | | | | | | | | | | | | | | | | | | | | | | | | | |
| | | | | | | |
 | |
 | | | | | | | | | | | |

 |

 | |
 | | | | | | | | | | | |

 | | | | | | | | | | | | | | | | | | | | | | | | | | | |

 | | | | | | | | | | | | | | | | | | | | | | | | | | | | | | | | | | | | | | | | | | | | | | | | | | | | | | | | | | | | | | | | | | | | | | | |
 | |
 | | | | | | | | | | | |
 |

 | |
 | | | | | | | | | | | |
 | |
 | | | | | | | | | | | | | | | | | | | | | | | | | |

 | | | | | | | | | | | | | | | | | | | | | | | | | | | | | | | | | | | | | | | | | | | | | | | | | | | | | | | | | | | | | | | | | | | | | | | |
 | | | | | | | | | | | | | |
 |
 |
 | | | | | | | | | | | | |
 | |
 | | | | | | | | | | | | | | | | | | | | | | | | | |
 | |
 | | | | | | | | | | | | | | | | | | | | | | | | | | | | | | | | | | | | | | | | | | | | | | | | | | | | | | | | | | | | | | | | | | | | | | | | | | | | | | | | | | | | |
 | |
 | | | | | | | | | | | | | | | | | | | | | | | | | | | | | | | | | | | | | | | | | | | | | | | | | | | | | | | | | | | | | | | | | | | | | | | | | | | | | | | | | | | | | | | |
 | | | | | | | | | | | | | | | | | | | | | | | | | | | |
 | | | | | | | | | | | | | | | | | | | | | | | | | | | | | | | | | | | | | | | | | | | | | | | | | | | | | | | | | | | | | | | | | | | | | | | | | | | | | | | | | | | | | | | |
 | | | | | | | | | | | | | | | | | | | | | | | | | | | | | | | | | | | | | | | | | | | | | | | | | | | | | | | | | | | | | | | | | | | | | |
|

 | 1 | 2
 | 3 | 4 | R08 | S08 | T08 | N08 | E8 | E8 | E8 | E8 | E8 |

 | |
 | | | | | | | | | | | |

 | | | | | | | | | | | | | |

 | | | | | | | | | | | | | | | | | | | | | | | | | | | | | | | | | | | | | | | | | | | | | | | | | | | | | | | | | | | | | | | | | | | | | | | | | | | | | | | | | | | | | |

 | | | | | | | | | | | | | |

 |

 |
 | | | | | | | | | | | | |

 | | | | | | | | | | | | | | | | | | | | | | | | | | | |

 | | | | | | | | | | | | | | | | | | | | | | | | | | | | | | | | | | | | | | | | | | | | | | | | | | | | | | | | | | | | | | | |
| | | | | | | |
 | |
 | | | | | | | | | | | |

 |

 | |
 | | | | | | | | | | | |

 | | | | | | | | | | | | | | | | | | | | | | | | | | | |

 | | | | | | | | | | | | | | | | | | | | | | | | | | | | | | | | | | | | | | | | | | | | | | | | | | | | | | | | | | | | | | | | | | | | | | | |
 | |
 | | | | | | | | | | | |
 |

 | |
 | | | | | | | | | | | |
 | |
 | | | | | | | | | | | | | | | | | | | | | | | | | |

 | | | | | | | | | | | | | | | | | | | | | | | | | | | | | | | | | | | | | | | | | | | | | | | | | | | | | | | | | | | | | | | | | | | | | | | |
 | | | | | | | | | | | | | |
 |
 |
 | | | | | | | | | | | | |
 | |
 | | | | | | | | | | | | | | | | | | | | | | | | | |
 | |
 | | | | | | | | | | | | | | | | | | | | | | | | | | | | | | | | | | | | | | | | | | | | | | | | | | | | | | | | | | | | | | | | | | | | | | | | | | | | | | | | | | | | |
 | |
 | | | | | | | | | | | | | | | | | | | | | | | | | | | | | | | | | | | | | | | | | | | | | | | | | | | | | | | | | | | | | | | | | | | | | | | | | | | | | | | | | | | | | | | |
 | | | | | | | | | | | | | | | | | | | | | | | | | | | |
 | | | | | | | | | | | | | | | | | | | | | | | | | | | | | | | | | | | | | | | | | | | | | | | | | | | | | | | | | | | | | | | | | | | | | | | | | | | | | | | | | | | | | | | |
 | | | | | | | | | | | | | | | | | | | | | | | | | | | | | | | | | | | | | | | | | | | | | | | | | | | | | | | | | | | | | | | | | | | | | |
|

 | <table border="0"> <tr> <td style="width: 10%;"></td> <td style="width: 10%;"></td> <td style="width: 10%;"></td> <td style="width: 10%;"></td> <td style="width: 10%;"></td> <td style="width: 10%;"></td> <td style="width: 10%;"></td> <td style="width: 10%;"></td> <td style="width: 10%;"></td> <td style="width: 10%;"></td> <td style="width: 10%;"></td> <td style="width: 10%;"></td> <td style="width: 10%;"></td> <td style="width: 10%;"></td> </tr> <tr> <td style="text-align: center;">XA</td> <td style="text-align: center;">1</td> <td style="text-align: center;">2</td> <td style="text-align: center;">3</td> <td style="text-align: center;">4</td> <td style="text-align: center;">R01</td> <td style="text-align: center;">S01</td> <td style="text-align: center;">T01</td> <td style="text-align: center;">N01</td> <td style="text-align: center;">E1</td> <td style="text-align: center;">E1</td> <td style="text-align: center;">E1</td> <td style="text-align: center;">E1</td> <td style="text-align: center;">E1</td> </tr> <tr> <td></td> <td style="text-align: center;">1</td> <td style="text-align: center;">2</td> <td style="text-align: center;">3</td> <td style="text-align: center;">4</td> <td style="text-align: center;">R02</td> <td style="text-align: center;">S02</td> <td style="text-align: center;">T02</td> <td style="text-align: center;">N02</td> <td style="text-align: center;">E2</td> <td style="text-align: center;">E2</td> <td style="text-align: center;">E2</td> <td style="text-align: center;">E2</td> <td style="text-align: center;">E2</td> </tr> <tr> <td></td> <td style="text-align: center;">1</td> <td style="text-align: center;">2</td> <td style="text-align: center;">3</td> <td style="text-align: center;">4</td> <td style="text-align: center;">R03</td> <td style="text-align: center;">S03</td> <td style="text-align: center;">T03</td> <td style="text-align: center;">N03</td> <td style="text-align: center;">E3</td> <td style="text-align: center;">E3</td> <td style="text-align: center;">E3</td> <td style="text-align: center;">E3</td> <td style="text-align: center;">E3</td> </tr> <tr> <td></td> <td style="text-align: center;">1</td> <td style="text-align: center;">2</td> <td style="text-align: center;">3</td> <td style="text-align: center;">4</td> <td style="text-align: center;">R04</td> <td style="text-align: center;">S04</td> <td style="text-align: center;">T04</td> <td style="text-align: center;">N04</td> <td style="text-align: center;">E4</td> <td style="text-align: center;">E4</td> <td style="text-align: center;">E4</td> <td style="text-align: center;">E4</td> <td style="text-align: center;">E4</td> </tr> <tr> <td></td> <td style="text-align: center;">1</td> <td style="text-align: center;">2</td> <td style="text-align: center;">3</td> <td style="text-align: center;">4</td> <td style="text-align: center;">R05</td> <td style="text-align: center;">S05</td> <td style="text-align: center;">T05</td> <td style="text-align: center;">N05</td> <td style="text-align: center;">E5</td> <td style="text-align: center;">E5</td> <td style="text-align: center;">E5</td> <td style="text-align: center;">E5</td> <td style="text-align: center;">E5</td> </tr> <tr> <td></td> <td style="text-align: center;">1</td> <td style="text-align: center;">2</td> <td style="text-align: center;">3</td> <td style="text-align: center;">4</td> <td style="text-align: center;">R06</td> <td style="text-align: center;">S06</td> <td style="text-align: center;">T06</td> <td style="text-align: center;">N06</td> <td style="text-align: center;">E6</td> <td style="text-align: center;">E6</td> <td style="text-align: center;">E6</td> <td style="text-align: center;">E6</td> <td style="text-align: center;">E6</td> </tr> <tr> <td></td> <td style="text-align: center;">1</td> <td style="text-align: center;">2</td> <td style="text-align: center;">3</td> <td style="text-align: center;">4</td> <td style="text-align: center;">R07</td> <td style="text-align: center;">S07</td> <td style="text-align: center;">T07</td> <td style="text-align: center;">N07</td> <td style="text-align: center;">E7</td> <td style="text-align: center;">E7</td> <td style="text-align: center;">E7</td> <td style="text-align: center;">E7</td> <td style="text-align: center;">E7</td> </tr> <tr> <td></td> <td style="text-align: center;">1</td> <td style="text-align: center;">2</td> <td style="text-align: center;">3</td> <td style="text-align: center;">4</td> <td style="text-align: center;">R08</td> <td style="text-align: center;">S08</td> <td style="text-align: center;">T08</td> <td style="text-align: center;">N08</td> <td style="text-align: center;">E8</td> <td style="text-align: center;">E8</td> <td style="text-align: center;">E8</td> <td style="text-align: center;">E8</td> <td style="text-align: center;">E8</td> </tr> </table> |
 | | | | | | | | | | | |

 | | XA
 | 1 | 2 | 3 | 4 | R01 | S01 | T01 | N01 | E1 | E1 | E1 | E1

 | E1 | | 1 | 2 | 3 | 4 | R02 | S02 | T02 | N02 | E2 | E2 | E2 | E2

 | E2 | | 1 | 2 | 3 | 4 | R03 | S03 | T03 | N03 | E3 | E3 | E3 | E3 | E3 | | 1 | 2 | 3 | 4 | R04 | S04 | T04 | N04 | E4 | E4 | E4 | E4 | E4 | | 1 | 2 | 3 | 4 | R05 | S05 | T05 | N05 | E5 | E5 | E5 | E5 | E5 | | 1 | 2 | 3 | 4 | R06 | S06 | T06 | N06 | E6 | E6 | E6 | E6 | E6 | | 1 | 2 | 3 | 4 | R07 | S07 | T07 | N07 | E7 | E7 | E7 | E7 | E7 | | 1 | 2 | 3 | 4 | R08 | S08 | T08 | N08 | E8 | E8 | E8 | E8 | E8 | <table border="0" style="width: 100%;"> <tr> <td style="width: 50%;"></td> <td style="width: 50%; text-align: center;"> <table border="0"> <tr> <td style="width: 10%;"></td> <td style="width: 10%;"></td> <td style="width: 10%;"></td> <td style="width: 10%;"></td> <td style="width:
10%;"></td> <td style="width: 10%;"></td> <td style="width: 10%;"></td> <td style="width: 10%;"></td> <td style="width: 10%;"></td> <td style="width: 10%;"></td> <td style="width: 10%;"></td> <td style="width: 10%;"></td> <td style="width: 10%;"></td> <td style="width: 10%;"></td> </tr> <tr> <td style="text-align: center;">XA</td> <td style="text-align: center;">1</td> <td style="text-align: center;">2</td> <td style="text-align: center;">3</td> <td style="text-align: center;">4</td> <td style="text-align: center;">R01</td> <td style="text-align: center;">S01</td> <td style="text-align: center;">T01</td> <td style="text-align: center;">N01</td> <td style="text-align: center;">E1</td> <td style="text-align: center;">E1</td> <td style="text-align: center;">E1</td> <td style="text-align: center;">E1</td> <td style="text-align: center;">E1</td> </tr> <tr> <td></td> <td style="text-align: center;">1</td> <td style="text-align: center;">2</td> <td style="text-align: center;">3</td> <td style="text-align: center;">4</td> <td style="text-align: center;">R02</td> <td style="text-align: center;">S02</td> <td style="text-align: center;">T02</td> <td style="text-align: center;">N02</td> <td style="text-align: center;">E2</td> <td style="text-align: center;">E2</td> <td style="text-align: center;">E2</td> <td style="text-align: center;">E2</td> <td style="text-align: center;">E2</td> </tr> <tr> <td></td> <td style="text-align: center;">1</td> <td style="text-align: center;">2</td> <td style="text-align: center;">3</td> <td style="text-align: center;">4</td> <td style="text-align: center;">R03</td> <td style="text-align: center;">S03</td> <td style="text-align: center;">T03</td> <td style="text-align: center;">N03</td> <td style="text-align: center;">E3</td> <td style="text-align: center;">E3</td> <td style="text-align: center;">E3</td> <td style="text-align: center;">E3</td> <td style="text-align: center;">E3</td> </tr> <tr> <td></td> <td style="text-align: center;">1</td> <td style="text-align: center;">2</td> <td style="text-align: center;">3</td> <td style="text-align: center;">4</td> <td style="text-align: center;">R04</td> <td style="text-align: center;">S04</td> <td style="text-align: center;">T04</td> <td style="text-align: center;">N04</td> <td style="text-align: center;">E4</td> <td style="text-align: center;">E4</td> <td style="text-align: center;">E4</td> <td style="text-align: center;">E4</td> <td style="text-align: center;">E4</td> </tr> <tr> <td></td> <td style="text-align: center;">1</td> <td style="text-align: center;">2</td> <td style="text-align: center;">3</td> <td style="text-align: center;">4</td> <td style="text-align: center;">R05</td> <td style="text-align: center;">S05</td> <td style="text-align: center;">T05</td> <td style="text-align: center;">N05</td> <td style="text-align: center;">E5</td> <td style="text-align: center;">E5</td> <td style="text-align: center;">E5</td> <td style="text-align: center;">E5</td> <td style="text-align: center;">E5</td> </tr> <tr> <td></td> <td style="text-align: center;">1</td> <td style="text-align: center;">2</td> <td style="text-align: center;">3</td> <td style="text-align: center;">4</td> <td style="text-align: center;">R06</td> <td style="text-align: center;">S06</td> <td style="text-align: center;">T06</td> <td style="text-align: center;">N06</td> <td style="text-align: center;">E6</td> <td style="text-align: center;">E6</td> <td style="text-align: center;">E6</td> <td style="text-align: center;">E6</td> <td style="text-align: center;">E6</td> </tr> <tr> <td></td> <td style="text-align: center;">1</td> <td style="text-align: center;">2</td> <td style="text-align: center;">3</td> <td style="text-align: center;">4</td> <td style="text-align: center;">R07</td> <td style="text-align: center;">S07</td> <td style="text-align: center;">T07</td> <td style="text-align: center;">N07</td> <td style="text-align: center;">E7</td> <td style="text-align: center;">E7</td> <td style="text-align: center;">E7</td> <td style="text-align: center;">E7</td> <td style="text-align: center;">E7</td> </tr> <tr> <td></td> <td style="text-align: center;">1</td> <td style="text-align: center;">2</td> <td style="text-align: center;">3</td> <td style="text-align: center;">4</td> <td style="text-align: center;">R08</td> <td style="text-align: center;">S08</td> <td style="text-align: center;">T08</td> <td style="text-align: center;">N08</td> <td style="text-align: center;">E8</td> <td style="text-align: center;">E8</td> <td style="text-align: center;">E8</td> <td style="text-align: center;">E8</td> <td style="text-align: center;">E8</td> </tr> </table> </td> <td style="width: 50%; vertical-align: top;"> <table border="0" style="width: 100%;"> <tr> <td style="width: 50%;"></td> <td style="width: 50%; text-align: center;"> <table border="0"> <tr> <td style="width: 10%;"></td> <td style="width: 10%;"></td> <td style="width: 10%;"></td> <td style="width: 10%;"></td> <td style="width: 10%;"></td> <td style="width: 10%;"></td> <td style="width: 10%;"></td> <td style="width: 10%;"></td> <td style="width: 10%;"></td> <td style="width: 10%;"></td> <td style="width: 10%;"></td> <td style="width: 10%;"></td> <td style="width: 10%;"></td> <td style="width: 10%;"></td> </tr> <tr> <td style="text-align: center;">XA</td> <td style="text-align: center;">1</td> <td style="text-align: center;">2</td> <td style="text-align: center;">3</td> <td style="text-align: center;">4</td> <td style="text-align: center;">R01</td> <td style="text-align: center;">S01</td> <td style="text-align: center;">T01</td> <td style="text-align: center;">N01</td> <td style="text-align: center;">E1</td> <td style="text-align: center;">E1</td> <td style="text-align: center;">E1</td> <td style="text-align: center;">E1</td> <td style="text-align: center;">E1</td> </tr> <tr> <td></td> <td style="text-align: center;">1</td> <td style="text-align: center;">2</td> <td style="text-align: center;">3</td> <td style="text-align: center;">4</td> <td style="text-align: center;">R02</td> <td style="text-align: center;">S02</td> <td style="text-align: center;">T02</td> <td style="text-align: center;">N02</td> <td style="text-align: center;">E2</td> <td style="text-align: center;">E2</td> <td style="text-align: center;">E2</td> <td style="text-align: center;">E2</td> <td style="text-align: center;">E2</td> </tr> <tr> <td></td> <td style="text-align: center;">1</td> <td style="text-align: center;">2</td> <td style="text-align: center;">3</td> <td style="text-align: center;">4</td> <td style="text-align: center;">R03</td> <td style="text-align: center;">S03</td> <td style="text-align: center;">T03</td> <td style="text-align: center;">N03</td> <td style="text-align: center;">E3</td> <td style="text-align: center;">E3</td> <td style="text-align: center;">E3</td> <td style="text-align: center;">E3</td> <td style="text-align: center;">E3</td> </tr> <tr> <td></td> <td style="text-align: center;">1</td> <td style="text-align: center;">2</td> <td style="text-align: center;">3</td> <td style="text-align: center;">4</td> <td style="text-align: center;">R04</td> <td style="text-align: center;">S04</td> <td style="text-align: center;">T04</td> <td style="text-align: center;">N04</td> <td style="text-align: center;">E4</td> <td style="text-align: center;">E4</td> <td style="text-align: center;">E4</td> <td style="text-align: center;">E4</td> <td style="text-align: center;">E4</td> </tr> <tr> <td></td> <td style="text-align: center;">1</td> <td style="text-align: center;">2</td> <td style="text-align: center;">3</td> <td style="text-align: center;">4</td> <td style="text-align: center;">R05</td> <td style="text-align: center;">S05</td> <td style="text-align: center;">T05</td> <td style="text-align: center;">N05</td> <td style="text-align: center;">E5</td> <td style="text-align: center;">E5</td> <td style="text-align: center;">E5</td> <td style="text-align: center;">E5</td> <td style="text-align: center;">E5</td> </tr> <tr> <td></td> <td style="text-align: center;">1</td> <td style="text-align: center;">2</td> <td style="text-align: center;">3</td> <td style="text-align: center;">4</td> <td style="text-align: center;">R06</td> <td style="text-align: center;">S06</td> <td style="text-align: center;">T06</td> <td style="text-align: center;">N06</td> <td style="text-align: center;">E6</td> <td style="text-align: center;">E6</td> <td style="text-align: center;">E6</td> <td style="text-align: center;">E6</td> <td style="text-align: center;">E6</td> </tr> <tr> <td></td> <td style="text-align: center;">1</td> <td style="text-align: center;">2</td> <td style="text-align: center;">3</td> <td style="text-align: center;">4</td> <td style="text-align: center;">R07</td> <td style="text-align: center;">S07</td> <td style="text-align: center;">T07</td> <td style="text-align: center;">N07</td> <td style="text-align: center;">E7</td> <td style="text-align: center;">E7</td> <td style="text-align: center;">E7</td> <td style="text-align: center;">E7</td> <td style="text-align: center;">E7</td> </tr> <tr> <td></td> <td style="text-align: center;">1</td> <td style="text-align: center;">2</td> <td style="text-align: center;">3</td> <td style="text-align: center;">4</td> <td style="text-align: center;">R08</td> <td style="text-align: center;">S08</td> <td style="text-align: center;">T08</td> <td style="text-align: center;">N08</td> <td style="text-align: center;">E8</td> <td style="text-align: center;">E8</td> <td style="text-align: center;">E8</td> <td style="text-align: center;">E8</td> <td style="text-align: center;">E8</td> </tr> </table> </td> <td style="width: 50%; vertical-align: top;"> <table border="0" style="width: 100%;"> <tr> <td style="width: 50%;"></td> <td style="width: 50%; text-align: center;"> <table border="0"> <tr> <td style="width: 10%;"></td> <td style="width: 10%;"></td> <td style="width: 10%;"></td> <td style="width: 10%;"></td> <td style="width: 10%;"></td> <td
style="width: 10%;"></td> <td style="width: 10%;"></td> <td style="width: 10%;"></td> <td style="width: 10%;"></td> <td style="width: 10%;"></td> <td style="width: 10%;"></td> <td style="width: 10%;"></td> <td style="width: 10%;"></td> <td style="width: 10%;"></td> </tr> <tr> <td style="text-align: center;">XA</td> <td style="text-align: center;">1</td> <td style="text-align: center;">2</td> <td style="text-align: center;">3</td> <td style="text-align: center;">4</td> <td style="text-align: center;">R01</td> <td style="text-align: center;">S01</td> <td style="text-align: center;">T01</td> <td style="text-align: center;">N01</td> <td style="text-align: center;">E1</td> <td style="text-align: center;">E1</td> <td style="text-align: center;">E1</td> </tr></table></td></tr></table></td></tr></table></td></tr></table>
 | | <table border="0"> <tr> <td style="width: 10%;"></td> <td style="width: 10%;"></td> <td style="width: 10%;"></td> <td style="width: 10%;"></td> <td style="width: 10%;"></td> <td style="width: 10%;"></td> <td style="width: 10%;"></td> <td style="width: 10%;"></td> <td style="width: 10%;"></td> <td style="width: 10%;"></td> <td style="width: 10%;"></td> <td style="width: 10%;"></td> <td style="width: 10%;"></td> <td style="width: 10%;"></td> </tr> <tr> <td style="text-align: center;">XA</td> <td style="text-align: center;">1</td> <td style="text-align: center;">2</td> <td style="text-align: center;">3</td> <td style="text-align: center;">4</td> <td style="text-align: center;">R01</td> <td style="text-align: center;">S01</td> <td style="text-align: center;">T01</td> <td style="text-align: center;">N01</td> <td style="text-align: center;">E1</td> <td style="text-align: center;">E1</td> <td style="text-align: center;">E1</td> <td style="text-align: center;">E1</td> <td style="text-align: center;">E1</td> </tr> <tr> <td></td> <td style="text-align: center;">1</td> <td style="text-align: center;">2</td> <td style="text-align: center;">3</td> <td style="text-align: center;">4</td> <td style="text-align: center;">R02</td> <td style="text-align: center;">S02</td> <td style="text-align: center;">T02</td> <td style="text-align: center;">N02</td> <td style="text-align: center;">E2</td> <td style="text-align: center;">E2</td> <td style="text-align: center;">E2</td> <td style="text-align: center;">E2</td> <td style="text-align: center;">E2</td> </tr> <tr> <td></td> <td style="text-align: center;">1</td> <td style="text-align: center;">2</td> <td style="text-align: center;">3</td> <td style="text-align: center;">4</td> <td style="text-align: center;">R03</td> <td style="text-align: center;">S03</td> <td style="text-align: center;">T03</td> <td style="text-align: center;">N03</td> <td style="text-align: center;">E3</td> <td style="text-align: center;">E3</td> <td style="text-align: center;">E3</td> <td style="text-align: center;">E3</td> <td style="text-align: center;">E3</td> </tr> <tr> <td></td> <td style="text-align: center;">1</td> <td style="text-align: center;">2</td> <td style="text-align: center;">3</td> <td style="text-align: center;">4</td> <td style="text-align: center;">R04</td> <td style="text-align: center;">S04</td> <td style="text-align: center;">T04</td> <td style="text-align: center;">N04</td> <td style="text-align: center;">E4</td> <td style="text-align: center;">E4</td> <td style="text-align: center;">E4</td> <td style="text-align: center;">E4</td> <td style="text-align: center;">E4</td> </tr> <tr> <td></td> <td style="text-align: center;">1</td> <td style="text-align: center;">2</td> <td style="text-align: center;">3</td> <td style="text-align: center;">4</td> <td style="text-align: center;">R05</td> <td style="text-align: center;">S05</td> <td style="text-align: center;">T05</td> <td style="text-align: center;">N05</td> <td style="text-align: center;">E5</td> <td style="text-align: center;">E5</td> <td style="text-align: center;">E5</td> <td style="text-align: center;">E5</td> <td style="text-align: center;">E5</td> </tr> <tr> <td></td> <td style="text-align: center;">1</td> <td style="text-align: center;">2</td> <td style="text-align: center;">3</td> <td style="text-align: center;">4</td> <td style="text-align: center;">R06</td> <td style="text-align: center;">S06</td> <td style="text-align: center;">T06</td> <td style="text-align: center;">N06</td> <td style="text-align: center;">E6</td> <td style="text-align: center;">E6</td> <td style="text-align: center;">E6</td> <td style="text-align: center;">E6</td> <td style="text-align: center;">E6</td> </tr> <tr> <td></td> <td style="text-align: center;">1</td> <td style="text-align: center;">2</td> <td style="text-align: center;">3</td> <td style="text-align: center;">4</td> <td style="text-align: center;">R07</td> <td style="text-align: center;">S07</td> <td style="text-align: center;">T07</td> <td style="text-align: center;">N07</td> <td style="text-align: center;">E7</td> <td style="text-align: center;">E7</td> <td style="text-align: center;">E7</td> <td style="text-align: center;">E7</td> <td style="text-align: center;">E7</td> </tr> <tr> <td></td> <td style="text-align: center;">1</td> <td style="text-align: center;">2</td> <td style="text-align: center;">3</td> <td style="text-align: center;">4</td> <td style="text-align: center;">R08</td> <td style="text-align: center;">S08</td> <td style="text-align: center;">T08</td> <td style="text-align: center;">N08</td> <td style="text-align: center;">E8</td> <td style="text-align: center;">E8</td> <td style="text-align: center;">E8</td> <td style="text-align: center;">E8</td> <td style="text-align: center;">E8</td> </tr> </table> | | | | | | | | | | | |

 |

 |
 | XA | 1 | 2 | 3 | 4 | R01 | S01 | T01 | N01 | E1 | E1 | E1 | E1

 | E1 | | 1 | 2 | 3 | 4 | R02 | S02 | T02 | N02 | E2 | E2 | E2 | E2 | E2 | | 1 | 2 | 3 | 4 | R03 | S03 | T03 | N03 | E3 | E3 | E3 | E3

 | E3 | | 1 | 2 | 3 | 4 | R04 | S04 | T04 | N04 | E4 | E4 | E4 | E4 | E4 | | 1 | 2 | 3 | 4 | R05 | S05 | T05 | N05 | E5 | E5 | E5 | E5 | E5 | | 1 | 2 | 3 | 4 | R06 | S06 | T06 | N06 | E6 | E6 | E6 | E6 | E6 | | 1 | 2 | 3 | 4 | R07 | S07 | T07 | N07 | E7 | E7 | E7 | E7 | E7 | | 1 | 2 | 3 | 4
 R08 | S08 | T08 | N08 | E8 | E8 | E8 | E8 | E8 | <table border="0" style="width: 100%;"> <tr> <td style="width: 50%;"></td> <td style="width: 50%; text-align: center;"> <table border="0"> <tr> <td style="width: 10%;"></td> <td style="width: 10%;"></td> <td style="width: 10%;"></td> <td style="width: 10%;"></td> <td style="width: 10%;"></td> <td style="width: 10%;"></td> <td style="width: 10%;"></td> <td style="width: 10%;"></td> <td style="width: 10%;"></td> <td style="width: 10%;"></td> <td style="width: 10%;"></td> <td style="width: 10%;"></td> <td style="width: 10%;"></td> <td style="width: 10%;"></td> </tr> <tr> <td style="text-align: center;">XA</td> <td style="text-align: center;">1</td> <td style="text-align: center;">2</td> <td style="text-align: center;">3</td> <td style="text-align: center;">4</td> <td style="text-align: center;">R01</td> <td style="text-align: center;">S01</td> <td style="text-align: center;">T01</td> <td style="text-align: center;">N01</td> <td style="text-align: center;">E1</td> <td style="text-align: center;">E1</td> <td style="text-align: center;">E1</td> <td style="text-align: center;">E1</td> <td style="text-align: center;">E1</td> </tr> <tr> <td></td> <td style="text-align: center;">1</td> <td style="text-align: center;">2</td> <td style="text-align: center;">3</td> <td style="text-align: center;">4</td> <td style="text-align: center;">R02</td> <td style="text-align: center;">S02</td> <td style="text-align: center;">T02</td> <td style="text-align: center;">N02</td> <td style="text-align: center;">E2</td> <td style="text-align: center;">E2</td> <td style="text-align: center;">E2</td> <td style="text-align: center;">E2</td> <td style="text-align: center;">E2</td> </tr> <tr> <td></td> <td style="text-align: center;">1</td> <td style="text-align: center;">2</td> <td style="text-align: center;">3</td> <td style="text-align: center;">4</td> <td style="text-align: center;">R03</td> <td style="text-align: center;">S03</td> <td style="text-align: center;">T03</td> <td style="text-align: center;">N03</td> <td style="text-align: center;">E3</td> <td style="text-align: center;">E3</td> <td style="text-align: center;">E3</td> <td style="text-align: center;">E3</td> <td style="text-align: center;">E3</td> </tr> <tr> <td></td> <td style="text-align: center;">1</td> <td style="text-align: center;">2</td> <td style="text-align: center;">3</td> <td style="text-align: center;">4</td> <td style="text-align: center;">R04</td> <td style="text-align: center;">S04</td> <td style="text-align: center;">T04</td> <td style="text-align: center;">N04</td> <td style="text-align: center;">E4</td> <td style="text-align: center;">E4</td> <td style="text-align: center;">E4</td> <td style="text-align: center;">E4</td> <td style="text-align: center;">E4</td> </tr> <tr> <td></td> <td style="text-align: center;">1</td> <td style="text-align: center;">2</td> <td style="text-align: center;">3</td> <td style="text-align: center;">4</td> <td style="text-align: center;">R05</td> <td style="text-align: center;">S05</td> <td style="text-align: center;">T05</td> <td style="text-align: center;">N05</td> <td style="text-align: center;">E5</td> <td style="text-align: center;">E5</td> <td style="text-align: center;">E5</td> <td style="text-align: center;">E5</td> <td style="text-align: center;">E5</td> </tr> <tr> <td></td> <td style="text-align: center;">1</td> <td style="text-align: center;">2</td> <td style="text-align: center;">3</td> <td style="text-align: center;">4</td> <td style="text-align: center;">R06</td> <td style="text-align: center;">S06</td> <td style="text-align: center;">T06</td> <td style="text-align: center;">N06</td> <td style="text-align: center;">E6</td> <td style="text-align: center;">E6</td> <td style="text-align: center;">E6</td> <td style="text-align: center;">E6</td> <td style="text-align: center;">E6</td> </tr> <tr> <td></td> <td style="text-align: center;">1</td> <td style="text-align: center;">2</td> <td style="text-align: center;">3</td> <td style="text-align: center;">4</td> <td style="text-align: center;">R07</td> <td style="text-align: center;">S07</td> <td style="text-align: center;">T07</td> <td style="text-align: center;">N07</td> <td style="text-align: center;">E7</td> <td style="text-align: center;">E7</td> <td style="text-align: center;">E7</td> <td style="text-align: center;">E7</td> <td style="text-align: center;">E7</td> </tr> <tr> <td></td> <td style="text-align: center;">1</td> <td style="text-align: center;">2</td> <td style="text-align: center;">3</td> <td style="text-align: center;">4</td> <td style="text-align: center;">R08</td> <td style="text-align: center;">S08</td> <td style="text-align: center;">T08</td> <td style="text-align: center;">N08</td> <td style="text-align: center;">E8</td> <td style="text-align: center;">E8</td> <td style="text-align: center;">E8</td> <td style="text-align: center;">E8</td> <td style="text-align: center;">E8</td> </tr> </table> </td> <td style="width: 50%; vertical-align: top;"> <table border="0" style="width: 100%;"> <tr> <td style="width: 50%;"></td> <td style="width: 50%; text-align: center;"> <table border="0"> <tr> <td style="width: 10%;"></td> <td style="width: 10%;"></td> <td style="width: 10%;"></td> <td style="width: 10%;"></td> <td style="width: 10%;"></td> <td style="width: 10%;"></td> <td style="width: 10%;"></td> <td style="width: 10%;"></td> <td style="width: 10%;"></td> <td style="width: 10%;"></td> <td style="width: 10%;"></td> <td style="width: 10%;"></td> <td style="width: 10%;"></td> <td style="width: 10%;"></td> </tr> <tr> <td style="text-align: center;">XA</td> <td style="text-align: center;">1</td> <td style="text-align: center;">2</td> <td style="text-align: center;">3</td> <td style="text-align: center;">4</td> <td style="text-align: center;">R01</td> <td style="text-align: center;">S01</td> <td style="text-align: center;">T01</td> <td style="text-align: center;">N01</td> <td style="text-align: center;">E1</td> <td style="text-align: center;">E1</td> <td style="text-align: center;">E1</td> </tr></table></td></tr></table></td></tr></table>
 | | <table border="0"> <tr> <td style="width: 10%;"></td> <td style="width: 10%;"></td> <td style="width: 10%;"></td> <td style="width: 10%;"></td> <td style="width: 10%;"></td> <td style="width: 10%;"></td> <td style="width: 10%;"></td> <td style="width: 10%;"></td> <td style="width: 10%;"></td> <td style="width: 10%;"></td> <td style="width: 10%;"></td> <td style="width: 10%;"></td> <td style="width: 10%;"></td> <td style="width: 10%;"></td> </tr> <tr> <td style="text-align: center;">XA</td> <td style="text-align: center;">1</td> <td style="text-align: center;">2</td> <td style="text-align: center;">3</td> <td style="text-align: center;">4</td> <td style="text-align: center;">R01</td> <td style="text-align: center;">S01</td> <td style="text-align: center;">T01</td> <td style="text-align: center;">N01</td> <td style="text-align: center;">E1</td> <td style="text-align: center;">E1</td> <td style="text-align: center;">E1</td> <td style="text-align: center;">E1</td> <td style="text-align: center;">E1</td> </tr> <tr> <td></td> <td style="text-align: center;">1</td> <td style="text-align: center;">2</td> <td style="text-align: center;">3</td> <td style="text-align: center;">4</td> <td style="text-align: center;">R02</td> <td style="text-align: center;">S02</td> <td style="text-align: center;">T02</td> <td style="text-align: center;">N02</td> <td style="text-align: center;">E2</td> <td style="text-align: center;">E2</td> <td style="text-align: center;">E2</td> <td style="text-align: center;">E2</td> <td style="text-align: center;">E2</td> </tr> <tr> <td></td> <td style="text-align: center;">1</td> <td style="text-align: center;">2</td> <td style="text-align: center;">3</td> <td style="text-align: center;">4</td> <td style="text-align: center;">R03</td> <td style="text-align: center;">S03</td> <td style="text-align: center;">T03</td> <td style="text-align: center;">N03</td> <td style="text-align: center;">E3</td> <td style="text-align: center;">E3</td> <td style="text-align: center;">E3</td> <td style="text-align: center;">E3</td> <td style="text-align: center;">E3</td> </tr> <tr> <td></td> <td style="text-align: center;">1</td> <td style="text-align: center;">2</td> <td style="text-align: center;">3</td> <td style="text-align: center;">4</td> <td style="text-align: center;">R04</td> <td style="text-align: center;">S04</td> <td style="text-align: center;">T04</td> <td style="text-align: center;">N04</td> <td style="text-align: center;">E4</td> <td style="text-align: center;">E4</td> <td style="text-align: center;">E4</td> <td style="text-align: center;">E4</td> <td style="text-align: center;">E4</td> </tr> <tr> <td></td> <td style="text-align: center;">1</td> <td style="text-align: center;">2</td> <td style="text-align: center;">3</td> <td style="text-align: center;">4</td> <td style="text-align: center;">R05</td> <td style="text-align: center;">S05</td> <td style="text-align: center;">T05</td> <td style="text-align: center;">N05</td> <td style="text-align: center;">E5</td> <td style="text-align: center;">E5</td> <td style="text-align: center;">E5</td> <td style="text-align: center;">E5</td> <td style="text-align: center;">E5</td> </tr> <tr> <td></td> <td style="text-align: center;">1</td> <td style="text-align: center;">2</td> <td style="text-align: center;">3</td> <td style="text-align: center;">4</td> <td style="text-align: center;">R06</td> <td style="text-align: center;">S06</td> <td style="text-align: center;">T06</td> <td style="text-align: center;">N06</td> <td style="text-align: center;">E6</td> <td style="text-align: center;">E6</td> <td style="text-align: center;">E6</td> <td style="text-align: center;">E6</td> <td style="text-align: center;">E6</td> </tr> <tr> <td></td> <td style="text-align: center;">1</td> <td style="text-align: center;">2</td> <td
style="text-align: center;">3</td> <td style="text-align: center;">4</td> <td style="text-align: center;">R07</td> <td style="text-align: center;">S07</td> <td style="text-align: center;">T07</td> <td style="text-align: center;">N07</td> <td style="text-align: center;">E7</td> <td style="text-align: center;">E7</td> <td style="text-align: center;">E7</td> <td style="text-align: center;">E7</td> <td style="text-align: center;">E7</td> </tr> <tr> <td></td> <td style="text-align: center;">1</td> <td style="text-align: center;">2</td> <td style="text-align: center;">3</td> <td style="text-align: center;">4</td> <td style="text-align: center;">R08</td> <td style="text-align: center;">S08</td> <td style="text-align: center;">T08</td> <td style="text-align: center;">N08</td> <td style="text-align: center;">E8</td> <td style="text-align: center;">E8</td> <td style="text-align: center;">E8</td> <td style="text-align: center;">E8</td> <td style="text-align: center;">E8</td> </tr> </table> | | | | | | | | | | | |

 |

 | | XA
 | 1 | 2 | 3 | 4 | R01 | S01 | T01 | N01 | E1 | E1 | E1 | E1

 | E1 | | 1 | 2 | 3 | 4 | R02 | S02 | T02 | N02 | E2 | E2 | E2 | E2 | E2 | | 1 | 2 | 3 | 4 | R03 | S03 | T03 | N03 | E3 | E3 | E3 | E3

 | E3 | | 1 | 2 | 3 | 4 | R04 | S04 | T04 | N04 | E4 | E4 | E4 | E4 | E4 | | 1 | 2 | 3 | 4 | R05 | S05 | T05 | N05 | E5 | E5 | E5 | E5 | E5 | | 1 | 2 | 3 | 4 | R06 | S06 | T06 | N06 | E6 | E6 | E6 | E6 | E6 | | 1 | 2 | 3 | 4 | R07 | S07 | T07 | N07 | E7 | E7 | E7 | E7 | E7 | | 1 | 2 | 3 | 4 | R08 | S08 | T08 | N08 | E8 | E8 | E8 | E8 | E8 | <table border="0" style="width: 100%;"> <tr> <td style="width: 50%;"></td> <td style="width: 50%; text-align: center;"> <table border="0"> <tr> <td style="width: 10%;"></td> <td style="width: 10%;"></td> <td style="width: 10%;"></td> <td style="width: 10%;"></td> <td style="width: 10%;"></td> <td style="width: 10%;"></td> <td style="width: 10%;"></td> <td style="width: 10%;"></td> <td style="width: 10%;"></td> <td style="width: 10%;"></td> <td style="width: 10%;"></td> <td style="width: 10%;"></td> <td style="width: 10%;"></td> <td style="width: 10%;"></td> </tr> <tr> <td style="text-align: center;">XA</td> <td style="text-align: center;">1</td> <td style="text-align: center;">2</td> <td style="text-align: center;">3</td> <td style="text-align: center;">4</td> <td style="text-align: center;">R01</td> <td style="text-align: center;">S01</td> <td style="text-align: center;">T01</td> <td style="text-align: center;">N01</td> <td style="text-align: center;">E1</td> <td style="text-align: center;">E1</td> <td style="text-align: center;">E1</td> </tr></table></td></tr></table>
 | | <table border="0"> <tr> <td style="width: 10%;"></td> <td style="width: 10%;"></td> <td style="width: 10%;"></td> <td style="width: 10%;"></td> <td style="width: 10%;"></td> <td style="width: 10%;"></td> <td style="width: 10%;"></td> <td style="width: 10%;"></td> <td style="width: 10%;"></td> <td style="width: 10%;"></td> <td style="width: 10%;"></td> <td style="width: 10%;"></td> <td style="width: 10%;"></td> <td style="width: 10%;"></td> </tr> <tr> <td style="text-align: center;">XA</td> <td style="text-align: center;">1</td> <td style="text-align: center;">2</td> <td style="text-align: center;">3</td> <td style="text-align: center;">4</td> <td style="text-align: center;">R01</td> <td style="text-align: center;">S01</td> <td style="text-align: center;">T01</td> <td style="text-align: center;">N01</td> <td style="text-align: center;">E1</td> <td style="text-align: center;">E1</td> <td style="text-align: center;">E1</td> </tr></table>
 | | | | | | | | | | | |
 |

 | | XA
 | 1 | 2 | 3 | 4 | R01 | S01 | T01 | N01 | E1 | E1 | E1 |
 | |
 | | | | | | | | | | | | | | | | | | | | | | | | | |

 | | | | | | | | | | | | | | | | | | | | | | | | | | | | | | | | | | | | | | | | | | | | | | | | | | | | | | | | | | | | | | | | | | | | | | | |
 | | | | | | | | | | | | | |
 |
 |
 | | | | | | | | | | | | |
 | |
 | | | | | | | | | | | | | | | | | | | | | | | | | |
 | |
 | | | | | | | | | | | | | | | | | | | | | | | | | | | | | | | | | | | | | | | | | | | | | | | | | | | | | | | | | | | | | | | | | | | | | | | | | | | | | | | | | | | | |
 | |
 | | | | | | | | | | | | | | | | | | | | | | | | | | | | | | | | | | | | | | | | | | | | | | | | | | | | | | | | | | | | | | | | | | | | | | | | | | | | | | | | | | | | | | | |
 | | | | | | | | | | | | | | | | | | | | | | | | | | | |
 | | | | | | | | | | | | | | | | | | | | | | | | | | | | | | | | | | | | | | | | | | | | | | | | | | | | | | | | | | | | | | | | | | | | | | | | | | | | | | | | | | | | | | | |
 | | | | | | | | | | | | | | | | | | | | | | | | | | | | | | | | | | | | | | | | | | | | | | | | | | | | | | | | | | | | | | | | | | | | | |
|

 | |
 | | | | | | | | | | | |

 | |
 | | | | | | | | | | | |

 | | | | | | | | | | | | | |

 | | | | | | | | | | | | | | | | | | | | | | | | | | | | | | | | | | | | | | | | | | | | | | | | | | | | | | | | | | | | | | | | | | | | | | | | | | | | | | | | | | | | | |

 | | | | | | | | | | | | | |

 |

 |
 | | | | | | | | | | | | |

 | | | | | | | | | | | | | | | | | | | | | | | | | | | |

 | | | | | | | | | | | | | | | | | | | | | | | | | | | | | | | | | | | | | | | | | | | | | | | | | | | | | | | | | | | | | | | |
| | | | | | | |
 | |
 | | | | | | | | | | | |

 |

 | |
 | | | | | | | | | | | |

 | | | | | | | | | | | | | | | | | | | | | | | | | | | |

 | | | | | | | | | | | | | | | | | | | | | | | | | | | | | | | | | | | | | | | | | | | | | | | | | | | | | | | | | | | | | | | | | | | | | | | |
 | |
 | | | | | | | | | | | |
 |

 | |
 | | | | | | | | | | | |
 | |
 | | | | | | | | | | | | | | | | | | | | | | | | | |

 | | | | | | | | | | | | | | | | | | | | | | | | | | | | | | | | | | | | | | | | | | | | | | | | | | | | | | | | | | | | | | | | | | | | | | | |
 | | | | | | | | | | | | | |
 |
 |
 | | | | | | | | | | | | |
 | |
 | | | | | | | | | | | | | | | | | | | | | | | | | |
 | |
 | | | | | | | | | | | | | | | | | | | | | | | | | | | | | | | | | | | | | | | | | | | | | | | | | | | | | | | | | | | | | | | | | | | | | | | | | | | | | | | | | | | | |
 | |
 | | | | | | | | | | | | | | | | | | | | | | | | | | | | | | | | | | | | | | | | | | | | | | | | | | | | | | | | | | | | | | | | | | | | | | | | | | | | | | | | | | | | | | | |
 | | | | | | | | | | | | | | | | | | | | | | | | | | | |
 | | | | | | | | | | | | | | | | | | | | | | | | | | | | | | | | | | | | | | | | | | | | | | | | | | | | | | | | | | | | | | | | | | | | | | | | | | | | | | | | | | | | | | | |
 | | | | | | | | | | | | | | | | | | | | | | | | | | | | | | | | | | | | | | | | | | | | | | | | | | | | | | | | | | | | | | | | | | | | | |
| XA

 | 1 | 2
 | 3 | 4 | R01 | S01 | T01 | N01 | E1 | E1 | E1 | E1 | E1 |

 | |
 | | | | | | | | | | | |

 | | | | | | | | | | | | | |

 | | | | | | | | | | | | | | | | | | | | | | | | | | | | | | | | | | | | | | | | | | | | | | | | | | | | | | | | | | | | | | | | | | | | | | | | | | | | | | | | | | | | | |

 | | | | | | | | | | | | | |

 |

 |
 | | | | | | | | | | | | |

 | | | | | | | | | | | | | | | | | | | | | | | | | | | |

 | | | | | | | | | | | | | | | | | | | | | | | | | | | | | | | | | | | | | | | | | | | | | | | | | | | | | | | | | | | | | | | |
| | | | | | | |
 | |
 | | | | | | | | | | | |

 |

 | |
 | | | | | | | | | | | |

 | | | | | | | | | | | | | | | | | | | | | | | | | | | |

 | | | | | | | | | | | | | | | | | | | | | | | | | | | | | | | | | | | | | | | | | | | | | | | | | | | | | | | | | | | | | | | | | | | | | | | |
 | |
 | | | | | | | | | | | |
 |

 | |
 | | | | | | | | | | | |
 | |
 | | | | | | | | | | | | | | | | | | | | | | | | | |

 | | | | | | | | | | | | | | | | | | | | | | | | | | | | | | | | | | | | | | | | | | | | | | | | | | | | | | | | | | | | | | | | | | | | | | | |
 | | | | | | | | | | | | | |
 |
 |
 | | | | | | | | | | | | |
 | |
 | | | | | | | | | | | | | | | | | | | | | | | | | |
 | |
 | | | | | | | | | | | | | | | | | | | | | | | | | | | | | | | | | | | | | | | | | | | | | | | | | | | | | | | | | | | | | | | | | | | | | | | | | | | | | | | | | | | | |
 | |
 | | | | | | | | | | | | | | | | | | | | | | | | | | | | | | | | | | | | | | | | | | | | | | | | | | | | | | | | | | | | | | | | | | | | | | | | | | | | | | | | | | | | | | | |
 | | | | | | | | | | | | | | | | | | | | | | | | | | | |
 | | | | | | | | | | | | | | | | | | | | | | | | | | | | | | | | | | | | | | | | | | | | | | | | | | | | | | | | | | | | | | | | | | | | | | | | | | | | | | | | | | | | | | | |
 | | | | | | | | | | | | | | | | | | | | | | | | | | | | | | | | | | | | | | | | | | | | | | | | | | | | | | | | | | | | | | | | | | | | | |
|

 | 1 | 2
 | 3 | 4 | R02 | S02 | T02 | N02 | E2 | E2 | E2 | E2 | E2 |

 | |
 | | | | | | | | | | | |

 | | | | | | | | | | | | | |

 | | | | | | | | | | | | | | | | | | | | | | | | | | | | | | | | | | | | | | | | | | | | | | | | | | | | | | | | | | | | | | | | | | | | | | | | | | | | | | | | | | | | | |

 | | | | | | | | | | | | | |

 |

 |
 | | | | | | | | | | | | |

 | | | | | | | | | | | | | | | | | | | | | | | | | | | |

 | | | | | | | | | | | | | | | | | | | | | | | | | | | | | | | | | | | | | | | | | | | | | | | | | | | | | | | | | | | | | | | |
| | | | | | | |
 | |
 | | | | | | | | | | | |

 |

 | |
 | | | | | | | | | | | |

 | | | | | | | | | | | | | | | | | | | | | | | | | | | |

 | | | | | | | | | | | | | | | | | | | | | | | | | | | | | | | | | | | | | | | | | | | | | | | | | | | | | | | | | | | | | | | | | | | | | | | |
 | |
 | | | | | | | | | | | |
 |

 | |
 | | | | | | | | | | | |
 | |
 | | | | | | | | | | | | | | | | | | | | | | | | | |

 | | | | | | | | | | | | | | | | | | | | | | | | | | | | | | | | | | | | | | | | | | | | | | | | | | | | | | | | | | | | | | | | | | | | | | | |
 | | | | | | | | | | | | | |
 |
 |
 | | | | | | | | | | | | |
 | |
 | | | | | | | | | | | | | | | | | | | | | | | | | |
 | |
 | | | | | | | | | | | | | | | | | | | | | | | | | | | | | | | | | | | | | | | | | | | | | | | | | | | | | | | | | | | | | | | | | | | | | | | | | | | | | | | | | | | | |
 | |
 | | | | | | | | | | | | | | | | | | | | | | | | | | | | | | | | | | | | | | | | | | | | | | | | | | | | | | | | | | | | | | | | | | | | | | | | | | | | | | | | | | | | | | | |
 | | | | | | | | | | | | | | | | | | | | | | | | | | | |
 | | | | | | | | | | | | | | | | | | | | | | | | | | | | | | | | | | | | | | | | | | | | | | | | | | | | | | | | | | | | | | | | | | | | | | | | | | | | | | | | | | | | | | | |
 | | | | | | | | | | | | | | | | | | | | | | | | | | | | | | | | | | | | | | | | | | | | | | | | | | | | | | | | | | | | | | | | | | | | | |
|

 | 1 | 2
 | 3 | 4 | R03 | S03 | T03 | N03 | E3 | E3 | E3 | E3 | E3 |

 | |
 | | | | | | | | | | | |

 | | | | | | | | | | | | | |

 | | | | | | | | | | | | | | | | | | | | | | | | | | | | | | | | | | | | | | | | | | | | | | | | | | | | | | | | | | | | | | | | | | | | | | | | | | | | | | | | | | | | | |

 | | | | | | | | | | | | | |

 |

 |
 | | | | | | | | | | | | |

 | | | | | | | | | | | | | | | | | | | | | | | | | | | |

 | | | | | | | | | | | | | | | | | | | | | | | | | | | | | | | | | | | | | | | | | | | | | | | | | | | | | | | | | | | | | | | |
| | | | | | | |
 | |
 | | | | | | | | | | | |

 |

 | |
 | | | | | | | | | | | |

 | | | | | | | | | | | | | | | | | | | | | | | | | | | |

 | | | | | | | | | | | | | | | | | | | | | | | | | | | | | | | | | | | | | | | | | | | | | | | | | | | | | | | | | | | | | | | | | | | | | | | |
 | |
 | | | | | | | | | | | |
 |

 | |
 | | | | | | | | | | | |
 | |
 | | | | | | | | | | | | | | | | | | | | | | | | | |

 | | | | | | | | | | | | | | | | | | | | | | | | | | | | | | | | | | | | | | | | | | | | | | | | | | | | | | | | | | | | | | | | | | | | | | | |
 | | | | | | | | | | | | | |
 |
 |
 | | | | | | | | | | | | |
 | |
 | | | | | | | | | | | | | | | | | | | | | | | | | |
 | |
 | | | | | | | | | | | | | | | | | | | | | | | | | | | | | | | | | | | | | | | | | | | | | | | | | | | | | | | | | | | | | | | | | | | | | | | | | | | | | | | | | | | | |
 | |
 | | | | | | | | | | | | | | | | | | | | | | | | | | | | | | | | | | | | | | | | | | | | | | | | | | | | | | | | | | | | | | | | | | | | | | | | | | | | | | | | | | | | | | | |
 | | | | | | | | | | | | | | | | | | | | | | | | | | | |
 | | | | | | | | | | | | | | | | | | | | | | | | | | | | | | | | | | | | | | | | | | | | | | | | | | | | | | | | | | | | | | | | | | | | | | | | | | | | | | | | | | | | | | | |
 | | | | | | | | | | | | | | | | | | | | | | | | | | | | | | | | | | | | | | | | | | | | | | | | | | | | | | | | | | | | | | | | | | | | | |
|

 | 1 | 2
 | 3 | 4 | R04 | S04 | T04 | N04 | E4 | E4 | E4 | E4 | E4 |

 | |
 | | | | | | | | | | | |

 | | | | | | | | | | | | | |

 | | | | | | | | | | | | | | | | | | | | | | | | | | | | | | | | | | | | | | | | | | | | | | | | | | | | | | | | | | | | | | | | | | | | | | | | | | | | | | | | | | | | | |

 | | | | | | | | | | | | | |

 |

 |
 | | | | | | | | | | | | |

 | | | | | | | | | | | | | | | | | | | | | | | | | | | |

 | | | | | | | | | | | | | | | | | | | | | | | | | | | | | | | | | | | | | | | | | | | | | | | | | | | | | | | | | | | | | | | |
| | | | | | | |
 | |
 | | | | | | | | | | | |

 |

 | |
 | | | | | | | | | | | |

 | | | | | | | | | | | | | | | | | | | | | | | | | | | |

 | | | | | | | | | | | | | | | | | | | | | | | | | | | | | | | | | | | | | | | | | | | | | | | | | | | | | | | | | | | | | | | | | | | | | | | |
 | |
 | | | | | | | | | | | |
 |

 | |
 | | | | | | | | | | | |
 | |
 | | | | | | | | | | | | | | | | | | | | | | | | | |

 | | | | | | | | | | | | | | | | | | | | | | | | | | | | | | | | | | | | | | | | | | | | | | | | | | | | | | | | | | | | | | | | | | | | | | | |
 | | | | | | | | | | | | | |
 |
 |
 | | | | | | | | | | | | |
 | |
 | | | | | | | | | | | | | | | | | | | | | | | | | |
 | |
 | | | | | | | | | | | | | | | | | | | | | | | | | | | | | | | | | | | | | | | | | | | | | | | | | | | | | | | | | | | | | | | | | | | | | | | | | | | | | | | | | | | | |
 | |
 | | | | | | | | | | | | | | | | | | | | | | | | | | | | | | | | | | | | | | | | | | | | | | | | | | | | | | | | | | | | | | | | | | | | | | | | | | | | | | | | | | | | | | | |
 | | | | | | | | | | | | | | | | | | | | | | | | | | | |
 | | | | | | | | | | | | | | | | | | | | | | | | | | | | | | | | | | | | | | | | | | | | | | | | | | | | | | | | | | | | | | | | | | | | | | | | | | | | | | | | | | | | | | | |
 | | | | | | | | | | | | | | | | | | | | | | | | | | | | | | | | | | | | | | | | | | | | | | | | | | | | | | | | | | | | | | | | | | | | | |
|

 | 1 | 2
 | 3 | 4 | R05 | S05 | T05 | N05 | E5 | E5 | E5 | E5 | E5 |

 | |
 | | | | | | | | | | | |

 | | | | | | | | | | | | | |

 | | | | | | | | | | | | | | | | | | | | | | | | | | | | | | | | | | | | | | | | | | | | | | | | | | | | | | | | | | | | | | | | | | | | | | | | | | | | | | | | | | | | | |

 | | | | | | | | | | | | | |

 |

 |
 | | | | | | | | | | | | |

 | | | | | | | | | | | | | | | | | | | | | | | | | | | |

 | | | | | | | | | | | | | | | | | | | | | | | | | | | | | | | | | | | | | | | | | | | | | | | | | | | | | | | | | | | | | | | |
| | | | | | | |
 | |
 | | | | | | | | | | | |

 |

 | |
 | | | | | | | | | | | |

 | | | | | | | | | | | | | | | | | | | | | | | | | | | |

 | | | | | | | | | | | | | | | | | | | | | | | | | | | | | | | | | | | | | | | | | | | | | | | | | | | | | | | | | | | | | | | | | | | | | | | |
 | |
 | | | | | | | | | | | |
 |

 | |
 | | | | | | | | | | | |
 | |
 | | | | | | | | | | | | | | | | | | | | | | | | | |

 | | | | | | | | | | | | | | | | | | | | | | | | | | | | | | | | | | | | | | | | | | | | | | | | | | | | | | | | | | | | | | | | | | | | | | | |
 | | | | | | | | | | | | | |
 |
 |
 | | | | | | | | | | | | |
 | |
 | | | | | | | | | | | | | | | | | | | | | | | | | |
 | |
 | | | | | | | | | | | | | | | | | | | | | | | | | | | | | | | | | | | | | | | | | | | | | | | | | | | | | | | | | | | | | | | | | | | | | | | | | | | | | | | | | | | | |
 | |
 | | | | | | | | | | | | | | | | | | | | | | | | | | | | | | | | | | | | | | | | | | | | | | | | | | | | | | | | | | | | | | | | | | | | | | | | | | | | | | | | | | | | | | | |
 | | | | | | | | | | | | | | | | | | | | | | | | | | | |
 | | | | | | | | | | | | | | | | | | | | | | | | | | | | | | | | | | | | | | | | | | | | | | | | | | | | | | | | | | | | | | | | | | | | | | | | | | | | | | | | | | | | | | | |
 | | | | | | | | | | | | | | | | | | | | | | | | | | | | | | | | | | | | | | | | | | | | | | | | | | | | | | | | | | | | | | | | | | | | | |
|

 | 1 | 2
 | 3 | 4 | R06 | S06 | T06 | N06 | E6 | E6 | E6 | E6 | E6 |

 | |
 | | | | | | | | | | | |

 | | | | | | | | | | | | | |

 | | | | | | | | | | | | | | | | | | | | | | | | | | | | | | | | | | | | | | | | | | | | | | | | | | | | | | | | | | | | | | | | | | | | | | | | | | | | | | | | | | | | | |

 | | | | | | | | | | | | | |

 |

 |
 | | | | | | | | | | | | |

 | | | | | | | | | | | | | | | | | | | | | | | | | | | |

 | | | | | | | | | | | | | | | | | | | | | | | | | | | | | | | | | | | | | | | | | | | | | | | | | | | | | | | | | | | | | | | |
| | | | | | | |
 | |
 | | | | | | | | | | | |

 |

 | |
 | | | | | | | | | | | |

 | | | | | | | | | | | | | | | | | | | | | | | | | | | |

 | | | | | | | | | | | | | | | | | | | | | | | | | | | | | | | | | | | | | | | | | | | | | | | | | | | | | | | | | | | | | | | | | | | | | | | |
 | |
 | | | | | | | | | | | |
 |

 | |
 | | | | | | | | | | | |
 | |
 | | | | | | | | | | | | | | | | | | | | | | | | | |

 | | | | | | | | | | | | | | | | | | | | | | | | | | | | | | | | | | | | | | | | | | | | | | | | | | | | | | | | | | | | | | | | | | | | | | | |
 | | | | | | | | | | | | | |
 |
 |
 | | | | | | | | | | | | |
 | |
 | | | | | | | | | | | | | | | | | | | | | | | | | |
 | |
 | | | | | | | | | | | | | | | | | | | | | | | | | | | | | | | | | | | | | | | | | | | | | | | | | | | | | | | | | | | | | | | | | | | | | | | | | | | | | | | | | | | | |
 | |
 | | | | | | | | | | | | | | | | | | | | | | | | | | | | | | | | | | | | | | | | | | | | | | | | | | | | | | | | | | | | | | | | | | | | | | | | | | | | | | | | | | | | | | | |
 | | | | | | | | | | | | | | | | | | | | | | | | | | | |
 | | | | | | | | | | | | | | | | | | | | | | | | | | | | | | | | | | | | | | | | | | | | | | | | | | | | | | | | | | | | | | | | | | | | | | | | | | | | | | | | | | | | | | | |
 | | | | | | | | | | | | | | | | | | | | | | | | | | | | | | | | | | | | | | | | | | | | | | | | | | | | | | | | | | | | | | | | | | | | | |
|

 | 1 | 2
 | 3 | 4 | R07 | S07 | T07 | N07 | E7 | E7 | E7 | E7 | E7 |

 | |
 | | | | | | | | | | | |

 | | | | | | | | | | | | | |

 | | | | | | | | | | | | | | | | | | | | | | | | | | | | | | | | | | | | | | | | | | | | | | | | | | | | | | | | | | | | | | | | | | | | | | | | | | | | | | | | | | | | | |

 | | | | | | | | | | | | | |

 |

 |
 | | | | | | | | | | | | |

 | | | | | | | | | | | | | | | | | | | | | | | | | | | |

 | | | | | | | | | | | | | | | | | | | | | | | | | | | | | | | | | | | | | | | | | | | | | | | | | | | | | | | | | | | | | | | |
| | | | | | | |
 | |
 | | | | | | | | | | | |

 |

 | |
 | | | | | | | | | | | |

 | | | | | | | | | | | | | | | | | | | | | | | | | | | |

 | | | | | | | | | | | | | | | | | | | | | | | | | | | | | | | | | | | | | | | | | | | | | | | | | | | | | | | | | | | | | | | | | | | | | | | |
 | |
 | | | | | | | | | | | |
 |

 | |
 | | | | | | | | | | | |
 | |
 | | | | | | | | | | | | | | | | | | | | | | | | | |

 | | | | | | | | | | | | | | | | | | | | | | | | | | | | | | | | | | | | | | | | | | | | | | | | | | | | | | | | | | | | | | | | | | | | | | | |
 | | | | | | | | | | | | | |
 |
 |
 | | | | | | | | | | | | |
 | |
 | | | | | | | | | | | | | | | | | | | | | | | | | |
 | |
 | | | | | | | | | | | | | | | | | | | | | | | | | | | | | | | | | | | | | | | | | | | | | | | | | | | | | | | | | | | | | | | | | | | | | | | | | | | | | | | | | | | | |
 | |
 | | | | | | | | | | | | | | | | | | | | | | | | | | | | | | | | | | | | | | | | | | | | | | | | | | | | | | | | | | | | | | | | | | | | | | | | | | | | | | | | | | | | | | | |
 | | | | | | | | | | | | | | | | | | | | | | | | | | | |
 | | | | | | | | | | | | | | | | | | | | | | | | | | | | | | | | | | | | | | | | | | | | | | | | | | | | | | | | | | | | | | | | | | | | | | | | | | | | | | | | | | | | | | | |
 | | | | | | | | | | | | | | | | | | | | | | | | | | | | | | | | | | | | | | | | | | | | | | | | | | | | | | | | | | | | | | | | | | | | | |
|

 | 1 | 2
 | 3 | 4 | R08 | S08 | T08 | N08 | E8 | E8 | E8 | E8 | E8 |

 | |
 | | | | | | | | | | | |

 | | | | | | | | | | | | | |

 | | | | | | | | | | | | | | | | | | | | | | | | | | | | | | | | | | | | | | | | | | | | | | | | | | | | | | | | | | | | | | | | | | | | | | | | | | | | | | | | | | | | | |

 | | | | | | | | | | | | | |

 |

 |
 | | | | | | | | | | | | |

 | | | | | | | | | | | | | | | | | | | | | | | | | | | |

 | | | | | | | | | | | | | | | | | | | | | | | | | | | | | | | | | | | | | | | | | | | | | | | | | | | | | | | | | | | | | | | |
| | | | | | | |
 | |
 | | | | | | | | | | | |

 |

 | |
 | | | | | | | | | | | |

 | | | | | | | | | | | | | | | | | | | | | | | | | | | |

 | | | | | | | | | | | | | | | | | | | | | | | | | | | | | | | | | | | | | | | | | | | | | | | | | | | | | | | | | | | | | | | | | | | | | | | |
 | |
 | | | | | | | | | | | |
 |

 | |
 | | | | | | | | | | | |
 | |
 | | | | | | | | | | | | | | | | | | | | | | | | | |

 | | | | | | | | | | | | | | | | | | | | | | | | | | | | | | | | | | | | | | | | | | | | | | | | | | | | | | | | | | | | | | | | | | | | | | | |
 | | | | | | | | | | | | | |
 |
 |
 | | | | | | | | | | | | |
 | |
 | | | | | | | | | | | | | | | | | | | | | | | | | |
 | |
 | | | | | | | | | | | | | | | | | | | | | | | | | | | | | | | | | | | | | | | | | | | | | | | | | | | | | | | | | | | | | | | | | | | | | | | | | | | | | | | | | | | | |
 | |
 | | | | | | | | | | | | | | | | | | | | | | | | | | | | | | | | | | | | | | | | | | | | | | | | | | | | | | | | | | | | | | | | | | | | | | | | | | | | | | | | | | | | | | | |
 | | | | | | | | | | | | | | | | | | | | | | | | | | | |
 | | | | | | | | | | | | | | | | | | | | | | | | | | | | | | | | | | | | | | | | | | | | | | | | | | | | | | | | | | | | | | | | | | | | | | | | | | | | | | | | | | | | | | | |
 | | | | | | | | | | | | | | | | | | | | | | | | | | | | | | | | | | | | | | | | | | | | | | | | | | | | | | | | | | | | | | | | | | | | | |
|

 | <table border="0"> <tr> <td style="width: 10%;"></td> <td style="width: 10%;"></td> <td style="width: 10%;"></td> <td style="width: 10%;"></td> <td style="width: 10%;"></td> <td style="width: 10%;"></td> <td style="width: 10%;"></td> <td style="width: 10%;"></td> <td style="width: 10%;"></td> <td style="width: 10%;"></td> <td style="width: 10%;"></td> <td style="width: 10%;"></td> <td style="width: 10%;"></td> <td style="width: 10%;"></td> </tr> <tr> <td style="text-align: center;">XA</td> <td style="text-align: center;">1</td> <td style="text-align: center;">2</td> <td style="text-align: center;">3</td> <td style="text-align: center;">4</td> <td style="text-align: center;">R01</td> <td style="text-align: center;">S01</td> <td style="text-align: center;">T01</td> <td style="text-align: center;">N01</td> <td style="text-align: center;">E1</td> <td style="text-align: center;">E1</td> <td style="text-align: center;">E1</td> <td style="text-align: center;">E1</td> <td style="text-align: center;">E1</td> </tr> <tr> <td></td> <td style="text-align: center;">1</td> <td style="text-align: center;">2</td> <td style="text-align: center;">3</td> <td style="text-align: center;">4</td> <td style="text-align: center;">R02</td> <td style="text-align: center;">S02</td> <td style="text-align: center;">T02</td> <td style="text-align: center;">N02</td> <td style="text-align: center;">E2</td> <td style="text-align: center;">E2</td> <td style="text-align: center;">E2</td> <td style="text-align: center;">E2</td> <td style="text-align: center;">E2</td> </tr> <tr> <td></td> <td style="text-align: center;">1</td> <td style="text-align: center;">2</td> <td style="text-align: center;">3</td> <td style="text-align: center;">4</td> <td style="text-align: center;">R03</td> <td style="text-align: center;">S03</td> <td style="text-align: center;">T03</td> <td style="text-align: center;">N03</td> <td style="text-align: center;">E3</td> <td style="text-align: center;">E3</td> <td style="text-align: center;">E3</td> <td style="text-align: center;">E3</td> <td style="text-align: center;">E3</td> </tr> <tr> <td></td> <td style="text-align: center;">1</td> <td style="text-align: center;">2</td> <td style="text-align: center;">3</td> <td style="text-align: center;">4</td> <td style="text-align: center;">R04</td> <td style="text-align: center;">S04</td> <td style="text-align: center;">T04</td> <td style="text-align: center;">N04</td> <td style="text-align: center;">E4</td> <td style="text-align: center;">E4</td> <td style="text-align: center;">E4</td> <td style="text-align: center;">E4</td> <td style="text-align: center;">E4</td> </tr> <tr> <td></td> <td style="text-align: center;">1</td> <td style="text-align: center;">2</td> <td style="text-align: center;">3</td> <td style="text-align: center;">4</td> <td style="text-align: center;">R05</td> <td style="text-align: center;">S05</td> <td style="text-align: center;">T05</td> <td style="text-align: center;">N05</td> <td style="text-align: center;">E5</td> <td style="text-align: center;">E5</td> <td style="text-align: center;">E5</td> <td style="text-align: center;">E5</td> <td style="text-align: center;">E5</td> </tr> <tr> <td></td> <td style="text-align: center;">1</td> <td style="text-align: center;">2</td> <td style="text-align: center;">3</td> <td style="text-align: center;">4</td> <td style="text-align: center;">R06</td> <td style="text-align: center;">S06</td> <td style="text-align: center;">T06</td> <td style="text-align: center;">N06</td> <td style="text-align: center;">E6</td> <td style="text-align: center;">E6</td> <td style="text-align: center;">E6</td> <td style="text-align: center;">E6</td> <td style="text-align: center;">E6</td> </tr> <tr> <td></td> <td style="text-align: center;">1</td> <td style="text-align: center;">2</td> <td style="text-align: center;">3</td> <td style="text-align: center;">4</td> <td style="text-align: center;">R07</td> <td style="text-align: center;">S07</td> <td style="text-align: center;">T07</td> <td style="text-align: center;">N07</td> <td style="text-align: center;">E7</td> <td style="text-align: center;">E7</td> <td style="text-align: center;">E7</td> <td style="text-align: center;">E7</td> <td style="text-align: center;">E7</td> </tr> <tr> <td></td> <td style="text-align: center;">1</td> <td style="text-align: center;">2</td> <td style="text-align: center;">3</td> <td style="text-align: center;">4</td> <td style="text-align: center;">R08</td> <td style="text-align: center;">S08</td> <td style="text-align: center;">T08</td> <td style="text-align: center;">N08</td> <td style="text-align: center;">E8</td> <td style="text-align: center;">E8</td> <td style="text-align: center;">E8</td> <td style="text-align: center;">E8</td> <td style="text-align: center;">E8</td> </tr> </table> |
 | | | | | | | | | | | |

 | | XA
 | 1 | 2 | 3 | 4 | R01 | S01 | T01 | N01 | E1 | E1 | E1 | E1

 | E1 | | 1 | 2 | 3 | 4 | R02 | S02 | T02 | N02 | E2 | E2 | E2 | E2

 | E2 | | 1 | 2 | 3 | 4 | R03 | S03 | T03 | N03 | E3 | E3 | E3 | E3 | E3 | | 1 | 2 | 3 | 4 | R04 | S04 | T04 | N04 | E4 | E4 | E4 | E4 | E4 | | 1 | 2 | 3 | 4 | R05 | S05 | T05 | N05 | E5 | E5 | E5 | E5 | E5 | | 1 | 2 | 3 | 4 | R06 | S06 | T06 | N06 | E6 | E6 | E6 | E6 | E6 | | 1 | 2 | 3 | 4 | R07 | S07 | T07 | N07 | E7 | E7 | E7 | E7 | E7 | | 1 | 2 | 3 | 4 | R08 | S08 | T08 | N08 | E8 | E8 | E8 | E8 | E8 | <table border="0" style="width: 100%;"> <tr> <td style="width: 50%;"></td> <td style="width: 50%; text-align: center;"> <table border="0"> <tr> <td style="width: 10%;"></td> <td style="width: 10%;"></td> <td style="width: 10%;"></td> <td style="width: 10%;"></td> <td style="width:
10%;"></td> <td style="width: 10%;"></td> <td style="width: 10%;"></td> <td style="width: 10%;"></td> <td style="width: 10%;"></td> <td style="width: 10%;"></td> <td style="width: 10%;"></td> <td style="width: 10%;"></td> <td style="width: 10%;"></td> <td style="width: 10%;"></td> </tr> <tr> <td style="text-align: center;">XA</td> <td style="text-align: center;">1</td> <td style="text-align: center;">2</td> <td style="text-align: center;">3</td> <td style="text-align: center;">4</td> <td style="text-align: center;">R01</td> <td style="text-align: center;">S01</td> <td style="text-align: center;">T01</td> <td style="text-align: center;">N01</td> <td style="text-align: center;">E1</td> <td style="text-align: center;">E1</td> <td style="text-align: center;">E1</td> <td style="text-align: center;">E1</td> <td style="text-align: center;">E1</td> </tr> <tr> <td></td> <td style="text-align: center;">1</td> <td style="text-align: center;">2</td> <td style="text-align: center;">3</td> <td style="text-align: center;">4</td> <td style="text-align: center;">R02</td> <td style="text-align: center;">S02</td> <td style="text-align: center;">T02</td> <td style="text-align: center;">N02</td> <td style="text-align: center;">E2</td> <td style="text-align: center;">E2</td> <td style="text-align: center;">E2</td> <td style="text-align: center;">E2</td> <td style="text-align: center;">E2</td> </tr> <tr> <td></td> <td style="text-align: center;">1</td> <td style="text-align: center;">2</td> <td style="text-align: center;">3</td> <td style="text-align: center;">4</td> <td style="text-align: center;">R03</td> <td style="text-align: center;">S03</td> <td style="text-align: center;">T03</td> <td style="text-align: center;">N03</td> <td style="text-align: center;">E3</td> <td style="text-align: center;">E3</td> <td style="text-align: center;">E3</td> <td style="text-align: center;">E3</td> <td style="text-align: center;">E3</td> </tr> <tr> <td></td> <td style="text-align: center;">1</td> <td style="text-align: center;">2</td> <td style="text-align: center;">3</td> <td style="text-align: center;">4</td> <td style="text-align: center;">R04</td> <td style="text-align: center;">S04</td> <td style="text-align: center;">T04</td> <td style="text-align: center;">N04</td> <td style="text-align: center;">E4</td> <td style="text-align: center;">E4</td> <td style="text-align: center;">E4</td> <td style="text-align: center;">E4</td> <td style="text-align: center;">E4</td> </tr> <tr> <td></td> <td style="text-align: center;">1</td> <td style="text-align: center;">2</td> <td style="text-align: center;">3</td> <td style="text-align: center;">4</td> <td style="text-align: center;">R05</td> <td style="text-align: center;">S05</td> <td style="text-align: center;">T05</td> <td style="text-align: center;">N05</td> <td style="text-align: center;">E5</td> <td style="text-align: center;">E5</td> <td style="text-align: center;">E5</td> <td style="text-align: center;">E5</td> <td style="text-align: center;">E5</td> </tr> <tr> <td></td> <td style="text-align: center;">1</td> <td style="text-align: center;">2</td> <td style="text-align: center;">3</td> <td style="text-align: center;">4</td> <td style="text-align: center;">R06</td> <td style="text-align: center;">S06</td> <td style="text-align: center;">T06</td> <td style="text-align: center;">N06</td> <td style="text-align: center;">E6</td> <td style="text-align: center;">E6</td> <td style="text-align: center;">E6</td> <td style="text-align: center;">E6</td> <td style="text-align: center;">E6</td> </tr> <tr> <td></td> <td style="text-align: center;">1</td> <td style="text-align: center;">2</td> <td style="text-align: center;">3</td> <td style="text-align: center;">4</td> <td style="text-align: center;">R07</td> <td style="text-align: center;">S07</td> <td style="text-align: center;">T07</td> <td style="text-align: center;">N07</td> <td style="text-align: center;">E7</td> <td style="text-align: center;">E7</td> <td style="text-align: center;">E7</td> <td style="text-align: center;">E7</td> <td style="text-align: center;">E7</td> </tr> <tr> <td></td> <td style="text-align: center;">1</td> <td style="text-align: center;">2</td> <td style="text-align: center;">3</td> <td style="text-align: center;">4</td> <td style="text-align: center;">R08</td> <td style="text-align: center;">S08</td> <td style="text-align: center;">T08</td> <td style="text-align: center;">N08</td> <td style="text-align: center;">E8</td> <td style="text-align: center;">E8</td> <td style="text-align: center;">E8</td> <td style="text-align: center;">E8</td> <td style="text-align: center;">E8</td> </tr> </table> </td> <td style="width: 50%; vertical-align: top;"> <table border="0" style="width: 100%;"> <tr> <td style="width: 50%;"></td> <td style="width: 50%; text-align: center;"> <table border="0"> <tr> <td style="width: 10%;"></td> <td style="width: 10%;"></td> <td style="width: 10%;"></td> <td style="width: 10%;"></td> <td style="width: 10%;"></td> <td style="width: 10%;"></td> <td style="width: 10%;"></td> <td style="width: 10%;"></td> <td style="width: 10%;"></td> <td style="width: 10%;"></td> <td style="width: 10%;"></td> <td style="width: 10%;"></td> <td style="width: 10%;"></td> <td style="width: 10%;"></td> </tr> <tr> <td style="text-align: center;">XA</td> <td style="text-align: center;">1</td> <td style="text-align: center;">2</td> <td style="text-align: center;">3</td> <td style="text-align: center;">4</td> <td style="text-align: center;">R01</td> <td style="text-align: center;">S01</td> <td style="text-align: center;">T01</td> <td style="text-align: center;">N01</td> <td style="text-align: center;">E1</td> <td style="text-align: center;">E1</td> <td style="text-align: center;">E1</td> </tr></table></td></tr></table></td></tr></table>

 | | <table border="0"> <tr> <td style="width: 10%;"></td> <td style="width: 10%;"></td> <td style="width: 10%;"></td> <td style="width: 10%;"></td> <td style="width: 10%;"></td> <td style="width: 10%;"></td> <td style="width: 10%;"></td> <td style="width: 10%;"></td> <td style="width: 10%;"></td> <td style="width: 10%;"></td> <td style="width: 10%;"></td> <td style="width: 10%;"></td> <td style="width: 10%;"></td> <td style="width: 10%;"></td> </tr> <tr> <td style="text-align: center;">XA</td> <td style="text-align: center;">1</td> <td style="text-align: center;">2</td> <td style="text-align: center;">3</td> <td style="text-align: center;">4</td> <td style="text-align: center;">R01</td> <td style="text-align: center;">S01</td> <td style="text-align: center;">T01</td> <td style="text-align: center;">N01</td> <td style="text-align: center;">E1</td> <td style="text-align: center;">E1</td> <td style="text-align: center;">E1</td> <td style="text-align: center;">E1</td> <td style="text-align: center;">E1</td> </tr> <tr> <td></td> <td style="text-align: center;">1</td> <td style="text-align: center;">2</td> <td style="text-align: center;">3</td> <td style="text-align: center;">4</td> <td style="text-align: center;">R02</td> <td style="text-align: center;">S02</td> <td style="text-align: center;">T02</td> <td style="text-align: center;">N02</td> <td style="text-align: center;">E2</td> <td style="text-align: center;">E2</td> <td style="text-align: center;">E2</td> <td style="text-align: center;">E2</td> <td style="text-align: center;">E2</td> </tr> <tr> <td></td> <td style="text-align: center;">1</td> <td style="text-align: center;">2</td> <td style="text-align: center;">3</td> <td style="text-align: center;">4</td> <td style="text-align: center;">R03</td> <td style="text-align: center;">S03</td> <td style="text-align: center;">T03</td> <td style="text-align: center;">N03</td> <td style="text-align: center;">E3</td> <td style="text-align: center;">E3</td> <td style="text-align: center;">E3</td> <td style="text-align: center;">E3</td> <td style="text-align: center;">E3</td> </tr> <tr> <td></td> <td style="text-align: center;">1</td> <td style="text-align: center;">2</td> <td style="text-align: center;">3</td> <td style="text-align: center;">4</td> <td style="text-align: center;">R04</td> <td style="text-align: center;">S04</td> <td style="text-align: center;">T04</td> <td style="text-align: center;">N04</td> <td style="text-align: center;">E4</td> <td style="text-align: center;">E4</td> <td style="text-align: center;">E4</td> <td style="text-align: center;">E4</td> <td style="text-align: center;">E4</td> </tr> <tr> <td></td> <td style="text-align: center;">1</td> <td style="text-align: center;">2</td> <td style="text-align: center;">3</td> <td style="text-align: center;">4</td> <td style="text-align: center;">R05</td> <td style="text-align: center;">S05</td> <td style="text-align: center;">T05</td> <td style="text-align: center;">N05</td> <td style="text-align: center;">E5</td> <td style="text-align: center;">E5</td> <td style="text-align: center;">E5</td> <td style="text-align: center;">E5</td> <td style="text-align: center;">E5</td> </tr> <tr> <td></td> <td style="text-align: center;">1</td> <td style="text-align: center;">2</td> <td style="text-align: center;">3</td> <td style="text-align: center;">4</td> <td style="text-align: center;">R06</td> <td style="text-align: center;">S06</td> <td style="text-align: center;">T06</td> <td style="text-align: center;">N06</td> <td style="text-align: center;">E6</td> <td style="text-align: center;">E6</td> <td style="text-align: center;">E6</td> <td style="text-align: center;">E6</td> <td style="text-align: center;">E6</td> </tr> <tr> <td></td> <td style="text-align: center;">1</td> <td style="text-align: center;">2</td> <td style="text-align: center;">3</td> <td style="text-align: center;">4</td> <td style="text-align: center;">R07</td> <td style="text-align: center;">S07</td> <td style="text-align: center;">T07</td> <td style="text-align: center;">N07</td> <td style="text-align: center;">E7</td> <td style="text-align: center;">E7</td> <td style="text-align: center;">E7</td> <td style="text-align: center;">E7</td> <td style="text-align: center;">E7</td> </tr> <tr> <td></td> <td style="text-align: center;">1</td> <td style="text-align: center;">2</td> <td style="text-align: center;">3</td> <td style="text-align: center;">4</td> <td style="text-align: center;">R08</td> <td style="text-align: center;">S08</td> <td style="text-align: center;">T08</td> <td style="text-align: center;">N08</td> <td style="text-align: center;">E8</td> <td style="text-align: center;">E8</td> <td style="text-align: center;">E8</td> <td style="text-align: center;">E8</td> <td style="text-align: center;">E8</td> </tr> </table> | | | | | | | | | | | |

 |

 |
 | XA | 1 | 2 | 3 | 4 | R01 | S01 | T01 | N01 | E1 | E1 | E1 | E1

 | E1 | | 1 | 2 | 3 | 4 | R02 | S02 | T02 | N02 | E2 | E2 | E2 | E2 | E2 | | 1 | 2 | 3 | 4 | R03 | S03 | T03 | N03 | E3 | E3 | E3 | E3

 | E3 | | 1 | 2 | 3 | 4 | R04 | S04 | T04 | N04 | E4 | E4 | E4 | E4 | E4 | | 1 | 2 | 3 | 4 | R05 | S05 | T05 | N05 | E5 | E5 | E5 | E5 | E5 | | 1 | 2 | 3 | 4 | R06 | S06 | T06 | N06 | E6 | E6 | E6 | E6 | E6 | | 1 | 2 | 3 | 4 | R07 | S07 | T07 | N07 | E7 | E7 | E7 | E7 | E7 | | 1 | 2 | 3 | 4 | R08
 S08 | T08 | N08 | E8 | E8 | E8 | E8 | E8 | <table border="0" style="width: 100%;"> <tr> <td style="width: 50%;"></td> <td style="width: 50%; text-align: center;"> <table border="0"> <tr> <td style="width: 10%;"></td> <td style="width: 10%;"></td> <td style="width: 10%;"></td> <td style="width: 10%;"></td> <td style="width: 10%;"></td> <td style="width: 10%;"></td> <td style="width: 10%;"></td> <td style="width: 10%;"></td> <td style="width: 10%;"></td> <td style="width: 10%;"></td> <td style="width: 10%;"></td> <td style="width: 10%;"></td> <td style="width: 10%;"></td> <td style="width: 10%;"></td> </tr> <tr> <td style="text-align: center;">XA</td> <td style="text-align: center;">1</td> <td style="text-align: center;">2</td> <td style="text-align: center;">3</td> <td style="text-align: center;">4</td> <td style="text-align: center;">R01</td> <td style="text-align: center;">S01</td> <td style="text-align: center;">T01</td> <td style="text-align: center;">N01</td> <td style="text-align: center;">E1</td> <td style="text-align: center;">E1</td> <td style="text-align: center;">E1</td> </tr></table></td></tr></table>
 | | <table border="0"> <tr> <td style="width: 10%;"></td> <td style="width: 10%;"></td> <td style="width: 10%;"></td> <td style="width: 10%;"></td> <td style="width: 10%;"></td> <td style="width: 10%;"></td> <td style="width: 10%;"></td> <td style="width: 10%;"></td> <td style="width: 10%;"></td> <td style="width: 10%;"></td> <td style="width: 10%;"></td> <td style="width: 10%;"></td> <td style="width: 10%;"></td> <td style="width: 10%;"></td> </tr> <tr> <td style="text-align: center;">XA</td> <td style="text-align: center;">1</td> <td style="text-align: center;">2</td> <td style="text-align: center;">3</td> <td style="text-align: center;">4</td> <td style="text-align: center;">R01</td> <td style="text-align: center;">S01</td> <td style="text-align: center;">T01</td> <td style="text-align: center;">N01</td> <td style="text-align: center;">E1</td> <td style="text-align: center;">E1</td> <td style="text-align: center;">E1</td> </tr></table>
 | | | | | | | | | | | |

 |

 | | XA
 | 1 | 2 | 3 | 4 | R01 | S01 | T01 | N01 | E1 | E1 | E1 |

 | | | | | | | | | | | | | | | | | | | | | | | | | | | |

 | | | | | | | | | | | | | | | | | | | | | | | | | | | | | | | | | | | | | | | | | | | | | | | | | | | | | | | | | | | | | | | | | | | | | | | |
 | |
 | | | | | | | | | | | |
 |

 | |
 | | | | | | | | | | | |
 | |
 | | | | | | | | | | | | | | | | | | | | | | | | | |

 | | | | | | | | | | | | | | | | | | | | | | | | | | | | | | | | | | | | | | | | | | | | | | | | | | | | | | | | | | | | | | | | | | | | | | | |
 | | | | | | | | | | | | | |
 |
 |
 | | | | | | | | | | | | |
 | |
 | | | | | | | | | | | | | | | | | | | | | | | | | |
 | |
 | | | | | | | | | | | | | | | | | | | | | | | | | | | | | | | | | | | | | | | | | | | | | | | | | | | | | | | | | | | | | | | | | | | | | | | | | | | | | | | | | | | | |
 | |
 | | | | | | | | | | | | | | | | | | | | | | | | | | | | | | | | | | | | | | | | | | | | | | | | | | | | | | | | | | | | | | | | | | | | | | | | | | | | | | | | | | | | | | | |
 | | | | | | | | | | | | | | | | | | | | | | | | | | | |
 | | | | | | | | | | | | | | | | | | | | | | | | | | | | | | | | | | | | | | | | | | | | | | | | | | | | | | | | | | | | | | | | | | | | | | | | | | | | | | | | | | | | | | | |
 | | | | | | | | | | | | | | | | | | | | | | | | | | | | | | | | | | | | | | | | | | | | | | | | | | | | | | | | | | | | | | | | | | | | | |
|

 | |
 | | | | | | | | | | | |

 | |
 | | | | | | | | | | | |

 | | | | | | | | | | | | | |

 | | | | | | | | | | | | | | | | | | | | | | | | | | | | | | | | | | | | | | | | | | | | | | | | | | | | | | | | | | | | | | | | | | | | | | | | | | | | | | | | | | | | | |

 | | | | | | | | | | | | | |

 |

 |
 | | | | | | | | | | | | |

 | | | | | | | | | | | | | | | | | | | | | | | | | | | |

 | | | | | | | | | | | | | | | | | | | | | | | | | | | | | | | | | | | | | | | | | | | | | | | | | | | | | | | | | | | | | | | |
| | | | | | | |
 | |
 | | | | | | | | | | | |

 |

 | |
 | | | | | | | | | | | |

 | | | | | | | | | | | | | | | | | | | | | | | | | | | |

 | | | | | | | | | | | | | | | | | | | | | | | | | | | | | | | | | | | | | | | | | | | | | | | | | | | | | | | | | | | | | | | | | | | | | | | |
 | |
 | | | | | | | | | | | |
 |

 | |
 | | | | | | | | | | | |
 | |
 | | | | | | | | | | | | | | | | | | | | | | | | | |

 | | | | | | | | | | | | | | | | | | | | | | | | | | | | | | | | | | | | | | | | | | | | | | | | | | | | | | | | | | | | | | | | | | | | | | | |
 | | | | | | | | | | | | | |
 |
 |
 | | | | | | | | | | | | |
 | |
 | | | | | | | | | | | | | | | | | | | | | | | | | |
 | |
 | | | | | | | | | | | | | | | | | | | | | | | | | | | | | | | | | | | | | | | | | | | | | | | | | | | | | | | | | | | | | | | | | | | | | | | | | | | | | | | | | | | | |
 | |
 | | | | | | | | | | | | | | | | | | | | | | | | | | | | | | | | | | | | | | | | | | | | | | | | | | | | | | | | | | | | | | | | | | | | | | | | | | | | | | | | | | | | | | | |
 | | | | | | | | | | | | | | | | | | | | | | | | | | | |
 | | | | | | | | | | | | | | | | | | | | | | | | | | | | | | | | | | | | | | | | | | | | | | | | | | | | | | | | | | | | | | | | | | | | | | | | | | | | | | | | | | | | | | | |
 | | | | | | | | | | | | | | | | | | | | | | | | | | | | | | | | | | | | | | | | | | | | | | | | | | | | | | | | | | | | | | | | | | | | | |
| XA

 | 1 | 2
 | 3 | 4 | R01 | S01 | T01 | N01 | E1 | E1 | E1 | E1 | E1 |

 | |
 | | | | | | | | | | | |

 | | | | | | | | | | | | | |

 | | | | | | | | | | | | | | | | | | | | | | | | | | | | | | | | | | | | | | | | | | | | | | | | | | | | | | | | | | | | | | | | | | | | | | | | | | | | | | | | | | | | | |

 | | | | | | | | | | | | | |

 |

 |
 | | | | | | | | | | | | |

 | | | | | | | | | | | | | | | | | | | | | | | | | | | |

 | | | | | | | | | | | | | | | | | | | | | | | | | | | | | | | | | | | | | | | | | | | | | | | | | | | | | | | | | | | | | | | |
| | | | | | | |
 | |
 | | | | | | | | | | | |

 |

 | |
 | | | | | | | | | | | |

 | | | | | | | | | | | | | | | | | | | | | | | | | | | |

 | | | | | | | | | | | | | | | | | | | | | | | | | | | | | | | | | | | | | | | | | | | | | | | | | | | | | | | | | | | | | | | | | | | | | | | |
 | |
 | | | | | | | | | | | |
 |

 | |
 | | | | | | | | | | | |
 | |
 | | | | | | | | | | | | | | | | | | | | | | | | | |

 | | | | | | | | | | | | | | | | | | | | | | | | | | | | | | | | | | | | | | | | | | | | | | | | | | | | | | | | | | | | | | | | | | | | | | | |
 | | | | | | | | | | | | | |
 |
 |
 | | | | | | | | | | | | |
 | |
 | | | | | | | | | | | | | | | | | | | | | | | | | |
 | |
 | | | | | | | | | | | | | | | | | | | | | | | | | | | | | | | | | | | | | | | | | | | | | | | | | | | | | | | | | | | | | | | | | | | | | | | | | | | | | | | | | | | | |
 | |
 | | | | | | | | | | | | | | | | | | | | | | | | | | | | | | | | | | | | | | | | | | | | | | | | | | | | | | | | | | | | | | | | | | | | | | | | | | | | | | | | | | | | | | | |
 | | | | | | | | | | | | | | | | | | | | | | | | | | | |
 | | | | | | | | | | | | | | | | | | | | | | | | | | | | | | | | | | | | | | | | | | | | | | | | | | | | | | | | | | | | | | | | | | | | | | | | | | | | | | | | | | | | | | | |
 | | | | | | | | | | | | | | | | | | | | | | | | | | | | | | | | | | | | | | | | | | | | | | | | | | | | | | | | | | | | | | | | | | | | | |
|

 | 1 | 2
 | 3 | 4 | R02 | S02 | T02 | N02 | E2 | E2 | E2 | E2 | E2 |

 | |
 | | | | | | | | | | | |

 | | | | | | | | | | | | | |

 | | | | | | | | | | | | | | | | | | | | | | | | | | | | | | | | | | | | | | | | | | | | | | | | | | | | | | | | | | | | | | | | | | | | | | | | | | | | | | | | | | | | | |

 | | | | | | | | | | | | | |

 |

 |
 | | | | | | | | | | | | |

 | | | | | | | | | | | | | | | | | | | | | | | | | | | |

 | | | | | | | | | | | | | | | | | | | | | | | | | | | | | | | | | | | | | | | | | | | | | | | | | | | | | | | | | | | | | | | |
| | | | | | | |
 | |
 | | | | | | | | | | | |

 |

 | |
 | | | | | | | | | | | |

 | | | | | | | | | | | | | | | | | | | | | | | | | | | |

 | | | | | | | | | | | | | | | | | | | | | | | | | | | | | | | | | | | | | | | | | | | | | | | | | | | | | | | | | | | | | | | | | | | | | | | |
 | |
 | | | | | | | | | | | |
 |

 | |
 | | | | | | | | | | | |
 | |
 | | | | | | | | | | | | | | | | | | | | | | | | | |

 | | | | | | | | | | | | | | | | | | | | | | | | | | | | | | | | | | | | | | | | | | | | | | | | | | | | | | | | | | | | | | | | | | | | | | | |
 | | | | | | | | | | | | | |
 |
 |
 | | | | | | | | | | | | |
 | |
 | | | | | | | | | | | | | | | | | | | | | | | | | |
 | |
 | | | | | | | | | | | | | | | | | | | | | | | | | | | | | | | | | | | | | | | | | | | | | | | | | | | | | | | | | | | | | | | | | | | | | | | | | | | | | | | | | | | | |
 | |
 | | | | | | | | | | | | | | | | | | | | | | | | | | | | | | | | | | | | | | | | | | | | | | | | | | | | | | | | | | | | | | | | | | | | | | | | | | | | | | | | | | | | | | | |
 | | | | | | | | | | | | | | | | | | | | | | | | | | | |
 | | | | | | | | | | | | | | | | | | | | | | | | | | | | | | | | | | | | | | | | | | | | | | | | | | | | | | | | | | | | | | | | | | | | | | | | | | | | | | | | | | | | | | | |
 | | | | | | | | | | | | | | | | | | | | | | | | | | | | | | | | | | | | | | | | | | | | | | | | | | | | | | | | | | | | | | | | | | | | | |
|

 | 1 | 2
 | 3 | 4 | R03 | S03 | T03 | N03 | E3 | E3 | E3 | E3 | E3 |

 | |
 | | | | | | | | | | | |

 | | | | | | | | | | | | | |

 | | | | | | | | | | | | | | | | | | | | | | | | | | | | | | | | | | | | | | | | | | | | | | | | | | | | | | | | | | | | | | | | | | | | | | | | | | | | | | | | | | | | | |

 | | | | | | | | | | | | | |

 |

 |
 | | | | | | | | | | | | |

 | | | | | | | | | | | | | | | | | | | | | | | | | | | |

 | | | | | | | | | | | | | | | | | | | | | | | | | | | | | | | | | | | | | | | | | | | | | | | | | | | | | | | | | | | | | | | |
| | | | | | | |
 | |
 | | | | | | | | | | | |

 |

 | |
 | | | | | | | | | | | |

 | | | | | | | | | | | | | | | | | | | | | | | | | | | |

 | | | | | | | | | | | | | | | | | | | | | | | | | | | | | | | | | | | | | | | | | | | | | | | | | | | | | | | | | | | | | | | | | | | | | | | |
 | |
 | | | | | | | | | | | |
 |

 | |
 | | | | | | | | | | | |
 | |
 | | | | | | | | | | | | | | | | | | | | | | | | | |

 | | | | | | | | | | | | | | | | | | | | | | | | | | | | | | | | | | | | | | | | | | | | | | | | | | | | | | | | | | | | | | | | | | | | | | | |
 | | | | | | | | | | | | | |
 |
 |
 | | | | | | | | | | | | |
 | |
 | | | | | | | | | | | | | | | | | | | | | | | | | |
 | |
 | | | | | | | | | | | | | | | | | | | | | | | | | | | | | | | | | | | | | | | | | | | | | | | | | | | | | | | | | | | | | | | | | | | | | | | | | | | | | | | | | | | | |
 | |
 | | | | | | | | | | | | | | | | | | | | | | | | | | | | | | | | | | | | | | | | | | | | | | | | | | | | | | | | | | | | | | | | | | | | | | | | | | | | | | | | | | | | | | | |
 | | | | | | | | | | | | | | | | | | | | | | | | | | | |
 | | | | | | | | | | | | | | | | | | | | | | | | | | | | | | | | | | | | | | | | | | | | | | | | | | | | | | | | | | | | | | | | | | | | | | | | | | | | | | | | | | | | | | | |
 | | | | | | | | | | | | | | | | | | | | | | | | | | | | | | | | | | | | | | | | | | | | | | | | | | | | | | | | | | | | | | | | | | | | | |
|

 | 1 | 2
 | 3 | 4 | R04 | S04 | T04 | N04 | E4 | E4 | E4 | E4 | E4 |

 | |
 | | | | | | | | | | | |

 | | | | | | | | | | | | | |

 | | | | | | | | | | | | | | | | | | | | | | | | | | | | | | | | | | | | | | | | | | | | | | | | | | | | | | | | | | | | | | | | | | | | | | | | | | | | | | | | | | | | | |

 | | | | | | | | | | | | | |

 |

 |
 | | | | | | | | | | | | |

 | | | | | | | | | | | | | | | | | | | | | | | | | | | |

 | | | | | | | | | | | | | | | | | | | | | | | | | | | | | | | | | | | | | | | | | | | | | | | | | | | | | | | | | | | | | | | |
| | | | | | | |
 | |
 | | | | | | | | | | | |

 |

 | |
 | | | | | | | | | | | |

 | | | | | | | | | | | | | | | | | | | | | | | | | | | |

 | | | | | | | | | | | | | | | | | | | | | | | | | | | | | | | | | | | | | | | | | | | | | | | | | | | | | | | | | | | | | | | | | | | | | | | |
 | |
 | | | | | | | | | | | |
 |

 | |
 | | | | | | | | | | | |
 | |
 | | | | | | | | | | | | | | | | | | | | | | | | | |

 | | | | | | | | | | | | | | | | | | | | | | | | | | | | | | | | | | | | | | | | | | | | | | | | | | | | | | | | | | | | | | | | | | | | | | | |
 | | | | | | | | | | | | | |
 |
 |
 | | | | | | | | | | | | |
 | |
 | | | | | | | | | | | | | | | | | | | | | | | | | |
 | |
 | | | | | | | | | | | | | | | | | | | | | | | | | | | | | | | | | | | | | | | | | | | | | | | | | | | | | | | | | | | | | | | | | | | | | | | | | | | | | | | | | | | | |
 | |
 | | | | | | | | | | | | | | | | | | | | | | | | | | | | | | | | | | | | | | | | | | | | | | | | | | | | | | | | | | | | | | | | | | | | | | | | | | | | | | | | | | | | | | | |
 | | | | | | | | | | | | | | | | | | | | | | | | | | | |
 | | | | | | | | | | | | | | | | | | | | | | | | | | | | | | | | | | | | | | | | | | | | | | | | | | | | | | | | | | | | | | | | | | | | | | | | | | | | | | | | | | | | | | | |
 | | | | | | | | | | | | | | | | | | | | | | | | | | | | | | | | | | | | | | | | | | | | | | | | | | | | | | | | | | | | | | | | | | | | | |
|

 | 1 | 2
 | 3 | 4 | R05 | S05 | T05 | N05 | E5 | E5 | E5 | E5 | E5 |

 | |
 | | | | | | | | | | | |

 | | | | | | | | | | | | | |

 | | | | | | | | | | | | | | | | | | | | | | | | | | | | | | | | | | | | | | | | | | | | | | | | | | | | | | | | | | | | | | | | | | | | | | | | | | | | | | | | | | | | | |

 | | | | | | | | | | | | | |

 |

 |
 | | | | | | | | | | | | |

 | | | | | | | | | | | | | | | | | | | | | | | | | | | |

 | | | | | | | | | | | | | | | | | | | | | | | | | | | | | | | | | | | | | | | | | | | | | | | | | | | | | | | | | | | | | | | |
| | | | | | | |
 | |
 | | | | | | | | | | | |

 |

 | |
 | | | | | | | | | | | |

 | | | | | | | | | | | | | | | | | | | | | | | | | | | |

 | | | | | | | | | | | | | | | | | | | | | | | | | | | | | | | | | | | | | | | | | | | | | | | | | | | | | | | | | | | | | | | | | | | | | | | |
 | |
 | | | | | | | | | | | |
 |

 | |
 | | | | | | | | | | | |
 | |
 | | | | | | | | | | | | | | | | | | | | | | | | | |

 | | | | | | | | | | | | | | | | | | | | | | | | | | | | | | | | | | | | | | | | | | | | | | | | | | | | | | | | | | | | | | | | | | | | | | | |
 | | | | | | | | | | | | | |
 |
 |
 | | | | | | | | | | | | |
 | |
 | | | | | | | | | | | | | | | | | | | | | | | | | |
 | |
 | | | | | | | | | | | | | | | | | | | | | | | | | | | | | | | | | | | | | | | | | | | | | | | | | | | | | | | | | | | | | | | | | | | | | | | | | | | | | | | | | | | | |
 | |
 | | | | | | | | | | | | | | | | | | | | | | | | | | | | | | | | | | | | | | | | | | | | | | | | | | | | | | | | | | | | | | | | | | | | | | | | | | | | | | | | | | | | | | | |
 | | | | | | | | | | | | | | | | | | | | | | | | | | | |
 | | | | | | | | | | | | | | | | | | | | | | | | | | | | | | | | | | | | | | | | | | | | | | | | | | | | | | | | | | | | | | | | | | | | | | | | | | | | | | | | | | | | | | | |
 | | | | | | | | | | | | | | | | | | | | | | | | | | | | | | | | | | | | | | | | | | | | | | | | | | | | | | | | | | | | | | | | | | | | | |
|

 | 1 | 2
 | 3 | 4 | R06 | S06 | T06 | N06 | E6 | E6 | E6 | E6 | E6 |

 | |
 | | | | | | | | | | | |

 | | | | | | | | | | | | | |

 | | | | | | | | | | | | | | | | | | | | | | | | | | | | | | | | | | | | | | | | | | | | | | | | | | | | | | | | | | | | | | | | | | | | | | | | | | | | | | | | | | | | | |

 | | | | | | | | | | | | | |

 |

 |
 | | | | | | | | | | | | |

 | | | | | | | | | | | | | | | | | | | | | | | | | | | |

 | | | | | | | | | | | | | | | | | | | | | | | | | | | | | | | | | | | | | | | | | | | | | | | | | | | | | | | | | | | | | | | |
| | | | | | | |
 | |
 | | | | | | | | | | | |

 |

 | |
 | | | | | | | | | | | |

 | | | | | | | | | | | | | | | | | | | | | | | | | | | |

 | | | | | | | | | | | | | | | | | | | | | | | | | | | | | | | | | | | | | | | | | | | | | | | | | | | | | | | | | | | | | | | | | | | | | | | |
 | |
 | | | | | | | | | | | |
 |

 | |
 | | | | | | | | | | | |
 | |
 | | | | | | | | | | | | | | | | | | | | | | | | | |

 | | | | | | | | | | | | | | | | | | | | | | | | | | | | | | | | | | | | | | | | | | | | | | | | | | | | | | | | | | | | | | | | | | | | | | | |
 | | | | | | | | | | | | | |
 |
 |
 | | | | | | | | | | | | |
 | |
 | | | | | | | | | | | | | | | | | | | | | | | | | |
 | |
 | | | | | | | | | | | | | | | | | | | | | | | | | | | | | | | | | | | | | | | | | | | | | | | | | | | | | | | | | | | | | | | | | | | | | | | | | | | | | | | | | | | | |
 | |
 | | | | | | | | | | | | | | | | | | | | | | | | | | | | | | | | | | | | | | | | | | | | | | | | | | | | | | | | | | | | | | | | | | | | | | | | | | | | | | | | | | | | | | | |
 | | | | | | | | | | | | | | | | | | | | | | | | | | | |
 | | | | | | | | | | | | | | | | | | | | | | | | | | | | | | | | | | | | | | | | | | | | | | | | | | | | | | | | | | | | | | | | | | | | | | | | | | | | | | | | | | | | | | | |
 | | | | | | | | | | | | | | | | | | | | | | | | | | | | | | | | | | | | | | | | | | | | | | | | | | | | | | | | | | | | | | | | | | | | | |
|

 | 1 | 2
 | 3 | 4 | R07 | S07 | T07 | N07 | E7 | E7 | E7 | E7 | E7 |

 | |
 | | | | | | | | | | | |

 | | | | | | | | | | | | | |

 | | | | | | | | | | | | | | | | | | | | | | | | | | | | | | | | | | | | | | | | | | | | | | | | | | | | | | | | | | | | | | | | | | | | | | | | | | | | | | | | | | | | | |

 | | | | | | | | | | | | | |

 |

 |
 | | | | | | | | | | | | |

 | | | | | | | | | | | | | | | | | | | | | | | | | | | |

 | | | | | | | | | | | | | | | | | | | | | | | | | | | | | | | | | | | | | | | | | | | | | | | | | | | | | | | | | | | | | | | |
| | | | | | | |
 | |
 | | | | | | | | | | | |

 |

 | |
 | | | | | | | | | | | |

 | | | | | | | | | | | | | | | | | | | | | | | | | | | |

 | | | | | | | | | | | | | | | | | | | | | | | | | | | | | | | | | | | | | | | | | | | | | | | | | | | | | | | | | | | | | | | | | | | | | | | |
 | |
 | | | | | | | | | | | |
 |

 | |
 | | | | | | | | | | | |
 | |
 | | | | | | | | | | | | | | | | | | | | | | | | | |

 | | | | | | | | | | | | | | | | | | | | | | | | | | | | | | | | | | | | | | | | | | | | | | | | | | | | | | | | | | | | | | | | | | | | | | | |
 | | | | | | | | | | | | | |
 |
 |
 | | | | | | | | | | | | |
 | |
 | | | | | | | | | | | | | | | | | | | | | | | | | |
 | |
 | | | | | | | | | | | | | | | | | | | | | | | | | | | | | | | | | | | | | | | | | | | | | | | | | | | | | | | | | | | | | | | | | | | | | | | | | | | | | | | | | | | | |
 | |
 | | | | | | | | | | | | | | | | | | | | | | | | | | | | | | | | | | | | | | | | | | | | | | | | | | | | | | | | | | | | | | | | | | | | | | | | | | | | | | | | | | | | | | | |
 | | | | | | | | | | | | | | | | | | | | | | | | | | | |
 | | | | | | | | | | | | | | | | | | | | | | | | | | | | | | | | | | | | | | | | | | | | | | | | | | | | | | | | | | | | | | | | | | | | | | | | | | | | | | | | | | | | | | | |
 | | | | | | | | | | | | | | | | | | | | | | | | | | | | | | | | | | | | | | | | | | | | | | | | | | | | | | | | | | | | | | | | | | | | | |
|

 | 1 | 2
 | 3 | 4 | R08 | S08 | T08 | N08 | E8 | E8 | E8 | E8 | E8 |

 | |
 | | | | | | | | | | | |

 | | | | | | | | | | | | | |

 | | | | | | | | | | | | | | | | | | | | | | | | | | | | | | | | | | | | | | | | | | | | | | | | | | | | | | | | | | | | | | | | | | | | | | | | | | | | | | | | | | | | | |

 | | | | | | | | | | | | | |

 |

 |
 | | | | | | | | | | | | |

 | | | | | | | | | | | | | | | | | | | | | | | | | | | |

 | | | | | | | | | | | | | | | | | | | | | | | | | | | | | | | | | | | | | | | | | | | | | | | | | | | | | | | | | | | | | | | |
| | | | | | | |
 | |
 | | | | | | | | | | | |

 |

 | |
 | | | | | | | | | | | |

 | | | | | | | | | | | | | | | | | | | | | | | | | | | |

 | | | | | | | | | | | | | | | | | | | | | | | | | | | | | | | | | | | | | | | | | | | | | | | | | | | | | | | | | | | | | | | | | | | | | | | |
 | |
 | | | | | | | | | | | |
 |

 | |
 | | | | | | | | | | | |
 | |
 | | | | | | | | | | | | | | | | | | | | | | | | | |

 | | | | | | | | | | | | | | | | | | | | | | | | | | | | | | | | | | | | | | | | | | | | | | | | | | | | | | | | | | | | | | | | | | | | | | | |
 | | | | | | | | | | | | | |
 |
 |
 | | | | | | | | | | | | |
 | |
 | | | | | | | | | | | | | | | | | | | | | | | | | |
 | |
 | | | | | | | | | | | | | | | | | | | | | | | | | | | | | | | | | | | | | | | | | | | | | | | | | | | | | | | | | | | | | | | | | | | | | | | | | | | | | | | | | | | | |
 | |
 | | | | | | | | | | | | | | | | | | | | | | | | | | | | | | | | | | | | | | | | | | | | | | | | | | | | | | | | | | | | | | | | | | | | | | | | | | | | | | | | | | | | | | | |
 | | | | | | | | | | | | | | | | | | | | | | | | | | | |
 | | | | | | | | | | | | | | | | | | | | | | | | | | | | | | | | | | | | | | | | | | | | | | | | | | | | | | | | | | | | | | | | | | | | | | | | | | | | | | | | | | | | | | | |
 | | | | | | | | | | | | | | | | | | | | | | | | | | | | | | | | | | | | | | | | | | | | | | | | | | | | | | | | | | | | | | | | | | | | | |
|

 | <table border="0"> <tr> <td style="width: 10%;"></td> <td style="width: 10%;"></td> <td style="width: 10%;"></td> <td style="width: 10%;"></td> <td style="width: 10%;"></td> <td style="width: 10%;"></td> <td style="width: 10%;"></td> <td style="width: 10%;"></td> <td style="width: 10%;"></td> <td style="width: 10%;"></td> <td style="width: 10%;"></td> <td style="width: 10%;"></td> <td style="width: 10%;"></td> <td style="width: 10%;"></td> </tr> <tr> <td style="text-align: center;">XA</td> <td style="text-align: center;">1</td> <td style="text-align: center;">2</td> <td style="text-align: center;">3</td> <td style="text-align: center;">4</td> <td style="text-align: center;">R01</td> <td style="text-align: center;">S01</td> <td style="text-align: center;">T01</td> <td style="text-align: center;">N01</td> <td style="text-align: center;">E1</td> <td style="text-align: center;">E1</td> <td style="text-align: center;">E1</td> <td style="text-align: center;">E1</td> <td style="text-align: center;">E1</td> </tr> <tr> <td></td> <td style="text-align: center;">1</td> <td style="text-align: center;">2</td> <td style="text-align: center;">3</td> <td style="text-align: center;">4</td> <td style="text-align: center;">R02</td> <td style="text-align: center;">S02</td> <td style="text-align: center;">T02</td> <td style="text-align: center;">N02</td> <td style="text-align: center;">E2</td> <td style="text-align: center;">E2</td> <td style="text-align: center;">E2</td> <td style="text-align: center;">E2</td> <td style="text-align: center;">E2</td> </tr> <tr> <td></td> <td style="text-align: center;">1</td> <td style="text-align: center;">2</td> <td style="text-align: center;">3</td> <td style="text-align: center;">4</td> <td style="text-align: center;">R03</td> <td style="text-align: center;">S03</td> <td style="text-align: center;">T03</td> <td style="text-align: center;">N03</td> <td style="text-align: center;">E3</td> <td style="text-align: center;">E3</td> <td style="text-align: center;">E3</td> <td style="text-align: center;">E3</td> <td style="text-align: center;">E3</td> </tr> <tr> <td></td> <td style="text-align: center;">1</td> <td style="text-align: center;">2</td> <td style="text-align: center;">3</td> <td style="text-align: center;">4</td> <td style="text-align: center;">R04</td> <td style="text-align: center;">S04</td> <td style="text-align: center;">T04</td> <td style="text-align: center;">N04</td> <td style="text-align: center;">E4</td> <td style="text-align: center;">E4</td> <td style="text-align: center;">E4</td> <td style="text-align: center;">E4</td> <td style="text-align: center;">E4</td> </tr> <tr> <td></td> <td style="text-align: center;">1</td> <td style="text-align: center;">2</td> <td style="text-align: center;">3</td> <td style="text-align: center;">4</td> <td style="text-align: center;">R05</td> <td style="text-align: center;">S05</td> <td style="text-align: center;">T05</td> <td style="text-align: center;">N05</td> <td style="text-align: center;">E5</td> <td style="text-align: center;">E5</td> <td style="text-align: center;">E5</td> <td style="text-align: center;">E5</td> <td style="text-align: center;">E5</td> </tr> <tr> <td></td> <td style="text-align: center;">1</td> <td style="text-align: center;">2</td> <td style="text-align: center;">3</td> <td style="text-align: center;">4</td> <td style="text-align: center;">R06</td> <td style="text-align: center;">S06</td> <td style="text-align: center;">T06</td> <td style="text-align: center;">N06</td> <td style="text-align: center;">E6</td> <td style="text-align: center;">E6</td> <td style="text-align: center;">E6</td> <td style="text-align: center;">E6</td> <td style="text-align: center;">E6</td> </tr> <tr> <td></td> <td style="text-align: center;">1</td> <td style="text-align: center;">2</td> <td style="text-align: center;">3</td> <td style="text-align: center;">4</td> <td style="text-align: center;">R07</td> <td style="text-align: center;">S07</td> <td style="text-align: center;">T07</td> <td style="text-align: center;">N07</td> <td style="text-align: center;">E7</td> <td style="text-align: center;">E7</td> <td style="text-align: center;">E7</td> <td style="text-align: center;">E7</td> <td style="text-align: center;">E7</td> </tr> <tr> <td></td> <td style="text-align: center;">1</td> <td style="text-align: center;">2</td> <td style="text-align: center;">3</td> <td style="text-align: center;">4</td> <td style="text-align: center;">R08</td> <td style="text-align: center;">S08</td> <td style="text-align: center;">T08</td> <td style="text-align: center;">N08</td> <td style="text-align: center;">E8</td> <td style="text-align: center;">E8</td> <td style="text-align: center;">E8</td> <td style="text-align: center;">E8</td> <td style="text-align: center;">E8</td> </tr> </table> |
 | | | | | | | | | | | |

 | | XA
 | 1 | 2 | 3 | 4 | R01 | S01 | T01 | N01 | E1 | E1 | E1 | E1

 | E1 | | 1 | 2 | 3 | 4 | R02 | S02 | T02 | N02 | E2 | E2 | E2 | E2

 | E2 | | 1 | 2 | 3 | 4 | R03 | S03 | T03 | N03 | E3 | E3 | E3 | E3 | E3 | | 1 | 2 | 3 | 4 | R04 | S04 | T04 | N04 | E4 | E4 | E4 | E4 | E4 | | 1 | 2 | 3 | 4 | R05 | S05 | T05 | N05 | E5 | E5 | E5 | E5 | E5 | | 1 | 2 | 3 | 4 | R06 | S06 | T06 | N06 | E6 | E6 | E6 | E6 | E6 | | 1 | 2 | 3 | 4 | R07 | S07 | T07 | N07 | E7 | E7 | E7 | E7 | E7 | | 1 | 2 | 3 | 4 | R08 | S08 | T08 | N08 | E8 | E8 | E8 | E8 | E8 | <table border="0" style="width: 100%;"> <tr> <td style="width: 50%;"></td> <td style="width: 50%; text-align: center;"> <table border="0"> <tr> <td style="width: 10%;"></td> <td style="width: 10%;"></td> <td style="width: 10%;"></td> <td style="width: 10%;"></td> <td style="width:
10%;"></td> <td style="width: 10%;"></td> <td style="width: 10%;"></td> <td style="width: 10%;"></td> <td style="width: 10%;"></td> <td style="width: 10%;"></td> <td style="width: 10%;"></td> <td style="width: 10%;"></td> <td style="width: 10%;"></td> <td style="width: 10%;"></td> </tr> <tr> <td style="text-align: center;">XA</td> <td style="text-align: center;">1</td> <td style="text-align: center;">2</td> <td style="text-align: center;">3</td> <td style="text-align: center;">4</td> <td style="text-align: center;">R01</td> <td style="text-align: center;">S01</td> <td style="text-align: center;">T01</td> <td style="text-align: center;">N01</td> <td style="text-align: center;">E1</td> <td style="text-align: center;">E1</td> <td style="text-align: center;">E1</td> </tr></table></td></tr></table>

 | | <table border="0"> <tr> <td style="width: 10%;"></td> <td style="width: 10%;"></td> <td style="width: 10%;"></td> <td style="width: 10%;"></td> <td style="width: 10%;"></td> <td style="width: 10%;"></td> <td style="width: 10%;"></td> <td style="width: 10%;"></td> <td style="width: 10%;"></td> <td style="width: 10%;"></td> <td style="width: 10%;"></td> <td style="width: 10%;"></td> <td style="width: 10%;"></td> <td style="width: 10%;"></td> </tr> <tr> <td style="text-align: center;">XA</td> <td style="text-align: center;">1</td> <td style="text-align: center;">2</td> <td style="text-align: center;">3</td> <td style="text-align: center;">4</td> <td style="text-align: center;">R01</td> <td style="text-align: center;">S01</td> <td style="text-align: center;">T01</td> <td style="text-align: center;">N01</td> <td style="text-align: center;">E1</td> <td style="text-align: center;">E1</td> <td style="text-align: center;">E1</td> </tr></table> | | | | | | | | | | | |

 |

 |
 | XA | 1 | 2 | 3 | 4 | R01 | S01 | T01 | N01 | E1 | E1 | E1 |

 | | | | | | | | | | | | | | | | | | | | | | | | | | | |

 | | | | | | | | | | | | | | | | | | | | | | | | | | | | | | | | | | | | | | | | | | | | | | | | | | | | | | | | | | | | | | |
 | | | | | | | |
 | |
 | | | | | | | | | | | |

 |

 | |
 | | | | | | | | | | | |

 | | | | | | | | | | | | | | | | | | | | | | | | | | | |

 | | | | | | | | | | | | | | | | | | | | | | | | | | | | | | | | | | | | | | | | | | | | | | | | | | | | | | | | | | | | | | | | | | | | | | | |
 | |
 | | | | | | | | | | | |
 |

 | |
 | | | | | | | | | | | |
 | |
 | | | | | | | | | | | | | | | | | | | | | | | | | |

 | | | | | | | | | | | | | | | | | | | | | | | | | | | | | | | | | | | | | | | | | | | | | | | | | | | | | | | | | | | | | | | | | | | | | | | |
 | | | | | | | | | | | | | |
 |
 |
 | | | | | | | | | | | | |
 | |
 | | | | | | | | | | | | | | | | | | | | | | | | | |
 | |
 | | | | | | | | | | | | | | | | | | | | | | | | | | | | | | | | | | | | | | | | | | | | | | | | | | | | | | | | | | | | | | | | | | | | | | | | | | | | | | | | | | | | |
 | |
 | | | | | | | | | | | | | | | | | | | | | | | | | | | | | | | | | | | | | | | | | | | | | | | | | | | | | | | | | | | | | | | | | | | | | | | | | | | | | | | | | | | | | | | |
 | | | | | | | | | | | | | | | | | | | | | | | | | | | |
 | | | | | | | | | | | | | | | | | | | | | | | | | | | | | | | | | | | | | | | | | | | | | | | | | | | | | | | | | | | | | | | | | | | | | | | | | | | | | | | | | | | | | | | |
 | | | | | | | | | | | | | | | | | | | | | | | | | | | | | | | | | | | | | | | | | | | | | | | | | | | | | | | | | | | | | | | | | | | | | |
|

 | |
 | | | | | | | | | | | |

 | |
 | | | | | | | | | | | |

 | | | | | | | | | | | | | |

 | | | | | | | | | | | | | | | | | | | | | | | | | | | | | | | | | | | | | | | | | | | | | | | | | | | | | | | | | | | | | | | | | | | | | | | | | | | | | | | | | | | | | |

 | | | | | | | | | | | | | |

 |

 |
 | | | | | | | | | | | | |

 | | | | | | | | | | | | | | | | | | | | | | | | | | | |

 | | | | | | | | | | | | | | | | | | | | | | | | | | | | | | | | | | | | | | | | | | | | | | | | | | | | | | | | | | | | | | | |
| | | | | | | |
 | |
 | | | | | | | | | | | |

 |

 | |
 | | | | | | | | | | | |

 | | | | | | | | | | | | | | | | | | | | | | | | | | | |

 | | | | | | | | | | | | | | | | | | | | | | | | | | | | | | | | | | | | | | | | | | | | | | | | | | | | | | | | | | | | | | | | | | | | | | | |
 | |
 | | | | | | | | | | | |
 |

 | |
 | | | | | | | | | | | |
 | |
 | | | | | | | | | | | | | | | | | | | | | | | | | |

 | | | | | | | | | | | | | | | | | | | | | | | | | | | | | | | | | | | | | | | | | | | | | | | | | | | | | | | | | | | | | | | | | | | | | | | |
 | | | | | | | | | | | | | |
 |
 |
 | | | | | | | | | | | | |
 | |
 | | | | | | | | | | | | | | | | | | | | | | | | | |
 | |
 | | | | | | | | | | | | | | | | | | | | | | | | | | | | | | | | | | | | | | | | | | | | | | | | | | | | | | | | | | | | | | | | | | | | | | | | | | | | | | | | | | | | |
 | |
 | | | | | | | | | | | | | | | | | | | | | | | | | | | | | | | | | | | | | | | | | | | | | | | | | | | | | | | | | | | | | | | | | | | | | | | | | | | | | | | | | | | | | | | |
 | | | | | | | | | | | | | | | | | | | | | | | | | | | |
 | | | | | | | | | | | | | | | | | | | | | | | | | | | | | | | | | | | | | | | | | | | | | | | | | | | | | | | | | | | | | | | | | | | | | | | | | | | | | | | | | | | | | | | |
 | | | | | | | | | | | | | | | | | | | | | | | | | | | | | | | | | | | | | | | | | | | | | | | | | | | | | | | | | | | | | | | | | | | | | |
| XA

 | 1 | 2
 | 3 | 4 | R01 | S01 | T01 | N01 | E1 | E1 | E1 | E1 | E1 |

 | |
 | | | | | | | | | | | |

 | | | | | | | | | | | | | |

 | | | | | | | | | | | | | | | | | | | | | | | | | | | | | | | | | | | | | | | | | | | | | | | | | | | | | | | | | | | | | | | | | | | | | | | | | | | | | | | | | | | | | |

 | | | | | | | | | | | | | |

 |

 |
 | | | | | | | | | | | | |

 | | | | | | | | | | | | | | | | | | | | | | | | | | | |

 | | | | | | | | | | | | | | | | | | | | | | | | | | | | | | | | | | | | | | | | | | | | | | | | | | | | | | | | | | | | | | | |
| | | | | | | |
 | |
 | | | | | | | | | | | |

 |

 | |
 | | | | | | | | | | | |

 | | | | | | | | | | | | | | | | | | | | | | | | | | | |

 | | | | | | | | | | | | | | | | | | | | | | | | | | | | | | | | | | | | | | | | | | | | | | | | | | | | | | | | | | | | | | | | | | | | | | | |
 | |
 | | | | | | | | | | | |
 |

 | |
 | | | | | | | | | | | |
 | |
 | | | | | | | | | | | | | | | | | | | | | | | | | |

 | | | | | | | | | | | | | | | | | | | | | | | | | | | | | | | | | | | | | | | | | | | | | | | | | | | | | | | | | | | | | | | | | | | | | | | |
 | | | | | | | | | | | | | |
 |
 |
 | | | | | | | | | | | | |
 | |
 | | | | | | | | | | | | | | | | | | | | | | | | | |
 | |
 | | | | | | | | | | | | | | | | | | | | | | | | | | | | | | | | | | | | | | | | | | | | | | | | | | | | | | | | | | | | | | | | | | | | | | | | | | | | | | | | | | | | |
 | |
 | | | | | | | | | | | | | | | | | | | | | | | | | | | | | | | | | | | | | | | | | | | | | | | | | | | | | | | | | | | | | | | | | | | | | | | | | | | | | | | | | | | | | | | |
 | | | | | | | | | | | | | | | | | | | | | | | | | | | |
 | | | | | | | | | | | | | | | | | | | | | | | | | | | | | | | | | | | | | | | | | | | | | | | | | | | | | | | | | | | | | | | | | | | | | | | | | | | | | | | | | | | | | | | |
 | | | | | | | | | | | | | | | | | | | | | | | | | | | | | | | | | | | | | | | | | | | | | | | | | | | | | | | | | | | | | | | | | | | | | |
|

 | 1 | 2
 | 3 | 4 | R02 | S02 | T02 | N02 | E2 | E2 | E2 | E2 | E2 |

 | |
 | | | | | | | | | | | |

 | | | | | | | | | | | | | |

 | | | | | | | | | | | | | | | | | | | | | | | | | | | | | | | | | | | | | | | | | | | | | | | | | | | | | | | | | | | | | | | | | | | | | | | | | | | | | | | | | | | | | |

 | | | | | | | | | | | | | |

 |

 |
 | | | | | | | | | | | | |

 | | | | | | | | | | | | | | | | | | | | | | | | | | | |

 | | | | | | | | | | | | | | | | | | | | | | | | | | | | | | | | | | | | | | | | | | | | | | | | | | | | | | | | | | | | | | | |
| | | | | | | |
 | |
 | | | | | | | | | | | |

 |

 | |
 | | | | | | | | | | | |

 | | | | | | | | | | | | | | | | | | | | | | | | | | | |

 | | | | | | | | | | | | | | | | | | | | | | | | | | | | | | | | | | | | | | | | | | | | | | | | | | | | | | | | | | | | | | | | | | | | | | | |
 | |
 | | | | | | | | | | | |
 |

 | |
 | | | | | | | | | | | |
 | |
 | | | | | | | | | | | | | | | | | | | | | | | | | |

 | | | | | | | | | | | | | | | | | | | | | | | | | | | | | | | | | | | | | | | | | | | | | | | | | | | | | | | | | | | | | | | | | | | | | | | |
 | | | | | | | | | | | | | |
 |
 |
 | | | | | | | | | | | | |
 | |
 | | | | | | | | | | | | | | | | | | | | | | | | | |
 | |
 | | | | | | | | | | | | | | | | | | | | | | | | | | | | | | | | | | | | | | | | | | | | | | | | | | | | | | | | | | | | | | | | | | | | | | | | | | | | | | | | | | | | |
 | |
 | | | | | | | | | | | | | | | | | | | | | | | | | | | | | | | | | | | | | | | | | | | | | | | | | | | | | | | | | | | | | | | | | | | | | | | | | | | | | | | | | | | | | | | |
 | | | | | | | | | | | | | | | | | | | | | | | | | | | |
 | | | | | | | | | | | | | | | | | | | | | | | | | | | | | | | | | | | | | | | | | | | | | | | | | | | | | | | | | | | | | | | | | | | | | | | | | | | | | | | | | | | | | | | |
 | | | | | | | | | | | | | | | | | | | | | | | | | | | | | | | | | | | | | | | | | | | | | | | | | | | | | | | | | | | | | | | | | | | | | |
|

 | 1 | 2
 | 3 | 4 | R03 | S03 | T03 | N03 | E3 | E3 | E3 | E3 | E3 |

 | |
 | | | | | | | | | | | |

 | | | | | | | | | | | | | |

 | | | | | | | | | | | | | | | | | | | | | | | | | | | | | | | | | | | | | | | | | | | | | | | | | | | | | | | | | | | | | | | | | | | | | | | | | | | | | | | | | | | | | |

 | | | | | | | | | | | | | |

 |

 |
 | | | | | | | | | | | | |

 | | | | | | | | | | | | | | | | | | | | | | | | | | | |

 | | | | | | | | | | | | | | | | | | | | | | | | | | | | | | | | | | | | | | | | | | | | | | | | | | | | | | | | | | | | | | | |
| | | | | | | |
 | |
 | | | | | | | | | | | |

 |

 | |
 | | | | | | | | | | | |

 | | | | | | | | | | | | | | | | | | | | | | | | | | | |

 | | | | | | | | | | | | | | | | | | | | | | | | | | | | | | | | | | | | | | | | | | | | | | | | | | | | | | | | | | | | | | | | | | | | | | | |
 | |
 | | | | | | | | | | | |
 |

 | |
 | | | | | | | | | | | |
 | |
 | | | | | | | | | | | | | | | | | | | | | | | | | |

 | | | | | | | | | | | | | | | | | | | | | | | | | | | | | | | | | | | | | | | | | | | | | | | | | | | | | | | | | | | | | | | | | | | | | | | |
 | | | | | | | | | | | | | |
 |
 |
 | | | | | | | | | | | | |
 | |
 | | | | | | | | | | | | | | | | | | | | | | | | | |
 | |
 | | | | | | | | | | | | | | | | | | | | | | | | | | | | | | | | | | | | | | | | | | | | | | | | | | | | | | | | | | | | | | | | | | | | | | | | | | | | | | | | | | | | |
 | |
 | | | | | | | | | | | | | | | | | | | | | | | | | | | | | | | | | | | | | | | | | | | | | | | | | | | | | | | | | | | | | | | | | | | | | | | | | | | | | | | | | | | | | | | |
 | | | | | | | | | | | | | | | | | | | | | | | | | | | |
 | | | | | | | | | | | | | | | | | | | | | | | | | | | | | | | | | | | | | | | | | | | | | | | | | | | | | | | | | | | | | | | | | | | | | | | | | | | | | | | | | | | | | | | |
 | | | | | | | | | | | | | | | | | | | | | | | | | | | | | | | | | | | | | | | | | | | | | | | | | | | | | | | | | | | | | | | | | | | | | |
|

 | 1 | 2
 | 3 | 4 | R04 | S04 | T04 | N04 | E4 | E4 | E4 | E4 | E4 |

 | |
 | | | | | | | | | | | |

 | | | | | | | | | | | | | |

 | | | | | | | | | | | | | | | | | | | | | | | | | | | | | | | | | | | | | | | | | | | | | | | | | | | | | | | | | | | | | | | | | | | | | | | | | | | | | | | | | | | | | |

 | | | | | | | | | | | | | |

 |

 |
 | | | | | | | | | | | | |

 | | | | | | | | | | | | | | | | | | | | | | | | | | | |

 | | | | | | | | | | | | | | | | | | | | | | | | | | | | | | | | | | | | | | | | | | | | | | | | | | | | | | | | | | | | | | | |
| | | | | | | |
 | |
 | | | | | | | | | | | |

 |

 | |
 | | | | | | | | | | | |

 | | | | | | | | | | | | | | | | | | | | | | | | | | | |

 | | | | | | | | | | | | | | | | | | | | | | | | | | | | | | | | | | | | | | | | | | | | | | | | | | | | | | | | | | | | | | | | | | | | | | | |
 | |
 | | | | | | | | | | | |
 |

 | |
 | | | | | | | | | | | |
 | |
 | | | | | | | | | | | | | | | | | | | | | | | | | |

 | | | | | | | | | | | | | | | | | | | | | | | | | | | | | | | | | | | | | | | | | | | | | | | | | | | | | | | | | | | | | | | | | | | | | | | |
 | | | | | | | | | | | | | |
 |
 |
 | | | | | | | | | | | | |
 | |
 | | | | | | | | | | | | | | | | | | | | | | | | | |
 | |
 | | | | | | | | | | | | | | | | | | | | | | | | | | | | | | | | | | | | | | | | | | | | | | | | | | | | | | | | | | | | | | | | | | | | | | | | | | | | | | | | | | | | |
 | |
 | | | | | | | | | | | | | | | | | | | | | | | | | | | | | | | | | | | | | | | | | | | | | | | | | | | | | | | | | | | | | | | | | | | | | | | | | | | | | | | | | | | | | | | |
 | | | | | | | | | | | | | | | | | | | | | | | | | | | |
 | | | | | | | | | | | | | | | | | | | | | | | | | | | | | | | | | | | | | | | | | | | | | | | | | | | | | | | | | | | | | | | | | | | | | | | | | | | | | | | | | | | | | | | |
 | | | | | | | | | | | | | | | | | | | | | | | | | | | | | | | | | | | | | | | | | | | | | | | | | | | | | | | | | | | | | | | | | | | | | |
|

 | 1 | 2
 | 3 | 4 | R05 | S05 | T05 | N05 | E5 | E5 | E5 | E5 | E5 |

 | |
 | | | | | | | | | | | |

 | | | | | | | | | | | | | |

 | | | | | | | | | | | | | | | | | | | | | | | | | | | | | | | | | | | | | | | | | | | | | | | | | | | | | | | | | | | | | | | | | | | | | | | | | | | | | | | | | | | | | |

 | | | | | | | | | | | | | |

 |

 |
 | | | | | | | | | | | | |

 | | | | | | | | | | | | | | | | | | | | | | | | | | | |

 | | | | | | | | | | | | | | | | | | | | | | | | | | | | | | | | | | | | | | | | | | | | | | | | | | | | | | | | | | | | | | | |
| | | | | | | |
 | |
 | | | | | | | | | | | |

 |

 | |
 | | | | | | | | | | | |

 | | | | | | | | | | | | | | | | | | | | | | | | | | | |

 | | | | | | | | | | | | | | | | | | | | | | | | | | | | | | | | | | | | | | | | | | | | | | | | | | | | | | | | | | | | | | | | | | | | | | | |
 | |
 | | | | | | | | | | | |
 |

 | |
 | | | | | | | | | | | |
 | |
 | | | | | | | | | | | | | | | | | | | | | | | | | |

 | | | | | | | | | | | | | | | | | | | | | | | | | | | | | | | | | | | | | | | | | | | | | | | | | | | | | | | | | | | | | | | | | | | | | | | |
 | | | | | | | | | | | | | |
 |
 |
 | | | | | | | | | | | | |
 | |
 | | | | | | | | | | | | | | | | | | | | | | | | | |
 | |
 | | | | | | | | | | | | | | | | | | | | | | | | | | | | | | | | | | | | | | | | | | | | | | | | | | | | | | | | | | | | | | | | | | | | | | | | | | | | | | | | | | | | |
 | |
 | | | | | | | | | | | | | | | | | | | | | | | | | | | | | | | | | | | | | | | | | | | | | | | | | | | | | | | | | | | | | | | | | | | | | | | | | | | | | | | | | | | | | | | |
 | | | | | | | | | | | | | | | | | | | | | | | | | | | |
 | | | | | | | | | | | | | | | | | | | | | | | | | | | | | | | | | | | | | | | | | | | | | | | | | | | | | | | | | | | | | | | | | | | | | | | | | | | | | | | | | | | | | | | |
 | | | | | | | | | | | | | | | | | | | | | | | | | | | | | | | | | | | | | | | | | | | | | | | | | | | | | | | | | | | | | | | | | | | | | |
|

 | 1 | 2
 | 3 | 4 | R06 | S06 | T06 | N06 | E6 | E6 | E6 | E6 | E6 |

 | |
 | | | | | | | | | | | |

 | | | | | | | | | | | | | |

 | | | | | | | | | | | | | | | | | | | | | | | | | | | | | | | | | | | | | | | | | | | | | | | | | | | | | | | | | | | | | | | | | | | | | | | | | | | | | | | | | | | | | |

 | | | | | | | | | | | | | |

 |

 |
 | | | | | | | | | | | | |

 | | | | | | | | | | | | | | | | | | | | | | | | | | | |

 | | | | | | | | | | | | | | | | | | | | | | | | | | | | | | | | | | | | | | | | | | | | | | | | | | | | | | | | | | | | | | | |
| | | | | | | |
 | |
 | | | | | | | | | | | |

 |

 | |
 | | | | | | | | | | | |

 | | | | | | | | | | | | | | | | | | | | | | | | | | | |

 | | | | | | | | | | | | | | | | | | | | | | | | | | | | | | | | | | | | | | | | | | | | | | | | | | | | | | | | | | | | | | | | | | | | | | | |
 | |
 | | | | | | | | | | | |
 |

 | |
 | | | | | | | | | | | |
 | |
 | | | | | | | | | | | | | | | | | | | | | | | | | |

 | | | | | | | | | | | | | | | | | | | | | | | | | | | | | | | | | | | | | | | | | | | | | | | | | | | | | | | | | | | | | | | | | | | | | | | |
 | | | | | | | | | | | | | |
 |
 |
 | | | | | | | | | | | | |
 | |
 | | | | | | | | | | | | | | | | | | | | | | | | | |
 | |
 | | | | | | | | | | | | | | | | | | | | | | | | | | | | | | | | | | | | | | | | | | | | | | | | | | | | | | | | | | | | | | | | | | | | | | | | | | | | | | | | | | | | |
 | |
 | | | | | | | | | | | | | | | | | | | | | | | | | | | | | | | | | | | | | | | | | | | | | | | | | | | | | | | | | | | | | | | | | | | | | | | | | | | | | | | | | | | | | | | |
 | | | | | | | | | | | | | | | | | | | | | | | | | | | |
 | | | | | | | | | | | | | | | | | | | | | | | | | | | | | | | | | | | | | | | | | | | | | | | | | | | | | | | | | | | | | | | | | | | | | | | | | | | | | | | | | | | | | | | |
 | | | | | | | | | | | | | | | | | | | | | | | | | | | | | | | | | | | | | | | | | | | | | | | | | | | | | | | | | | | | | | | | | | | | | |
|

 | 1 | 2
 | 3 | 4 | R07 | S07 | T07 | N07 | E7 | E7 | E7 | E7 | E7 |

 | |
 | | | | | | | | | | | |

 | | | | | | | | | | | | | |

 | | | | | | | | | | | | | | | | | | | | | | | | | | | | | | | | | | | | | | | | | | | | | | | | | | | | | | | | | | | | | | | | | | | | | | | | | | | | | | | | | | | | | |

 | | | | | | | | | | | | | |

 |

 |
 | | | | | | | | | | | | |

 | | | | | | | | | | | | | | | | | | | | | | | | | | | |

 | | | | | | | | | | | | | | | | | | | | | | | | | | | | | | | | | | | | | | | | | | | | | | | | | | | | | | | | | | | | | | | |
| | | | | | | |
 | |
 | | | | | | | | | | | |

 |

 | |
 | | | | | | | | | | | |

 | | | | | | | | | | | | | | | | | | | | | | | | | | | |

 | | | | | | | | | | | | | | | | | | | | | | | | | | | | | | | | | | | | | | | | | | | | | | | | | | | | | | | | | | | | | | | | | | | | | | | |
 | |
 | | | | | | | | | | | |
 |

 | |
 | | | | | | | | | | | |
 | |
 | | | | | | | | | | | | | | | | | | | | | | | | | |

 | | | | | | | | | | | | | | | | | | | | | | | | | | | | | | | | | | | | | | | | | | | | | | | | | | | | | | | | | | | | | | | | | | | | | | | |
 | | | | | | | | | | | | | |
 |
 |
 | | | | | | | | | | | | |
 | |
 | | | | | | | | | | | | | | | | | | | | | | | | | |
 | |
 | | | | | | | | | | | | | | | | | | | | | | | | | | | | | | | | | | | | | | | | | | | | | | | | | | | | | | | | | | | | | | | | | | | | | | | | | | | | | | | | | | | | |
 | |
 | | | | | | | | | | | | | | | | | | | | | | | | | | | | | | | | | | | | | | | | | | | | | | | | | | | | | | | | | | | | | | | | | | | | | | | | | | | | | | | | | | | | | | | |
 | | | | | | | | | | | | | | | | | | | | | | | | | | | |
 | | | | | | | | | | | | | | | | | | | | | | | | | | | | | | | | | | | | | | | | | | | | | | | | | | | | | | | | | | | | | | | | | | | | | | | | | | | | | | | | | | | | | | | |
 | | | | | | | | | | | | | | | | | | | | | | | | | | | | | | | | | | | | | | | | | | | | | | | | | | | | | | | | | | | | | | | | | | | | | |
|

 | 1 | 2
 | 3 | 4 | R08 | S08 | T08 | N08 | E8 | E8 | E8 | E8 | E8 |

 | |
 | | | | | | | | | | | |

 | | | | | | | | | | | | | |

 | | | | | | | | | | | | | | | | | | | | | | | | | | | | | | | | | | | | | | | | | | | | | | | | | | | | | | | | | | | | | | | | | | | | | | | | | | | | | | | | | | | | | |

 | | | | | | | | | | | | | |

 |

 |
 | | | | | | | | | | | | |

 | | | | | | | | | | | | | | | | | | | | | | | | | | | |

 | | | | | | | | | | | | | | | | | | | | | | | | | | | | | | | | | | | | | | | | | | | | | | | | | | | | | | | | | | | | | | | |
| | | | | | | |
 | |
 | | | | | | | | | | | |

 |

 | |
 | | | | | | | | | | | |

 | | | | | | | | | | | | | | | | | | | | | | | | | | | |

 | | | | | | | | | | | | | | | | | | | | | | | | | | | | | | | | | | | | | | | | | | | | | | | | | | | | | | | | | | | | | | | | | | | | | | | |
 | |
 | | | | | | | | | | | |
 |

 | |
 | | | | | | | | | | | |
 | |
 | | | | | | | | | | | | | | | | | | | | | | | | | |

 | | | | | | | | | | | | | | | | | | | | | | | | | | | | | | | | | | | | | | | | | | | | | | | | | | | | | | | | | | | | | | | | | | | | | | | |
 | | | | | | | | | | | | | |
 |
 |
 | | | | | | | | | | | | |
 | |
 | | | | | | | | | | | | | | | | | | | | | | | | | |
 | |
 | | | | | | | | | | | | | | | | | | | | | | | | | | | | | | | | | | | | | | | | | | | | | | | | | | | | | | | | | | | | | | | | | | | | | | | | | | | | | | | | | | | | |
 | |
 | | | | | | | | | | | | | | | | | | | | | | | | | | | | | | | | | | | | | | | | | | | | | | | | | | | | | | | | | | | | | | | | | | | | | | | | | | | | | | | | | | | | | | | |
 | | | | | | | | | | | | | | | | | | | | | | | | | | | |
 | | | | | | | | | | | | | | | | | | | | | | | | | | | | | | | | | | | | | | | | | | | | | | | | | | | | | | | | | | | | | | | | | | | | | | | | | | | | | | | | | | | | | | | |
 | | | | | | | | | | | | | | | | | | | | | | | | | | | | | | | | | | | | | | | | | | | | | | | | | | | | | | | | | | | | | | | | | | | | | |
|

 | <table border="0"> <tr> <td style="width: 10%;"></td> <td style="width: 10%;"></td> <td style="width: 10%;"></td> <td style="width: 10%;"></td> <td style="width: 10%;"></td> <td style="width: 10%;"></td> <td style="width: 10%;"></td> <td style="width: 10%;"></td> <td style="width: 10%;"></td> <td style="width: 10%;"></td> <td style="width: 10%;"></td> <td style="width: 10%;"></td> <td style="width: 10%;"></td> <td style="width: 10%;"></td> </tr> <tr> <td style="text-align: center;">XA</td> <td style="text-align: center;">1</td> <td style="text-align: center;">2</td> <td style="text-align: center;">3</td> <td style="text-align: center;">4</td> <td style="text-align: center;">R01</td> <td style="text-align: center;">S01</td> <td style="text-align: center;">T01</td> <td style="text-align: center;">N01</td> <td style="text-align: center;">E1</td> <td style="text-align: center;">E1</td> <td style="text-align: center;">E1</td> </tr></table> |
 | | | | | | | | | | | |

 | | XA
 | 1 | 2 | 3 | 4 | R01 | S01 | T01 | N01 | E1 | E1 | E1 |

 | | | | | | | | | | | | | |

 | | | | | | | | | | | | | | | | | | | | | | | | | | | | | | | | | | | | | | | | | | | | | | | | | | | | | | | | | | | | | | | | | | | | | | | | | | | | | | | | | | | | | |

 | | | | | | | | | | | | | |

 |

 |
 | | | | | | | | | | | | |

 | | | | | | | | | | | | | | | | | | | | | | | | | | | |

 | | | | | | | | | | | | | | | | | | | | | | | | | | | | | | | | | | | | | | | | | | | | | | | | | | | | | | | | | | | | | | | |
| | | | | | | |
 | |
 | | | | | | | | | | | |

 |

 | |
 | | | | | | | | | | | |

 | | | | | | | | | | | | | | | | | | | | | | | | | | | |

 | | | | | | | | | | | | | | | | | | | | | | | | | | | | | | | | | | | | | | | | | | | | | | | | | | | | | | | | | | | | | | | | | | | | | | | |
 | |
 | | | | | | | | | | | |
 |

 | |
 | | | | | | | | | | | |
 | |
 | | | | | | | | | | | | | | | | | | | | | | | | | |

 | | | | | | | | | | | | | | | | | | | | | | | | | | | | | | | | | | | | | | | | | | | | | | | | | | | | | | | | | | | | | | | | | | | | | | | |
 | | | | | | | | | | | | | |
 |
 |
 | | | | | | | | | | | | |
 | |
 | | | | | | | | | | | | | | | | | | | | | | | | | |
 | |
 | | | | | | | | | | | | | | | | | | | | | | | | | | | | | | | | | | | | | | | | | | | | | | | | | | | | | | | | | | | | | | | | | | | | | | | | | | | | | | | | | | | | |
 | |
 | | | | | | | | | | | | | | | | | | | | | | | | | | | | | | | | | | | | | | | | | | | | | | | | | | | | | | | | | | | | | | | | | | | | | | | | | | | | | | | | | | | | | | | |
 | | | | | | | | | | | | | | | | | | | | | | | | | | | |
 | | | | | | | | | | | | | | | | | | | | | | | | | | | | | | | | | | | | | | | | | | | | | | | | | | | | | | | | | | | | | | | | | | | | | | | | | | | | | | | | | | | | | | | |
 | | | | | | | | | | | | | | | | | | | | | | | | | | | | | | | | | | | | | | | | | | | | | | | | | | | | | | | | | | | | | | | | | | | | | |
|

 | |
 | | | | | | | | | | | |

 | |
 | | | | | | | | | | | |

 | | | | | | | | | | | | | |

 | | | | | | | | | | | | | | | | | | | | | | | | | | | | | | | | | | | | | | | | | | | | | | | | | | | | | | | | | | | | | | | | | | | | | | | | | | | | | | | | | | | | | |

 | | | | | | | | | | | | | |

 |

 |
 | | | | | | | | | | | | |

 | | | | | | | | | | | | | | | | | | | | | | | | | | | |

 | | | | | | | | | | | | | | | | | | | | | | | | | | | | | | | | | | | | | | | | | | | | | | | | | | | | | | | | | | | | | | | |
| | | | | | | |
 | |
 | | | | | | | | | | | |

 |

 | |
 | | | | | | | | | | | |

 | | | | | | | | | | | | | | | | | | | | | | | | | | | |

 | | | | | | | | | | | | | | | | | | | | | | | | | | | | | | | | | | | | | | | | | | | | | | | | | | | | | | | | | | | | | | | | | | | | | | | |
 | |
 | | | | | | | | | | | |
 |

 | |
 | | | | | | | | | | | |
 | |
 | | | | | | | | | | | | | | | | | | | | | | | | | |

 | | | | | | | | | | | | | | | | | | | | | | | | | | | | | | | | | | | | | | | | | | | | | | | | | | | | | | | | | | | | | | | | | | | | | | | |
 | | | | | | | | | | | | | |
 |
 |
 | | | | | | | | | | | | |
 | |
 | | | | | | | | | | | | | | | | | | | | | | | | | |
 | |
 | | | | | | | | | | | | | | | | | | | | | | | | | | | | | | | | | | | | | | | | | | | | | | | | | | | | | | | | | | | | | | | | | | | | | | | | | | | | | | | | | | | | |
 | |
 | | | | | | | | | | | | | | | | | | | | | | | | | | | | | | | | | | | | | | | | | | | | | | | | | | | | | | | | | | | | | | | | | | | | | | | | | | | | | | | | | | | | | | | |
 | | | | | | | | | | | | | | | | | | | | | | | | | | | |
 | | | | | | | | | | | | | | | | | | | | | | | | | | | | | | | | | | | | | | | | | | | | | | | | | | | | | | | | | | | | | | | | | | | | | | | | | | | | | | | | | | | | | | | |
 | | | | | | | | | | | | | | | | | | | | | | | | | | | | | | | | | | | | | | | | | | | | | | | | | | | | | | | | | | | | | | | | | | | | | |
| XA

 | 1 | 2
 | 3 | 4 | R01 | S01 | T01 | N01 | E1 | E1 | E1 | | |

 | |
 | | | | | | | | | | | |

 | | | | | | | | | | | | | |

 | | | | | | | | | | | | | | | | | | | | | | | | | | | | | | | | | | | | | | | | | | | | | | | | | | | | | | | | | | | | | | | | | | | | | | | | | | | | | | | | | | | | | |

 | | | | | | | | | | | | | |

 |

 |
 | | | | | | | | | | | | |

 | | | | | | | | | | | | | | | | | | | | | | | | | | | |

 | | | | | | | | | | | | | | | | | | | | | | | | | | | | | | | | | | | | | | | | | | | | | | | | | | | | | | | | | | | | | | | |
| | | | | | | |
 | |
 | | | | | | | | | | | |

 |

 | |
 | | | | | | | | | | | |

 | | | | | | | | | | | | | | | | | | | | | | | | | | | |

 | | | | | | | | | | | | | | | | | | | | | | | | | | | | | | | | | | | | | | | | | | | | | | | | | | | | | | | | | | | | | | | | | | | | | | | |
 | |
 | | | | | | | | | | | |
 |

 | |
 | | | | | | | | | | | |
 | |
 | | | | | | | | | | | | | | | | | | | | | | | | | |

 | | | | | | | | | | | | | | | | | | | | | | | | | | | | | | | | | | | | | | | | | | | | | | | | | | | | | | | | | | | | | | | | | | | | | | | |
 | | | | | | | | | | | | | |
 |
 |
 | | | | | | | | | | | | |
 | |
 | | | | | | | | | | | | | | | | | | | | | | | | | |
 | |
 | | | | | | | | | | | | | | | | | | | | | | | | | | | | | | | | | | | | | | | | | | | | | | | | | | | | | | | | | | | | | | | | | | | | | | | | | | | | | | | | | | | | |
 | |
 | | | | | | | | | | | | | | | | | | | | | | | | | | | | | | | | | | | | | | | | | | | | | | | | | | | | | | | | | | | | | | | | | | | | | | | | | | | | | | | | | | | | | | | |
 | | | | | | | | | | | | | | | | | | | | | | | | | | | |
 | | | | | | | | | | | | | | | | | | | | | | | | | | | | | | | | | | | | | | | | | | | | | | | | | | | | | | | | | | | | | | | | | | | | | | | | | | | | | | | | | | | | | | | |
 | | | | | | | | | | | | | | | | | | | | | | | | | | | | | | | | | | | | | | | | | | | | | | | | | | | | | | | | | | | | | | | | | | | | | |

MORSETTO
 N. TIPO

1.1 C	1.1 NA	1.1 NC	1.2 NA	1.2 NC	2.1 C	2.1 NA	2.1 NC	2.2 NA	2.2 NC	3.1 C	3.1 NA	3.1 NC	3.2 NA	3.2 NC	4.1 C	4.1 NA	4.1 NC	4.2 NA	4.2 NC	5.1 C	5.1 NA	5.1 NC	5.2 NA	5.2 NC	6.1 C	6.1 NA	6.1 NC	6.2 NA	6.2 NC	7.1 C	7.1 NA	7.1 NC	7.2 NA	7.2 NC	8.1 C	8.1 NA	8.1 NC	8.2 NA	8.2 NC	9.1 C	9.1 NA	9.1 NC	9.2 NA	9.2 NC	10.1 C	10.1 NA	10.1 NC	10.2 NA	10.2 NC	11.1 C	11.1 NA	11.1 NC	11.2 NA	11.2 NC
QF0/E0		QF1/E1		QF2/E2		QF3/E3		QF4/E4		QF5/E5		QF6/E6		QF7/E7		QF8/E8		QF9A/E9A		QF9B/E9B																																		

Titolo: COCIV - NV08	Foglio: 11	Segue: 12	Tot. fogli:
	Descrizione MORSETTIERA DI SEGNALE		
			
Commitente	Disegni.: Contr.: Visto:		
	Progetto PROGETTO ESECUTIVO		
Nr.	Data	Descrizione	

Non e' permesso consegnare a terzi o riprodurre questo documento, ne' utilizzarne il contenuto o renderlo comunquato a terzi senza esplicita autorizzazione di SINA SPA. Ogni infrazione comporta il risarcimento dei danni subiti. E' fatta riserva di tutti i diritti derivanti da brevetti o modelli.

Copying of this document and giving it to others and the use or communication of the contents thereof are forbidden without express authority of SINA SPA. Offenders are liable to the payment of damages.

All rights are reserved in the event of the grant of a patent or the registration of a utility model or design.

QUADRO ILLUMINAZIONE Q02

TARGA DA APPLICARE AL
QUADRO

IN MODO INAMOVIBILE CON SCRITTE
INDELEBILI

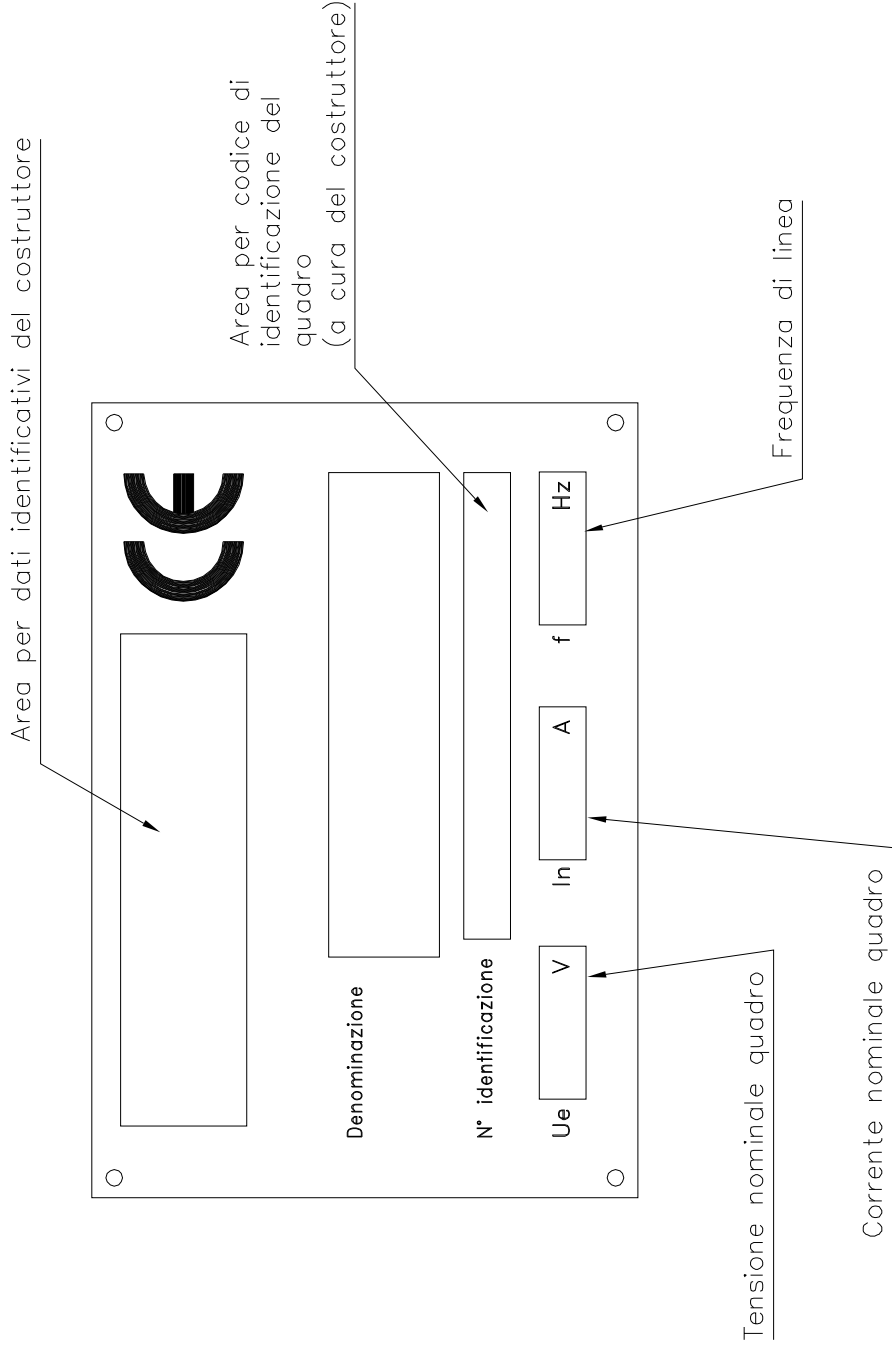

Y	Committente		Titolo:		COCIV - NV08	
	Disegn.:		Descrizione	Foglio:	12	Segue: 13
Z	Contr.:		TARGHETTA QUADRO			
X	Visto:		Tot. fogli: 13			
	Nr.	Data				

TARGHETTA QUADRO

COCIV - NV08



PROGETTO ESECUTIVO

Non e' permesso consegnare a terzi o riprodurre questo documento, ne' utilizzarne il contenuto o fare furto di informazioni senza autorizzazione di SINA SPA. Ogni infrazione comporta il risarcimento dei danni subiti. E' fatta riserva di tutti i diritti derivanti da brevetti o modelli. All rights are reserved in the event of the grant of a patent or the registration of the contents thereof or design. Copying of this document and giving it to others and the use or communication of the contents thereof are forbidden without express authority of SINA SPA. Offenders are liable to the payment of damages. The infringer shall be liable to pay compensation for damages.

RIF. CIRCUITO
 DENOMINAZIONE QUADRO
 QUADRO ILLUMINAZIONE Q02
 OPERA NV08

ALIMENTAZIONE DA
 ENTE DISTRIBUITORE
 CARATT. ELETTRICHE GENERALI

TENSIONE DI ESERCIZIO 400V
 TENSIONI AUSILIARIE 110 Vc.a.
 TENDITA AL COPPIO CIRCUITO DELLE BARRE 16 KA
 TIPO DI SEGREGAZIONE FORMA 2
 MISURE DI PROTEZIONE DELLE PERSONE(7.4) CEI 17-13
 GRADO DI PROTEZIONE DEL QUADRO IP 55
 SISTEMA DI TERRA TT

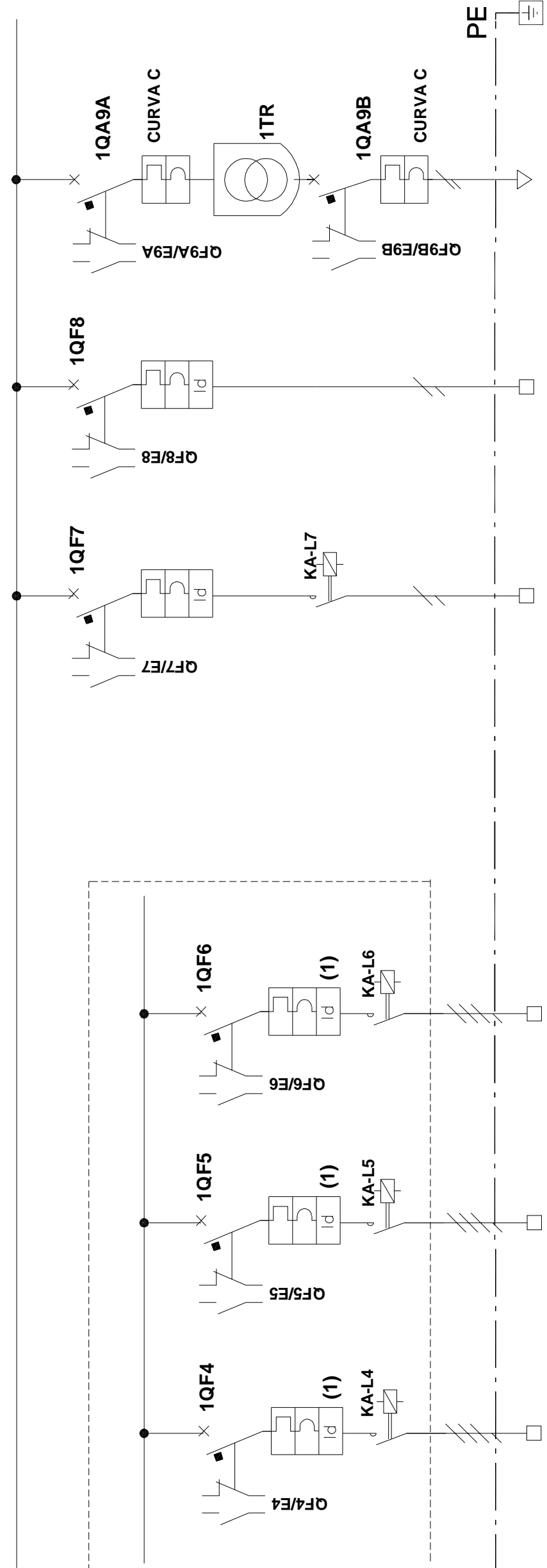

NUM. INVOLUCRO	A	A	A	A	A	A	A	A	A
NUMERAZ. MORSETTIERA	E-4	E-5	E-6	E-7	E-8	E-9			
POTENZA kW/KVA/KVAR	0,72 kW	0,72 kW	0,54 kW	0,3 kW	0,1 kW	300 VA			
Corrente d'impiego Ib (A)	1,2	1,2	0,9	1,50	0,5	1,5			
INTERRUTTI. o SEZIONATI.	MODULARE	MODULARE	MODULARE	MODULARE	MODULARE	MODULARE			
CONTATTATORE	4x10	4x10	4x10	2x6	2x6	2x16			
R. TERMICO (o CURVA)	AC7a	AC7a	AC7a	AC7a					
DIFFERENZ.	20	20	16	16					
LINEA di POTENZA	C	C	C	C	C	C			
DESTINAZIONE / UTENZA	10	10	10	6	6	16			
	AC 0,3	AC 0,3	AC 0,3	AC 0,03	AC 0,03				
	3(1x6)+6N	3(1x6)+6N	3(1x6)+6N	3G1,5	3G1,5	3G1,5			
	FG7R	FG7R	FG7R	FG7OR	FG7OR	FG7OR			
	270 61	295 61	245 61	1 15	1 15	1 15			
	31	31	31	26	26	26			
	ciruito 4; PALI 13-16-19-22	ciruito 5; PALI 14-17-20-23	ciruito 6; PALI 15-18-21						
				ALIMENTAZIONE SCALDIGLIA	INTERRUTTORE CREPUSCOLARE	ALIMENTAZIONE TRASF. AUX.			

Disegn.: _____		Committente _____		Titolo: COCIV - NV08	
Contr.: _____		Progetto PROGETTO ESECUTIVO		Descrizione SCHEMA UNIFILARE DI POTENZA	
Visto: _____				Foglio: 15	
Nr. _____		Data _____		Segue: 16	
Descrizione _____				Tot. fogli: _____	

Non e' permesso consegnare a terzi o riprodurre questo documento, ne utilizzarne il contenuto o renderlo comunemente a terzi senza esplicita autorizzazione di SINA SPA. Ogni infrazione comporta il risarcimento dei danni subiti. E' fatta riserva di tutti i diritti derivanti da brevetti o modelli.

Copying of this document and giving it to others and the use or communication of the contents thereof are forbidden without express authority of SINA SPA. Offenders are liable to the payment of damages.

All rights are reserved in the event of the grant of a patent or the registration of a utility model or design.

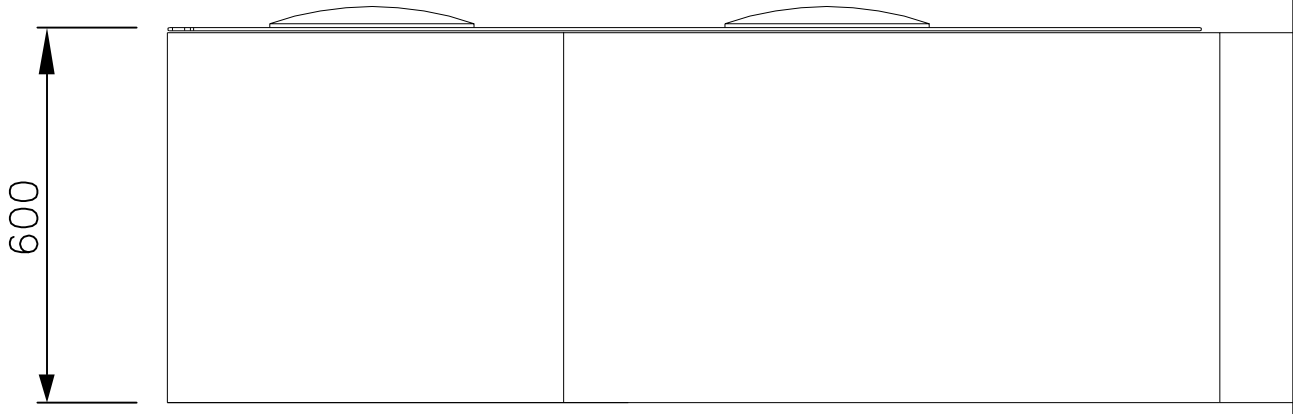
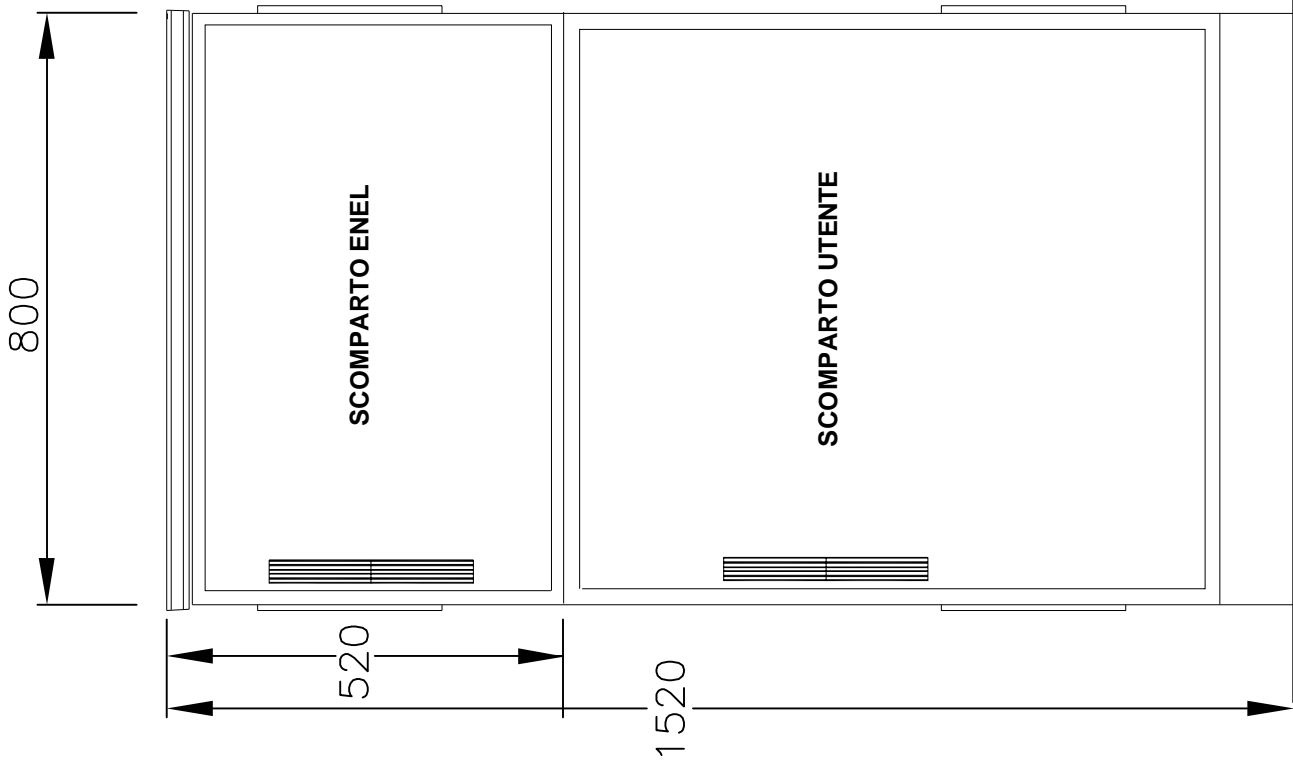

Armadio stampato in resina (SMC) per posa a pavimento con telaio di ancoraggio
 Porta frontale cieca incernierata completa di chiusura tipo cremonese azionabile con maniglia a scomparsa con serratura cifrata
 Parete di fondo dotata di inserti annegati di stampaggio in ottone per applicazione apparecchiature direttamente attraverso piastra di fondo
 Grado di protezione: IP44 secondo CEI EN 60529
 Colore RAL 7040
 Prese d'aria inferiori e sottotetto per ventilazione naturale interna

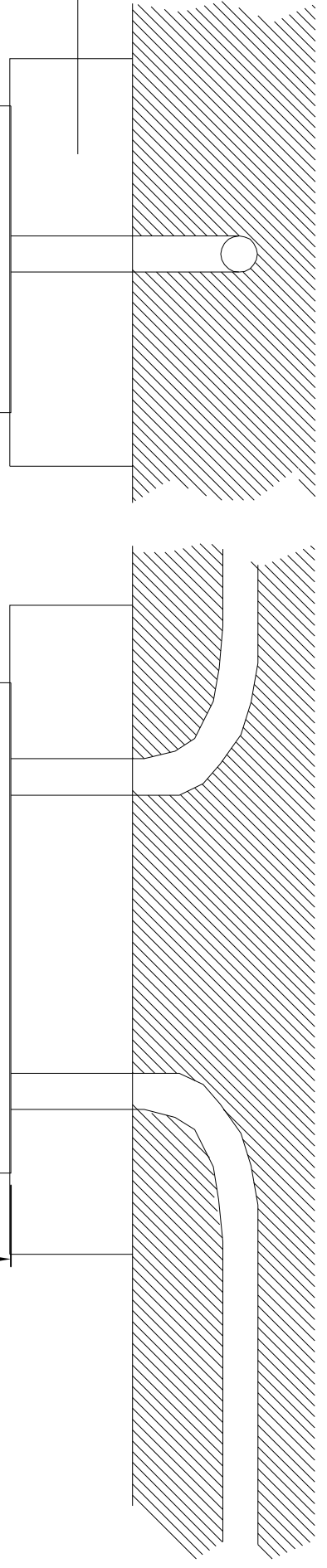

NOTA :
IL QUADRO DOVRA' ESSERE DI TIPO STRADALE IN SMC (VETRORESINA) CORREDATO DI PIEDISTALLO DA FISSARE SU BASAMENTO IN CLS

Nr.	Data	Descrizione	Disegn.:	Committente			Foglio:	Tot. fogli:
			Contr.:	PROGETTO ESECUTIVO			16	17
			Visto:				COCIV - NV08	
					FRONTEQUADRO E SEZIONI			

Non e' permesso consegnare a terzi o riprodurre questo documento, ne' utilizzarne il contenuto o fare fotocopie senza autorizzazione di SINA SPA. Ogni infrazione commessa e' punita secondo le leggi in vigore. E' fatta riserva di tutti i diritti derivanti da brevetti o modelli. All rights are reserved in the event of the grant of a patent or the registration of the contents thereof or design. Copying of this document and giving it to others and the use or communication of the contents thereof are forbidden without express authority of SINA SPA. Offenders are liable to the payment of damages. Il risarcimento dei danni subiti. E' fatta riserva di tutti i diritti derivanti da brevetti o modelli.

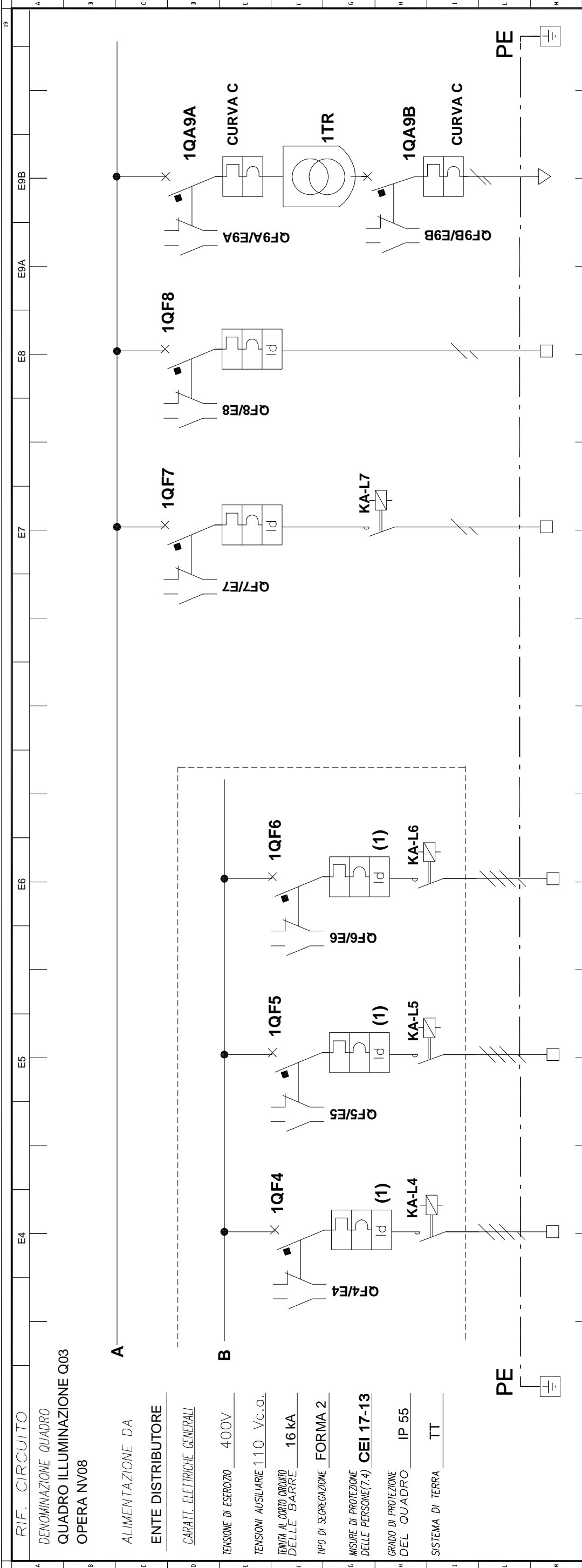

RIF. CIRCUITO _____ E9B

DENOMINAZIONE QUADRO
QUADRO ILLUMINAZIONE Q03
 OPERA NV08

ALIMENTAZIONE DA _____ E9A

ENTE DISTRIBUTORE _____ E8

CARATT. ELETTRICHE GENERALI

TENSIONE DI ESERCIZIO 400V _____ E7

TENSIONI AUSILIARIE 110 Vc.a. _____

TELVITA' AL COPPIO CIRCUITO DELLE BARRE 16 KA _____

TIPO DI SEGREGAZIONE FORMA 2 _____

MISURE DI PROTEZIONE DELLE PERSONE(7.4) CEI 17-13 _____

GRADO DI PROTEZIONE DEL QUADRO IP 55 _____

SISTEMA DI TERRA TT _____

NUM. INVOLUCRO	A	A	A	A	A	A	A	A	A
NUMERAZ. MORSETTIERA	E-4	E-5	E-6	E-7	E-8	E-9			
POTENZA kW/KVA/KVAR	0,90 kW	0,72 kW	0,72 kW	0,3 kW	0,1 kW	300 VA			
Corrente d'impiego Ib (A)	1,5	1,2	1,2	1,50	0,5	1,5			
INTERRUTTI. o SEZIONATI.	MODULARE	MODULARE	MODULARE	MODULARE	MODULARE	MODULARE			
CONTATTATORE	4x10	4x10	4x10	2x6	2x6	2x16			
R. TERMICO (o CURVA)	AC7a	AC7a	AC7a	AC7a					
DIFFERENZ.	20	20	16	16					
LINEA di POTENZA	AC 0,3	AC 0,3	AC 0,3	AC 0,03	AC 0,03				
DESTINAZIONE / UTENZA	3(1x6)+6N	3(1x6)+6N	3(1x6)+6N	3G1,5	3G1,5	3G1,5			
	FG7R	FG7R	FG7R	FG7OR	FG7OR	FG7OR			
	325 61	300 61	275 61	1 15	1 15	1 15			
	31	31	31	26	26	26			
	ciruito 5: PALI 13- 16-19-22-25	ciruito 5: PALI 14- 17-20-23	ciruito 6: PALI 15- 18-21-24						
				ALIMENTAZIONE SCALDIGLIA	INTERRUTTORE CREPUSCOLARE	ALIMENTAZIONE TRASF. AUX.			

Disegn.: _____

Contr.: _____

Visto: _____

Committente _____

Progetto _____

PROGETTO ESECUTIVO

Descrizione _____

COCIV - NV08

Descrizione _____

Foglio: **23**

Segue: **24**

Tot. fogli: _____



Non e' permesso consegnare a terzi o riprodurre questo documento, ne utilizzarne il contenuto o renderlo comunificato a terzi senza esplicita autorizzazione di SINA SPA. Ogni infrazione comporta il risarcimento dei danni subiti. E' fatta riserva di tutti i diritti derivanti da brevetti o modelli.

Copying of this document and giving it to others and the use or communication of the contents thereof are forbidden without express authority of SINA SPA. Offenders are liable to the payment of damages.

All rights are reserved in the event of the grant of a patent or the registration of a utility model or design.

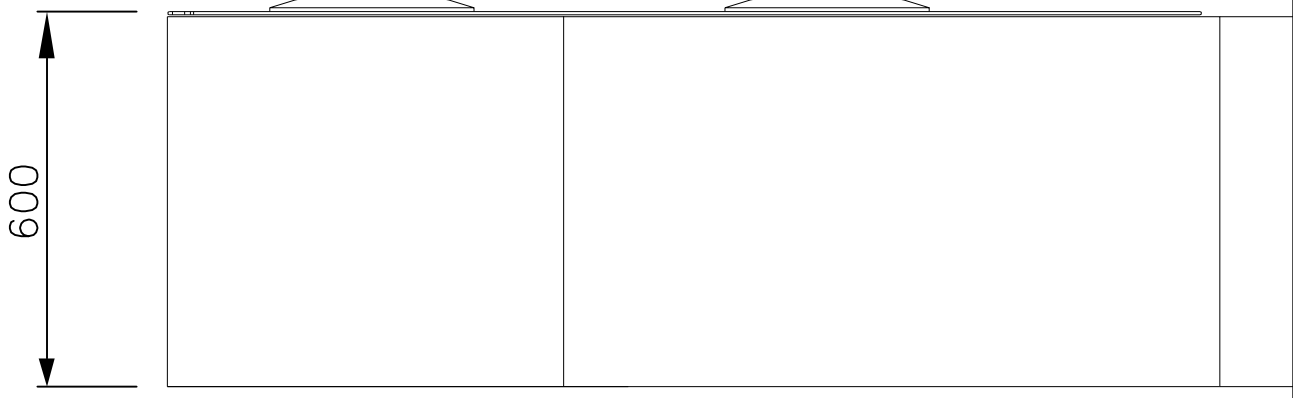
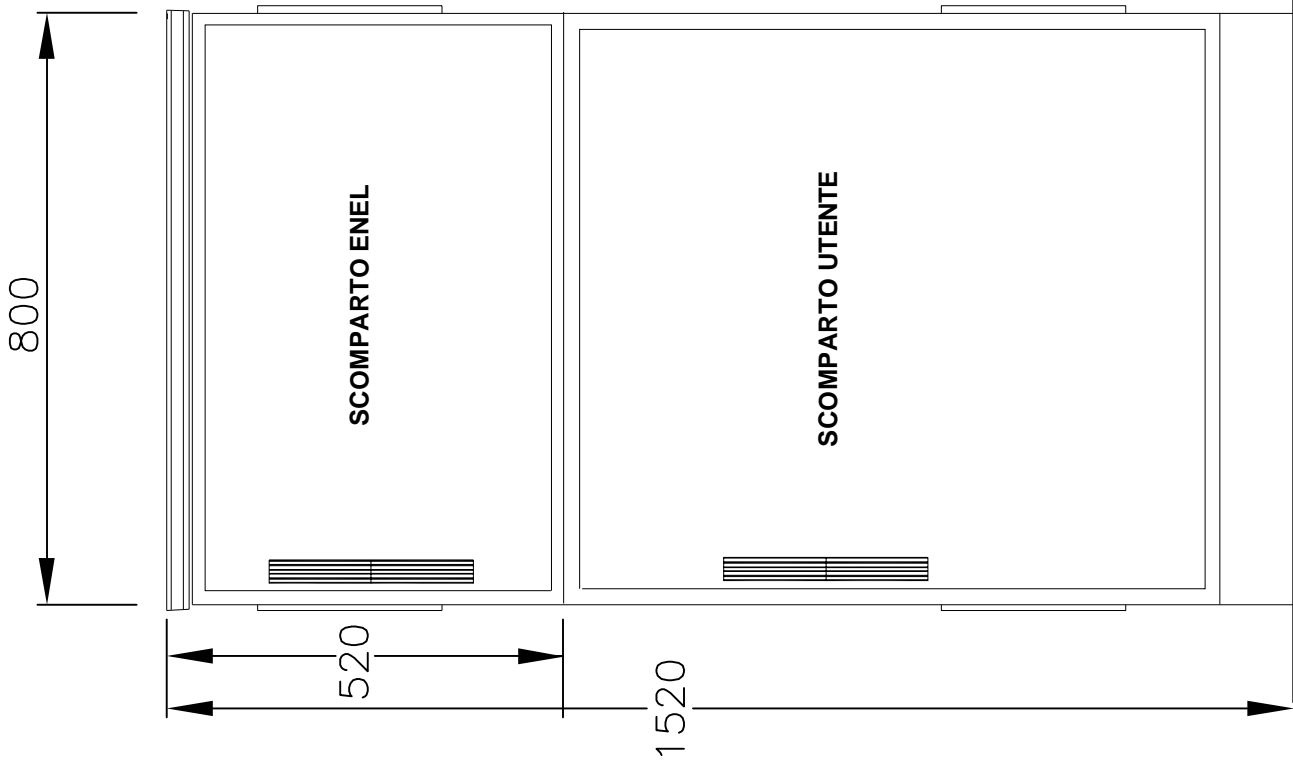

Armadio stampato in resina (SMC) per posa a pavimento con telaio di ancoraggio
 Porta frontale cieca incernierata completa di chiusura tipo cremonese azionabile con maniglia a scomparsa con serratura cifrata
 Parete di fondo dotata di inserti annegati di stampaggio in ottone per applicazione apparecchiature direttamente attraverso piastra di fondo
 Grado di protezione: IP44 secondo CEI EN 60529
 Colore RAL 7040
 Prese d'aria inferiori e sottotetto per ventilazione naturale interna

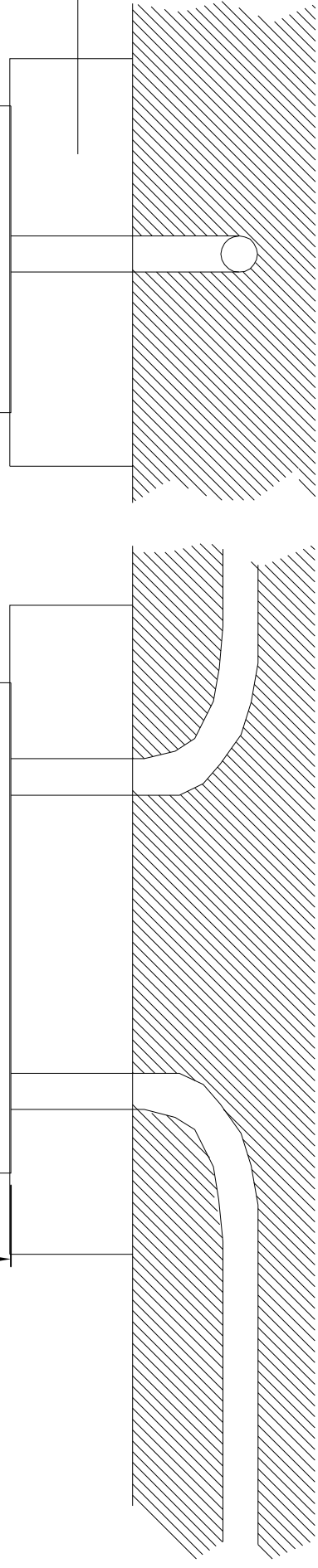

NOTA :
IL QUADRO DOVRA' ESSERE DI TIPO STRADALE IN SMC (VETRORESINA) CORREDATO DI PIEDISTALLO DA FISSARE SU BASAMENTO IN CLS

Nr.	Data	Descrizione	Disegn.:		Committente			Titolo: COCIV - NV08	Foglio: 24	Segue: 25	Tot. fogli: 25
			Contr.:		Progetto						

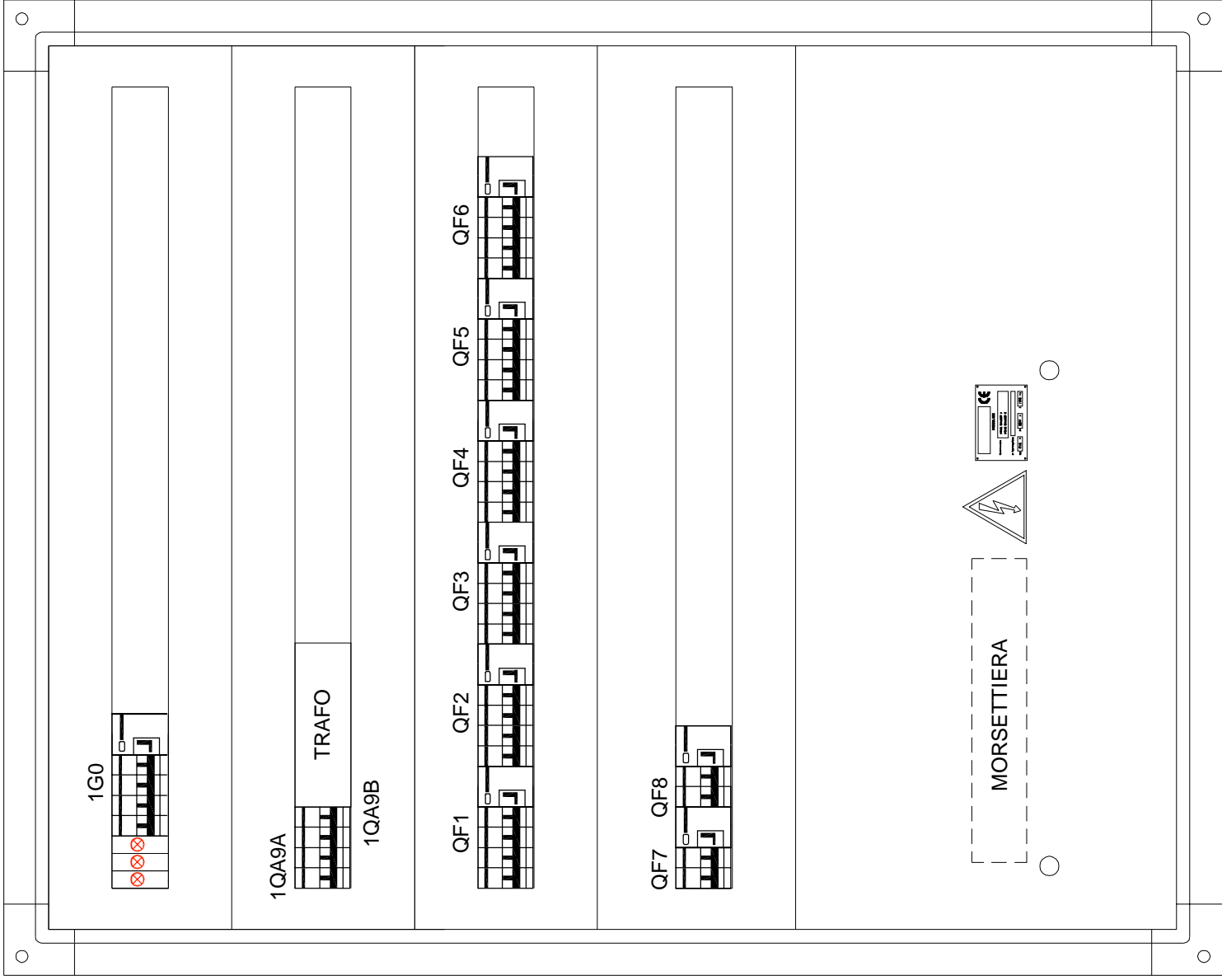

Fronte quadro quadro illuminazione

Nr.	Data	Descrizione

Disegn.: _____	Committente
Contr.: _____	Progetto
Visto: _____	PROGETTO ESECUTIVO

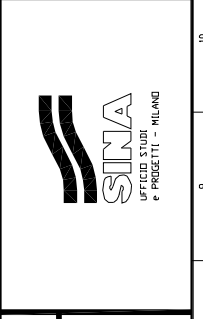

Titolo:		COCIV - NV08	
Descrizione		FRONTEQUADRO	
Foglio:	25	Segue:	26
Tot. fogli:		26	

MORSETTO
 N. TIPO

1.1 C	1.1 NA	1.1 NC	1.2 NA	1.2 NC	2.1 C	2.1 NA	2.1 NC	2.2 NA	2.2 NC	3.1 C	3.1 NA	3.1 NC	3.2 NA	3.2 NC	4.1 C	4.1 NA	4.1 NC	4.2 NA	4.2 NC	5.1 C	5.1 NA	5.1 NC	5.2 NA	5.2 NC	6.1 C	6.1 NA	6.1 NC	6.2 NA	6.2 NC	7.1 C	7.1 NA	7.1 NC	7.2 NA	7.2 NC	8.1 C	8.1 NA	8.1 NC	8.2 NA	8.2 NC	9.1 C	9.1 NA	9.1 NC	9.2 NA	9.2 NC	10.1 C	10.1 NA	10.1 NC	10.2 NA	10.2 NC	11.1 C	11.1 NA	11.1 NC	11.2 NA	11.2 NC
QF0/E0		QF1/E1		QF2/E2		QF3/E3		QF4/E4		QF5/E5		QF6/E6		QF7/E7		QF8/E8		QF9A/E9A		QF9B/E9B																																		

Titolo: COCIV - NV08	Foglio: 27	Segue: -	Tot. fogli:
	Descrizione MORSETTIERA DI SEGNALE		
			
Commitente PROGETTO ESECUTIVO		Disegni: Contr.: Visto:	
Nr.	Data	Descrizione	